

PU238 NEUTRON ACER TENDL-2024 LIBRARY; T=293.6K
Principal cross sections

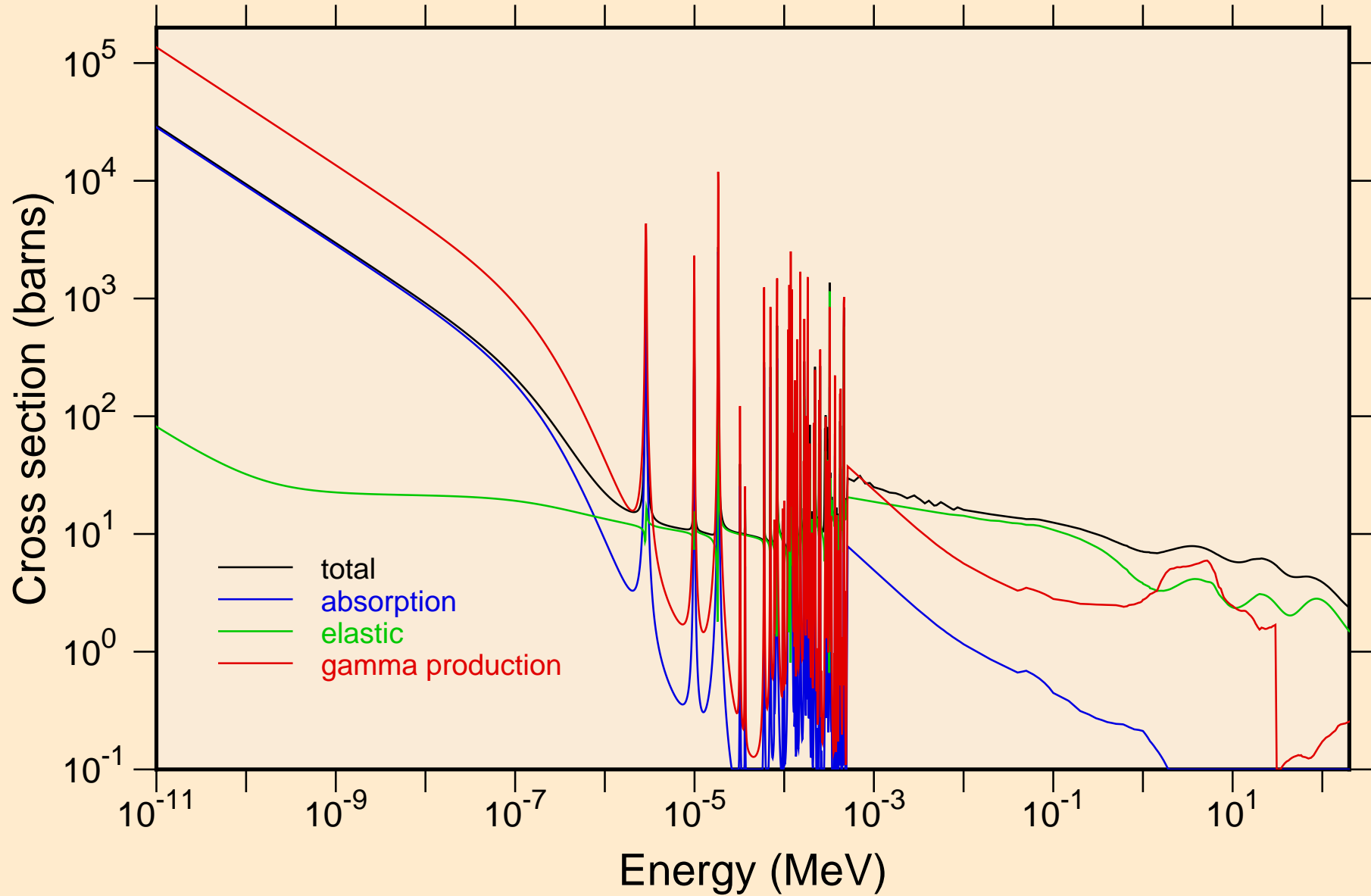

PU238 NEUTRON ACER TENDL-2024 LIBRARY; T=293.6K
resonance total cross section

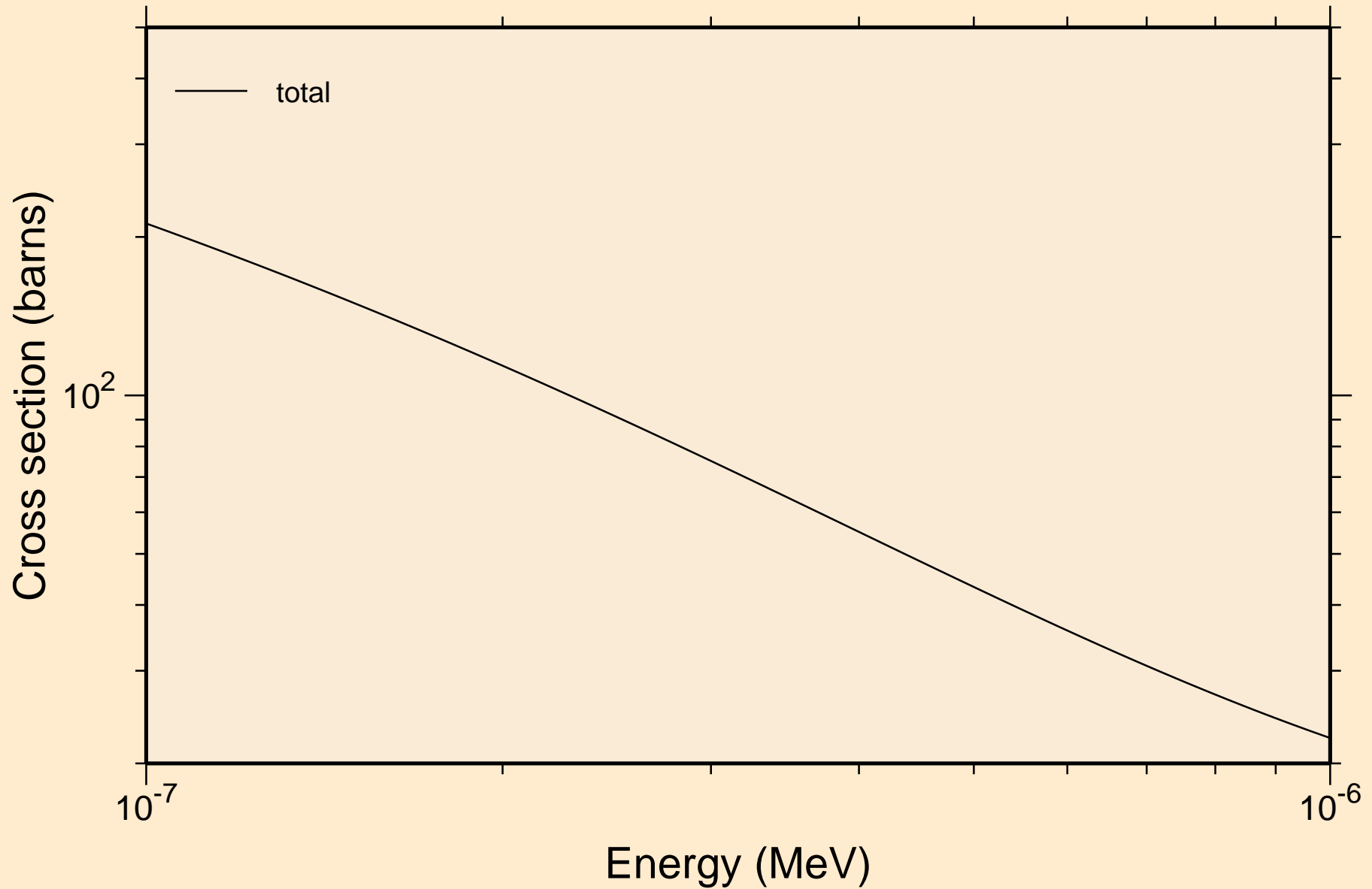

PU238 NEUTRON ACER TENDL-2024 LIBRARY; T=293.6K
resonance total cross section

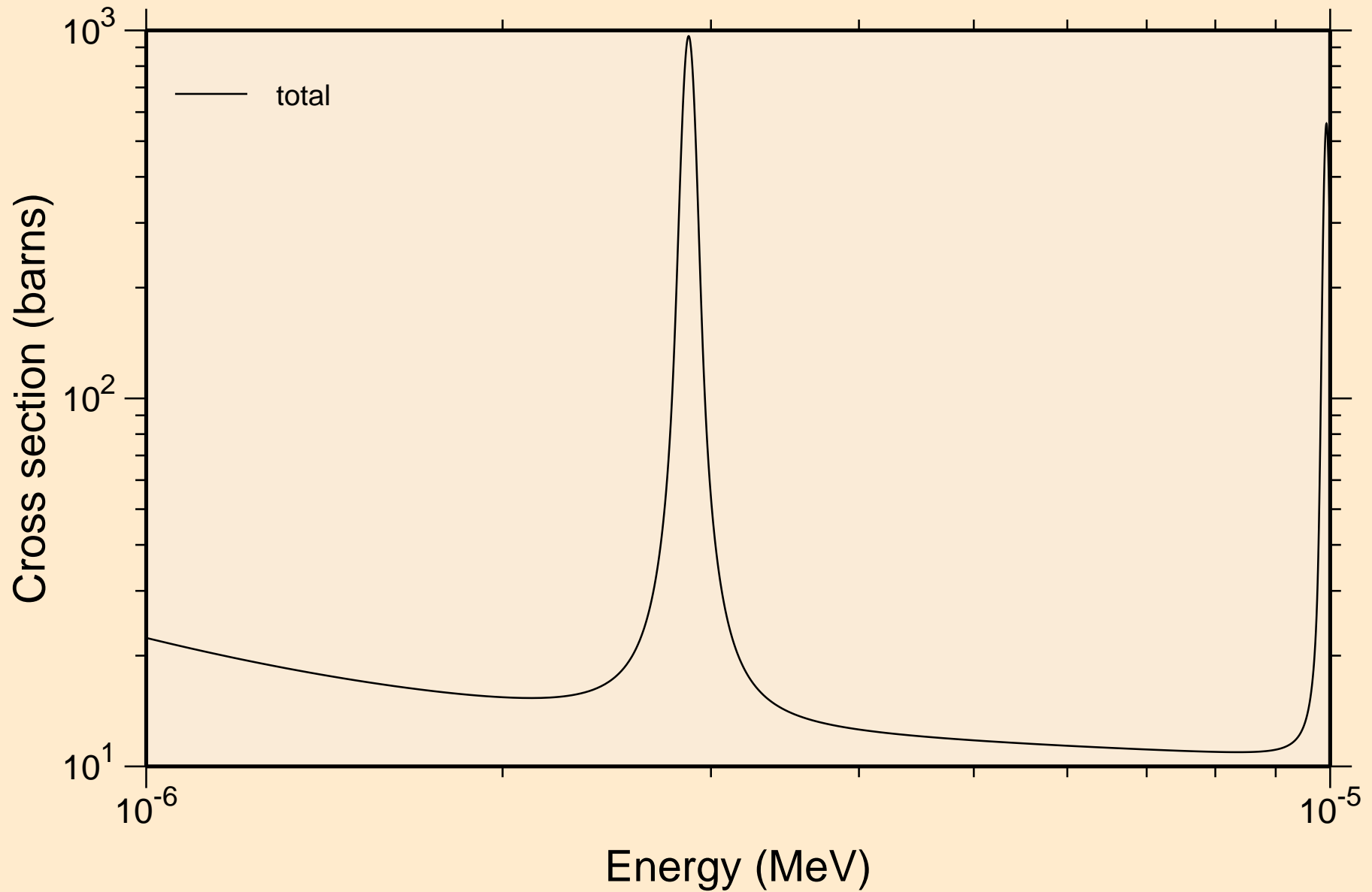

PU238 NEUTRON ACER TENDL-2024 LIBRARY; T=293.6K
resonance total cross section

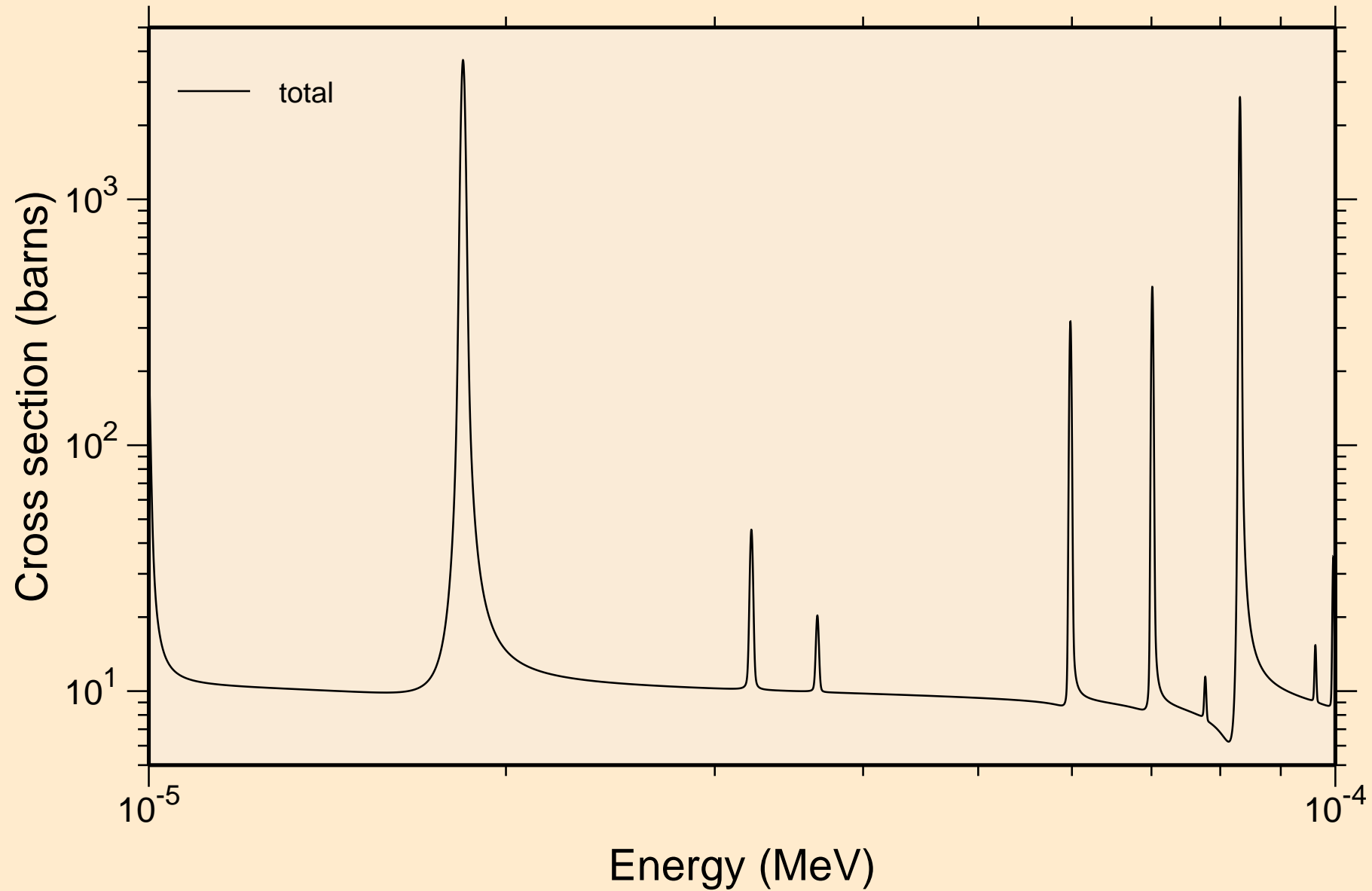

PU238 NEUTRON ACER TENDL-2024 LIBRARY; T=293.6K
resonance total cross section

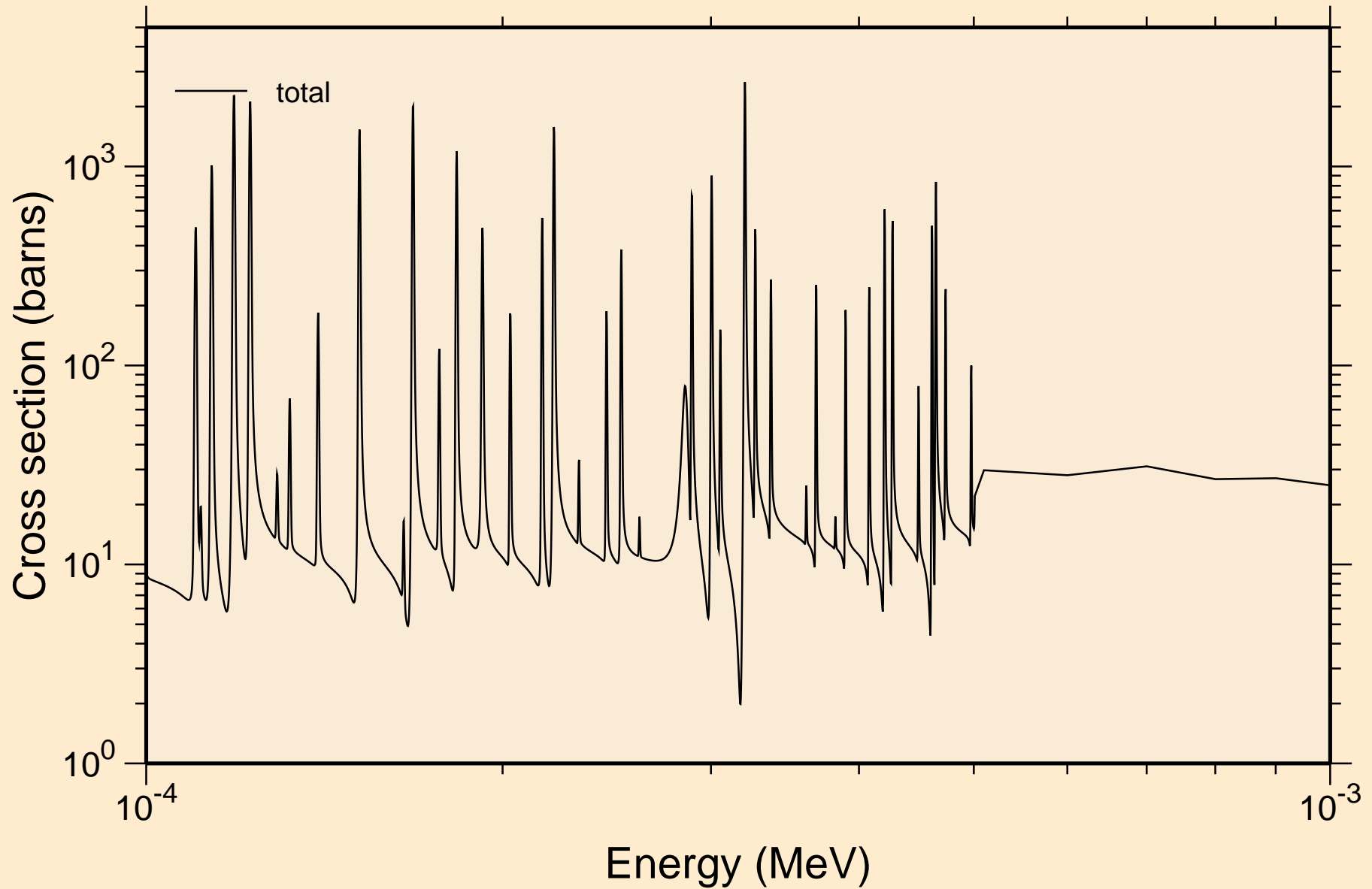

PU238 NEUTRON ACER TENDL-2024 LIBRARY; T=293.6K
resonance total cross section

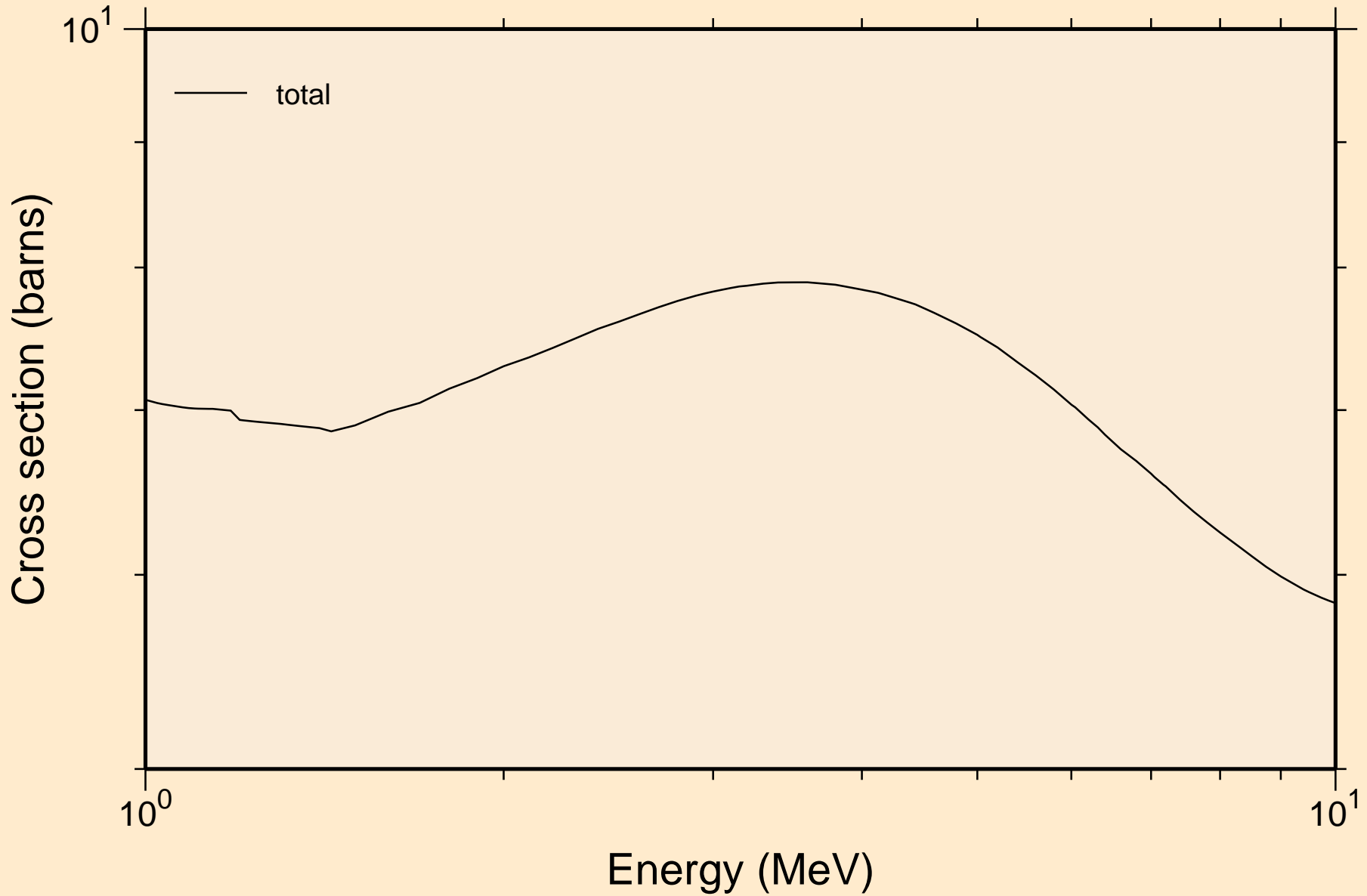

PU238 NEUTRON ACER TENDL-2024 LIBRARY; T=293.6K
resonance absorption cross sections

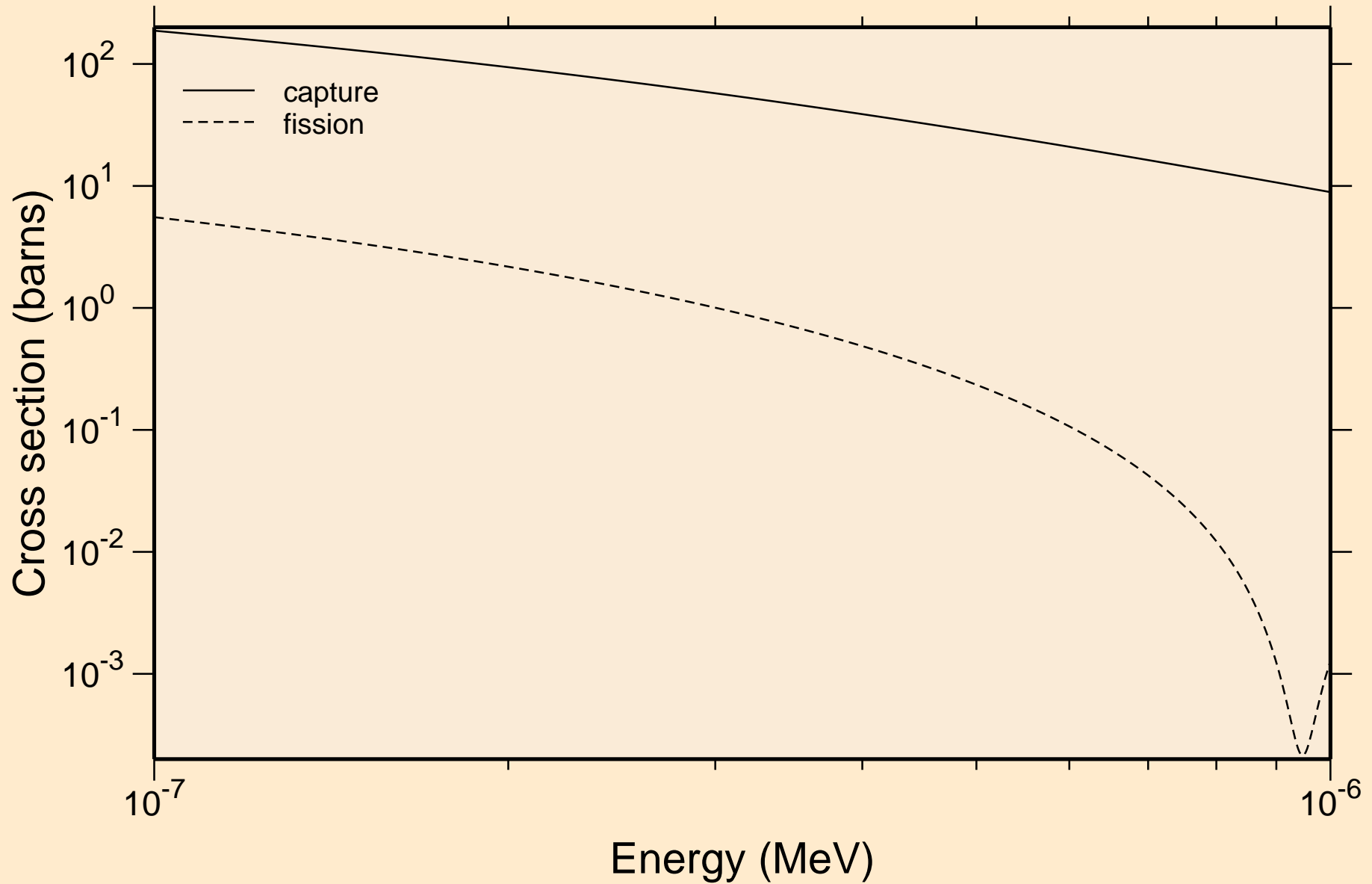

PU238 NEUTRON ACER TENDL-2024 LIBRARY; T=293.6K
resonance absorption cross sections

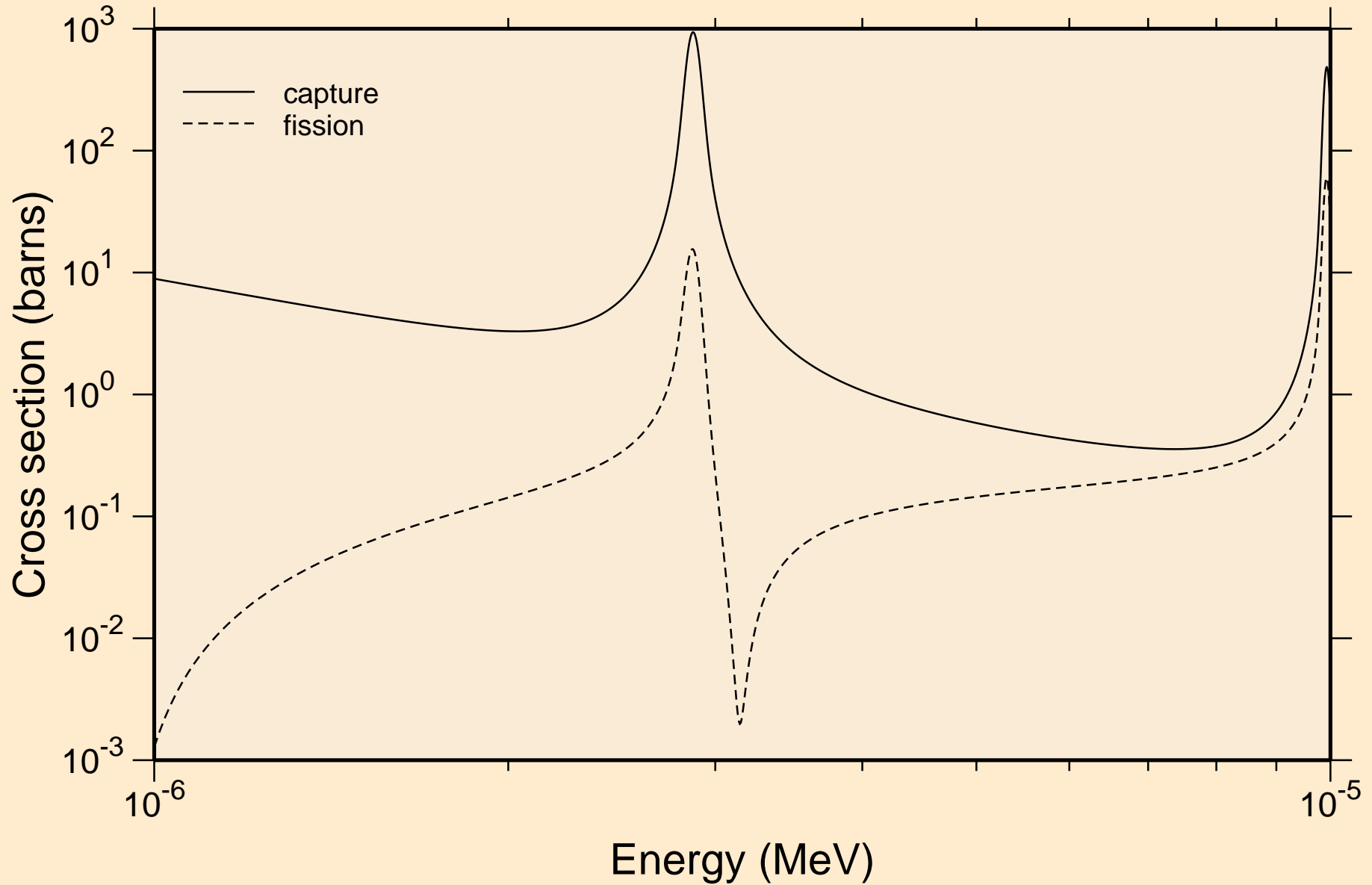

PU238 NEUTRON ACER TENDL-2024 LIBRARY; T=293.6K
resonance absorption cross sections

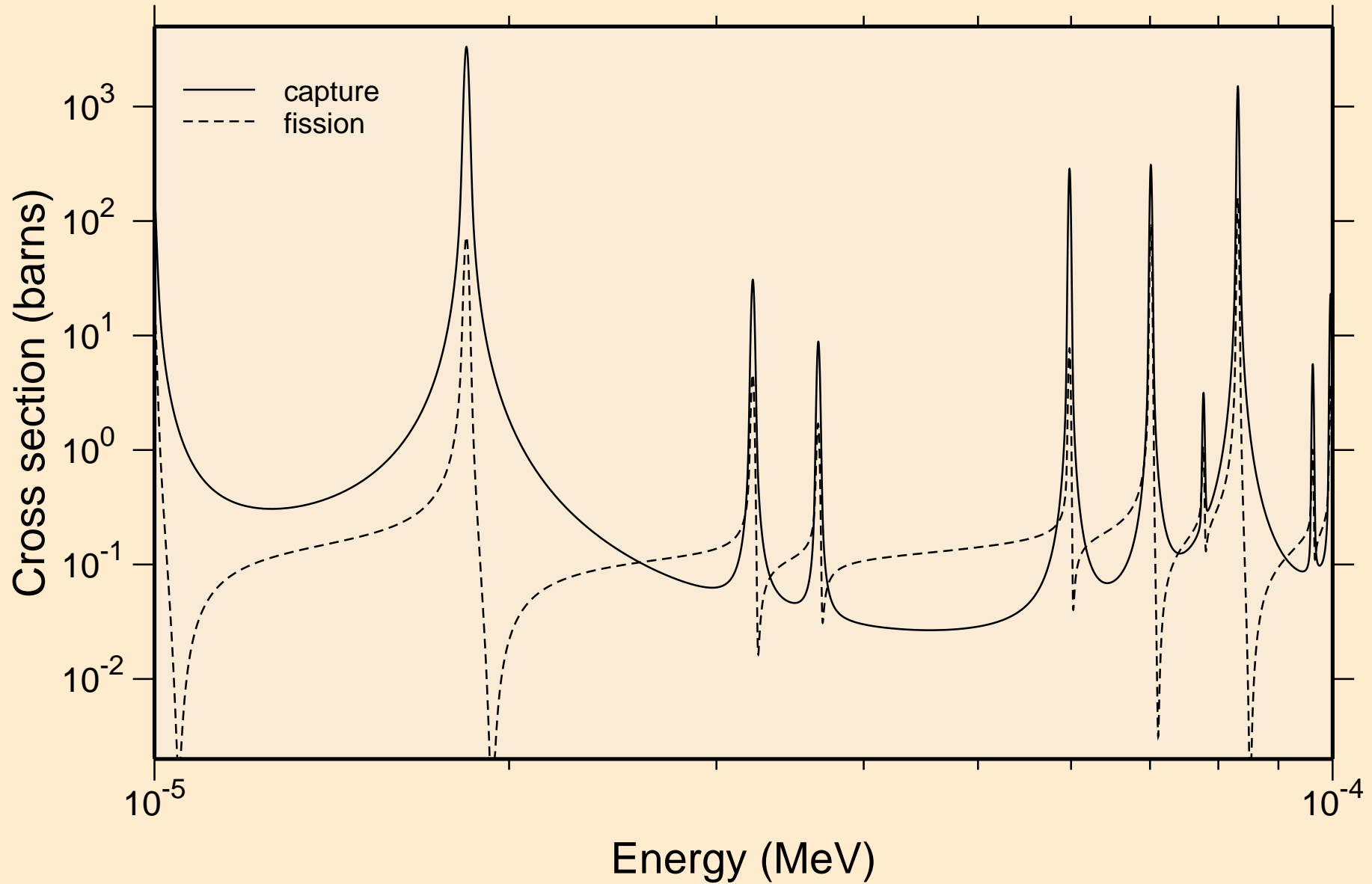

PU238 NEUTRON ACER TENDL-2024 LIBRARY; T=293.6K
resonance absorption cross sections

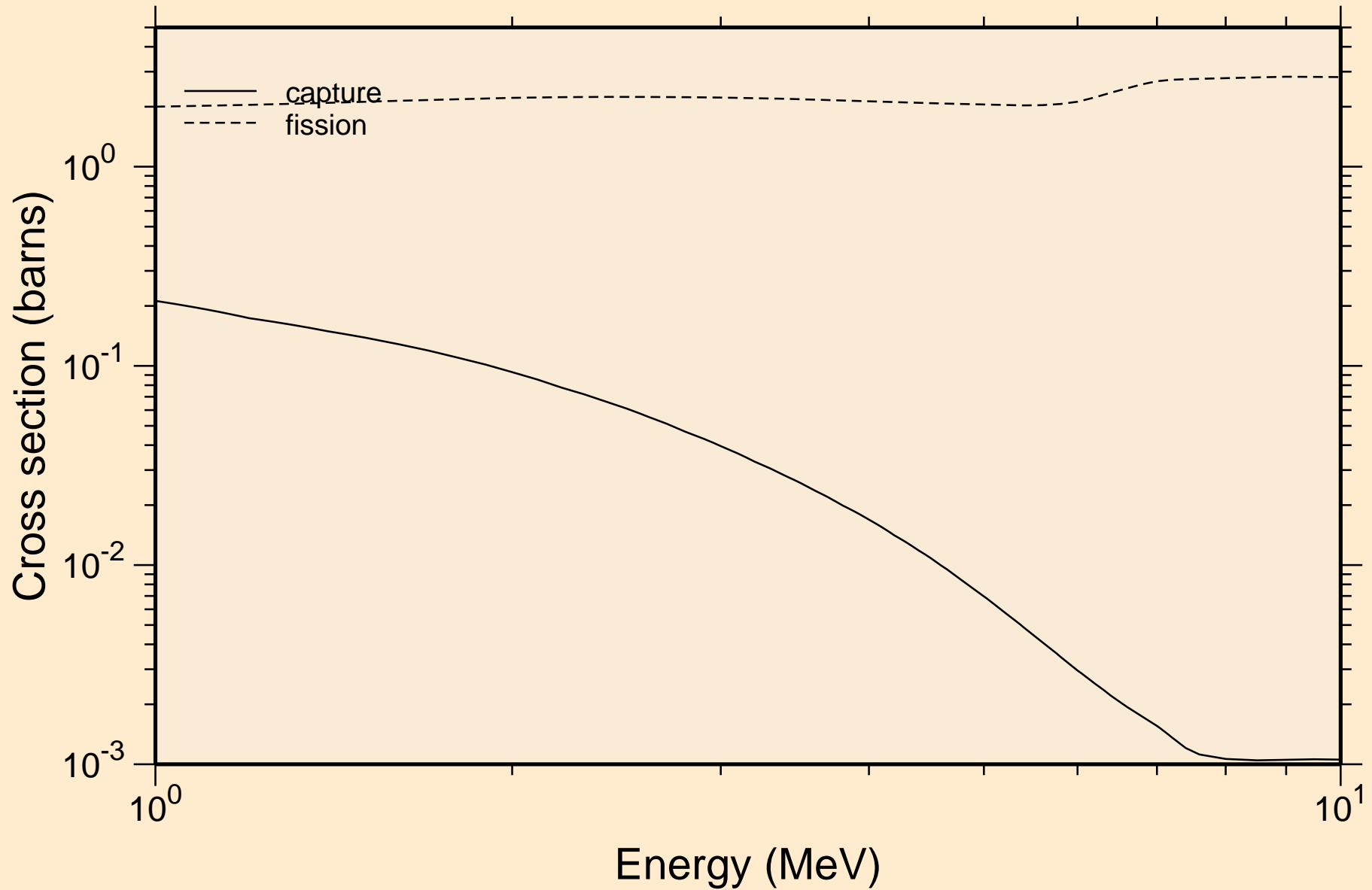

PU238 NEUTRON ACER TENDL-2024 LIBRARY; T=293.6K
Heating

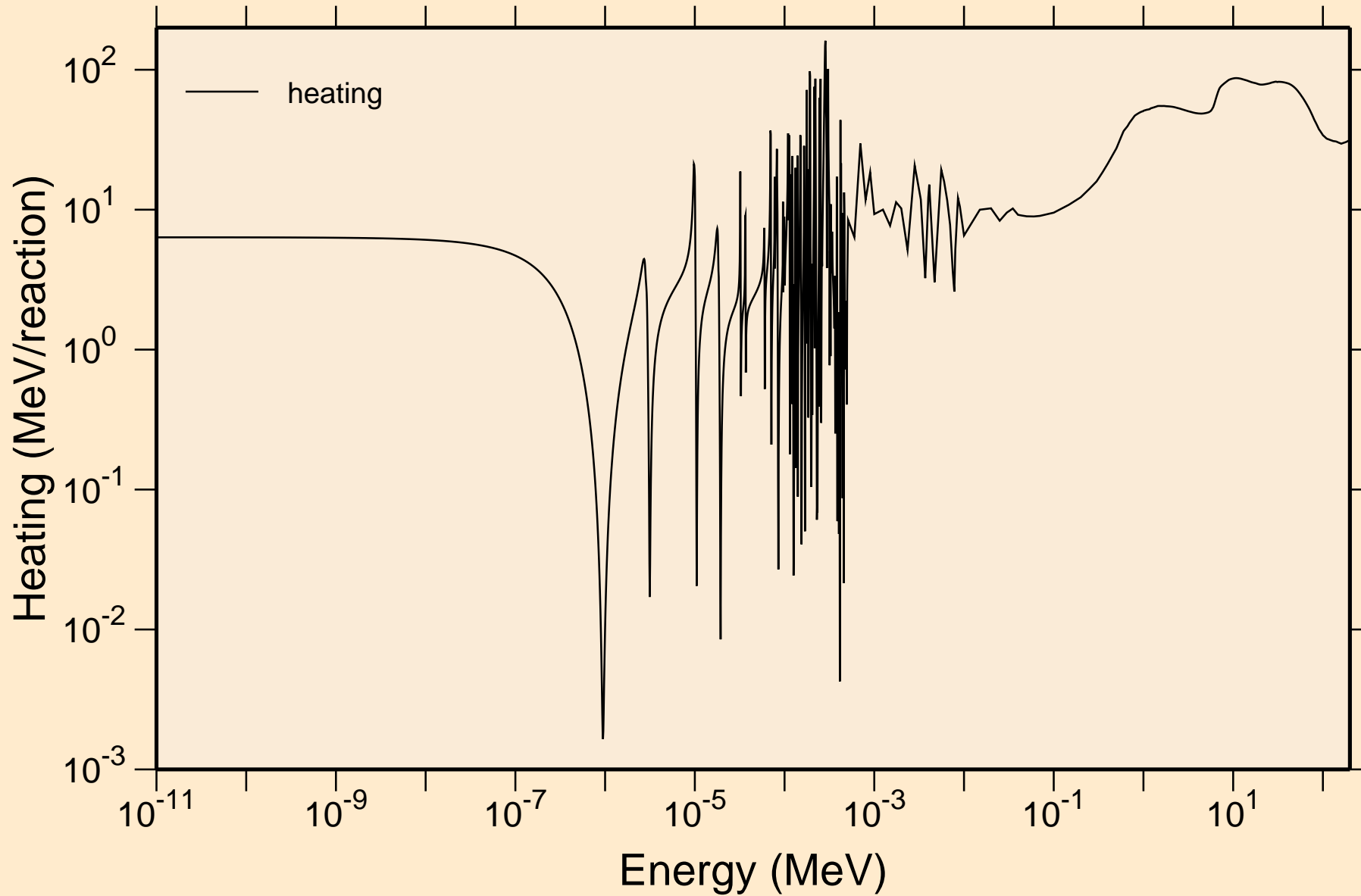

PU238 NEUTRON ACER TENDL-2024 LIBRARY; T=293.6K
Damage

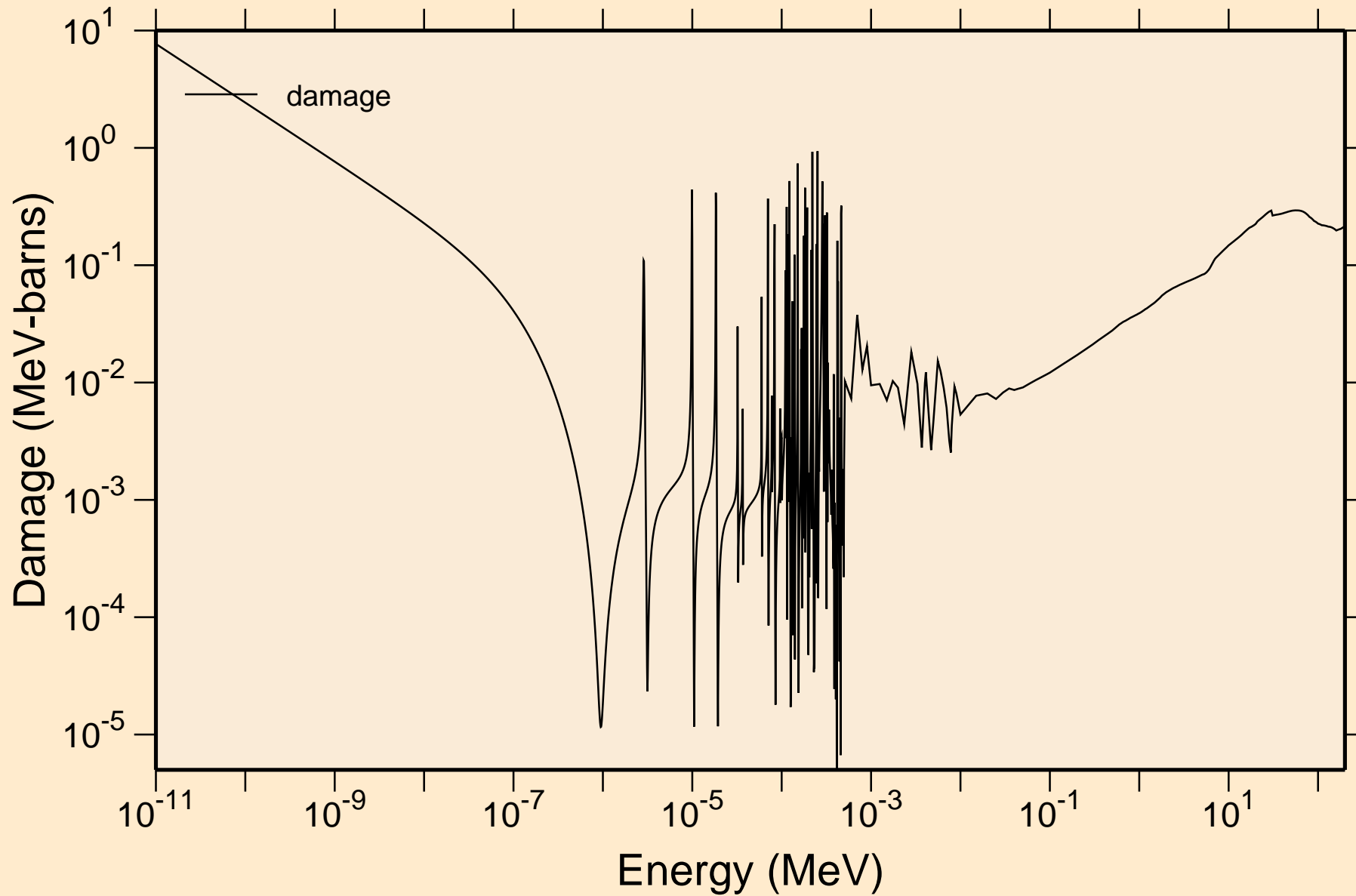

PU238 NEUTRON ACER TENDL-2024 LIBRARY; T=293.6K
Non-threshold reactions

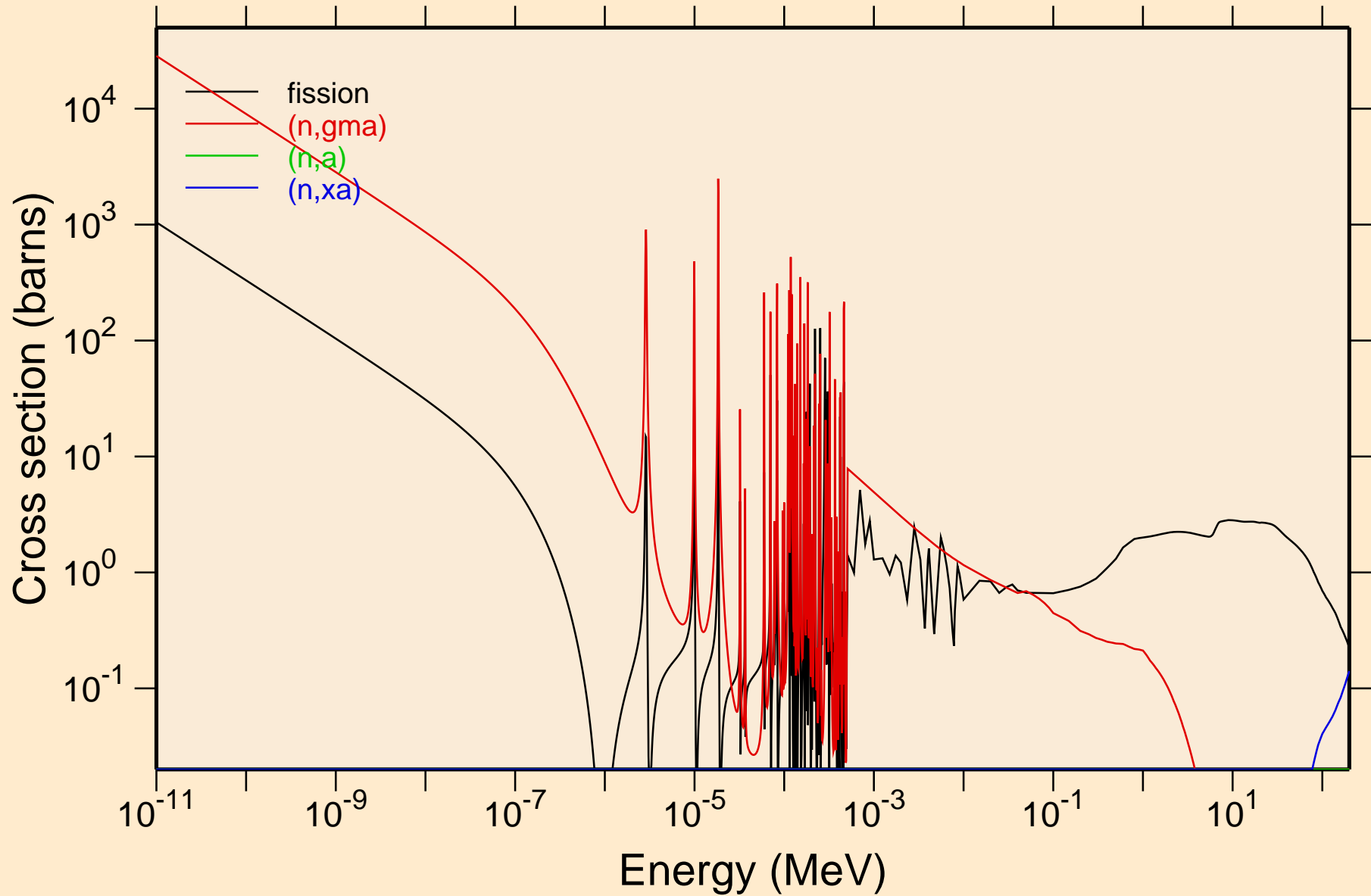

PU238 NEUTRON ACER TENDL-2024 LIBRARY; T=293.6K

Principal cross sections

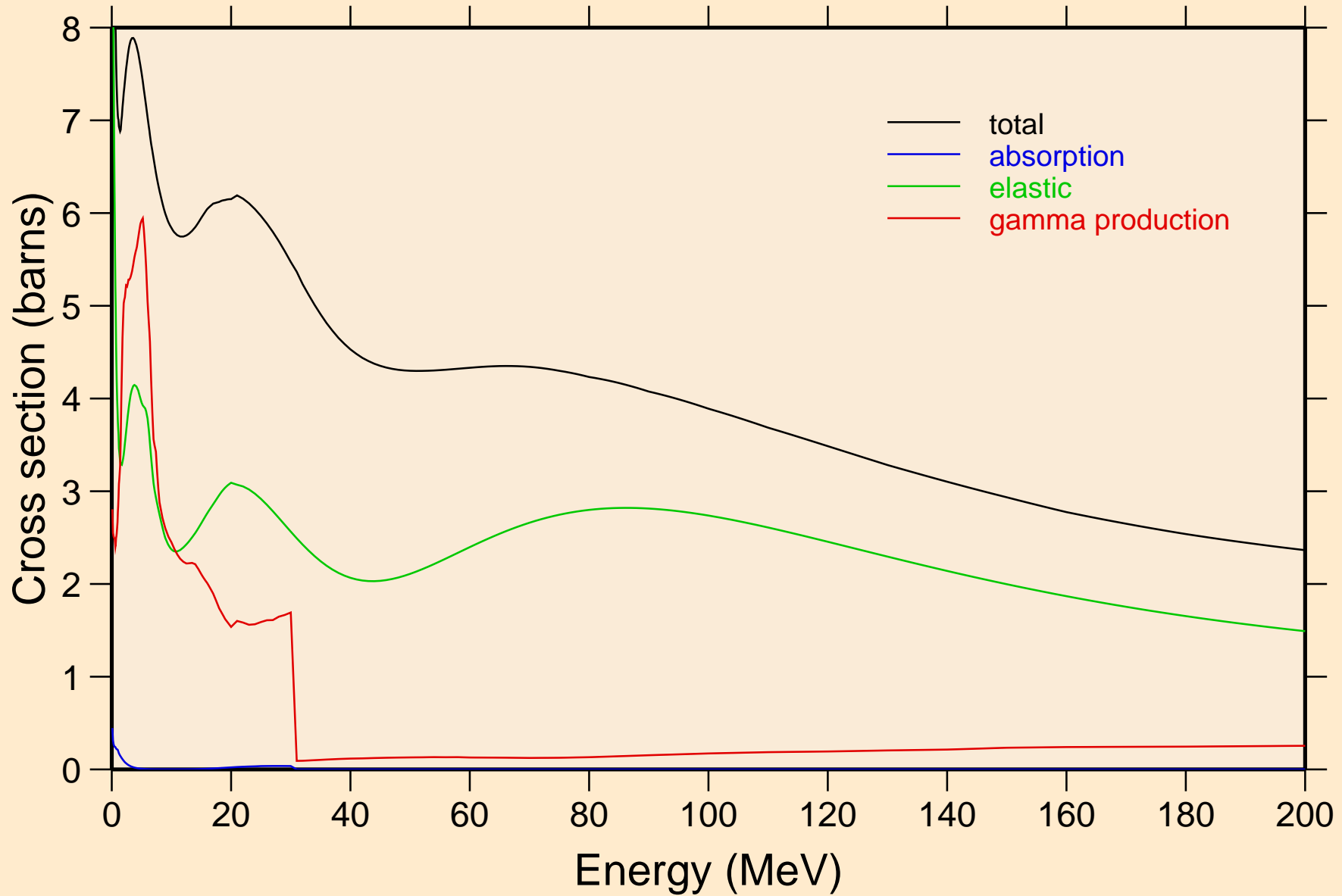

PU238 NEUTRON ACER TENDL-2024 LIBRARY; T=293.6K
Heating

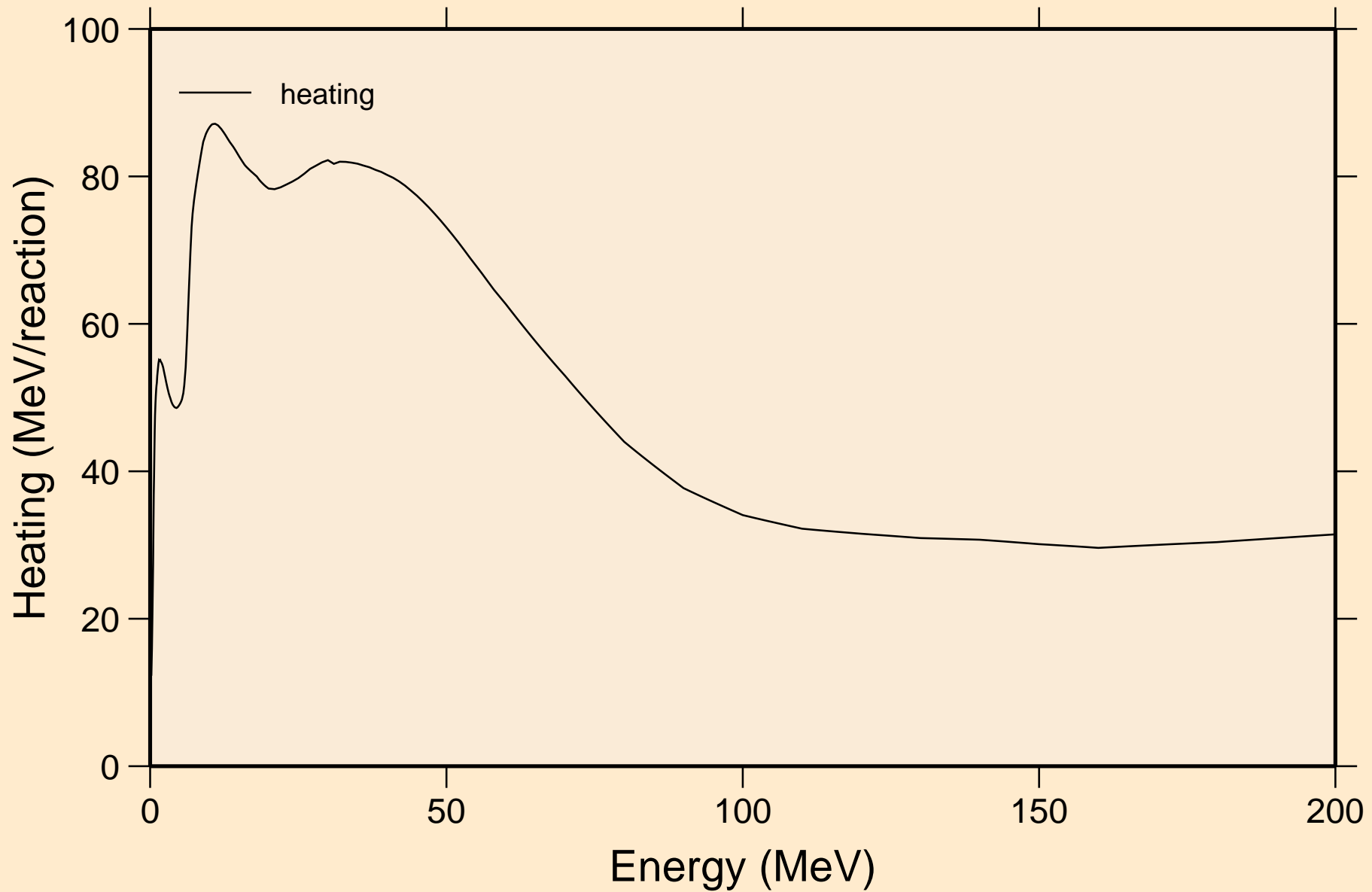

PU238 NEUTRON ACER TENDL-2024 LIBRARY; T=293.6K
Damage

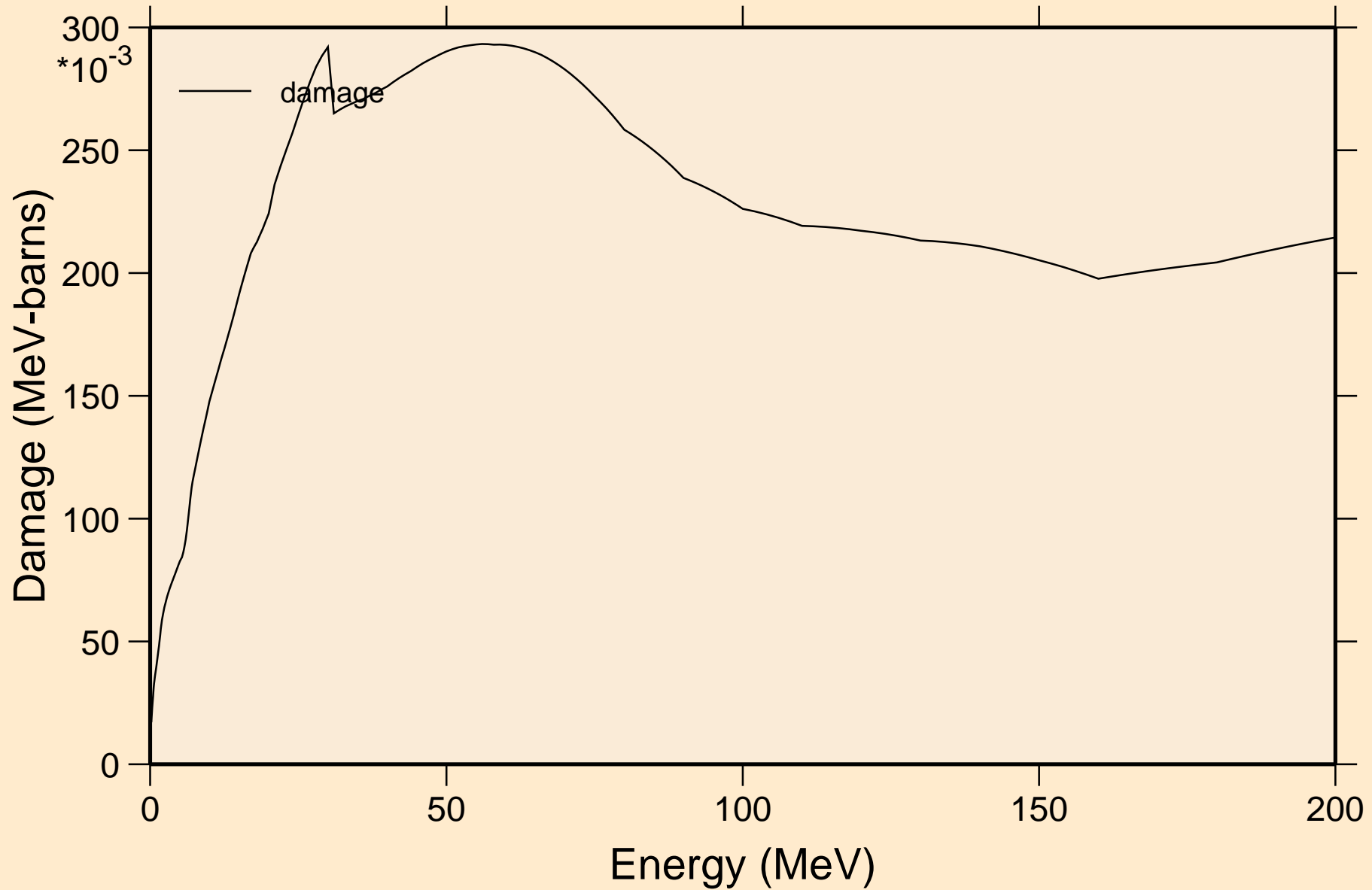

PU238 NEUTRON ACER TENDL-2024 LIBRARY; T=293.6K
Non-threshold reactions

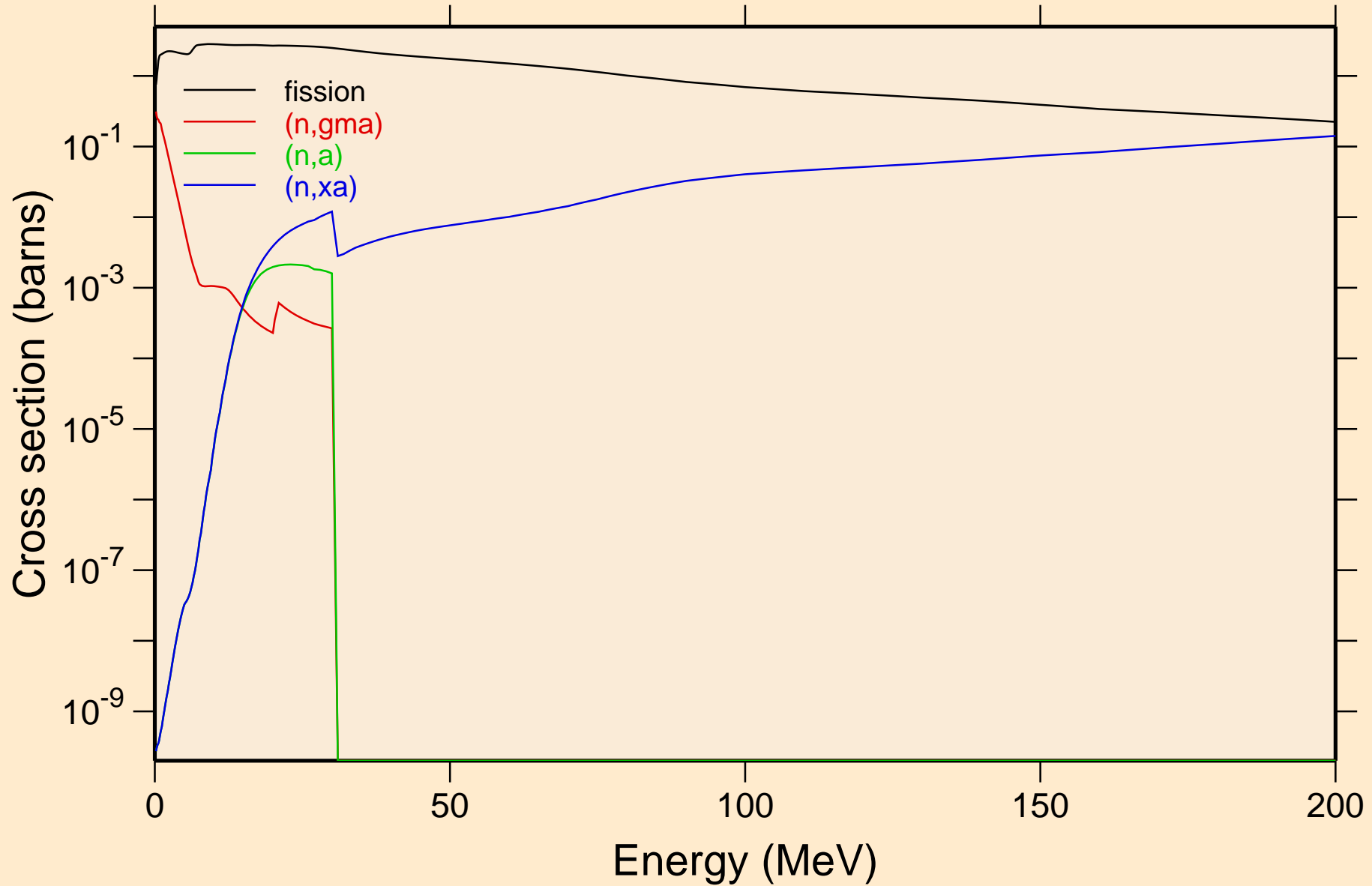

PU238 NEUTRON ACER TENDL-2024 LIBRARY; T=293.6K
Inelastic levels

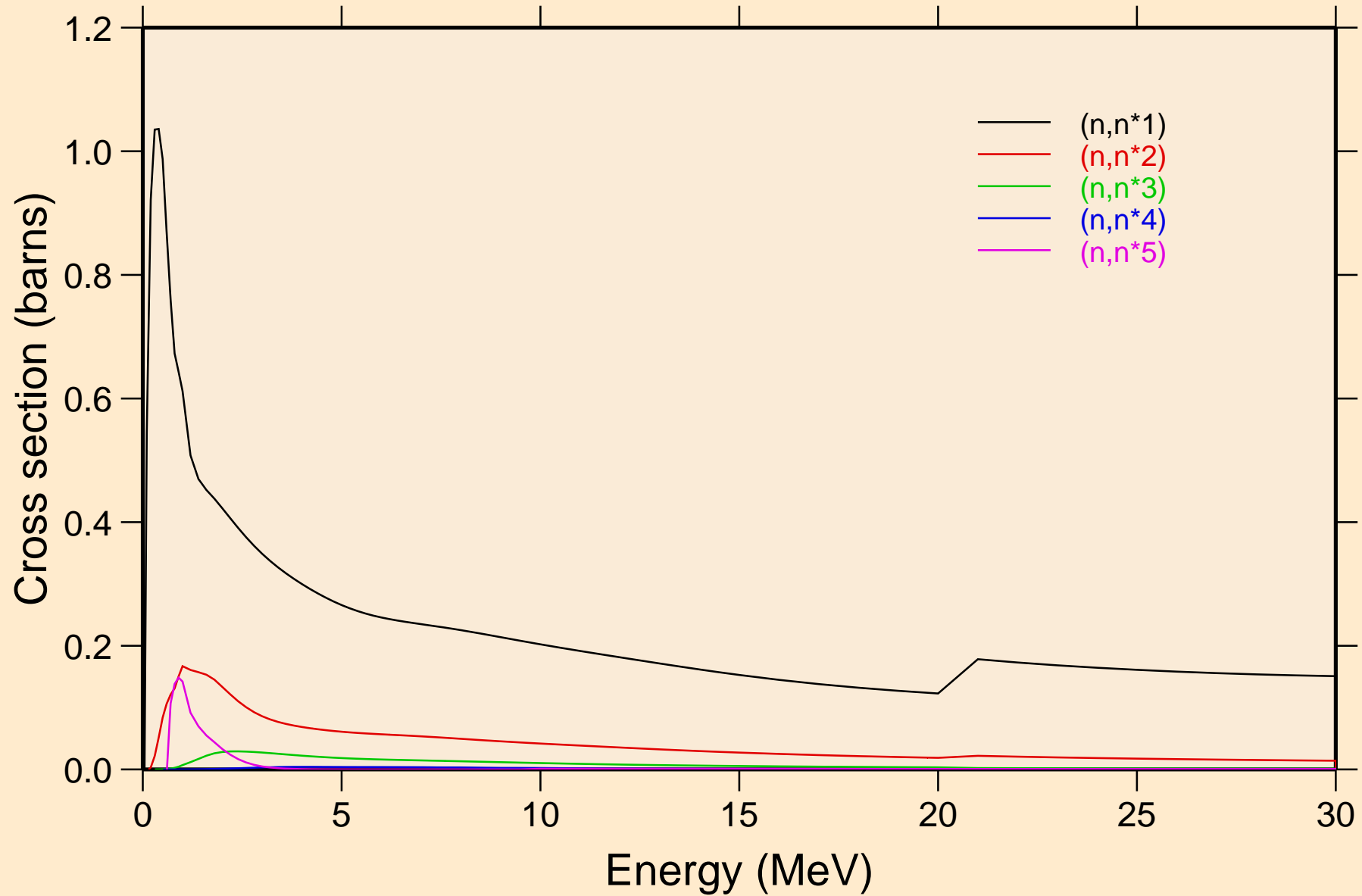

PU238 NEUTRON ACER TENDL-2024 LIBRARY; T=293.6K
Inelastic levels

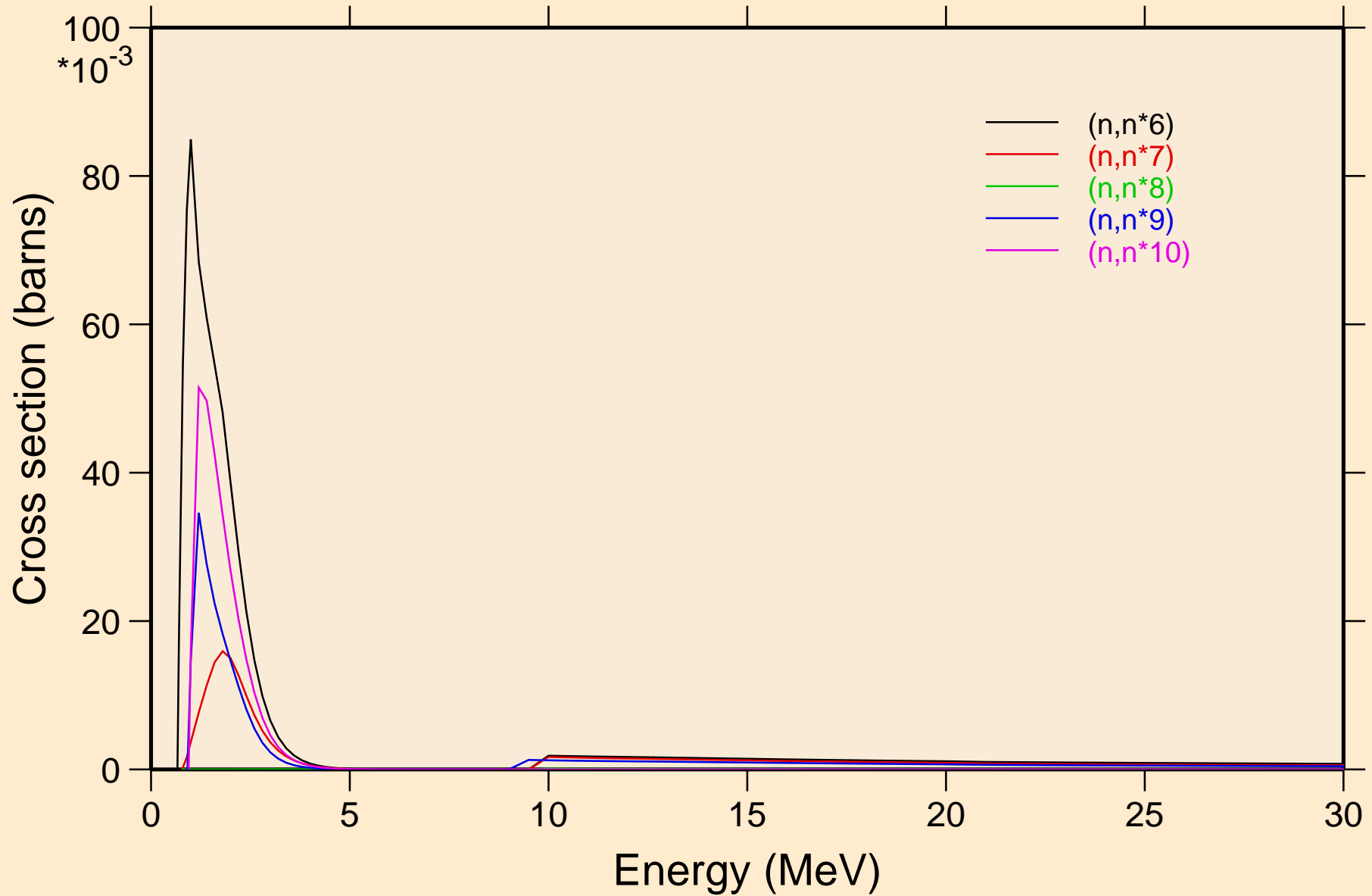

PU238 NEUTRON ACER TENDL-2024 LIBRARY; T=293.6K
Inelastic levels

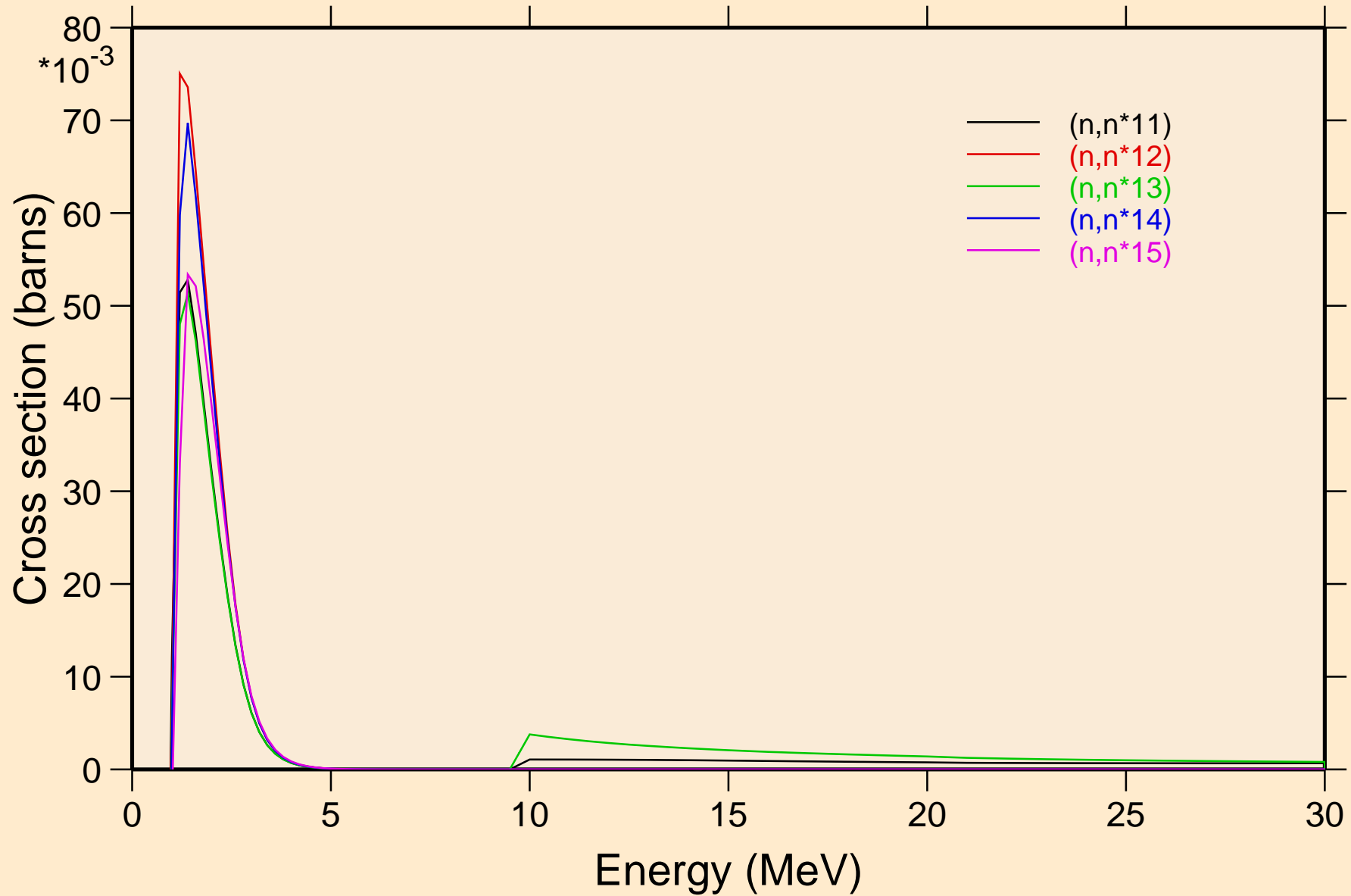

PU238 NEUTRON ACER TENDL-2024 LIBRARY; T=293.6K
Inelastic levels

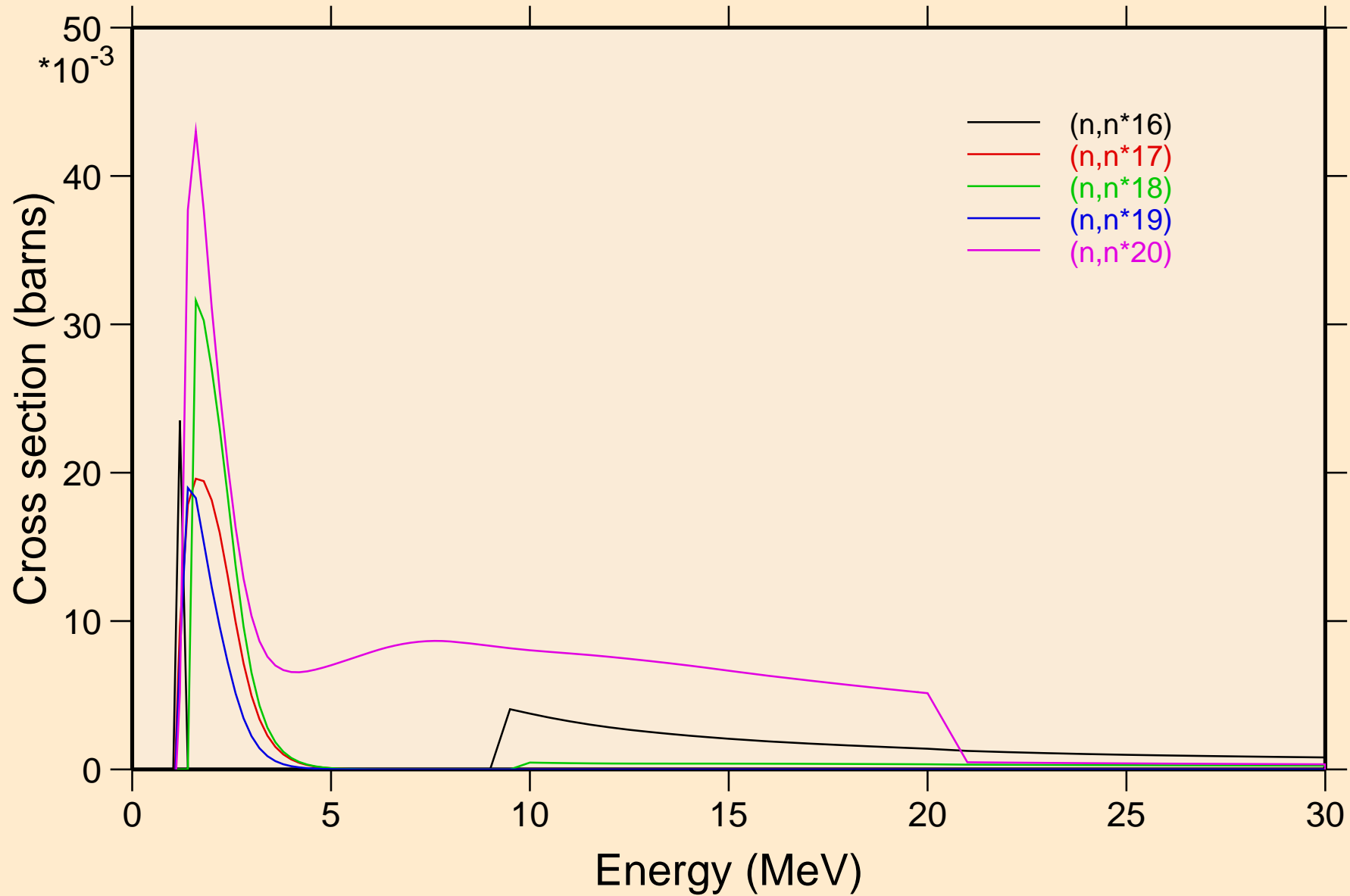

PU238 NEUTRON ACER TENDL-2024 LIBRARY; T=293.6K
Inelastic levels

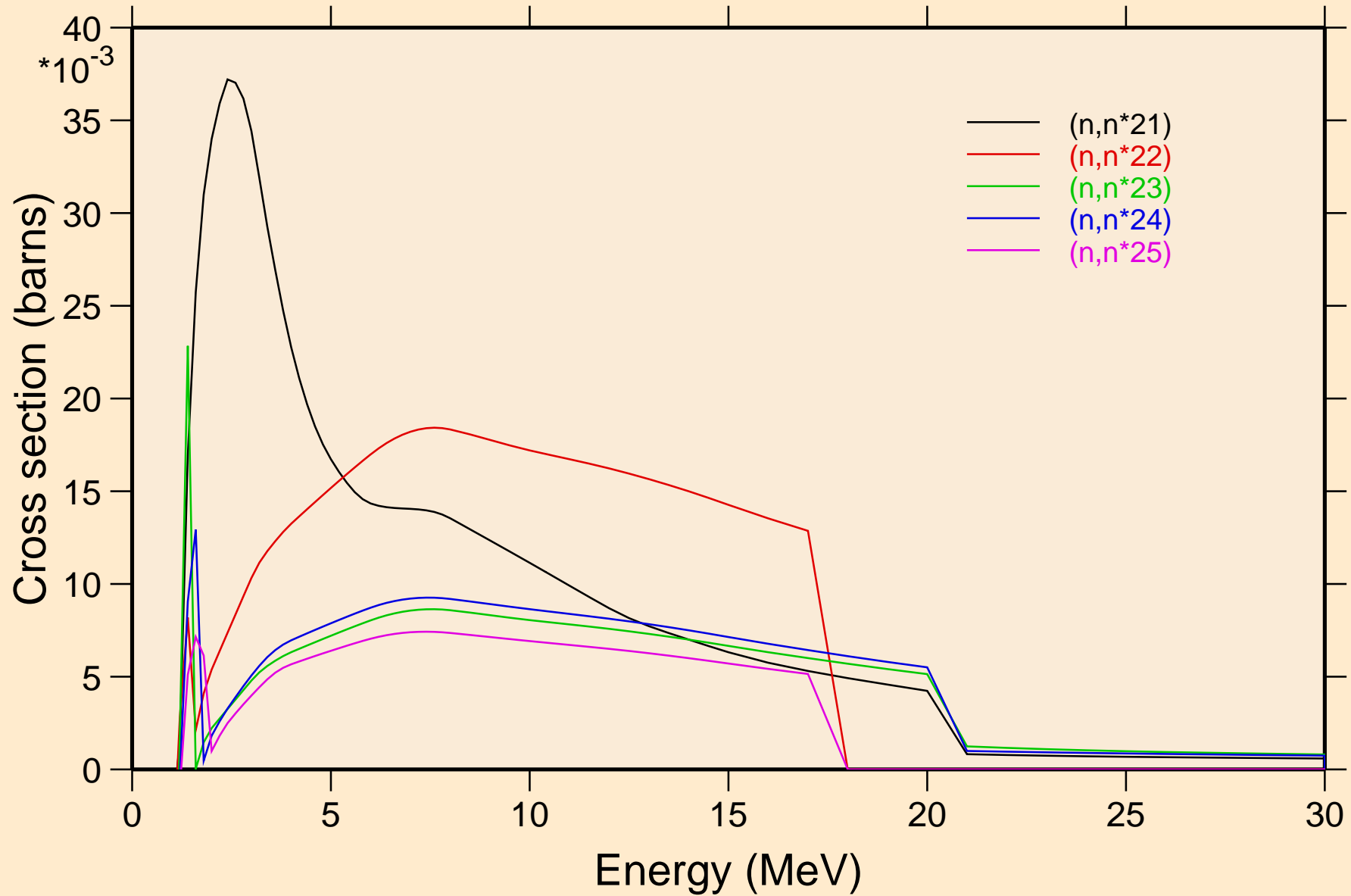

PU238 NEUTRON ACER TENDL-2024 LIBRARY; T=293.6K
Inelastic levels

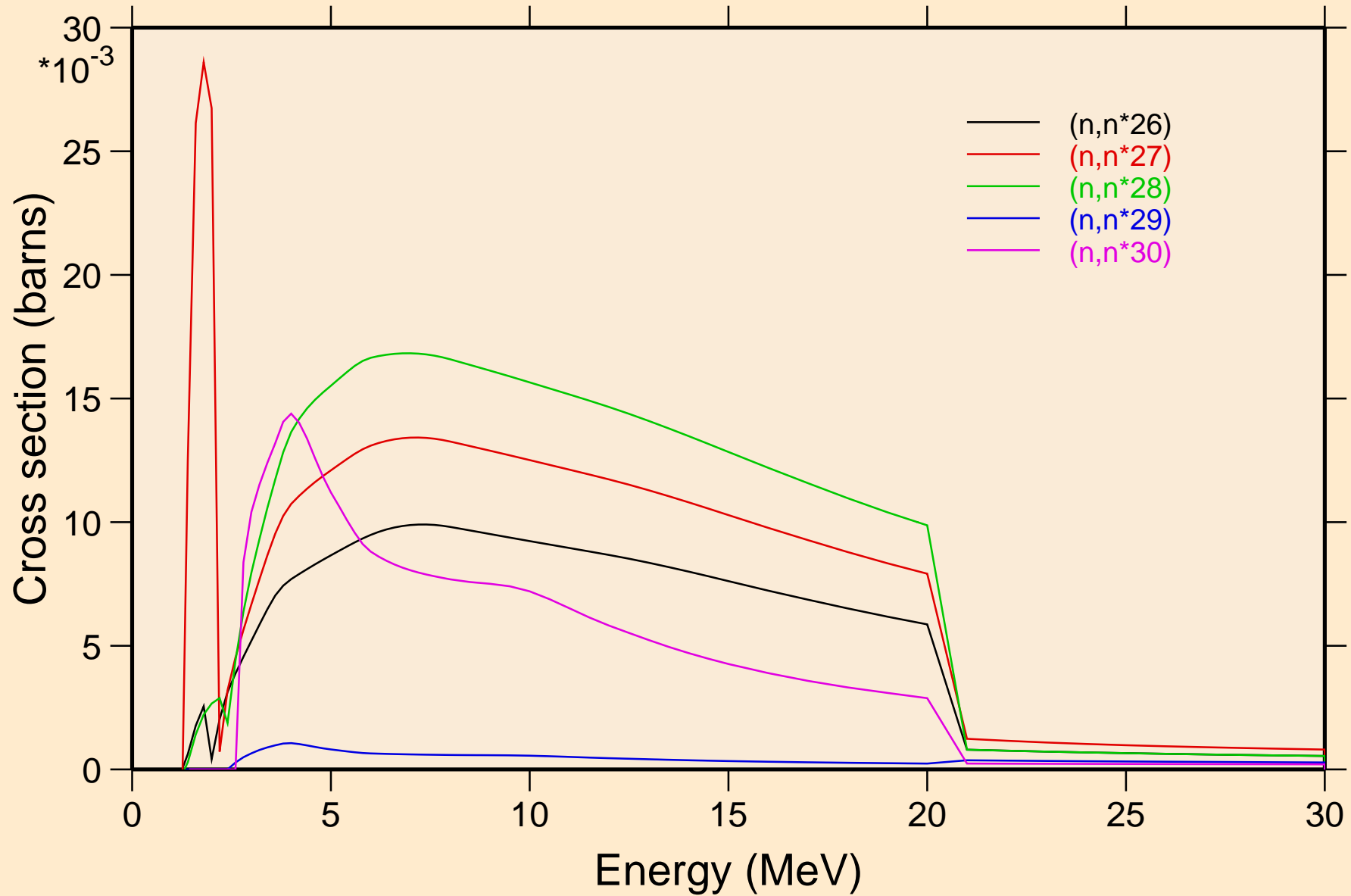

PU238 NEUTRON ACER TENDL-2024 LIBRARY; T=293.6K
Threshold reactions

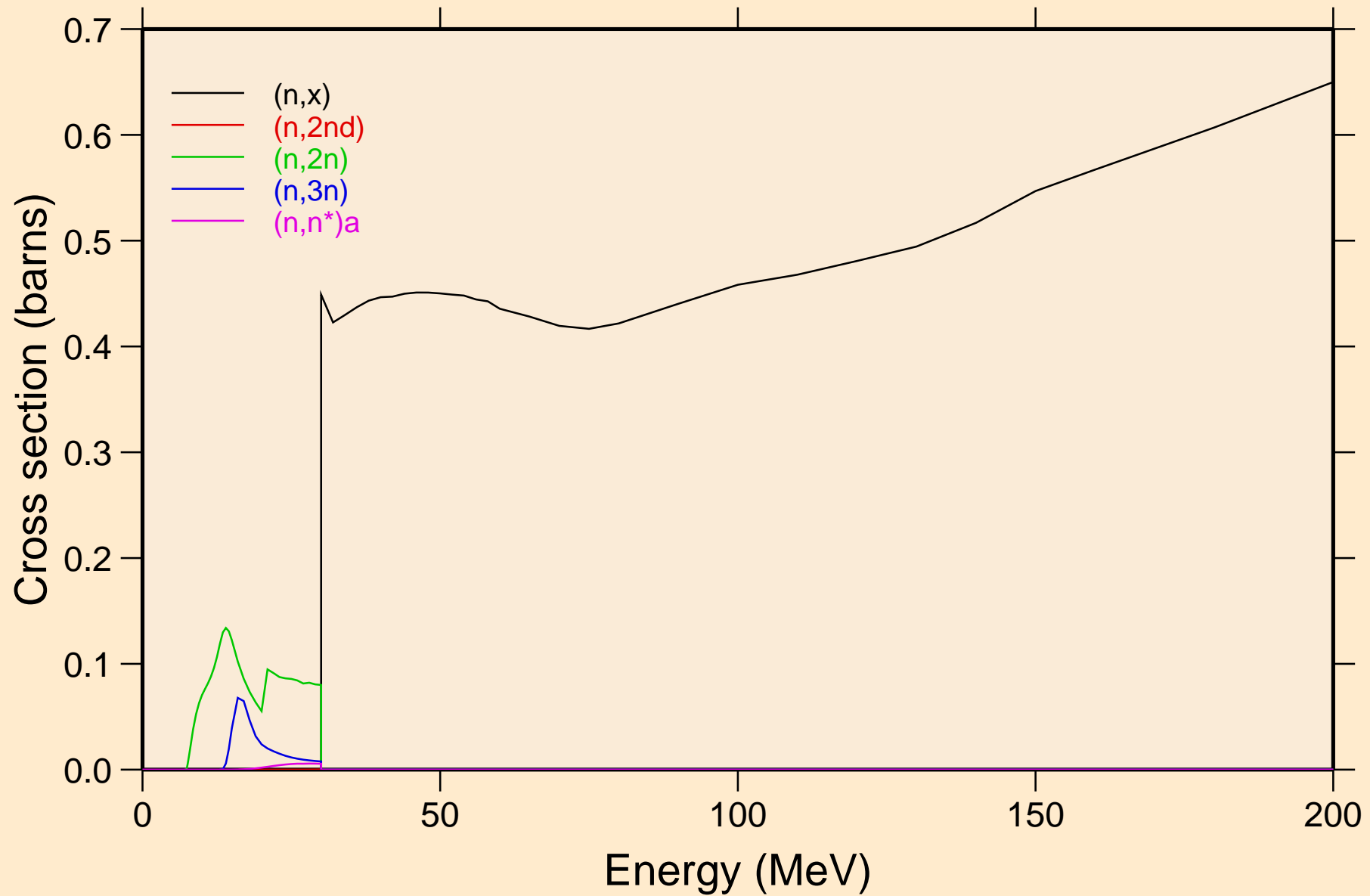

PU238 NEUTRON ACER TENDL-2024 LIBRARY; T=293.6K
Threshold reactions

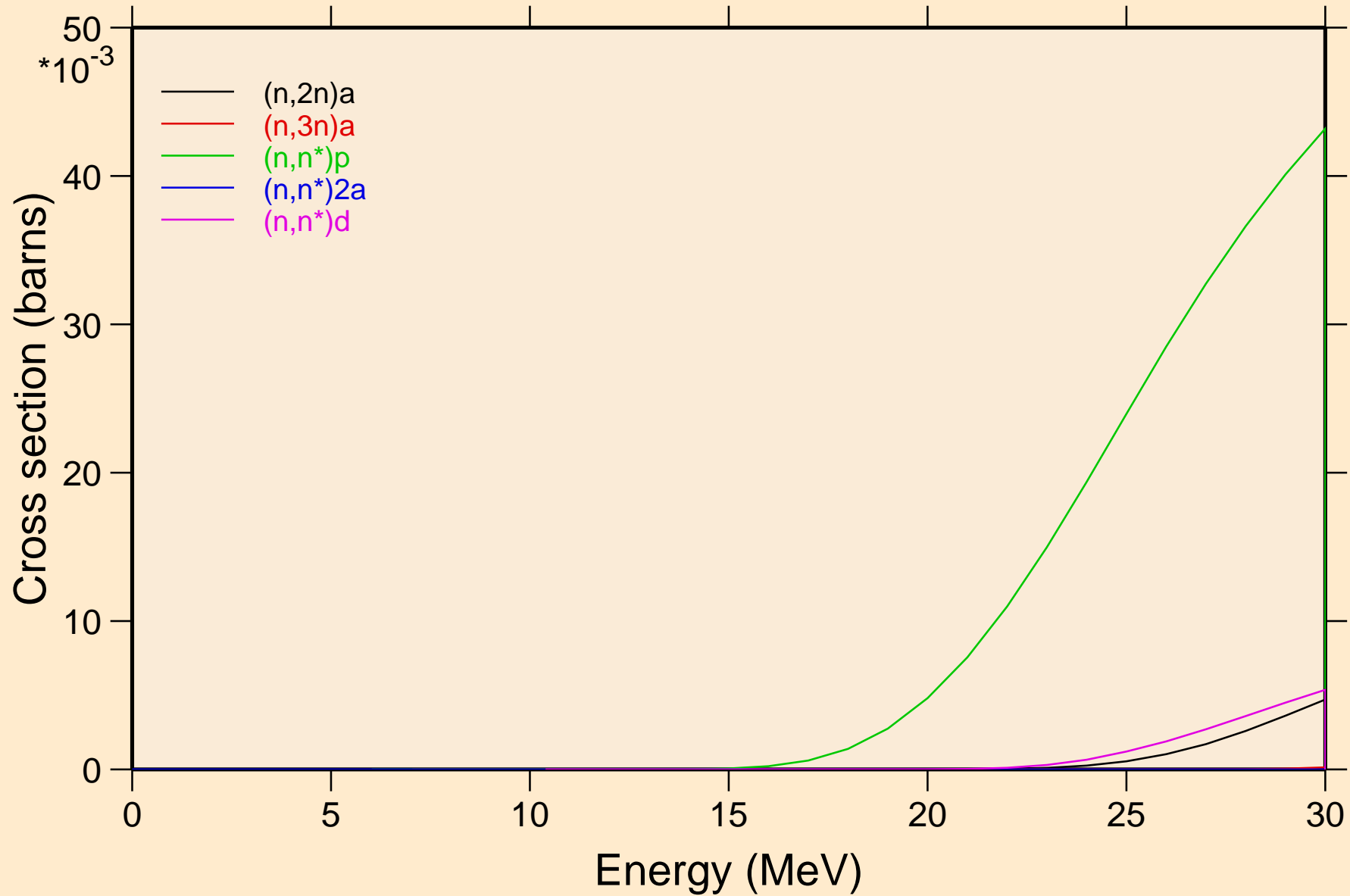

PU238 NEUTRON ACER TENDL-2024 LIBRARY; T=293.6K
Threshold reactions

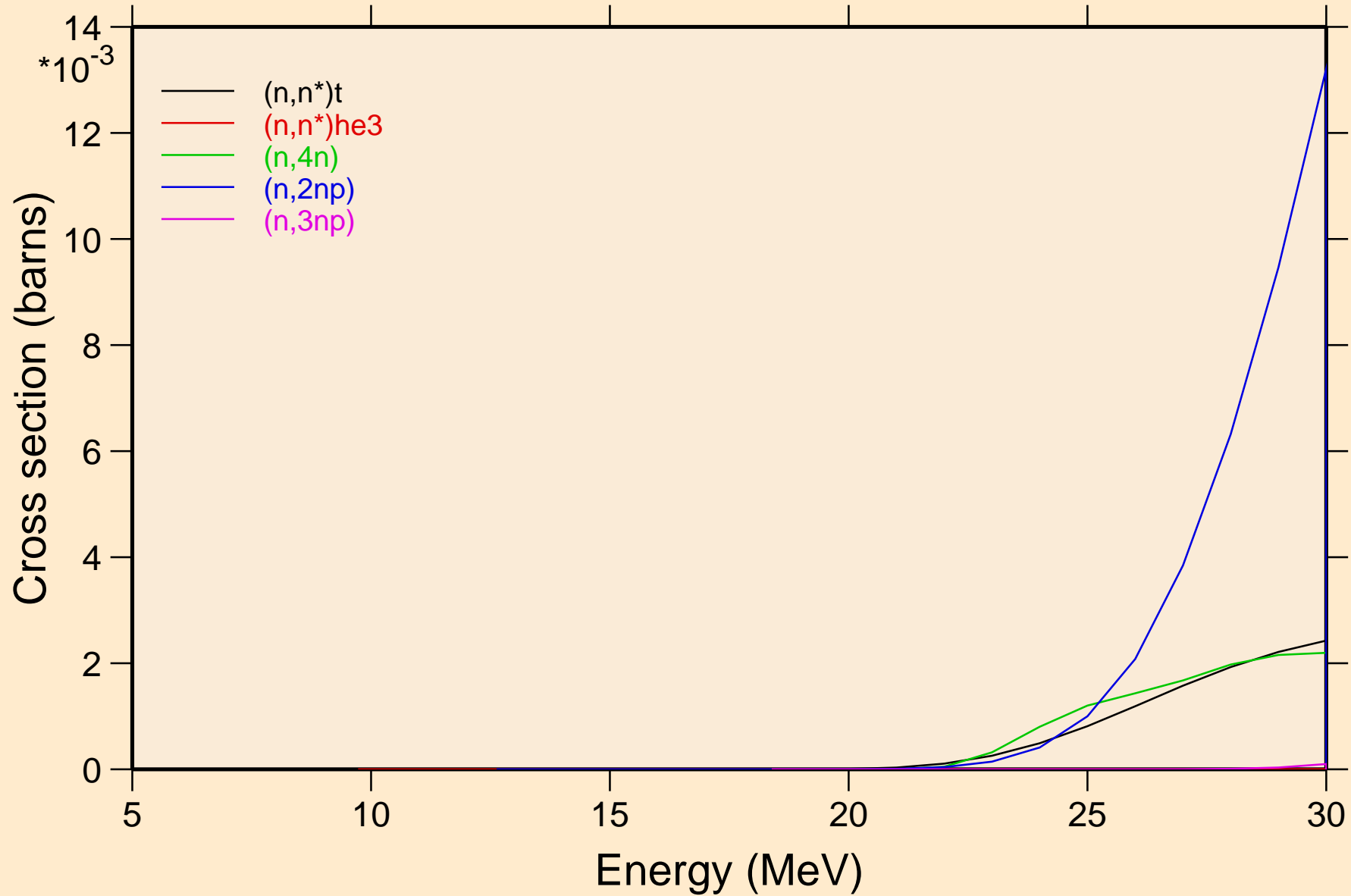

PU238 NEUTRON ACER TENDL-2024 LIBRARY; T=293.6K
Threshold reactions

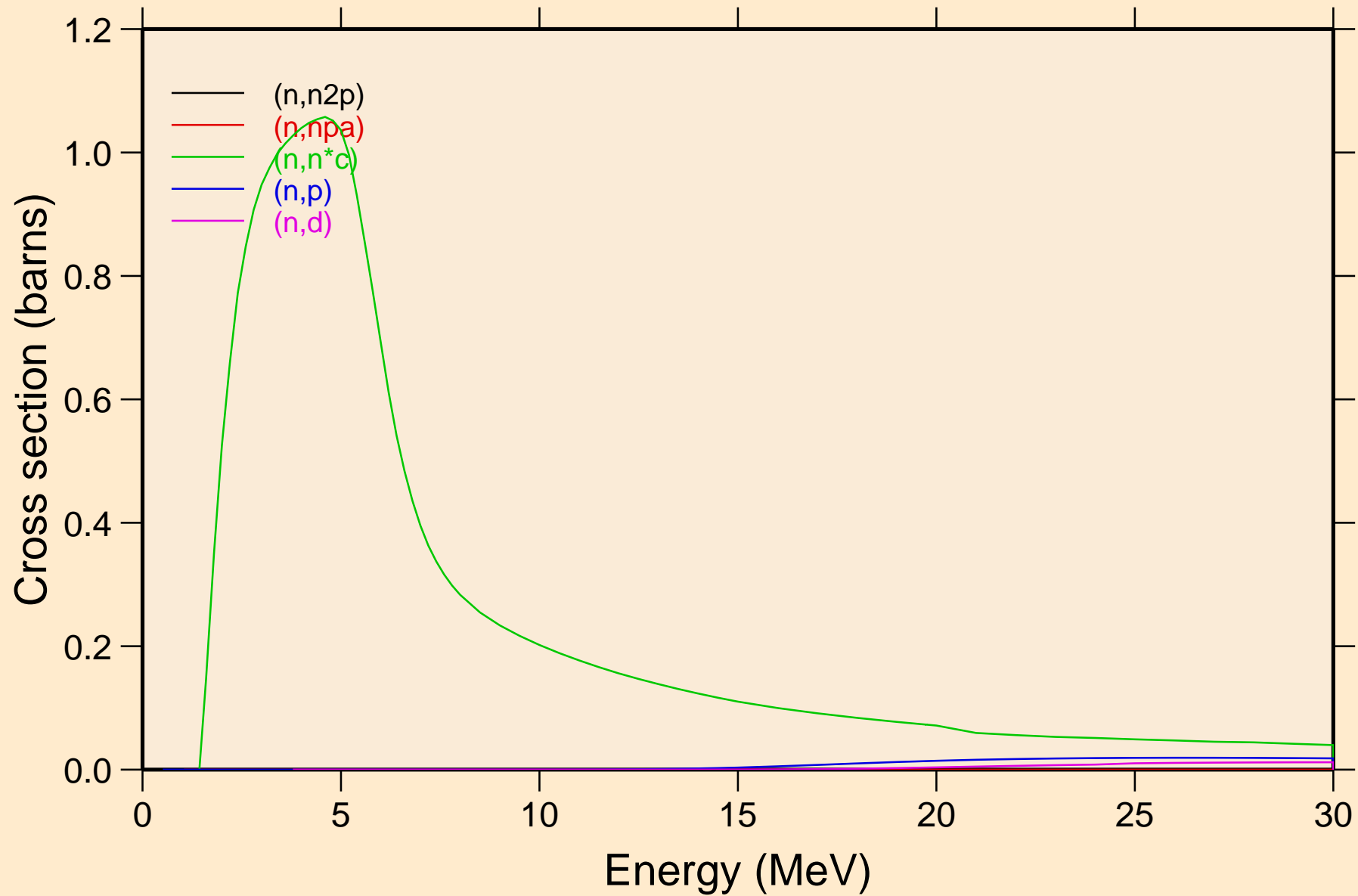

PU238 NEUTRON ACER TENDL-2024 LIBRARY; T=293.6K
Threshold reactions

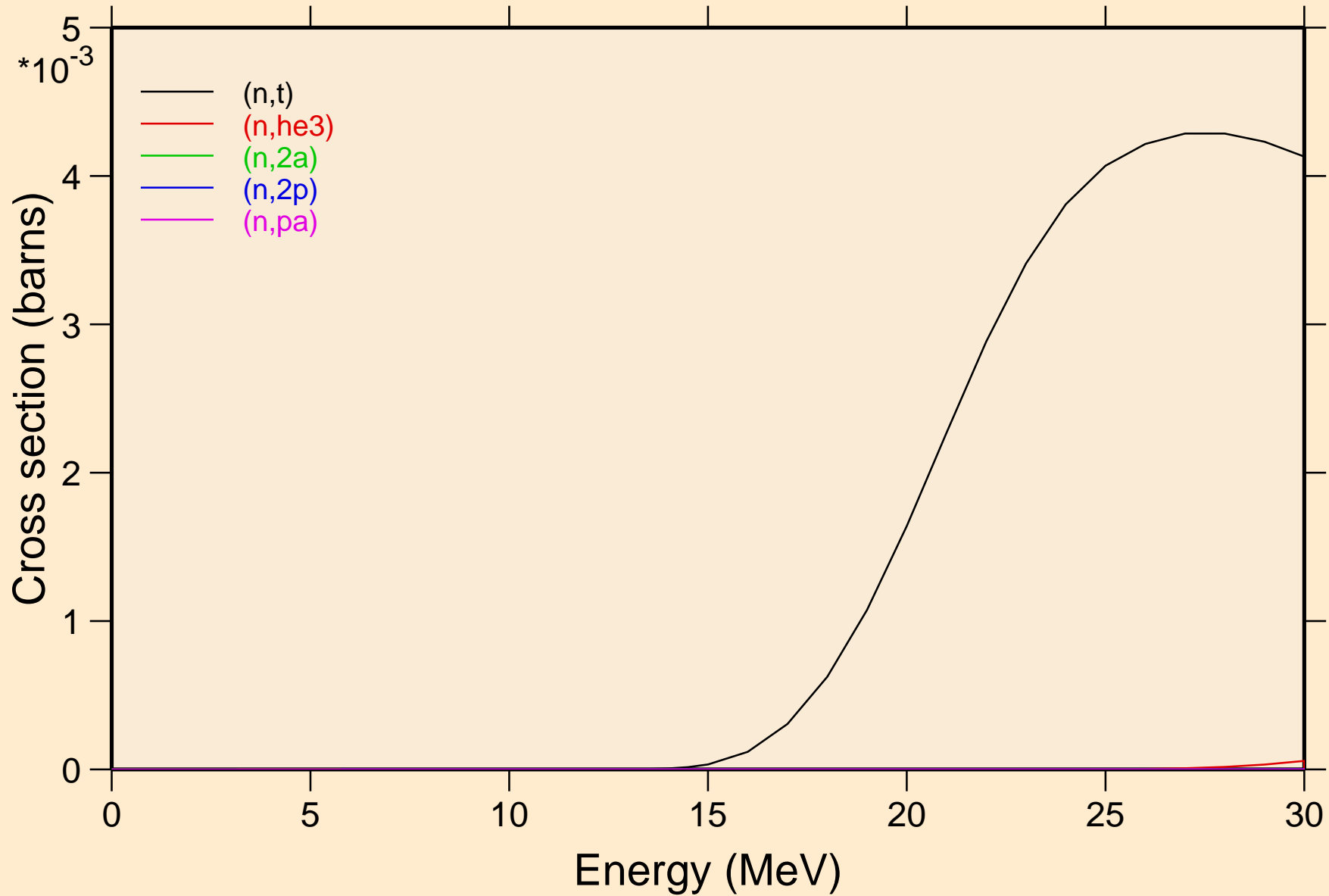

PU238 NEUTRON ACER TENDL-2024 LIBRARY; T=293.6K
Threshold reactions

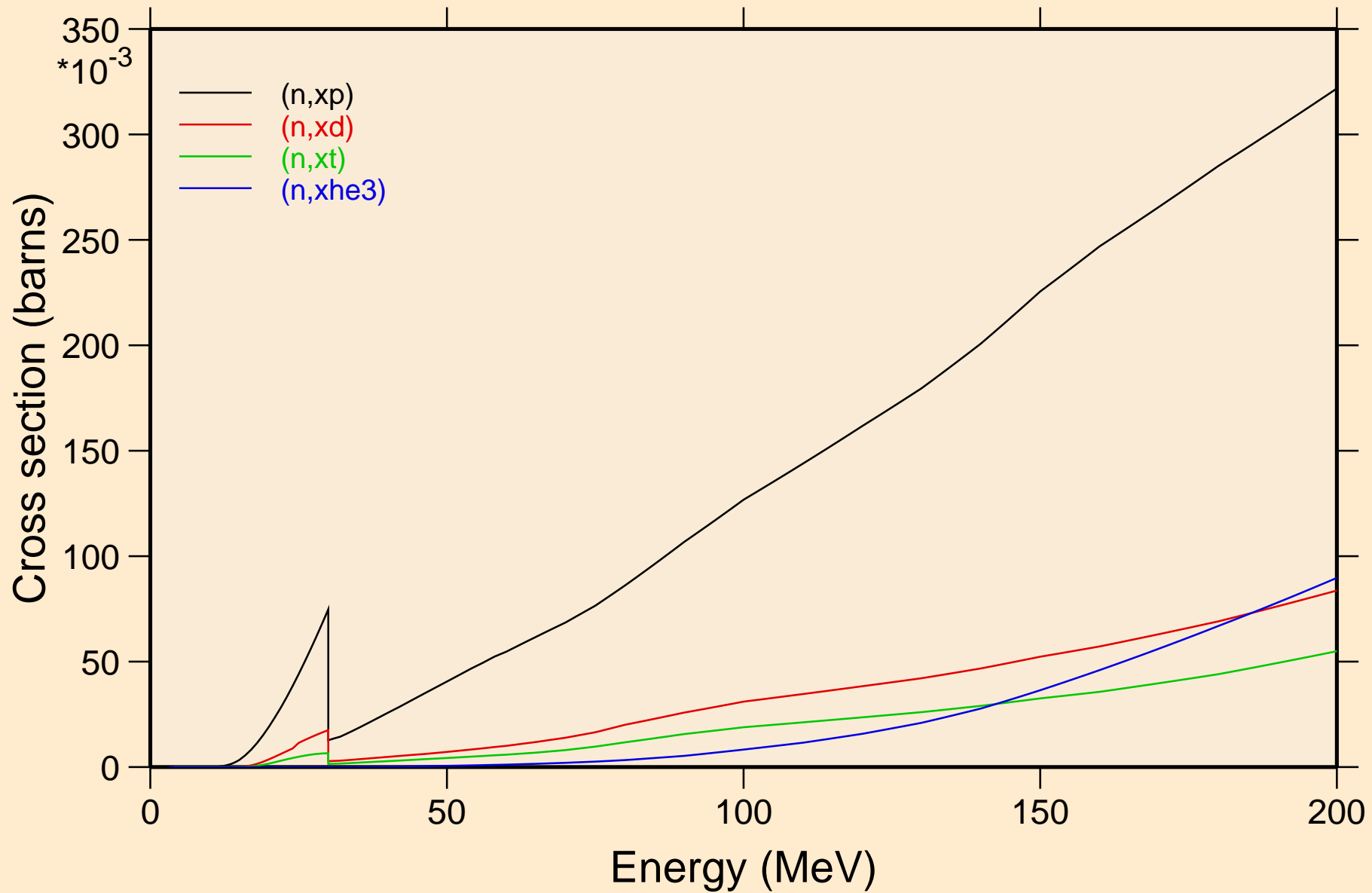

PU238 NEUTRON ACER TENDL-2024 LIBRARY; T=293.6K
angular distribution for elastic

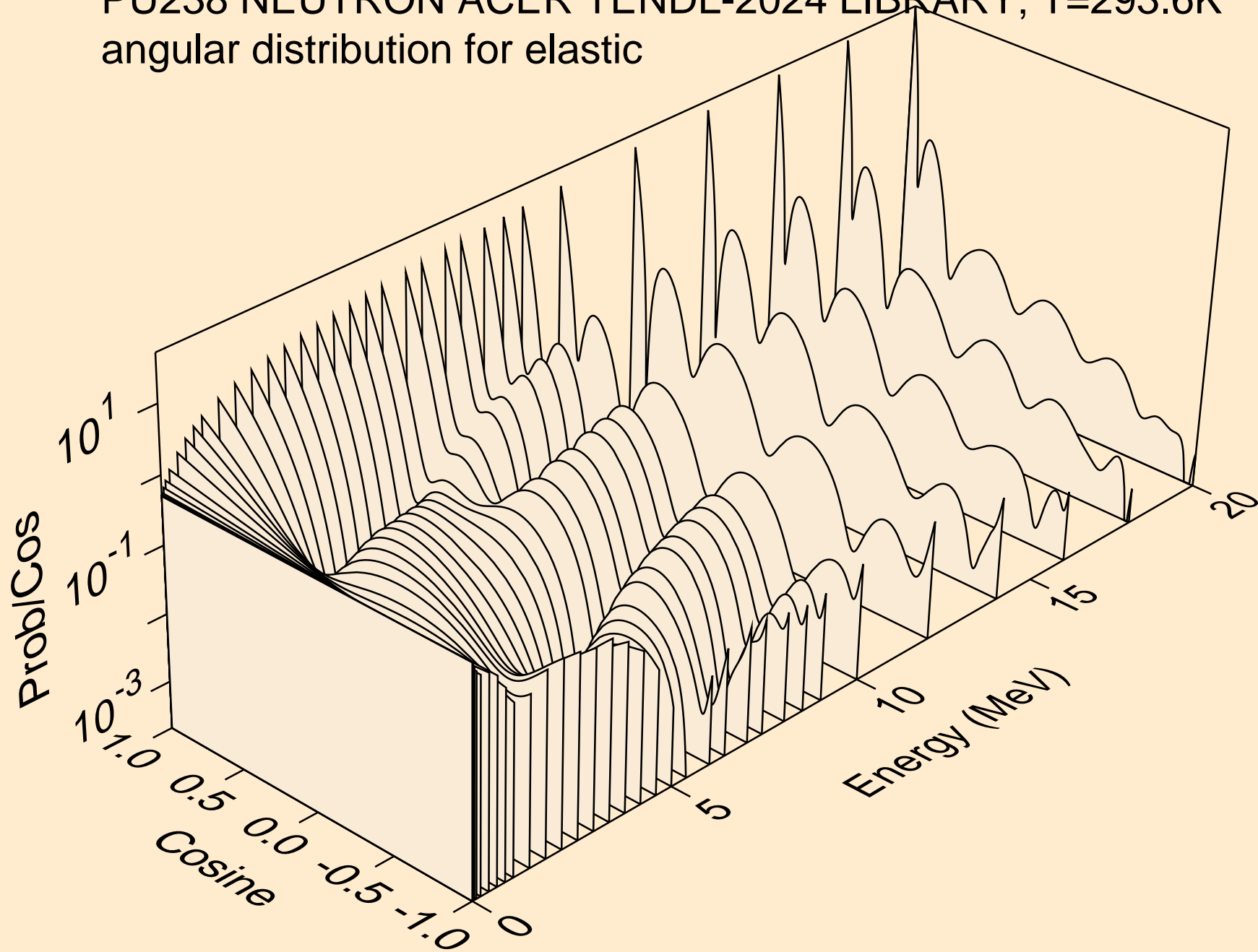

PU238 NEUTRON ACER TENDL-2024 LIBRARY; T=293.6K
angular distribution for elastic

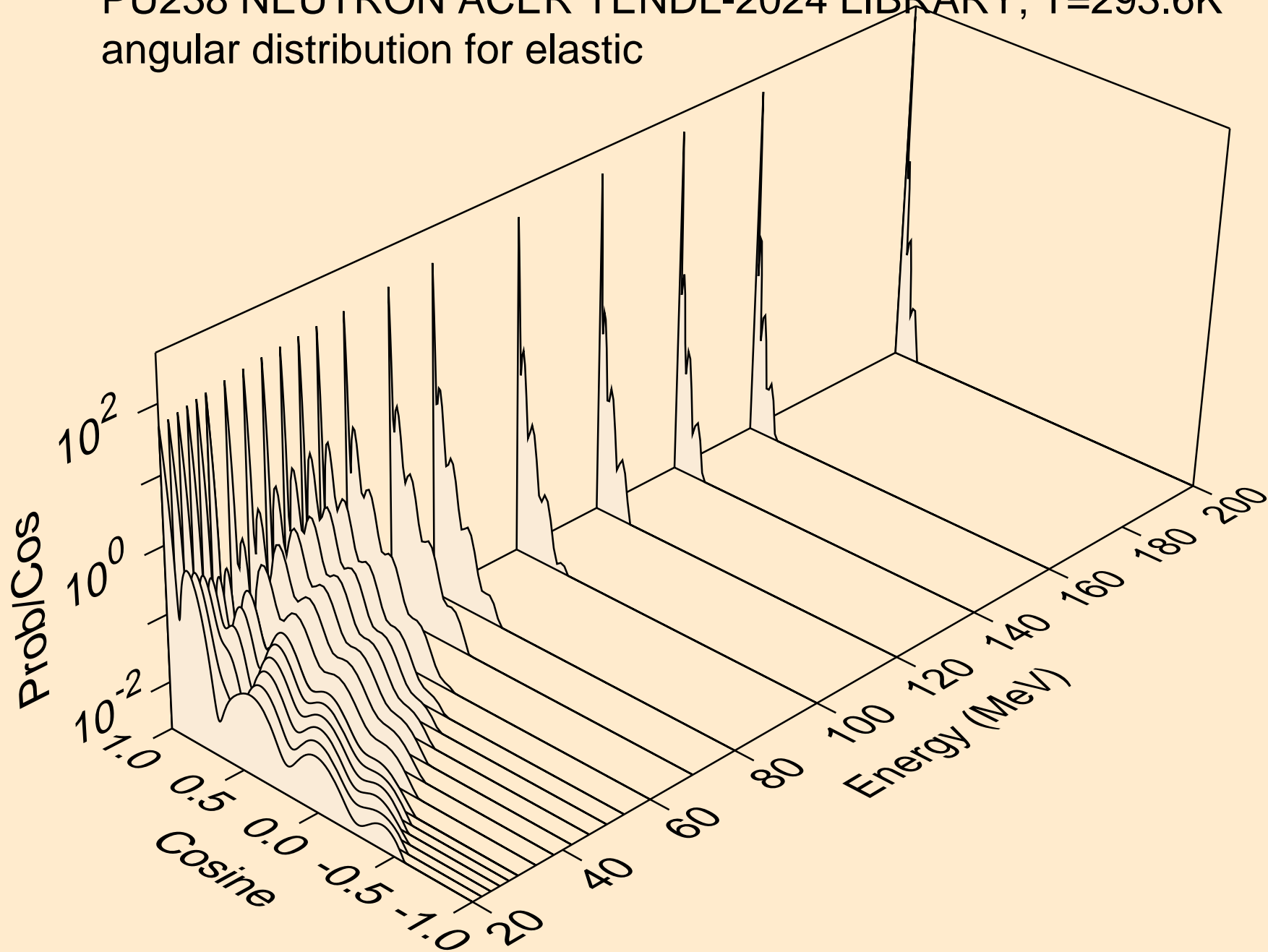

PU238 NEUTRON ACER TENDL-2024 LIBRARY; T=293.6K
angular distribution for (n,n*1)

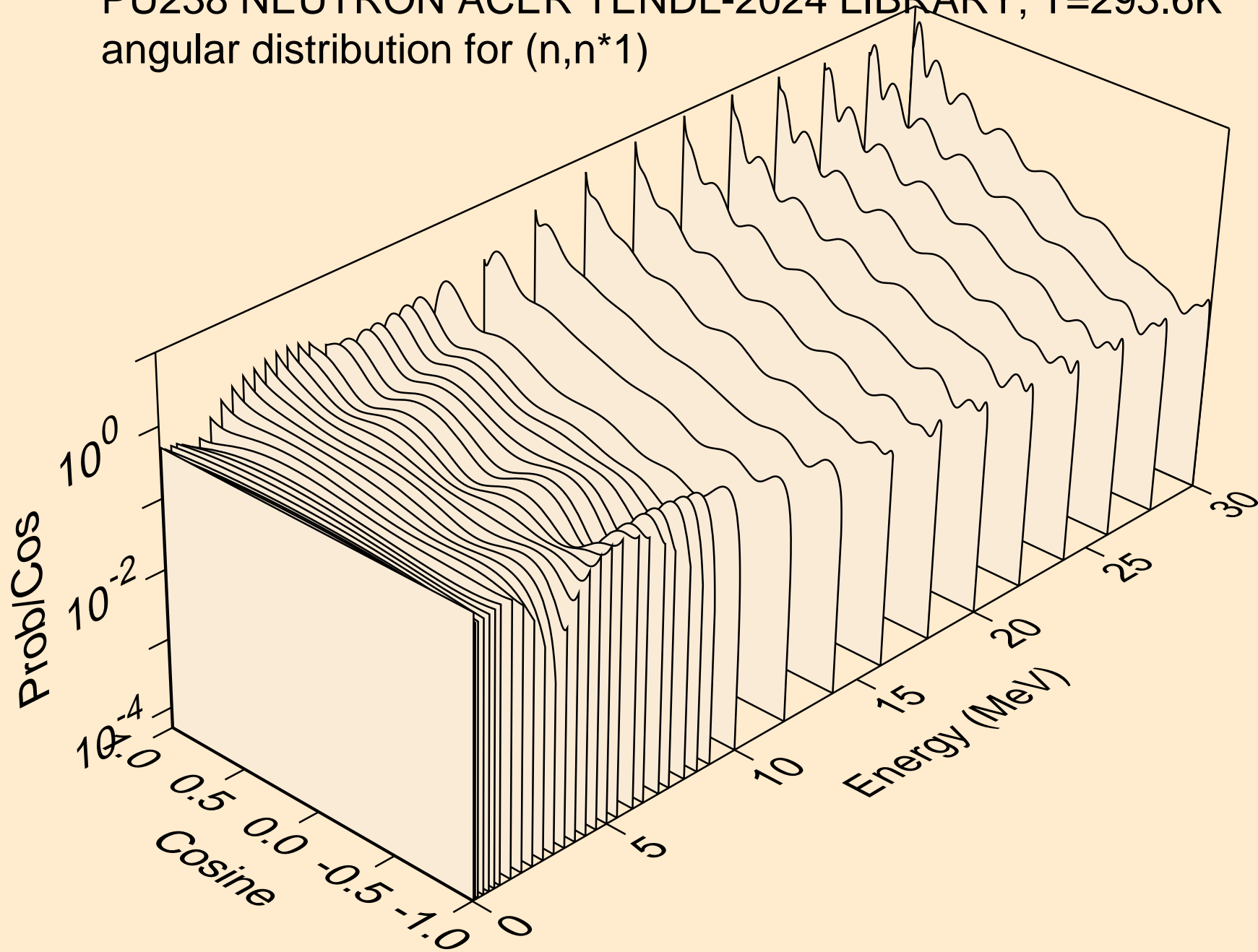

PU238 NEUTRON ACER TENDL-2024 LIBRARY; T=293.6K
angular distribution for (n,n*2)

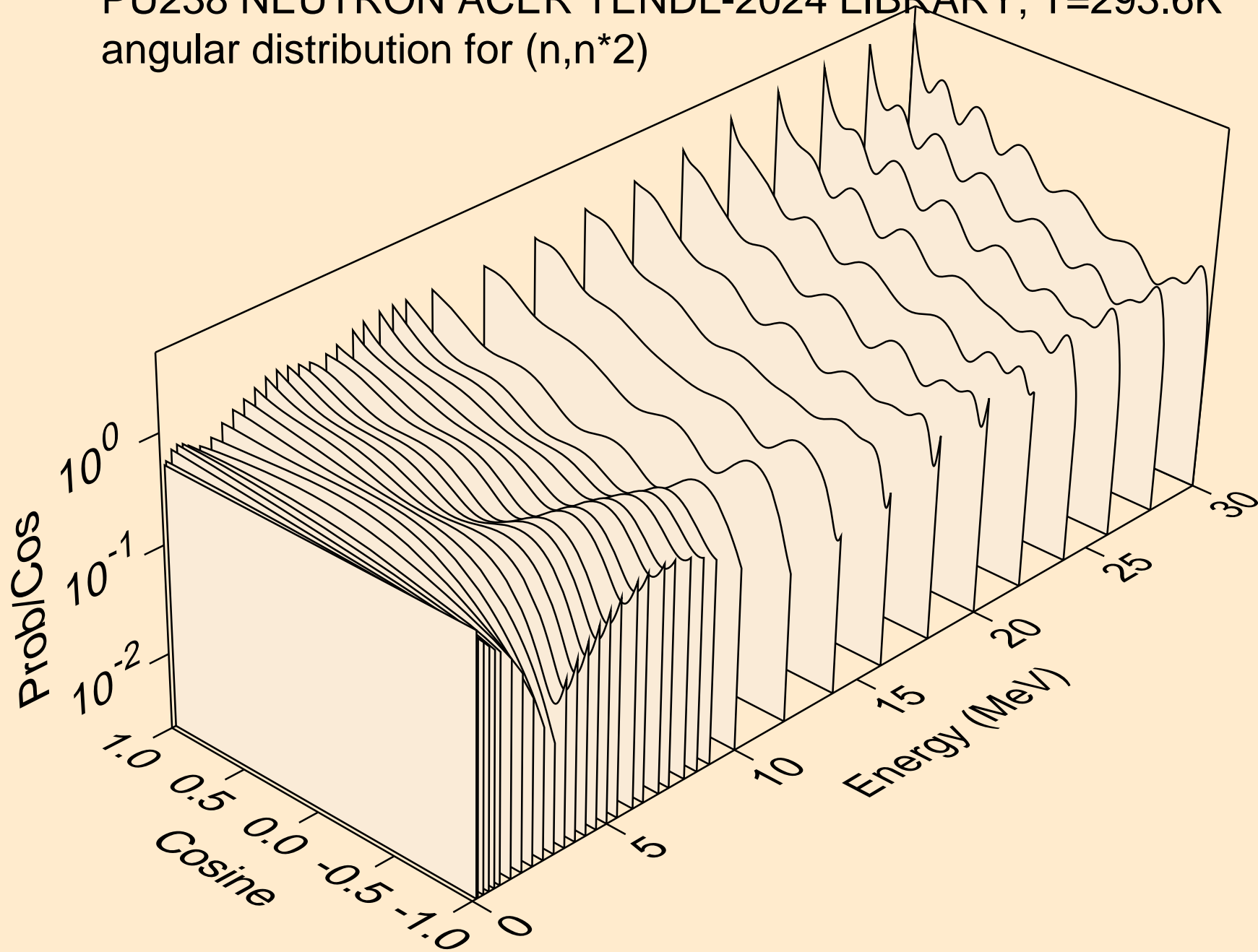

PU238 NEUTRON ACER TENDL-2024 LIBRARY; T=293.6K
angular distribution for (n,n*3)

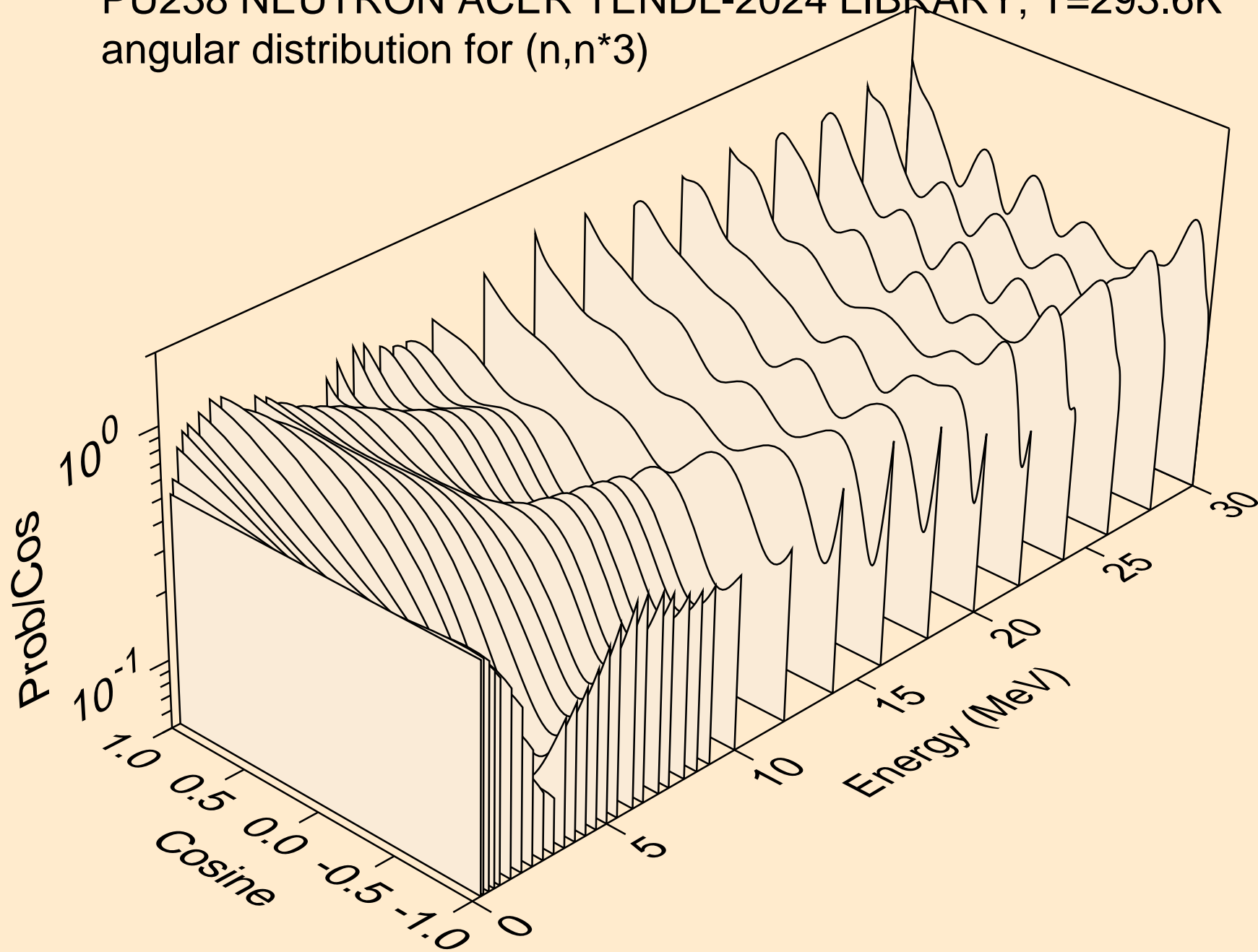

PU238 NEUTRON ACER TENDL-2024 LIBRARY; T=293.6K
angular distribution for (n,n*4)

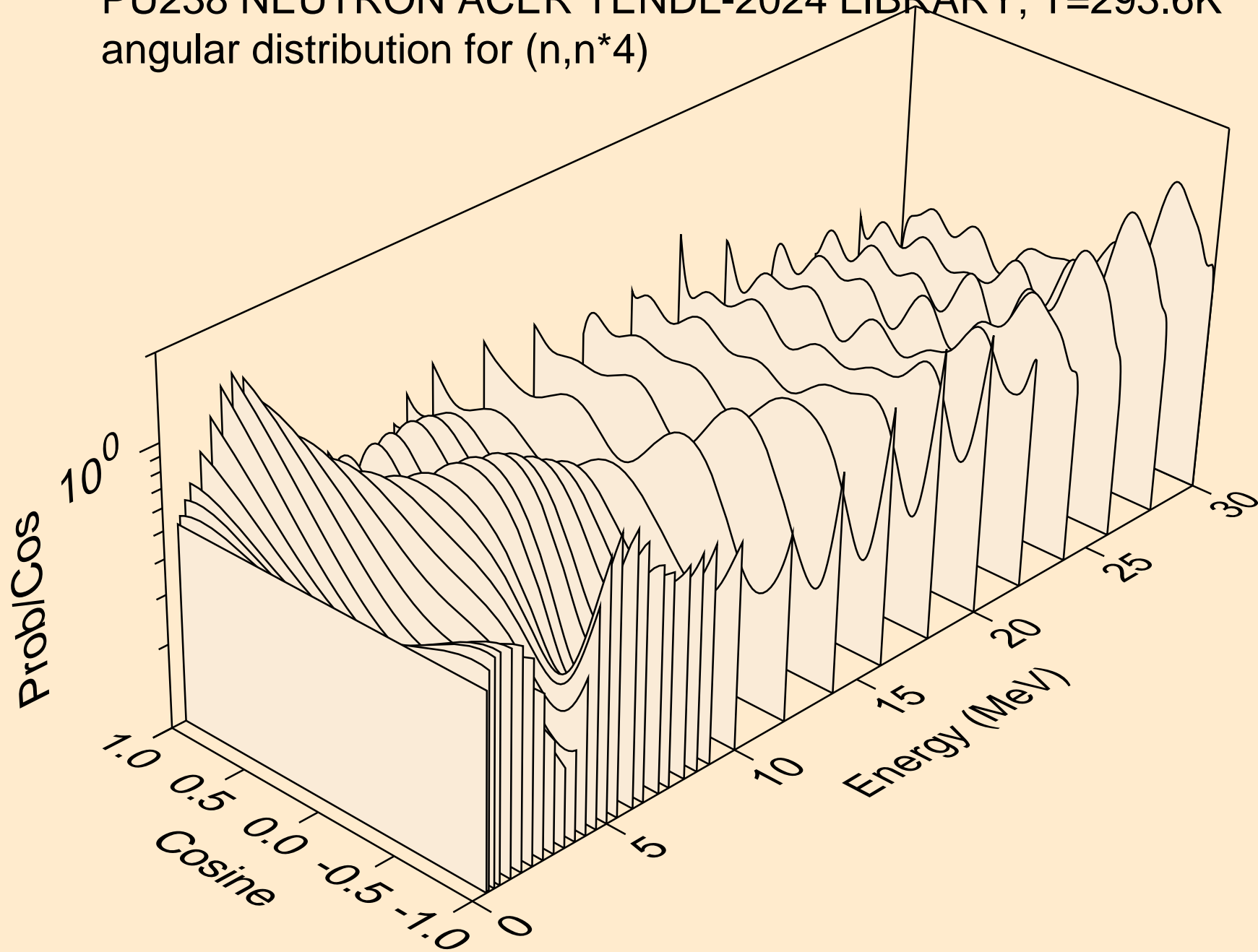

PU238 NEUTRON ACER TENDL-2024 LIBRARY; T=293.6K
angular distribution for (n,n*5)

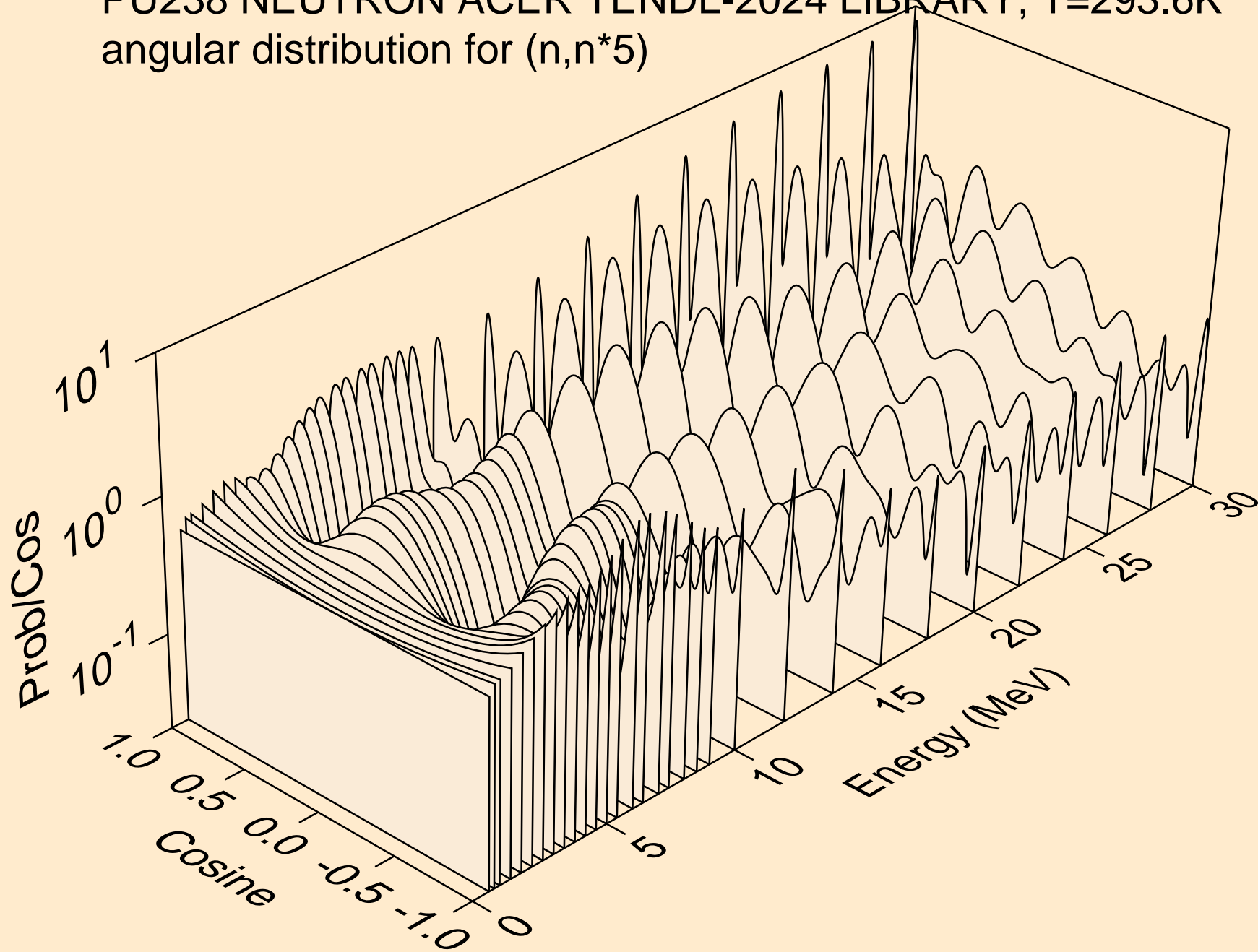

PU238 NEUTRON ACER TENDL-2024 LIBRARY; T=293.6K
angular distribution for (n,n*6)

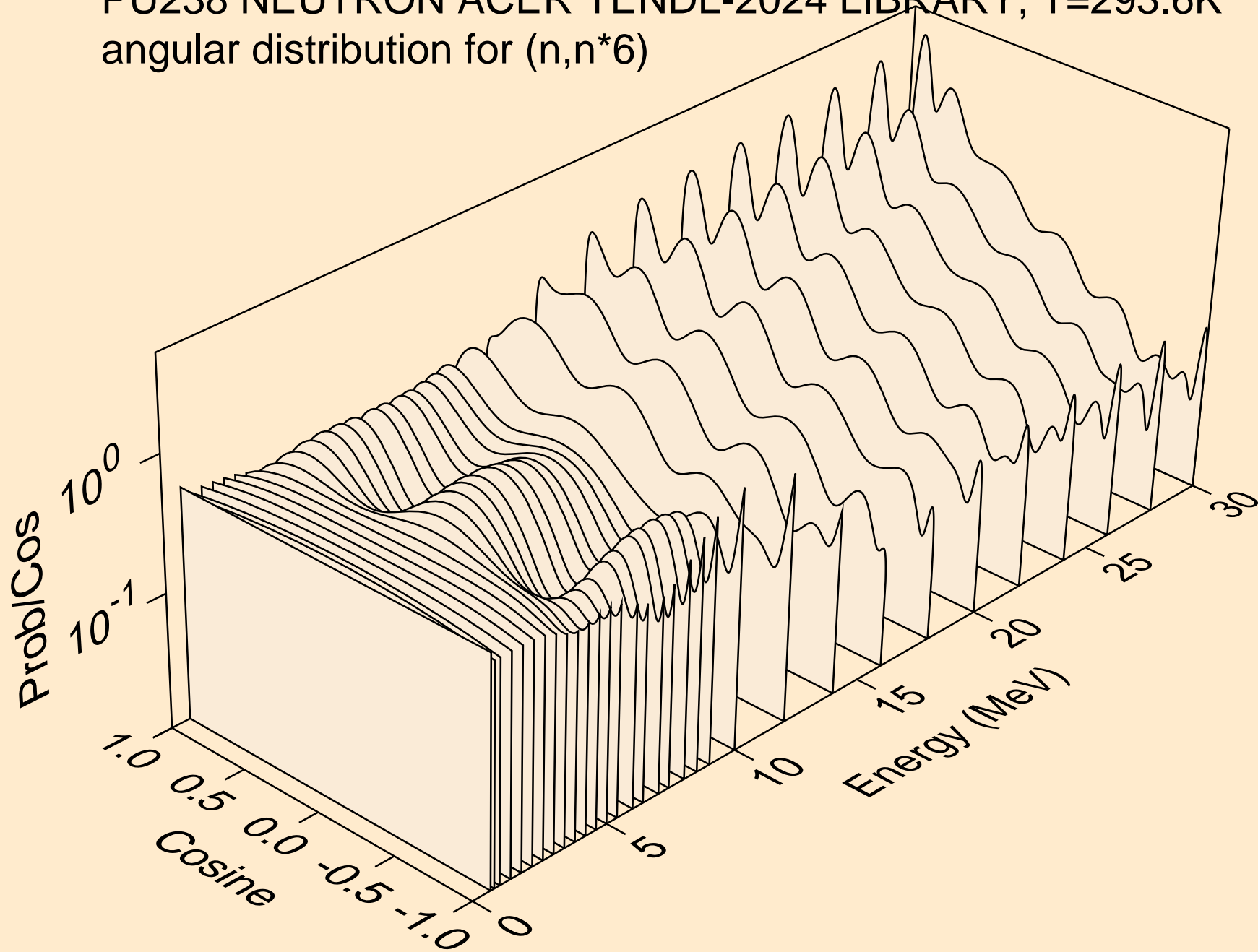

PU238 NEUTRON ACER TENDL-2024 LIBRARY; T=293.6K
angular distribution for (n,n*7)

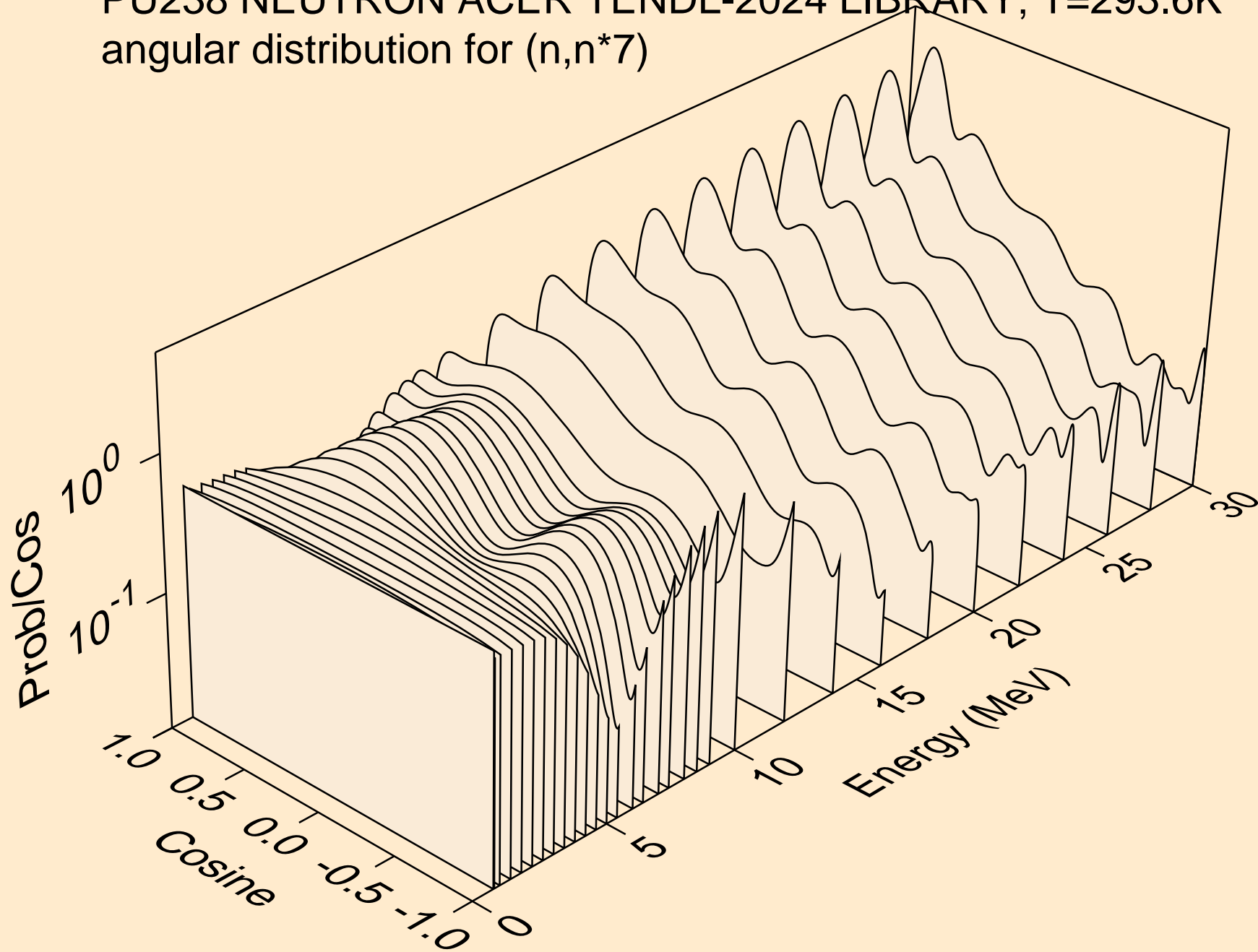

PU238 NEUTRON ACER TENDL-2024 LIBRARY; T=293.6K
angular distribution for (n,n*8)

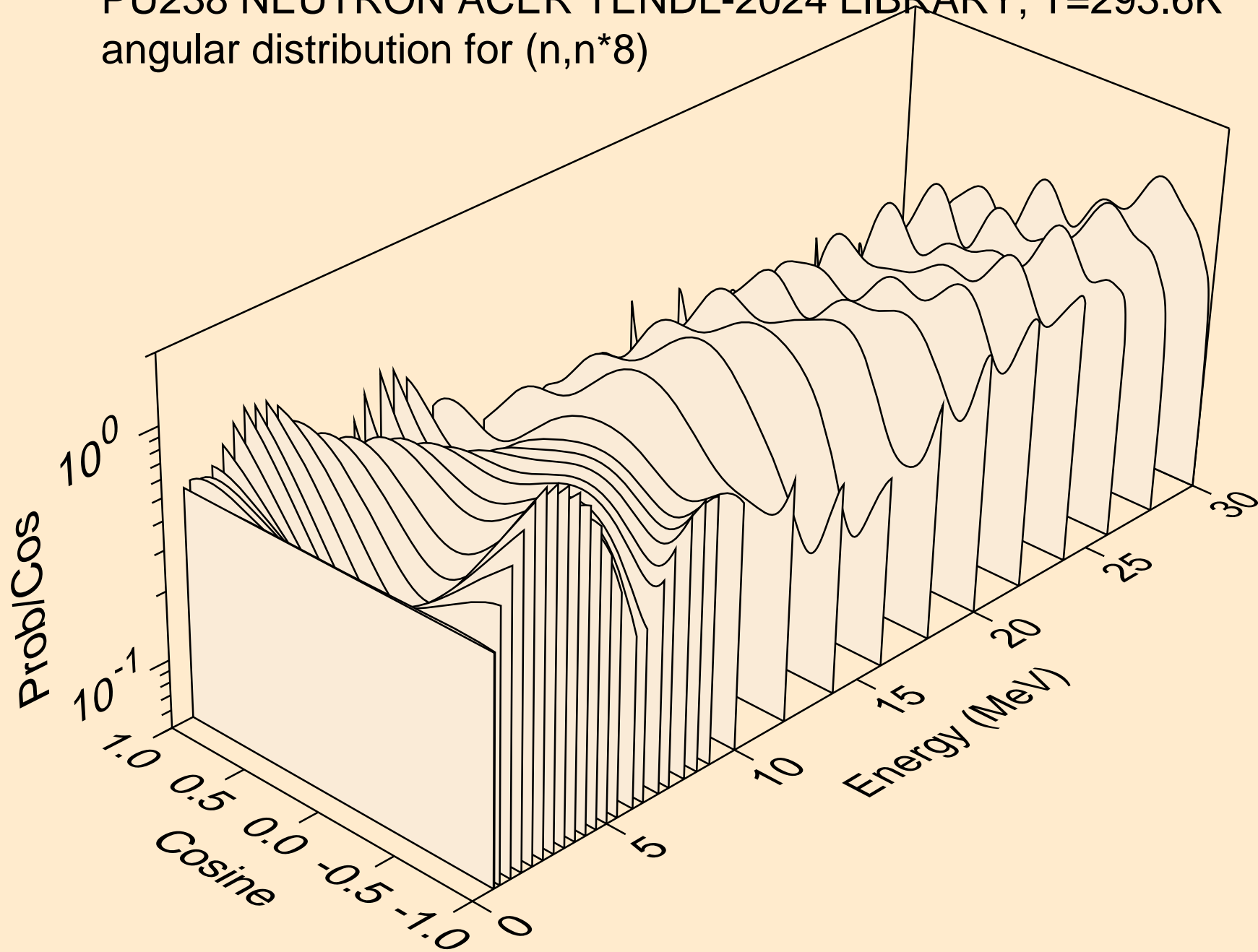

PU238 NEUTRON ACER TENDL-2024 LIBRARY; T=293.6K
angular distribution for (n,n*9)

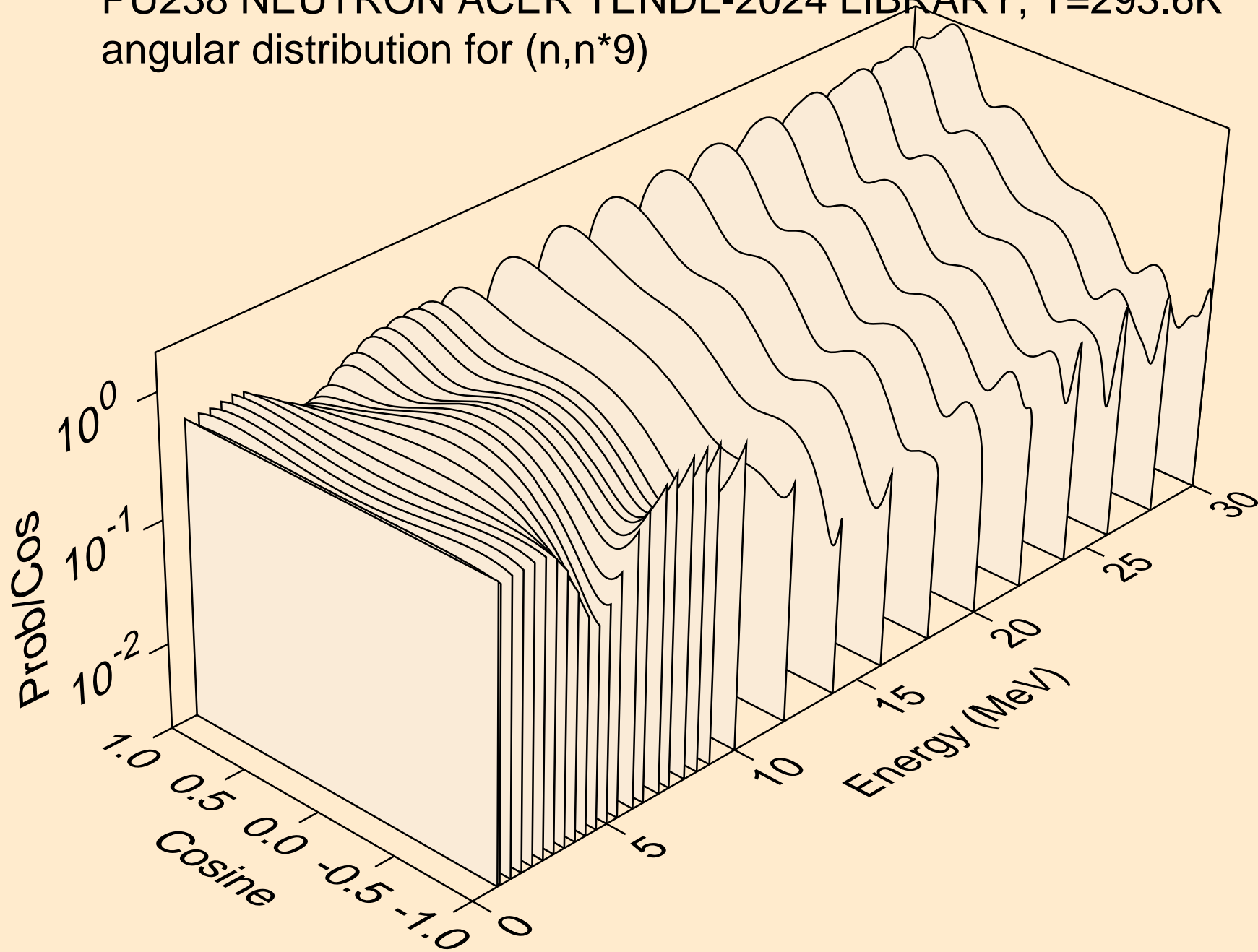

PU238 NEUTRON ACER TENDL-2024 LIBRARY; T=293.6K
angular distribution for (n,n*10)

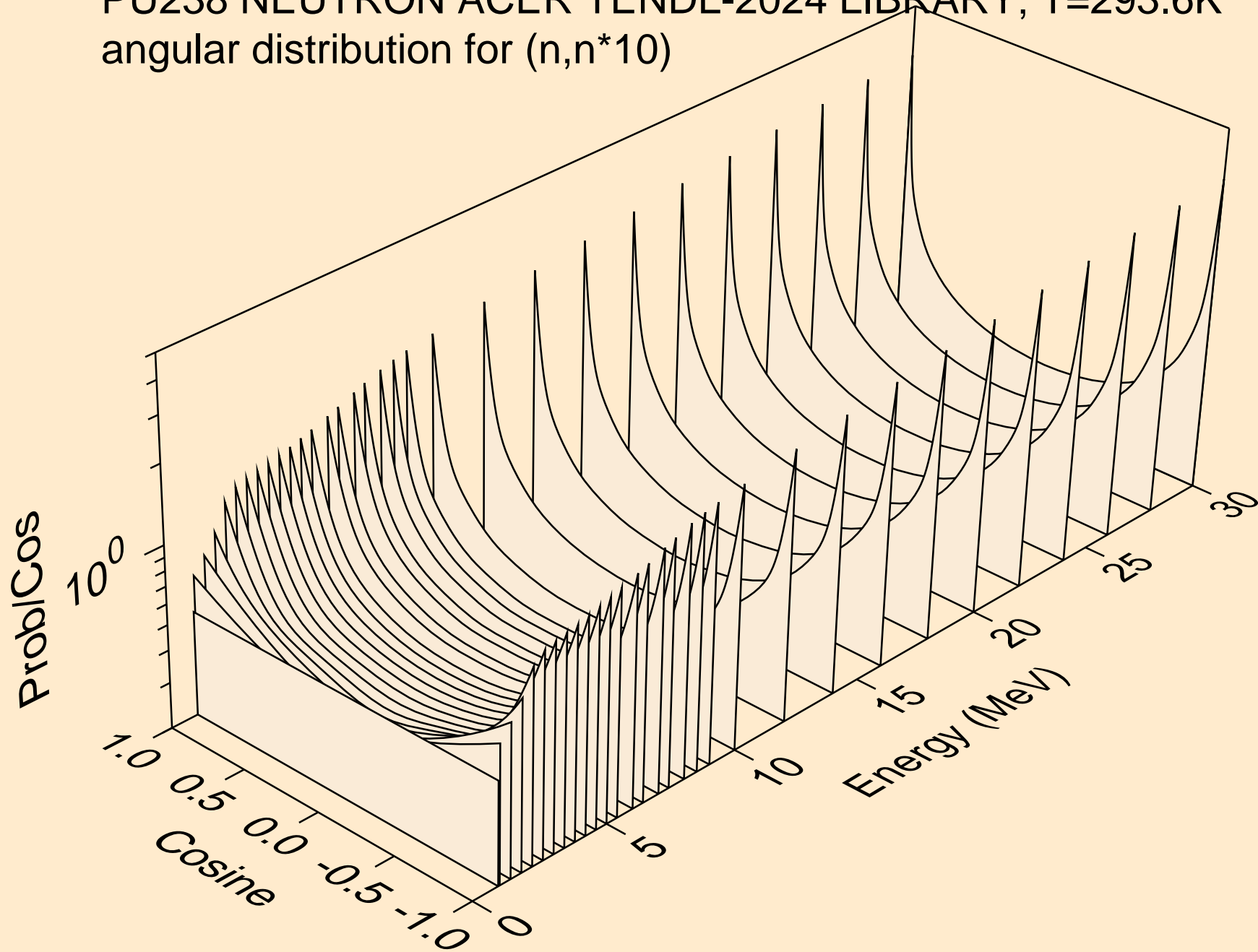

PU238 NEUTRON ACER TENDL-2024 LIBRARY; T=293.6K
angular distribution for (n,n*11)

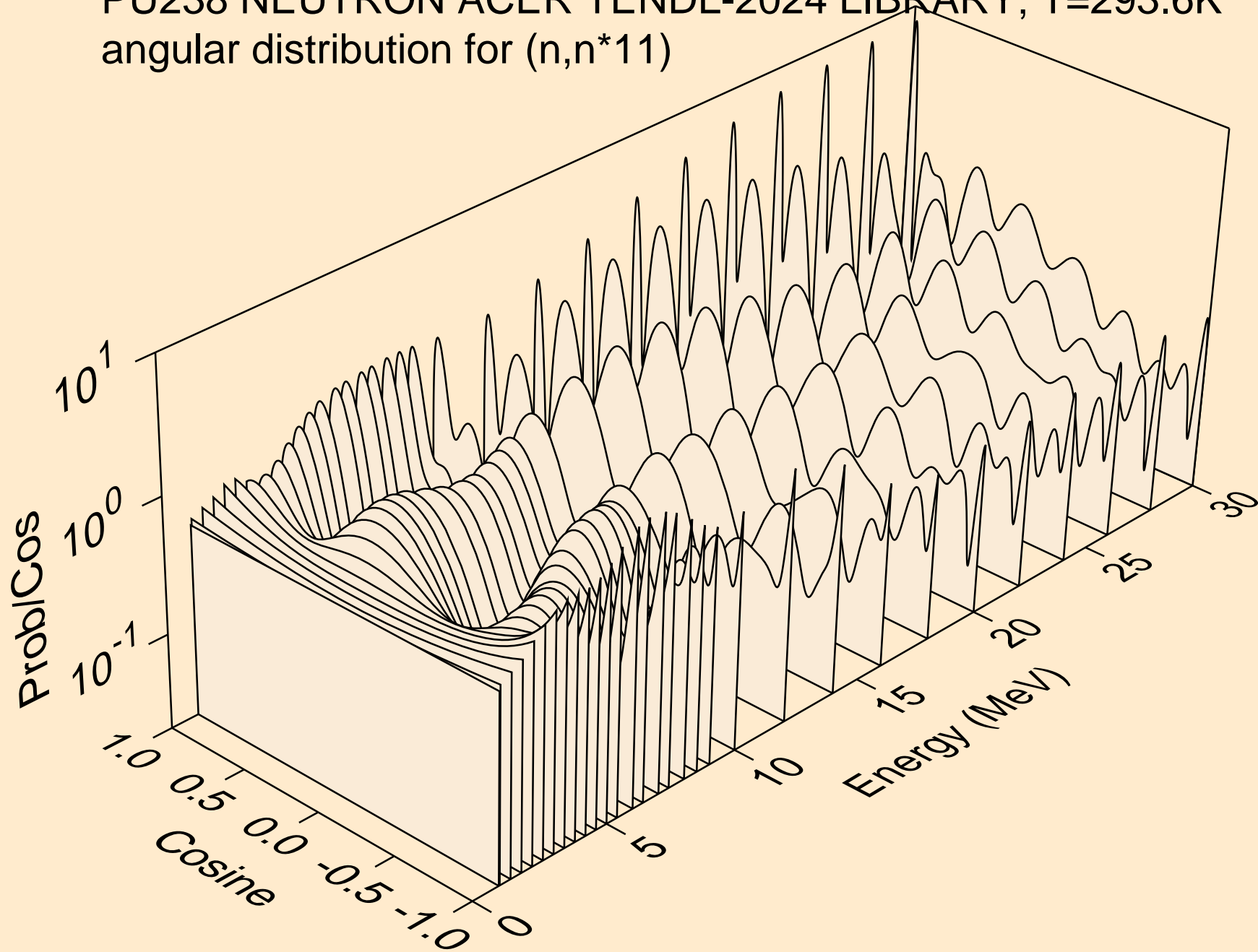

PU238 NEUTRON ACER TENDL-2024 LIBRARY; T=293.6K
angular distribution for (n,n*12)

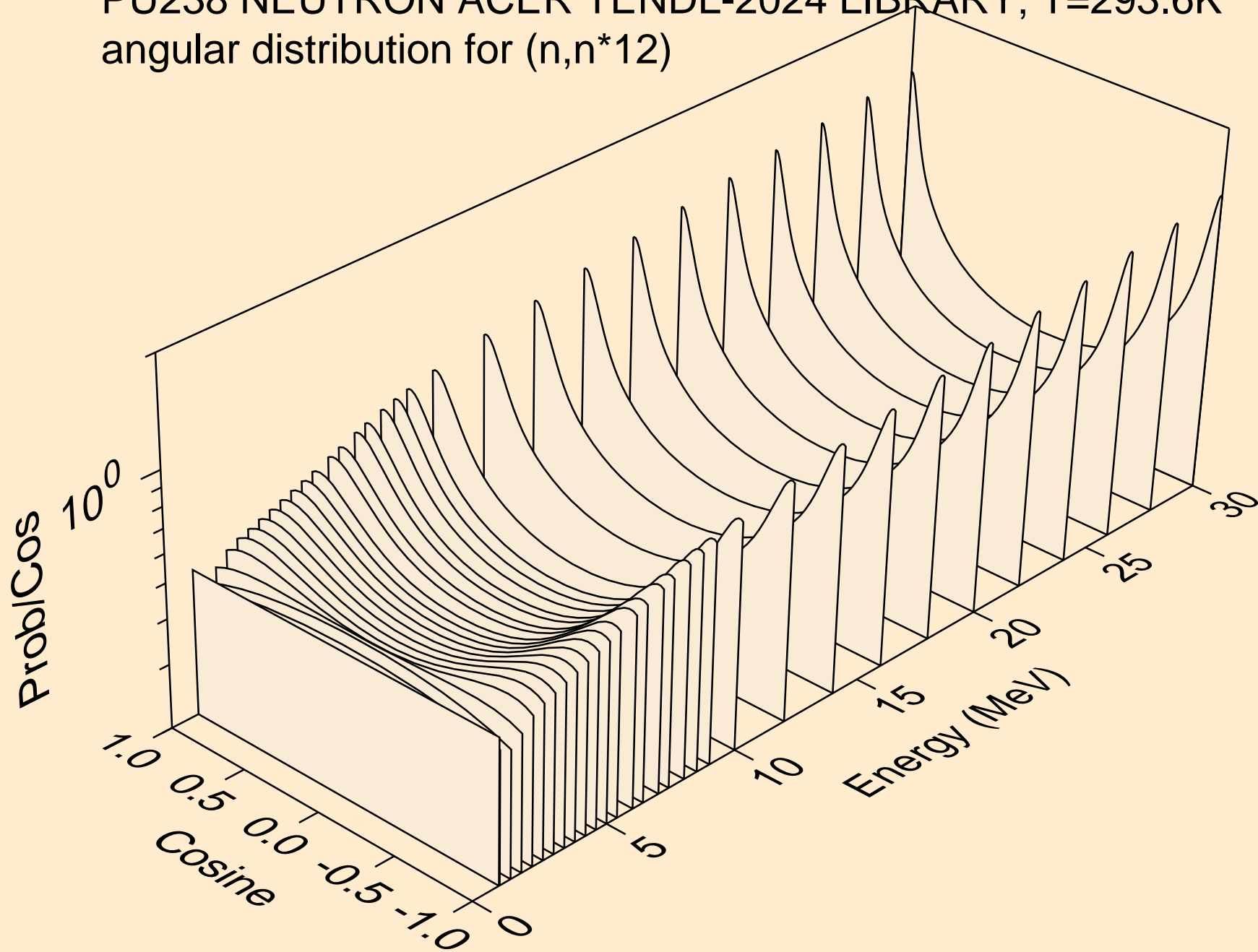

PU238 NEUTRON ACER TENDL-2024 LIBRARY; T=293.6K
angular distribution for (n,n*13)

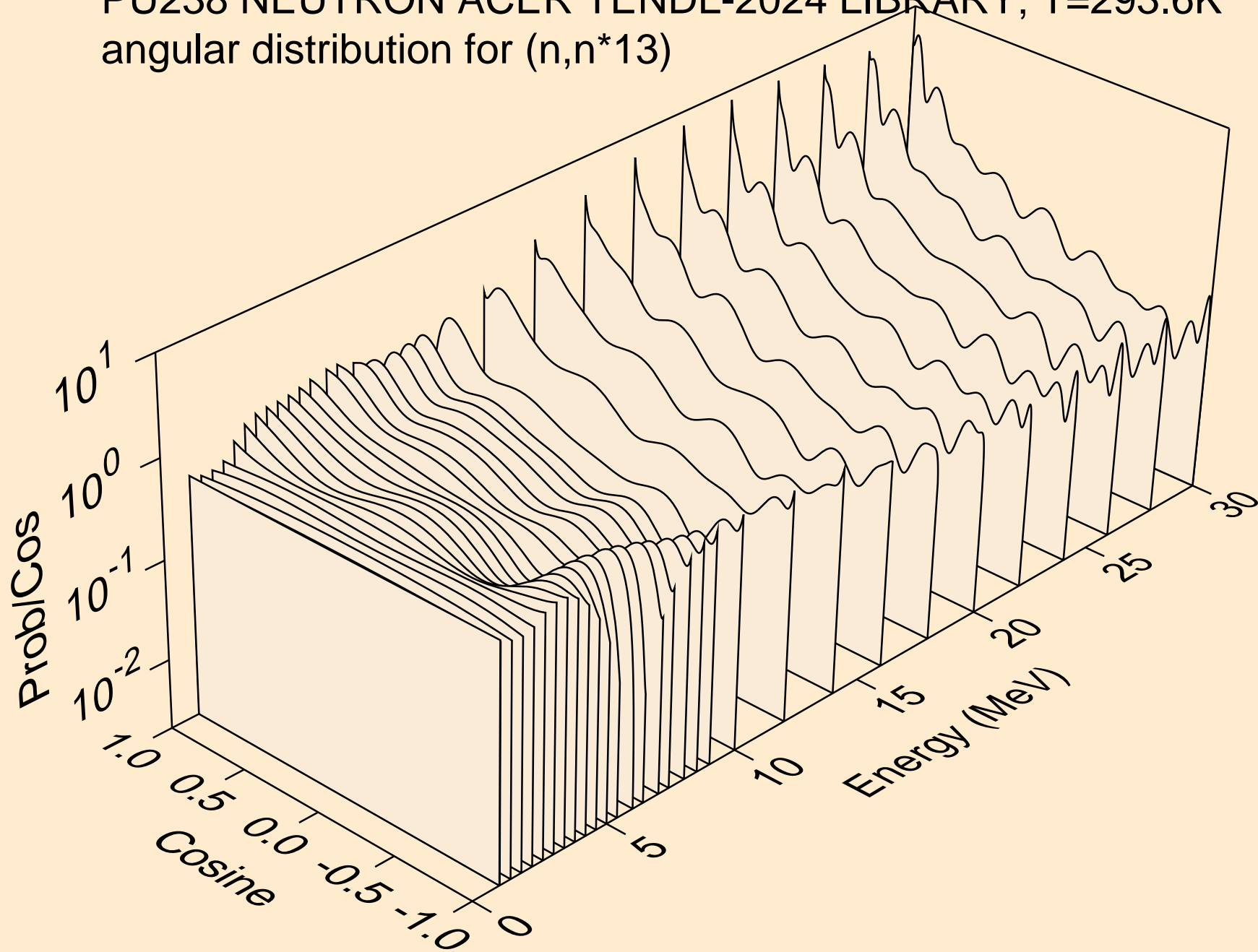

PU238 NEUTRON ACER TENDL-2024 LIBRARY; T=293.6K
angular distribution for (n,n*14)

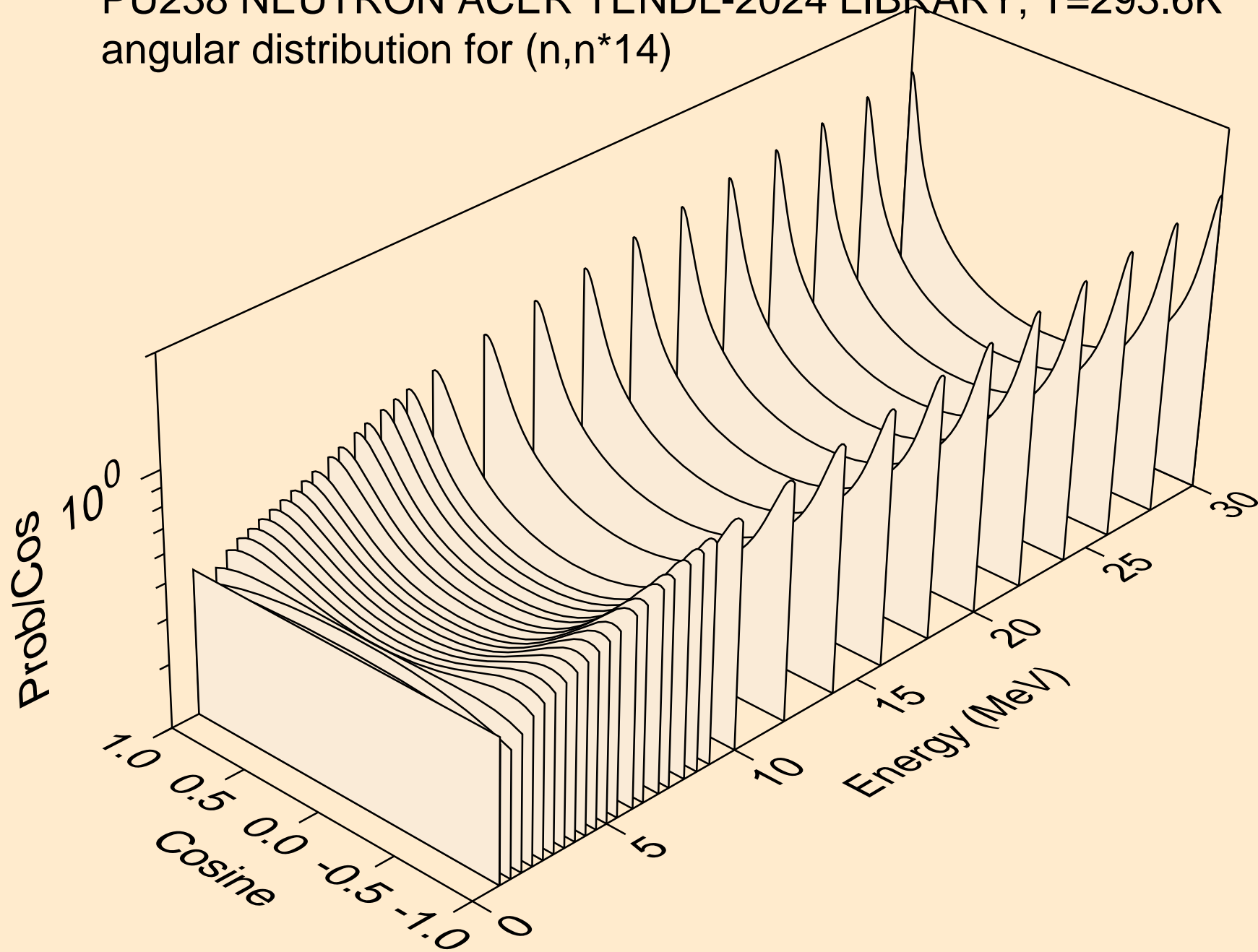

PU238 NEUTRON ACER TENDL-2024 LIBRARY; T=293.6K
angular distribution for (n,n*15)

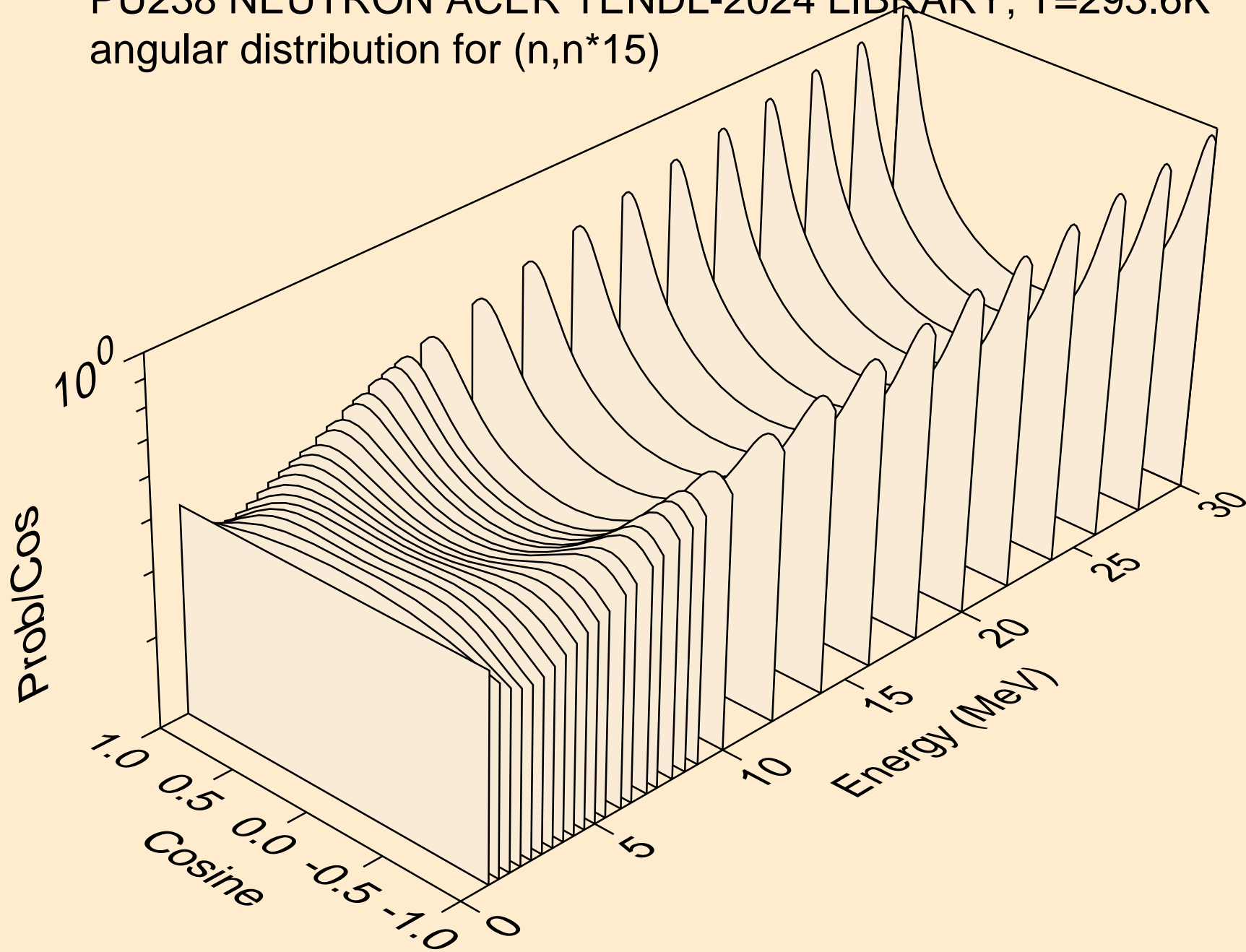

PU238 NEUTRON ACER TENDL-2024 LIBRARY; T=293.6K
angular distribution for (n,n*16)

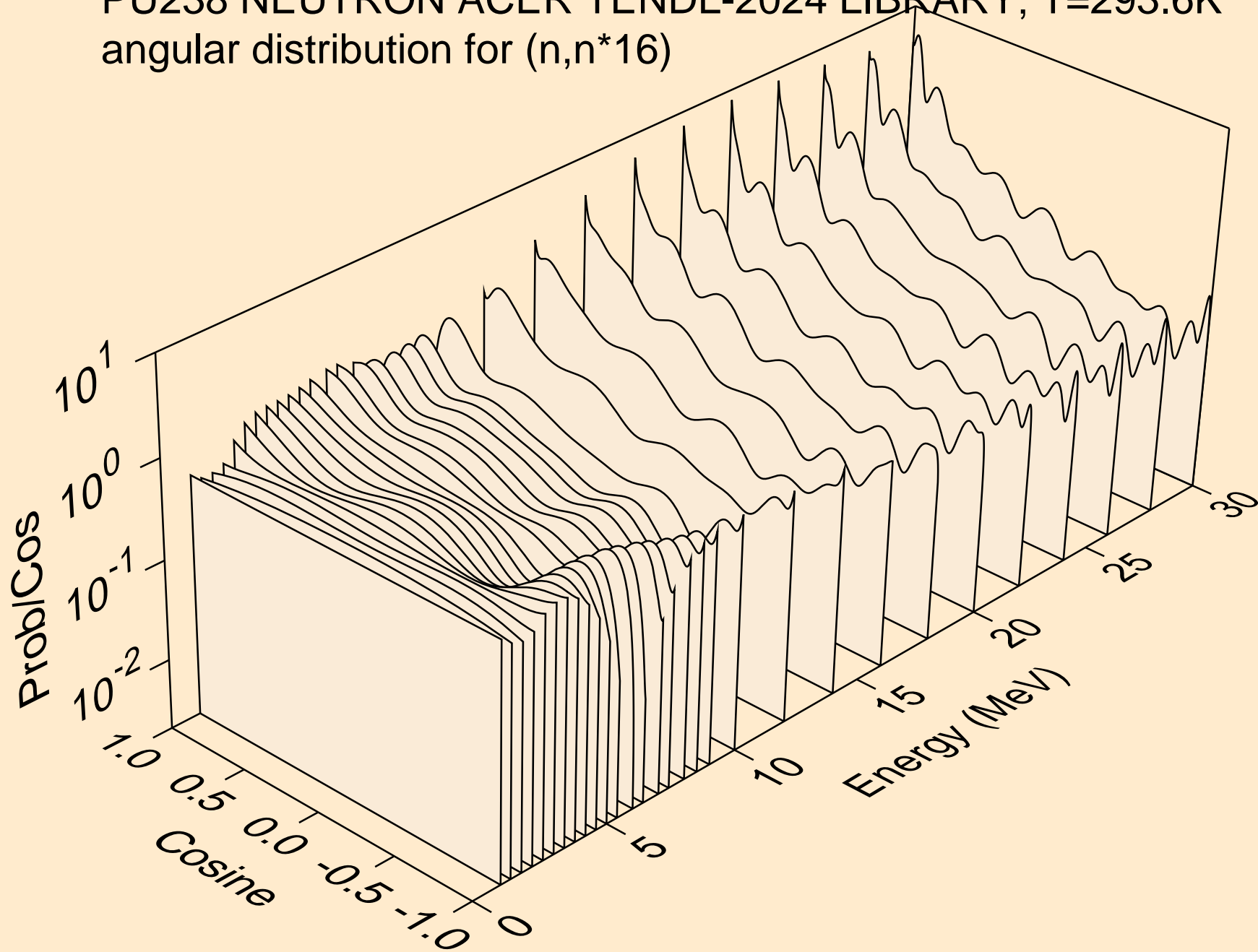

PU238 NEUTRON ACER TENDL-2024 LIBRARY; T=293.6K
angular distribution for (n,n*17)

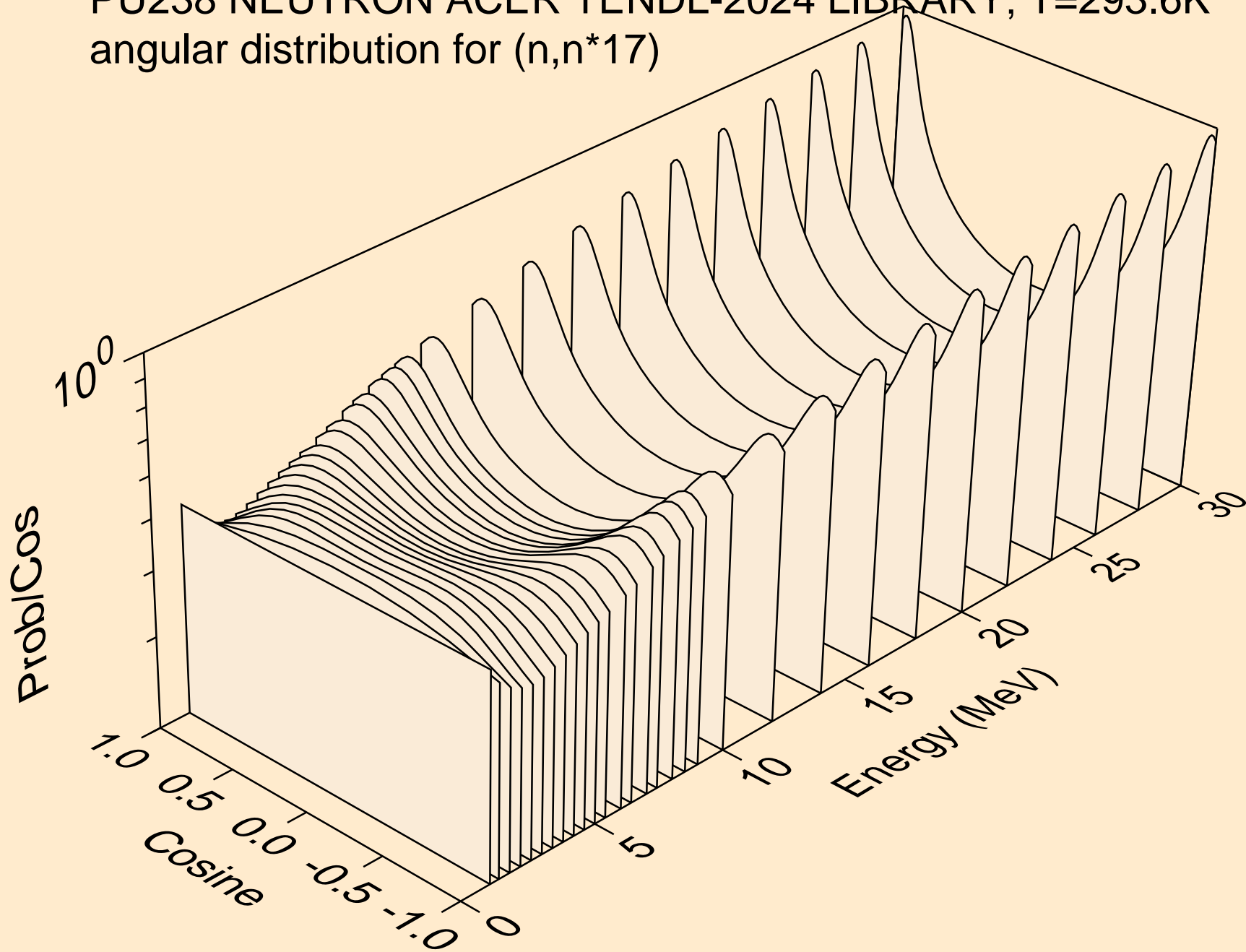

PU238 NEUTRON ACER TENDL-2024 LIBRARY; T=293.6K
angular distribution for (n,n*18)

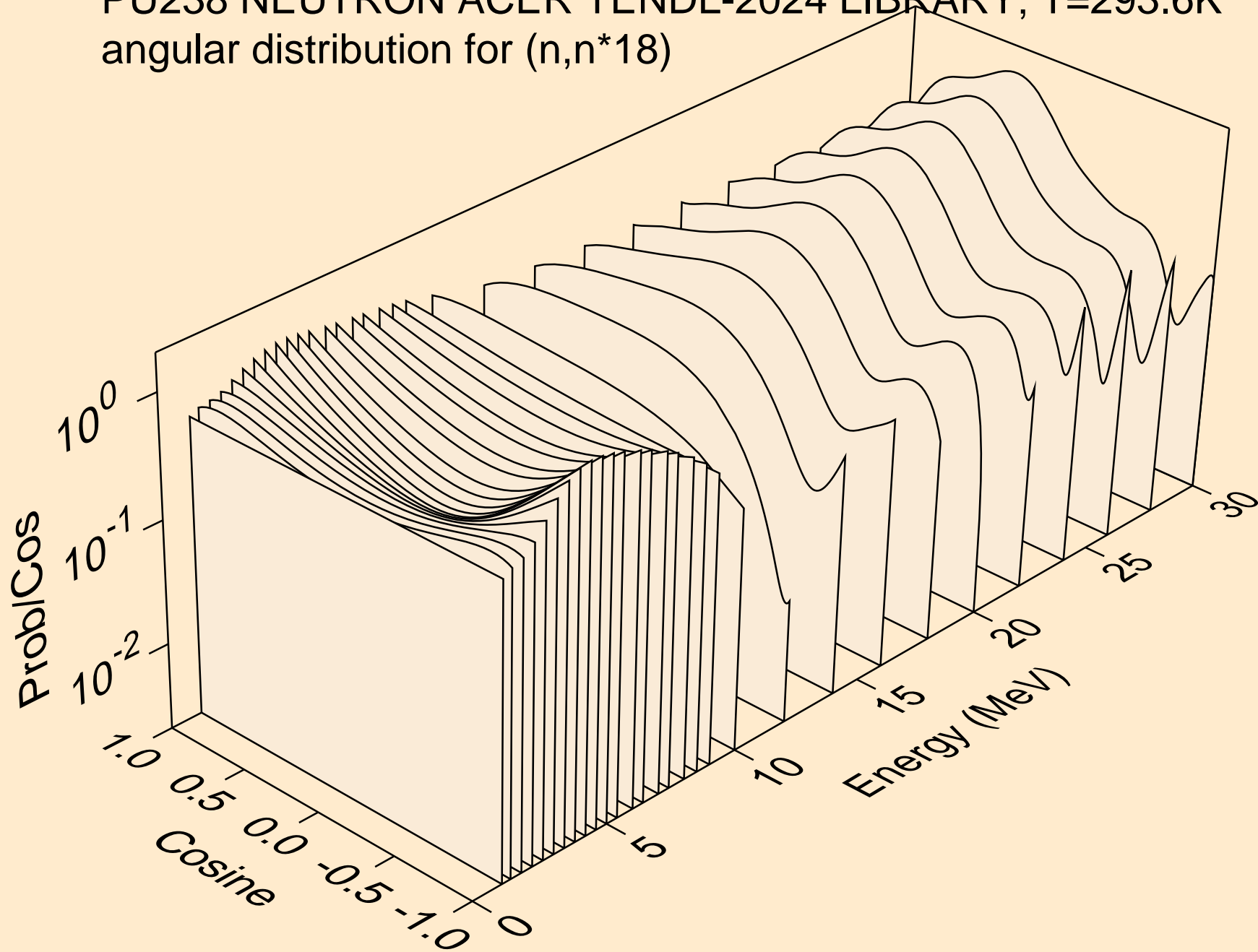

PU238 NEUTRON ACER TENDL-2024 LIBRARY; T=293.6K
angular distribution for (n,n*19)

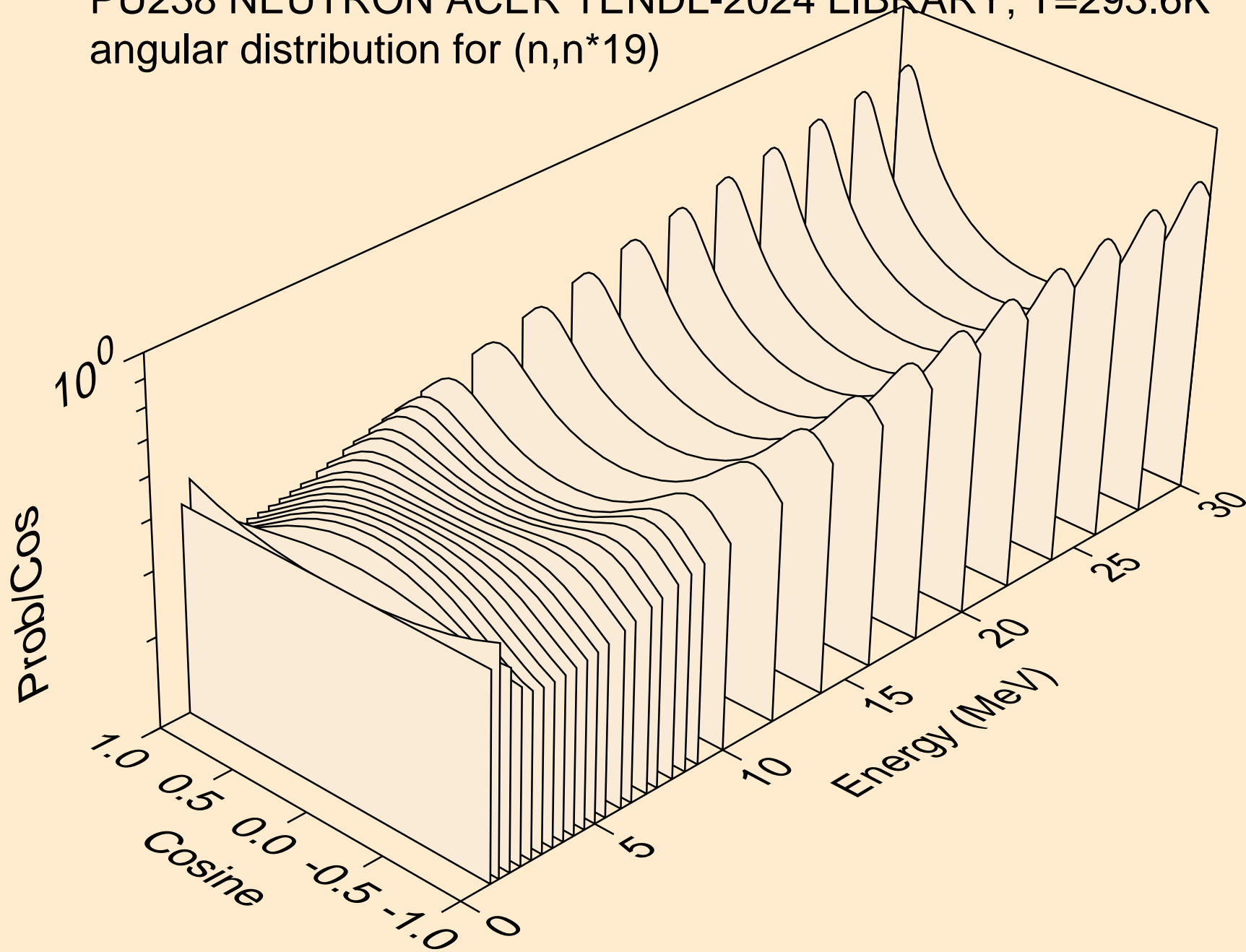

PU238 NEUTRON ACER TENDL-2024 LIBRARY; T=293.6K
angular distribution for (n,n*20)

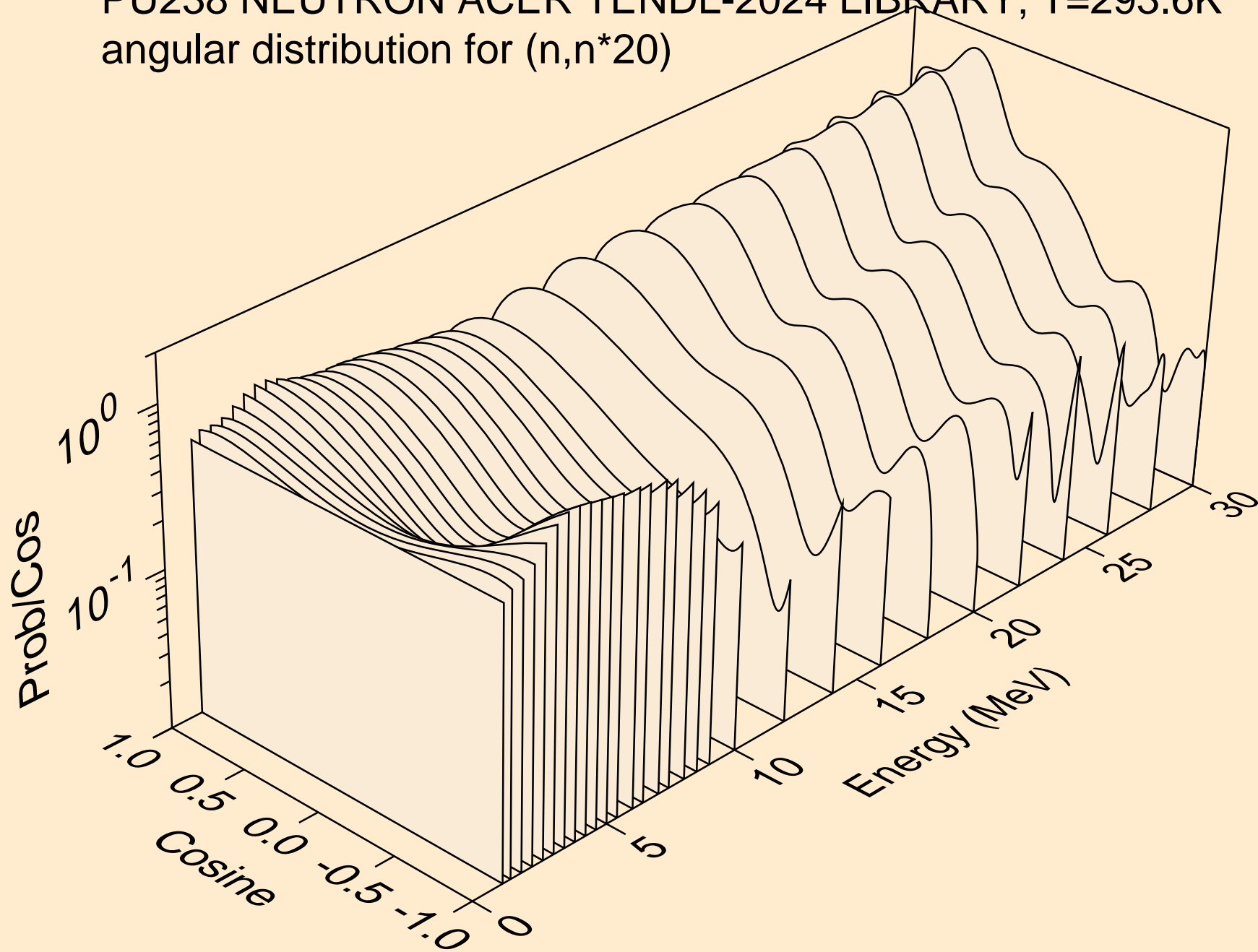

PU238 NEUTRON ACER TENDL-2024 LIBRARY; T=293.6K
angular distribution for (n,n*21)

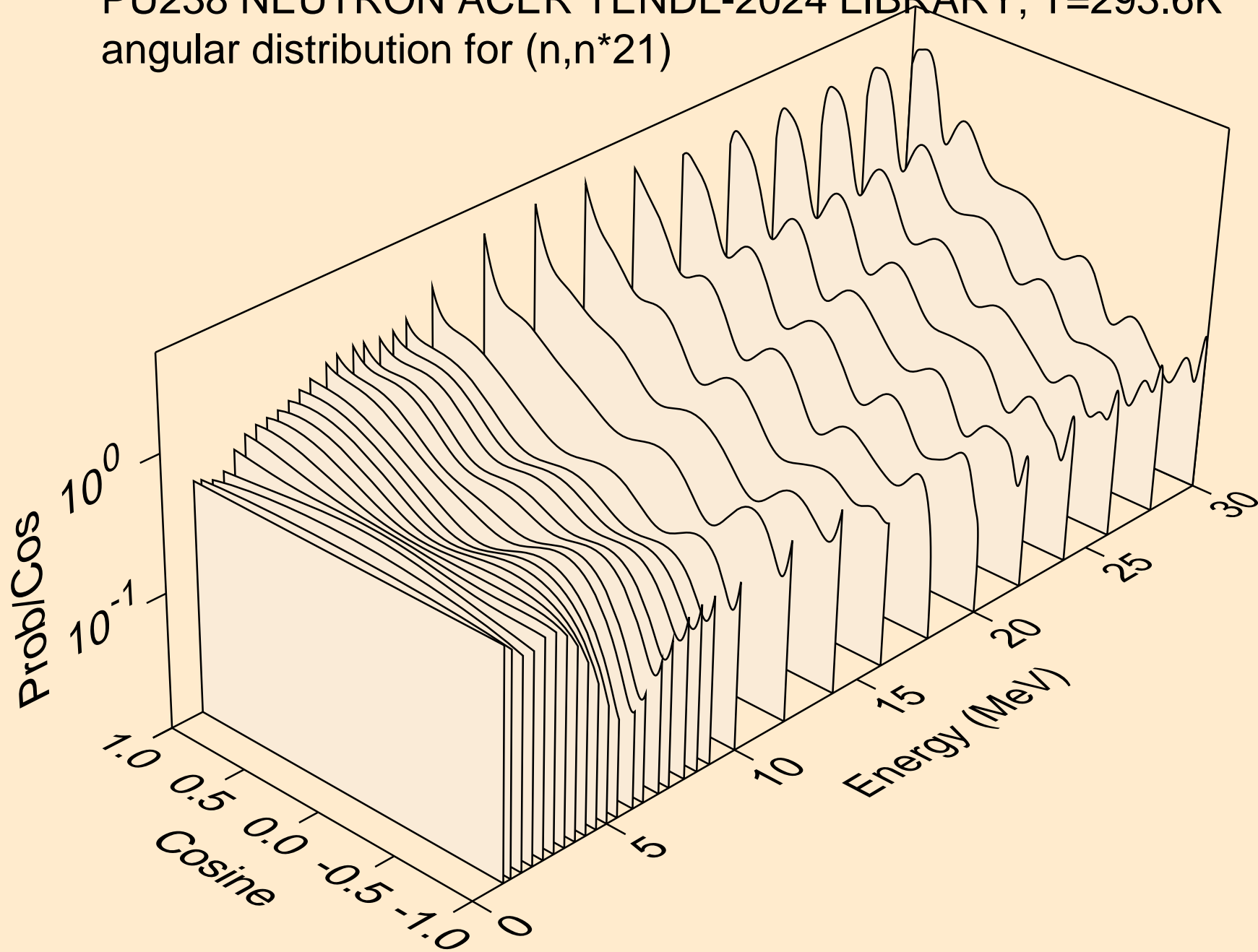

PU238 NEUTRON ACER TENDL-2024 LIBRARY; T=293.6K
angular distribution for (n,n*22)

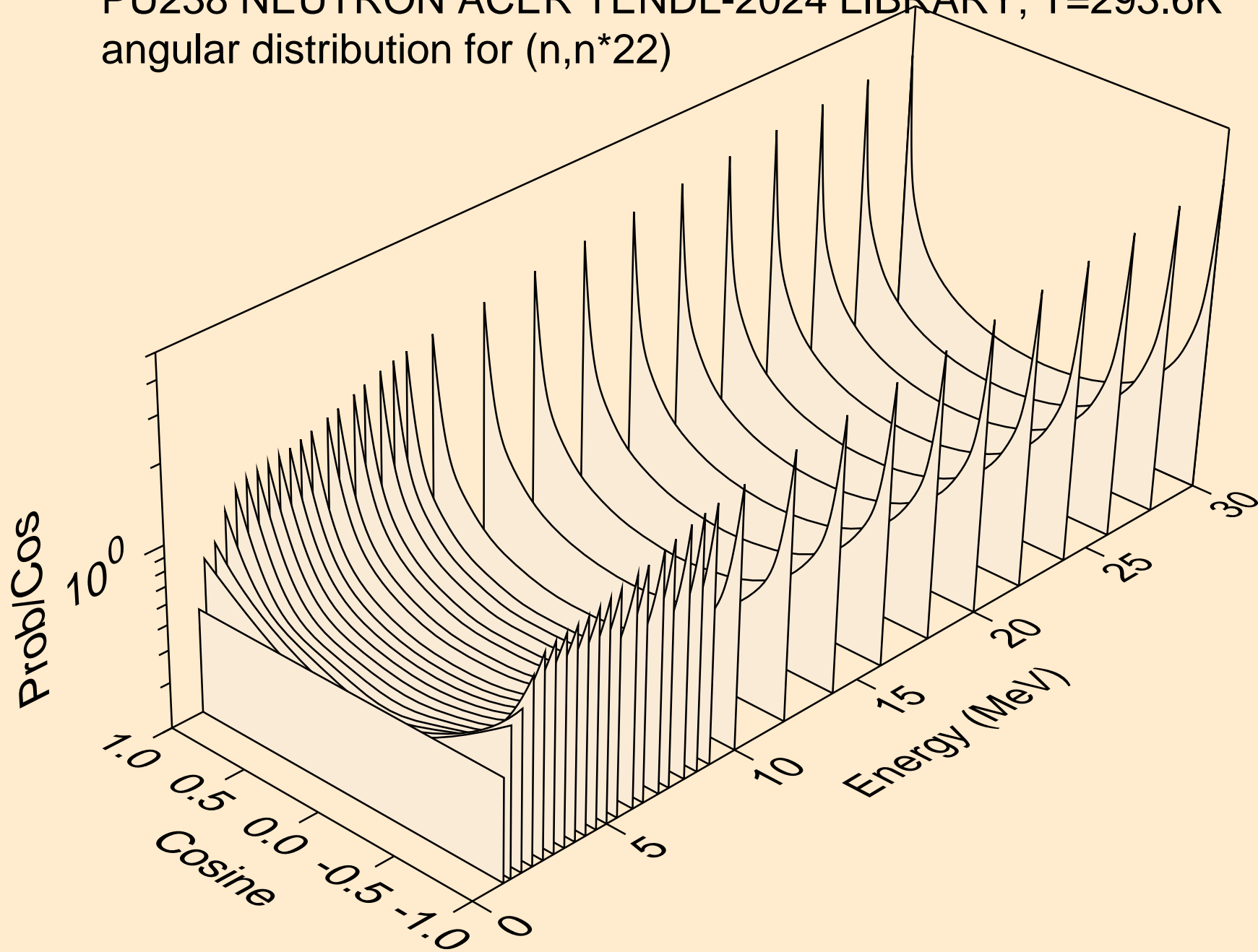

PU238 NEUTRON ACER TENDL-2024 LIBRARY; T=293.6K
angular distribution for (n,n*23)

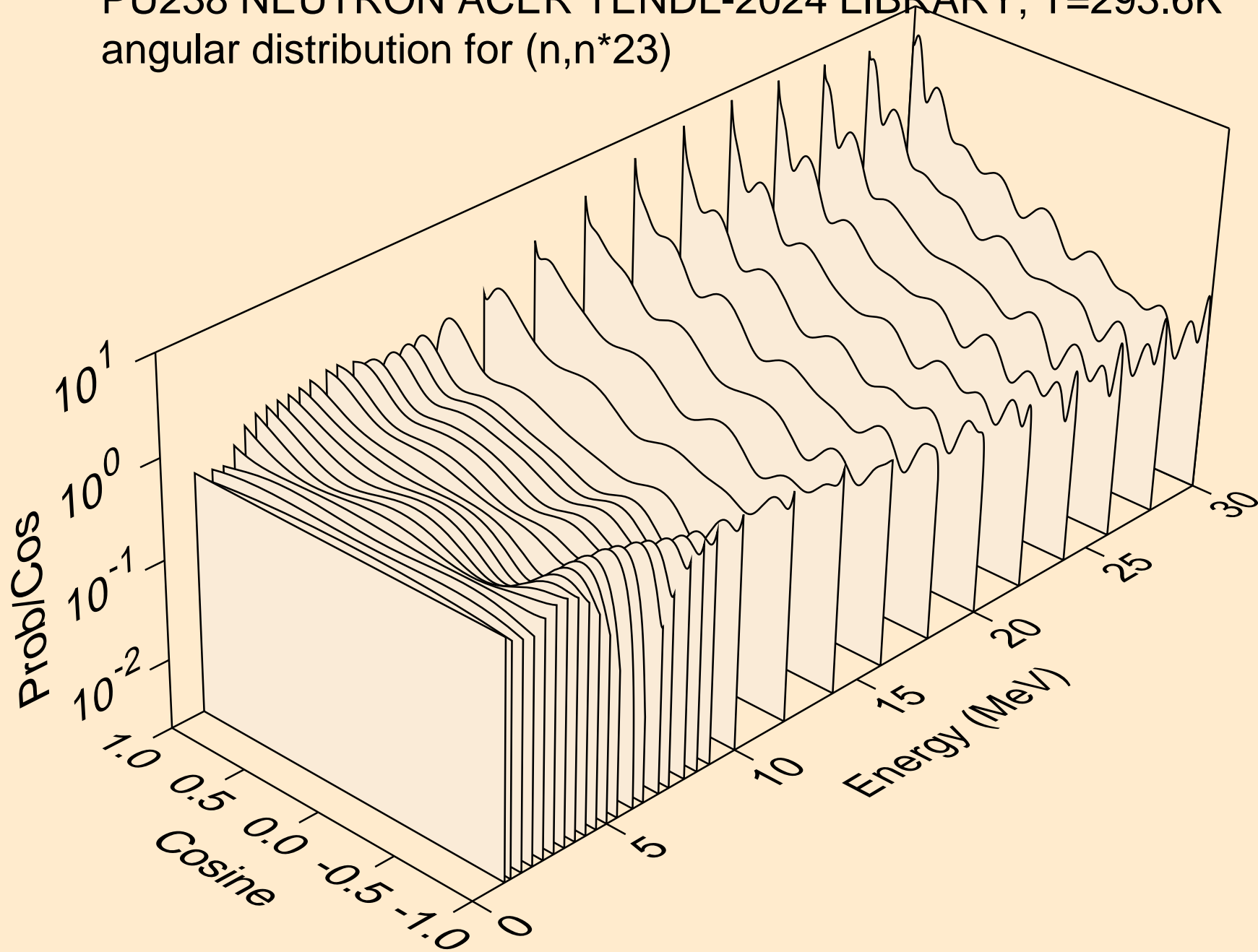

PU238 NEUTRON ACER TENDL-2024 LIBRARY; T=293.6K
angular distribution for (n,n*24)

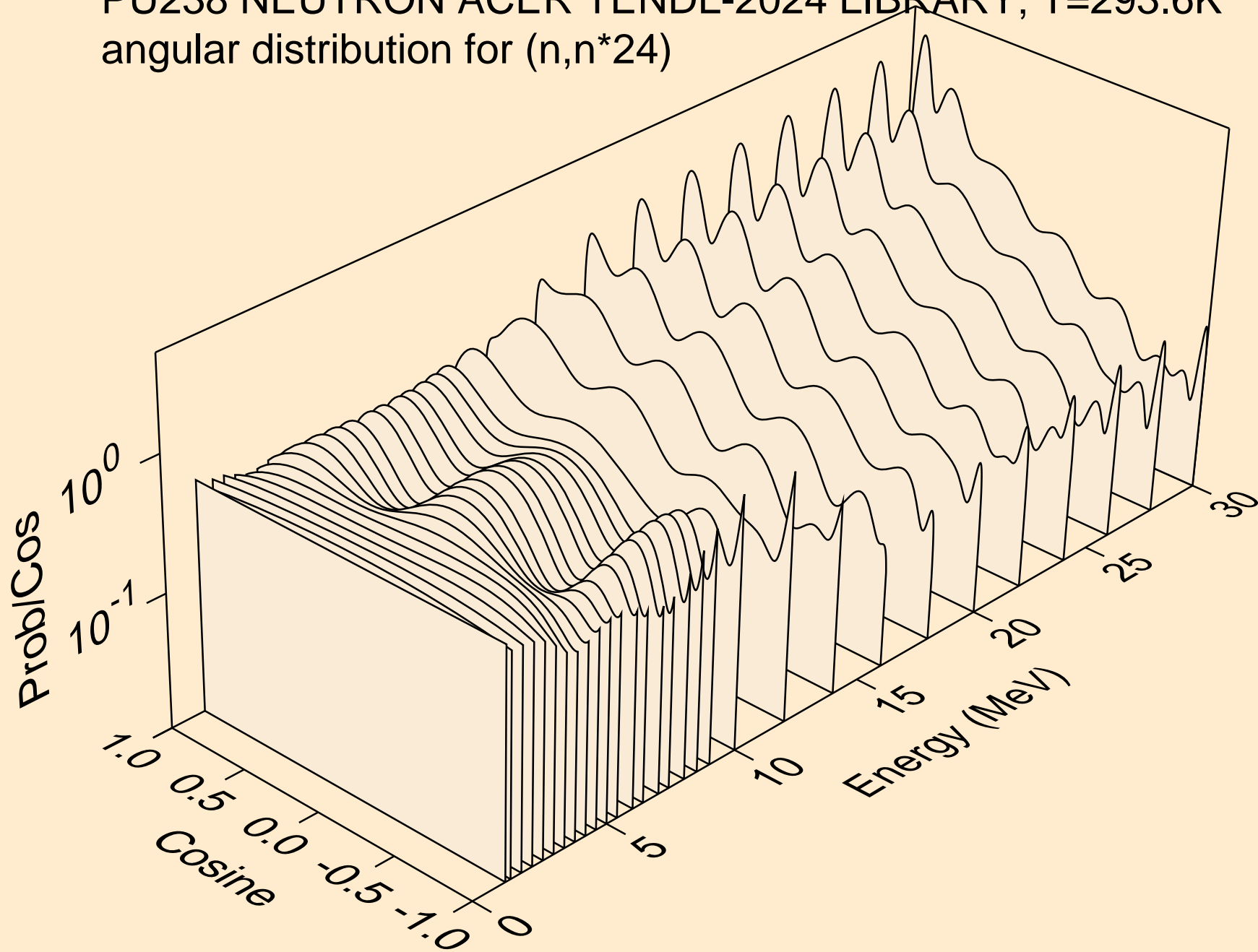

PU238 NEUTRON ACER TENDL-2024 LIBRARY; T=293.6K
angular distribution for (n,n*25)

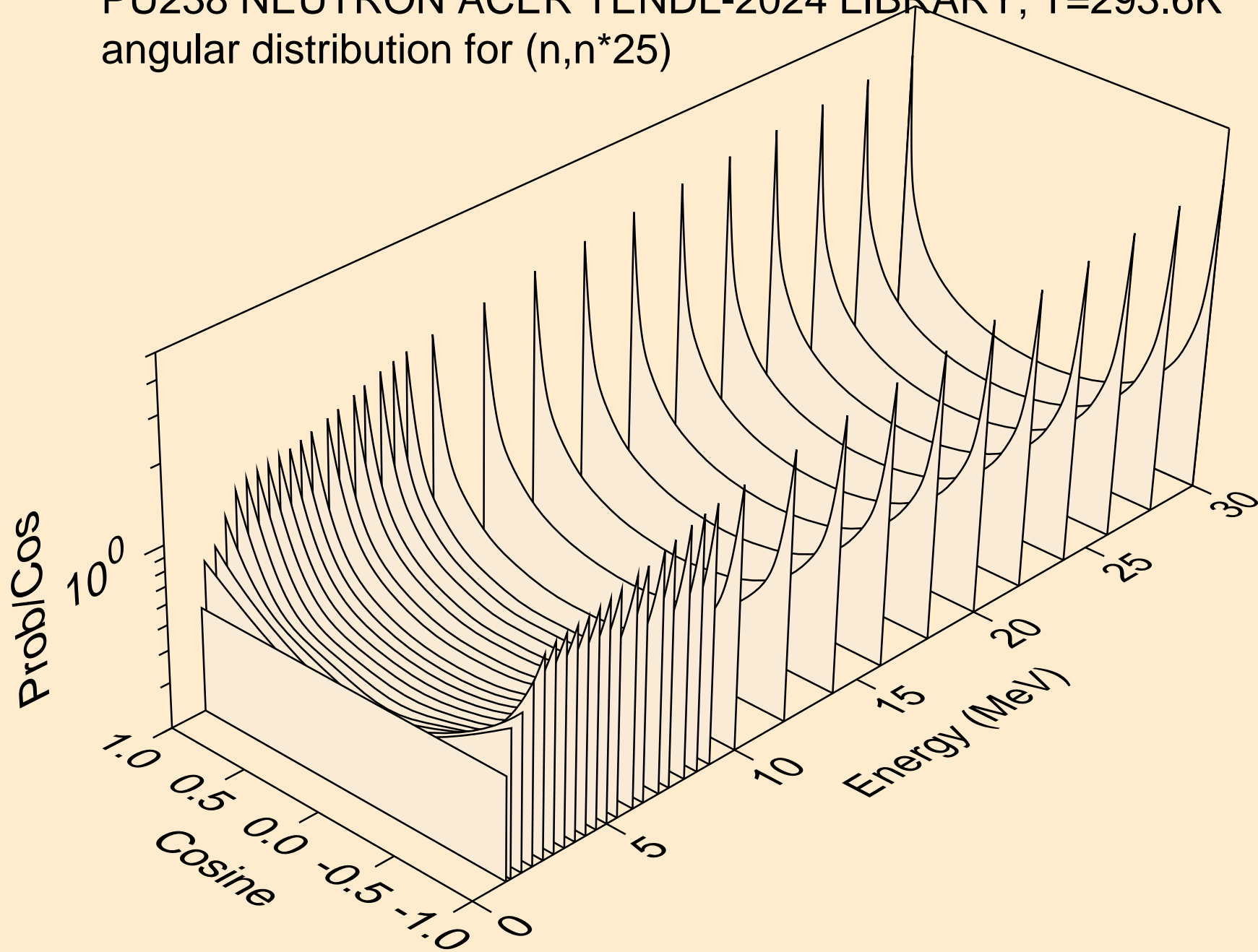

PU238 NEUTRON ACER TENDL-2024 LIBRARY; T=293.6K
angular distribution for (n,n*26)

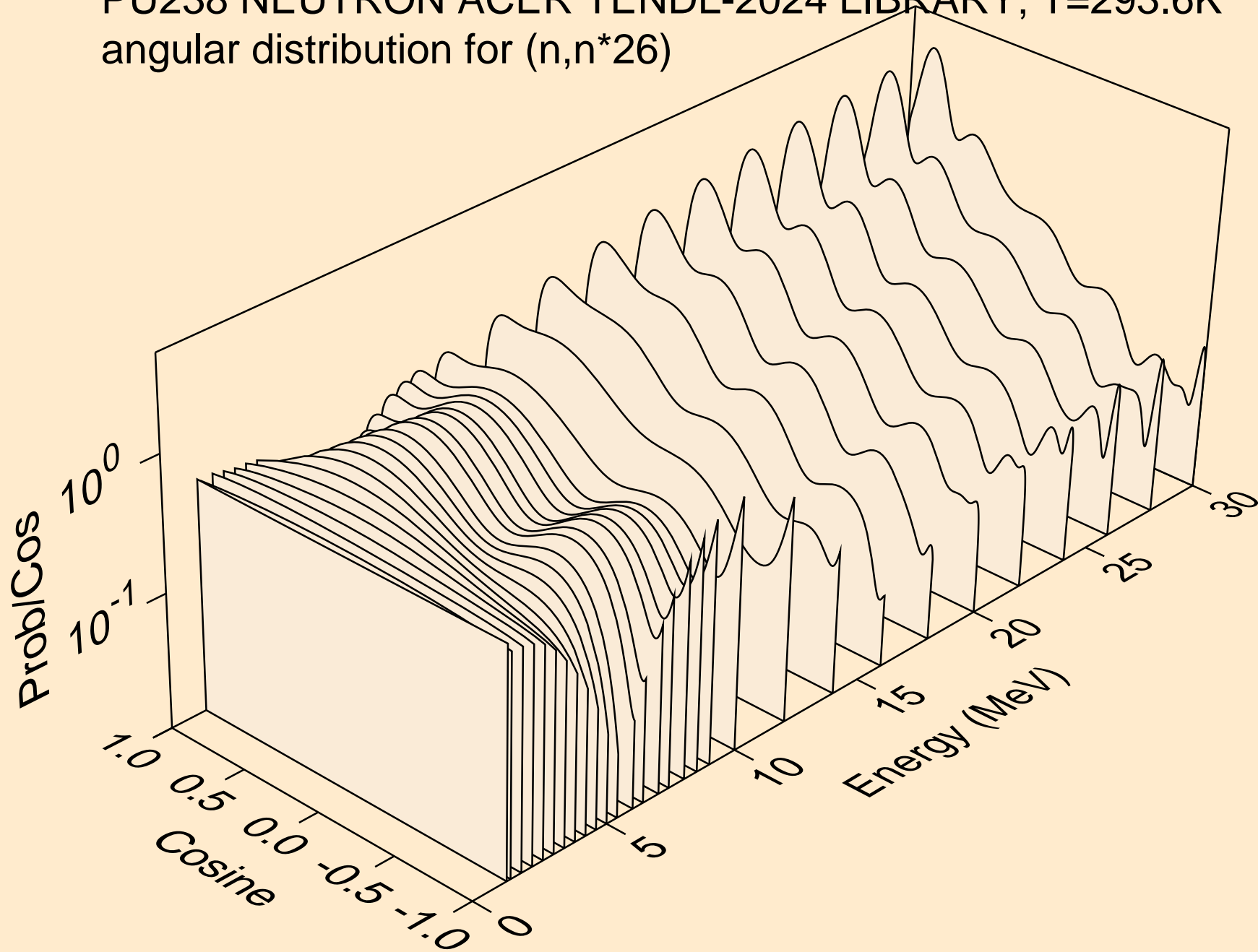

PU238 NEUTRON ACER TENDL-2024 LIBRARY; T=293.6K
angular distribution for (n,n*27)

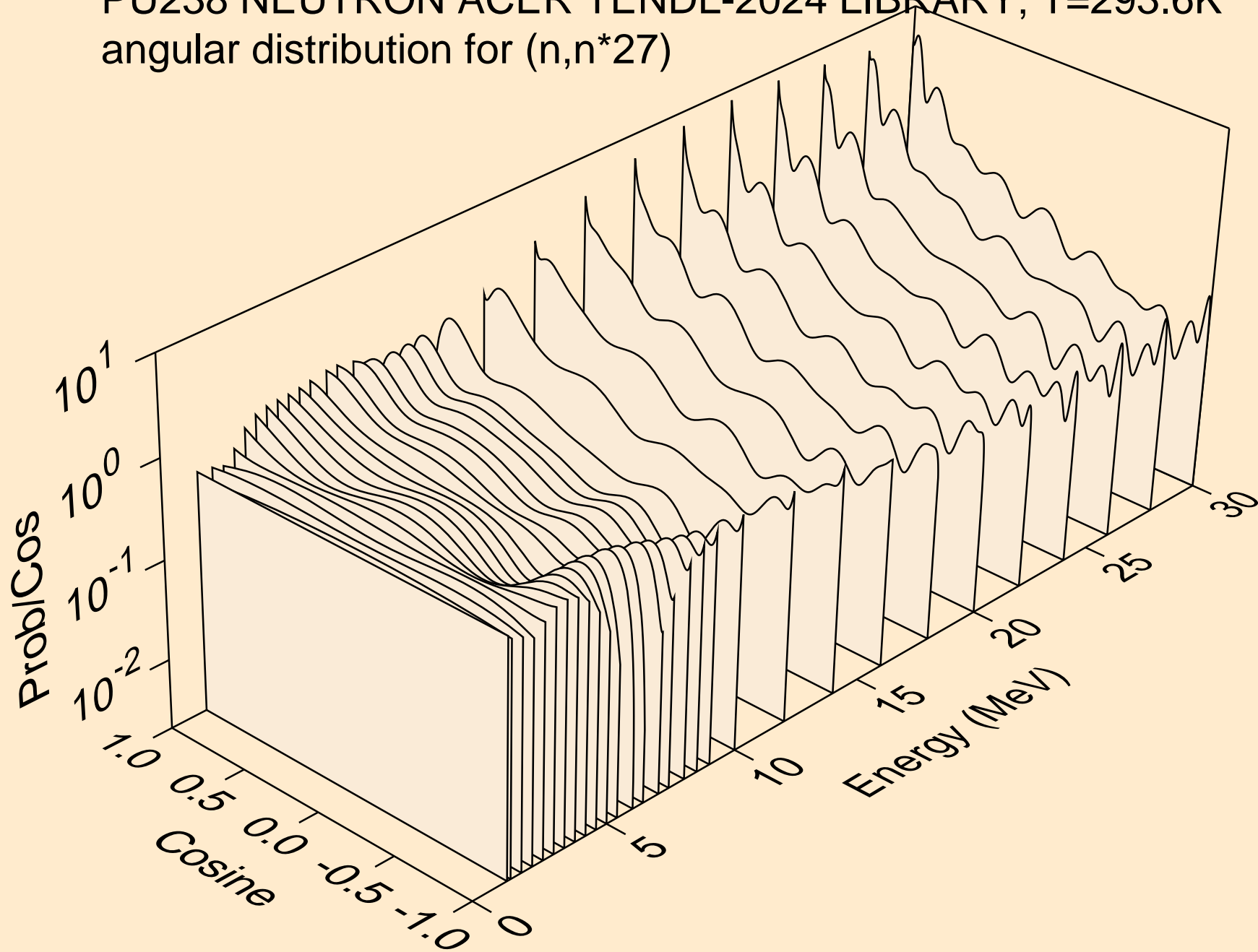

PU238 NEUTRON ACER TENDL-2024 LIBRARY; T=293.6K
angular distribution for (n,n*28)

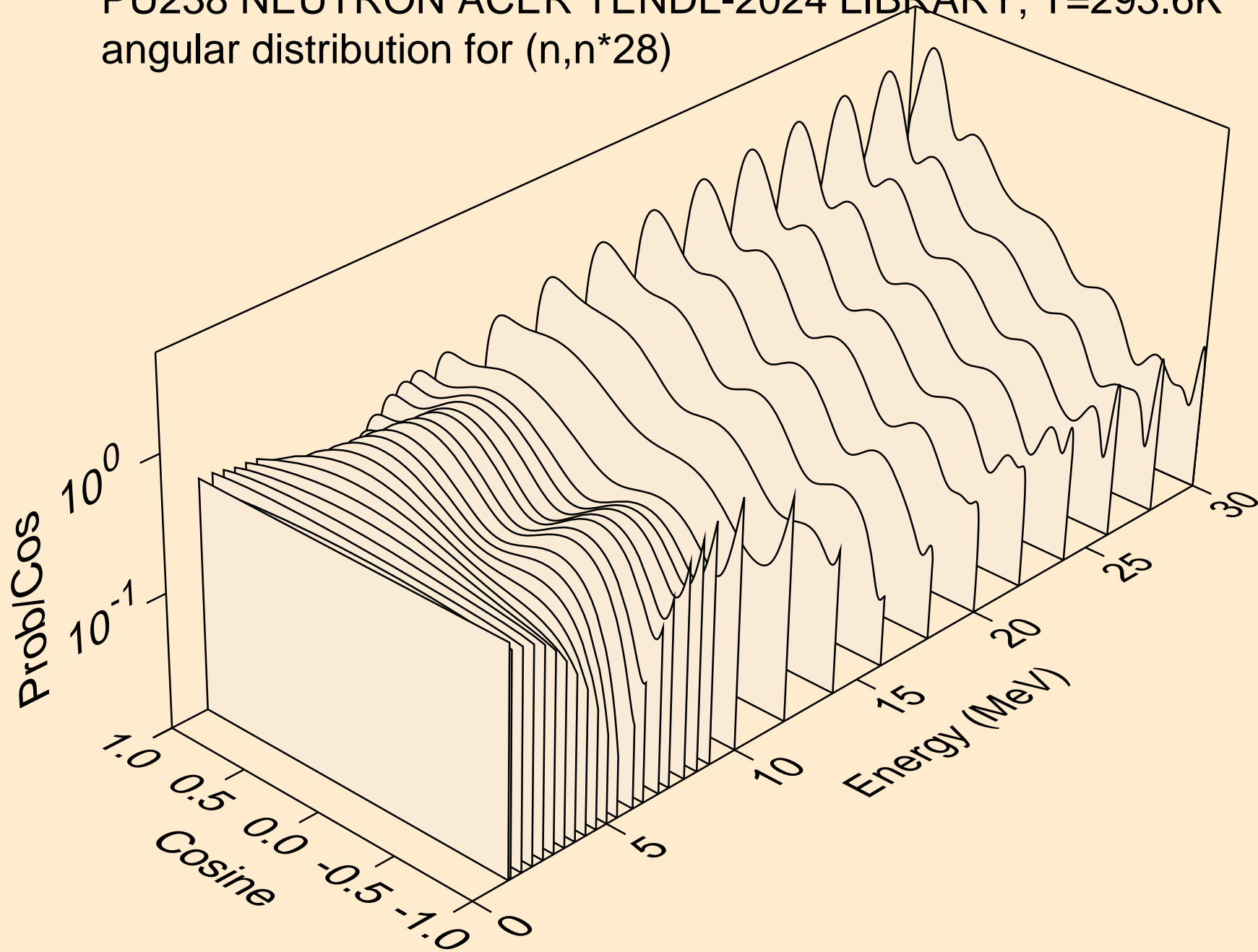

PU238 NEUTRON ACER TENDL-2024 LIBRARY; T=293.6K
angular distribution for (n,n*29)

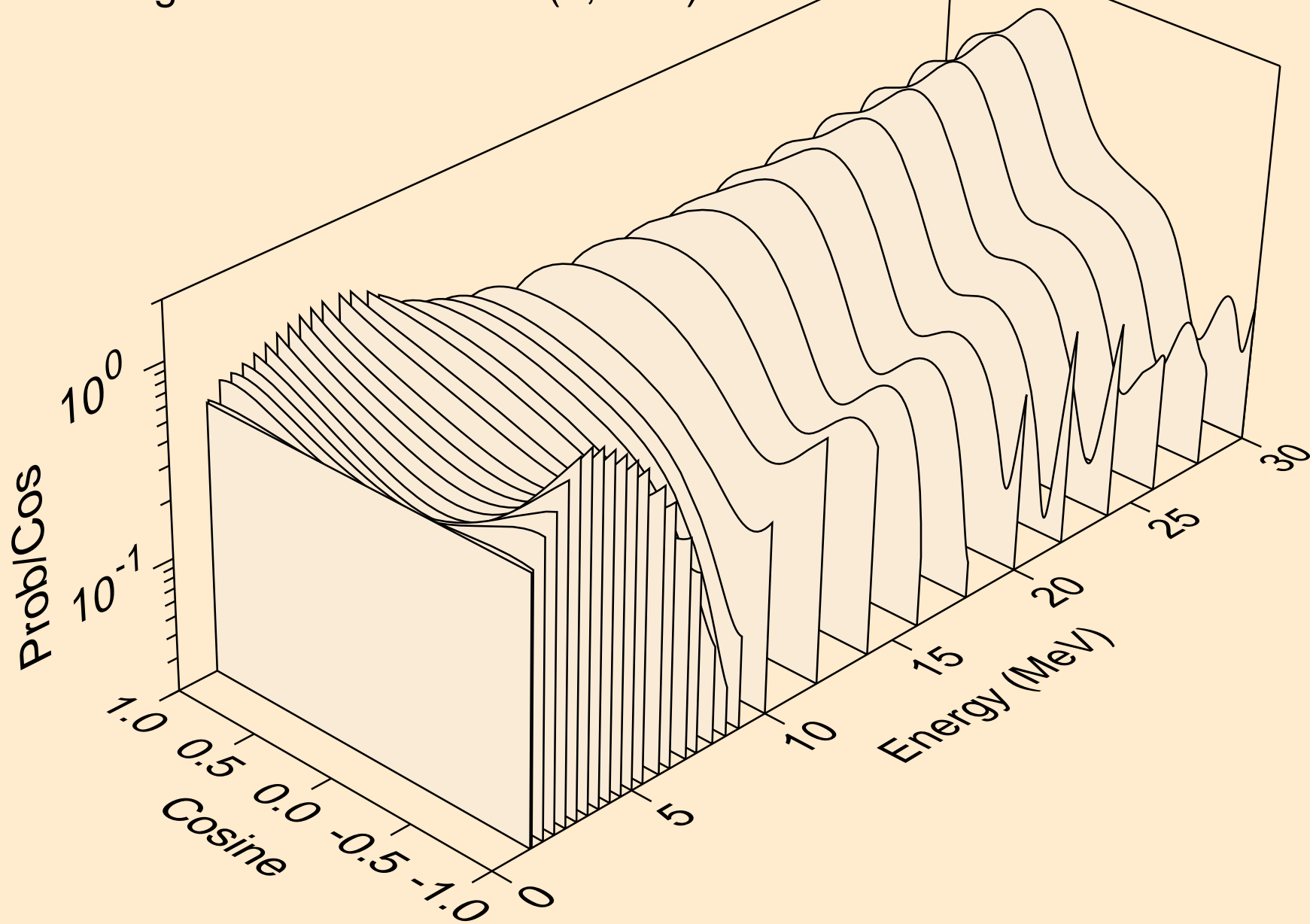

PU238 NEUTRON ACER TENDL-2024 LIBRARY; T=293.6K
angular distribution for (n,n*30)

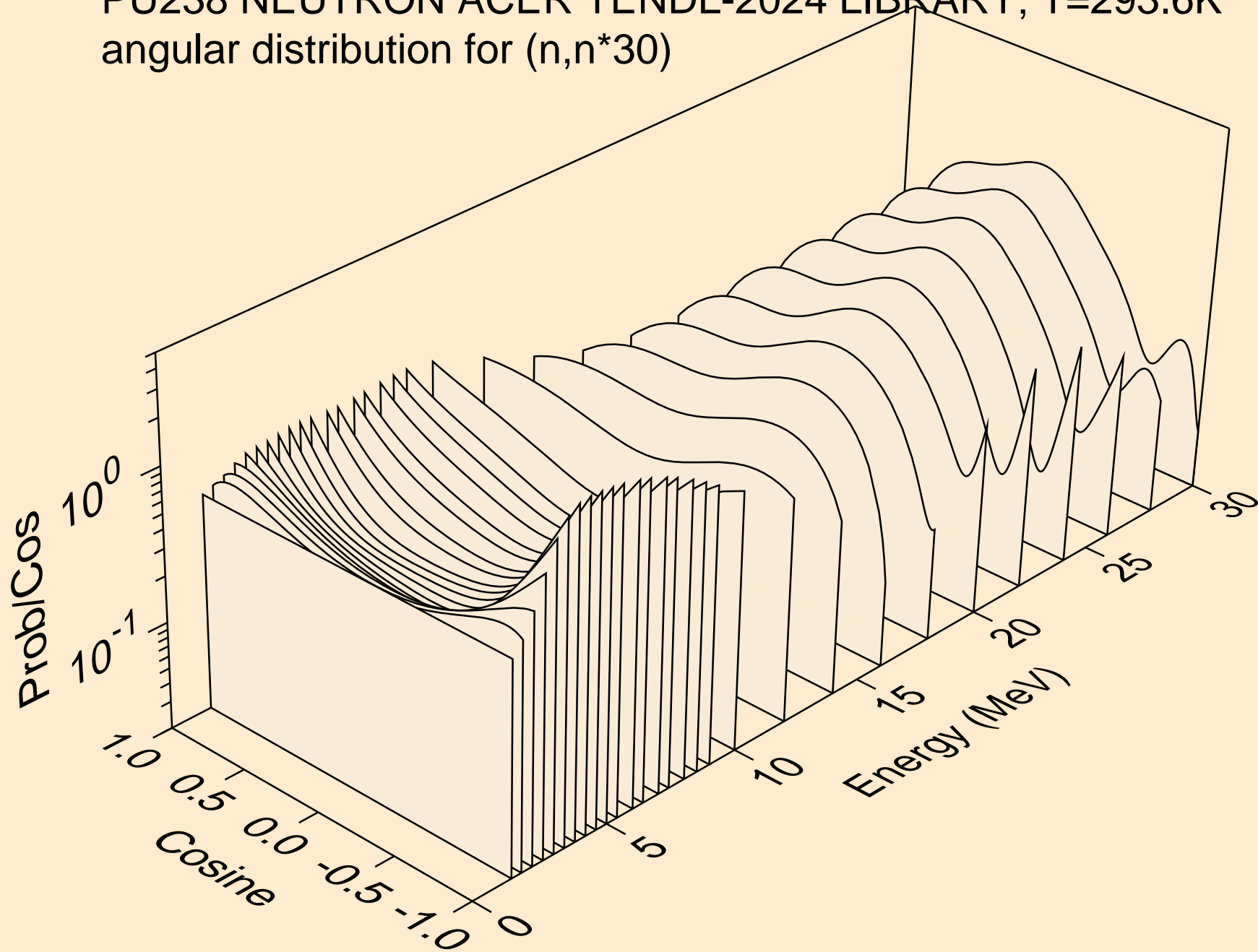

PU238 NEUTRON ACER TENDL-2024 LIBRARY; T=293.6K

Total fission nubar

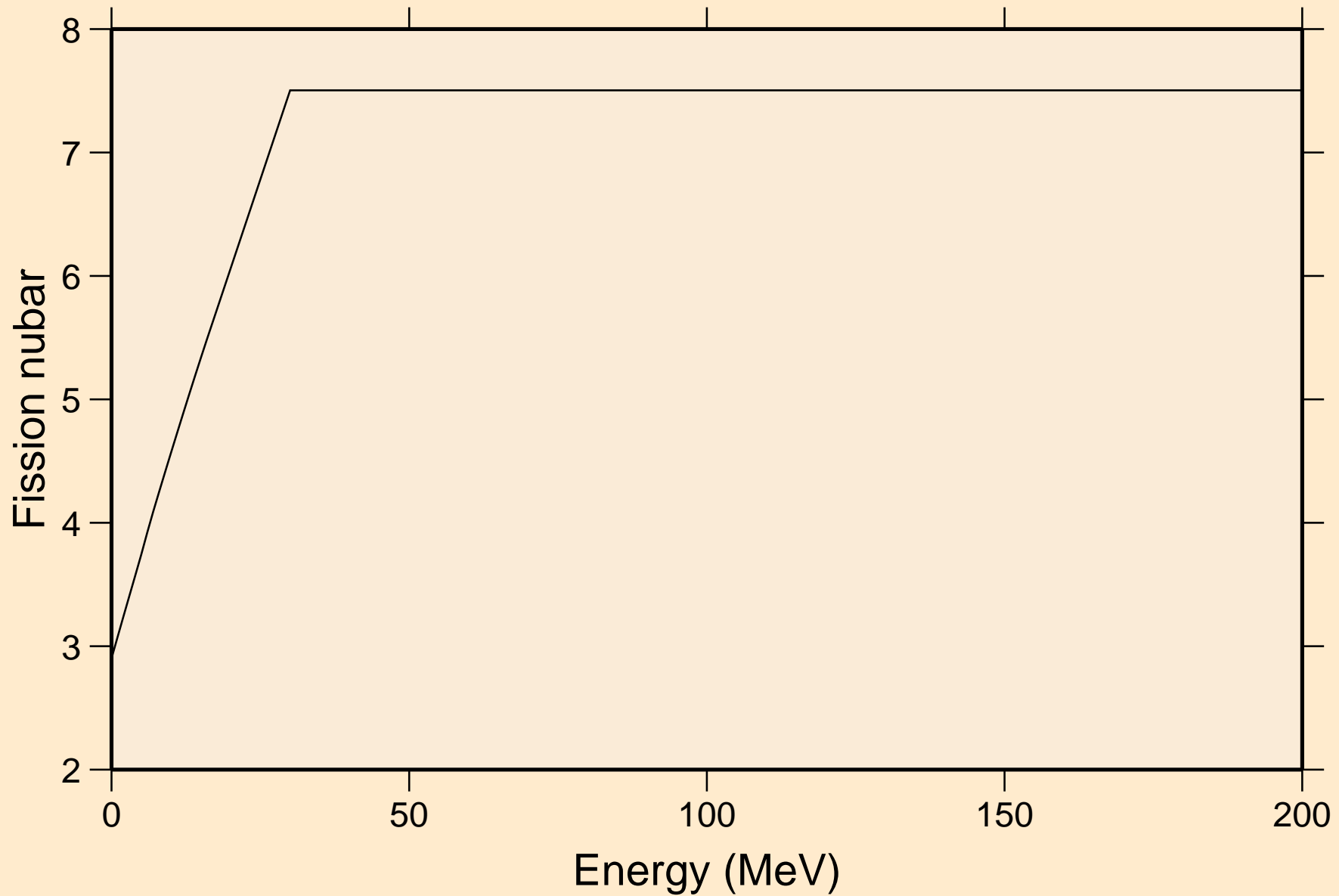

PU238 NEUTRON ACER TENDL-2024 LIBRARY; T=293.6K
Neutron emission for (n,x)

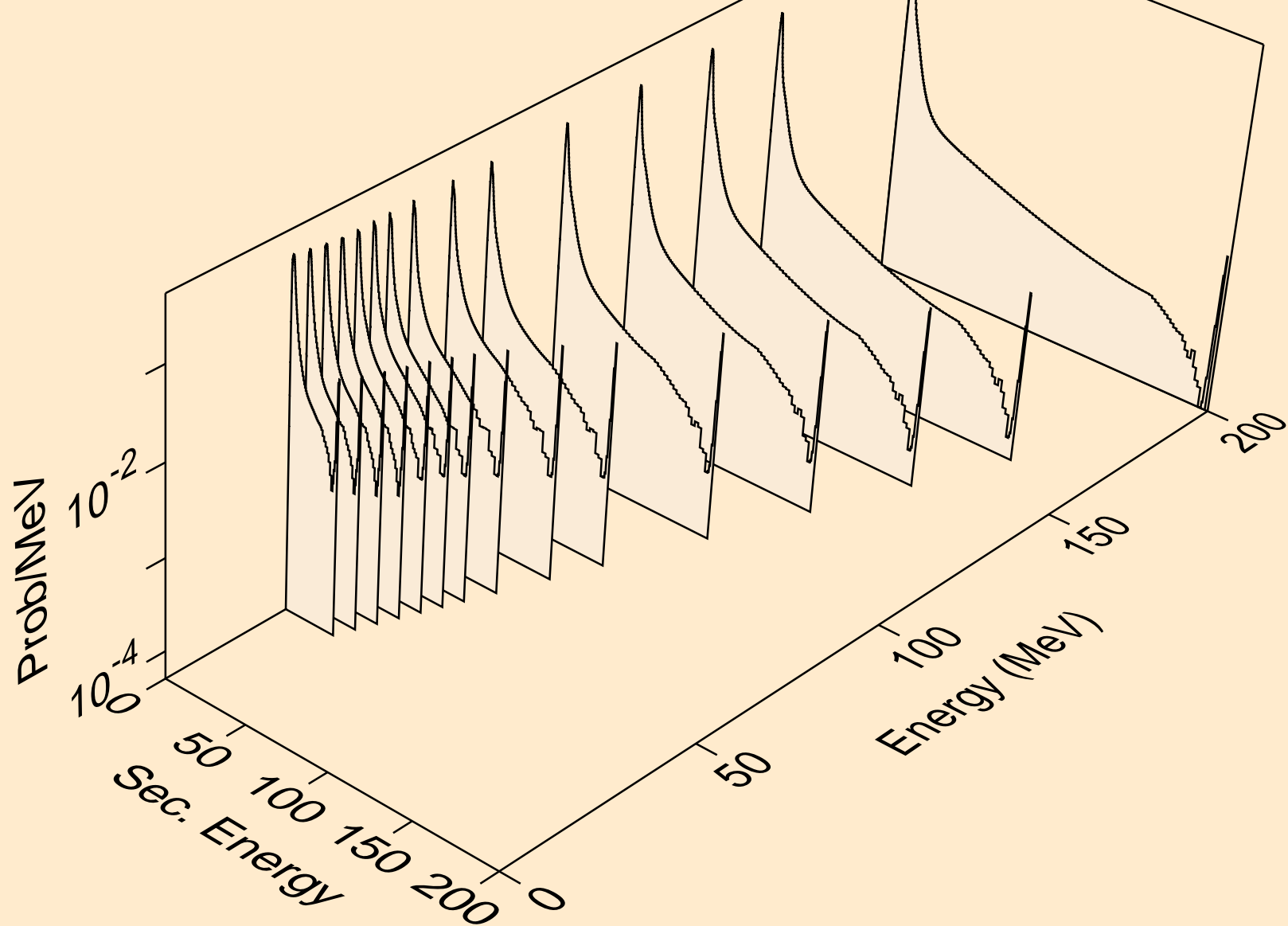

PU238 NEUTRON ACER TENDL-2024 LIBRARY; T=293.6K
Neutron emission for (n,2nd)

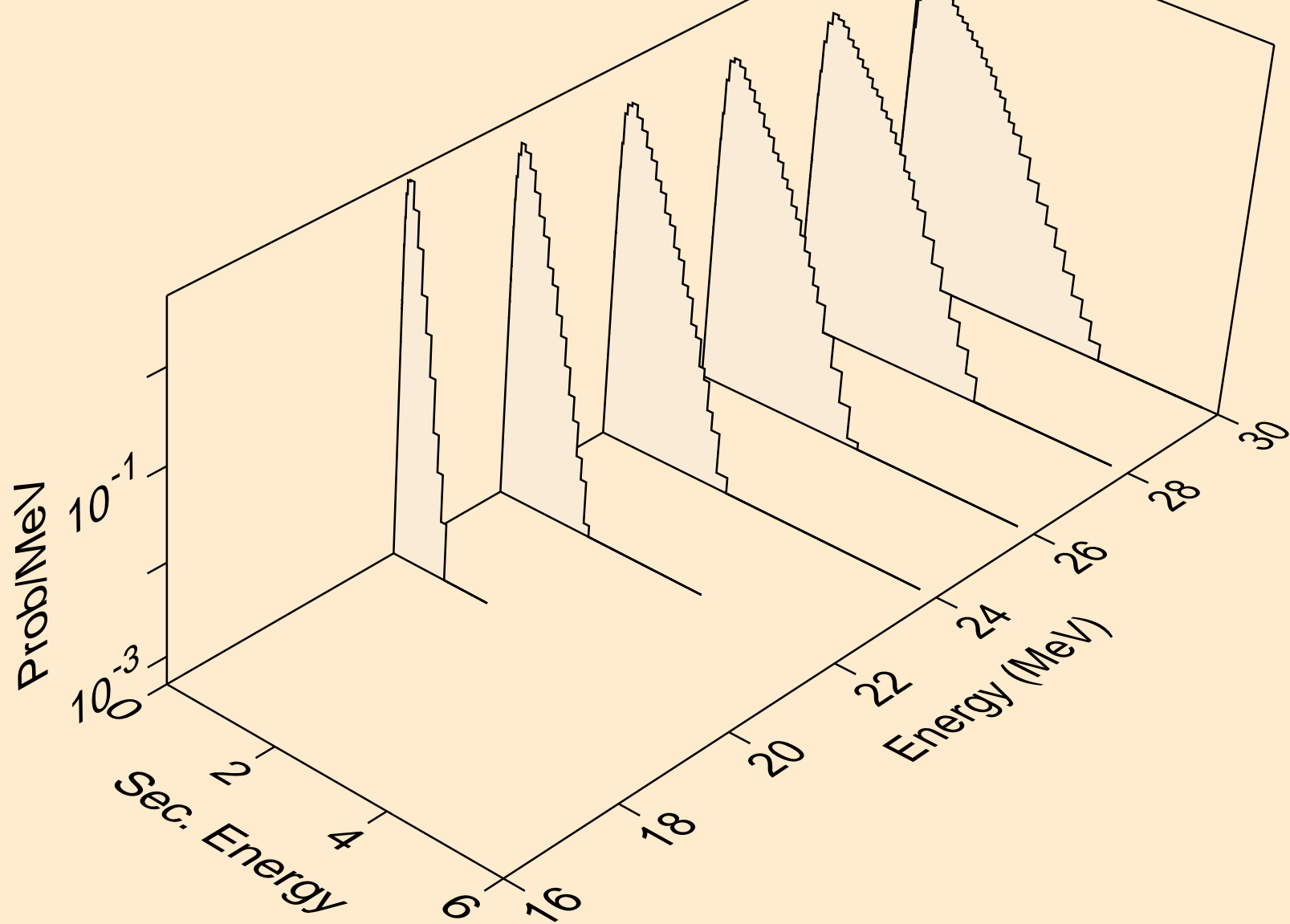

PU238 NEUTRON ACER TENDL-2024 LIBRARY; T=293.6K
Neutron emission for (n,2n)

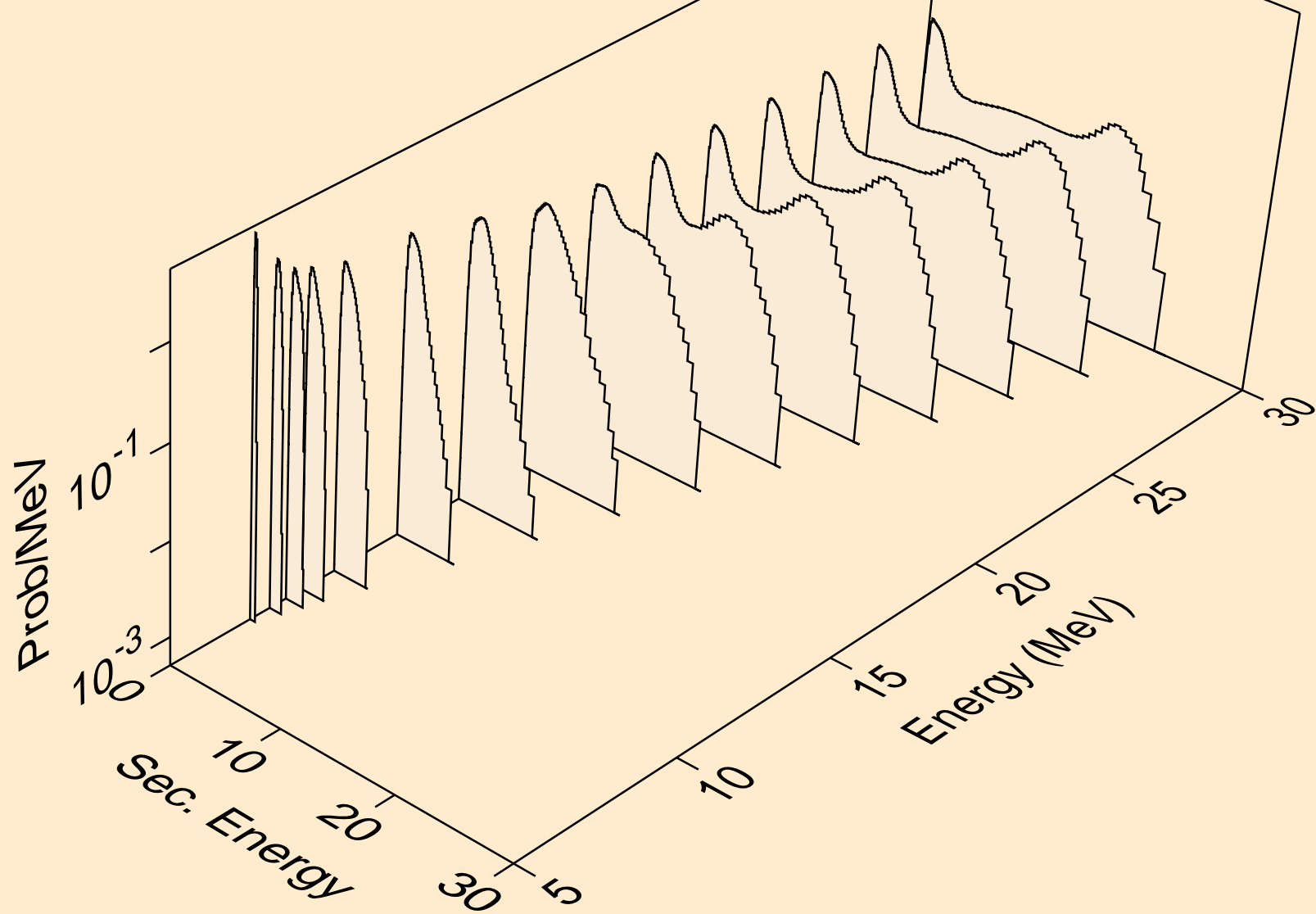

PU238 NEUTRON ACER TENDL-2024 LIBRARY; T=293.6K
Neutron emission for (n,3n)

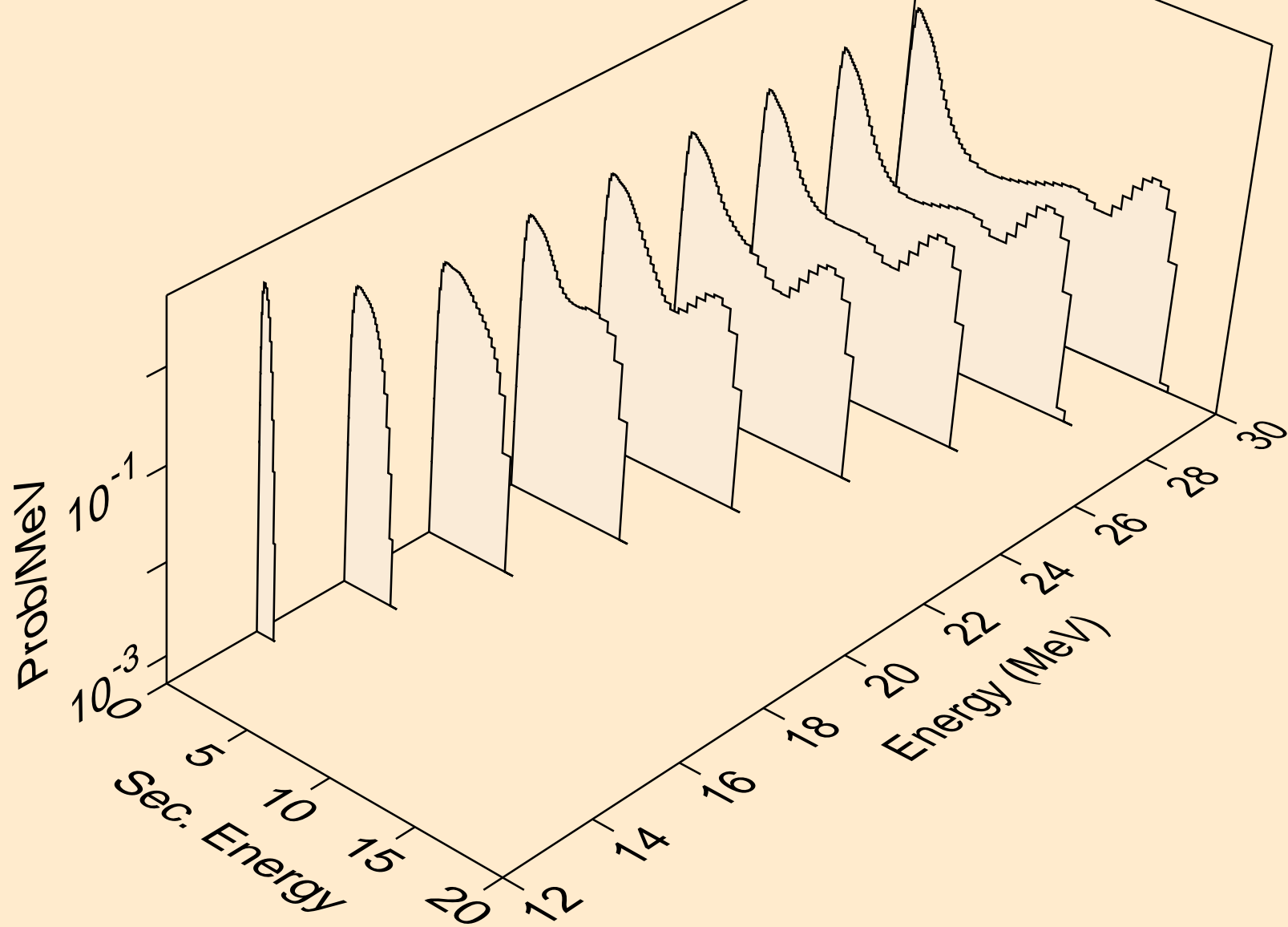

PU238 NEUTRON ACER TENDL-2024 LIBRARY; T=293.6K
Neutron emission for fission

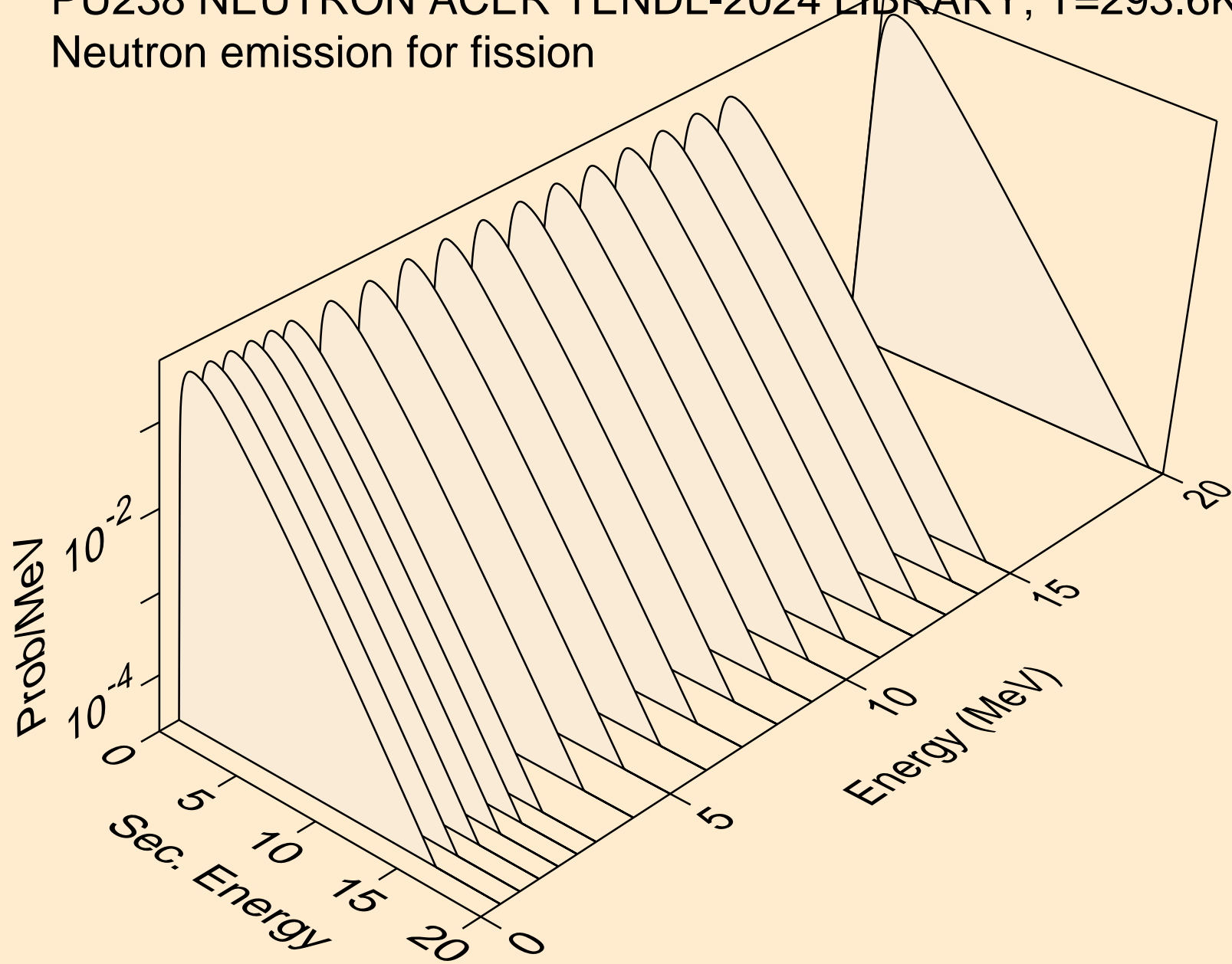

PU238 NEUTRON ACER TENDL-2024 LIBRARY; T=293.6K
Neutron emission for (n,n*)a

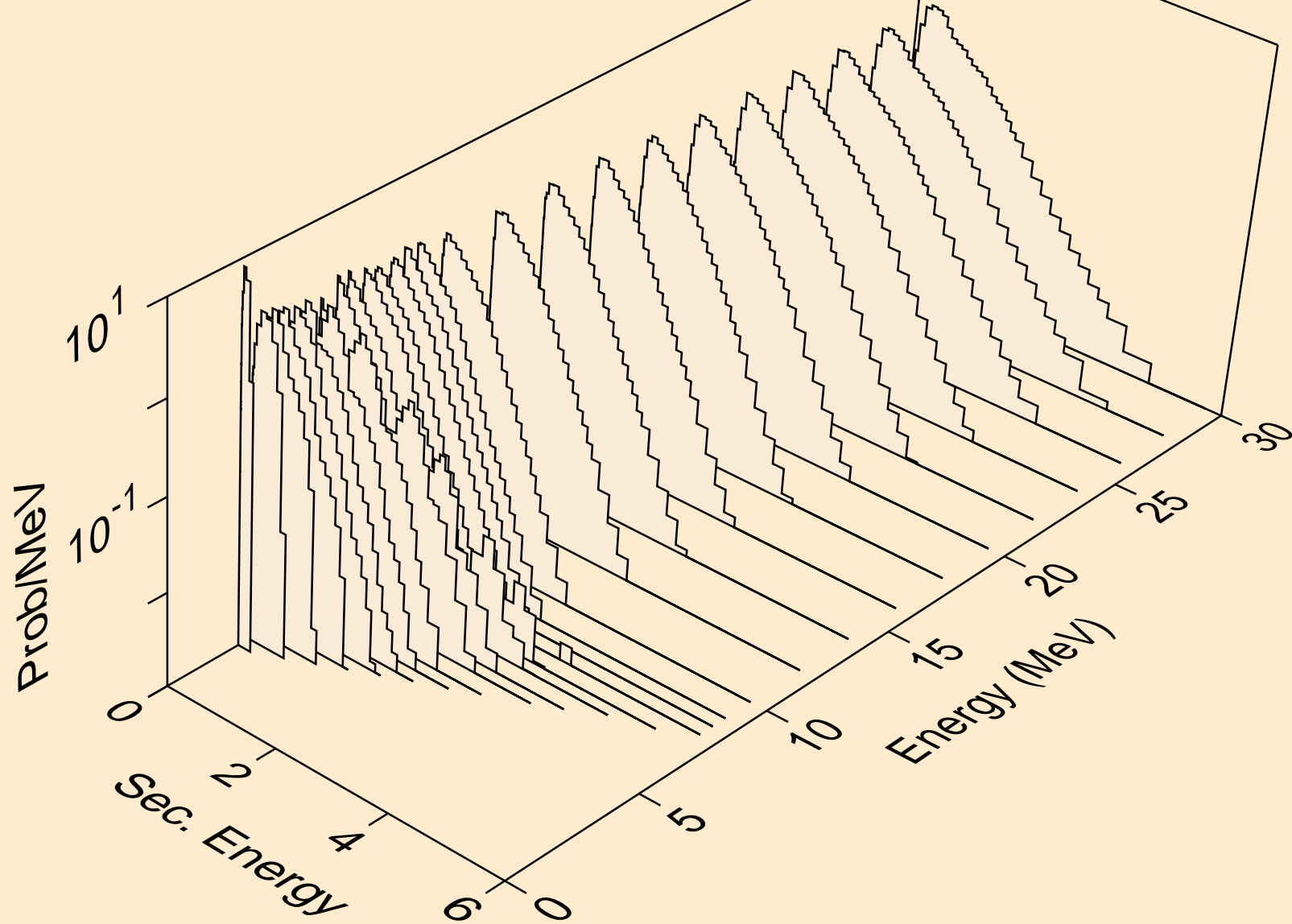

PU238 NEUTRON ACER TENDL-2024 LIBRARY; T=293.6K
Neutron emission for (n,2n)a

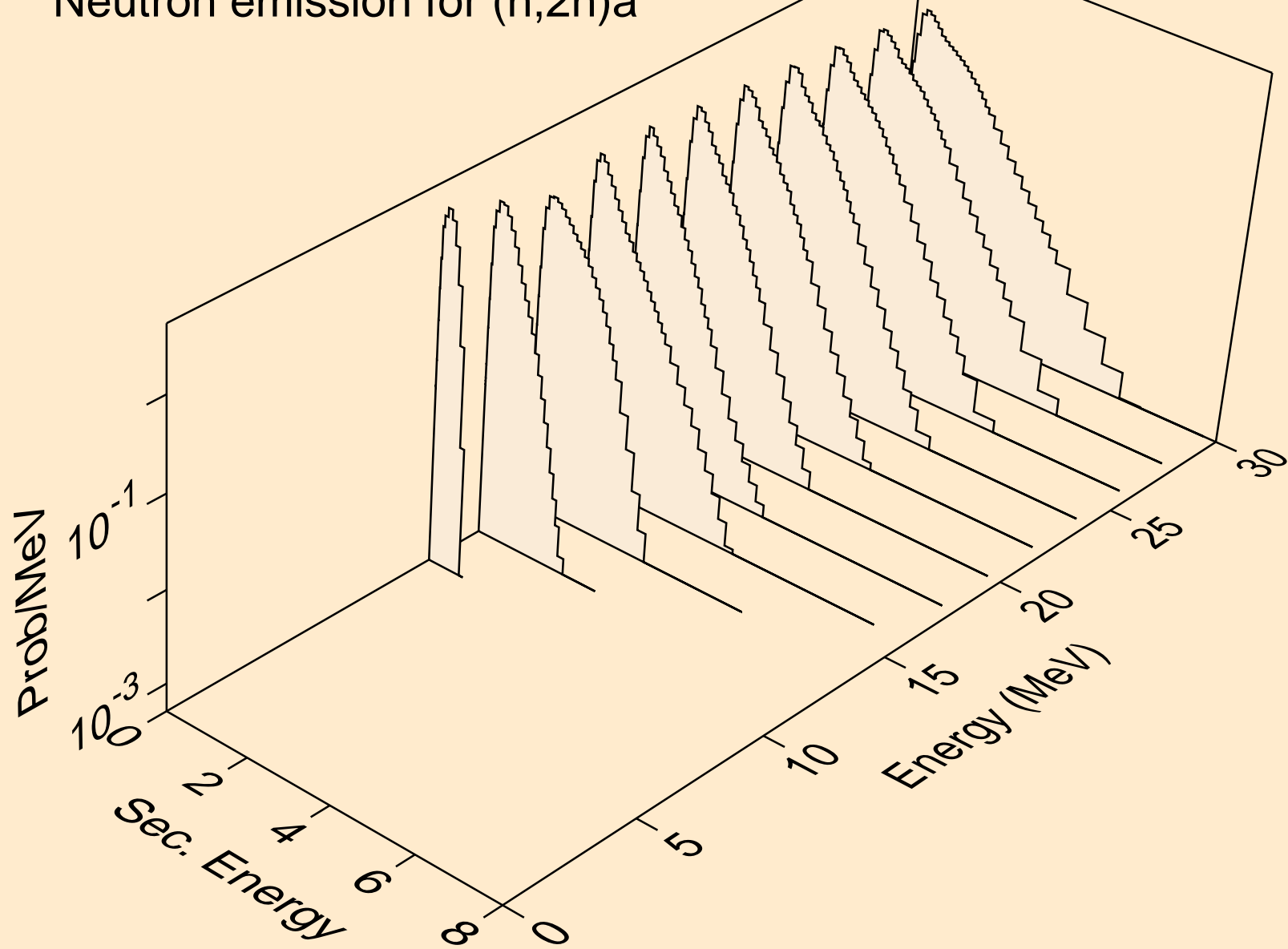

PU238 NEUTRON ACER TENDL-2024 LIBRARY; T=293.6K
Neutron emission for (n,3n)a

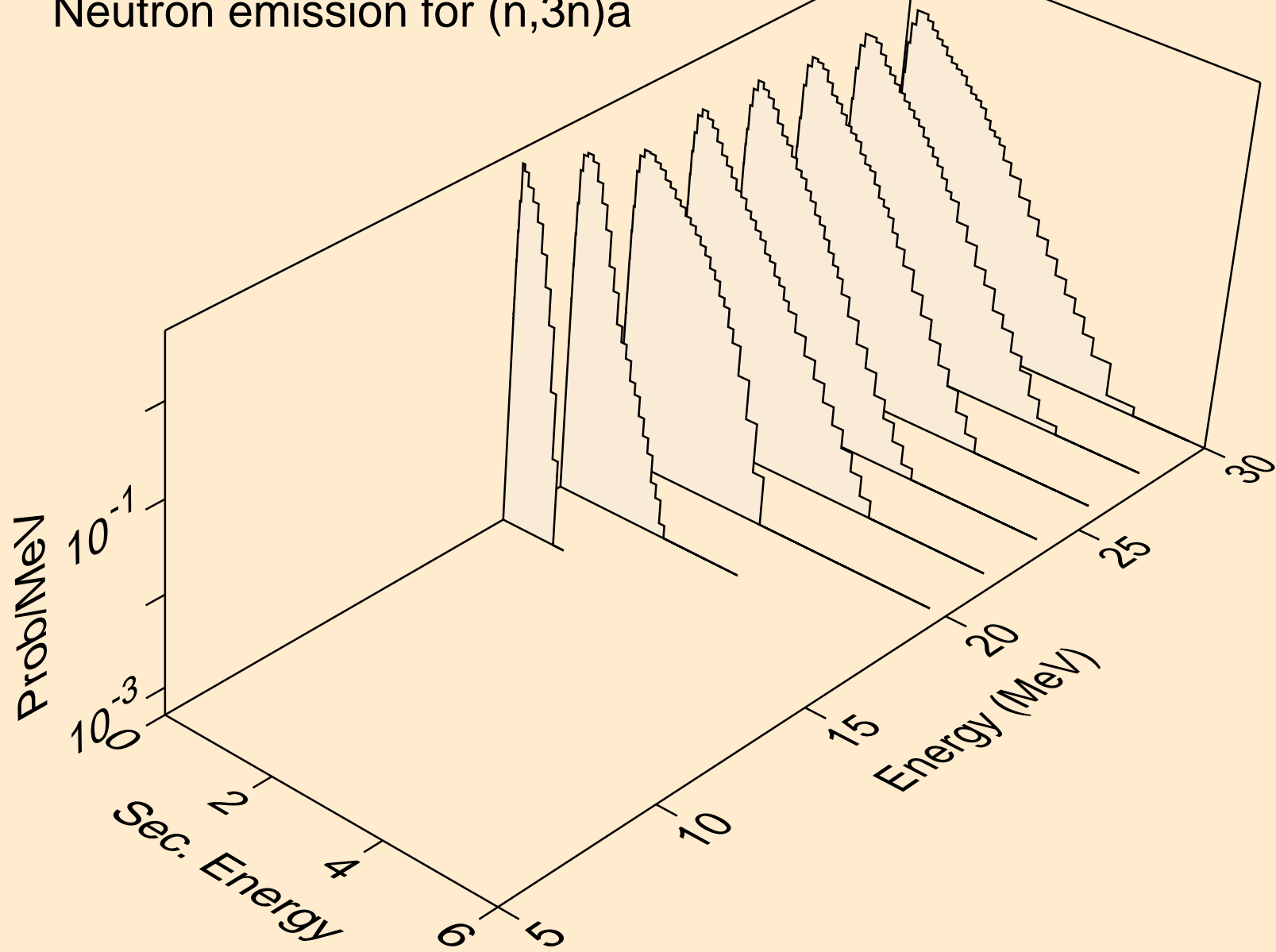

PU238 NEUTRON ACER TENDL-2024 LIBRARY; T=293.6K
Neutron emission for (n,n*)p

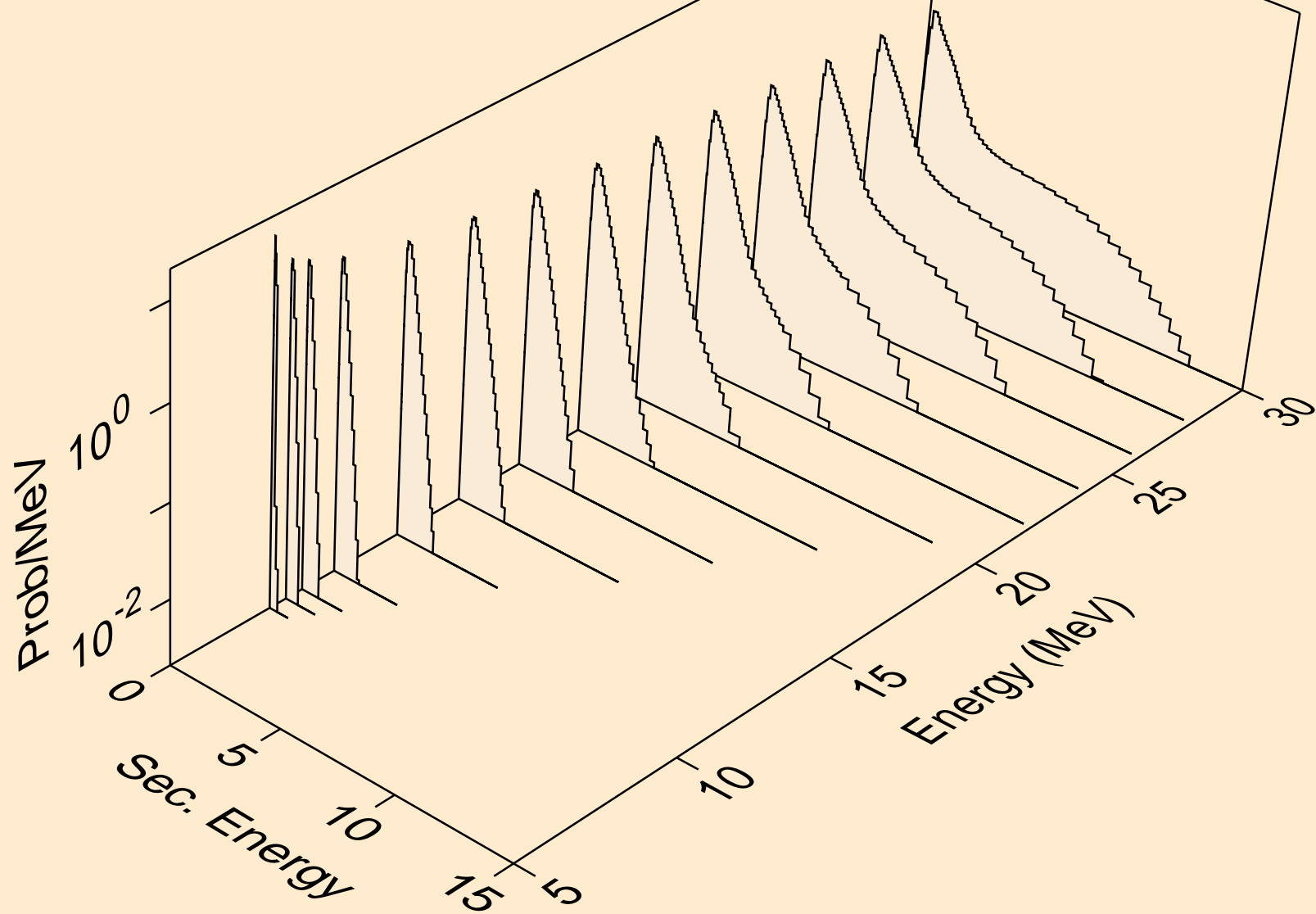

PU238 NEUTRON ACER TENDL-2024 LIBRARY; T=293.6K
Neutron emission for (n,n*)2a

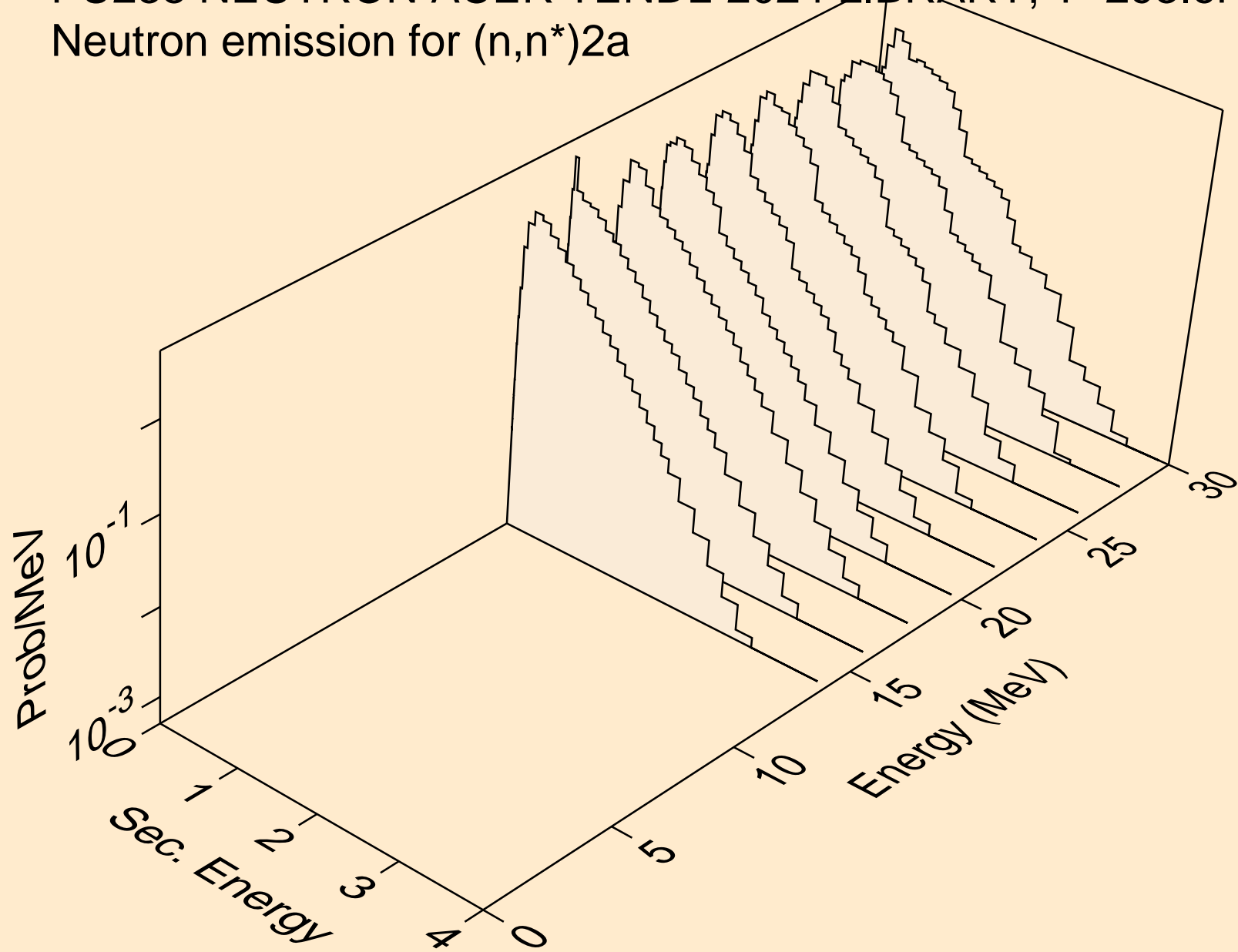

PU238 NEUTRON ACER TENDL-2024 LIBRARY; T=293.6K
Neutron emission for (n,n*)d

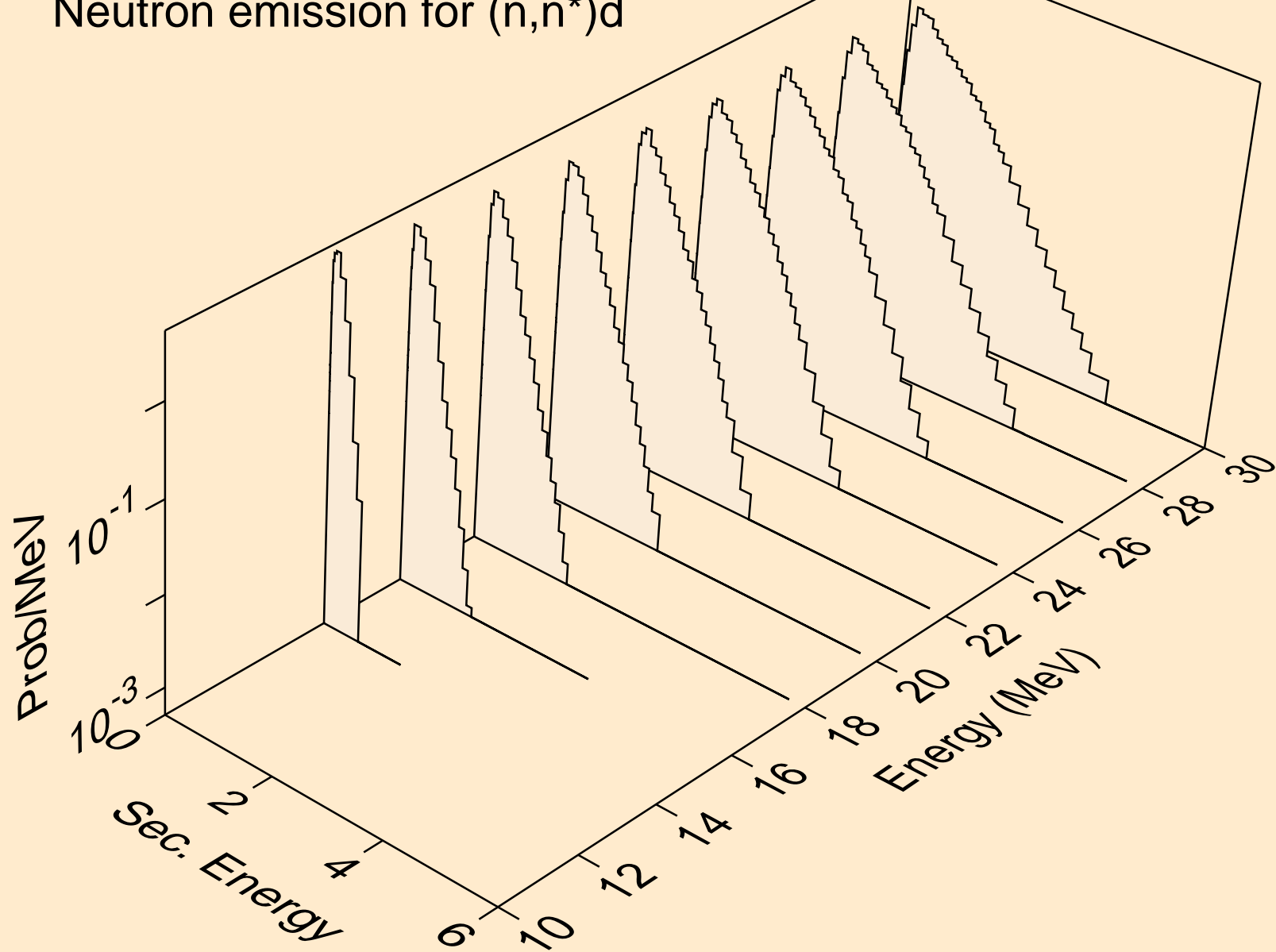

PU238 NEUTRON ACER TENDL-2024 LIBRARY; T=293.6K
Neutron emission for (n,n*)t

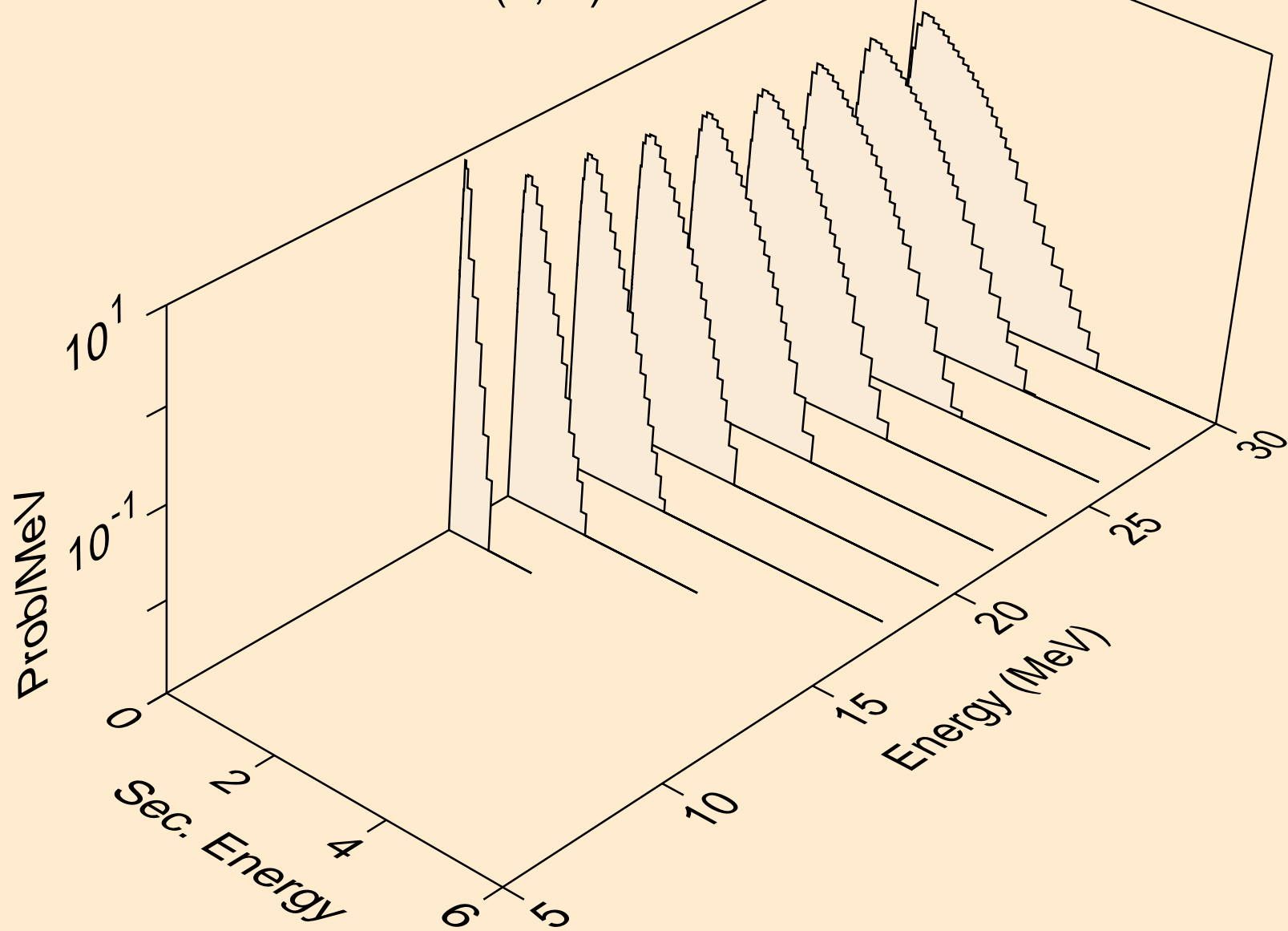

PU238 NEUTRON ACER TENDL-2024 LIBRARY; T=293.6K
Neutron emission for (n,n*)he3

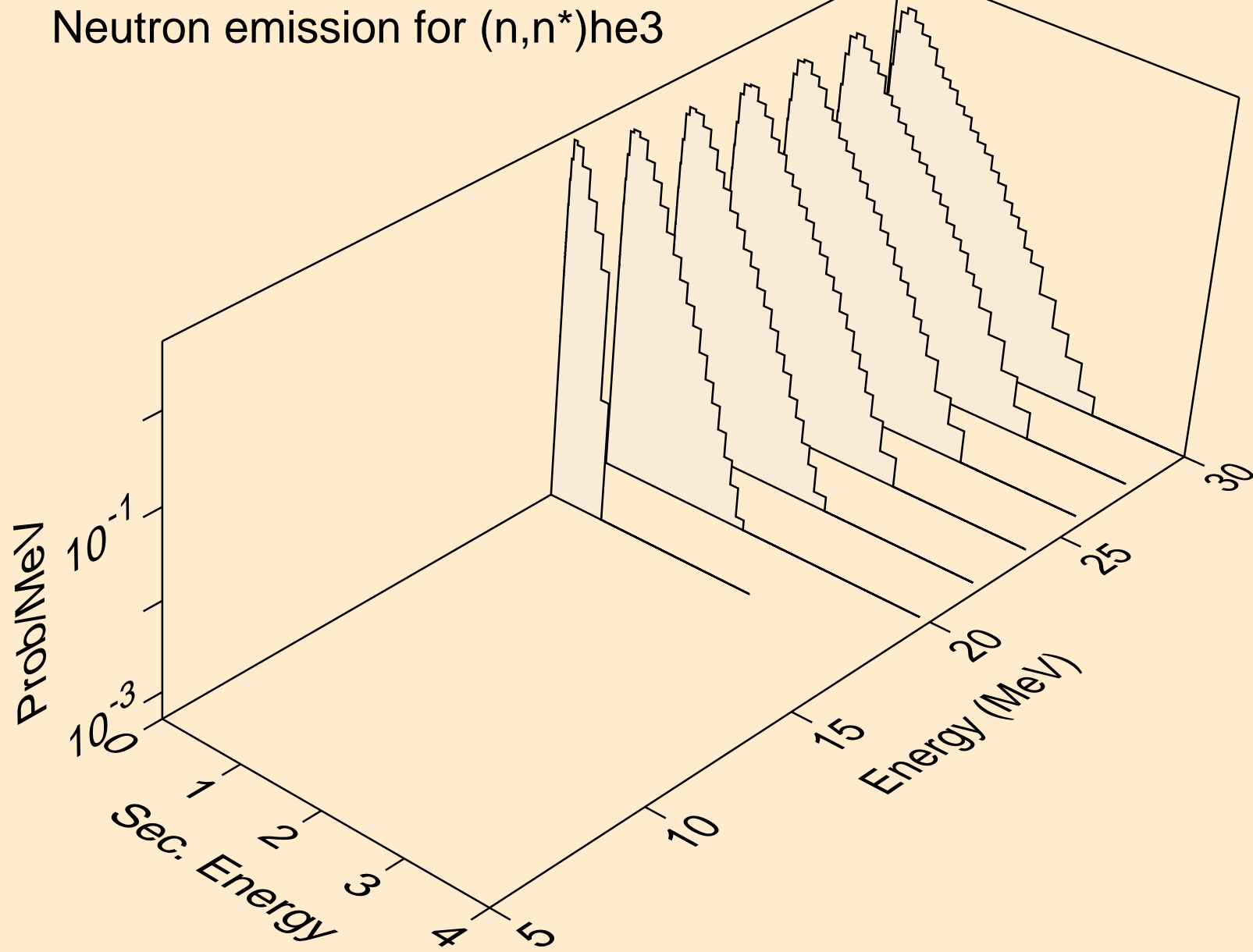

PU238 NEUTRON ACER TENDL-2024 LIBRARY; T=293.6K
Neutron emission for (n,4n)

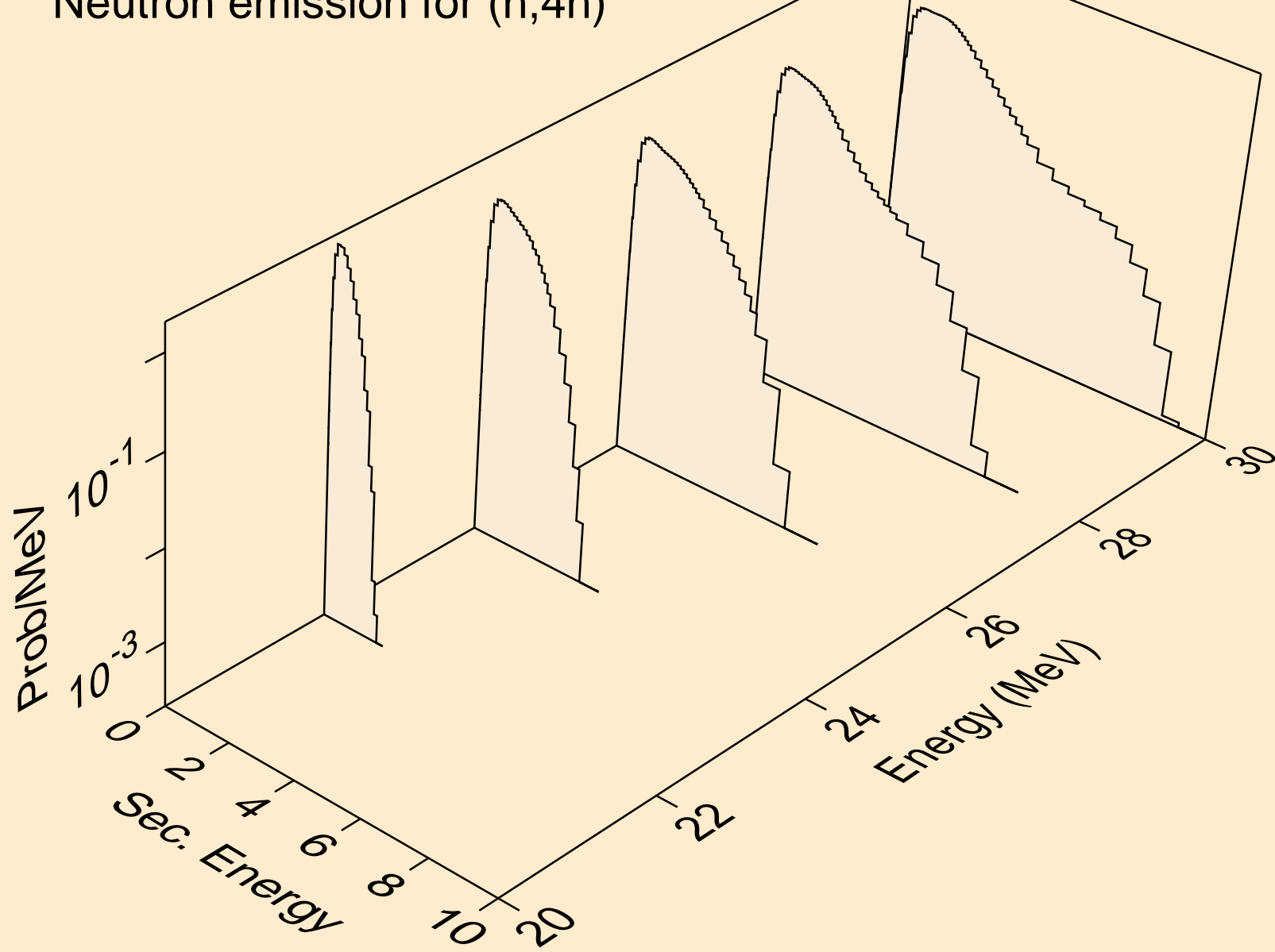

PU238 NEUTRON ACER TENDL-2024 LIBRARY; T=293.6K
Neutron emission for (n,2np)

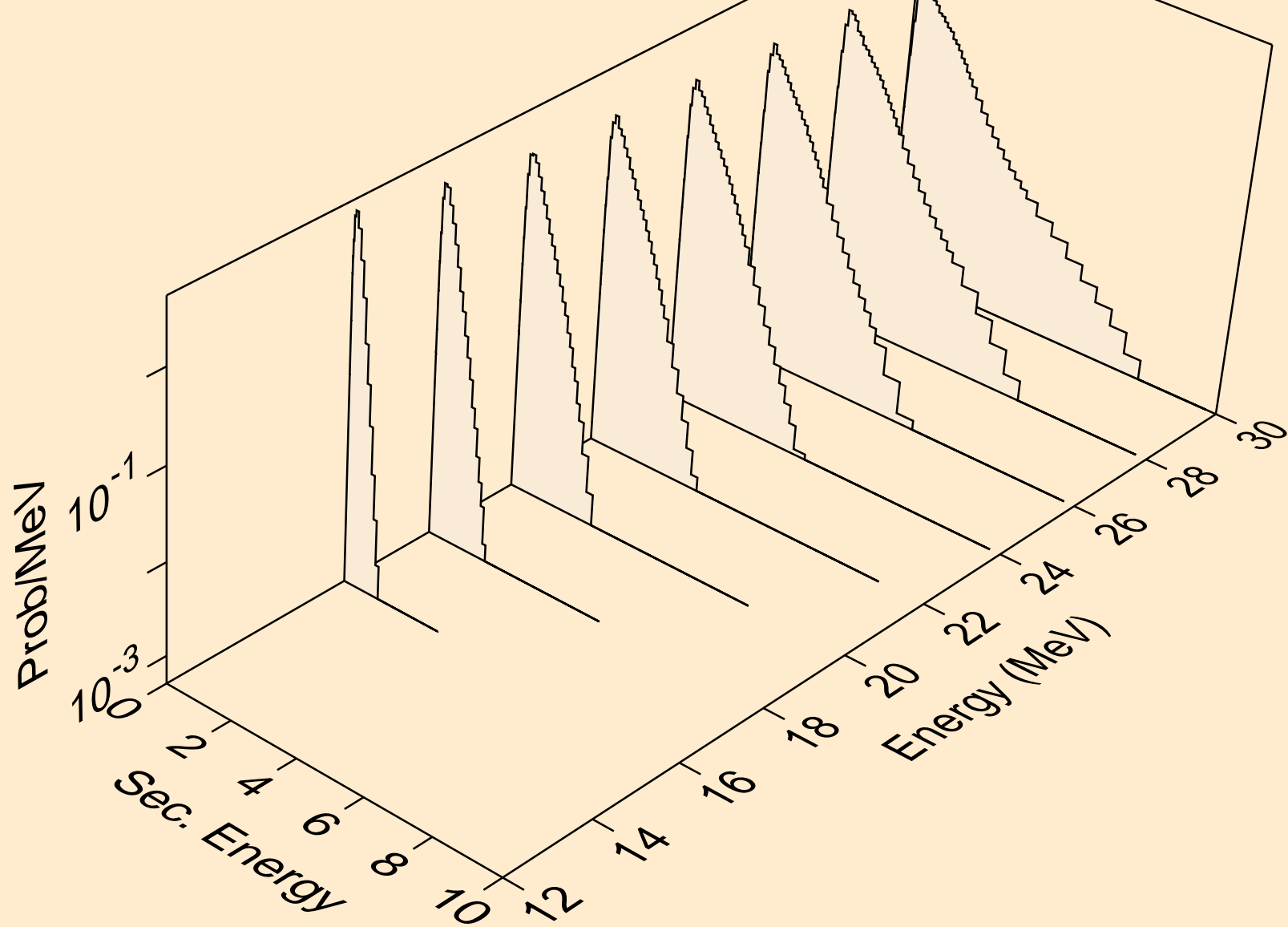

PU238 NEUTRON ACER TENDL-2024 LIBRARY; T=293.6K
Neutron emission for (n,3np)

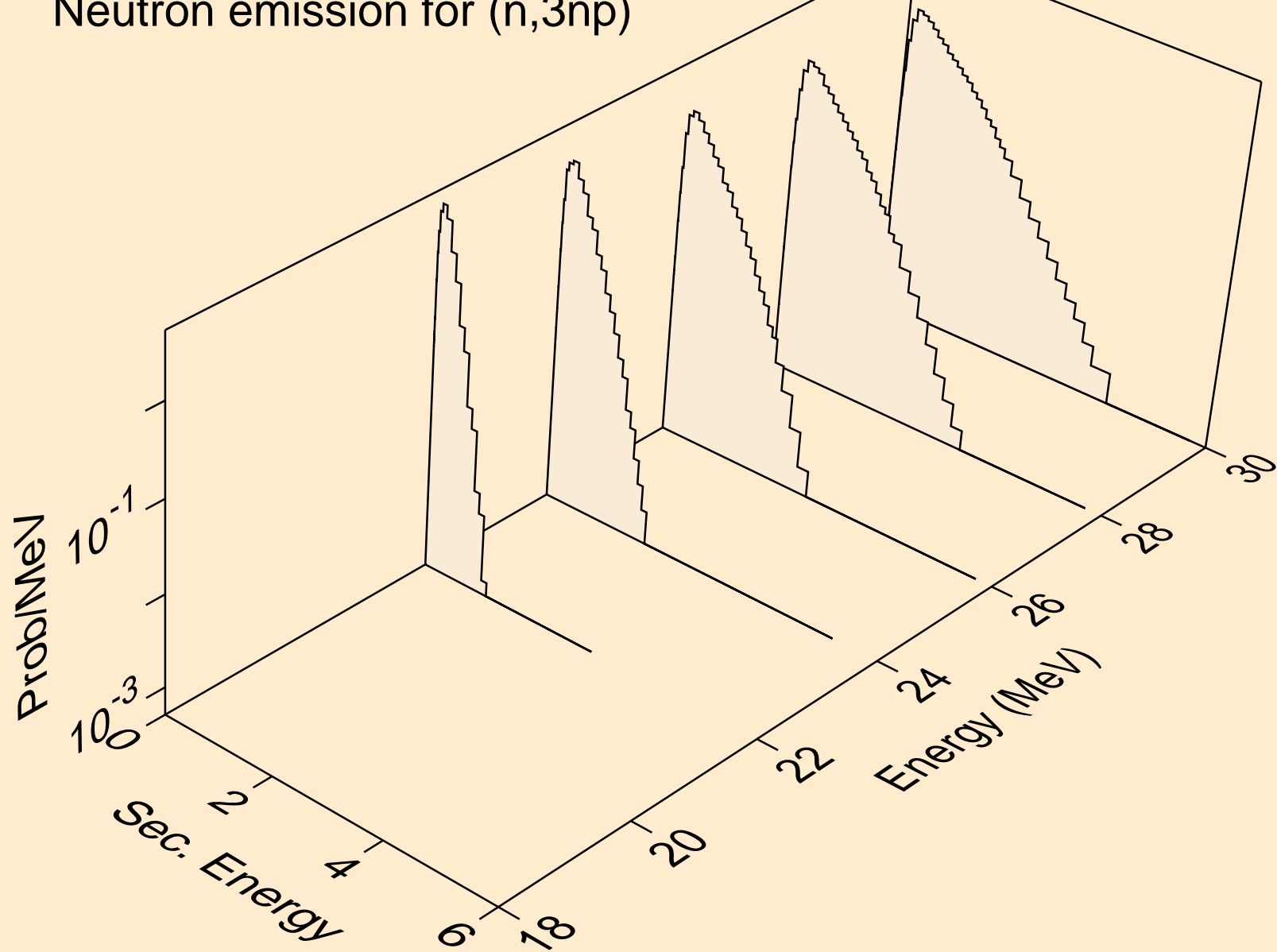

PU238 NEUTRON ACER TENDL-2024 LIBRARY; T=293.6K
Neutron emission for (n,n2p)

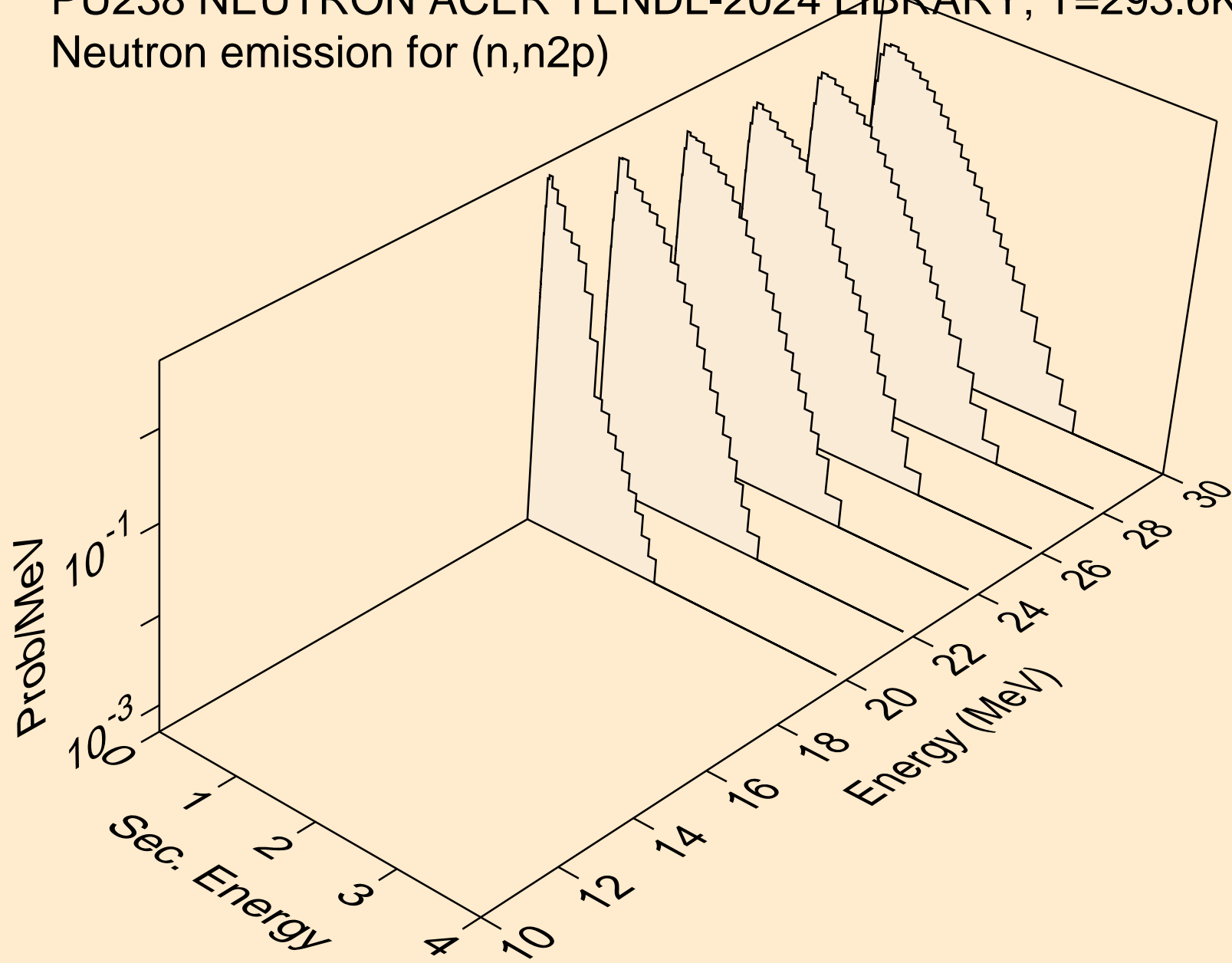

PU238 NEUTRON ACER TENDL-2024 LIBRARY; T=293.6K
Neutron emission for (n,npa)

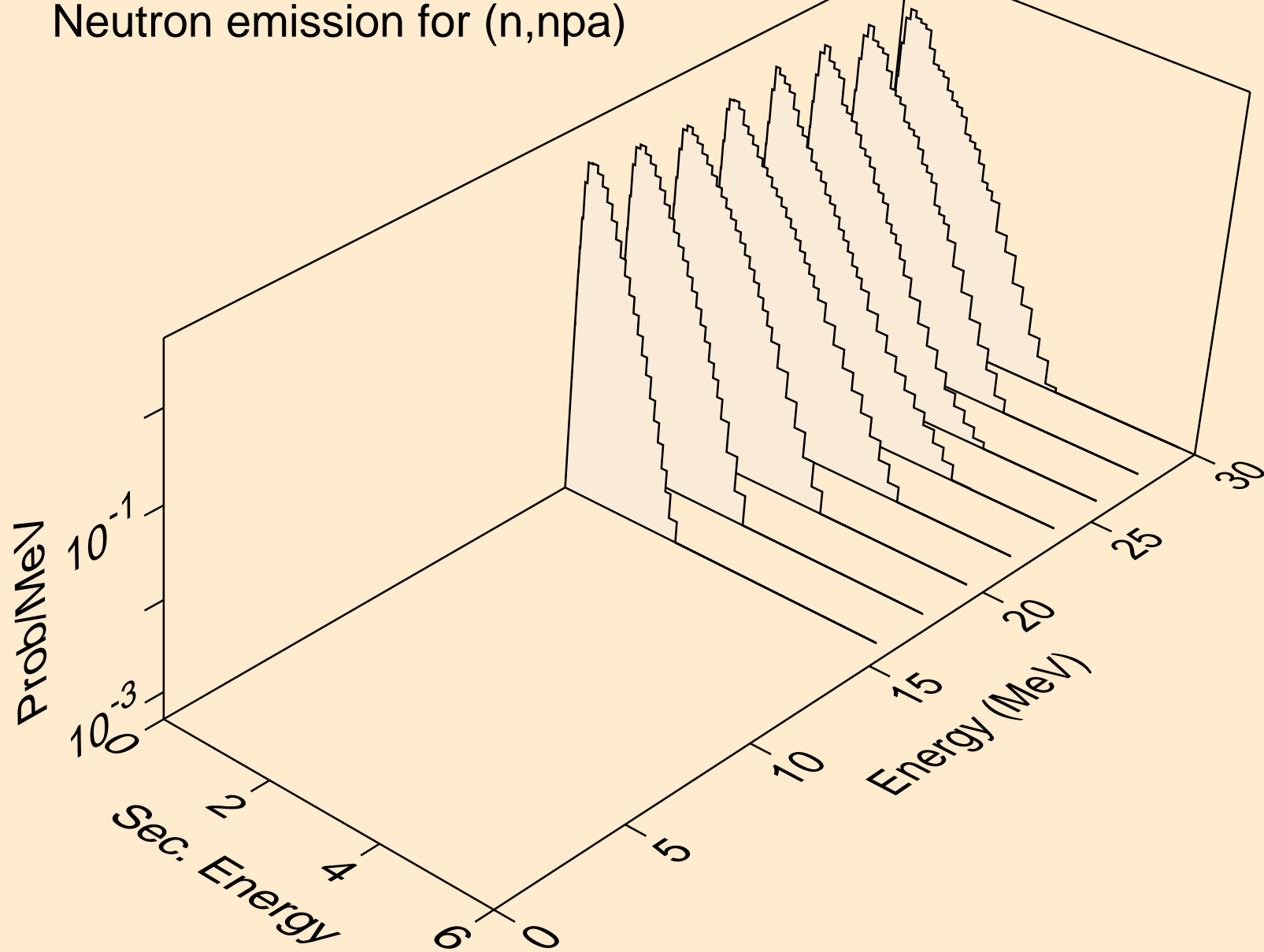

PU238 NEUTRON ACER TENDL-2024 LIBRARY; T=293.6K
Neutron emission for (n,n*c)

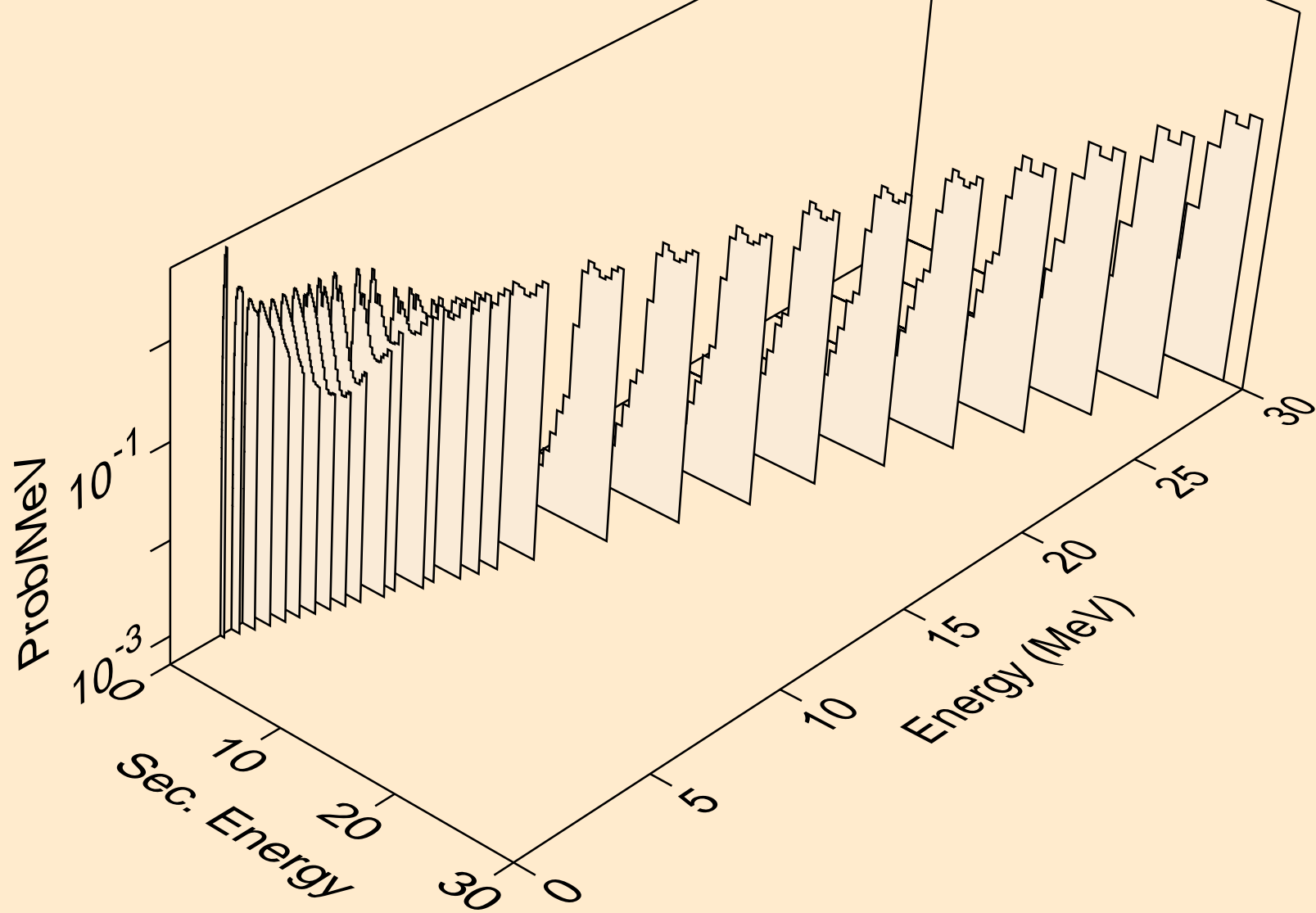

PU238 NEUTRON ACER TENDL-2024 LIBRARY; T=293.6K

Delayed nubar

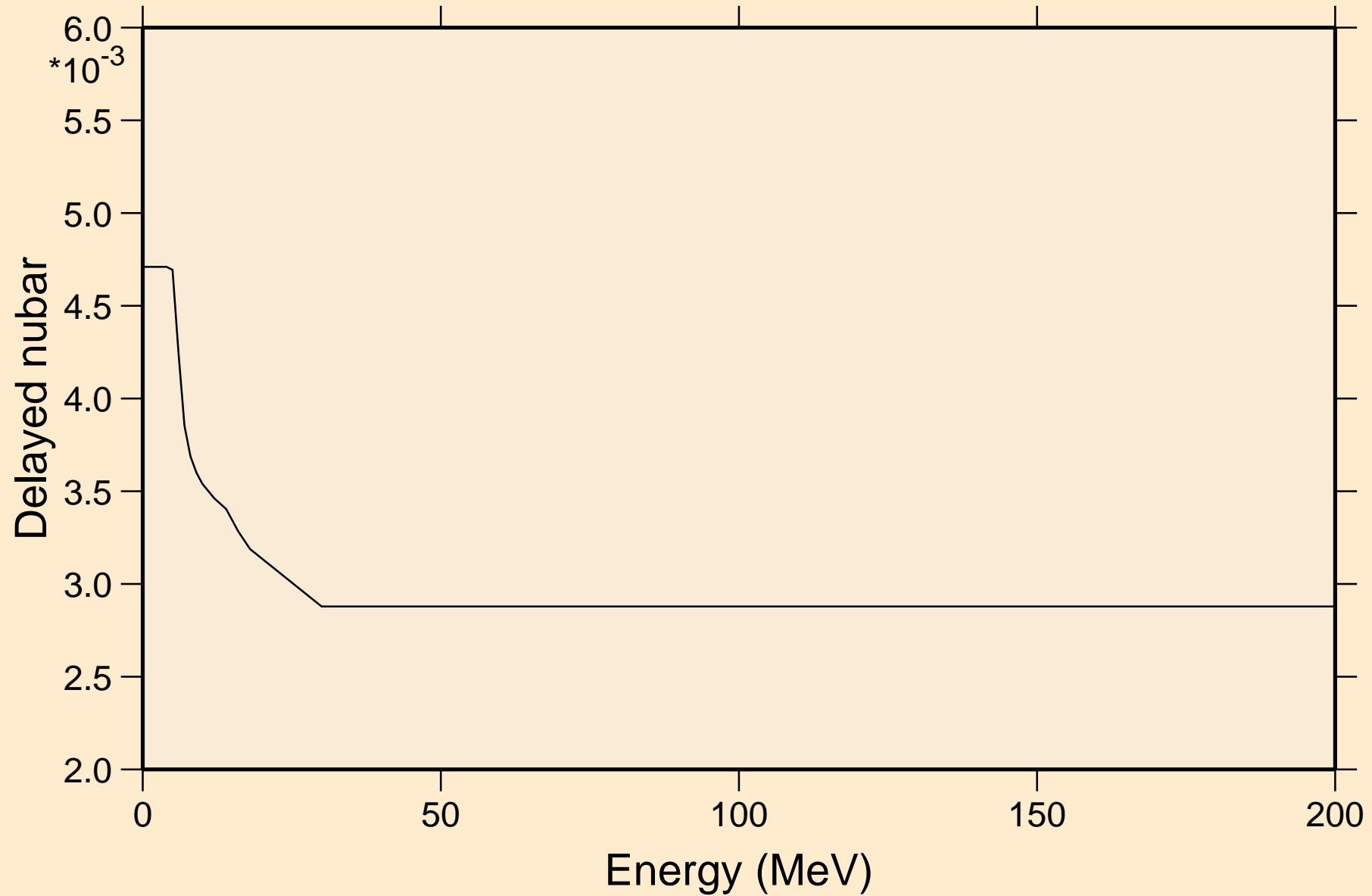

PU238 NEUTRON ACER TENDL-2024 LIBRARY; T=293.6K

Delayed neutron spectra

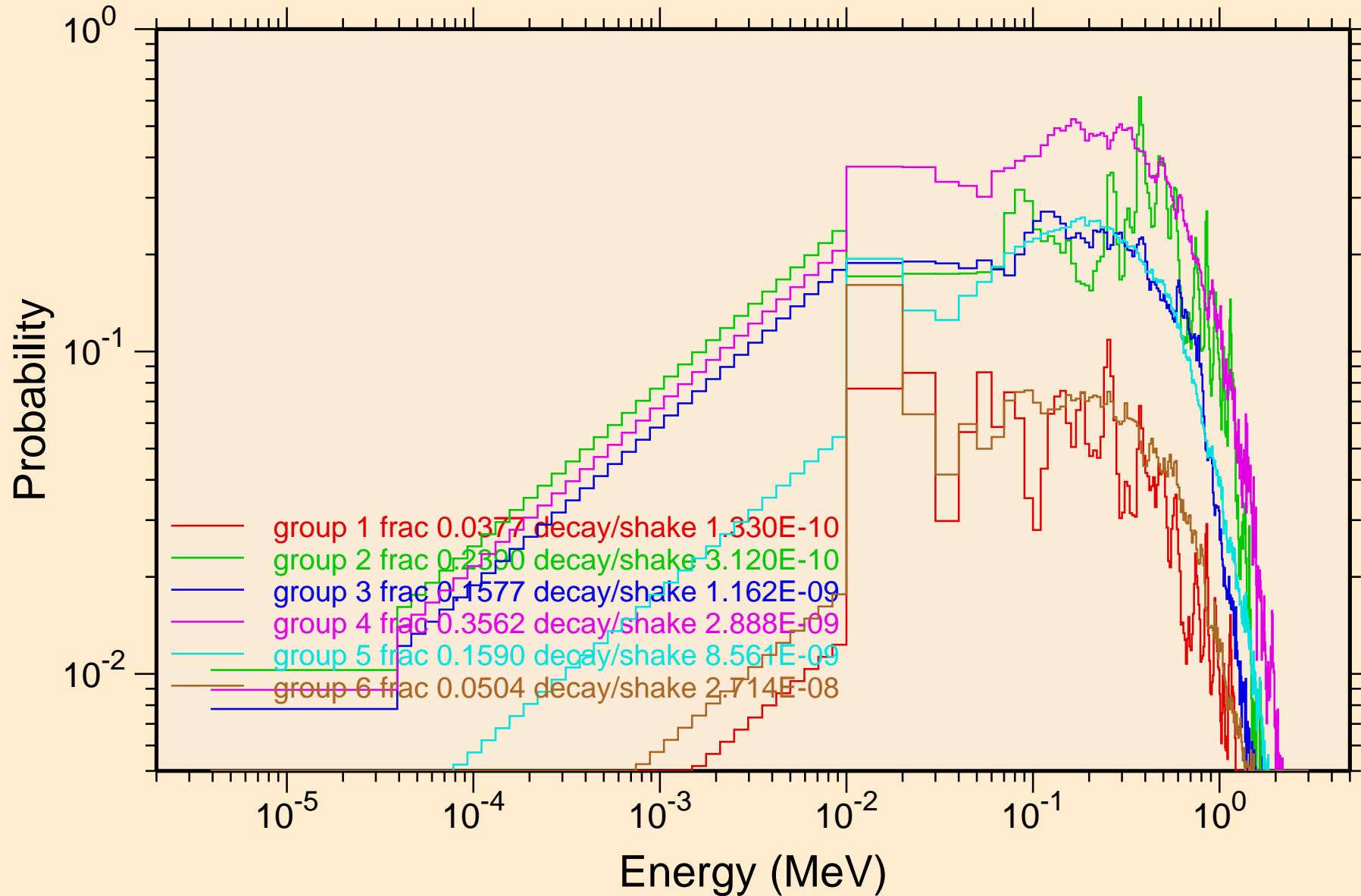

PU238 NEUTRON ACER TENDL-2024 LIBRARY; T=293.6K
Photon emission for (n,x)

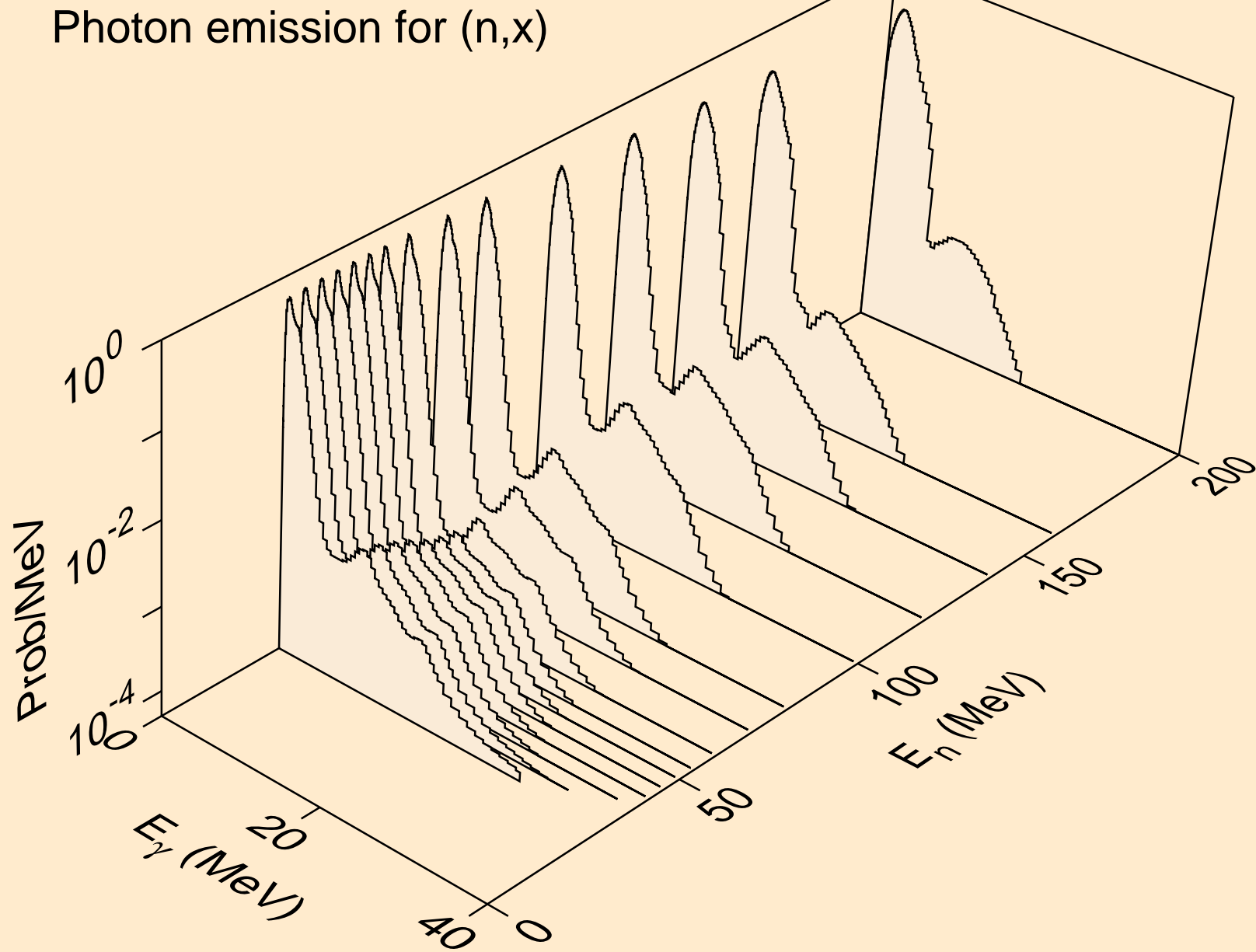

PU238 NEUTRON ACER TENDL-2024 LIBRARY; T=293.6K
Photon emission for (n,2nd)

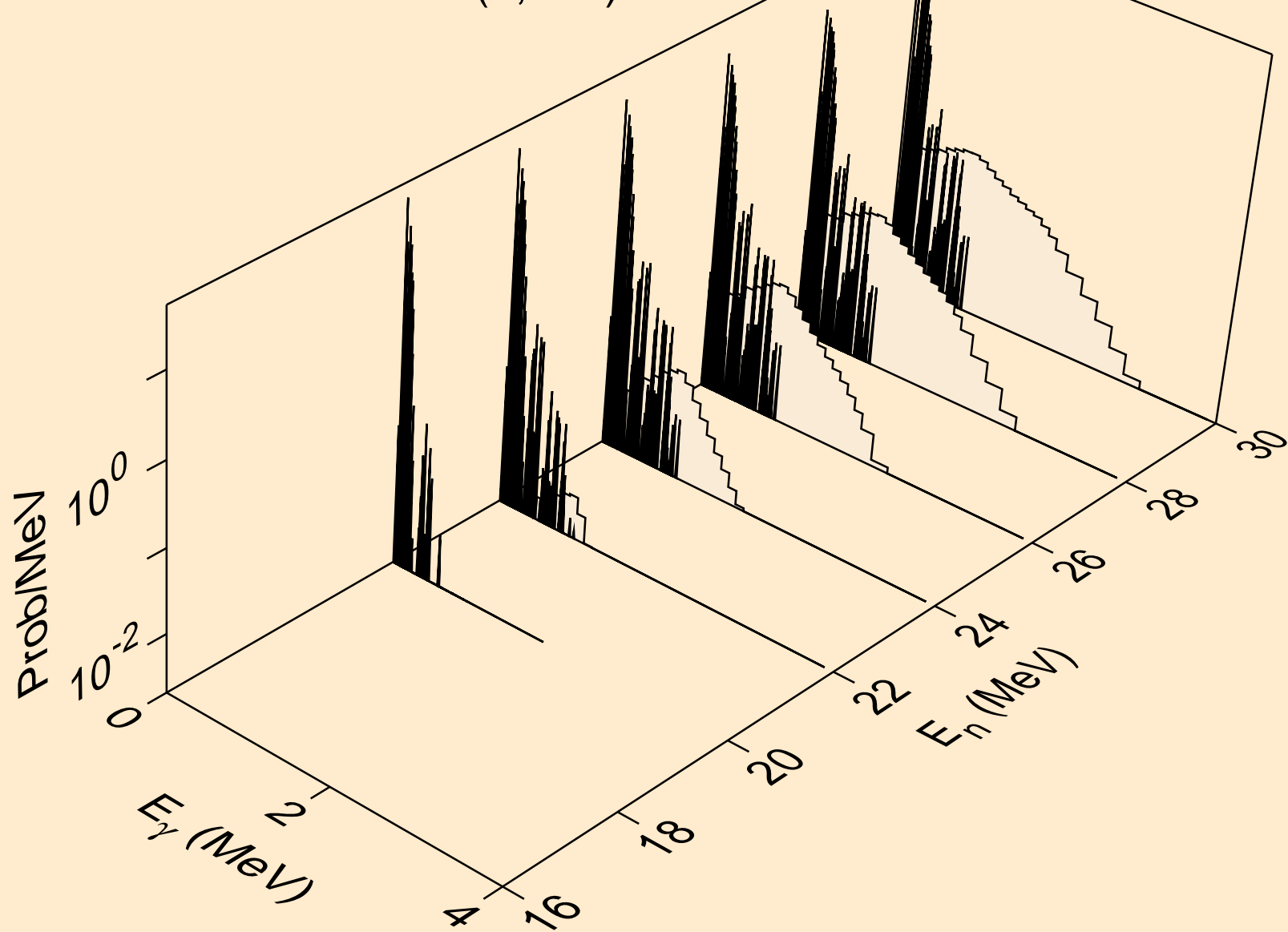

PU238 NEUTRON ACER TENDL-2024 LIBRARY; T=293.6K
Photon emission for (n,2n)

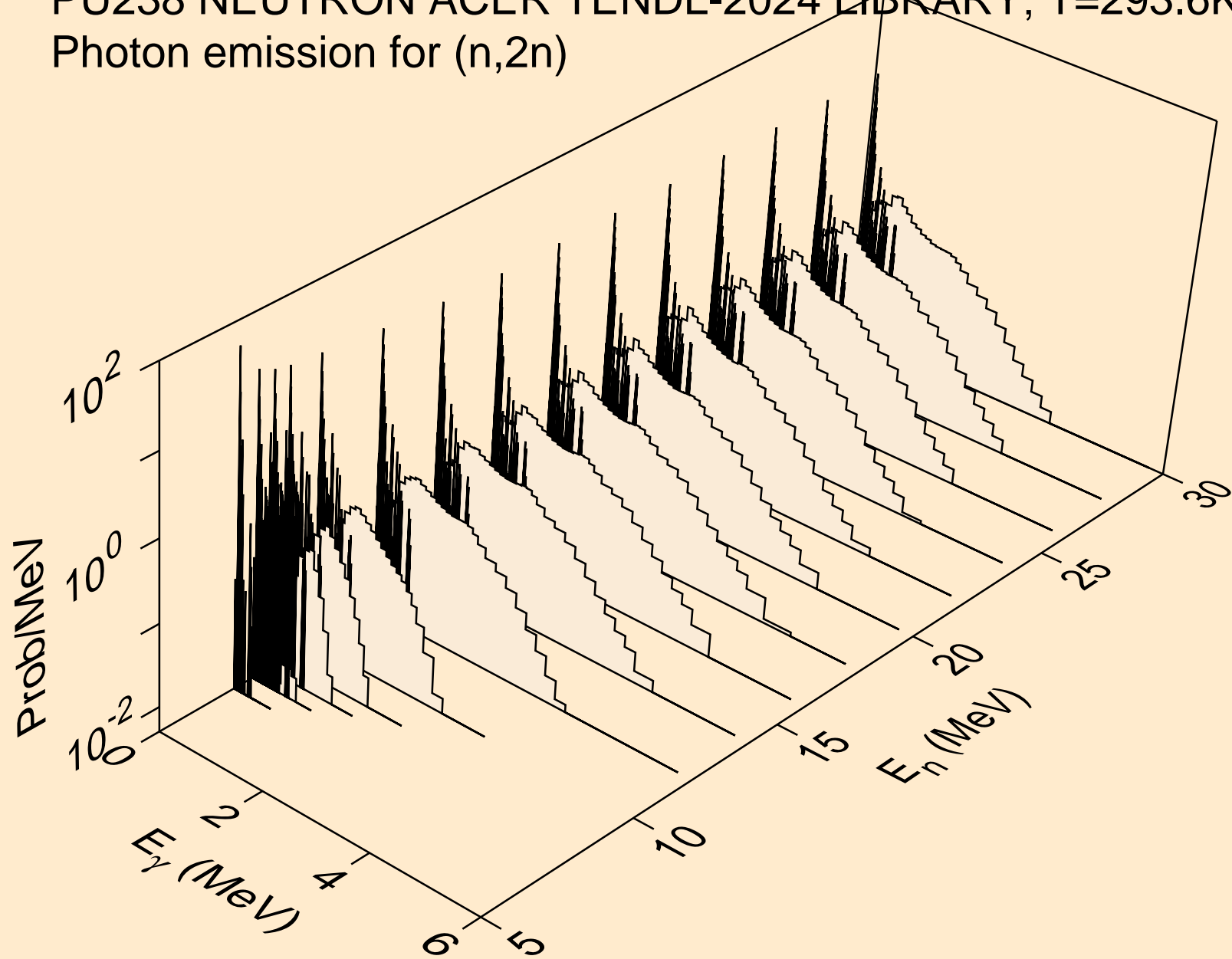

PU238 NEUTRON ACER TENDL-2024 LIBRARY; T=293.6K
Photon emission for (n,3n)

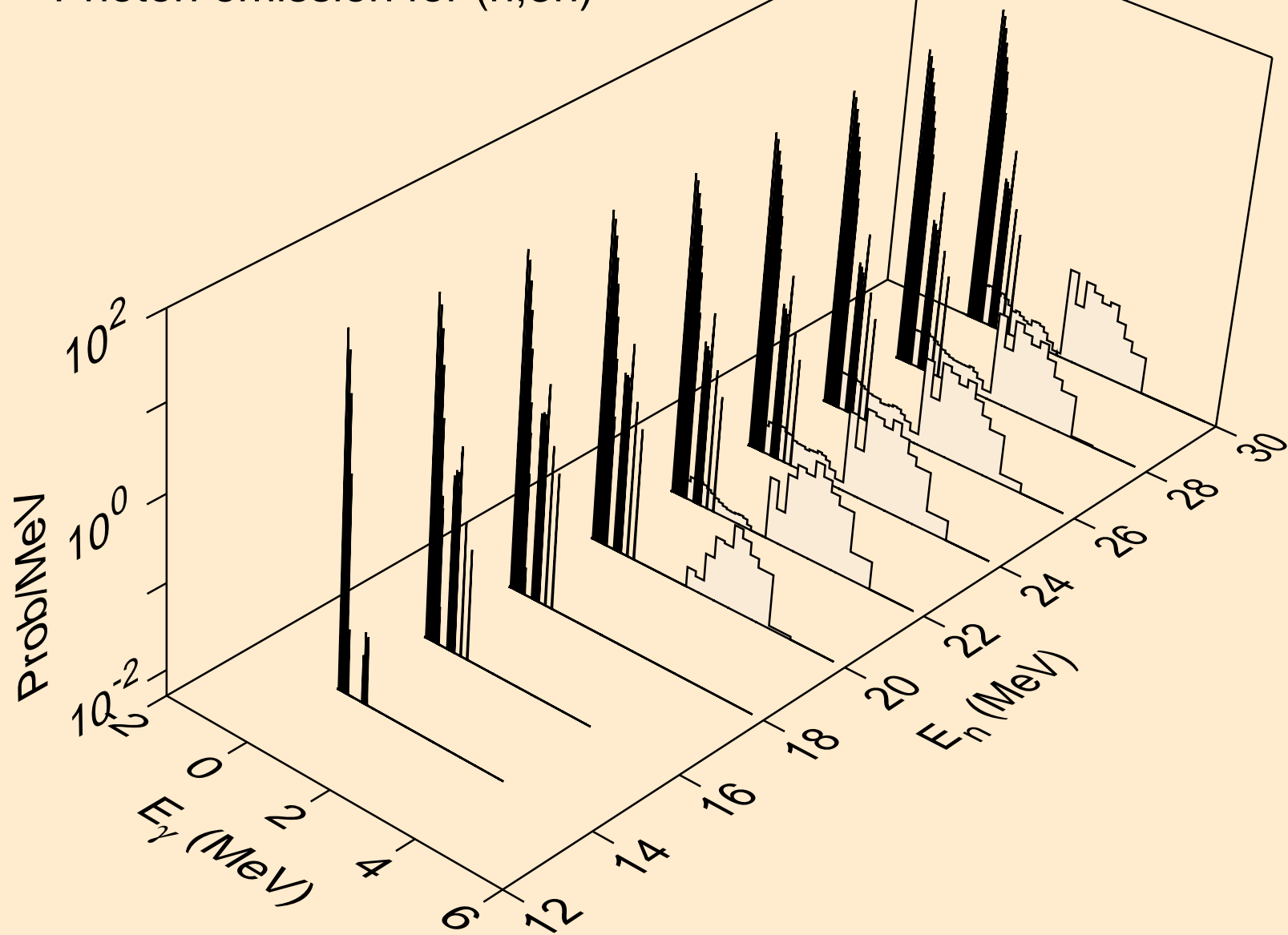

PU238 NEUTRON ACER TENDL-2024 LIBRARY; T=293.6K
Photon emission for (n,n*)a

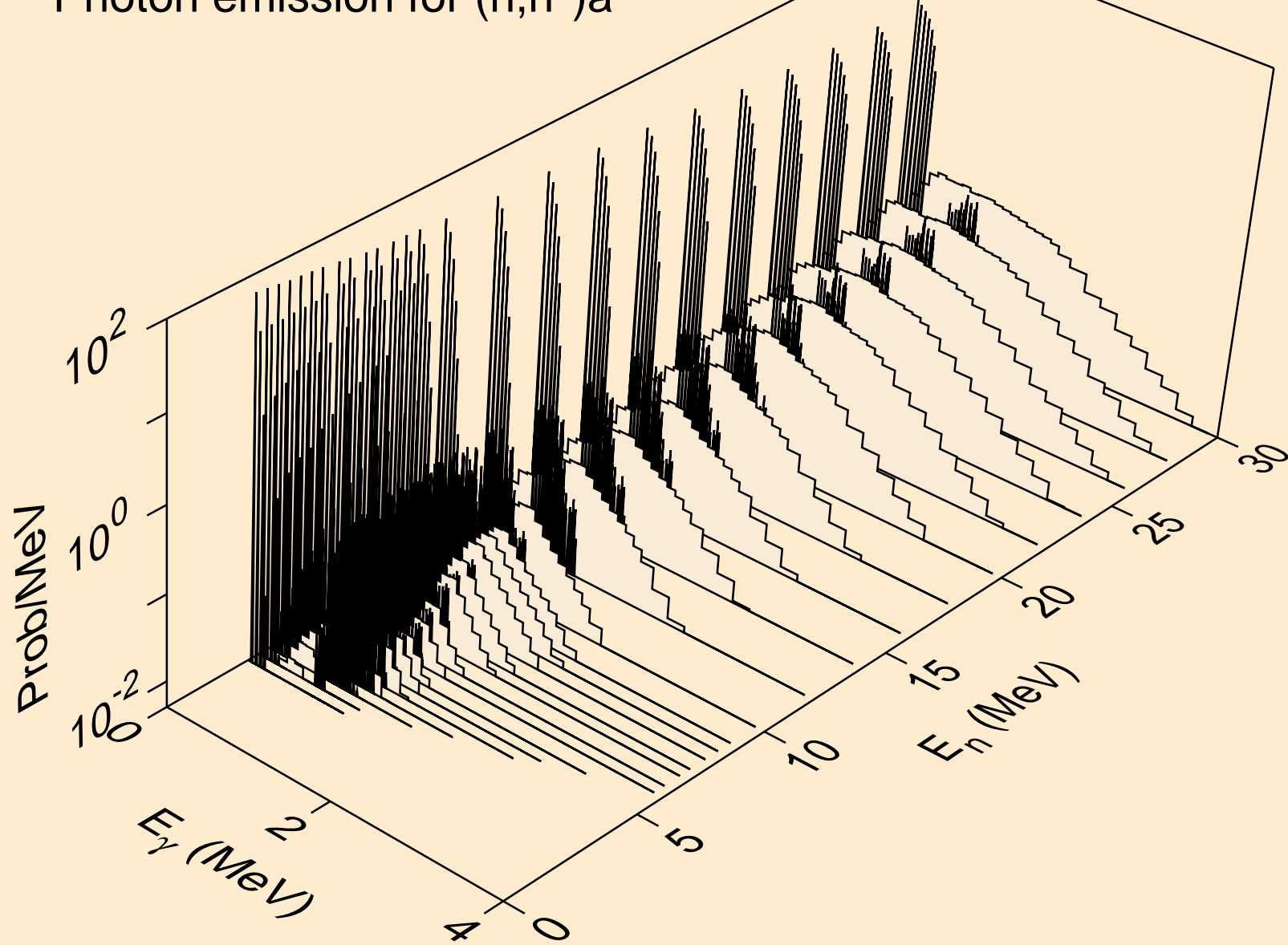

PU238 NEUTRON ACER TENDL-2024 LIBRARY; T=293.6K
Photon emission for (n,2n)a

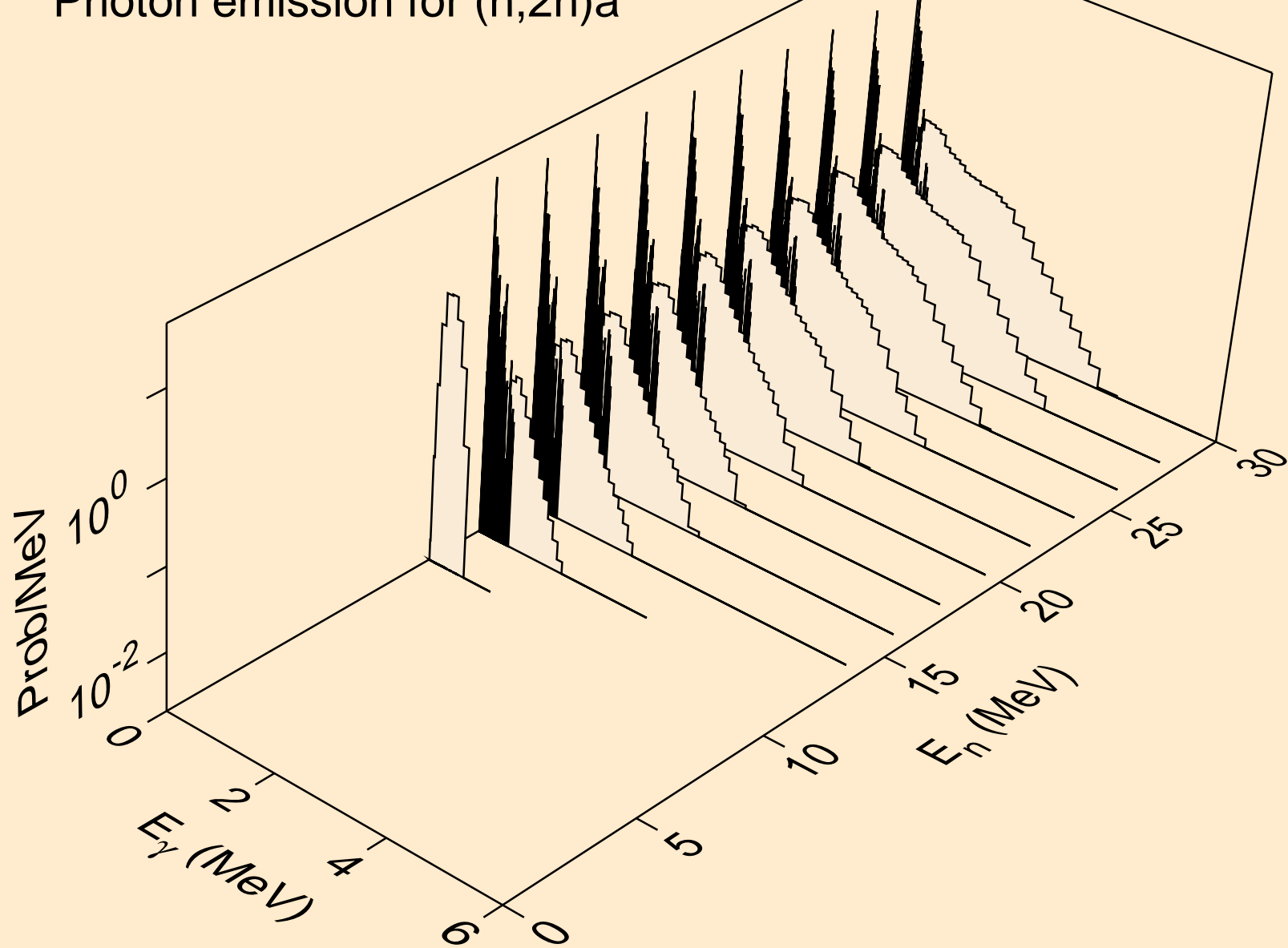

PU238 NEUTRON ACER TENDL-2024 LIBRARY; T=293.6K
Photon emission for (n,3n)a

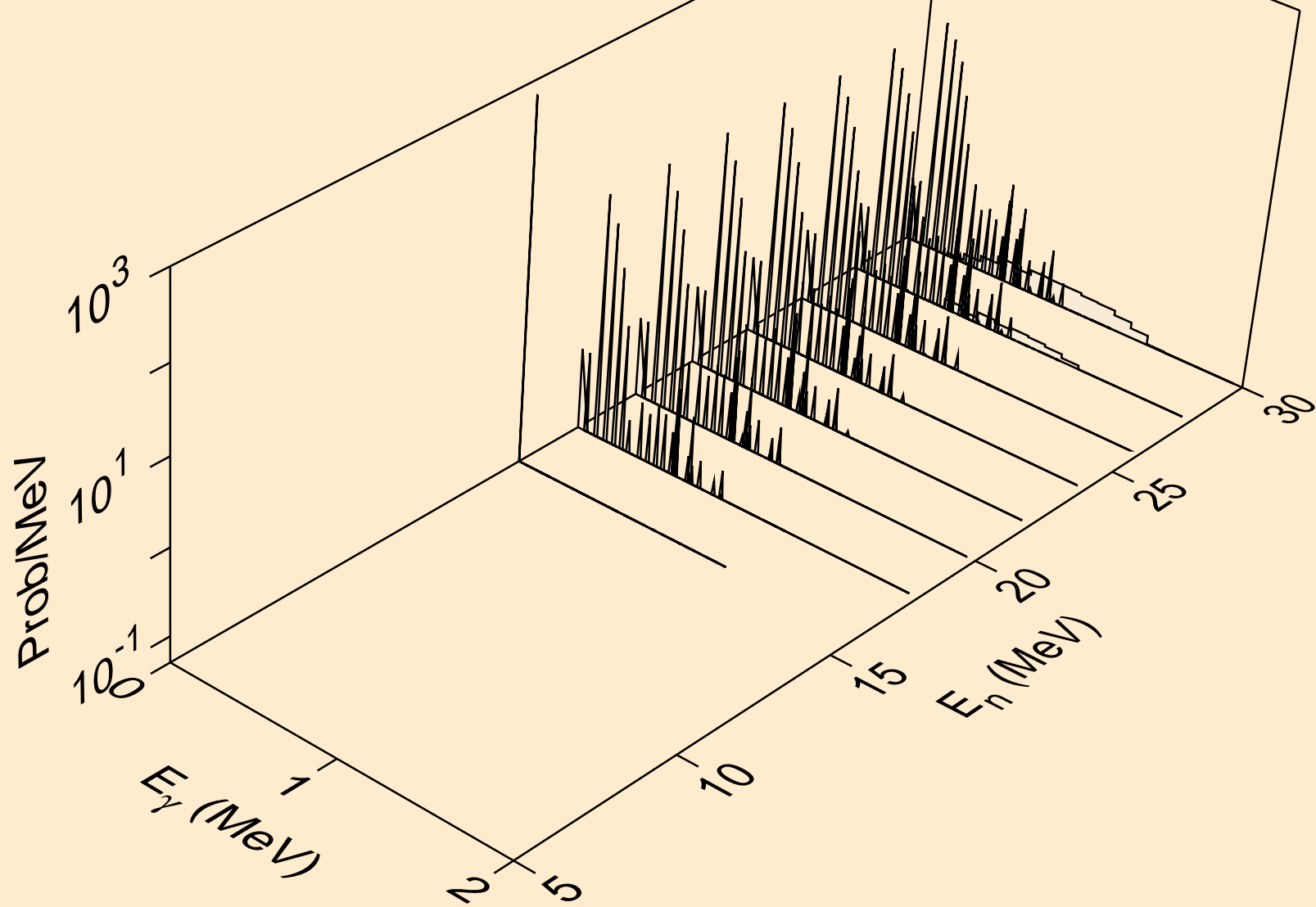

PU238 NEUTRON ACER TENDL-2024 LIBRARY; T=293.6K
Photon emission for (n,n*)p

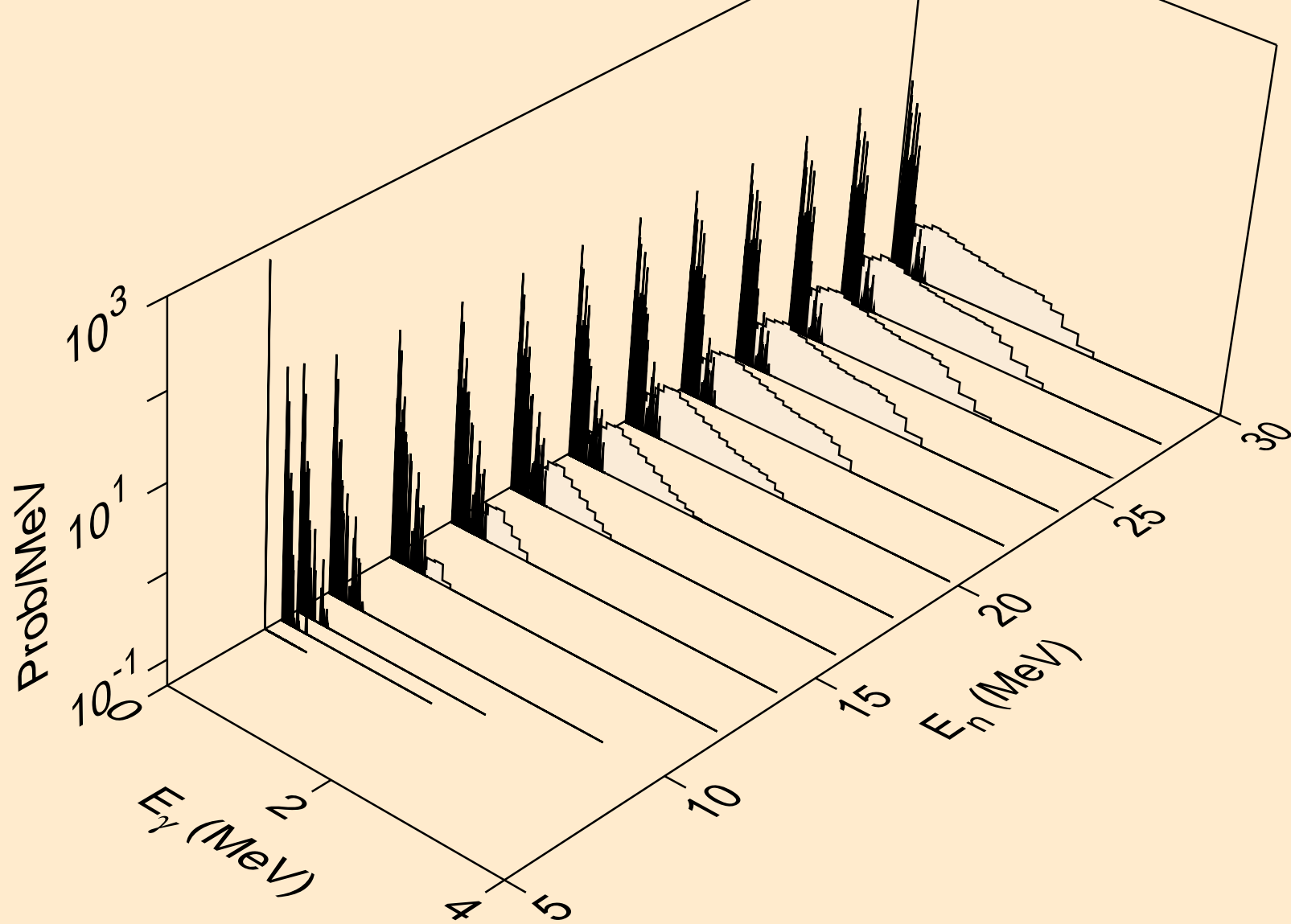

PU238 NEUTRON ACER TENDL-2024 LIBRARY; T=293.6K
Photon emission for (n,n*)2a

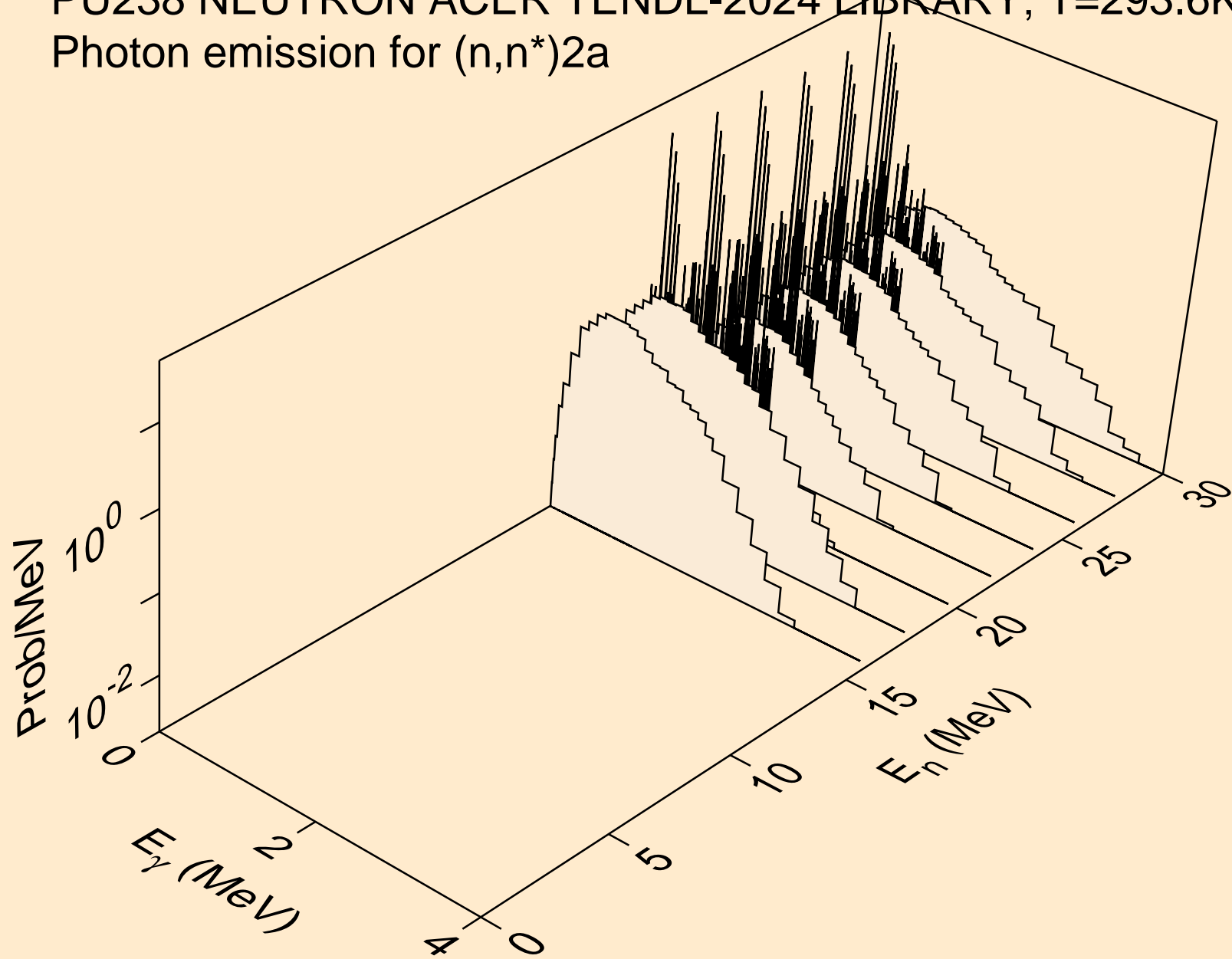

PU238 NEUTRON ACER TENDL-2024 LIBRARY; T=293.6K
Photon emission for (n,n*)d

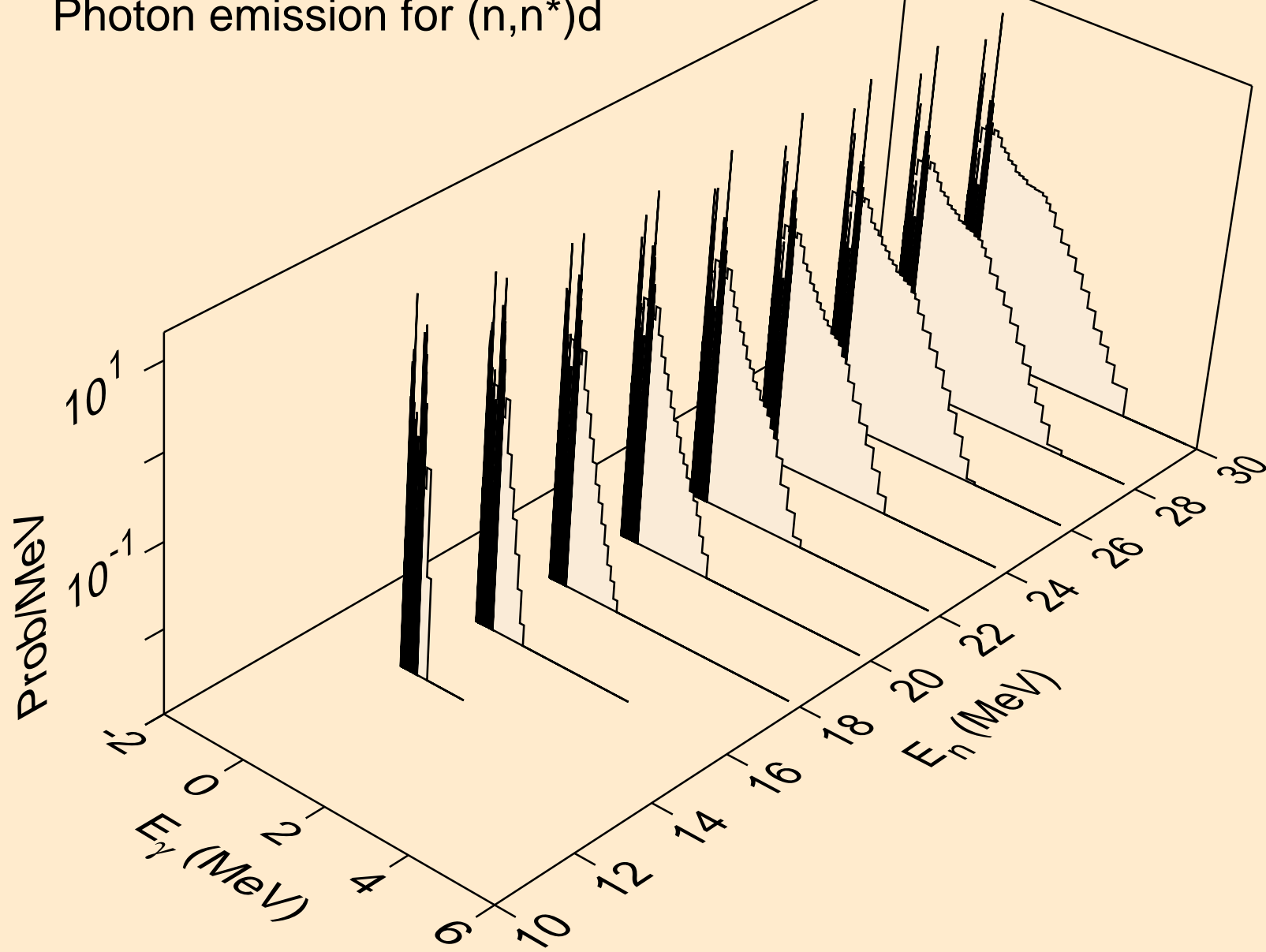

PU238 NEUTRON ACER TENDL-2024 LIBRARY; T=293.6K
Photon emission for (n,n*)t

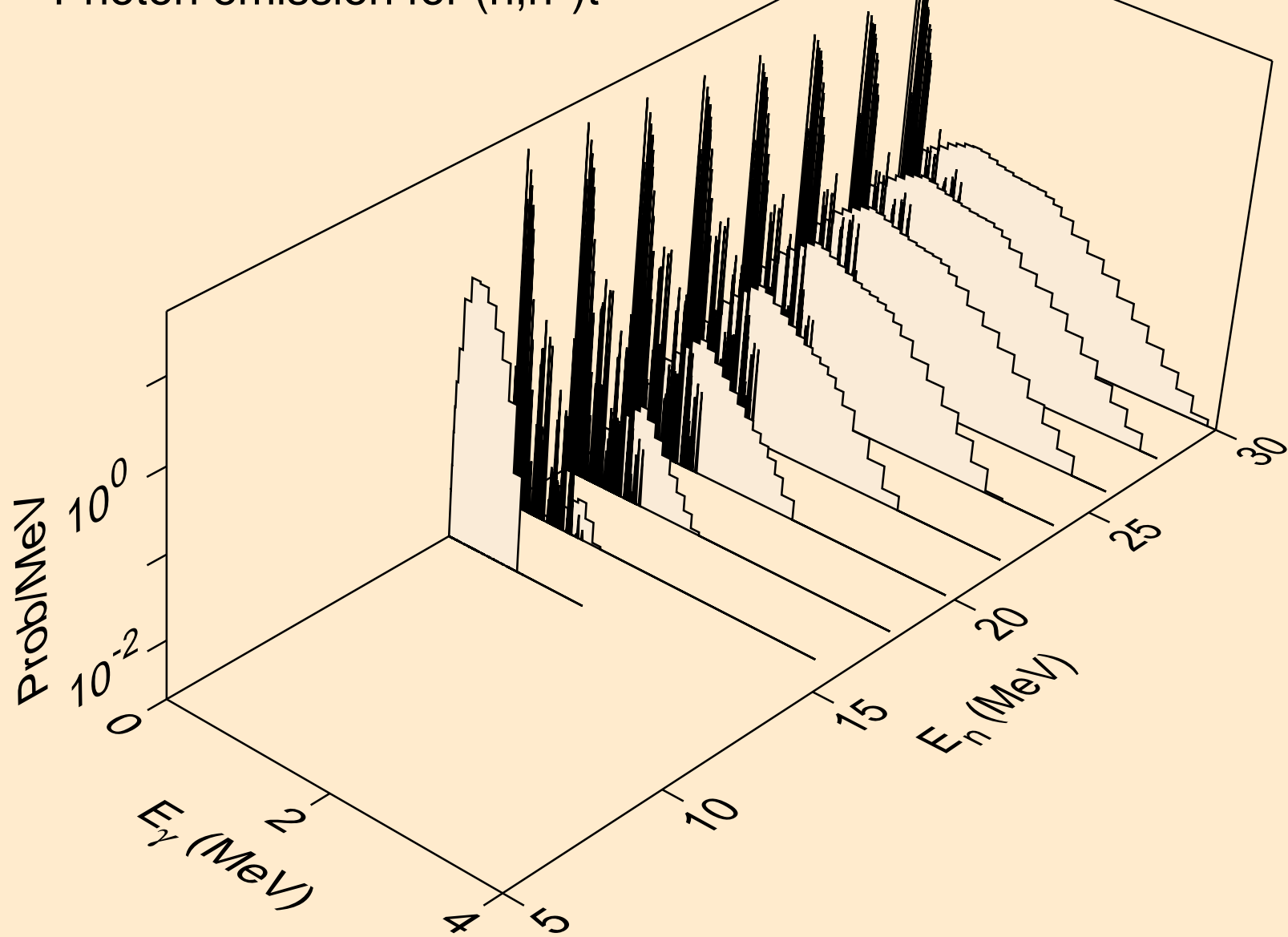

PU238 NEUTRON ACER TENDL-2024 LIBRARY; T=293.6K
Photon emission for (n,n*)he3

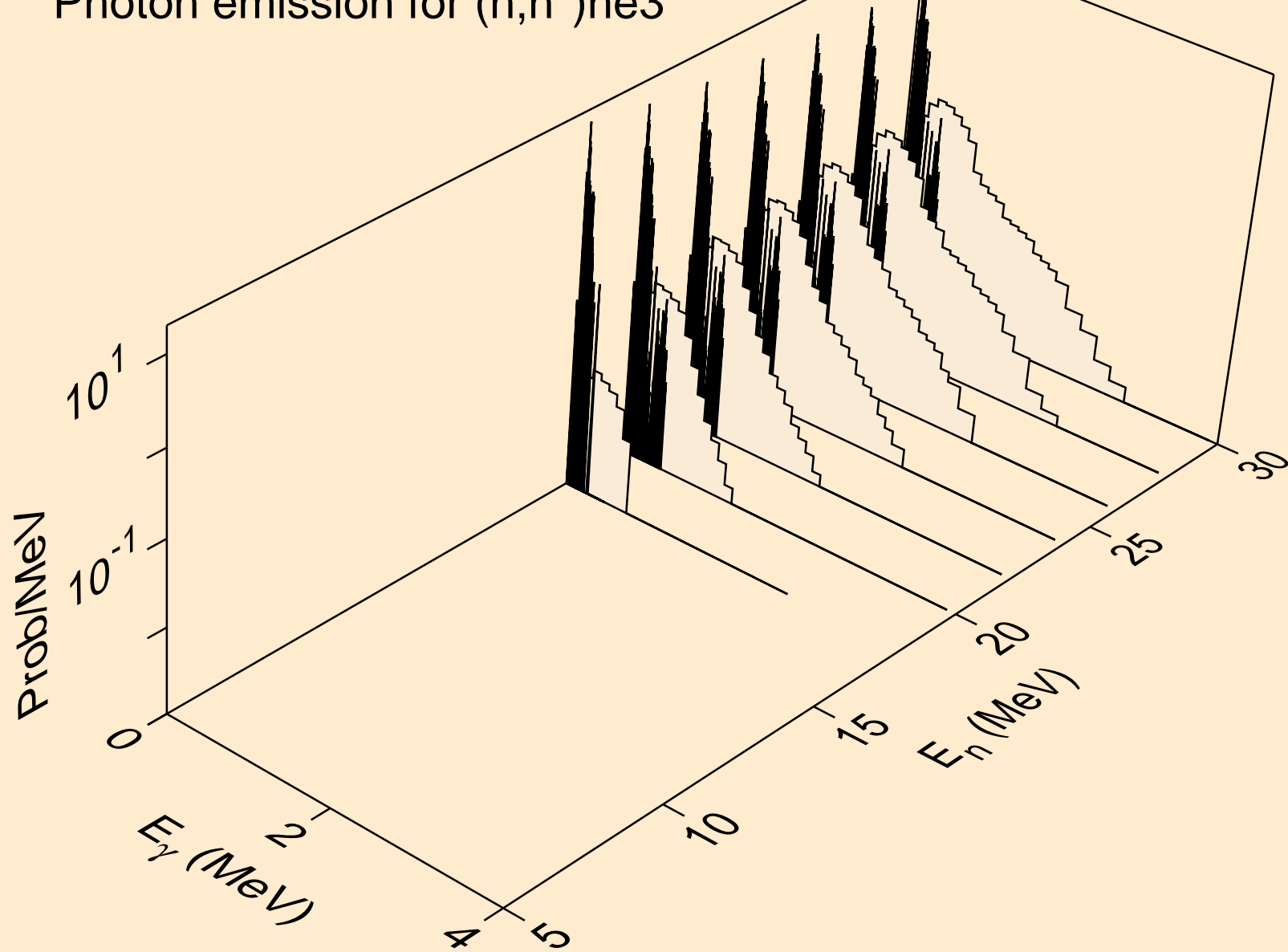

PU238 NEUTRON ACER TENDL-2024 LIBRARY; T=293.6K
Photon emission for (n,4n)

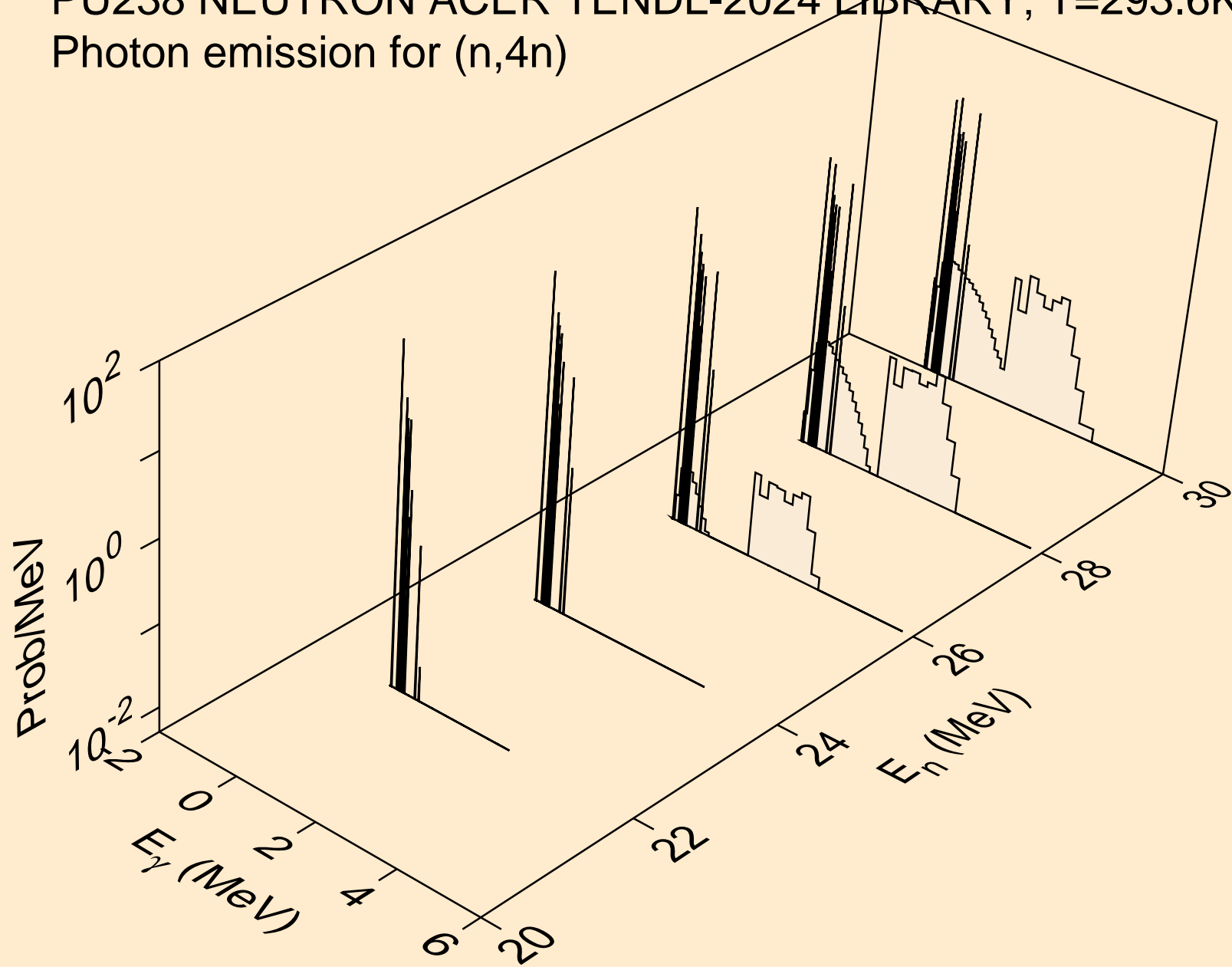

PU238 NEUTRON ACER TENDL-2024 LIBRARY; T=293.6K
Photon emission for (n,2np)

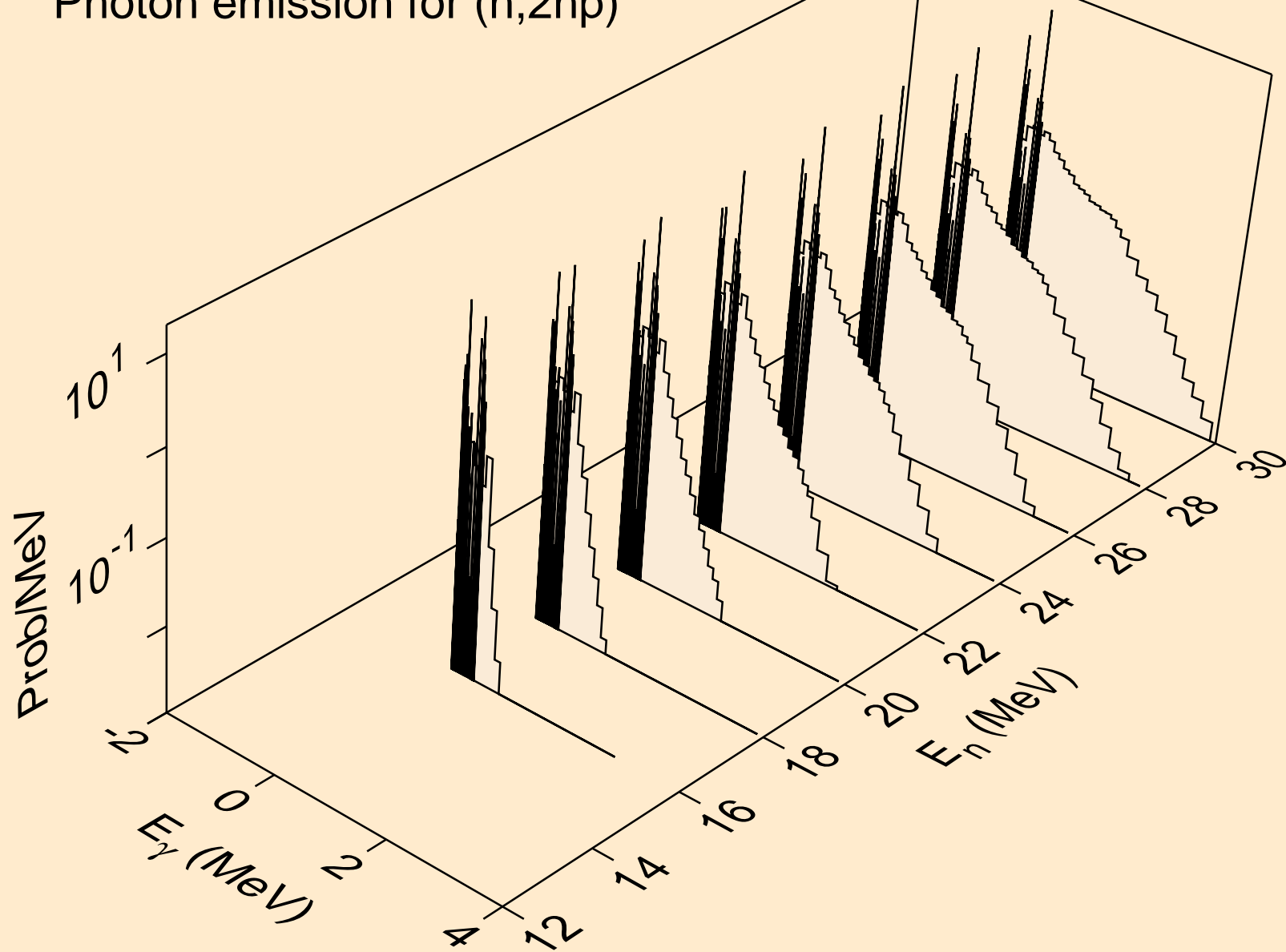

PU238 NEUTRON ACER TENDL-2024 LIBRARY; T=293.6K
Photon emission for (n,3np)

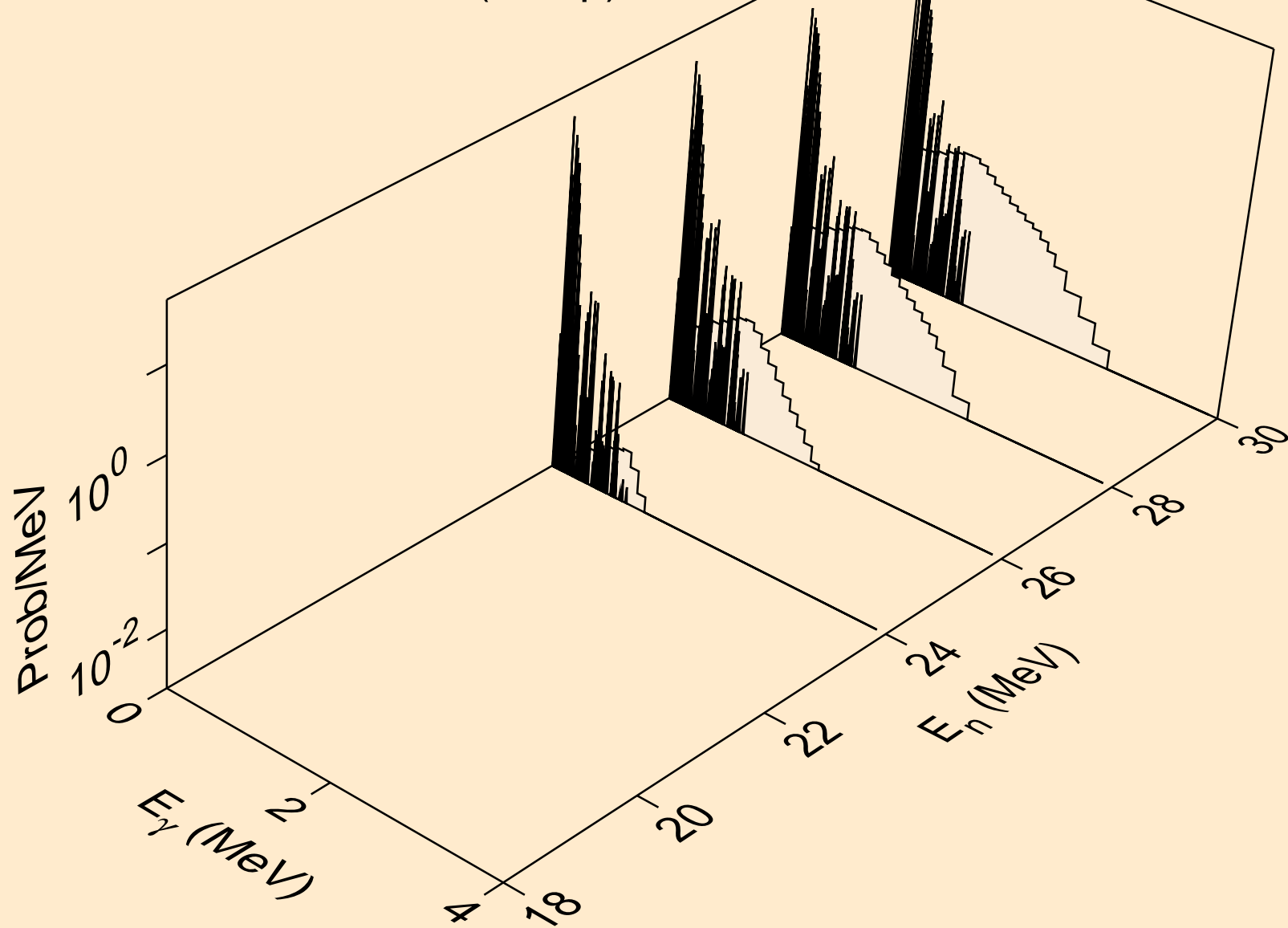

PU238 NEUTRON ACER TENDL-2024 LIBRARY; T=293.6K
Photon emission for (n,n2p)

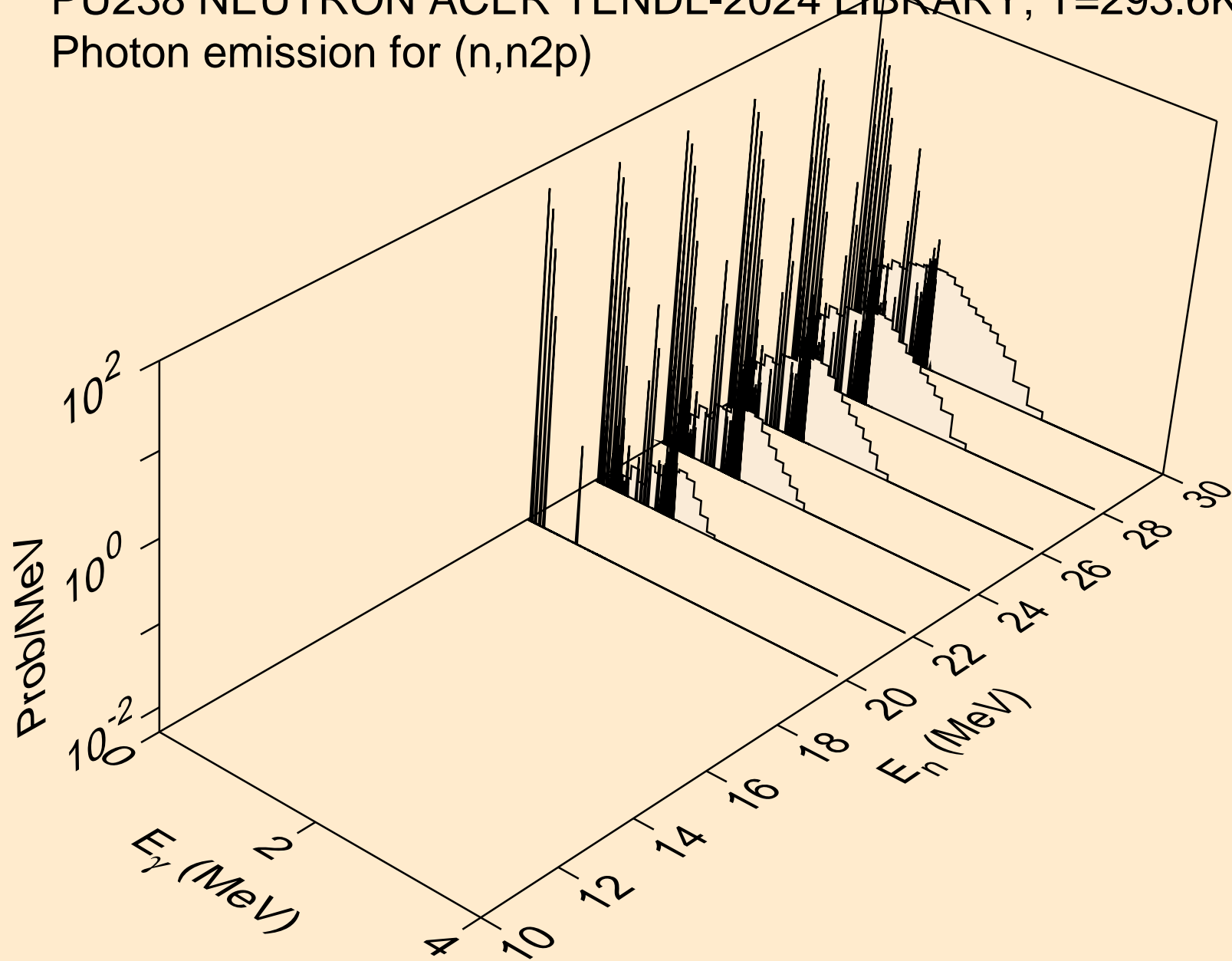

PU238 NEUTRON ACER TENDL-2024 LIBRARY; T=293.6K
Photon emission for (n,npa)

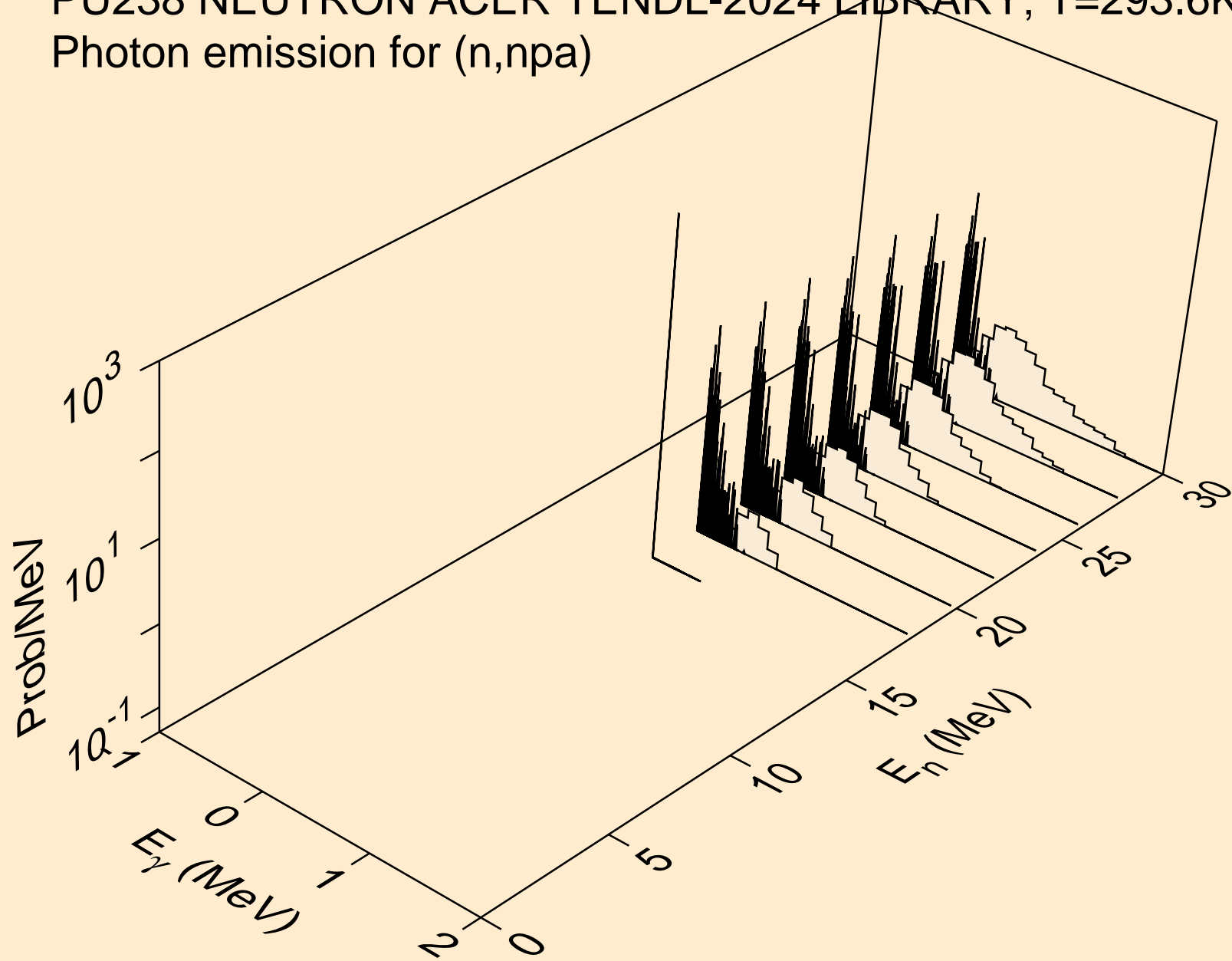

PU238 NEUTRON ACER TENDL-2024 LIBRARY; T=293.6K
Photon emission for (n,n*c)

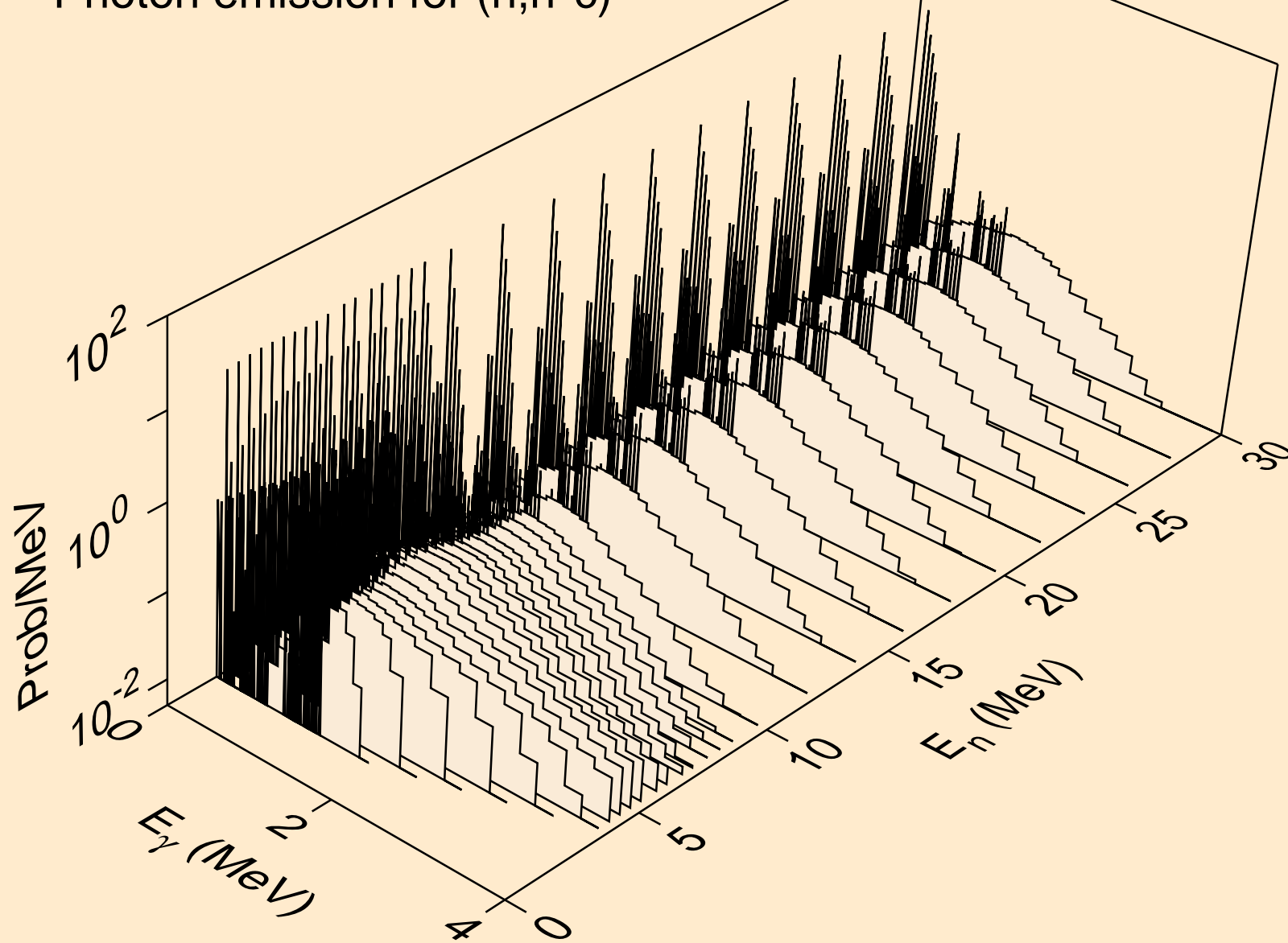

PU238 NEUTRON ACER TENDL-2024 LIBRARY; T=293.6K
Photon emission for (n,gma)

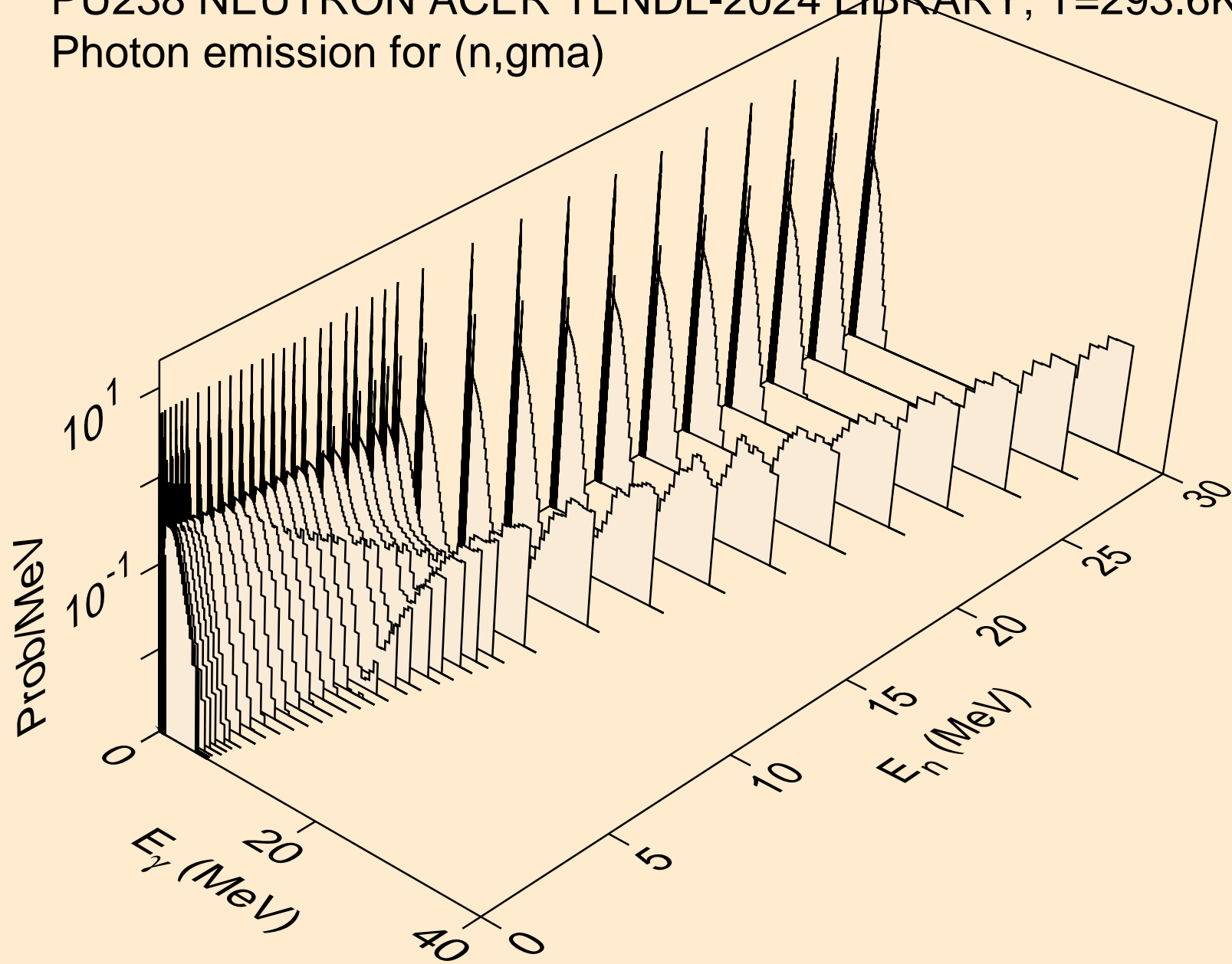

PU238 NEUTRON ACER TENDL-2024 LIBRARY; T=293.6K
Photon emission for (n,p)

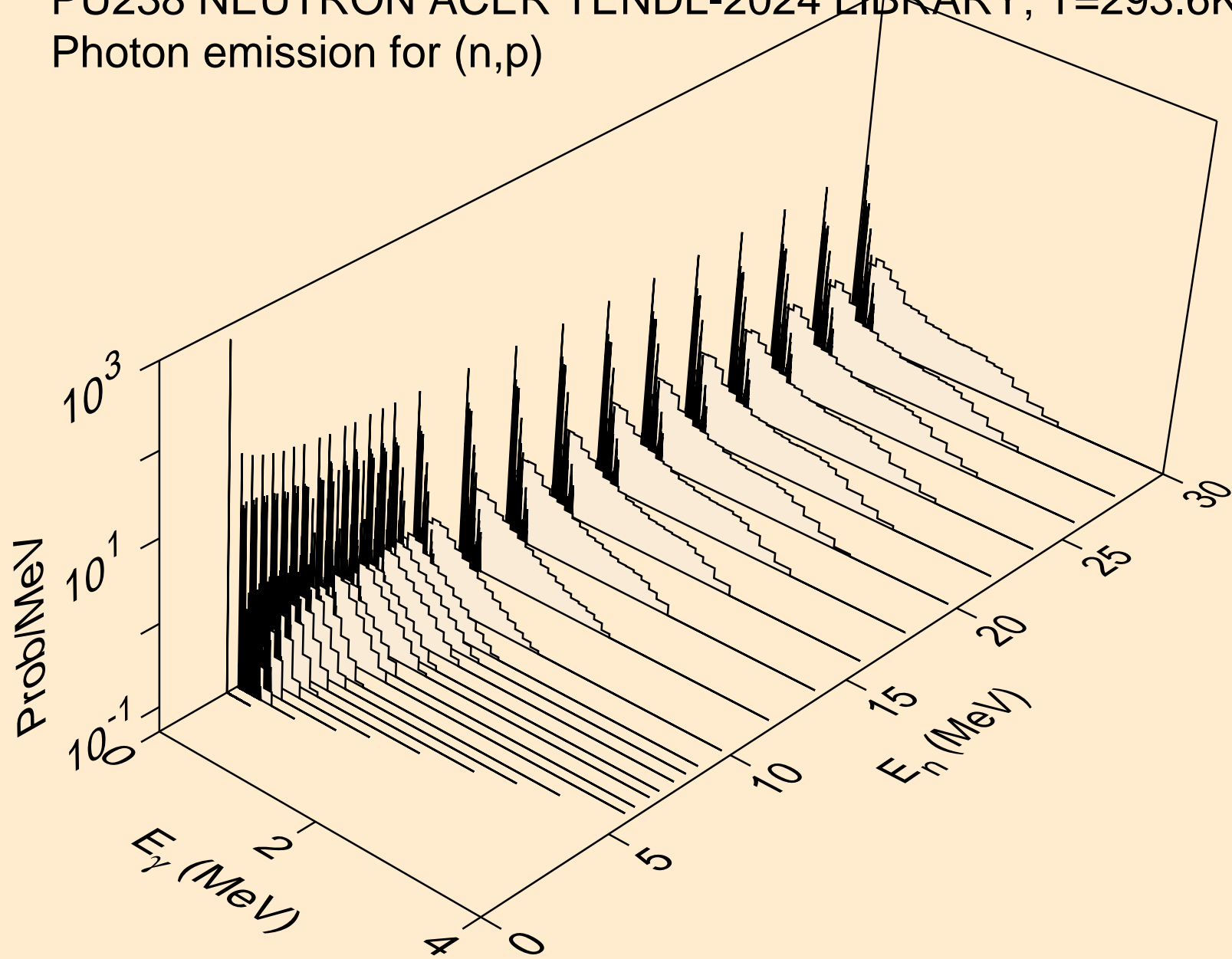

PU238 NEUTRON ACER TENDL-2024 LIBRARY; T=293.6K
Photon emission for (n,d)

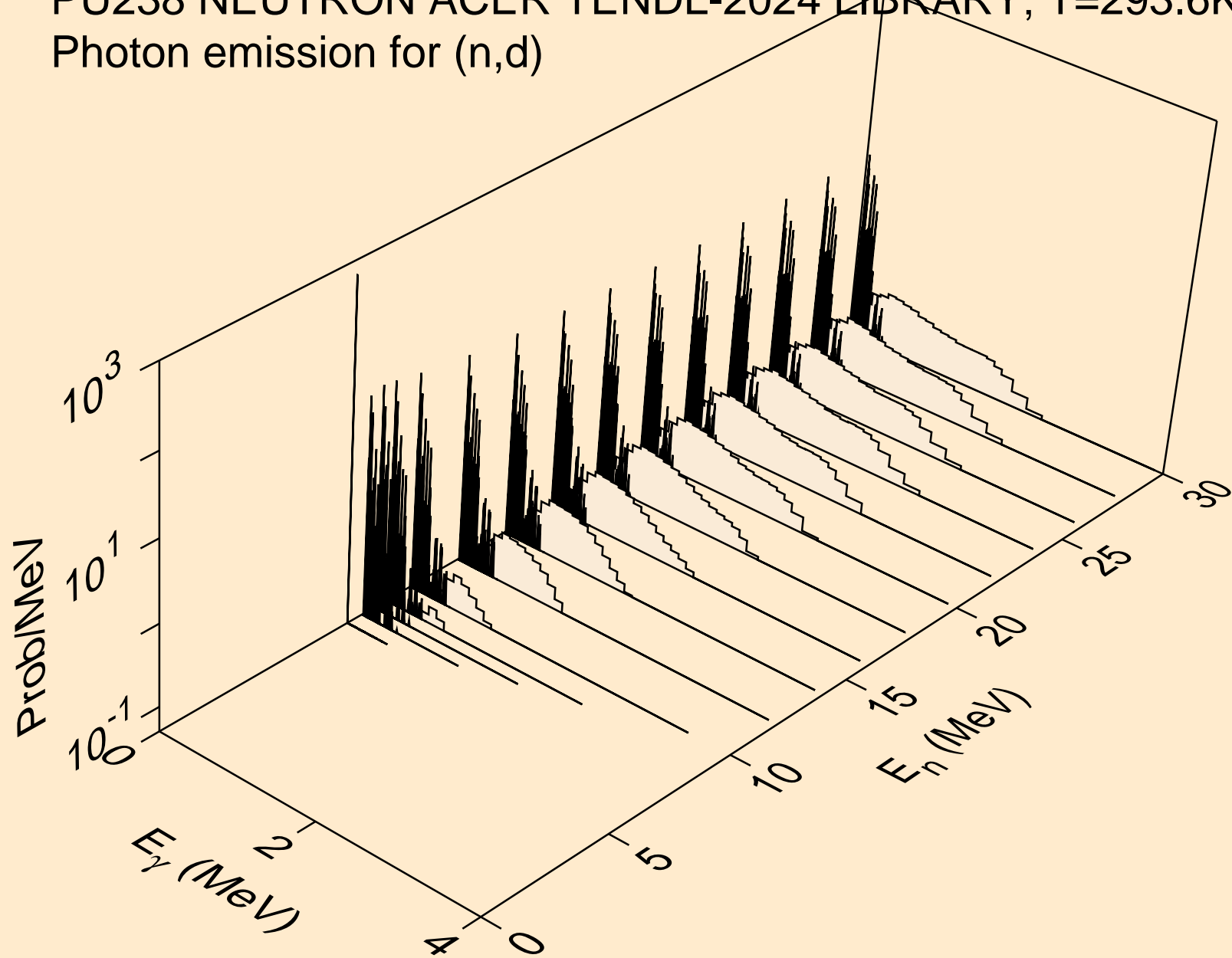

PU238 NEUTRON ACER TENDL-2024 LIBRARY; T=293.6K
Photon emission for (n,t)

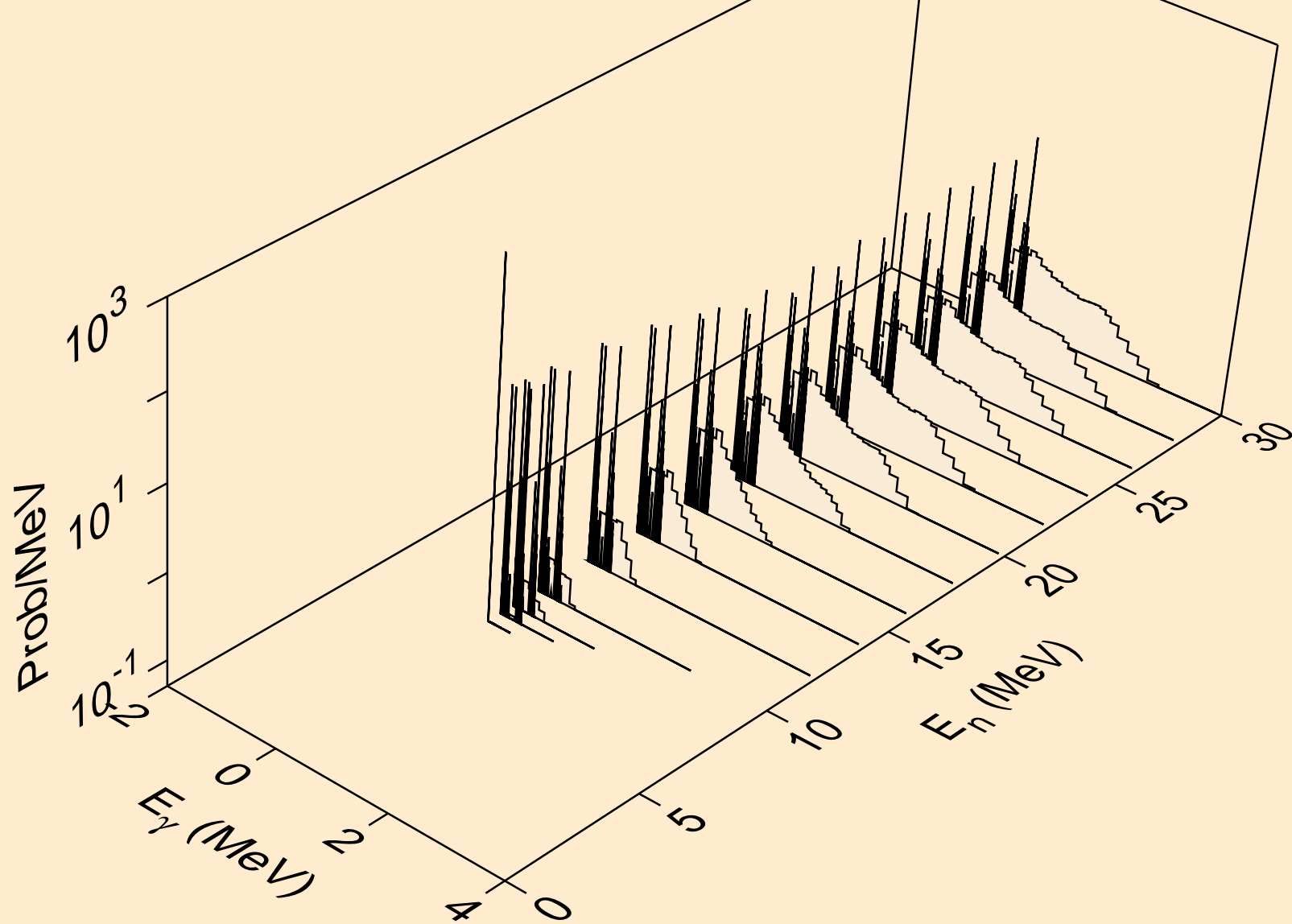

PU238 NEUTRON ACER TENDL-2024 LIBRARY; T=293.6K
Photon emission for (n,he3)

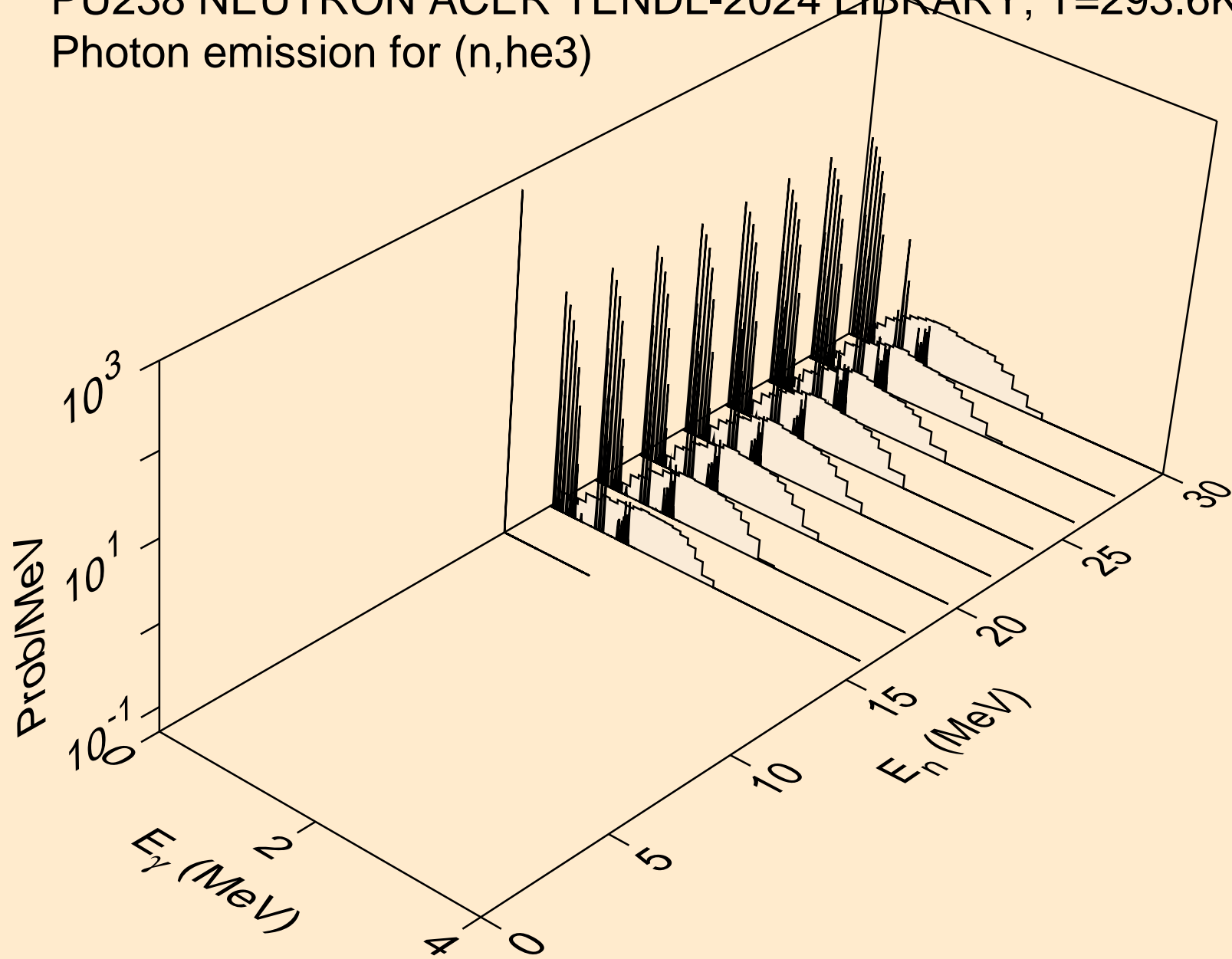

PU238 NEUTRON ACER TENDL-2024 LIBRARY; T=293.6K
Photon emission for (n,a)

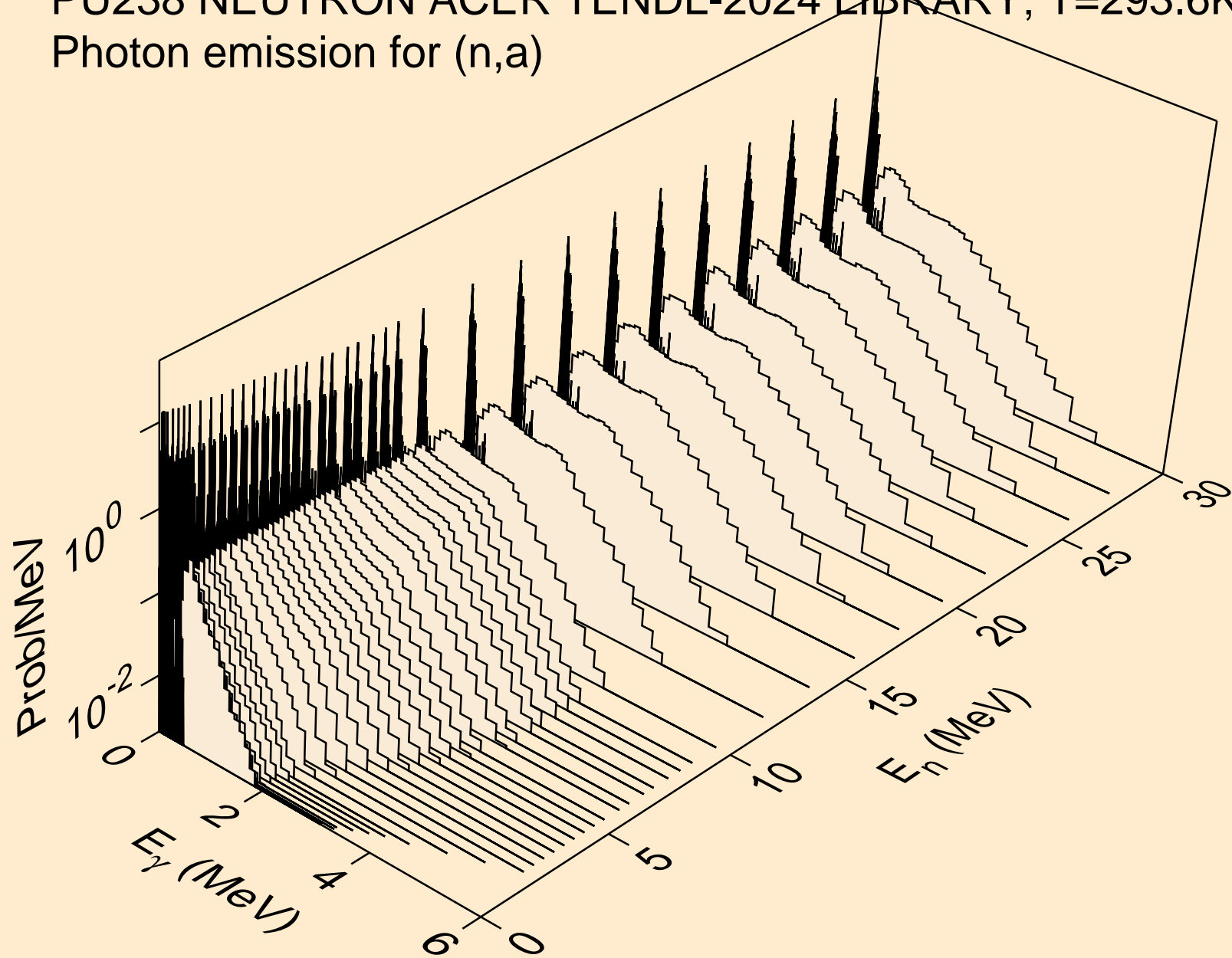

PU238 NEUTRON ACER TENDL-2024 LIBRARY; T=293.6K
Photon emission for (n,2a)

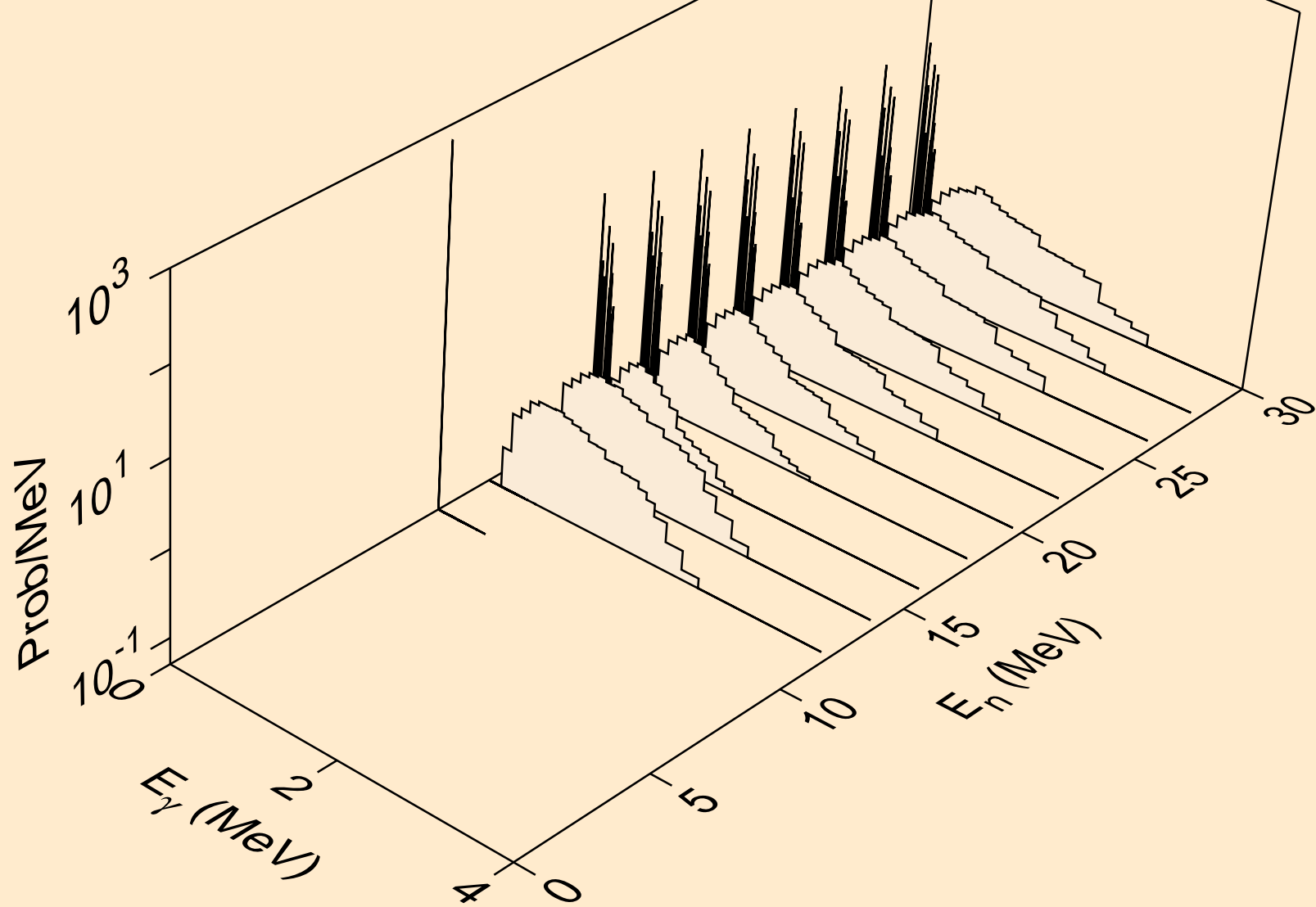

PU238 NEUTRON ACER TENDL-2024 LIBRARY; T=293.6K
Photon emission for (n,2p)

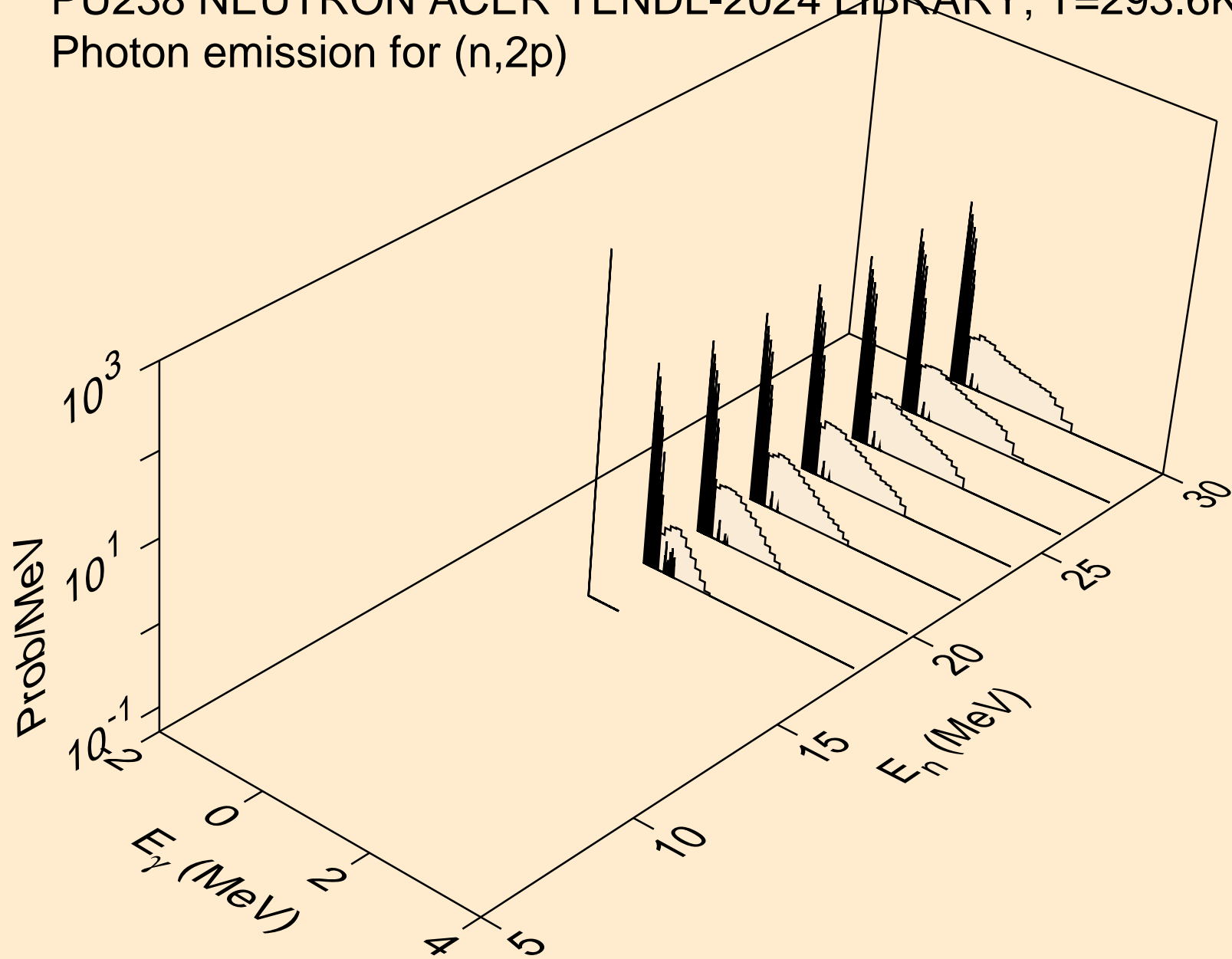

PU238 NEUTRON ACER TENDL-2024 LIBRARY; T=293.6K
Photon emission for (n,p α)

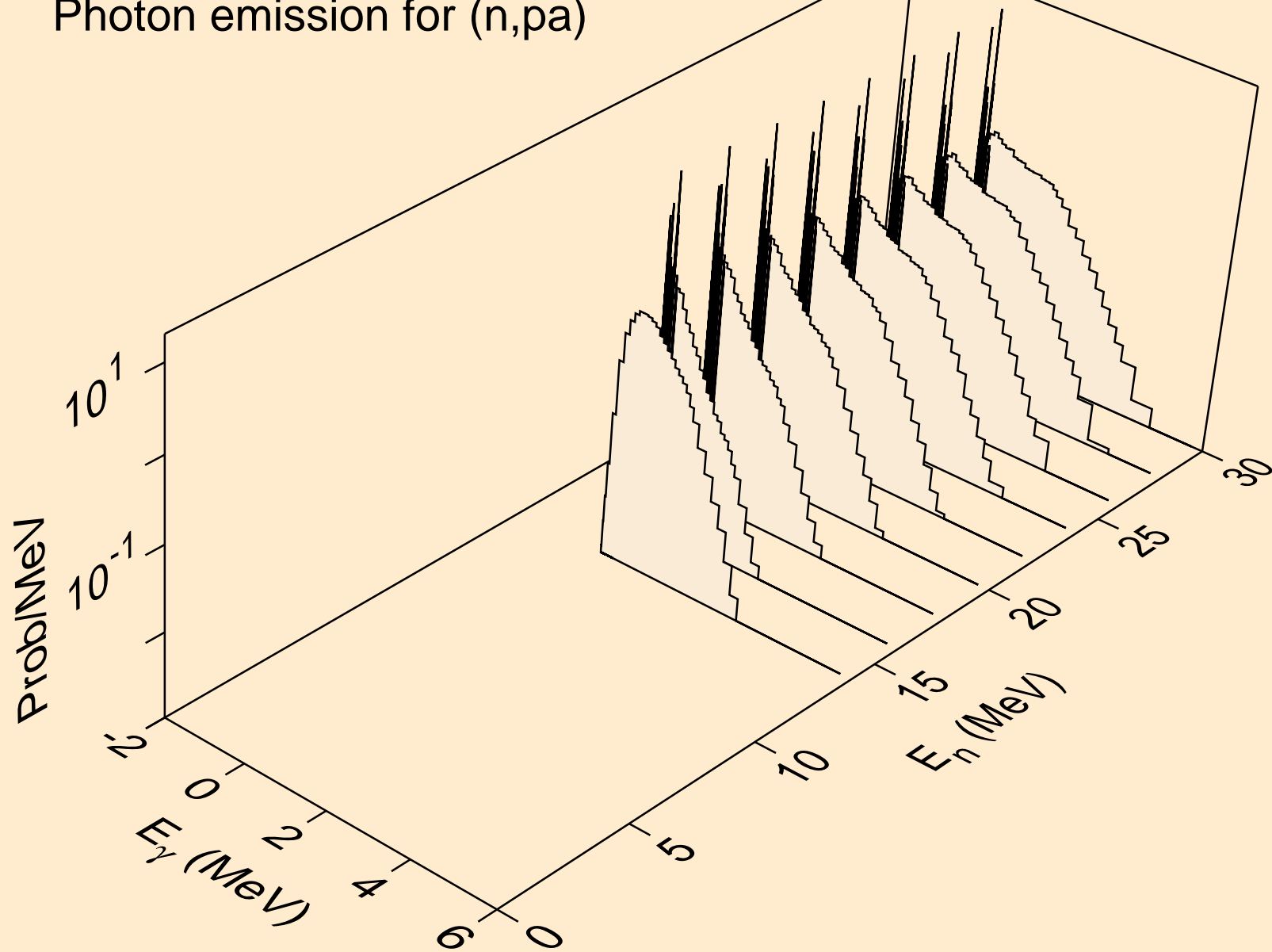

PU238 NEUTRON ACER TENDL-2024 LIBRARY; T=293.6K
thermal capture photon spectrum

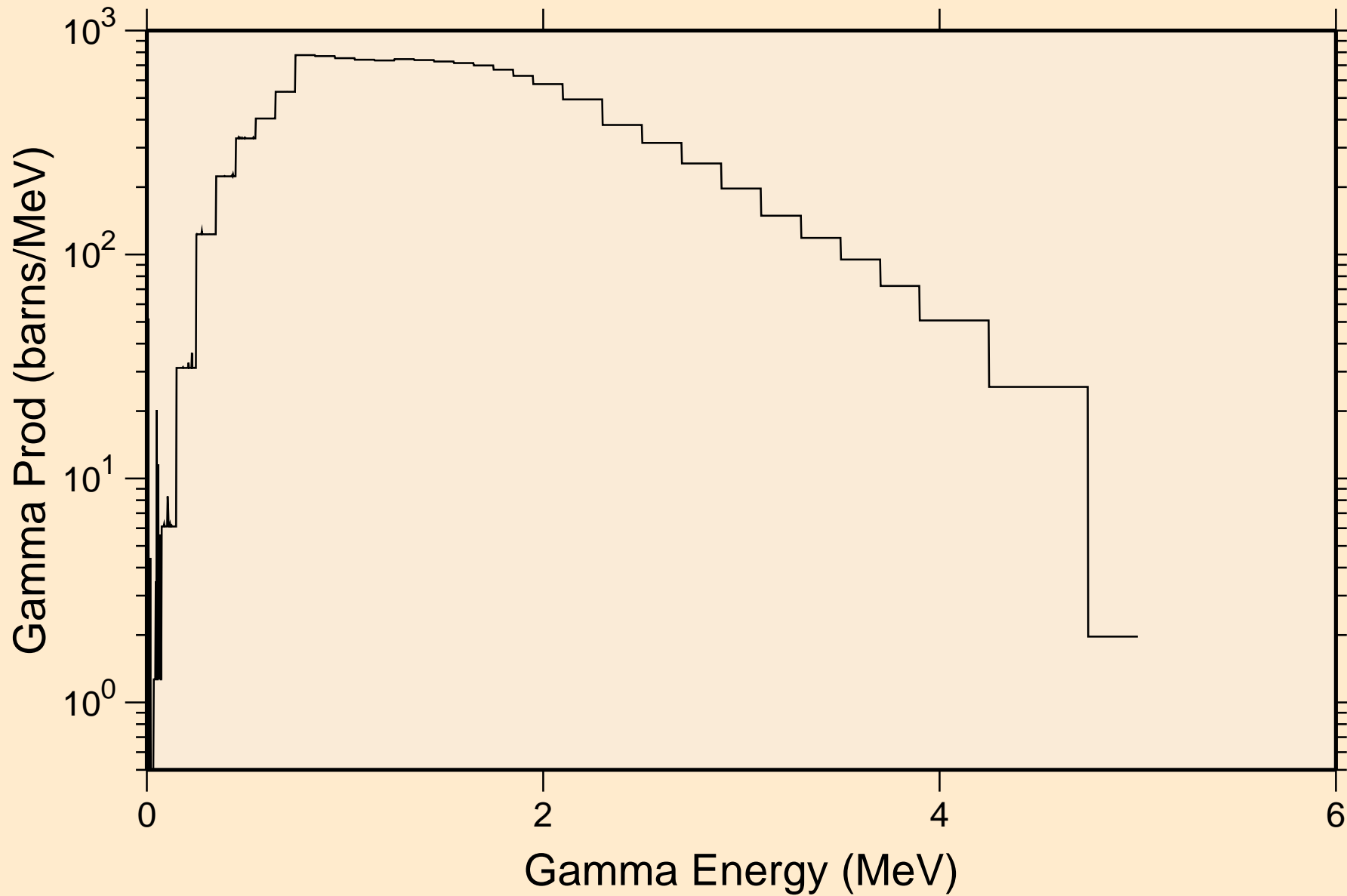

PU238 NEUTRON ACER TENDL-2024 LIBRARY; T=293.6K
14 MeV photon spectrum

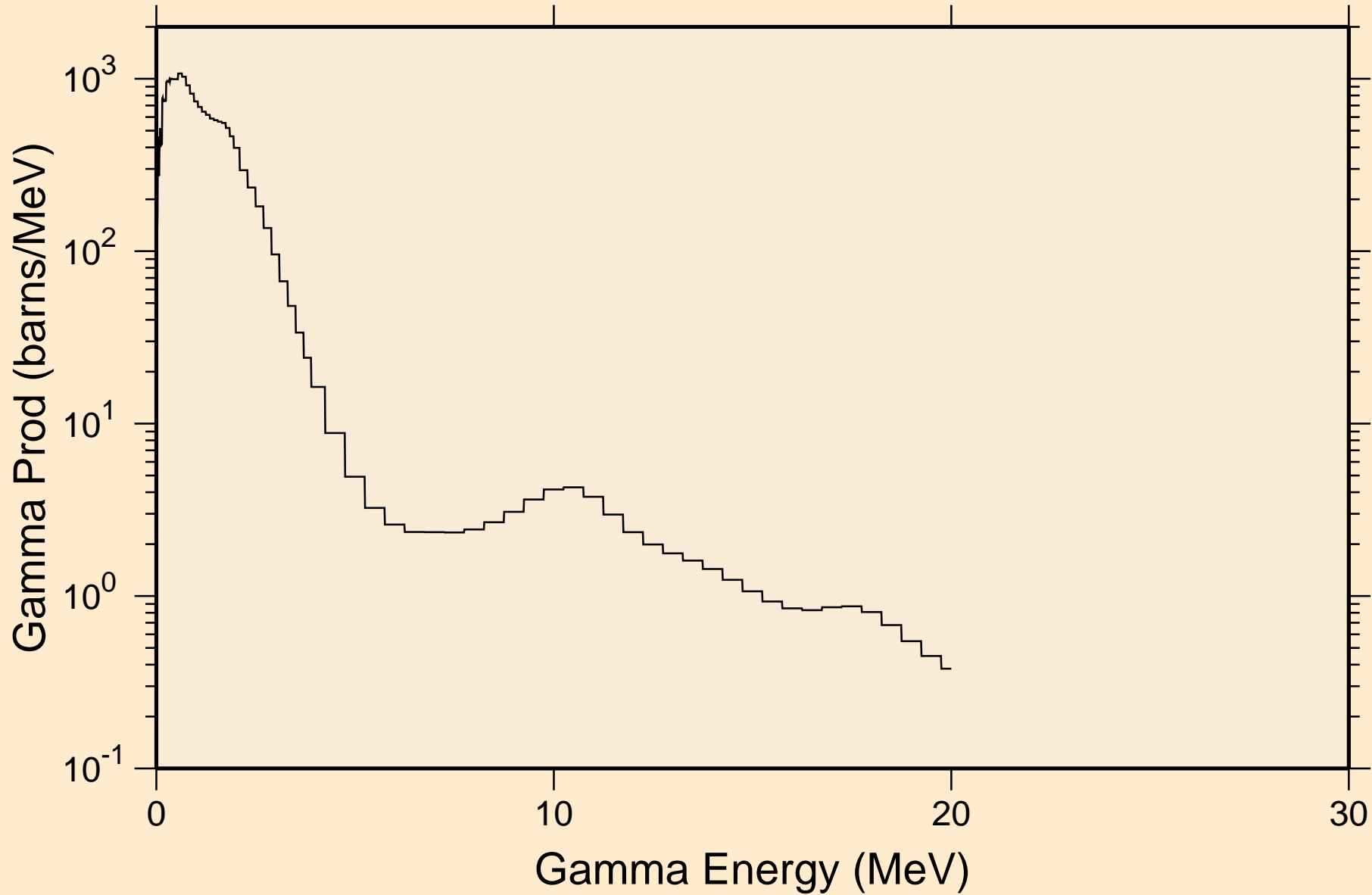

PU238 NEUTRON ACER TENDL-2024 LIBRARY; T=293.6K
Particle heating contributions

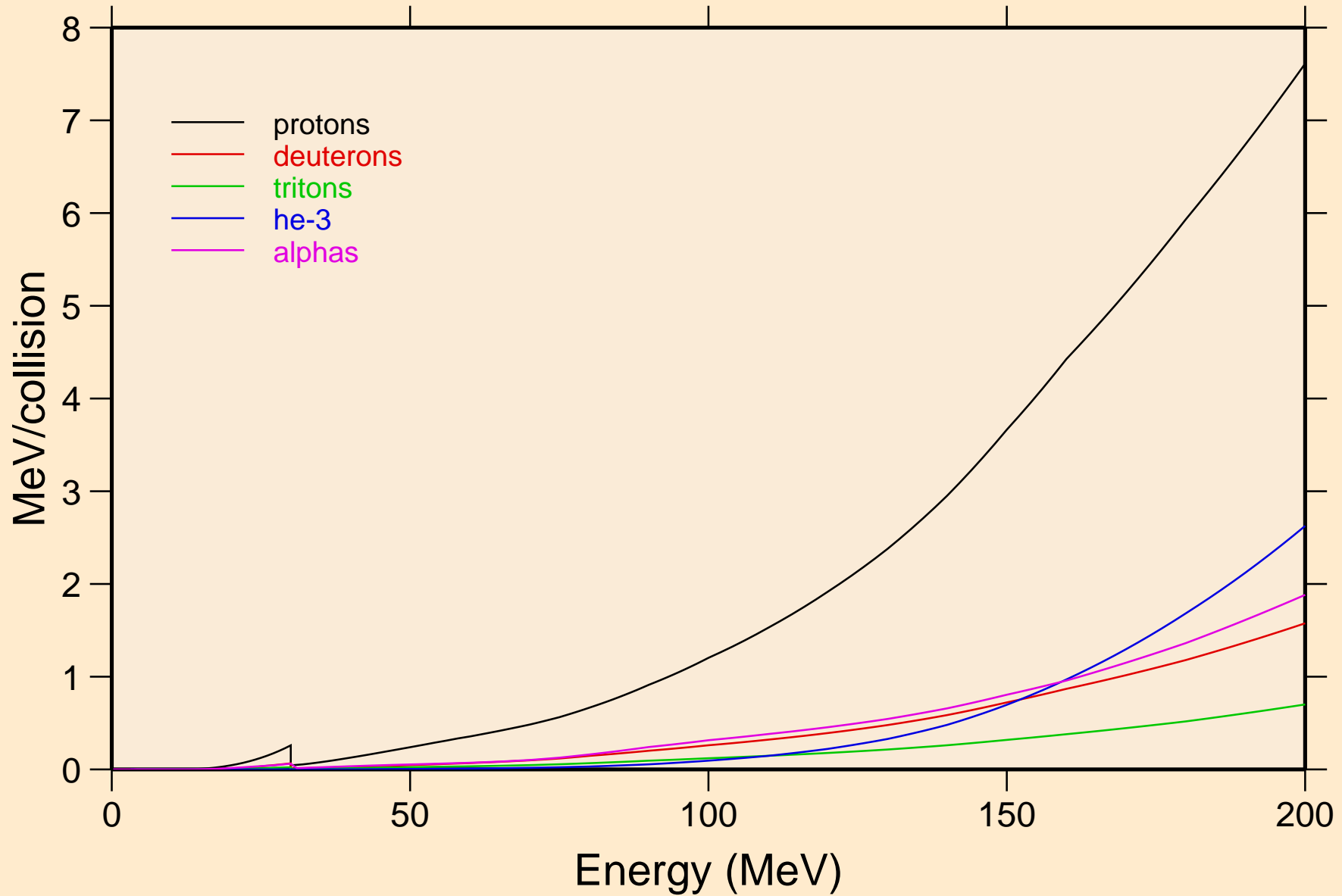

PU238 NEUTRON ACER TENDL-2024 LIBRARY; T=293.6K
Recoil Heating

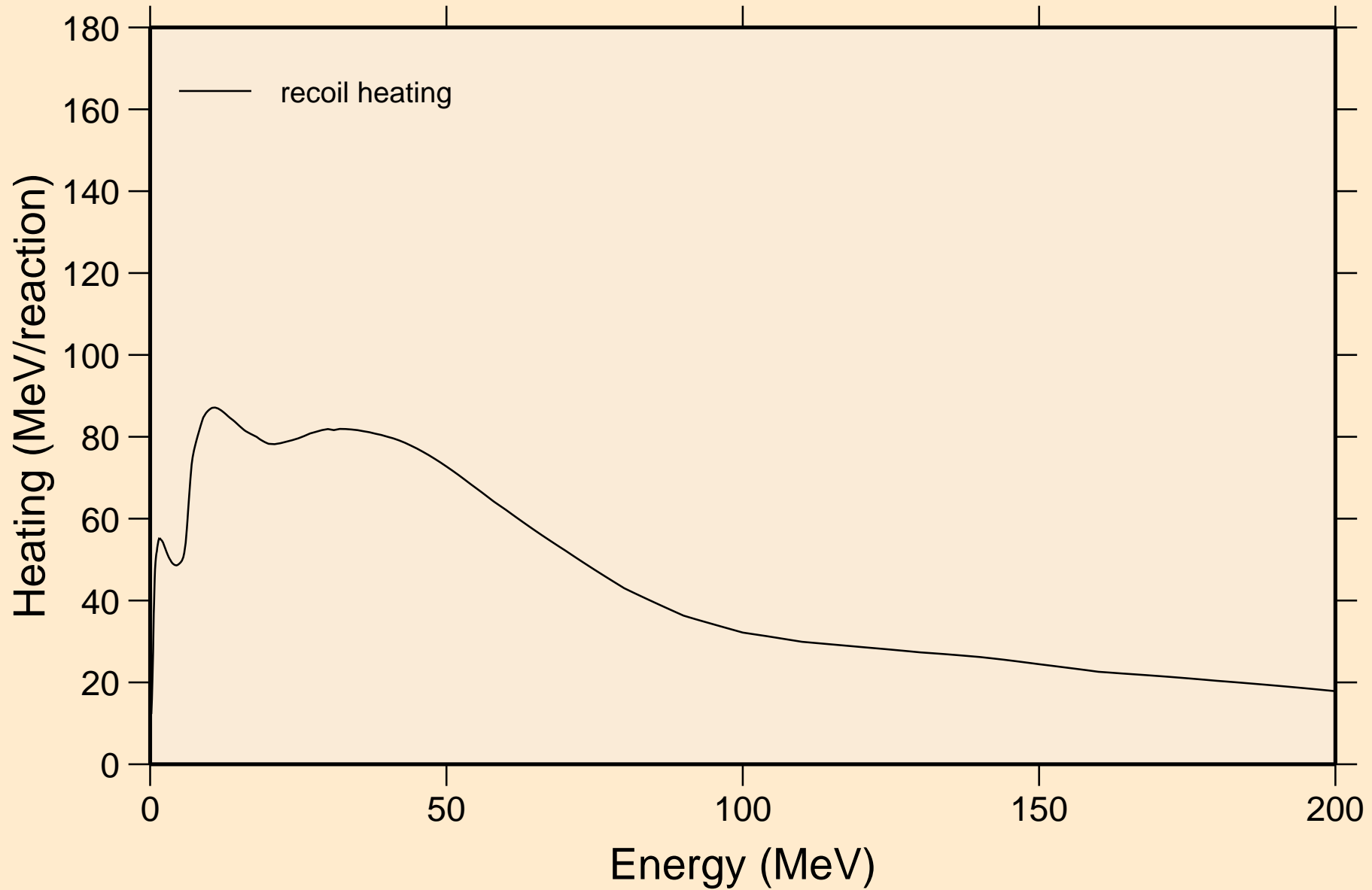

PU238 NEUTRON ACER TENDL-2024 LIBRARY; T=293.6K
Particle production cross sections

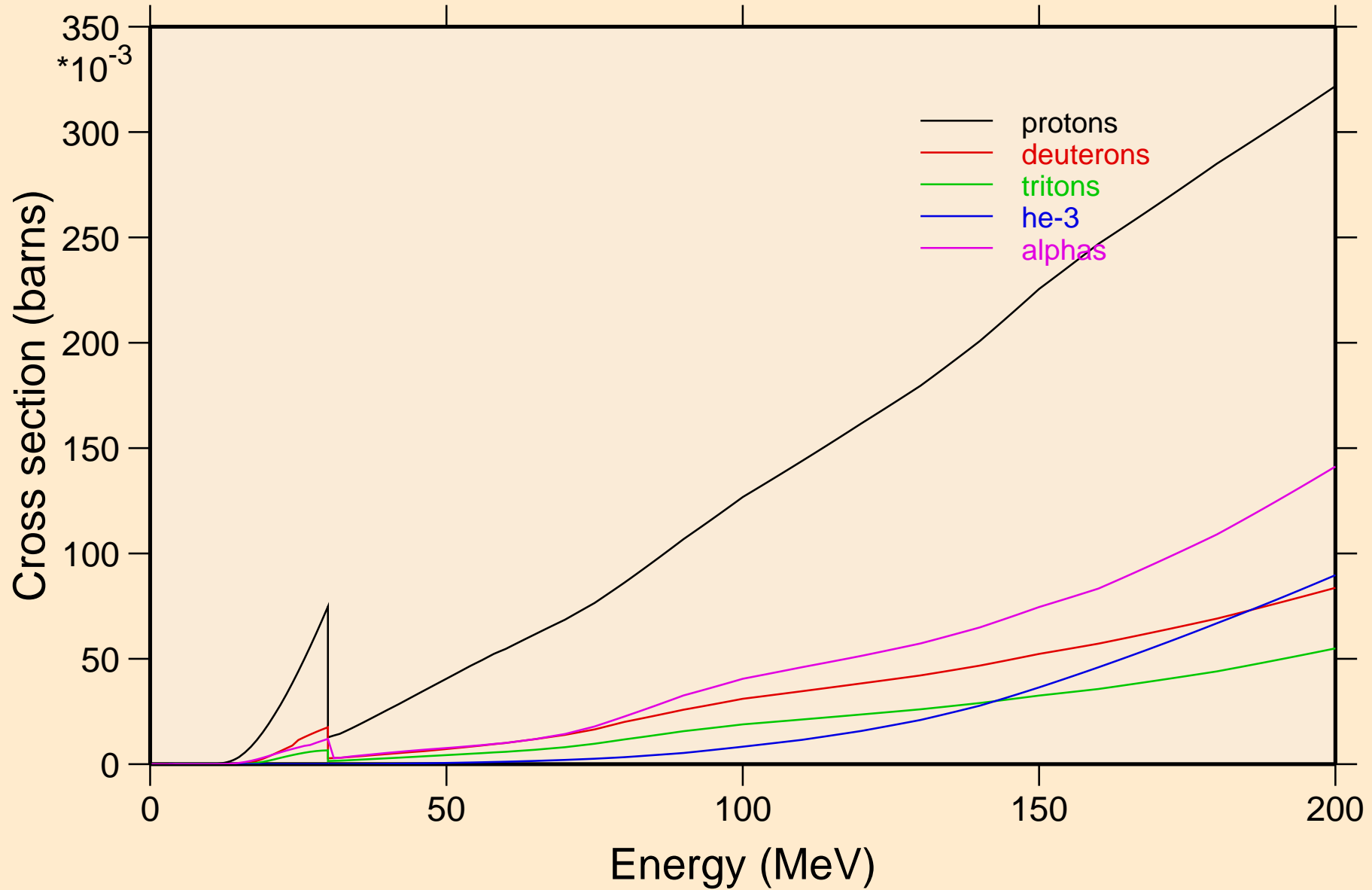

PU238 NEUTRON ACER TENDL-2024 LIBRARY; T=293.6K
protons from (n,x)

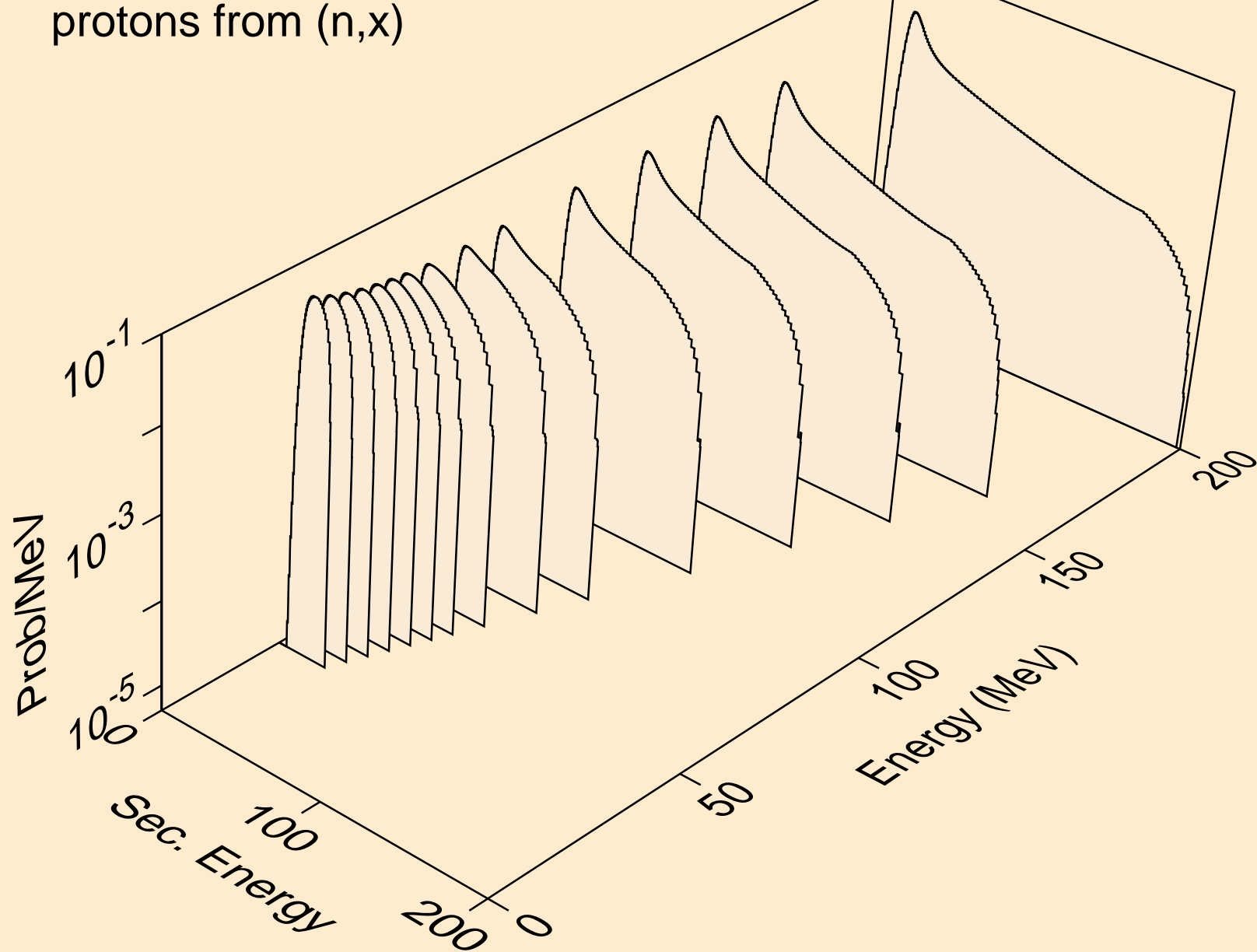

PU238 NEUTRON ACER TENDL-2024 LIBRARY; T=293.6K
protons from (n,n*)p

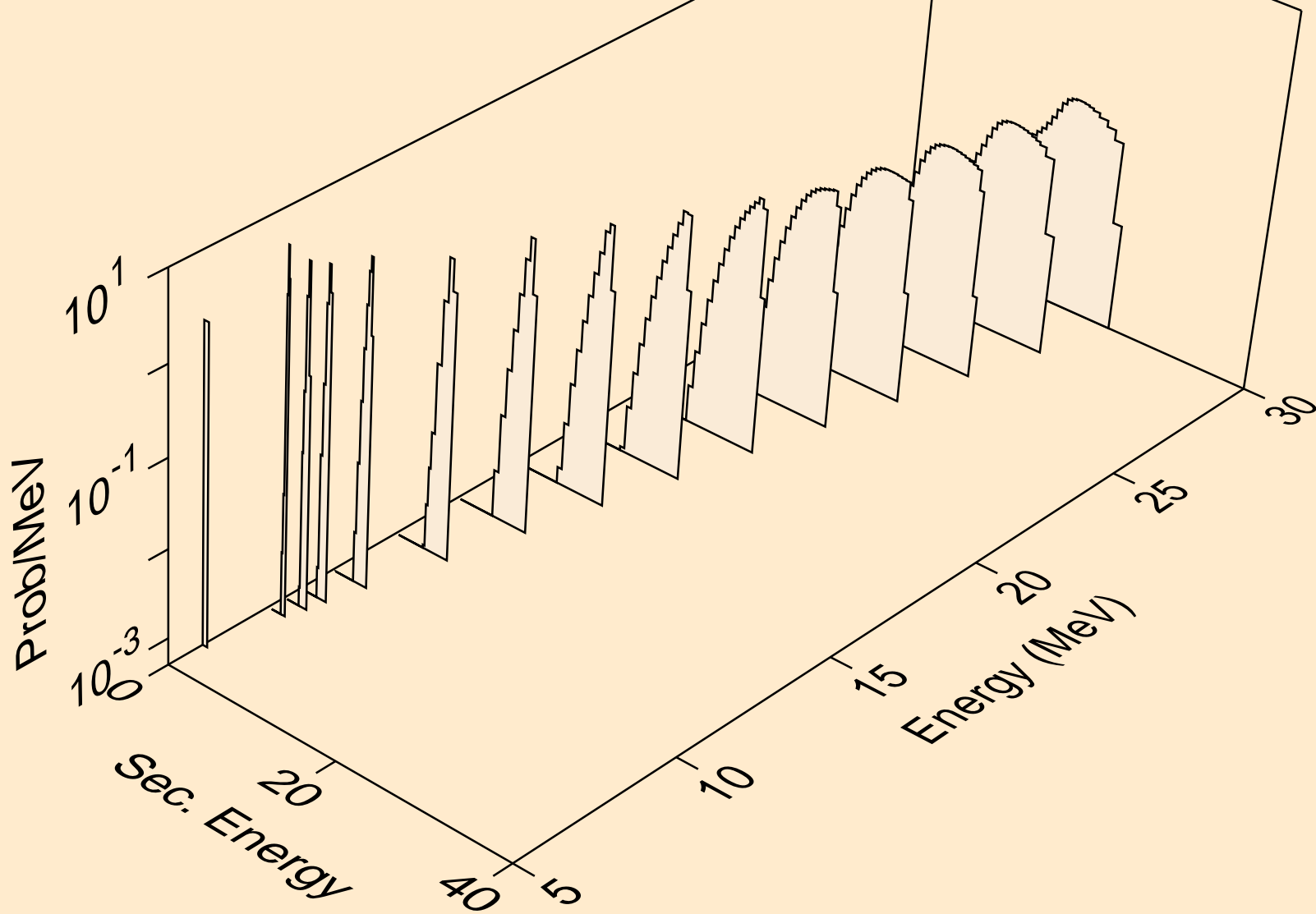

PU238 NEUTRON ACER TENDL-2024 LIBRARY; T=293.6K
protons from (n,2np)

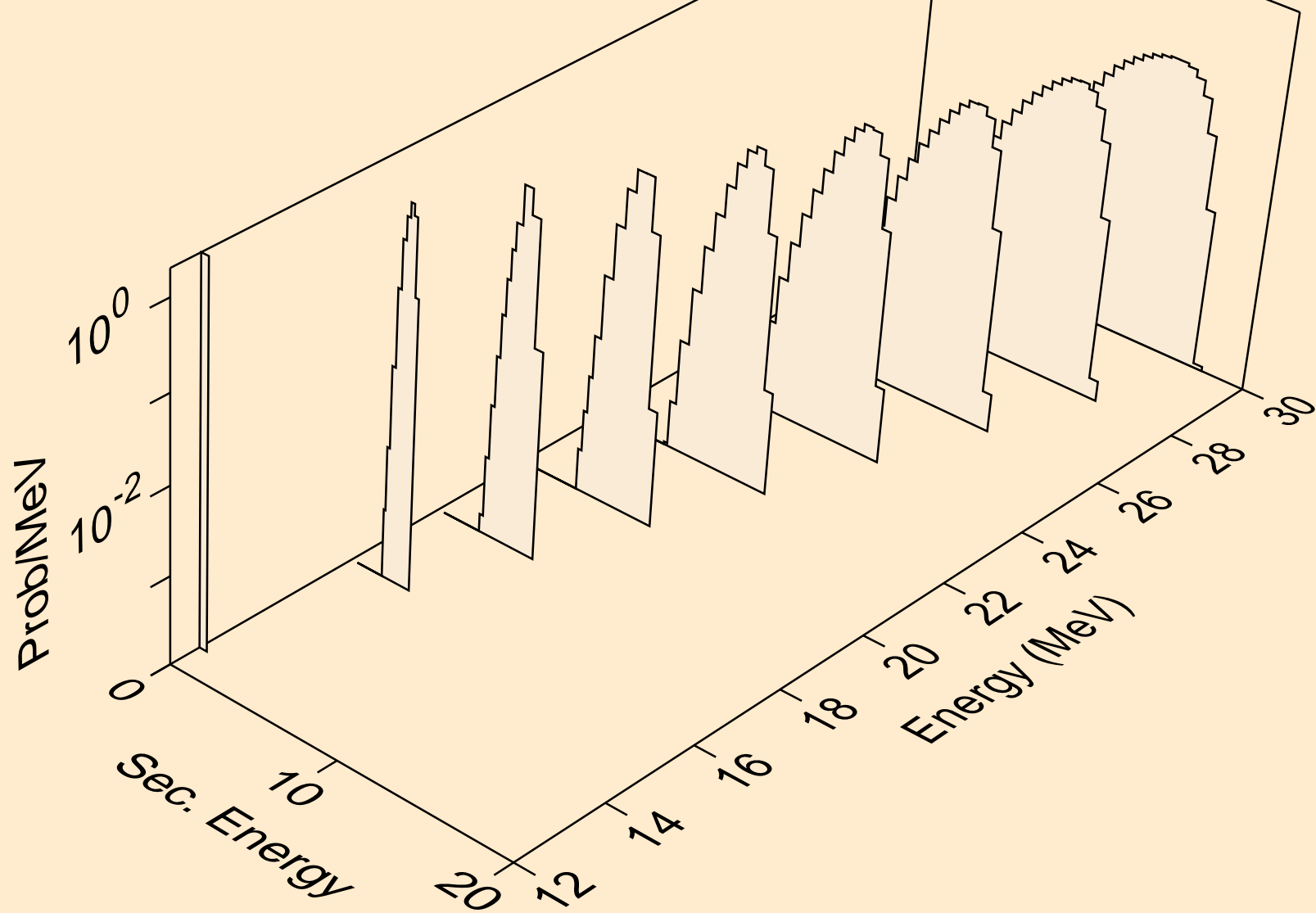

PU238 NEUTRON ACER TENDL-2024 LIBRARY; T=293.6K
protons from (n,3np)

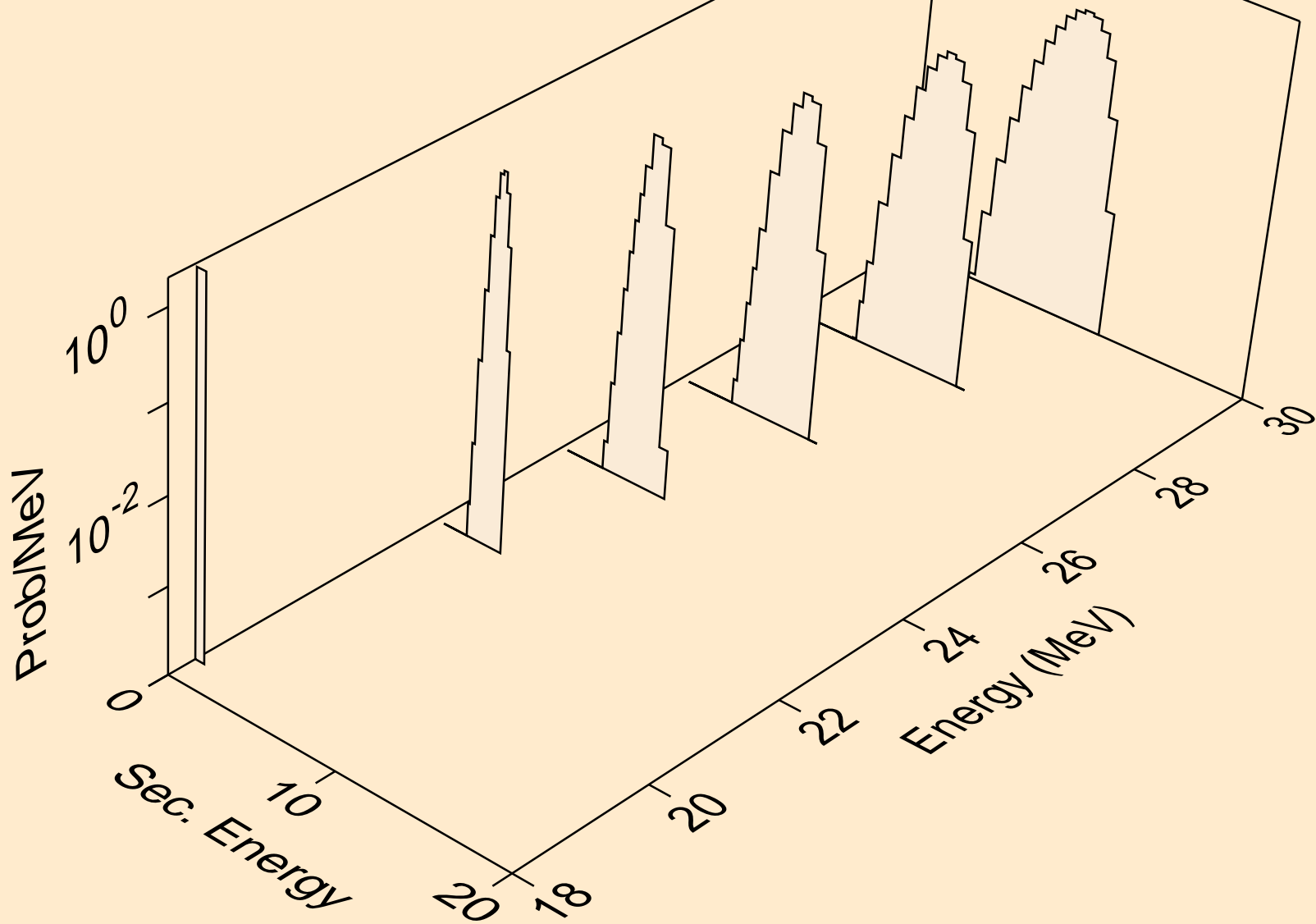

PU238 NEUTRON ACER TENDL-2024 LIBRARY; T=293.6K
protons from (n,n2p)

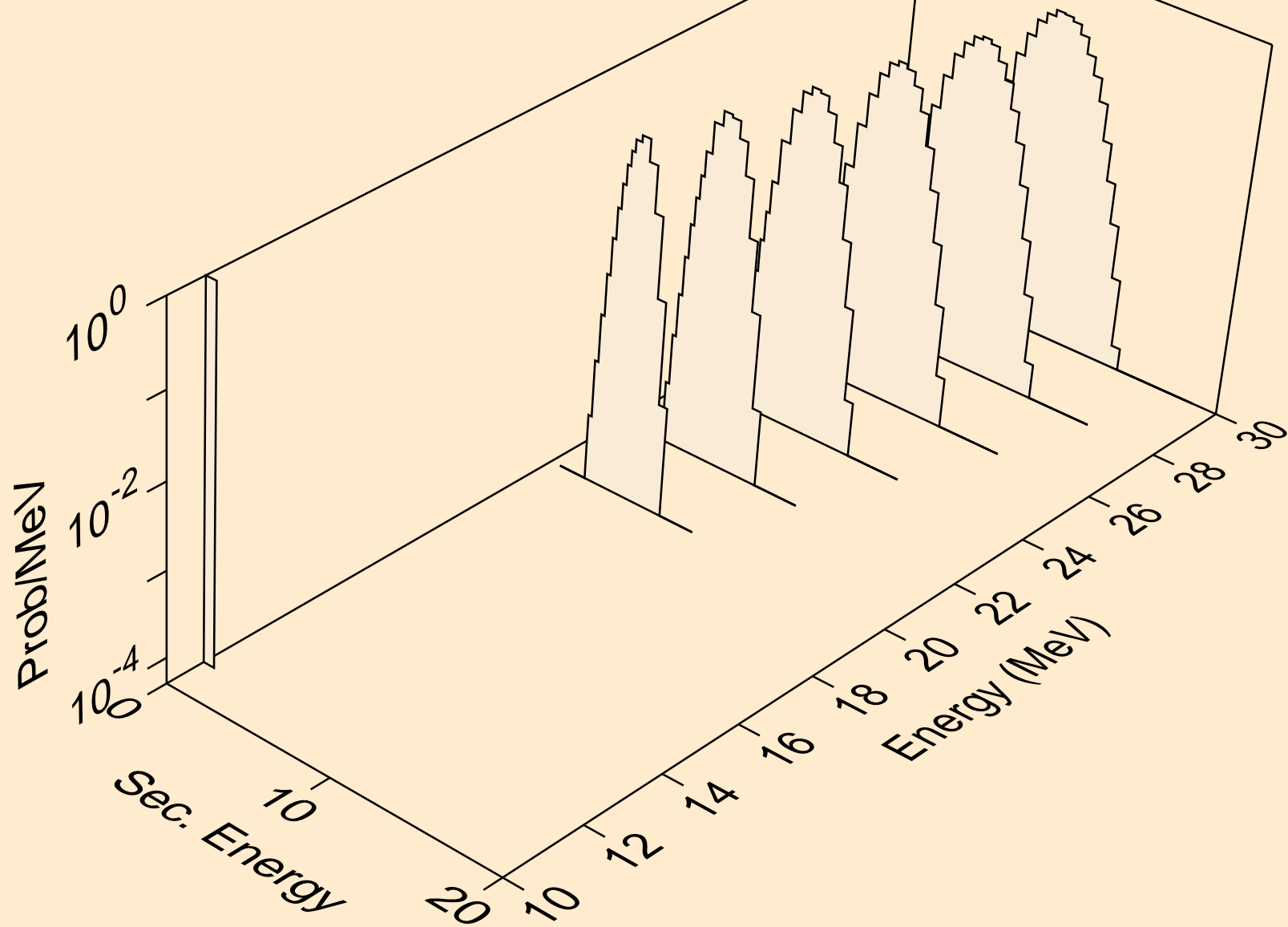

PU238 NEUTRON ACER TENDL-2024 LIBRARY; T=293.6K
protons from (n,npa)

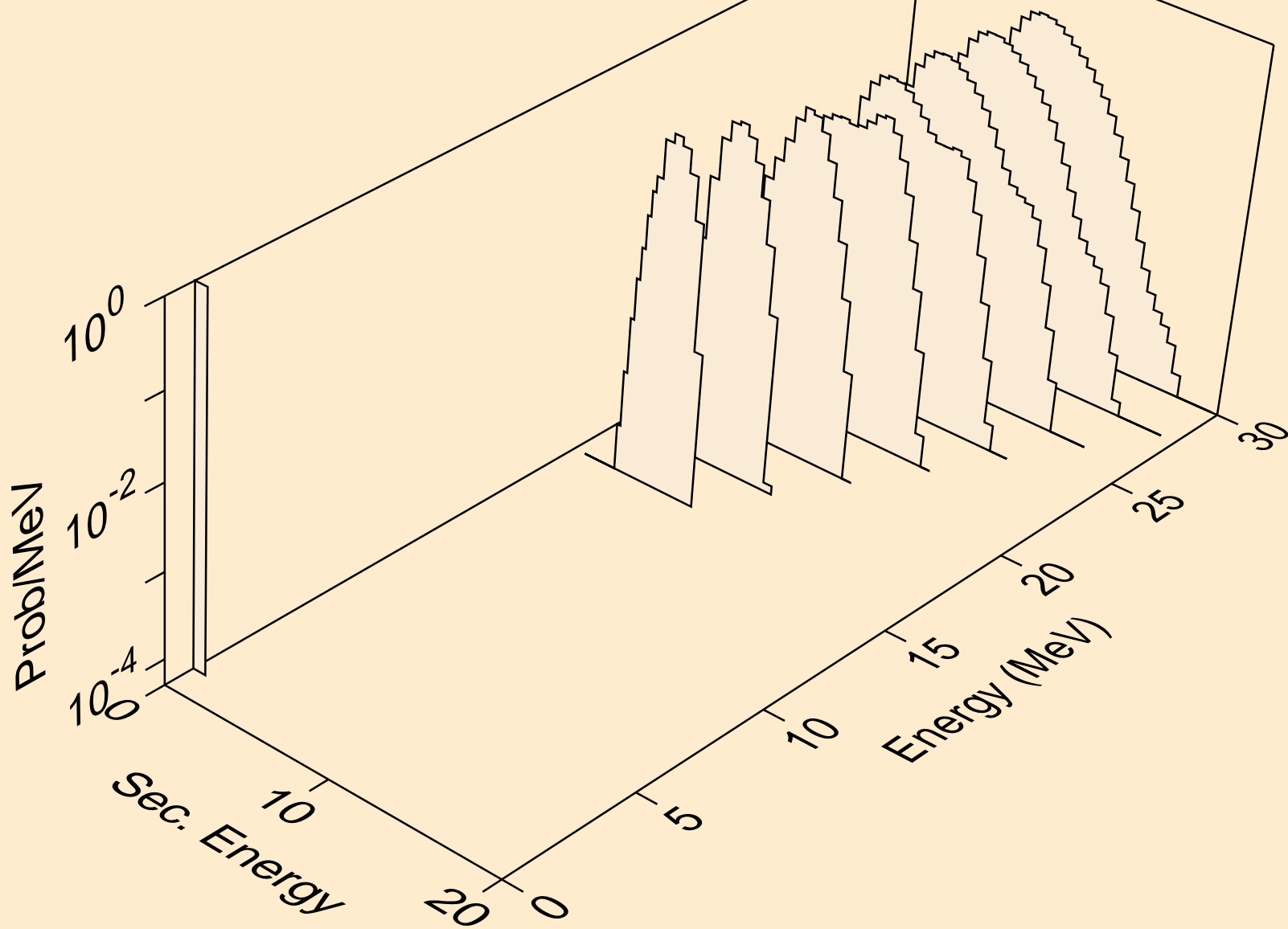

PU238 NEUTRON ACER TENDL-2024 LIBRARY; T=293.6K
protons from (n,p)

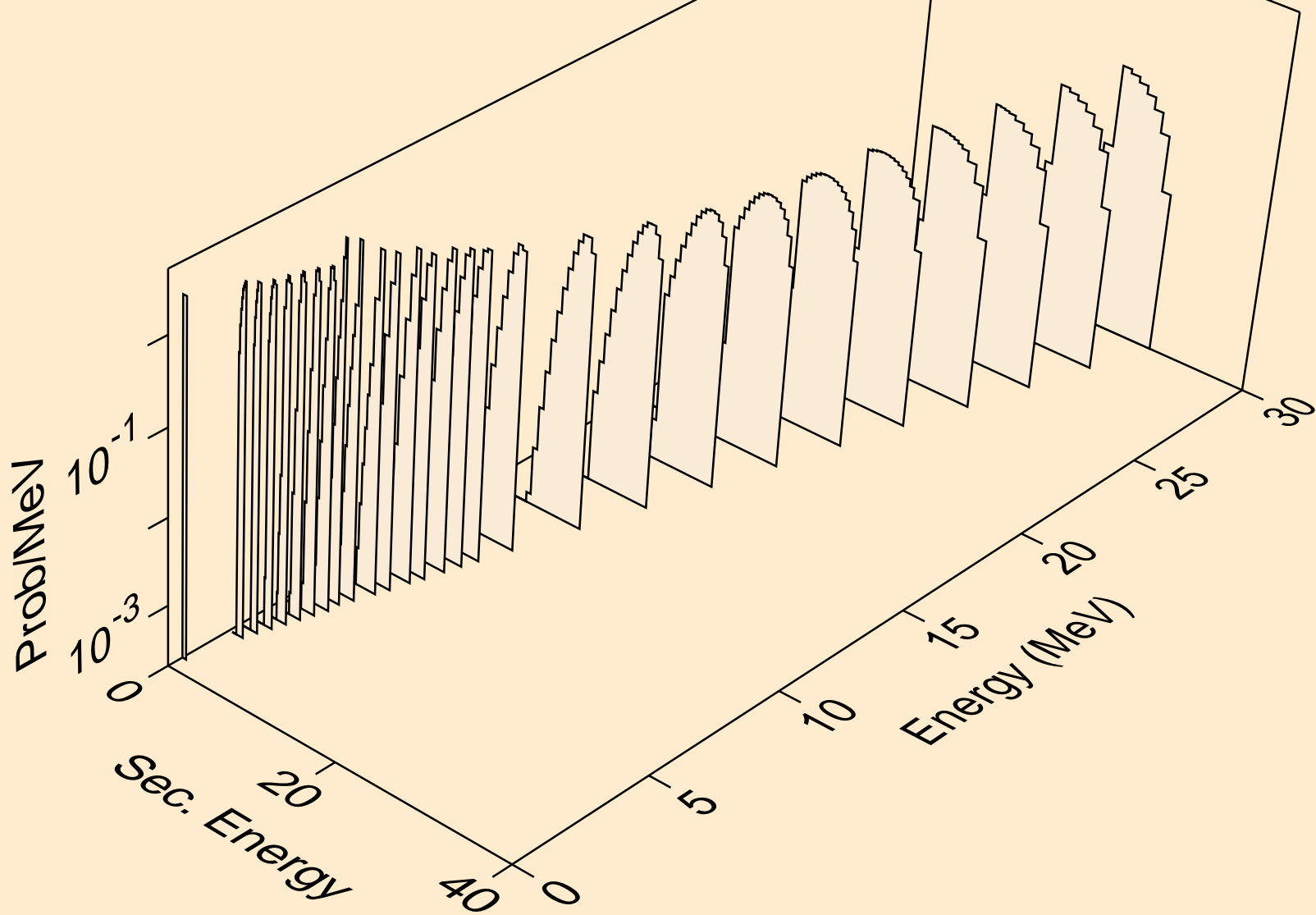

PU238 NEUTRON ACER TENDL-2024 LIBRARY; T=293.6K
protons from (n,2p)

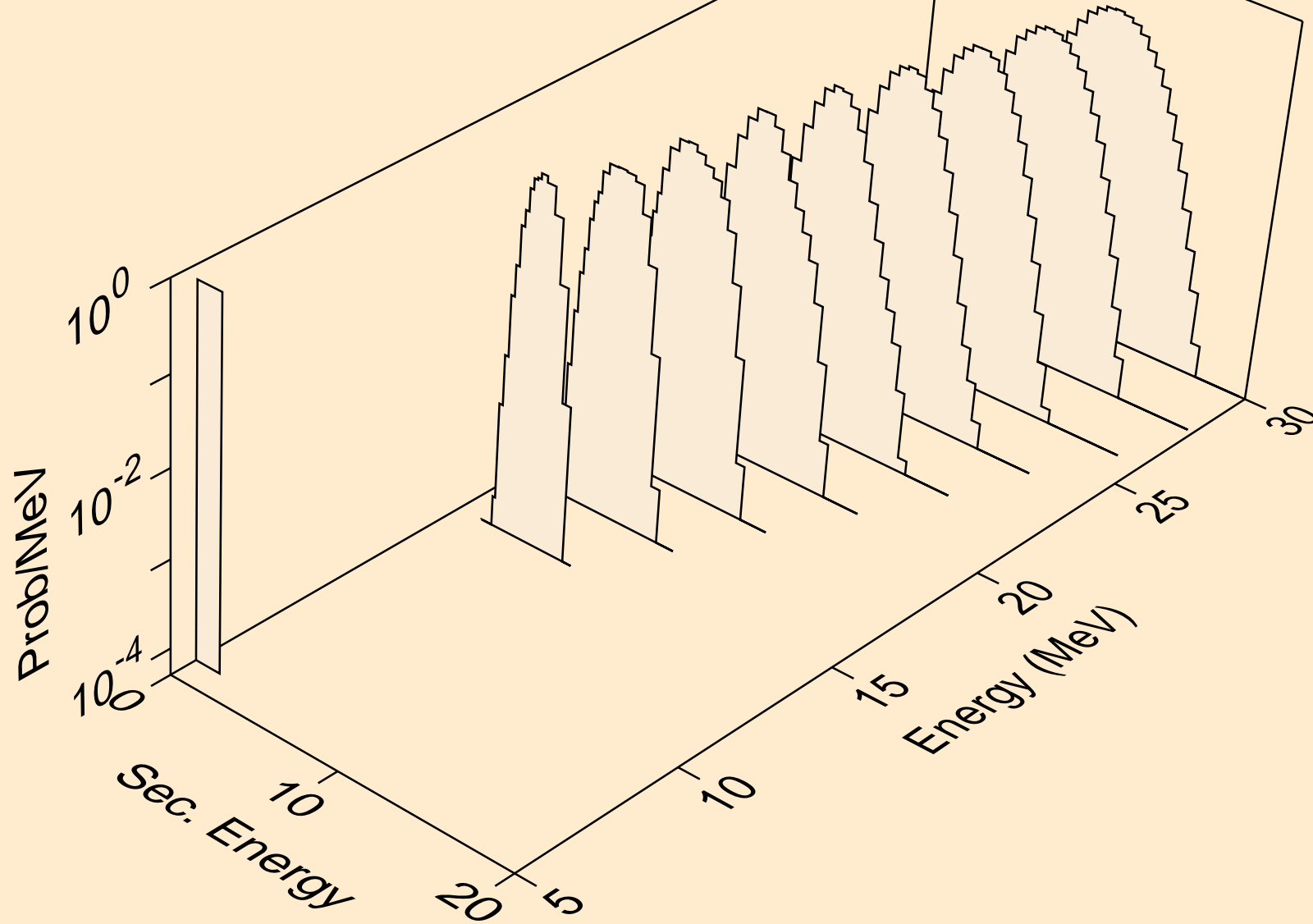

PU238 NEUTRON ACER TENDL-2024 LIBRARY; T=293.6K
protons from (n,p)

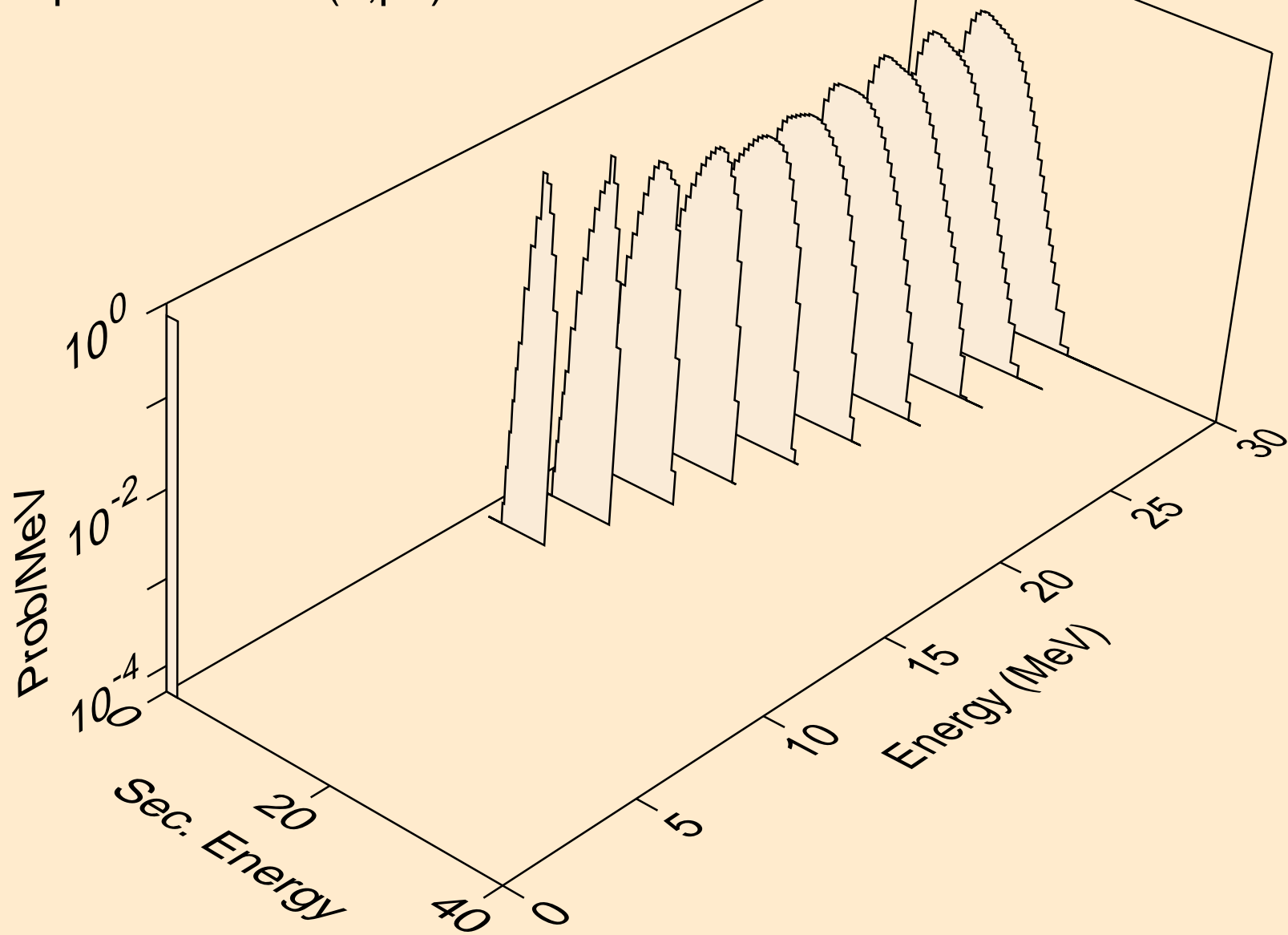

PU238 NEUTRON ACER TENDL-2024 LIBRARY; T=293.6K
deuterons from (n,x)

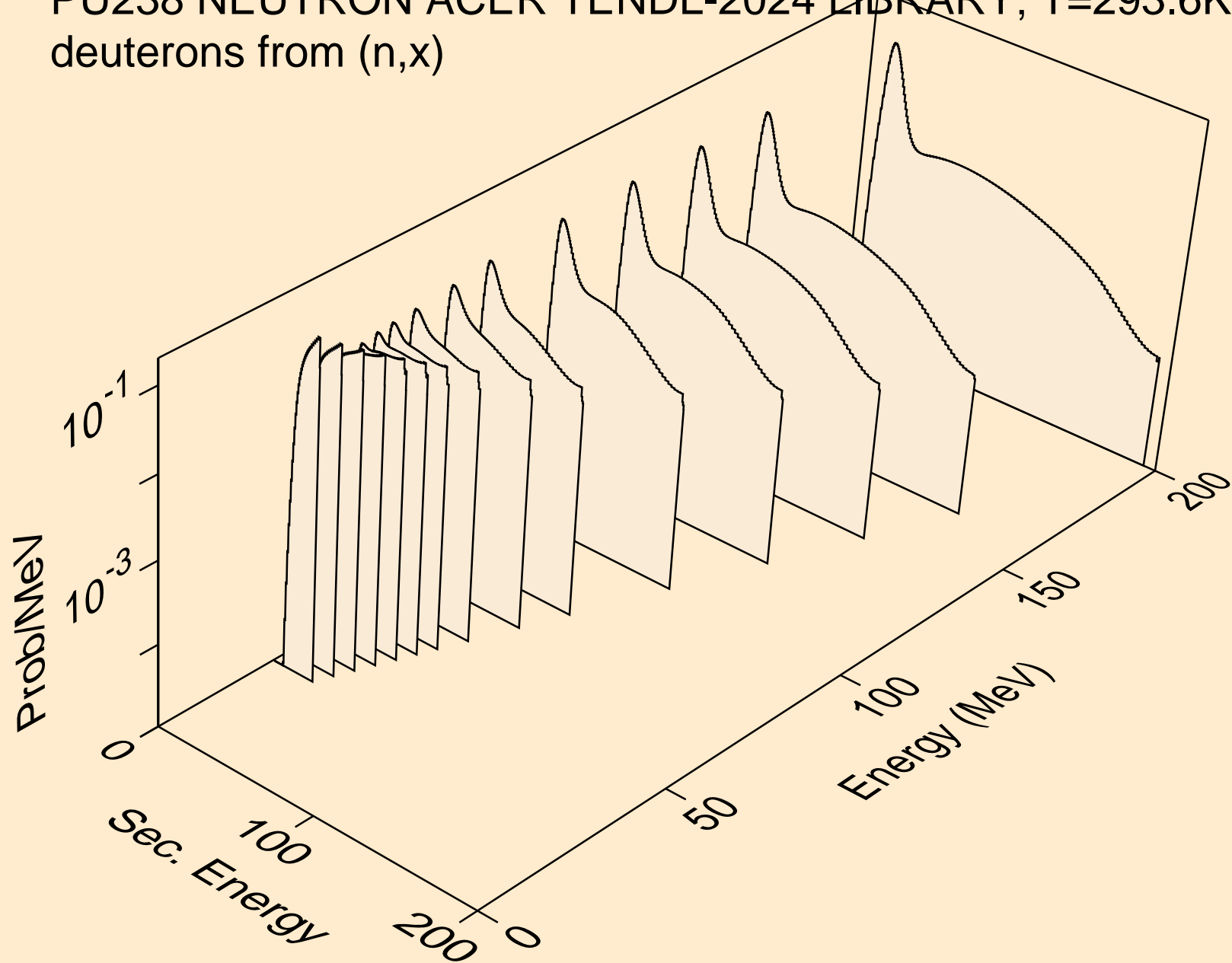

PU238 NEUTRON ACER TENDL-2024 LIBRARY; T=293.6K
deuterons from (n,2nd)

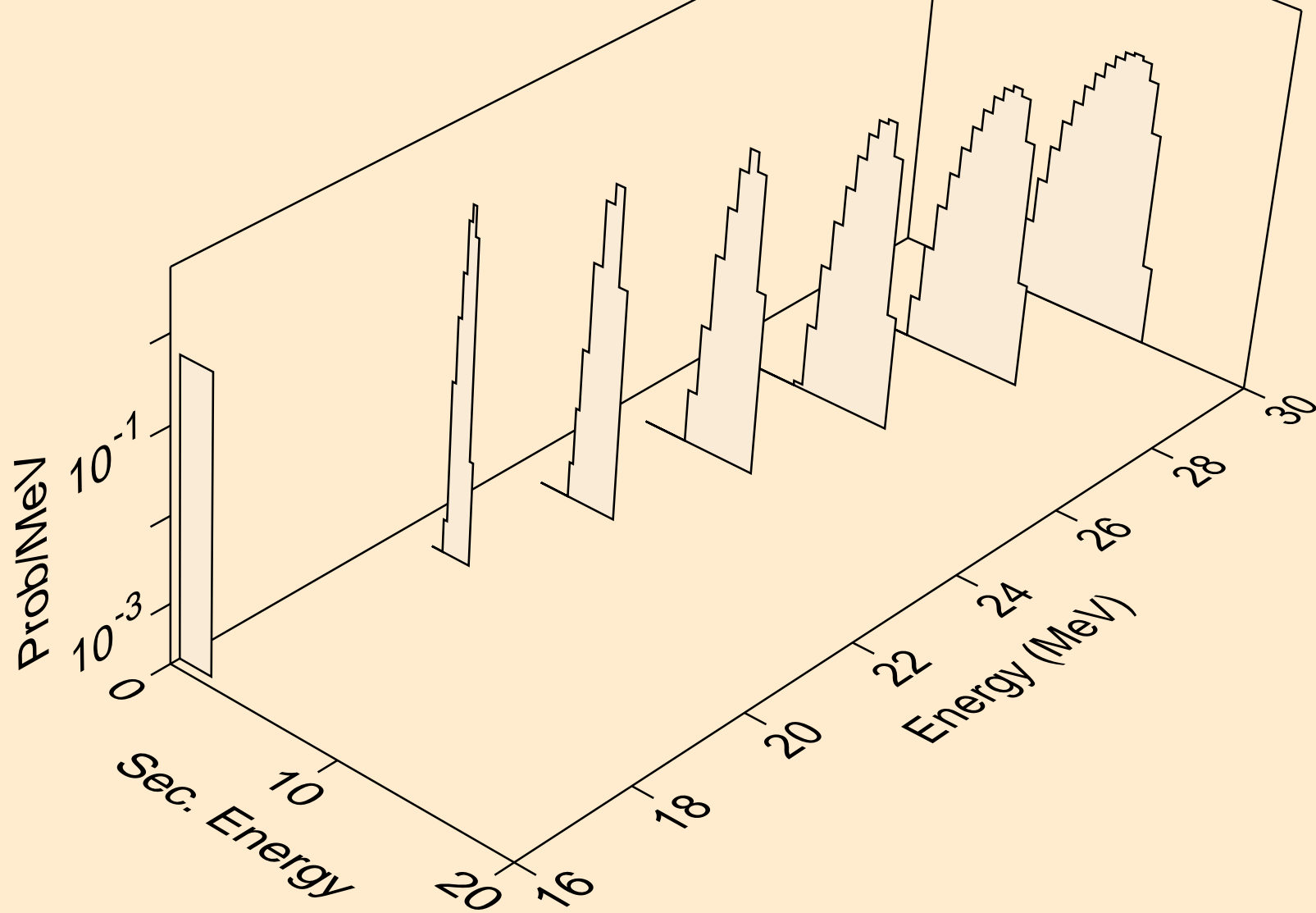

PU238 NEUTRON ACER TENDL-2024 LIBRARY; T=293.6K
deuterons from (n,n*)d

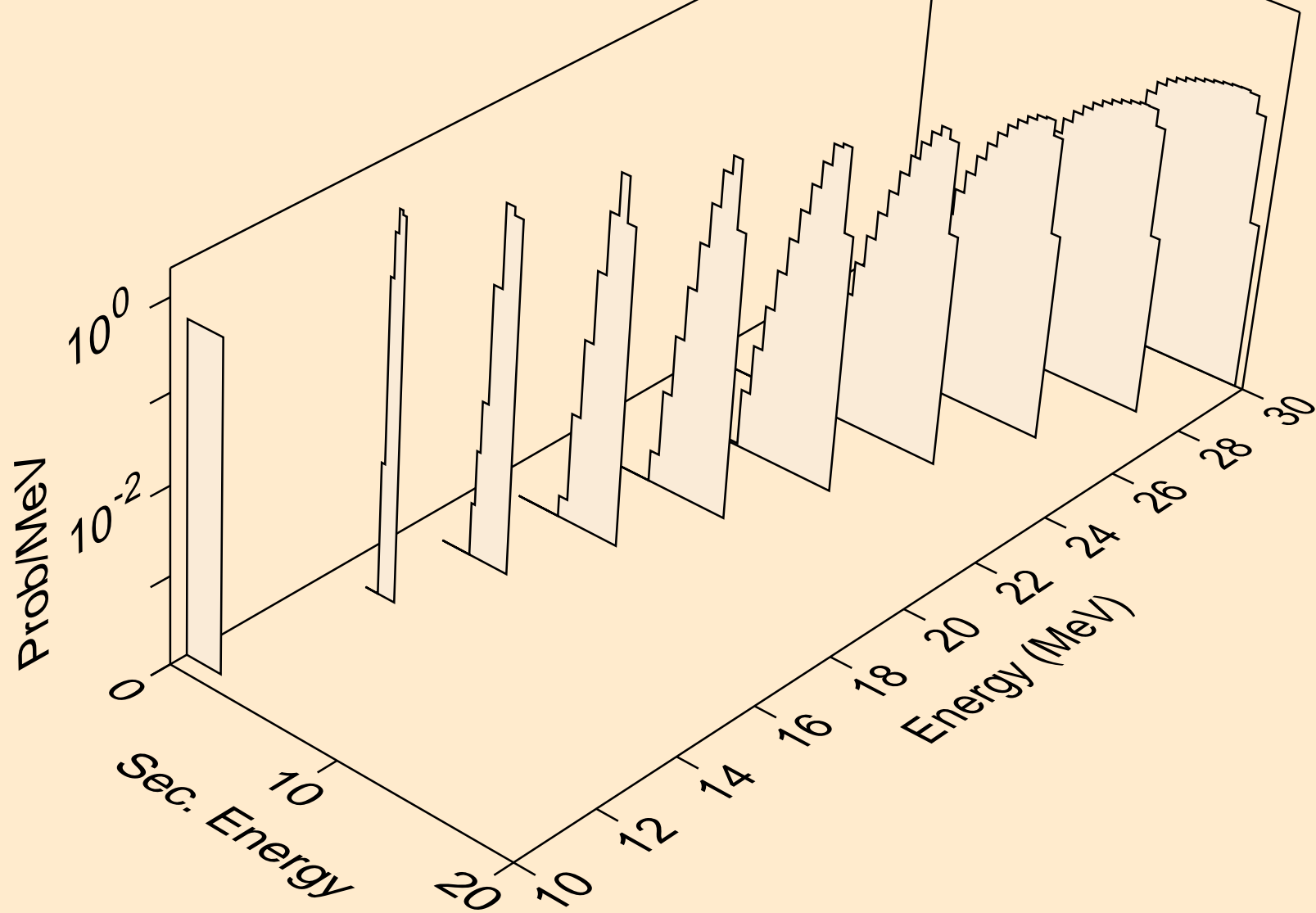

PU238 NEUTRON ACER TENDL-2024 LIBRARY; T=293.6K
deuterons from (n,d)

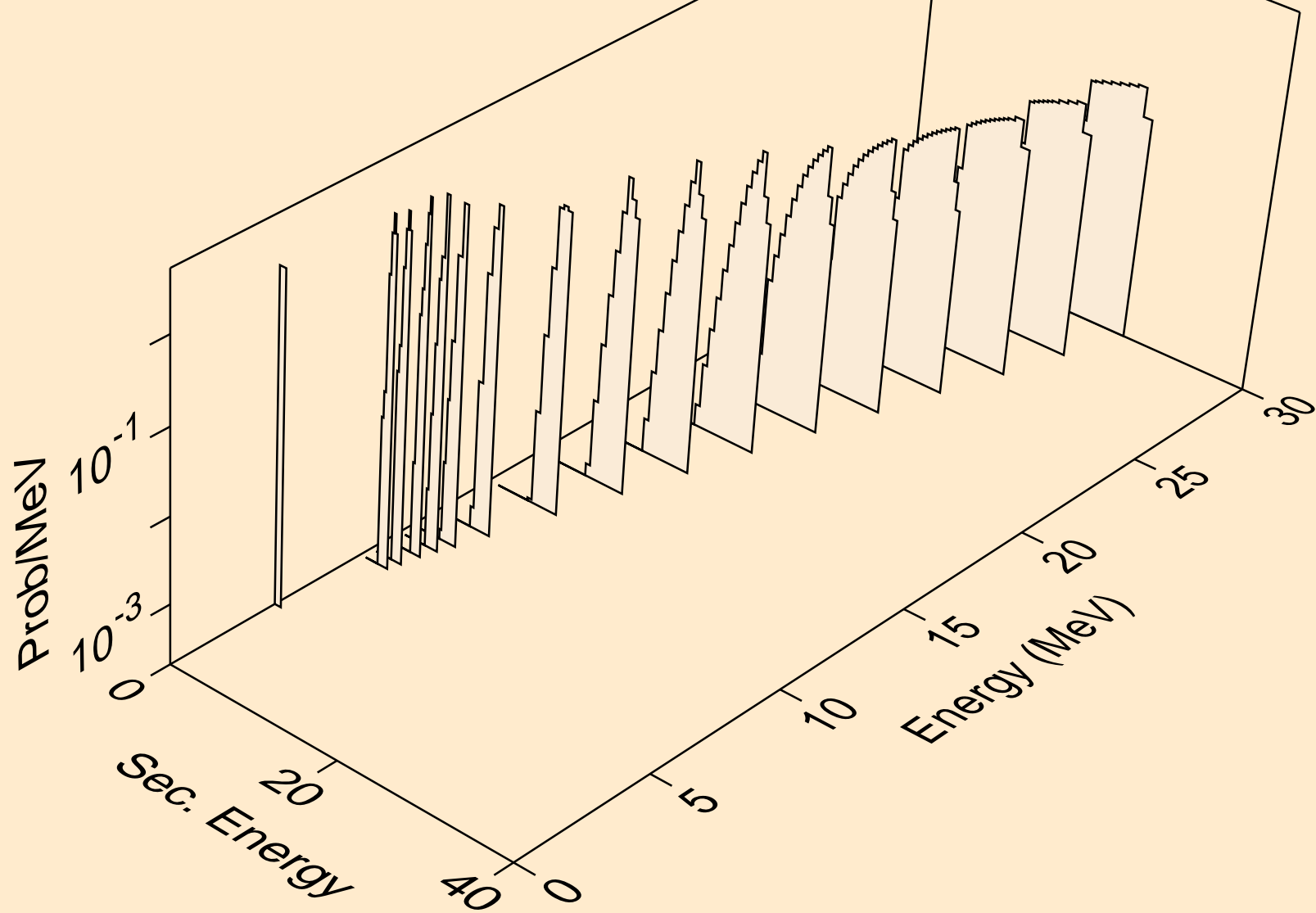

PU238 NEUTRON ACER TENDL-2024 LIBRARY; T=293.6K
tritons from (n,x)

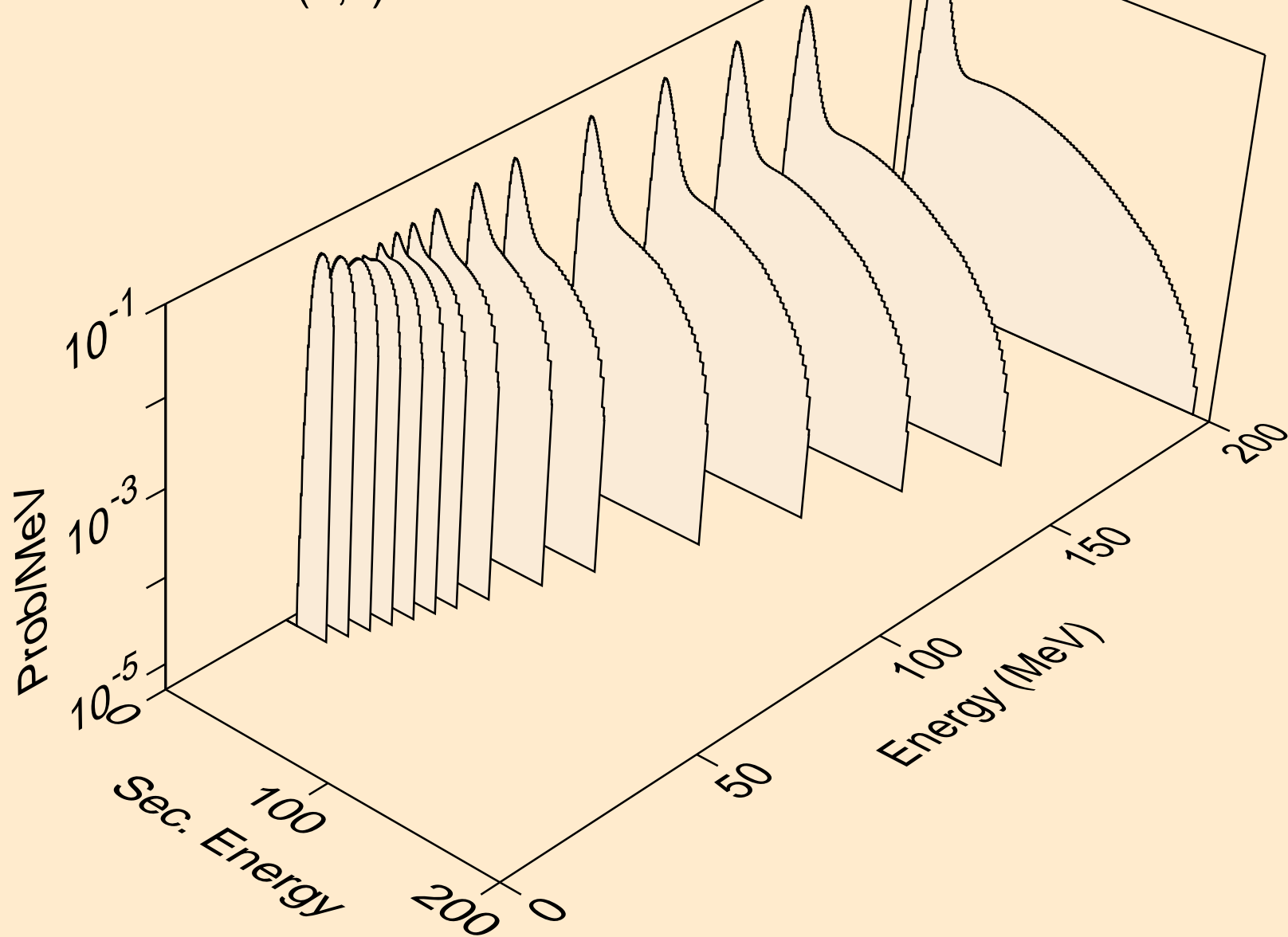

PU238 NEUTRON ACER TENDL-2024 LIBRARY; T=293.6K
tritons from (n,n*)t

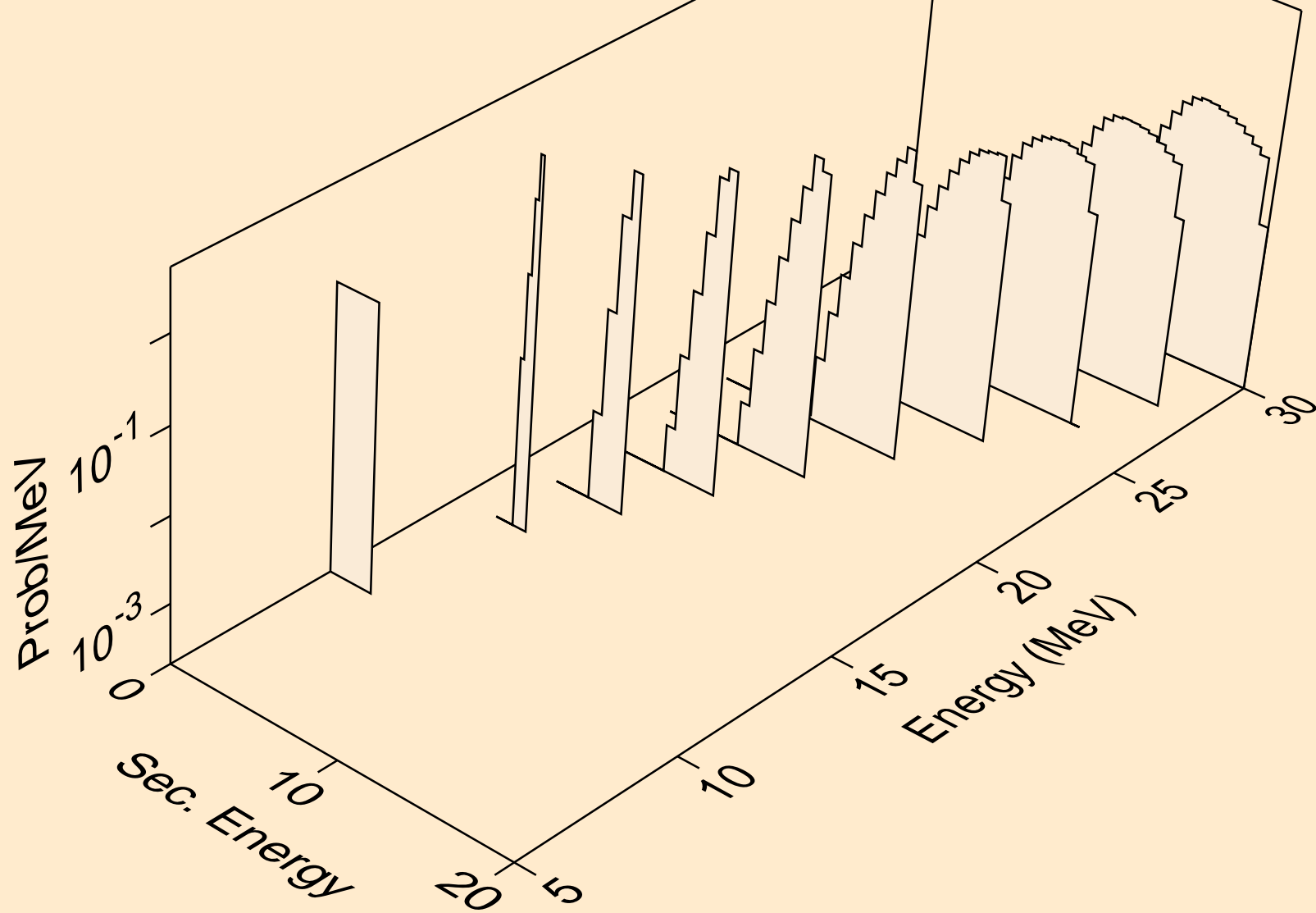

PU238 NEUTRON ACER TENDL-2024 LIBRARY; T=293.6K
tritons from (n,t)

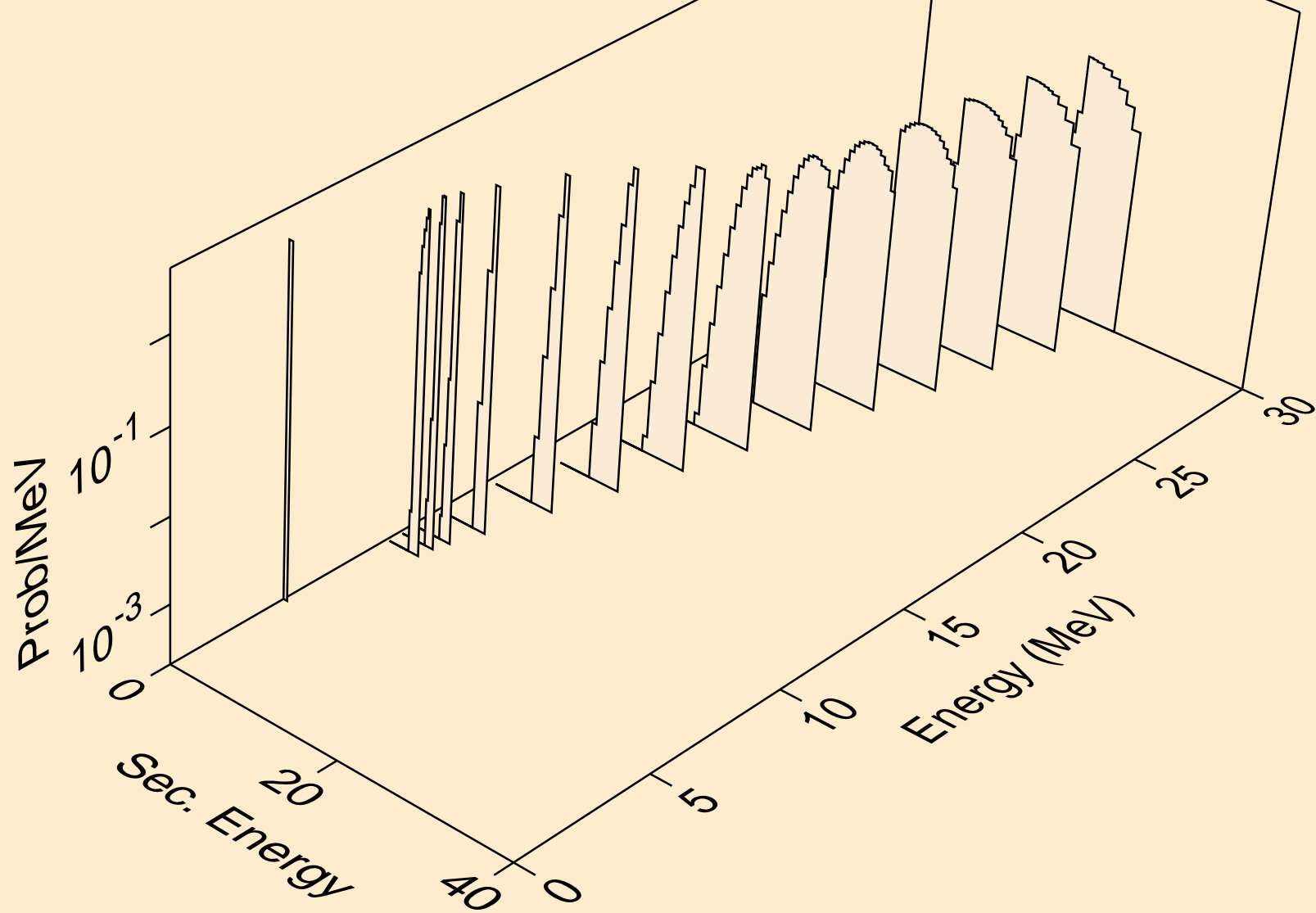

PU238 NEUTRON ACER TENDL-2024 LIBRARY; T=293.6K
he3s from (n,x)

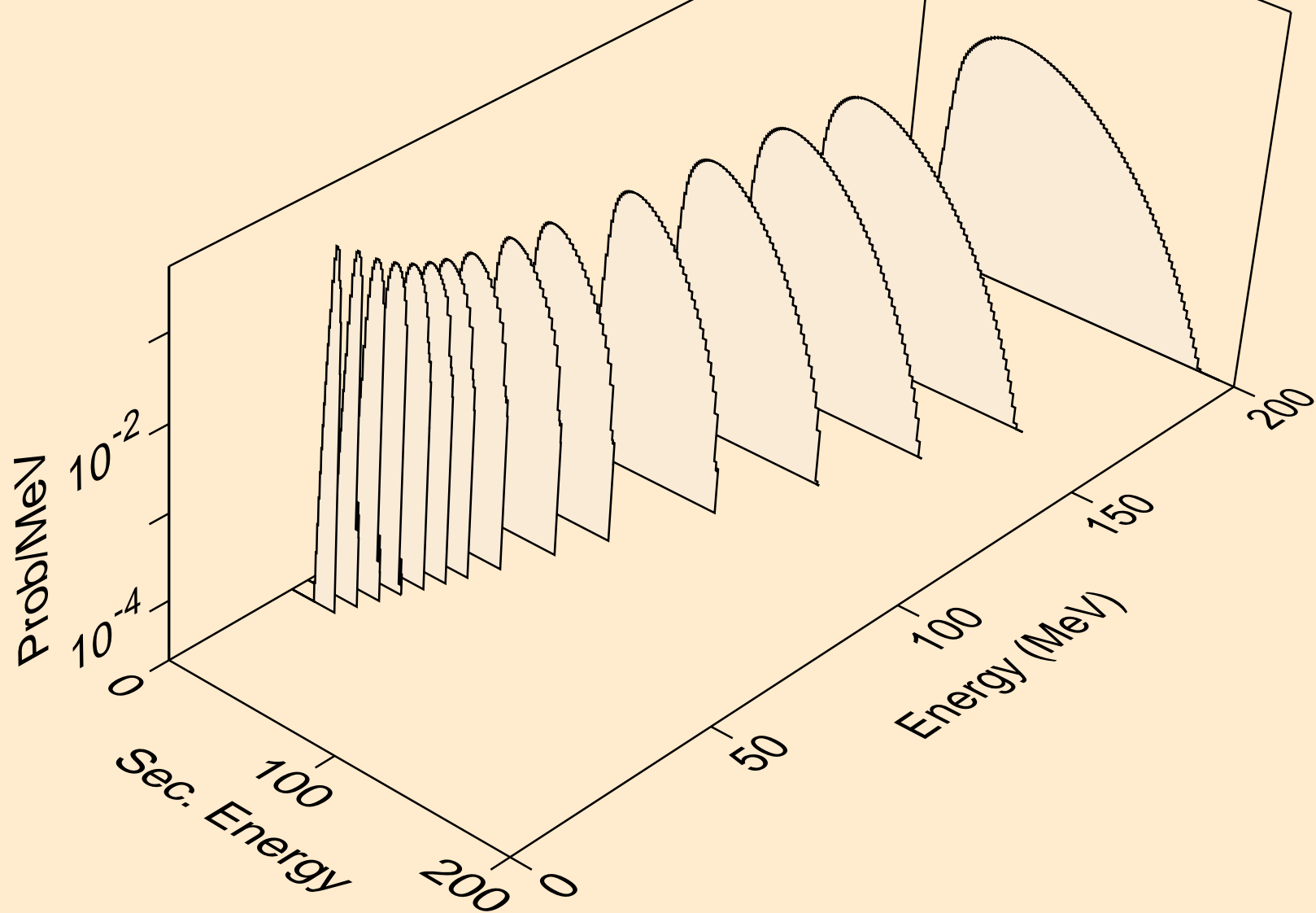

PU238 NEUTRON ACER TENDL-2024 LIBRARY; T=293.6K
he3s from (n,n*)he3

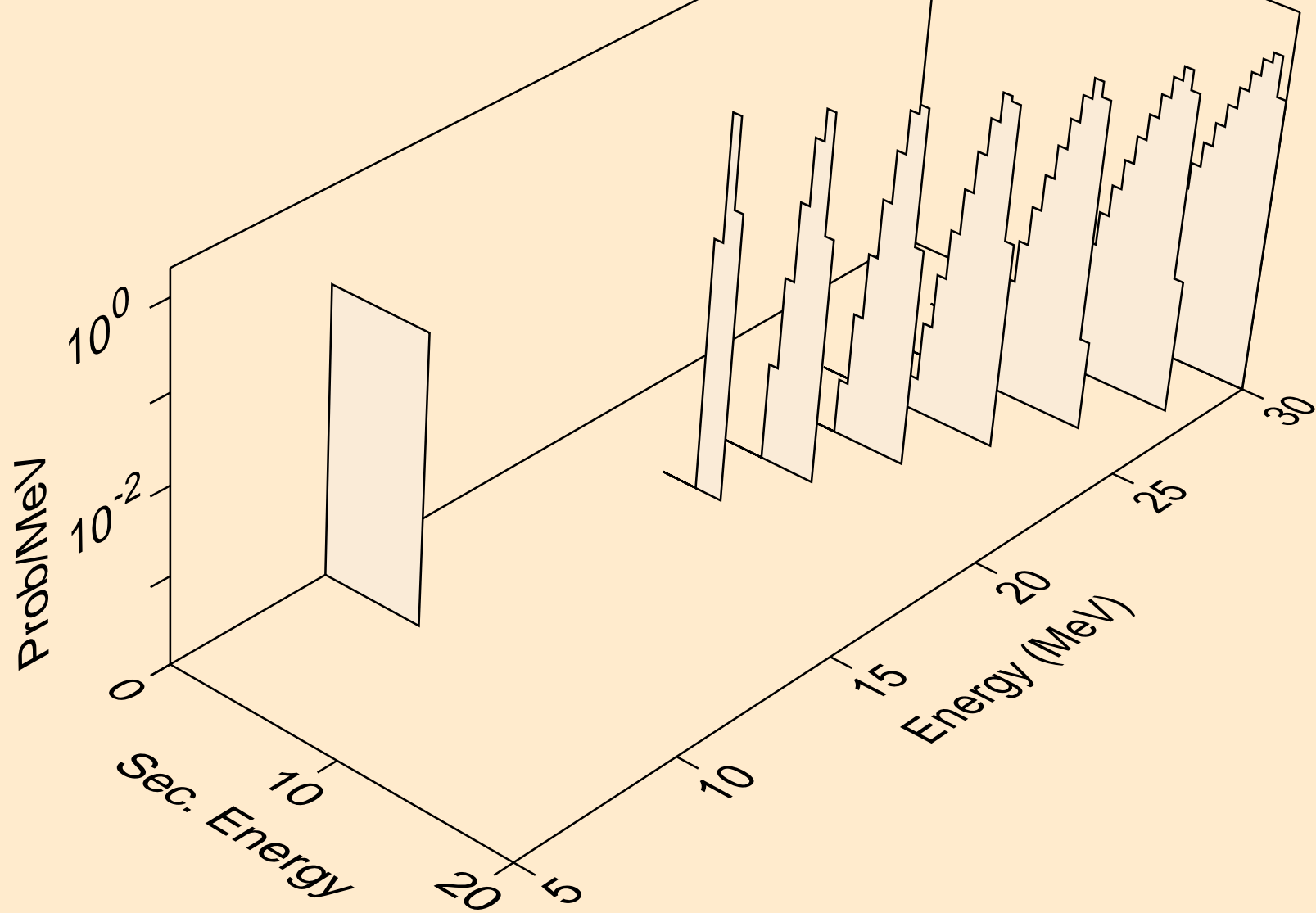

PU238 NEUTRON ACER TENDL-2024 LIBRARY; T=293.6K
he3s from (n,he3)

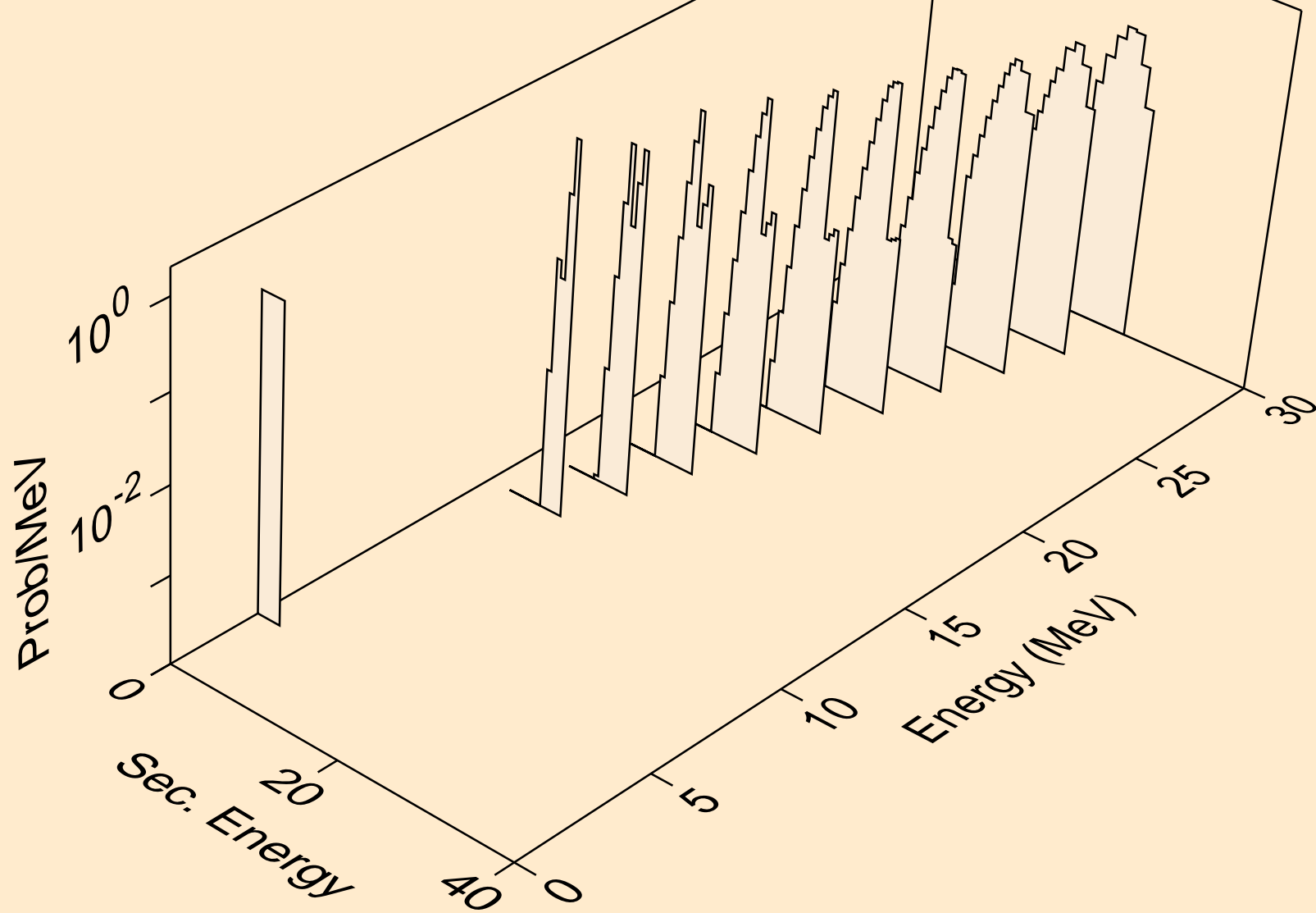

PU238 NEUTRON ACER TENDL-2024 LIBRARY; T=293.6K
alphas from (n,x)

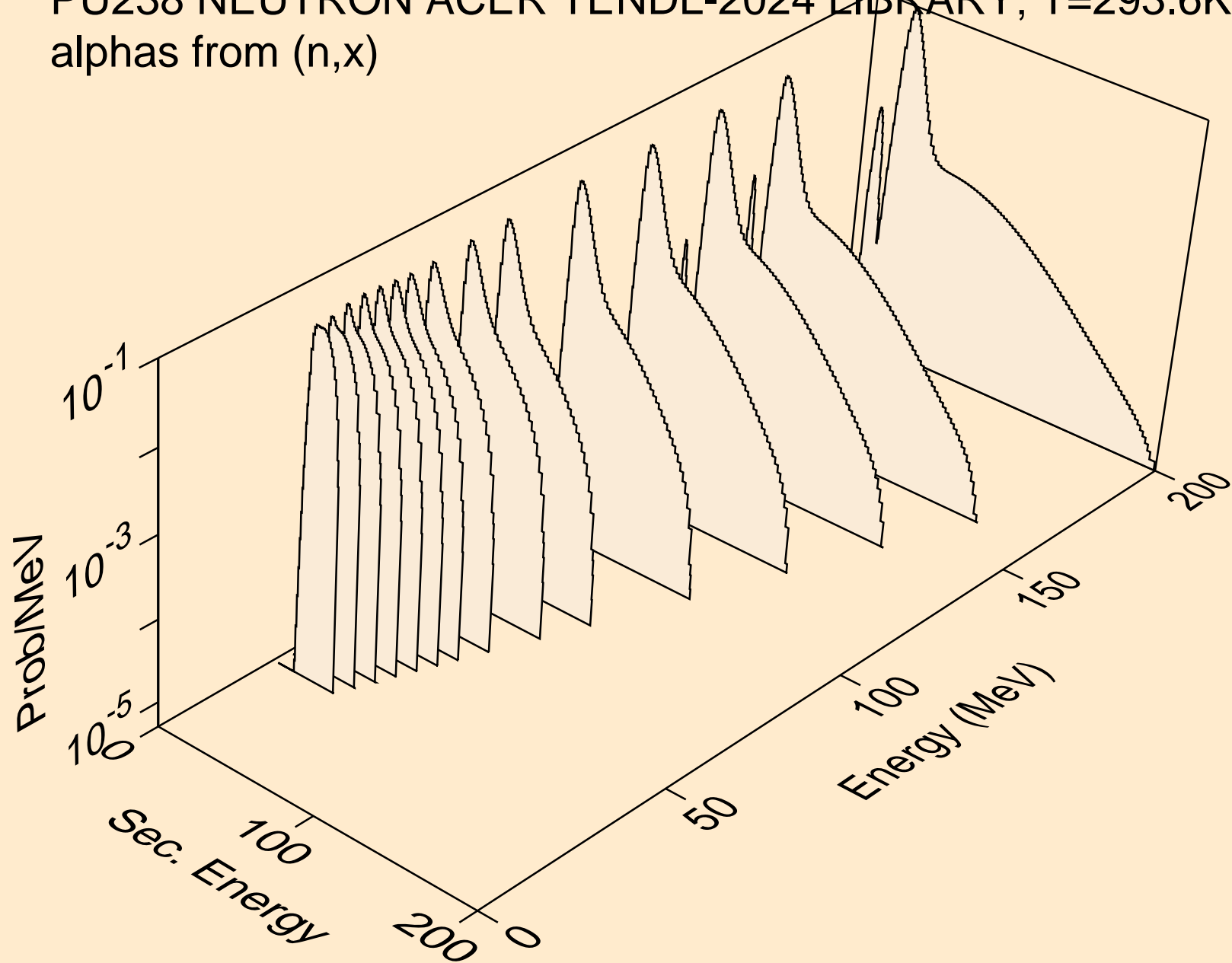

PU238 NEUTRON ACER TENDL-2024 LIBRARY; T=293.6K
alphas from (n,n*)a

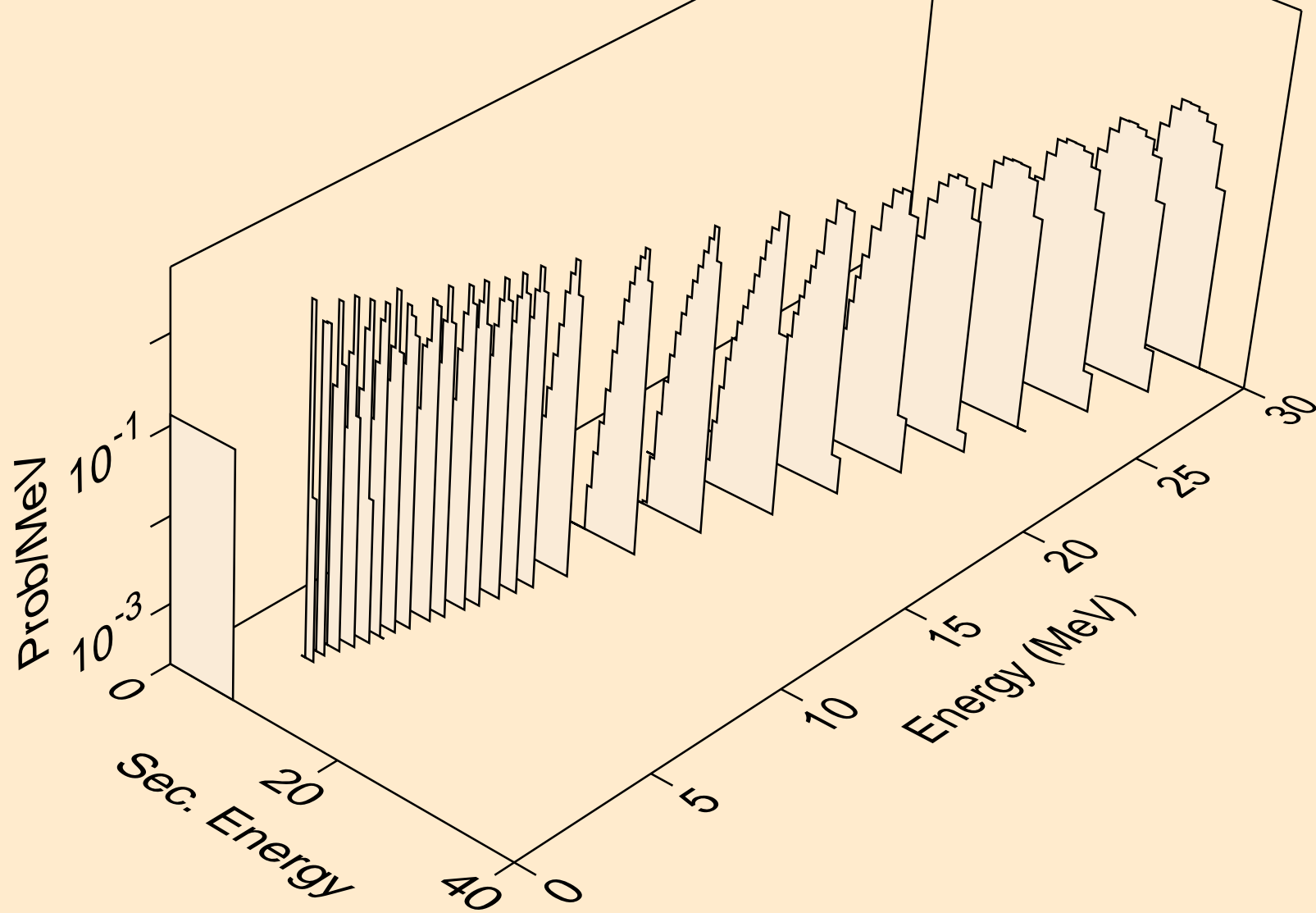

PU238 NEUTRON ACER TENDL-2024 LIBRARY; T=293.6K
alphas from (n,2n)a

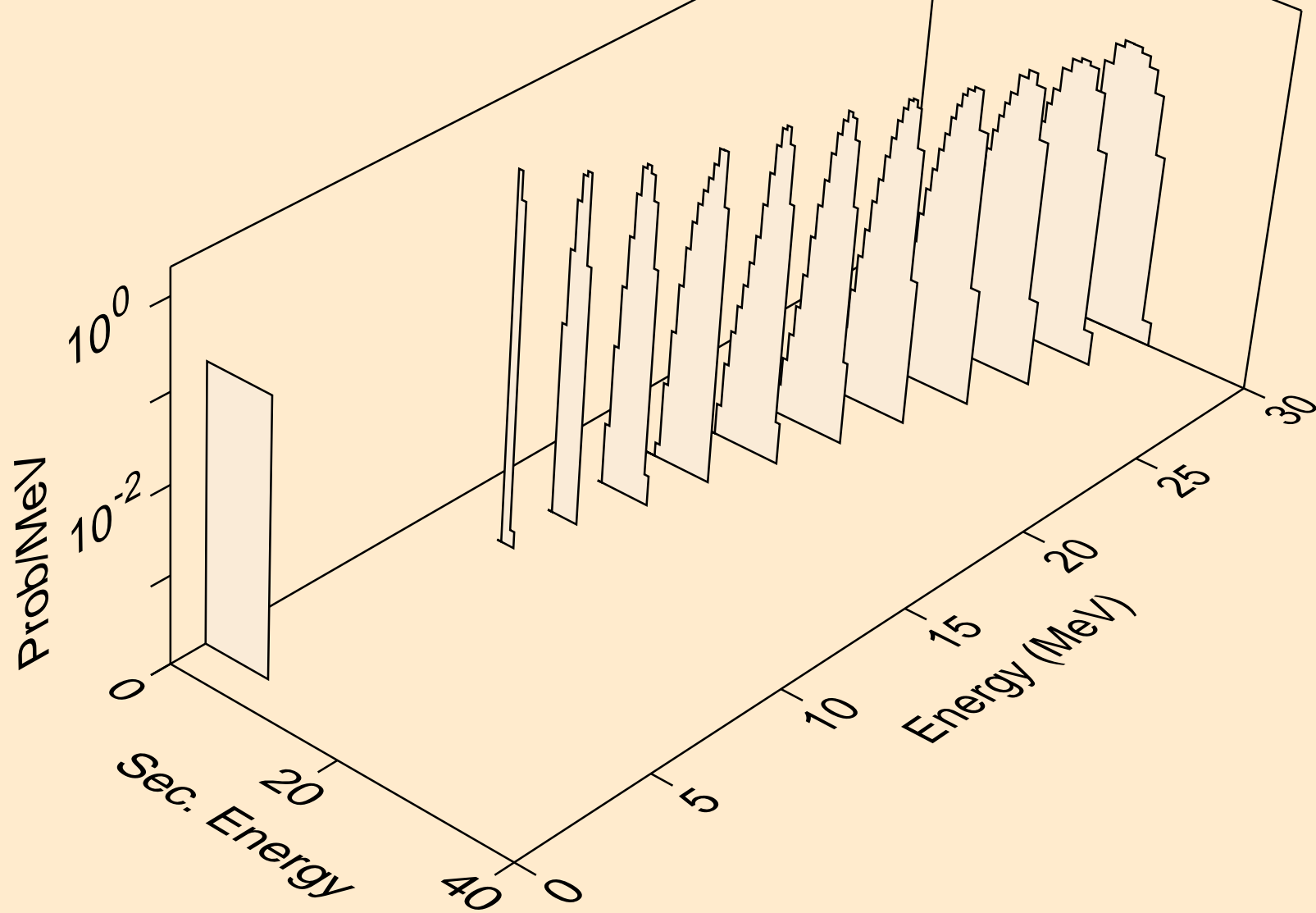

PU238 NEUTRON ACER TENDL-2024 LIBRARY; T=293.6K
alphas from (n,3n)a

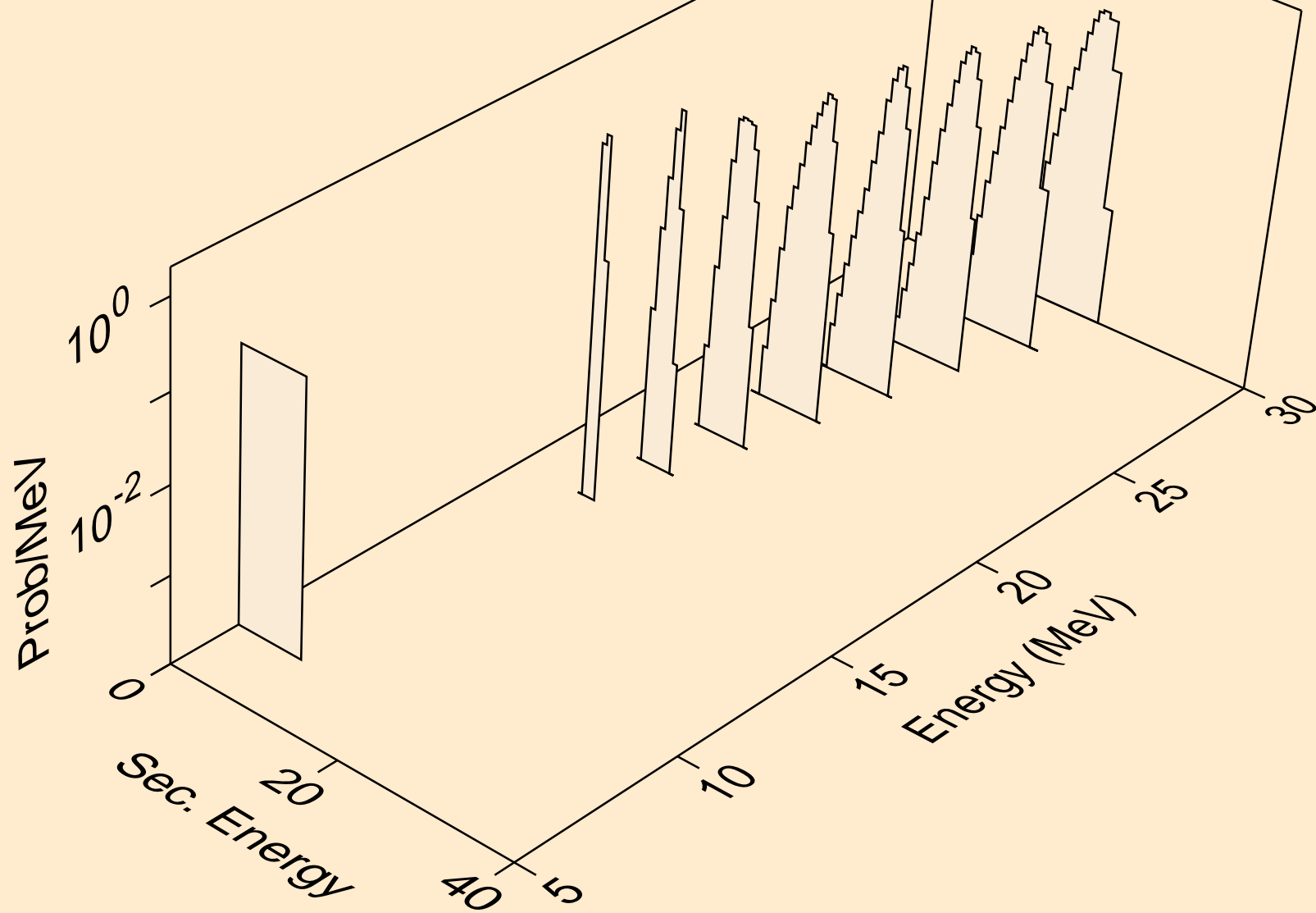

PU238 NEUTRON ACER TENDL-2024 LIBRARY; T=293.6K
alphas from (n,n*)2a

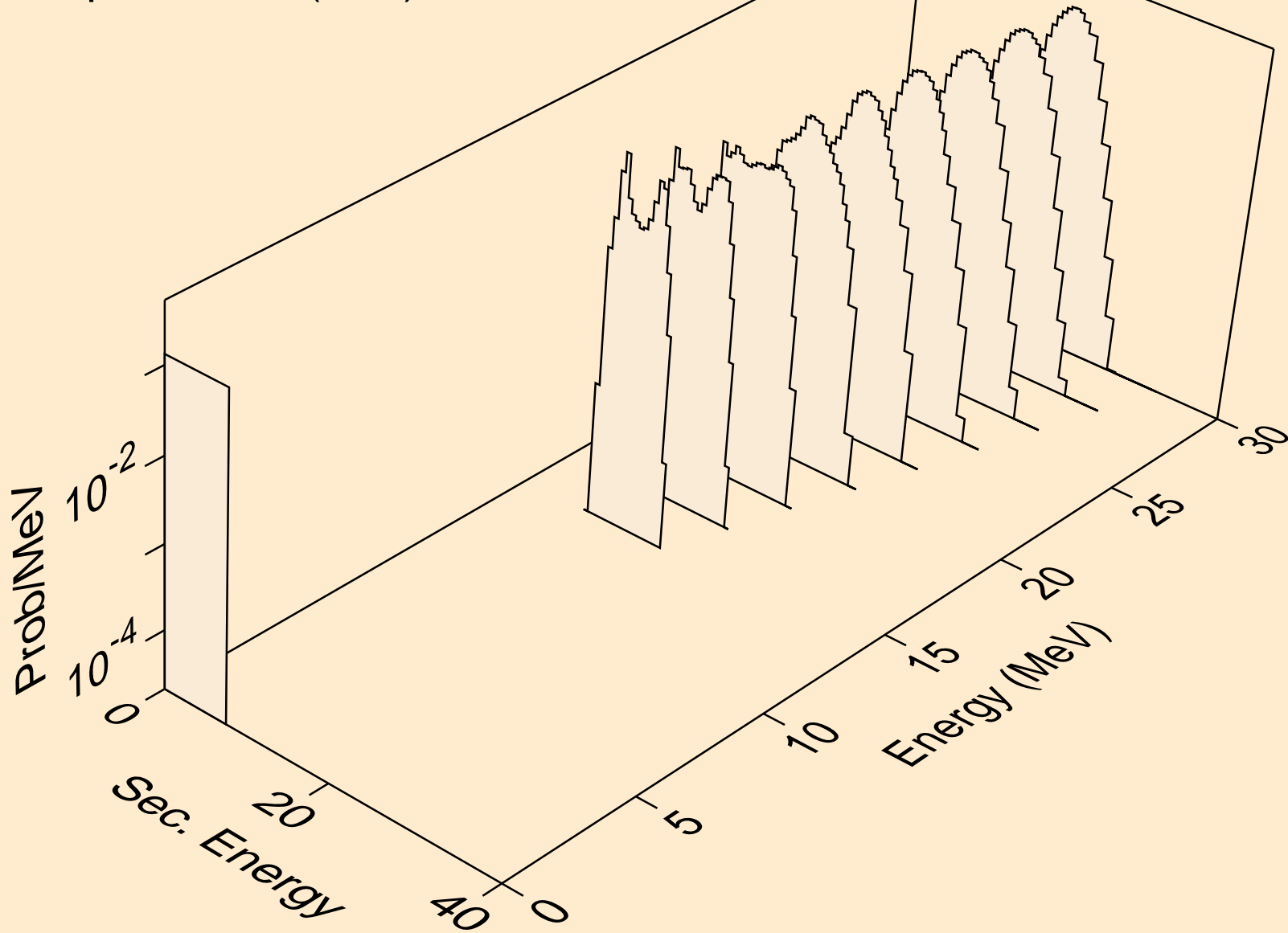

PU238 NEUTRON ACER TENDL-2024 LIBRARY; T=293.6K
alphas from (n,npa)

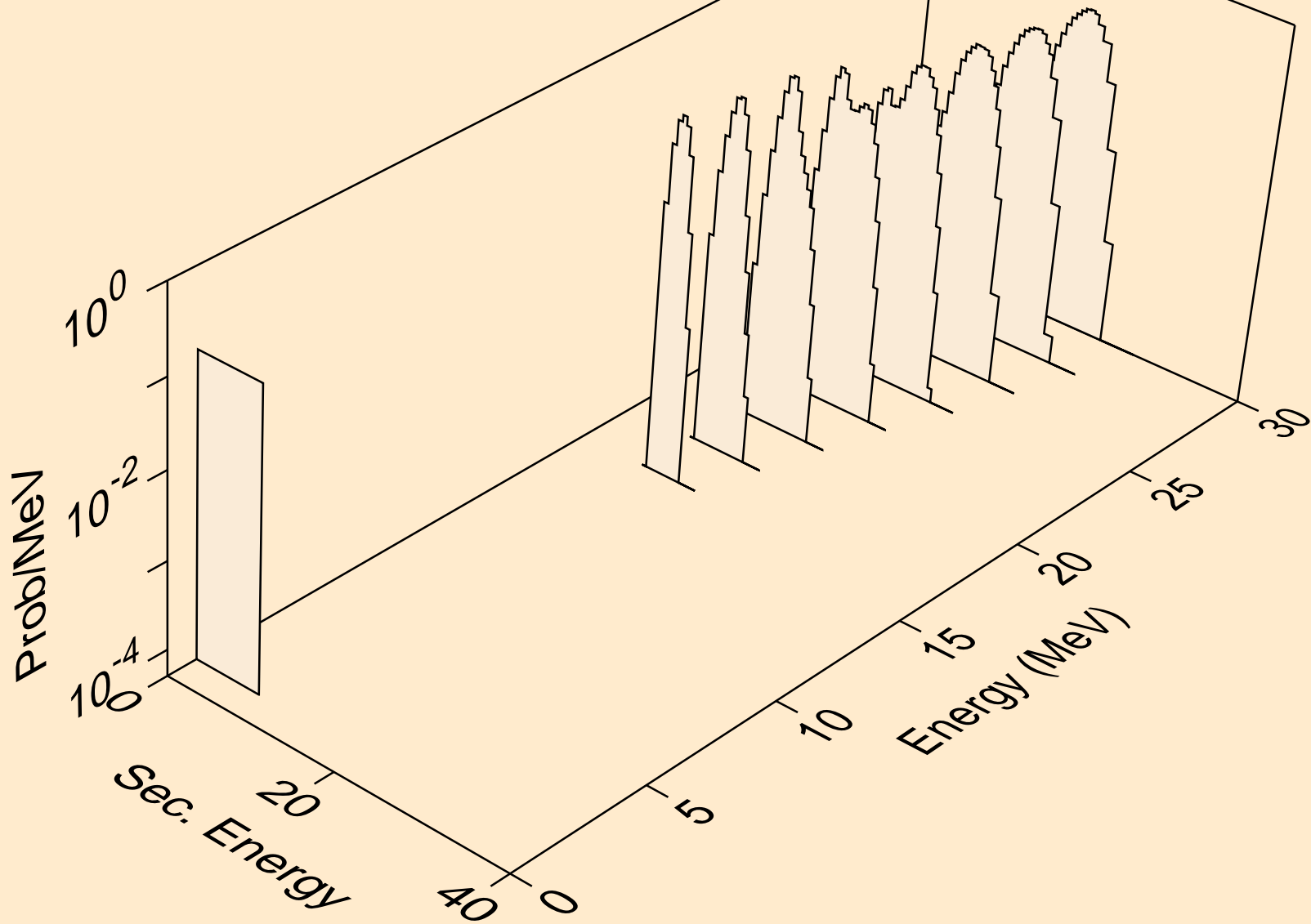

PU238 NEUTRON ACER TENDL-2024 LIBRARY; T=293.6K
alphas from (n,a)

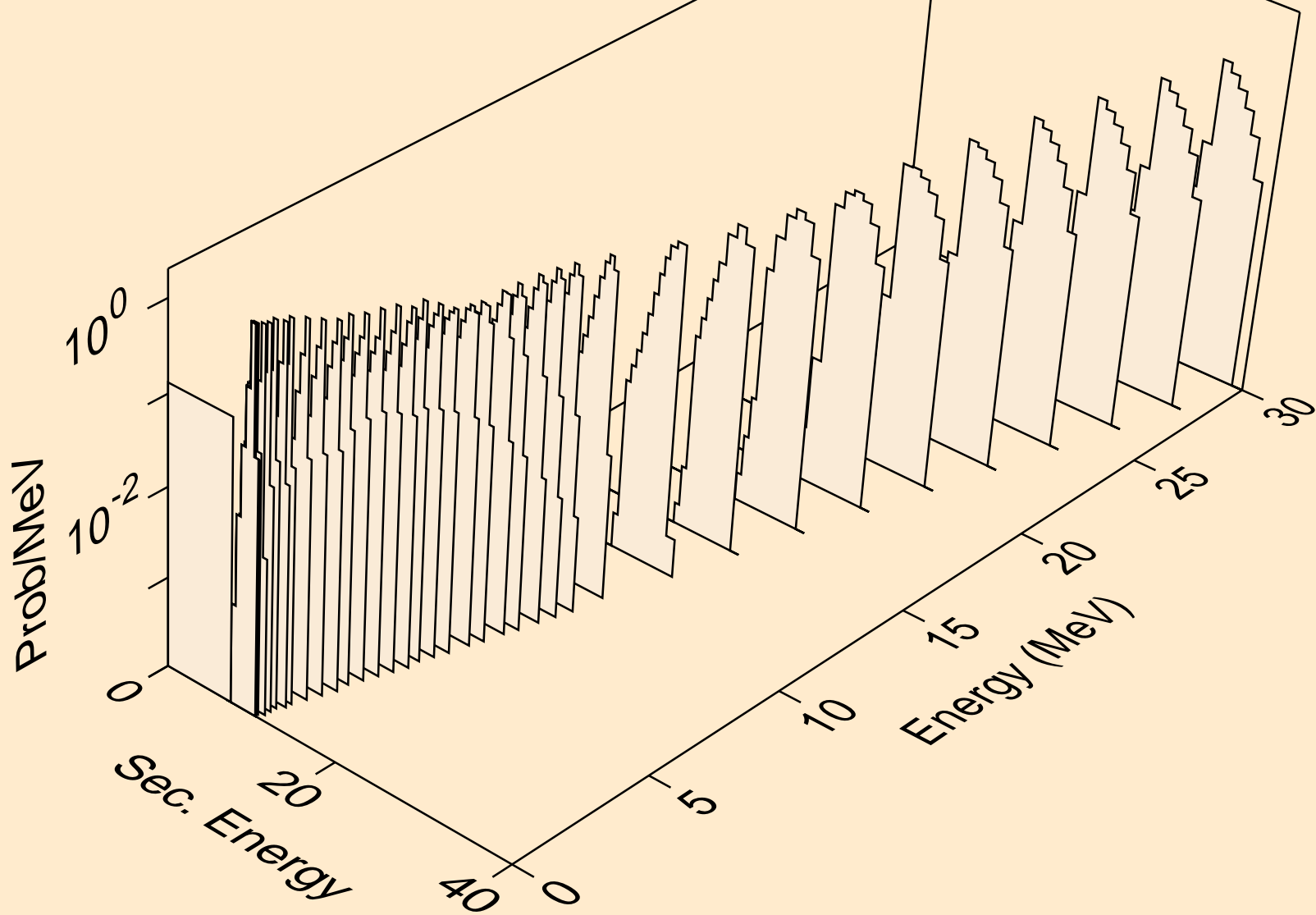

PU238 NEUTRON ACER TENDL-2024 LIBRARY; T=293.6K
alphas from (n,2a)

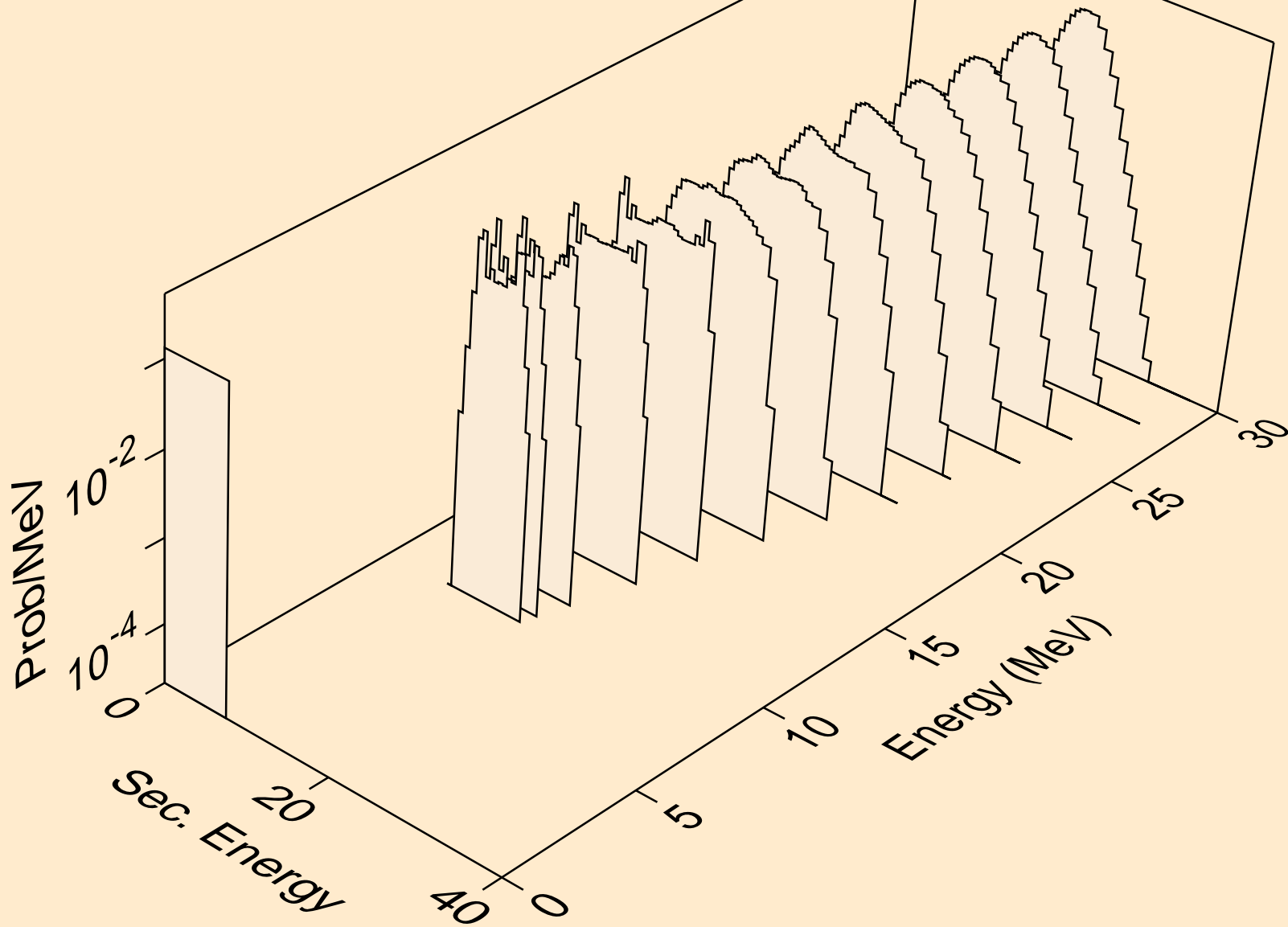

PU238 NEUTRON ACER TENDL-2024 LIBRARY; T=293.6K
alphas from (n,pa)

