

RE178 NEUTRON ACER TENDL-2024 LIBRARY; T=293.6K

Principal cross sections

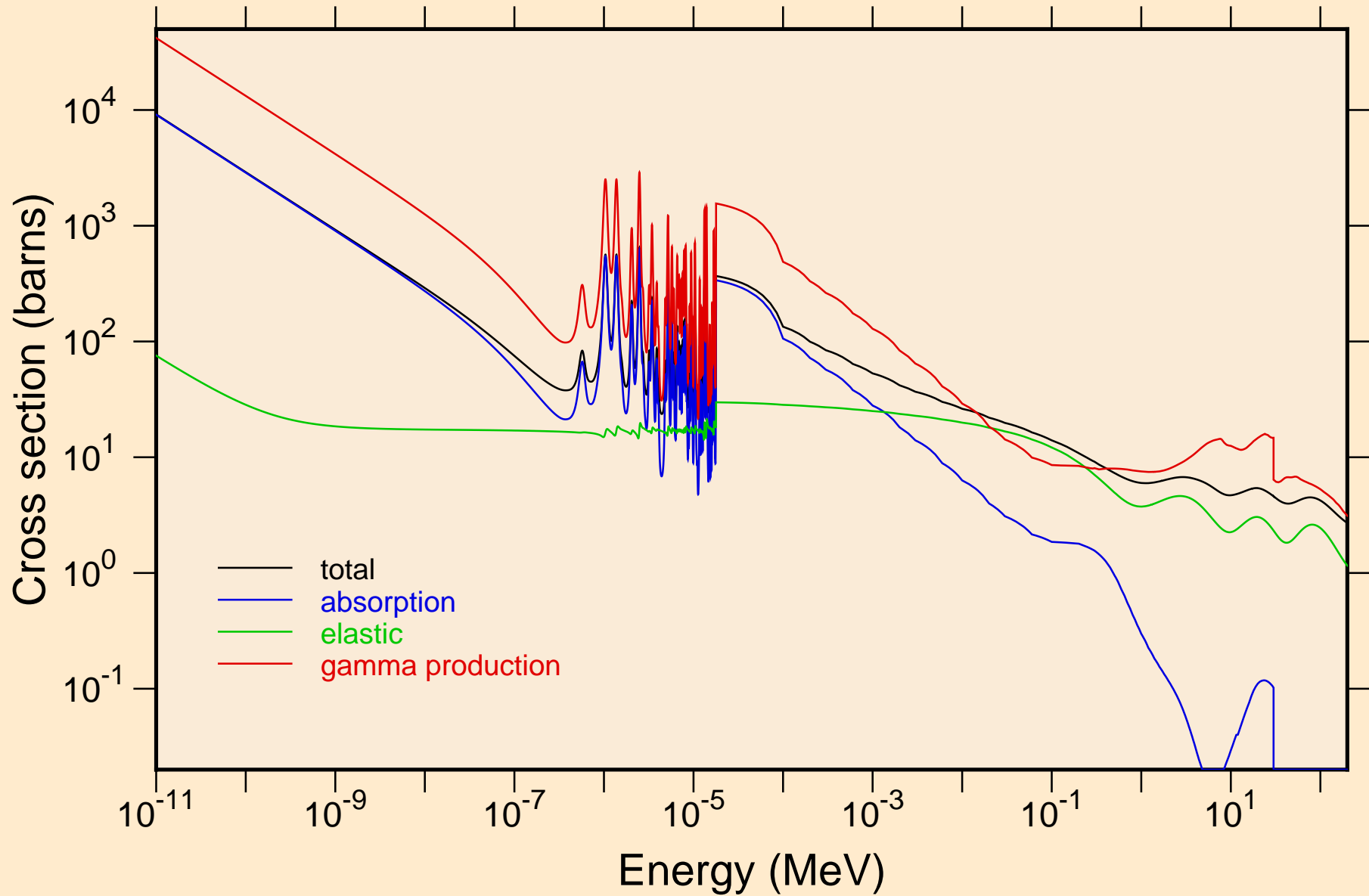

RE178 NEUTRON ACER TENDL-2024 LIBRARY; T=293.6K
resonance total cross section

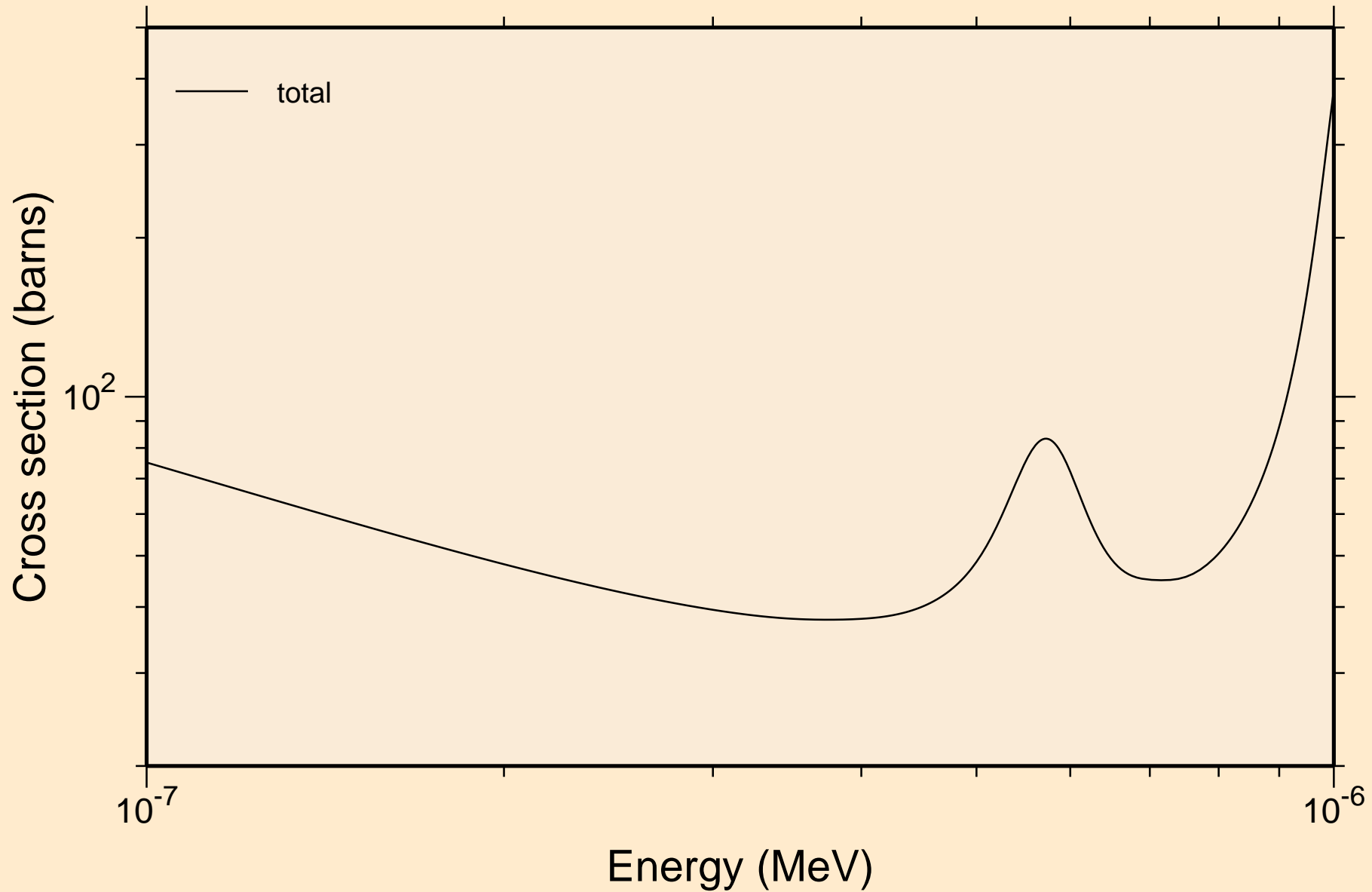

RE178 NEUTRON ACER TENDL-2024 LIBRARY; T=293.6K
resonance total cross section

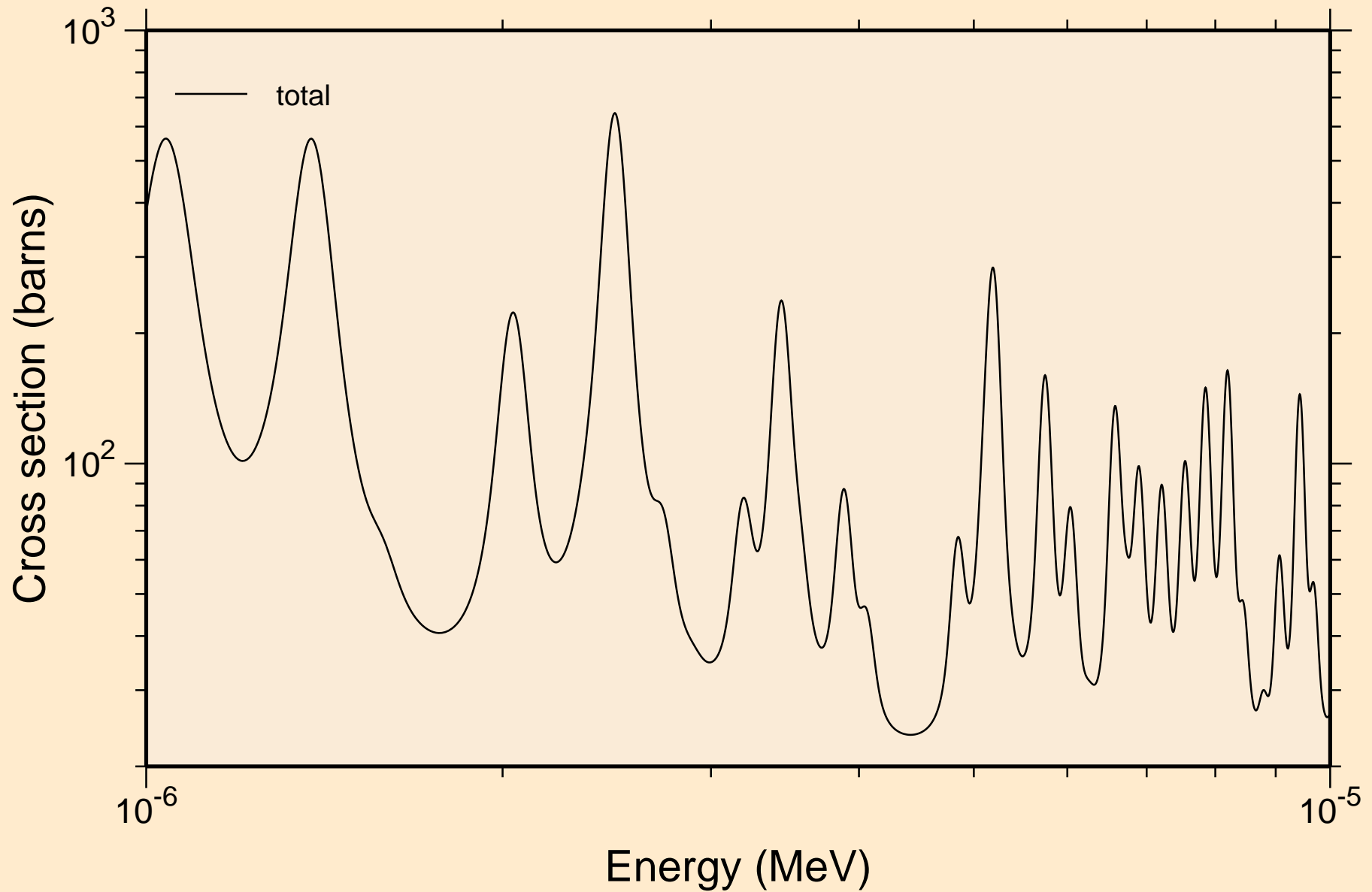

RE178 NEUTRON ACER TENDL-2024 LIBRARY; T=293.6K
resonance total cross section

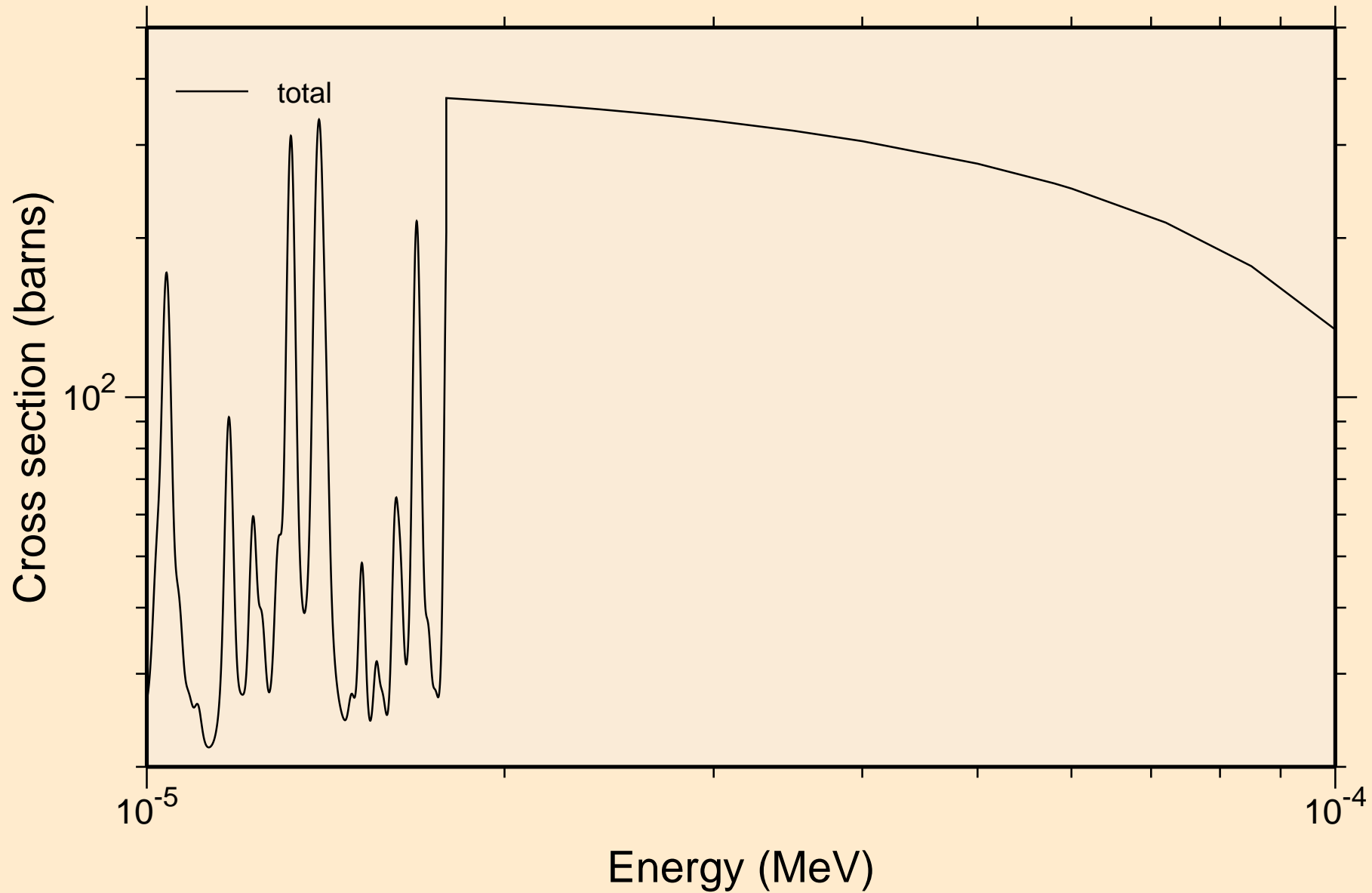

RE178 NEUTRON ACER TENDL-2024 LIBRARY; T=293.6K
resonance total cross section

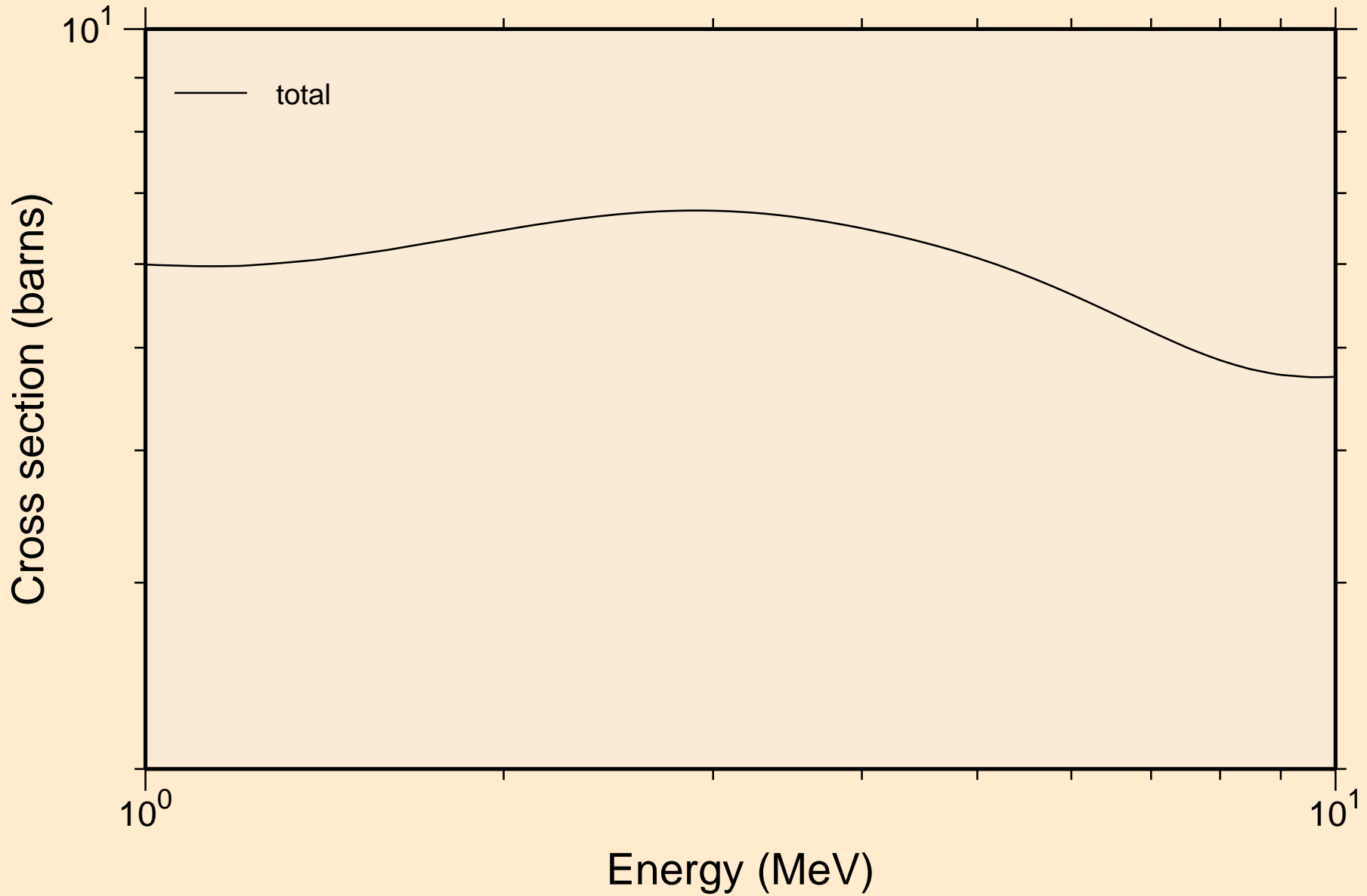

RE178 NEUTRON ACER TENDL-2024 LIBRARY; T=293.6K
resonance absorption cross sections

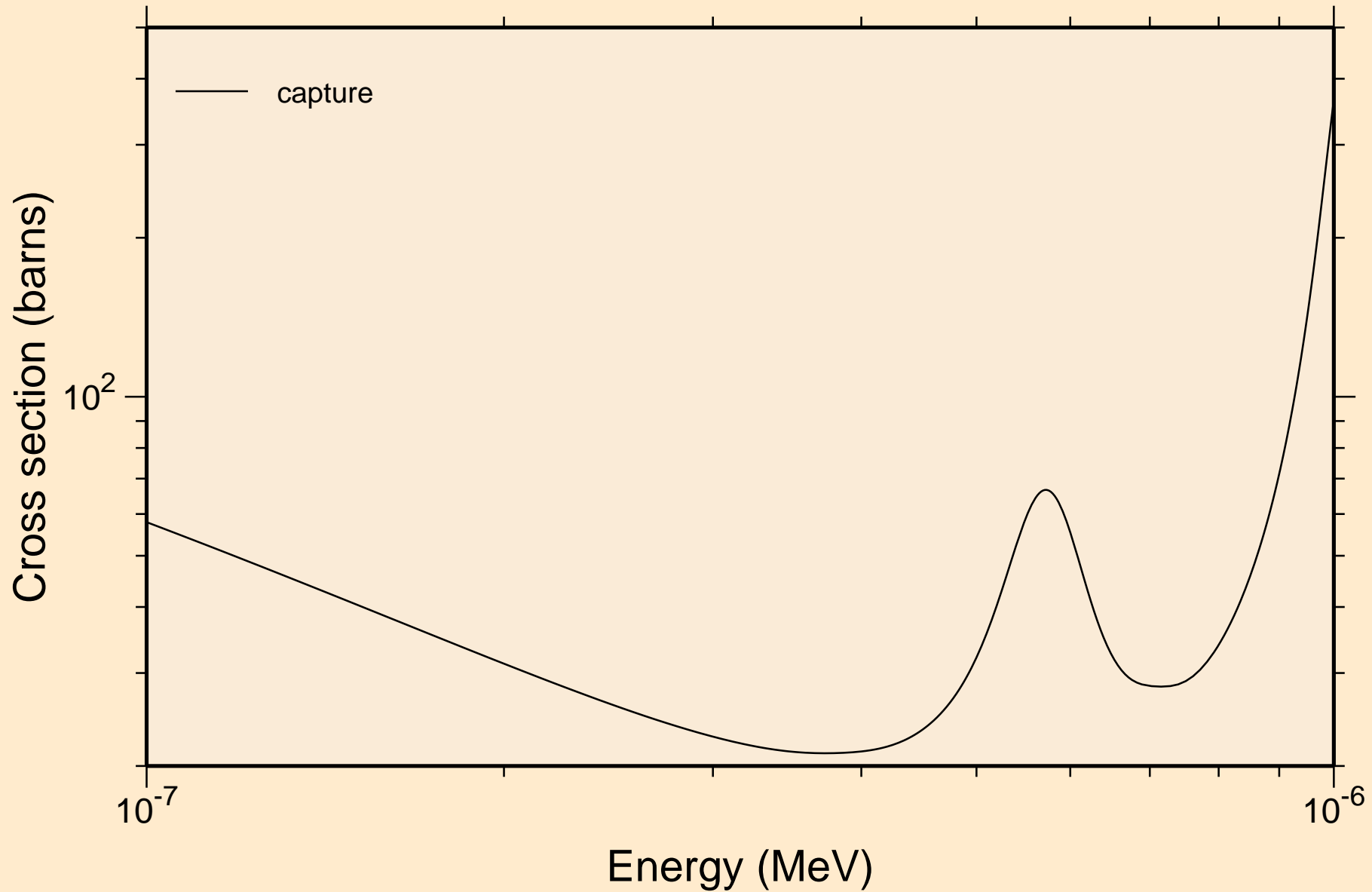

RE178 NEUTRON ACER TENDL-2024 LIBRARY; T=293.6K
resonance absorption cross sections

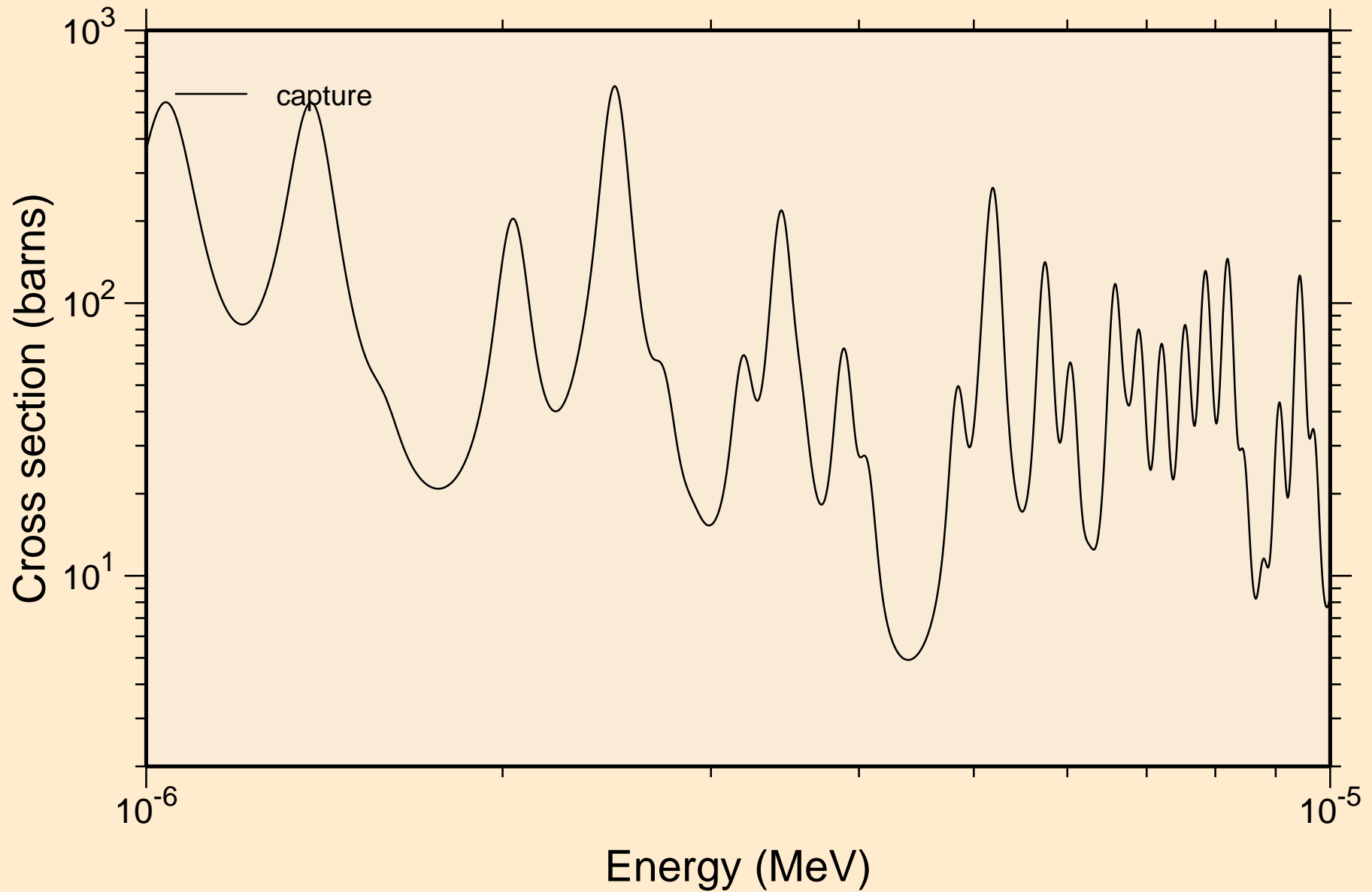

RE178 NEUTRON ACER TENDL-2024 LIBRARY; T=293.6K
resonance absorption cross sections

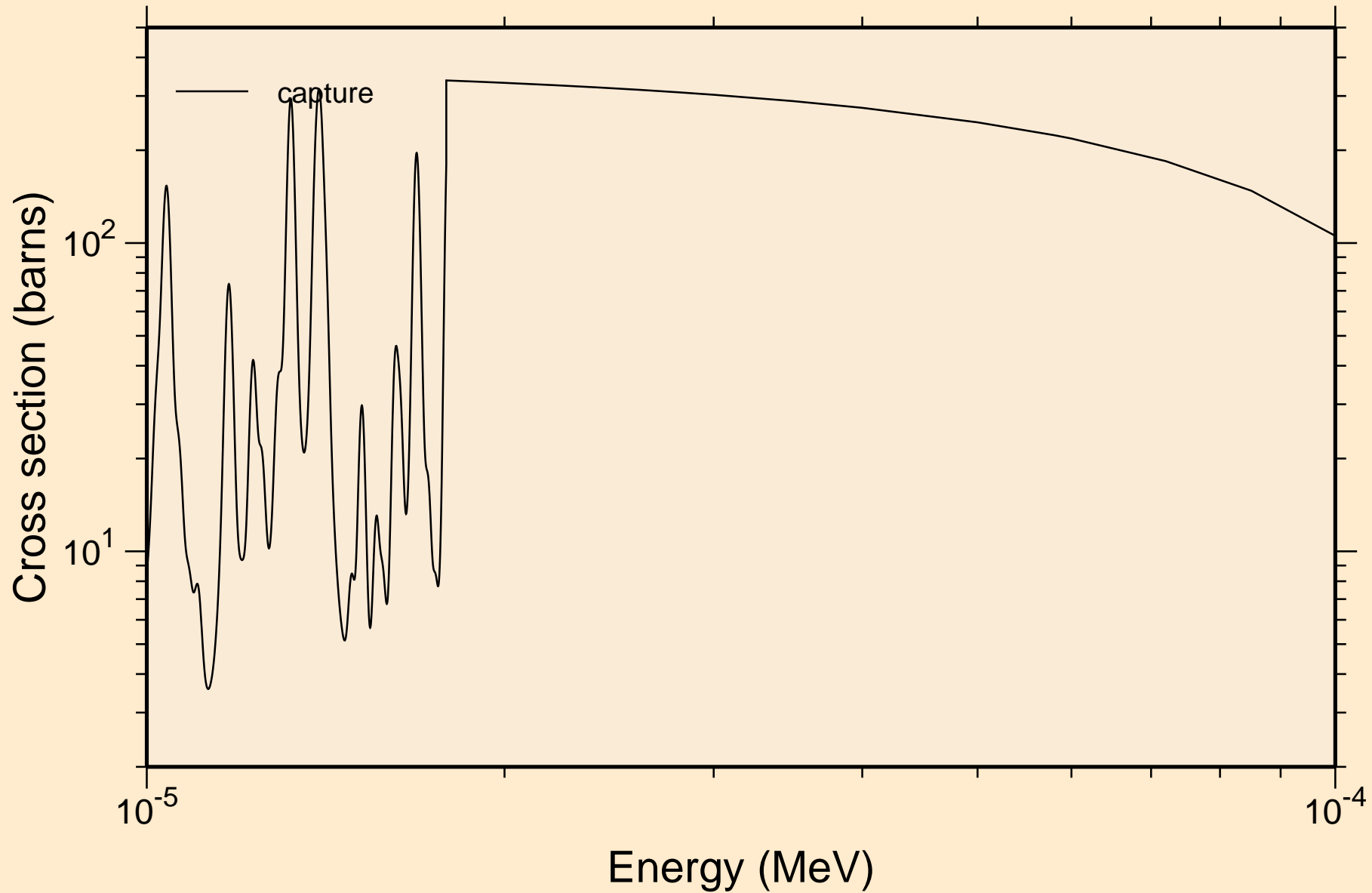

RE178 NEUTRON ACER TENDL-2024 LIBRARY; T=293.6K
resonance absorption cross sections

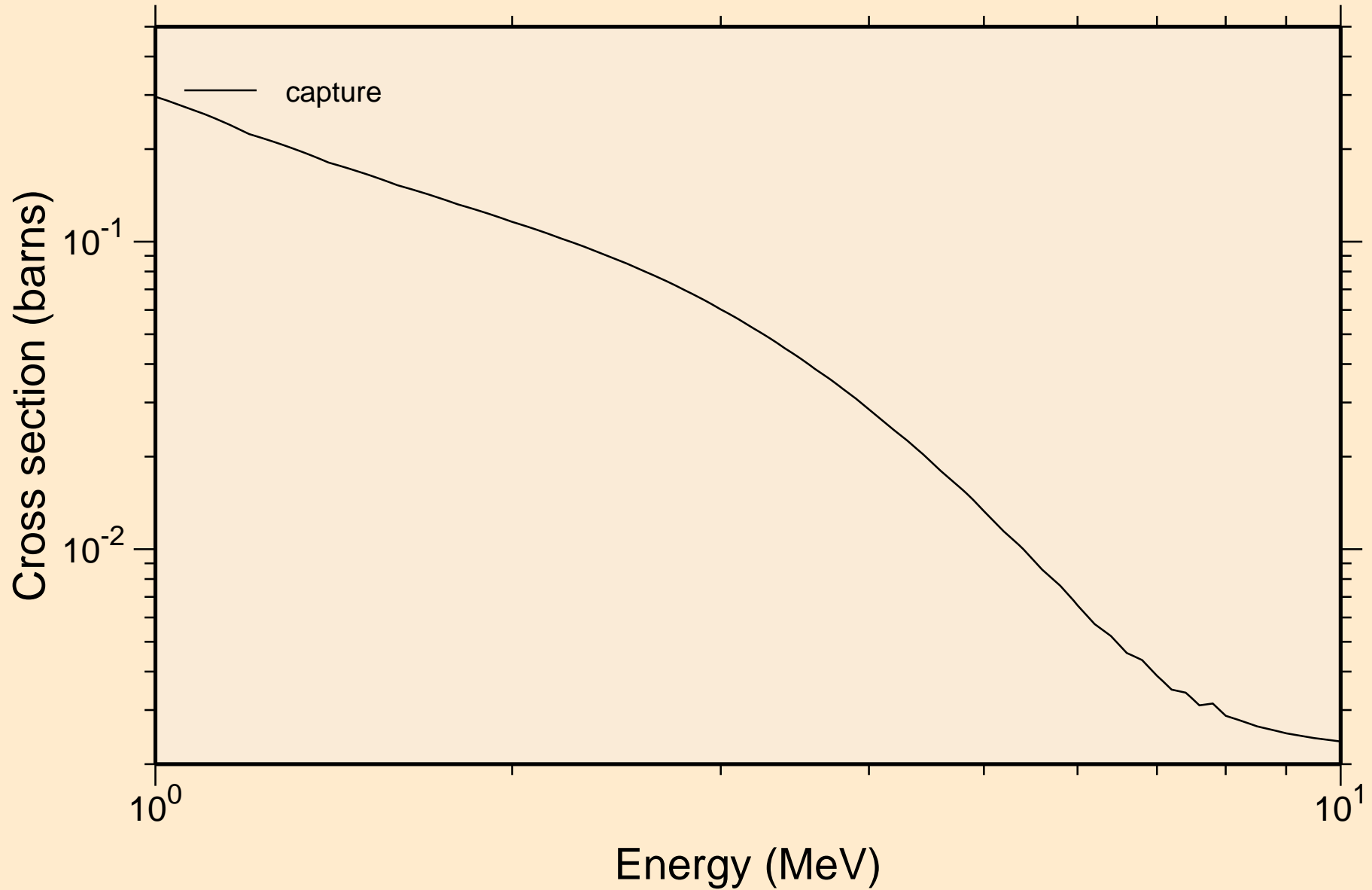

RE178 NEUTRON ACER TENDL-2024 LIBRARY; T=293.6K
Heating

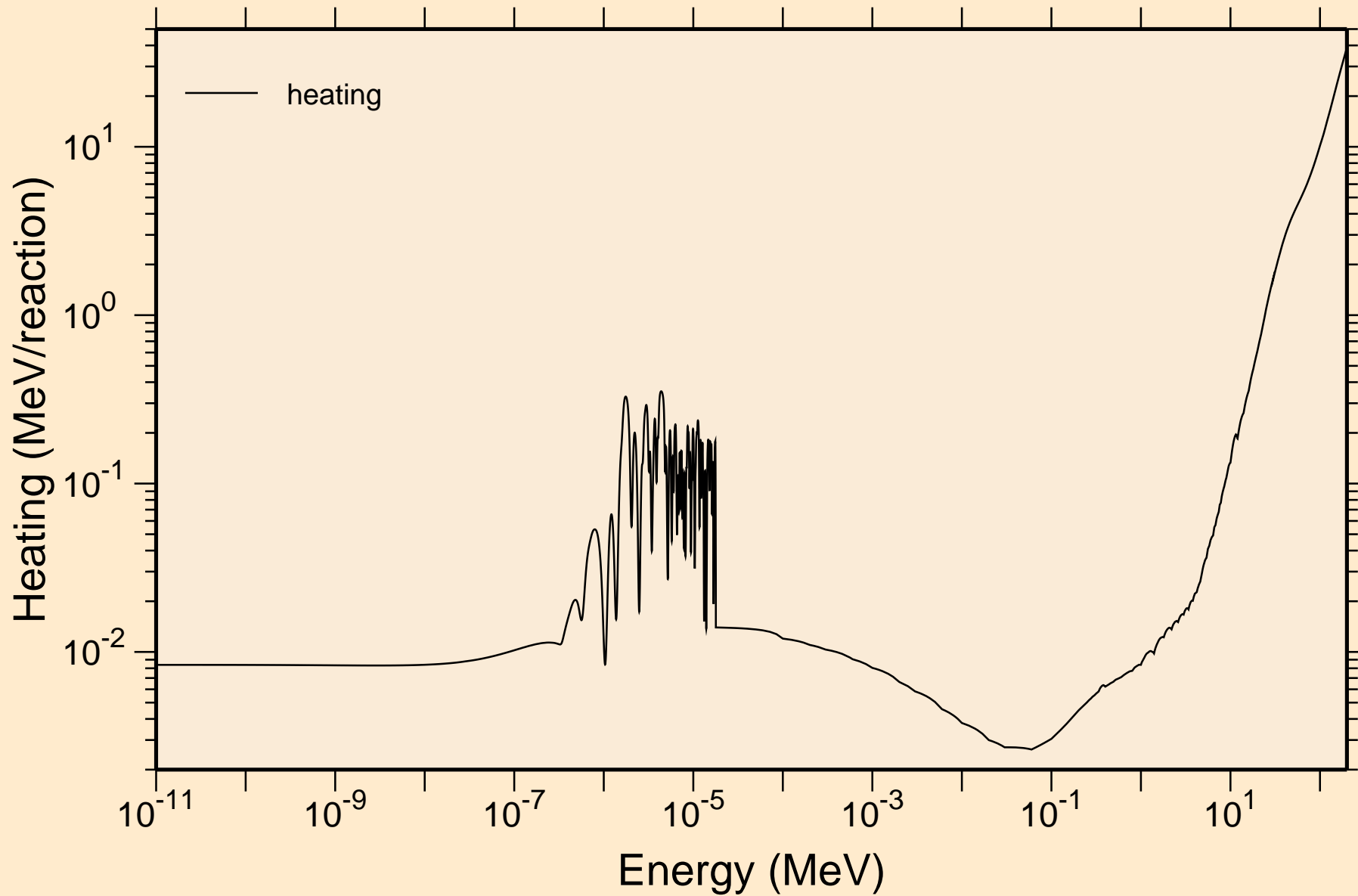

RE178 NEUTRON ACER TENDL-2024 LIBRARY; T=293.6K

Damage

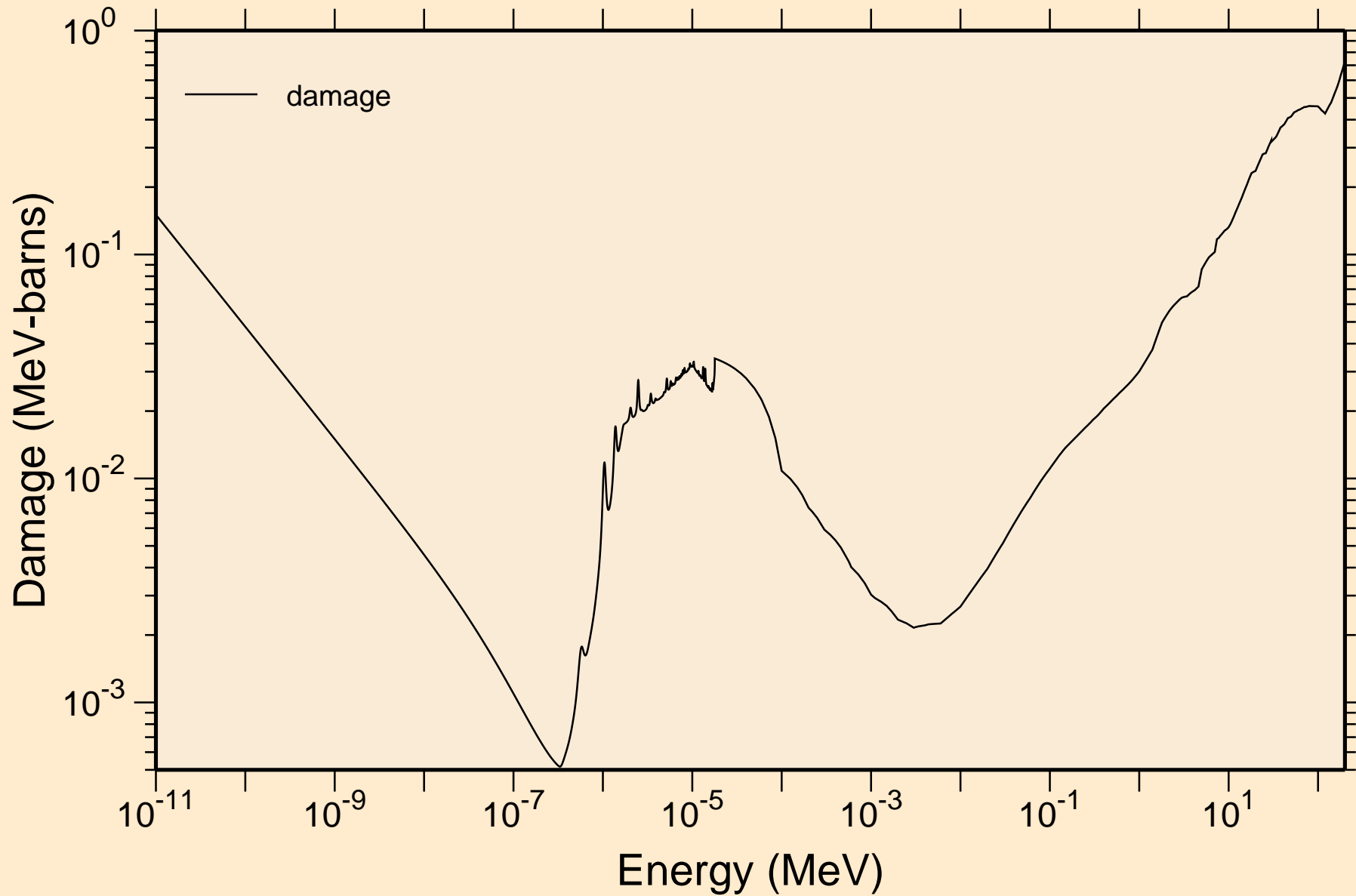

RE178 NEUTRON ACER TENDL-2024 LIBRARY; T=293.6K
Non-threshold reactions

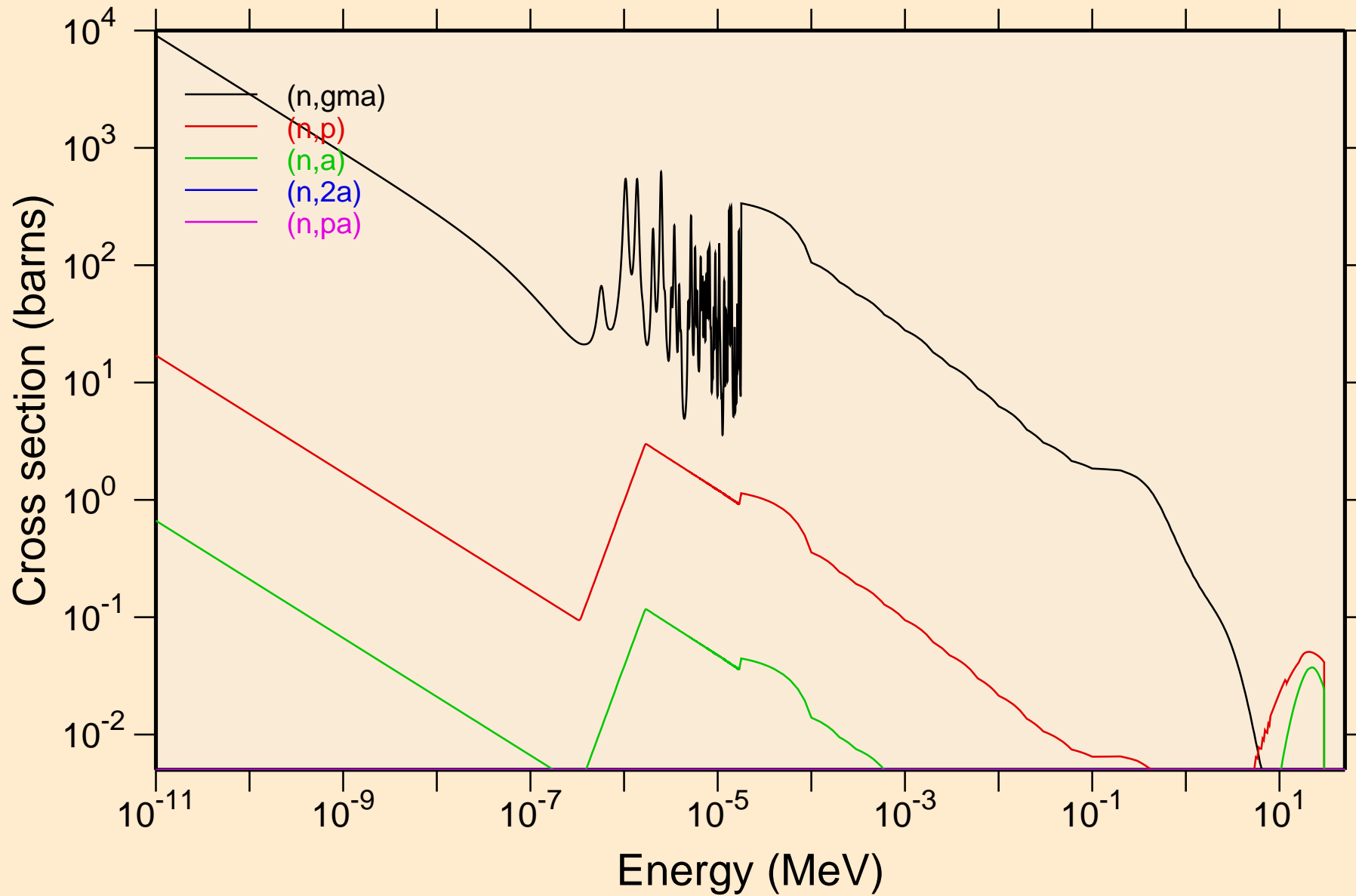

RE178 NEUTRON ACER TENDL-2024 LIBRARY; T=293.6K
Non-threshold reactions

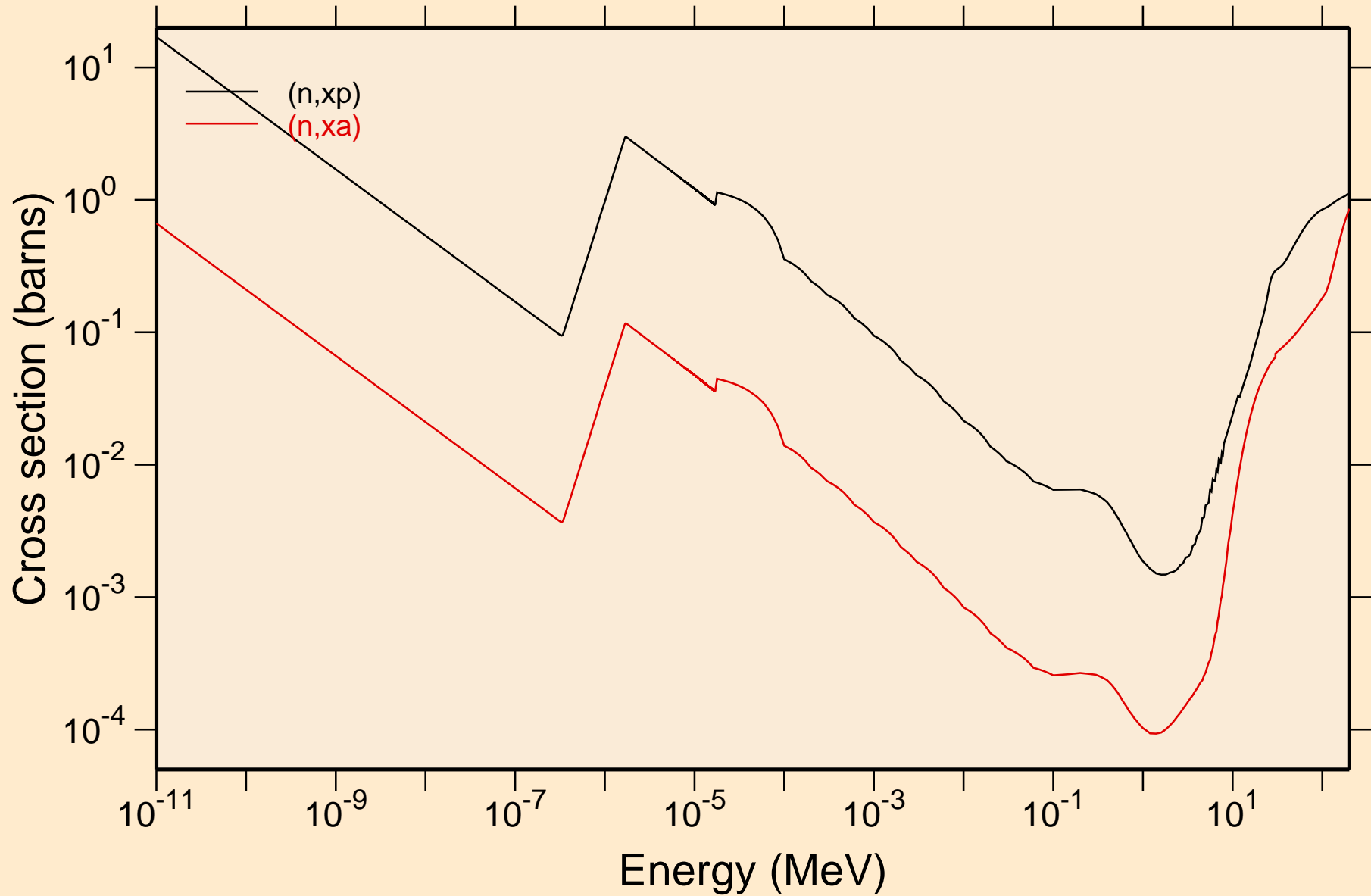

RE178 NEUTRON ACER TENDL-2024 LIBRARY; T=293.6K

Principal cross sections

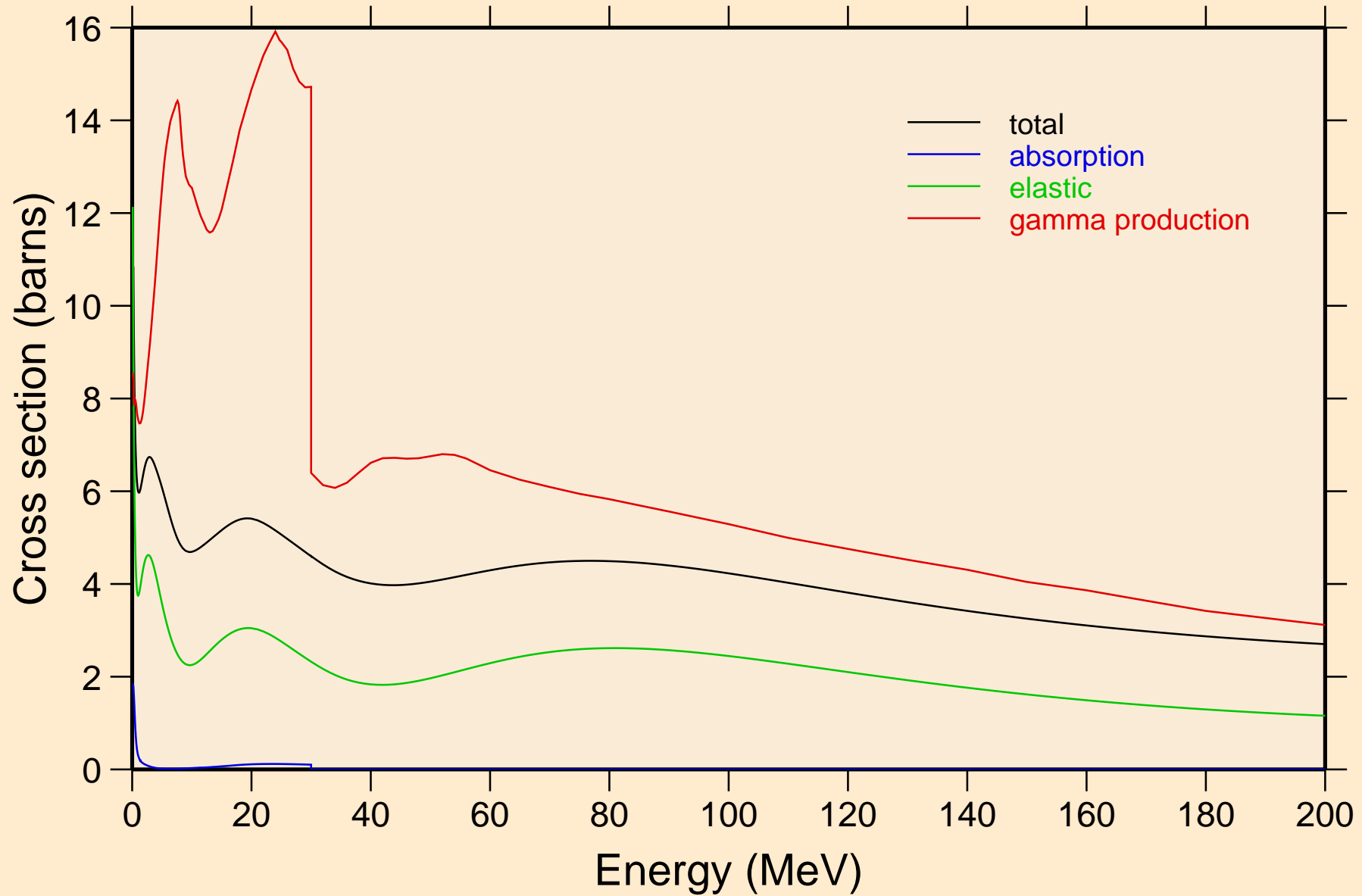

RE178 NEUTRON ACER TENDL-2024 LIBRARY; T=293.6K

Heating

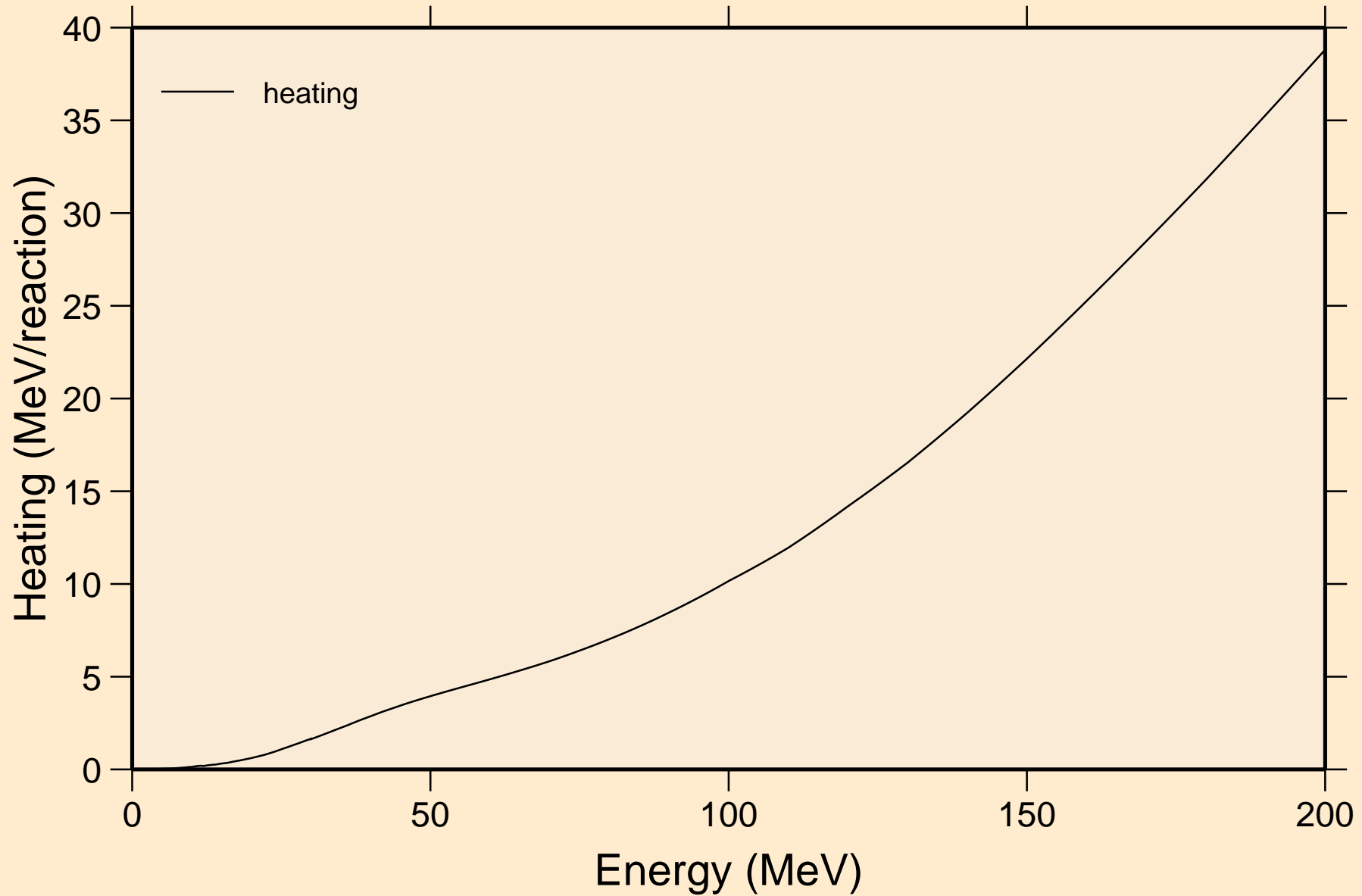

RE178 NEUTRON ACER TENDL-2024 LIBRARY; T=293.6K
Damage

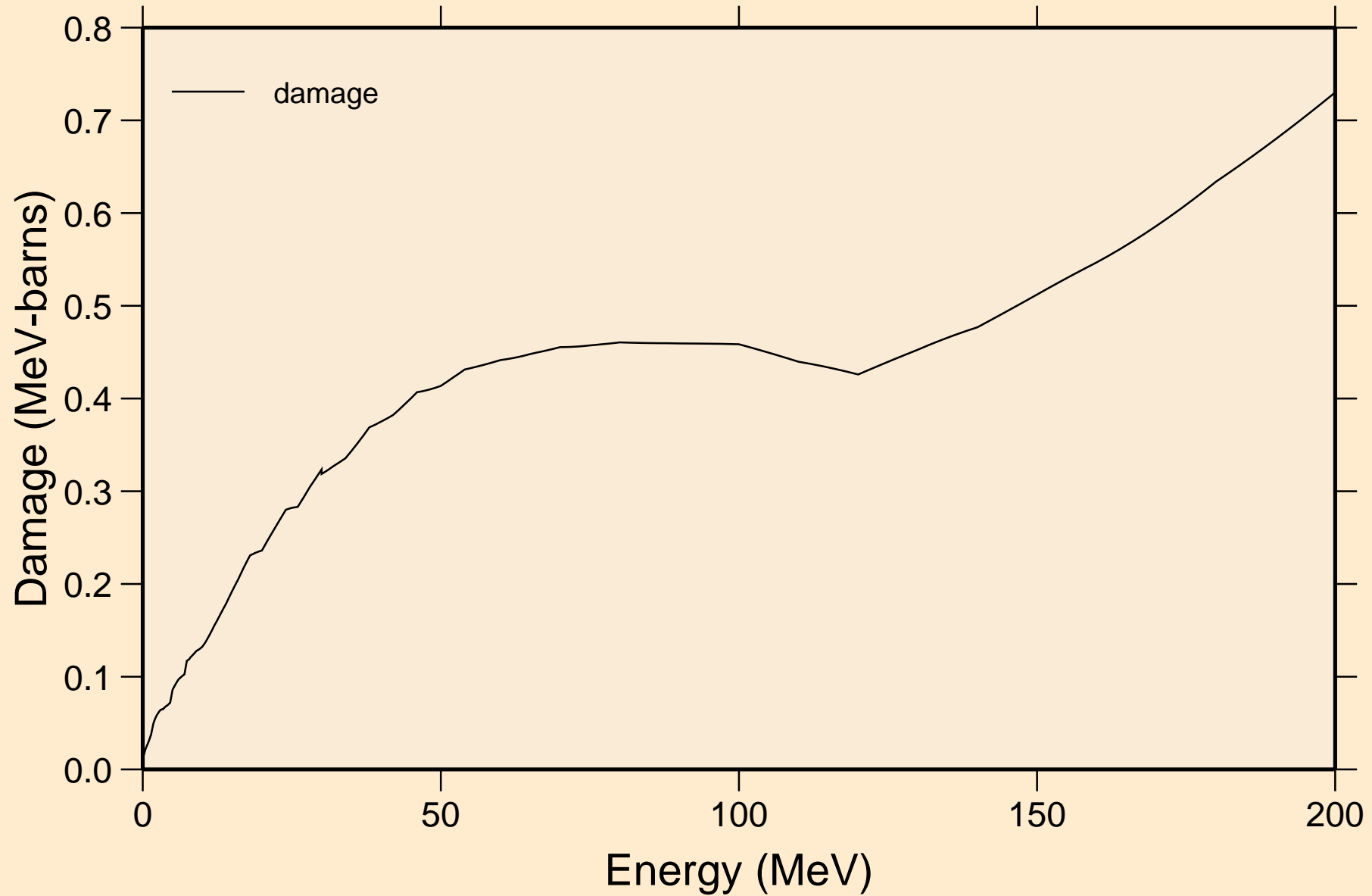

RE178 NEUTRON ACER TENDL-2024 LIBRARY; T=293.6K
Non-threshold reactions

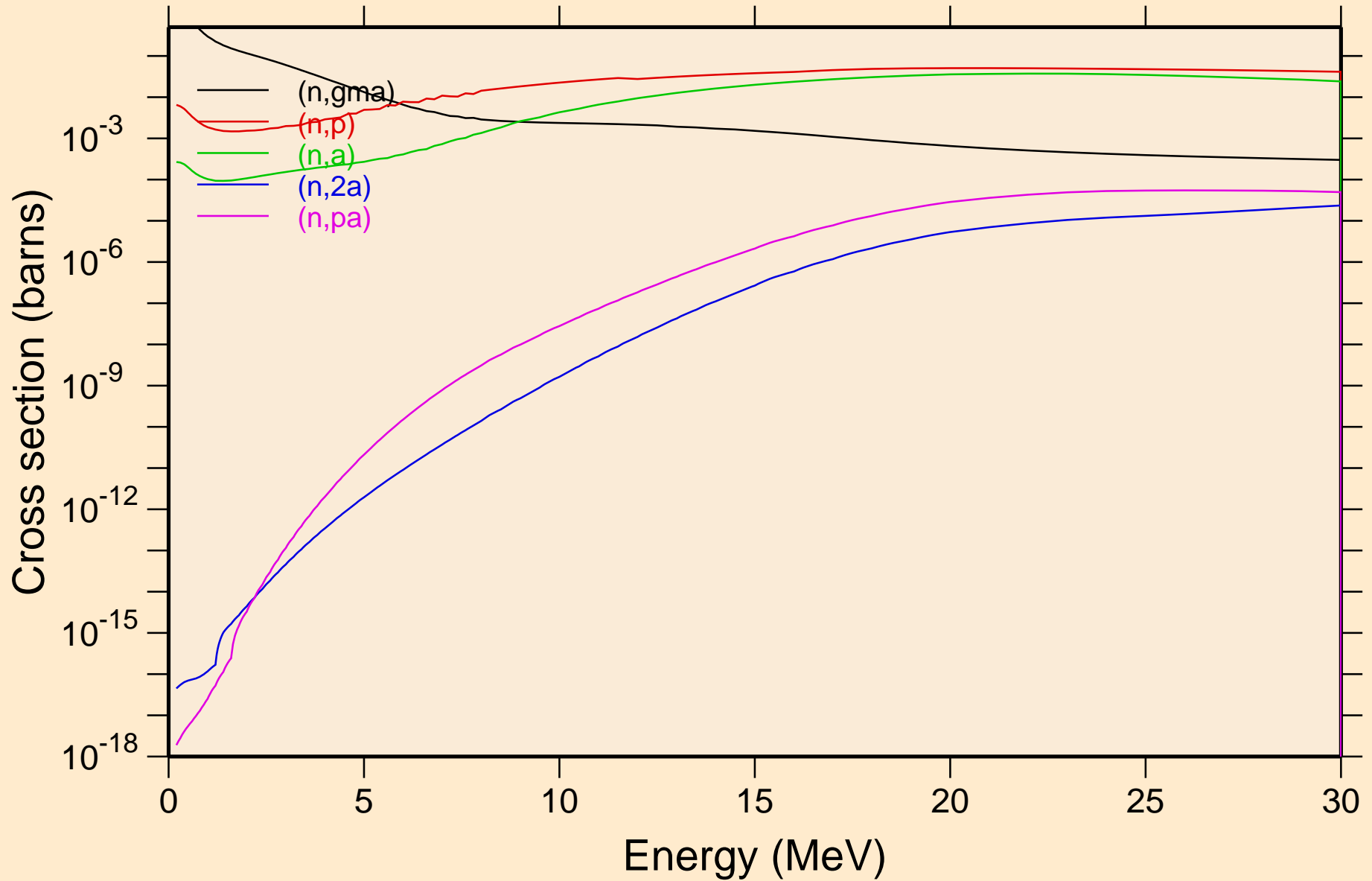

RE178 NEUTRON ACER TENDL-2024 LIBRARY; T=293.6K
Non-threshold reactions

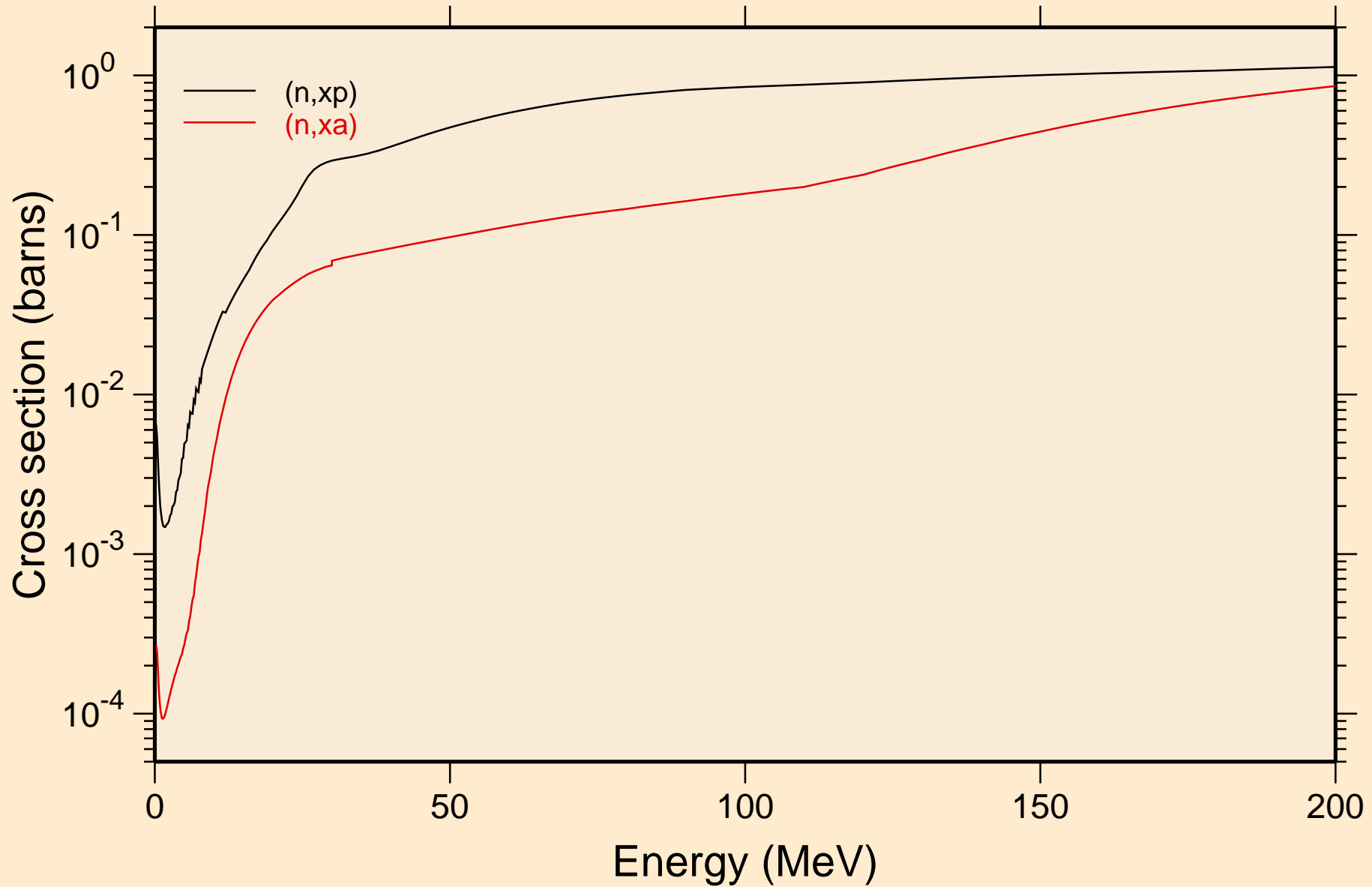

RE178 NEUTRON ACER TENDL-2024 LIBRARY; T=293.6K
Inelastic levels

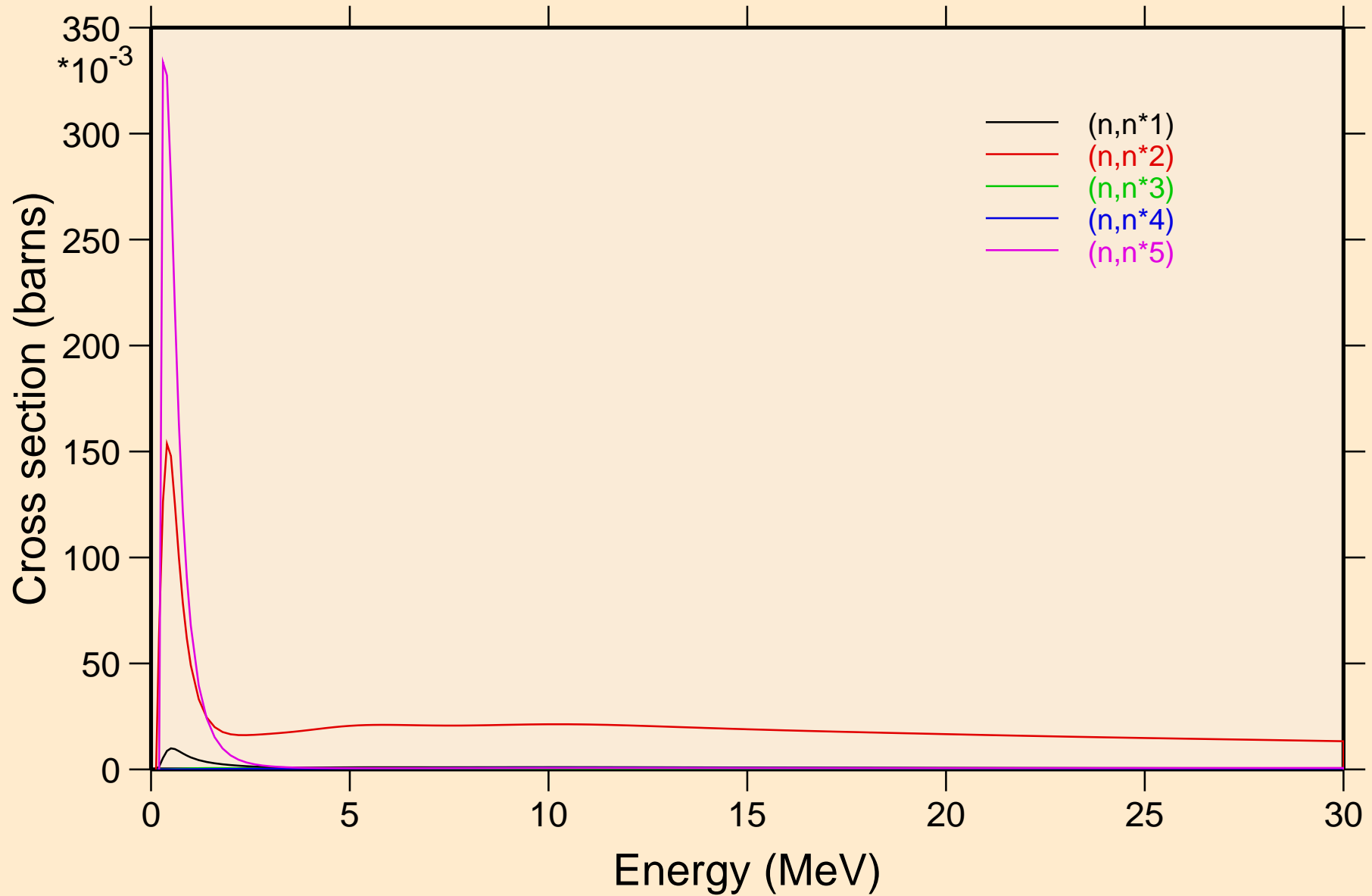

RE178 NEUTRON ACER TENDL-2024 LIBRARY; T=293.6K
Inelastic levels

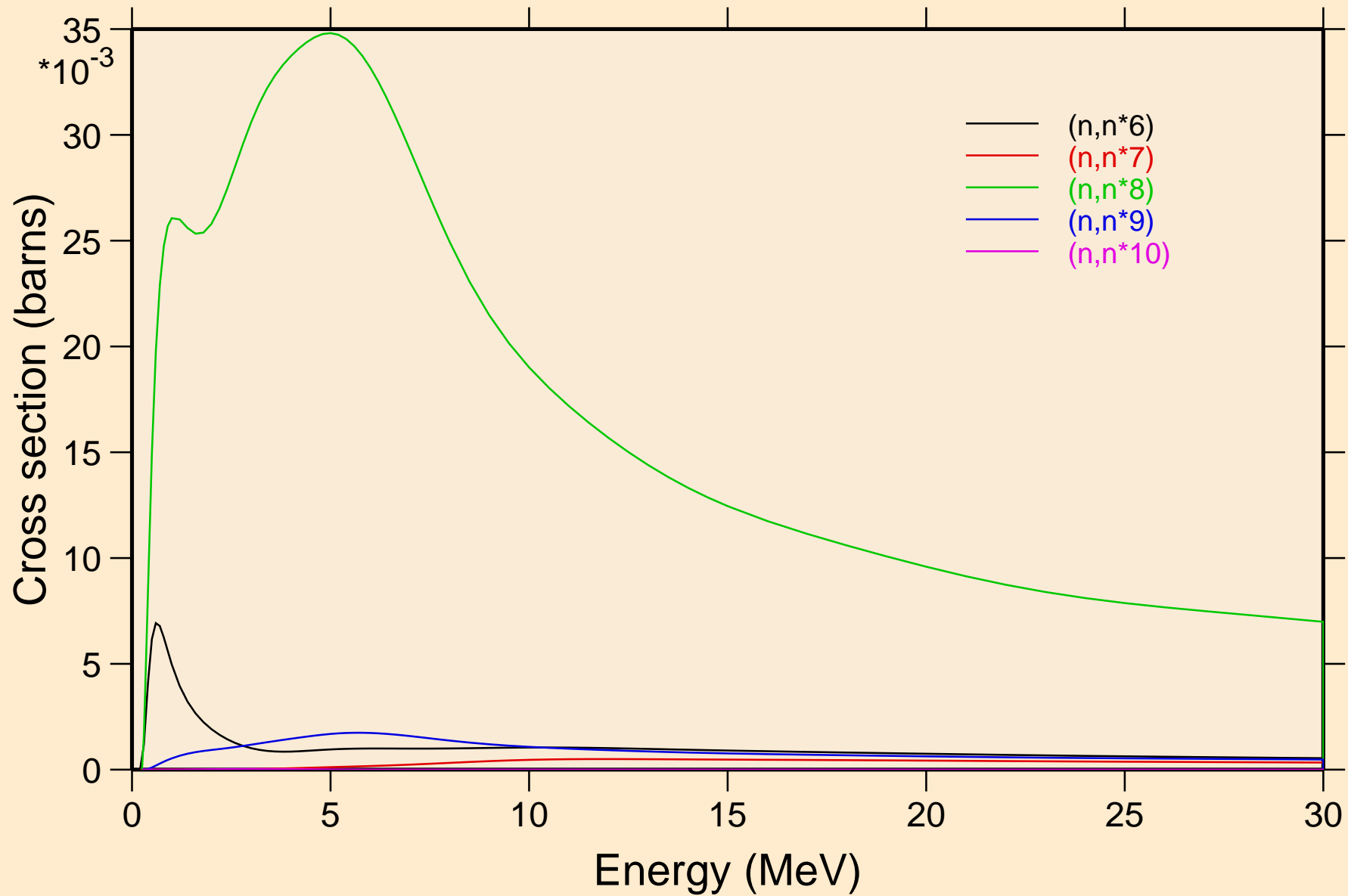

RE178 NEUTRON ACER TENDL-2024 LIBRARY; T=293.6K
Inelastic levels

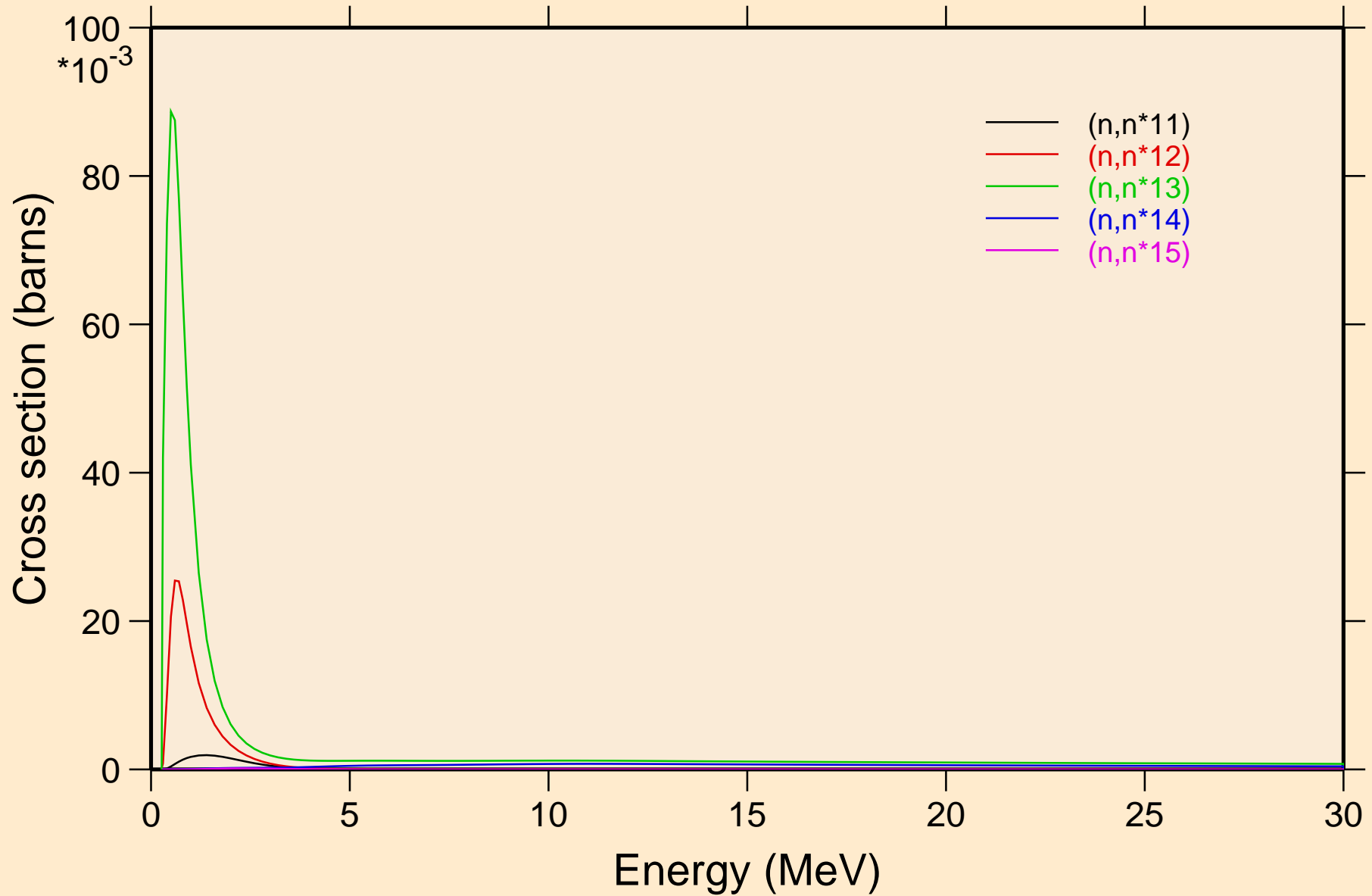

RE178 NEUTRON ACER TENDL-2024 LIBRARY; T=293.6K
Inelastic levels

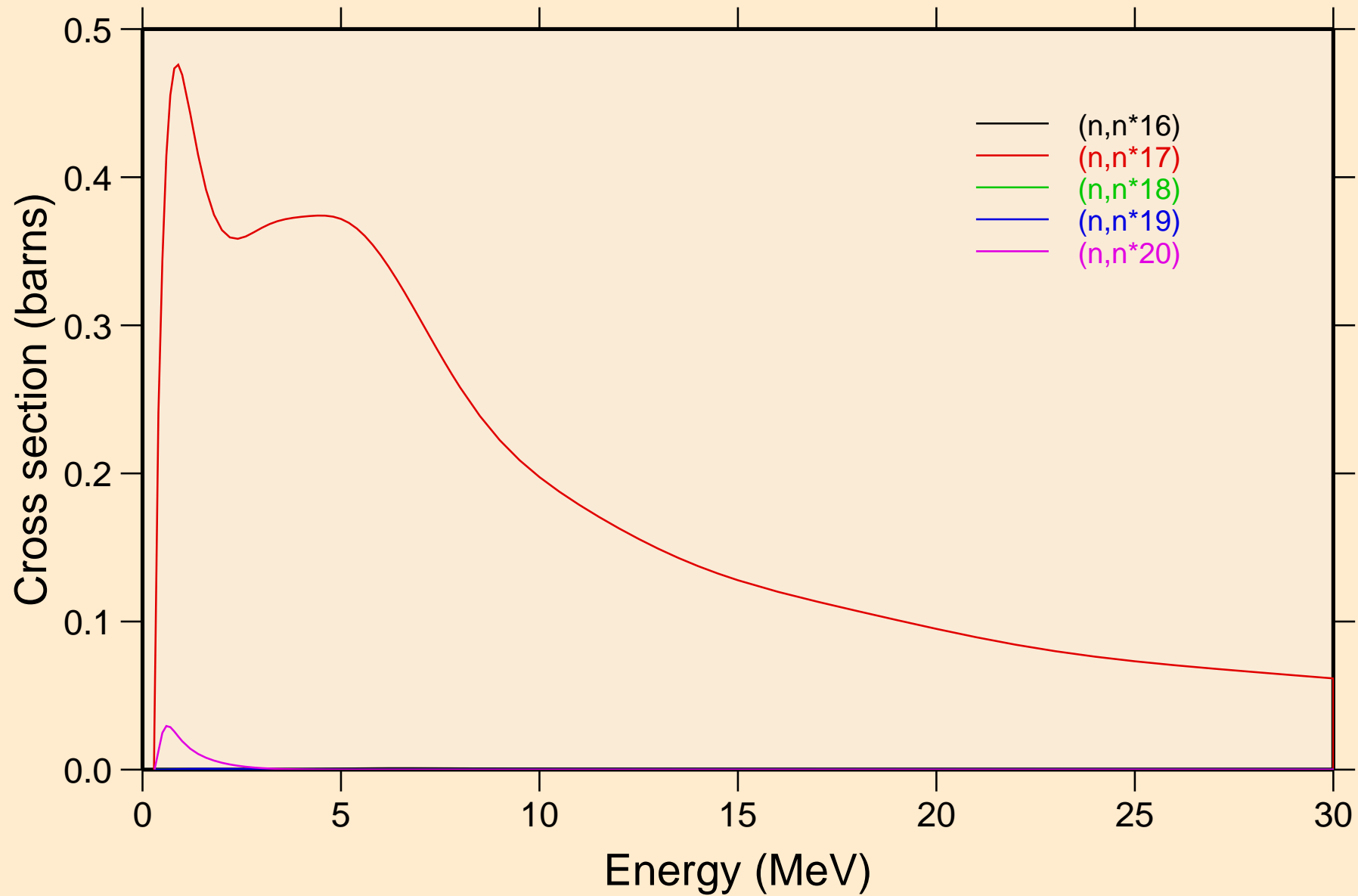

RE178 NEUTRON ACER TENDL-2024 LIBRARY; T=293.6K
Inelastic levels

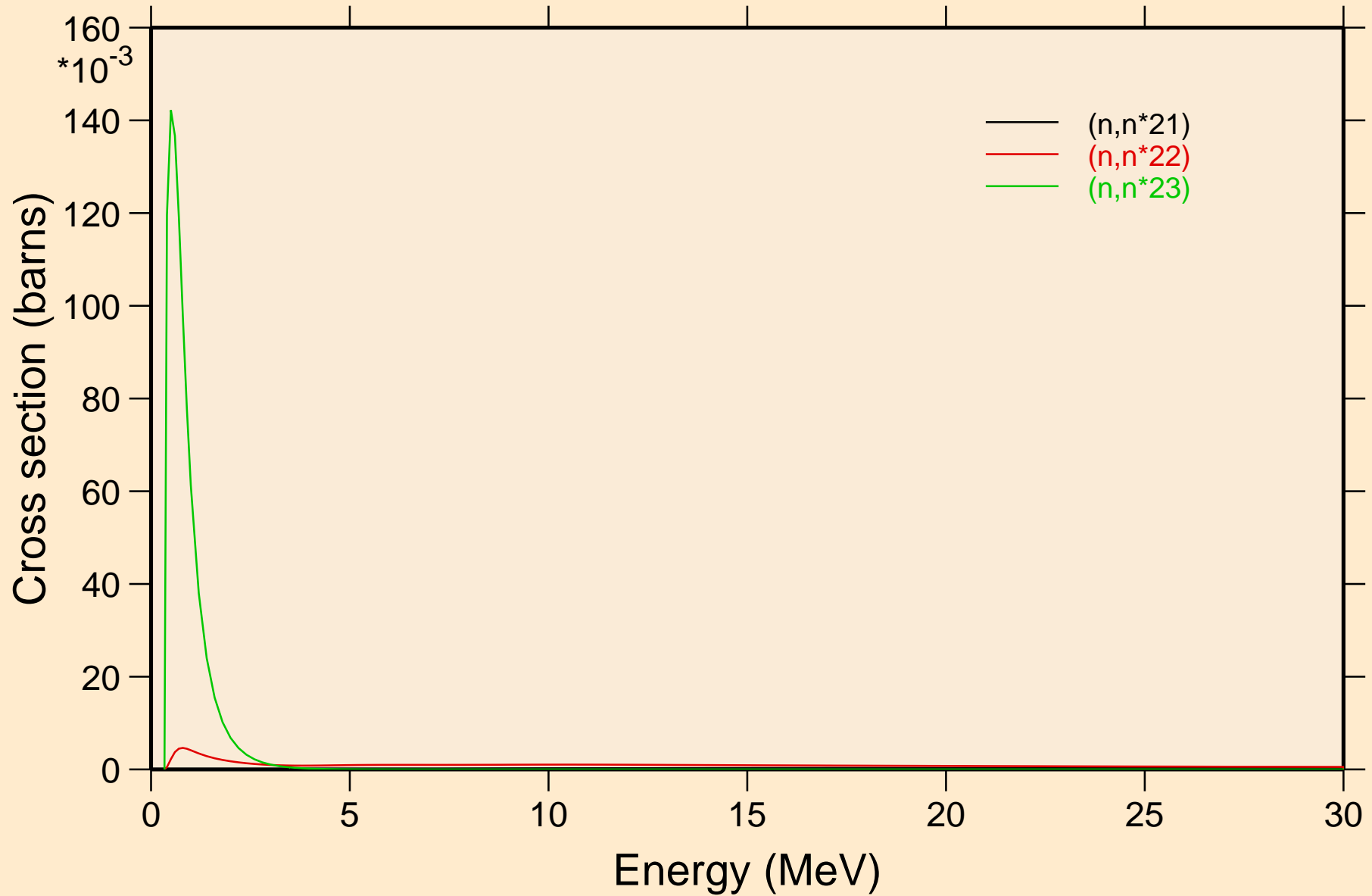

RE178 NEUTRON ACER TENDL-2024 LIBRARY; T=293.6K
Threshold reactions

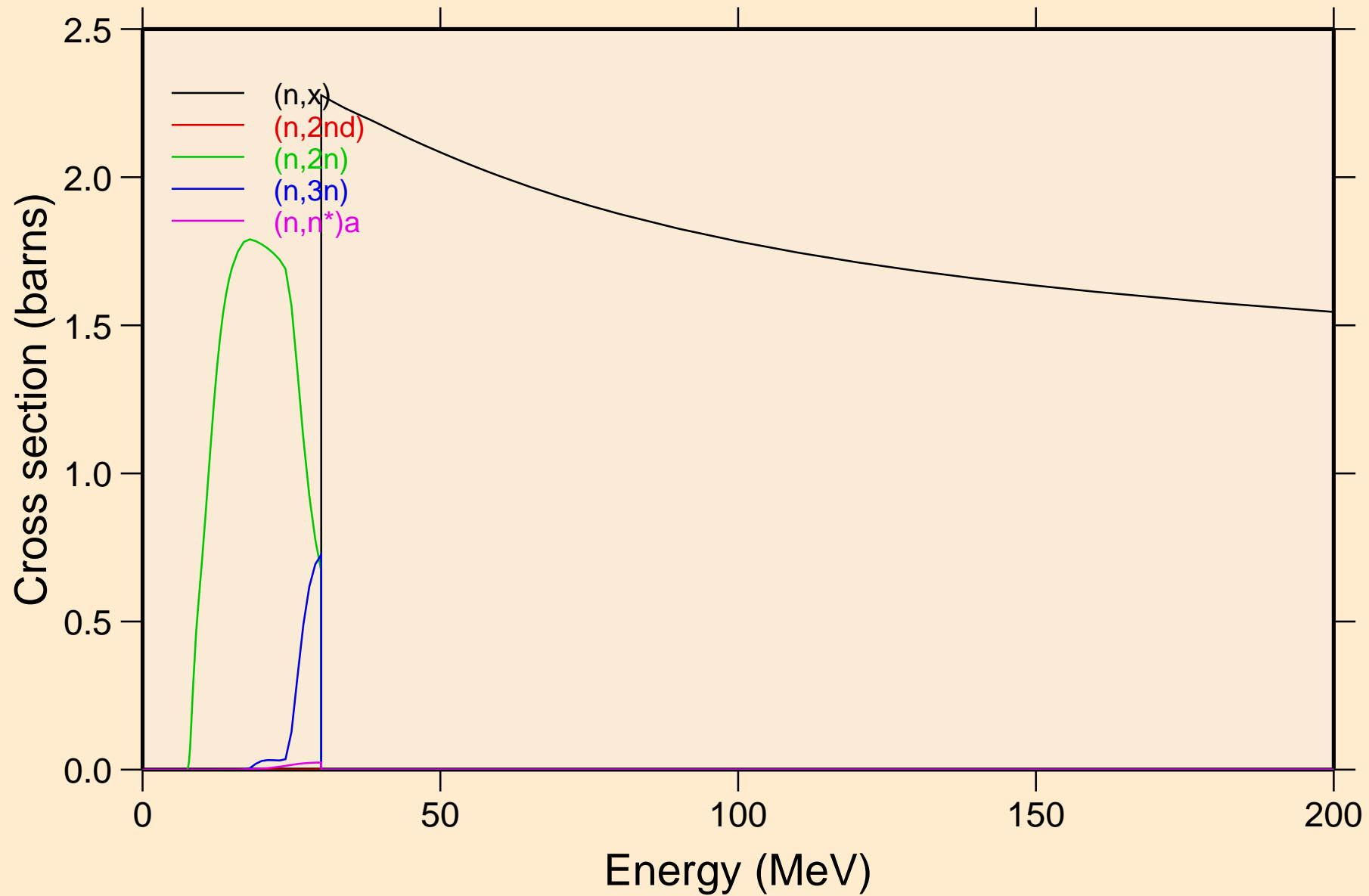

RE178 NEUTRON ACER TENDL-2024 LIBRARY; T=293.6K
Threshold reactions

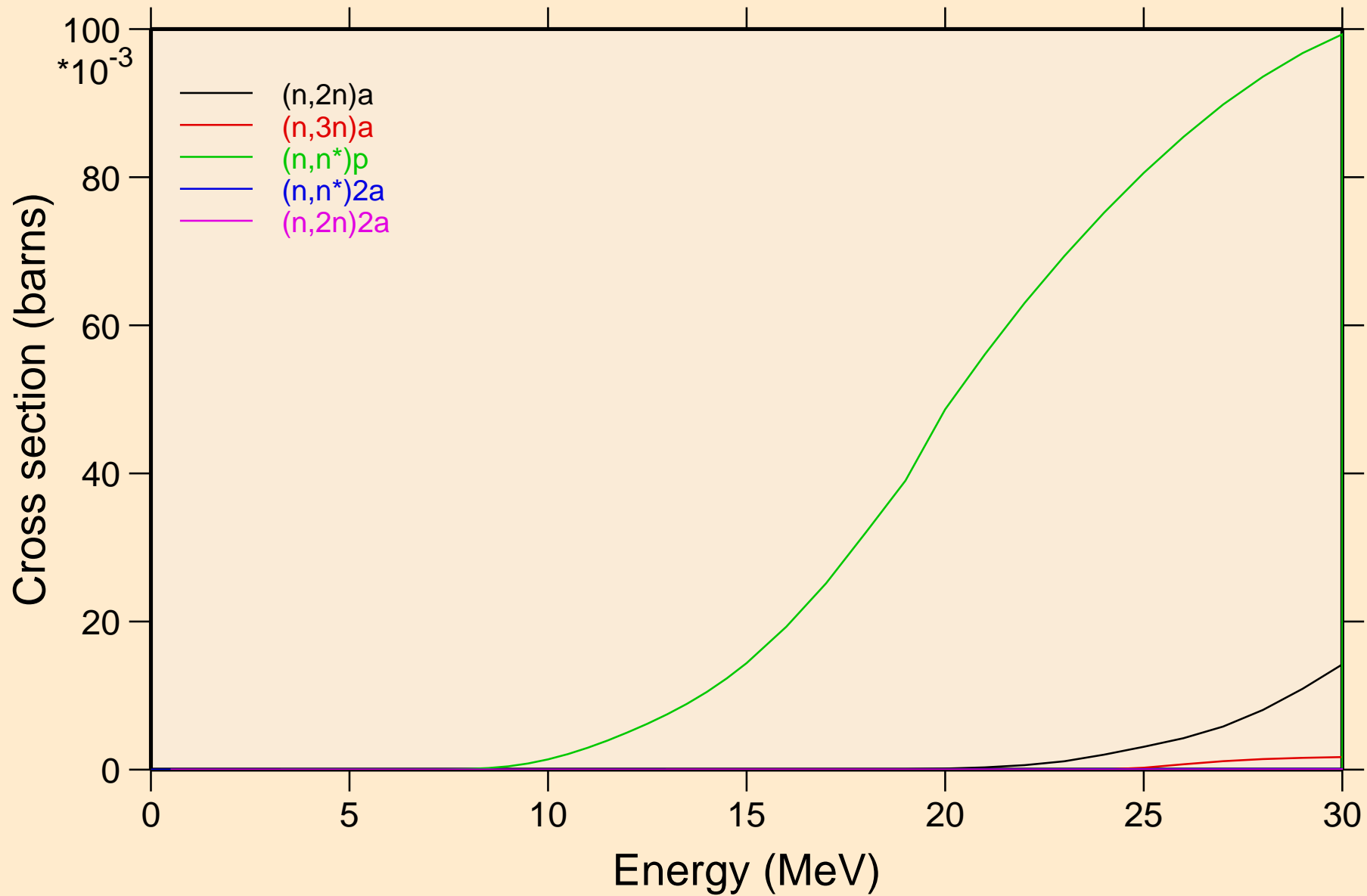

RE178 NEUTRON ACER TENDL-2024 LIBRARY; T=293.6K
Threshold reactions

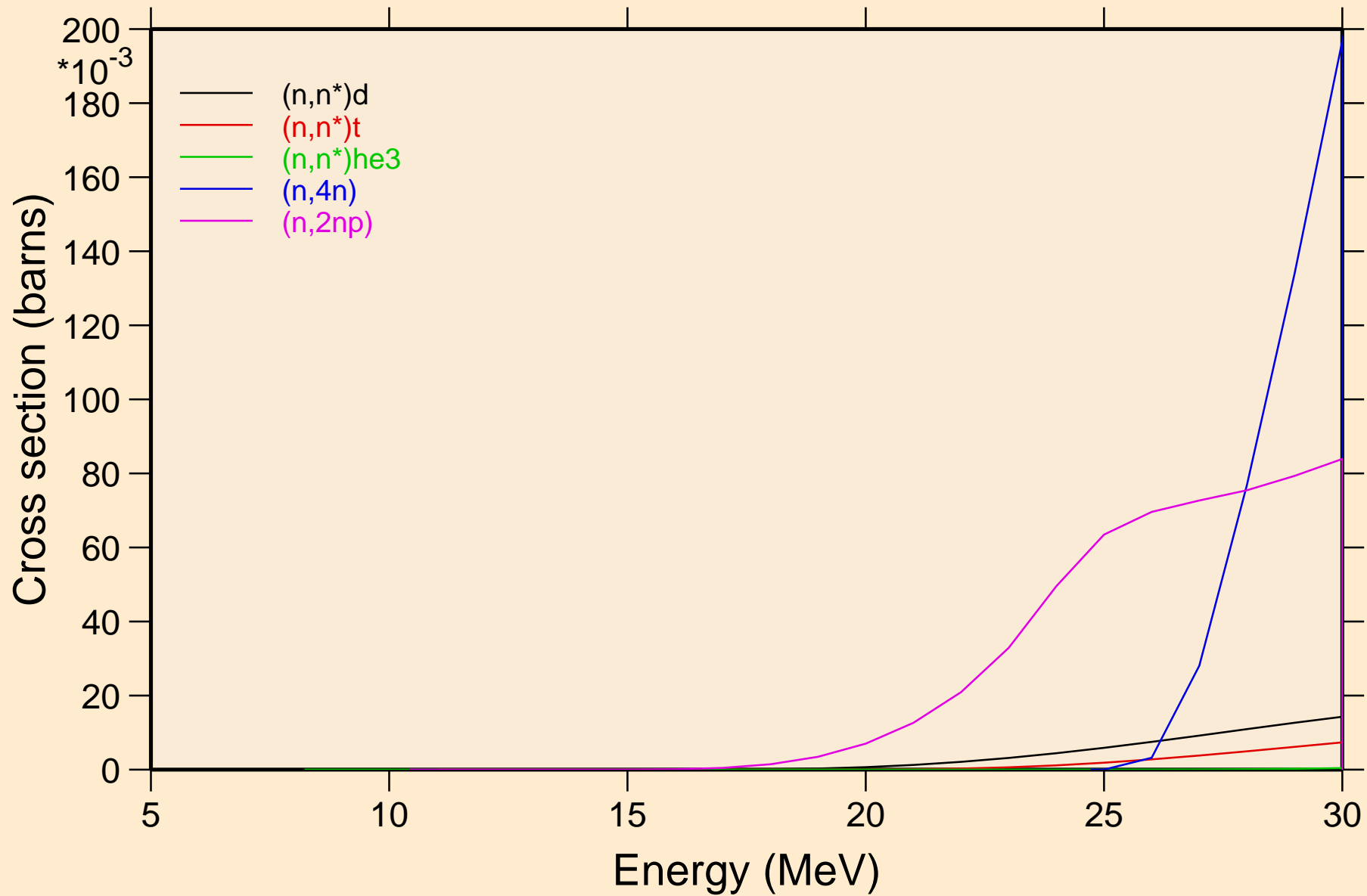

RE178 NEUTRON ACER TENDL-2024 LIBRARY; T=293.6K
Threshold reactions

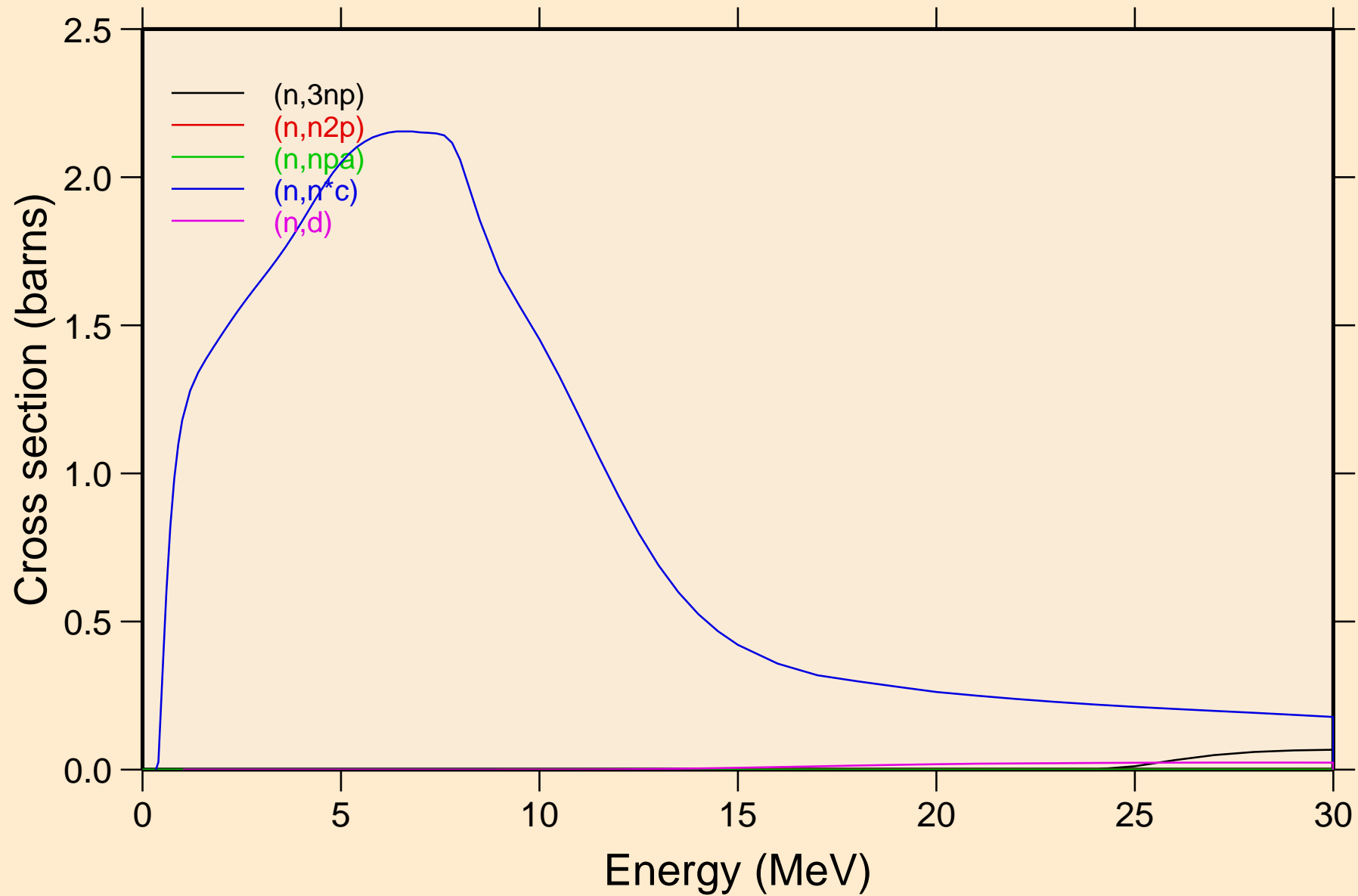

RE178 NEUTRON ACER TENDL-2024 LIBRARY; T=293.6K
Threshold reactions

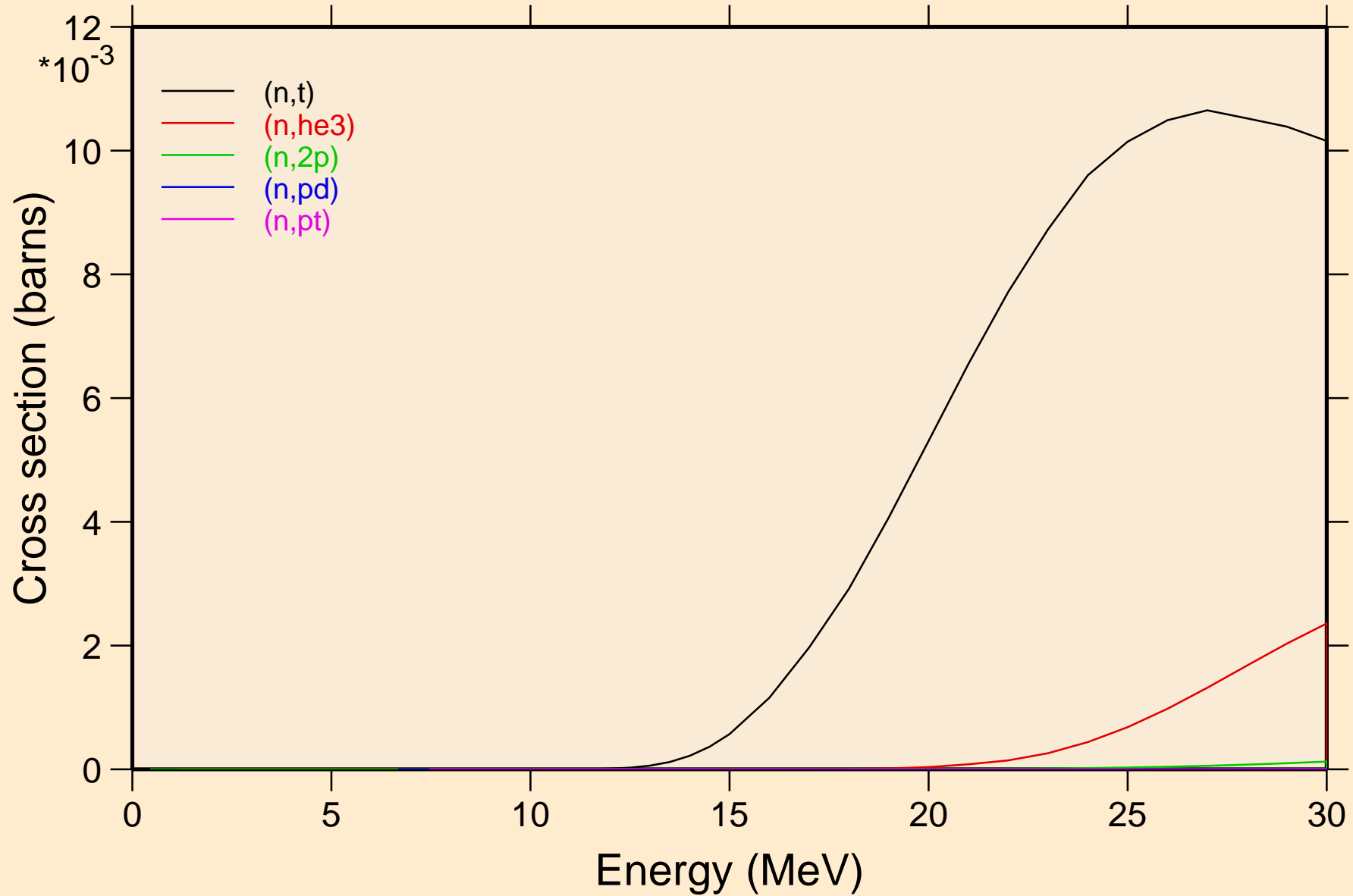

RE178 NEUTRON ACER TENDL-2024 LIBRARY; T=293.6K
Threshold reactions

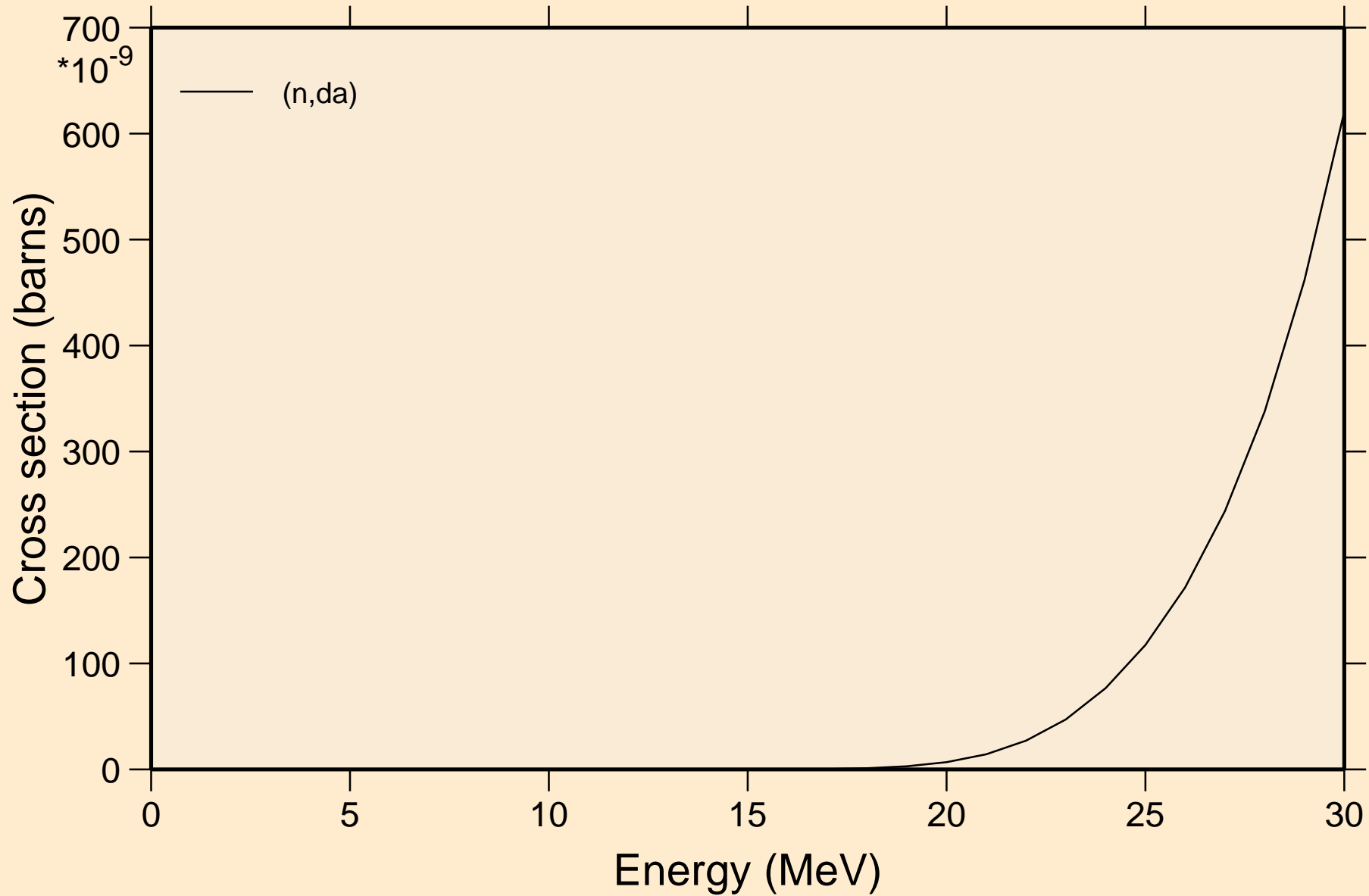

RE178 NEUTRON ACER TENDL-2024 LIBRARY; T=293.6K
Threshold reactions

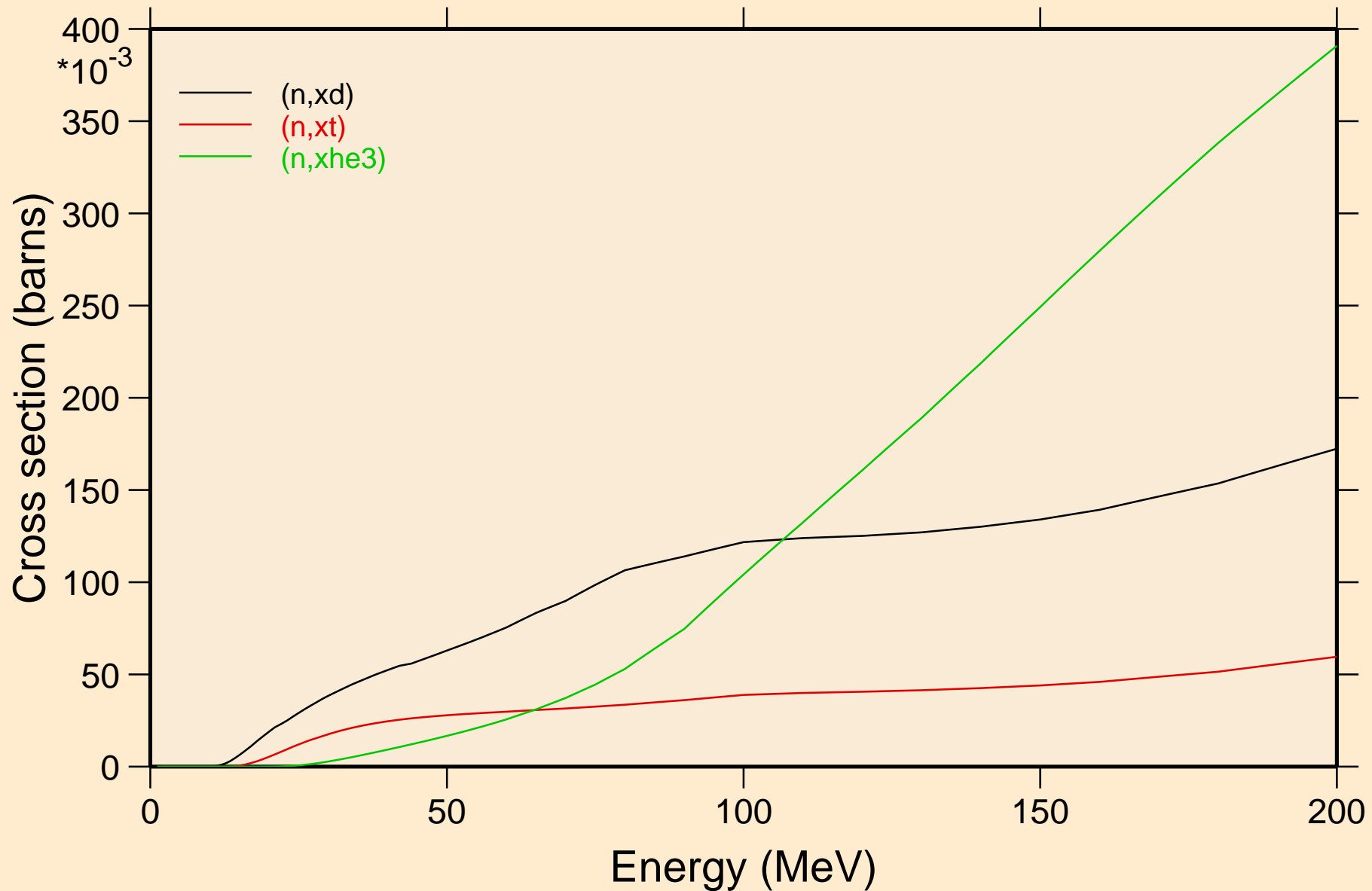

RE178 NEUTRON ACER TENDL-2024 LIBRARY; T=293.6K
angular distribution for elastic

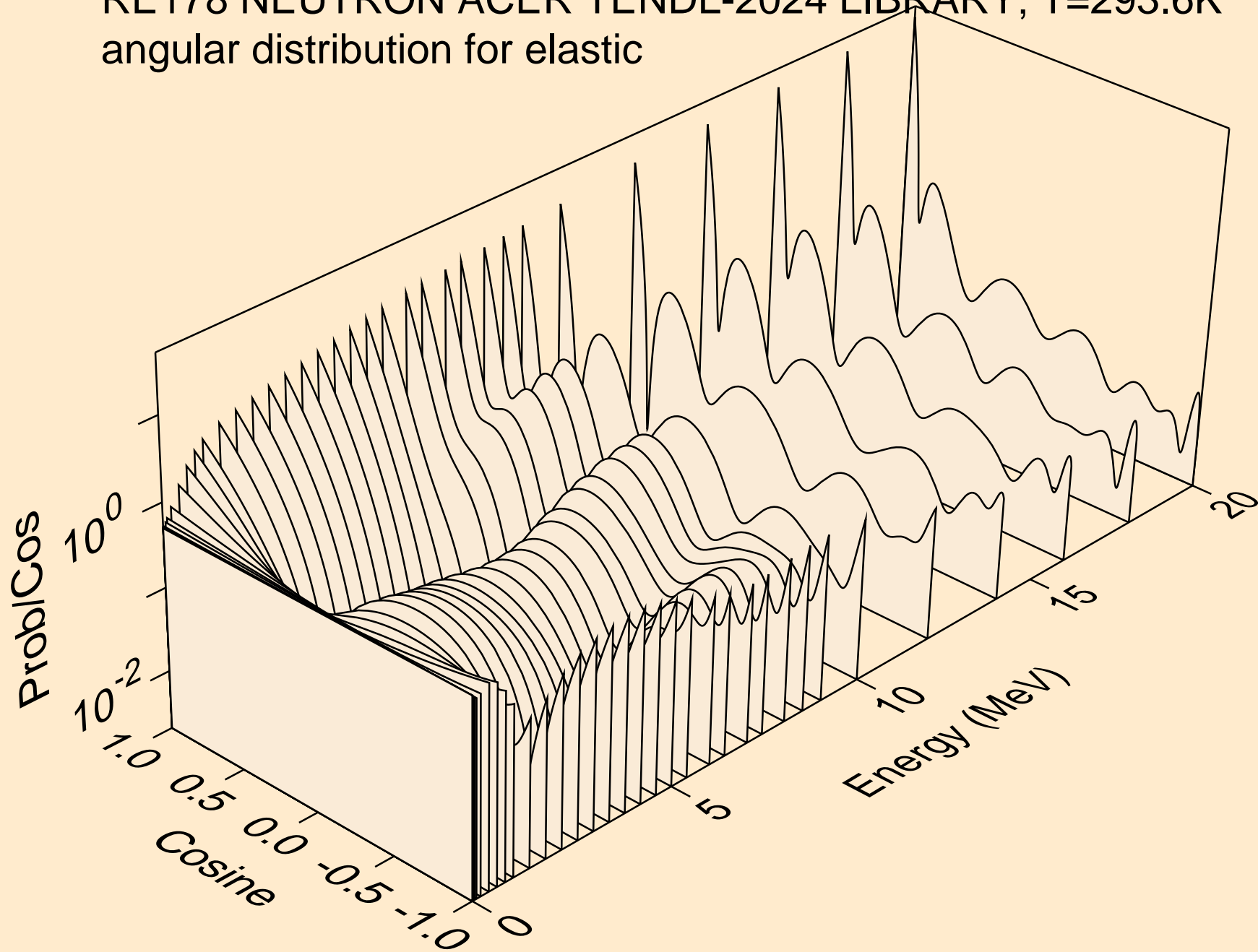

RE178 NEUTRON ACER TENDL-2024 LIBRARY; T=293.6K
angular distribution for elastic

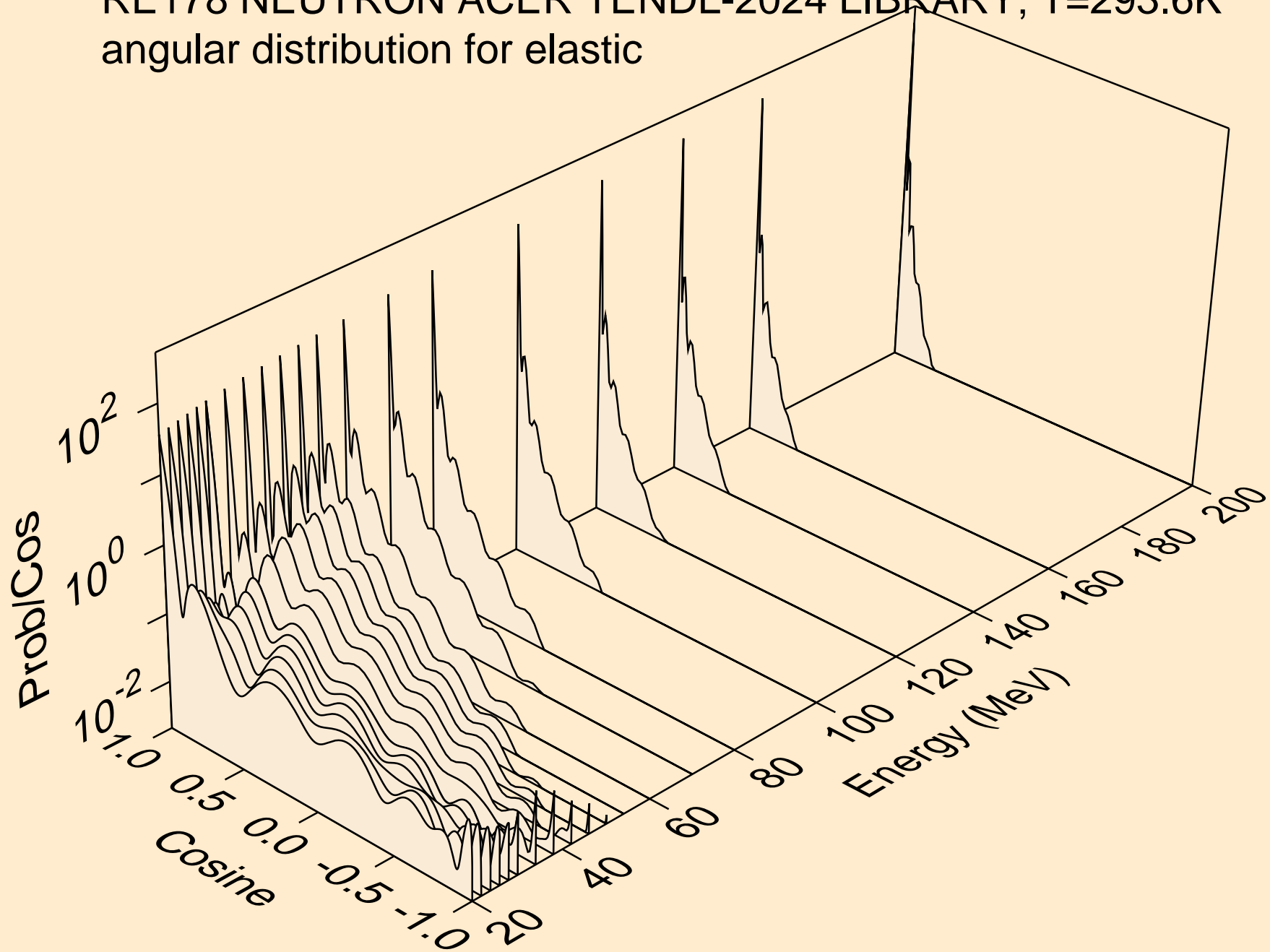

RE178 NEUTRON ACER TENDL-2024 LIBRARY; T=293.6K
angular distribution for (n,n*1)

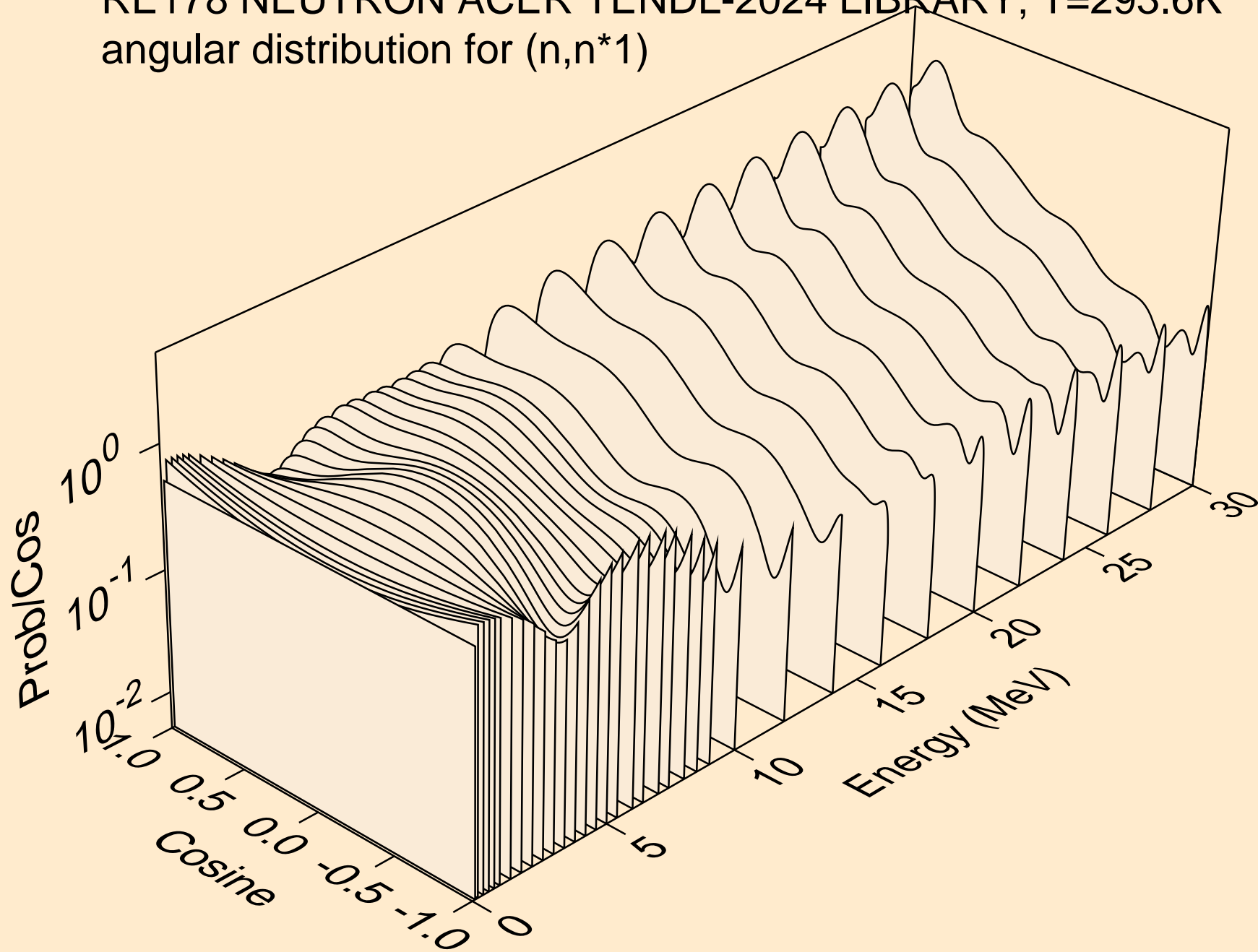

RE178 NEUTRON ACER TENDL-2024 LIBRARY; T=293.6K
angular distribution for (n,n*2)

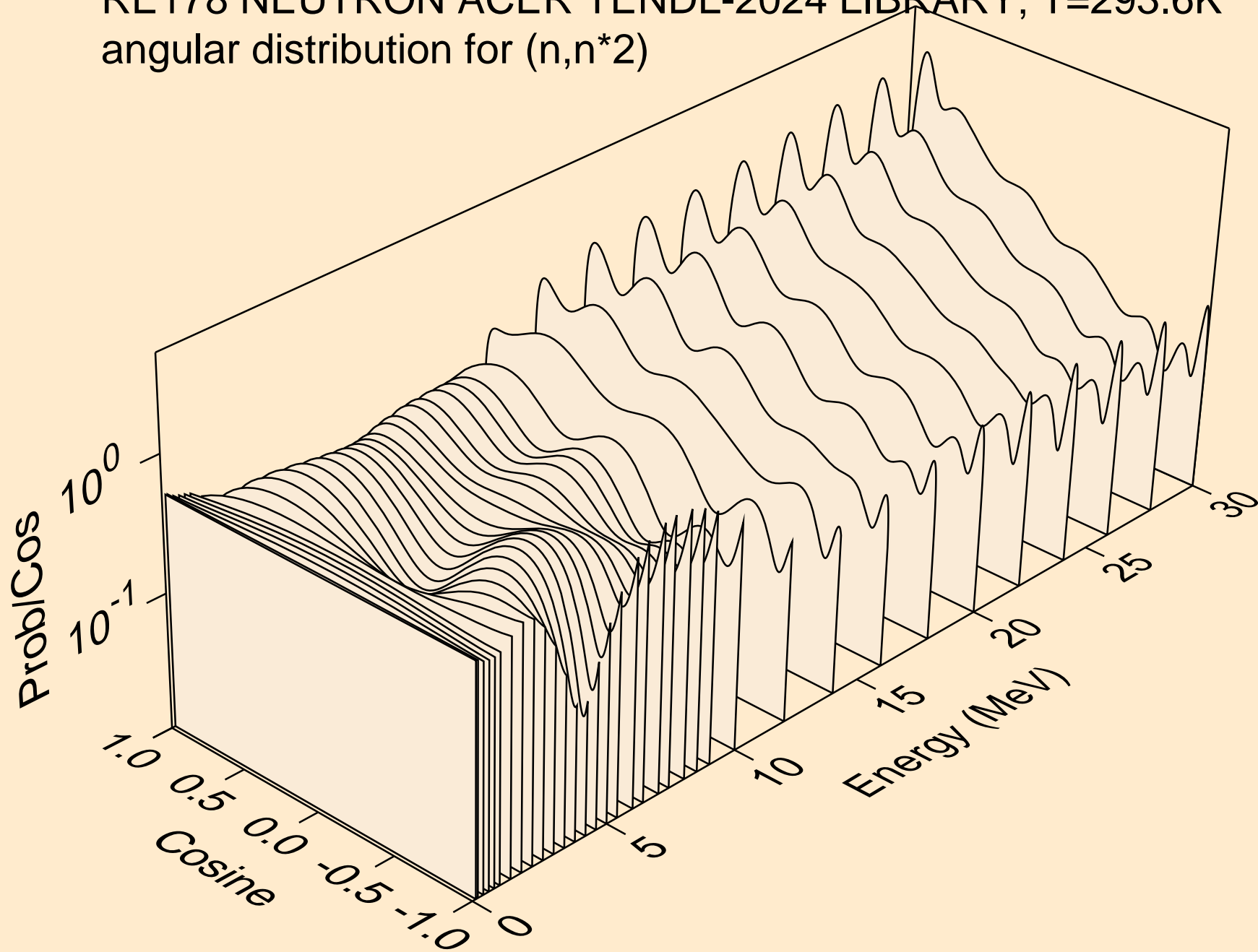

RE178 NEUTRON ACER TENDL-2024 LIBRARY; T=293.6K
angular distribution for (n,n*3)

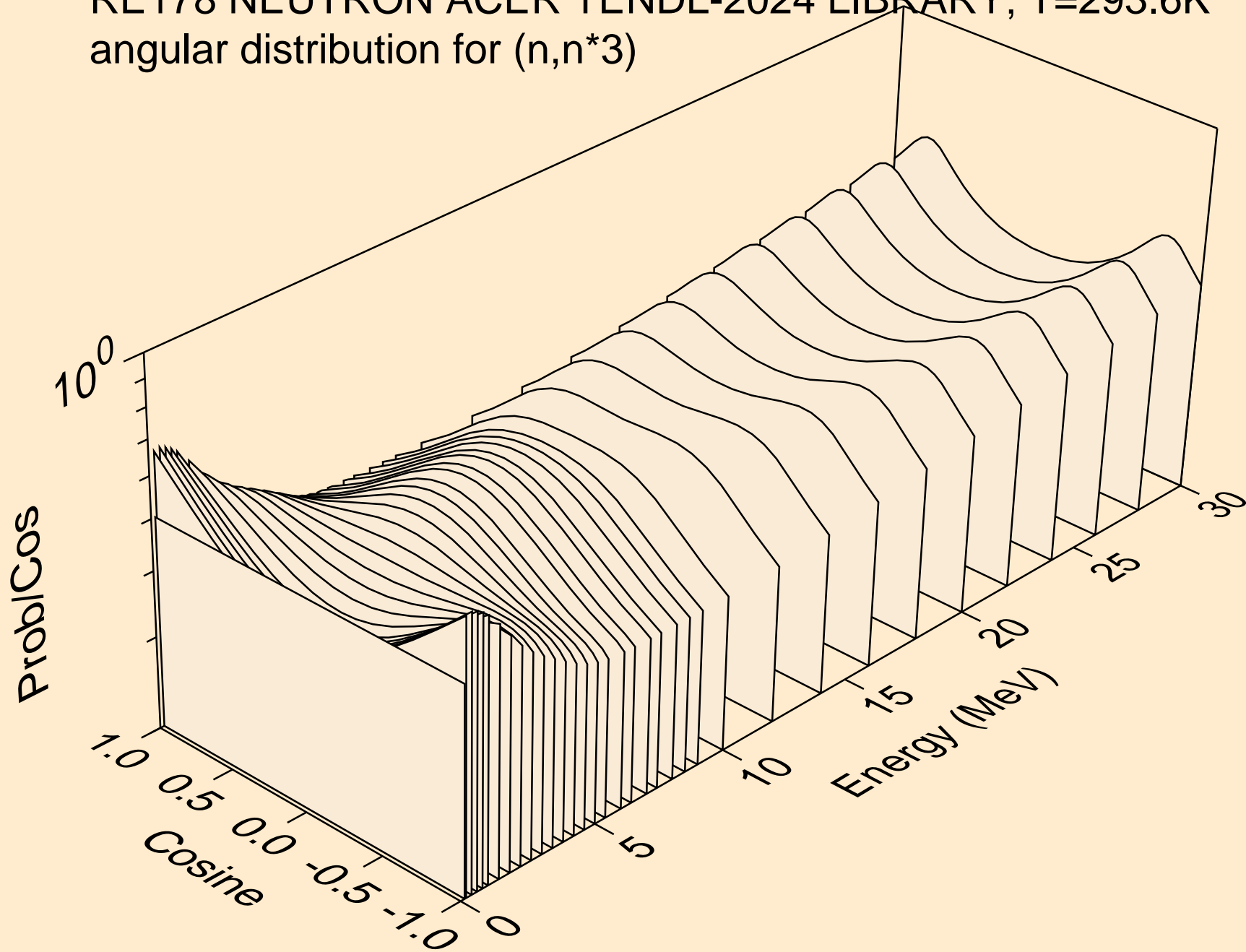

RE178 NEUTRON ACER TENDL-2024 LIBRARY; T=293.6K
angular distribution for (n,n*4)

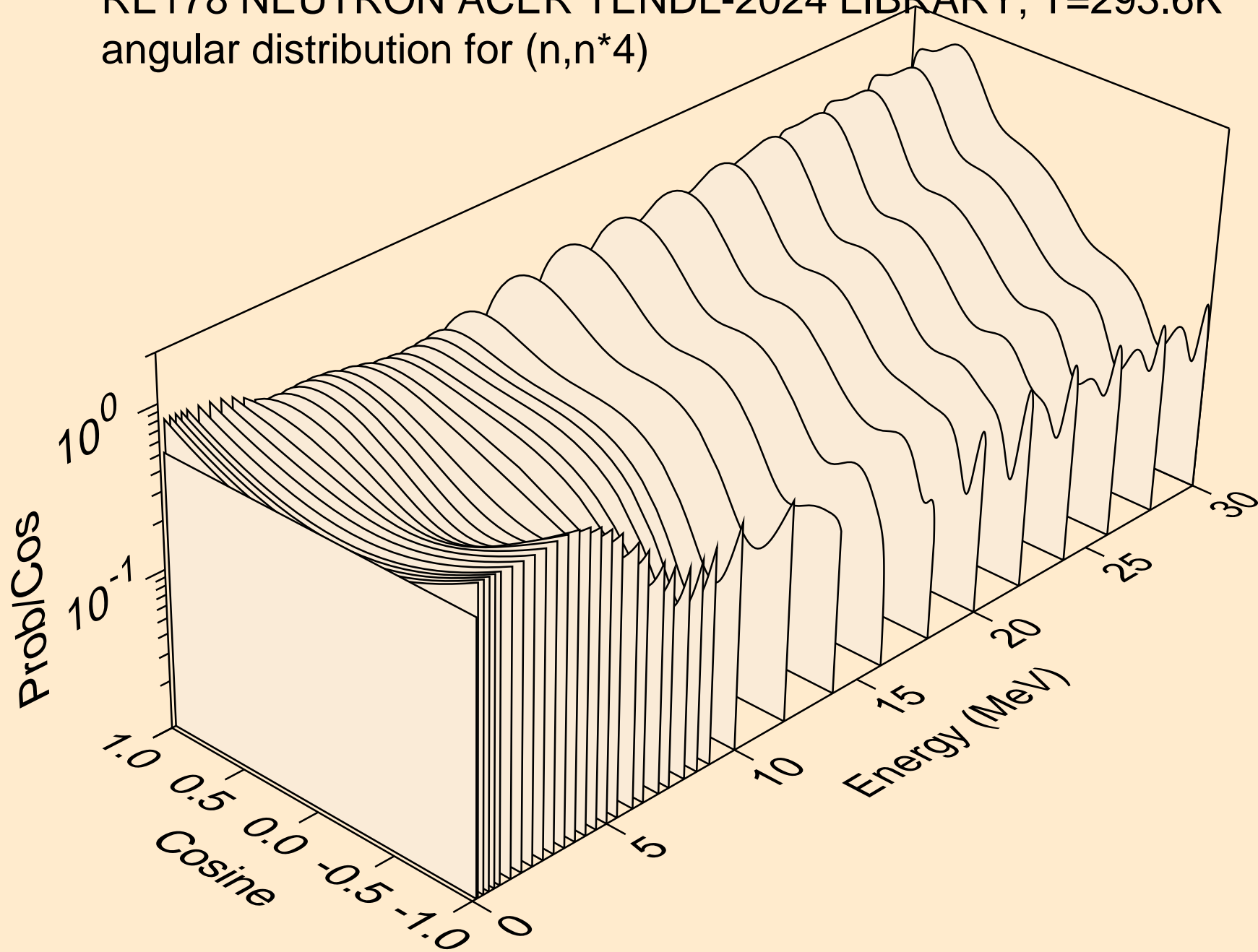

RE178 NEUTRON ACER TENDL-2024 LIBRARY; T=293.6K
angular distribution for (n,n*5)

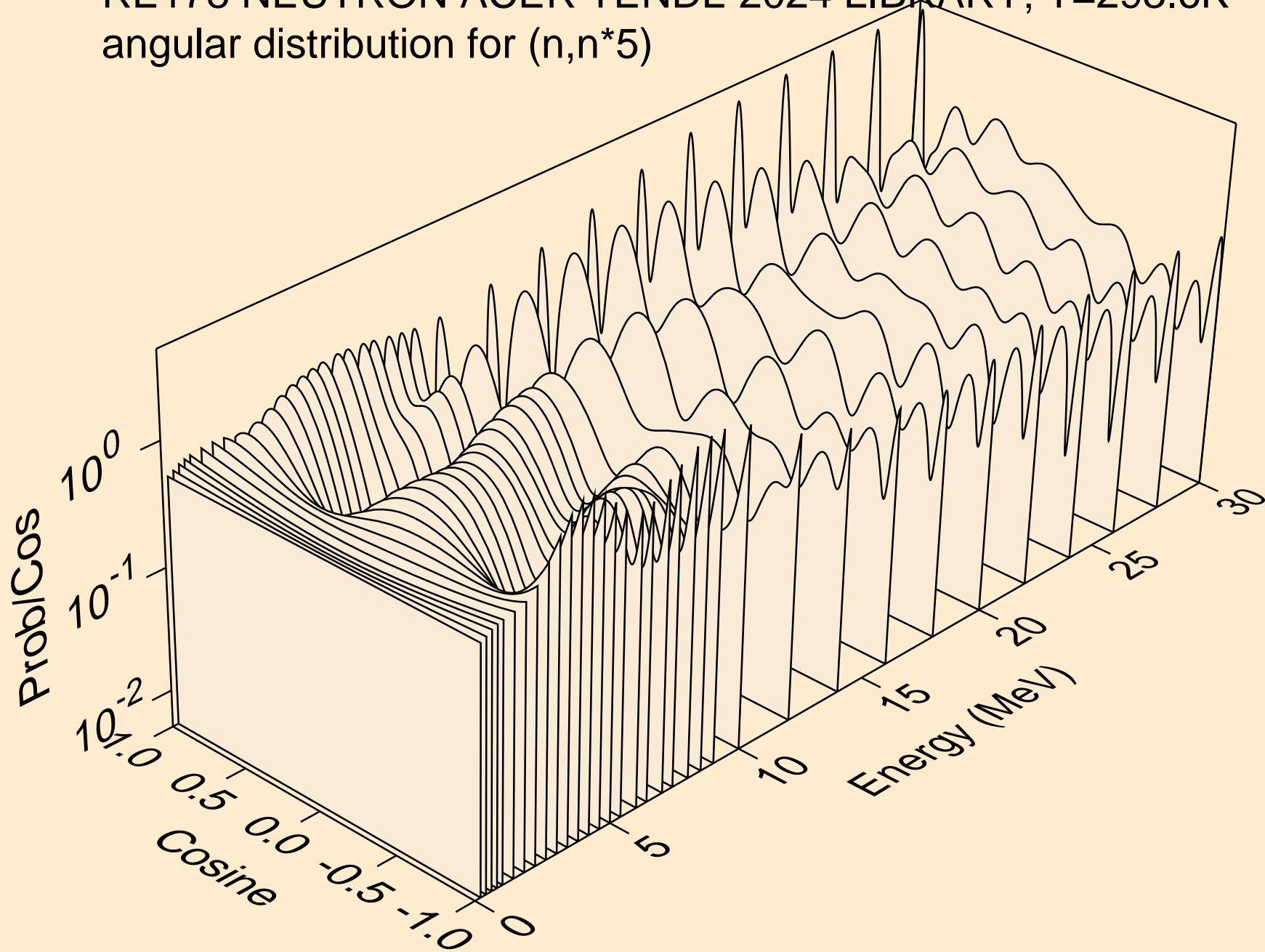

RE178 NEUTRON ACER TENDL-2024 LIBRARY; T=293.6K
angular distribution for (n,n*6)

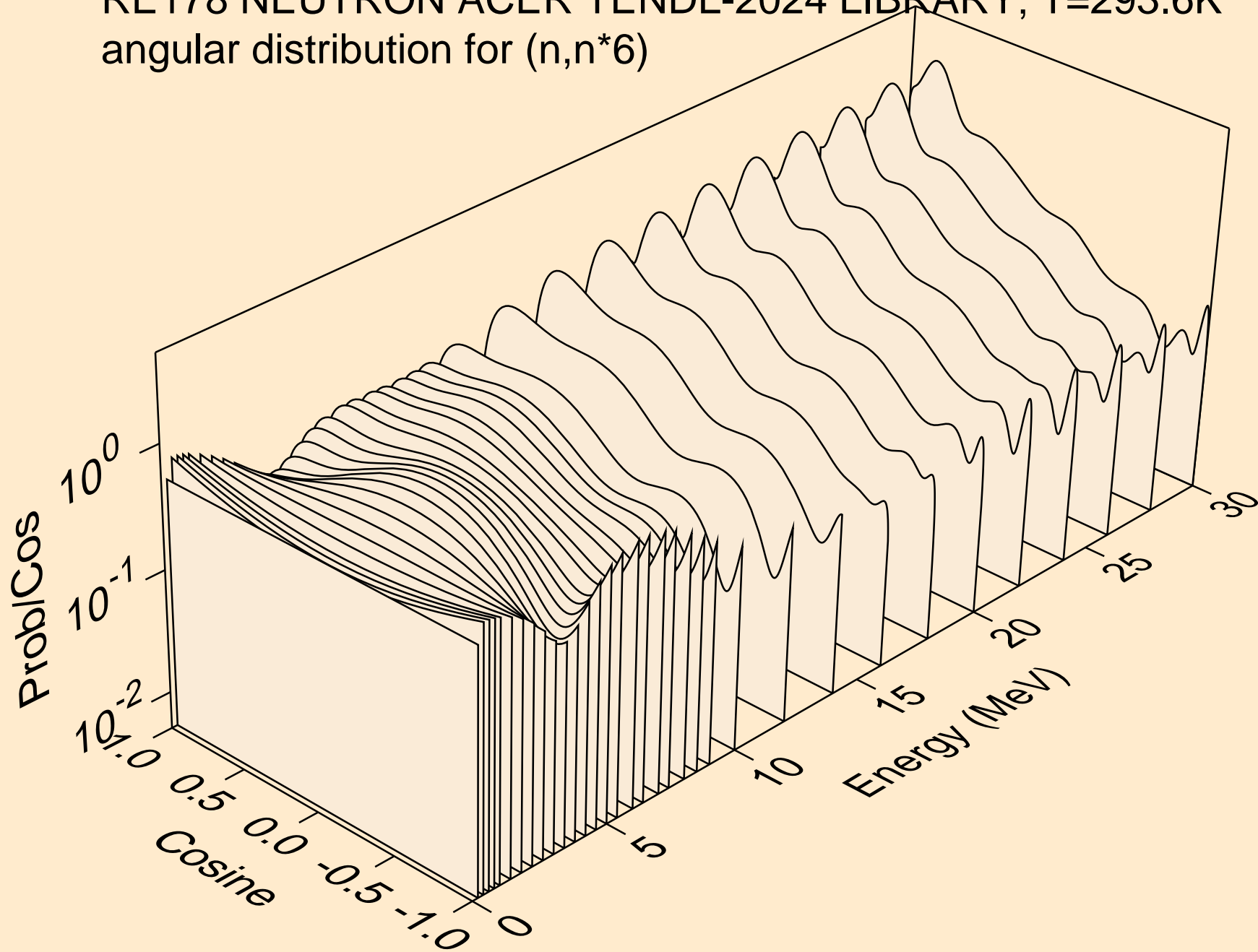

RE178 NEUTRON ACER TENDL-2024 LIBRARY; T=293.6K
angular distribution for (n,n*7)

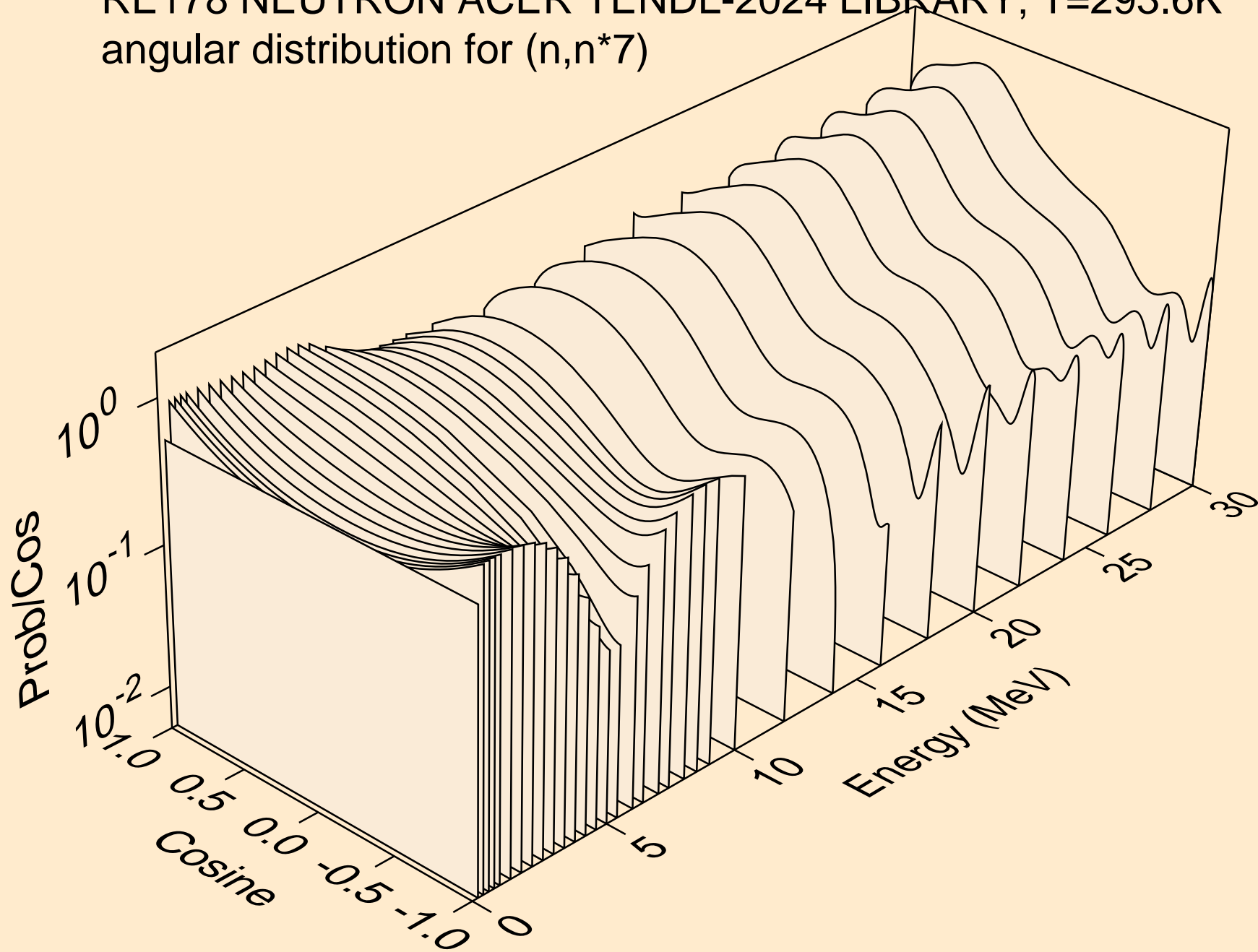

RE178 NEUTRON ACER TENDL-2024 LIBRARY; T=293.6K
angular distribution for (n,n*8)

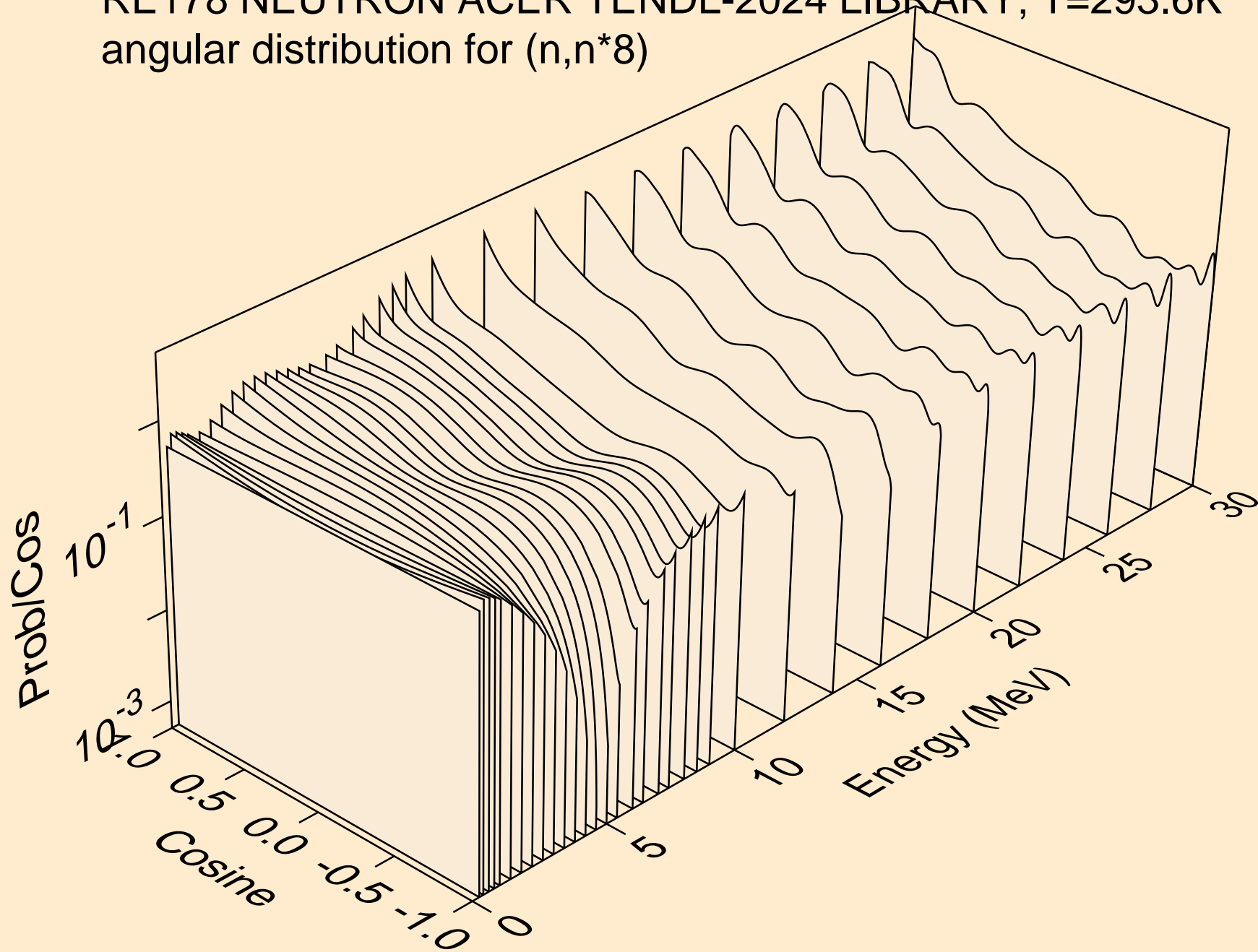

RE178 NEUTRON ACER TENDL-2024 LIBRARY; T=293.6K
angular distribution for (n,n*9)

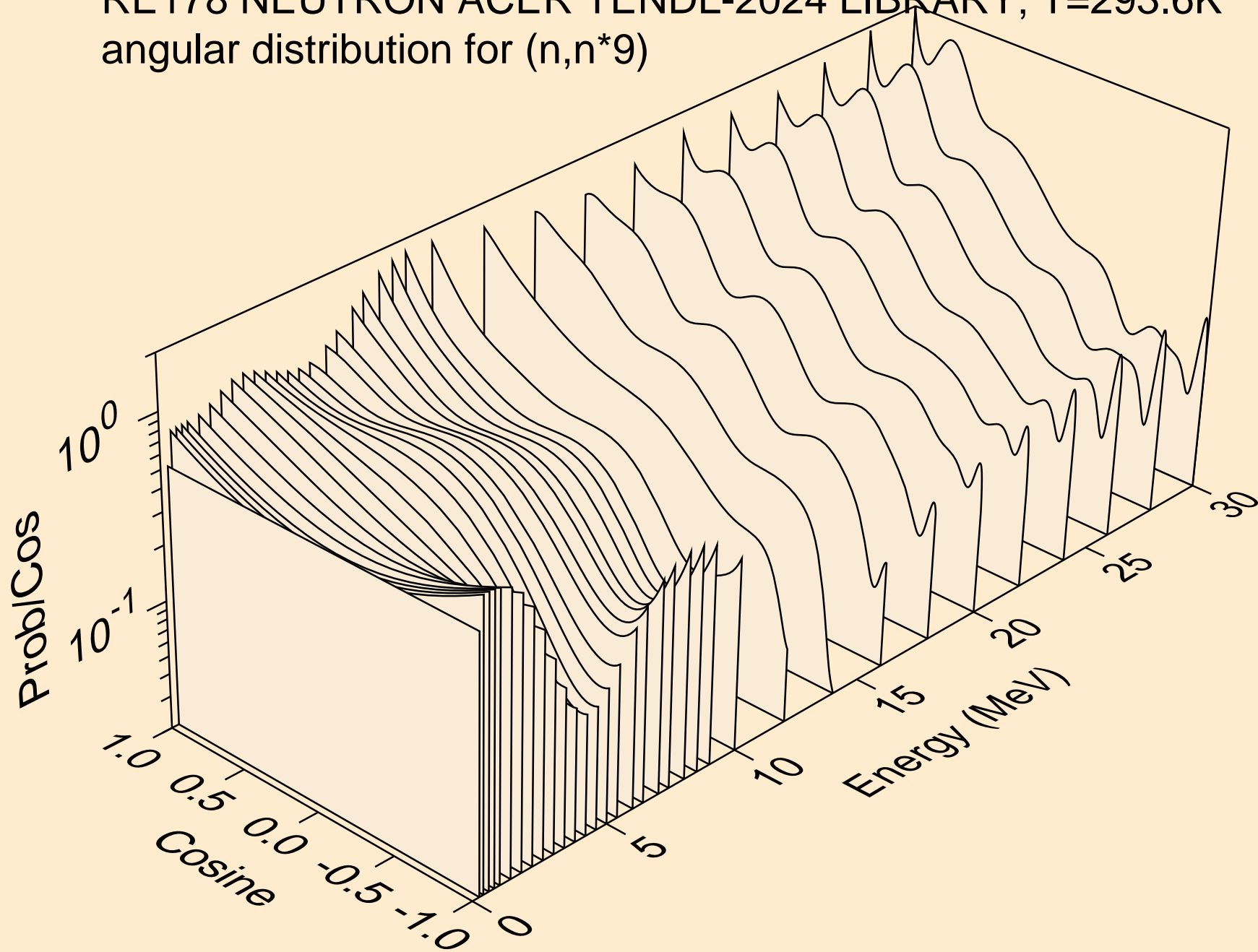

RE178 NEUTRON ACER TENDL-2024 LIBRARY; T=293.6K
angular distribution for (n,n*10)

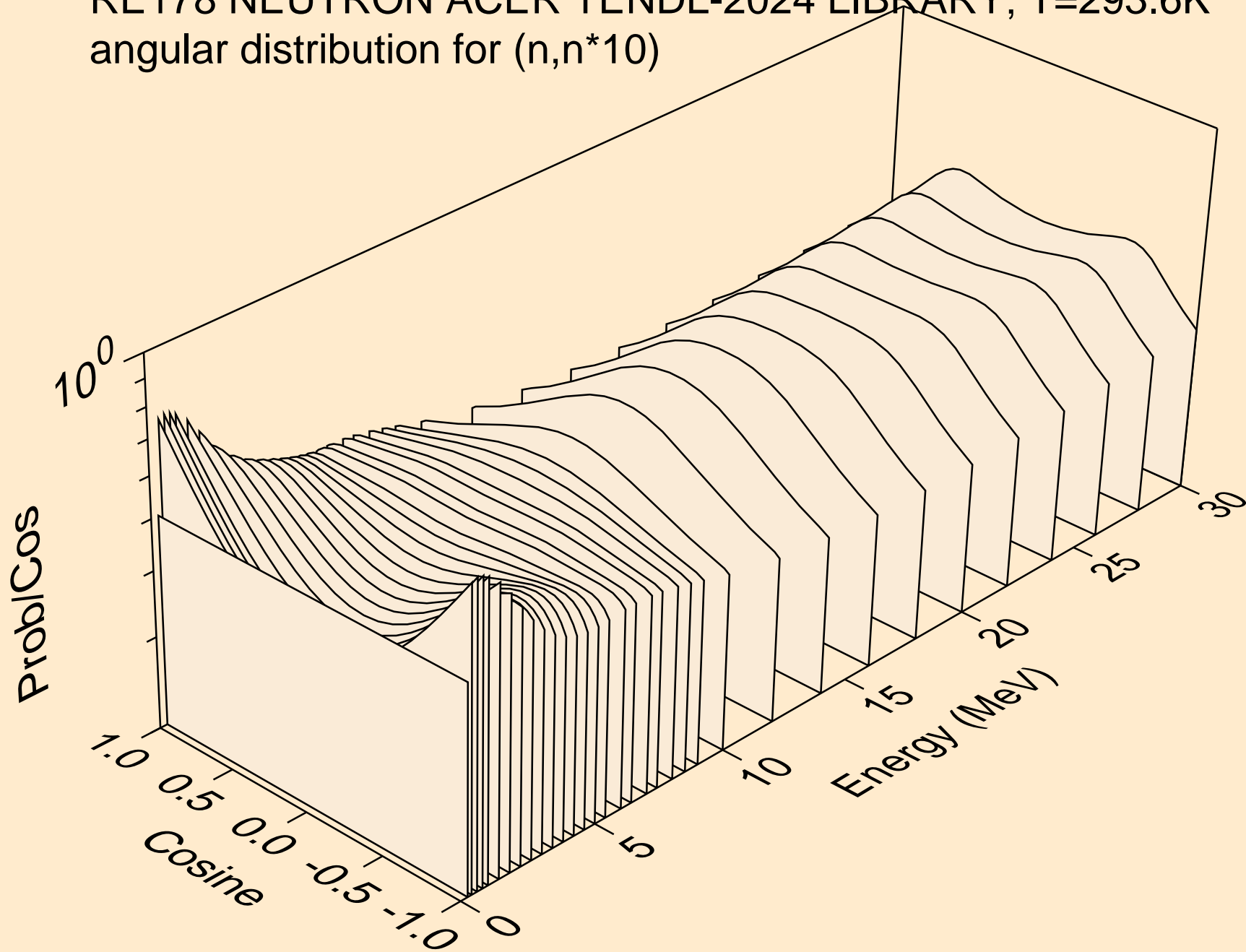

RE178 NEUTRON ACER TENDL-2024 LIBRARY; T=293.6K
angular distribution for (n,n*11)

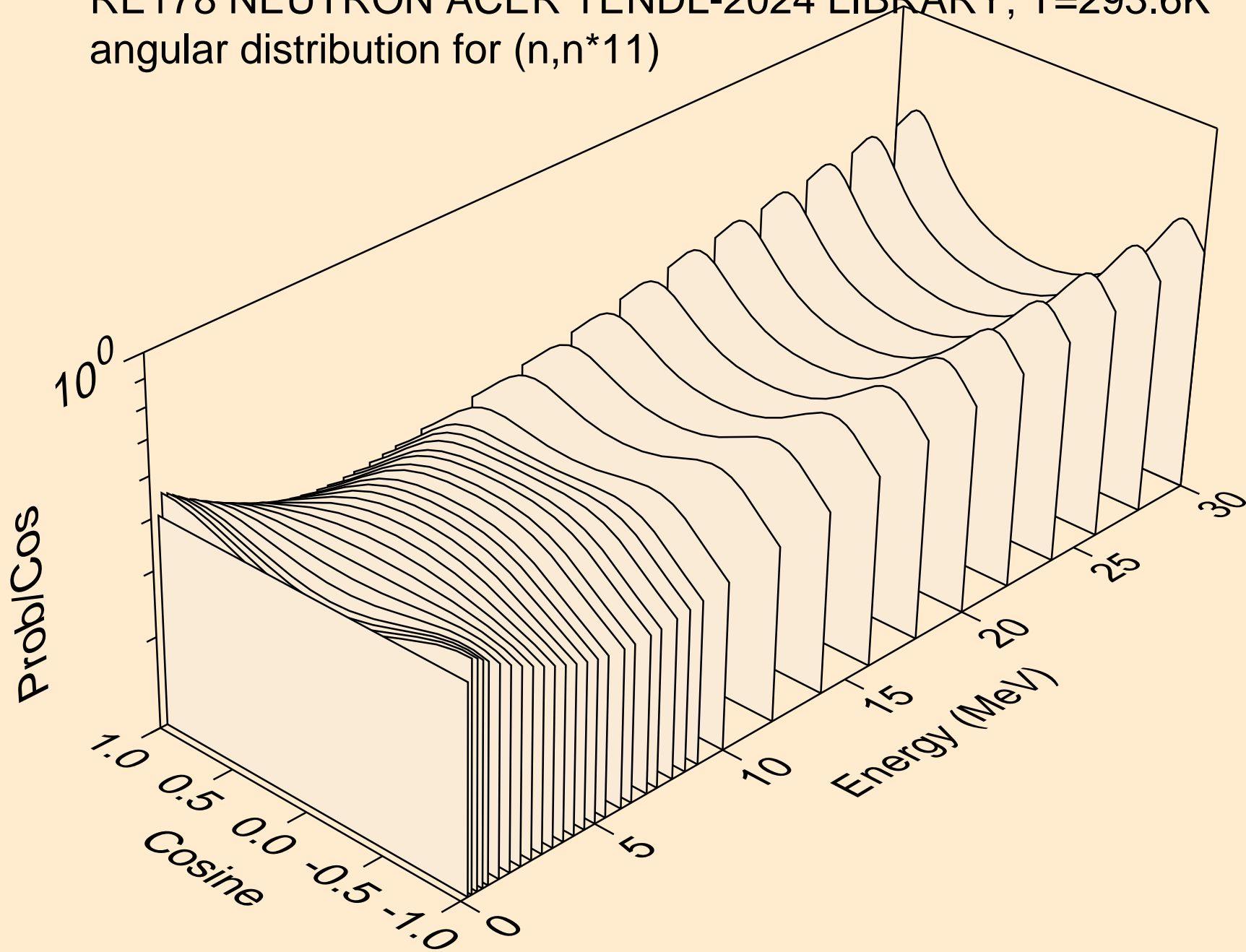

RE178 NEUTRON ACER TENDL-2024 LIBRARY; T=293.6K
angular distribution for (n,n*12)

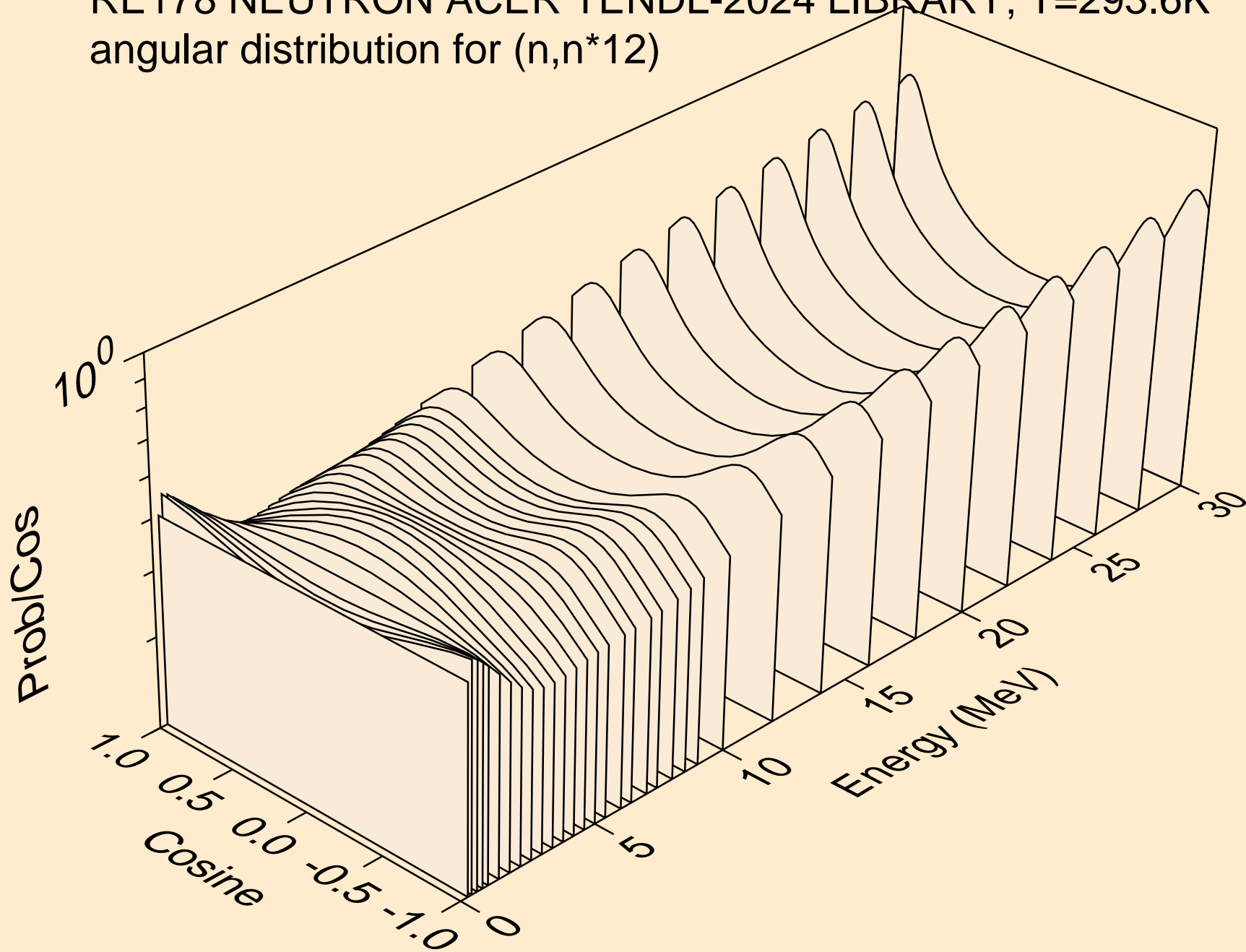

RE178 NEUTRON ACER TENDL-2024 LIBRARY; T=293.6K
angular distribution for (n,n*13)

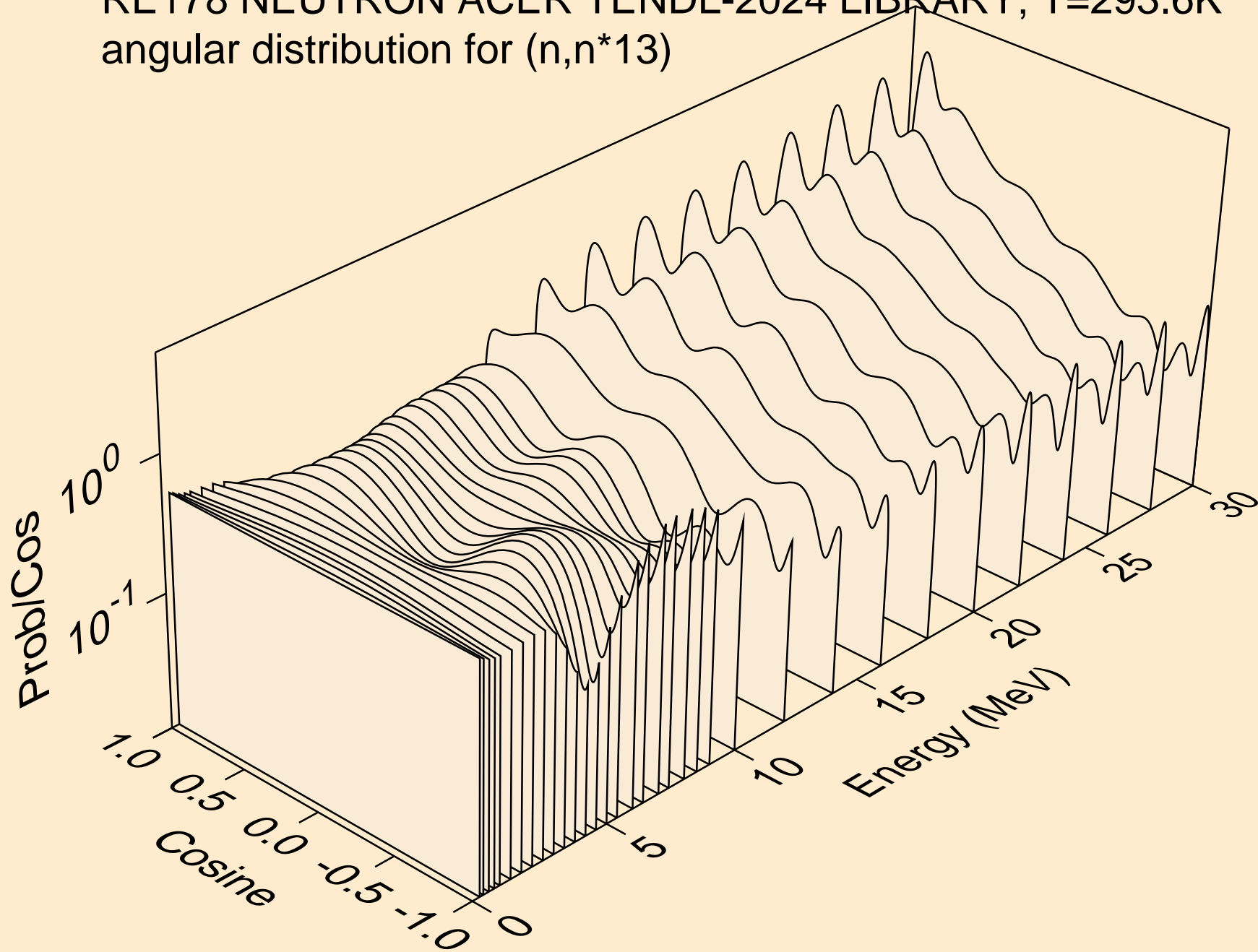

RE178 NEUTRON ACER TENDL-2024 LIBRARY; T=293.6K
angular distribution for (n,n*14)

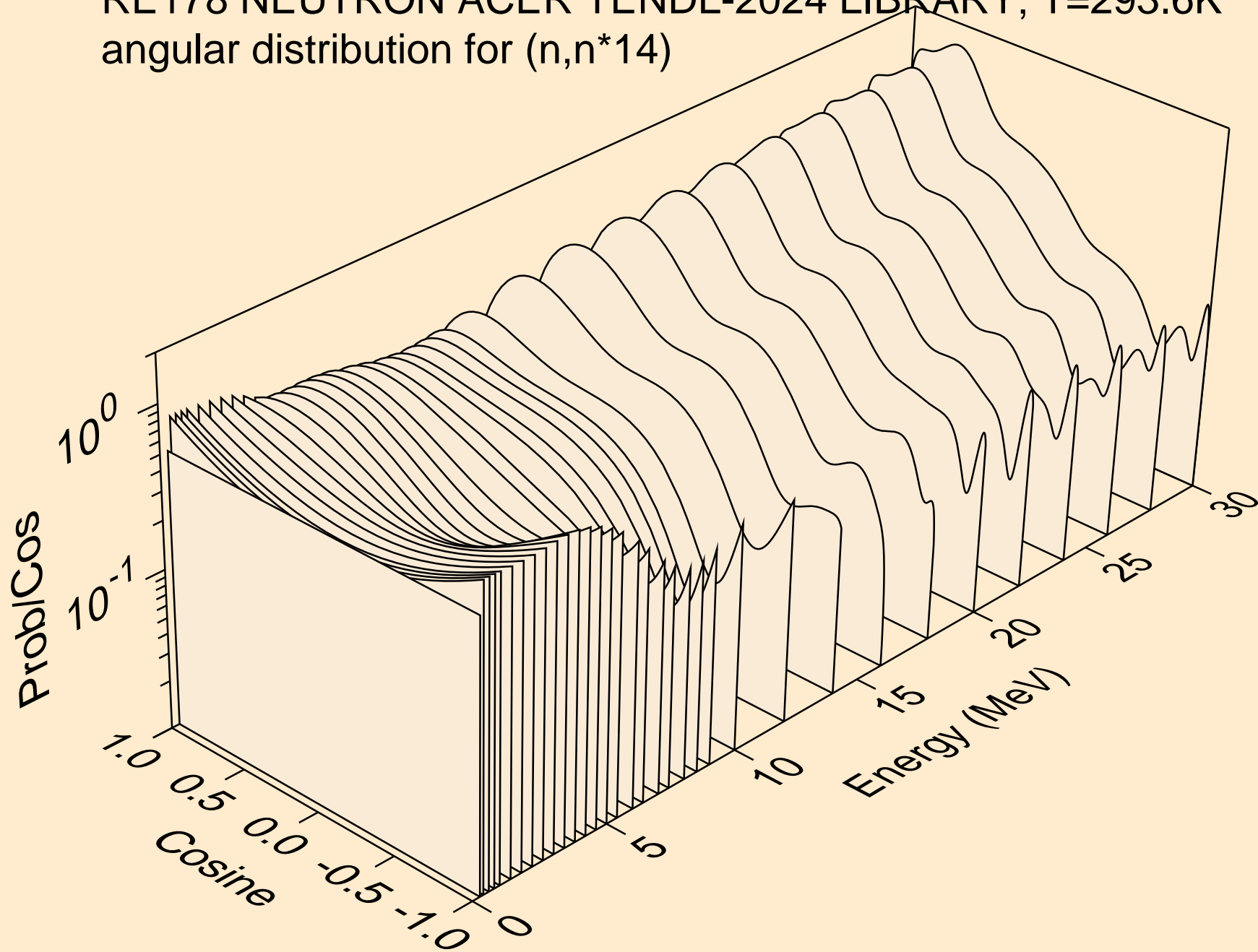

RE178 NEUTRON ACER TENDL-2024 LIBRARY; T=293.6K
angular distribution for (n,n*15)

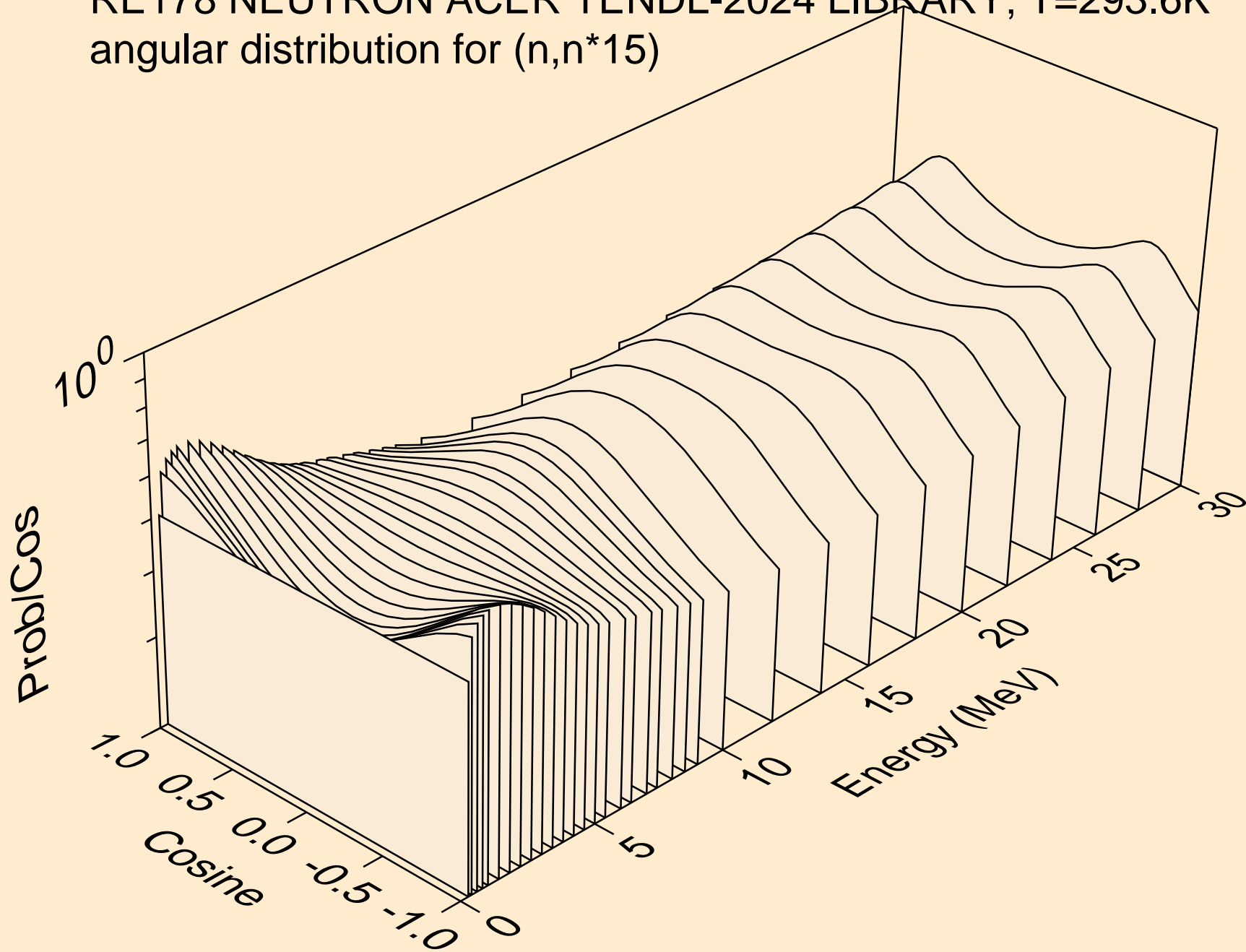

RE178 NEUTRON ACER TENDL-2024 LIBRARY; T=293.6K
angular distribution for (n,n*16)

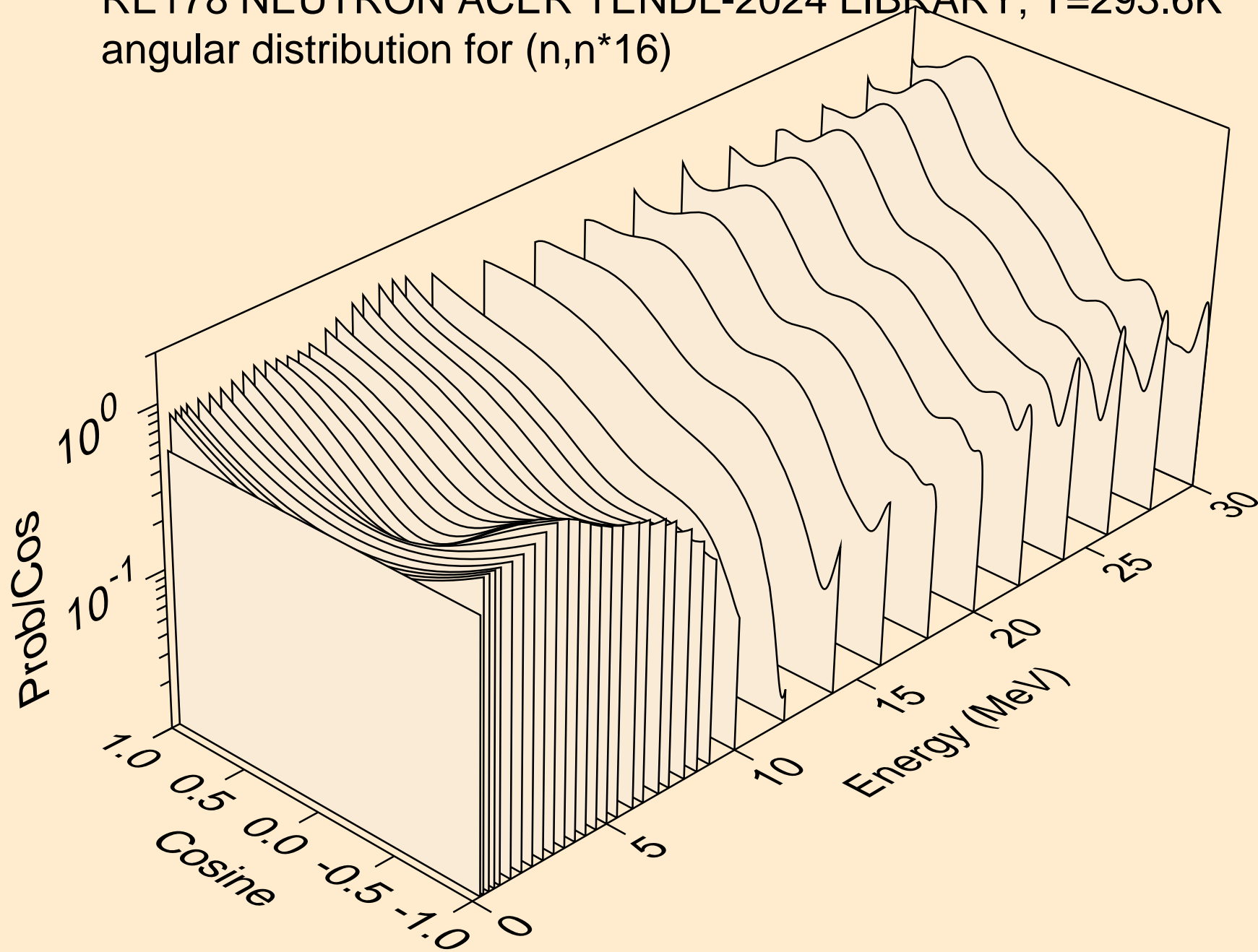

RE178 NEUTRON ACER TENDL-2024 LIBRARY; T=293.6K
angular distribution for (n,n*17)

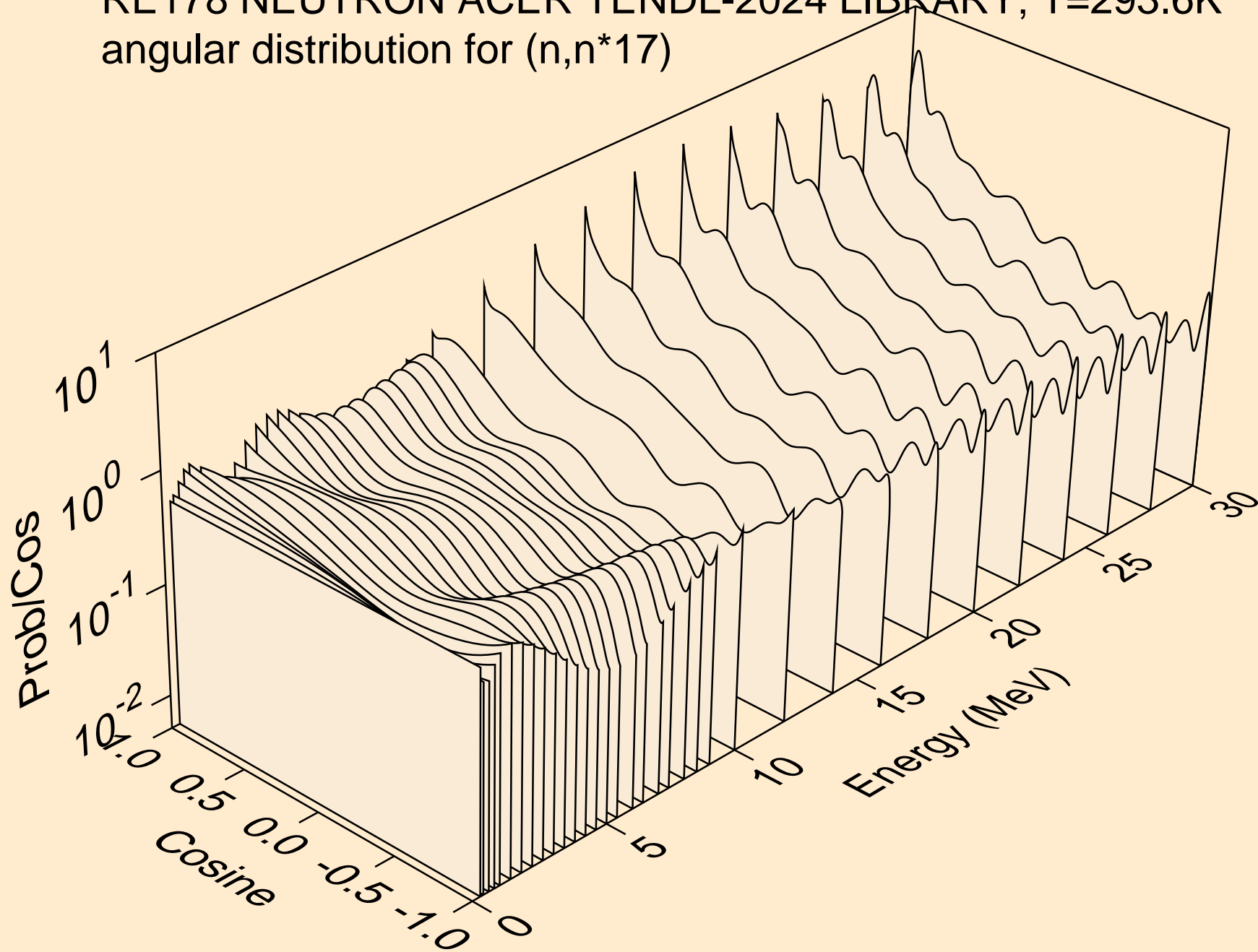

RE178 NEUTRON ACER TENDL-2024 LIBRARY; T=293.6K
angular distribution for (n,n*18)

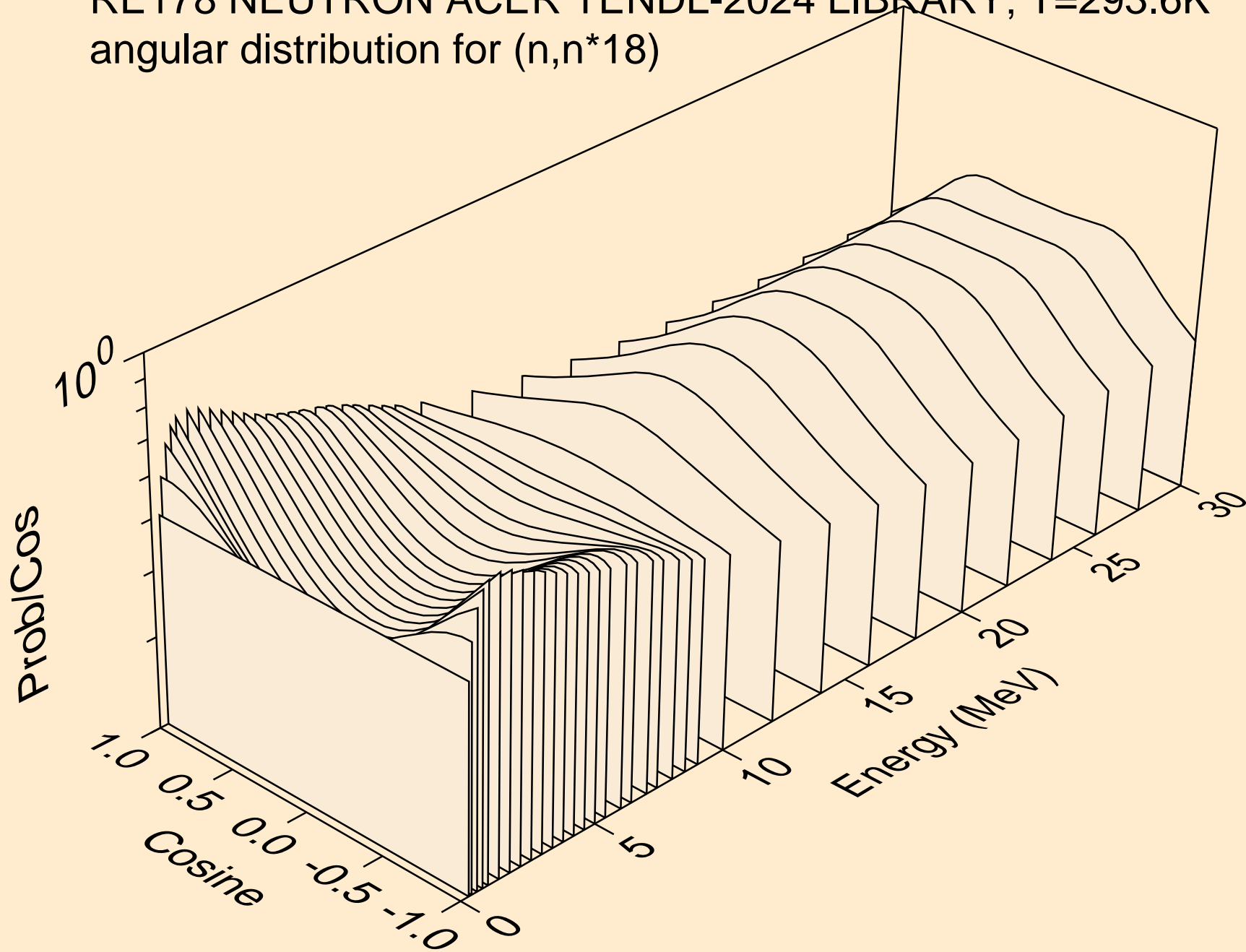

RE178 NEUTRON ACER TENDL-2024 LIBRARY; T=293.6K
angular distribution for (n,n*19)

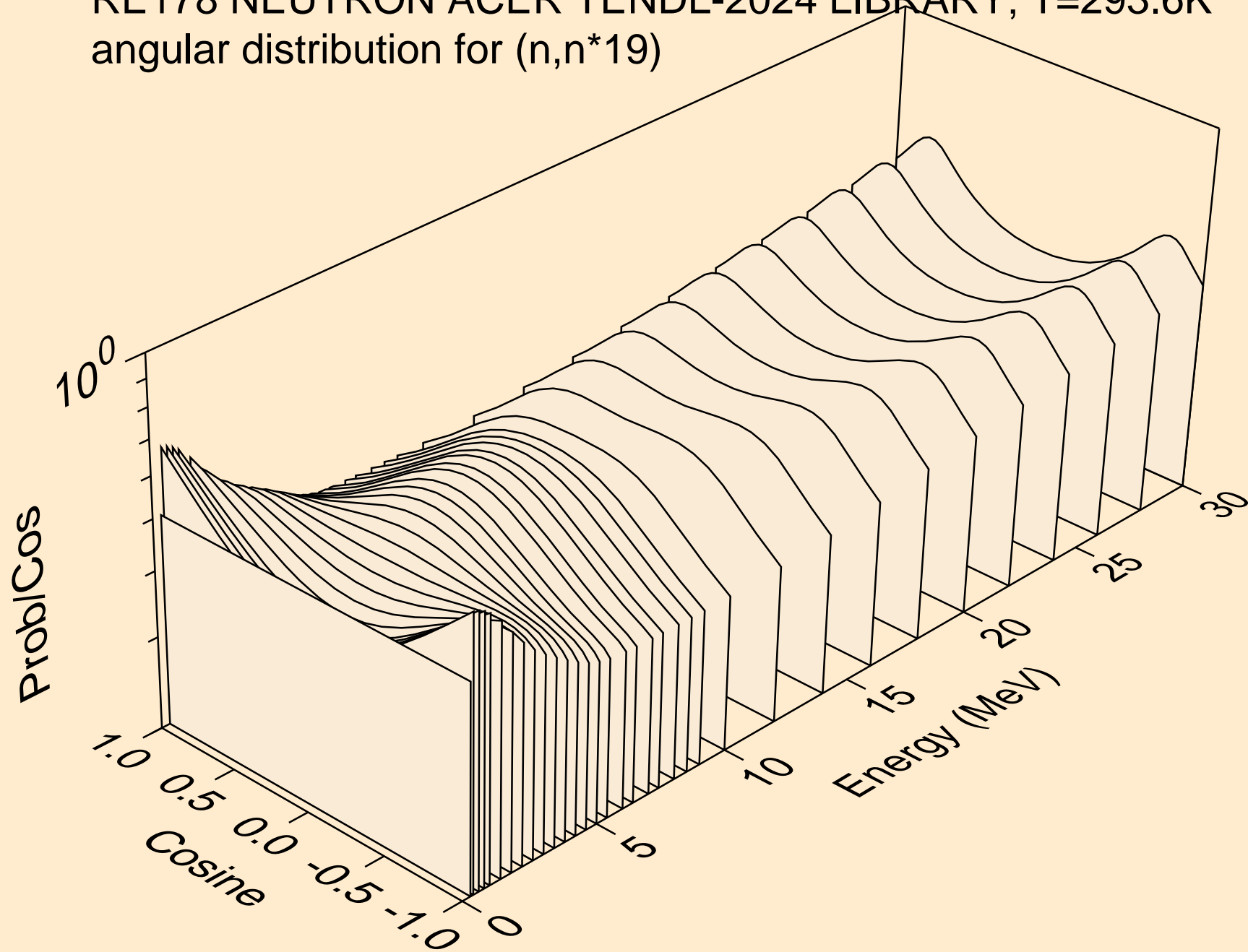

RE178 NEUTRON ACER TENDL-2024 LIBRARY; T=293.6K
angular distribution for (n,n*20)

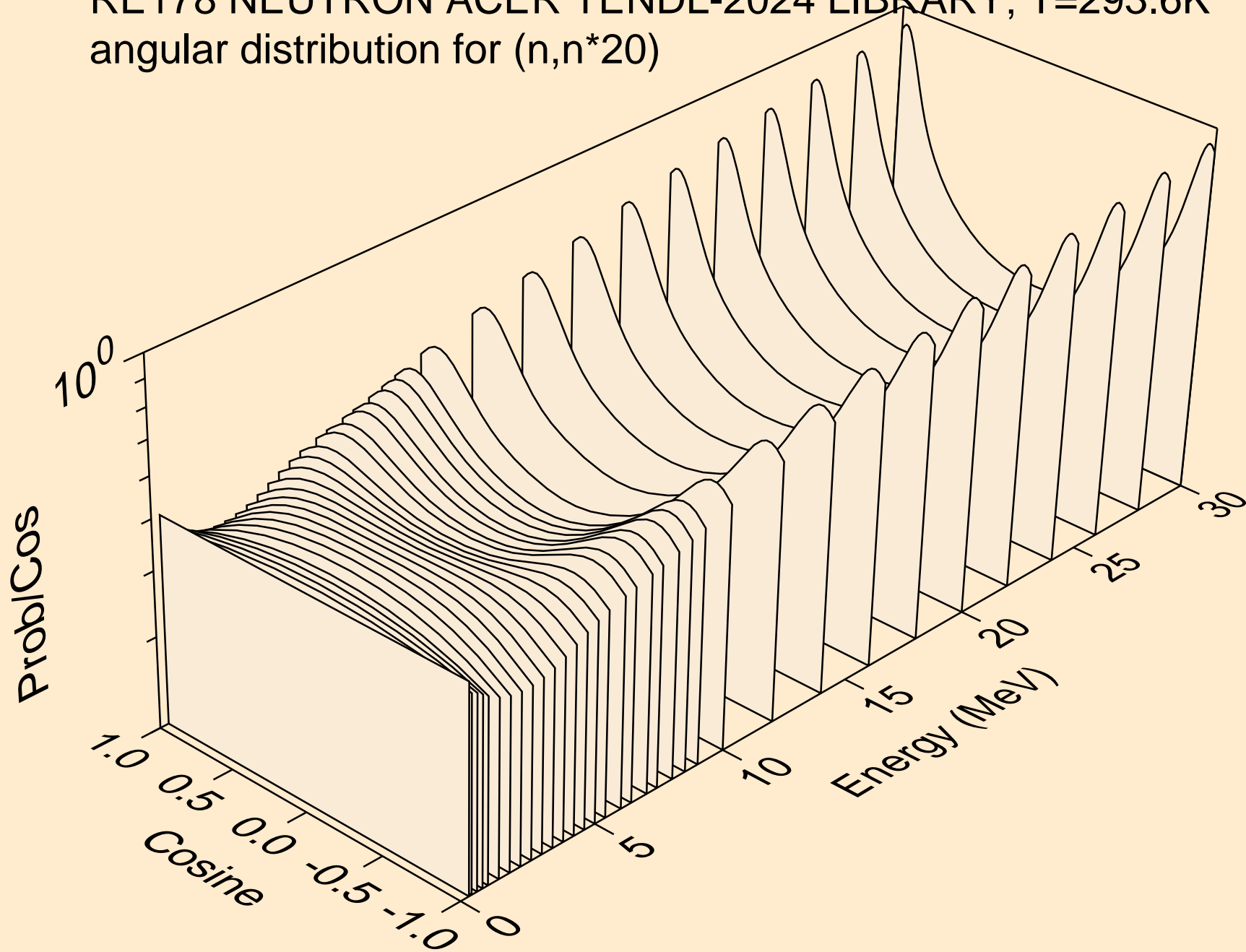

RE178 NEUTRON ACER TENDL-2024 LIBRARY; T=293.6K
angular distribution for (n,n*21)

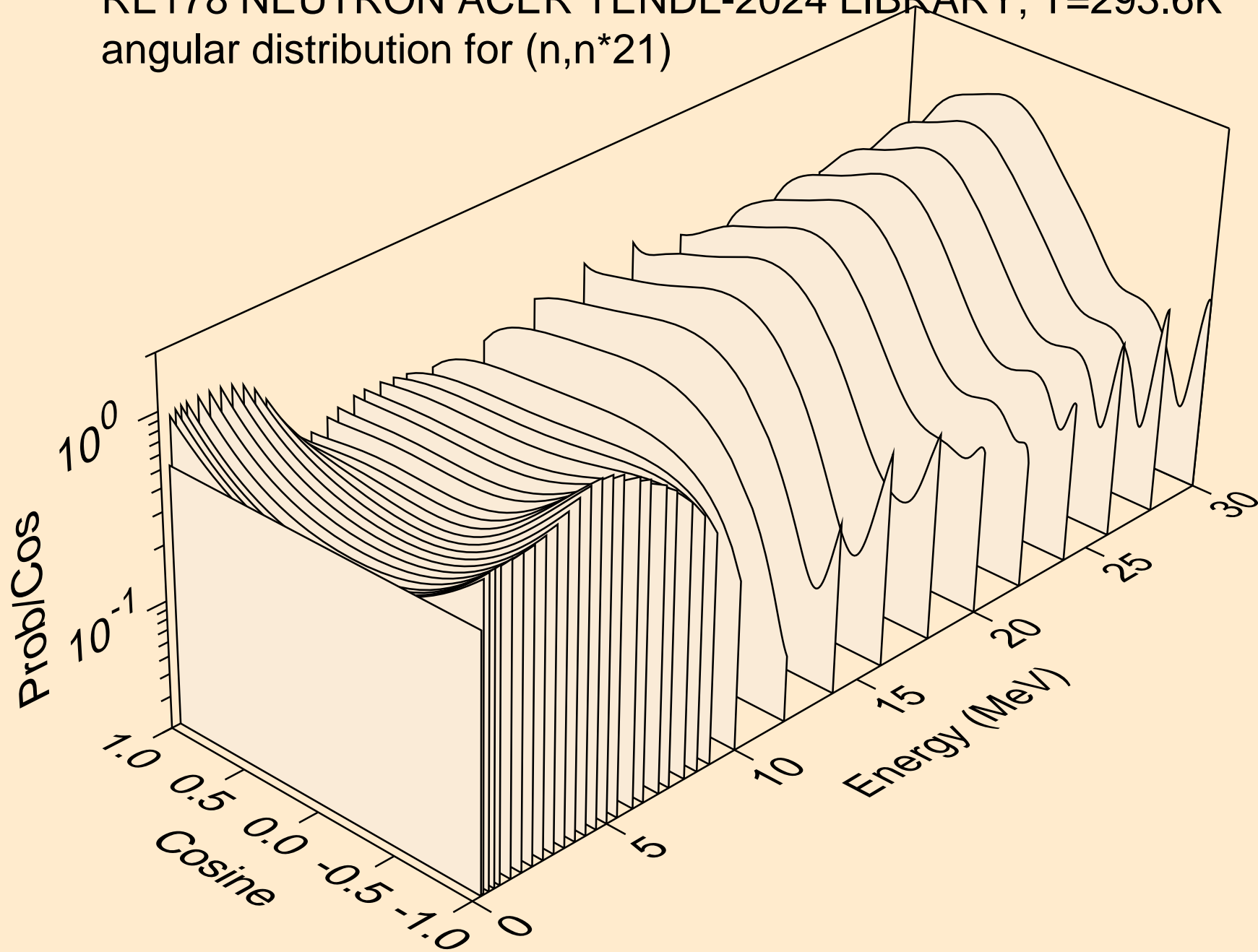

RE178 NEUTRON ACER TENDL-2024 LIBRARY; T=293.6K
angular distribution for (n,n*22)

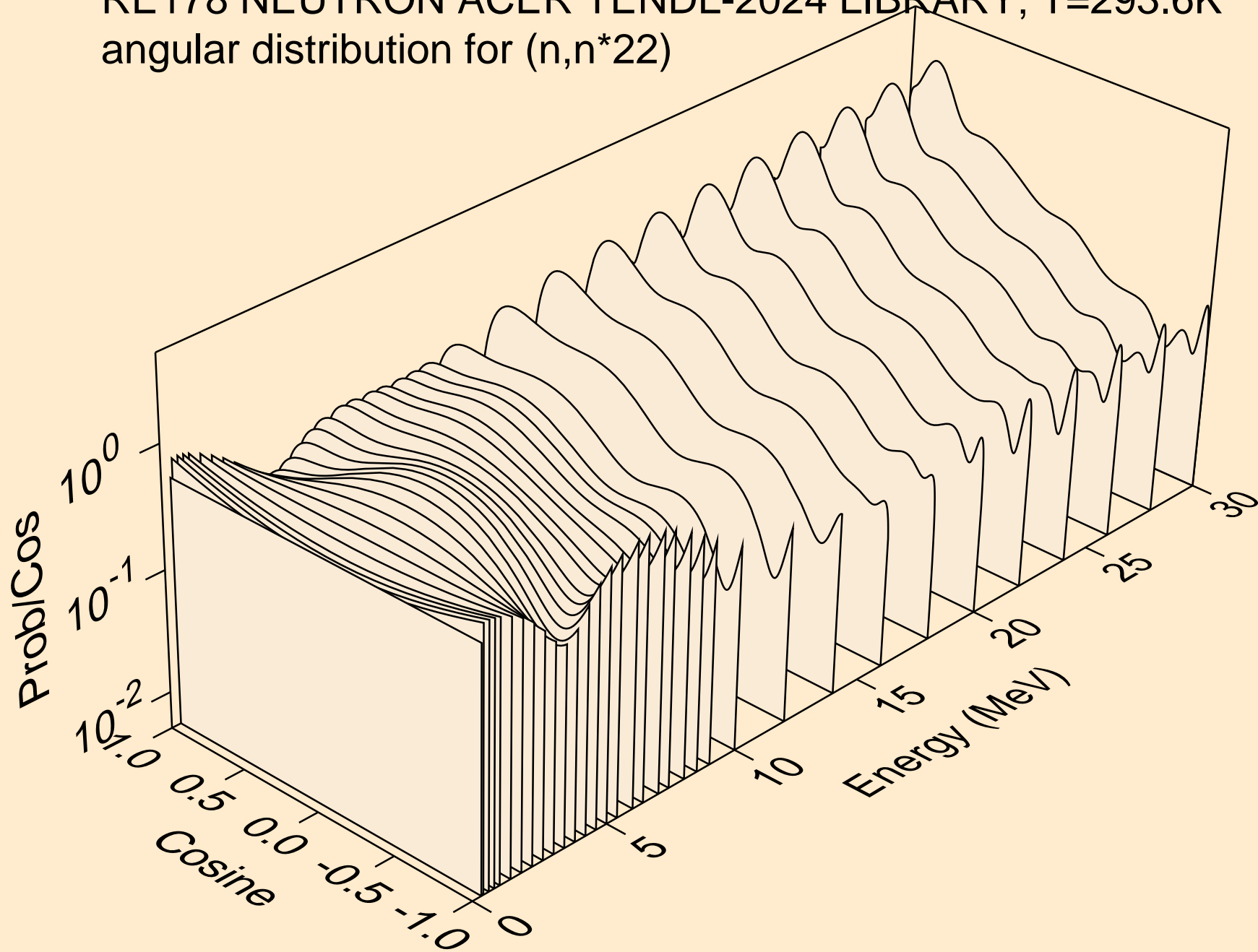

RE178 NEUTRON ACER TENDL-2024 LIBRARY; T=293.6K
angular distribution for (n,n*23)

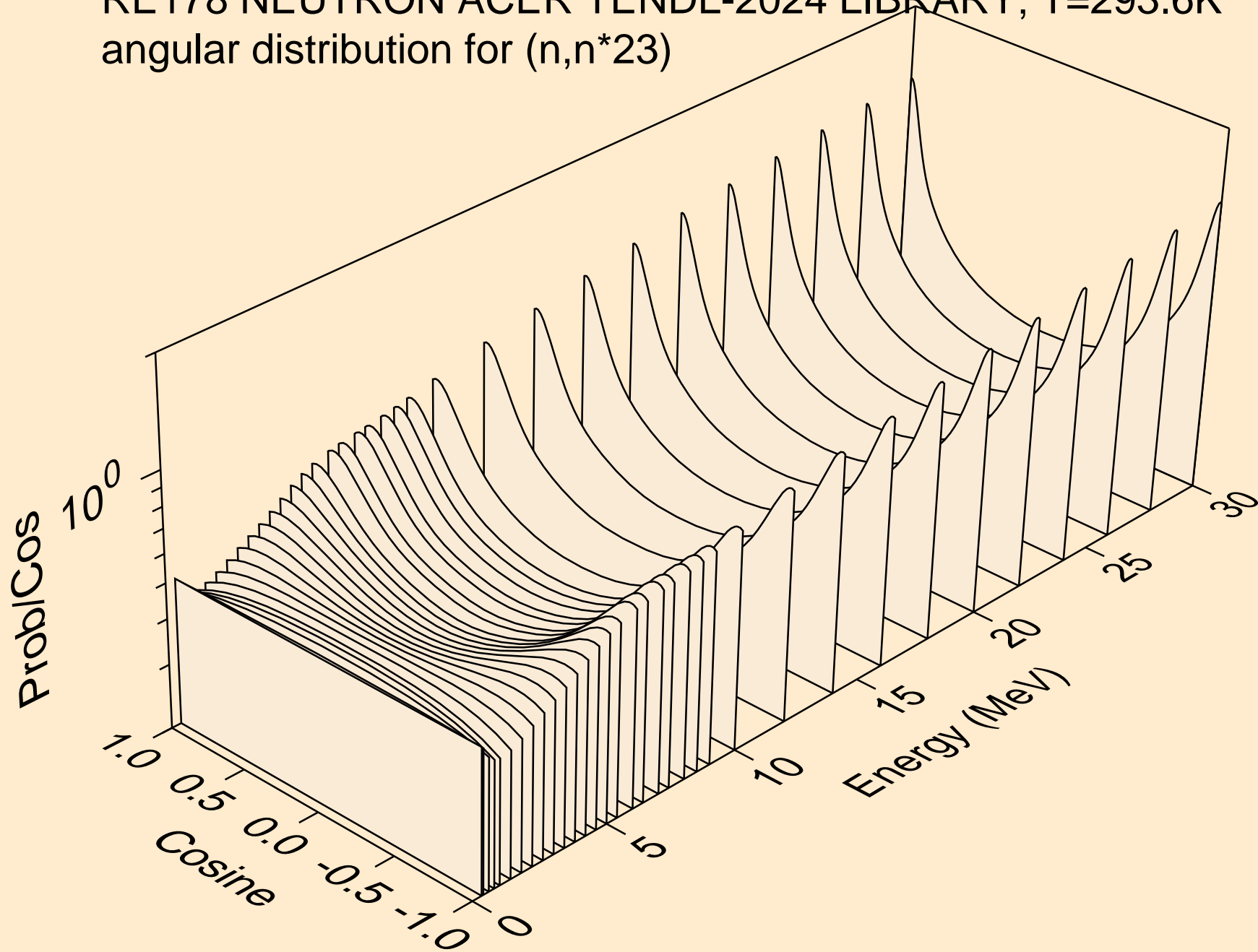

RE178 NEUTRON ACER TENDL-2024 LIBRARY; T=293.6K
Neutron emission for (n,x)

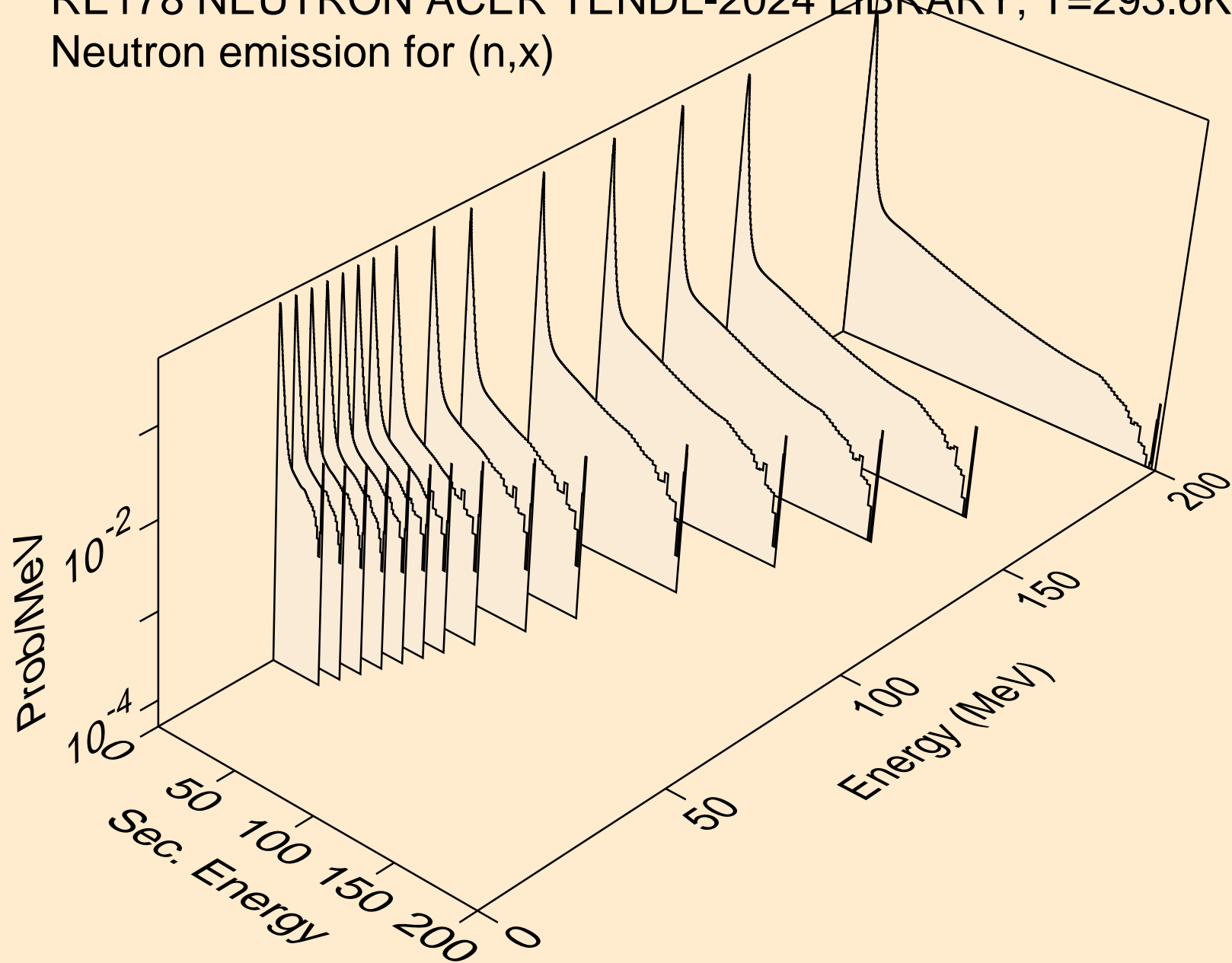

RE178 NEUTRON ACER TENDL-2024 LIBRARY; T=293.6K
Neutron emission for (n,2nd)

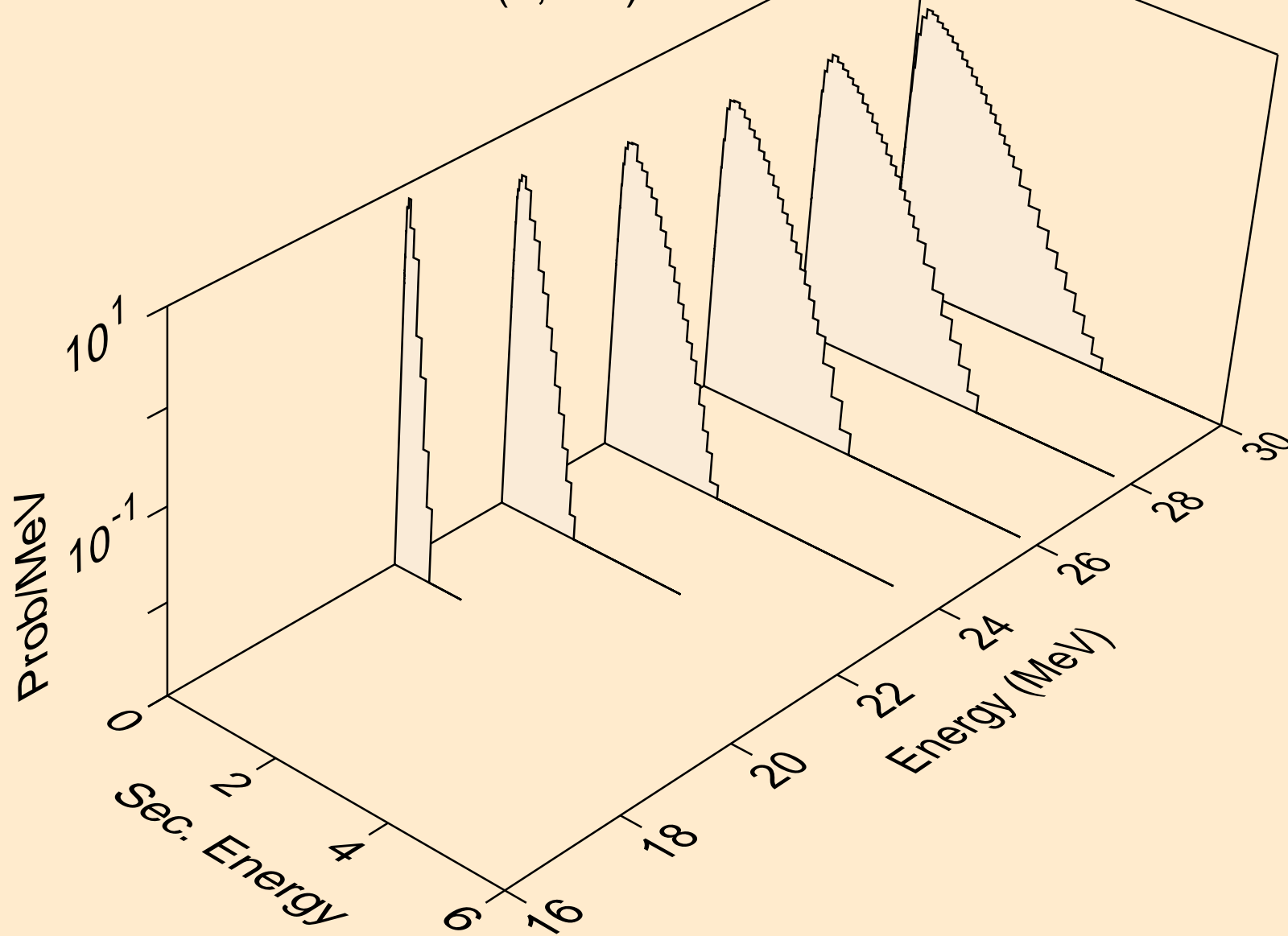

RE178 NEUTRON ACER TENDL-2024 LIBRARY; T=293.6K
Neutron emission for (n,2n)

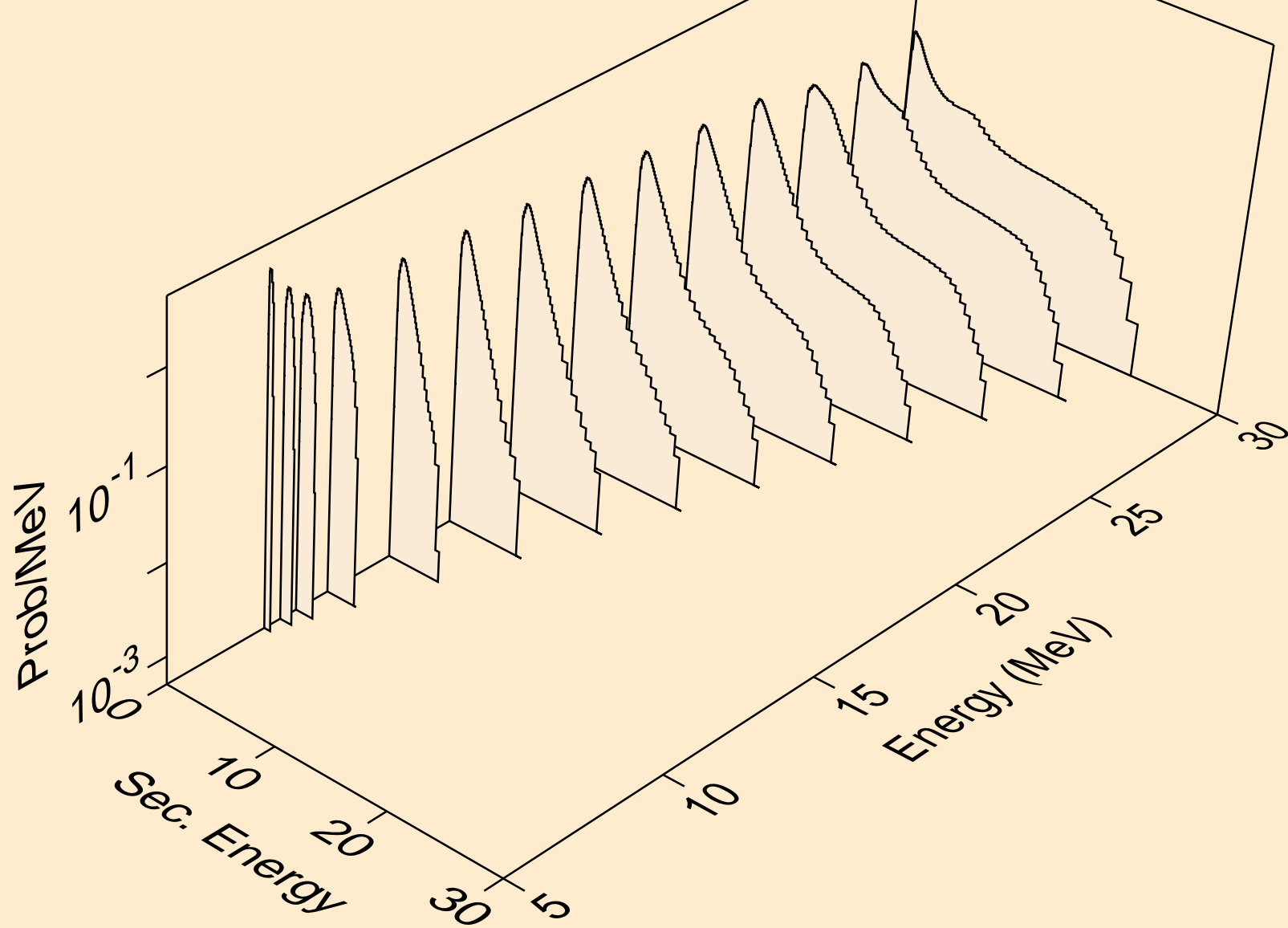

RE178 NEUTRON ACER TENDL-2024 LIBRARY; T=293.6K
Neutron emission for (n,3n)

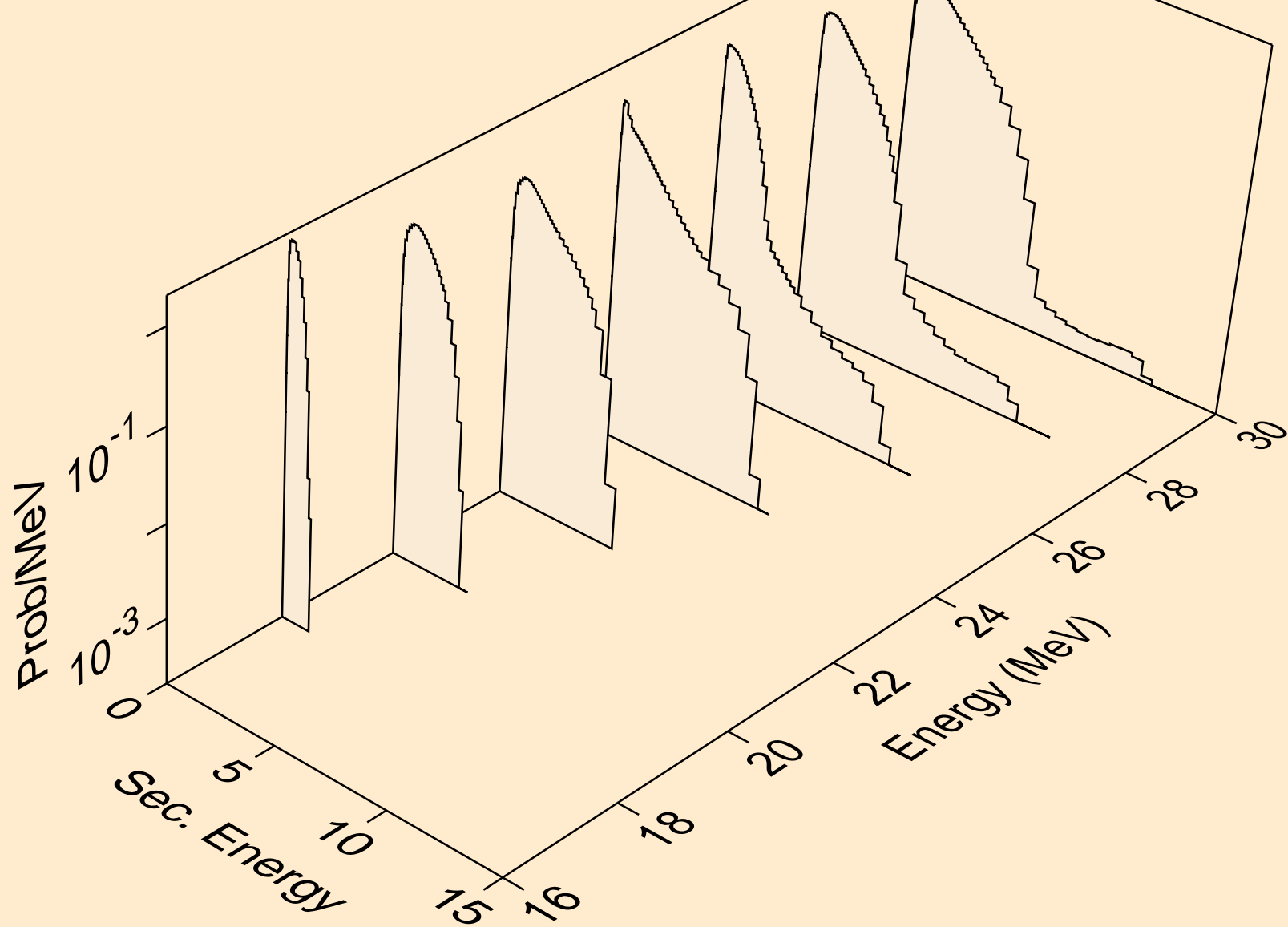

RE178 NEUTRON ACER TENDL-2024 LIBRARY; T=293.6K
Neutron emission for (n,n*)a

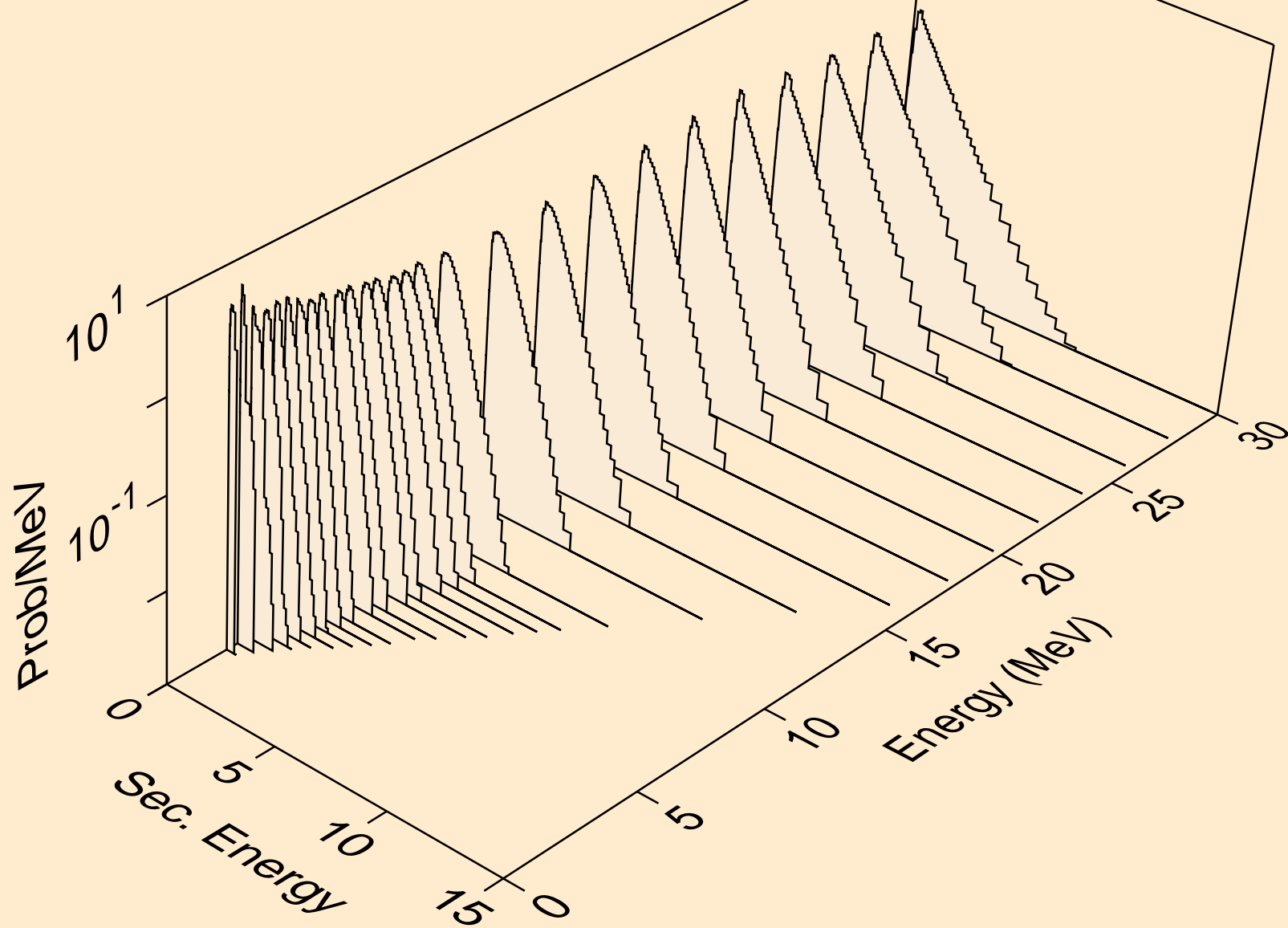

RE178 NEUTRON ACER TENDL-2024 LIBRARY; T=293.6K
Neutron emission for (n,2n)_a

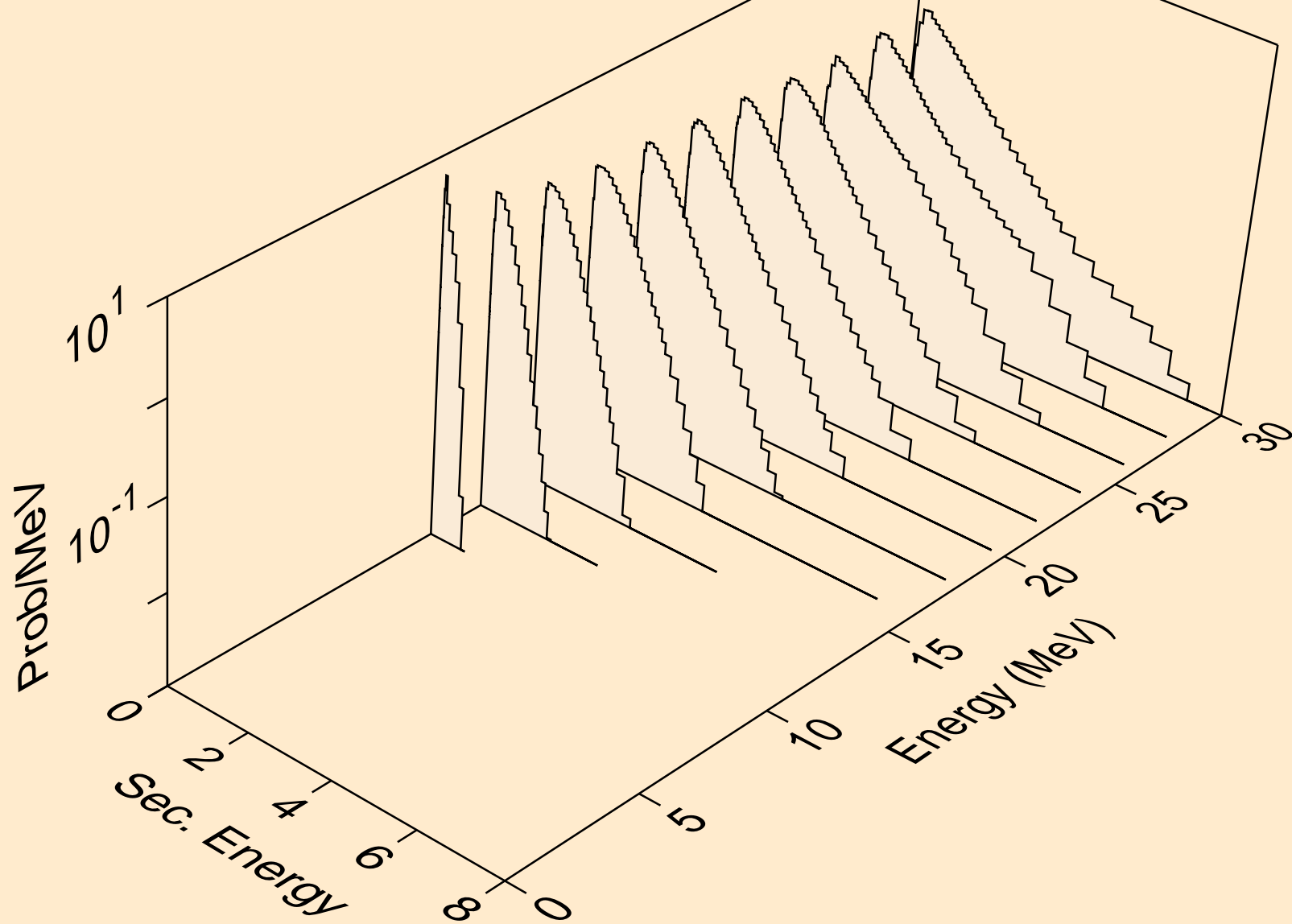

RE178 NEUTRON ACER TENDL-2024 LIBRARY; T=293.6K
Neutron emission for (n,3n)a

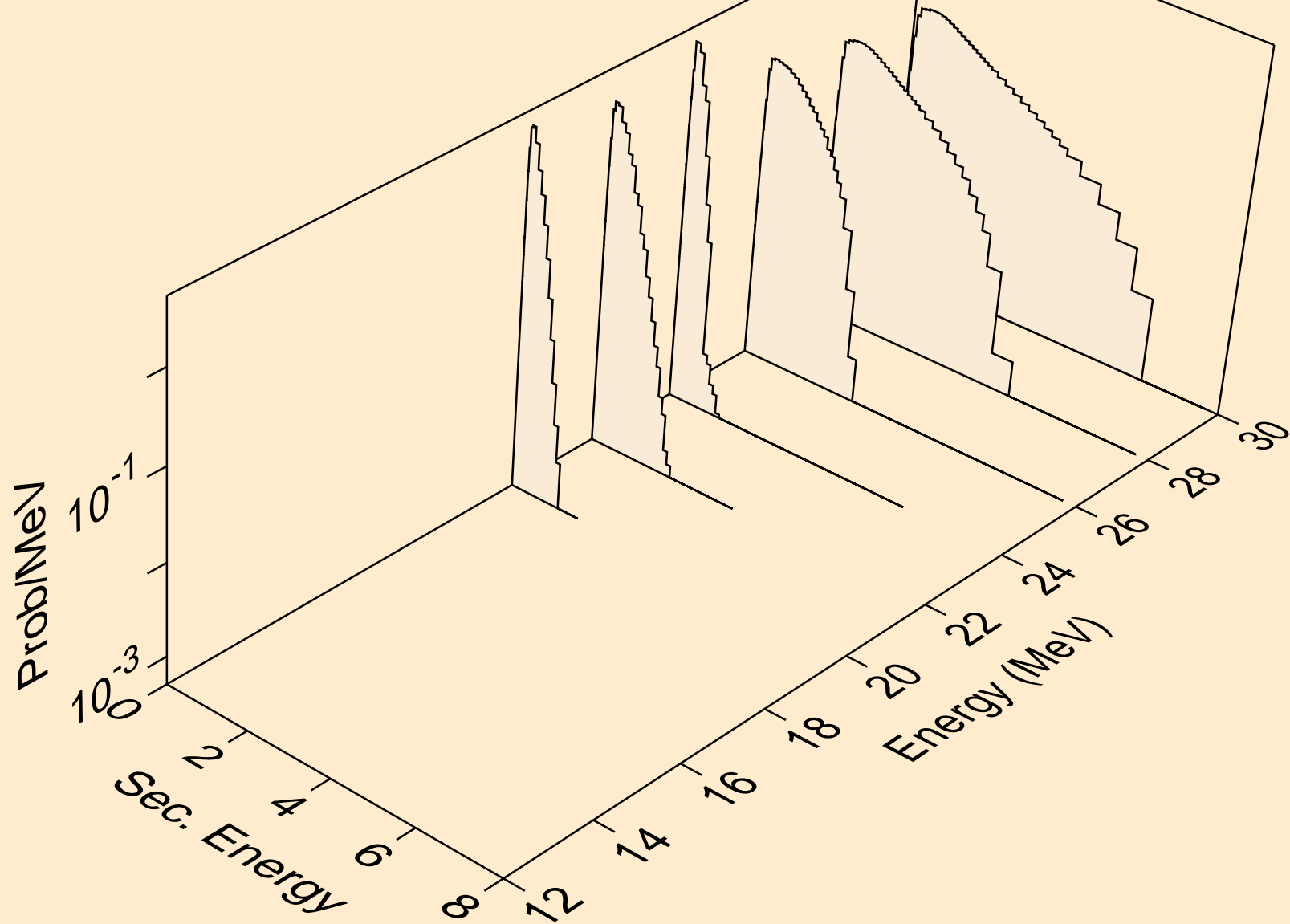

RE178 NEUTRON ACER TENDL-2024 LIBRARY; T=293.6K
Neutron emission for (n,n*)p

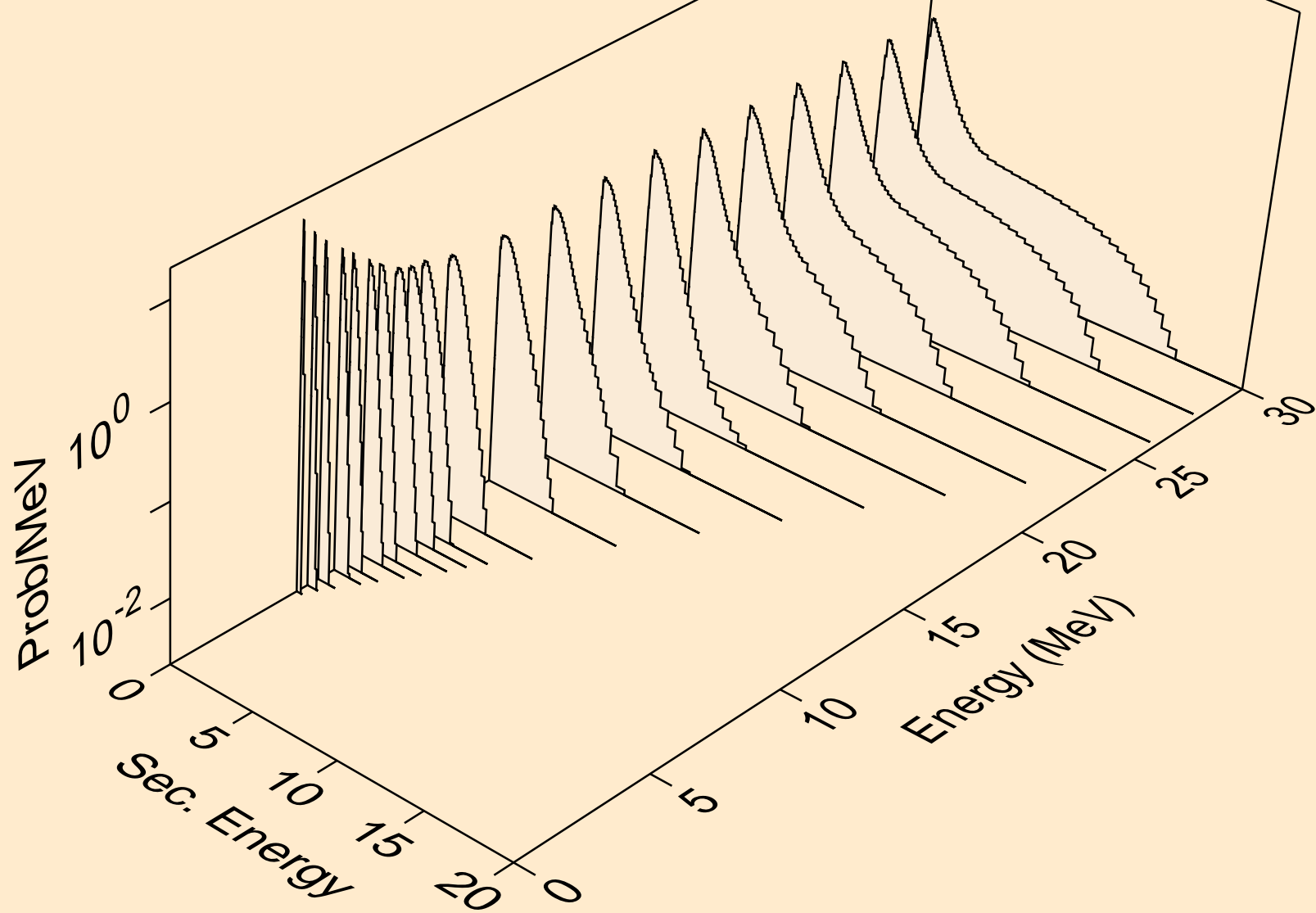

RE178 NEUTRON ACER TENDL-2024 LIBRARY; T=293.6K
Neutron emission for (n,n*)2a

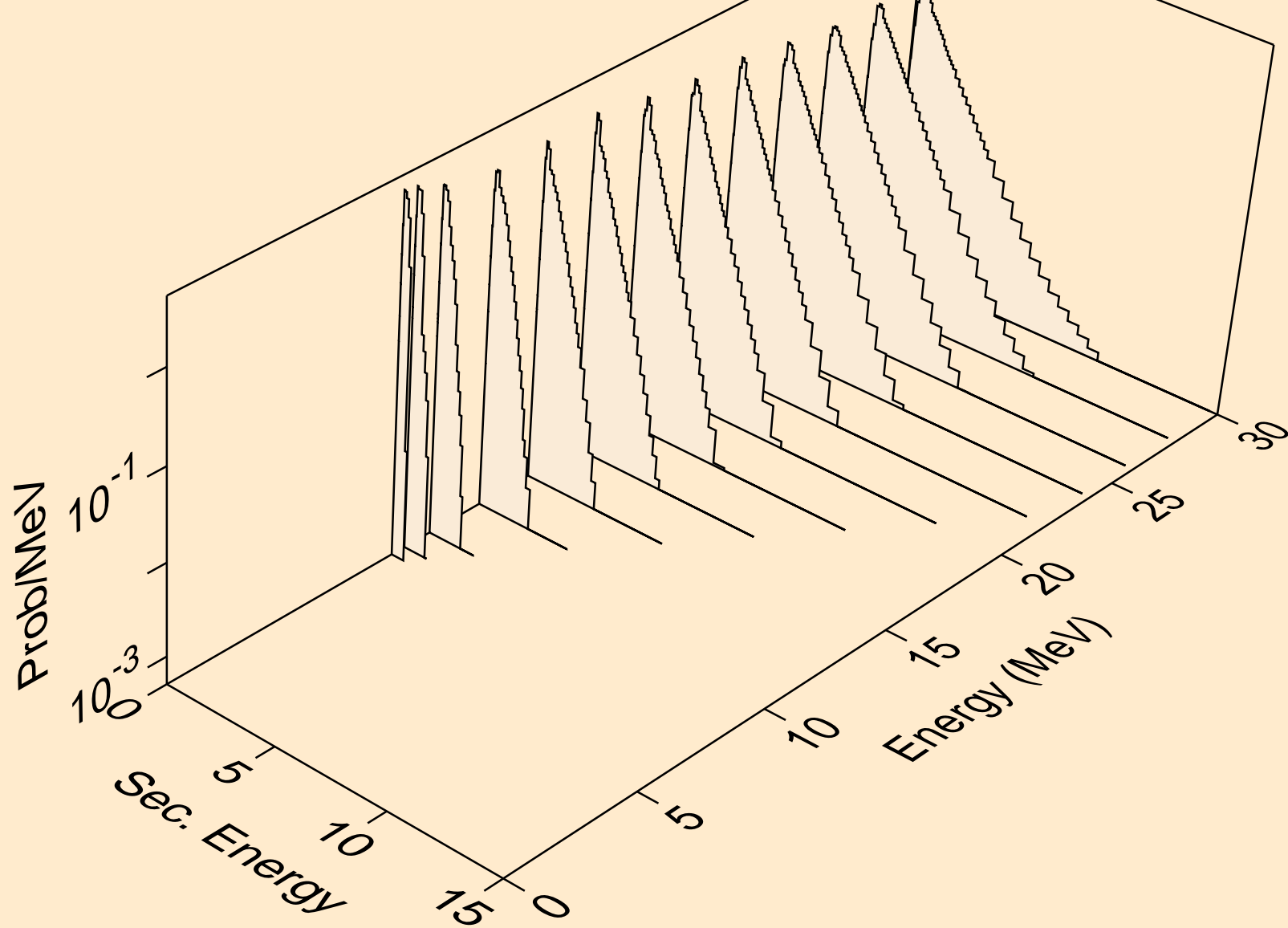

RE178 NEUTRON ACER TENDL-2024 LIBRARY; T=293.6K
Neutron emission for (n,2n)2a

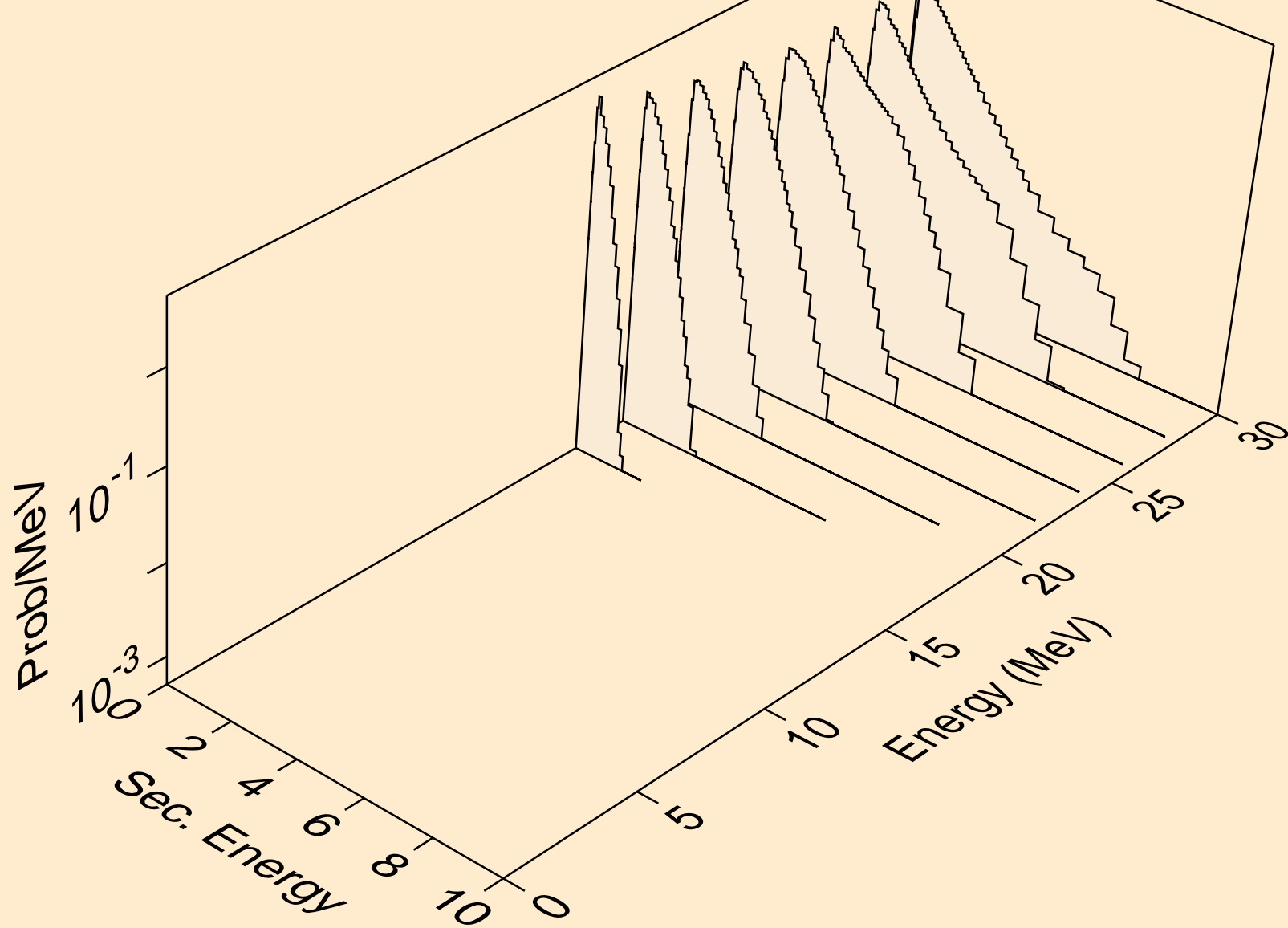

RE178 NEUTRON ACER TENDL-2024 LIBRARY; T=293.6K
Neutron emission for (n,n*)d

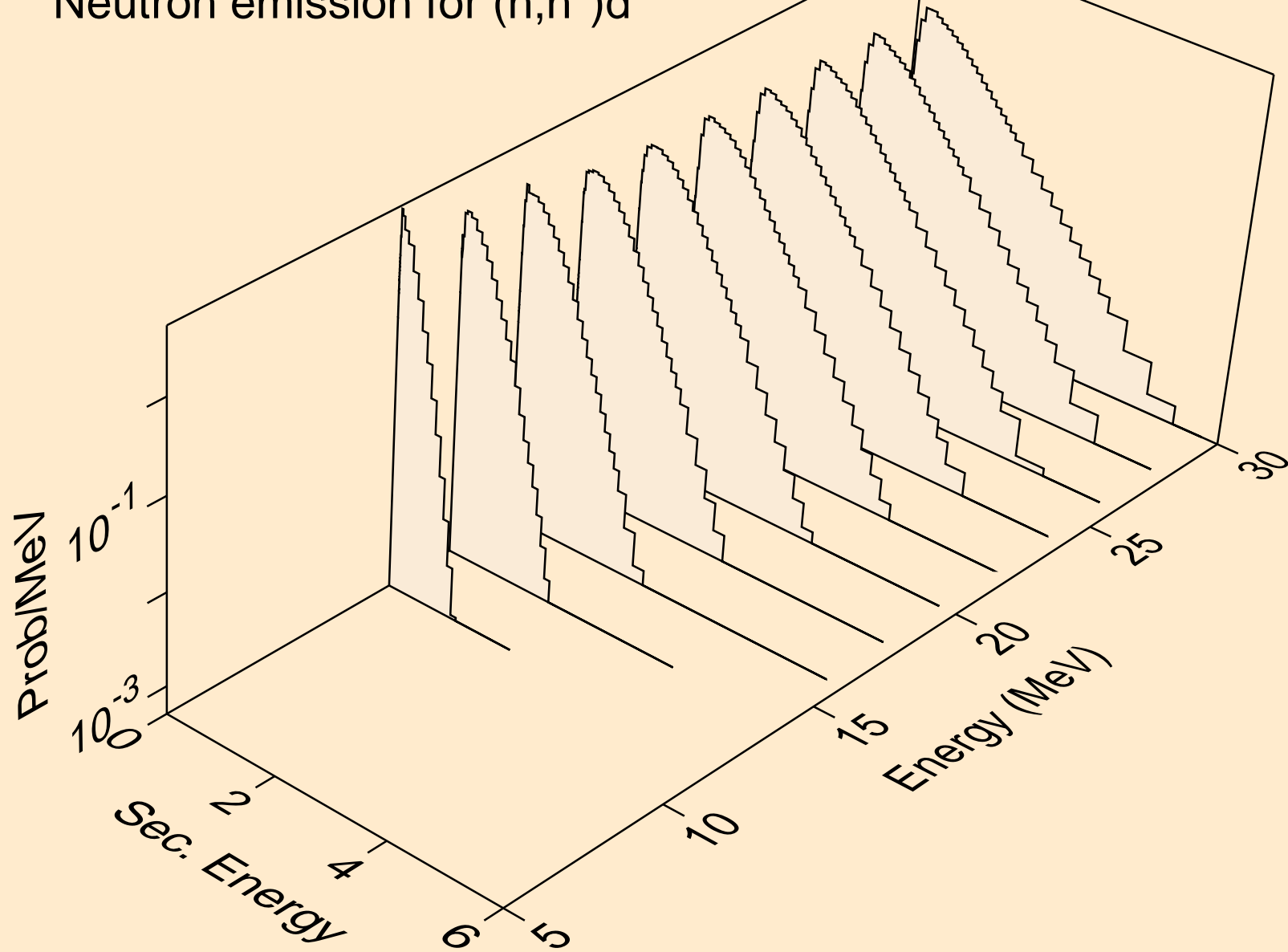

RE178 NEUTRON ACER TENDL-2024 LIBRARY; T=293.6K
Neutron emission for (n,n*)t

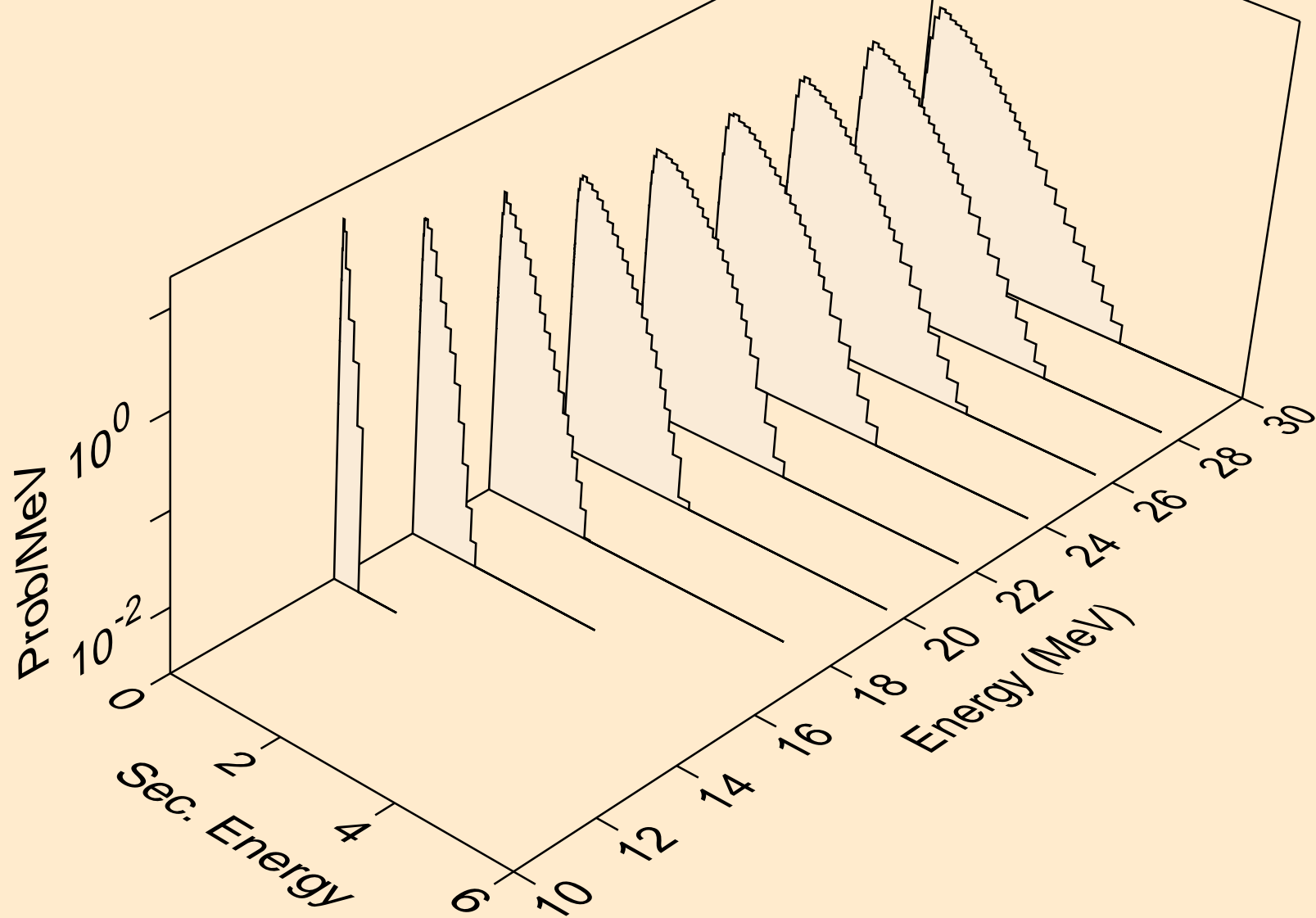

RE178 NEUTRON ACER TENDL-2024 LIBRARY; T=293.6K
Neutron emission for (n,n*)he3

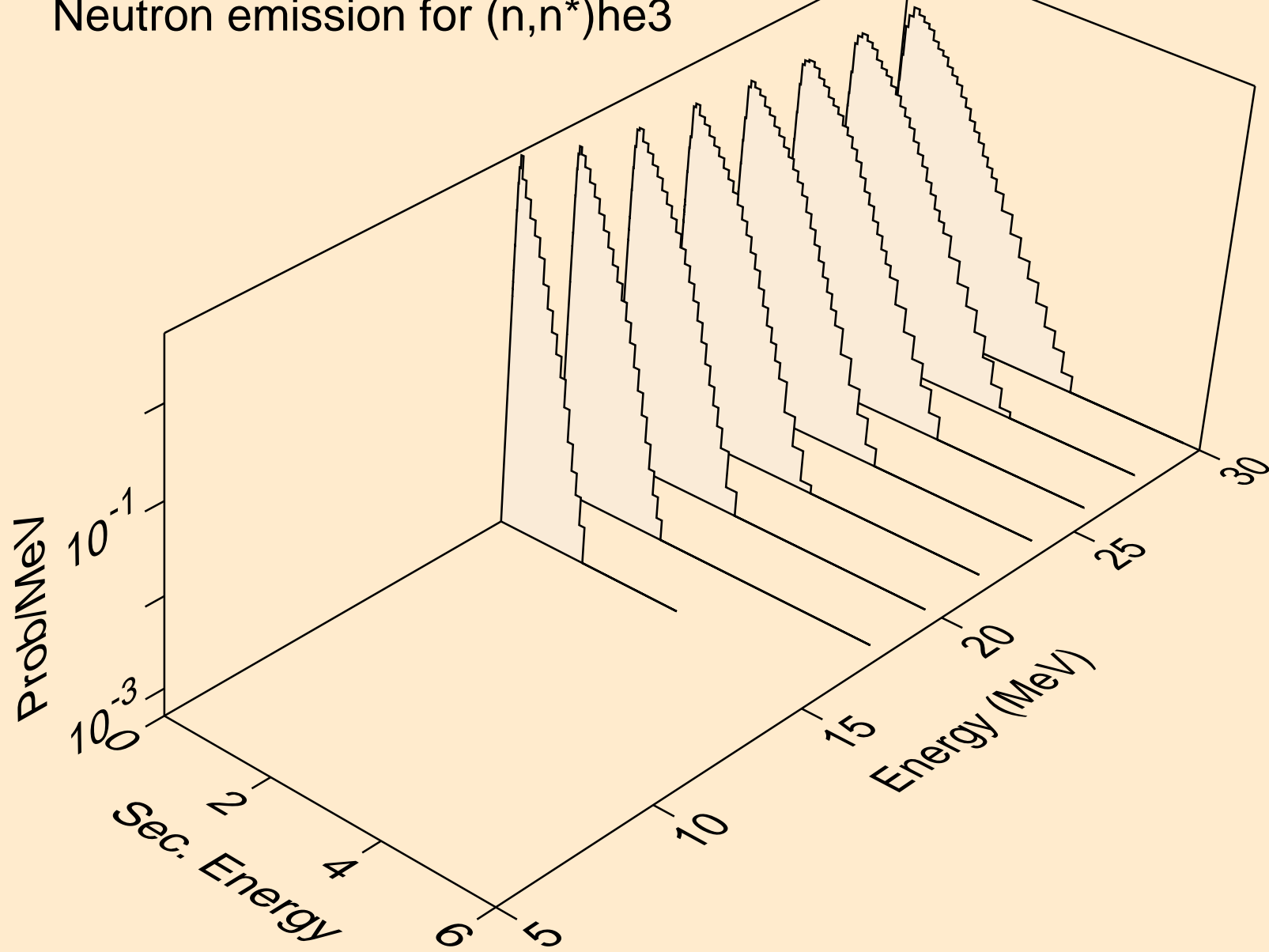

RE178 NEUTRON ACER TENDL-2024 LIBRARY; T=293.6K
Neutron emission for (n,4n)

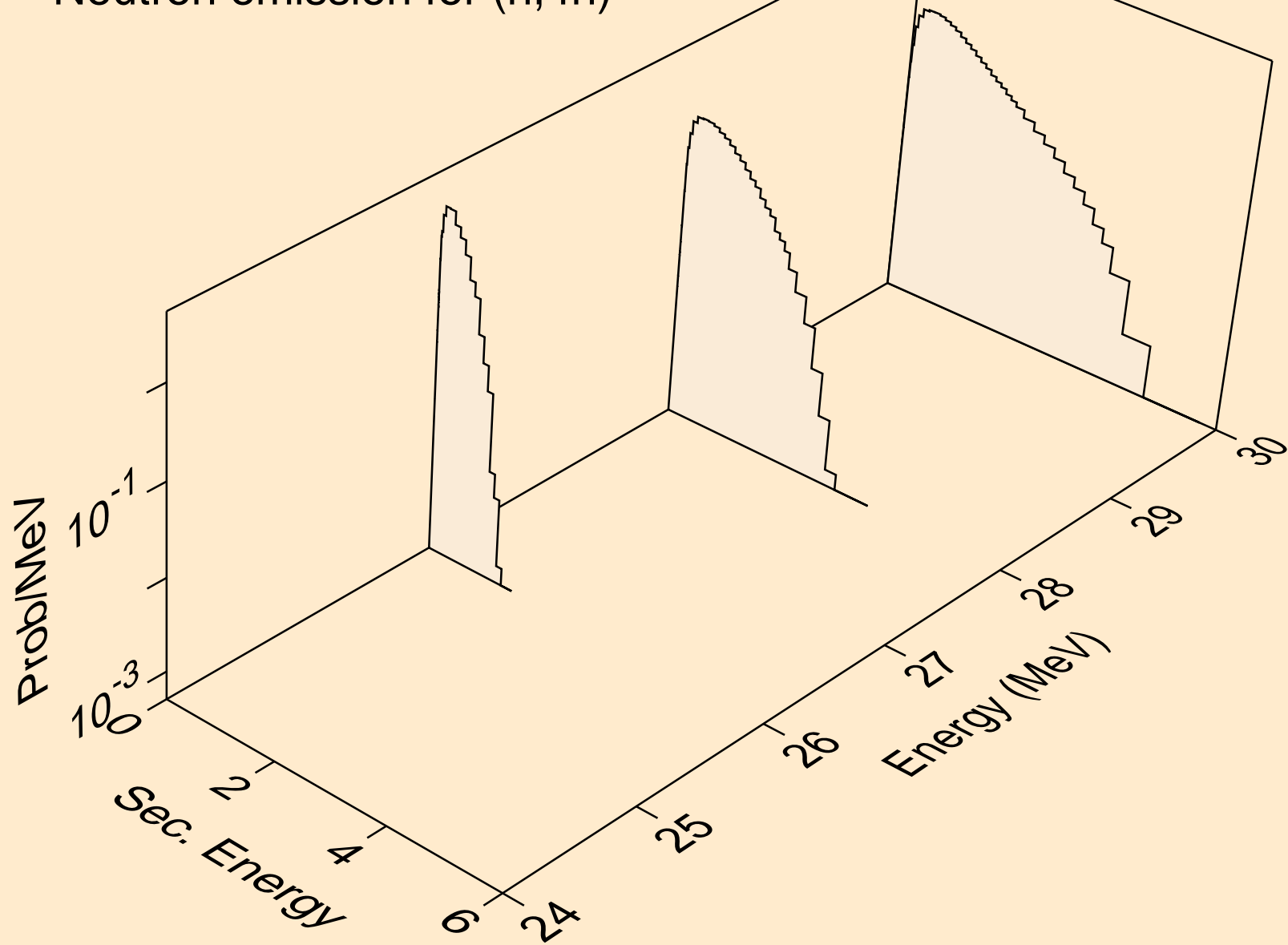

RE178 NEUTRON ACER TENDL-2024 LIBRARY; T=293.6K
Neutron emission for (n,2np)

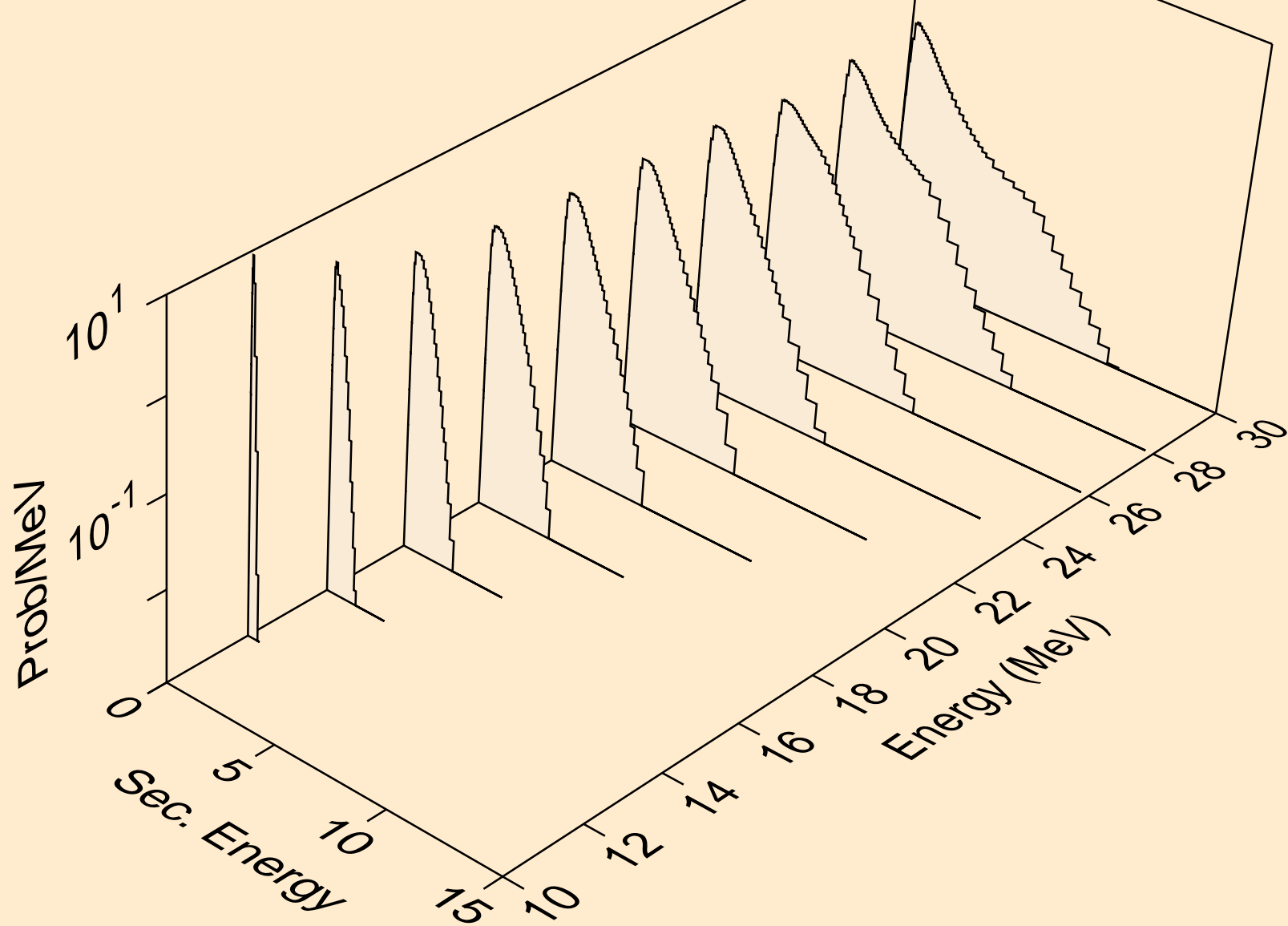

RE178 NEUTRON ACER TENDL-2024 LIBRARY; T=293.6K
Neutron emission for (n,3np)

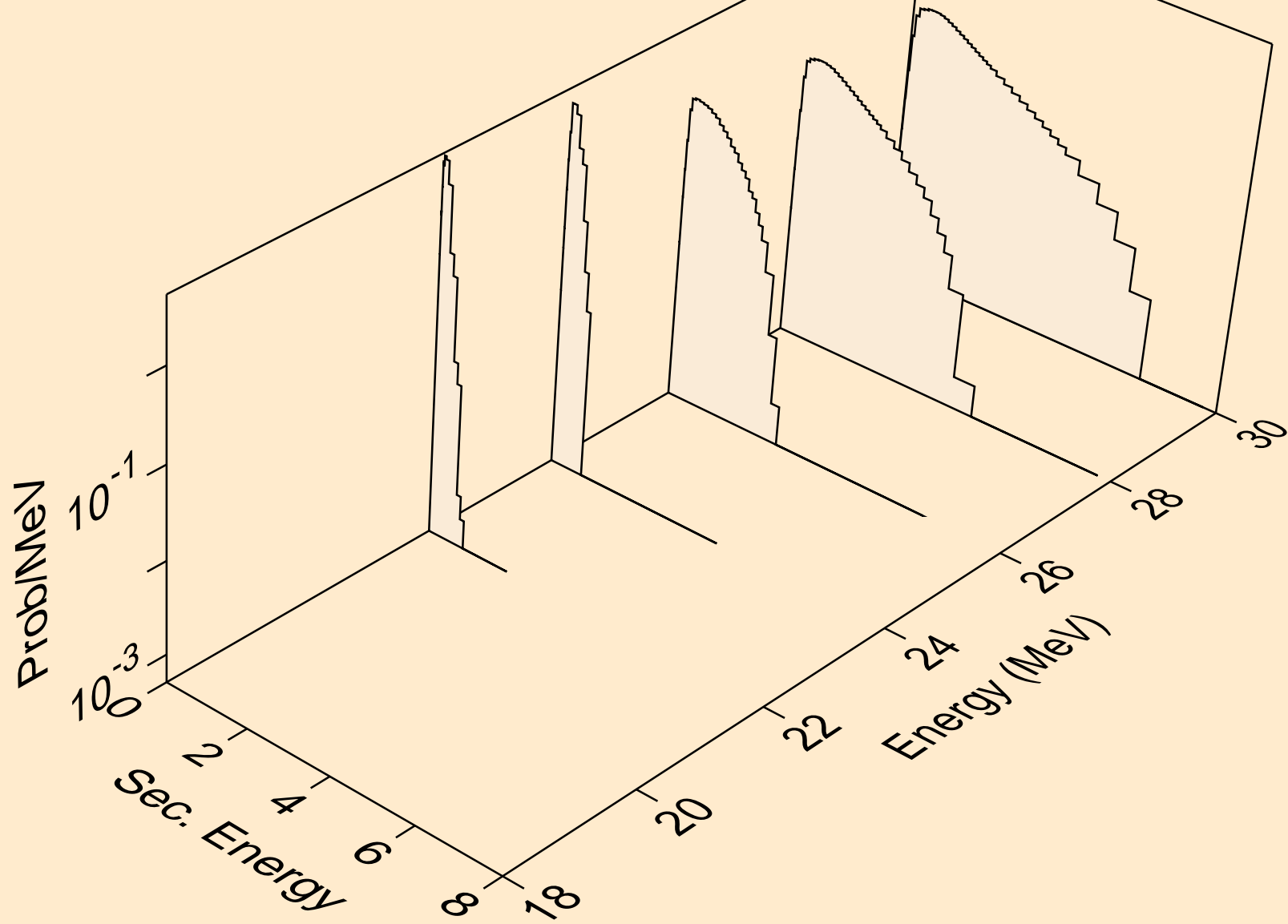

RE178 NEUTRON ACER TENDL-2024 LIBRARY; T=293.6K
Neutron emission for (n,n2p)

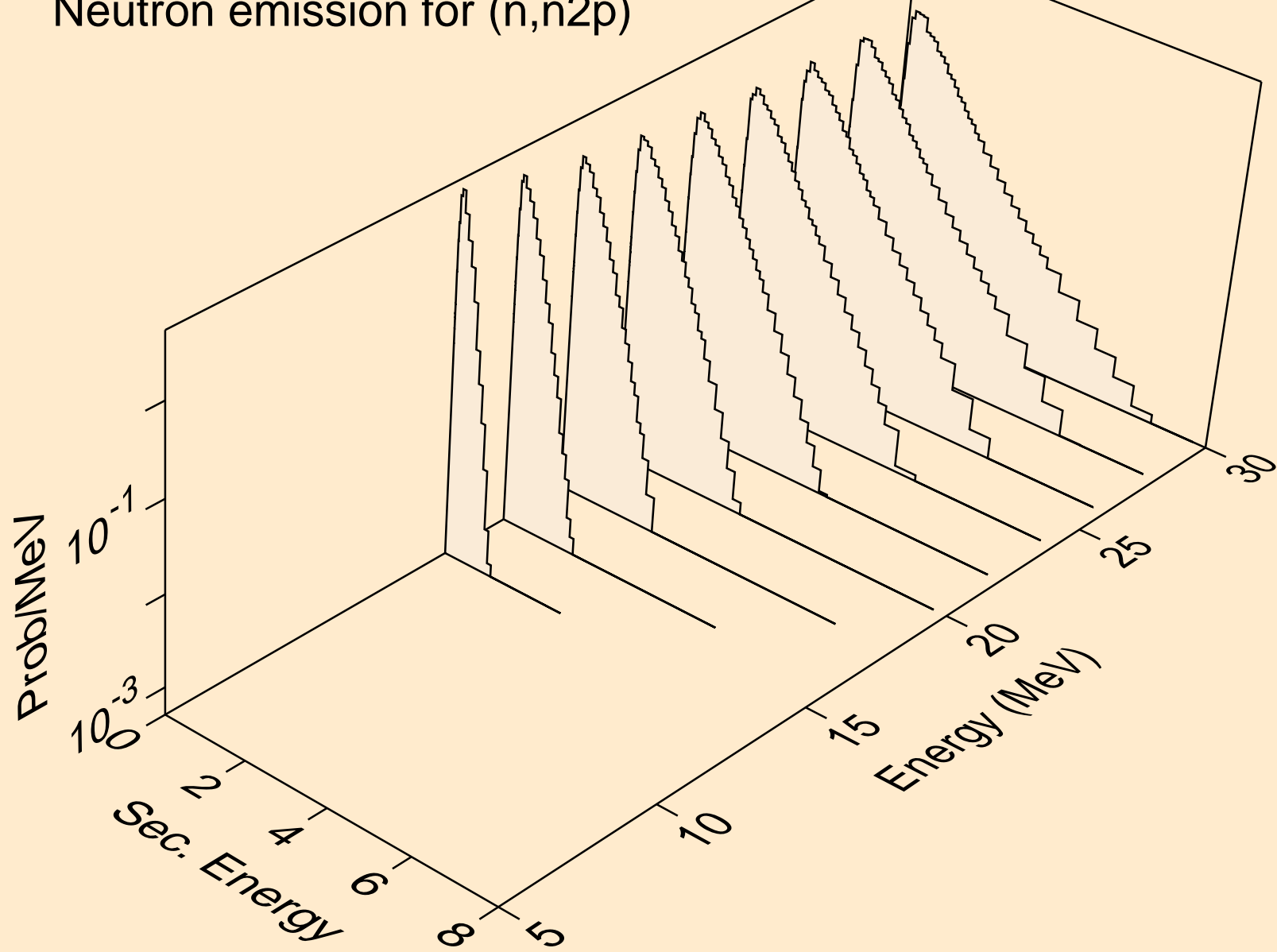

RE178 NEUTRON ACER TENDL-2024 LIBRARY; T=293.6K
Neutron emission for (n,npa)

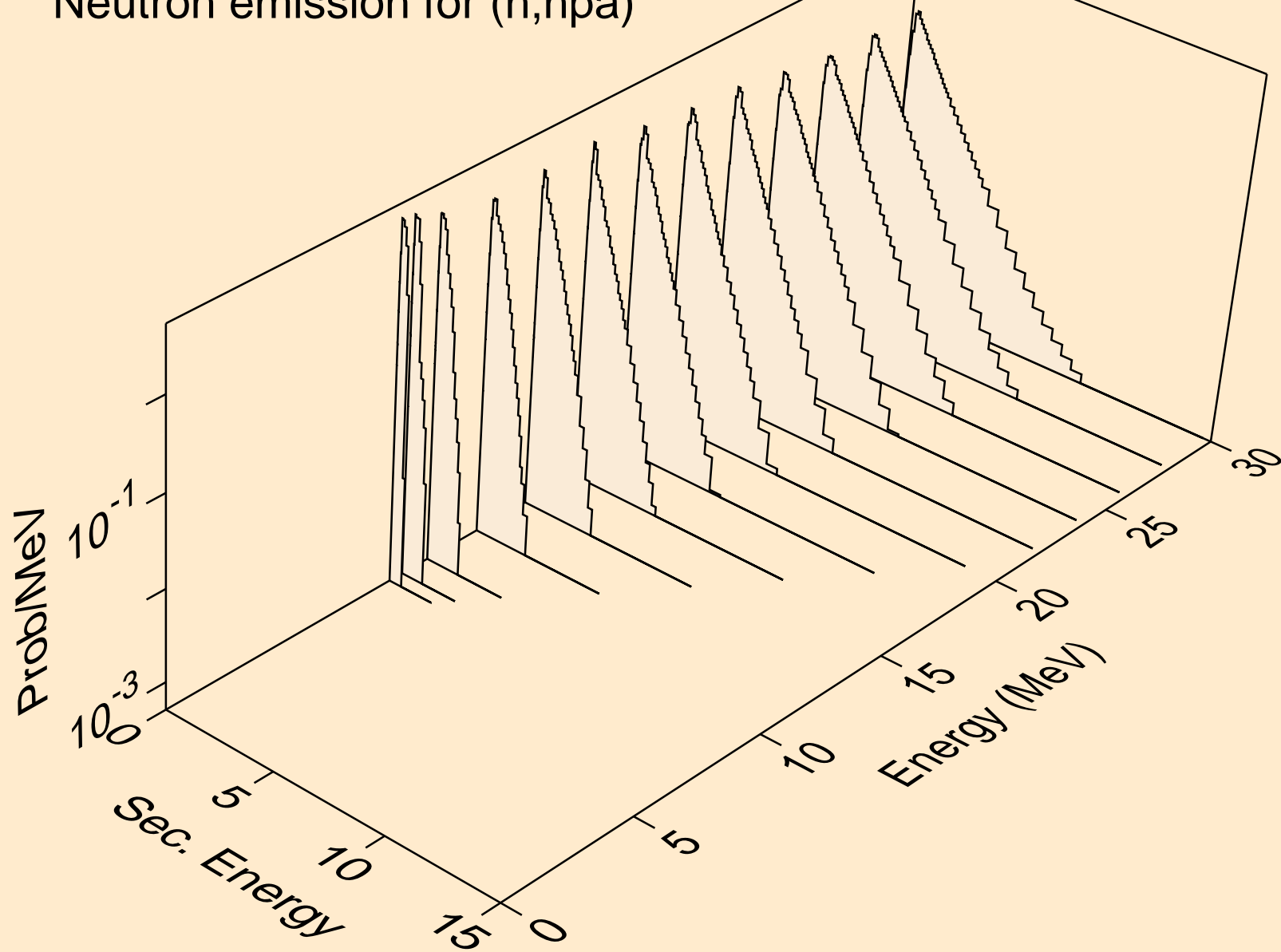

RE178 NEUTRON ACER TENDL-2024 LIBRARY; T=293.6K
Neutron emission for (n,n*c)

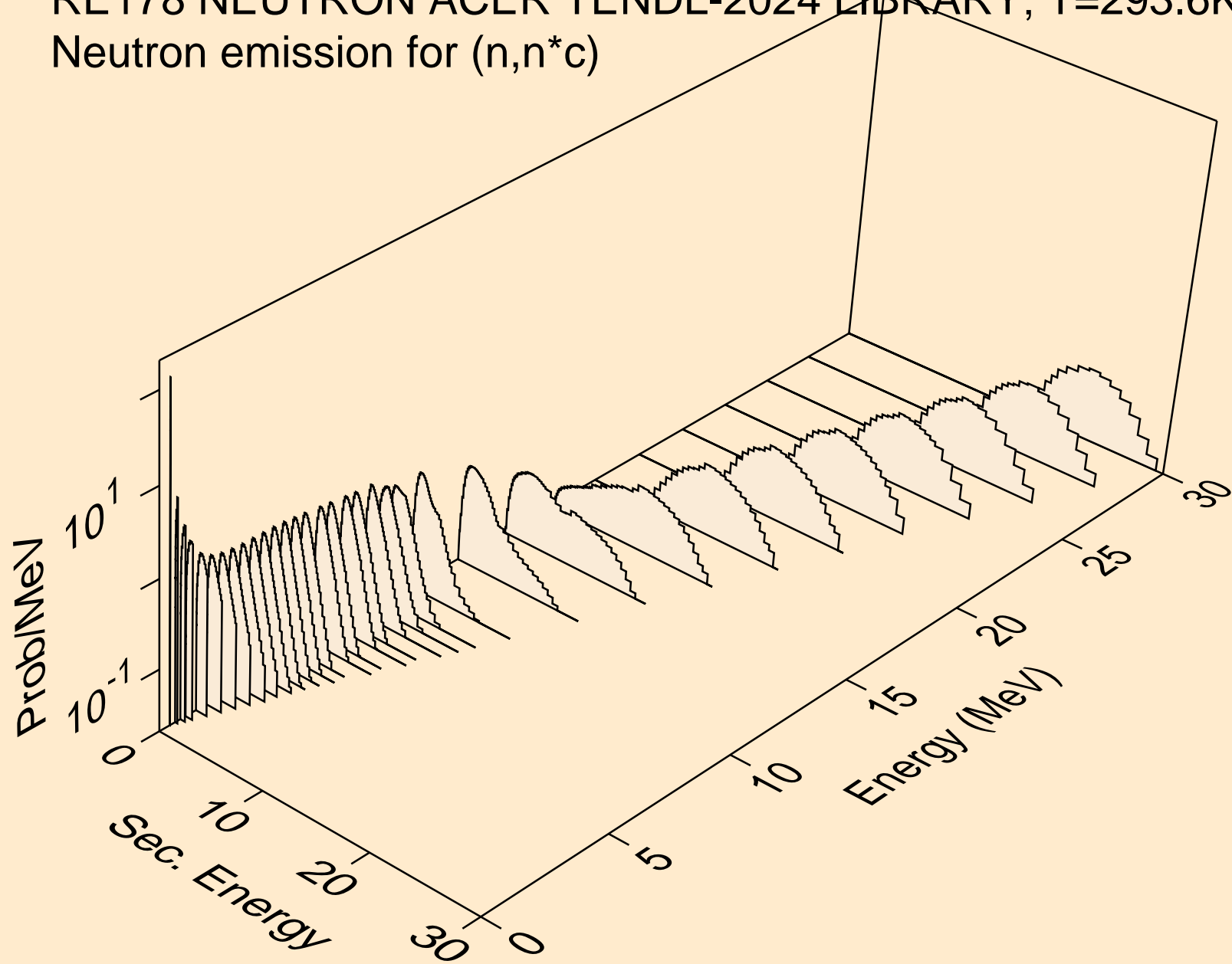

RE178 NEUTRON ACER TENDL-2024 LIBRARY; T=293.6K
Photon emission for (n,x)

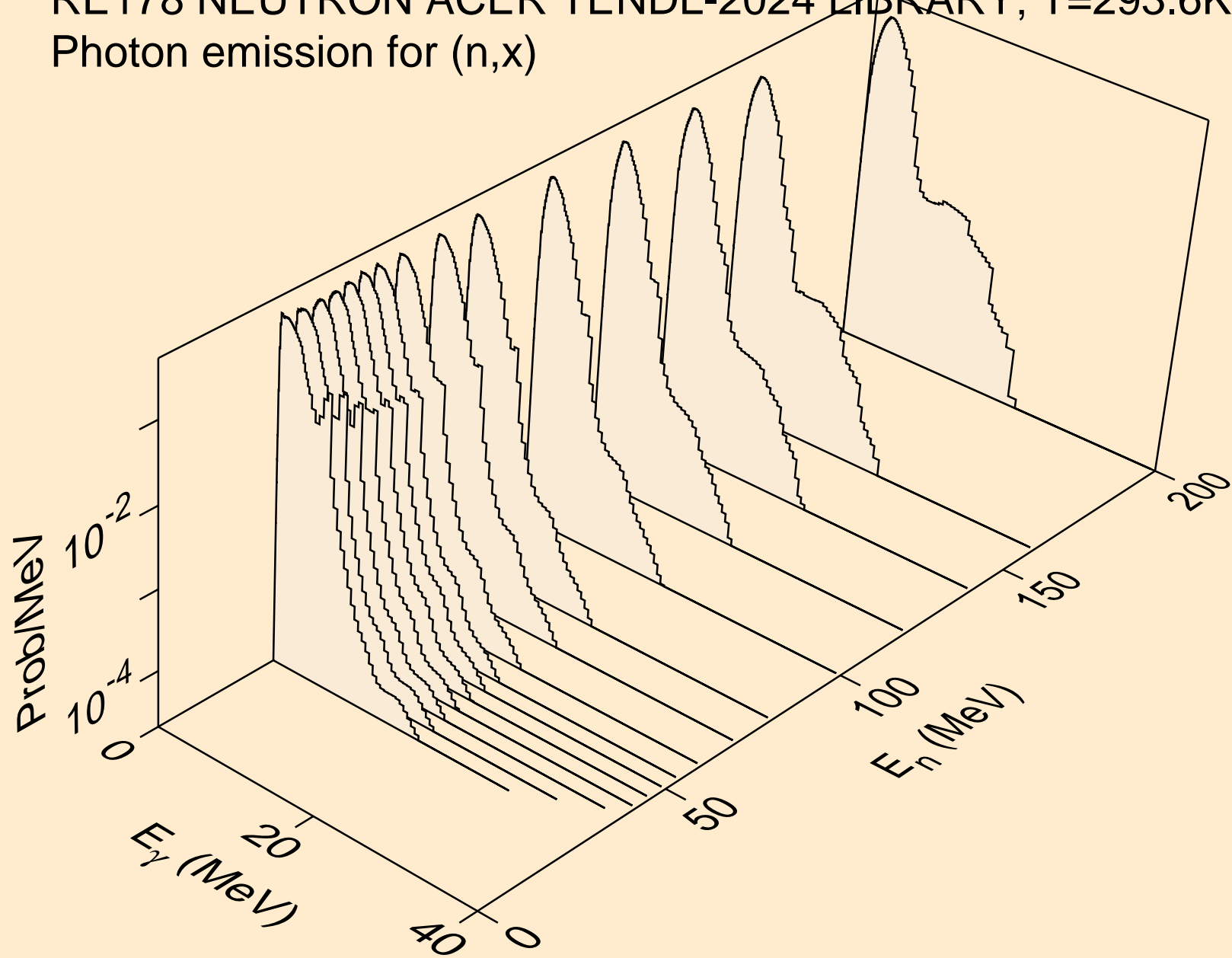

RE178 NEUTRON ACER TENDL-2024 LIBRARY; T=293.6K
Photon emission for (n,2nd)

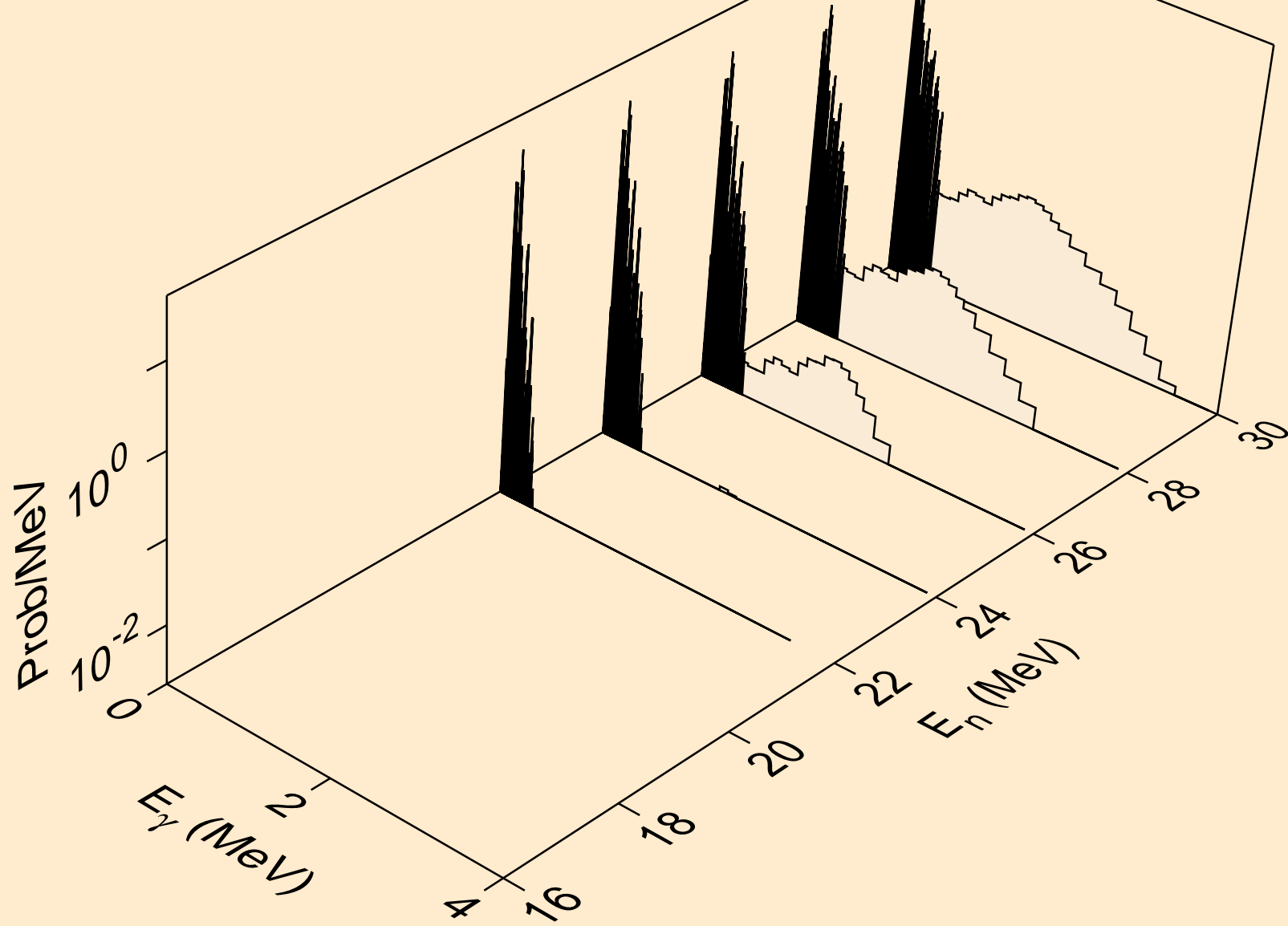

RE178 NEUTRON ACER TENDL-2024 LIBRARY; T=293.6K
Photon emission for (n,2n)

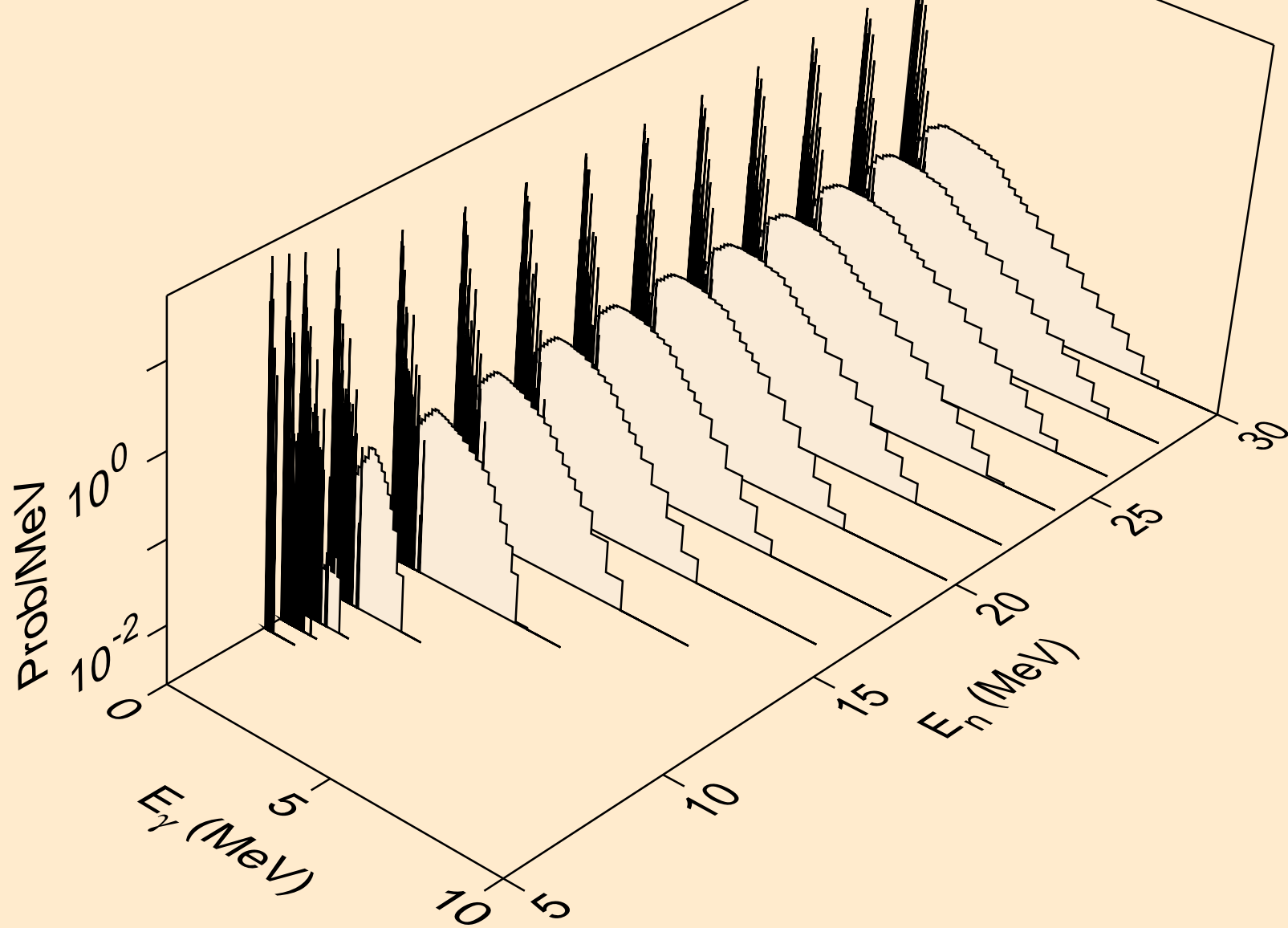

RE178 NEUTRON ACER TENDL-2024 LIBRARY; T=293.6K
Photon emission for (n,3n)

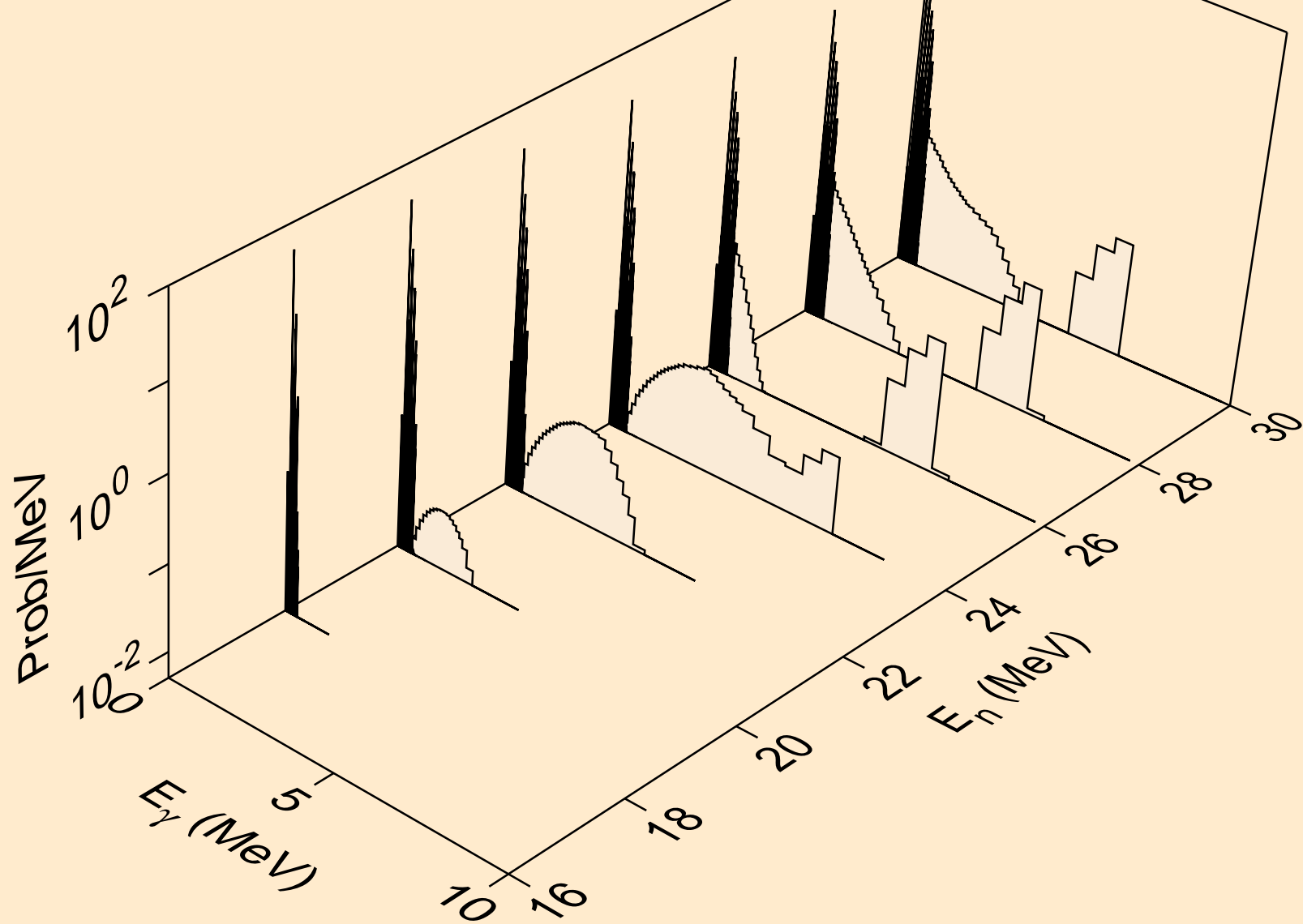

RE178 NEUTRON ACER TENDL-2024 LIBRARY; T=293.6K
Photon emission for (n,n*)a

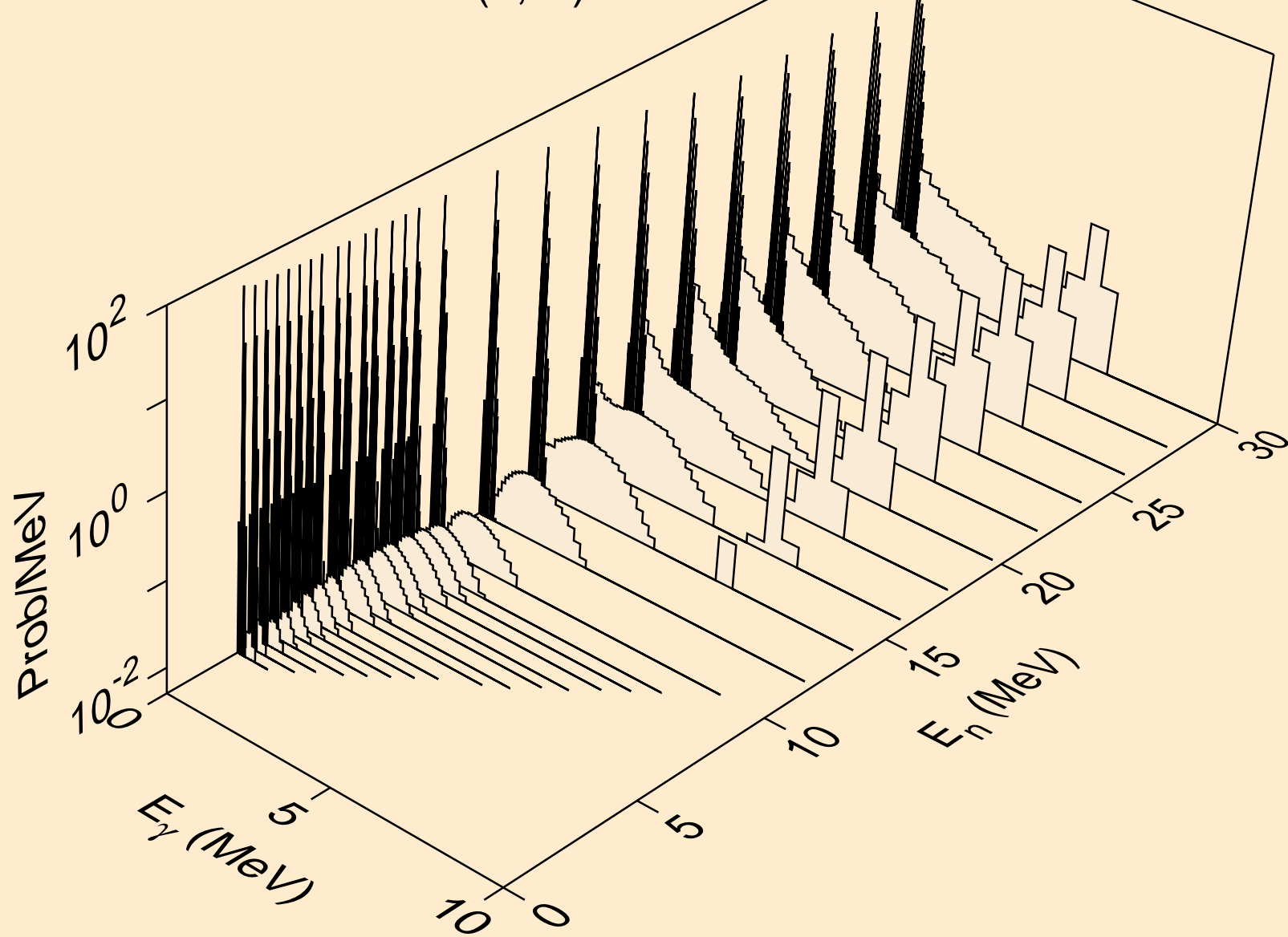

RE178 NEUTRON ACER TENDL-2024 LIBRARY; T=293.6K
Photon emission for (n,2n)a

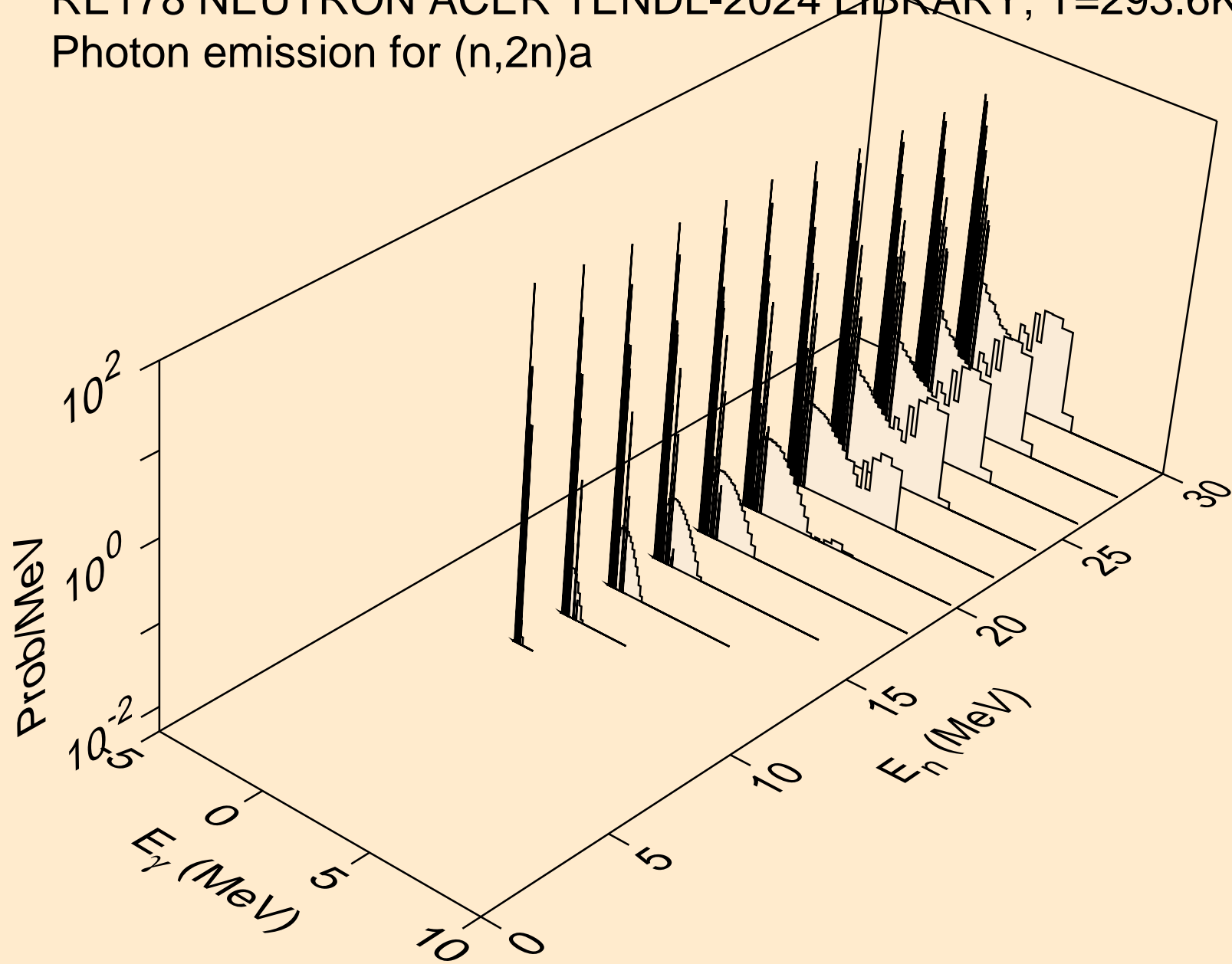

RE178 NEUTRON ACER TENDL-2024 LIBRARY; T=293.6K
Photon emission for (n,3n)a

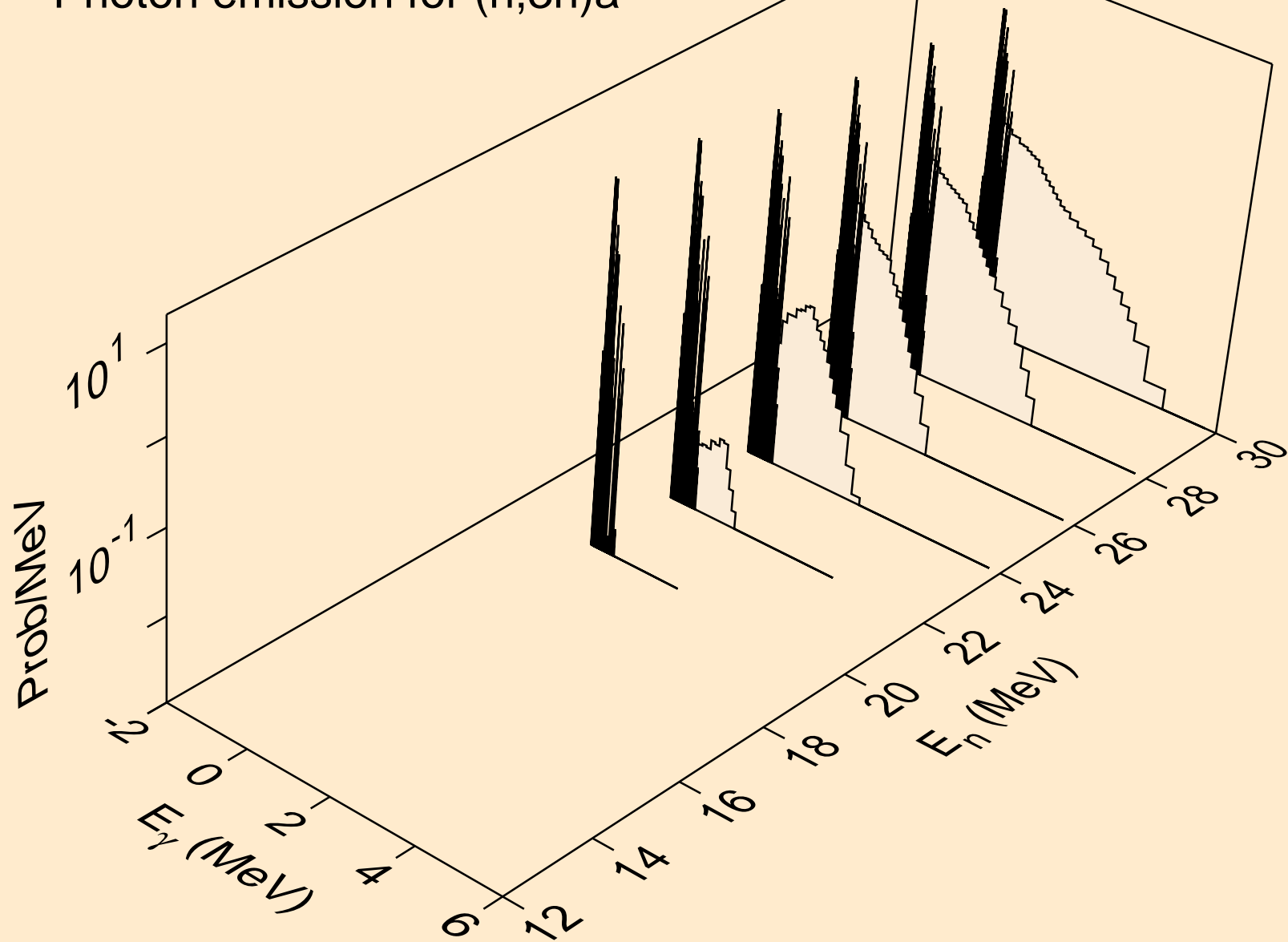

RE178 NEUTRON ACER TENDL-2024 LIBRARY; T=293.6K
Photon emission for (n,n*)p

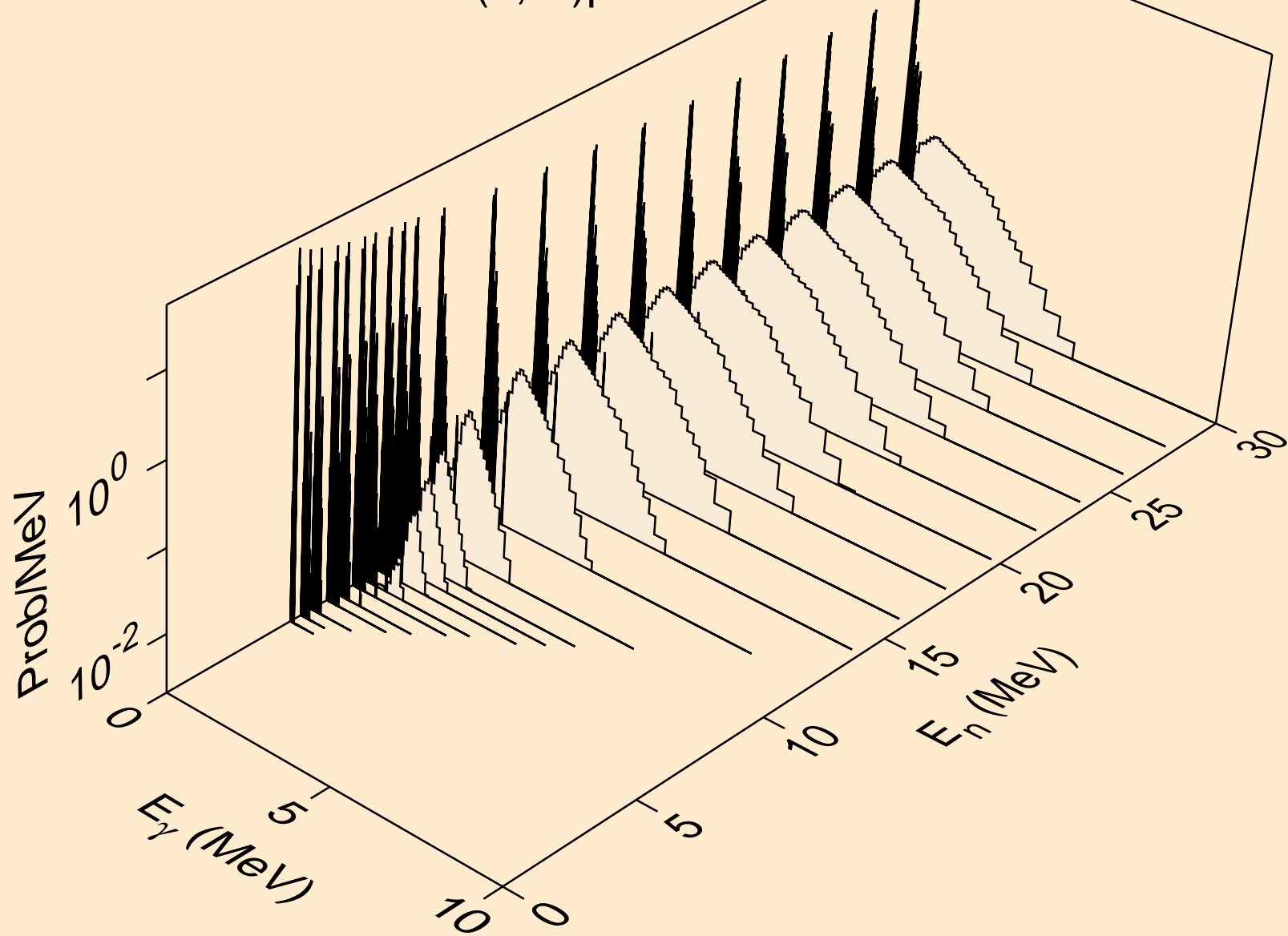

RE178 NEUTRON ACER TENDL-2024 LIBRARY; T=293.6K
Photon emission for (n,n*)2a

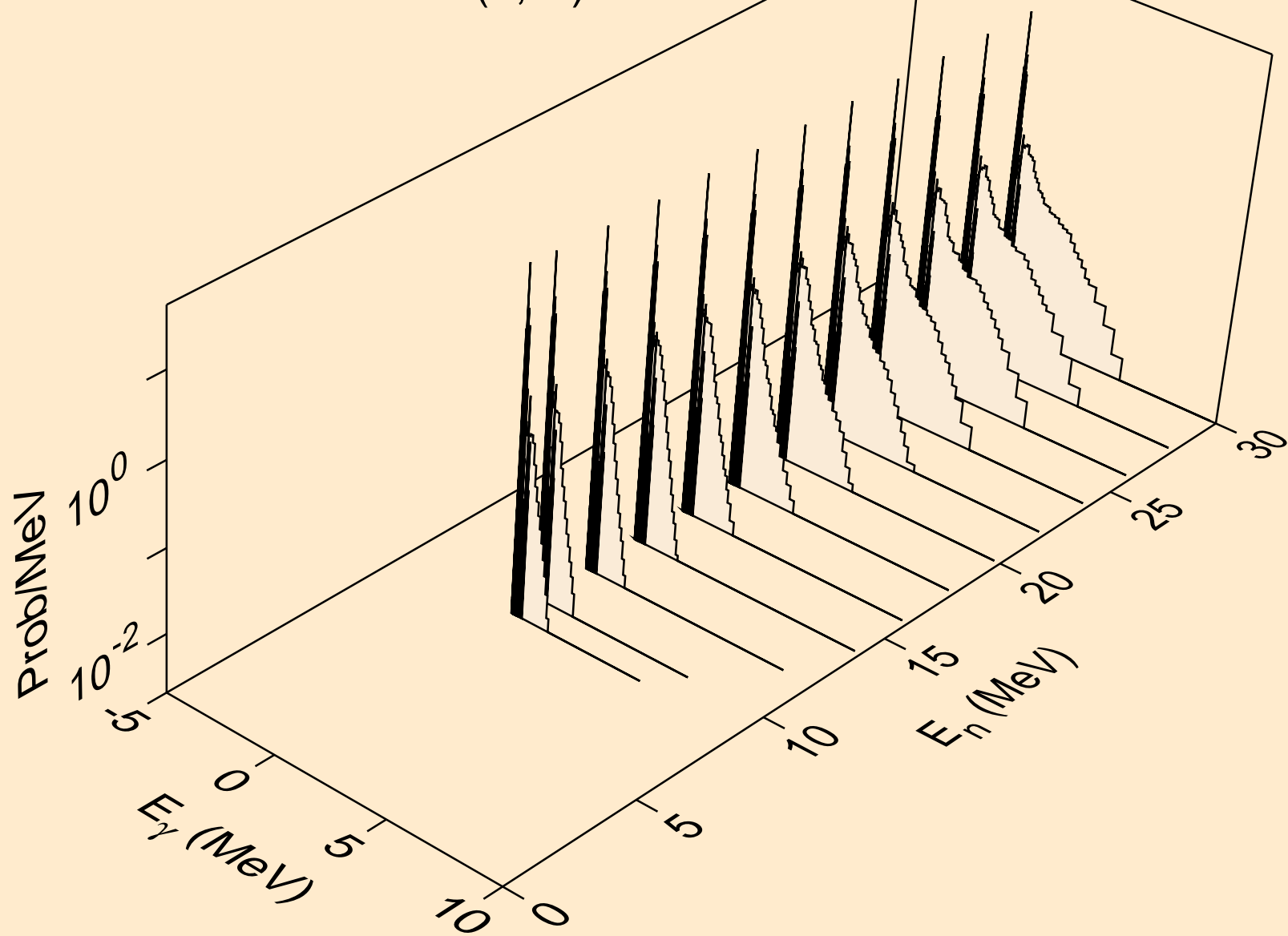

RE178 NEUTRON ACER TENDL-2024 LIBRARY; T=293.6K
Photon emission for (n,2n)2a

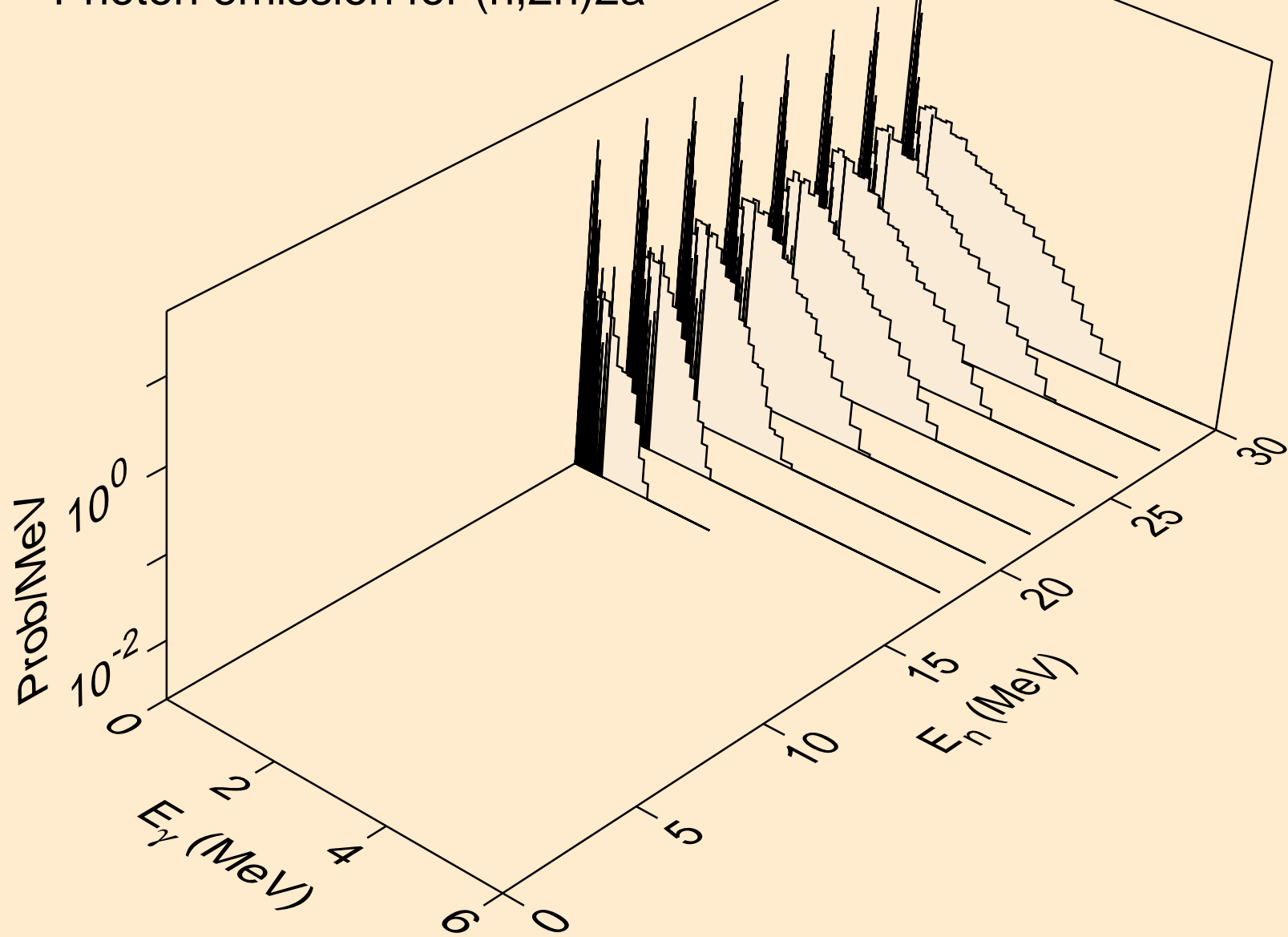

RE178 NEUTRON ACER TENDL-2024 LIBRARY; T=293.6K
Photon emission for (n,n*)d

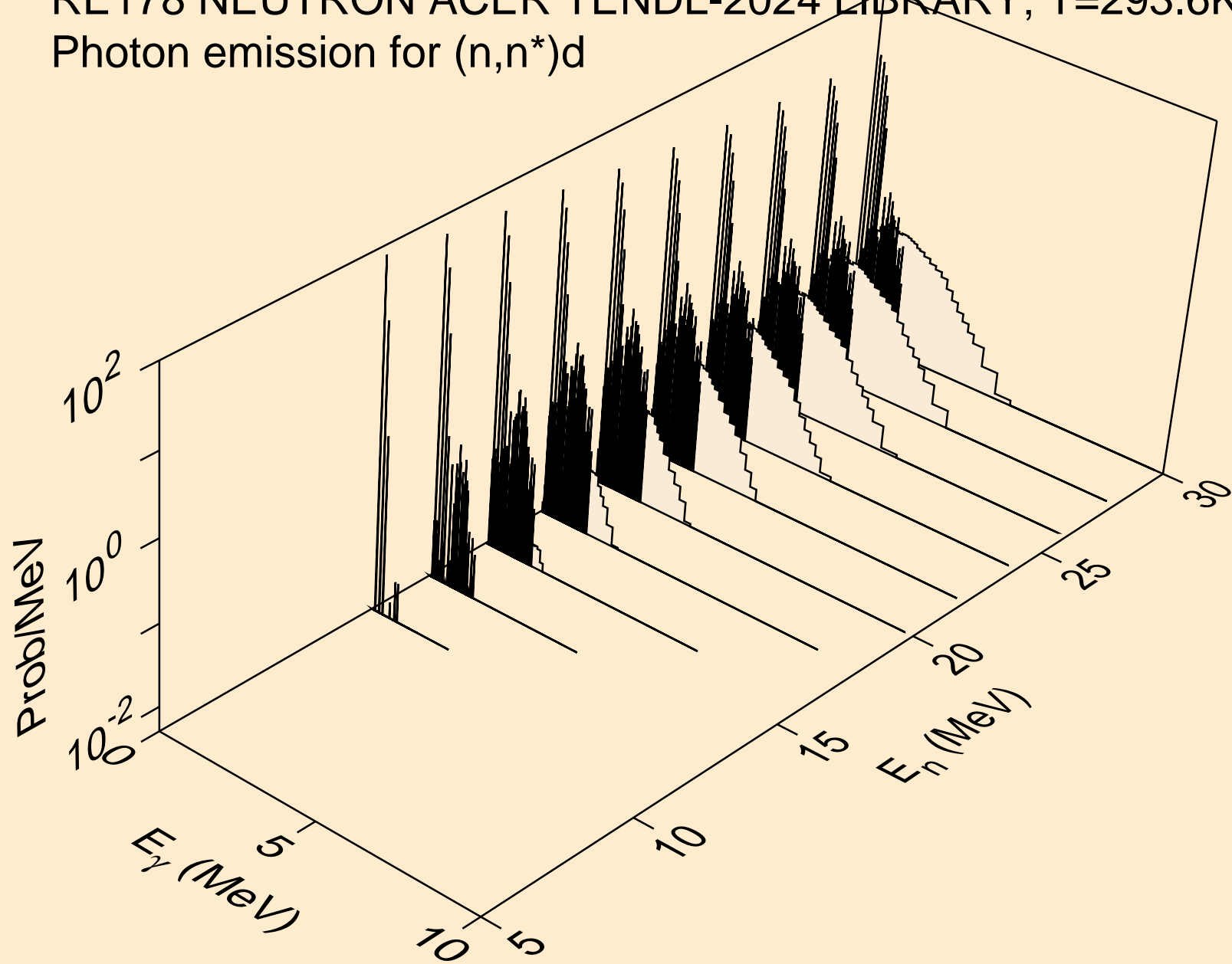

RE178 NEUTRON ACER TENDL-2024 LIBRARY; T=293.6K
Photon emission for (n,n*)t

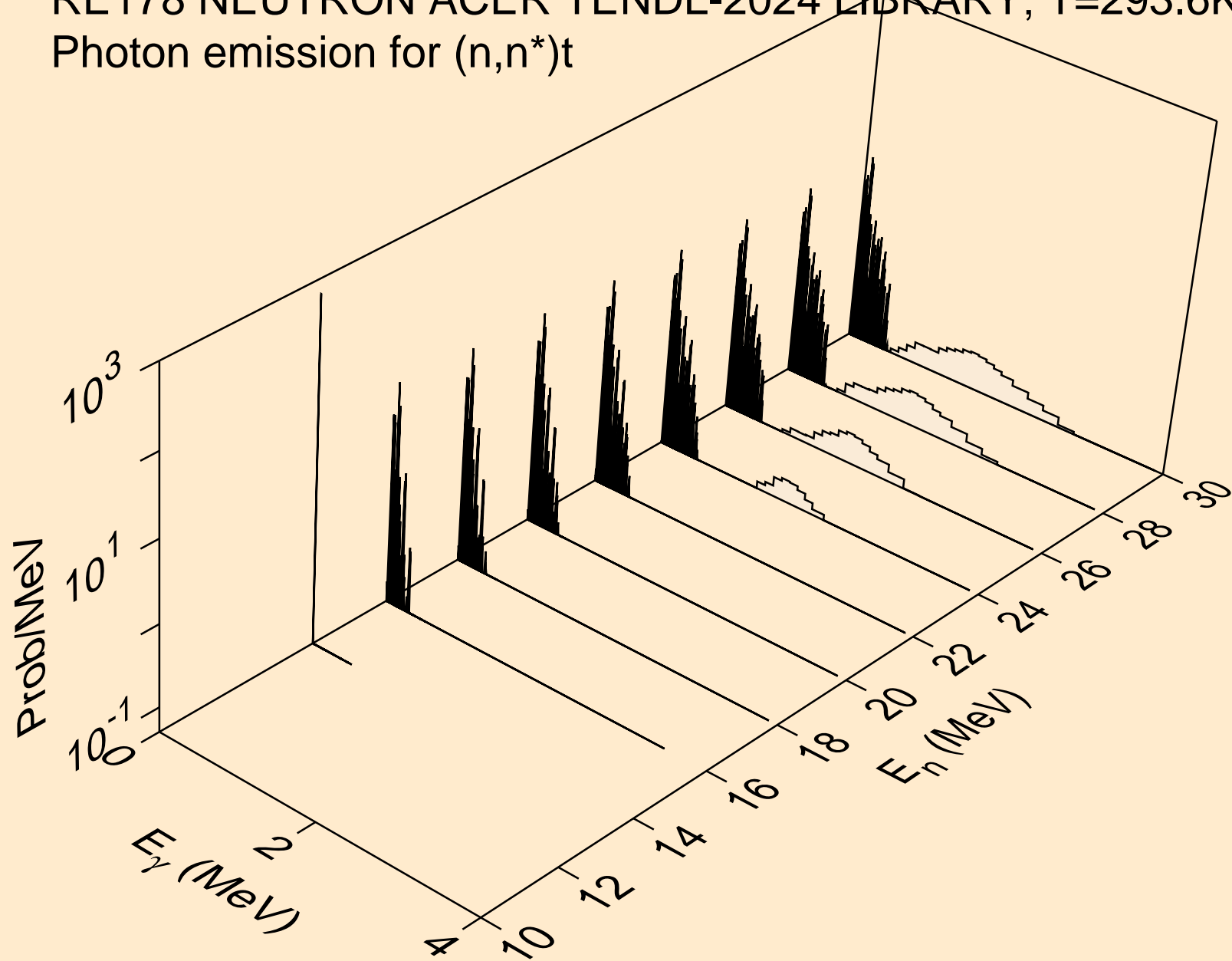

RE178 NEUTRON ACER TENDL-2024 LIBRARY; T=293.6K
Photon emission for (n,n*)he3

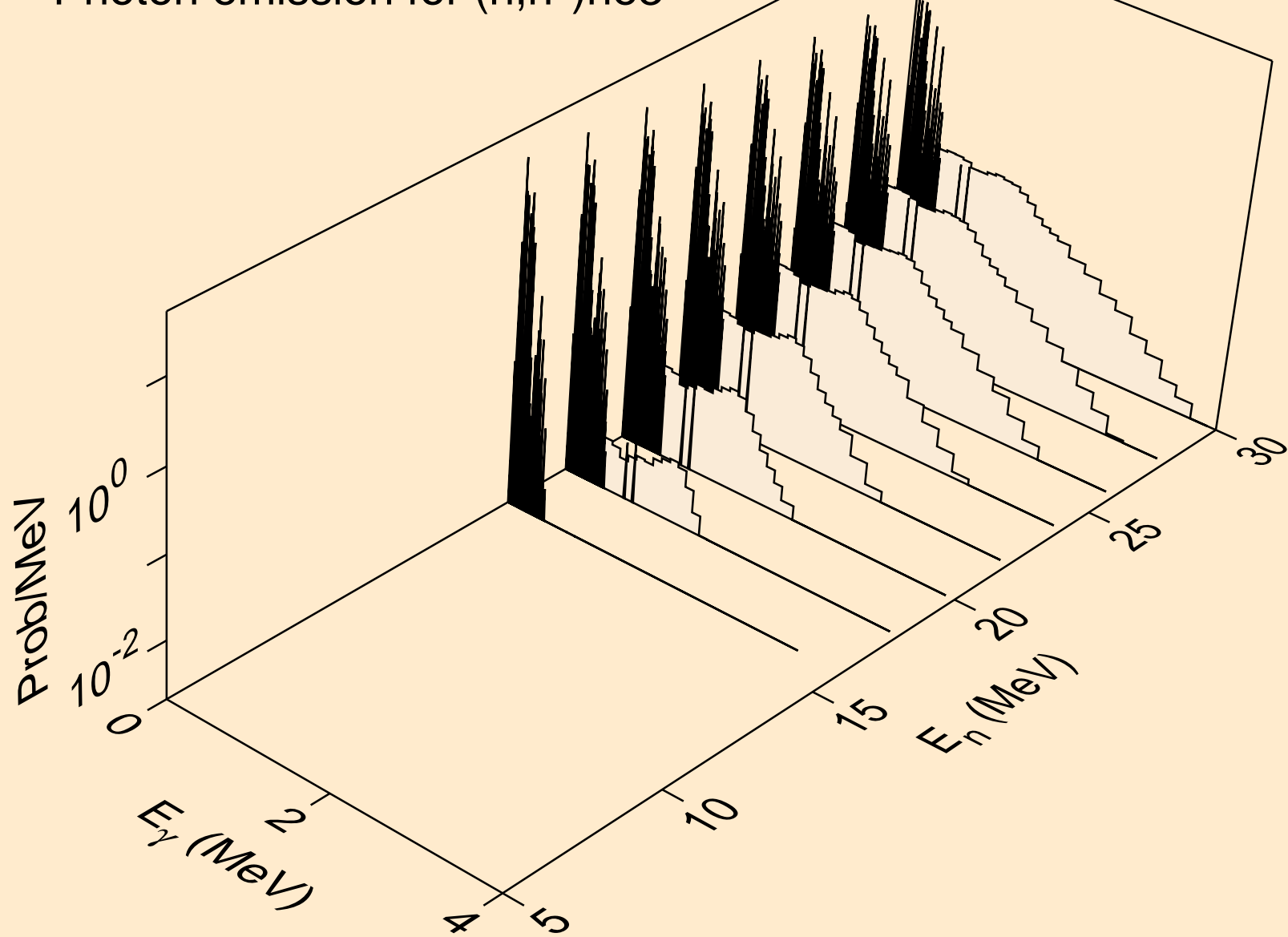

RE178 NEUTRON ACER TENDL-2024 LIBRARY; T=293.6K
Photon emission for (n,4n)

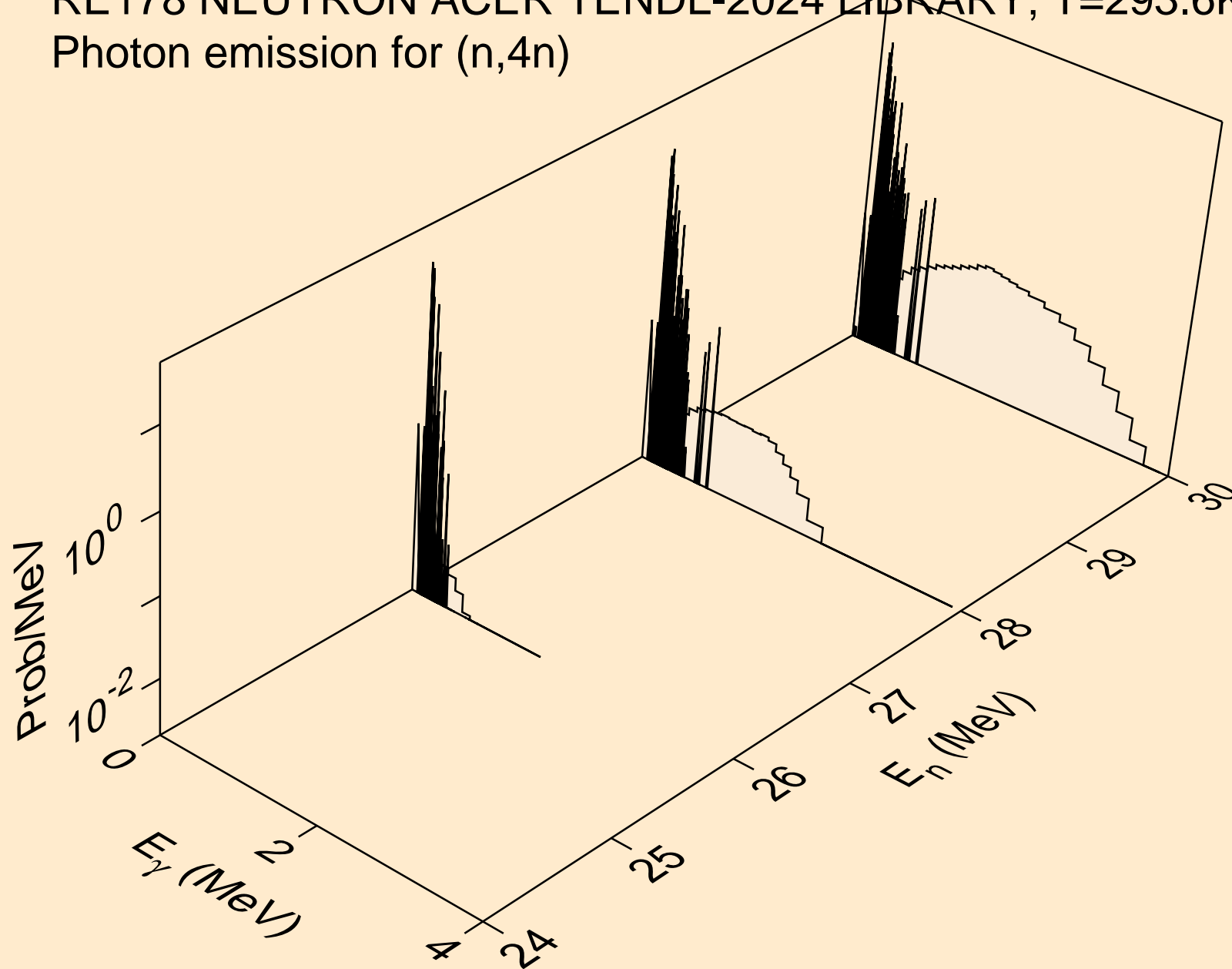

RE178 NEUTRON ACER TENDL-2024 LIBRARY; T=293.6K
Photon emission for (n,2np)

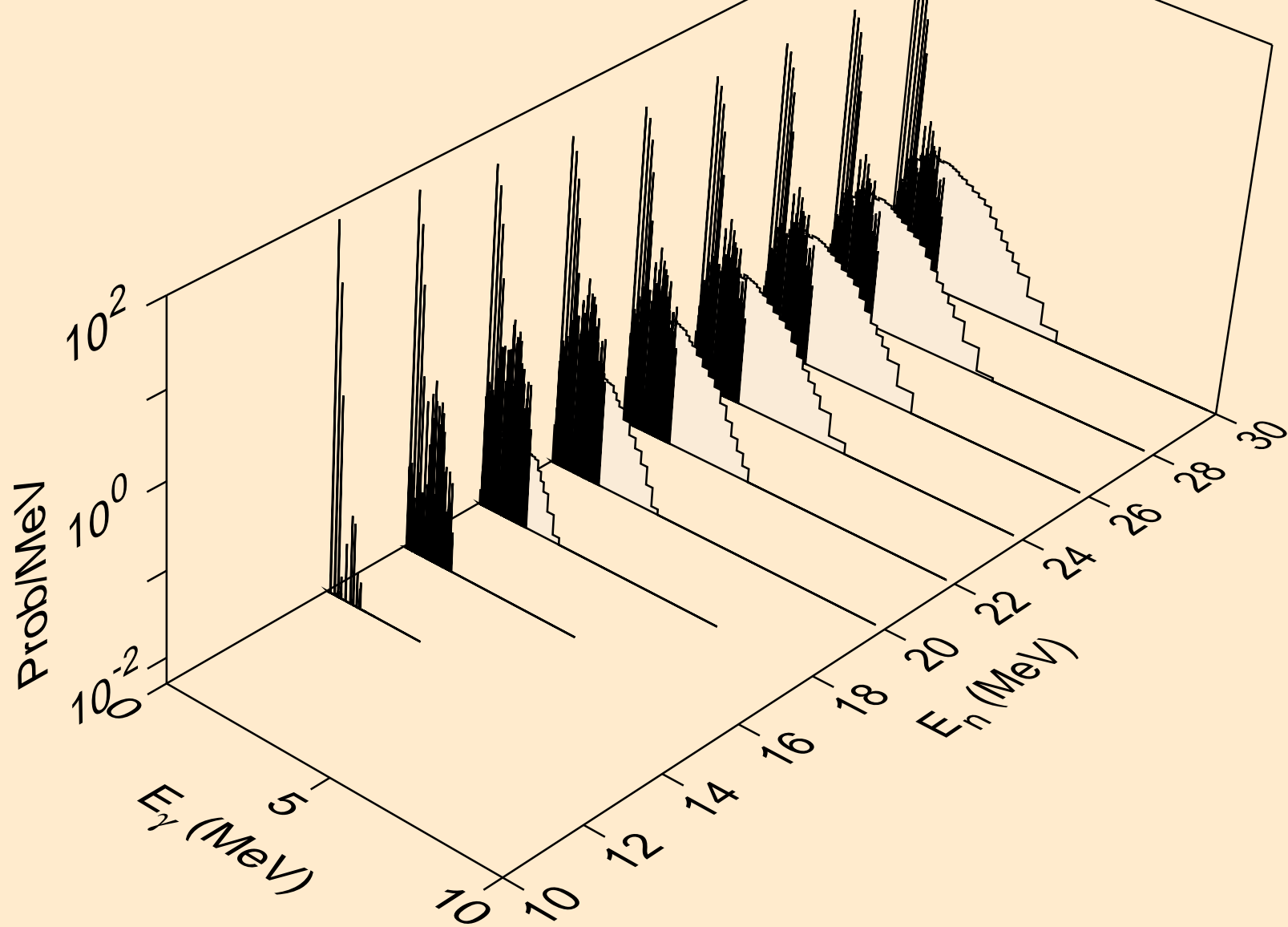

RE178 NEUTRON ACER TENDL-2024 LIBRARY; T=293.6K
Photon emission for (n,3np)

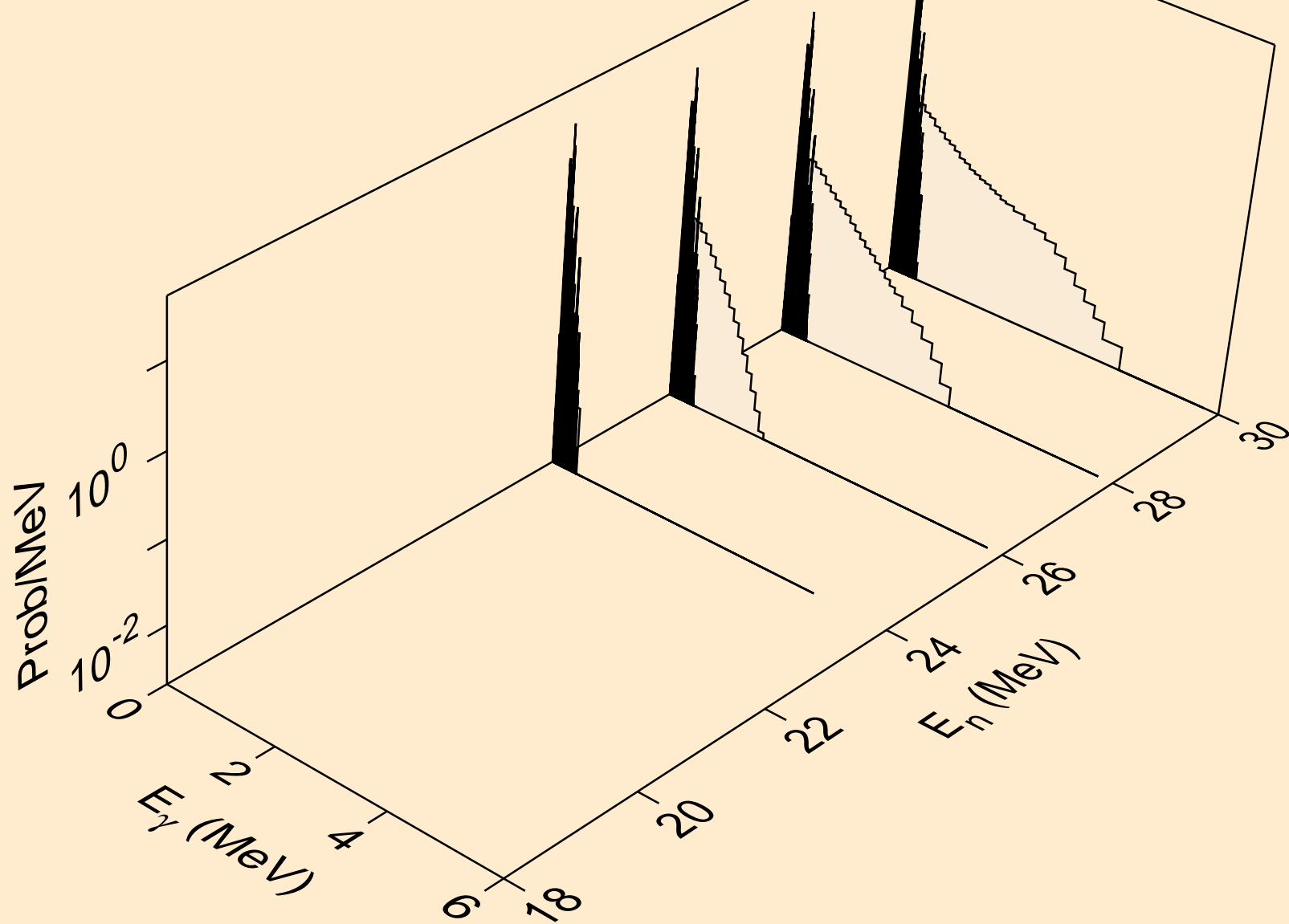

RE178 NEUTRON ACER TENDL-2024 LIBRARY; T=293.6K
Photon emission for (n,n2p)

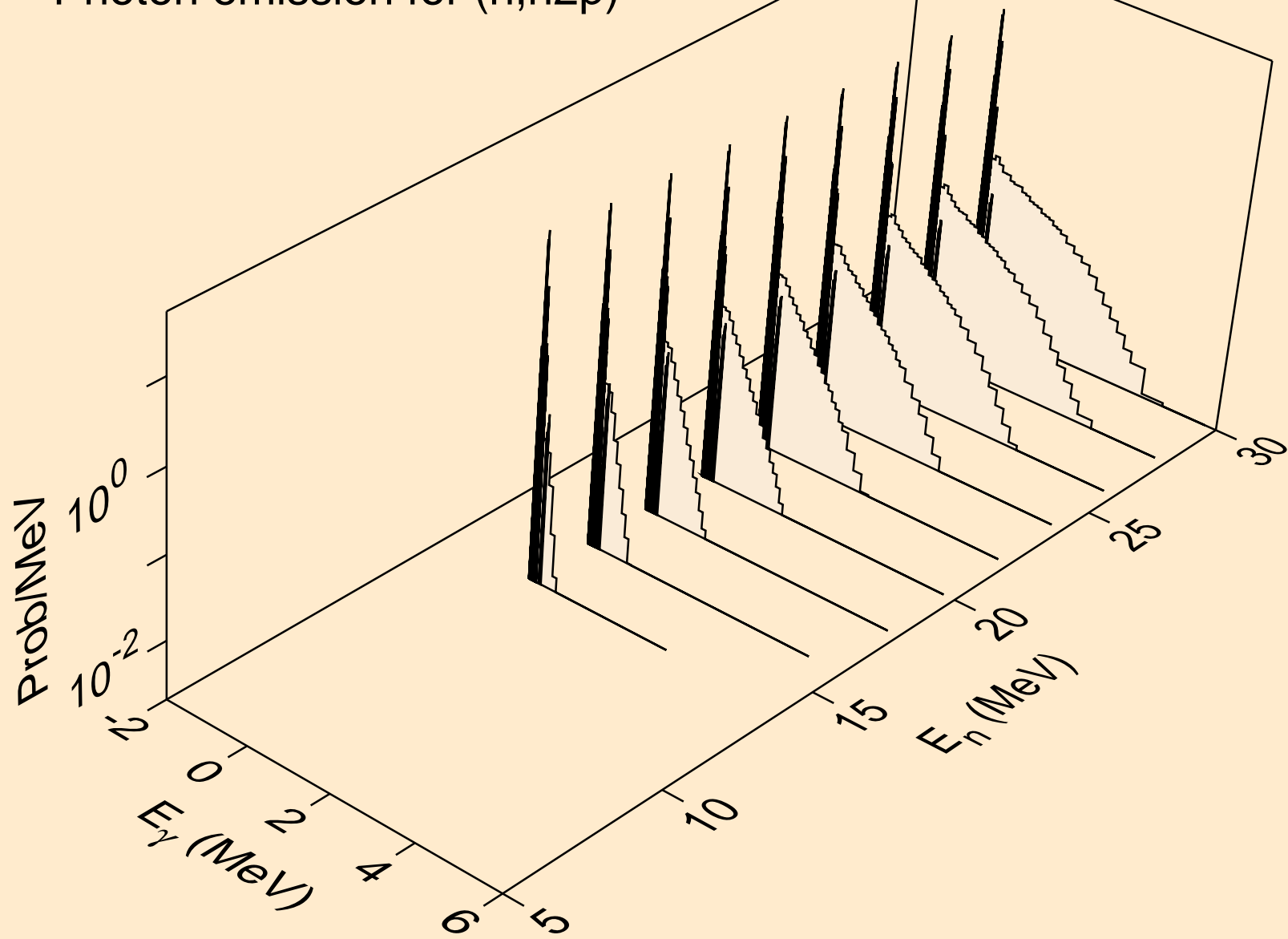

RE178 NEUTRON ACER TENDL-2024 LIBRARY; T=293.6K
Photon emission for (n,npa)

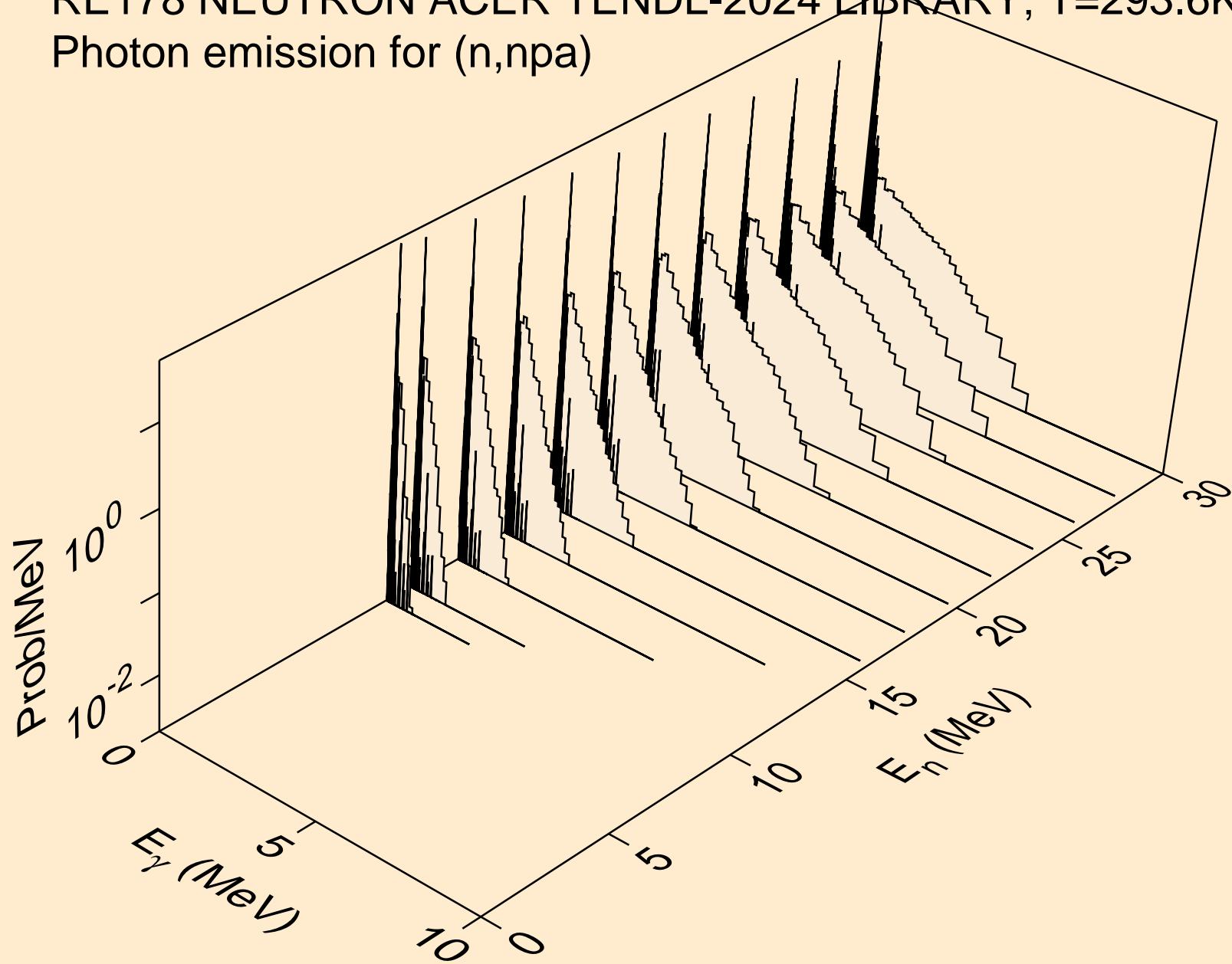

RE178 NEUTRON ACER TENDL-2024 LIBRARY; T=293.6K
Photon emission for (n,n*c)

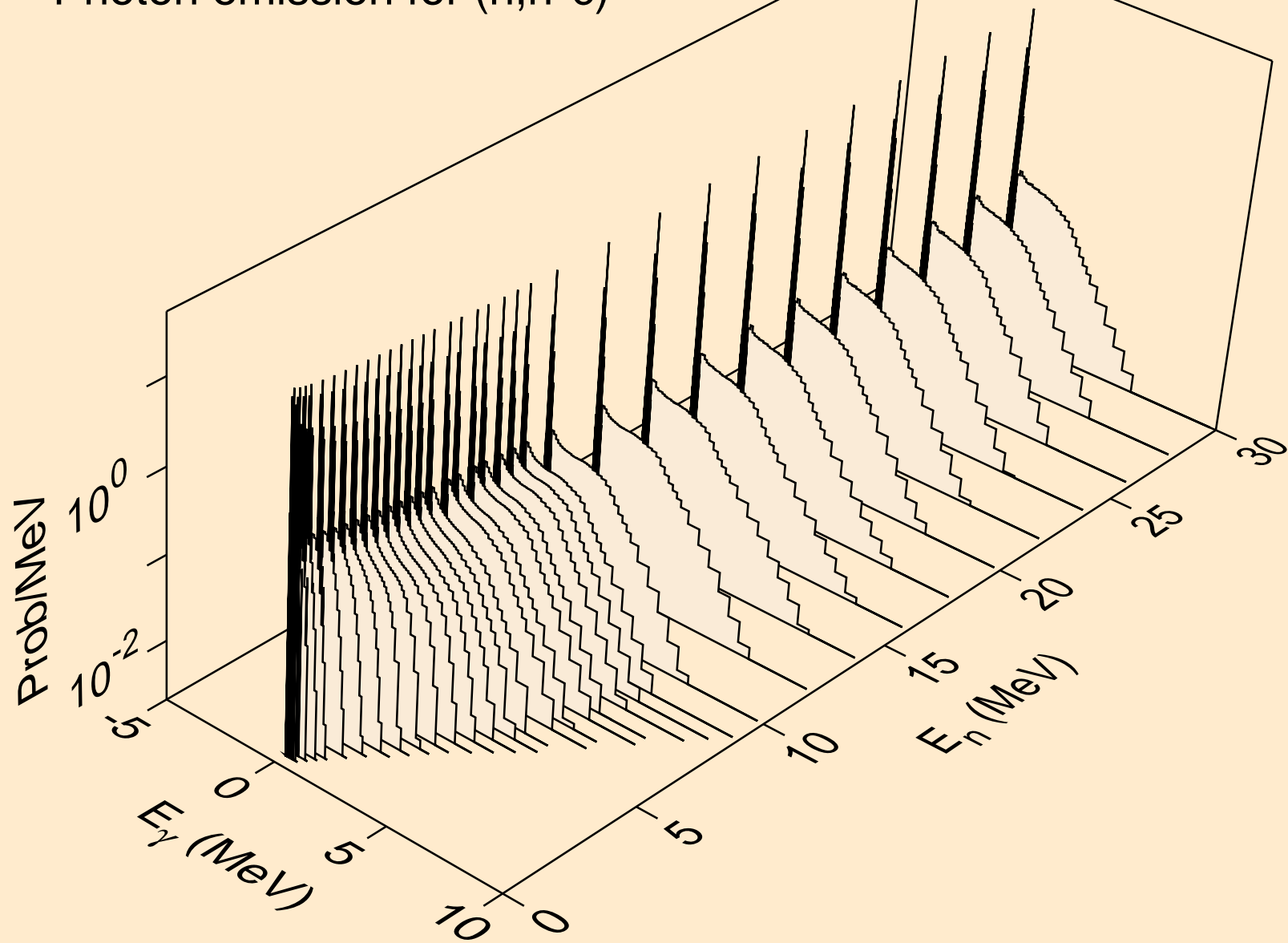

RE178 NEUTRON ACER TENDL-2024 LIBRARY; T=293.6K
Photon emission for (n,gma)

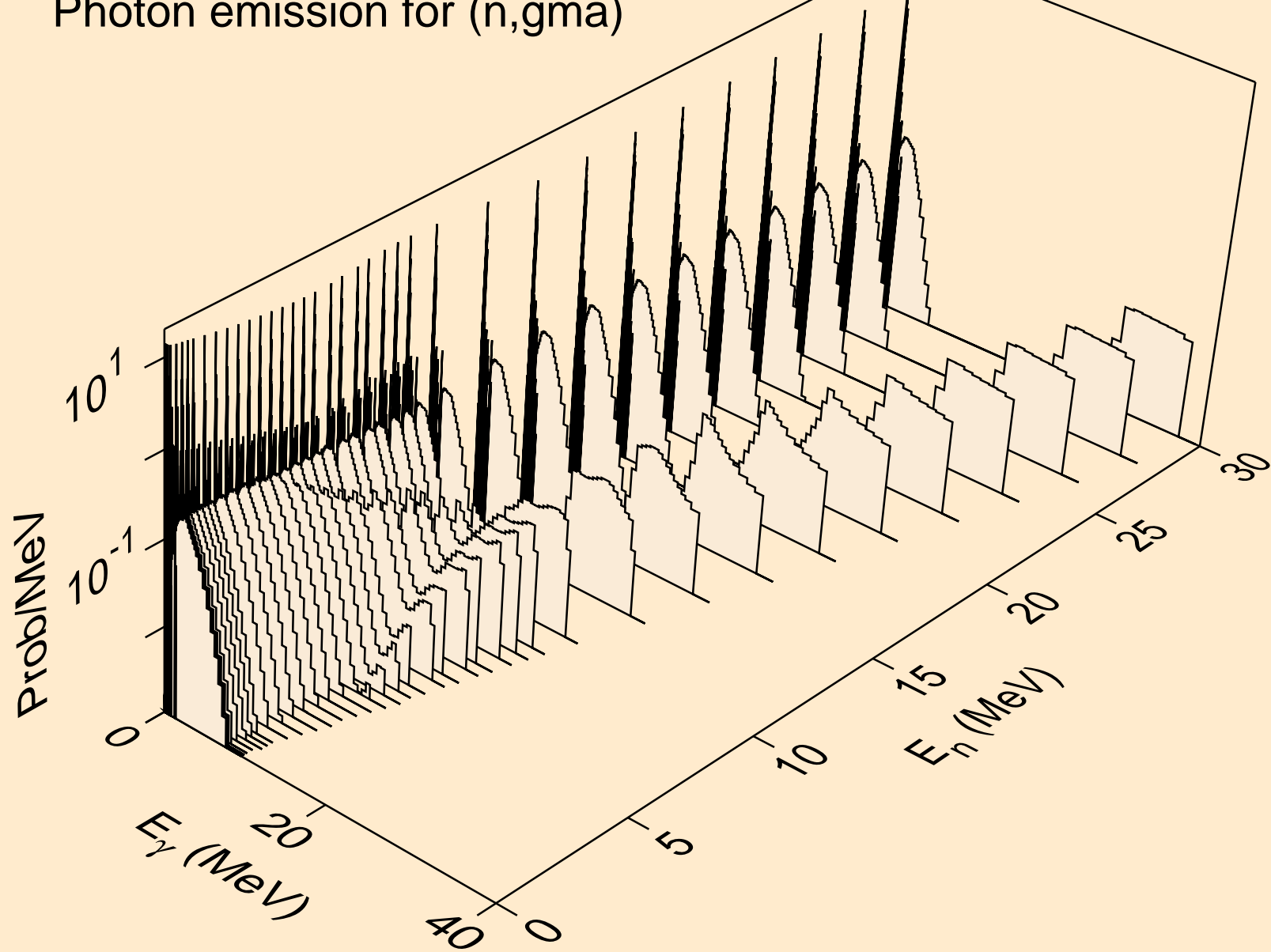

RE178 NEUTRON ACER TENDL-2024 LIBRARY; T=293.6K
Photon emission for (n,p)

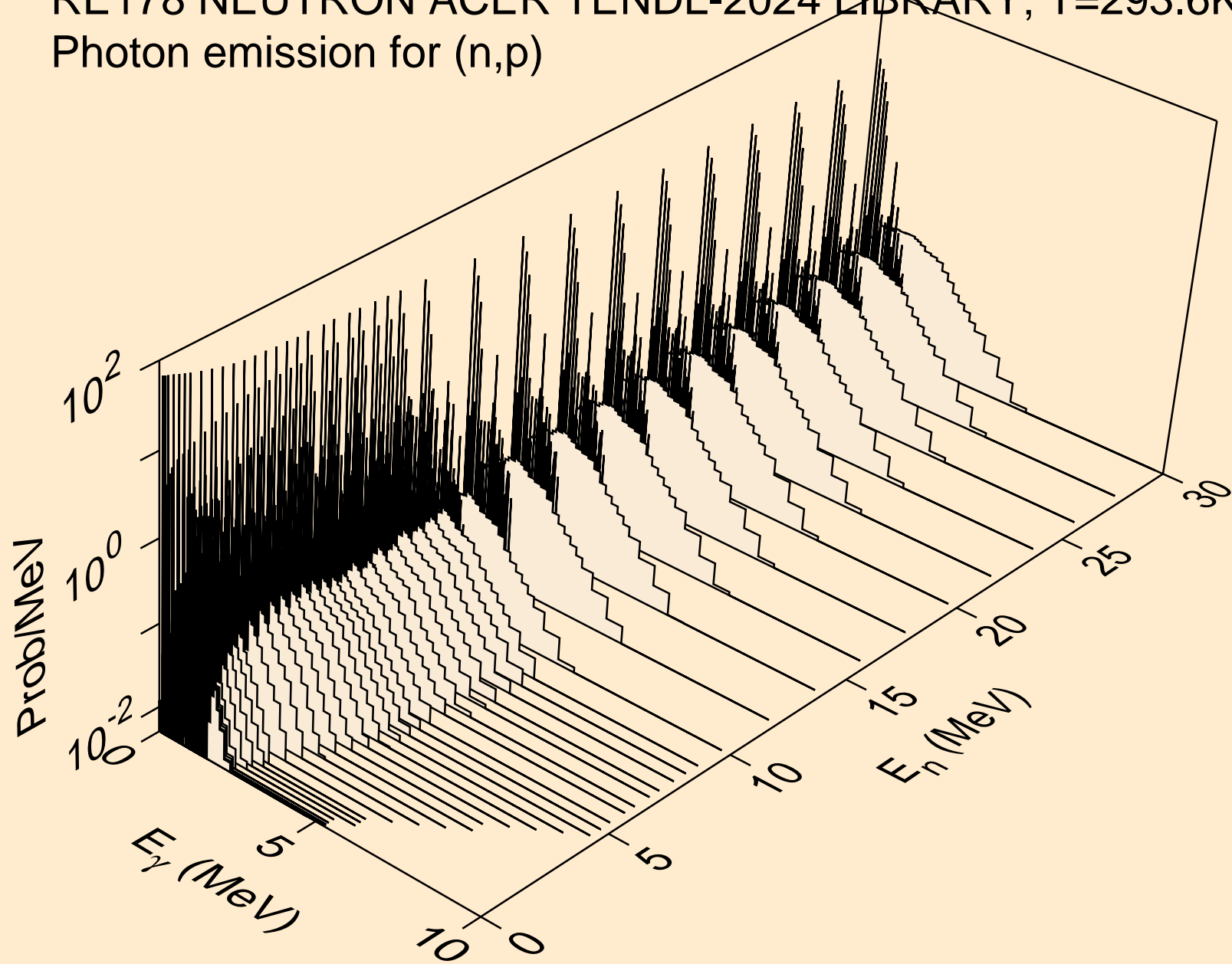

RE178 NEUTRON ACER TENDL-2024 LIBRARY; T=293.6K
Photon emission for (n,d)

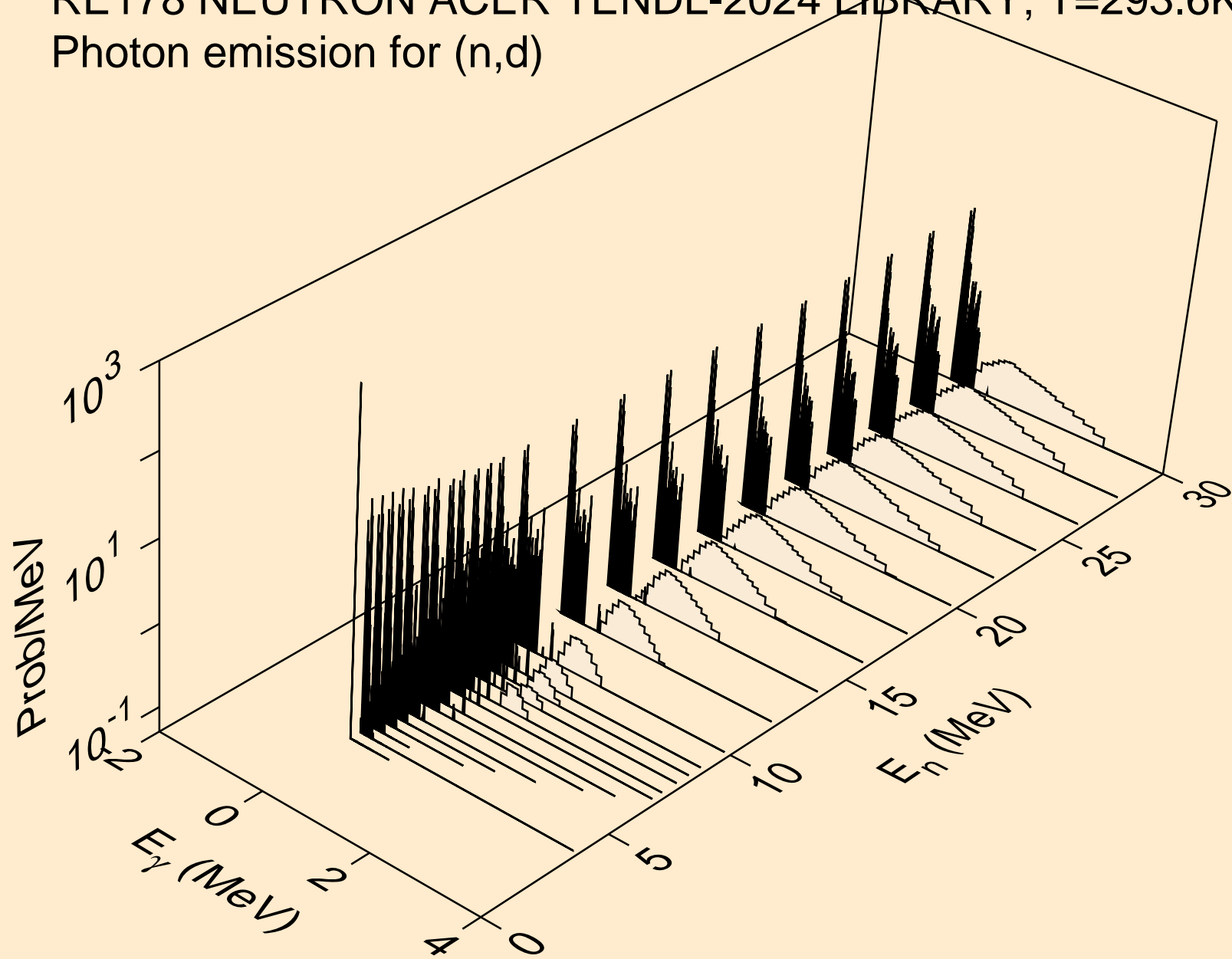

RE178 NEUTRON ACER TENDL-2024 LIBRARY; T=293.6K
Photon emission for (n,t)

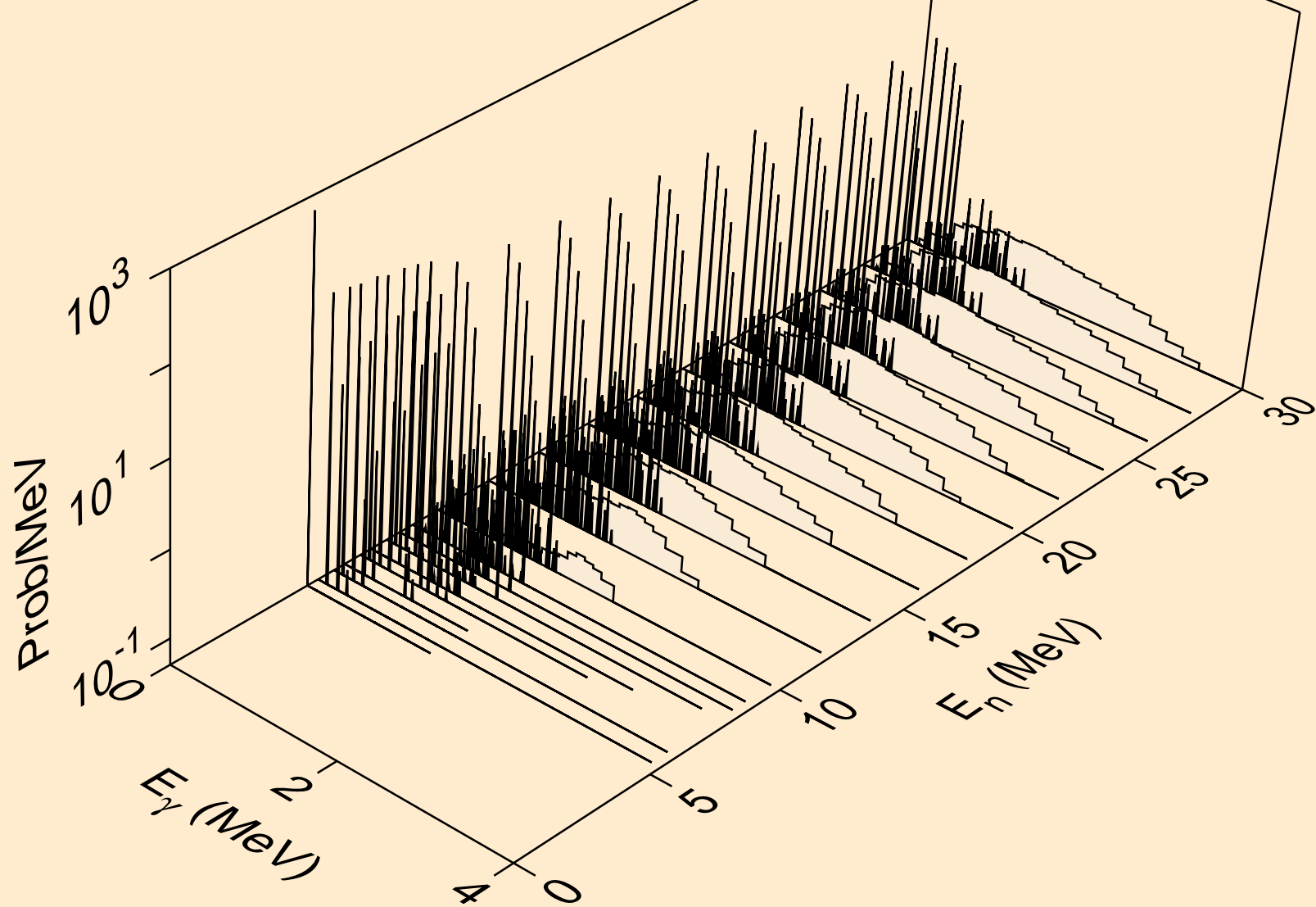

RE178 NEUTRON ACER TENDL-2024 LIBRARY; T=293.6K
Photon emission for (n,he3)

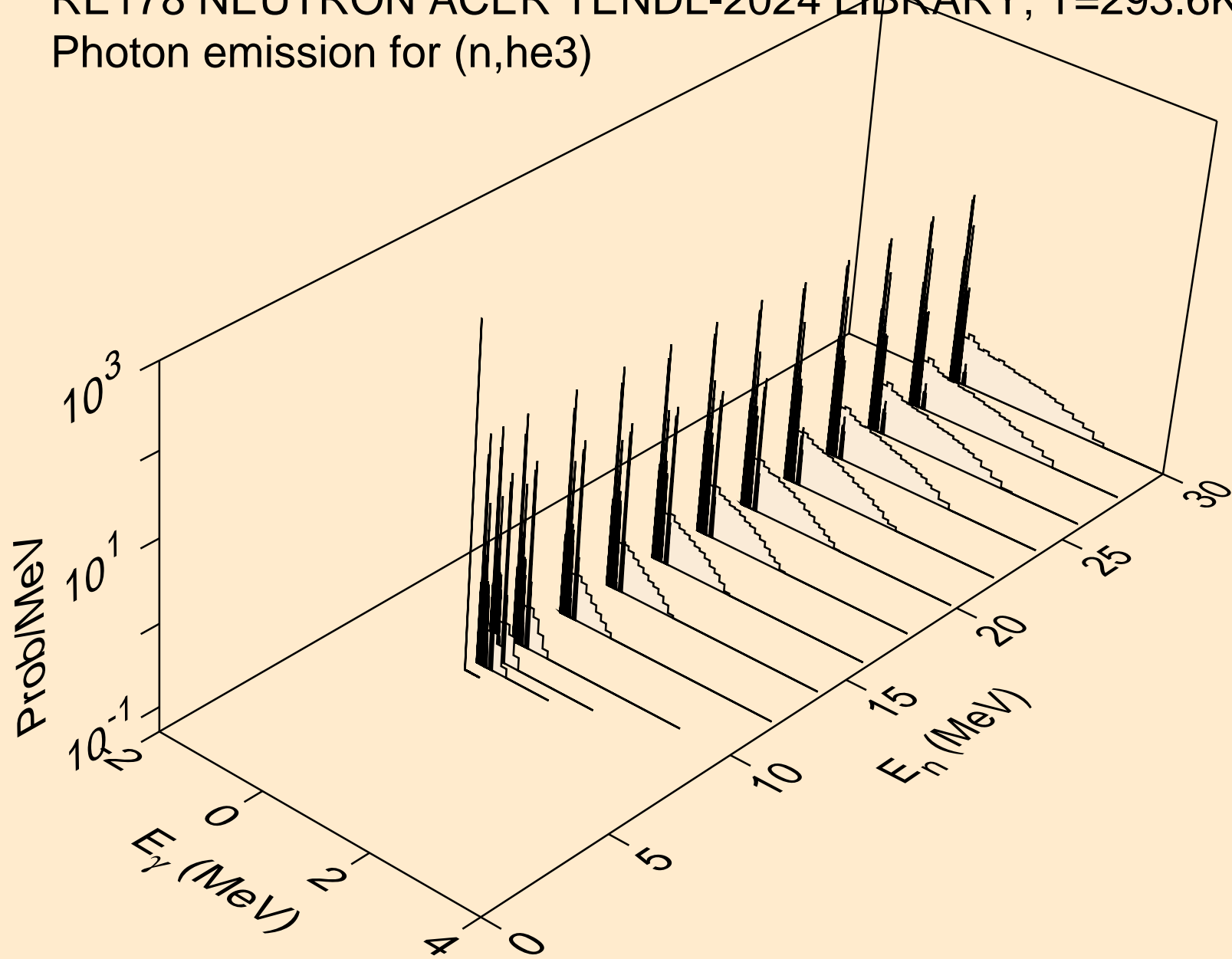

RE178 NEUTRON ACER TENDL-2024 LIBRARY; T=293.6K
Photon emission for (n,a)

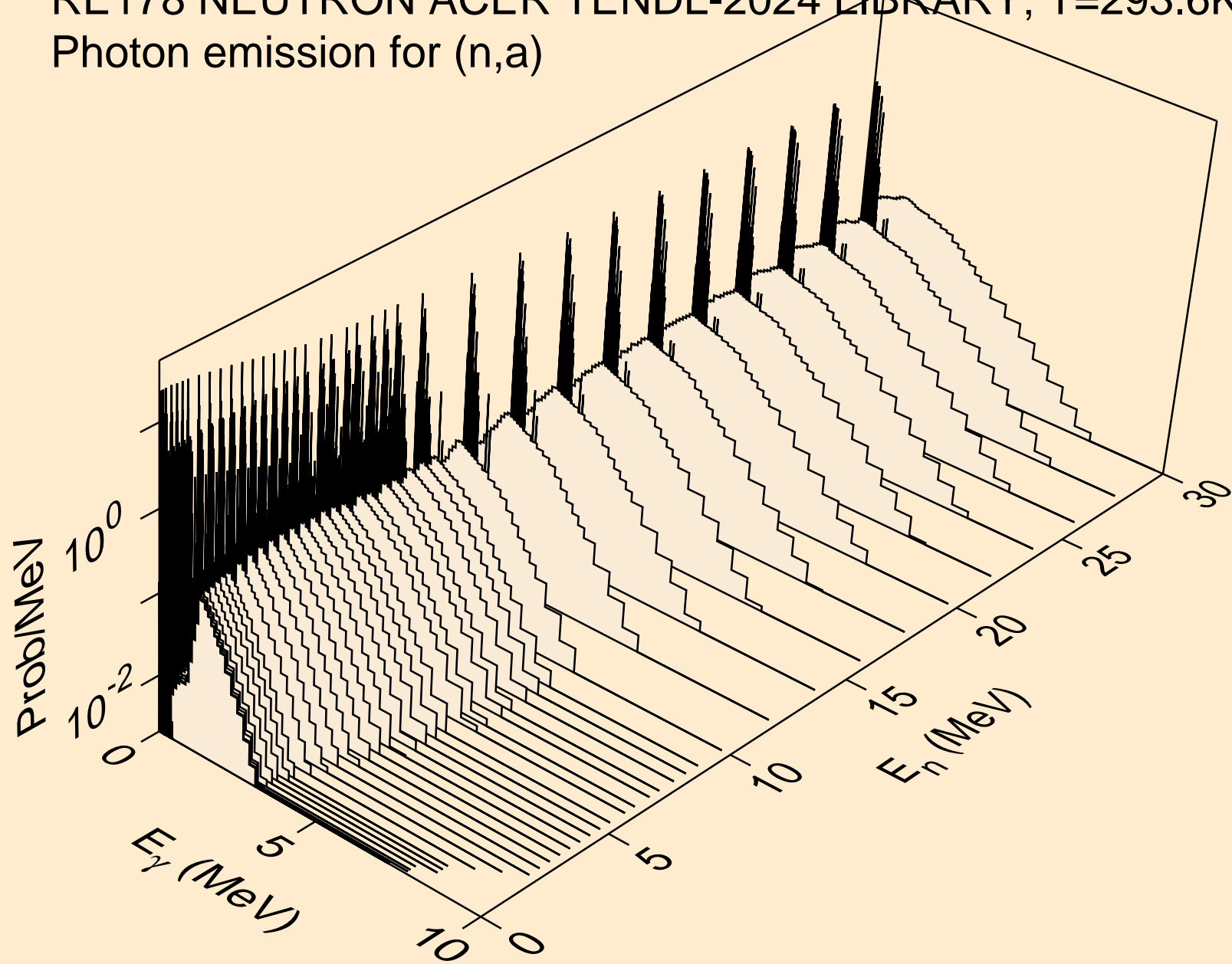

RE178 NEUTRON ACER TENDL-2024 LIBRARY; T=293.6K
Photon emission for (n,2a)

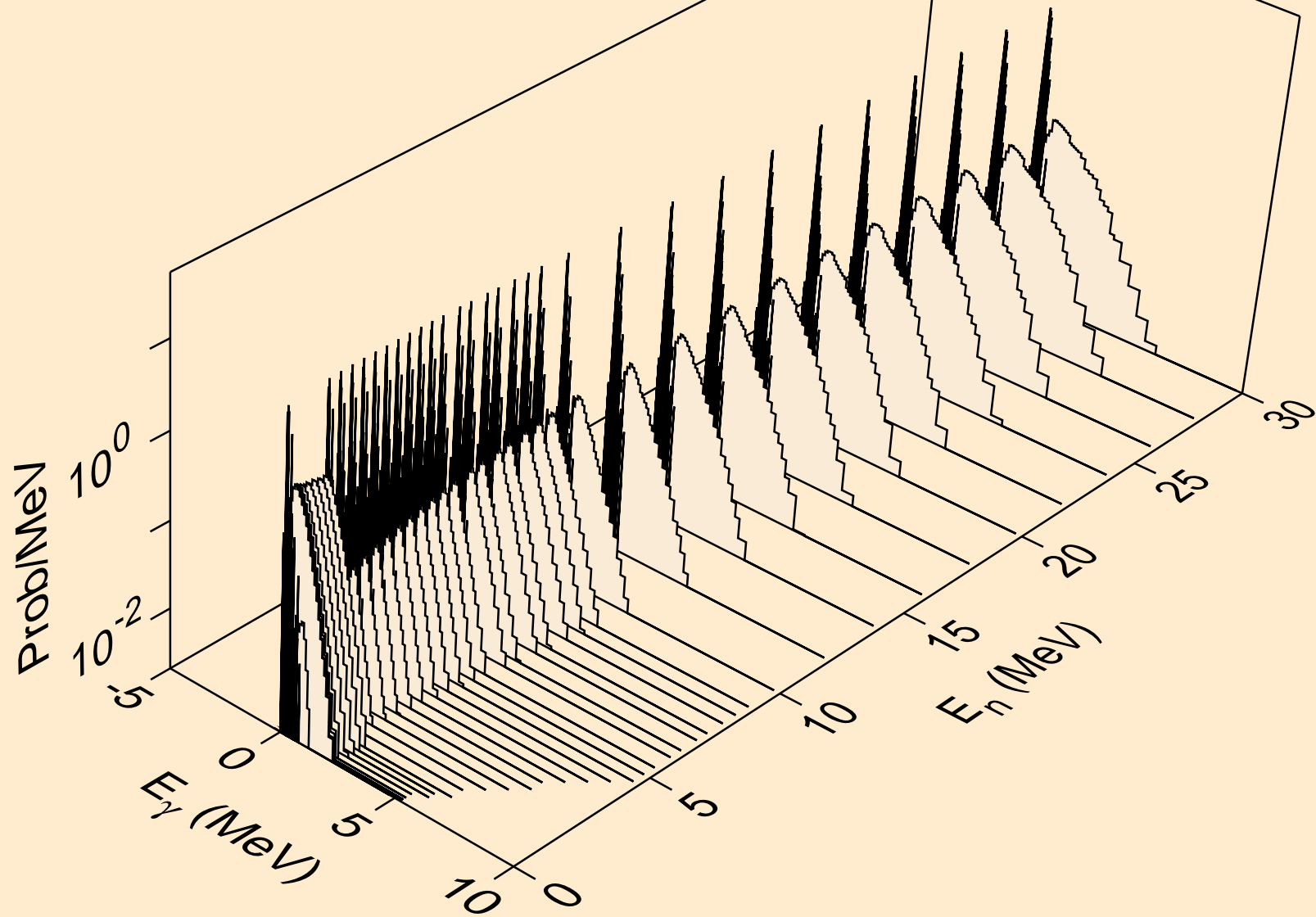

RE178 NEUTRON ACER TENDL-2024 LIBRARY; T=293.6K
Photon emission for (n,2p)

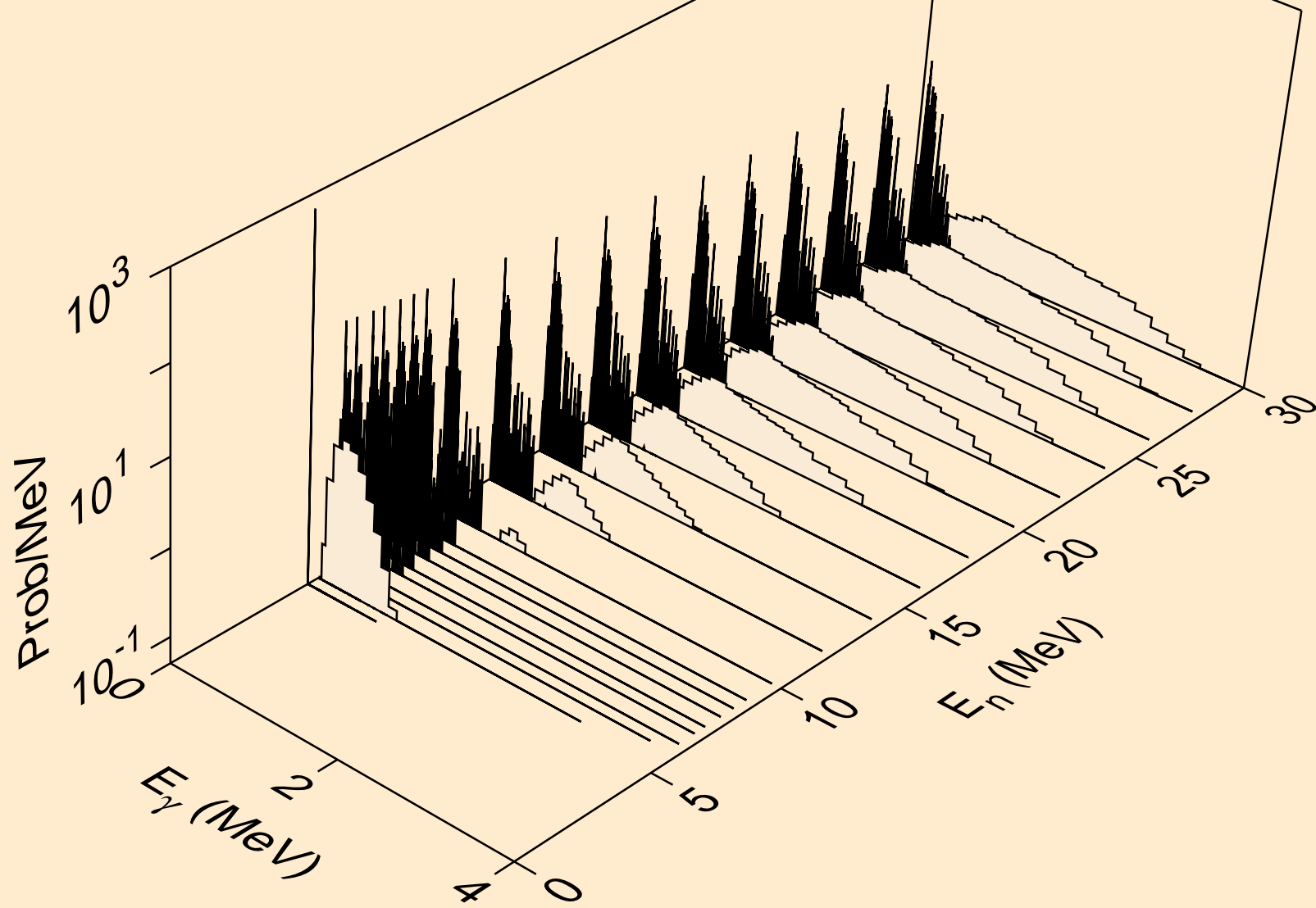

RE178 NEUTRON ACER TENDL-2024 LIBRARY; T=293.6K
Photon emission for (n,p α)

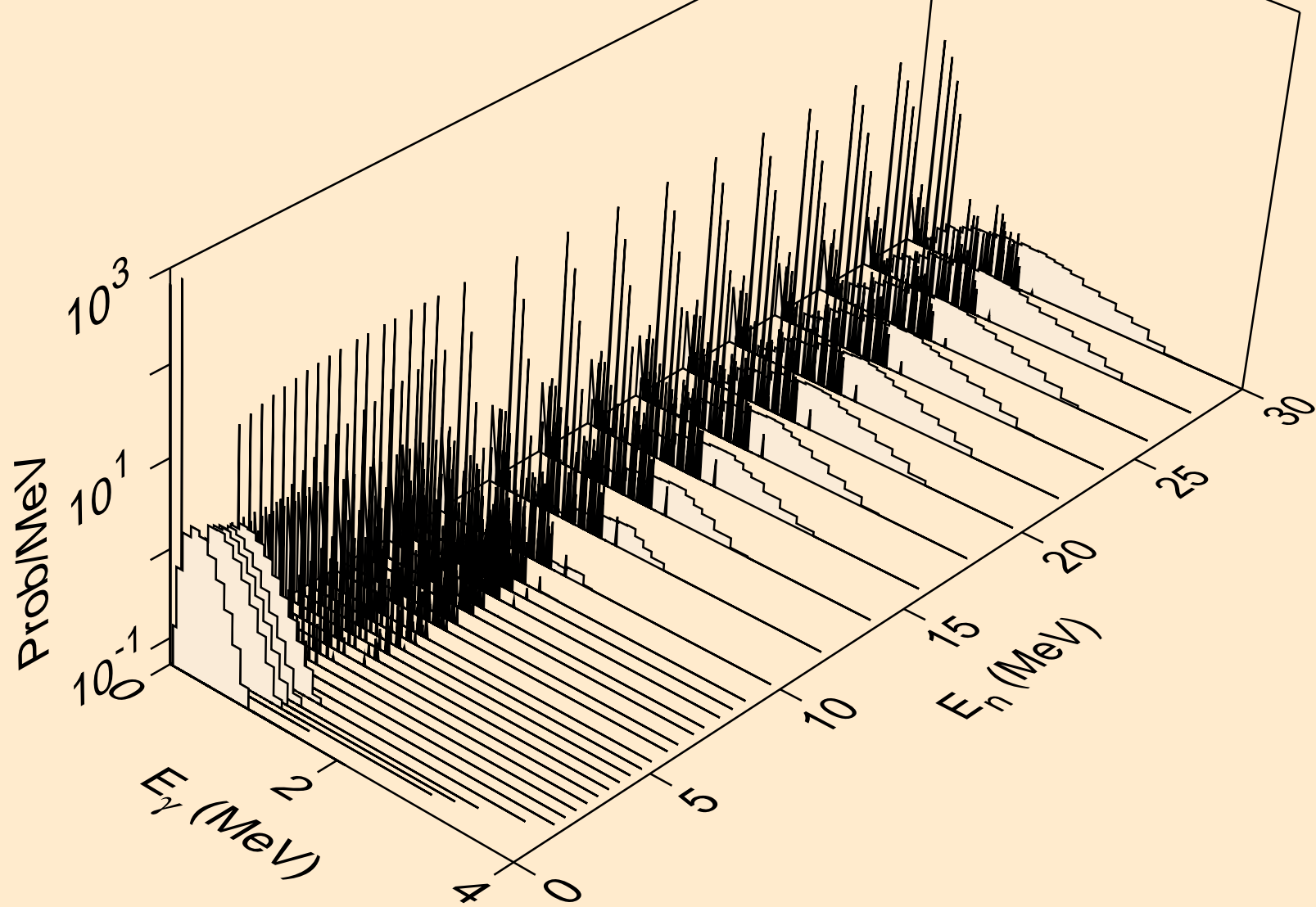

RE178 NEUTRON ACER TENDL-2024 LIBRARY; T=293.6K
Photon emission for (n,pd)

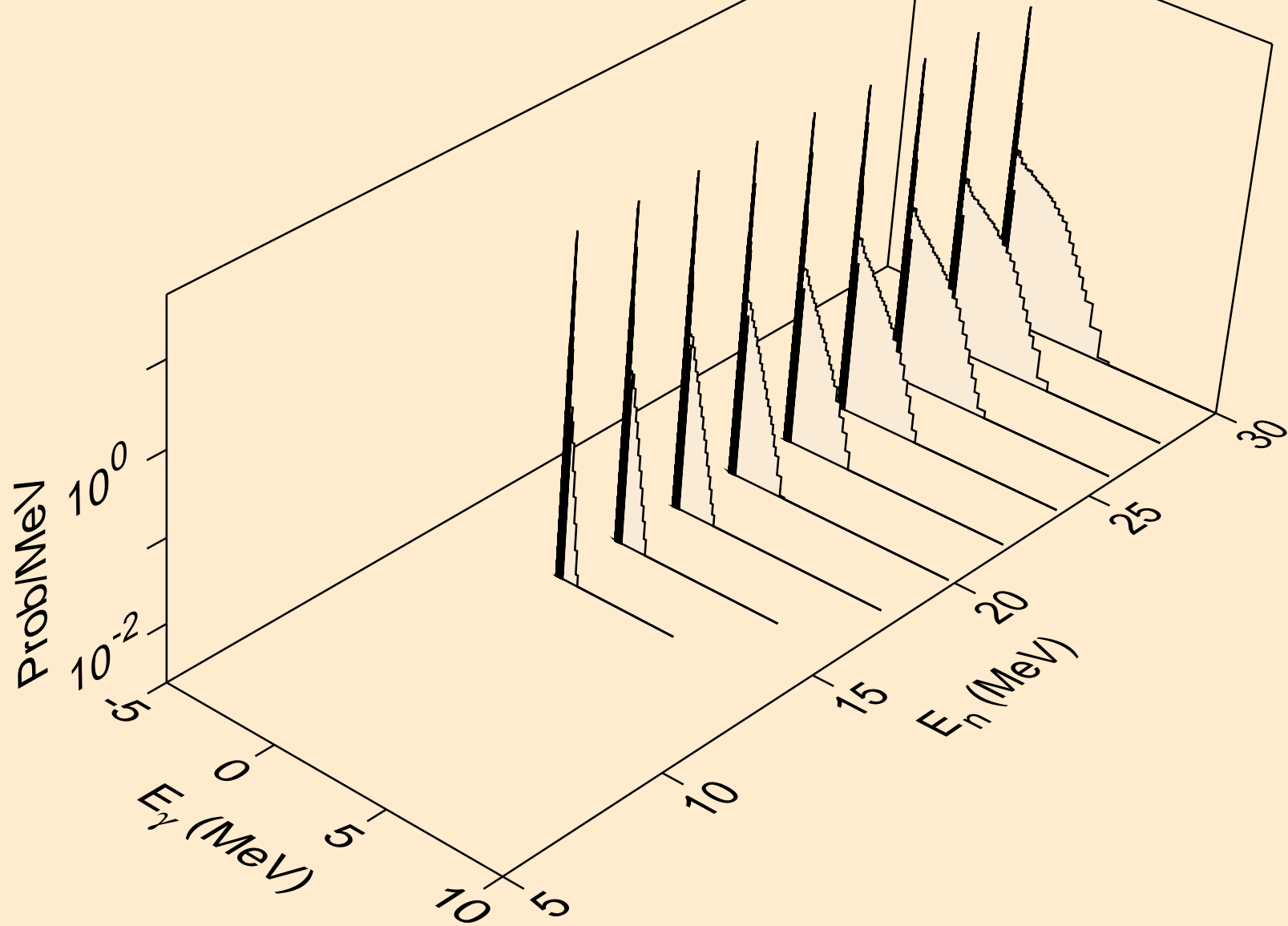

RE178 NEUTRON ACER TENDL-2024 LIBRARY; T=293.6K
Photon emission for (n,pt)

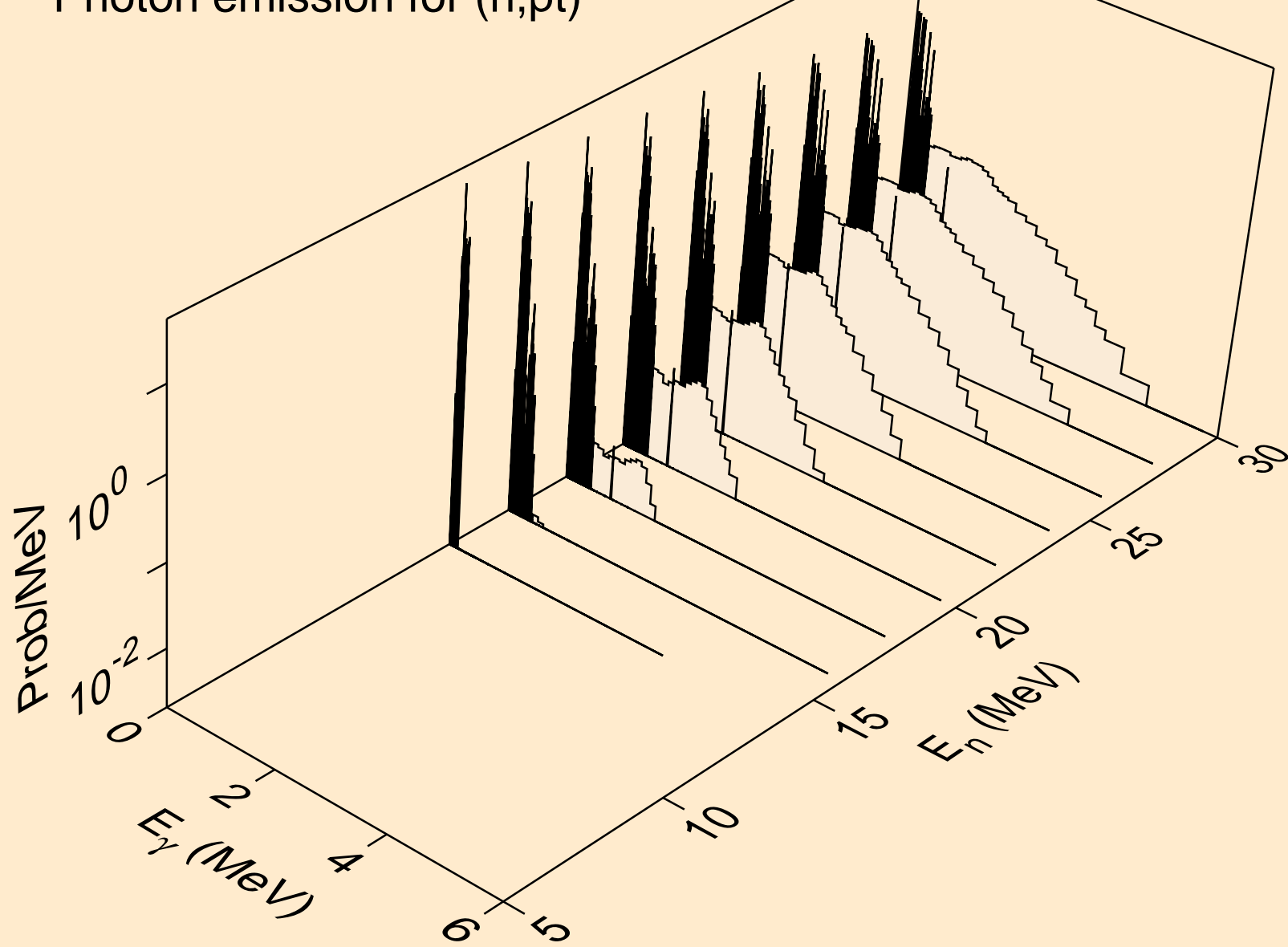

RE178 NEUTRON ACER TENDL-2024 LIBRARY; T=293.6K
Photon emission for (n,da)

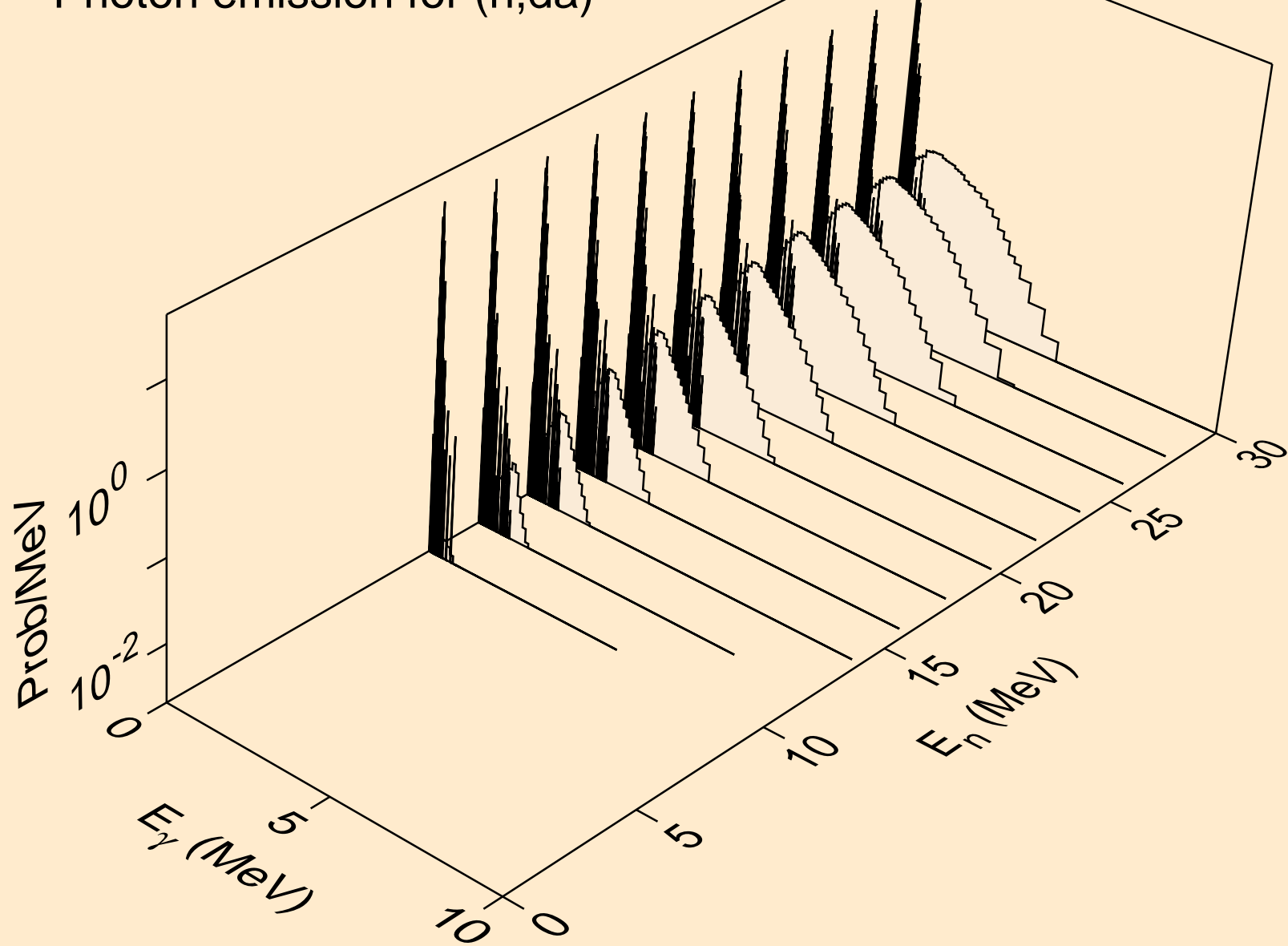

RE178 NEUTRON ACER TENDL-2024 LIBRARY; T=293.6K
thermal capture photon spectrum

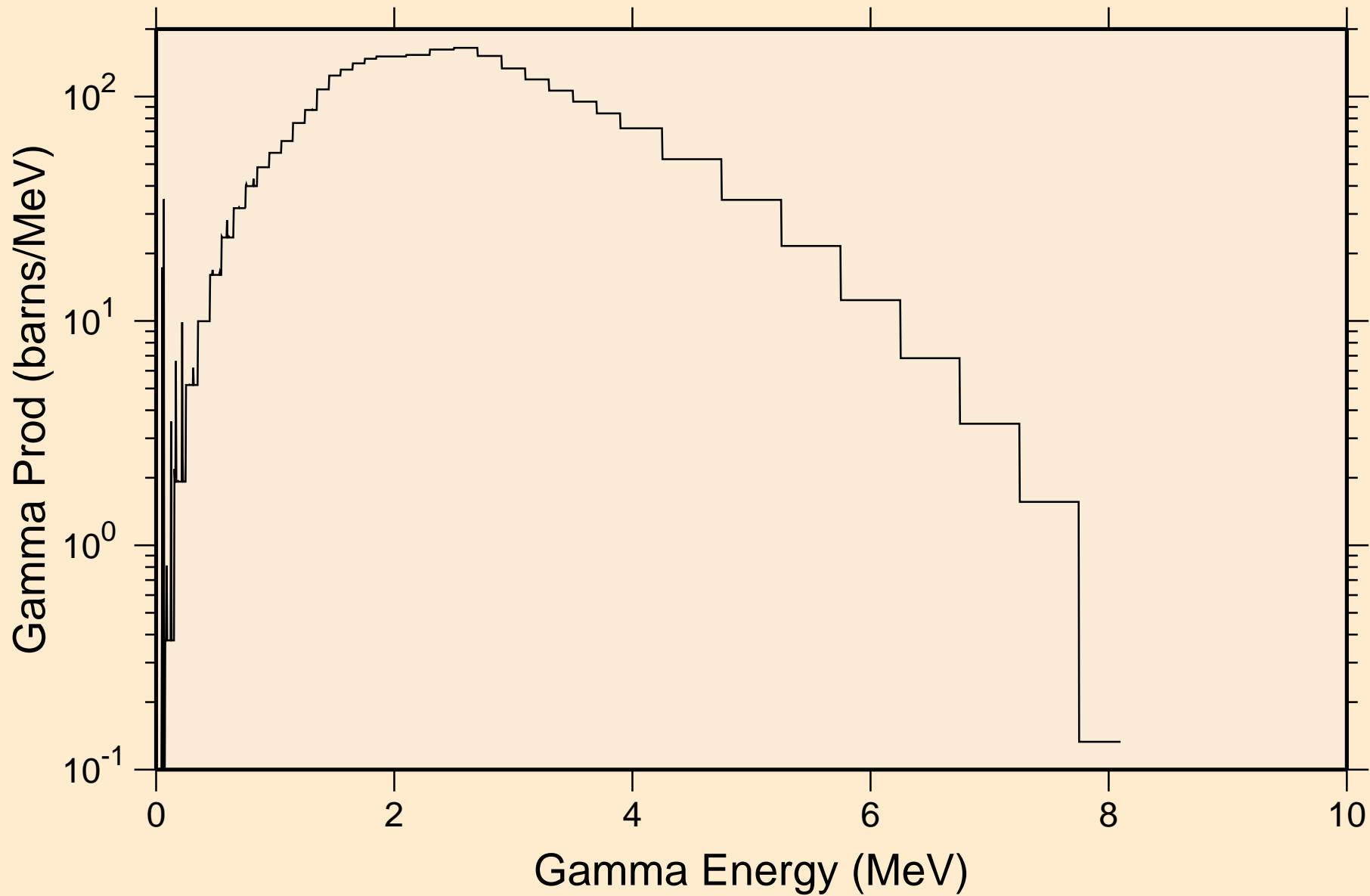

RE178 NEUTRON ACER TENDL-2024 LIBRARY; T=293.6K
14 MeV photon spectrum

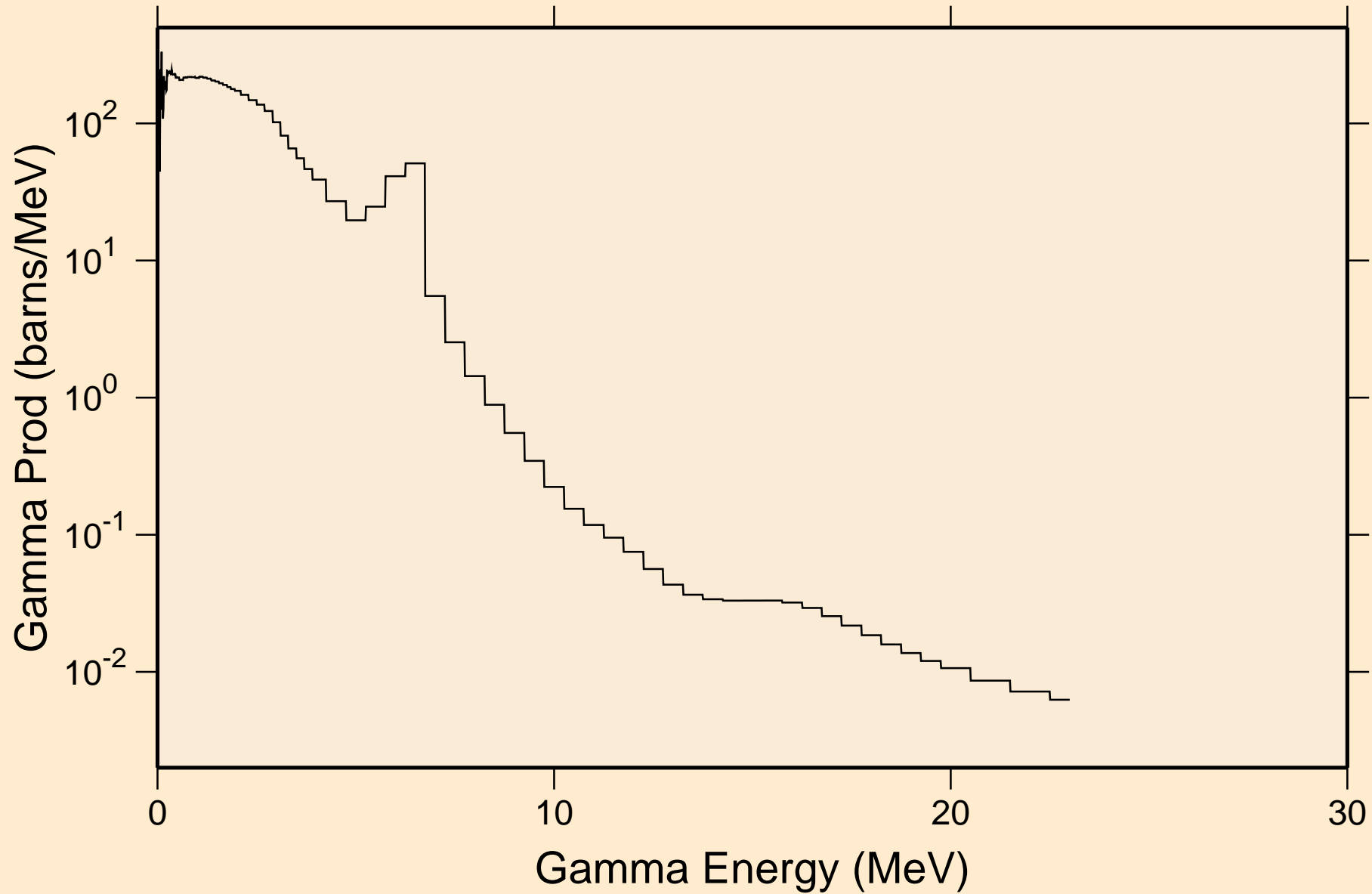

RE178 NEUTRON ACER TENDL-2024 LIBRARY; T=293.6K

Particle heating contributions

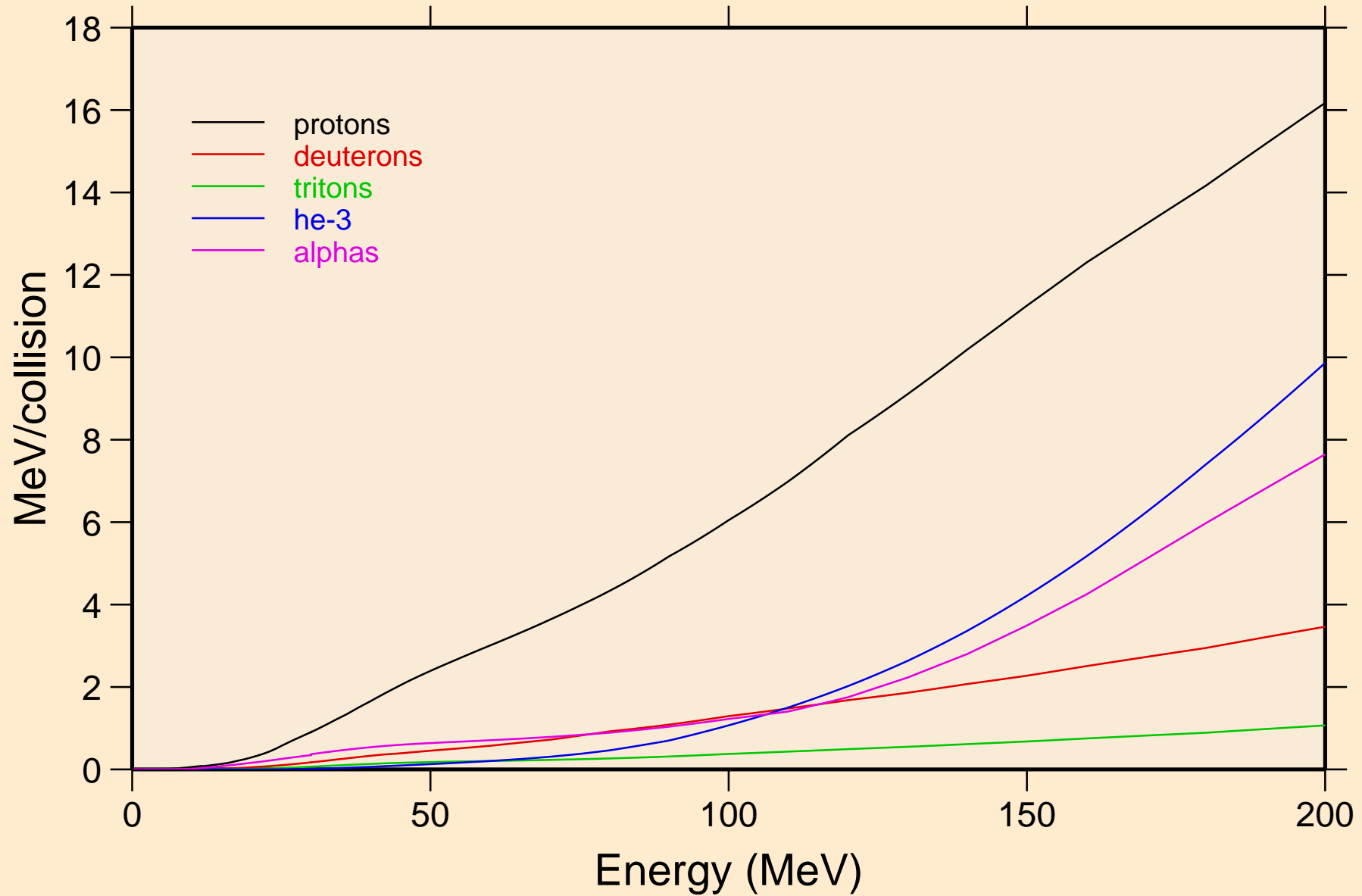

RE178 NEUTRON ACER TENDL-2024 LIBRARY; T=293.6K
Recoil Heating

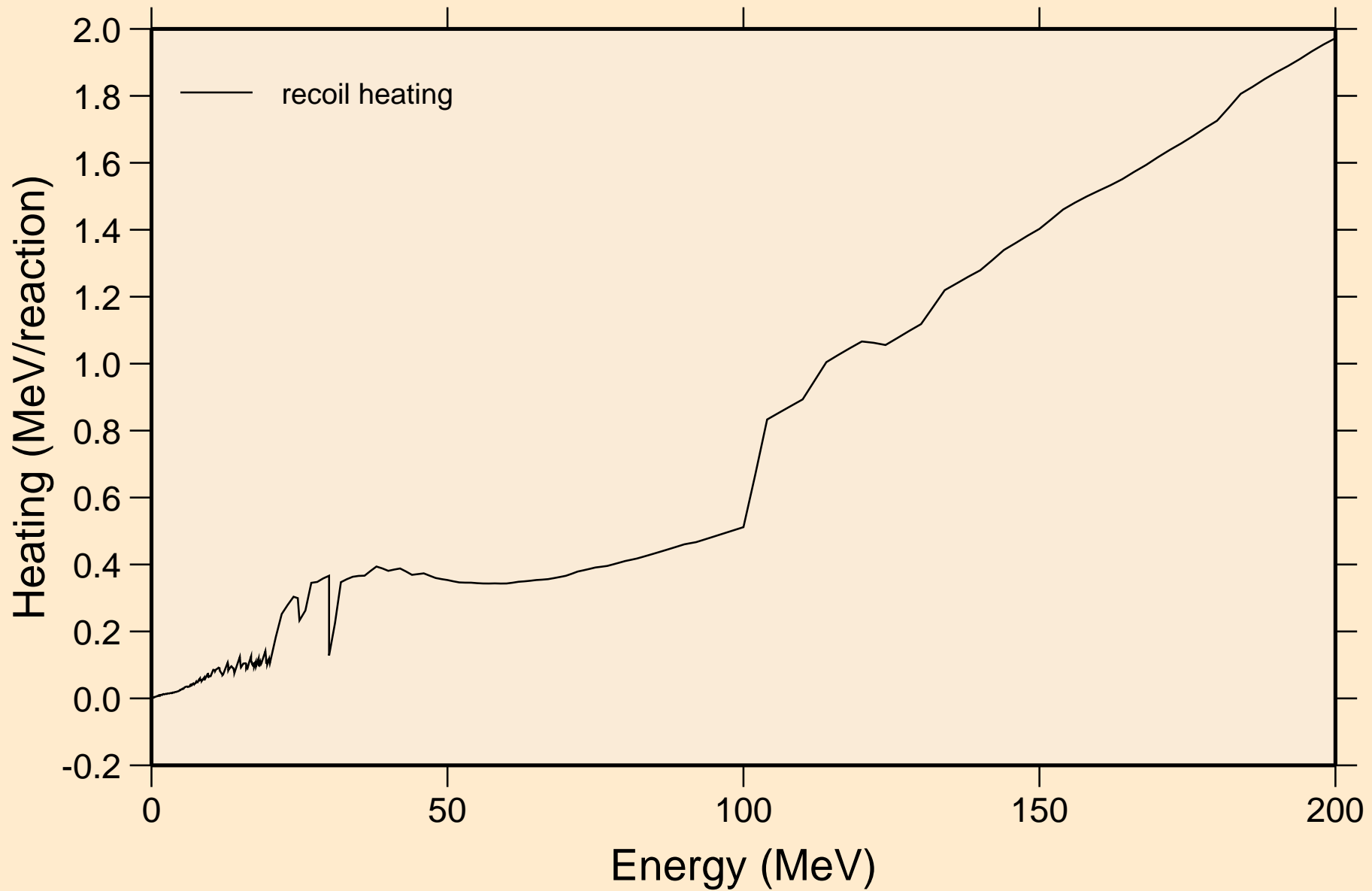

RE178 NEUTRON ACER TENDL-2024 LIBRARY; T=293.6K
Particle production cross sections

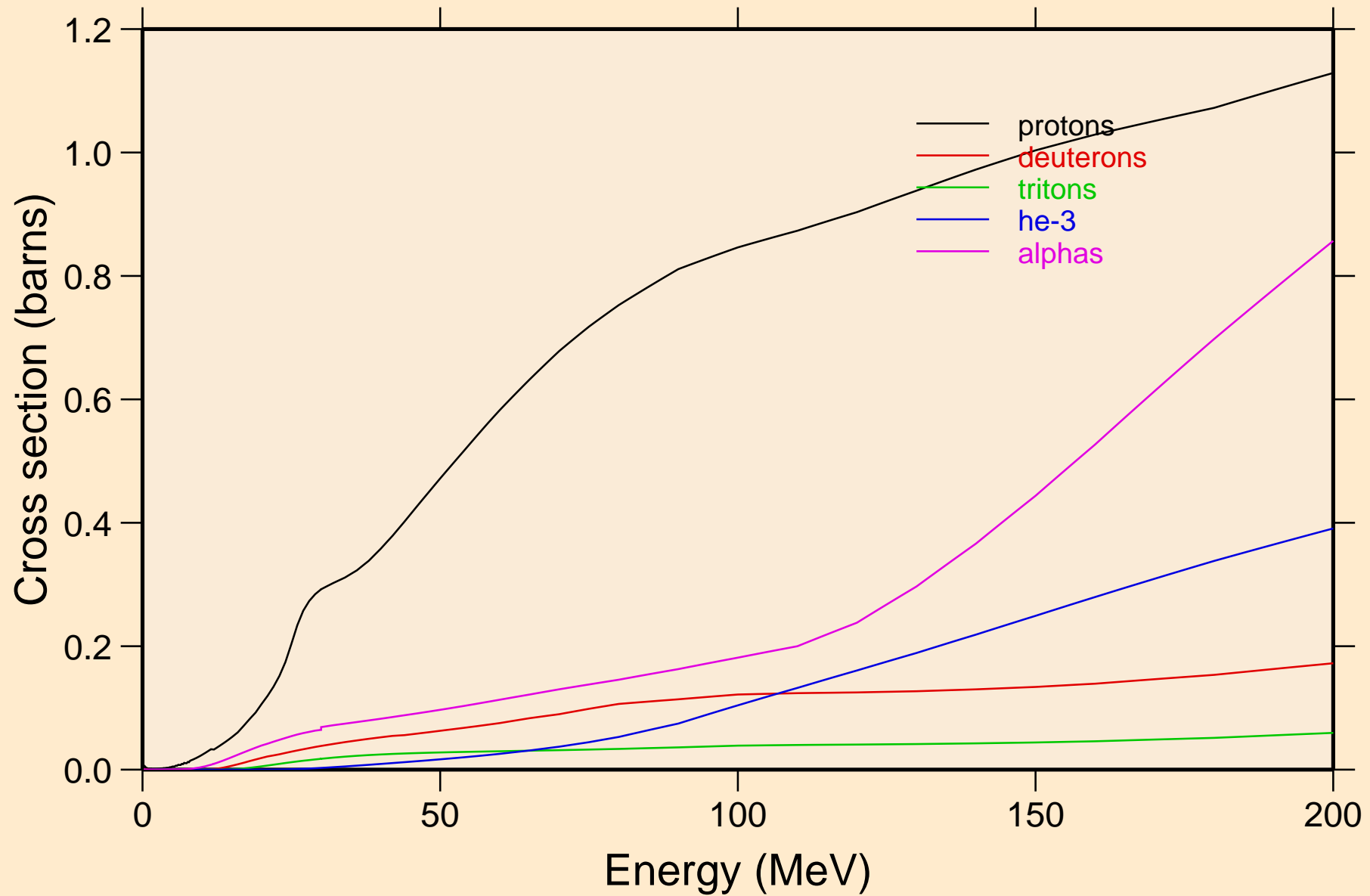

RE178 NEUTRON ACER TENDL-2024 LIBRARY; T=293.6K
protons from (n,x)

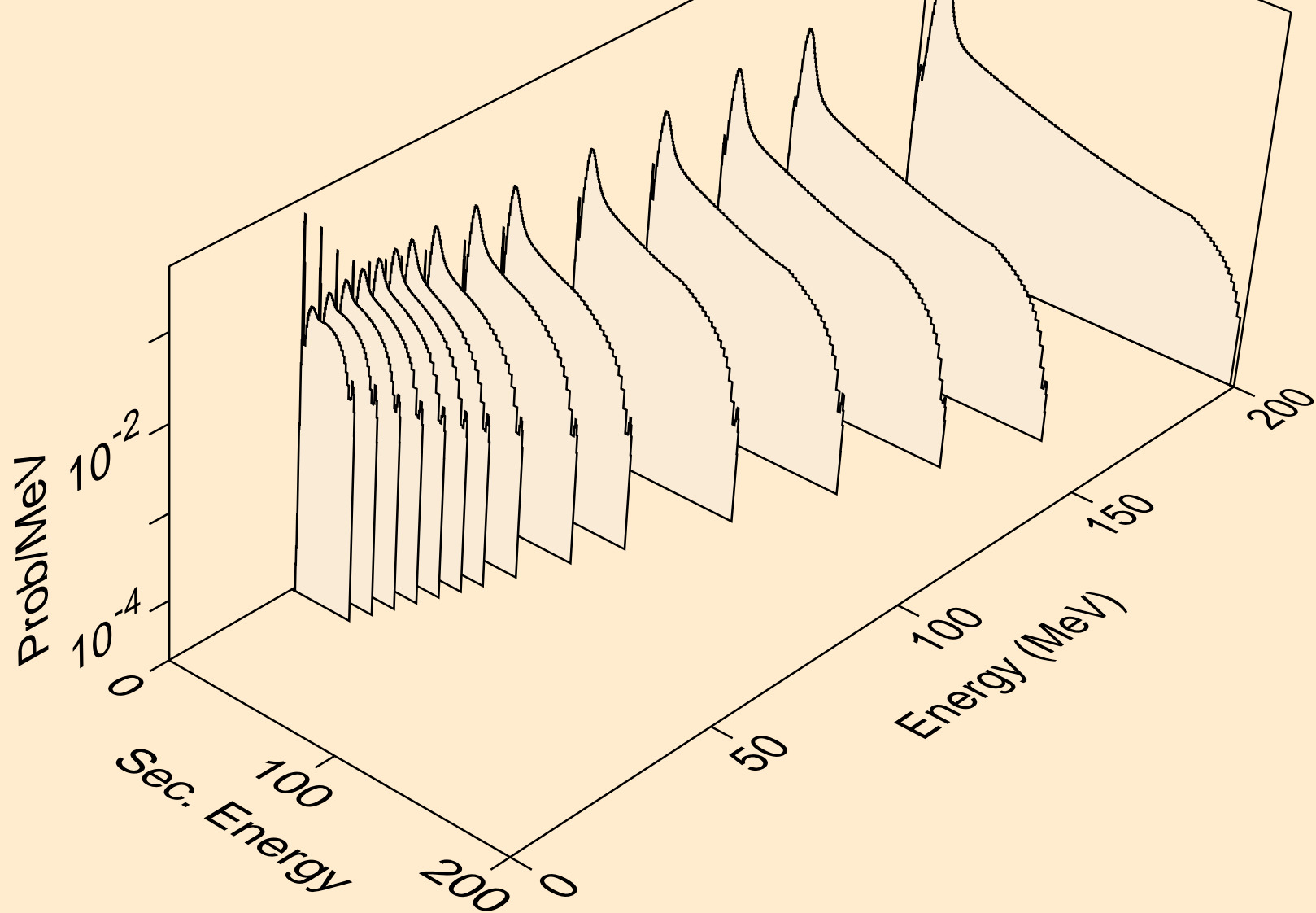

RE178 NEUTRON ACER TENDL-2024 LIBRARY; T=293.6K
protons from (n,n*)p

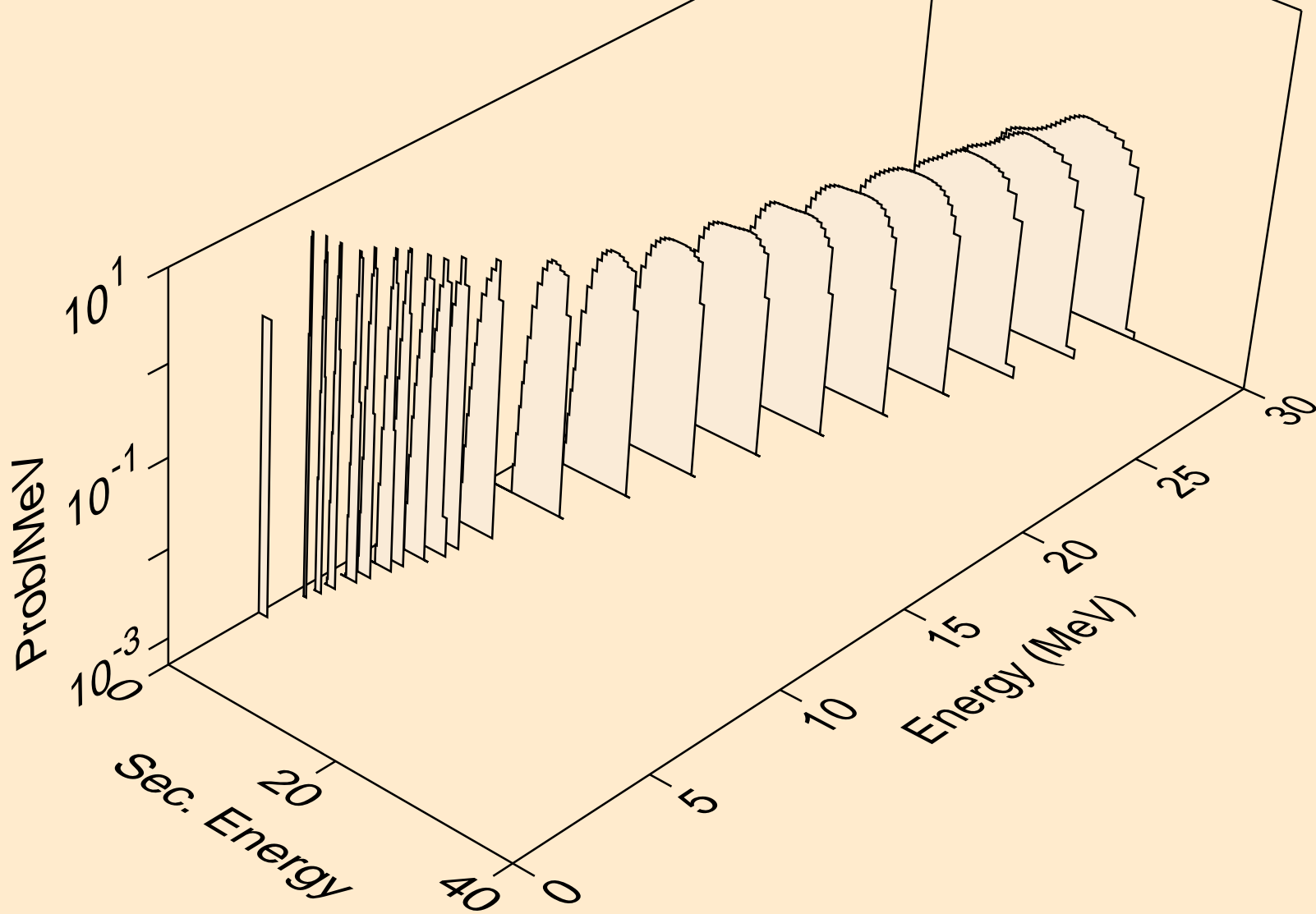

RE178 NEUTRON ACER TENDL-2024 LIBRARY; T=293.6K
protons from (n,2np)

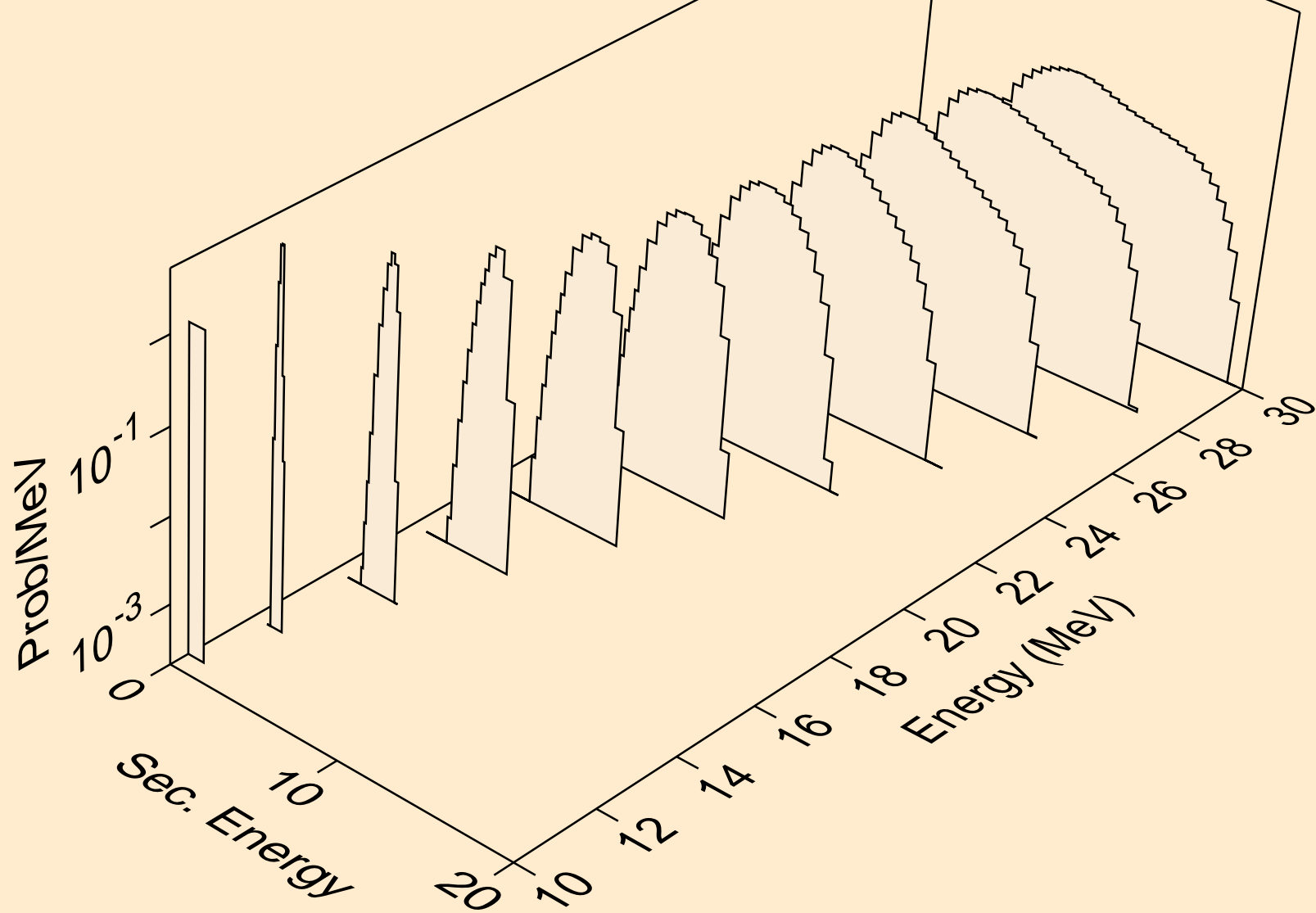

RE178 NEUTRON ACER TENDL-2024 LIBRARY; T=293.6K
protons from (n,3np)

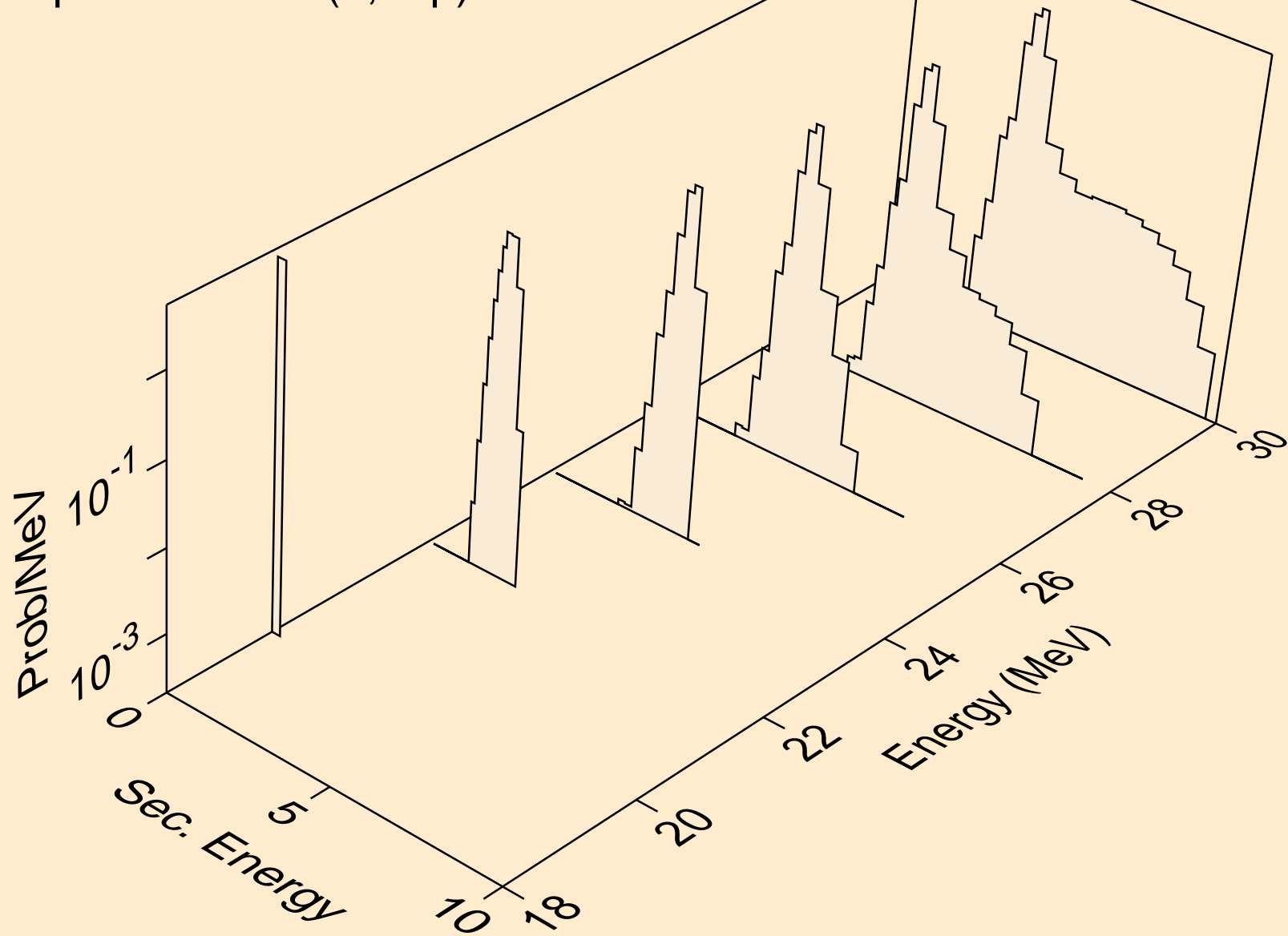

RE178 NEUTRON ACER TENDL-2024 LIBRARY; T=293.6K
protons from (n,n2p)

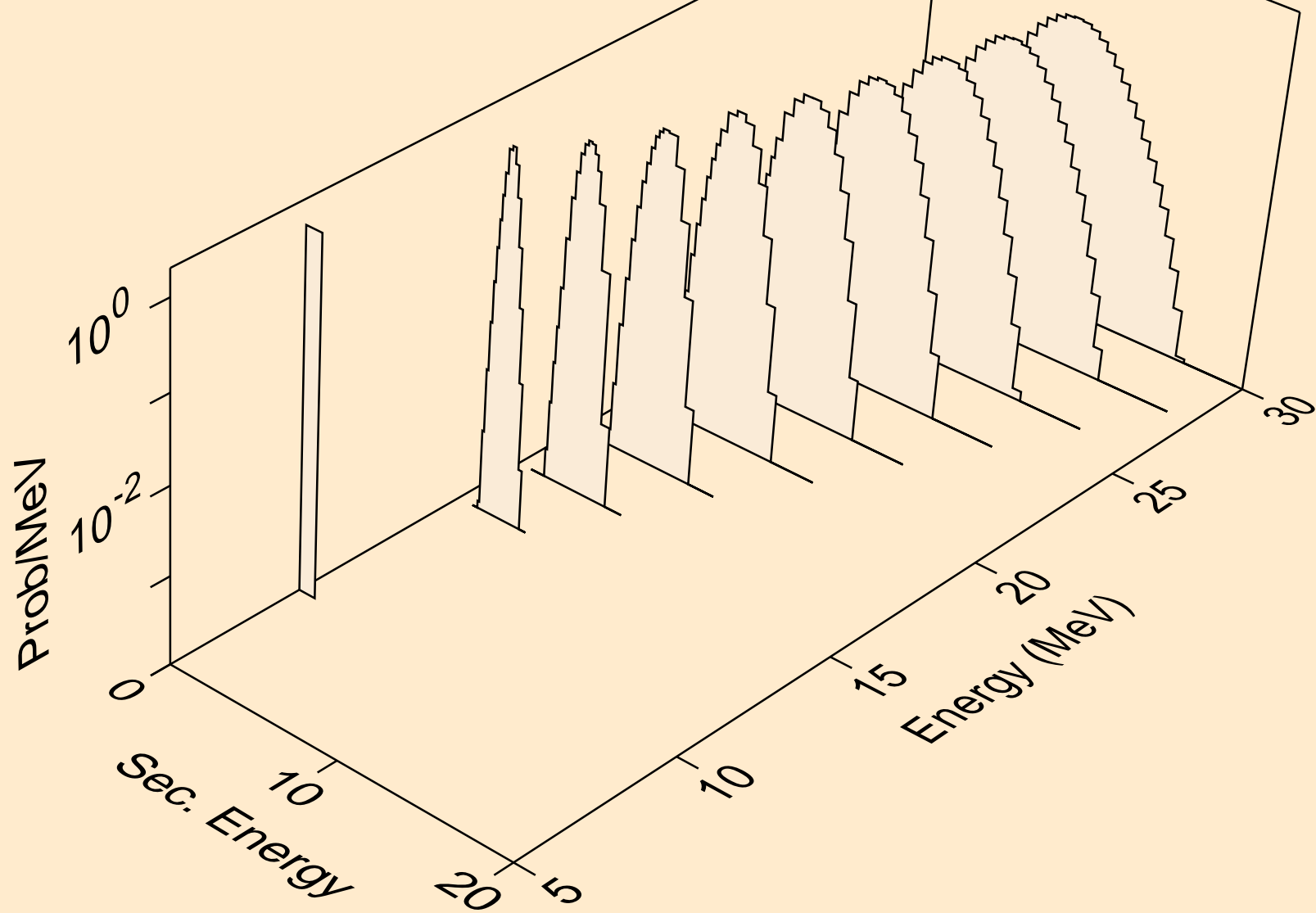

RE178 NEUTRON ACER TENDL-2024 LIBRARY; T=293.6K
protons from (n,npa)

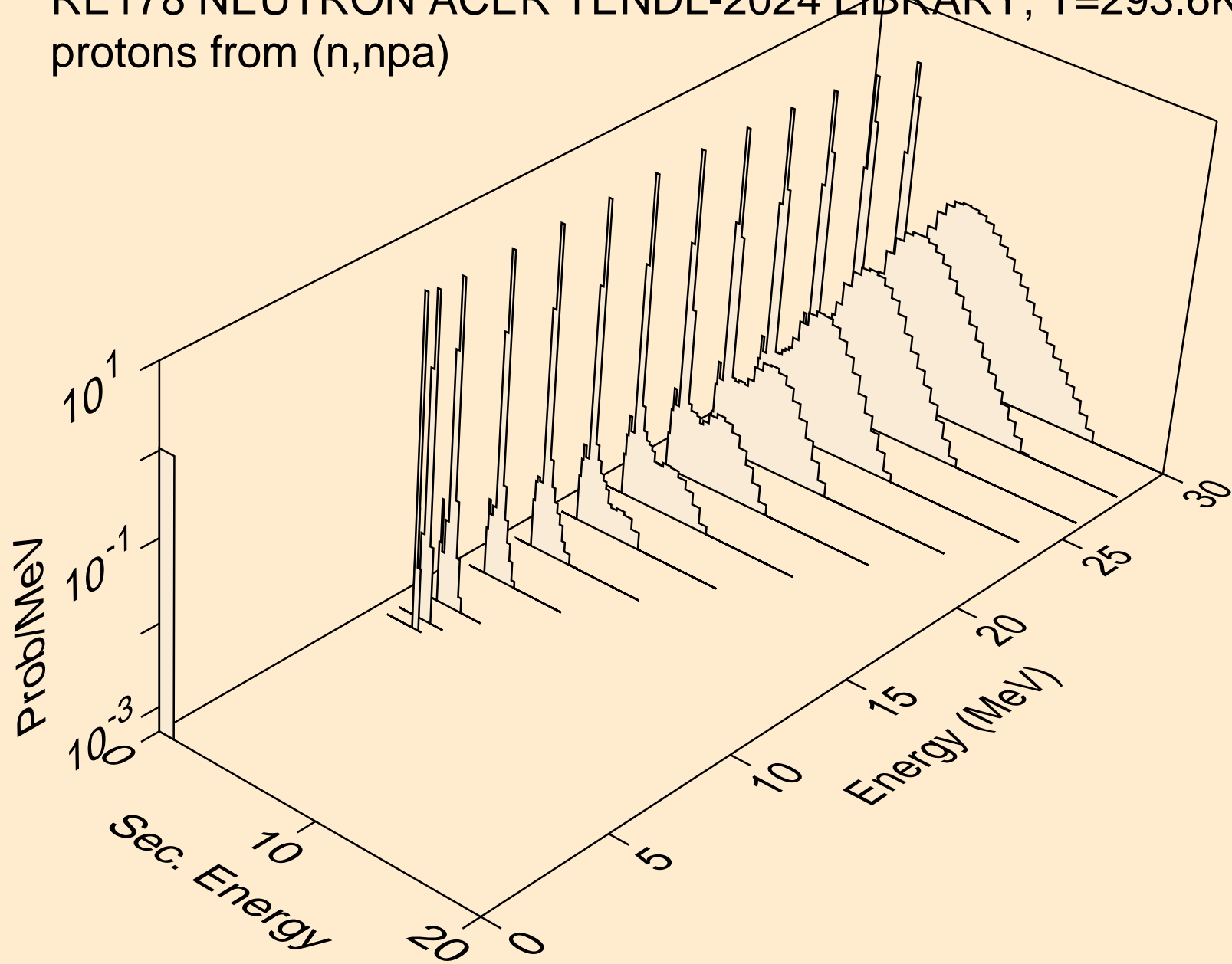

RE178 NEUTRON ACER TENDL-2024 LIBRARY; T=293.6K
protons from (n,p)

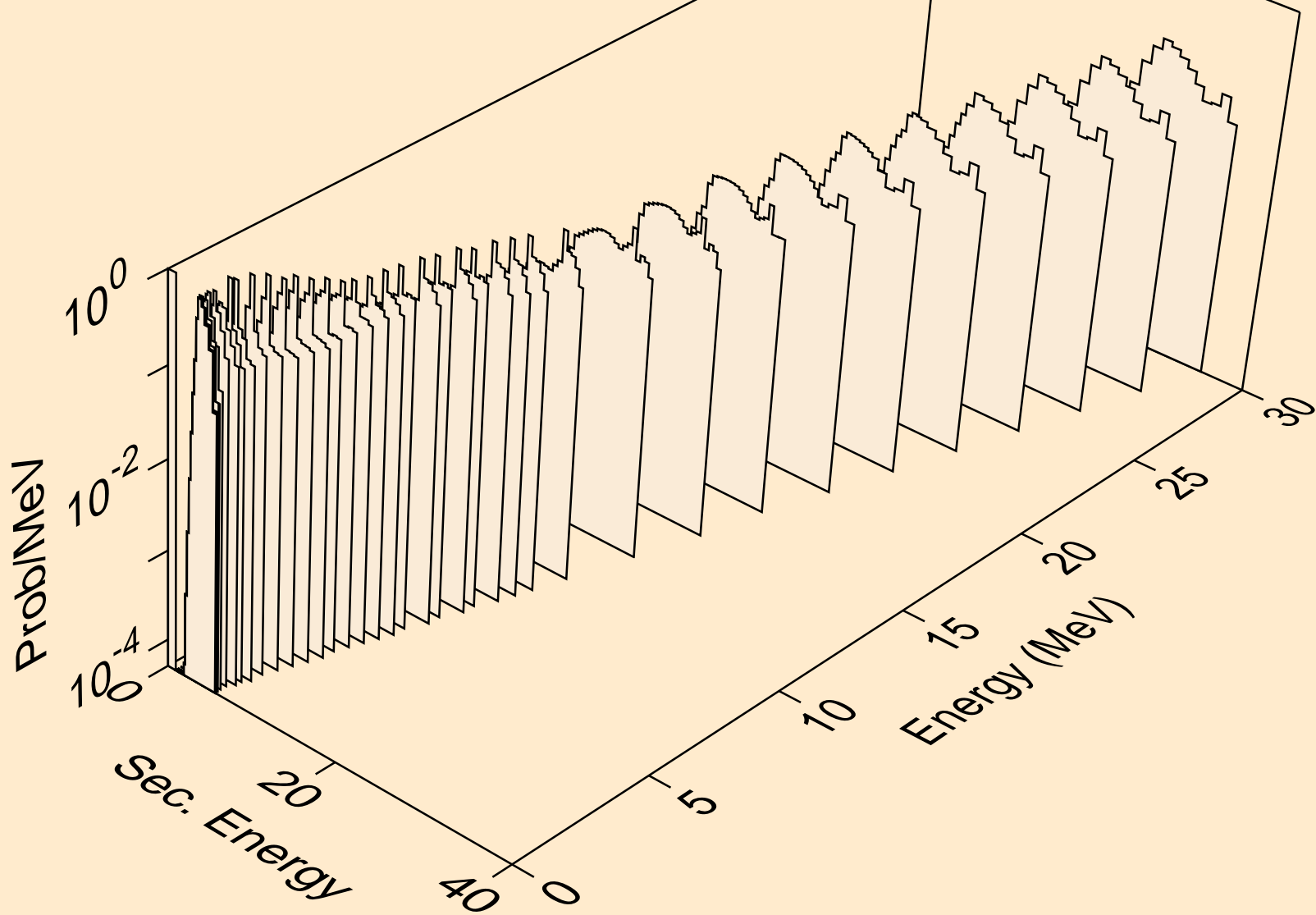

RE178 NEUTRON ACER TENDL-2024 LIBRARY; T=293.6K
protons from (n,2p)

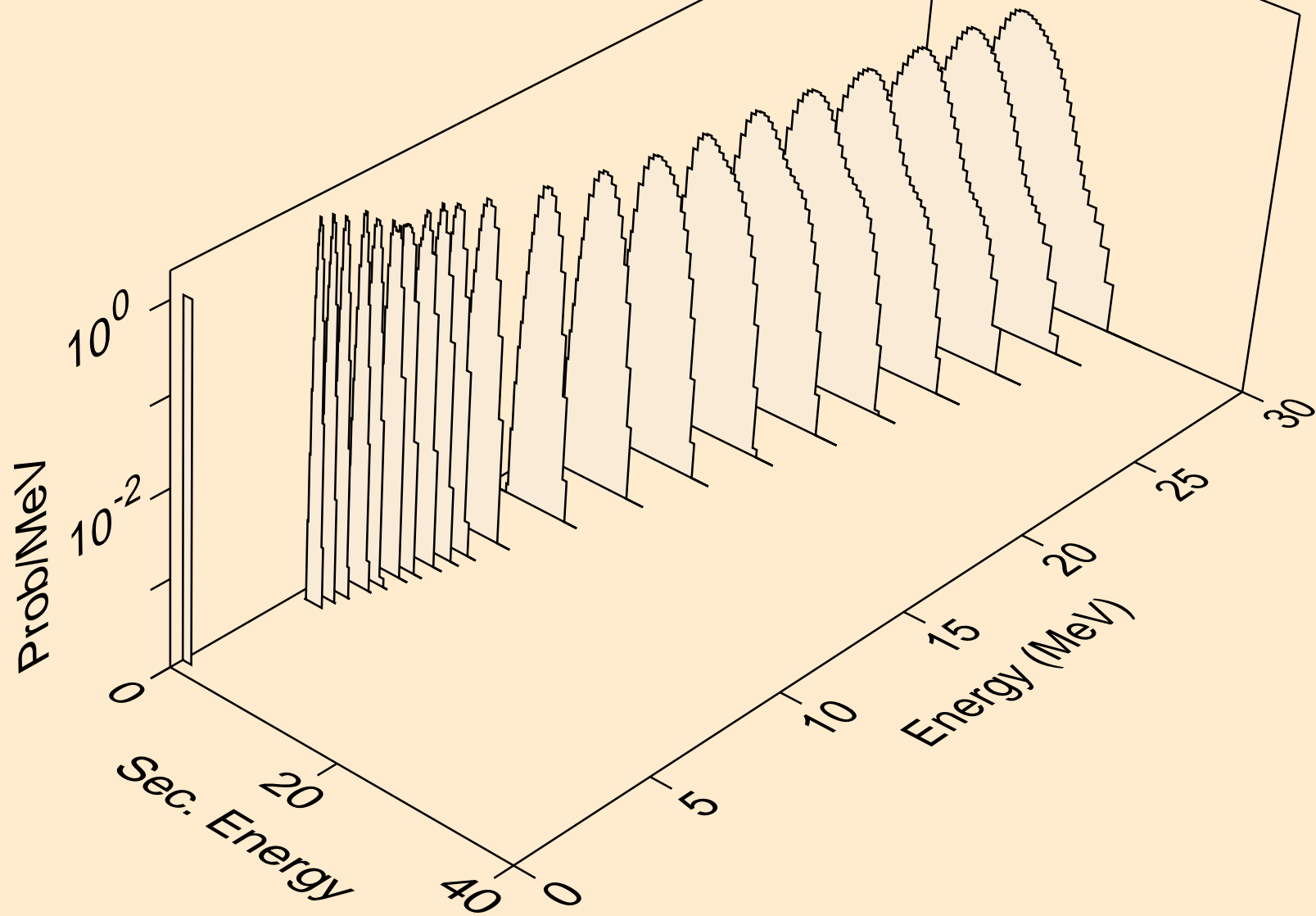

RE178 NEUTRON ACER TENDL-2024 LIBRARY; T=293.6K
protons from (n,p)

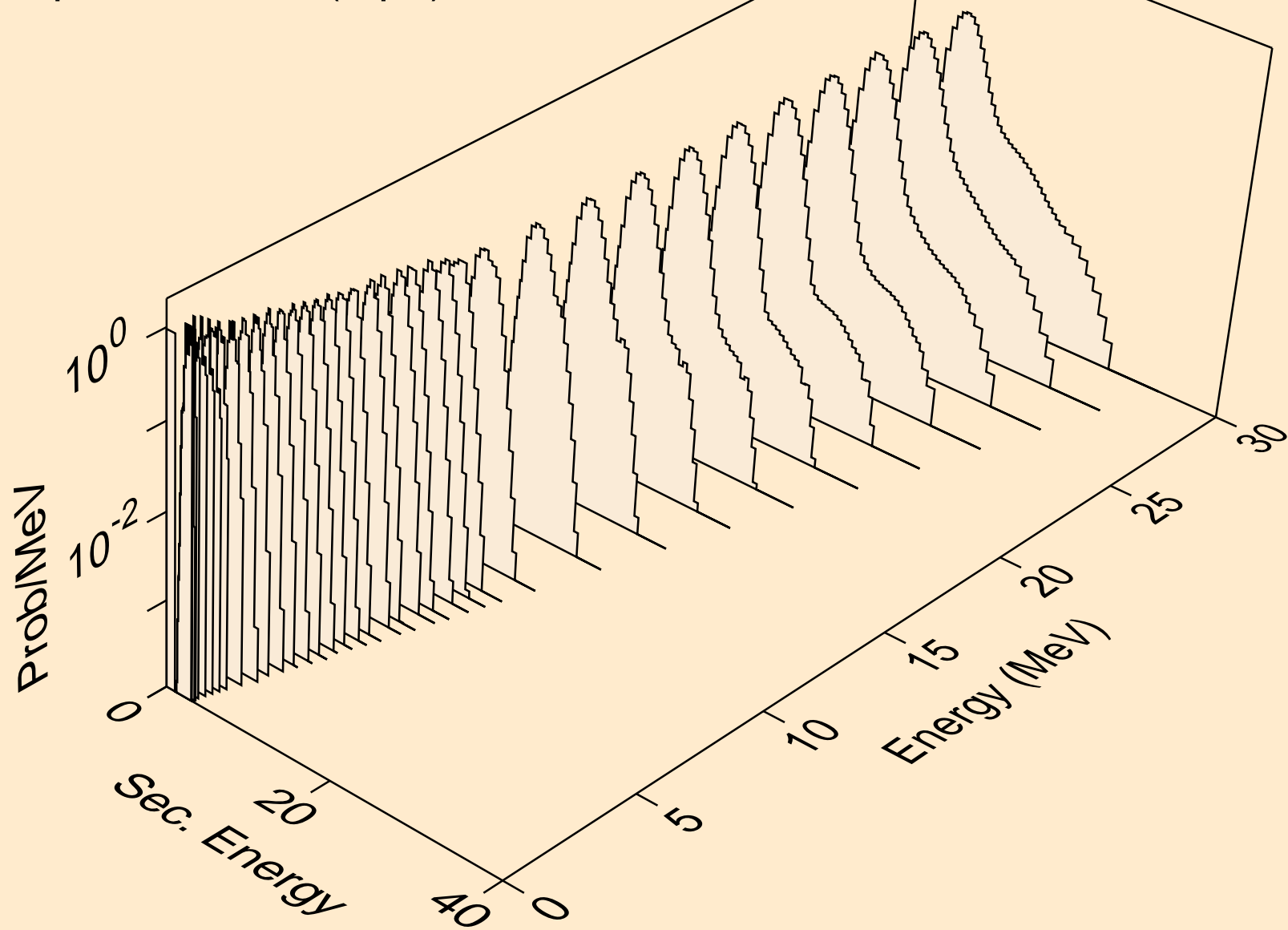

RE178 NEUTRON ACER TENDL-2024 LIBRARY; T=293.6K
protons from (n,pd)

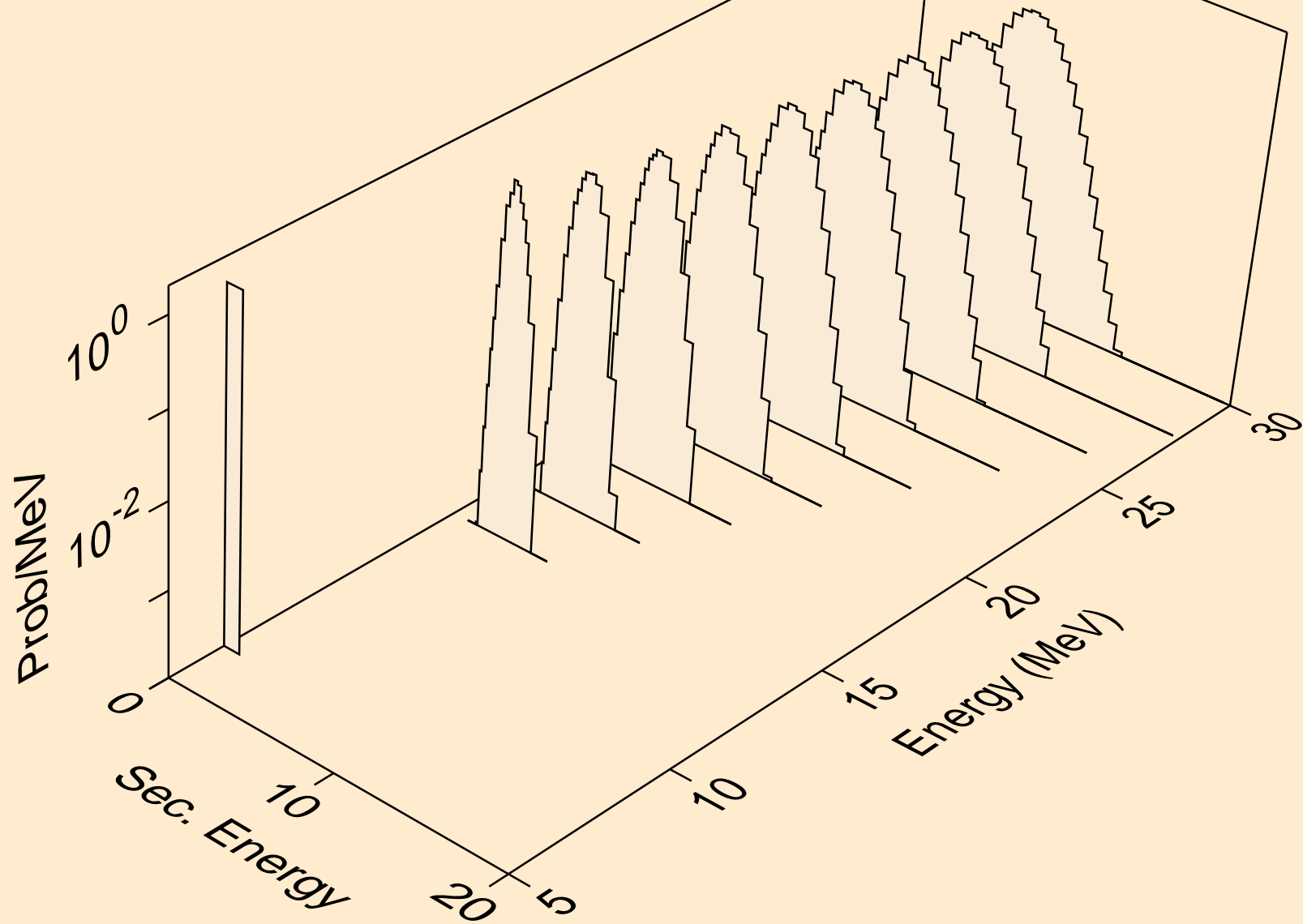

RE178 NEUTRON ACER TENDL-2024 LIBRARY; T=293.6K
protons from (n,pt)

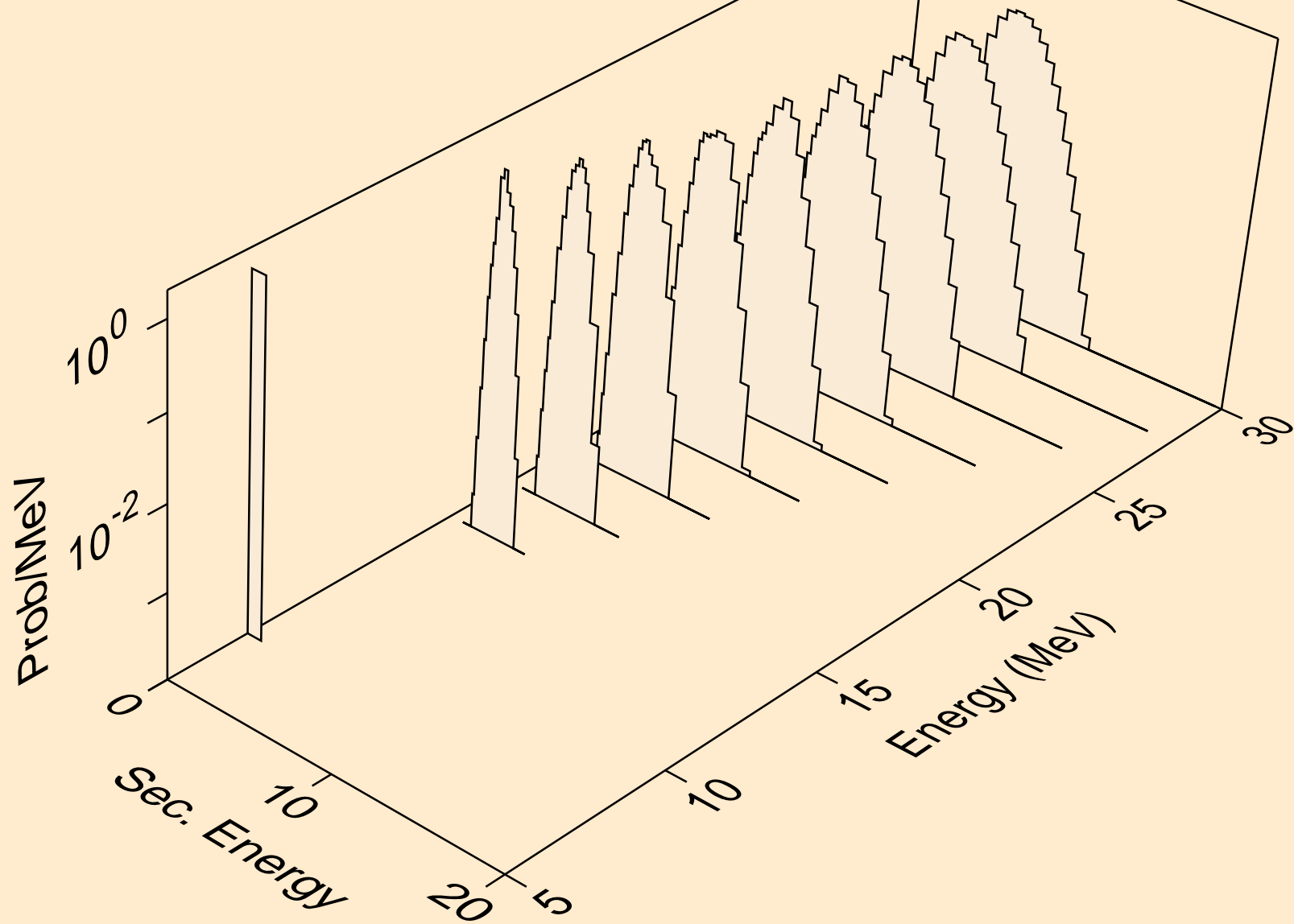

RE178 NEUTRON ACER TENDL-2024 LIBRARY; T=293.6K
deuterons from (n,x)

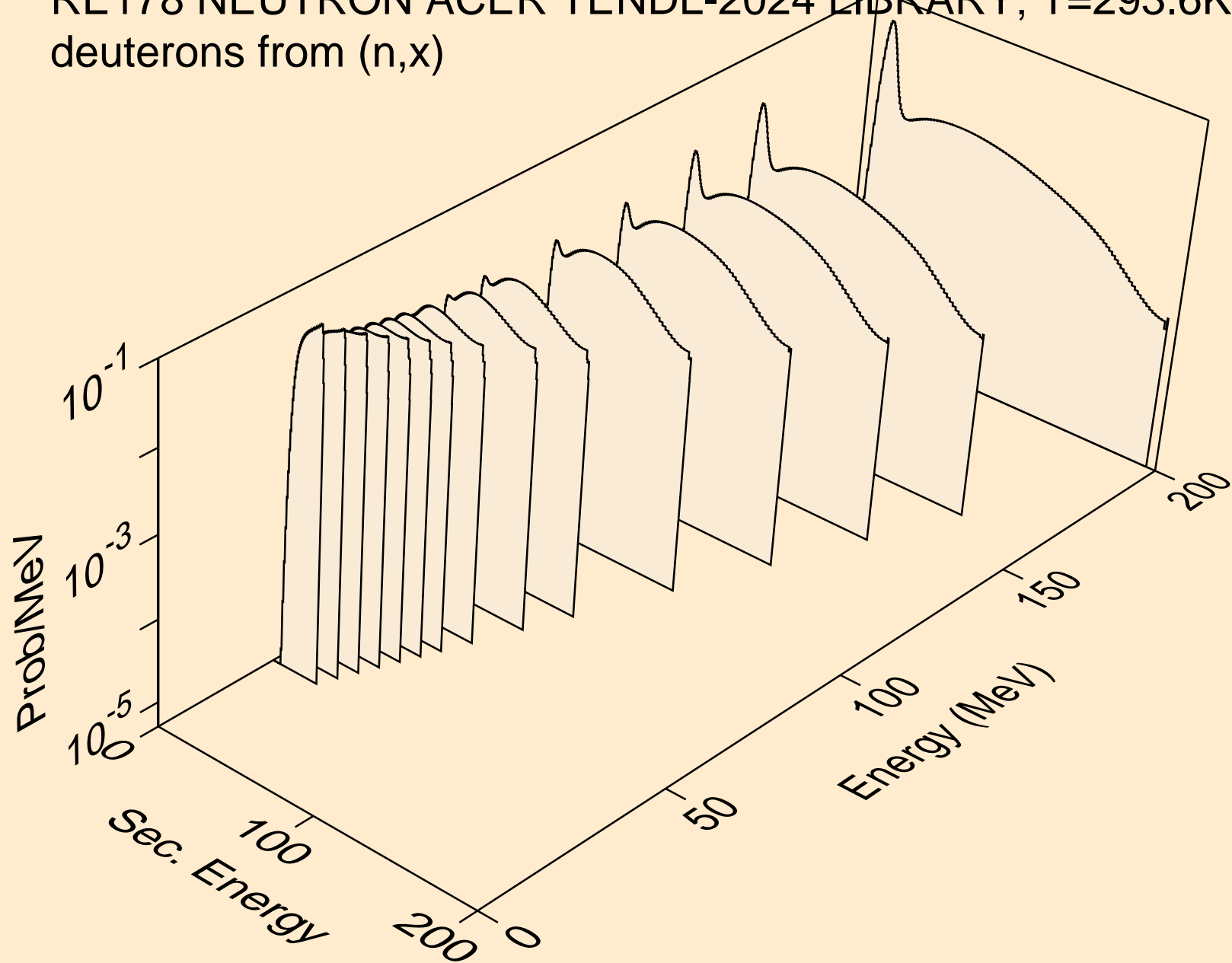

RE178 NEUTRON ACER TENDL-2024 LIBRARY; T=293.6K
deuterons from (n,2nd)

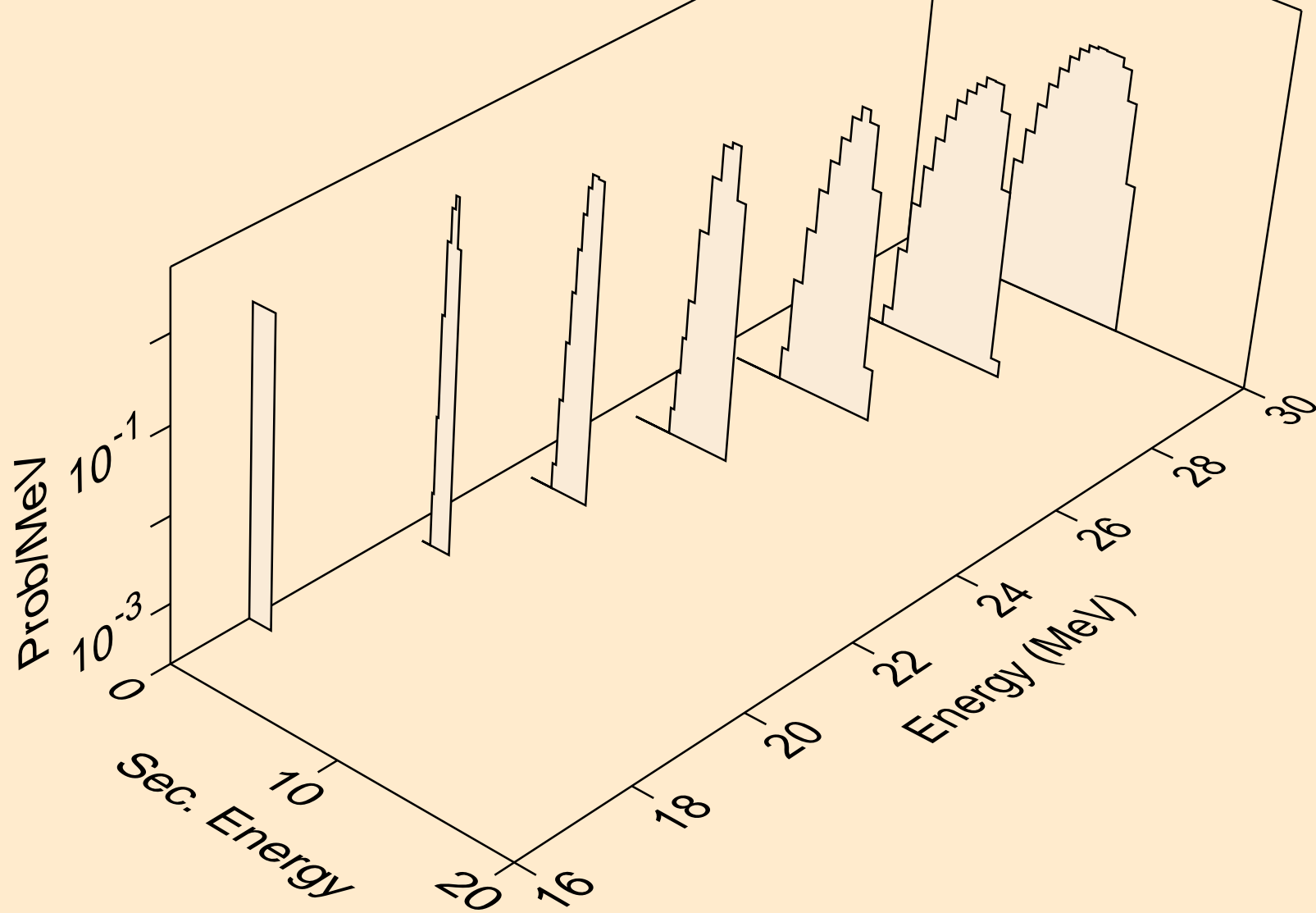

RE178 NEUTRON ACER TENDL-2024 LIBRARY; T=293.6K
deuterons from (n,n*)d

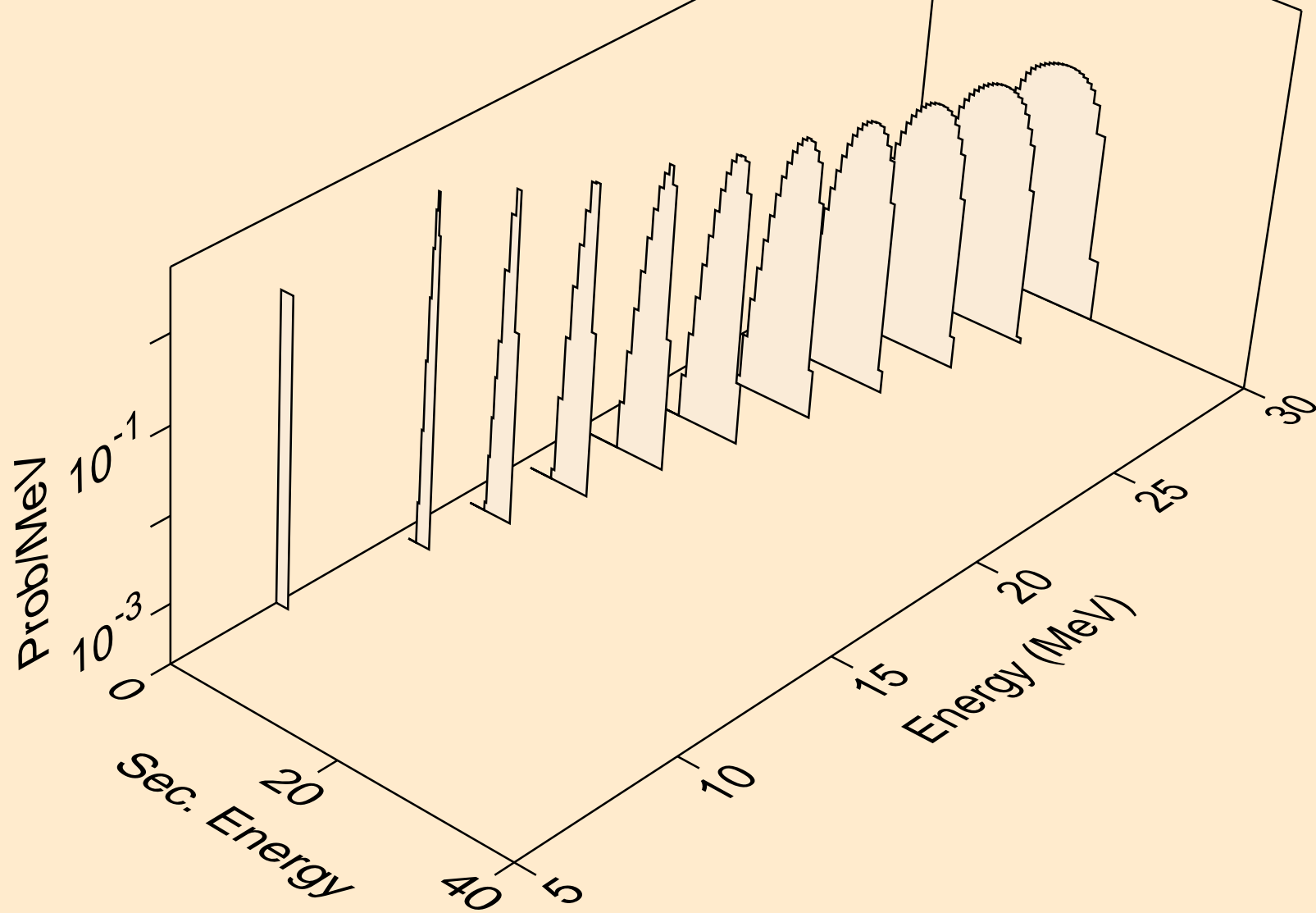

RE178 NEUTRON ACER TENDL-2024 LIBRARY; T=293.6K
deuterons from (n,d)

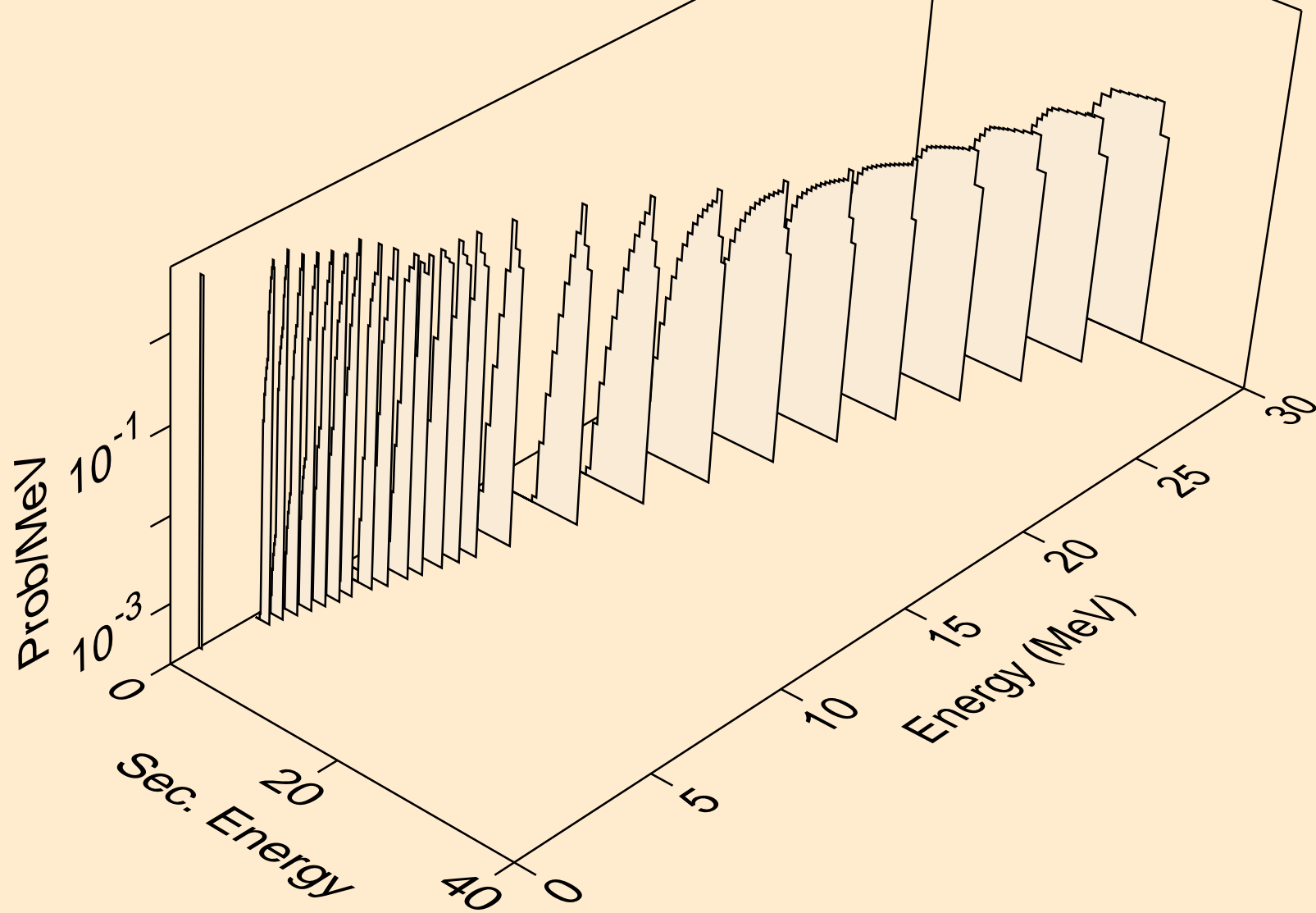

RE178 NEUTRON ACER TENDL-2024 LIBRARY; T=293.6K
deuterons from (n,pd)

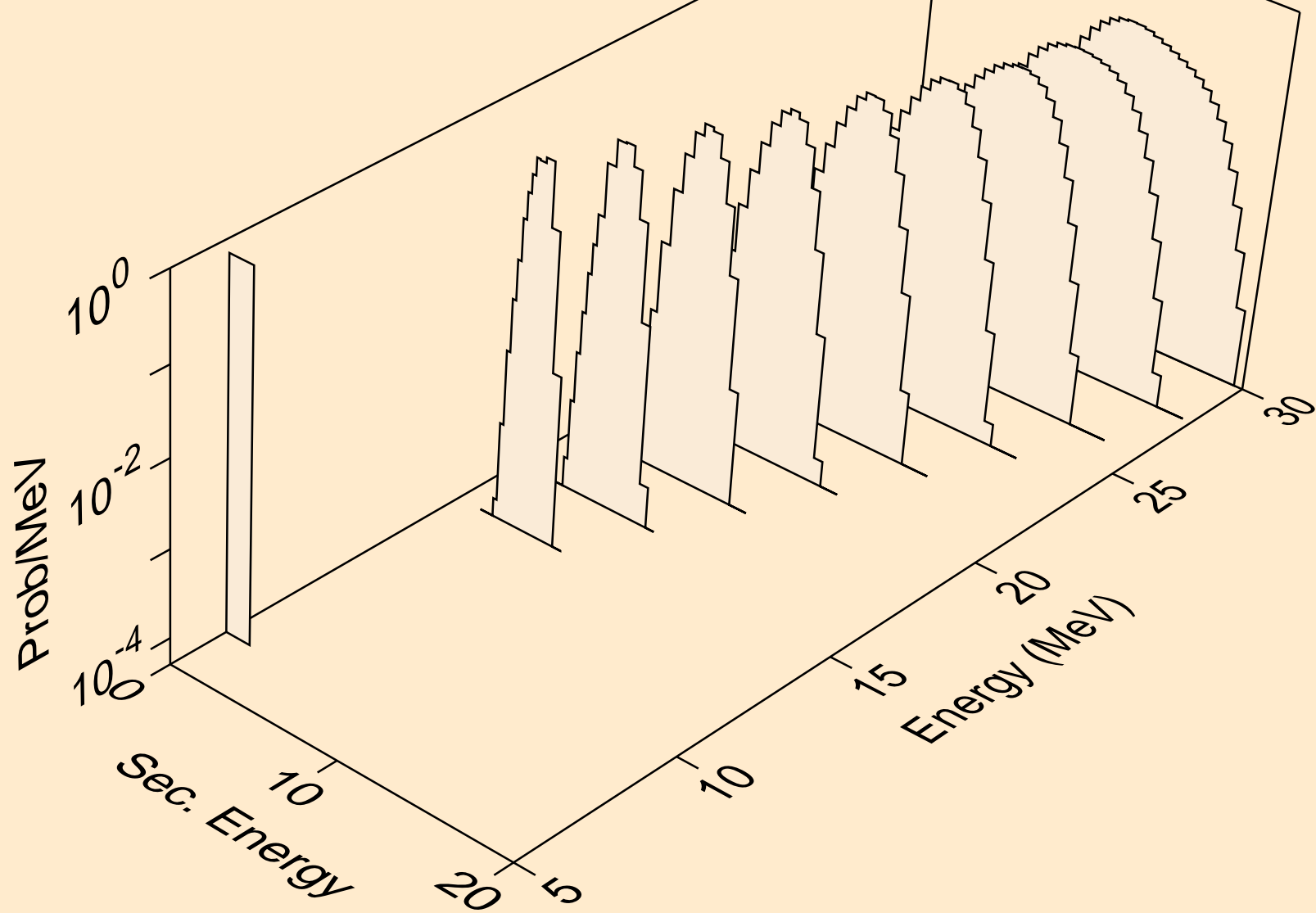

RE178 NEUTRON ACER TENDL-2024 LIBRARY; T=293.6K
deuterons from (n,da)

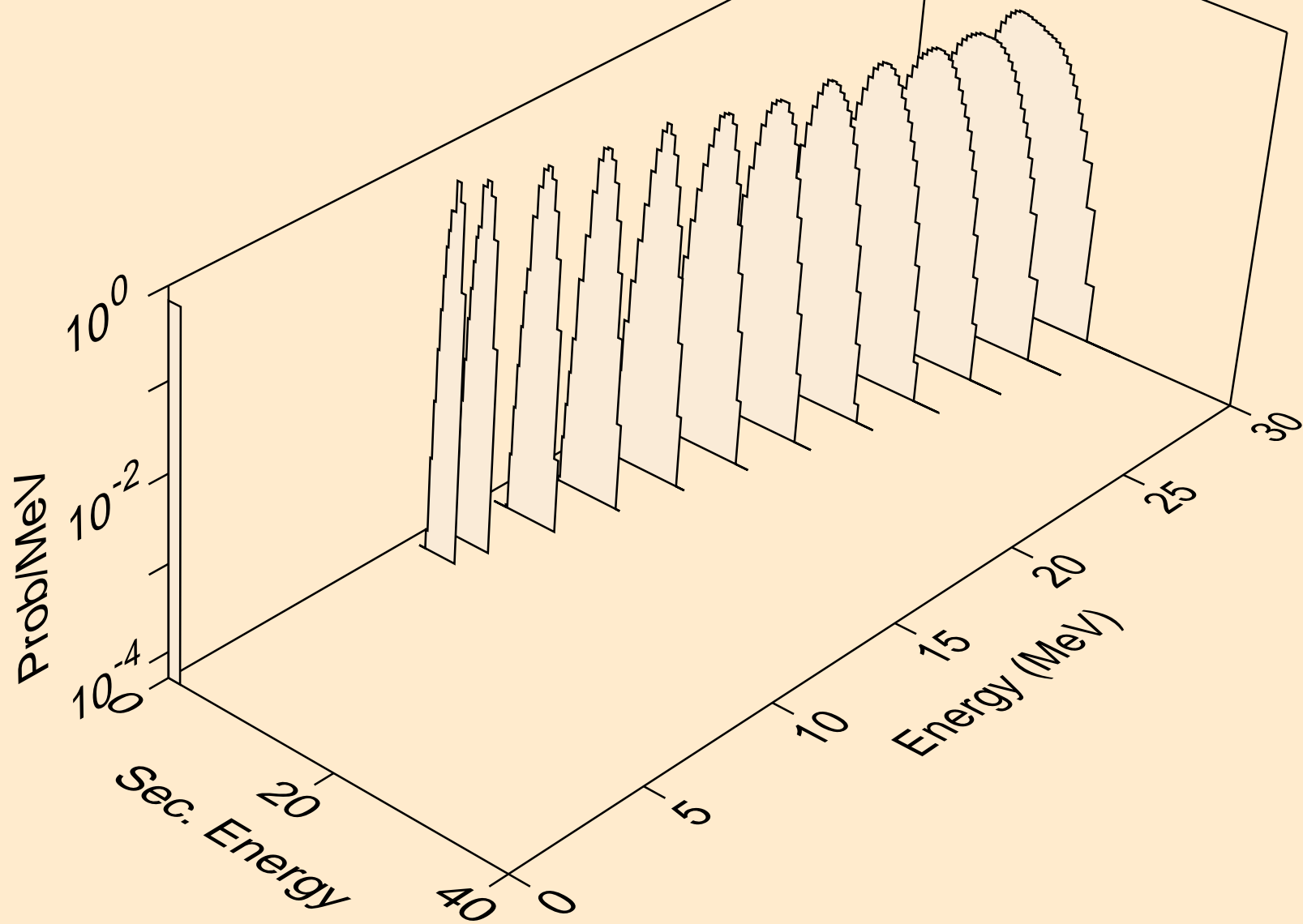

RE178 NEUTRON ACER TENDL-2024 LIBRARY; T=293.6K
tritons from (n,x)

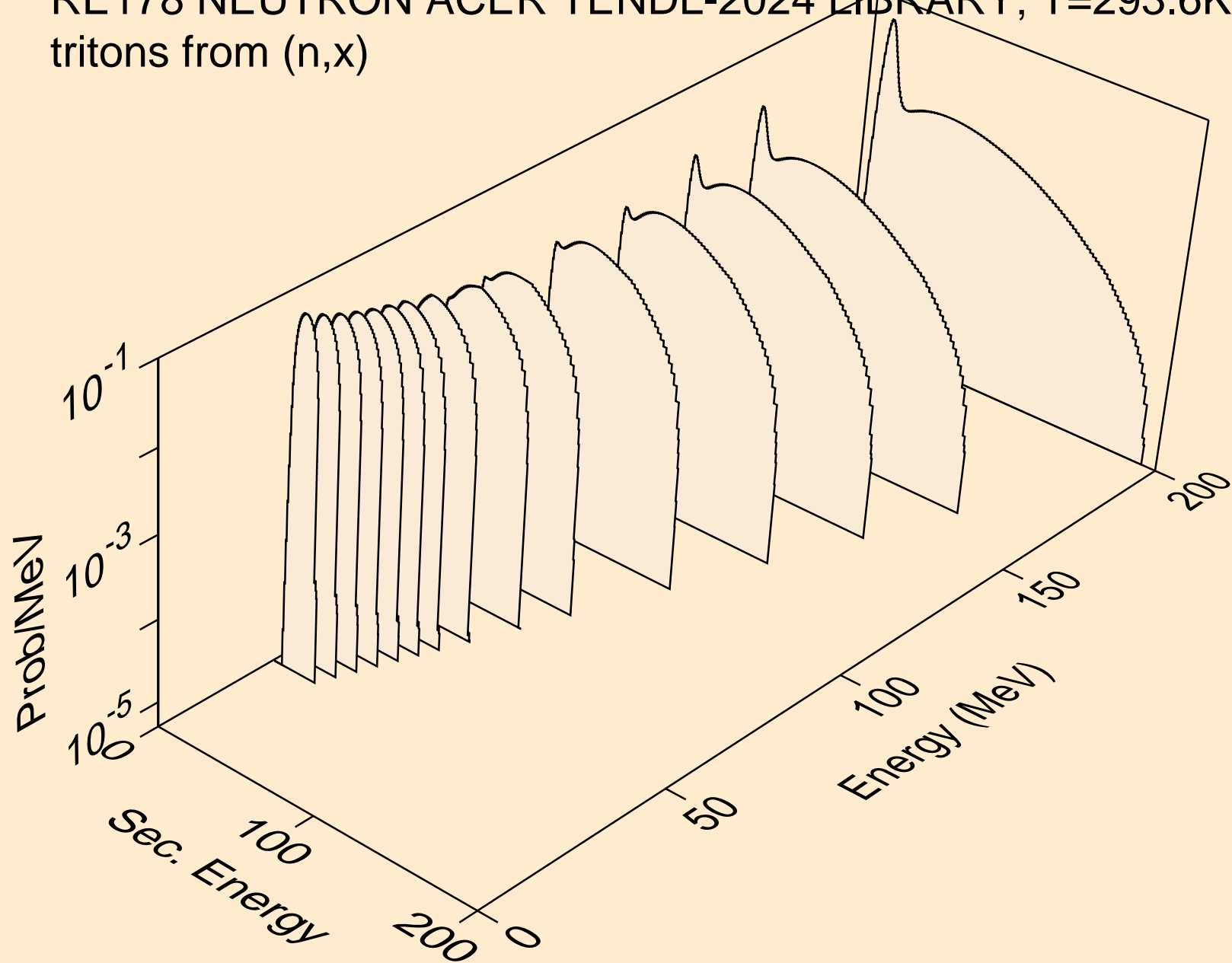

RE178 NEUTRON ACER TENDL-2024 LIBRARY; T=293.6K
tritons from (n,t)

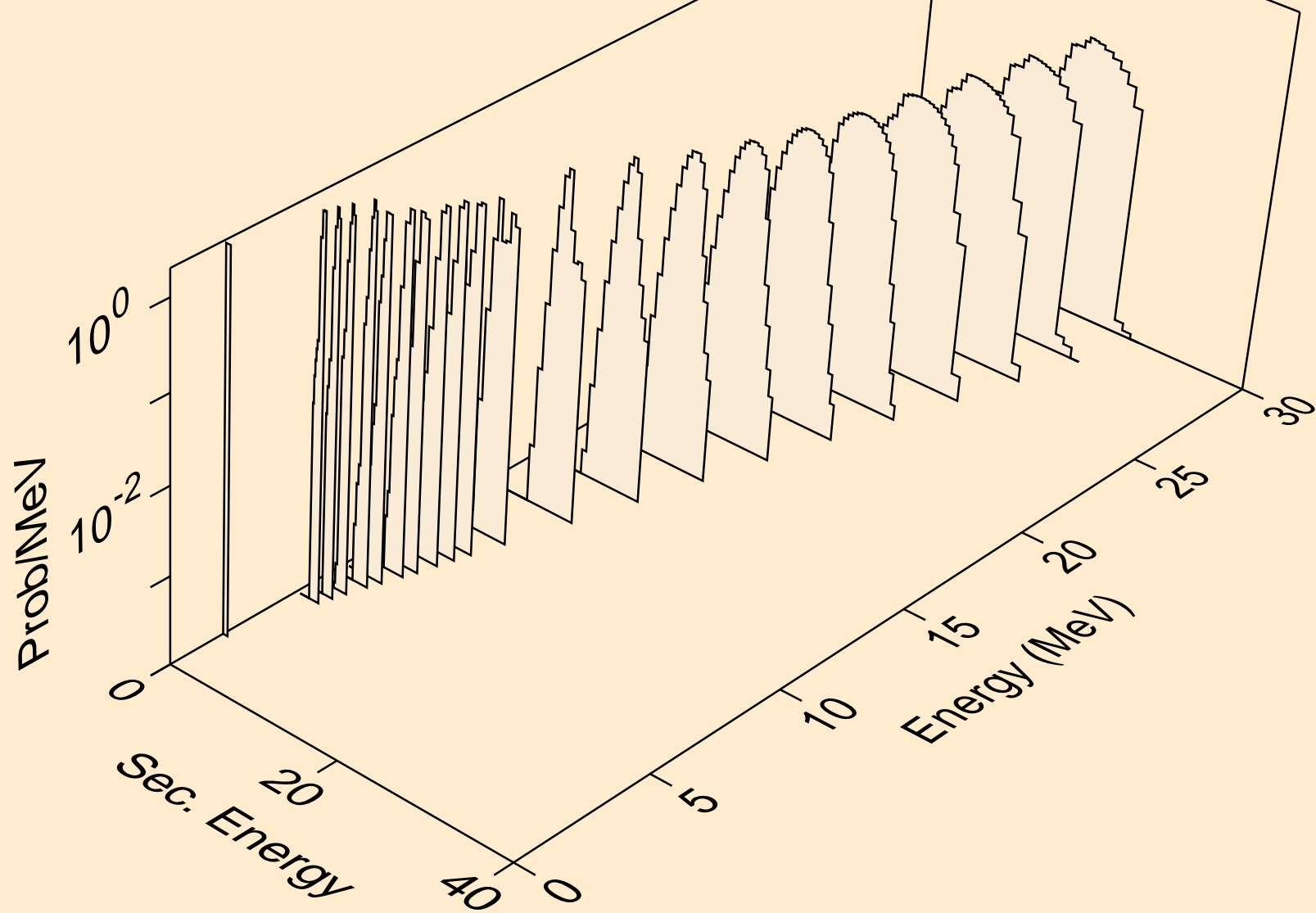

RE178 NEUTRON ACER TENDL-2024 LIBRARY; T=293.6K
tritons from (n,pt)

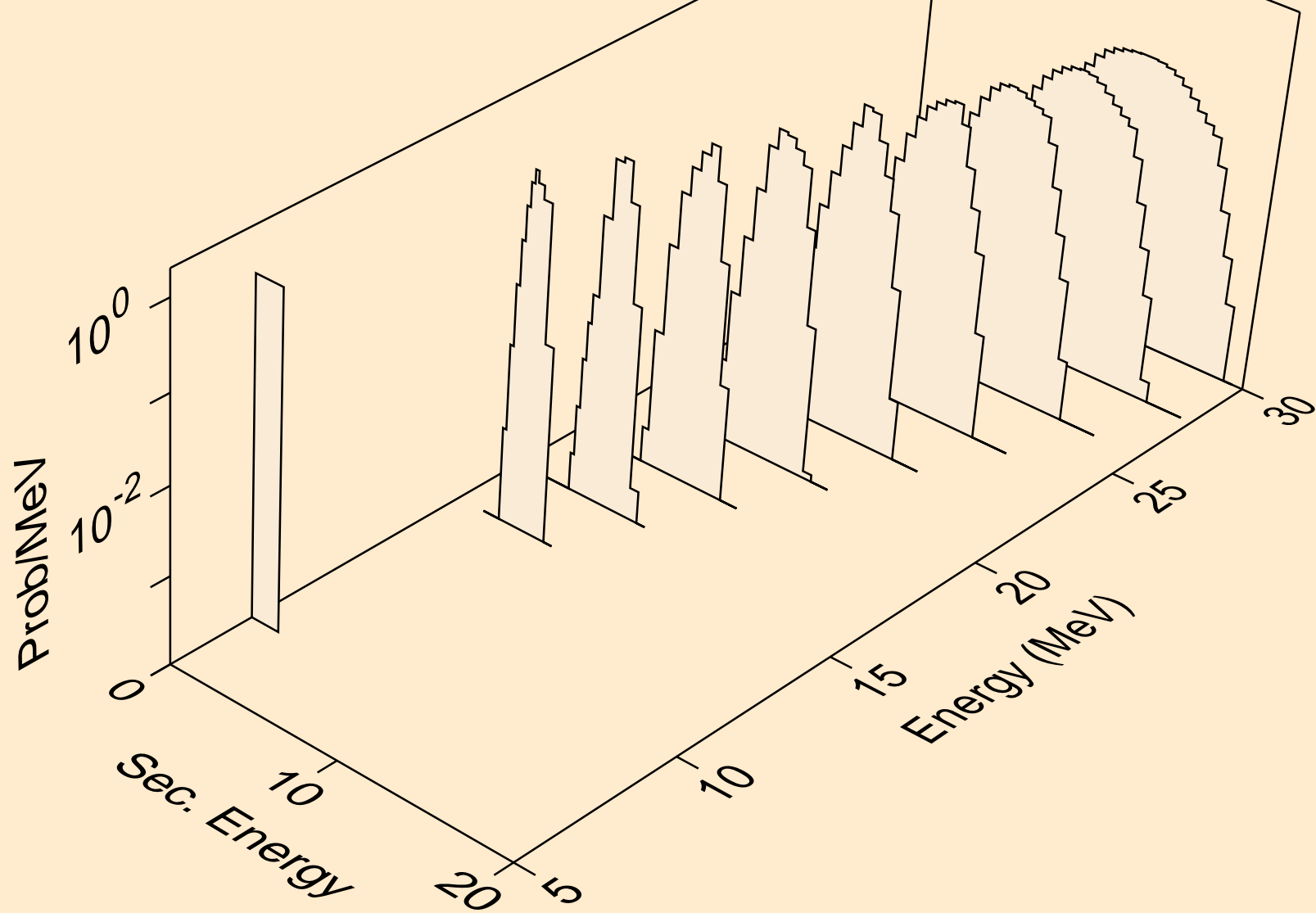

RE178 NEUTRON ACER TENDL-2024 LIBRARY; T=293.6K
he3s from (n,x)

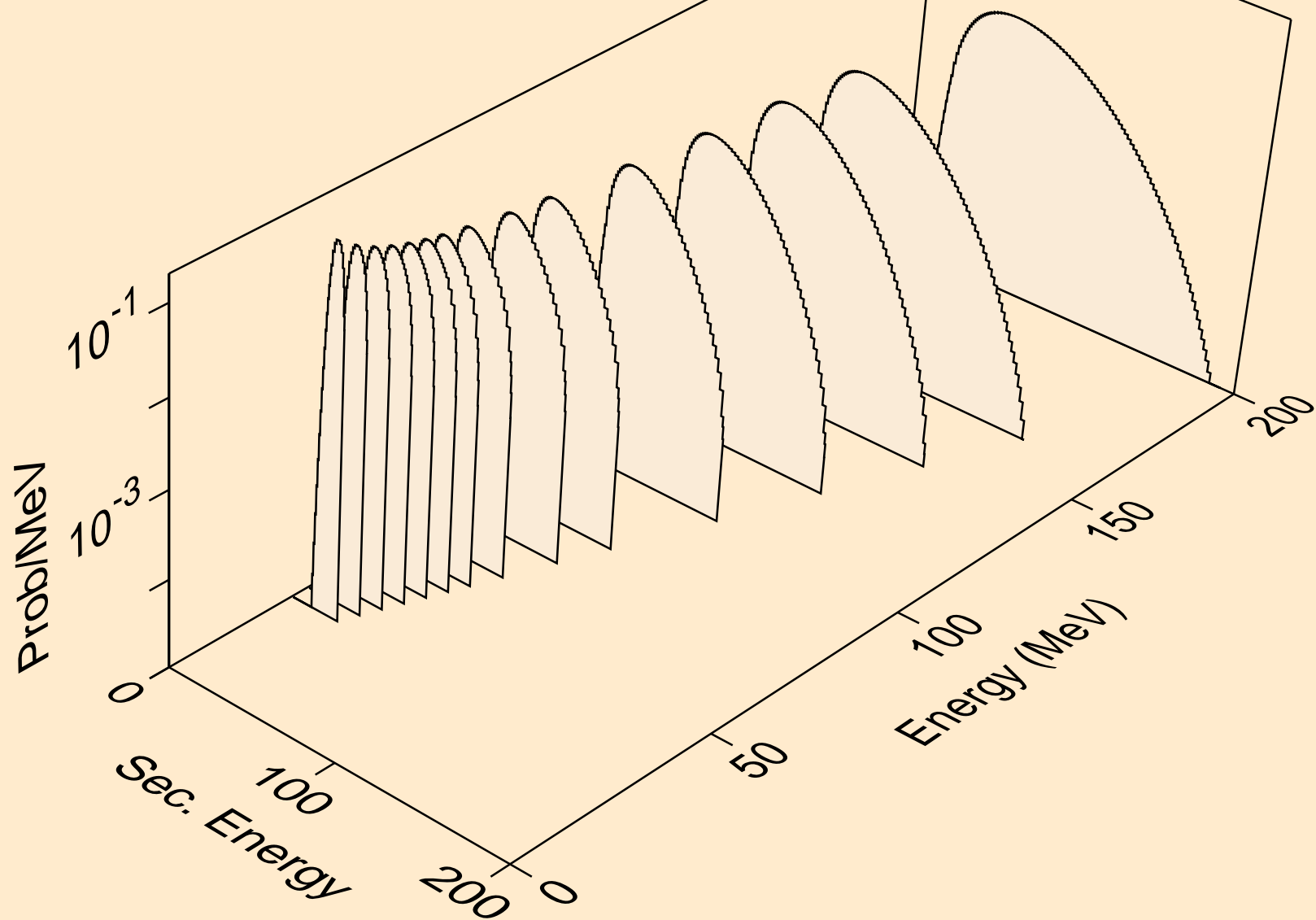

RE178 NEUTRON ACER TENDL-2024 LIBRARY; T=293.6K
he3s from (n,n*)he3

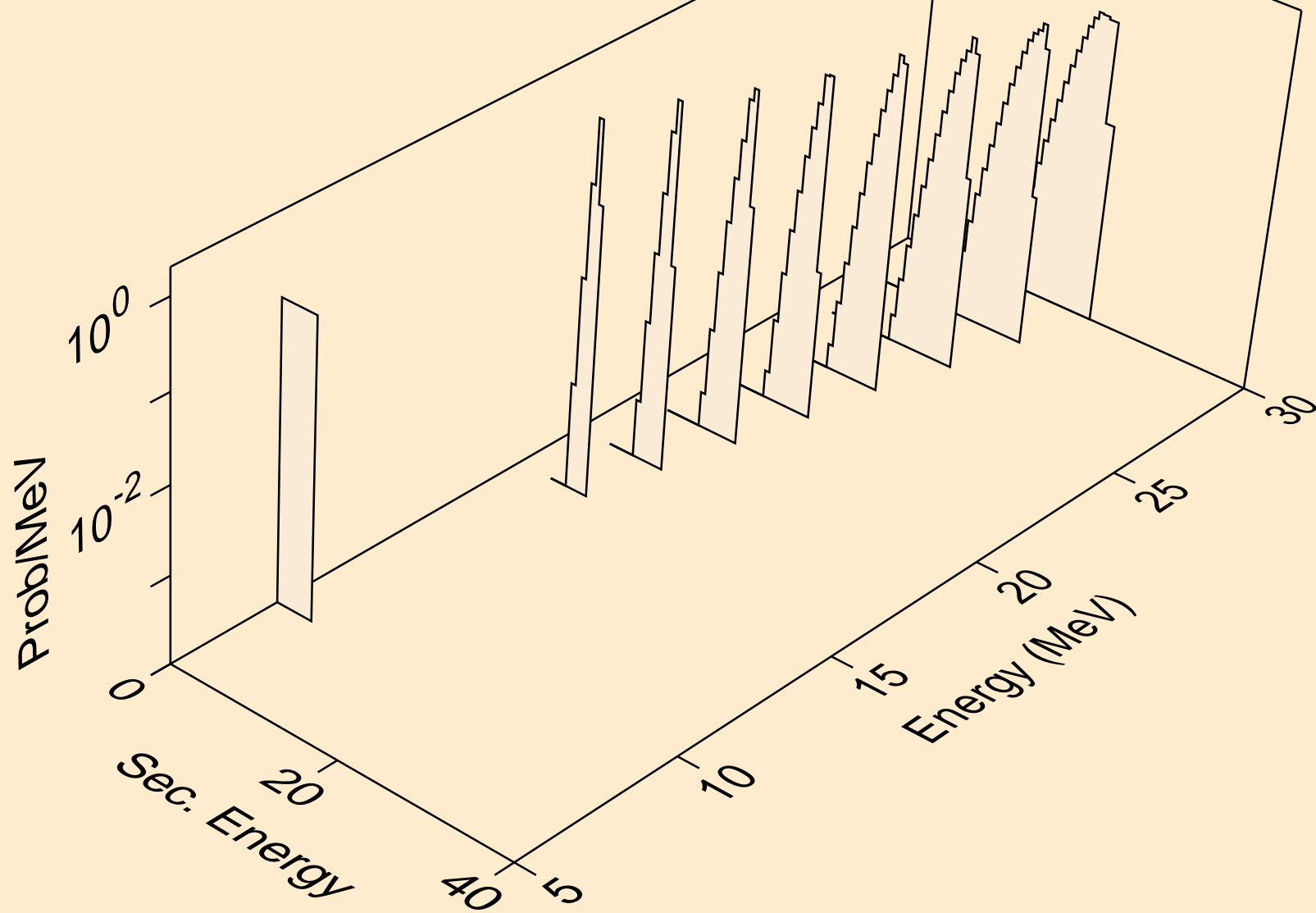

RE178 NEUTRON ACER TENDL-2024 LIBRARY; T=293.6K
he3s from (n,he3)

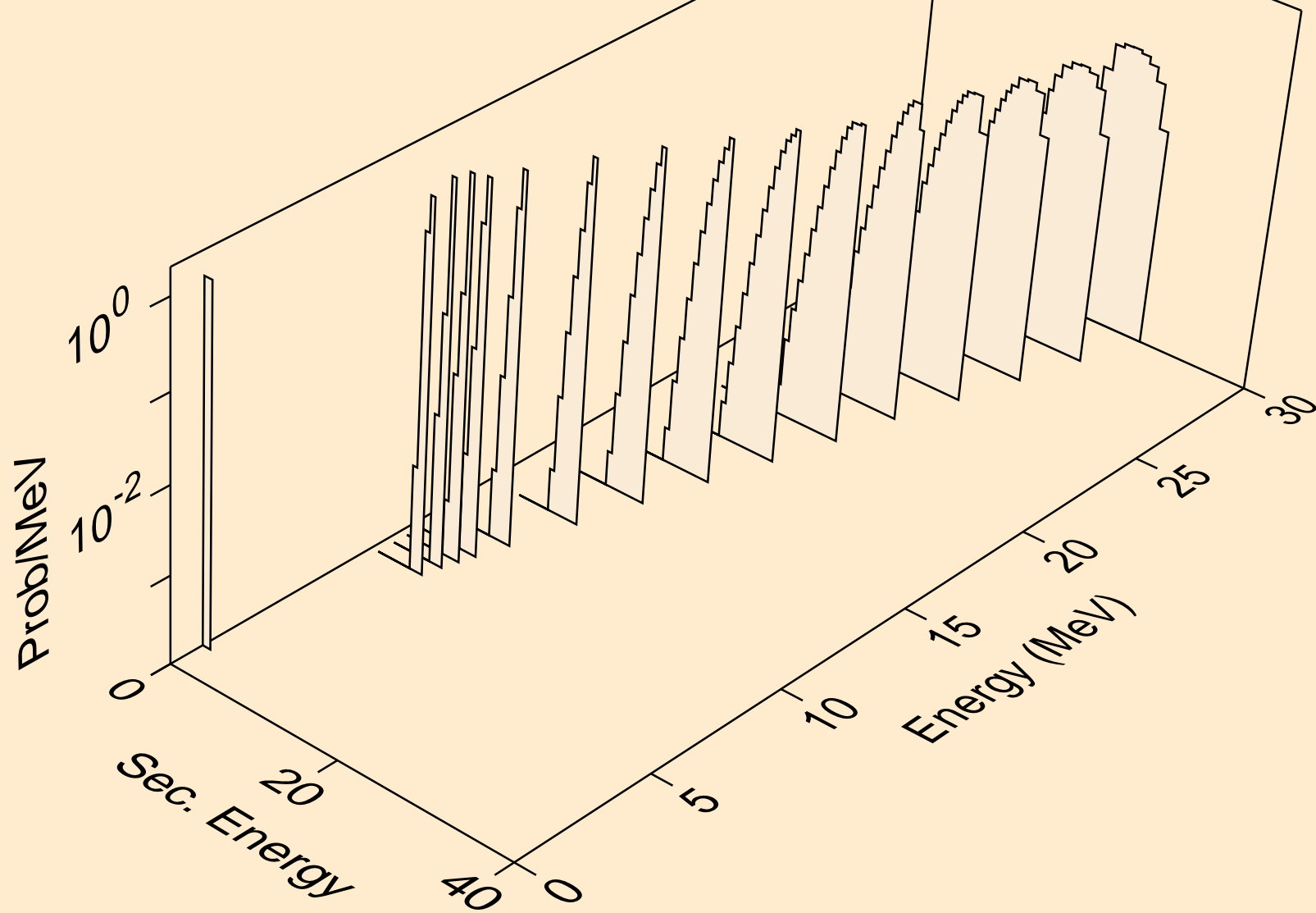

RE178 NEUTRON ACER TENDL-2024 LIBRARY; T=293.6K
alphas from (n,x)

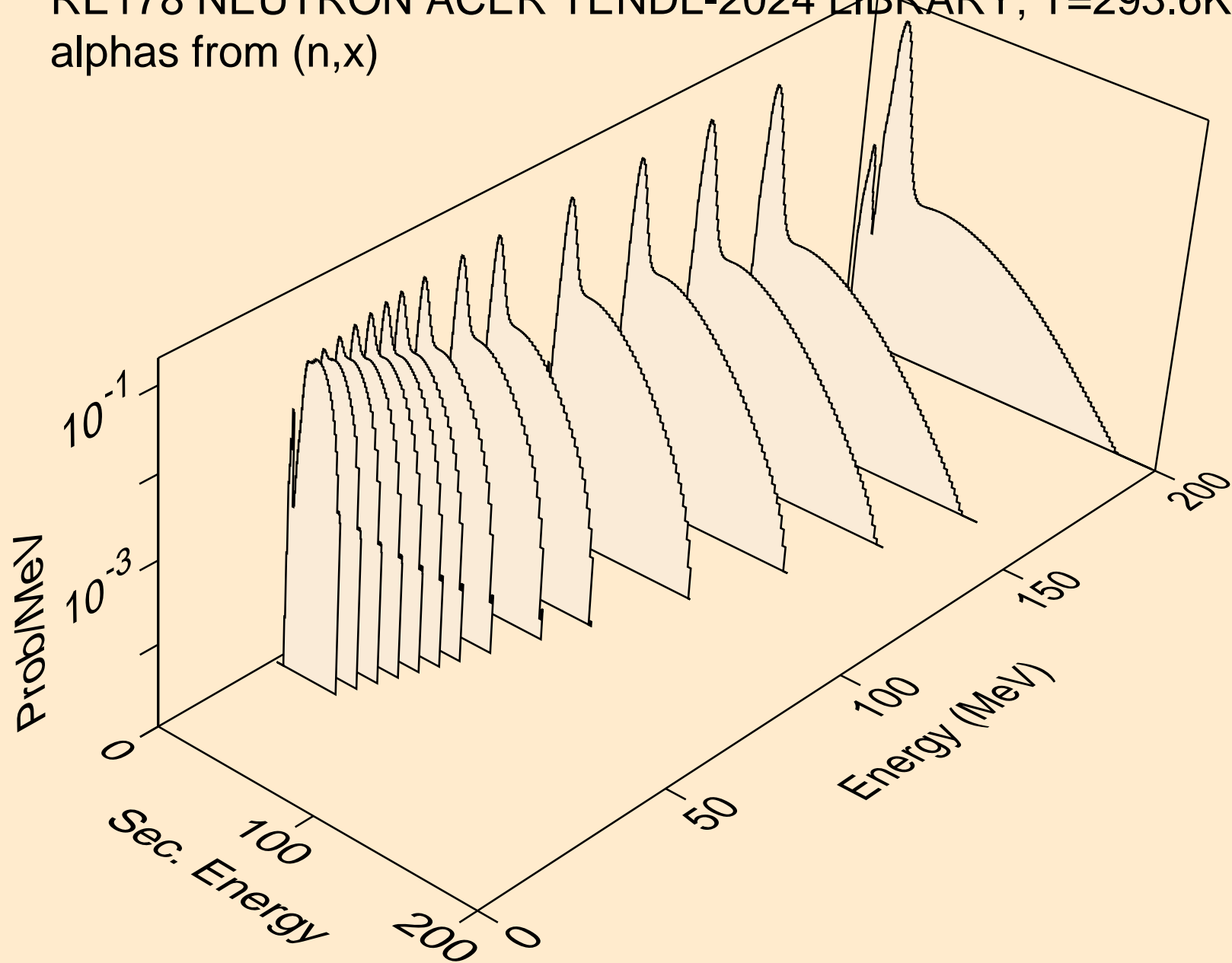

RE178 NEUTRON ACER TENDL-2024 LIBRARY; T=293.6K
alphas from (n,n*)a

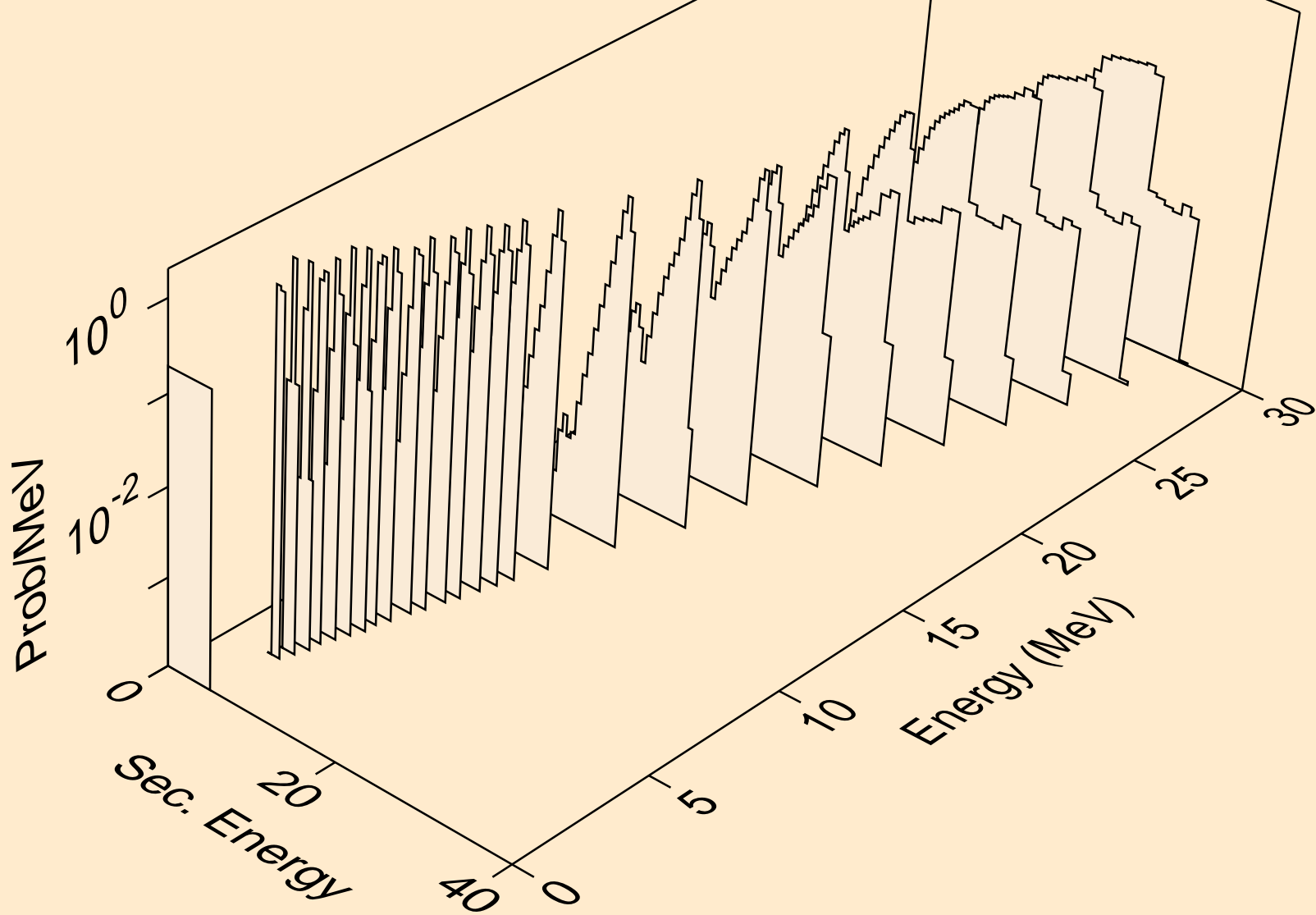

RE178 NEUTRON ACER TENDL-2024 LIBRARY; T=293.6K
alphas from (n,2n)a

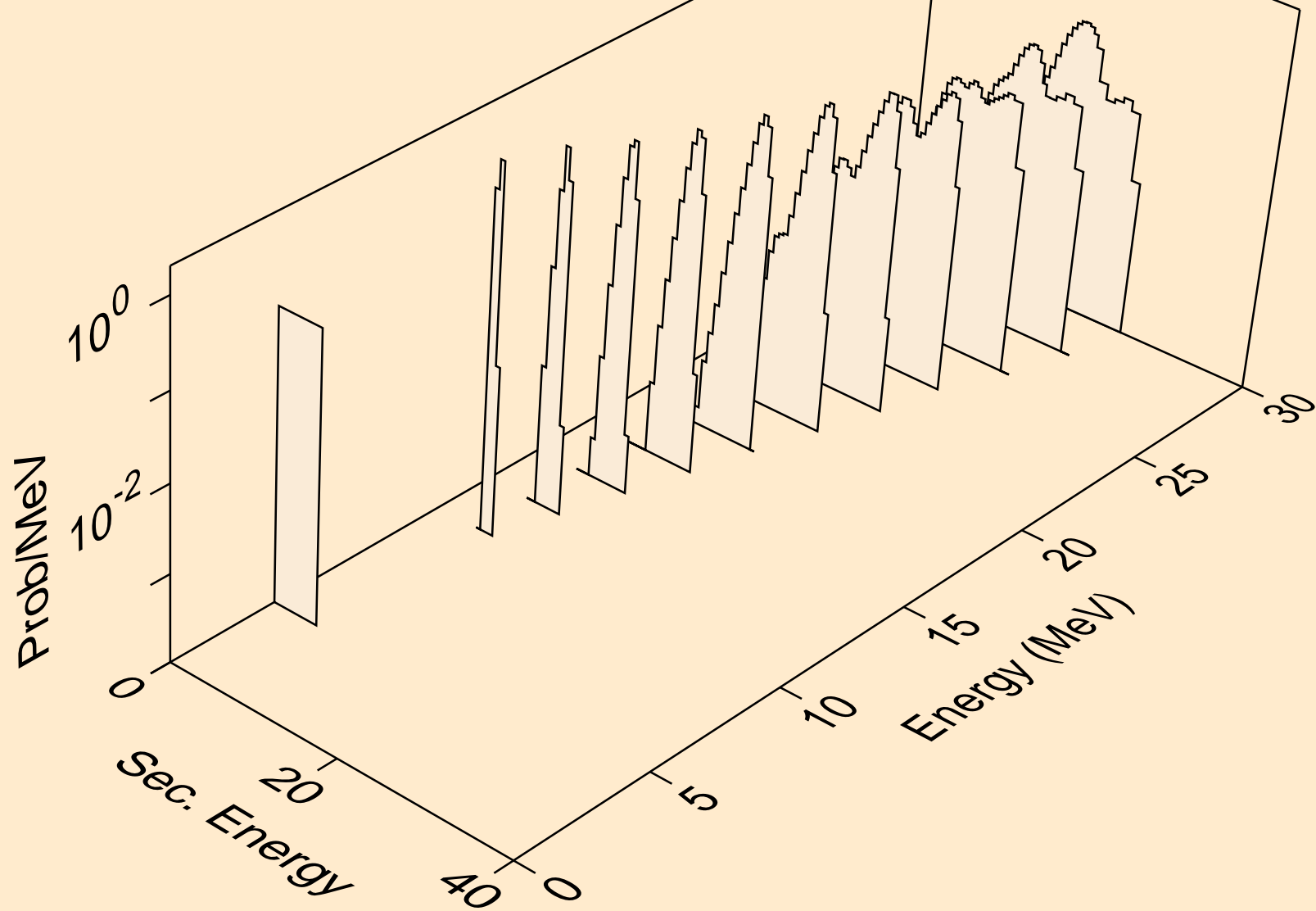

RE178 NEUTRON ACER TENDL-2024 LIBRARY; T=293.6K
alphas from (n,3n)a

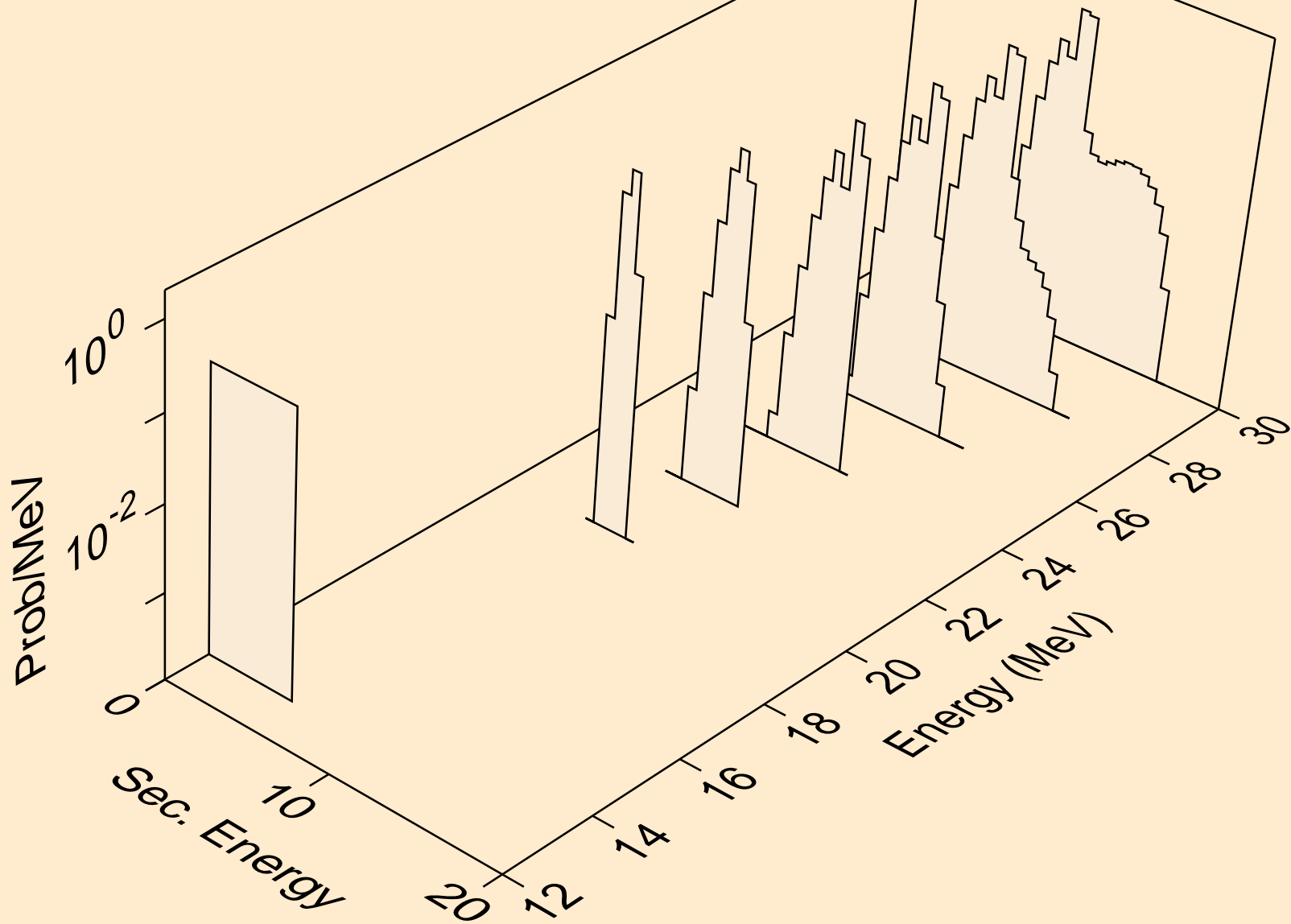

RE178 NEUTRON ACER TENDL-2024 LIBRARY; T=293.6K
alphas from (n,n*)2a

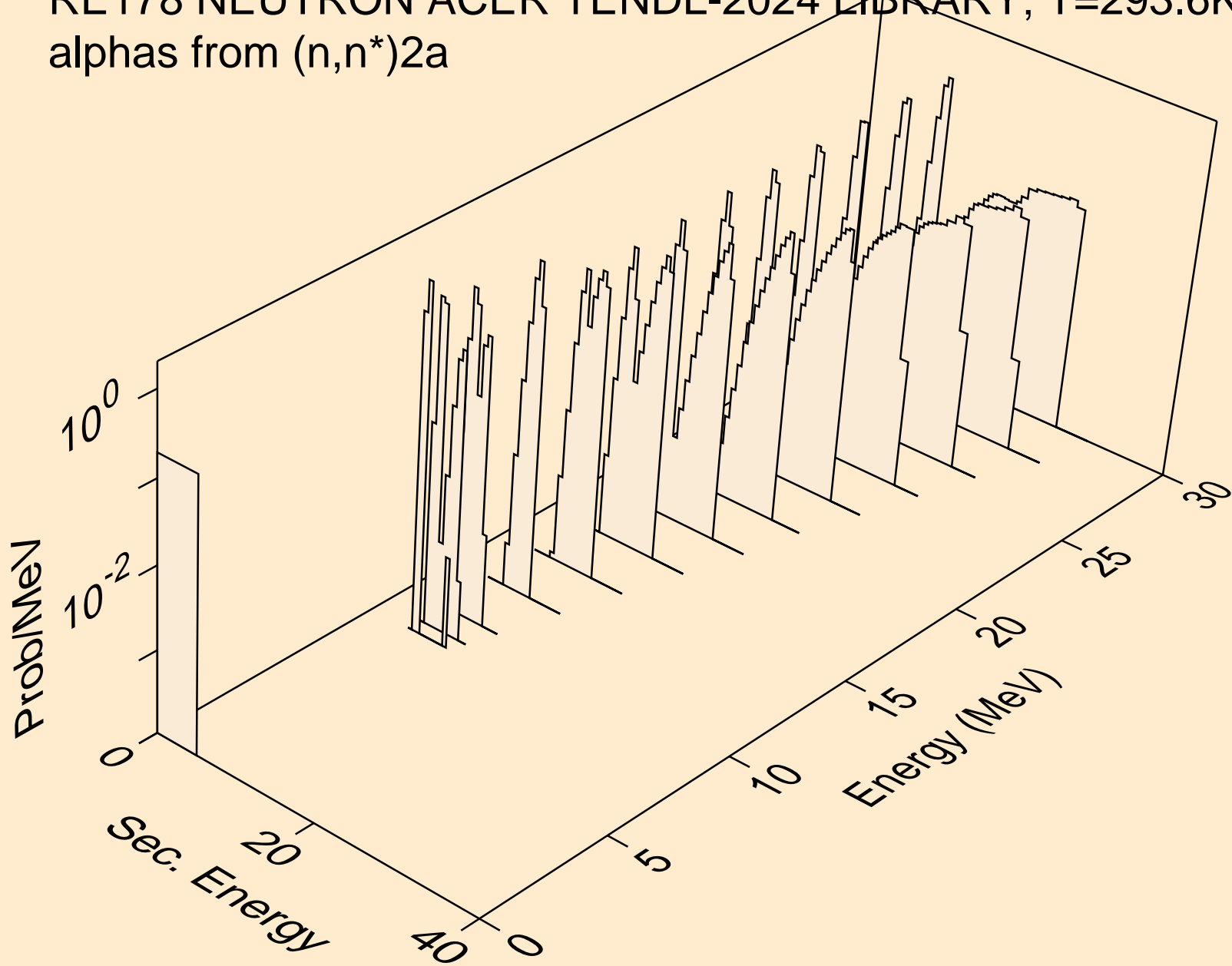

RE178 NEUTRON ACER TENDL-2024 LIBRARY; T=293.6K
alphas from (n,2n)2a

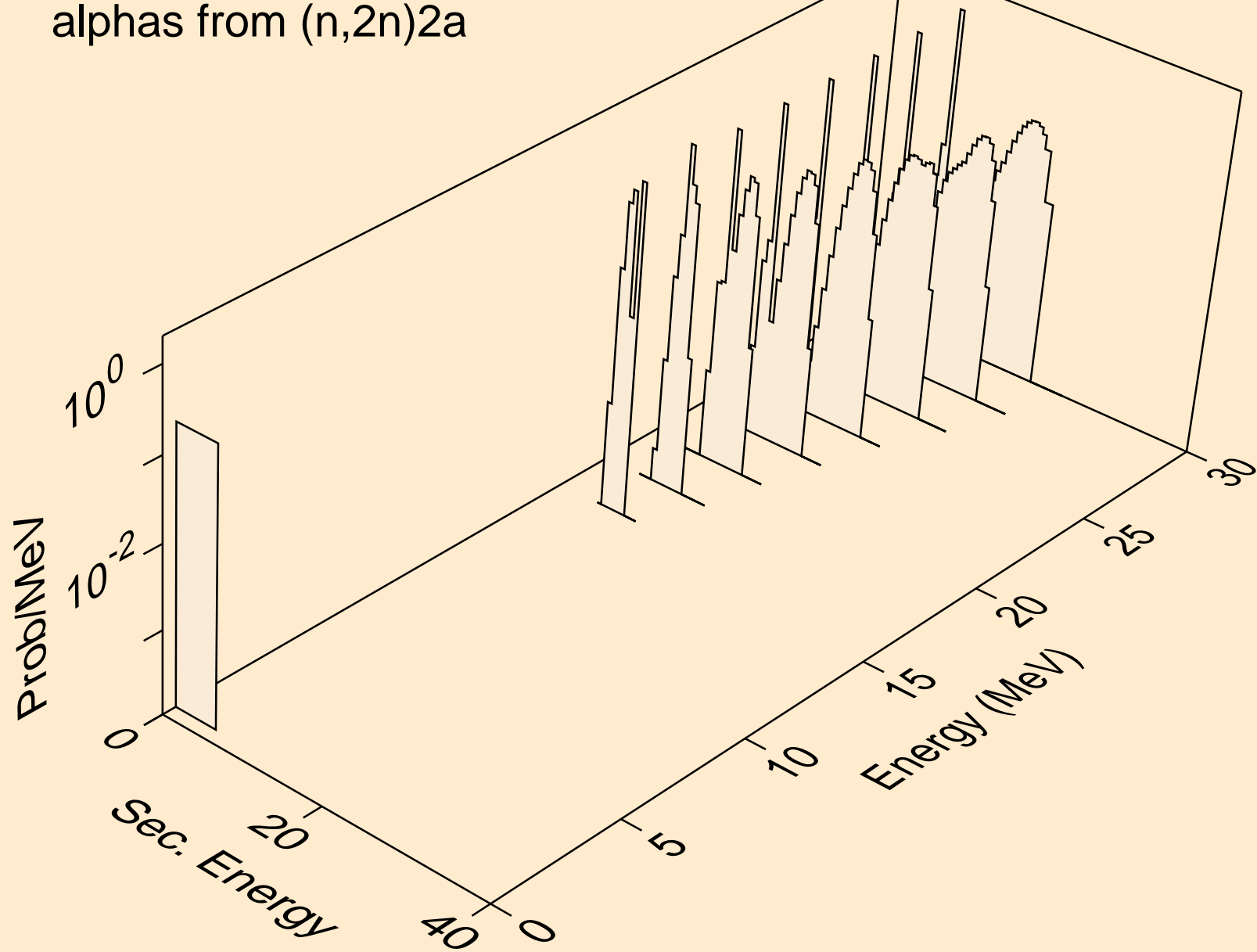

RE178 NEUTRON ACER TENDL-2024 LIBRARY; T=293.6K
alphas from (n,npa)

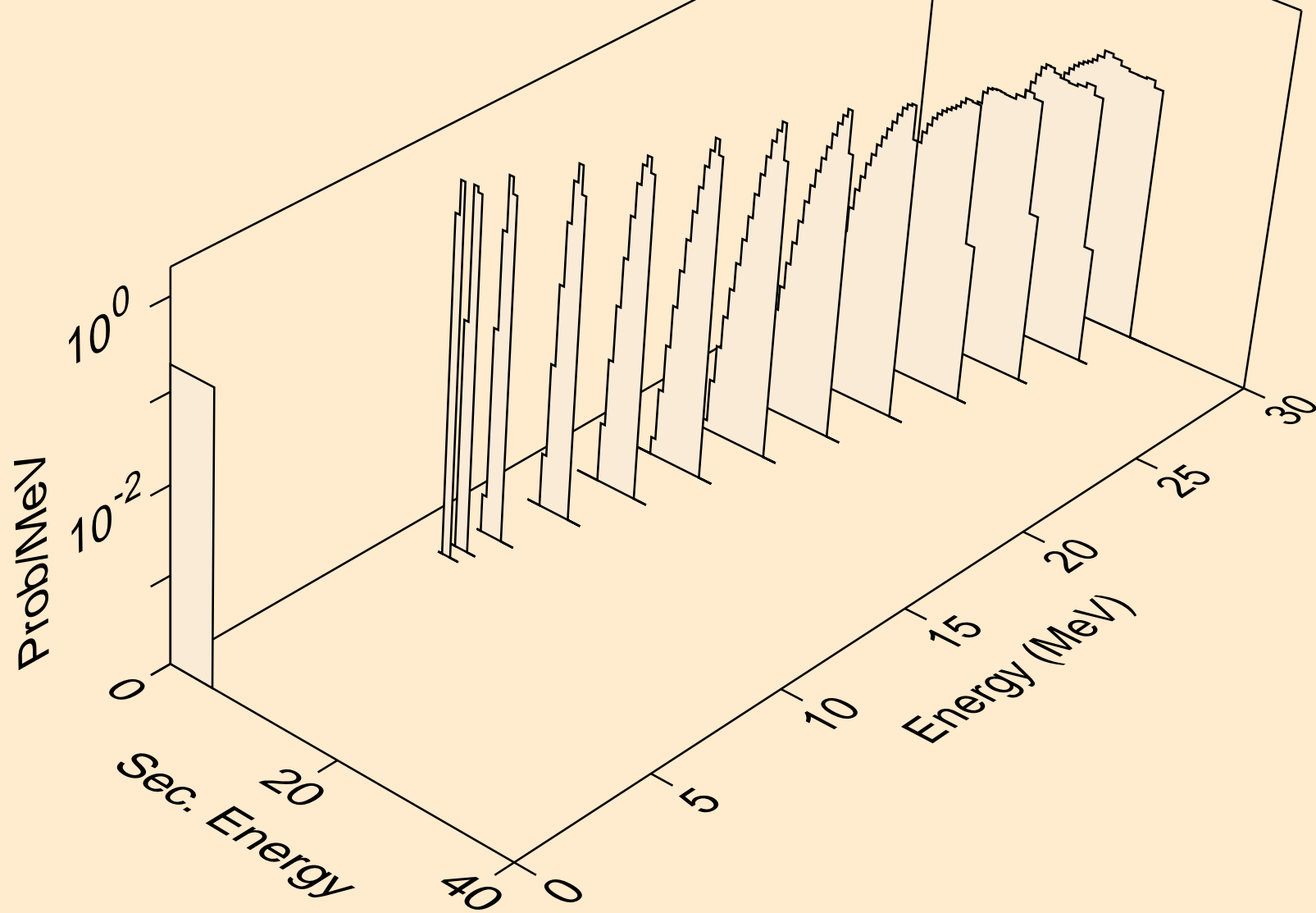

RE178 NEUTRON ACER TENDL-2024 LIBRARY; T=293.6K
alphas from (n,a)

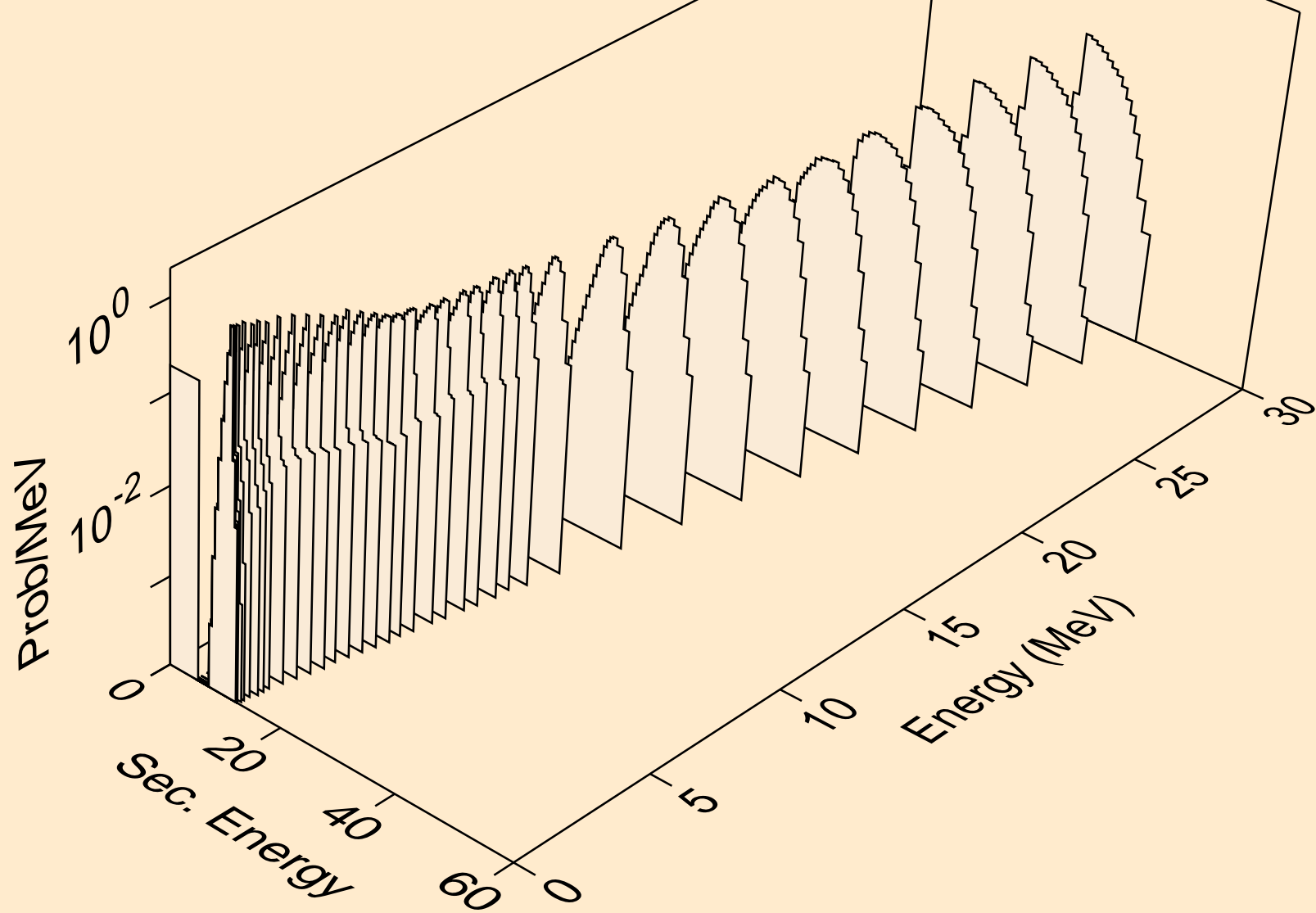

RE178 NEUTRON ACER TENDL-2024 LIBRARY; T=293.6K
alphas from (n,2a)

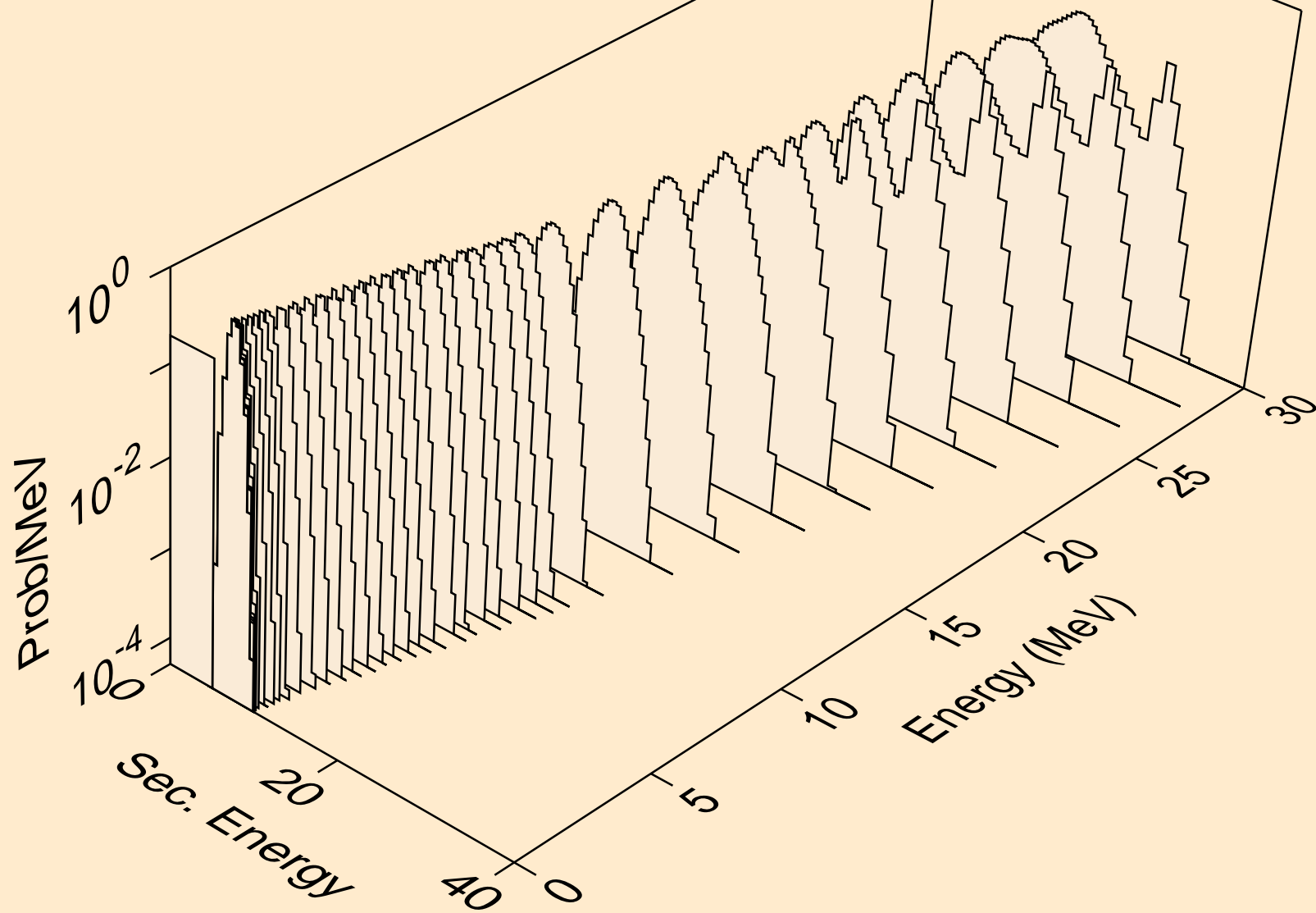

RE178 NEUTRON ACER TENDL-2024 LIBRARY; T=293.6K
alphas from (n,pa)

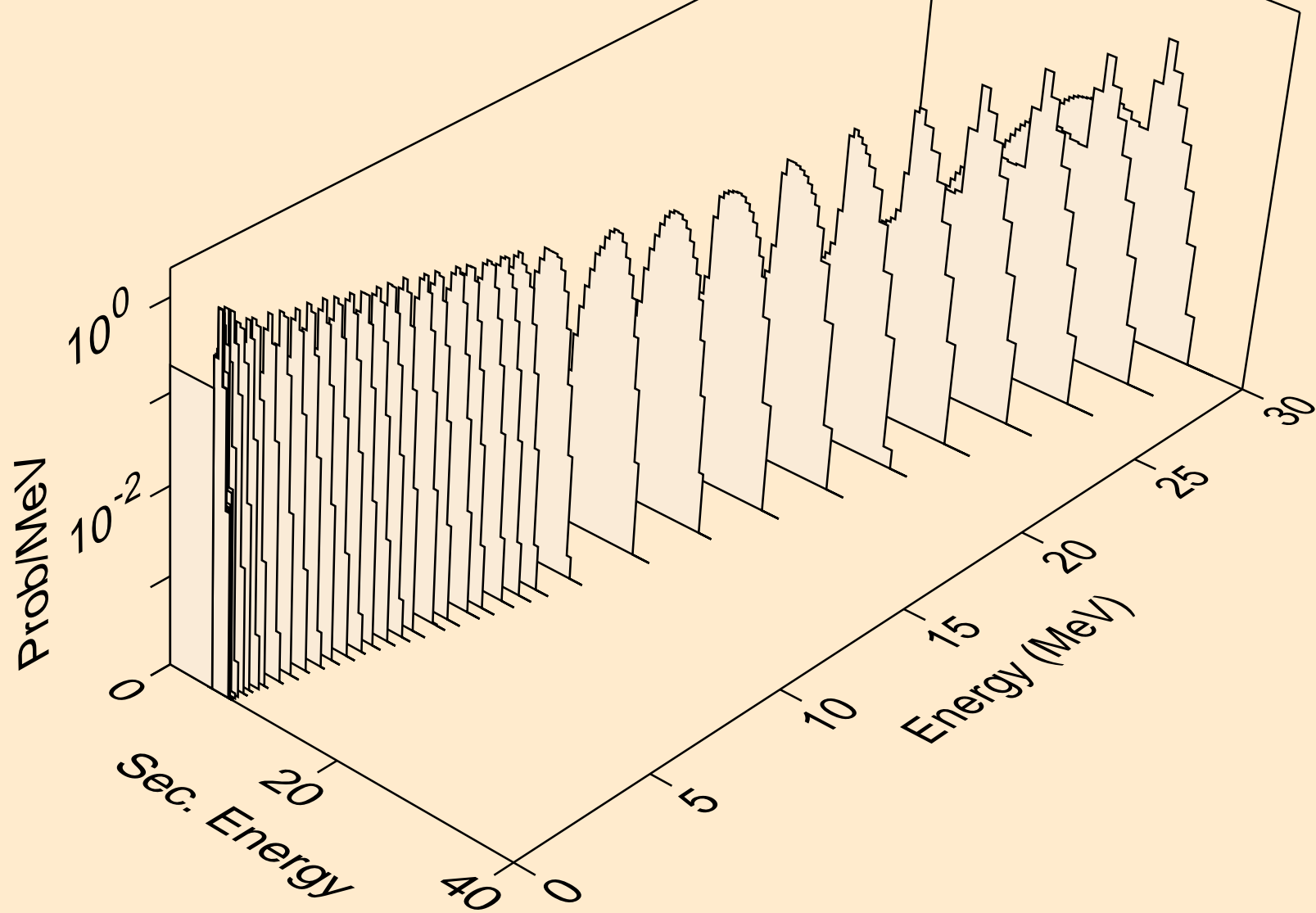

RE178 NEUTRON ACER TENDL-2024 LIBRARY; T=293.6K
alphas from (n,da)

