

RU088 NEUTRON ACER TENDL-2024 LIBRARY; T=293.6K

Principal cross sections

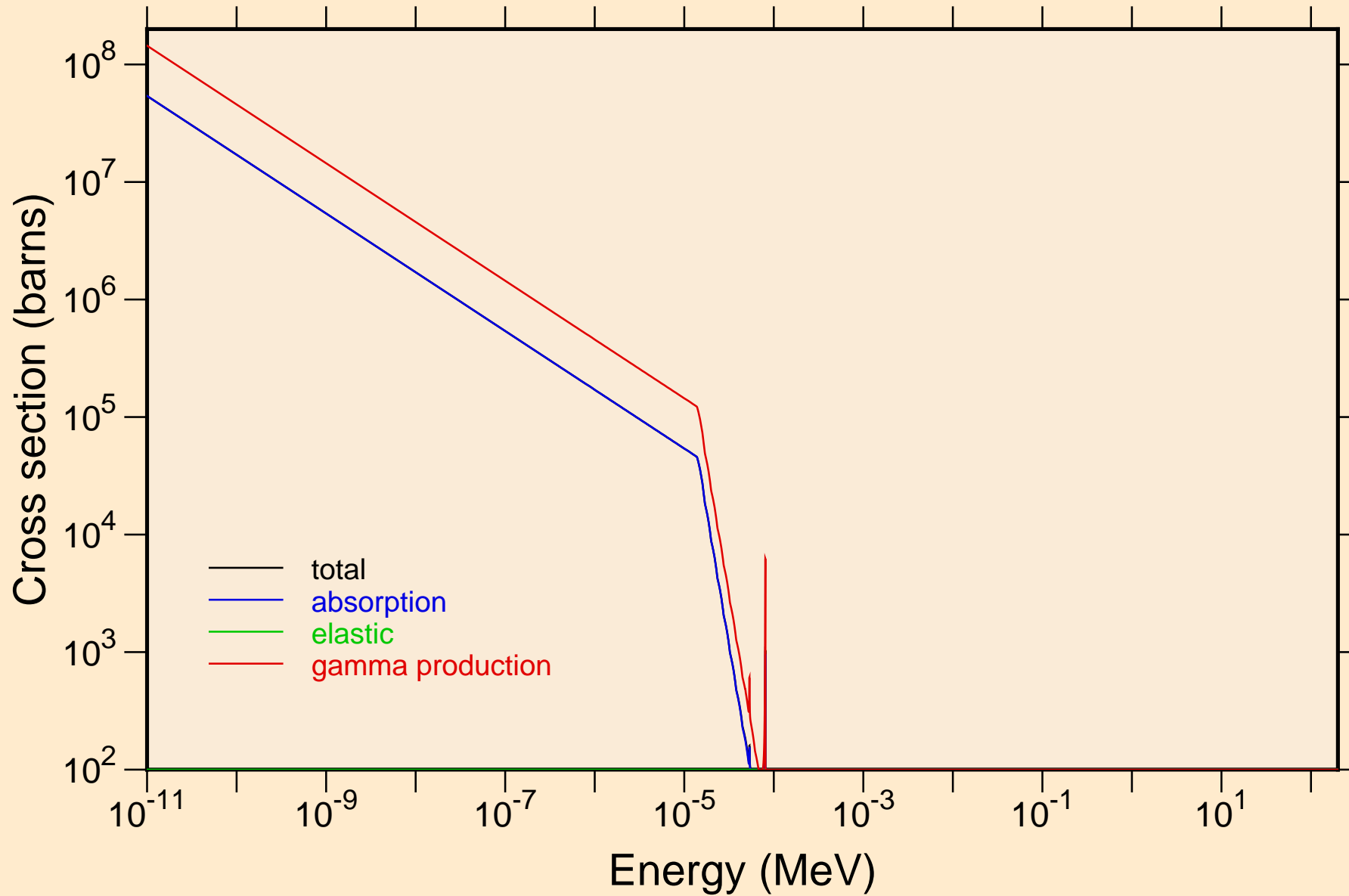

RU088 NEUTRON ACER TENDL-2024 LIBRARY; T=293.6K
Heating

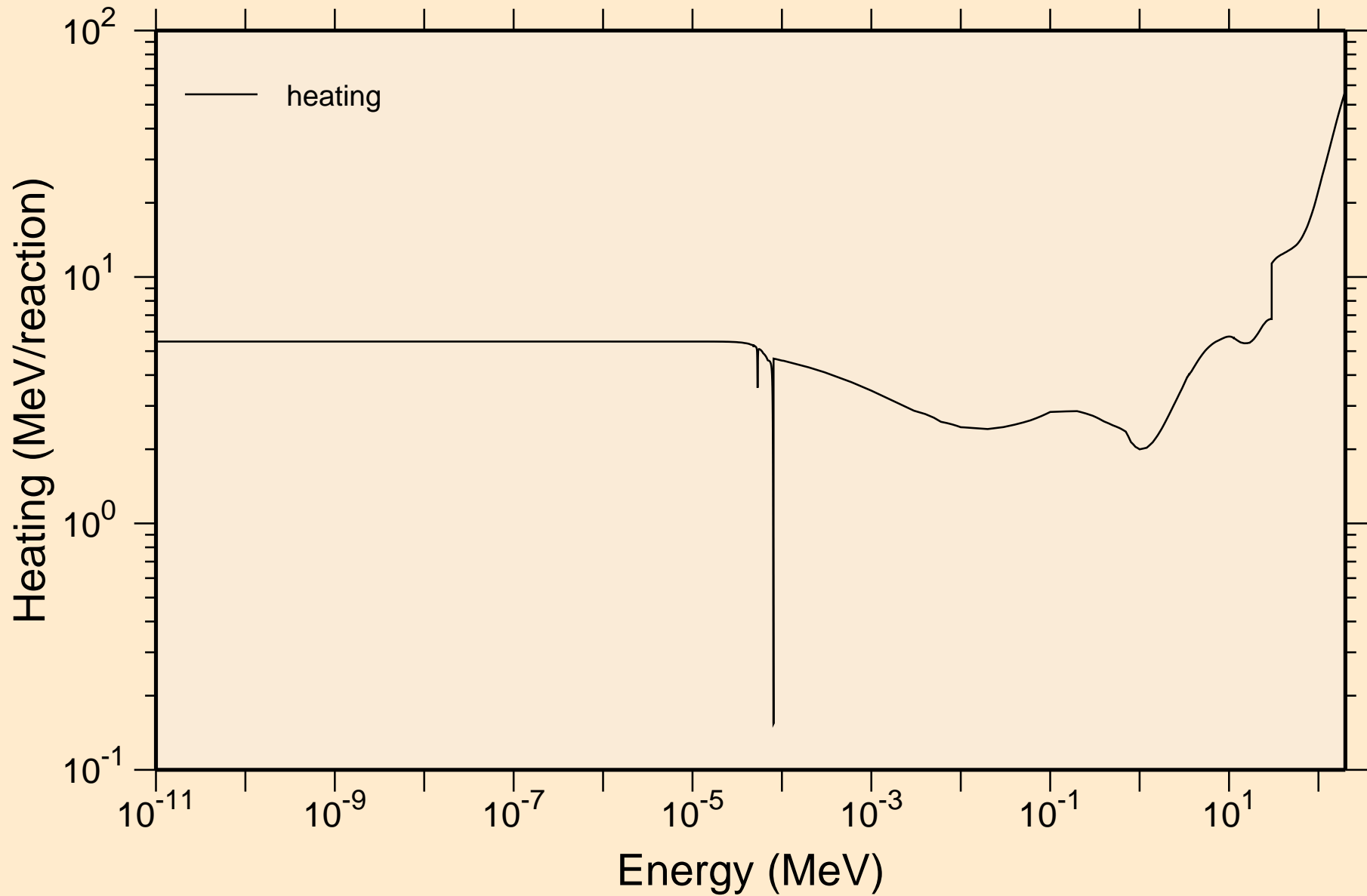

RU088 NEUTRON ACER TENDL-2024 LIBRARY; T=293.6K
Damage

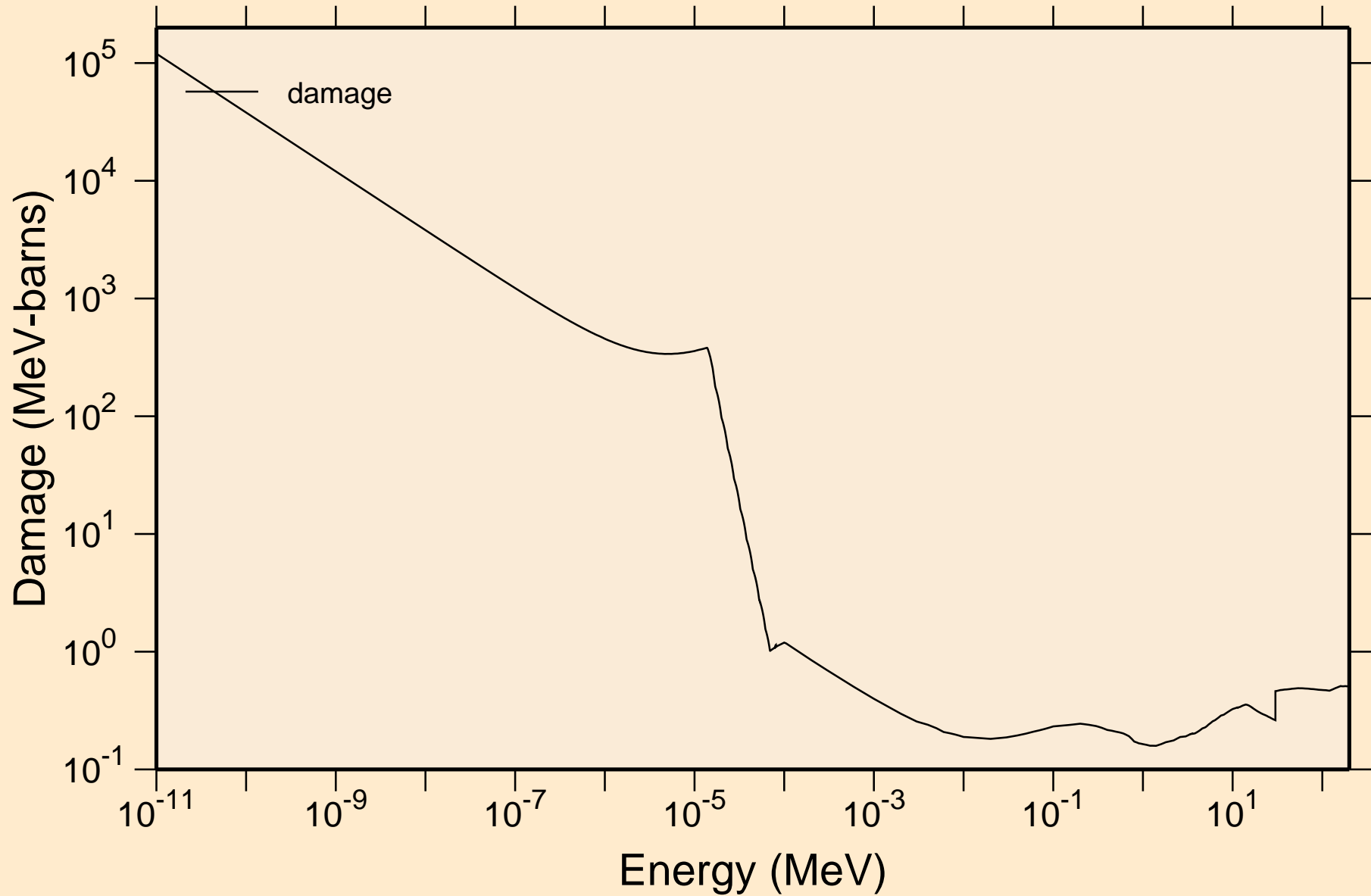

RU088 NEUTRON ACER TENDL-2024 LIBRARY; T=293.6K
Non-threshold reactions

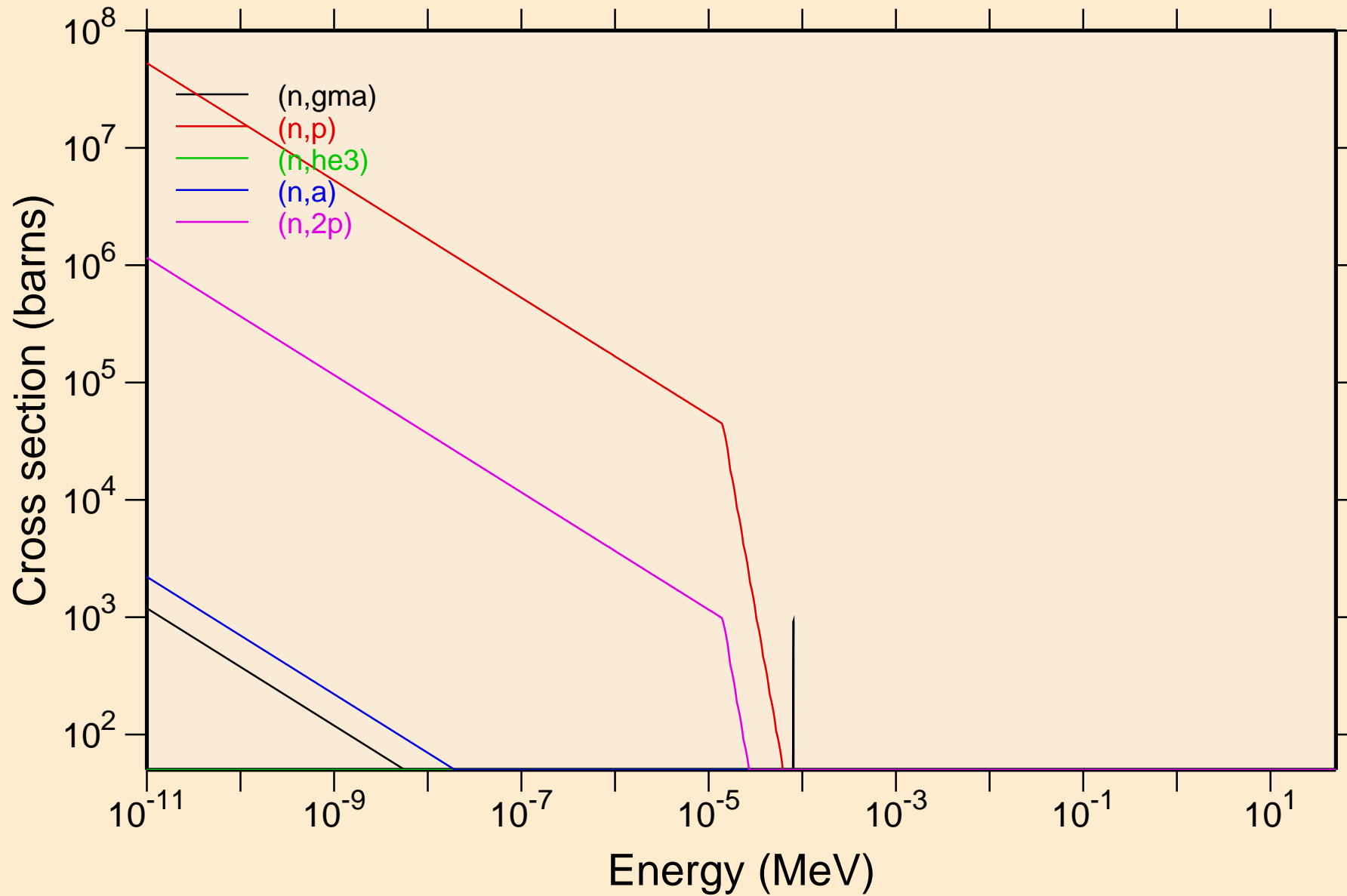

RU088 NEUTRON ACER TENDL-2024 LIBRARY; T=293.6K
Non-threshold reactions

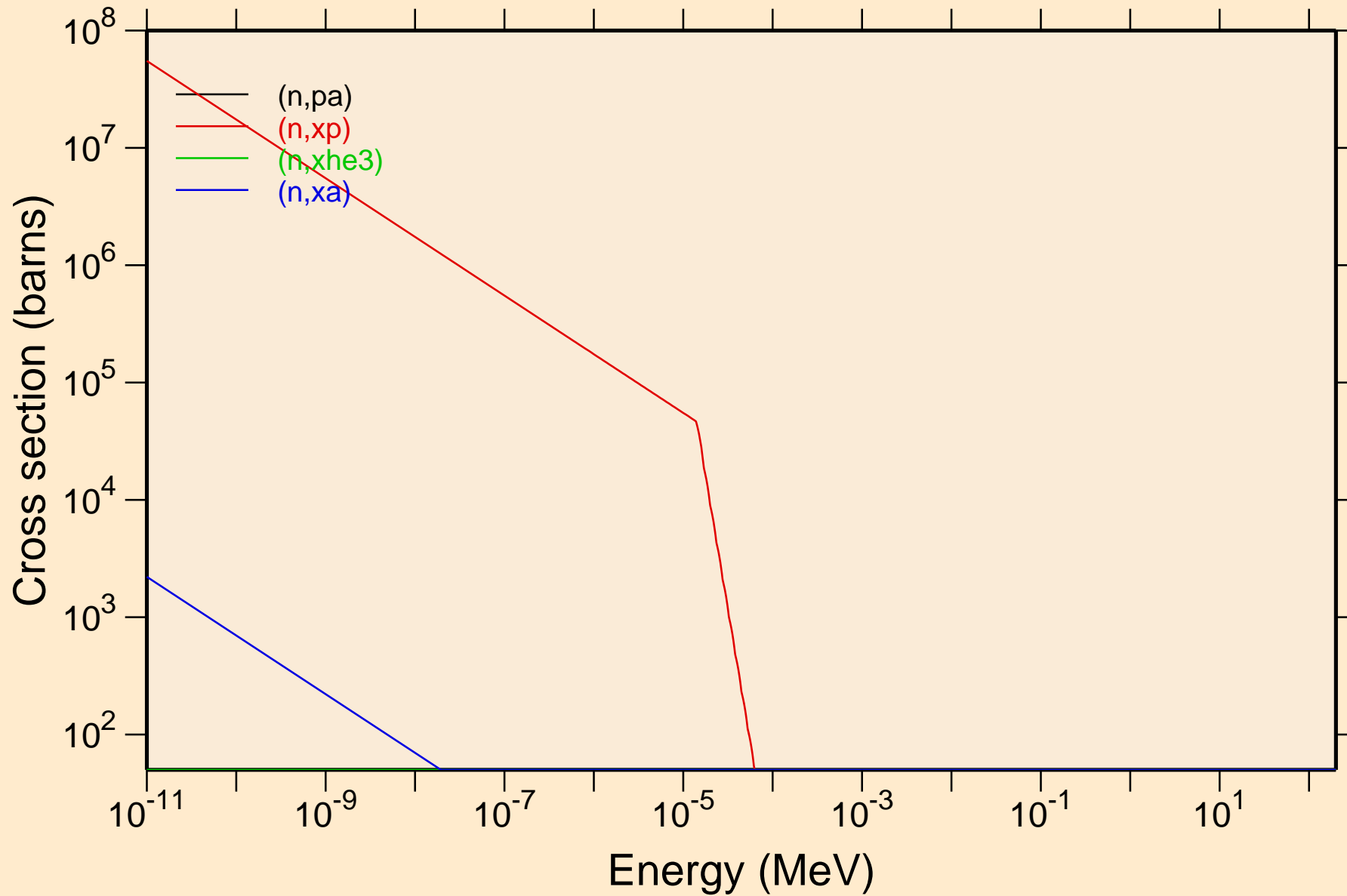

RU088 NEUTRON ACER TENDL-2024 LIBRARY; T=293.6K

Principal cross sections

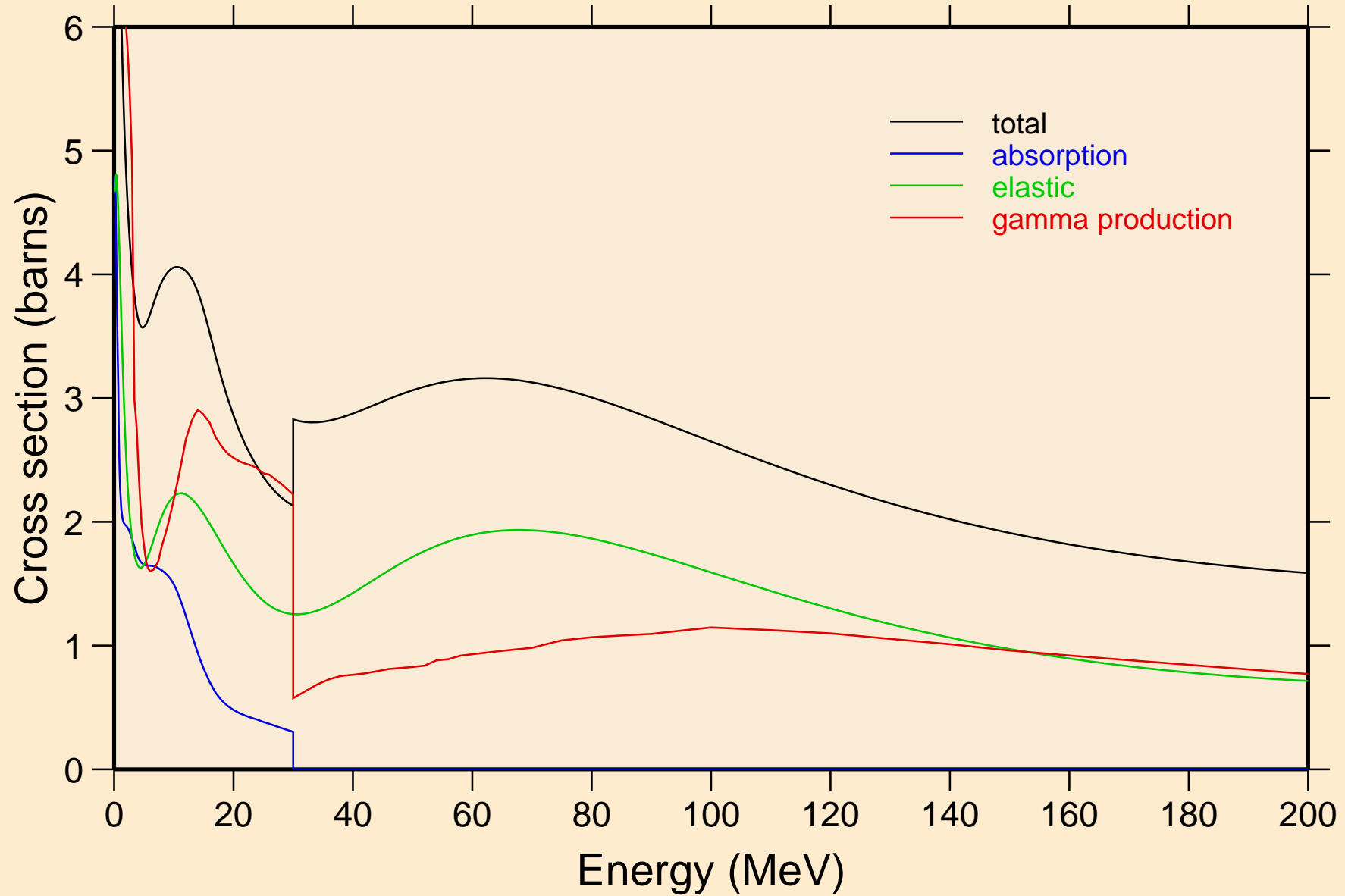

RU088 NEUTRON ACER TENDL-2024 LIBRARY; T=293.6K
Heating

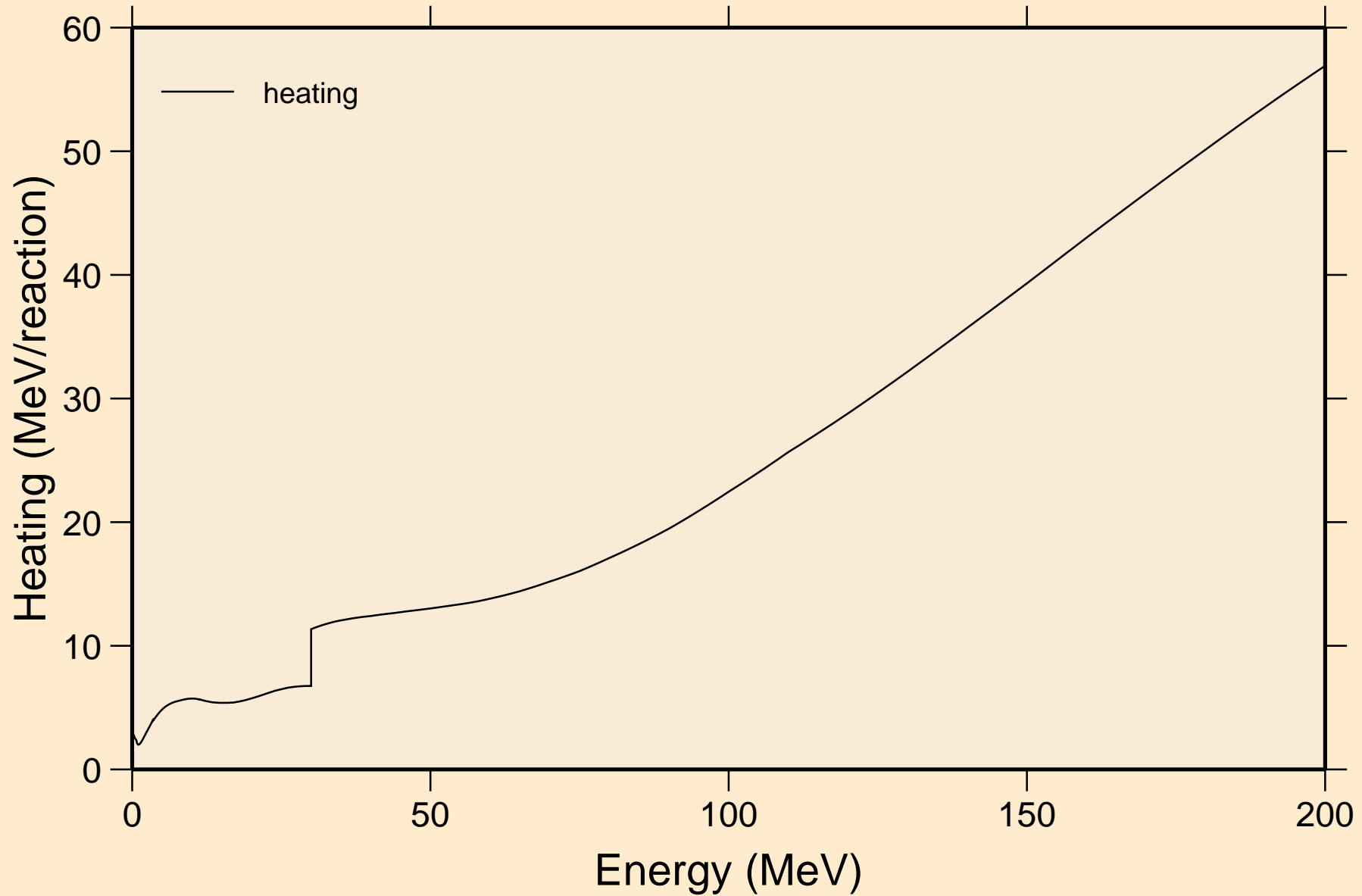

RU088 NEUTRON ACER TENDL-2024 LIBRARY; T=293.6K
Damage

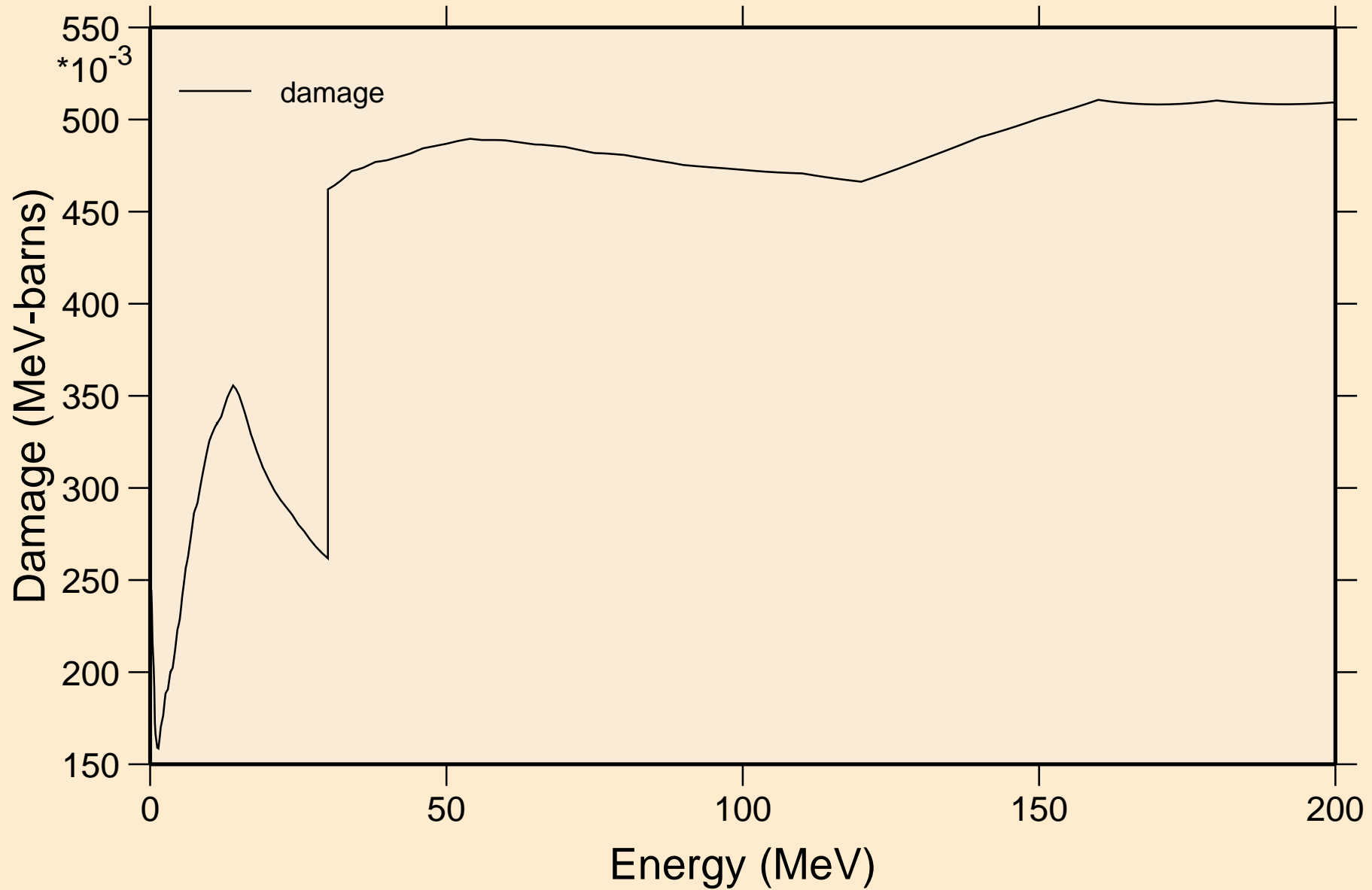

RU088 NEUTRON ACER TENDL-2024 LIBRARY; T=293.6K
Non-threshold reactions

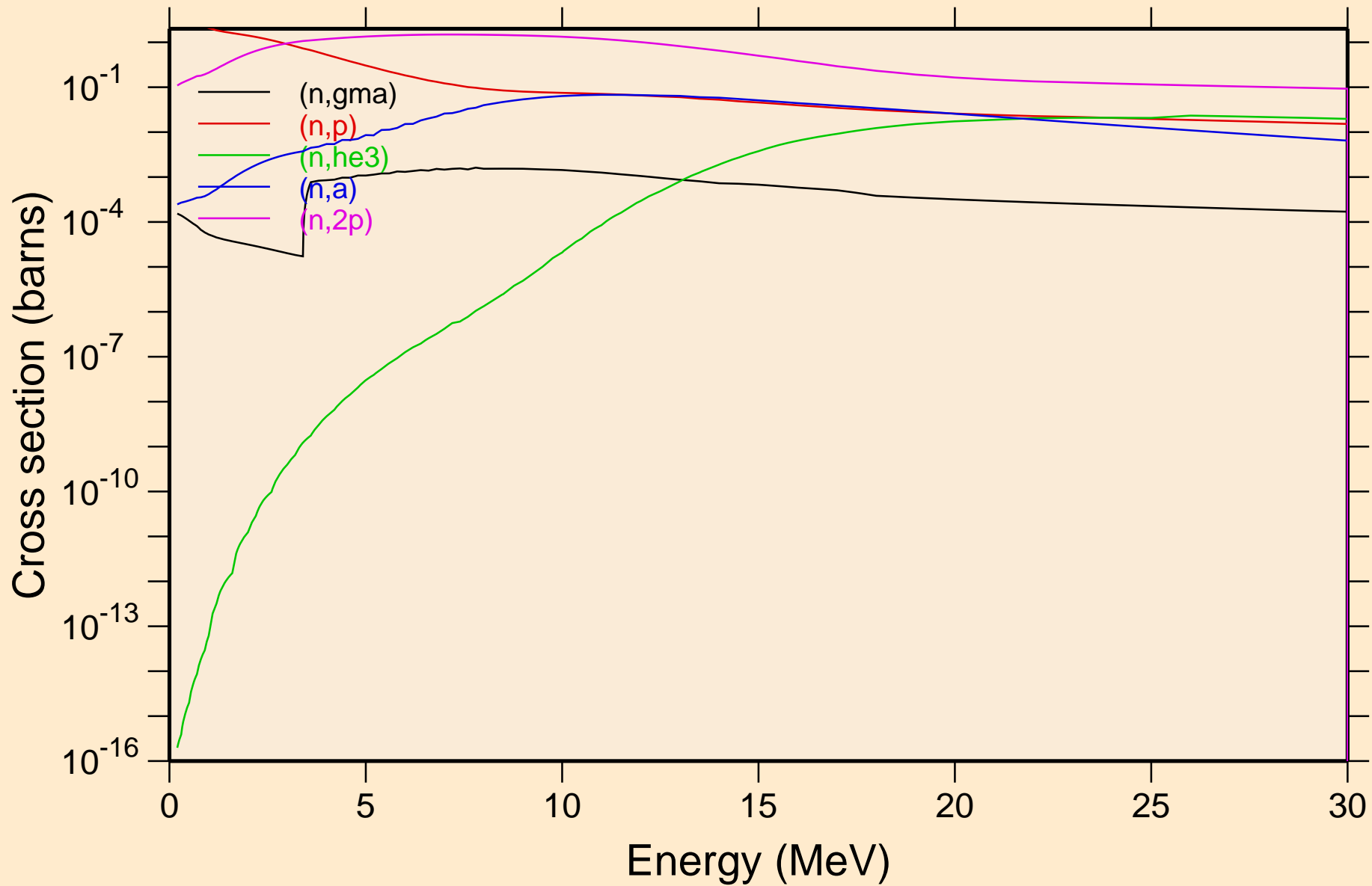

RU088 NEUTRON ACER TENDL-2024 LIBRARY; T=293.6K
Non-threshold reactions

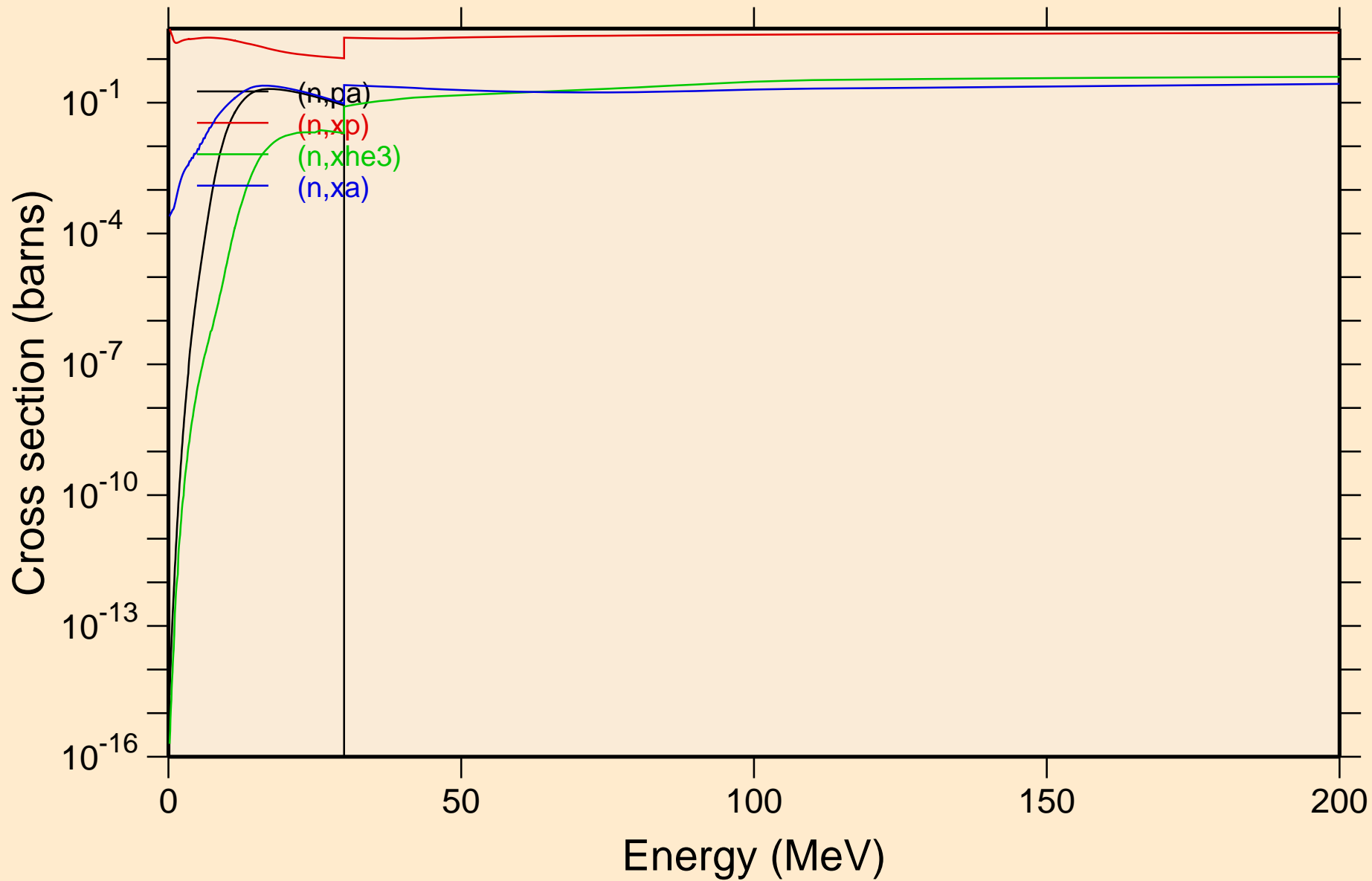

RU088 NEUTRON ACER TENDL-2024 LIBRARY; T=293.6K
Inelastic levels

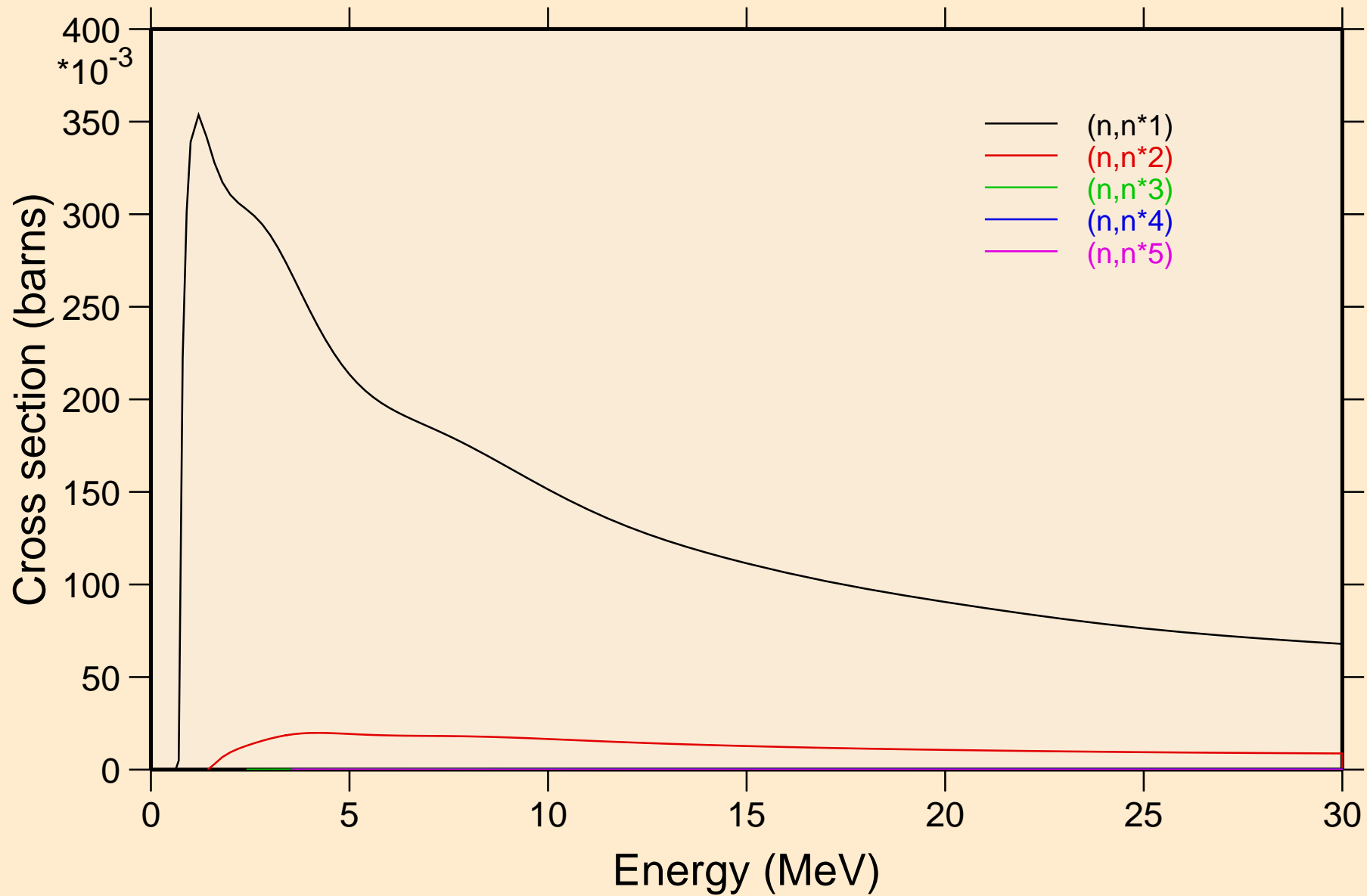

RU088 NEUTRON ACER TENDL-2024 LIBRARY; T=293.6K
Inelastic levels

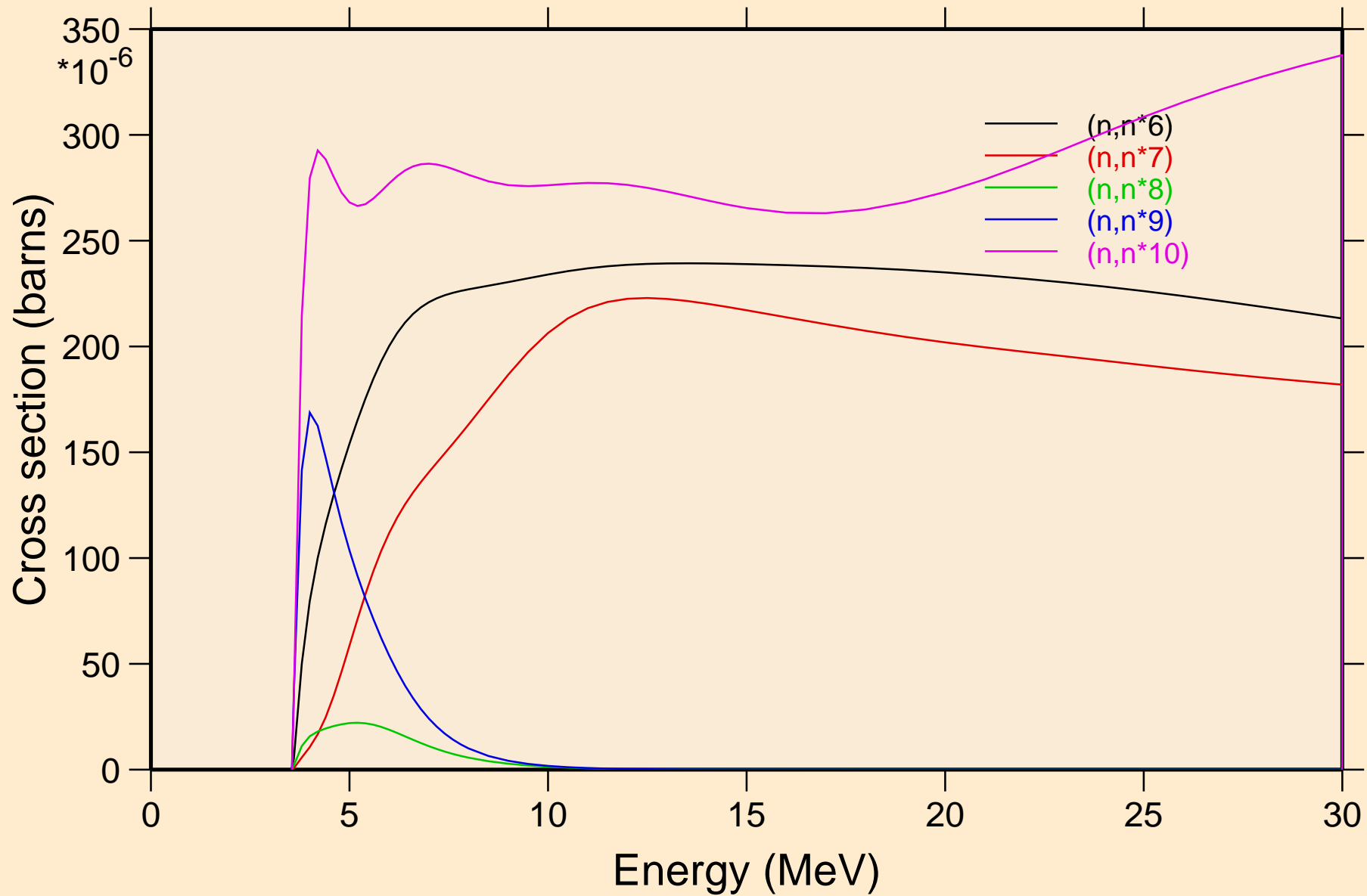

RU088 NEUTRON ACER TENDL-2024 LIBRARY; T=293.6K
Inelastic levels

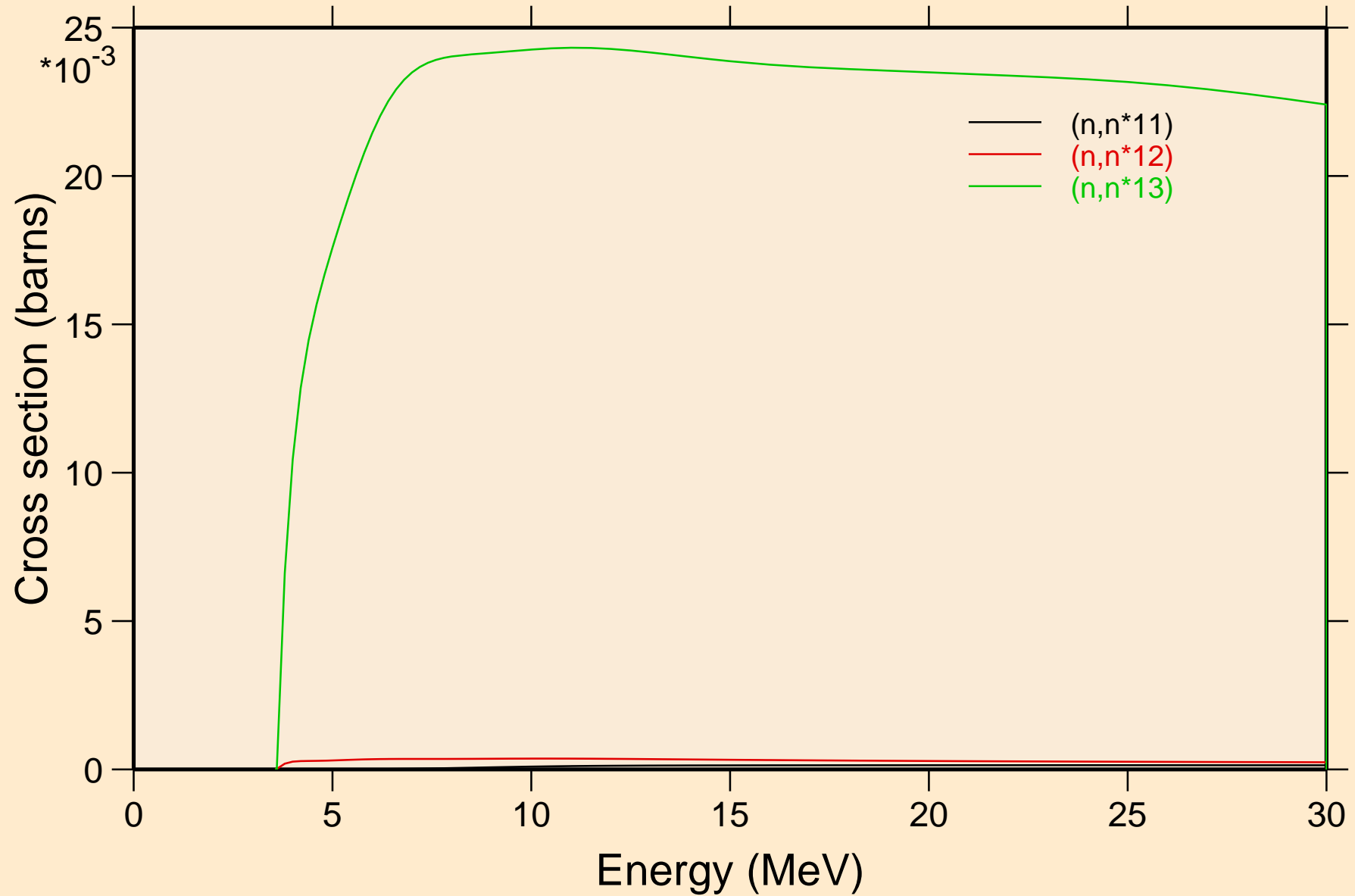

RU088 NEUTRON ACER TENDL-2024 LIBRARY; T=293.6K
Threshold reactions

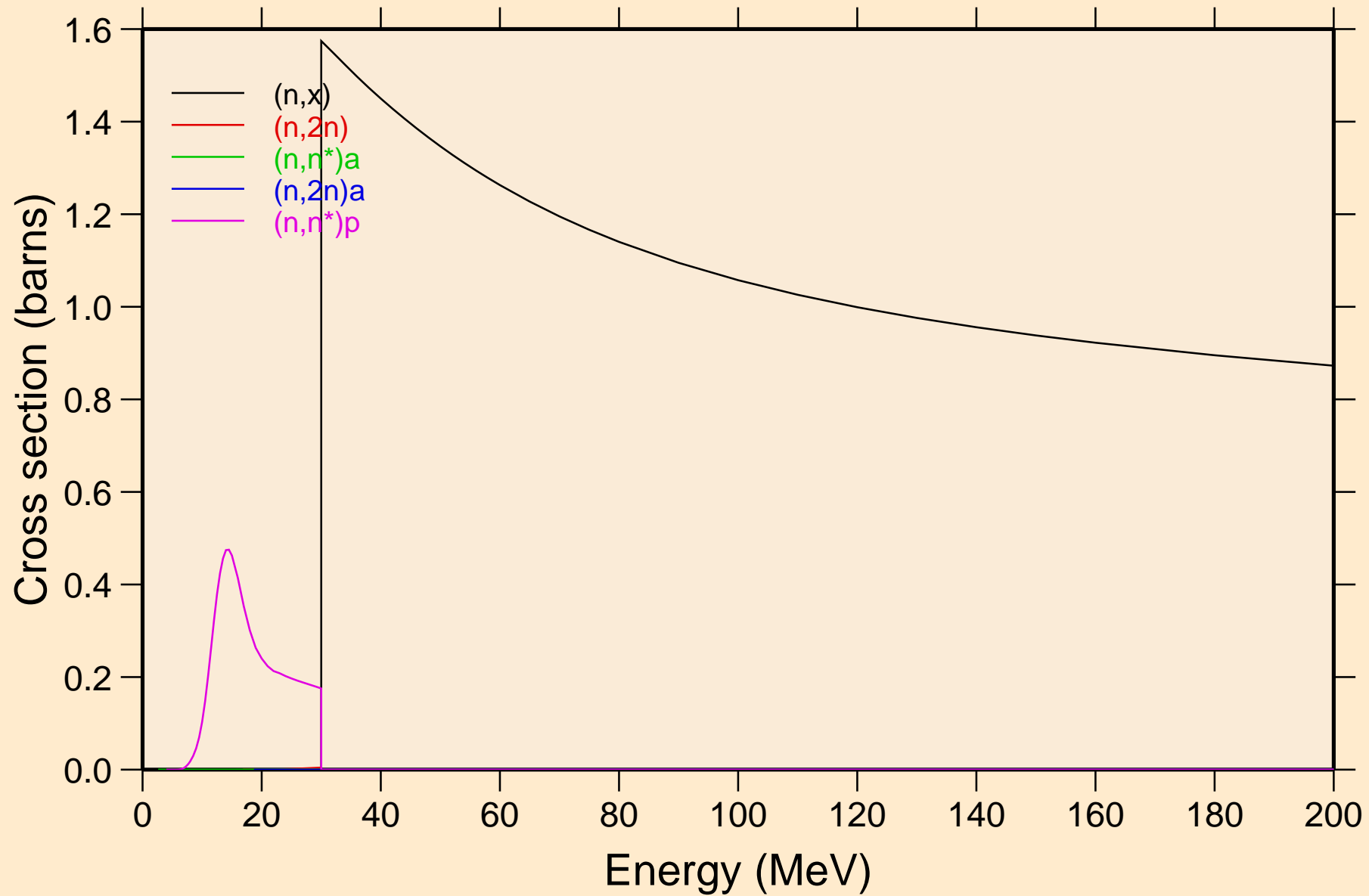

RU088 NEUTRON ACER TENDL-2024 LIBRARY; T=293.6K
Threshold reactions

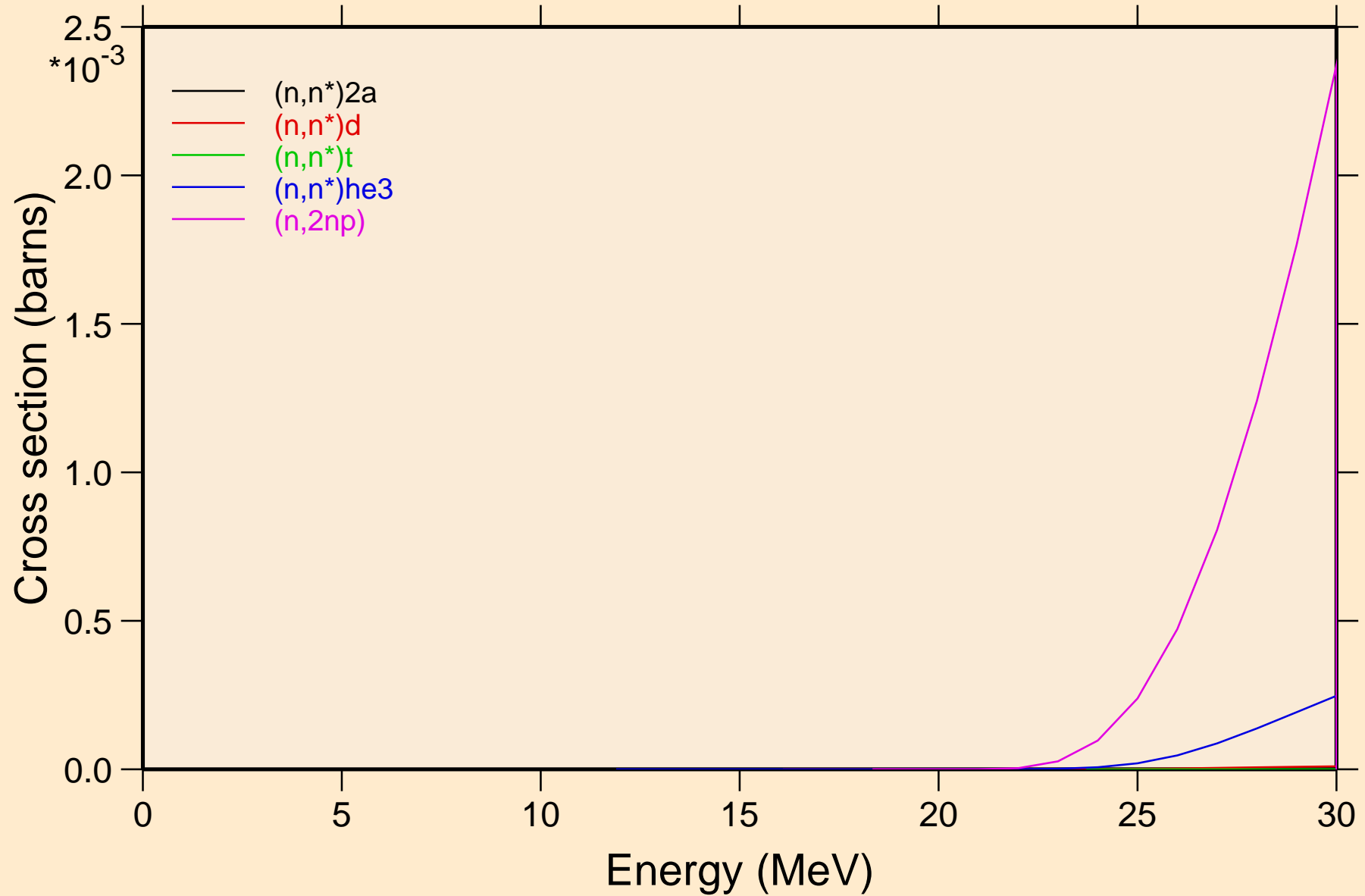

RU088 NEUTRON ACER TENDL-2024 LIBRARY; T=293.6K

Threshold reactions

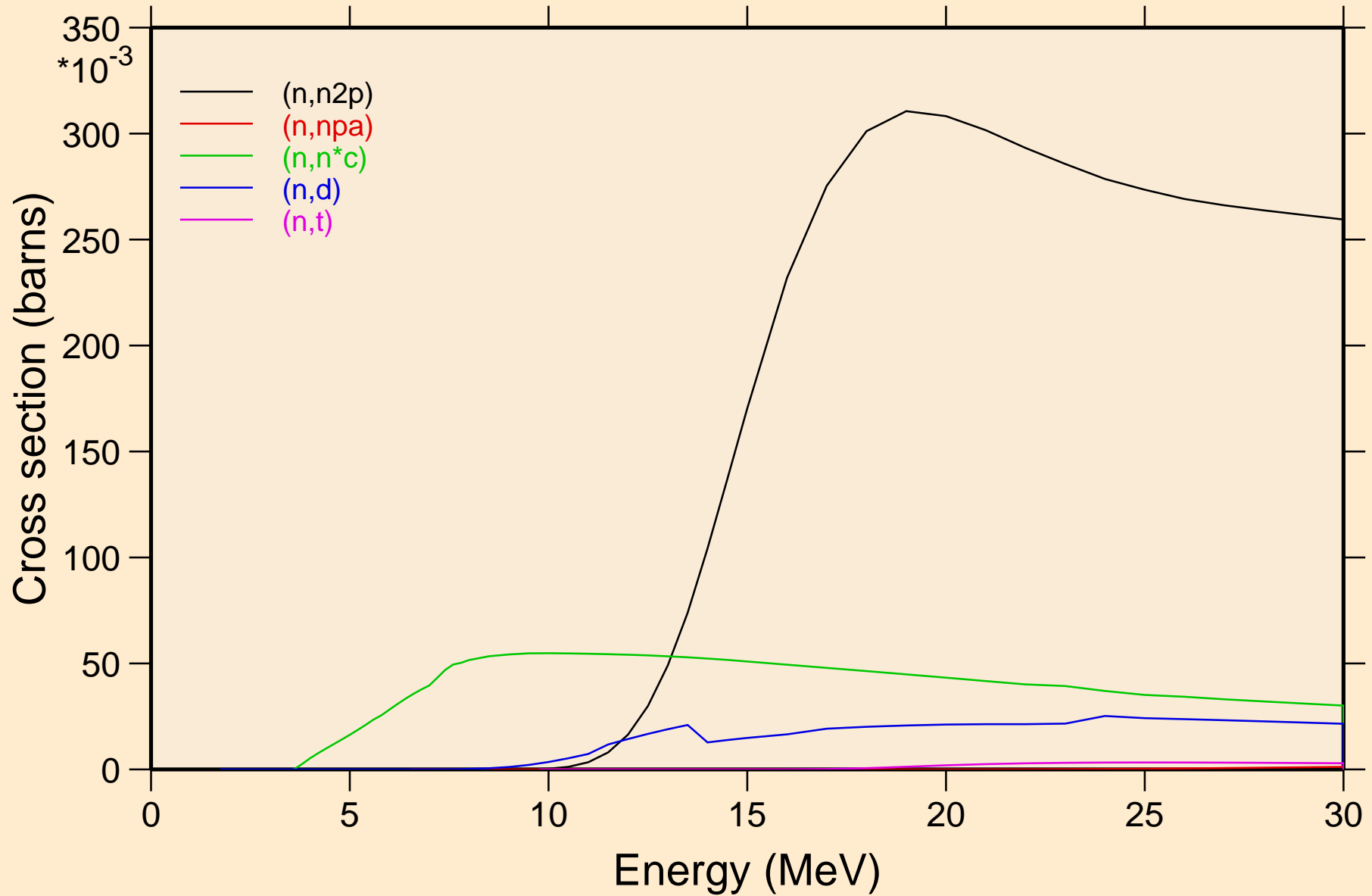

RU088 NEUTRON ACER TENDL-2024 LIBRARY; T=293.6K
Threshold reactions

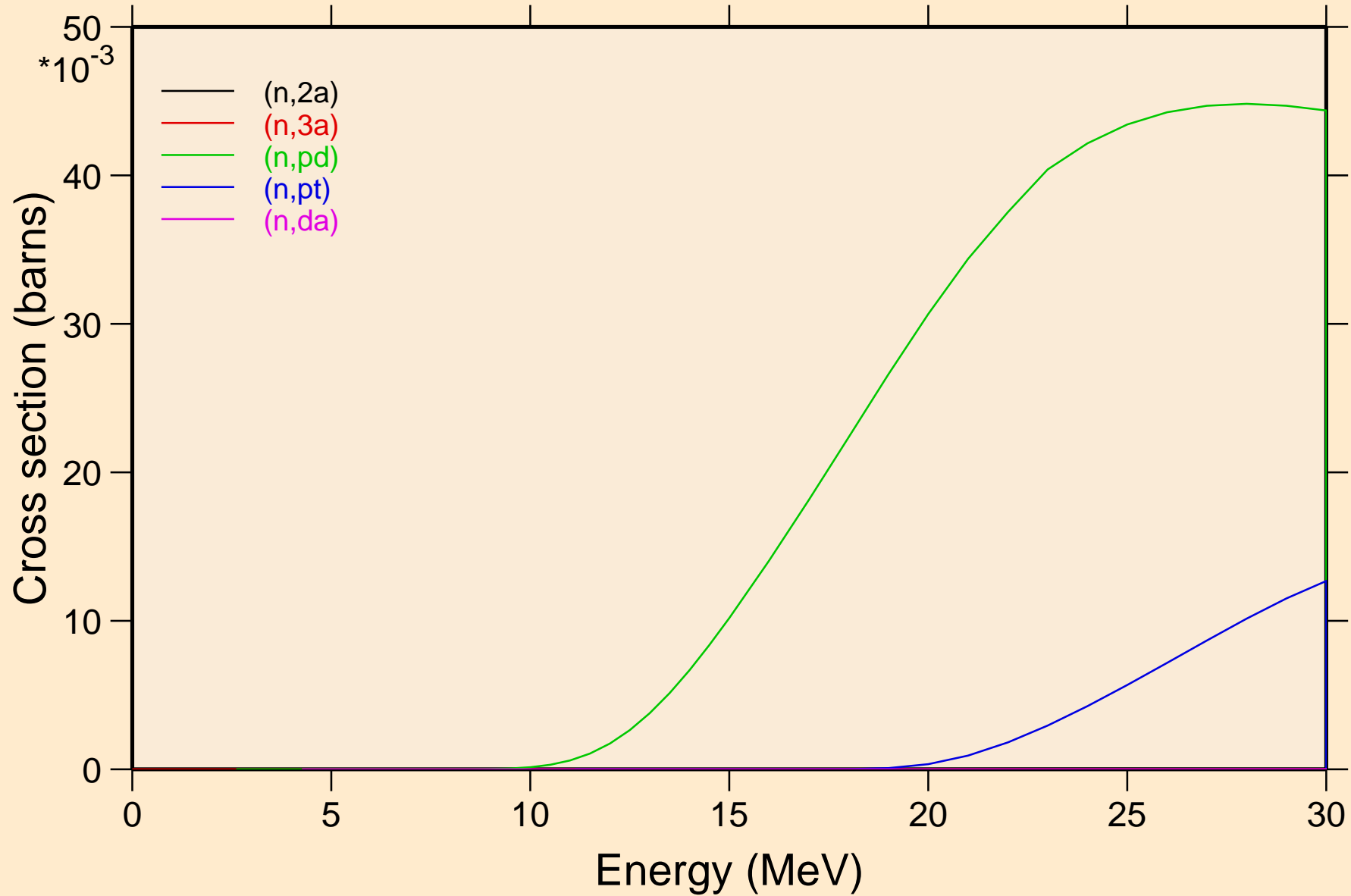

RU088 NEUTRON ACER TENDL-2024 LIBRARY; T=293.6K
Threshold reactions

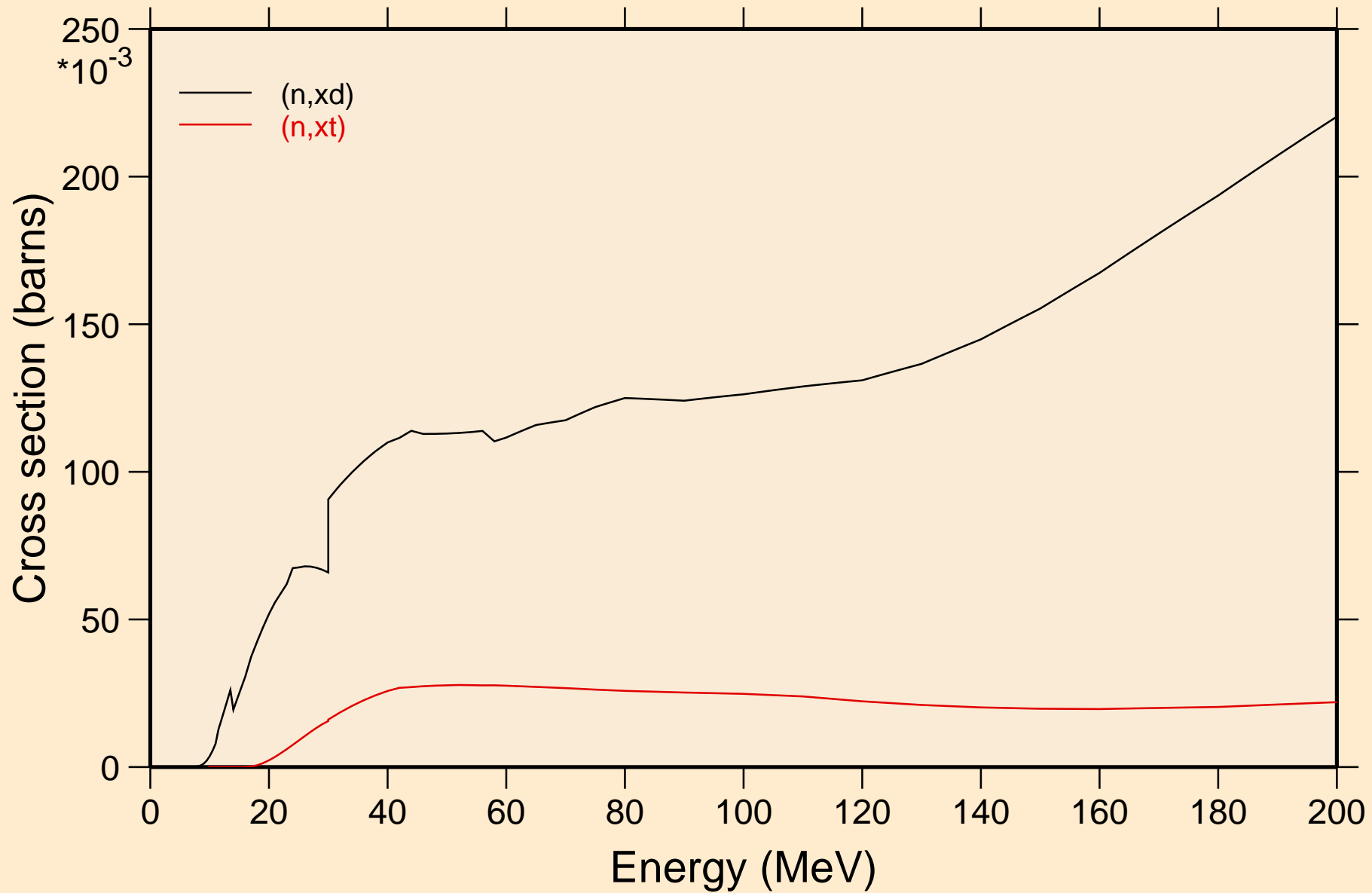

RU088 NEUTRON ACER TENDL-2024 LIBRARY; T=293.6K
angular distribution for elastic

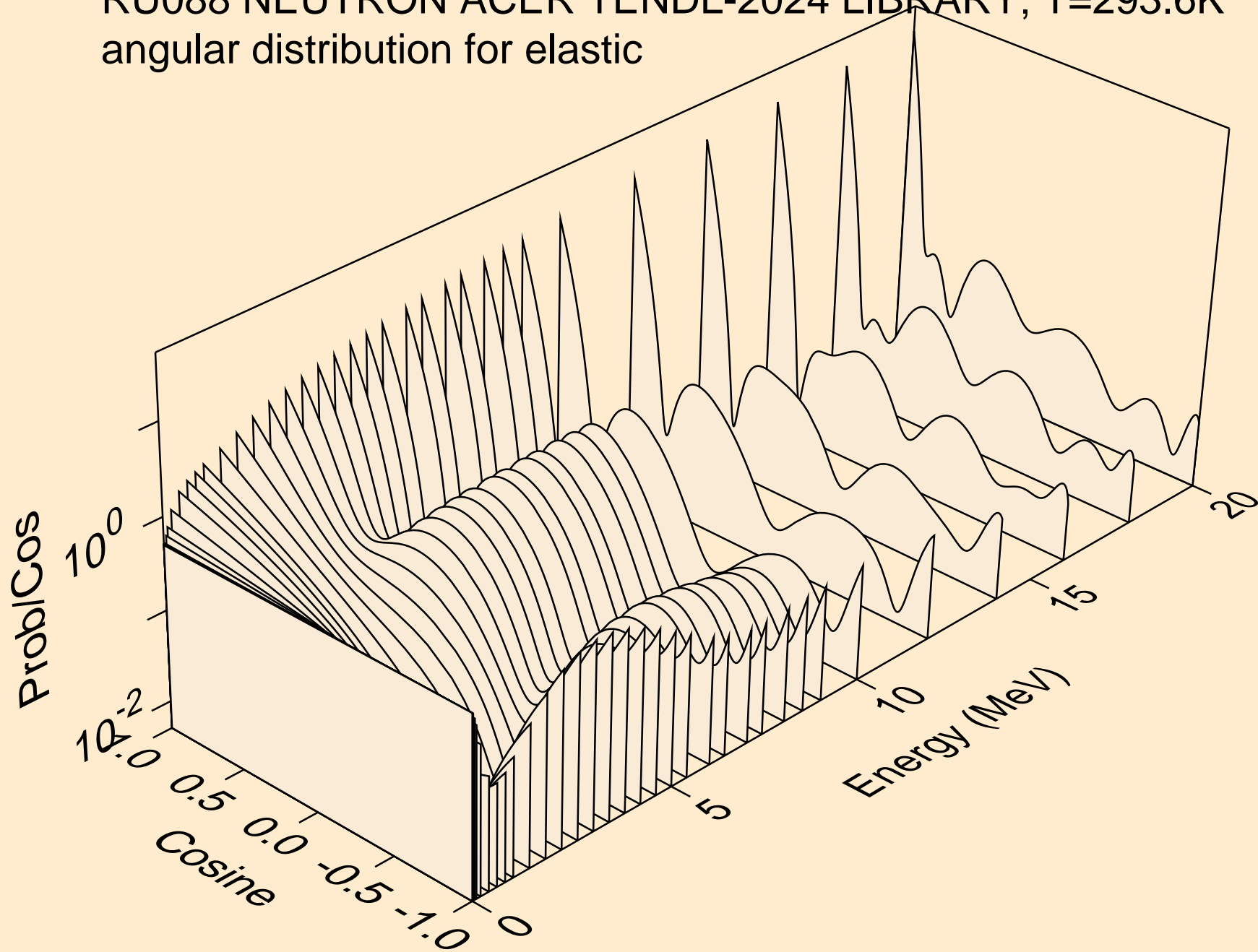

RU088 NEUTRON ACER TENDL-2024 LIBRARY; T=293.6K
angular distribution for elastic

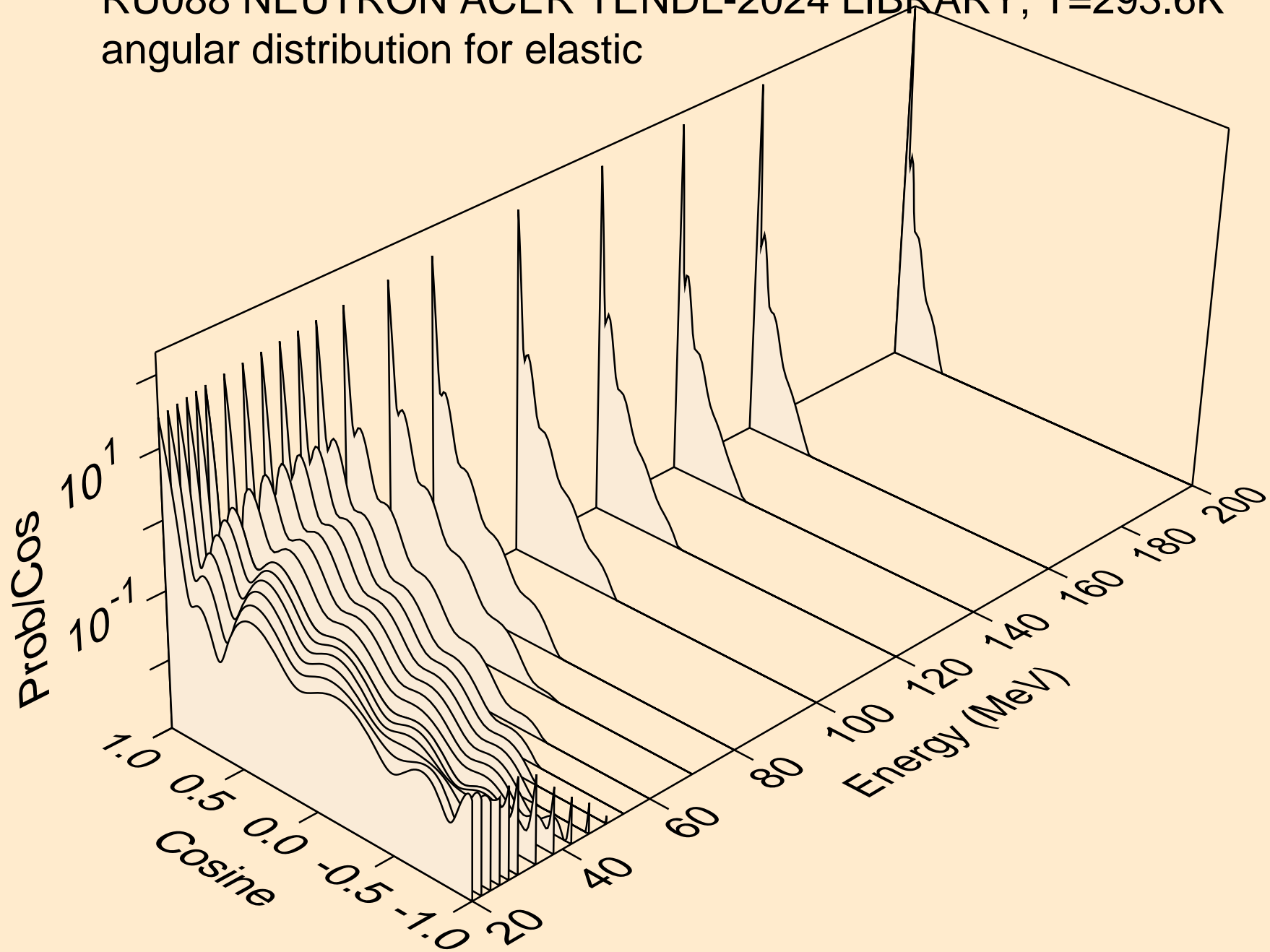

RU088 NEUTRON ACER TENDL-2024 LIBRARY; T=293.6K
angular distribution for (n,n*1)

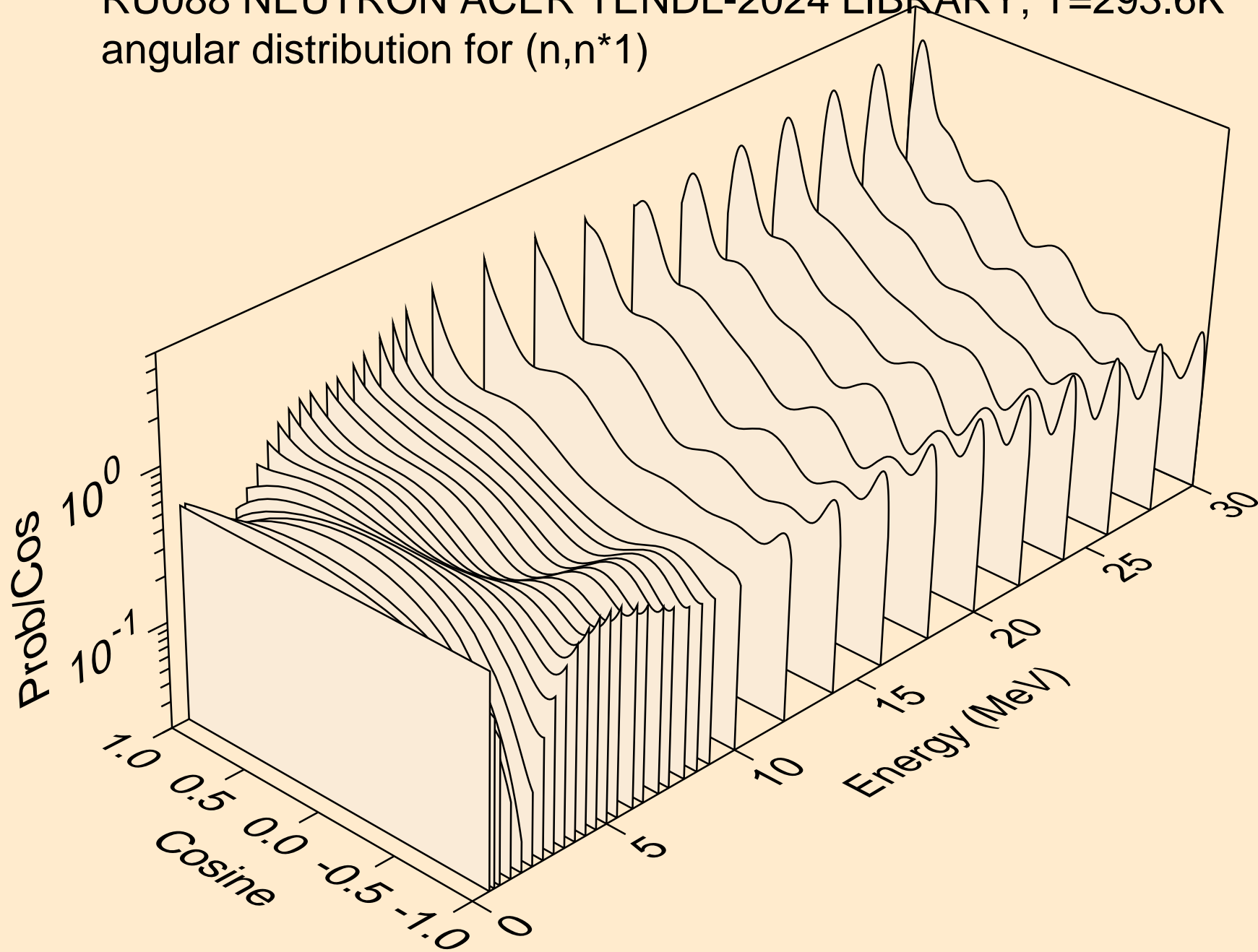

RU088 NEUTRON ACER TENDL-2024 LIBRARY; T=293.6K
angular distribution for (n,n*2)

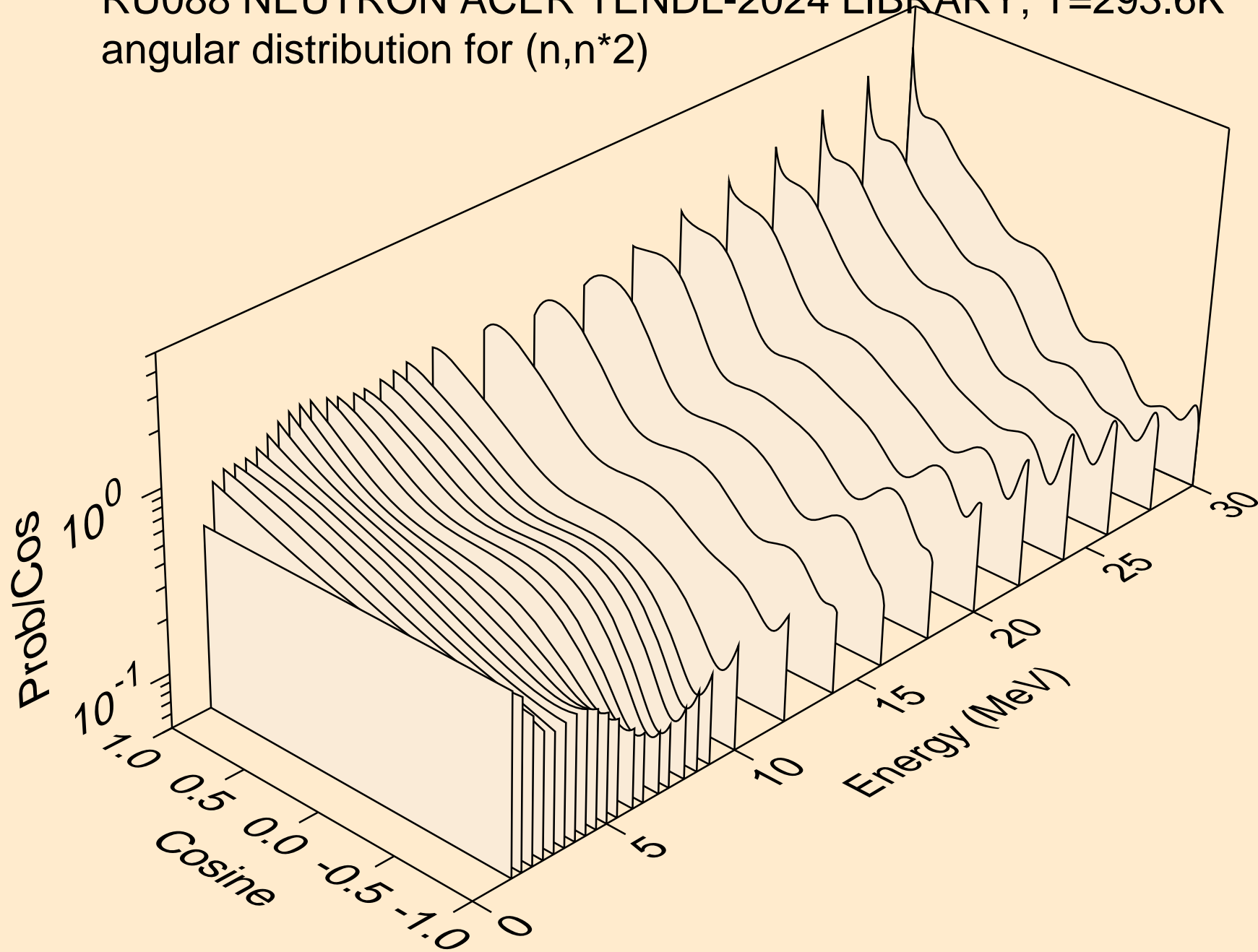

RU088 NEUTRON ACER TENDL-2024 LIBRARY; T=293.6K
angular distribution for (n,n*3)

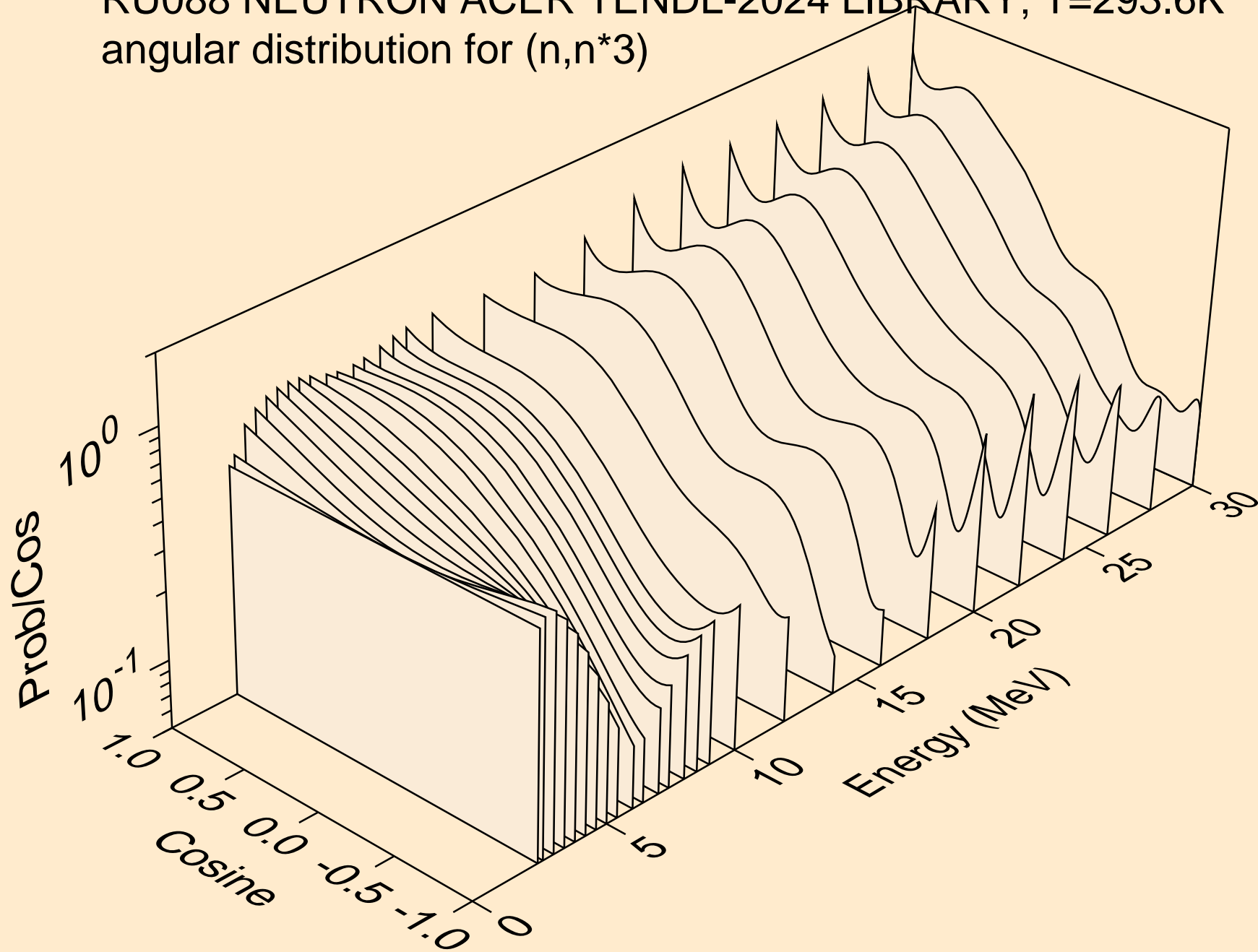

RU088 NEUTRON ACER TENDL-2024 LIBRARY; T=293.6K
angular distribution for (n,n*4)

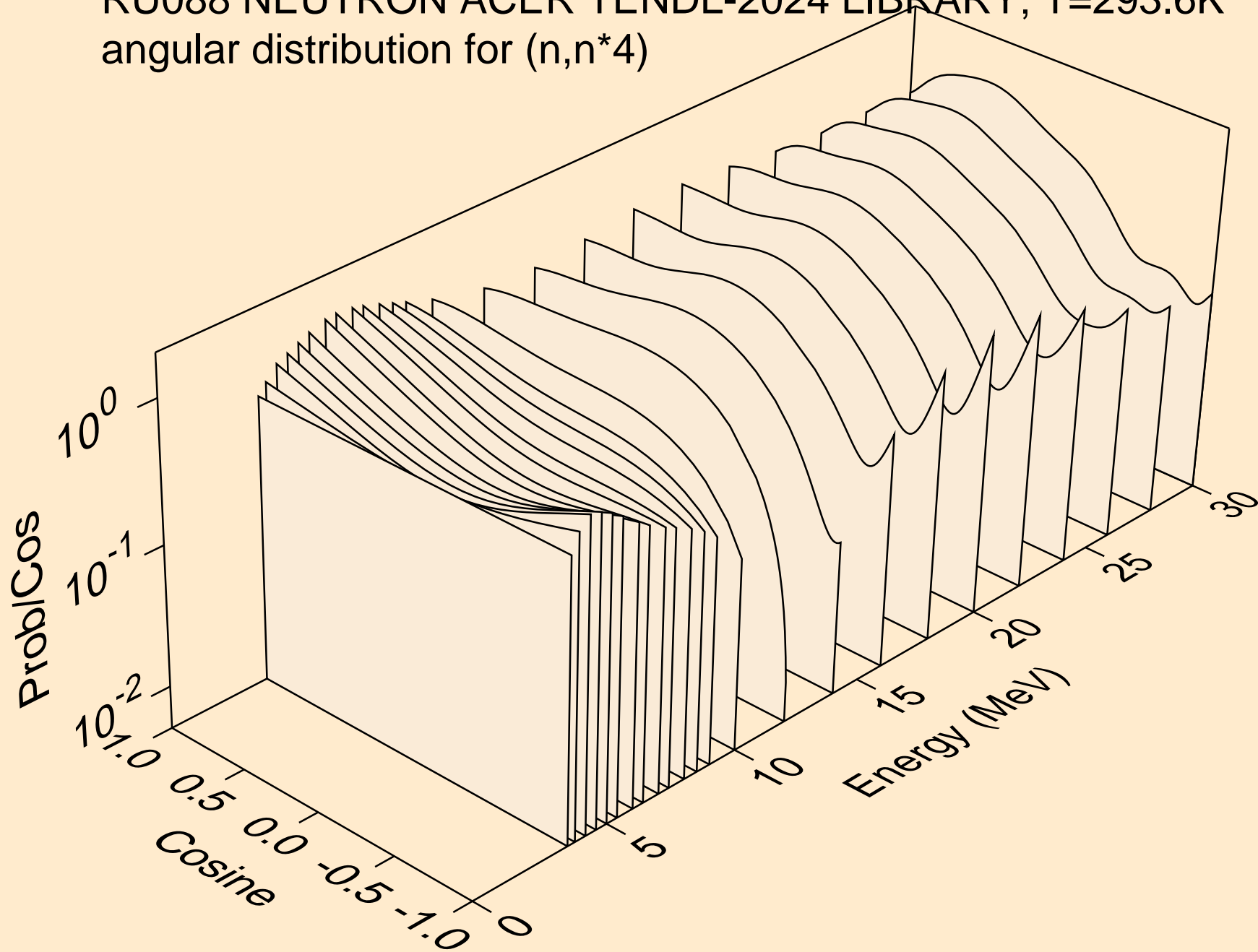

RU088 NEUTRON ACER TENDL-2024 LIBRARY; T=293.6K
angular distribution for (n,n*5)

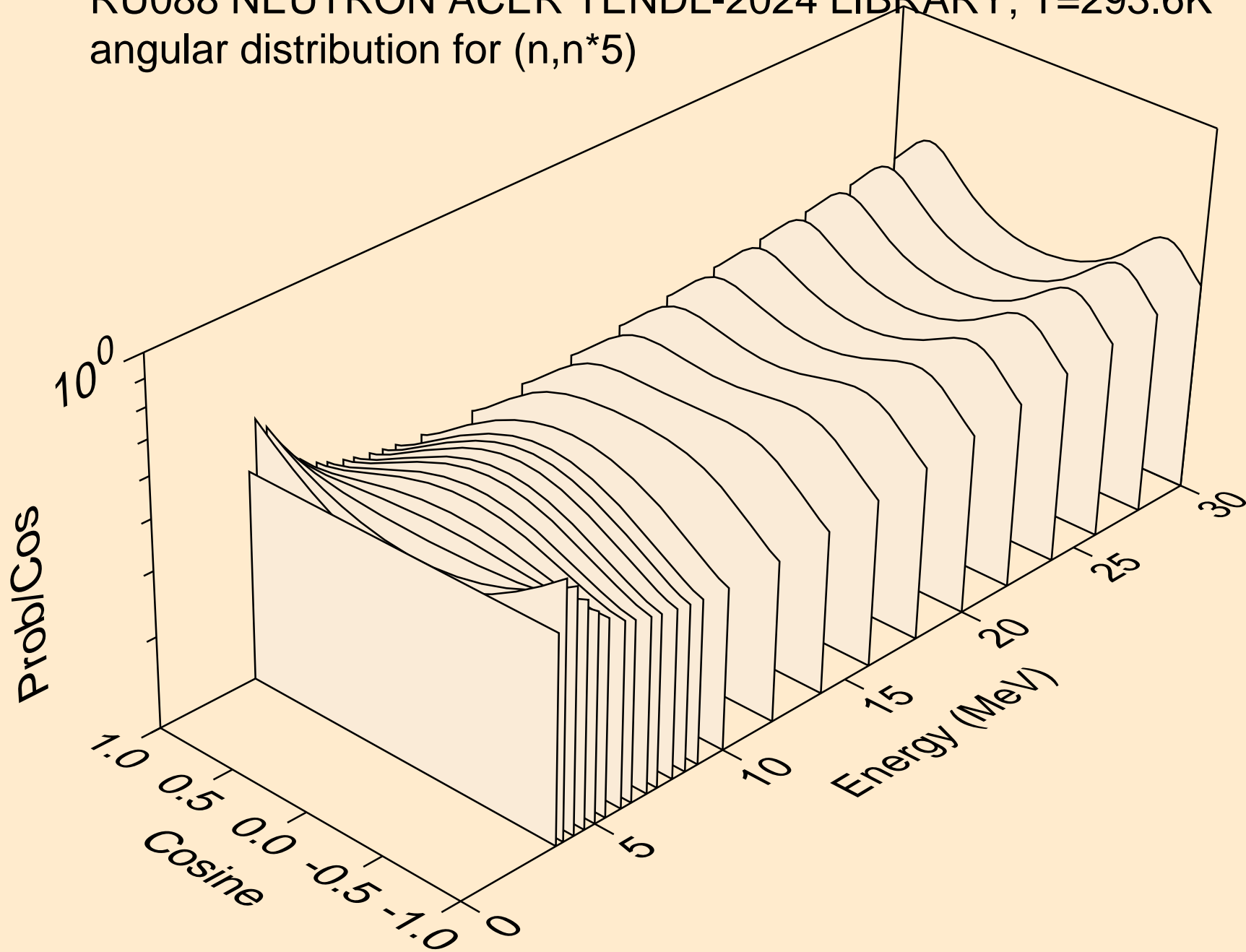

RU088 NEUTRON ACER TENDL-2024 LIBRARY; T=293.6K
angular distribution for (n,n*6)

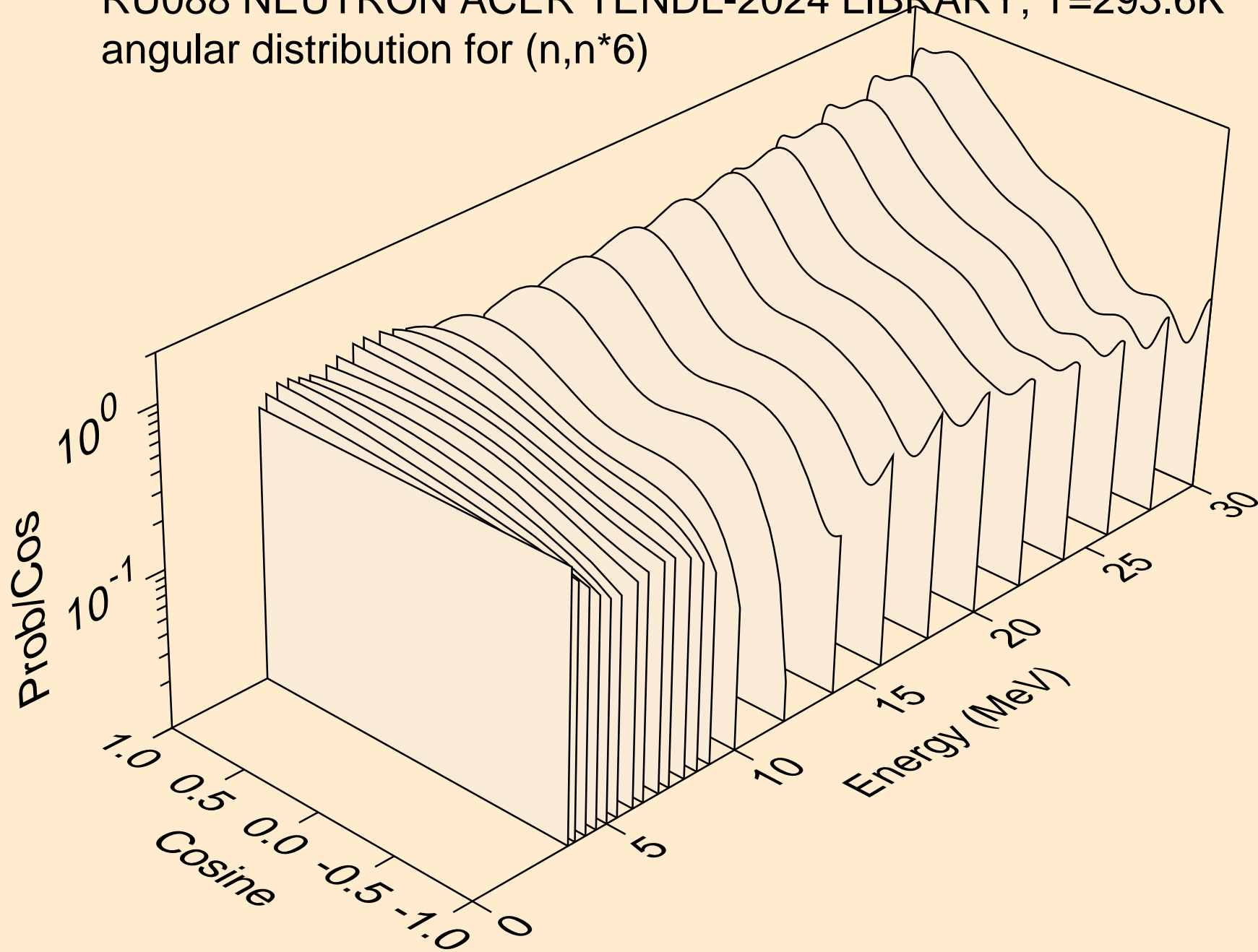

RU088 NEUTRON ACER TENDL-2024 LIBRARY; T=293.6K
angular distribution for (n,n*7)

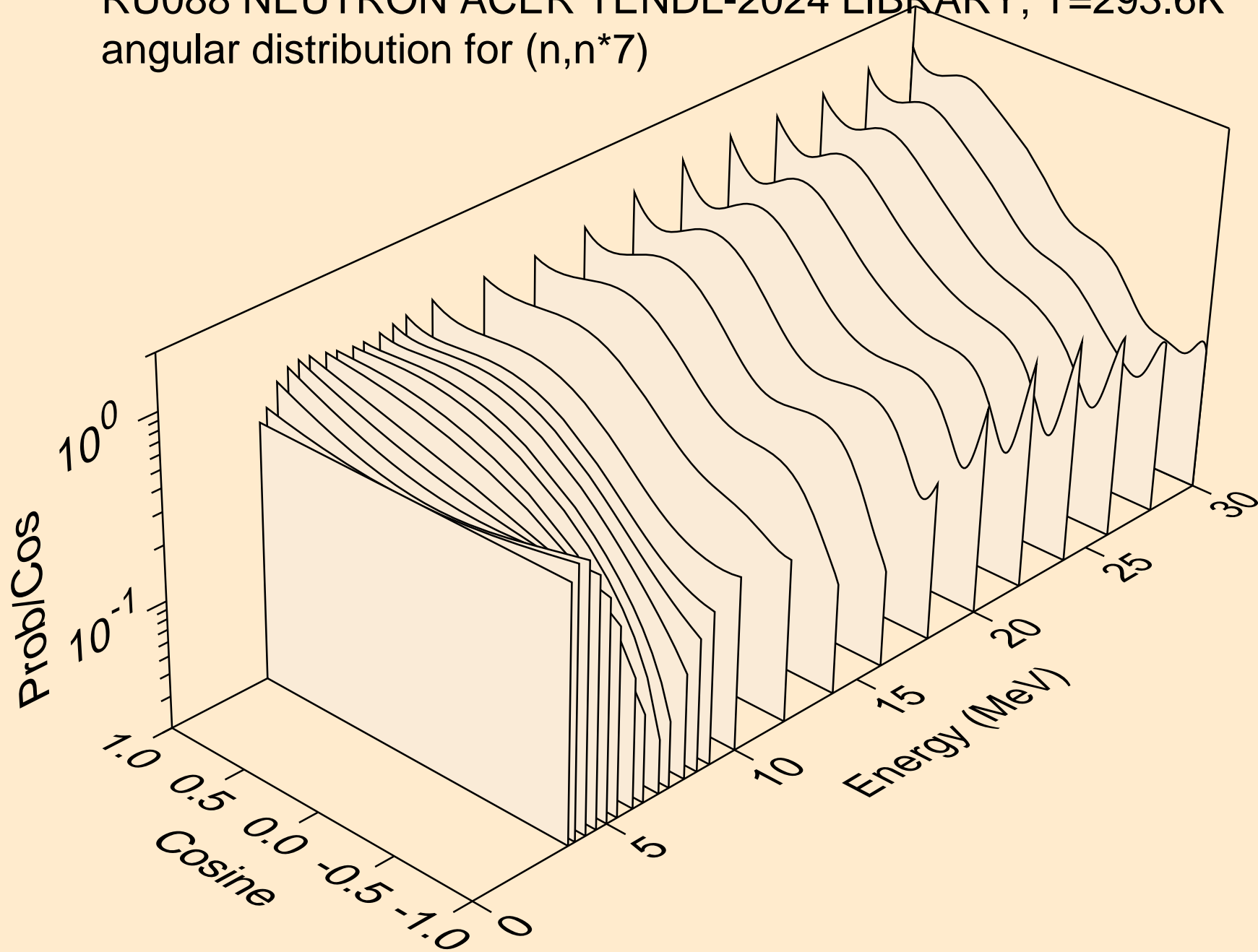

RU088 NEUTRON ACER TENDL-2024 LIBRARY; T=293.6K
angular distribution for (n,n*8)

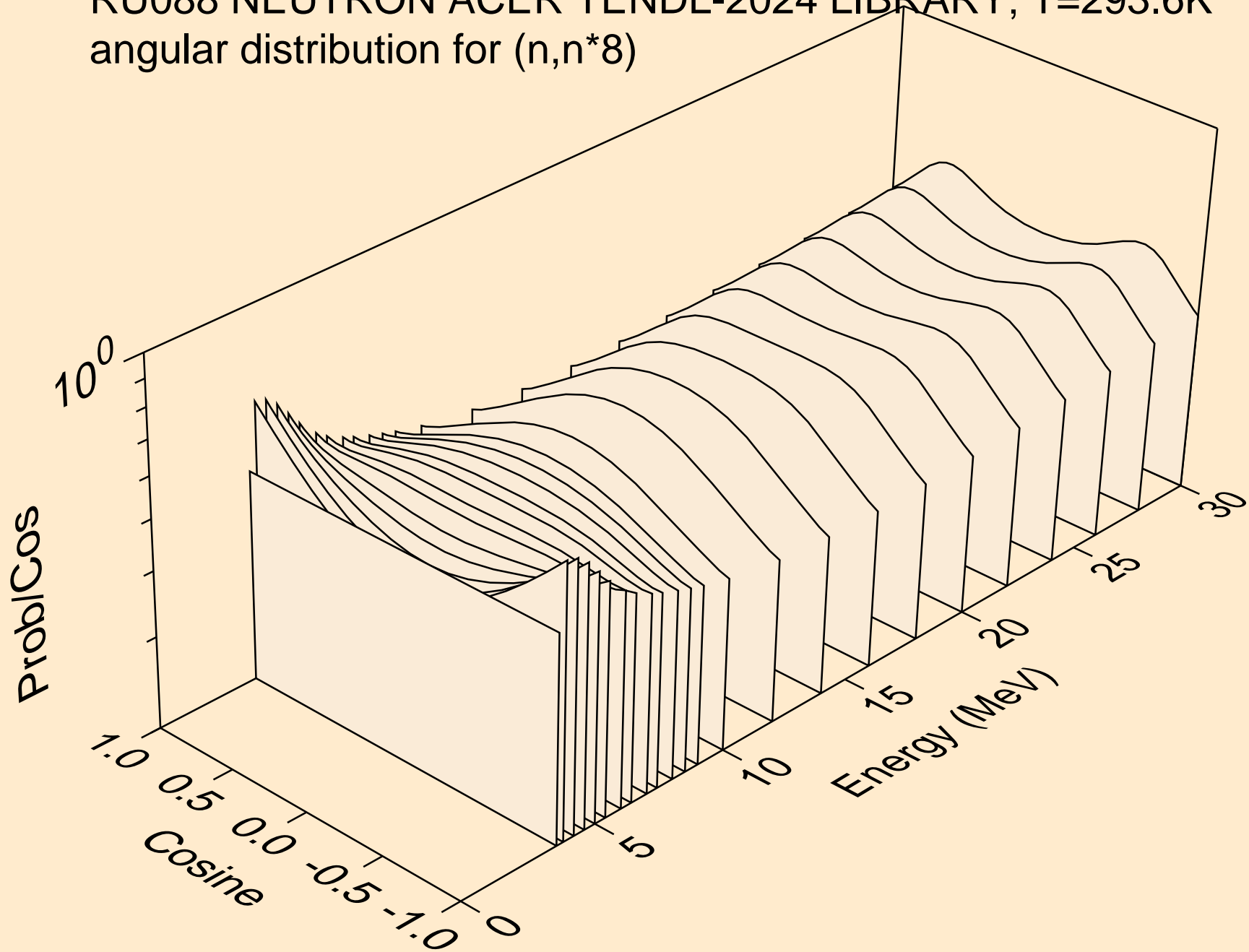

RU088 NEUTRON ACER TENDL-2024 LIBRARY; T=293.6K
angular distribution for (n,n*9)

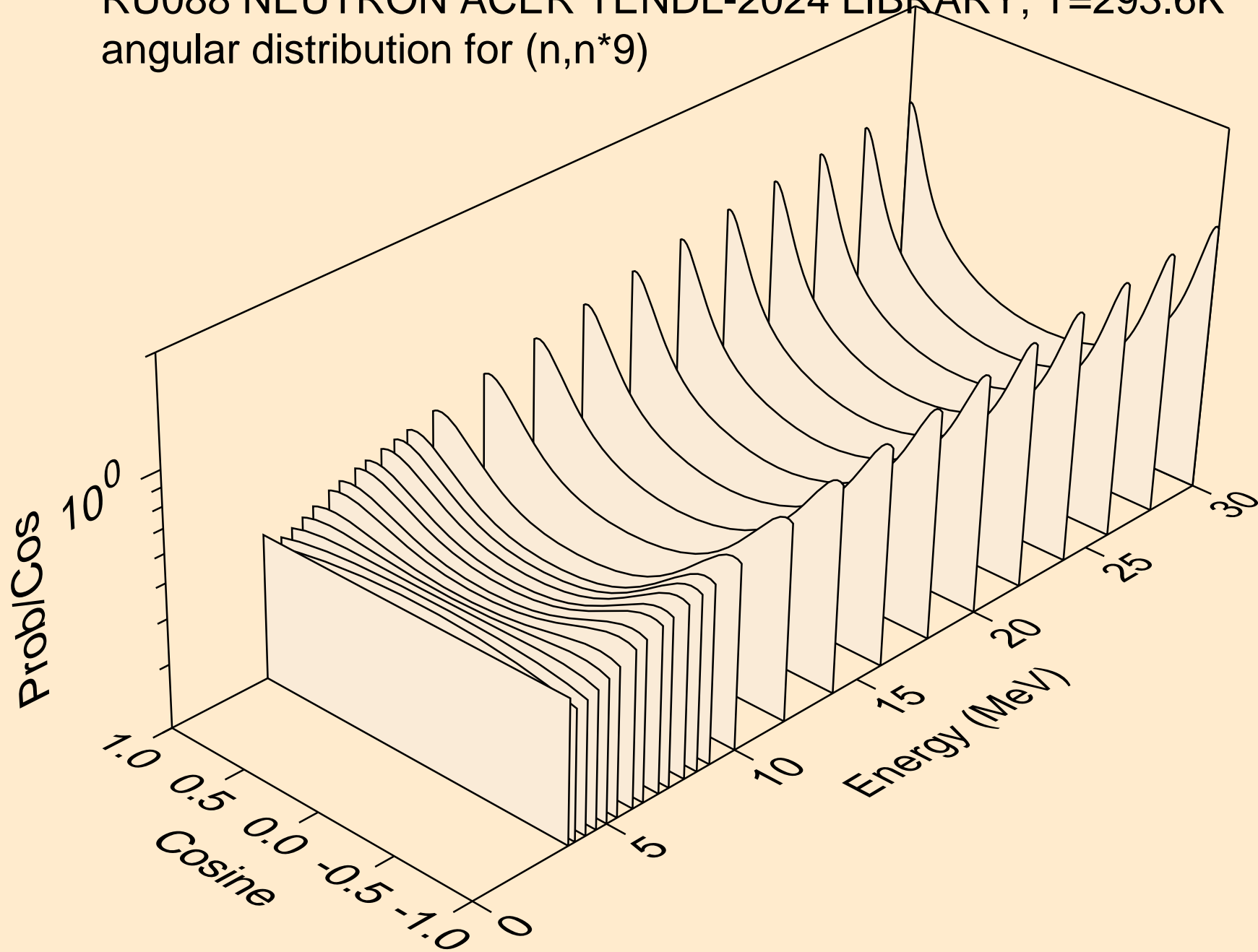

RU088 NEUTRON ACER TENDL-2024 LIBRARY; T=293.6K
angular distribution for (n,n*10)

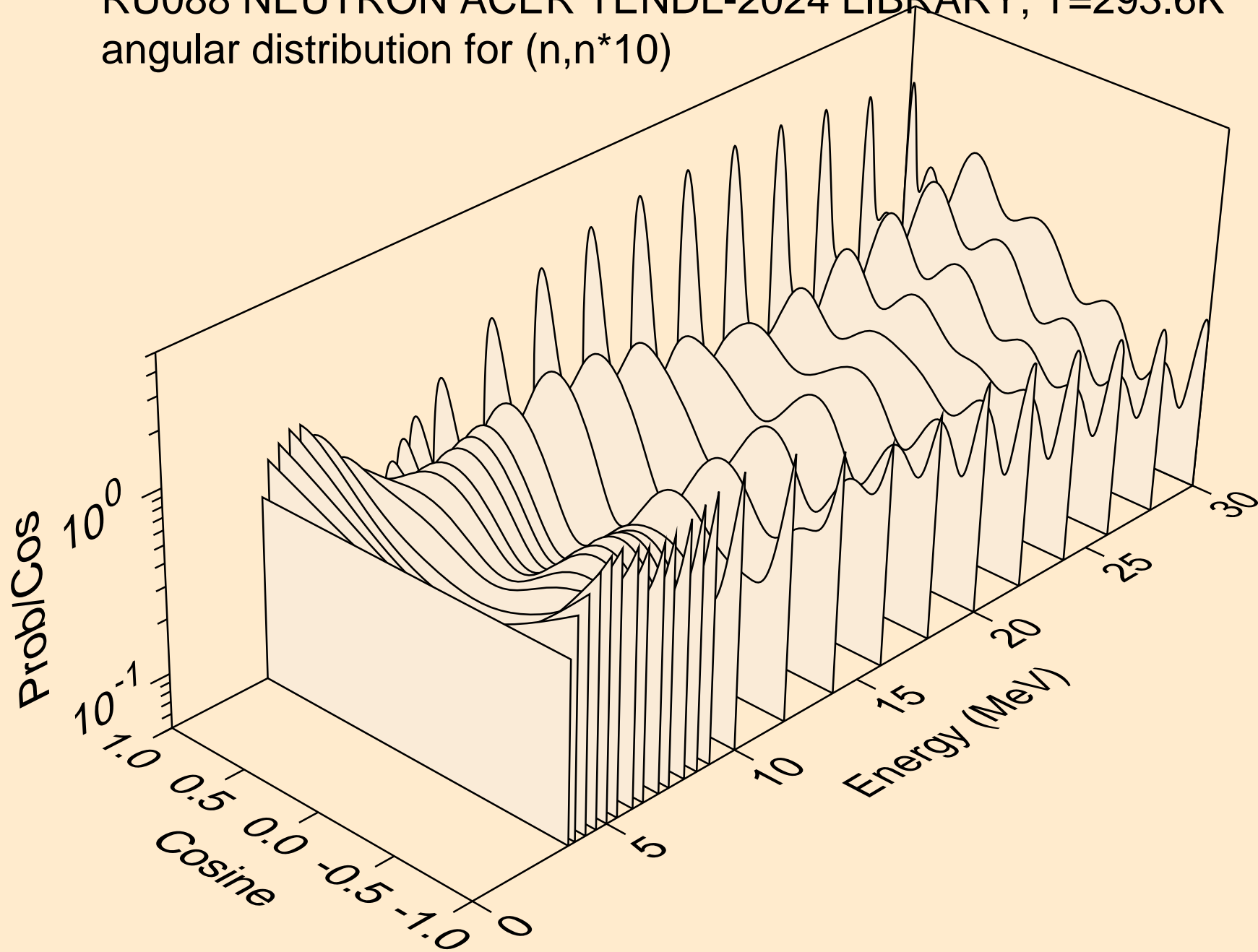

RU088 NEUTRON ACER TENDL-2024 LIBRARY; T=293.6K
angular distribution for (n,n*11)

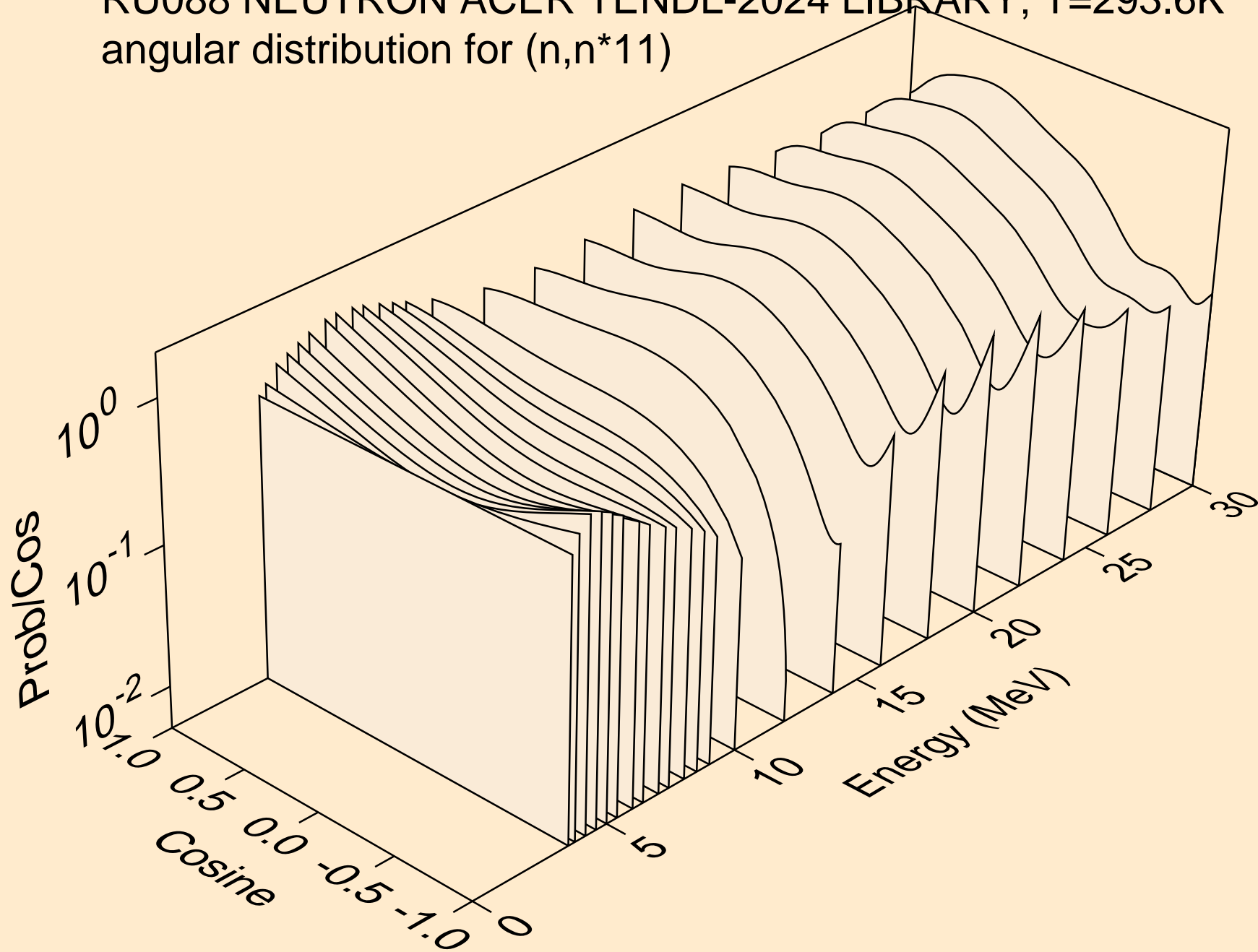

RU088 NEUTRON ACER TENDL-2024 LIBRARY; T=293.6K
angular distribution for (n,n*12)

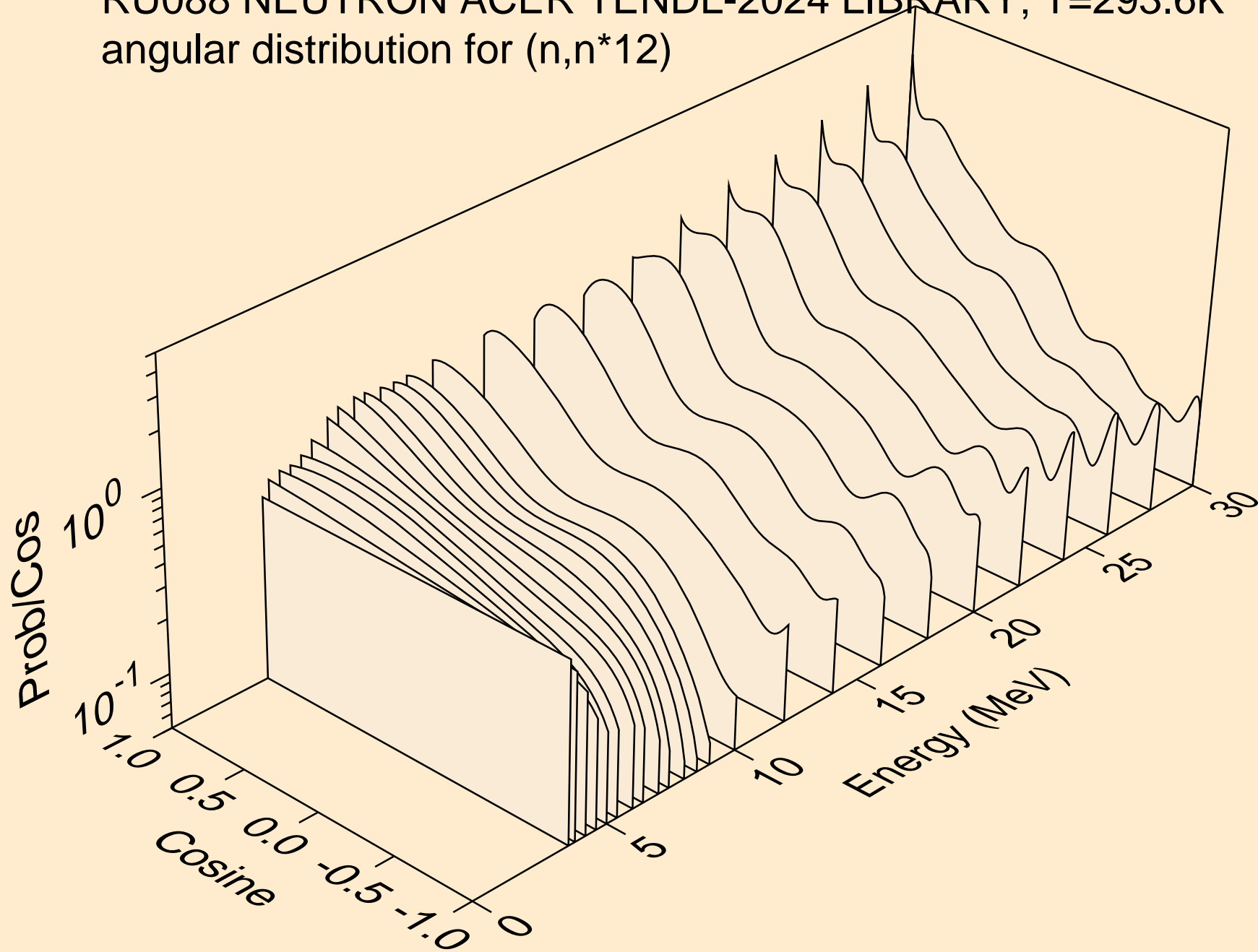

RU088 NEUTRON ACER TENDL-2024 LIBRARY; T=293.6K
angular distribution for (n,n*13)

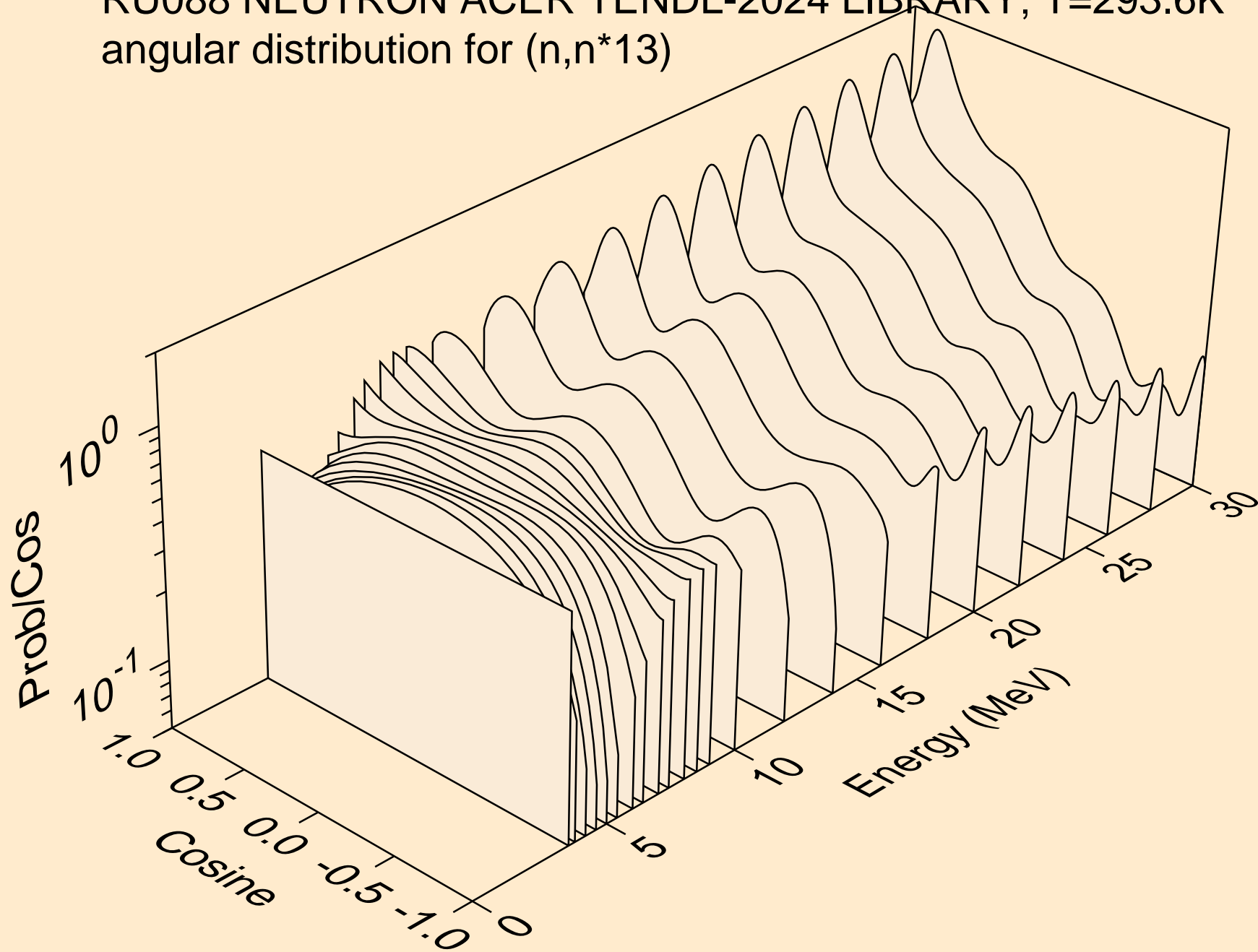

RU088 NEUTRON ACER TENDL-2024 LIBRARY; T=293.6K
Neutron emission for (n,x)

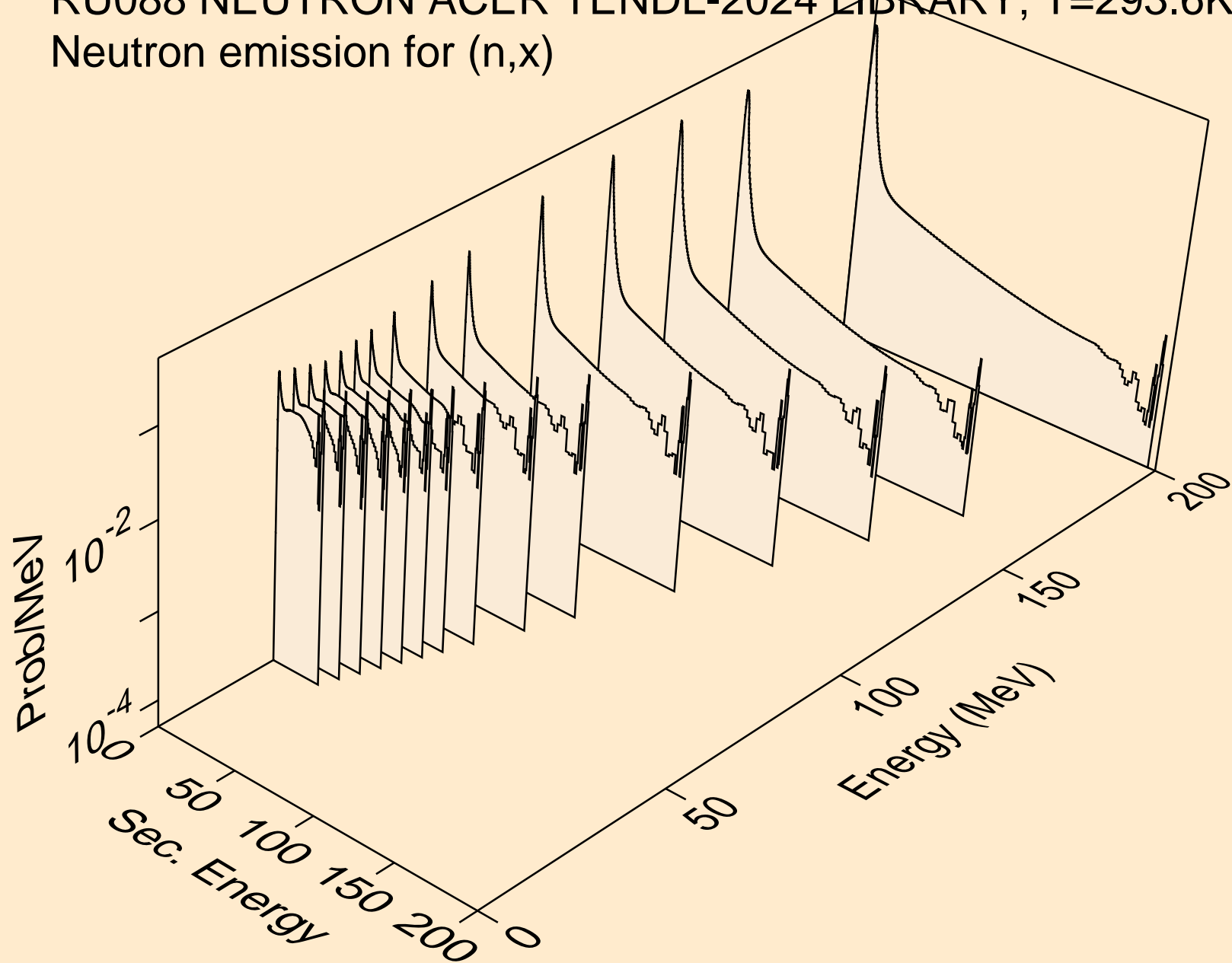

RU088 NEUTRON ACER TENDL-2024 LIBRARY; T=293.6K
Neutron emission for (n,2n)

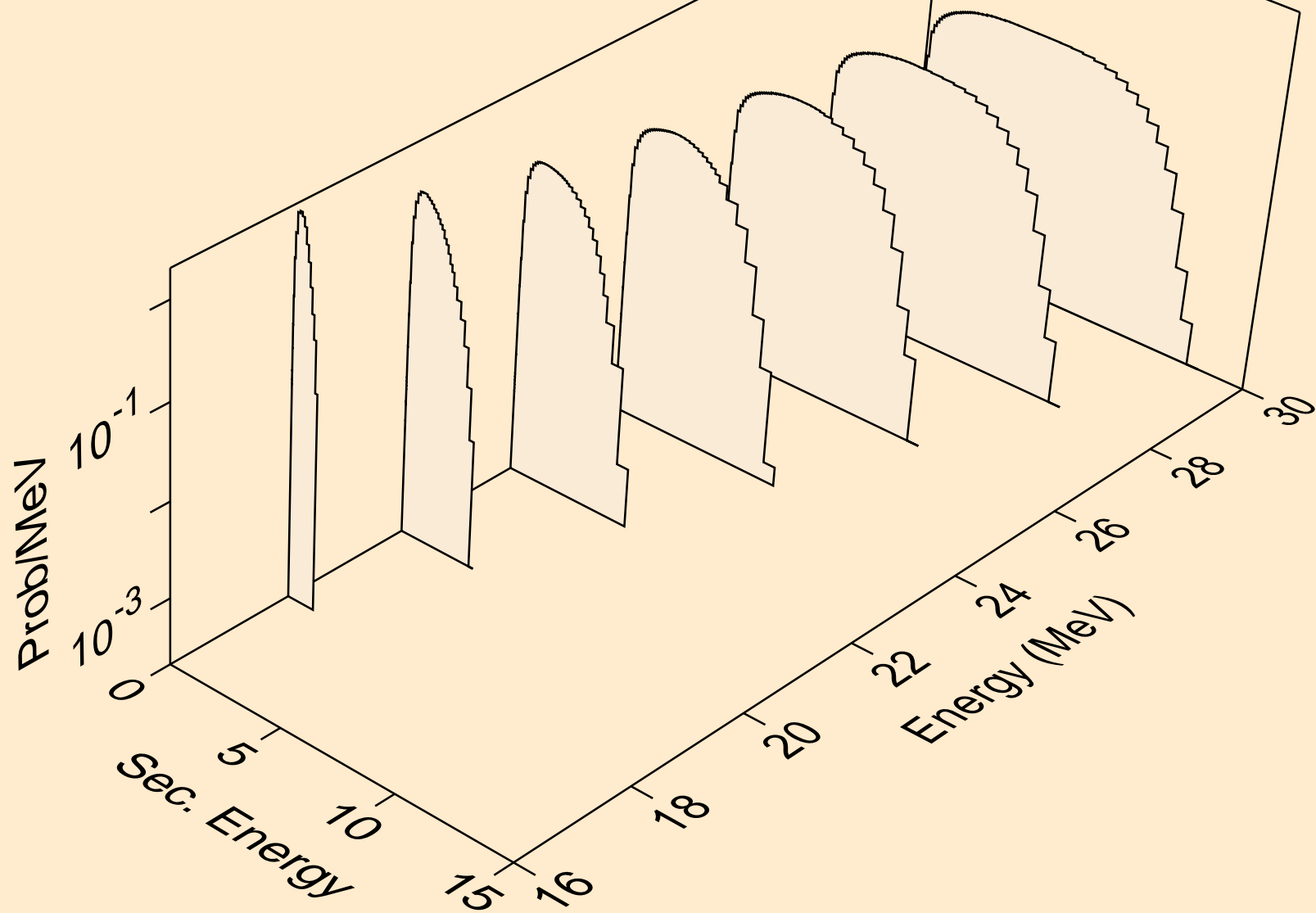

RU088 NEUTRON ACER TENDL-2024 LIBRARY; T=293.6K
Neutron emission for (n,n*)a

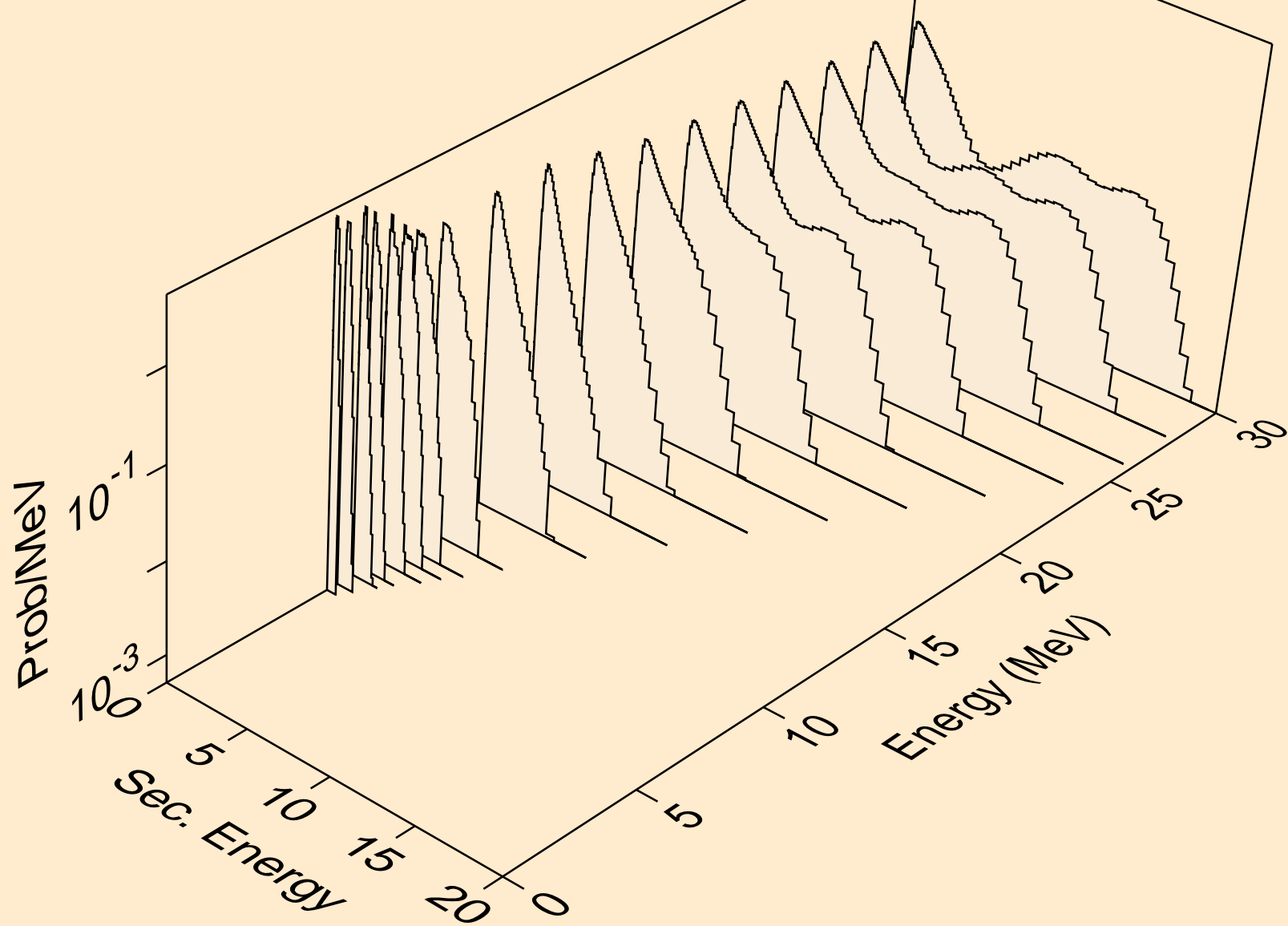

RU088 NEUTRON ACER TENDL-2024 LIBRARY; T=293.6K
Neutron emission for (n,2n)_a

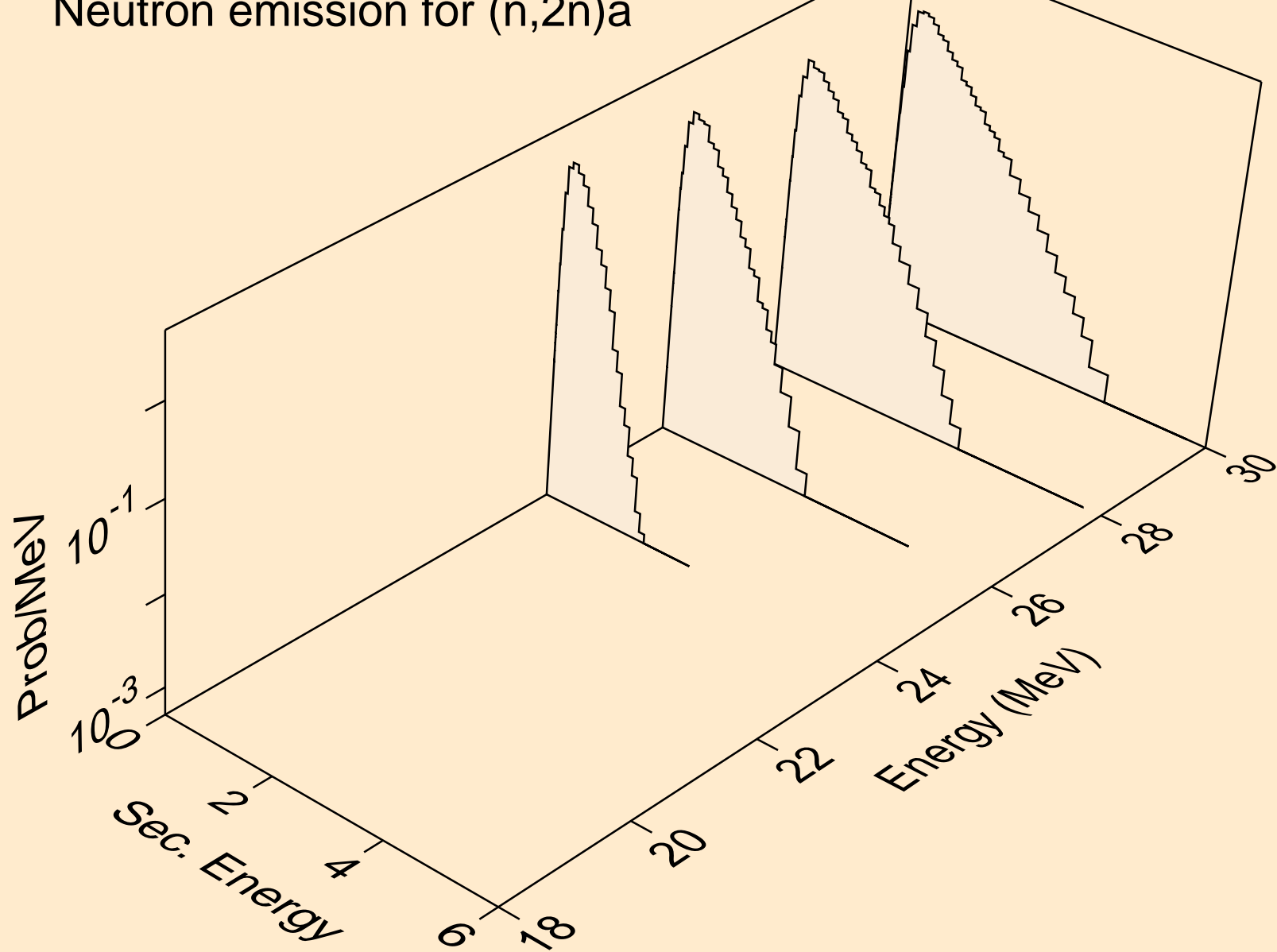

RU088 NEUTRON ACER TENDL-2024 LIBRARY; T=293.6K
Neutron emission for (n,n*)p

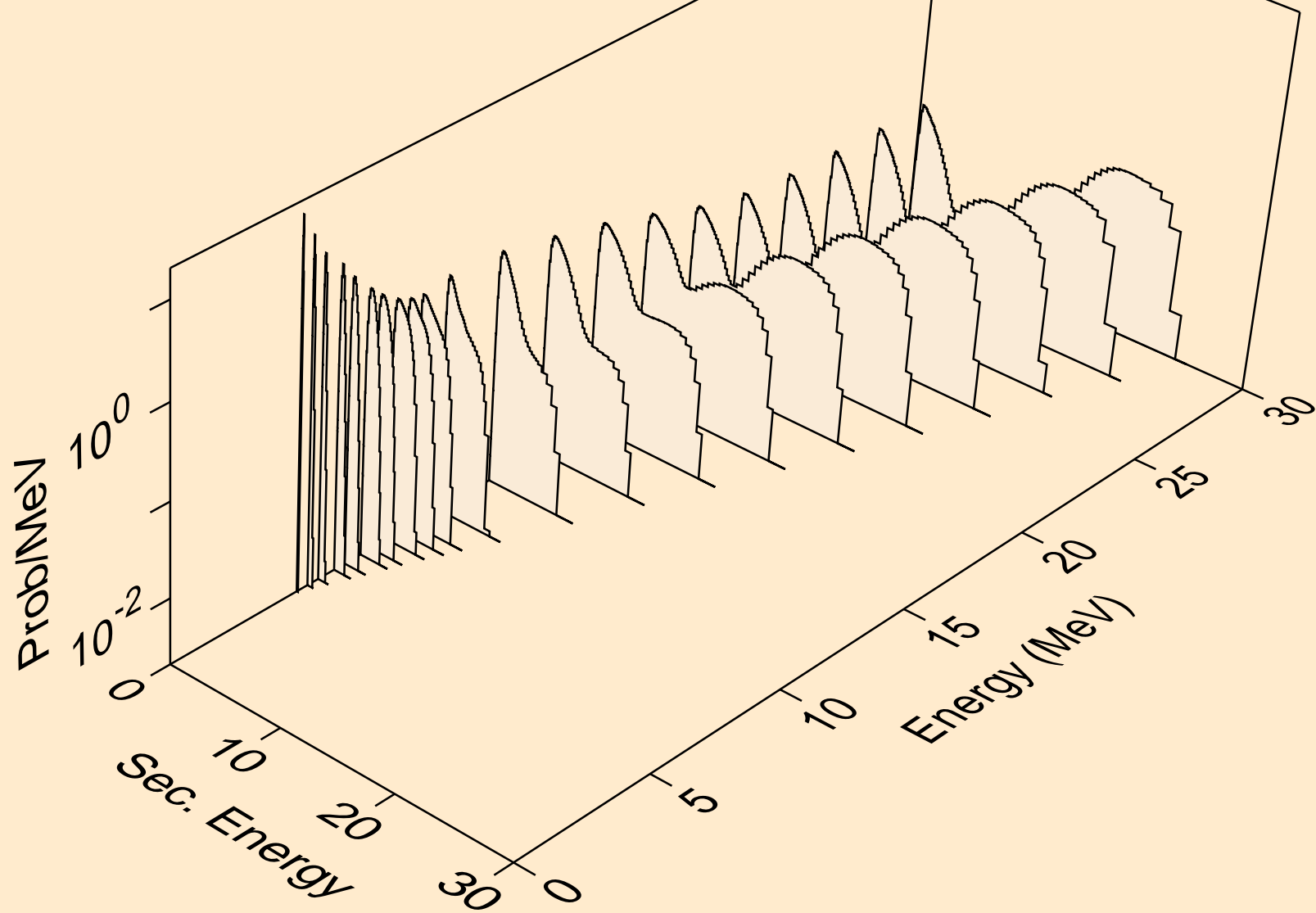

RU088 NEUTRON ACER TENDL-2024 LIBRARY; T=293.6K
Neutron emission for (n,n*)2a

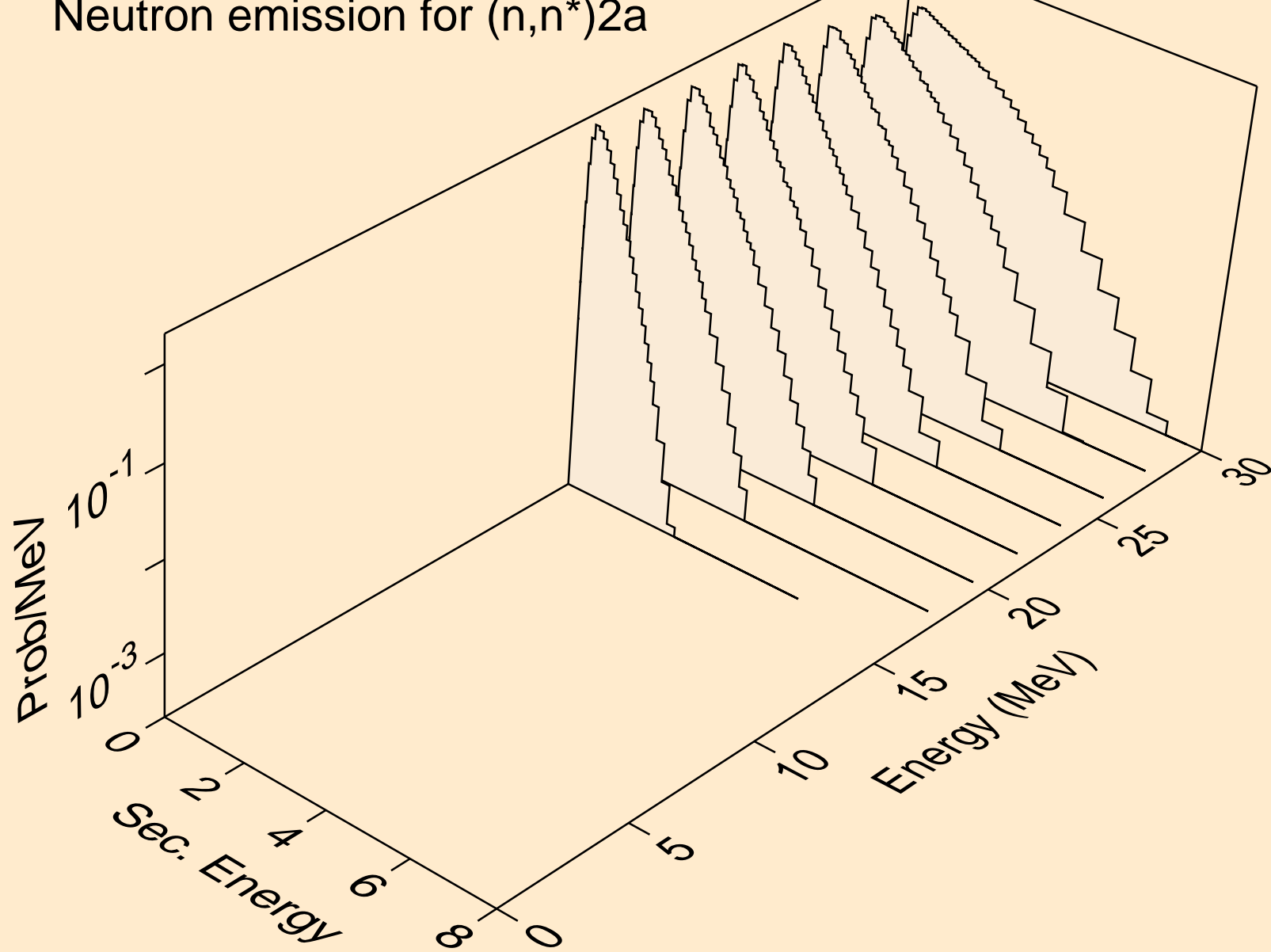

RU088 NEUTRON ACER TENDL-2024 LIBRARY; T=293.6K
Neutron emission for (n,n*)d

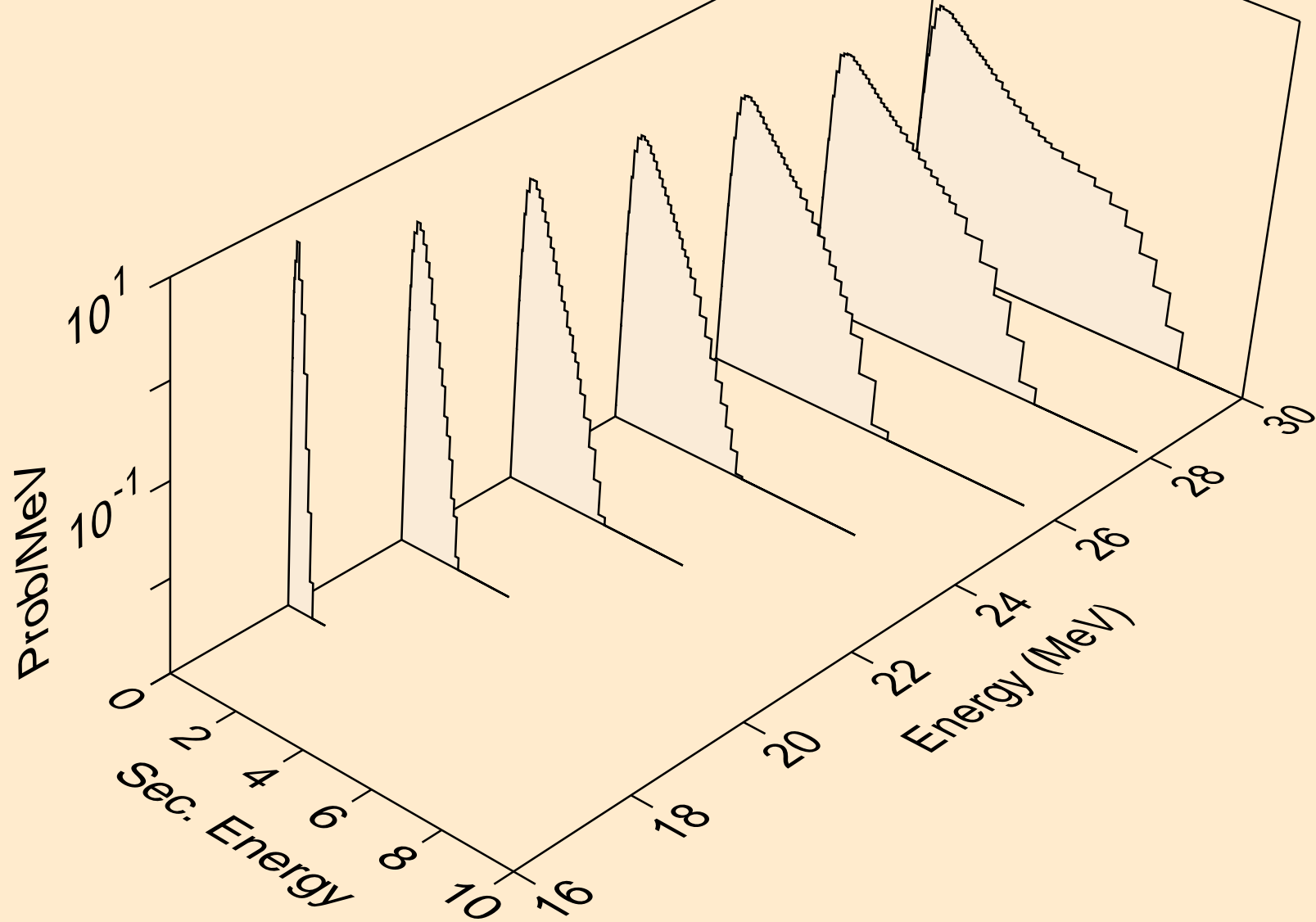

RU088 NEUTRON ACER TENDL-2024 LIBRARY; T=293.6K
Neutron emission for (n,n*)t

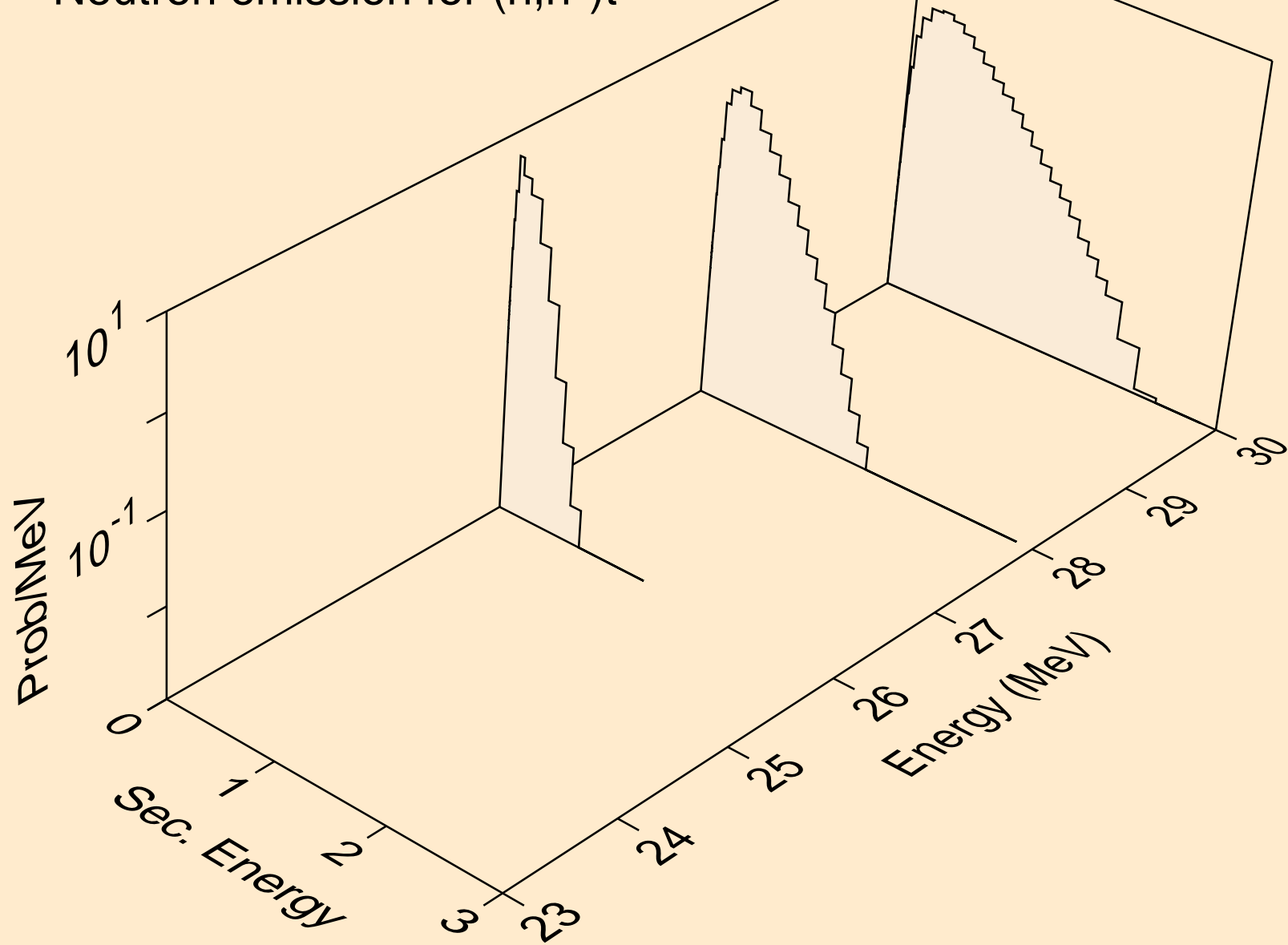

RU088 NEUTRON ACER TENDL-2024 LIBRARY; T=293.6K
Neutron emission for (n,n*)he3

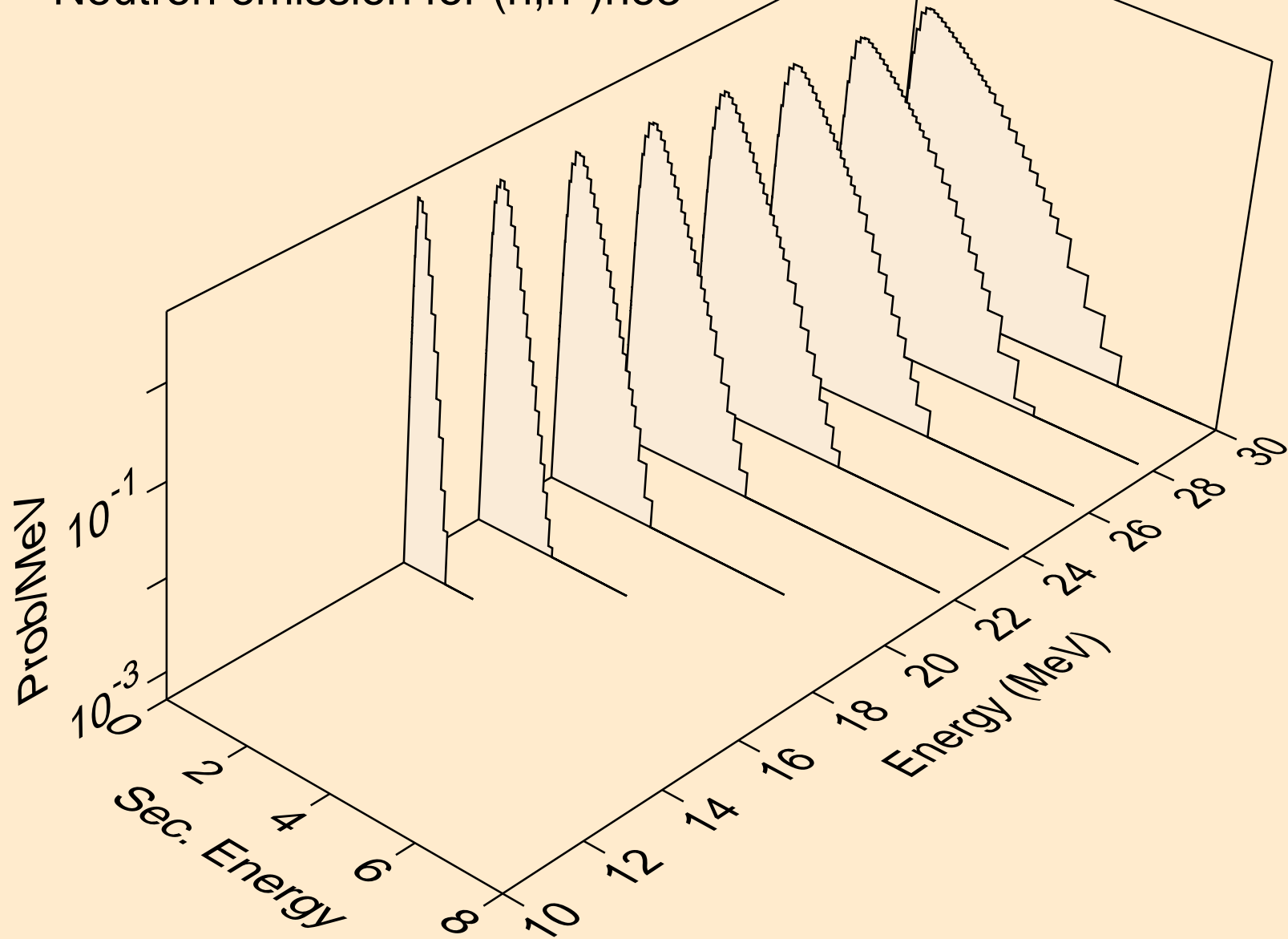

RU088 NEUTRON ACER TENDL-2024 LIBRARY; T=293.6K
Neutron emission for (n,2np)

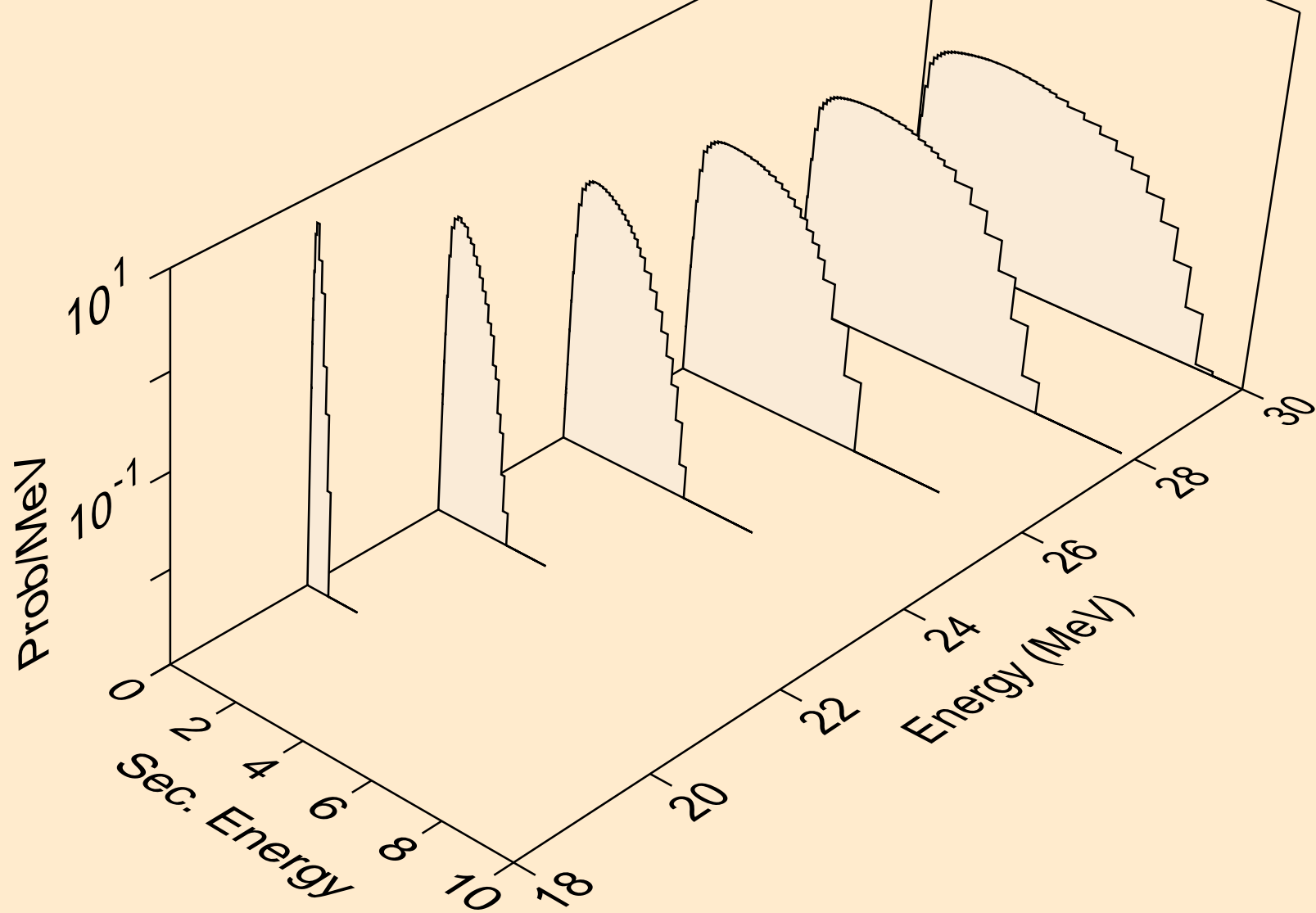

RU088 NEUTRON ACER TENDL-2024 LIBRARY; T=293.6K
Neutron emission for (n,n2p)

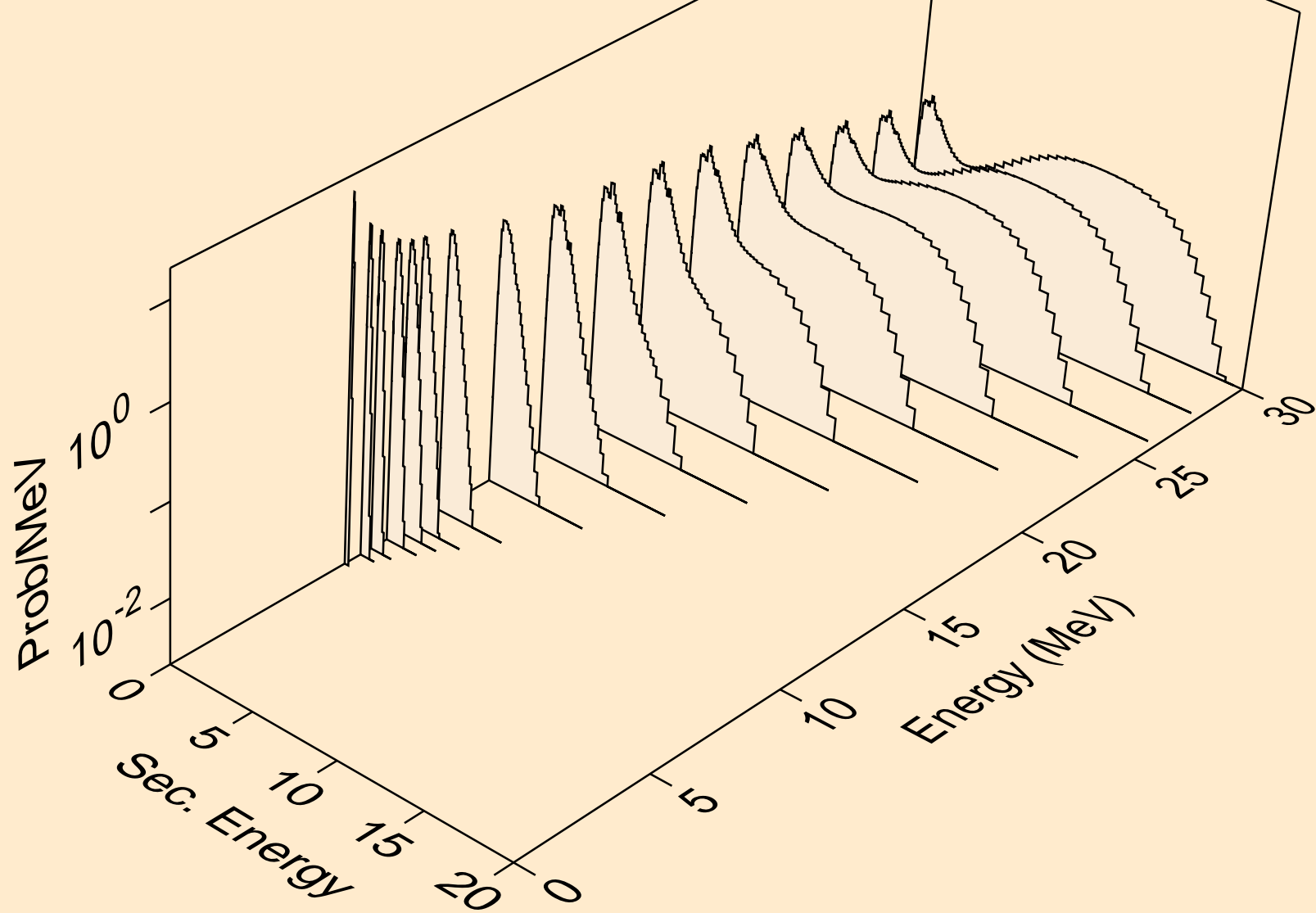

RU088 NEUTRON ACER TENDL-2024 LIBRARY; T=293.6K
Neutron emission for (n,npa)

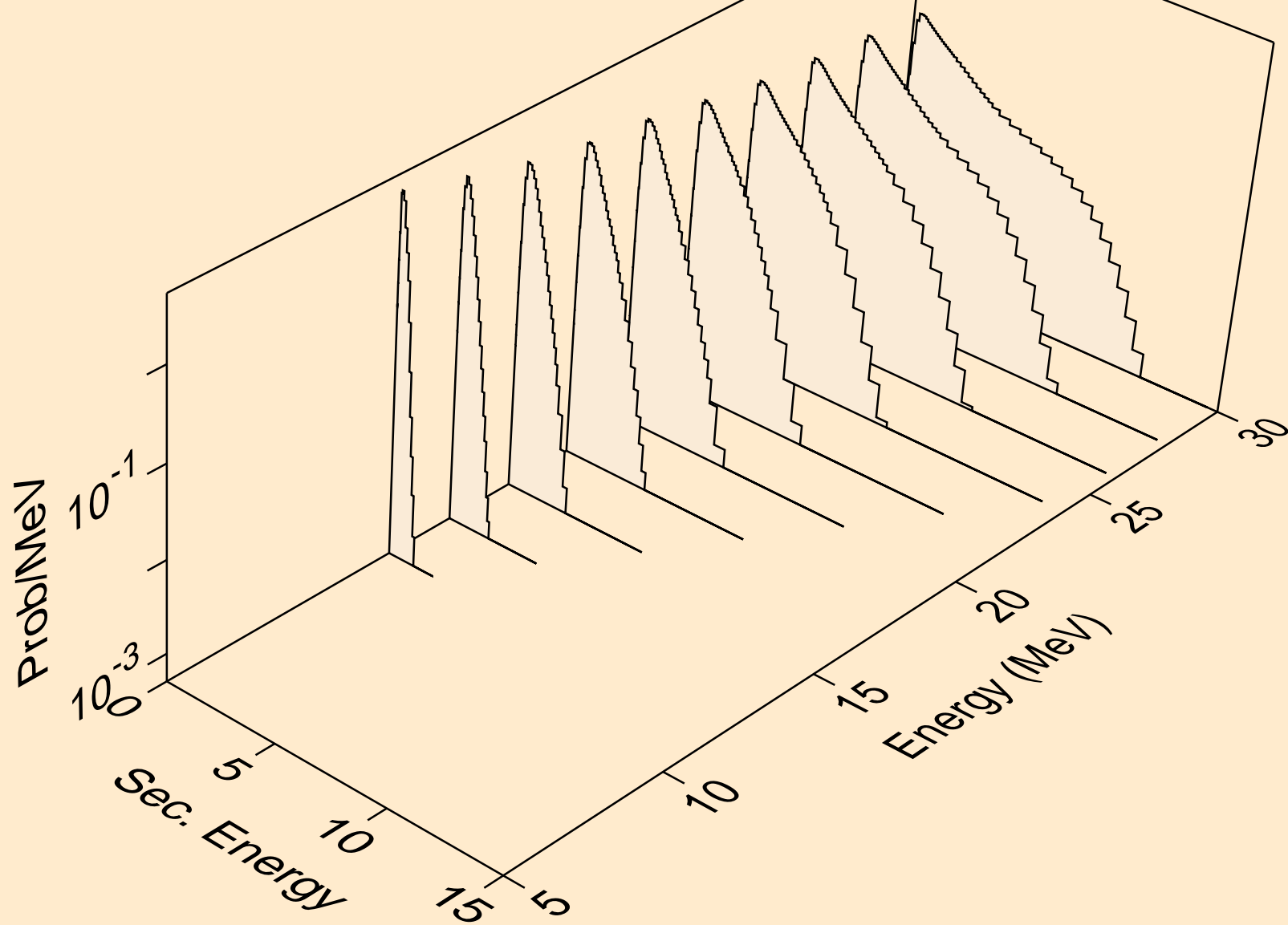

RU088 NEUTRON ACER TENDL-2024 LIBRARY; T=293.6K
Neutron emission for (n,n*c)

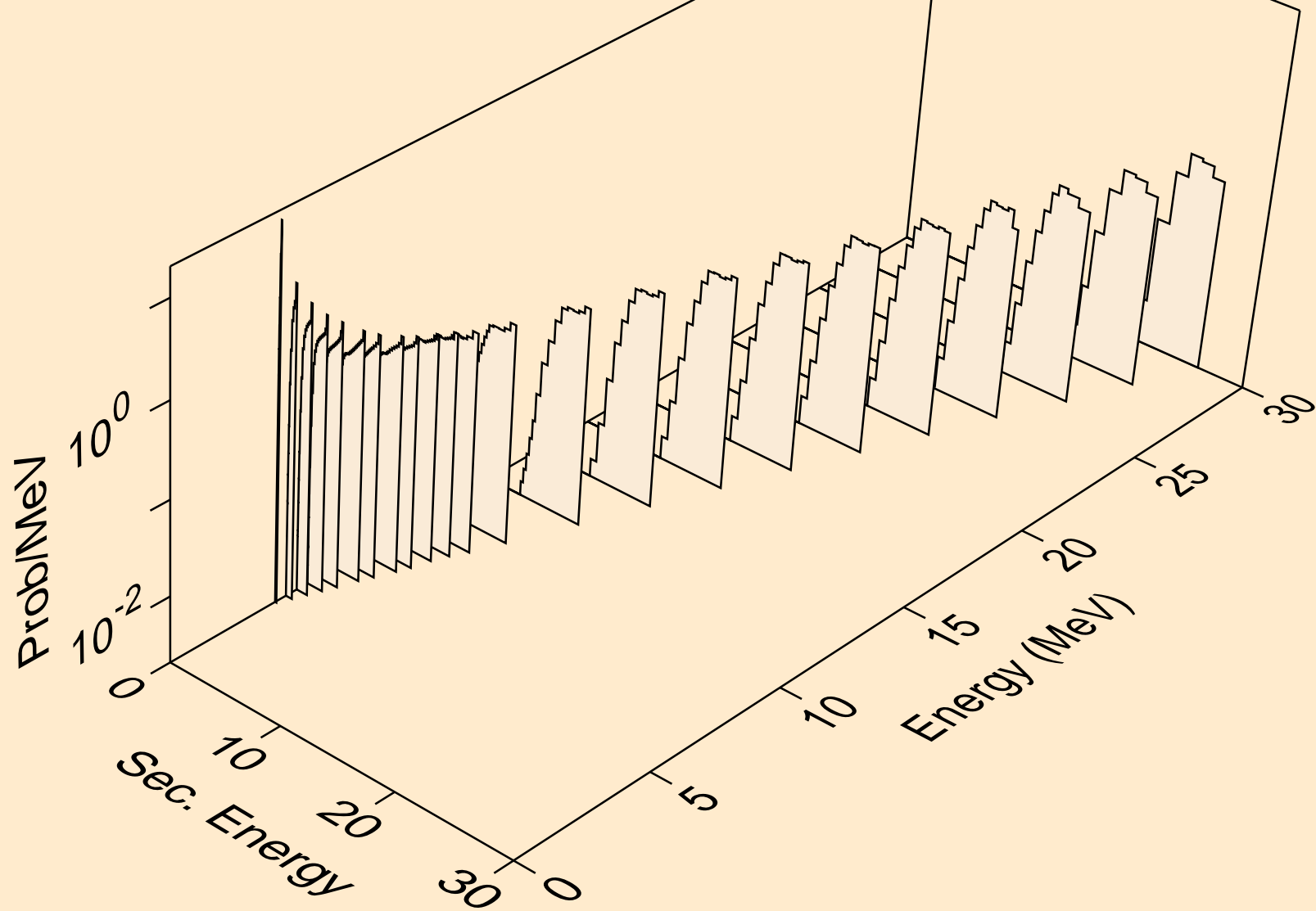

RU088 NEUTRON ACER TENDL-2024 LIBRARY; T=293.6K
Photon emission for (n,x)

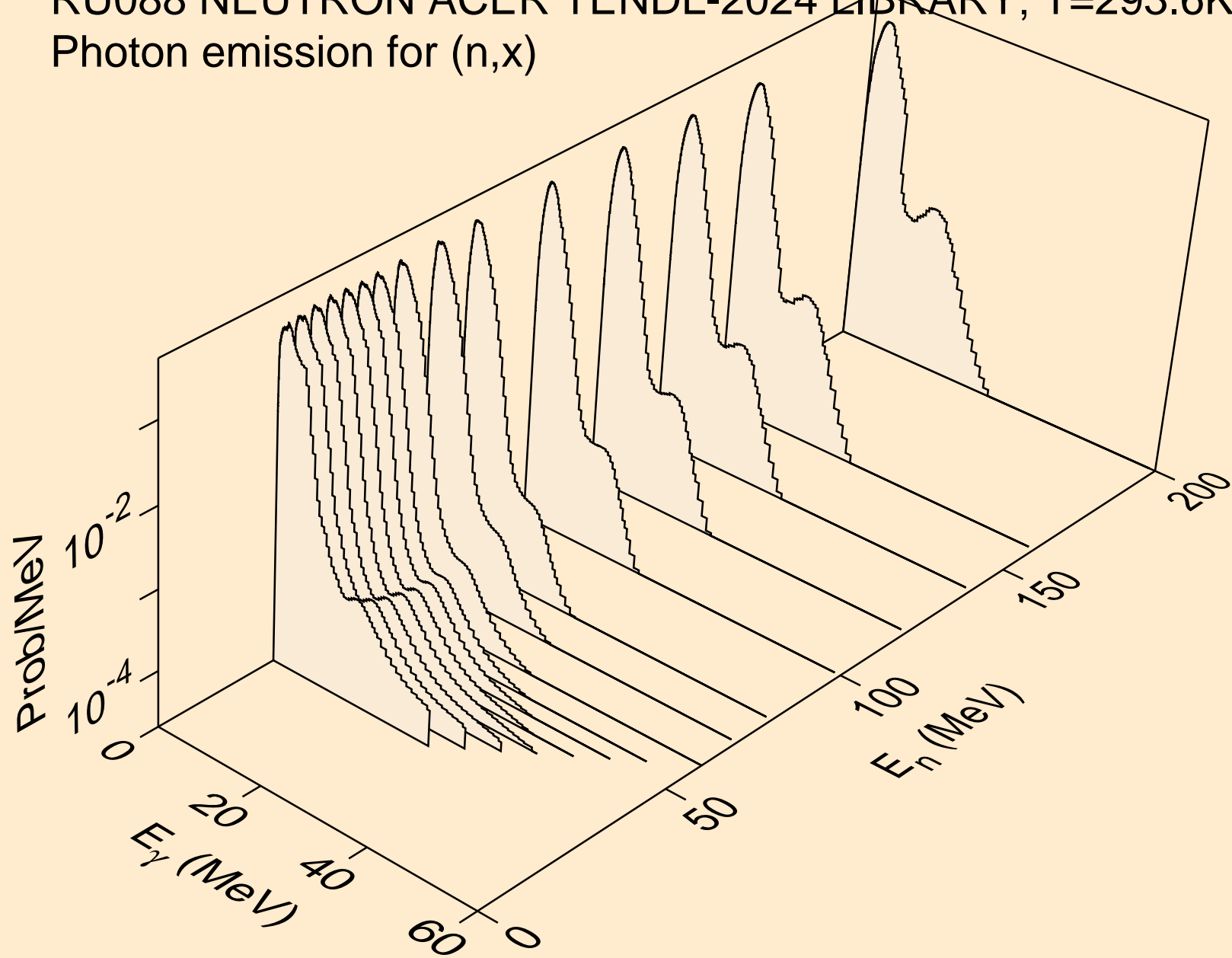

RU088 NEUTRON ACER TENDL-2024 LIBRARY; T=293.6K
Photon emission for (n,2n)

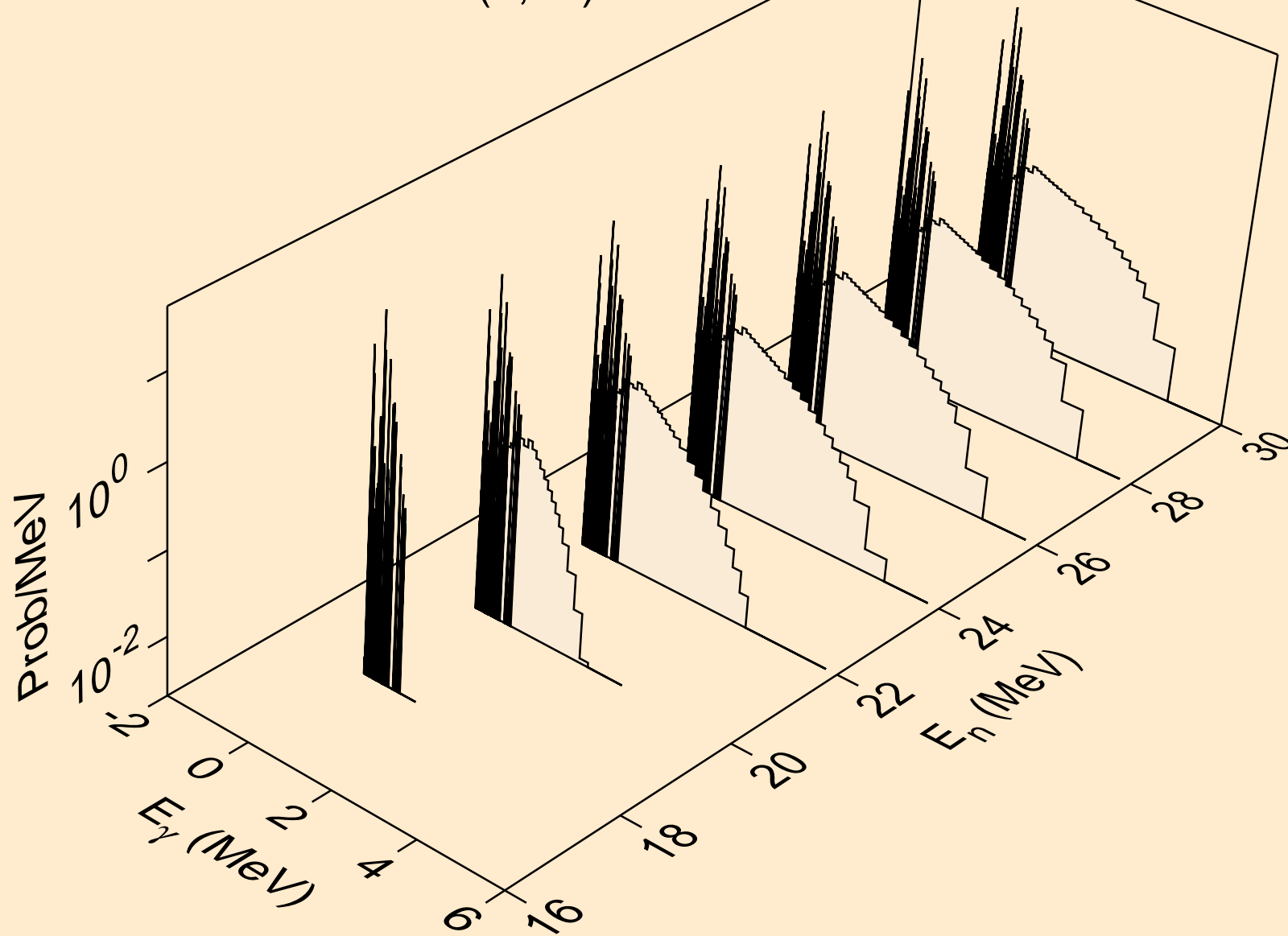

RU088 NEUTRON ACER TENDL-2024 LIBRARY; T=293.6K
Photon emission for (n,n*)a

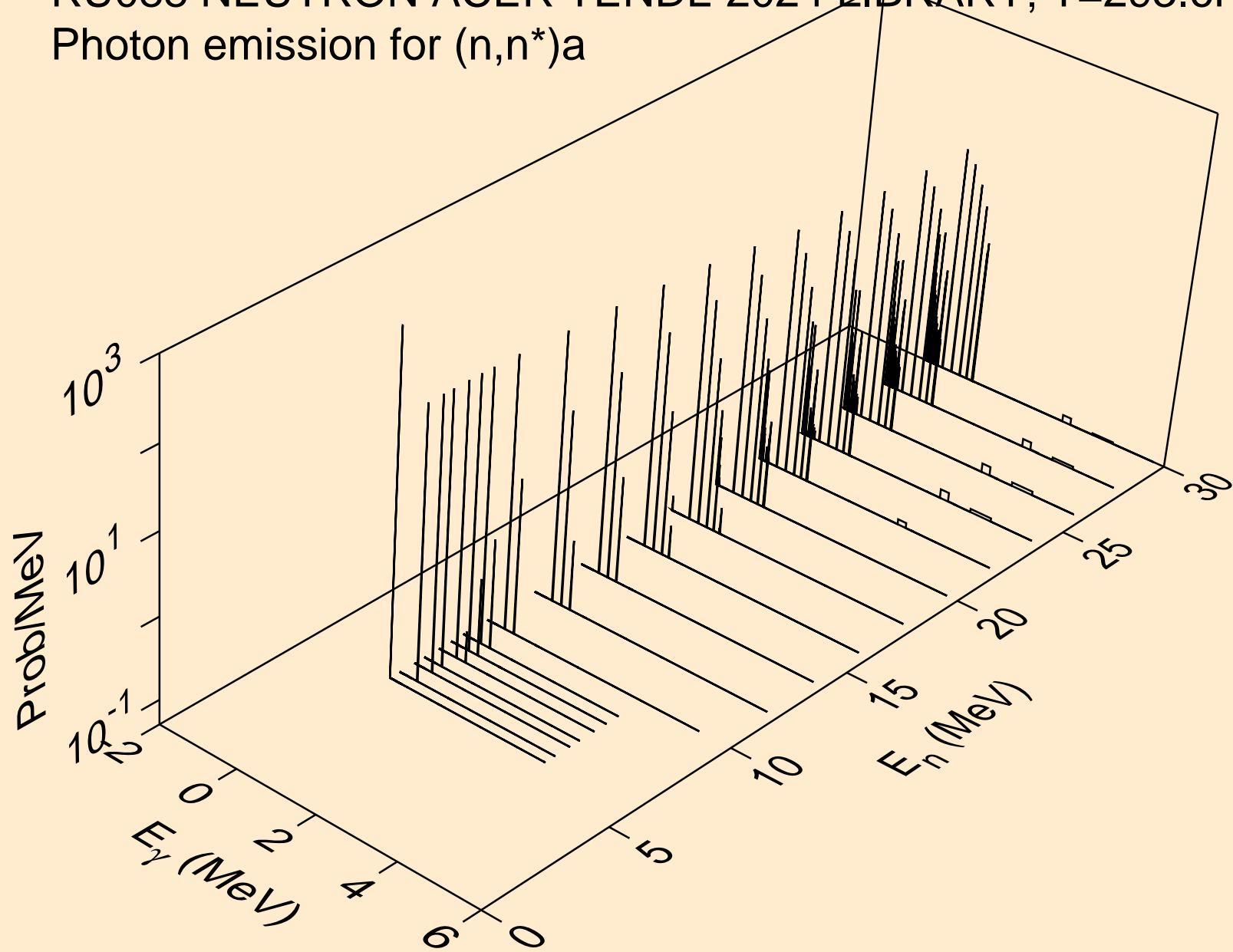

RU088 NEUTRON ACER TENDL-2024 LIBRARY; T=293.6K
Photon emission for (n,2n)a

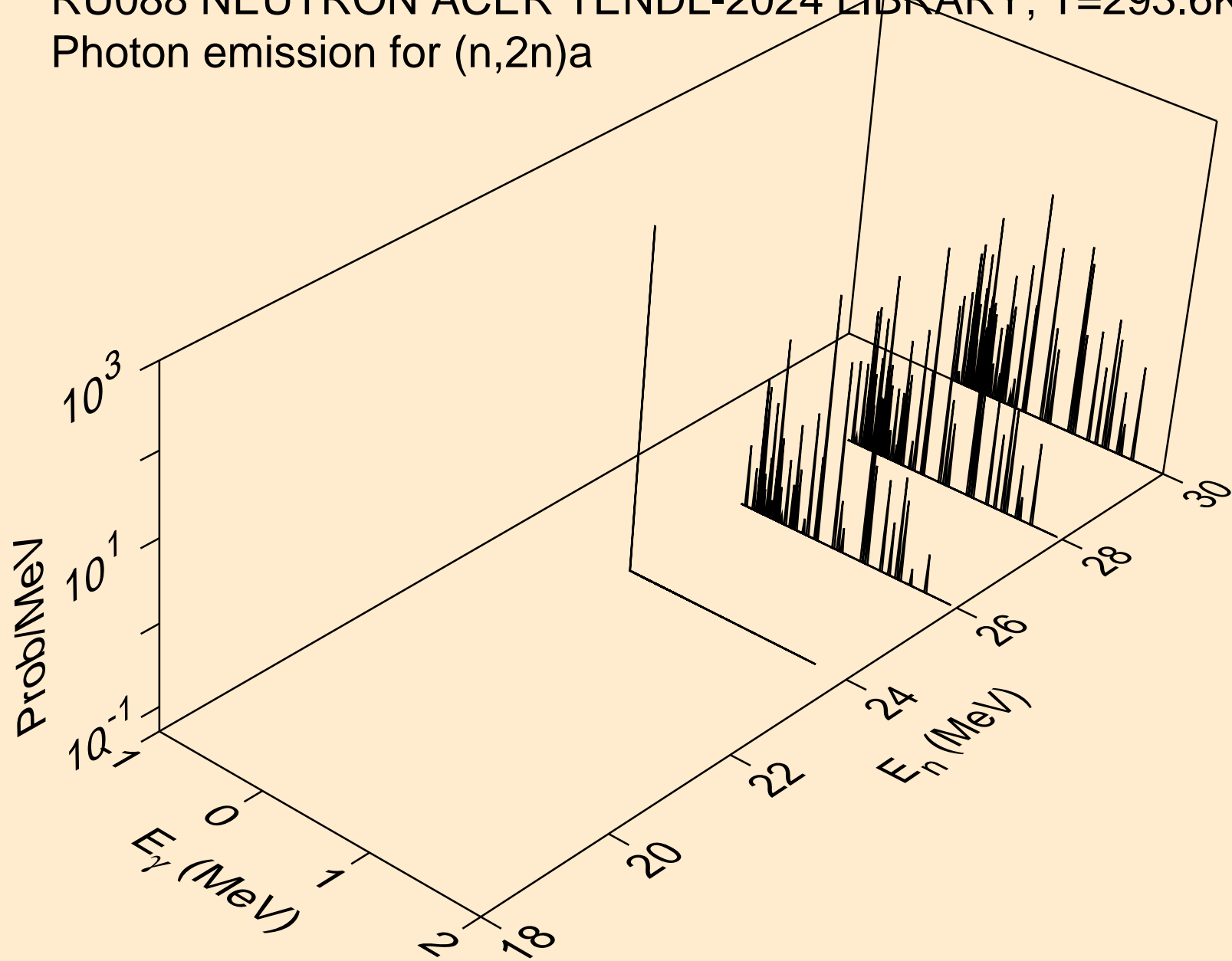

RU088 NEUTRON ACER TENDL-2024 LIBRARY; T=293.6K
Photon emission for (n,n*)p

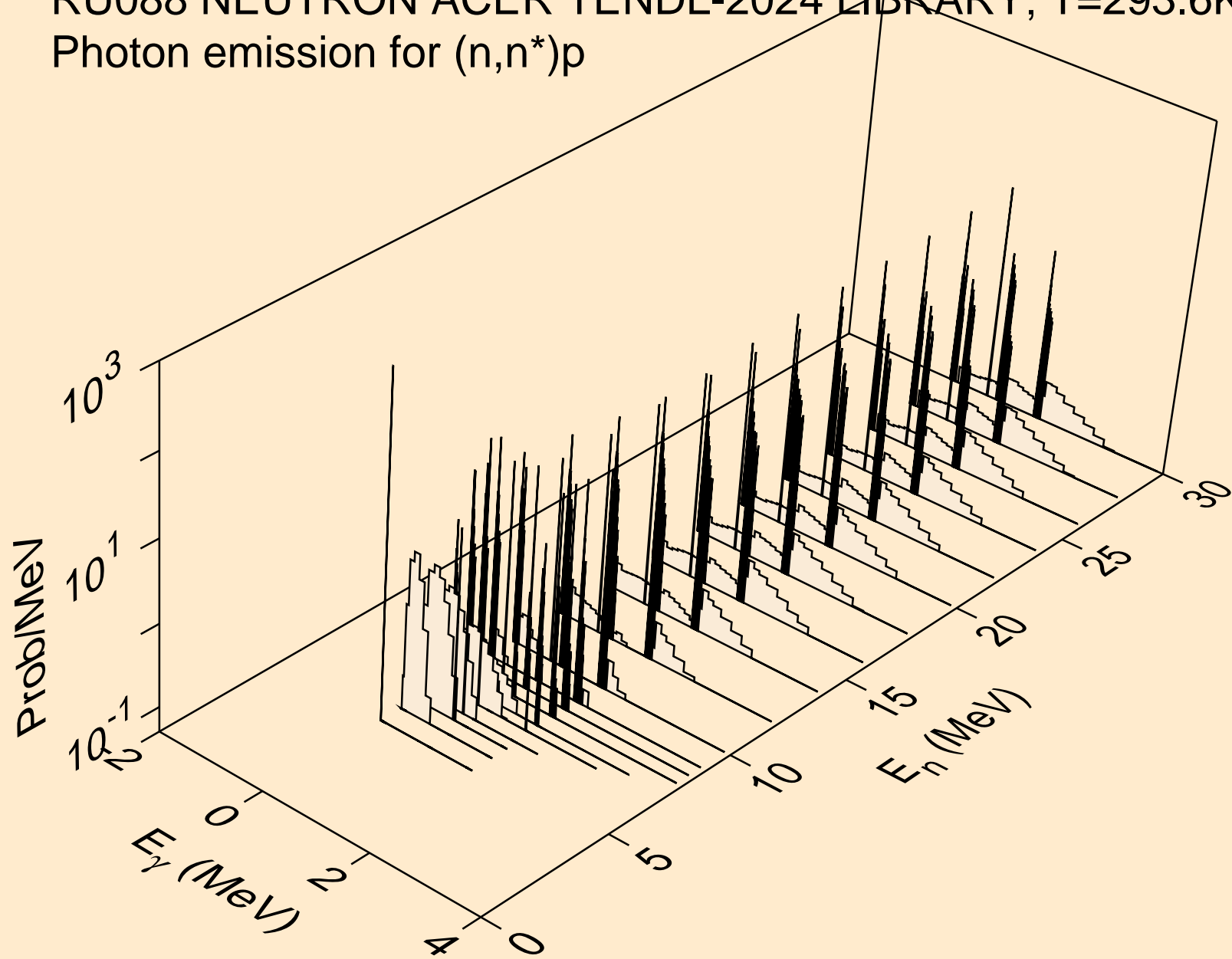

RU088 NEUTRON ACER TENDL-2024 LIBRARY; T=293.6K
Photon emission for (n,n*)2a

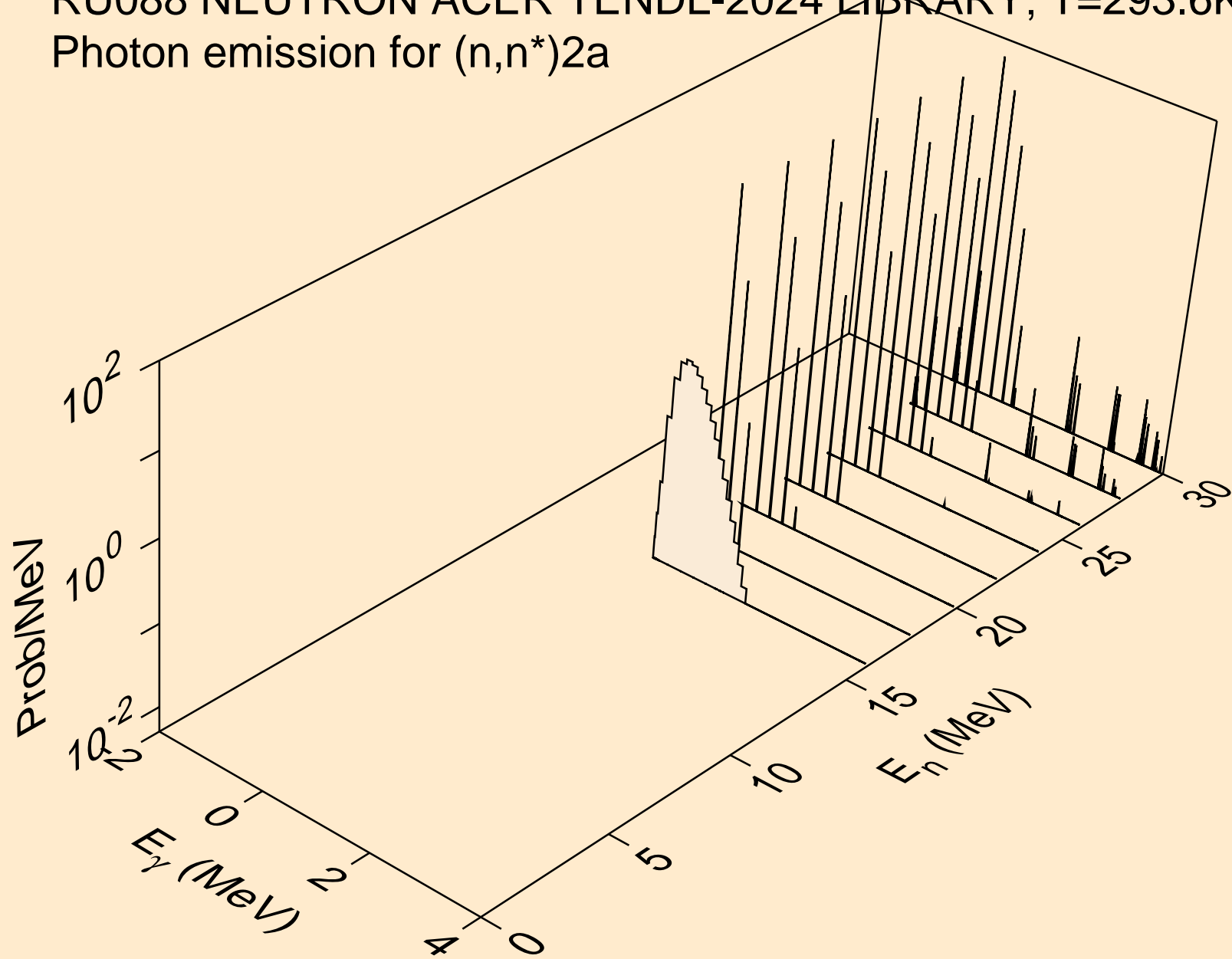

RU088 NEUTRON ACER TENDL-2024 LIBRARY; T=293.6K
Photon emission for (n,n*)d

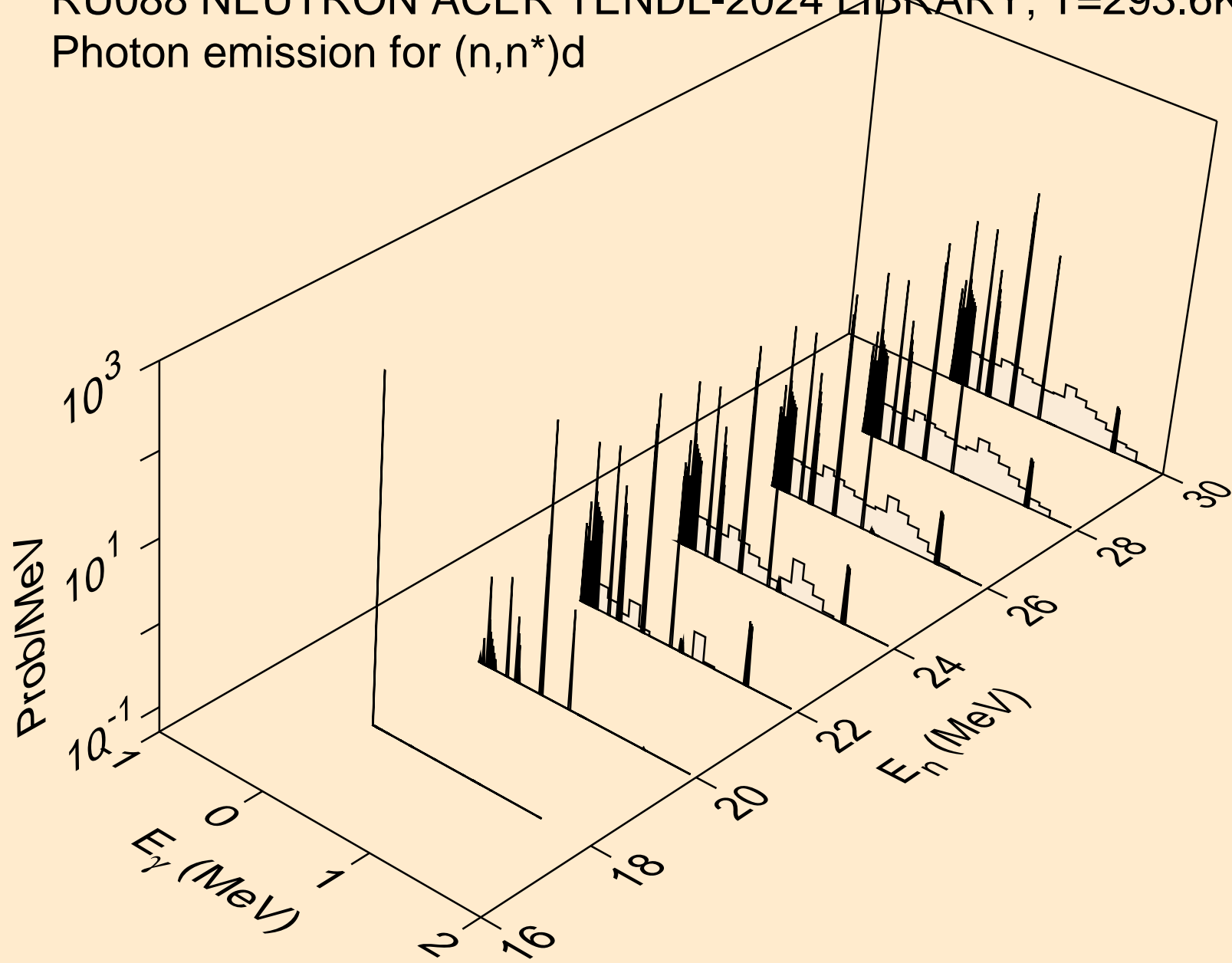

RU088 NEUTRON ACER TENDL-2024 LIBRARY; T=293.6K
Photon emission for (n,n*)t

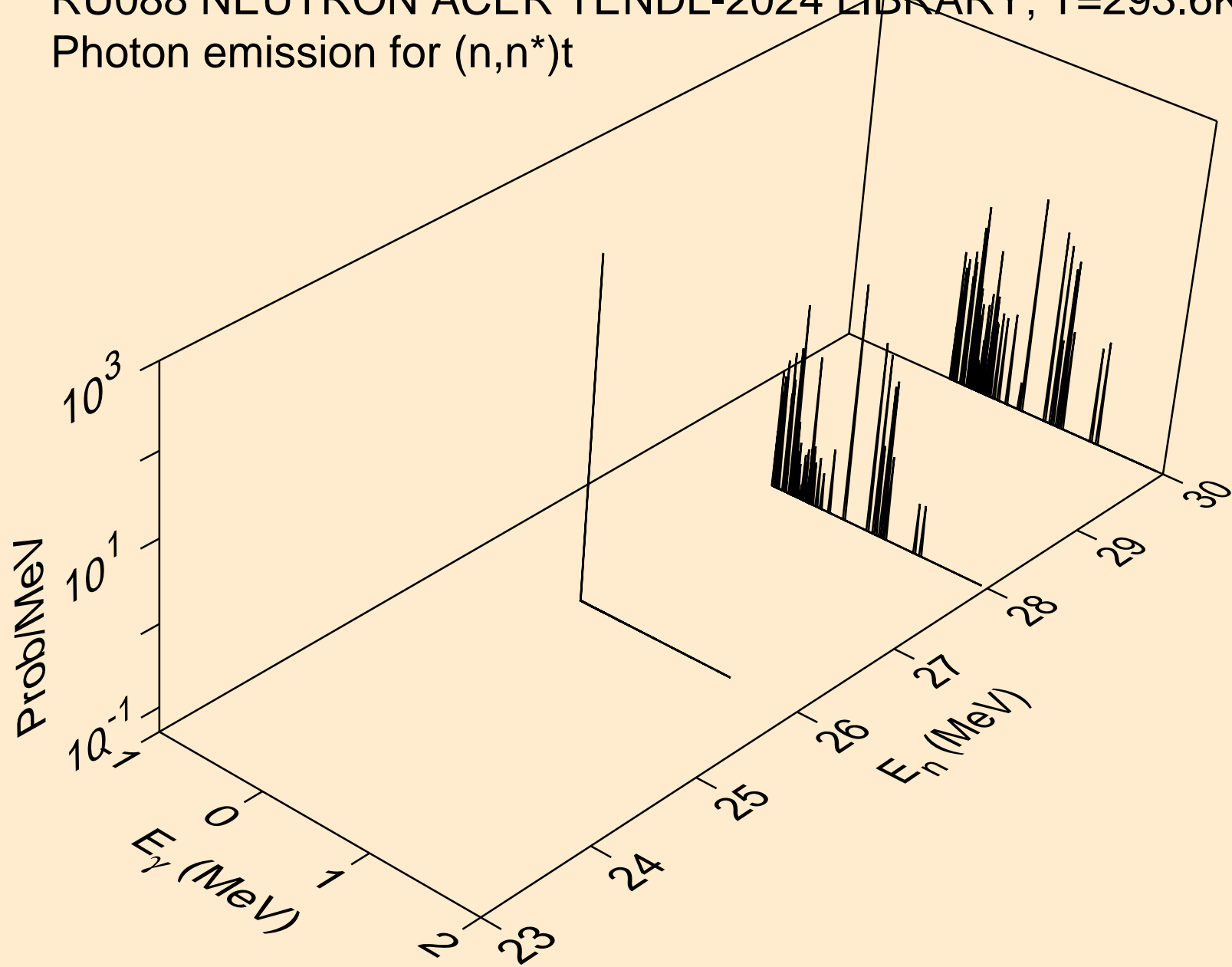

RU088 NEUTRON ACER TENDL-2024 LIBRARY; T=293.6K
Photon emission for (n,n*)he3

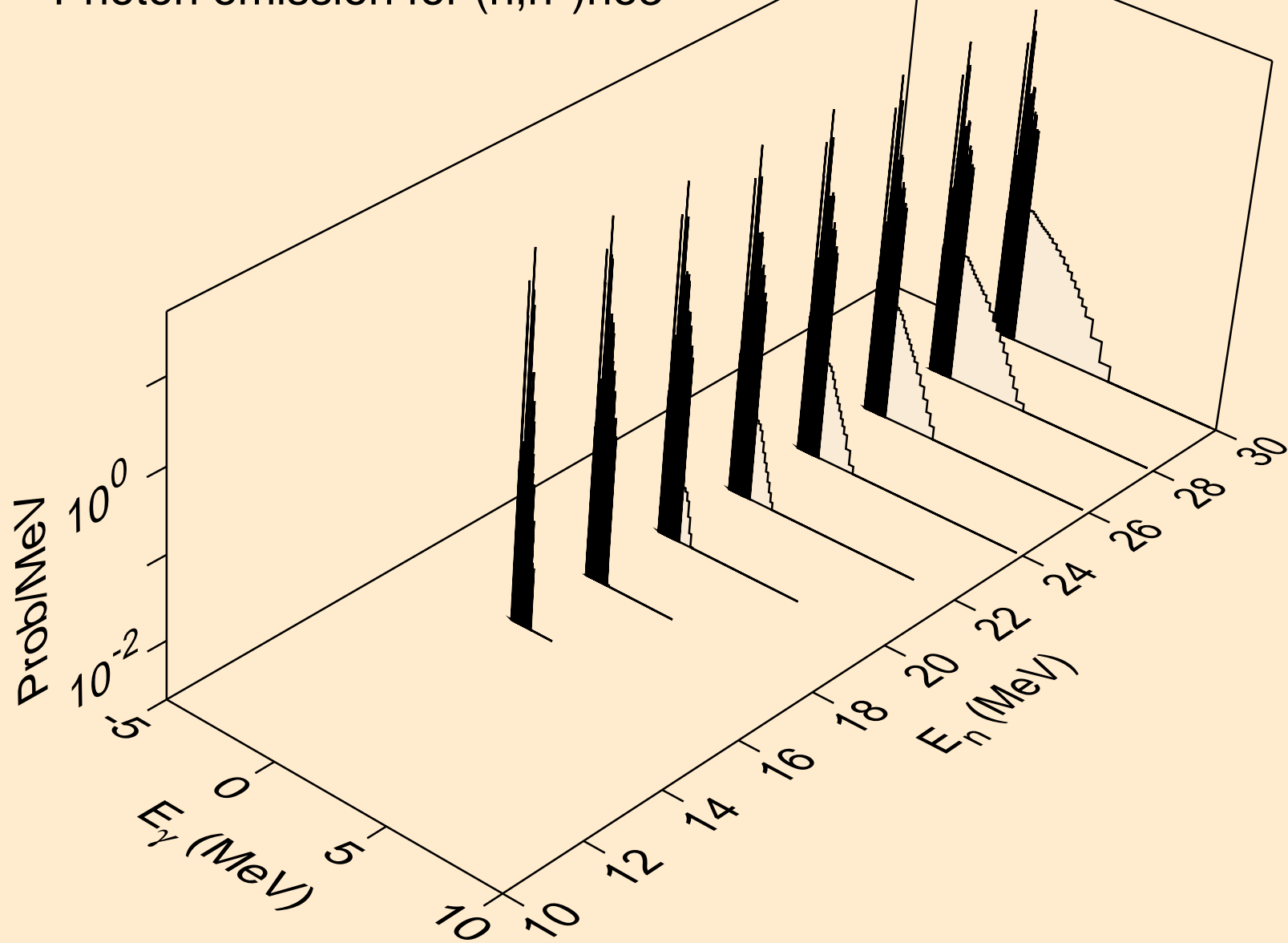

RU088 NEUTRON ACER TENDL-2024 LIBRARY; T=293.6K
Photon emission for (n,2np)

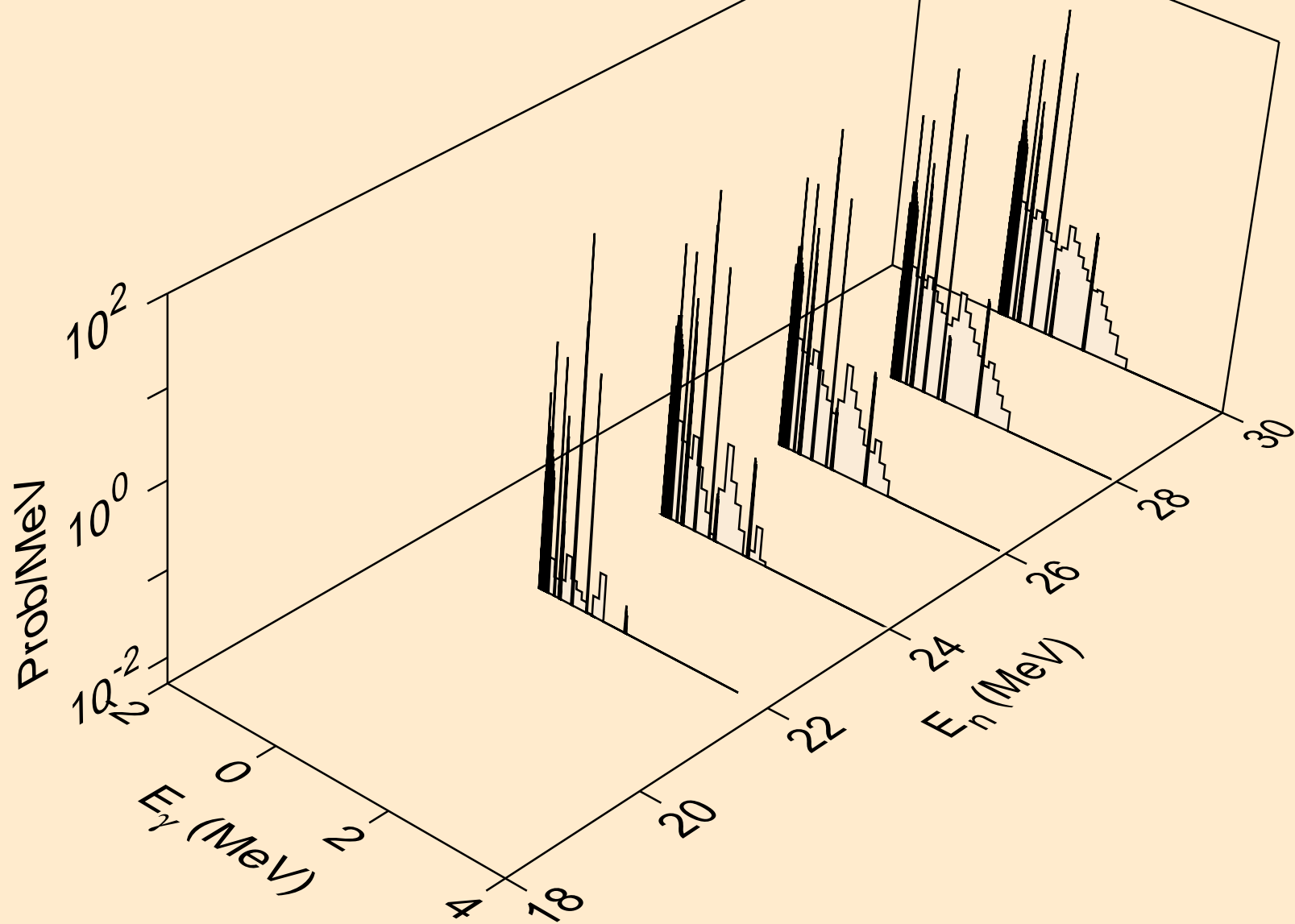

RU088 NEUTRON ACER TENDL-2024 LIBRARY; T=293.6K
Photon emission for (n,n2p)

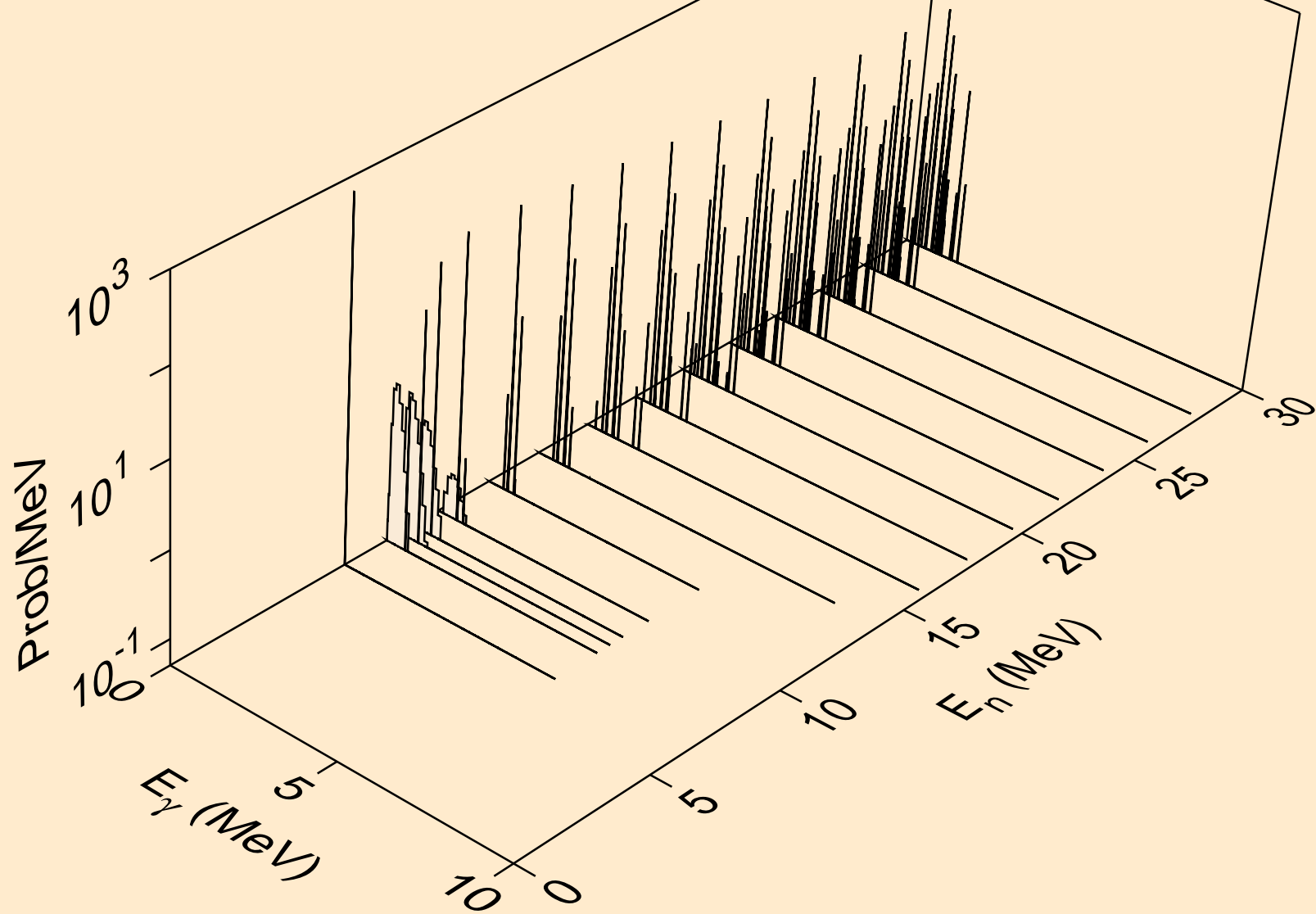

RU088 NEUTRON ACER TENDL-2024 LIBRARY; T=293.6K
Photon emission for (n,npa)

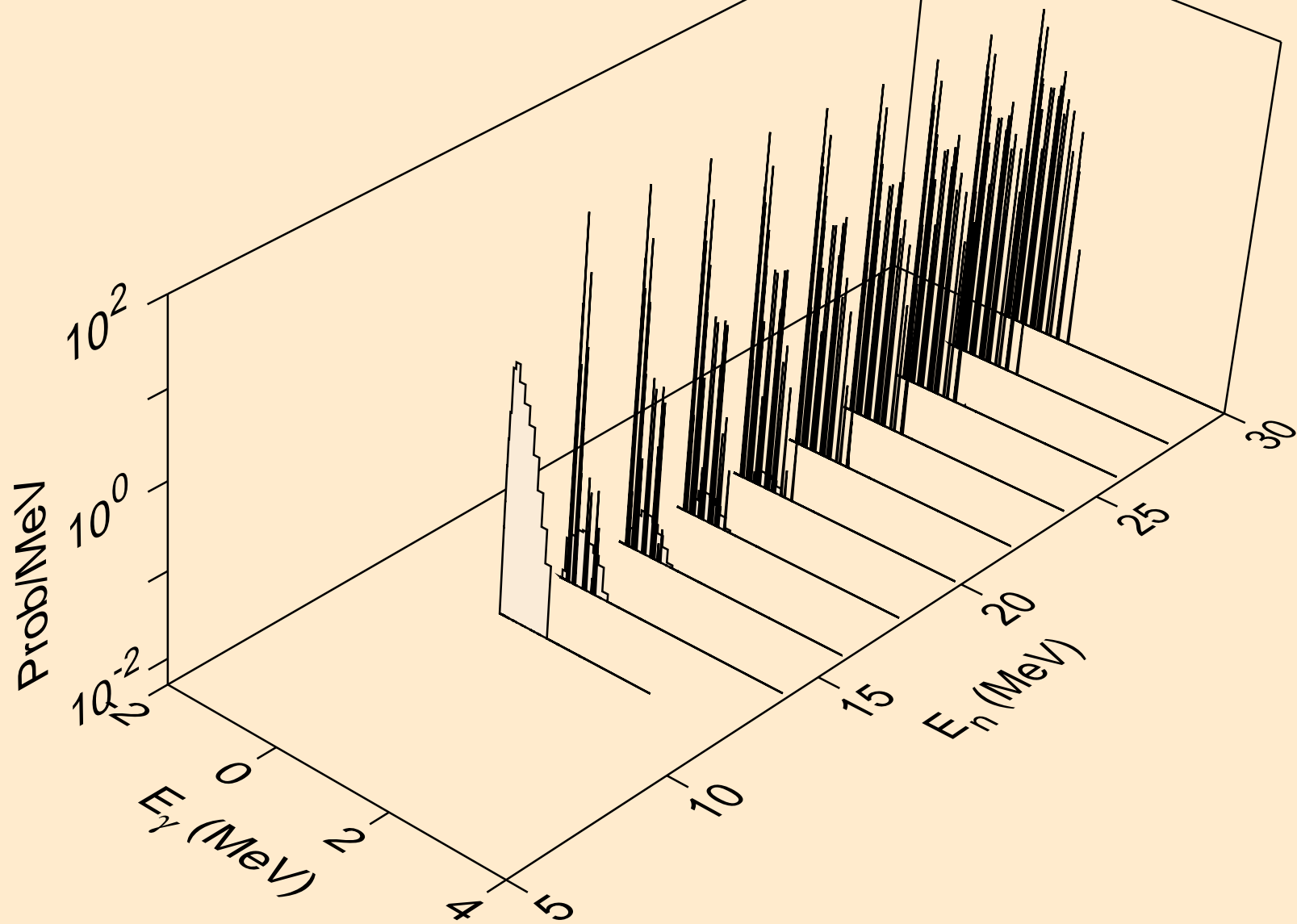

RU088 NEUTRON ACER TENDL-2024 LIBRARY; T=293.6K
Photon emission for (n,n*c)

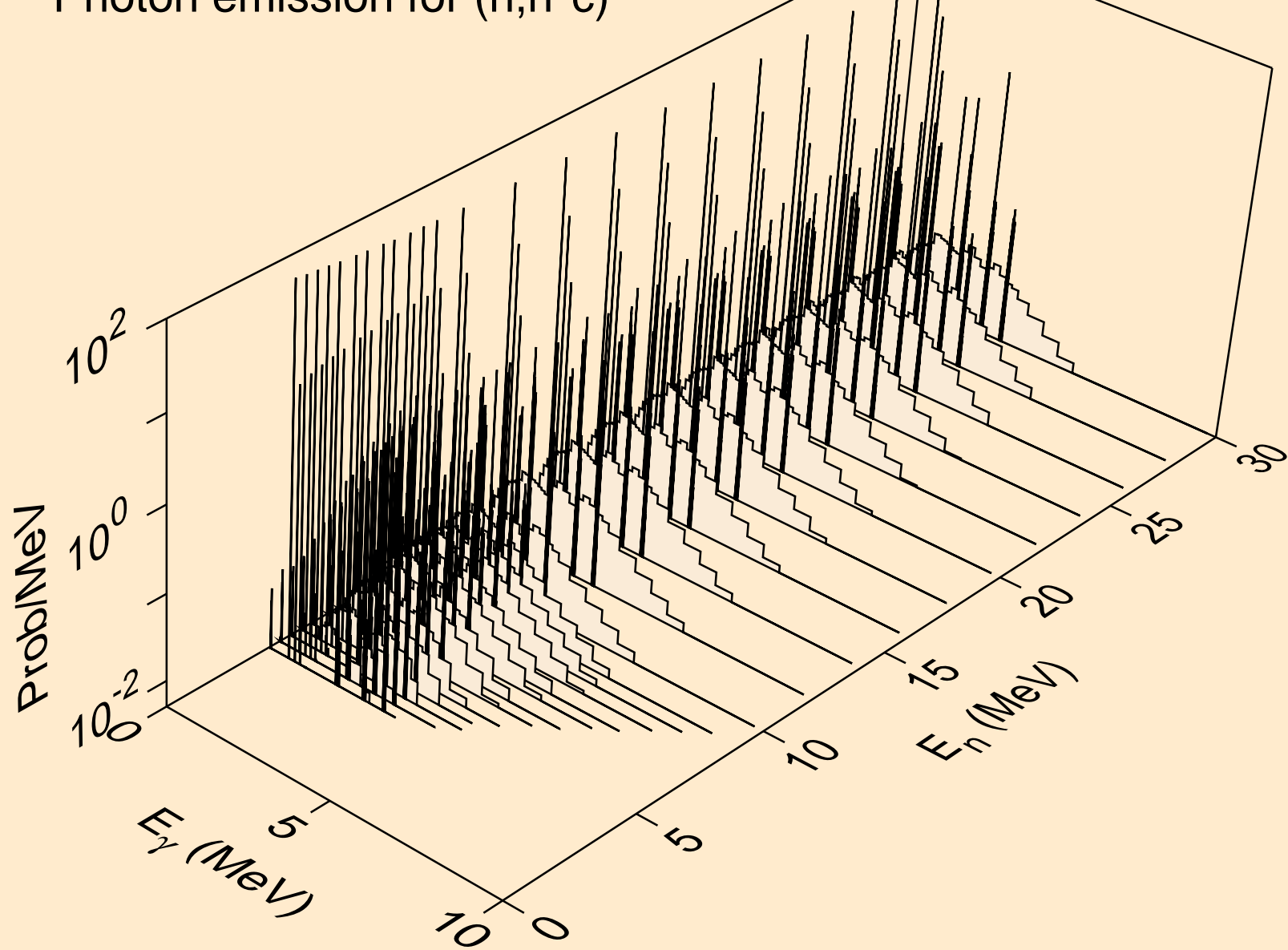

RU088 NEUTRON ACER TENDL-2024 LIBRARY; T=293.6K
Photon emission for (n,gma)

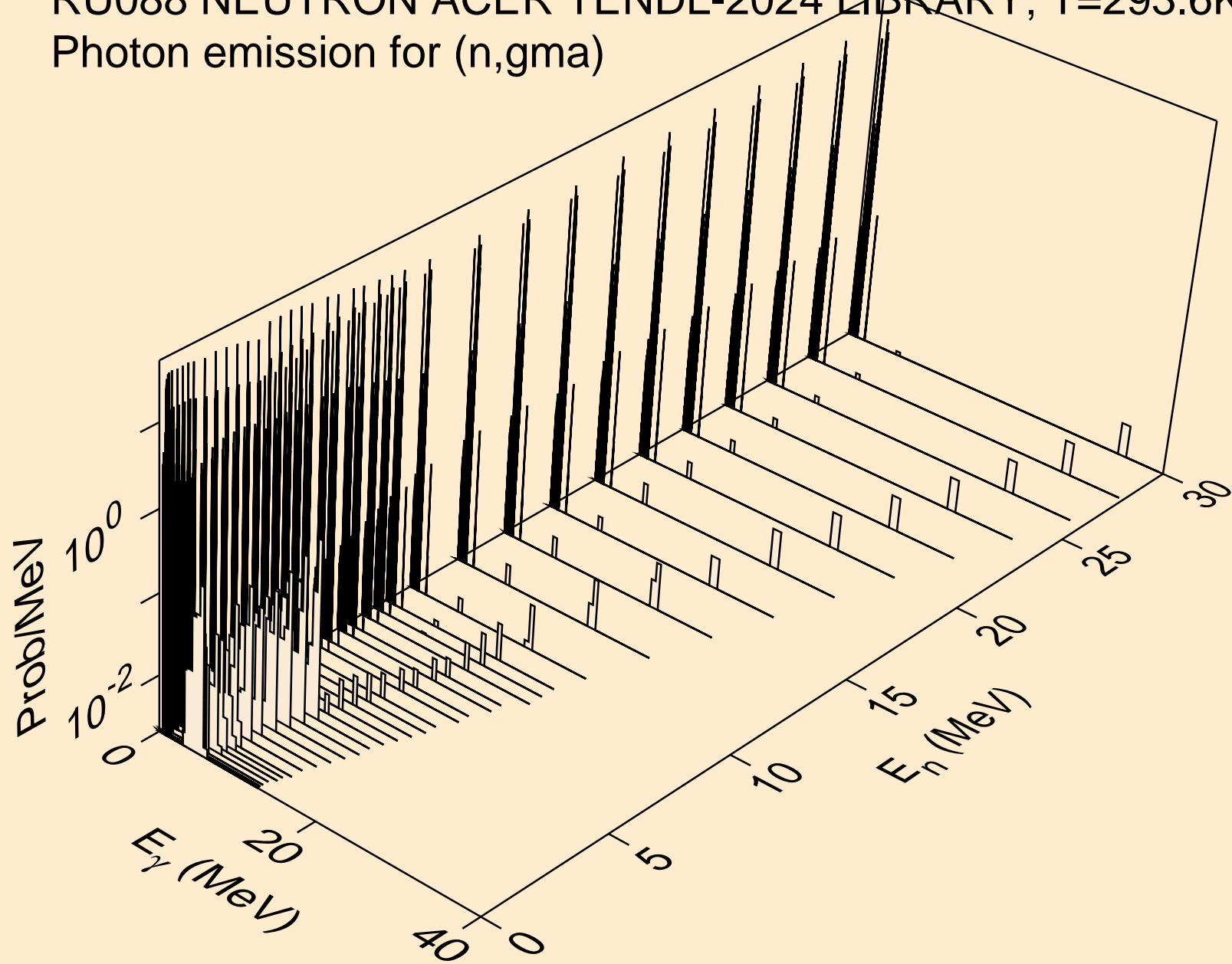

RU088 NEUTRON ACER TENDL-2024 LIBRARY; T=293.6K
Photon emission for (n,p)

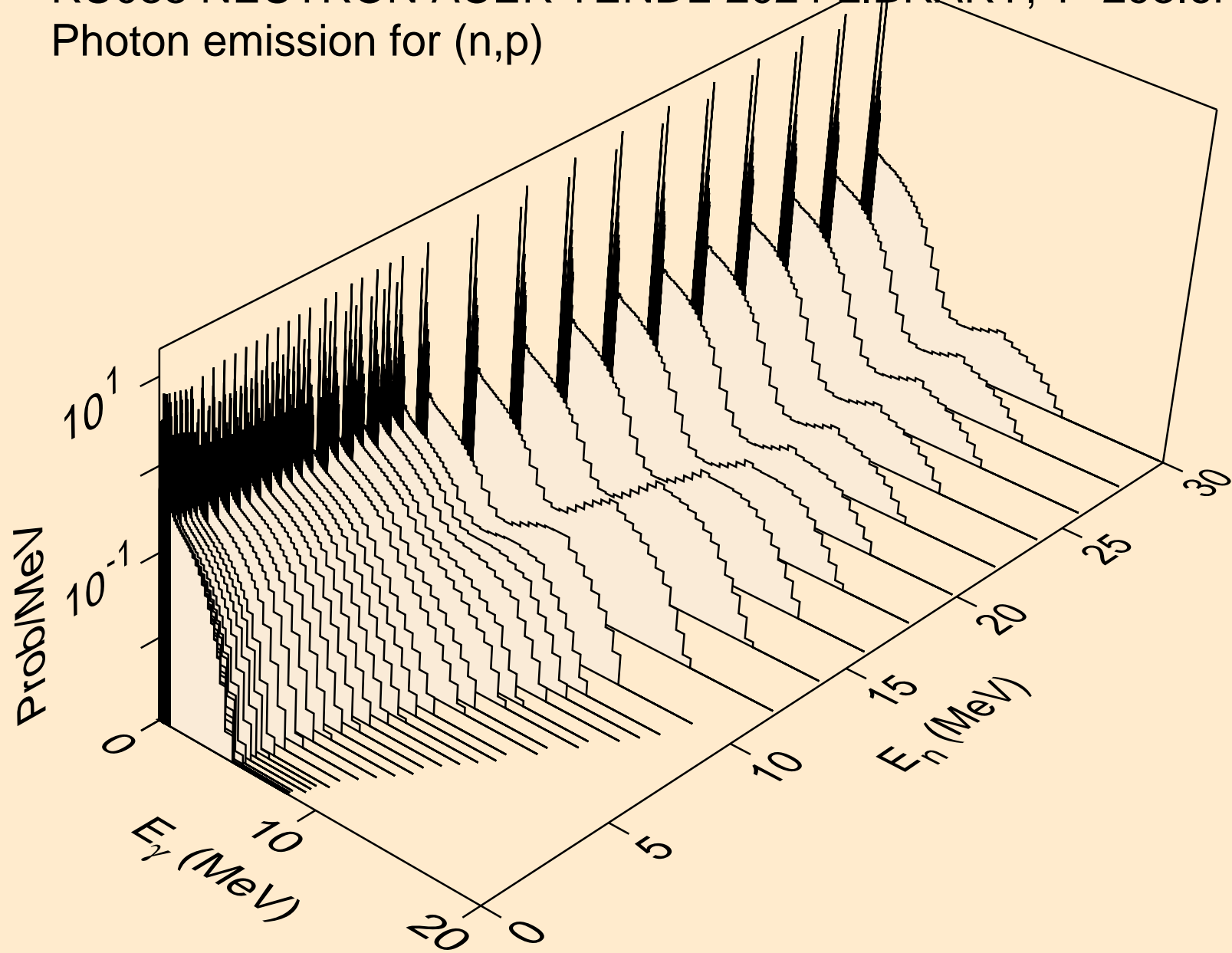

RU088 NEUTRON ACER TENDL-2024 LIBRARY; T=293.6K
Photon emission for (n,d)

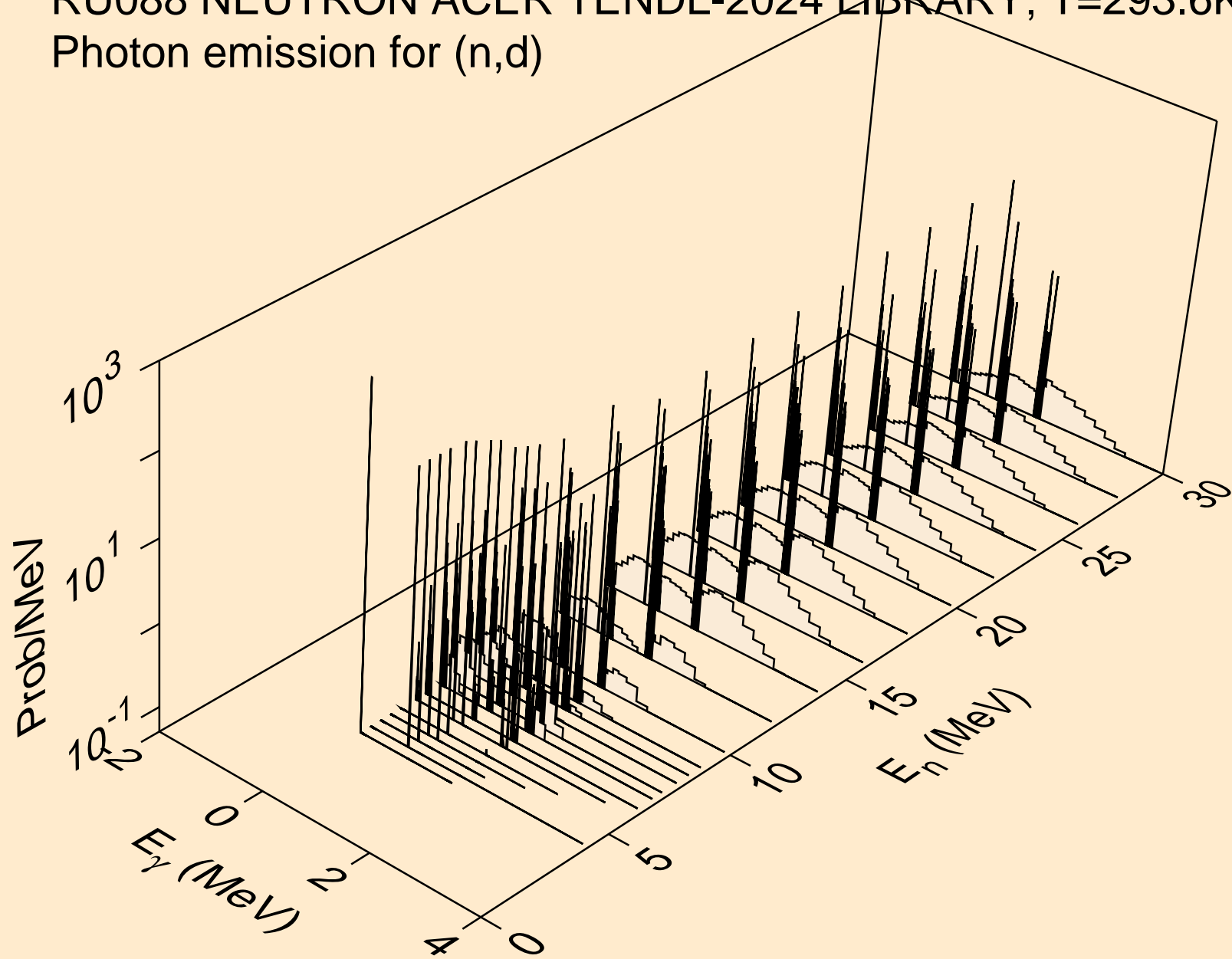

RU088 NEUTRON ACER TENDL-2024 LIBRARY; T=293.6K
Photon emission for (n,t)

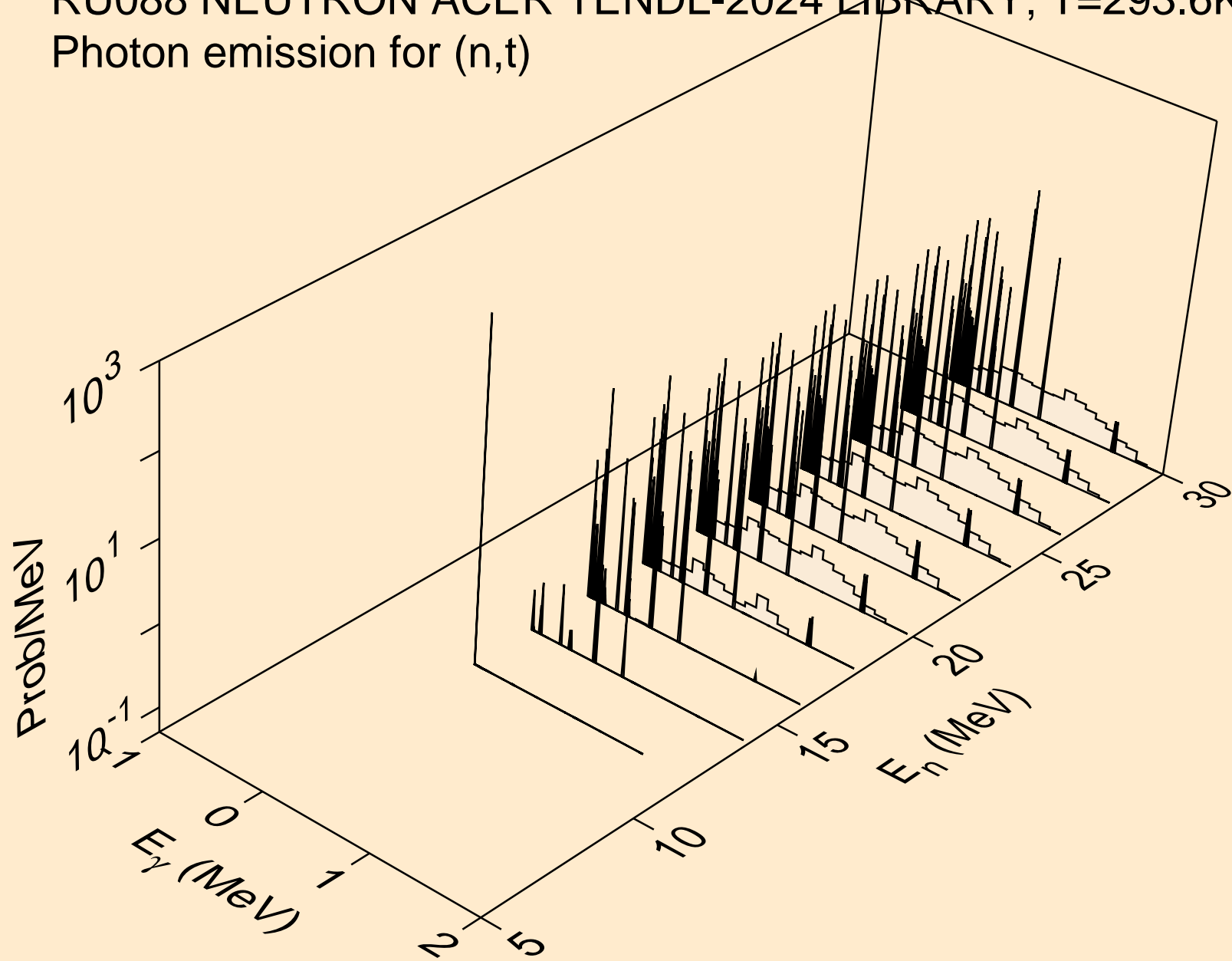

RU088 NEUTRON ACER TENDL-2024 LIBRARY; T=293.6K
Photon emission for (n,he3)

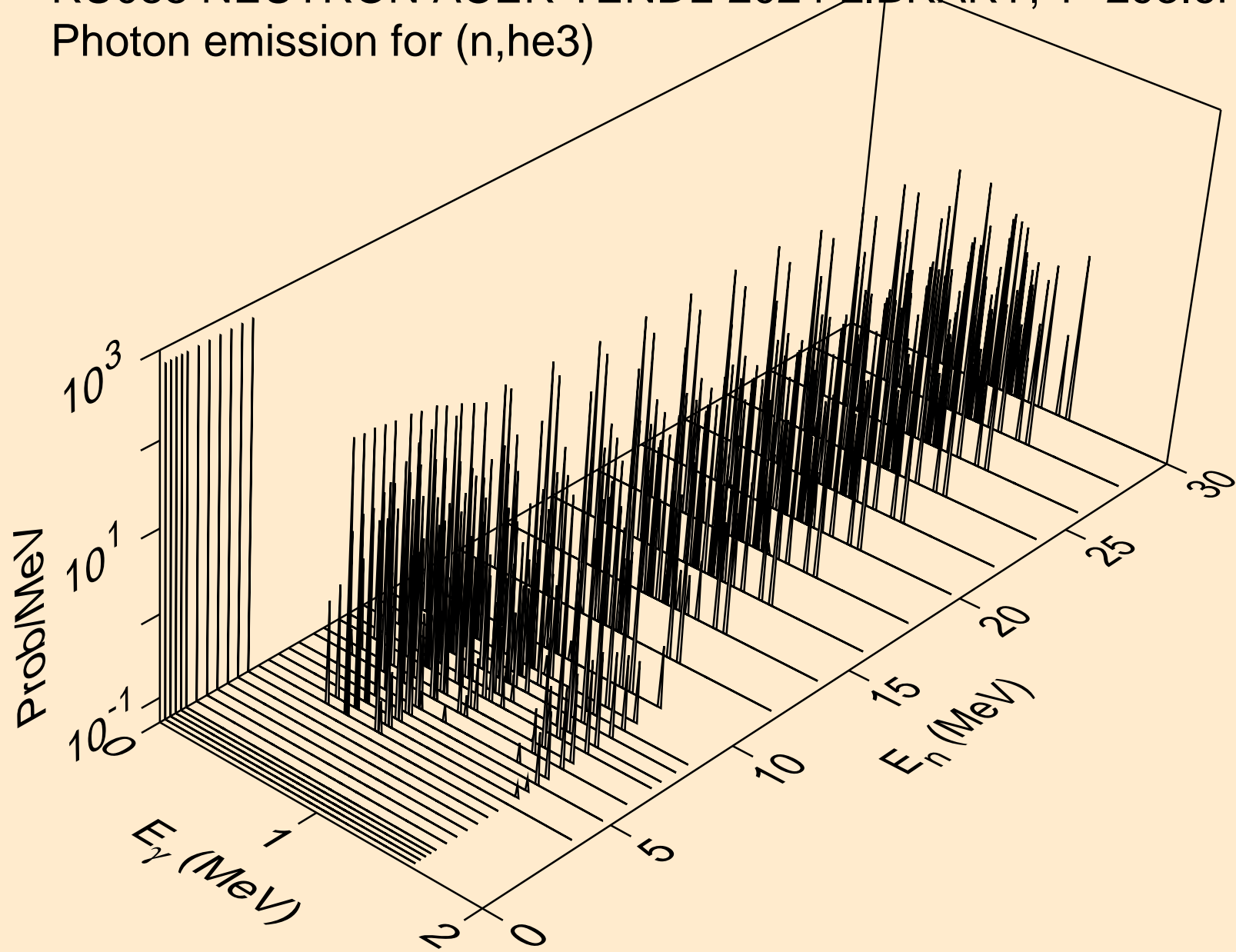

RU088 NEUTRON ACER TENDL-2024 LIBRARY; T=293.6K
Photon emission for (n,a)

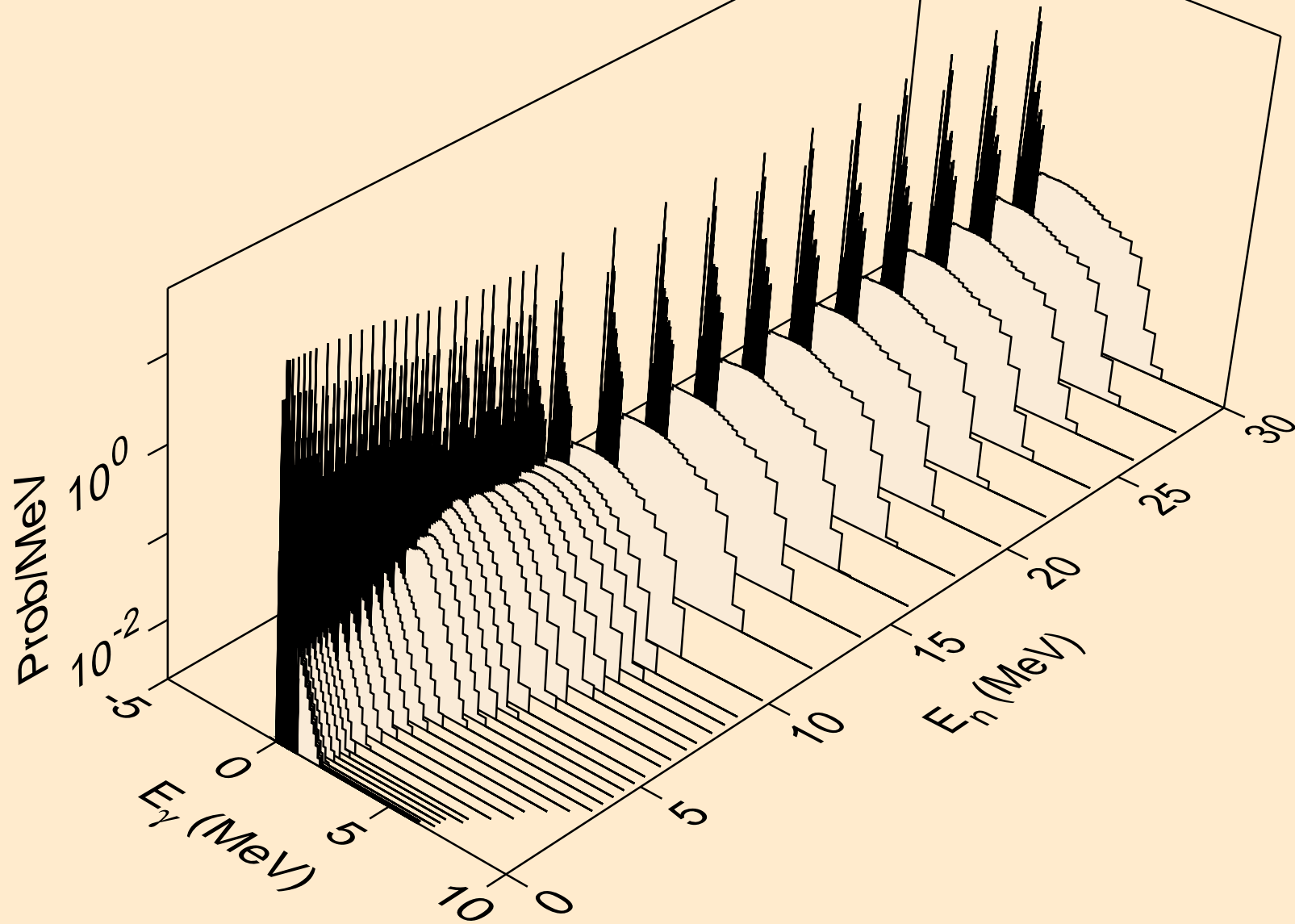

RU088 NEUTRON ACER TENDL-2024 LIBRARY; T=293.6K
Photon emission for (n,2a)

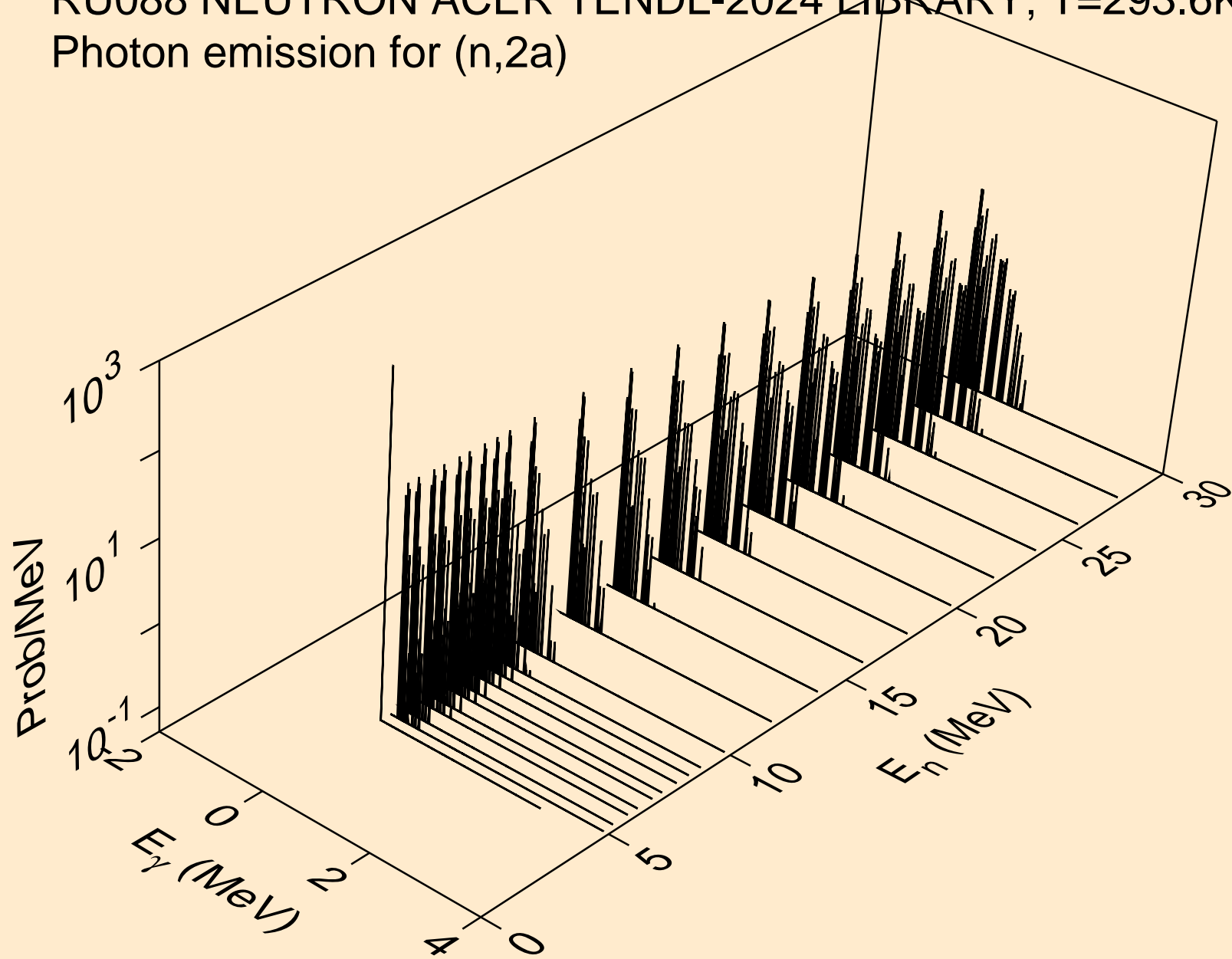

RU088 NEUTRON ACER TENDL-2024 LIBRARY; T=293.6K
Photon emission for (n,3a)

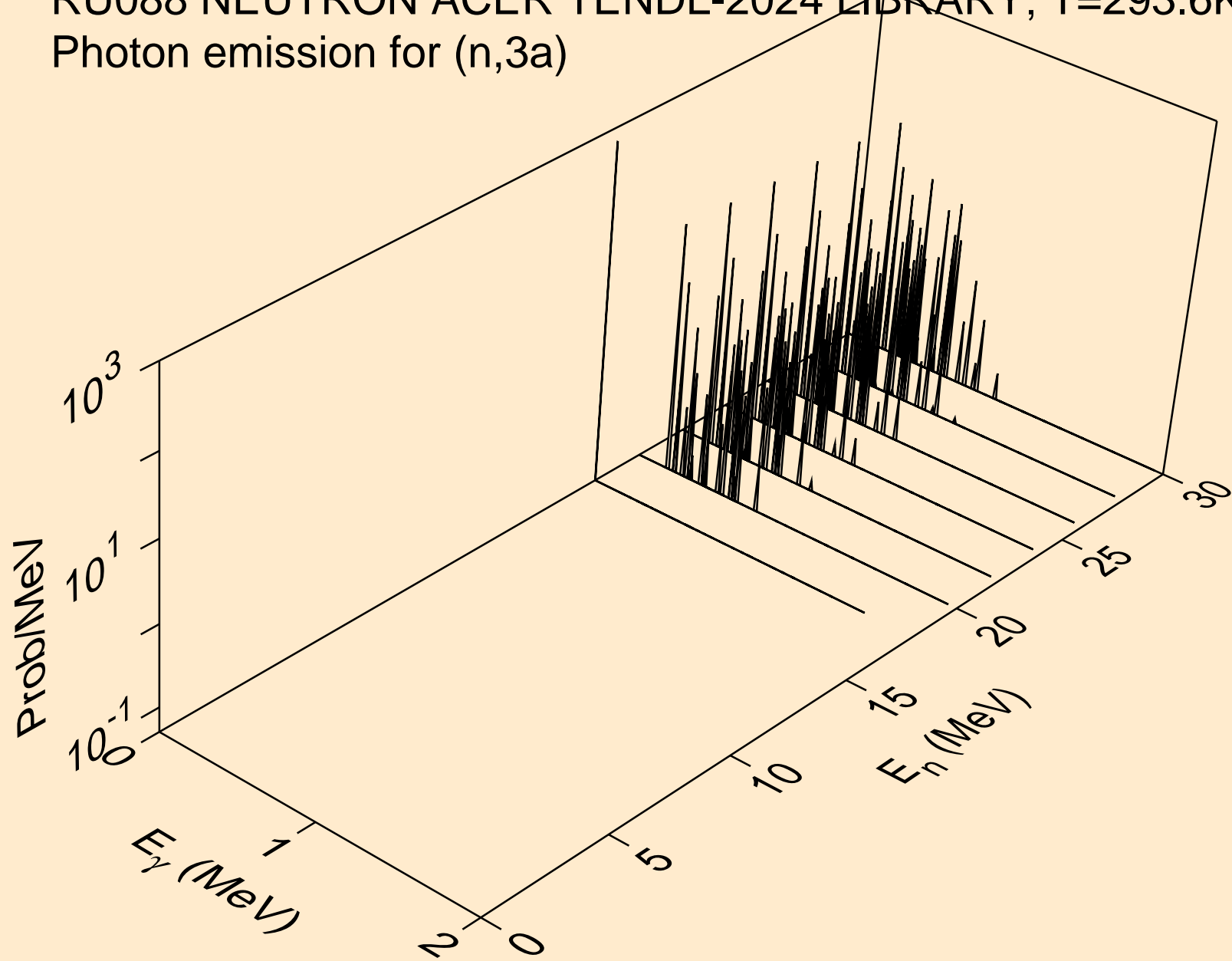

RU088 NEUTRON ACER TENDL-2024 LIBRARY; T=293.6K
Photon emission for (n,2p)

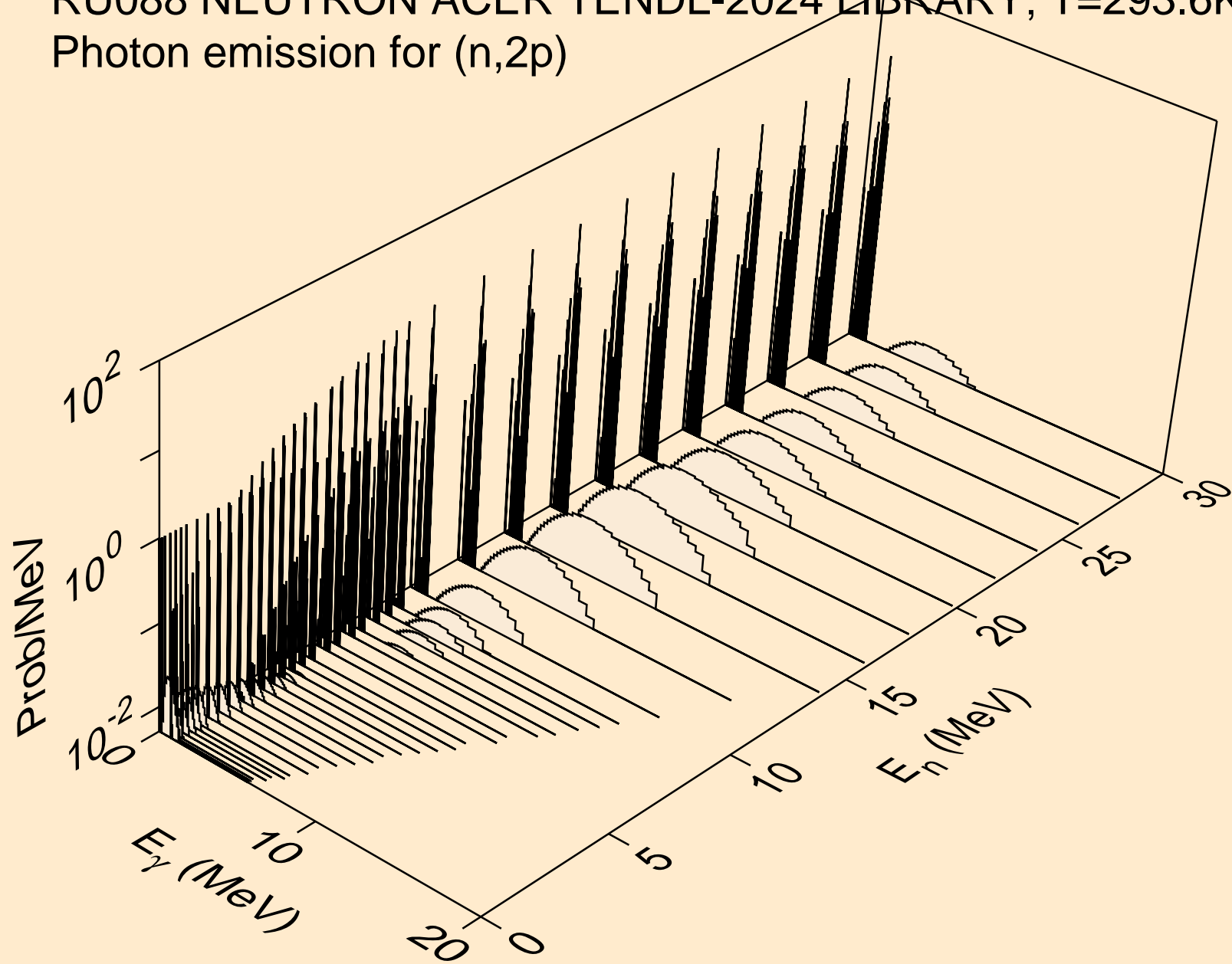

RU088 NEUTRON ACER TENDL-2024 LIBRARY; T=293.6K
Photon emission for (n,p α)

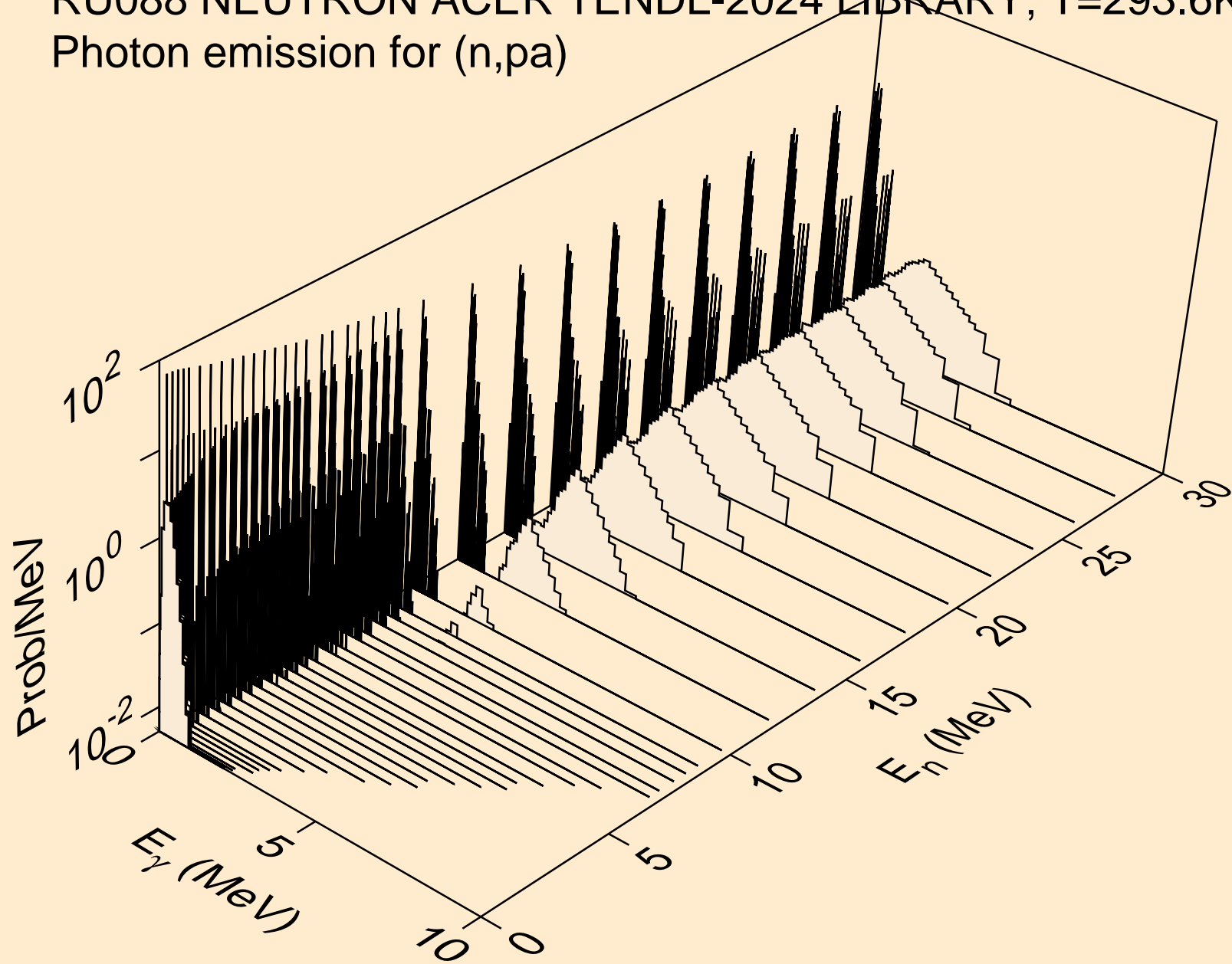

RU088 NEUTRON ACER TENDL-2024 LIBRARY; T=293.6K
Photon emission for (n,pd)

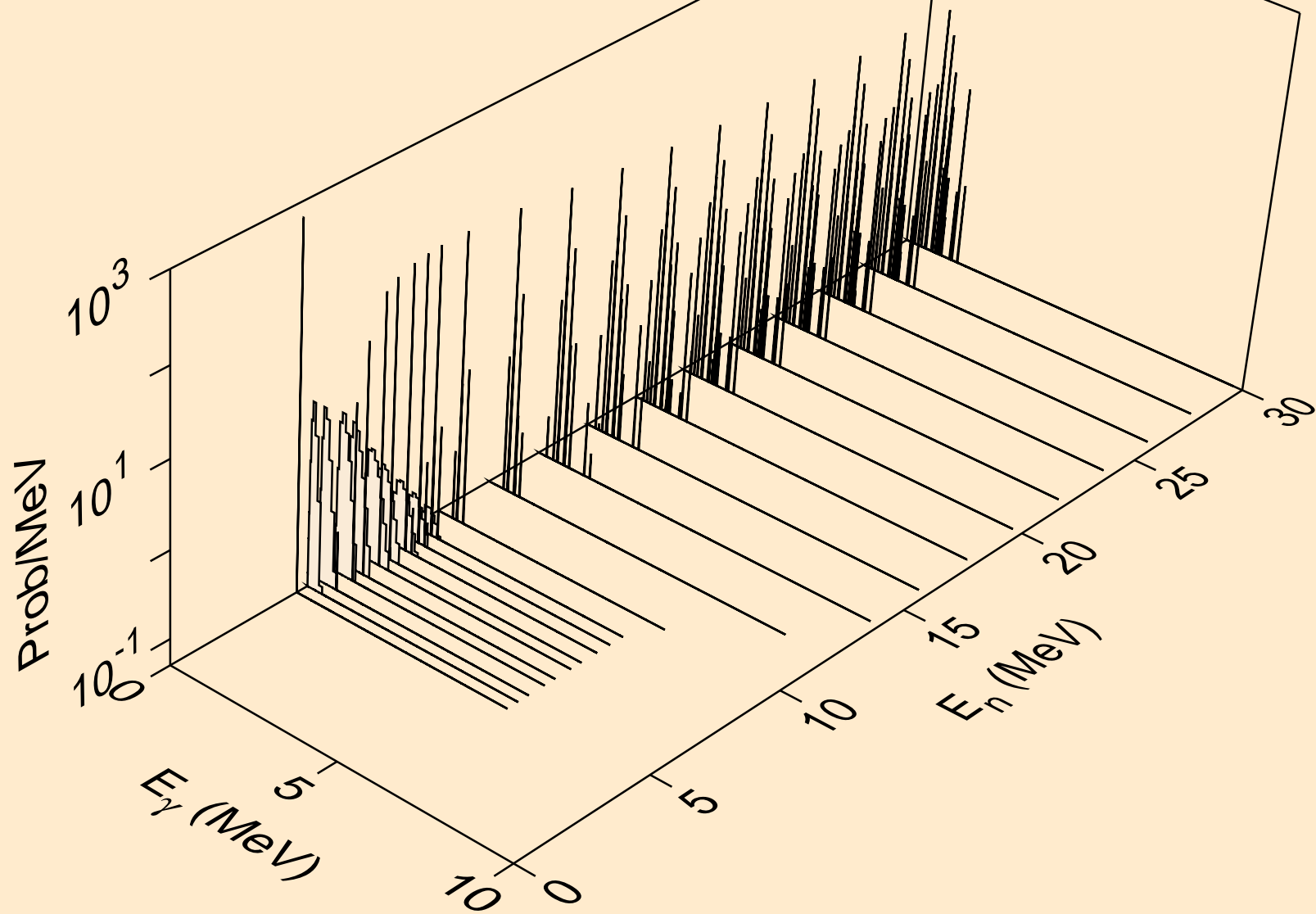

RU088 NEUTRON ACER TENDL-2024 LIBRARY; T=293.6K
Photon emission for (n,pt)

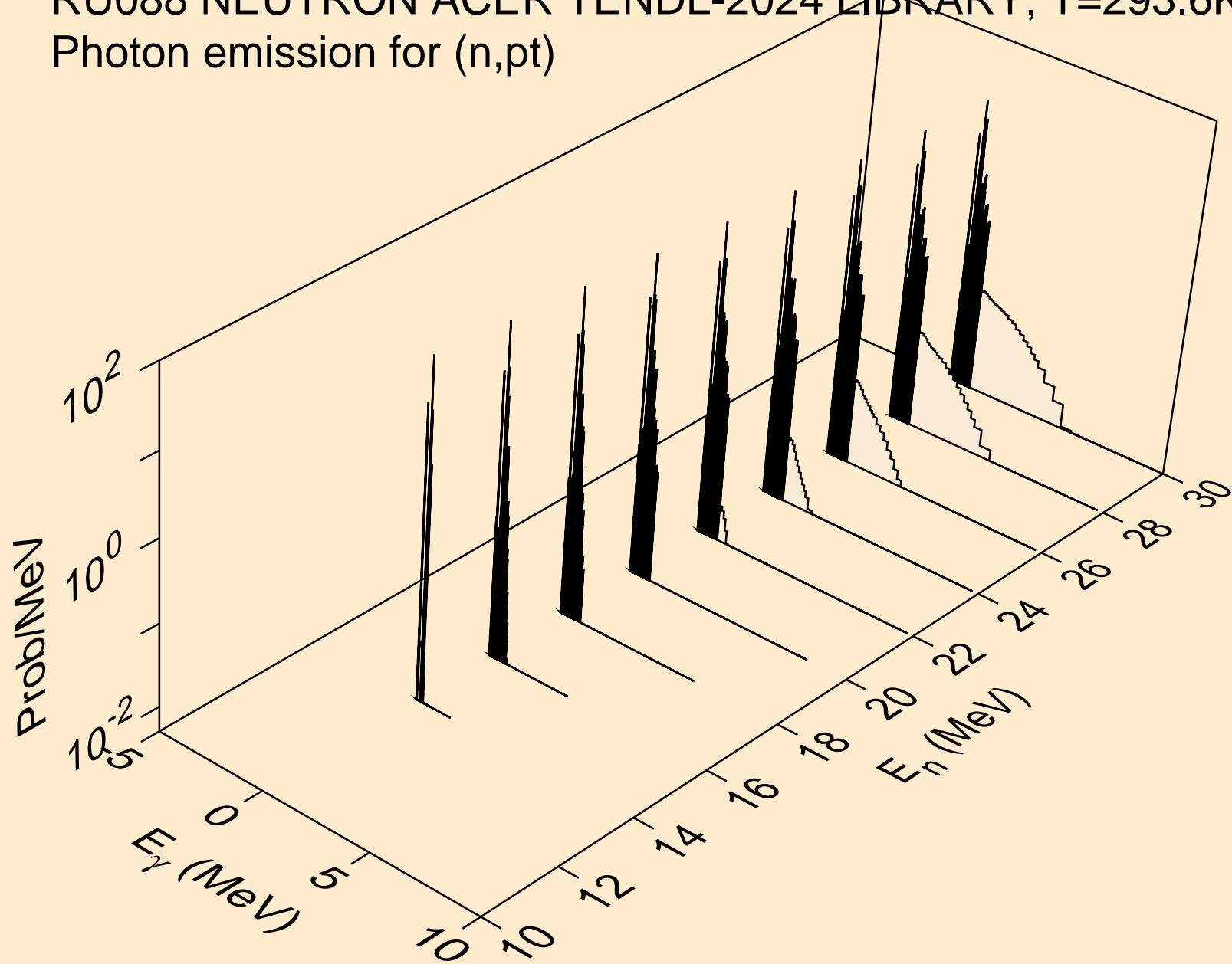

RU088 NEUTRON ACER TENDL-2024 LIBRARY; T=293.6K
Photon emission for (n,da)

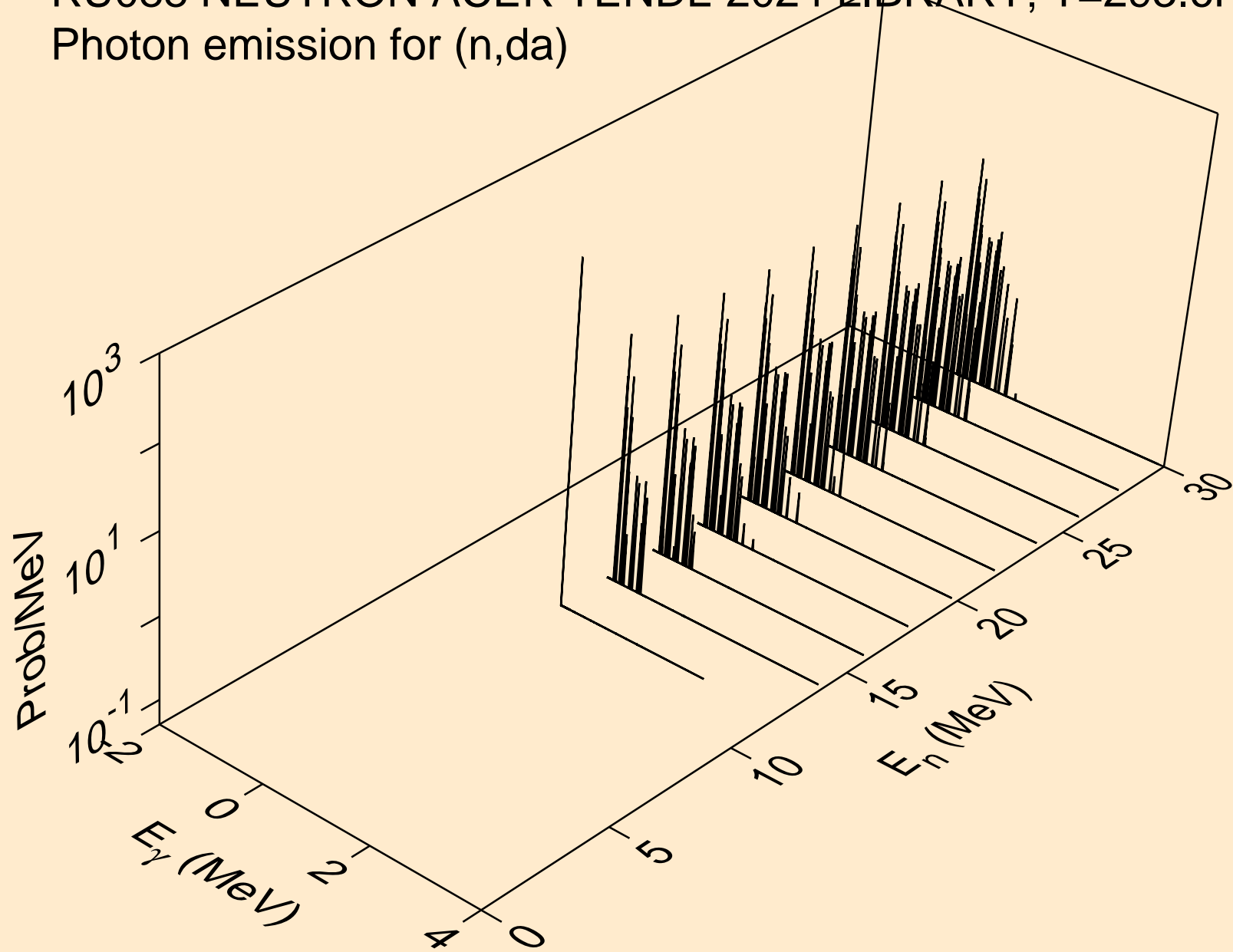

RU088 NEUTRON ACER TENDL-2024 LIBRARY; T=293.6K
thermal capture photon spectrum

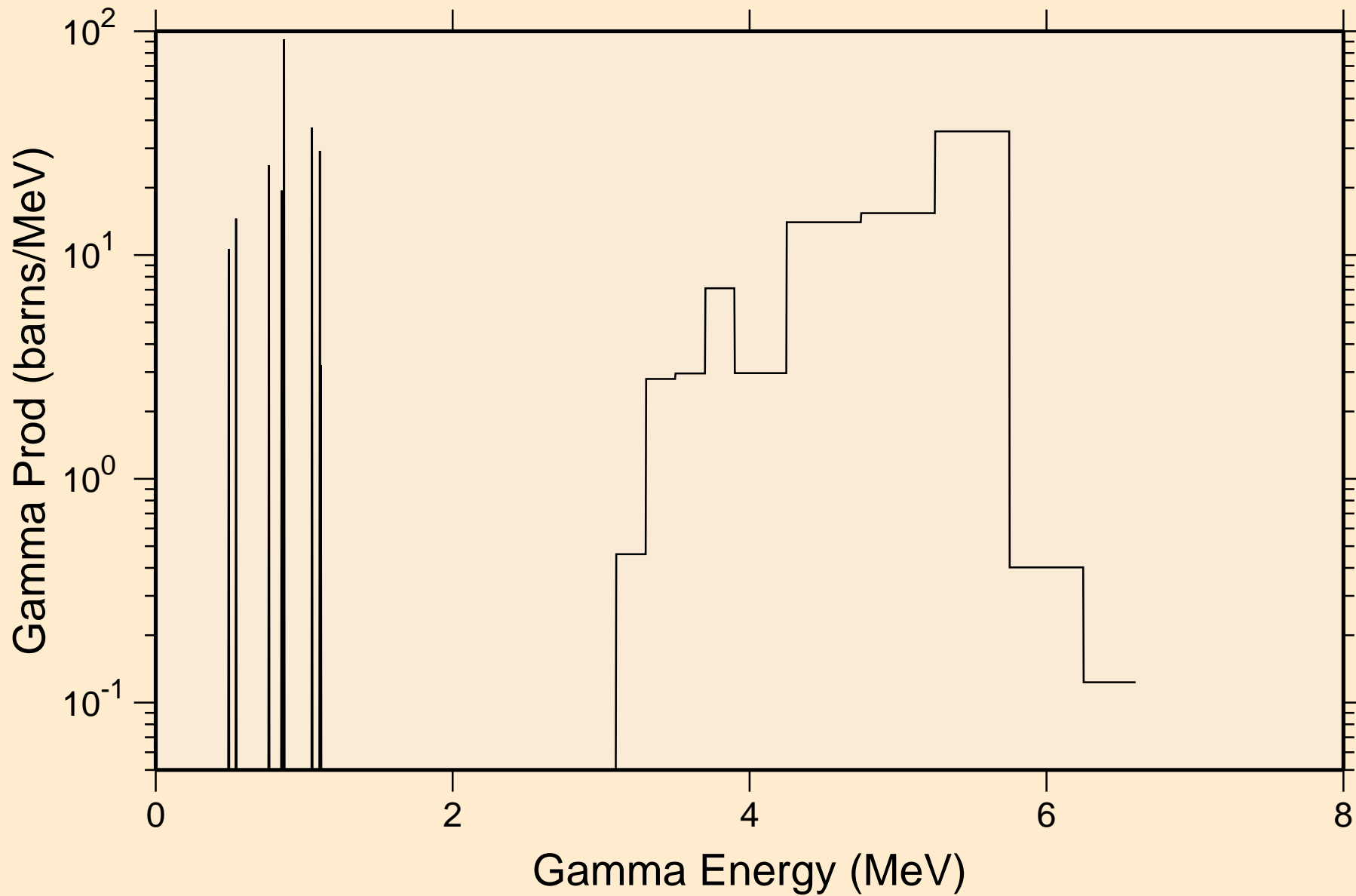

RU088 NEUTRON ACER TENDL-2024 LIBRARY; T=293.6K
14 MeV photon spectrum

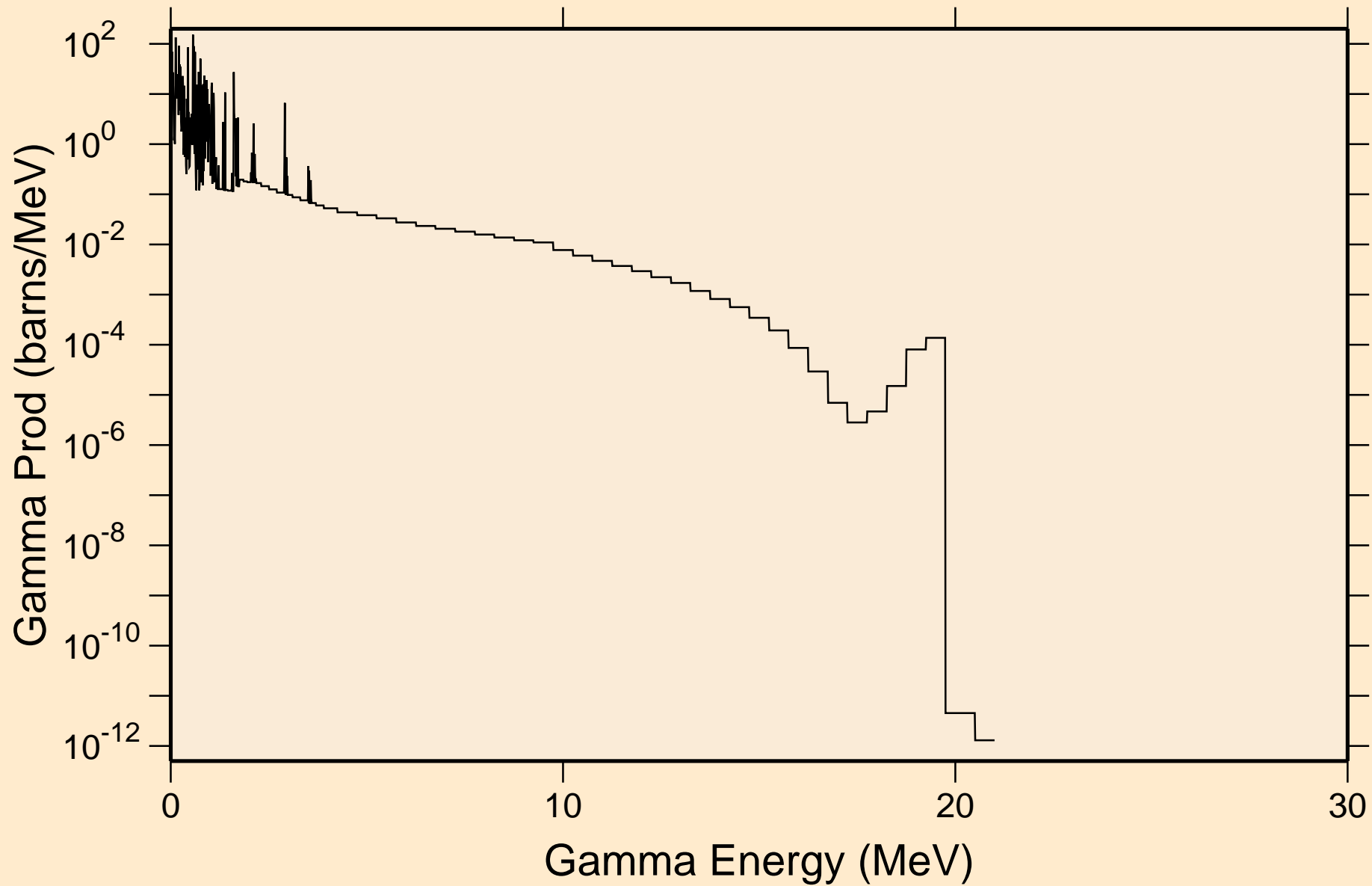

RU088 NEUTRON ACER TENDL-2024 LIBRARY; T=293.6K
Particle heating contributions

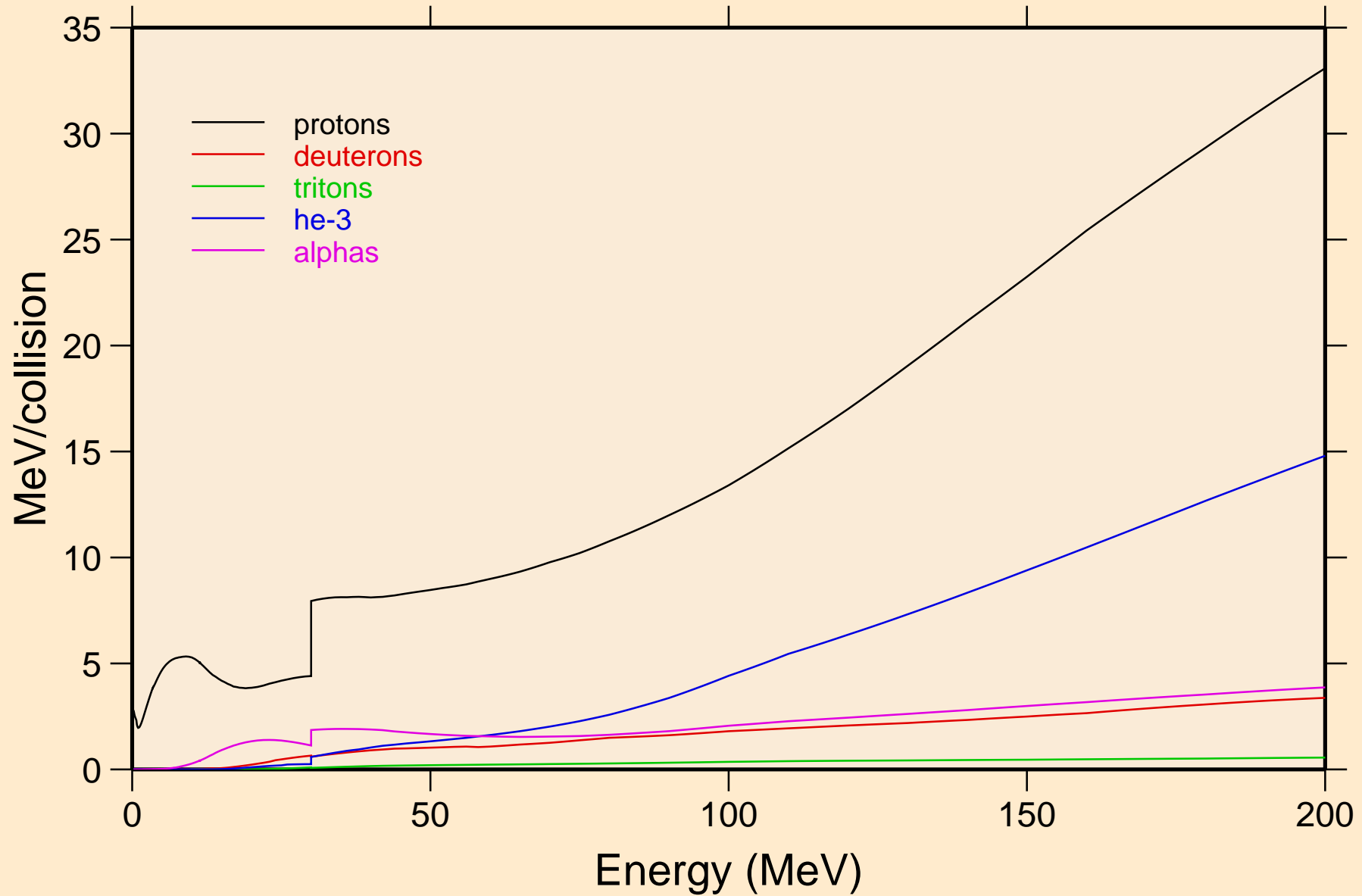

RU088 NEUTRON ACER TENDL-2024 LIBRARY; T=293.6K
Recoil Heating

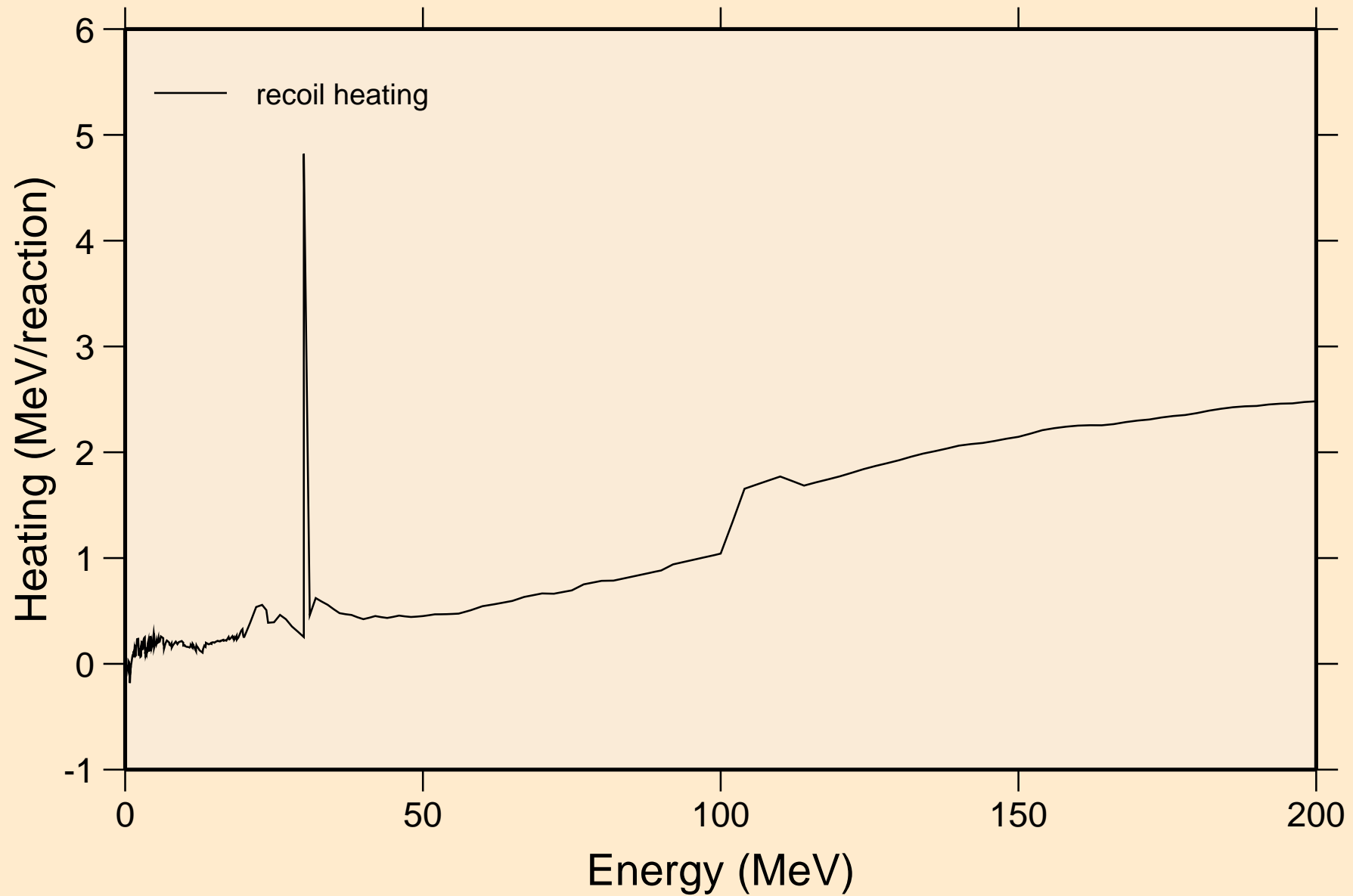

RU088 NEUTRON ACER TENDL-2024 LIBRARY; T=293.6K
Particle production cross sections

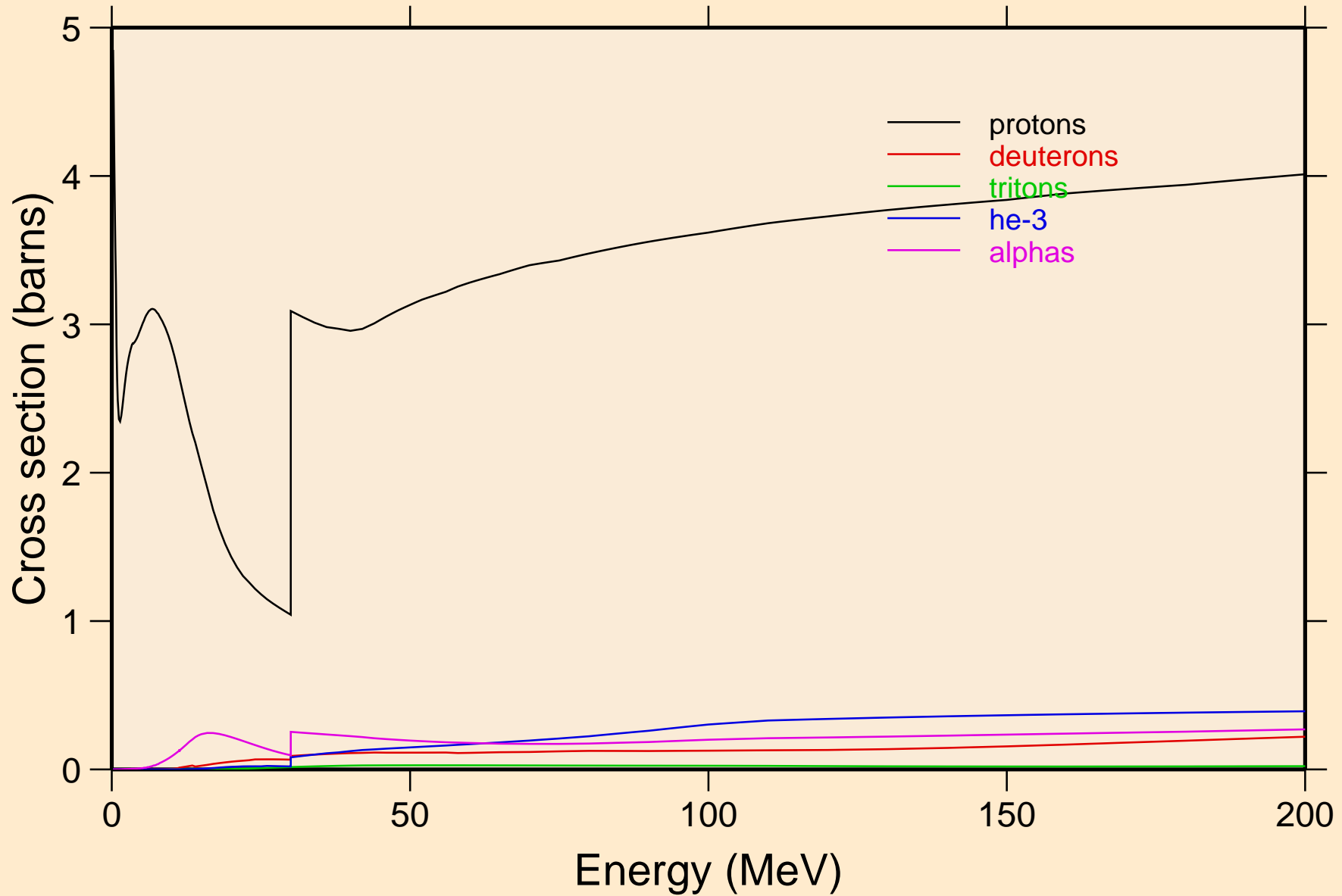

RU088 NEUTRON ACER TENDL-2024 LIBRARY; T=293.6K
protons from (n,x)

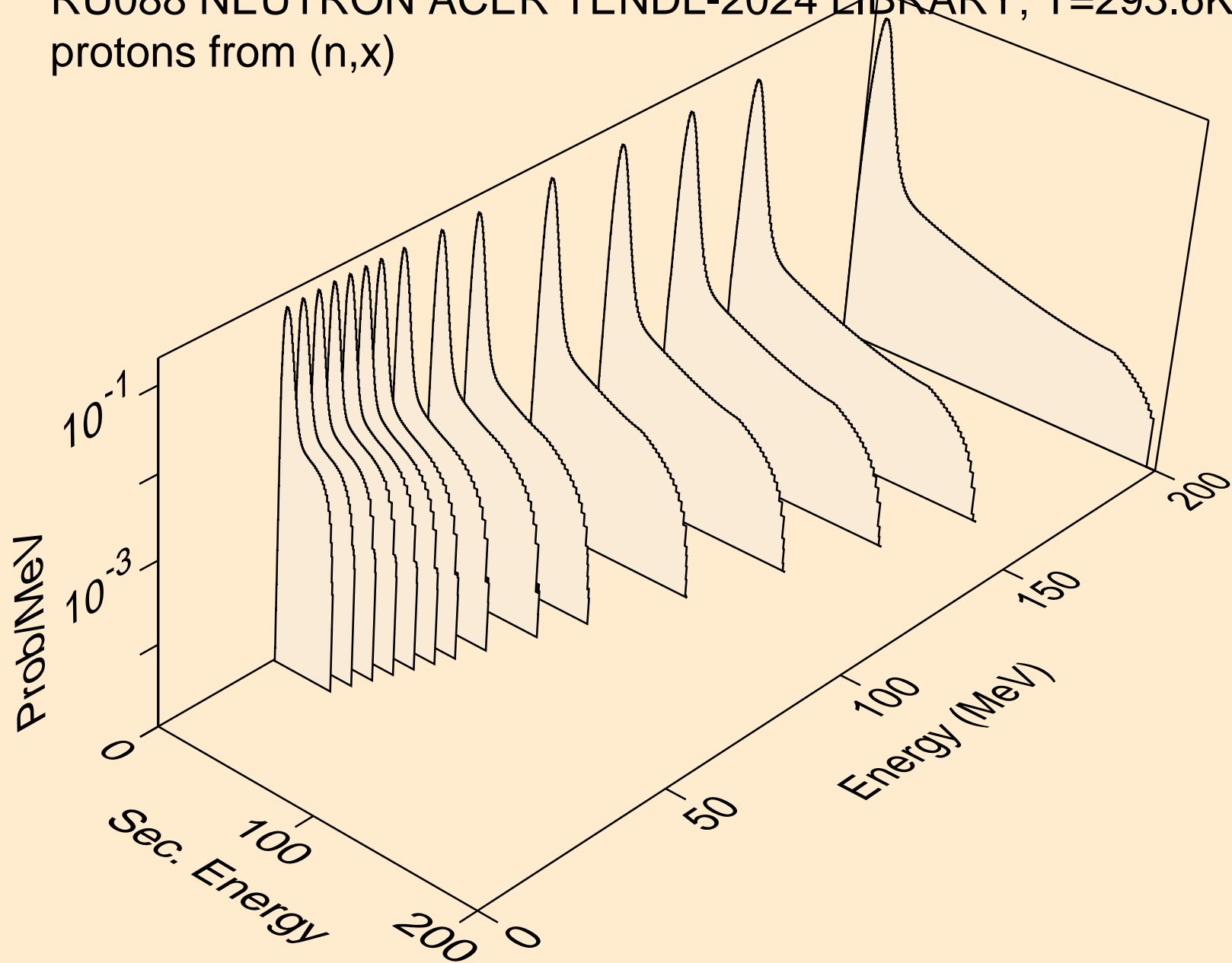

RU088 NEUTRON ACER TENDL-2024 LIBRARY; T=293.6K
protons from (n,n*)p

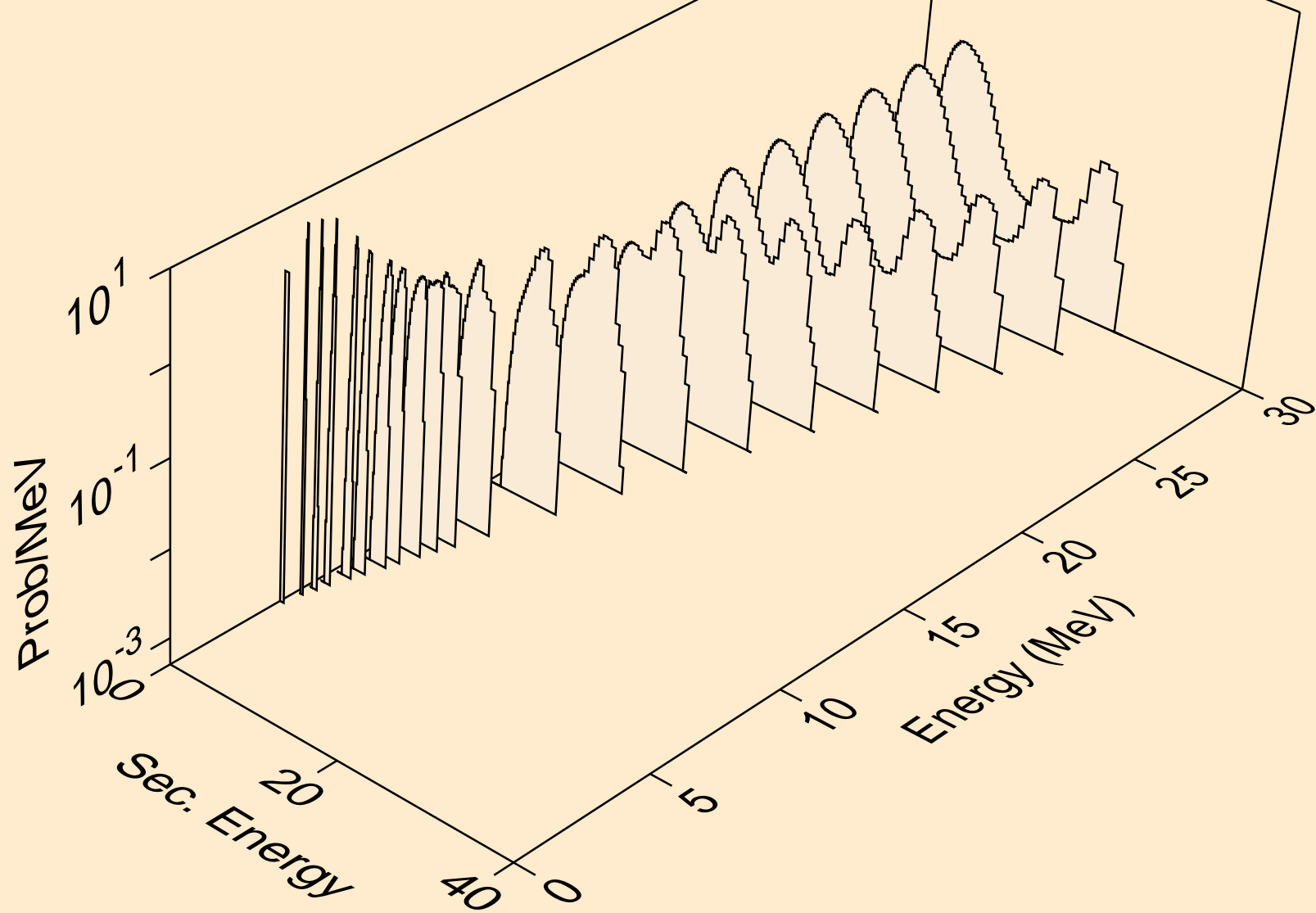

RU088 NEUTRON ACER TENDL-2024 LIBRARY; T=293.6K
protons from (n,2np)

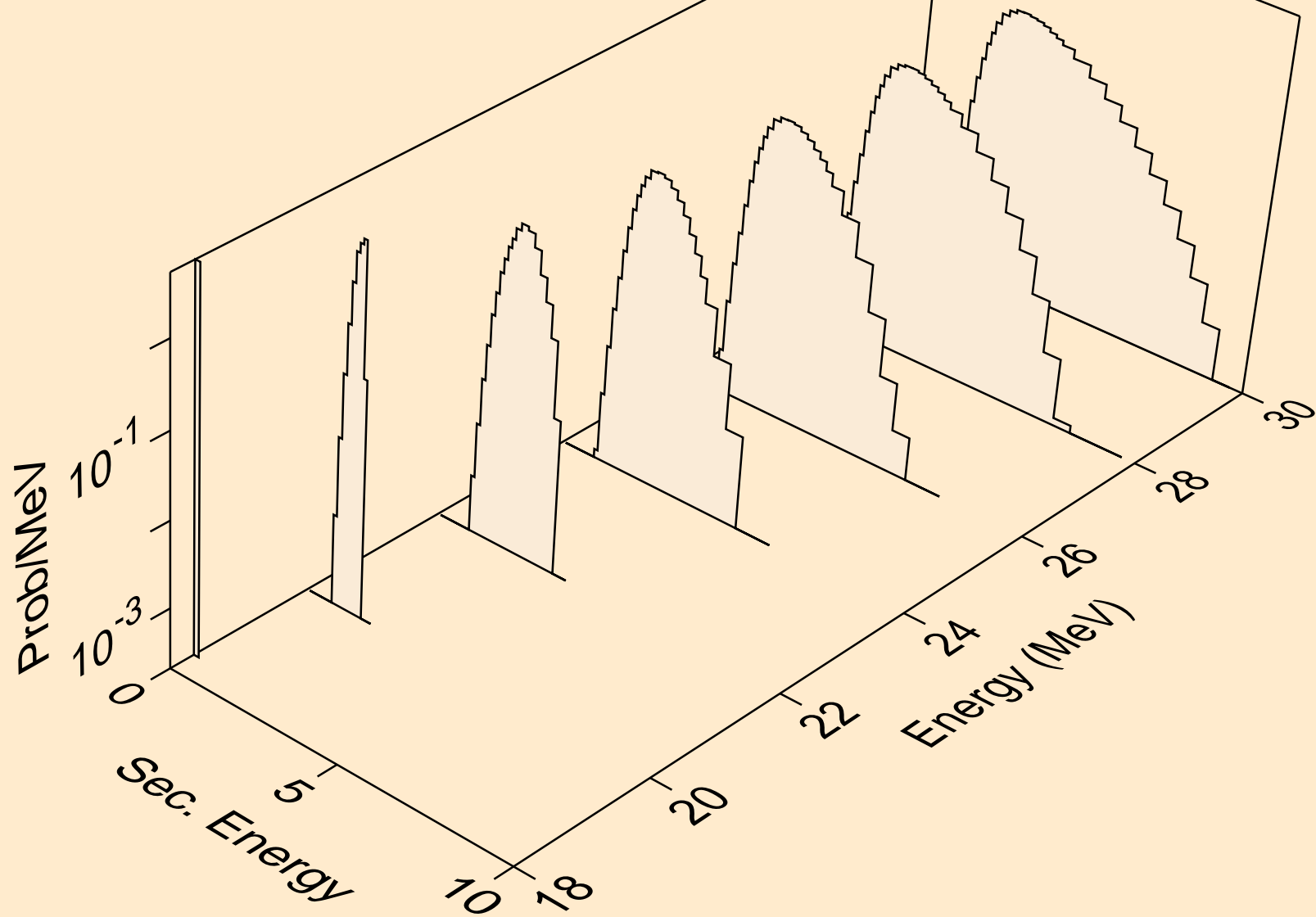

RU088 NEUTRON ACER TENDL-2024 LIBRARY; T=293.6K
protons from (n,n2p)

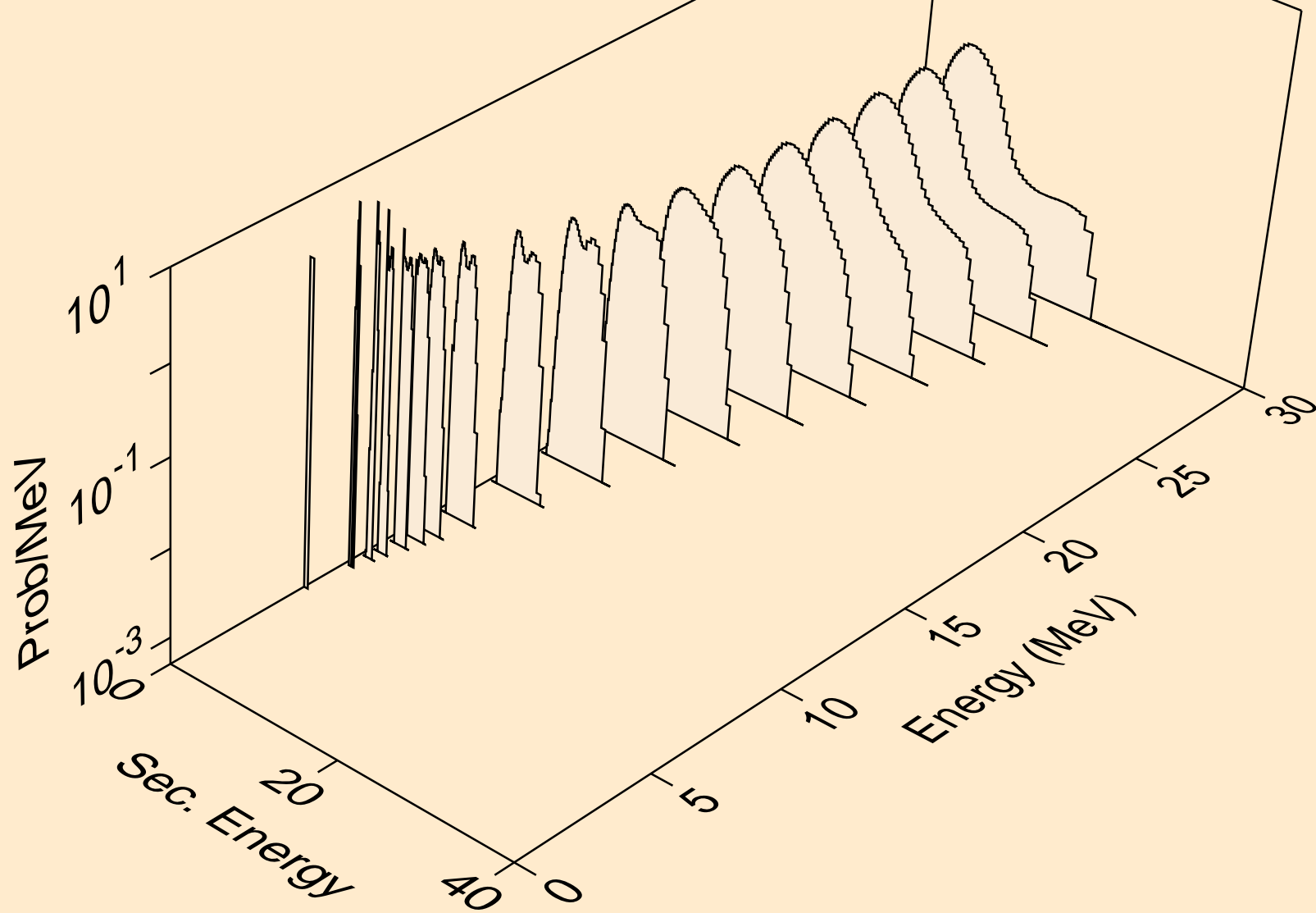

RU088 NEUTRON ACER TENDL-2024 LIBRARY; T=293.6K
protons from (n,npa)

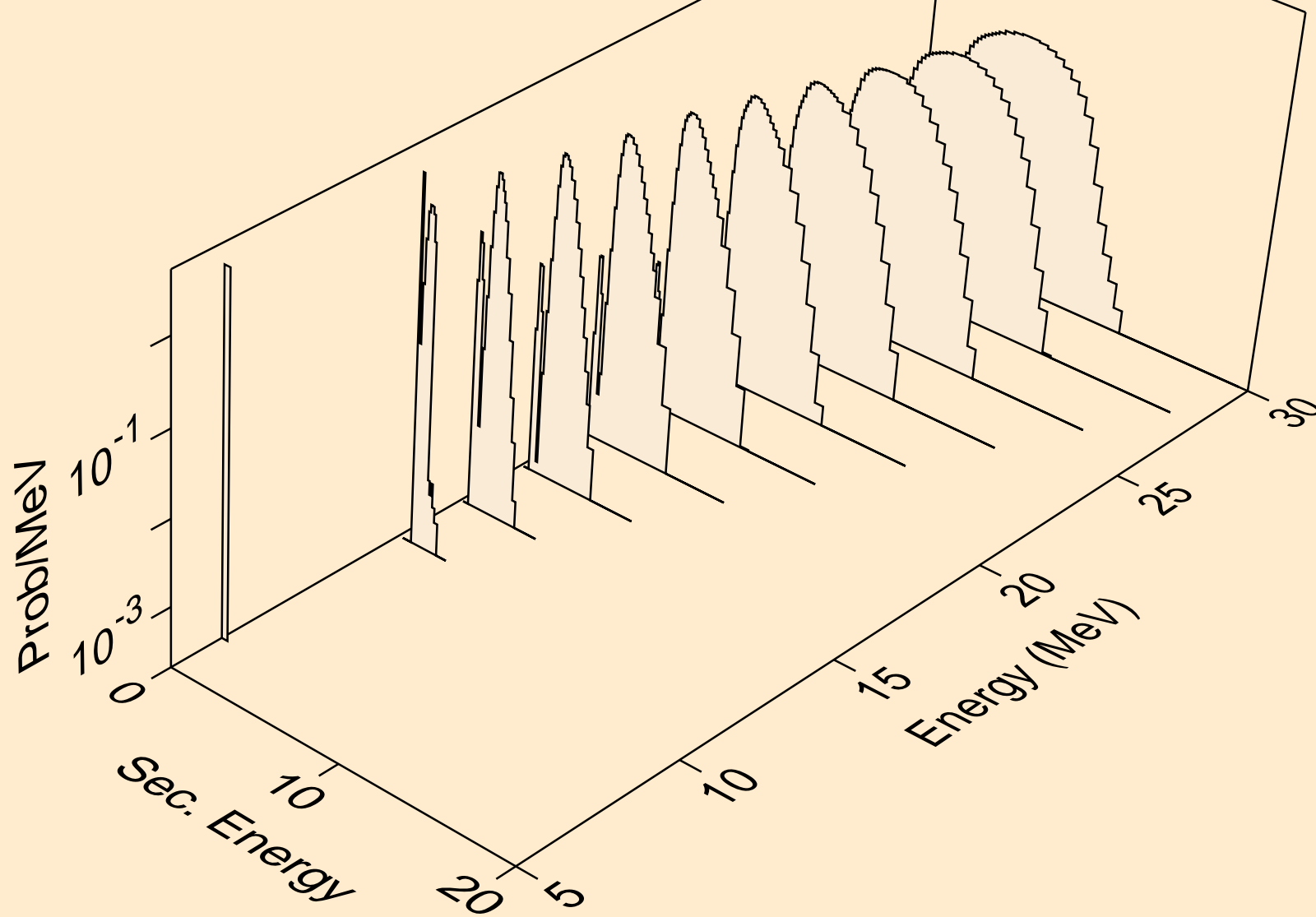

RU088 NEUTRON ACER TENDL-2024 LIBRARY; T=293.6K
protons from (n,p)

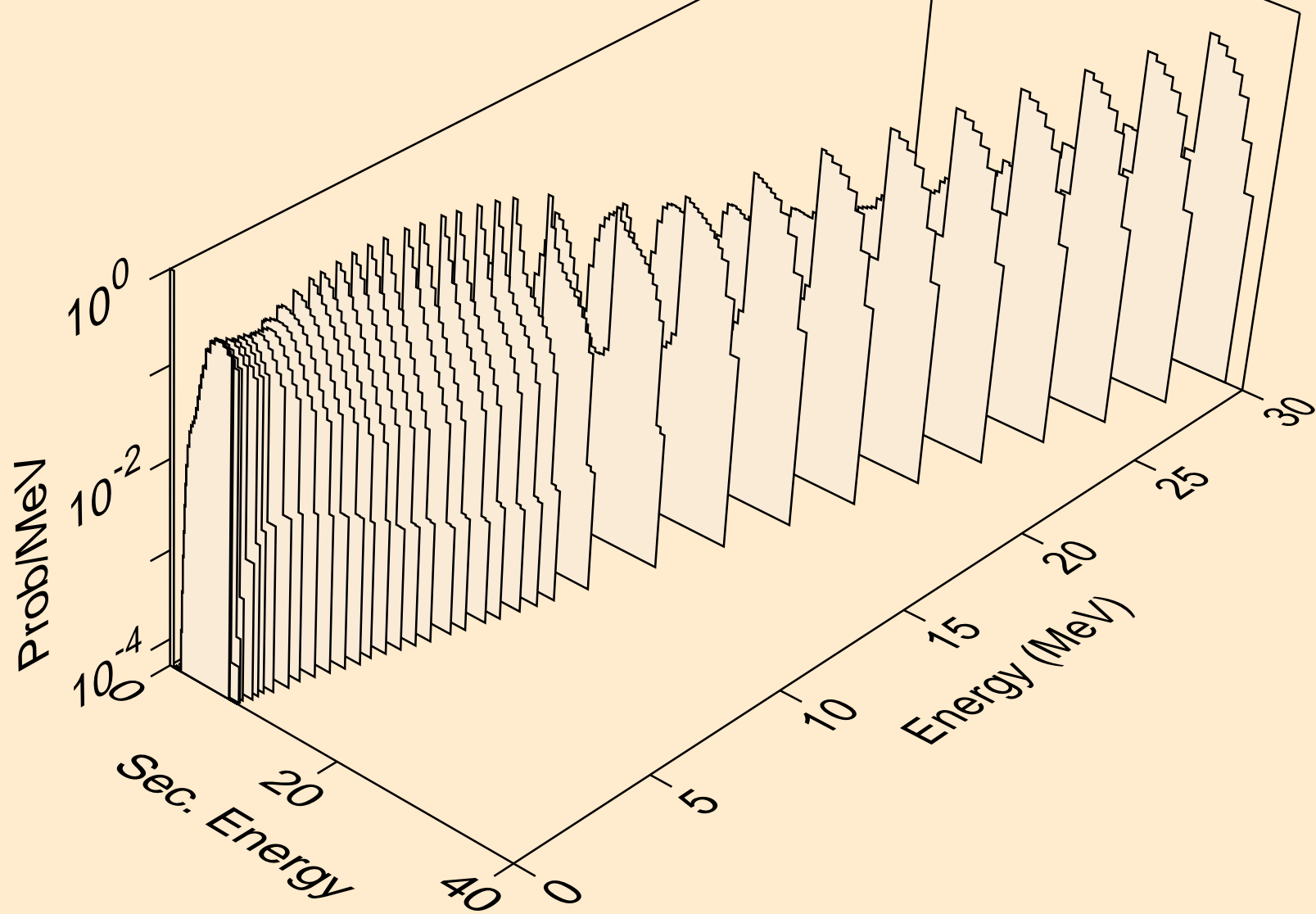

RU088 NEUTRON ACER TENDL-2024 LIBRARY; T=293.6K
protons from (n,2p)

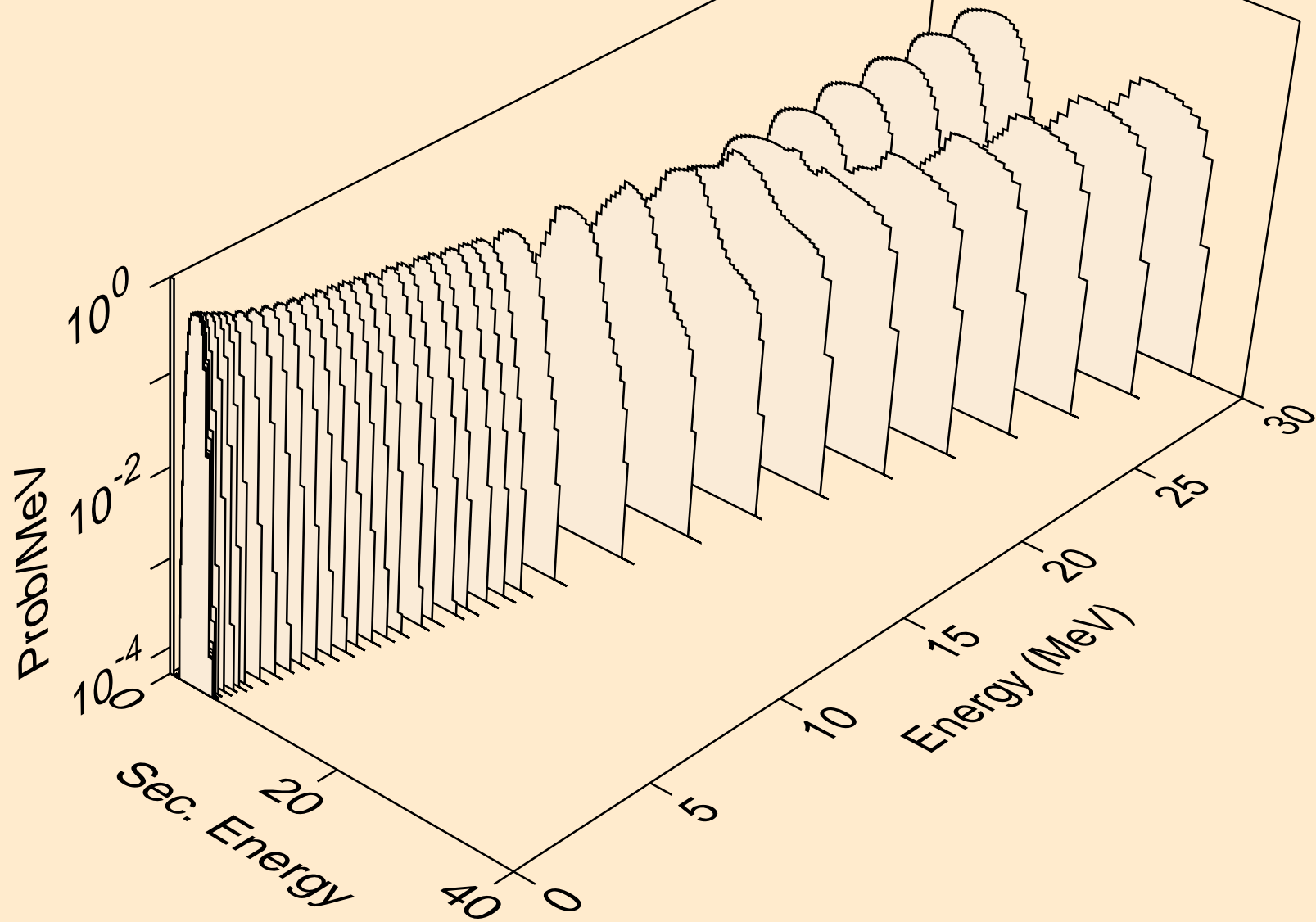

RU088 NEUTRON ACER TENDL-2024 LIBRARY; T=293.6K
protons from (n,p)

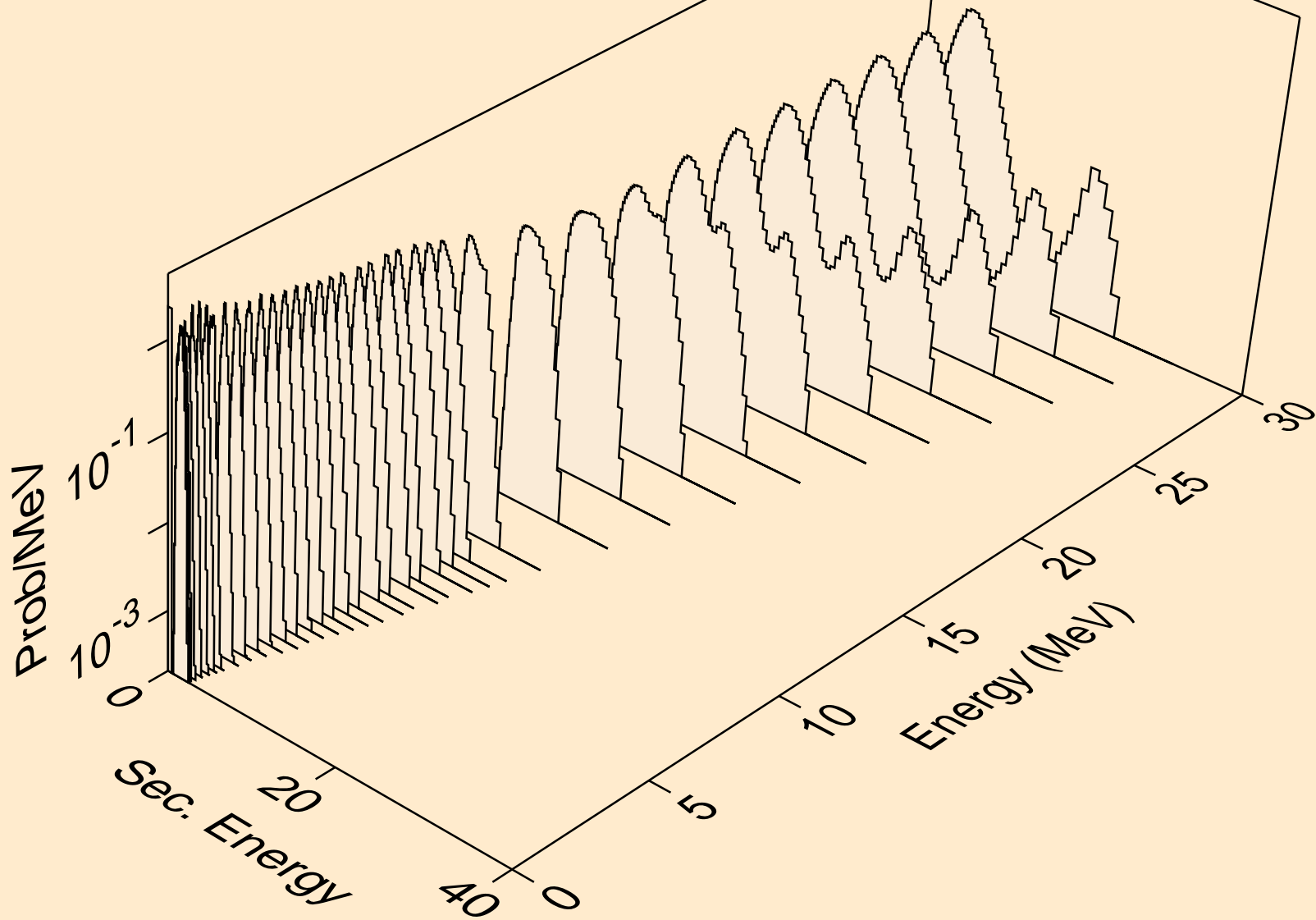

RU088 NEUTRON ACER TENDL-2024 LIBRARY; T=293.6K
protons from (n,pd)

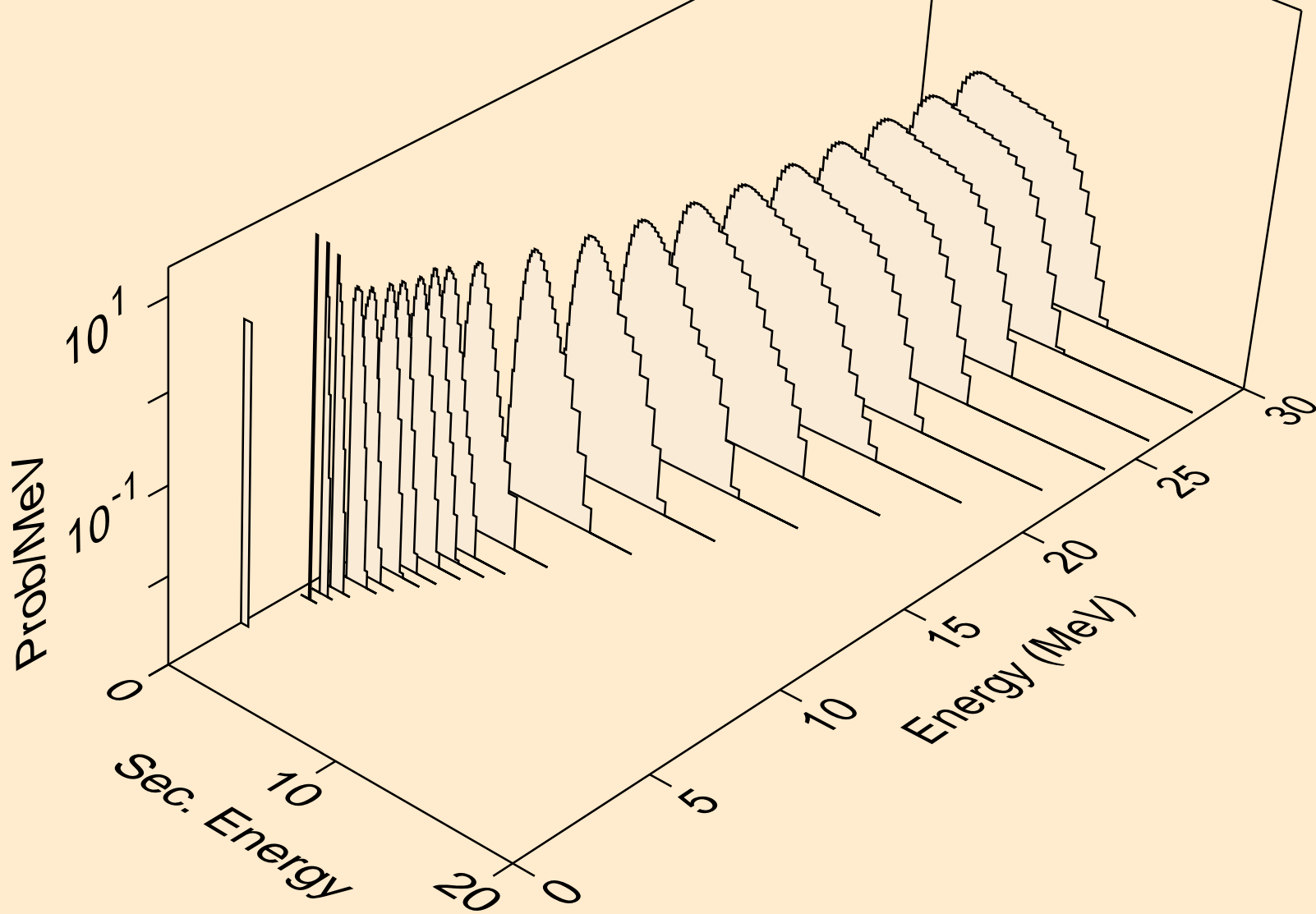

RU088 NEUTRON ACER TENDL-2024 LIBRARY; T=293.6K
protons from (n,pt)

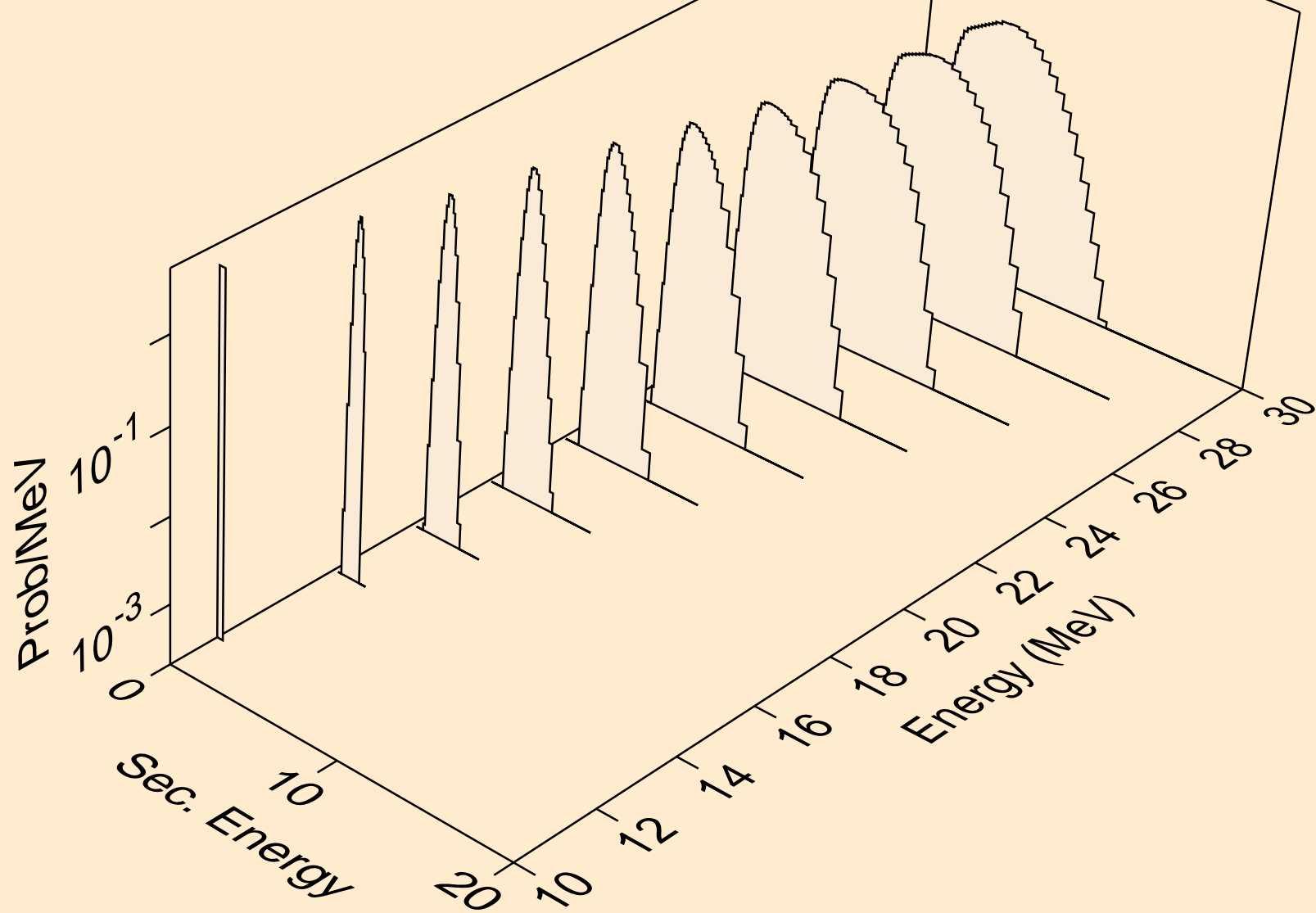

RU088 NEUTRON ACER TENDL-2024 LIBRARY; T=293.6K
deuterons from (n,x)

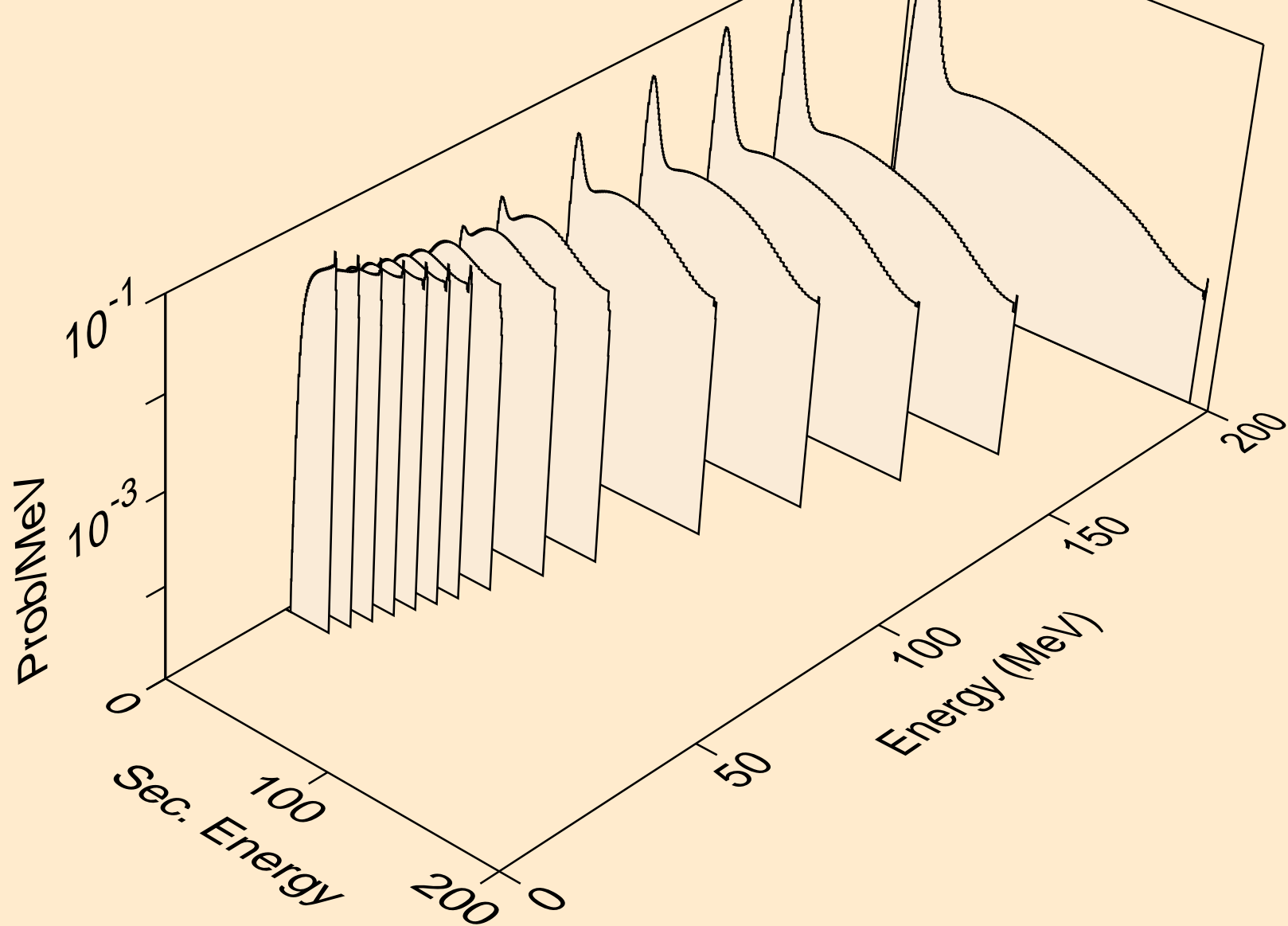

RU088 NEUTRON ACER TENDL-2024 LIBRARY; T=293.6K
deuterons from (n,n*)d

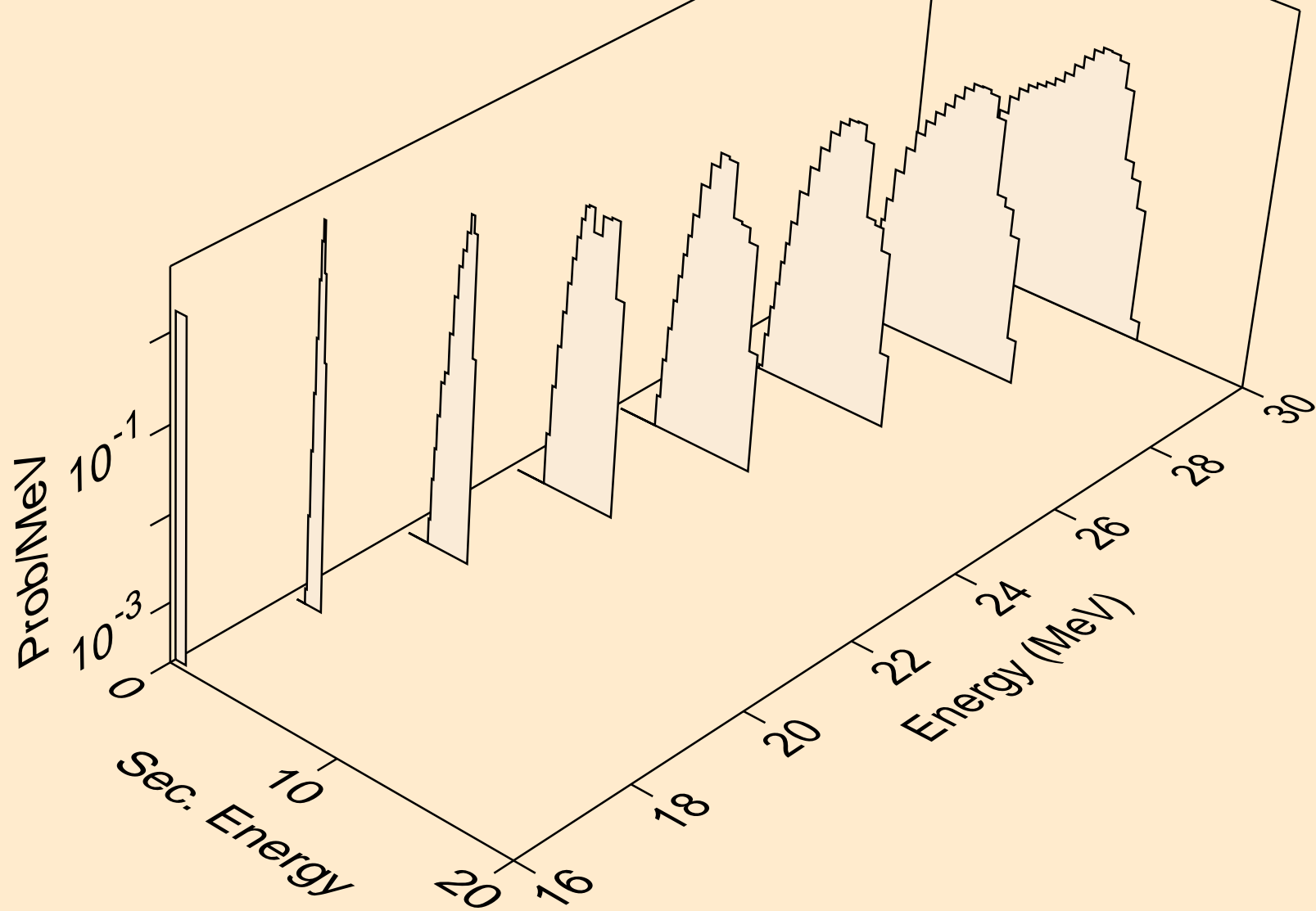

RU088 NEUTRON ACER TENDL-2024 LIBRARY; T=293.6K
deuterons from (n,d)

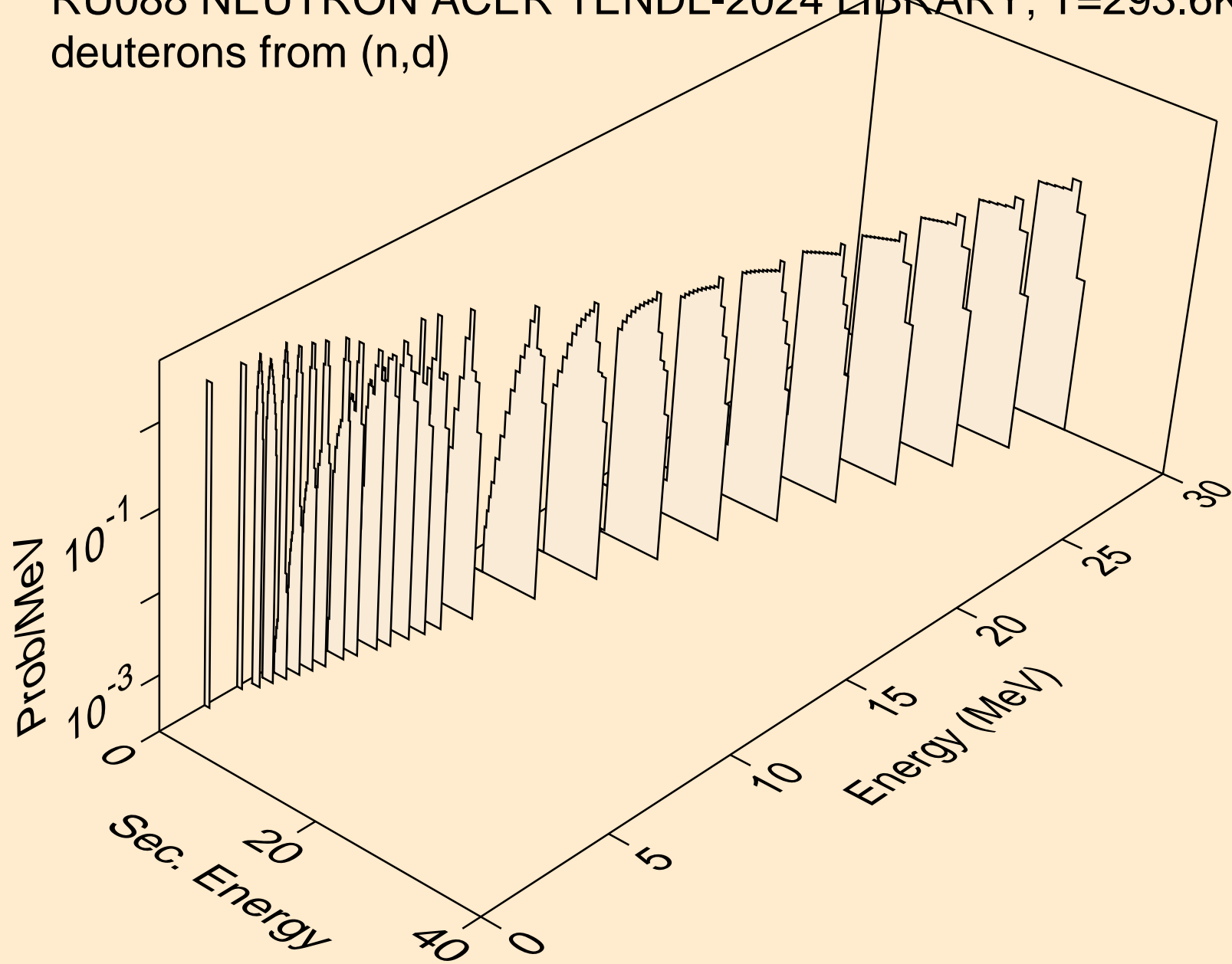

RU088 NEUTRON ACER TENDL-2024 LIBRARY; T=293.6K
deuterons from (n,pd)

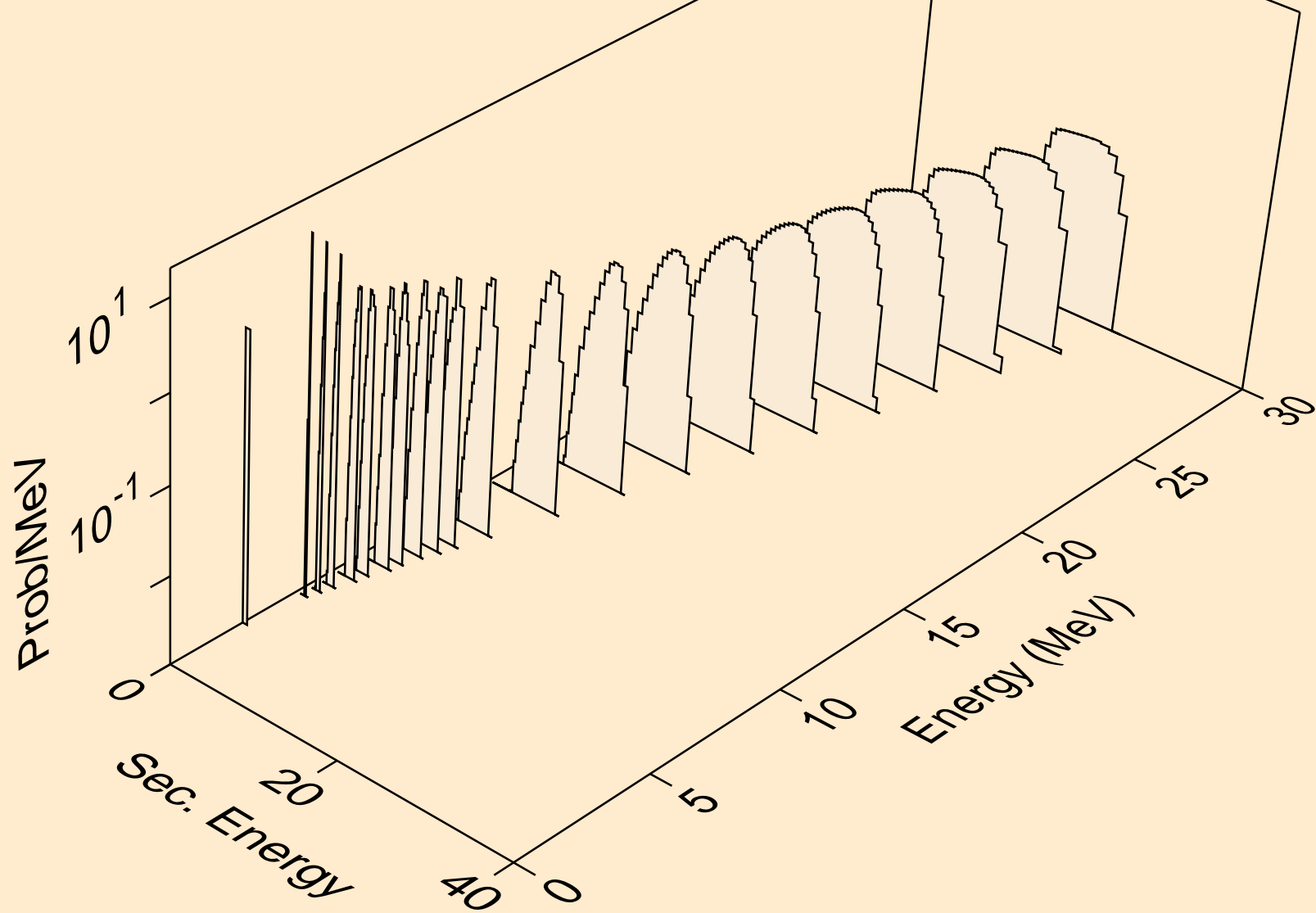

RU088 NEUTRON ACER TENDL-2024 LIBRARY; T=293.6K
deuterons from (n,da)

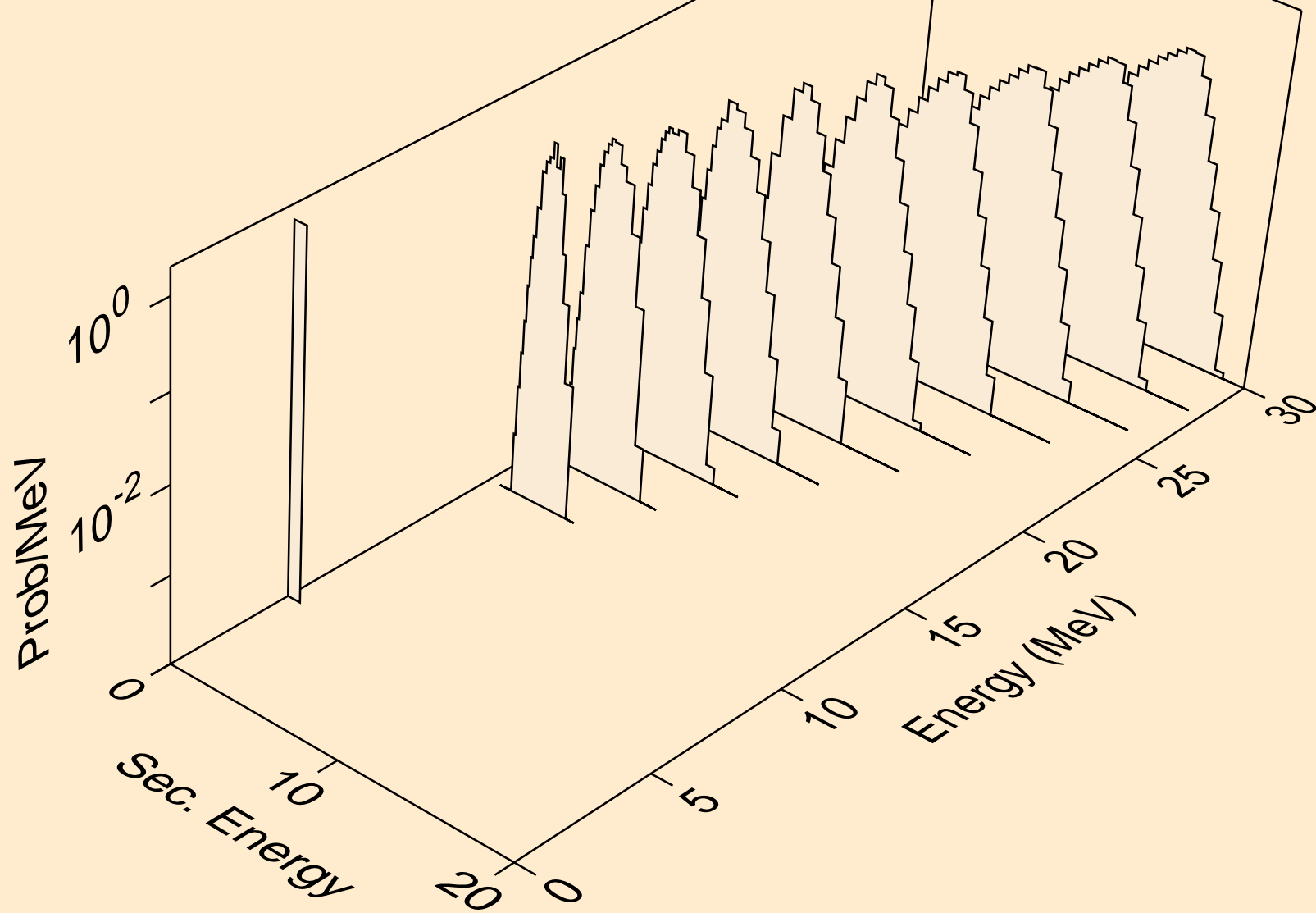

RU088 NEUTRON ACER TENDL-2024 LIBRARY; T=293.6K
tritons from (n,x)

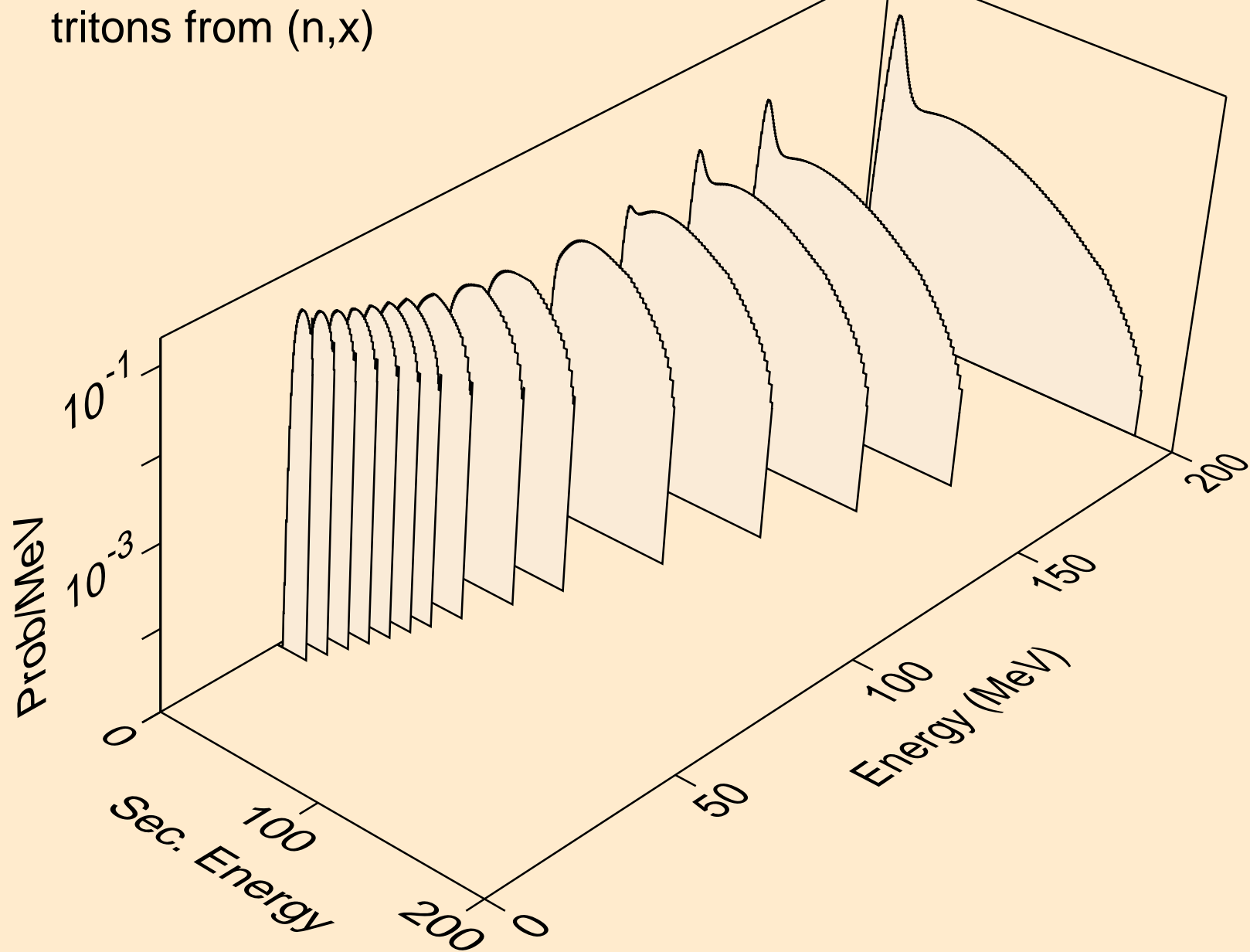

RU088 NEUTRON ACER TENDL-2024 LIBRARY; T=293.6K
tritons from (n,n*)t

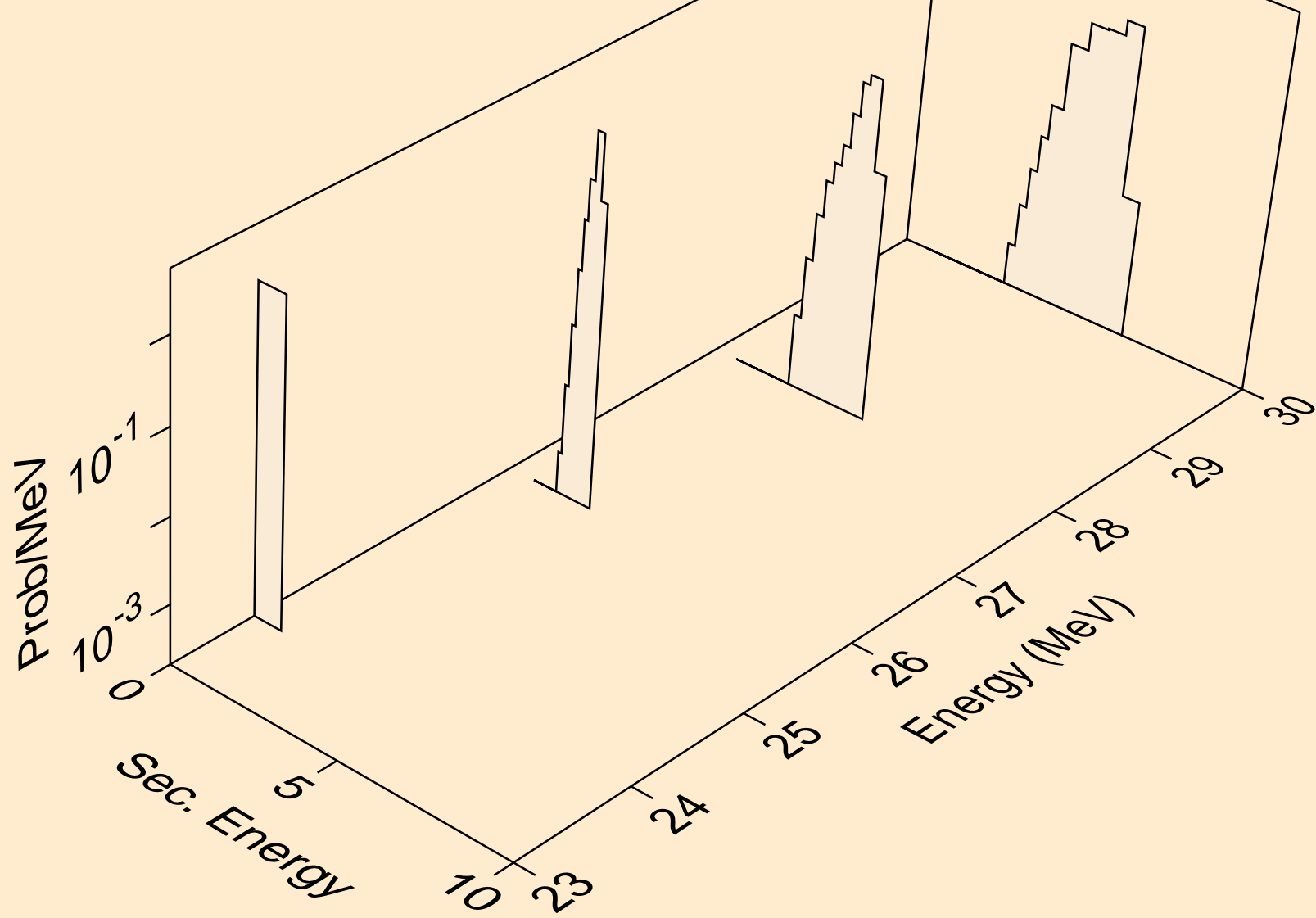

RU088 NEUTRON ACER TENDL-2024 LIBRARY; T=293.6K
tritons from (n,t)

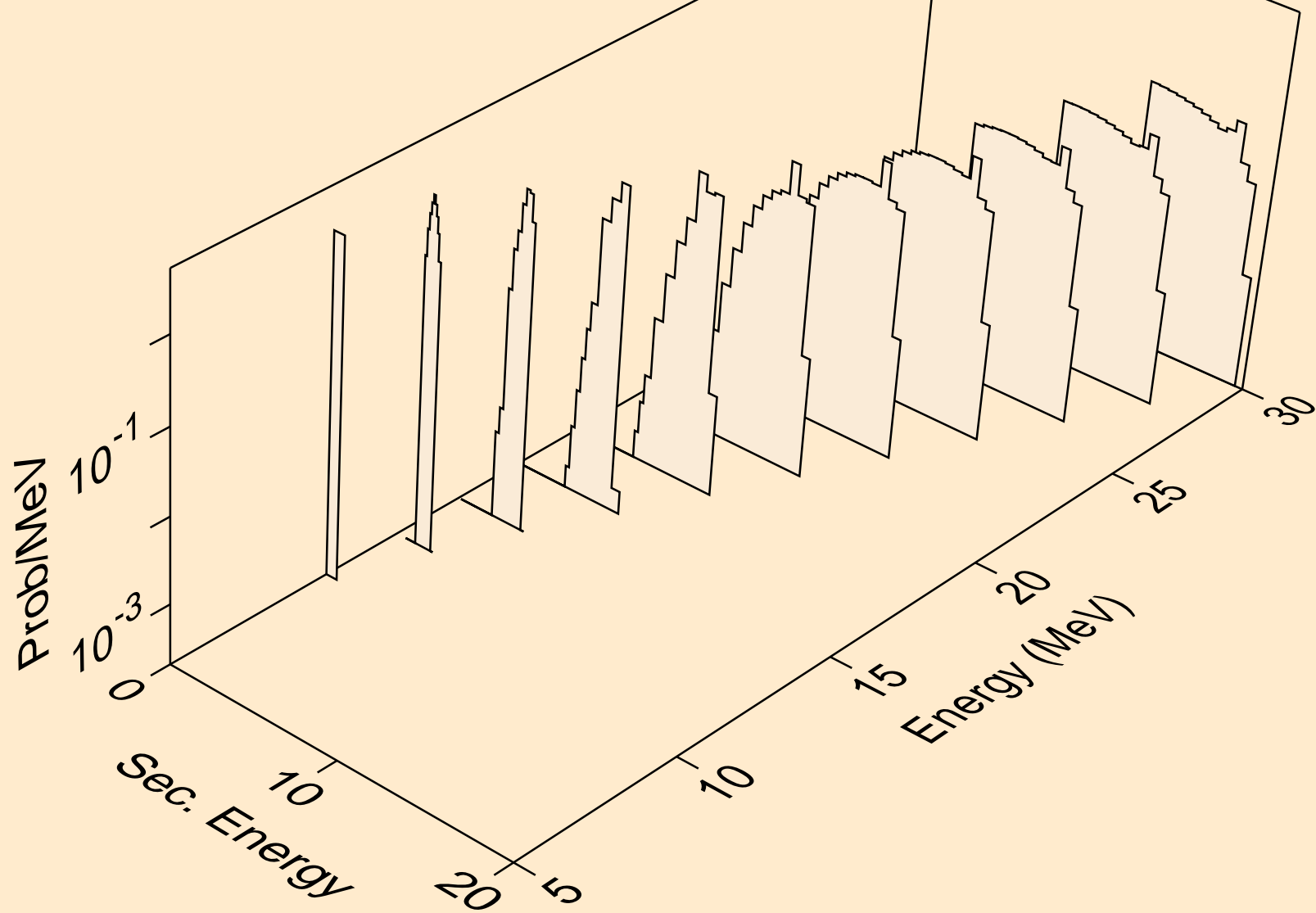

RU088 NEUTRON ACER TENDL-2024 LIBRARY; T=293.6K
tritons from (n,pt)

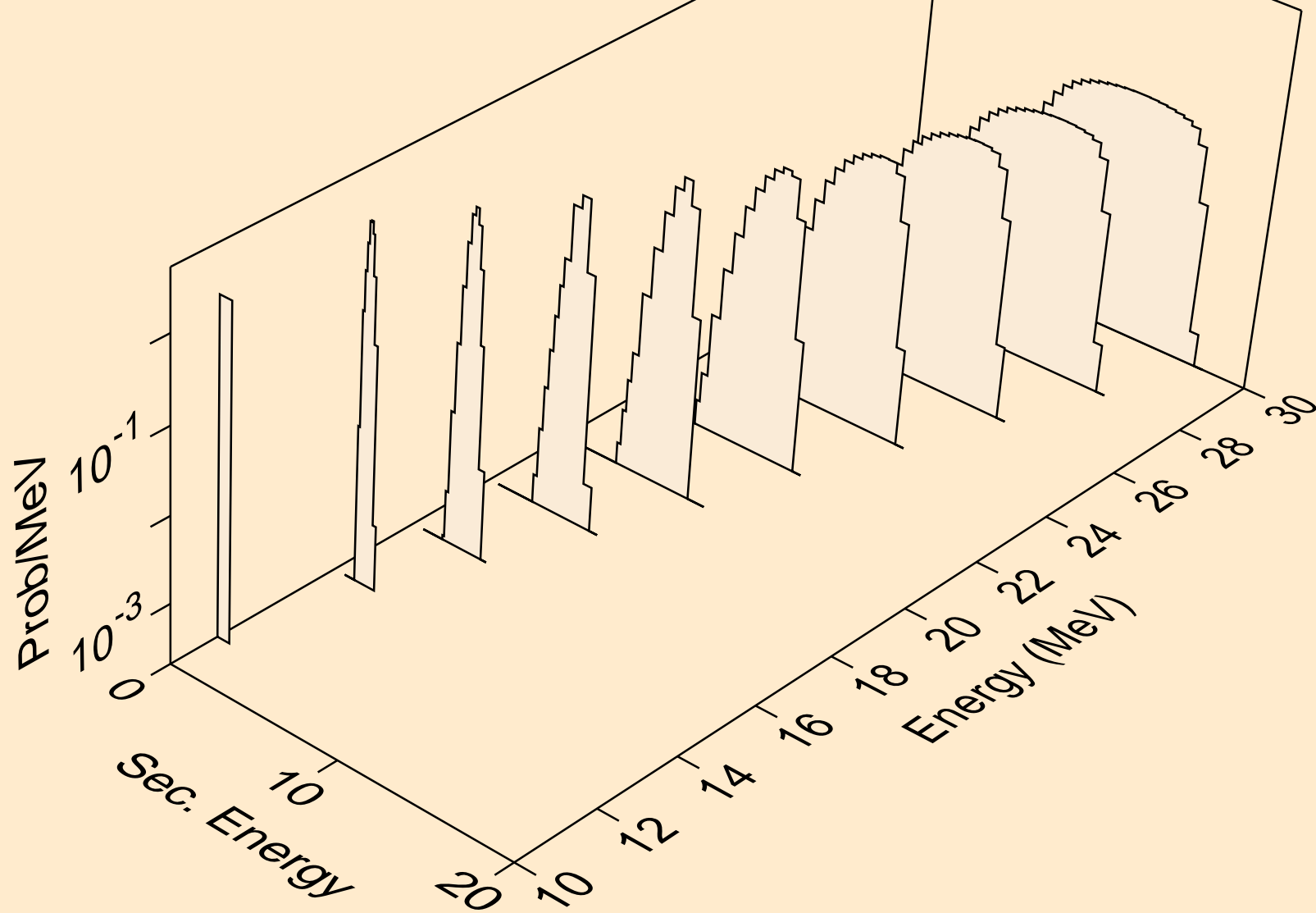

RU088 NEUTRON ACER TENDL-2024 LIBRARY; T=293.6K
he3s from (n,x)

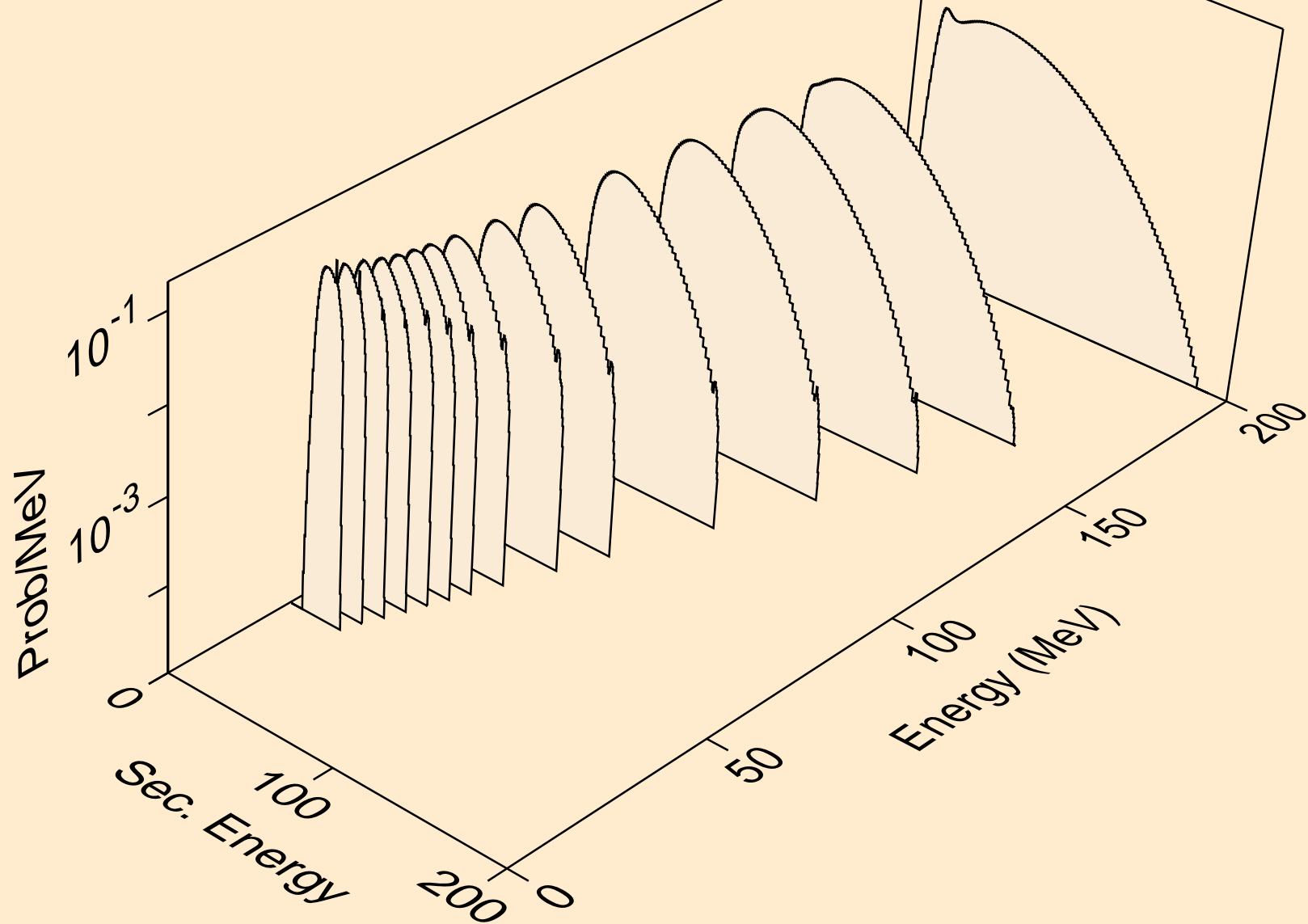

RU088 NEUTRON ACER TENDL-2024 LIBRARY; T=293.6K
he3s from (n,n*)he3

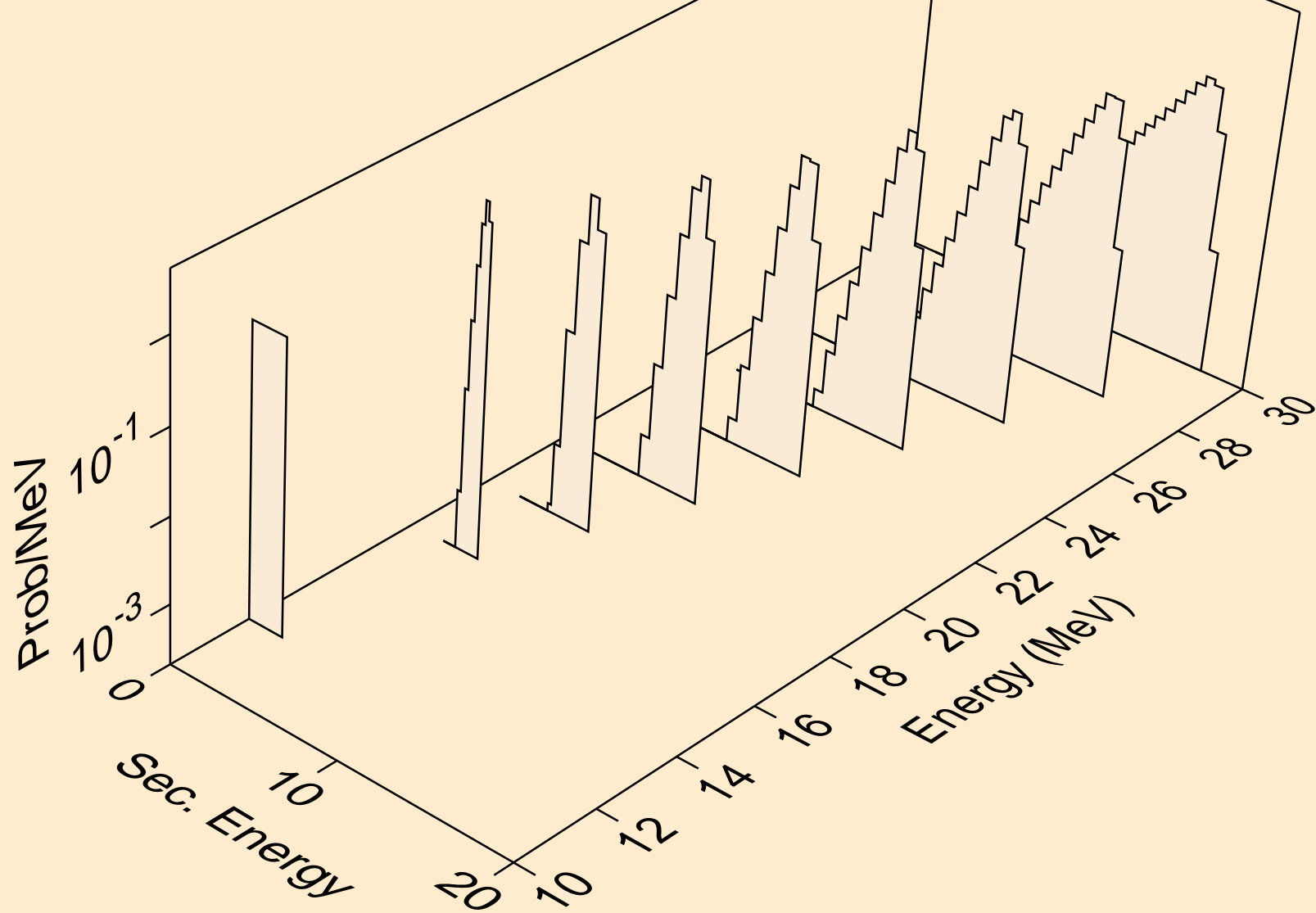

RU088 NEUTRON ACER TENDL-2024 LIBRARY; T=293.6K
he3s from (n,he3)

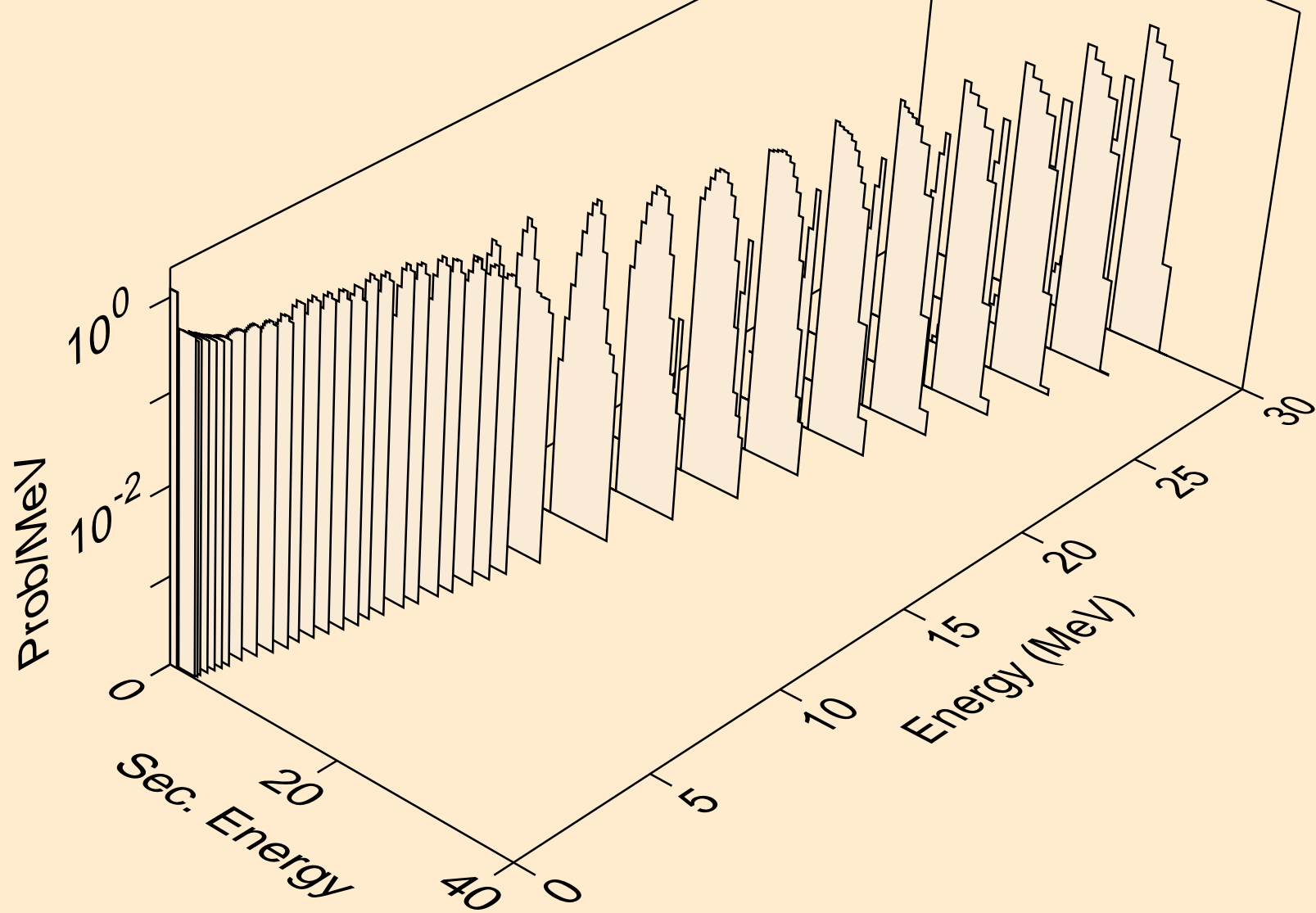

RU088 NEUTRON ACER TENDL-2024 LIBRARY; T=293.6K
alphas from (n,x)

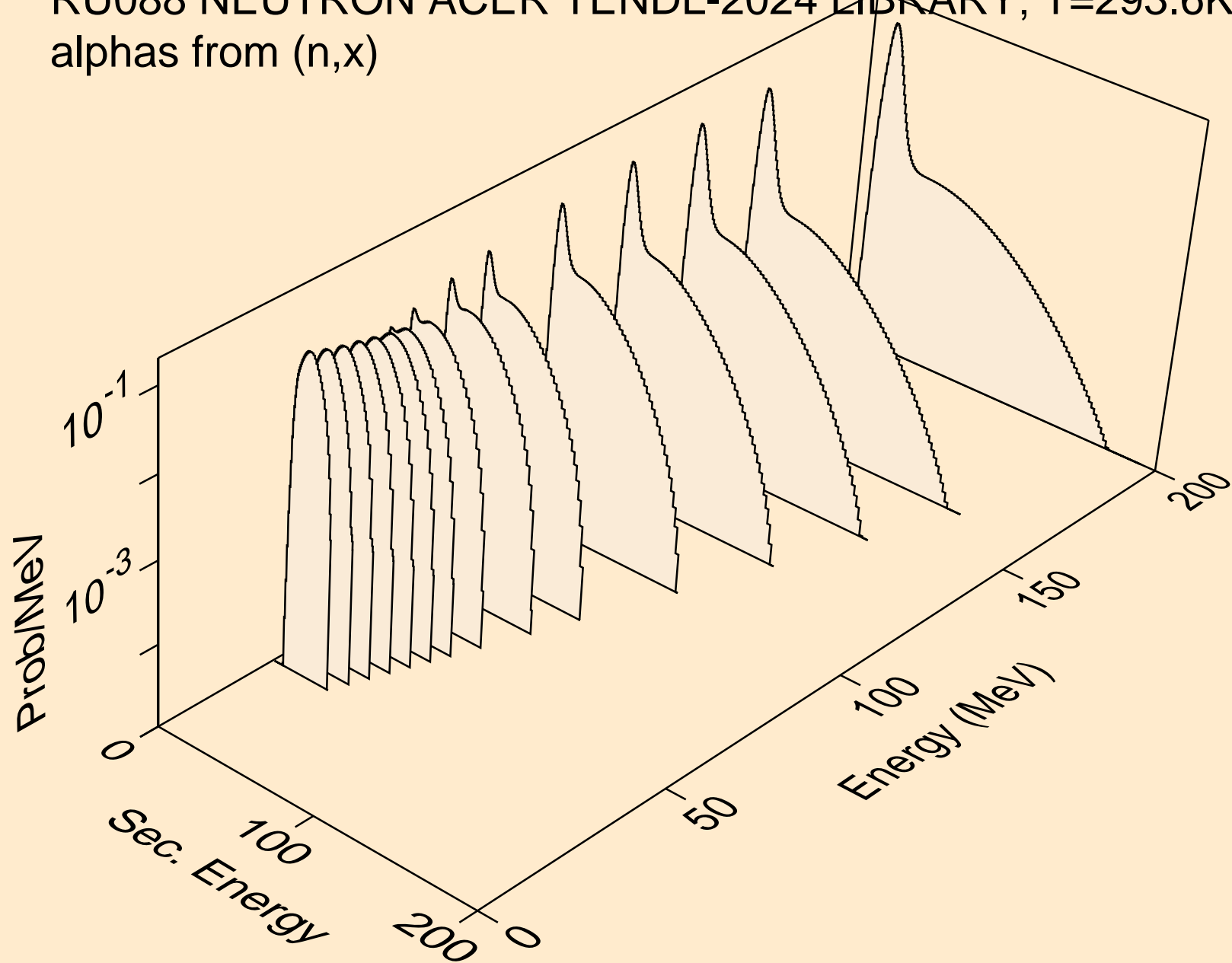

RU088 NEUTRON ACER TENDL-2024 LIBRARY; T=293.6K
alphas from (n,n*)a

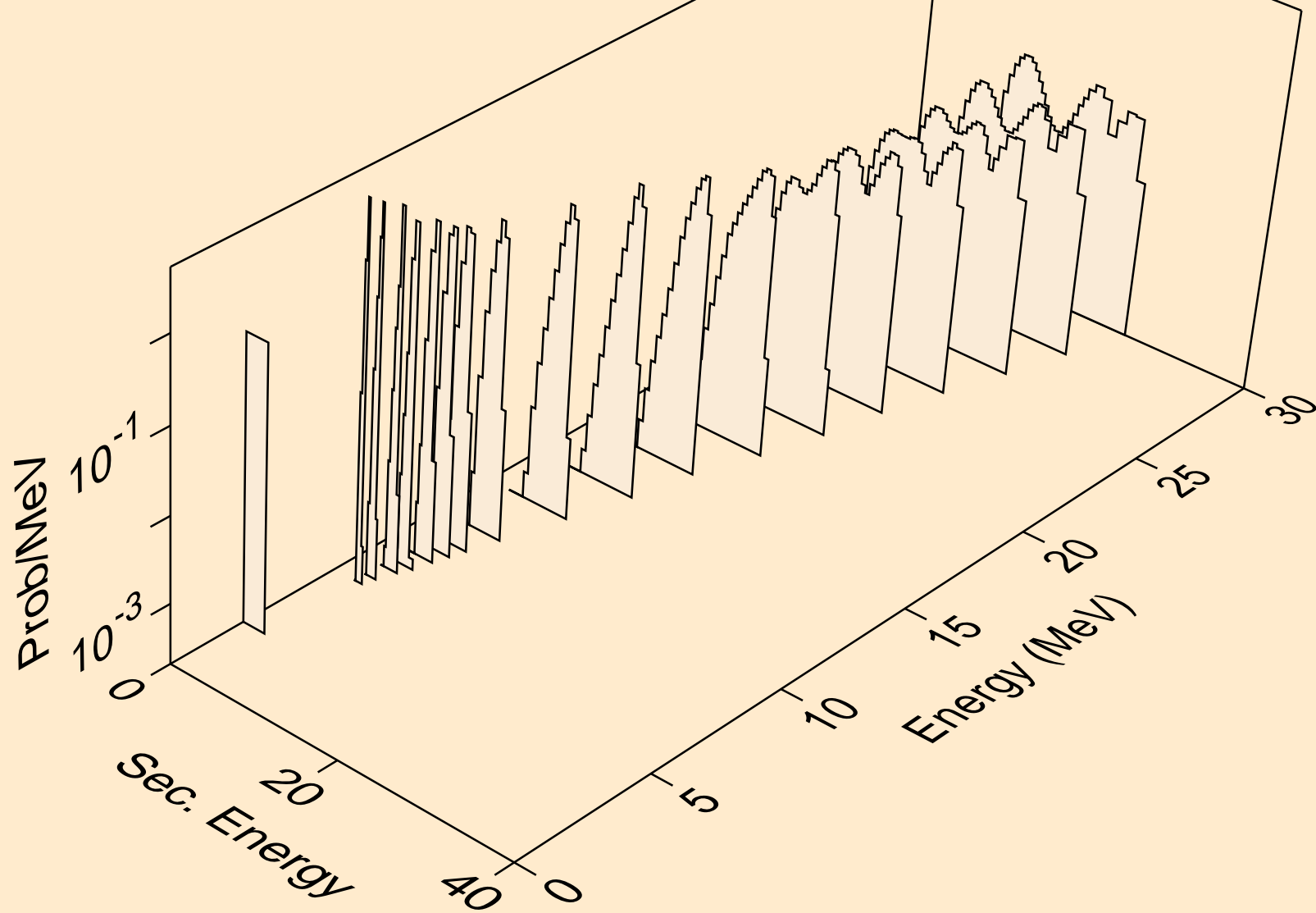

RU088 NEUTRON ACER TENDL-2024 LIBRARY; T=293.6K
alphas from (n,2n)a

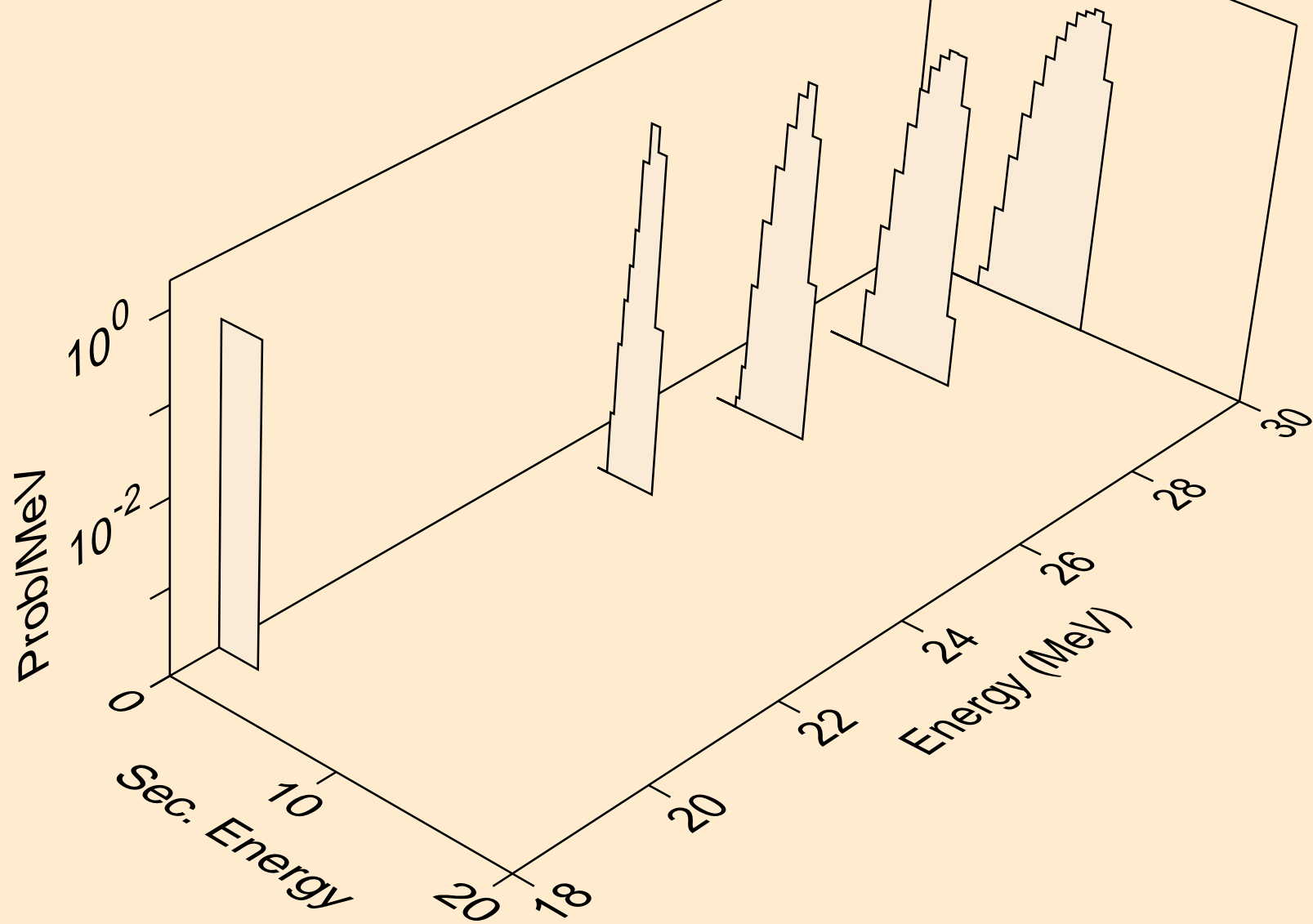

RU088 NEUTRON ACER TENDL-2024 LIBRARY; T=293.6K
alphas from (n,n*)2a

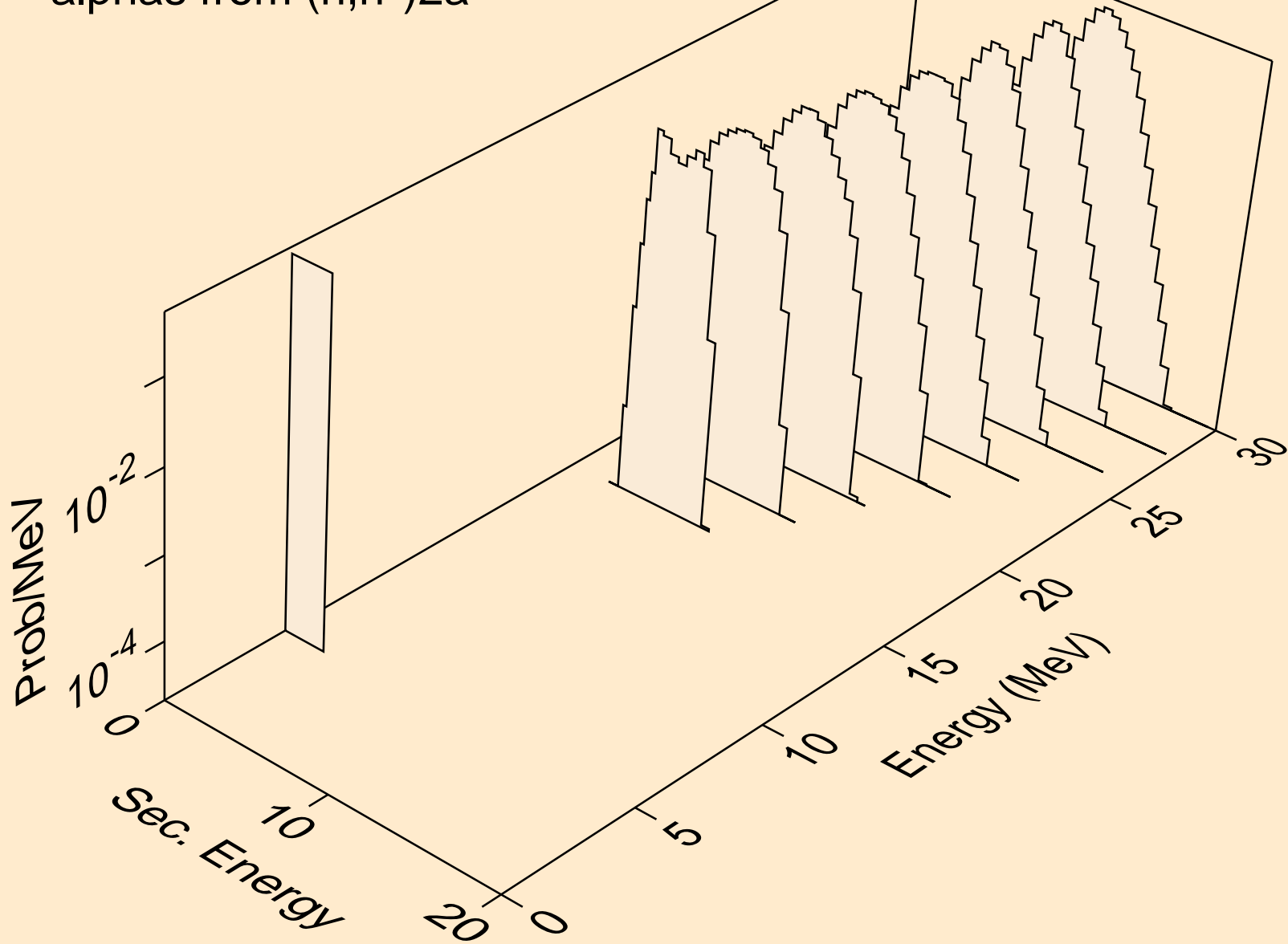

RU088 NEUTRON ACER TENDL-2024 LIBRARY; T=293.6K
alphas from (n,npa)

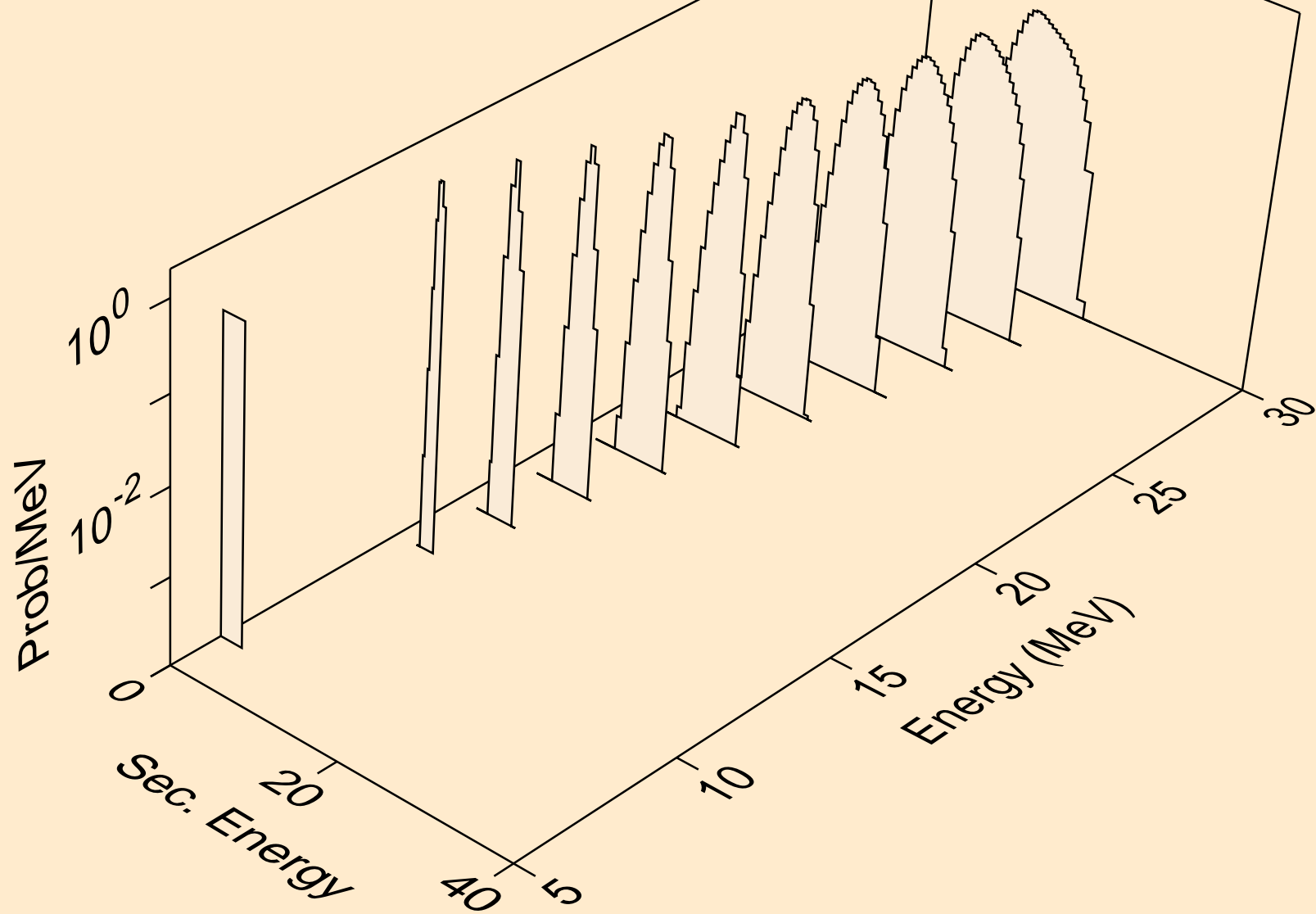

RU088 NEUTRON ACER TENDL-2024 LIBRARY; T=293.6K
alphas from (n,a)

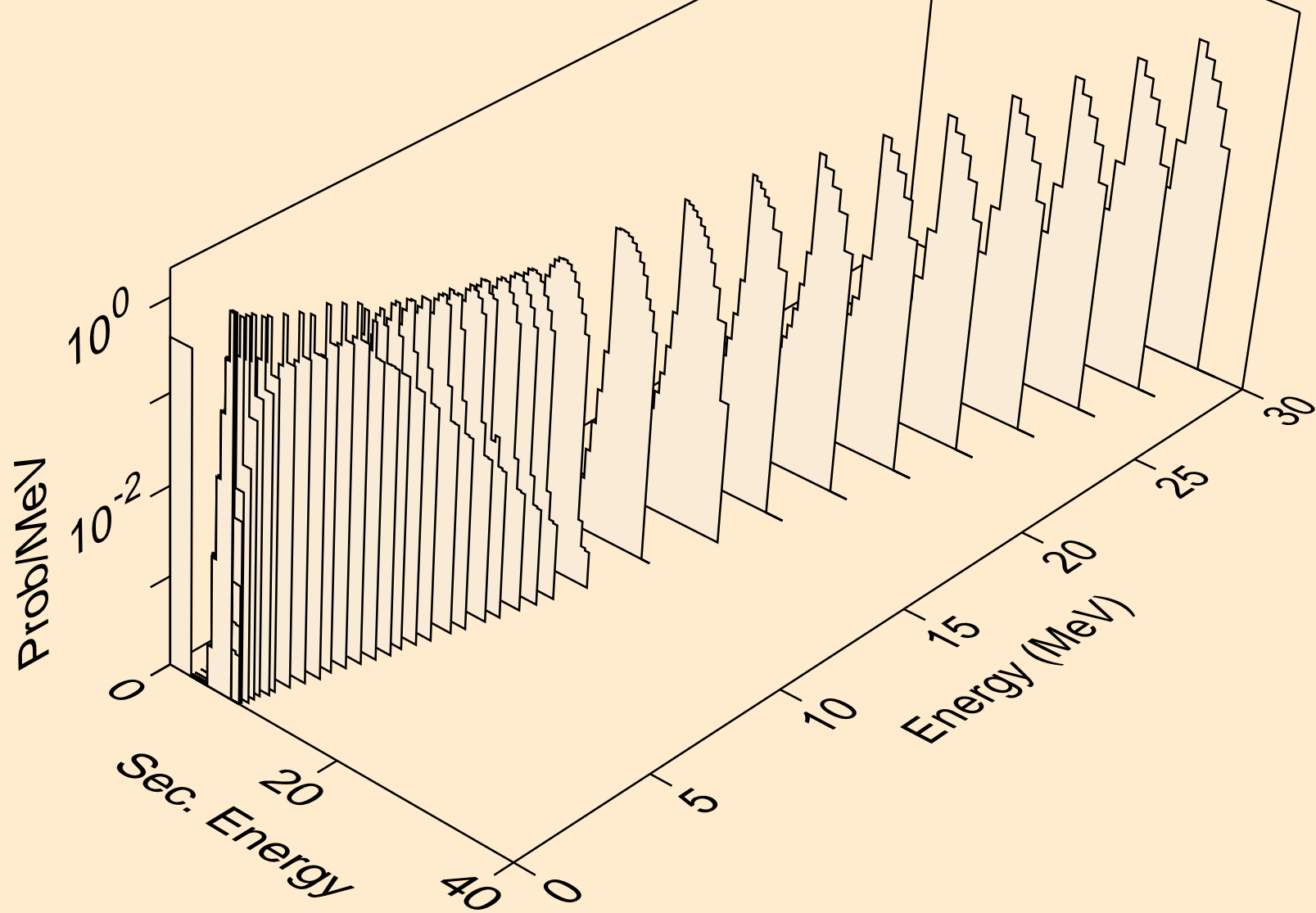

RU088 NEUTRON ACER TENDL-2024 LIBRARY; T=293.6K
alphas from (n,2a)

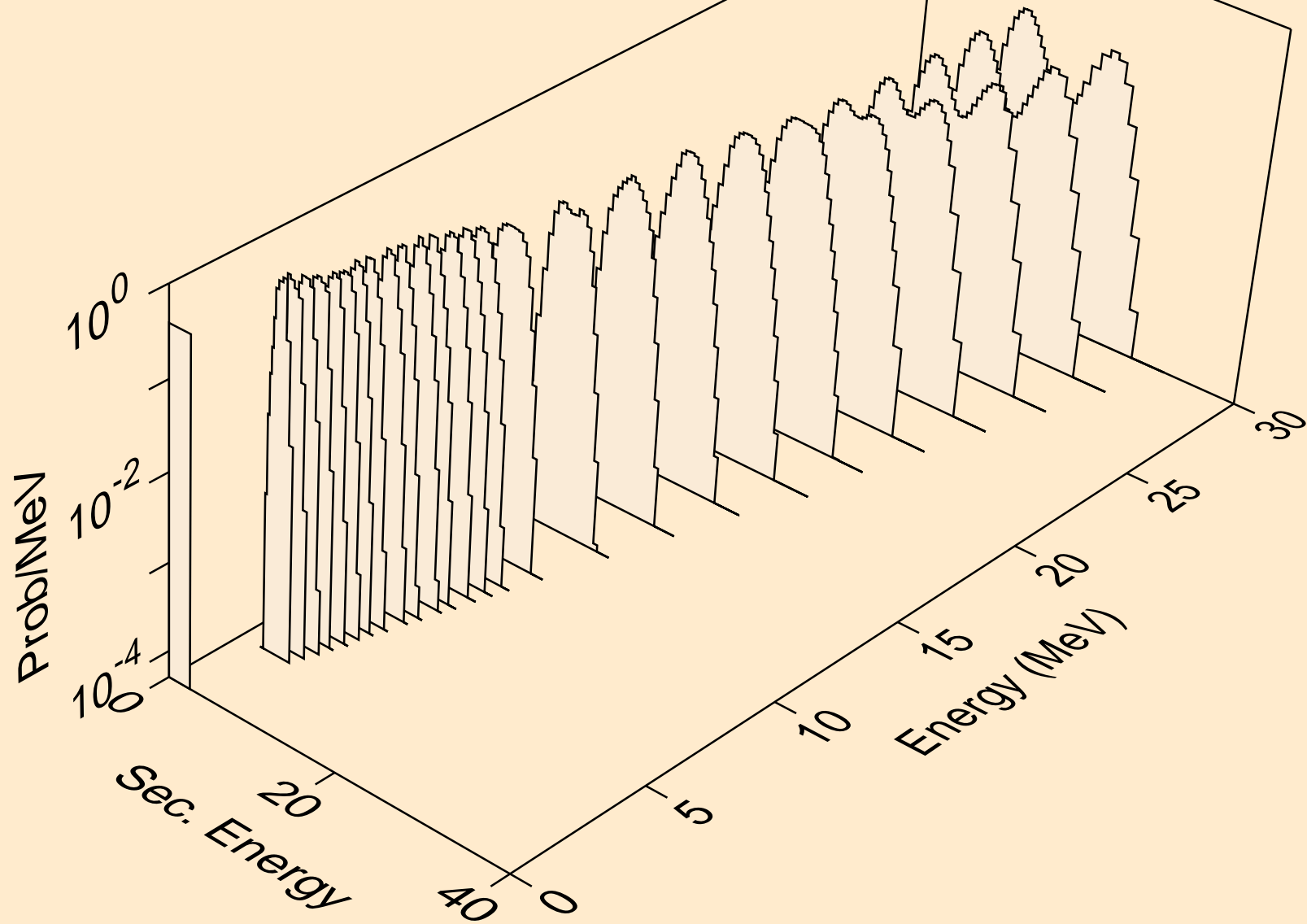

RU088 NEUTRON ACER TENDL-2024 LIBRARY; T=293.6K
alphas from (n,3a)

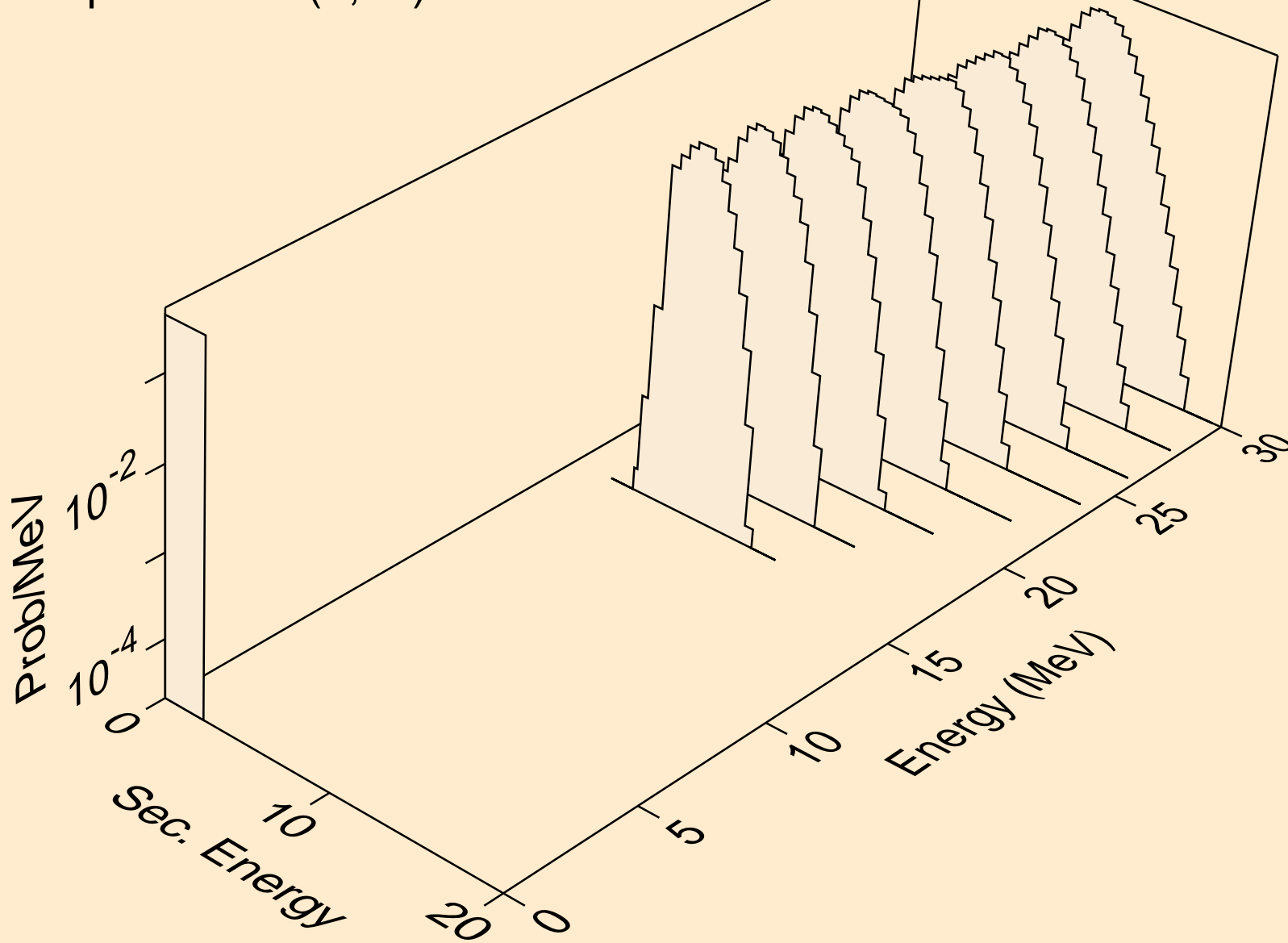

RU088 NEUTRON ACER TENDL-2024 LIBRARY; T=293.6K
alphas from (n,pa)

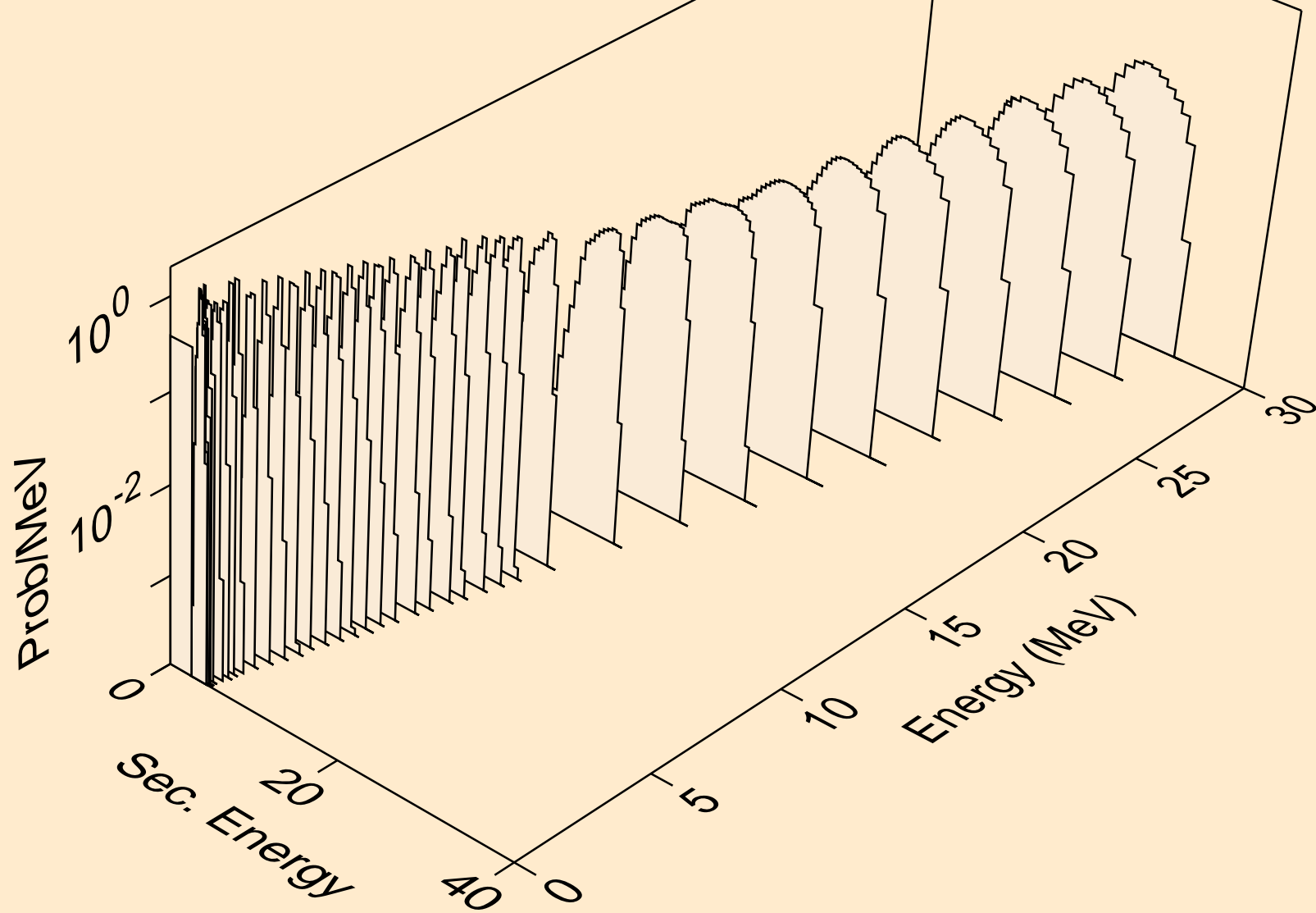

RU088 NEUTRON ACER TENDL-2024 LIBRARY; T=293.6K
alphas from (n,da)

