

RU092 NEUTRON ACER TENDL-2024 LIBRARY; T=293.6K

Principal cross sections

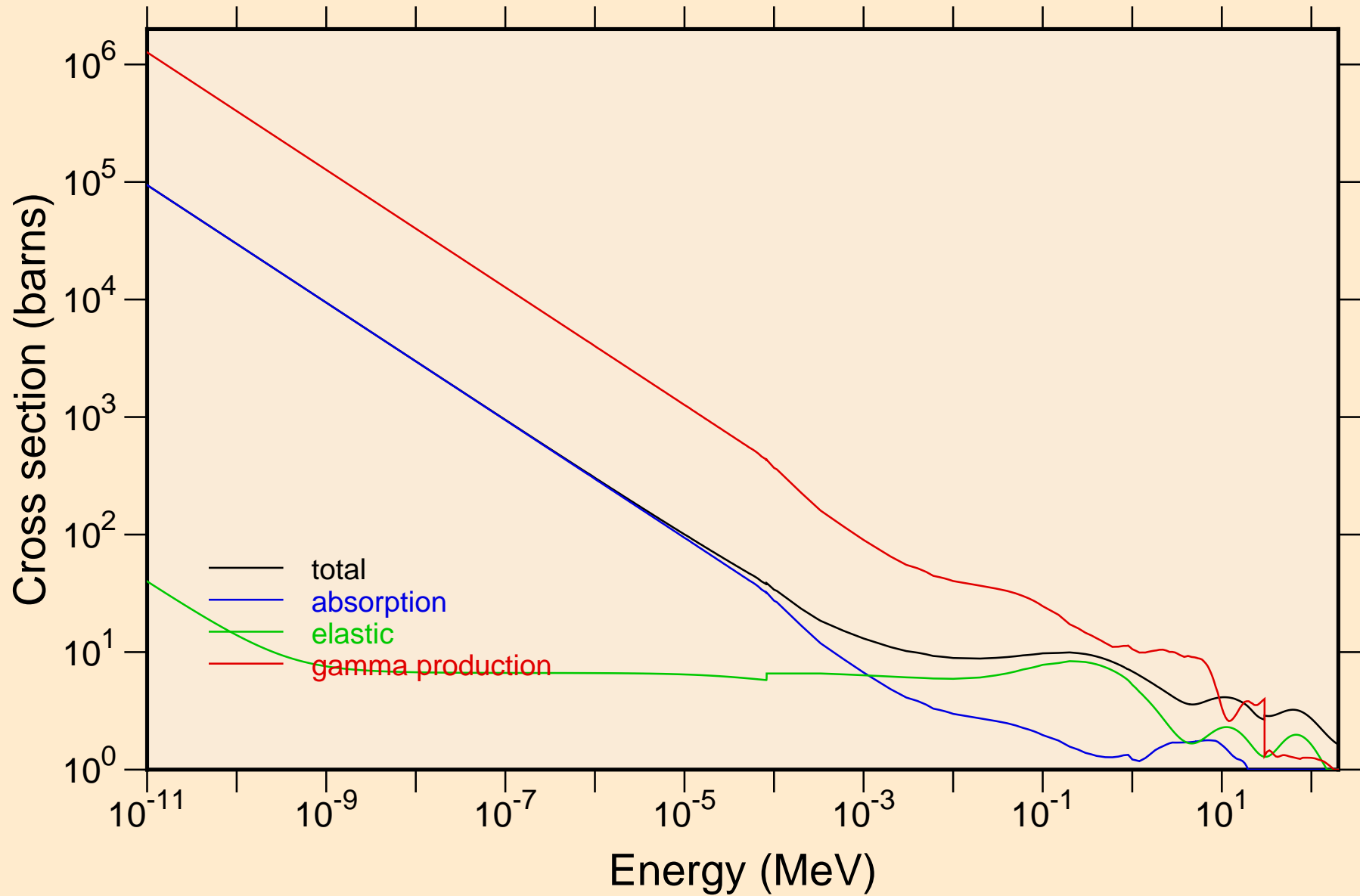

RU092 NEUTRON ACER TENDL-2024 LIBRARY; T=293.6K
Heating

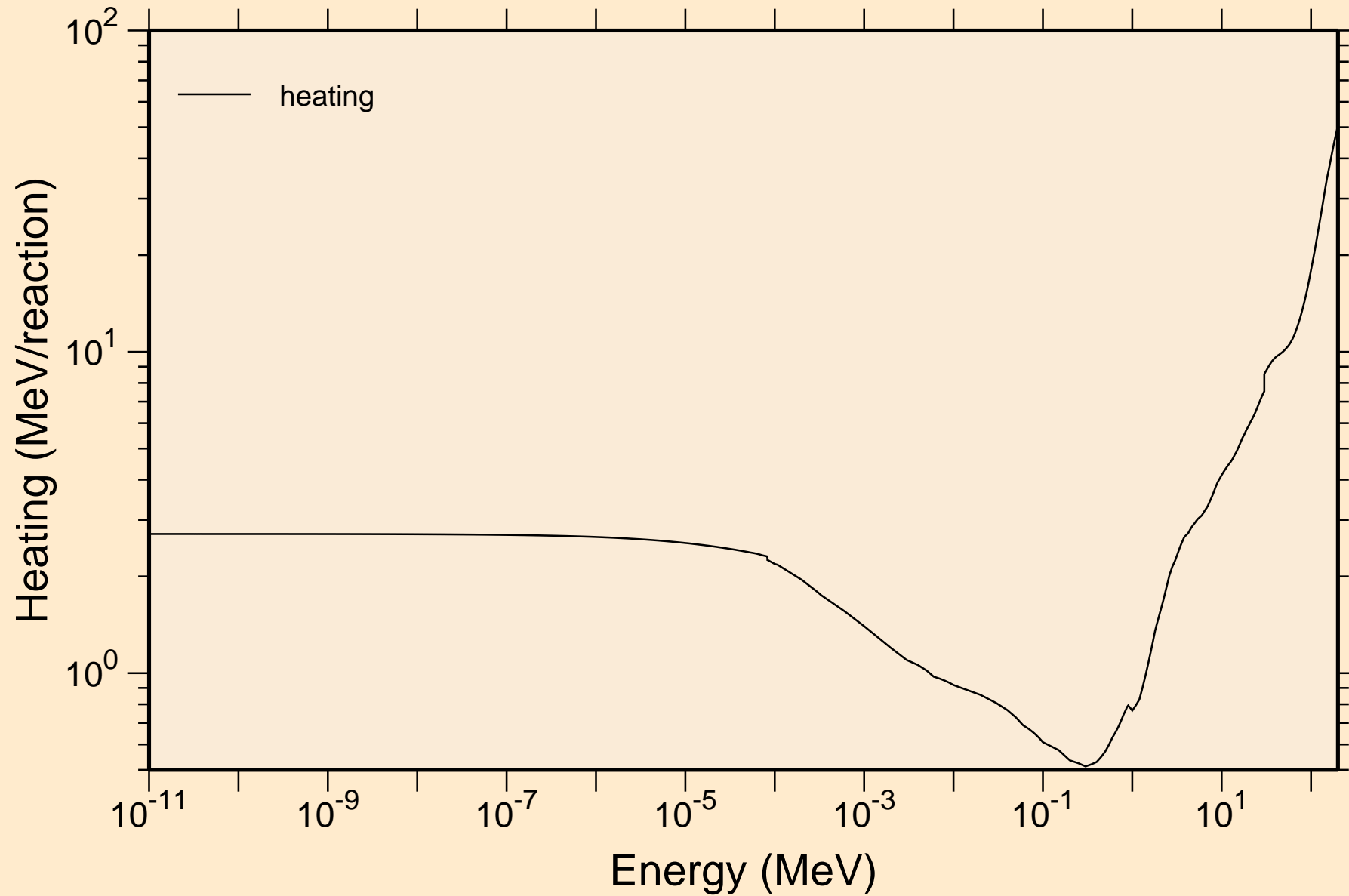

RU092 NEUTRON ACER TENDL-2024 LIBRARY; T=293.6K
Damage

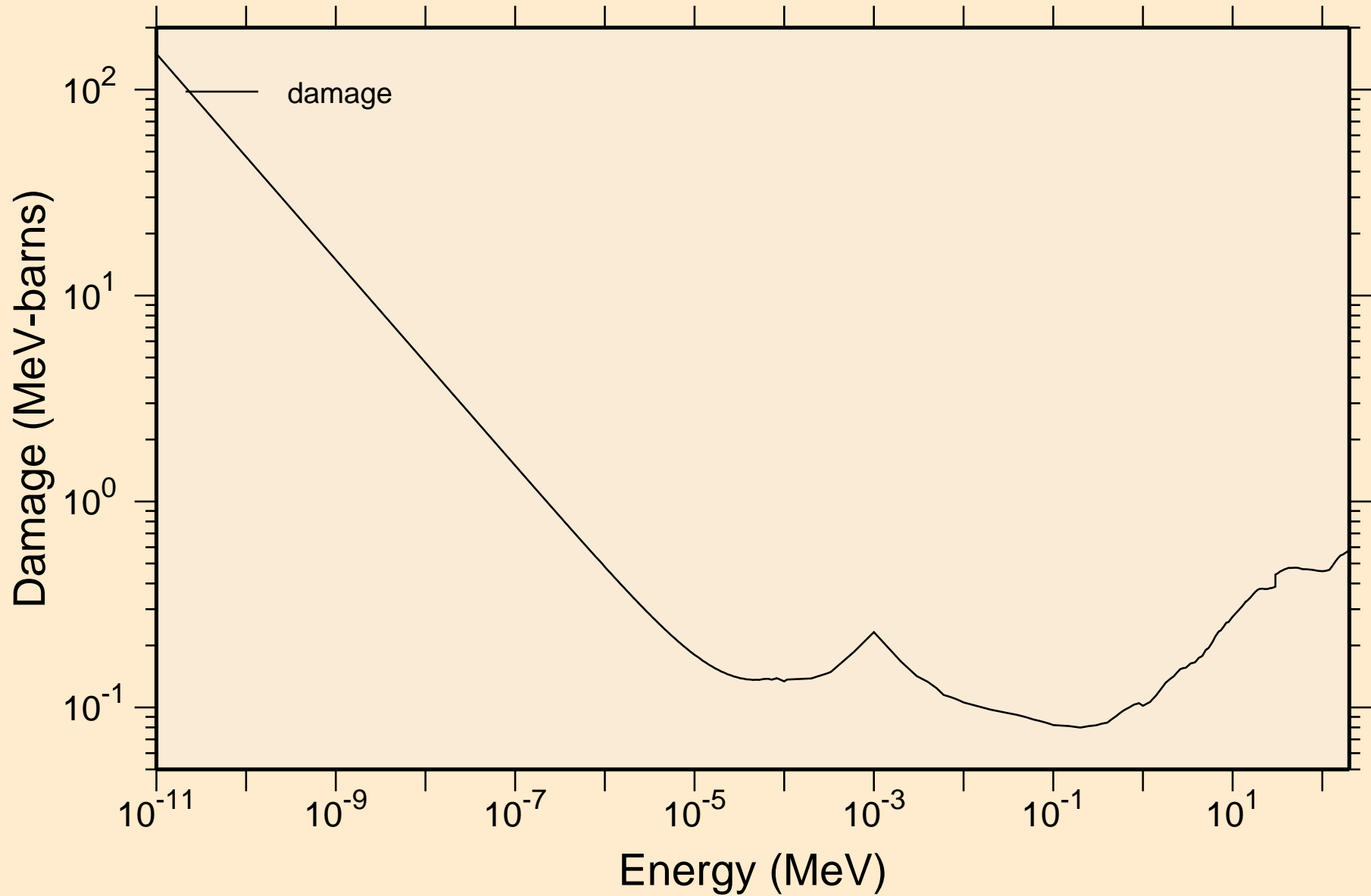

RU092 NEUTRON ACER TENDL-2024 LIBRARY; T=293.6K

Non-threshold reactions

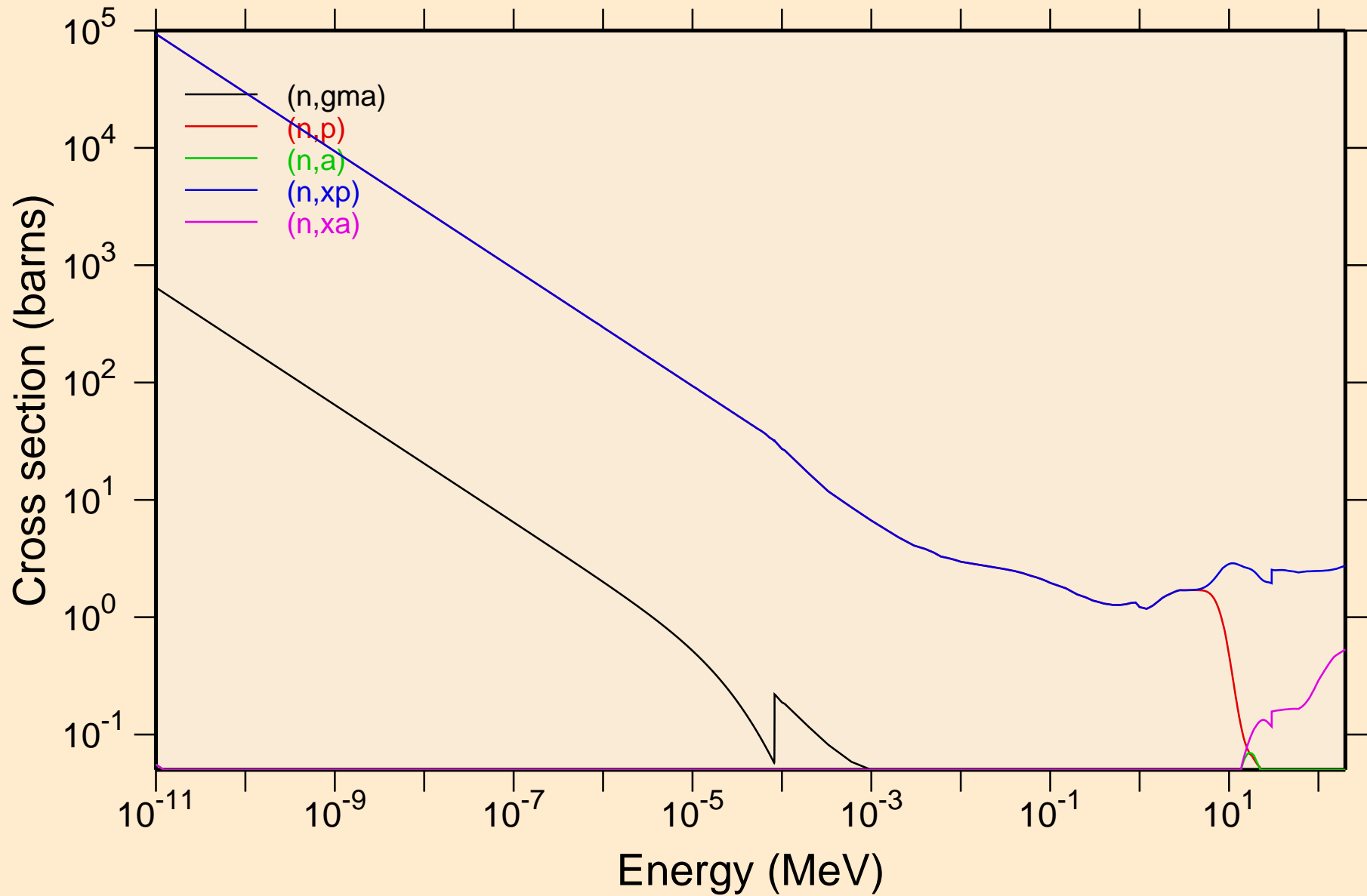

RU092 NEUTRON ACER TENDL-2024 LIBRARY; T=293.6K
Principal cross sections

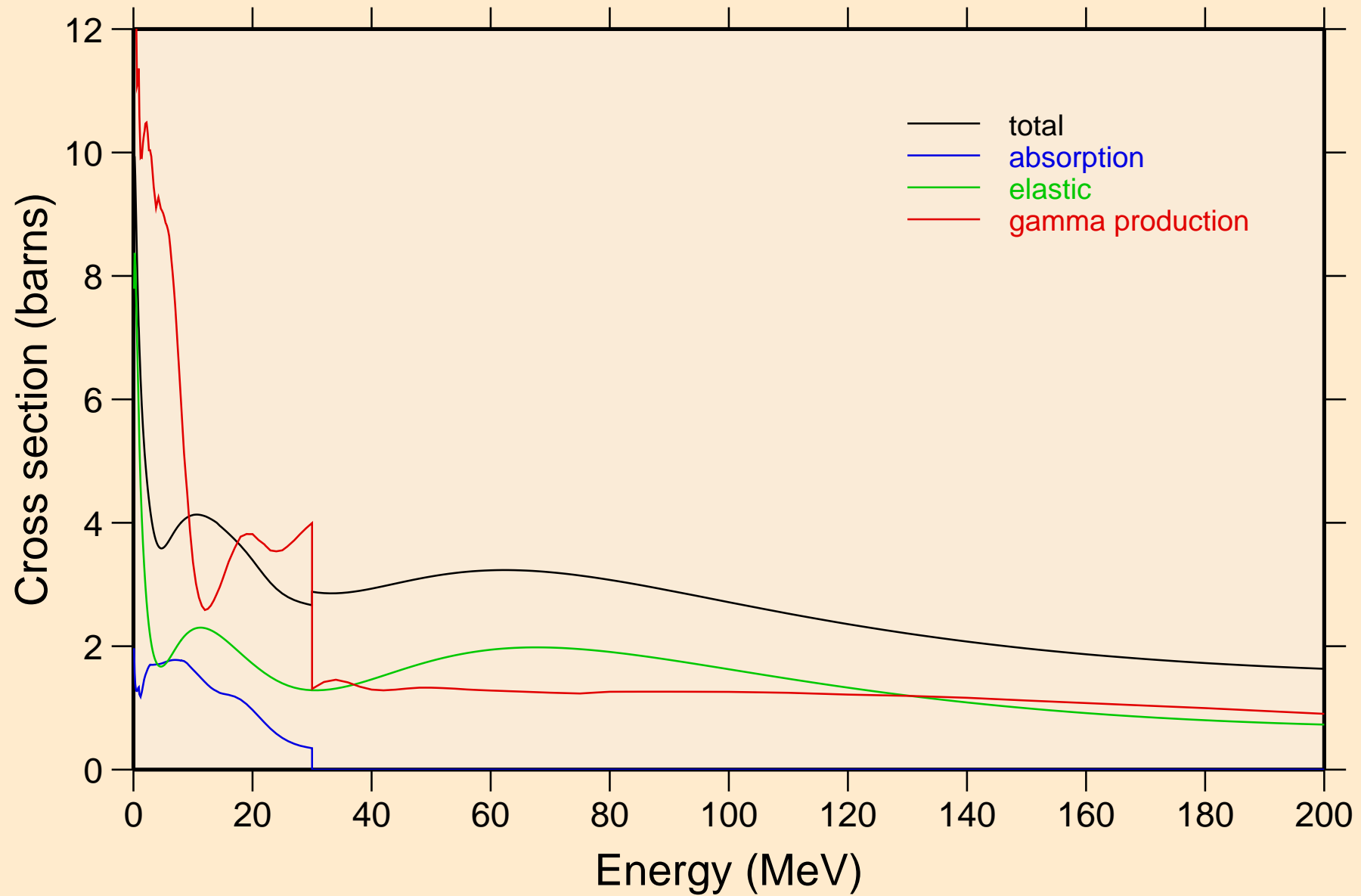

RU092 NEUTRON ACER TENDL-2024 LIBRARY; T=293.6K
Heating

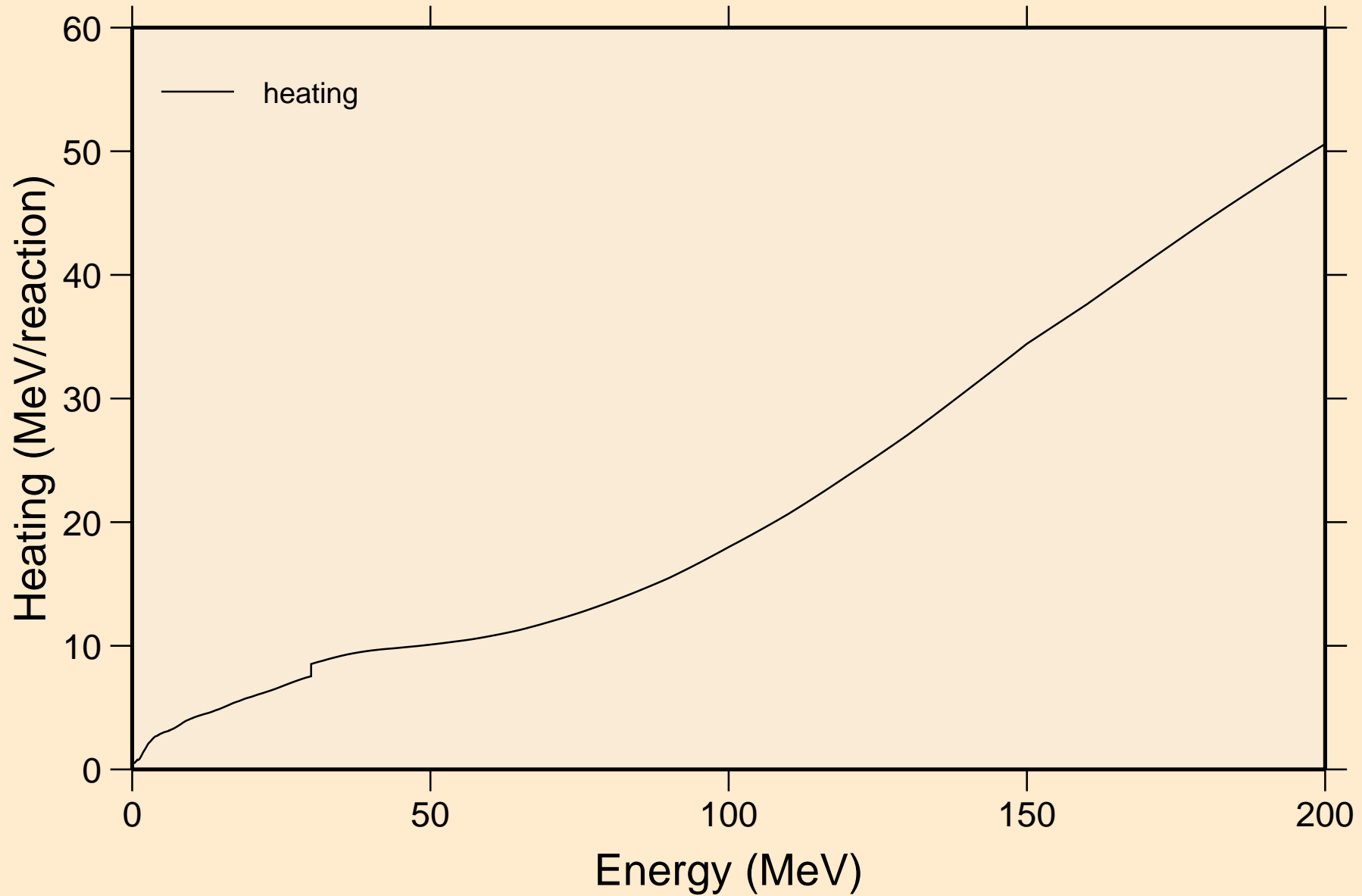

RU092 NEUTRON ACER TENDL-2024 LIBRARY; T=293.6K
Damage

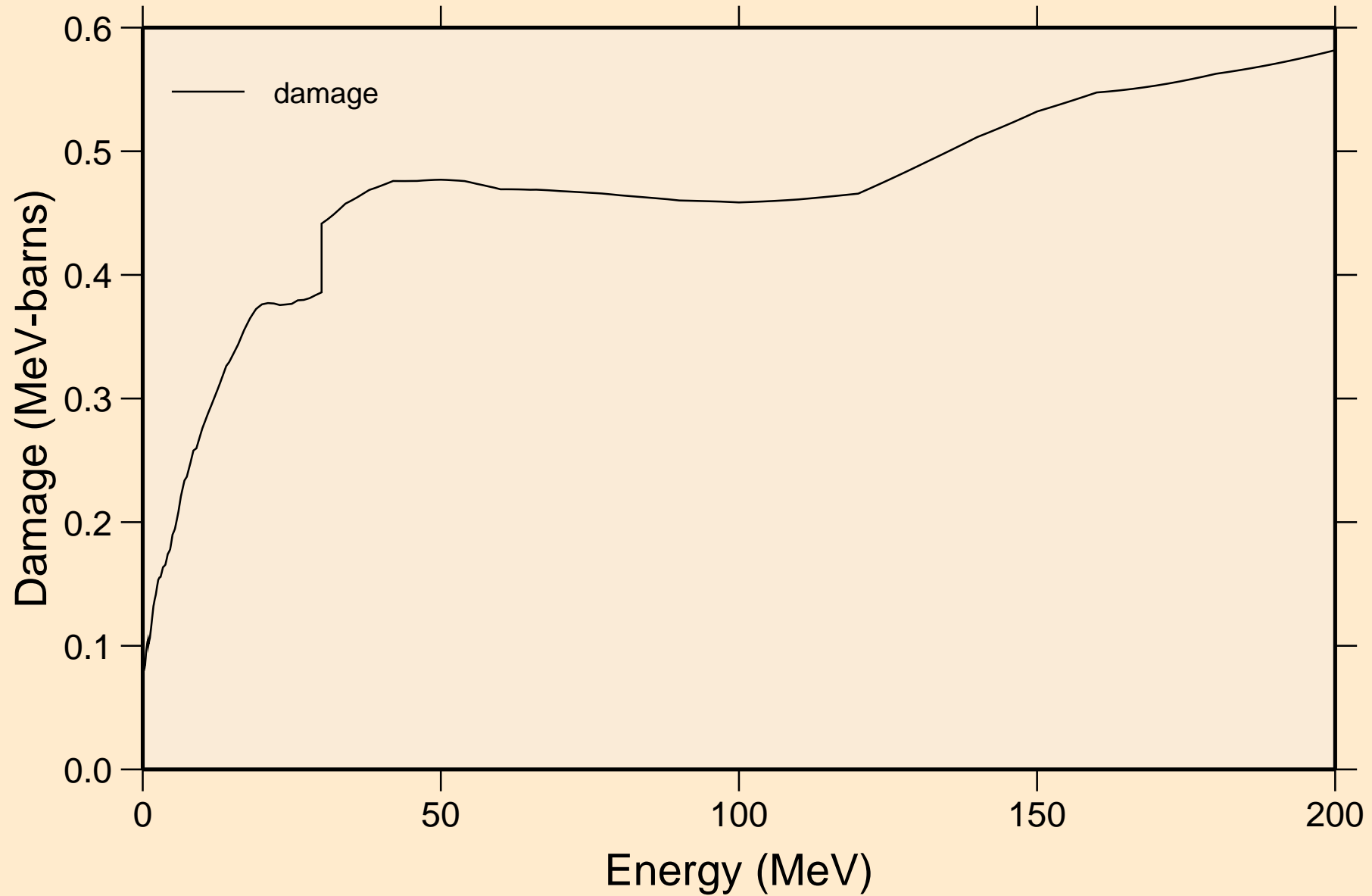

RU092 NEUTRON ACER TENDL-2024 LIBRARY; T=293.6K
Non-threshold reactions

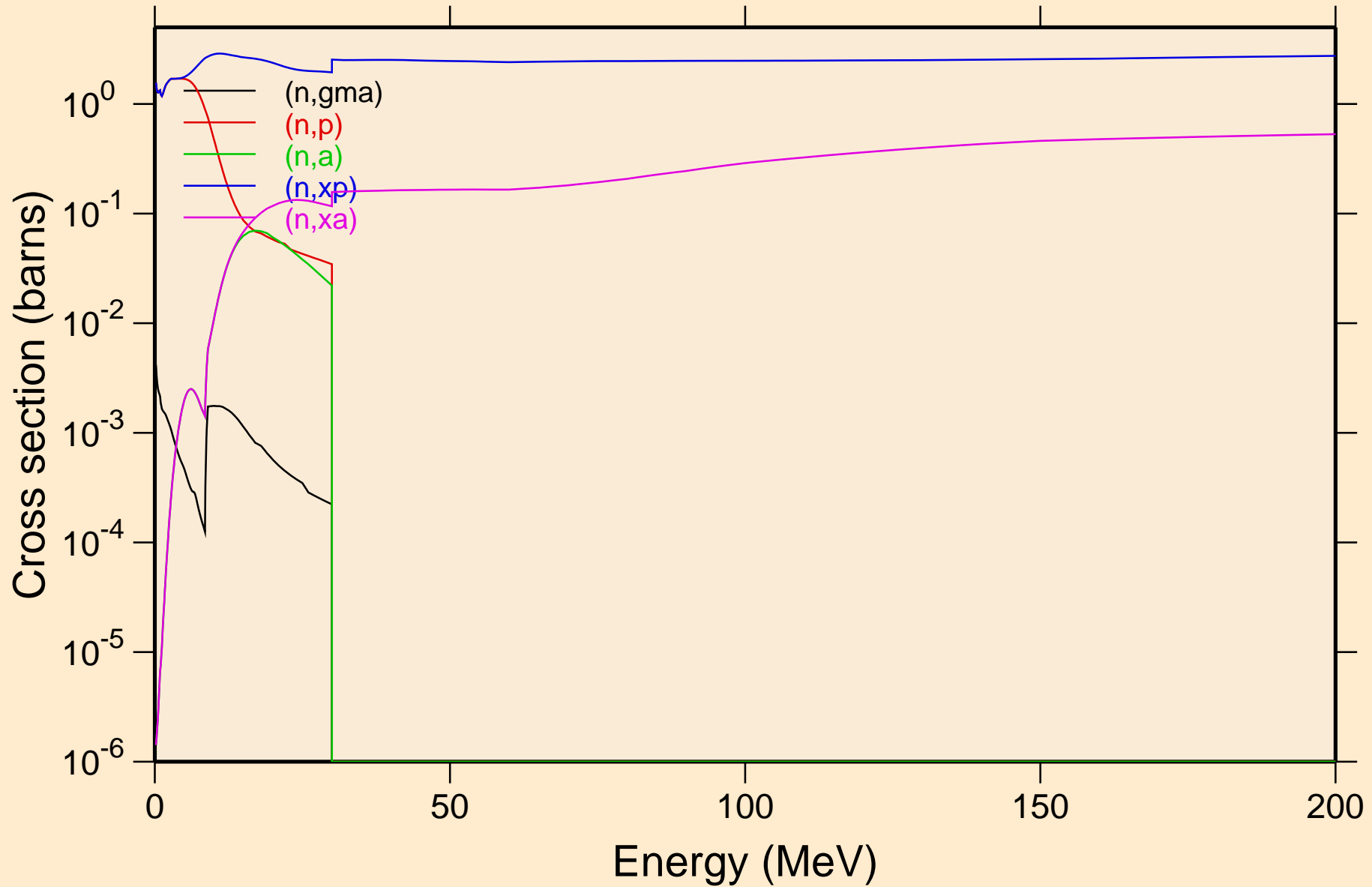

RU092 NEUTRON ACER TENDL-2024 LIBRARY; T=293.6K
Inelastic levels

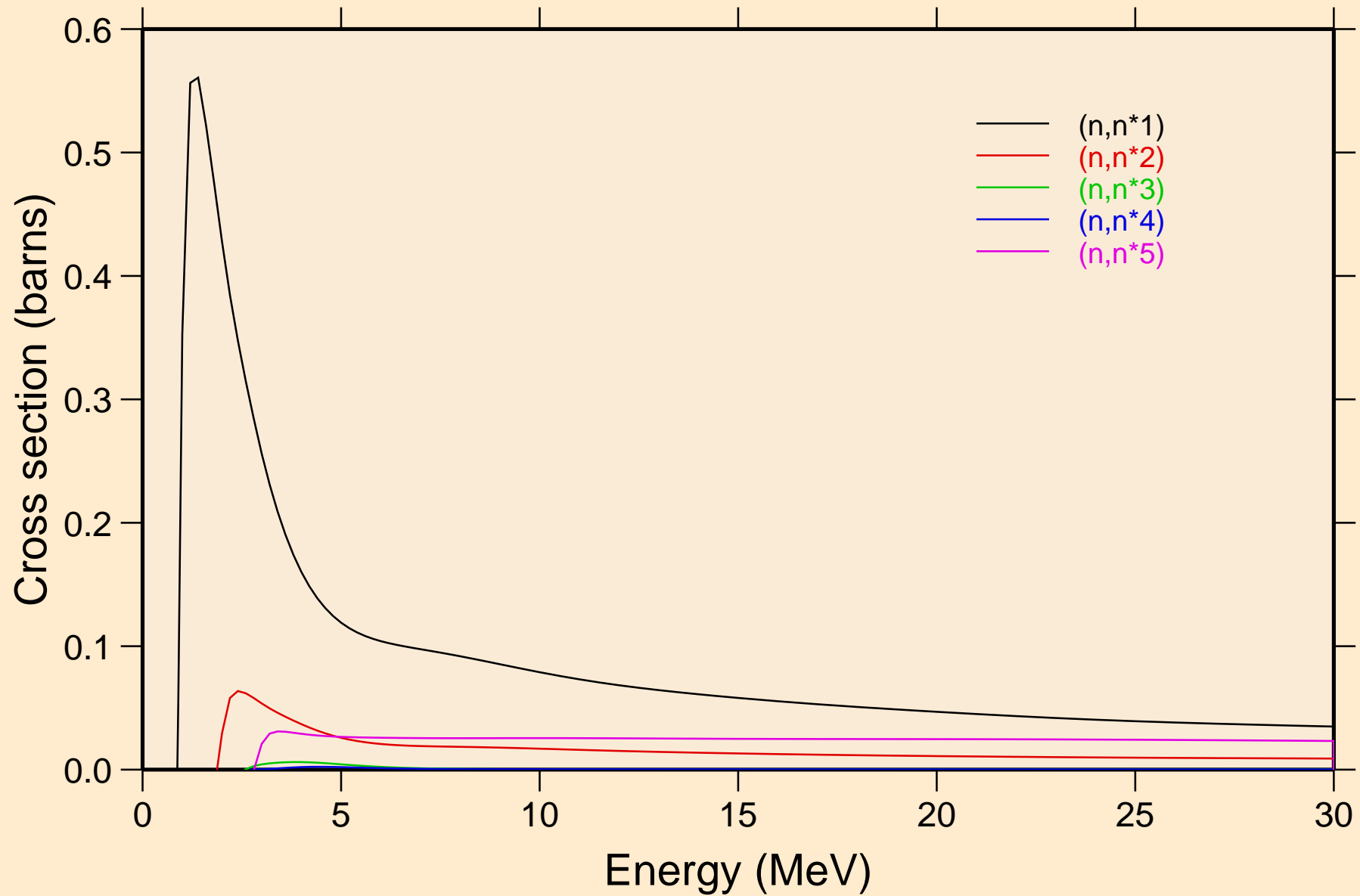

RU092 NEUTRON ACER TENDL-2024 LIBRARY; T=293.6K
Threshold reactions

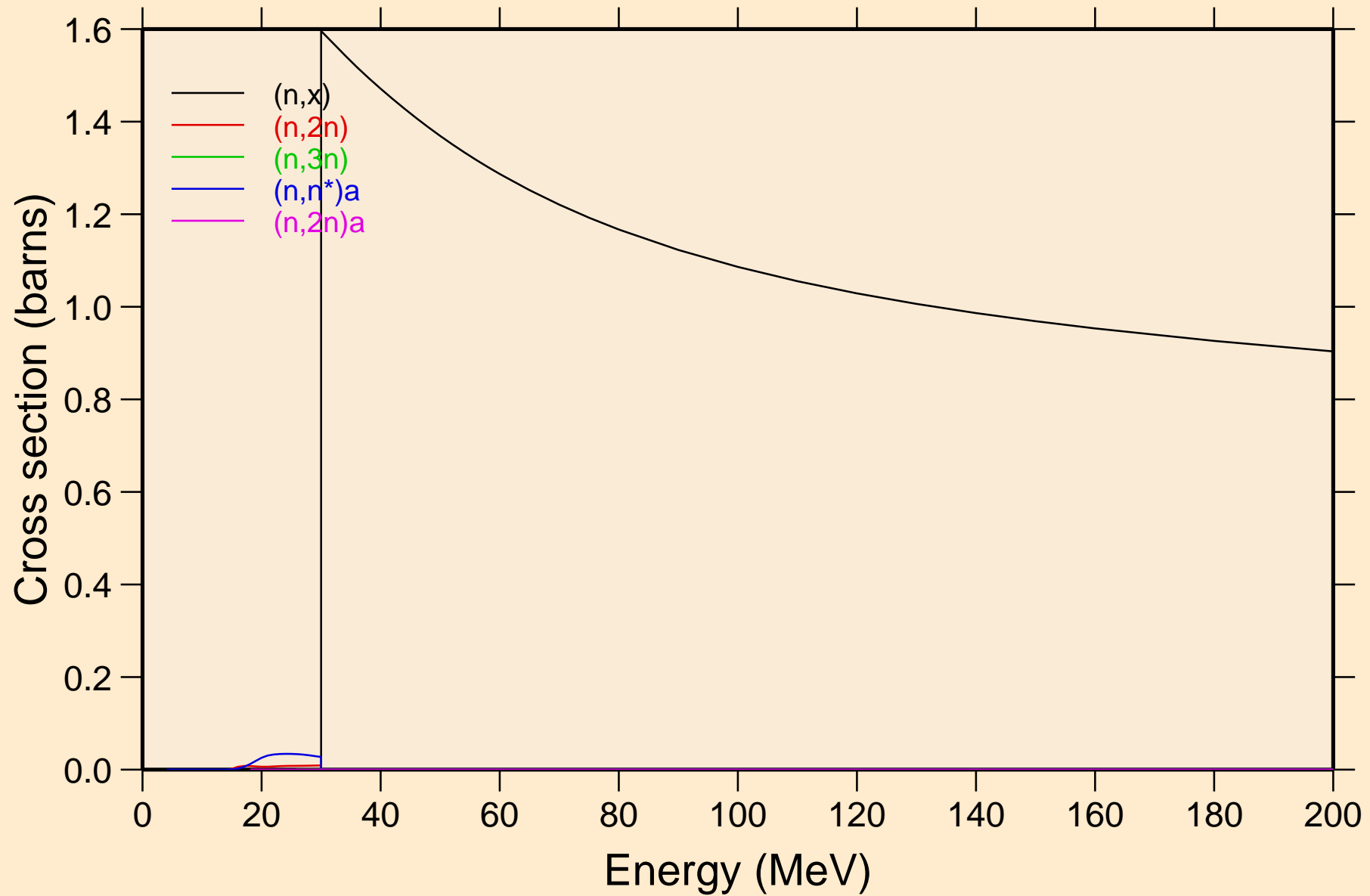

RU092 NEUTRON ACER TENDL-2024 LIBRARY; T=293.6K
Threshold reactions

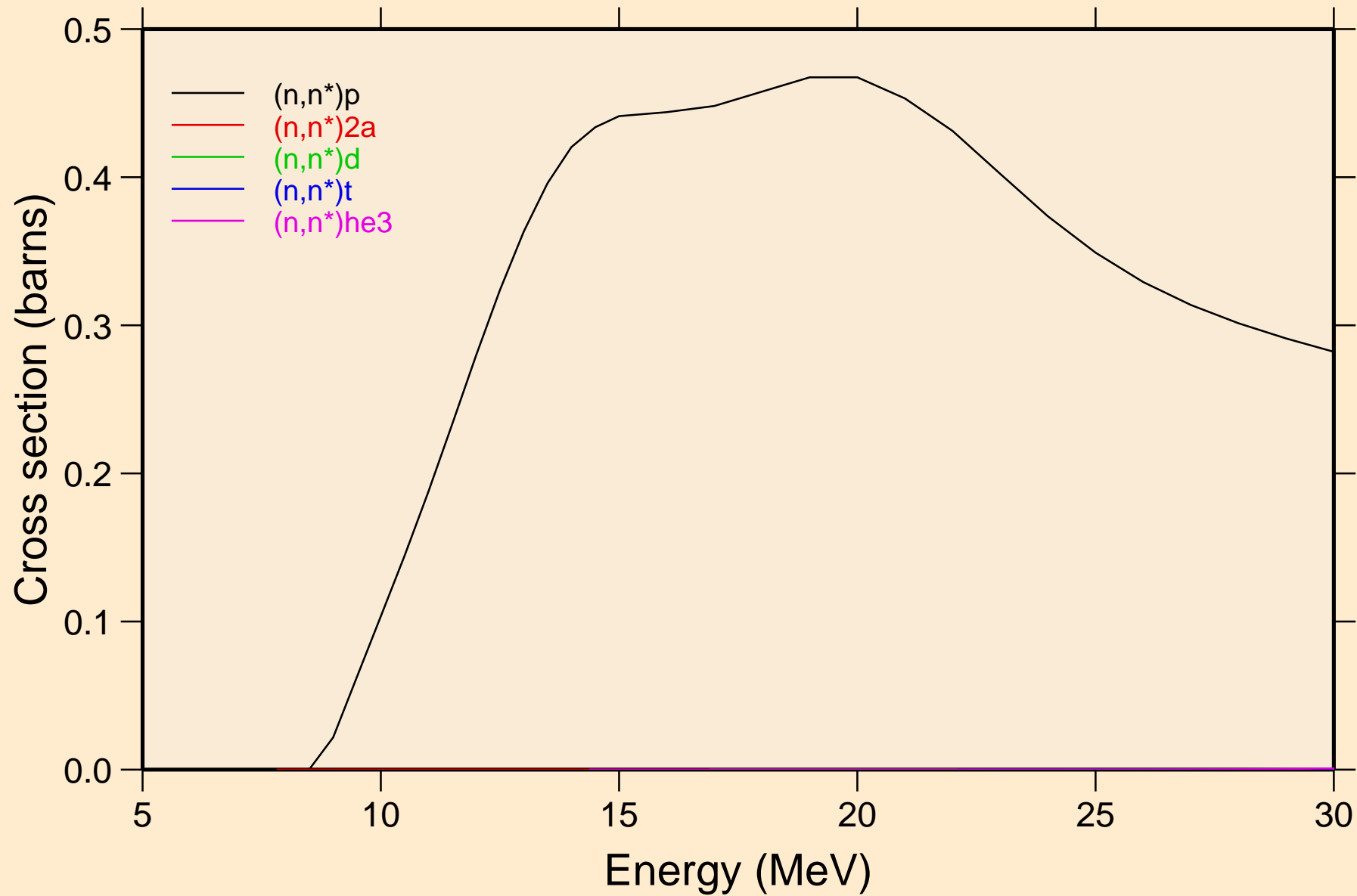

RU092 NEUTRON ACER TENDL-2024 LIBRARY; T=293.6K
Threshold reactions

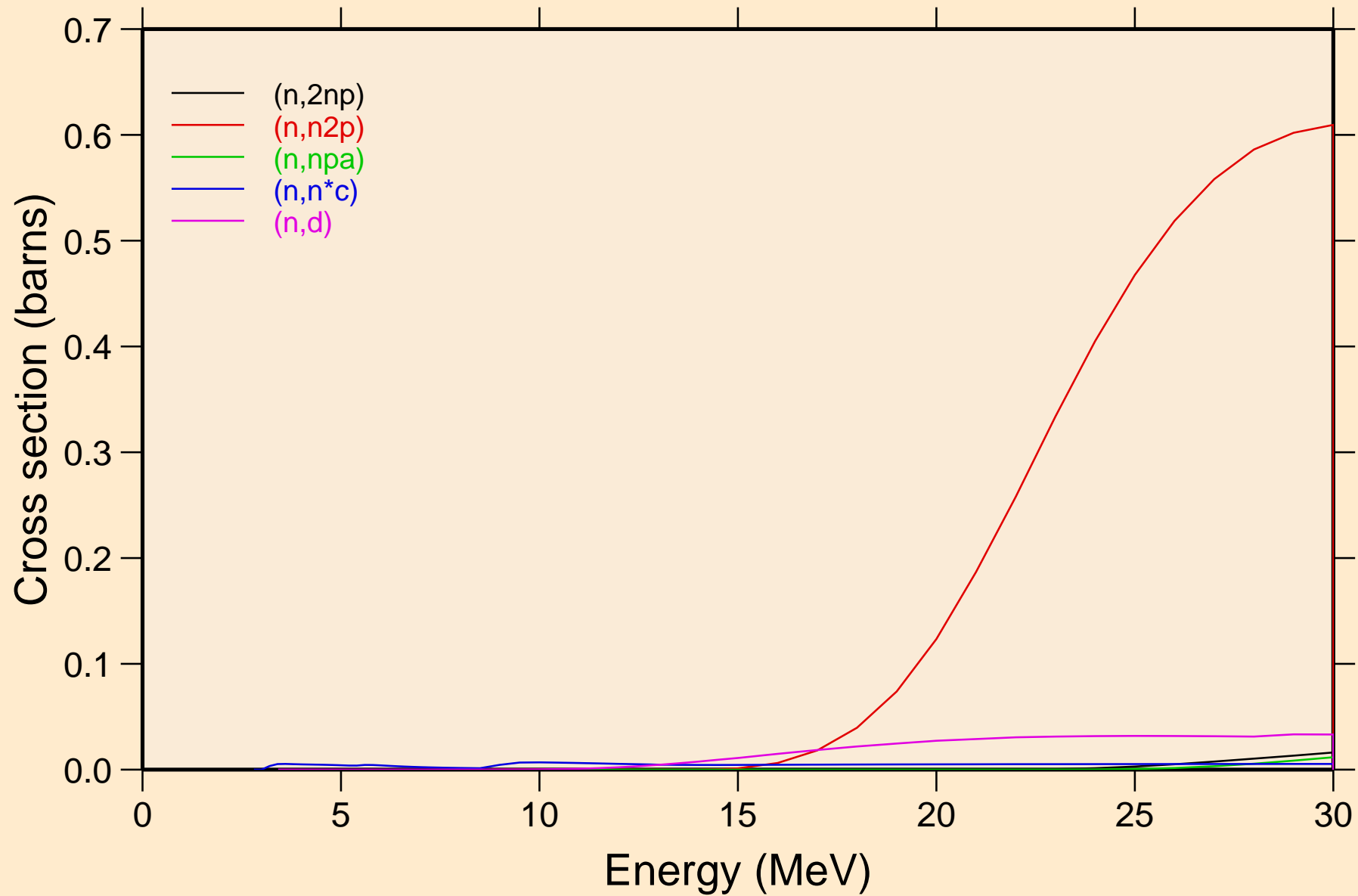

RU092 NEUTRON ACER TENDL-2024 LIBRARY; T=293.6K
Threshold reactions

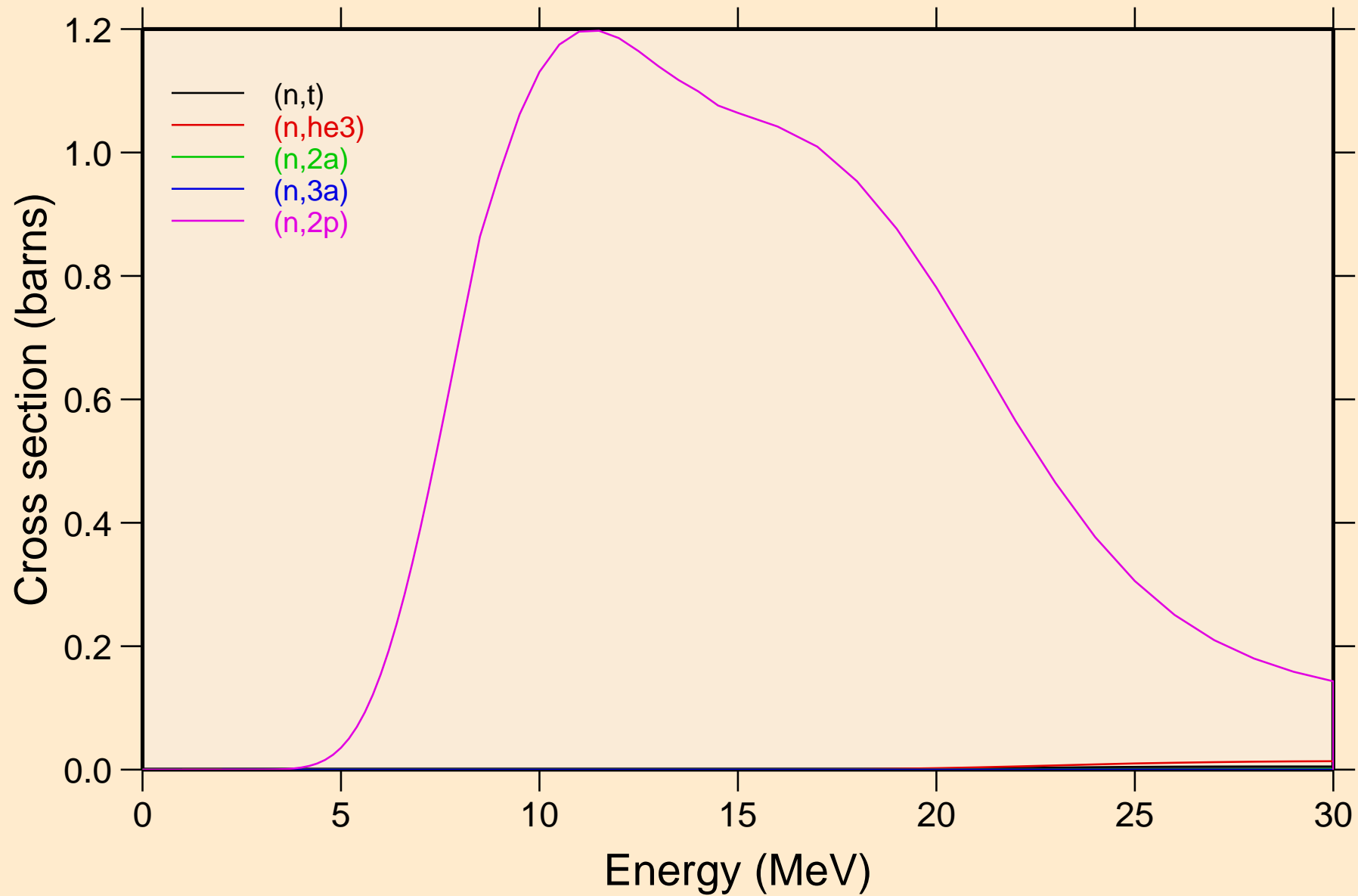

RU092 NEUTRON ACER TENDL-2024 LIBRARY; T=293.6K
Threshold reactions

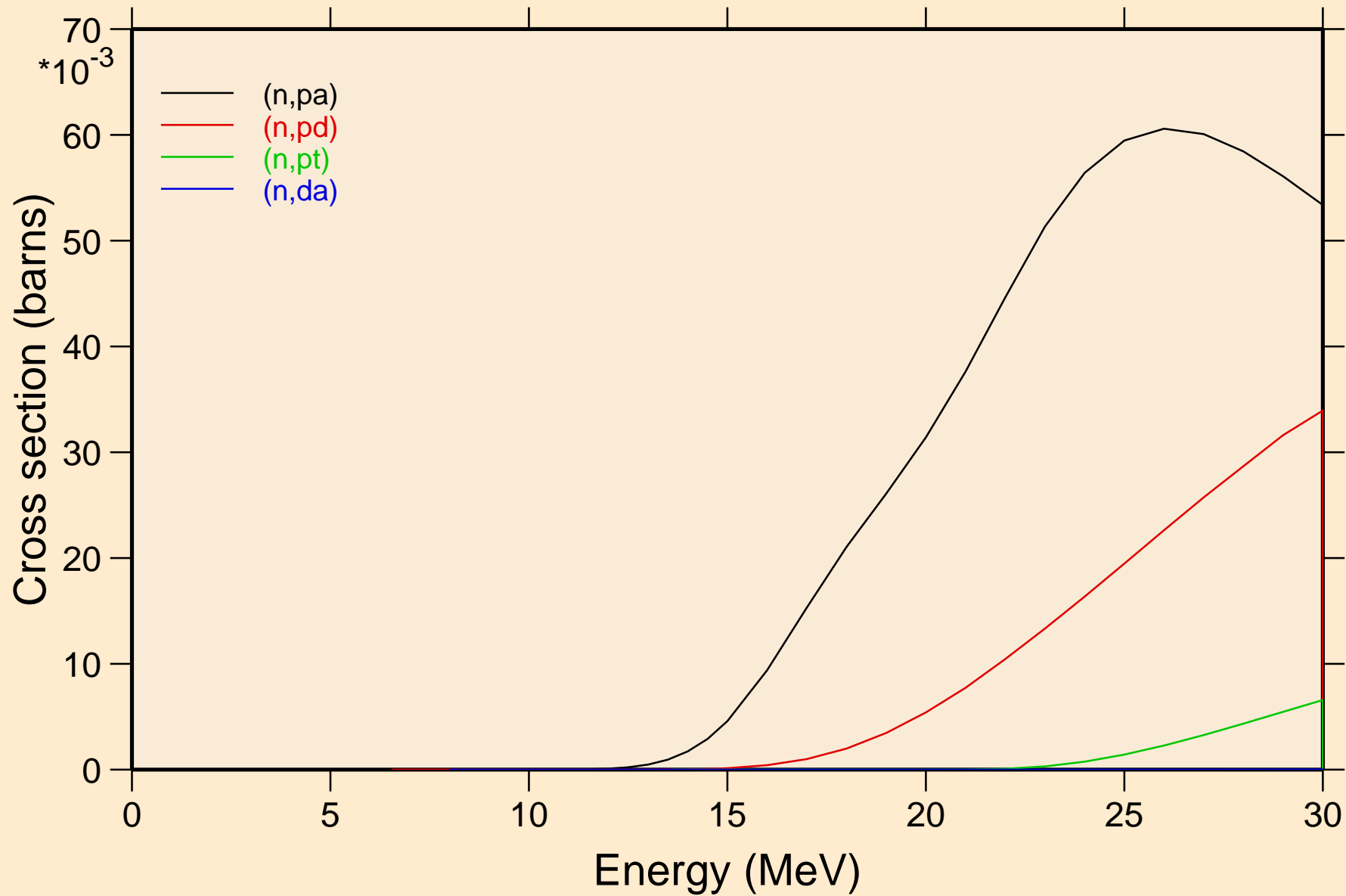

RU092 NEUTRON ACER TENDL-2024 LIBRARY; T=293.6K
Threshold reactions

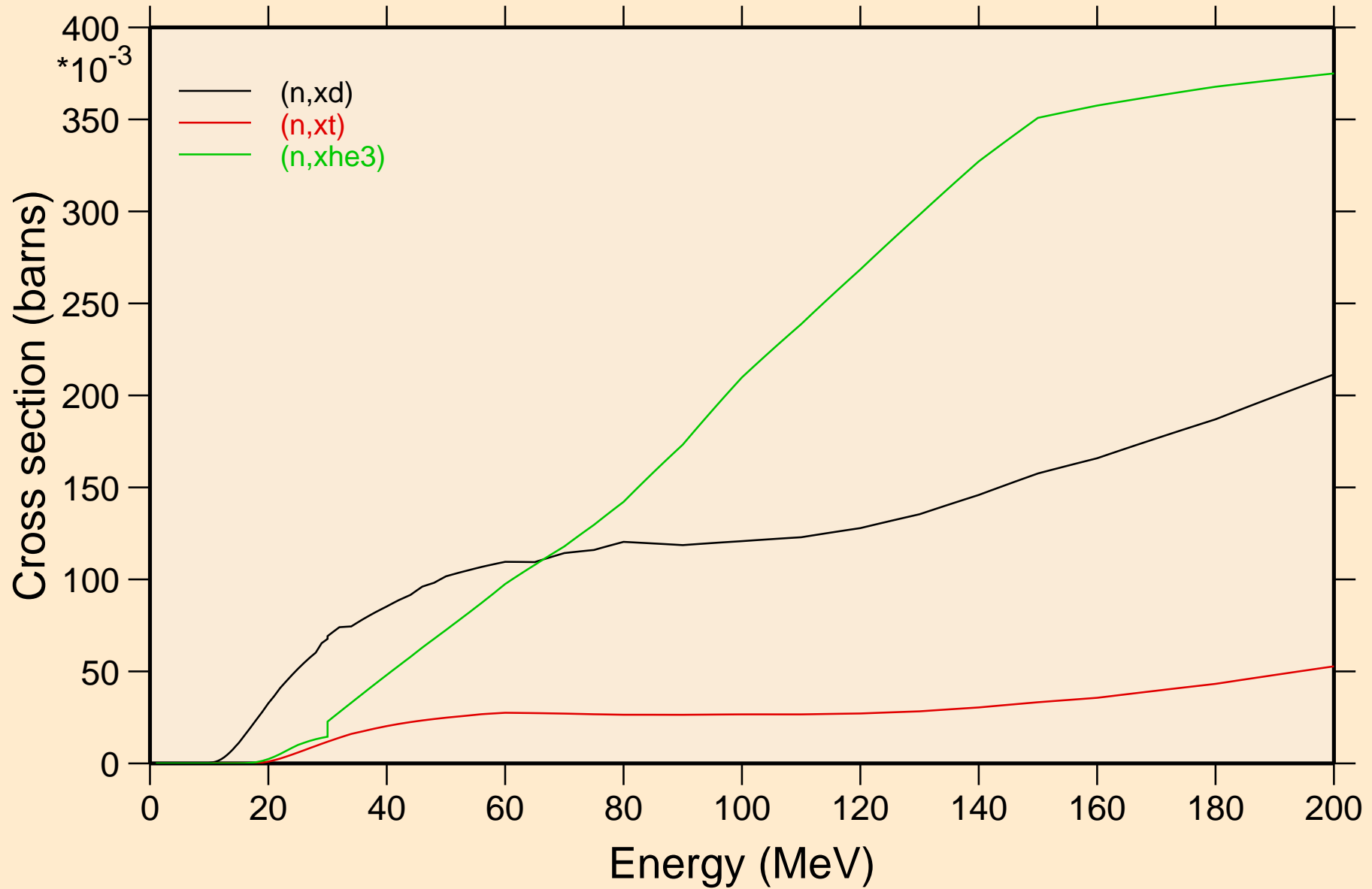

RU092 NEUTRON ACER TENDL-2024 LIBRARY; T=293.6K
angular distribution for elastic

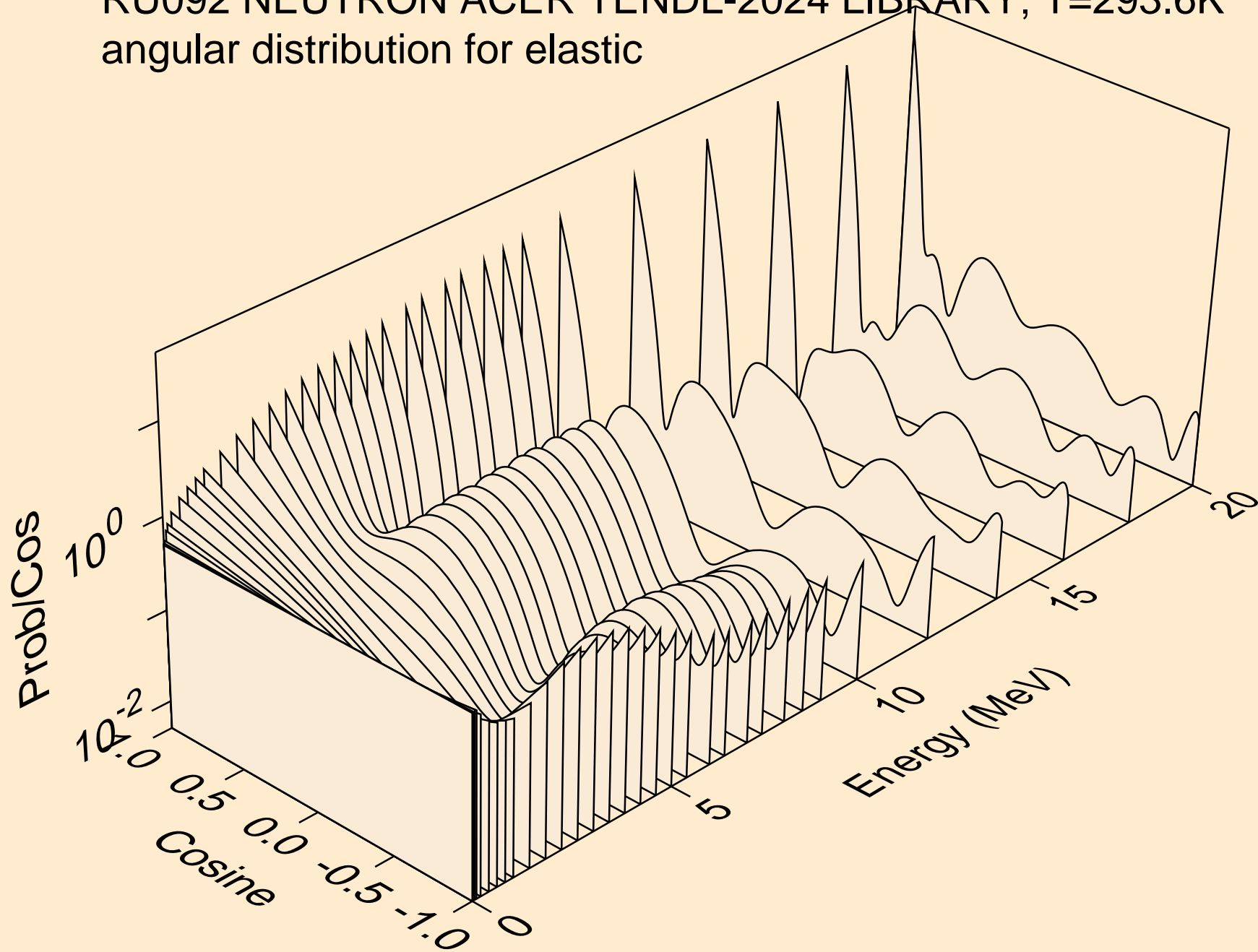

RU092 NEUTRON ACER TENDL-2024 LIBRARY; T=293.6K
angular distribution for elastic

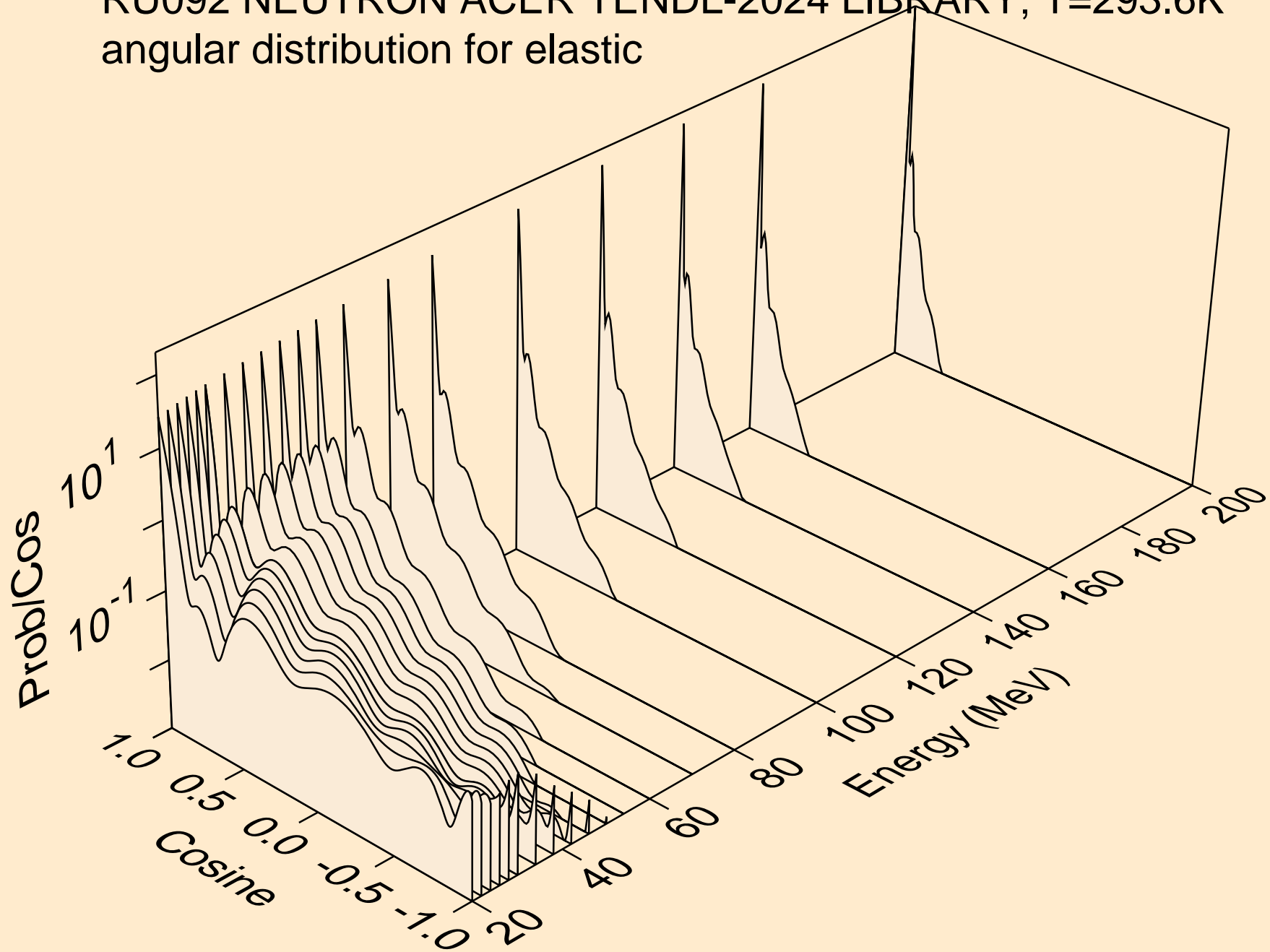

RU092 NEUTRON ACER TENDL-2024 LIBRARY; T=293.6K
angular distribution for (n,n*1)

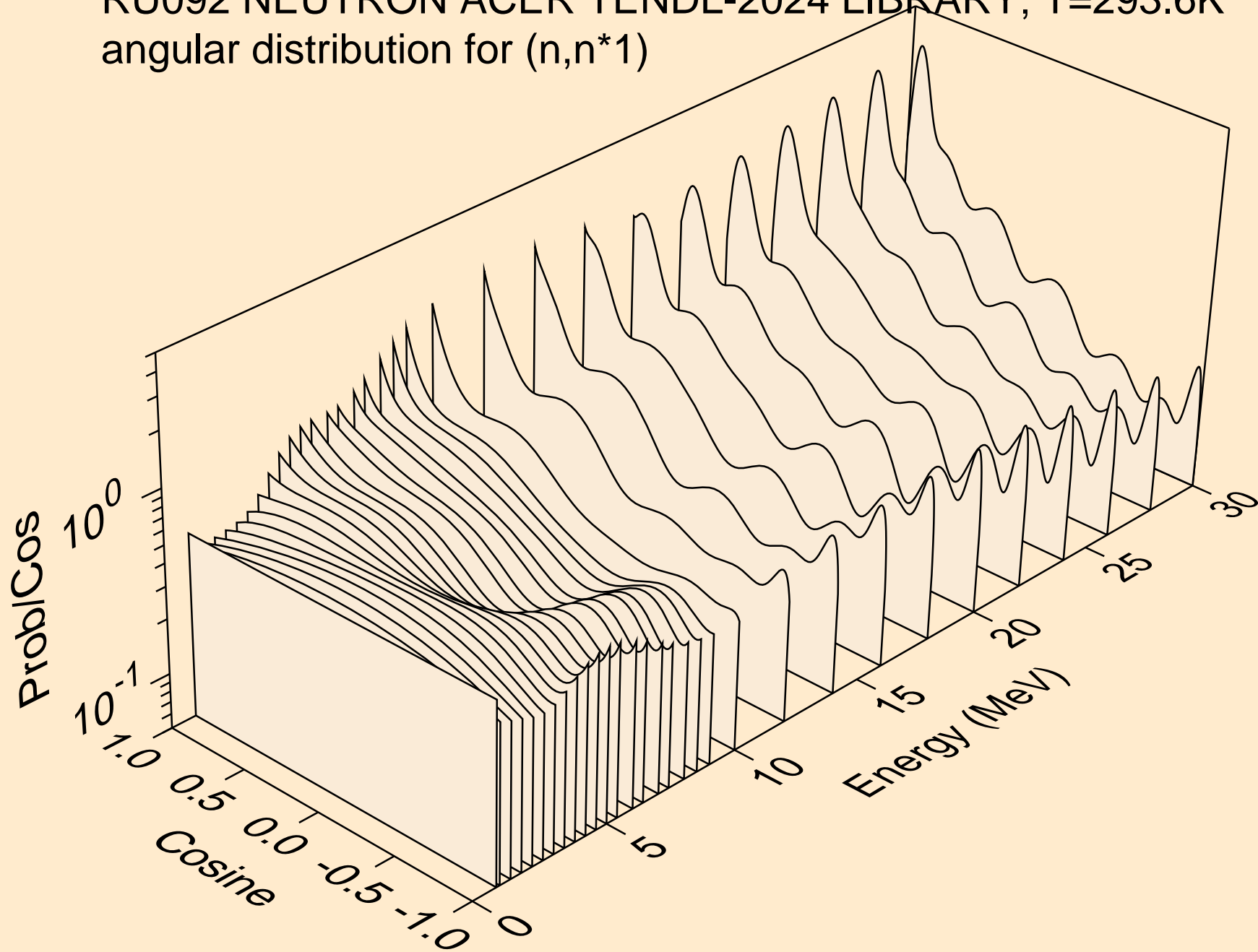

RU092 NEUTRON ACER TENDL-2024 LIBRARY; T=293.6K
angular distribution for (n,n*2)

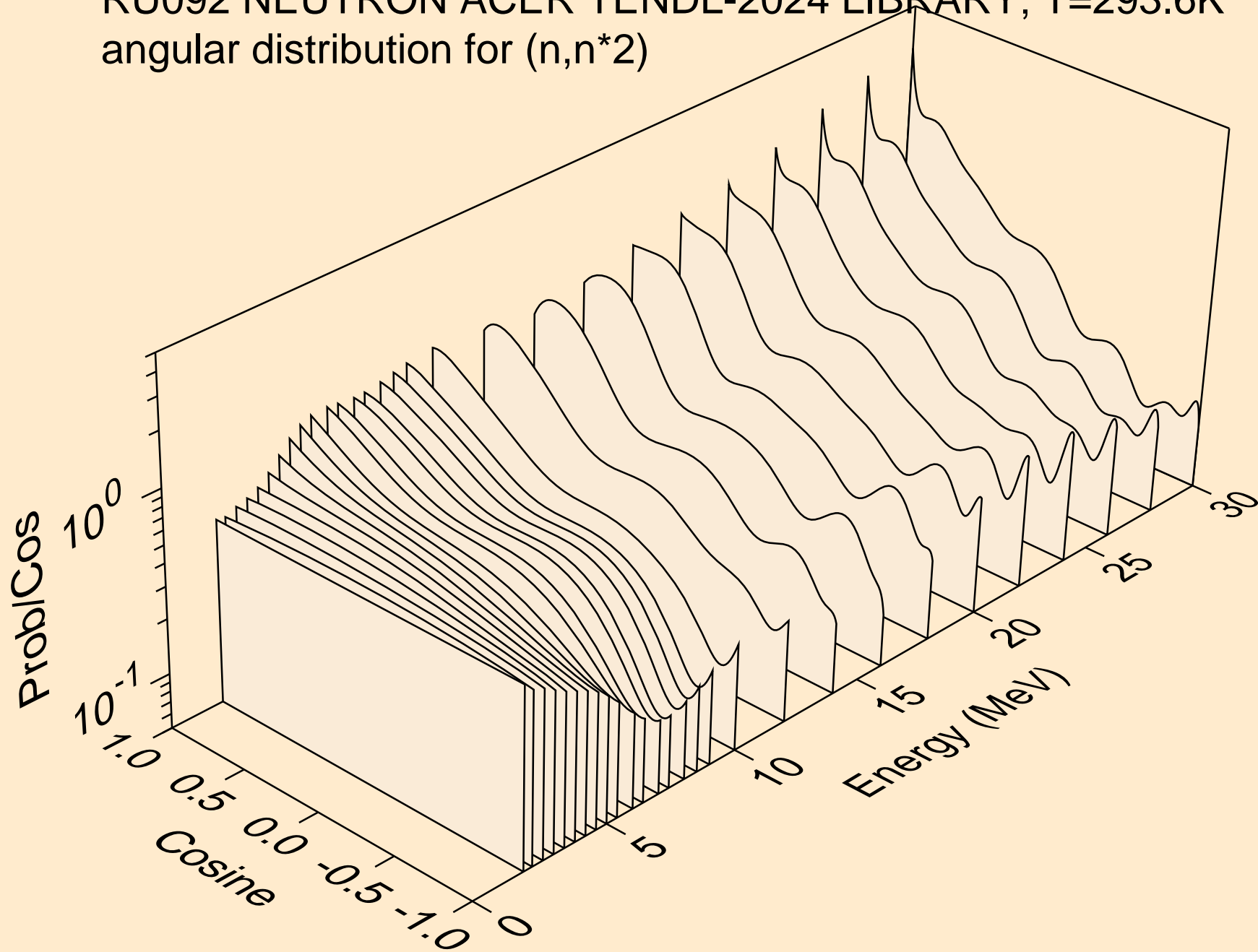

RU092 NEUTRON ACER TENDL-2024 LIBRARY; T=293.6K
angular distribution for (n,n*3)

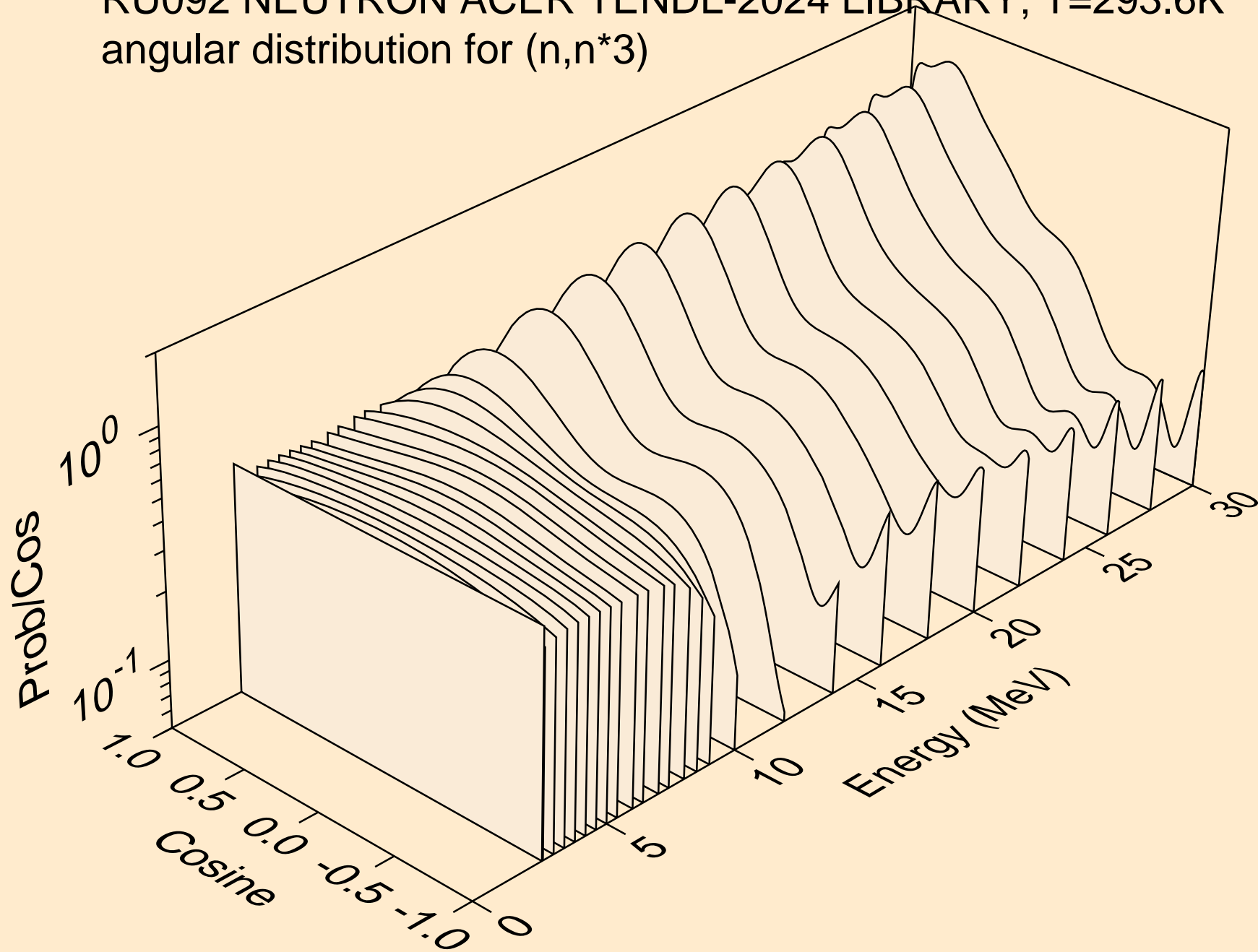

RU092 NEUTRON ACER TENDL-2024 LIBRARY; T=293.6K
angular distribution for (n,n*4)

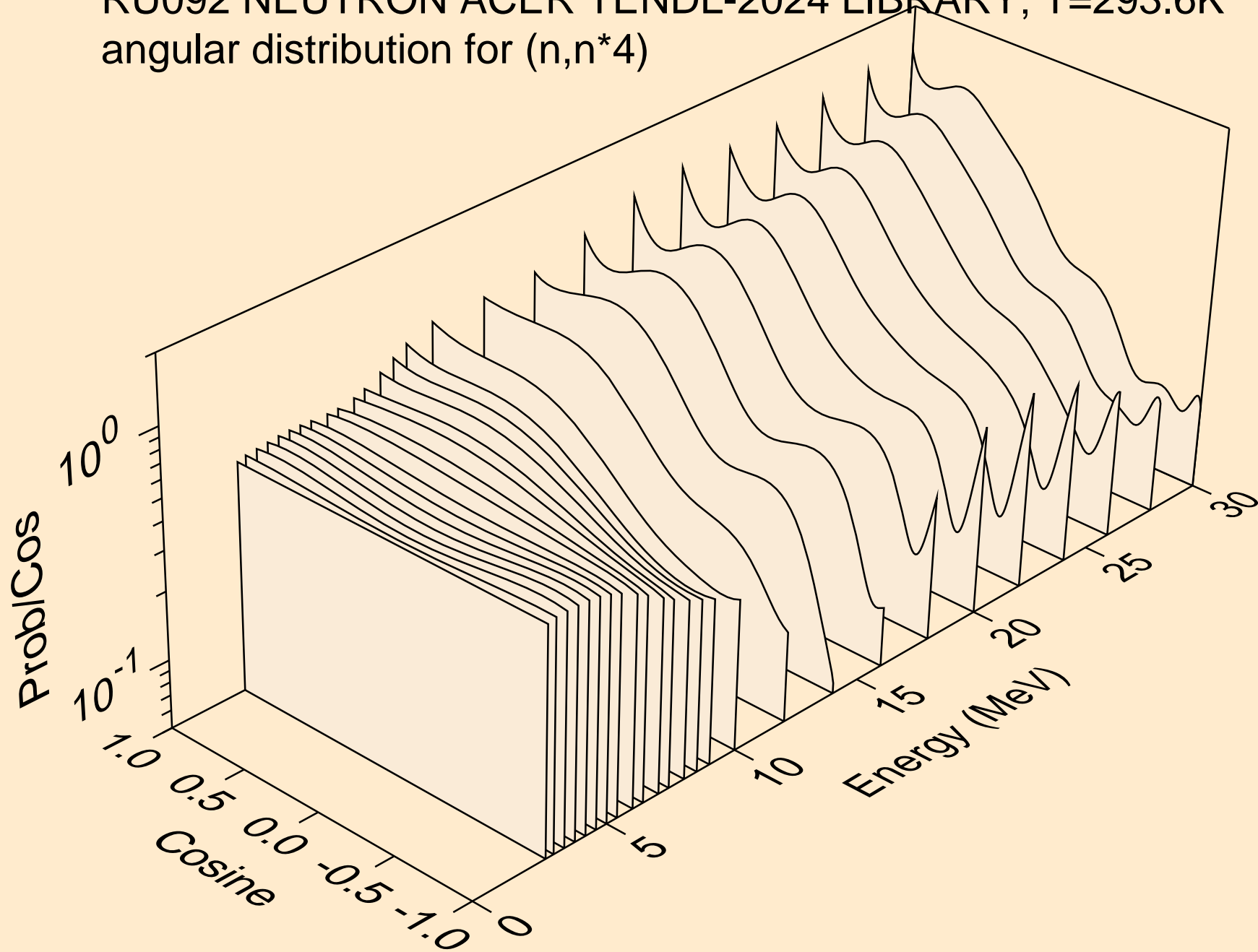

RU092 NEUTRON ACER TENDL-2024 LIBRARY; T=293.6K
angular distribution for (n,n*5)

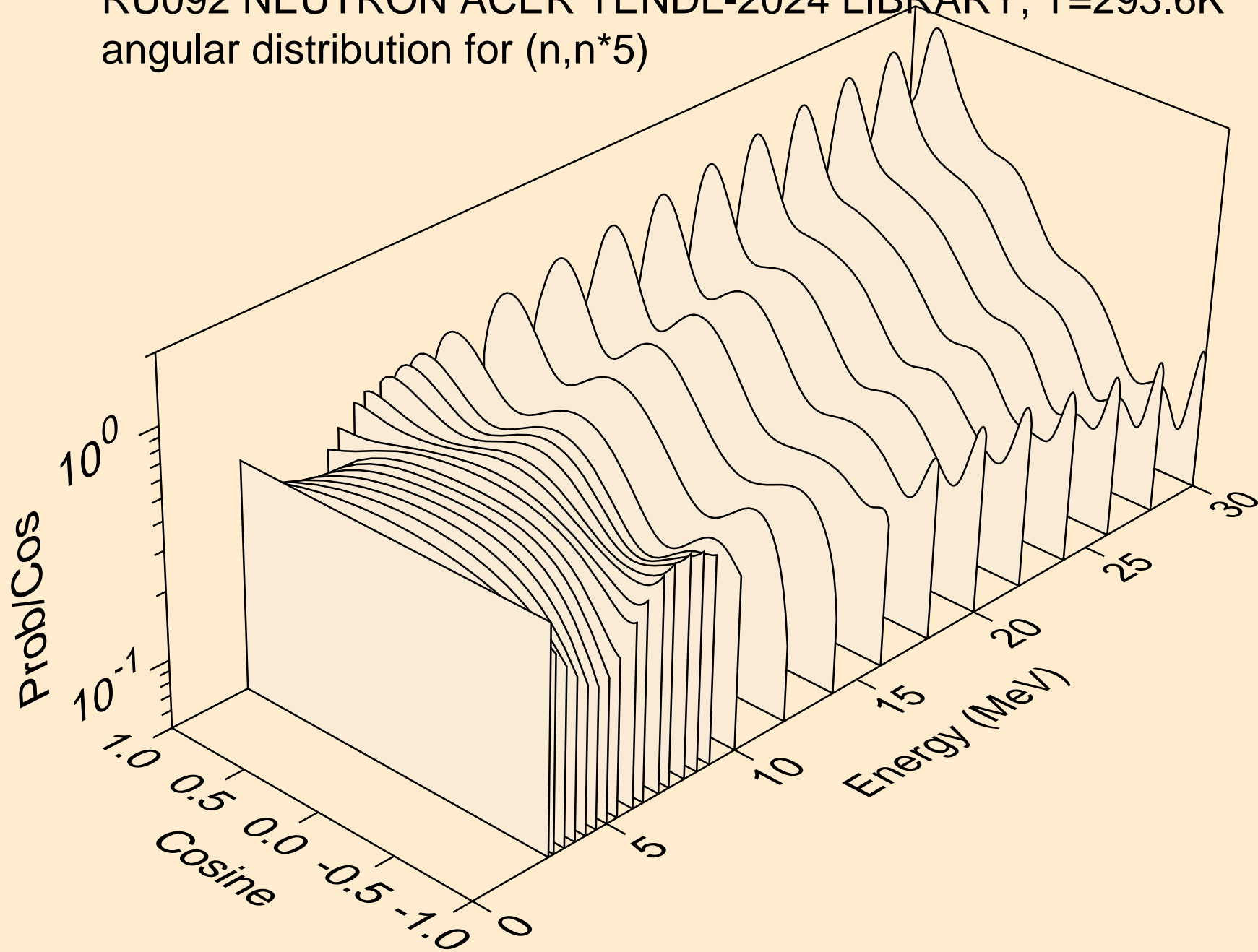

RU092 NEUTRON ACER TENDL-2024 LIBRARY; T=293.6K
Neutron emission for (n,x)

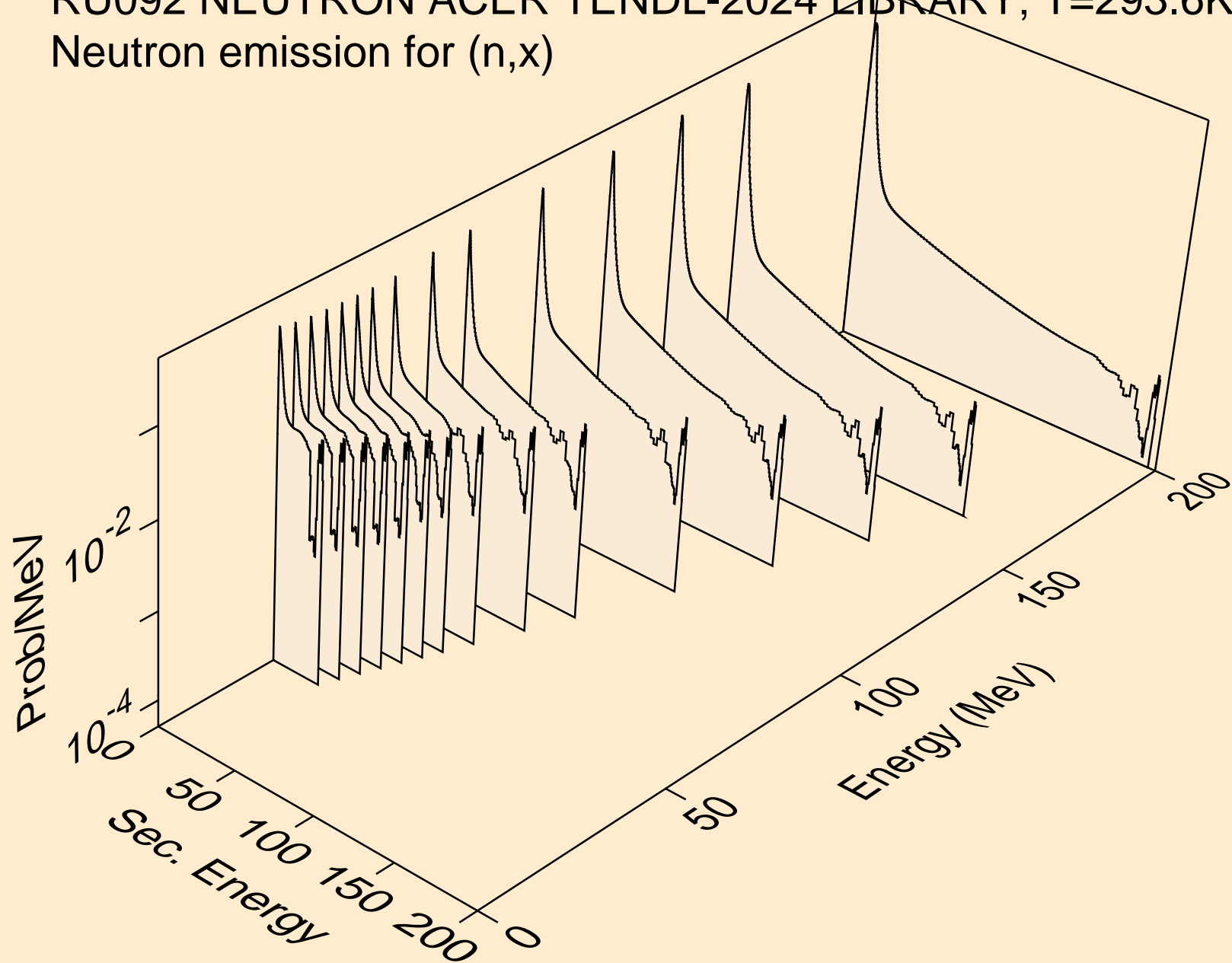

RU092 NEUTRON ACER TENDL-2024 LIBRARY; T=293.6K
Neutron emission for (n,2n)

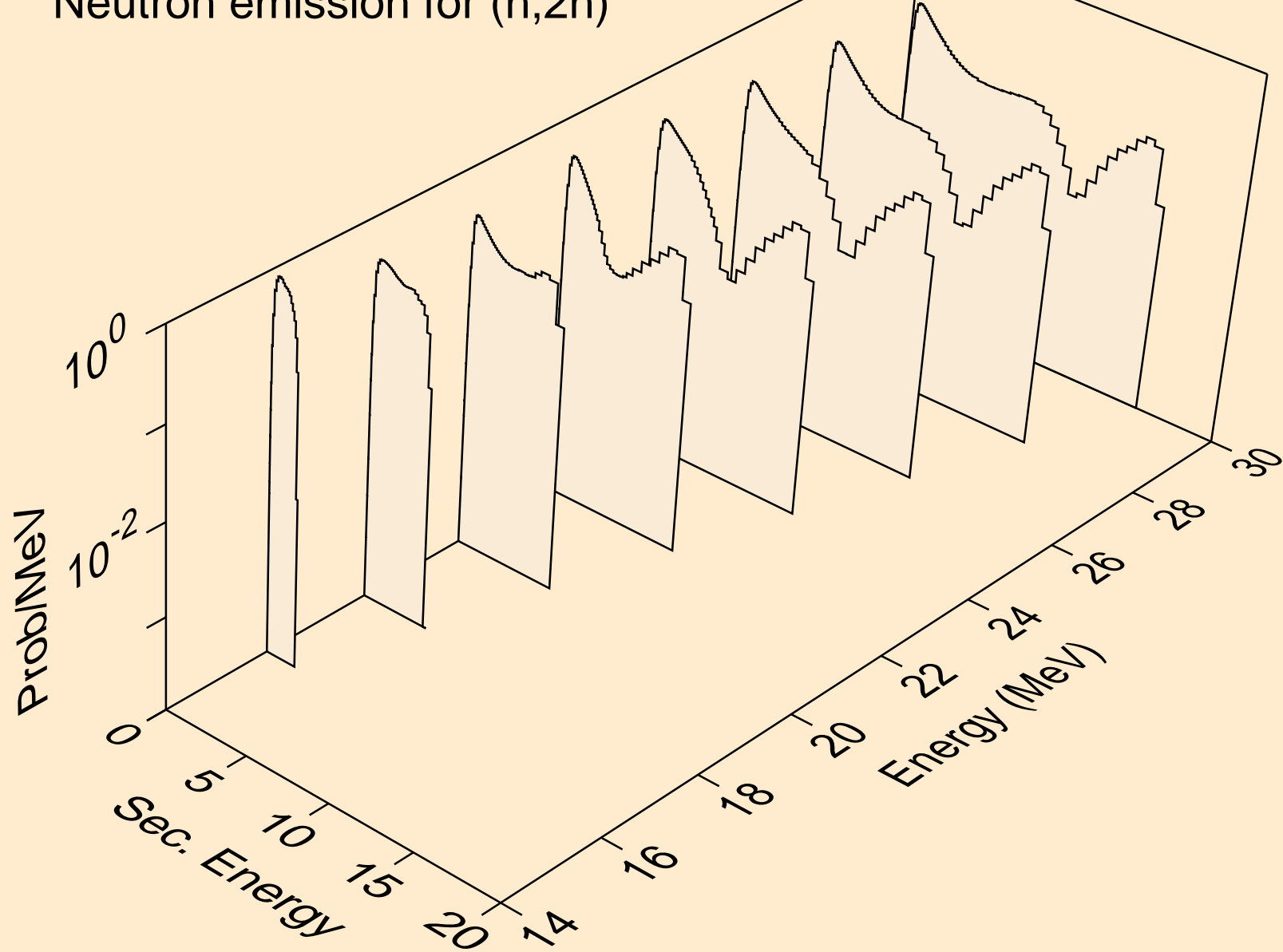

RU092 NEUTRON ACER TENDL-2024 LIBRARY; T=293.6K
Neutron emission for (n,3n)

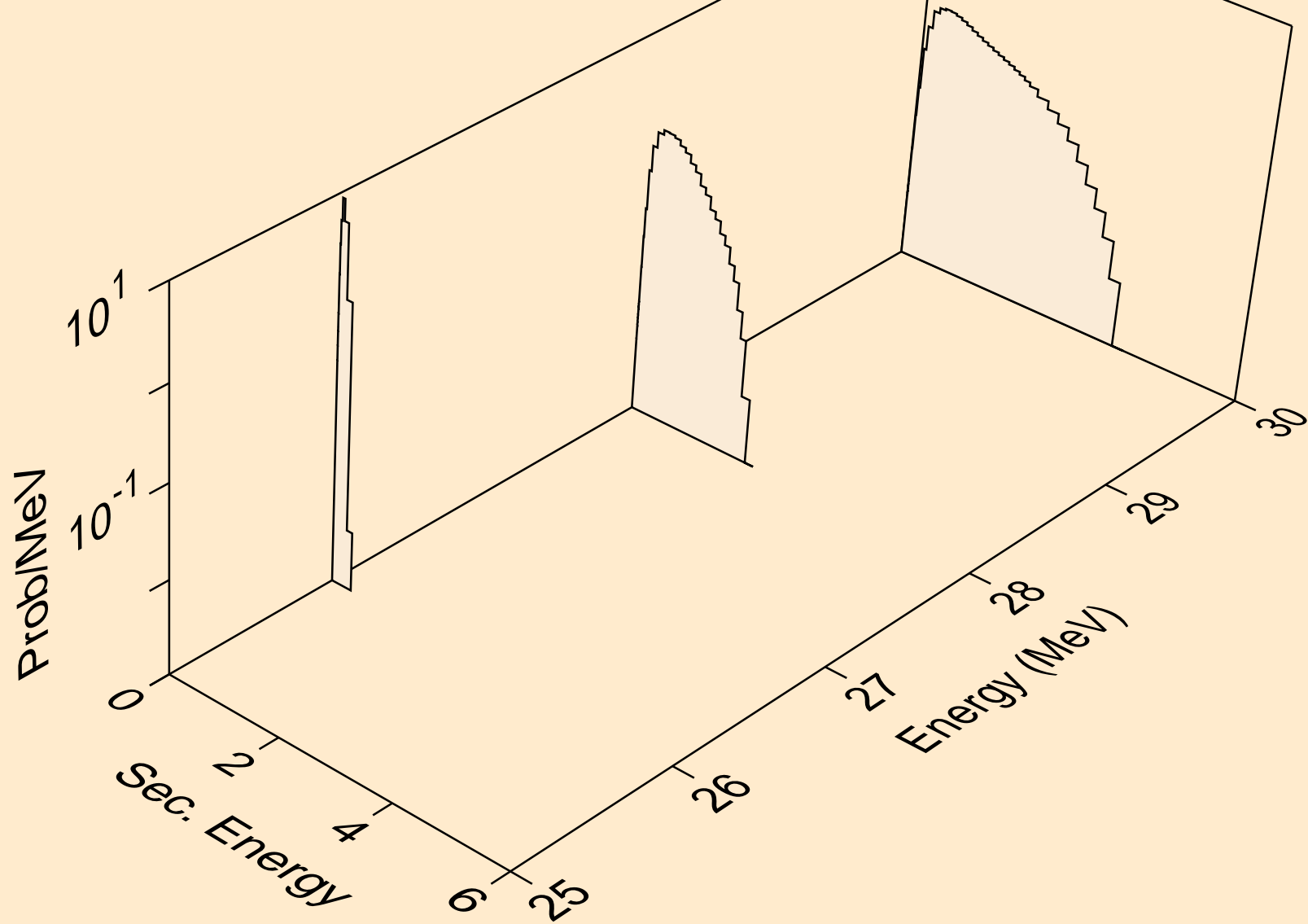

RU092 NEUTRON ACER TENDL-2024 LIBRARY; T=293.6K
Neutron emission for (n,n*)a

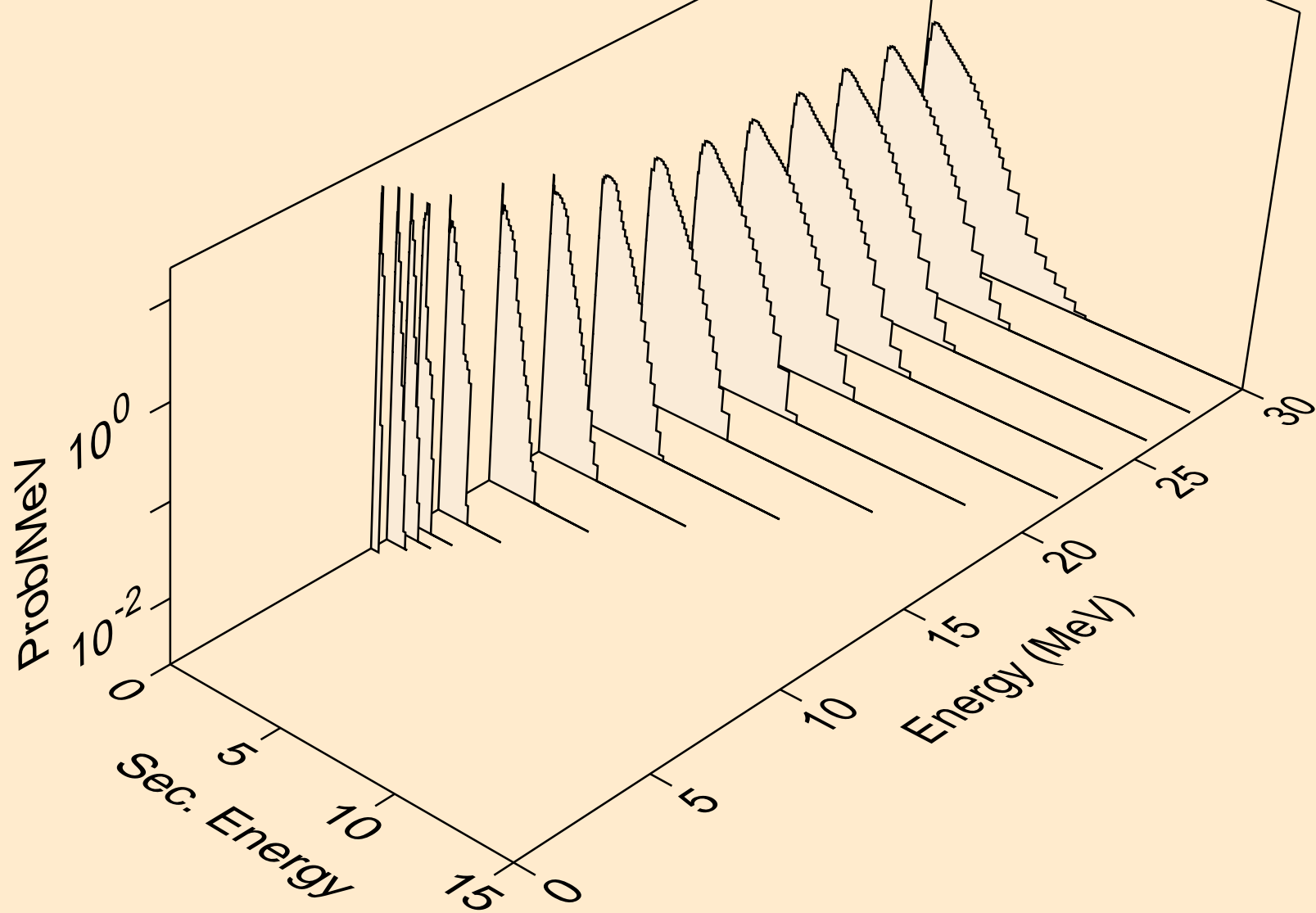

RU092 NEUTRON ACER TENDL-2024 LIBRARY; T=293.6K
Neutron emission for (n,2n)a

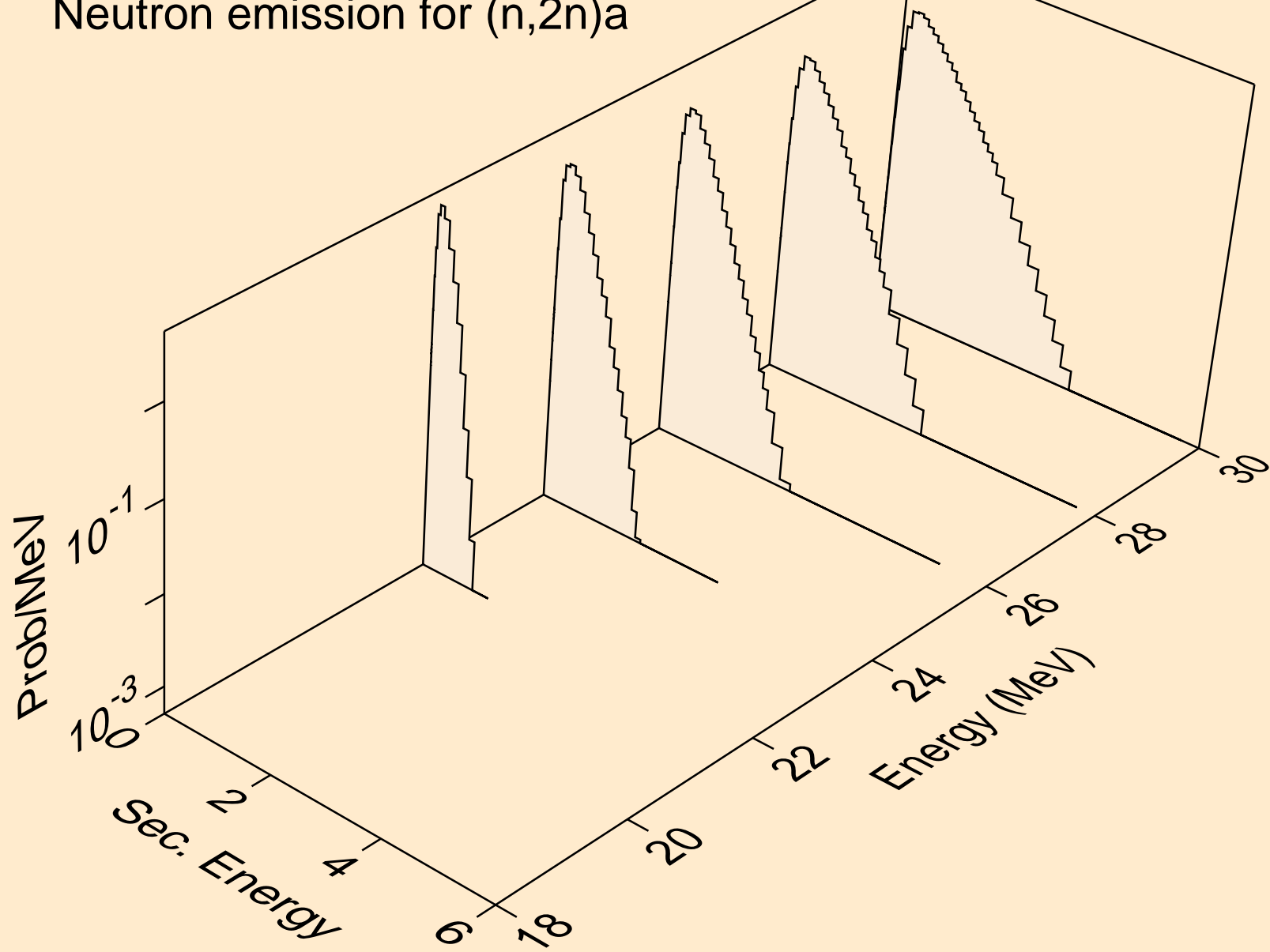

RU092 NEUTRON ACER TENDL-2024 LIBRARY; T=293.6K
Neutron emission for (n,n*)p

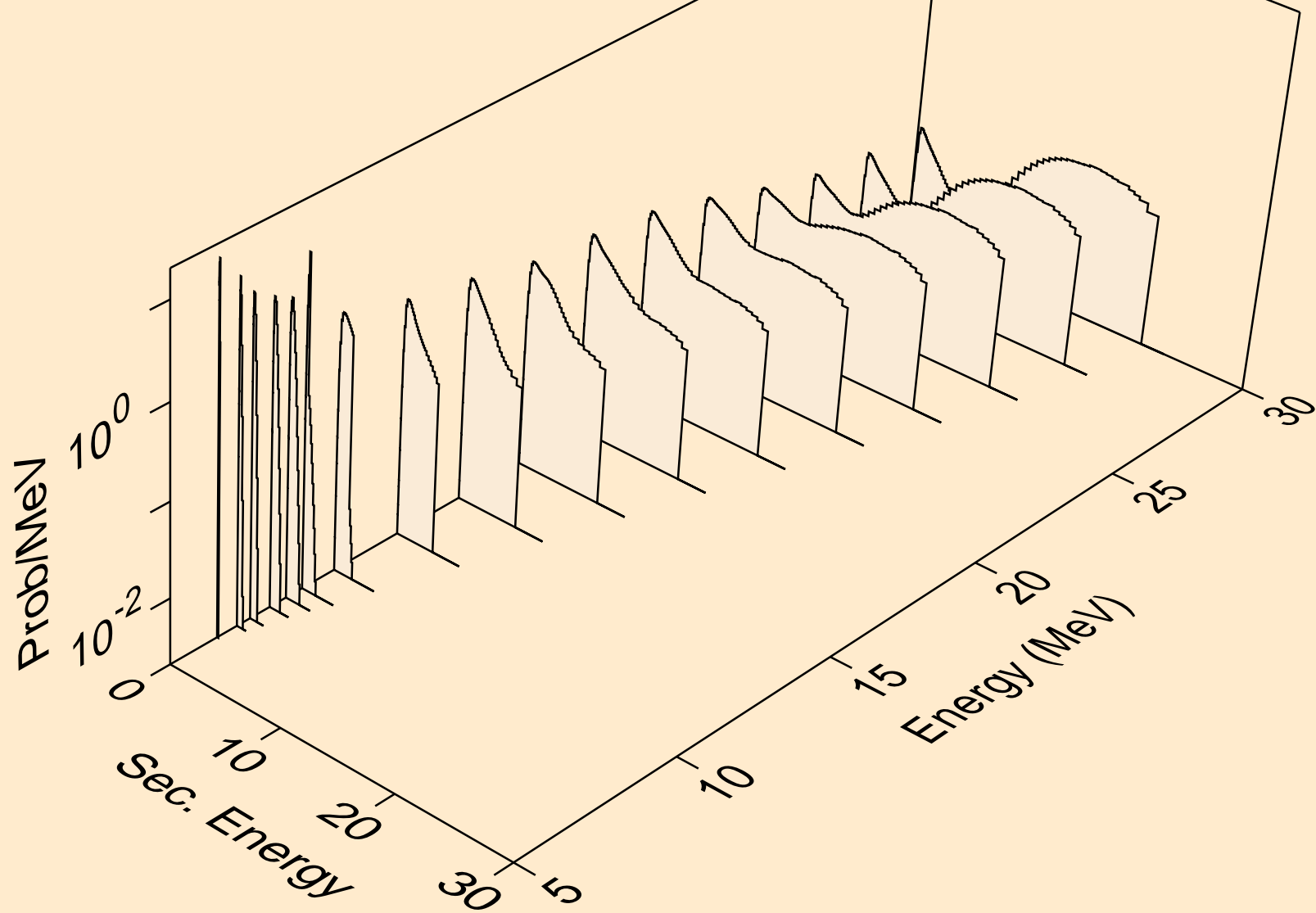

RU092 NEUTRON ACER TENDL-2024 LIBRARY; T=293.6K
Neutron emission for (n,n*)2a

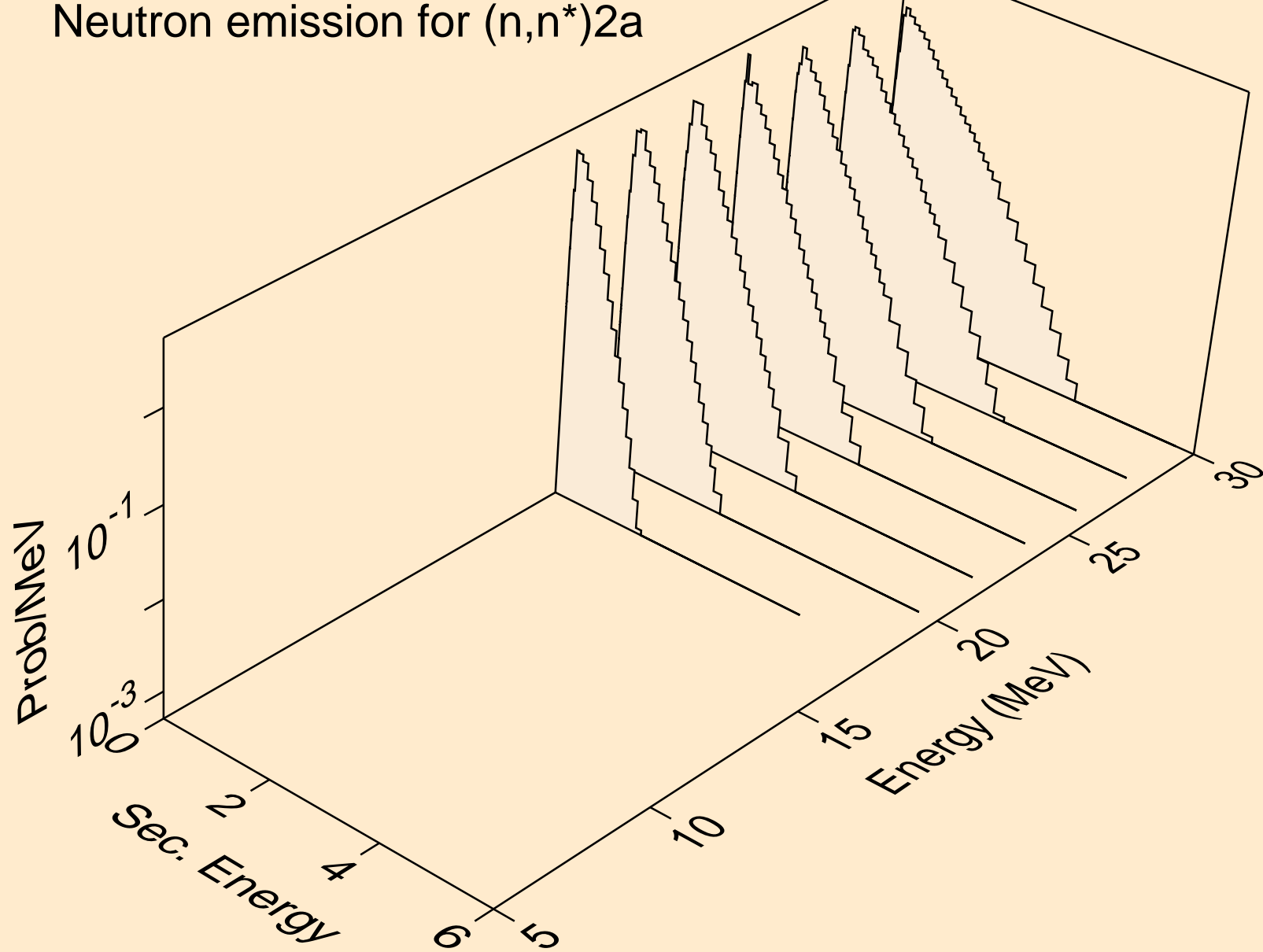

RU092 NEUTRON ACER TENDL-2024 LIBRARY; T=293.6K
Neutron emission for (n,n*)d

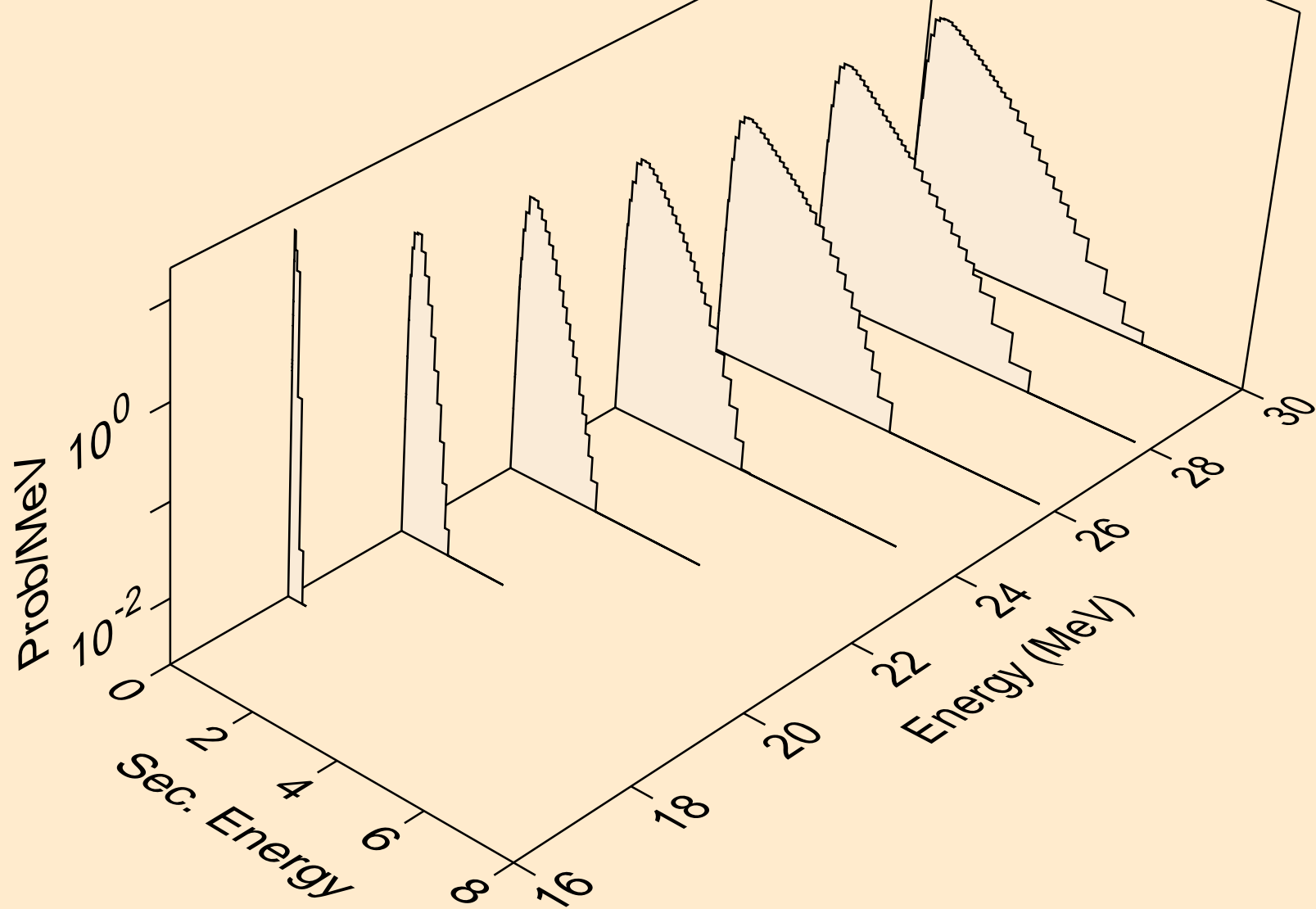

RU092 NEUTRON ACER TENDL-2024 LIBRARY; T=293.6K
Neutron emission for (n,n*)t

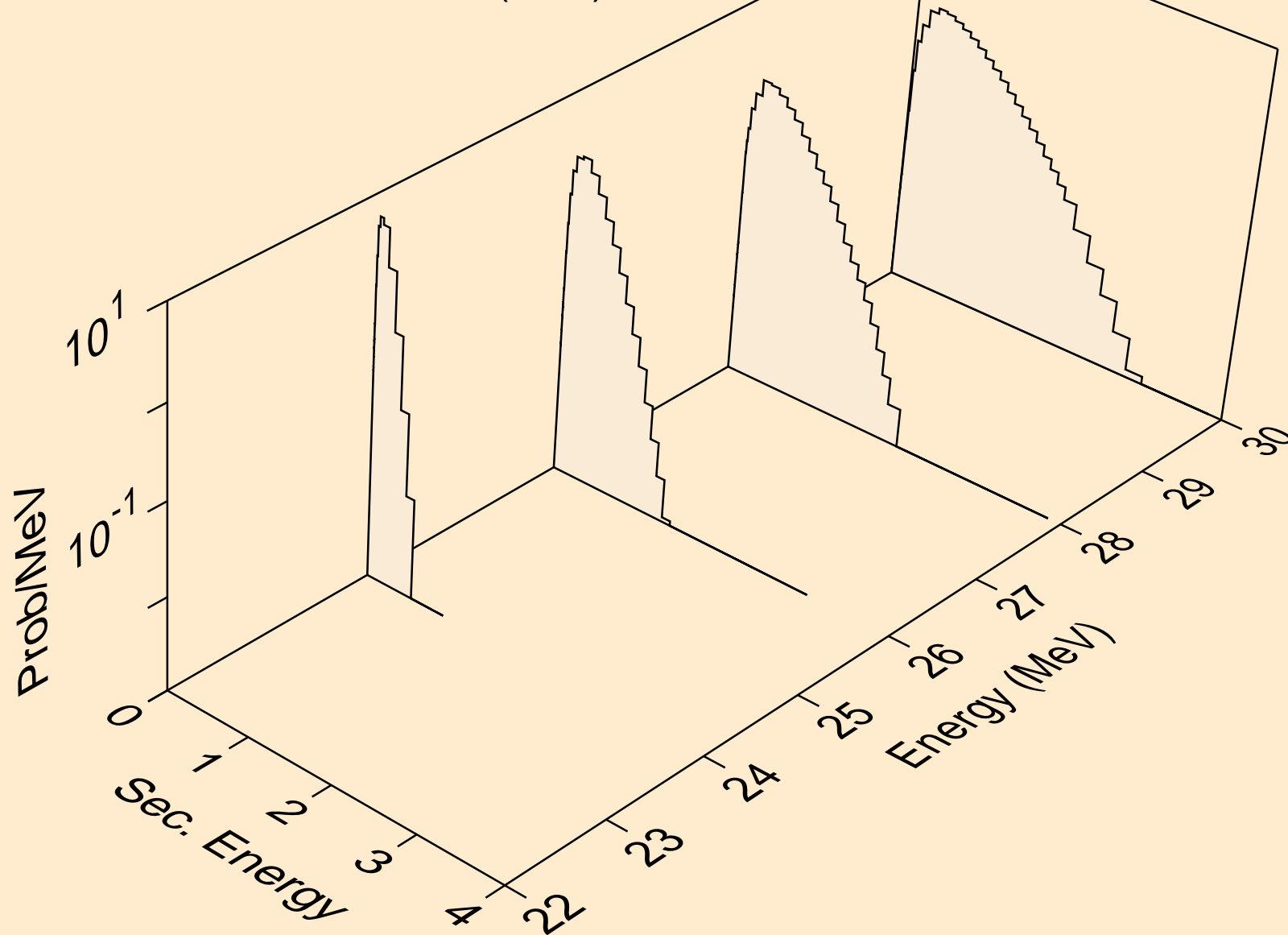

RU092 NEUTRON ACER TENDL-2024 LIBRARY; T=293.6K
Neutron emission for (n,n*)he3

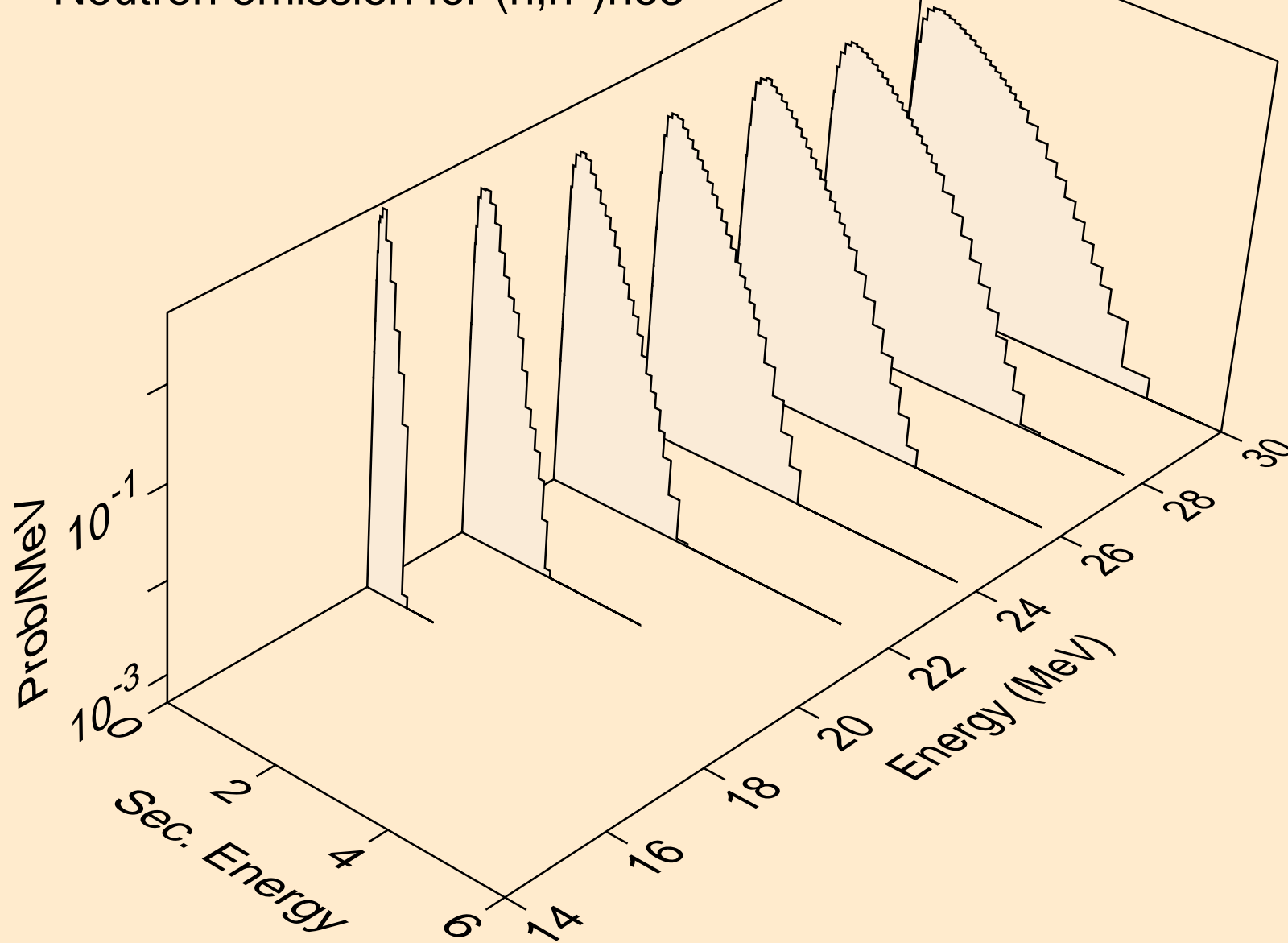

RU092 NEUTRON ACER TENDL-2024 LIBRARY; T=293.6K
Neutron emission for (n,2np)

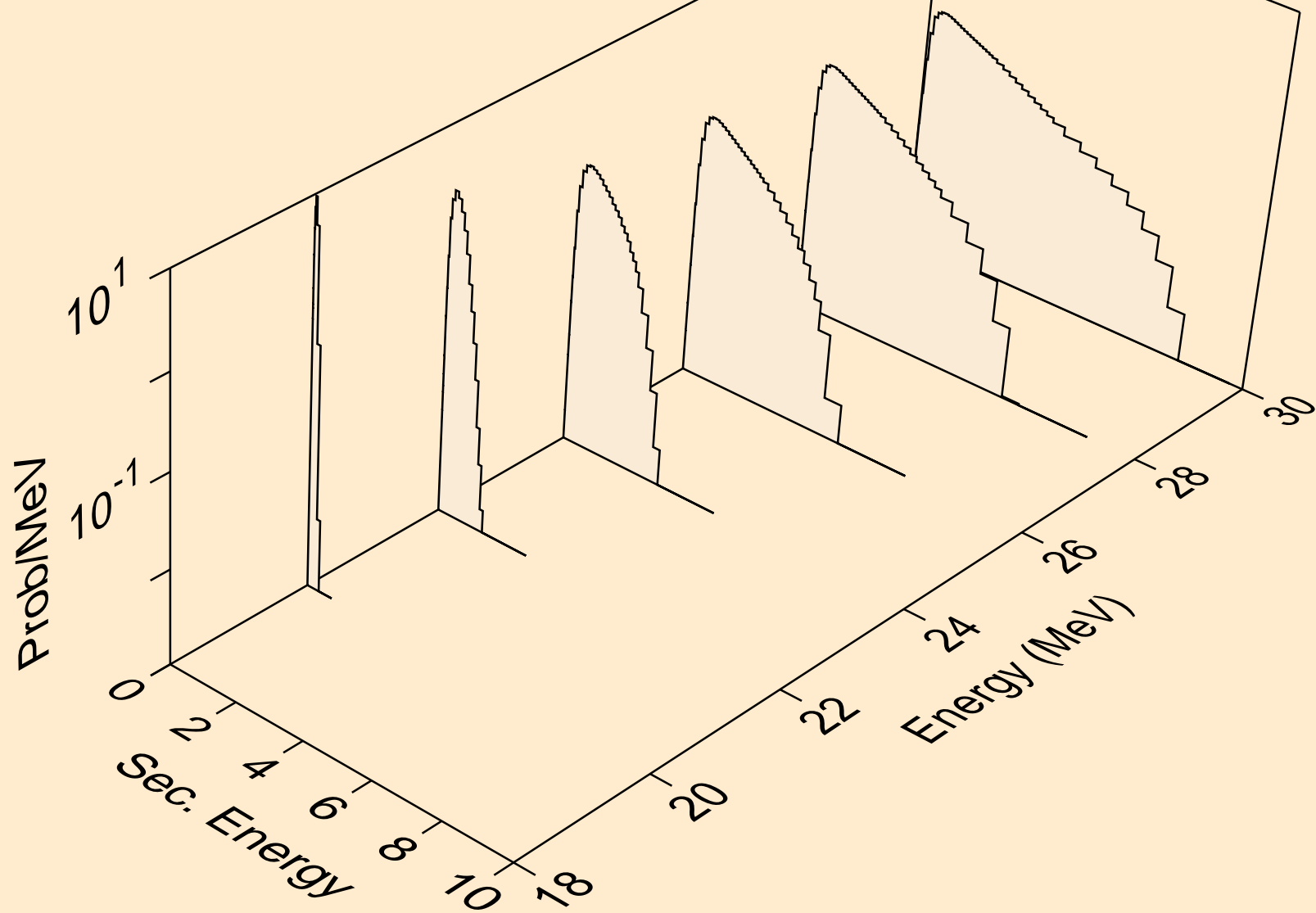

RU092 NEUTRON ACER TENDL-2024 LIBRARY; T=293.6K
Neutron emission for (n,n2p)

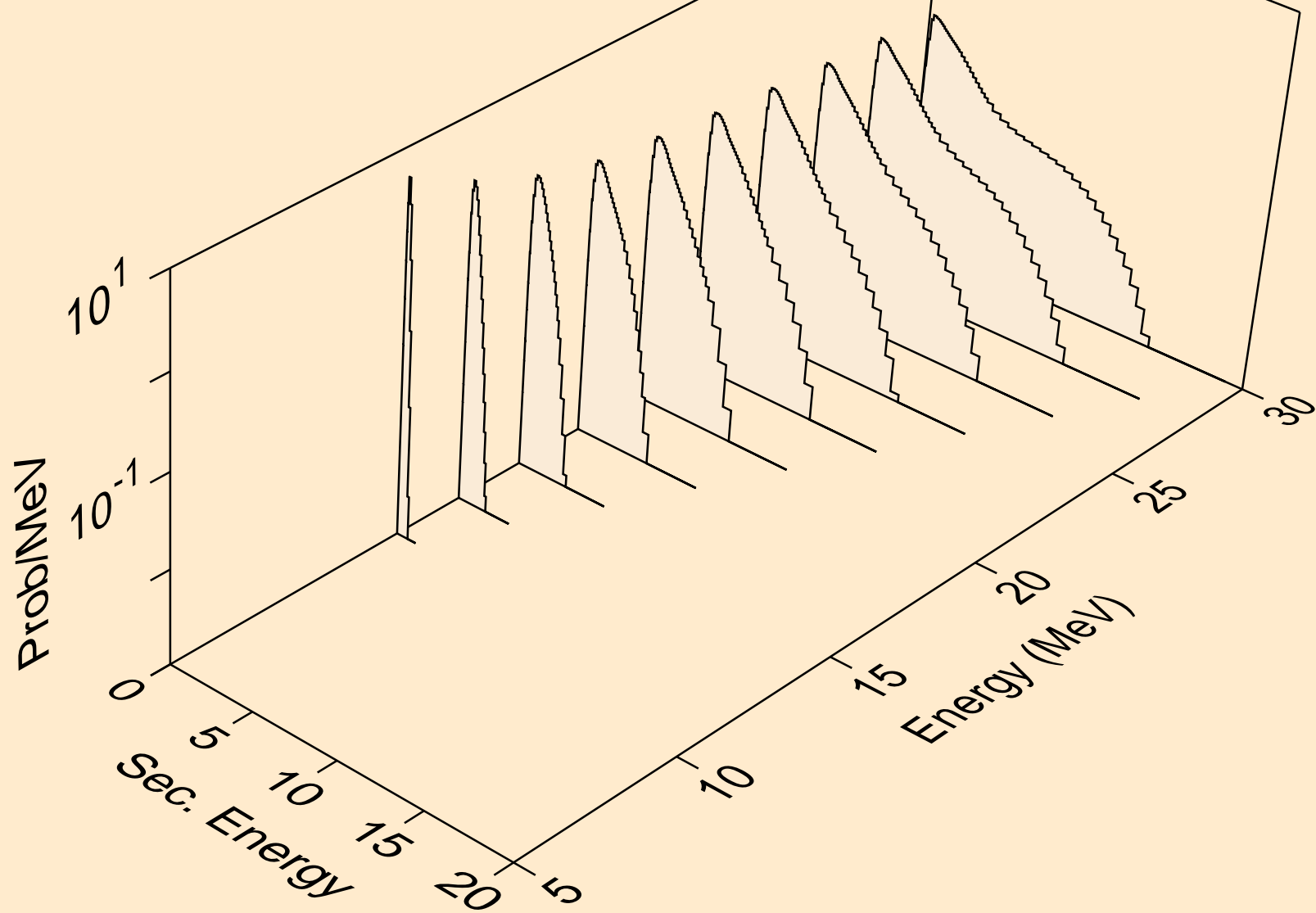

RU092 NEUTRON ACER TENDL-2024 LIBRARY; T=293.6K
Neutron emission for (n,npa)

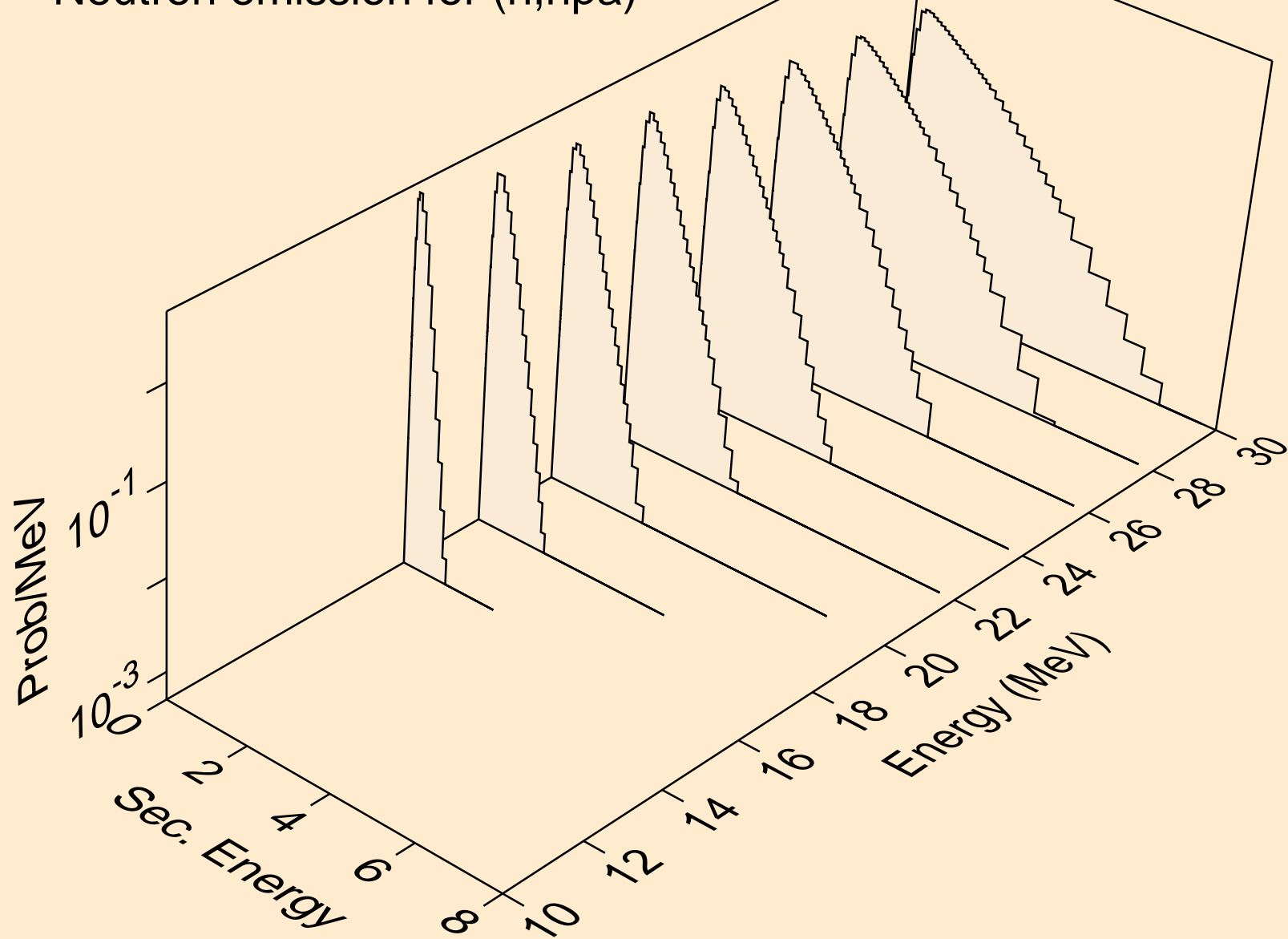

RU092 NEUTRON ACER TENDL-2024 LIBRARY; T=293.6K
Neutron emission for (n,n*c)

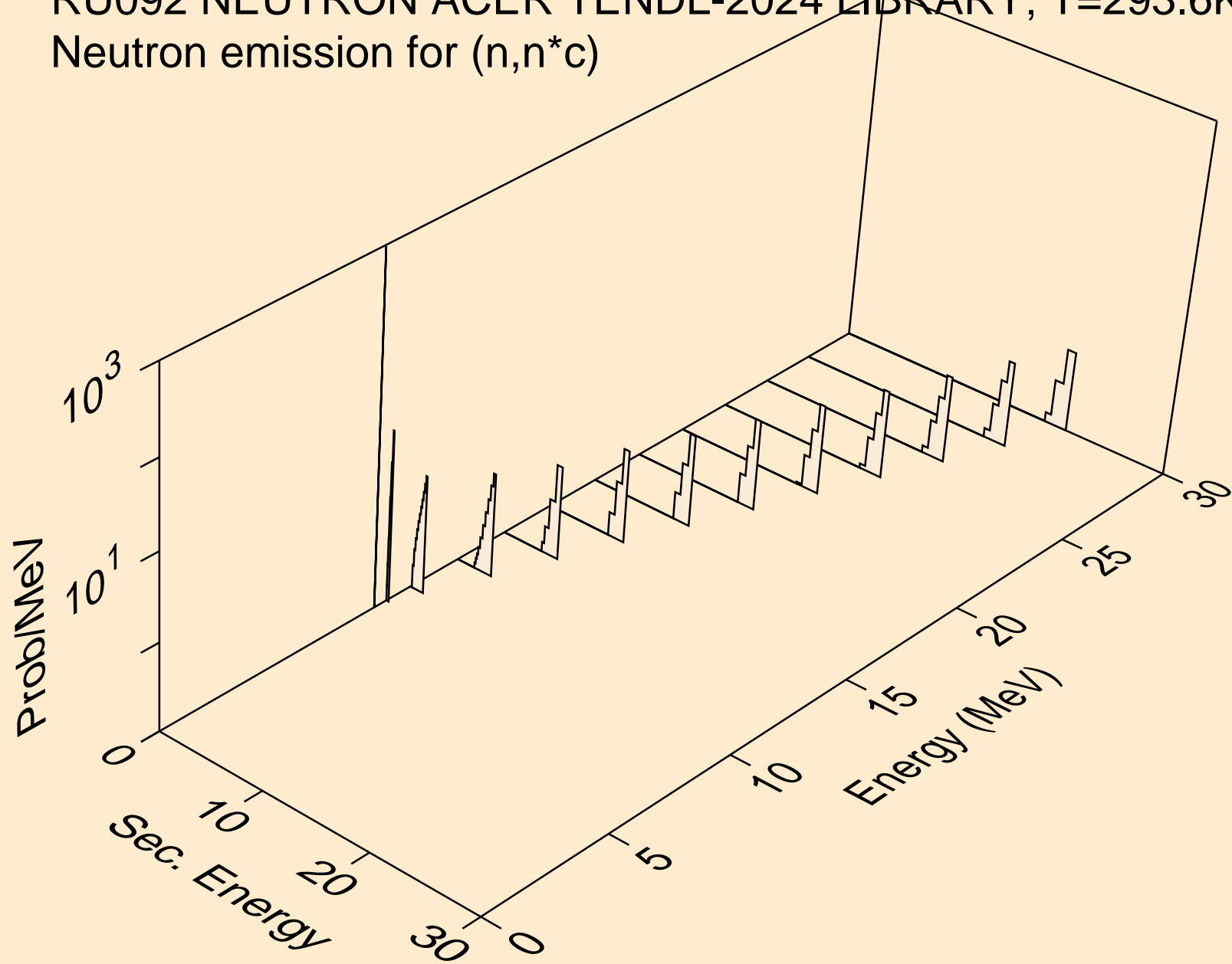

RU092 NEUTRON ACER TENDL-2024 LIBRARY; T=293.6K
Photon emission for (n,x)

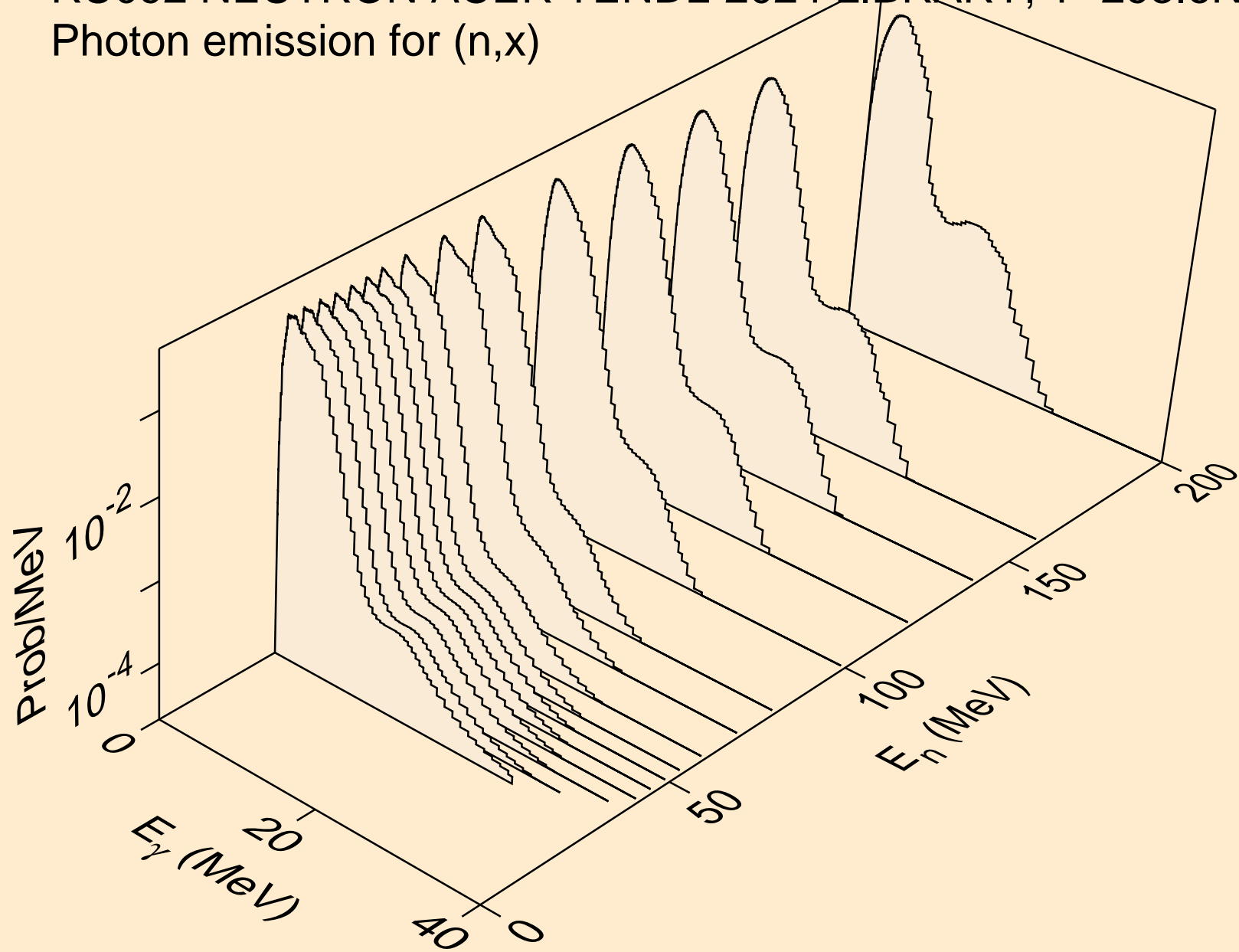

RU092 NEUTRON ACER TENDL-2024 LIBRARY; T=293.6K
Photon emission for (n,2n)

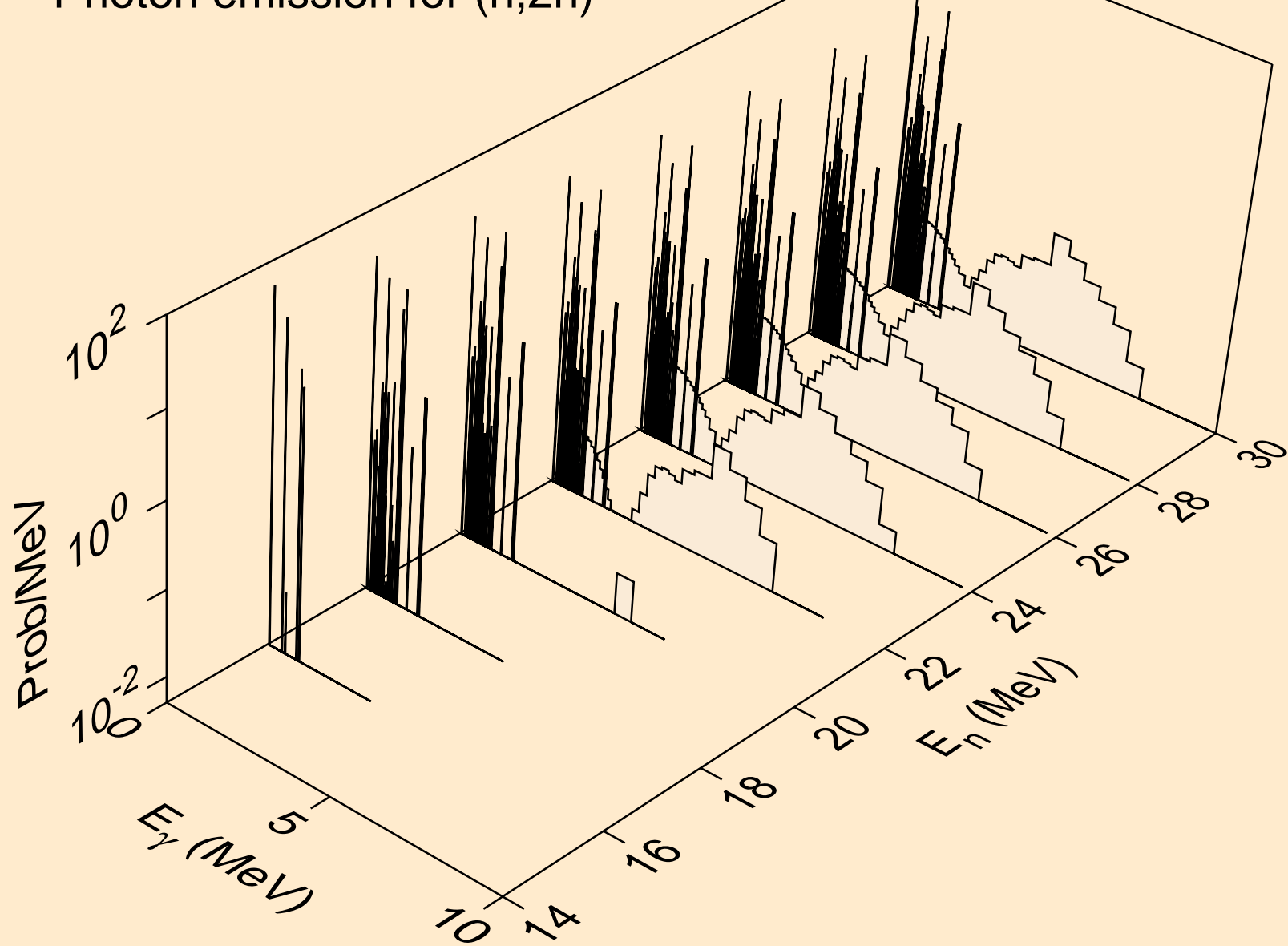

RU092 NEUTRON ACER TENDL-2024 LIBRARY; T=293.6K
Photon emission for (n,3n)

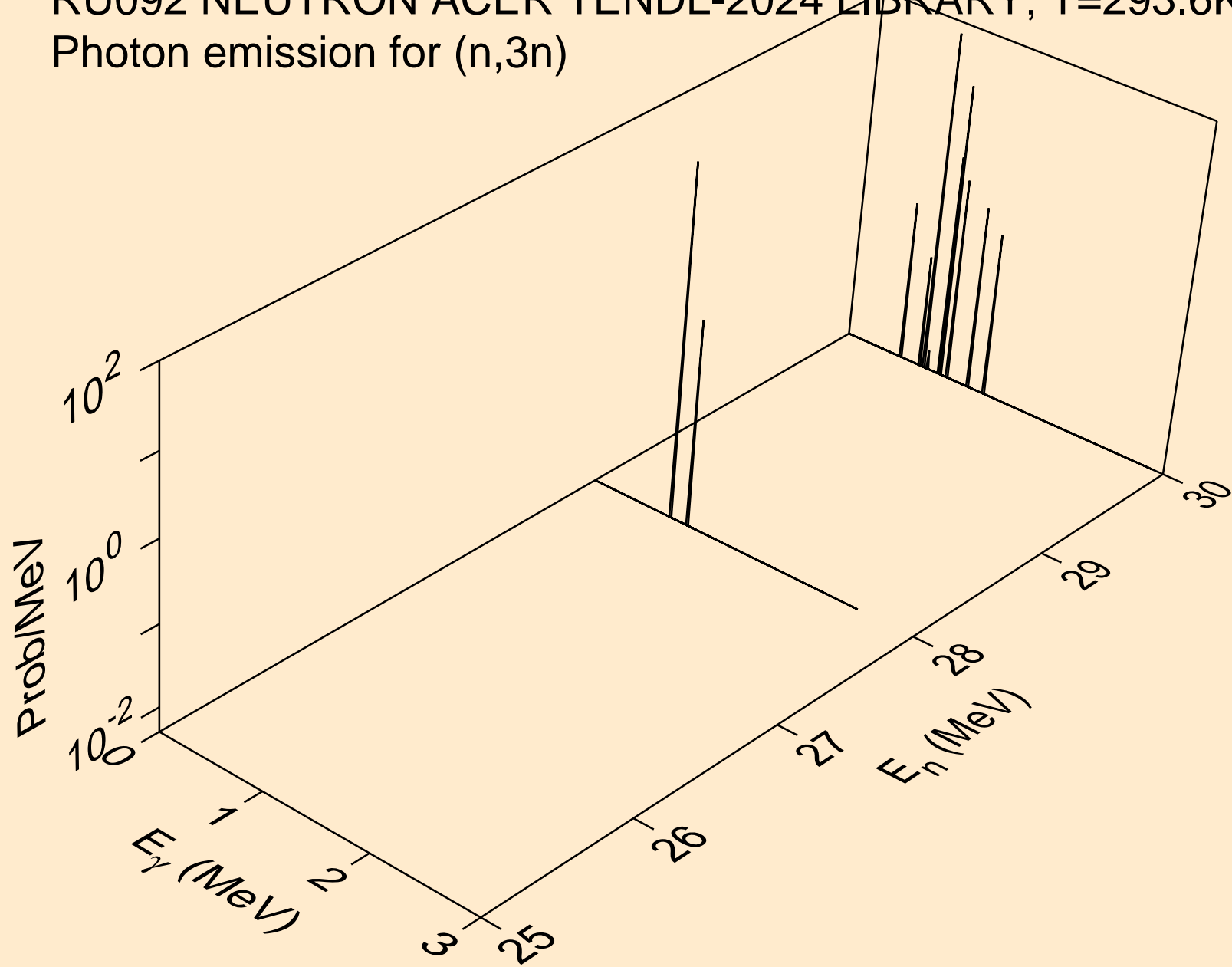

RU092 NEUTRON ACER TENDL-2024 LIBRARY; T=293.6K
Photon emission for (n,n*)a

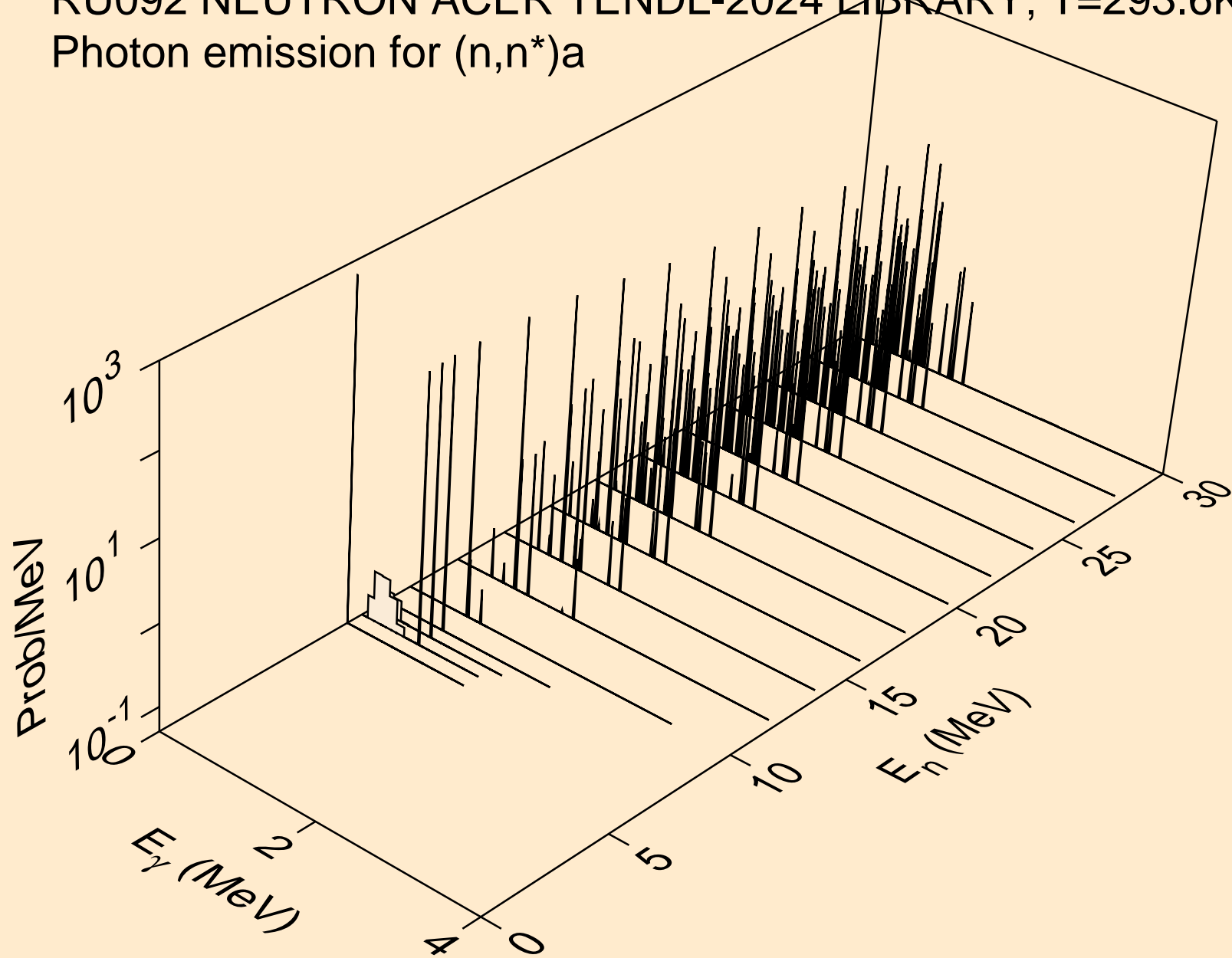

RU092 NEUTRON ACER TENDL-2024 LIBRARY; T=293.6K
Photon emission for (n,2n)a

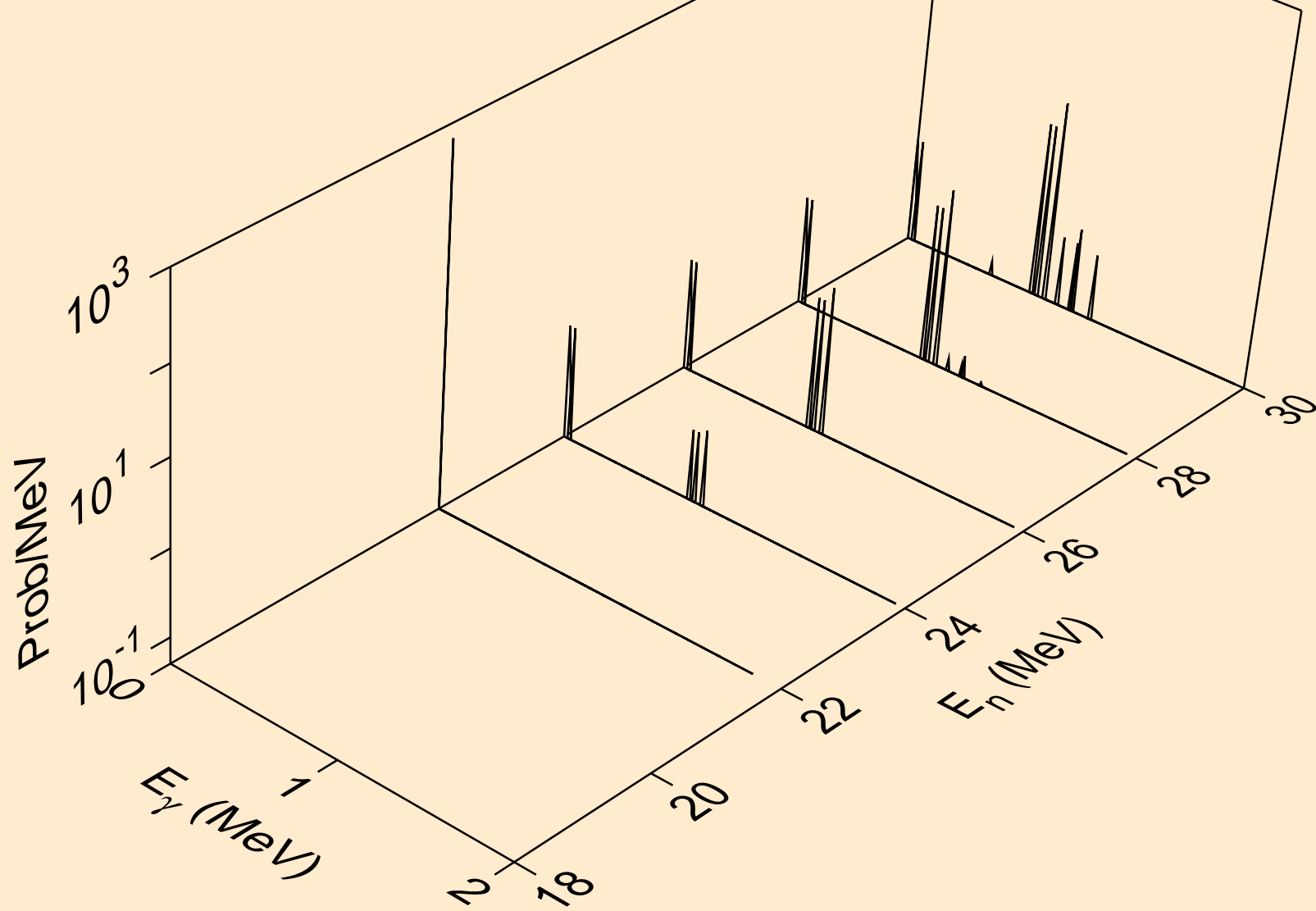

RU092 NEUTRON ACER TENDL-2024 LIBRARY; T=293.6K
Photon emission for (n,n*)p

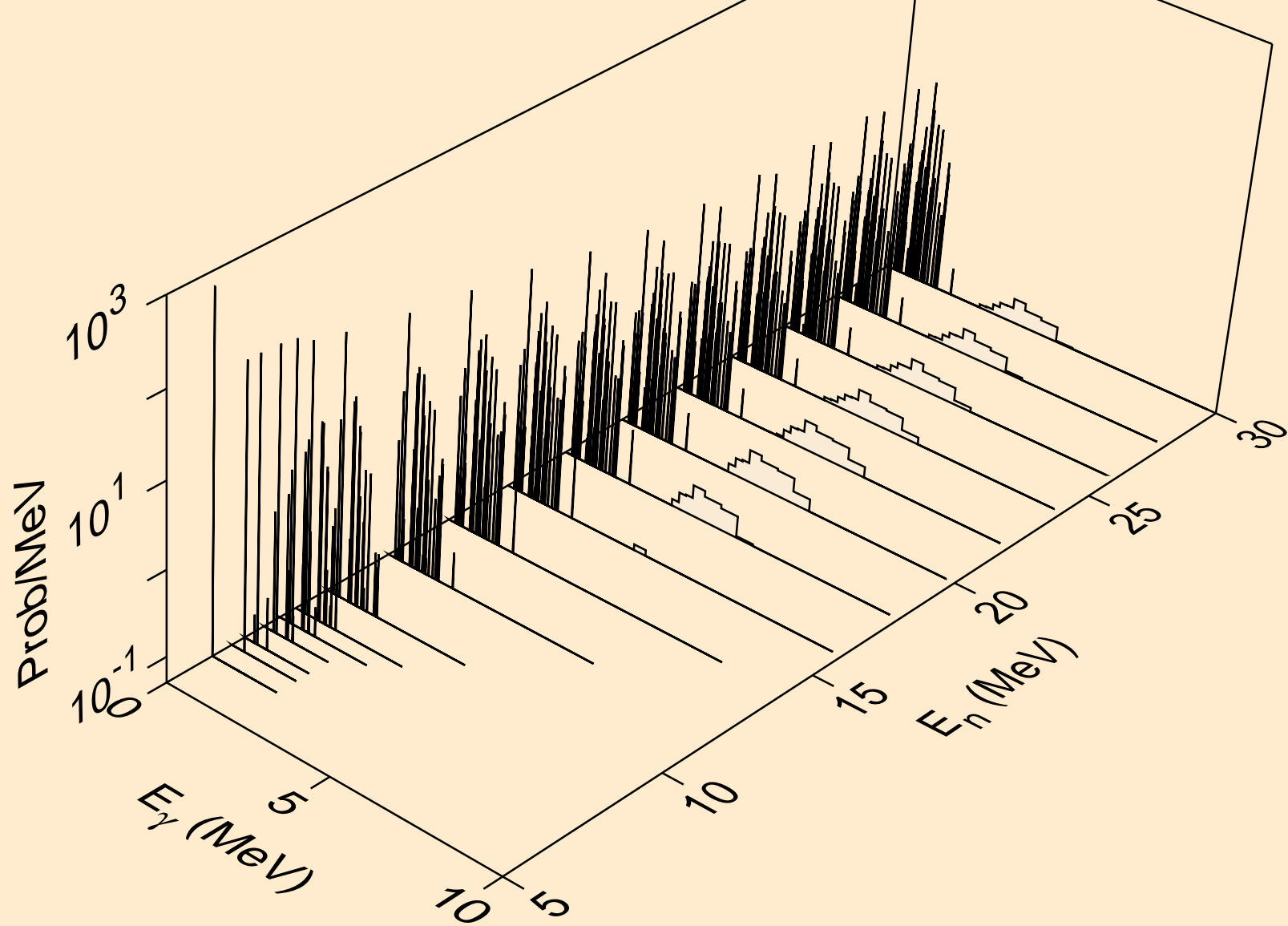

RU092 NEUTRON ACER TENDL-2024 LIBRARY; T=293.6K
Photon emission for (n,n*)2a

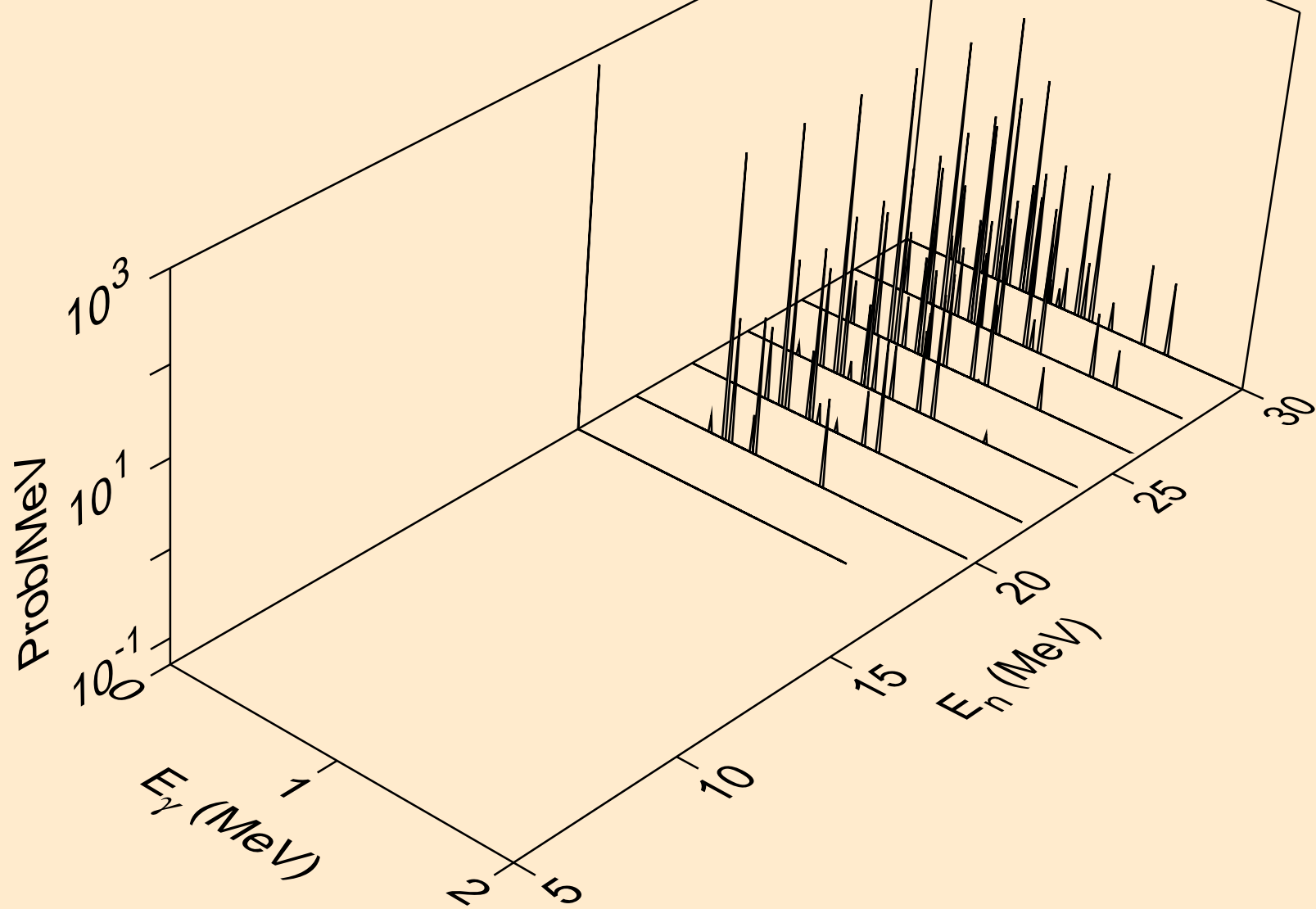

RU092 NEUTRON ACER TENDL-2024 LIBRARY; T=293.6K
Photon emission for (n,n*)d

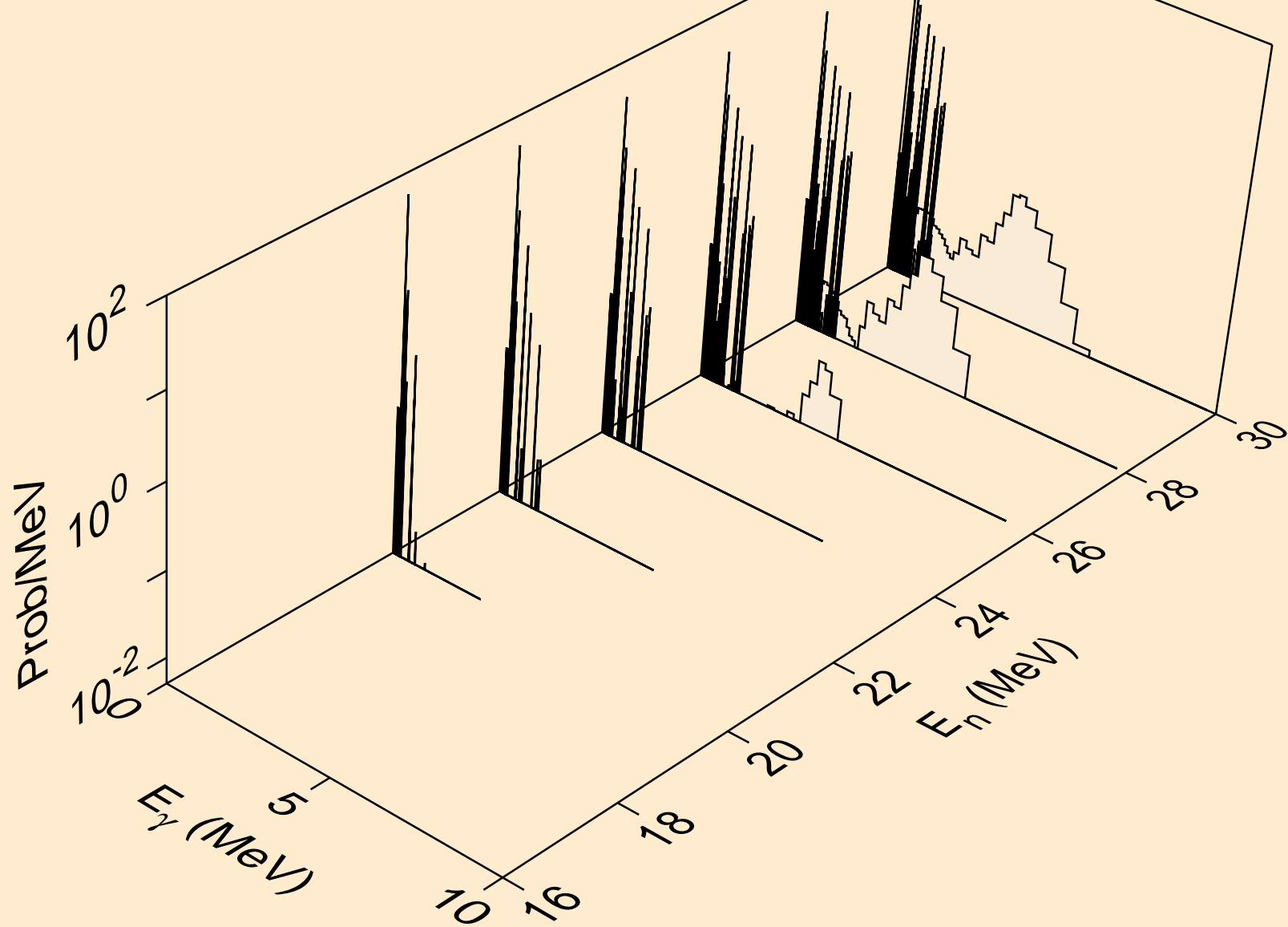

RU092 NEUTRON ACER TENDL-2024 LIBRARY; T=293.6K
Photon emission for (n,n*)t

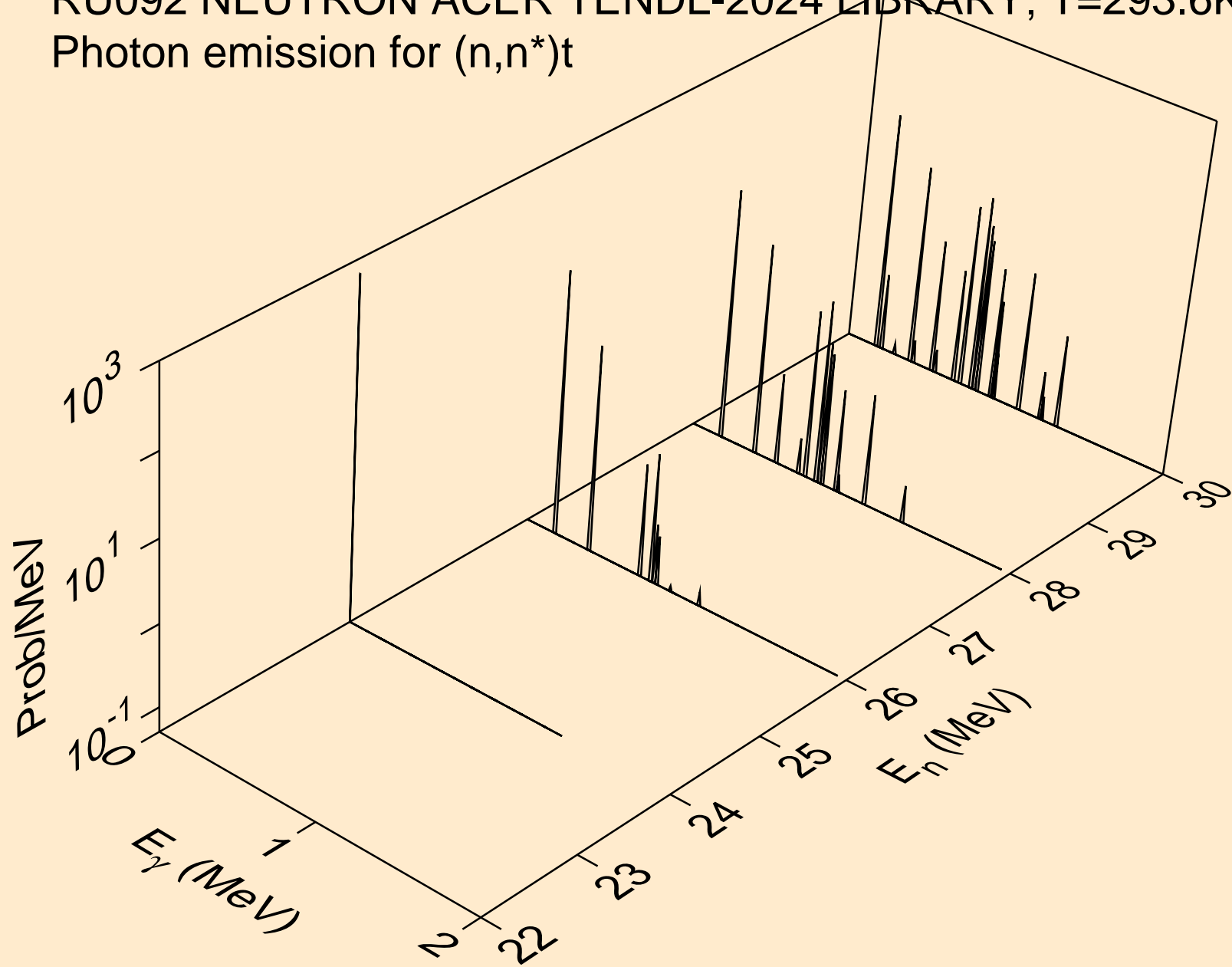

RU092 NEUTRON ACER TENDL-2024 LIBRARY; T=293.6K
Photon emission for (n,n*)he3

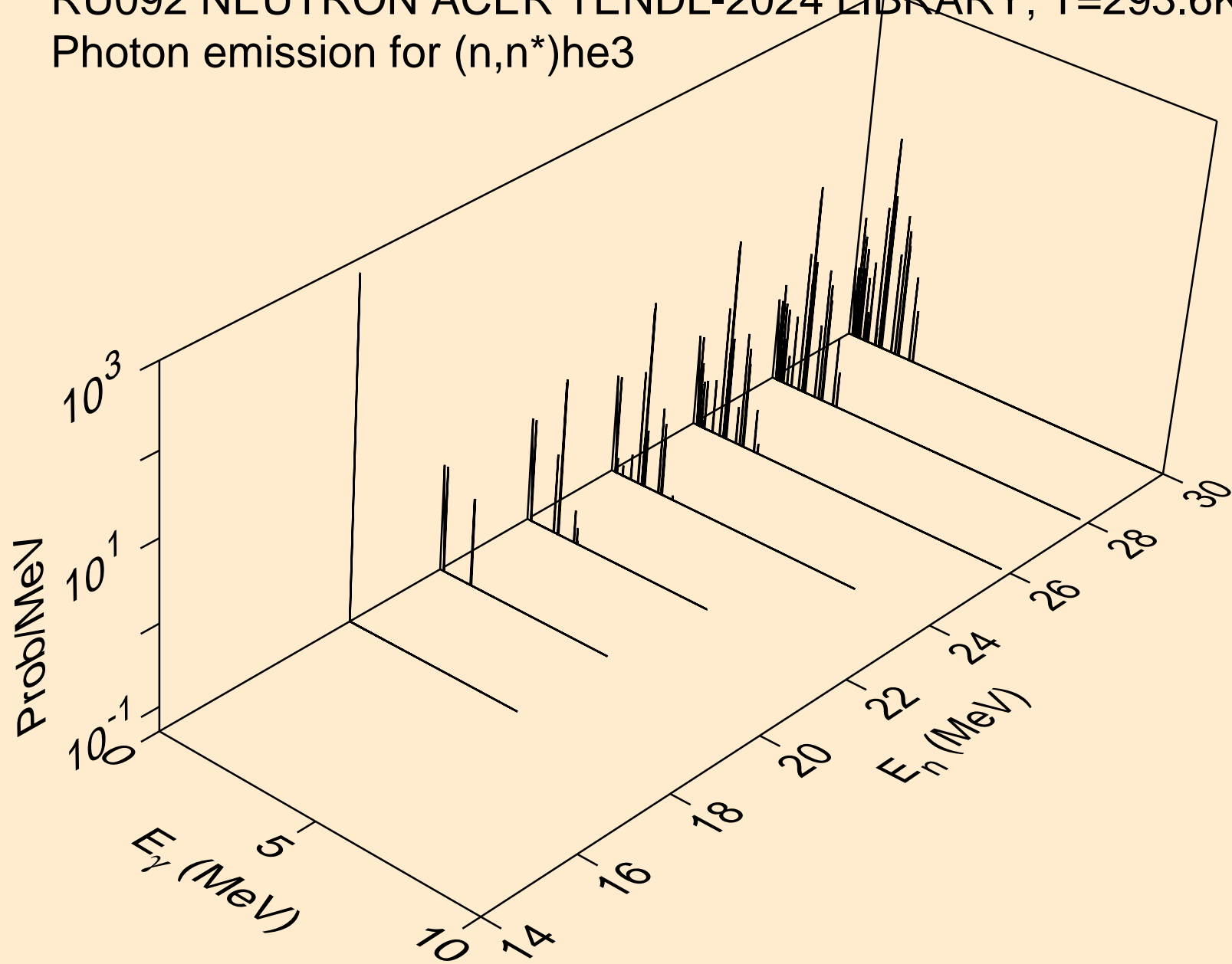

RU092 NEUTRON ACER TENDL-2024 LIBRARY; T=293.6K
Photon emission for (n,2np)

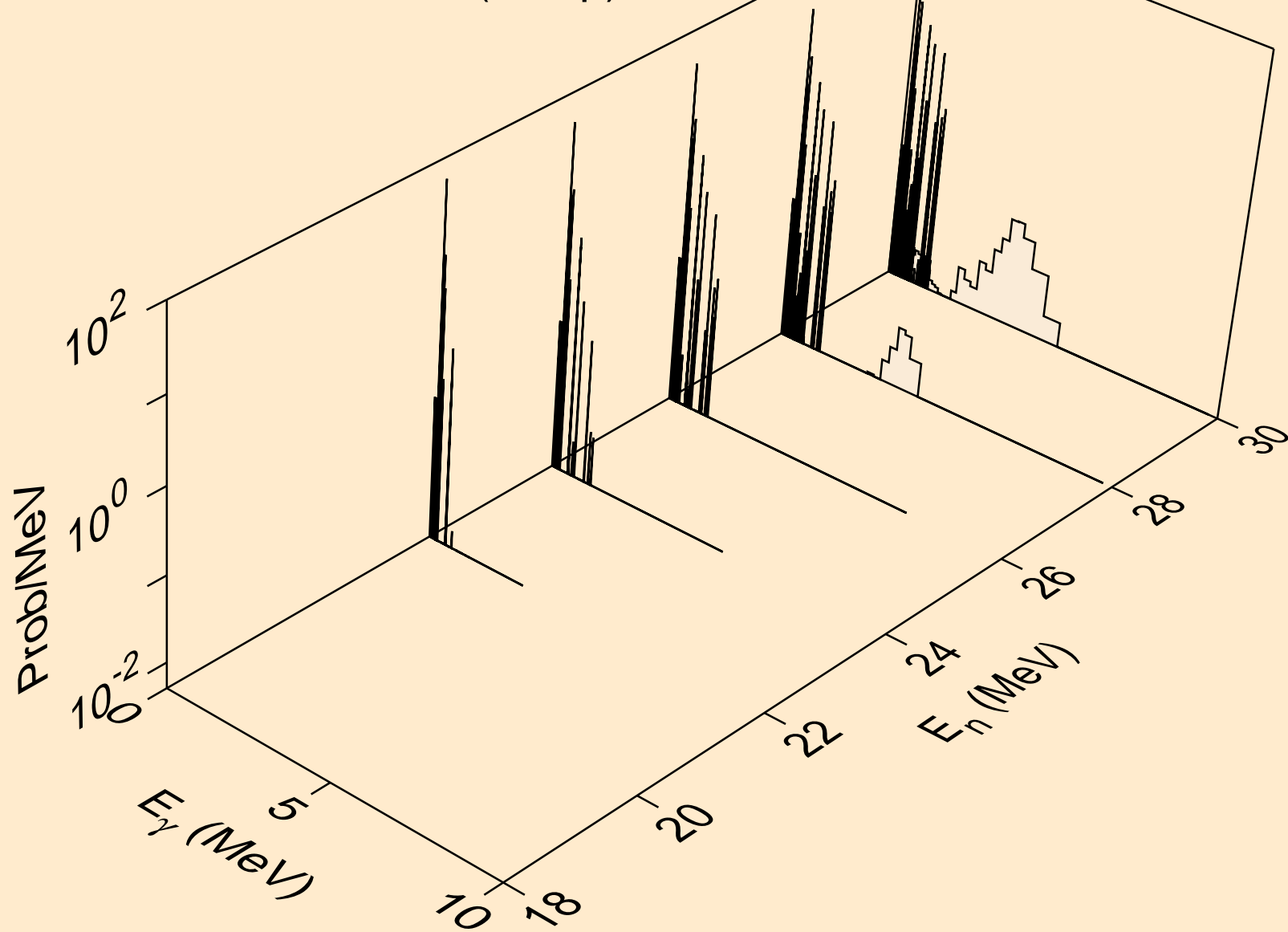

RU092 NEUTRON ACER TENDL-2024 LIBRARY; T=293.6K
Photon emission for (n,n2p)

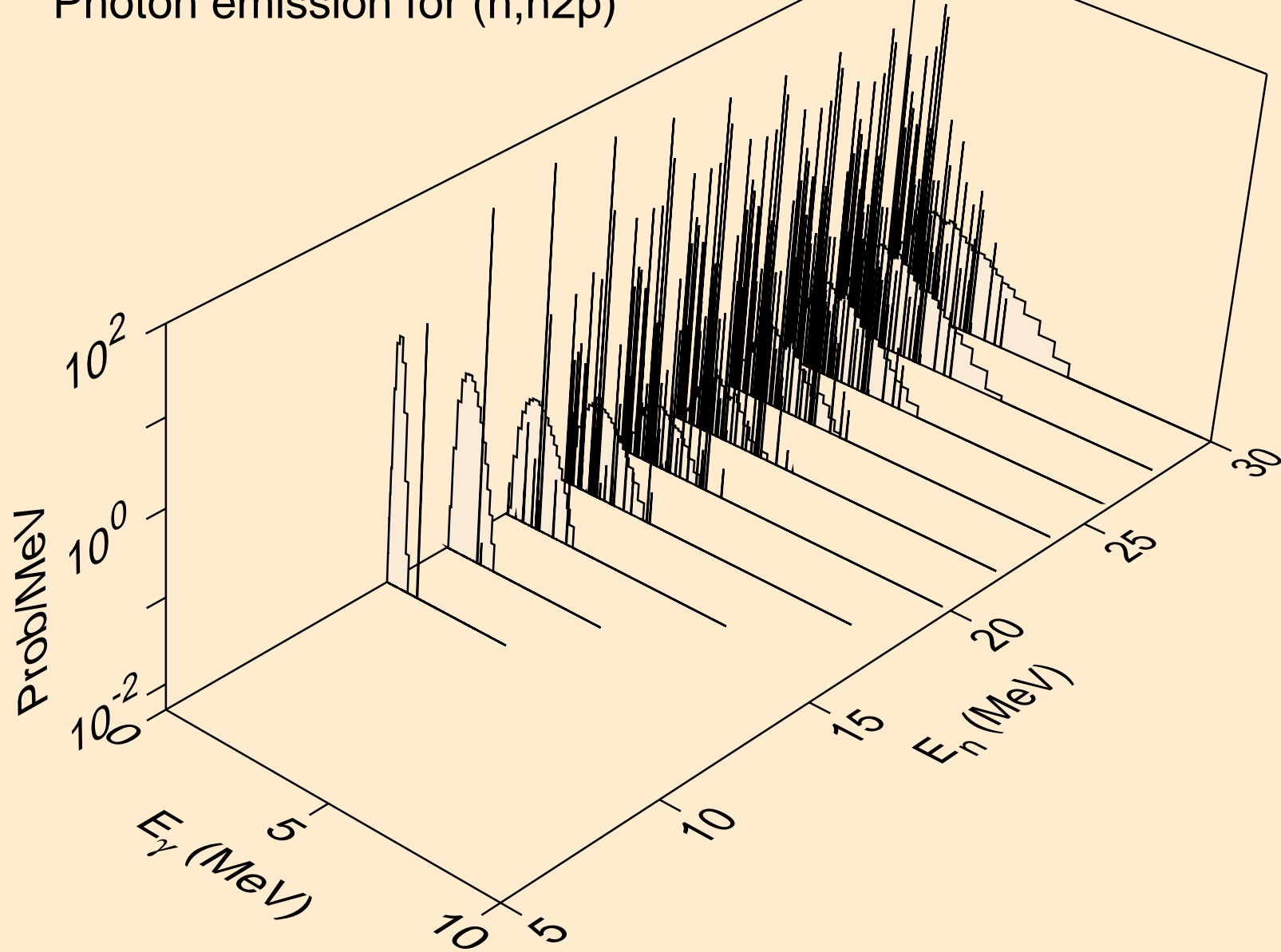

RU092 NEUTRON ACER TENDL-2024 LIBRARY; T=293.6K
Photon emission for (n,npa)

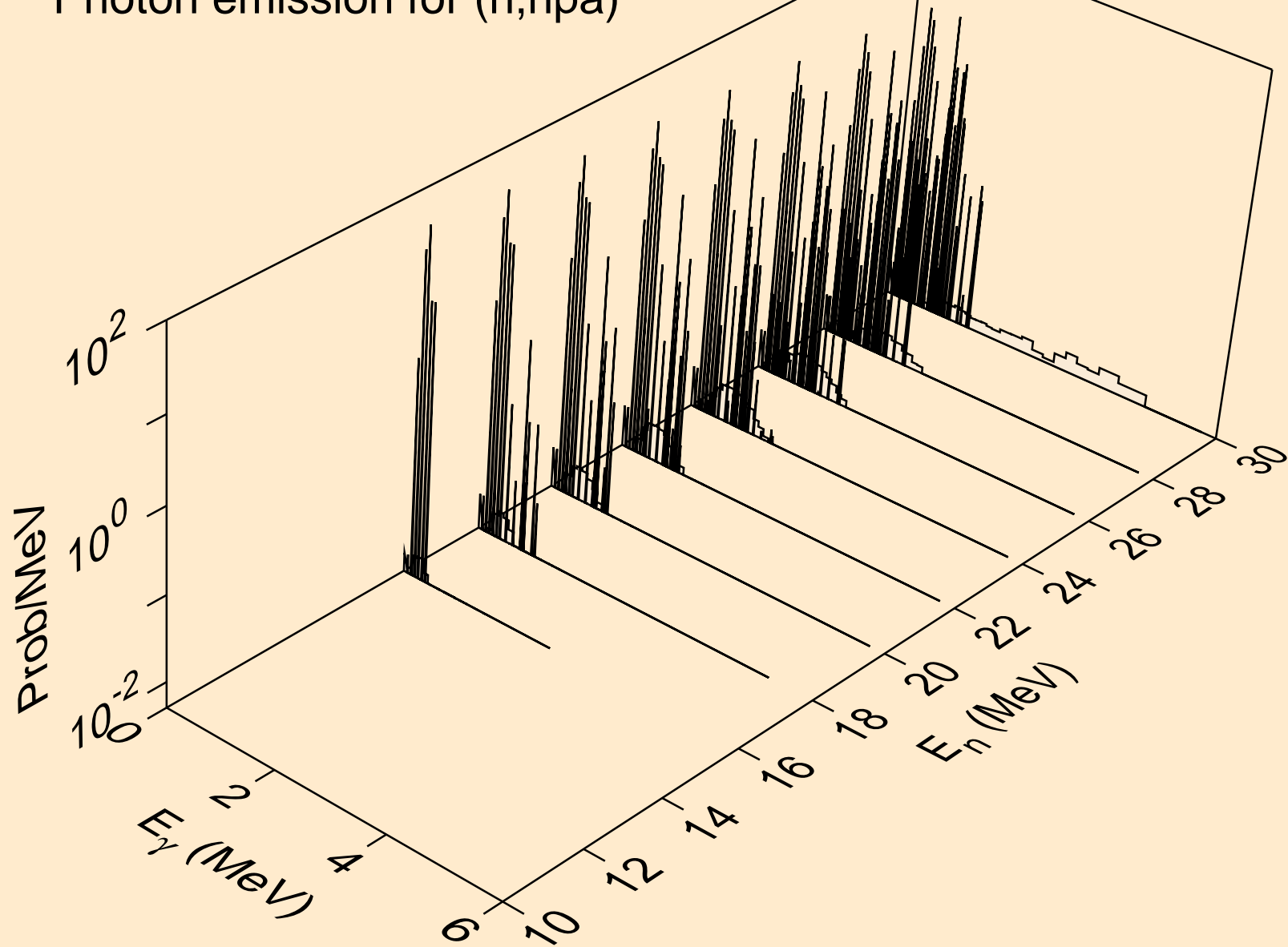

RU092 NEUTRON ACER TENDL-2024 LIBRARY; T=293.6K
Photon emission for (n,n*c)

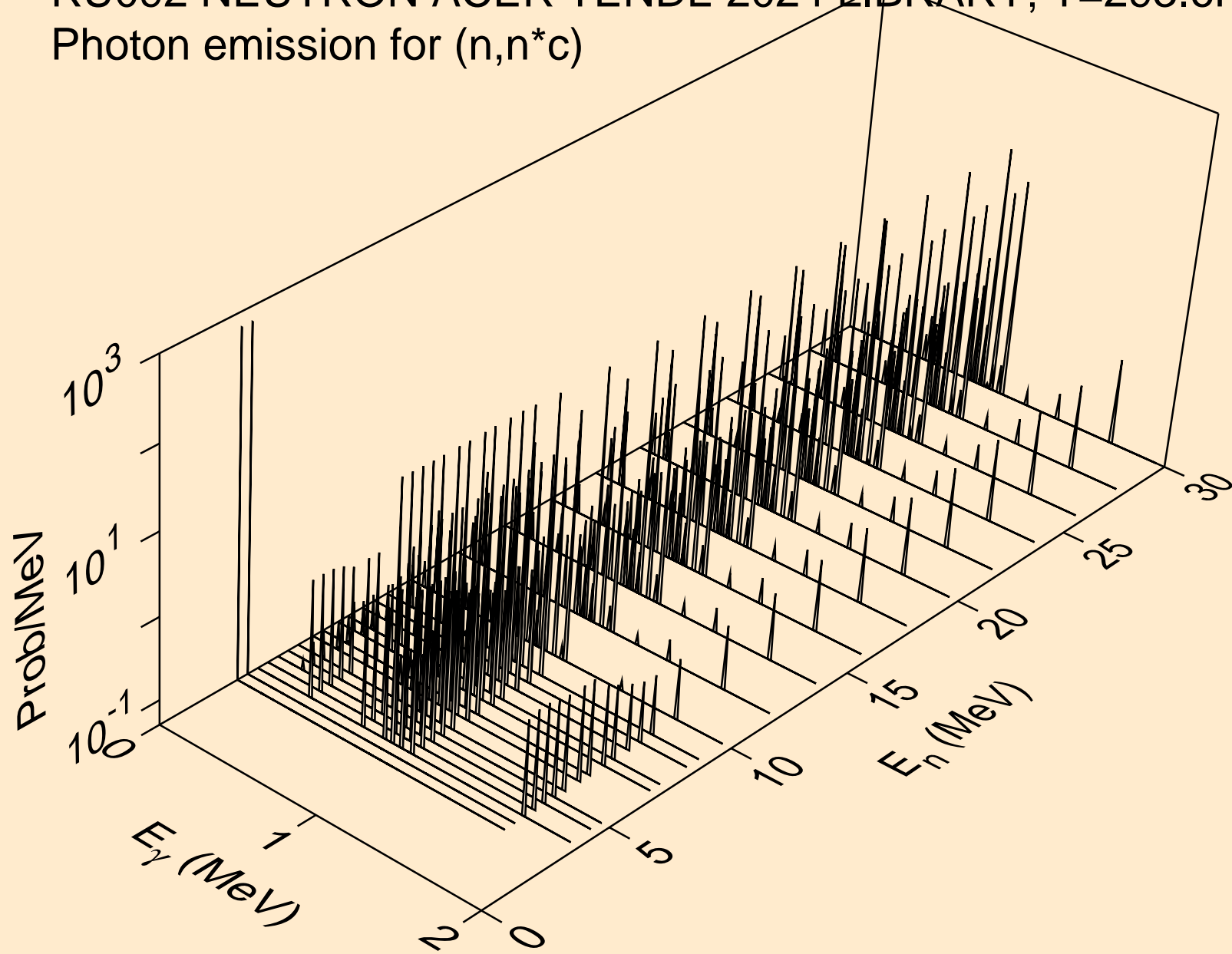

RU092 NEUTRON ACER TENDL-2024 LIBRARY; T=293.6K
Photon emission for (n,gma)

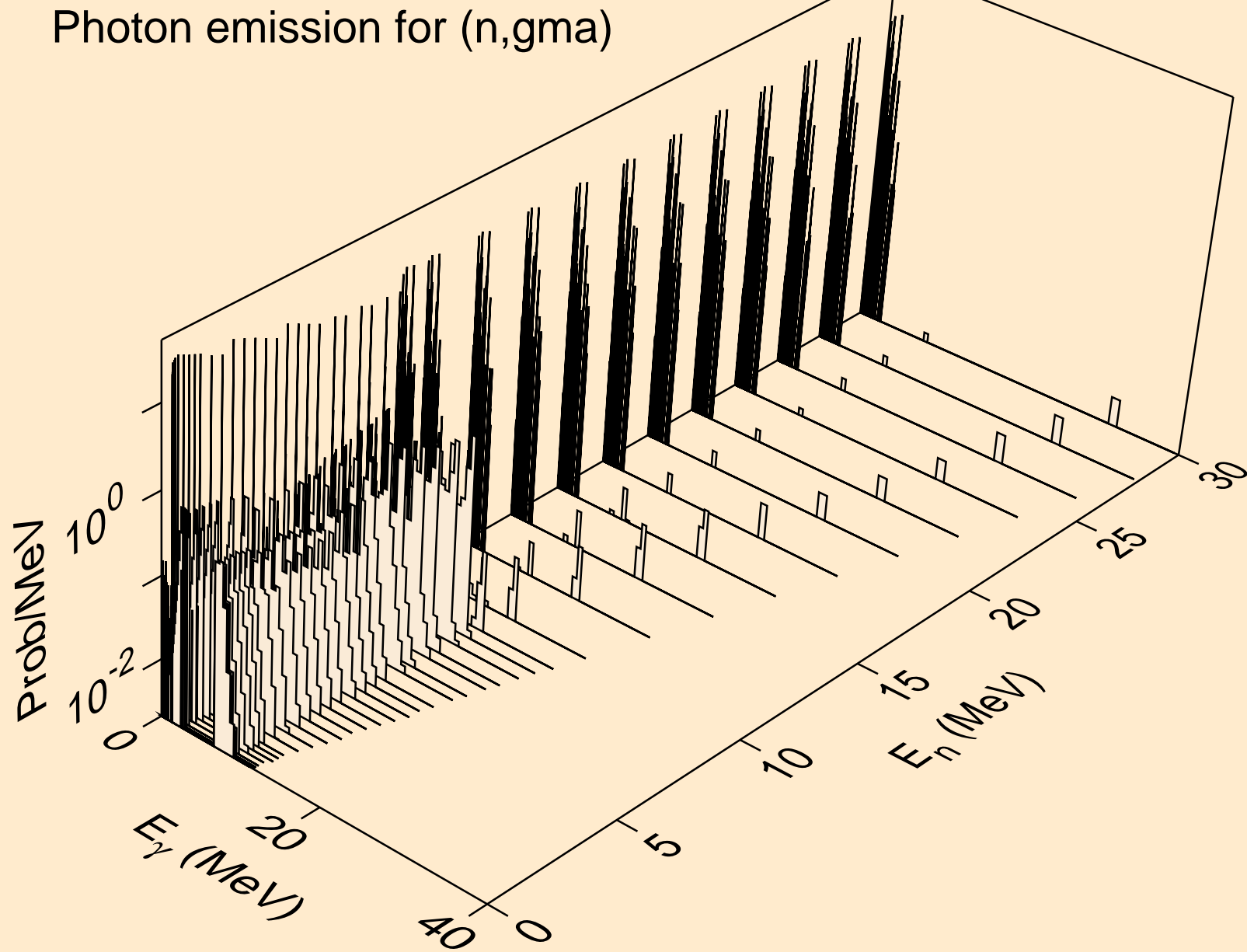

RU092 NEUTRON ACER TENDL-2024 LIBRARY; T=293.6K
Photon emission for (n,p)

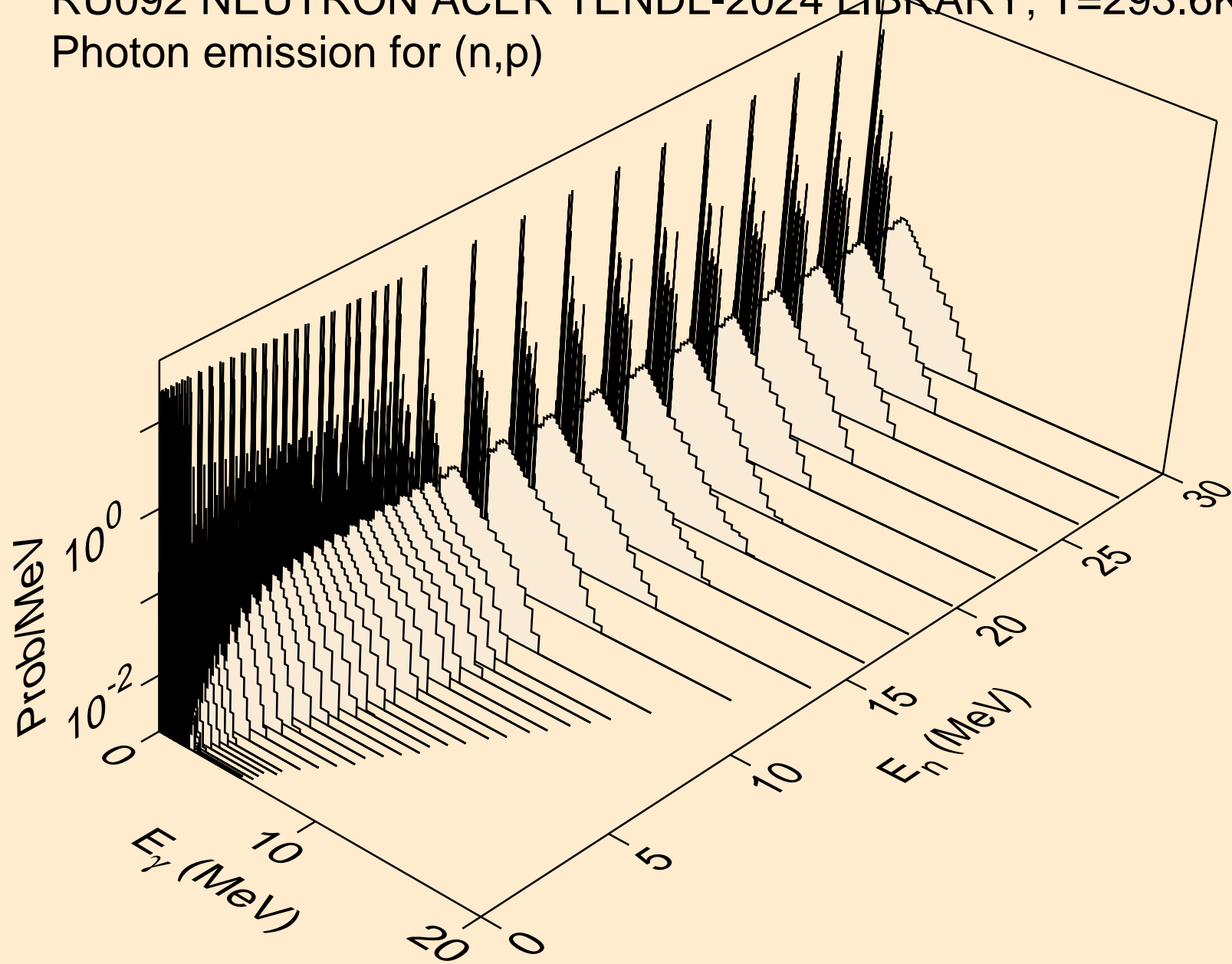

RU092 NEUTRON ACER TENDL-2024 LIBRARY; T=293.6K
Photon emission for (n,d)

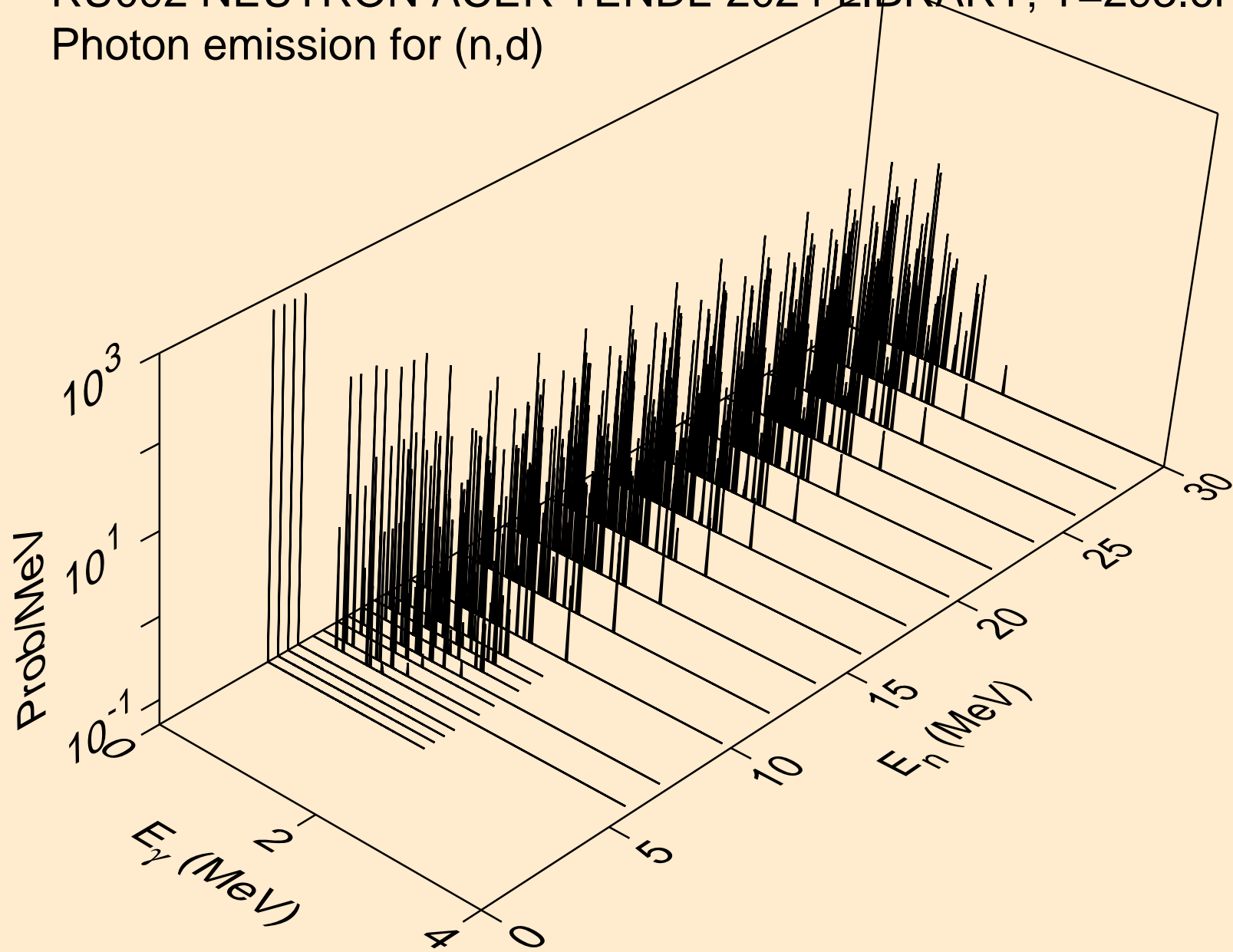

RU092 NEUTRON ACER TENDL-2024 LIBRARY; T=293.6K
Photon emission for (n,t)

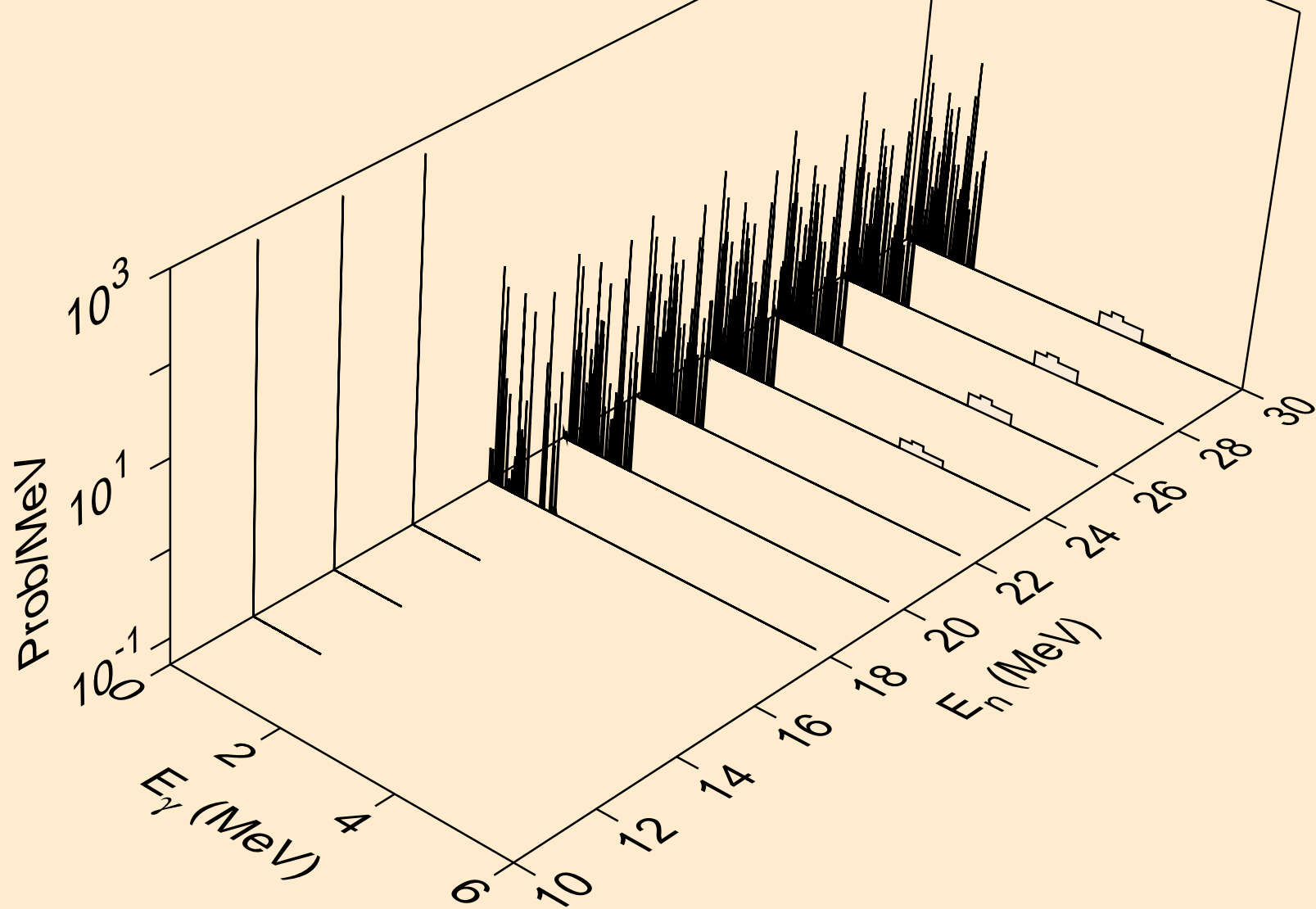

RU092 NEUTRON ACER TENDL-2024 LIBRARY; T=293.6K
Photon emission for (n,he3)

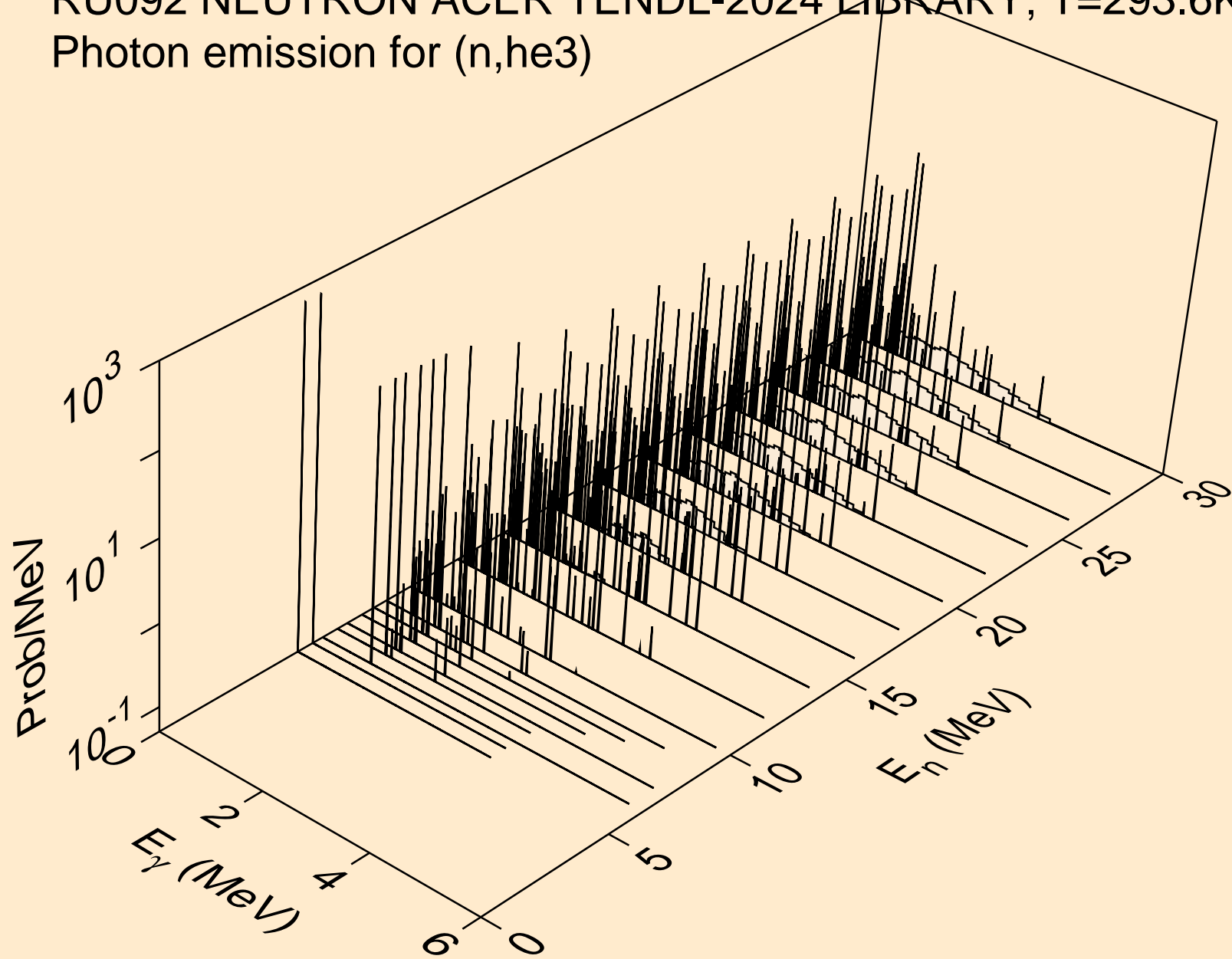

RU092 NEUTRON ACER TENDL-2024 LIBRARY; T=293.6K
Photon emission for (n,a)

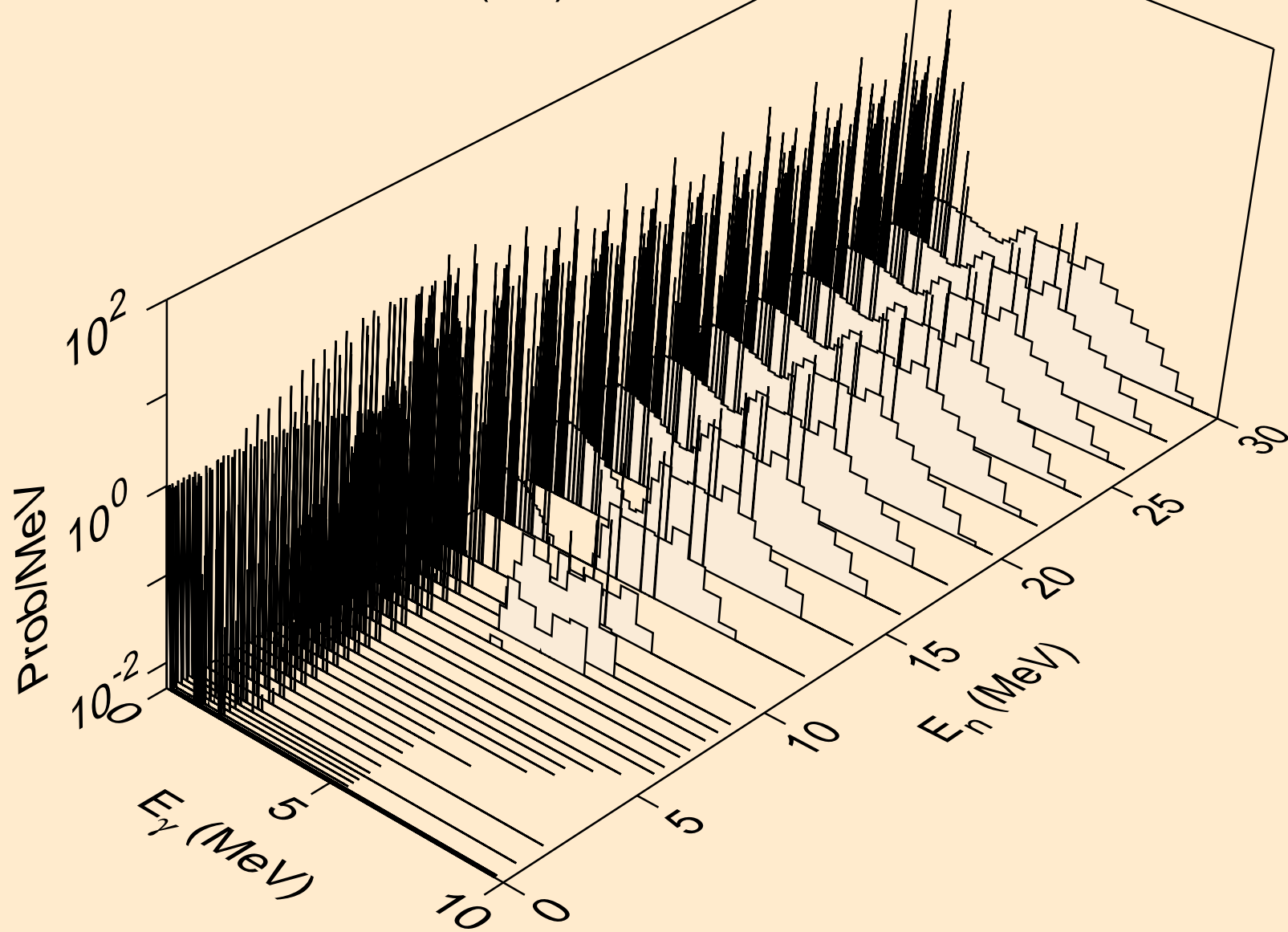

RU092 NEUTRON ACER TENDL-2024 LIBRARY; T=293.6K
Photon emission for (n,2a)

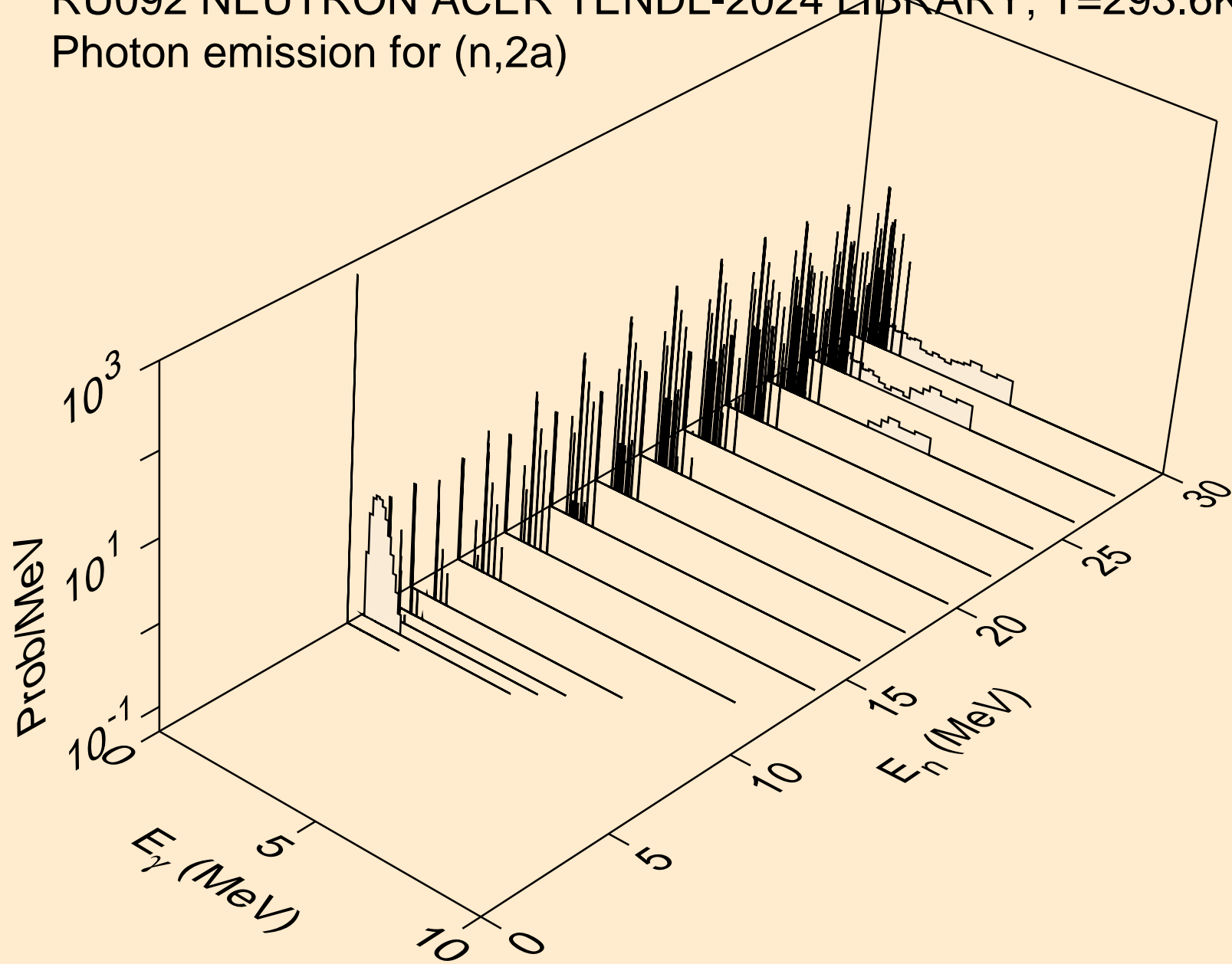

RU092 NEUTRON ACER TENDL-2024 LIBRARY; T=293.6K
Photon emission for (n,3a)

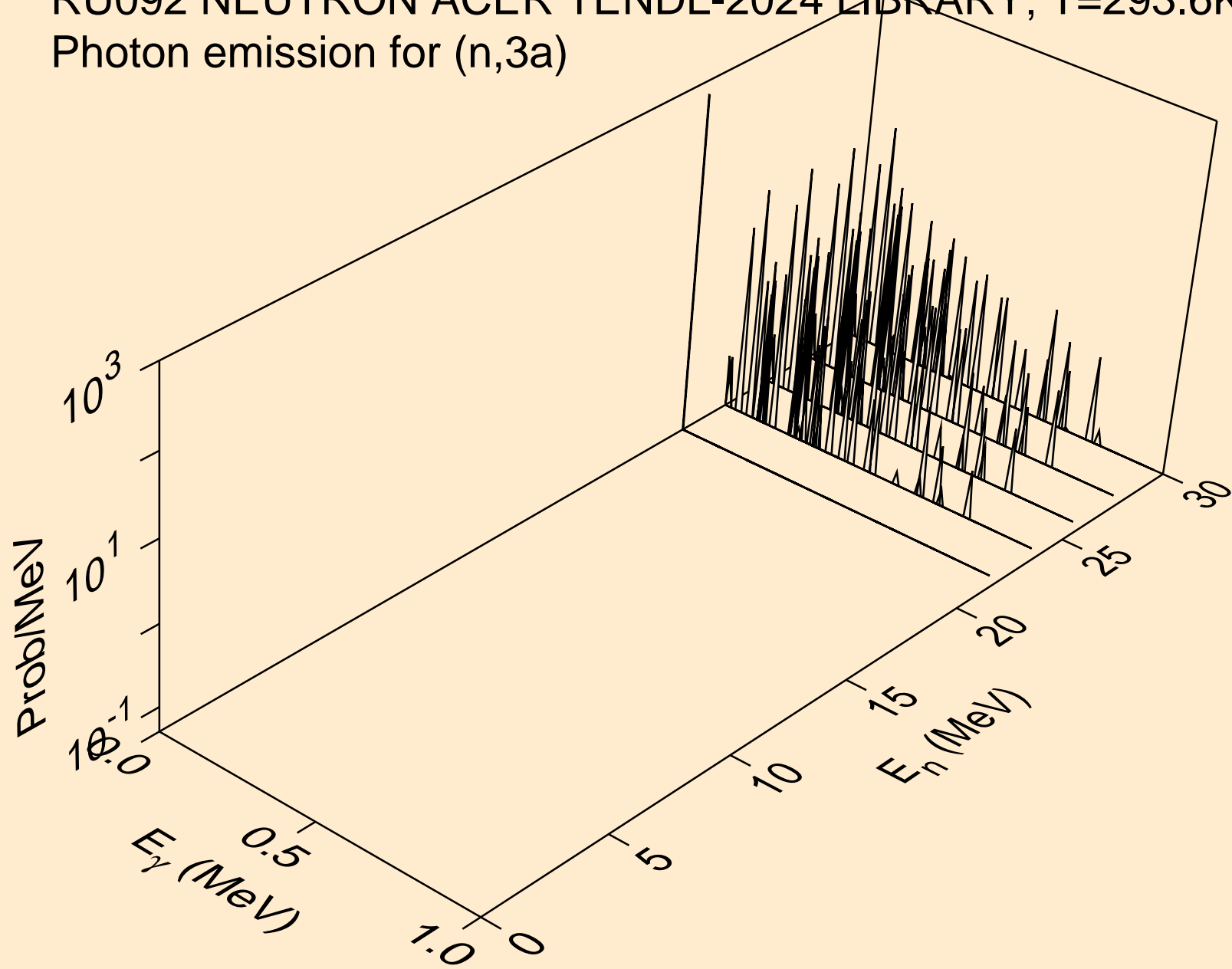

RU092 NEUTRON ACER TENDL-2024 LIBRARY; T=293.6K
Photon emission for (n,2p)

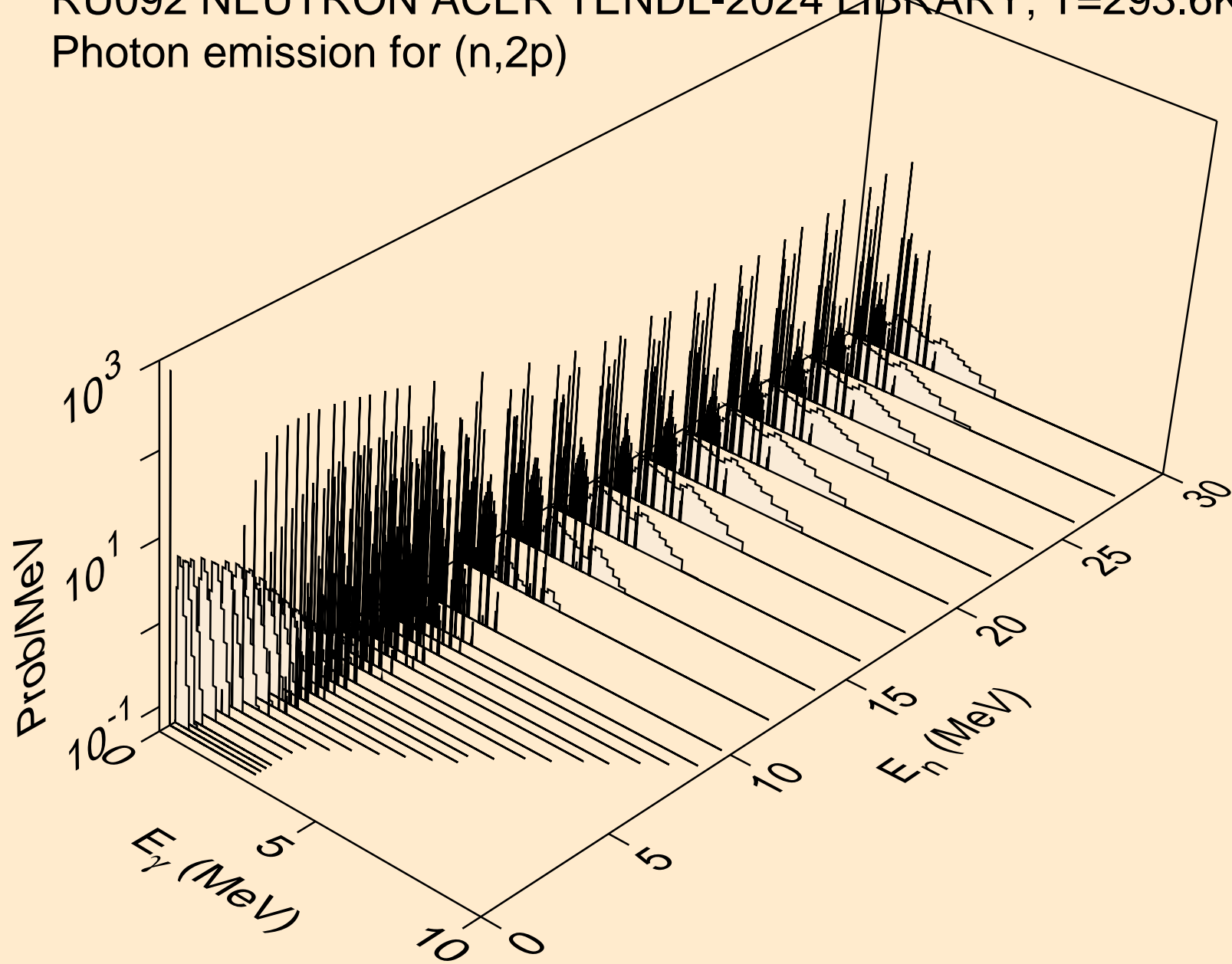

RU092 NEUTRON ACER TENDL-2024 LIBRARY; T=293.6K
Photon emission for (n,p)

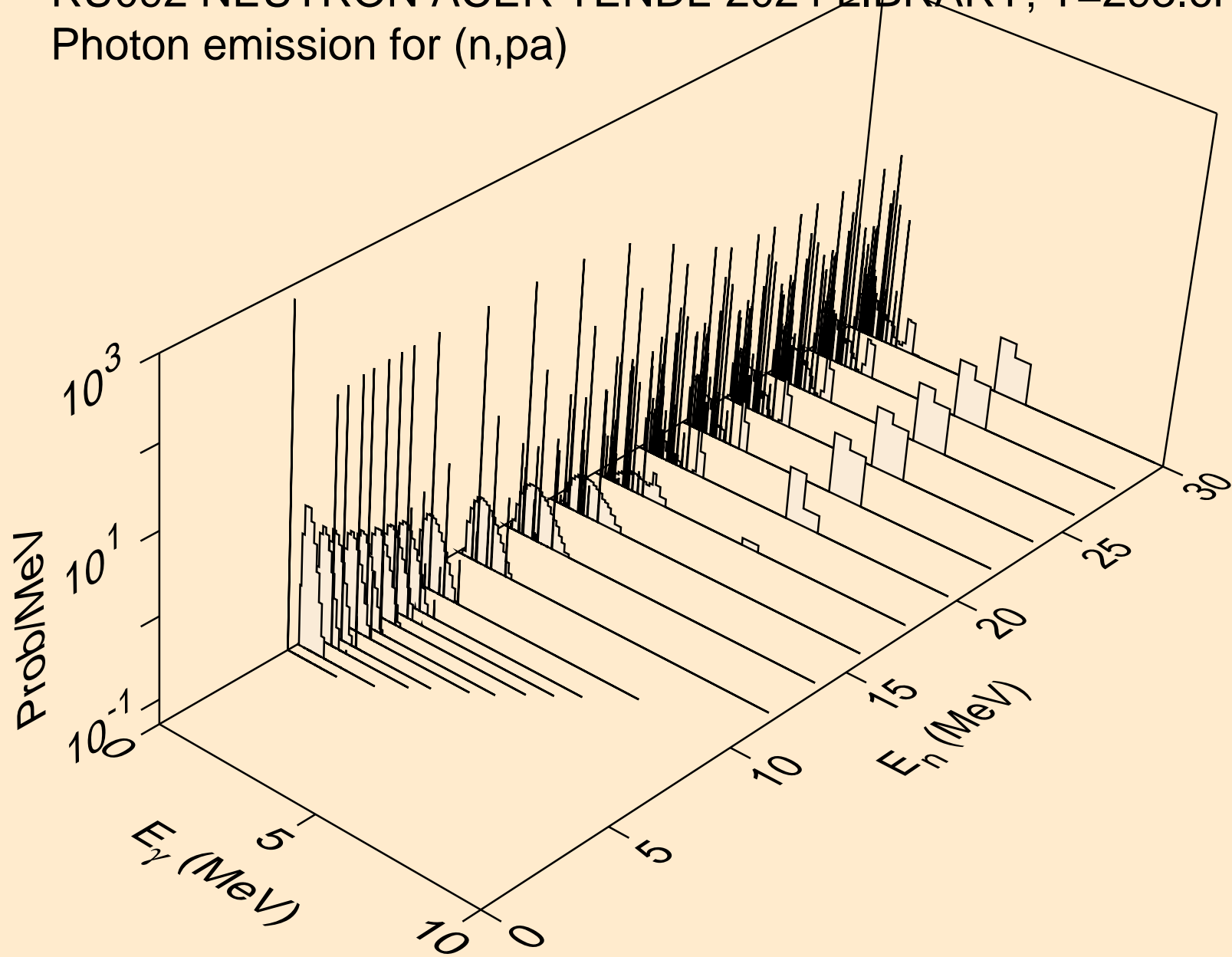

RU092 NEUTRON ACER TENDL-2024 LIBRARY; T=293.6K
Photon emission for (n,pd)

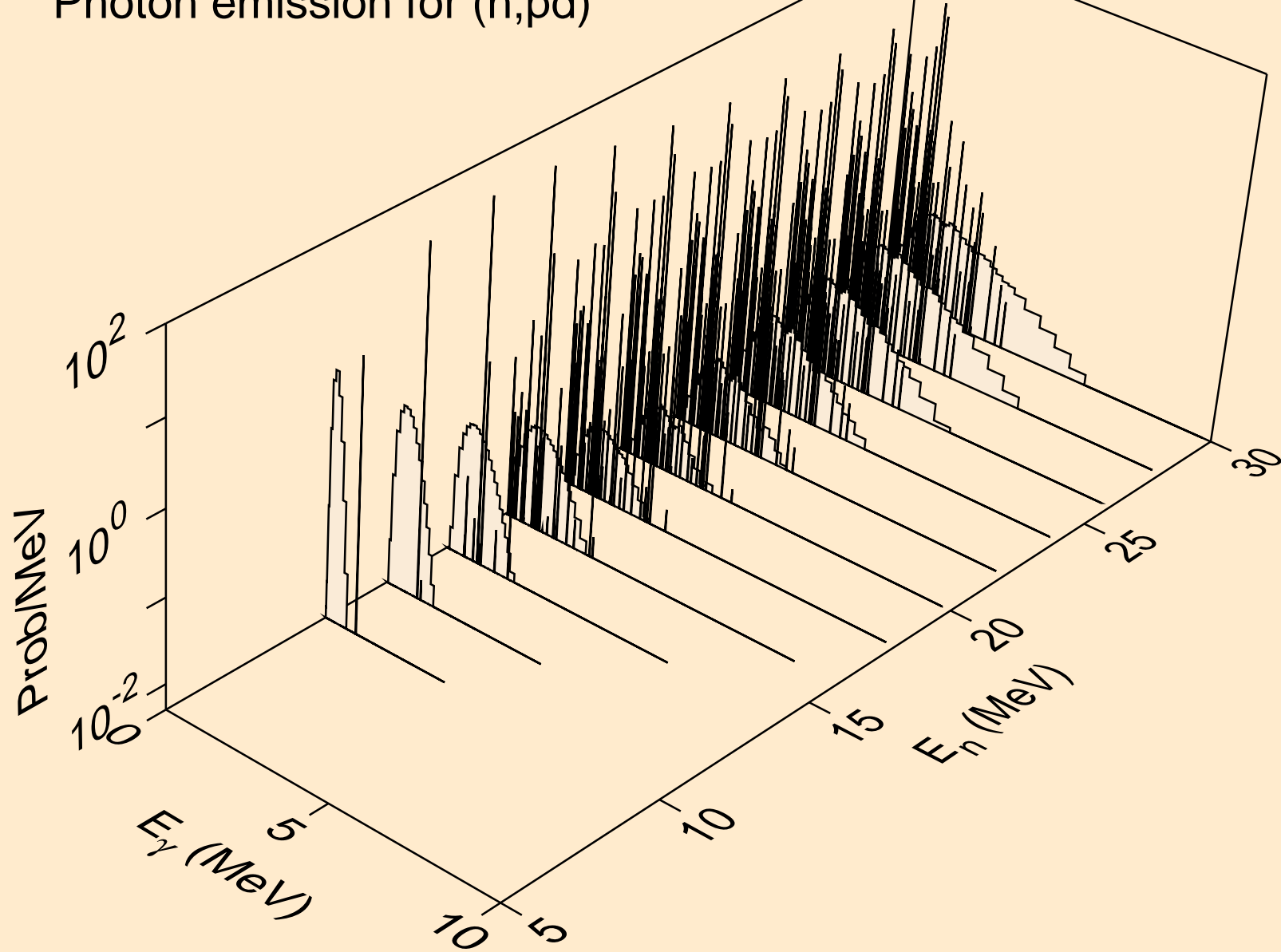

RU092 NEUTRON ACER TENDL-2024 LIBRARY; T=293.6K
Photon emission for (n,pt)

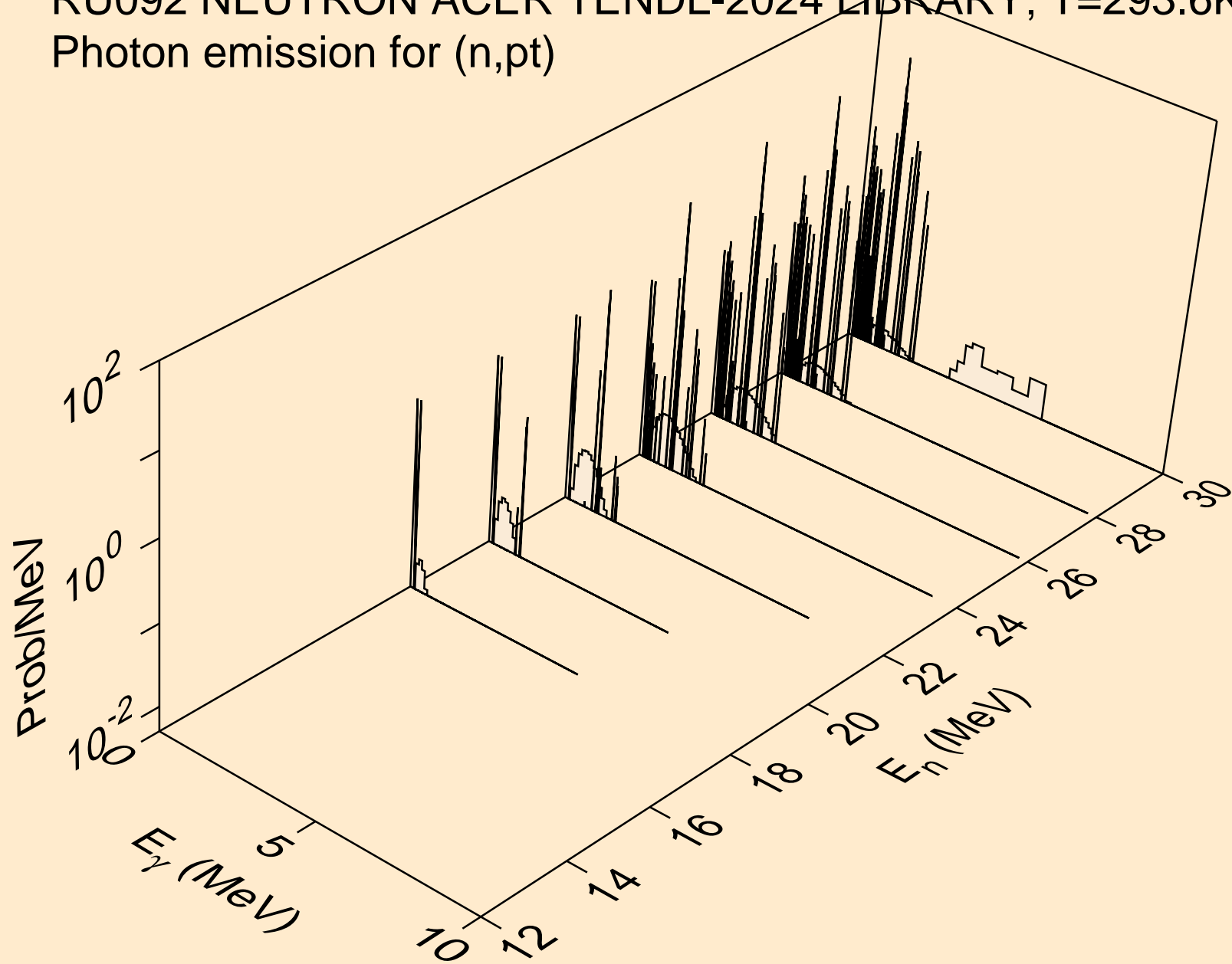

RU092 NEUTRON ACER TENDL-2024 LIBRARY; T=293.6K
Photon emission for (n,da)

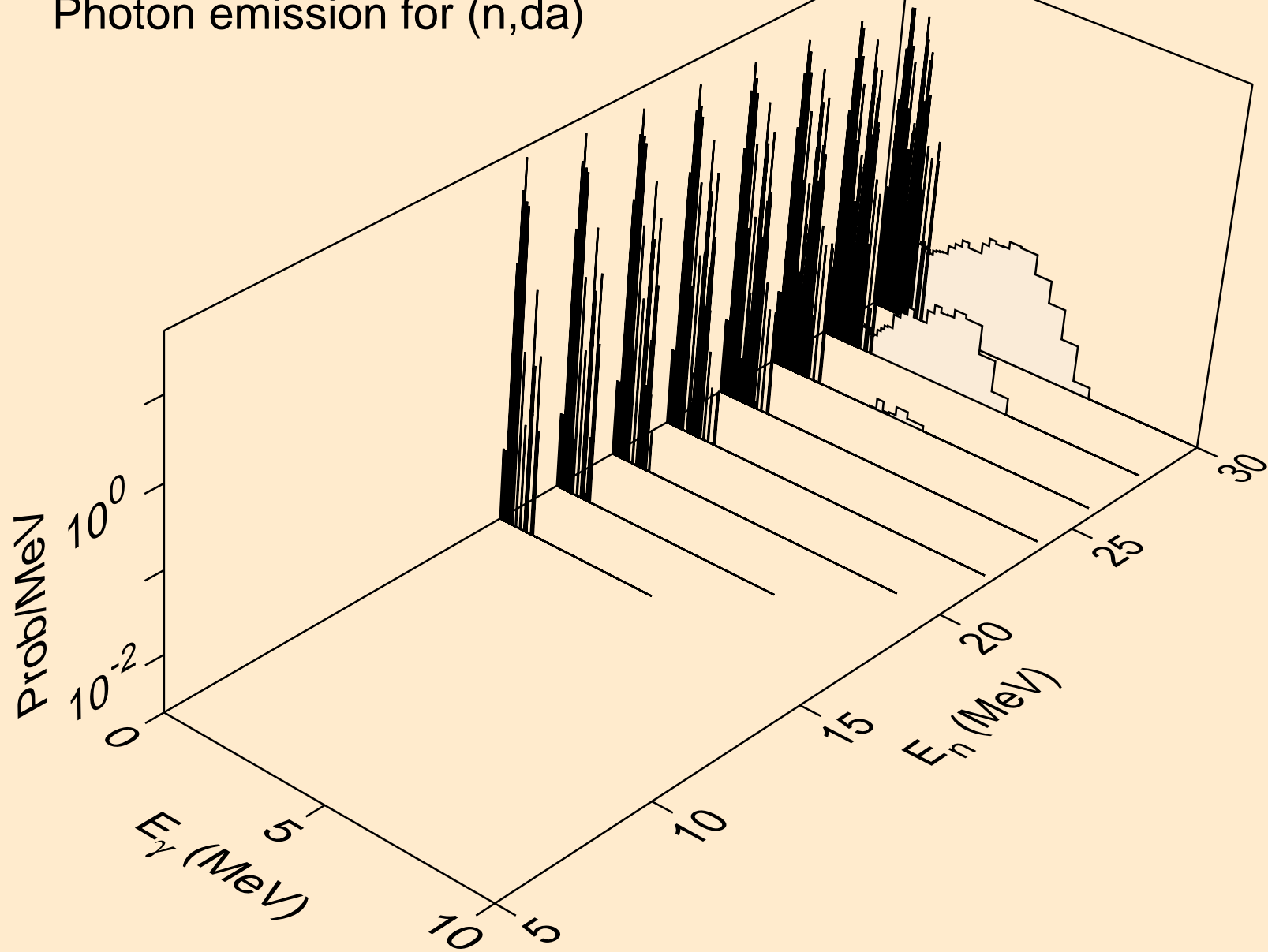

RU092 NEUTRON ACER TENDL-2024 LIBRARY; T=293.6K
thermal capture photon spectrum

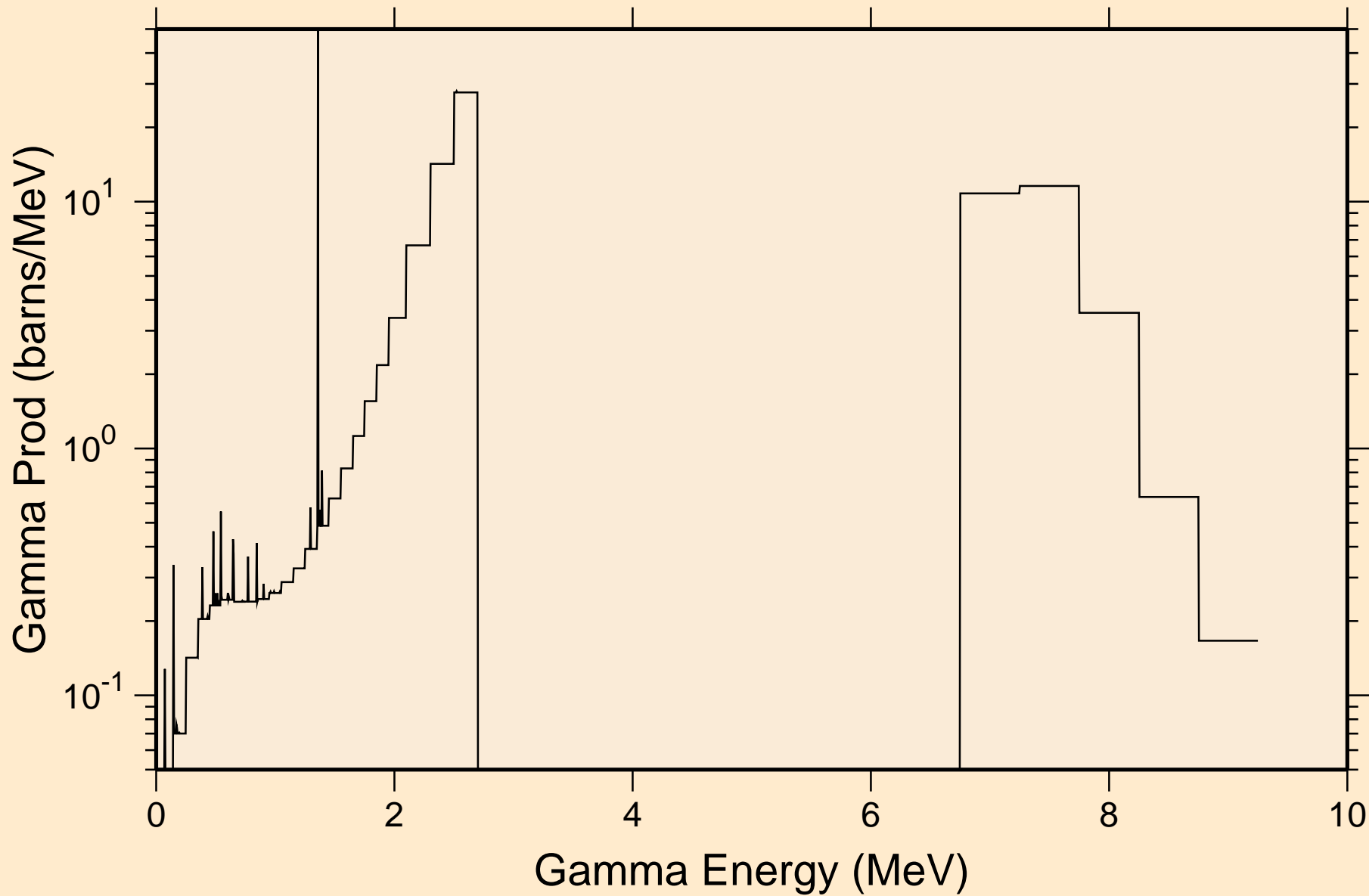

RU092 NEUTRON ACER TENDL-2024 LIBRARY; T=293.6K
14 MeV photon spectrum

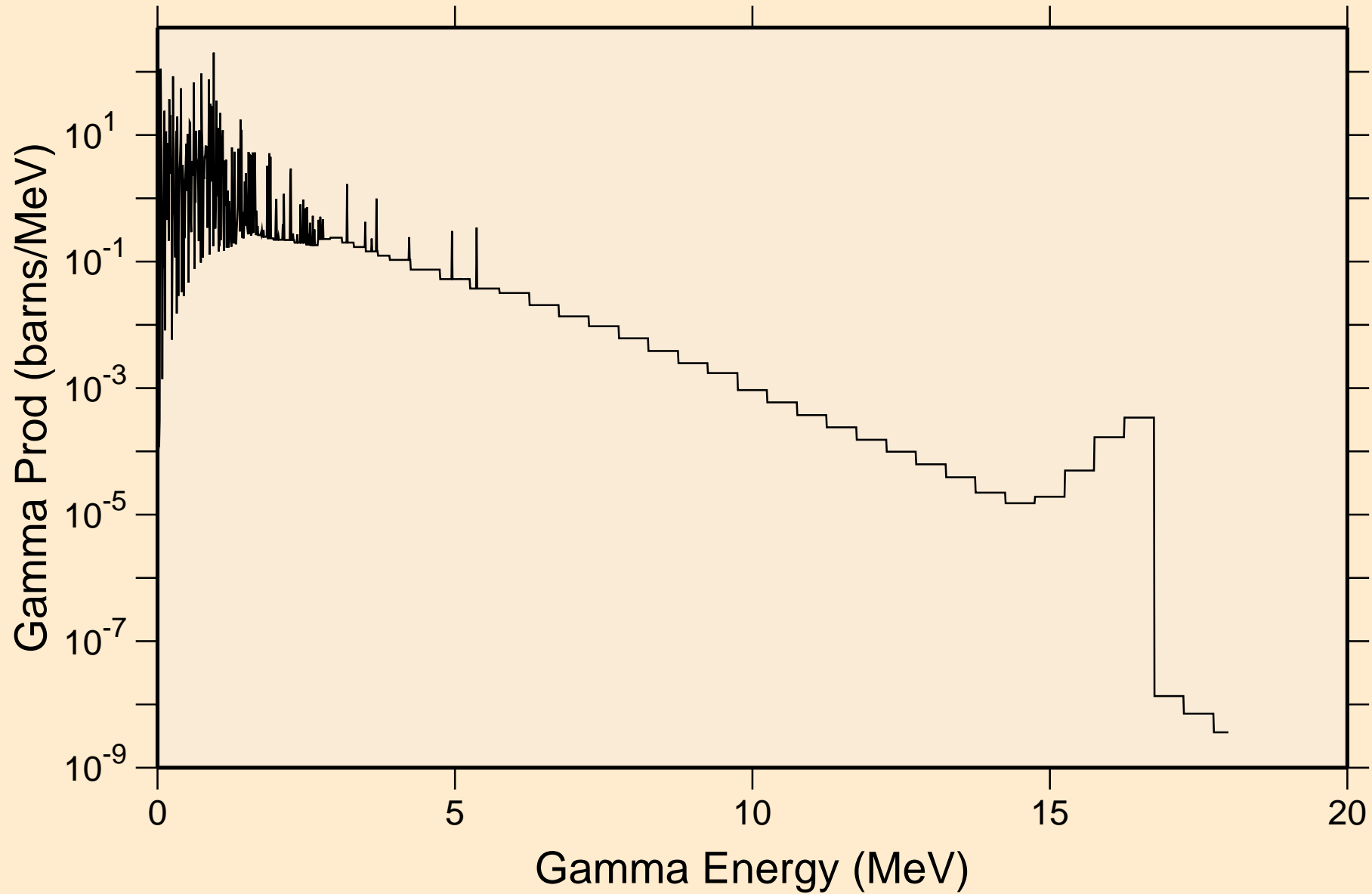

RU092 NEUTRON ACER TENDL-2024 LIBRARY; T=293.6K
Particle heating contributions

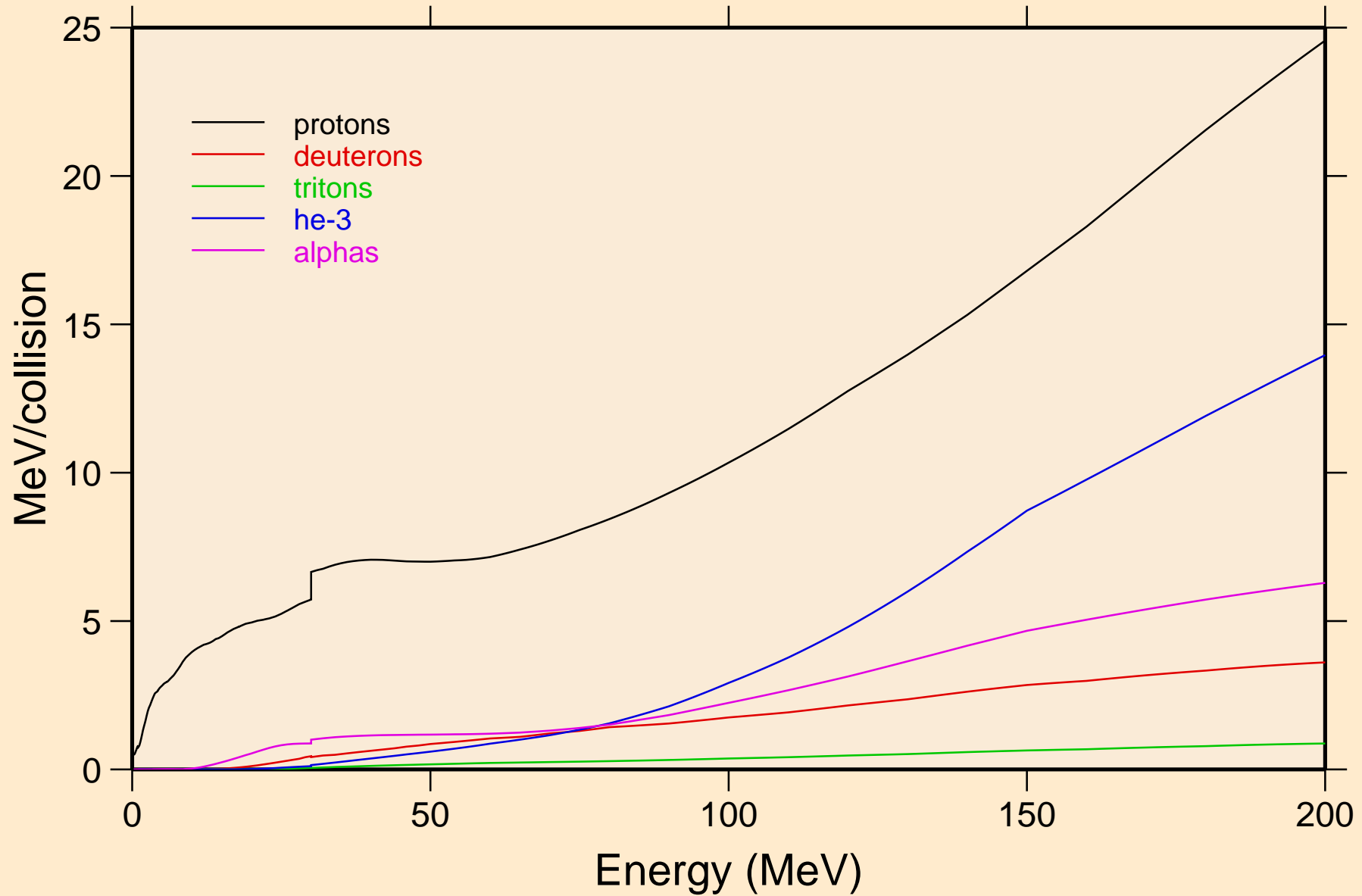

RU092 NEUTRON ACER TENDL-2024 LIBRARY; T=293.6K
Recoil Heating

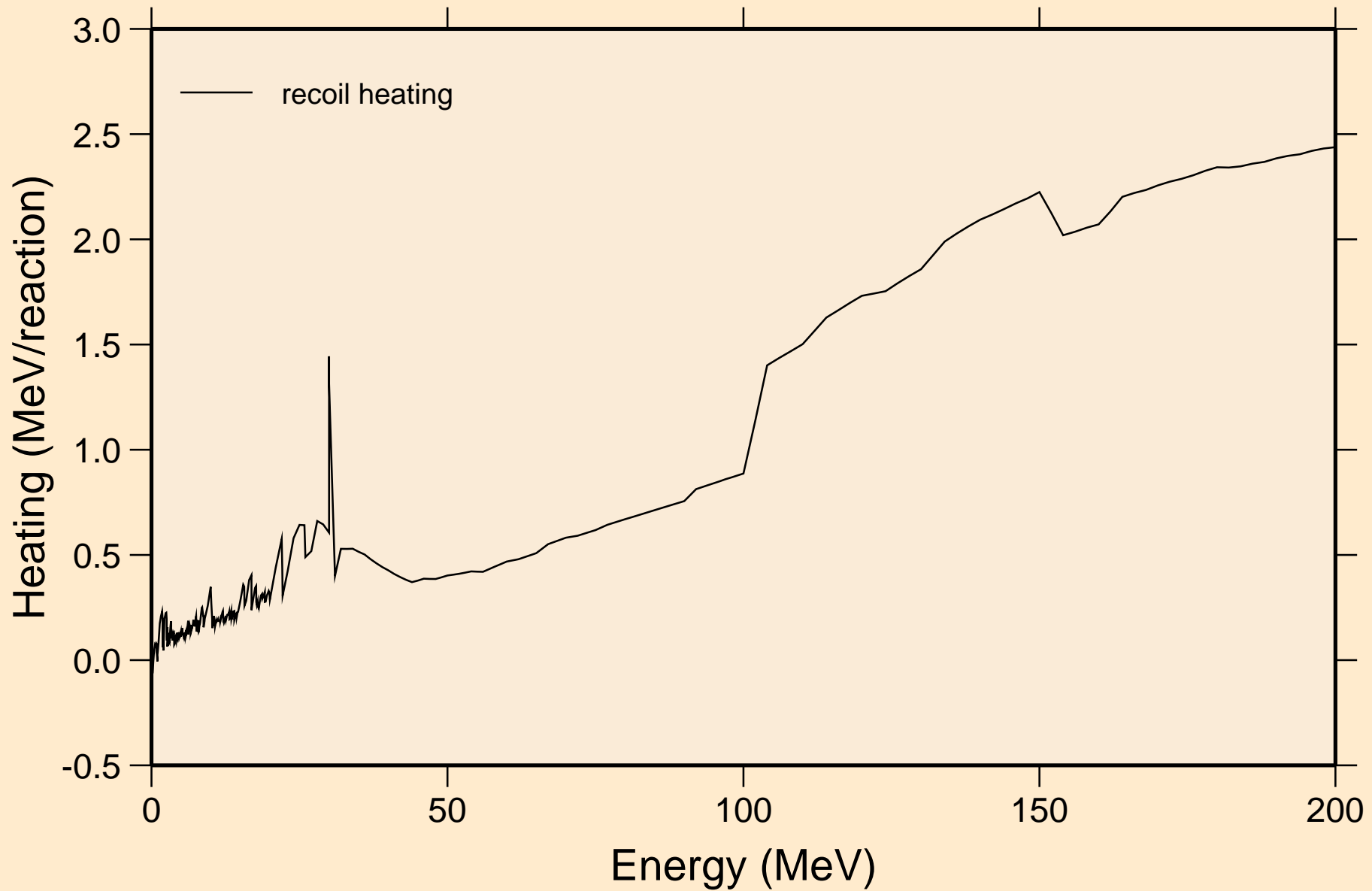

RU092 NEUTRON ACER TENDL-2024 LIBRARY; T=293.6K
Particle production cross sections

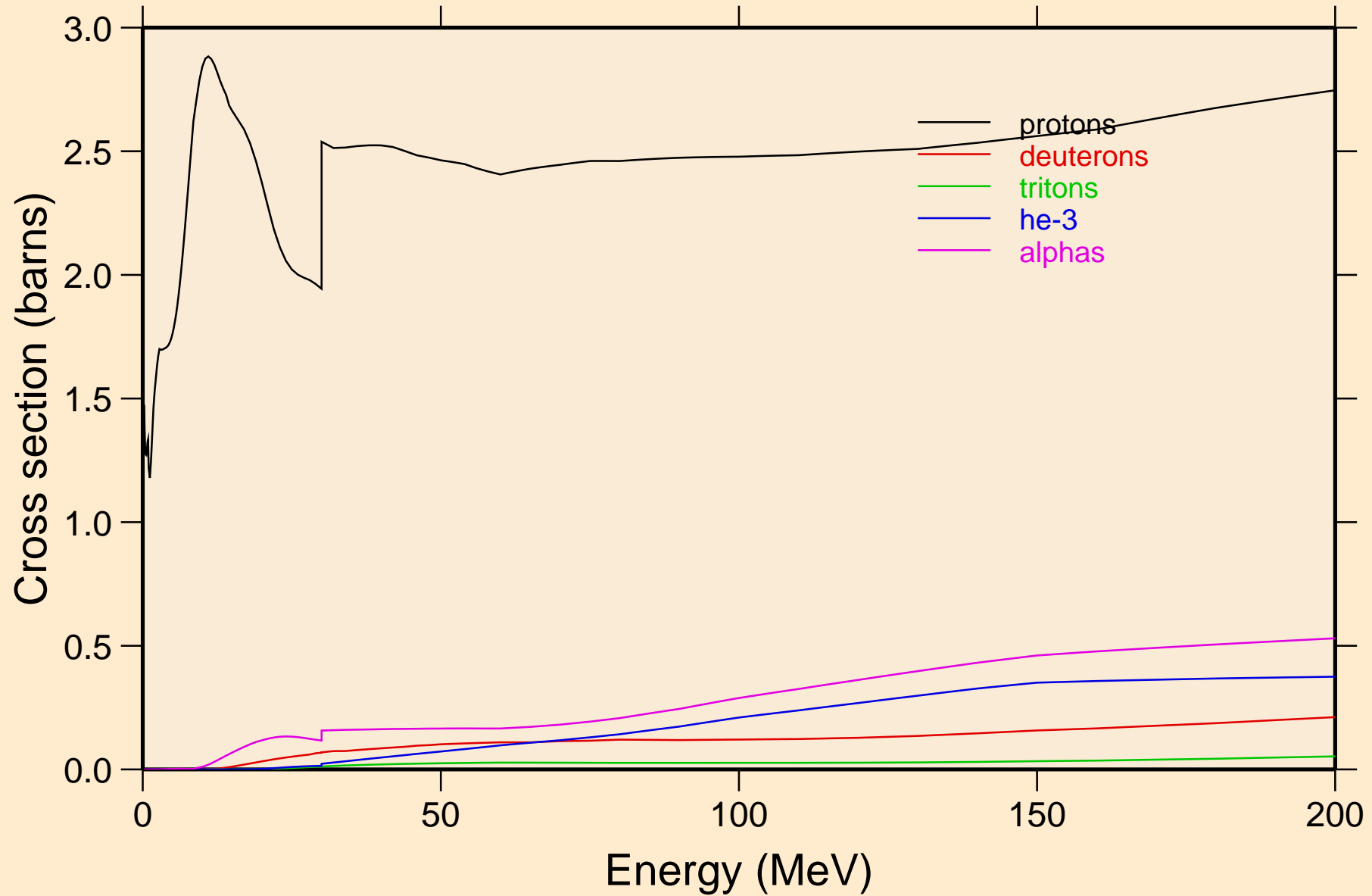

RU092 NEUTRON ACER TENDL-2024 LIBRARY; T=293.6K
protons from (n,x)

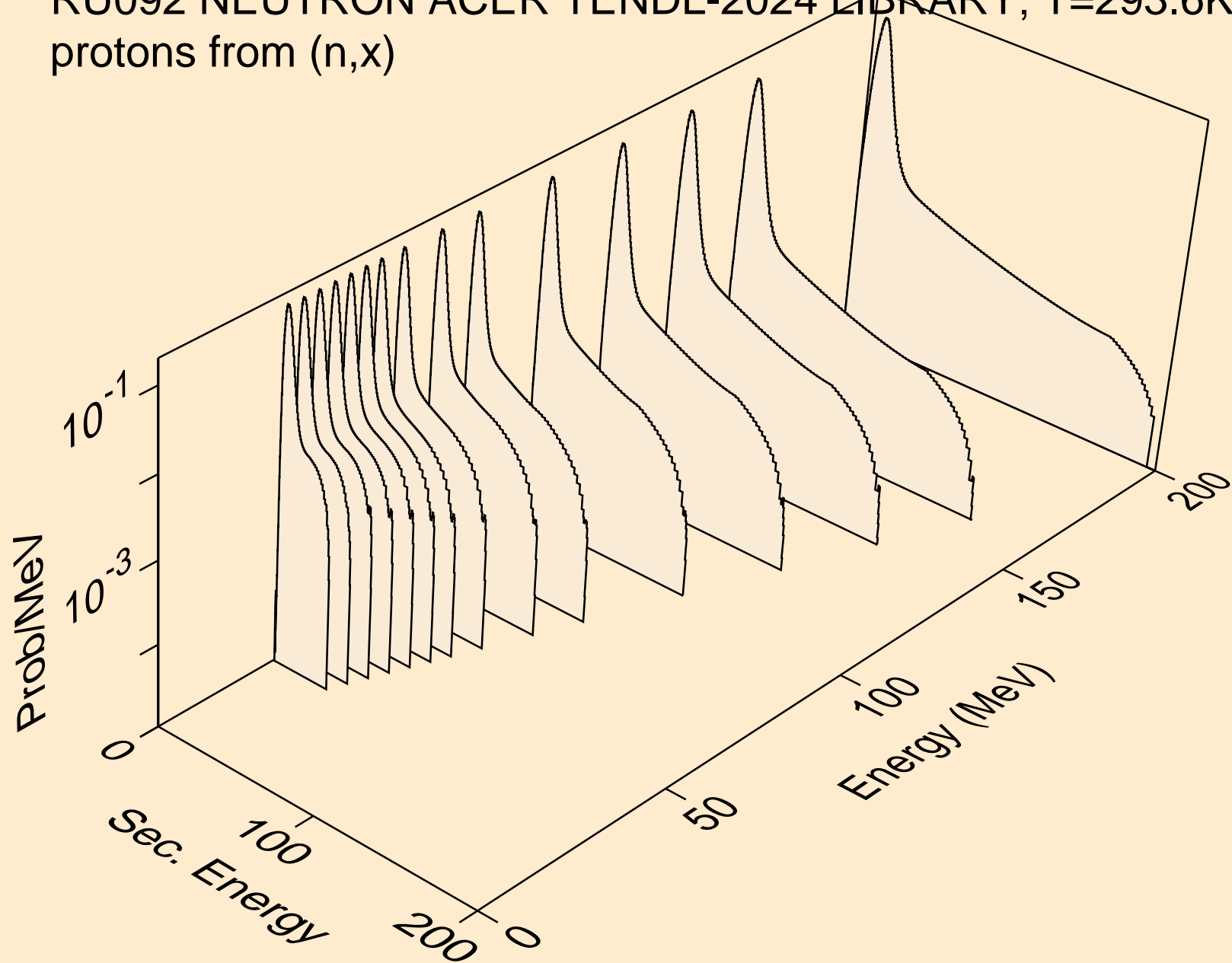

RU092 NEUTRON ACER TENDL-2024 LIBRARY; T=293.6K
protons from (n,n*)p

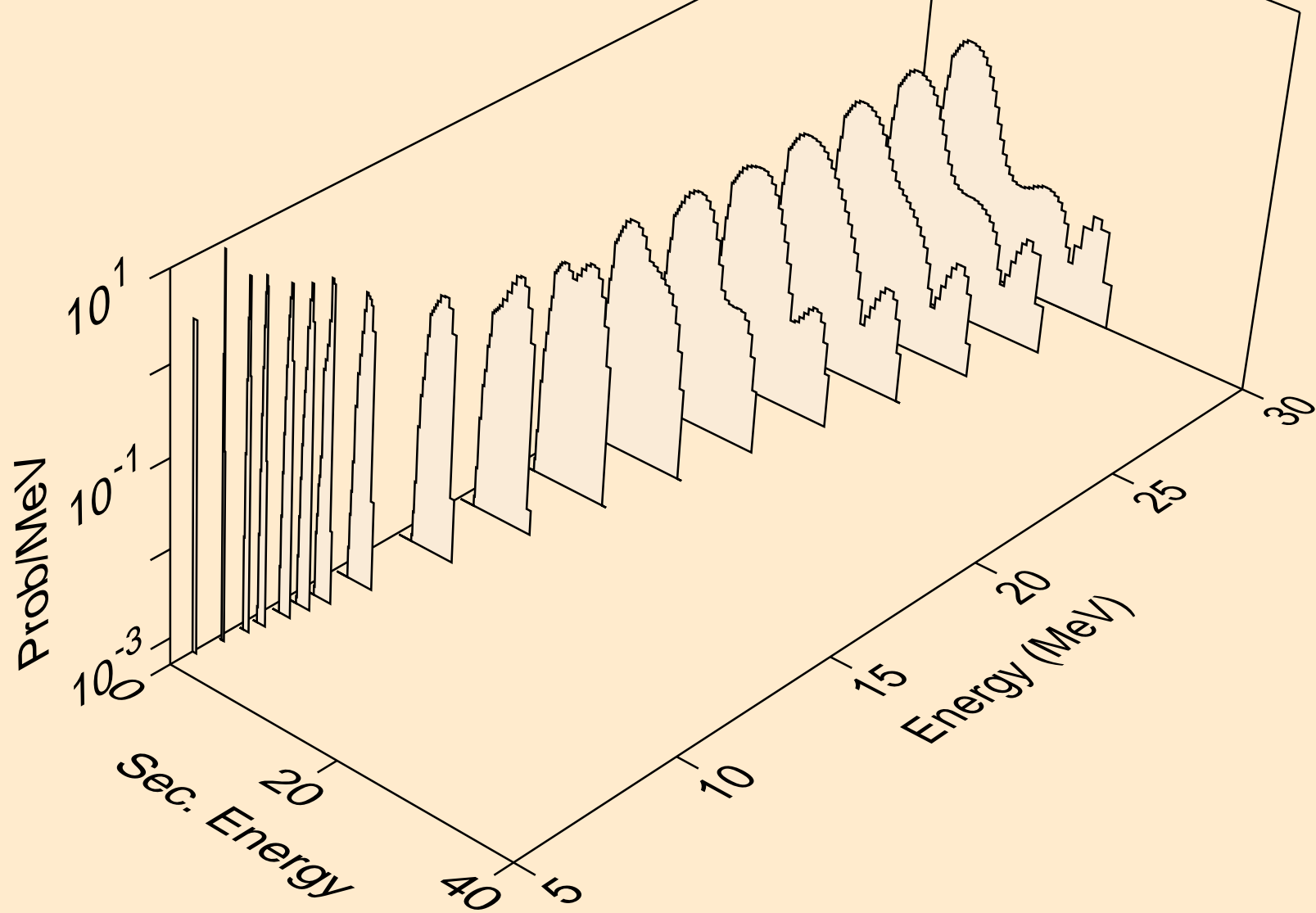

RU092 NEUTRON ACER TENDL-2024 LIBRARY; T=293.6K
protons from (n,2np)

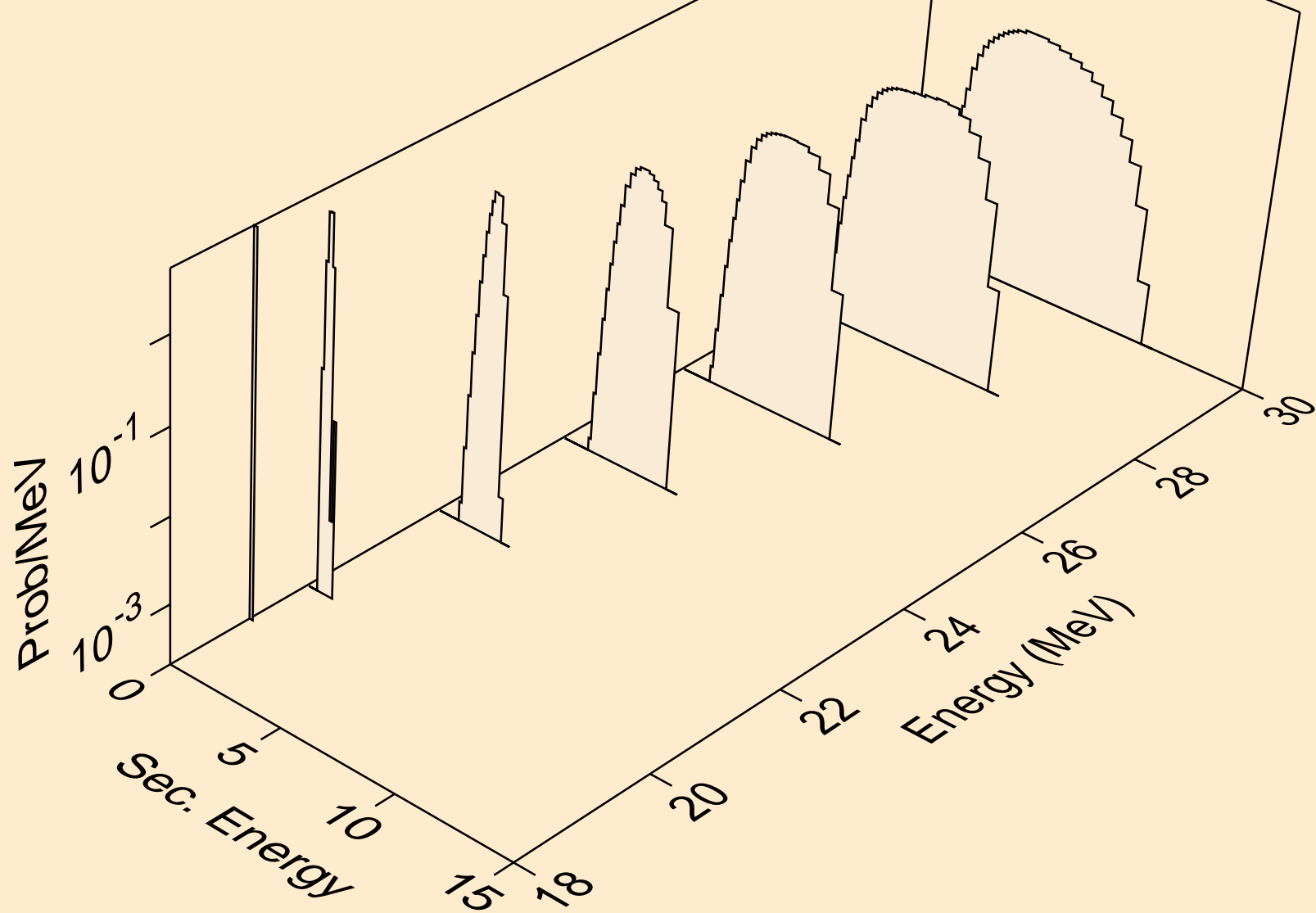

RU092 NEUTRON ACER TENDL-2024 LIBRARY; T=293.6K
protons from (n,n2p)

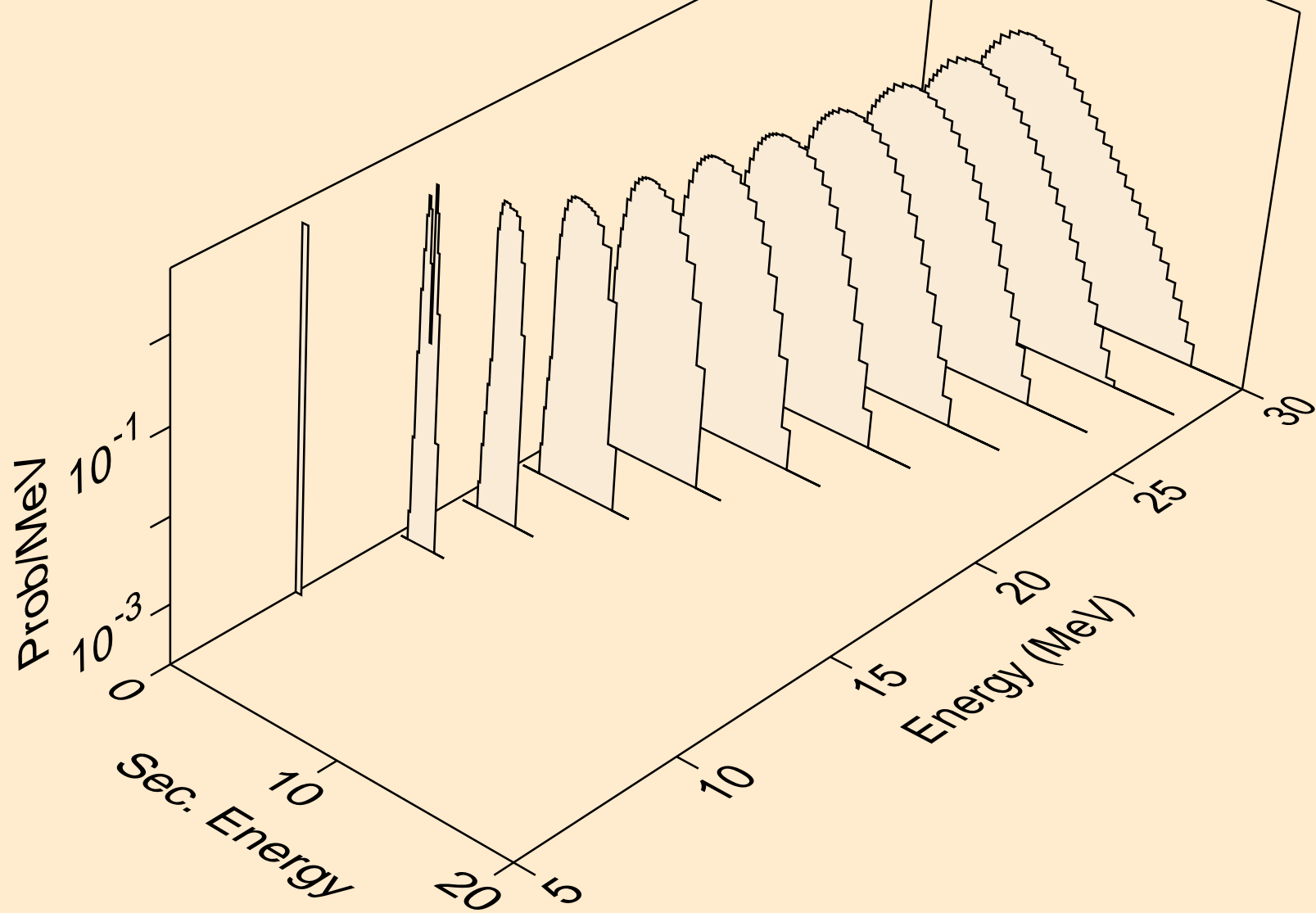

RU092 NEUTRON ACER TENDL-2024 LIBRARY; T=293.6K
protons from (n,npa)

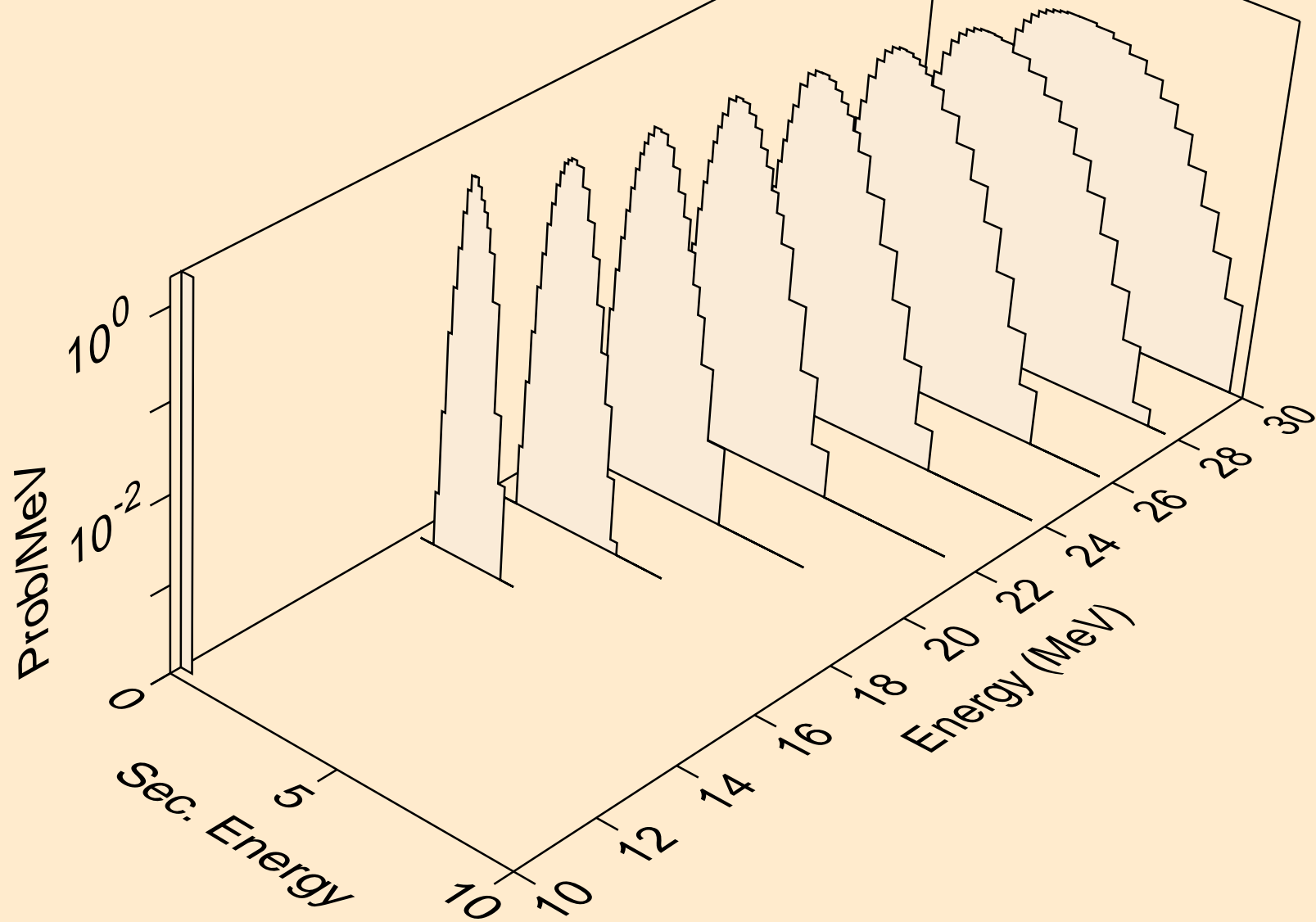

RU092 NEUTRON ACER TENDL-2024 LIBRARY; T=293.6K
protons from (n,p)

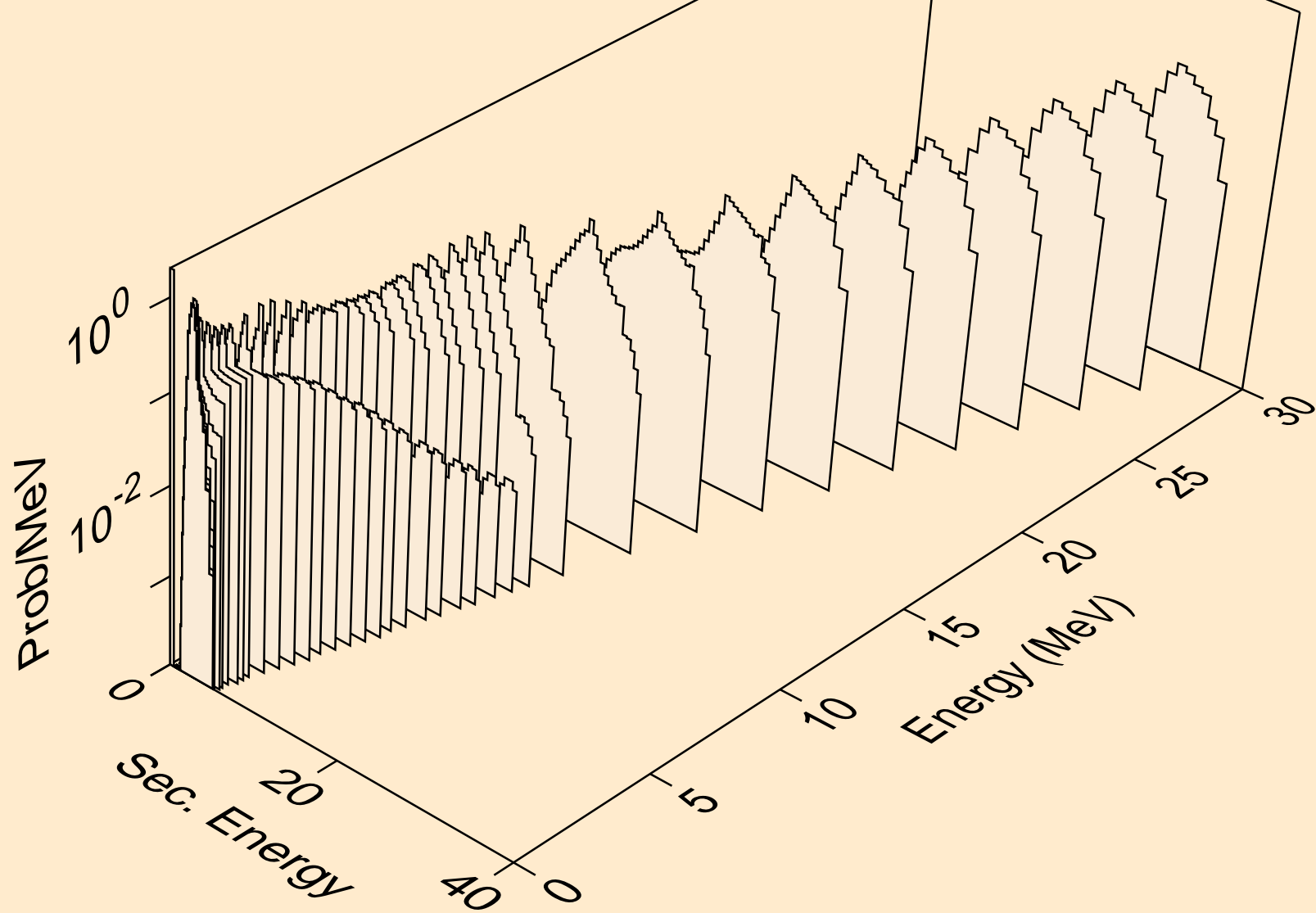

RU092 NEUTRON ACER TENDL-2024 LIBRARY; T=293.6K
protons from (n,2p)

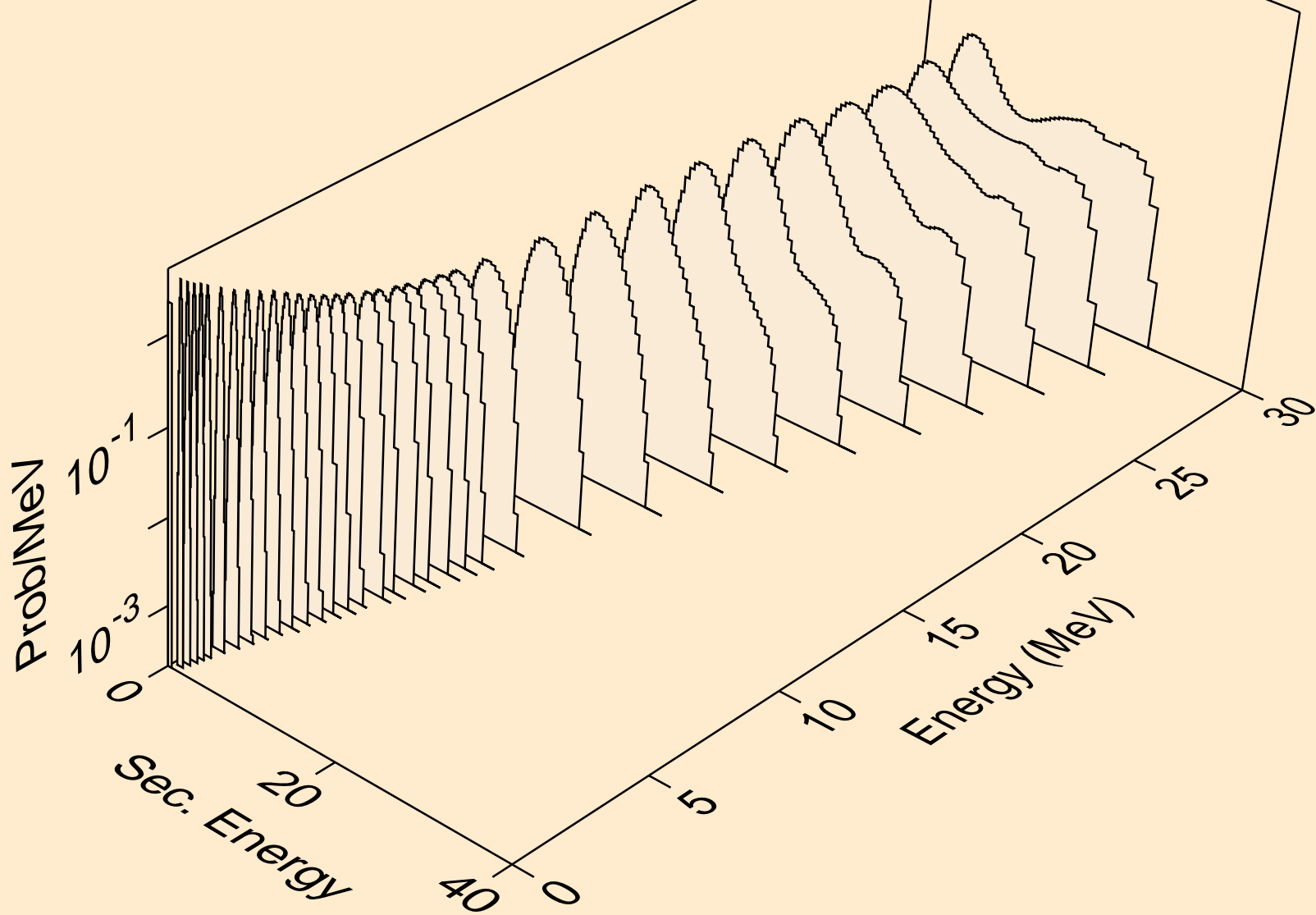

RU092 NEUTRON ACER TENDL-2024 LIBRARY; T=293.6K
protons from (n,p)

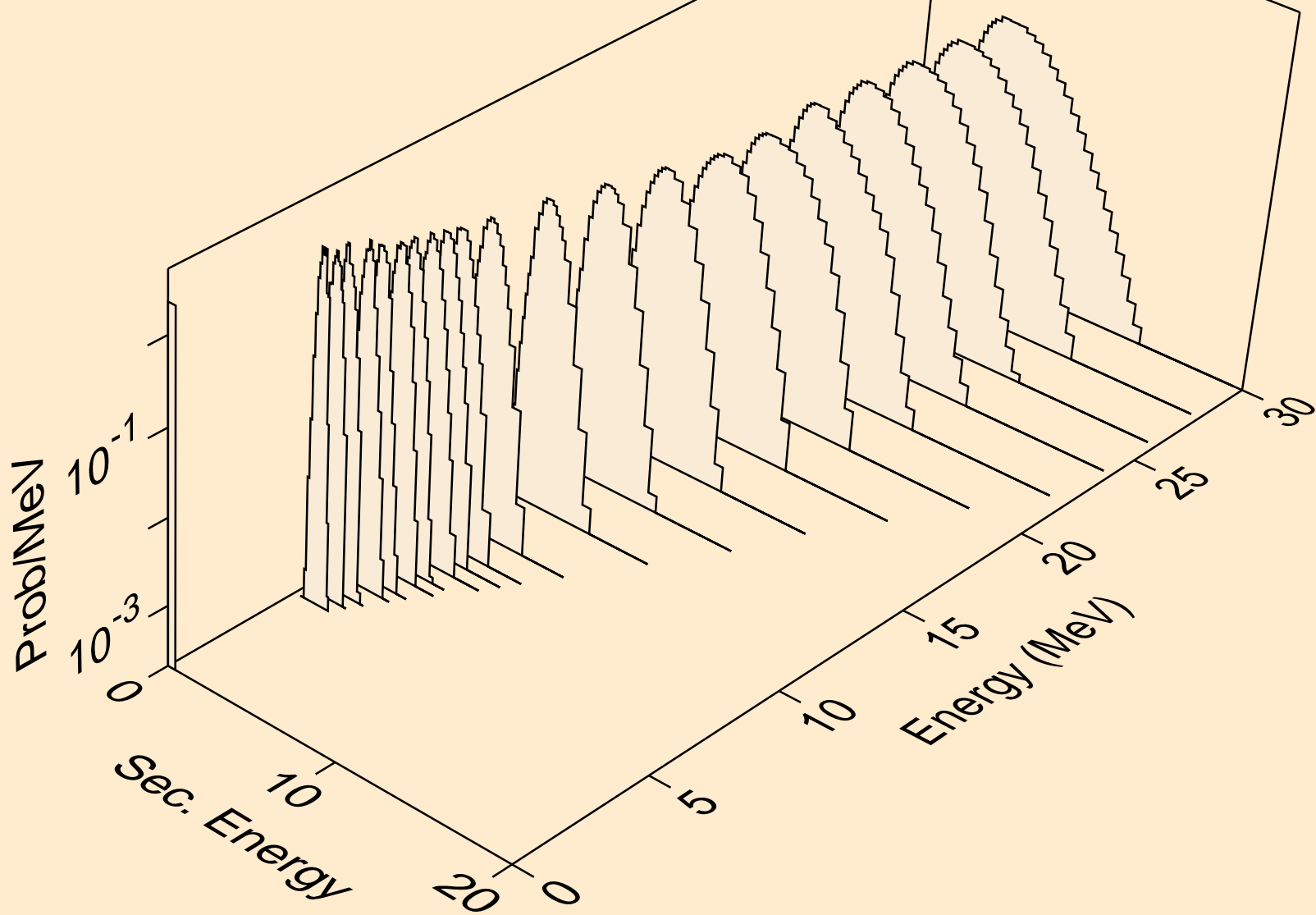

RU092 NEUTRON ACER TENDL-2024 LIBRARY; T=293.6K
protons from (n,pd)

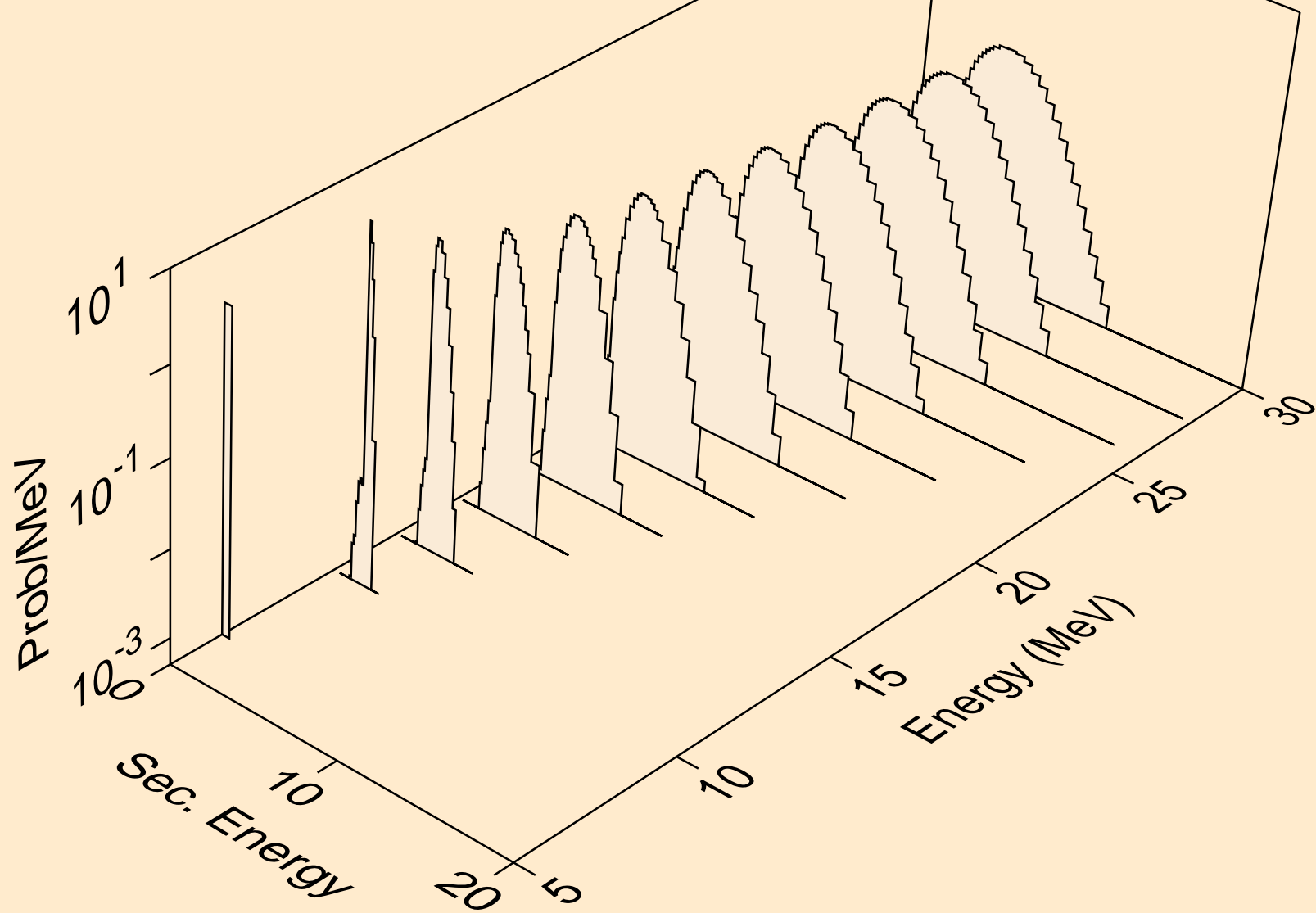

RU092 NEUTRON ACER TENDL-2024 LIBRARY; T=293.6K
protons from (n,pt)

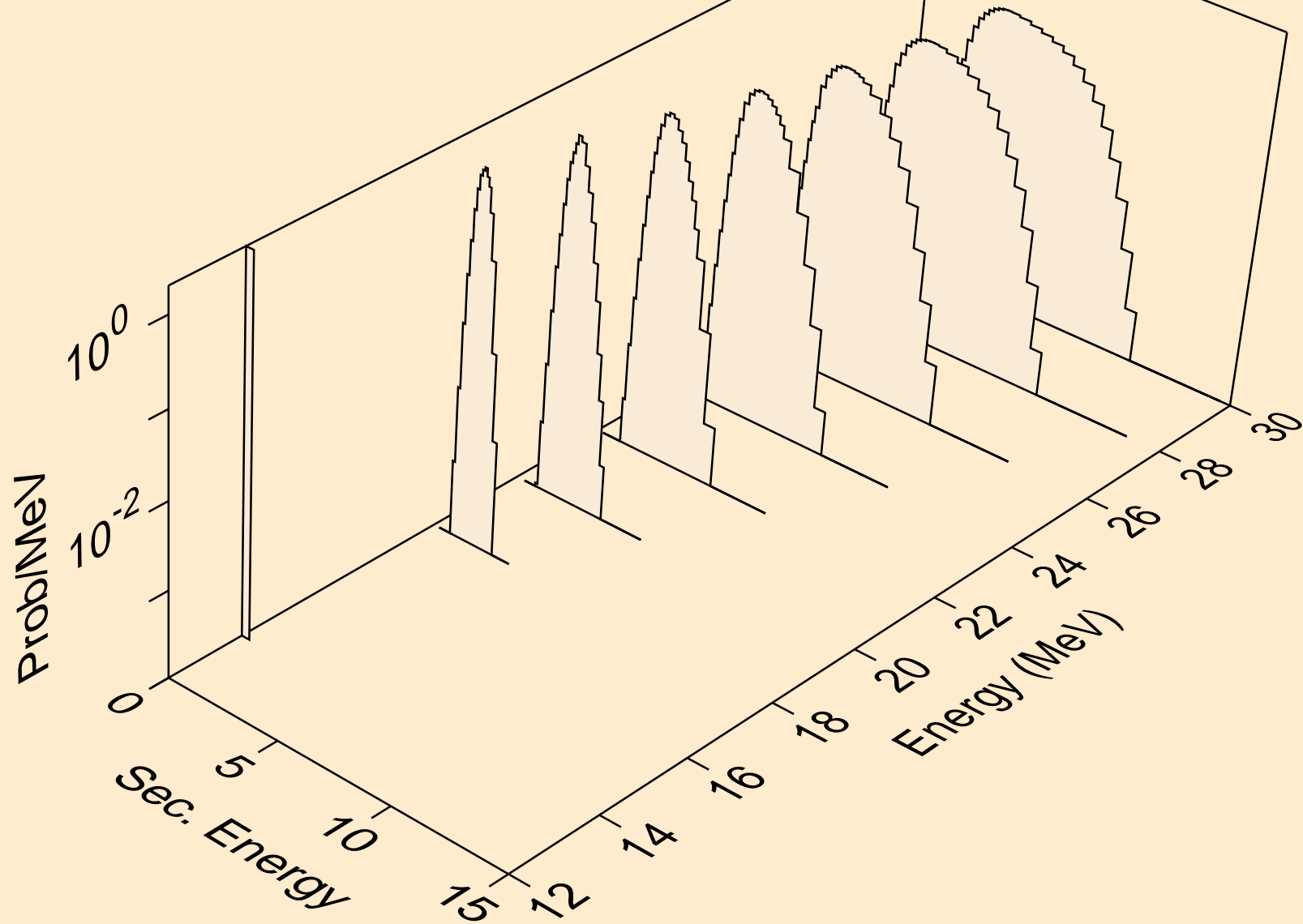

RU092 NEUTRON ACER TENDL-2024 LIBRARY; T=293.6K
deuterons from (n,x)

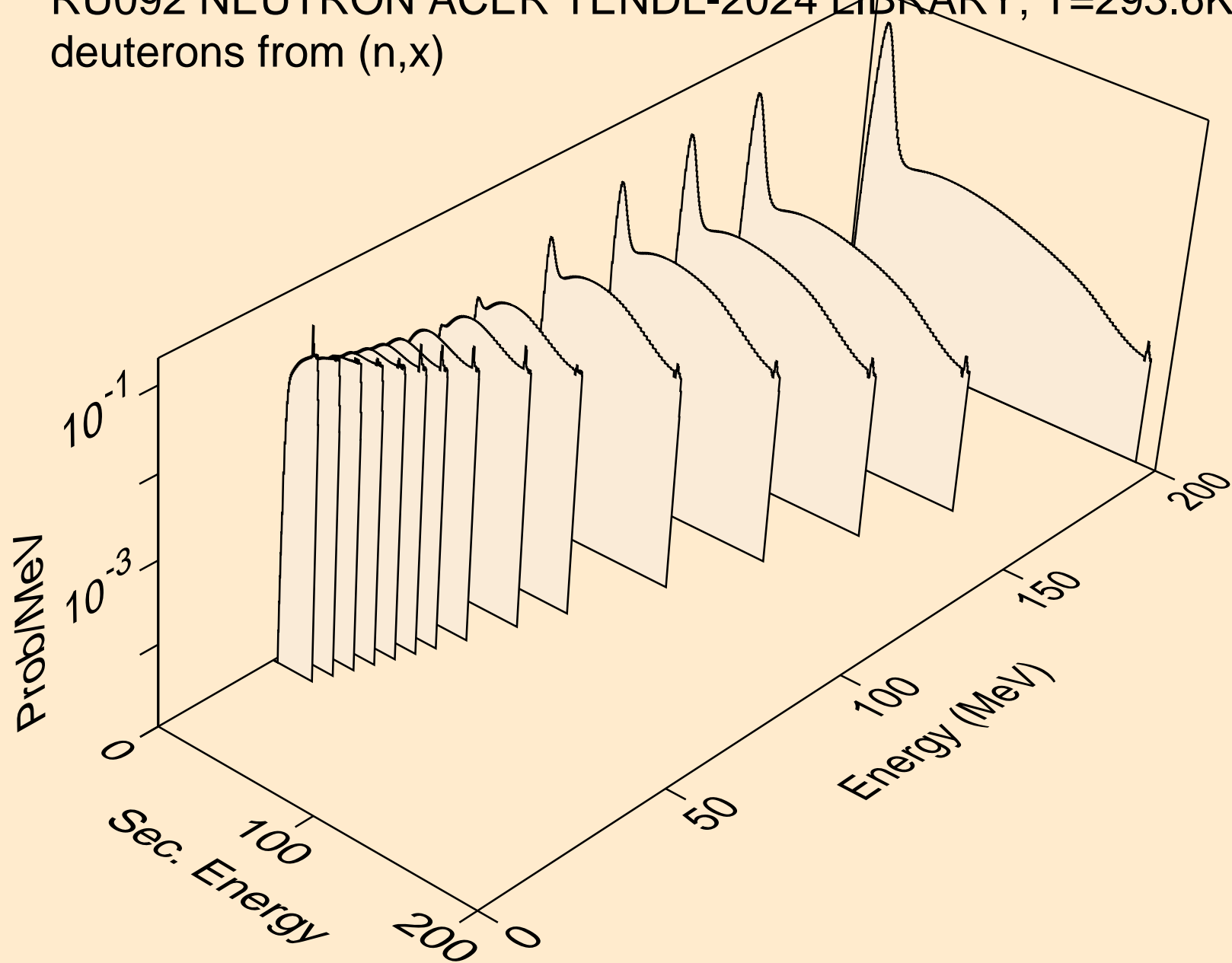

RU092 NEUTRON ACER TENDL-2024 LIBRARY; T=293.6K
deuterons from (n,n*)d

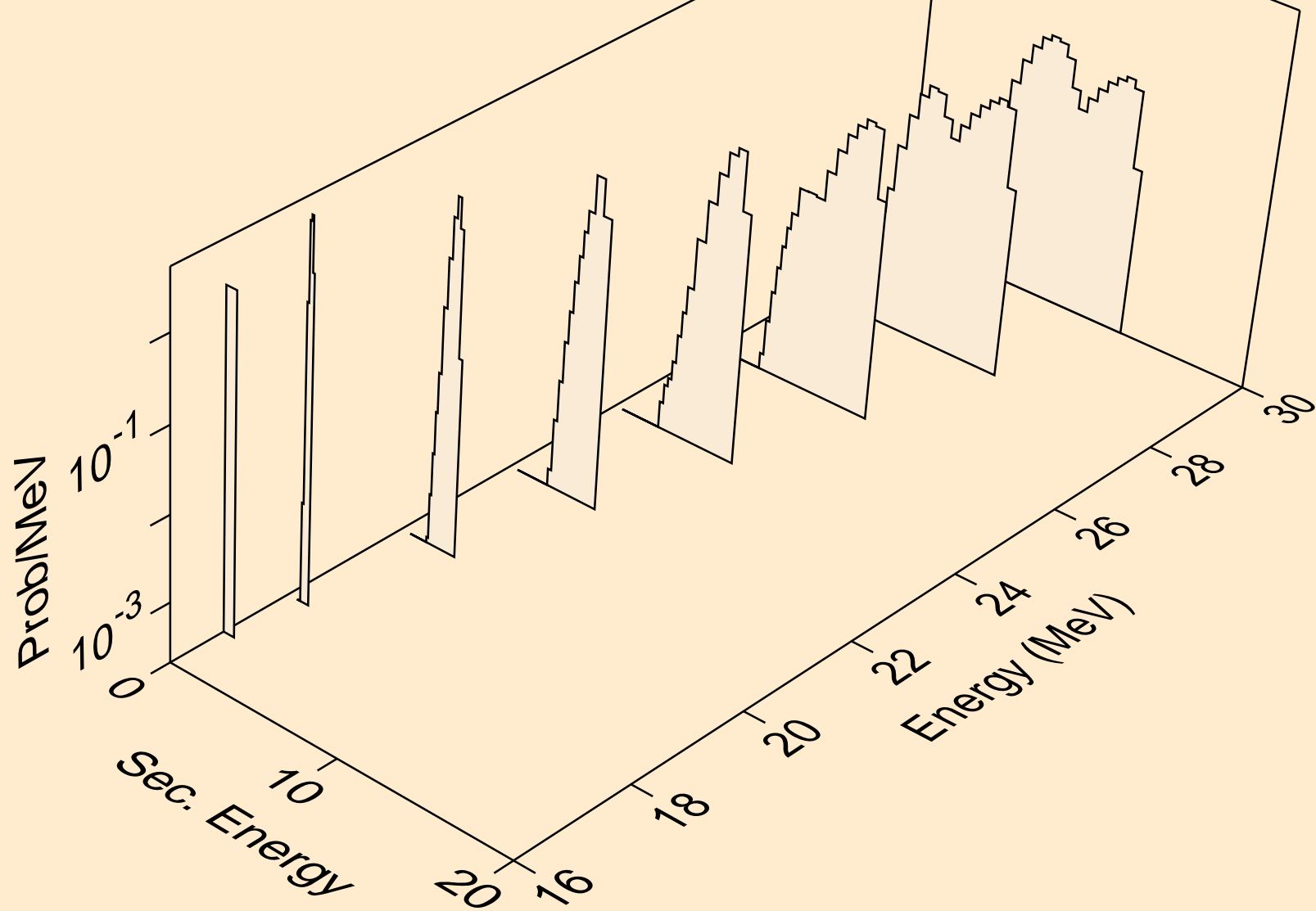

RU092 NEUTRON ACER TENDL-2024 LIBRARY; T=293.6K
deuterons from (n,d)

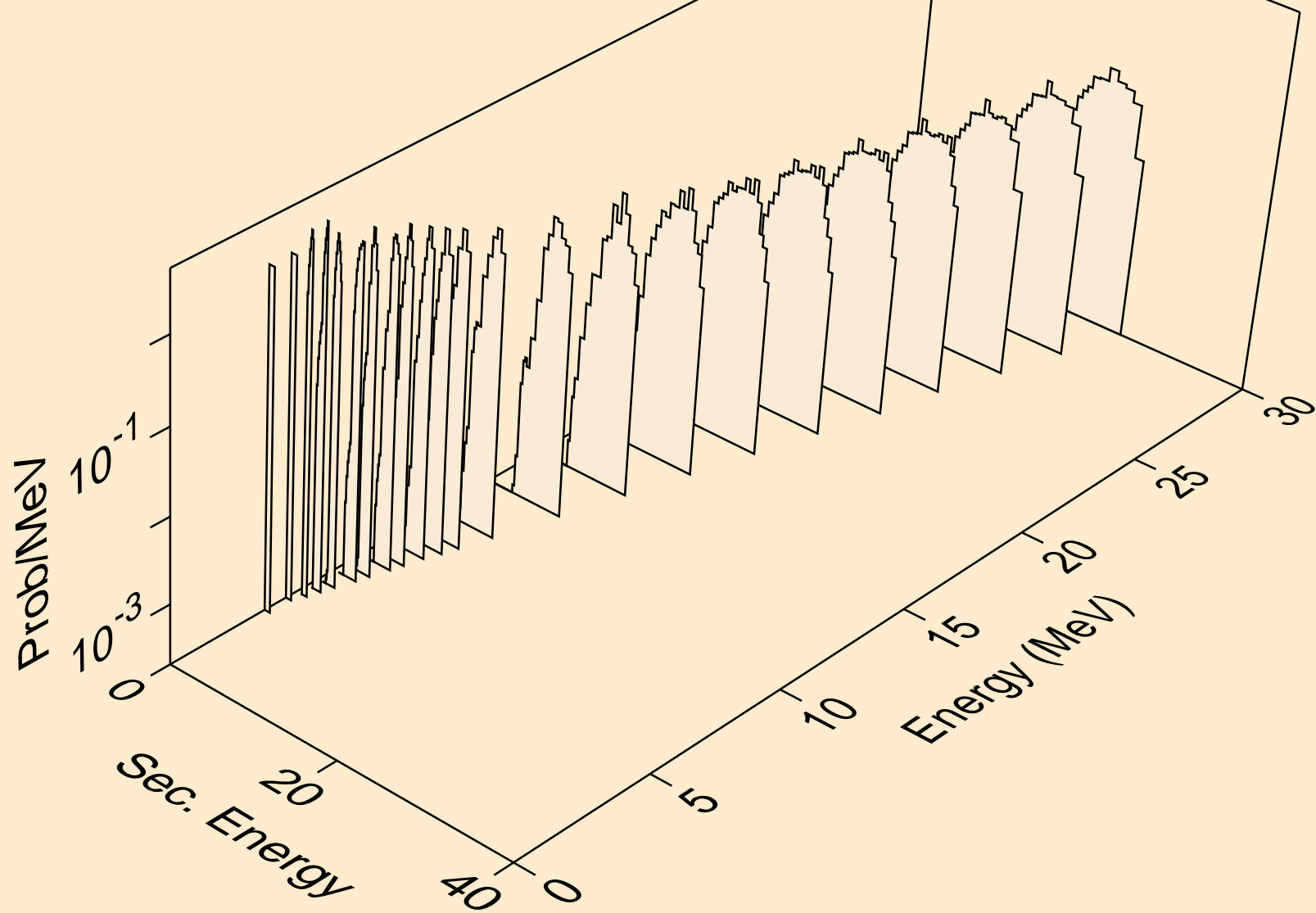

RU092 NEUTRON ACER TENDL-2024 LIBRARY; T=293.6K
deuterons from (n,pd)

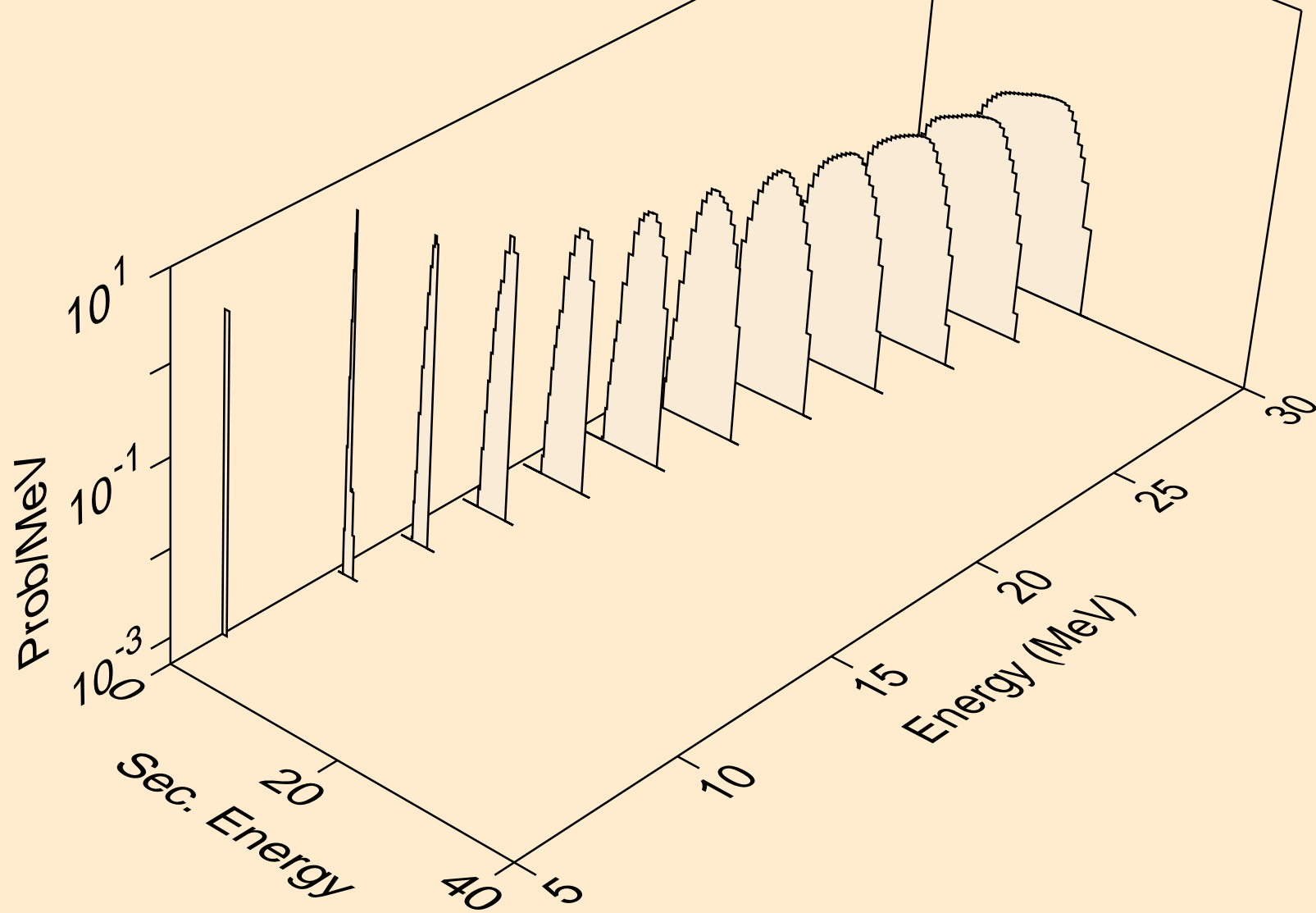

RU092 NEUTRON ACER TENDL-2024 LIBRARY; T=293.6K
deuterons from (n,da)

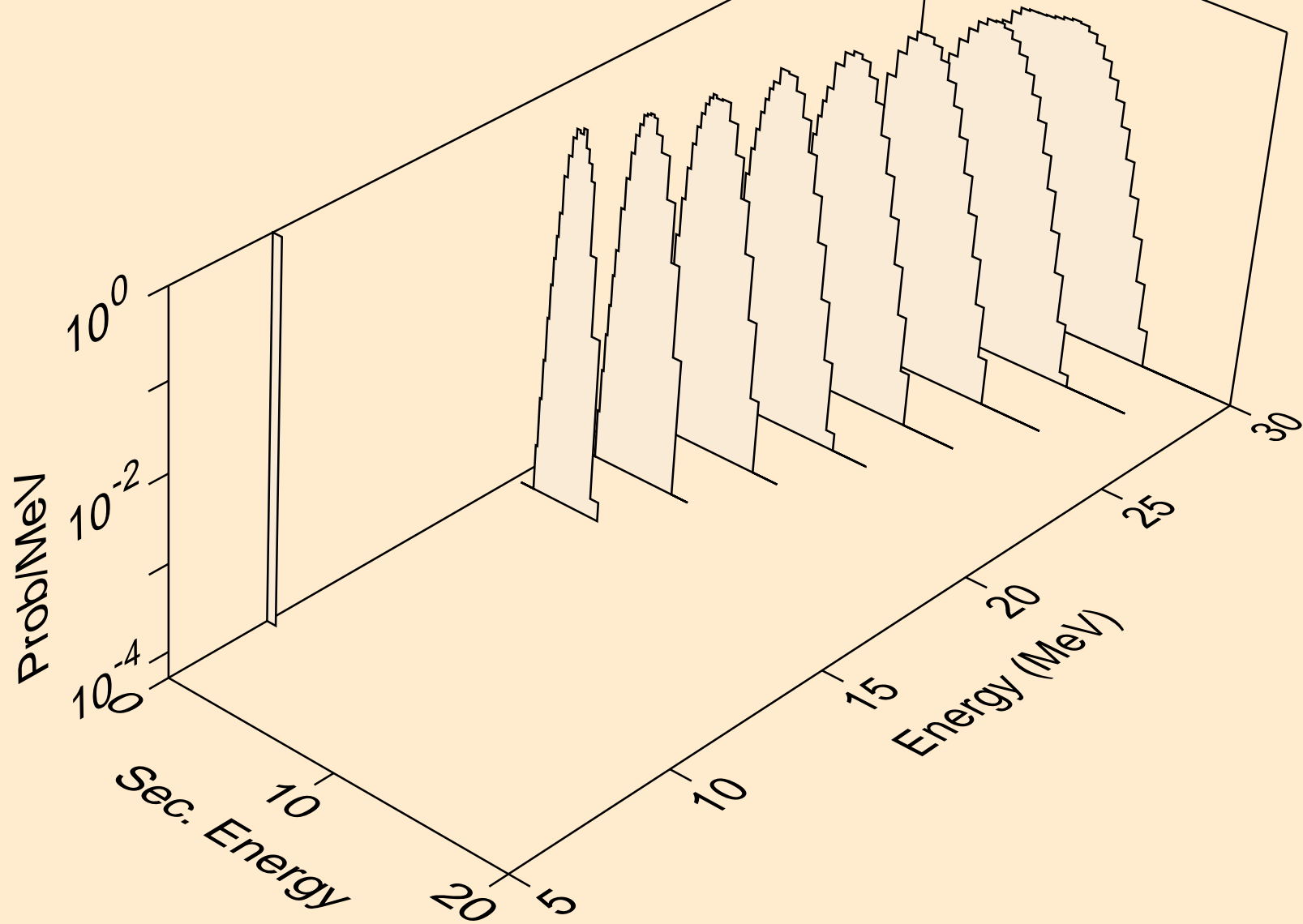

RU092 NEUTRON ACER TENDL-2024 LIBRARY; T=293.6K
tritons from (n,x)

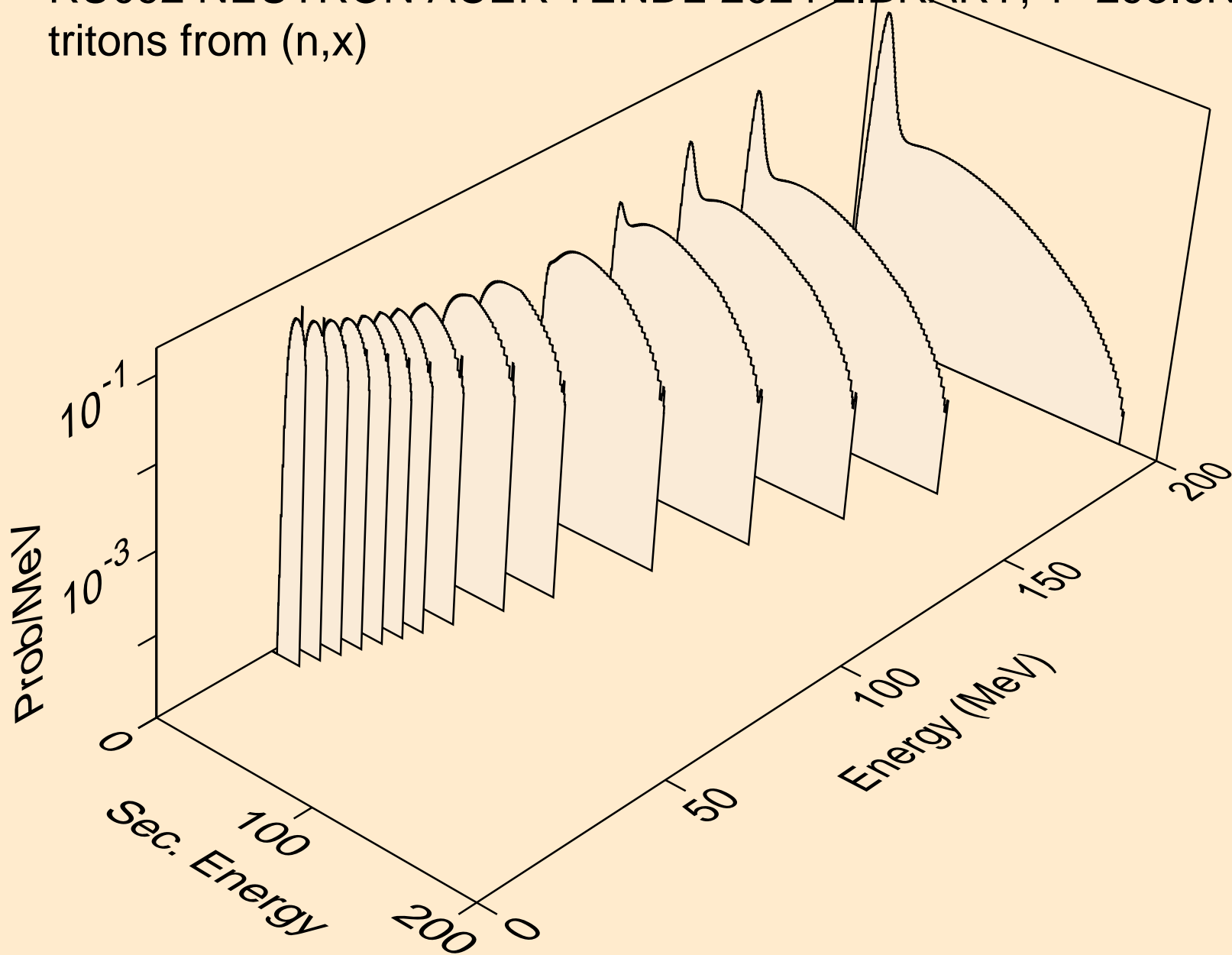

RU092 NEUTRON ACER TENDL-2024 LIBRARY; T=293.6K
tritons from (n,n*)t

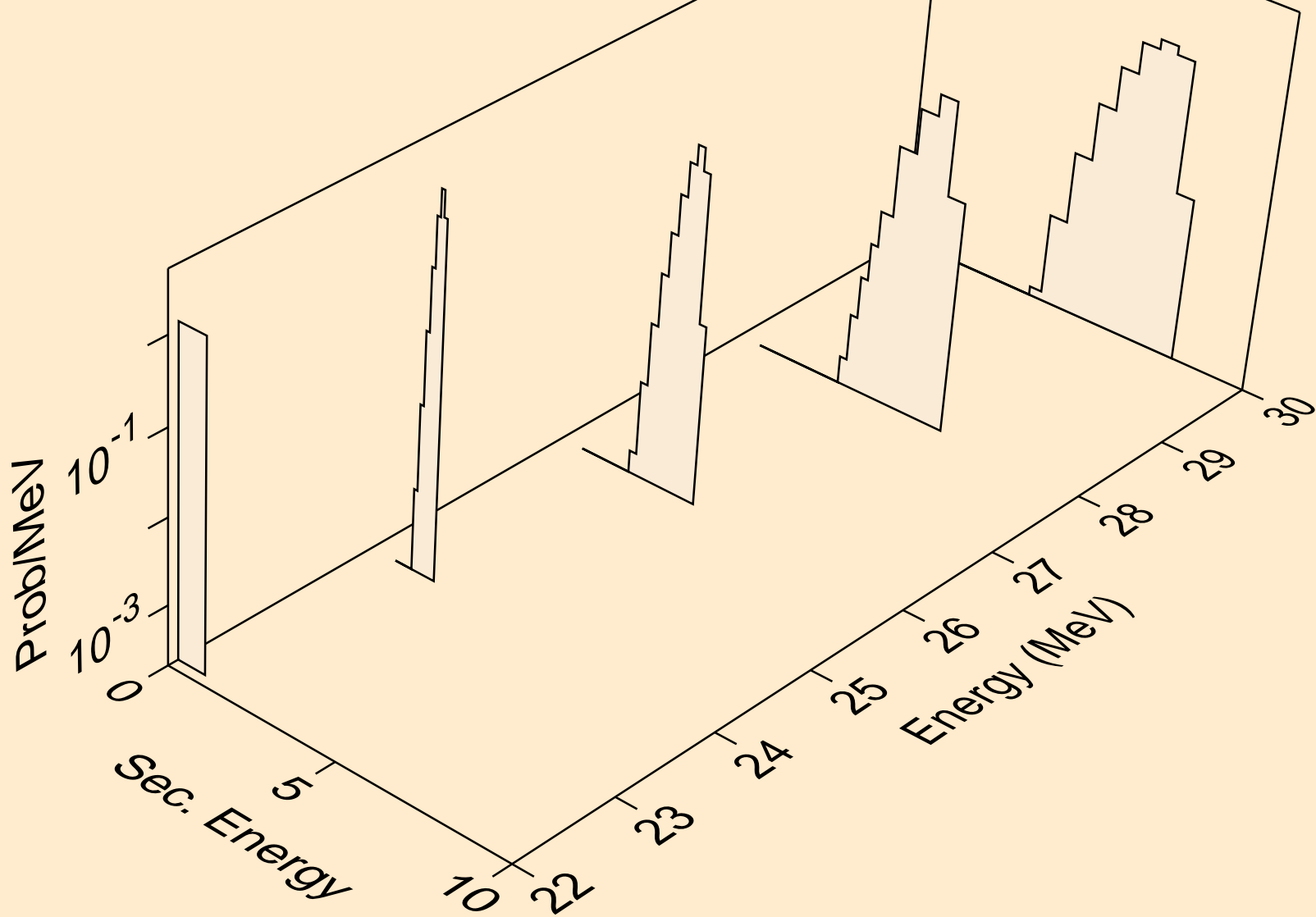

RU092 NEUTRON ACER TENDL-2024 LIBRARY; T=293.6K
tritons from (n,t)

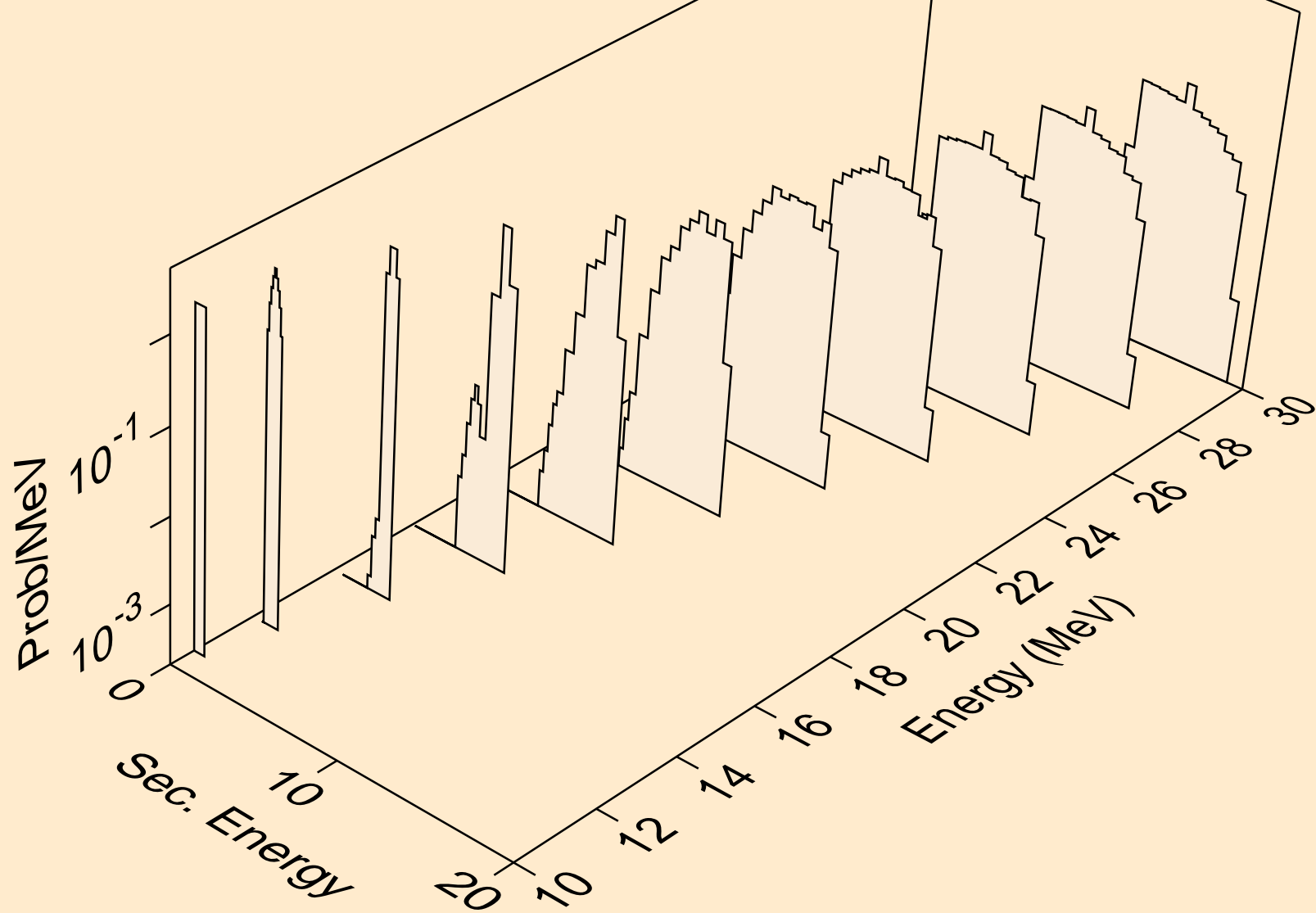

RU092 NEUTRON ACER TENDL-2024 LIBRARY; T=293.6K
tritons from (n,pt)

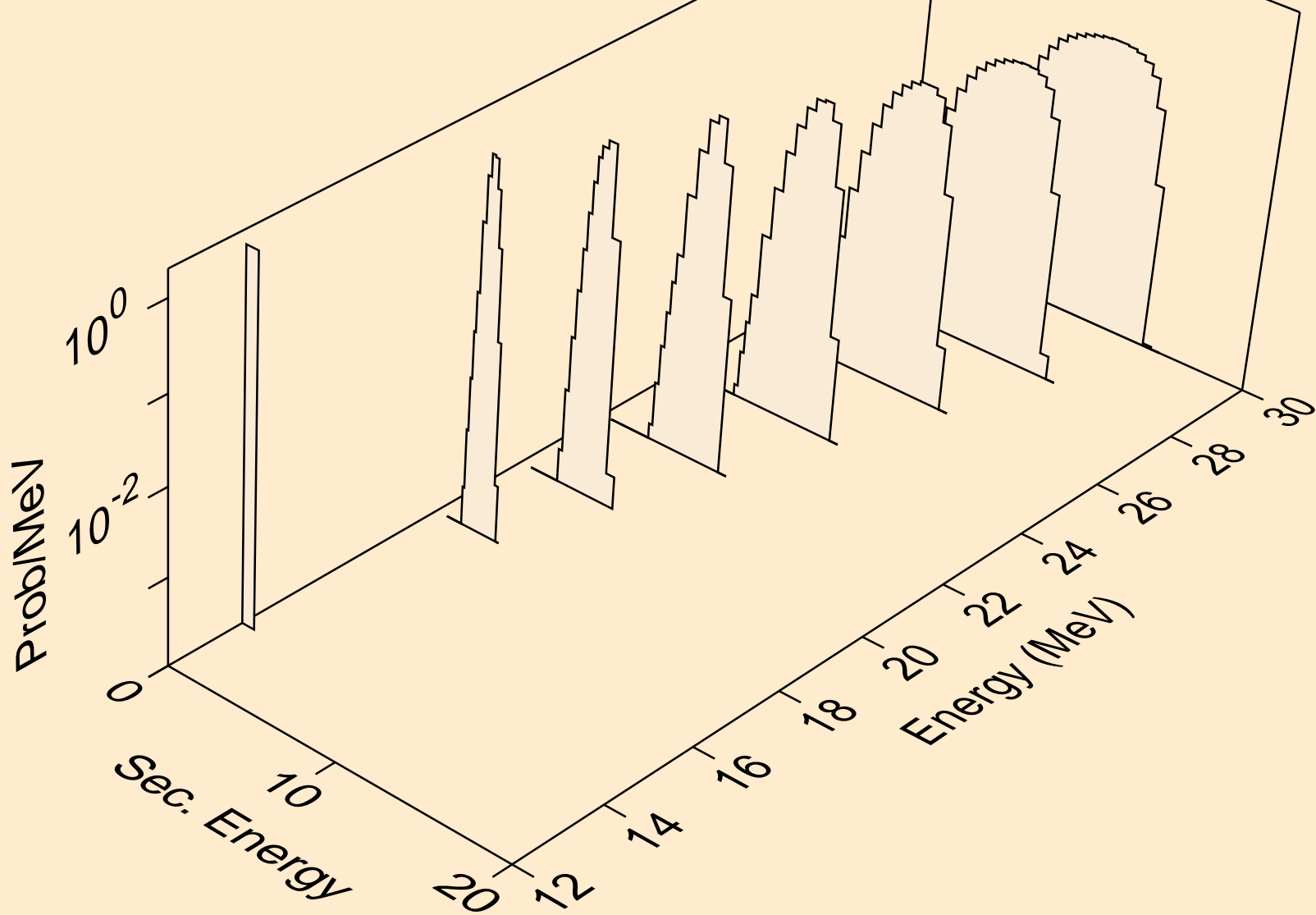

RU092 NEUTRON ACER TENDL-2024 LIBRARY; T=293.6K
he3s from (n,x)

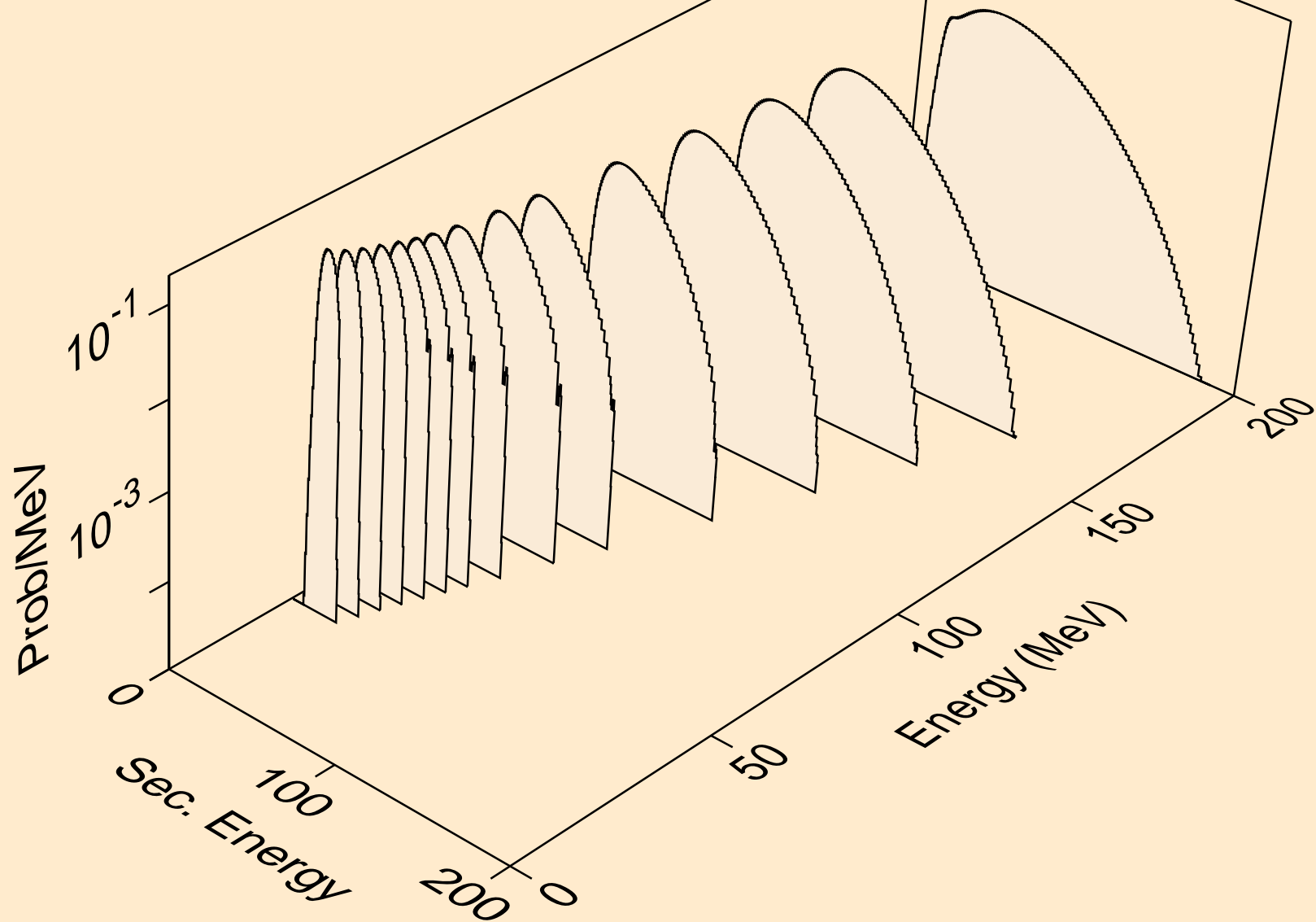

RU092 NEUTRON ACER TENDL-2024 LIBRARY; T=293.6K
he3s from (n,n*)he3

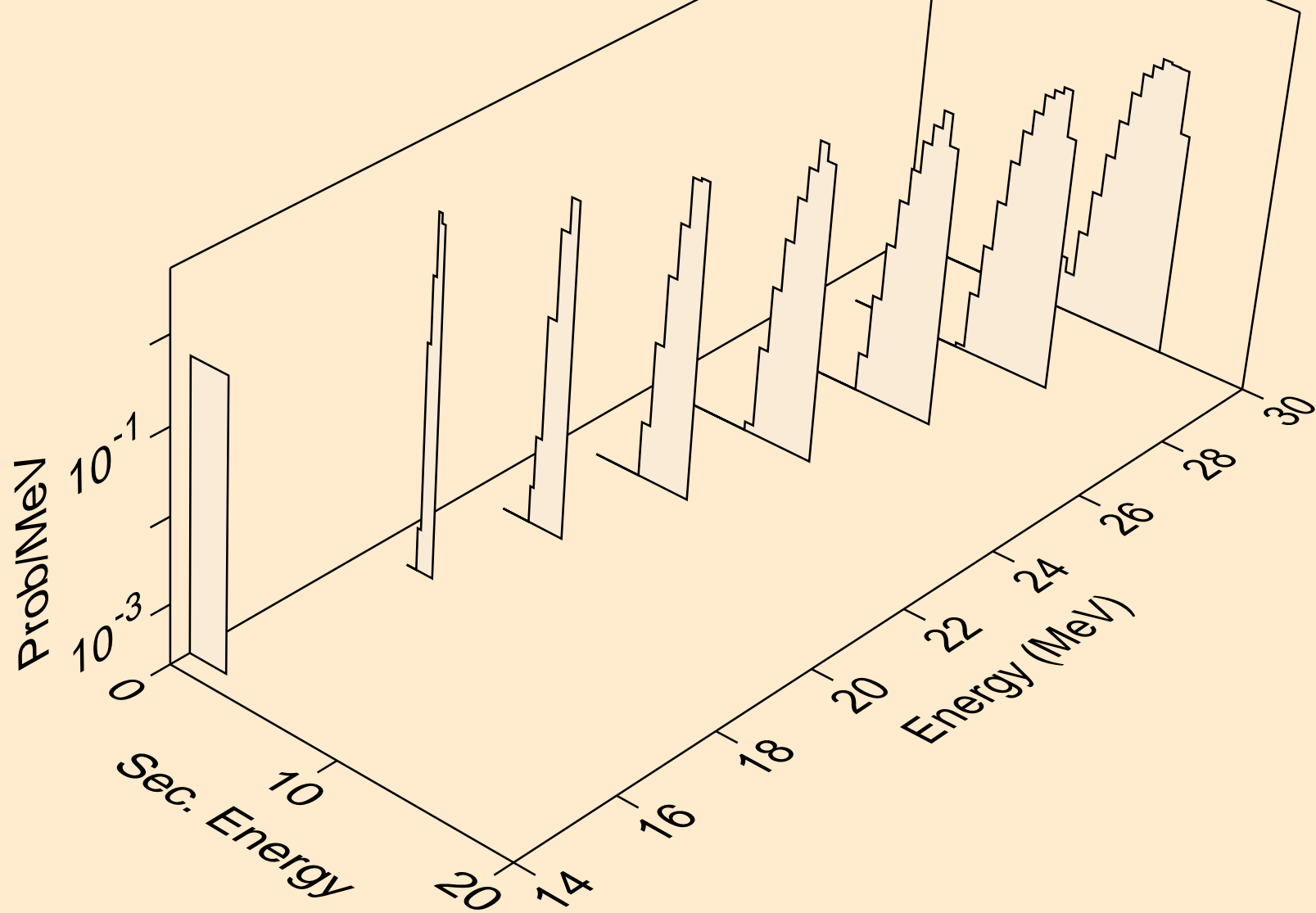

RU092 NEUTRON ACER TENDL-2024 LIBRARY; T=293.6K
he3s from (n,he3)

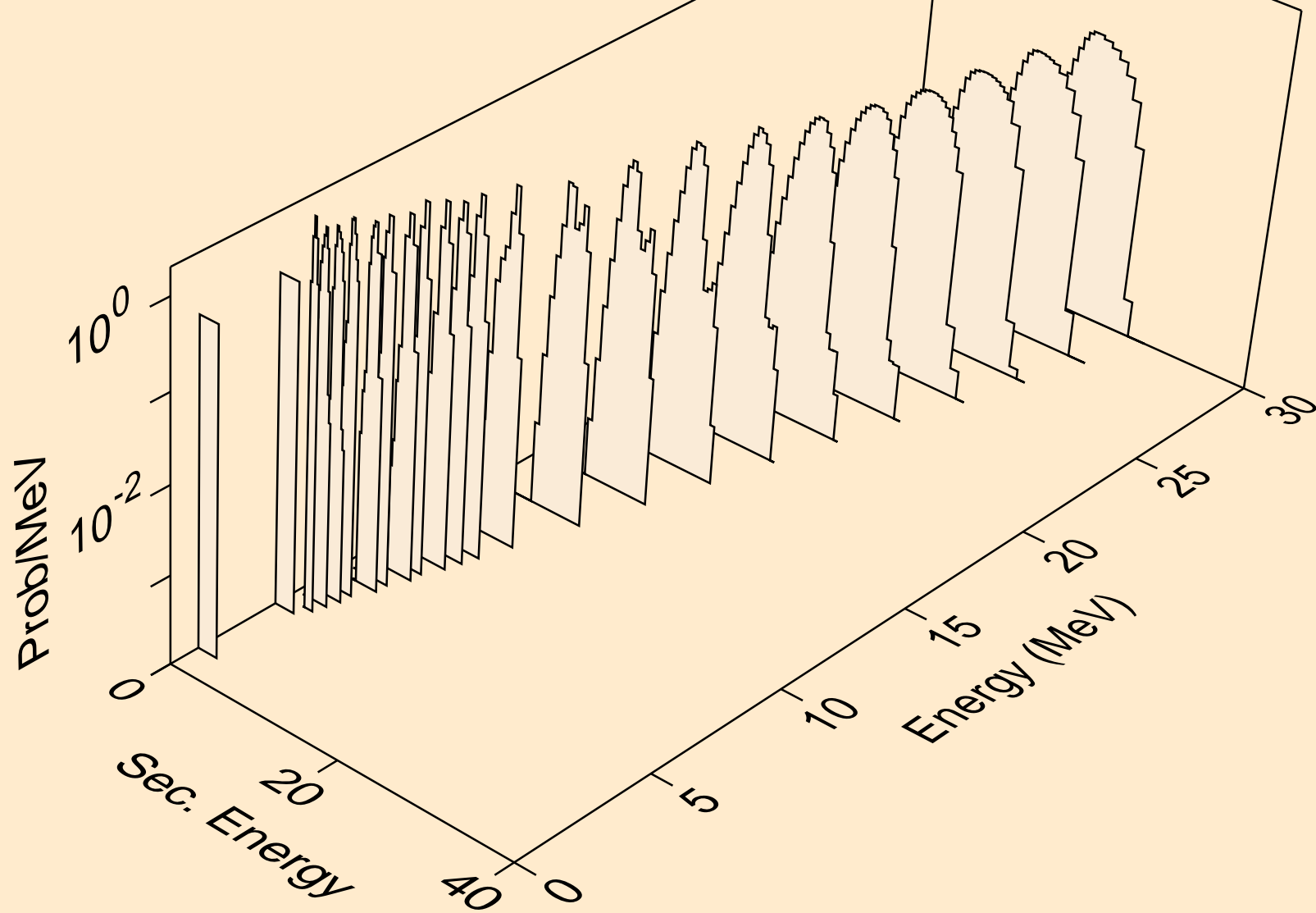

RU092 NEUTRON ACER TENDL-2024 LIBRARY; T=293.6K
alphas from (n,x)

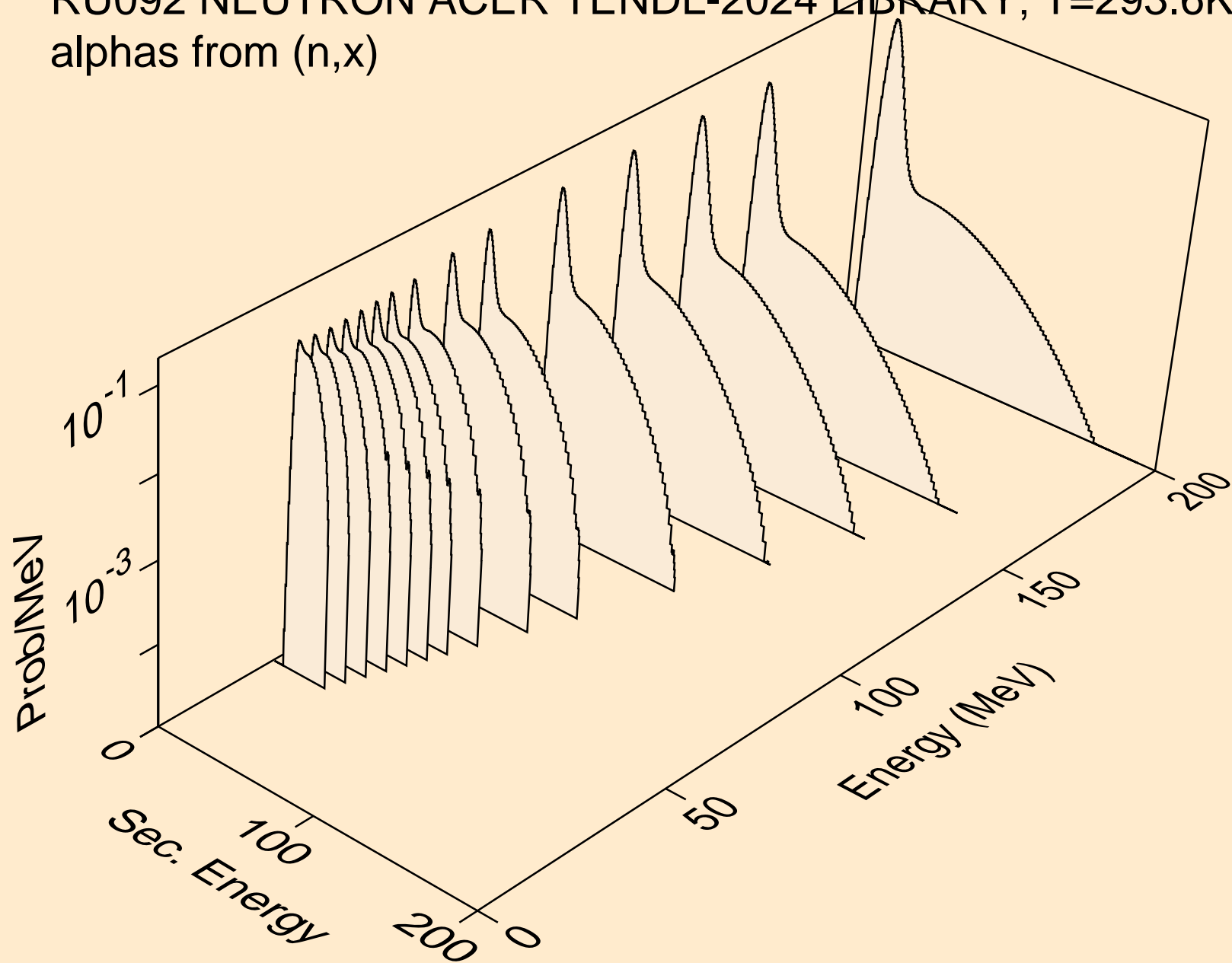

RU092 NEUTRON ACER TENDL-2024 LIBRARY; T=293.6K
alphas from (n,n*)a

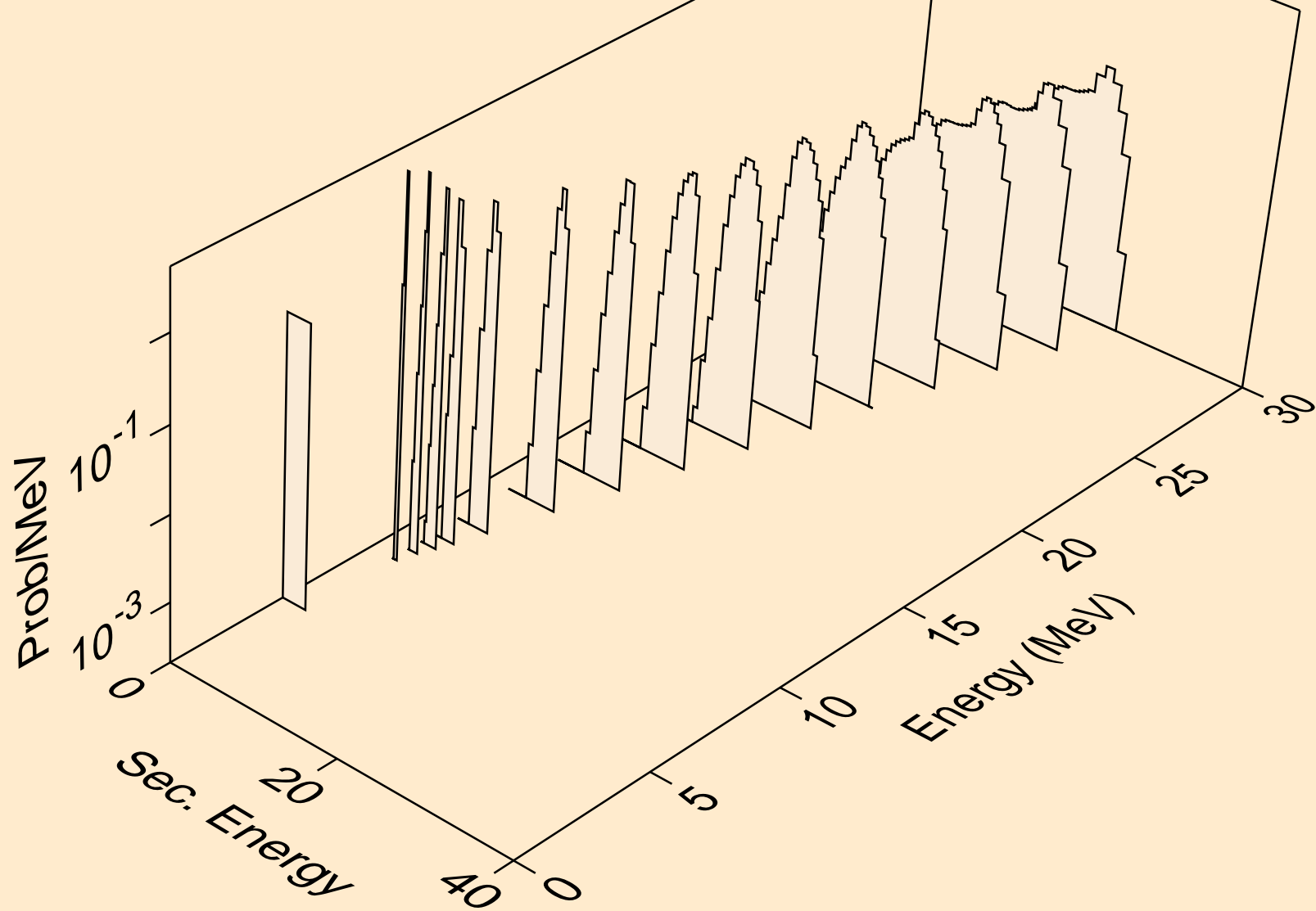

RU092 NEUTRON ACER TENDL-2024 LIBRARY; T=293.6K
alphas from (n,2n)a

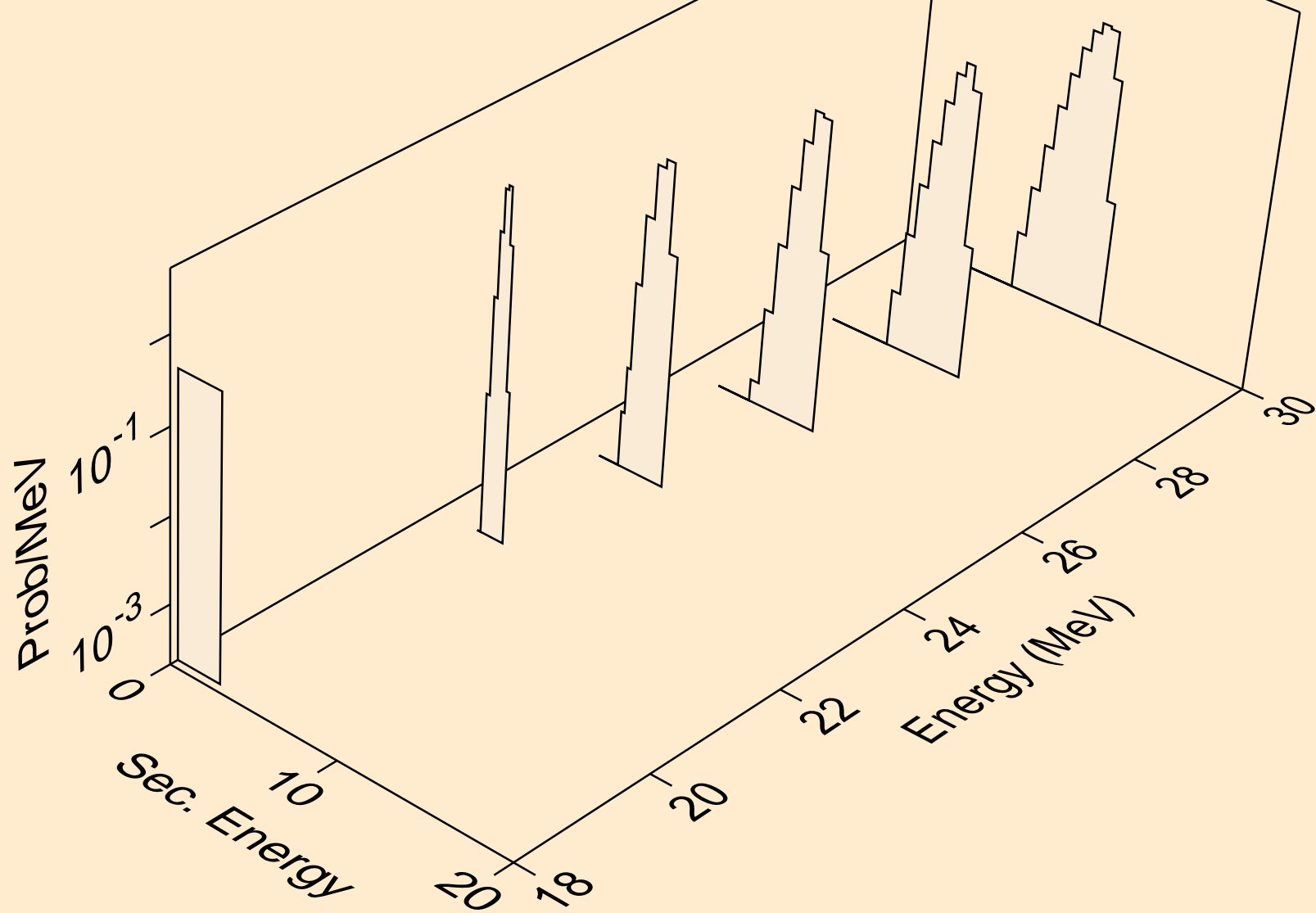

RU092 NEUTRON ACER TENDL-2024 LIBRARY; T=293.6K
alphas from (n,n*)2a

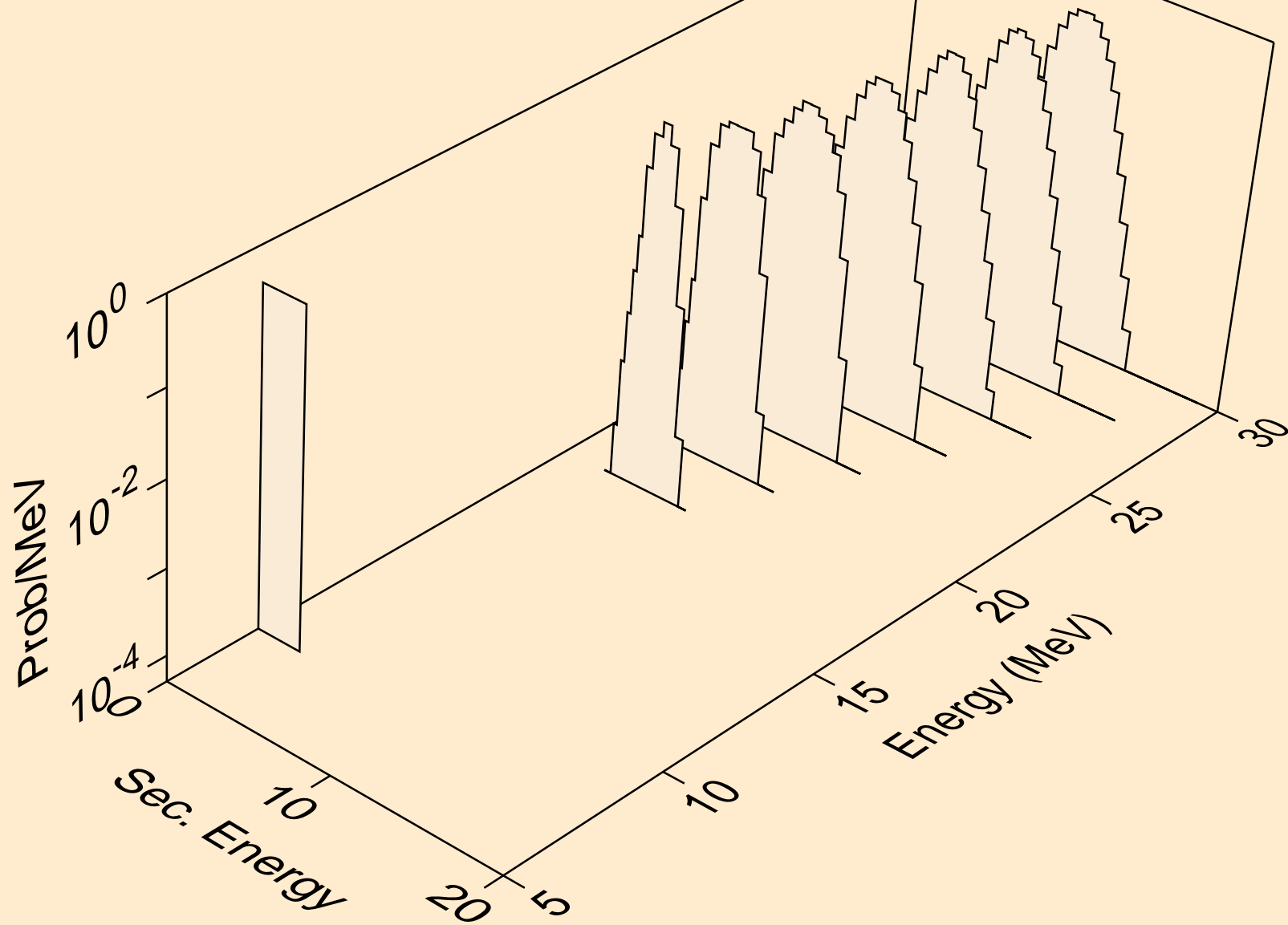

RU092 NEUTRON ACER TENDL-2024 LIBRARY; T=293.6K
alphas from (n,npa)

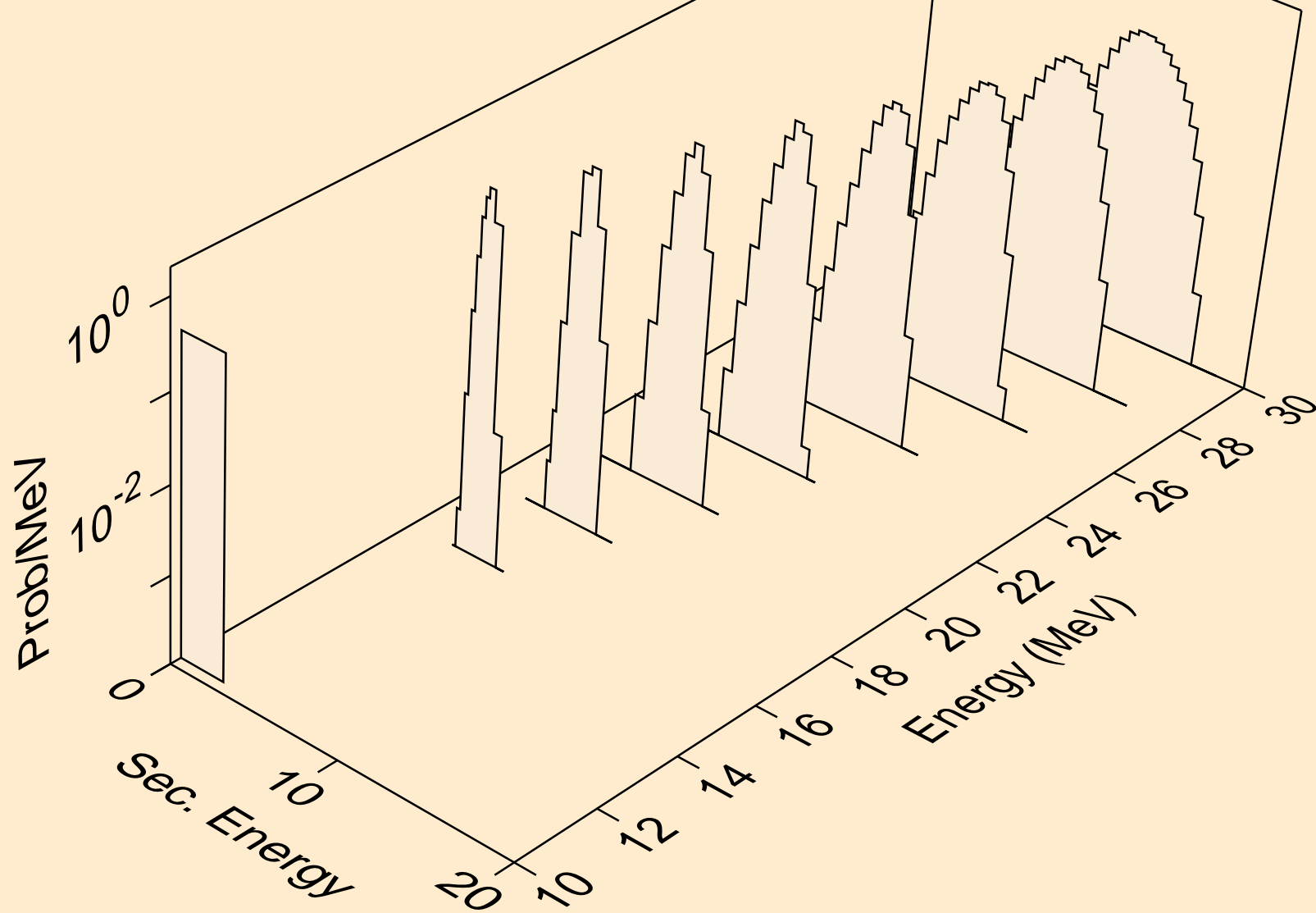

RU092 NEUTRON ACER TENDL-2024 LIBRARY; T=293.6K
alphas from (n,a)

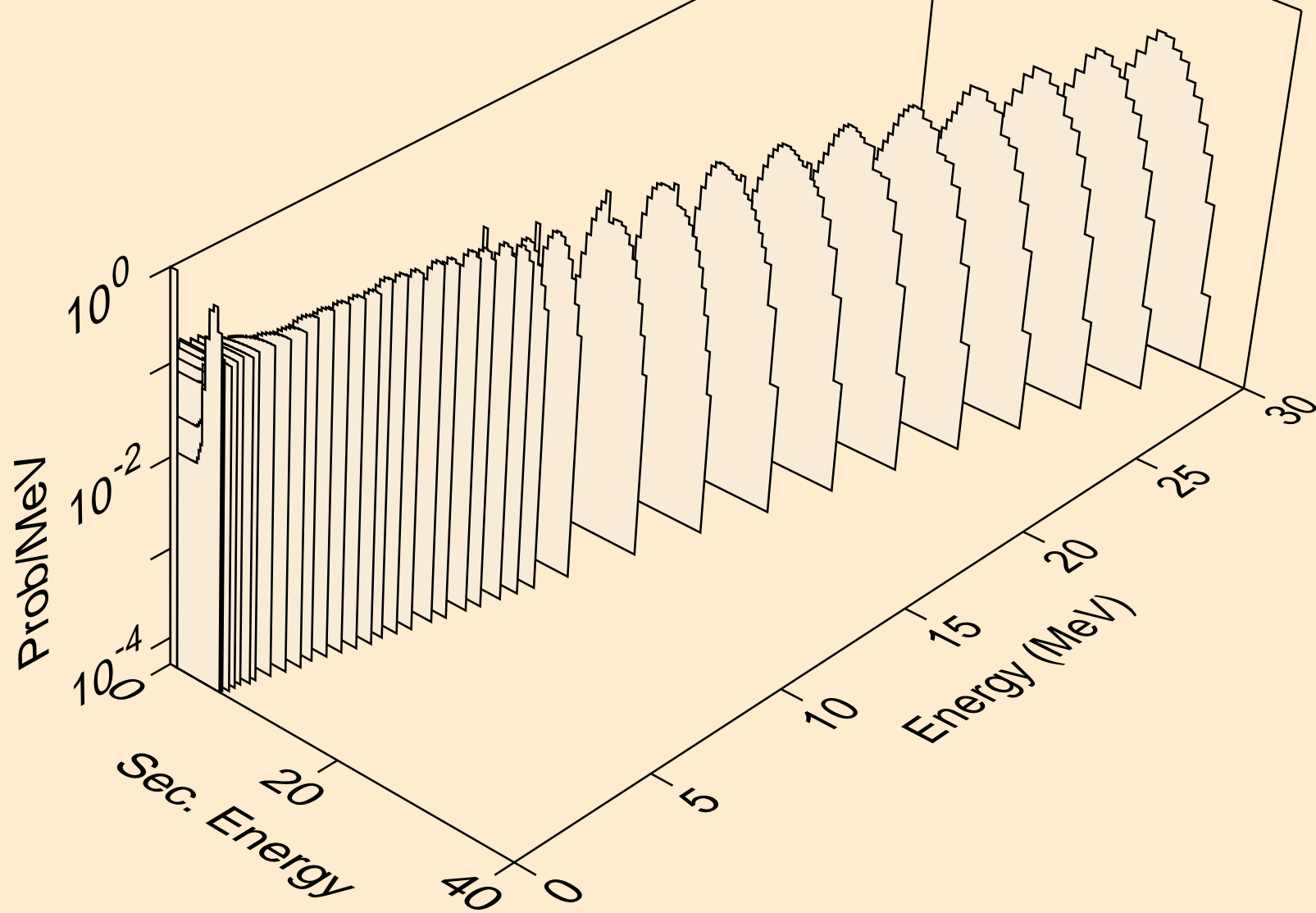

RU092 NEUTRON ACER TENDL-2024 LIBRARY; T=293.6K
alphas from (n,2a)

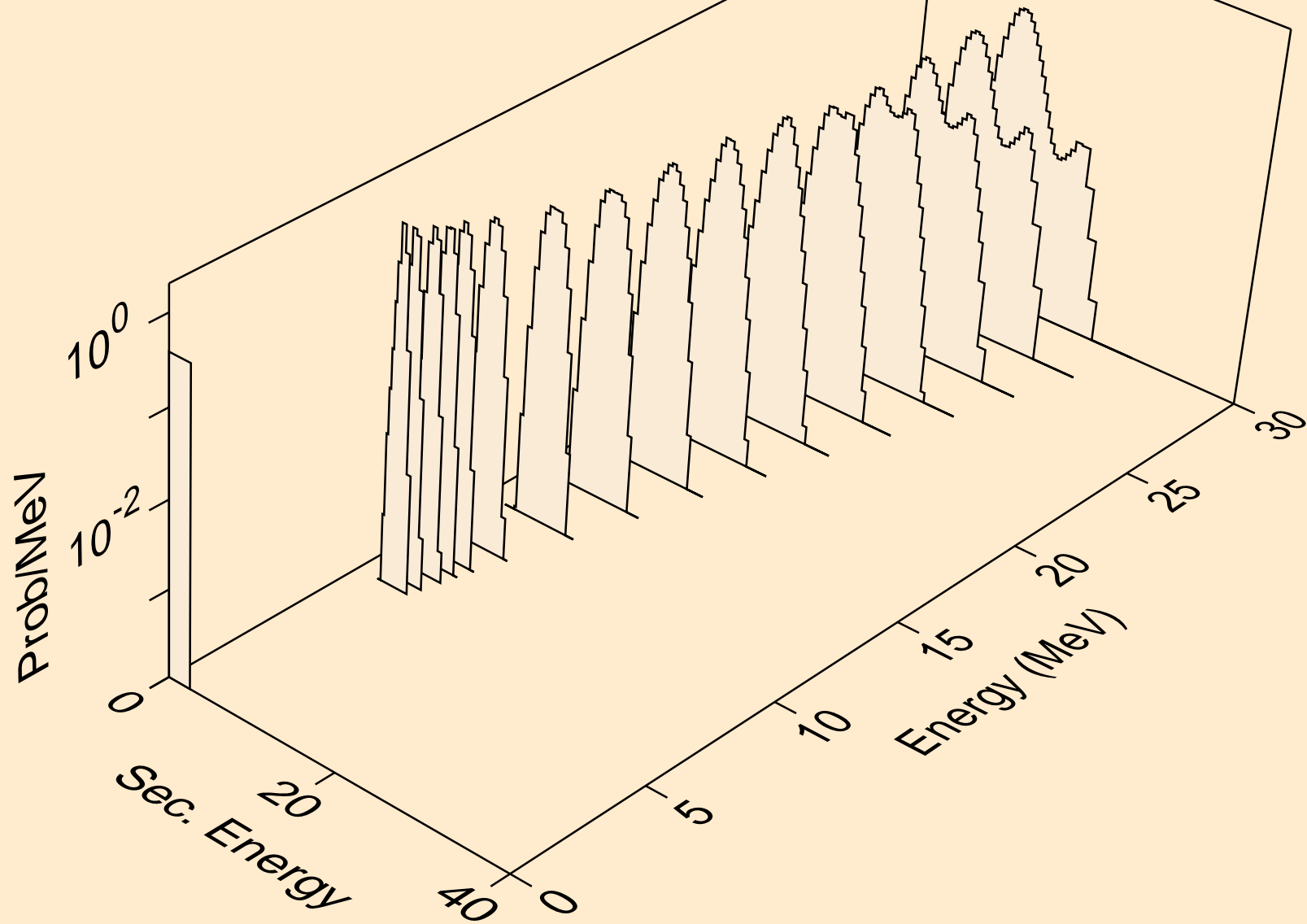

RU092 NEUTRON ACER TENDL-2024 LIBRARY; T=293.6K
alphas from (n,3a)

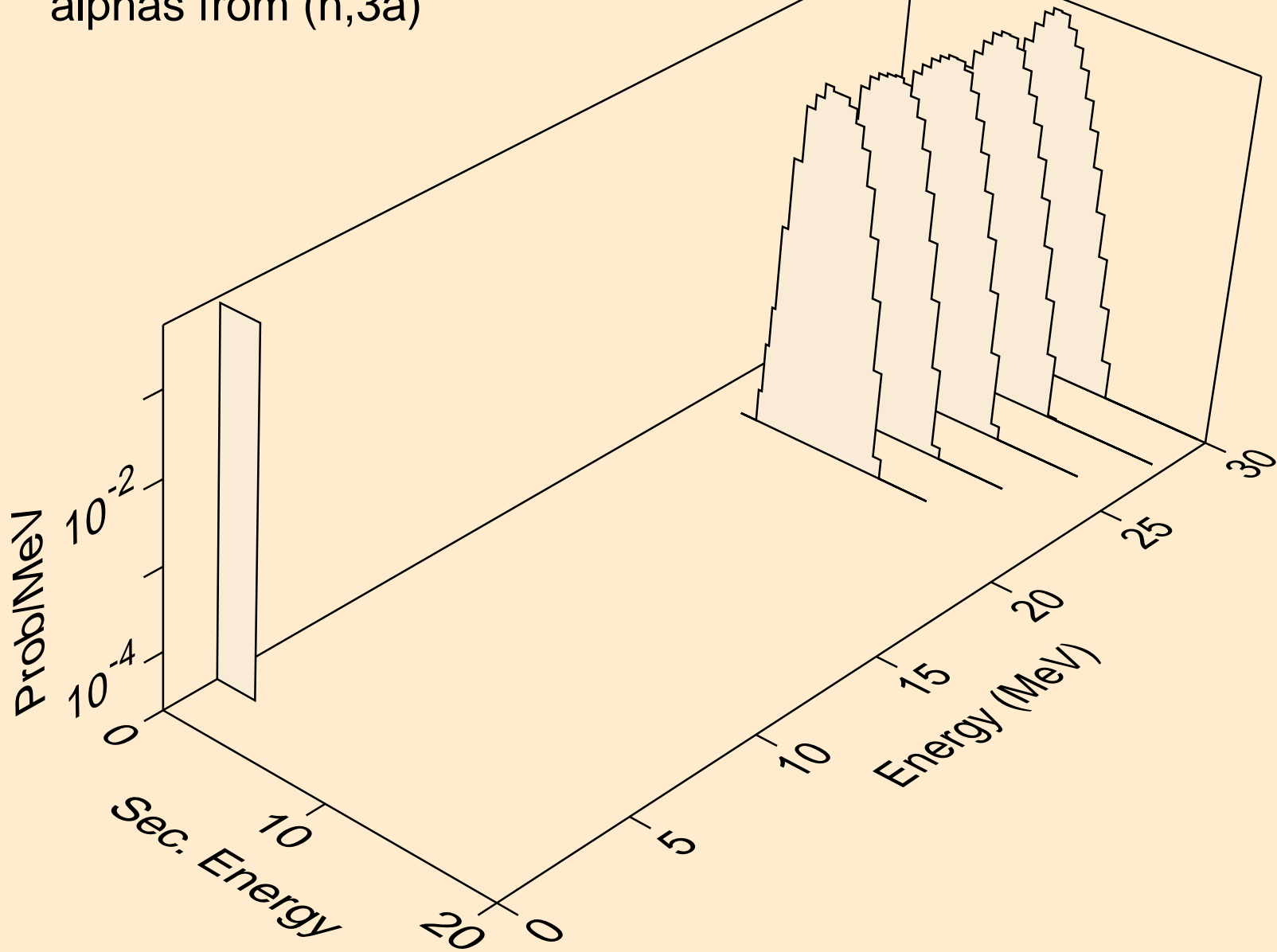

RU092 NEUTRON ACER TENDL-2024 LIBRARY; T=293.6K
alphas from (n,pa)

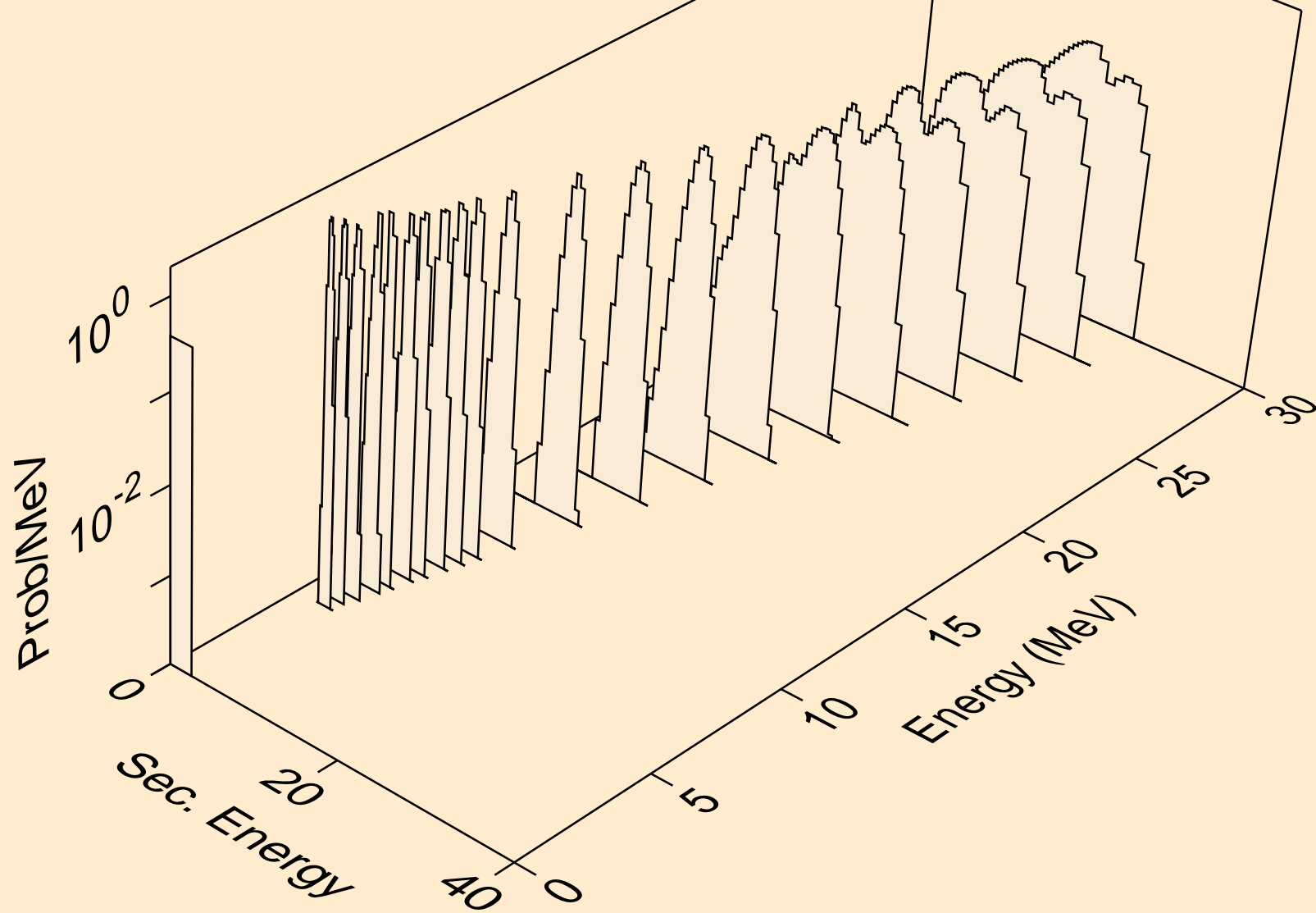

RU092 NEUTRON ACER TENDL-2024 LIBRARY; T=293.6K
alphas from (n,da)

