

SB108 NEUTRON ACER TENDL-2024 LIBRARY; T=293.6K

Principal cross sections

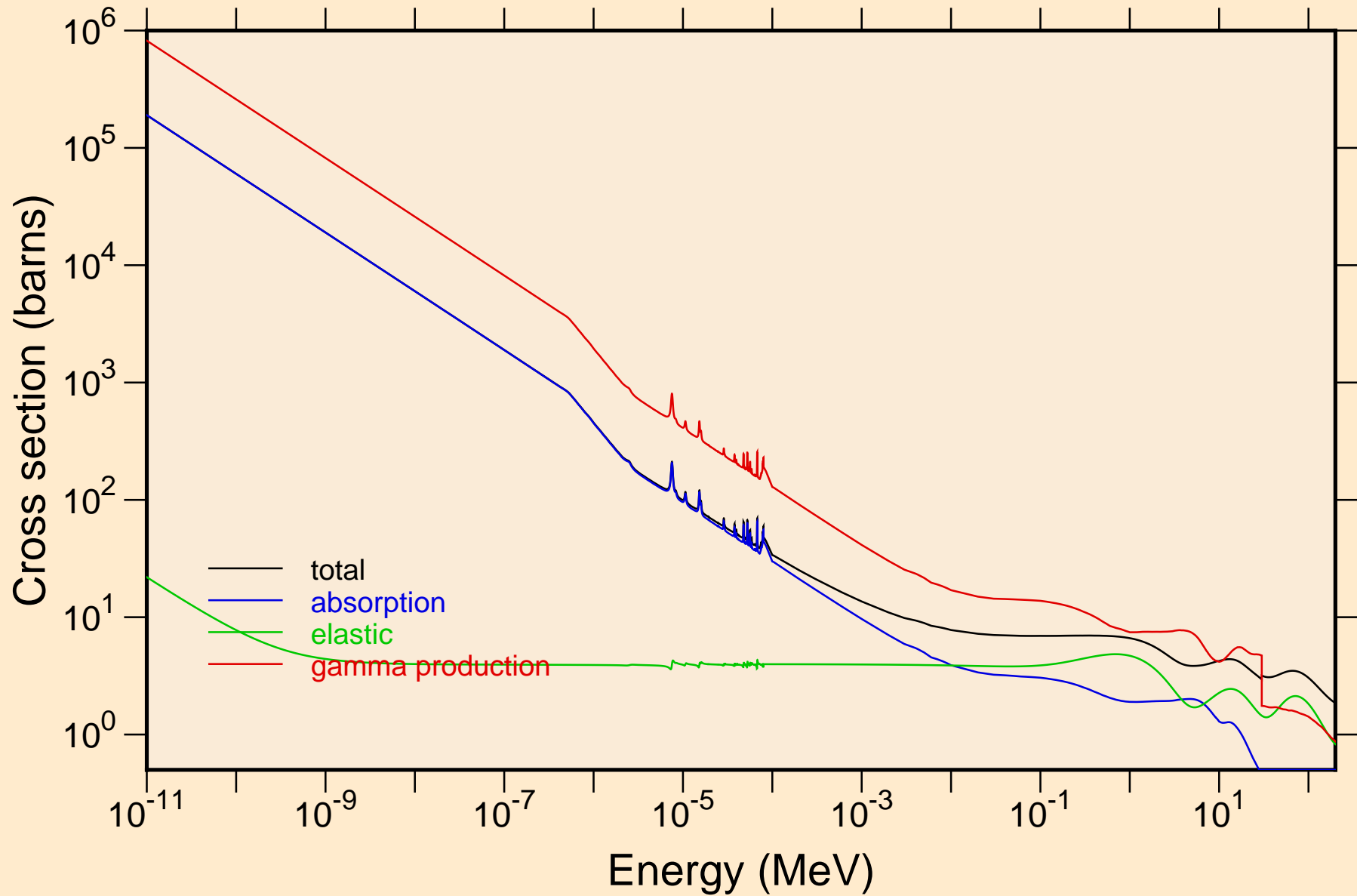

SB108 NEUTRON ACER TENDL-2024 LIBRARY; T=293.6K
resonance total cross section

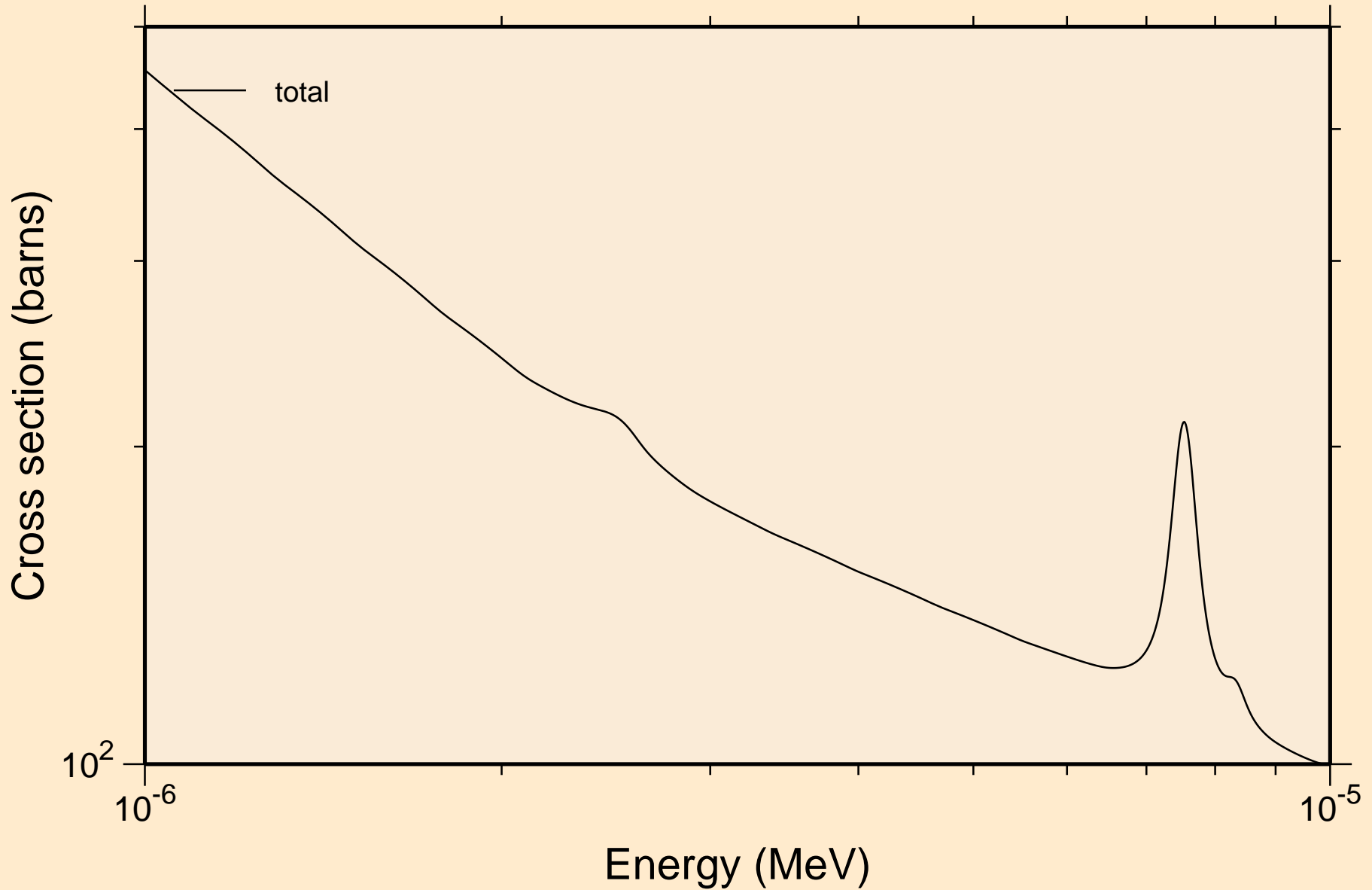

SB108 NEUTRON ACER TENDL-2024 LIBRARY; T=293.6K
resonance total cross section

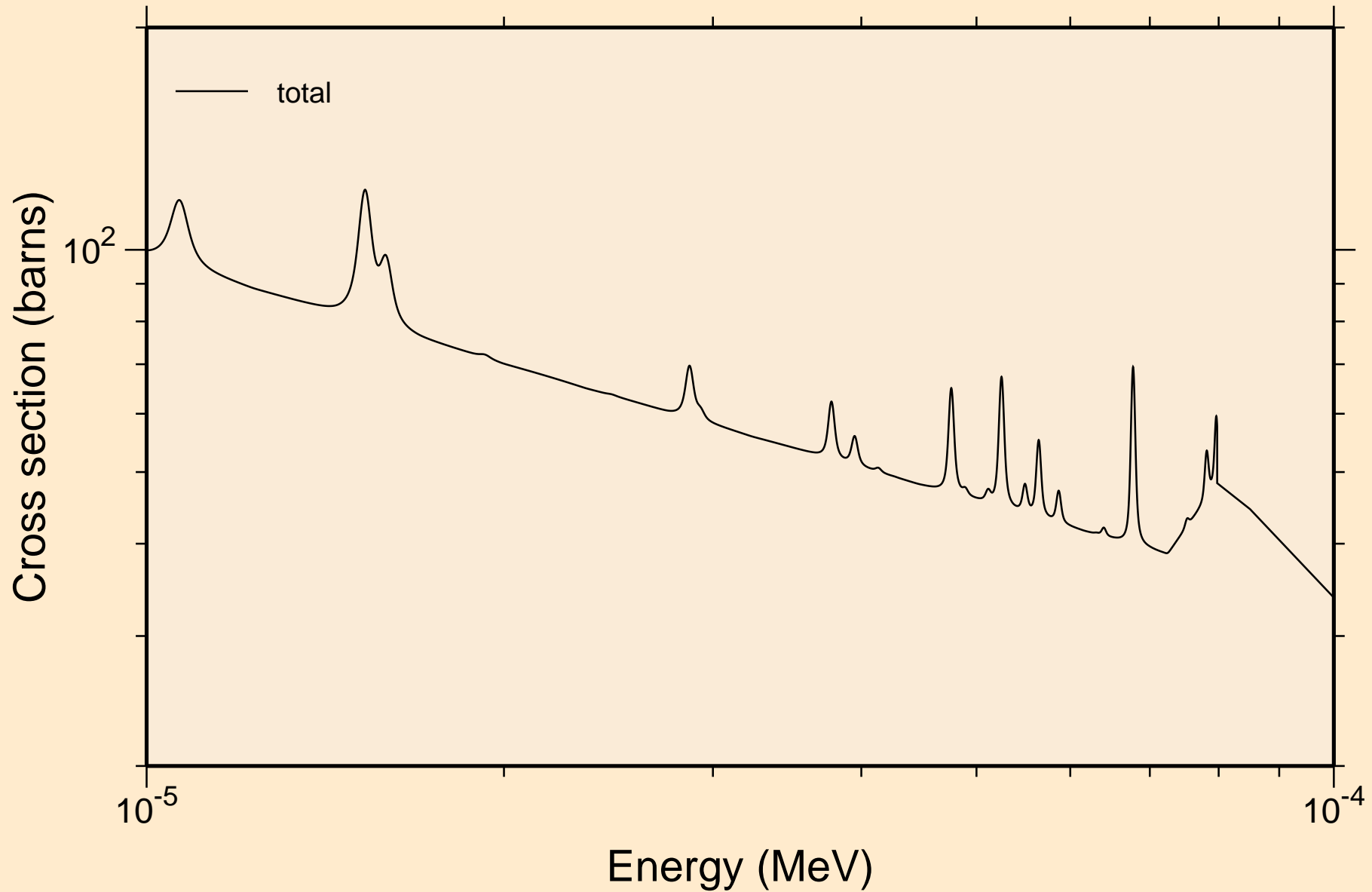

SB108 NEUTRON ACER TENDL-2024 LIBRARY; T=293.6K
resonance total cross section

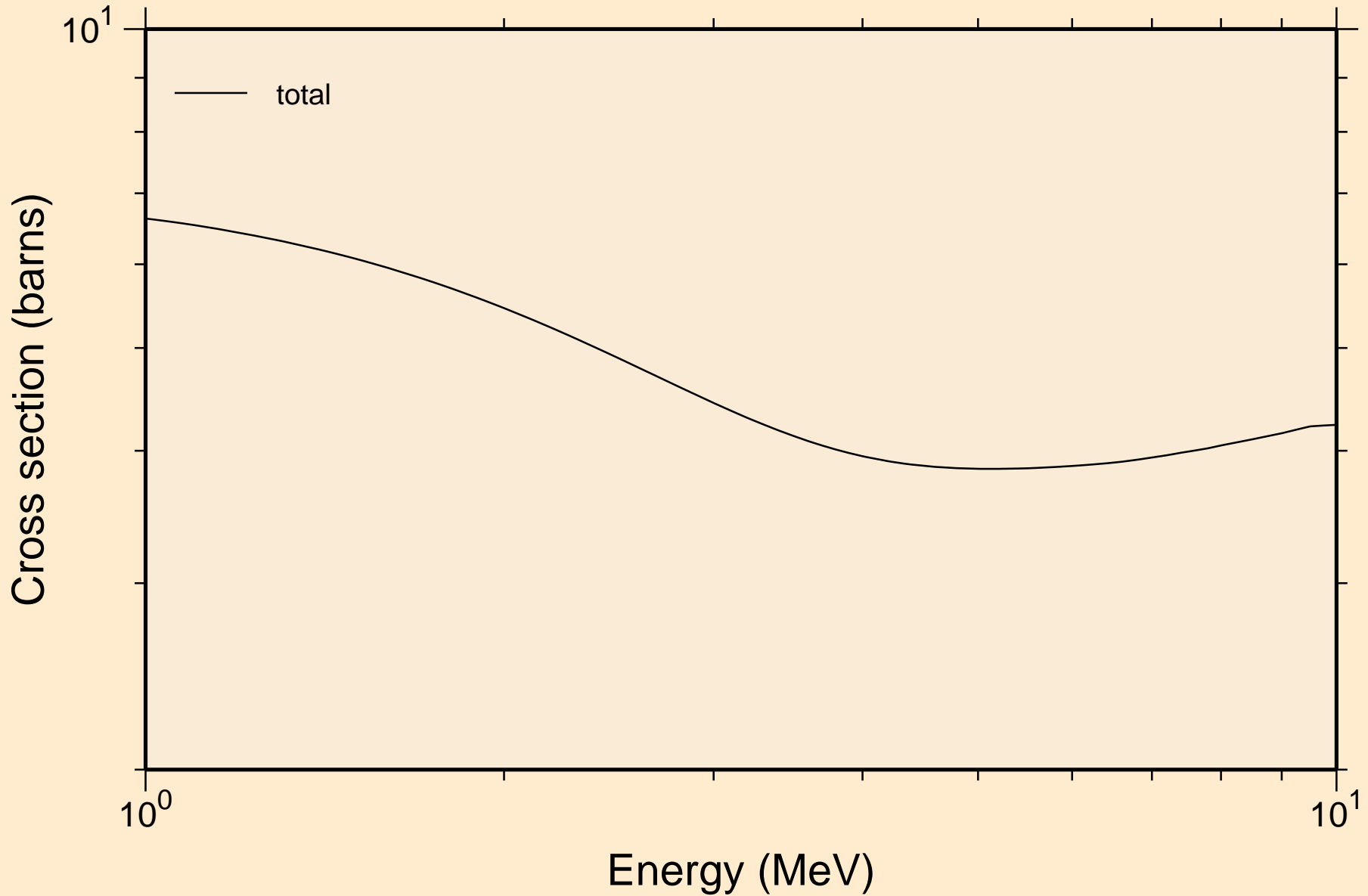

SB108 NEUTRON ACER TENDL-2024 LIBRARY; T=293.6K
resonance absorption cross sections

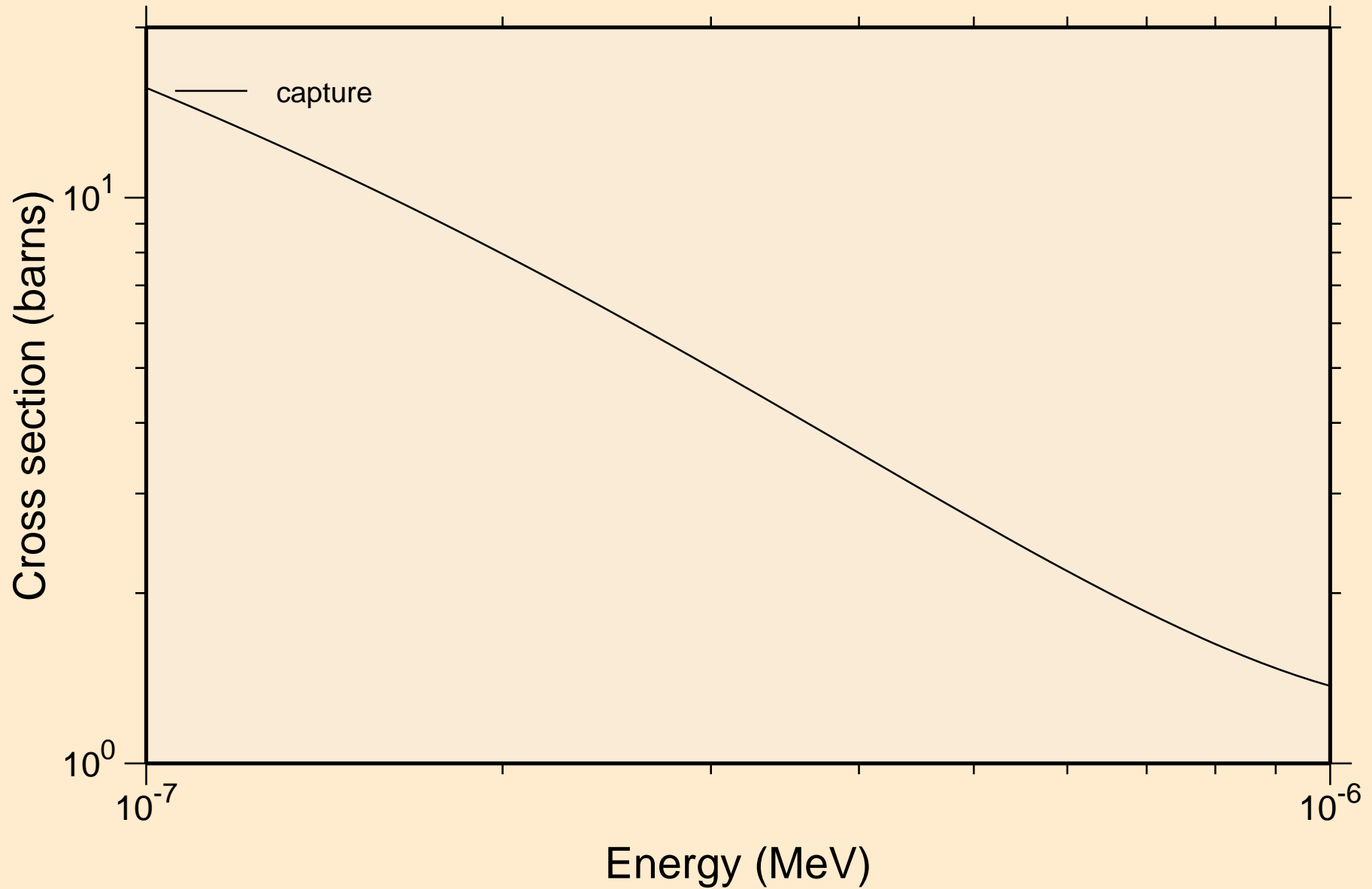

SB108 NEUTRON ACER TENDL-2024 LIBRARY; T=293.6K
resonance absorption cross sections

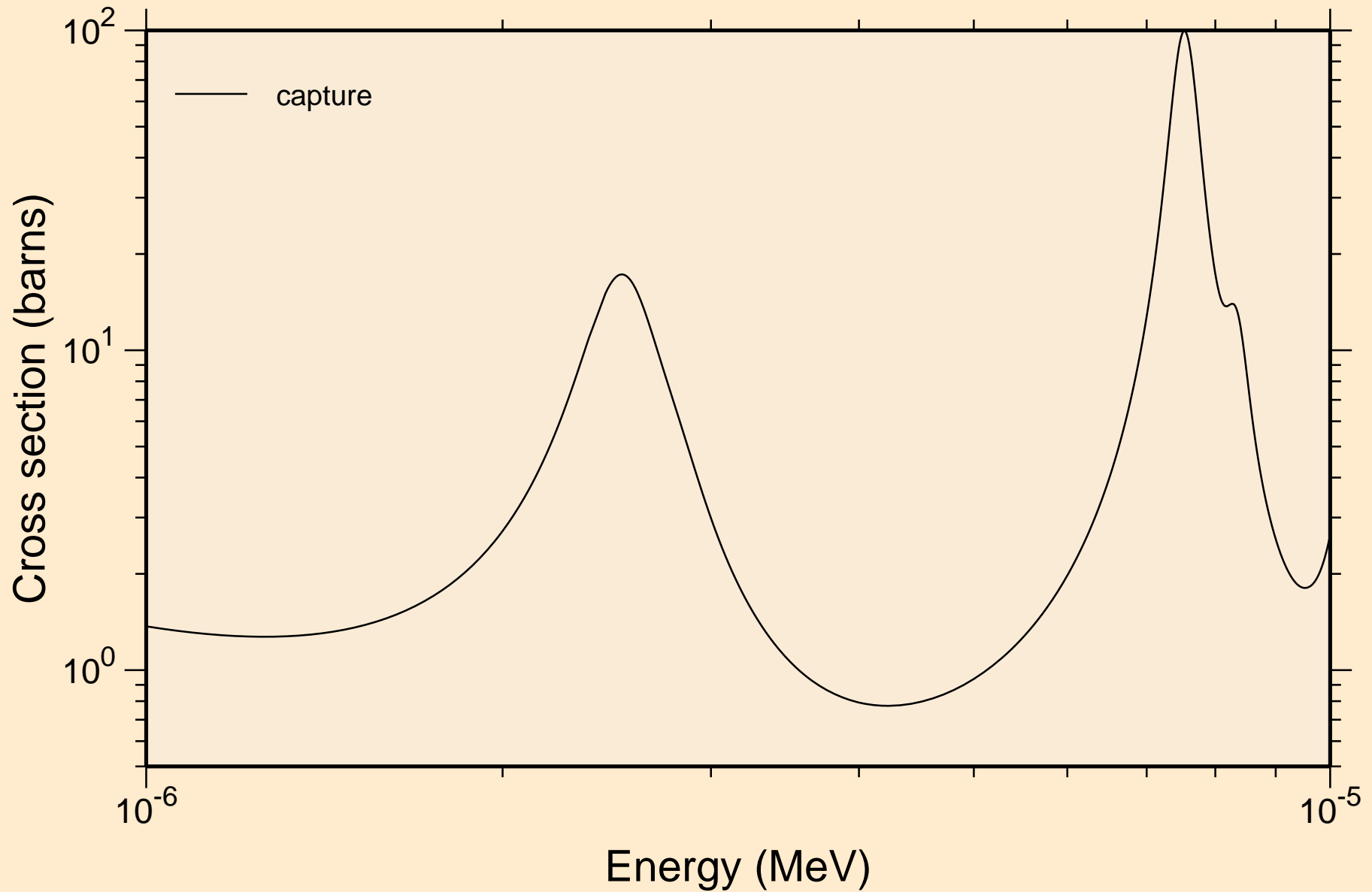

SB108 NEUTRON ACER TENDL-2024 LIBRARY; T=293.6K
resonance absorption cross sections

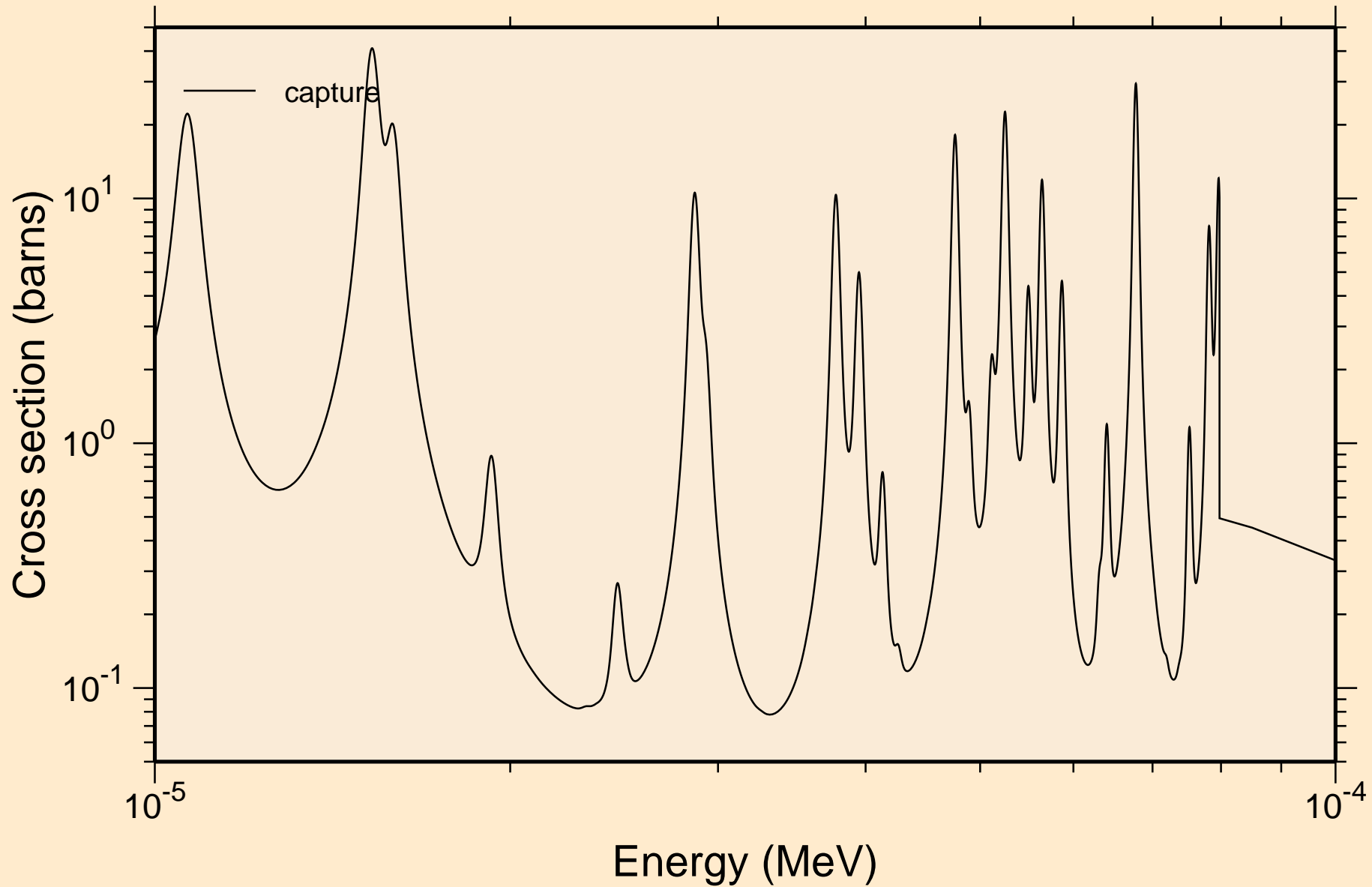

SB108 NEUTRON ACER TENDL-2024 LIBRARY; T=293.6K
resonance absorption cross sections

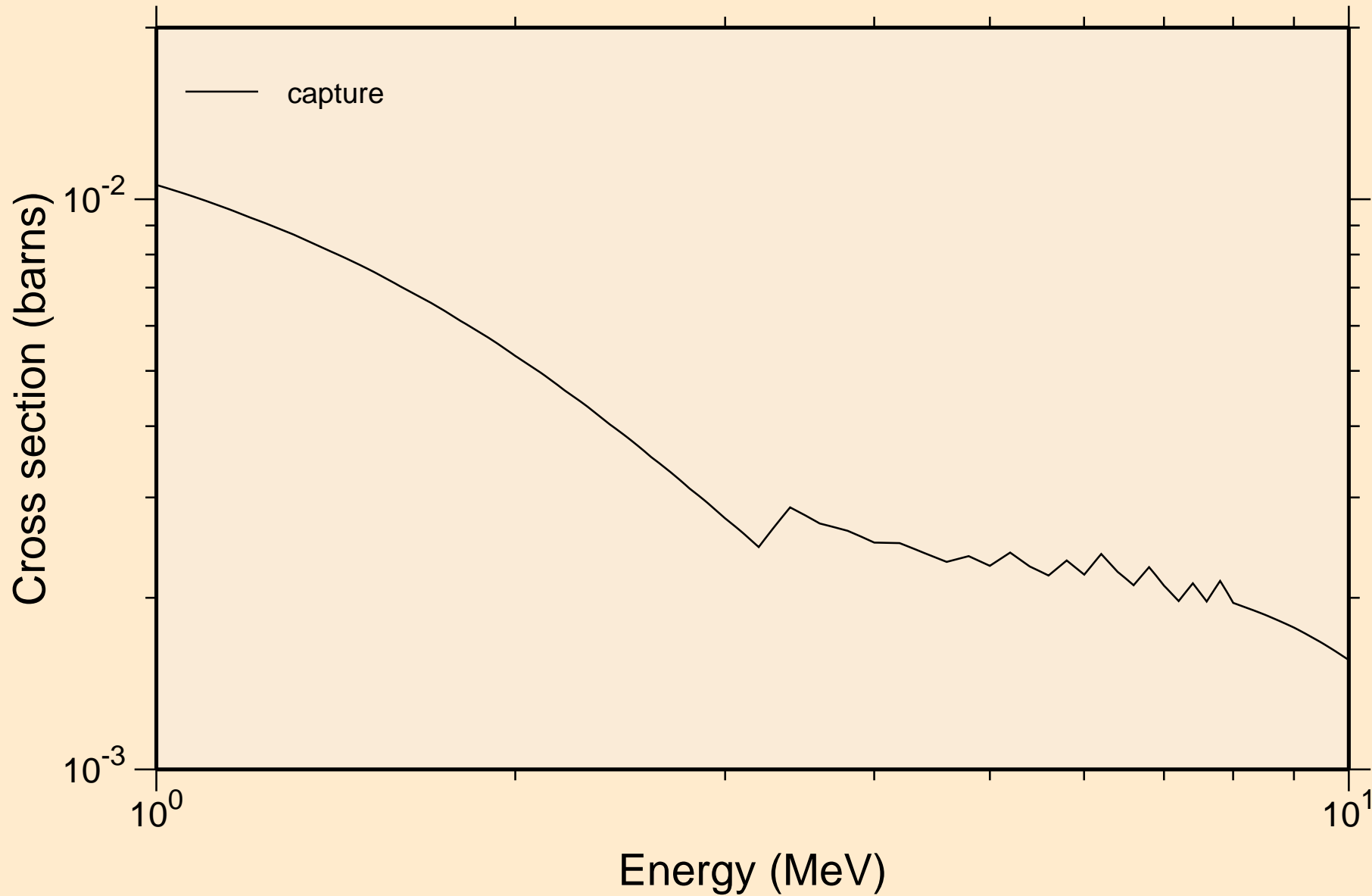

SB108 NEUTRON ACER TENDL-2024 LIBRARY; T=293.6K
Heating

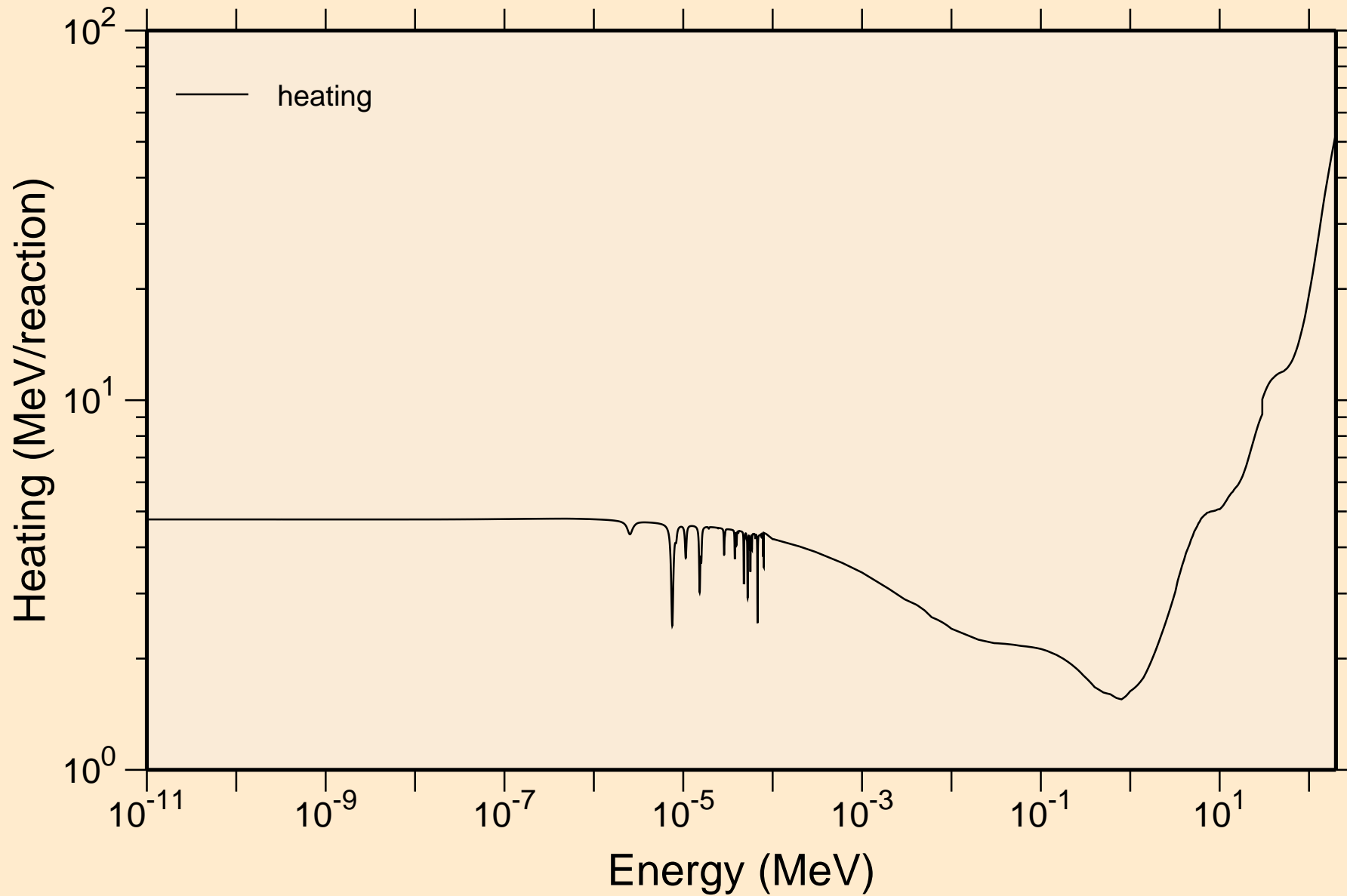

SB108 NEUTRON ACER TENDL-2024 LIBRARY; T=293.6K
Damage

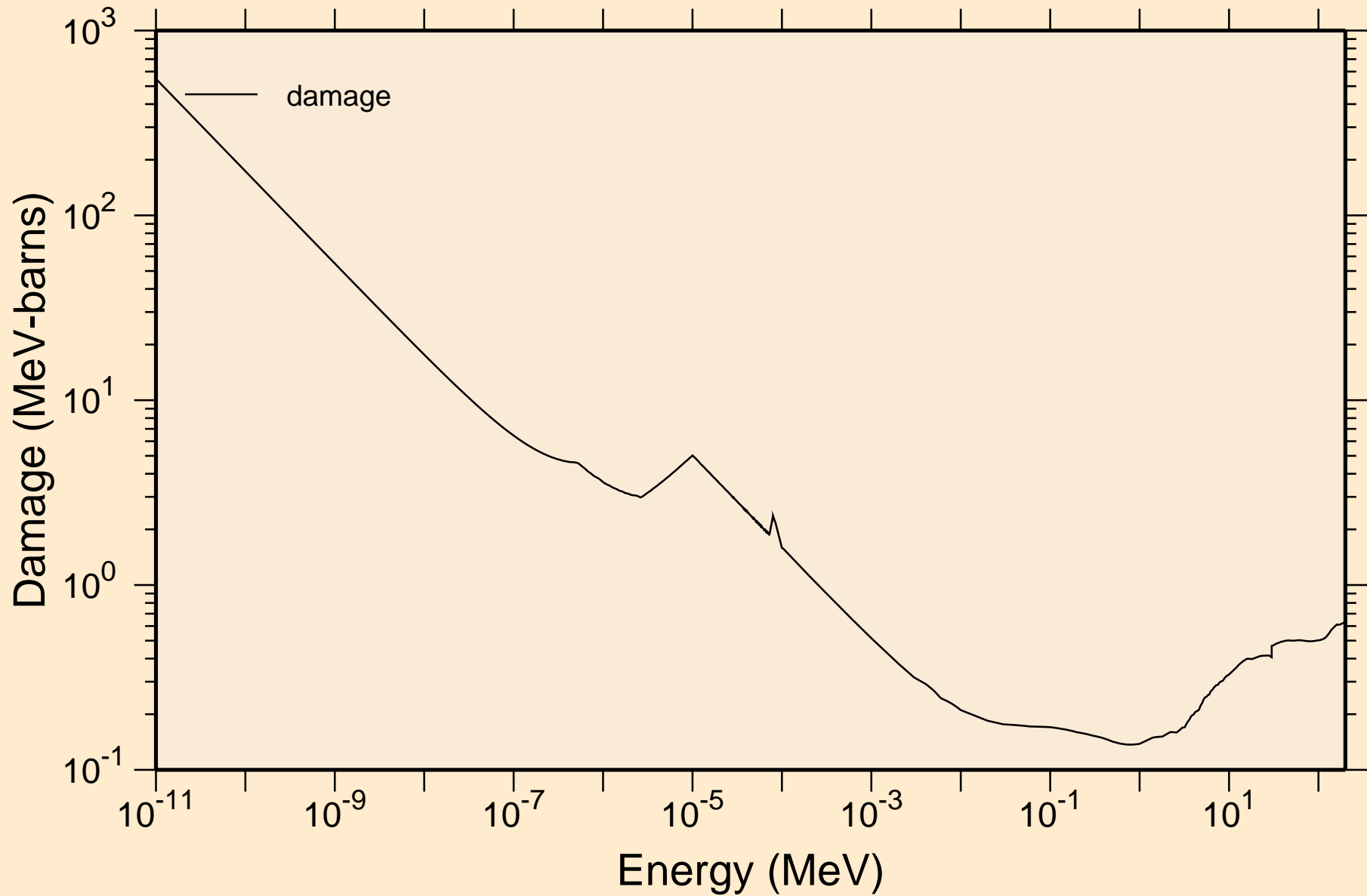

SB108 NEUTRON ACER TENDL-2024 LIBRARY; T=293.6K

Non-threshold reactions

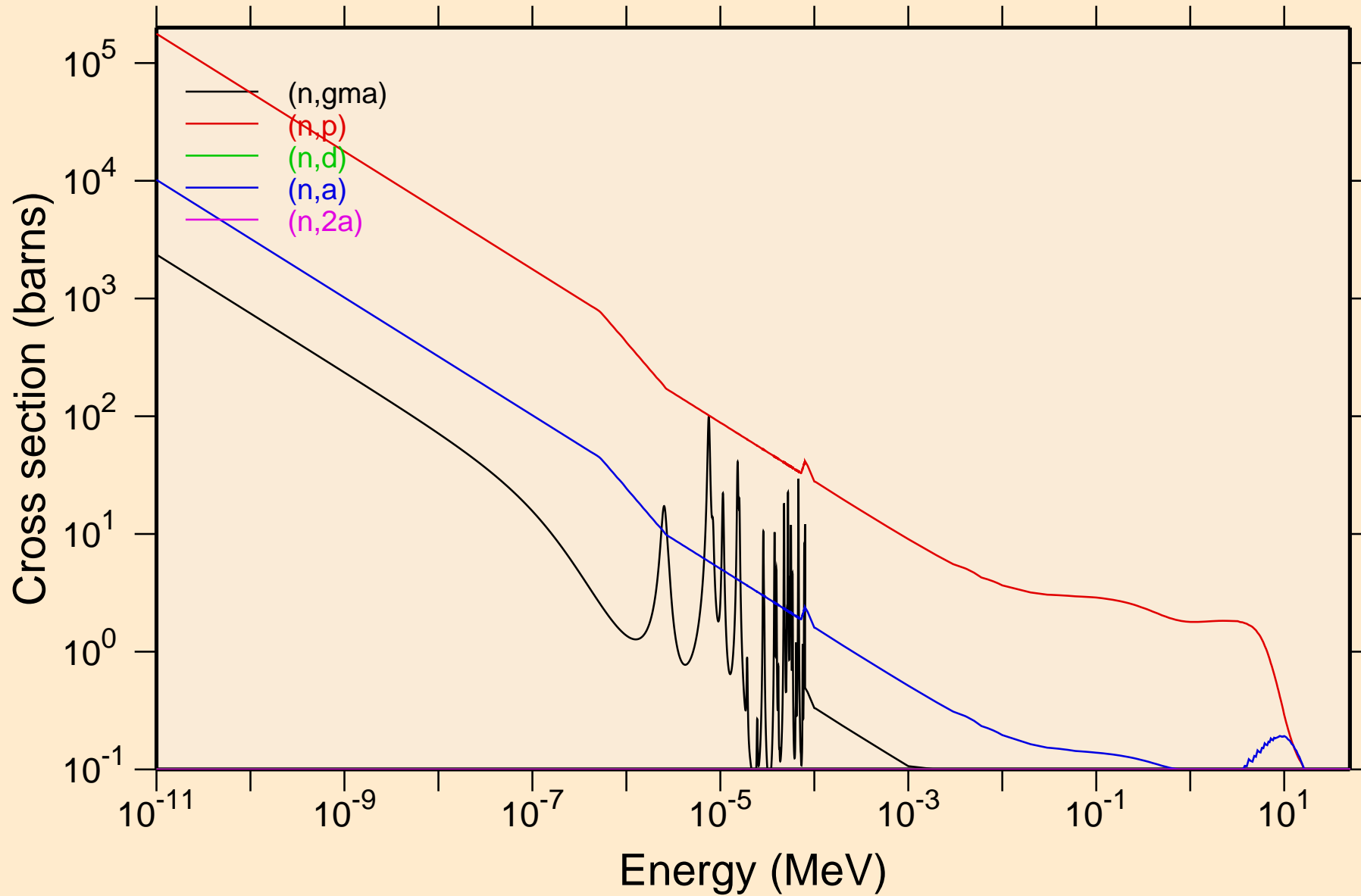

SB108 NEUTRON ACER TENDL-2024 LIBRARY; T=293.6K

Non-threshold reactions

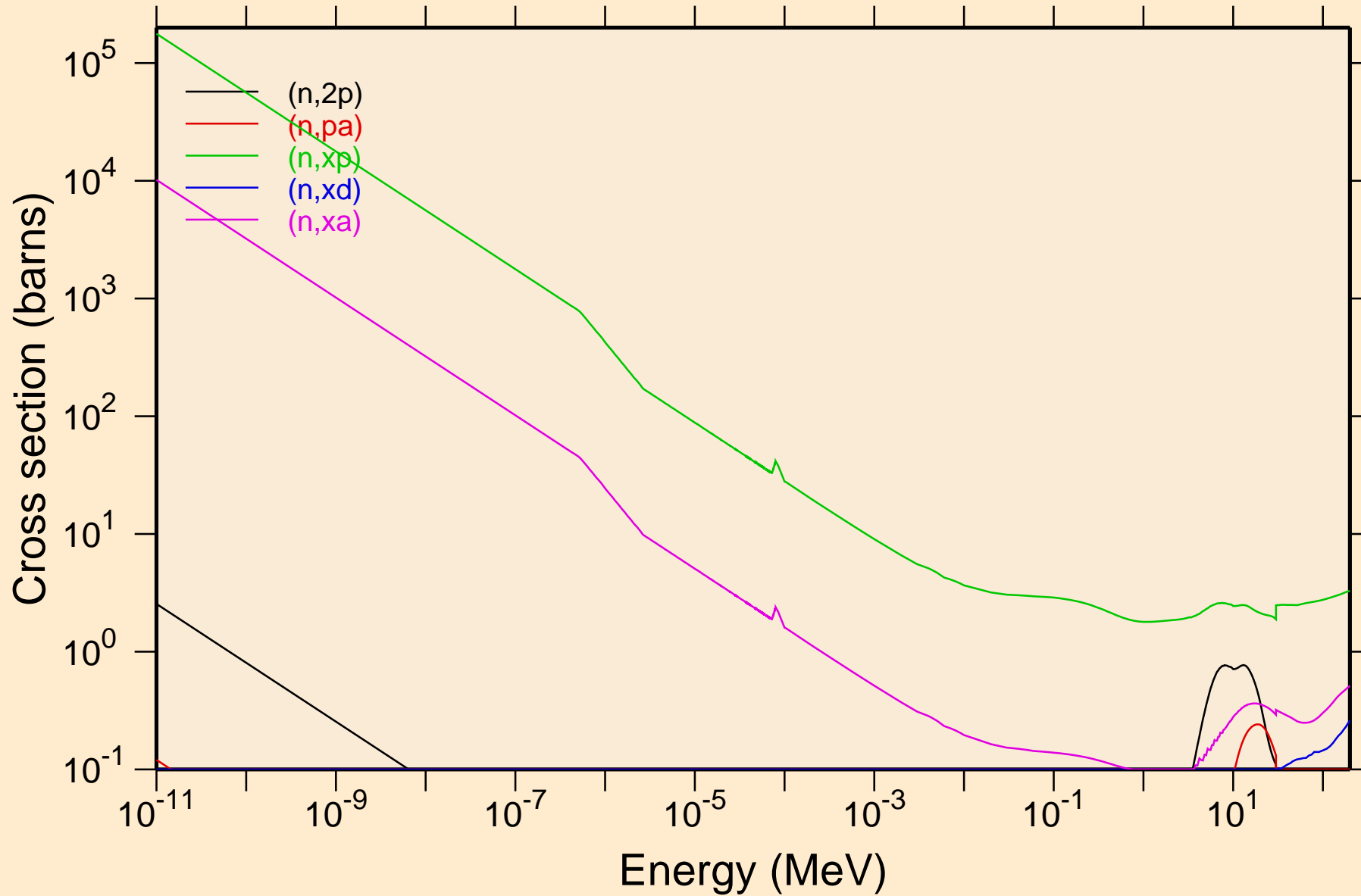

SB108 NEUTRON ACER TENDL-2024 LIBRARY; T=293.6K

Principal cross sections

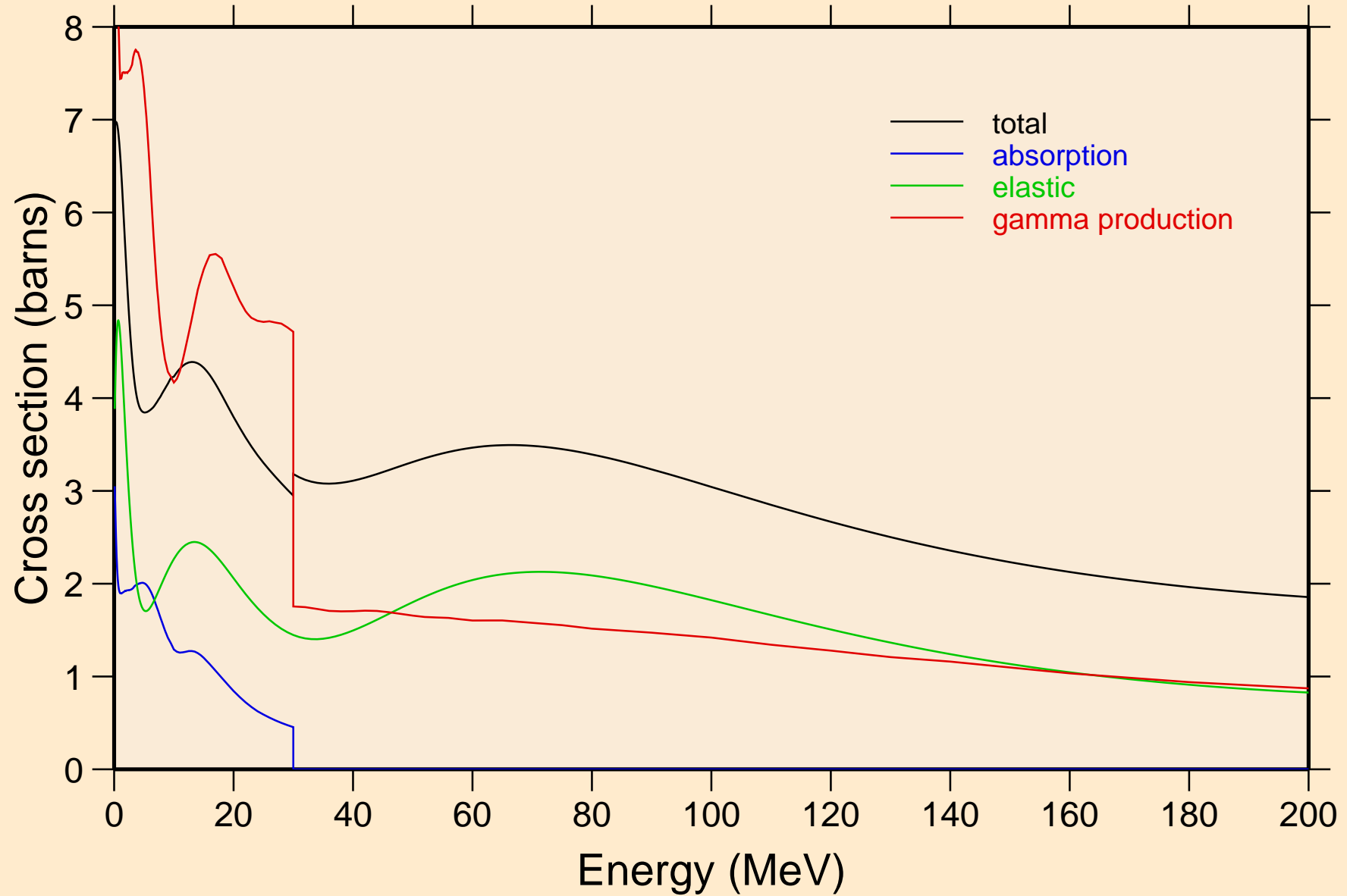

SB108 NEUTRON ACER TENDL-2024 LIBRARY; T=293.6K

Heating

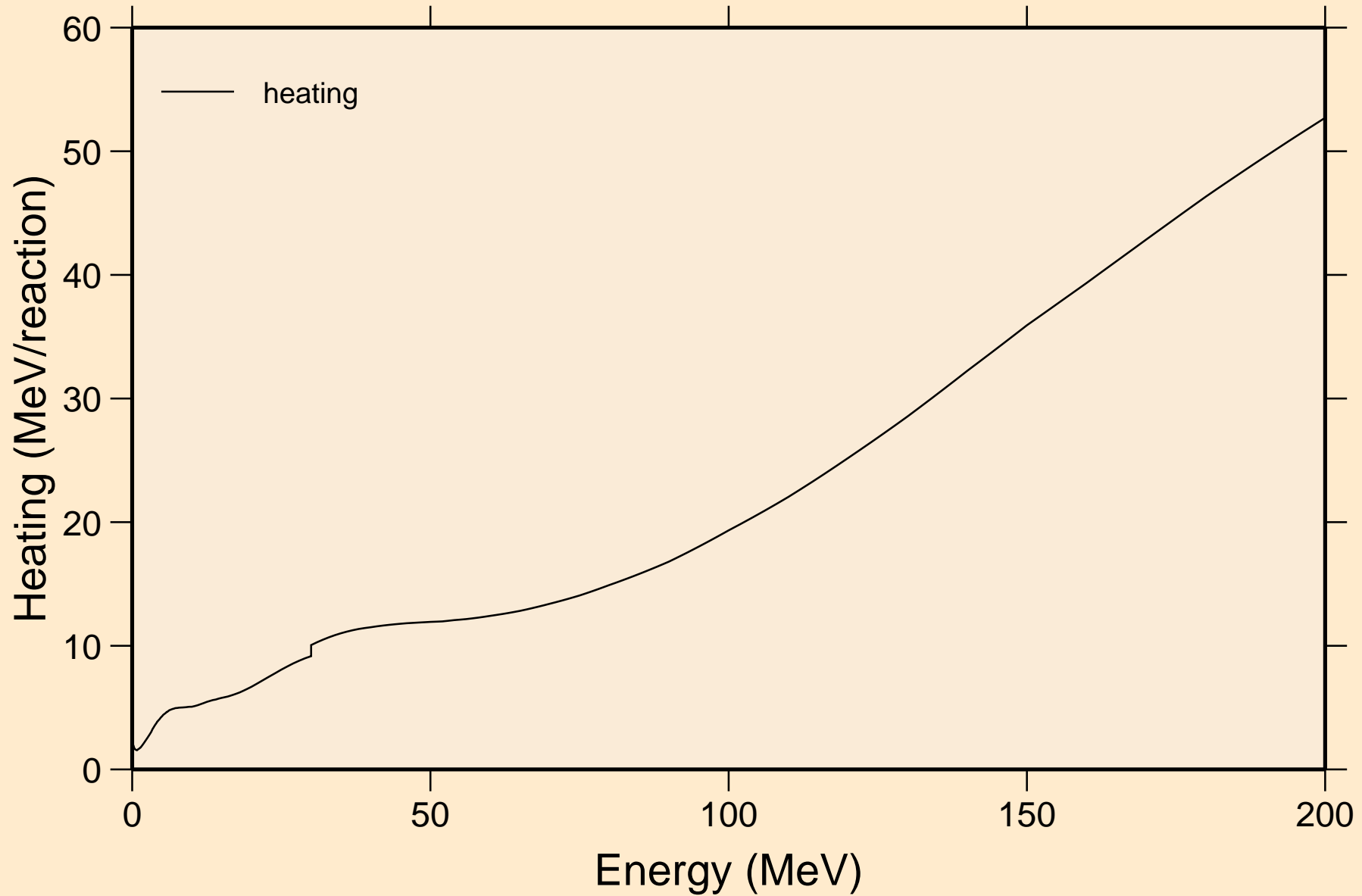

SB108 NEUTRON ACER TENDL-2024 LIBRARY; T=293.6K
Damage

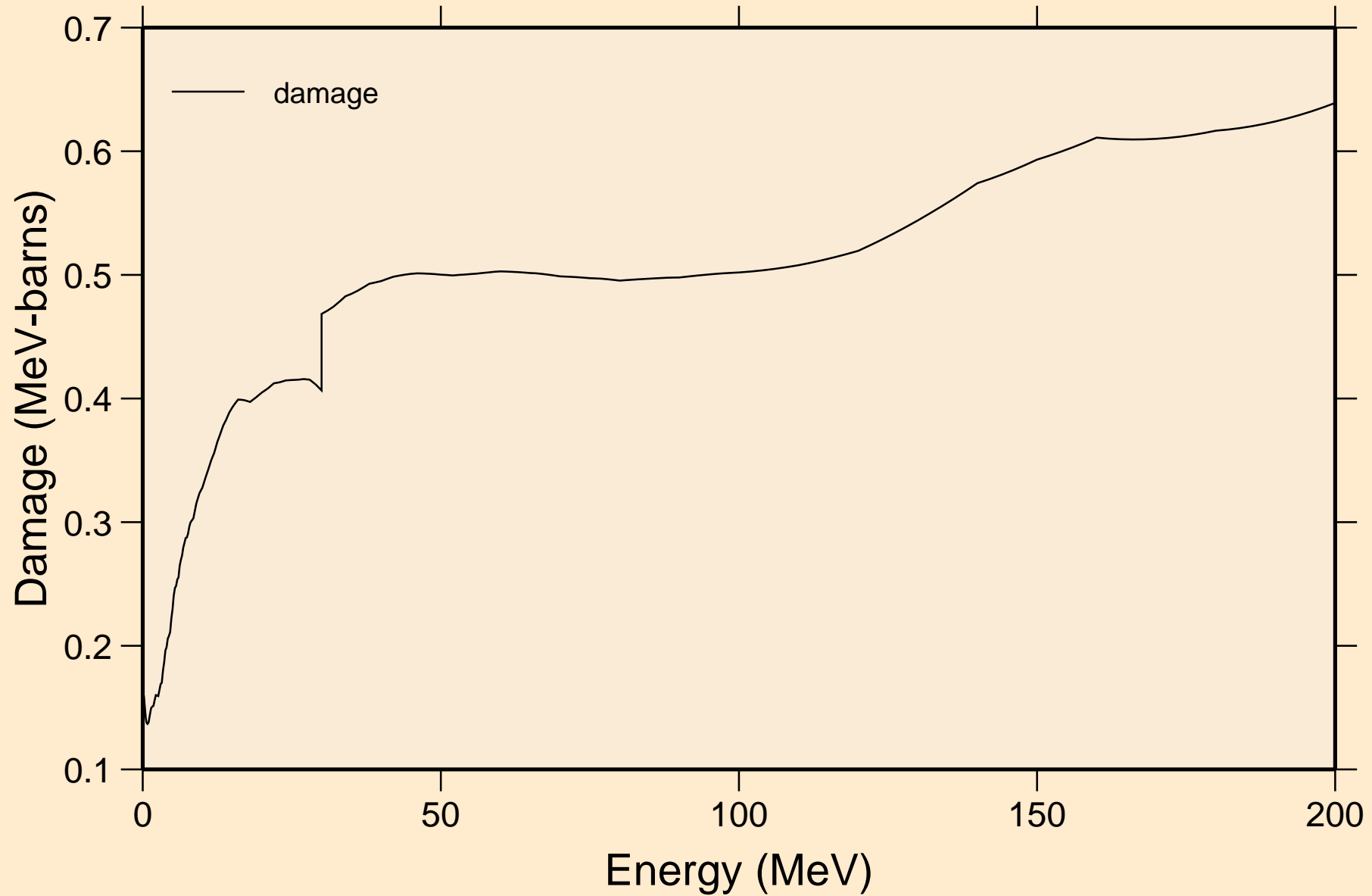

SB108 NEUTRON ACER TENDL-2024 LIBRARY; T=293.6K
Non-threshold reactions

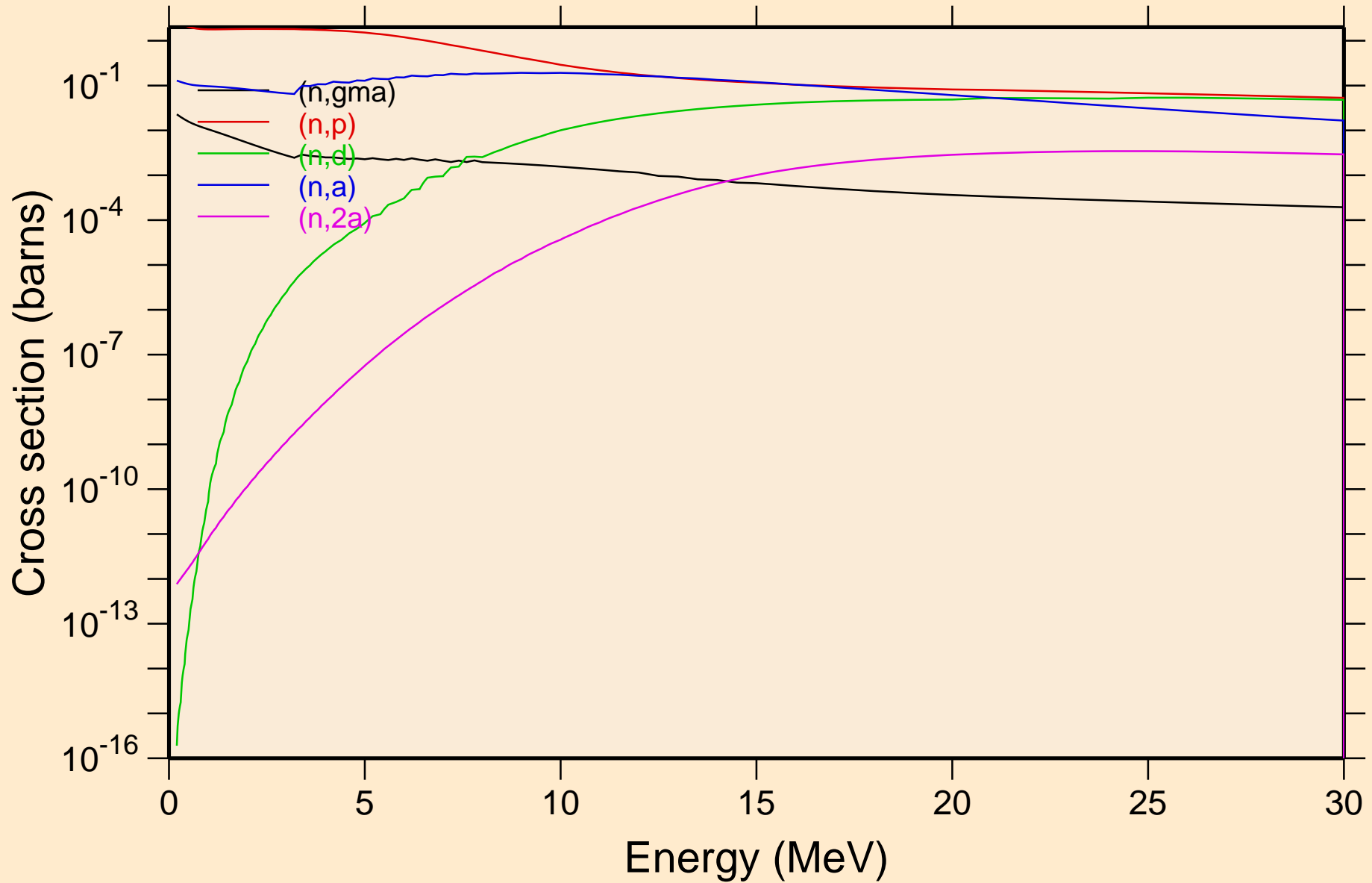

SB108 NEUTRON ACER TENDL-2024 LIBRARY; T=293.6K
Non-threshold reactions

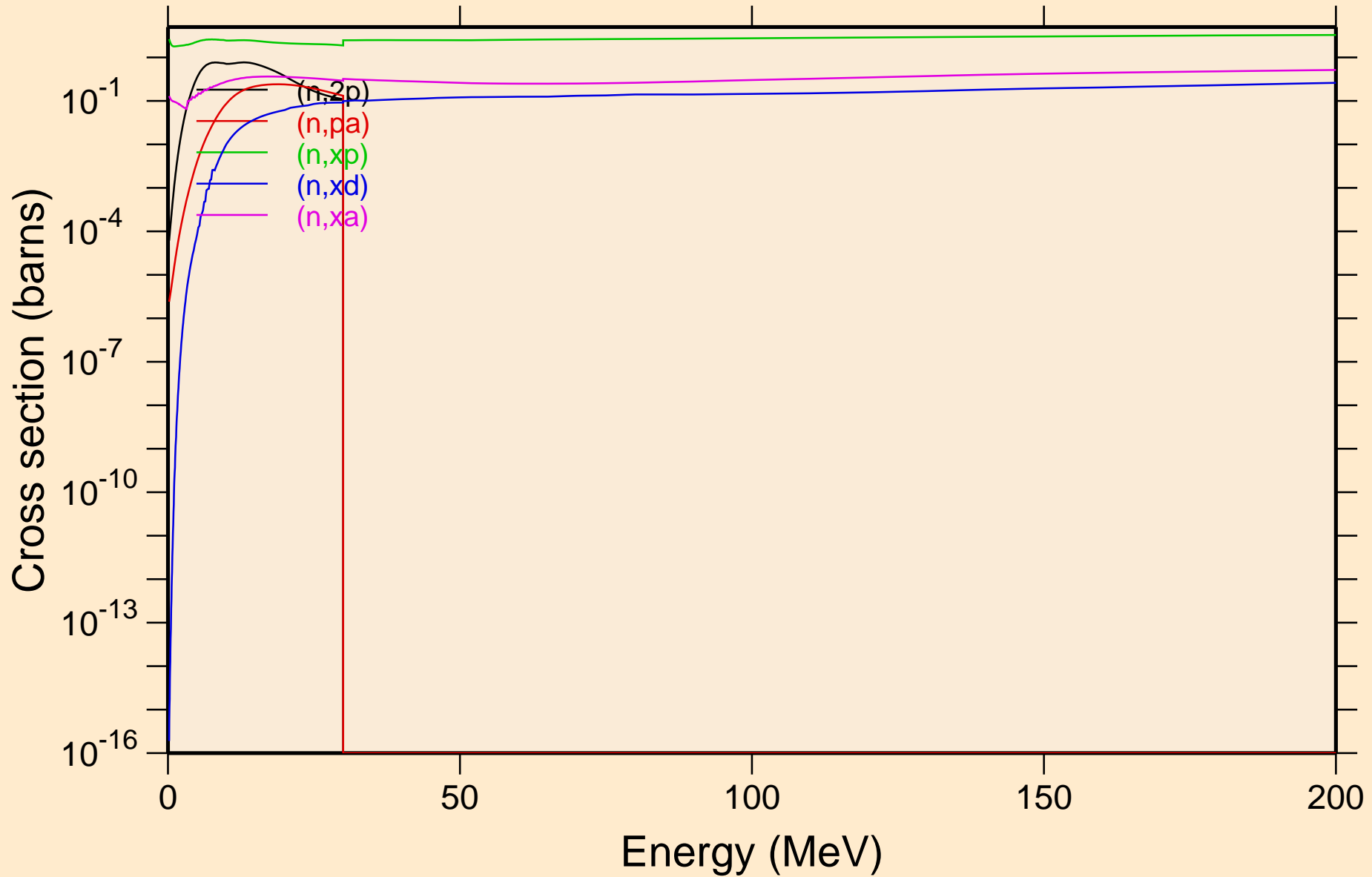

SB108 NEUTRON ACER TENDL-2024 LIBRARY; T=293.6K
Inelastic levels

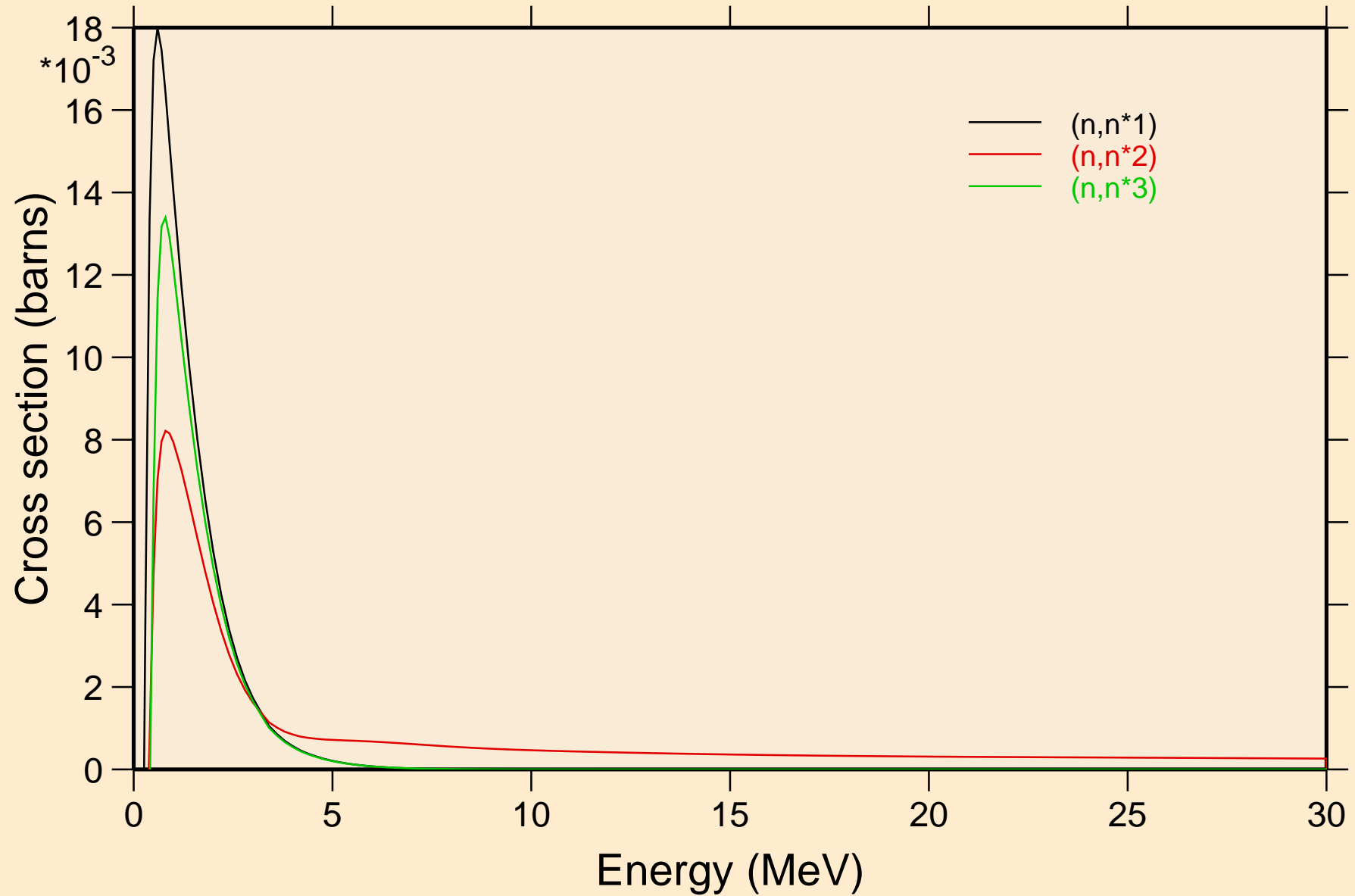

SB108 NEUTRON ACER TENDL-2024 LIBRARY; T=293.6K
Threshold reactions

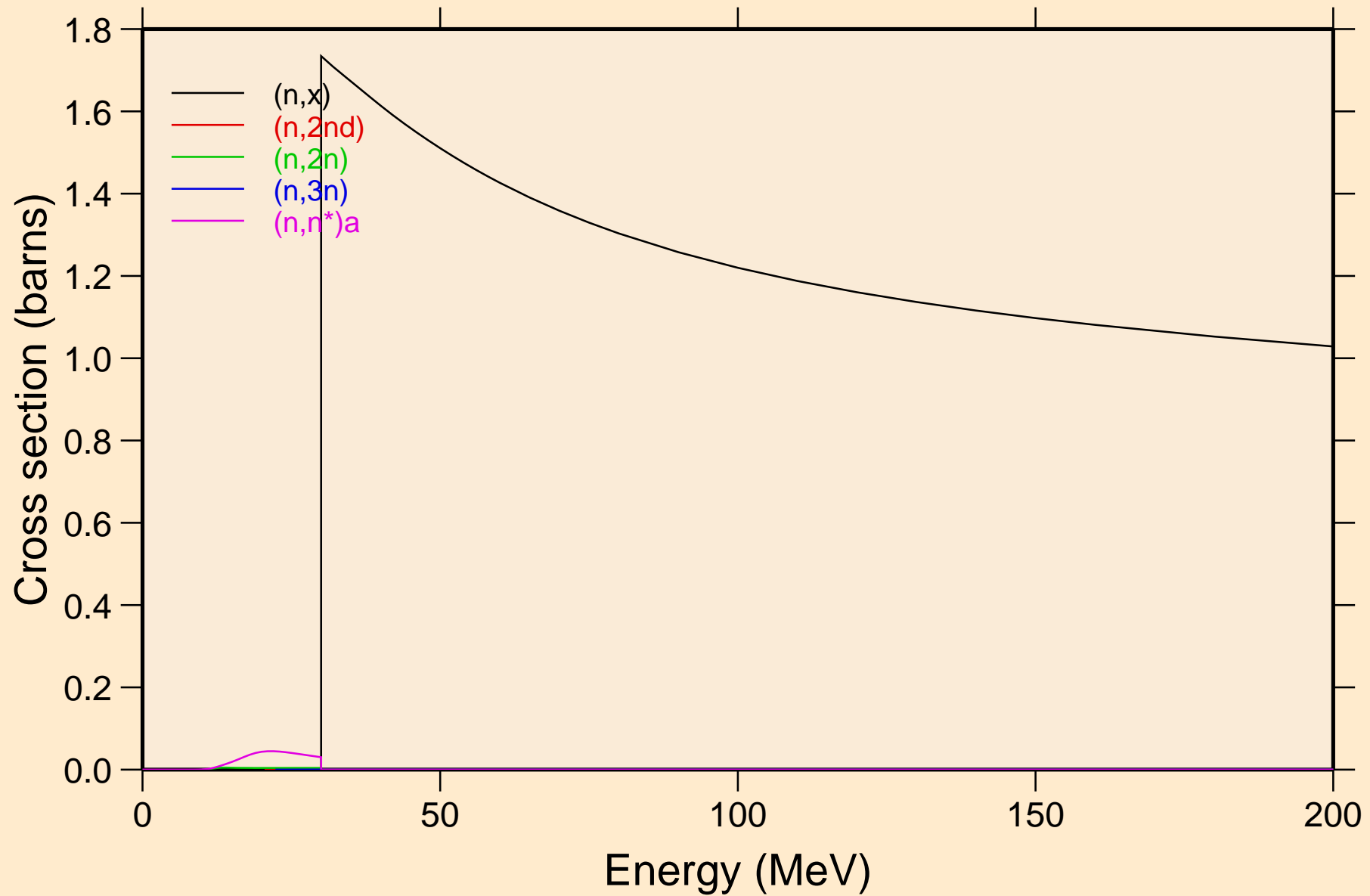

SB108 NEUTRON ACER TENDL-2024 LIBRARY; T=293.6K
Threshold reactions

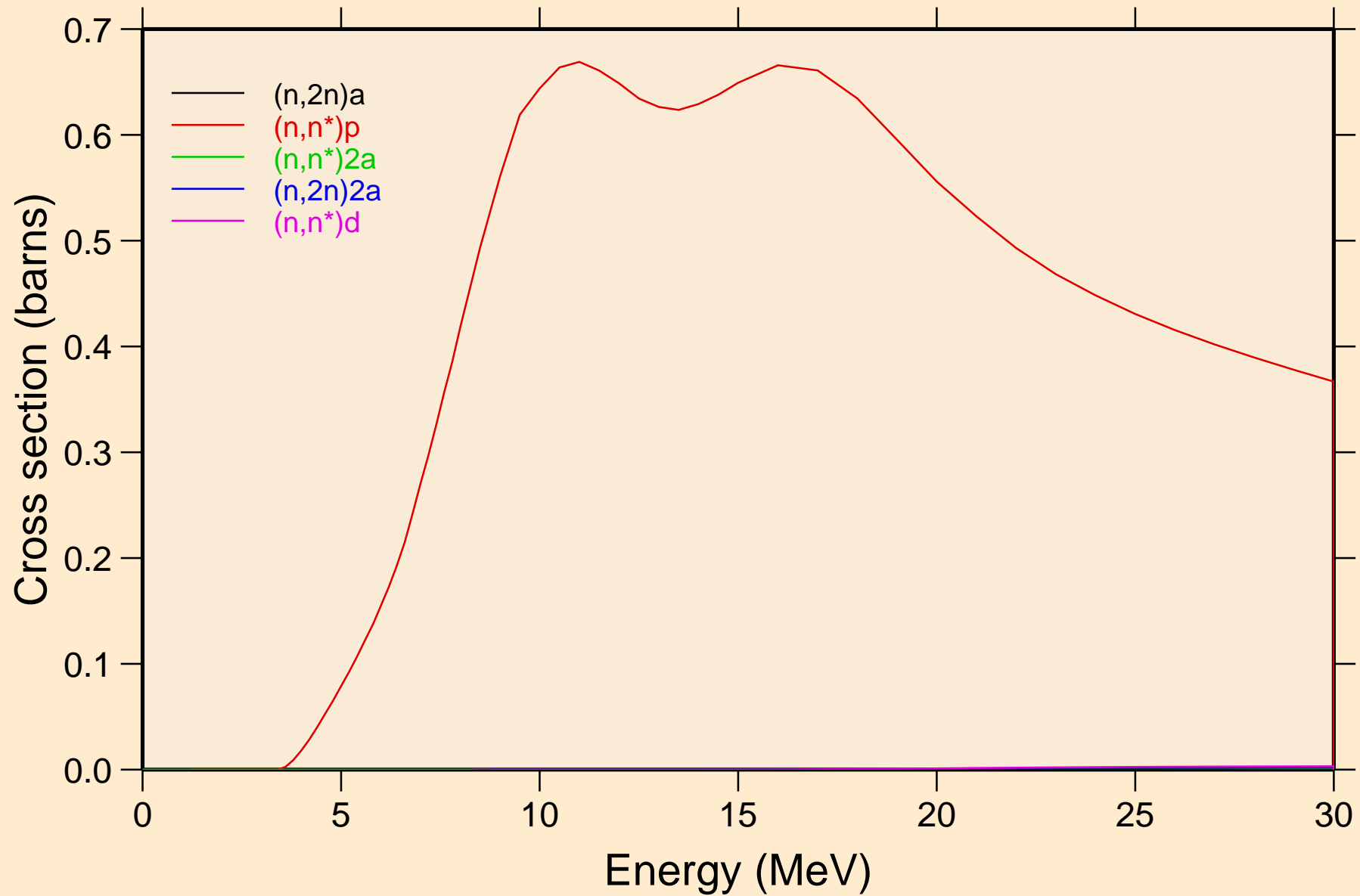

SB108 NEUTRON ACER TENDL-2024 LIBRARY; T=293.6K

Threshold reactions

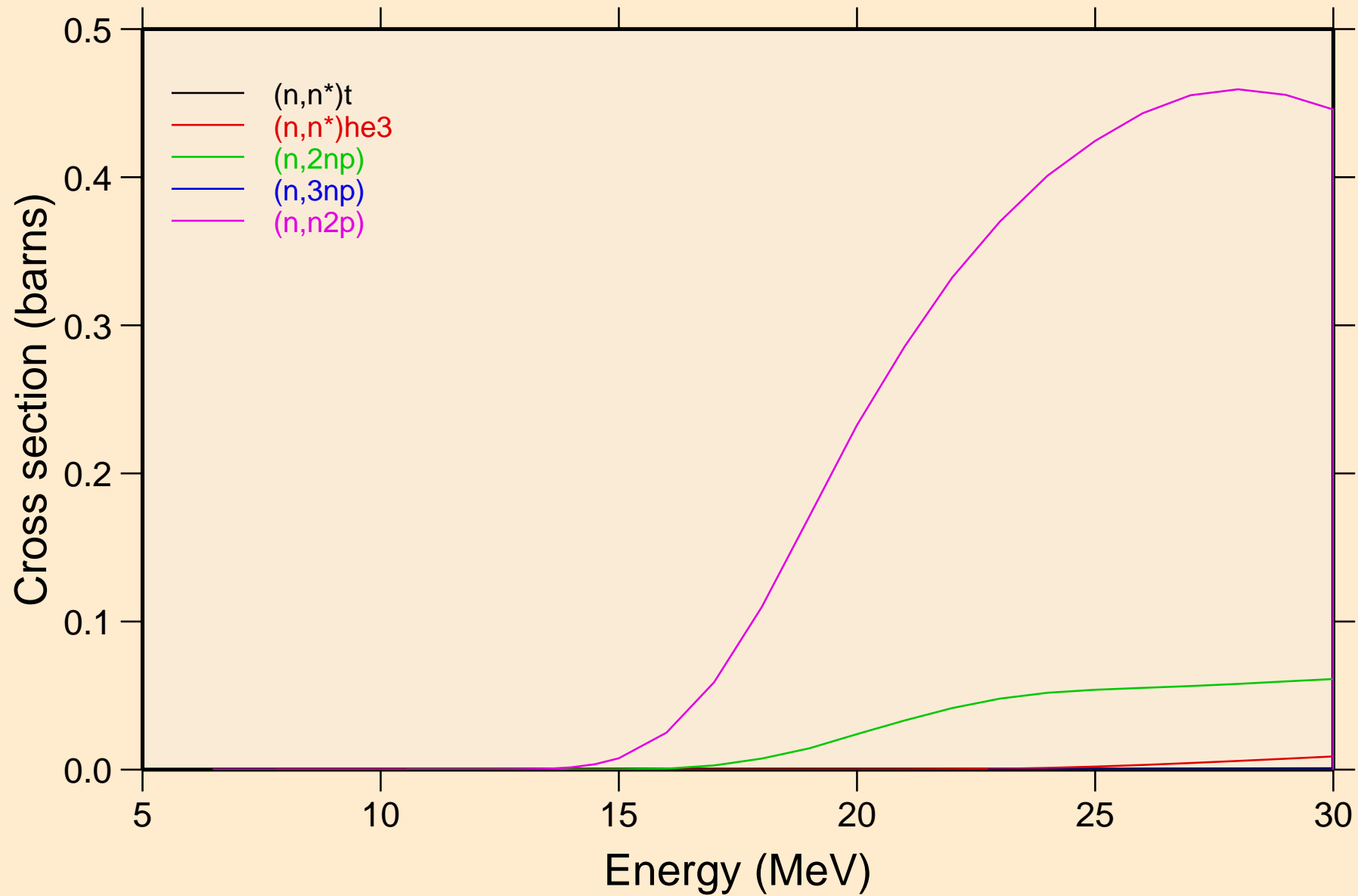

SB108 NEUTRON ACER TENDL-2024 LIBRARY; T=293.6K

Threshold reactions

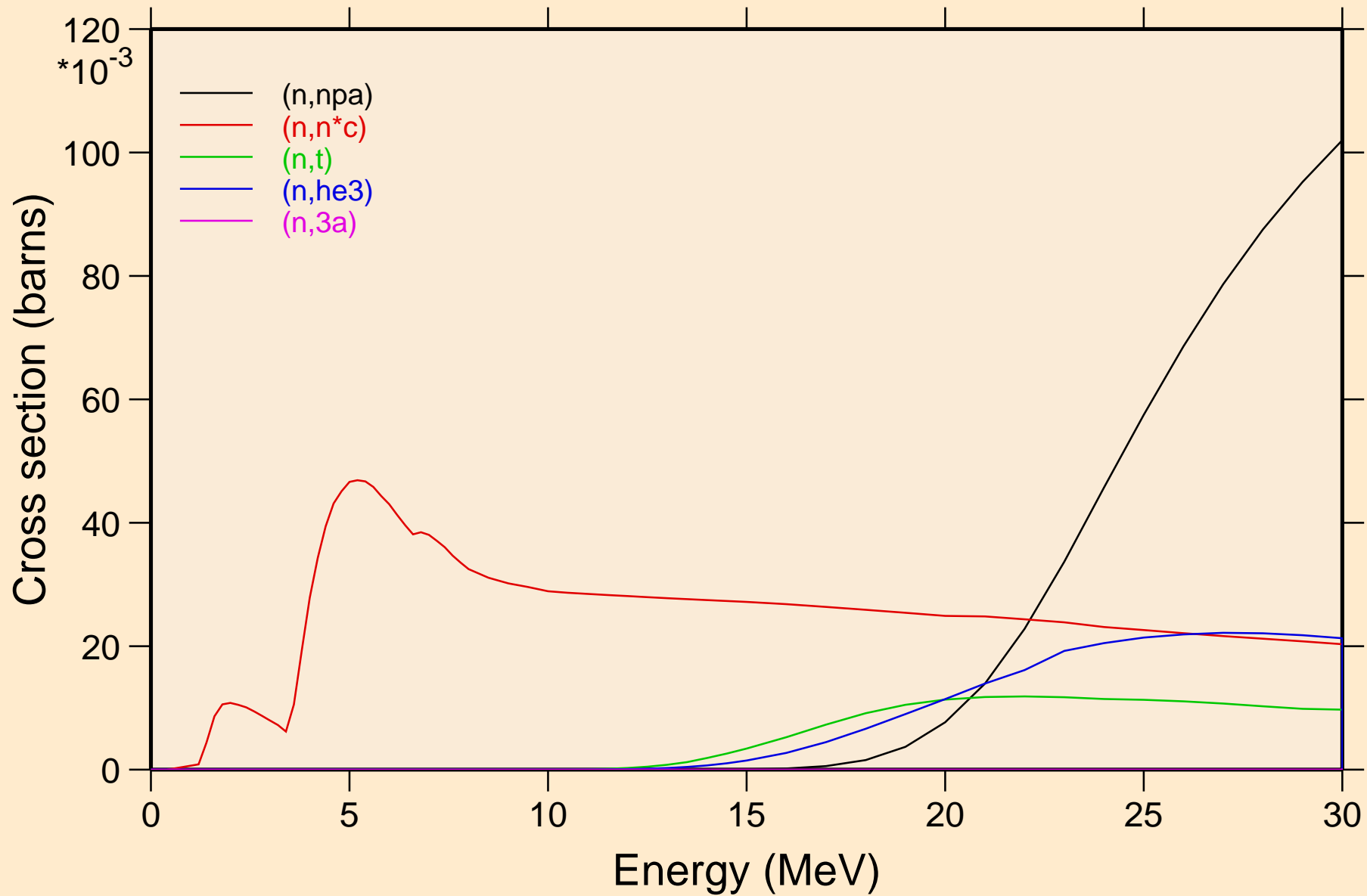

SB108 NEUTRON ACER TENDL-2024 LIBRARY; T=293.6K
Threshold reactions

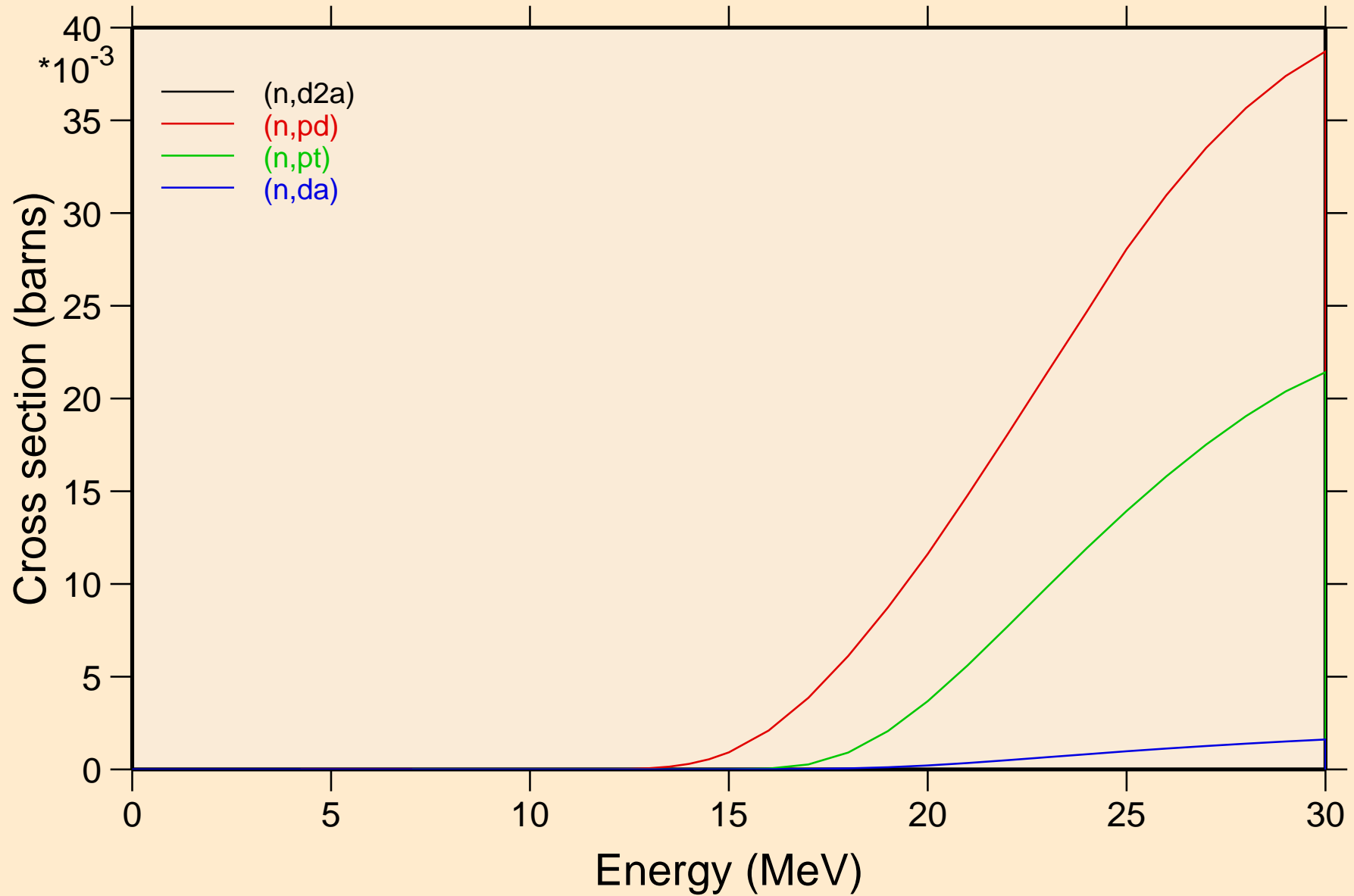

SB108 NEUTRON ACER TENDL-2024 LIBRARY; T=293.6K
Threshold reactions

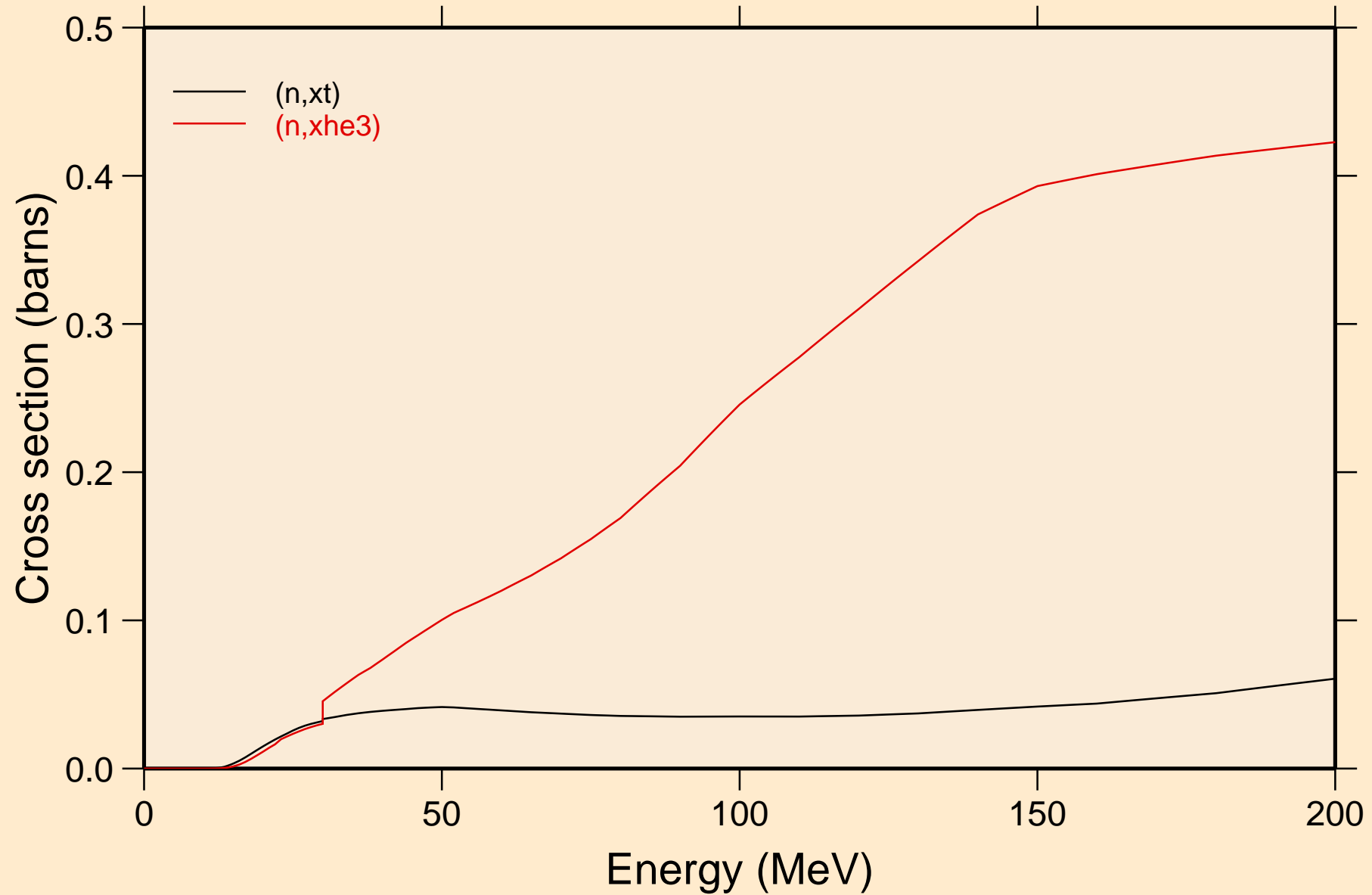

SB108 NEUTRON ACER TENDL-2024 LIBRARY; T=293.6K
angular distribution for elastic

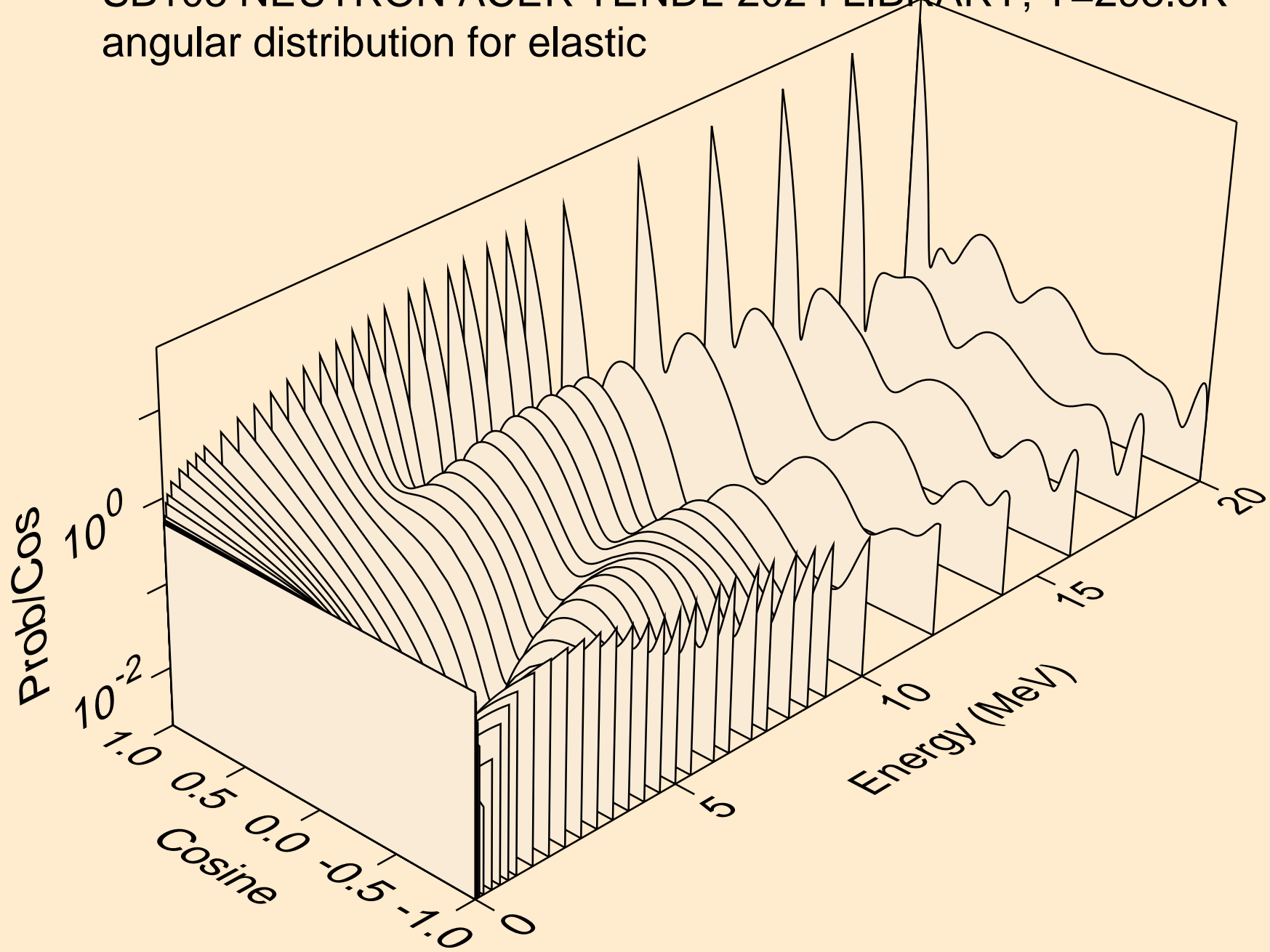

SB108 NEUTRON ACER TENDL-2024 LIBRARY; T=293.6K
angular distribution for elastic

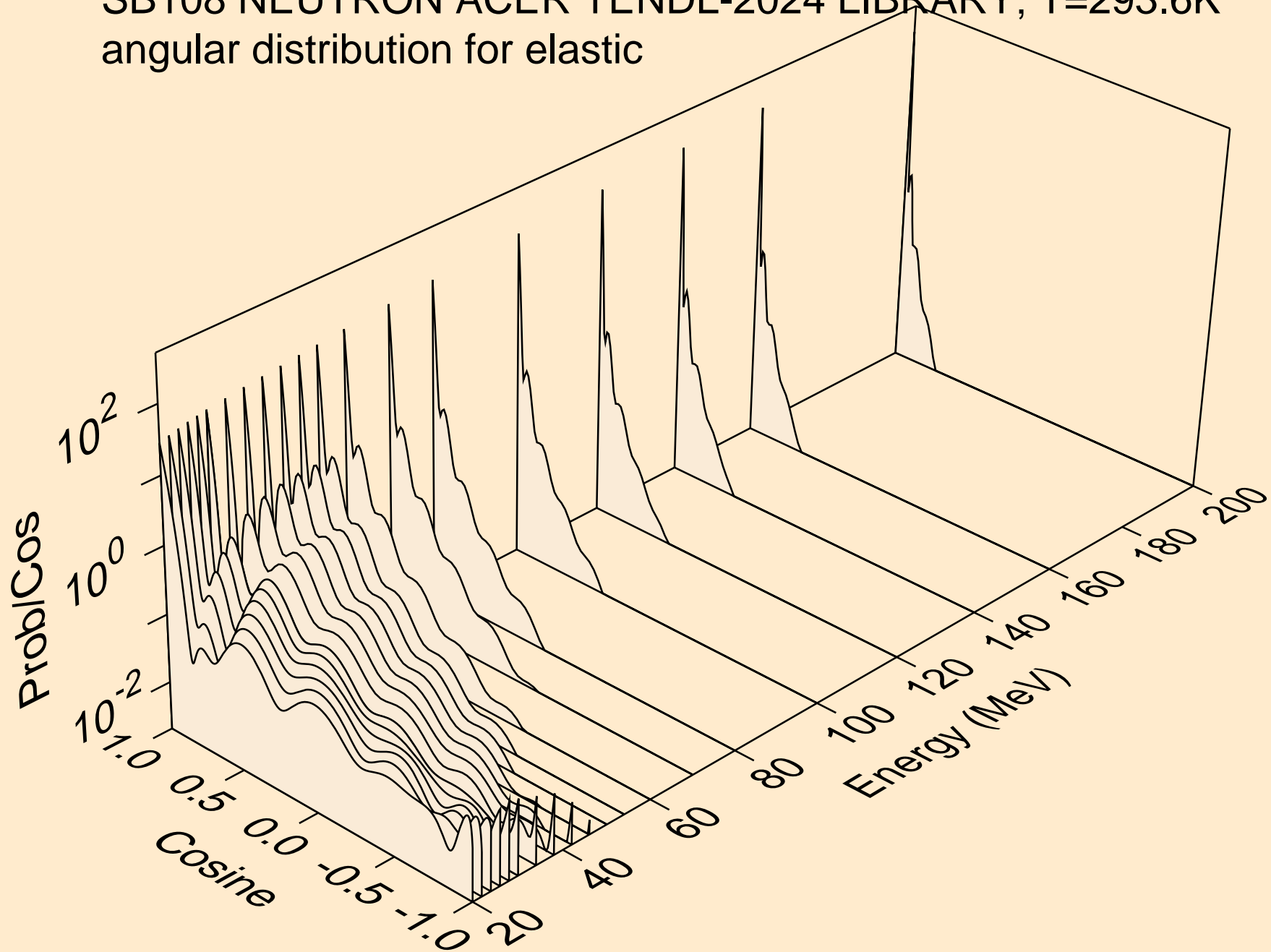

SB108 NEUTRON ACER TENDL-2024 LIBRARY; T=293.6K
angular distribution for (n,n*1)

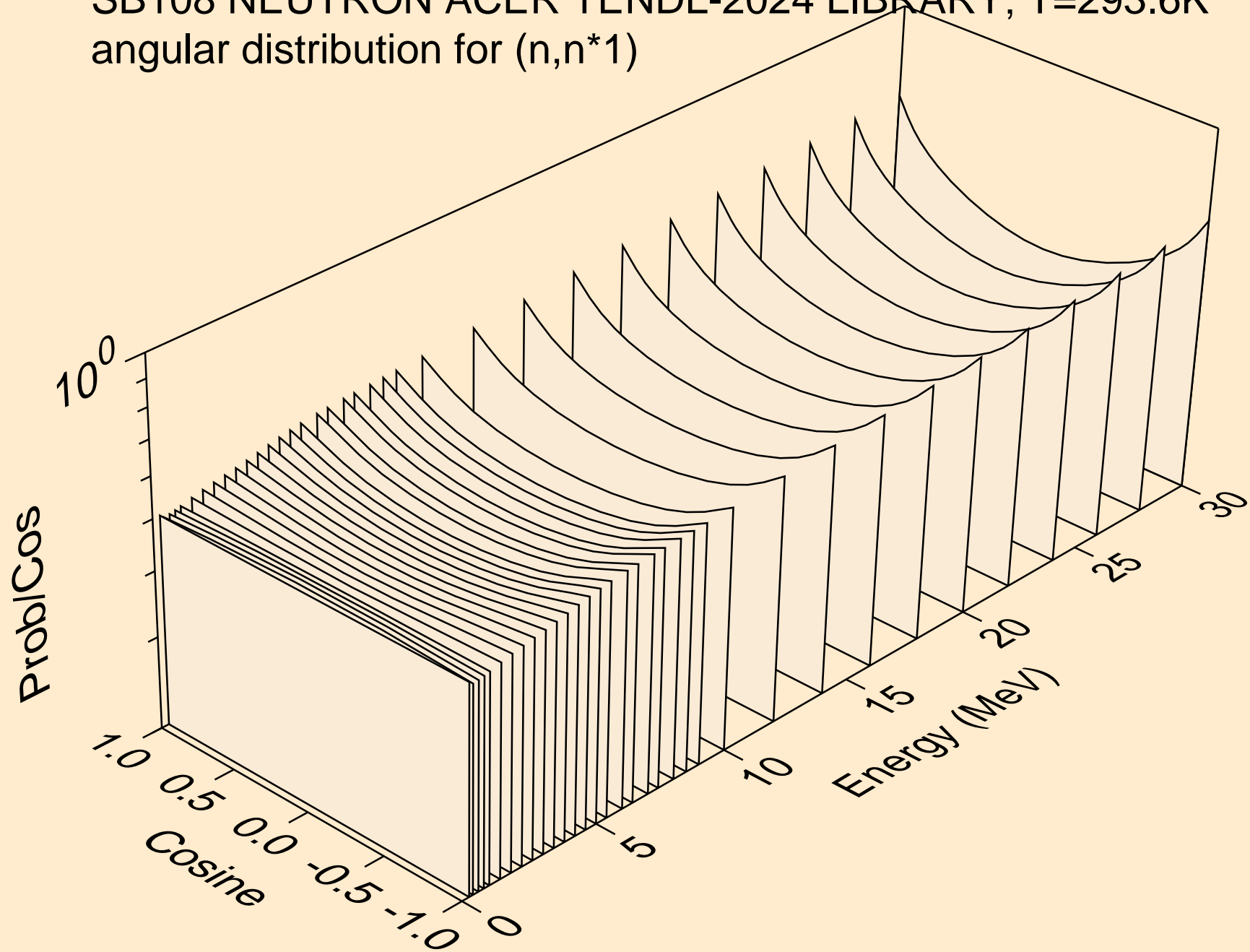

SB108 NEUTRON ACER TENDL-2024 LIBRARY; T=293.6K
angular distribution for (n,n*2)

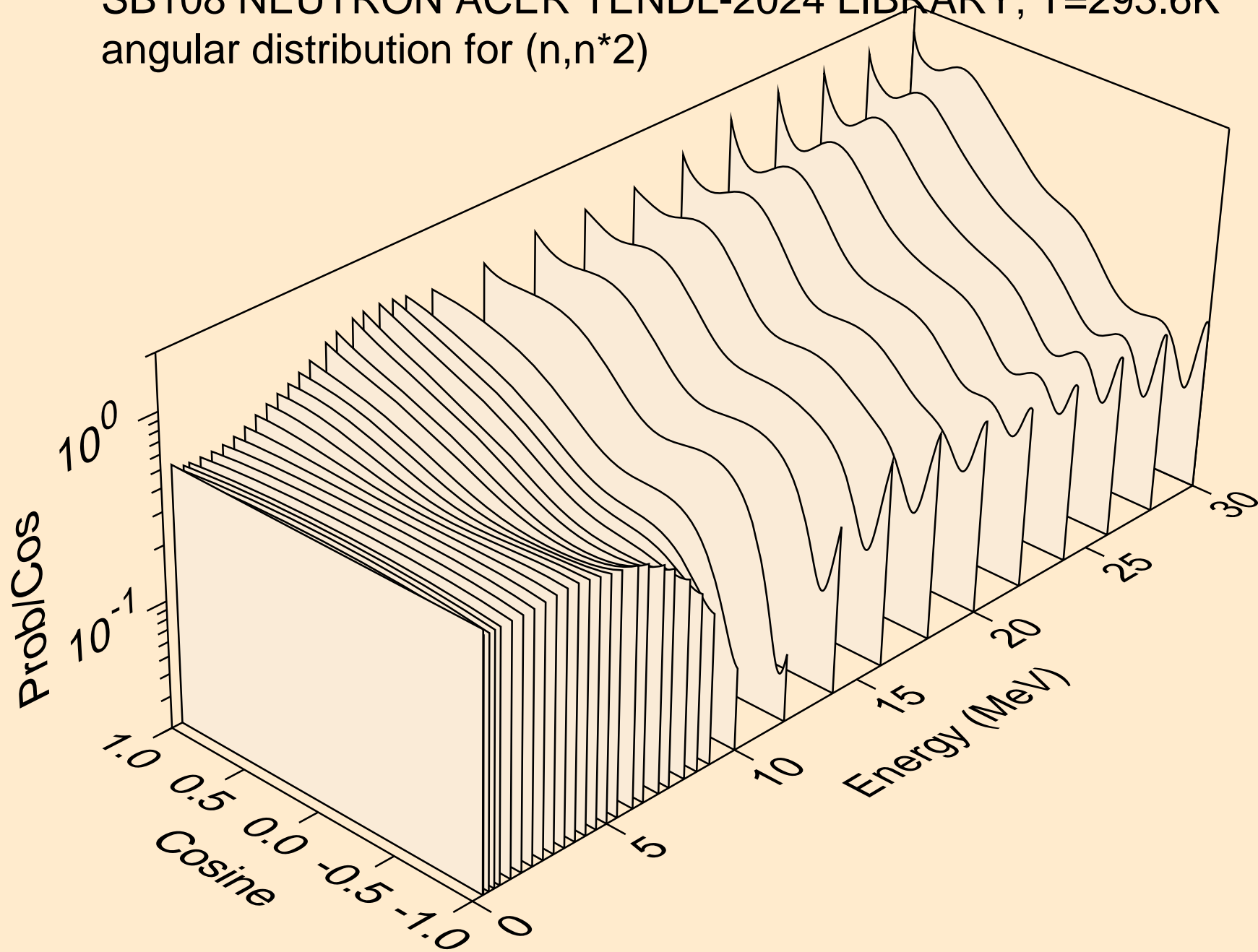

SB108 NEUTRON ACER TENDL-2024 LIBRARY; T=293.6K
angular distribution for (n,n*3)

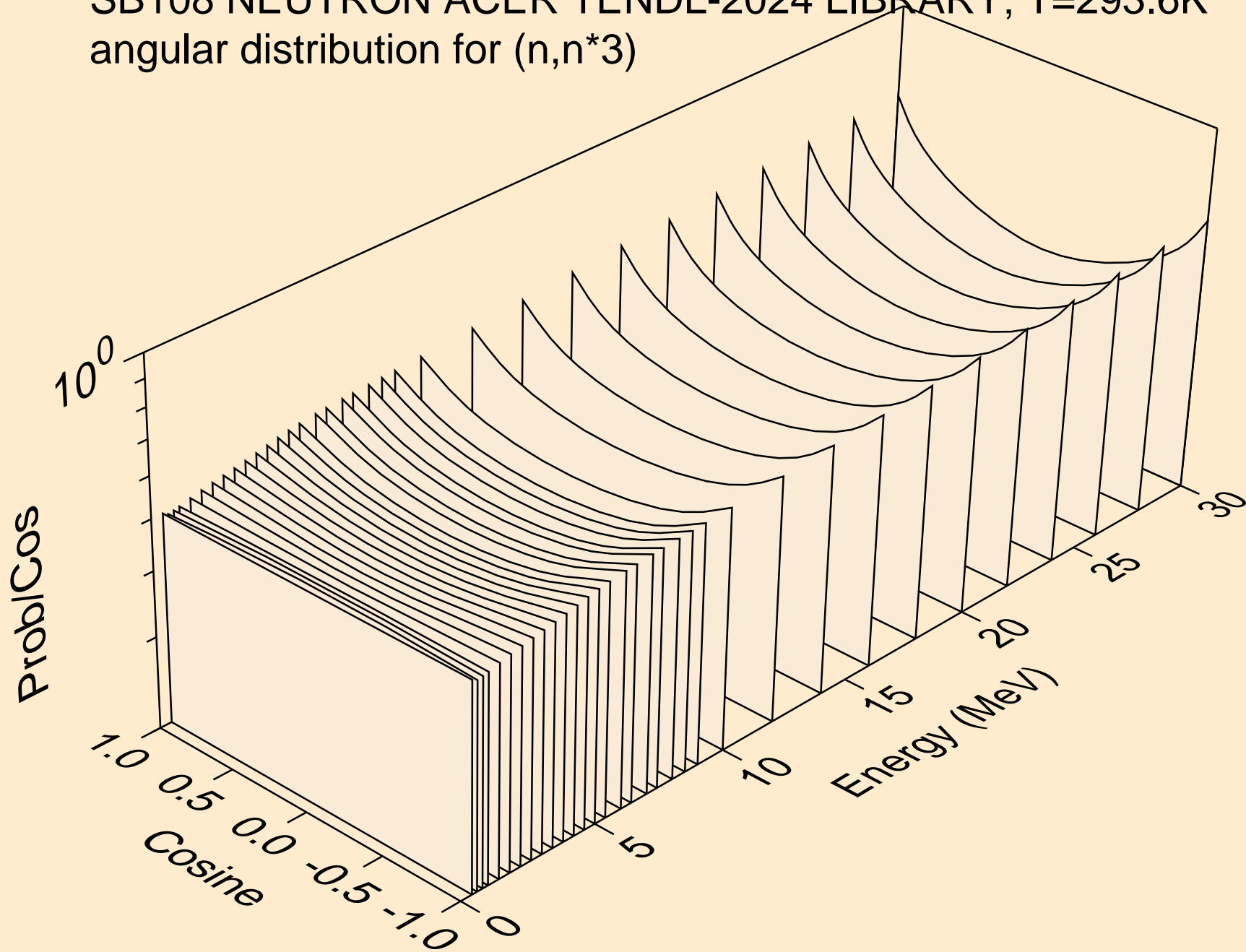

SB108 NEUTRON ACER TENDL-2024 LIBRARY; T=293.6K
Neutron emission for (n,x)

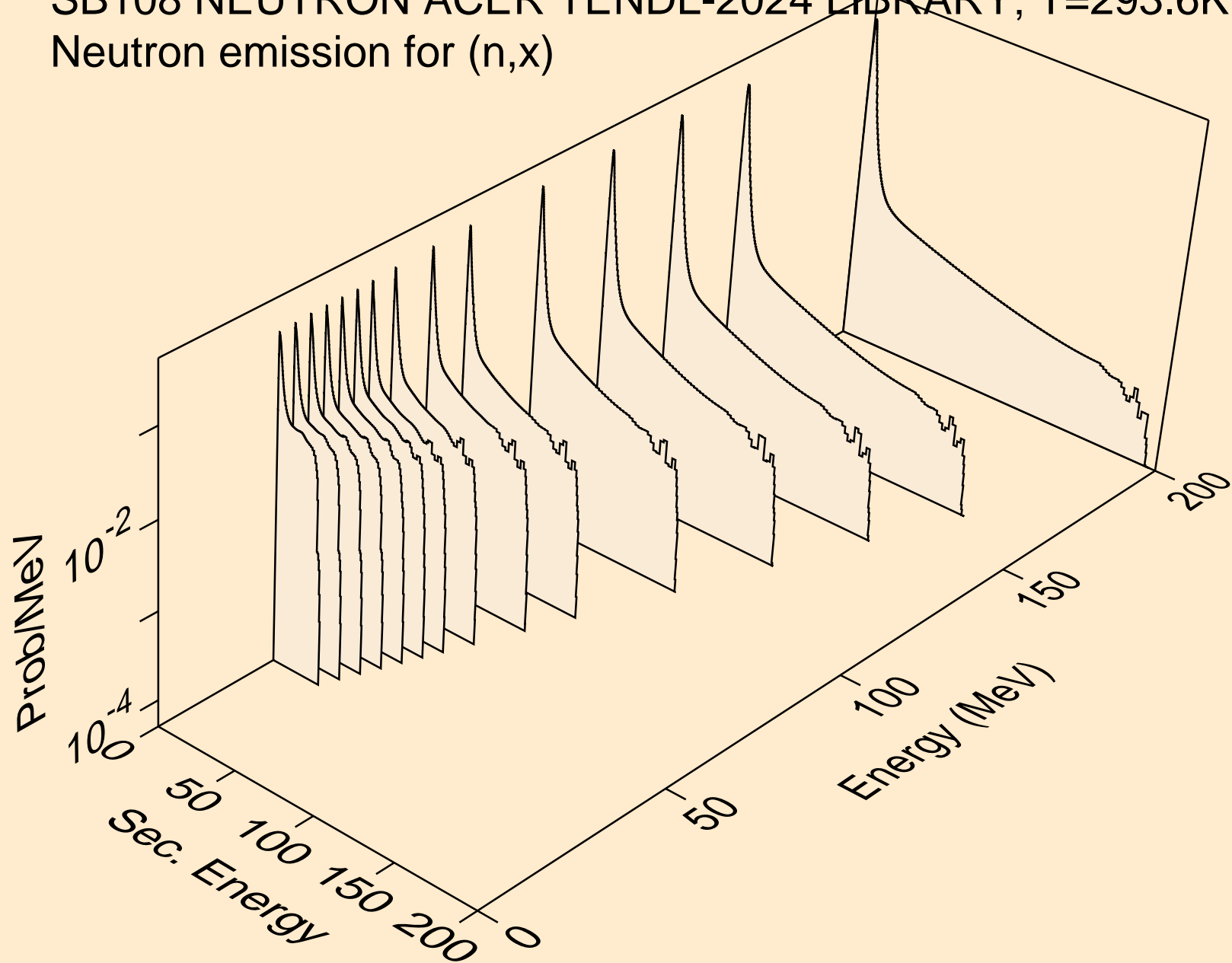

SB108 NEUTRON ACER TENDL-2024 LIBRARY; T=293.6K
Neutron emission for (n,2nd)

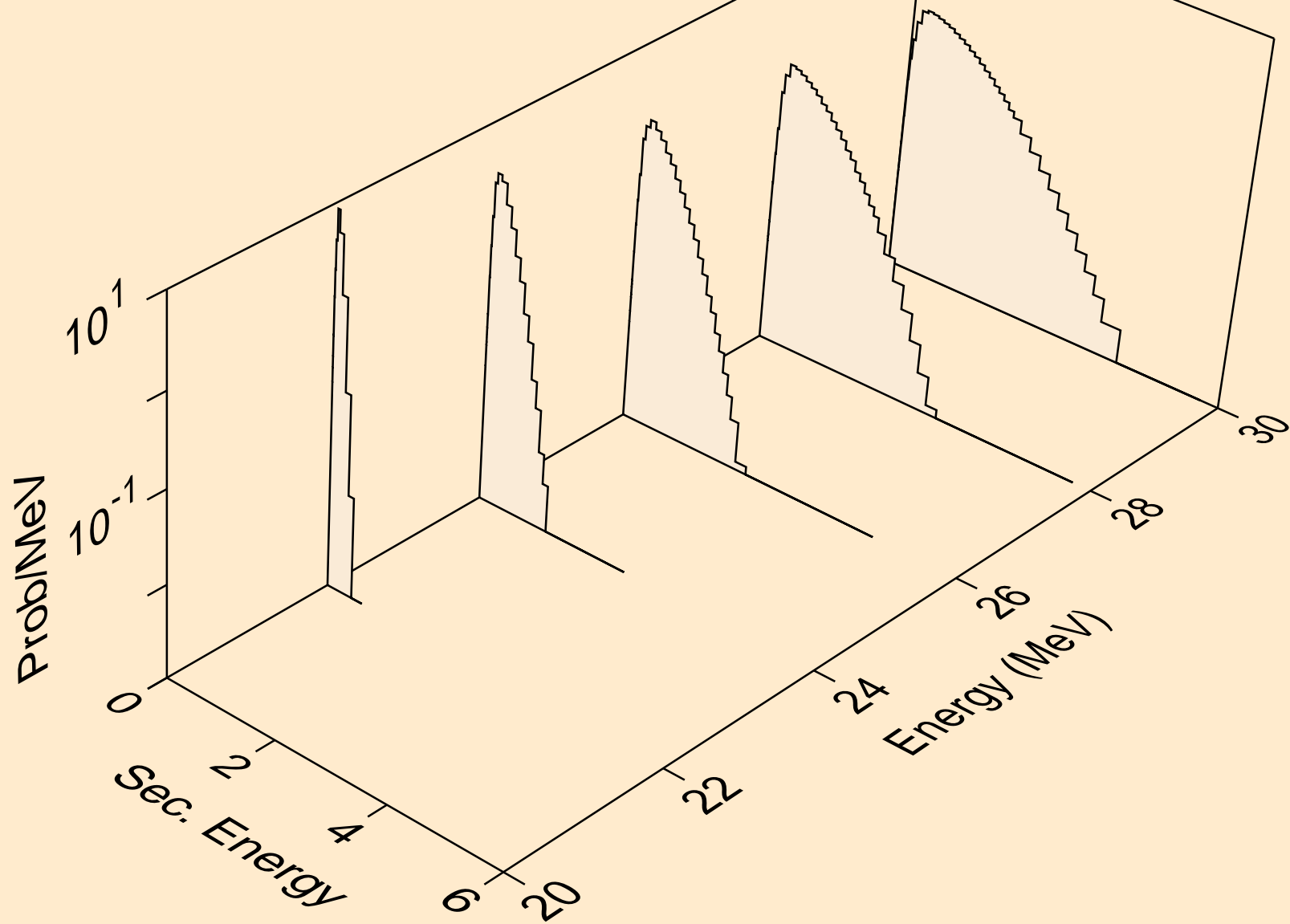

SB108 NEUTRON ACER TENDL-2024 LIBRARY; T=293.6K
Neutron emission for (n,2n)

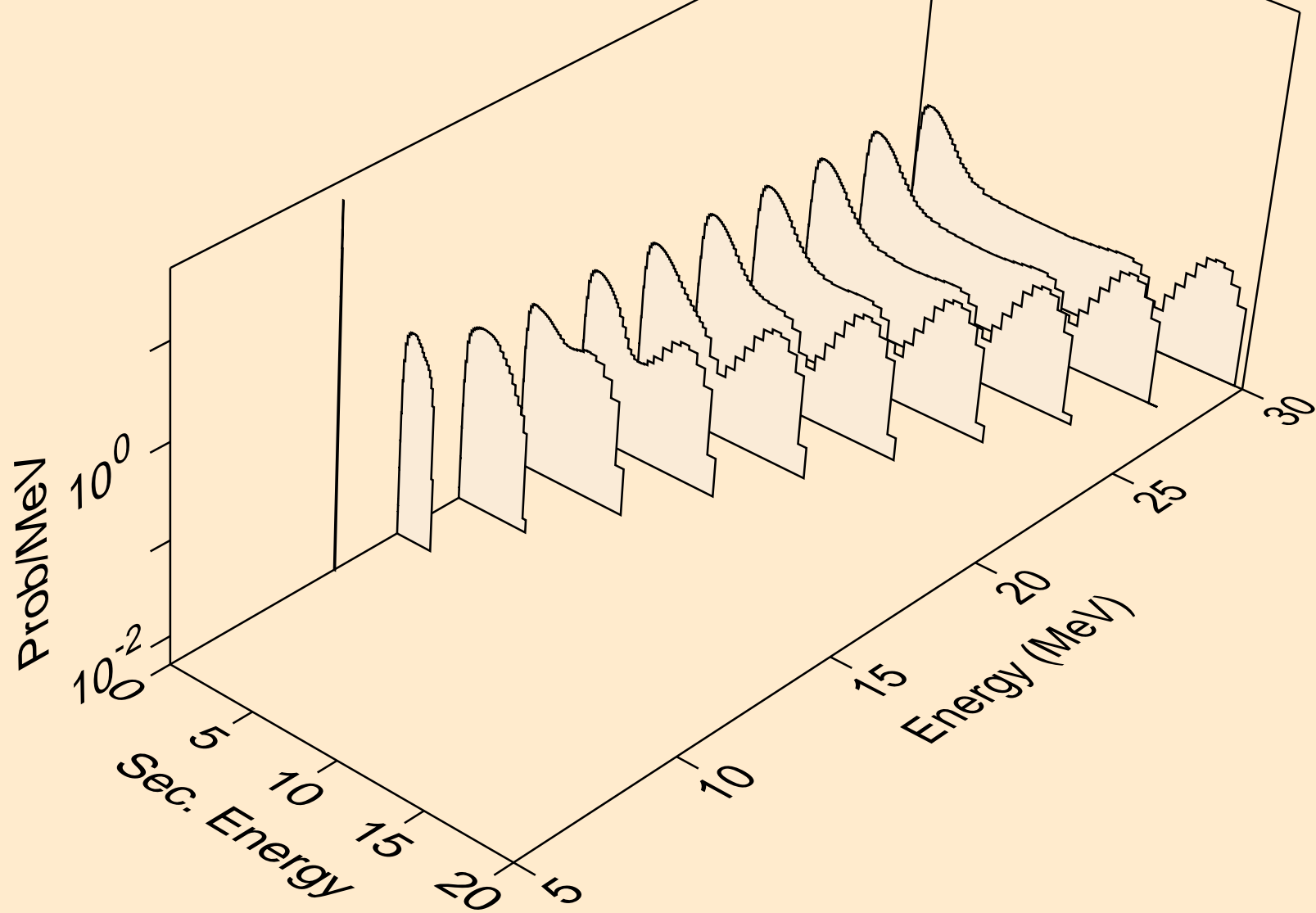

SB108 NEUTRON ACER TENDL-2024 LIBRARY; T=293.6K
Neutron emission for (n,3n)

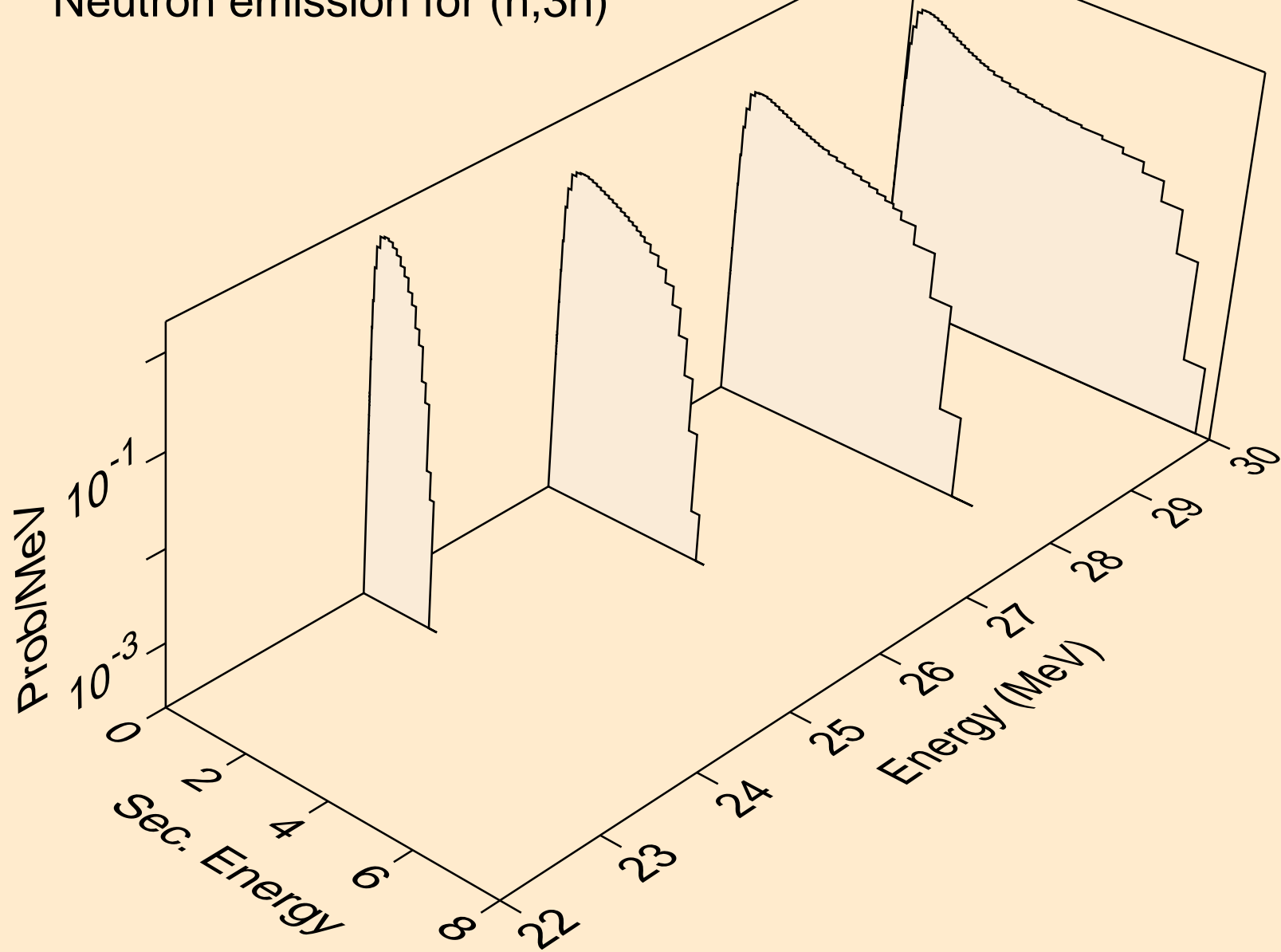

SB108 NEUTRON ACER TENDL-2024 LIBRARY; T=293.6K
Neutron emission for (n,n*)a

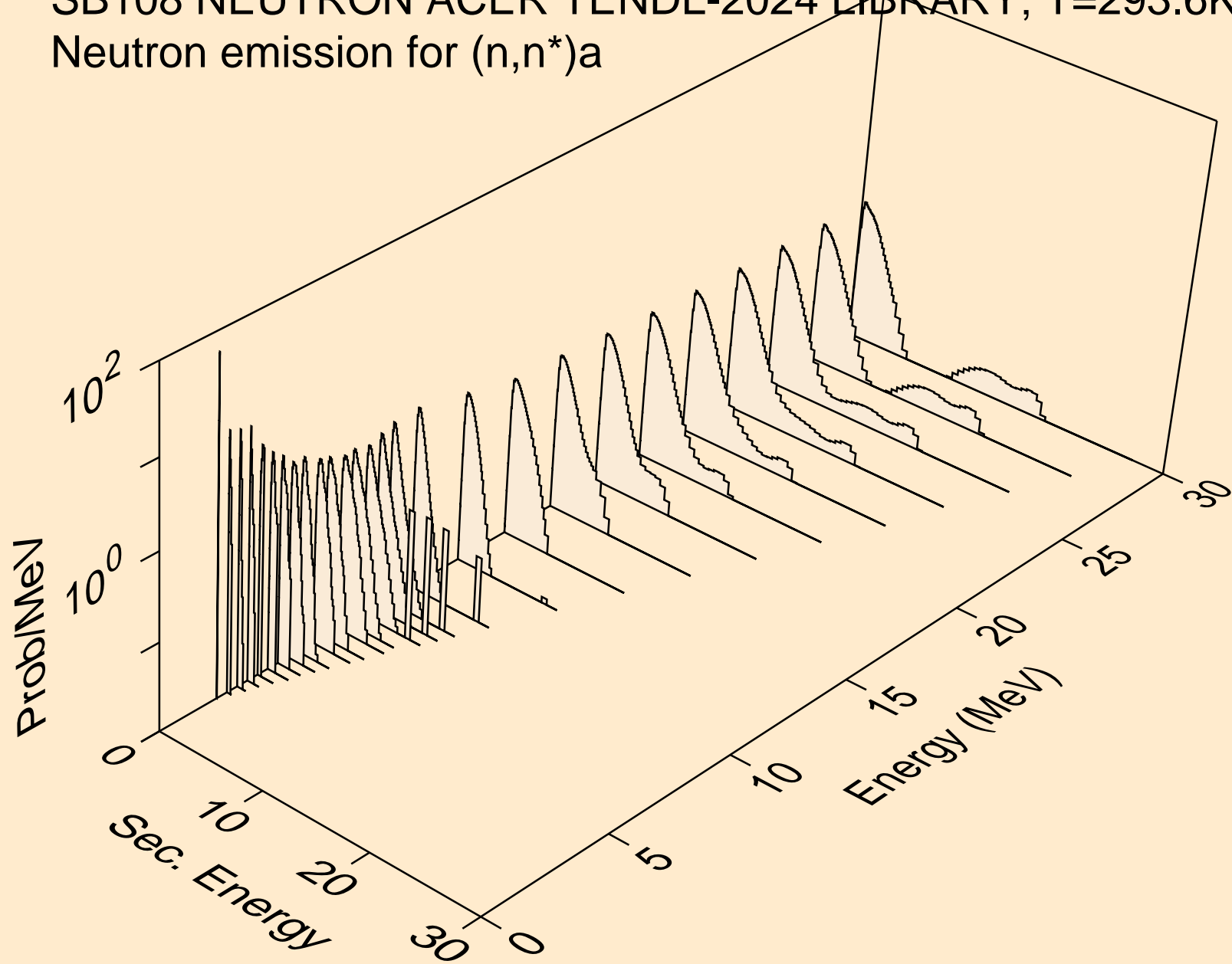

SB108 NEUTRON ACER TENDL-2024 LIBRARY; T=293.6K
Neutron emission for (n,2n)_a

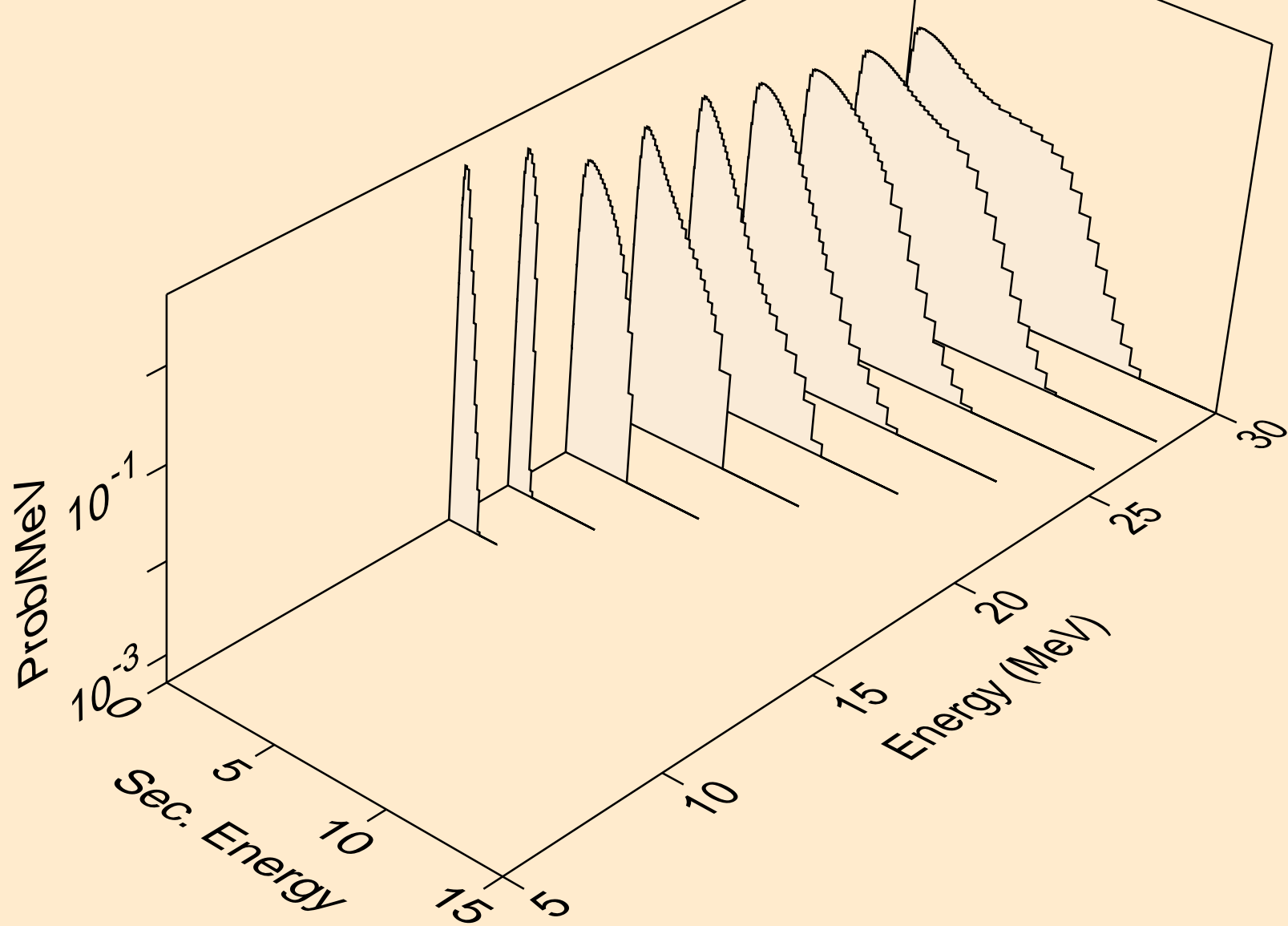

SB108 NEUTRON ACER TENDL-2024 LIBRARY; T=293.6K
Neutron emission for (n,n*)p

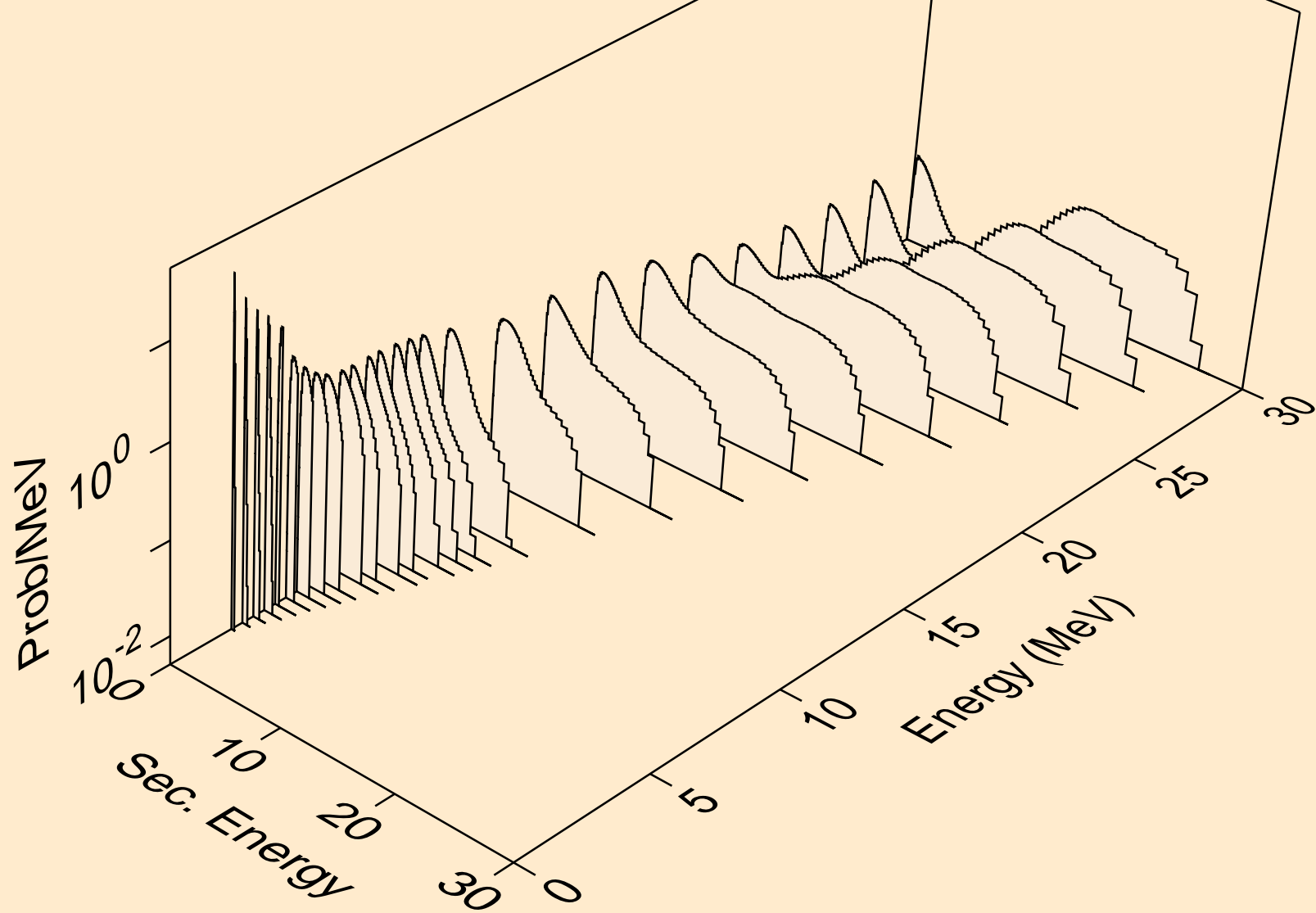

SB108 NEUTRON ACER TENDL-2024 LIBRARY; T=293.6K
Neutron emission for (n,n*)2a

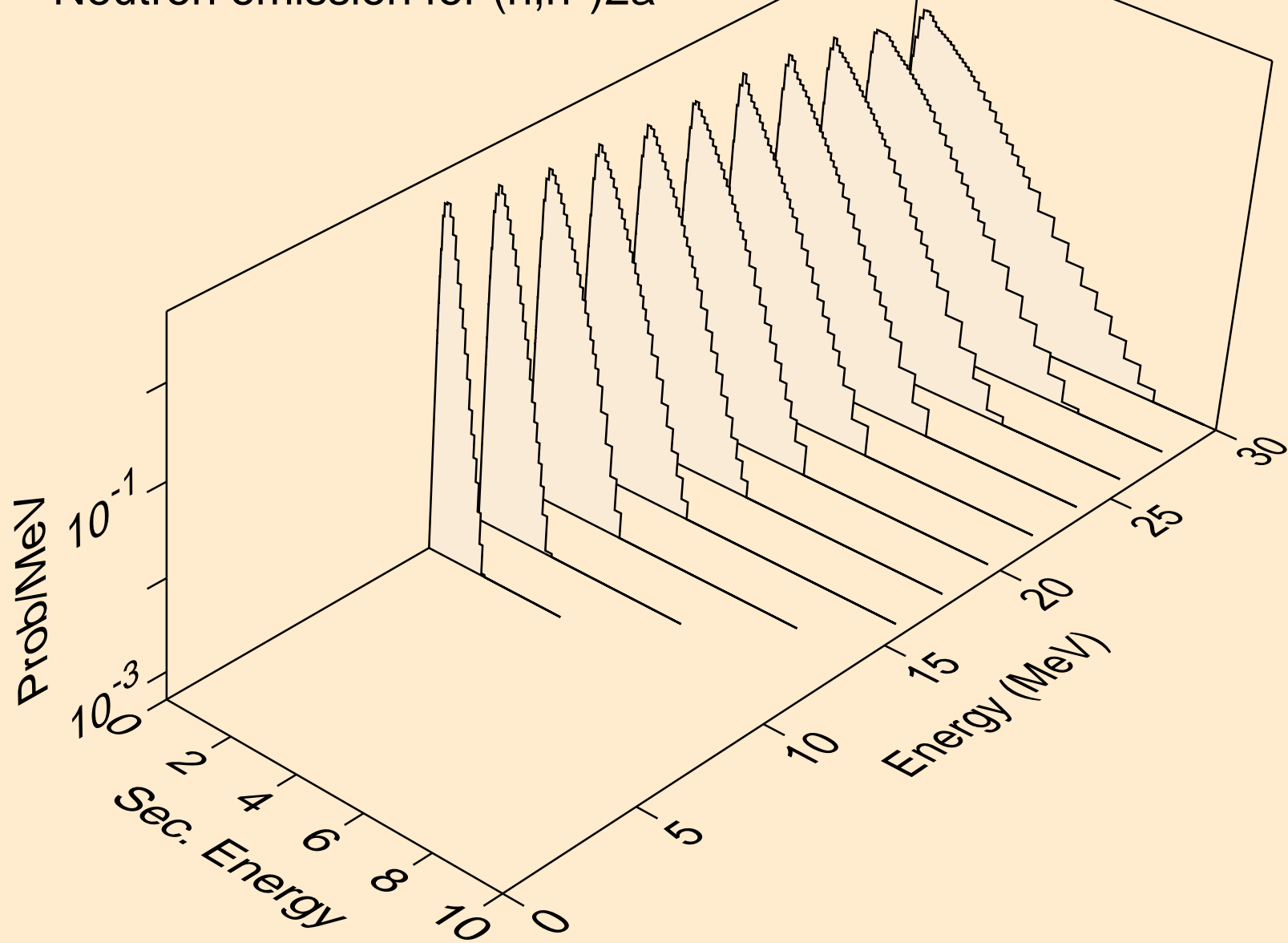

SB108 NEUTRON ACER TENDL-2024 LIBRARY; T=293.6K
Neutron emission for (n,2n)2a

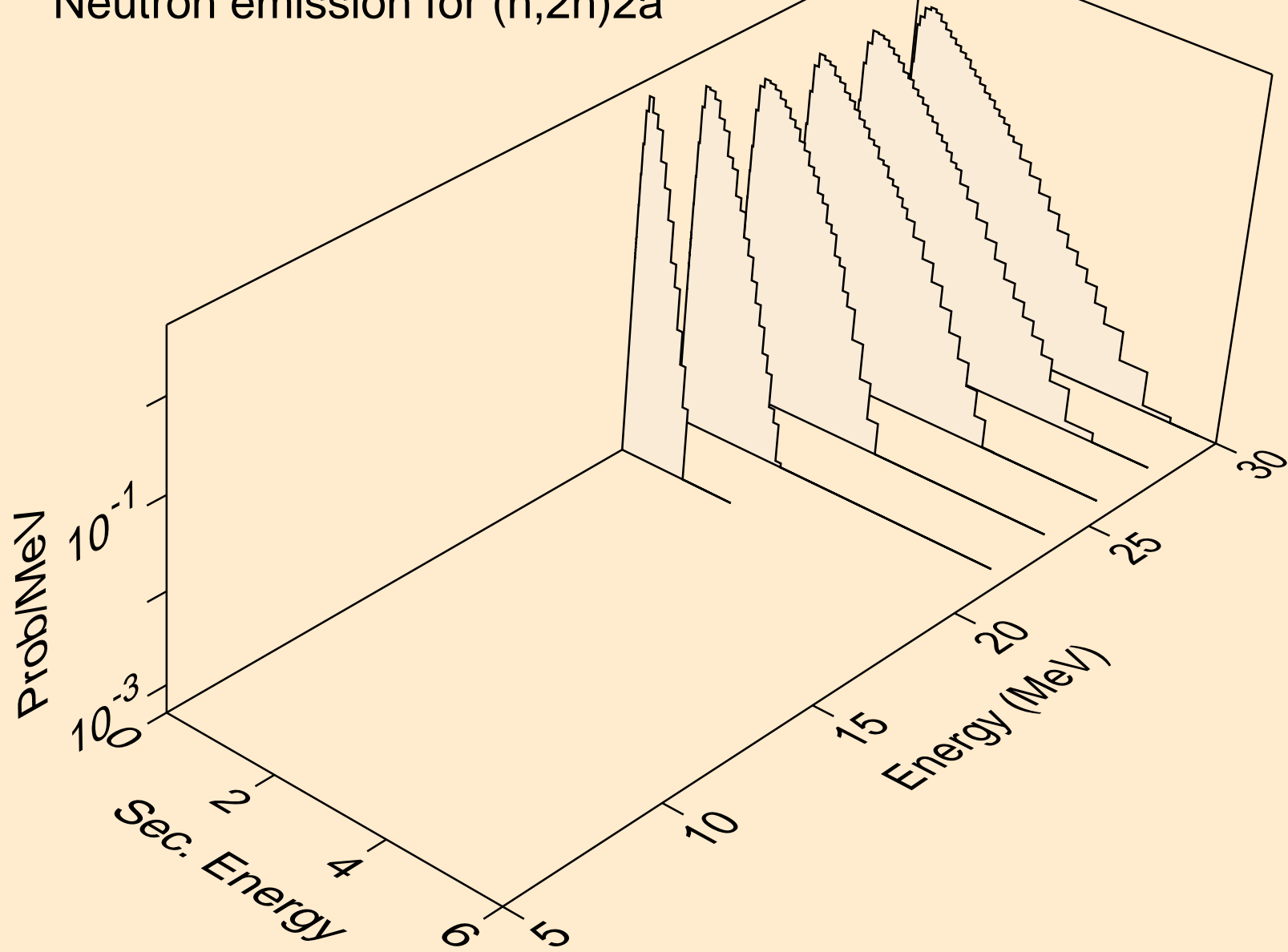

SB108 NEUTRON ACER TENDL-2024 LIBRARY; T=293.6K
Neutron emission for (n,n*)d

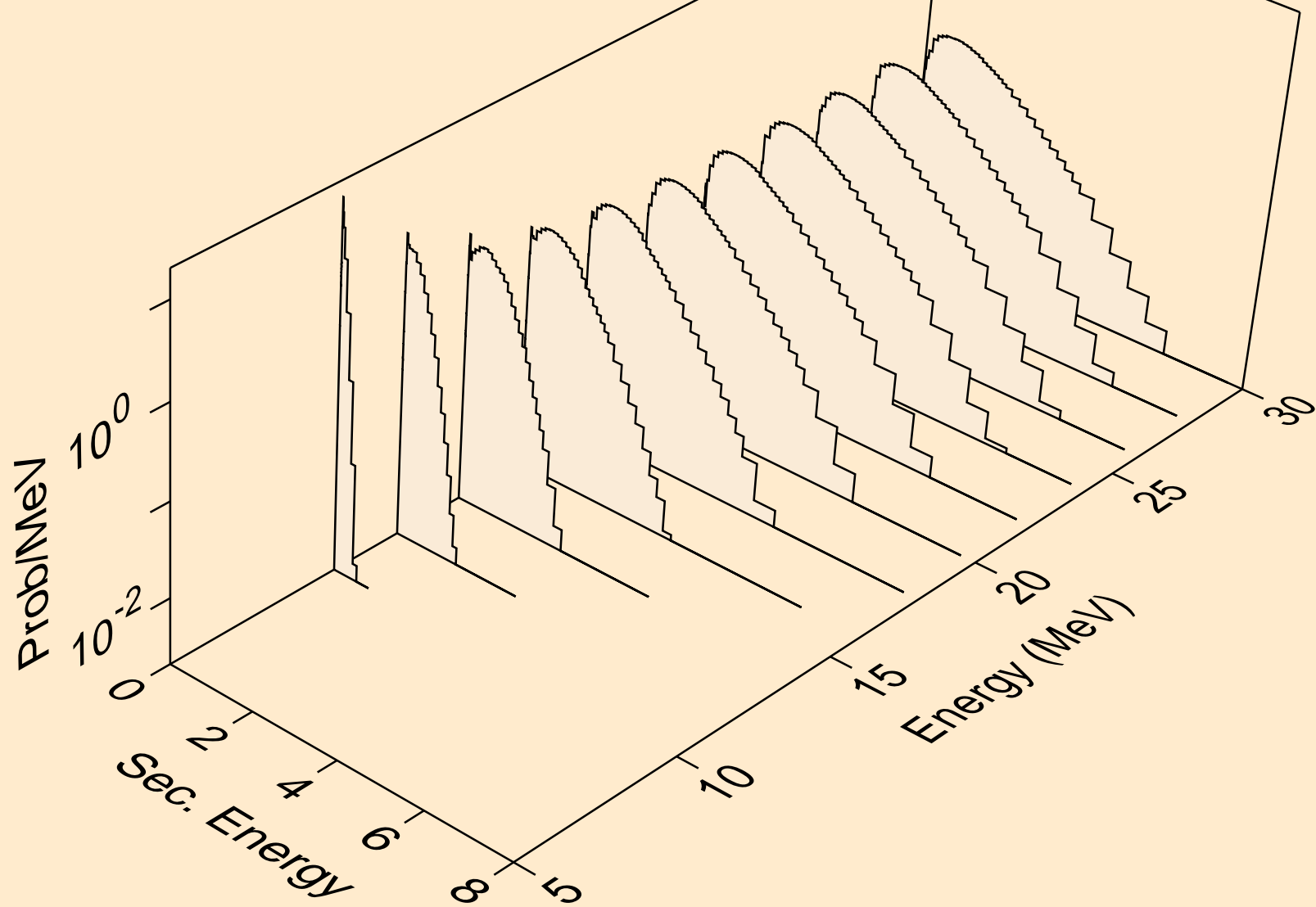

SB108 NEUTRON ACER TENDL-2024 LIBRARY; T=293.6K
Neutron emission for (n,n*)t

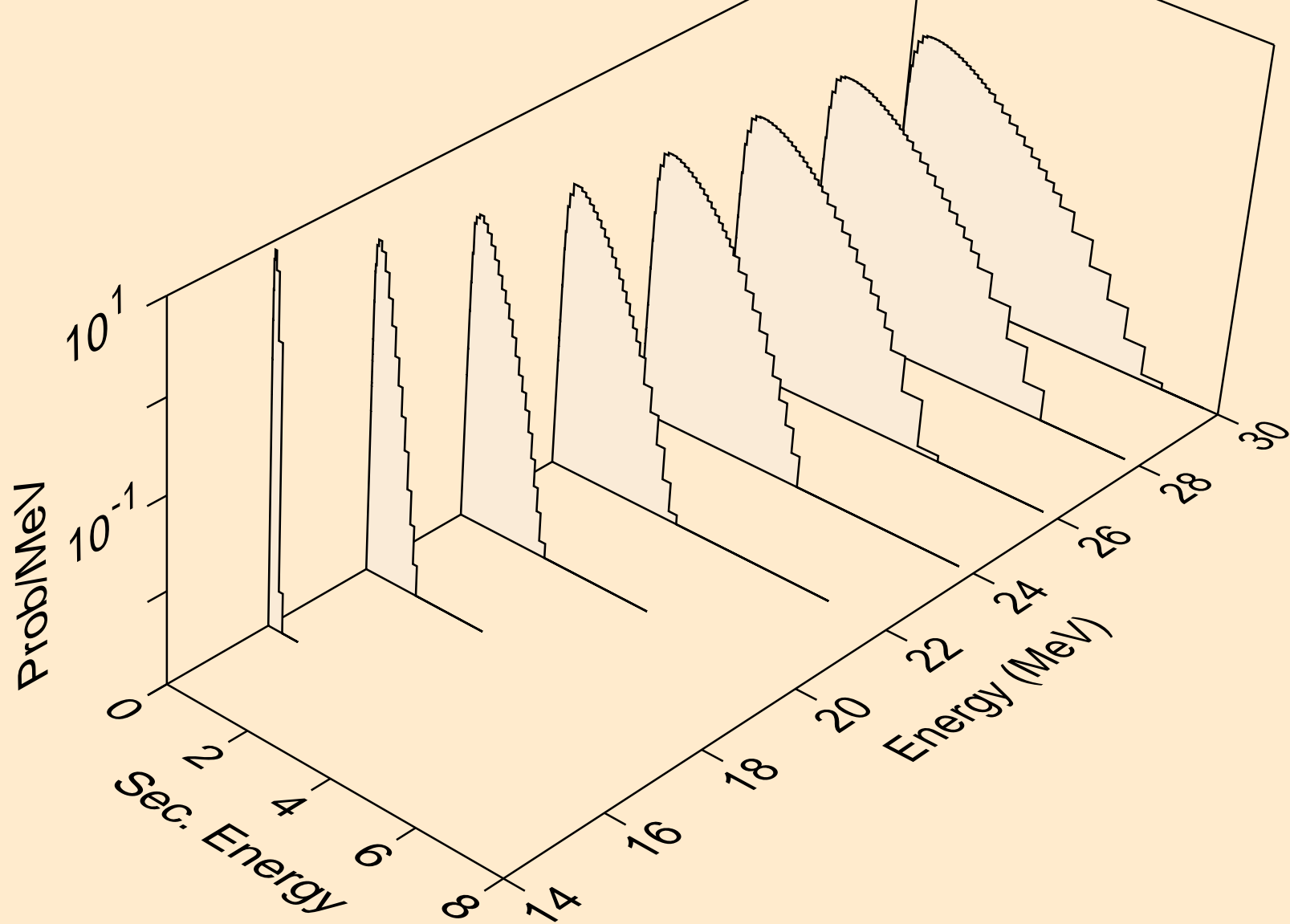

SB108 NEUTRON ACER TENDL-2024 LIBRARY; T=293.6K
Neutron emission for (n,n*)he3

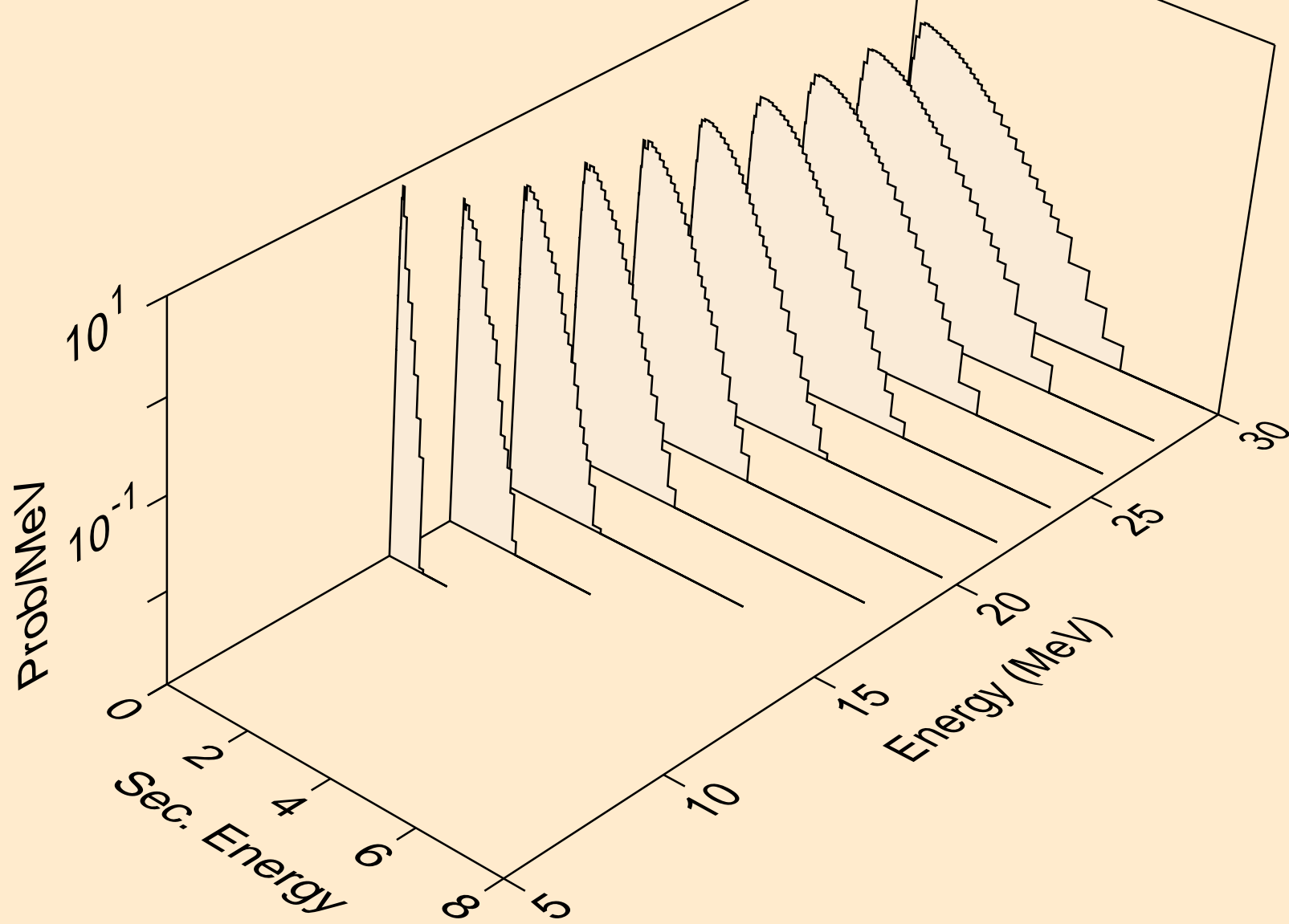

SB108 NEUTRON ACER TENDL-2024 LIBRARY; T=293.6K
Neutron emission for (n,2np)

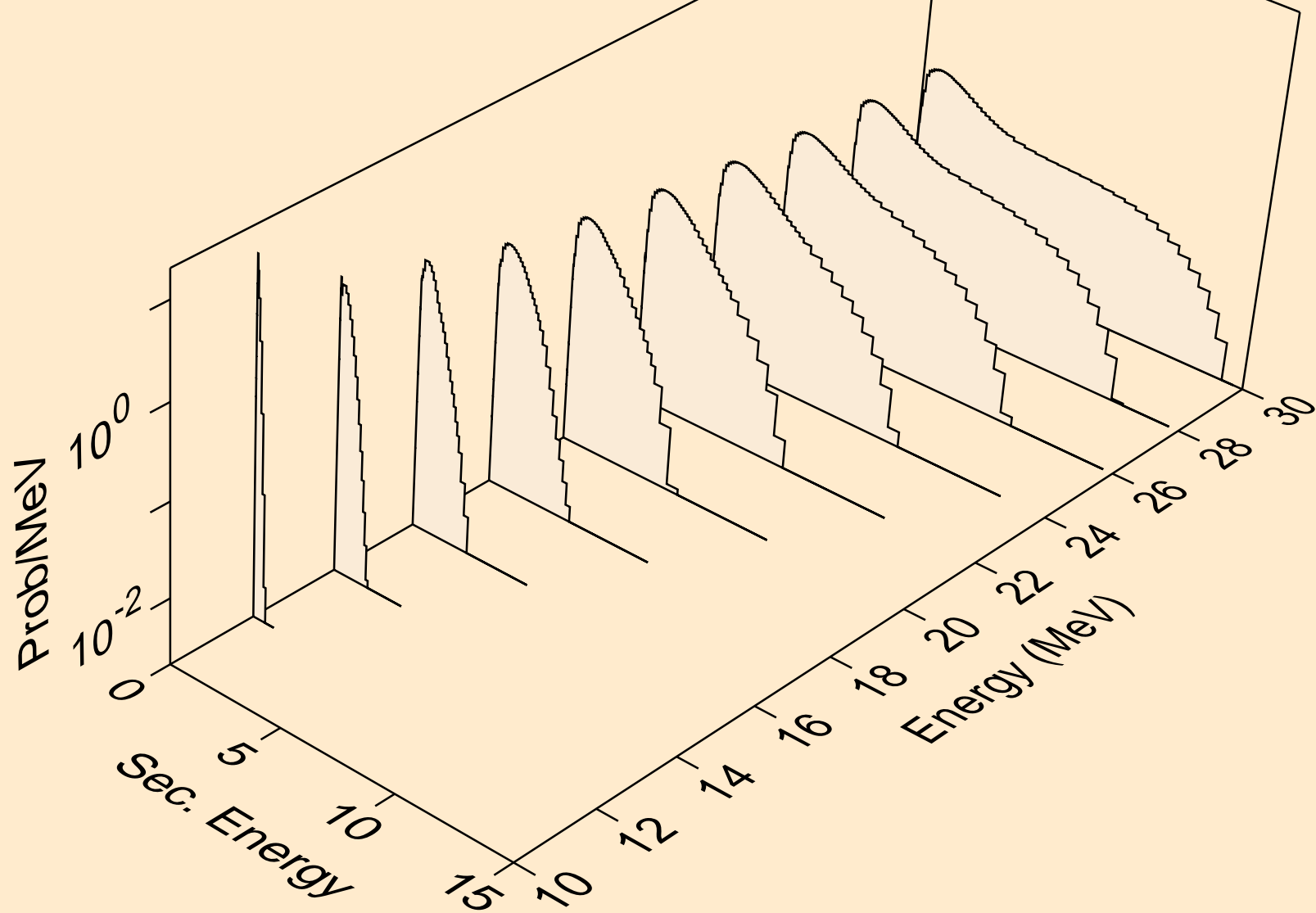

SB108 NEUTRON ACER TENDL-2024 LIBRARY; T=293.6K
Neutron emission for (n,3np)

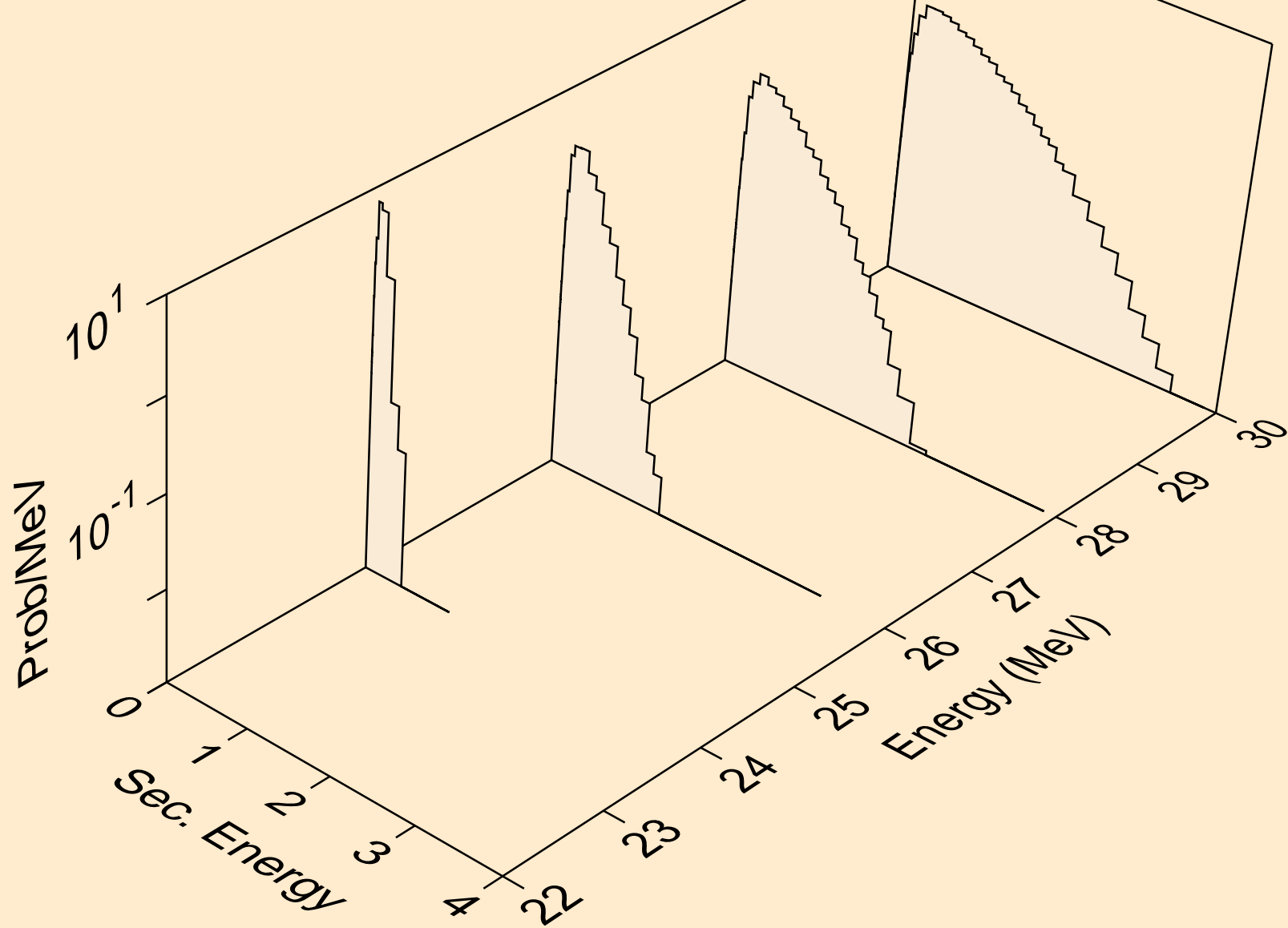

SB108 NEUTRON ACER TENDL-2024 LIBRARY; T=293.6K
Neutron emission for (n,n2p)

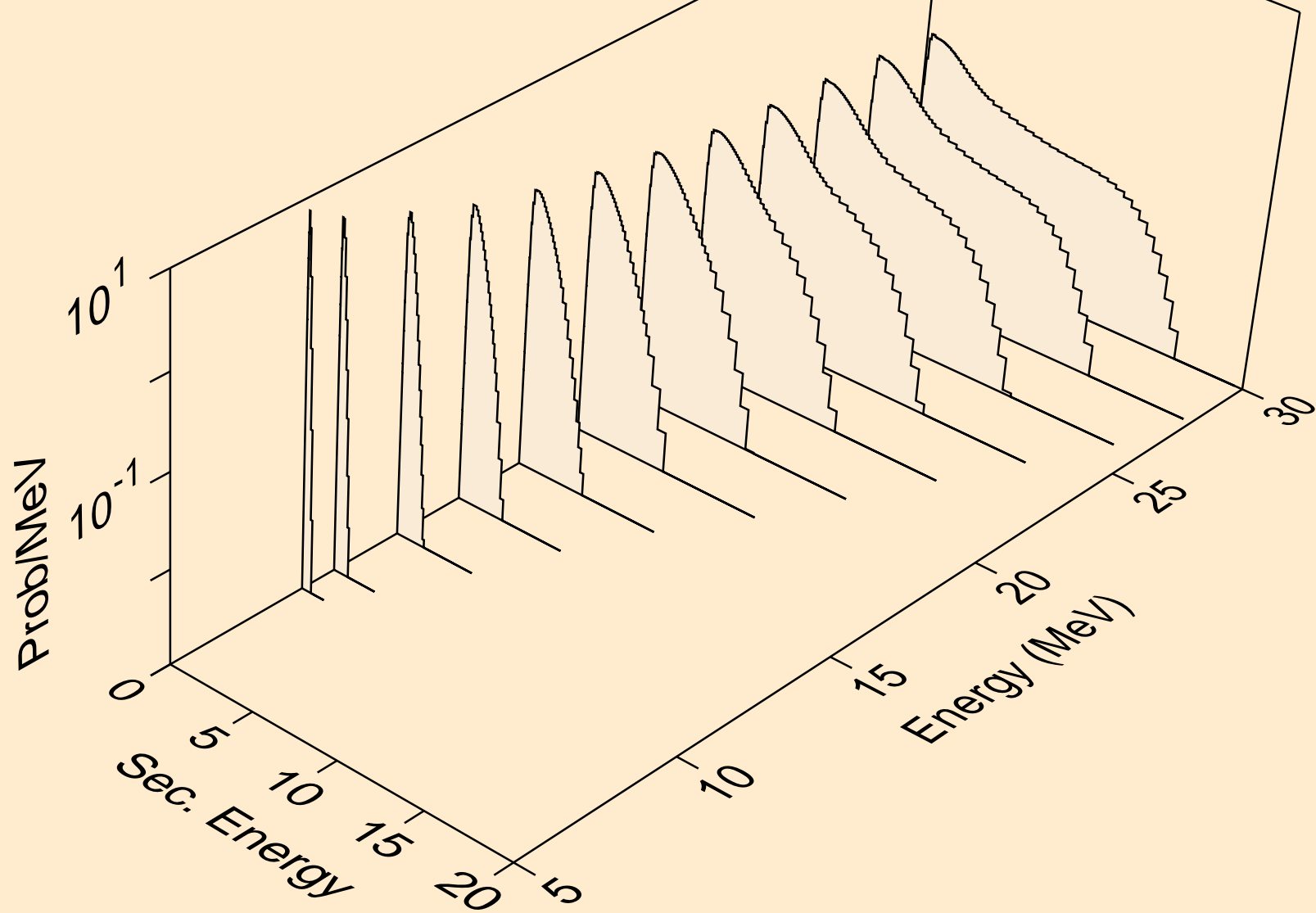

SB108 NEUTRON ACER TENDL-2024 LIBRARY; T=293.6K
Neutron emission for (n,npa)

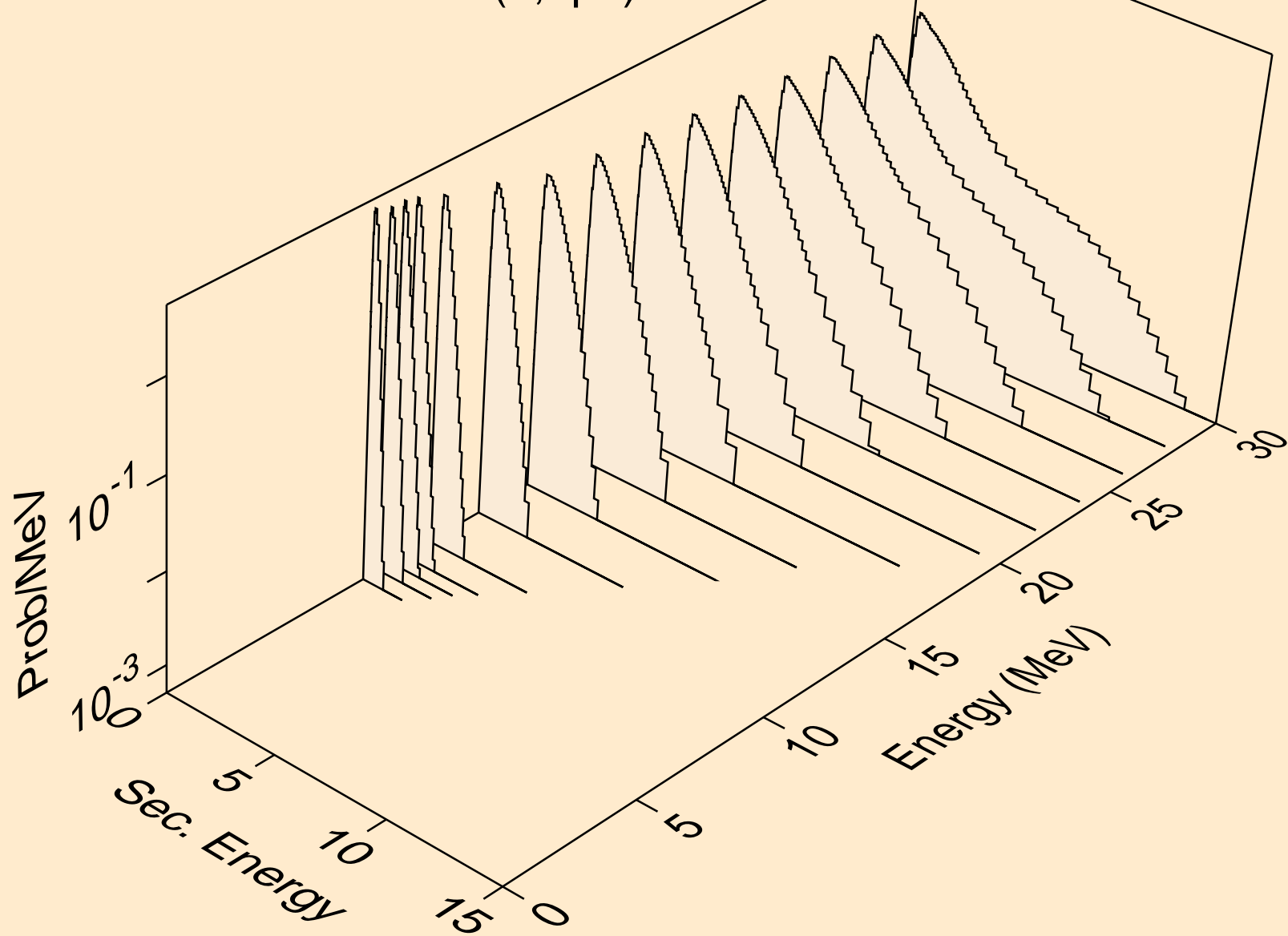

SB108 NEUTRON ACER TENDL-2024 LIBRARY; T=293.6K
Neutron emission for (n,n*c)

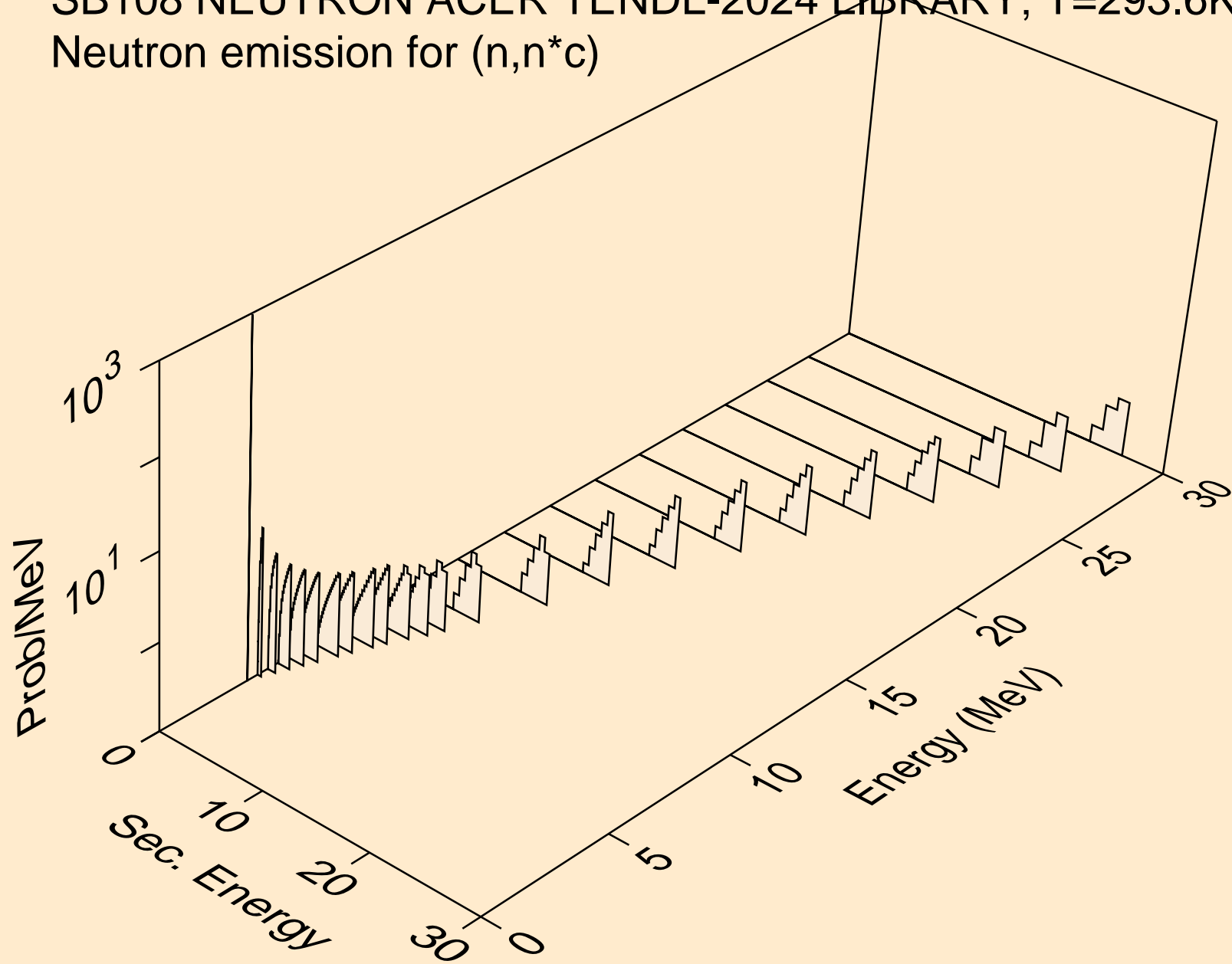

SB108 NEUTRON ACER TENDL-2024 LIBRARY; T=293.6K
Photon emission for (n,x)

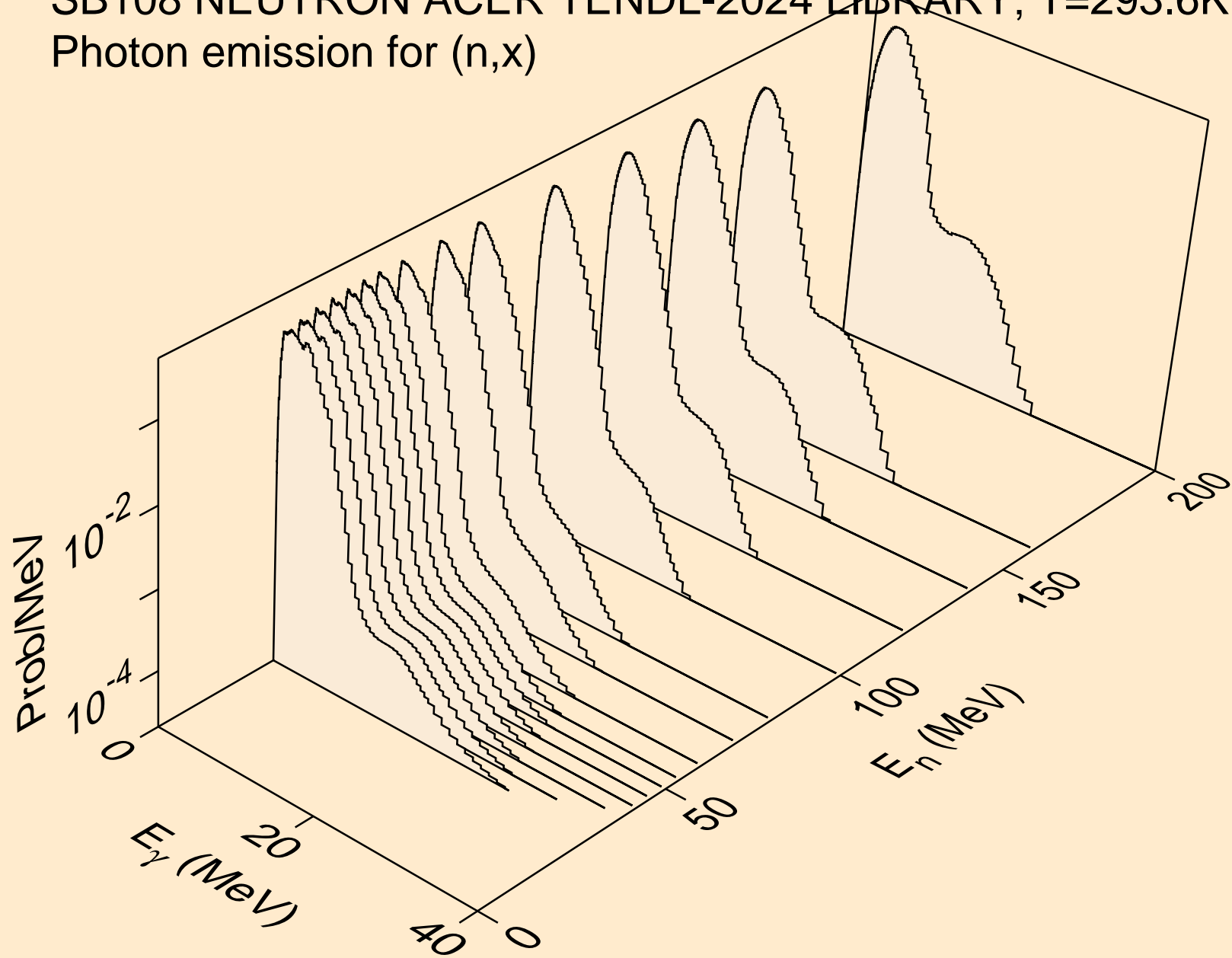

SB108 NEUTRON ACER TENDL-2024 LIBRARY; T=293.6K
Photon emission for (n,2nd)

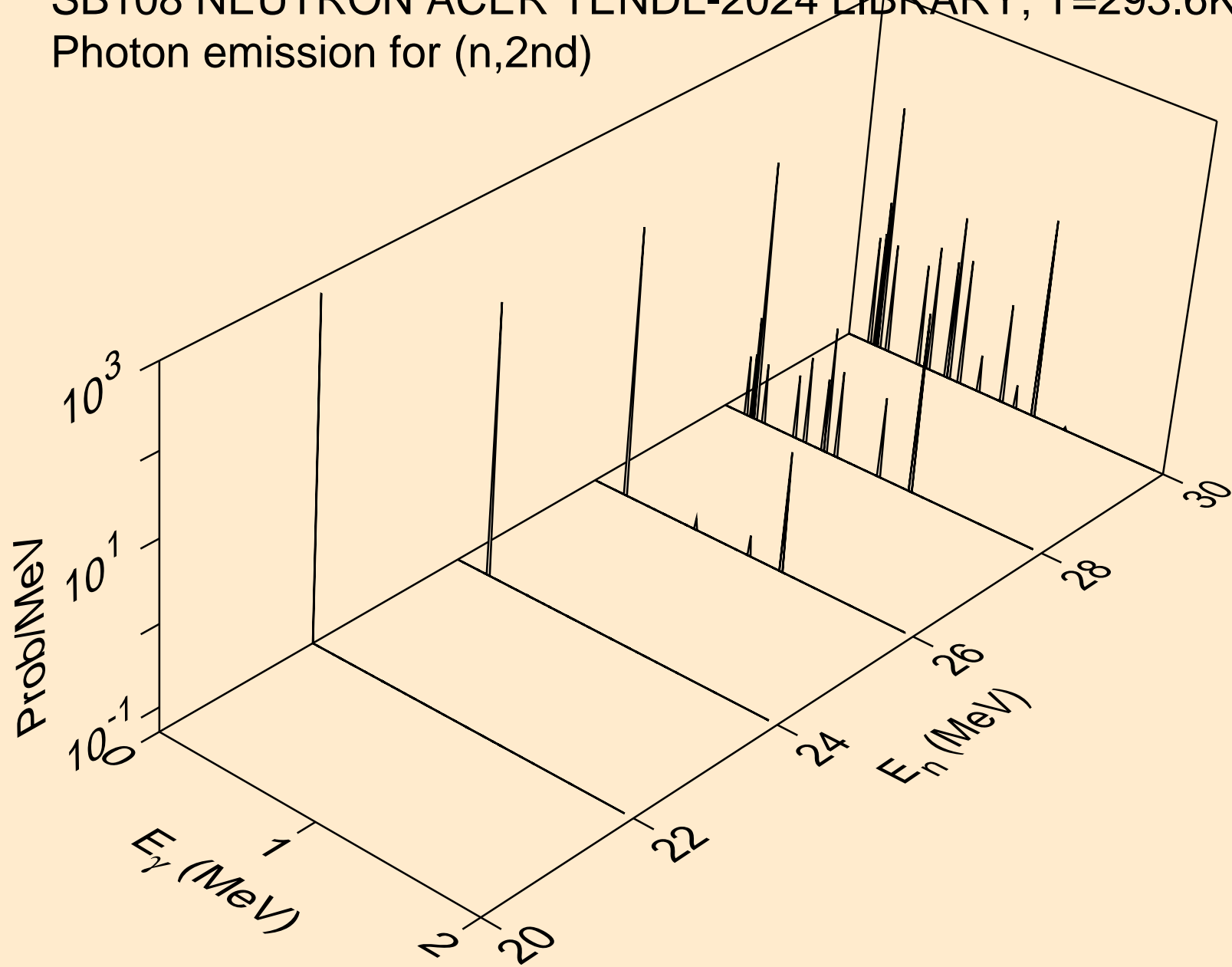

SB108 NEUTRON ACER TENDL-2024 LIBRARY; T=293.6K
Photon emission for (n,2n)

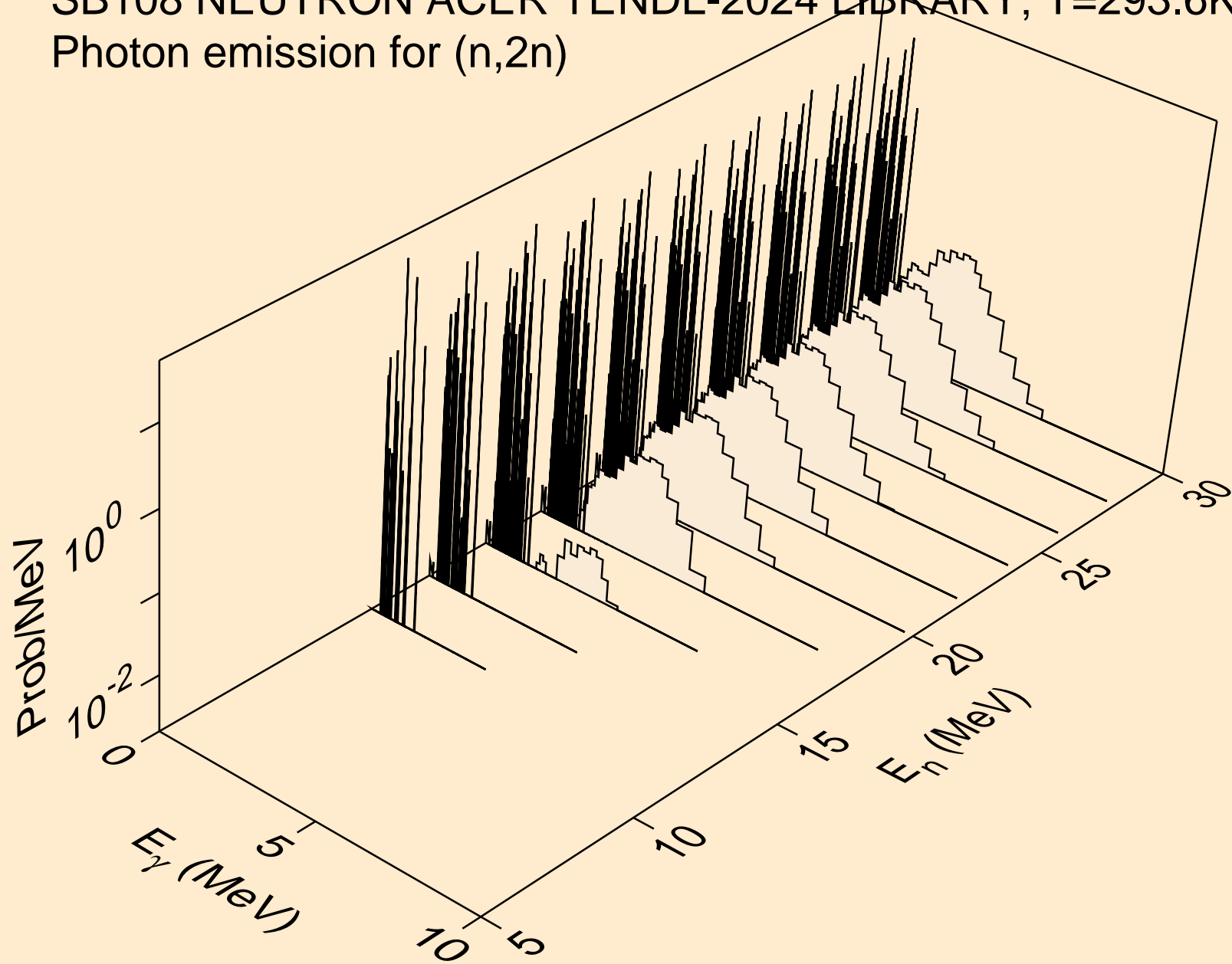

SB108 NEUTRON ACER TENDL-2024 LIBRARY; T=293.6K
Photon emission for (n,3n)

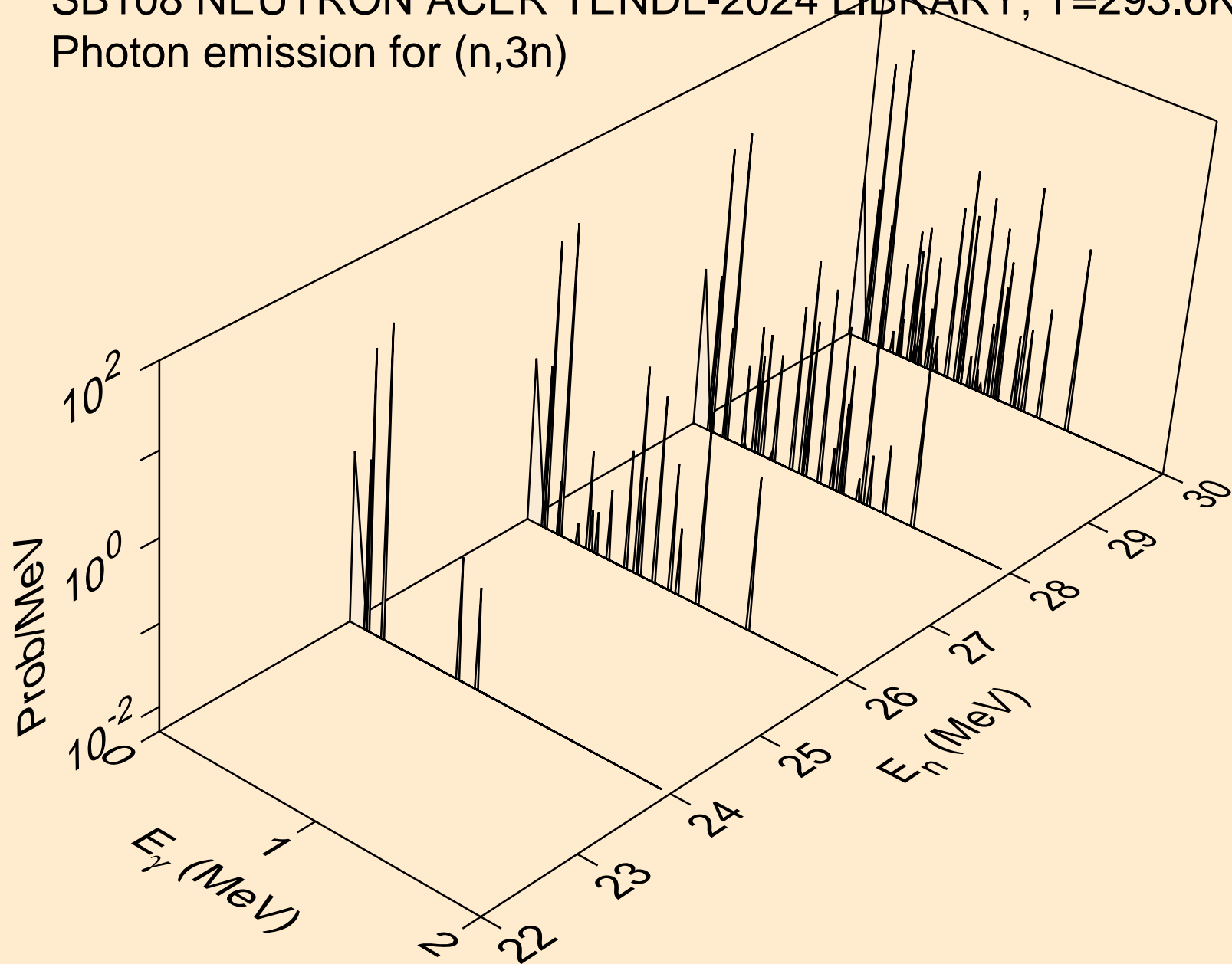

SB108 NEUTRON ACER TENDL-2024 LIBRARY; T=293.6K
Photon emission for (n,n*)a

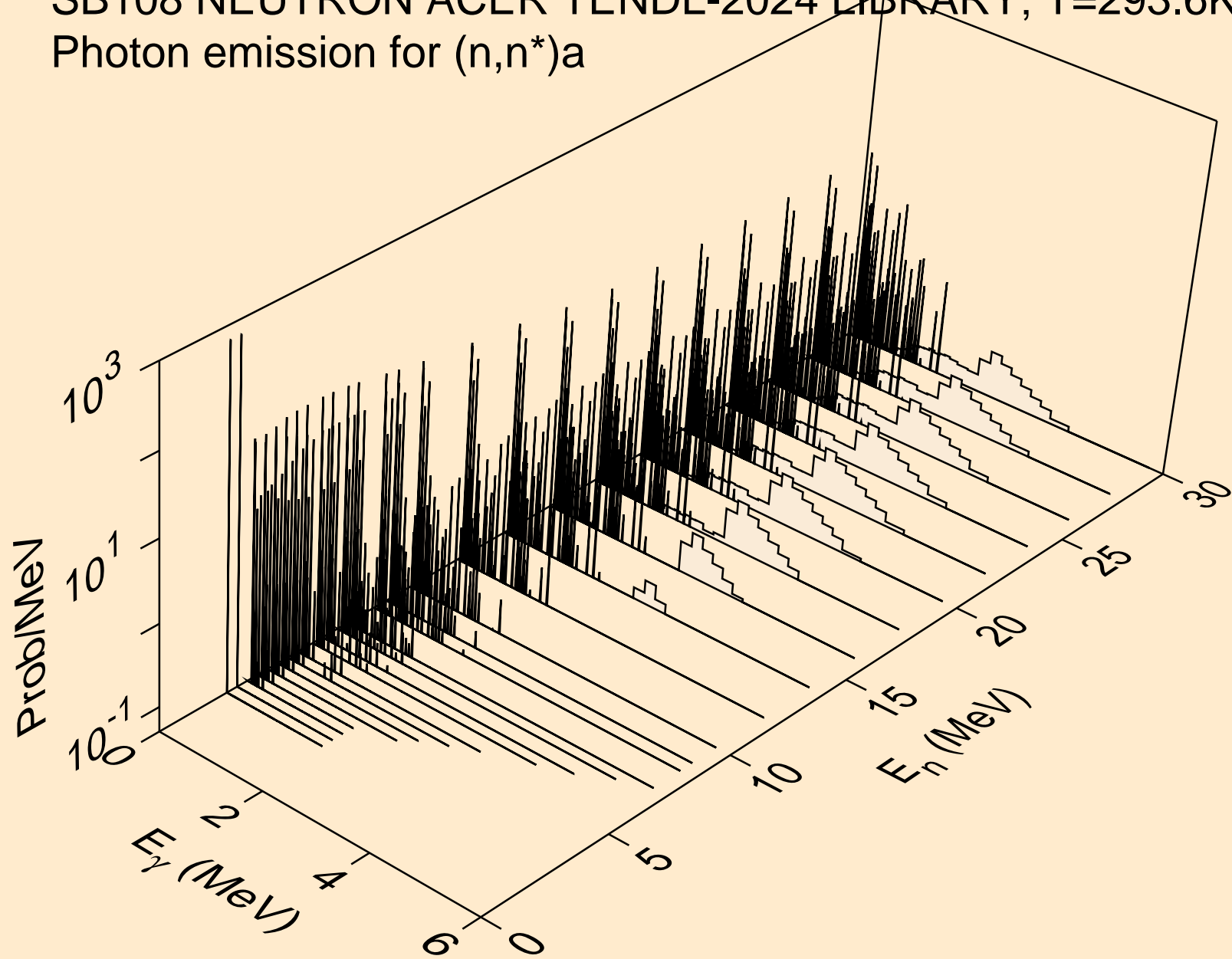

SB108 NEUTRON ACER TENDL-2024 LIBRARY; T=293.6K
Photon emission for (n,2n)a

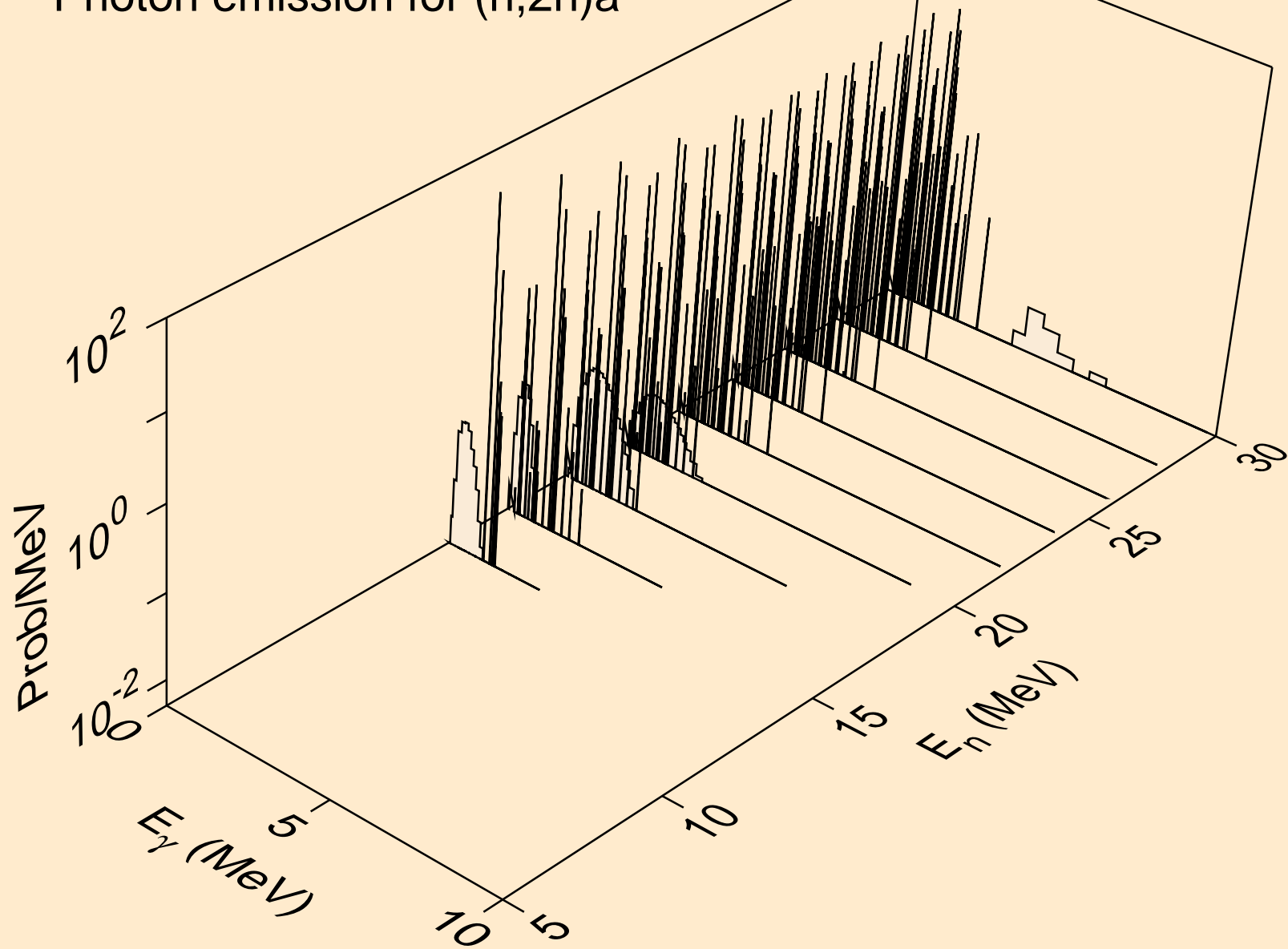

SB108 NEUTRON ACER TENDL-2024 LIBRARY; T=293.6K
Photon emission for (n,n*)p

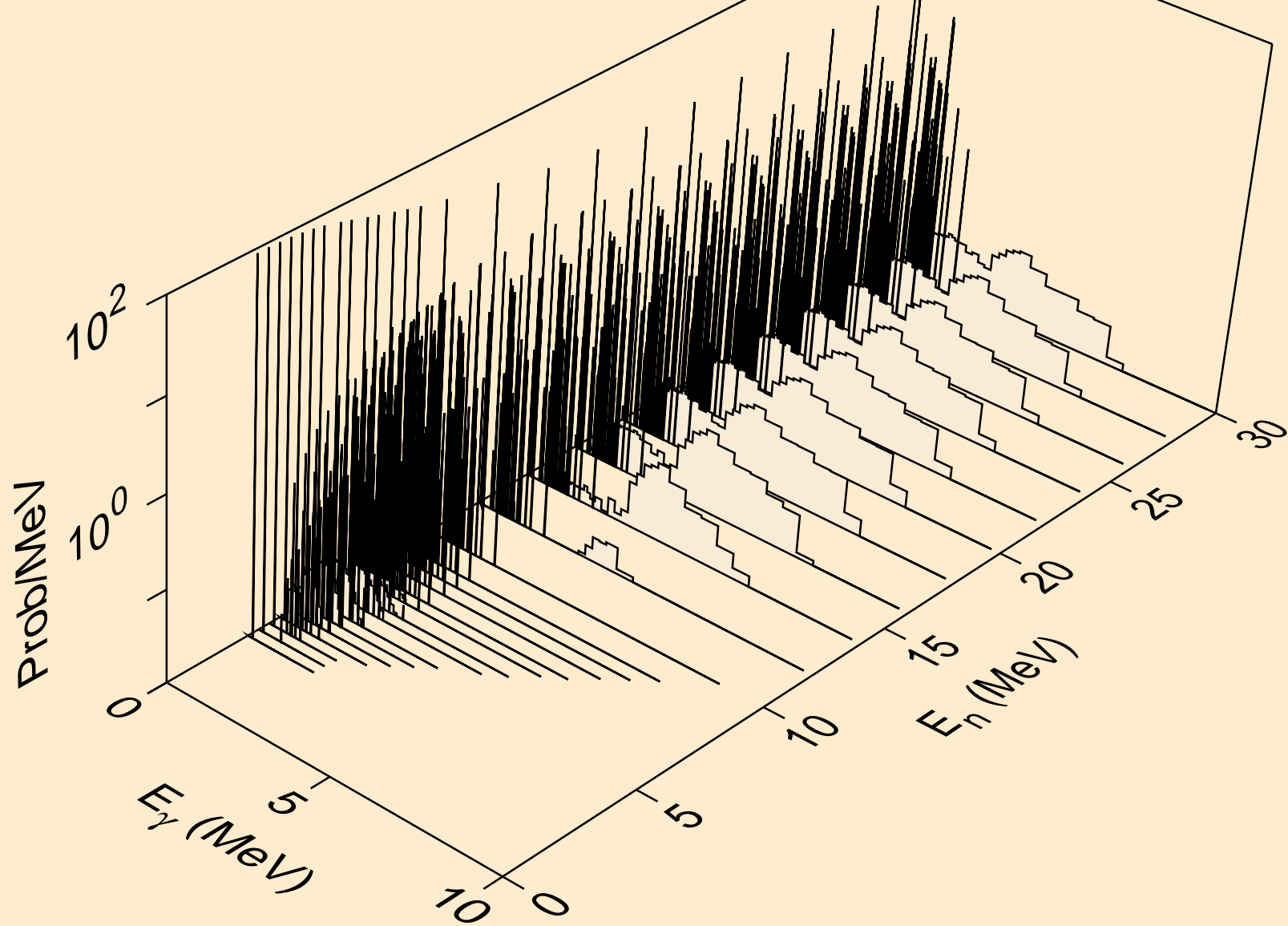

SB108 NEUTRON ACER TENDL-2024 LIBRARY; T=293.6K
Photon emission for (n,n*)2a

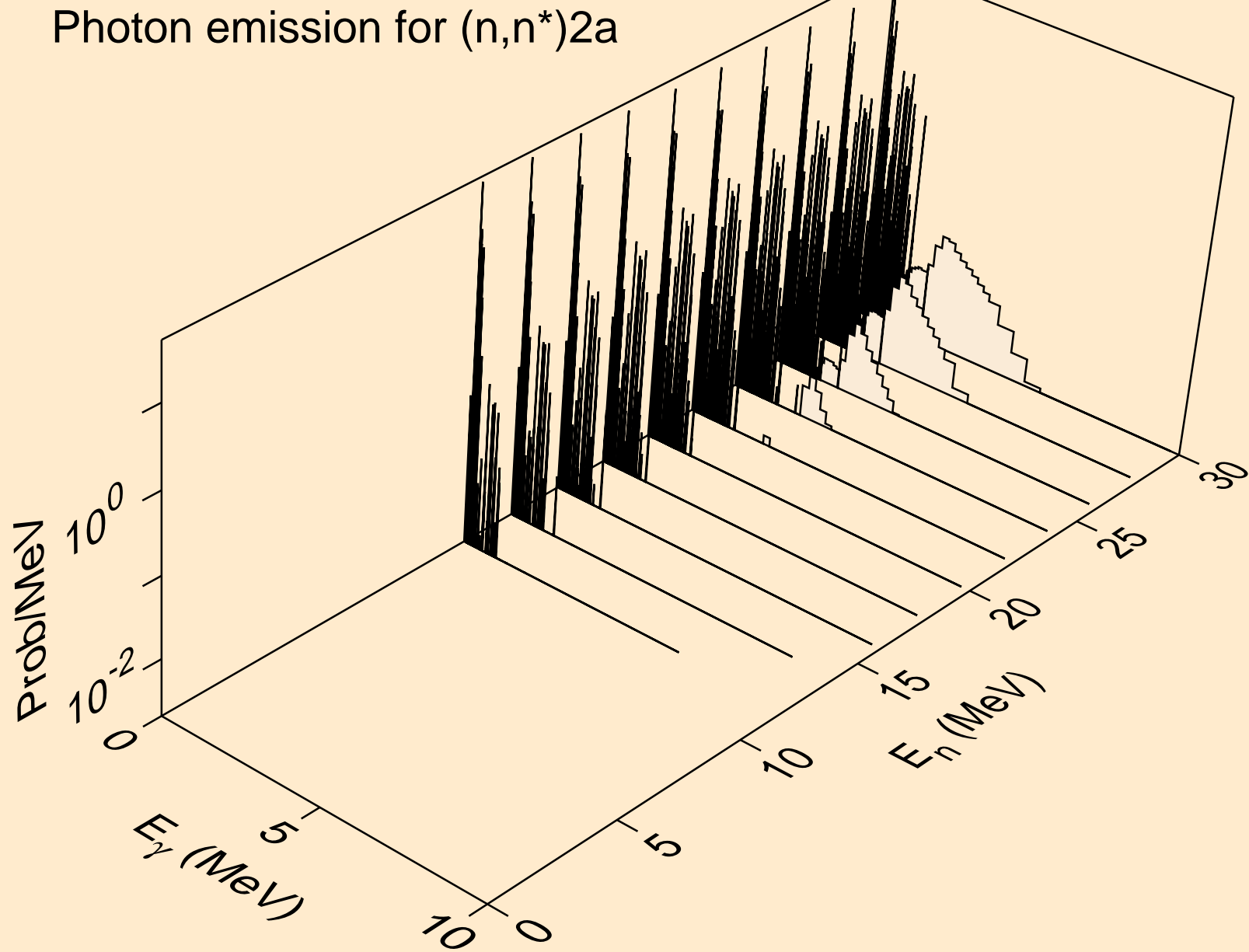

SB108 NEUTRON ACER TENDL-2024 LIBRARY; T=293.6K
Photon emission for (n,2n)2a

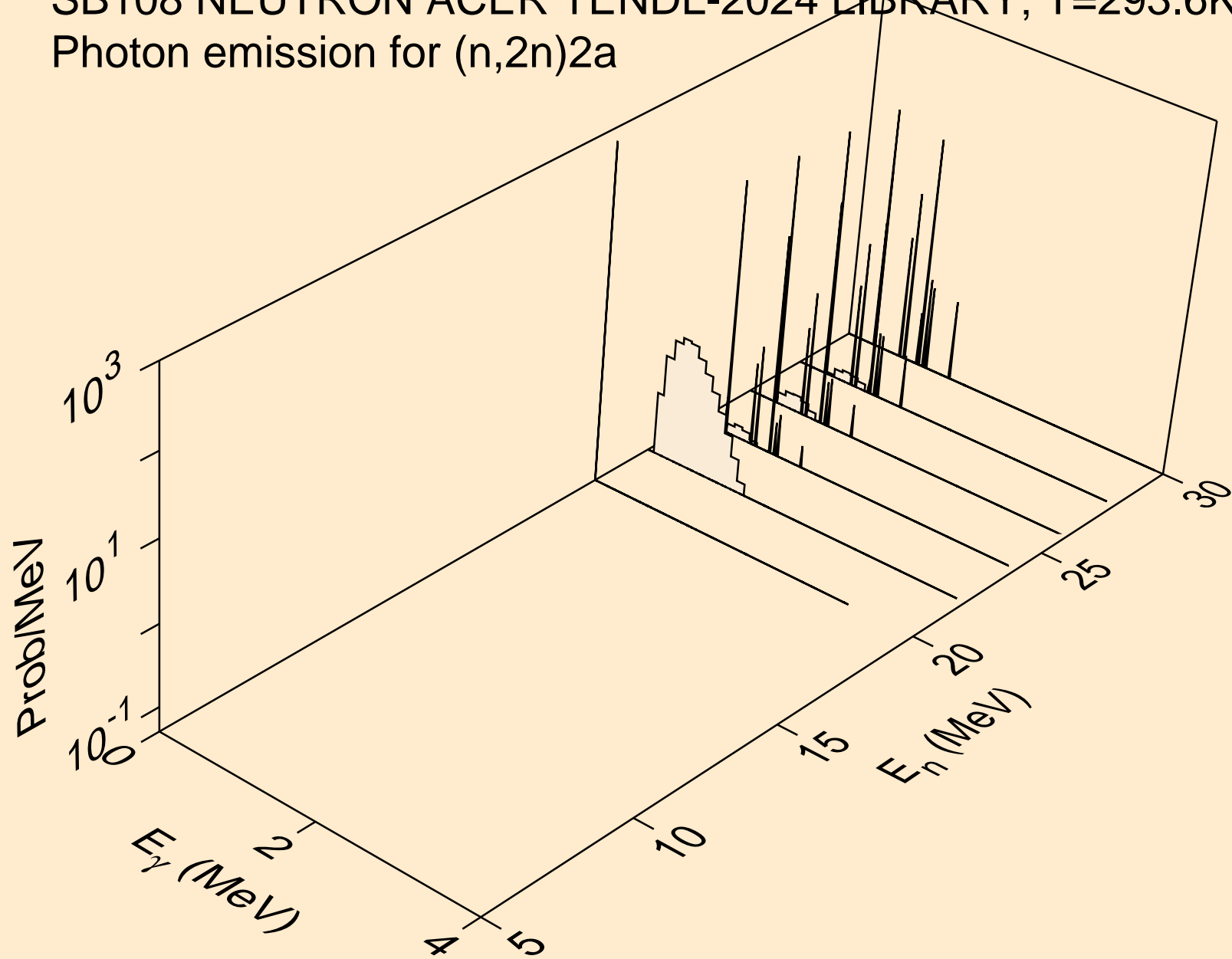

SB108 NEUTRON ACER TENDL-2024 LIBRARY; T=293.6K
Photon emission for (n,n*)d

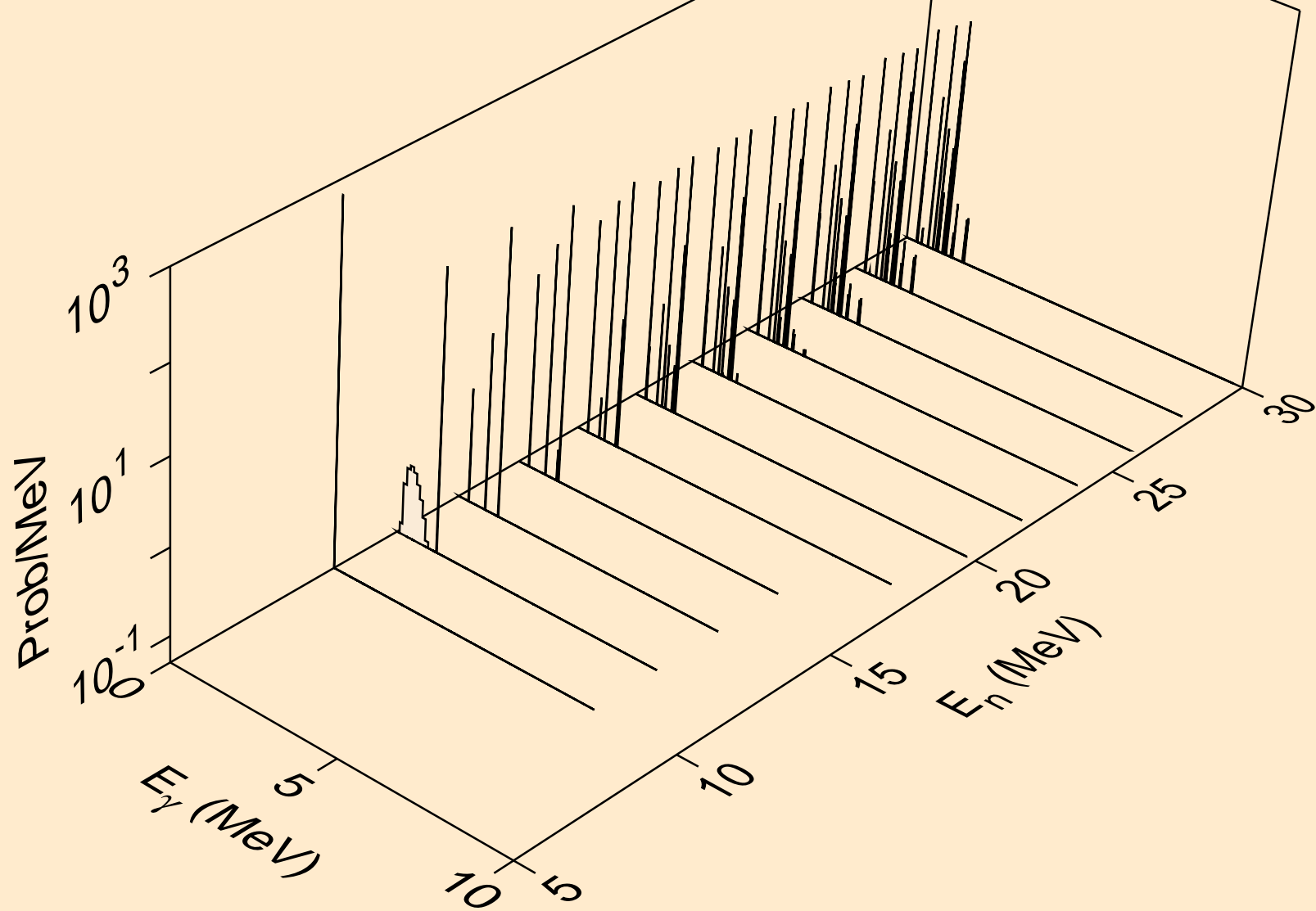

SB108 NEUTRON ACER TENDL-2024 LIBRARY; T=293.6K
Photon emission for (n,n*)t

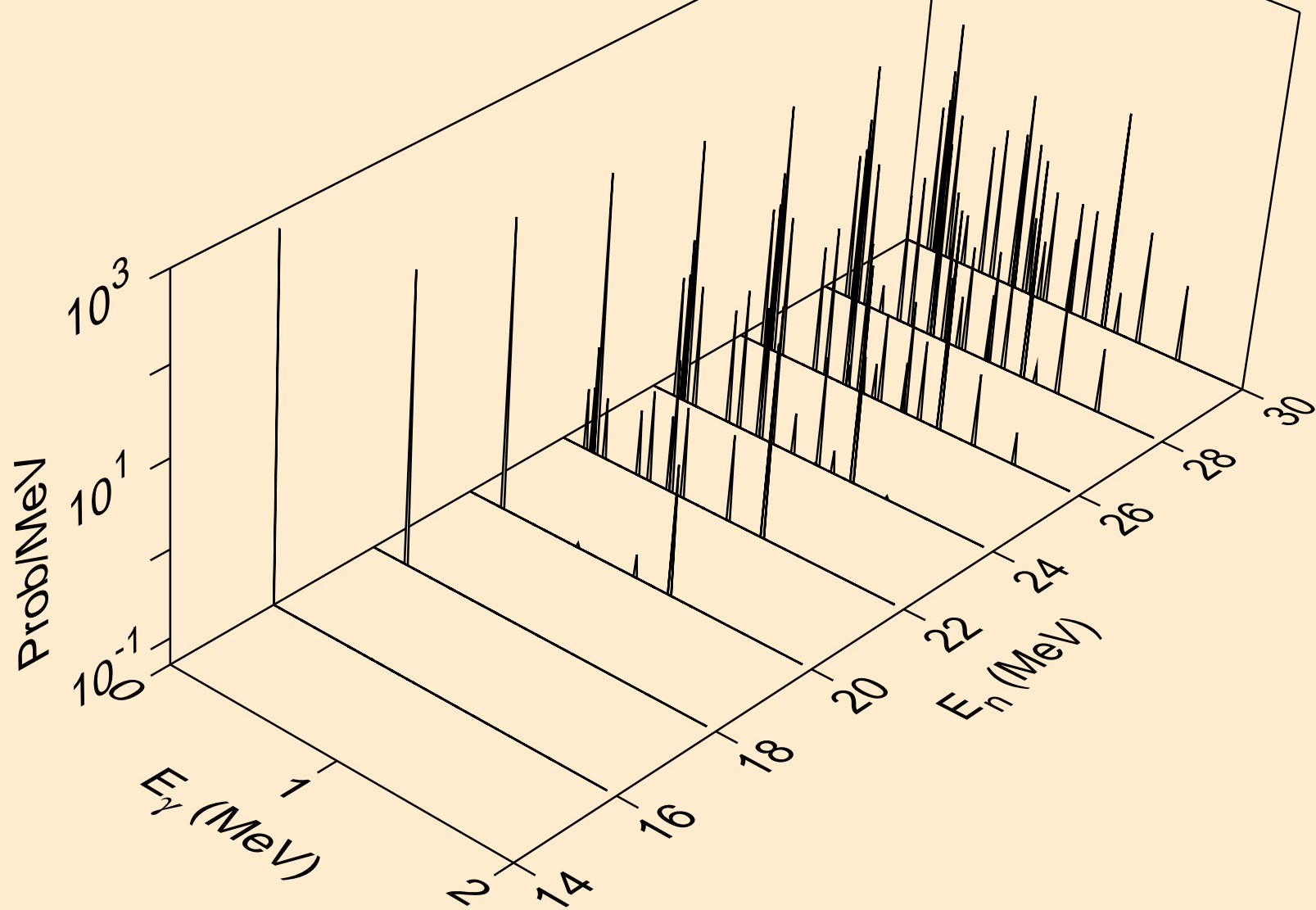

SB108 NEUTRON ACER TENDL-2024 LIBRARY; T=293.6K
Photon emission for (n,n*)he3

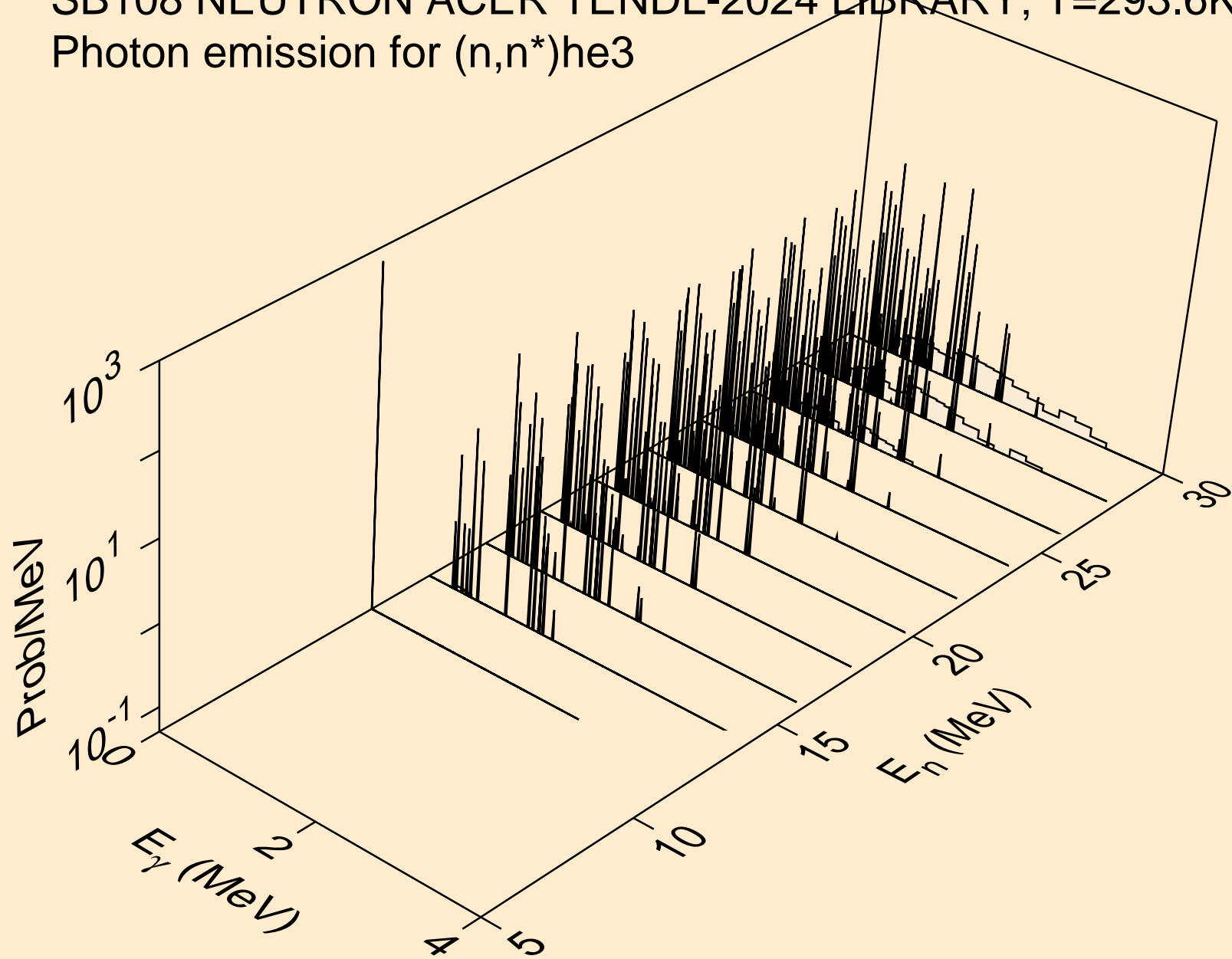

SB108 NEUTRON ACER TENDL-2024 LIBRARY; T=293.6K
Photon emission for (n,2np)

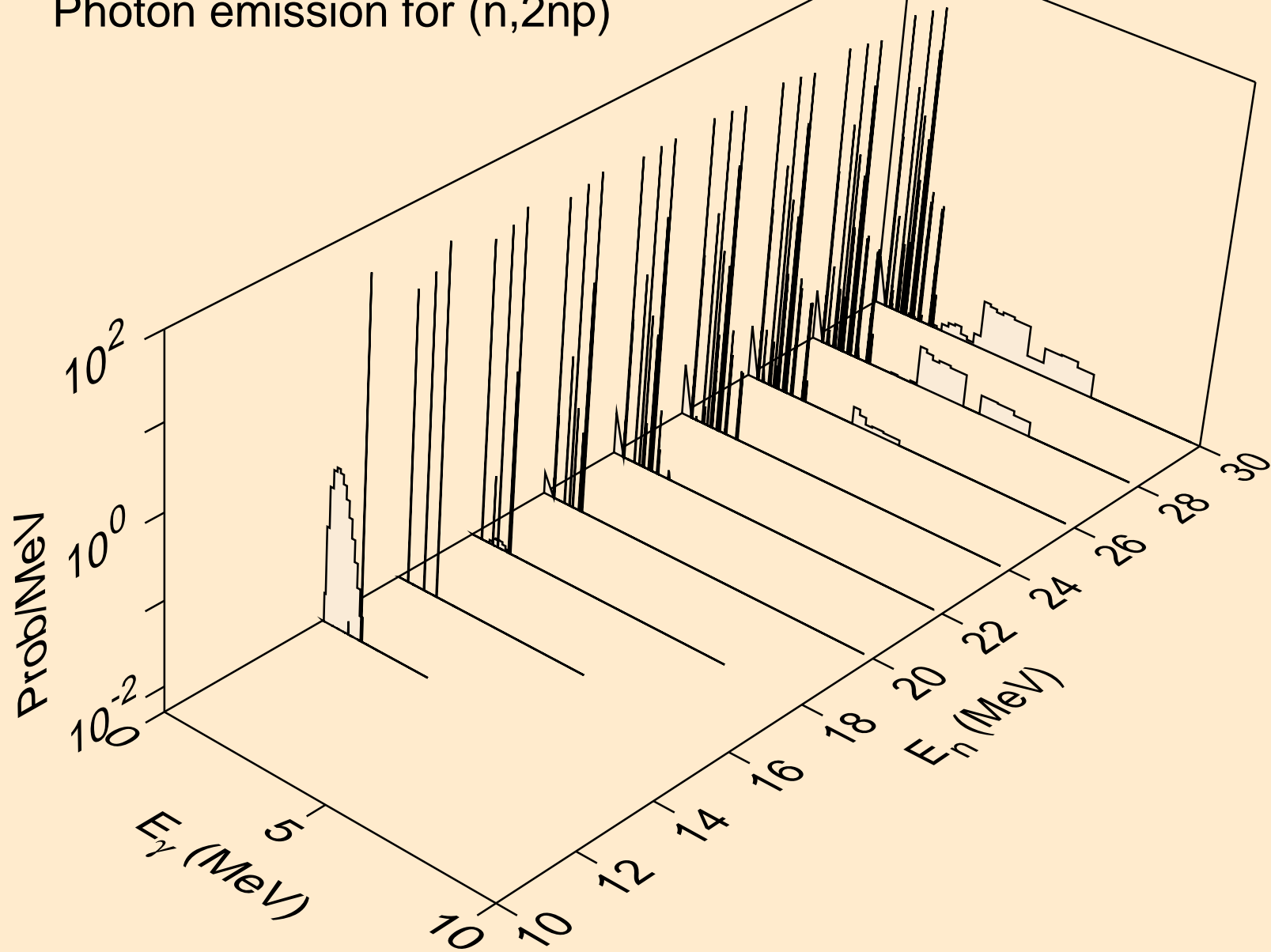

SB108 NEUTRON ACER TENDL-2024 LIBRARY; T=293.6K
Photon emission for (n,3np)

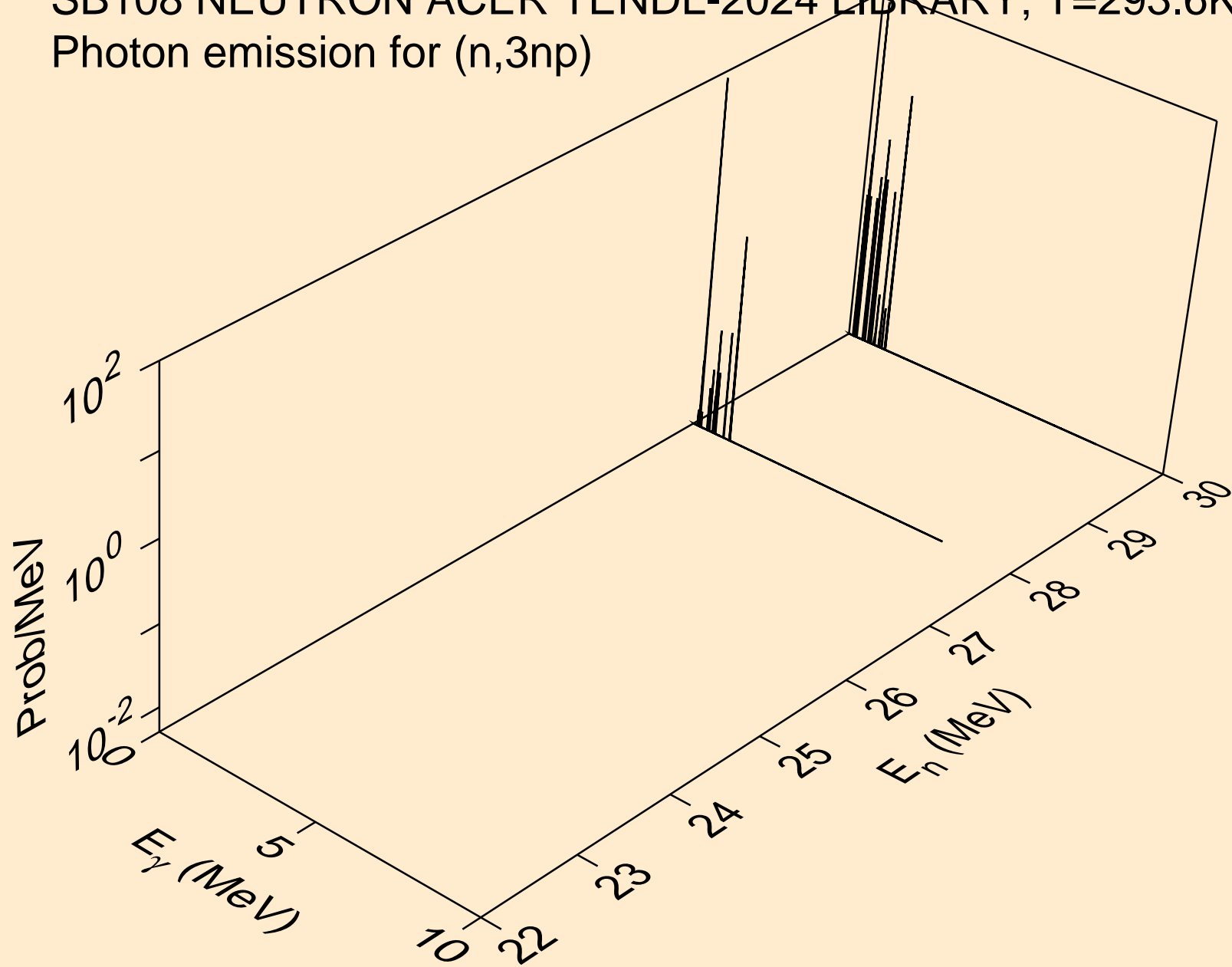

SB108 NEUTRON ACER TENDL-2024 LIBRARY; T=293.6K
Photon emission for (n,n2p)

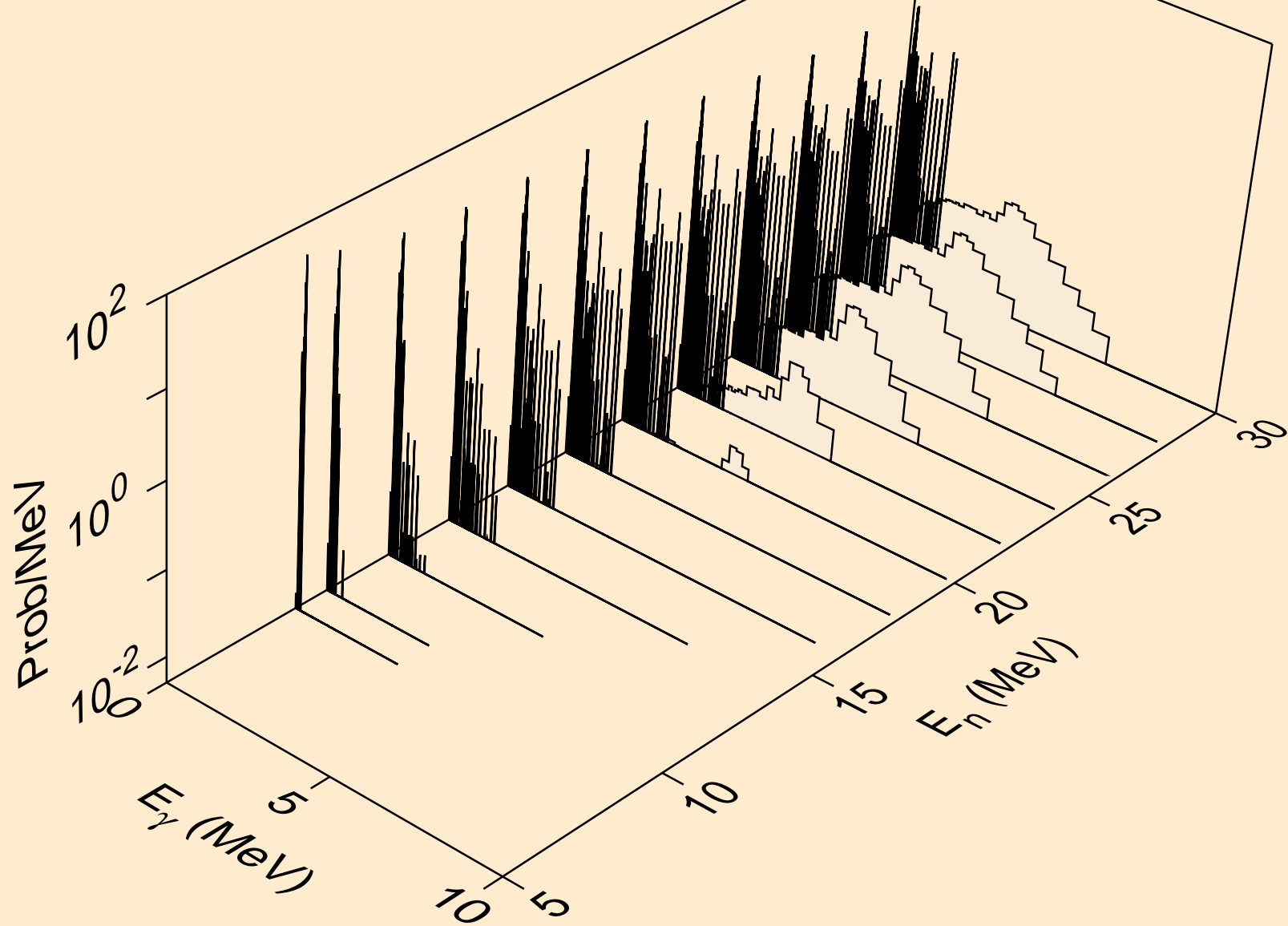

SB108 NEUTRON ACER TENDL-2024 LIBRARY; T=293.6K
Photon emission for (n,npa)

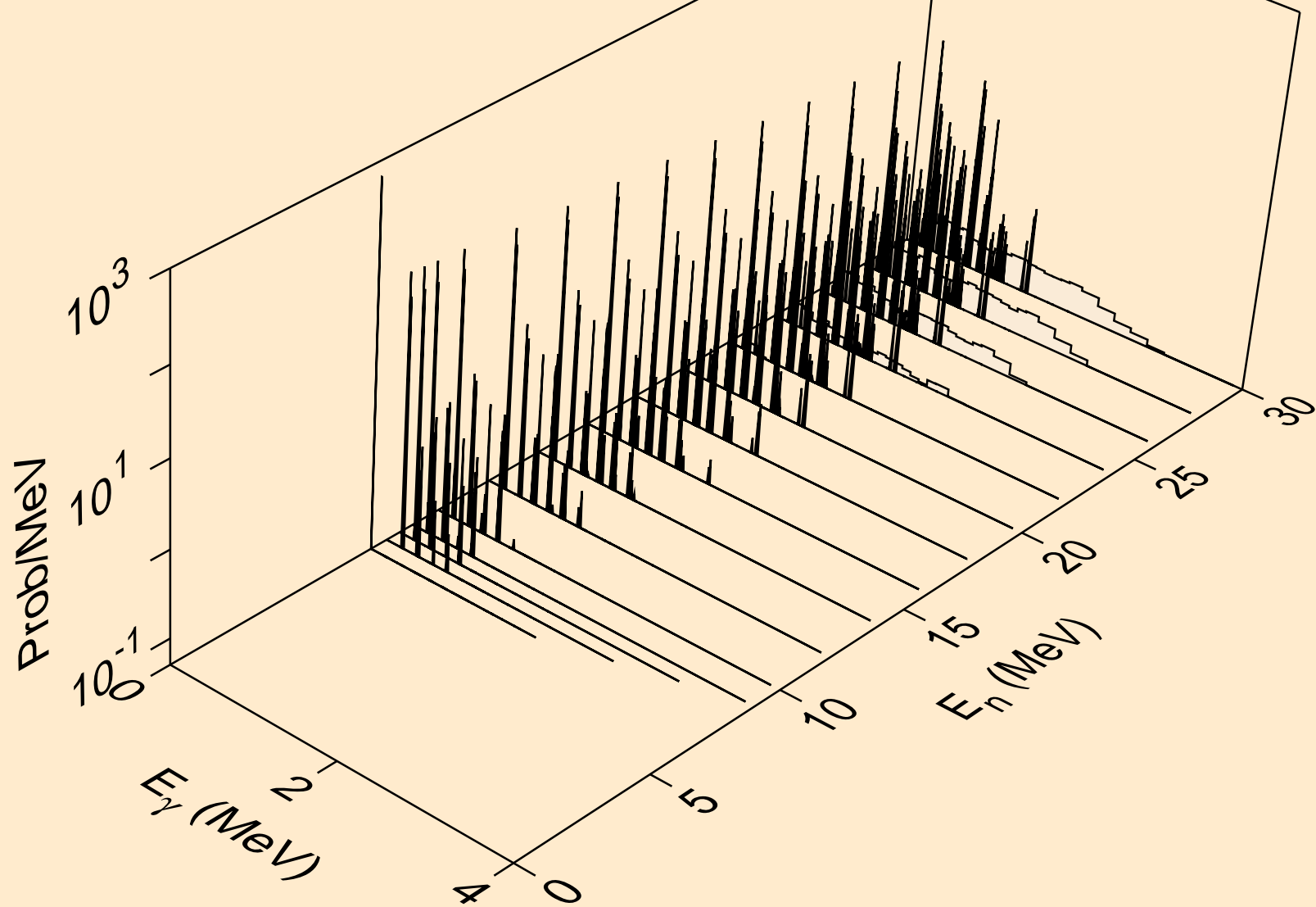

SB108 NEUTRON ACER TENDL-2024 LIBRARY; T=293.6K
Photon emission for (n,n*c)

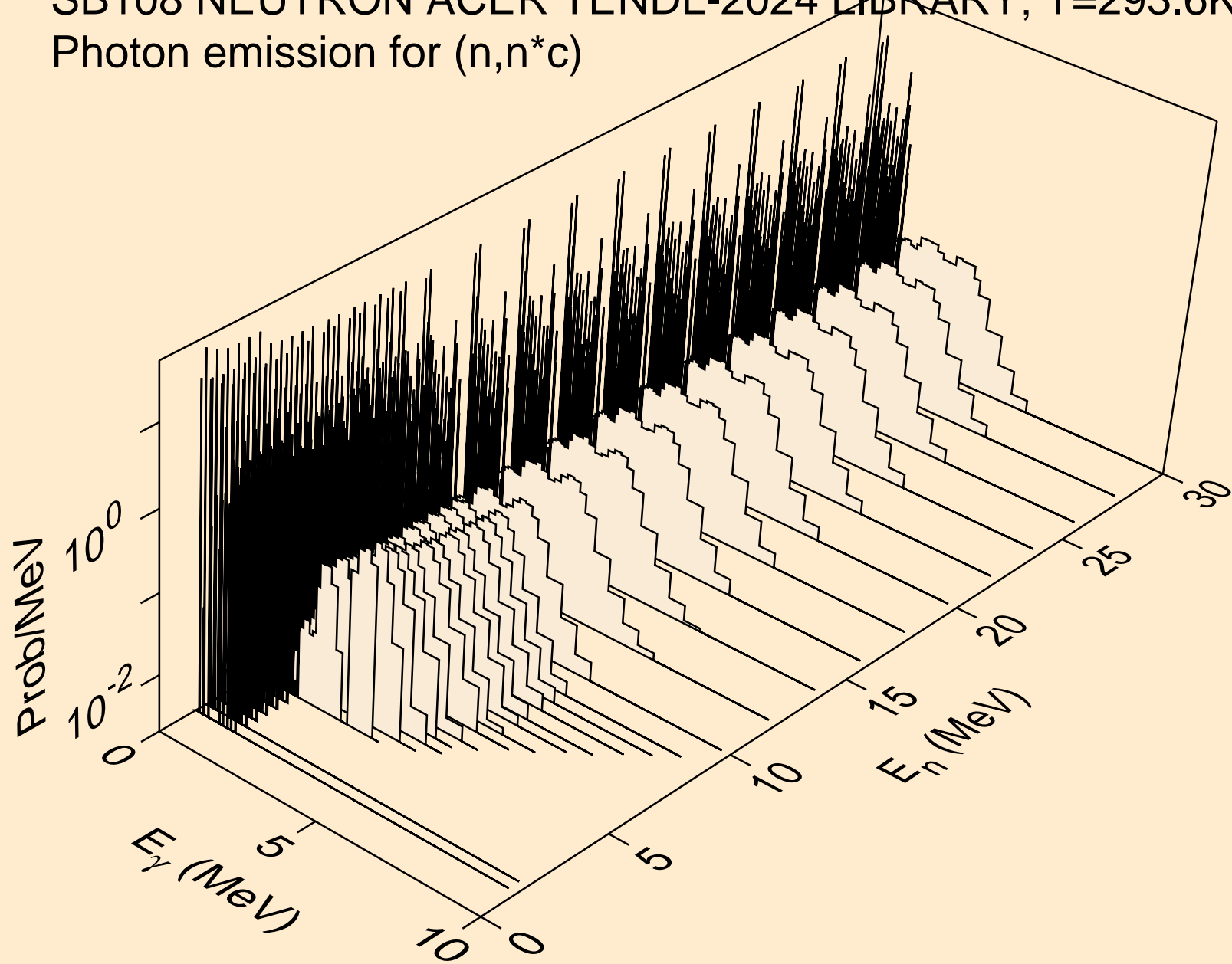

SB108 NEUTRON ACER TENDL-2024 LIBRARY; T=293.6K
Photon emission for (n,gma)

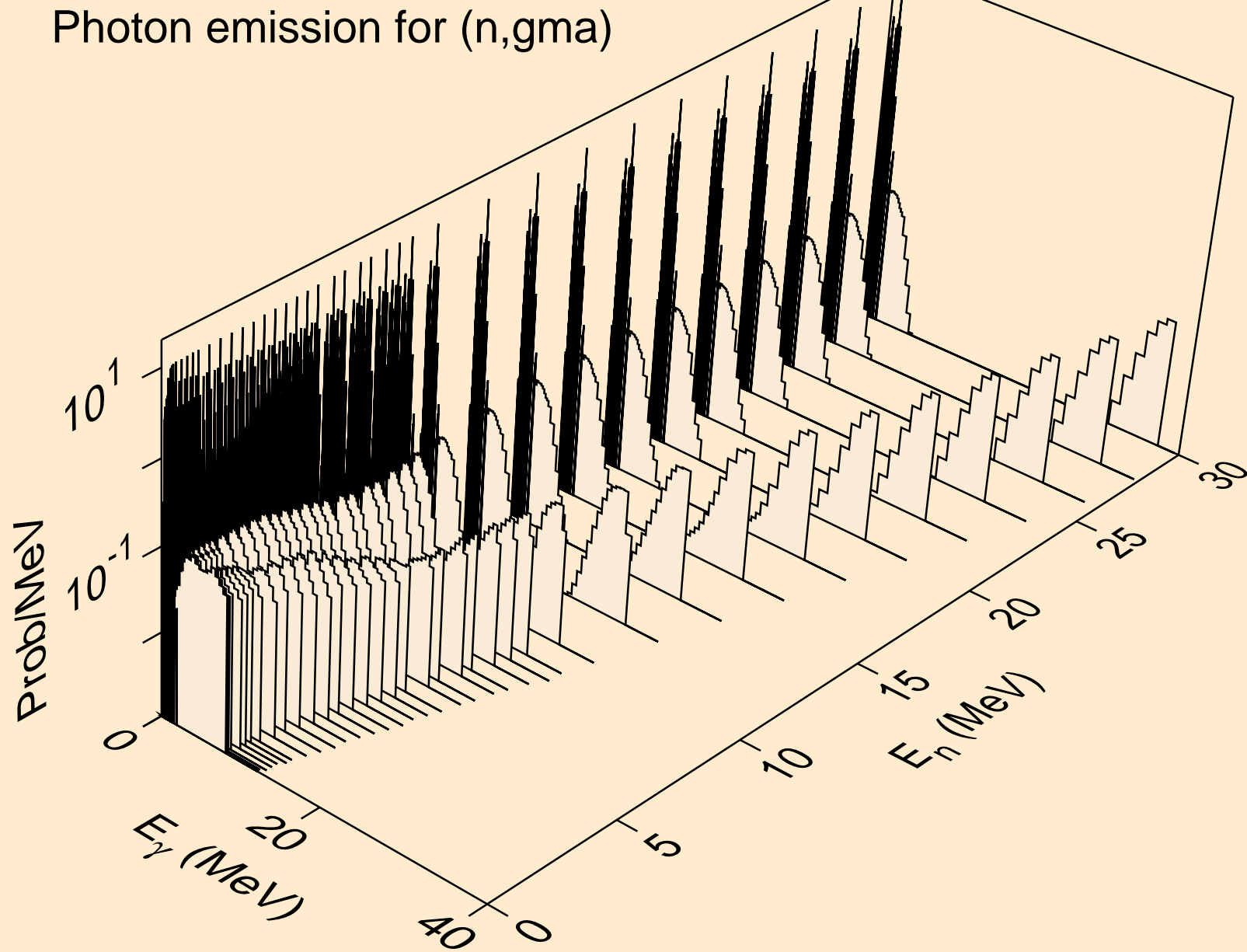

SB108 NEUTRON ACER TENDL-2024 LIBRARY; T=293.6K
Photon emission for (n,p)

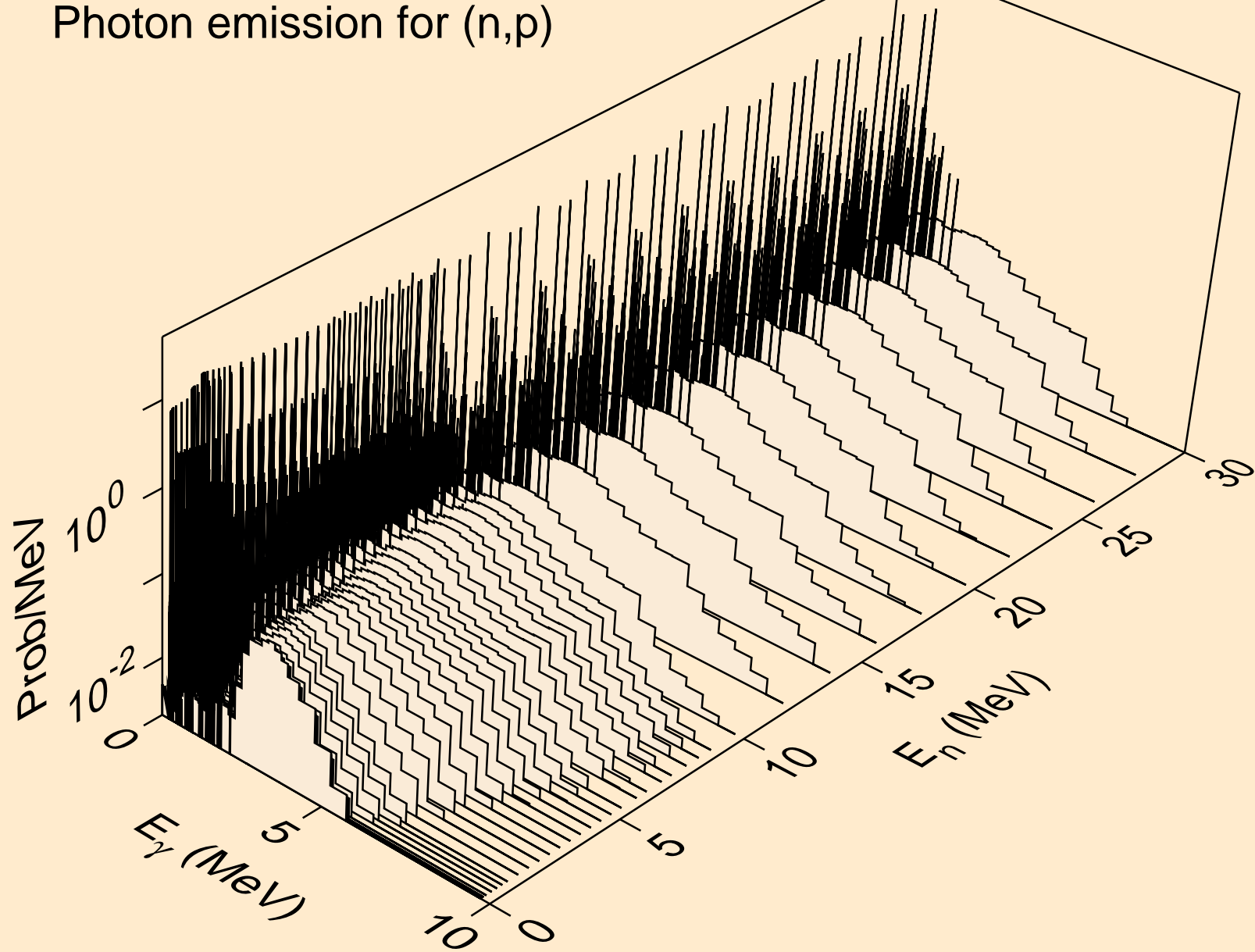

SB108 NEUTRON ACER TENDL-2024 LIBRARY; T=293.6K
Photon emission for (n,d)

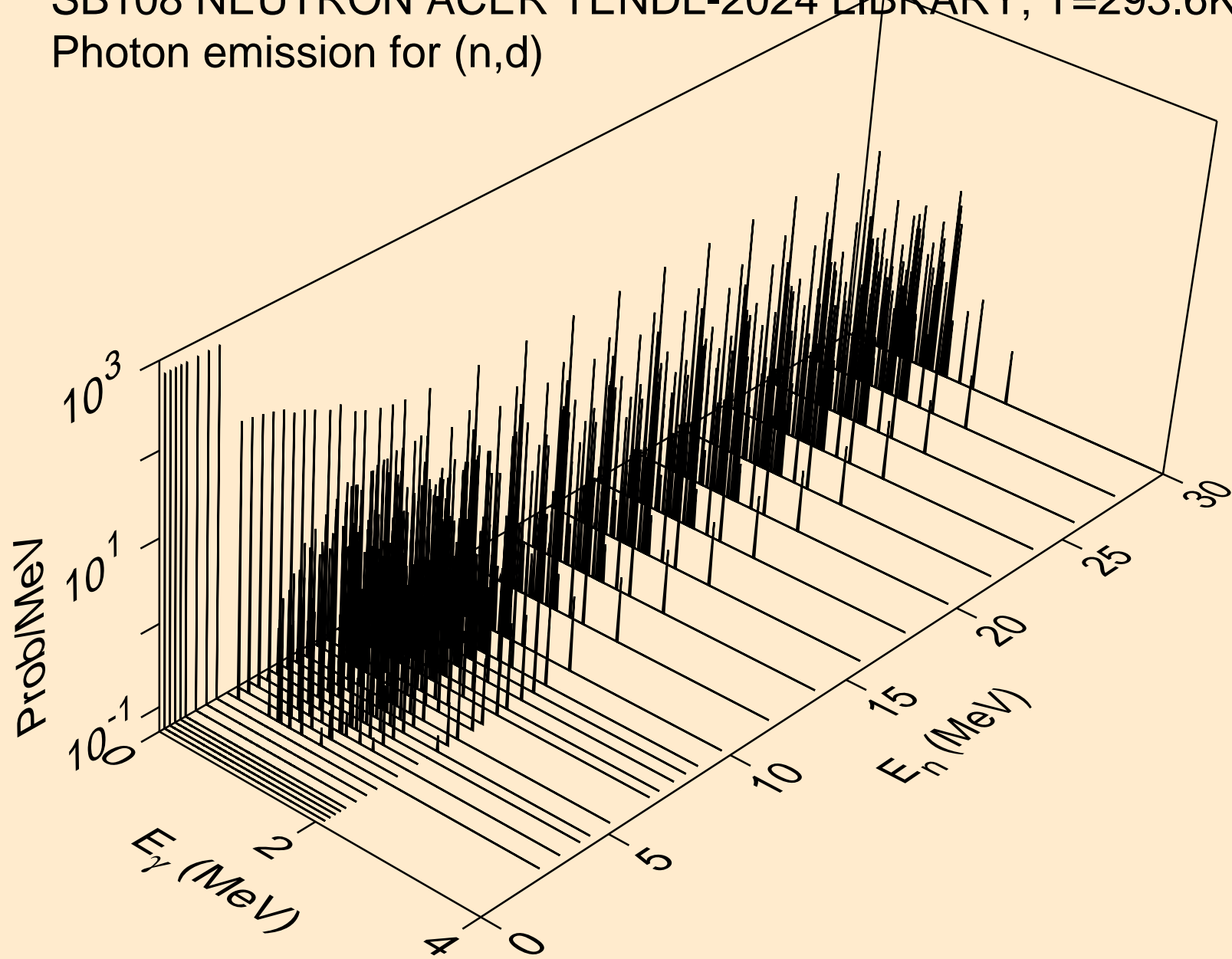

SB108 NEUTRON ACER TENDL-2024 LIBRARY; T=293.6K
Photon emission for (n,t)

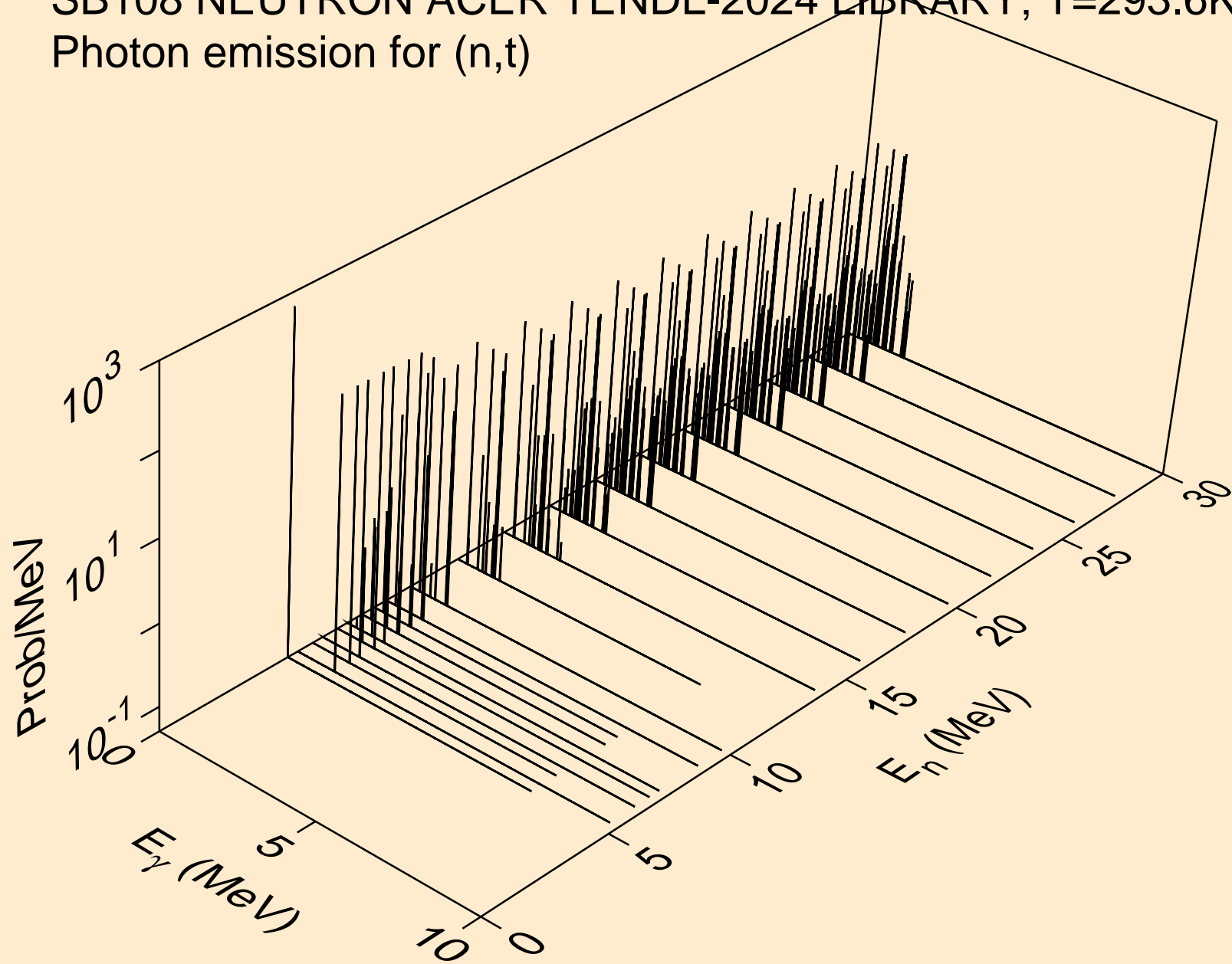

SB108 NEUTRON ACER TENDL-2024 LIBRARY; T=293.6K
Photon emission for (n,he3)

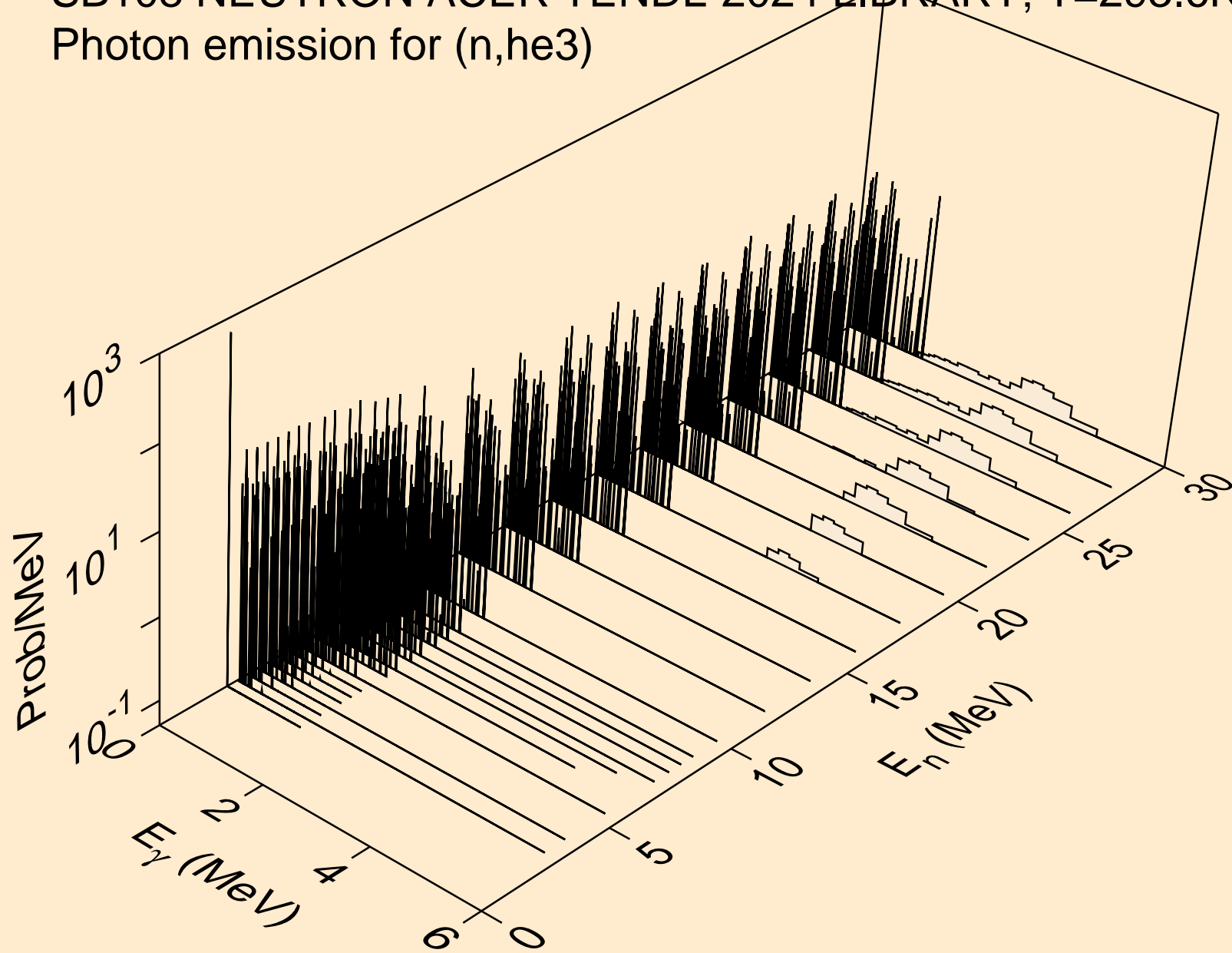

SB108 NEUTRON ACER TENDL-2024 LIBRARY; T=293.6K
Photon emission for (n,a)

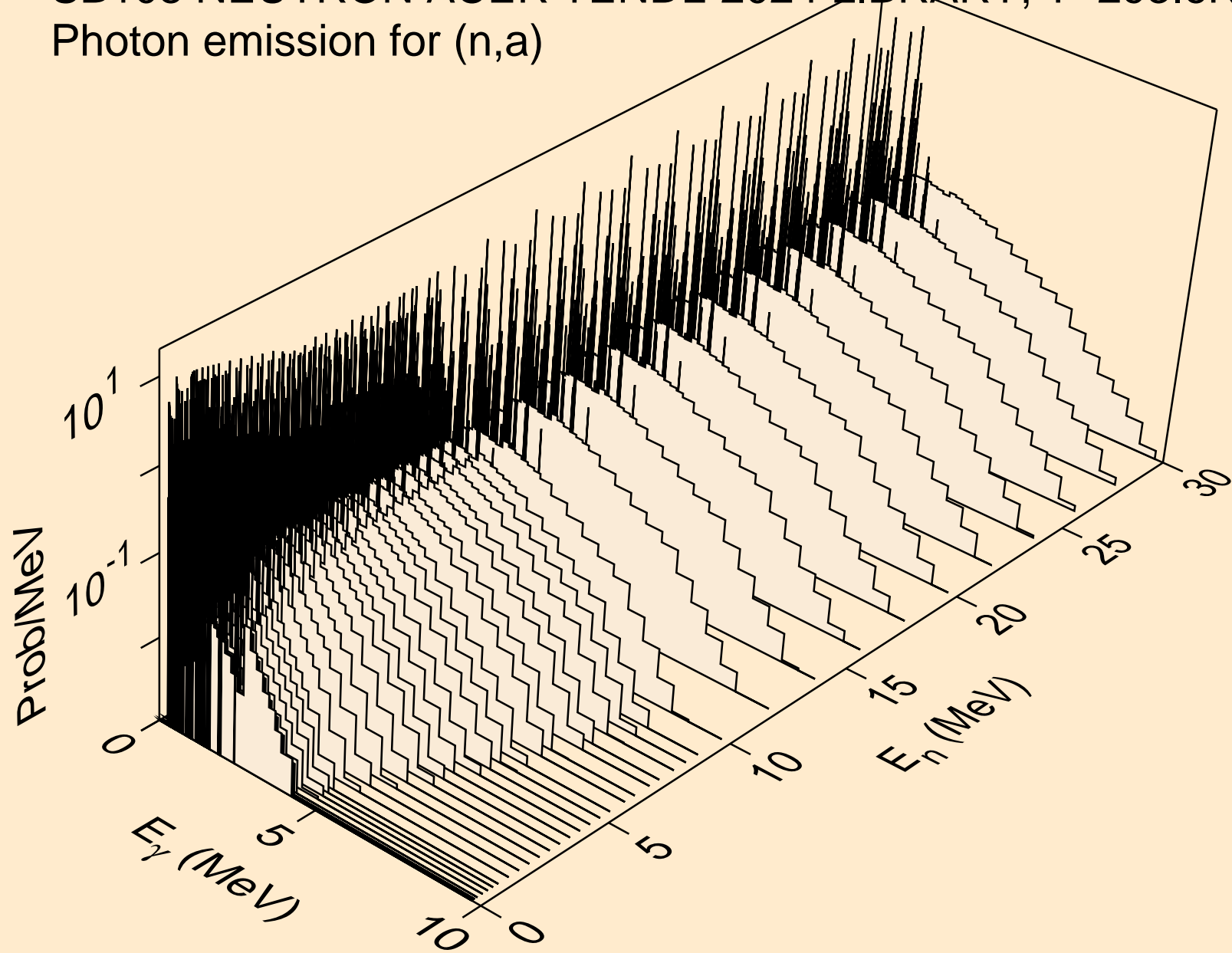

SB108 NEUTRON ACER TENDL-2024 LIBRARY; T=293.6K
Photon emission for (n,2a)

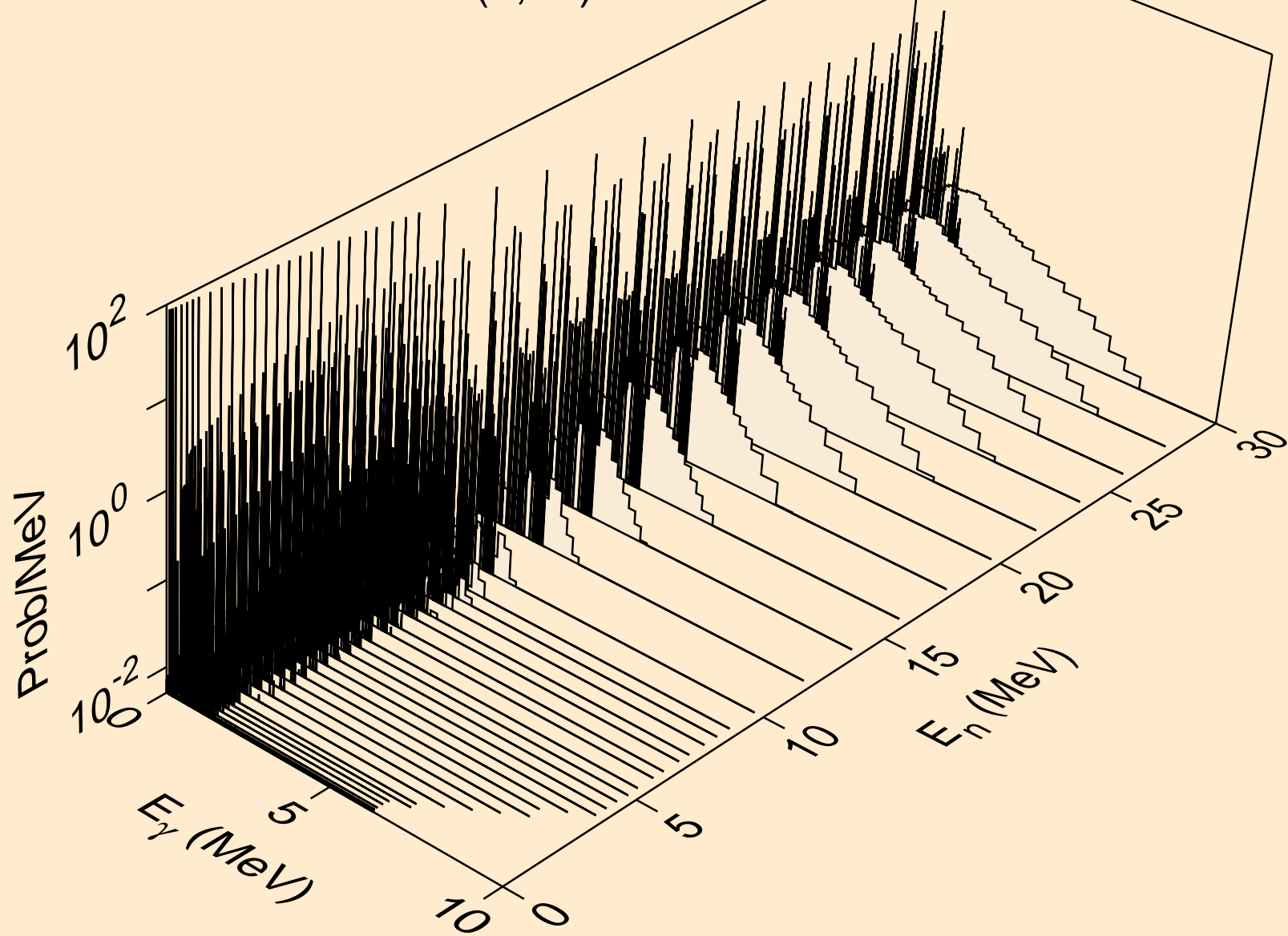

SB108 NEUTRON ACER TENDL-2024 LIBRARY; T=293.6K
Photon emission for (n,3a)

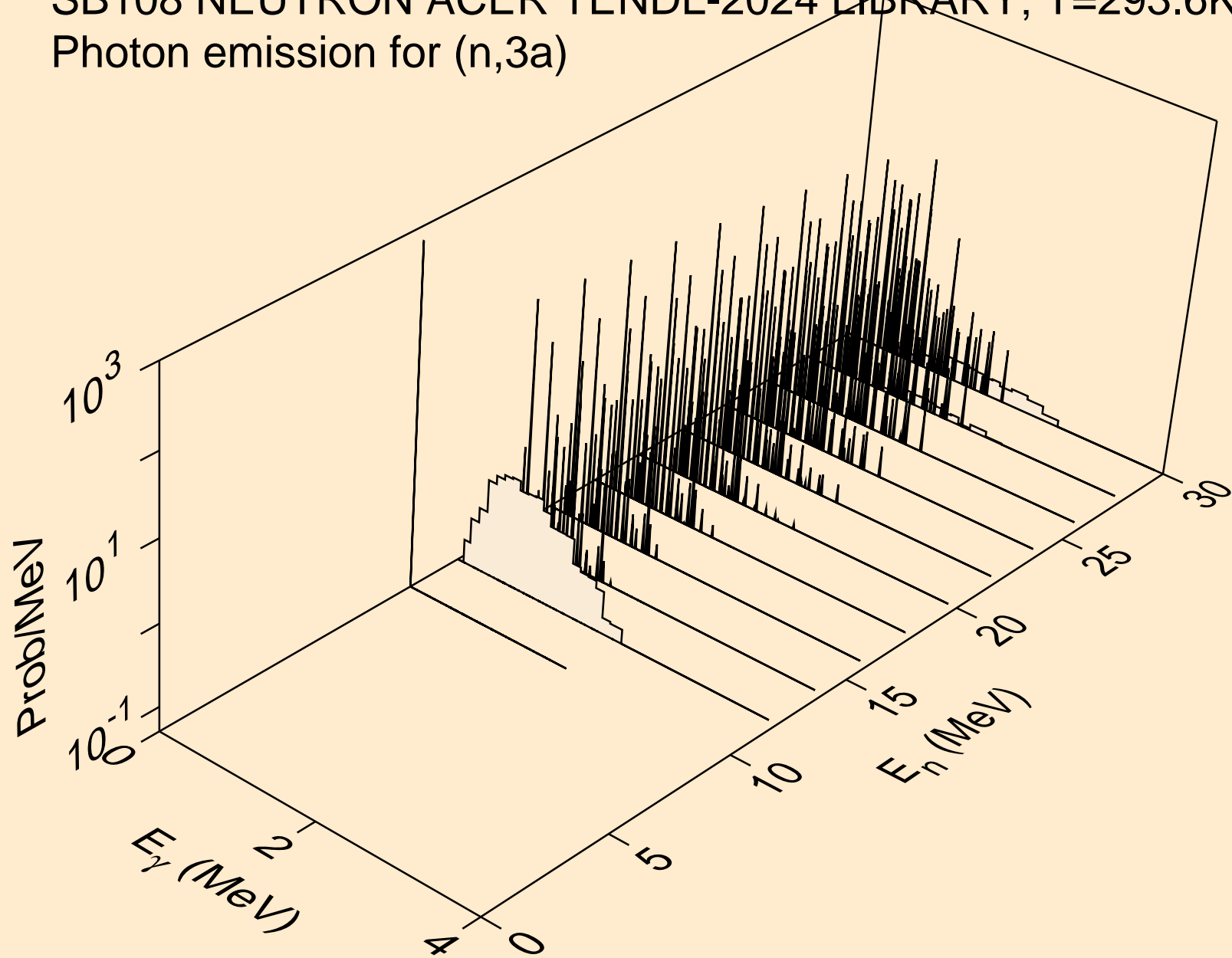

SB108 NEUTRON ACER TENDL-2024 LIBRARY; T=293.6K
Photon emission for (n,2p)

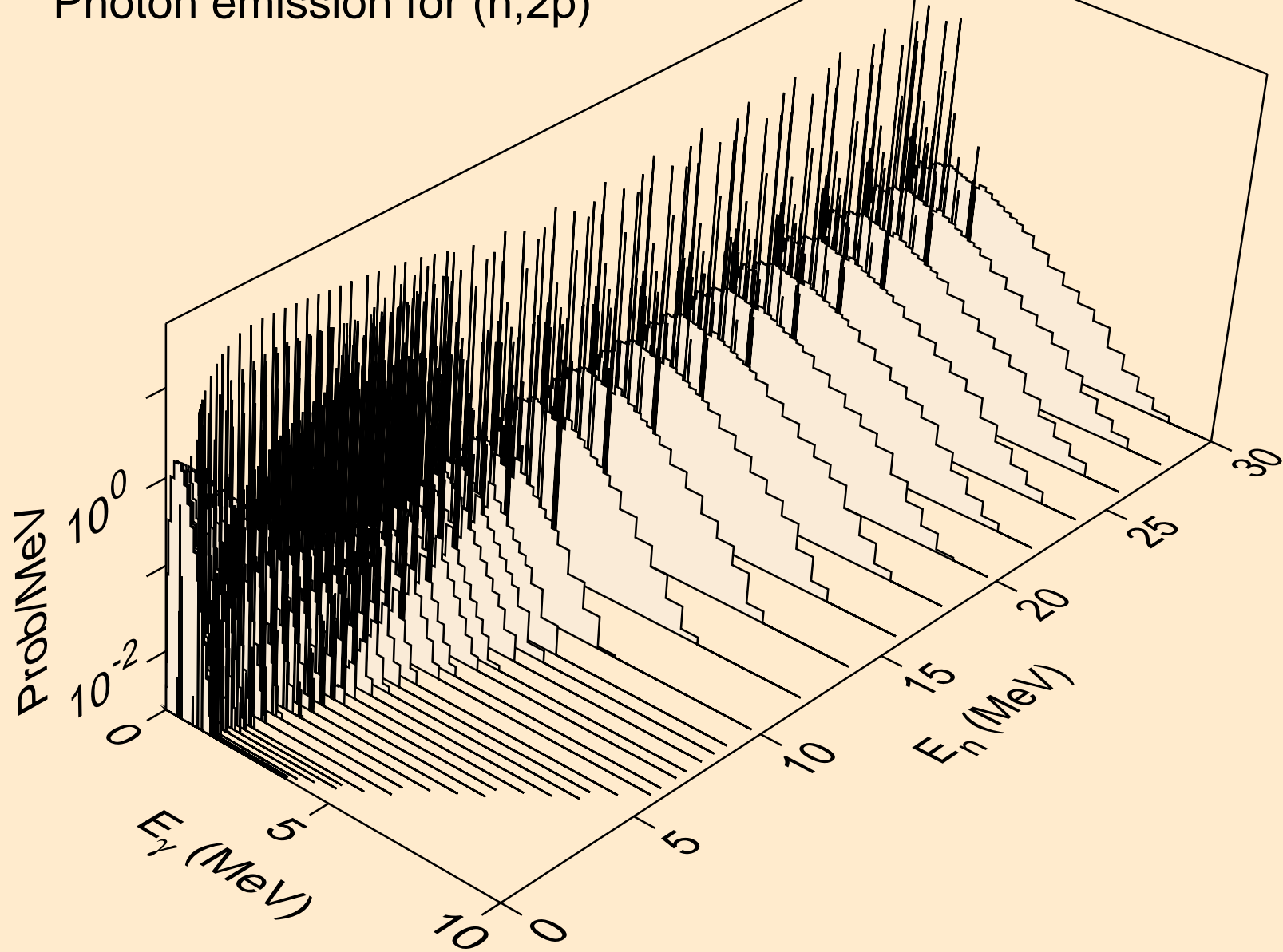

SB108 NEUTRON ACER TENDL-2024 LIBRARY; T=293.6K
Photon emission for (n,p α)

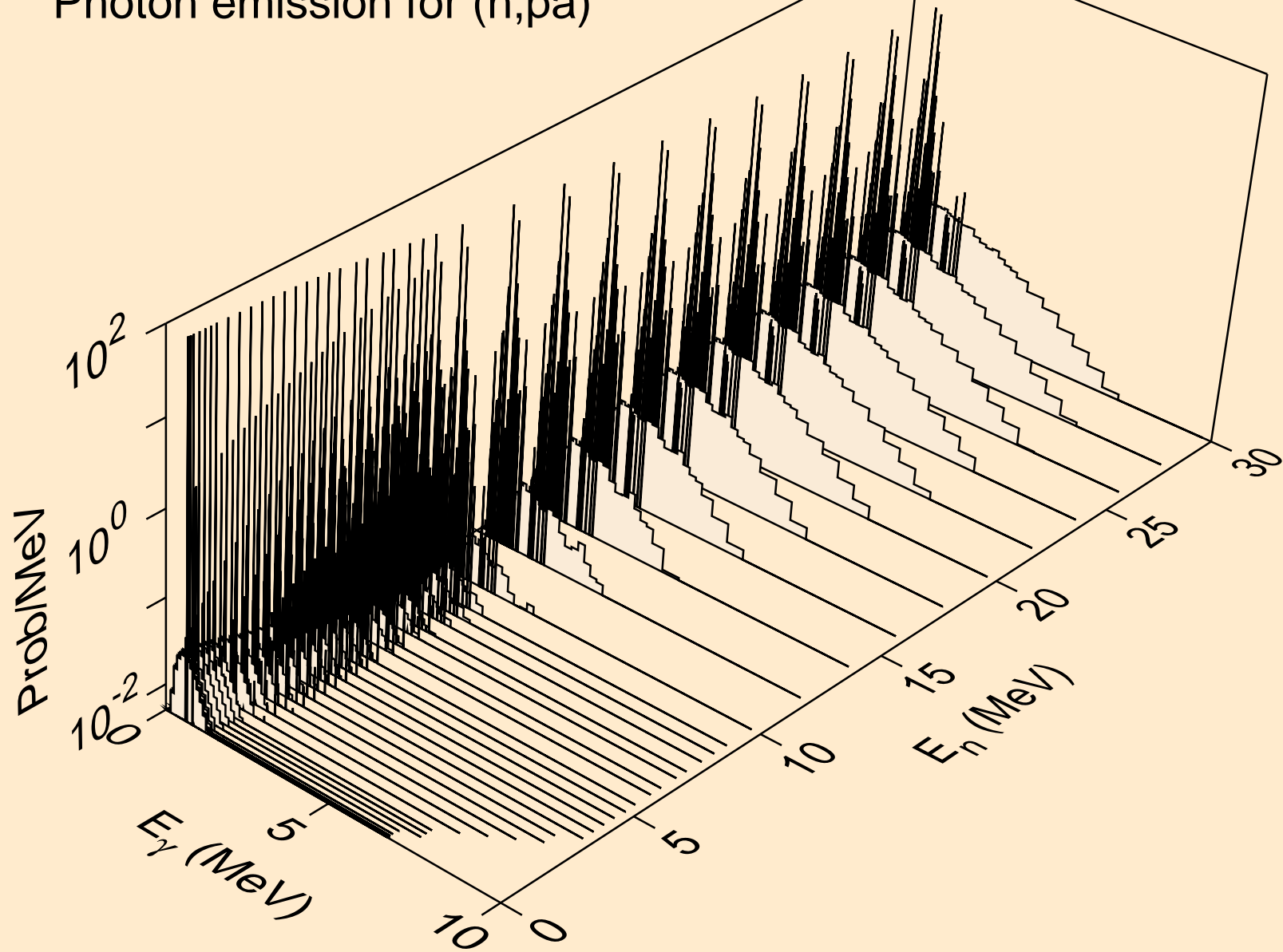

SB108 NEUTRON ACER TENDL-2024 LIBRARY; T=293.6K
Photon emission for (n,d2a)

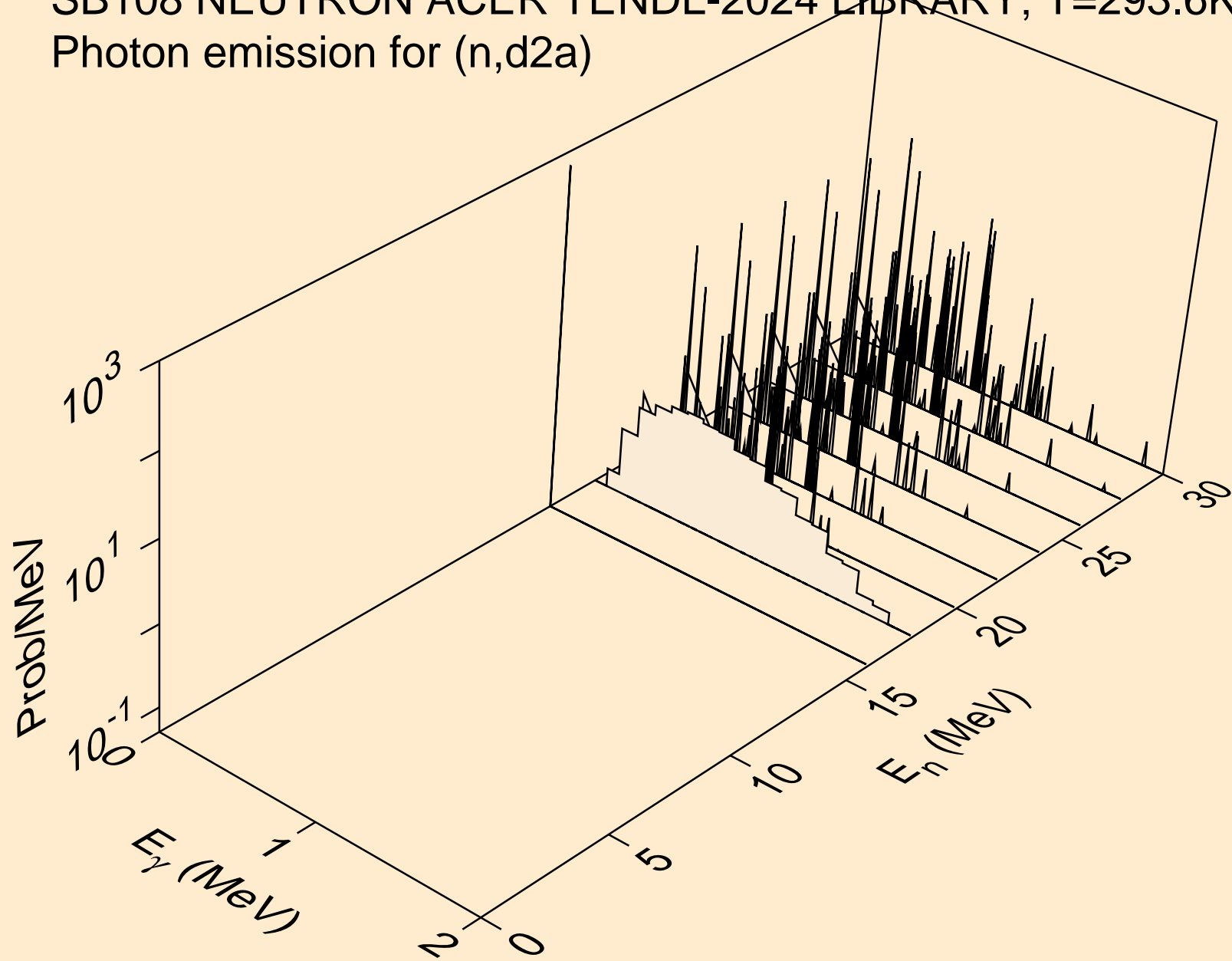

SB108 NEUTRON ACER TENDL-2024 LIBRARY; T=293.6K
Photon emission for (n,pd)

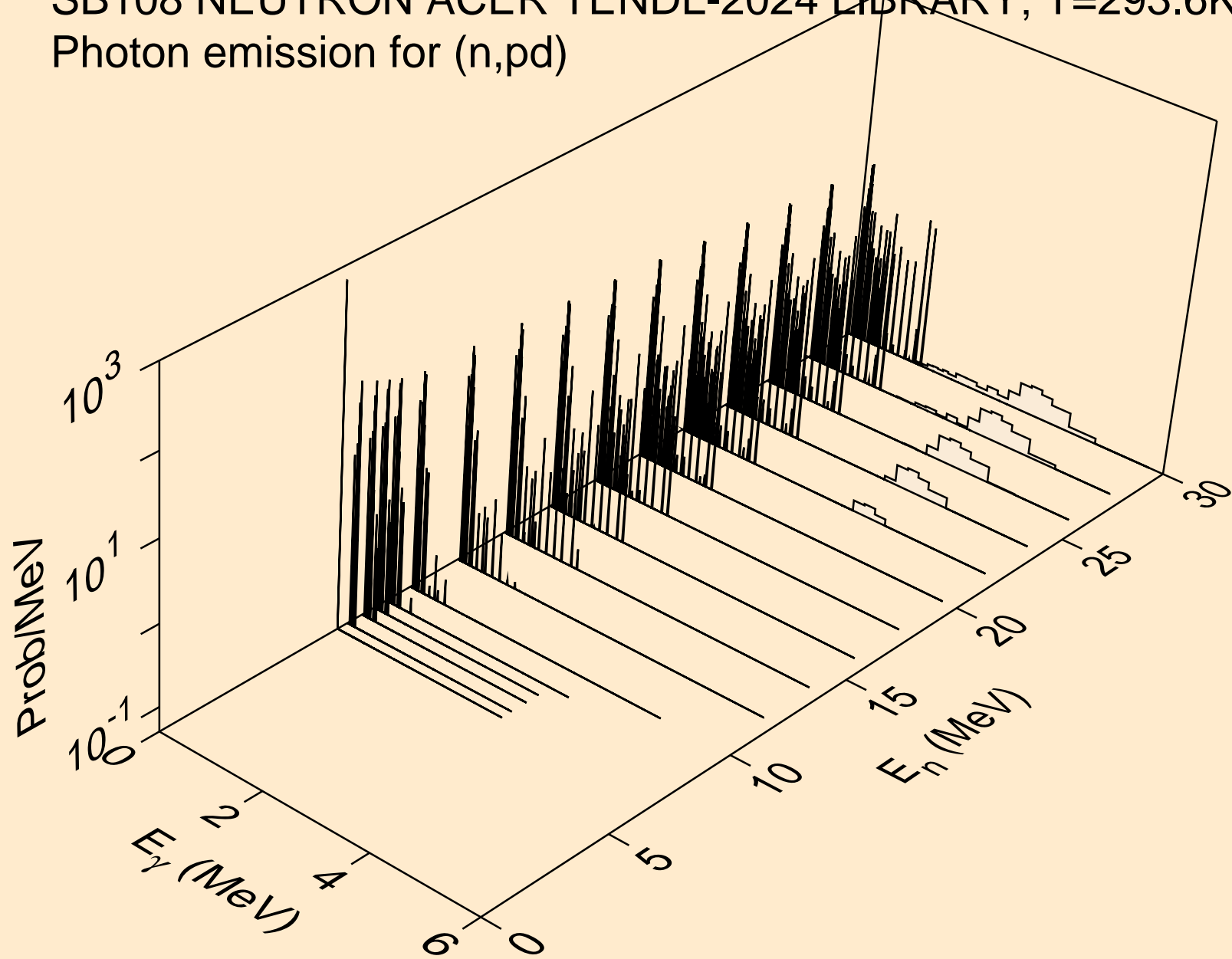

SB108 NEUTRON ACER TENDL-2024 LIBRARY; T=293.6K
Photon emission for (n,pt)

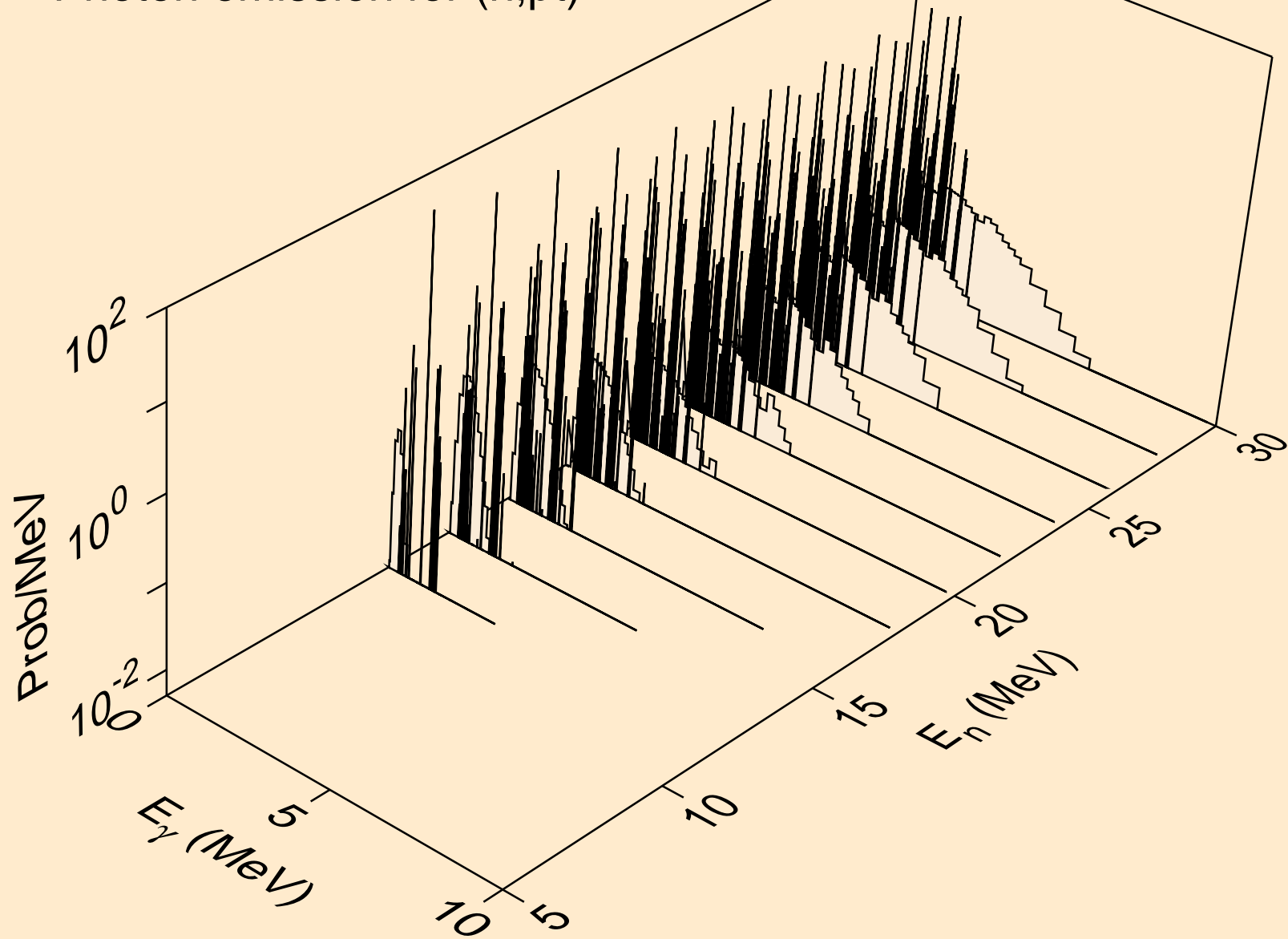

SB108 NEUTRON ACER TENDL-2024 LIBRARY; T=293.6K
Photon emission for (n,da)

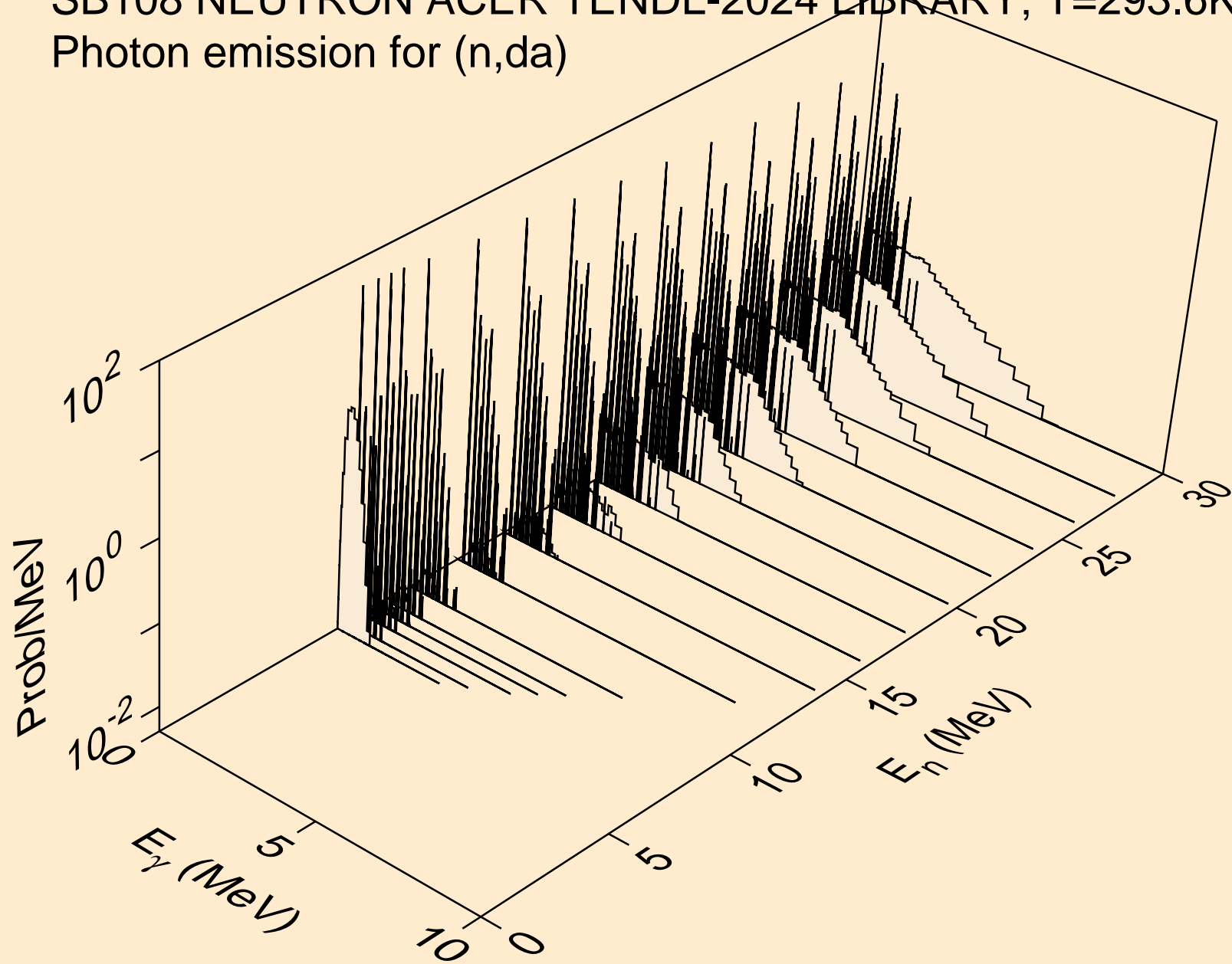

SB108 NEUTRON ACER TENDL-2024 LIBRARY; T=293.6K
thermal capture photon spectrum

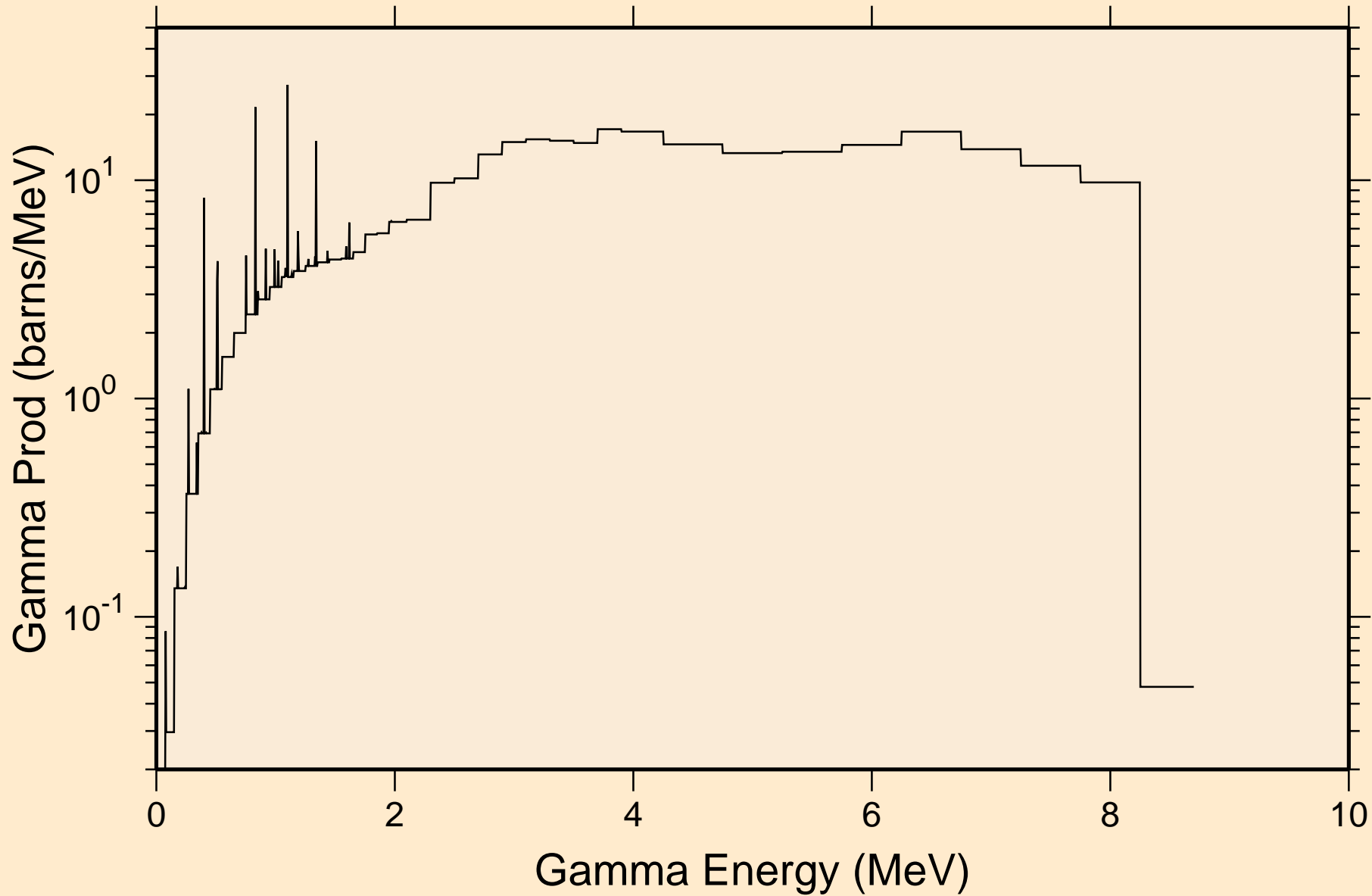

SB108 NEUTRON ACER TENDL-2024 LIBRARY; T=293.6K
14 MeV photon spectrum

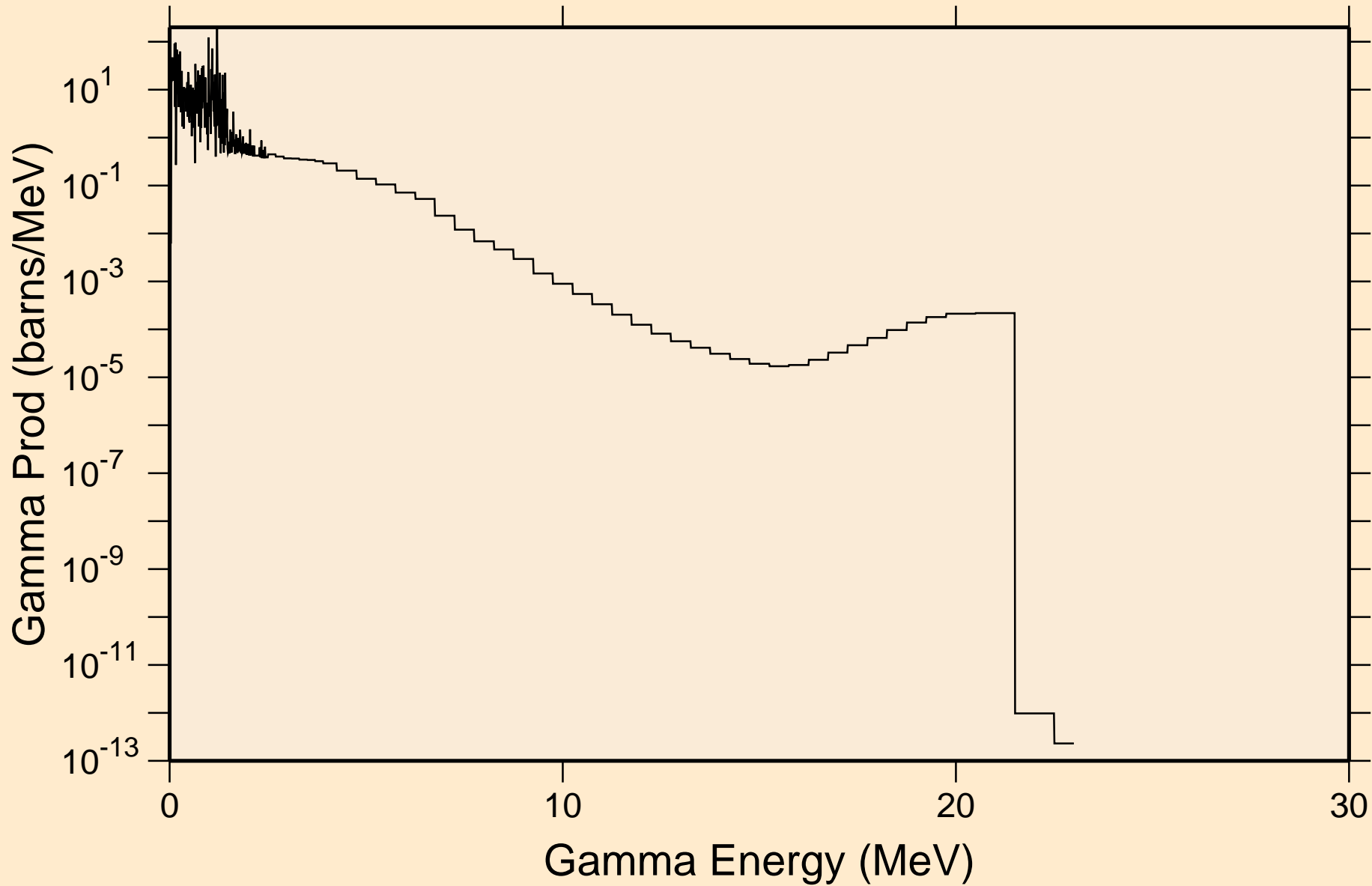

SB108 NEUTRON ACER TENDL-2024 LIBRARY; T=293.6K
Particle heating contributions

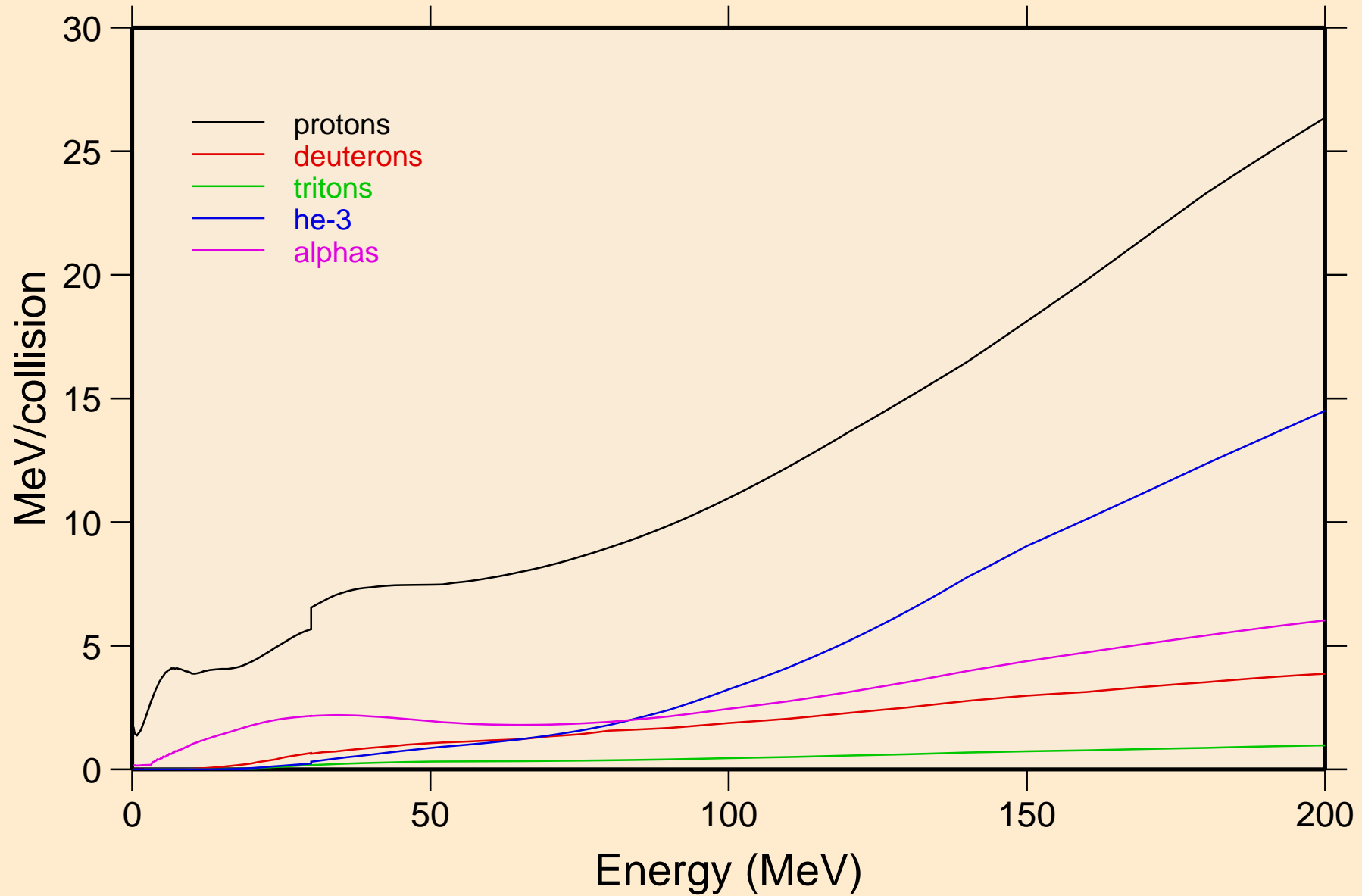

SB108 NEUTRON ACER TENDL-2024 LIBRARY; T=293.6K
Recoil Heating

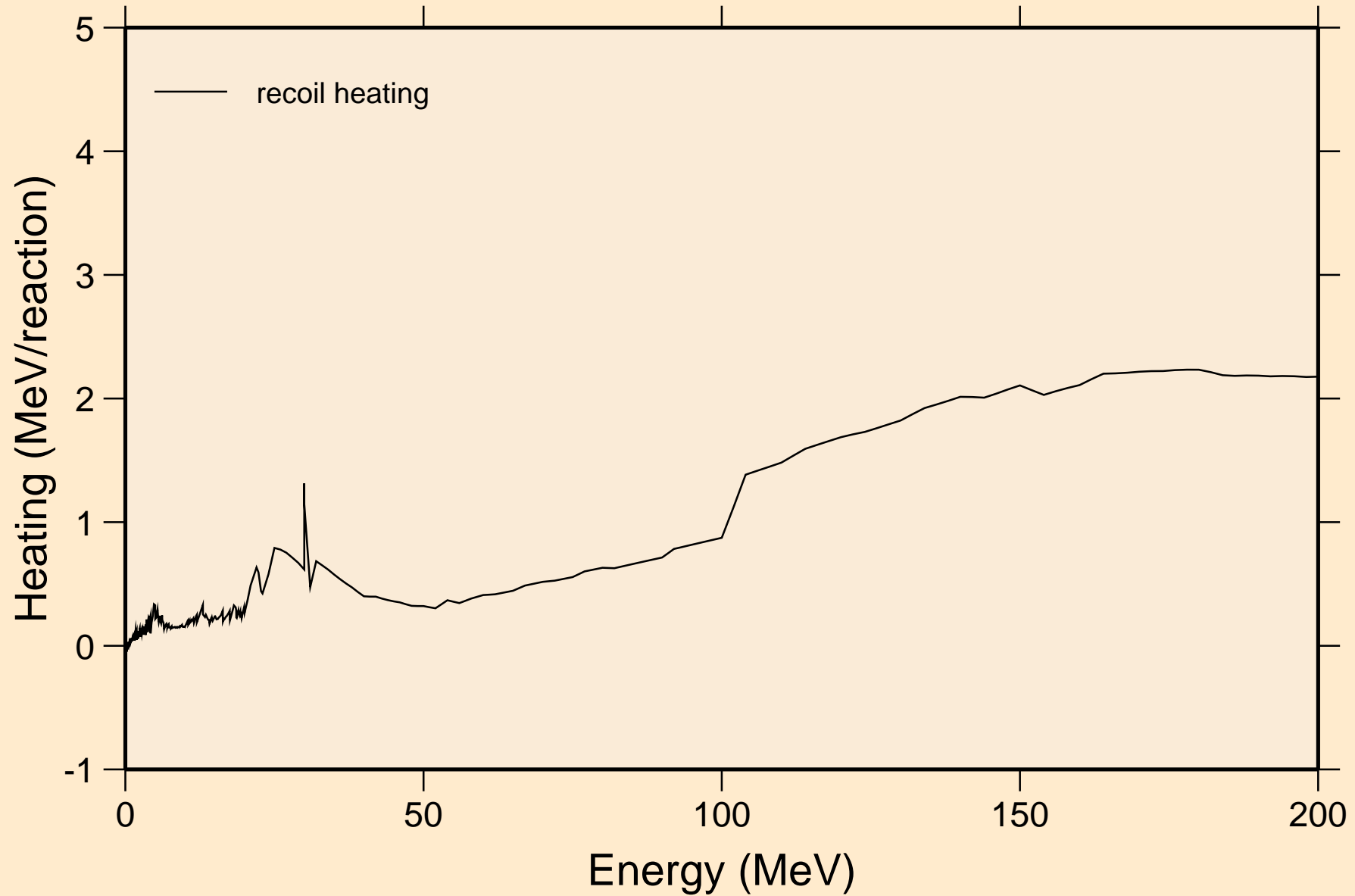

SB108 NEUTRON ACER TENDL-2024 LIBRARY; T=293.6K

Particle production cross sections

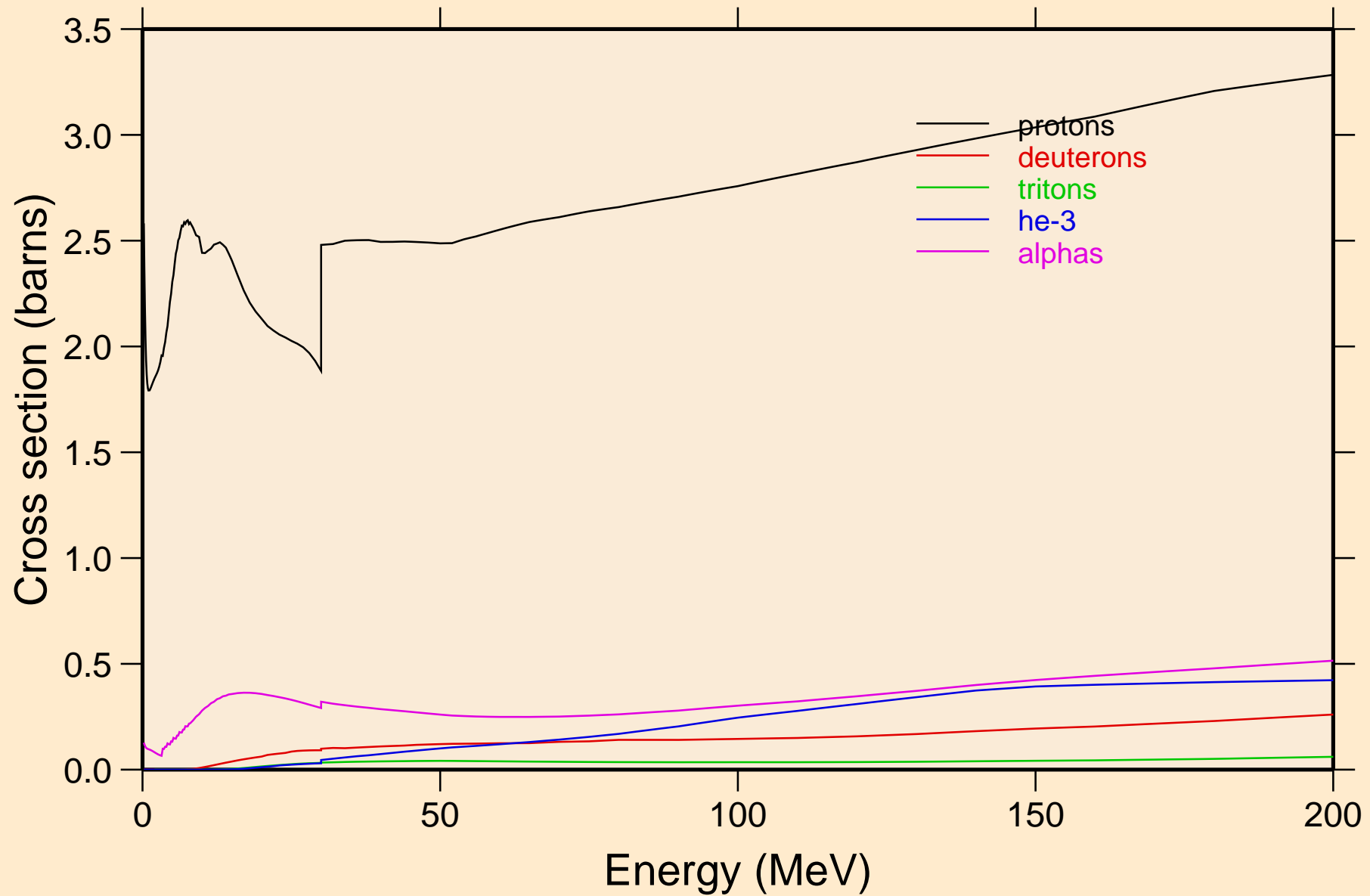

SB108 NEUTRON ACER TENDL-2024 LIBRARY; T=293.6K
protons from (n,x)

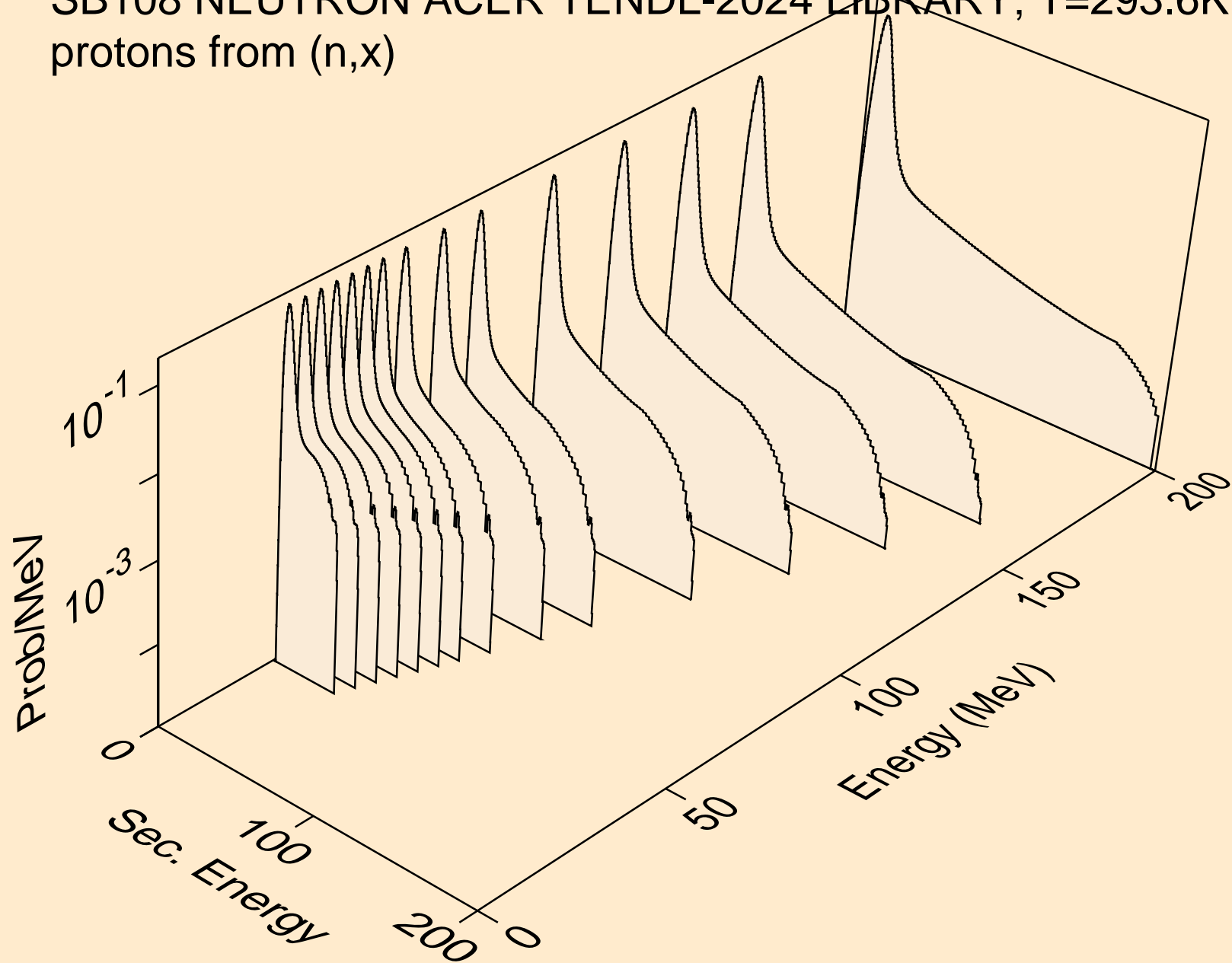

SB108 NEUTRON ACER TENDL-2024 LIBRARY; T=293.6K
protons from (n,n*)p

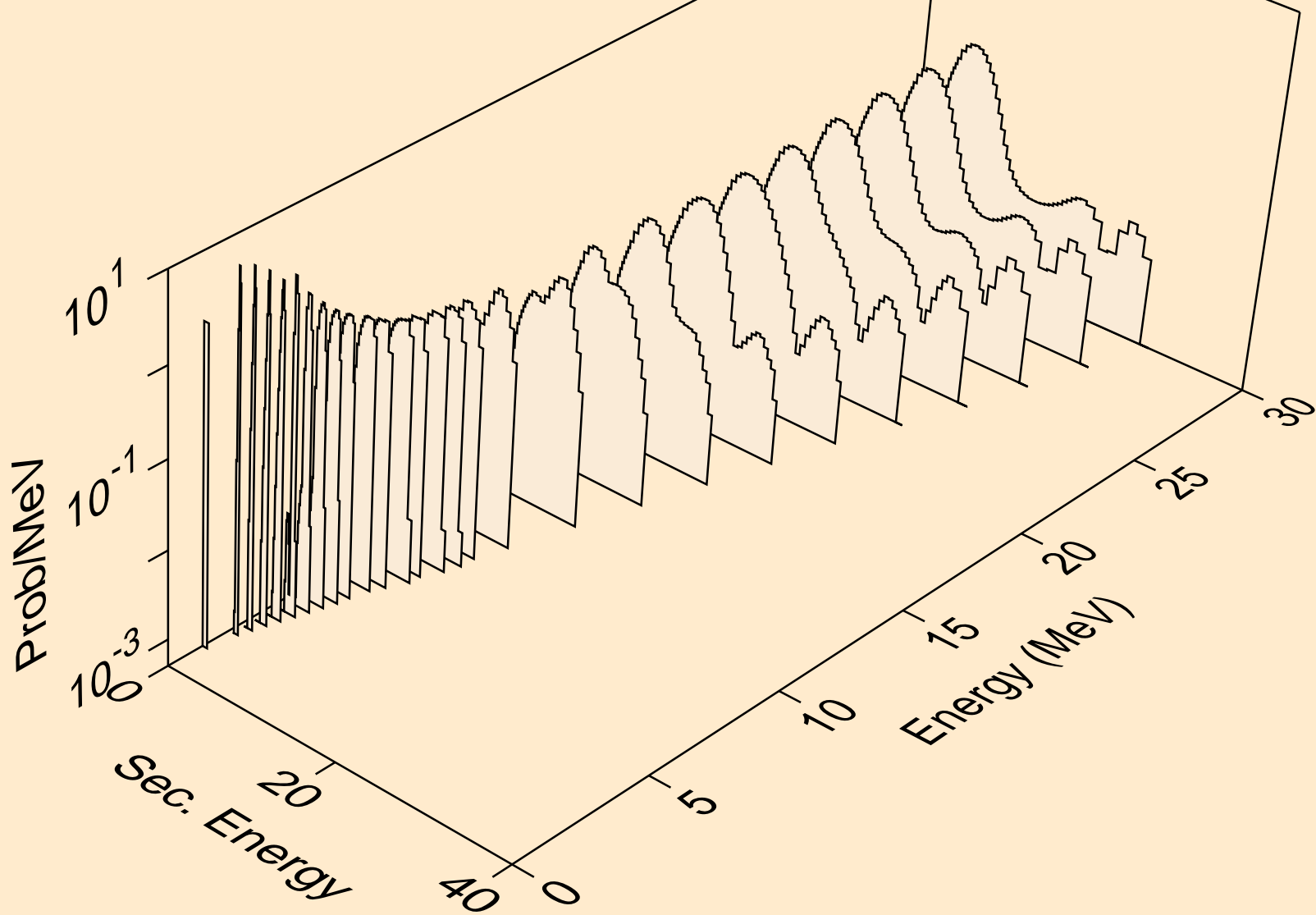

SB108 NEUTRON ACER TENDL-2024 LIBRARY; T=293.6K
protons from (n,2np)

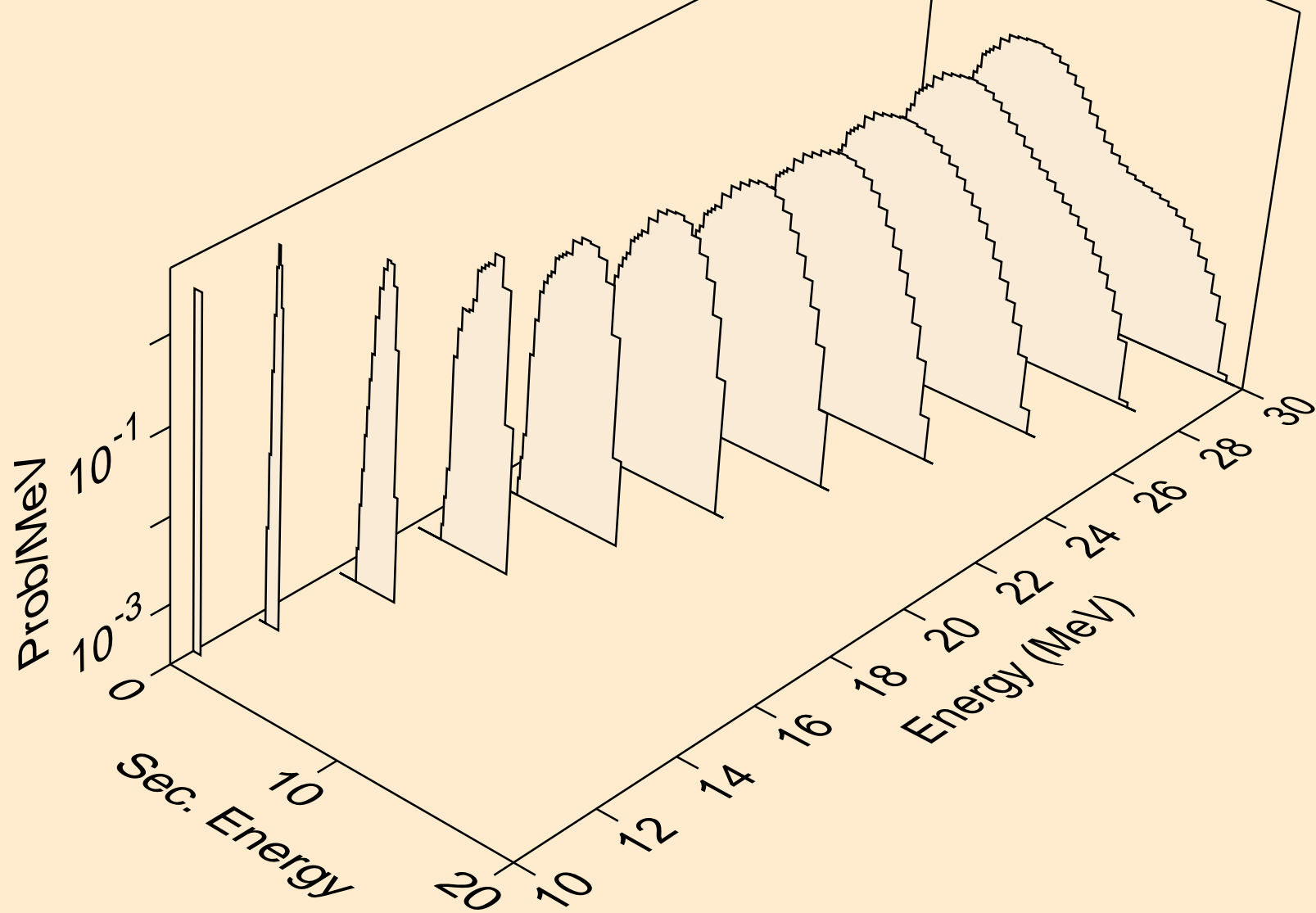

SB108 NEUTRON ACER TENDL-2024 LIBRARY; T=293.6K
protons from (n,3np)

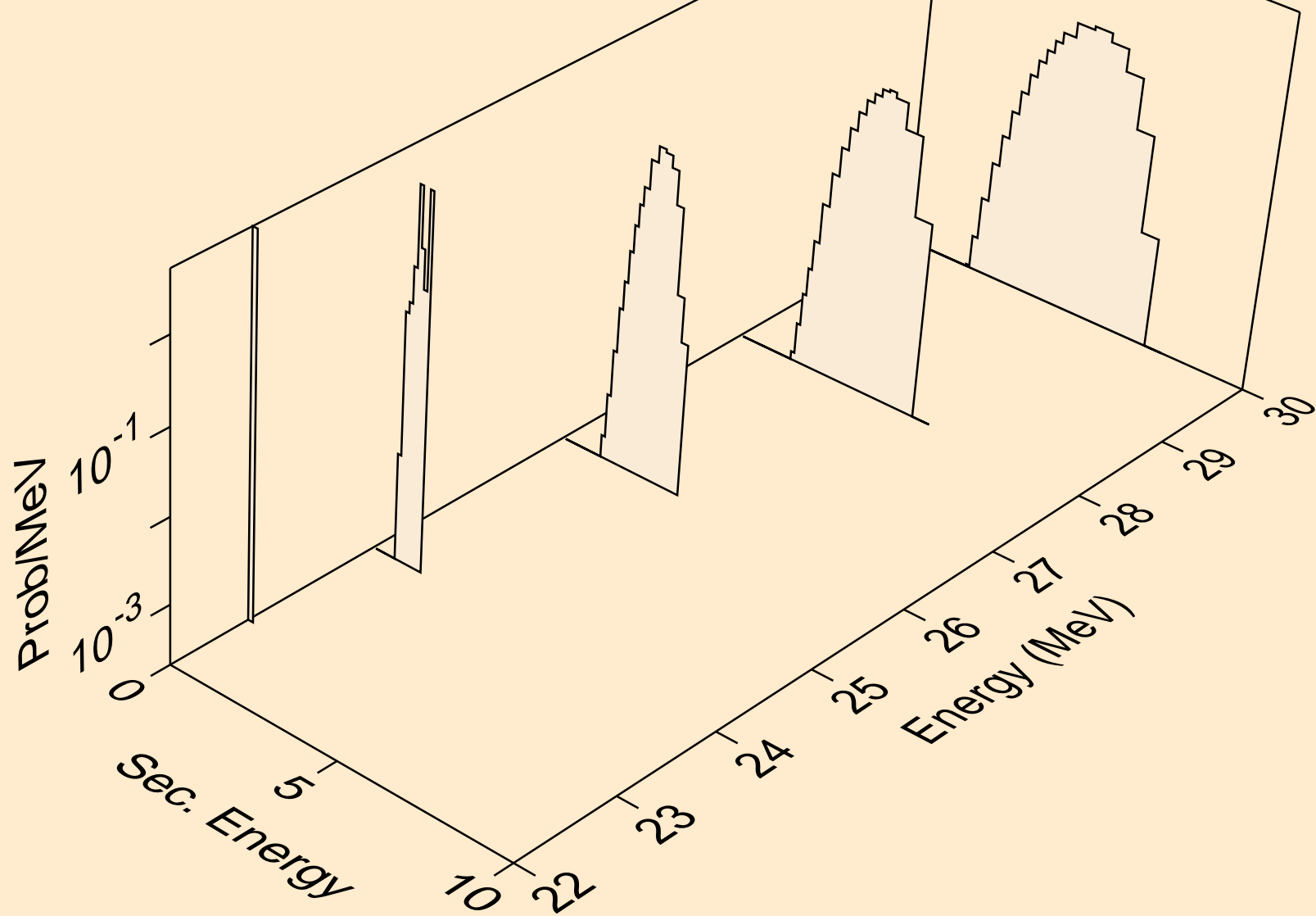

SB108 NEUTRON ACER TENDL-2024 LIBRARY; T=293.6K
protons from (n,n2p)

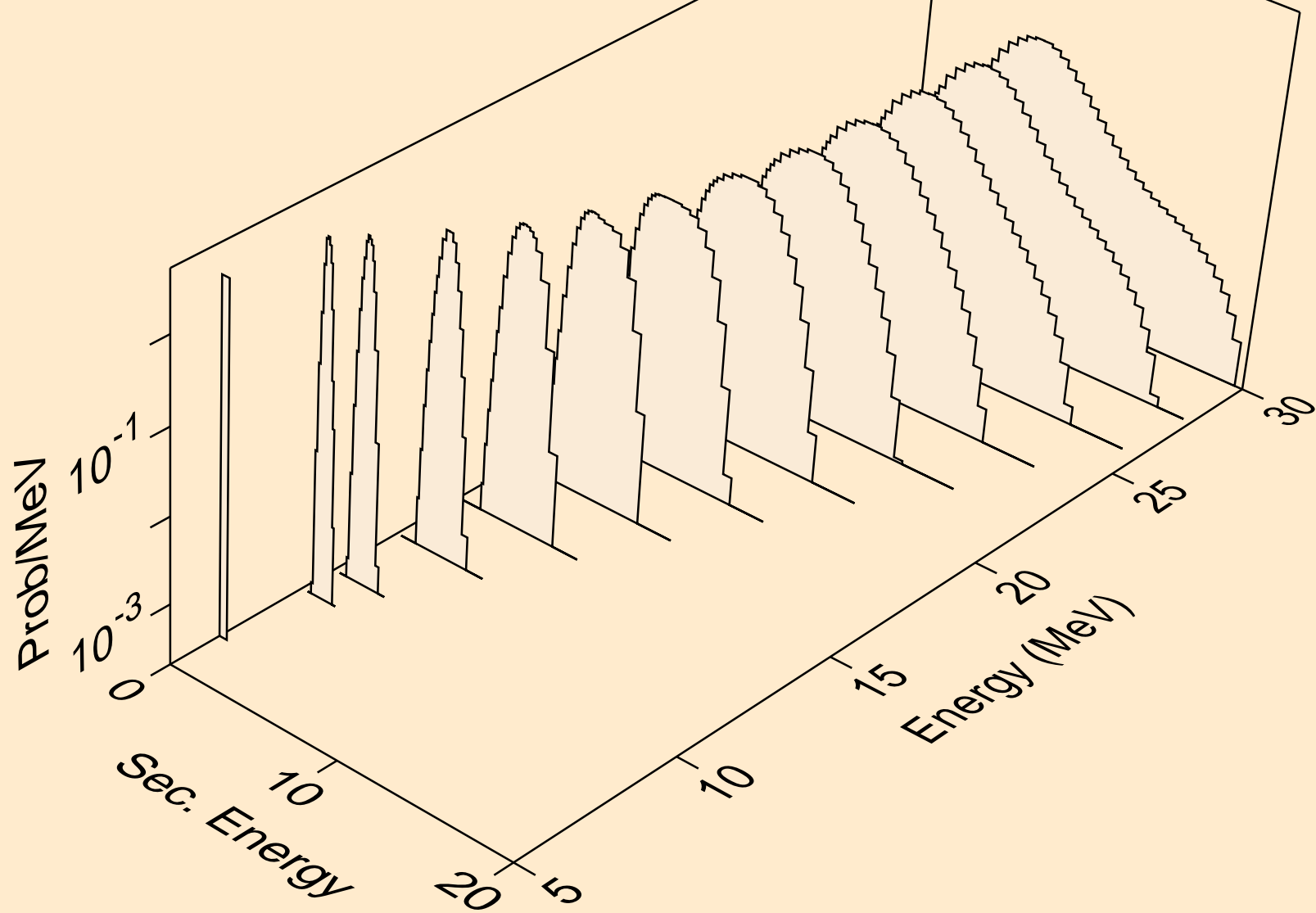

SB108 NEUTRON ACER TENDL-2024 LIBRARY; T=293.6K
protons from (n,npa)

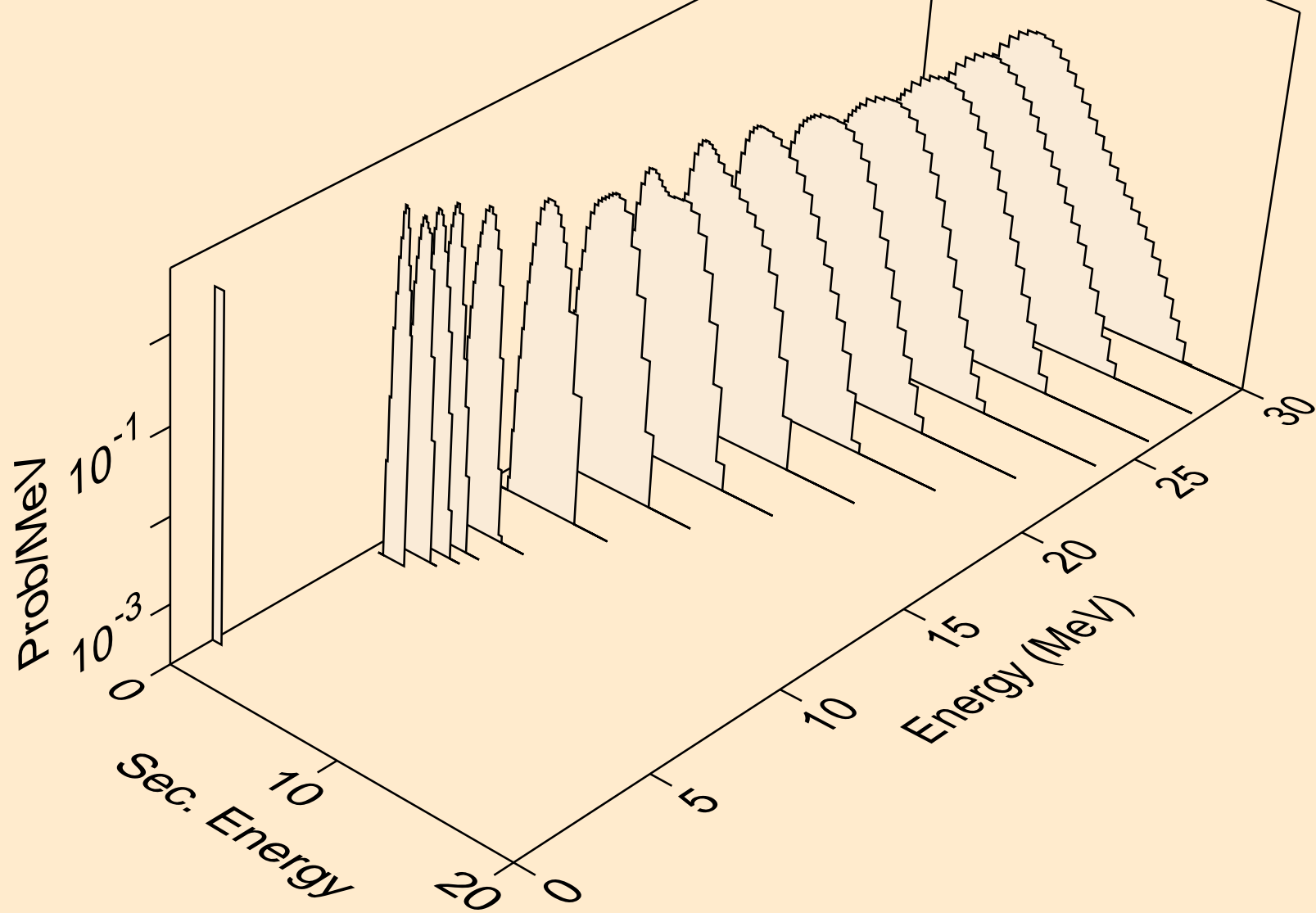

SB108 NEUTRON ACER TENDL-2024 LIBRARY; T=293.6K
protons from (n,p)

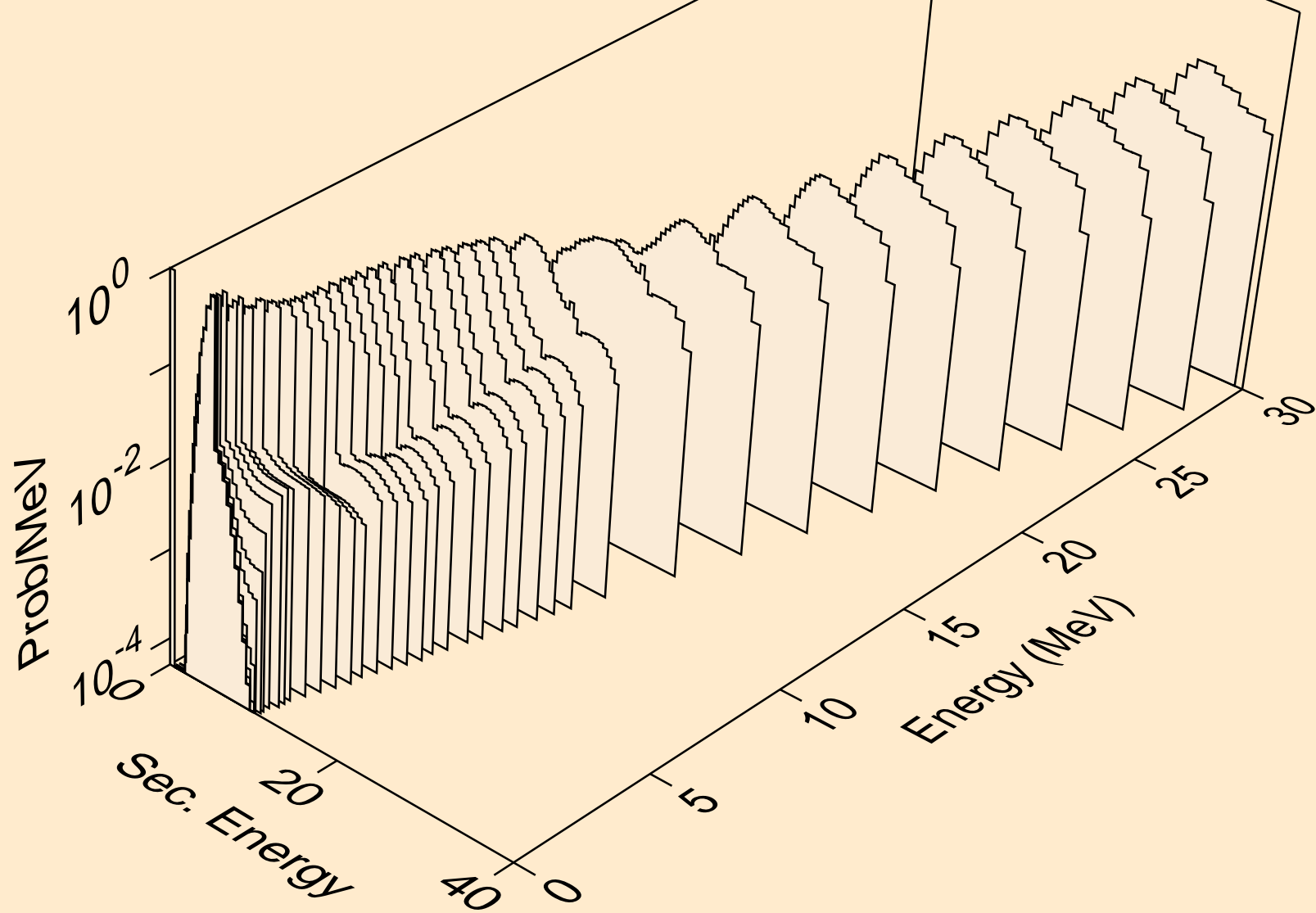

SB108 NEUTRON ACER TENDL-2024 LIBRARY; T=293.6K
protons from (n,2p)

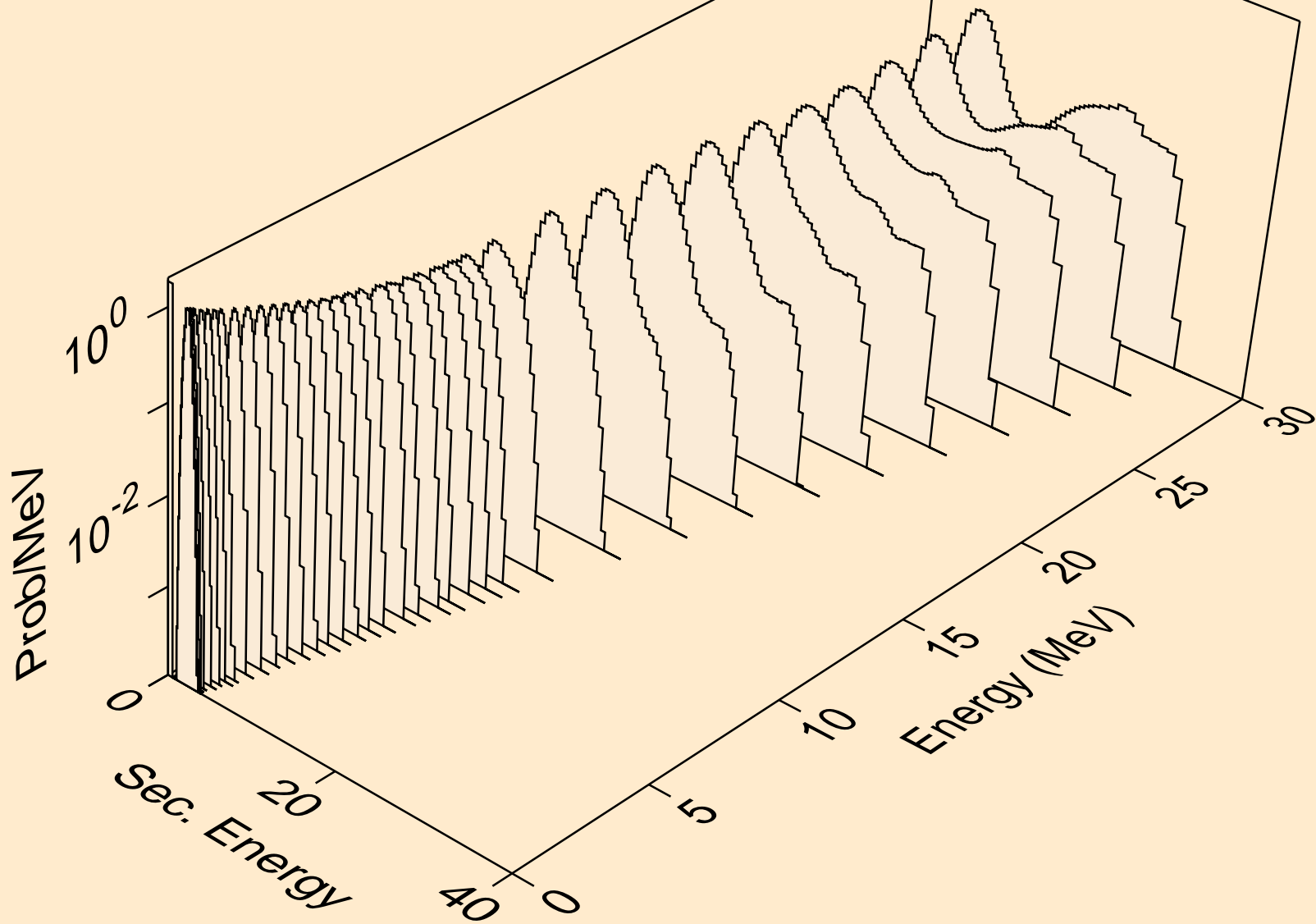

SB108 NEUTRON ACER TENDL-2024 LIBRARY; T=293.6K
protons from (n,p)

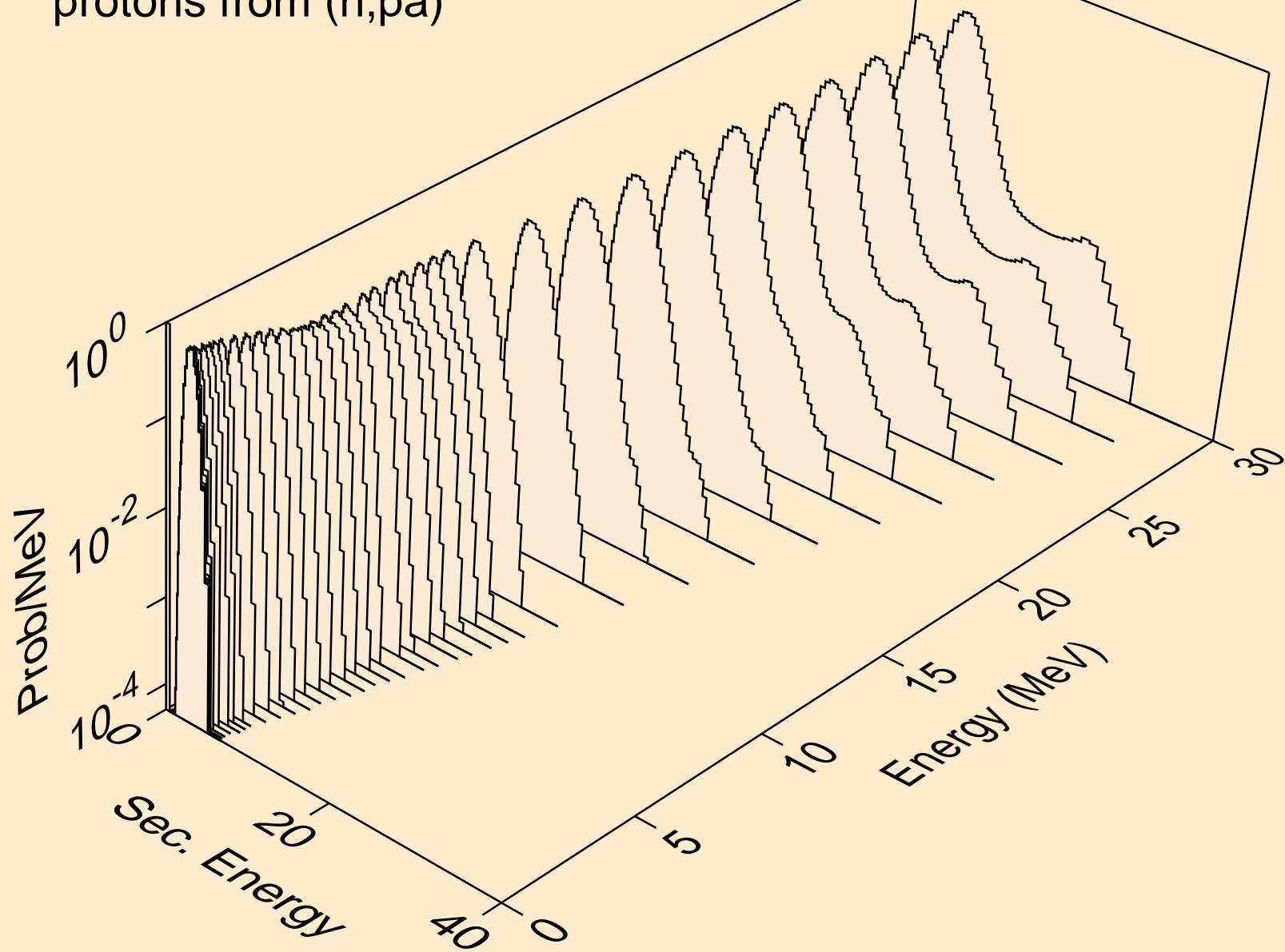

SB108 NEUTRON ACER TENDL-2024 LIBRARY; T=293.6K
protons from (n,pd)

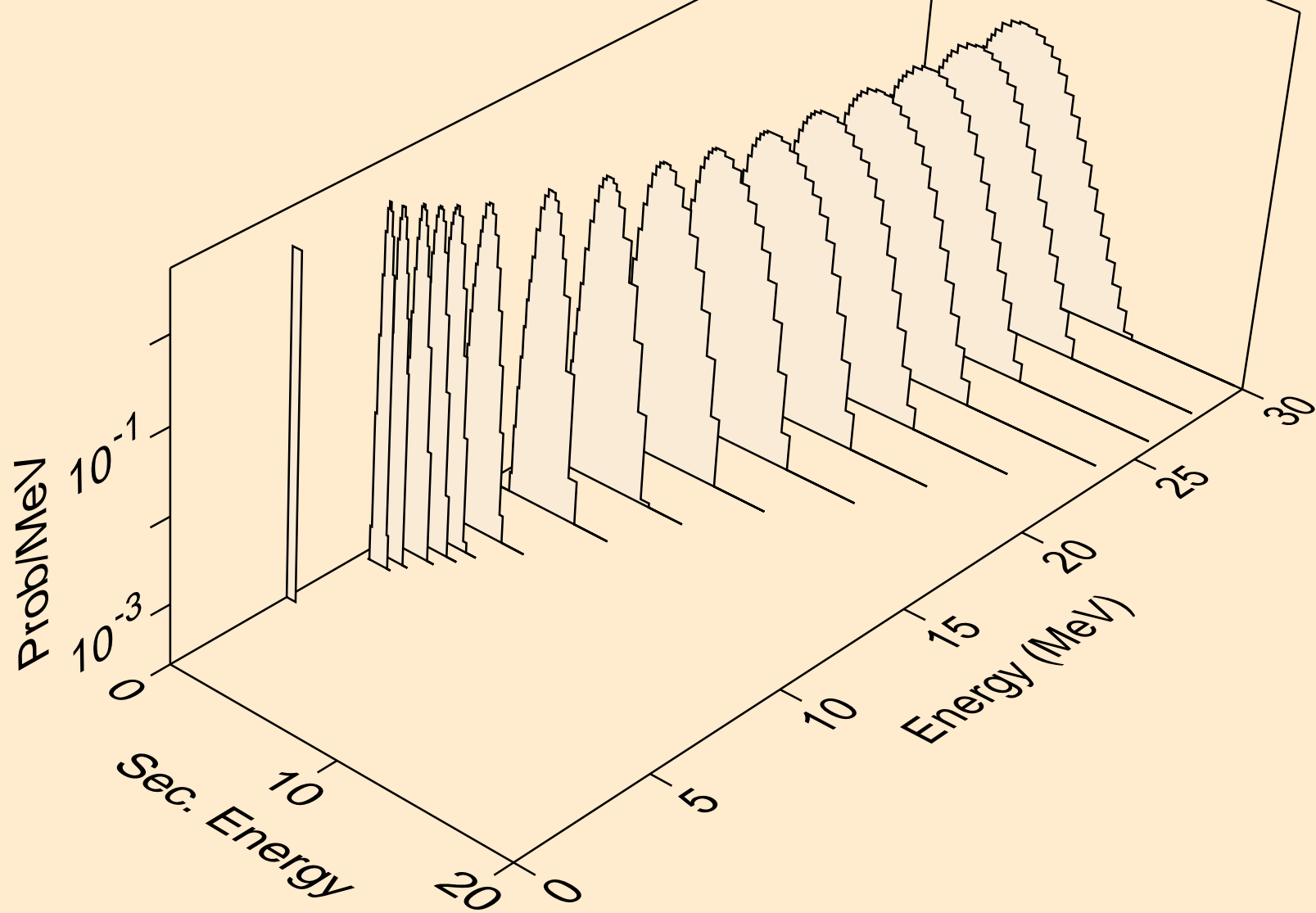

SB108 NEUTRON ACER TENDL-2024 LIBRARY; T=293.6K
protons from (n,pt)

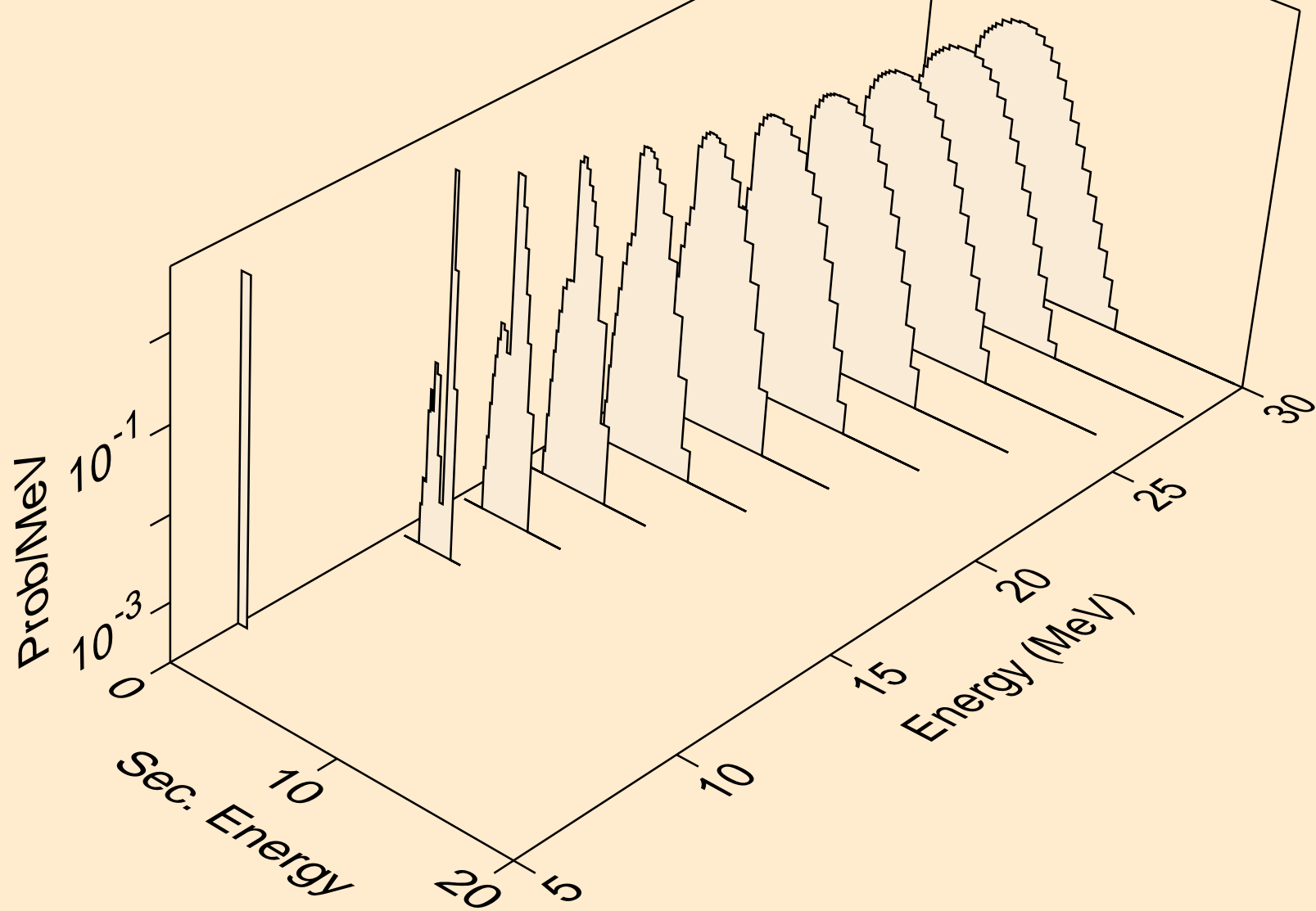

SB108 NEUTRON ACER TENDL-2024 LIBRARY; T=293.6K
deuterons from (n,x)

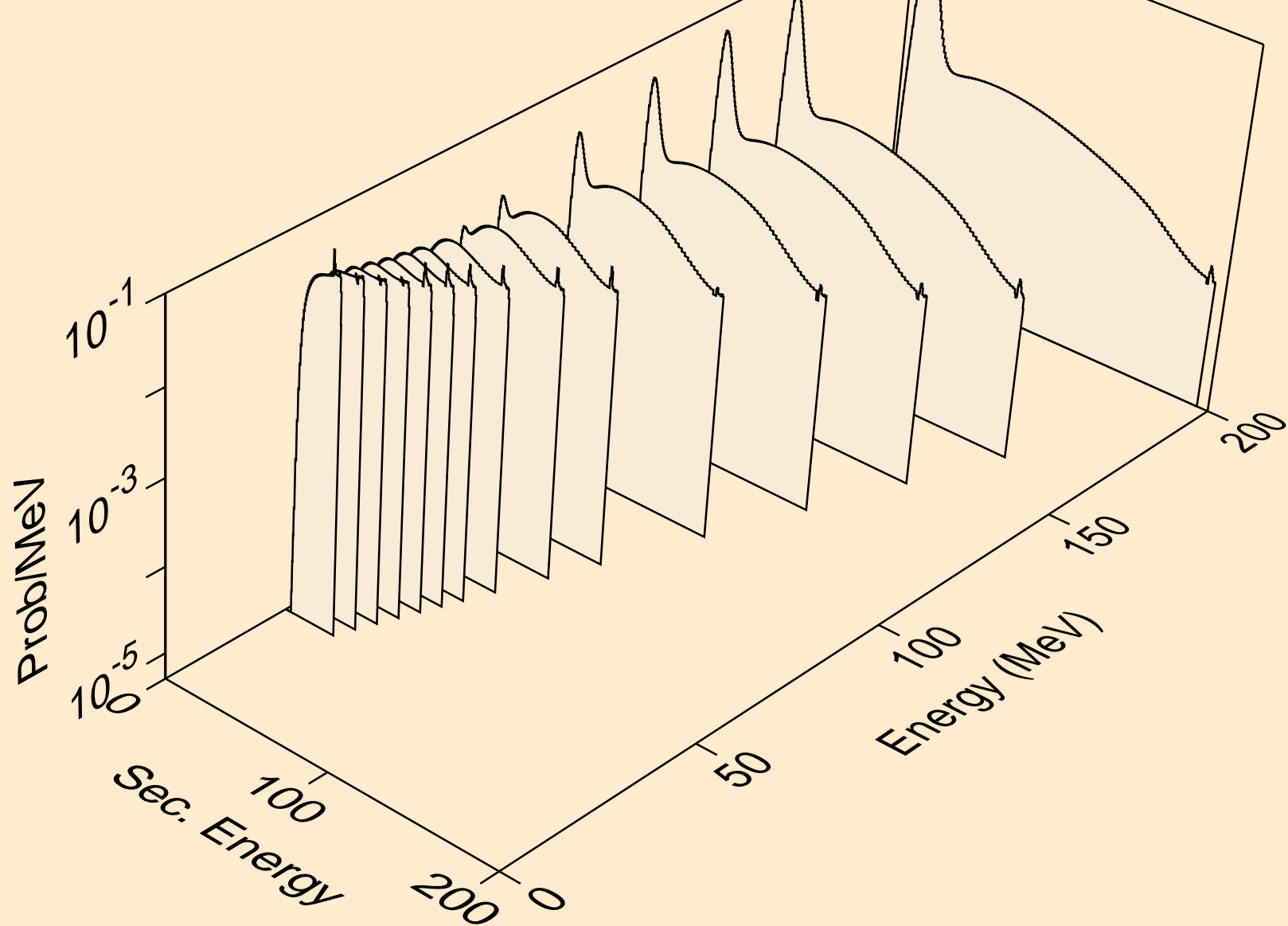

SB108 NEUTRON ACER TENDL-2024 LIBRARY; T=293.6K
deuterons from (n,2nd)

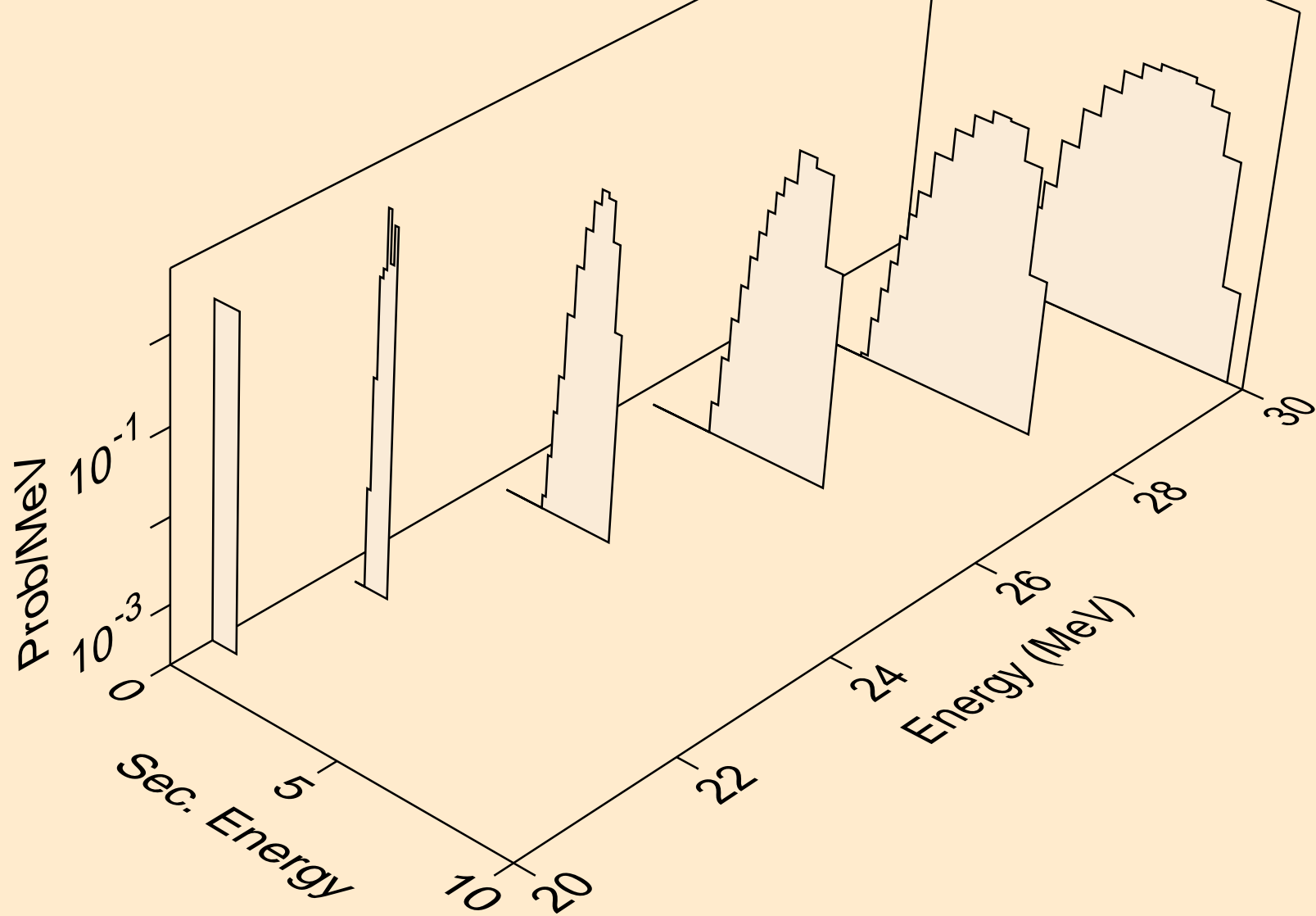

SB108 NEUTRON ACER TENDL-2024 LIBRARY; T=293.6K
deuterons from (n,n*)d

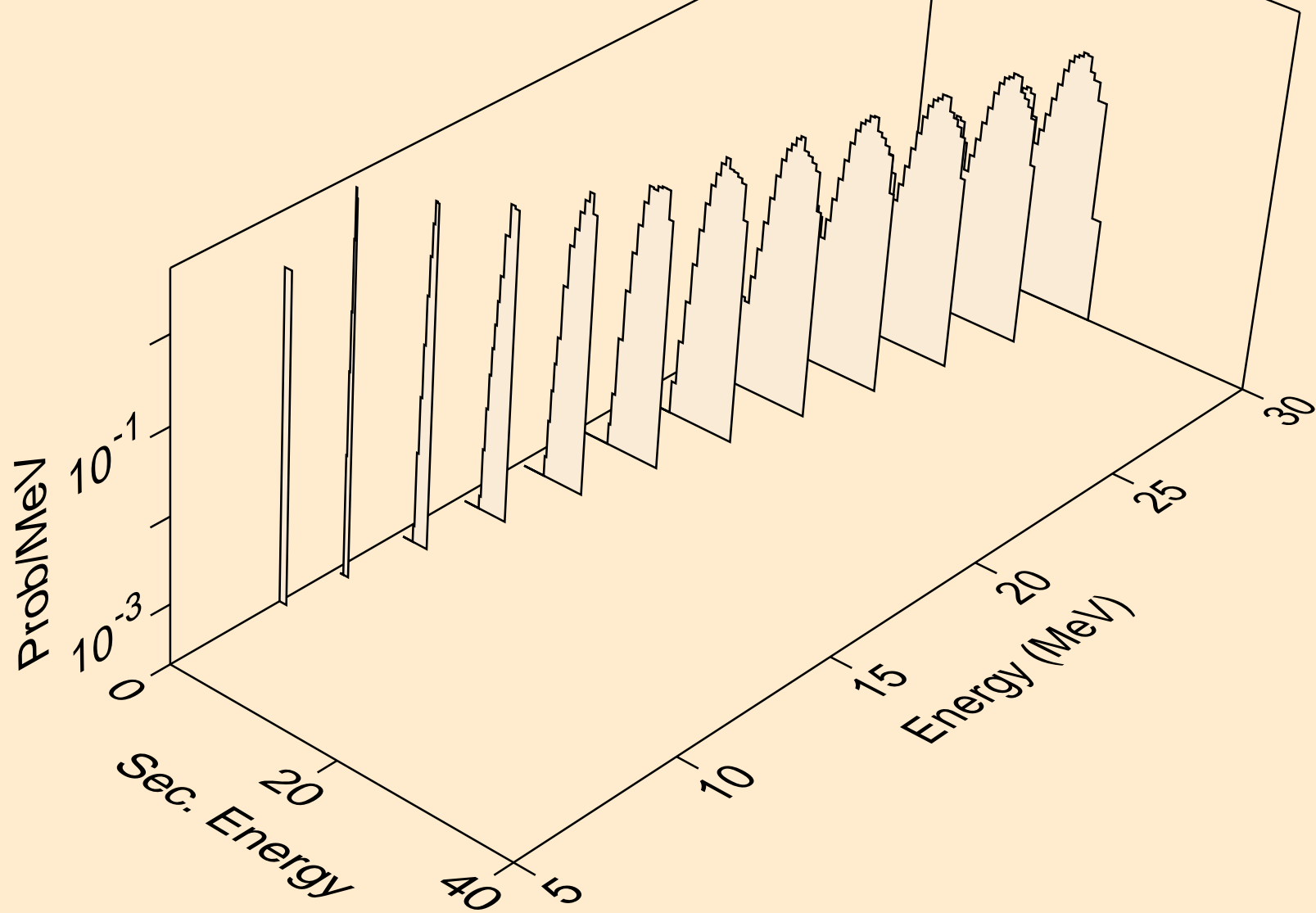

SB108 NEUTRON ACER TENDL-2024 LIBRARY; T=293.6K
deuterons from (n,d)

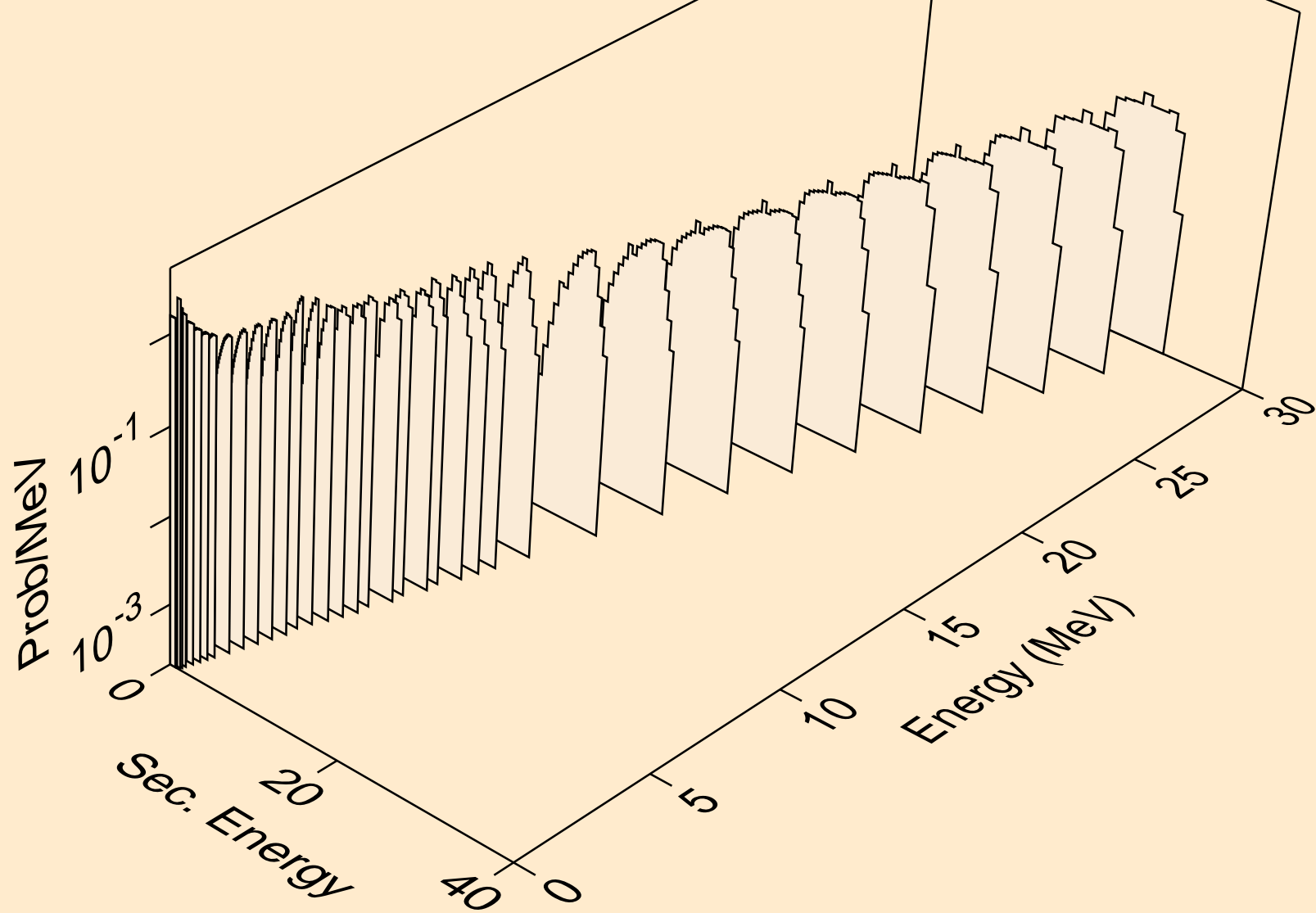

SB108 NEUTRON ACER TENDL-2024 LIBRARY; T=293.6K
deuterons from (n,d2a)

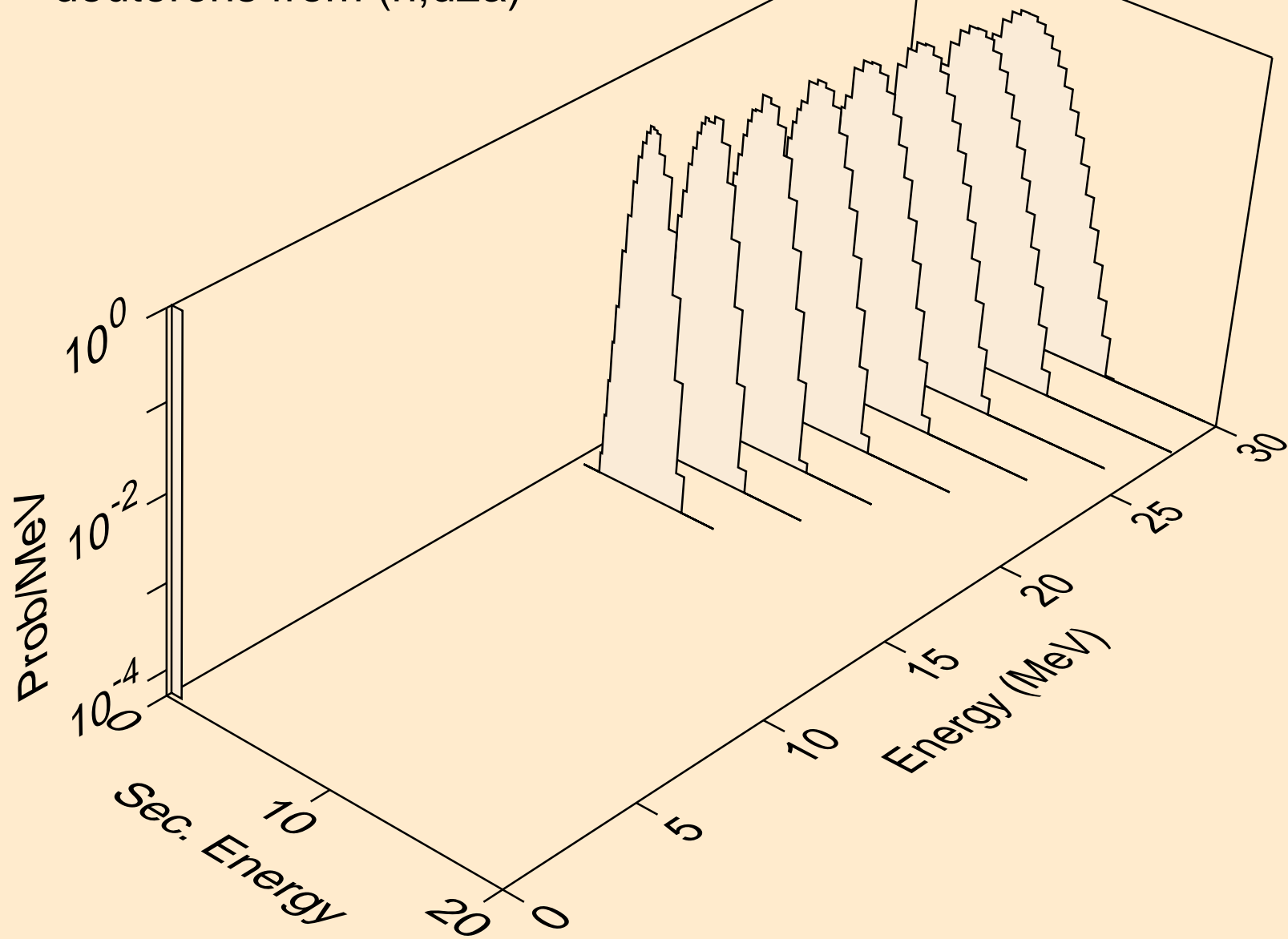

SB108 NEUTRON ACER TENDL-2024 LIBRARY; T=293.6K
deuterons from (n,pd)

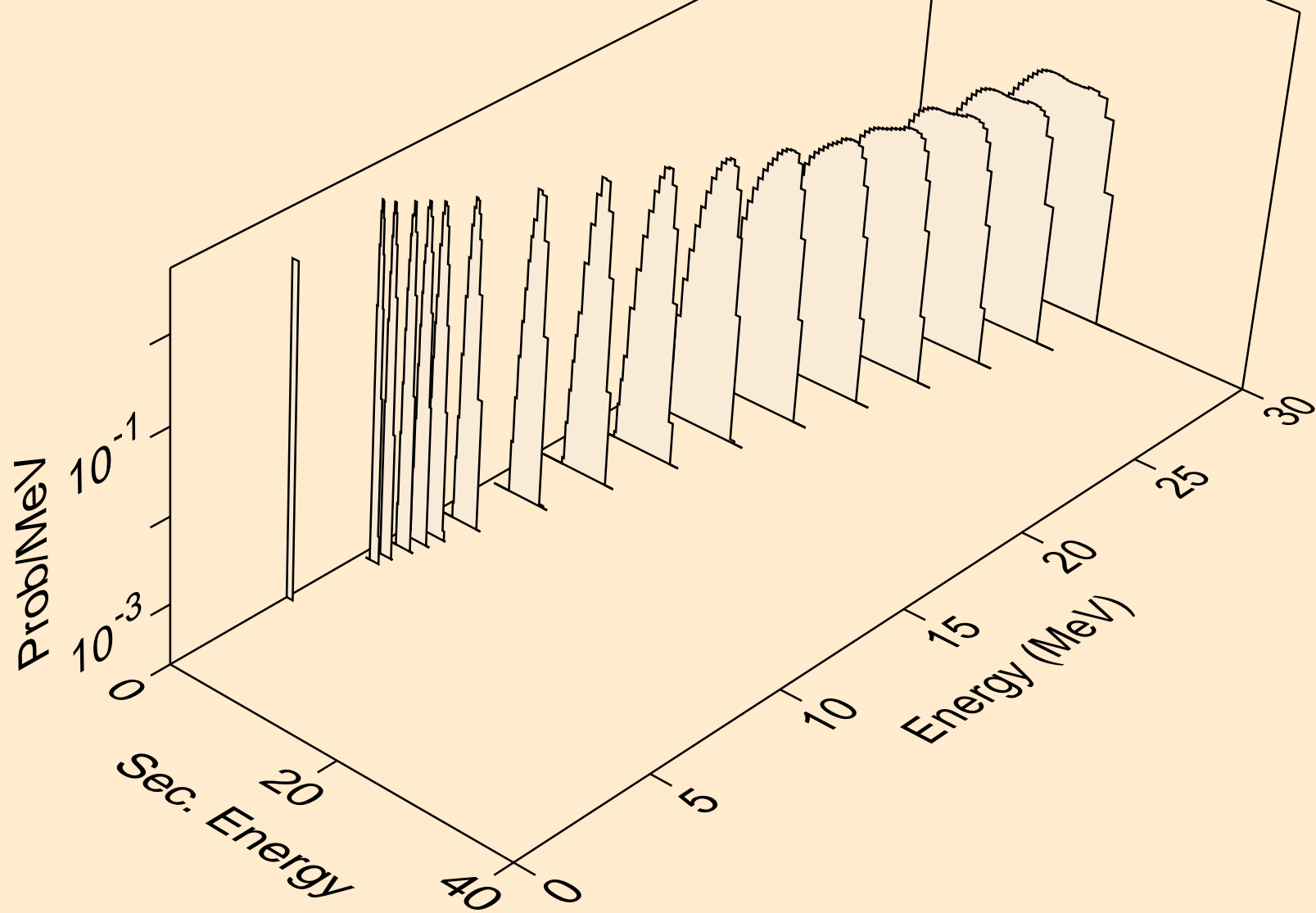

SB108 NEUTRON ACER TENDL-2024 LIBRARY; T=293.6K
deuterons from (n,da)

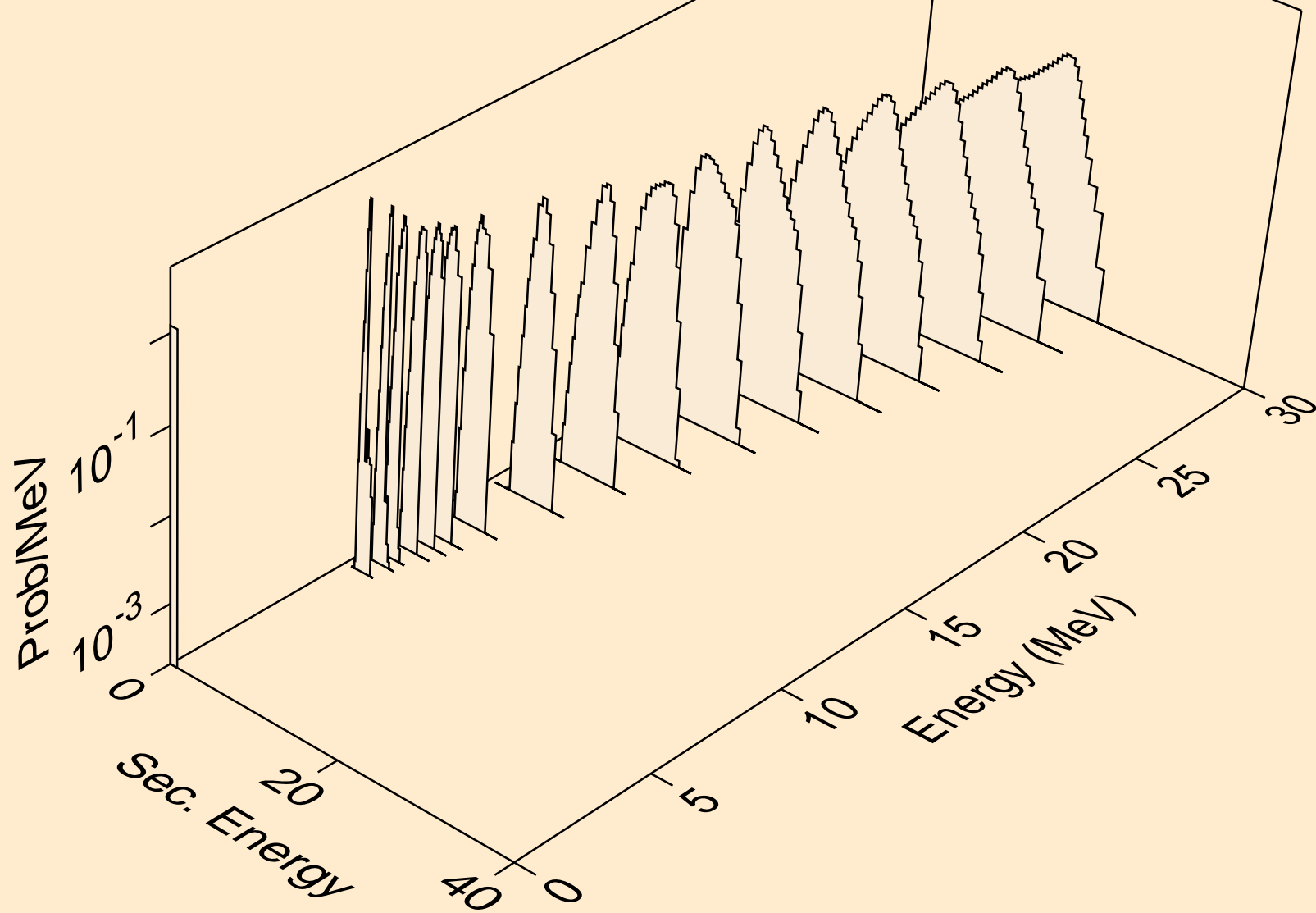

SB108 NEUTRON ACER TENDL-2024 LIBRARY; T=293.6K
tritons from (n,x)

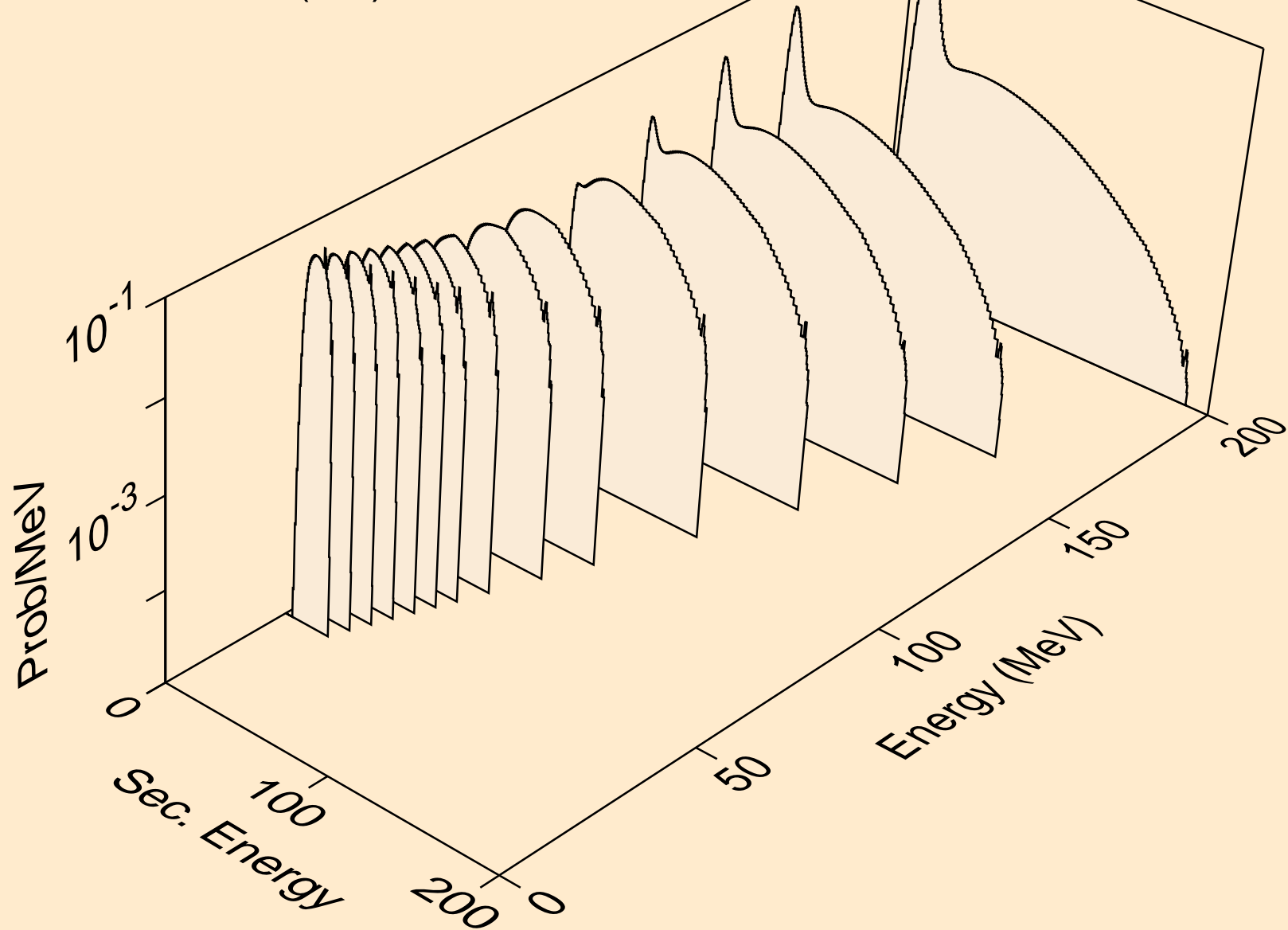

SB108 NEUTRON ACER TENDL-2024 LIBRARY; T=293.6K
tritons from (n,n*)t

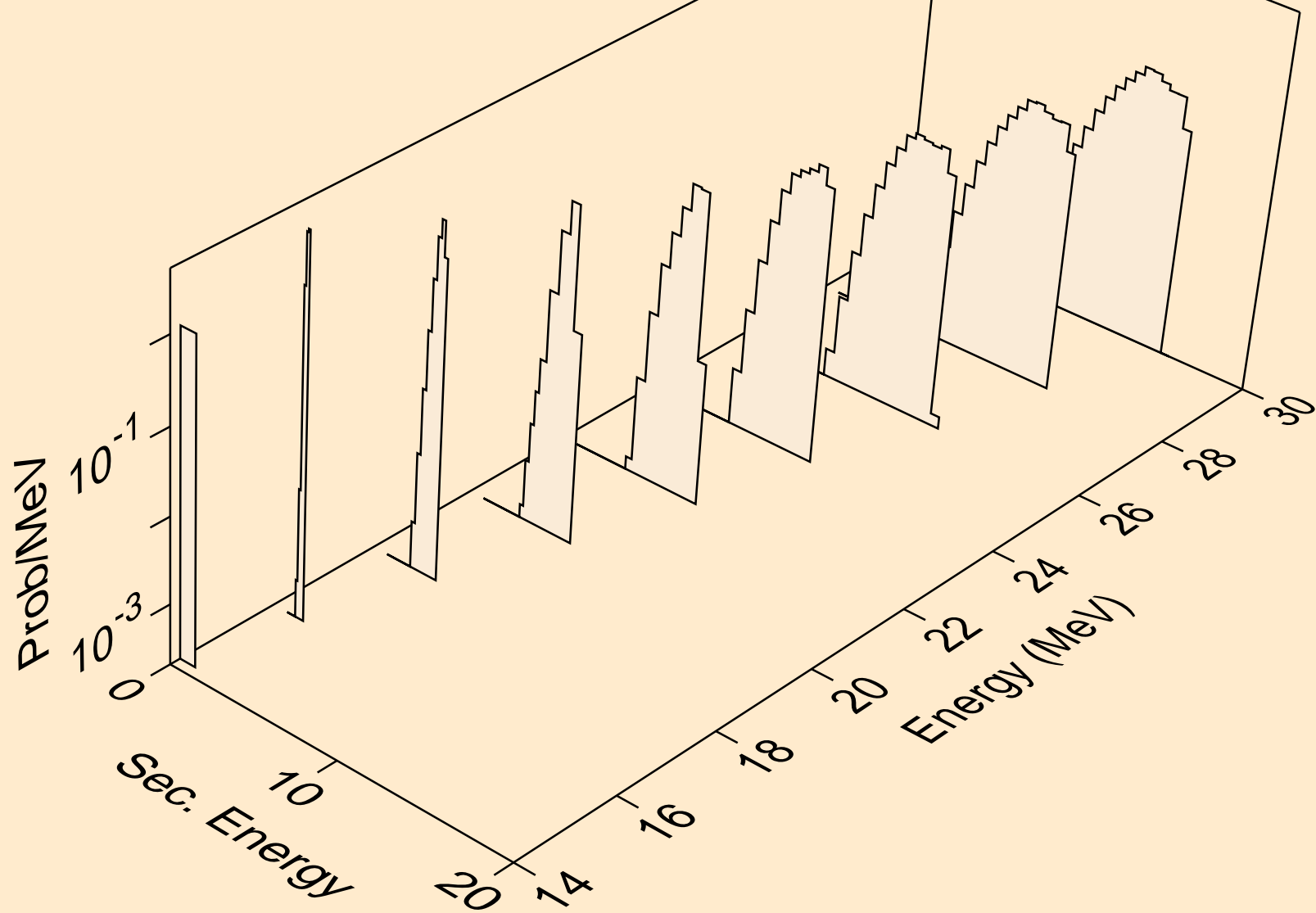

SB108 NEUTRON ACER TENDL-2024 LIBRARY; T=293.6K
tritons from (n,t)

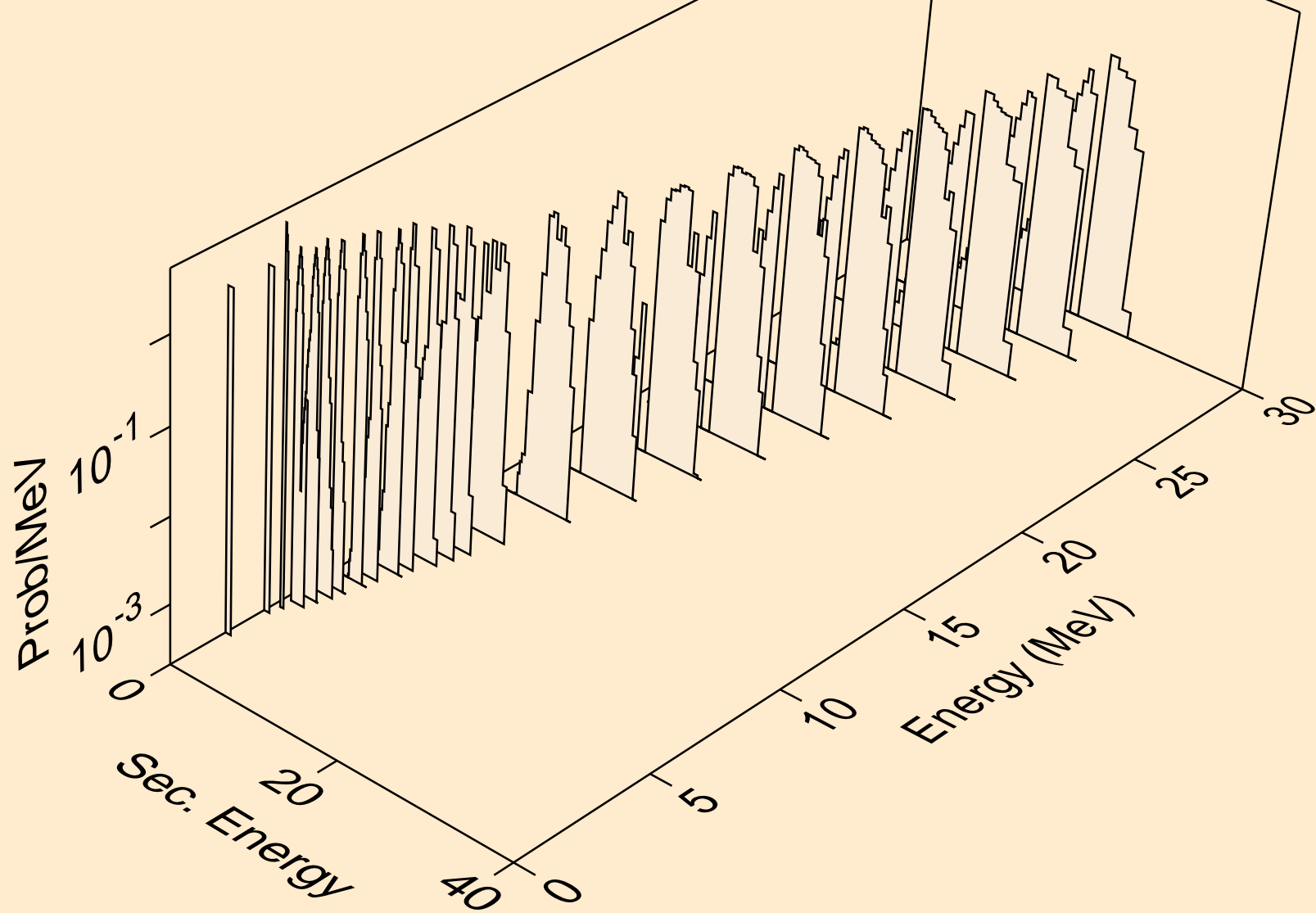

SB108 NEUTRON ACER TENDL-2024 LIBRARY; T=293.6K
tritons from (n,pt)

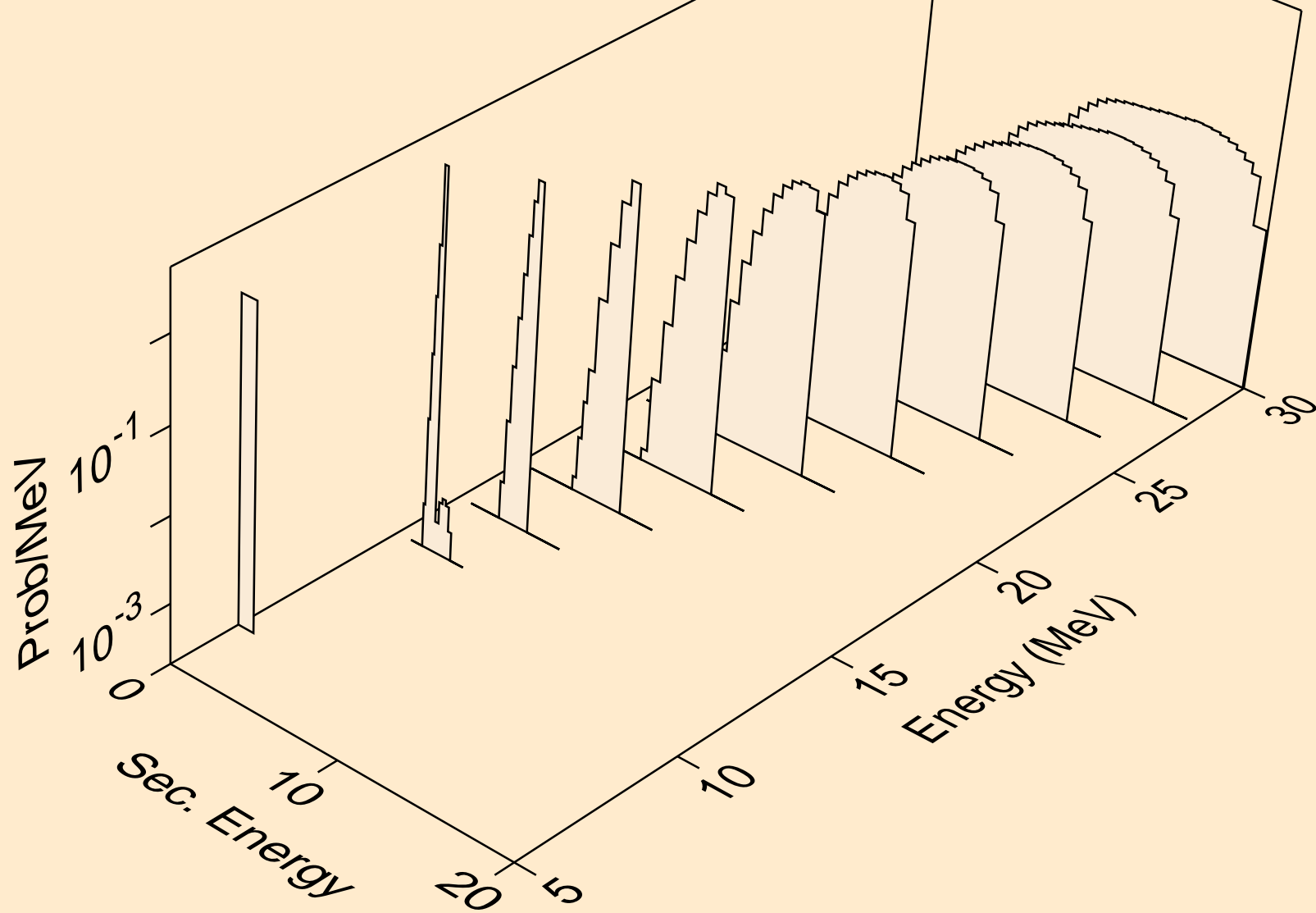

SB108 NEUTRON ACER TENDL-2024 LIBRARY; T=293.6K
he3s from (n,x)

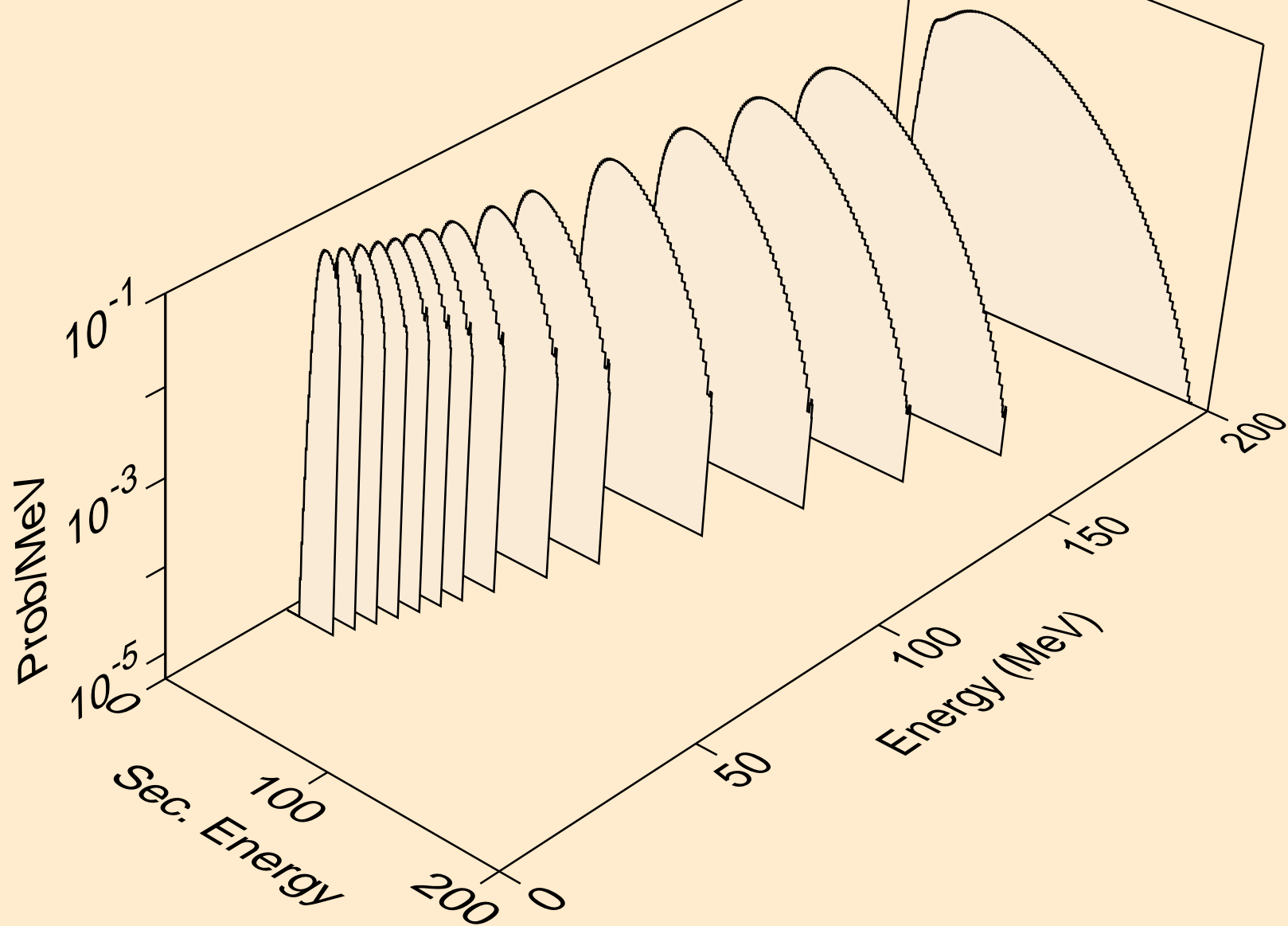

SB108 NEUTRON ACER TENDL-2024 LIBRARY; T=293.6K
he3s from (n,n*)he3

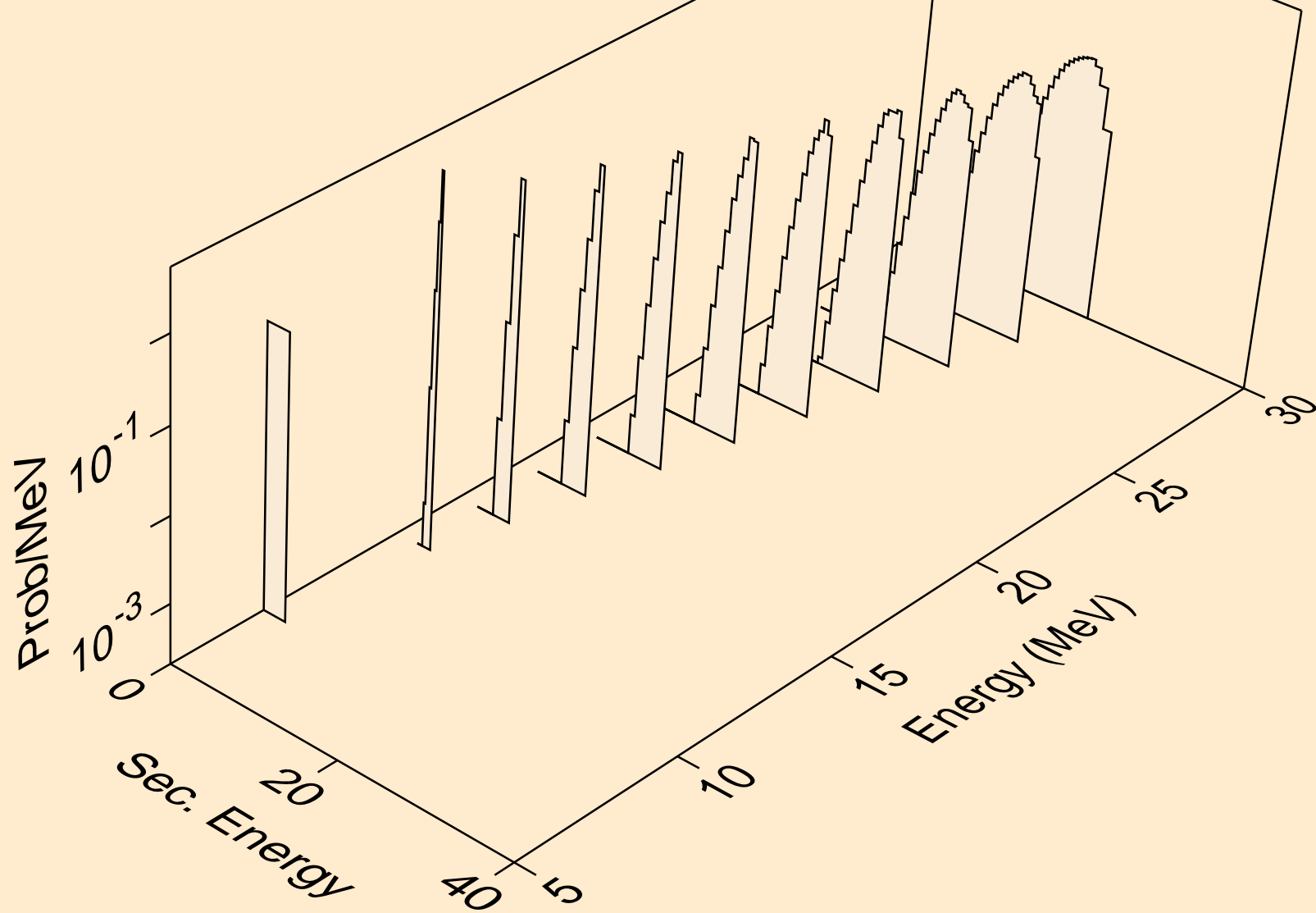

SB108 NEUTRON ACER TENDL-2024 LIBRARY; T=293.6K
he3s from (n,he3)

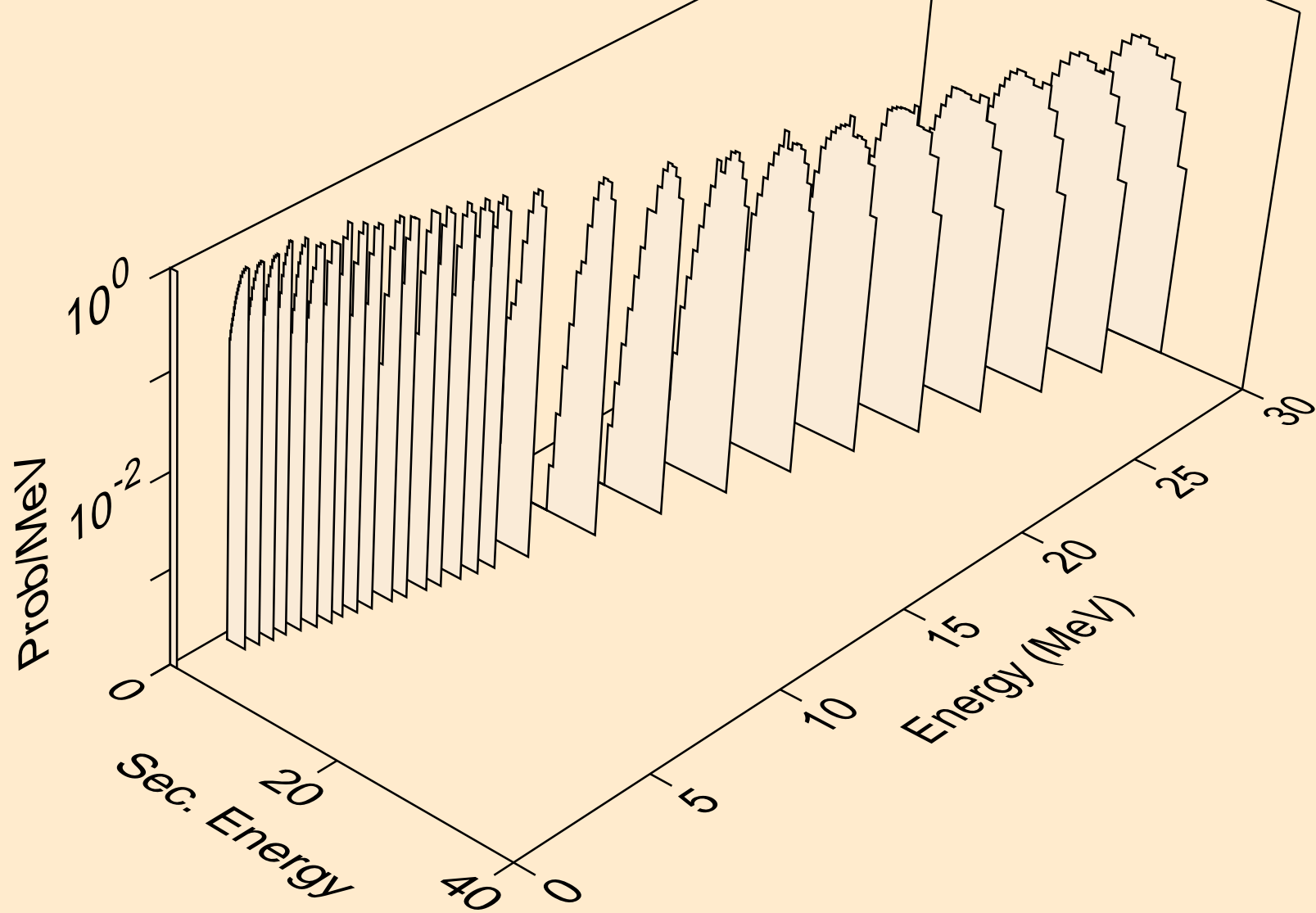

SB108 NEUTRON ACER TENDL-2024 LIBRARY; T=293.6K
alphas from (n,x)

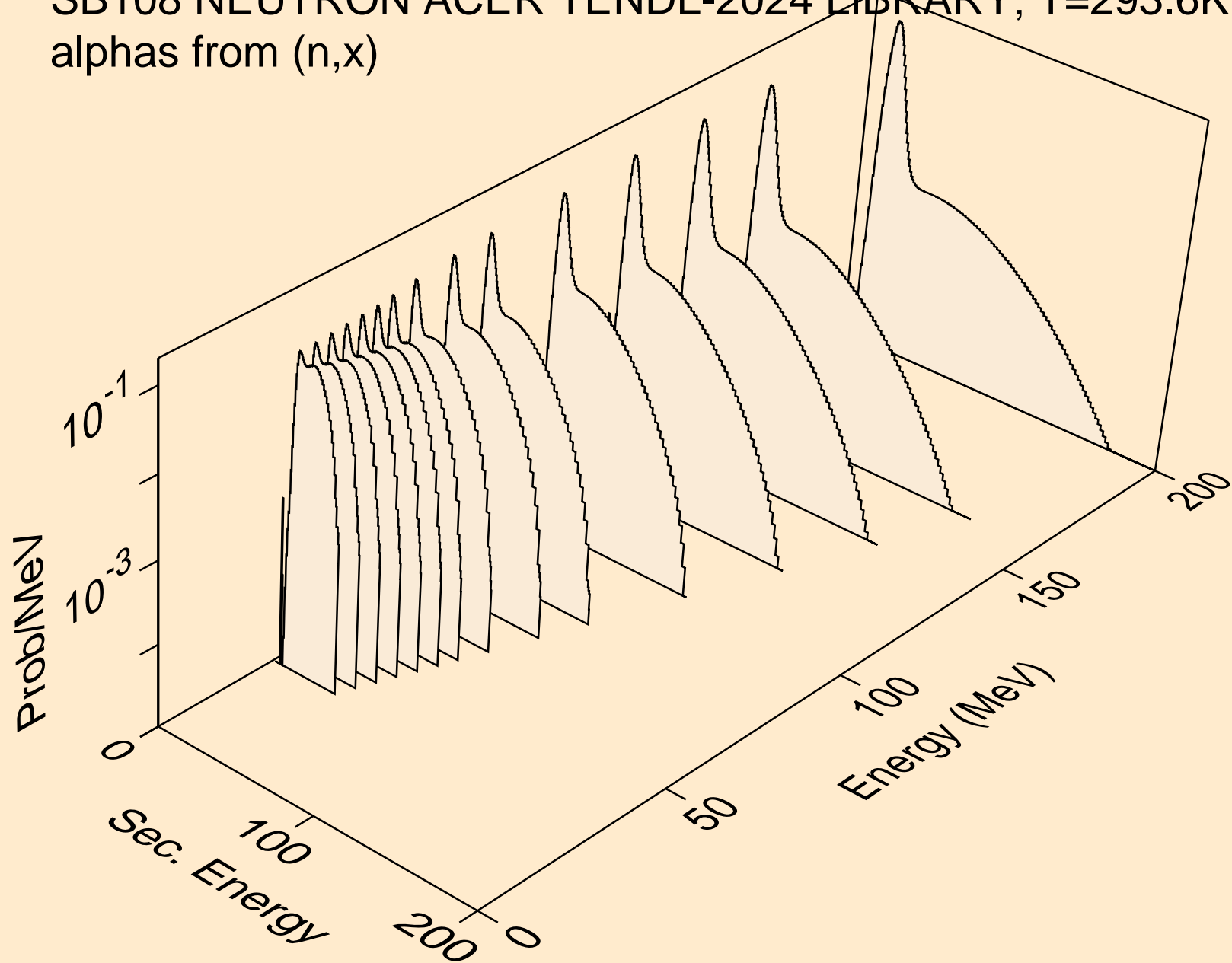

SB108 NEUTRON ACER TENDL-2024 LIBRARY; T=293.6K
alphas from (n,n*)a

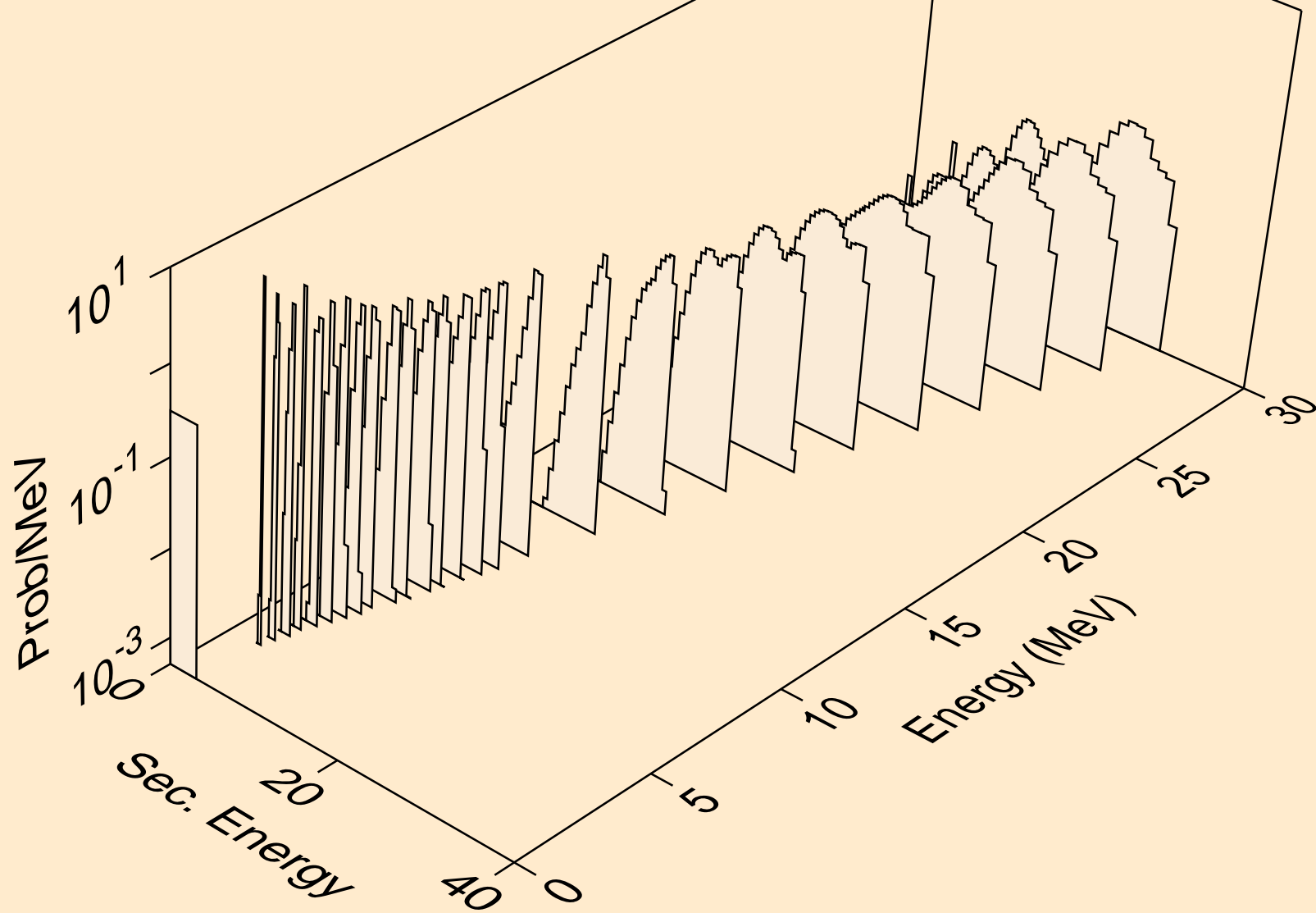

SB108 NEUTRON ACER TENDL-2024 LIBRARY; T=293.6K
alphas from (n,2n)a

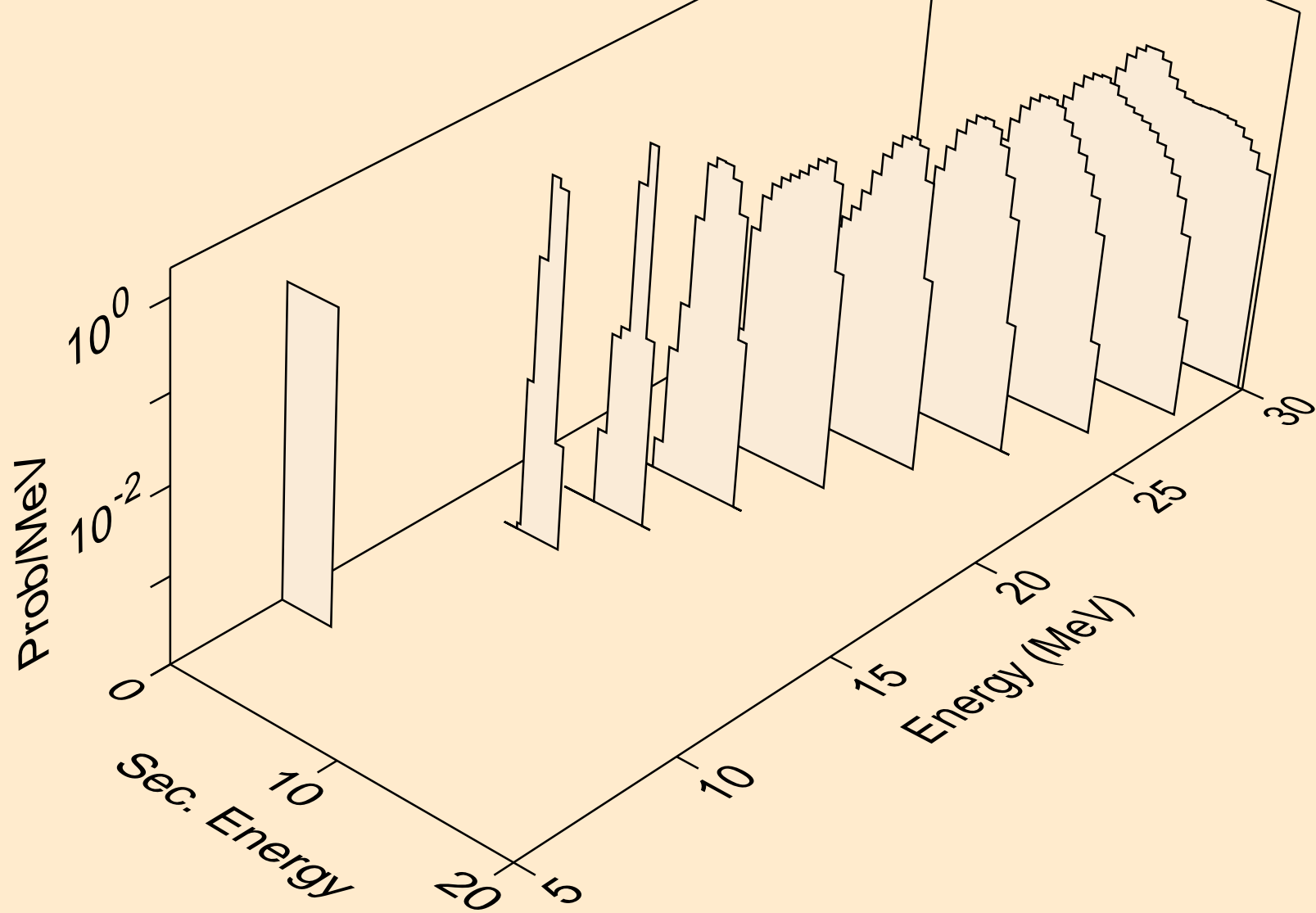

SB108 NEUTRON ACER TENDL-2024 LIBRARY; T=293.6K
alphas from (n,n*)2a

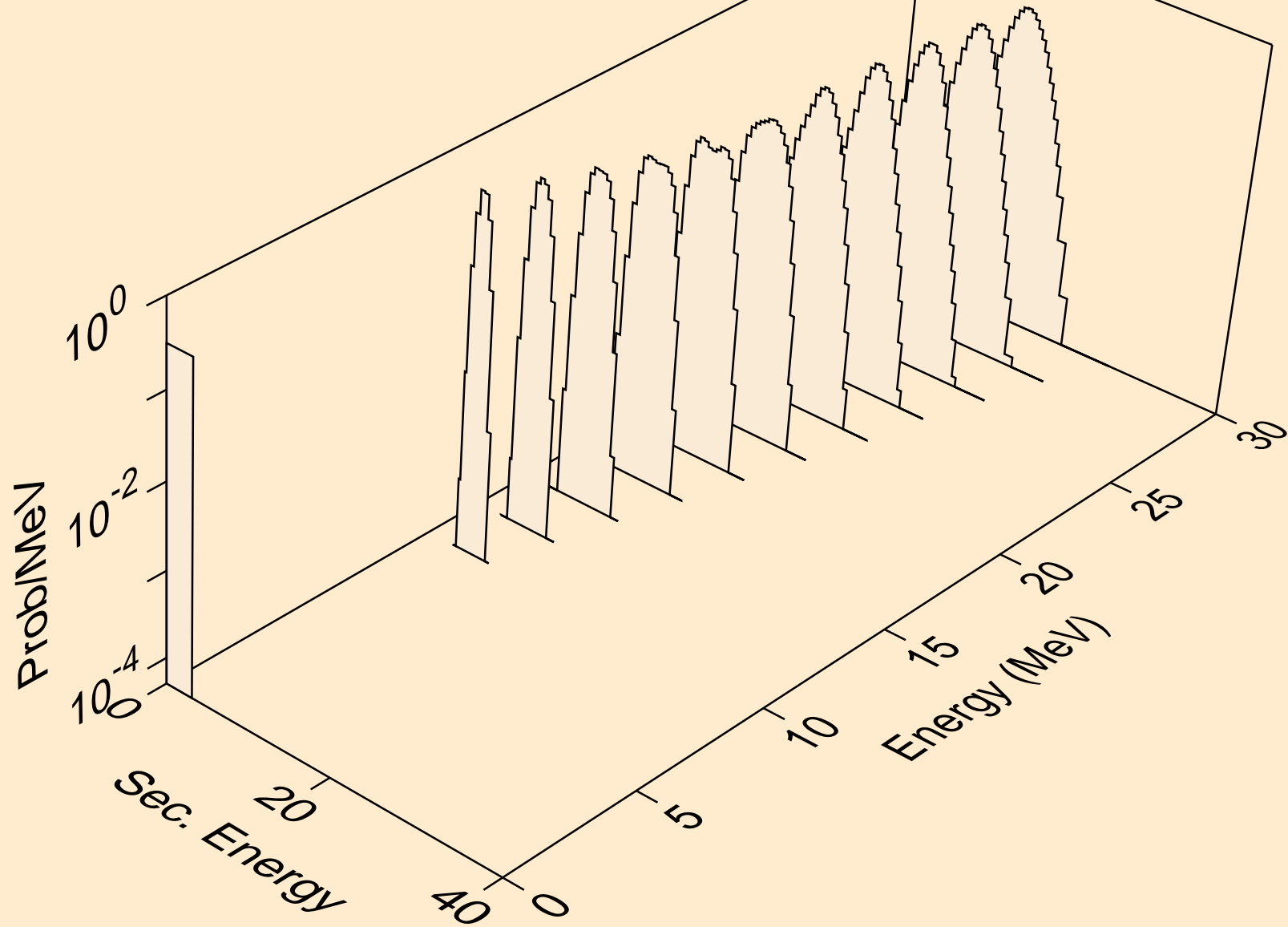

SB108 NEUTRON ACER TENDL-2024 LIBRARY; T=293.6K
alphas from (n,2n)2a

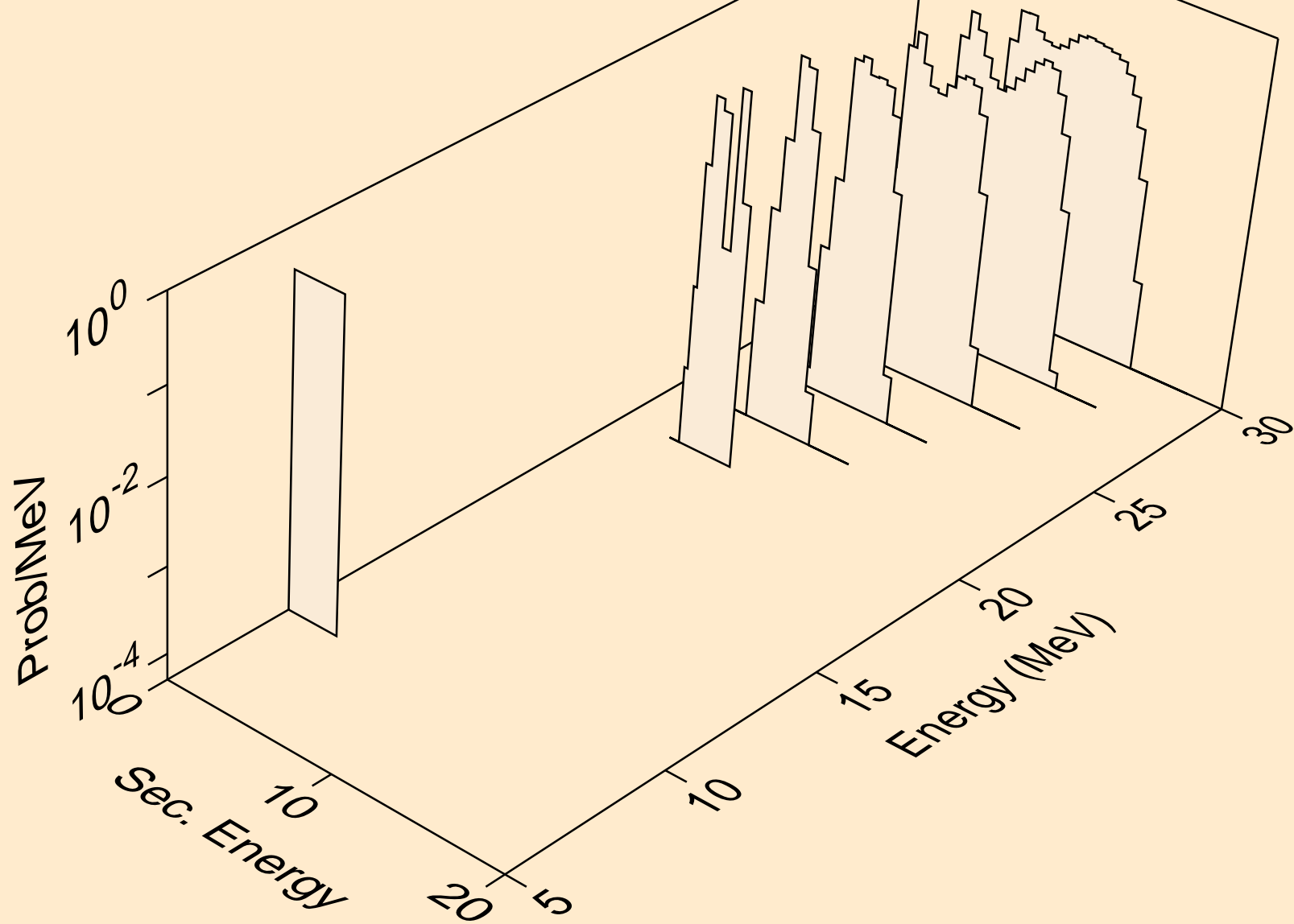

SB108 NEUTRON ACER TENDL-2024 LIBRARY; T=293.6K
alphas from (n,npa)

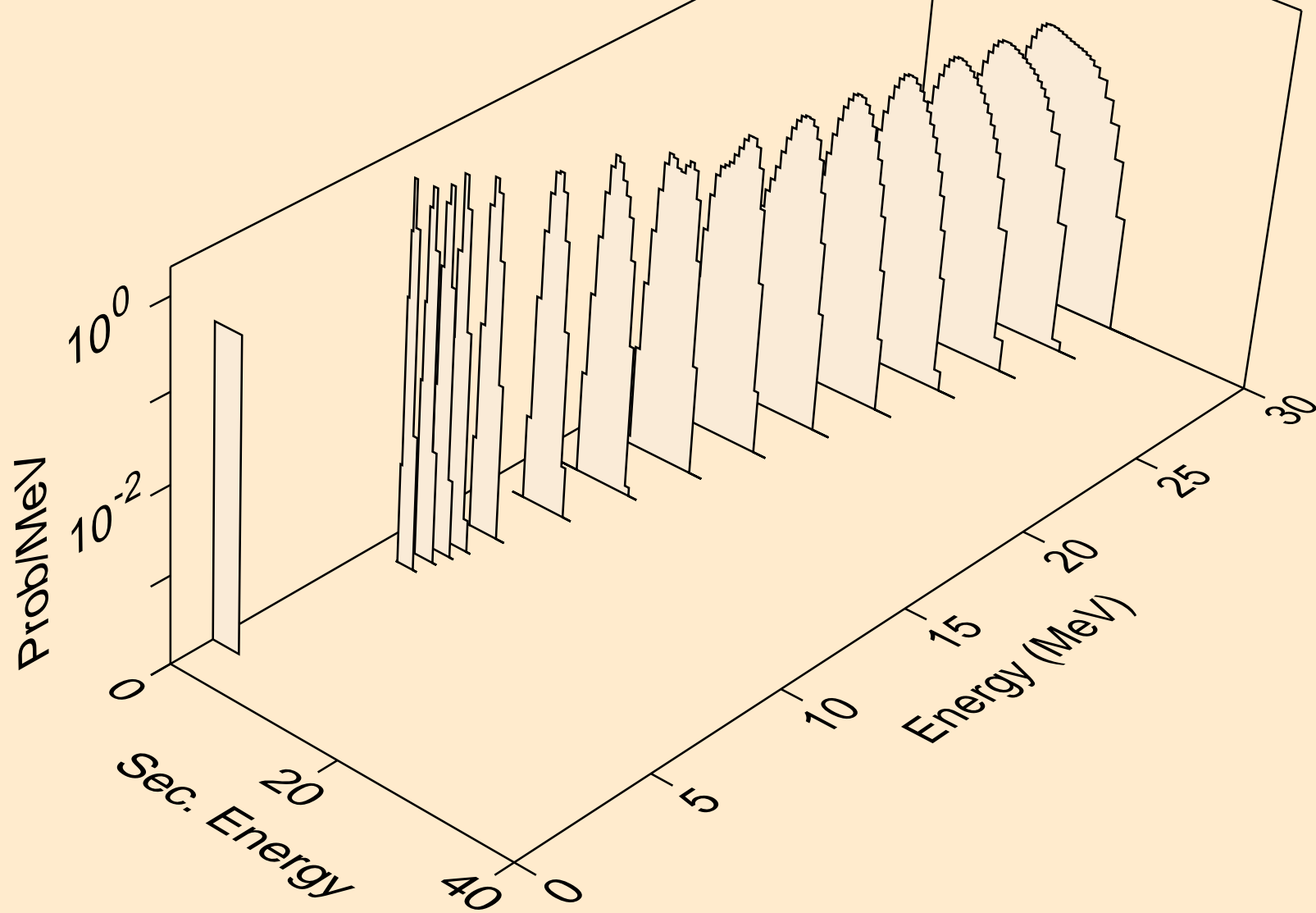

SB108 NEUTRON ACER TENDL-2024 LIBRARY; T=293.6K
alphas from (n,a)

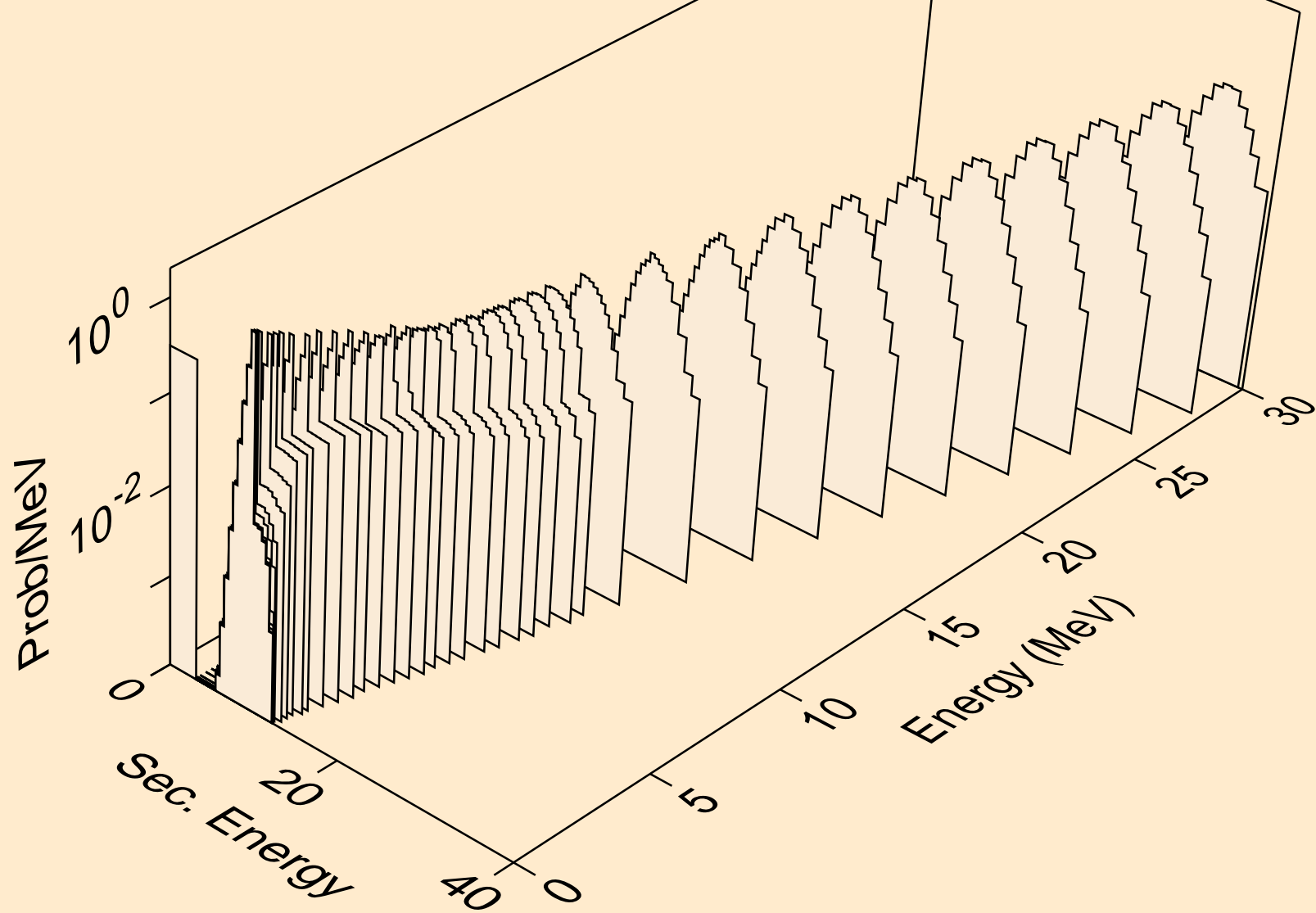

SB108 NEUTRON ACER TENDL-2024 LIBRARY; T=293.6K
alphas from (n,2a)

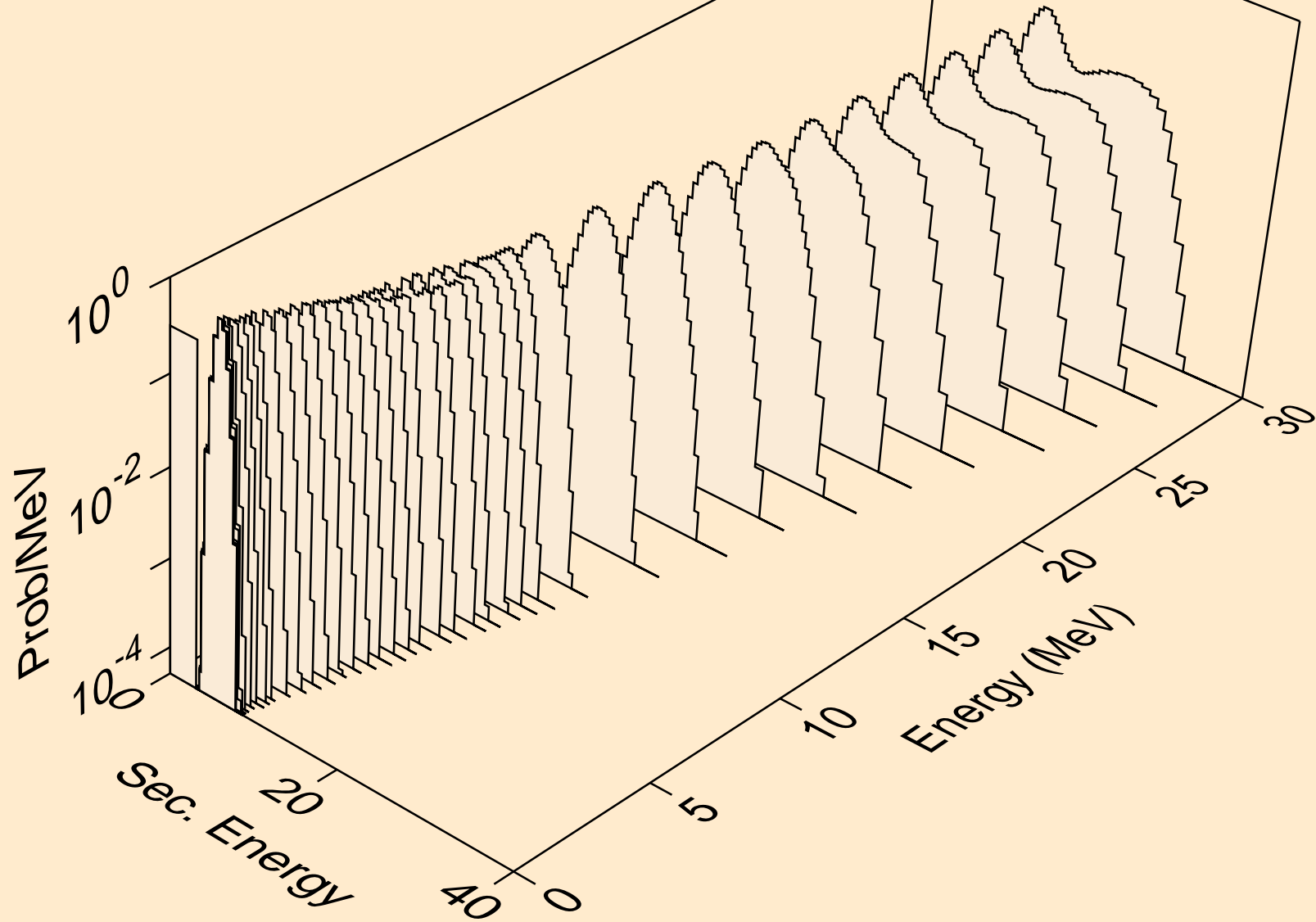

SB108 NEUTRON ACER TENDL-2024 LIBRARY; T=293.6K
alphas from (n,3a)

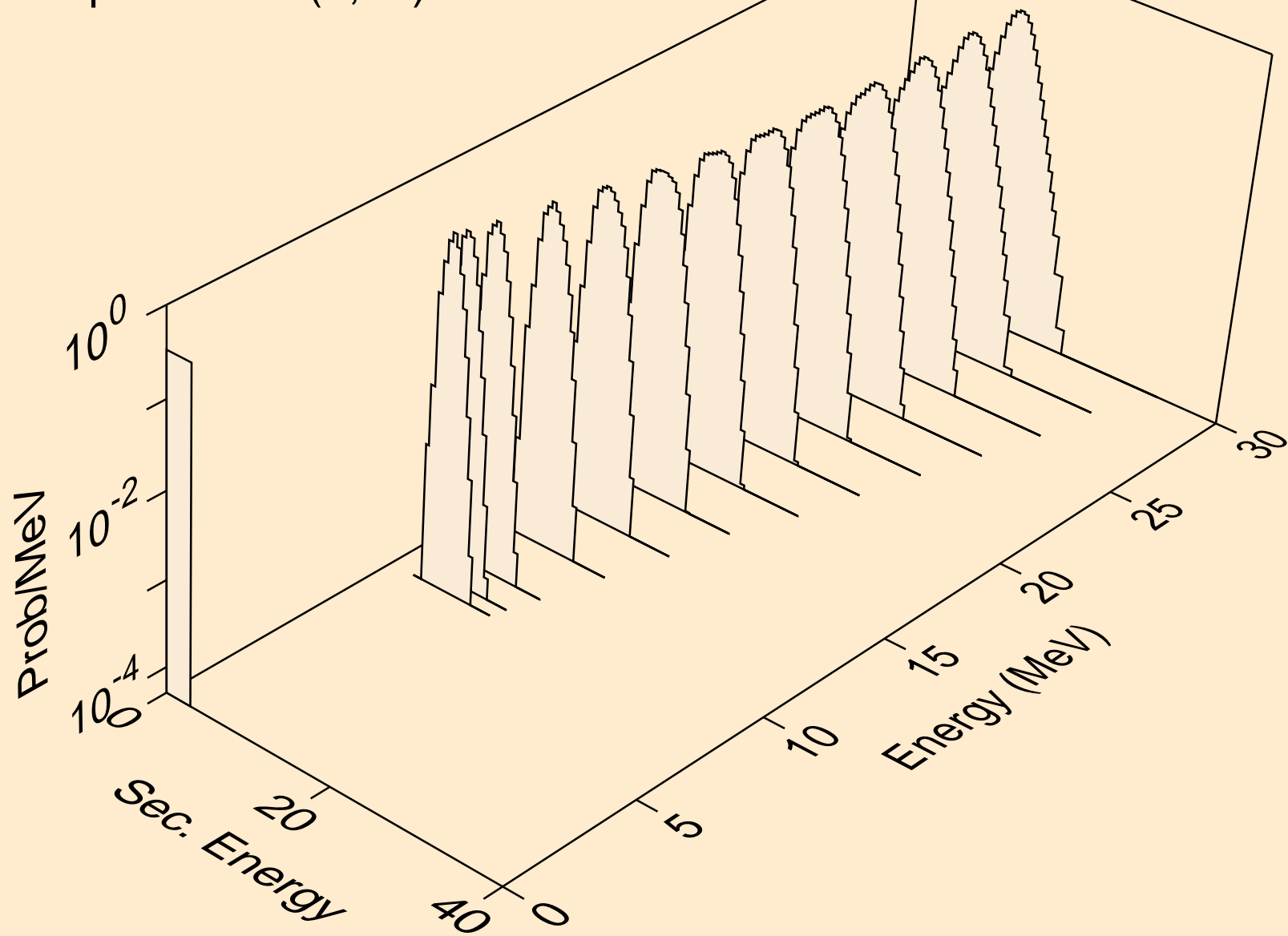

SB108 NEUTRON ACER TENDL-2024 LIBRARY; T=293.6K
alphas from (n,pa)

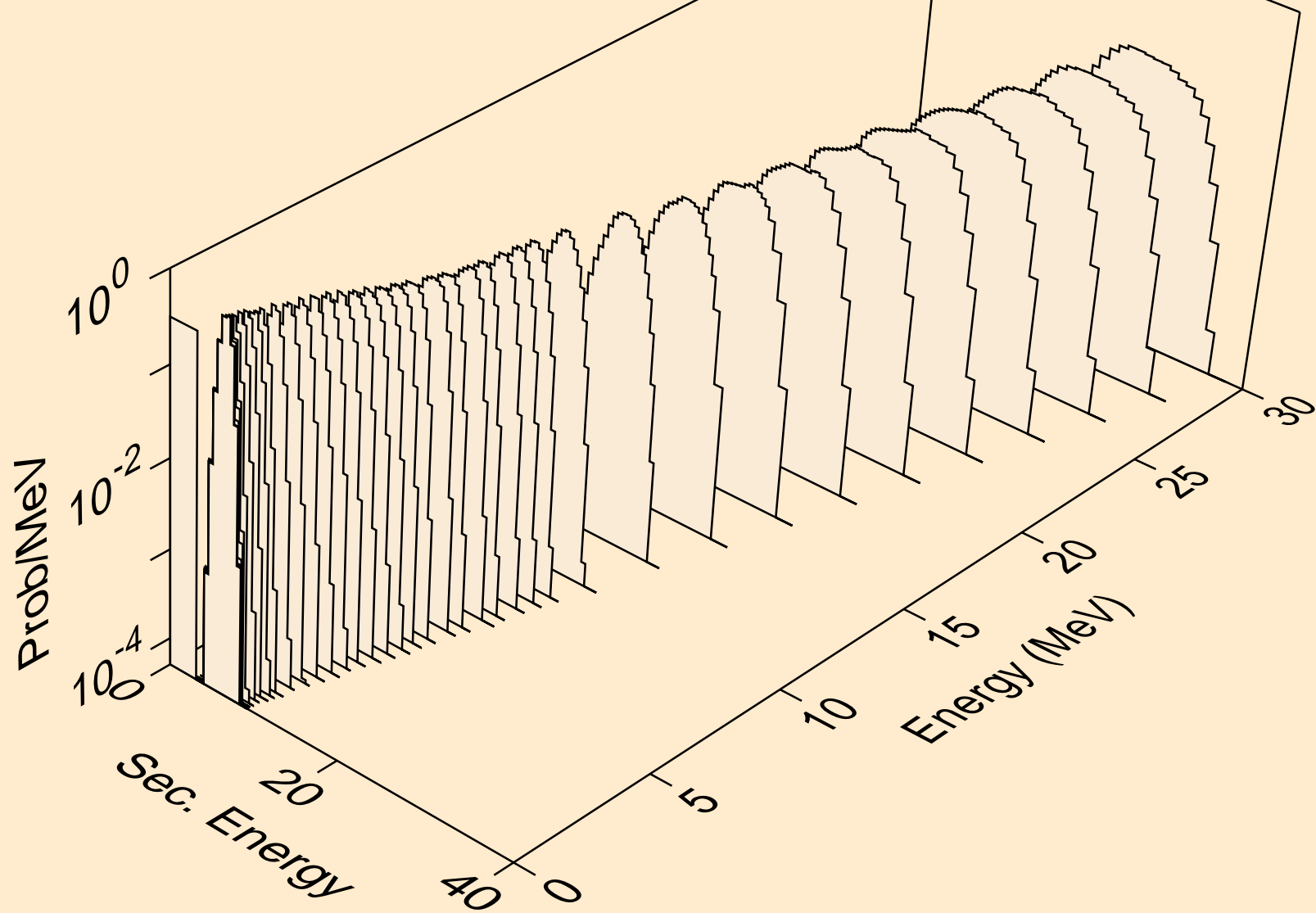

SB108 NEUTRON ACER TENDL-2024 LIBRARY; T=293.6K
alphas from (n,d2a)

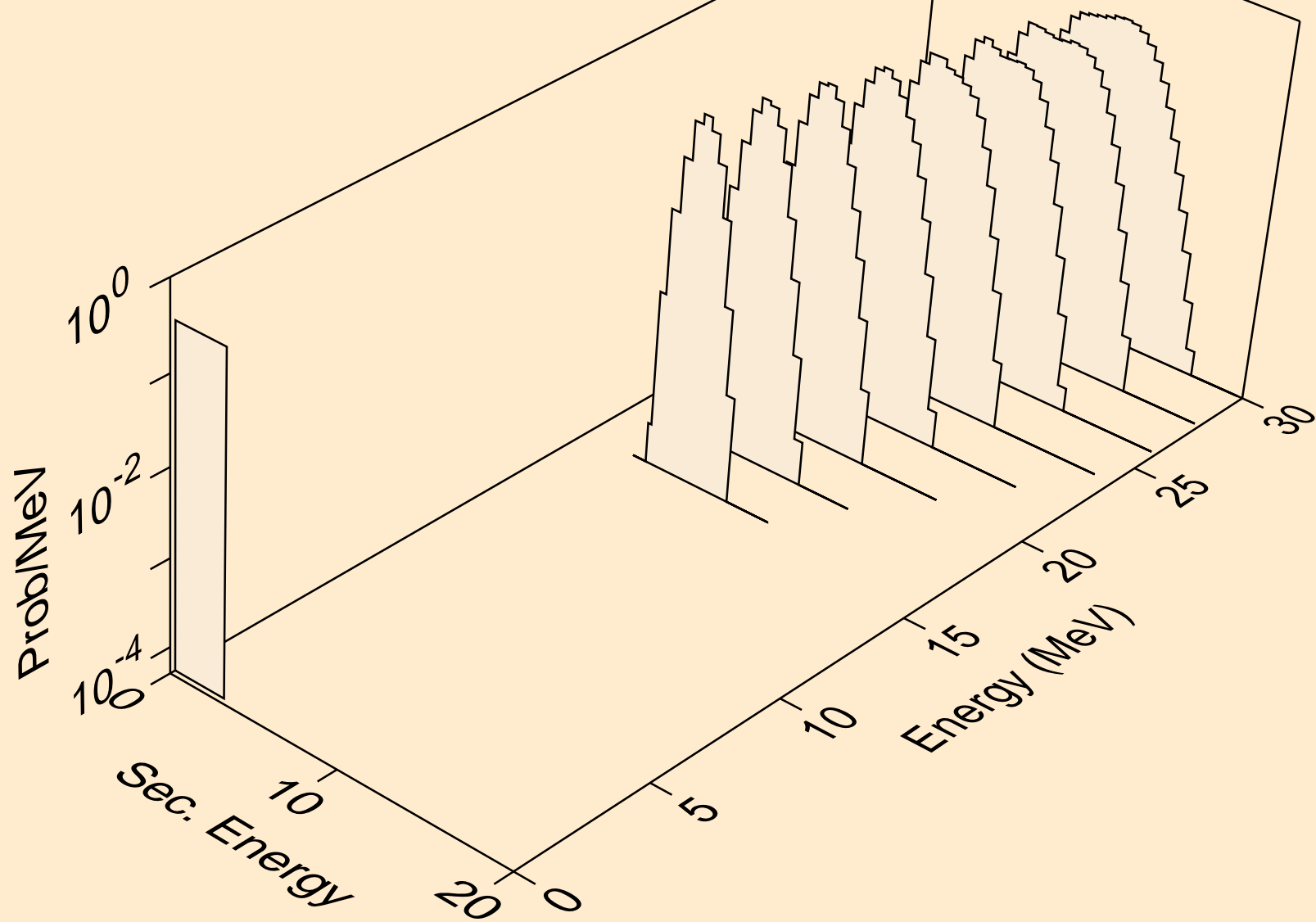

SB108 NEUTRON ACER TENDL-2024 LIBRARY; T=293.6K
alphas from (n,da)

