

SC051 NEUTRON ACER TENDL-2024 LIBRARY; T=293.6K

Principal cross sections

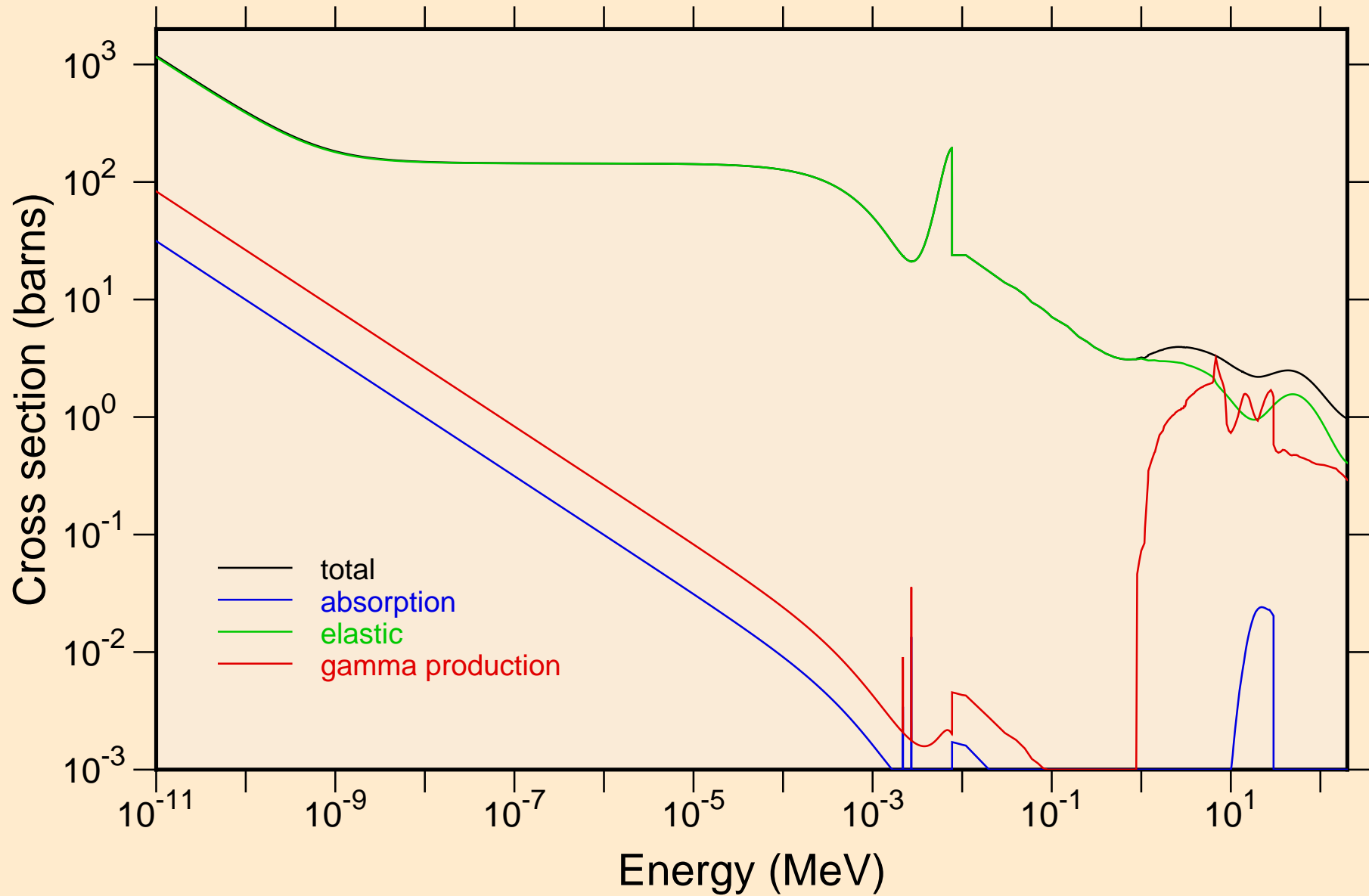

SC051 NEUTRON ACER TENDL-2024 LIBRARY; T=293.6K
Heating

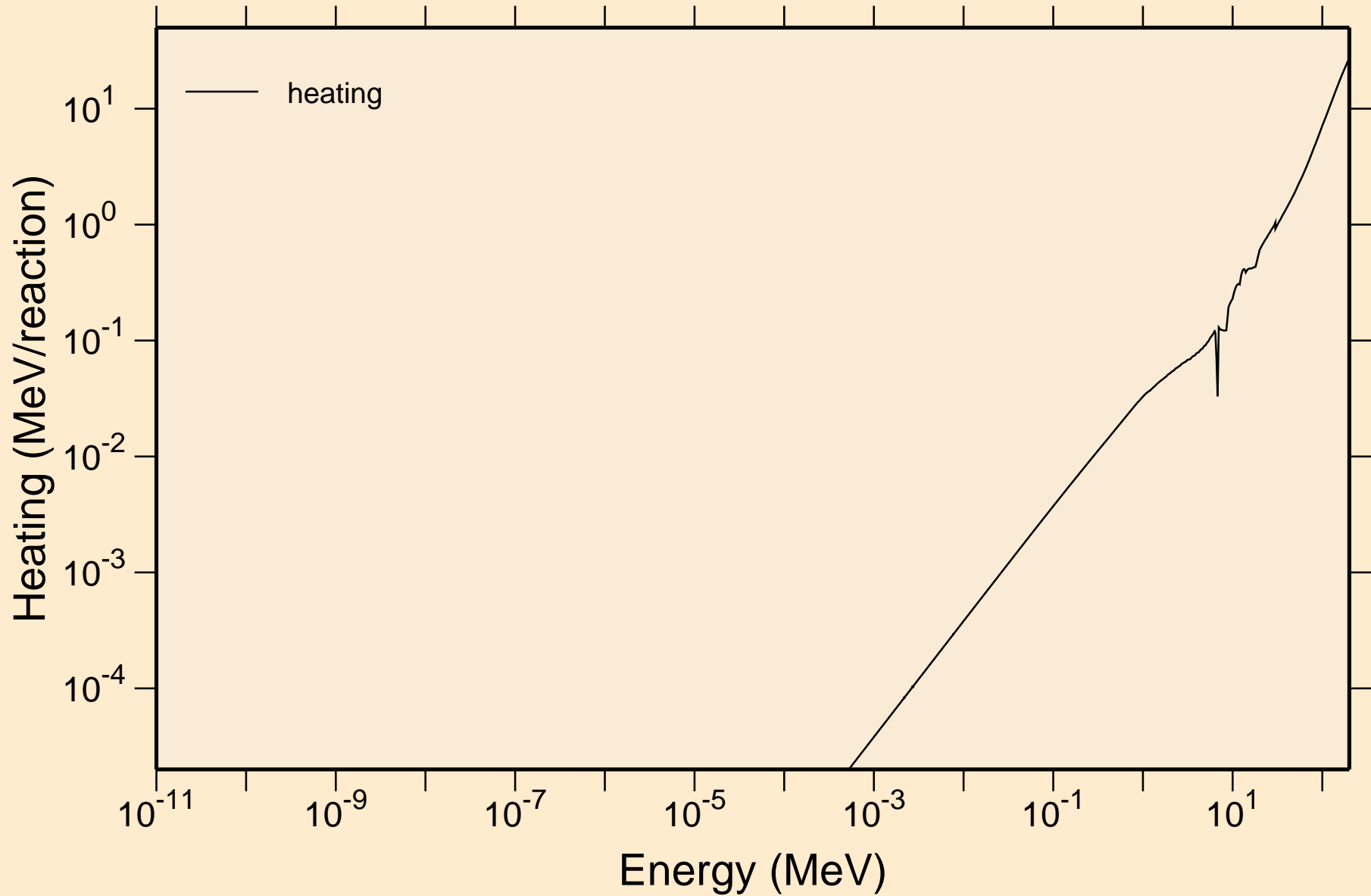

SC051 NEUTRON ACER TENDL-2024 LIBRARY; T=293.6K
Damage

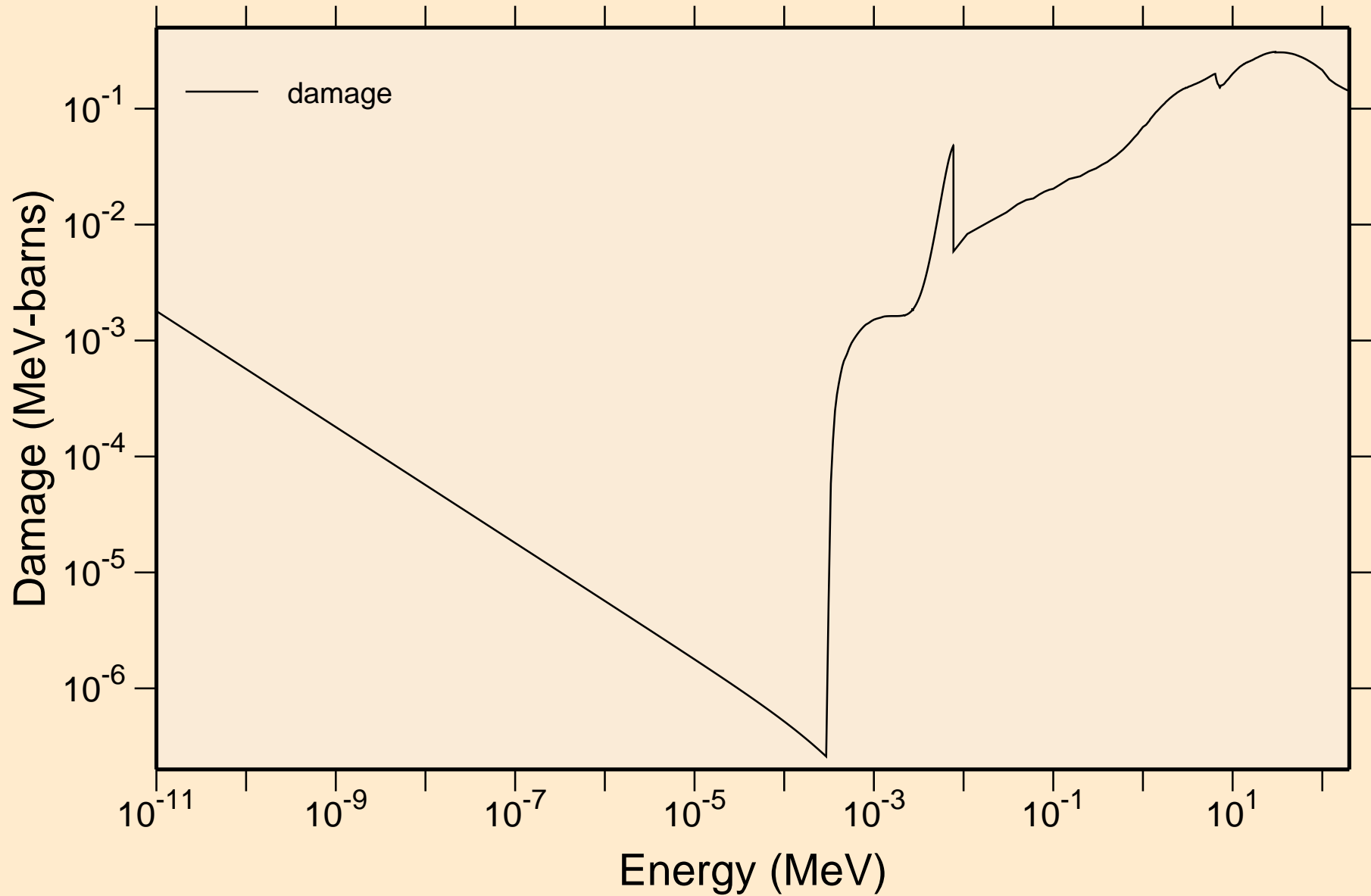

SC051 NEUTRON ACER TENDL-2024 LIBRARY; T=293.6K
Non-threshold reactions

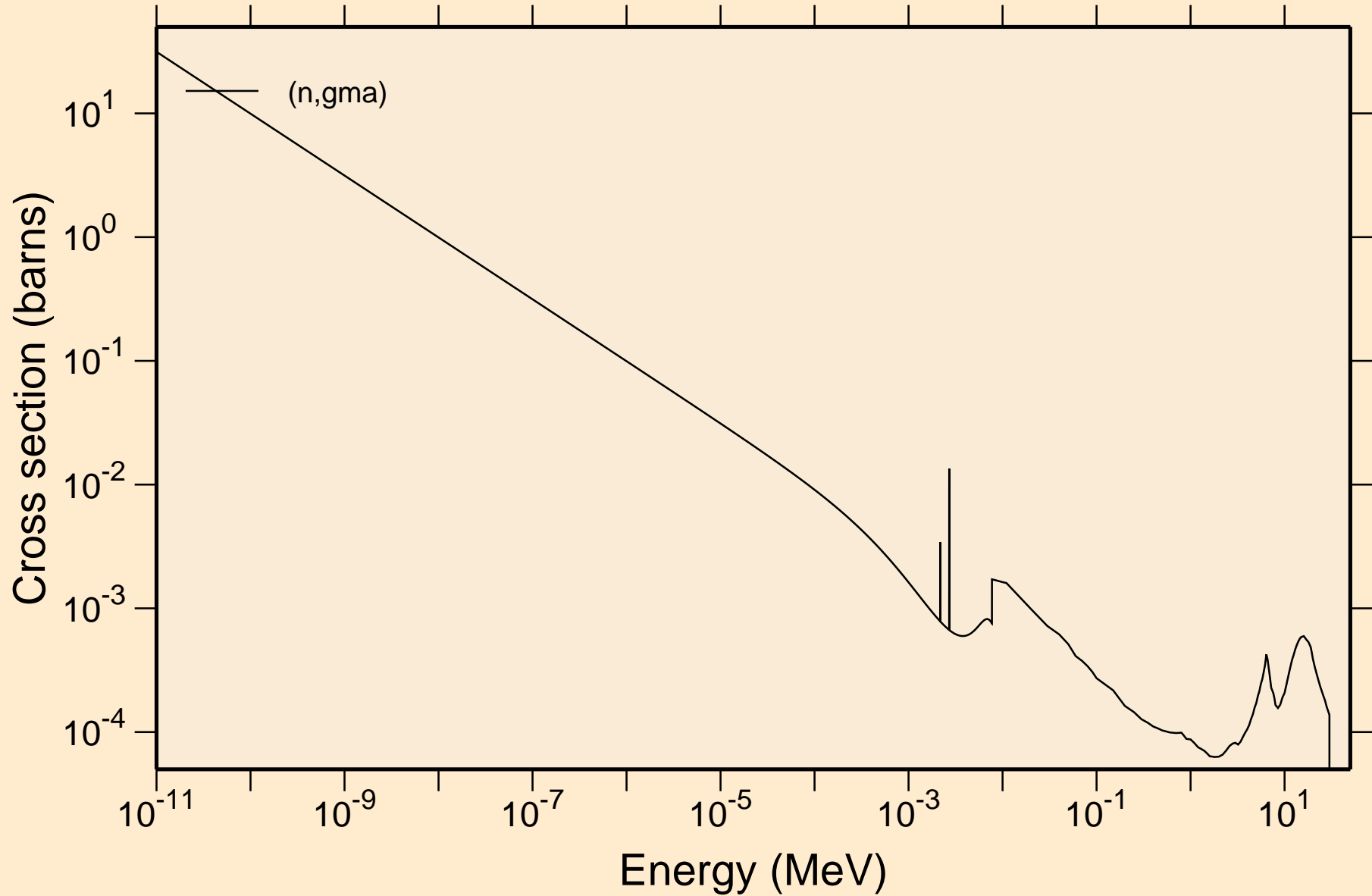

SC051 NEUTRON ACER TENDL-2024 LIBRARY; T=293.6K

Principal cross sections

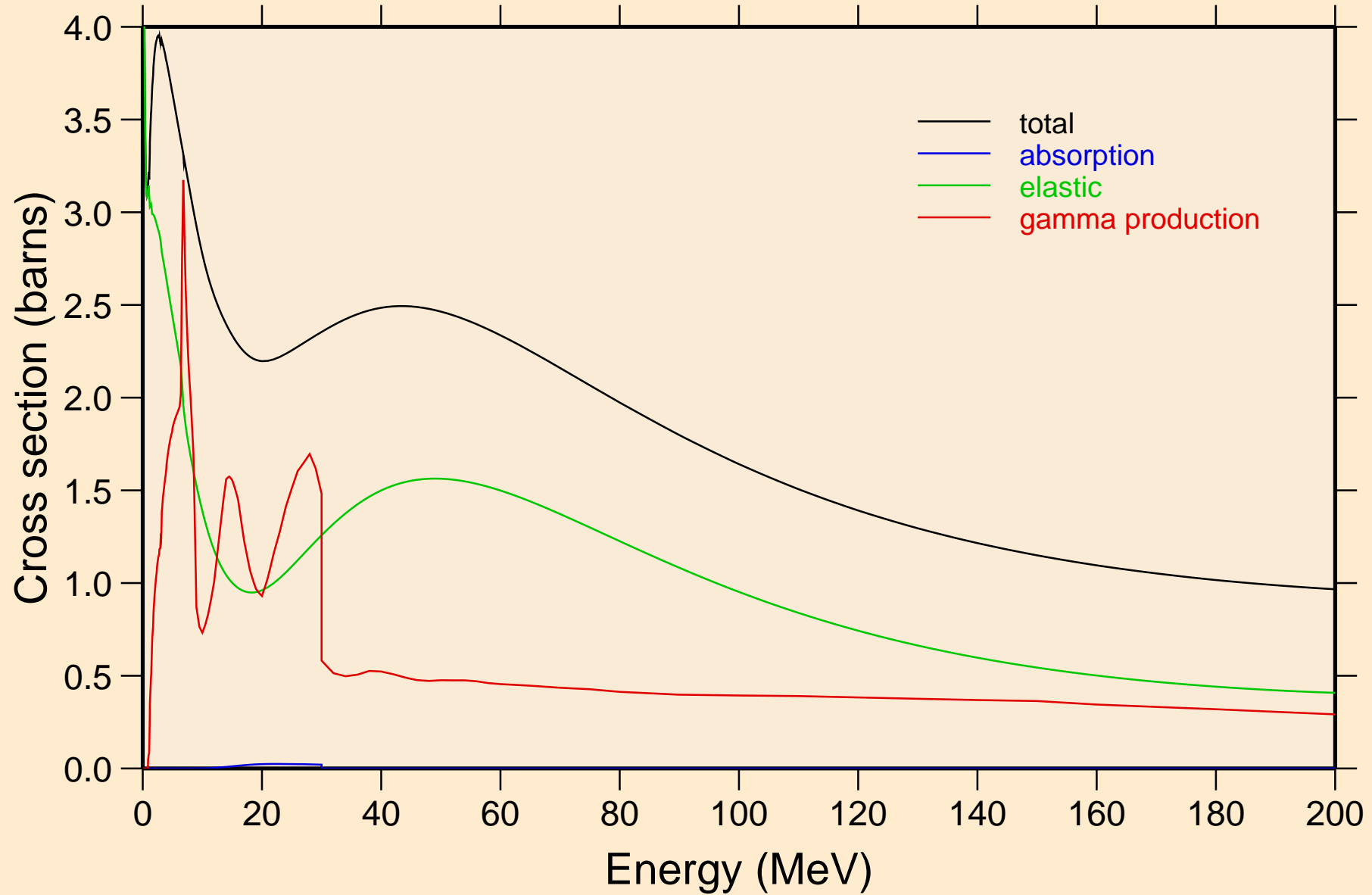

SC051 NEUTRON ACER TENDL-2024 LIBRARY; T=293.6K

Heating

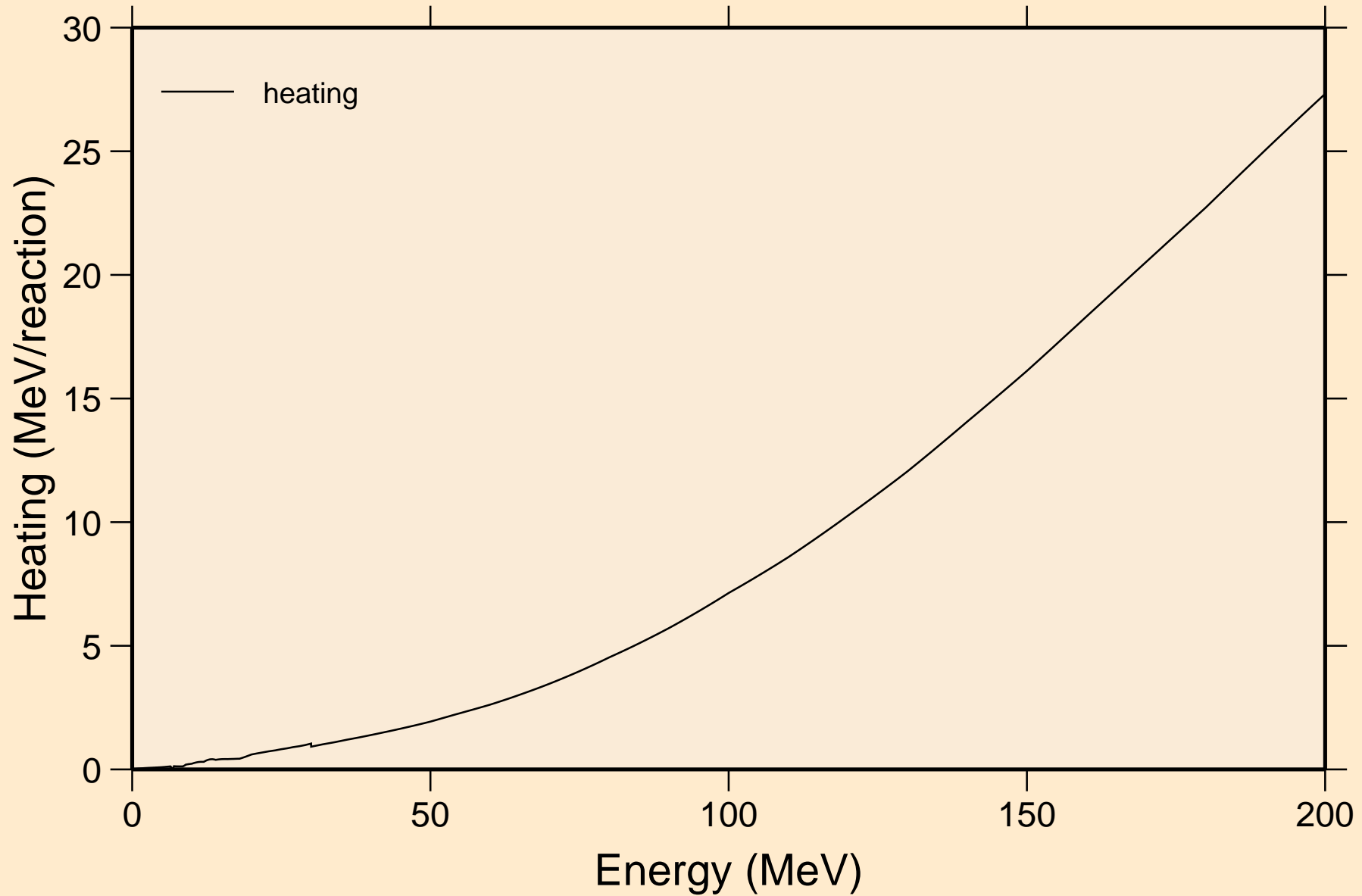

SC051 NEUTRON ACER TENDL-2024 LIBRARY; T=293.6K
Damage

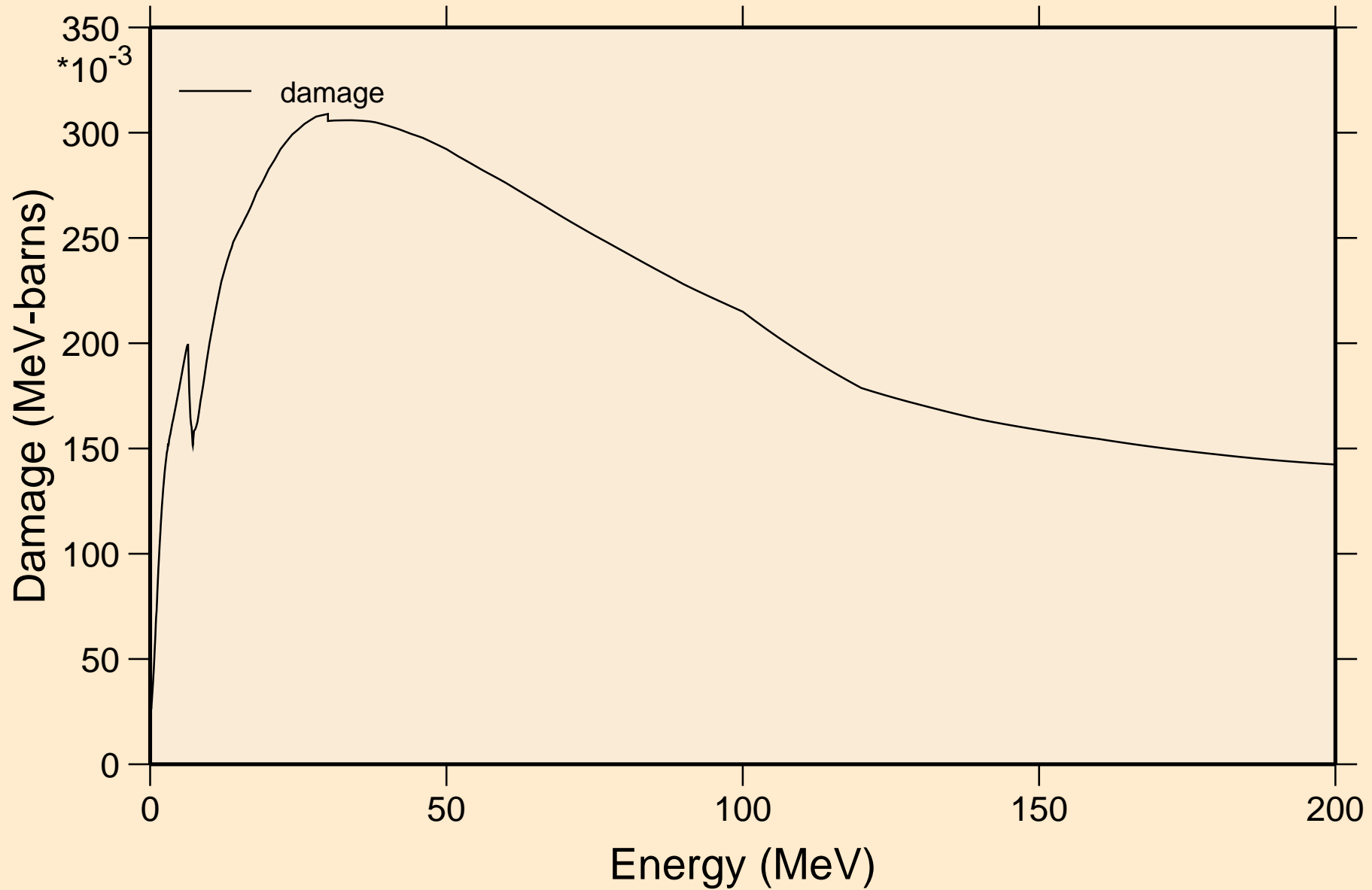

SC051 NEUTRON ACER TENDL-2024 LIBRARY; T=293.6K
Non-threshold reactions

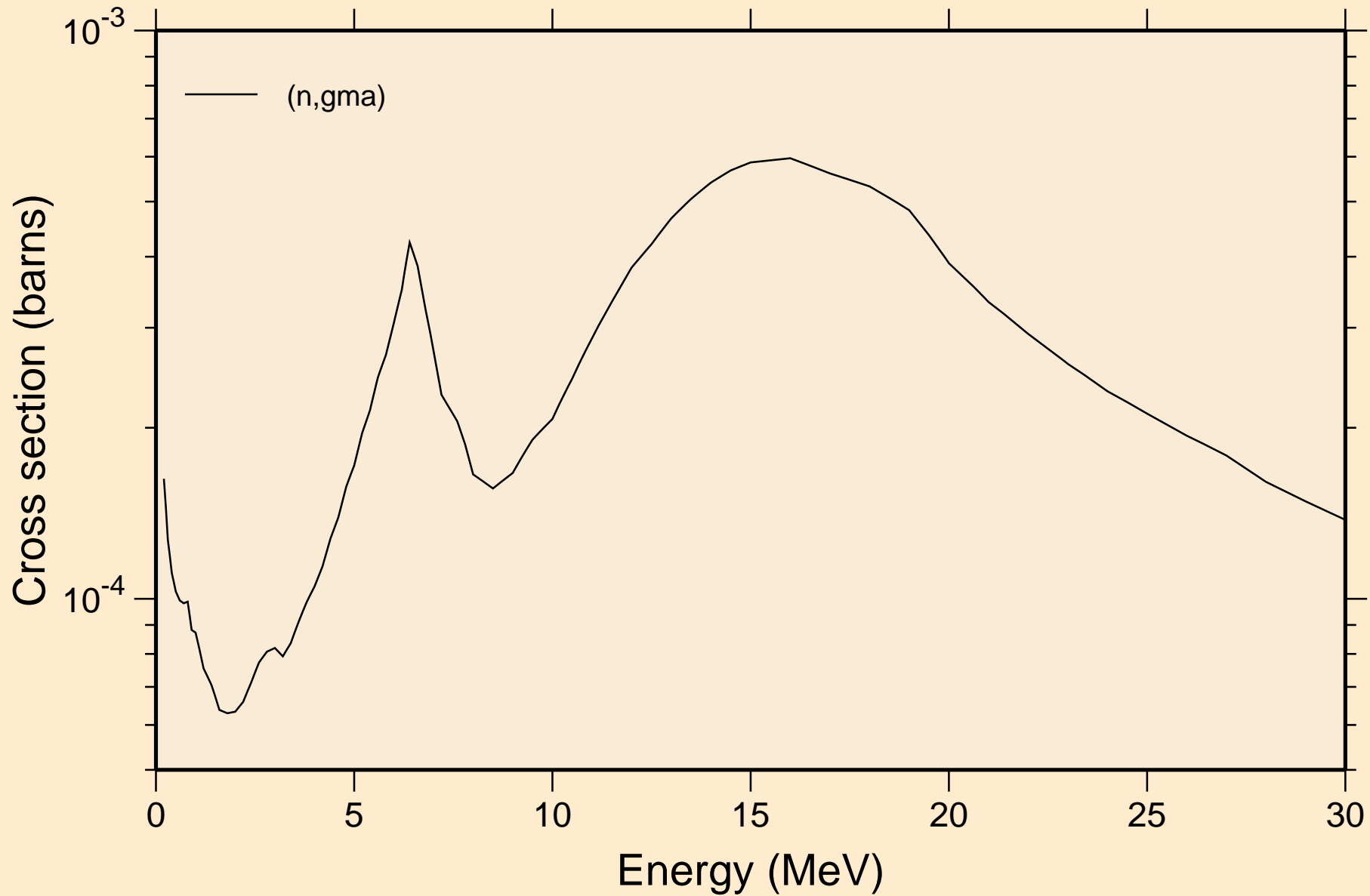

SC051 NEUTRON ACER TENDL-2024 LIBRARY; T=293.6K
Inelastic levels

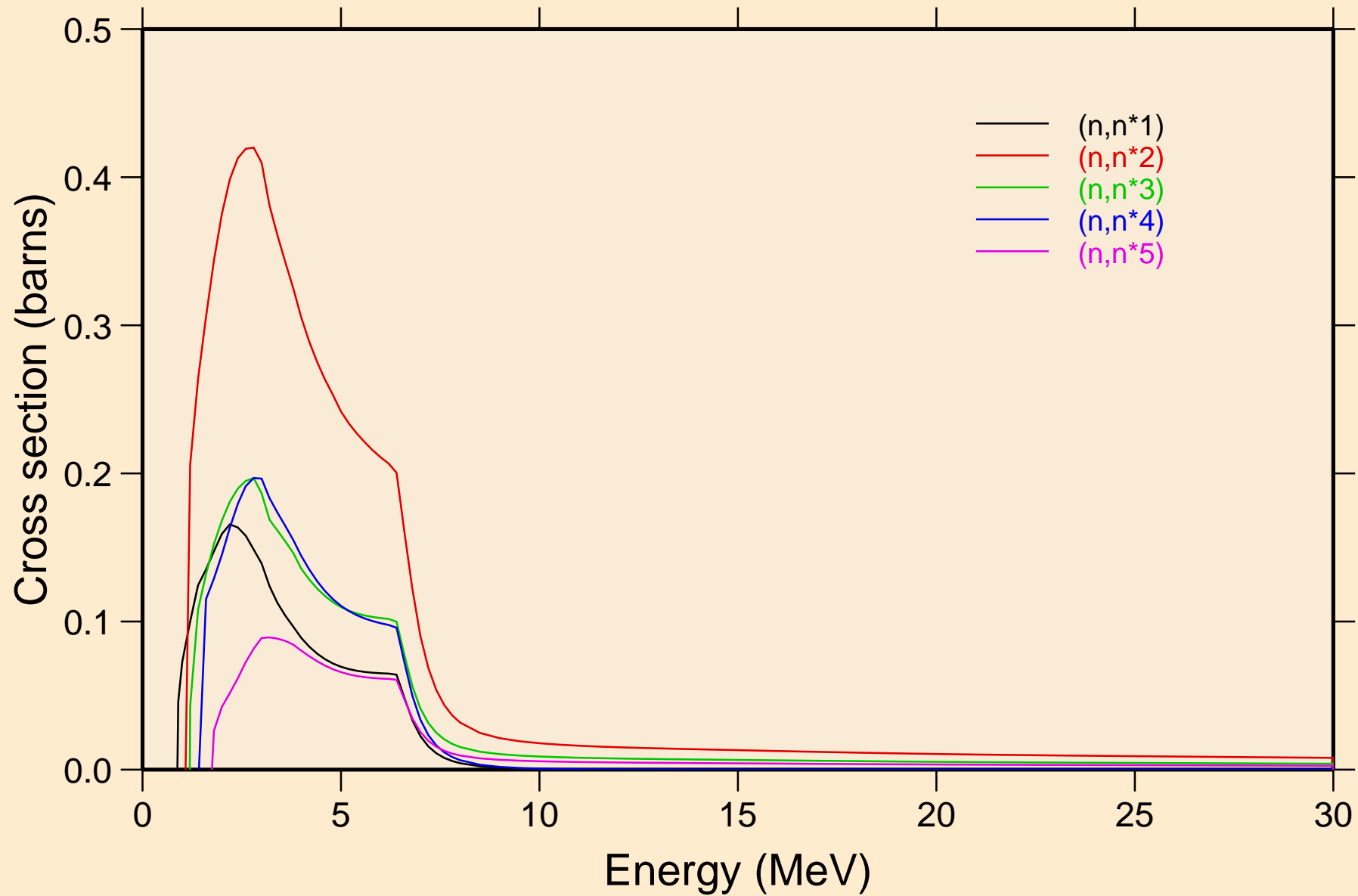

SC051 NEUTRON ACER TENDL-2024 LIBRARY; T=293.6K
Inelastic levels

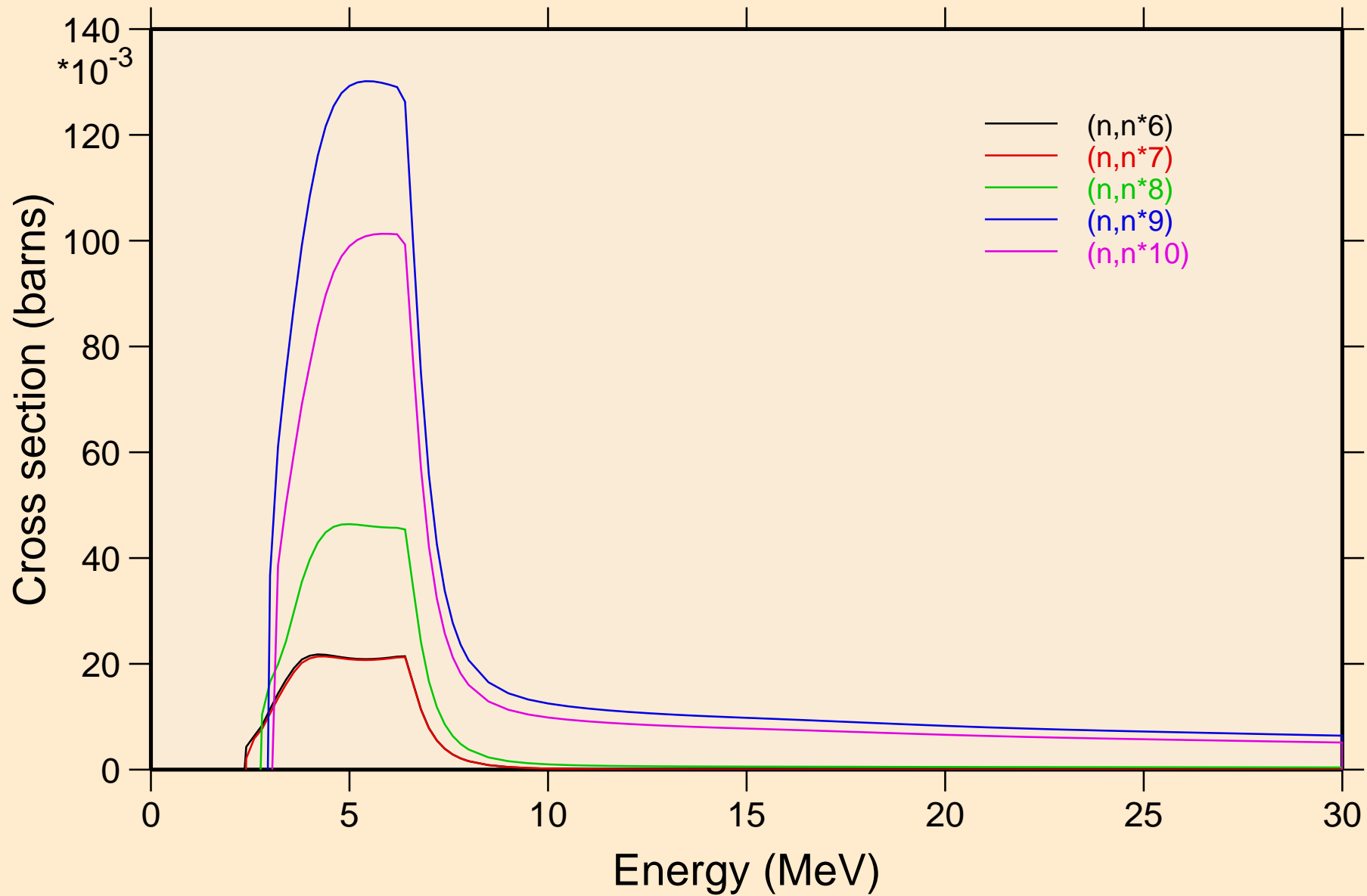

SC051 NEUTRON ACER TENDL-2024 LIBRARY; T=293.6K
Inelastic levels

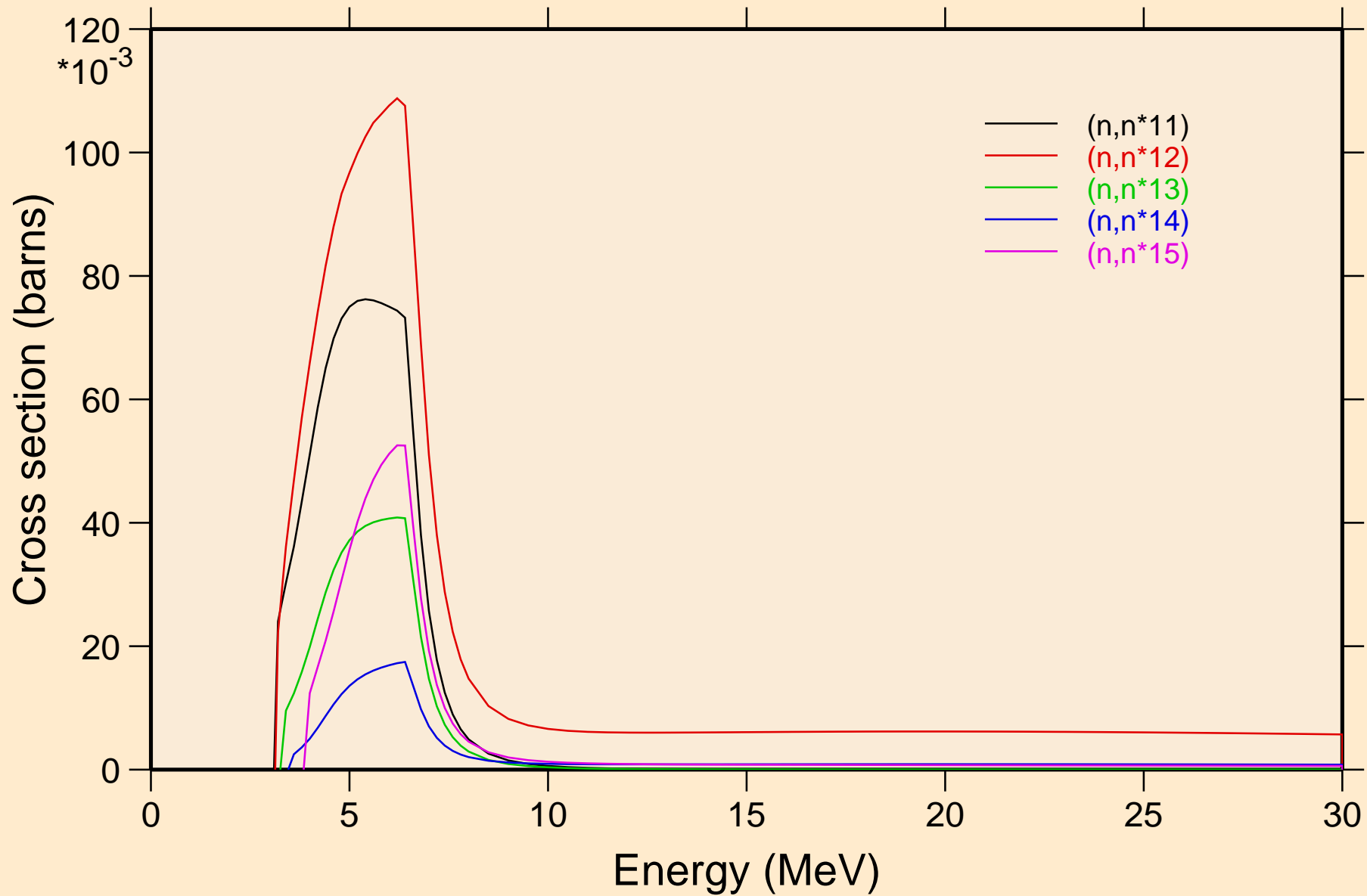

SC051 NEUTRON ACER TENDL-2024 LIBRARY; T=293.6K
Inelastic levels

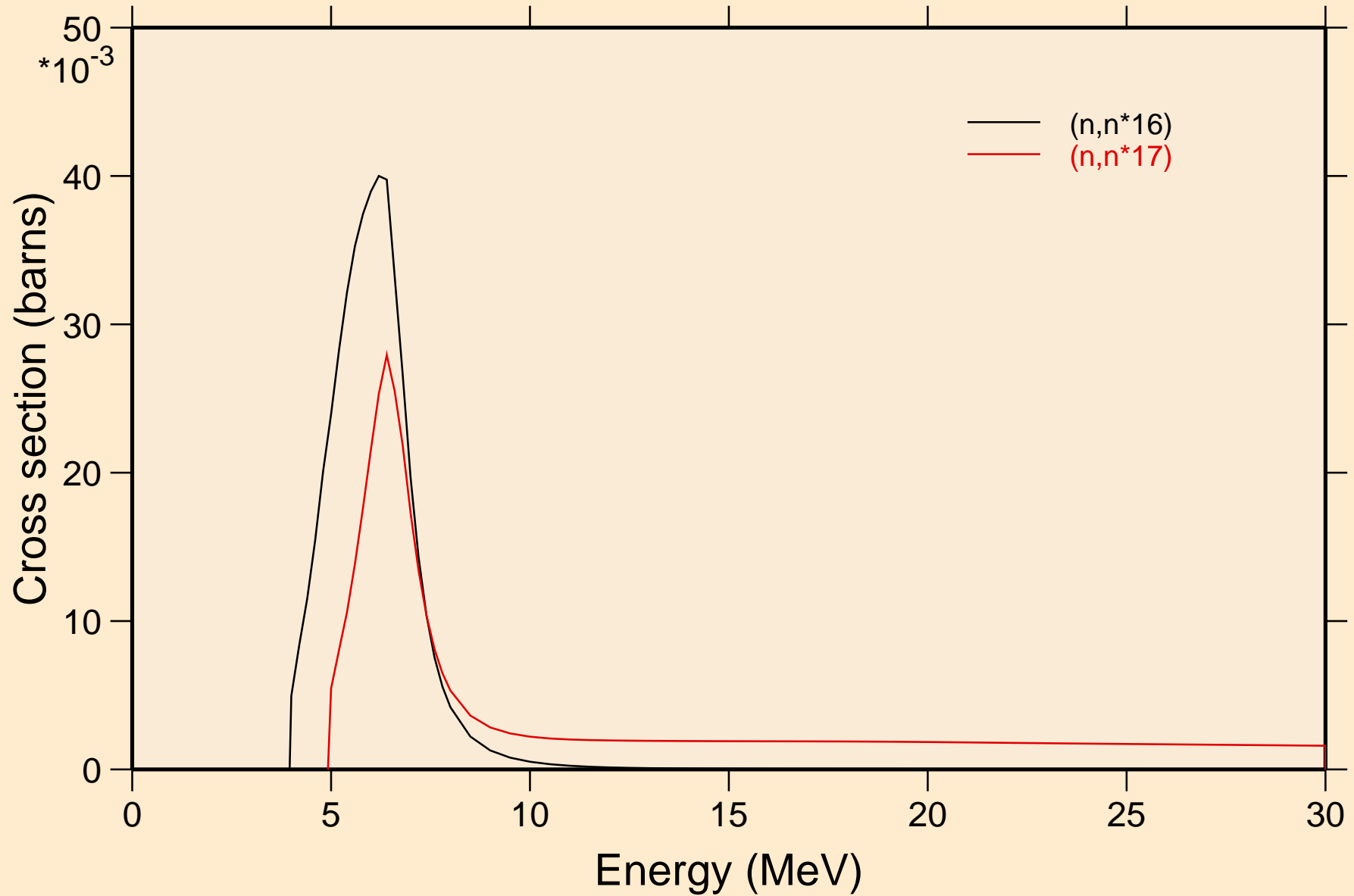

SC051 NEUTRON ACER TENDL-2024 LIBRARY; T=293.6K
Threshold reactions

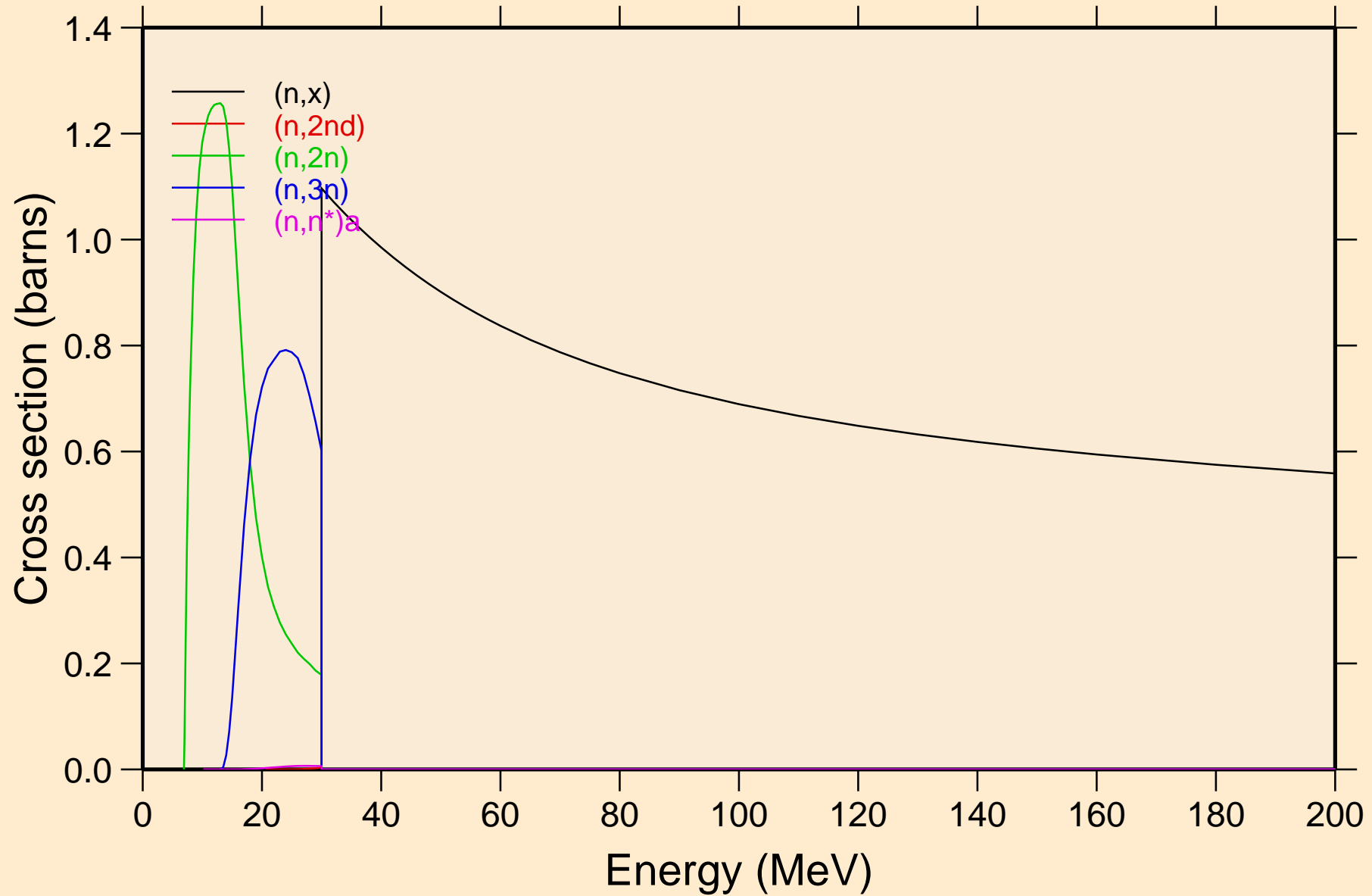

SC051 NEUTRON ACER TENDL-2024 LIBRARY; T=293.6K
Threshold reactions

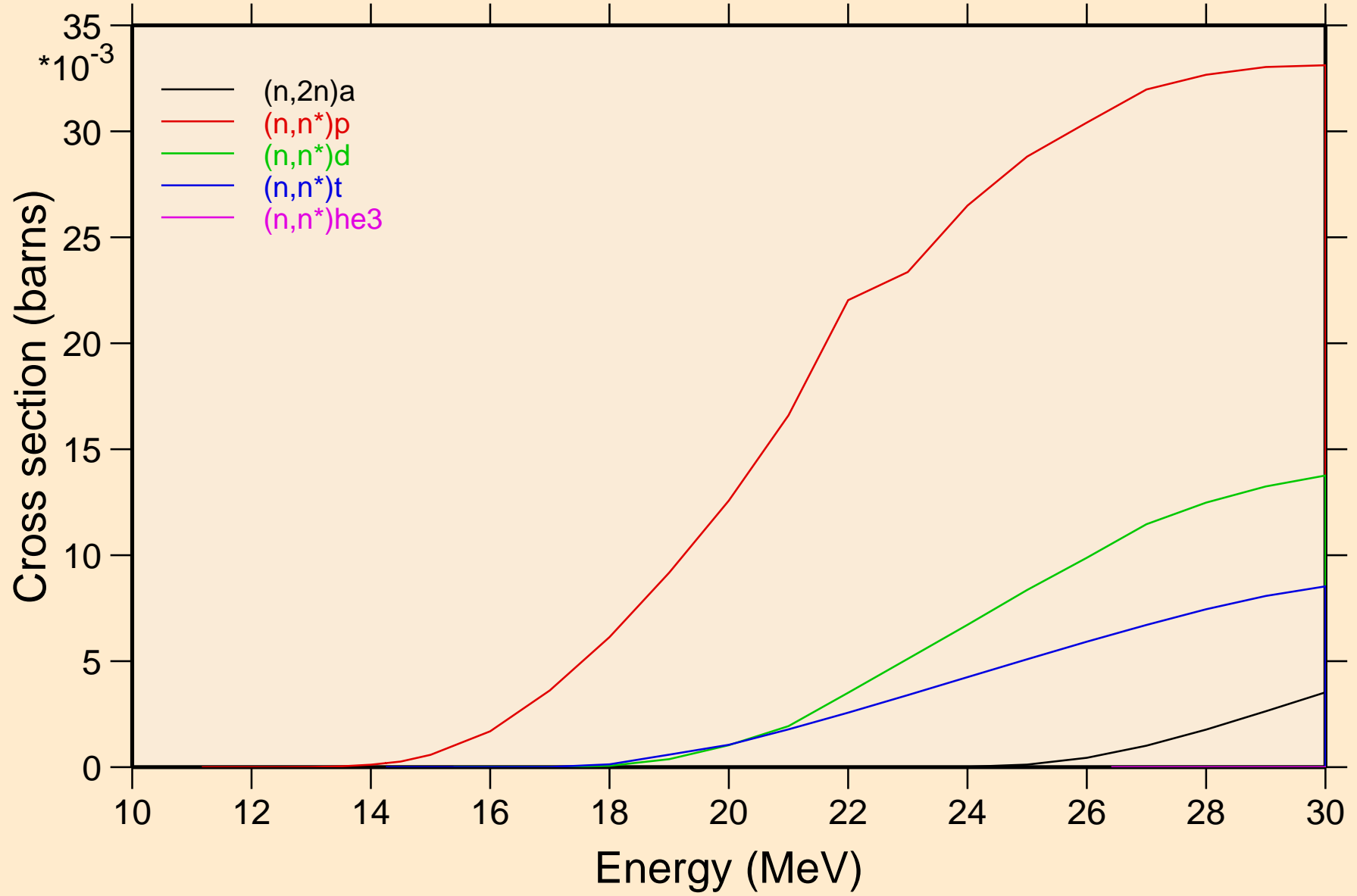

SC051 NEUTRON ACER TENDL-2024 LIBRARY; T=293.6K
Threshold reactions

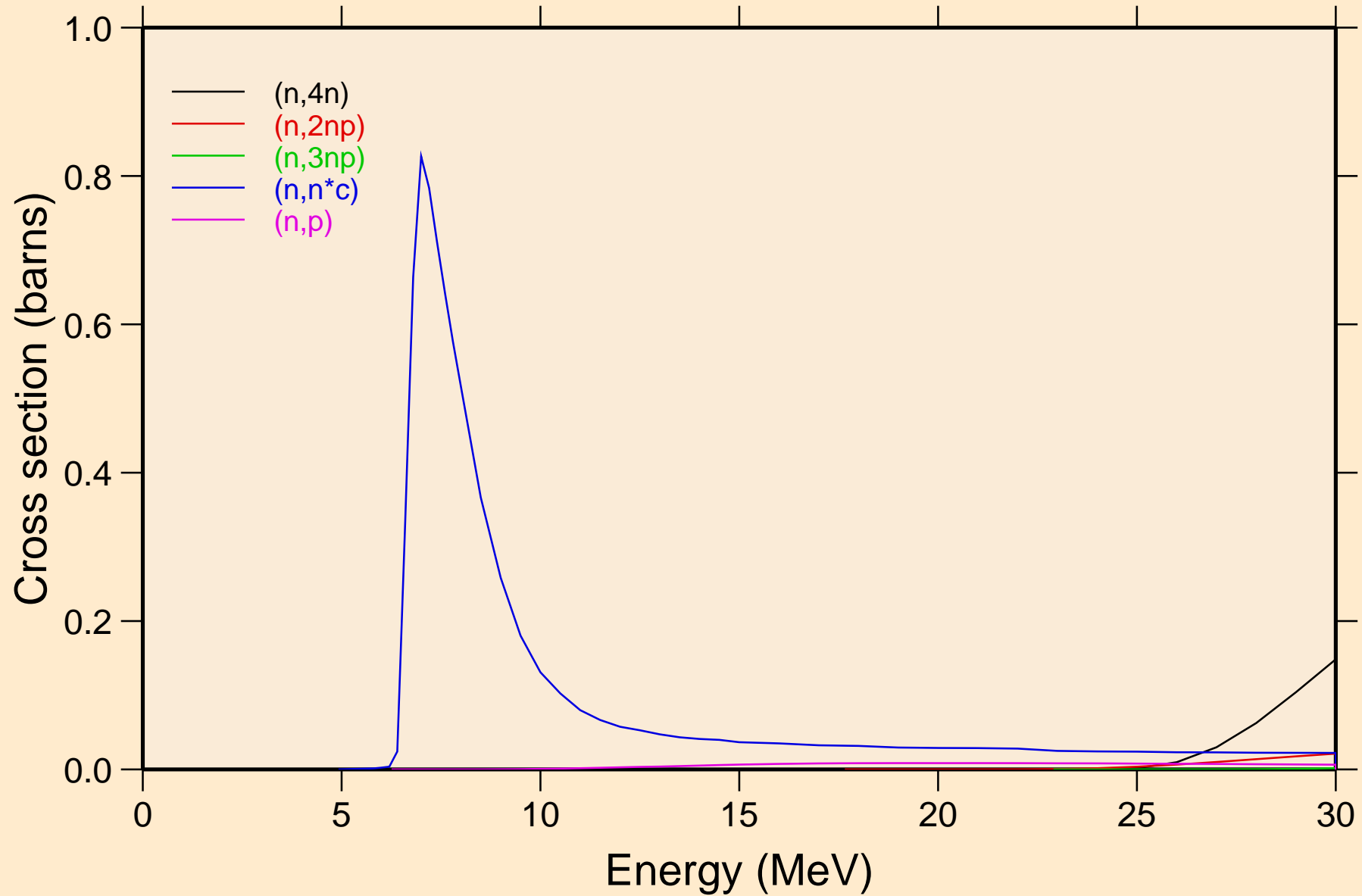

SC051 NEUTRON ACER TENDL-2024 LIBRARY; T=293.6K
Threshold reactions

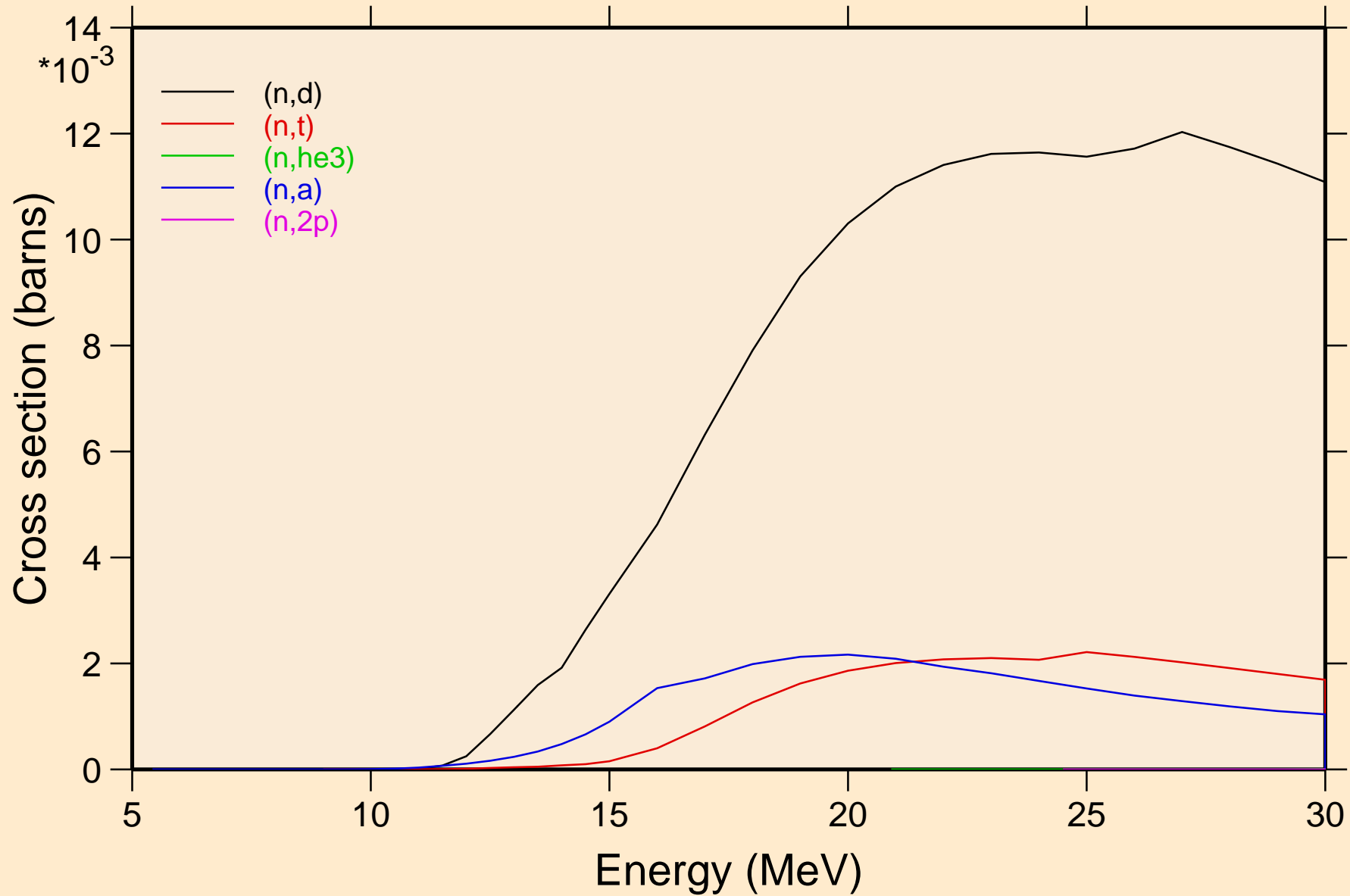

SC051 NEUTRON ACER TENDL-2024 LIBRARY; T=293.6K
Threshold reactions

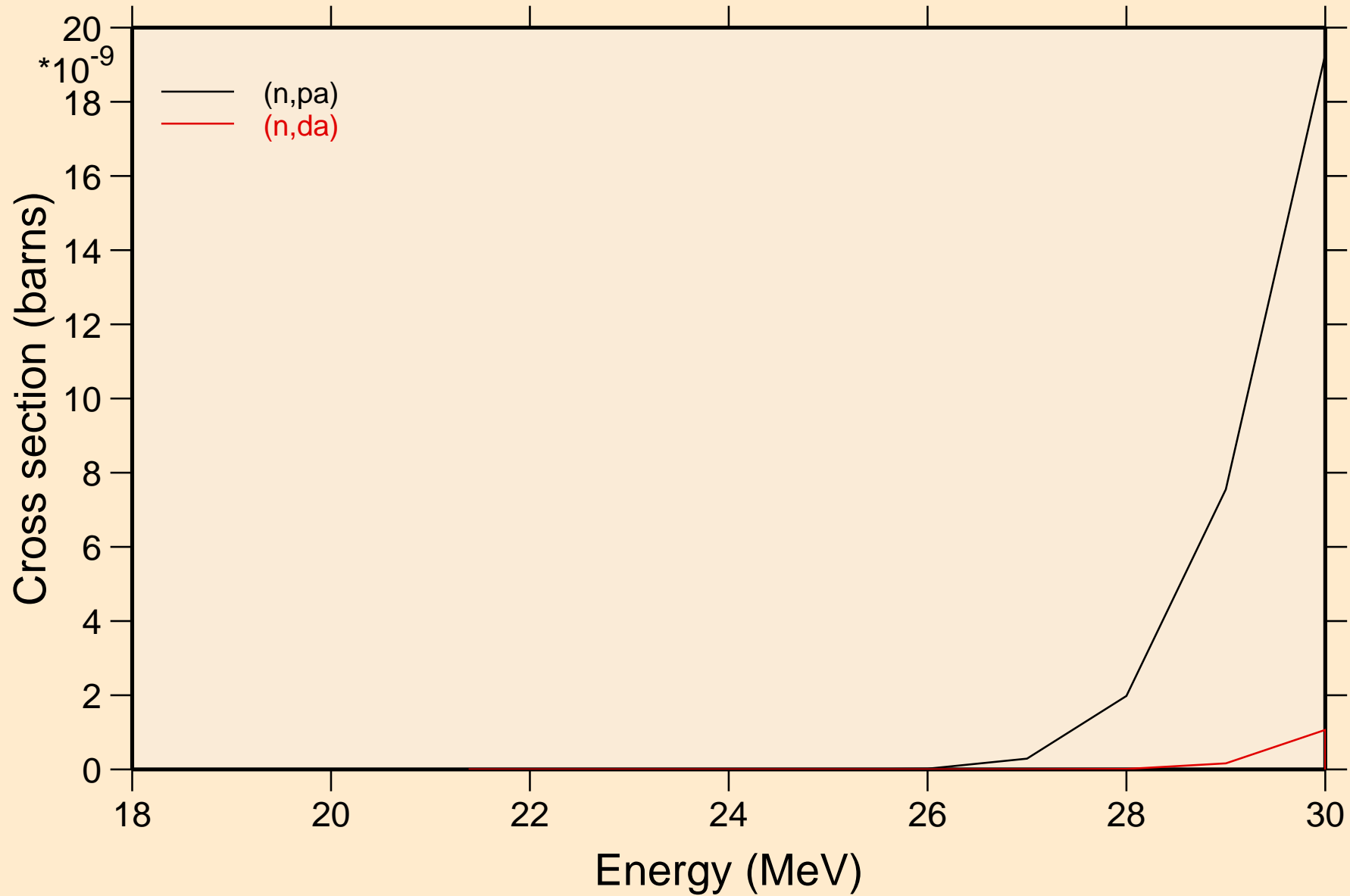

SC051 NEUTRON ACER TENDL-2024 LIBRARY; T=293.6K

Threshold reactions

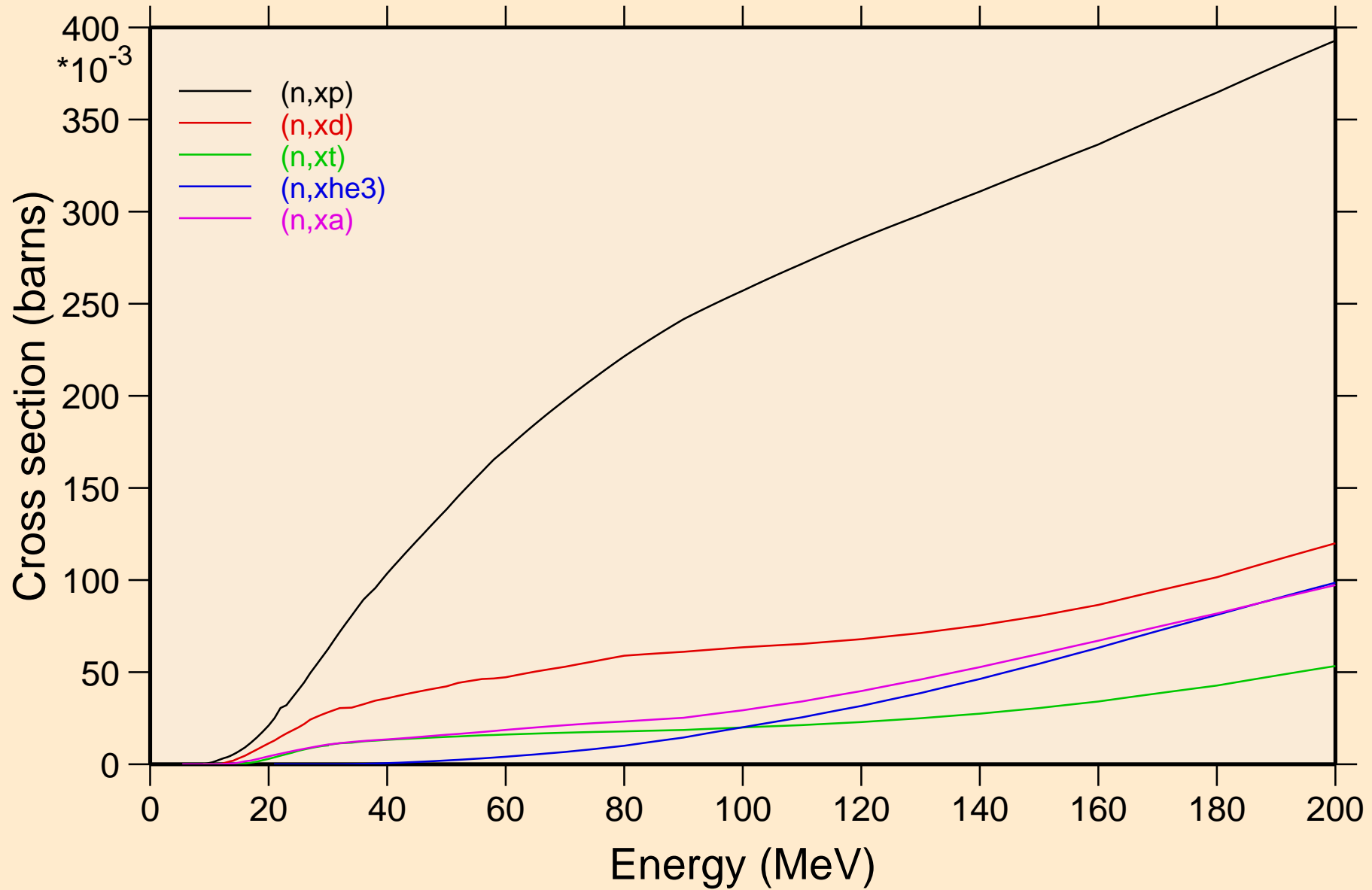

SC051 NEUTRON ACER TENDL-2024 LIBRARY; T=293.6K
angular distribution for elastic

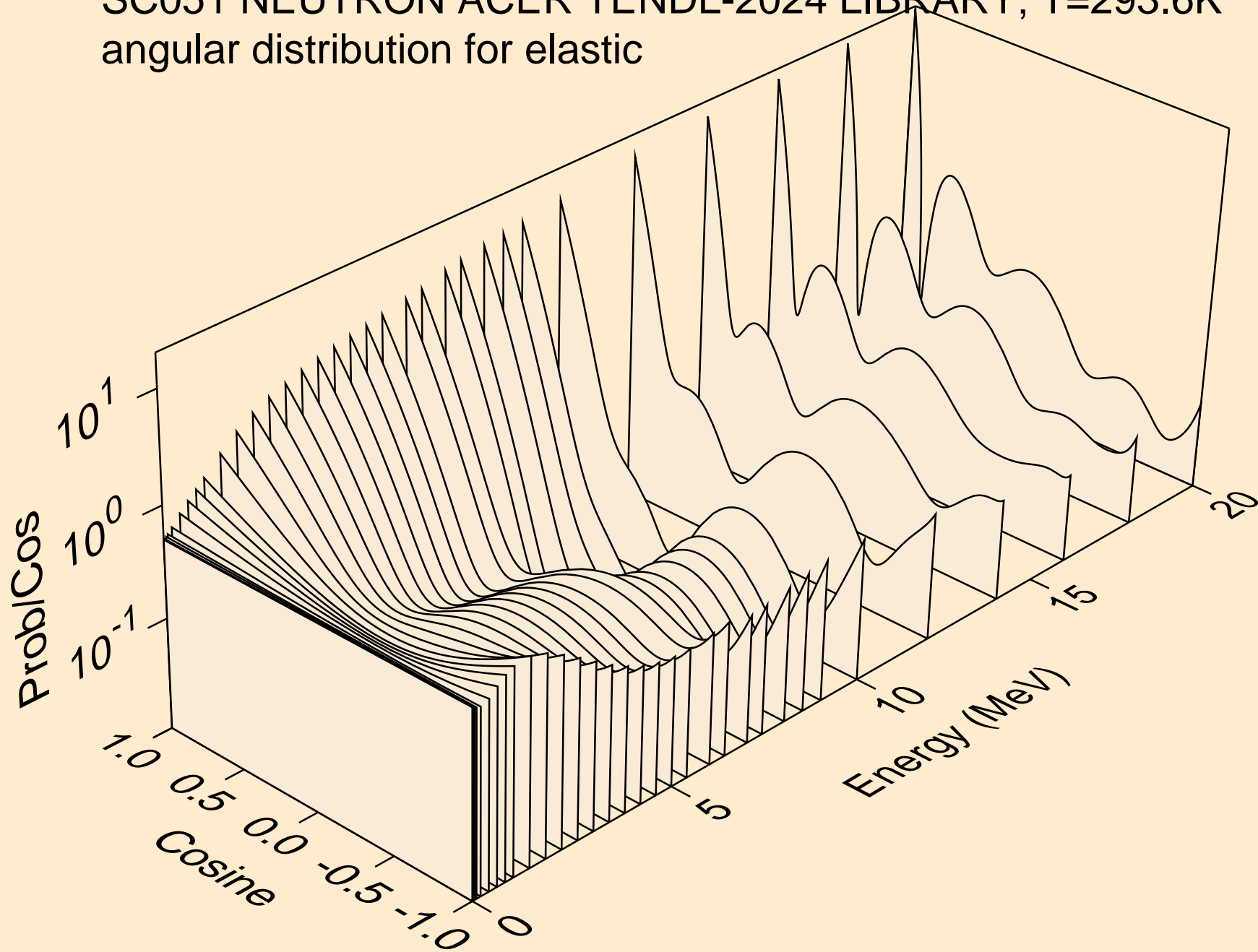

SC051 NEUTRON ACER TENDL-2024 LIBRARY; T=293.6K
angular distribution for elastic

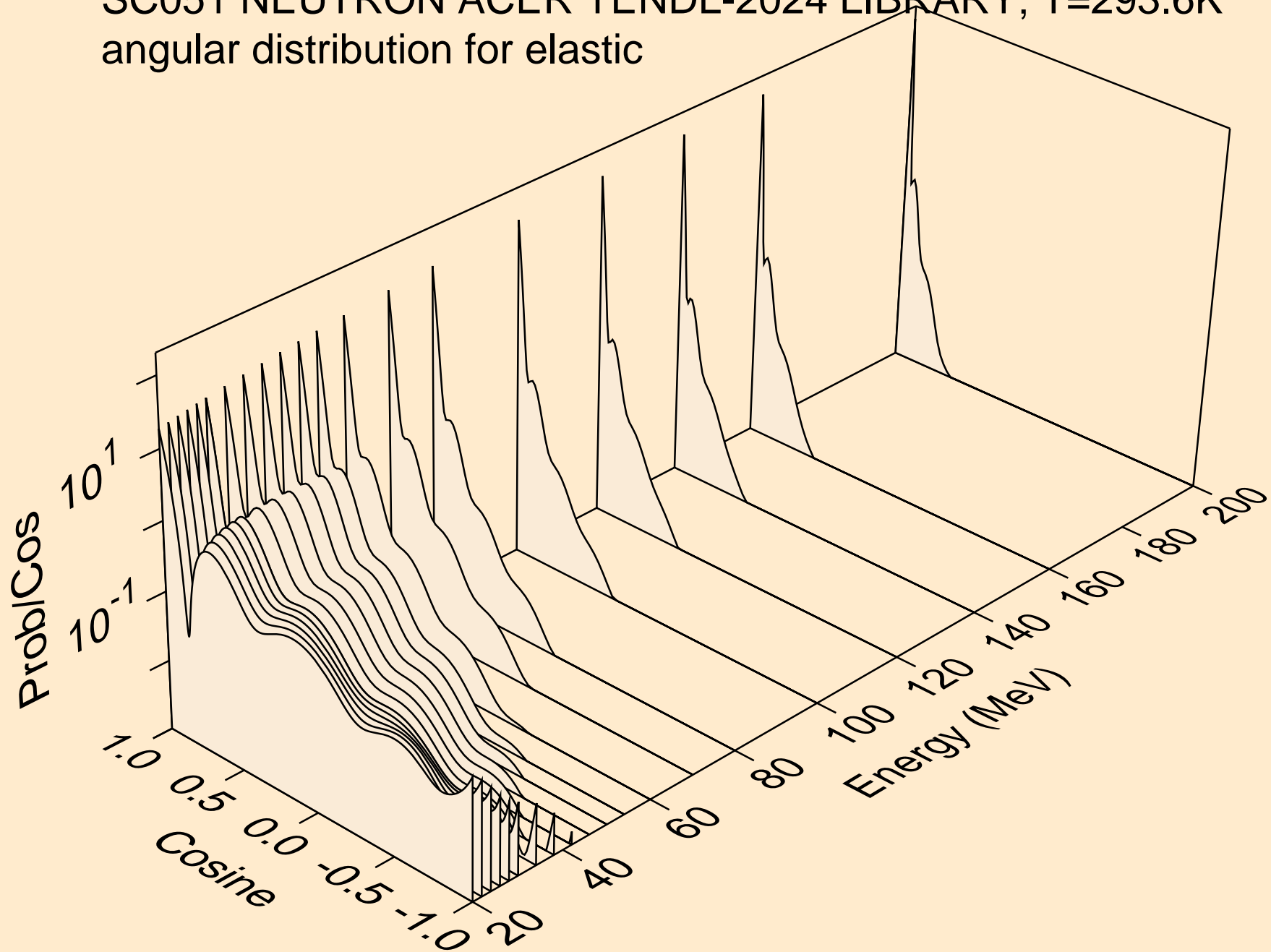

SC051 NEUTRON ACER TENDL-2024 LIBRARY; T=293.6K
angular distribution for (n,n*1)

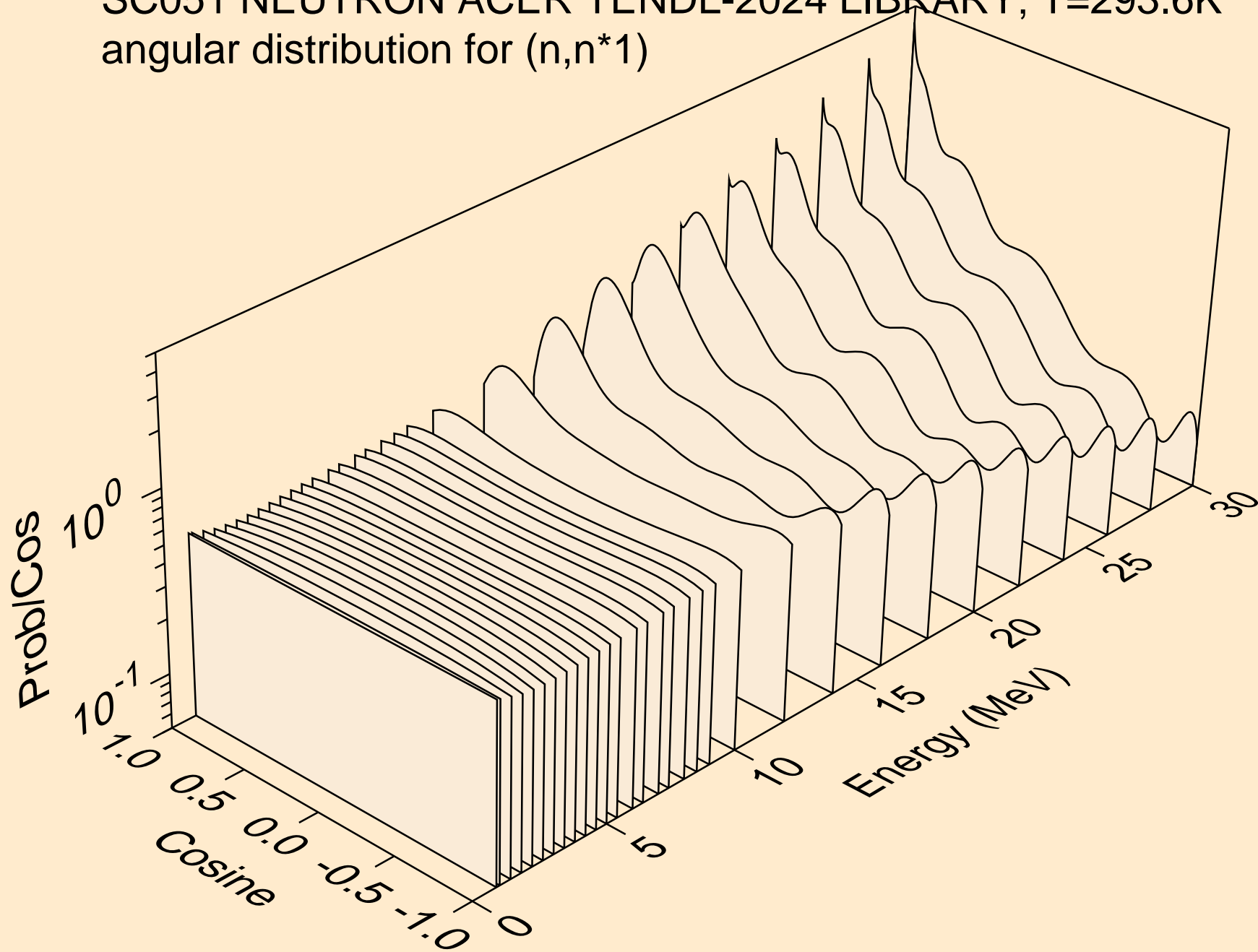

SC051 NEUTRON ACER TENDL-2024 LIBRARY; T=293.6K
angular distribution for (n,n*2)

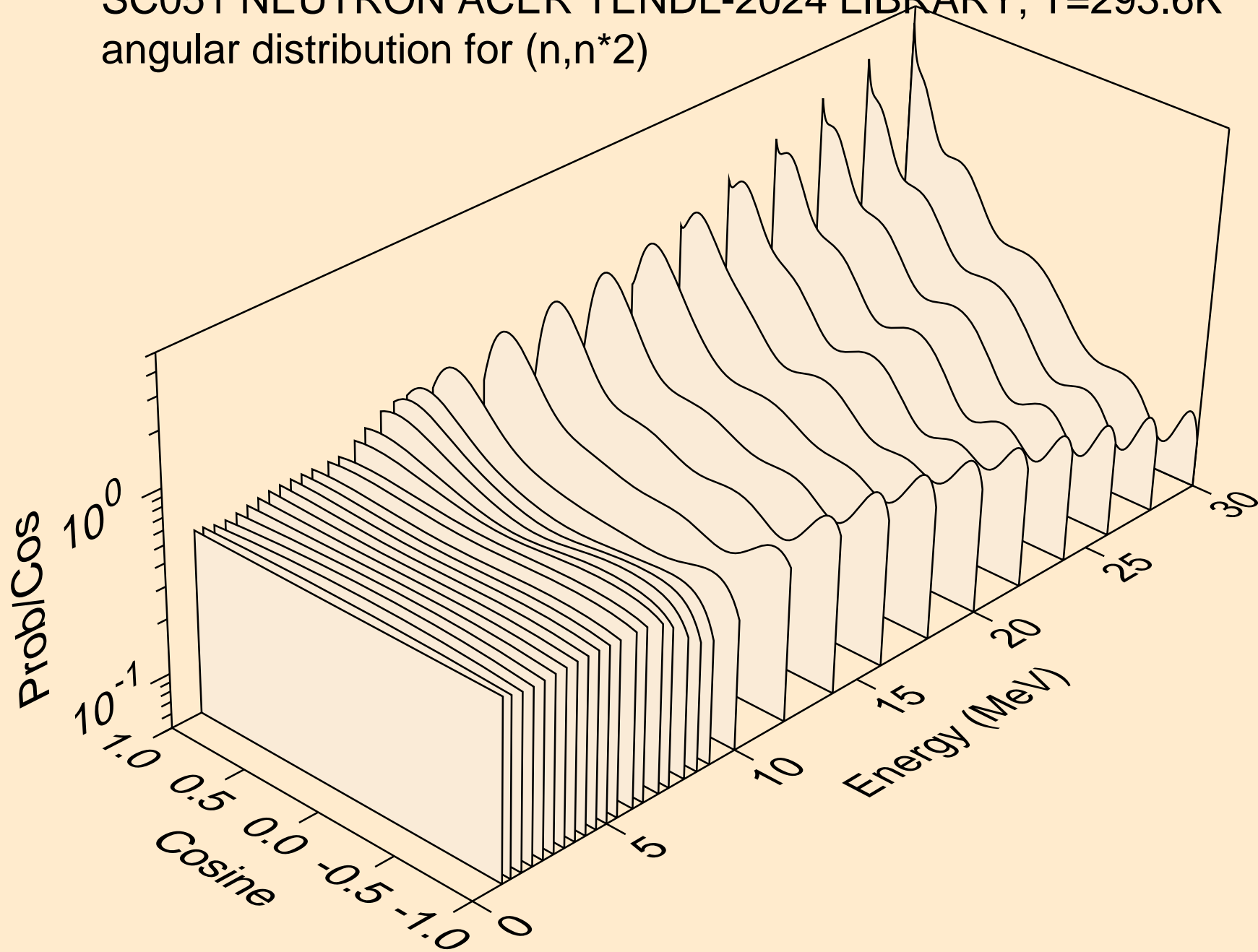

SC051 NEUTRON ACER TENDL-2024 LIBRARY; T=293.6K
angular distribution for (n,n*3)

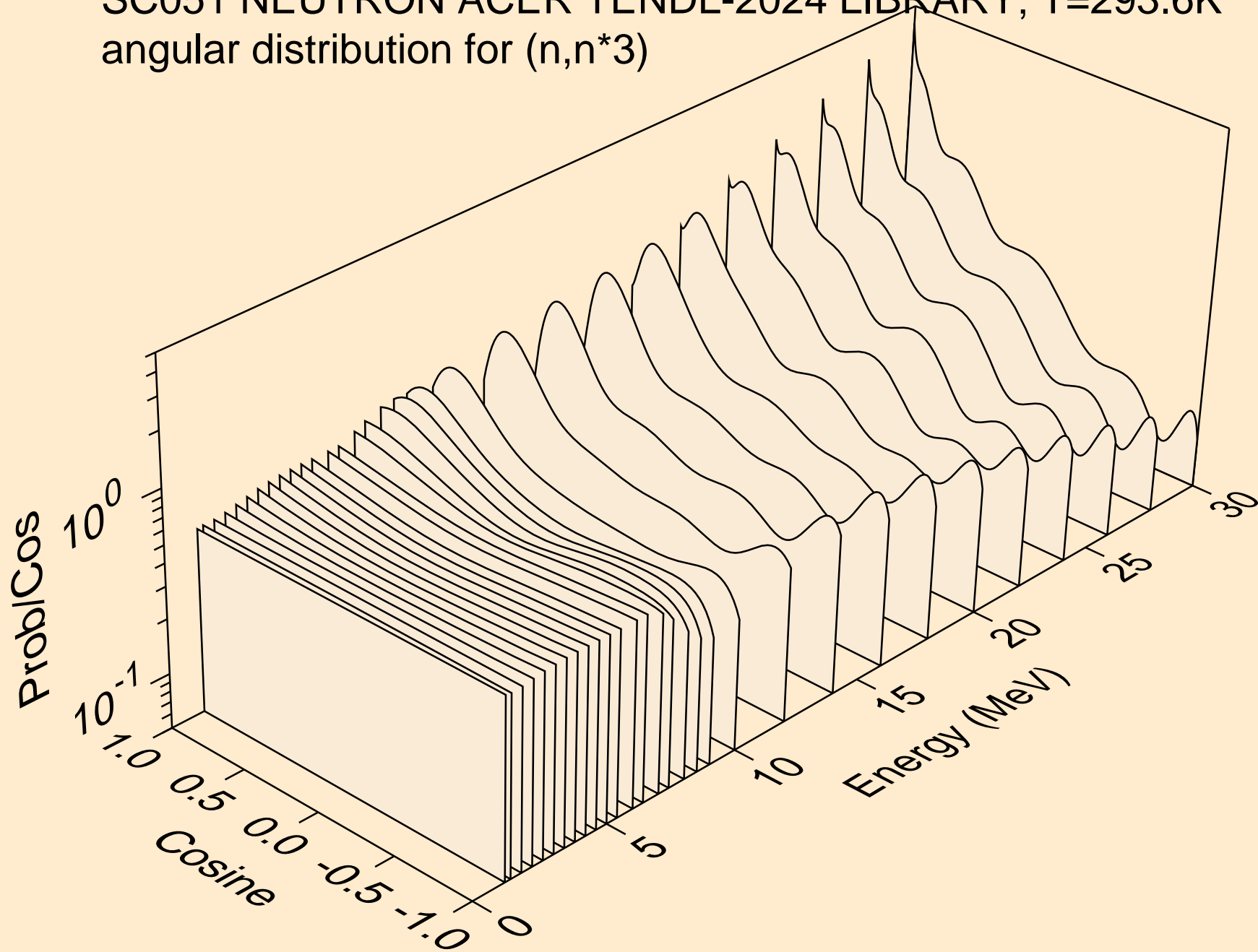

SC051 NEUTRON ACER TENDL-2024 LIBRARY; T=293.6K
angular distribution for (n,n*4)

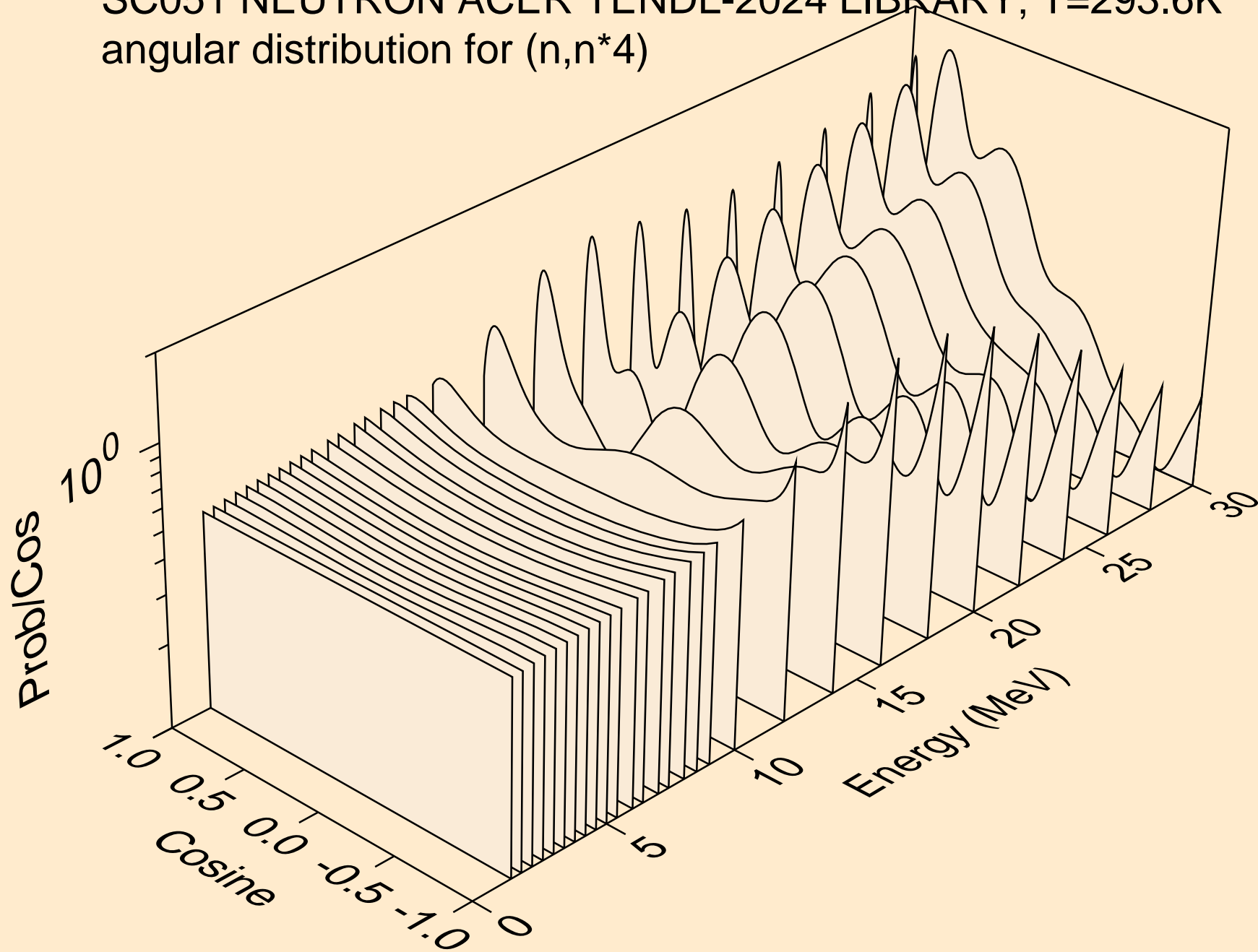

SC051 NEUTRON ACER TENDL-2024 LIBRARY; T=293.6K
angular distribution for (n,n*5)

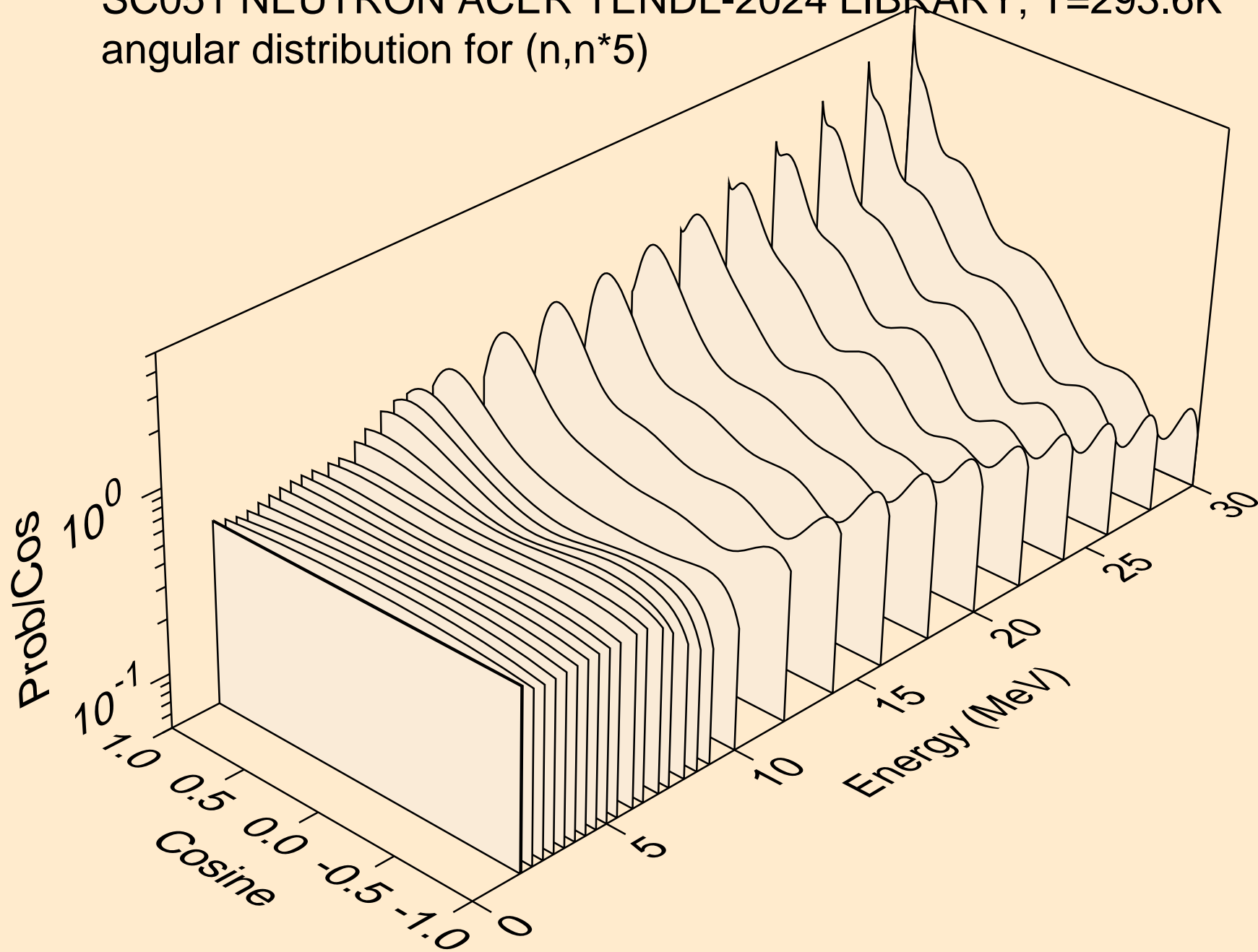

SC051 NEUTRON ACER TENDL-2024 LIBRARY; T=293.6K
angular distribution for (n,n*6)

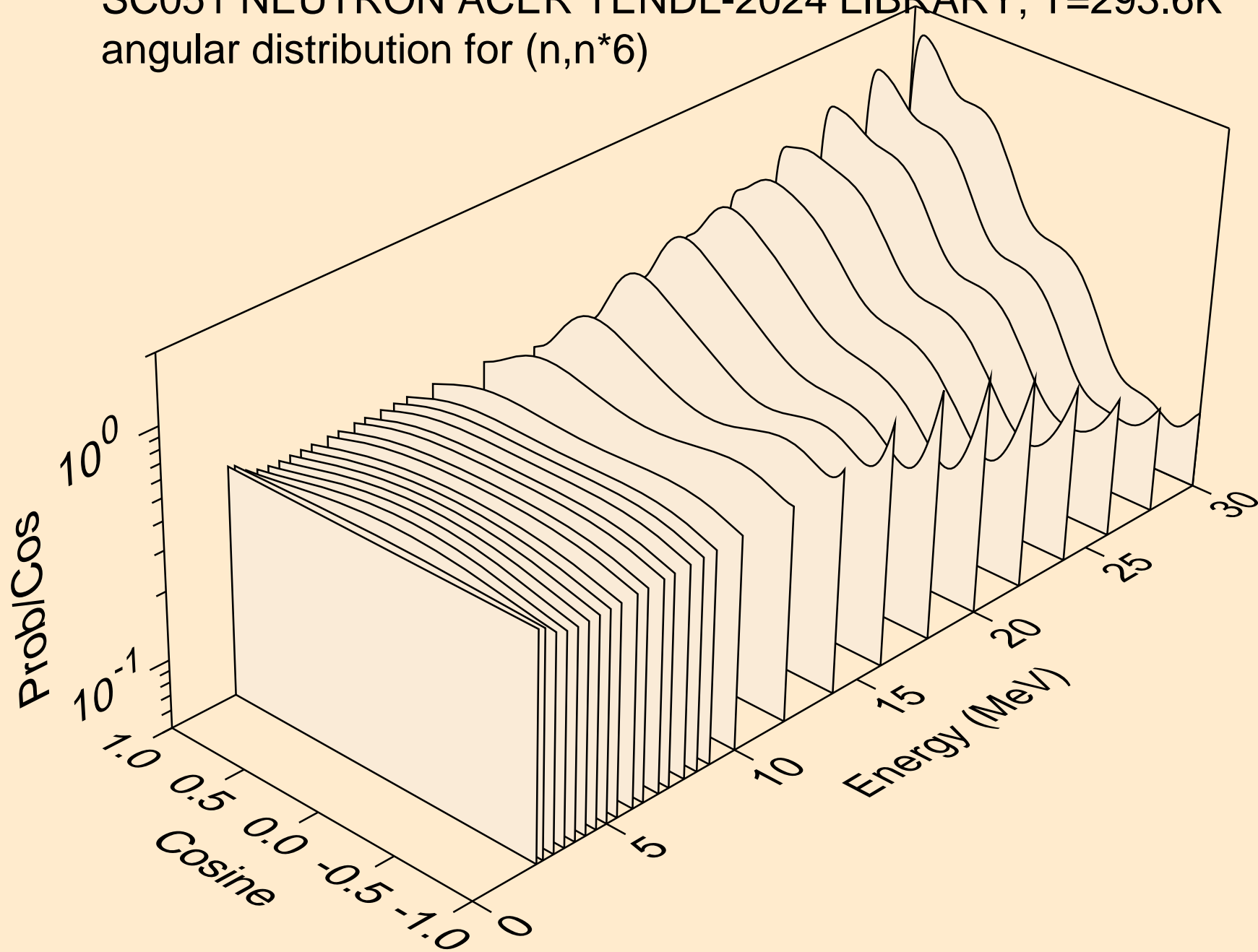

SC051 NEUTRON ACER TENDL-2024 LIBRARY; T=293.6K
angular distribution for (n,n*7)

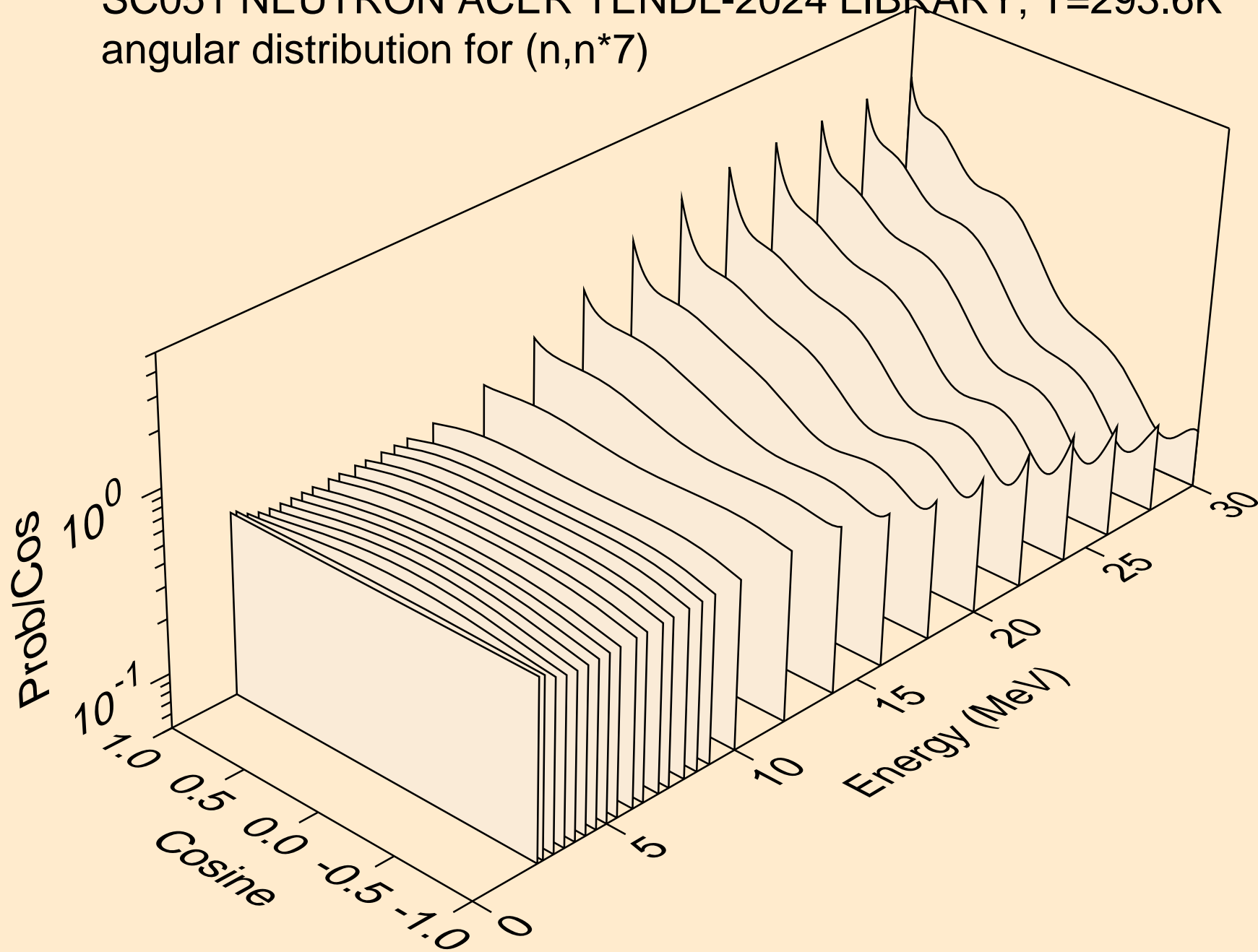

SC051 NEUTRON ACER TENDL-2024 LIBRARY; T=293.6K
angular distribution for (n,n*8)

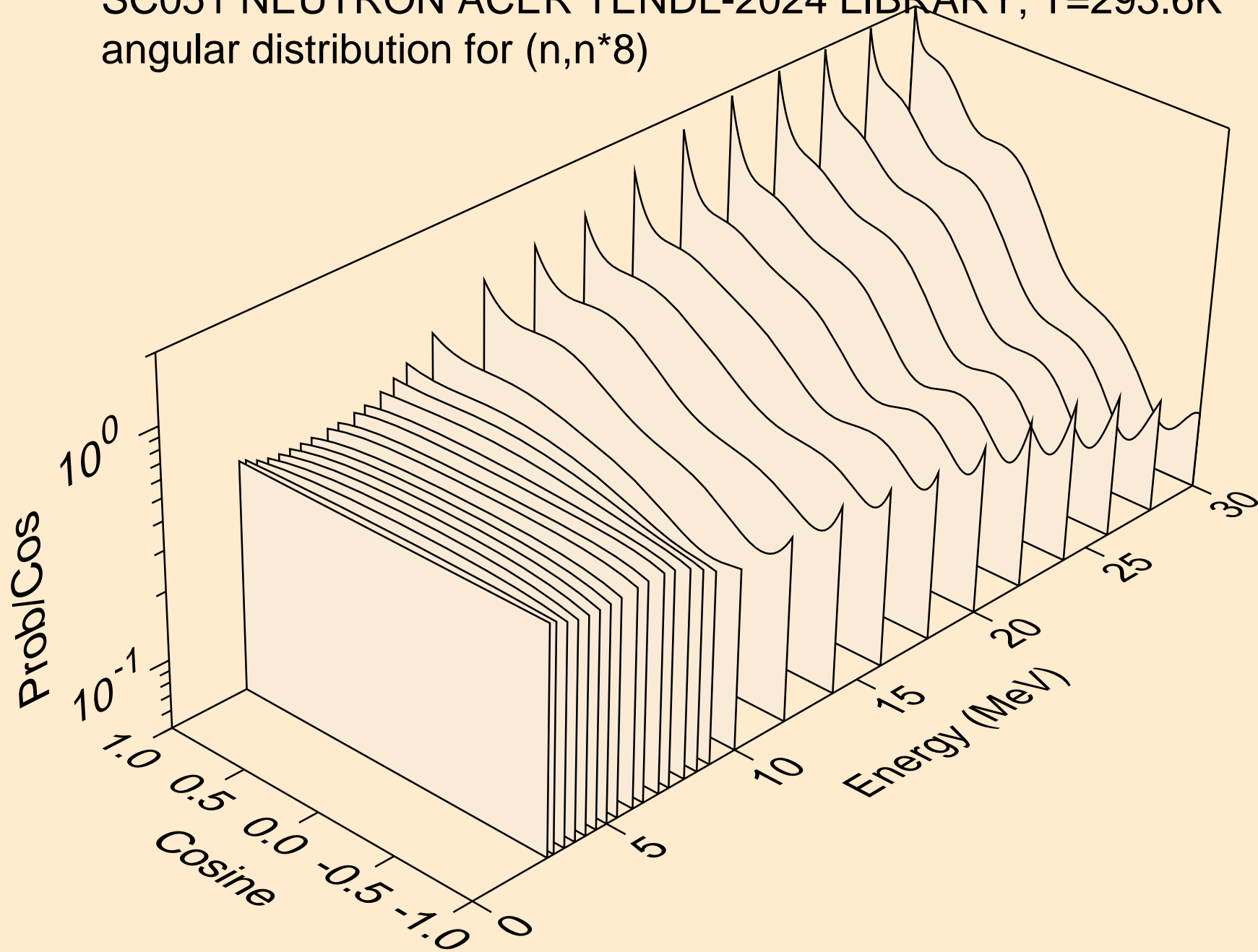

SC051 NEUTRON ACER TENDL-2024 LIBRARY; T=293.6K
angular distribution for (n,n*9)

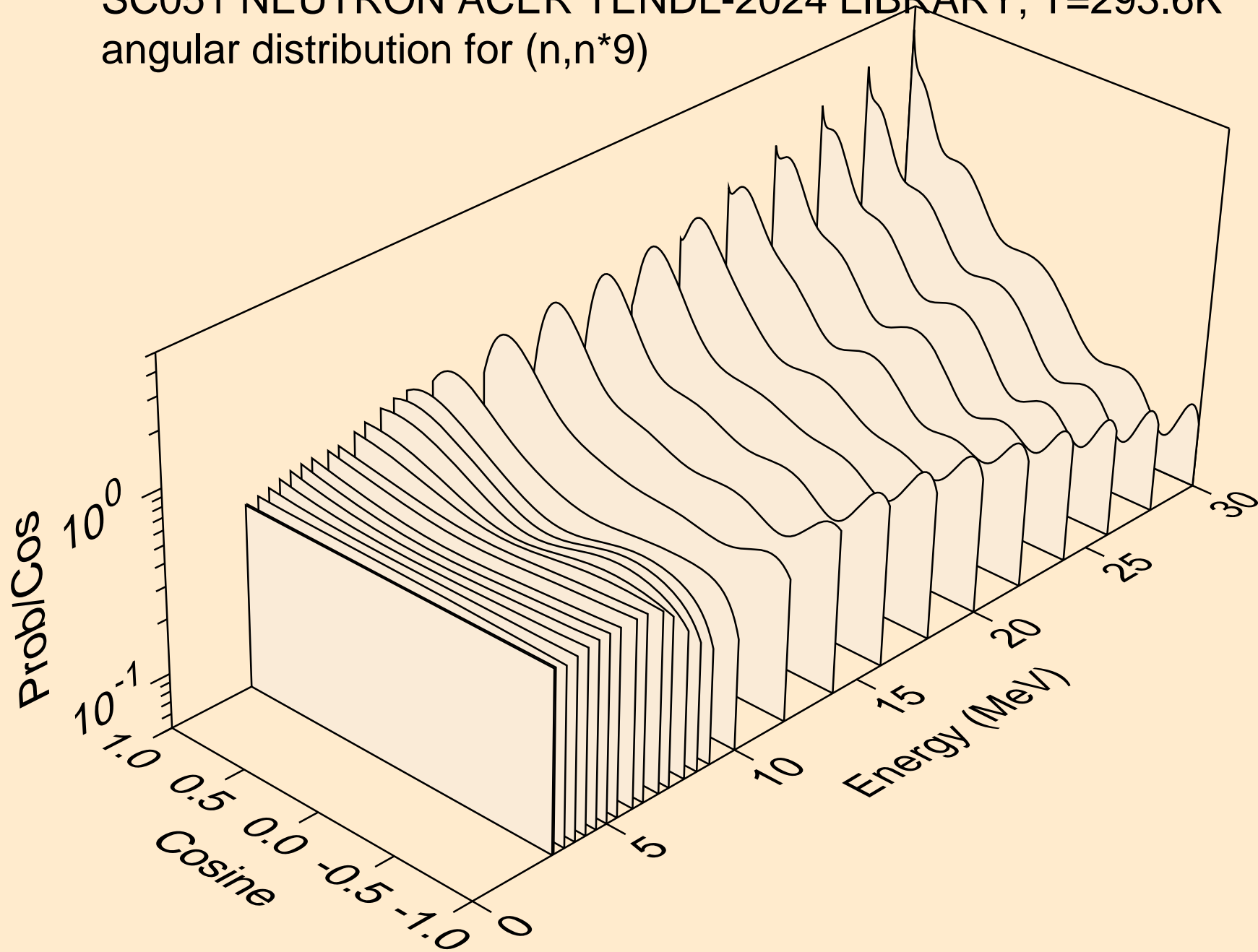

SC051 NEUTRON ACER TENDL-2024 LIBRARY; T=293.6K
angular distribution for (n,n*10)

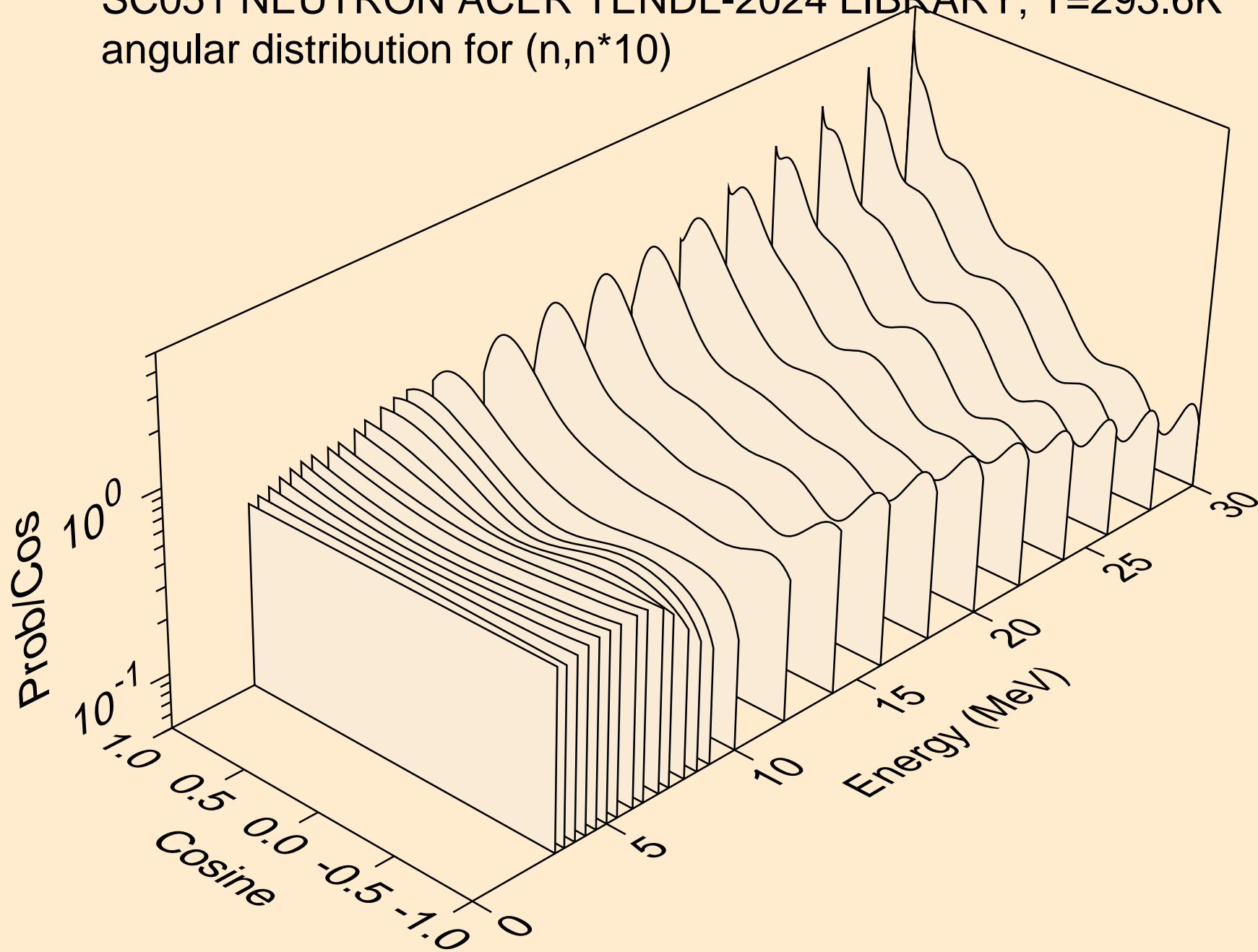

SC051 NEUTRON ACER TENDL-2024 LIBRARY; T=293.6K
angular distribution for (n,n*11)

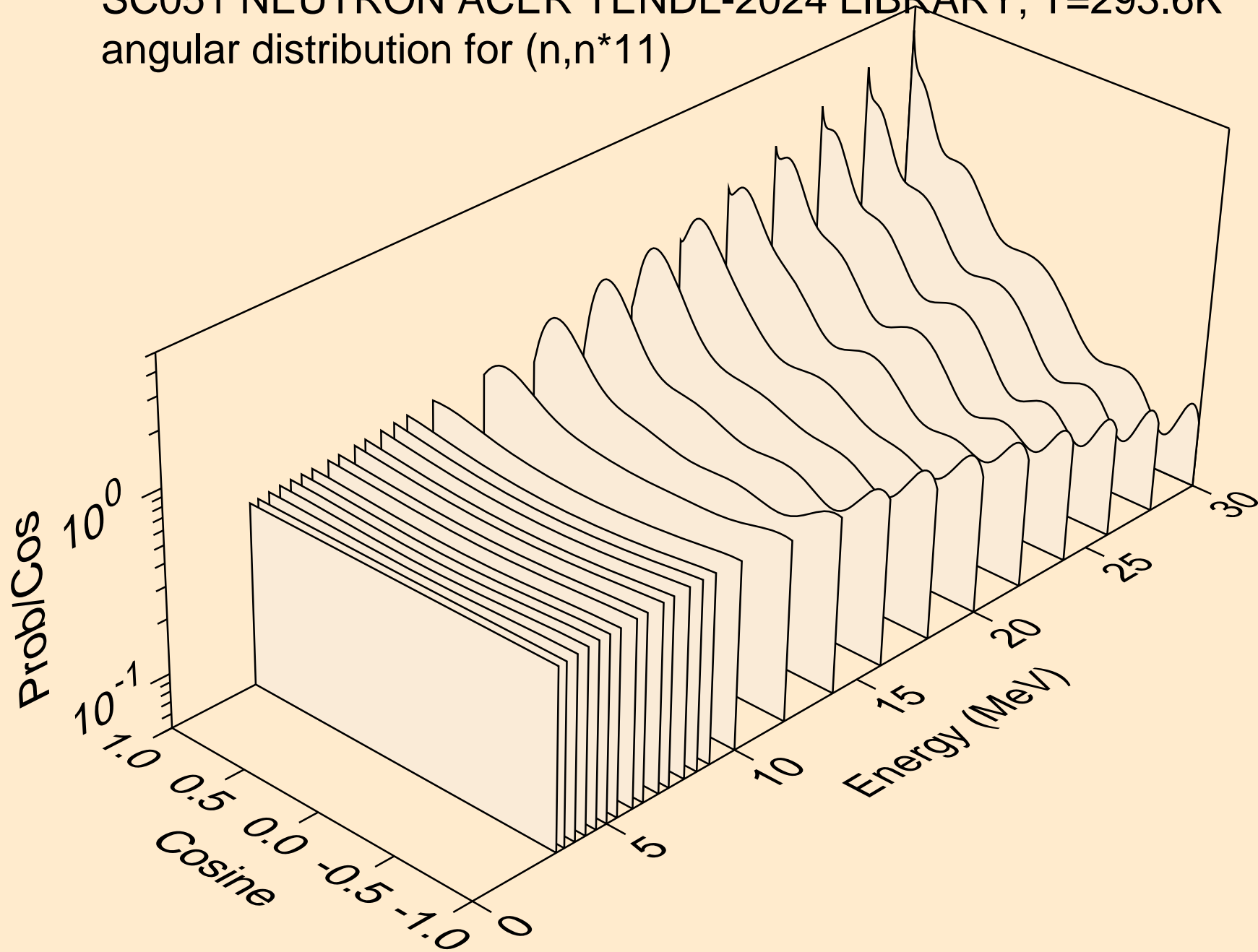

SC051 NEUTRON ACER TENDL-2024 LIBRARY; T=293.6K
angular distribution for (n,n*12)

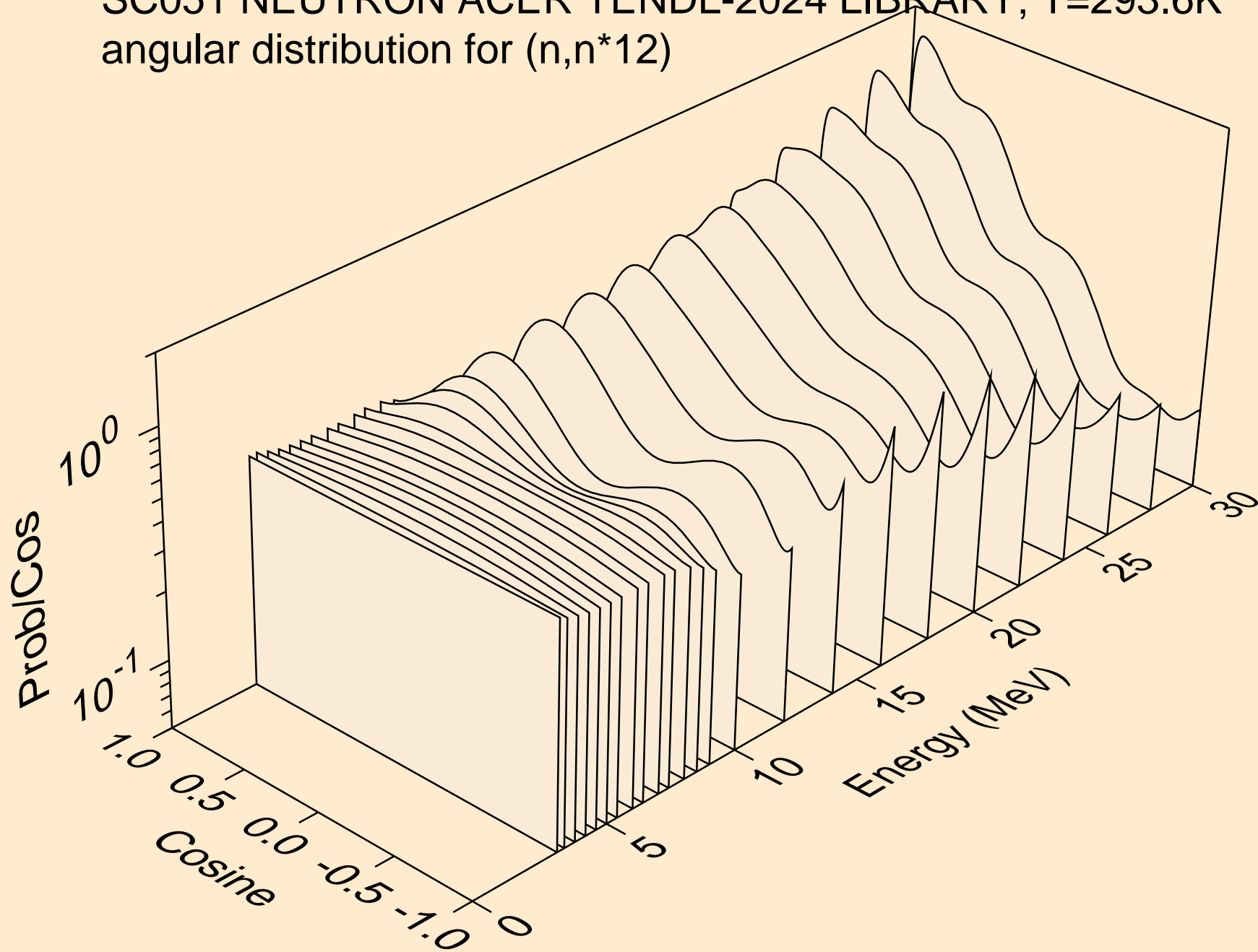

SC051 NEUTRON ACER TENDL-2024 LIBRARY; T=293.6K
angular distribution for (n,n*13)

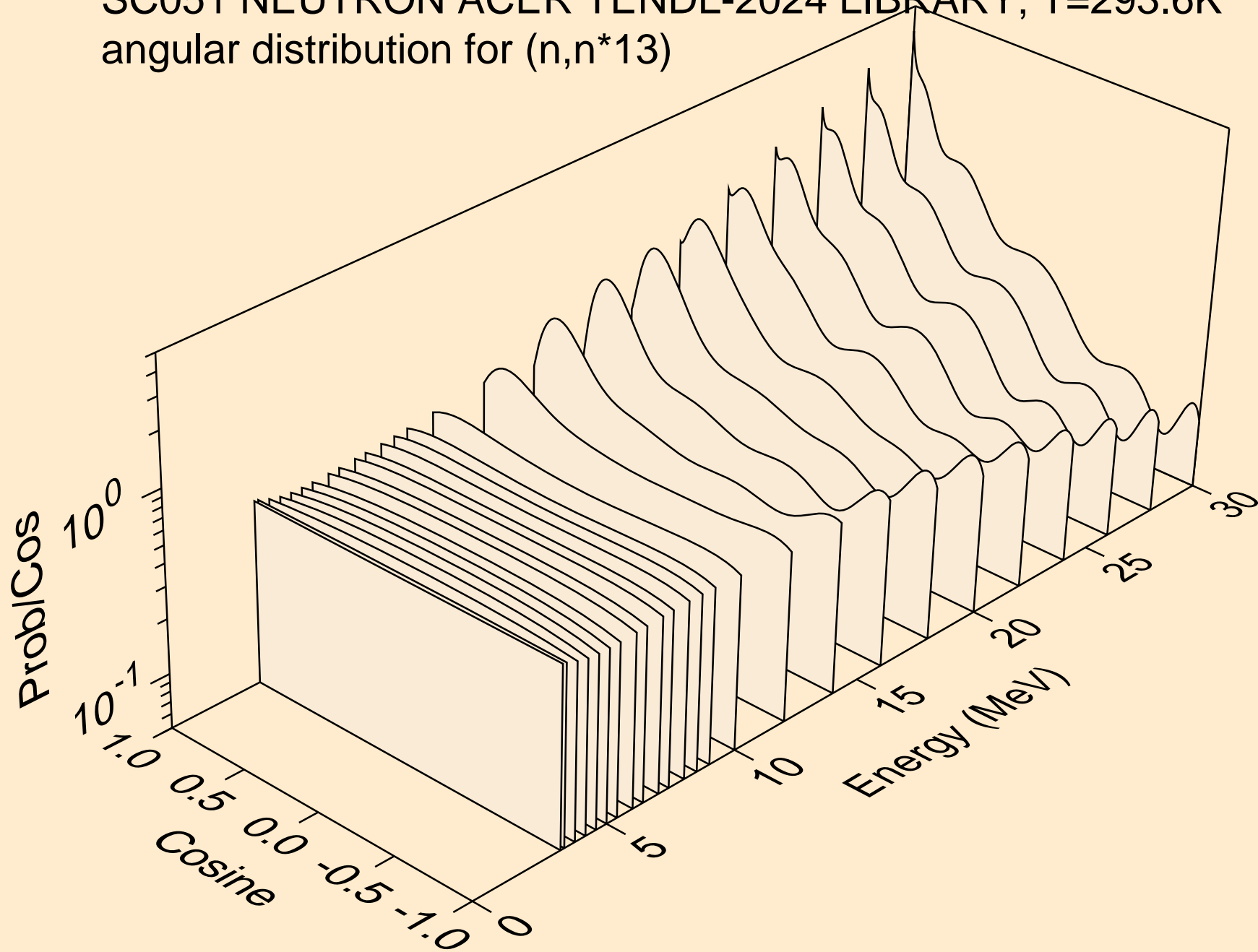

SC051 NEUTRON ACER TENDL-2024 LIBRARY; T=293.6K
angular distribution for (n,n*14)

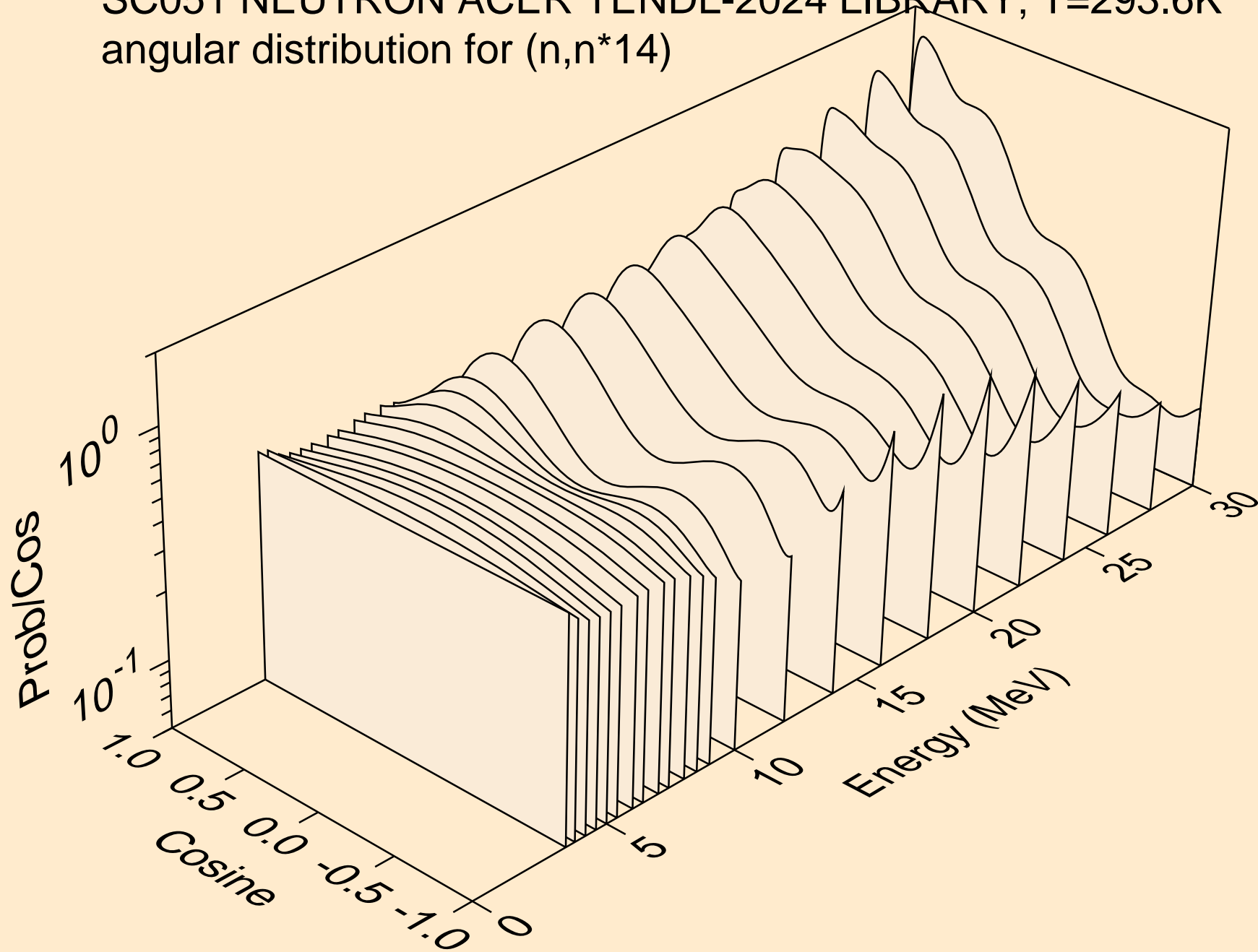

SC051 NEUTRON ACER TENDL-2024 LIBRARY; T=293.6K
angular distribution for (n,n*15)

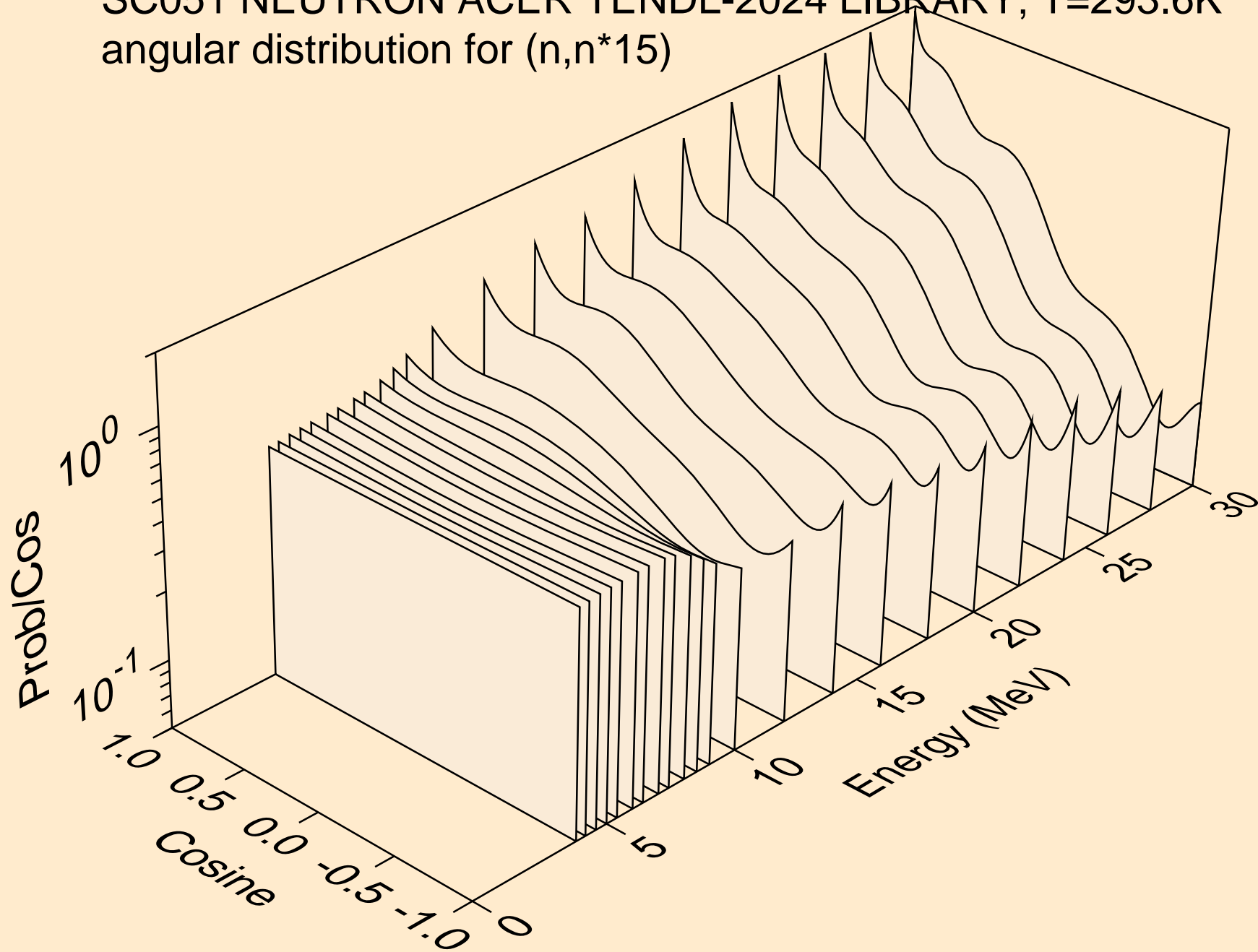

SC051 NEUTRON ACER TENDL-2024 LIBRARY; T=293.6K
angular distribution for (n,n*16)

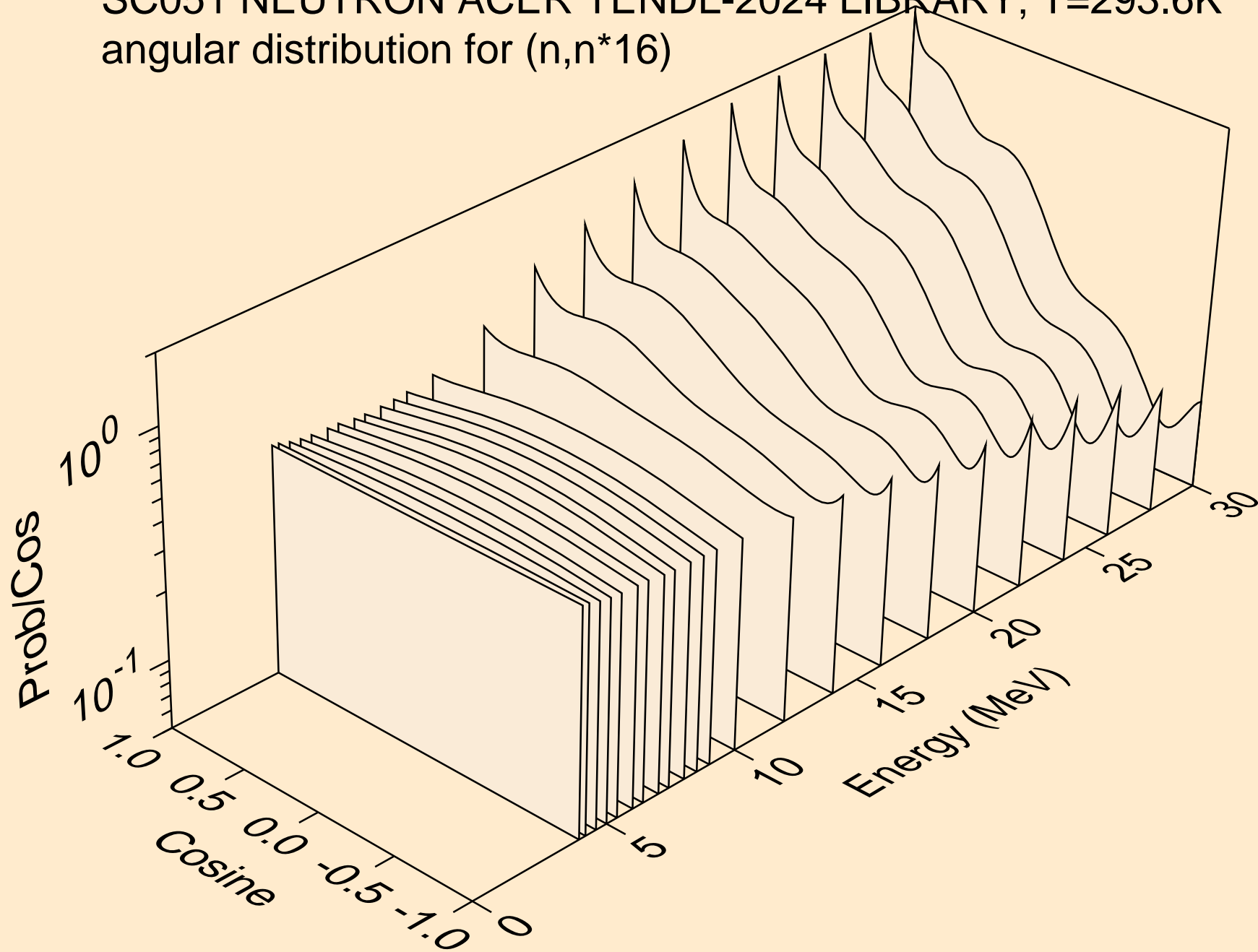

SC051 NEUTRON ACER TENDL-2024 LIBRARY; T=293.6K
angular distribution for (n,n*17)

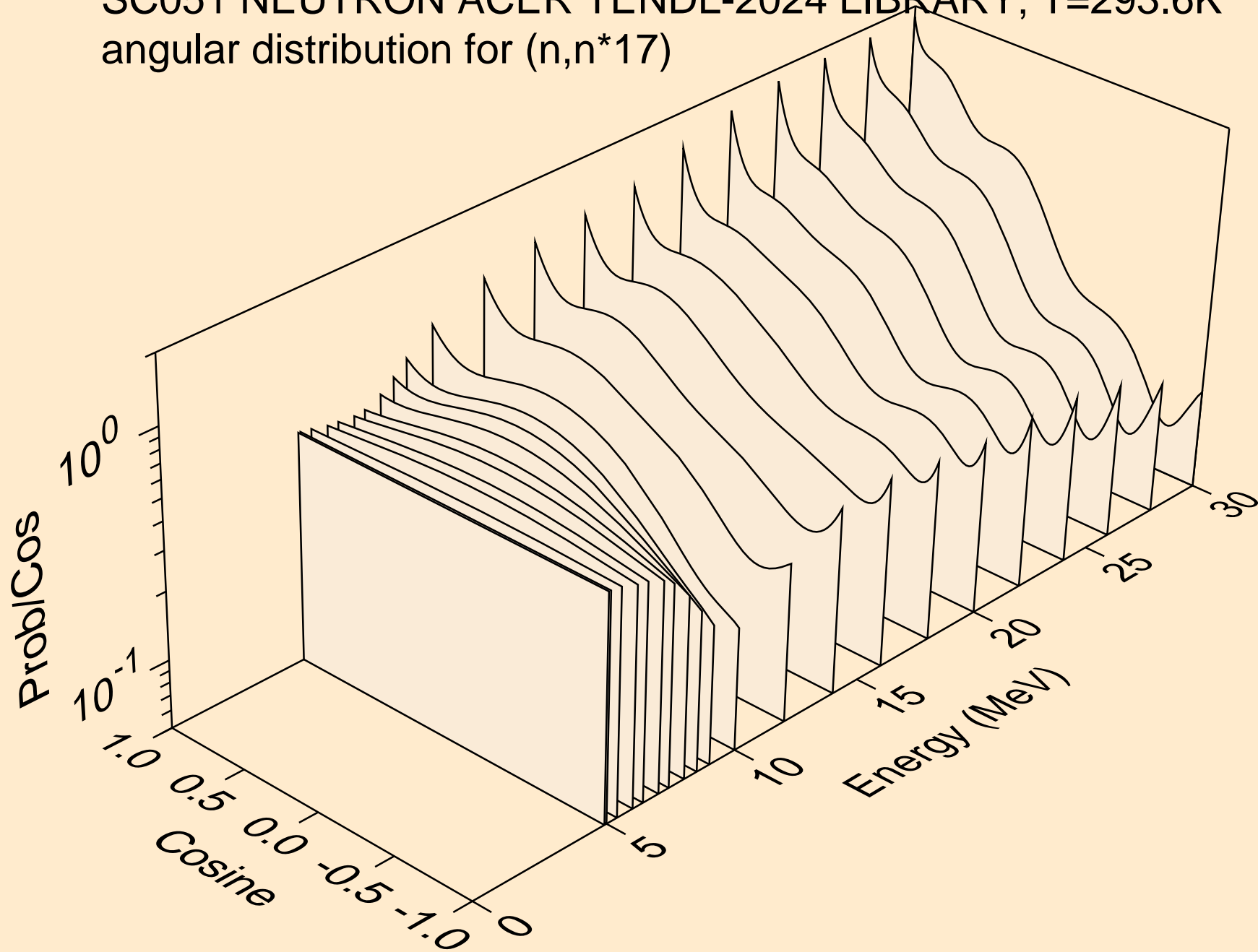

SC051 NEUTRON ACER TENDL-2024 LIBRARY; T=293.6K
Neutron emission for (n,x)

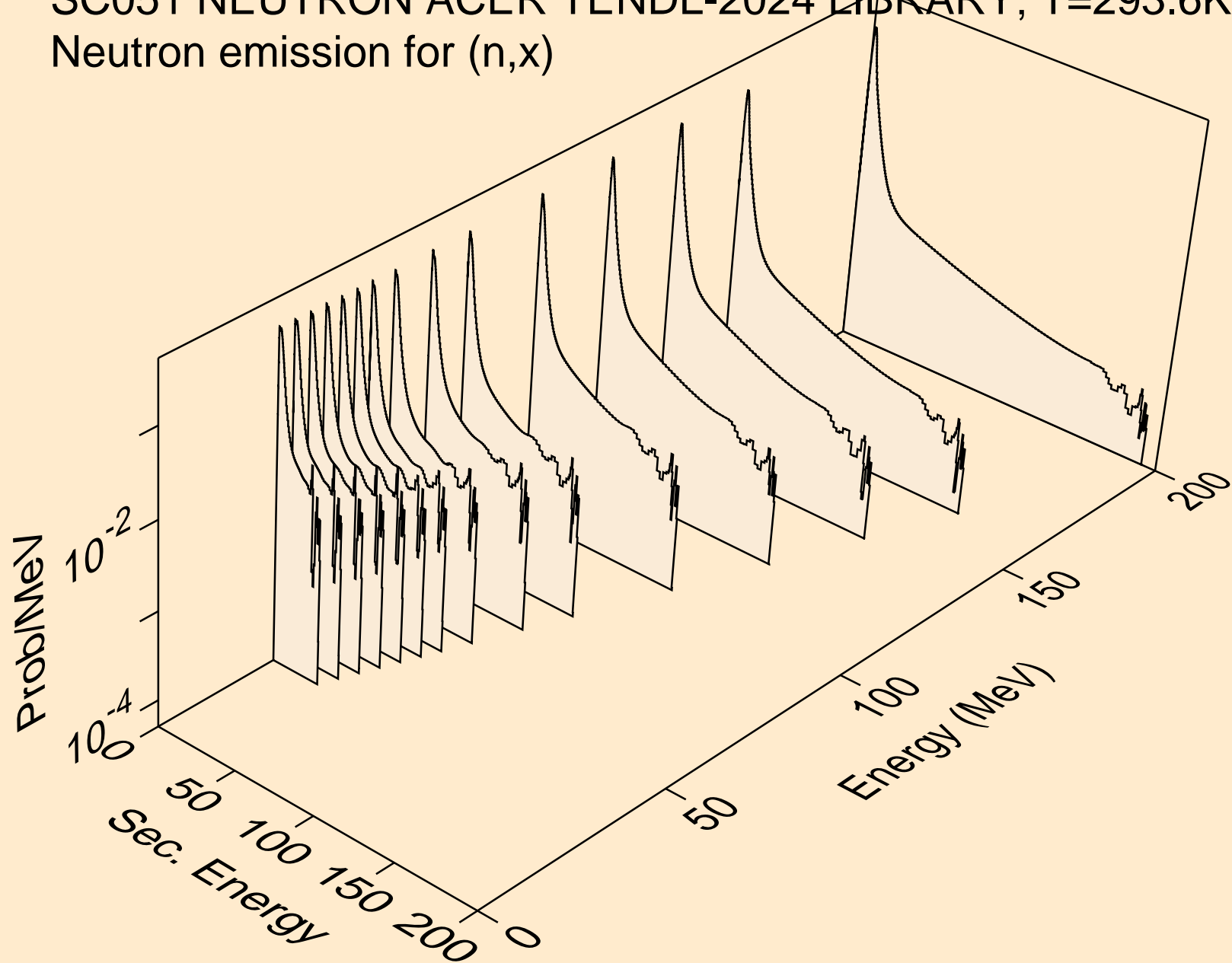

SC051 NEUTRON ACER TENDL-2024 LIBRARY; T=293.6K
Neutron emission for (n,2nd)

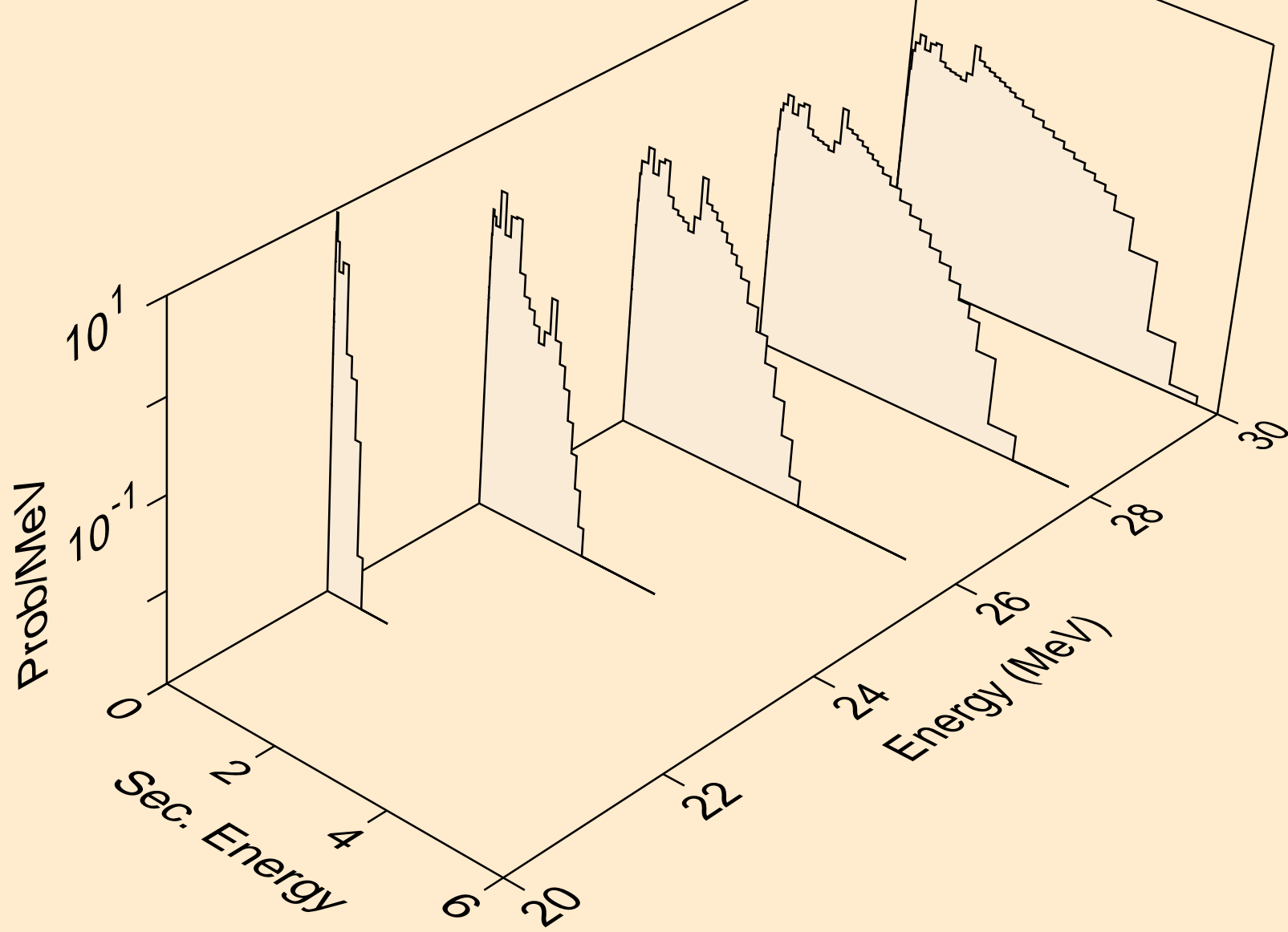

SC051 NEUTRON ACER TENDL-2024 LIBRARY; T=293.6K
Neutron emission for (n,2n)

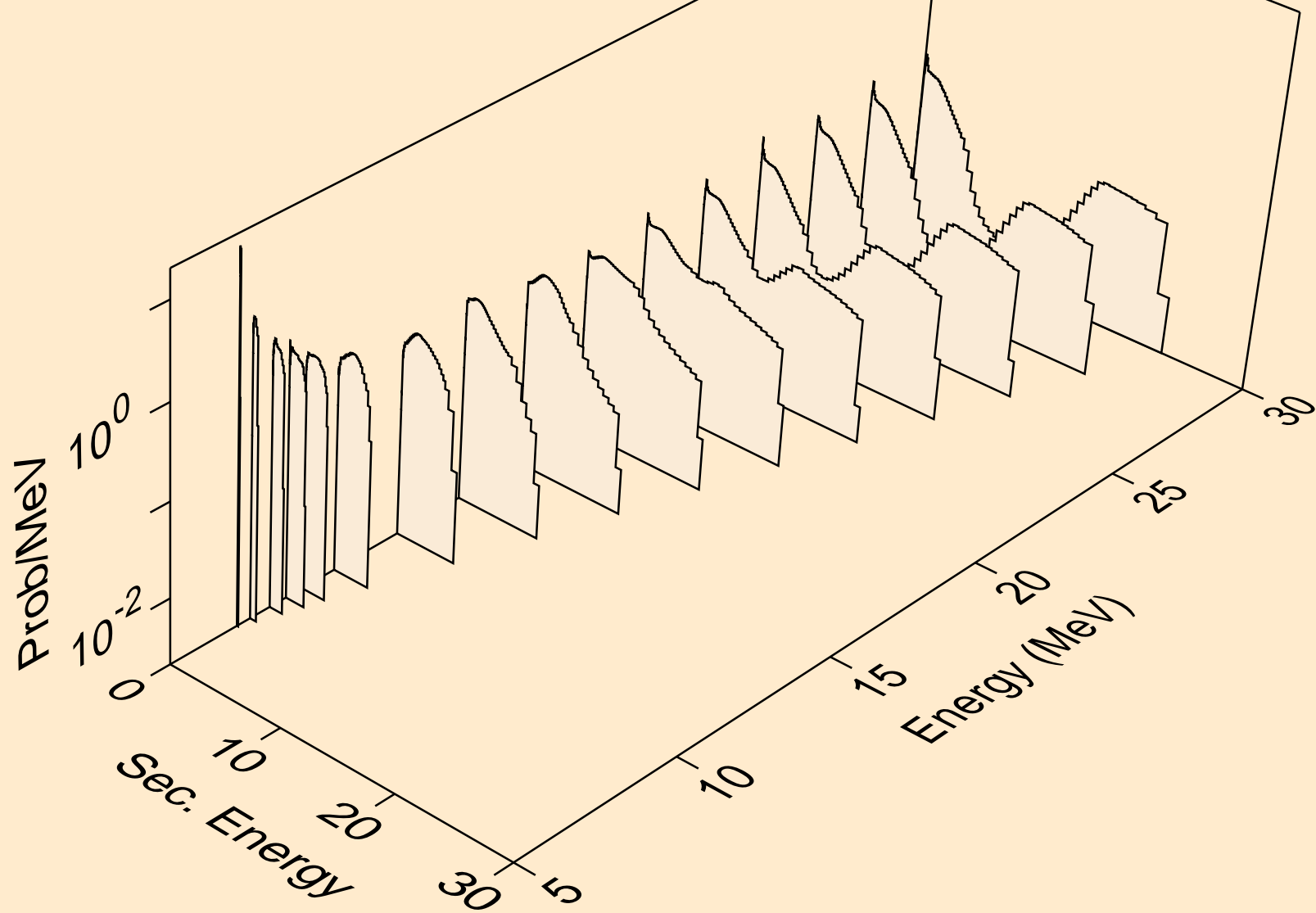

SC051 NEUTRON ACER TENDL-2024 LIBRARY; T=293.6K
Neutron emission for (n,3n)

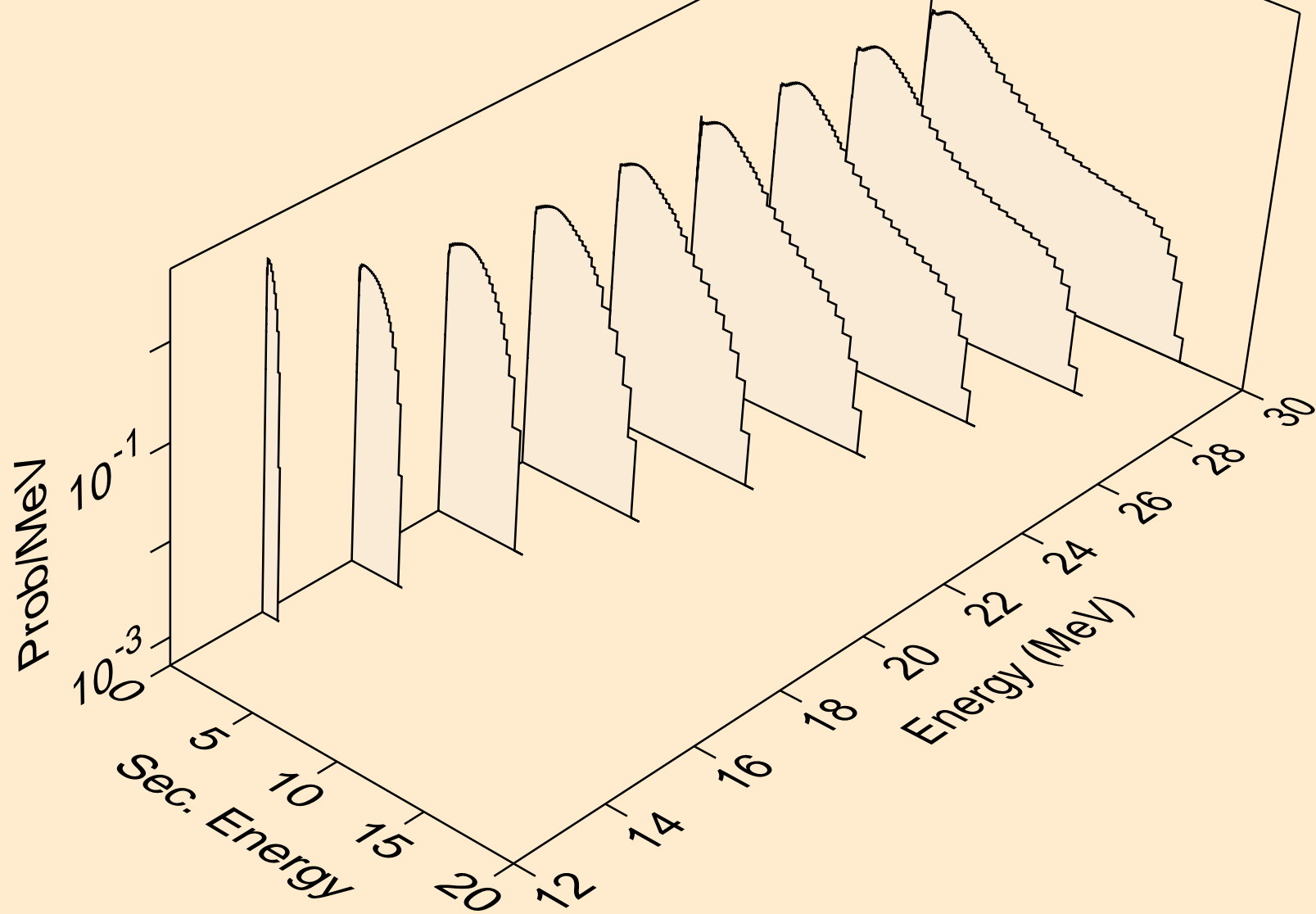

SC051 NEUTRON ACER TENDL-2024 LIBRARY; T=293.6K
Neutron emission for (n,n*)a

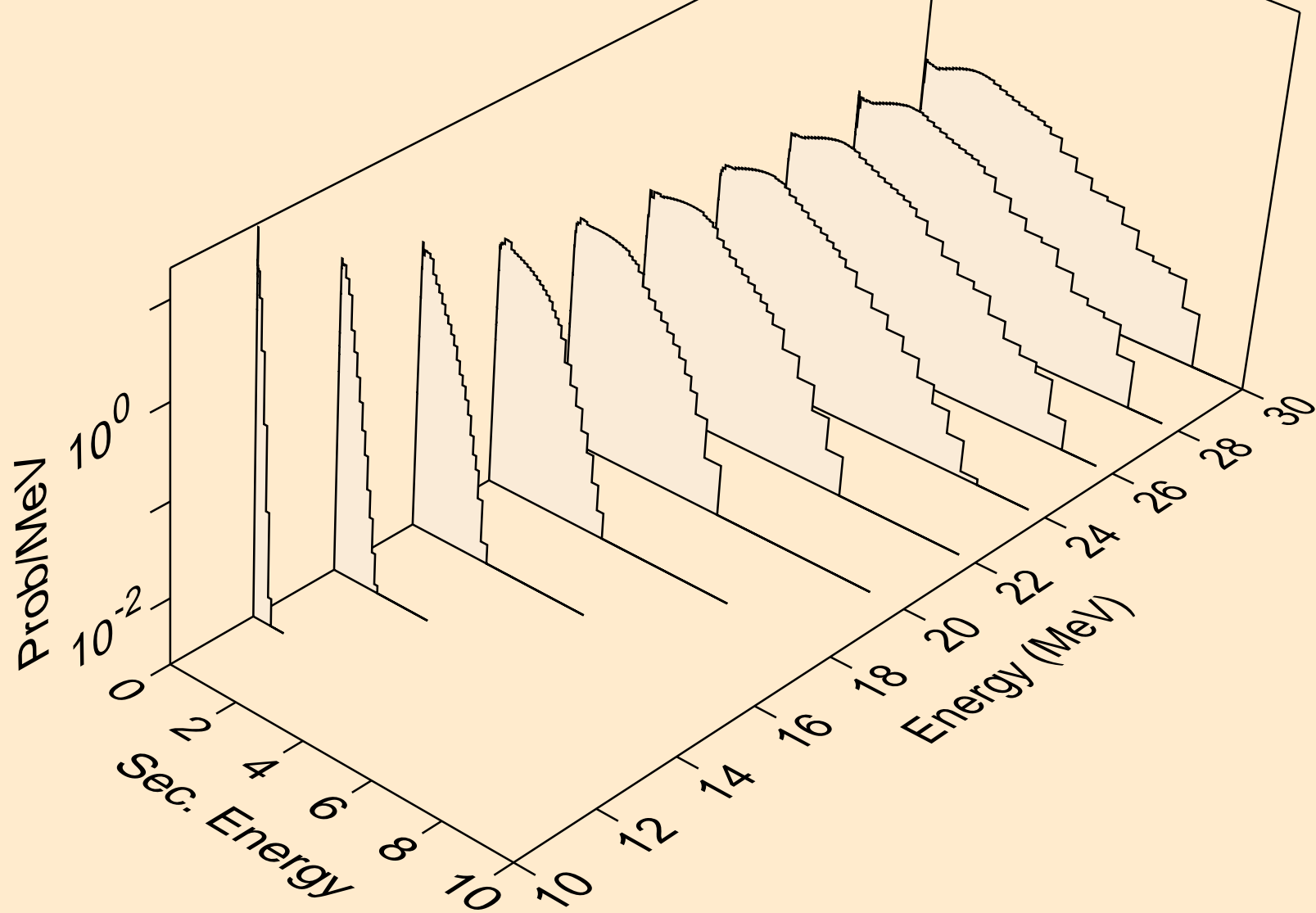

SC051 NEUTRON ACER TENDL-2024 LIBRARY; T=293.6K
Neutron emission for (n,2n)a

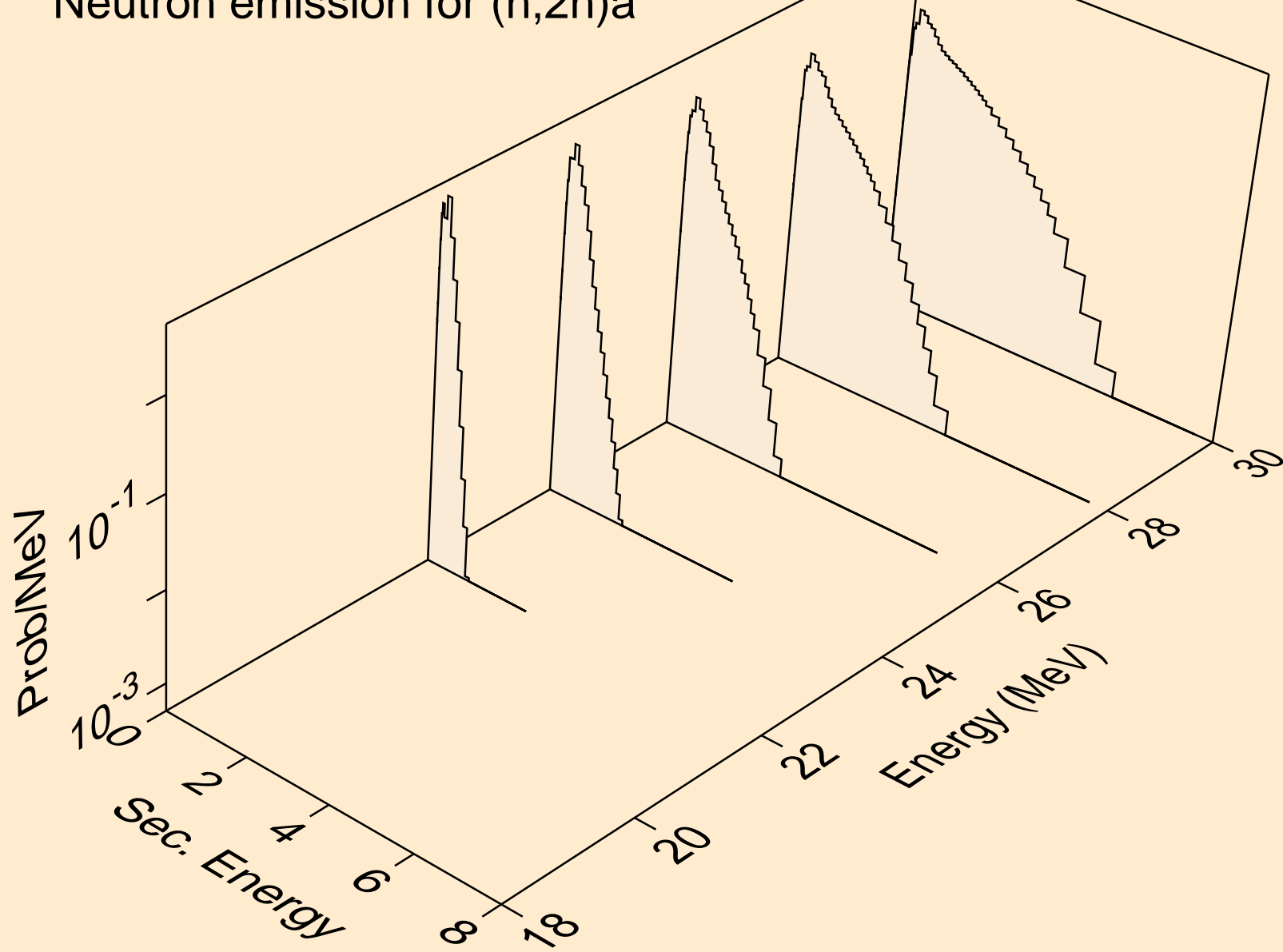

SC051 NEUTRON ACER TENDL-2024 LIBRARY; T=293.6K
Neutron emission for (n,n*)p

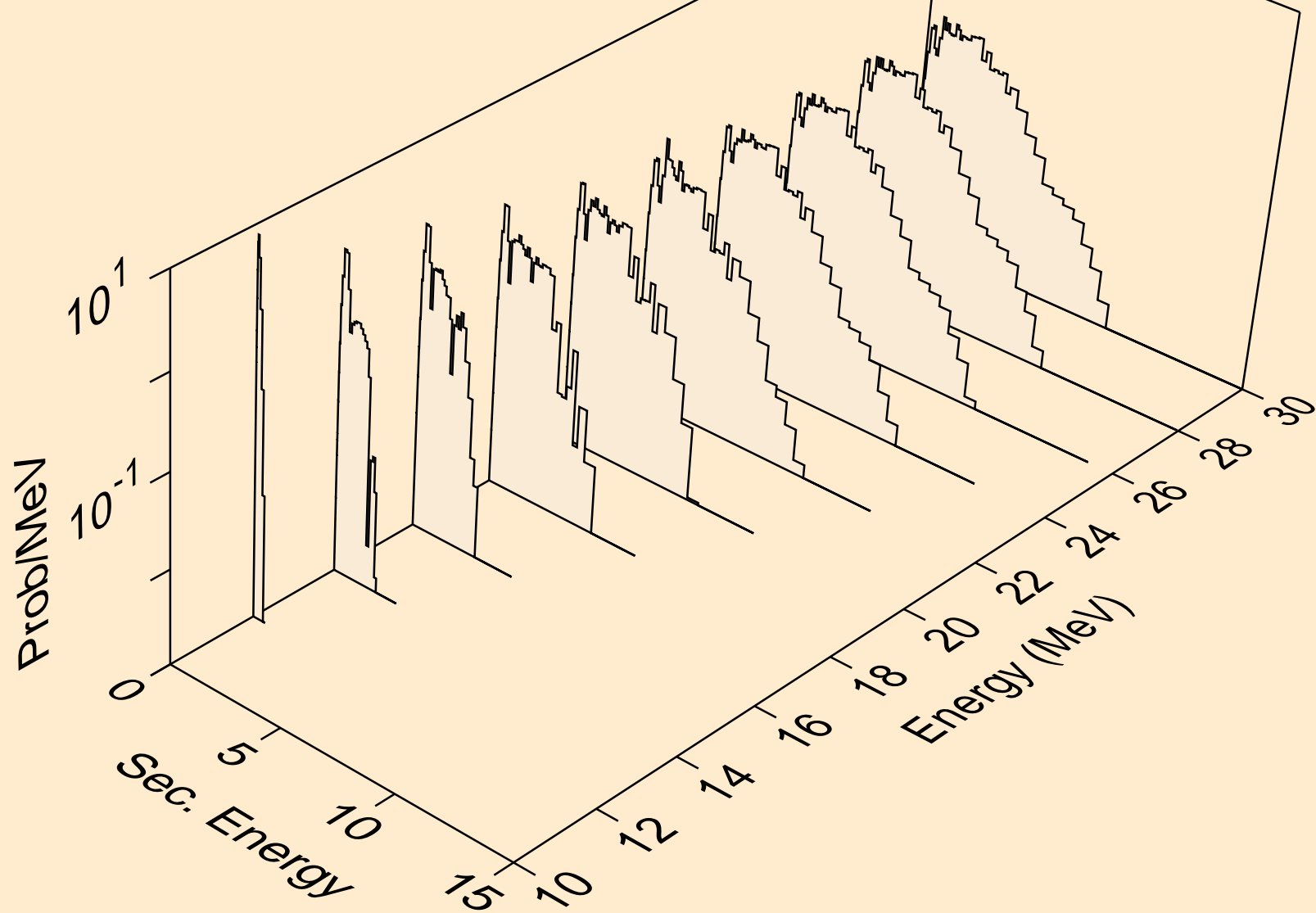

SC051 NEUTRON ACER TENDL-2024 LIBRARY; T=293.6K
Neutron emission for (n,n*)d

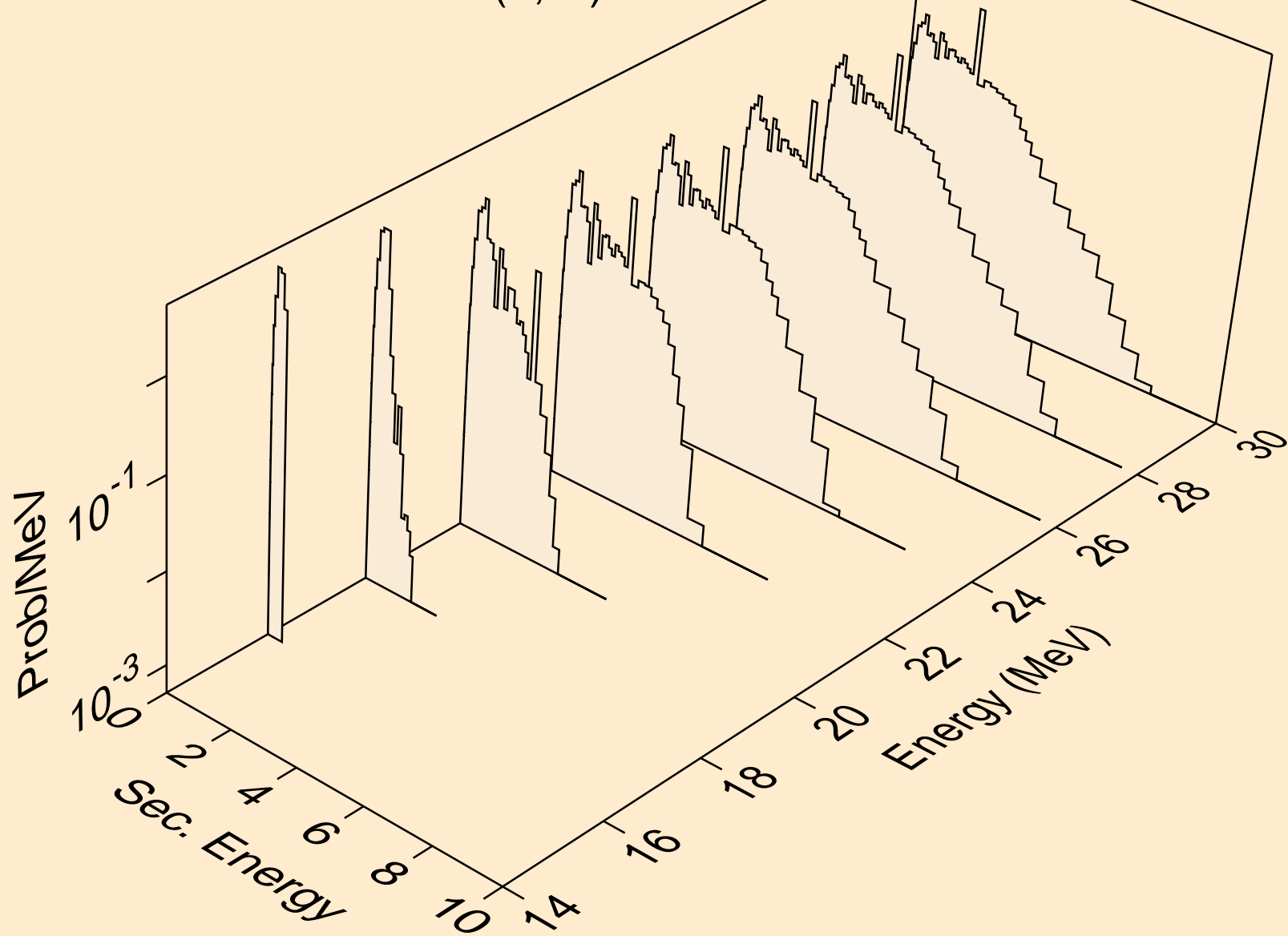

SC051 NEUTRON ACER TENDL-2024 LIBRARY; T=293.6K
Neutron emission for (n,n*)t

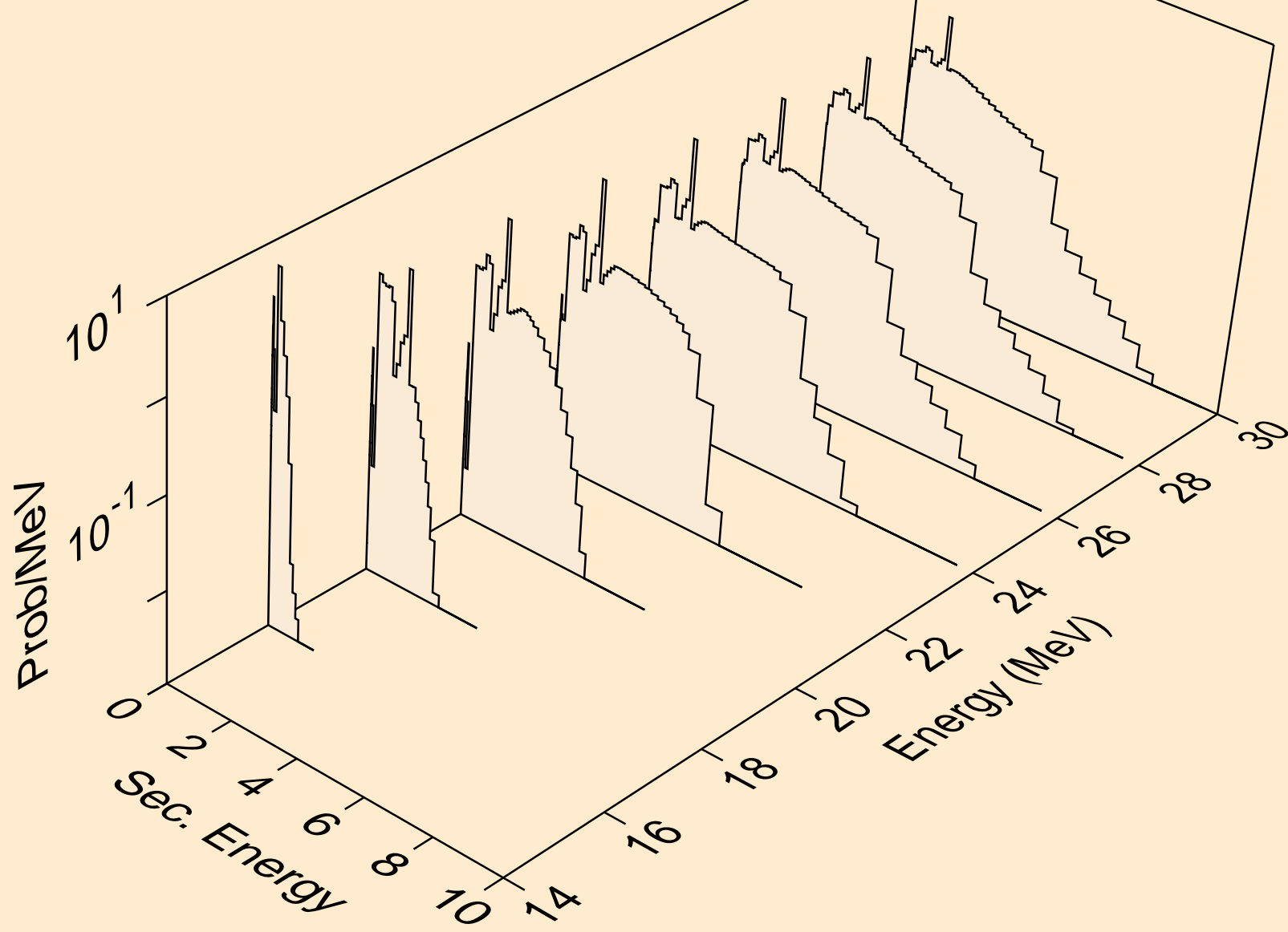

SC051 NEUTRON ACER TENDL-2024 LIBRARY; T=293.6K
Neutron emission for (n,n*)he3

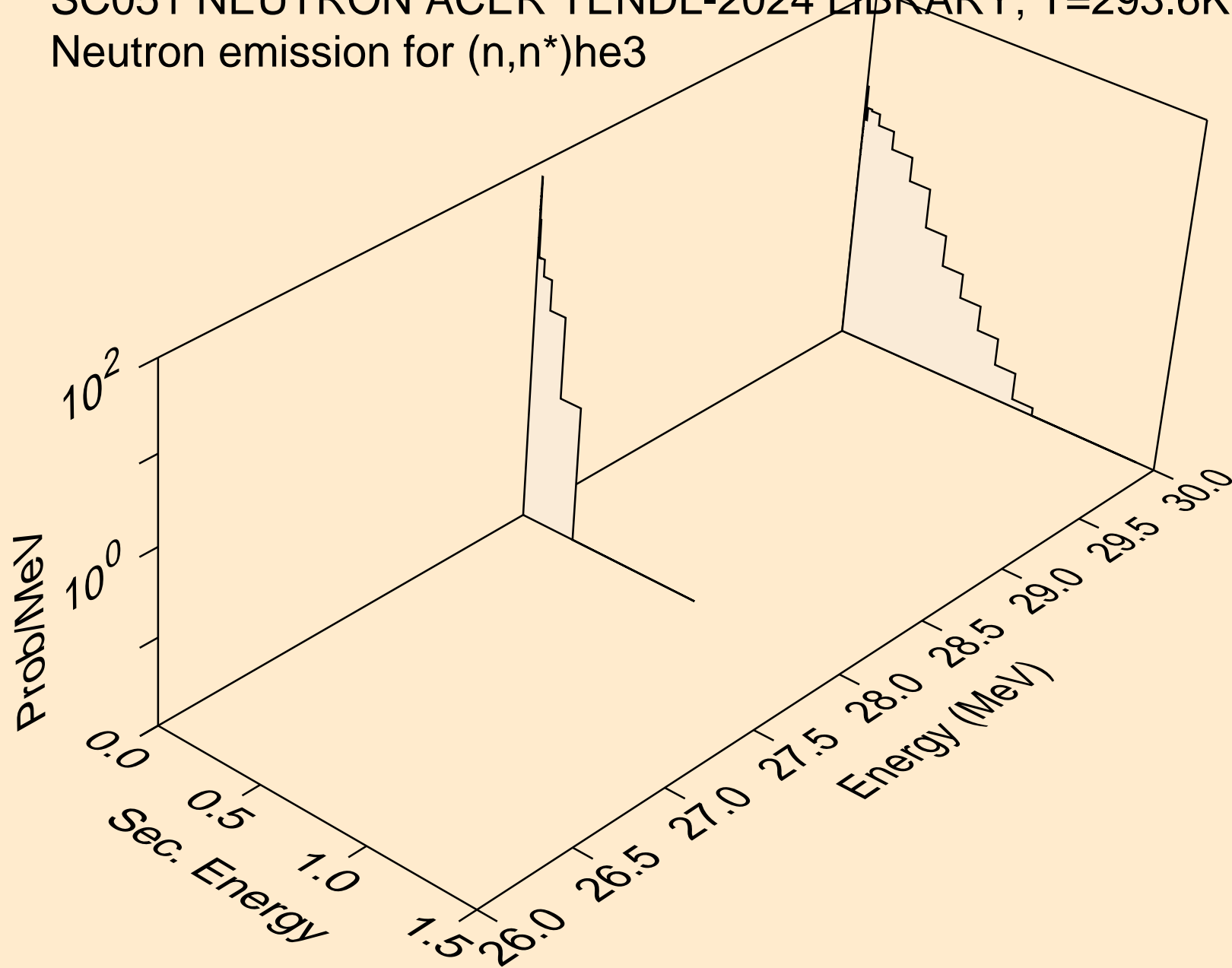

SC051 NEUTRON ACER TENDL-2024 LIBRARY; T=293.6K
Neutron emission for (n,4n)

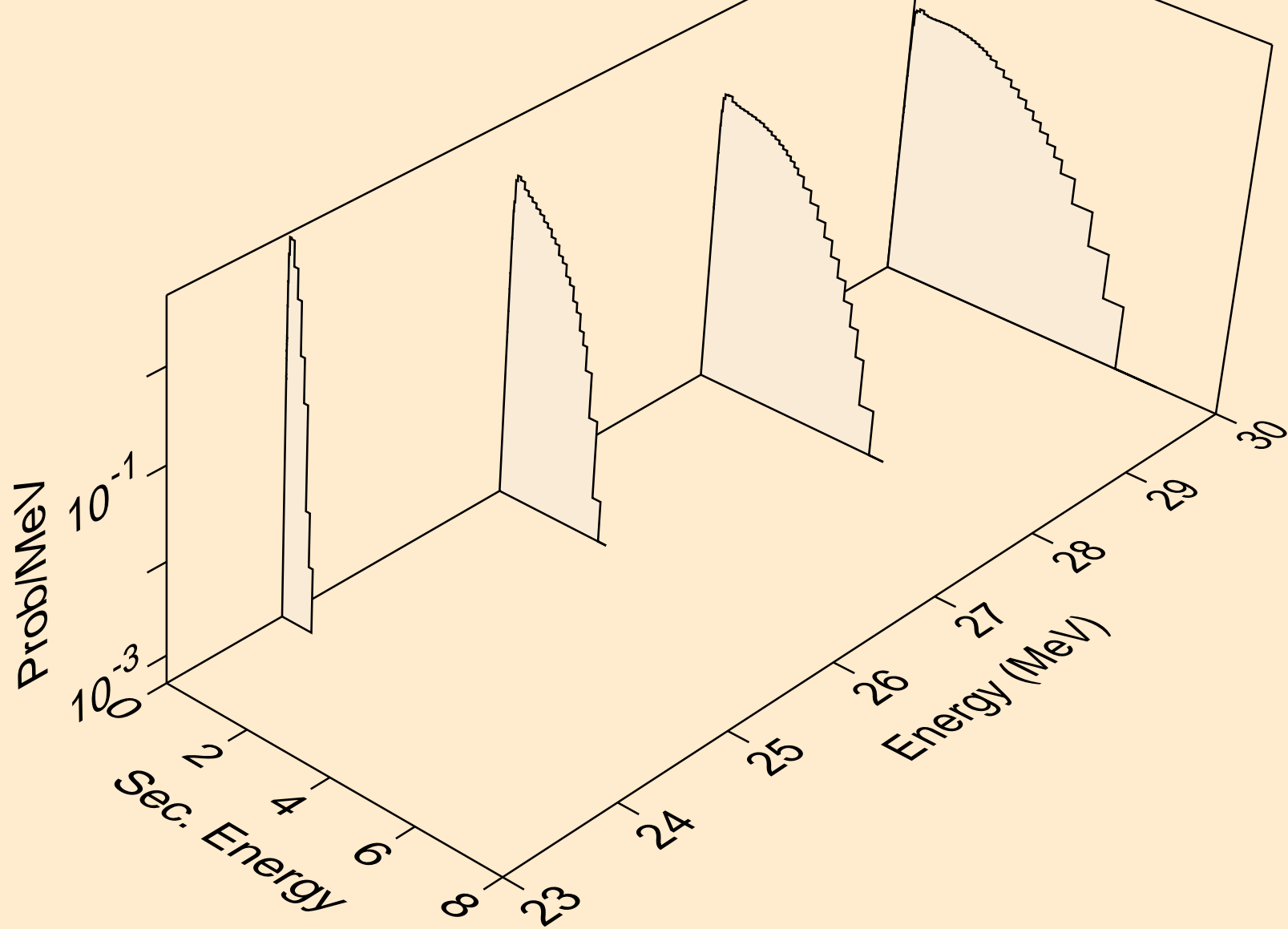

SC051 NEUTRON ACER TENDL-2024 LIBRARY; T=293.6K
Neutron emission for (n,2np)

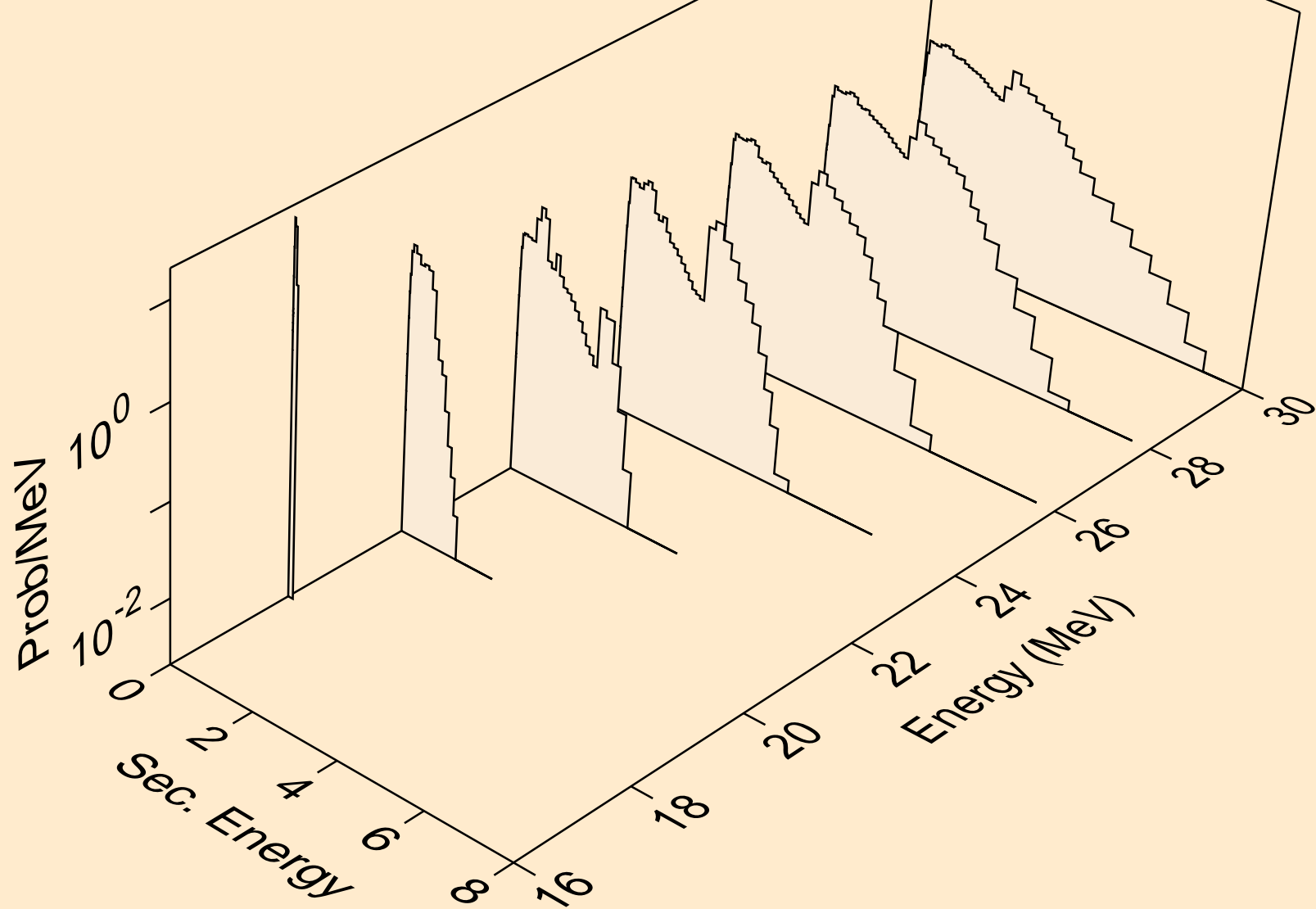

SC051 NEUTRON ACER TENDL-2024 LIBRARY; T=293.6K
Neutron emission for (n,3np)

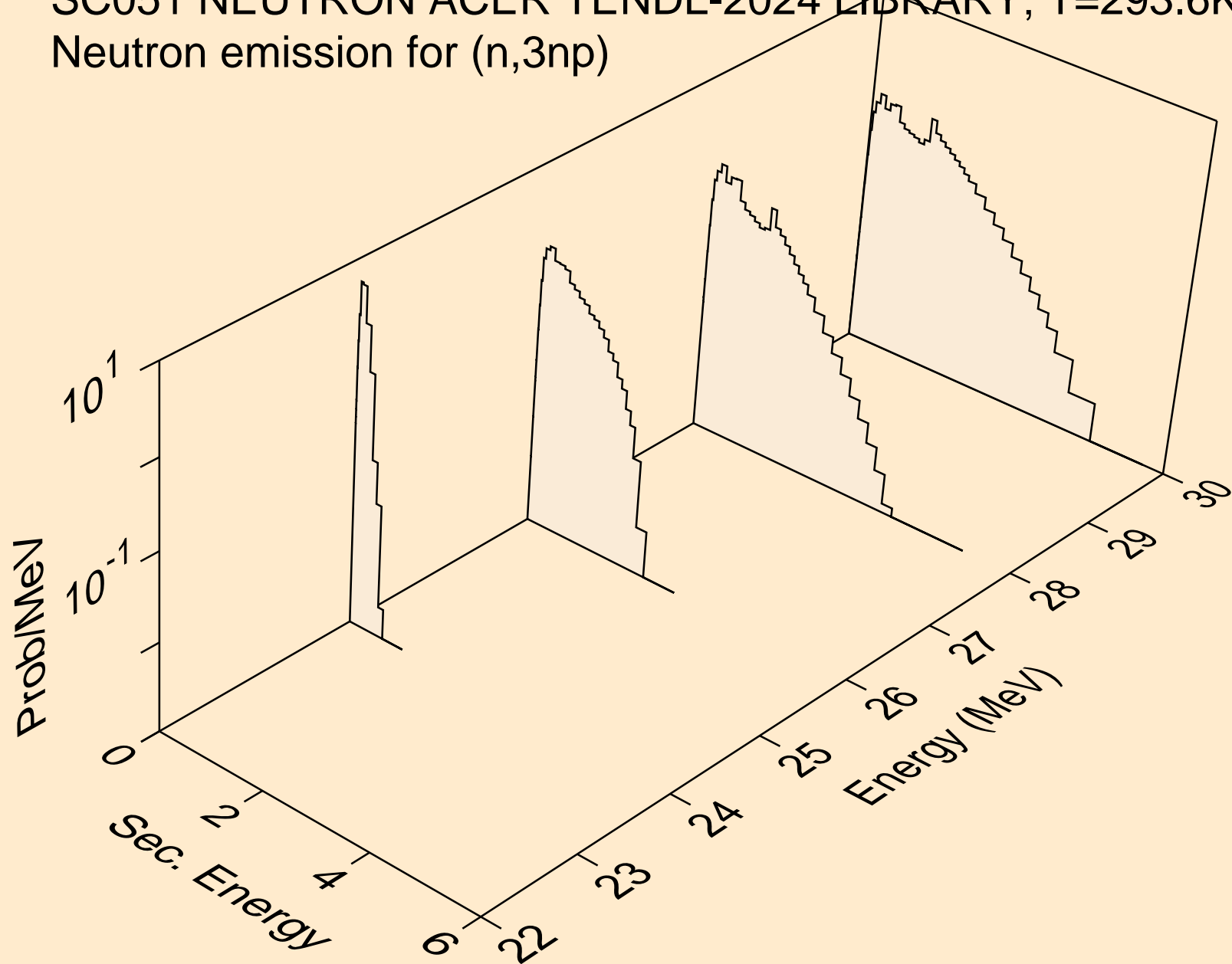

SC051 NEUTRON ACER TENDL-2024 LIBRARY; T=293.6K
Neutron emission for (n,n*c)

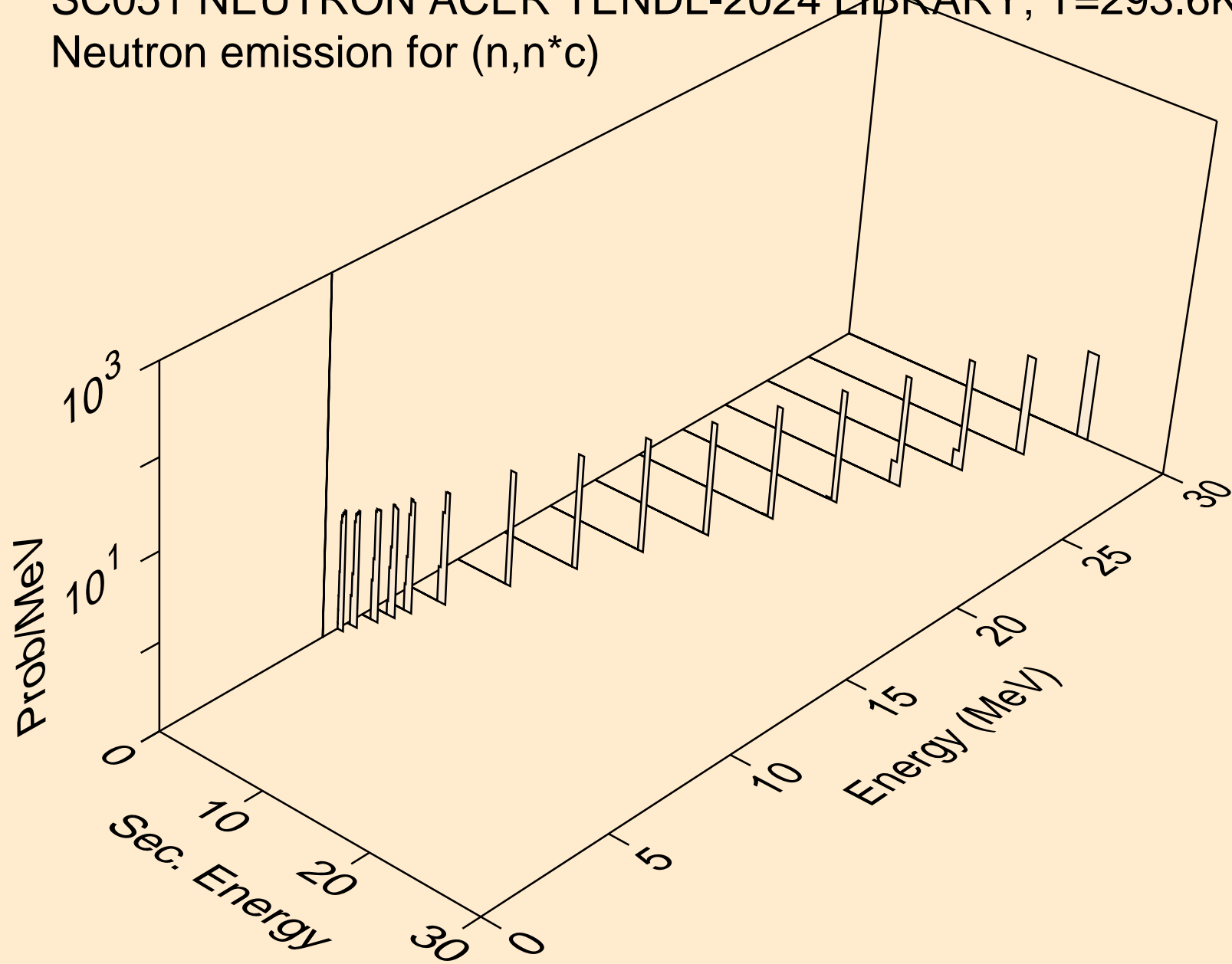

SC051 NEUTRON ACER TENDL-2024 LIBRARY; T=293.6K
Photon emission for (n,x)

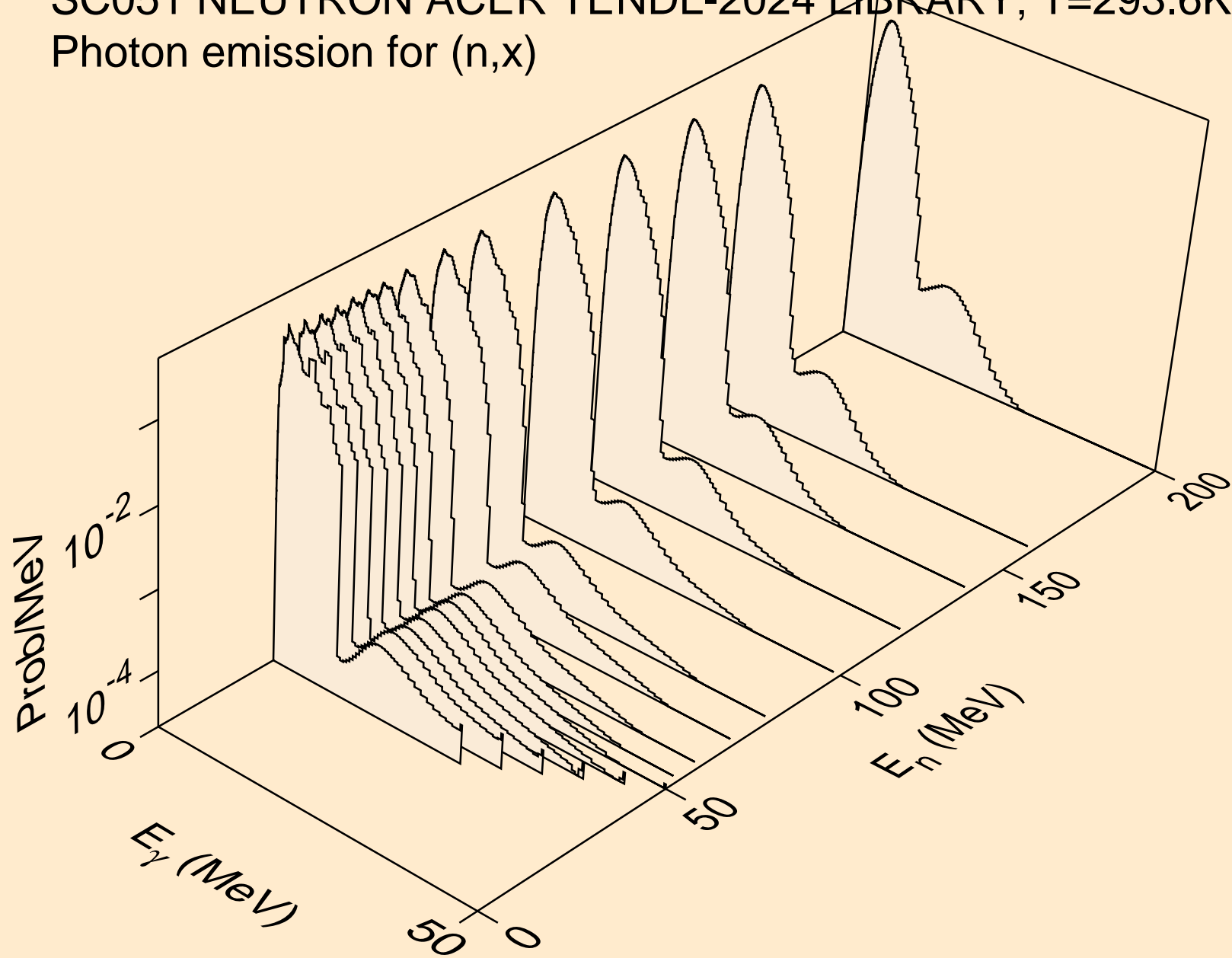

SC051 NEUTRON ACER TENDL-2024 LIBRARY; T=293.6K
Photon emission for (n,2nd)

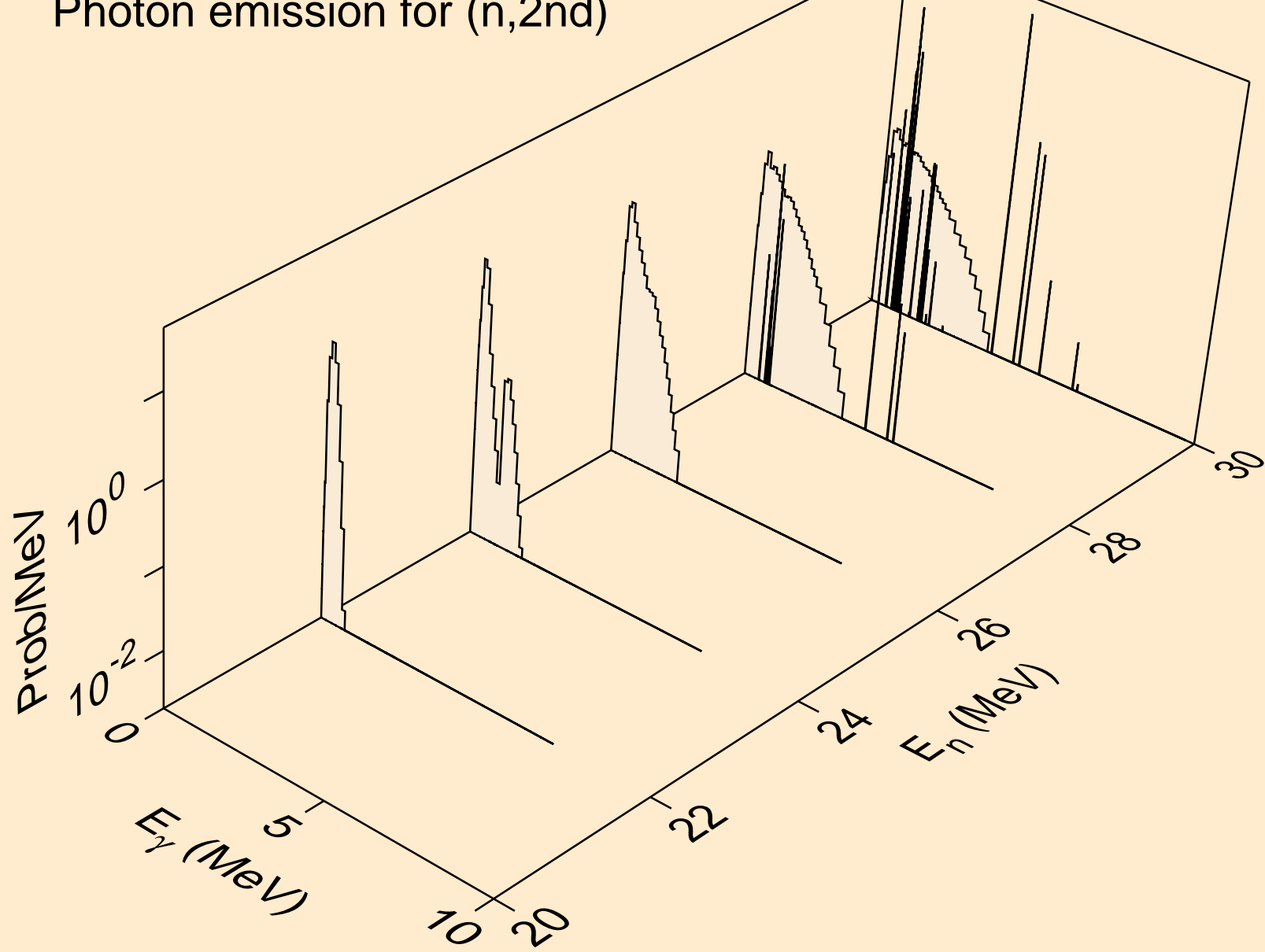

SC051 NEUTRON ACER TENDL-2024 LIBRARY; T=293.6K
Photon emission for (n,2n)

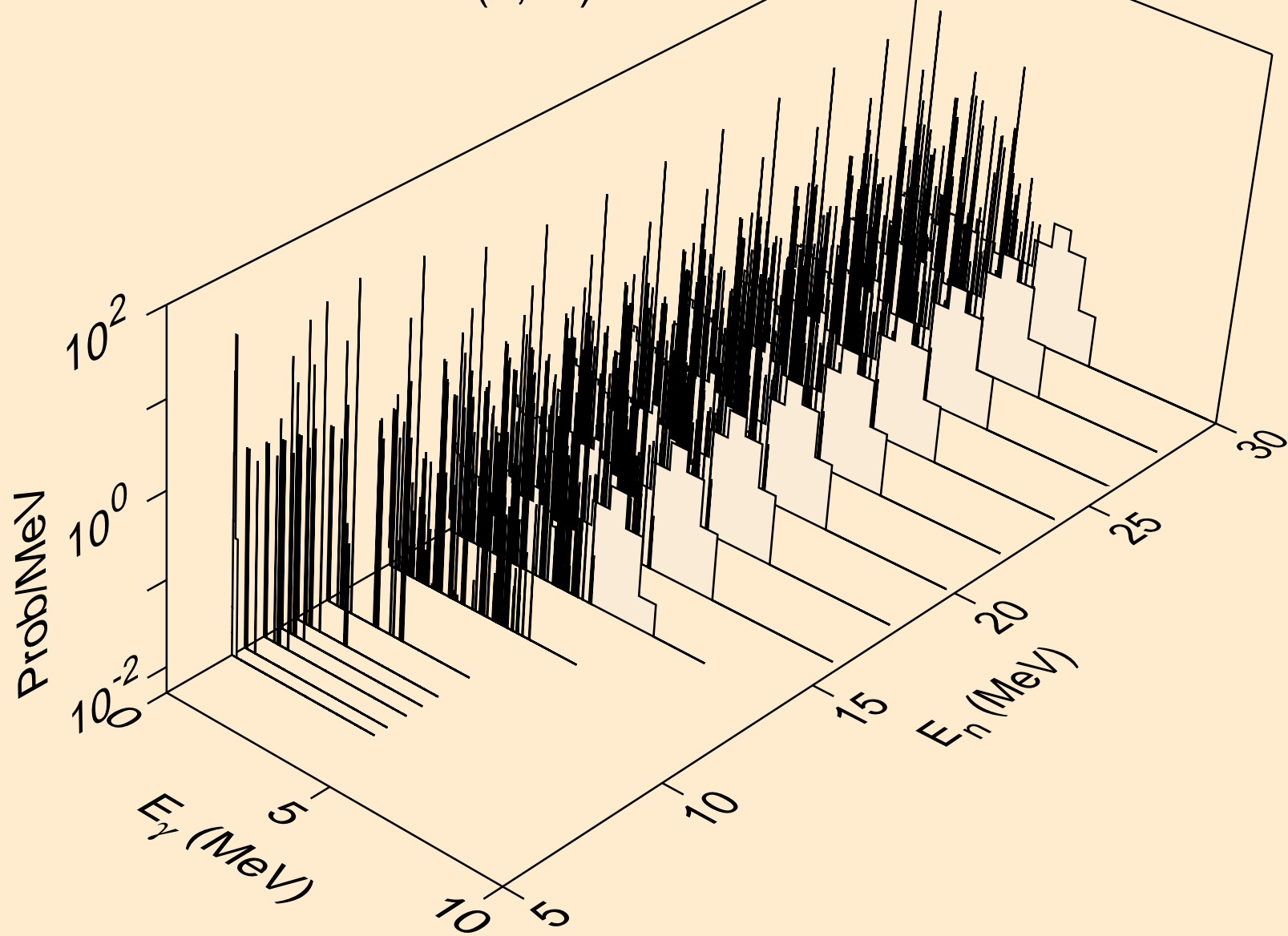

SC051 NEUTRON ACER TENDL-2024 LIBRARY; T=293.6K
Photon emission for (n,3n)

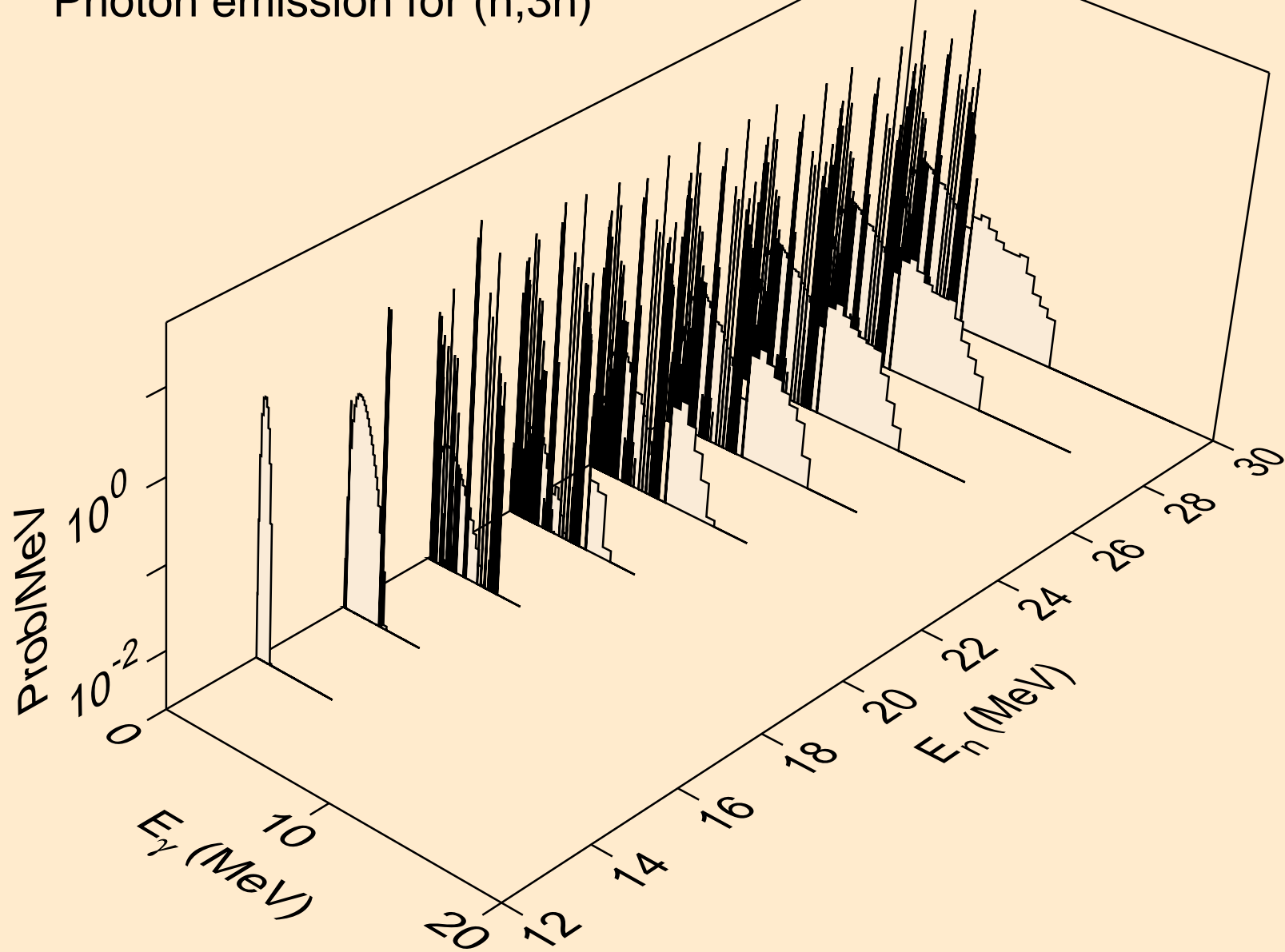

SC051 NEUTRON ACER TENDL-2024 LIBRARY; T=293.6K
Photon emission for (n,n*)a

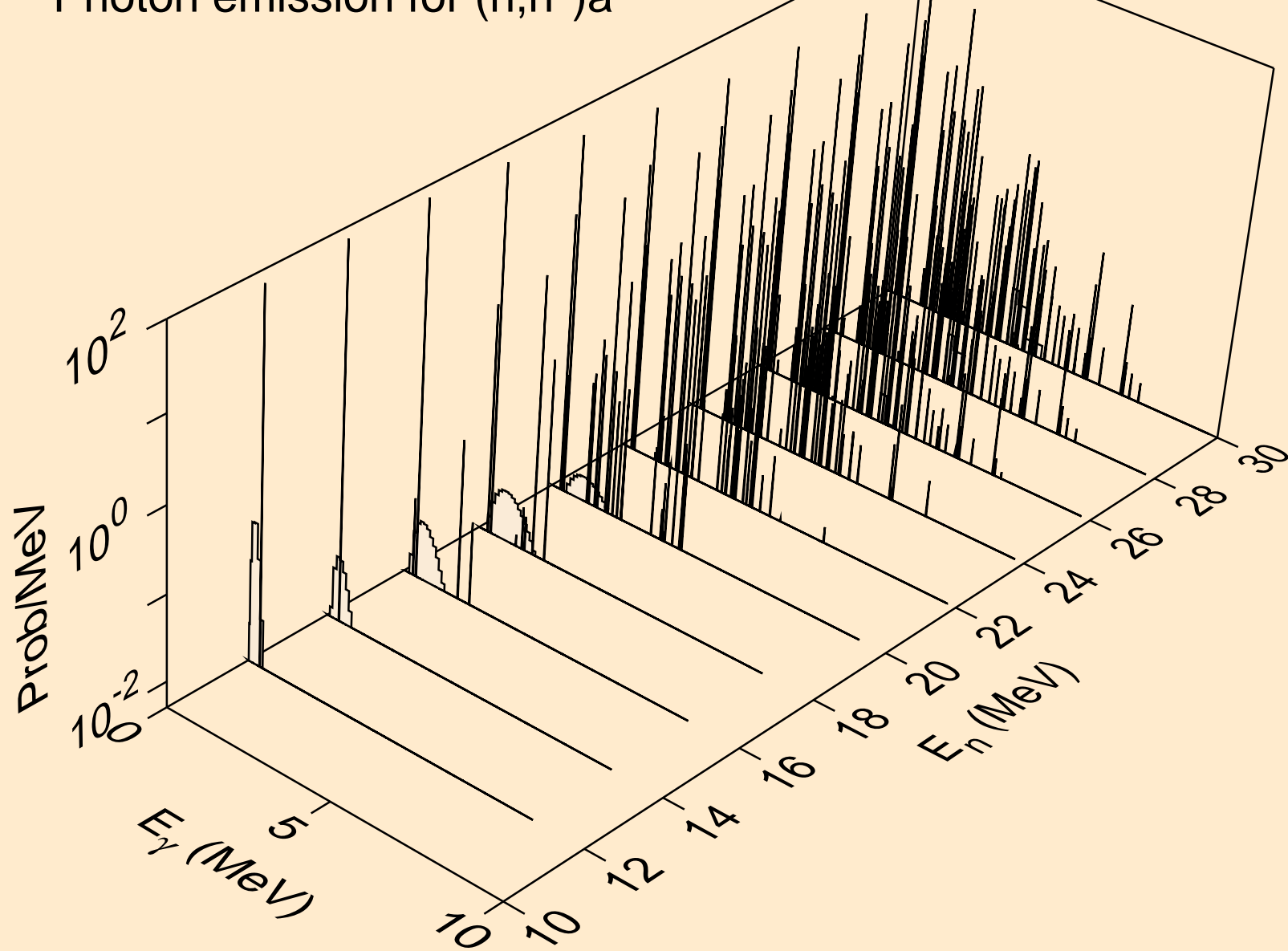

SC051 NEUTRON ACER TENDL-2024 LIBRARY; T=293.6K
Photon emission for (n,2n)a

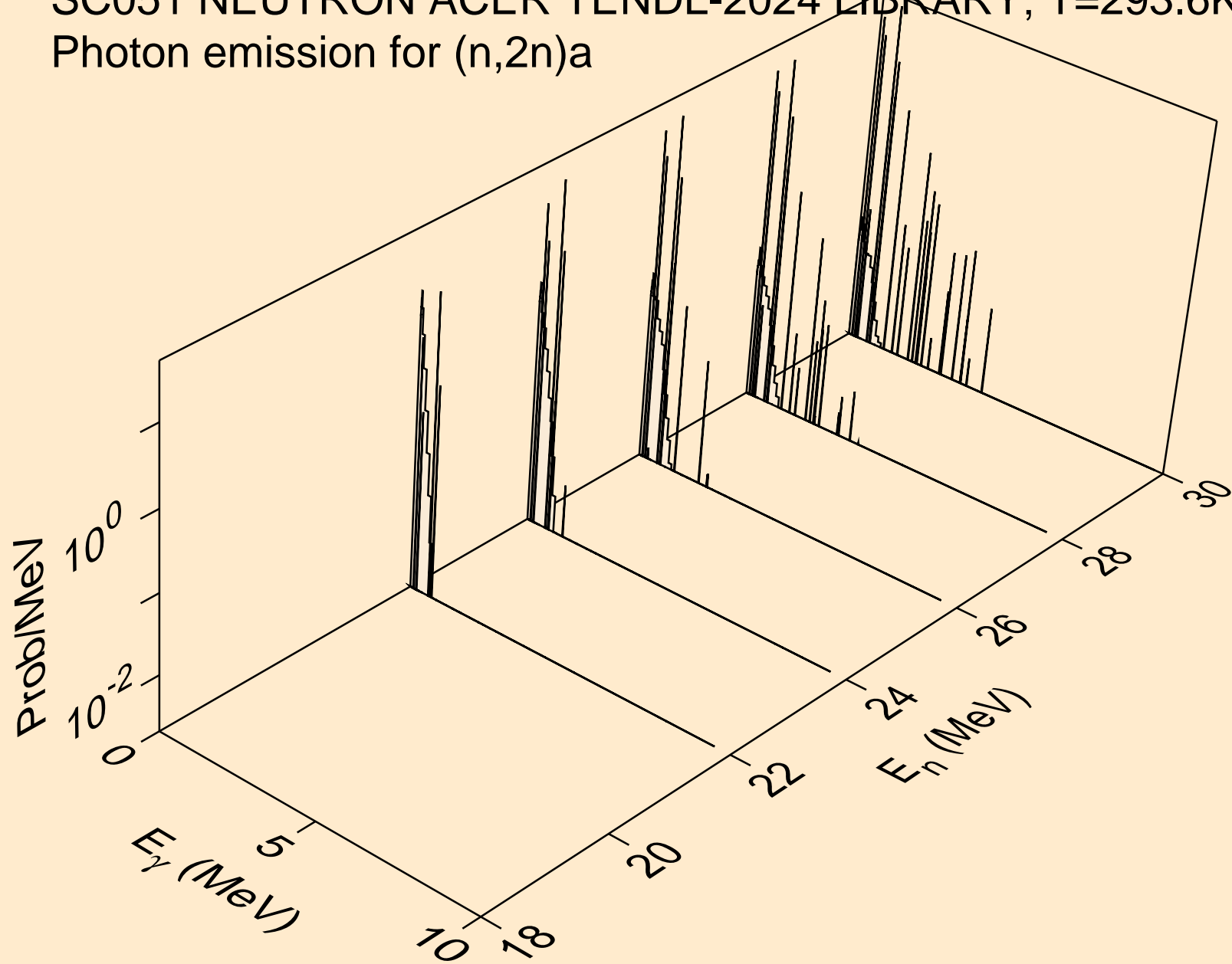

SC051 NEUTRON ACER TENDL-2024 LIBRARY; T=293.6K
Photon emission for (n,n*)p

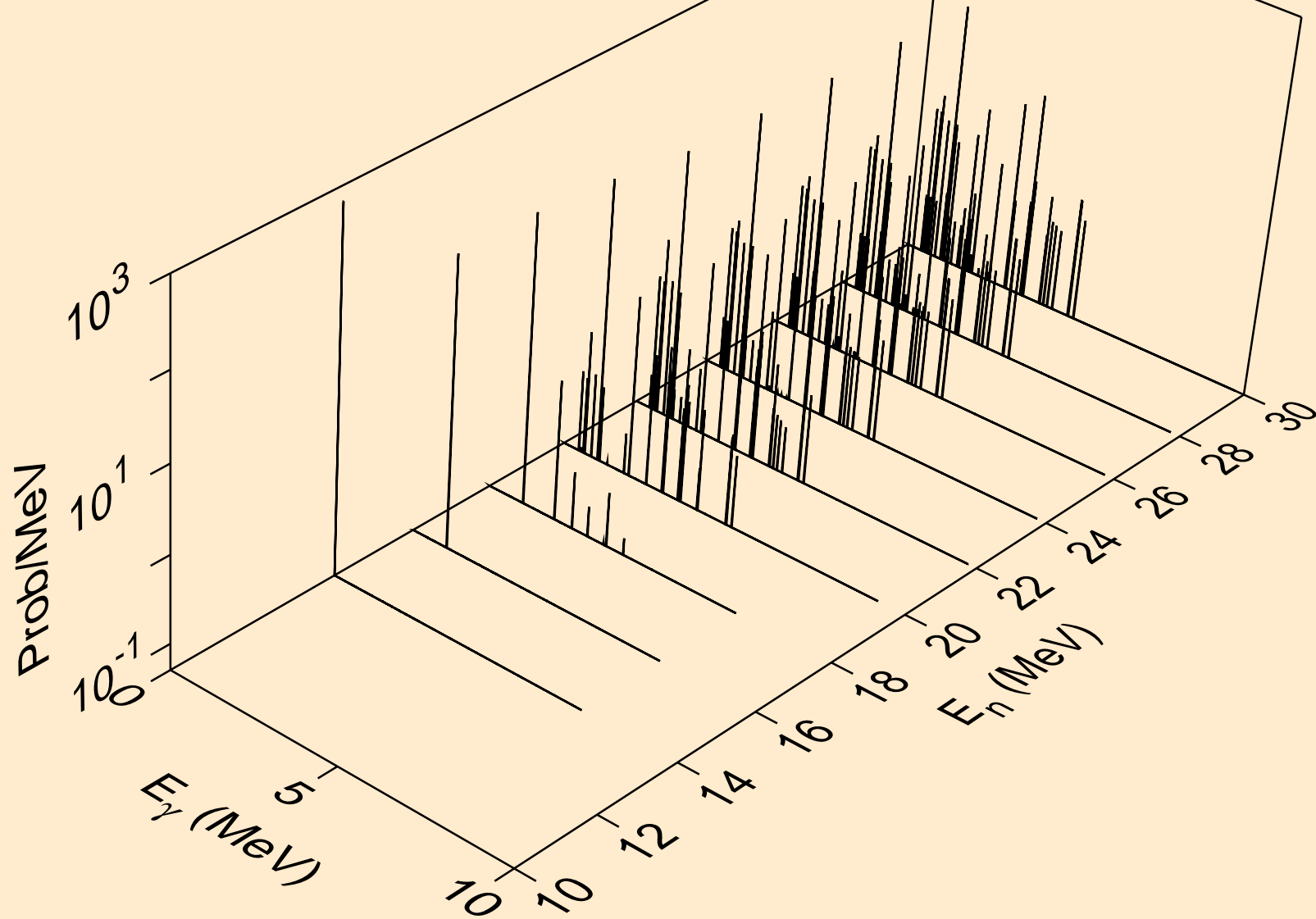

SC051 NEUTRON ACER TENDL-2024 LIBRARY; T=293.6K
Photon emission for (n,n*)d

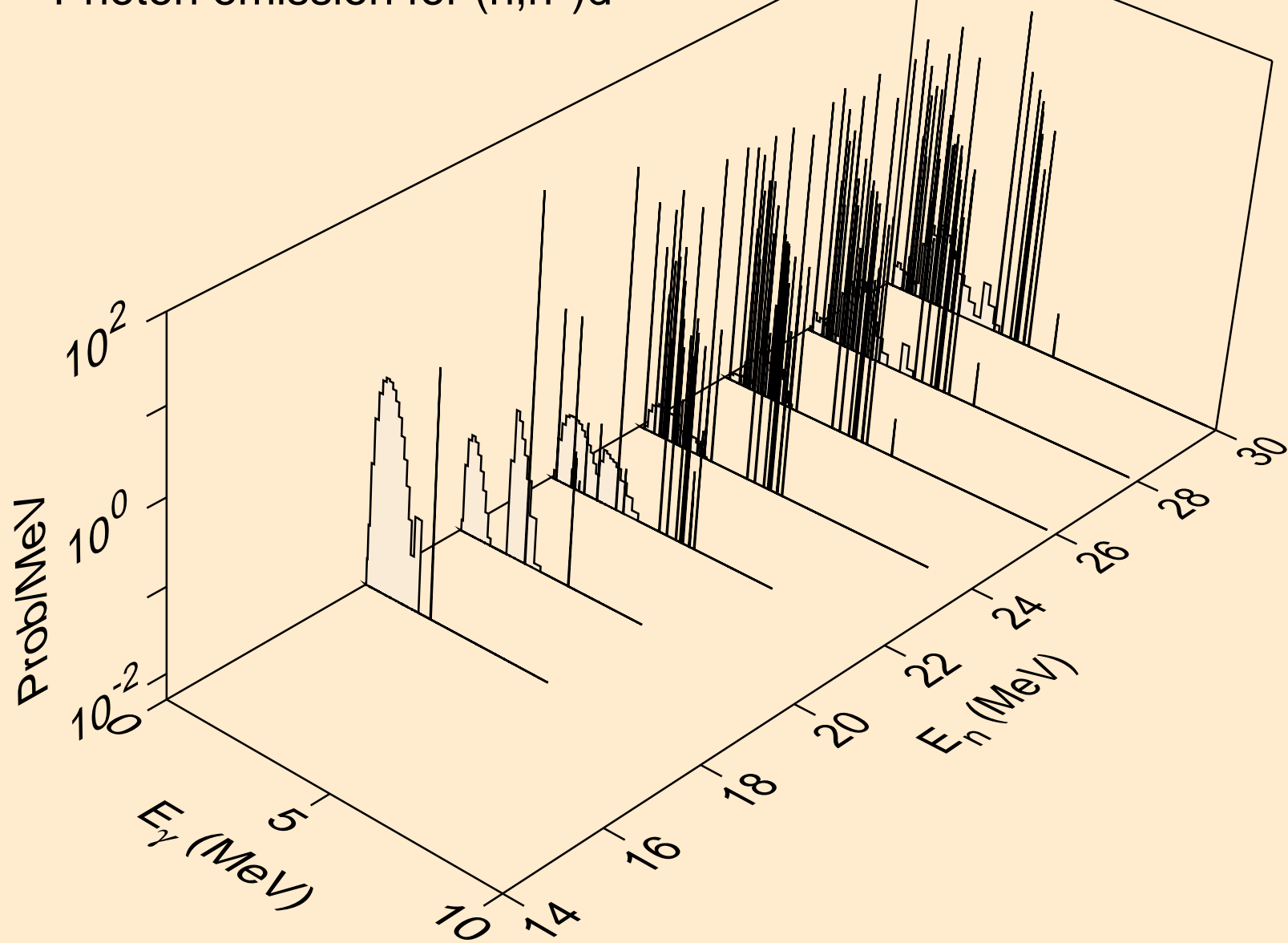

SC051 NEUTRON ACER TENDL-2024 LIBRARY; T=293.6K
Photon emission for (n,n*)t

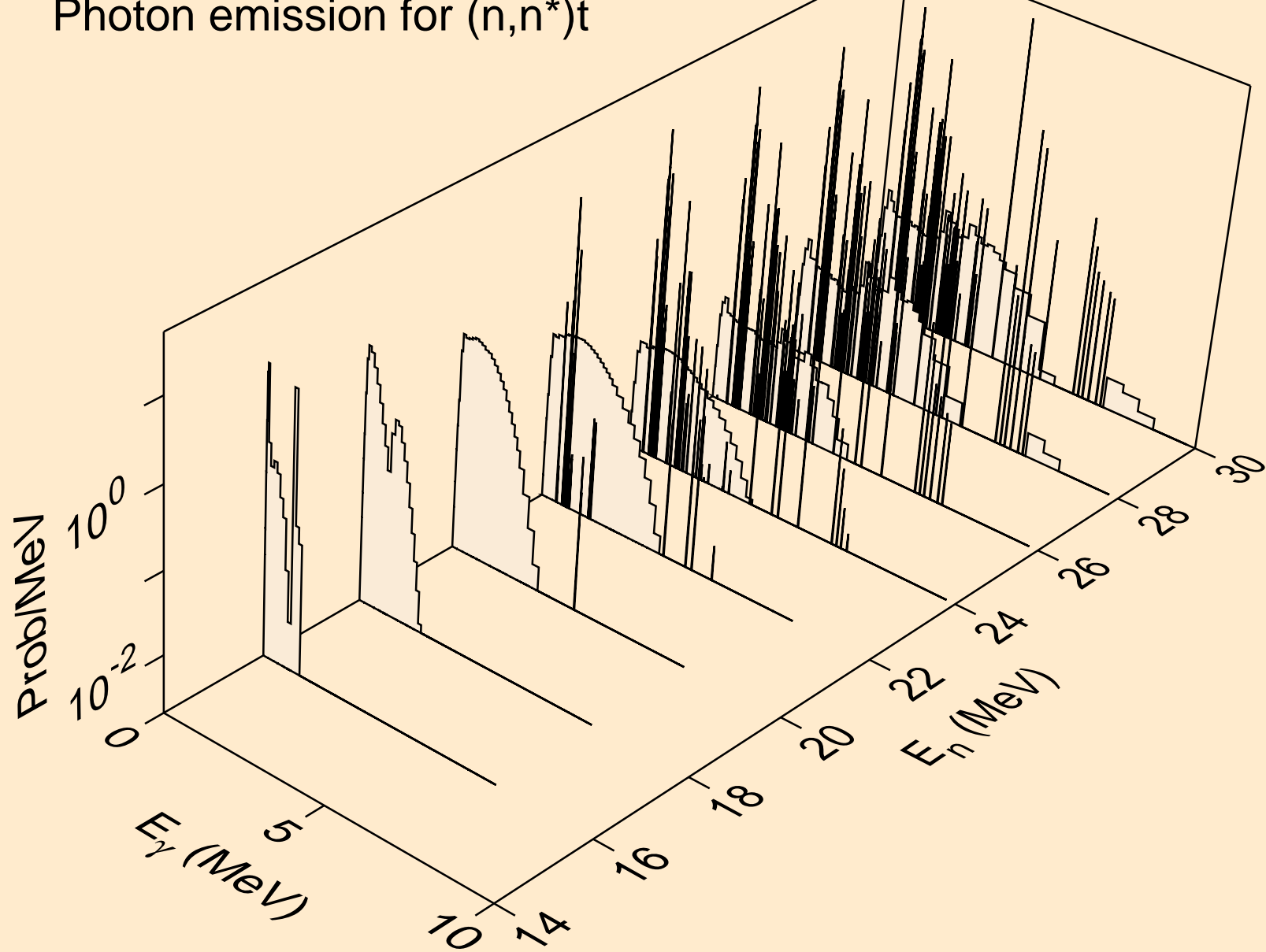

SC051 NEUTRON ACER TENDL-2024 LIBRARY; T=293.6K
Photon emission for (n,n*)he3

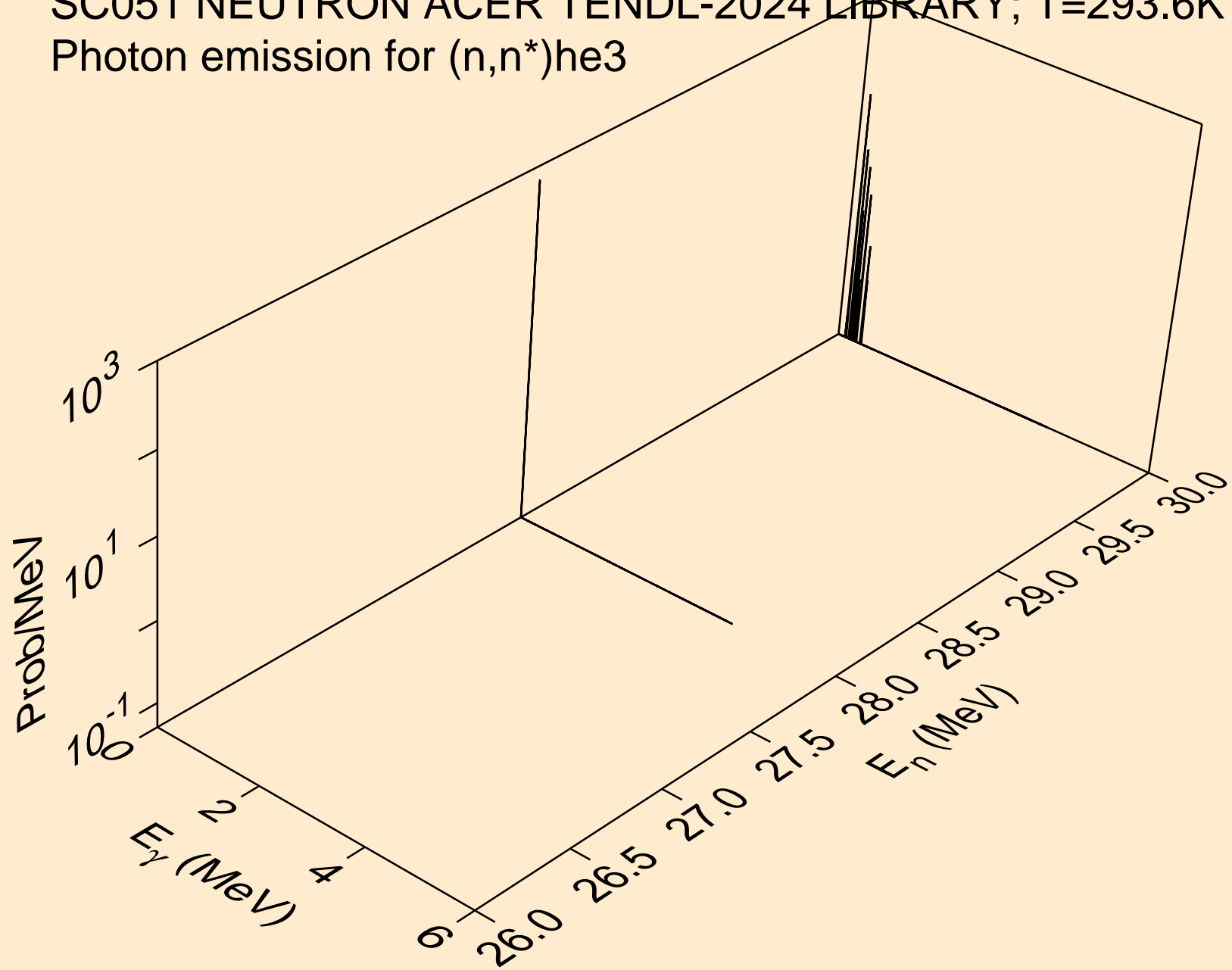

SC051 NEUTRON ACER TENDL-2024 LIBRARY; T=293.6K
Photon emission for (n,4n)

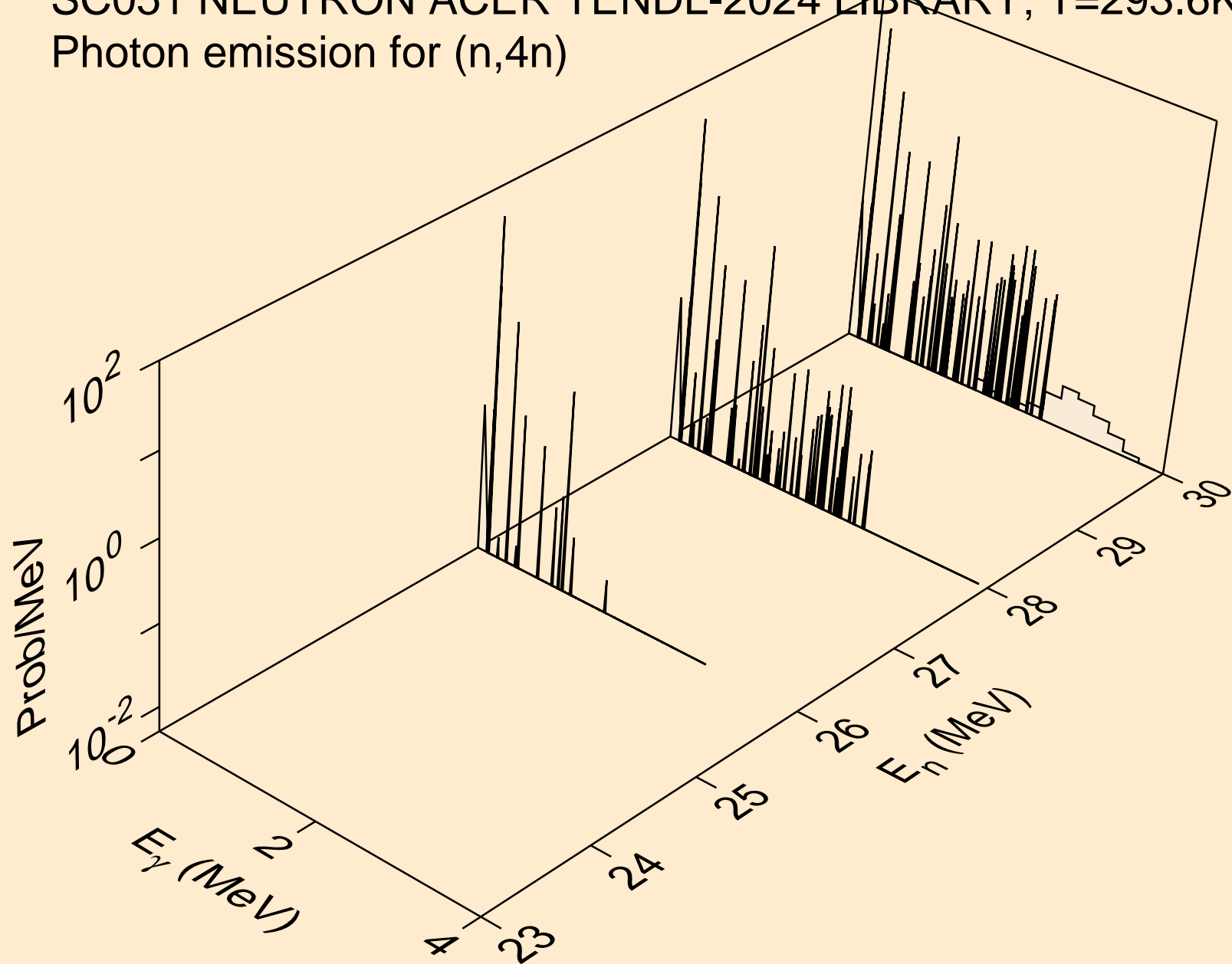

SC051 NEUTRON ACER TENDL-2024 LIBRARY; T=293.6K
Photon emission for (n,2np)

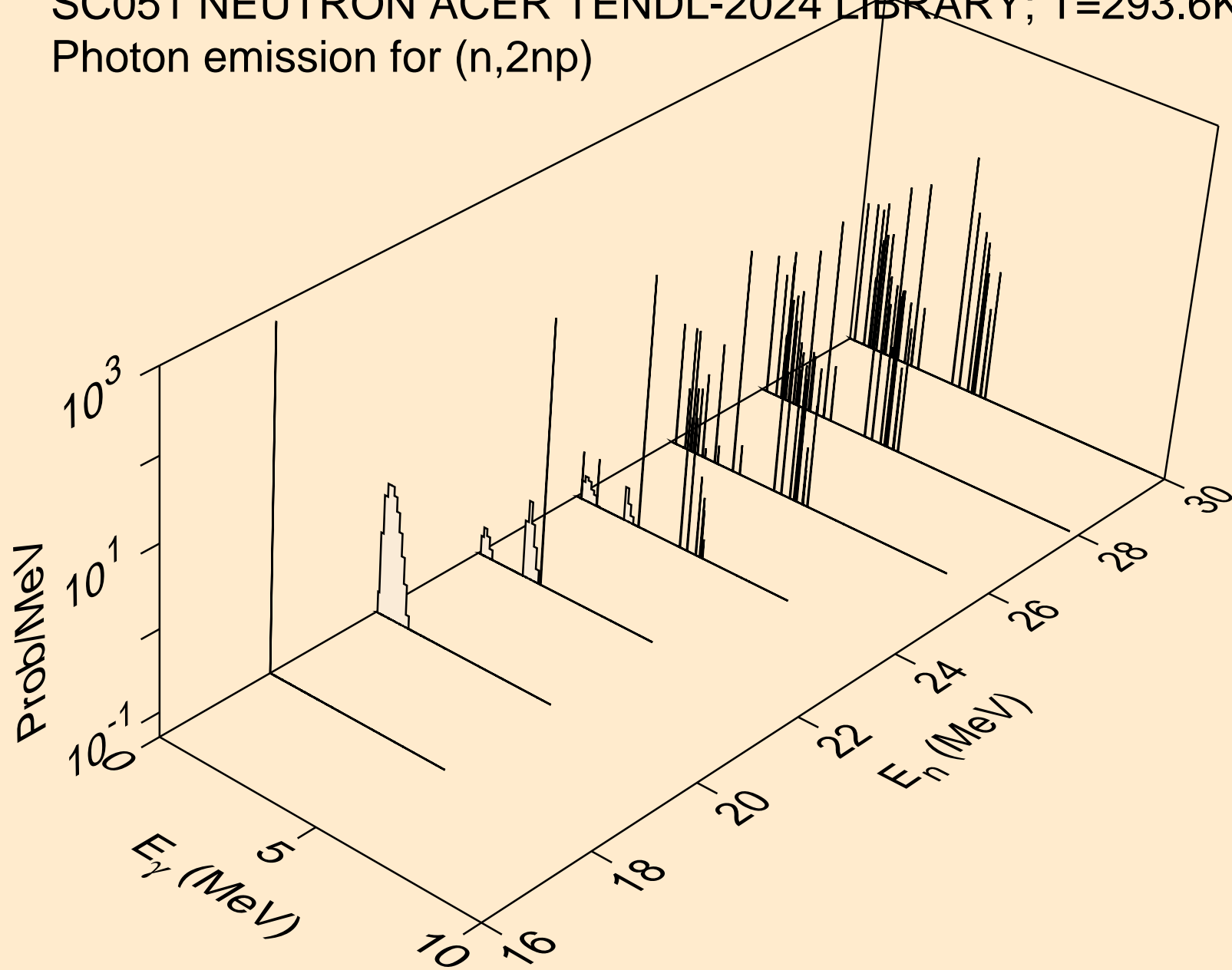

SC051 NEUTRON ACER TENDL-2024 LIBRARY; T=293.6K
Photon emission for (n,3np)

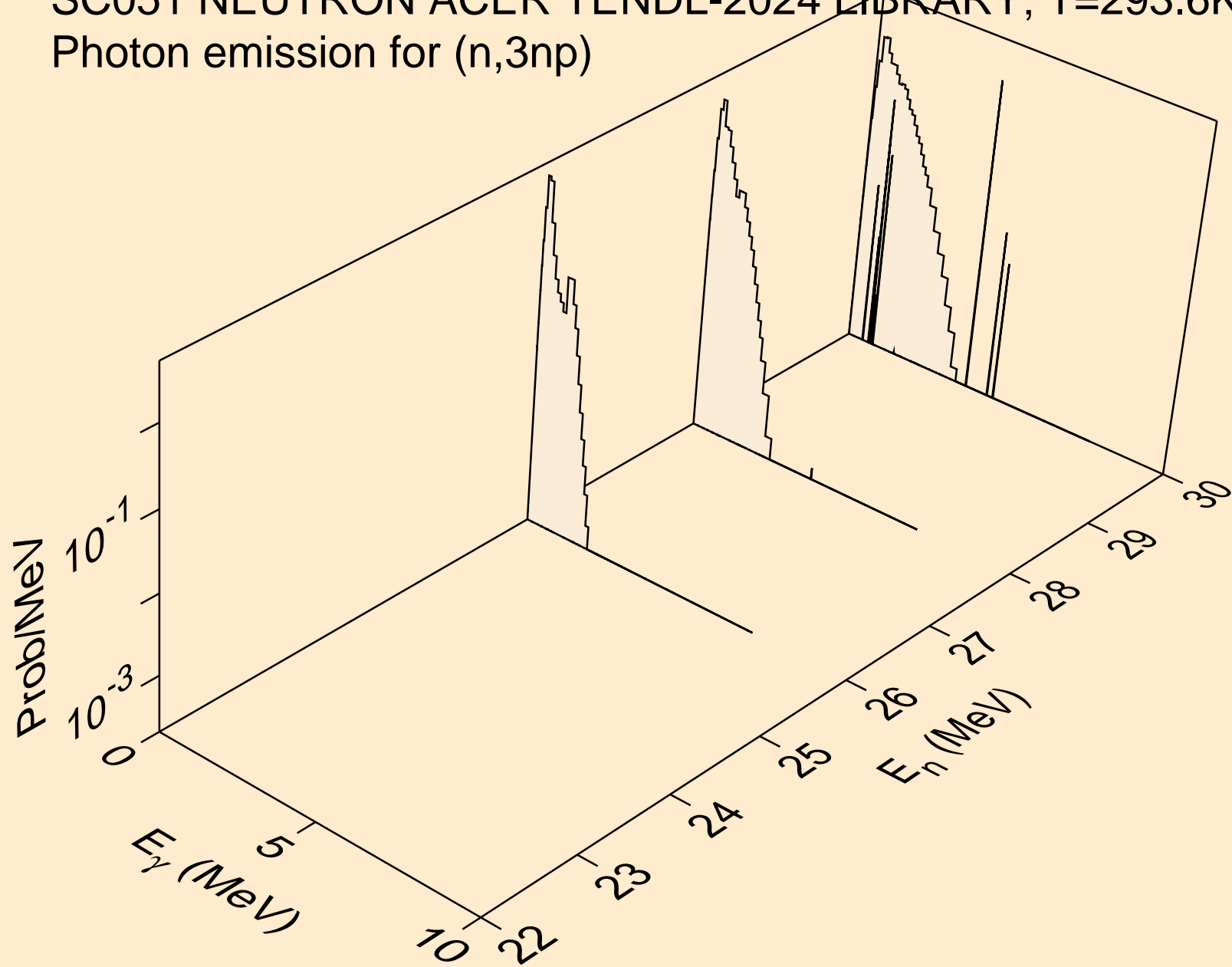

SC051 NEUTRON ACER TENDL-2024 LIBRARY; T=293.6K
Photon emission for (n,n*c)

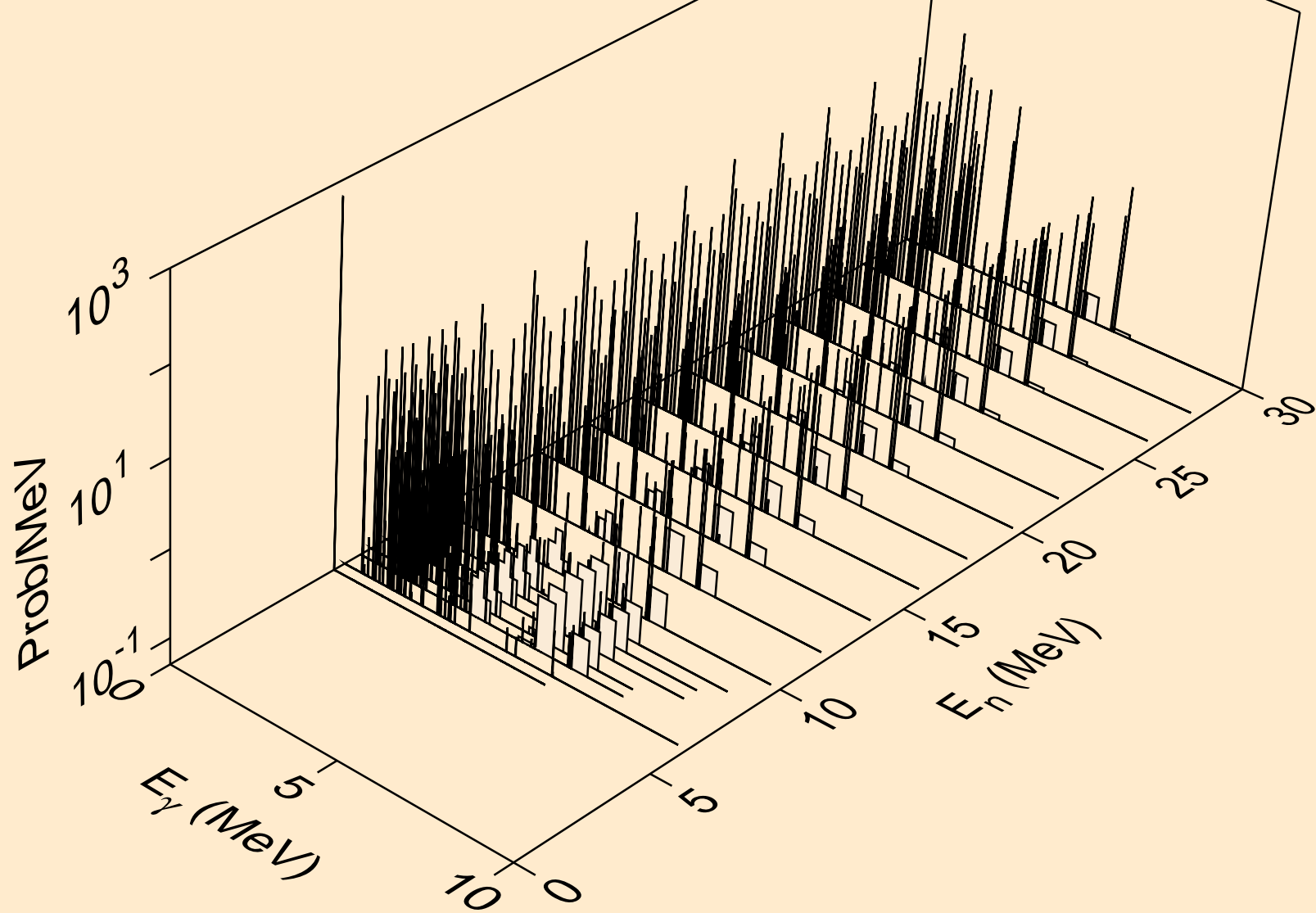

SC051 NEUTRON ACER TENDL-2024 LIBRARY; T=293.6K
Photon emission for (n,gma)

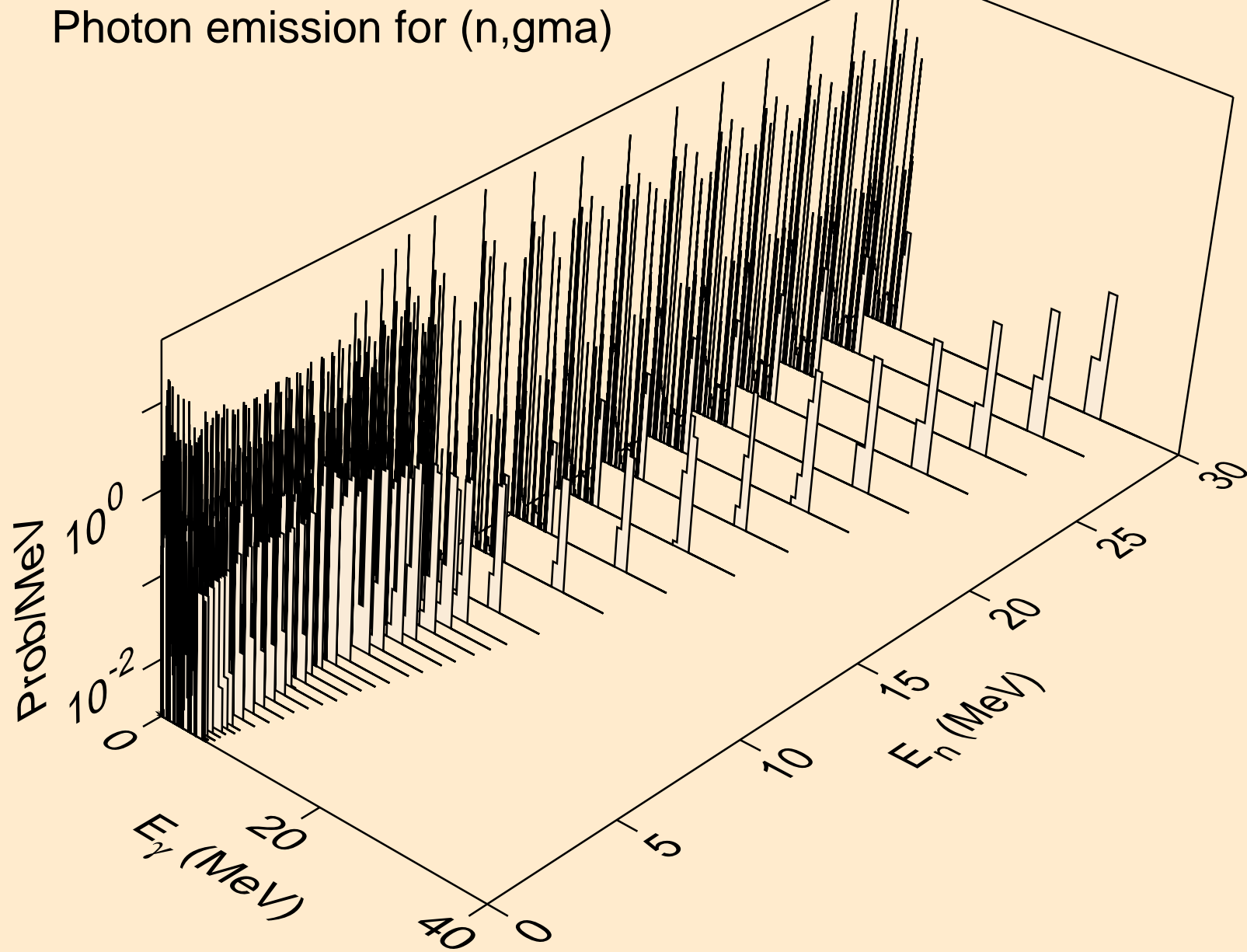

SC051 NEUTRON ACER TENDL-2024 LIBRARY; T=293.6K
Photon emission for (n,p)

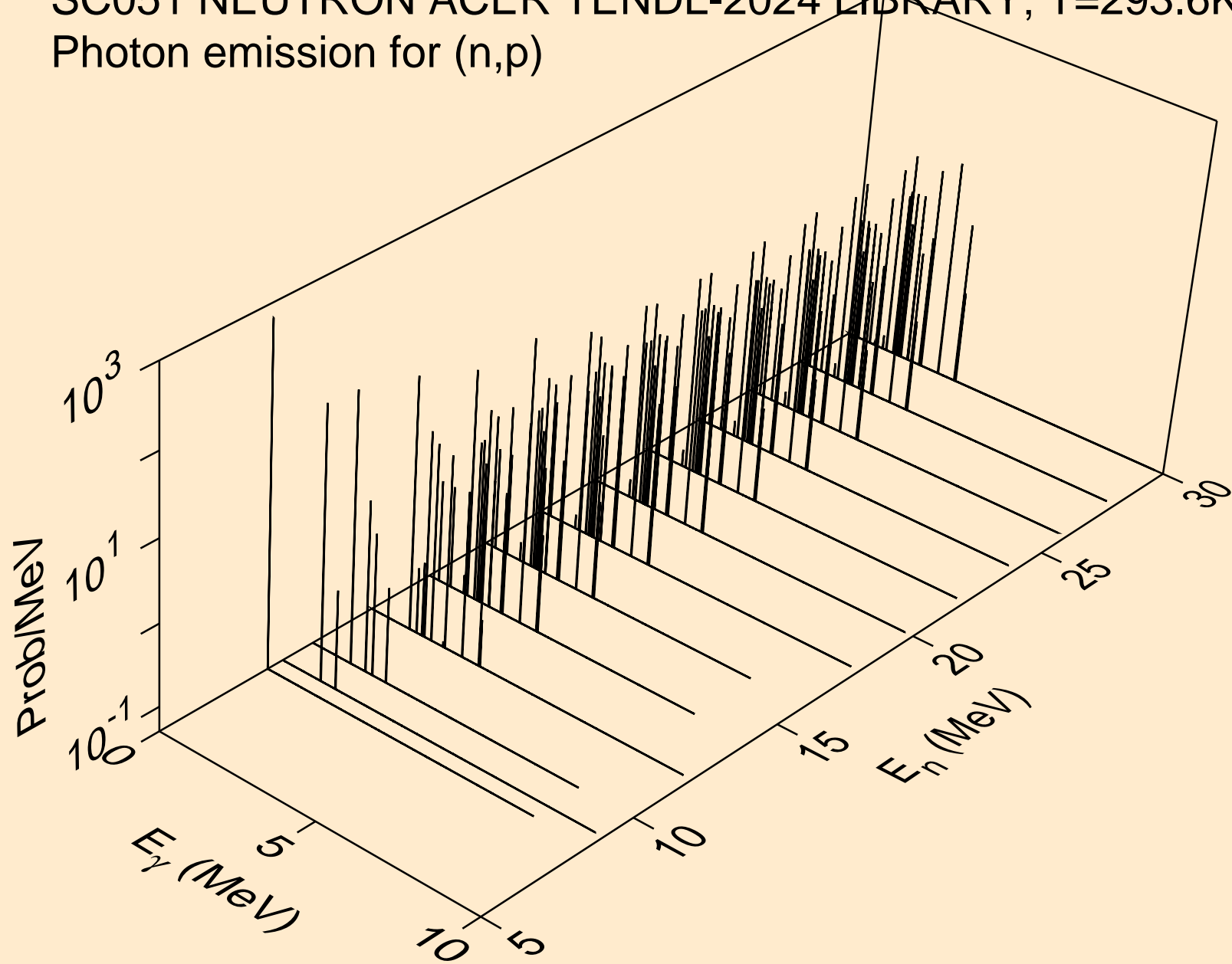

SC051 NEUTRON ACER TENDL-2024 LIBRARY; T=293.6K
Photon emission for (n,d)

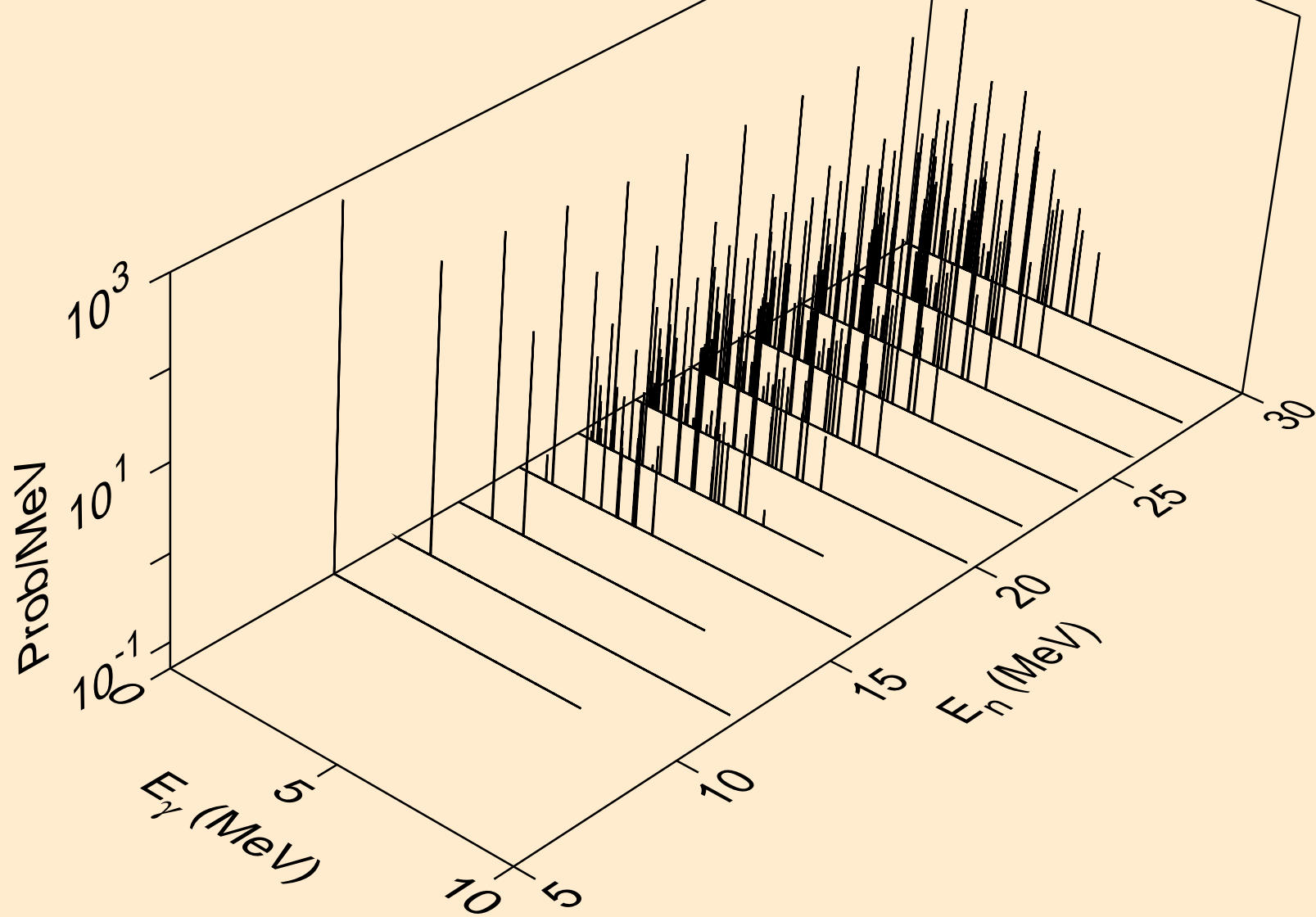

SC051 NEUTRON ACER TENDL-2024 LIBRARY; T=293.6K
Photon emission for (n,t)

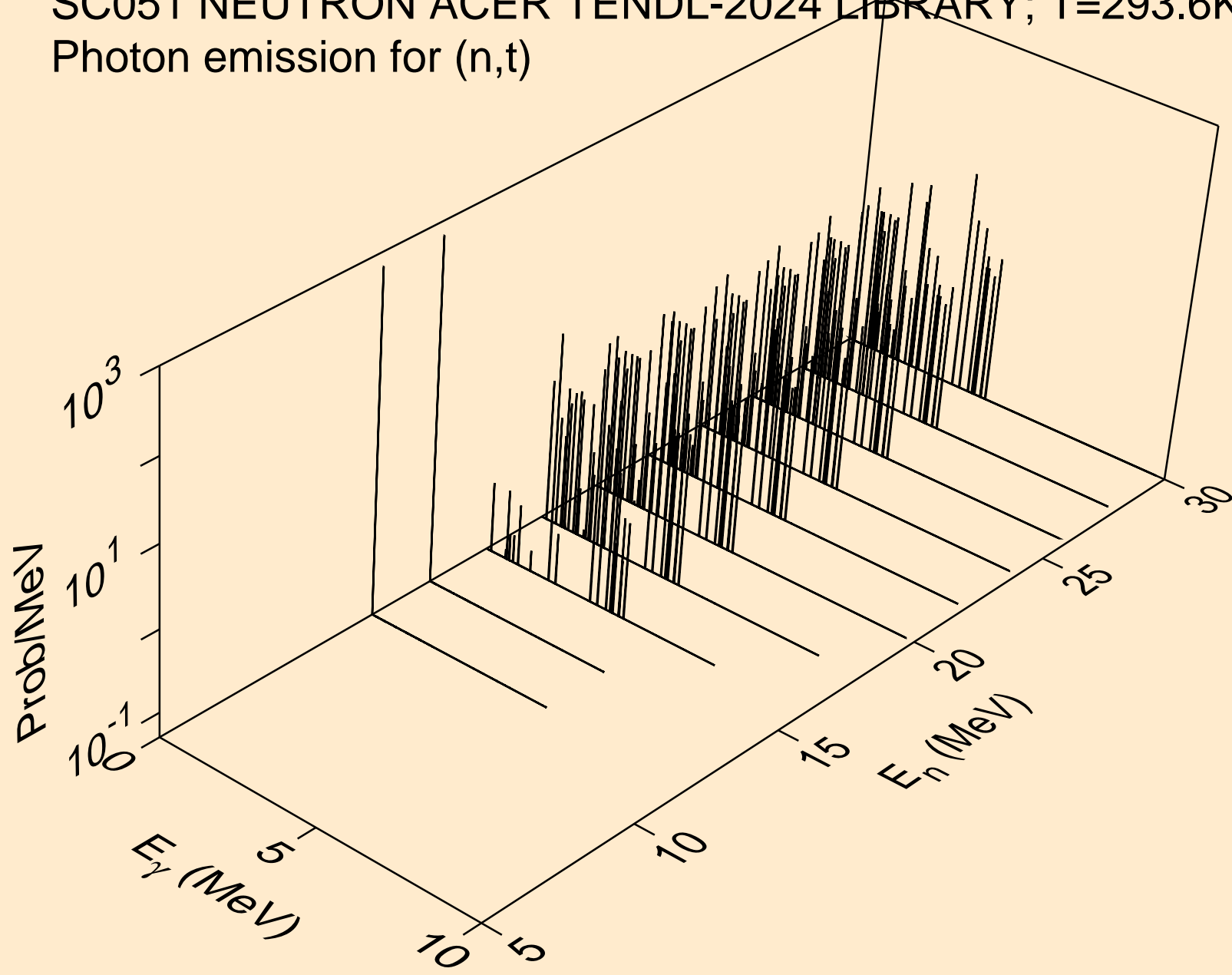

SC051 NEUTRON ACER TENDL-2024 LIBRARY; T=293.6K
Photon emission for (n,he3)

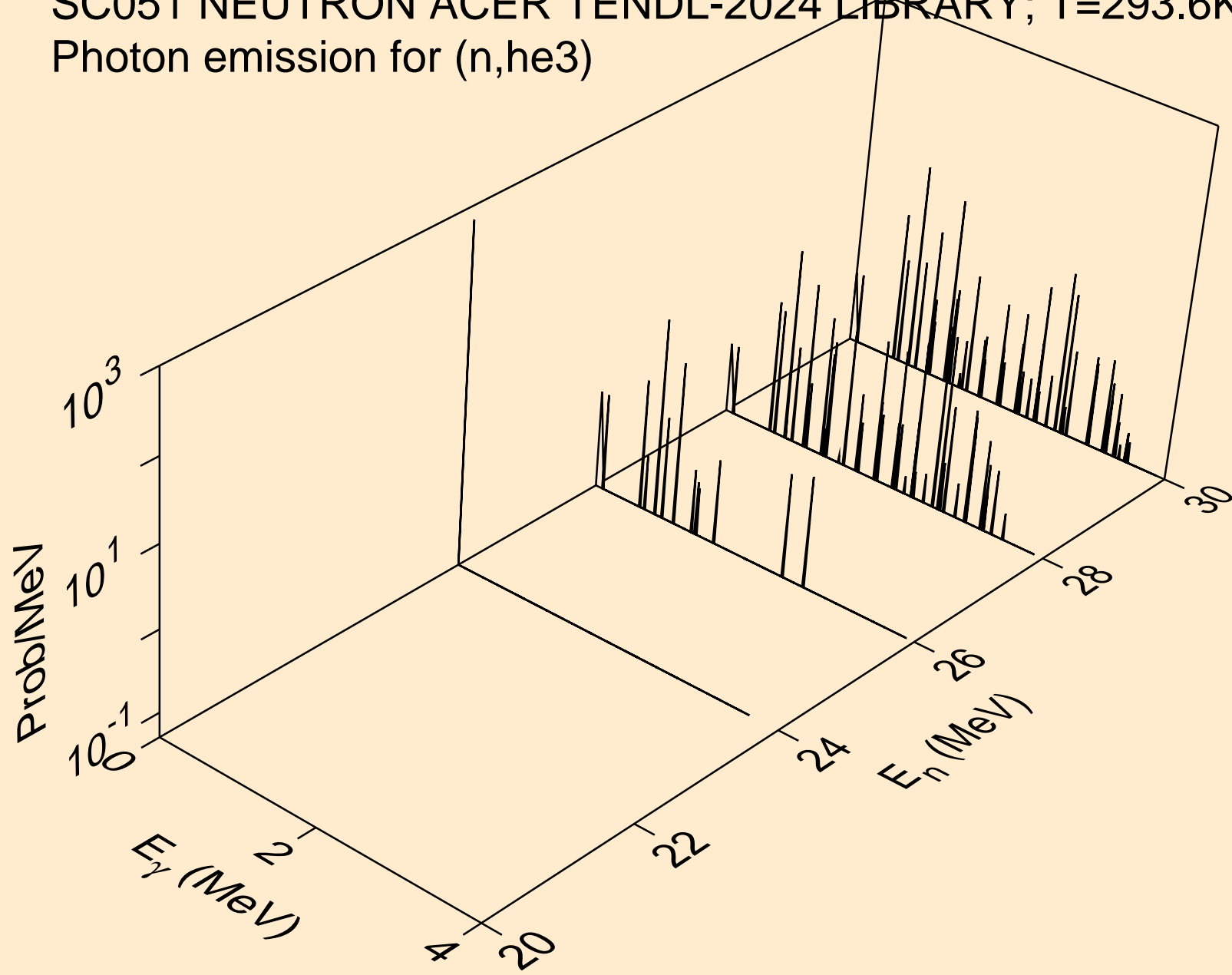

SC051 NEUTRON ACER TENDL-2024 LIBRARY; T=293.6K
Photon emission for (n,a)

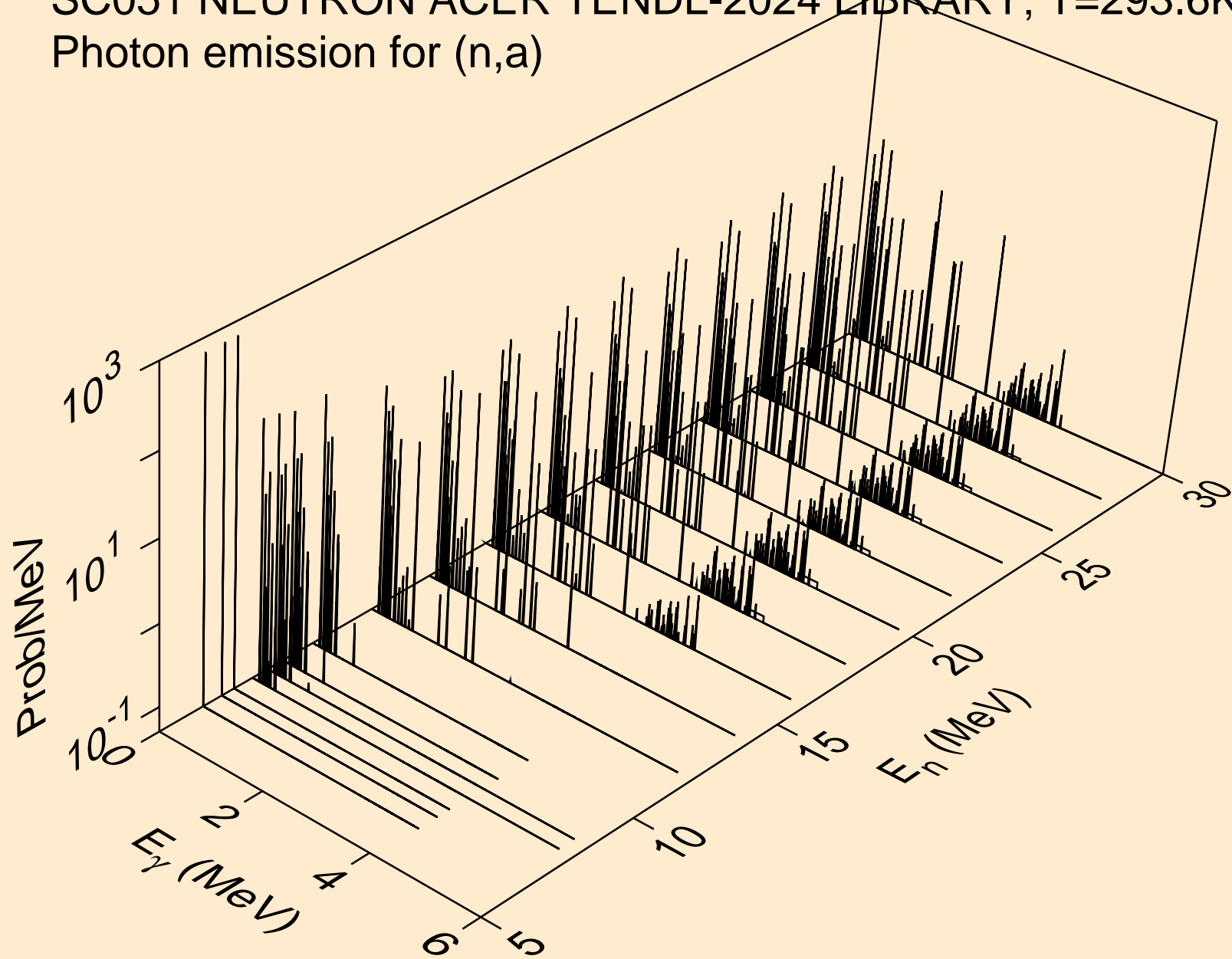

SC051 NEUTRON ACER TENDL-2024 LIBRARY; T=293.6K
Photon emission for (n,2p)

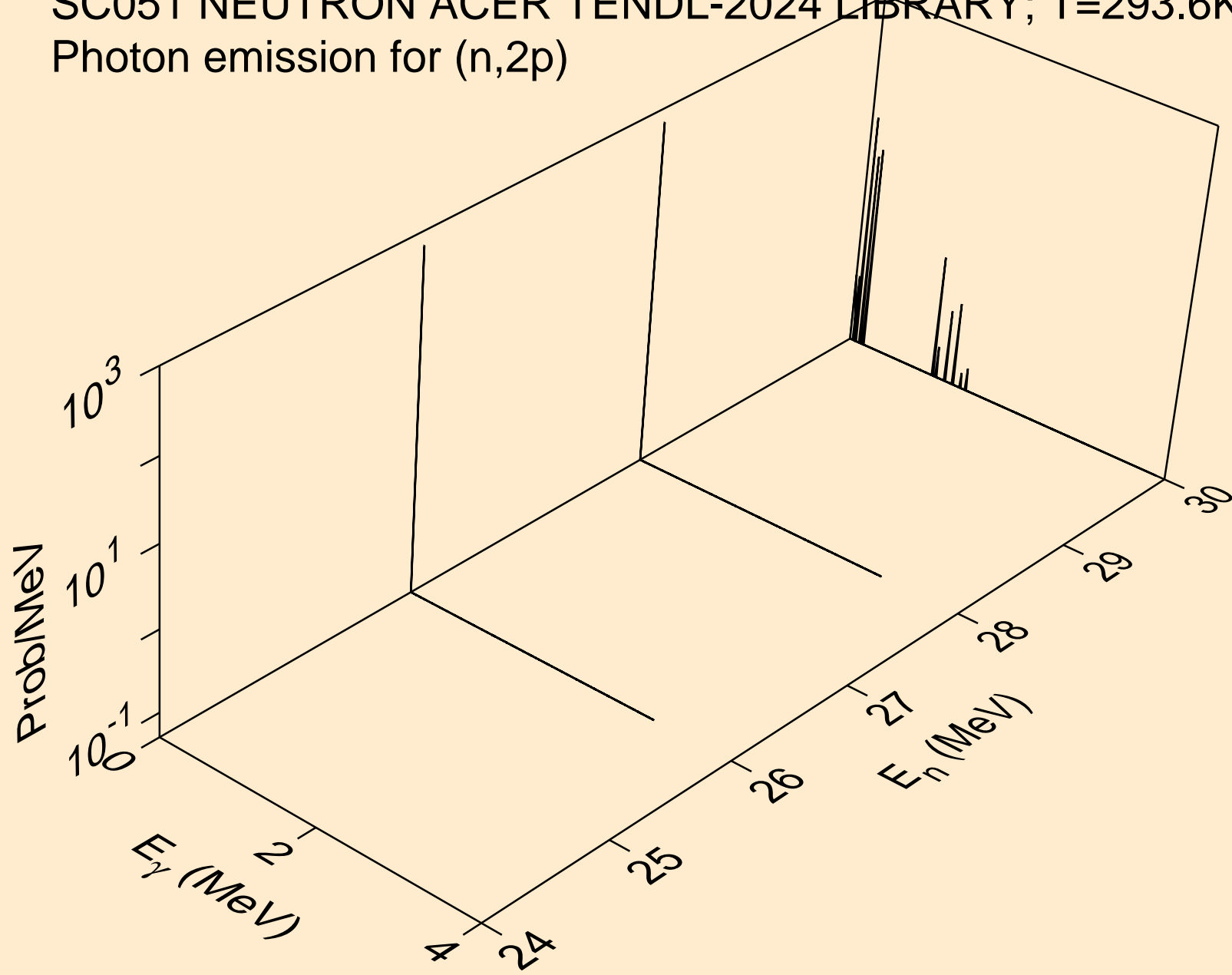

SC051 NEUTRON ACER TENDL-2024 LIBRARY; T=293.6K
Photon emission for (n,p α)

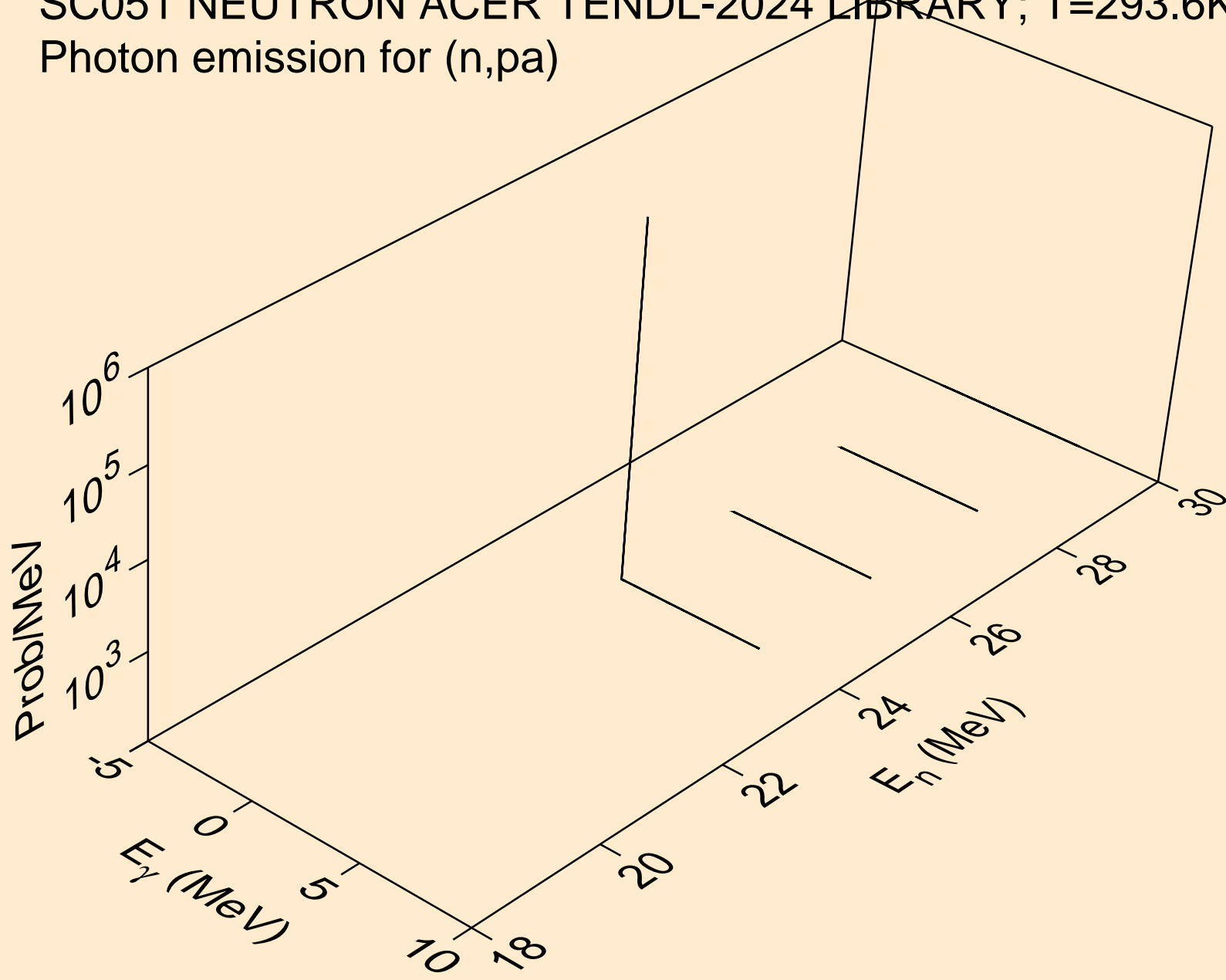

SC051 NEUTRON ACER TENDL-2024 LIBRARY; T=293.6K
Photon emission for (n,da)

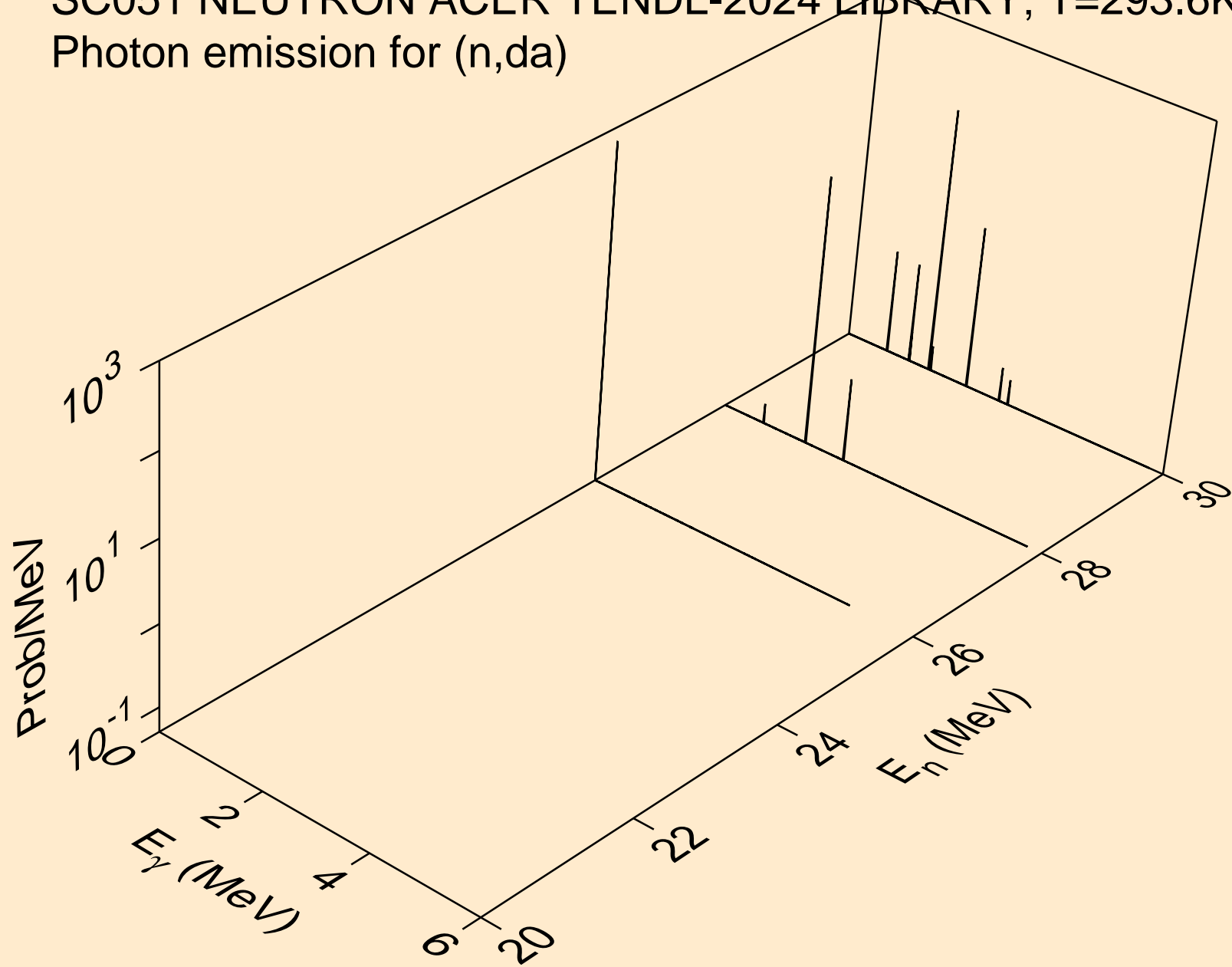

SC051 NEUTRON ACER TENDL-2024 LIBRARY; T=293.6K
thermal capture photon spectrum

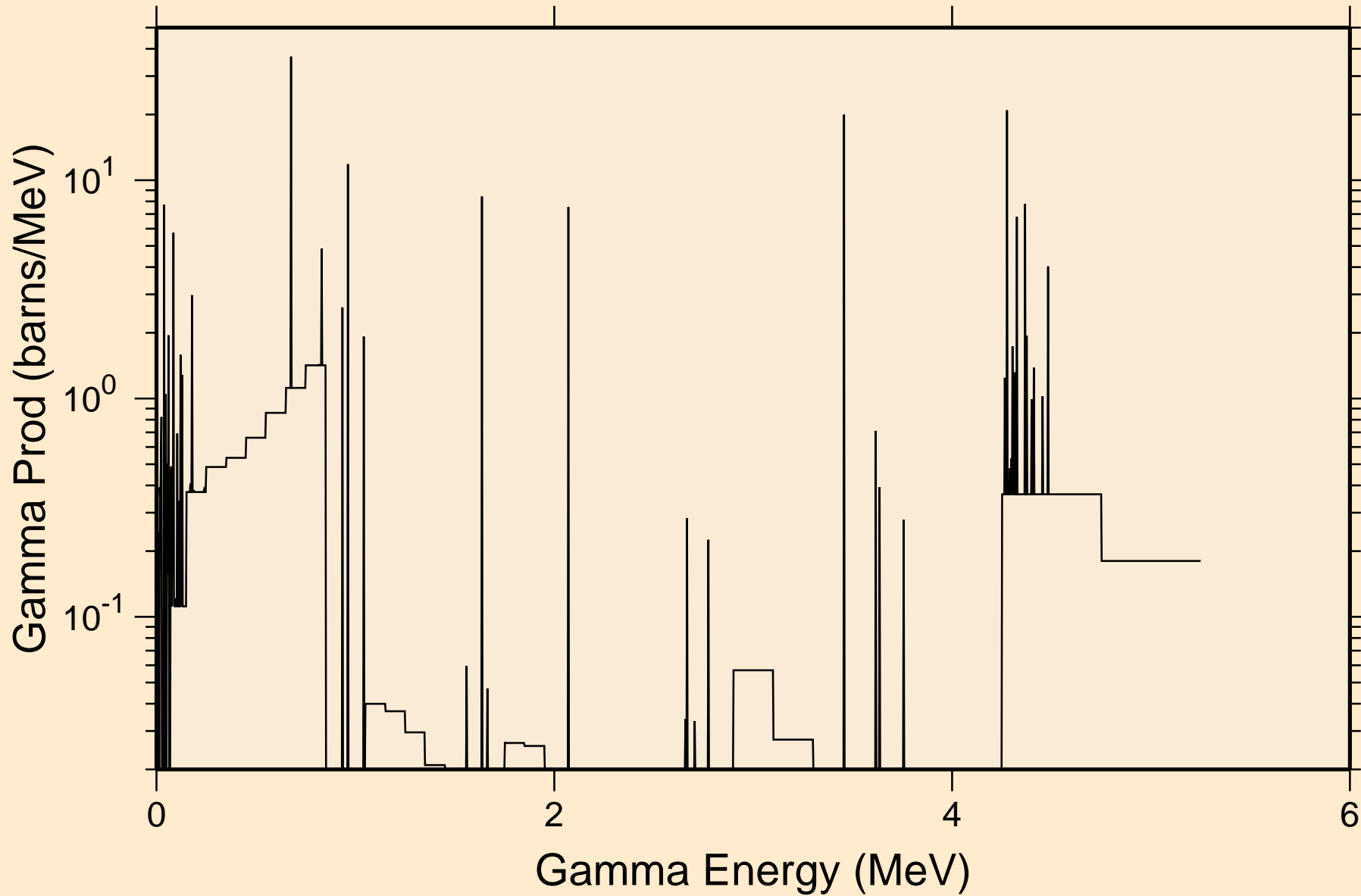

SC051 NEUTRON ACER TENDL-2024 LIBRARY; T=293.6K
14 MeV photon spectrum

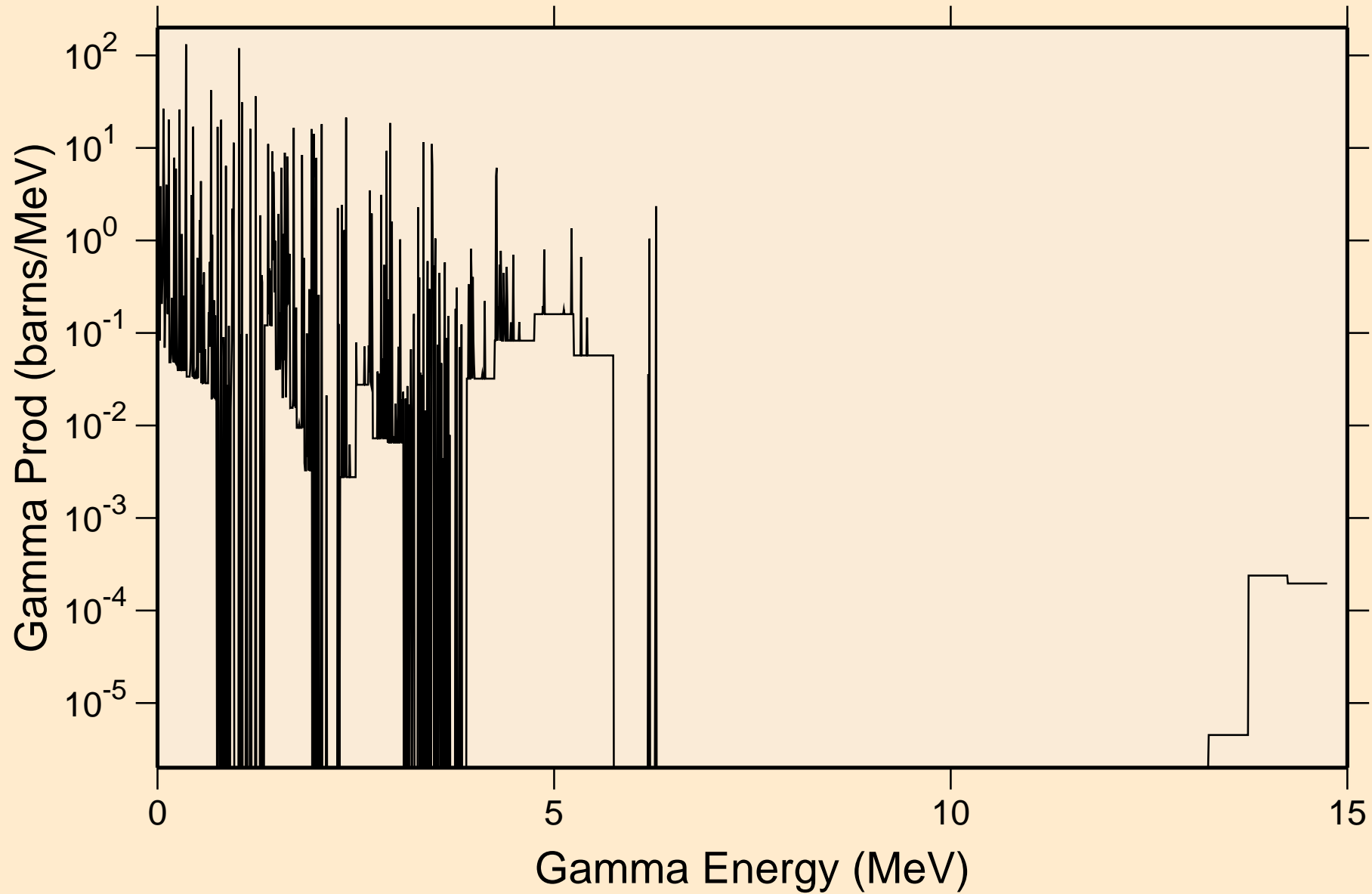

SC051 NEUTRON ACER TENDL-2024 LIBRARY; T=293.6K
Particle heating contributions

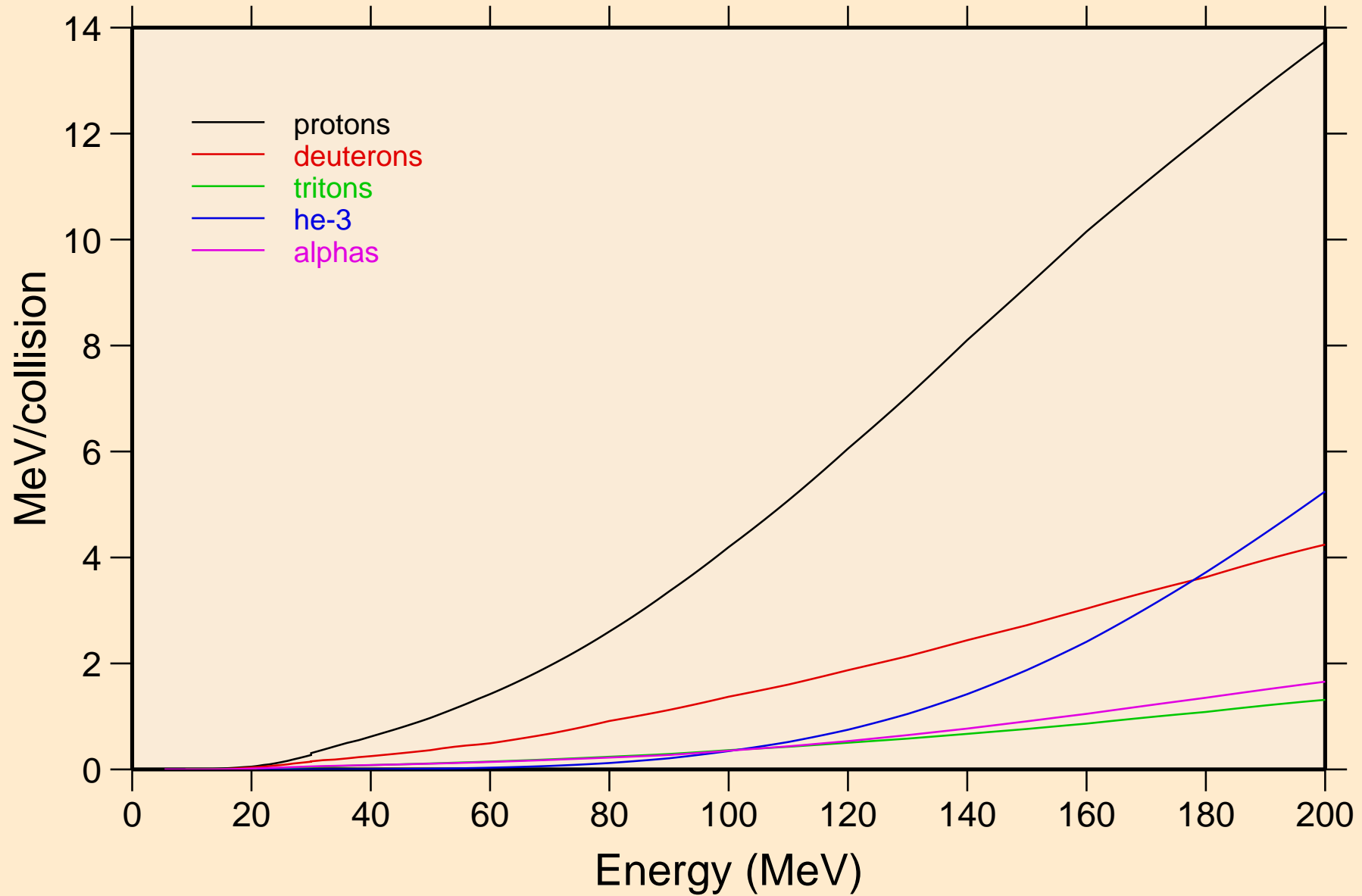

SC051 NEUTRON ACER TENDL-2024 LIBRARY; T=293.6K
Recoil Heating

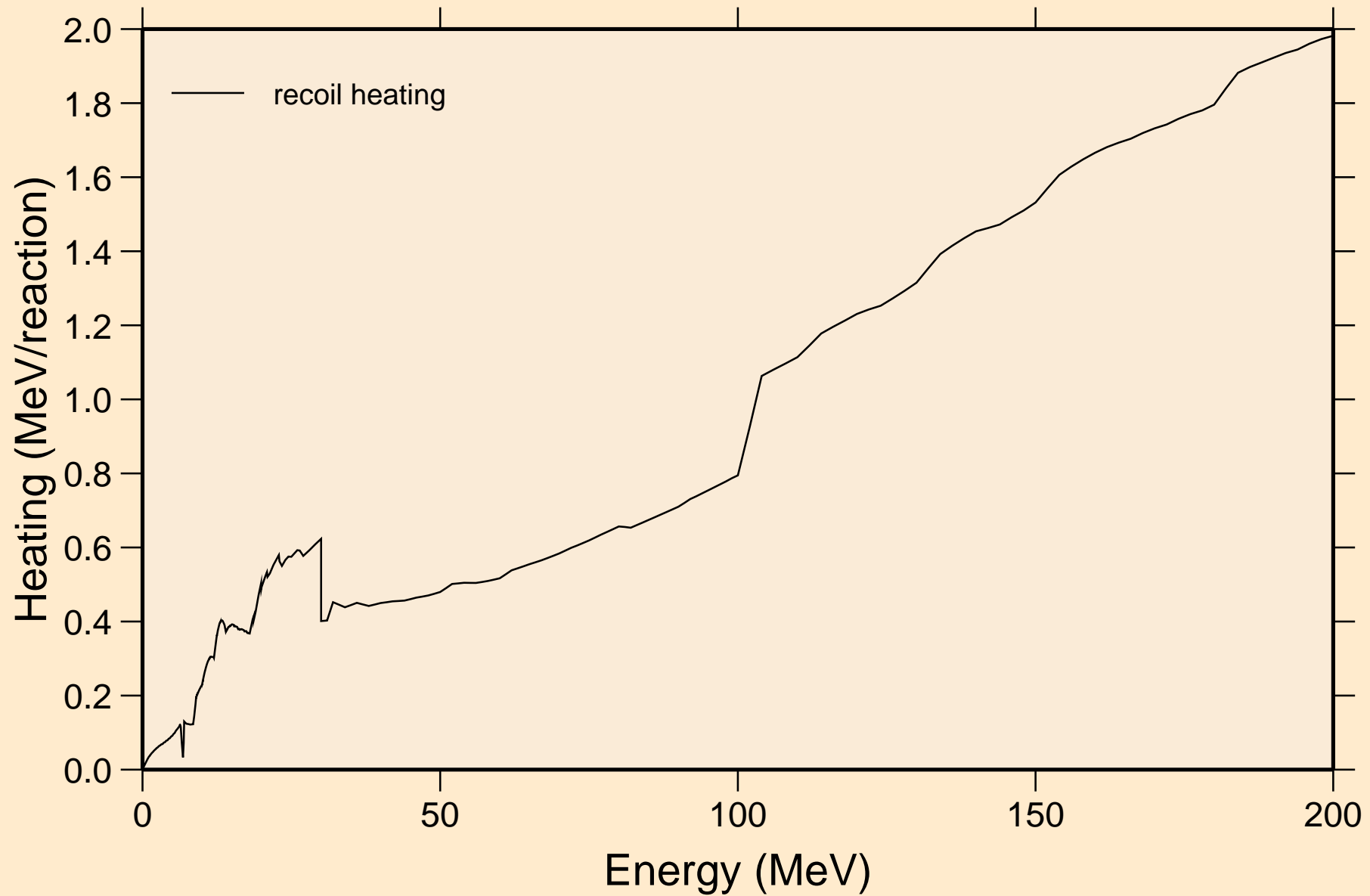

SC051 NEUTRON ACER TENDL-2024 LIBRARY; T=293.6K

Particle production cross sections

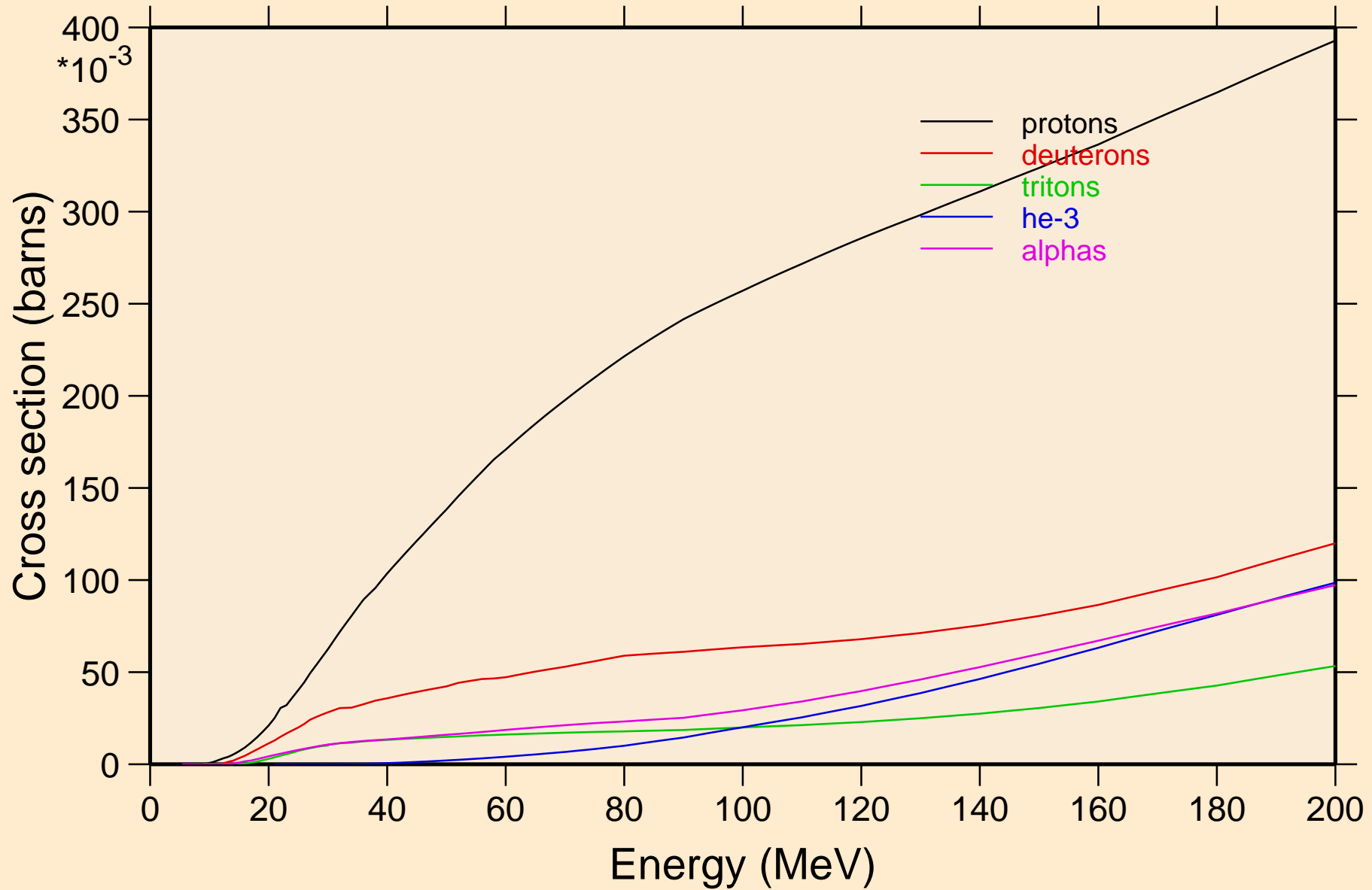

SC051 NEUTRON ACER TENDL-2024 LIBRARY; T=293.6K
protons from (n,x)

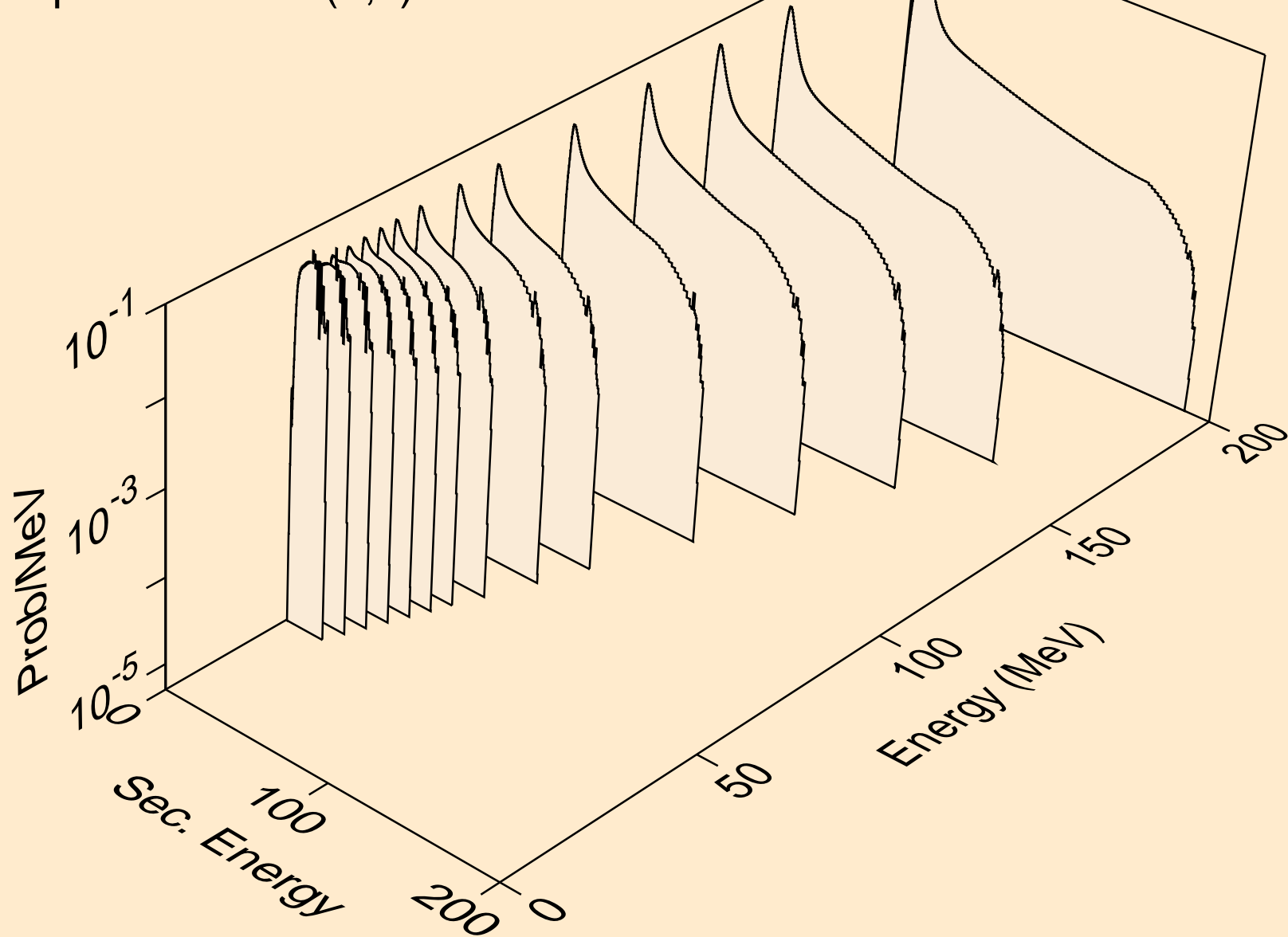

SC051 NEUTRON ACER TENDL-2024 LIBRARY; T=293.6K
protons from (n,n*)p

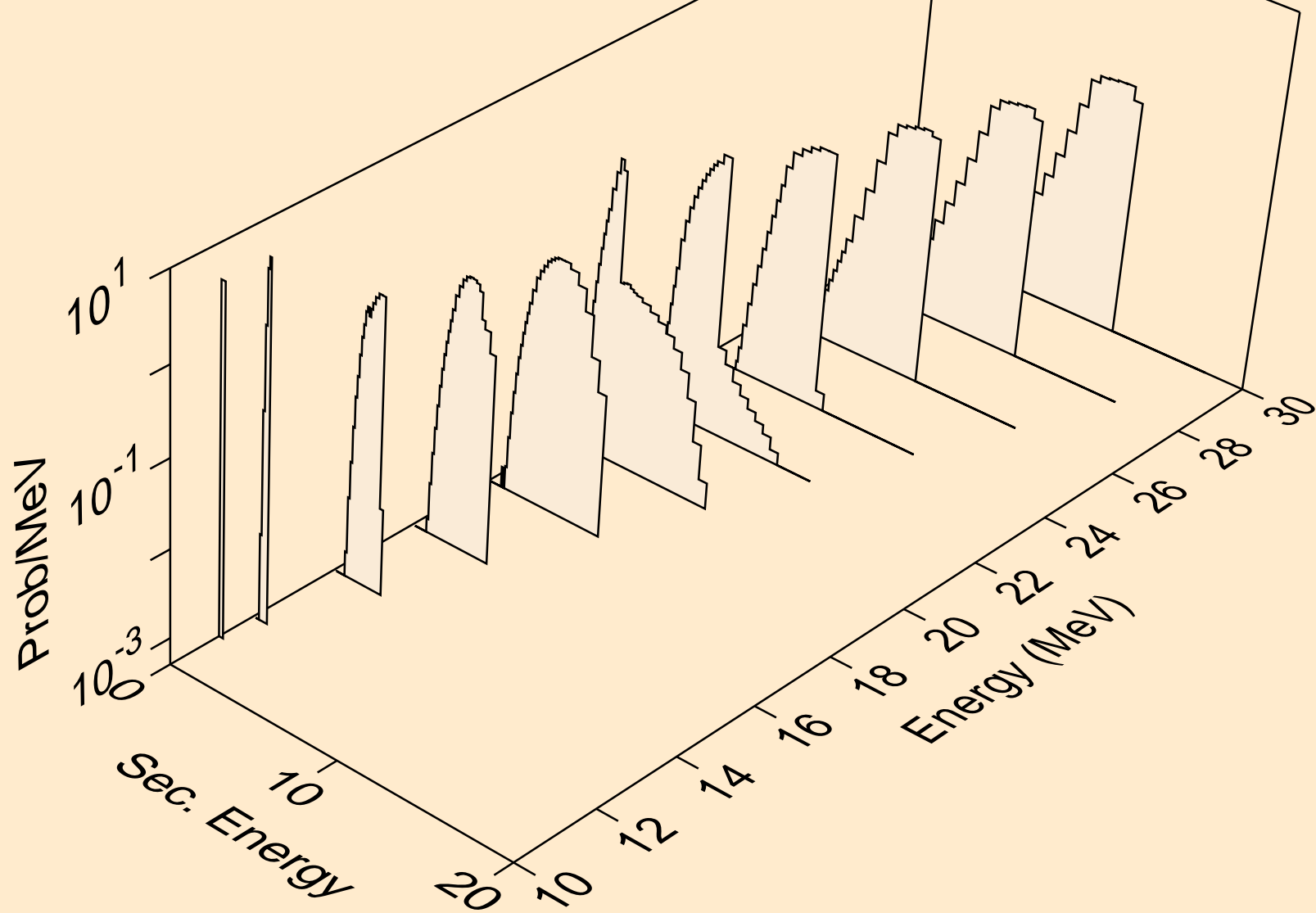

SC051 NEUTRON ACER TENDL-2024 LIBRARY; T=293.6K
protons from (n,2np)

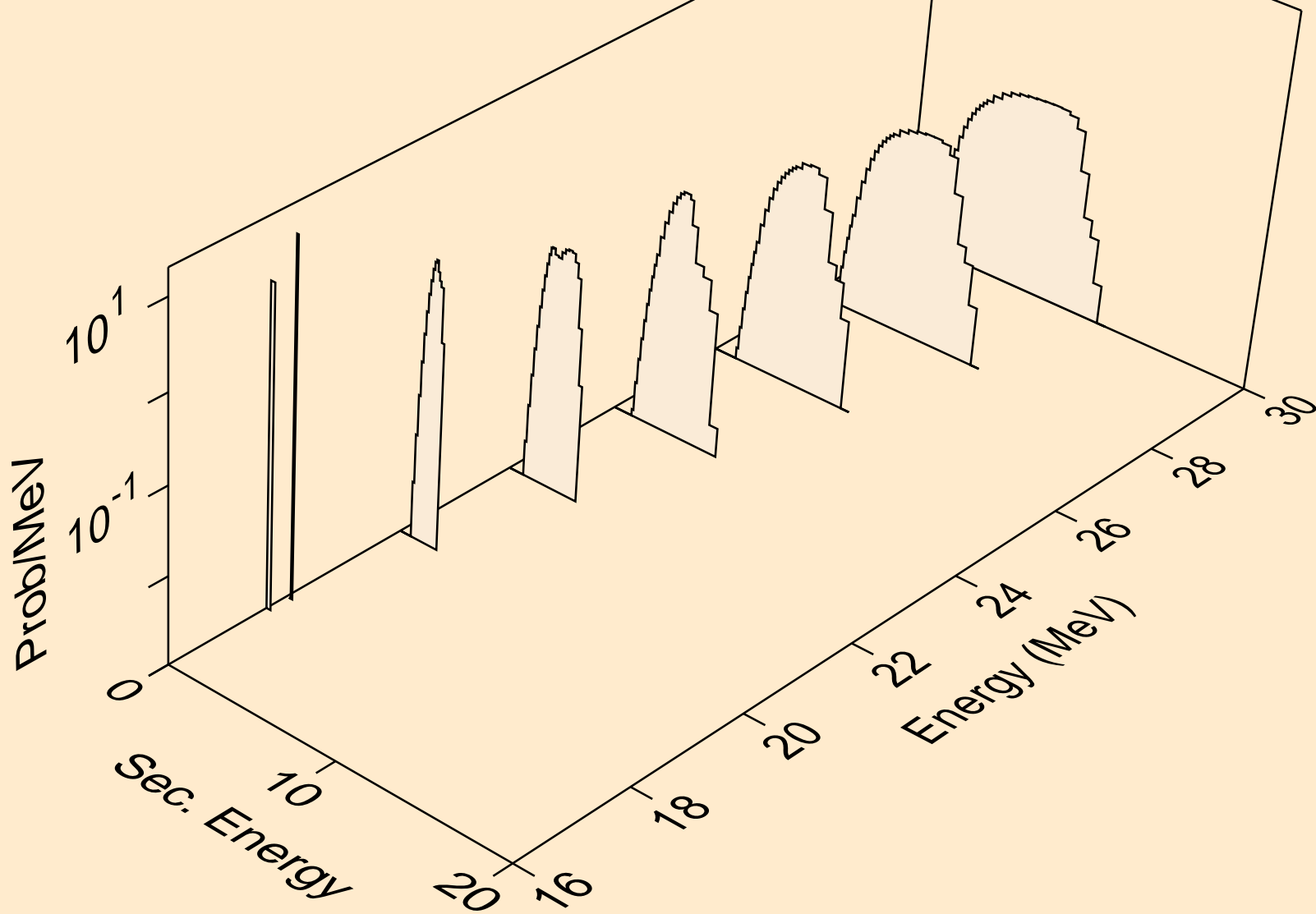

SC051 NEUTRON ACER TENDL-2024 LIBRARY; T=293.6K
protons from (n,3np)

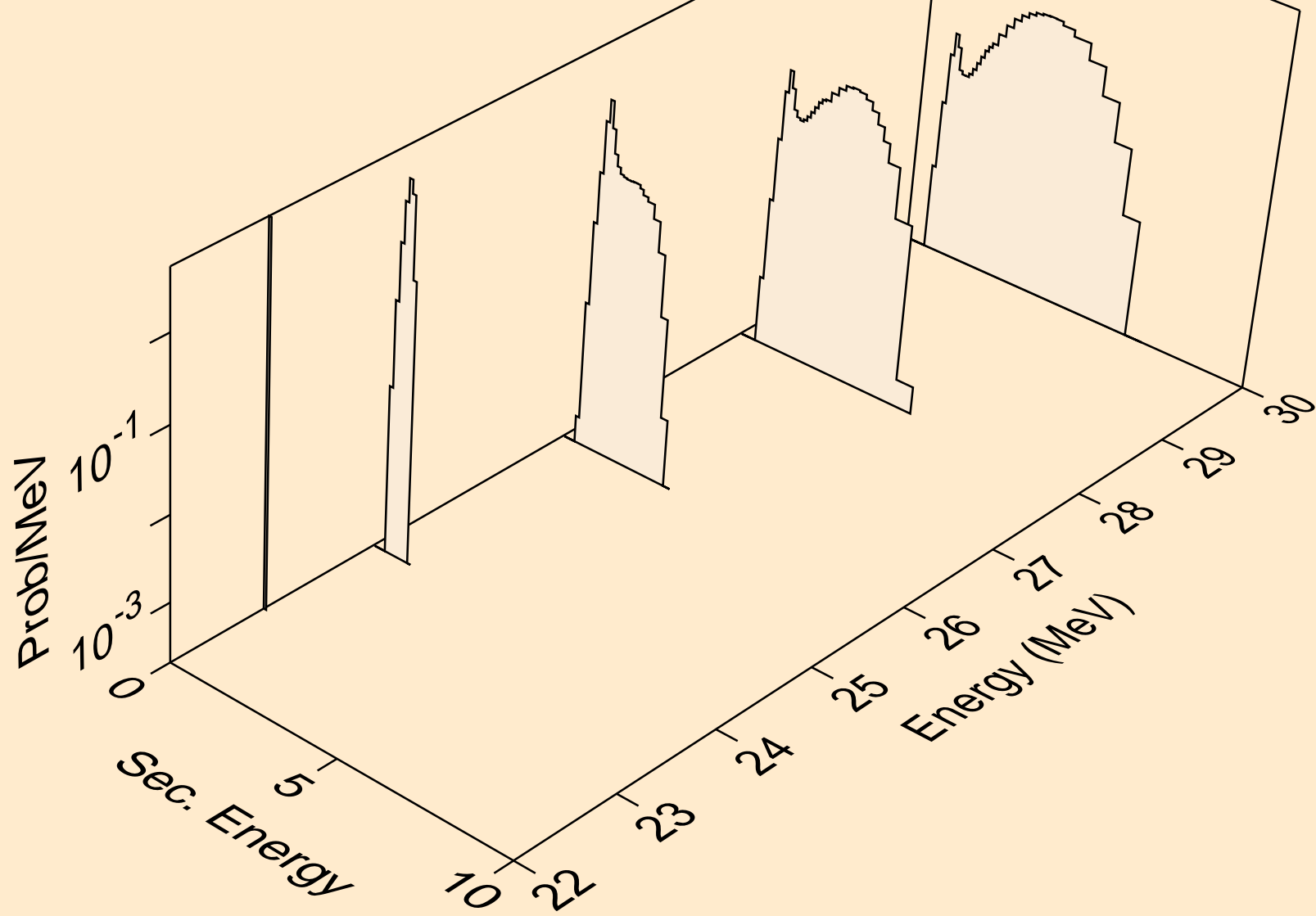

SC051 NEUTRON ACER TENDL-2024 LIBRARY; T=293.6K
protons from (n,p)

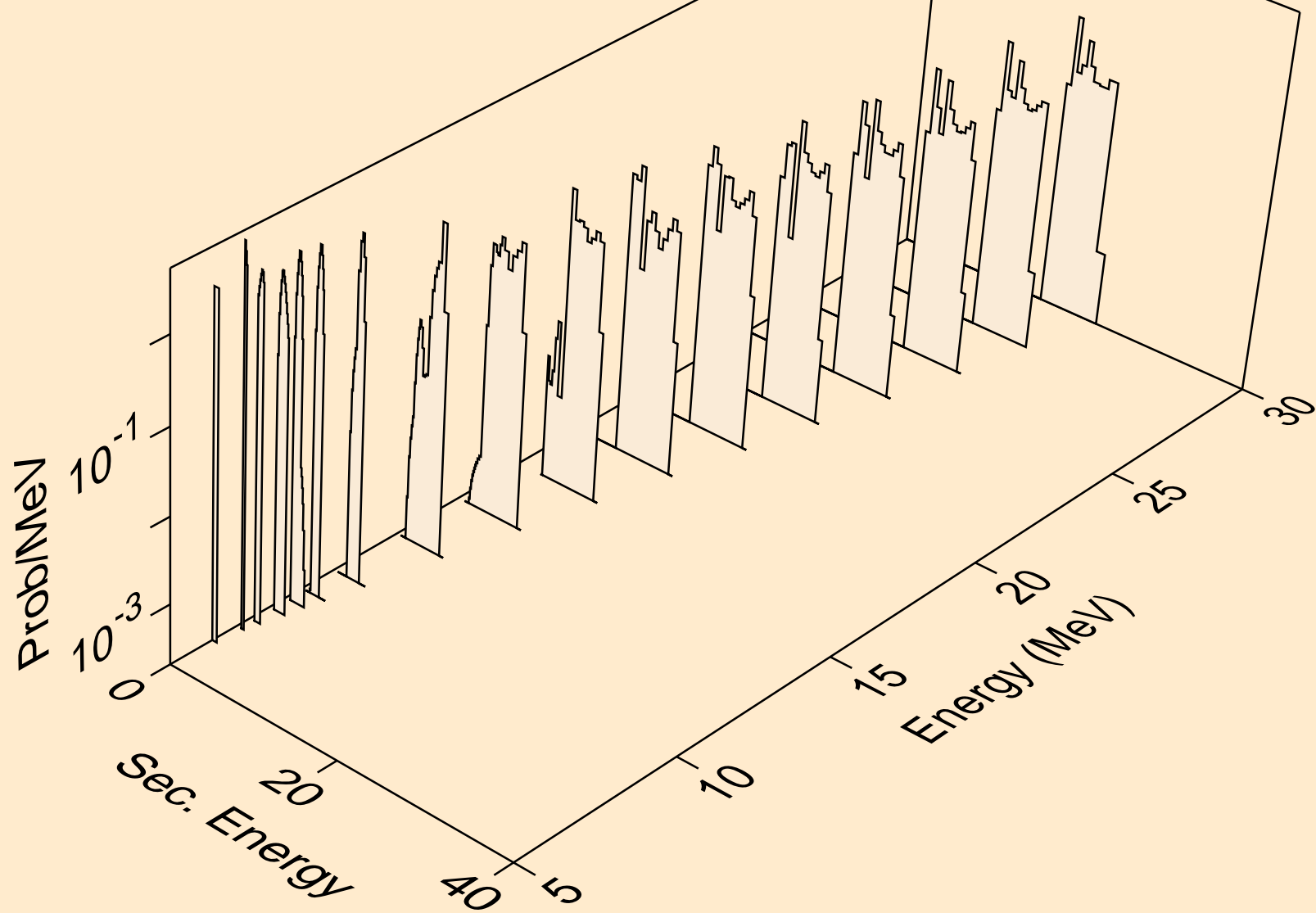

SC051 NEUTRON ACER TENDL-2024 LIBRARY; T=293.6K
protons from (n,2p)

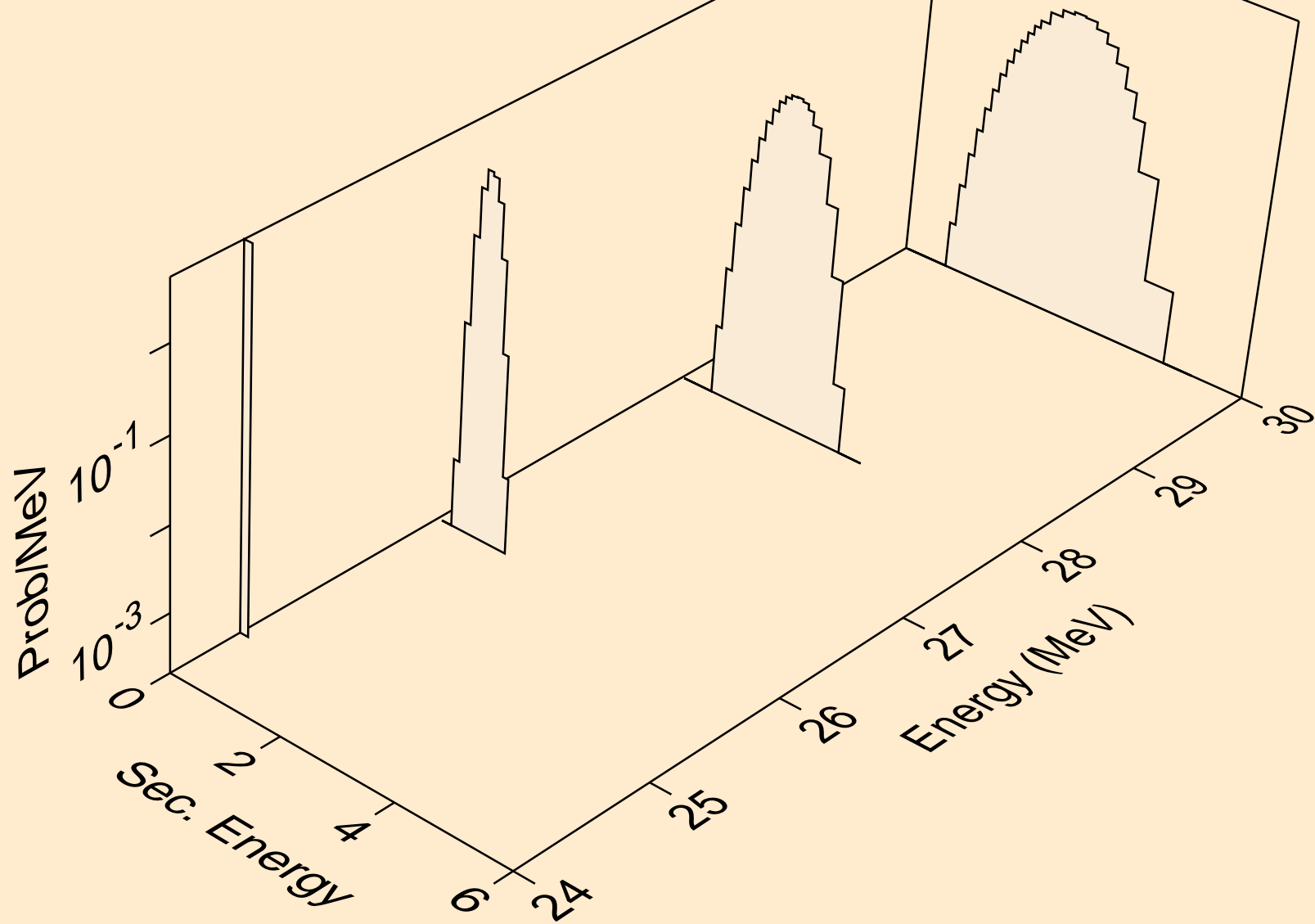

SC051 NEUTRON ACER TENDL-2024 LIBRARY; T=293.6K
protons from (n,p)

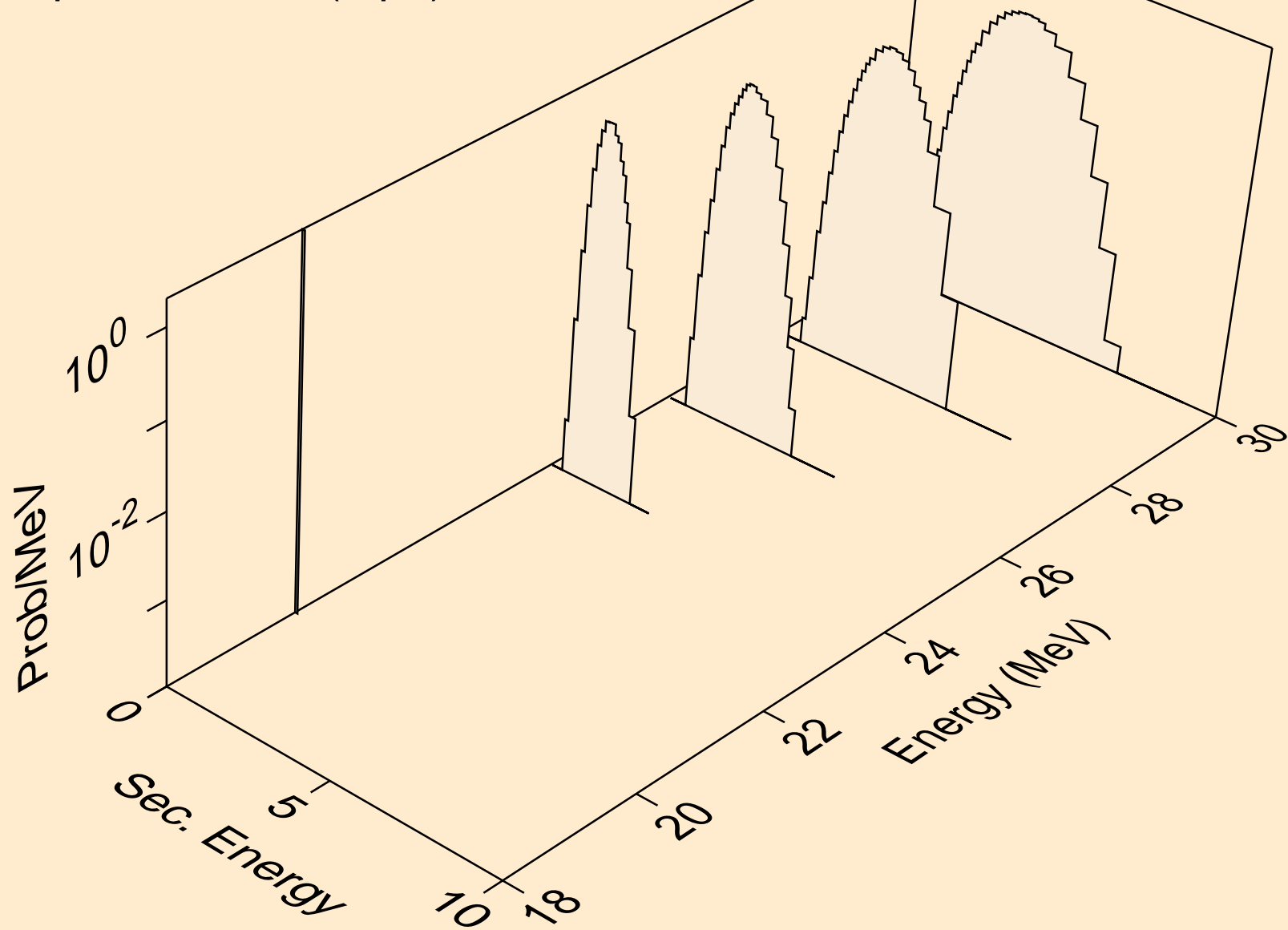

SC051 NEUTRON ACER TENDL-2024 LIBRARY; T=293.6K
deuterons from (n,x)

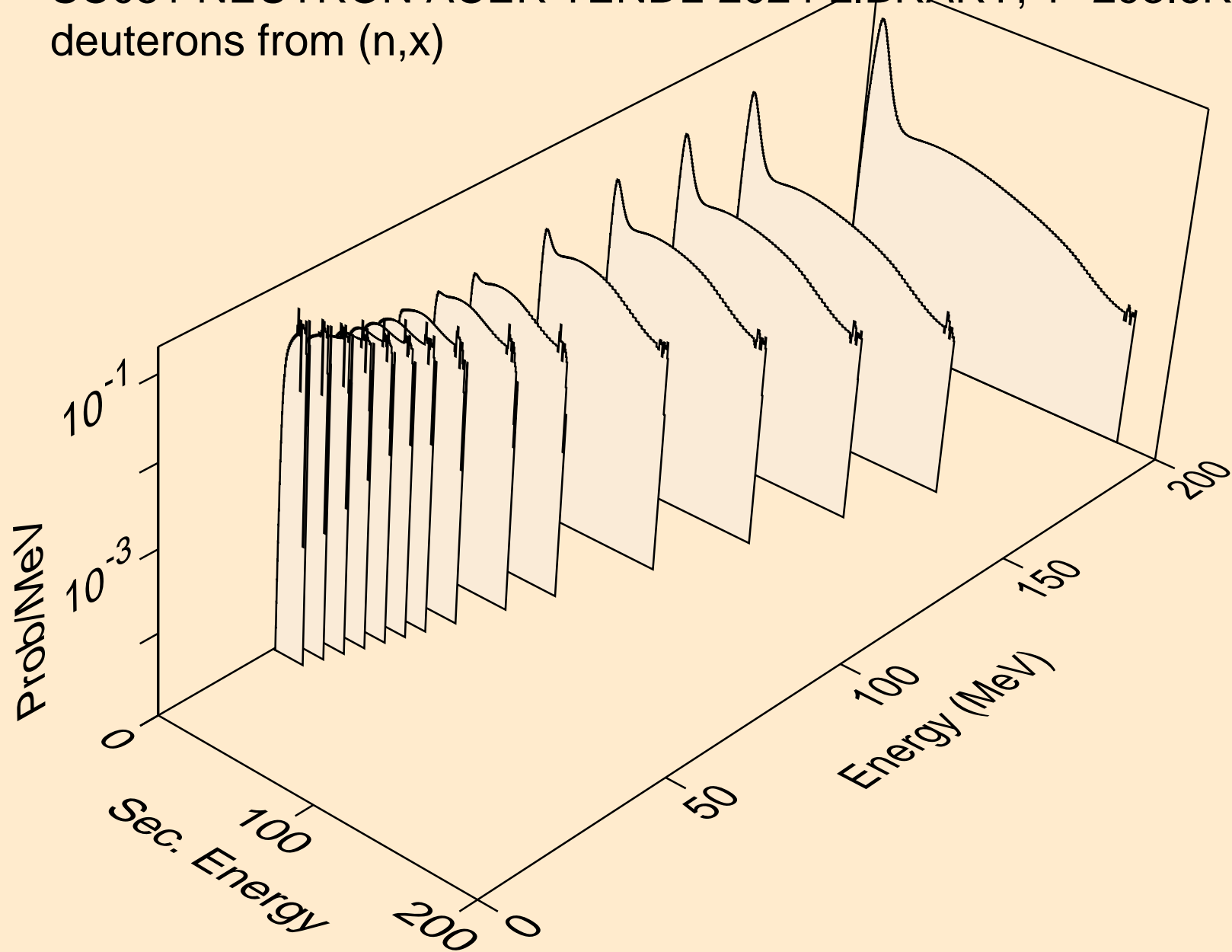

SC051 NEUTRON ACER TENDL-2024 LIBRARY; T=293.6K
deuterons from (n,2nd)

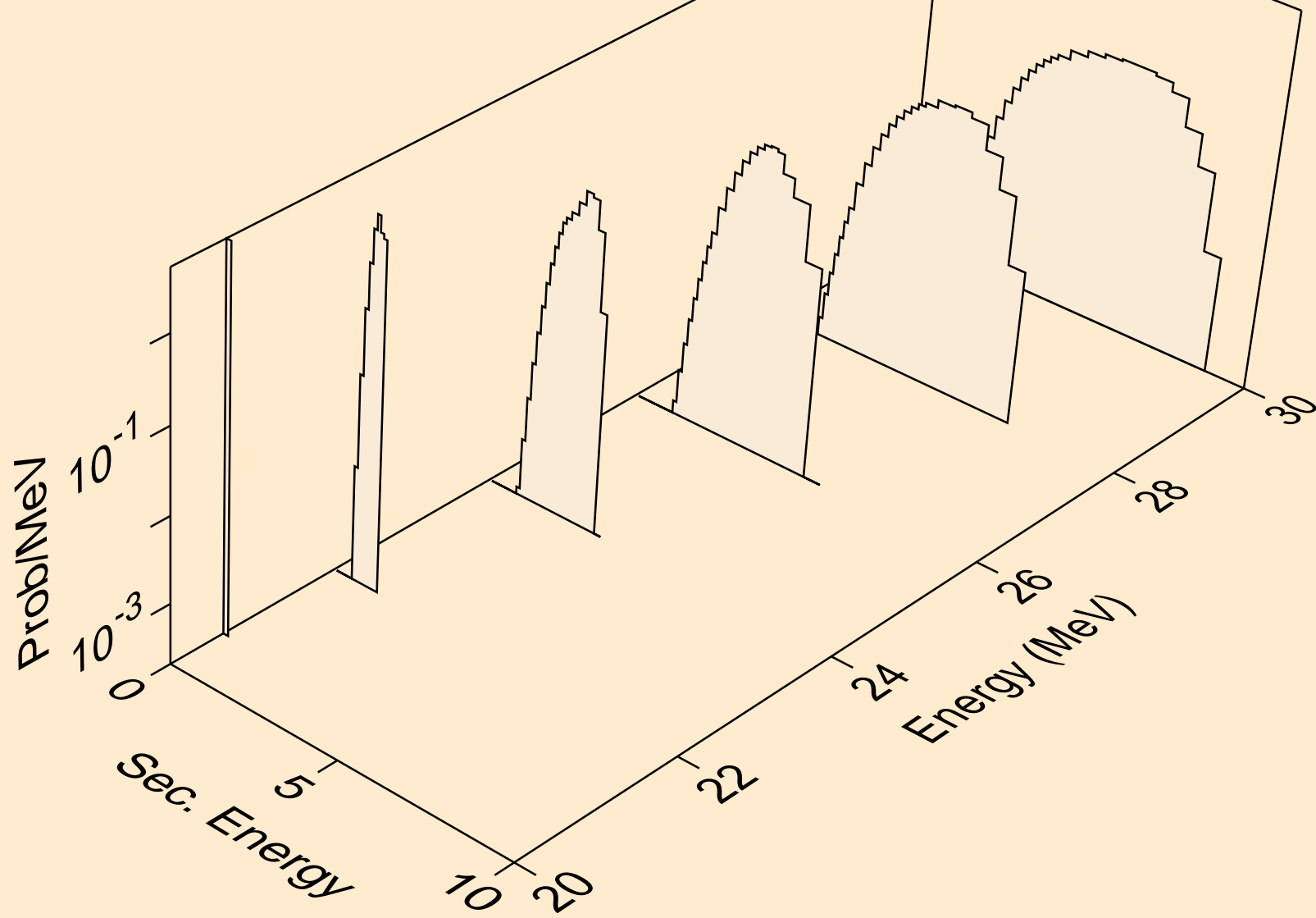

SC051 NEUTRON ACER TENDL-2024 LIBRARY; T=293.6K
deuterons from (n,n*)d

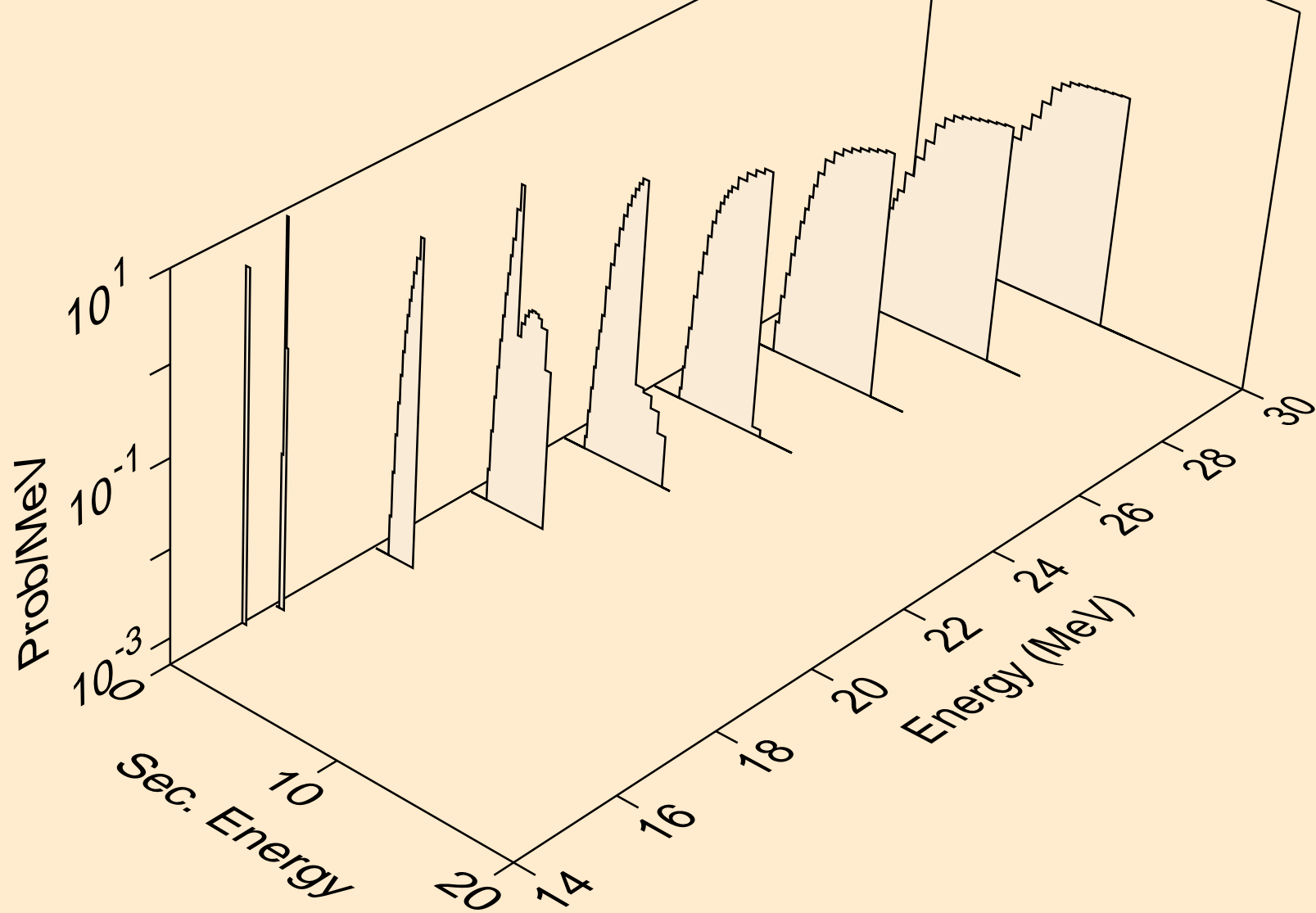

SC051 NEUTRON ACER TENDL-2024 LIBRARY; T=293.6K
deuterons from (n,d)

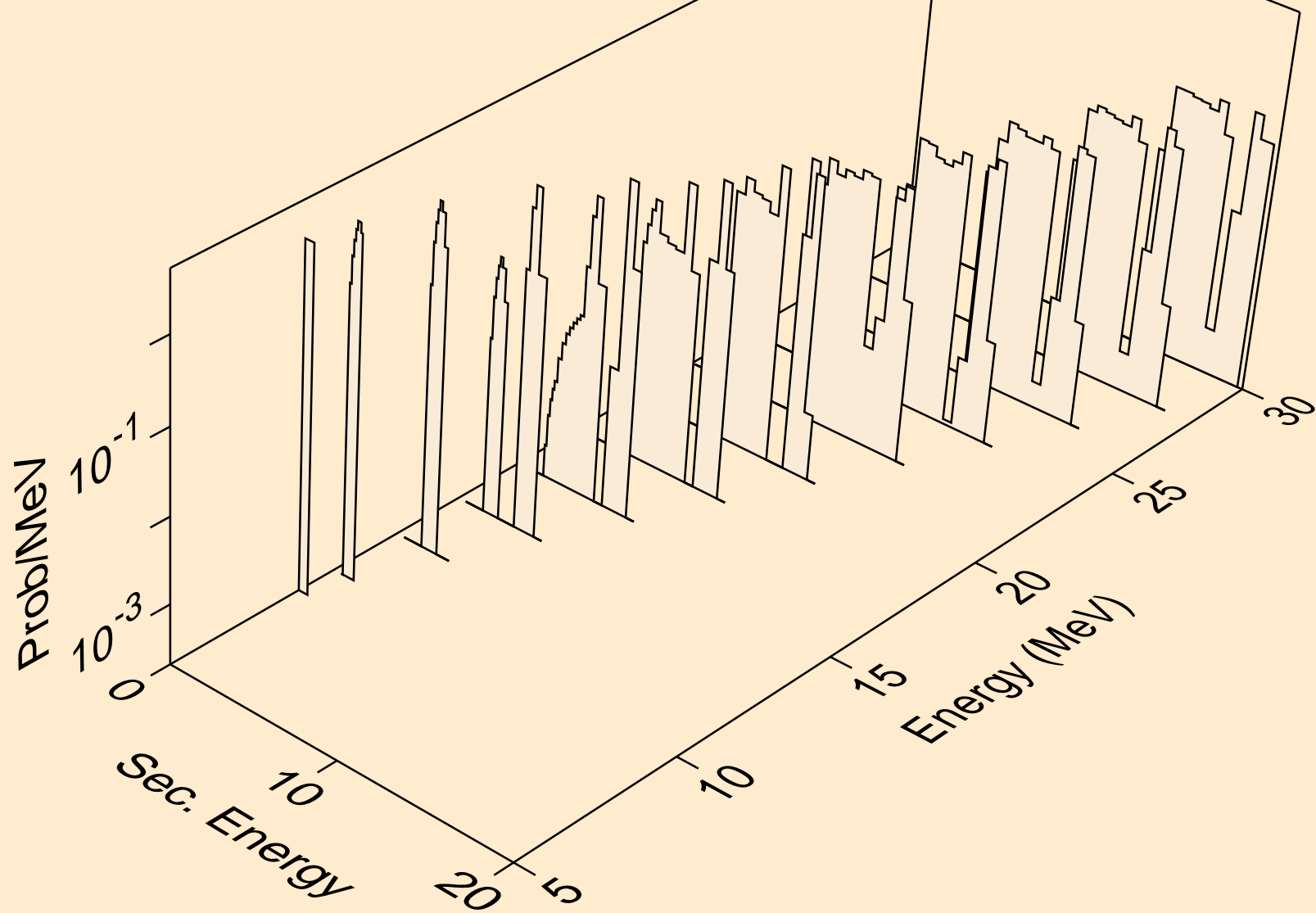

SC051 NEUTRON ACER TENDL-2024 LIBRARY; T=293.6K
deuterons from (n,da)

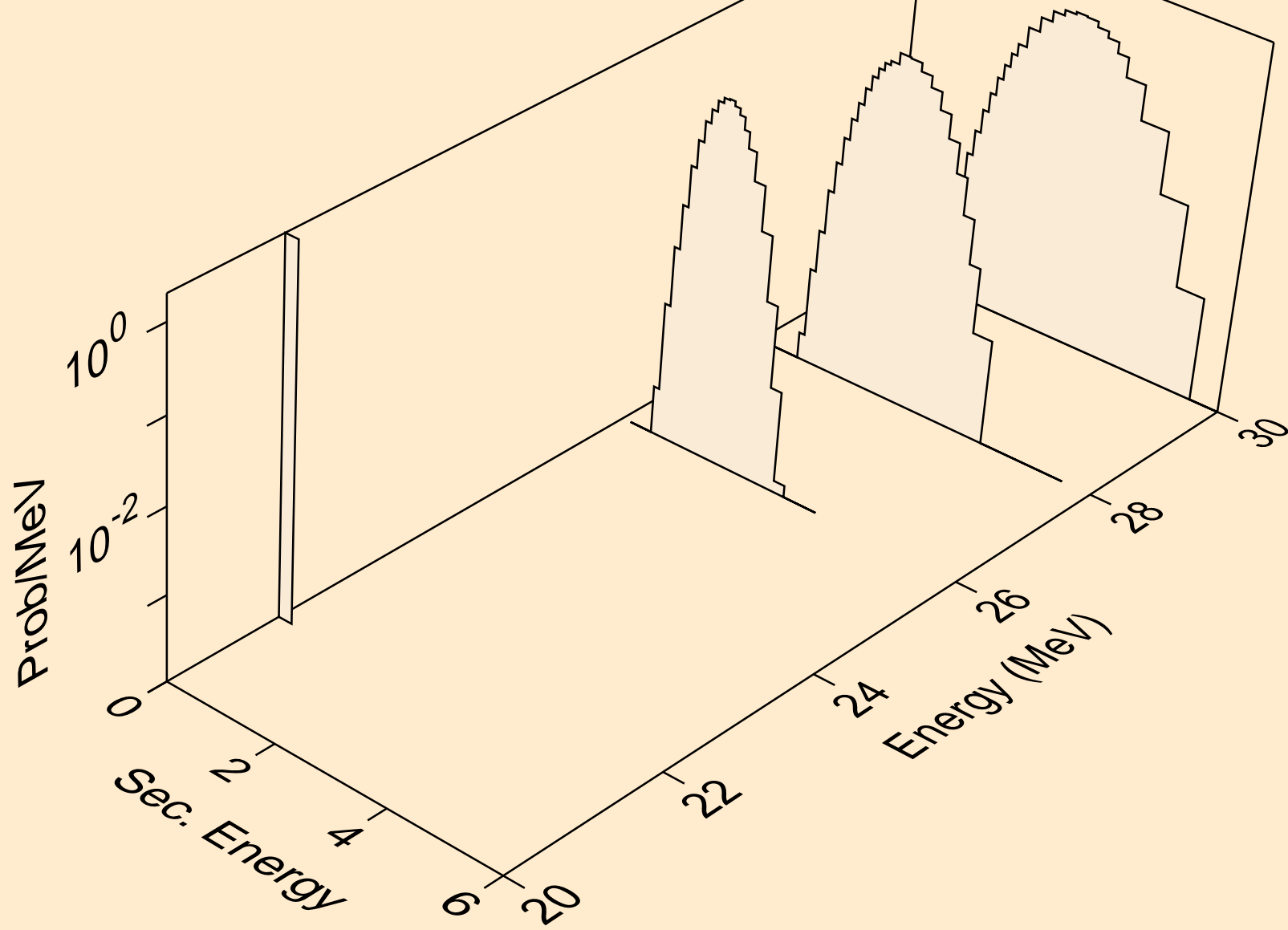

SC051 NEUTRON ACER TENDL-2024 LIBRARY; T=293.6K
tritons from (n,x)

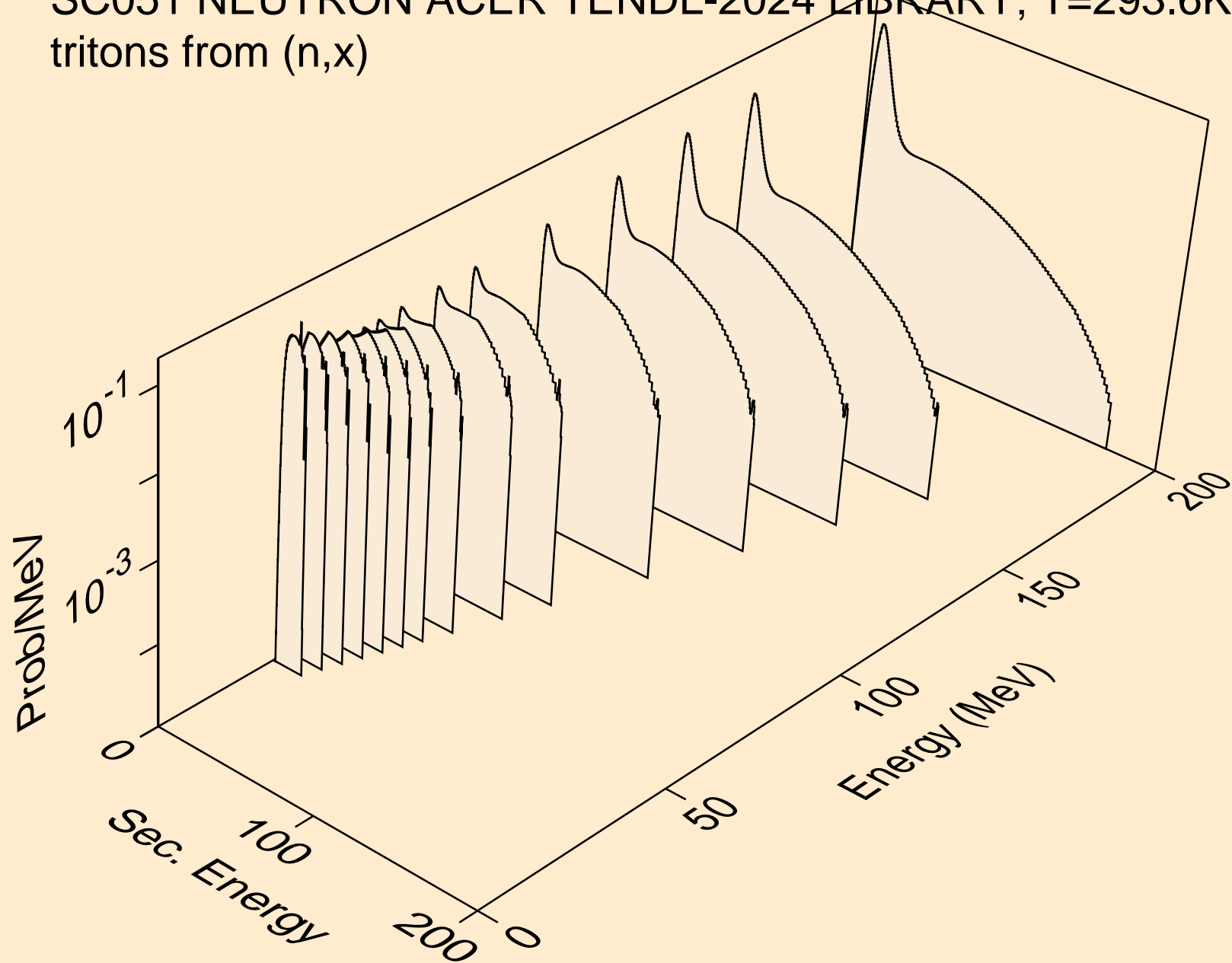

SC051 NEUTRON ACER TENDL-2024 LIBRARY; T=293.6K
tritons from (n,n*)t

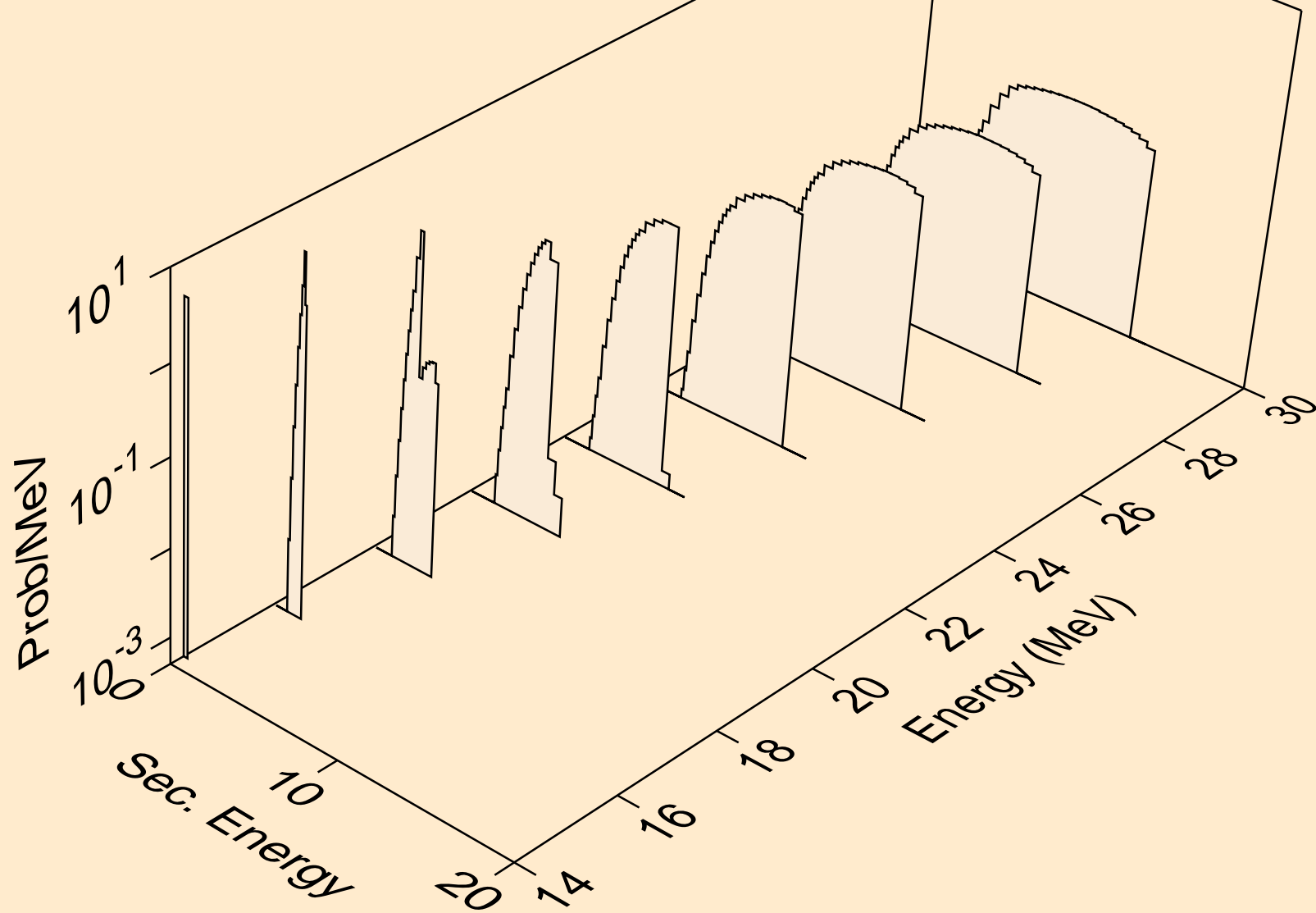

SC051 NEUTRON ACER TENDL-2024 LIBRARY; T=293.6K
tritons from (n,t)

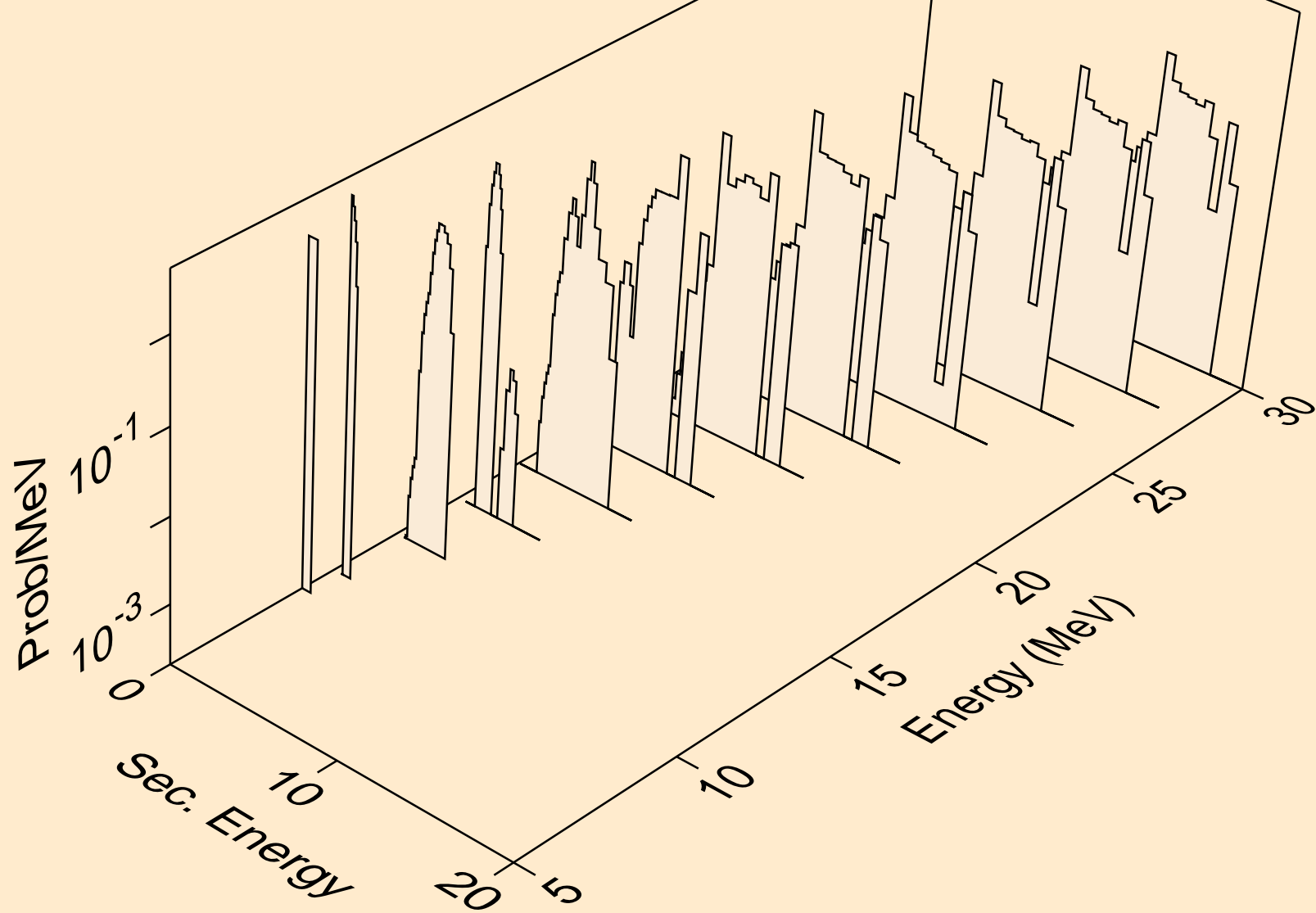

SC051 NEUTRON ACER TENDL-2024 LIBRARY; T=293.6K
he3s from (n,x)

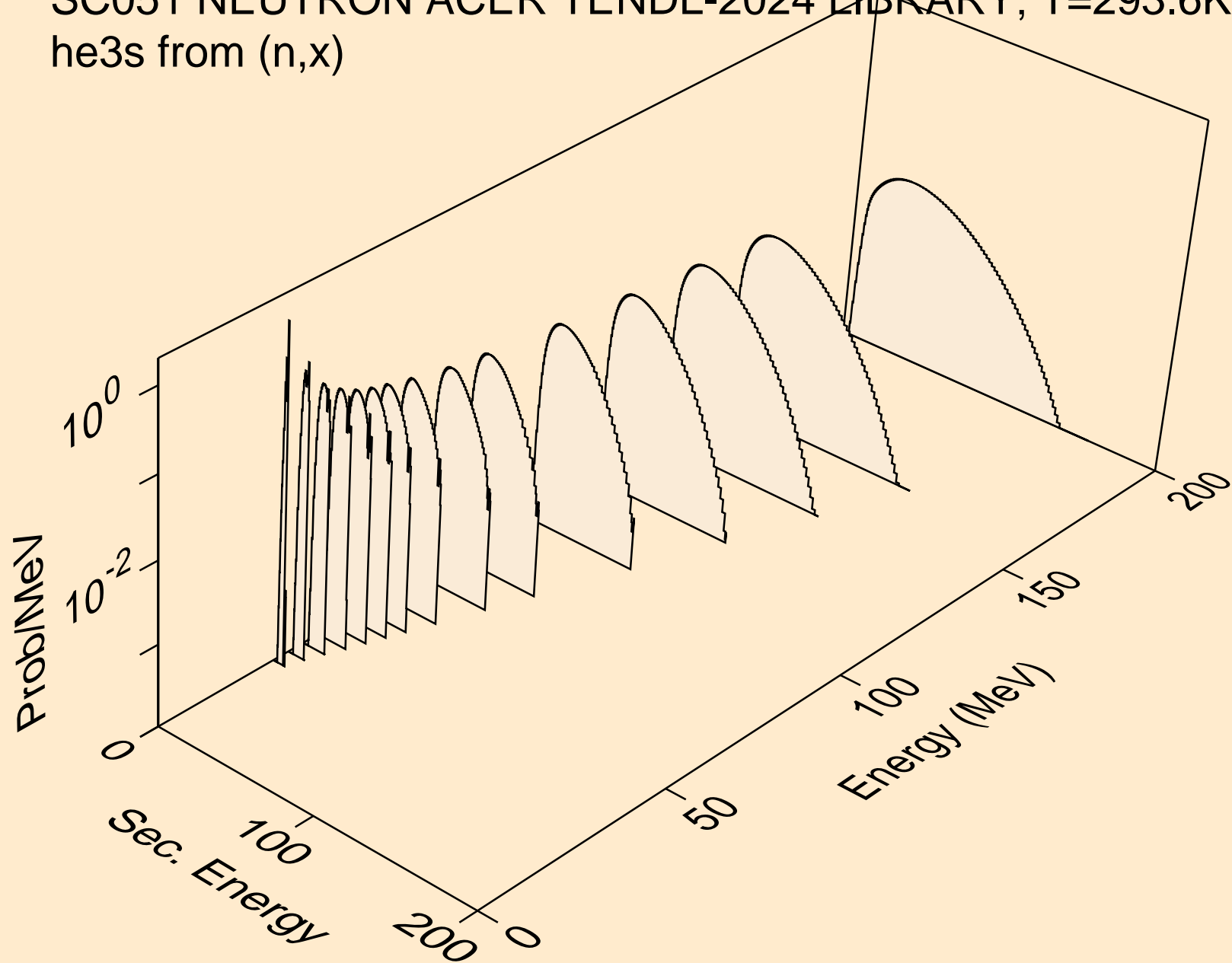

SC051 NEUTRON ACER TENDL-2024 LIBRARY; T=293.6K
he3s from (n,n*)he3

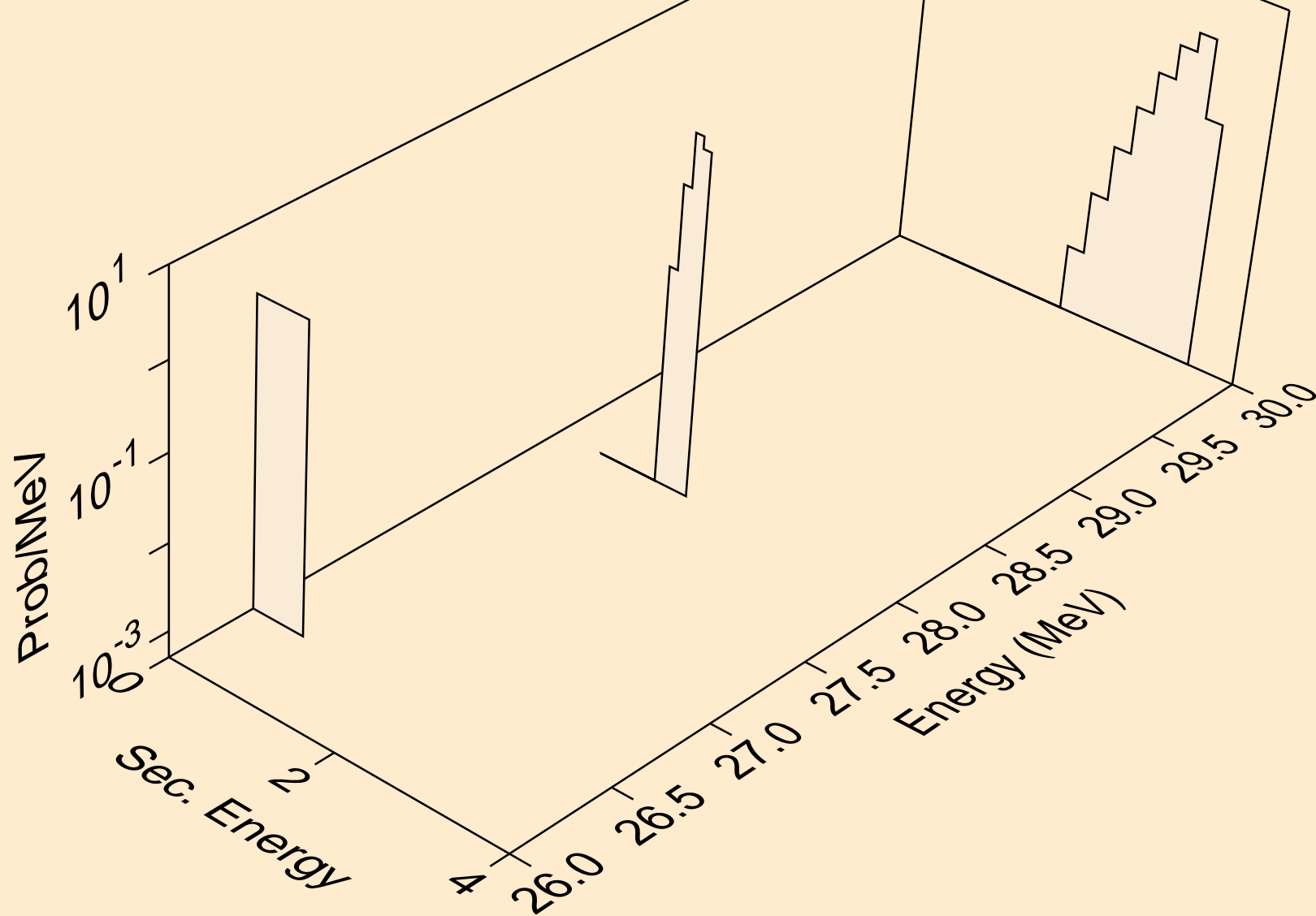

SC051 NEUTRON ACER TENDL-2024 LIBRARY; T=293.6K
he3s from (n,he3)

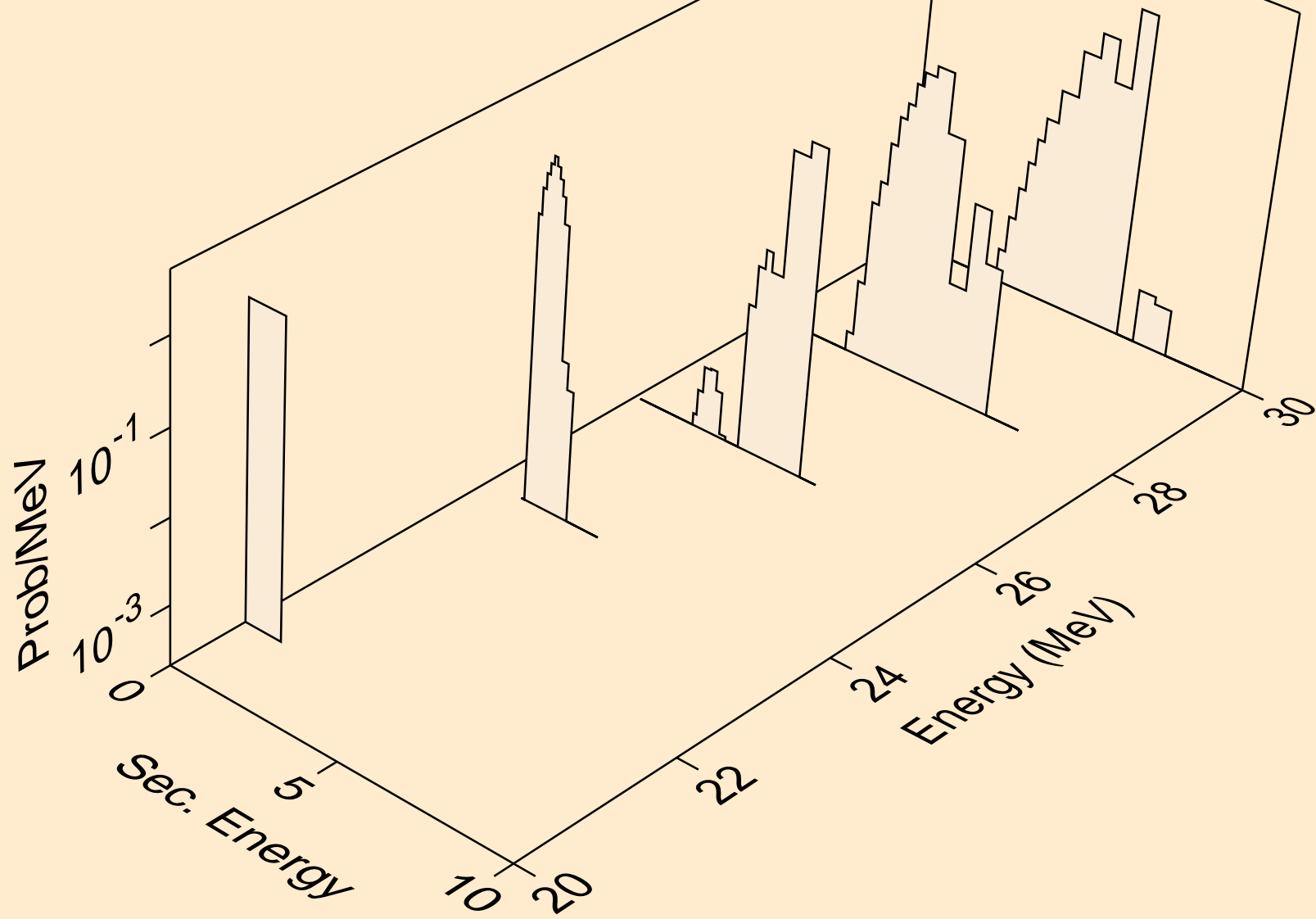

SC051 NEUTRON ACER TENDL-2024 LIBRARY; T=293.6K
alphas from (n,x)

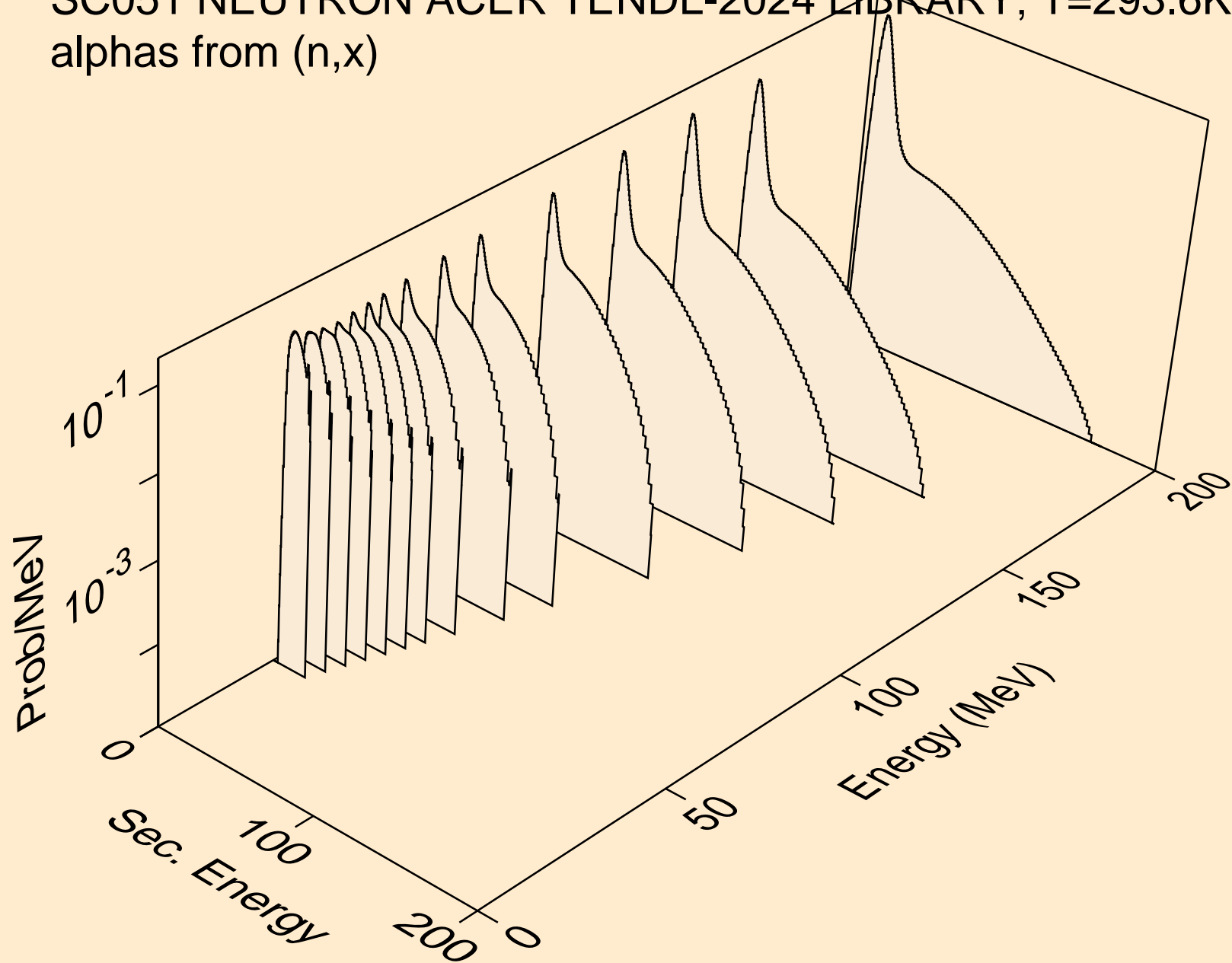

SC051 NEUTRON ACER TENDL-2024 LIBRARY; T=293.6K
alphas from (n,n*)a

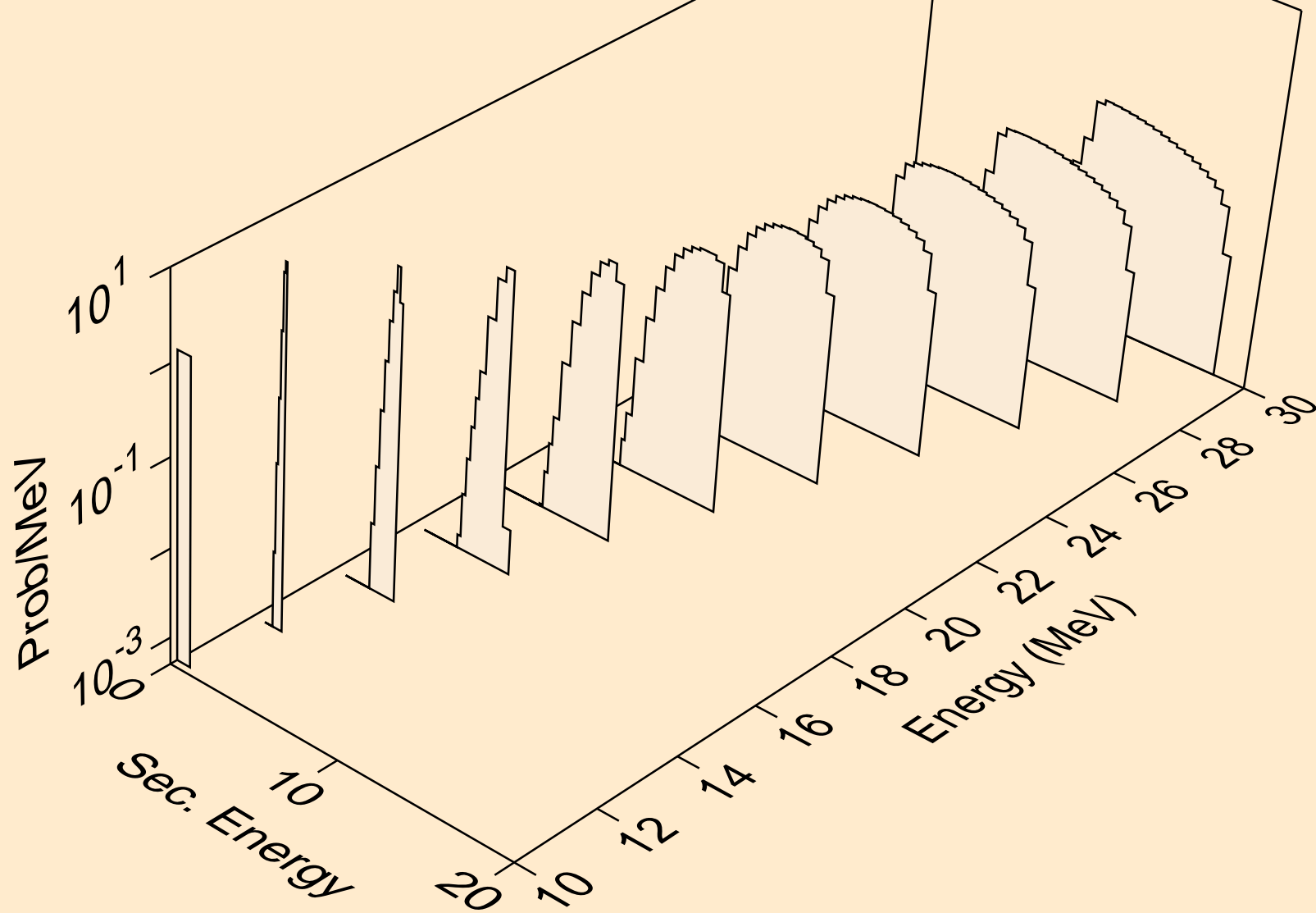

SC051 NEUTRON ACER TENDL-2024 LIBRARY; T=293.6K
alphas from (n,2n)a

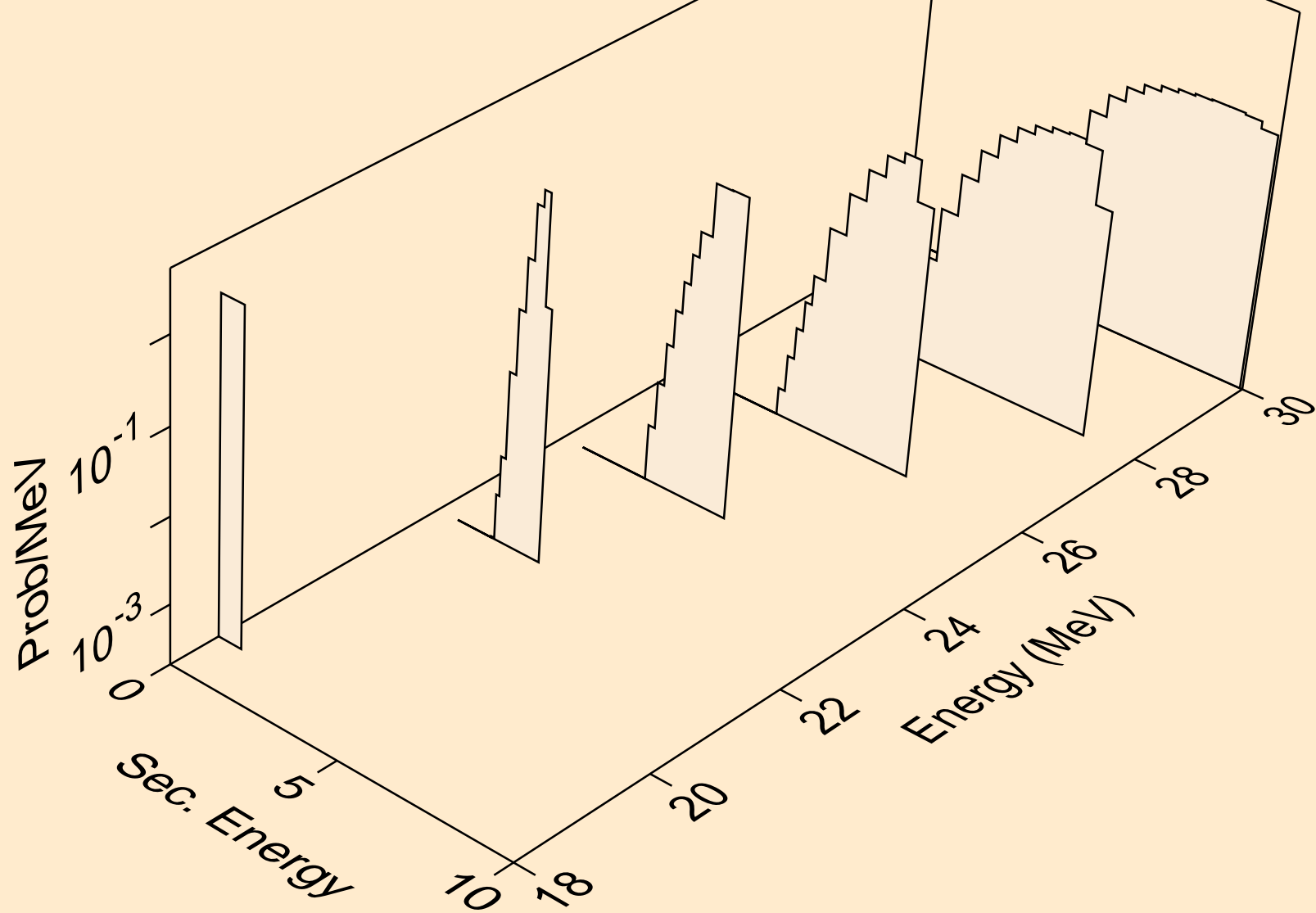

SC051 NEUTRON ACER TENDL-2024 LIBRARY; T=293.6K
alphas from (n,a)

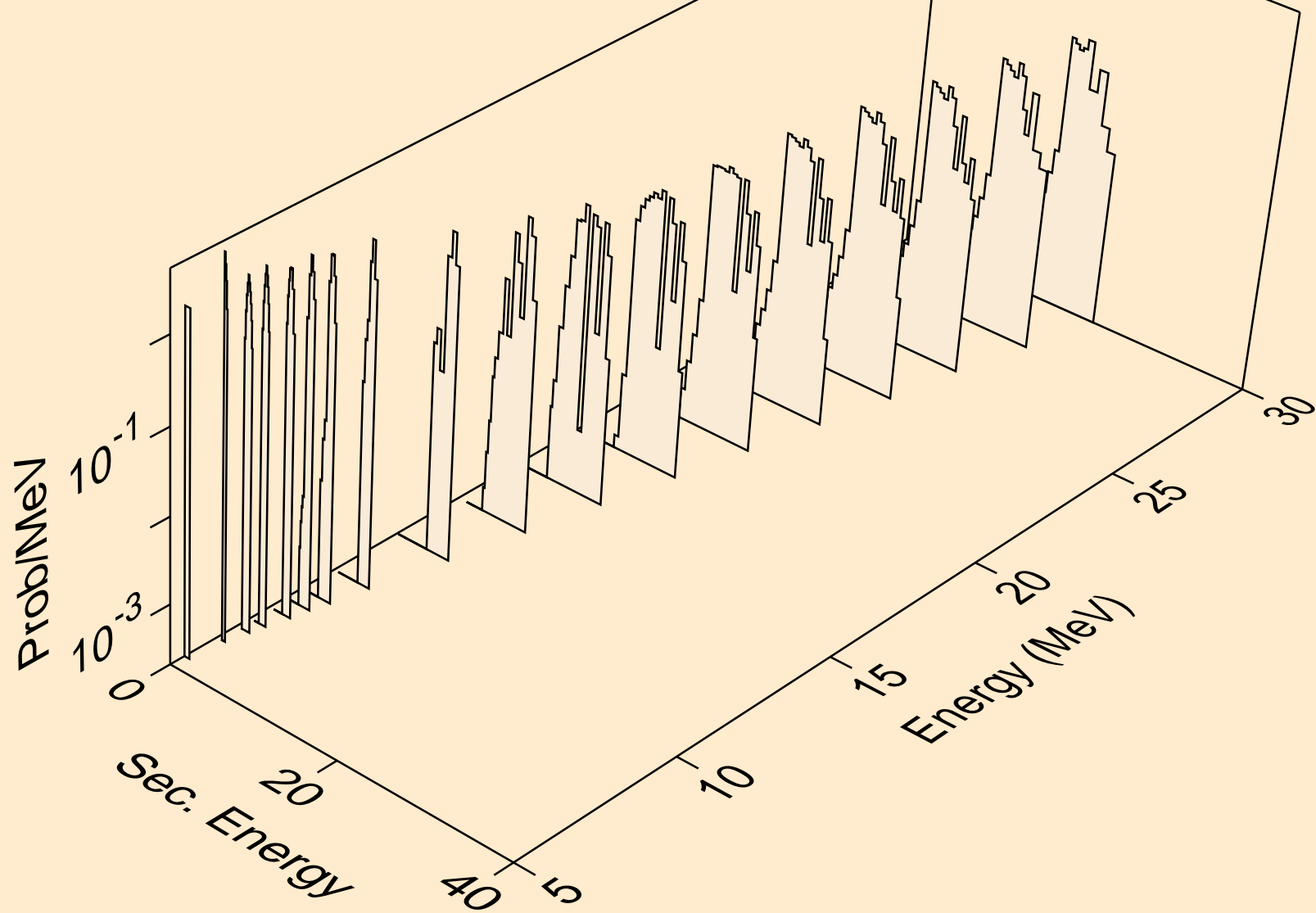

SC051 NEUTRON ACER TENDL-2024 LIBRARY; T=293.6K
alphas from (n,pa)

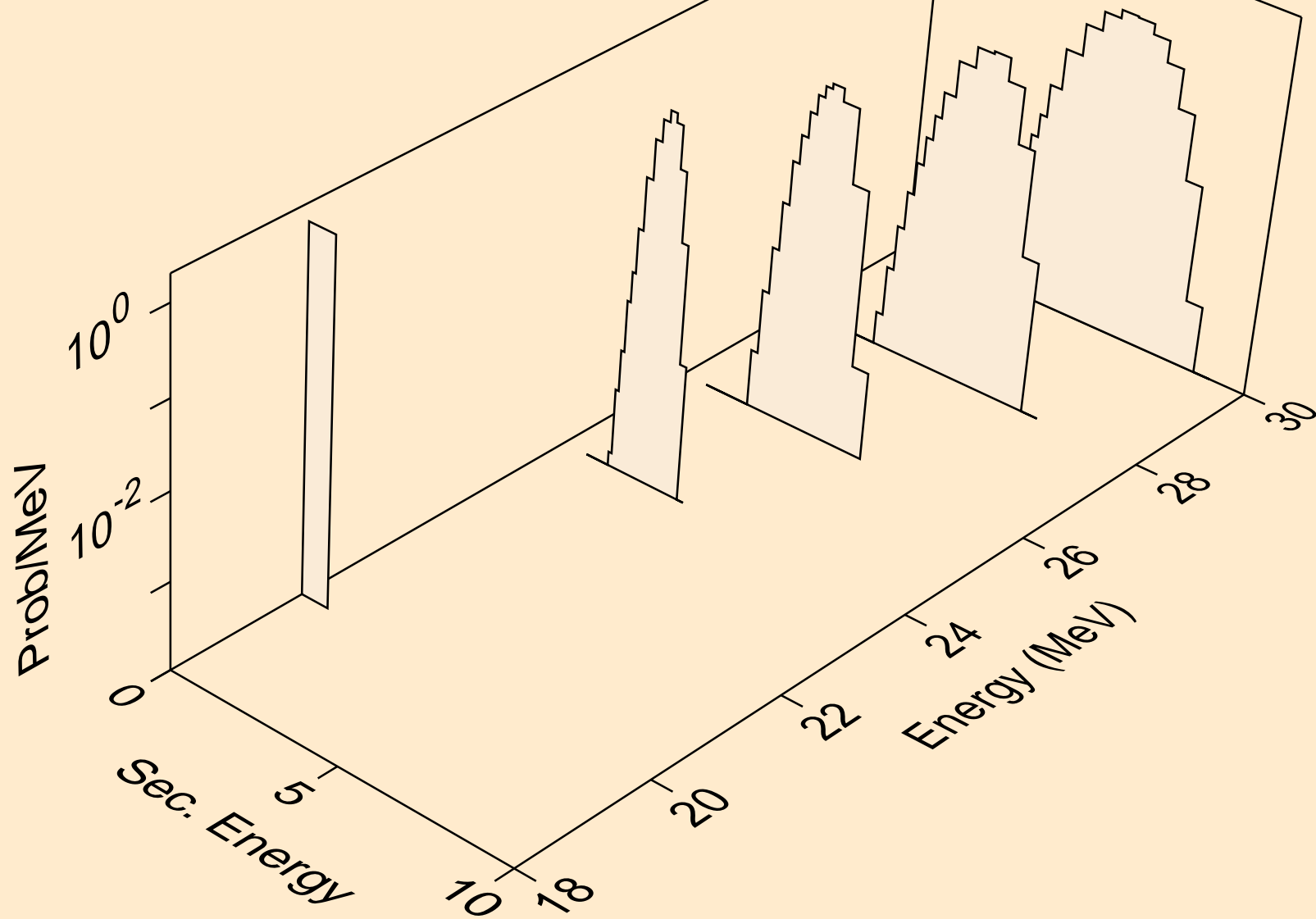

SC051 NEUTRON ACER TENDL-2024 LIBRARY; T=293.6K
alphas from (n,da)

