

SM137 NEUTRON ACER TENDL-2024 LIBRARY; T=293.6K

Principal cross sections

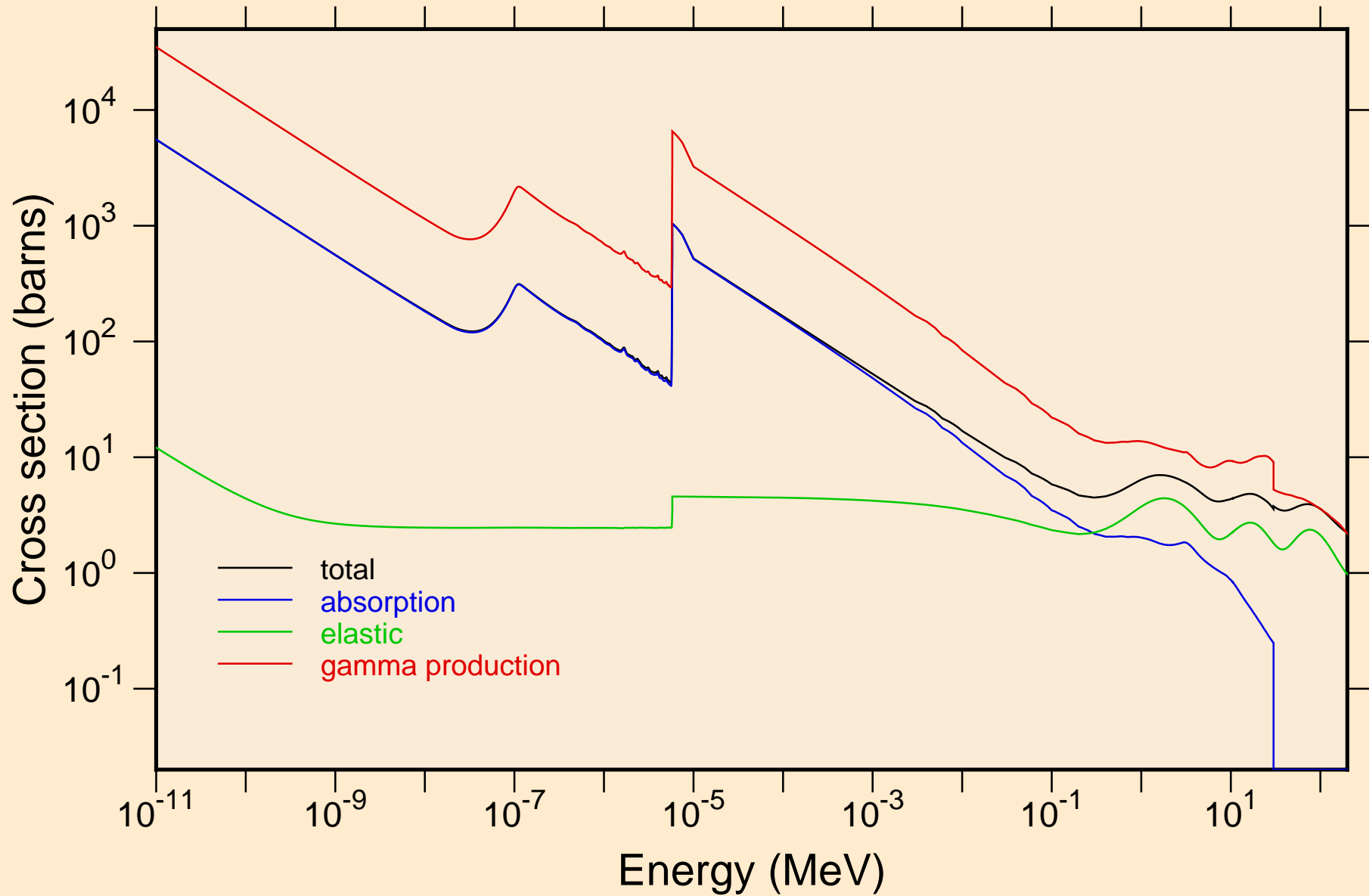

SM137 NEUTRON ACER TENDL-2024 LIBRARY; T=293.6K
resonance total cross section

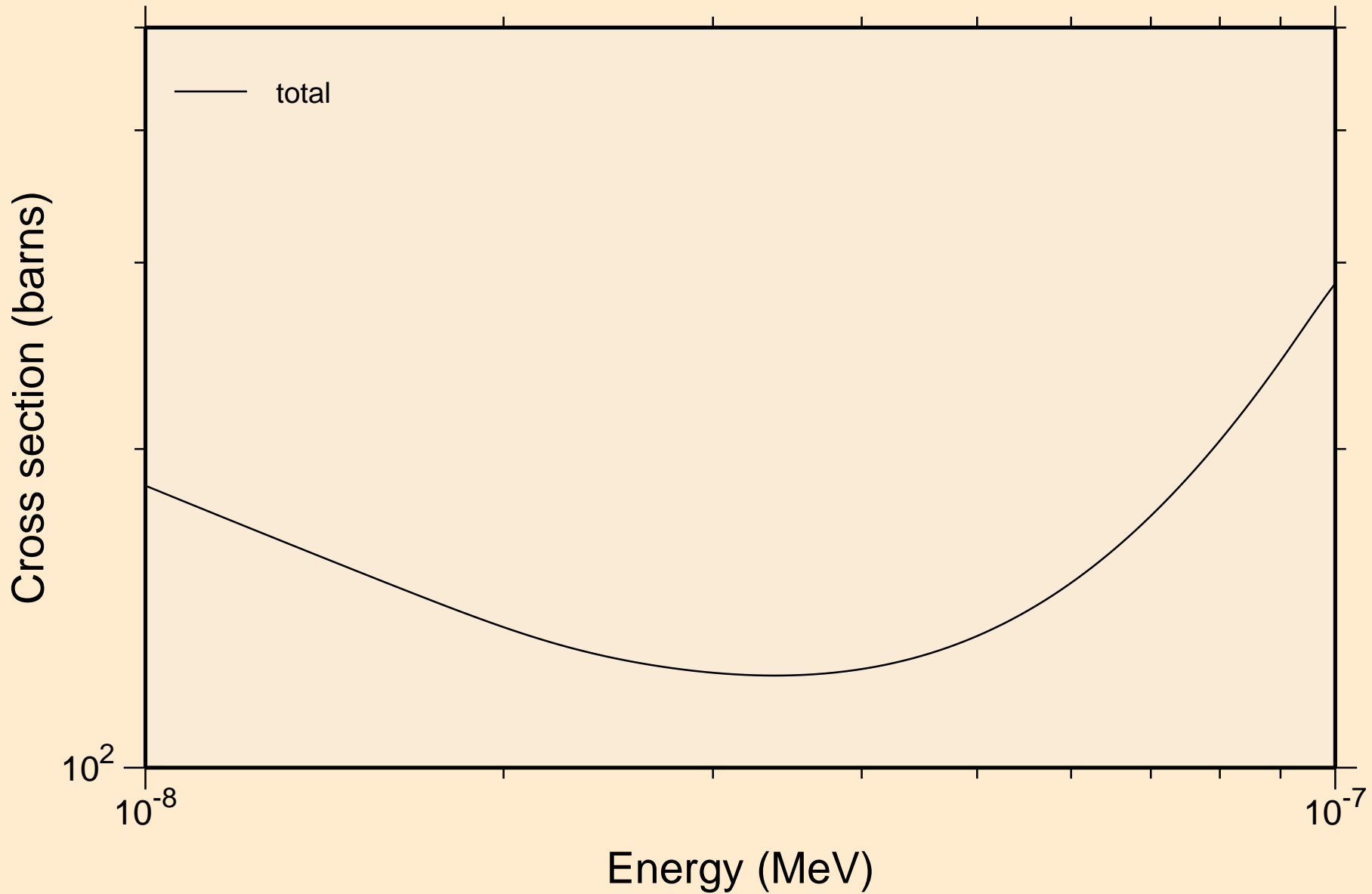

SM137 NEUTRON ACER TENDL-2024 LIBRARY; T=293.6K
resonance total cross section

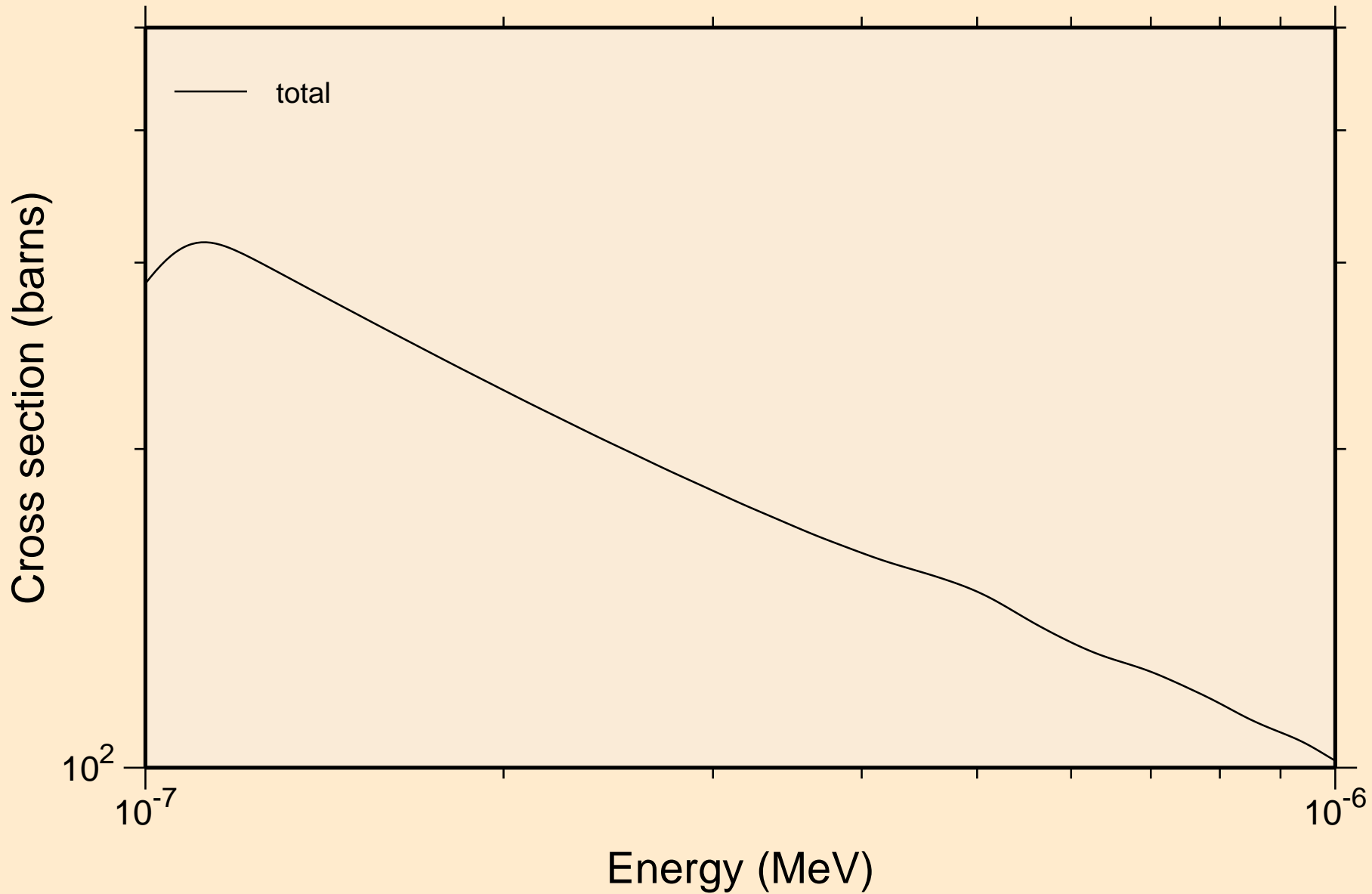

SM137 NEUTRON ACER TENDL-2024 LIBRARY; T=293.6K
resonance total cross section

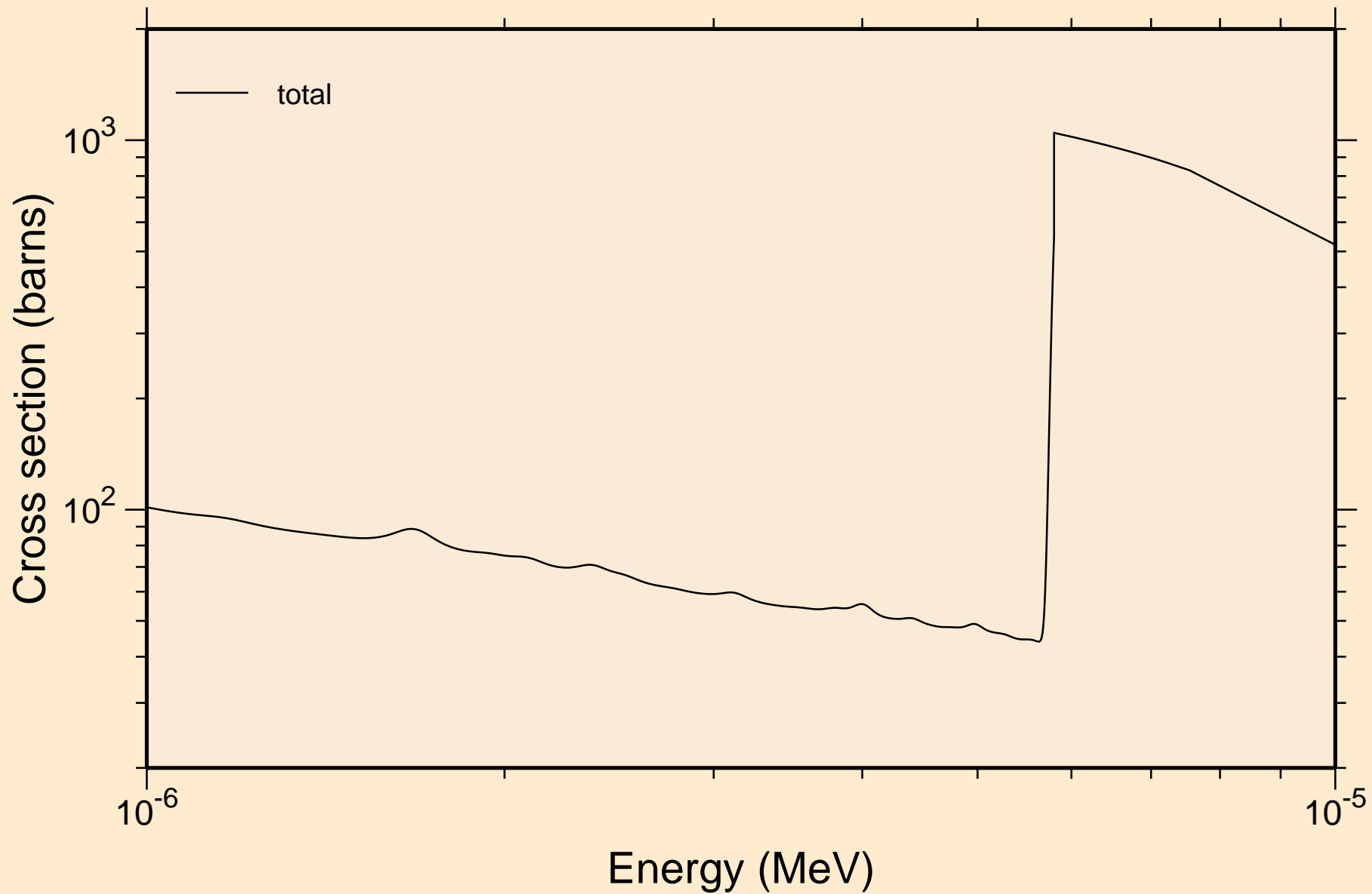

SM137 NEUTRON ACER TENDL-2024 LIBRARY; T=293.6K
resonance total cross section

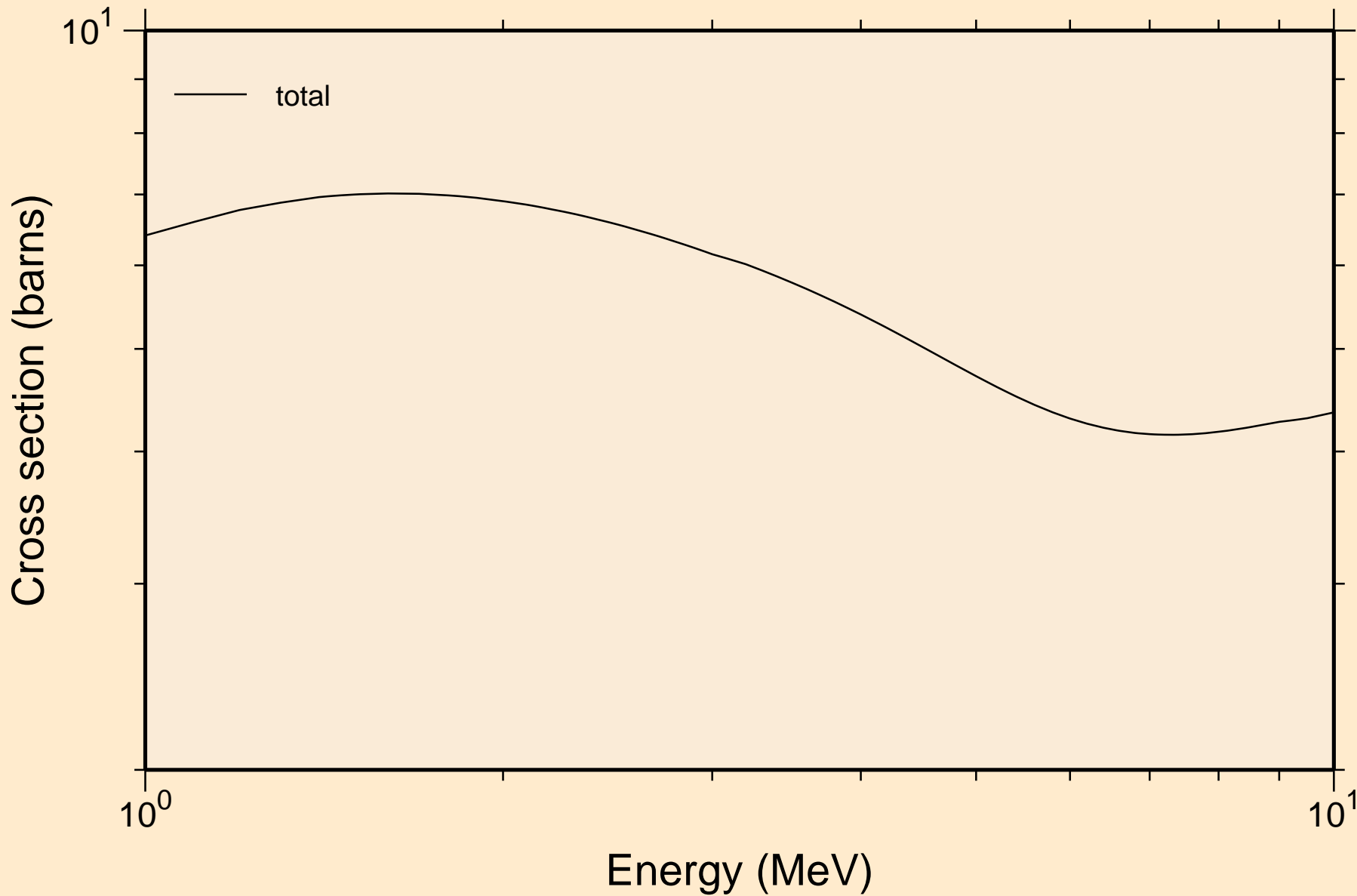

SM137 NEUTRON ACER TENDL-2024 LIBRARY; T=293.6K
resonance absorption cross sections

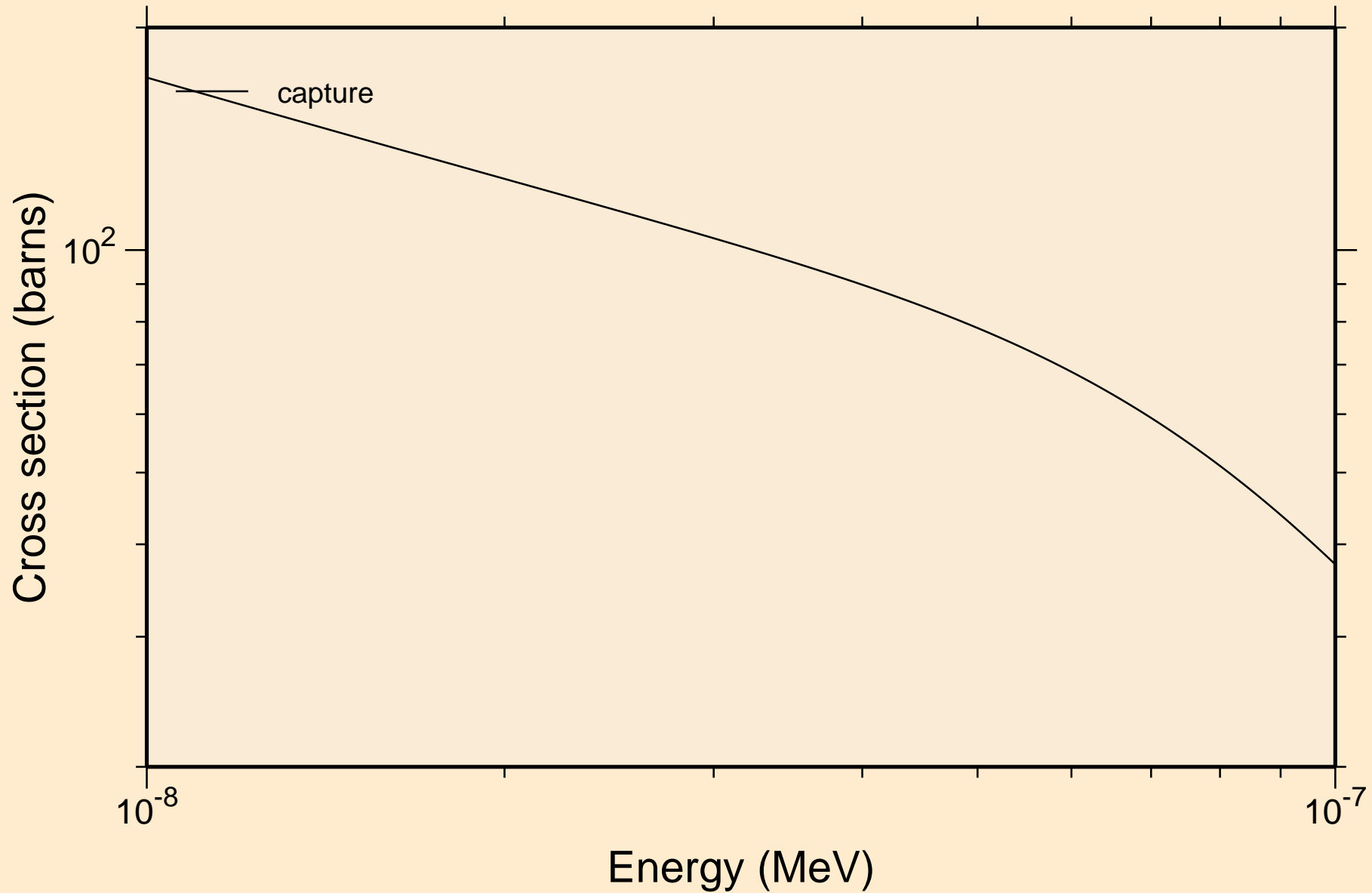

SM137 NEUTRON ACER TENDL-2024 LIBRARY; T=293.6K
resonance absorption cross sections

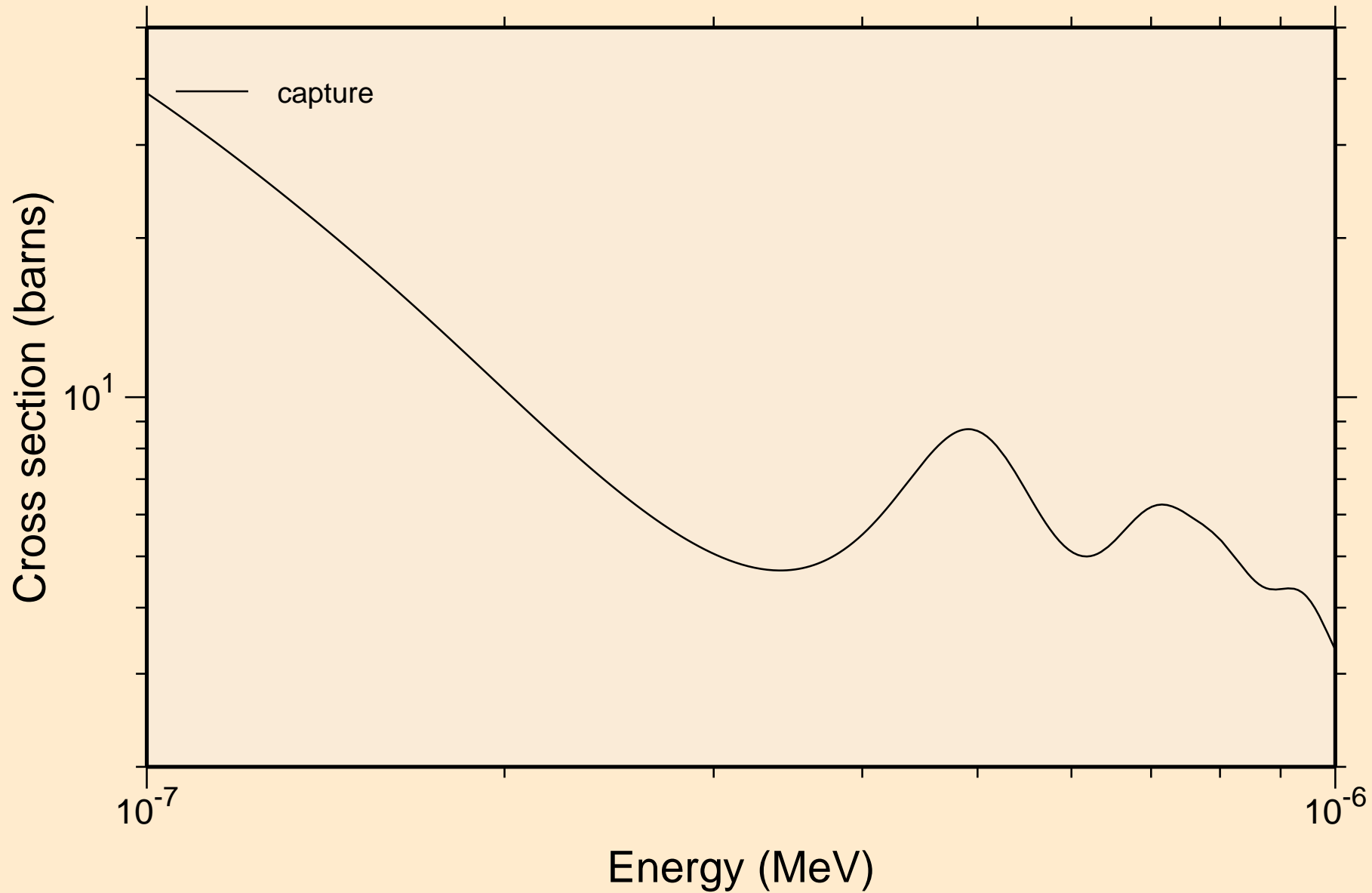

SM137 NEUTRON ACER TENDL-2024 LIBRARY; T=293.6K
resonance absorption cross sections

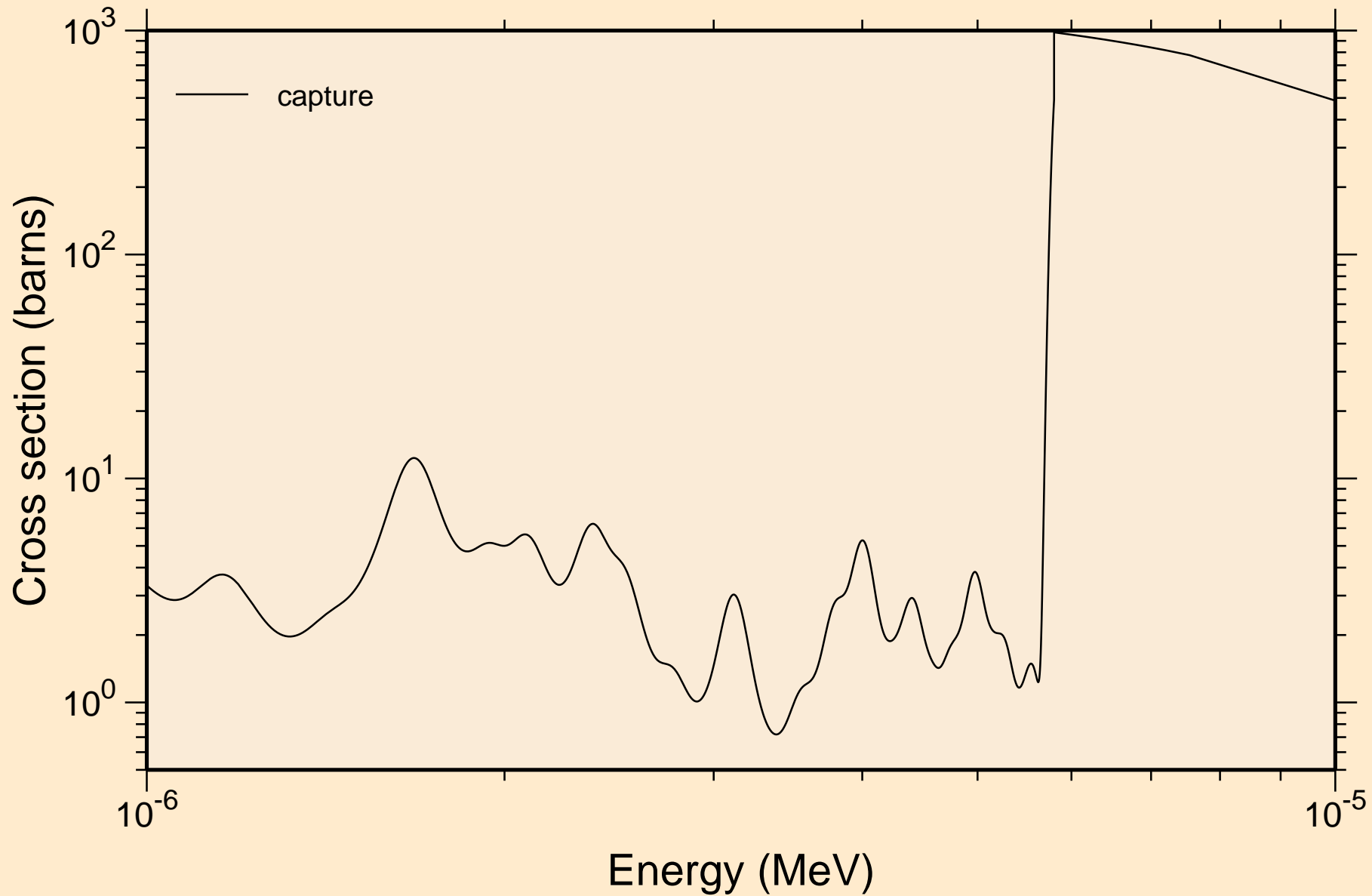

SM137 NEUTRON ACER TENDL-2024 LIBRARY; T=293.6K
resonance absorption cross sections

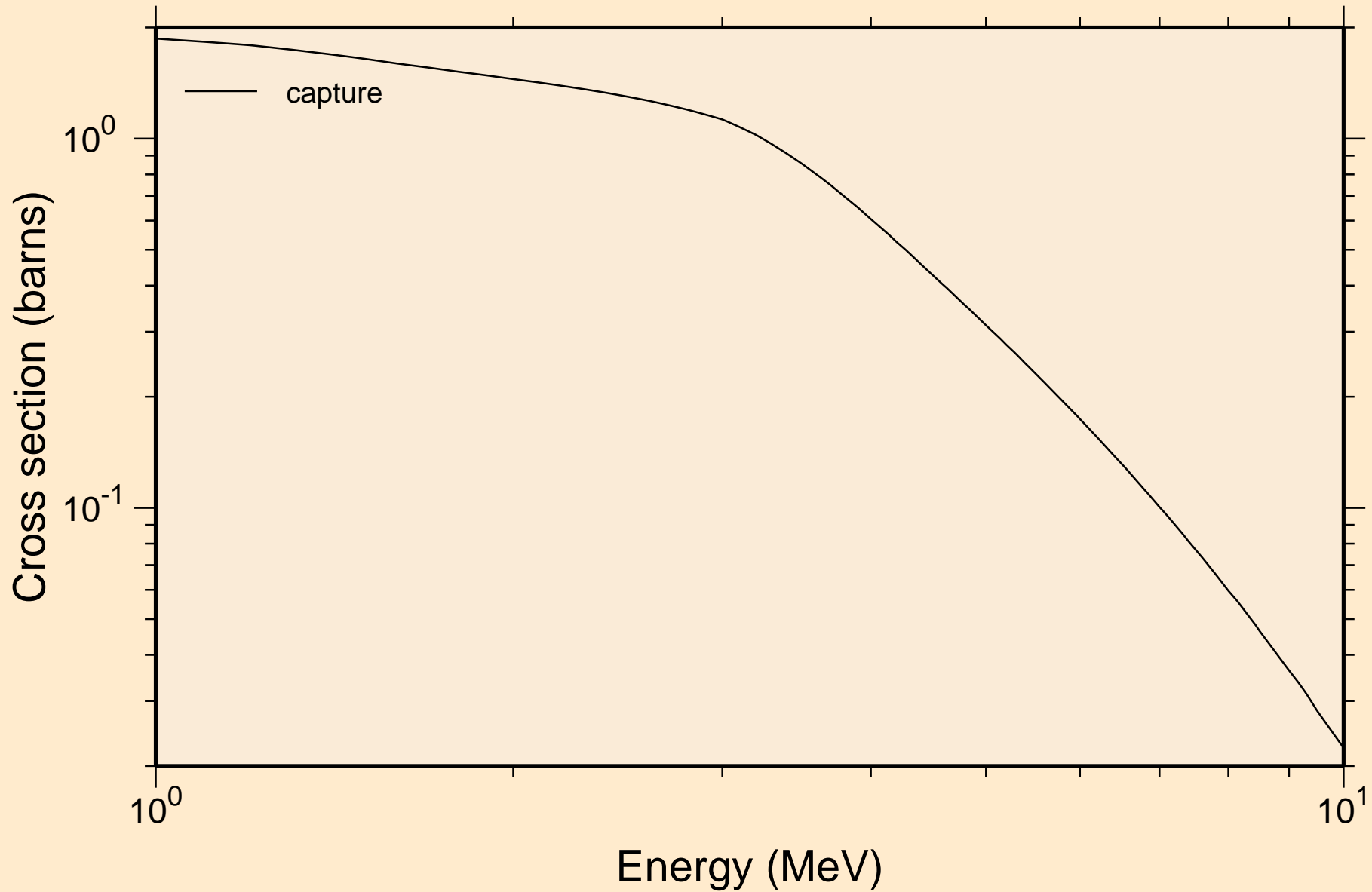

SM137 NEUTRON ACER TENDL-2024 LIBRARY; T=293.6K
Heating

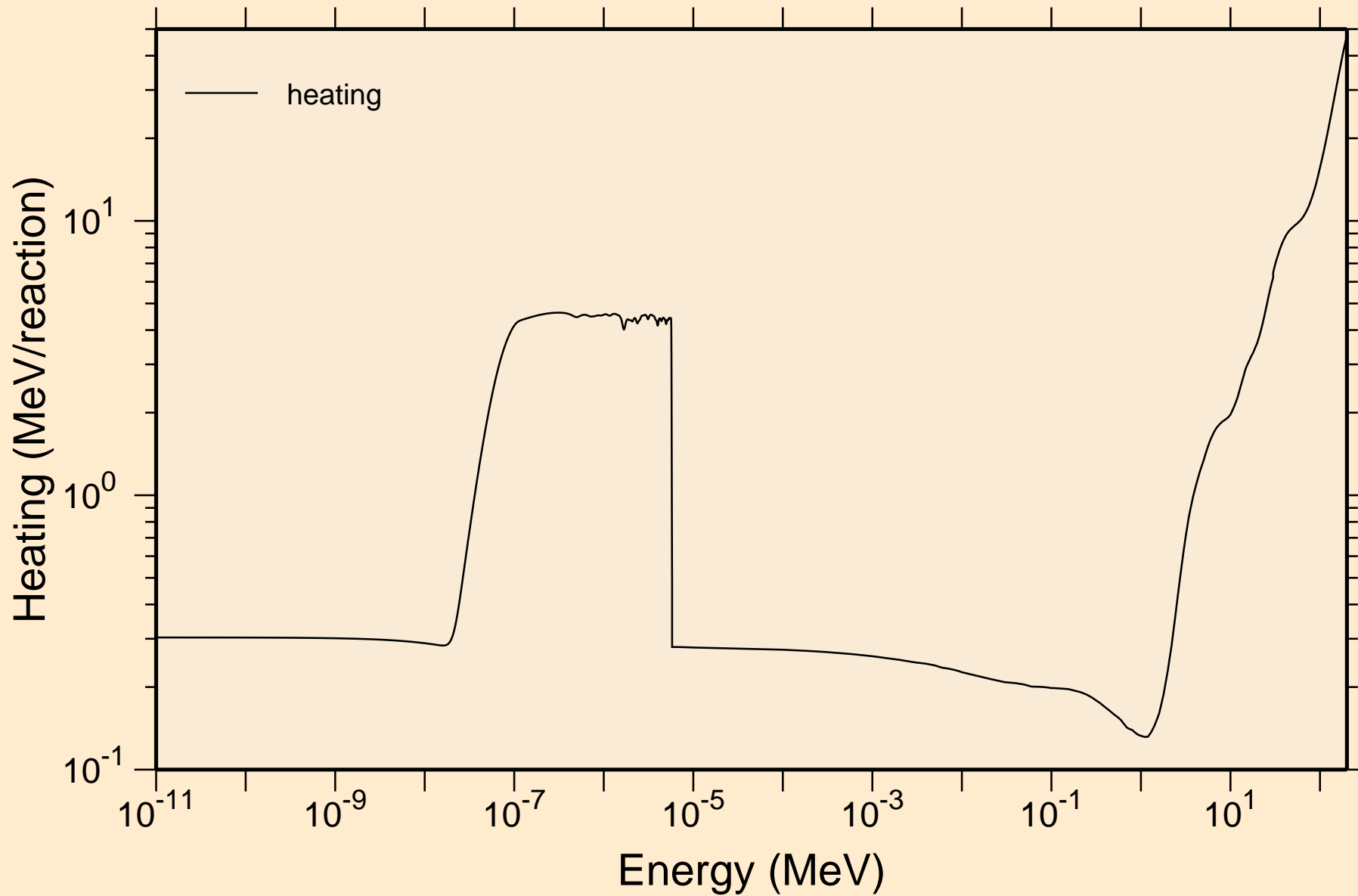

SM137 NEUTRON ACER TENDL-2024 LIBRARY; T=293.6K
Damage

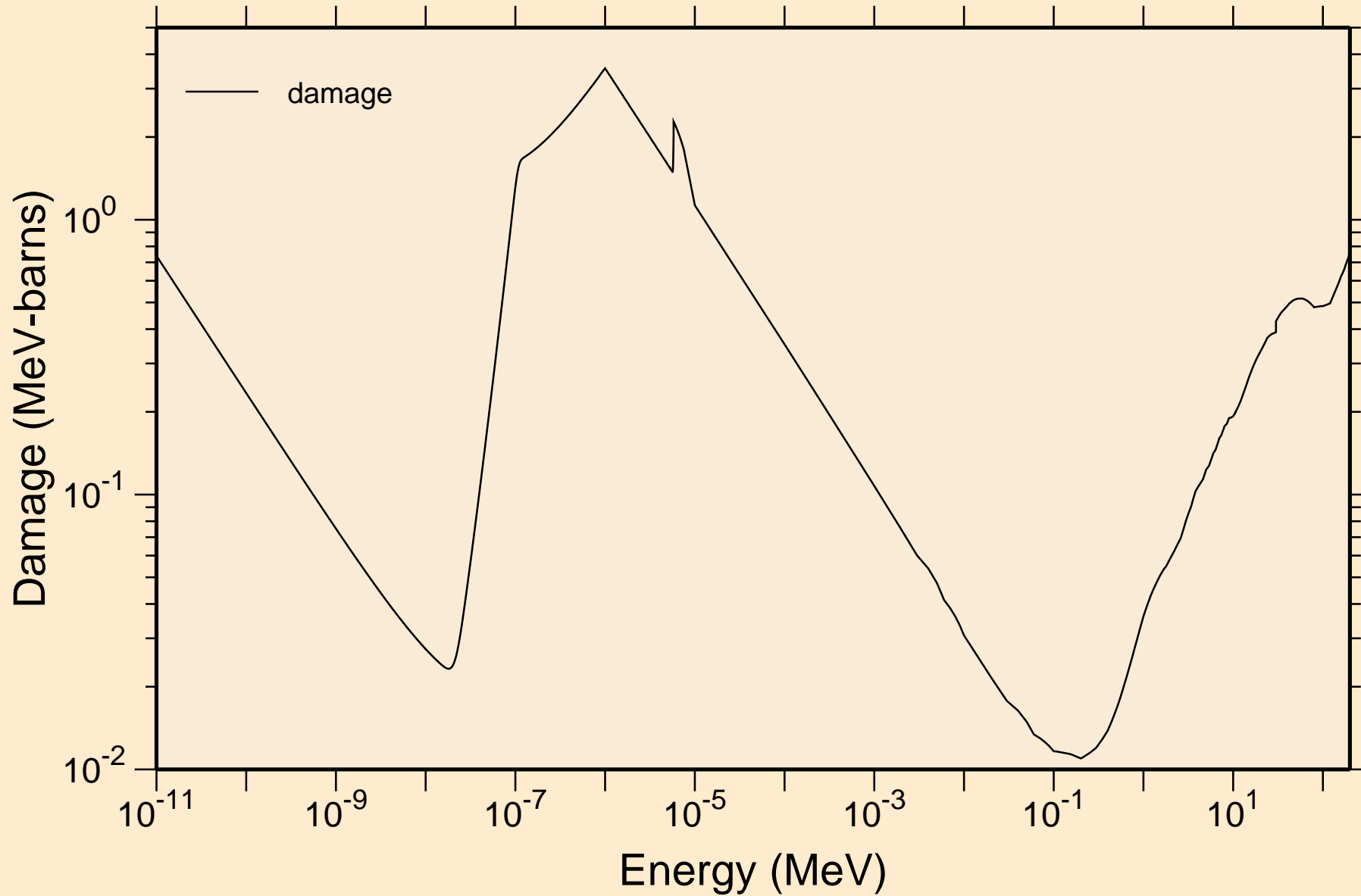

SM137 NEUTRON ACER TENDL-2024 LIBRARY; T=293.6K
Non-threshold reactions

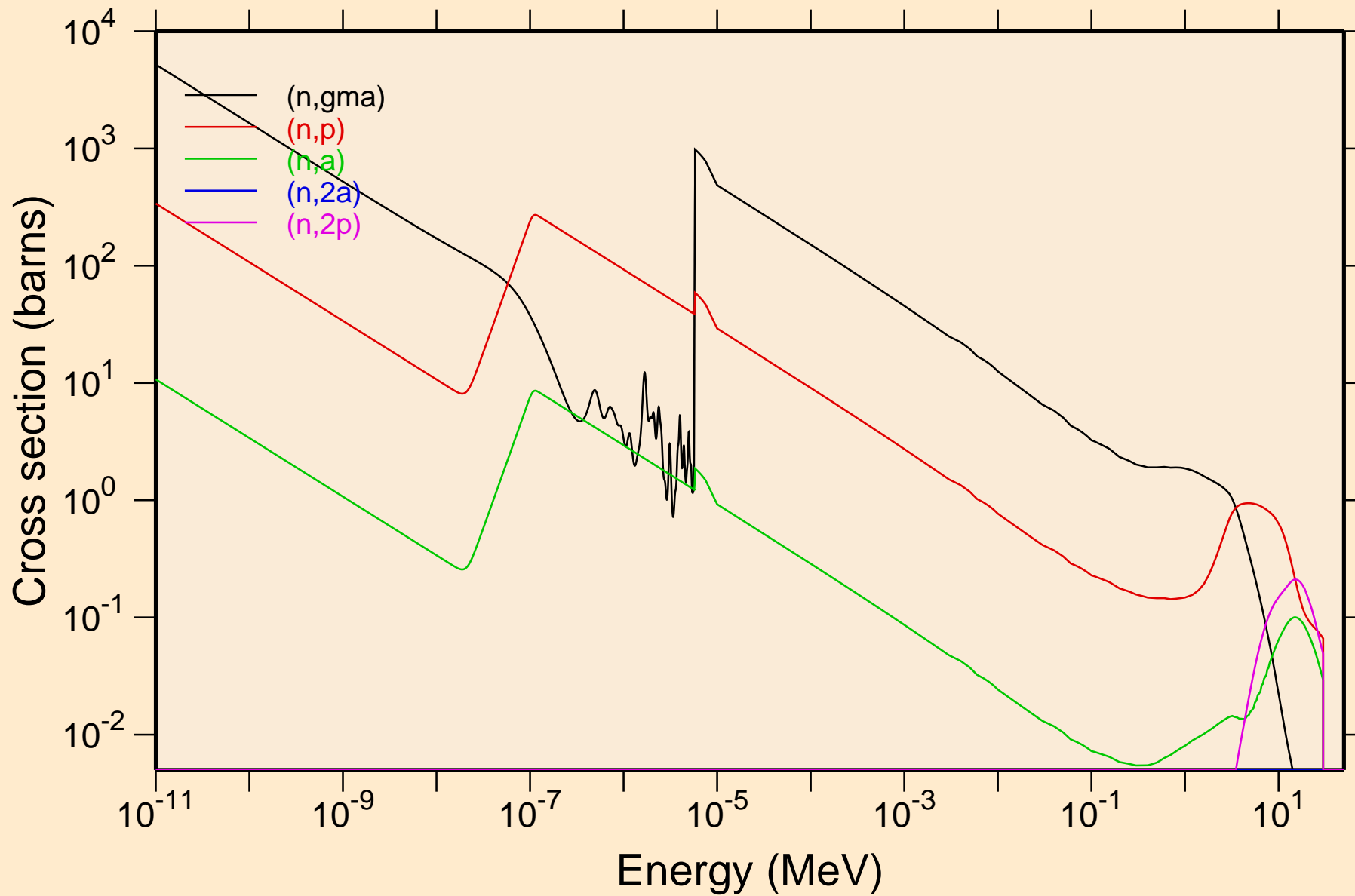

SM137 NEUTRON ACER TENDL-2024 LIBRARY; T=293.6K
Non-threshold reactions

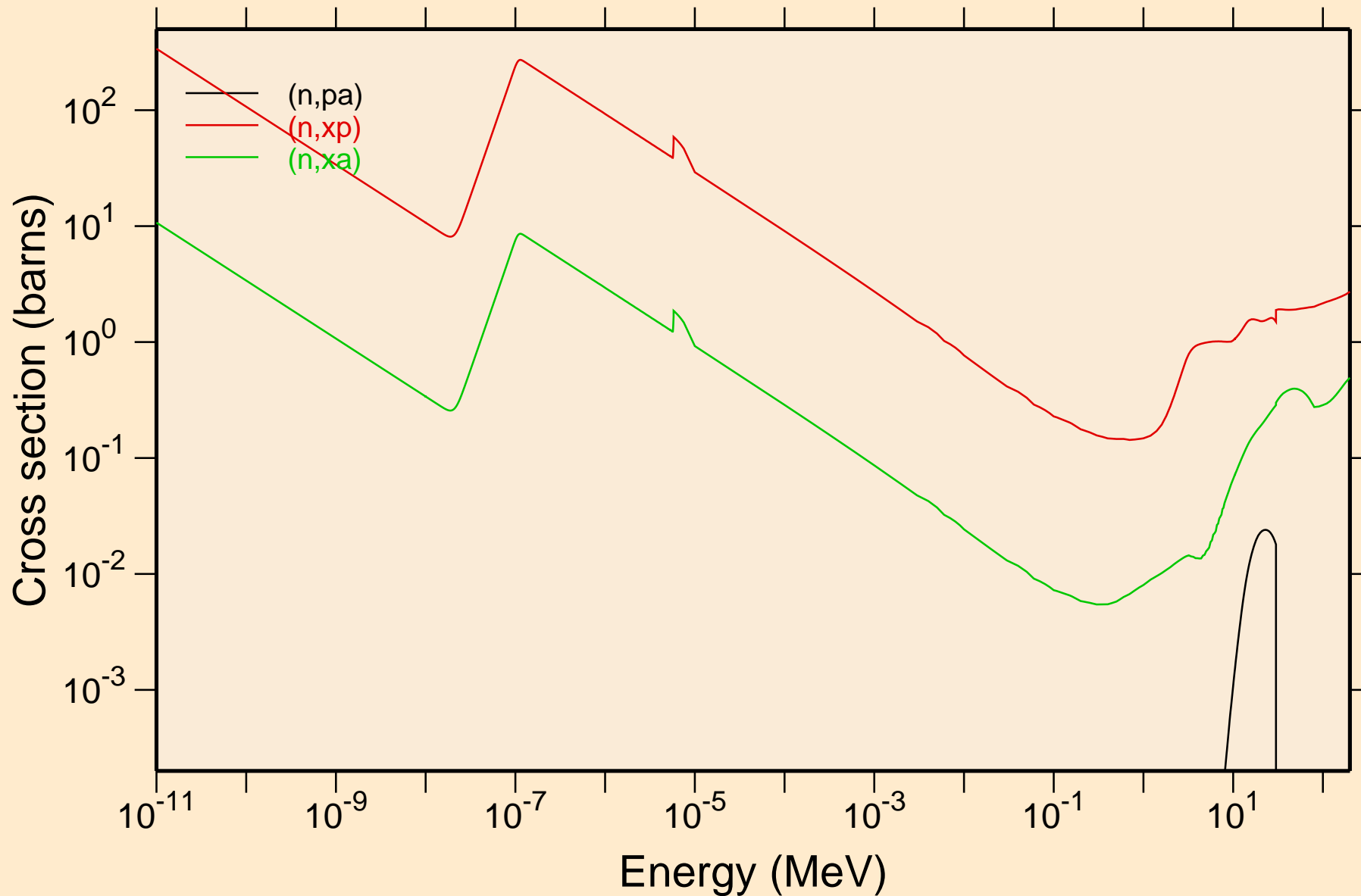

SM137 NEUTRON ACER TENDL-2024 LIBRARY; T=293.6K
Principal cross sections

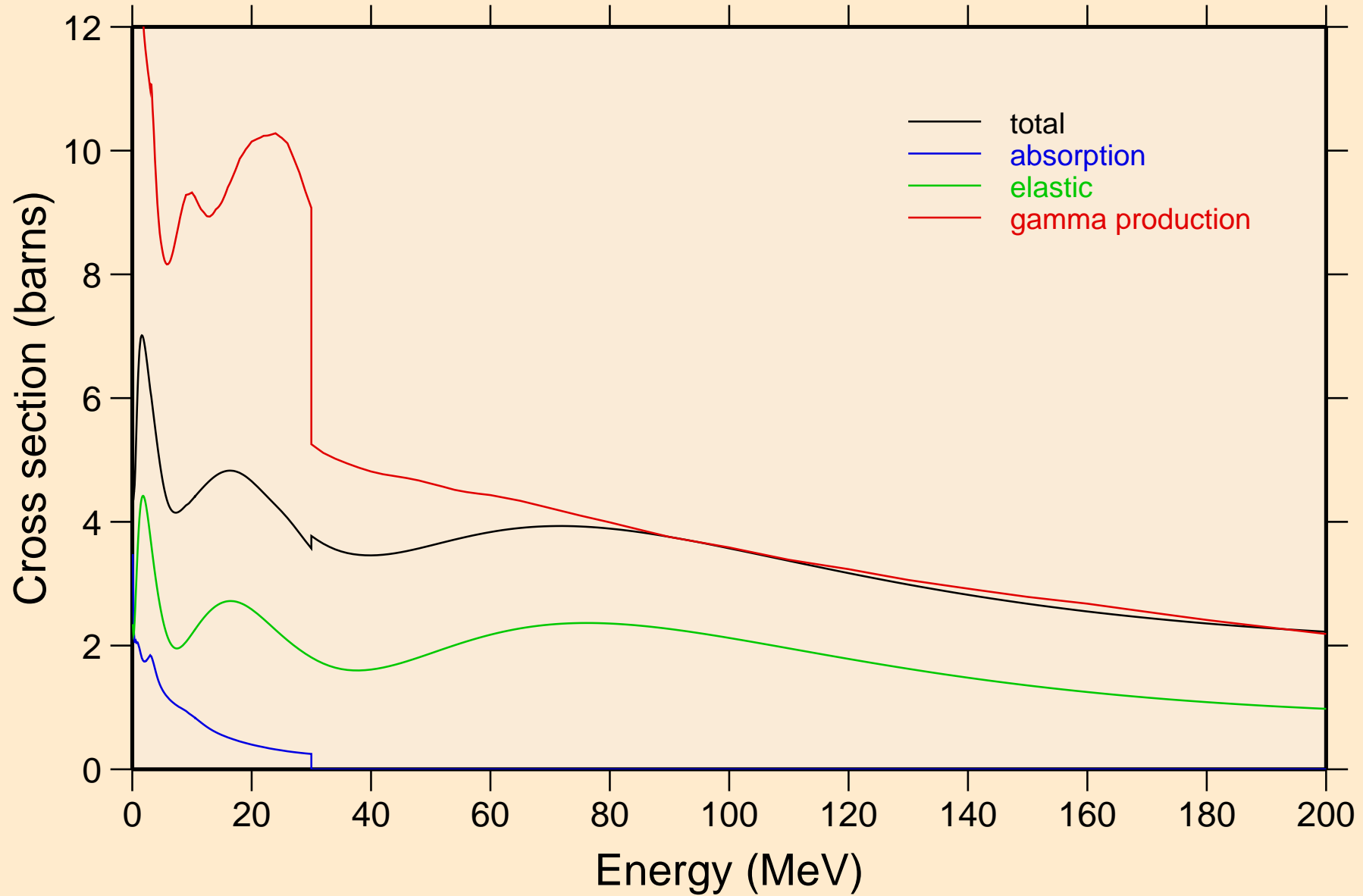

SM137 NEUTRON ACER TENDL-2024 LIBRARY; T=293.6K

Heating

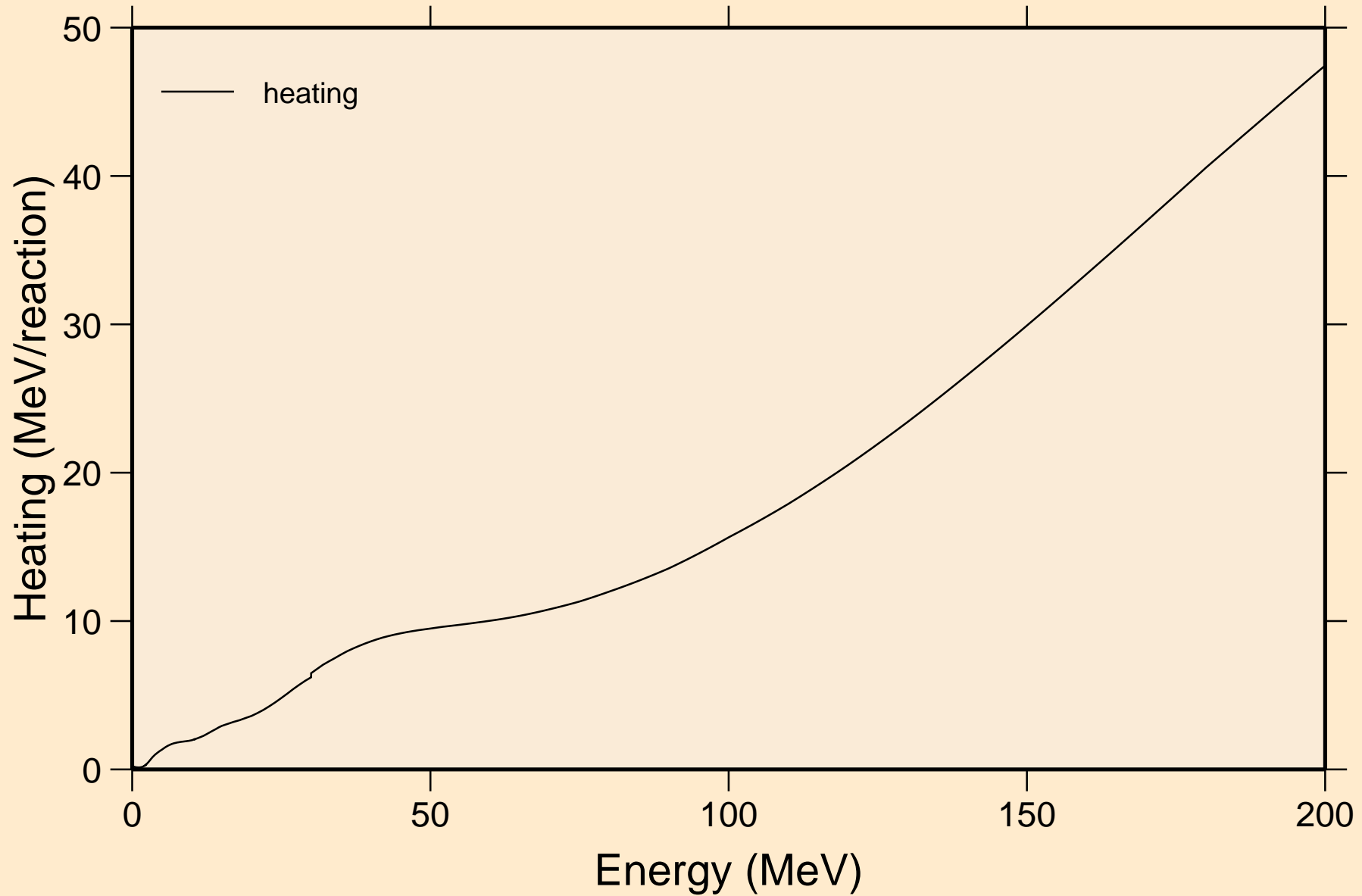

SM137 NEUTRON ACER TENDL-2024 LIBRARY; T=293.6K
Damage

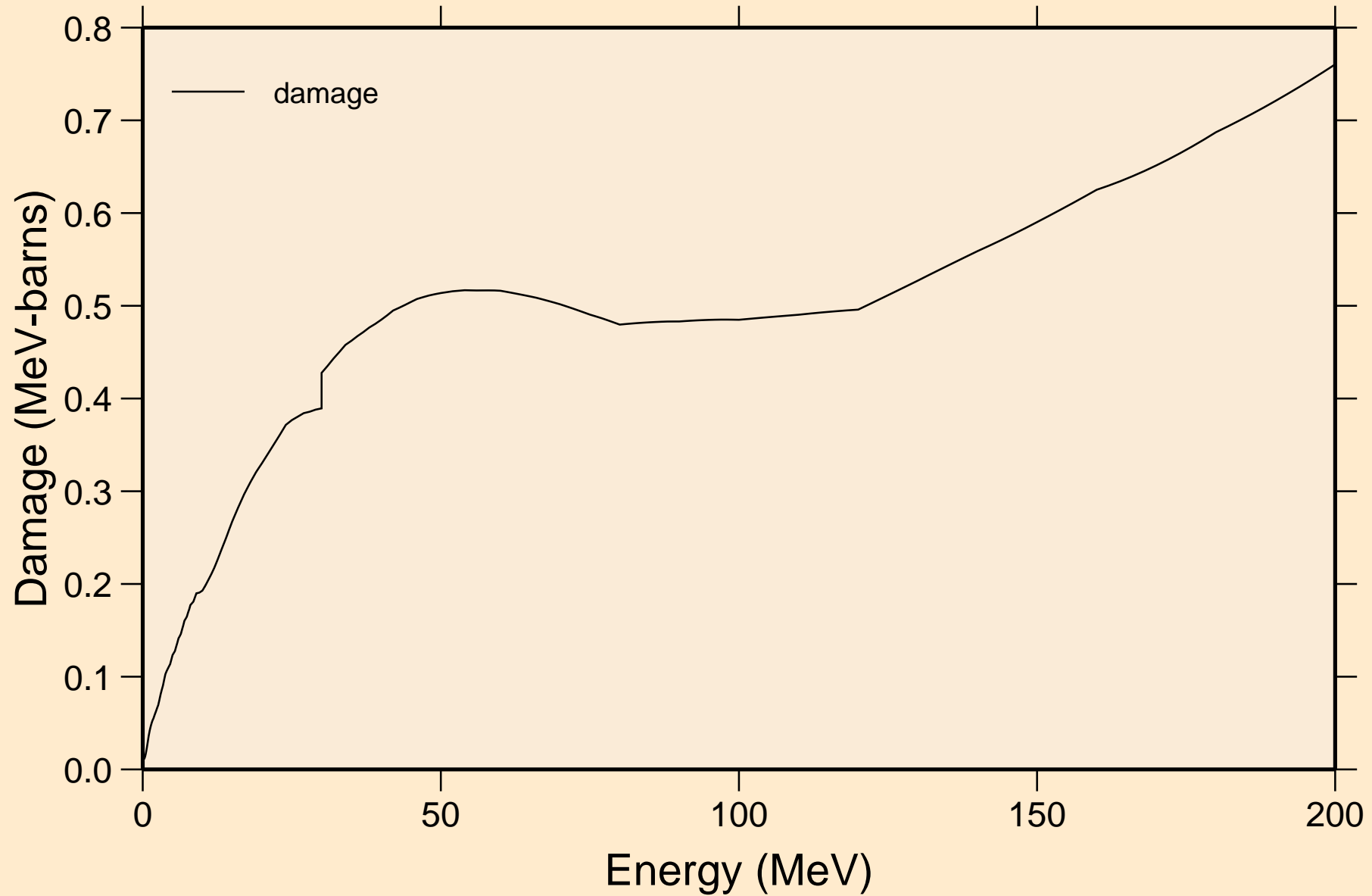

SM137 NEUTRON ACER TENDL-2024 LIBRARY; T=293.6K
Non-threshold reactions

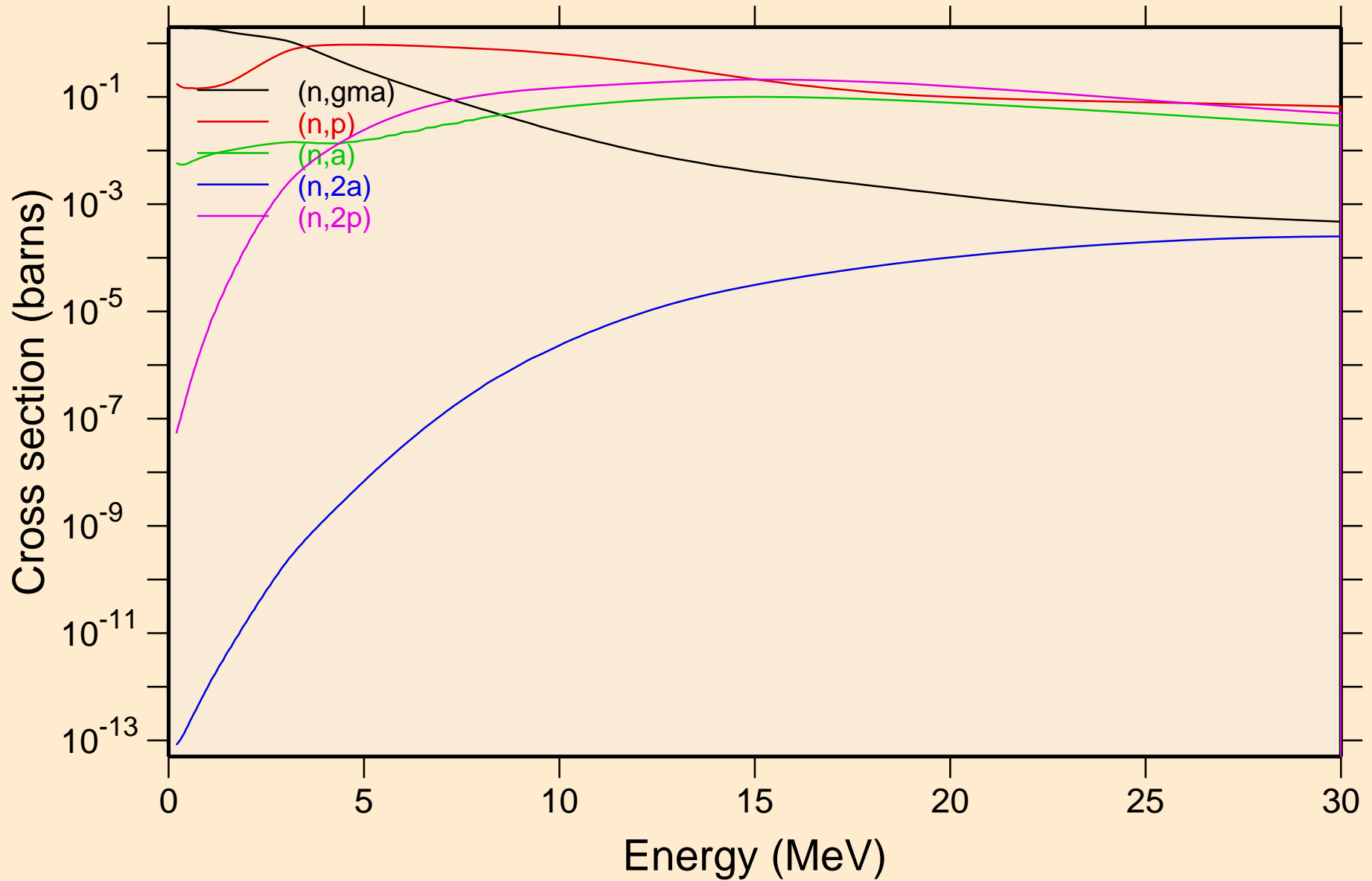

SM137 NEUTRON ACER TENDL-2024 LIBRARY; T=293.6K
Non-threshold reactions

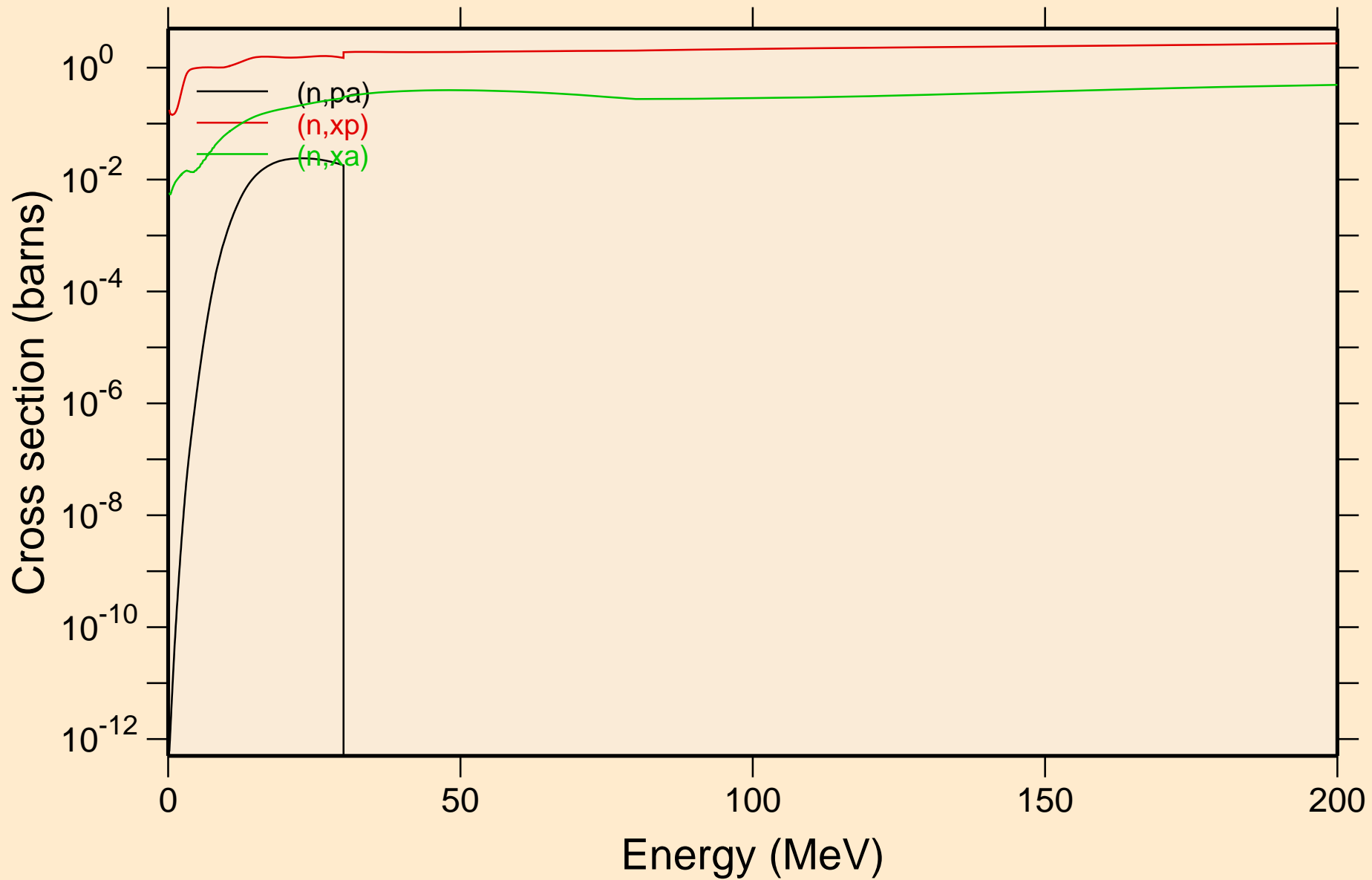

SM137 NEUTRON ACER TENDL-2024 LIBRARY; T=293.6K
Inelastic levels

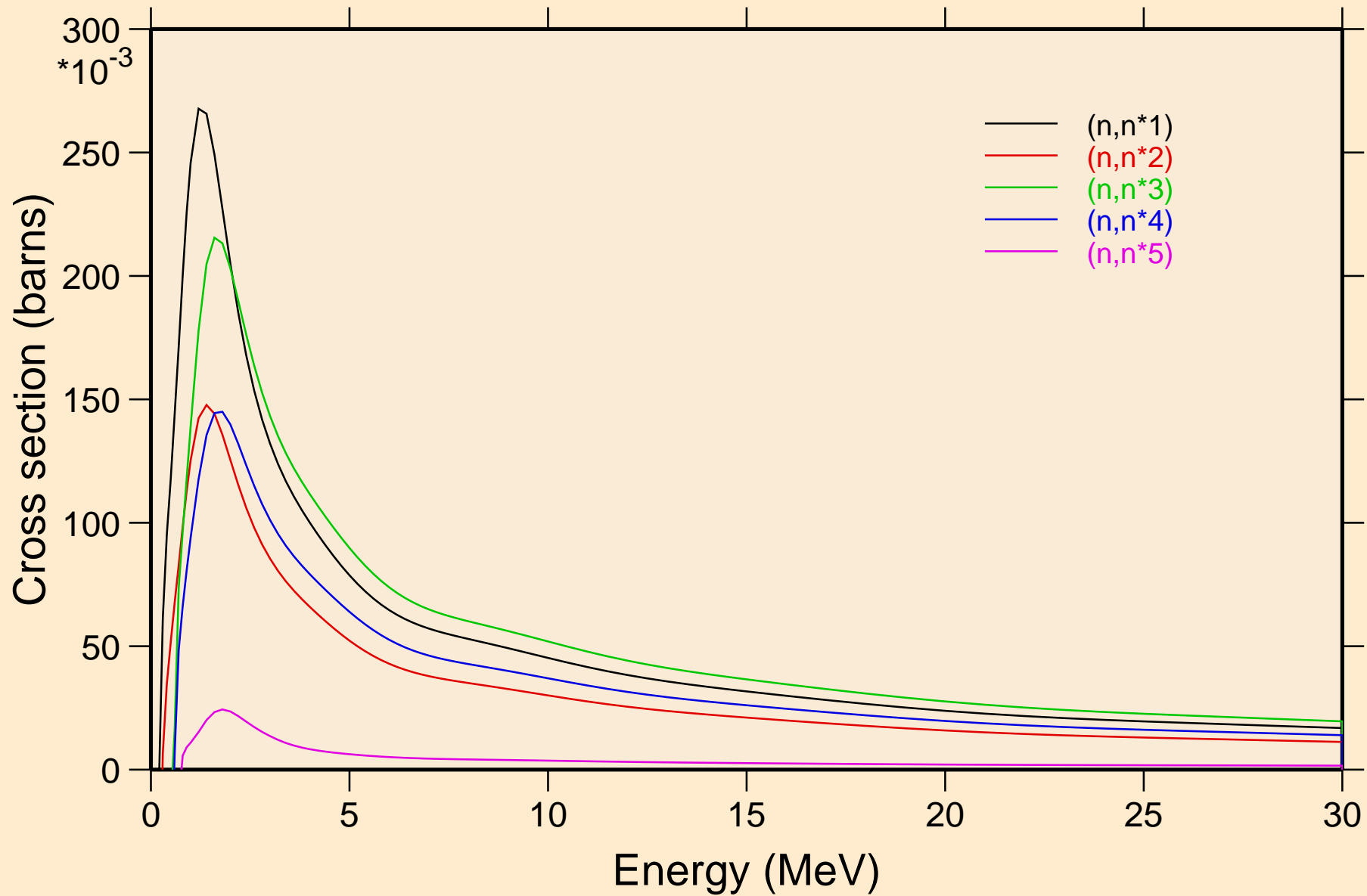

SM137 NEUTRON ACER TENDL-2024 LIBRARY; T=293.6K
Inelastic levels

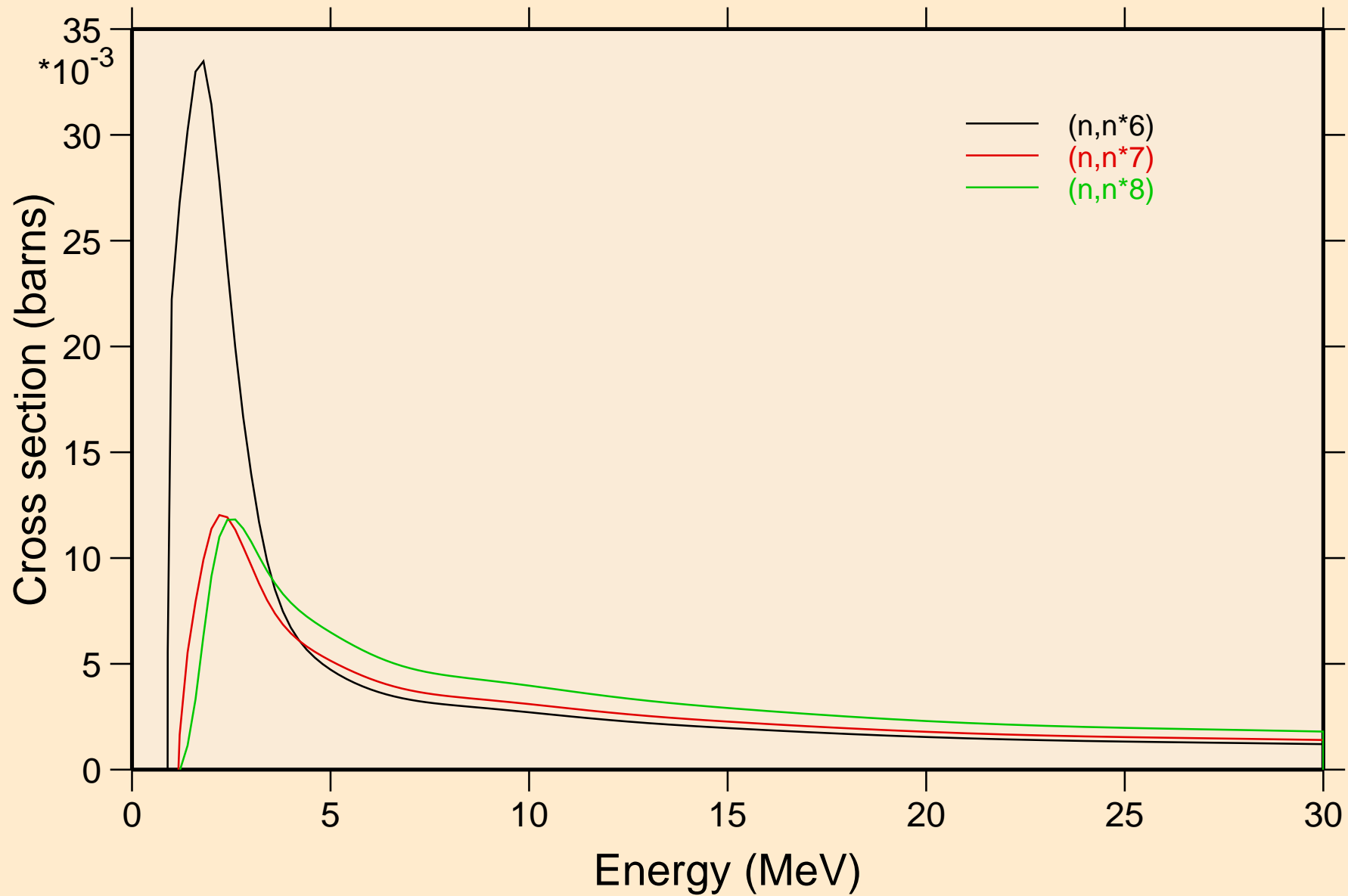

SM137 NEUTRON ACER TENDL-2024 LIBRARY; T=293.6K
Threshold reactions

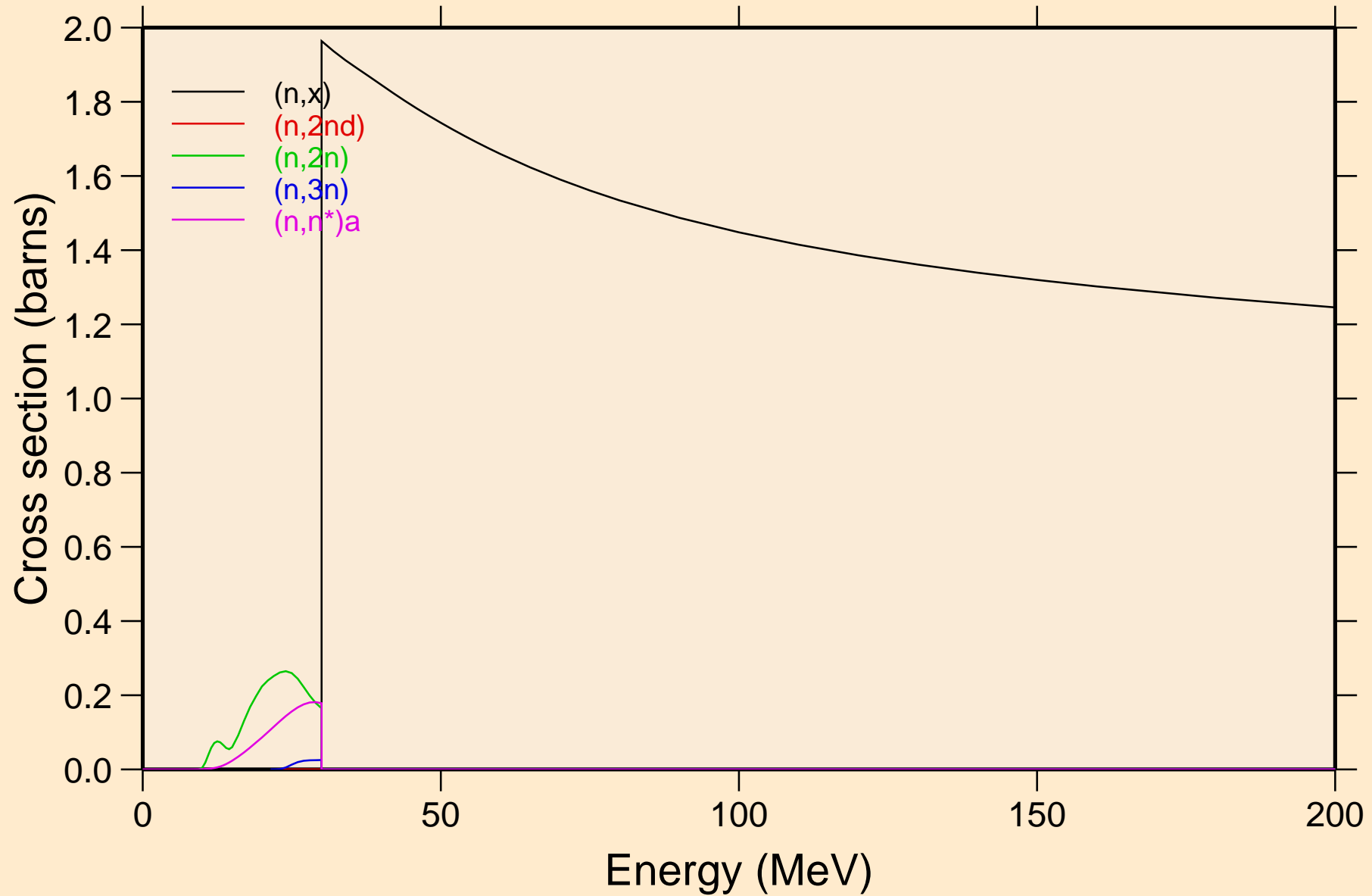

SM137 NEUTRON ACER TENDL-2024 LIBRARY; T=293.6K
Threshold reactions

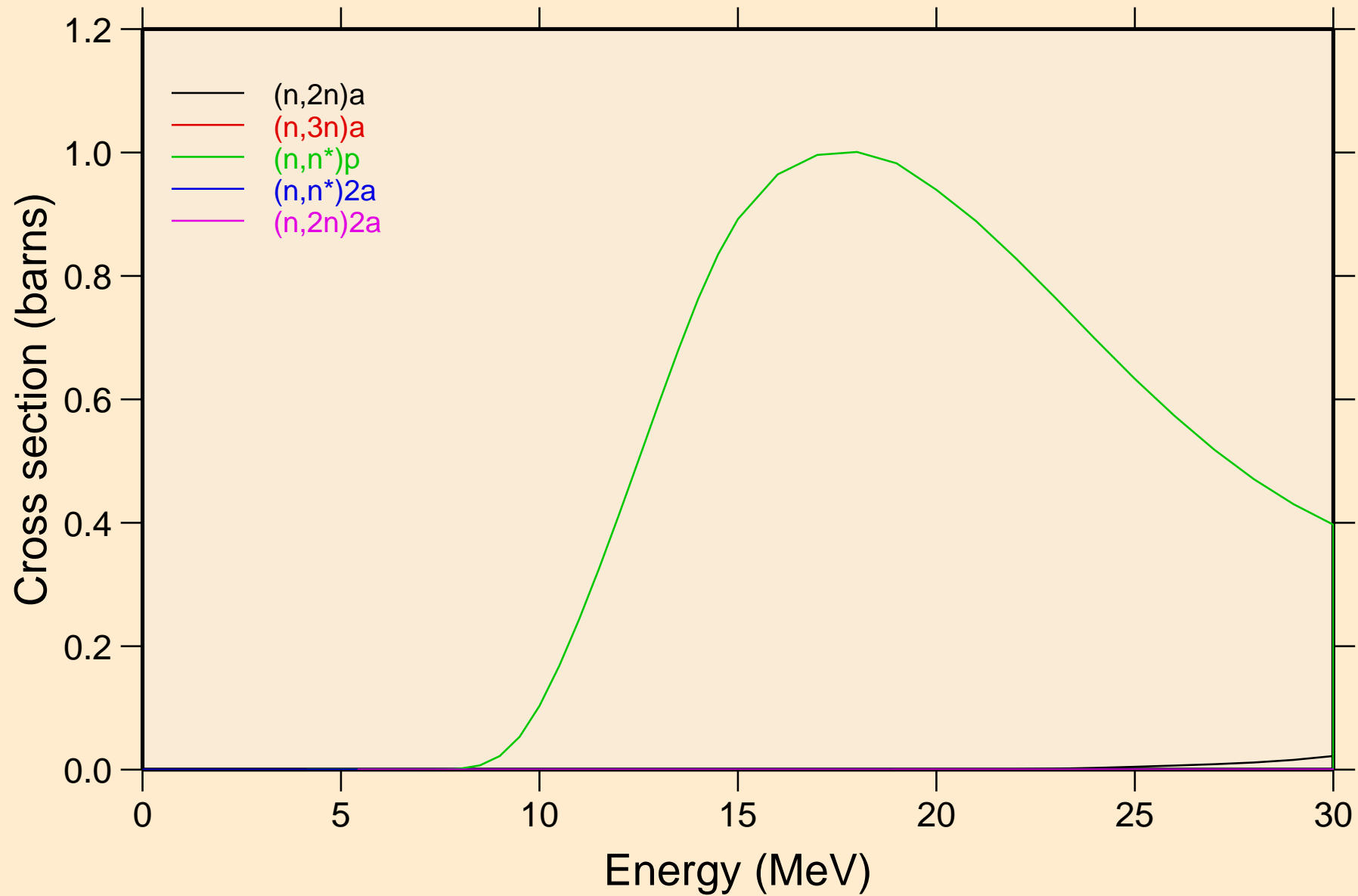

SM137 NEUTRON ACER TENDL-2024 LIBRARY; T=293.6K
Threshold reactions

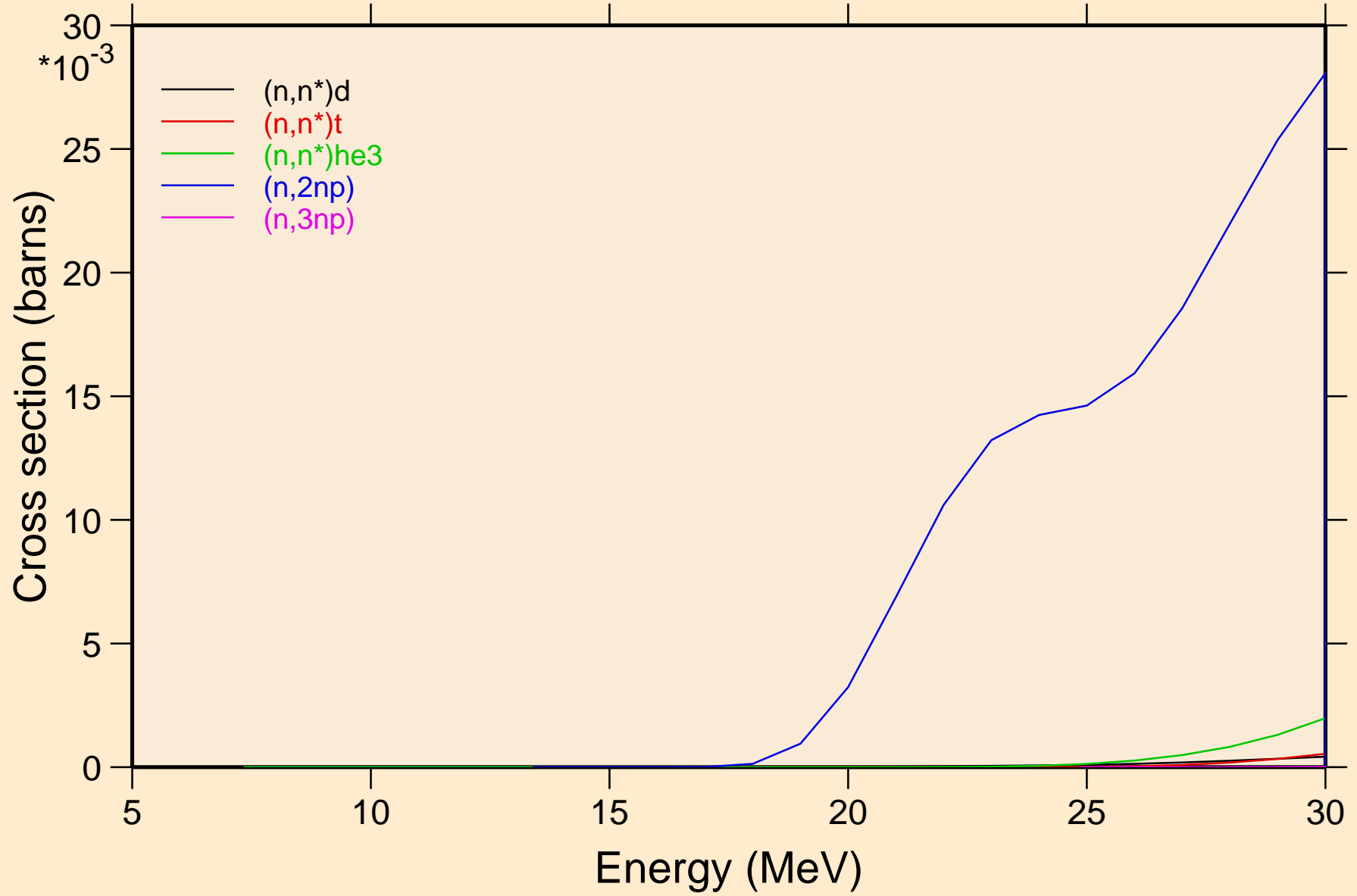

SM137 NEUTRON ACER TENDL-2024 LIBRARY; T=293.6K
Threshold reactions

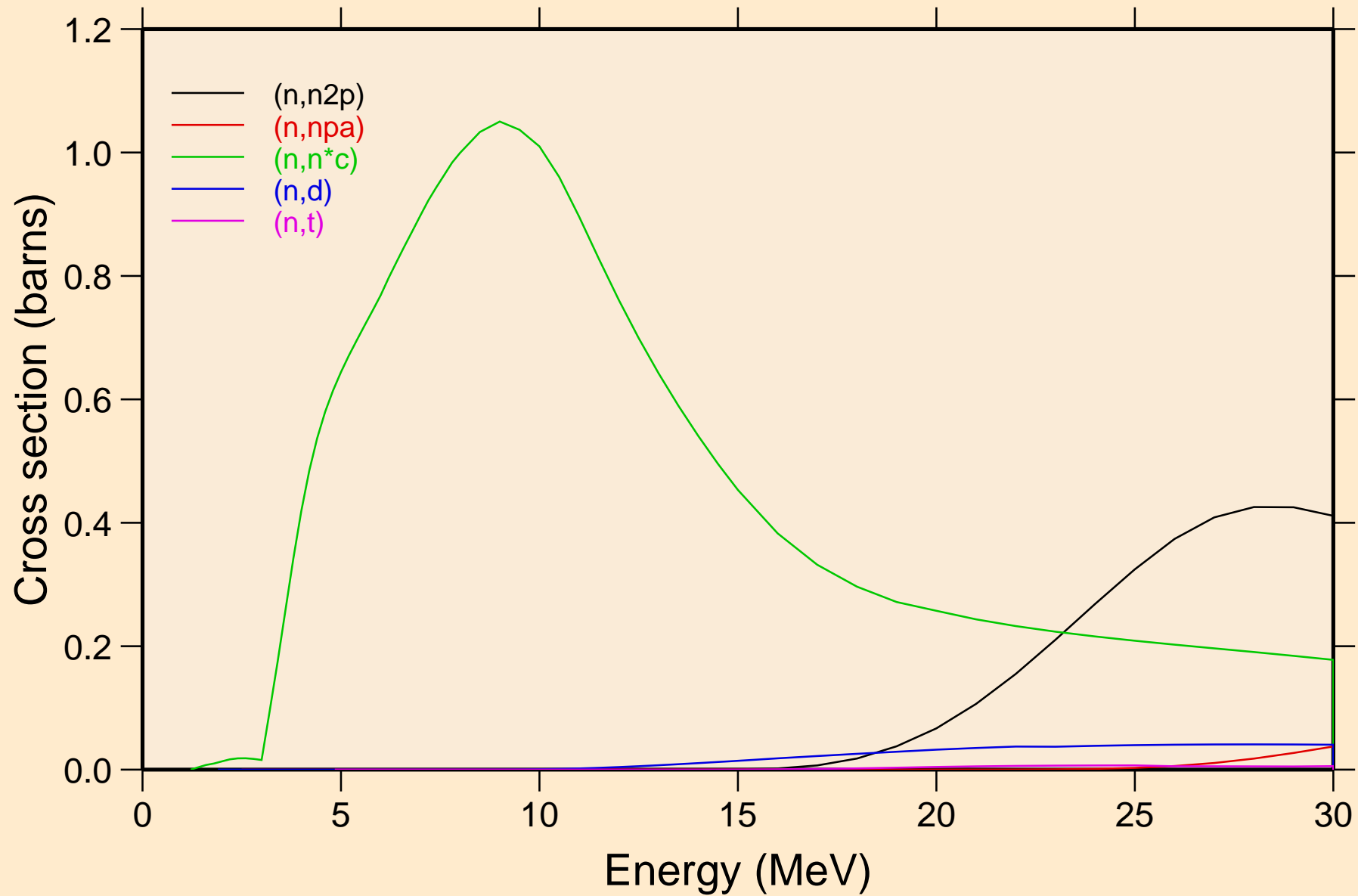

SM137 NEUTRON ACER TENDL-2024 LIBRARY; T=293.6K
Threshold reactions

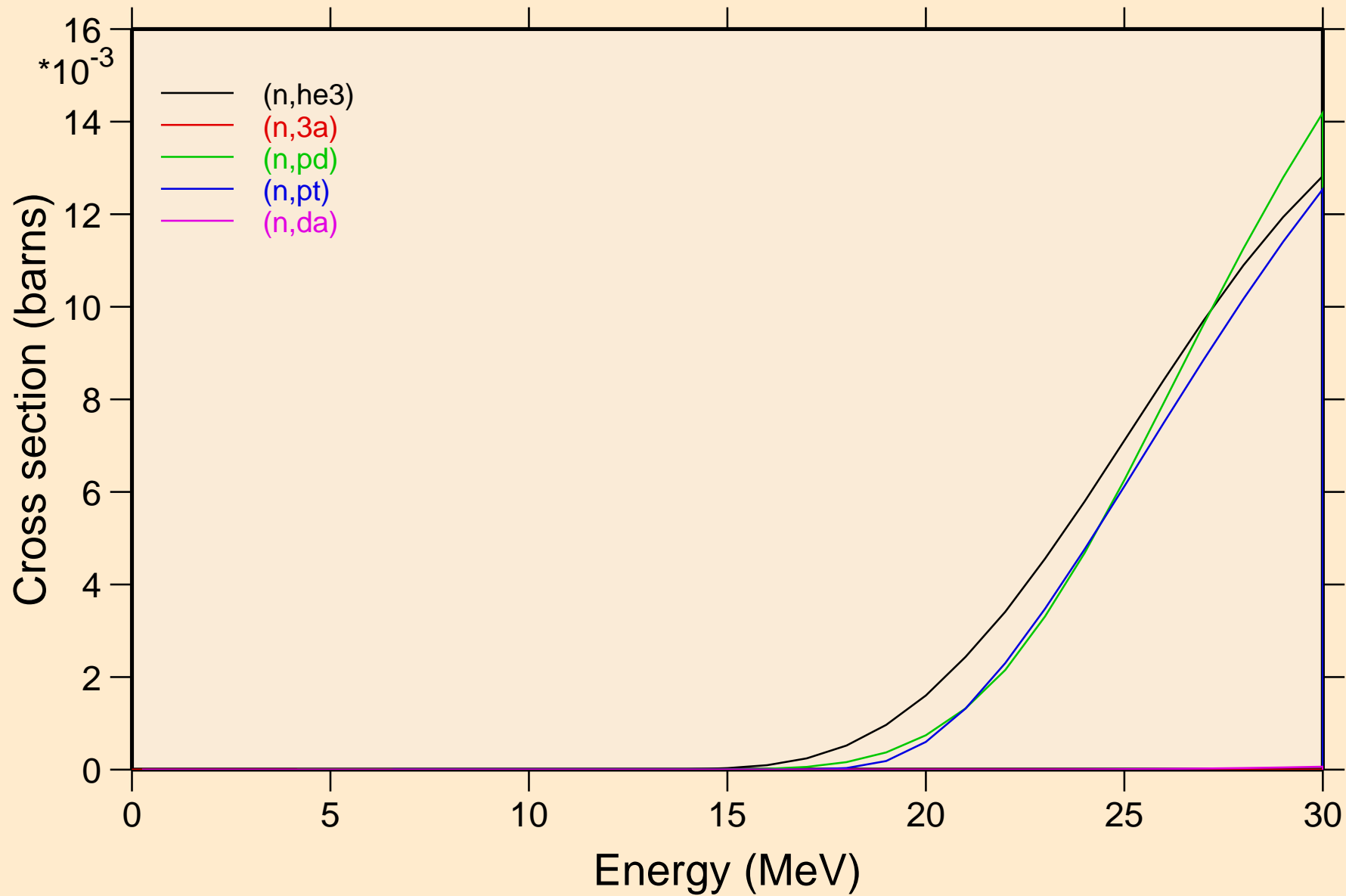

SM137 NEUTRON ACER TENDL-2024 LIBRARY; T=293.6K
Threshold reactions

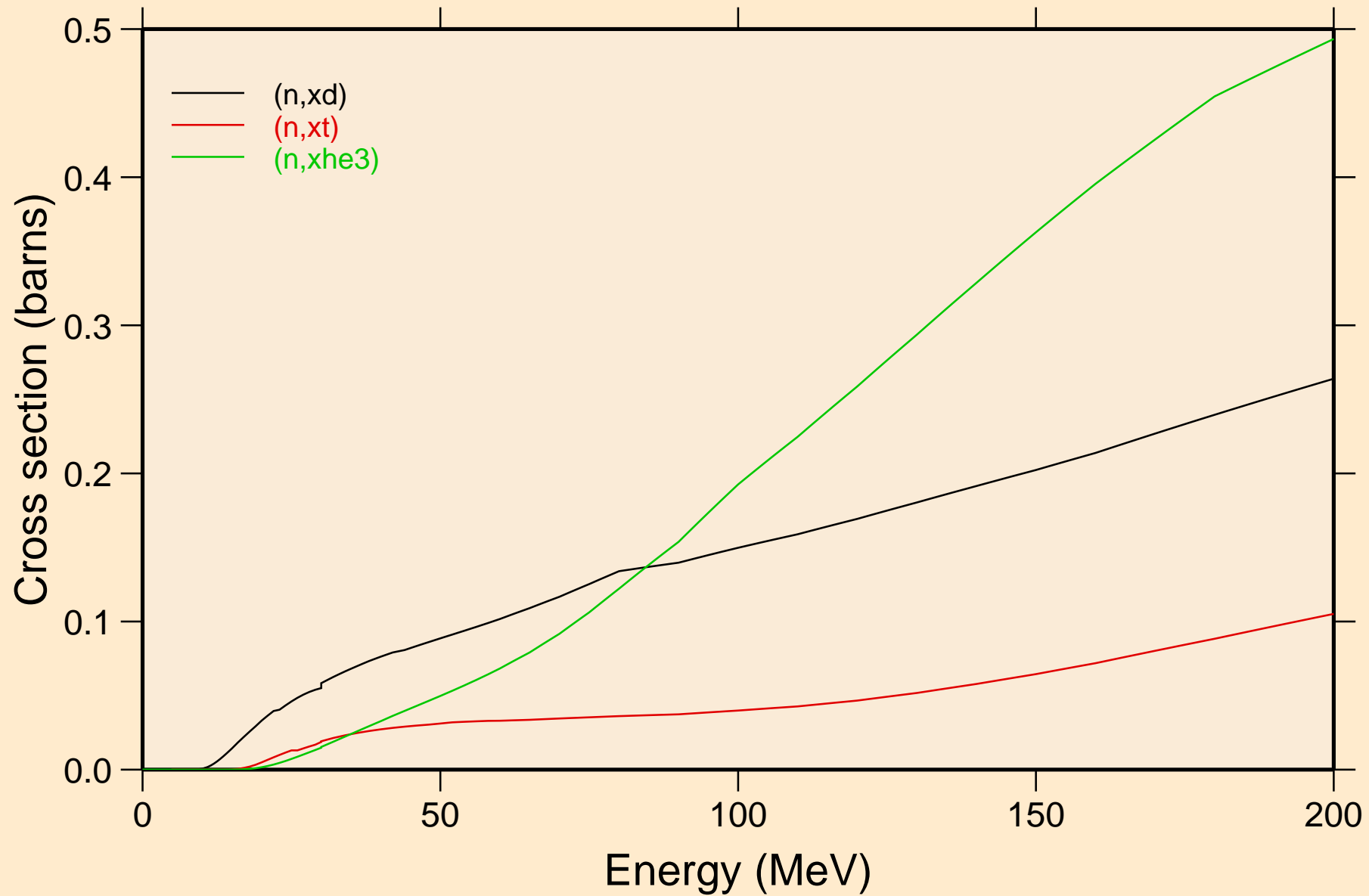

SM137 NEUTRON ACER TENDL-2024 LIBRARY; T=293.6K
angular distribution for elastic

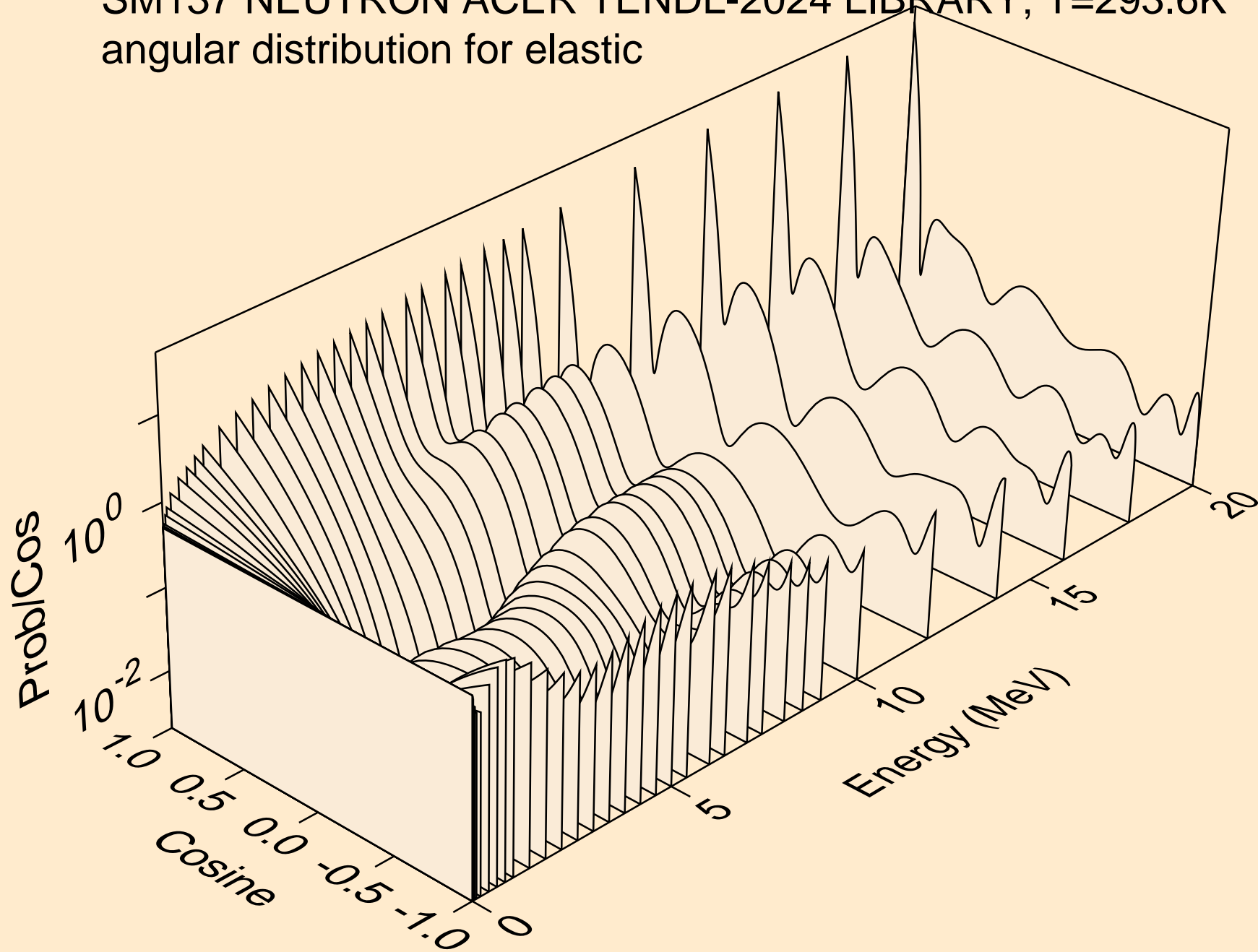

SM137 NEUTRON ACER TENDL-2024 LIBRARY; T=293.6K
angular distribution for elastic

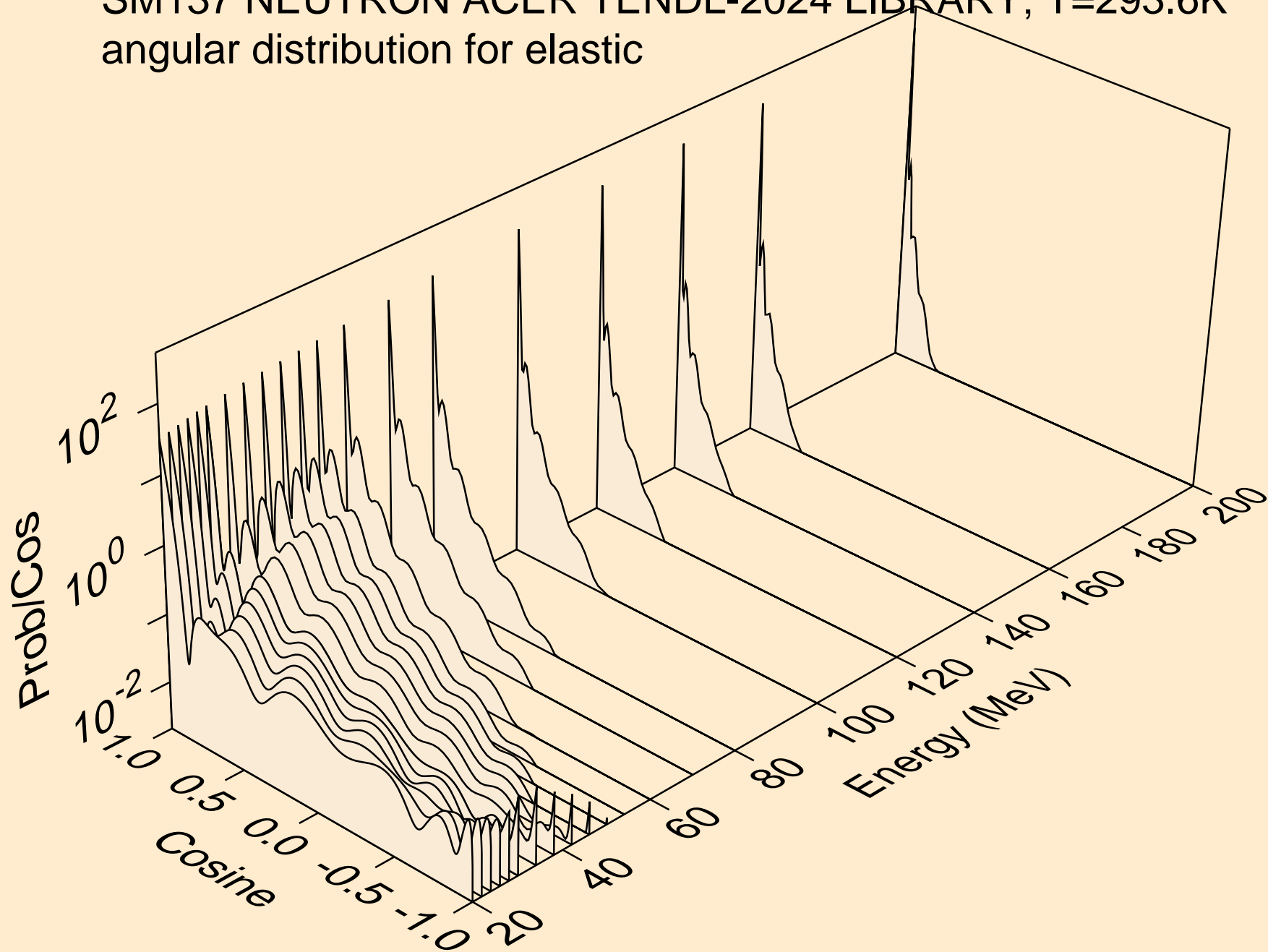

SM137 NEUTRON ACER TENDL-2024 LIBRARY; T=293.6K
angular distribution for (n,n*1)

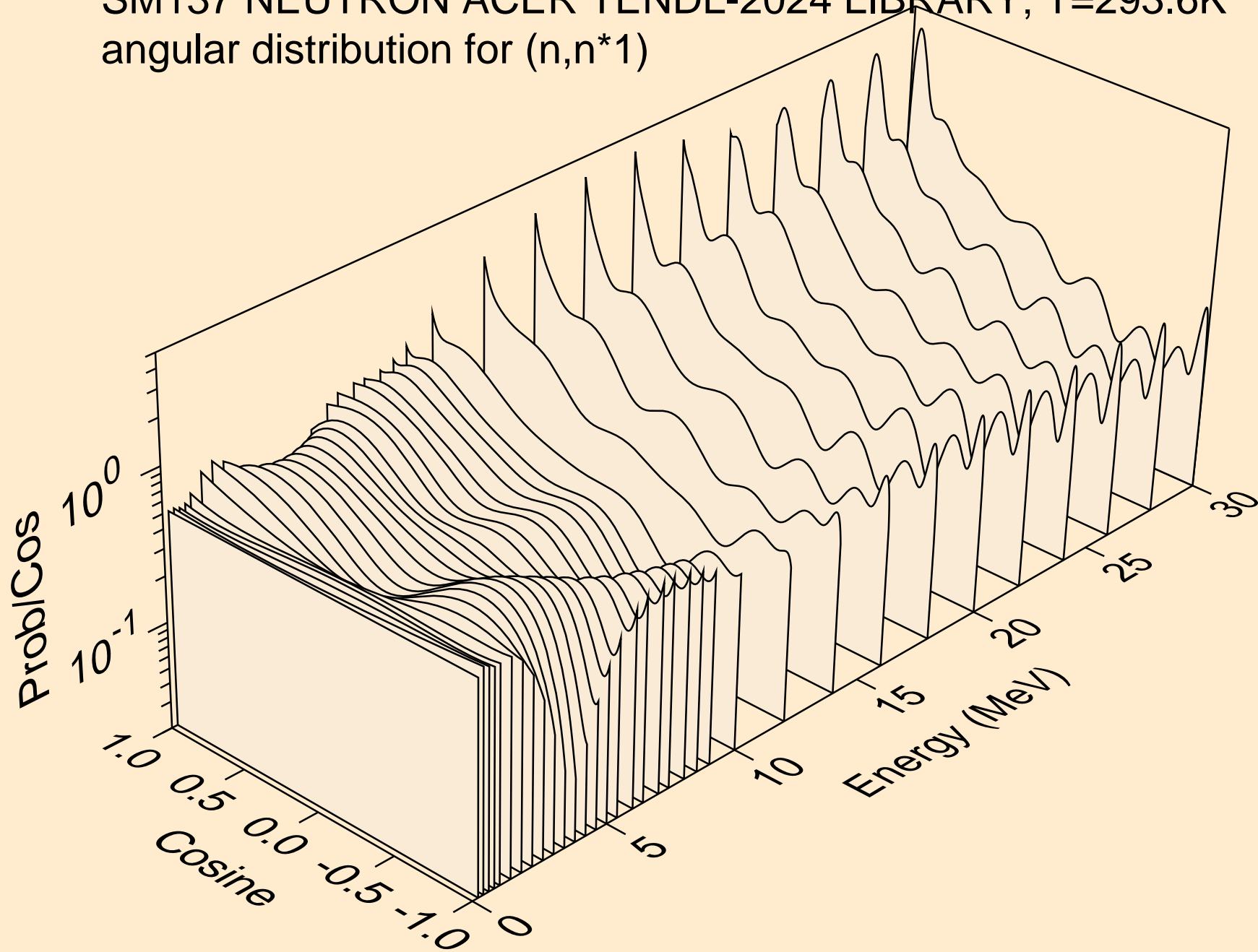

SM137 NEUTRON ACER TENDL-2024 LIBRARY; T=293.6K
angular distribution for (n,n*2)

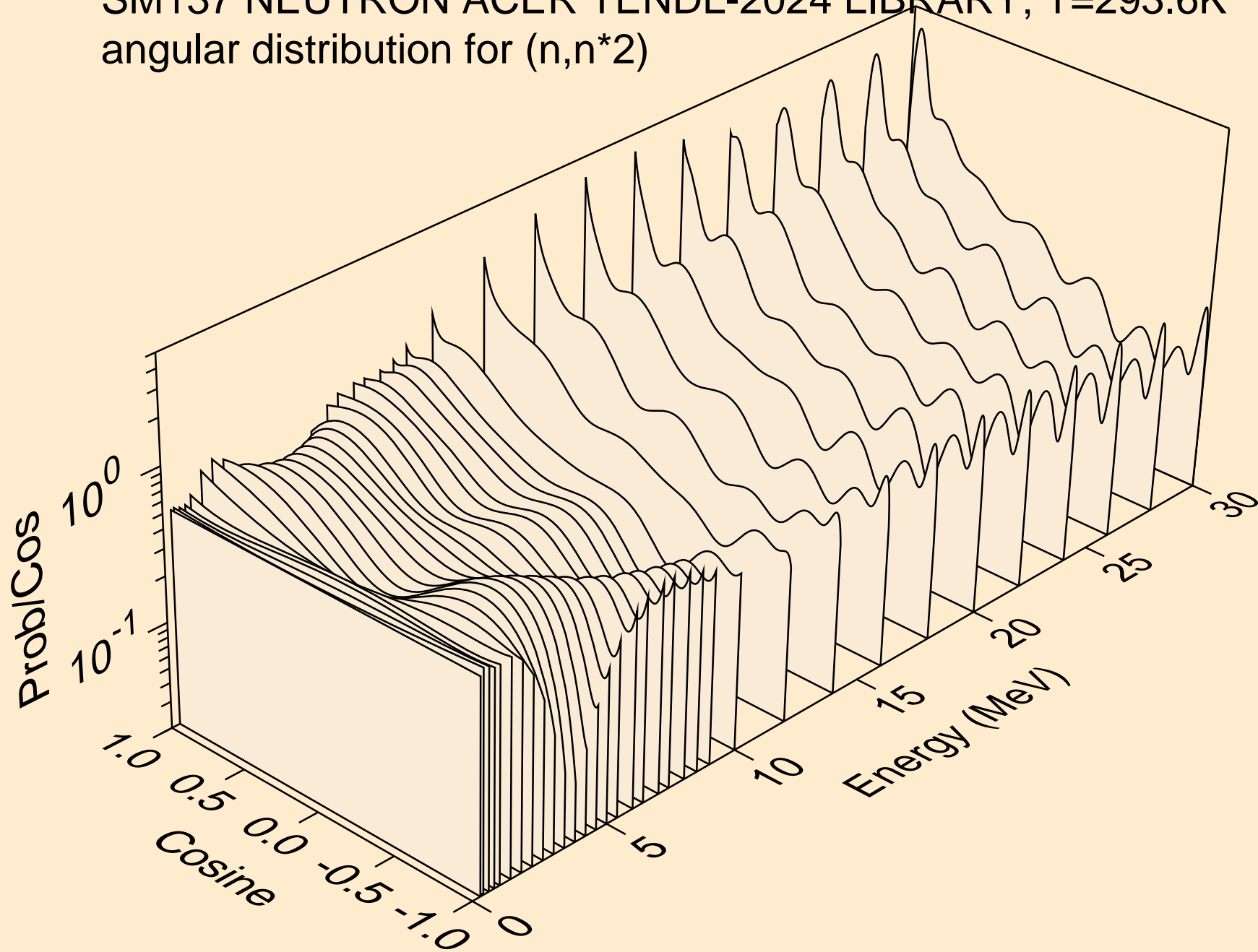

SM137 NEUTRON ACER TENDL-2024 LIBRARY; T=293.6K
angular distribution for (n,n*3)

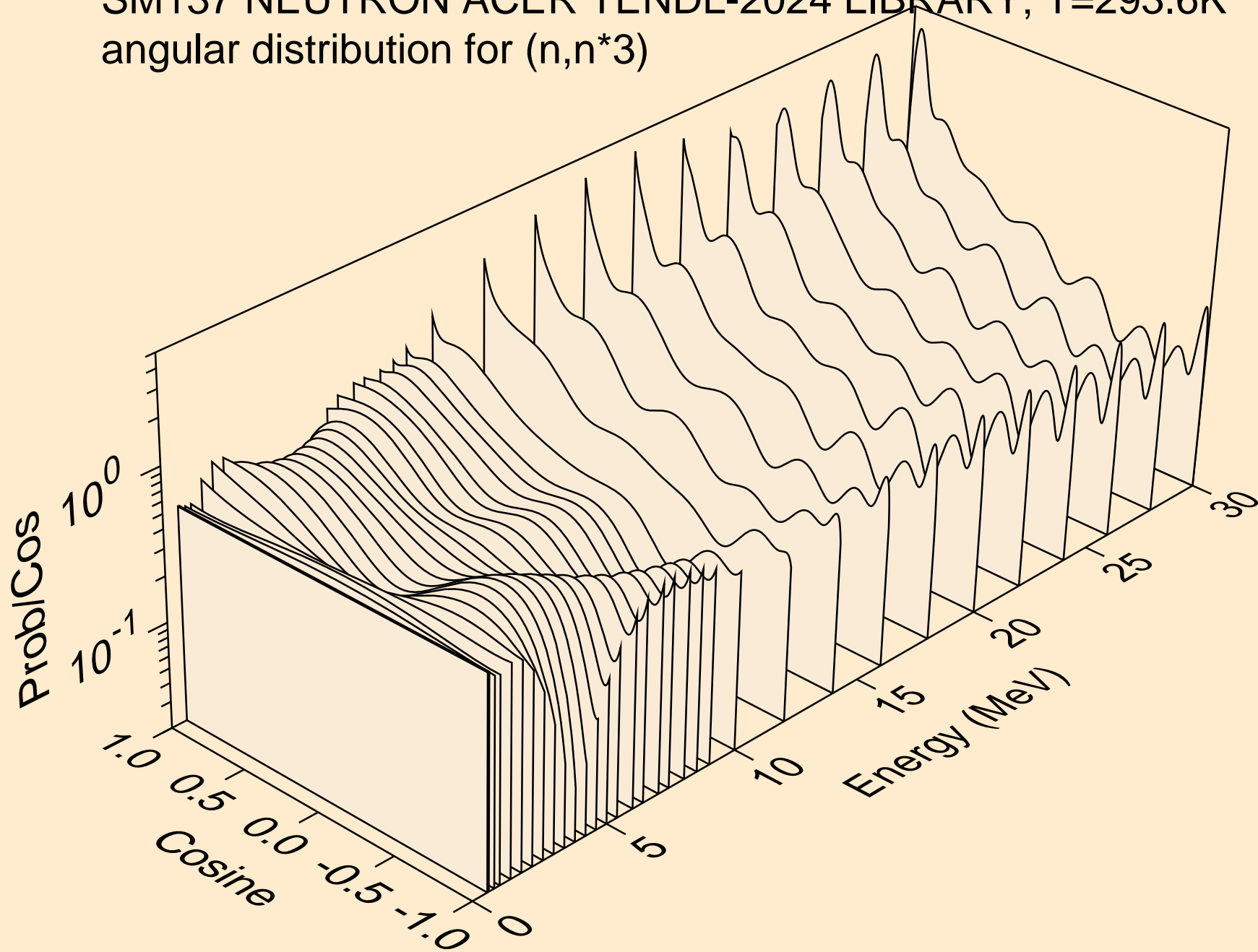

SM137 NEUTRON ACER TENDL-2024 LIBRARY; T=293.6K
angular distribution for (n,n*4)

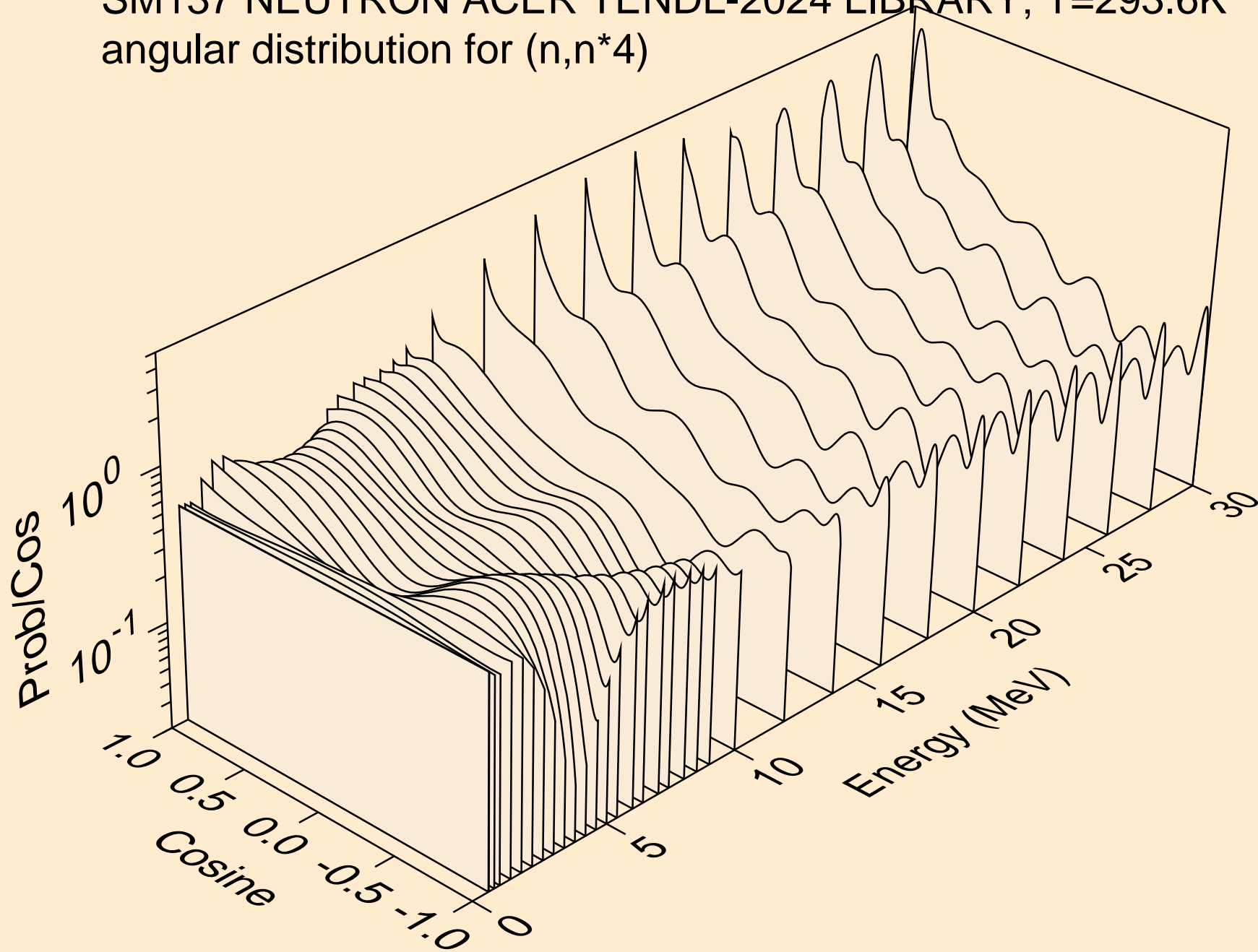

SM137 NEUTRON ACER TENDL-2024 LIBRARY; T=293.6K
angular distribution for (n,n*5)

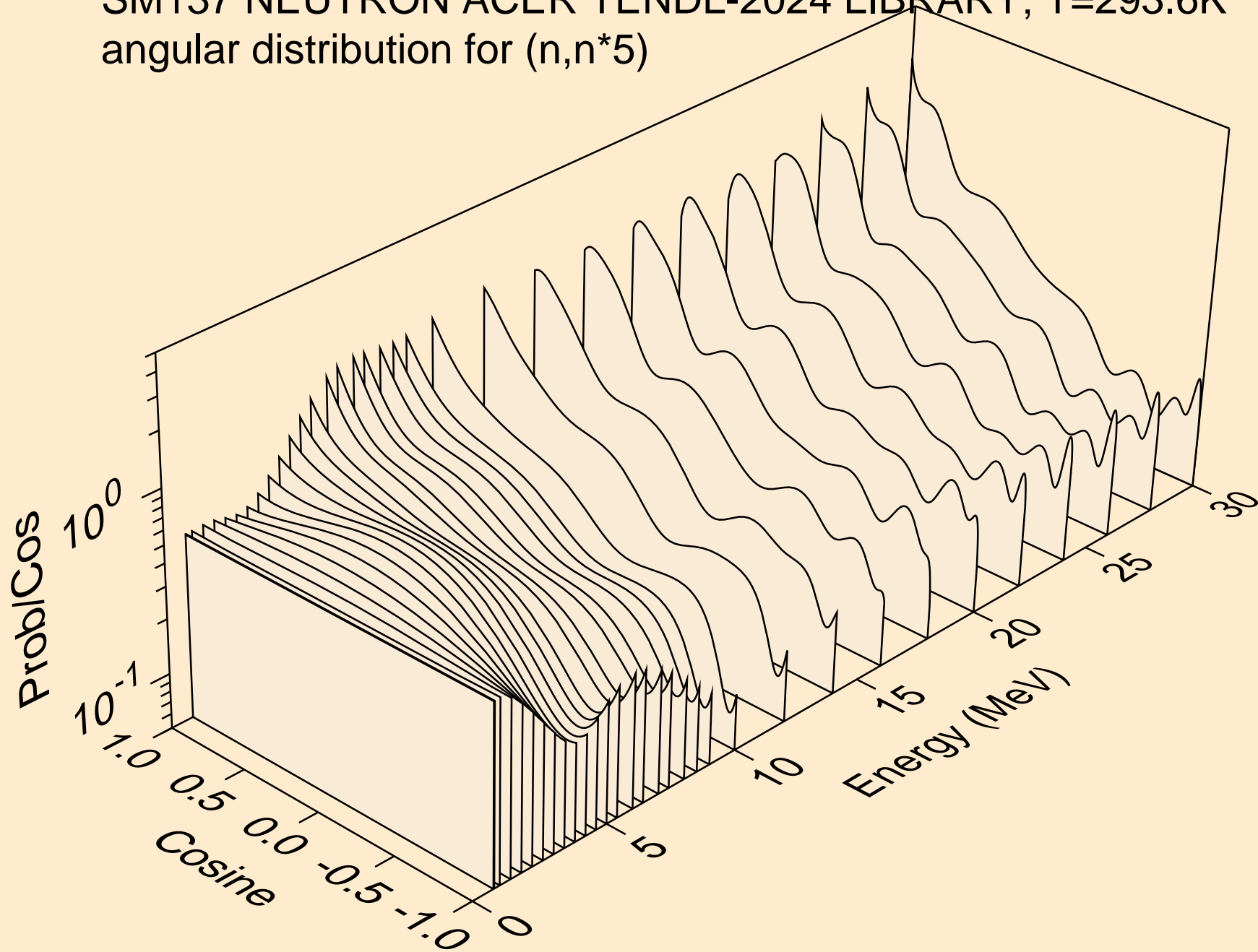

SM137 NEUTRON ACER TENDL-2024 LIBRARY; T=293.6K
angular distribution for (n,n*6)

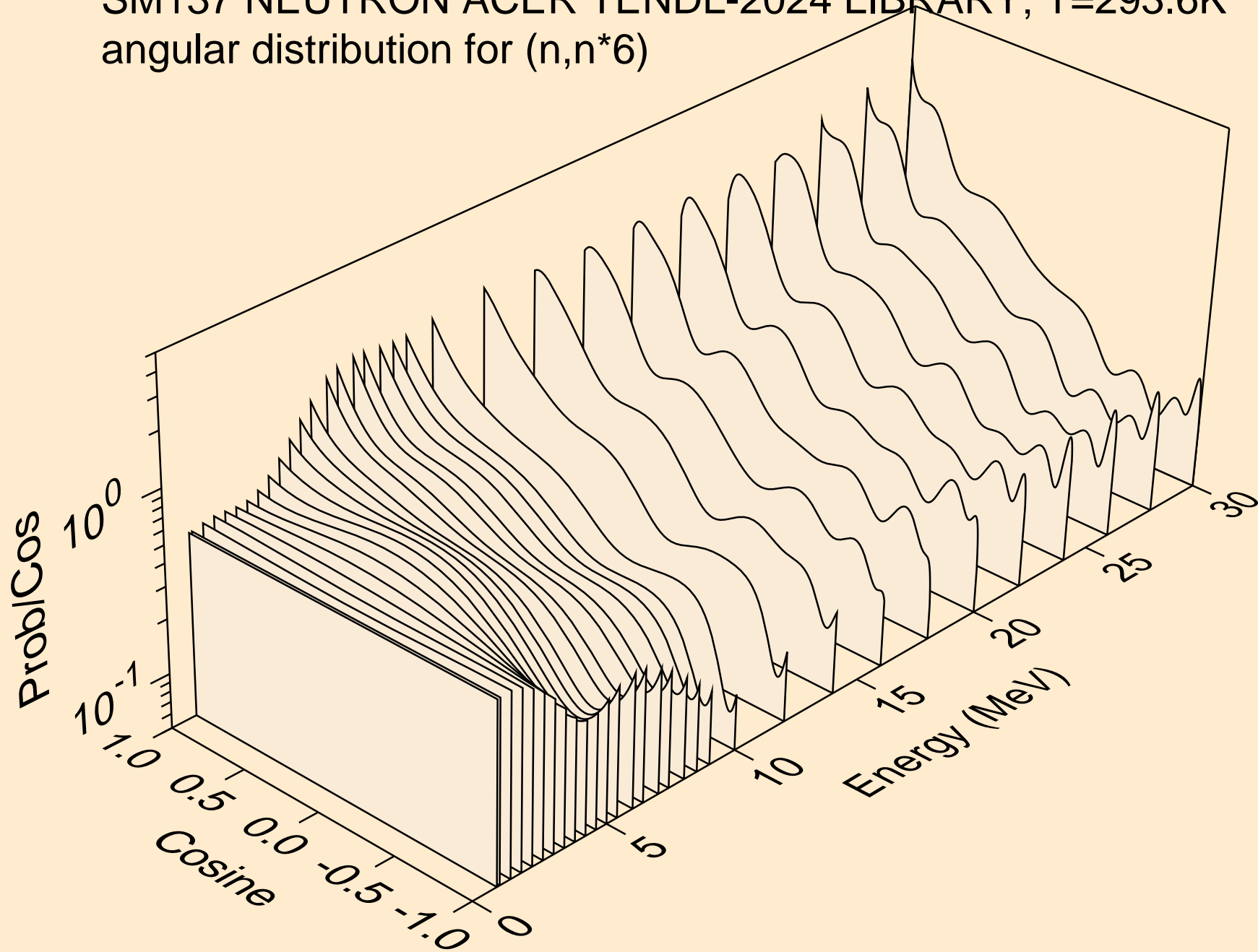

SM137 NEUTRON ACER TENDL-2024 LIBRARY; T=293.6K
angular distribution for (n,n*7)

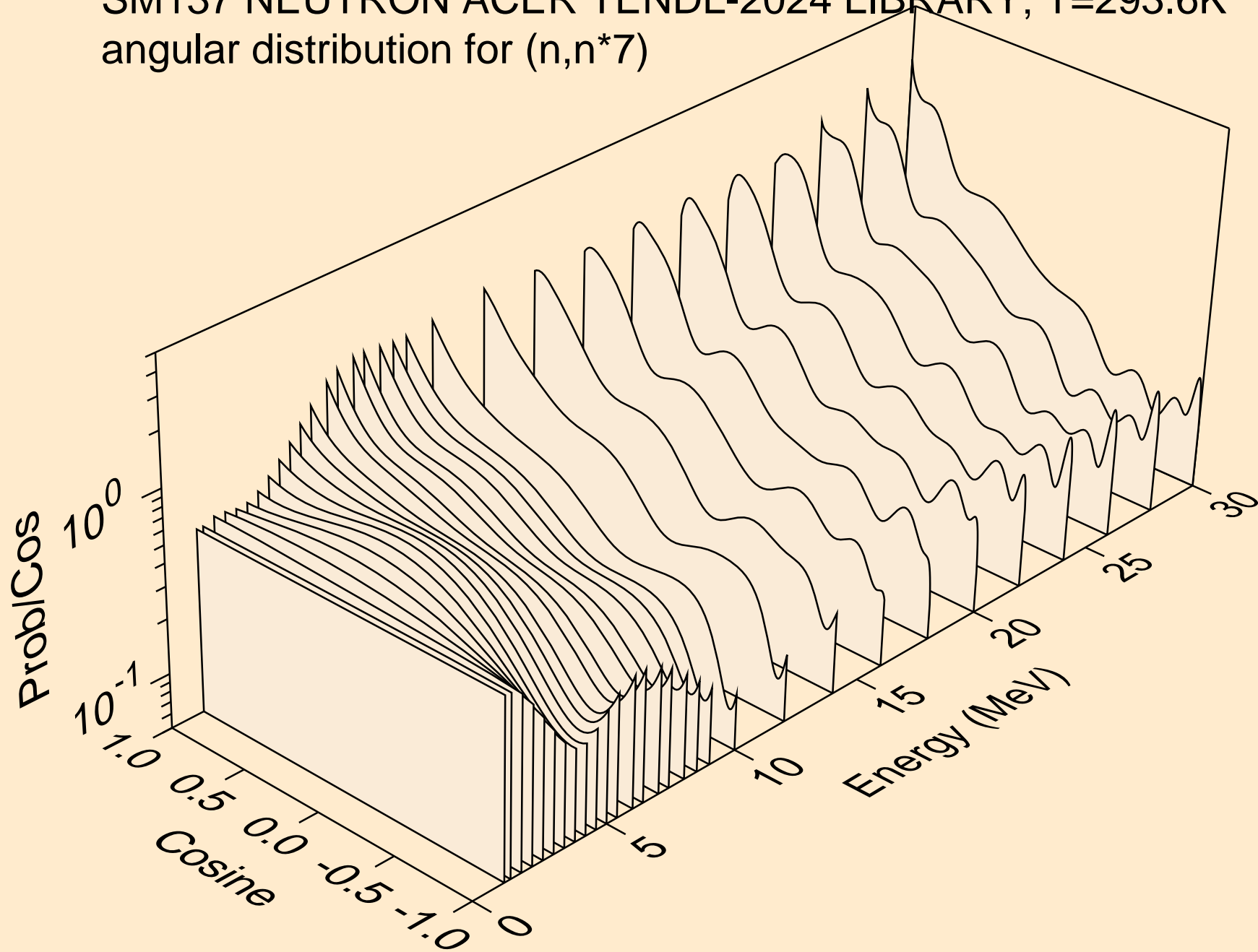

SM137 NEUTRON ACER TENDL-2024 LIBRARY; T=293.6K
angular distribution for (n,n*8)

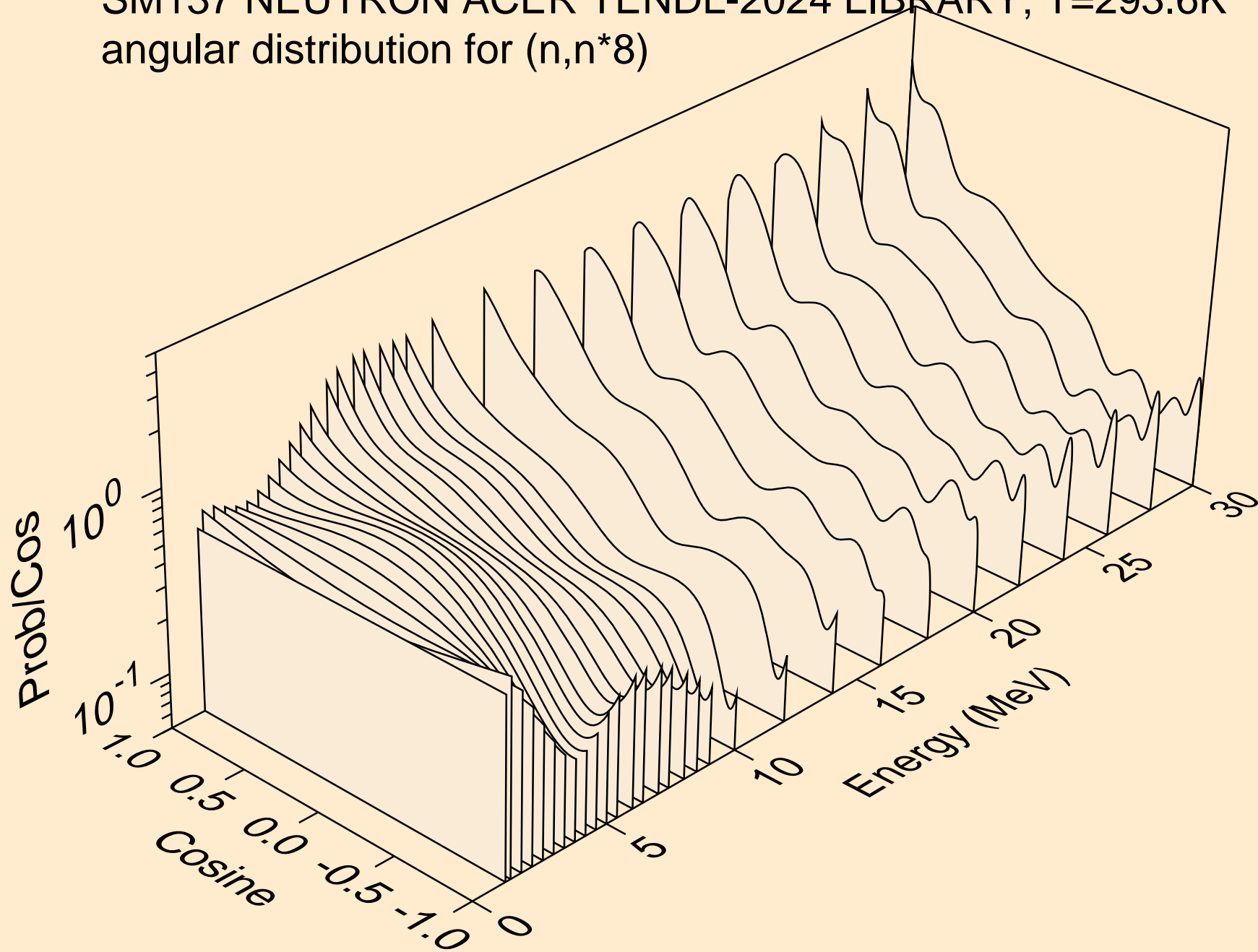

SM137 NEUTRON ACER TENDL-2024 LIBRARY; T=293.6K
Neutron emission for (n,x)

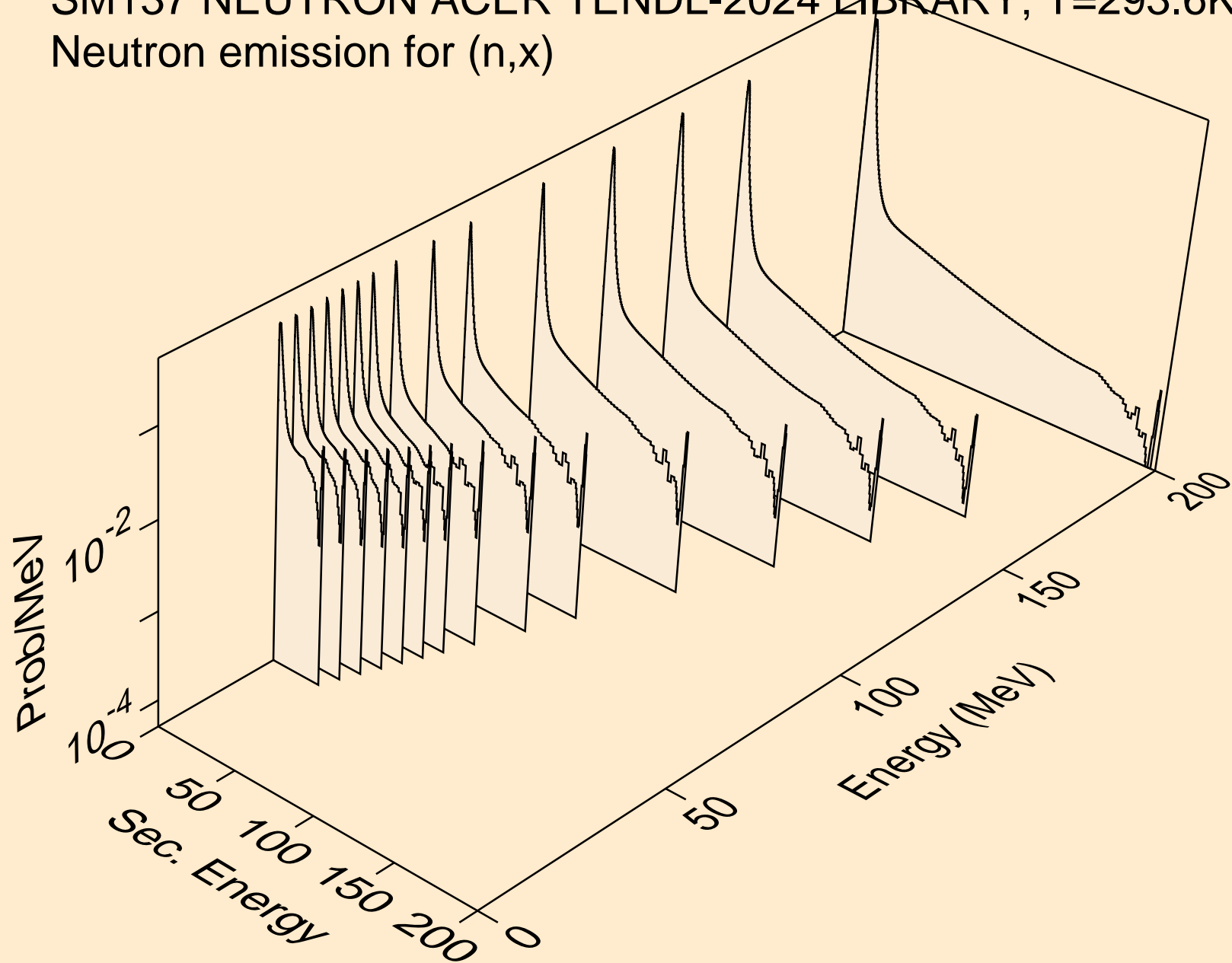

SM137 NEUTRON ACER TENDL-2024 LIBRARY; T=293.6K
Neutron emission for (n,2nd)

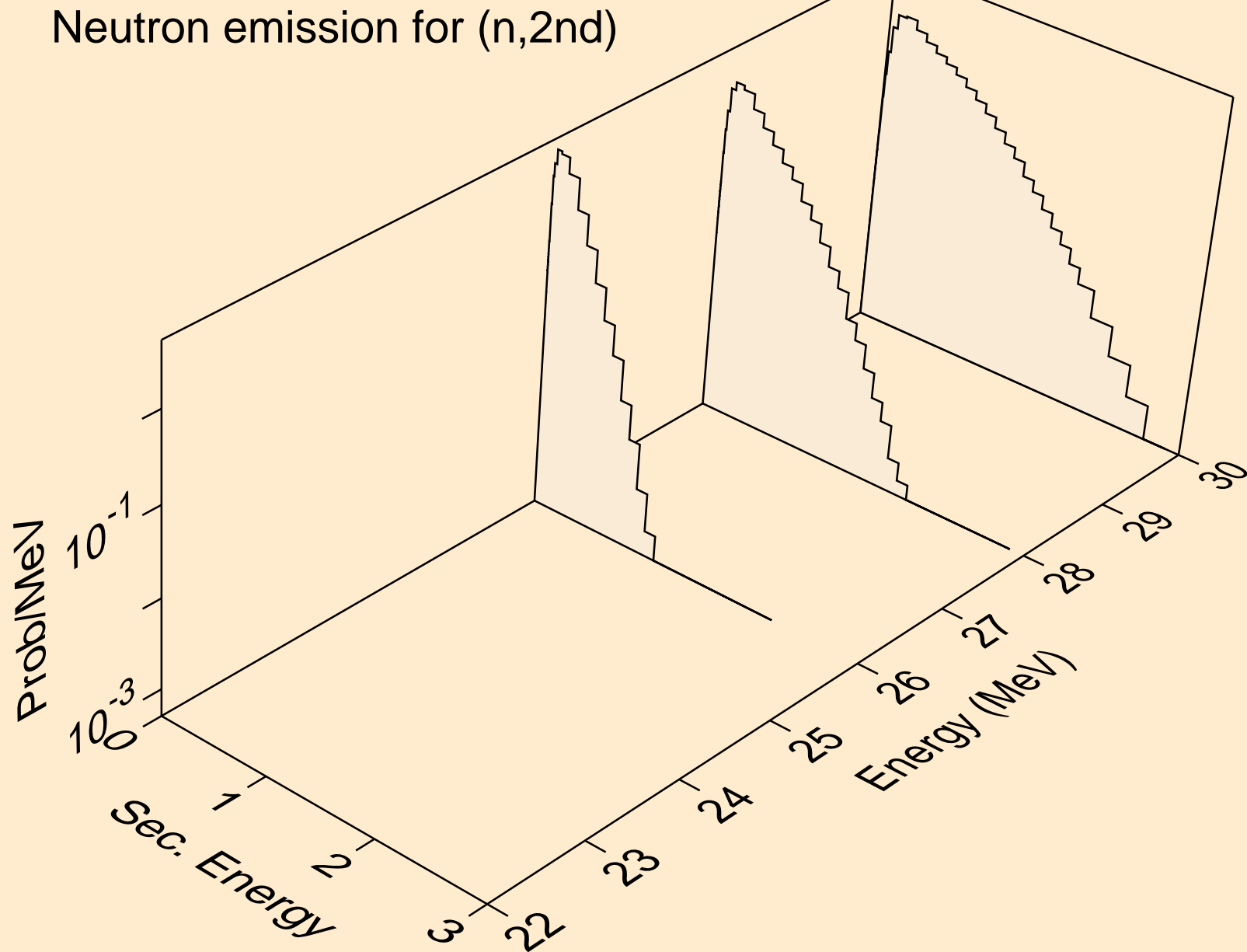

SM137 NEUTRON ACER TENDL-2024 LIBRARY; T=293.6K
Neutron emission for (n,2n)

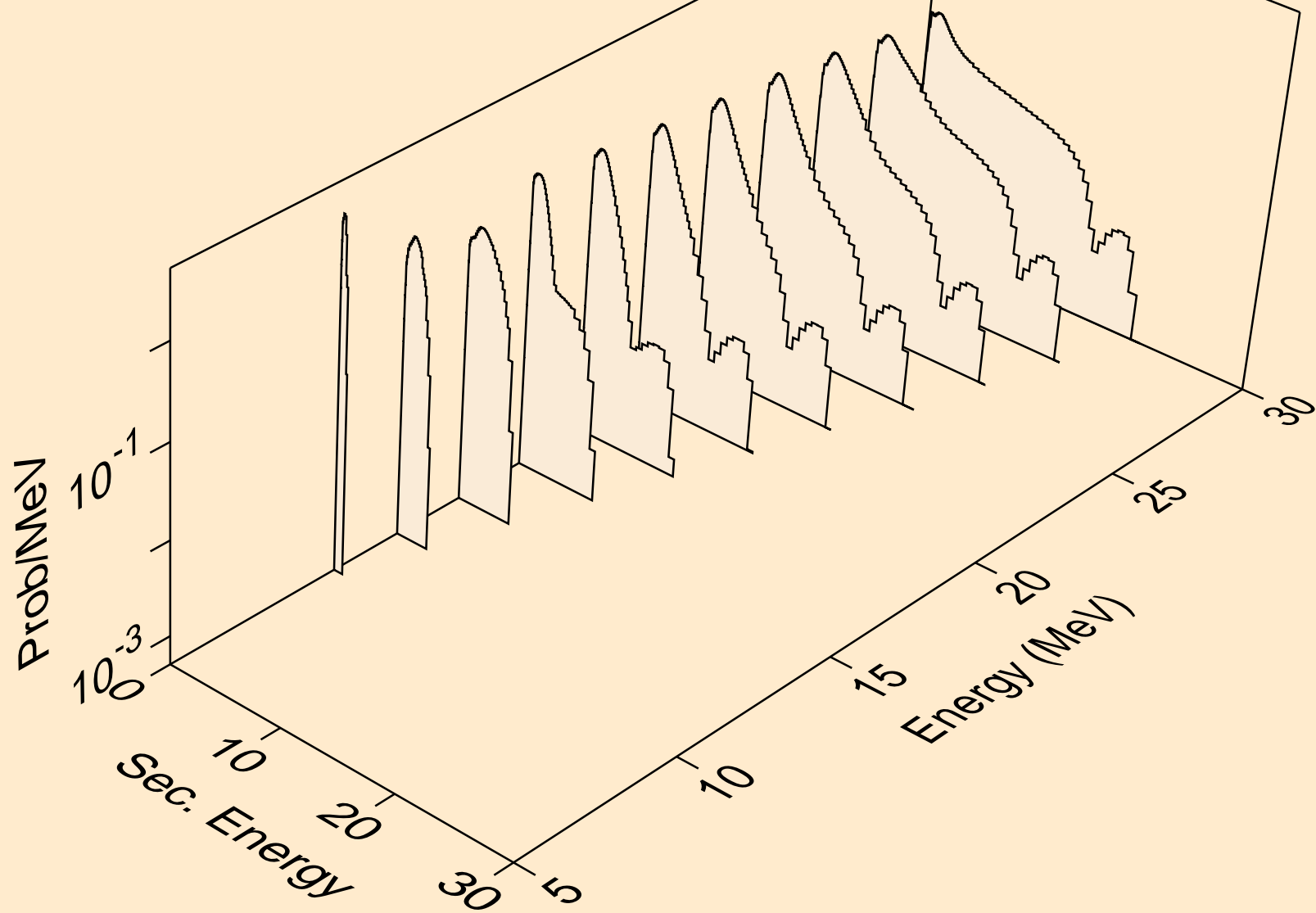

SM137 NEUTRON ACER TENDL-2024 LIBRARY; T=293.6K
Neutron emission for (n,3n)

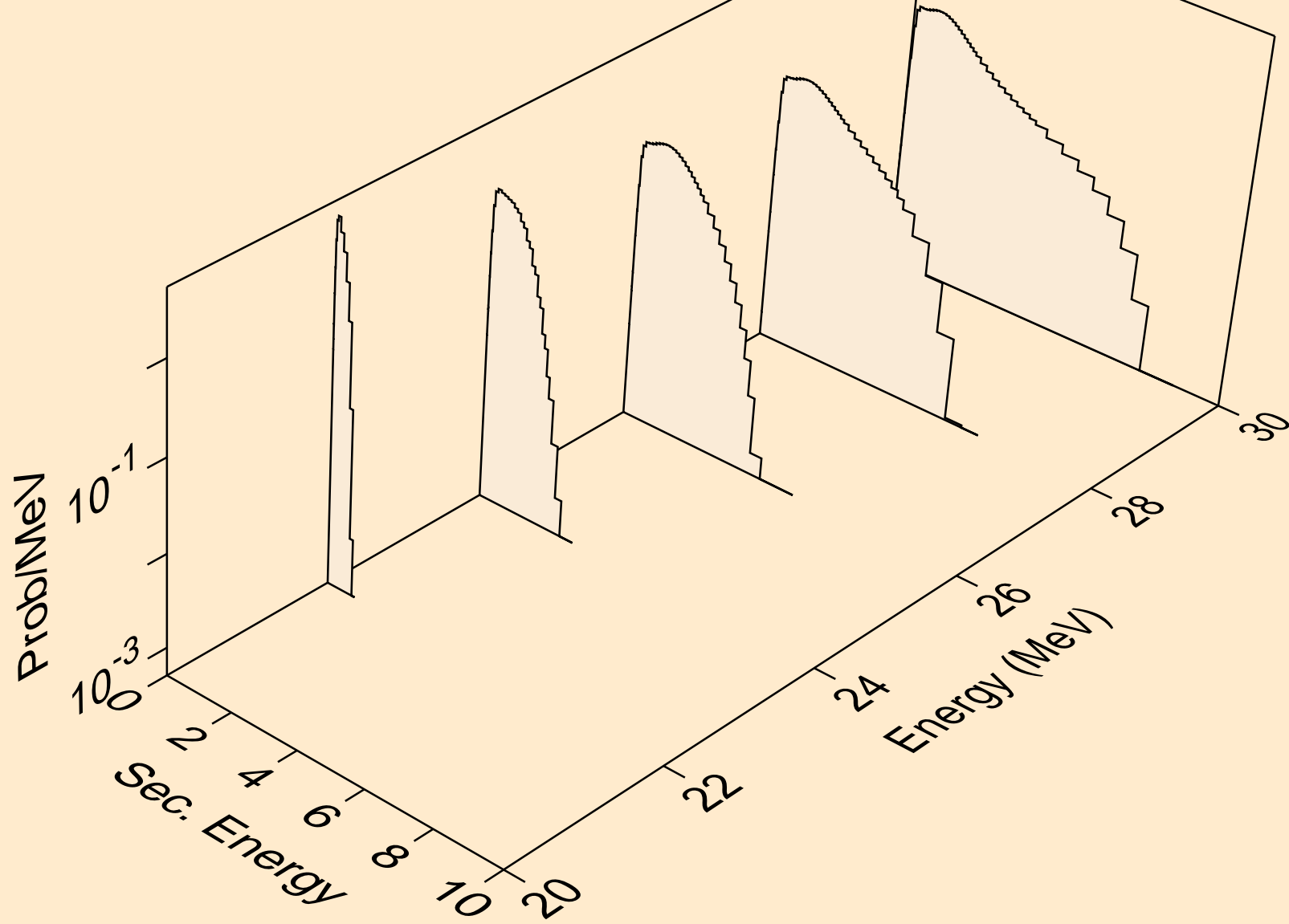

SM137 NEUTRON ACER TENDL-2024 LIBRARY; T=293.6K
Neutron emission for (n,n*)a

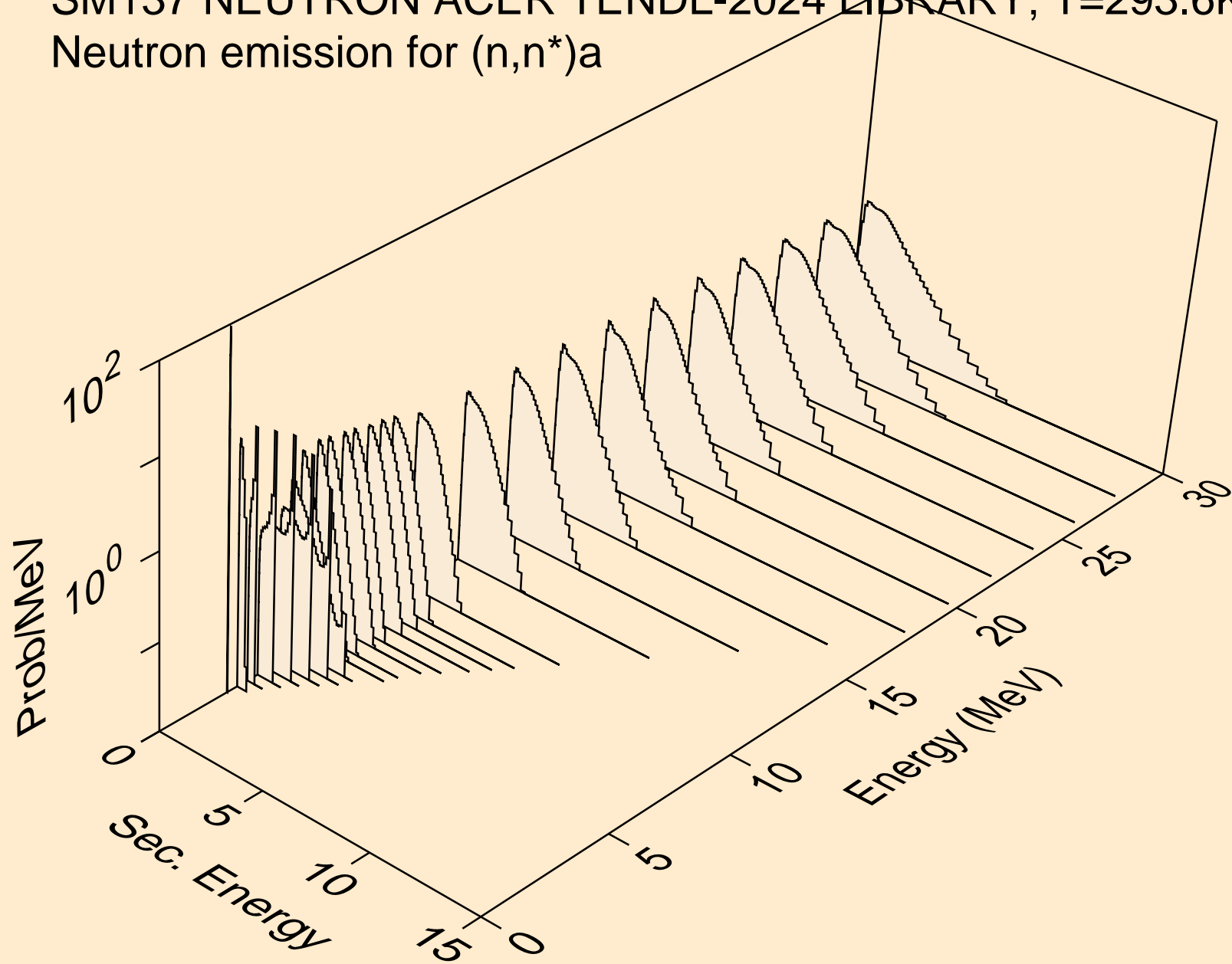

SM137 NEUTRON ACER TENDL-2024 LIBRARY; T=293.6K
Neutron emission for (n,2n)a

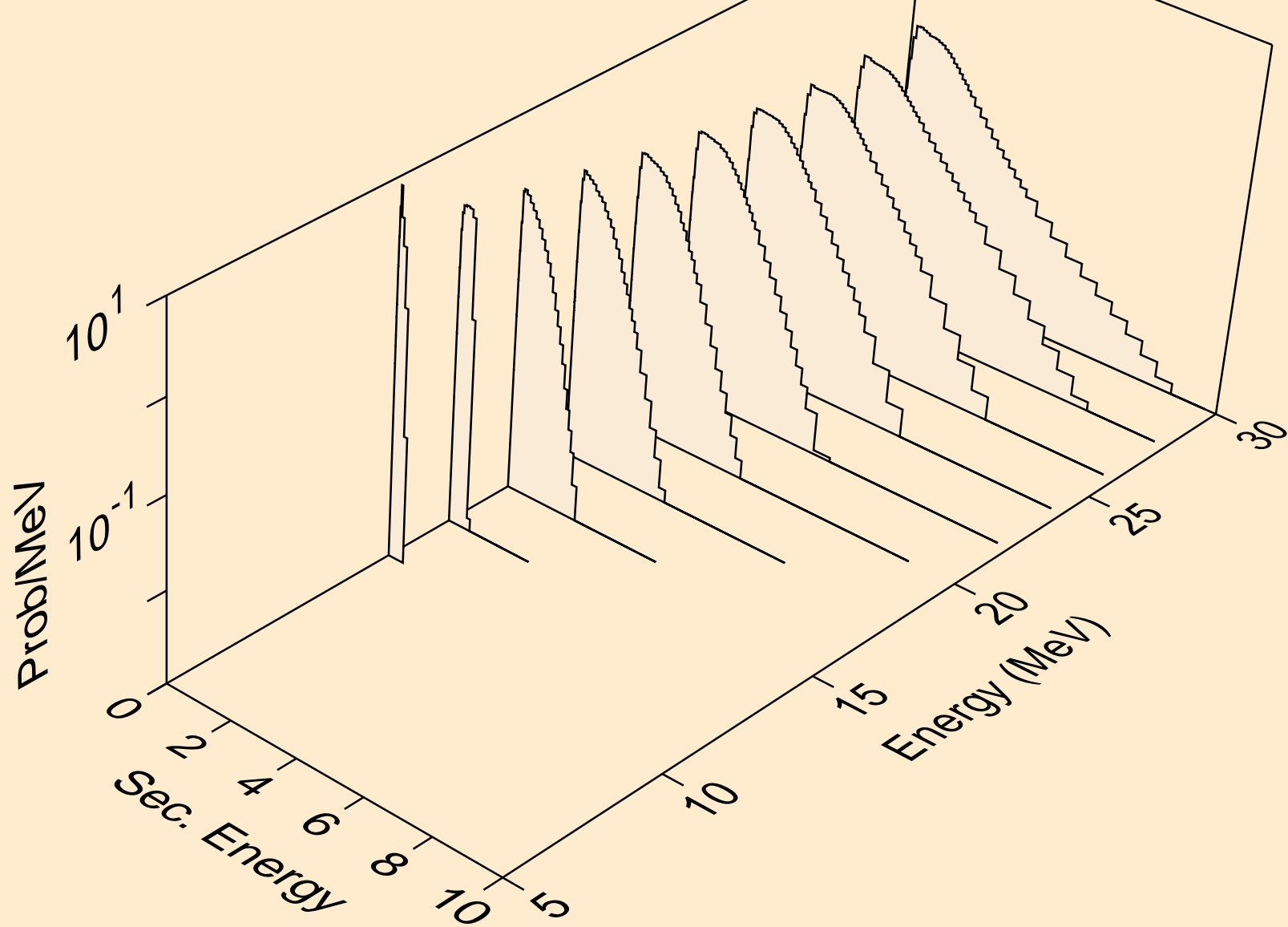

SM137 NEUTRON ACER TENDL-2024 LIBRARY; T=293.6K
Neutron emission for (n,3n)a

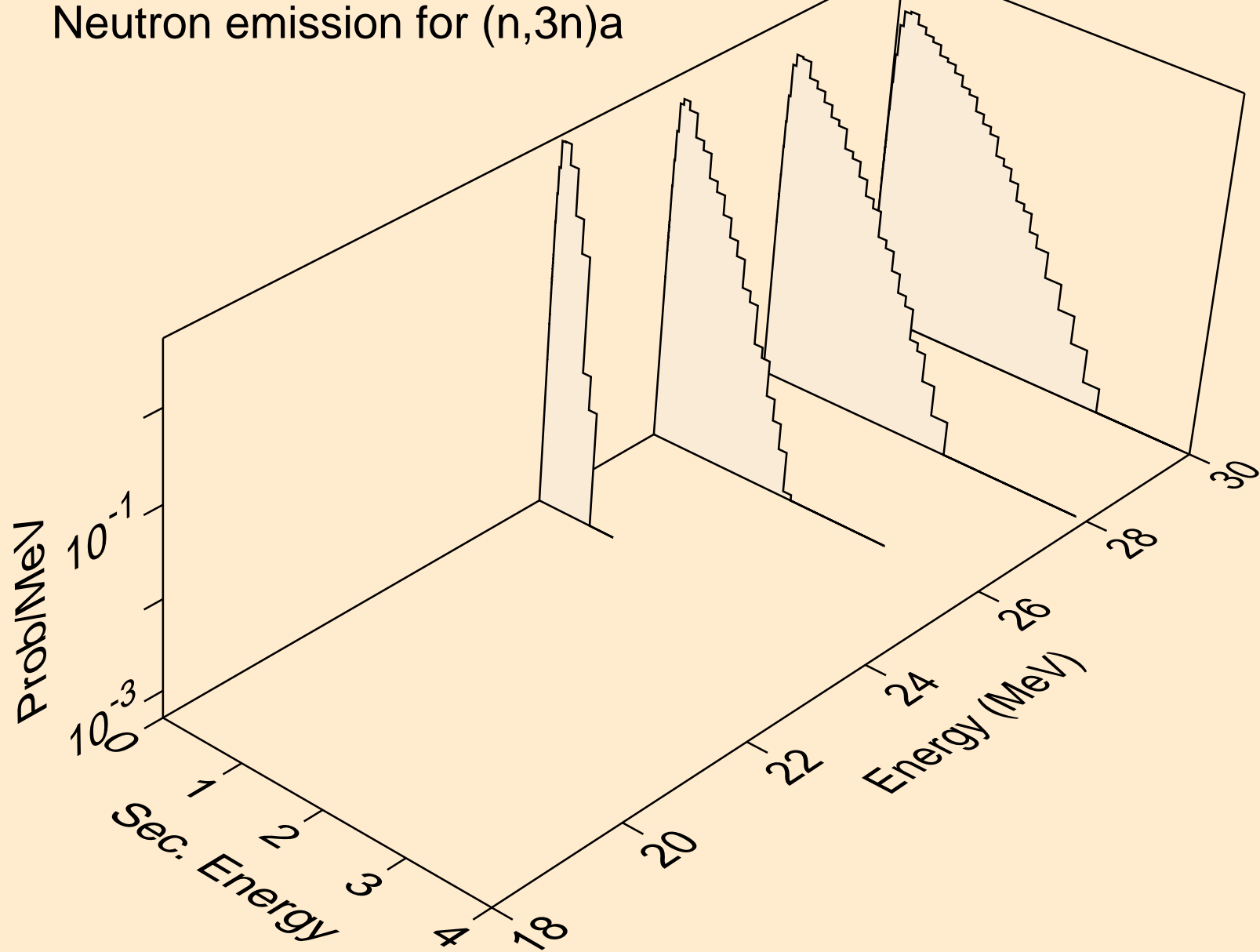

SM137 NEUTRON ACER TENDL-2024 LIBRARY; T=293.6K
Neutron emission for (n,n*)p

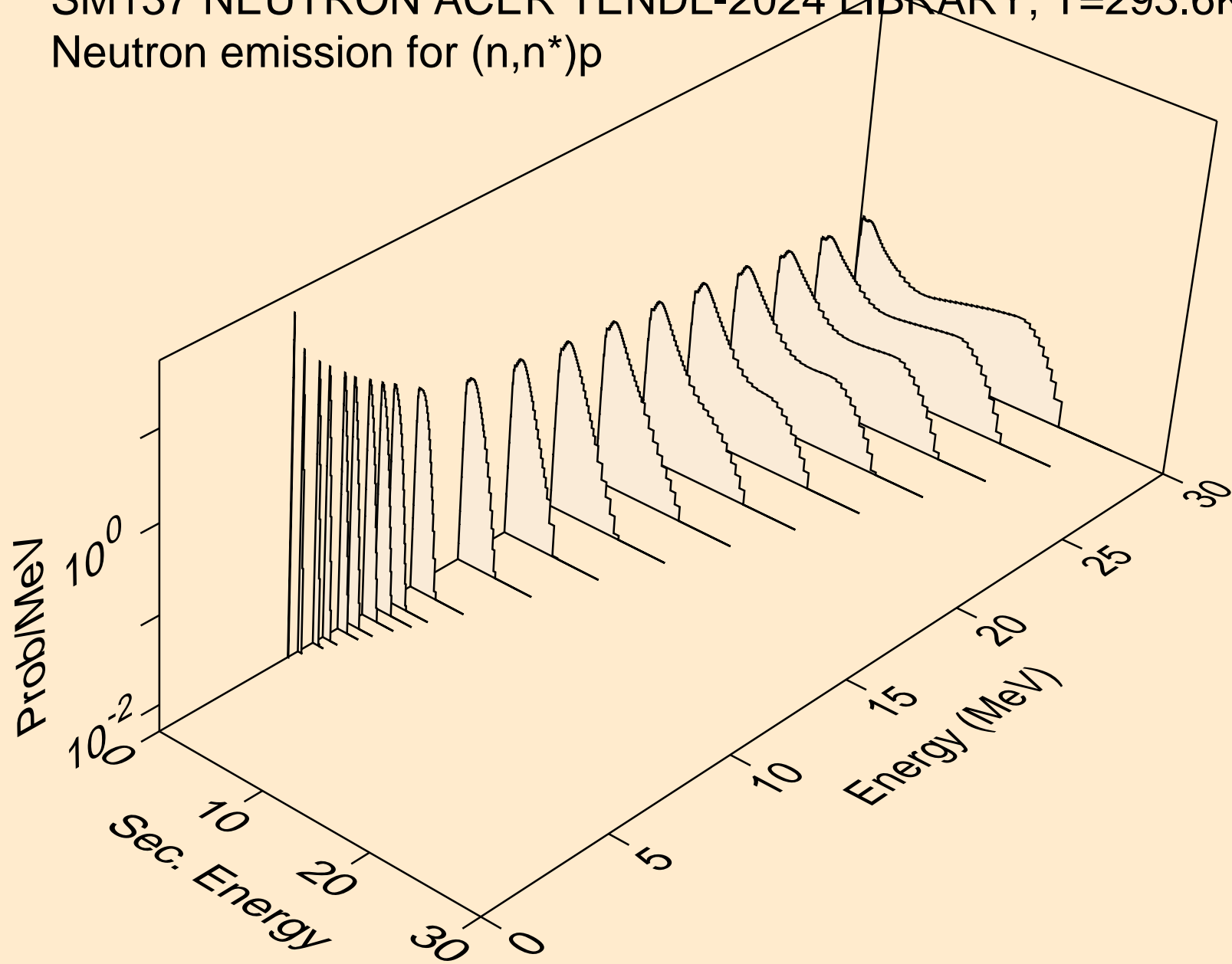

SM137 NEUTRON ACER TENDL-2024 LIBRARY; T=293.6K
Neutron emission for (n,n*)2a

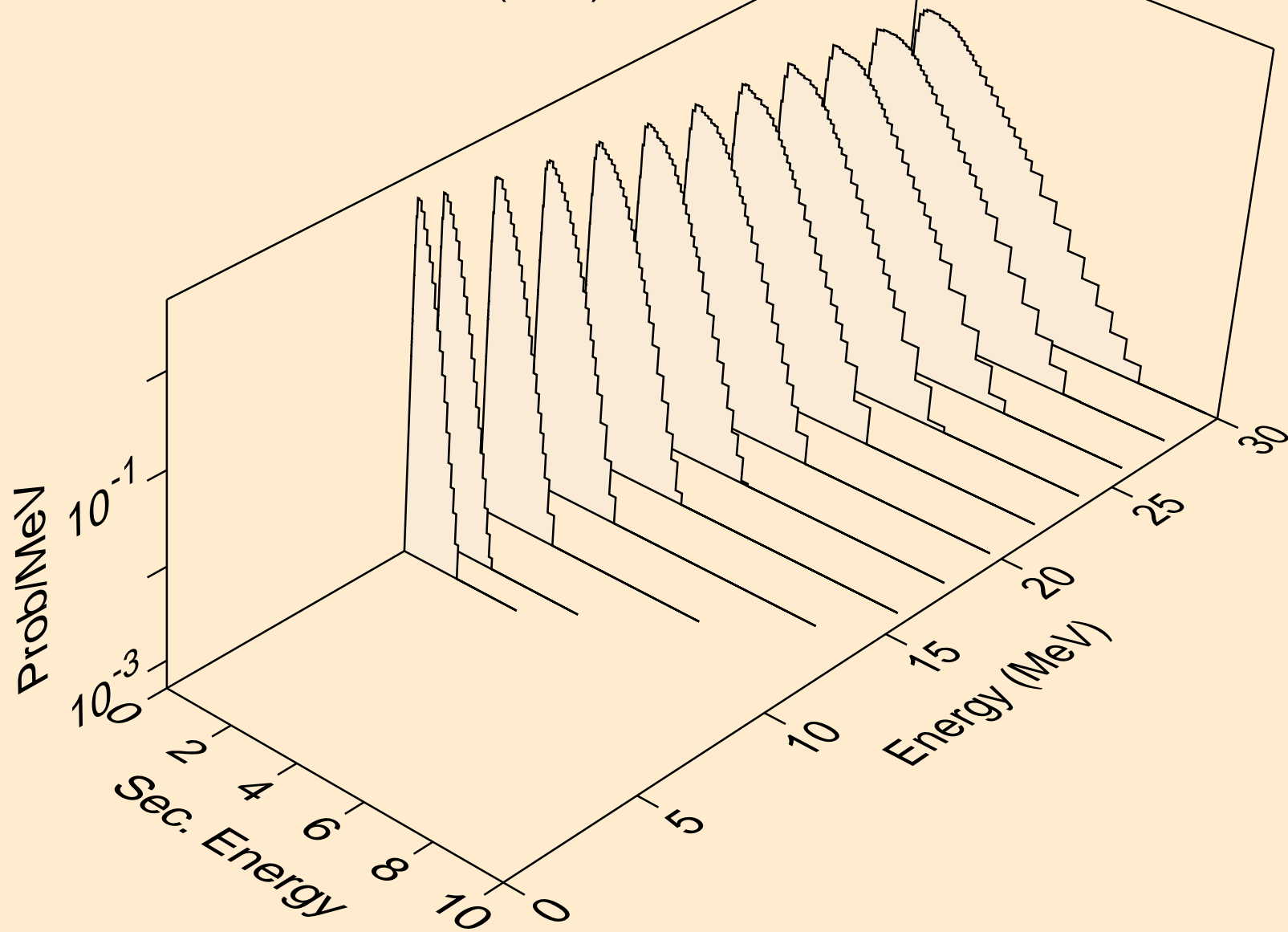

SM137 NEUTRON ACER TENDL-2024 LIBRARY; T=293.6K
Neutron emission for (n,2n)2a

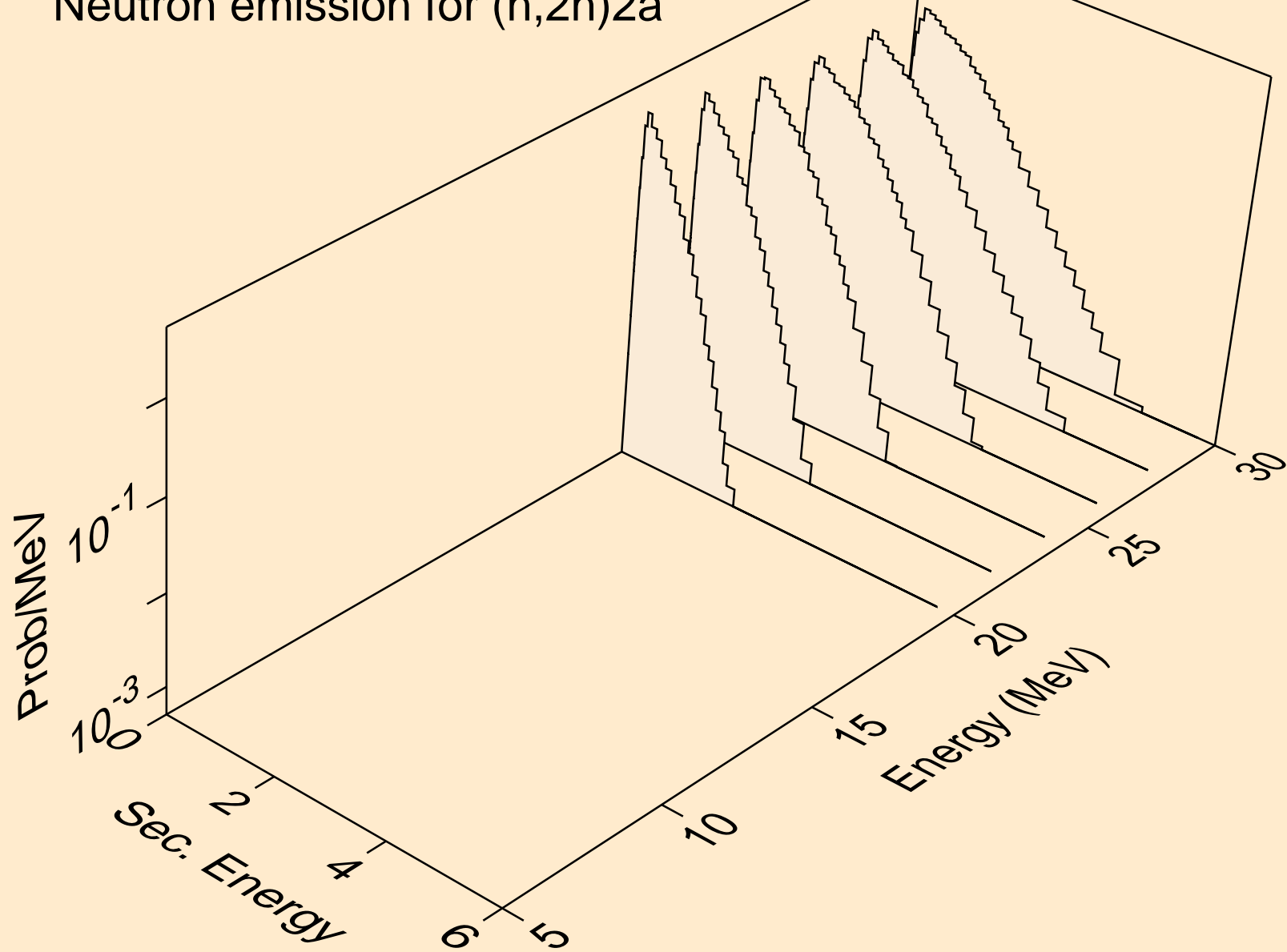

SM137 NEUTRON ACER TENDL-2024 LIBRARY; T=293.6K
Neutron emission for (n,n*)d

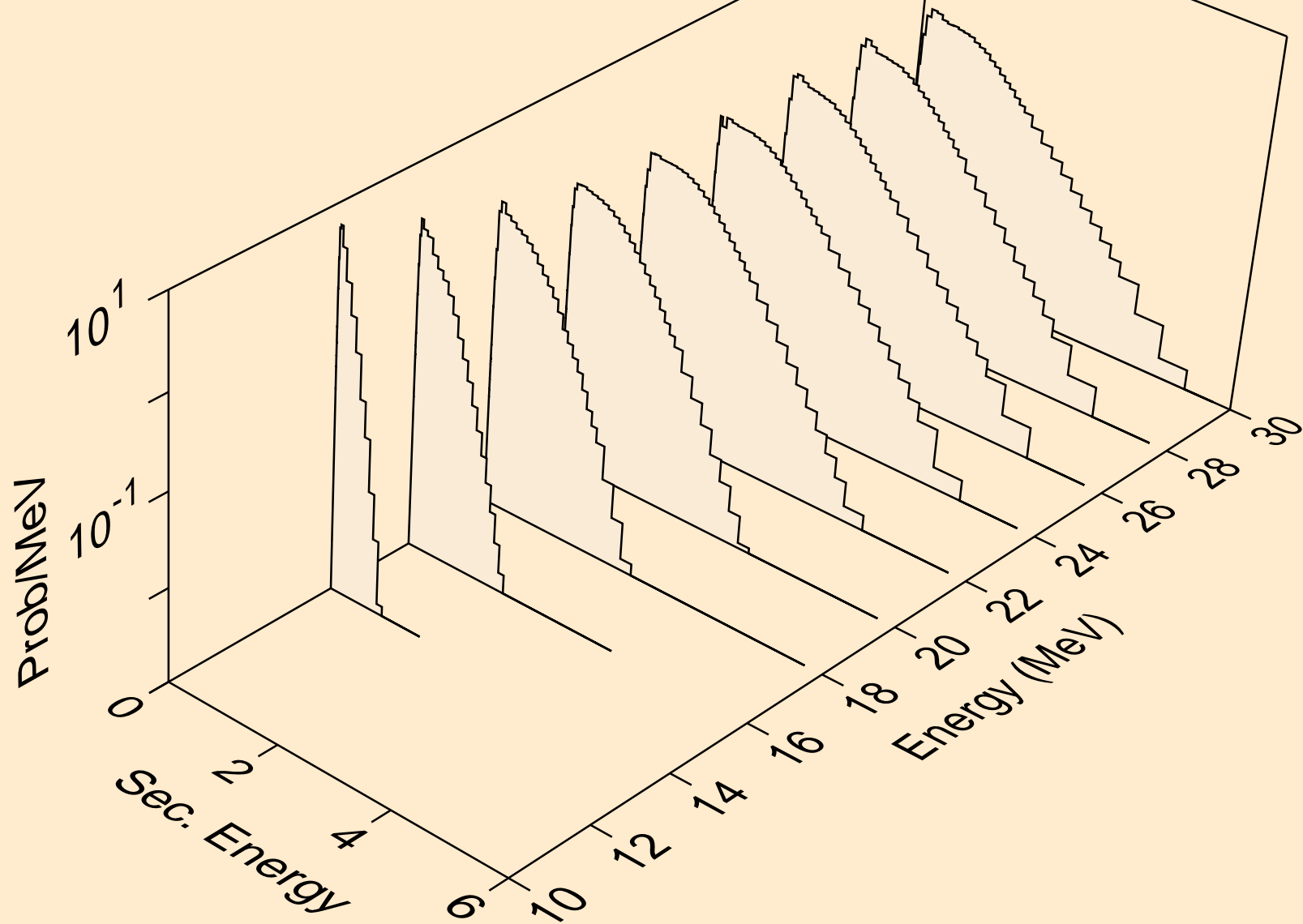

SM137 NEUTRON ACER TENDL-2024 LIBRARY; T=293.6K
Neutron emission for (n,n*)t

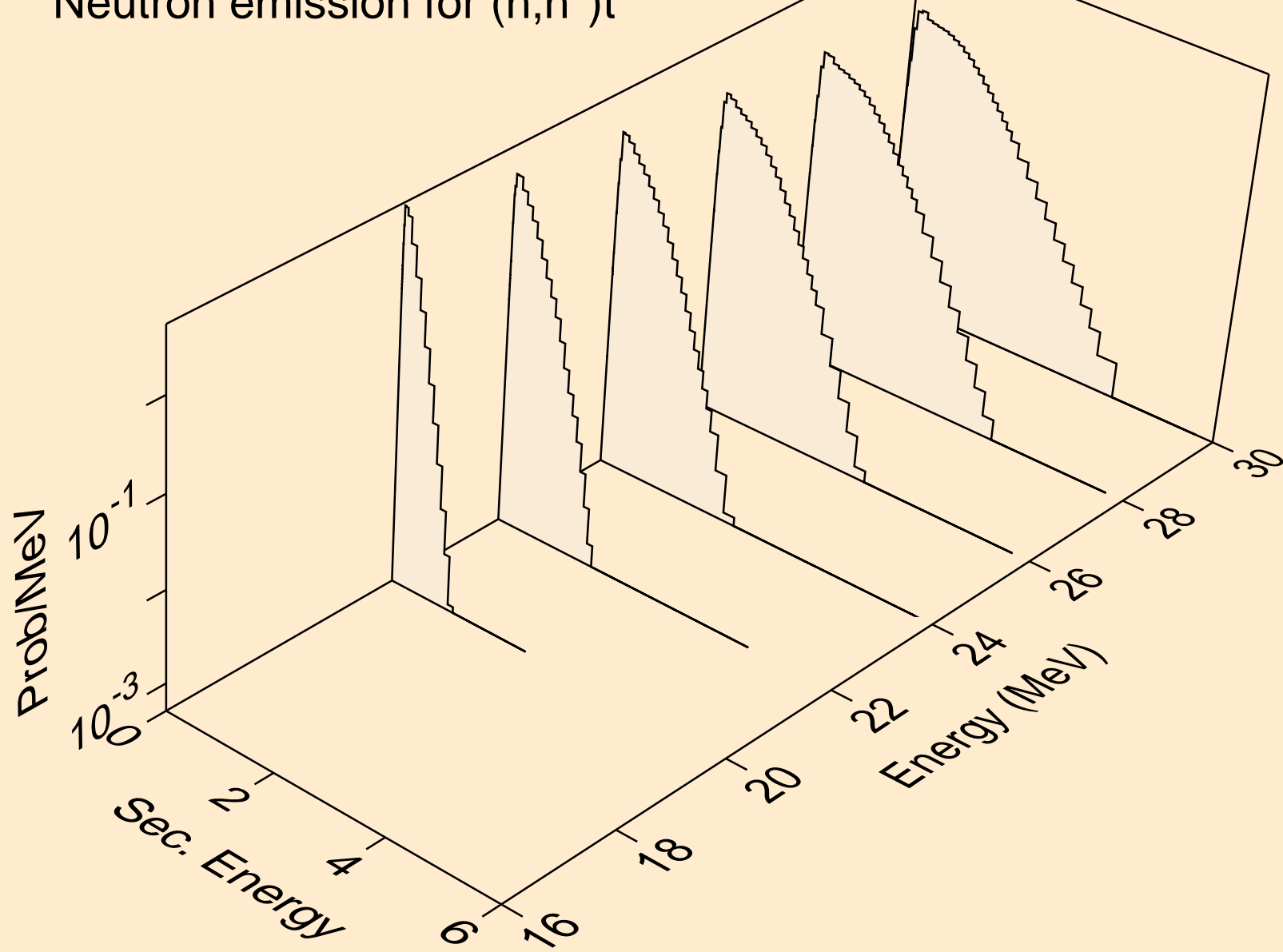

SM137 NEUTRON ACER TENDL-2024 LIBRARY; T=293.6K
Neutron emission for (n,n*)he3

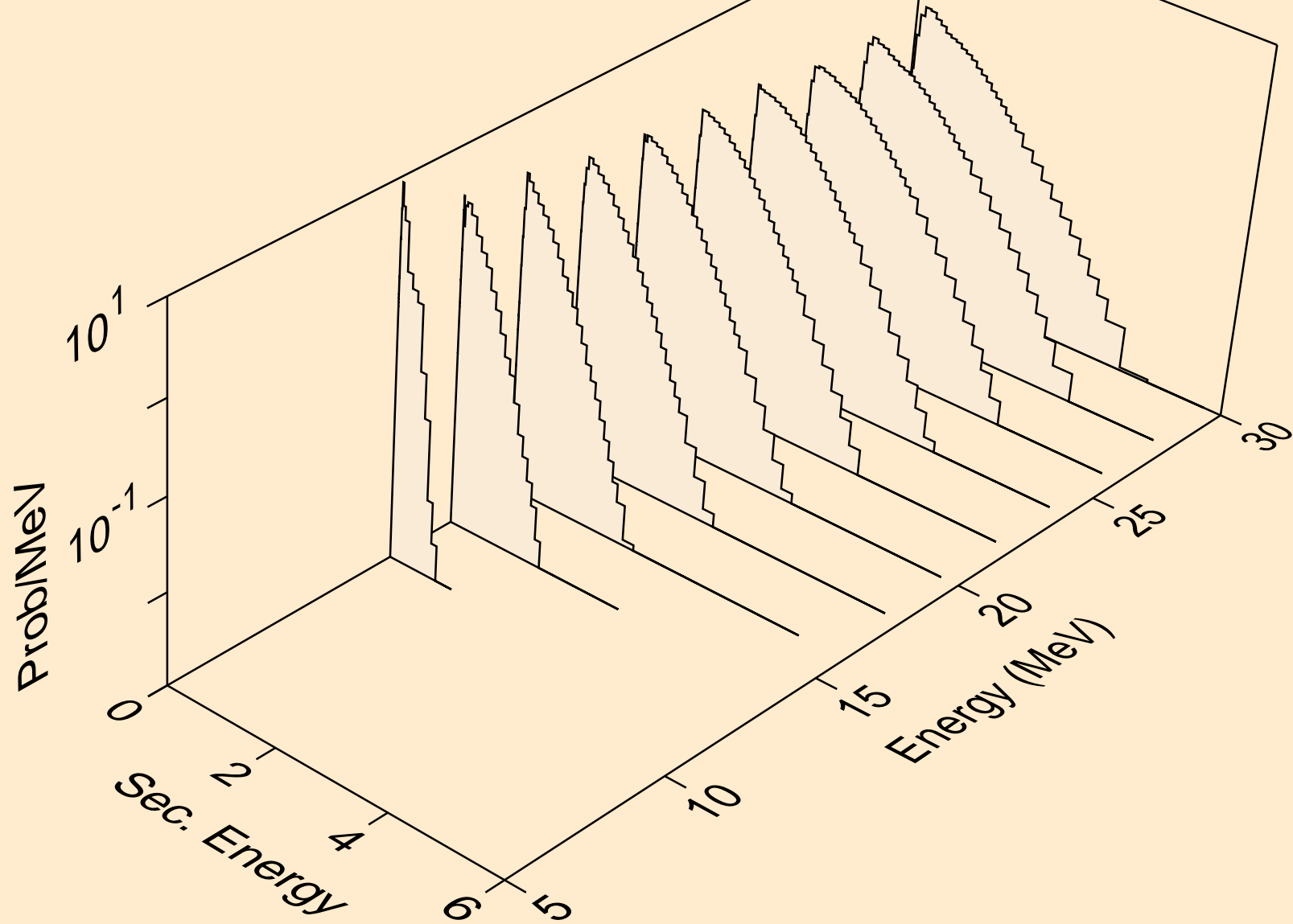

SM137 NEUTRON ACER TENDL-2024 LIBRARY; T=293.6K
Neutron emission for (n,2np)

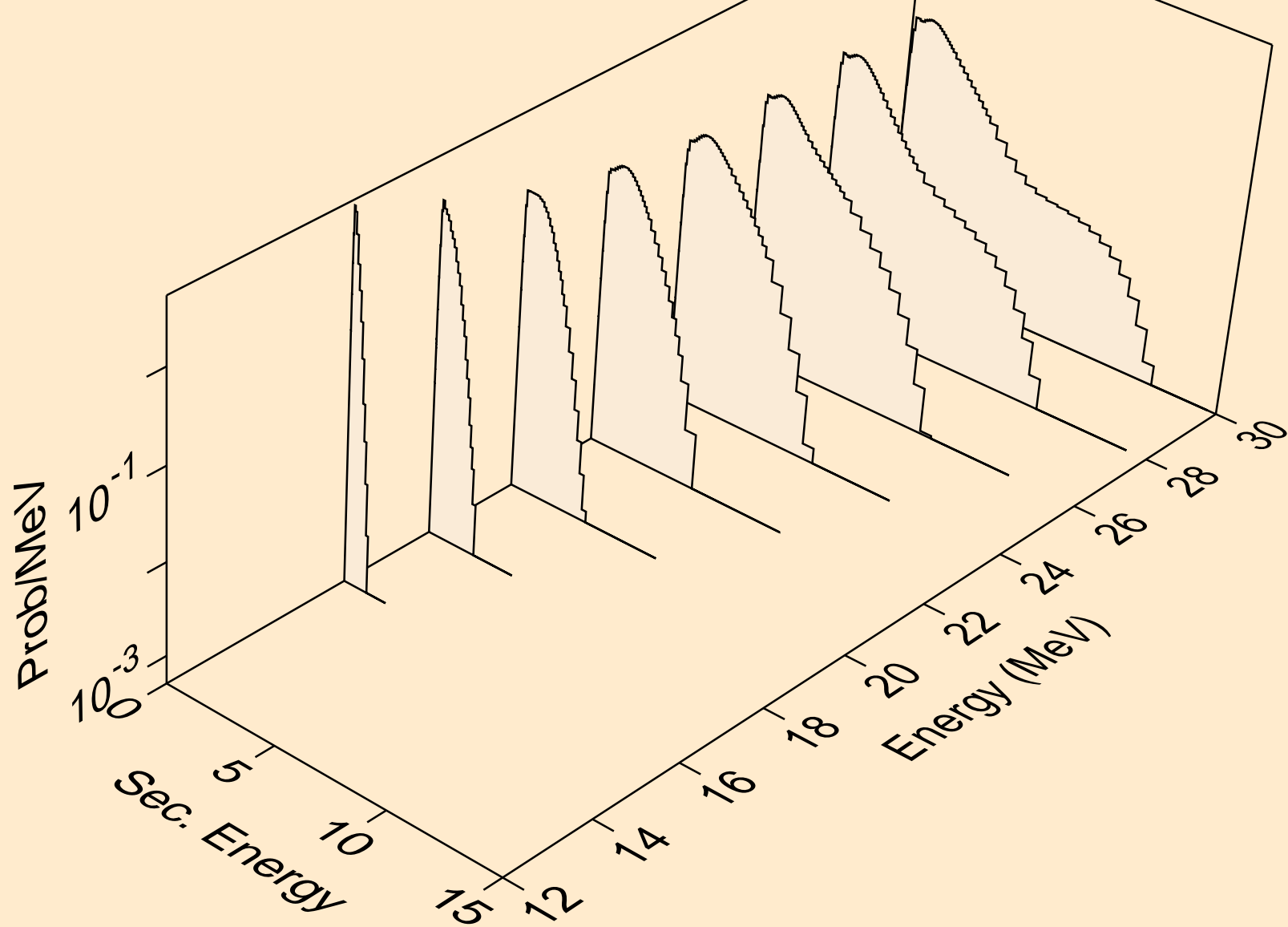

SM137 NEUTRON ACER TENDL-2024 LIBRARY; T=293.6K
Neutron emission for (n,3np)

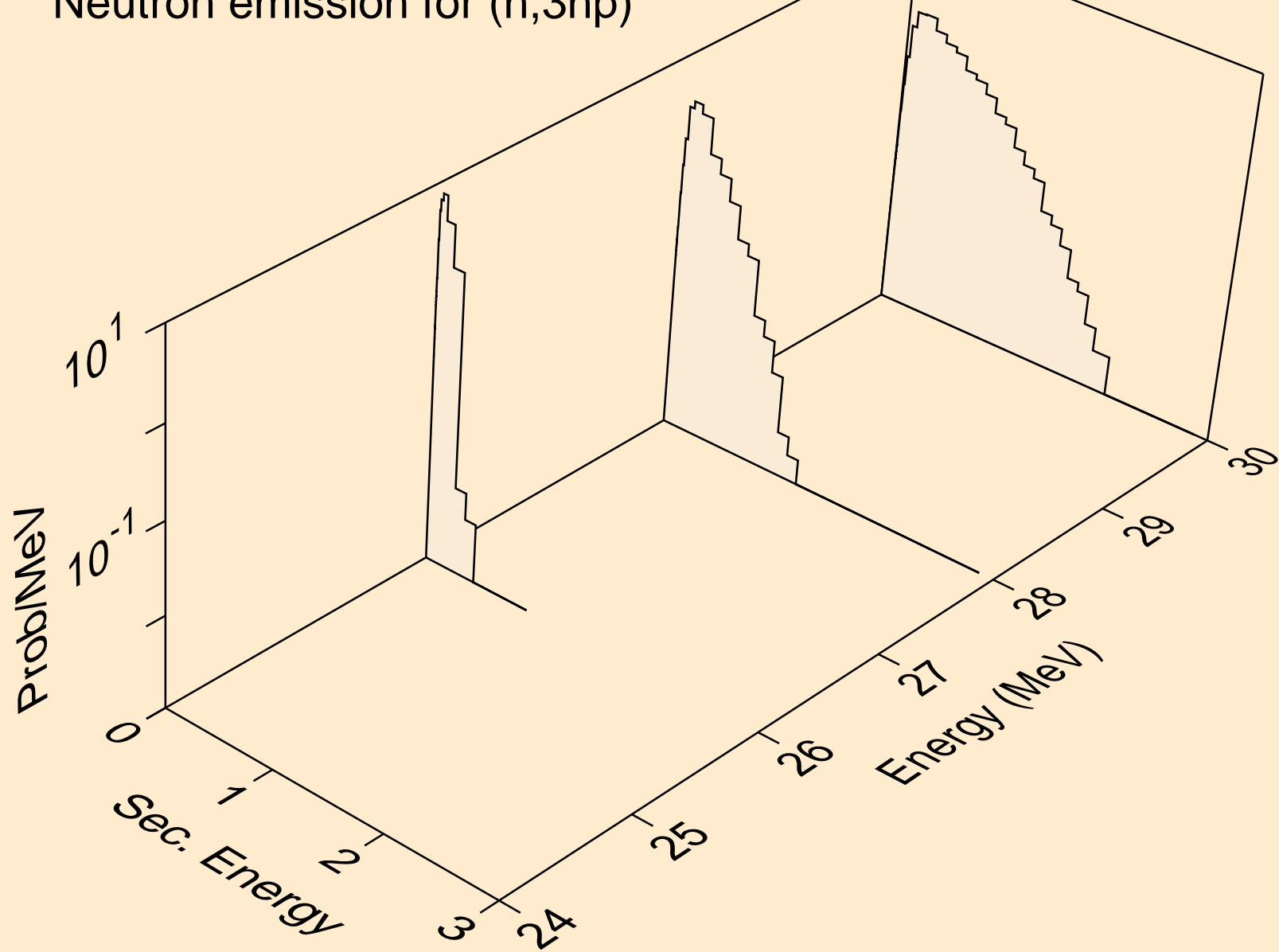

SM137 NEUTRON ACER TENDL-2024 LIBRARY; T=293.6K
Neutron emission for (n,n2p)

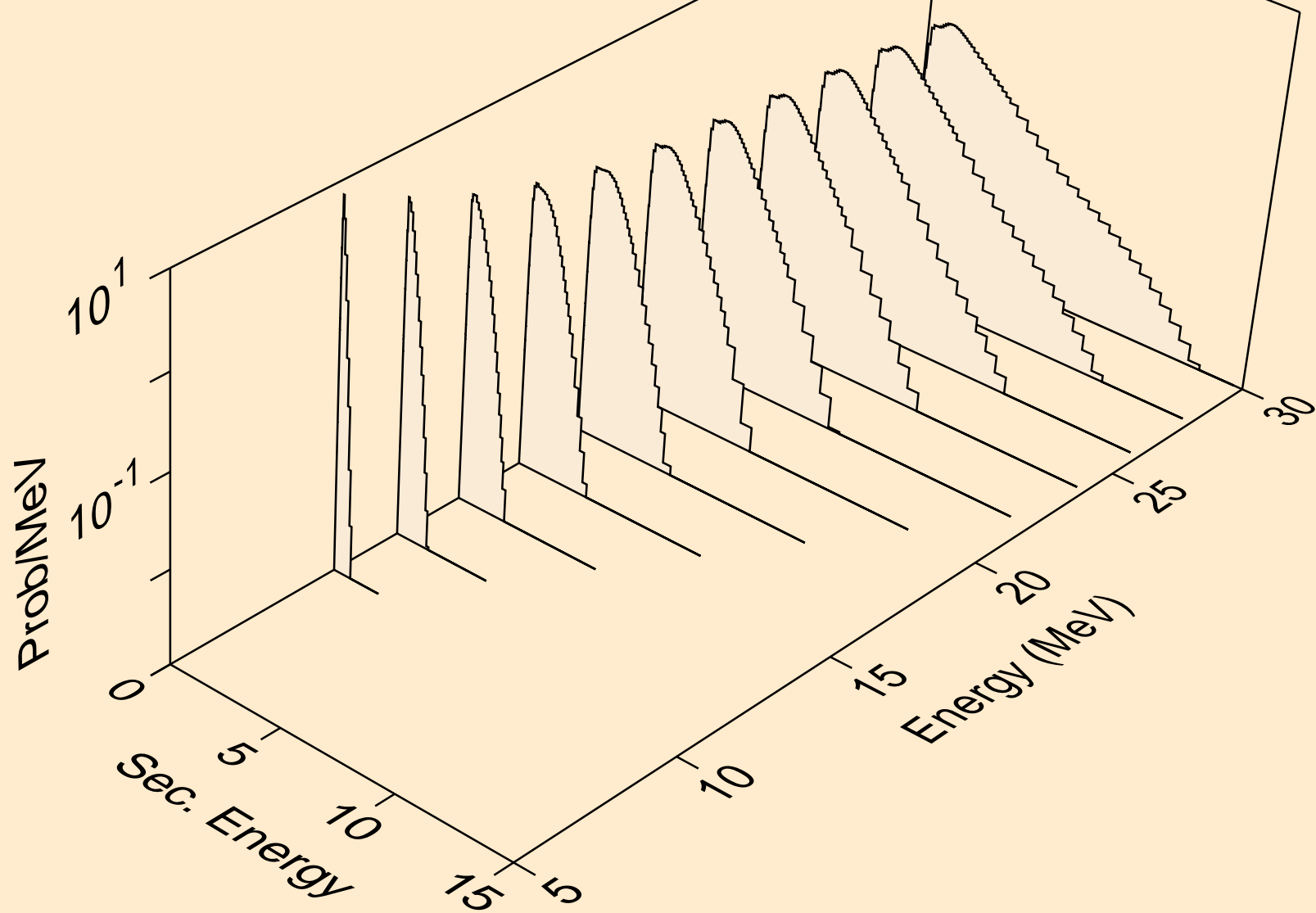

SM137 NEUTRON ACER TENDL-2024 LIBRARY; T=293.6K
Neutron emission for (n,npa)

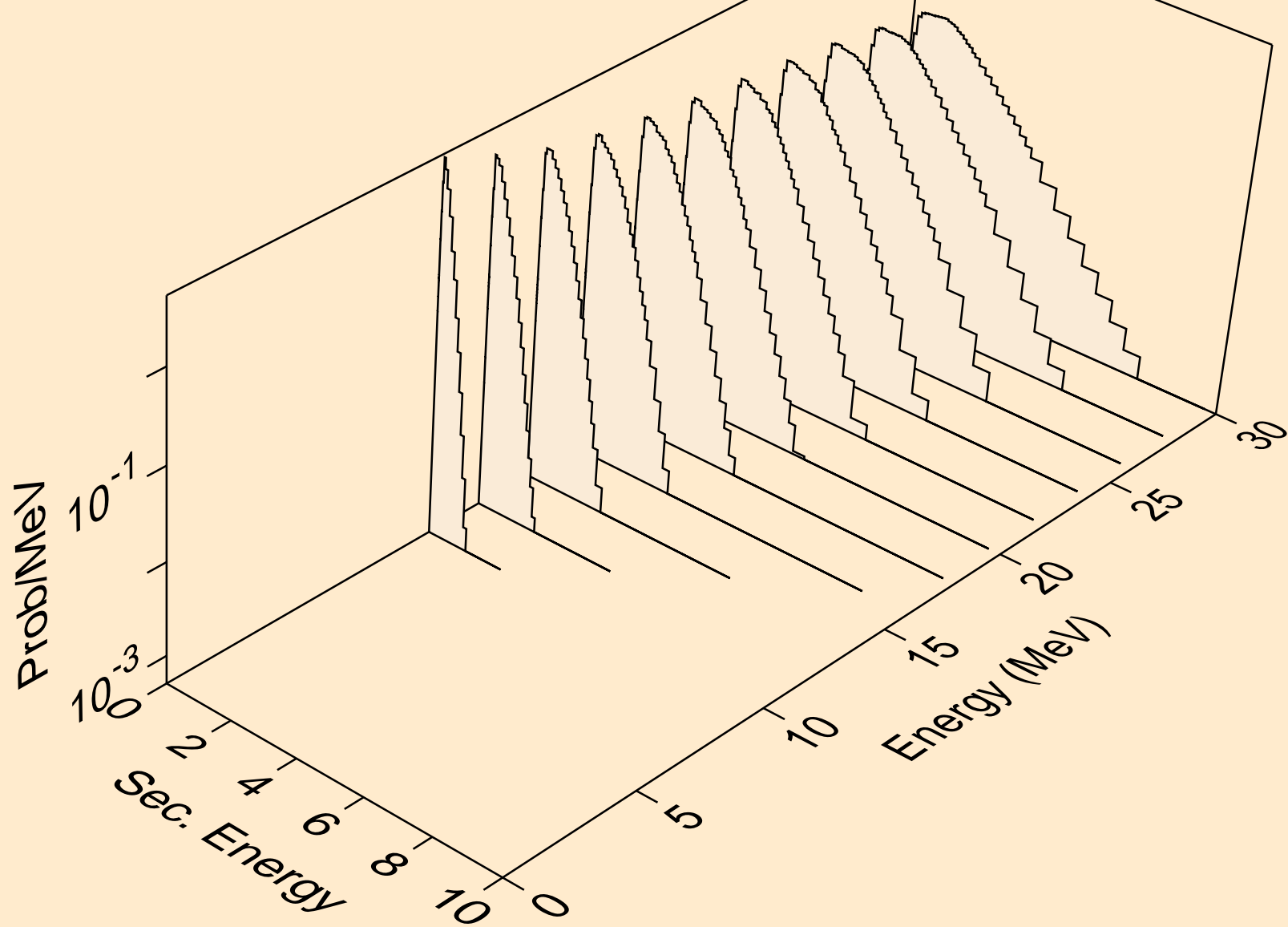

SM137 NEUTRON ACER TENDL-2024 LIBRARY; T=293.6K
Neutron emission for (n,n*c)

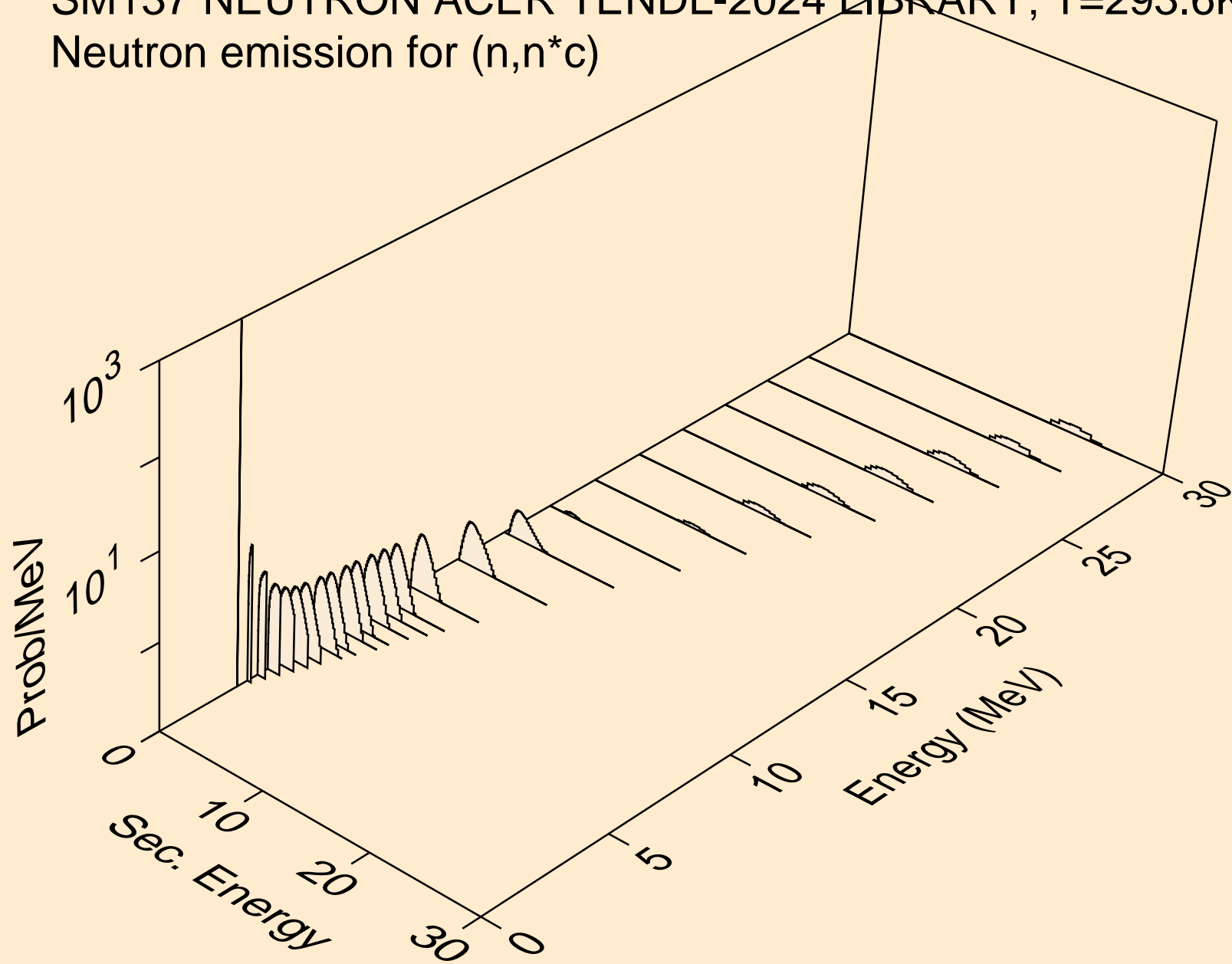

SM137 NEUTRON ACER TENDL-2024 LIBRARY; T=293.6K
Photon emission for (n,x)

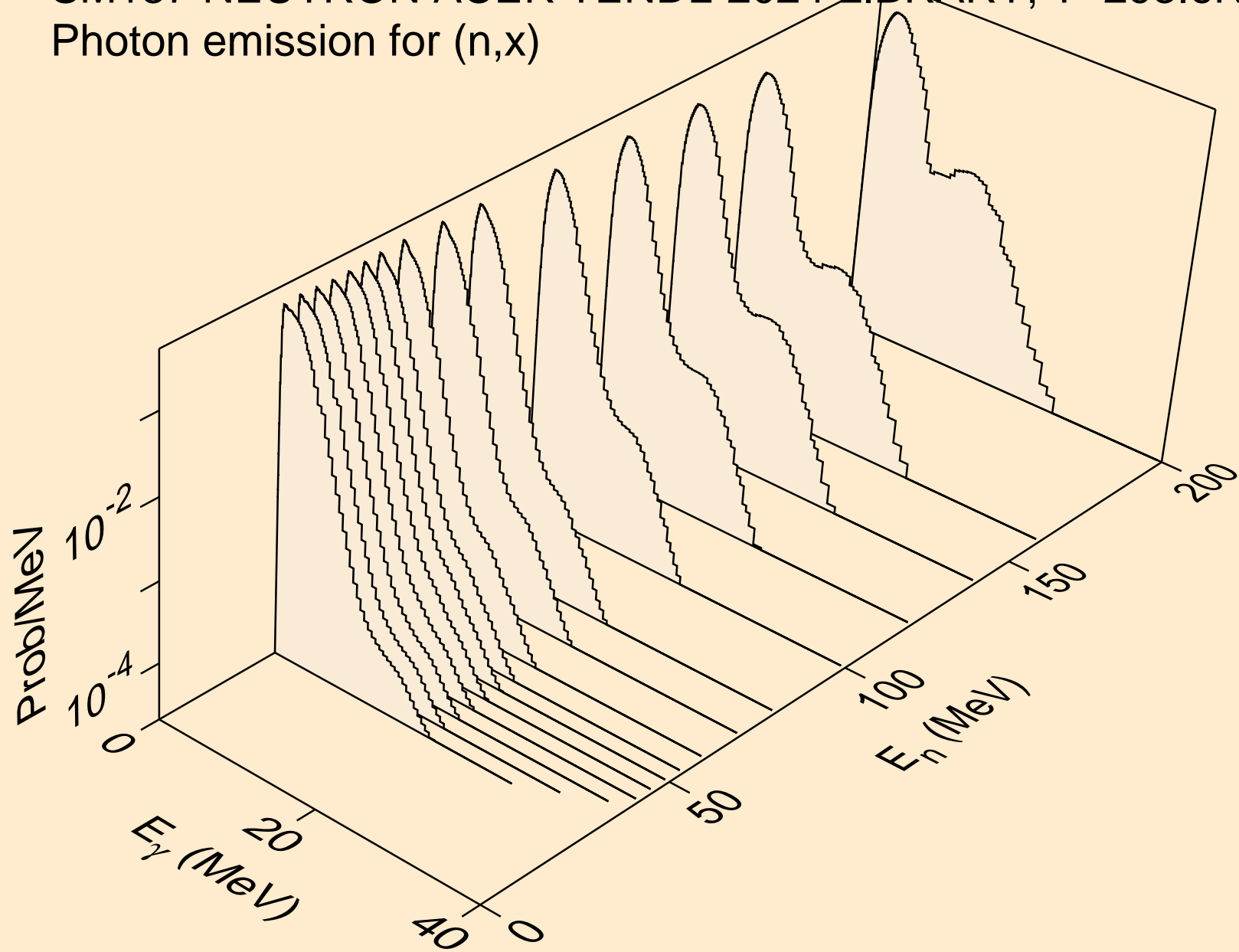

SM137 NEUTRON ACER TENDL-2024 LIBRARY; T=293.6K
Photon emission for (n,2nd)

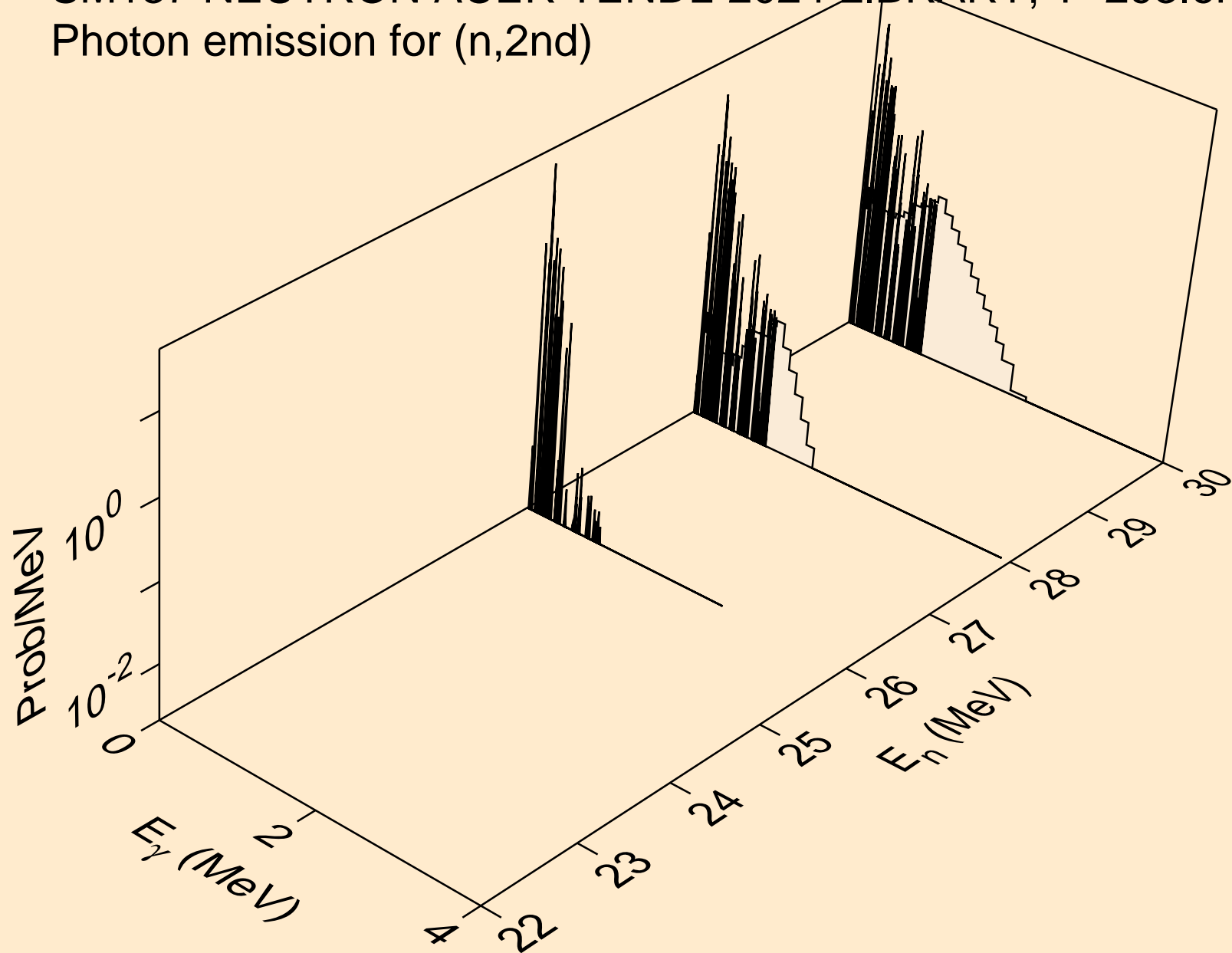

SM137 NEUTRON ACER TENDL-2024 LIBRARY; T=293.6K
Photon emission for (n,2n)

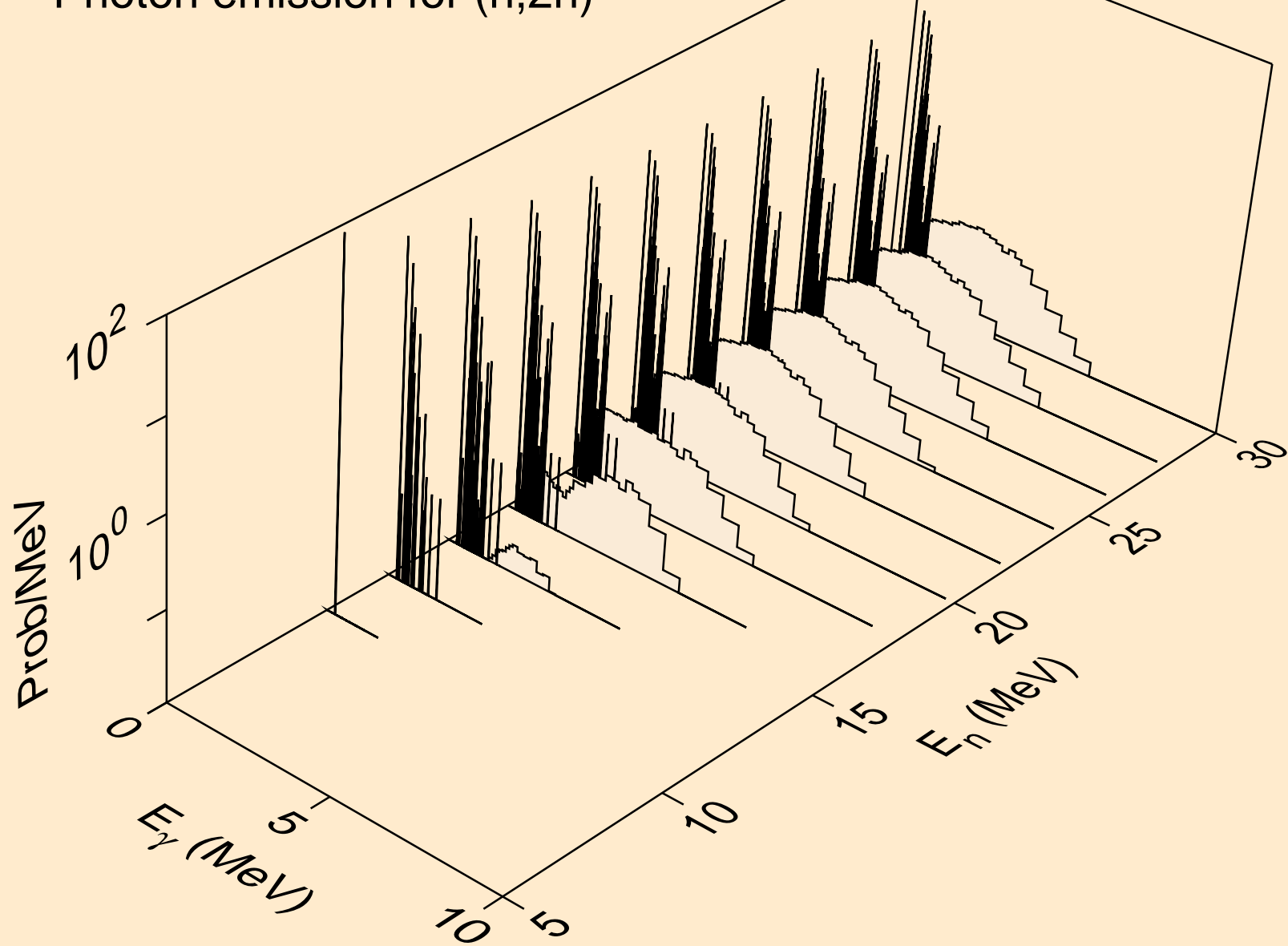

SM137 NEUTRON ACER TENDL-2024 LIBRARY; T=293.6K
Photon emission for (n,3n)

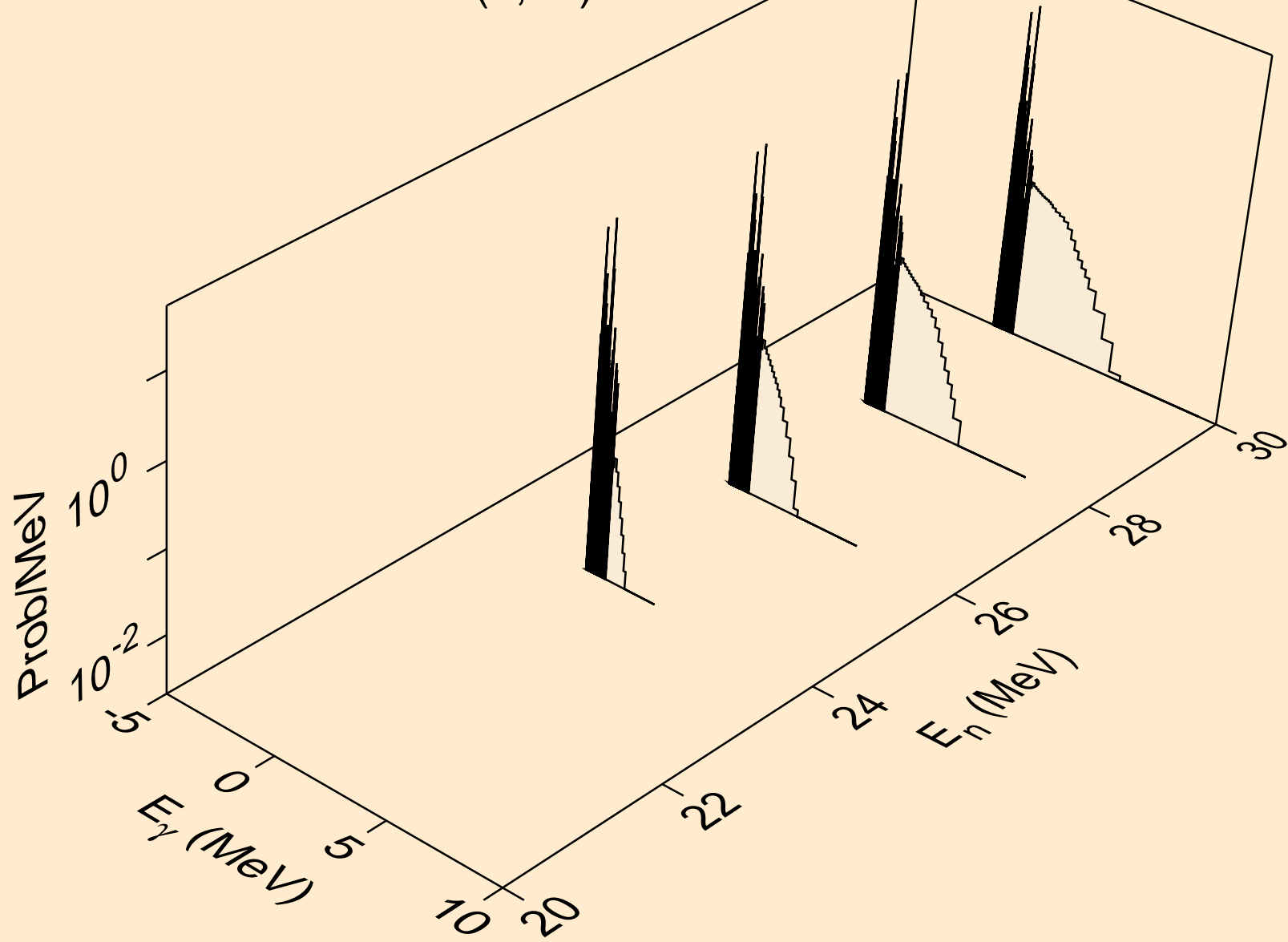

SM137 NEUTRON ACER TENDL-2024 LIBRARY; T=293.6K
Photon emission for (n,n*)a

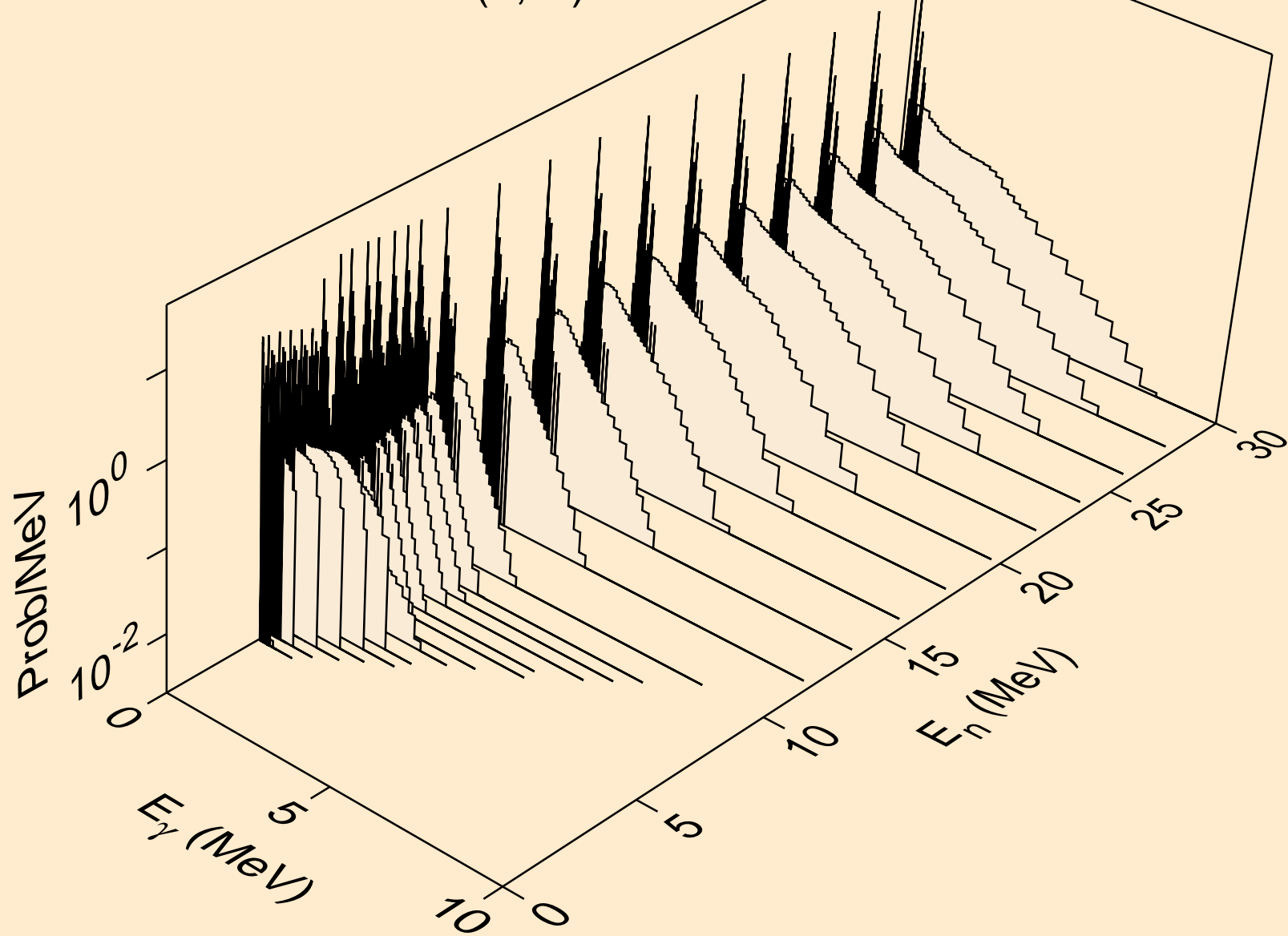

SM137 NEUTRON ACER TENDL-2024 LIBRARY; T=293.6K
Photon emission for (n,2n)a

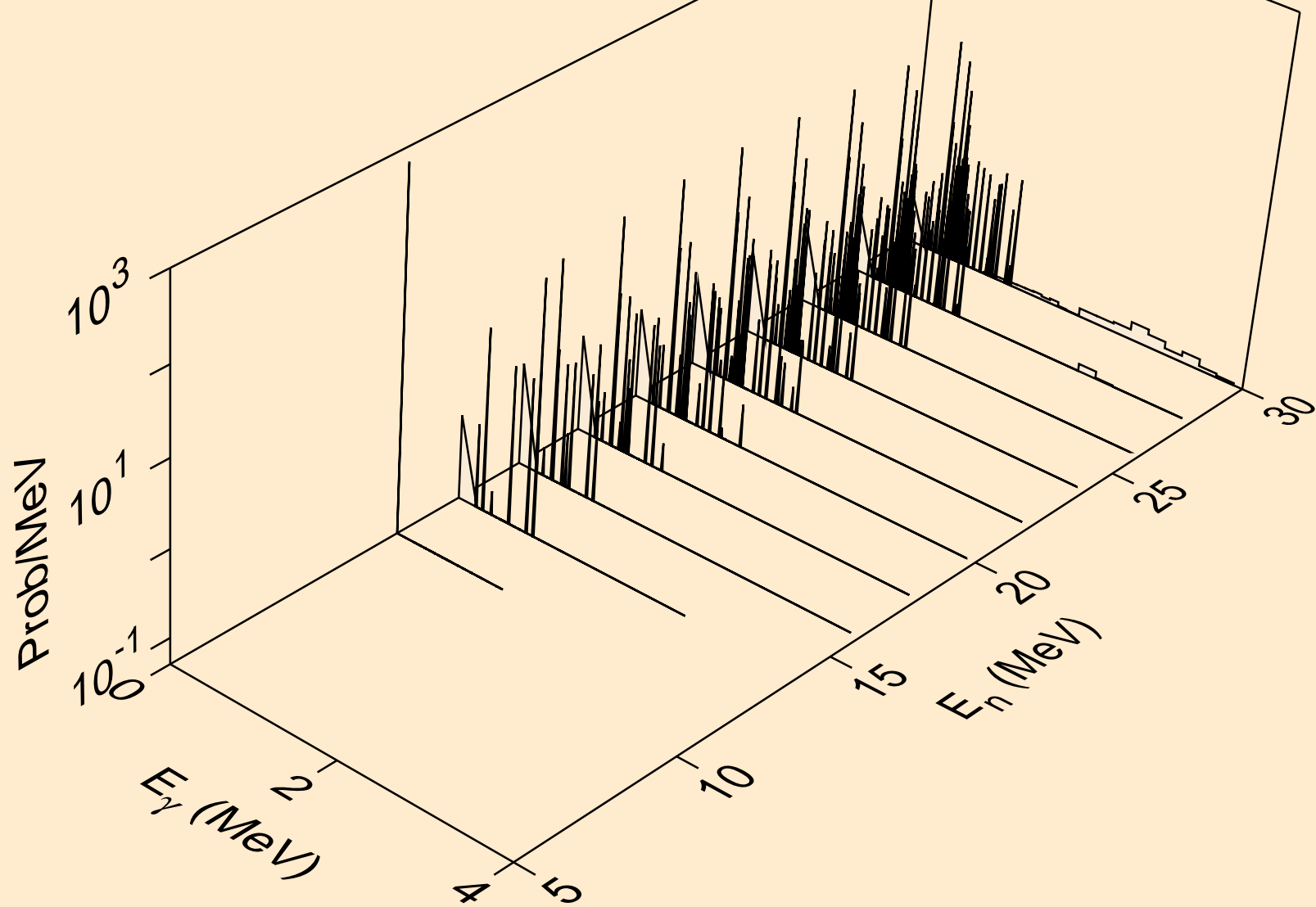

SM137 NEUTRON ACER TENDL-2024 LIBRARY; T=293.6K
Photon emission for (n,3n)a

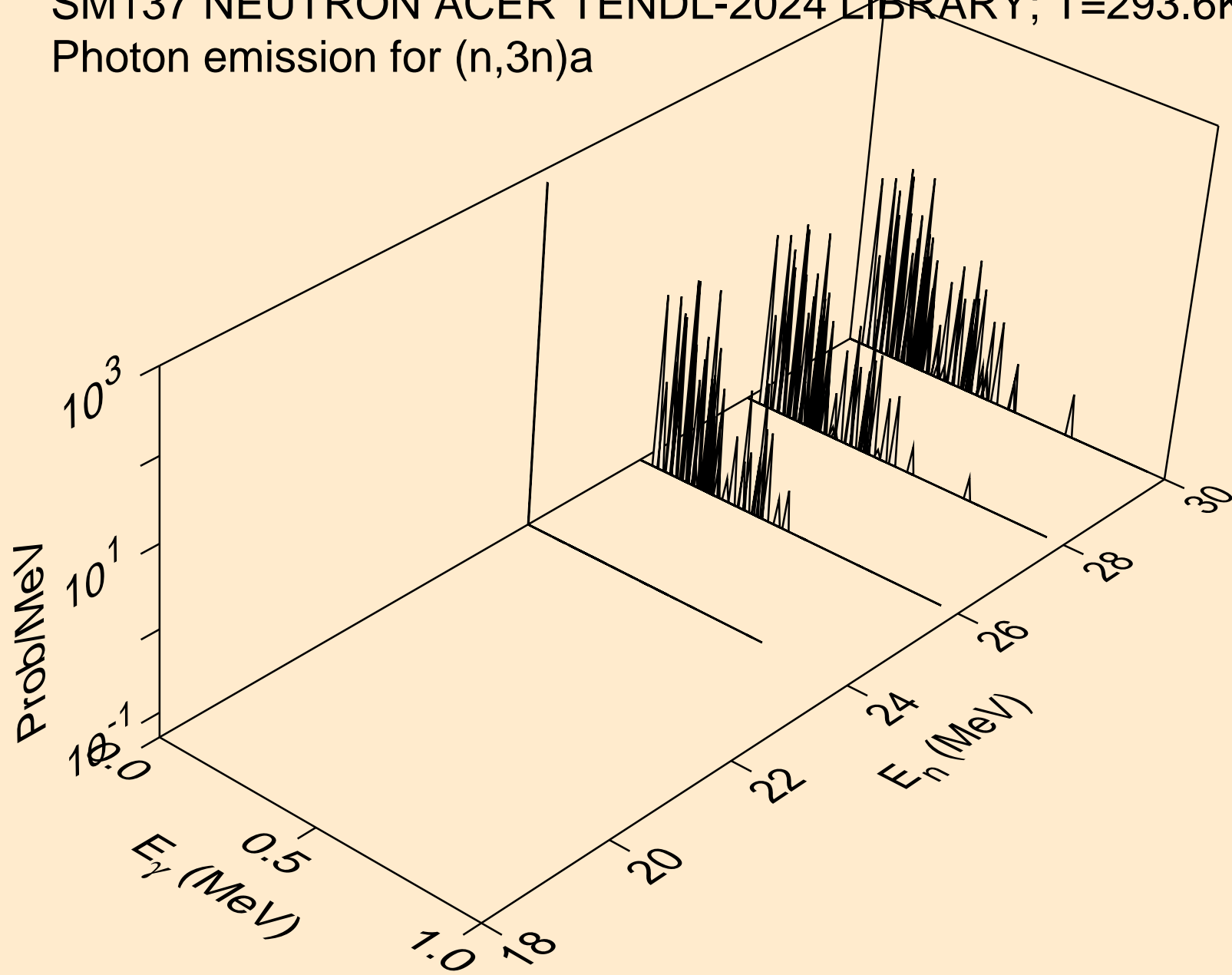

SM137 NEUTRON ACER TENDL-2024 LIBRARY; T=293.6K
Photon emission for (n,n*)p

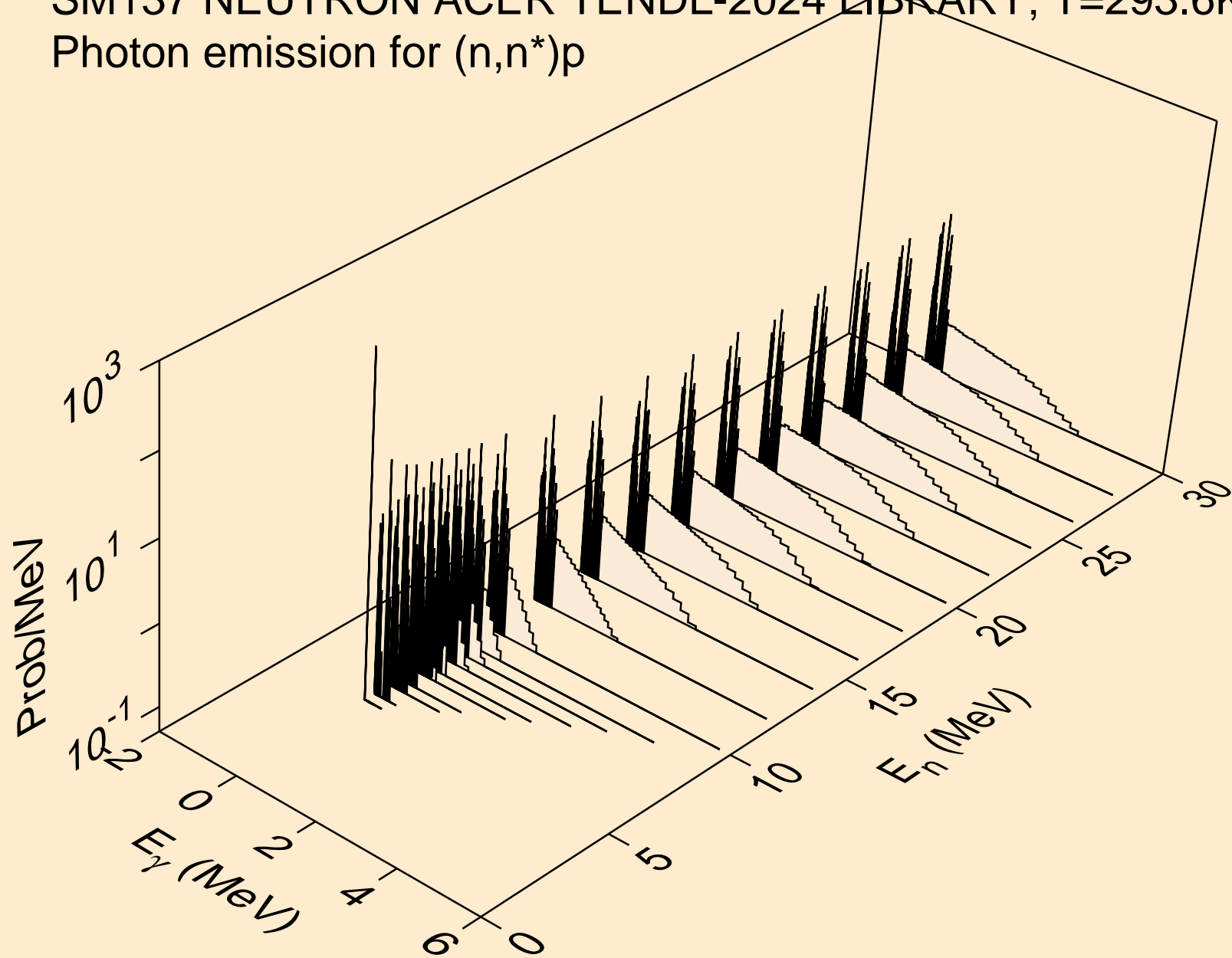

SM137 NEUTRON ACER TENDL-2024 LIBRARY; T=293.6K
Photon emission for (n,n*)2a

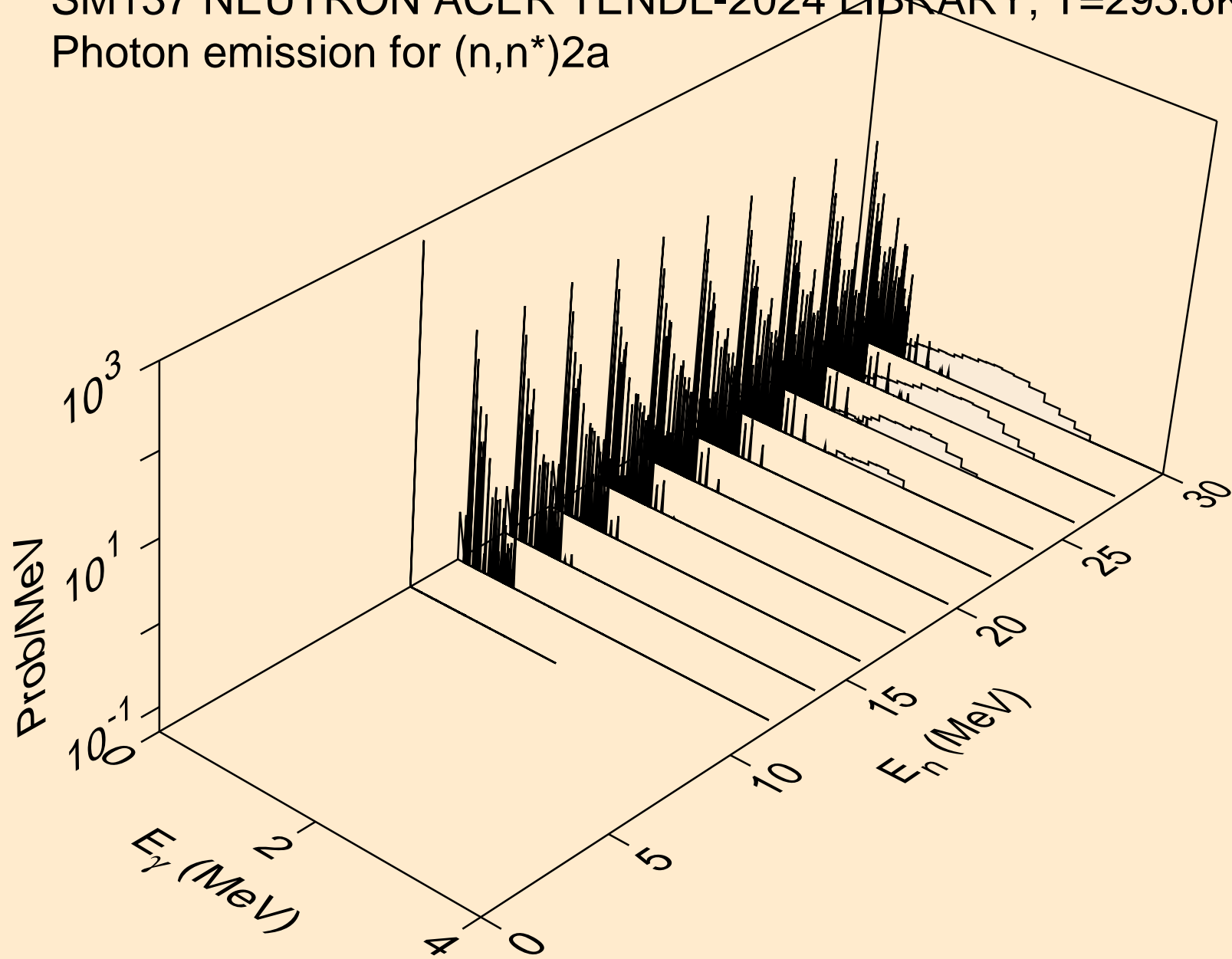

SM137 NEUTRON ACER TENDL-2024 LIBRARY; T=293.6K
Photon emission for (n,2n)2a

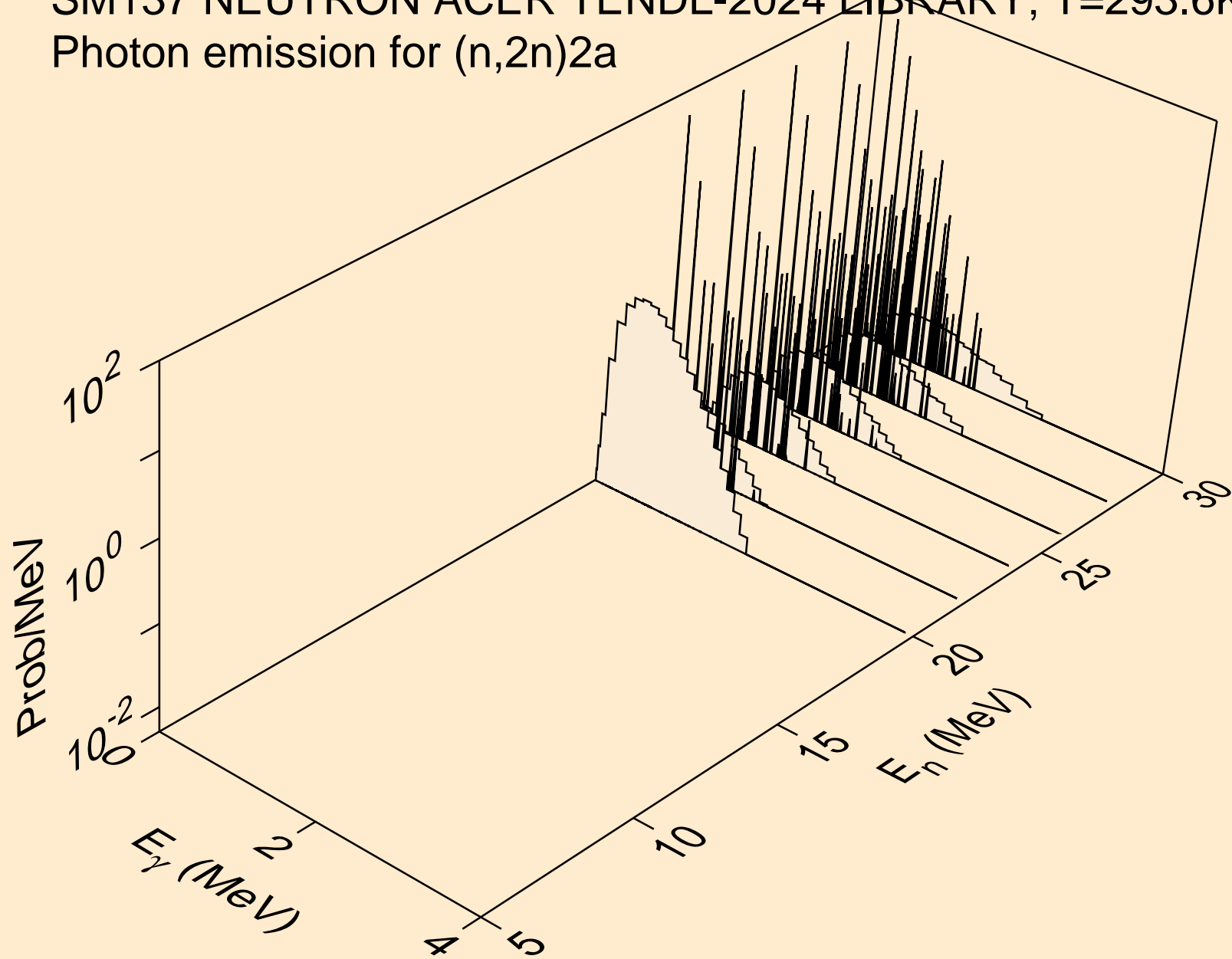

SM137 NEUTRON ACER TENDL-2024 LIBRARY; T=293.6K
Photon emission for (n,n*)d

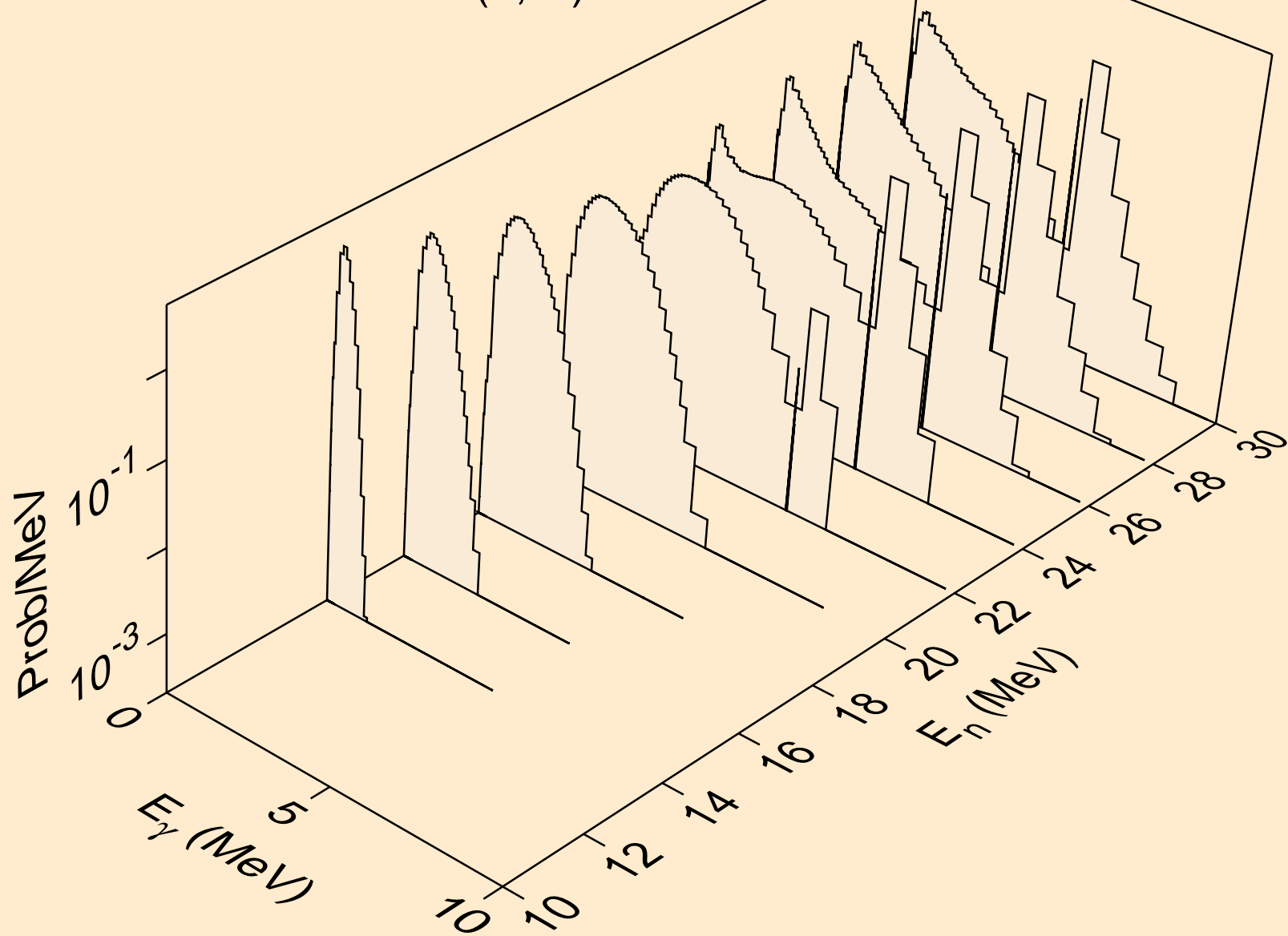

SM137 NEUTRON ACER TENDL-2024 LIBRARY; T=293.6K
Photon emission for (n,n*)t

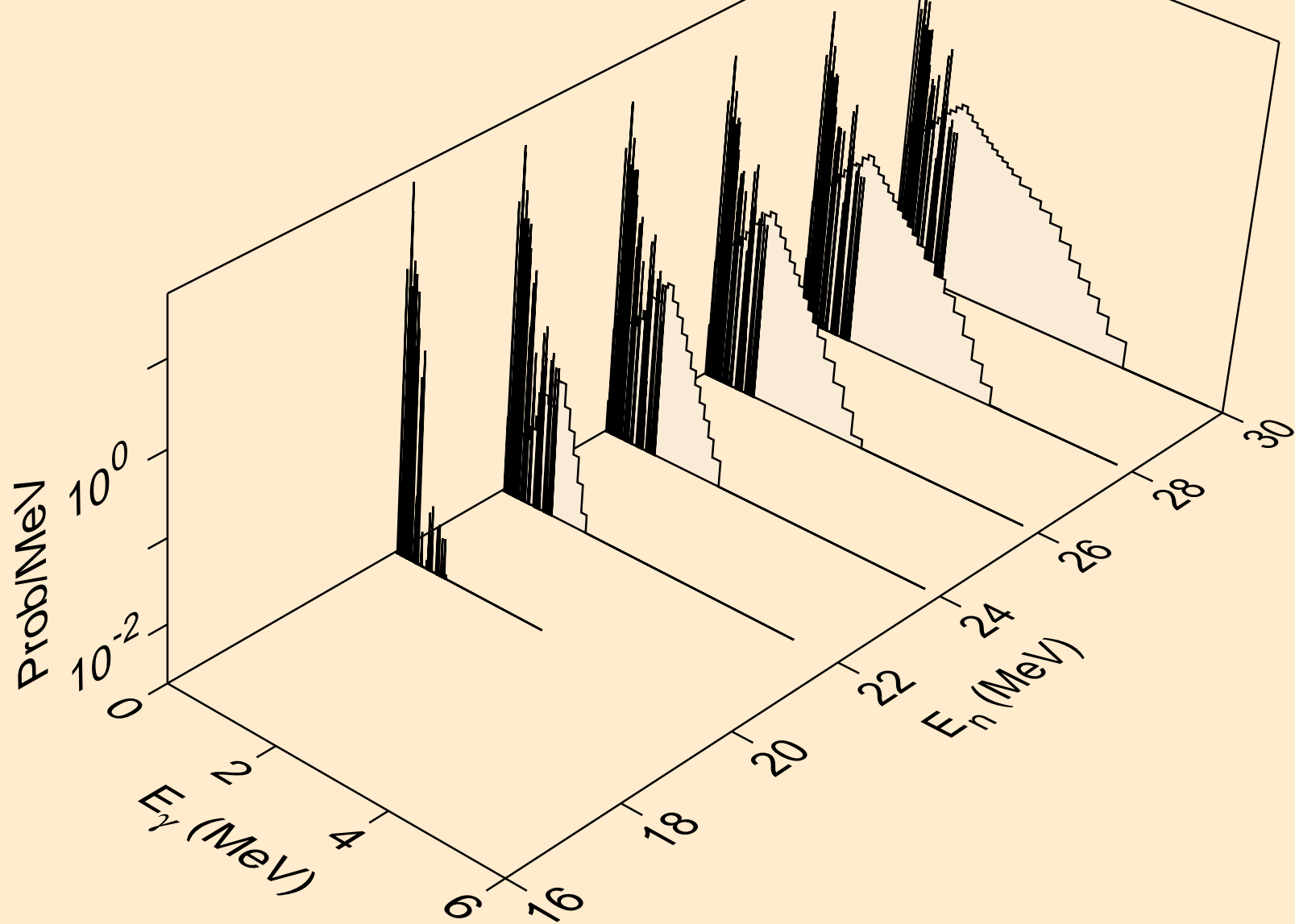

SM137 NEUTRON ACER TENDL-2024 LIBRARY; T=293.6K
Photon emission for (n,n*)he3

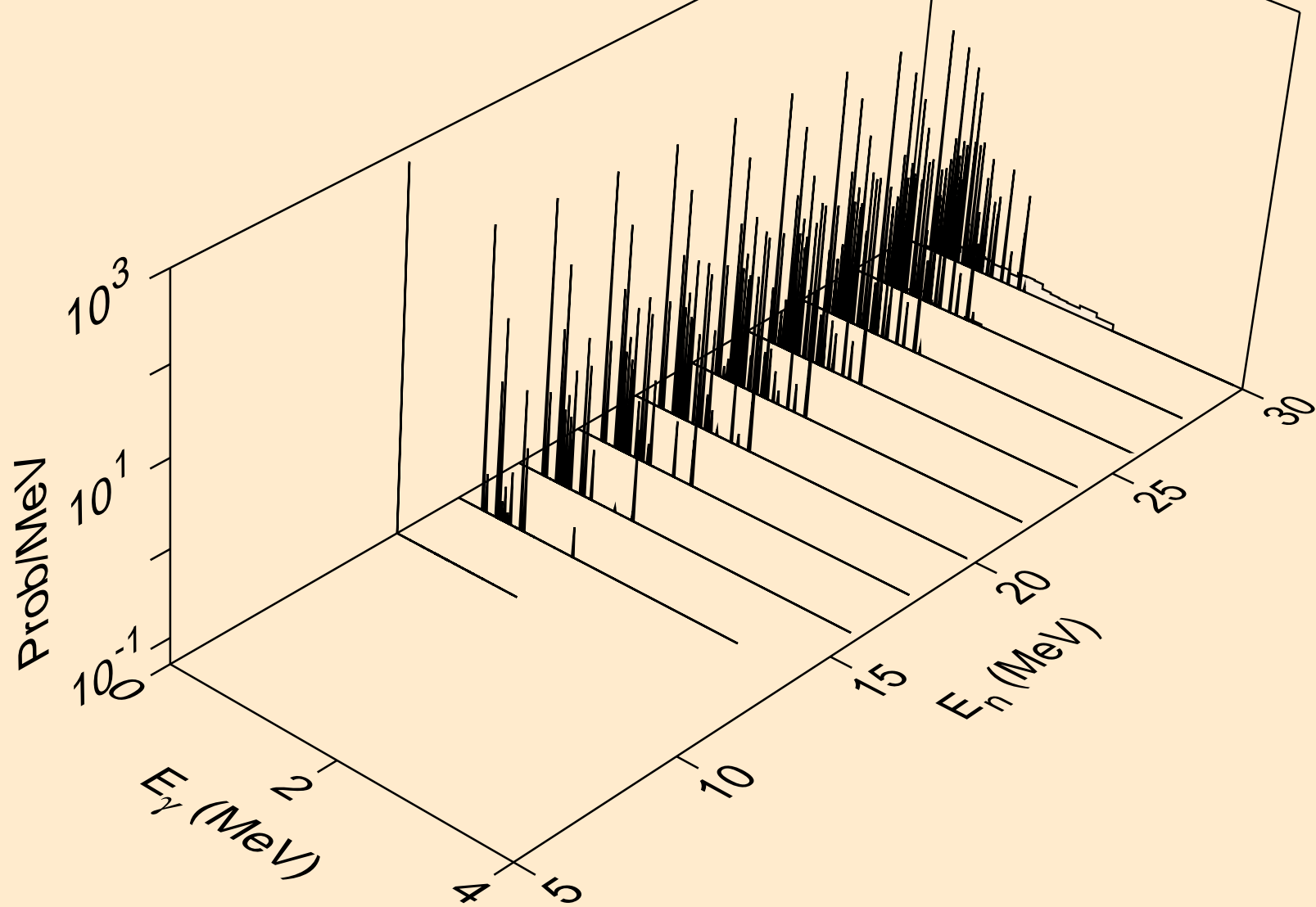

SM137 NEUTRON ACER TENDL-2024 LIBRARY; T=293.6K
Photon emission for (n,2np)

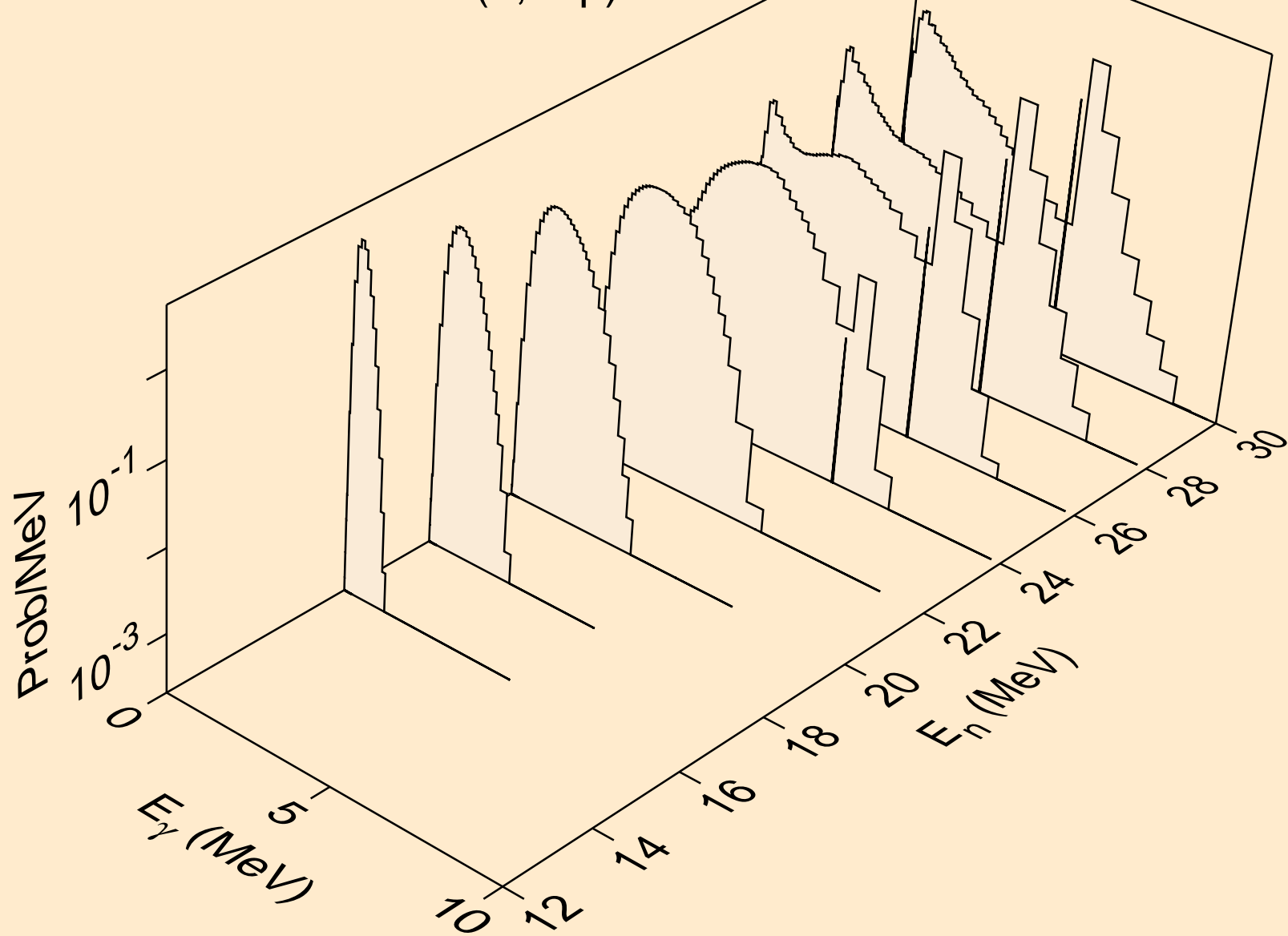

SM137 NEUTRON ACER TENDL-2024 LIBRARY; T=293.6K
Photon emission for (n,3np)

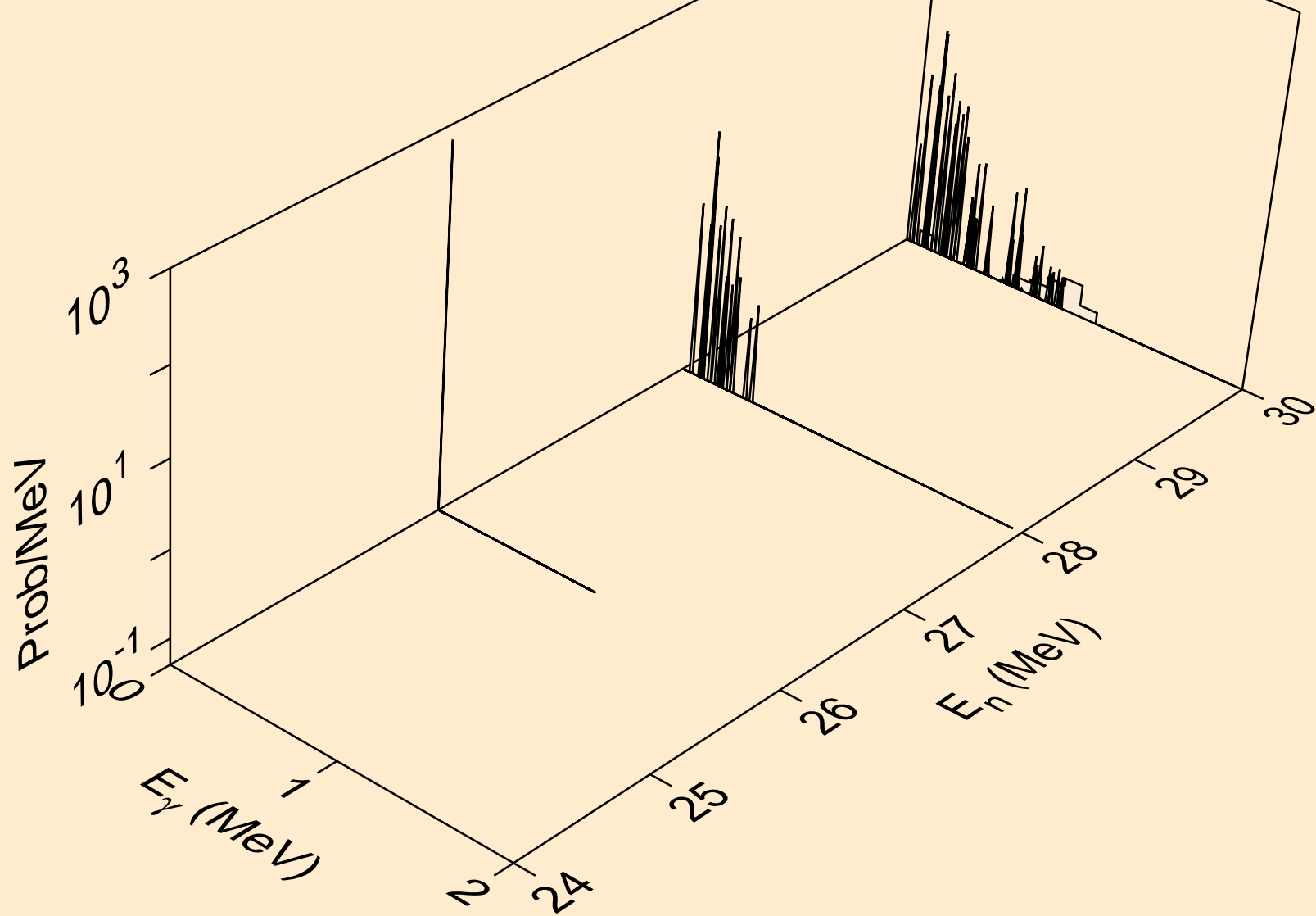

SM137 NEUTRON ACER TENDL-2024 LIBRARY; T=293.6K
Photon emission for (n,n2p)

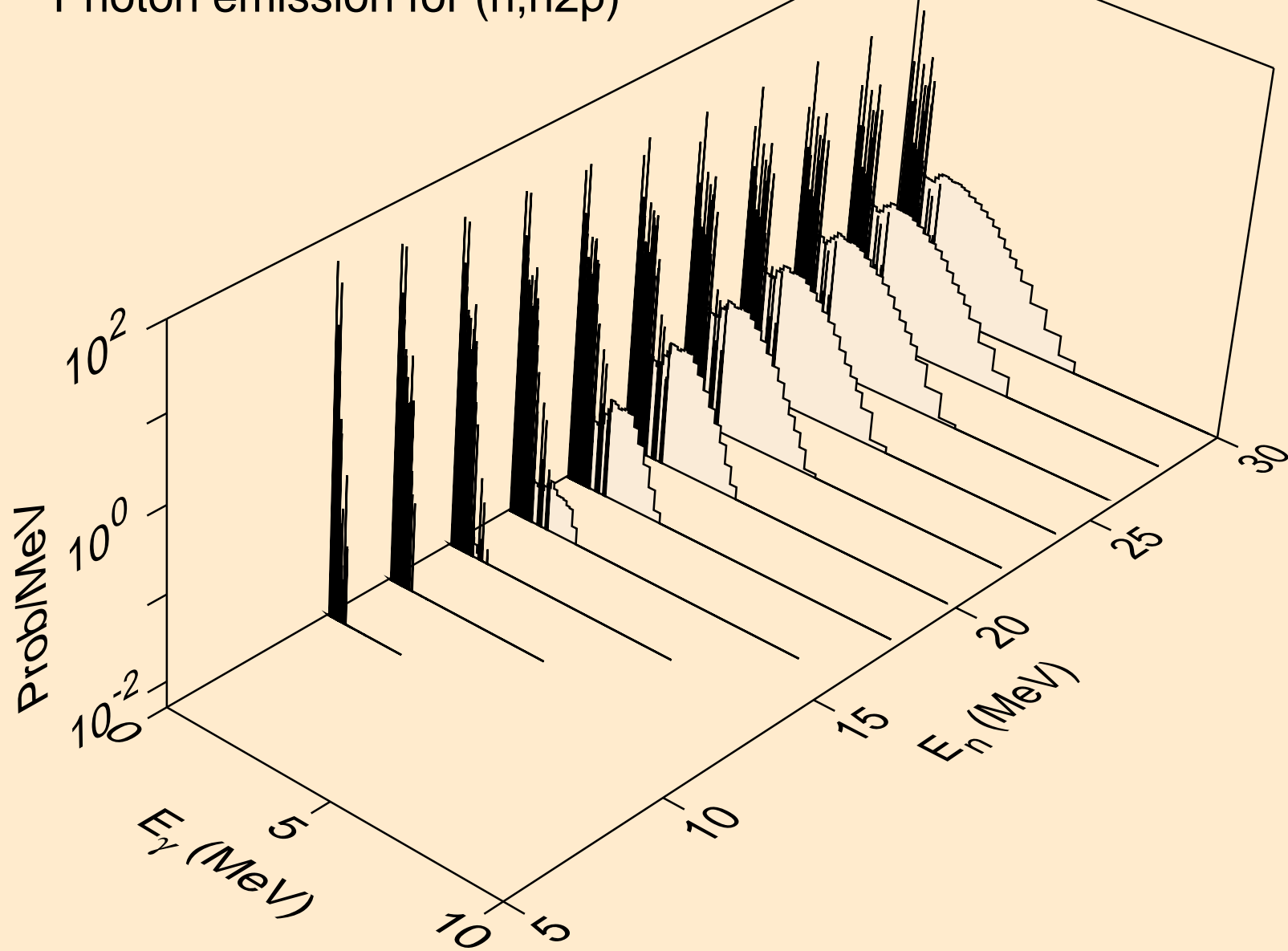

SM137 NEUTRON ACER TENDL-2024 LIBRARY; T=293.6K
Photon emission for (n,npa)

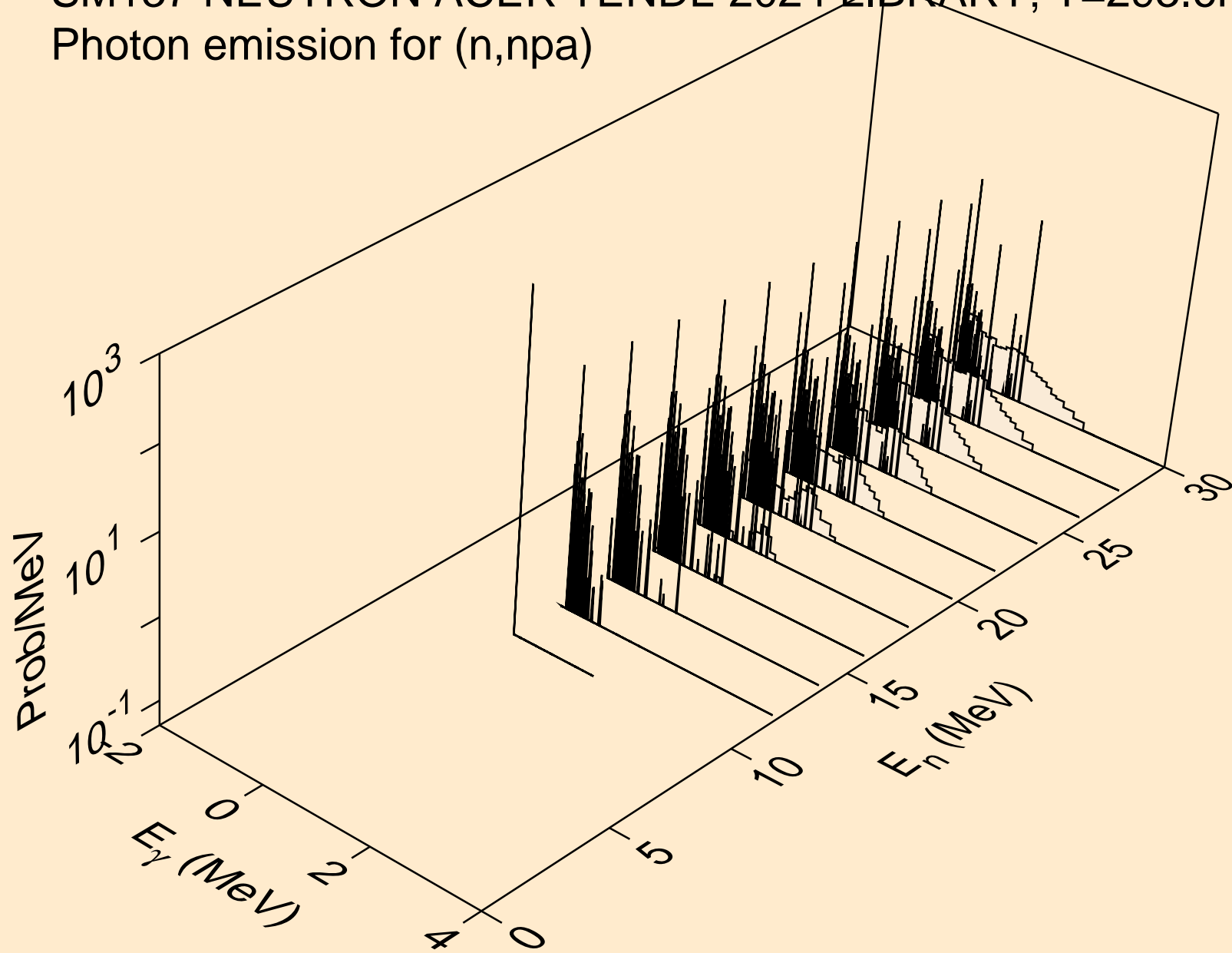

SM137 NEUTRON ACER TENDL-2024 LIBRARY; T=293.6K
Photon emission for (n,n*c)

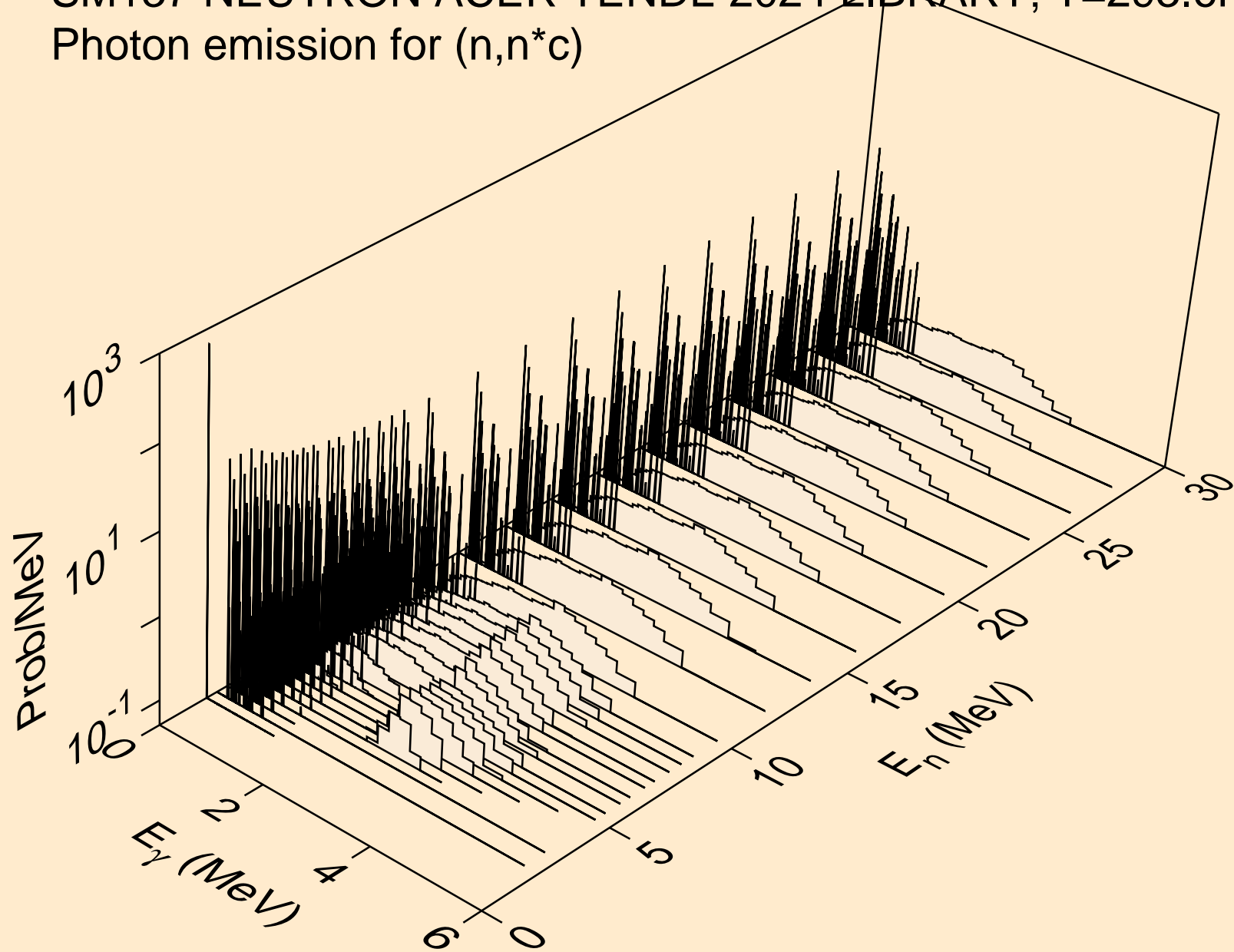

SM137 NEUTRON ACER TENDL-2024 LIBRARY; T=293.6K
Photon emission for (n,gma)

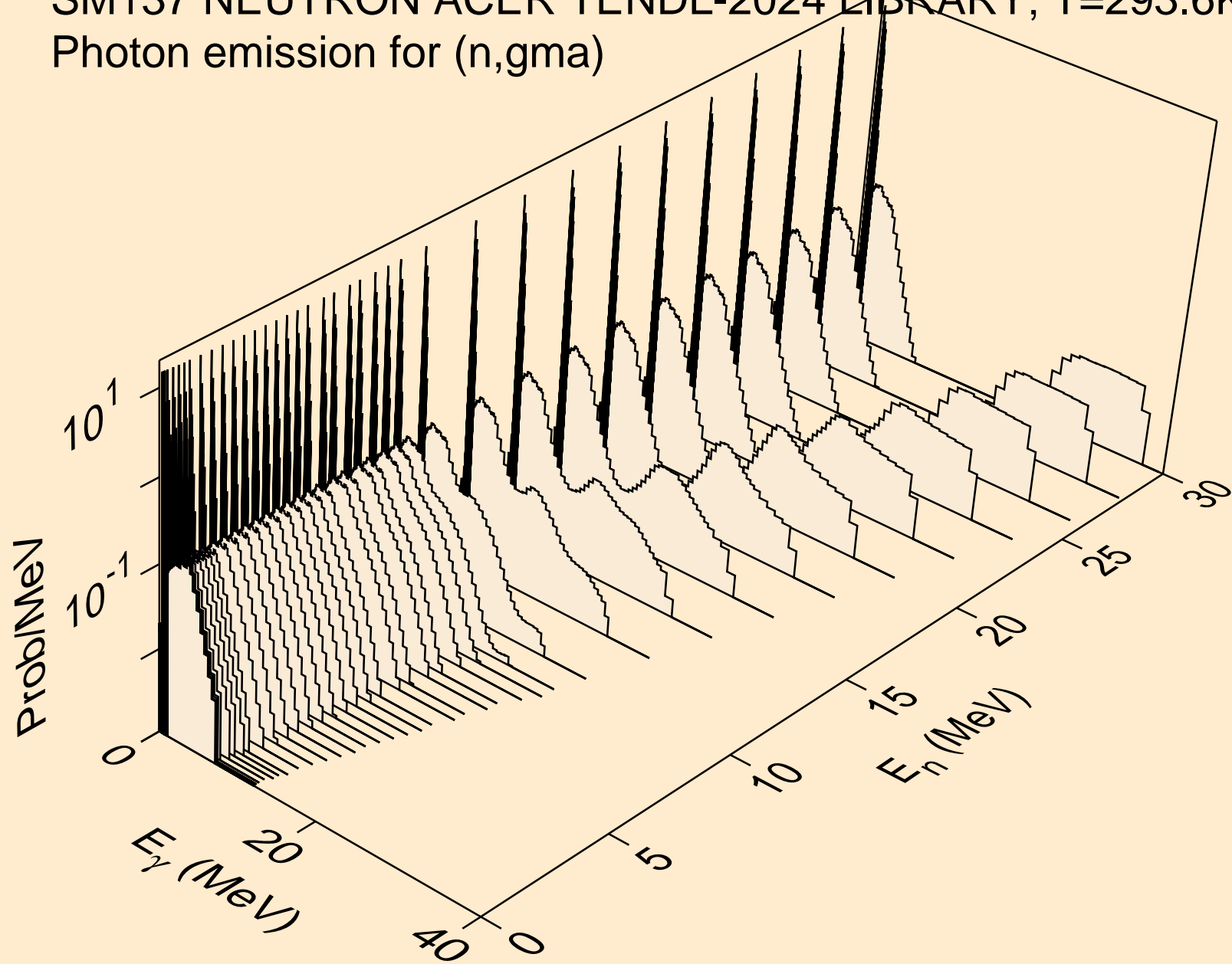

SM137 NEUTRON ACER TENDL-2024 LIBRARY; T=293.6K
Photon emission for (n,p)

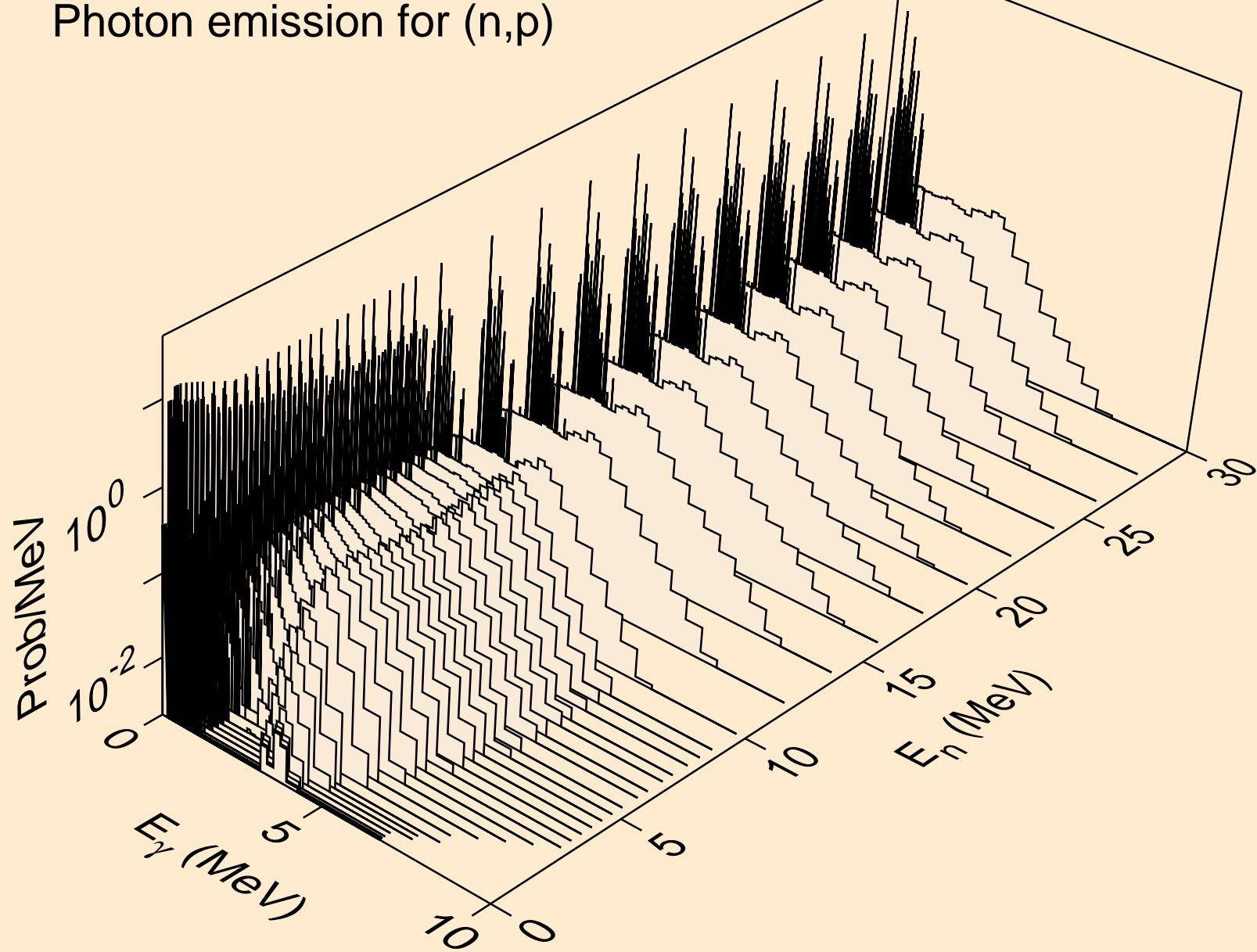

SM137 NEUTRON ACER TENDL-2024 LIBRARY; T=293.6K
Photon emission for (n,d)

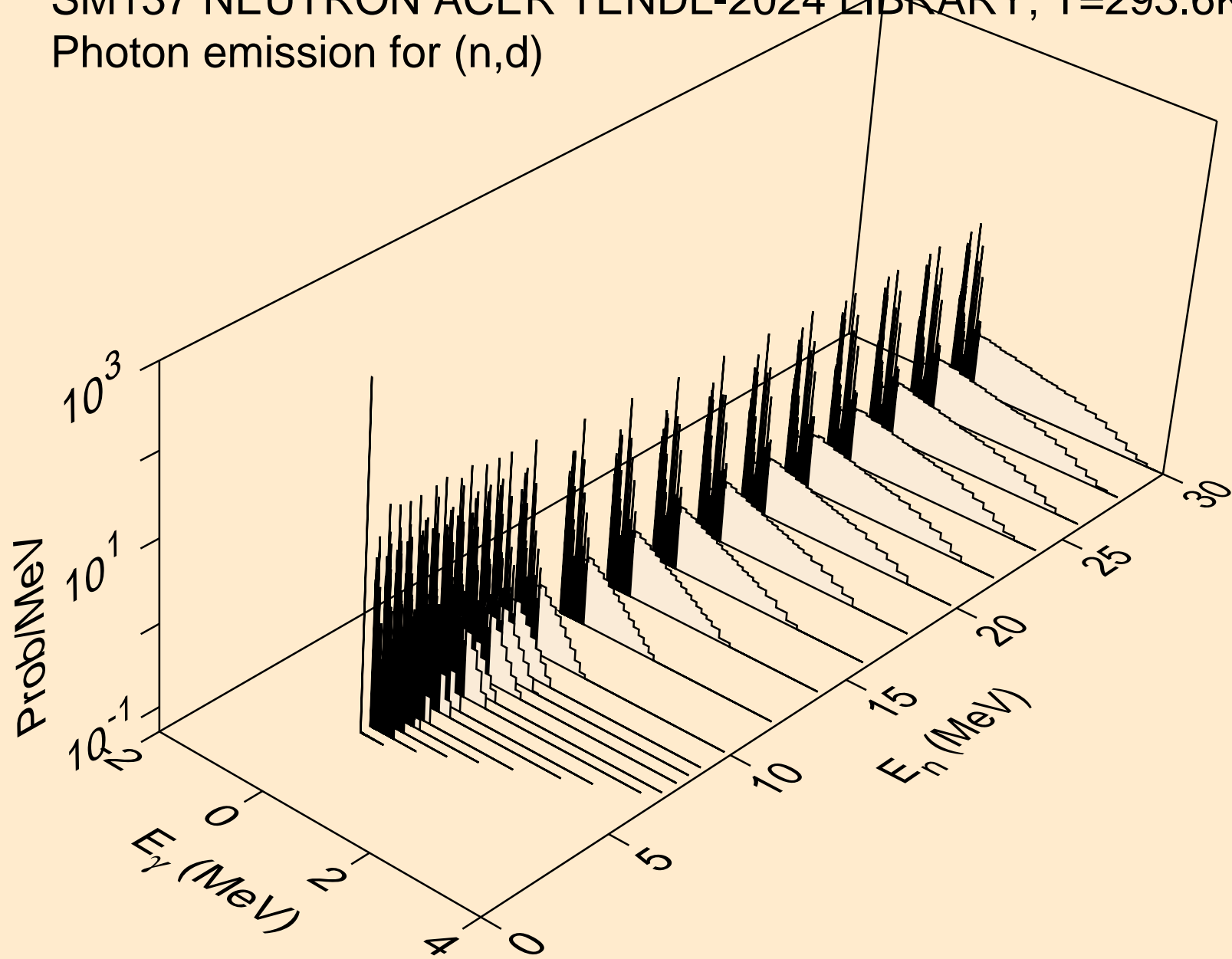

SM137 NEUTRON ACER TENDL-2024 LIBRARY; T=293.6K
Photon emission for (n,t)

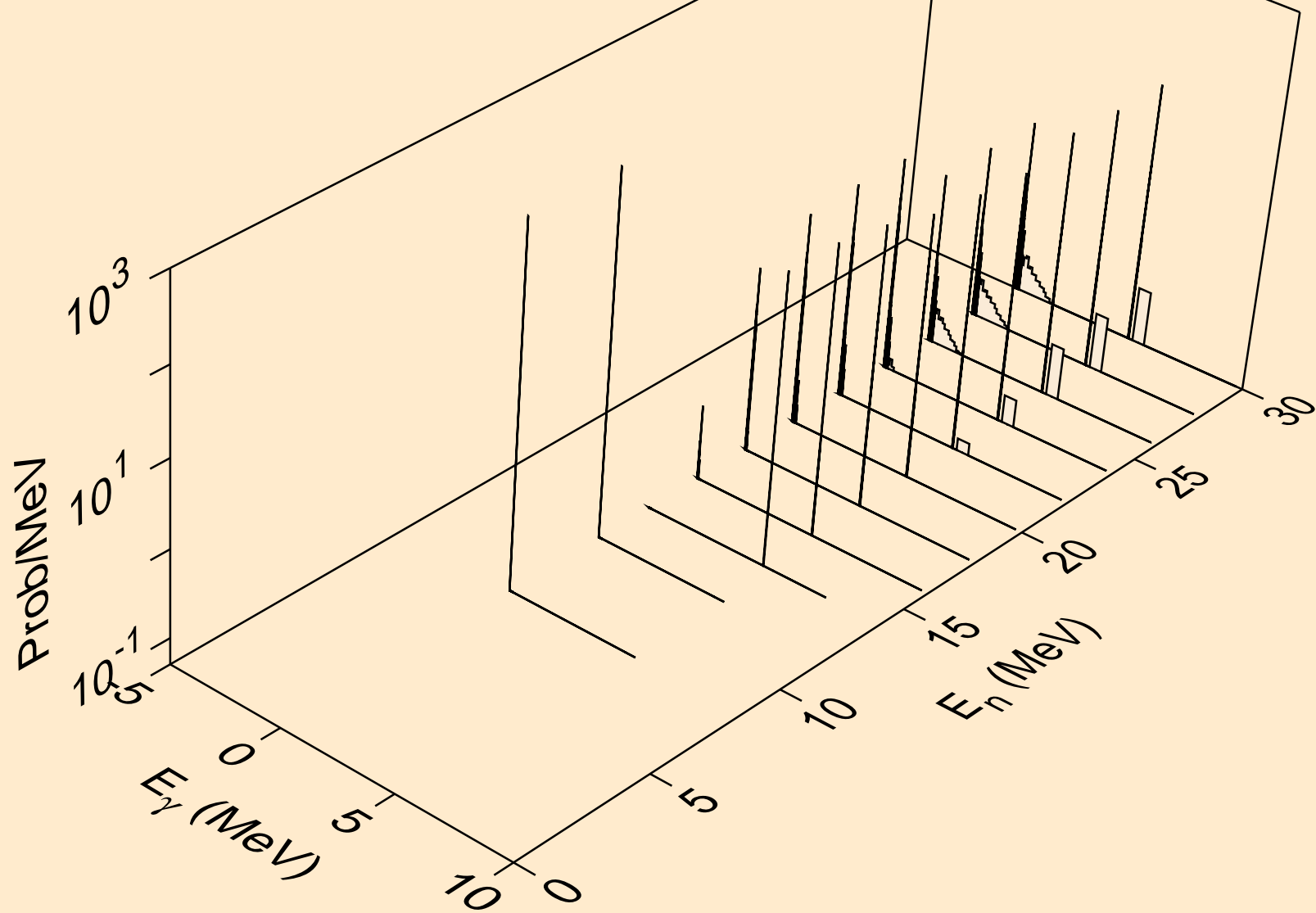

SM137 NEUTRON ACER TENDL-2024 LIBRARY; T=293.6K
Photon emission for (n,he3)

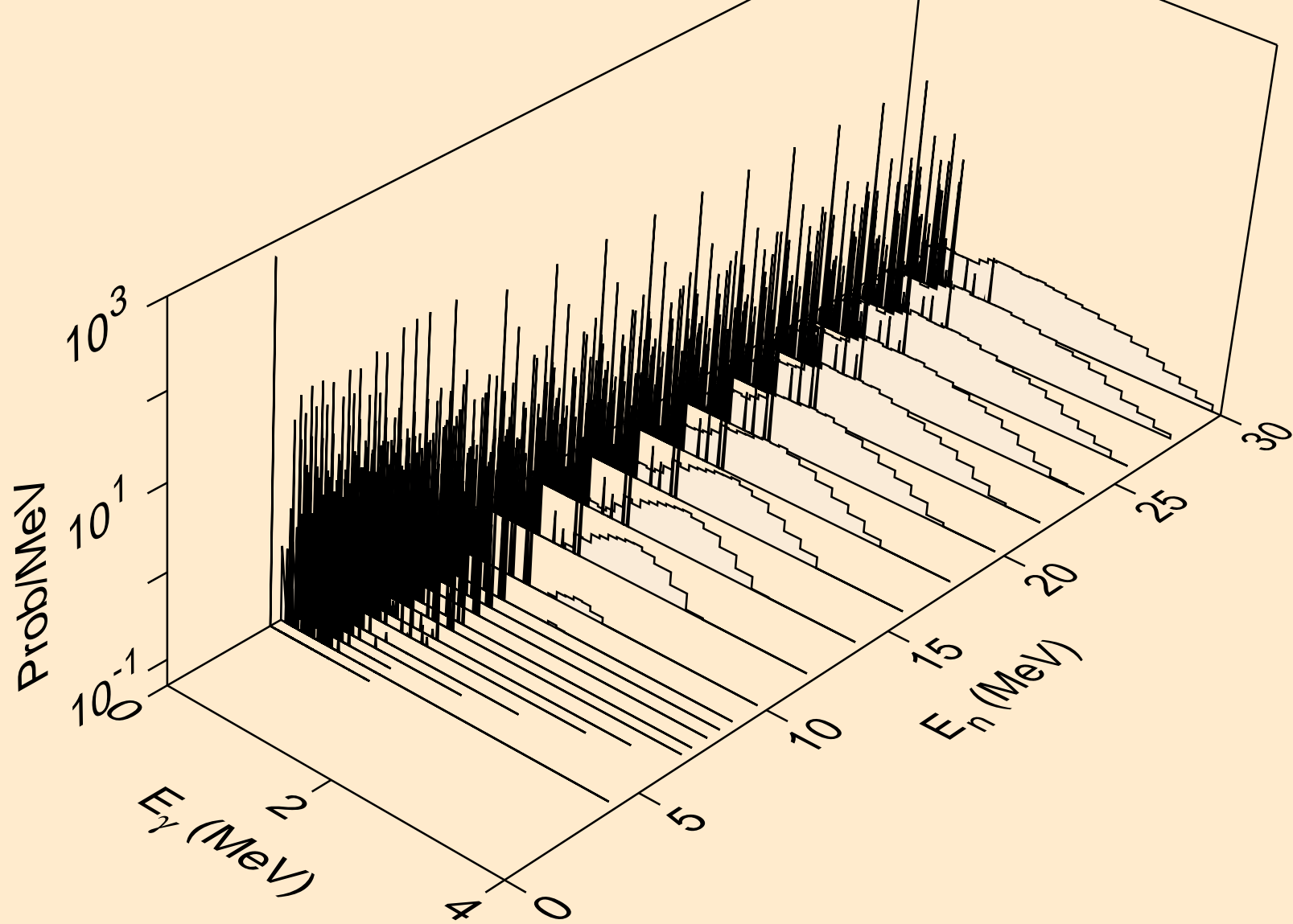

SM137 NEUTRON ACER TENDL-2024 LIBRARY; T=293.6K
Photon emission for (n,a)

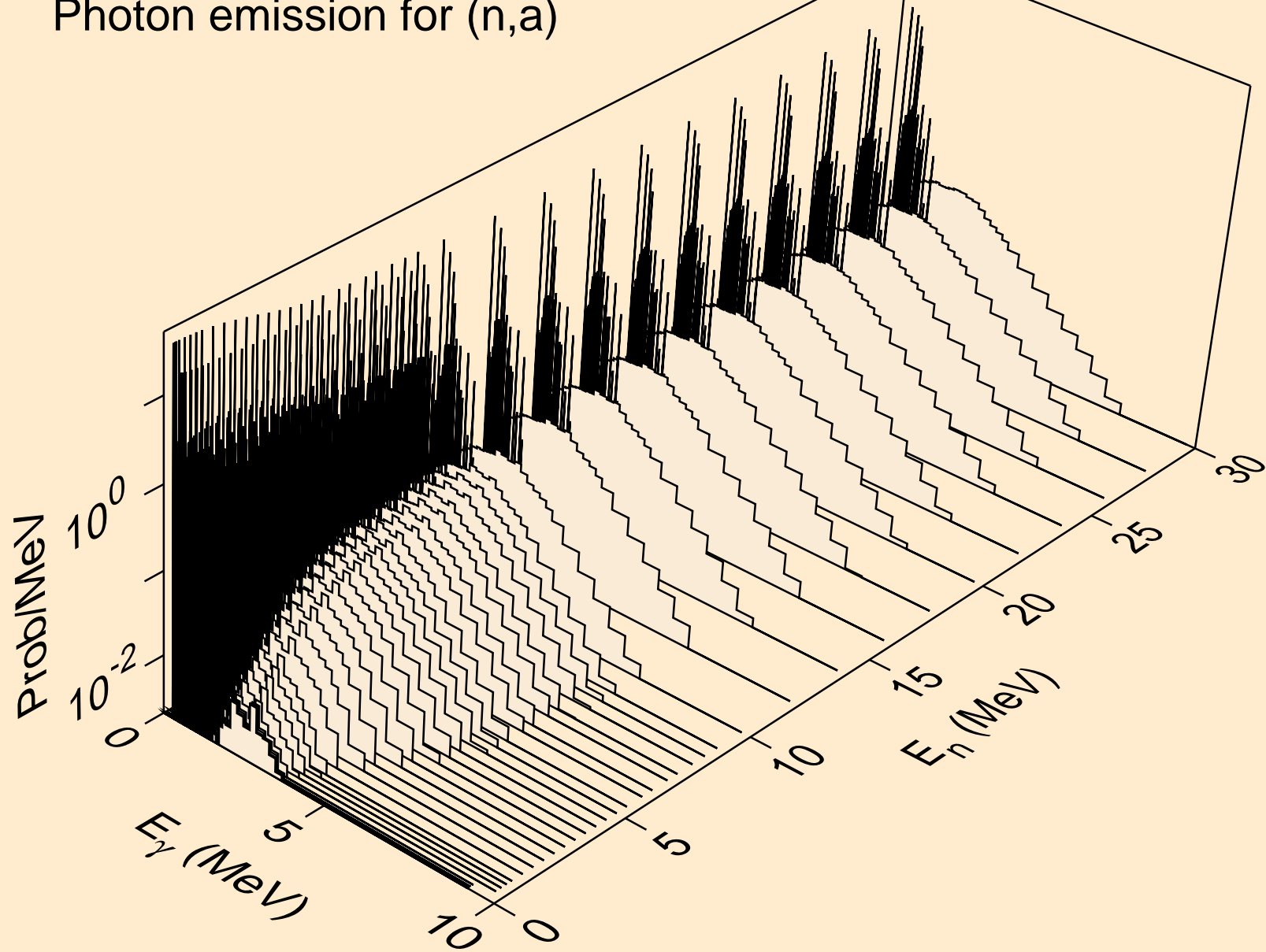

SM137 NEUTRON ACER TENDL-2024 LIBRARY; T=293.6K
Photon emission for (n,2a)

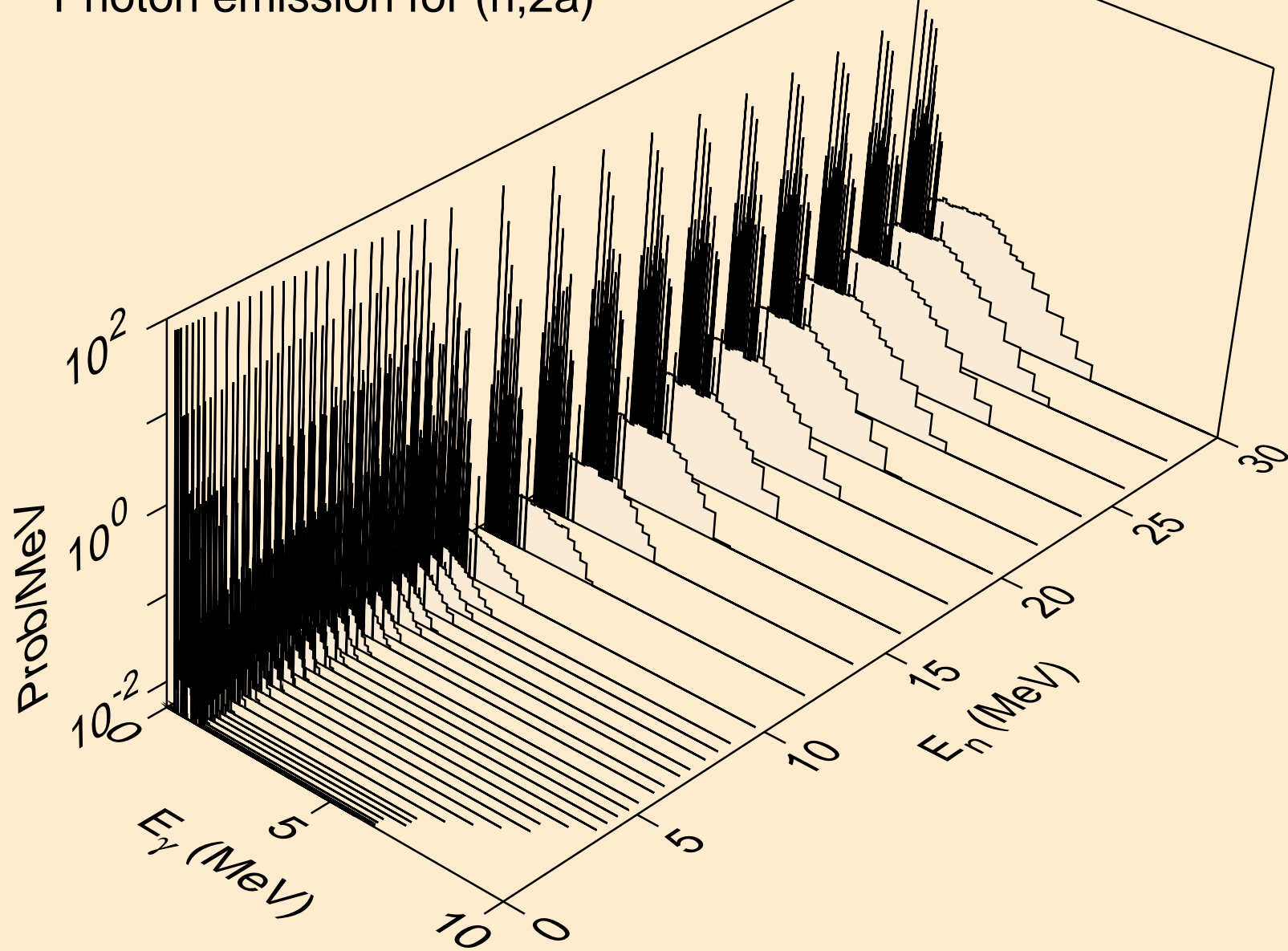

SM137 NEUTRON ACER TENDL-2024 LIBRARY; T=293.6K
Photon emission for (n,3a)

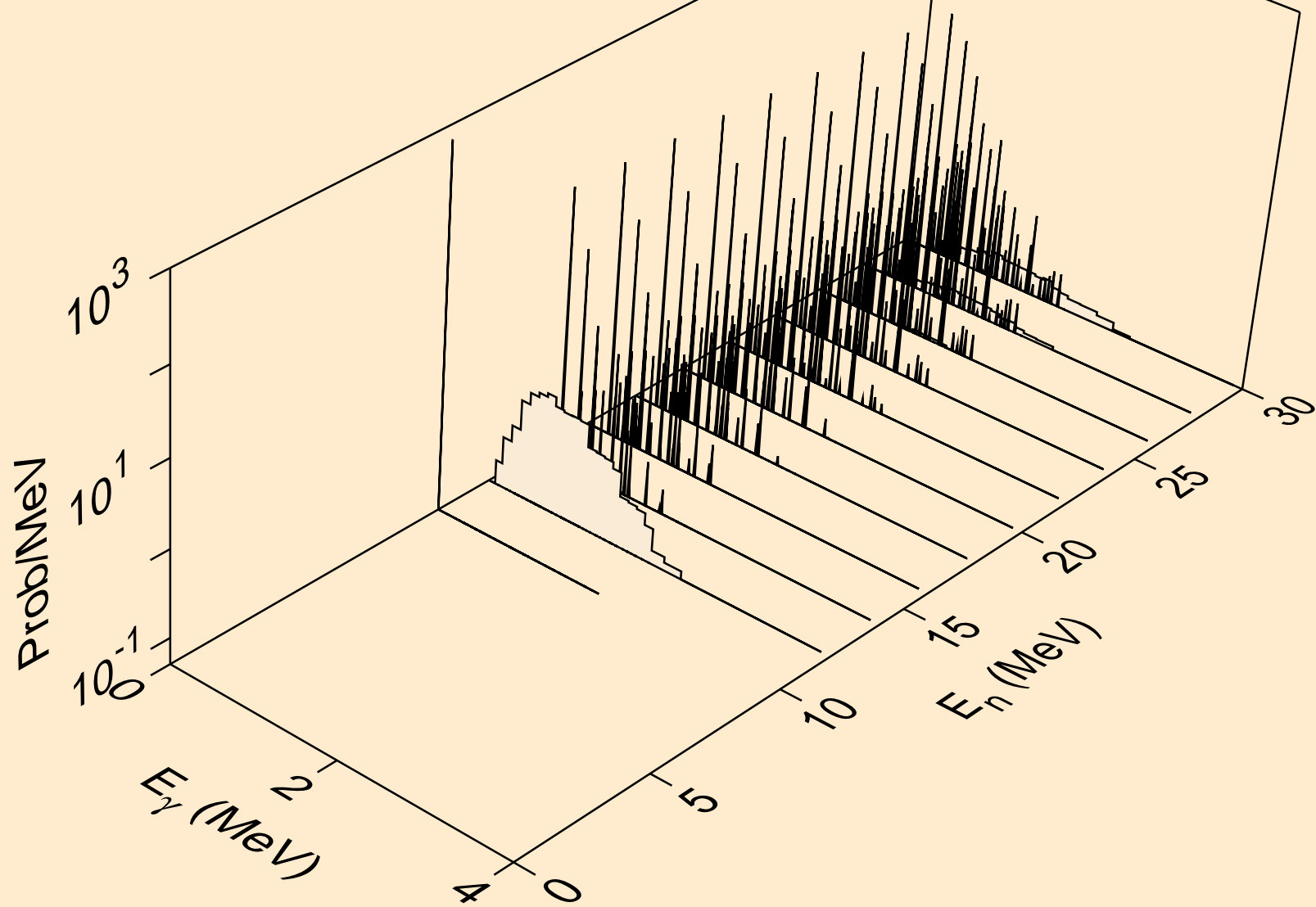

SM137 NEUTRON ACER TENDL-2024 LIBRARY; T=293.6K
Photon emission for (n,2p)

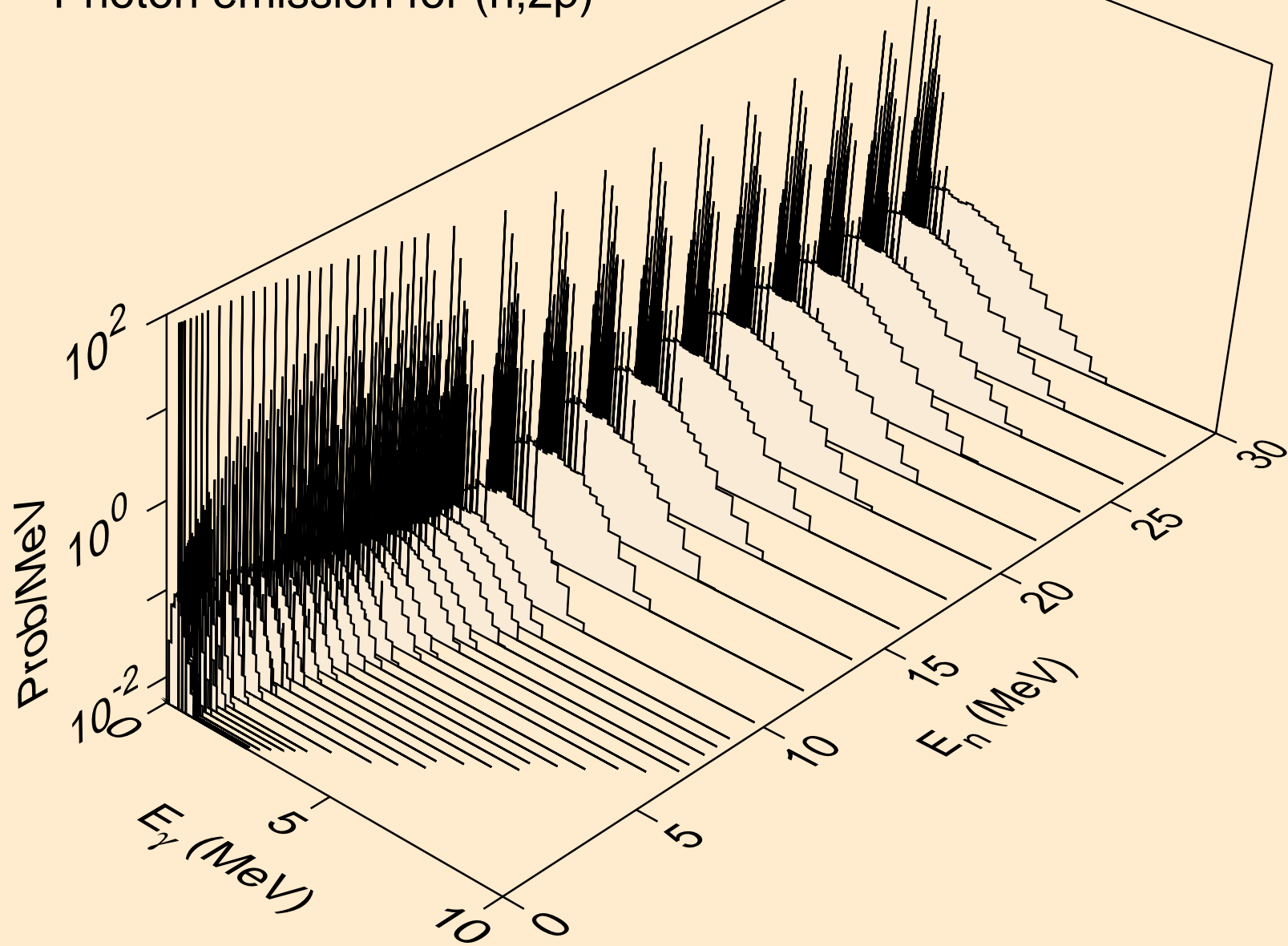

SM137 NEUTRON ACER TENDL-2024 LIBRARY; T=293.6K
Photon emission for (n,p α)

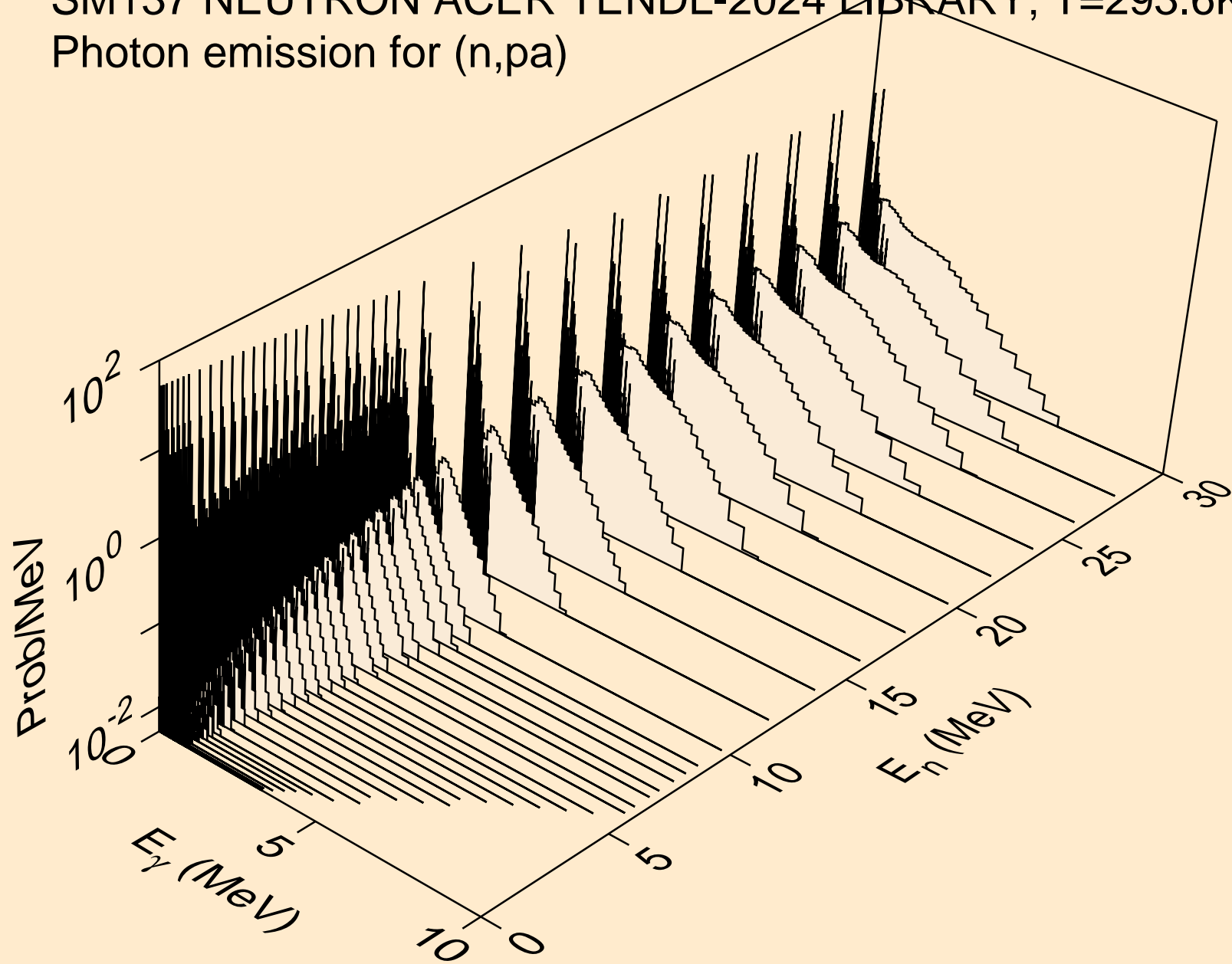

SM137 NEUTRON ACER TENDL-2024 LIBRARY; T=293.6K
Photon emission for (n,pd)

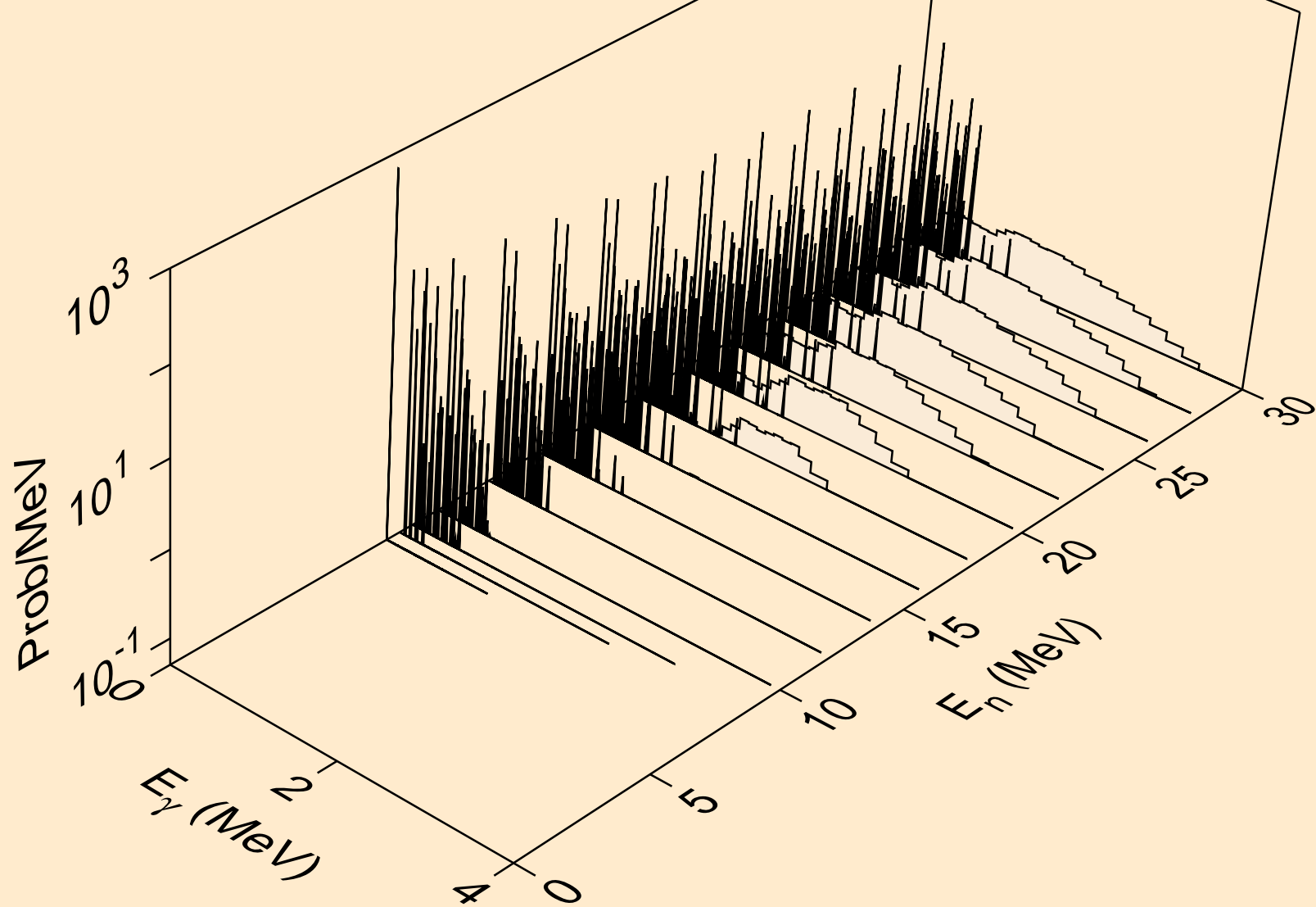

SM137 NEUTRON ACER TENDL-2024 LIBRARY; T=293.6K
Photon emission for (n,pt)

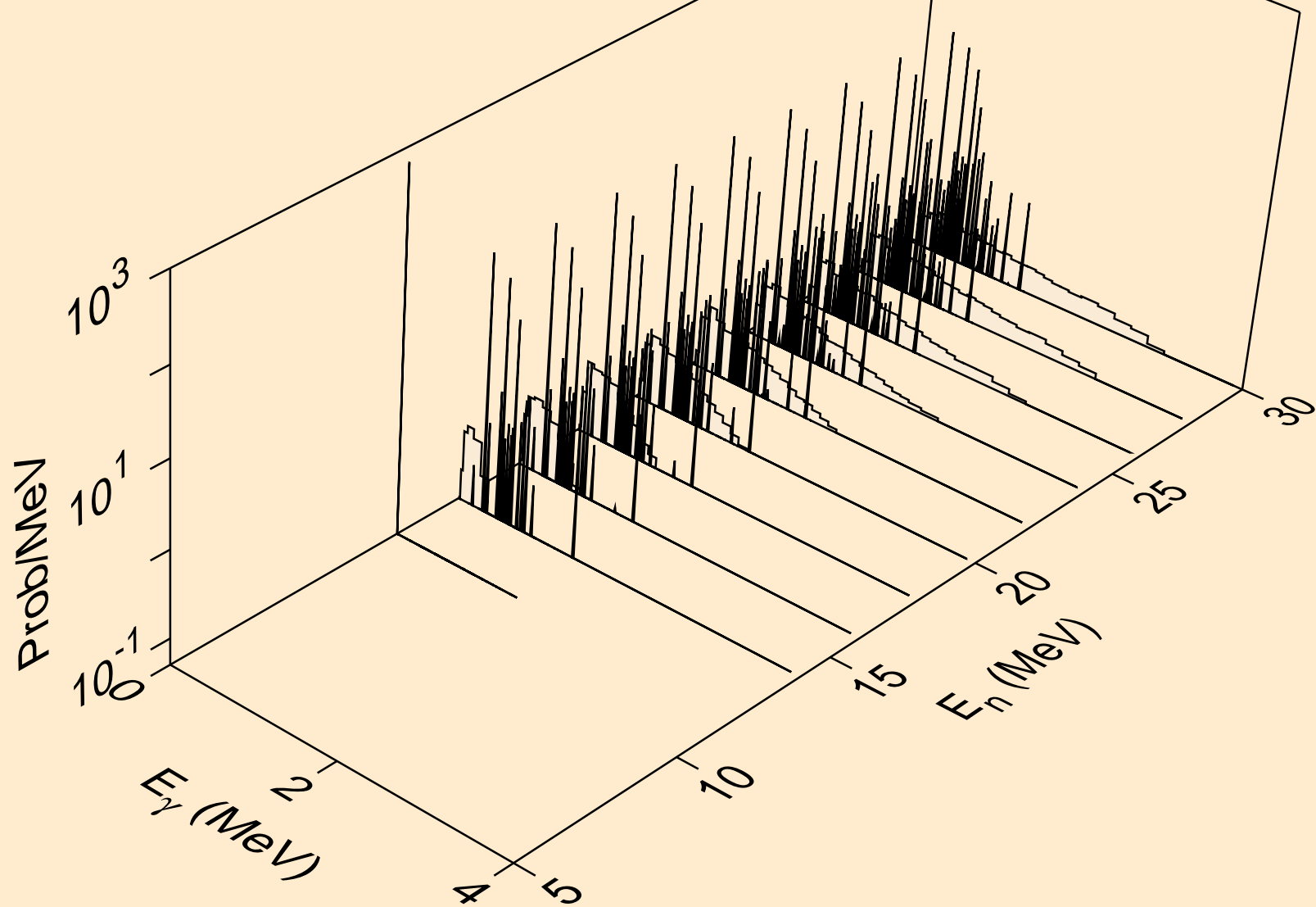

SM137 NEUTRON ACER TENDL-2024 LIBRARY; T=293.6K
Photon emission for (n,da)

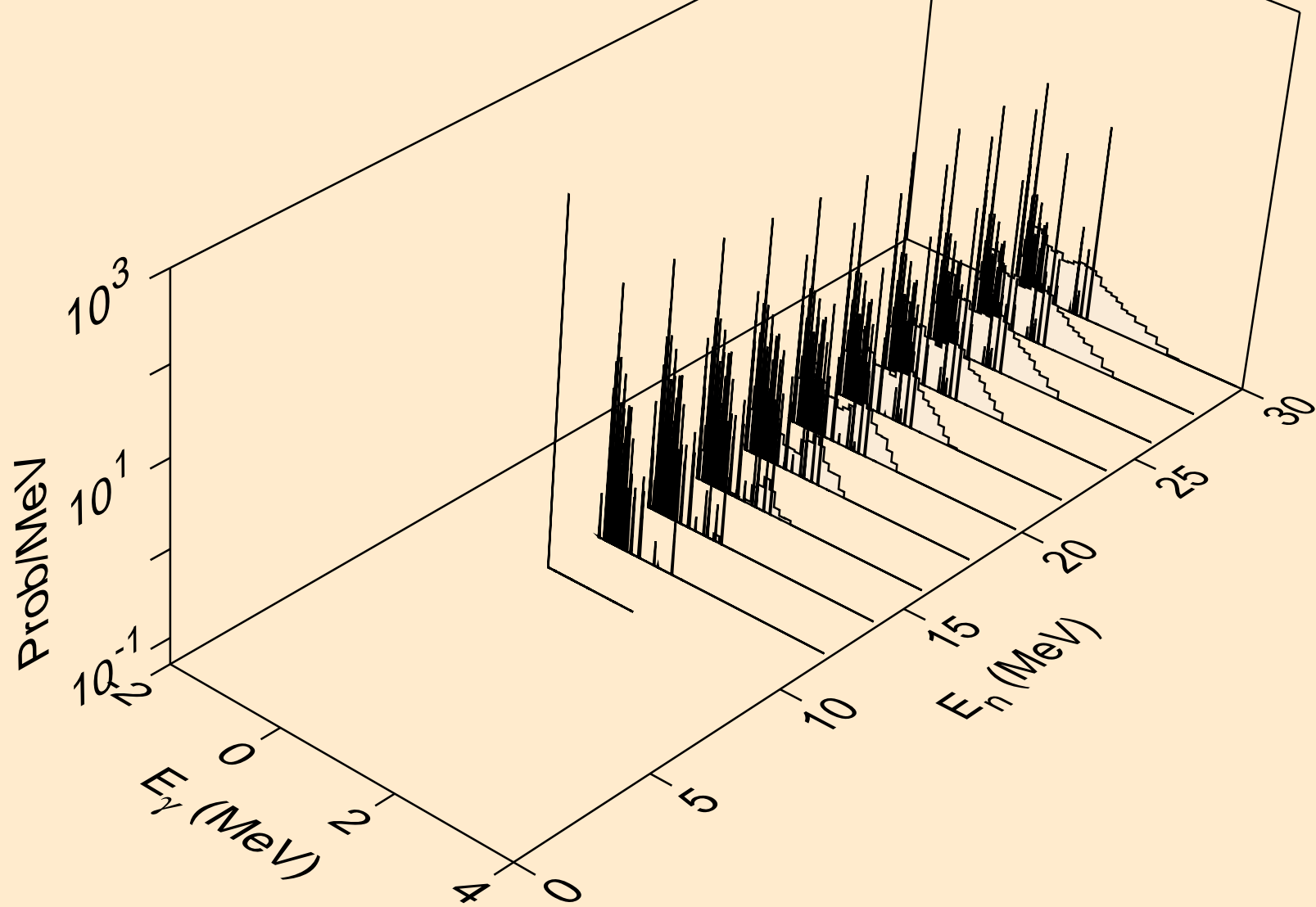

SM137 NEUTRON ACER TENDL-2024 LIBRARY; T=293.6K
thermal capture photon spectrum

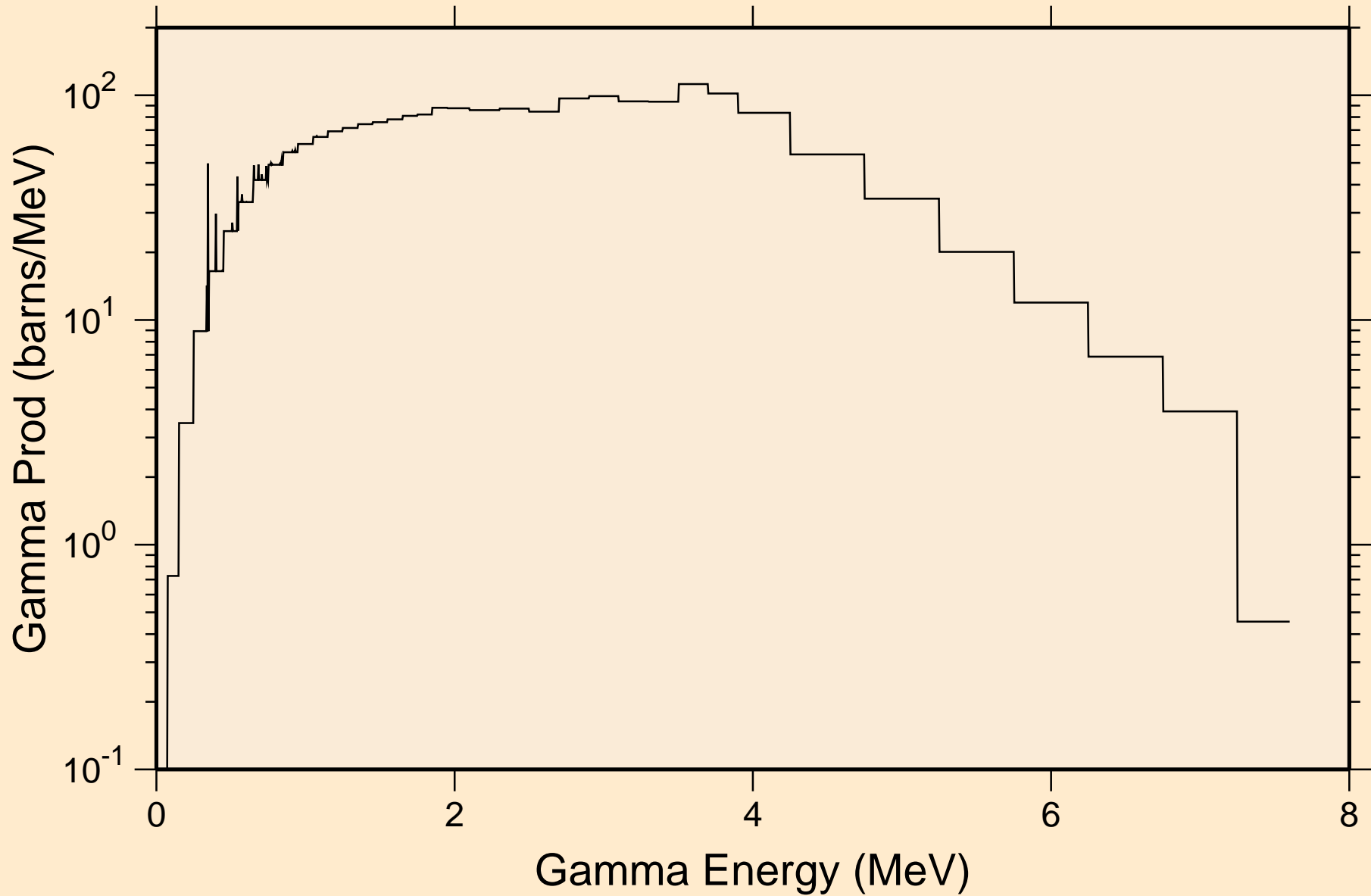

SM137 NEUTRON ACER TENDL-2024 LIBRARY; T=293.6K
14 MeV photon spectrum

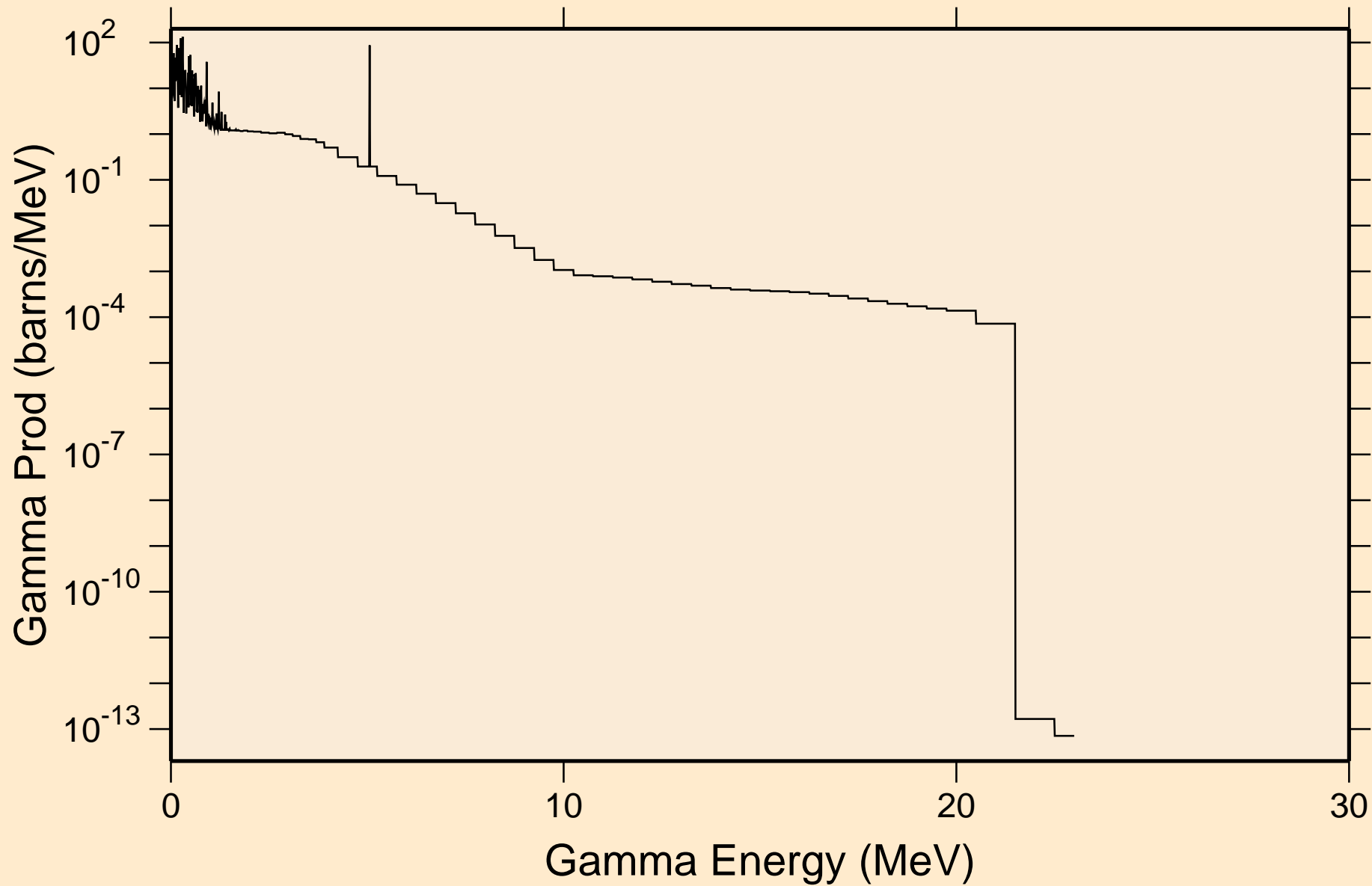

SM137 NEUTRON ACER TENDL-2024 LIBRARY; T=293.6K

Particle heating contributions

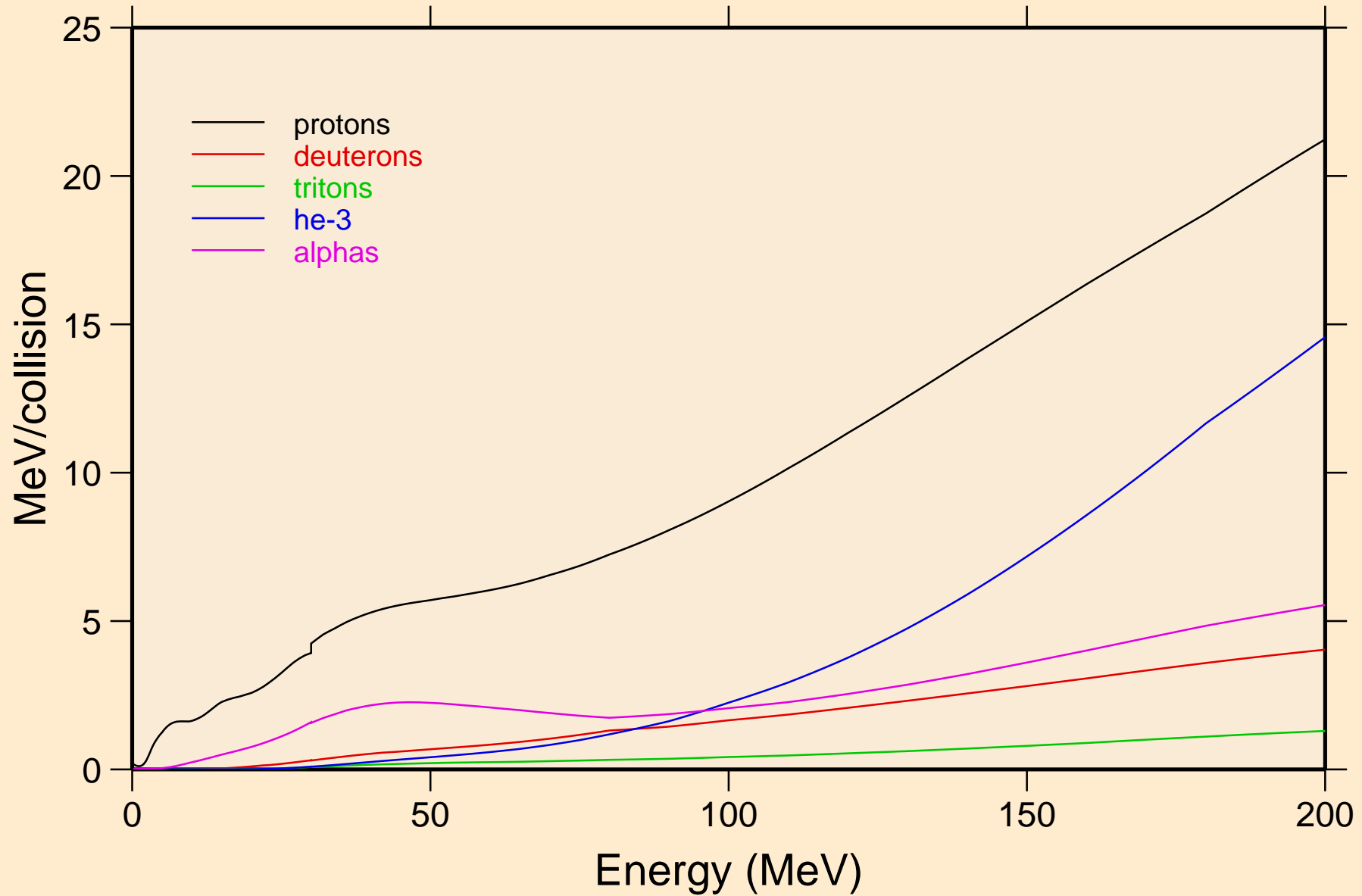

SM137 NEUTRON ACER TENDL-2024 LIBRARY; T=293.6K
Recoil Heating

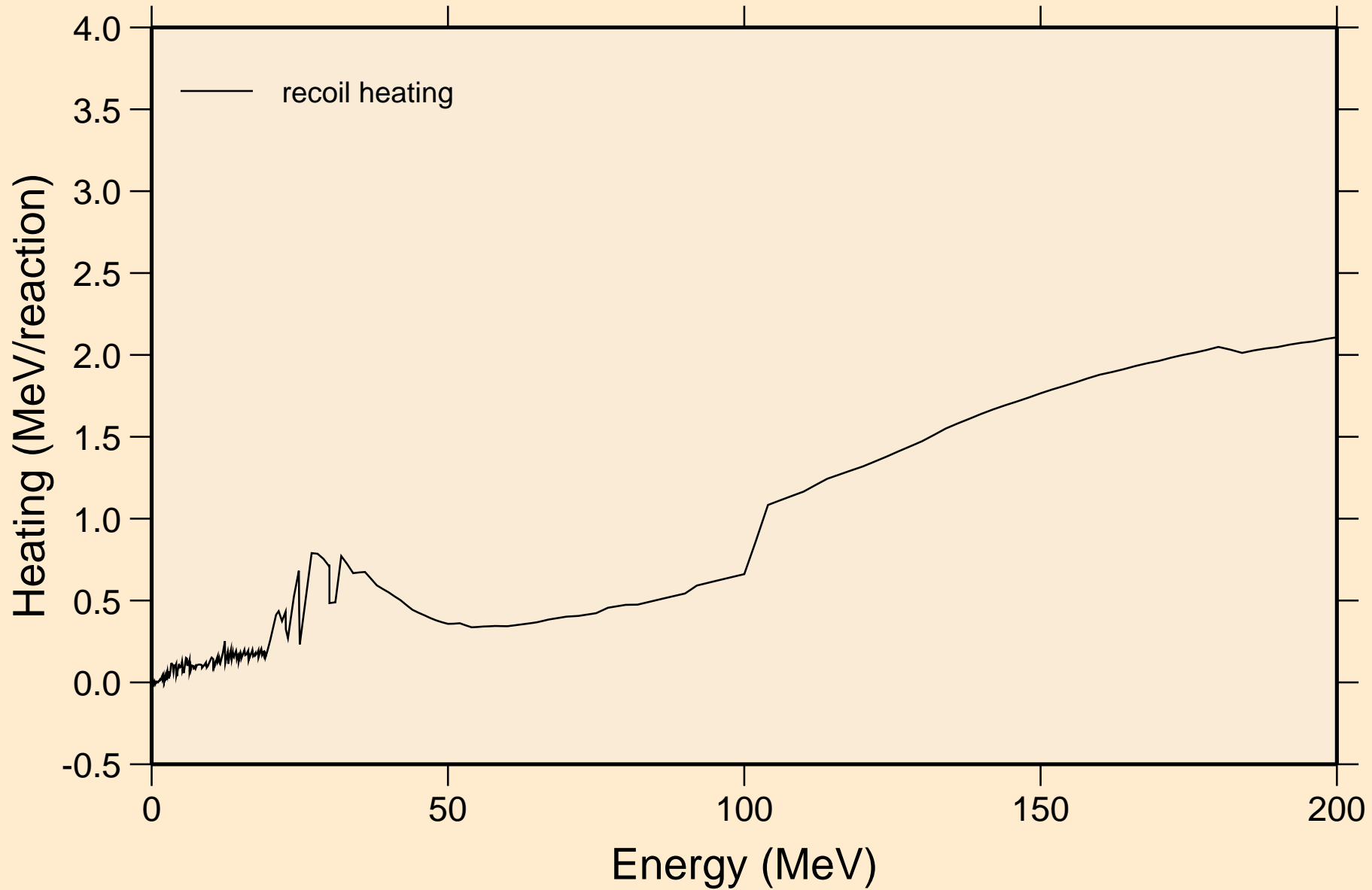

SM137 NEUTRON ACER TENDL-2024 LIBRARY; T=293.6K

Particle production cross sections

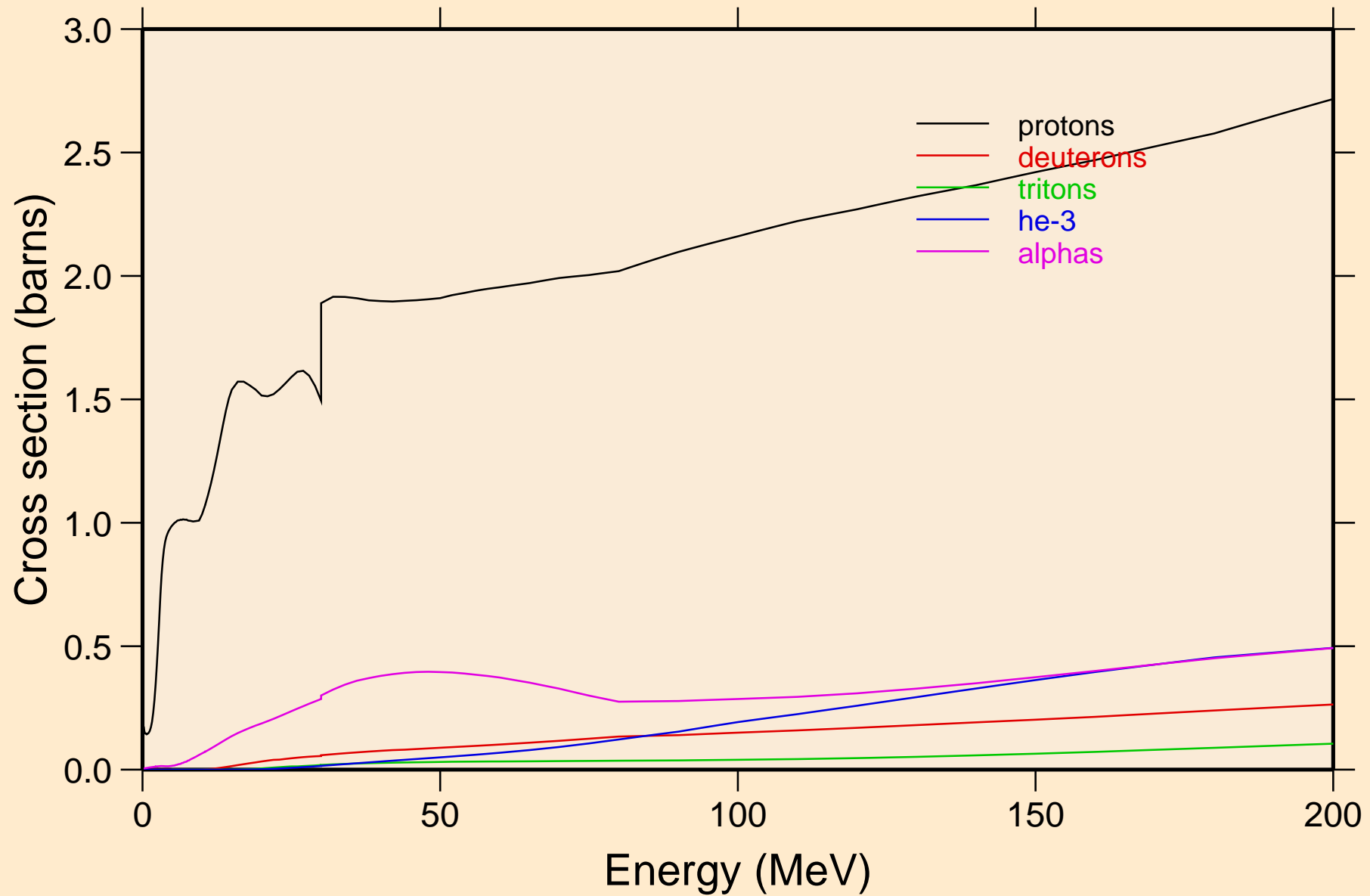

SM137 NEUTRON ACER TENDL-2024 LIBRARY; T=293.6K
protons from (n,x)

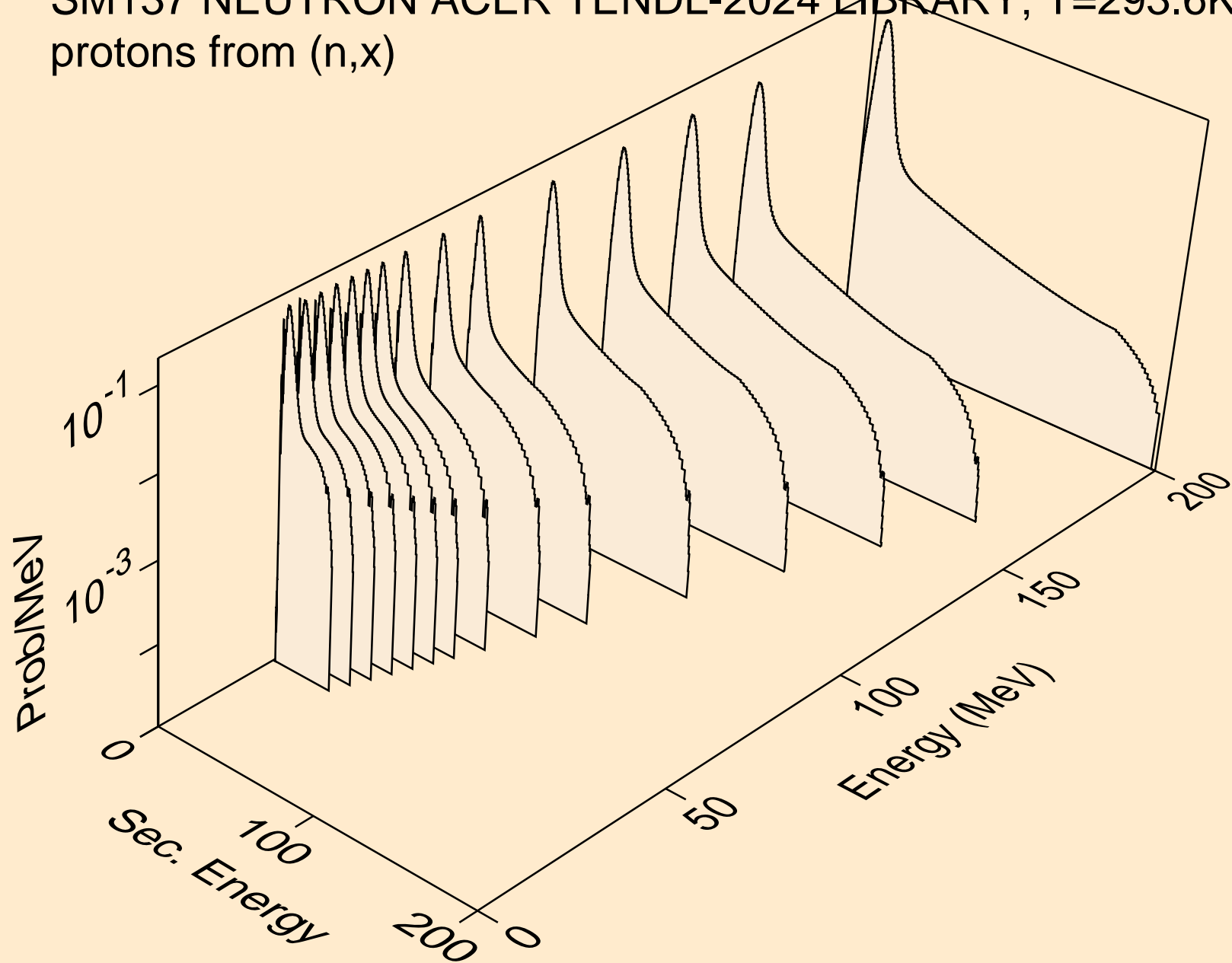

SM137 NEUTRON ACER TENDL-2024 LIBRARY; T=293.6K
protons from (n,n*)p

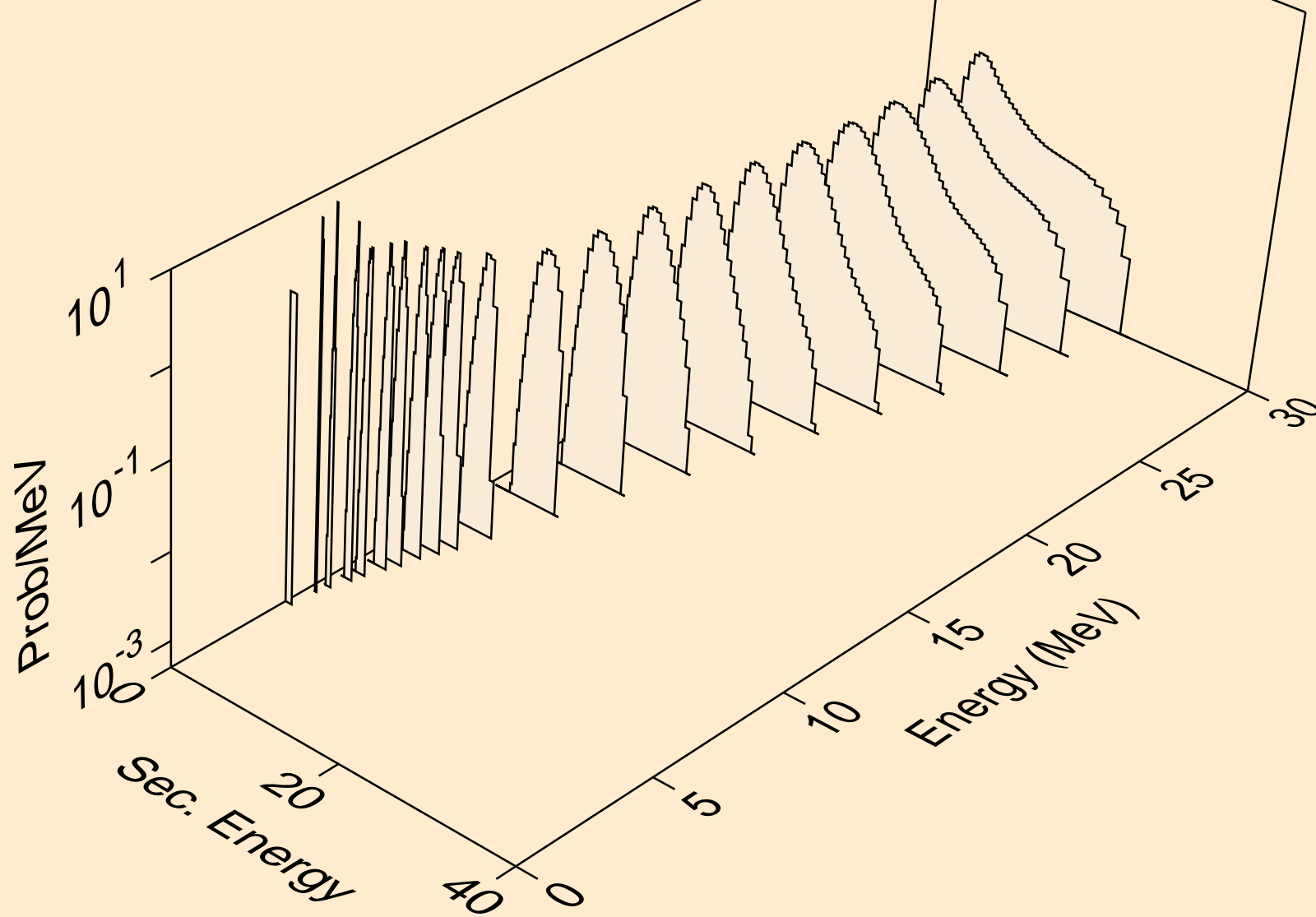

SM137 NEUTRON ACER TENDL-2024 LIBRARY; T=293.6K
protons from (n,2np)

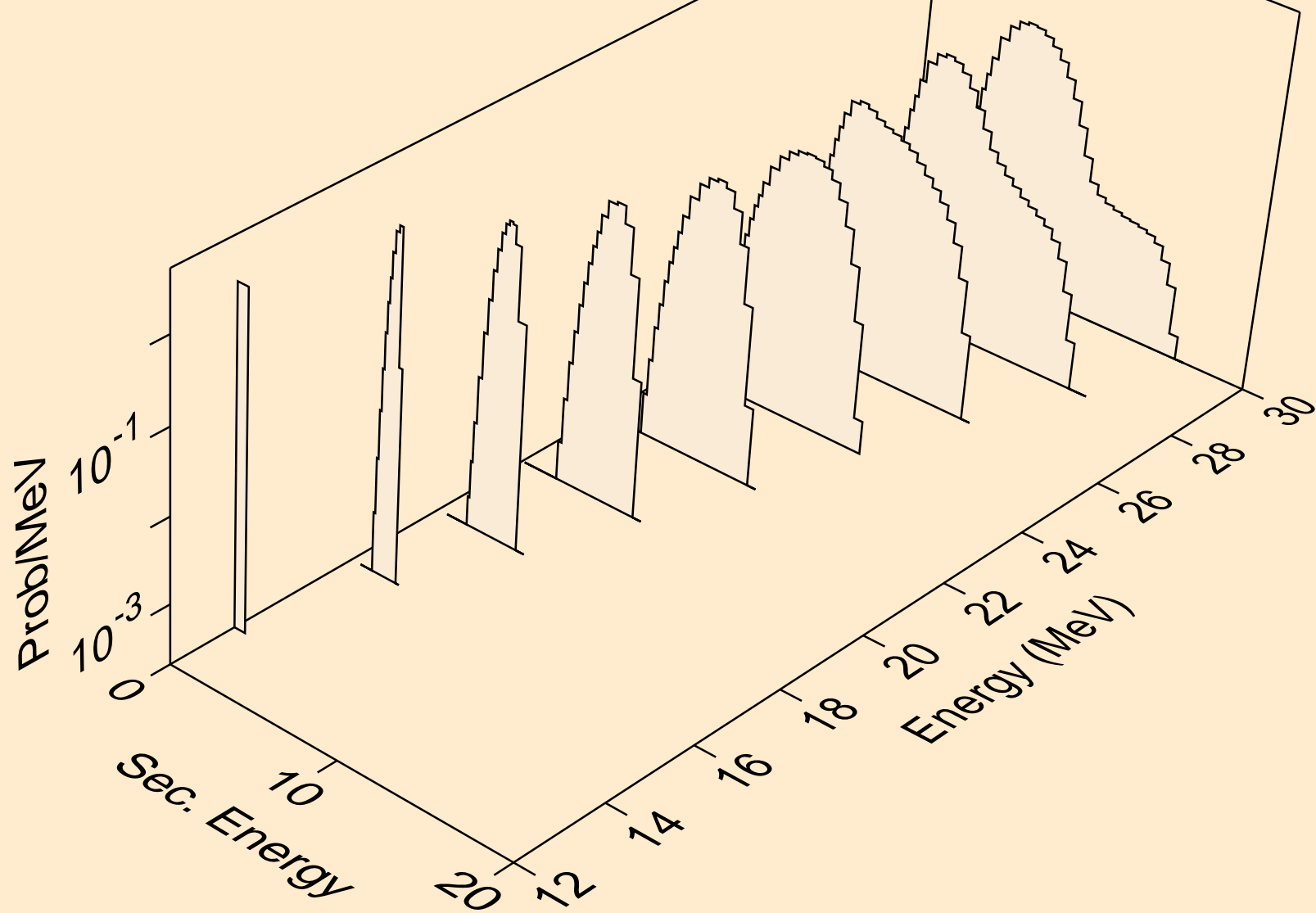

SM137 NEUTRON ACER TENDL-2024 LIBRARY; T=293.6K
protons from (n,3np)

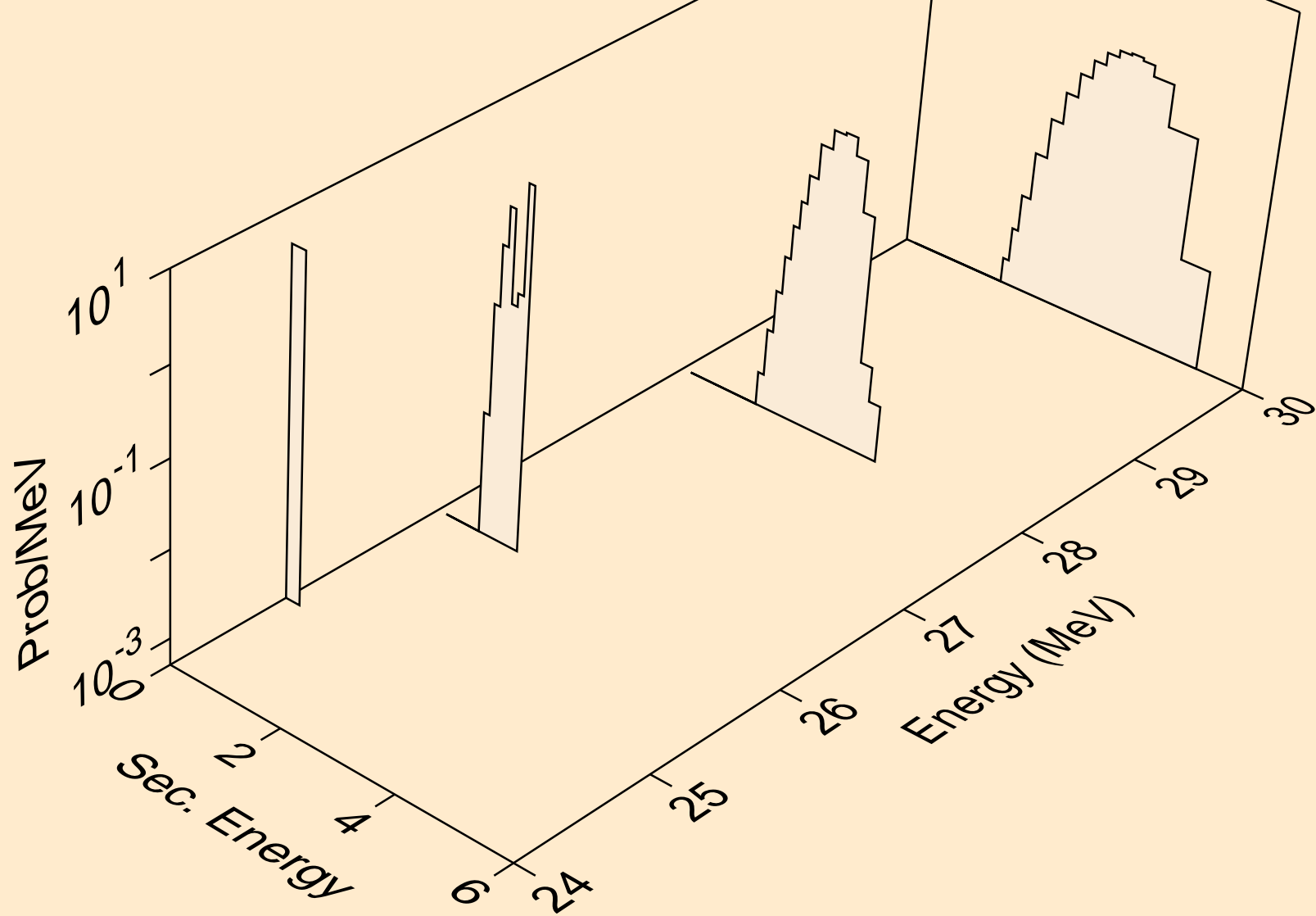

SM137 NEUTRON ACER TENDL-2024 LIBRARY; T=293.6K
protons from (n,n2p)

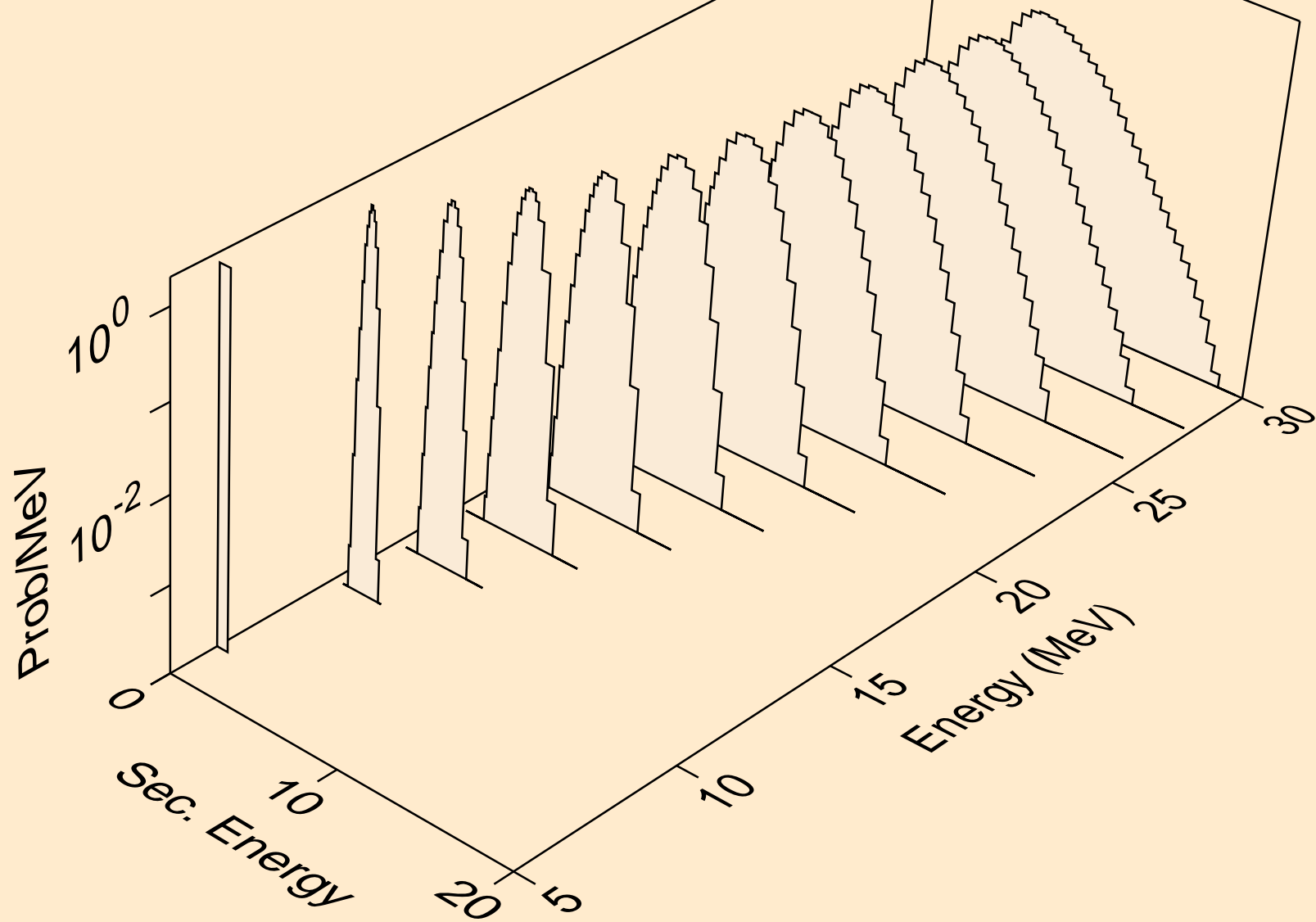

SM137 NEUTRON ACER TENDL-2024 LIBRARY; T=293.6K
protons from (n,npa)

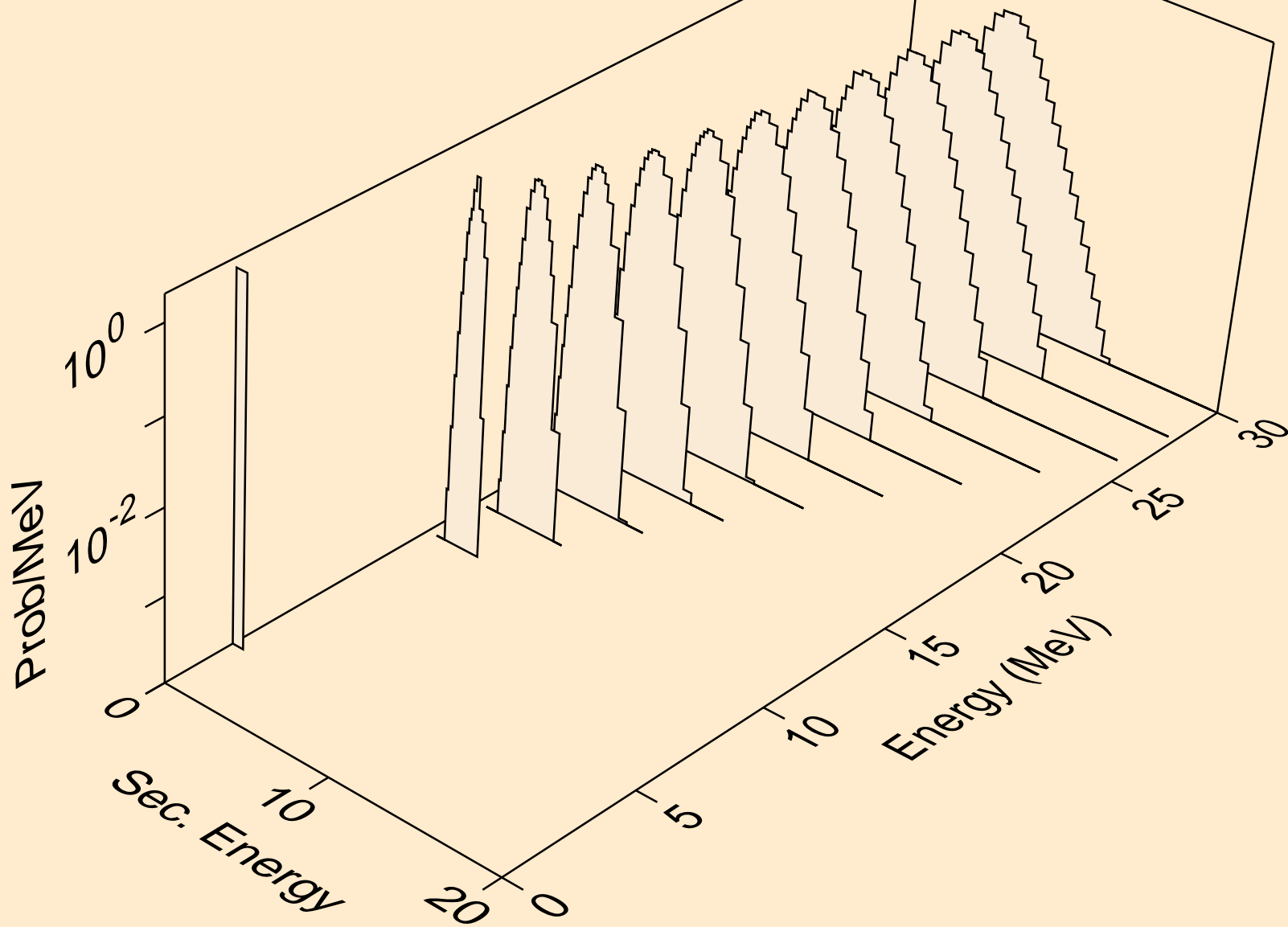

SM137 NEUTRON ACER TENDL-2024 LIBRARY; T=293.6K
protons from (n,p)

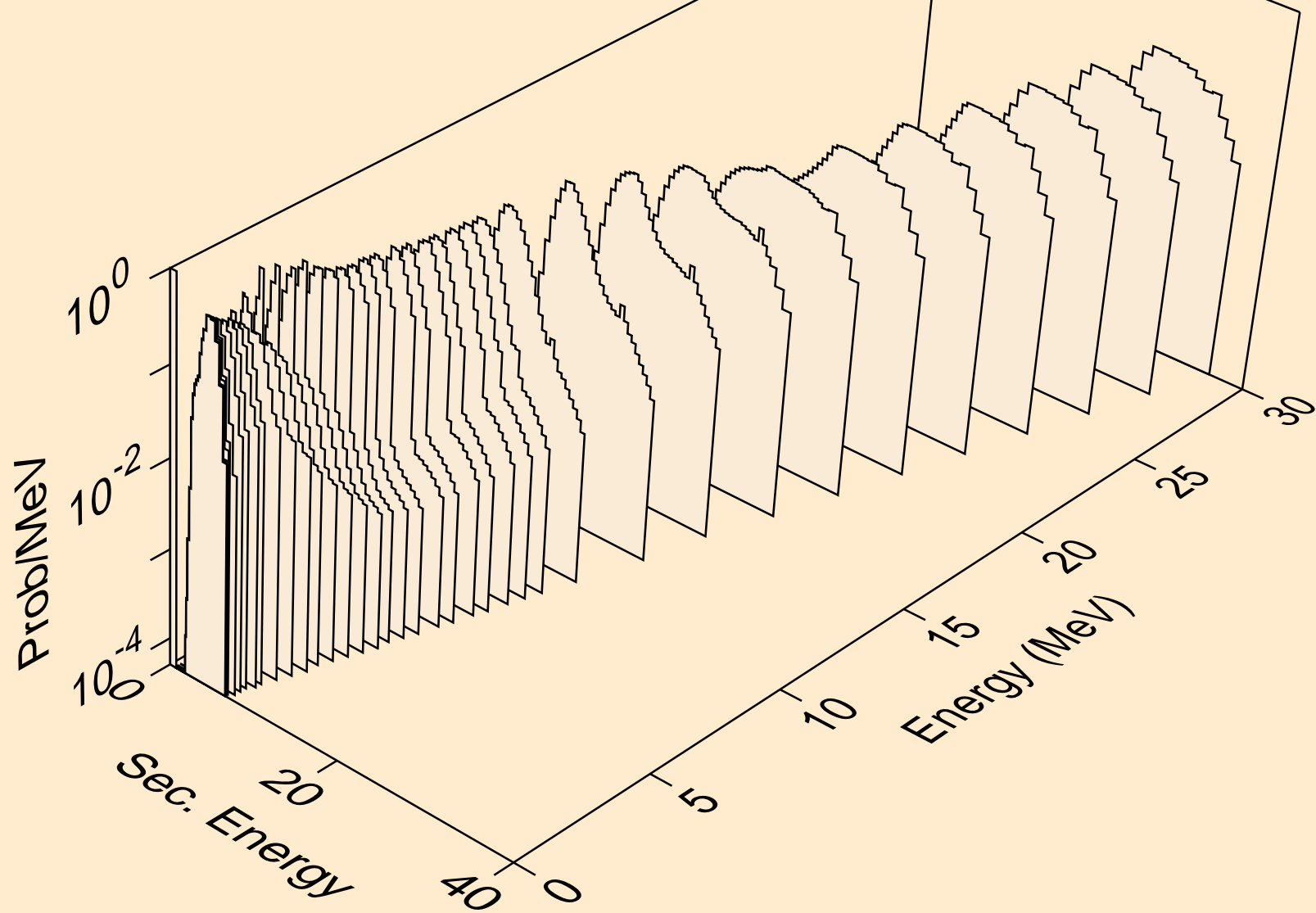

SM137 NEUTRON ACER TENDL-2024 LIBRARY; T=293.6K
protons from (n,2p)

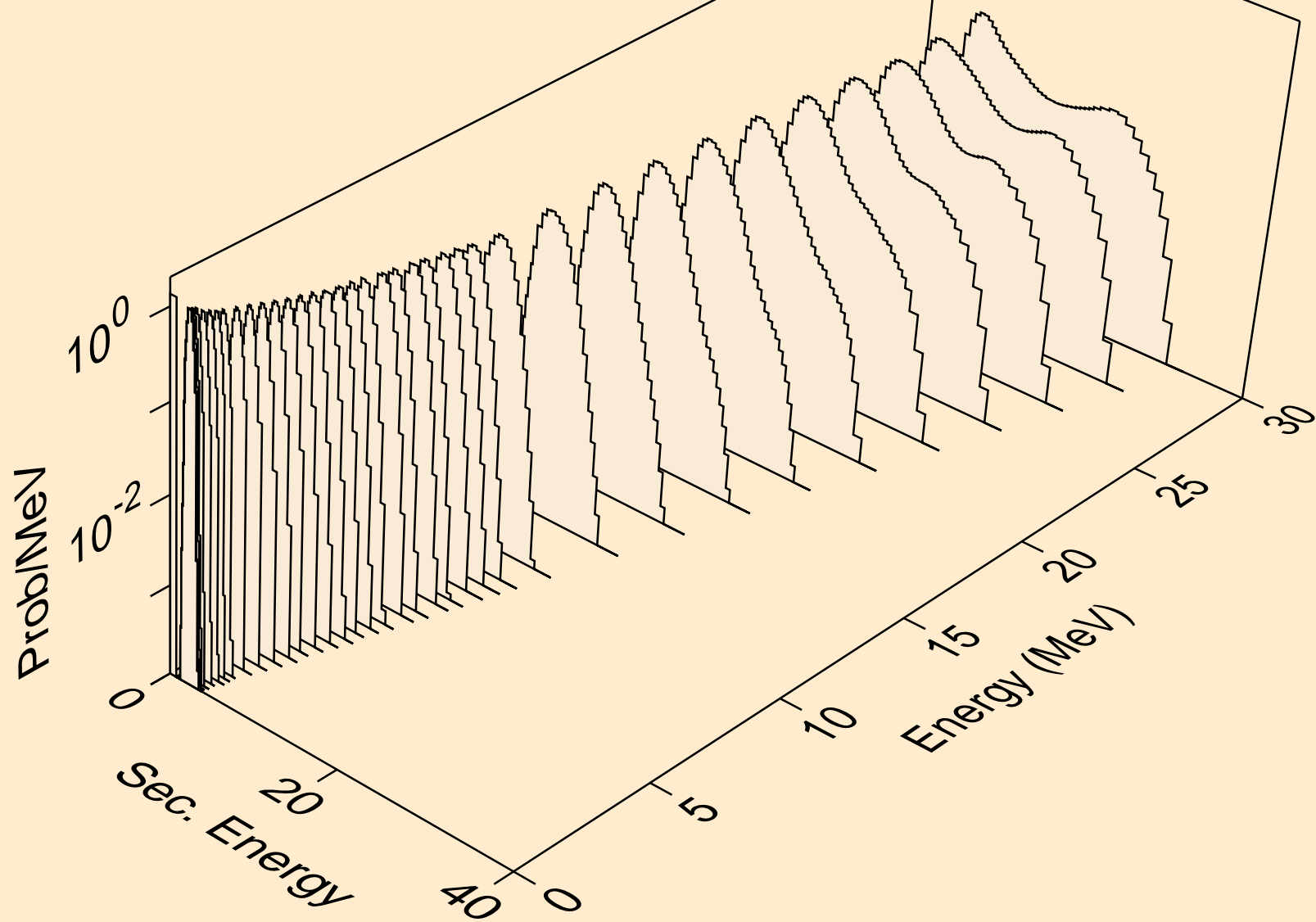

SM137 NEUTRON ACER TENDL-2024 LIBRARY; T=293.6K
protons from (n,p)

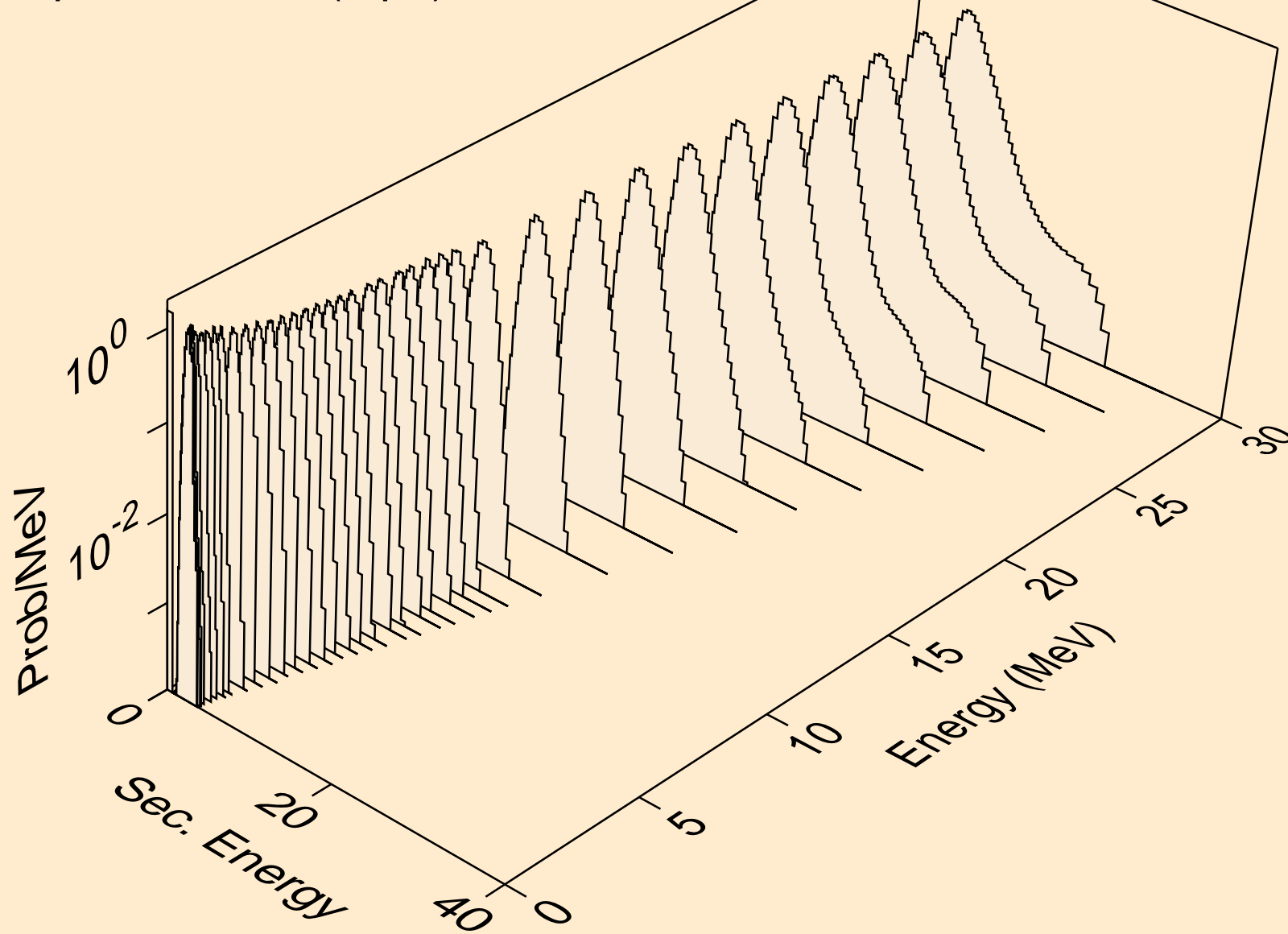

SM137 NEUTRON ACER TENDL-2024 LIBRARY; T=293.6K
protons from (n,pd)

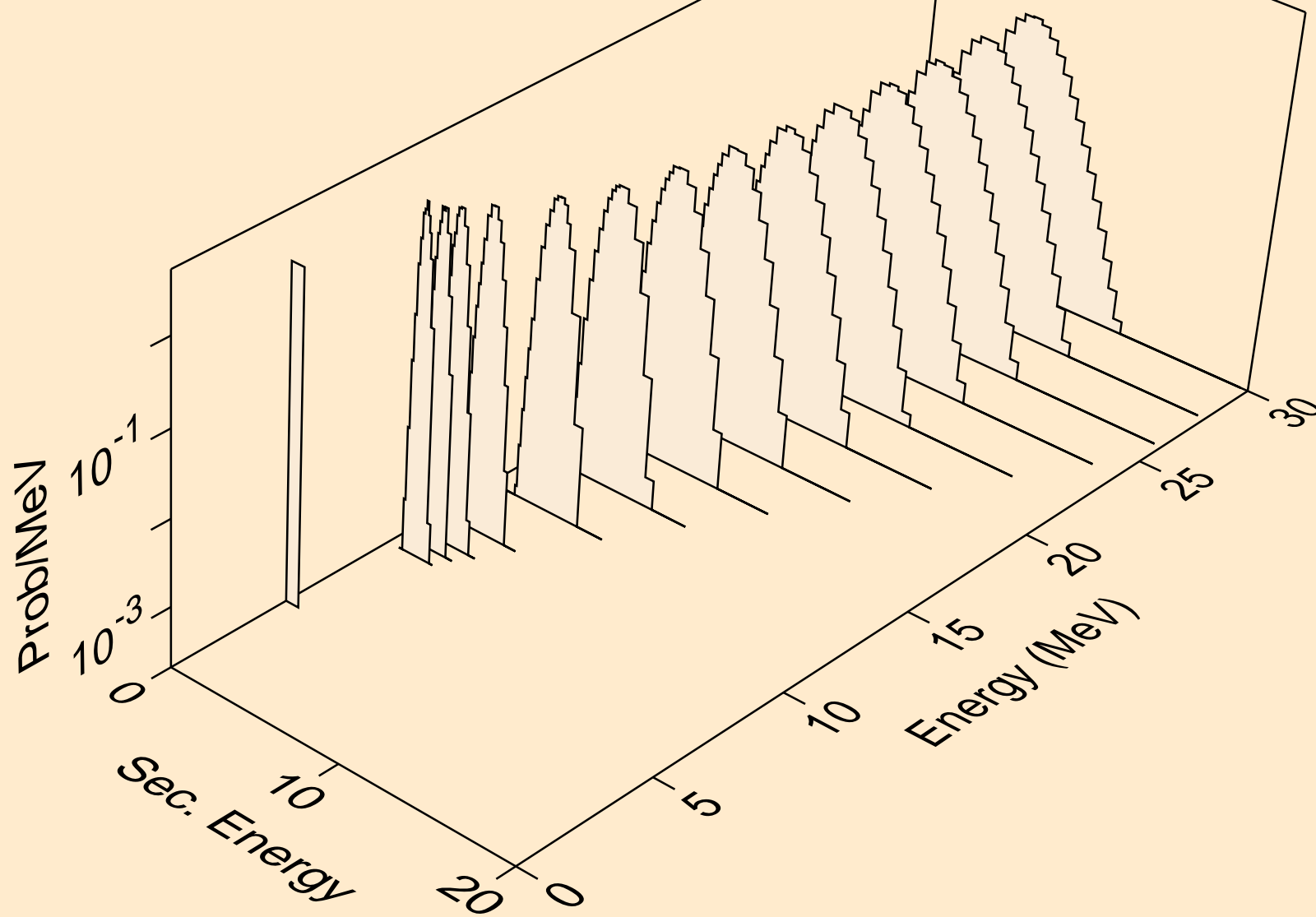

SM137 NEUTRON ACER TENDL-2024 LIBRARY; T=293.6K
protons from (n,pt)

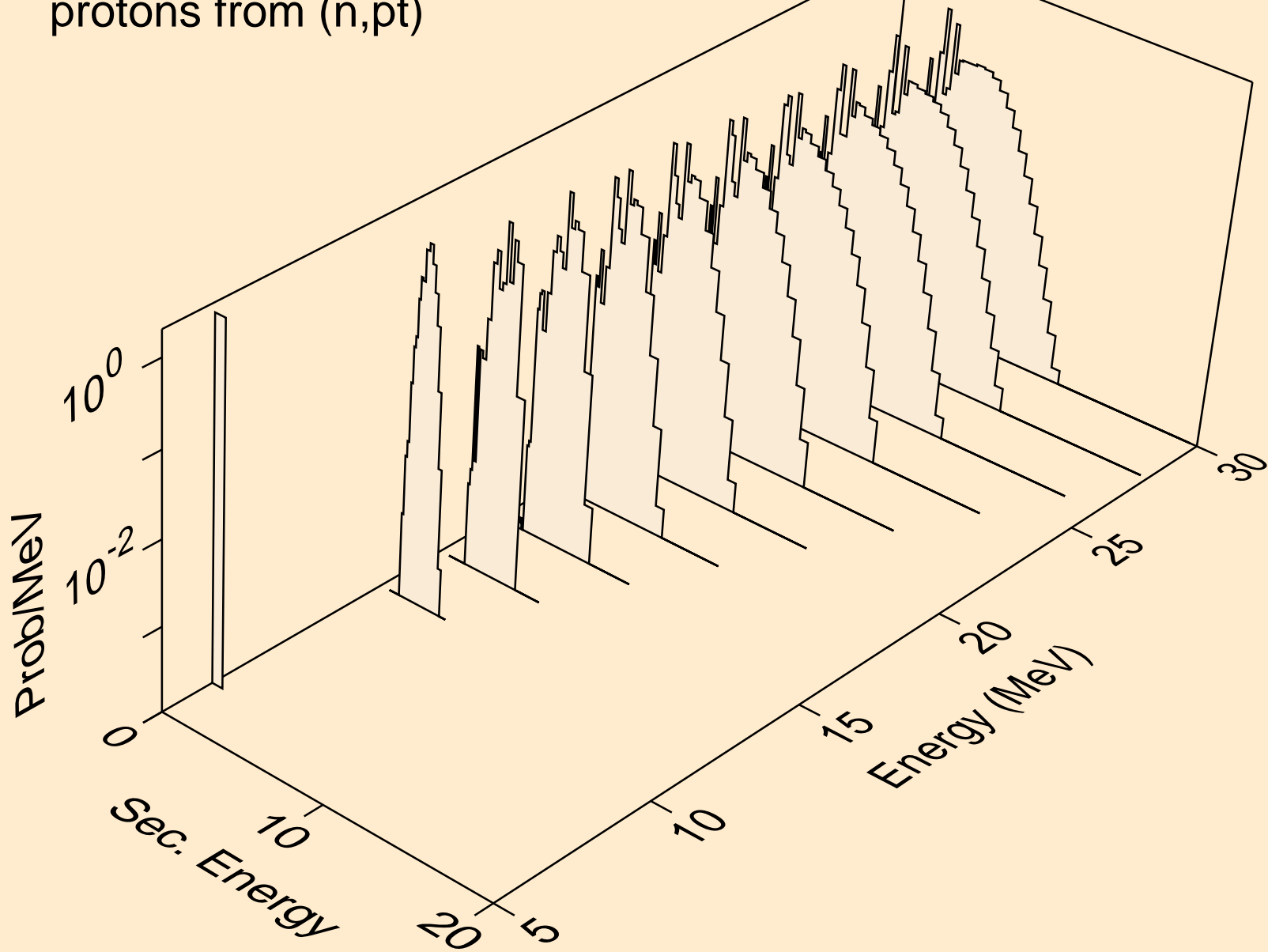

SM137 NEUTRON ACER TENDL-2024 LIBRARY; T=293.6K
deuterons from (n,x)

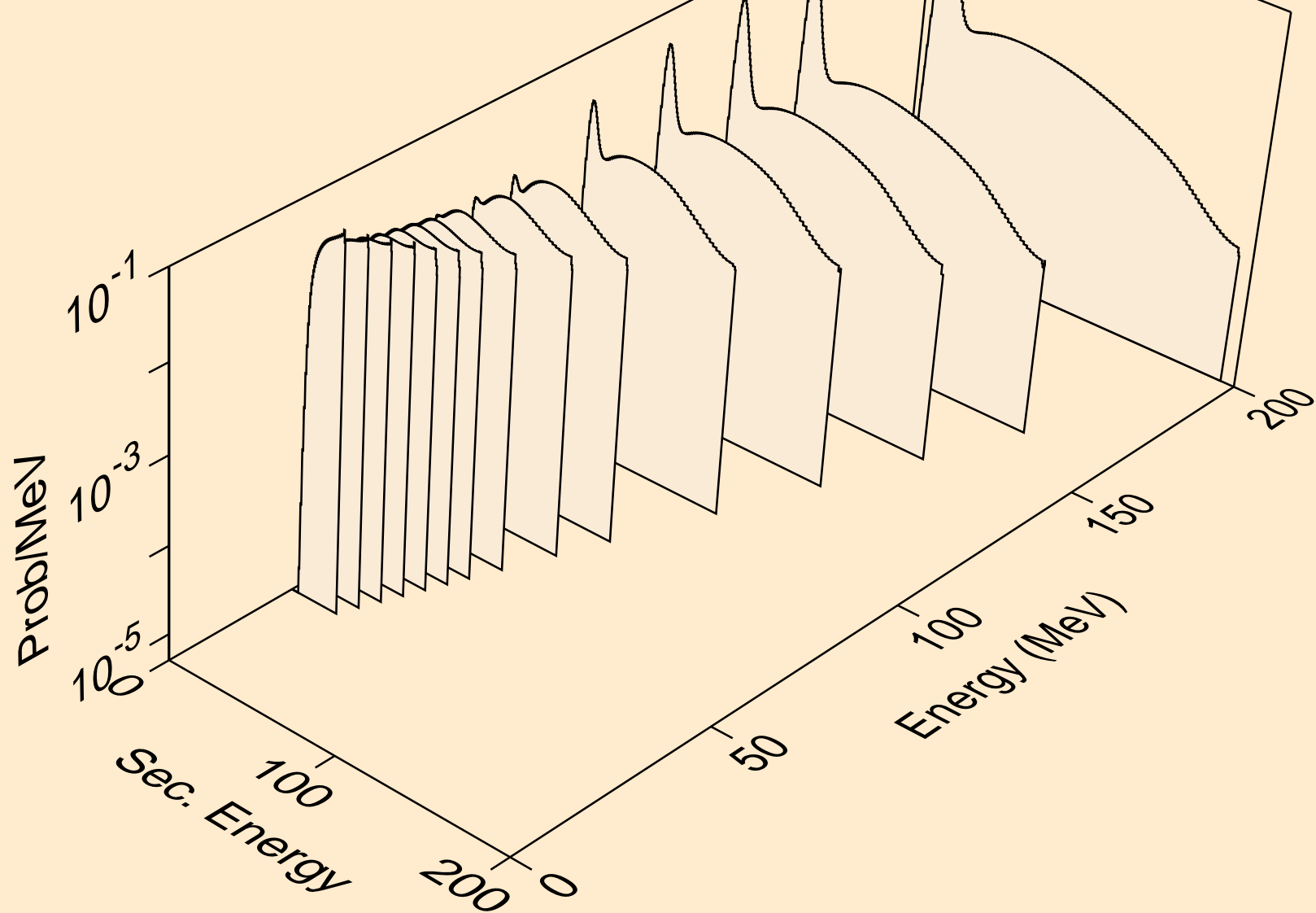

SM137 NEUTRON ACER TENDL-2024 LIBRARY; T=293.6K
deuterons from (n,2nd)

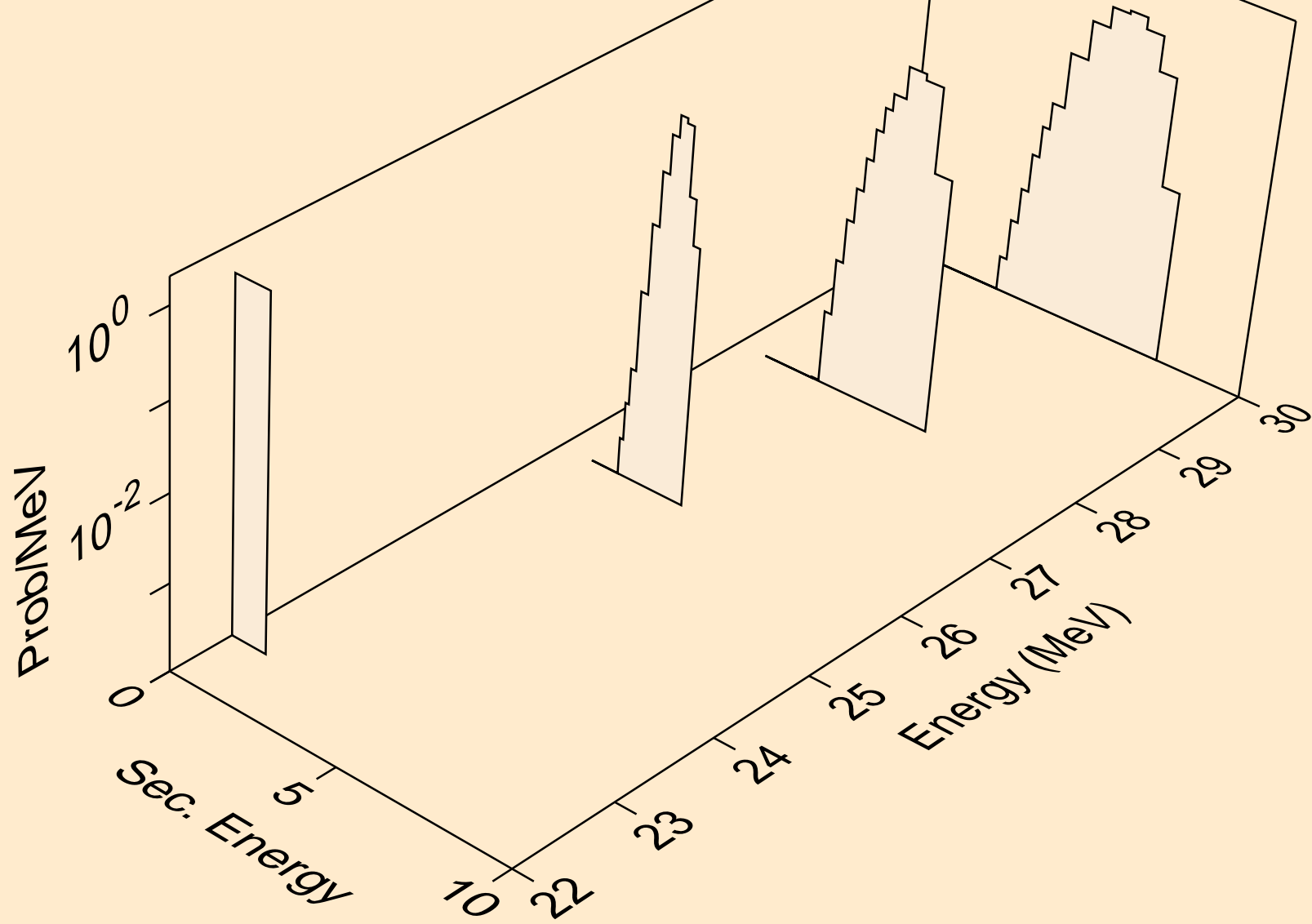

SM137 NEUTRON ACER TENDL-2024 LIBRARY; T=293.6K
deuterons from (n,n*)d

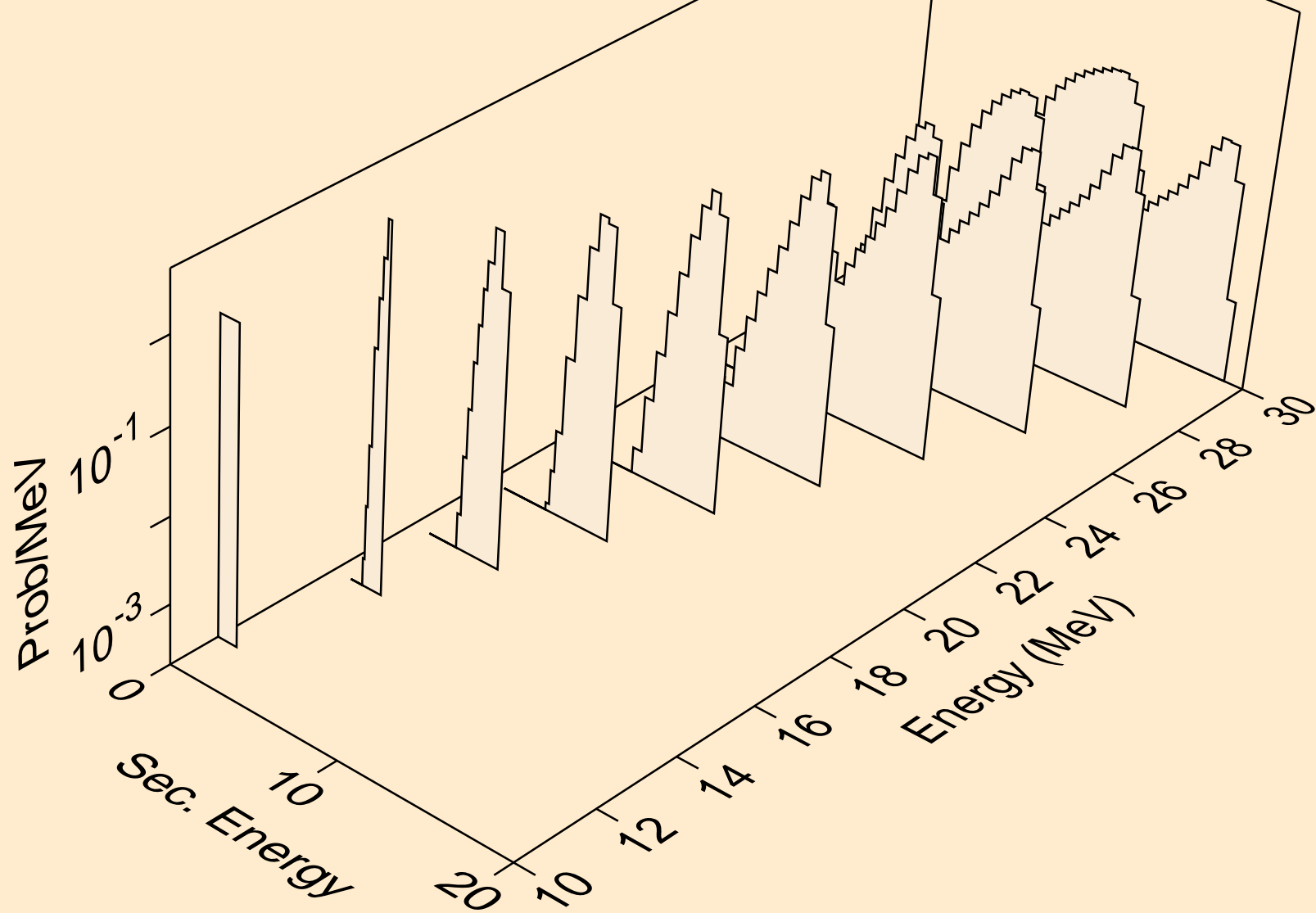

SM137 NEUTRON ACER TENDL-2024 LIBRARY; T=293.6K
deuterons from (n,d)

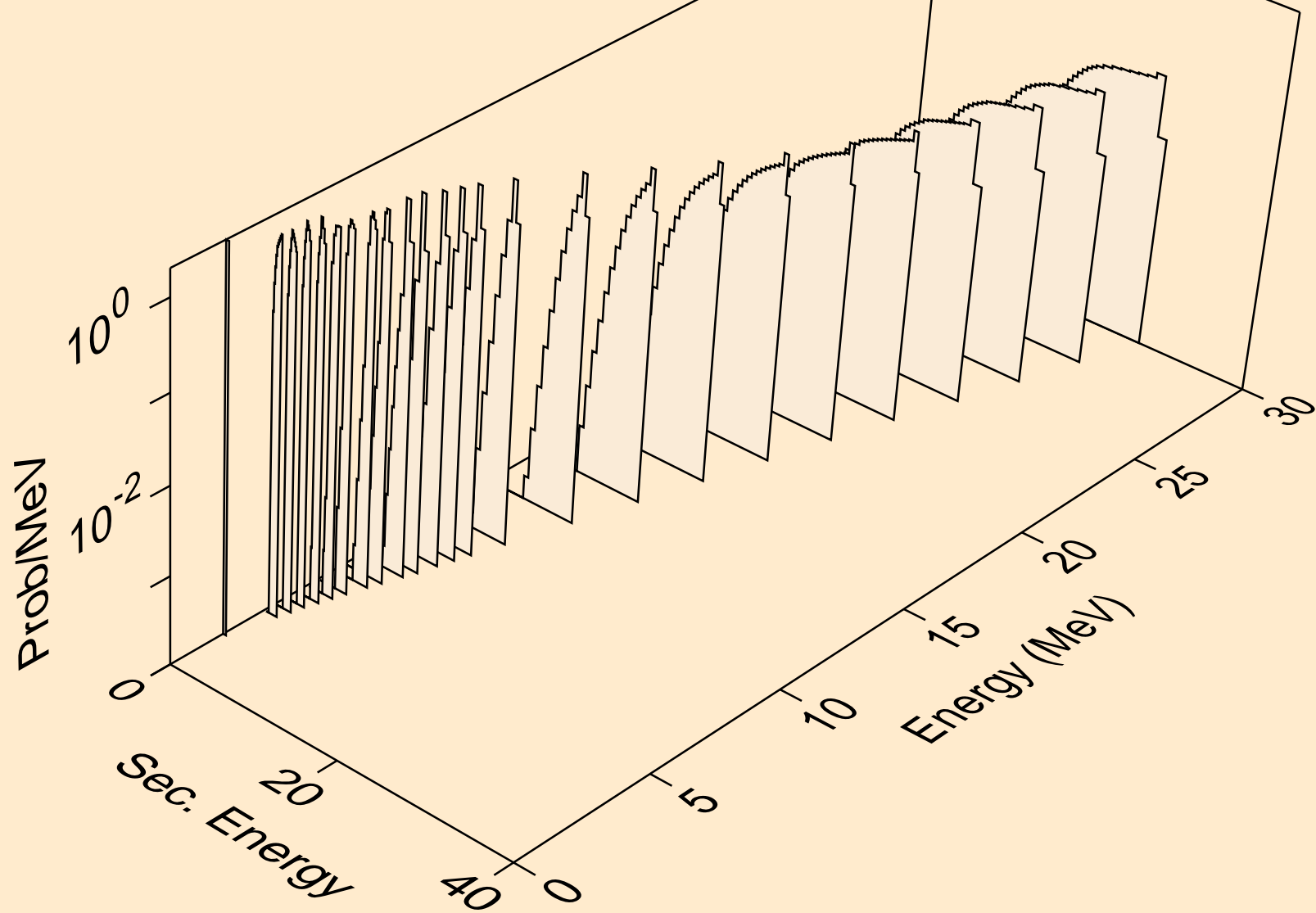

SM137 NEUTRON ACER TENDL-2024 LIBRARY; T=293.6K
deuterons from (n,pd)

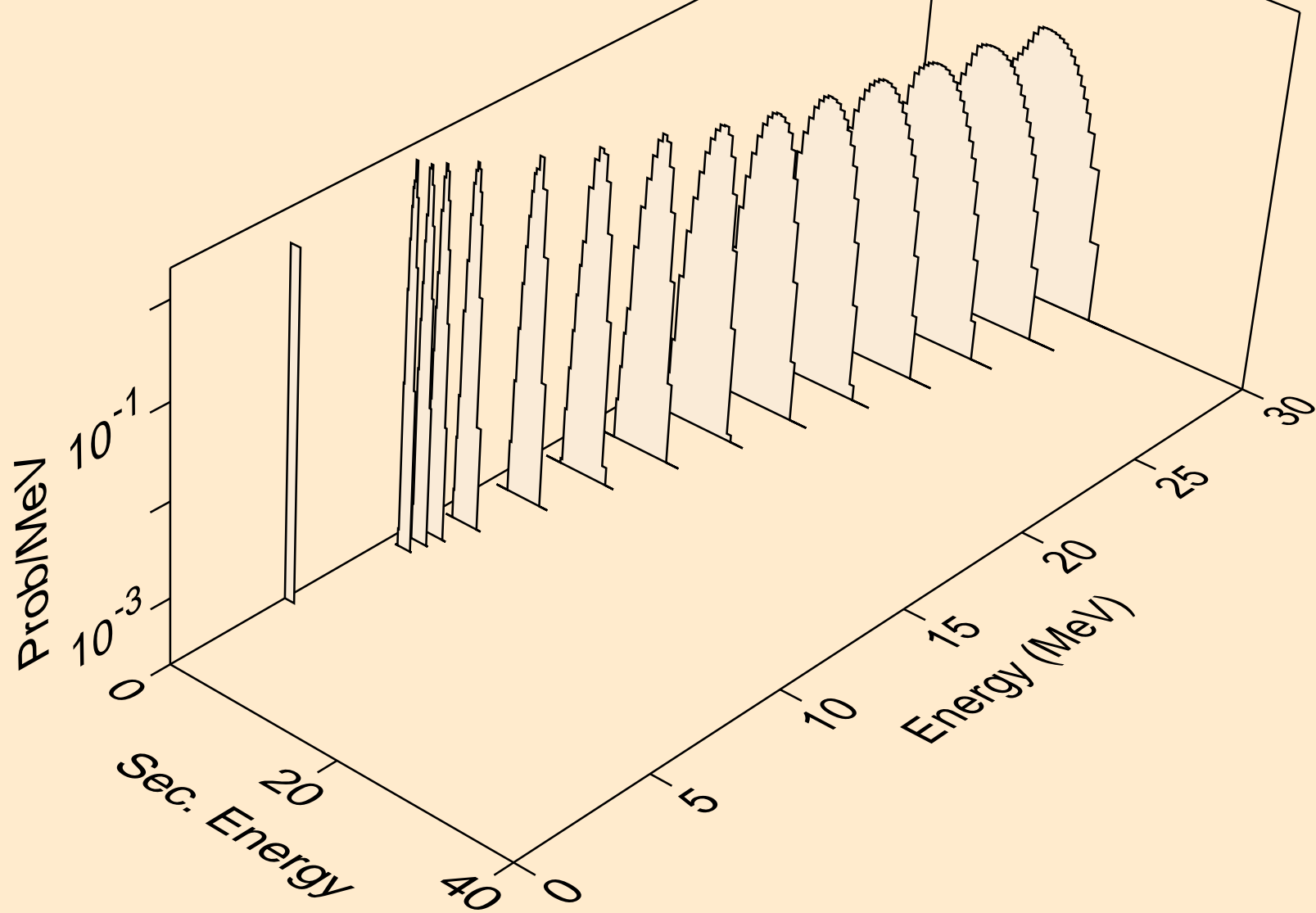

SM137 NEUTRON ACER TENDL-2024 LIBRARY; T=293.6K
deuterons from (n,da)

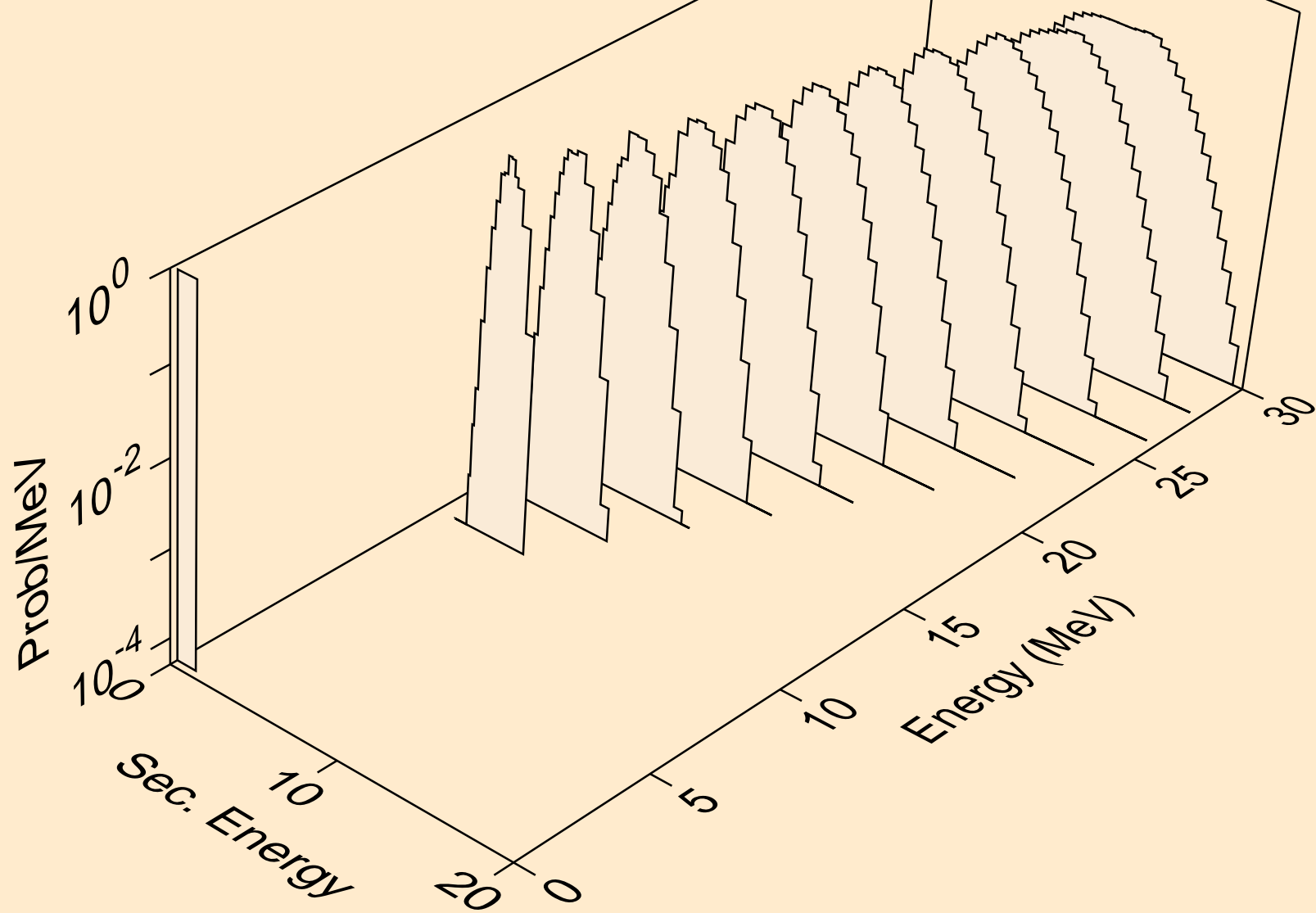

SM137 NEUTRON ACER TENDL-2024 LIBRARY; T=293.6K
tritons from (n,x)

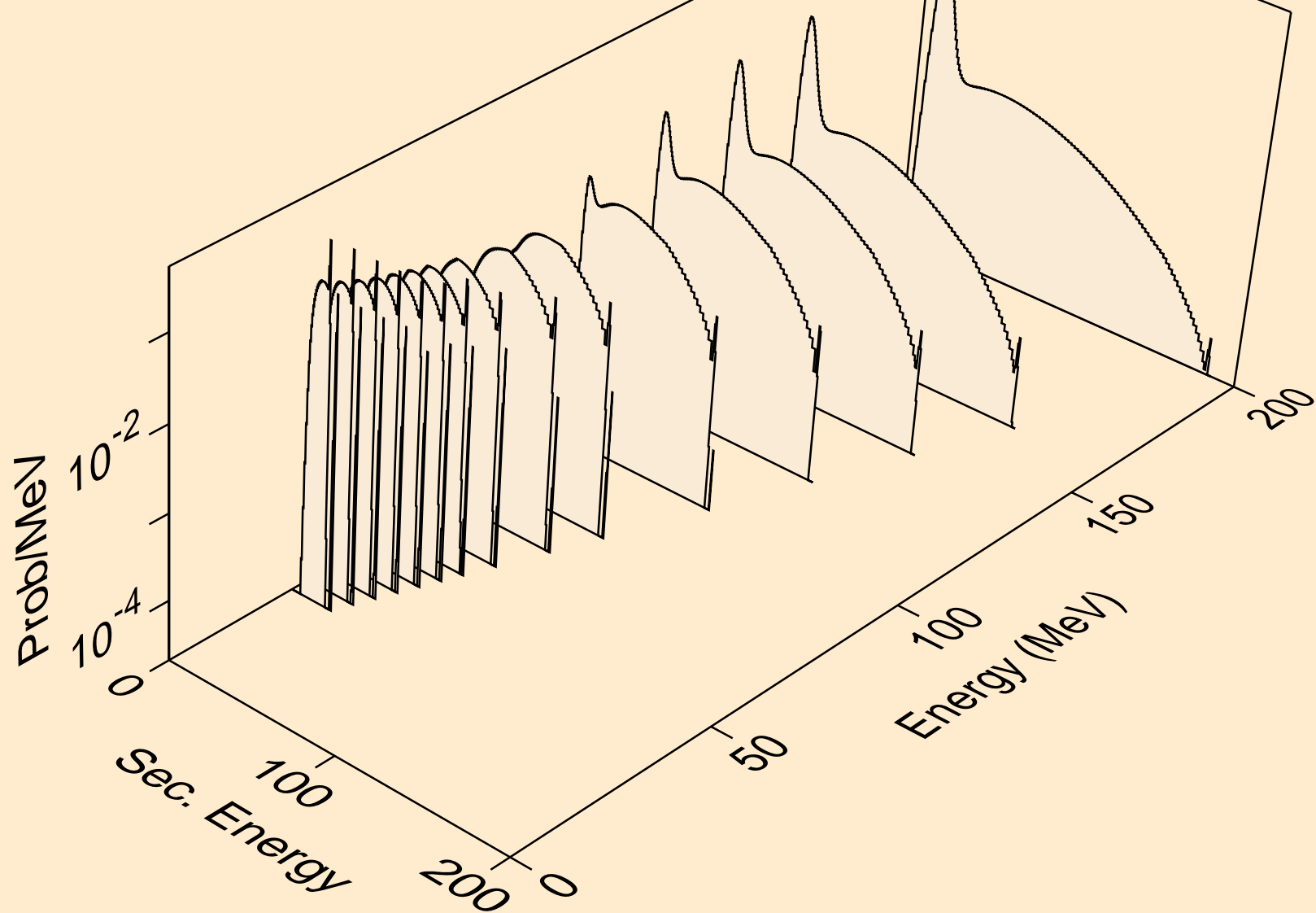

SM137 NEUTRON ACER TENDL-2024 LIBRARY; T=293.6K
tritons from (n,n*)t

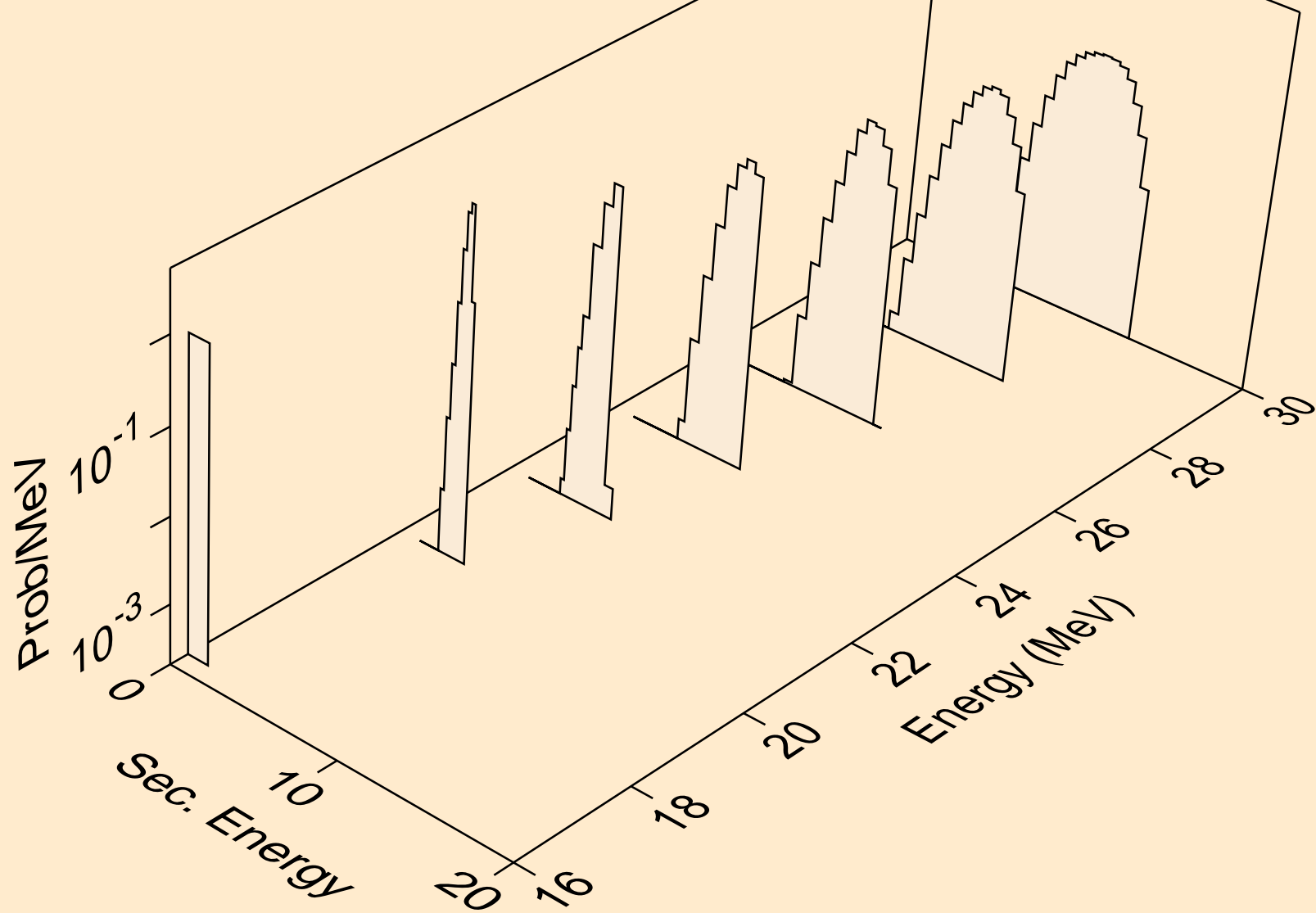

SM137 NEUTRON ACER TENDL-2024 LIBRARY; T=293.6K
tritons from (n,t)

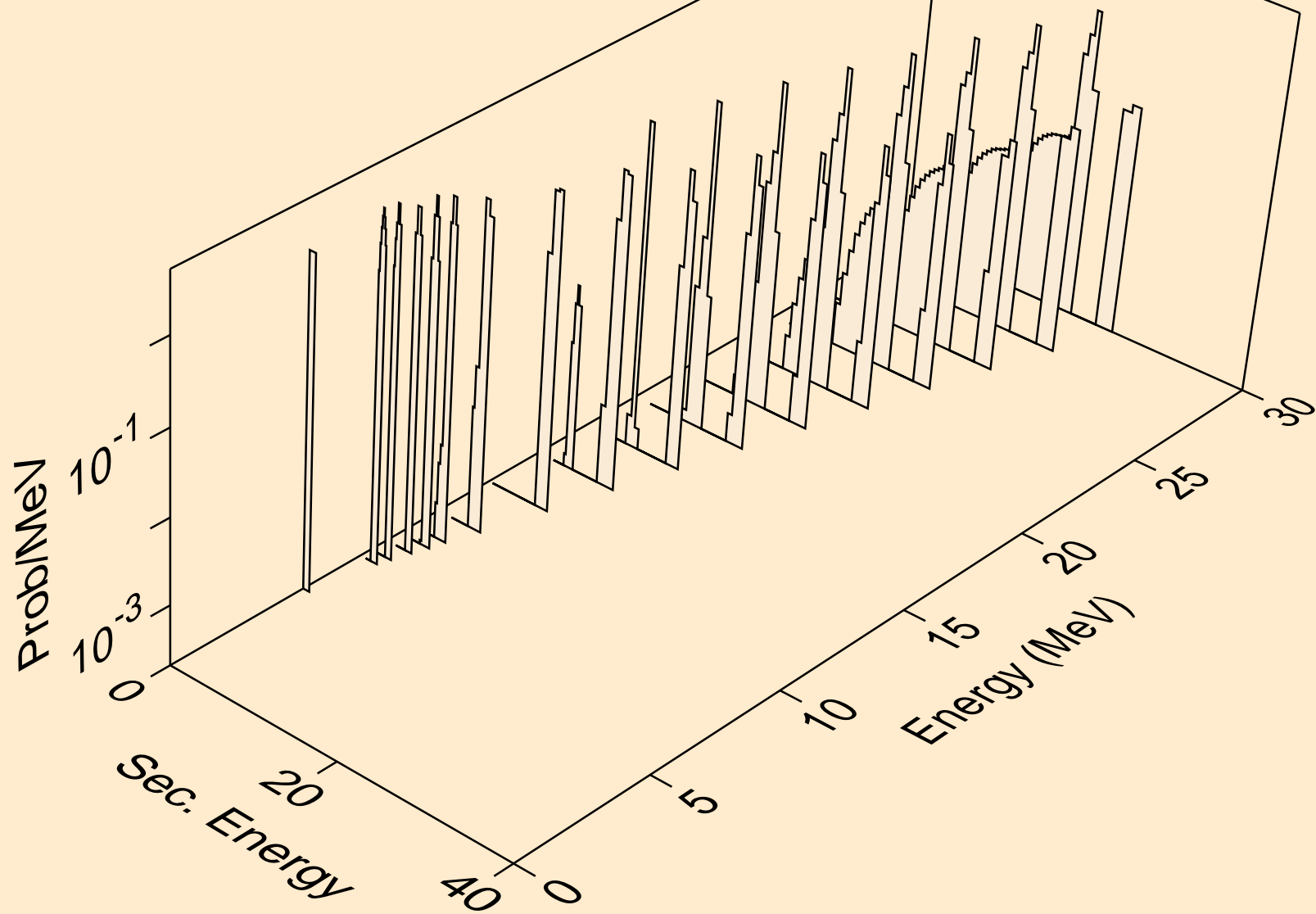

SM137 NEUTRON ACER TENDL-2024 LIBRARY; T=293.6K
tritons from (n,pt)

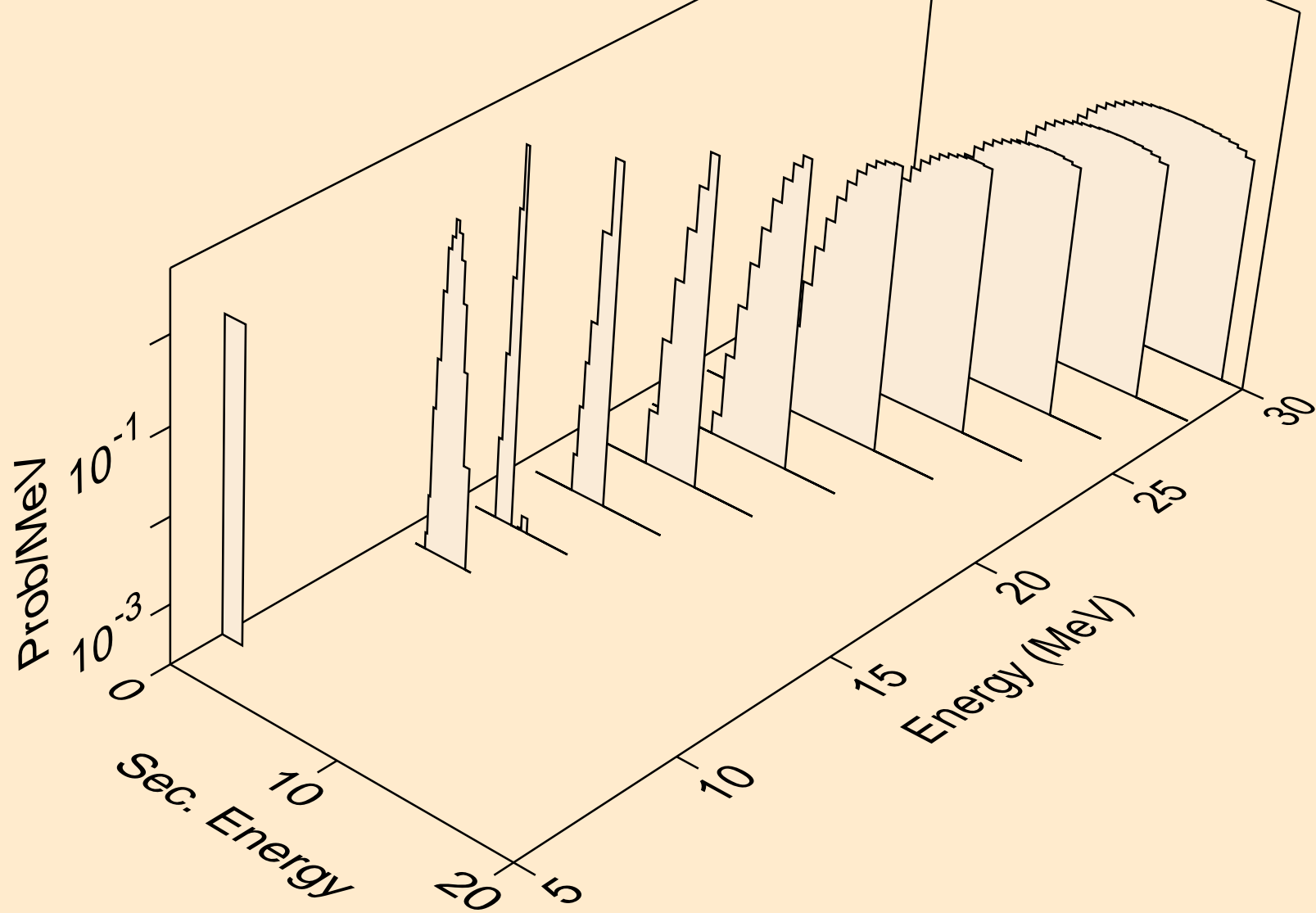

SM137 NEUTRON ACER TENDL-2024 LIBRARY; T=293.6K
he3s from (n,x)

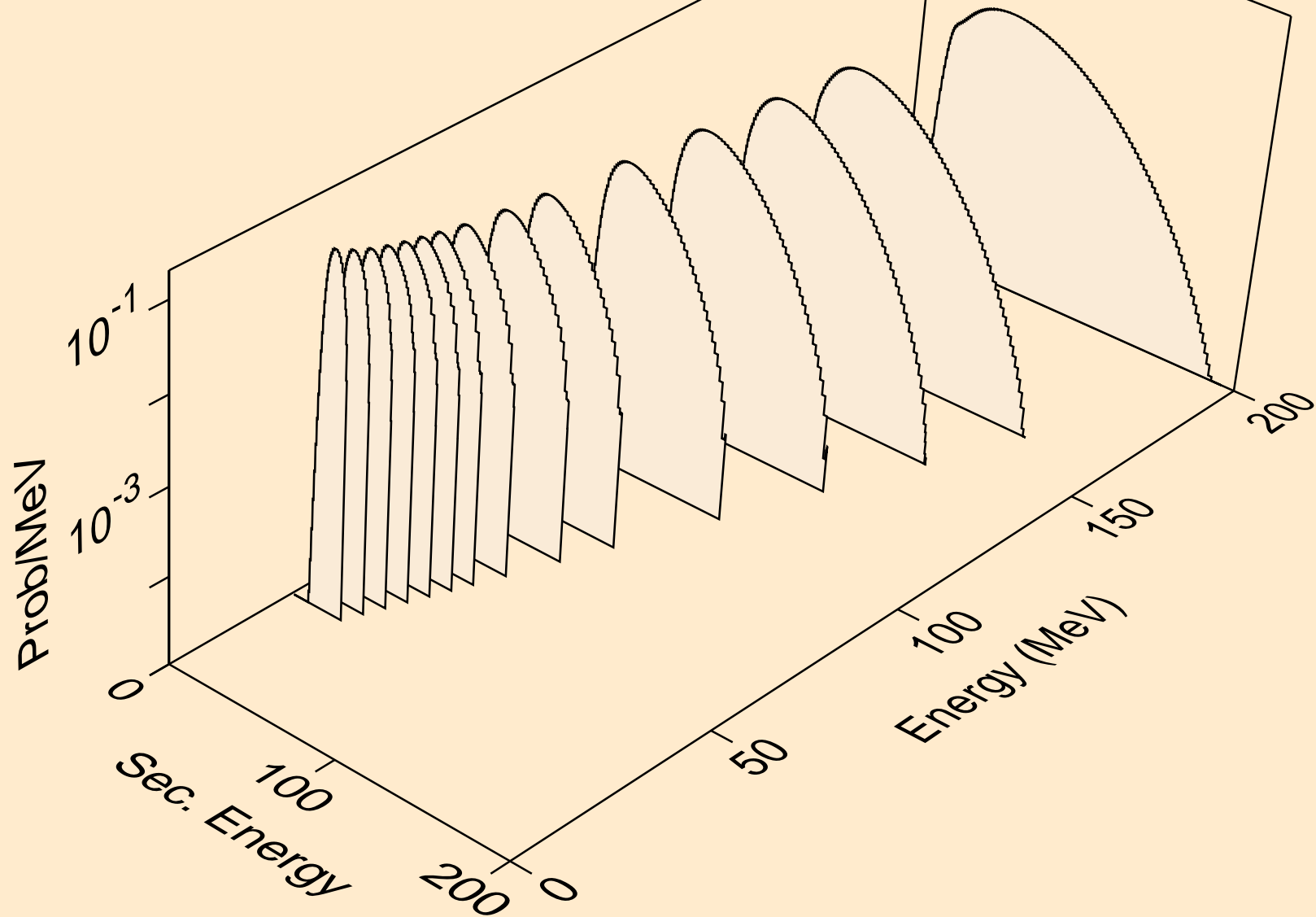

SM137 NEUTRON ACER TENDL-2024 LIBRARY; T=293.6K
he3s from (n,n*)he3

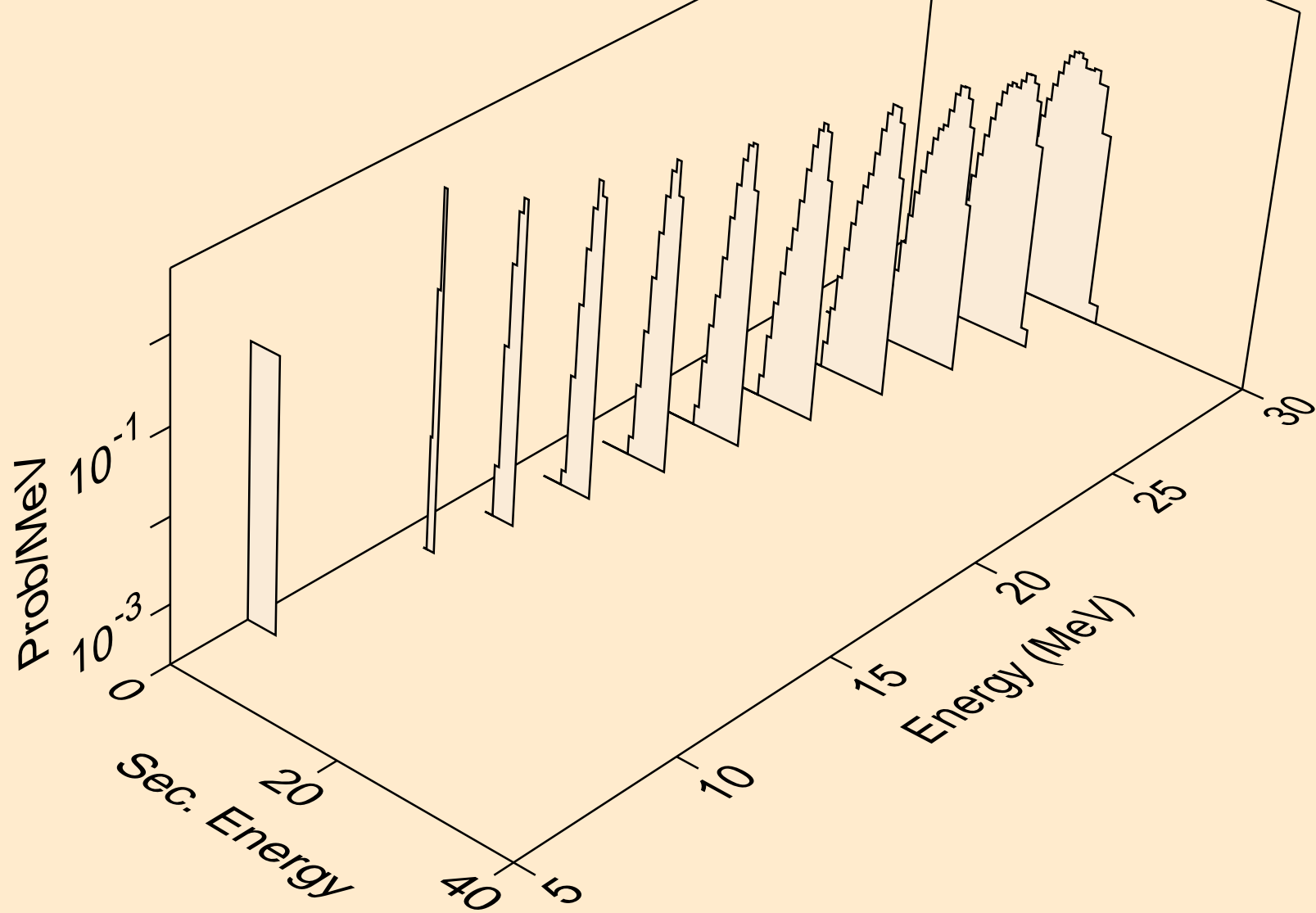

SM137 NEUTRON ACER TENDL-2024 LIBRARY; T=293.6K
he3s from (n,he3)

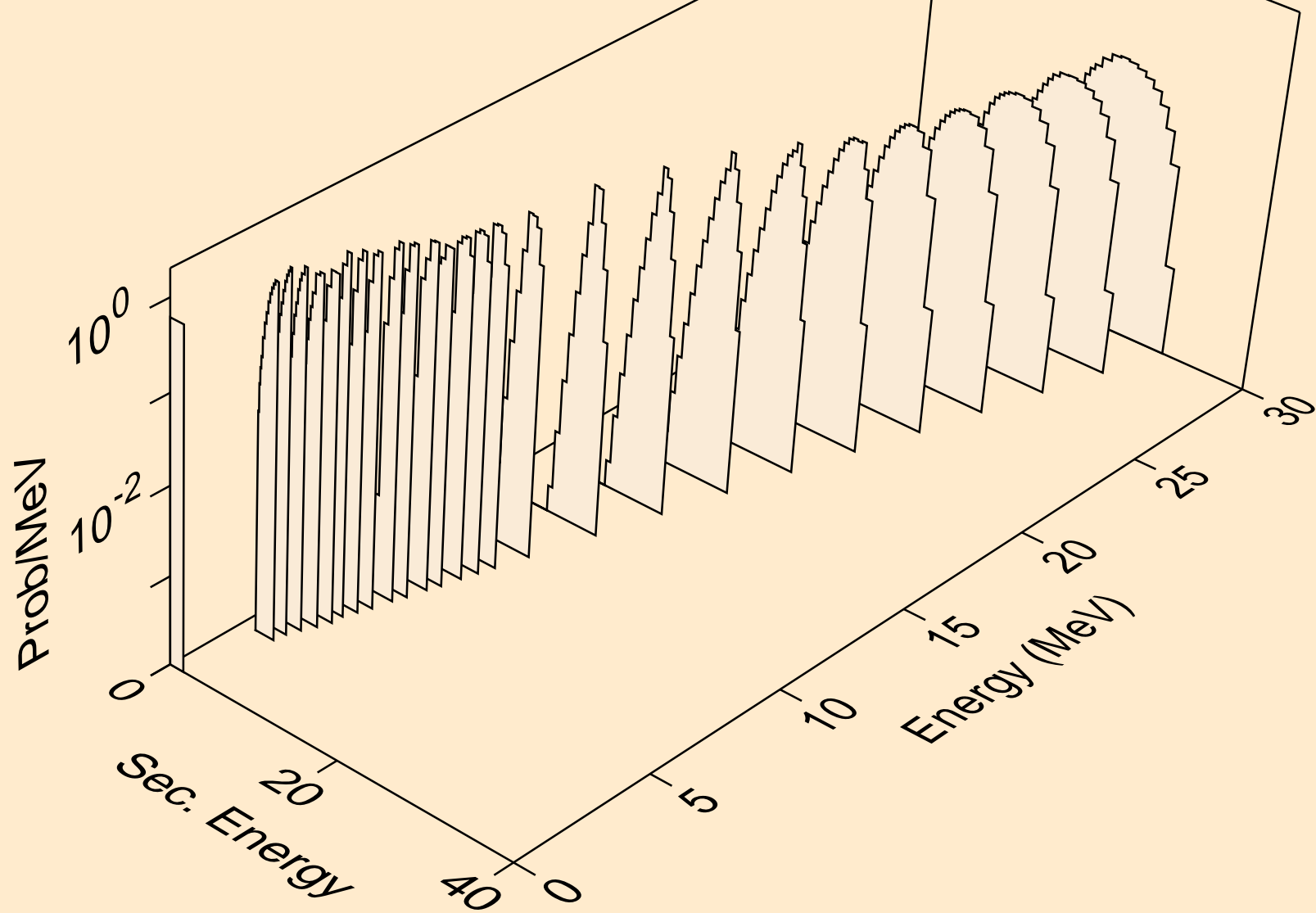

SM137 NEUTRON ACER TENDL-2024 LIBRARY; T=293.6K
alphas from (n,x)

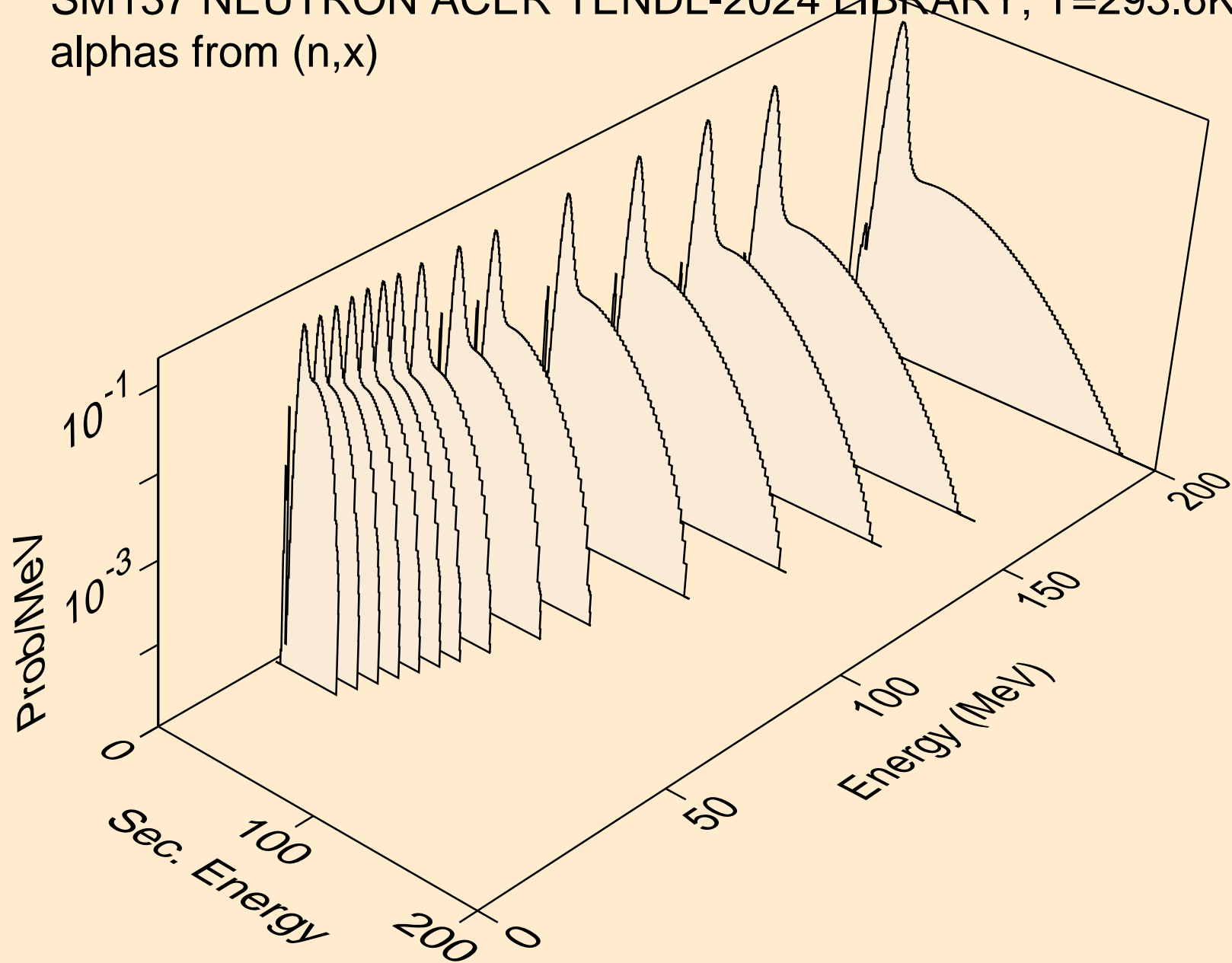

SM137 NEUTRON ACER TENDL-2024 LIBRARY; T=293.6K
alphas from (n,n*)a

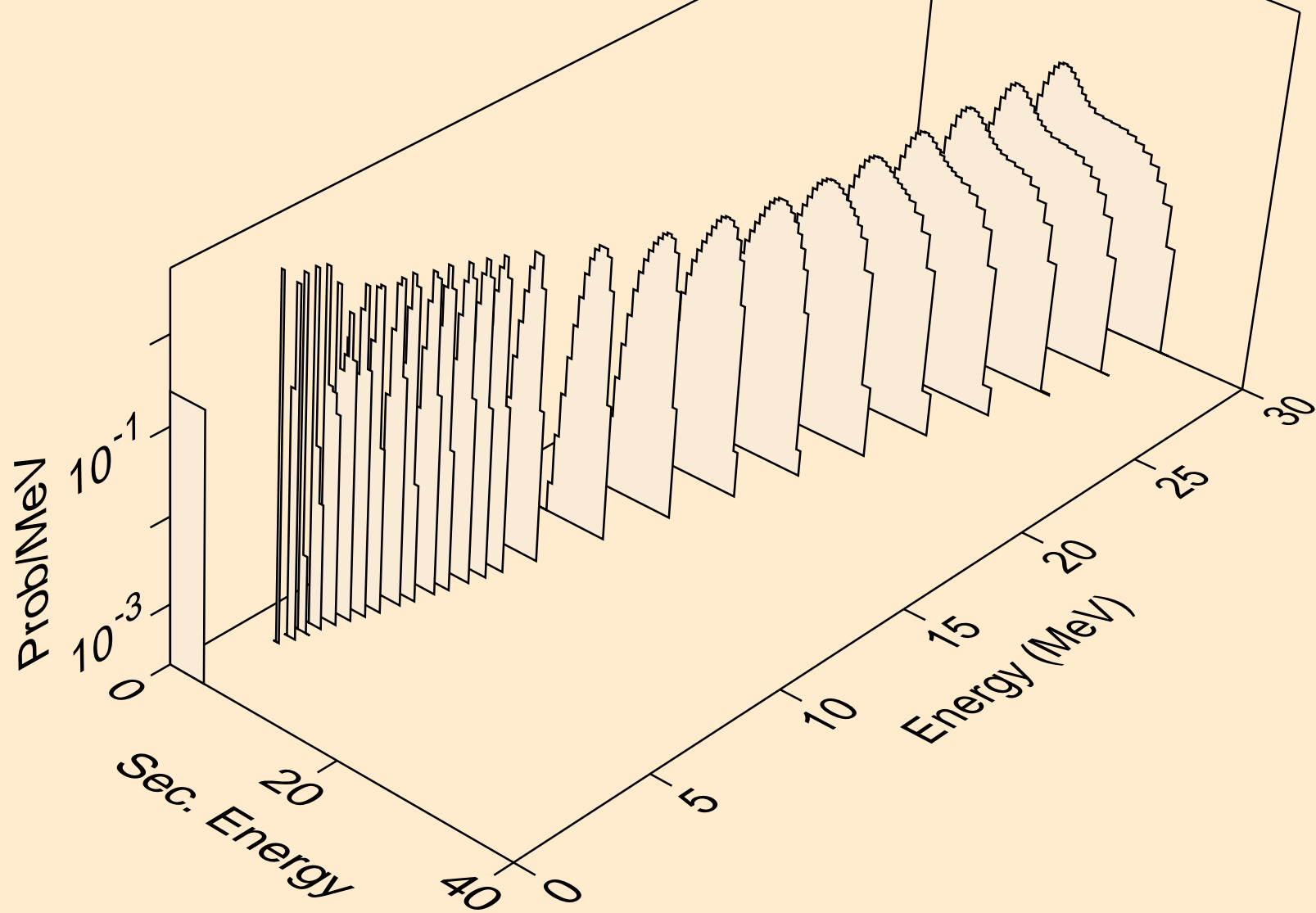

SM137 NEUTRON ACER TENDL-2024 LIBRARY; T=293.6K
alphas from (n,2n)a

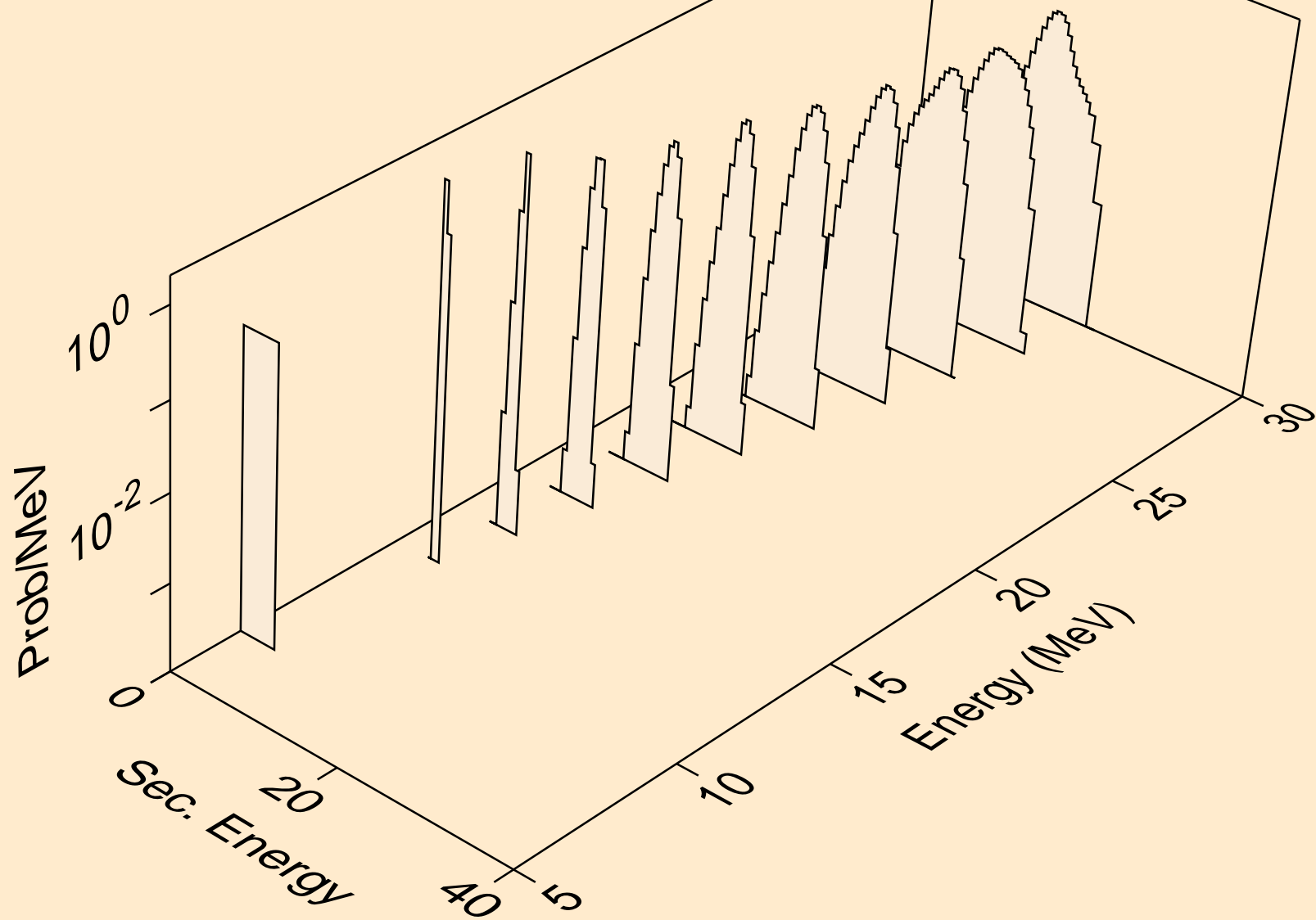

SM137 NEUTRON ACER TENDL-2024 LIBRARY; T=293.6K
alphas from (n,3n)a

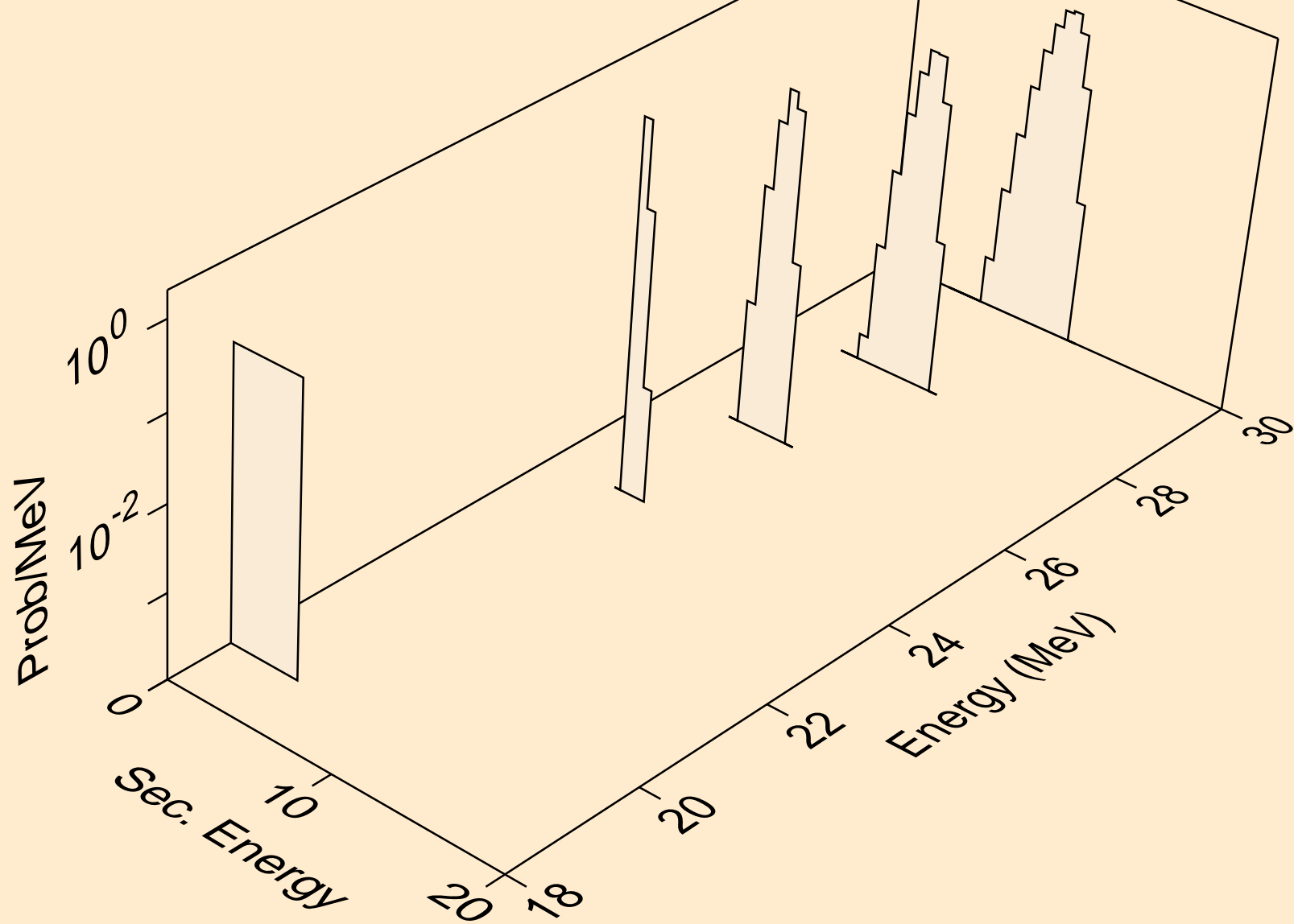

SM137 NEUTRON ACER TENDL-2024 LIBRARY; T=293.6K
alphas from (n,n*)2a

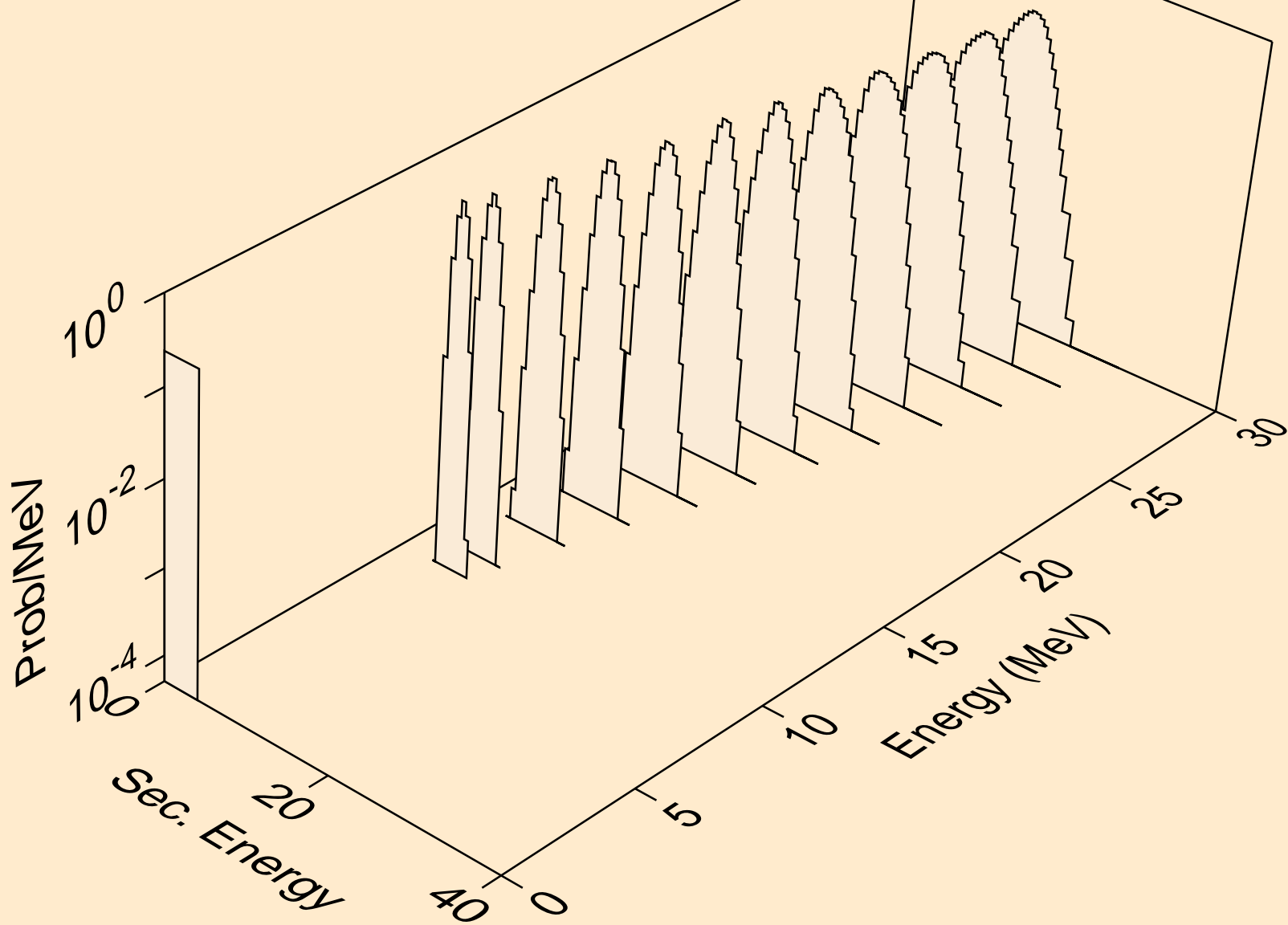

SM137 NEUTRON ACER TENDL-2024 LIBRARY; T=293.6K
alphas from (n,2n)2a

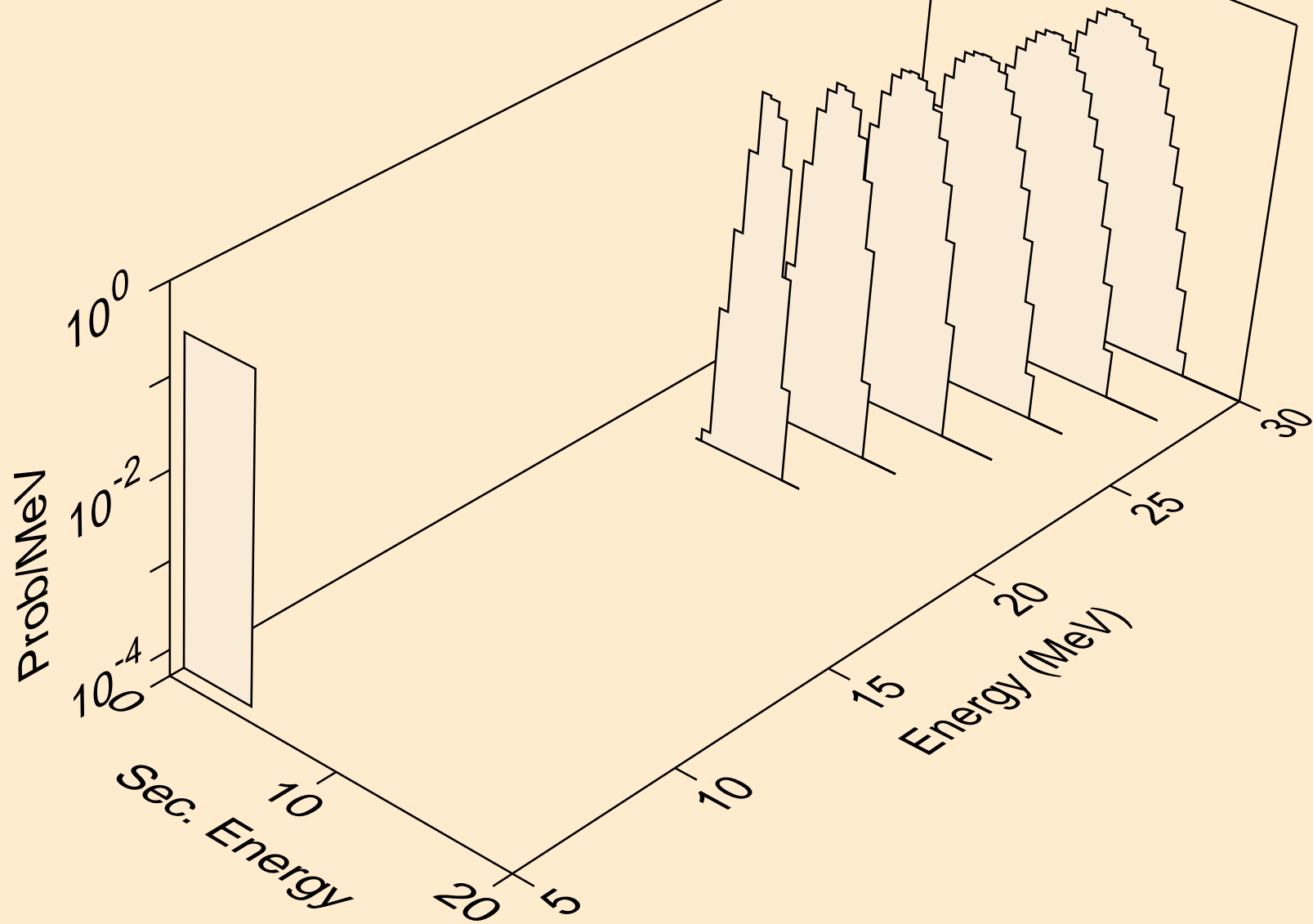

SM137 NEUTRON ACER TENDL-2024 LIBRARY; T=293.6K
alphas from (n,npa)

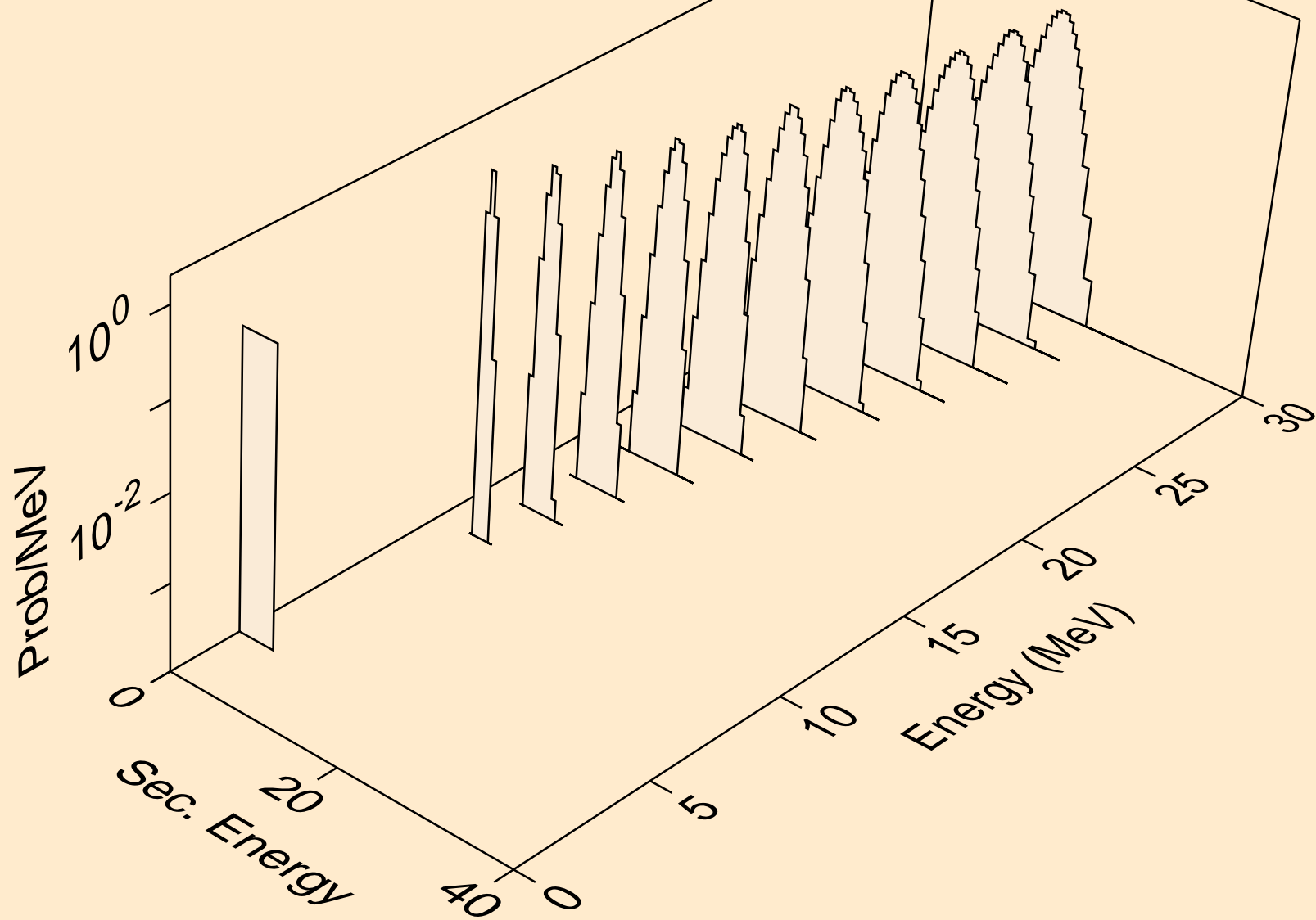

SM137 NEUTRON ACER TENDL-2024 LIBRARY; T=293.6K
alphas from (n,a)

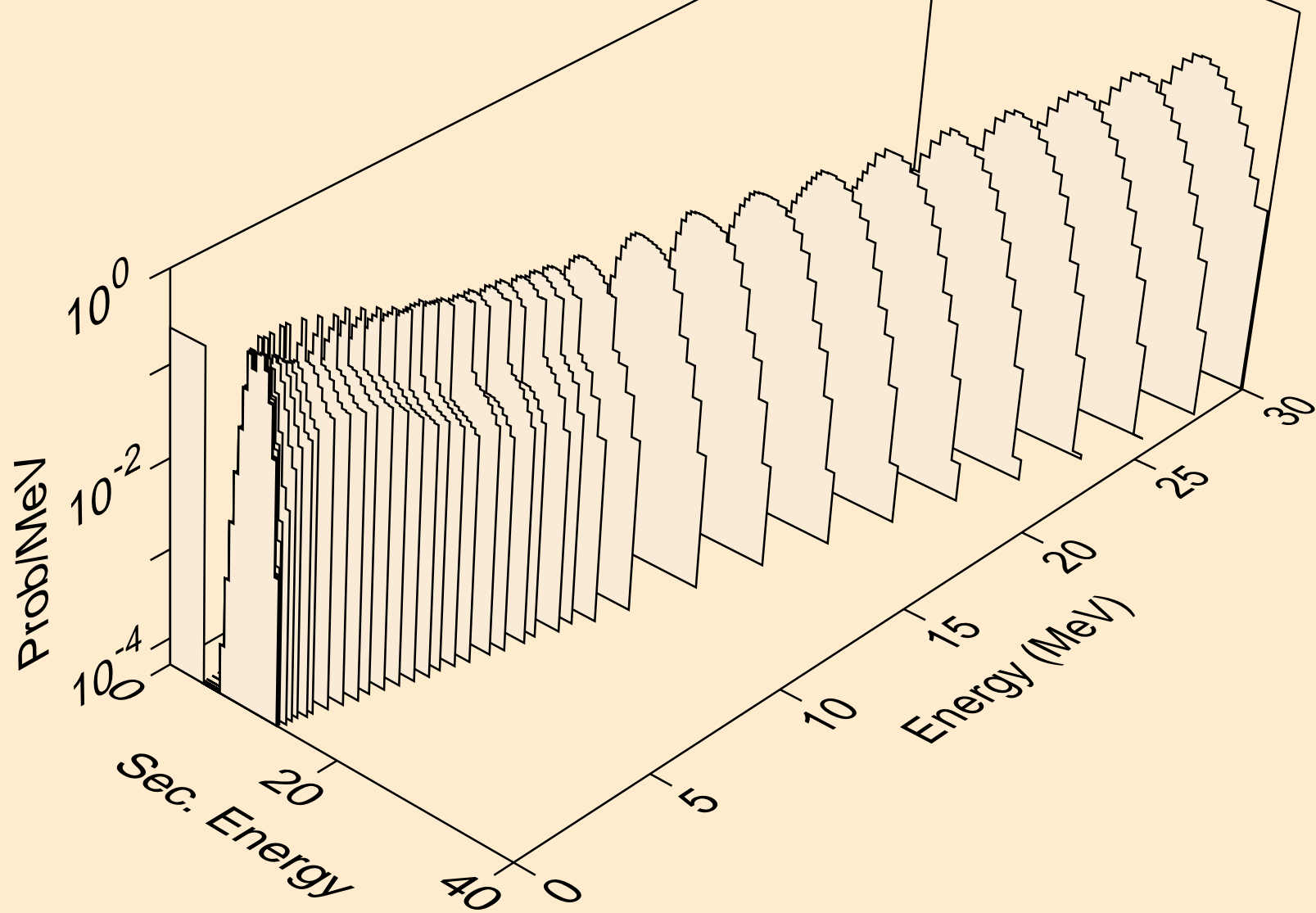

SM137 NEUTRON ACER TENDL-2024 LIBRARY; T=293.6K
alphas from (n,2a)

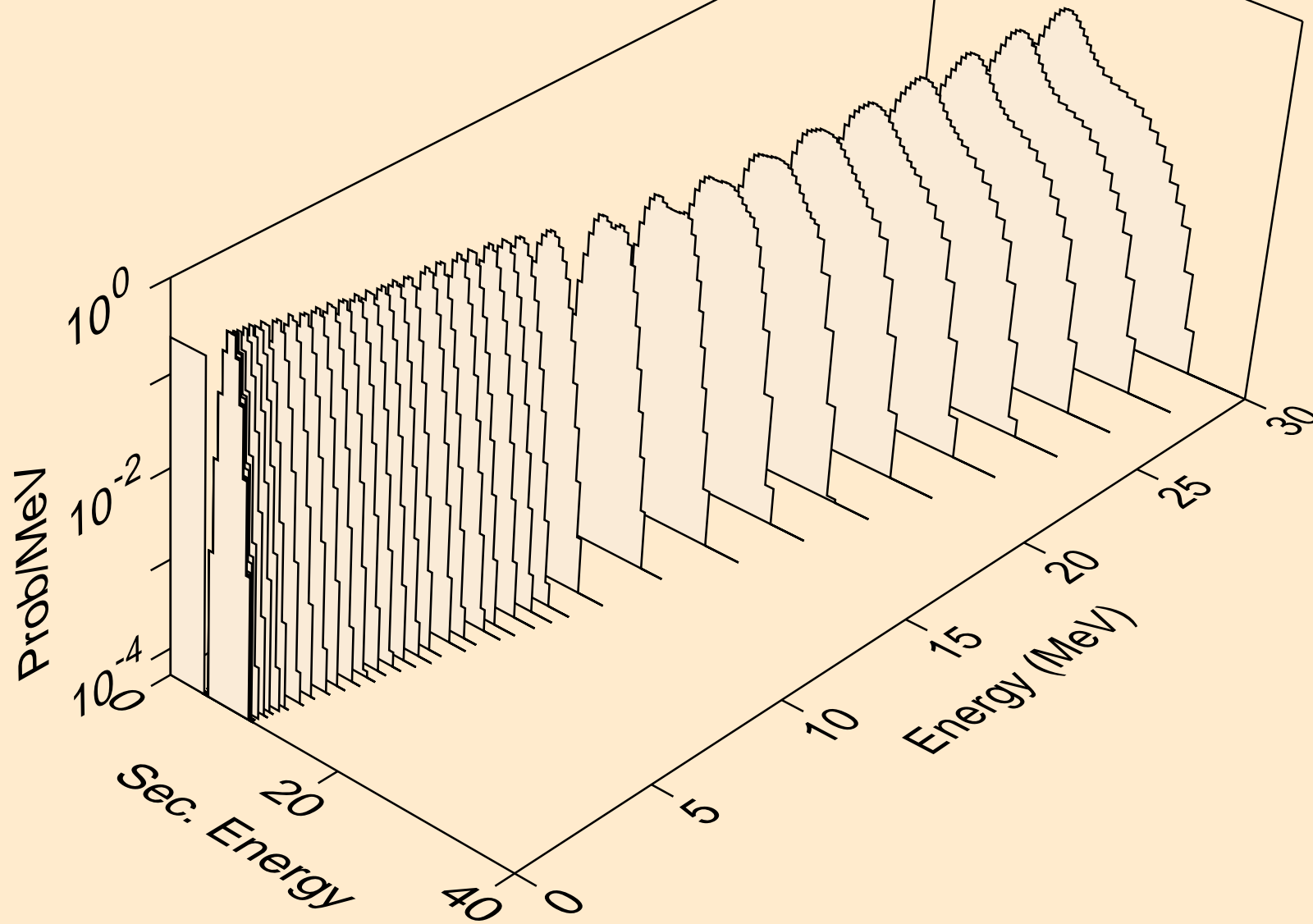

SM137 NEUTRON ACER TENDL-2024 LIBRARY; T=293.6K
alphas from (n,3a)

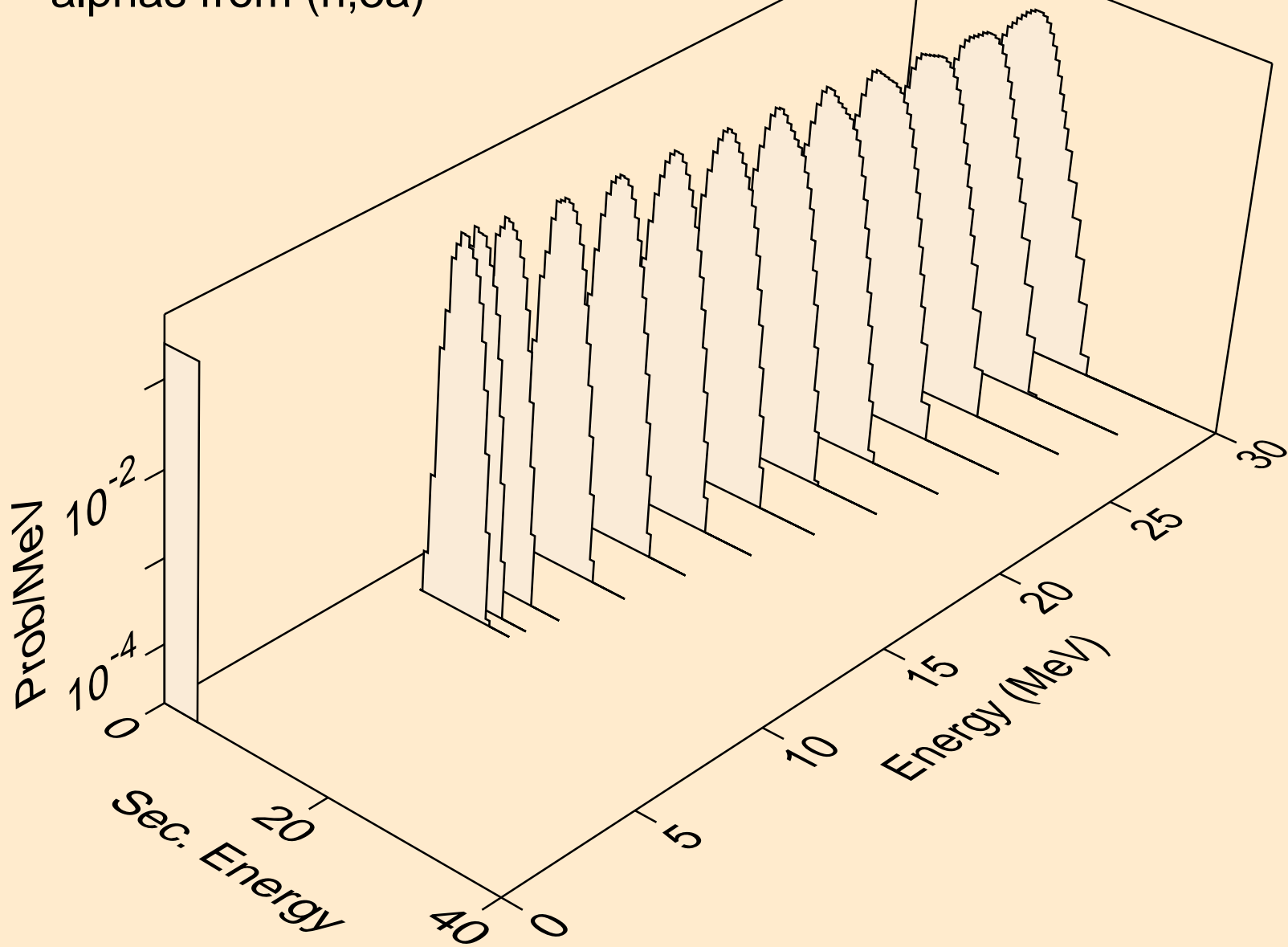

SM137 NEUTRON ACER TENDL-2024 LIBRARY; T=293.6K
alphas from (n,pa)

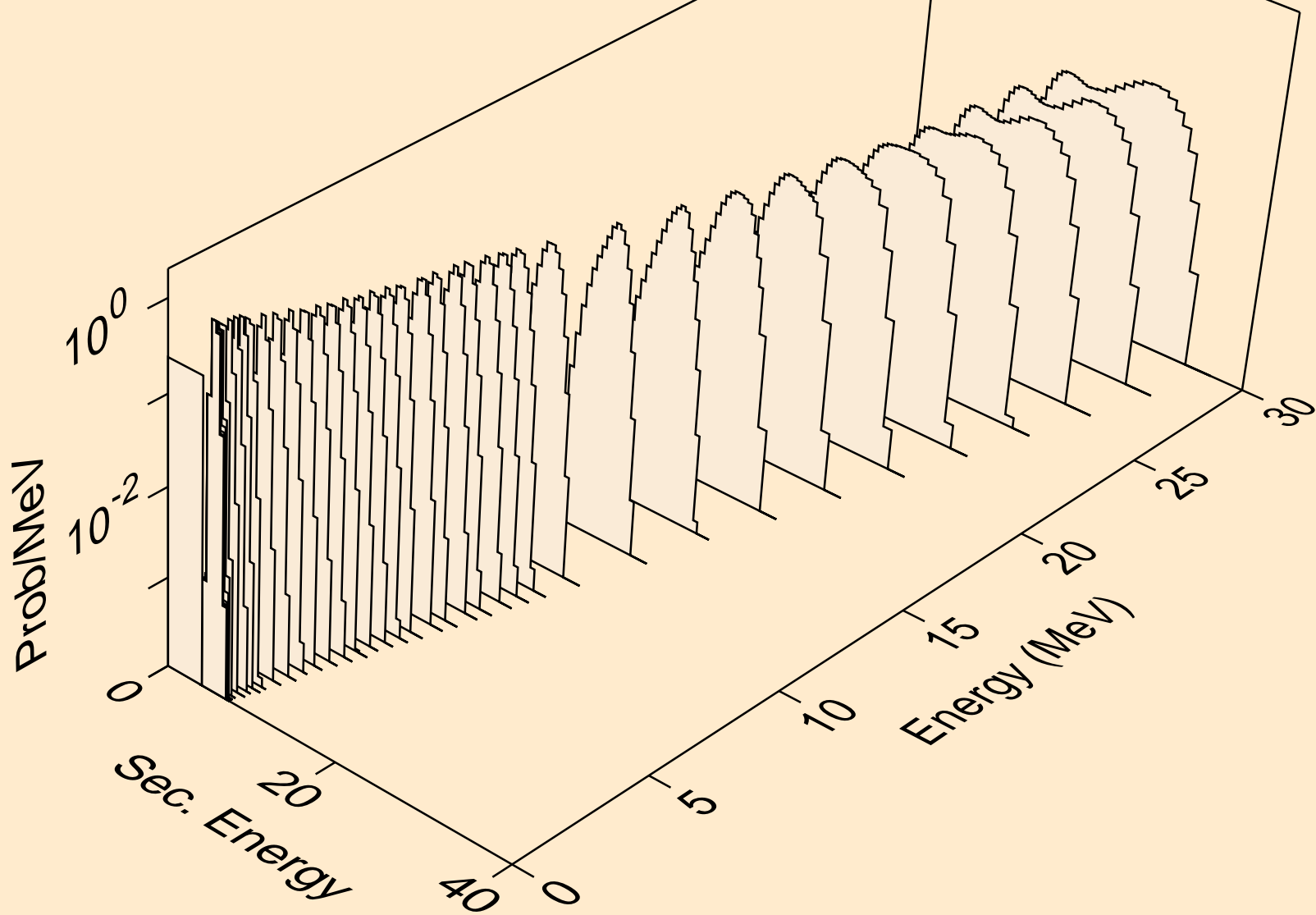

SM137 NEUTRON ACER TENDL-2024 LIBRARY; T=293.6K
alphas from (n,da)

