

SN109 NEUTRON ACER TENDL-2024 LIBRARY; T=293.6K

Principal cross sections

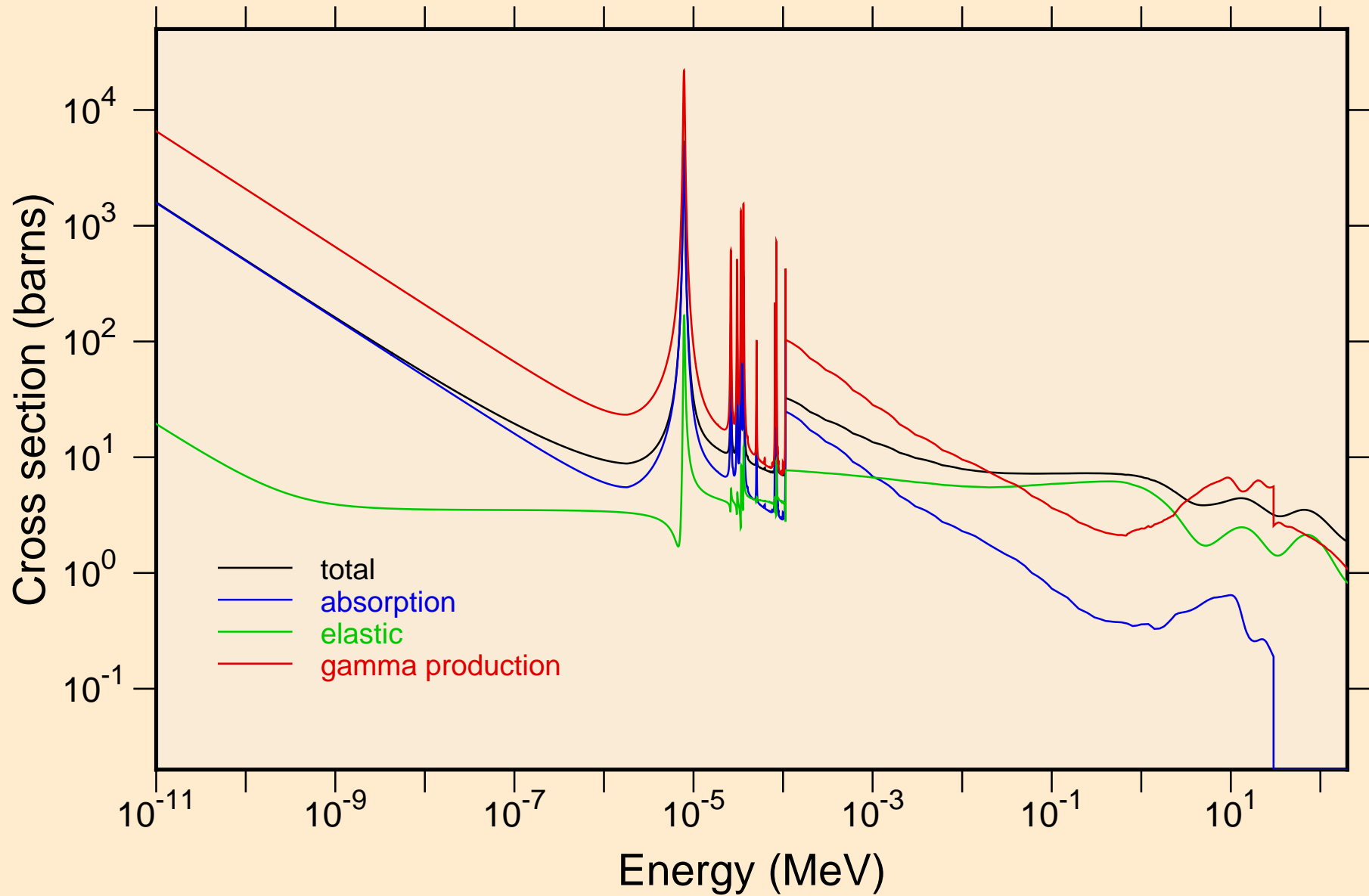

SN109 NEUTRON ACER TENDL-2024 LIBRARY; T=293.6K
resonance total cross section

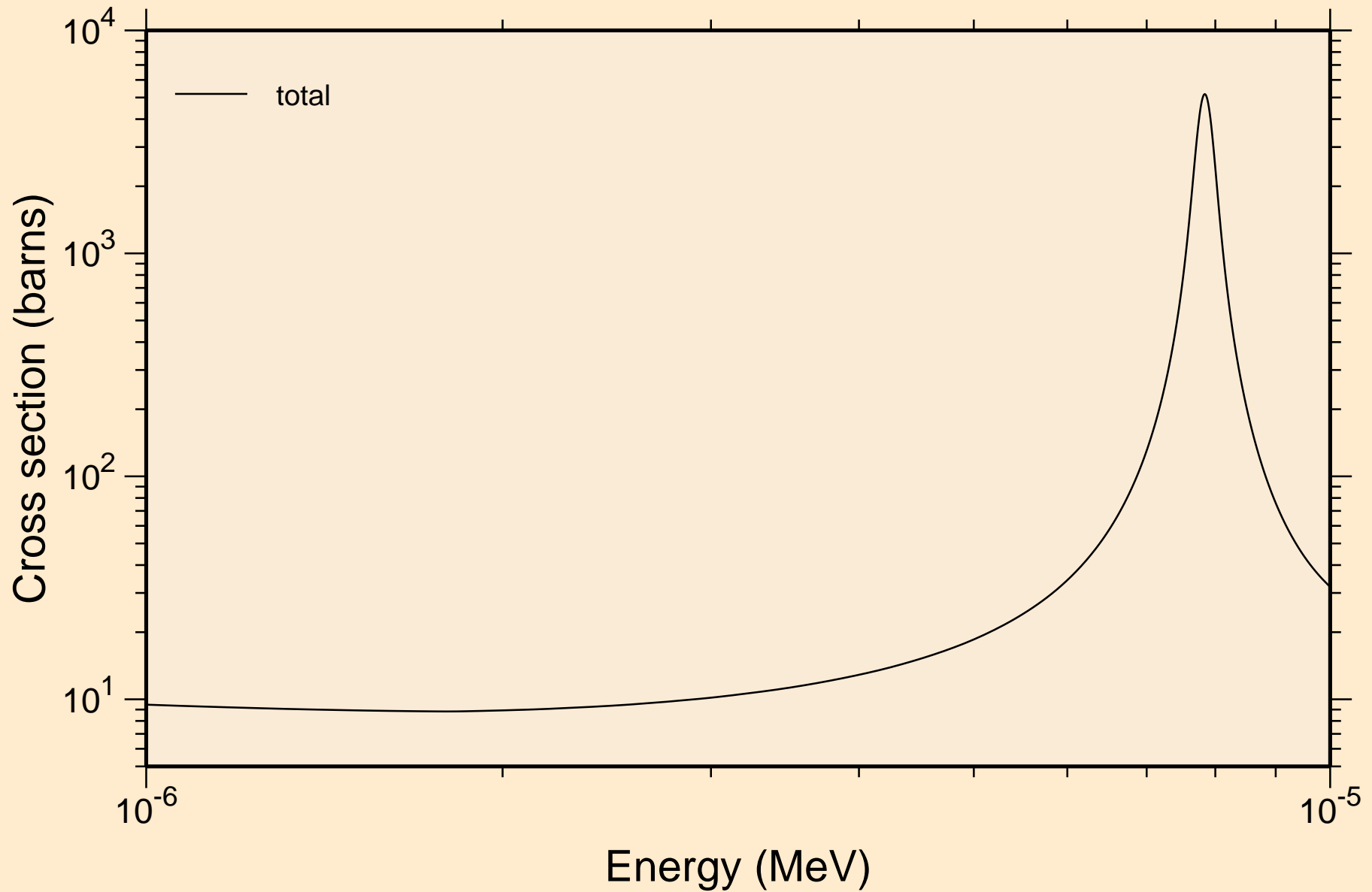

SN109 NEUTRON ACER TENDL-2024 LIBRARY; T=293.6K
resonance total cross section

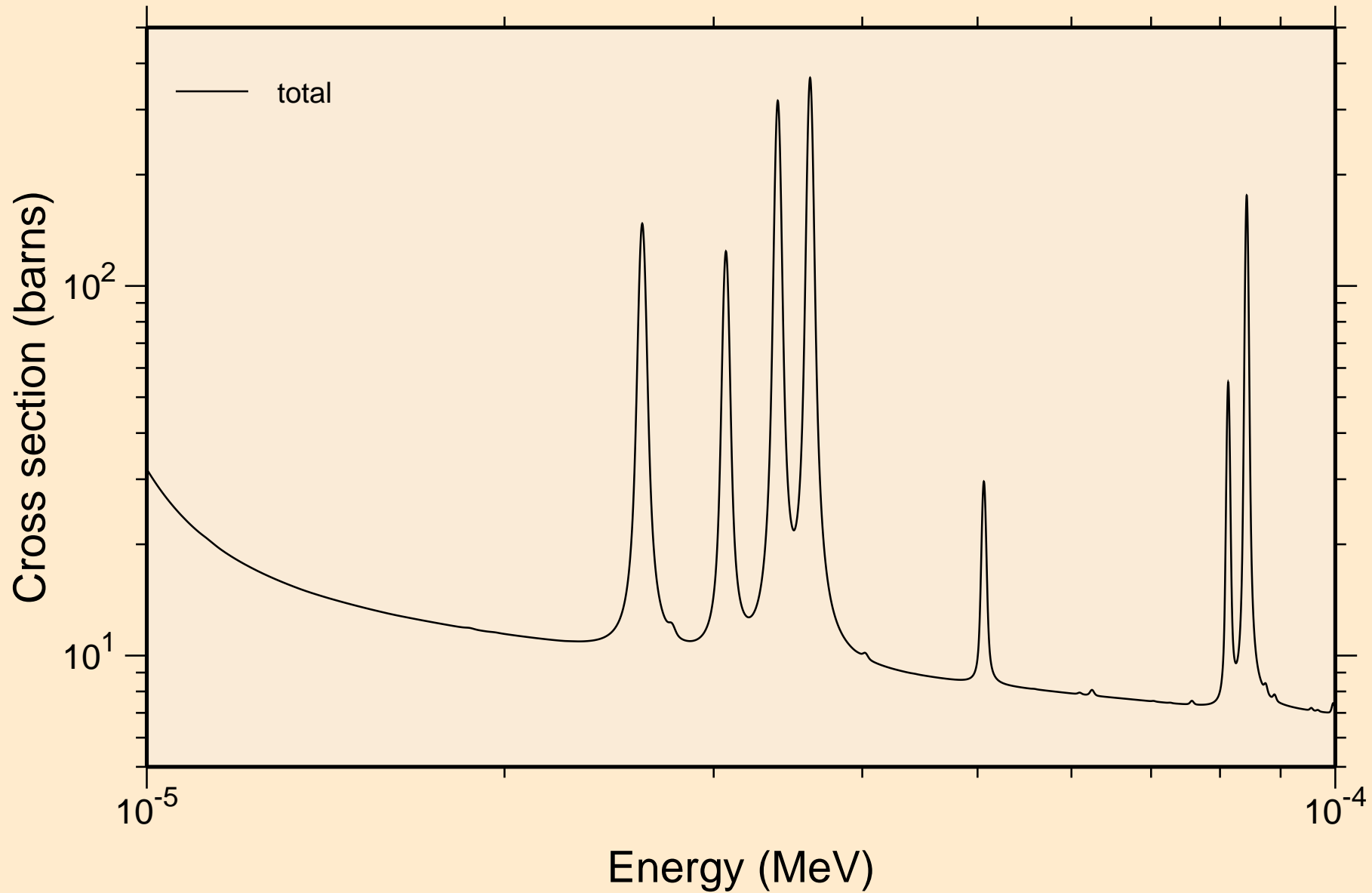

SN109 NEUTRON ACER TENDL-2024 LIBRARY; T=293.6K
resonance total cross section

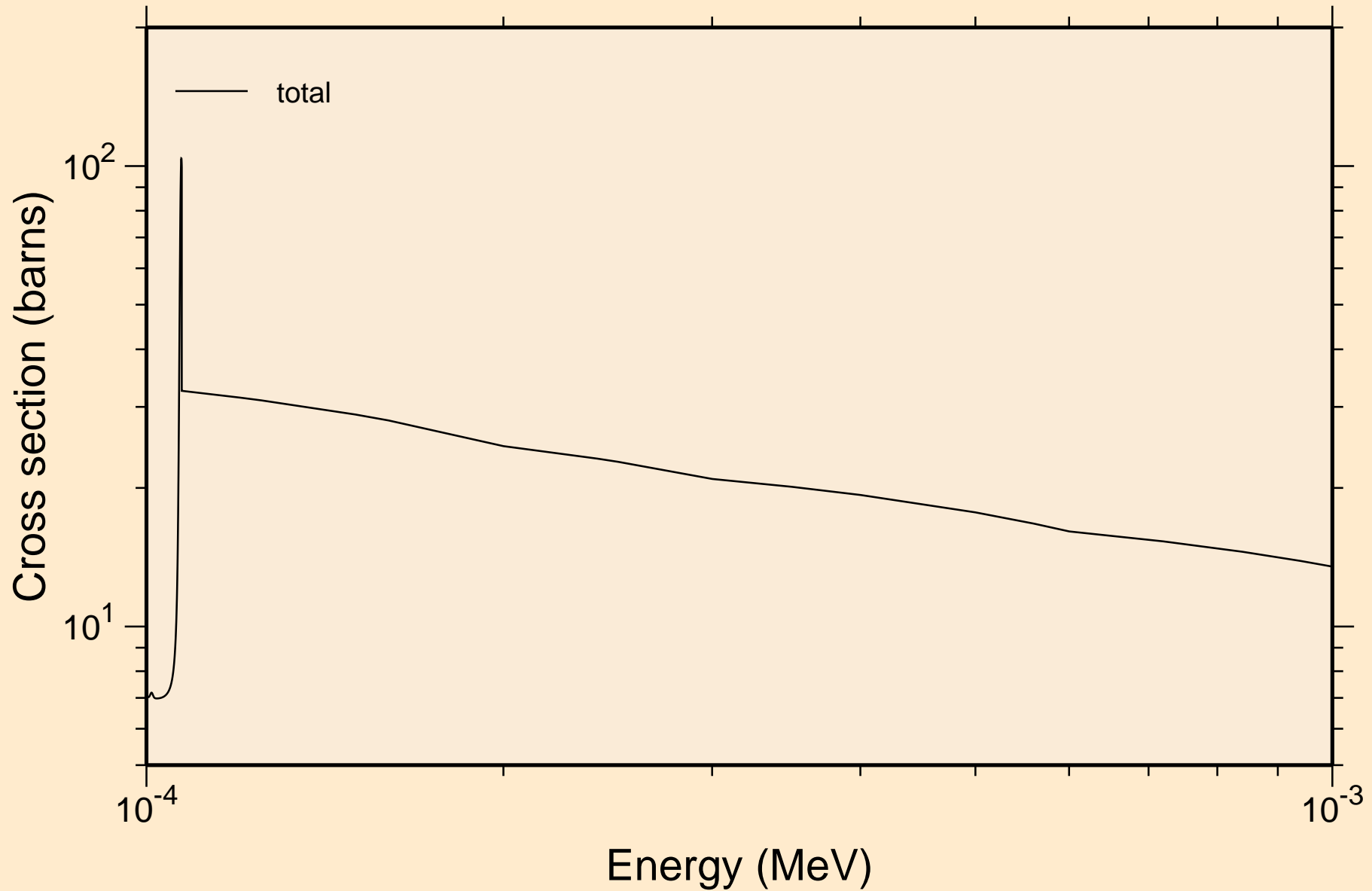

SN109 NEUTRON ACER TENDL-2024 LIBRARY; T=293.6K
resonance total cross section

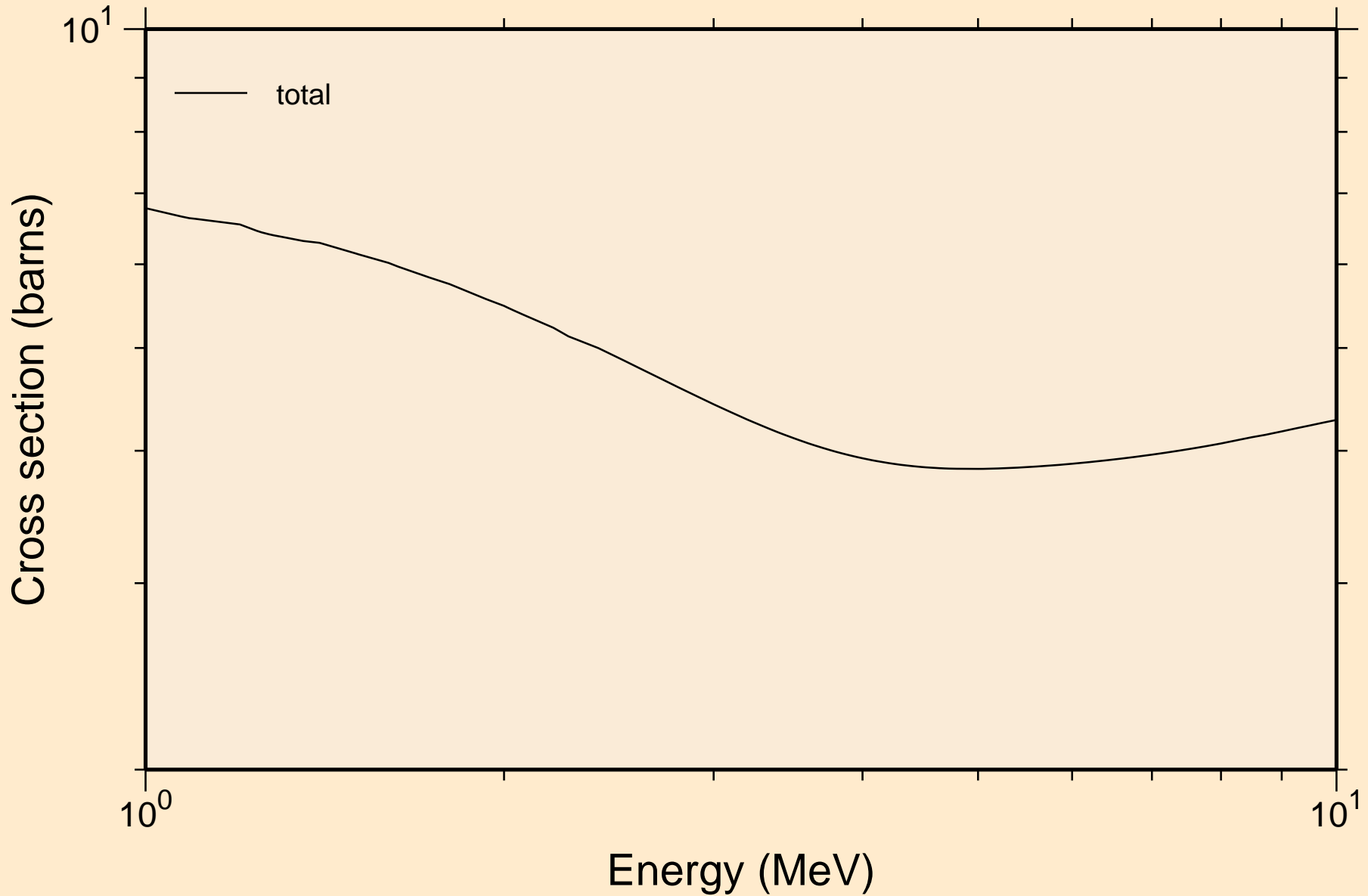

SN109 NEUTRON ACER TENDL-2024 LIBRARY; T=293.6K
resonance absorption cross sections

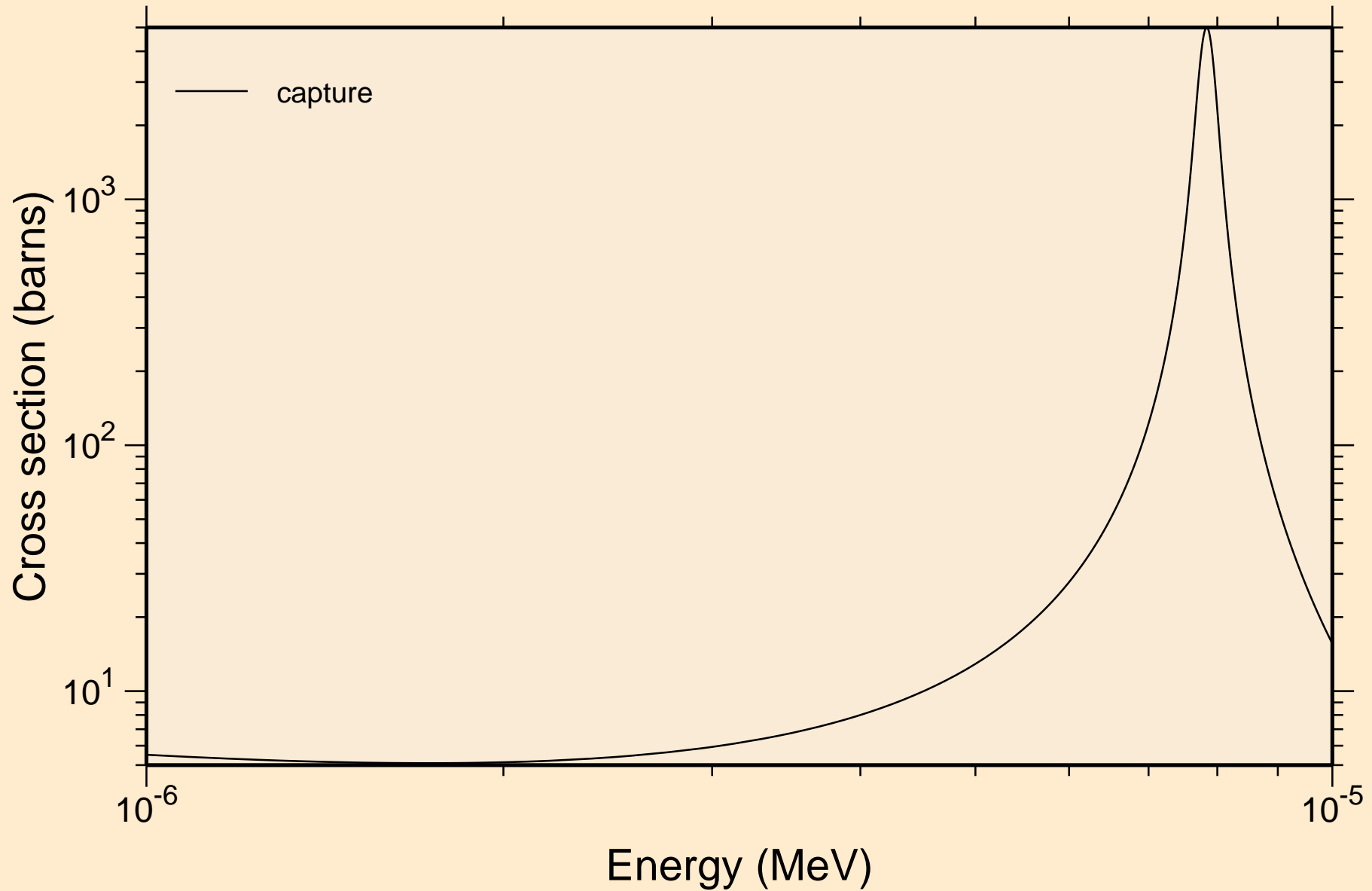

SN109 NEUTRON ACER TENDL-2024 LIBRARY; T=293.6K
resonance absorption cross sections

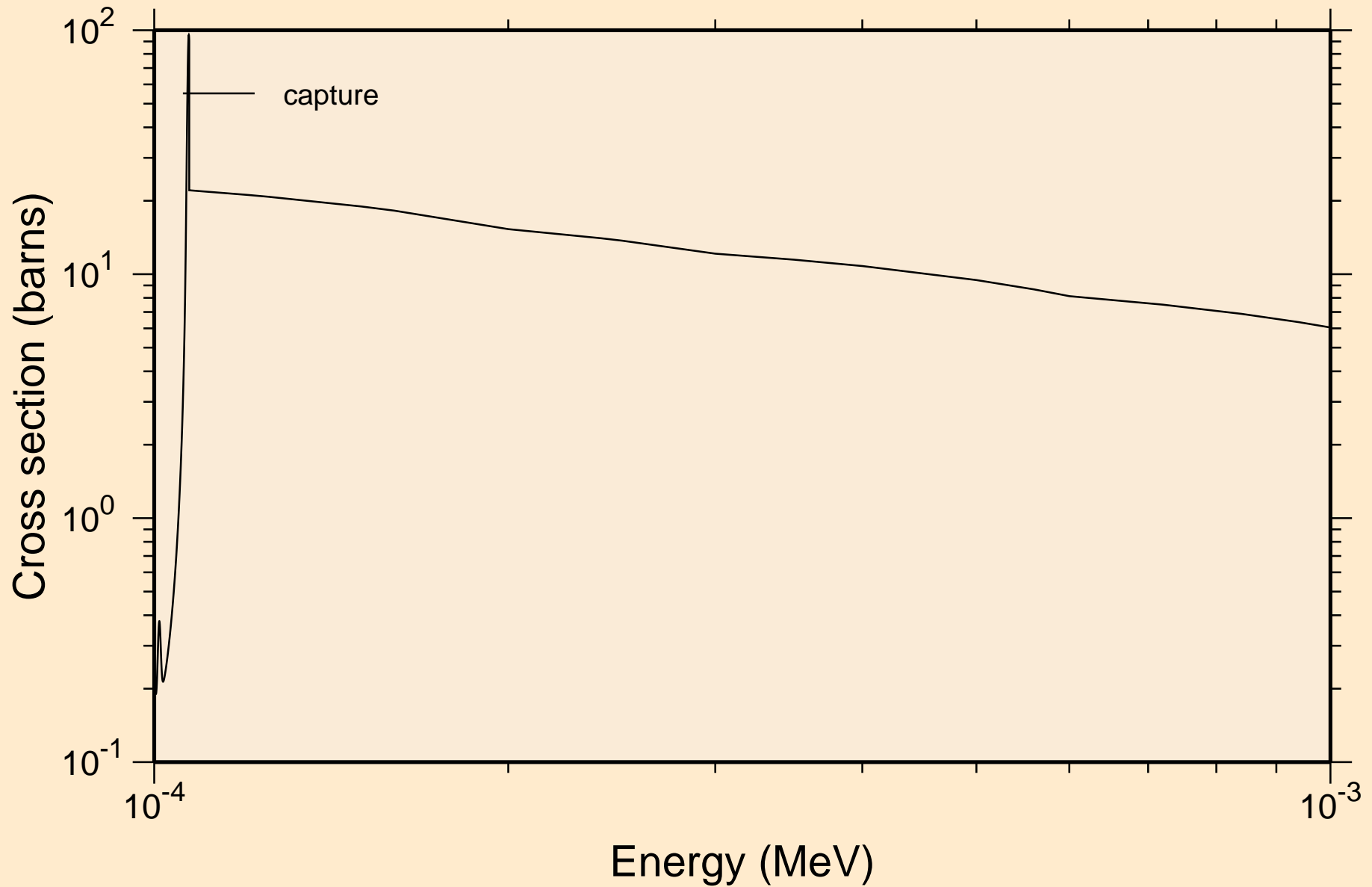

SN109 NEUTRON ACER TENDL-2024 LIBRARY; T=293.6K
resonance absorption cross sections

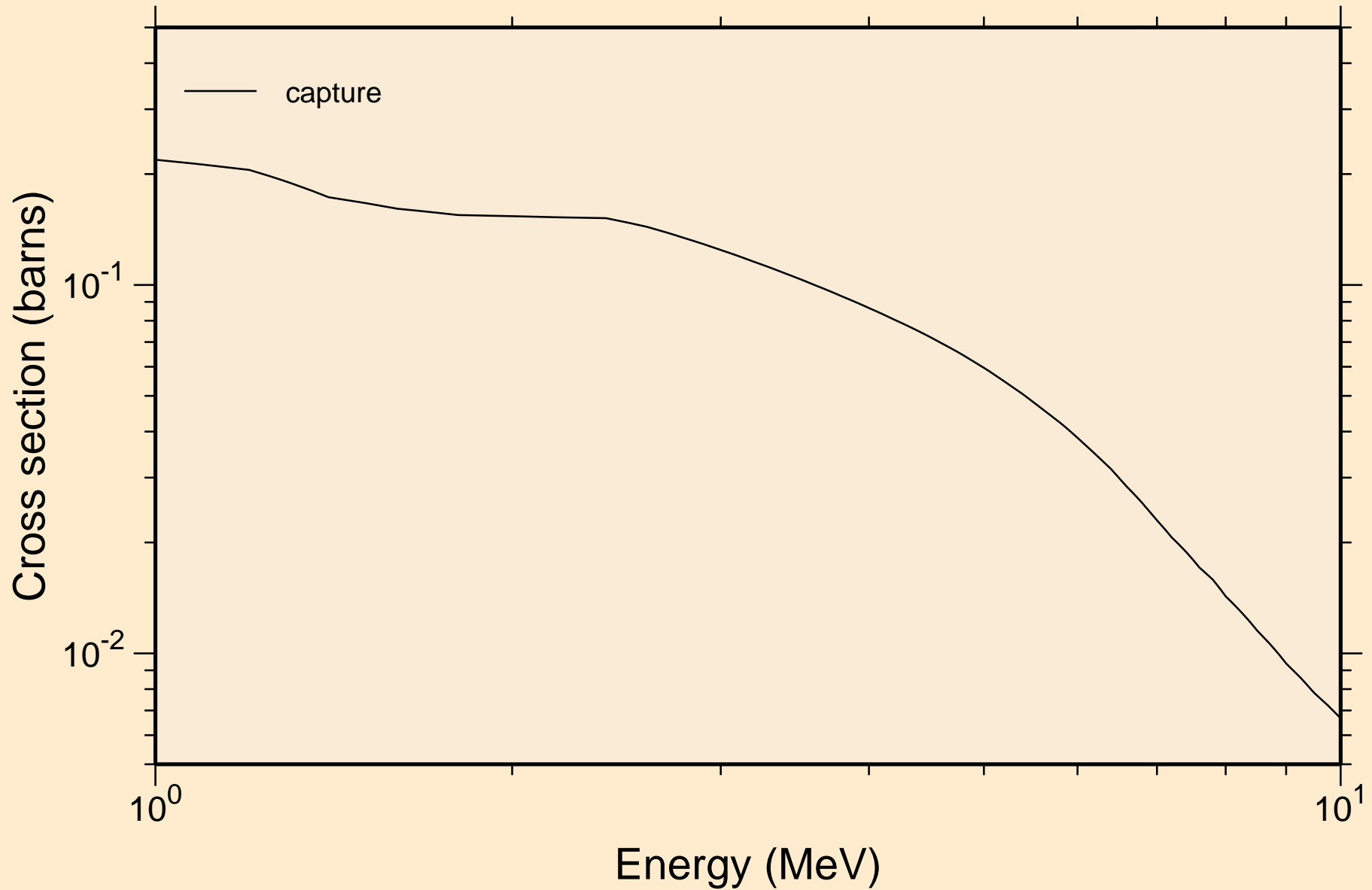

SN109 NEUTRON ACER TENDL-2024 LIBRARY; T=293.6K
Heating

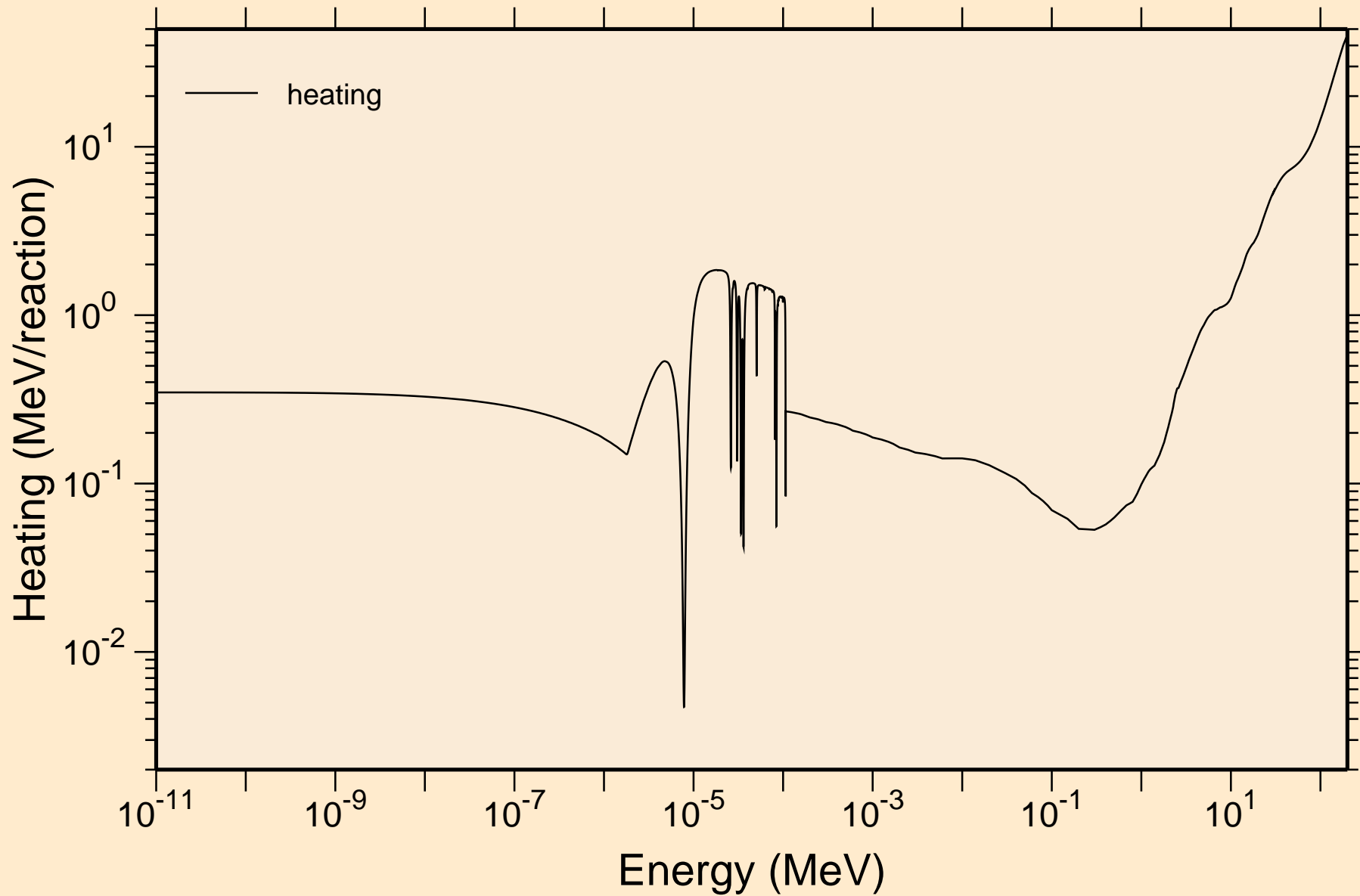

SN109 NEUTRON ACER TENDL-2024 LIBRARY; T=293.6K

Damage

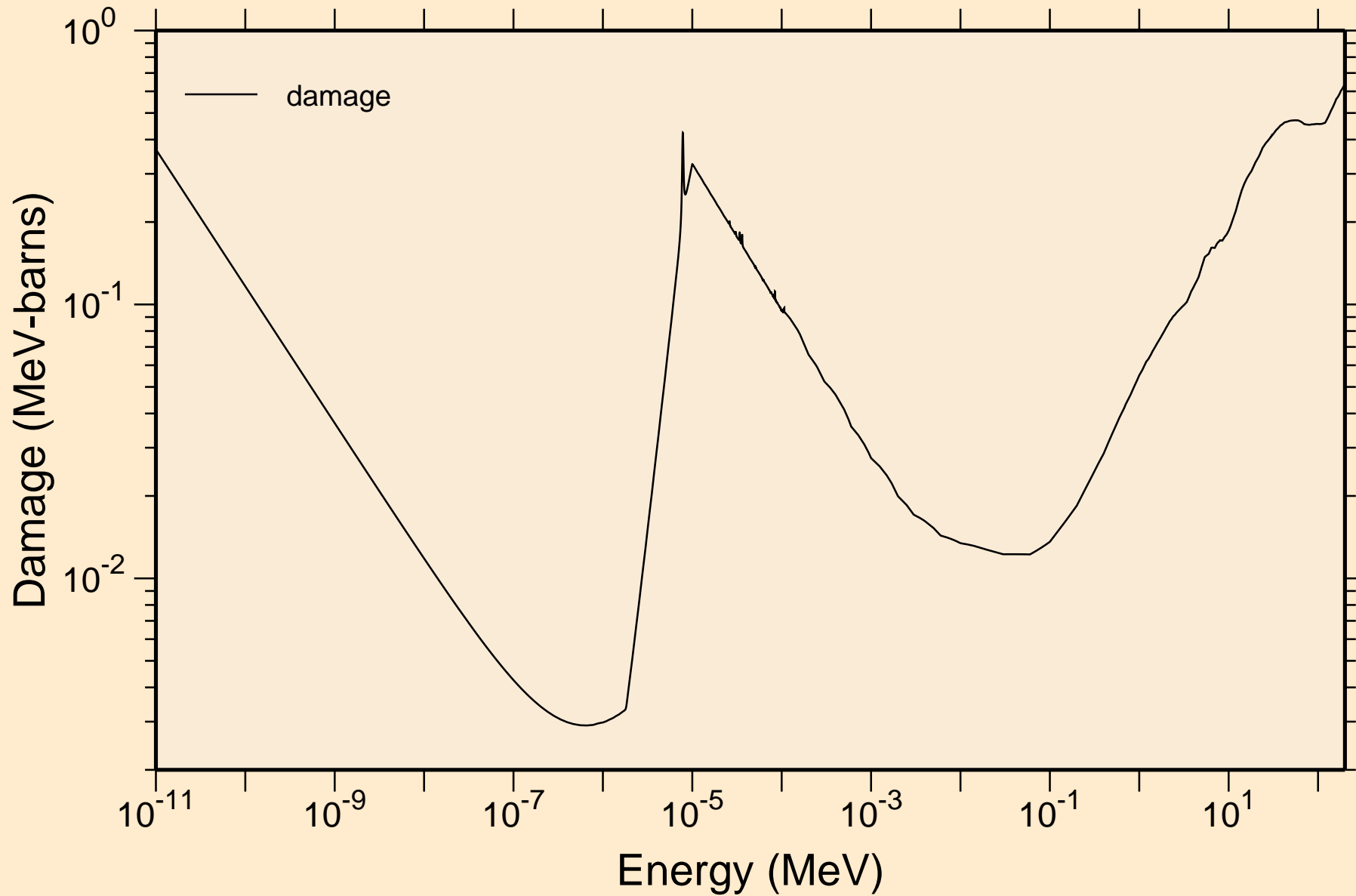

SN109 NEUTRON ACER TENDL-2024 LIBRARY; T=293.6K

Non-threshold reactions

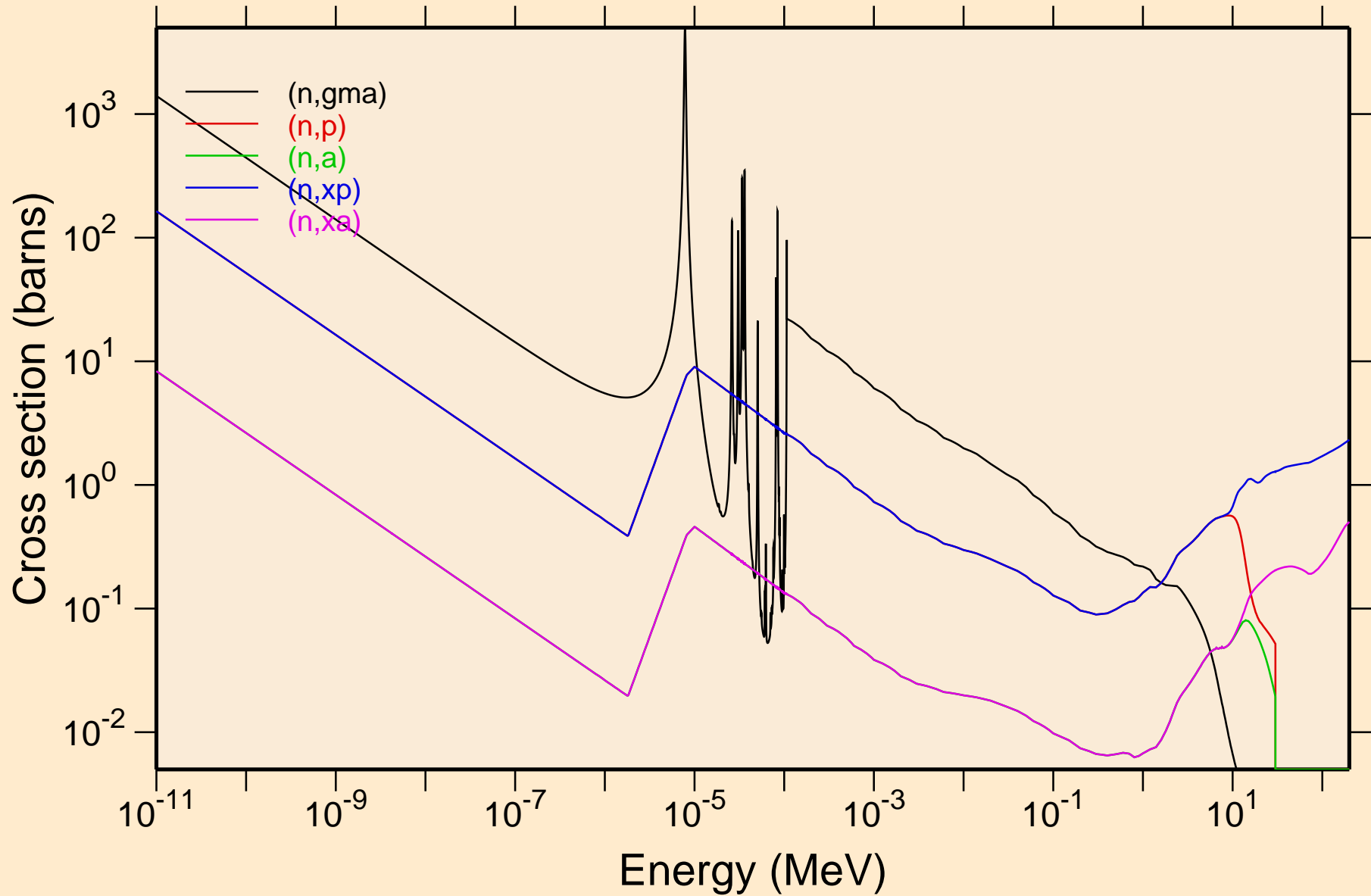

SN109 NEUTRON ACER TENDL-2024 LIBRARY; T=293.6K

Principal cross sections

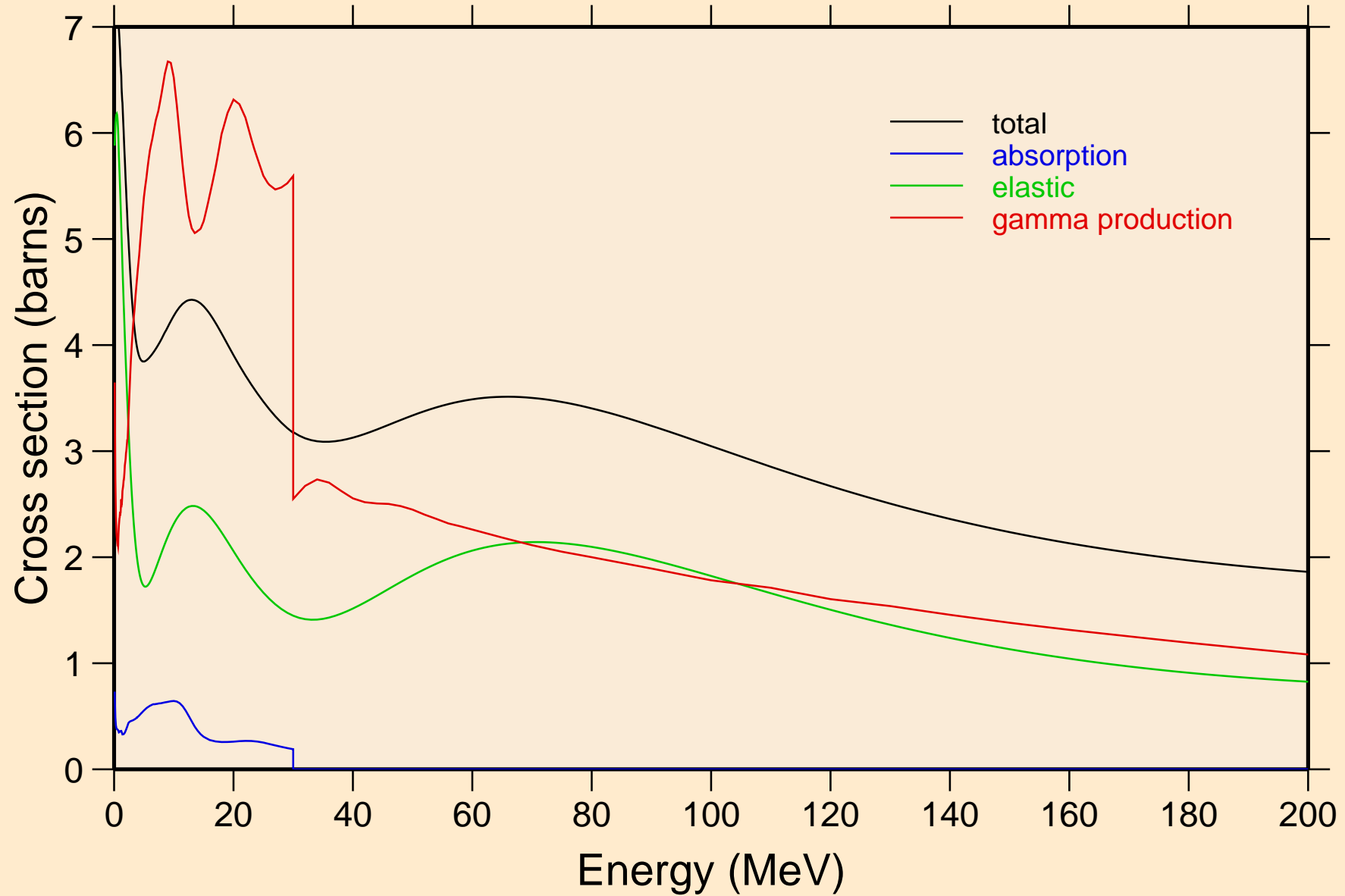

SN109 NEUTRON ACER TENDL-2024 LIBRARY; T=293.6K

Heating

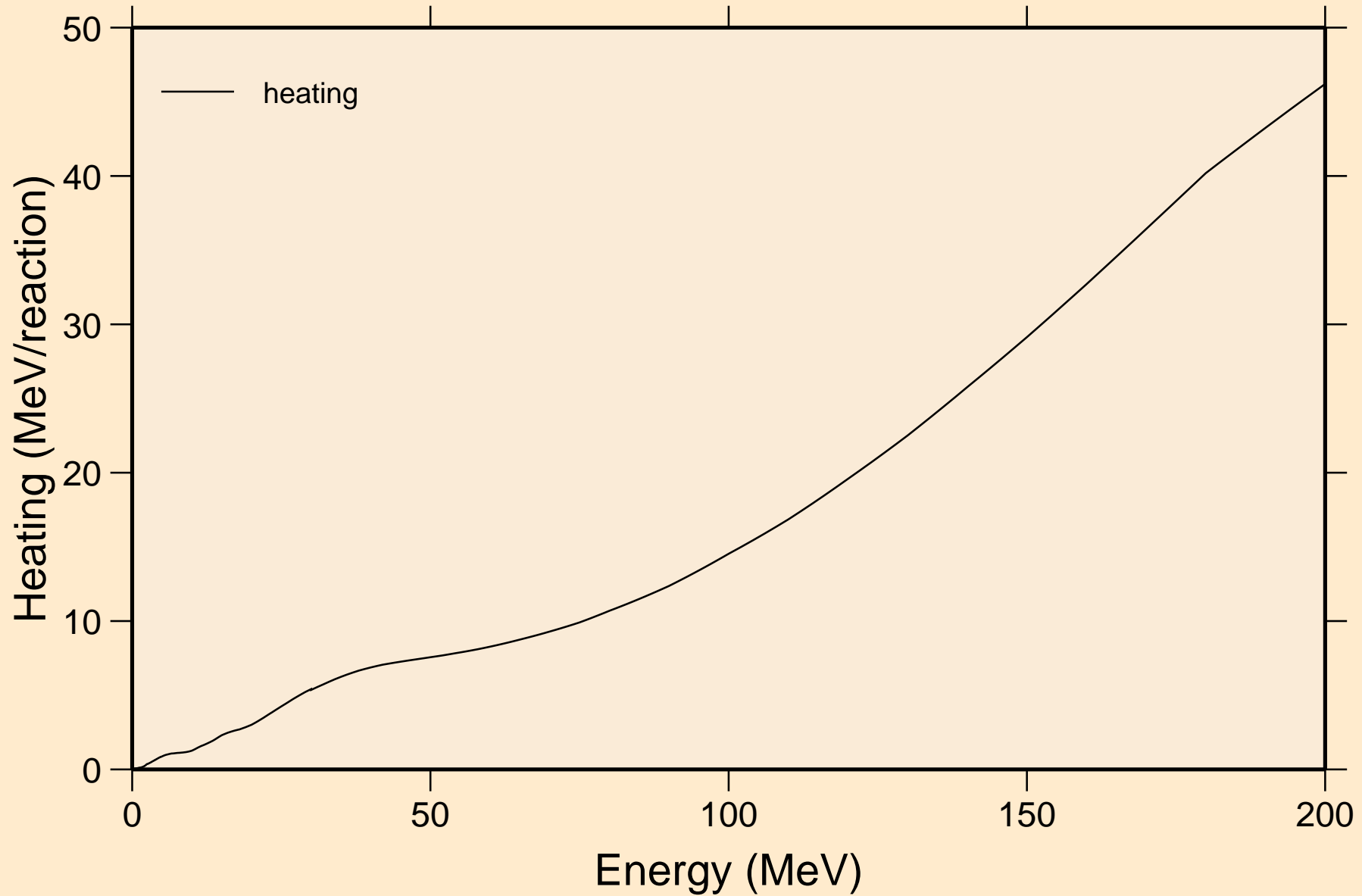

SN109 NEUTRON ACER TENDL-2024 LIBRARY; T=293.6K
Damage

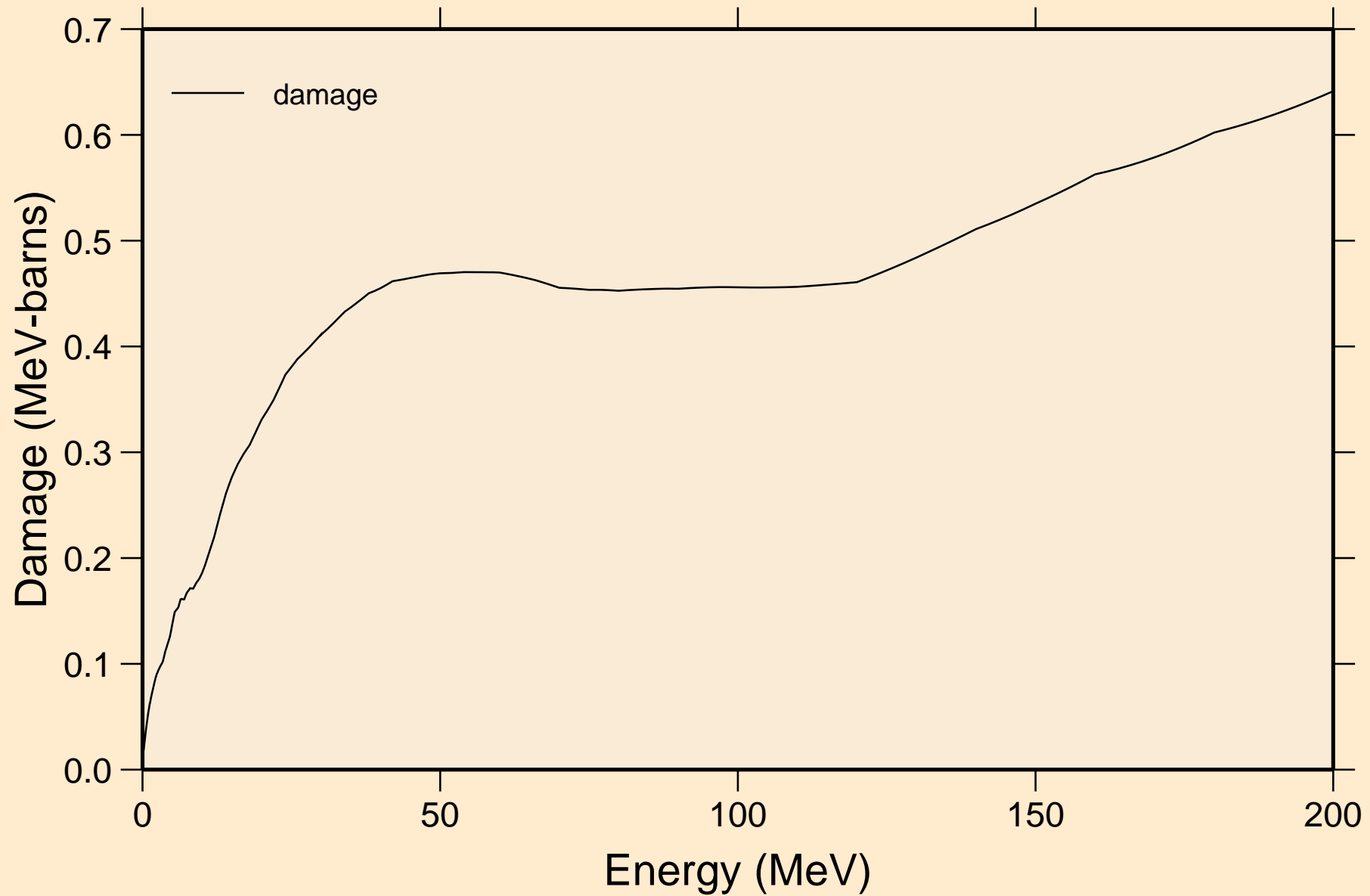

SN109 NEUTRON ACER TENDL-2024 LIBRARY; T=293.6K

Non-threshold reactions

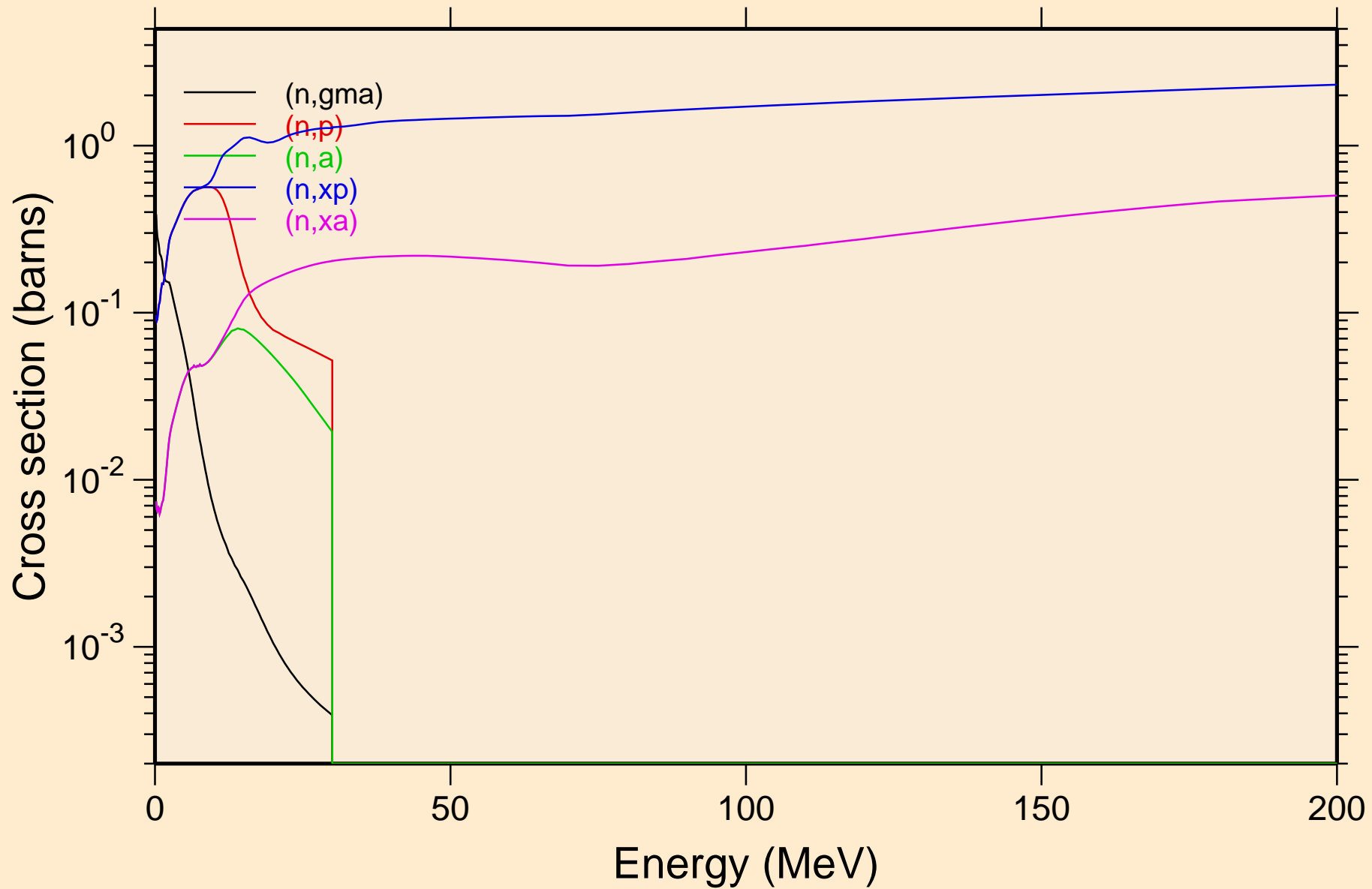

SN109 NEUTRON ACER TENDL-2024 LIBRARY; T=293.6K

Inelastic levels

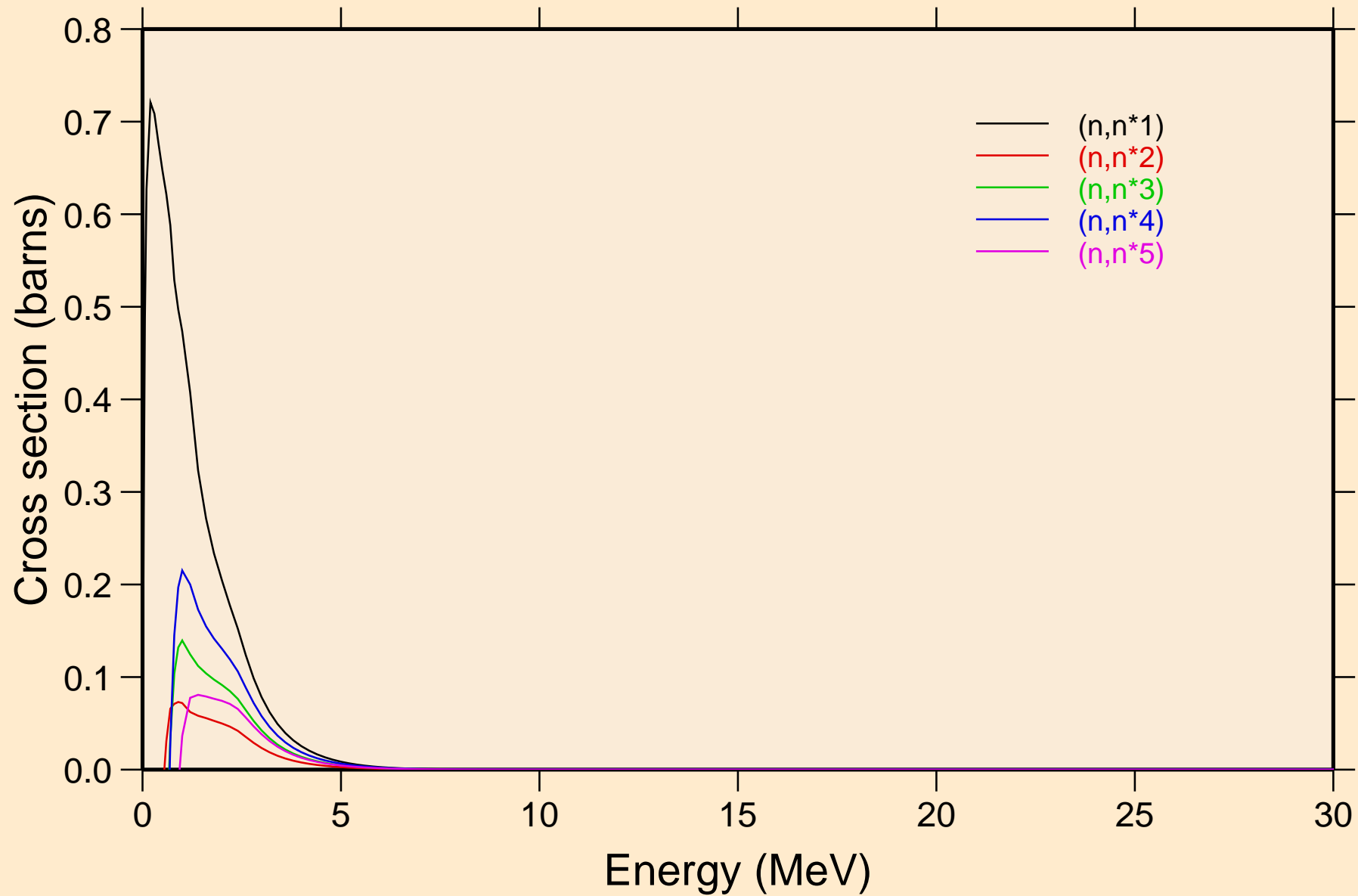

SN109 NEUTRON ACER TENDL-2024 LIBRARY; T=293.6K

Inelastic levels

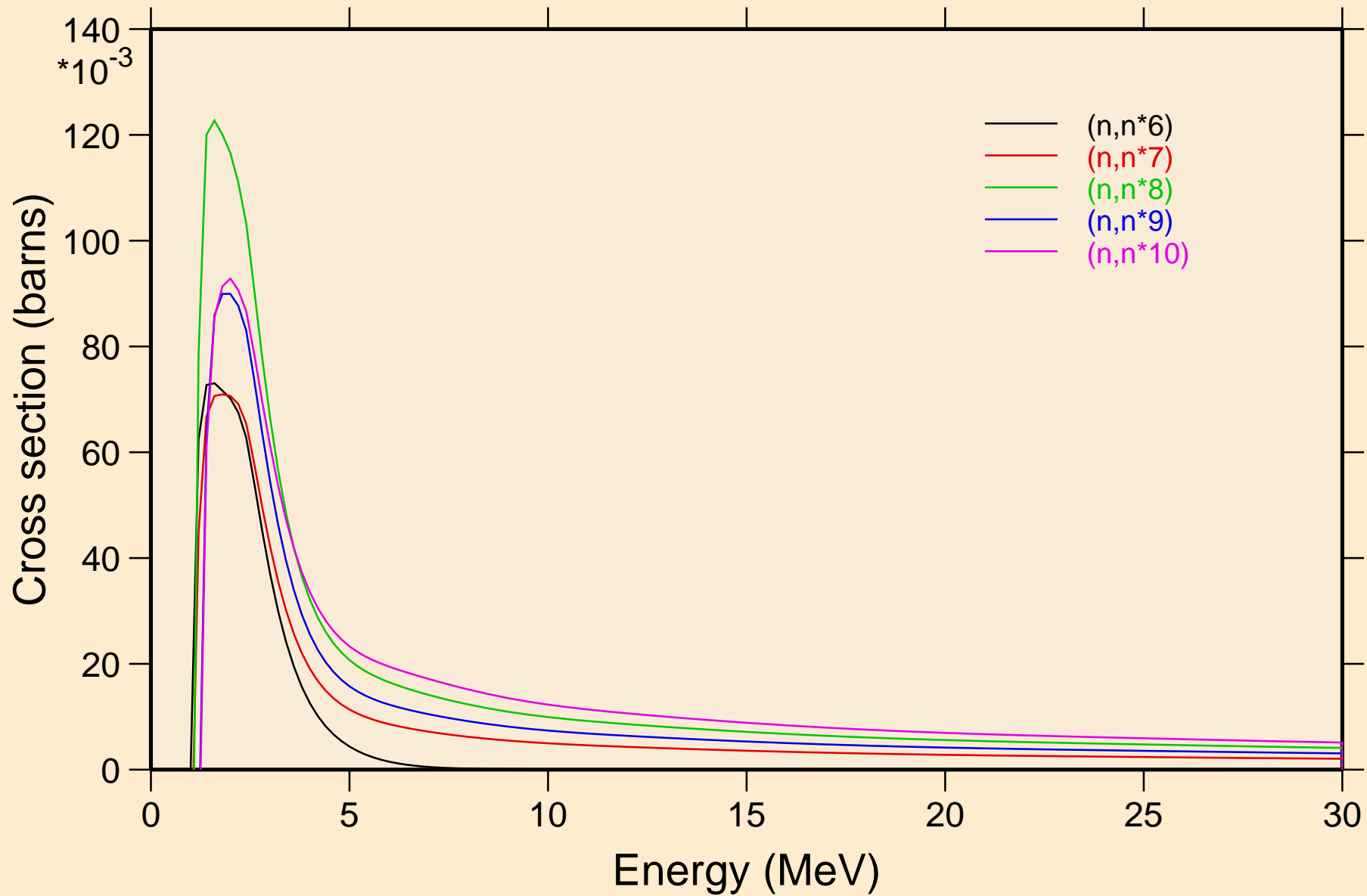

SN109 NEUTRON ACER TENDL-2024 LIBRARY; T=293.6K

Inelastic levels

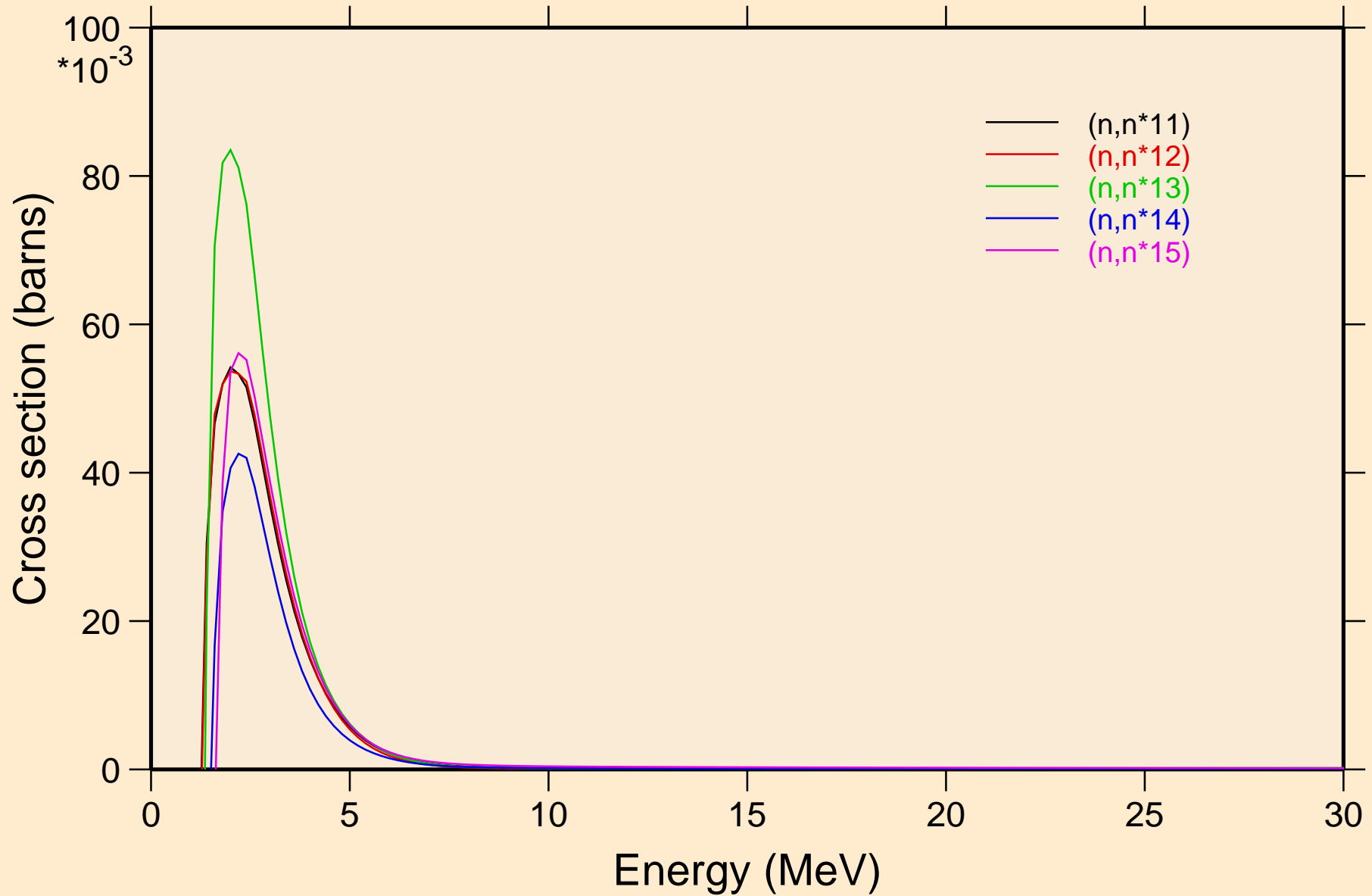

SN109 NEUTRON ACER TENDL-2024 LIBRARY; T=293.6K

Inelastic levels

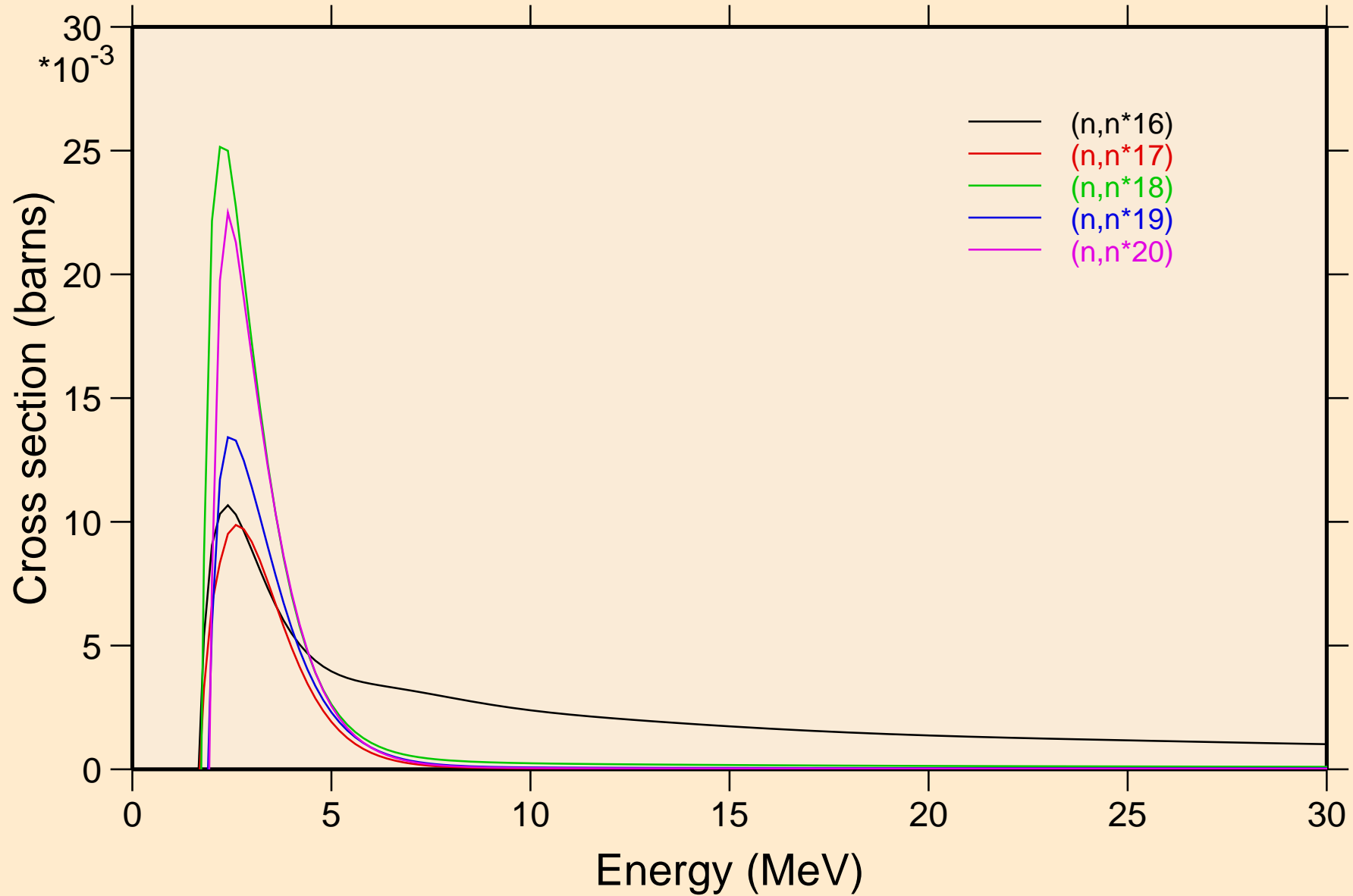

SN109 NEUTRON ACER TENDL-2024 LIBRARY; T=293.6K

Inelastic levels

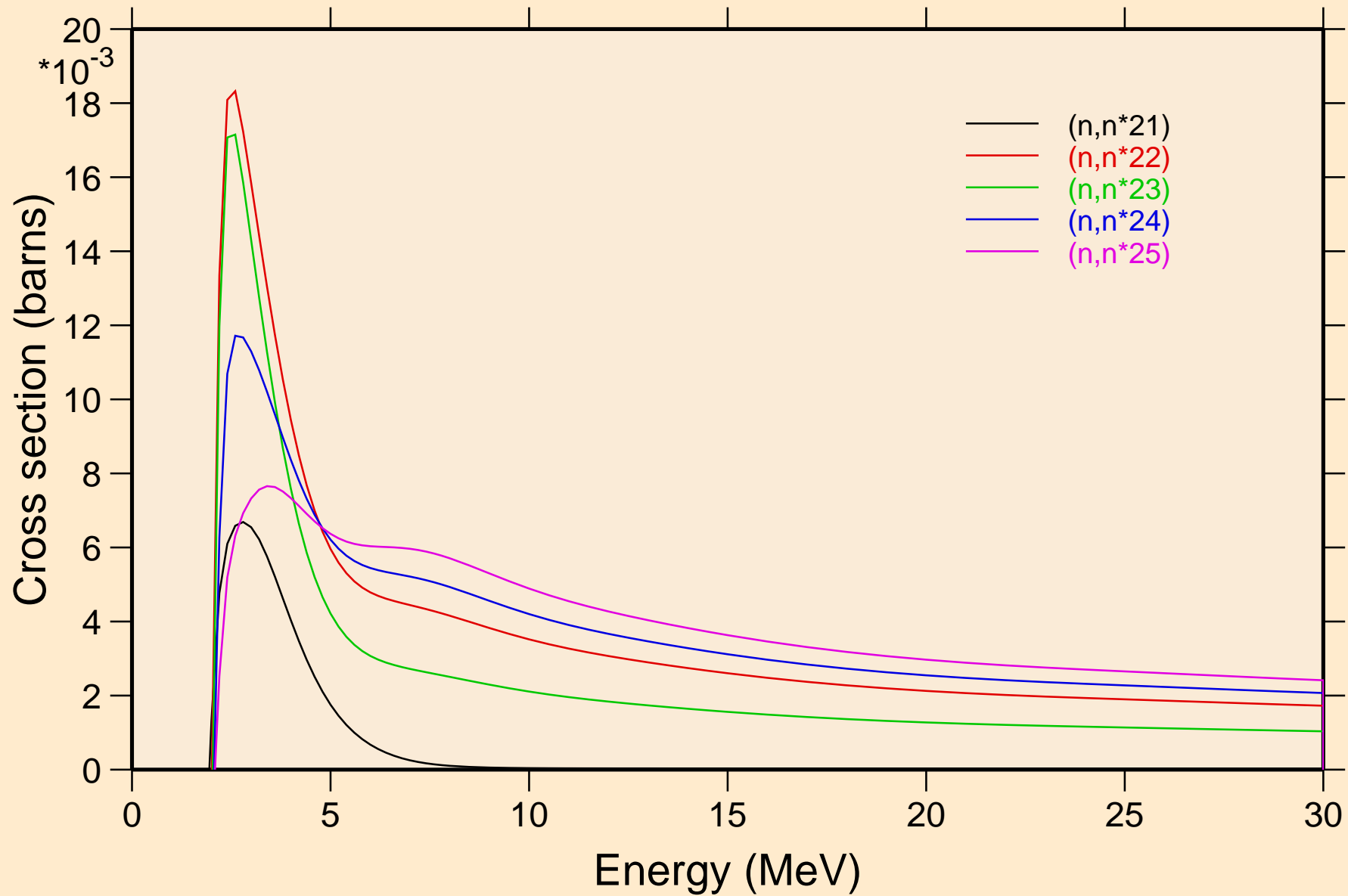

SN109 NEUTRON ACER TENDL-2024 LIBRARY; T=293.6K
Inelastic levels

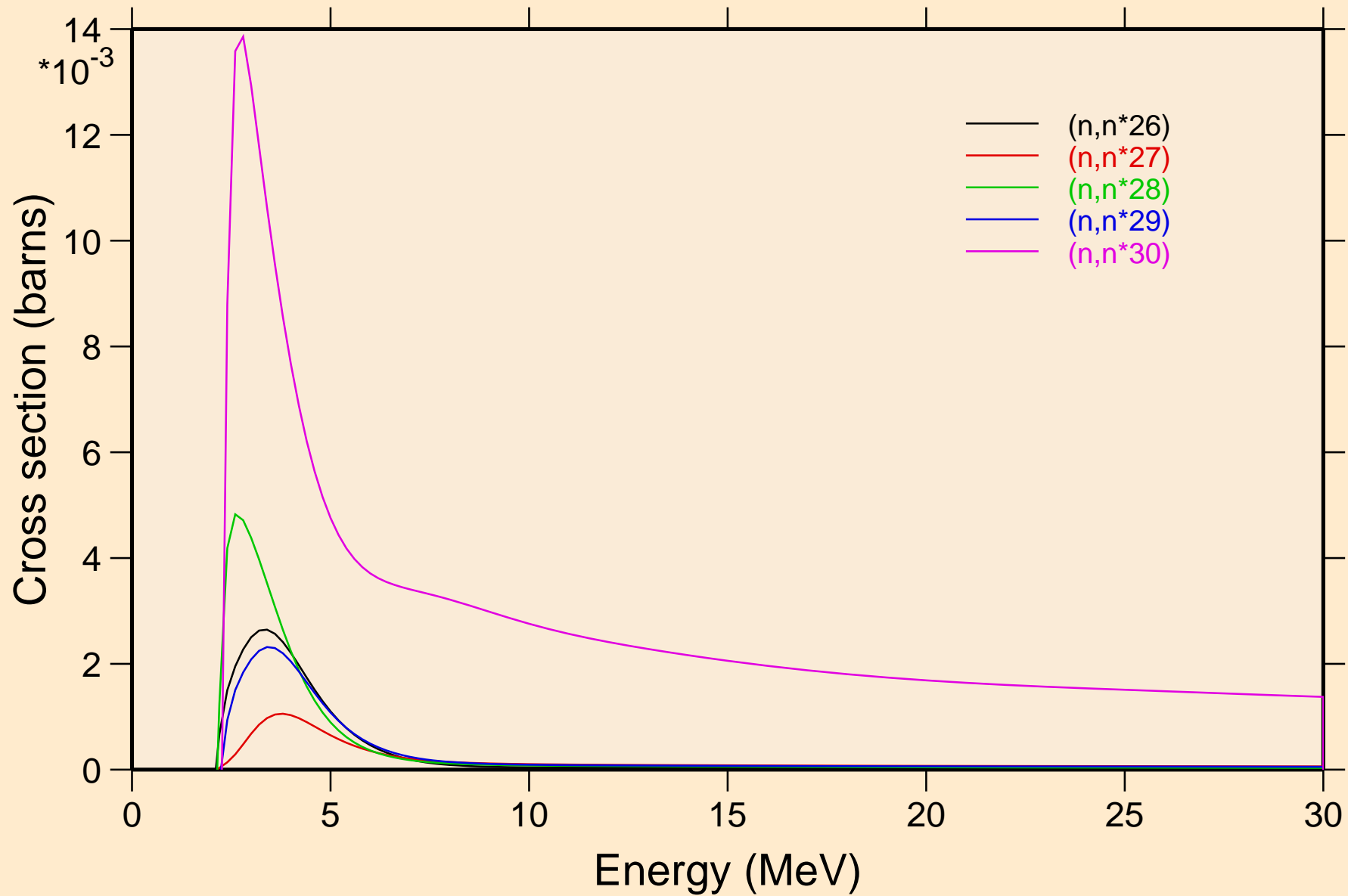

SN109 NEUTRON ACER TENDL-2024 LIBRARY; T=293.6K

Threshold reactions

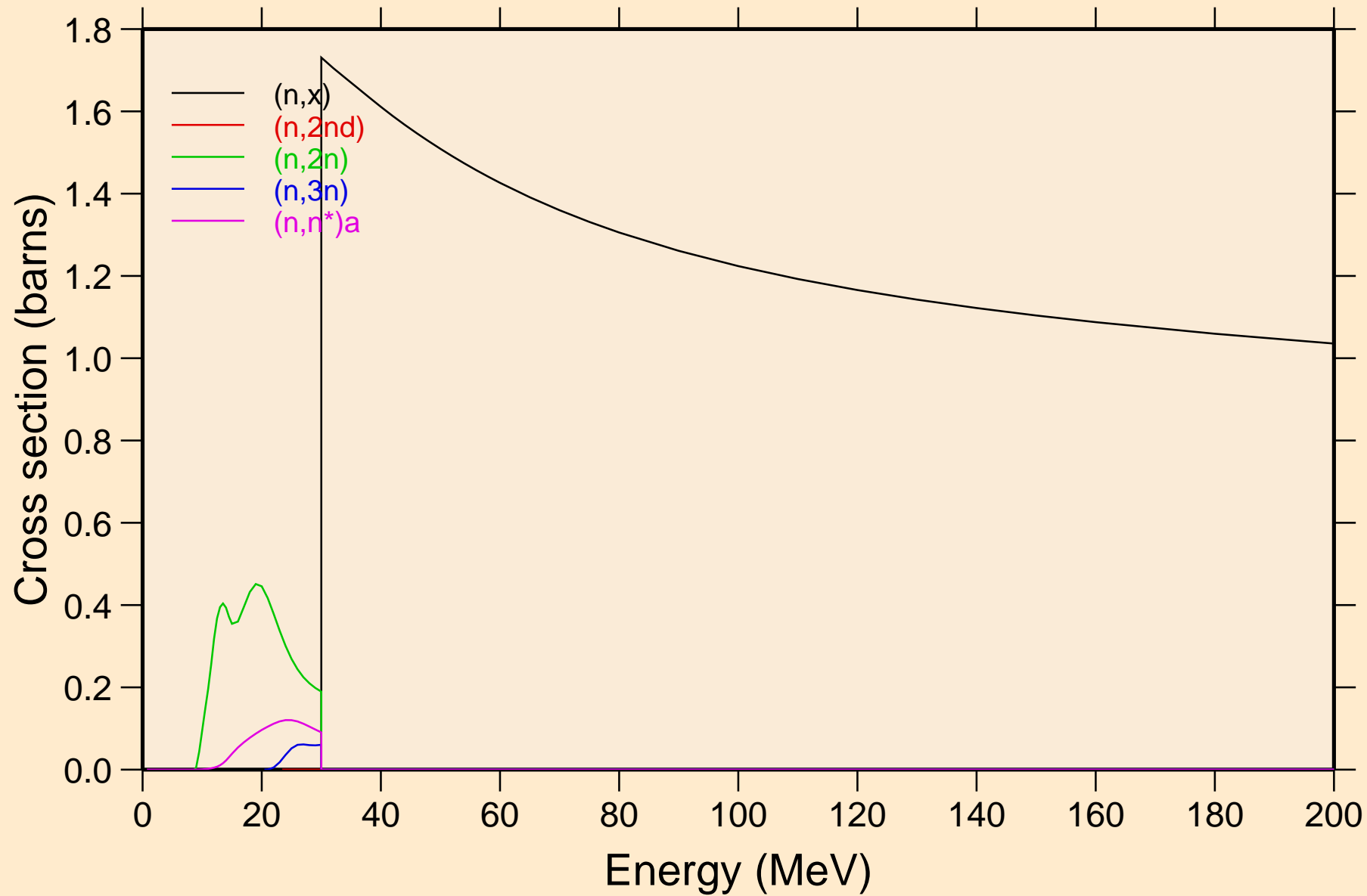

SN109 NEUTRON ACER TENDL-2024 LIBRARY; T=293.6K

Threshold reactions

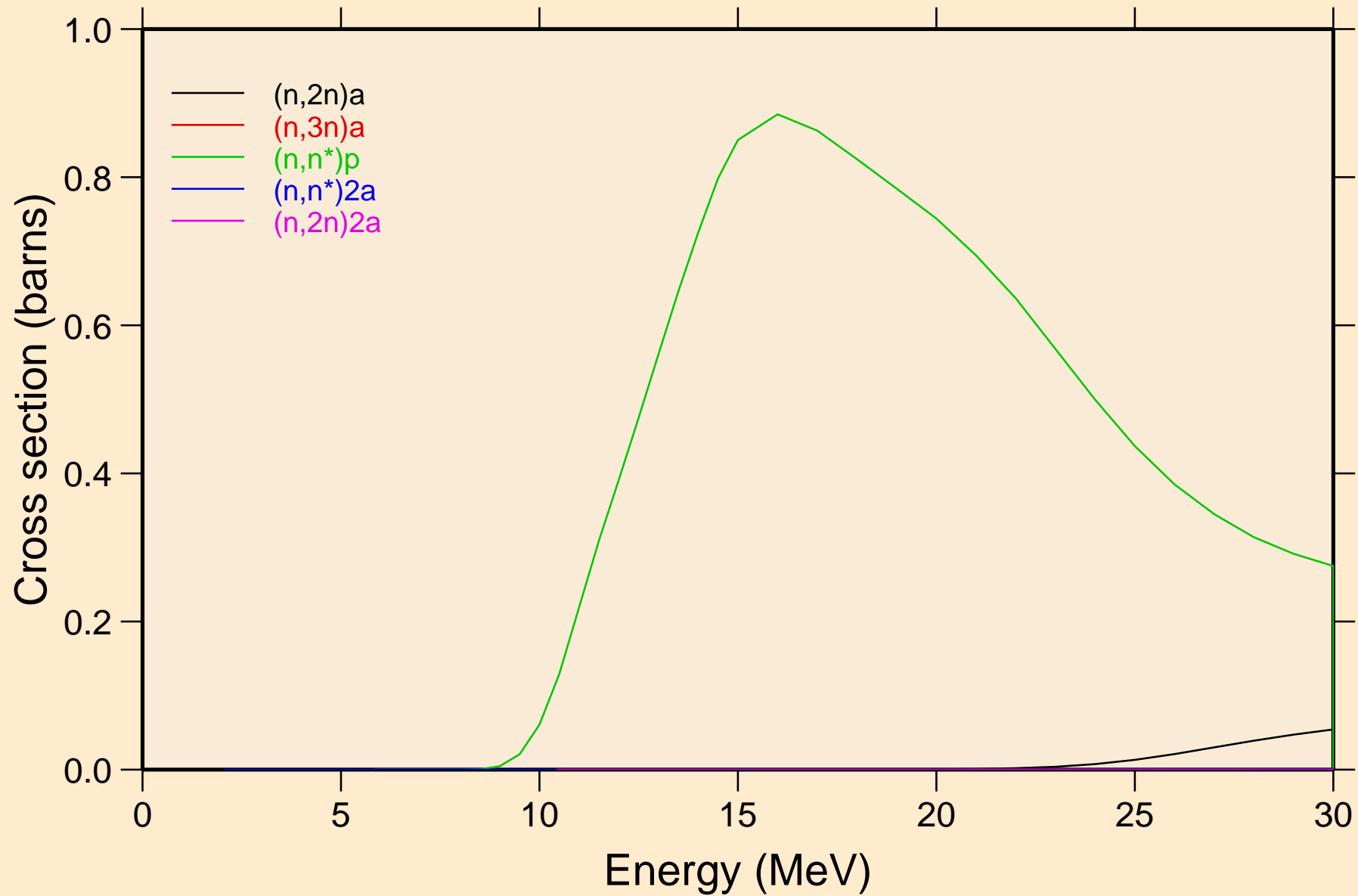

SN109 NEUTRON ACER TENDL-2024 LIBRARY; T=293.6K
Threshold reactions

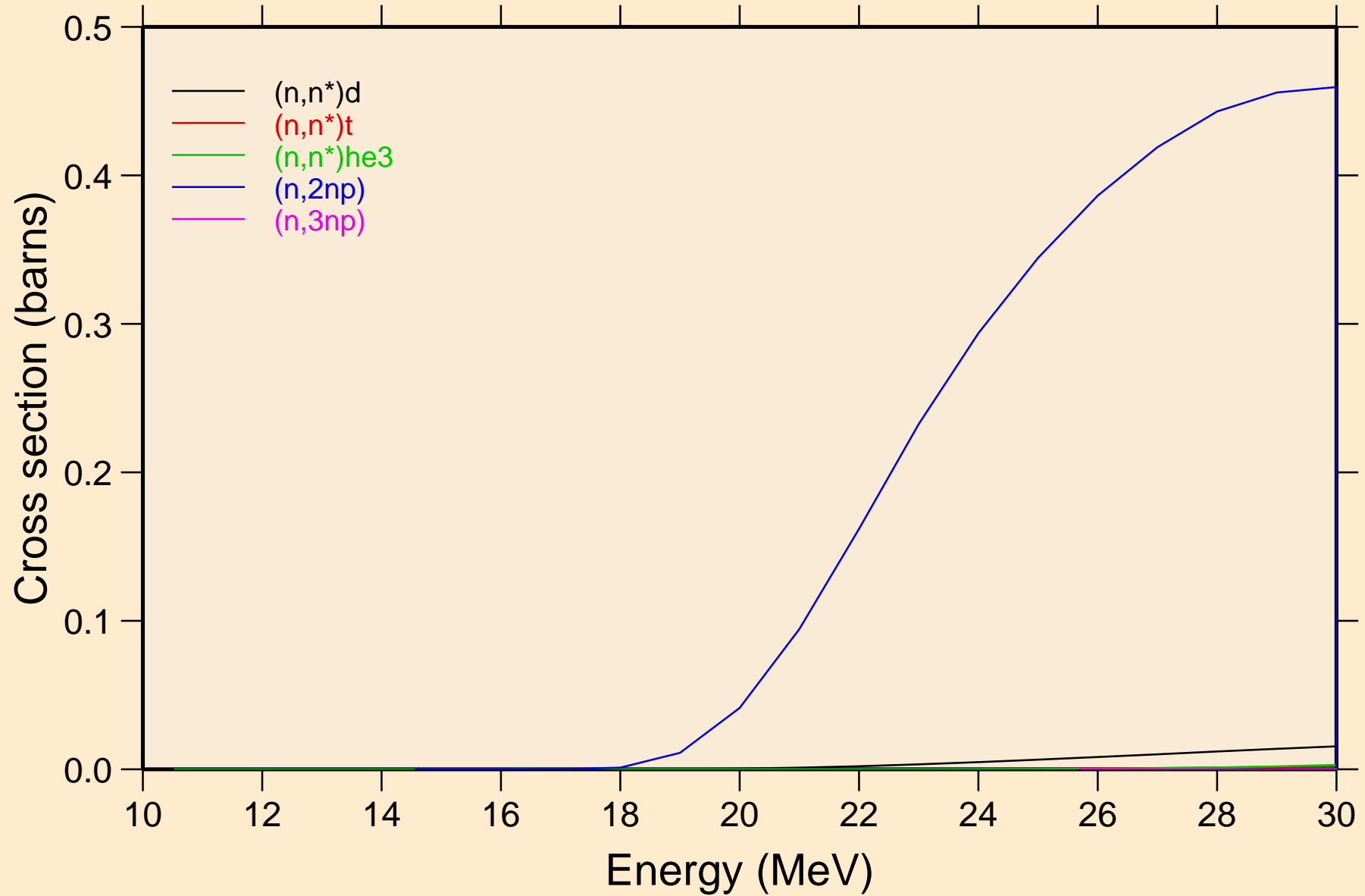

SN109 NEUTRON ACER TENDL-2024 LIBRARY; T=293.6K

Threshold reactions

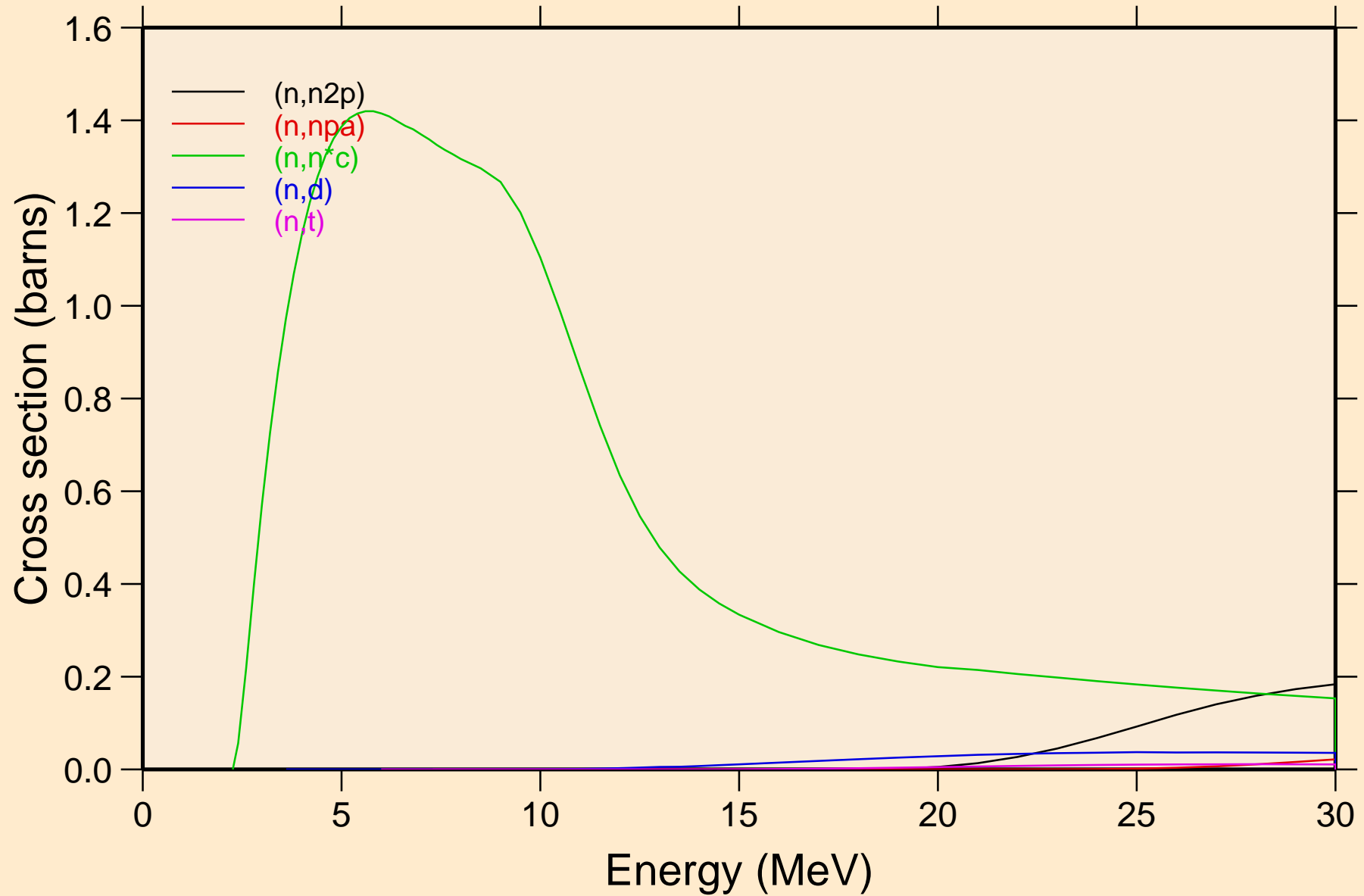

SN109 NEUTRON ACER TENDL-2024 LIBRARY; T=293.6K

Threshold reactions

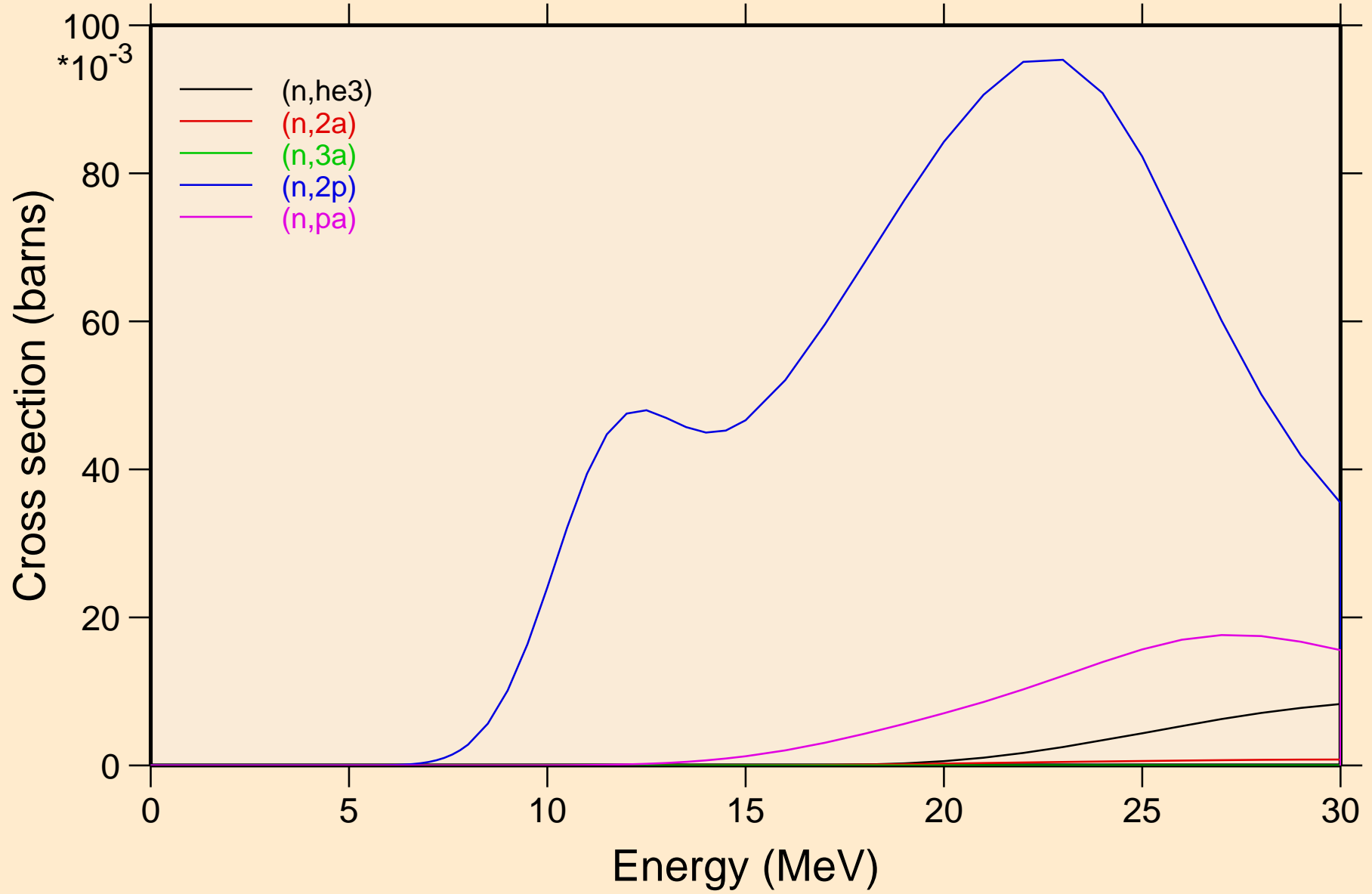

SN109 NEUTRON ACER TENDL-2024 LIBRARY; T=293.6K
Threshold reactions

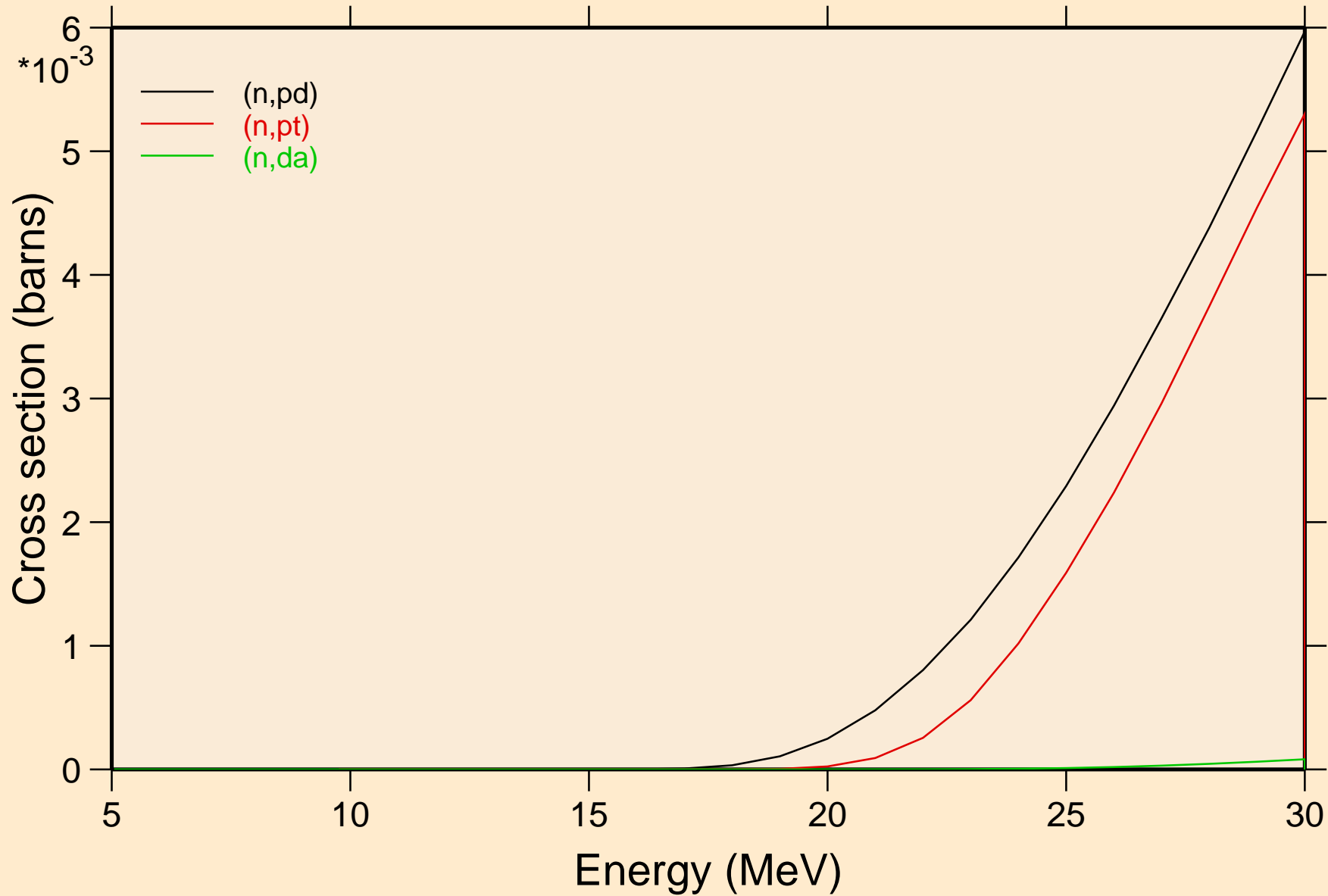

SN109 NEUTRON ACER TENDL-2024 LIBRARY; T=293.6K

Threshold reactions

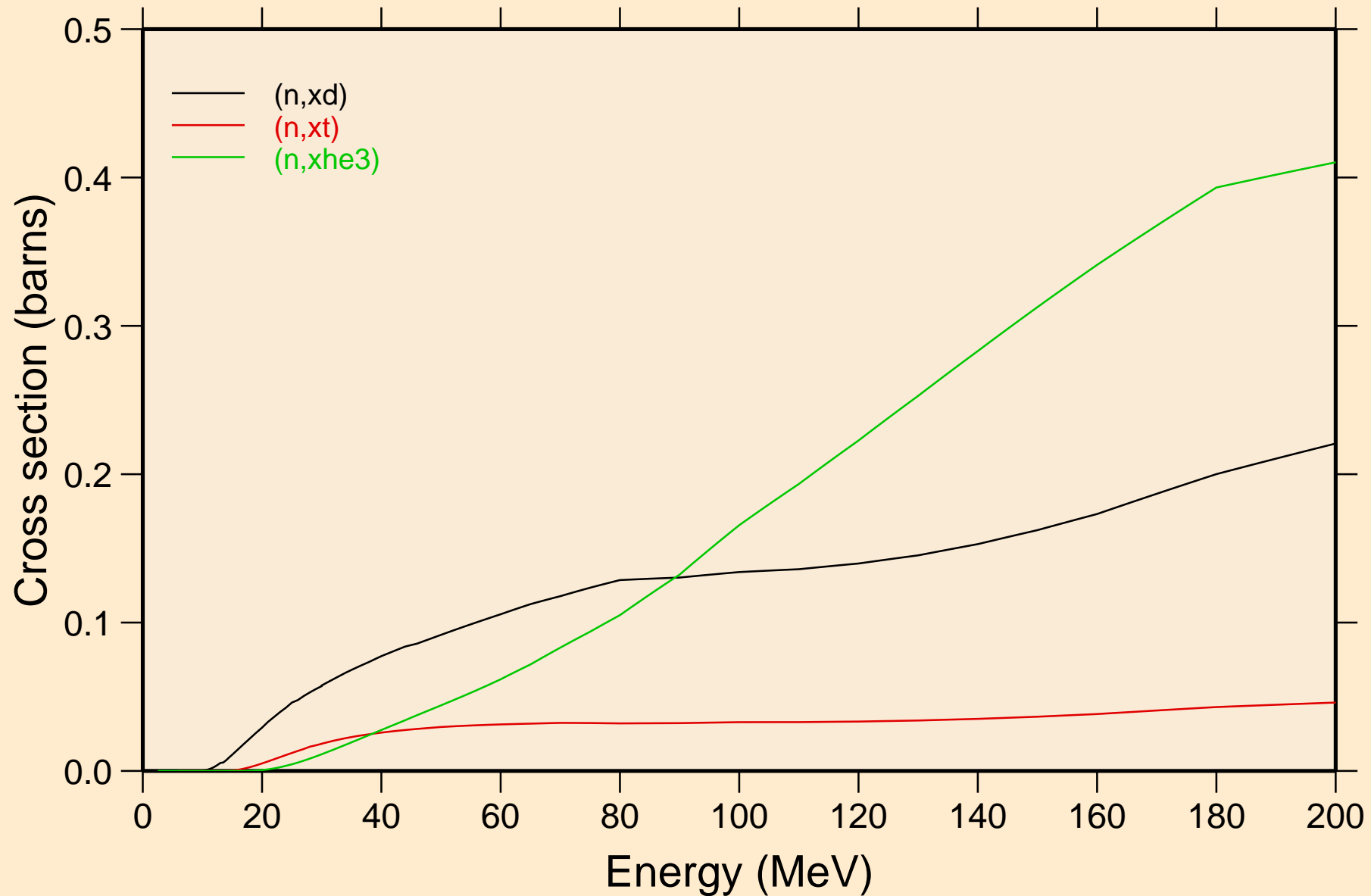

SN109 NEUTRON ACER TENDL-2024 LIBRARY; T=293.6K
angular distribution for elastic

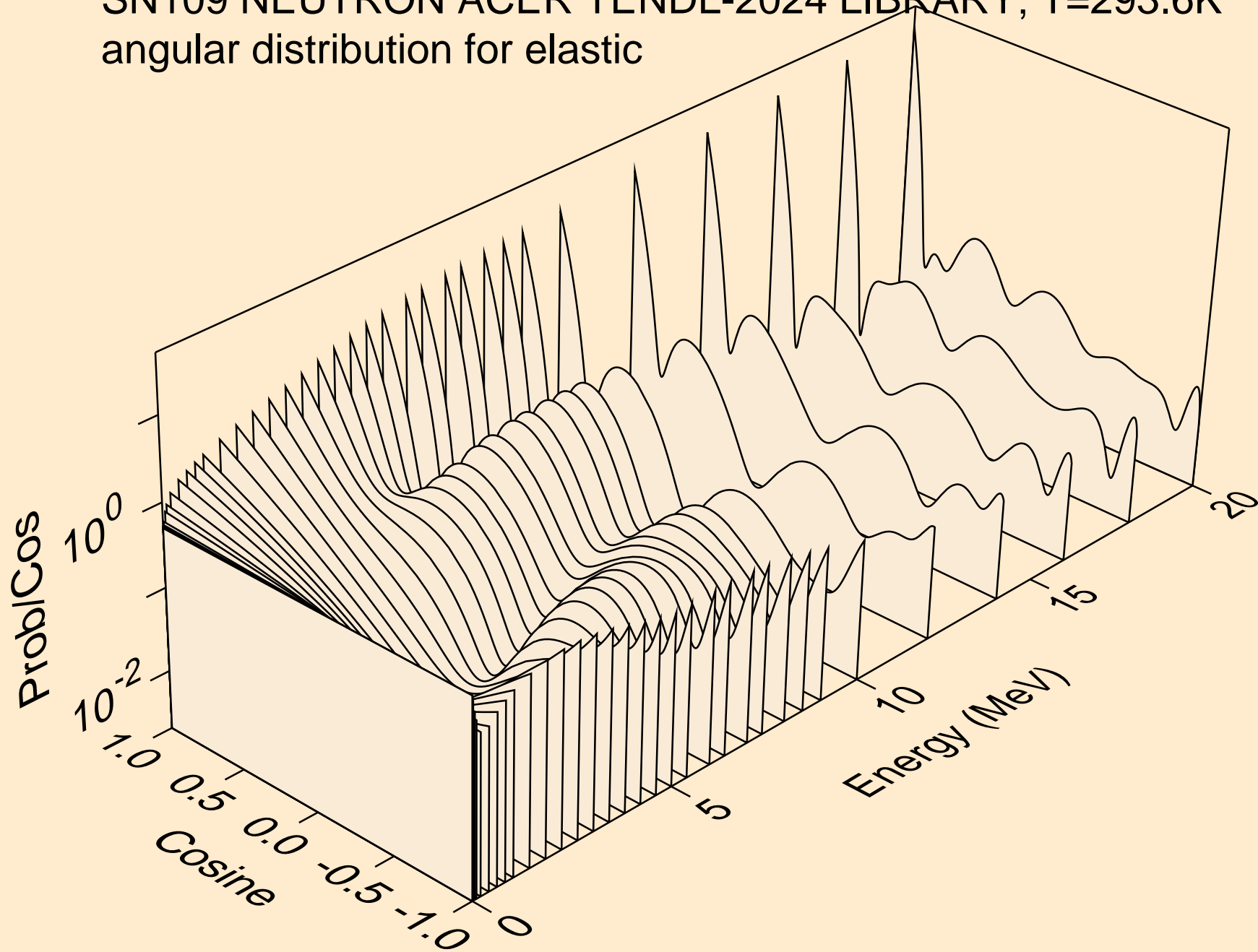

SN109 NEUTRON ACER TENDL-2024 LIBRARY; T=293.6K
angular distribution for elastic

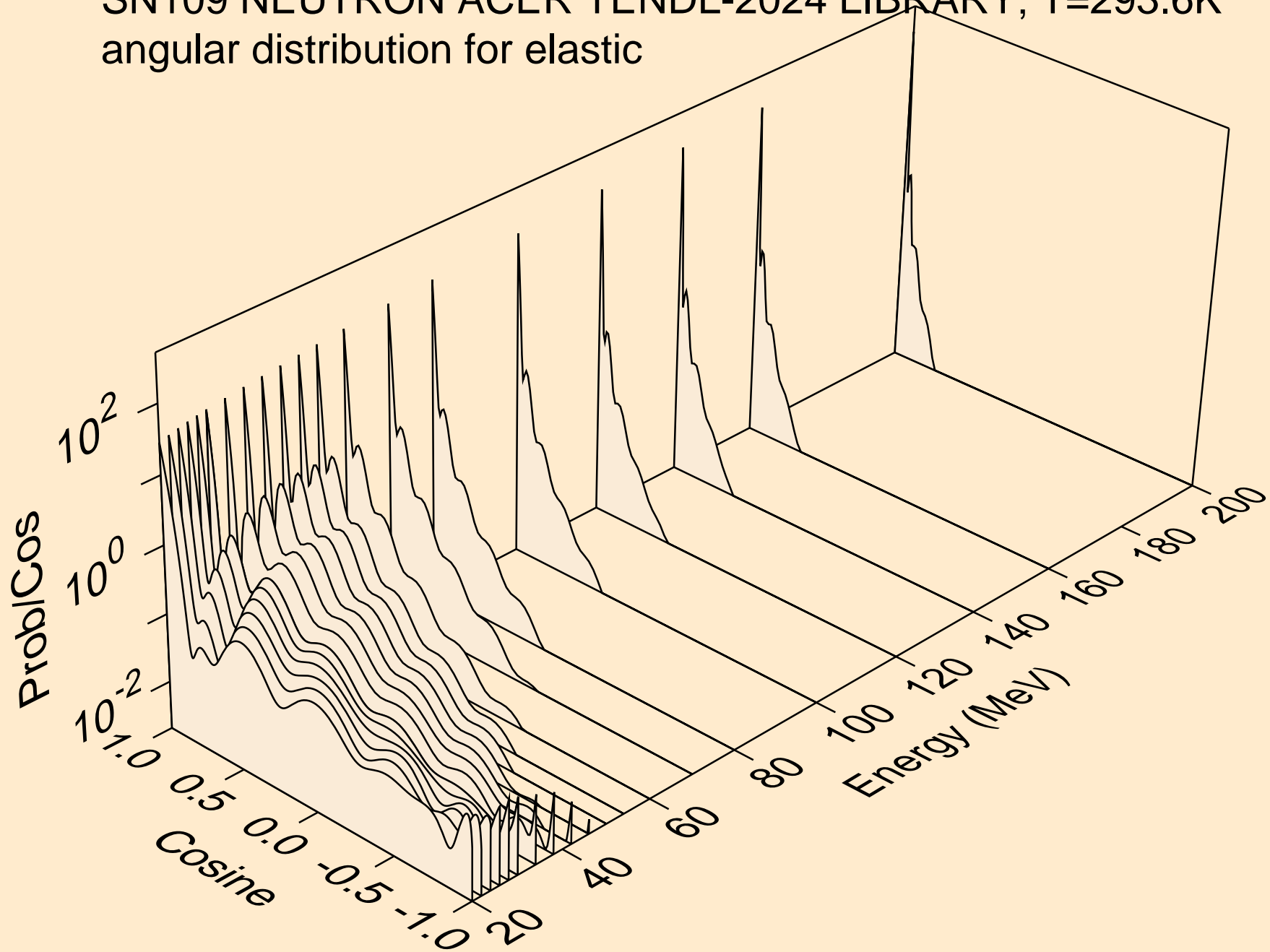

SN109 NEUTRON ACER TENDL-2024 LIBRARY; T=293.6K
angular distribution for (n,n*1)

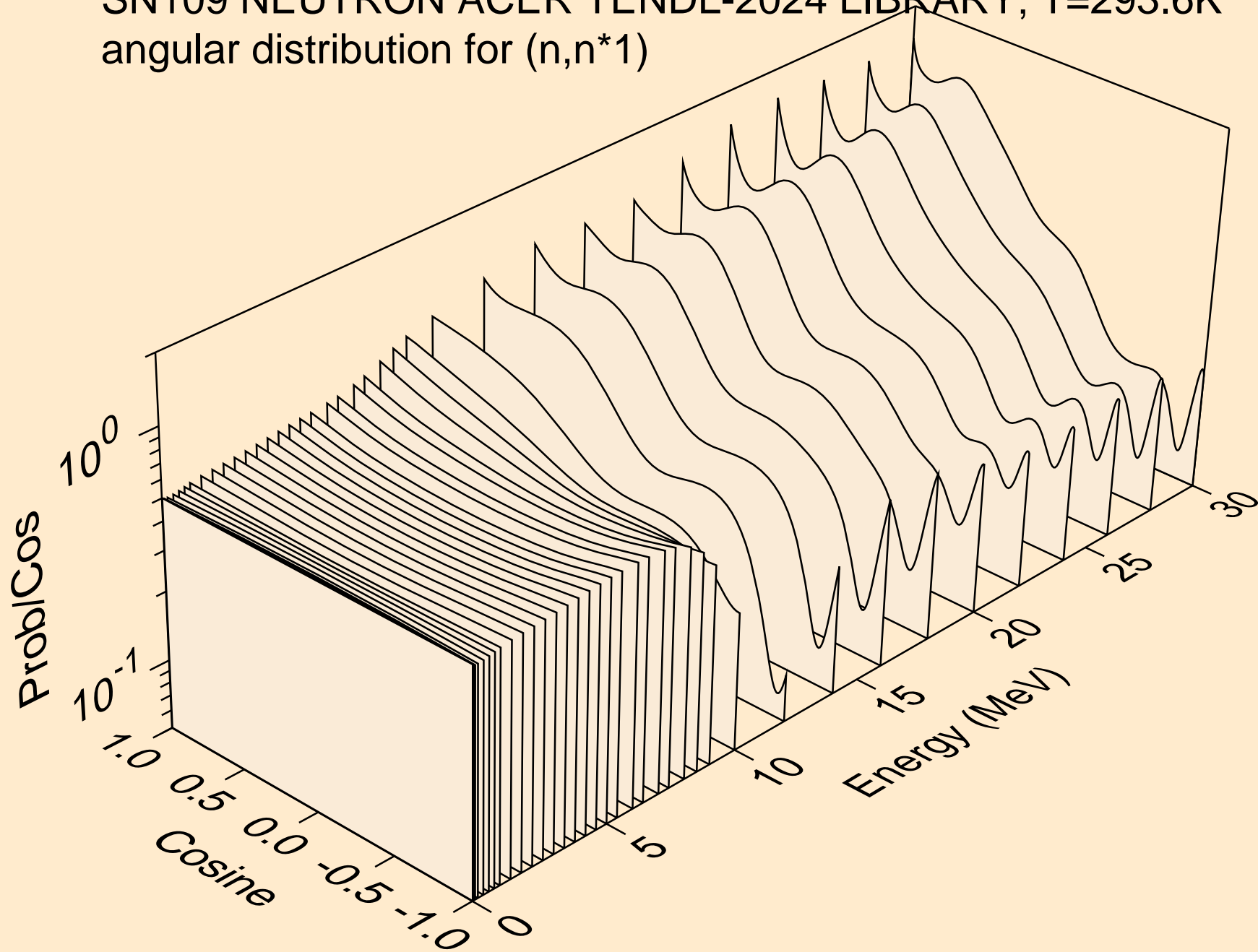

SN109 NEUTRON ACER TENDL-2024 LIBRARY; T=293.6K
angular distribution for (n,n*2)

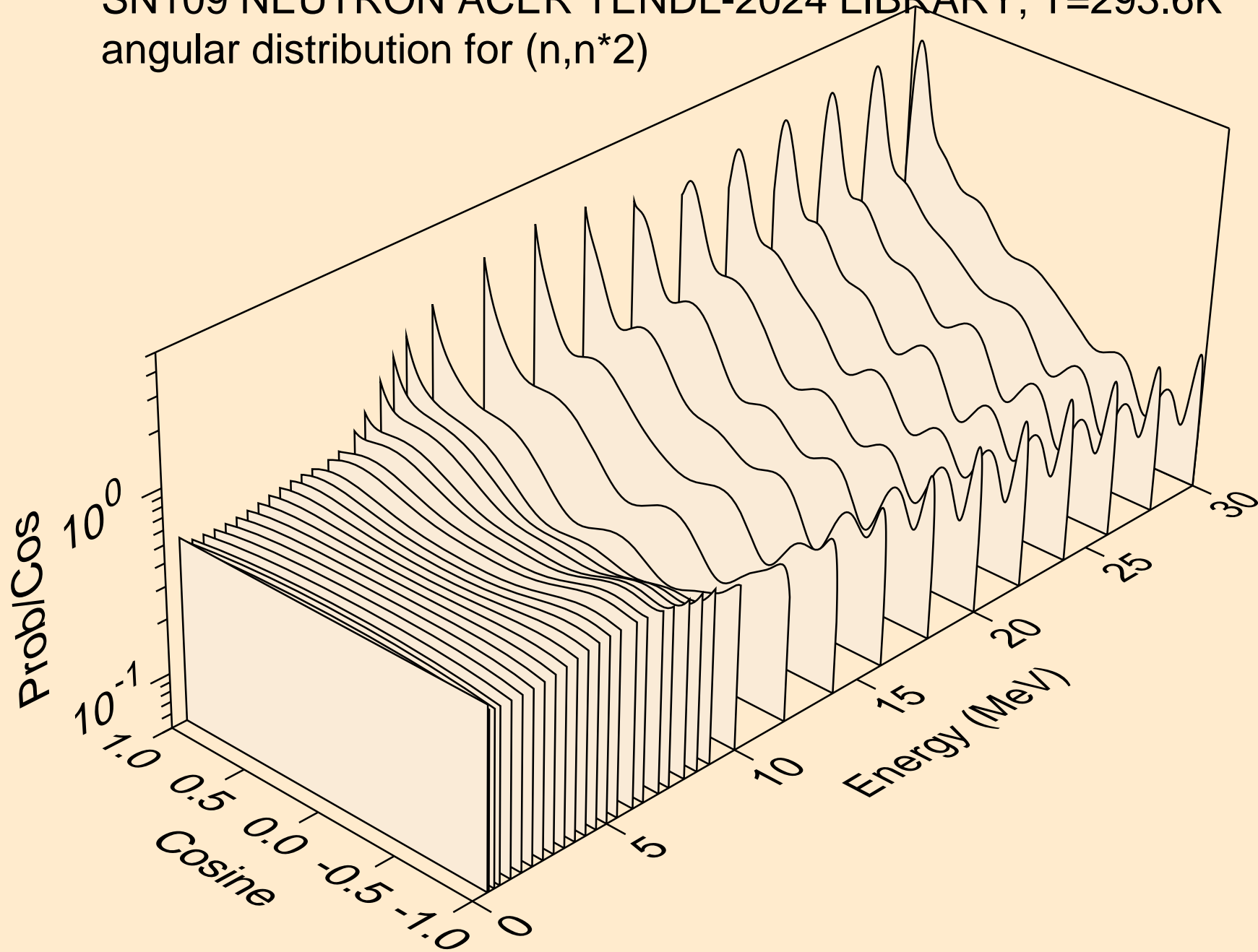

SN109 NEUTRON ACER TENDL-2024 LIBRARY; T=293.6K
angular distribution for (n,n*3)

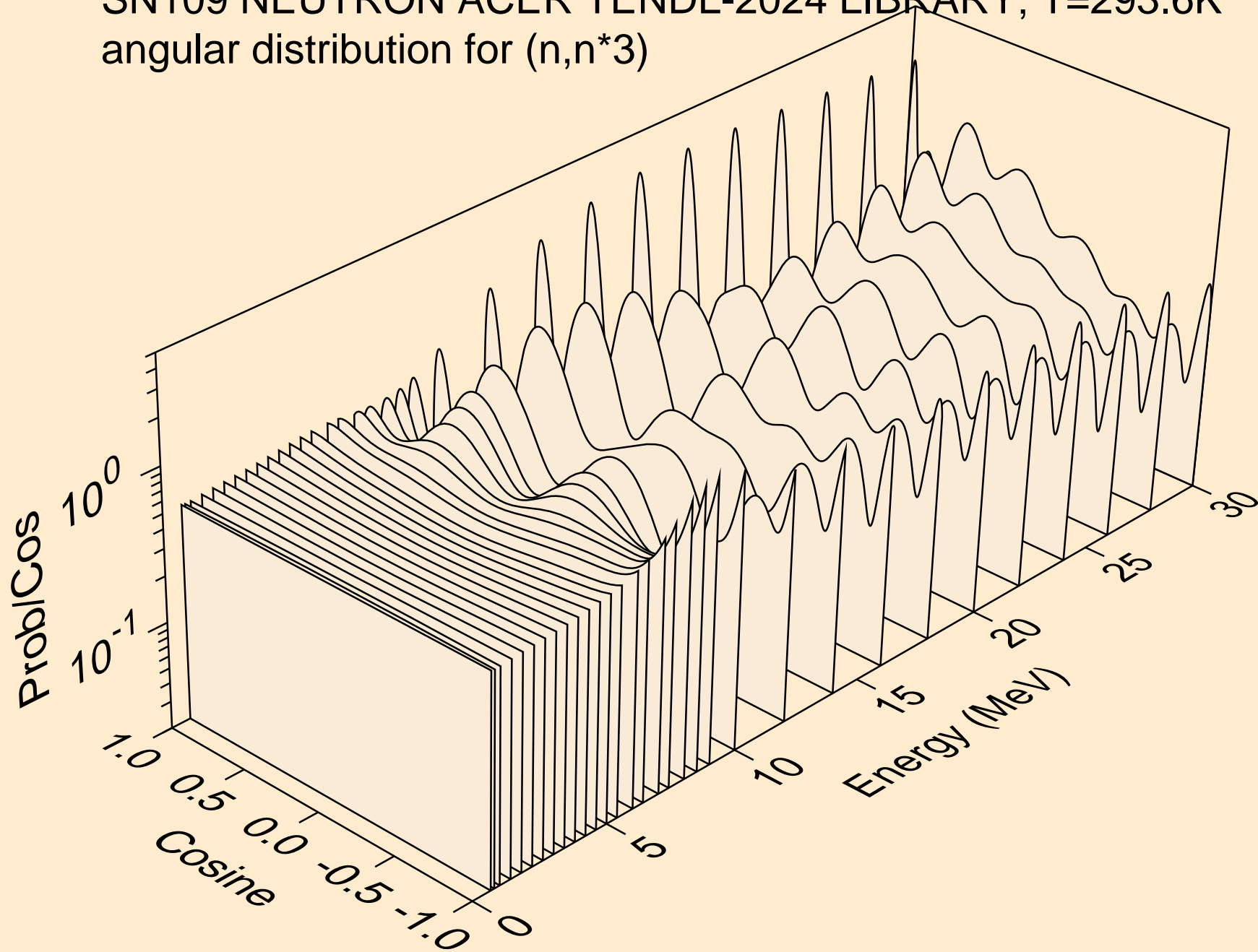

SN109 NEUTRON ACER TENDL-2024 LIBRARY; T=293.6K
angular distribution for (n,n*4)

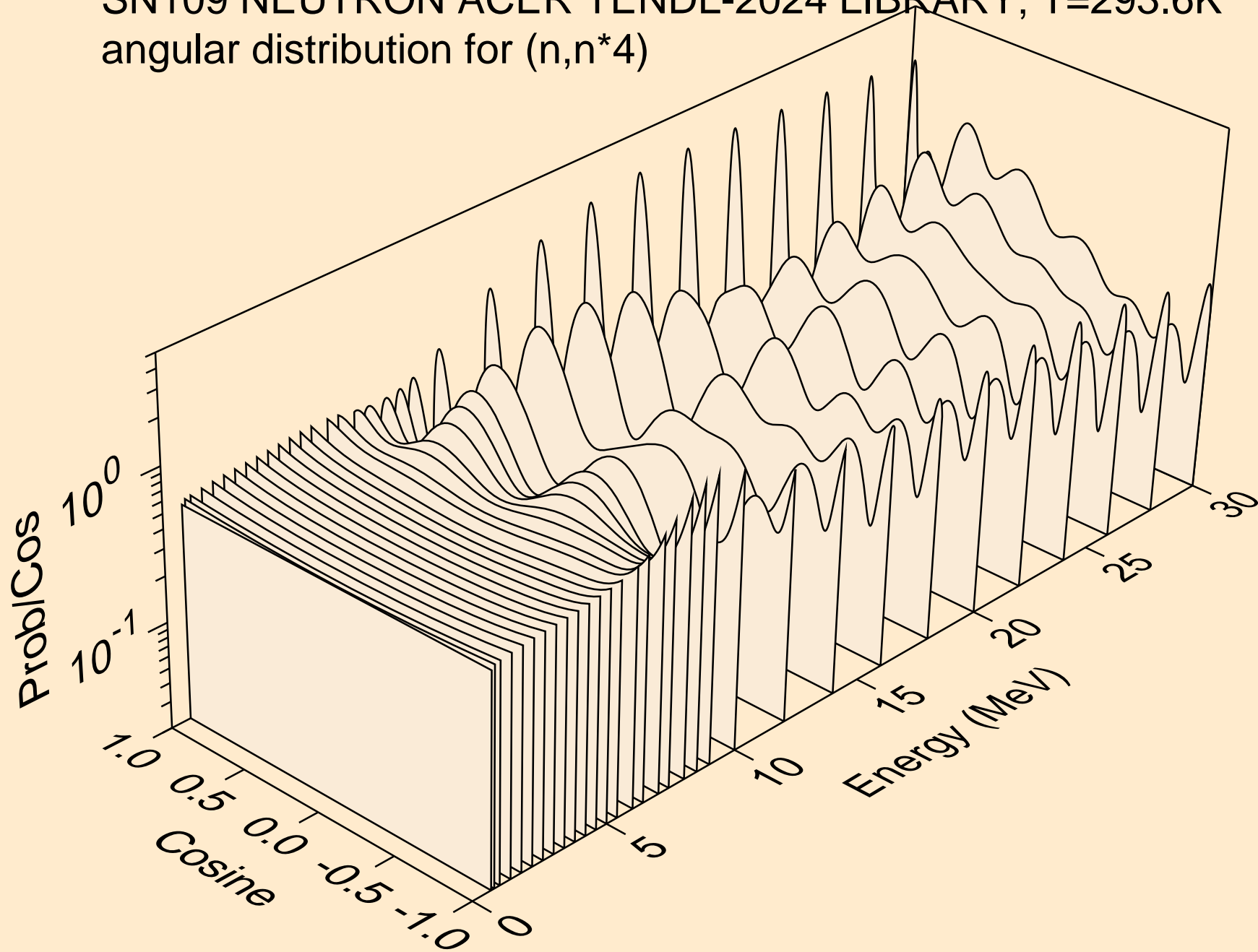

SN109 NEUTRON ACER TENDL-2024 LIBRARY; T=293.6K
angular distribution for (n,n*5)

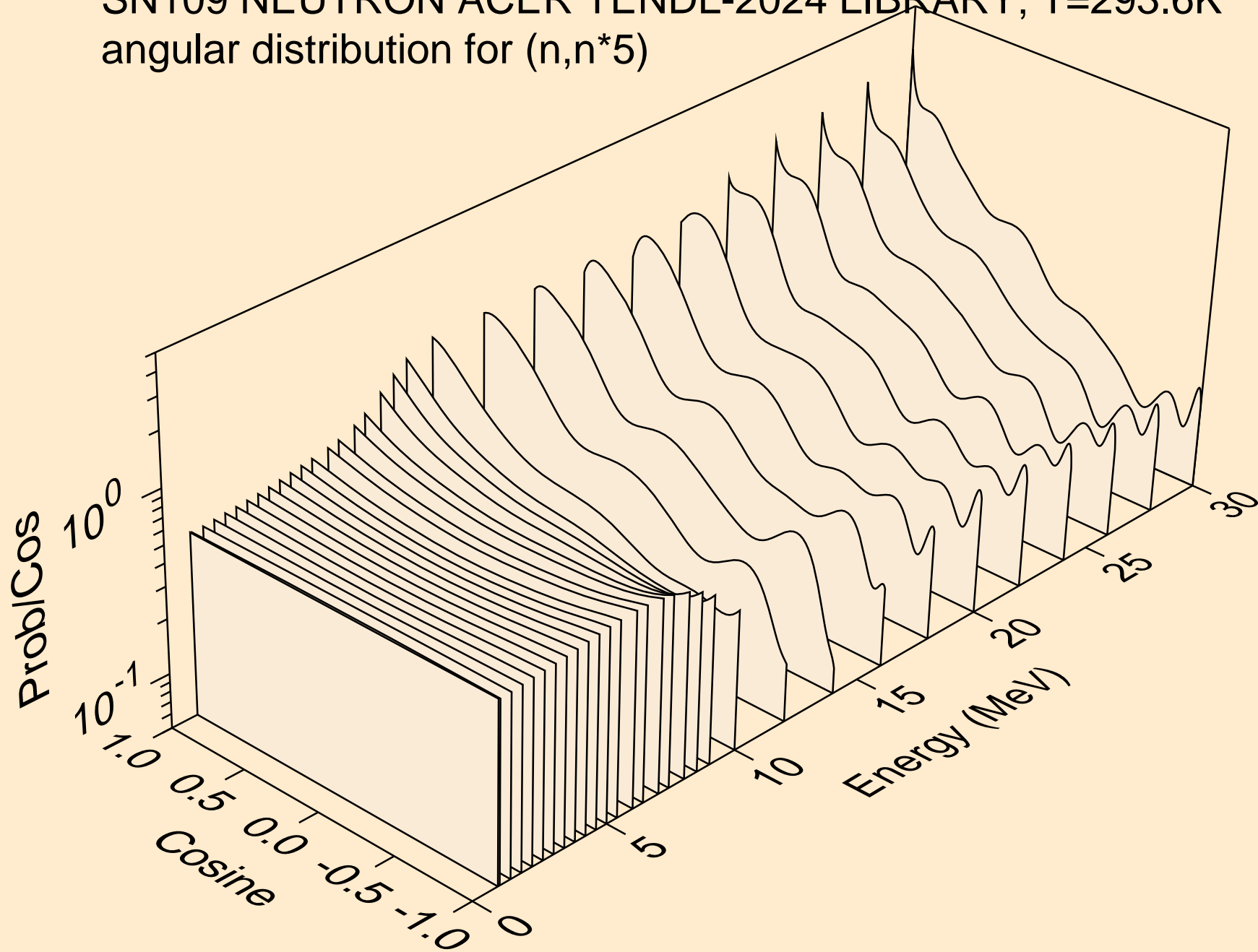

SN109 NEUTRON ACER TENDL-2024 LIBRARY; T=293.6K
angular distribution for (n,n*6)

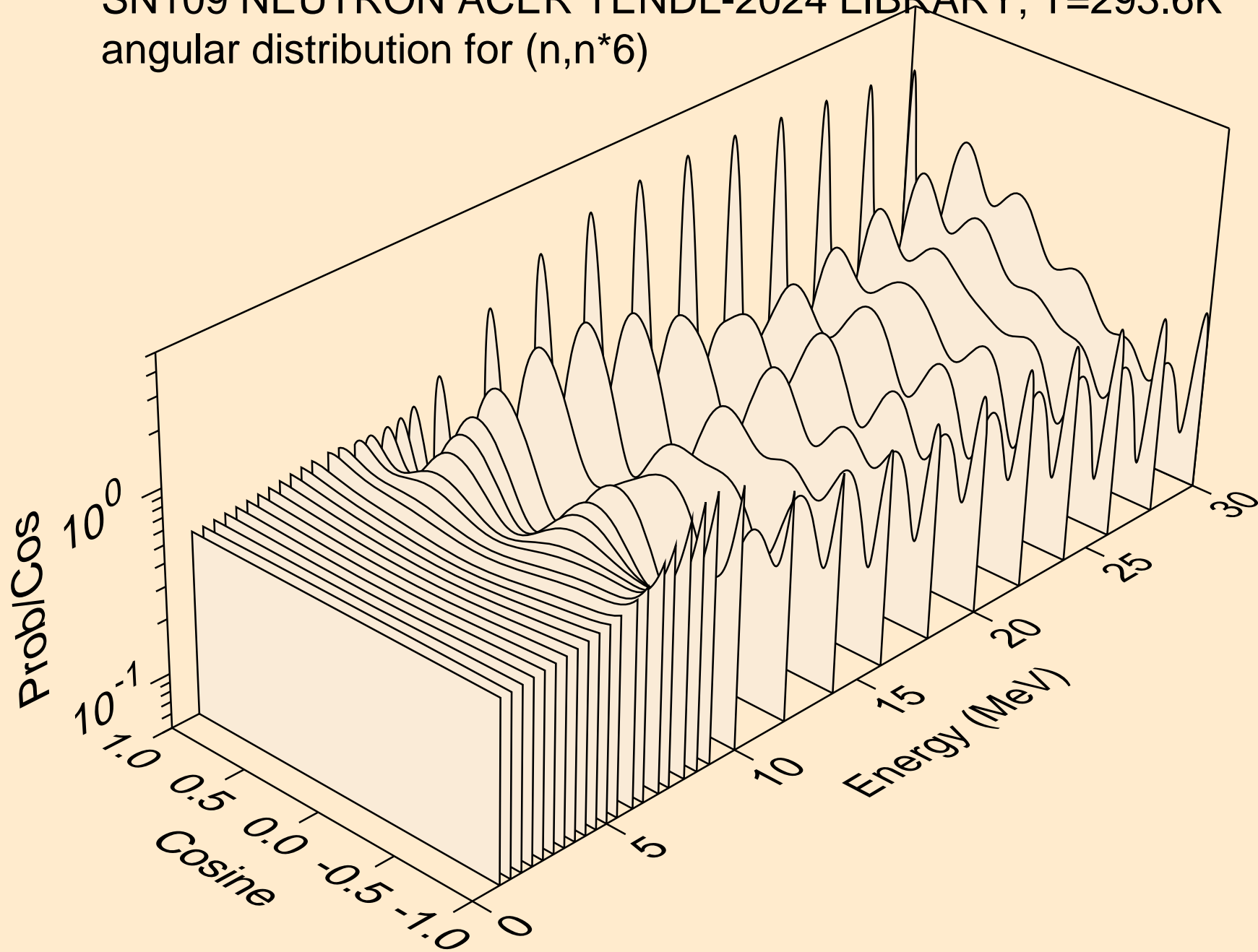

SN109 NEUTRON ACER TENDL-2024 LIBRARY; T=293.6K
angular distribution for (n,n*7)

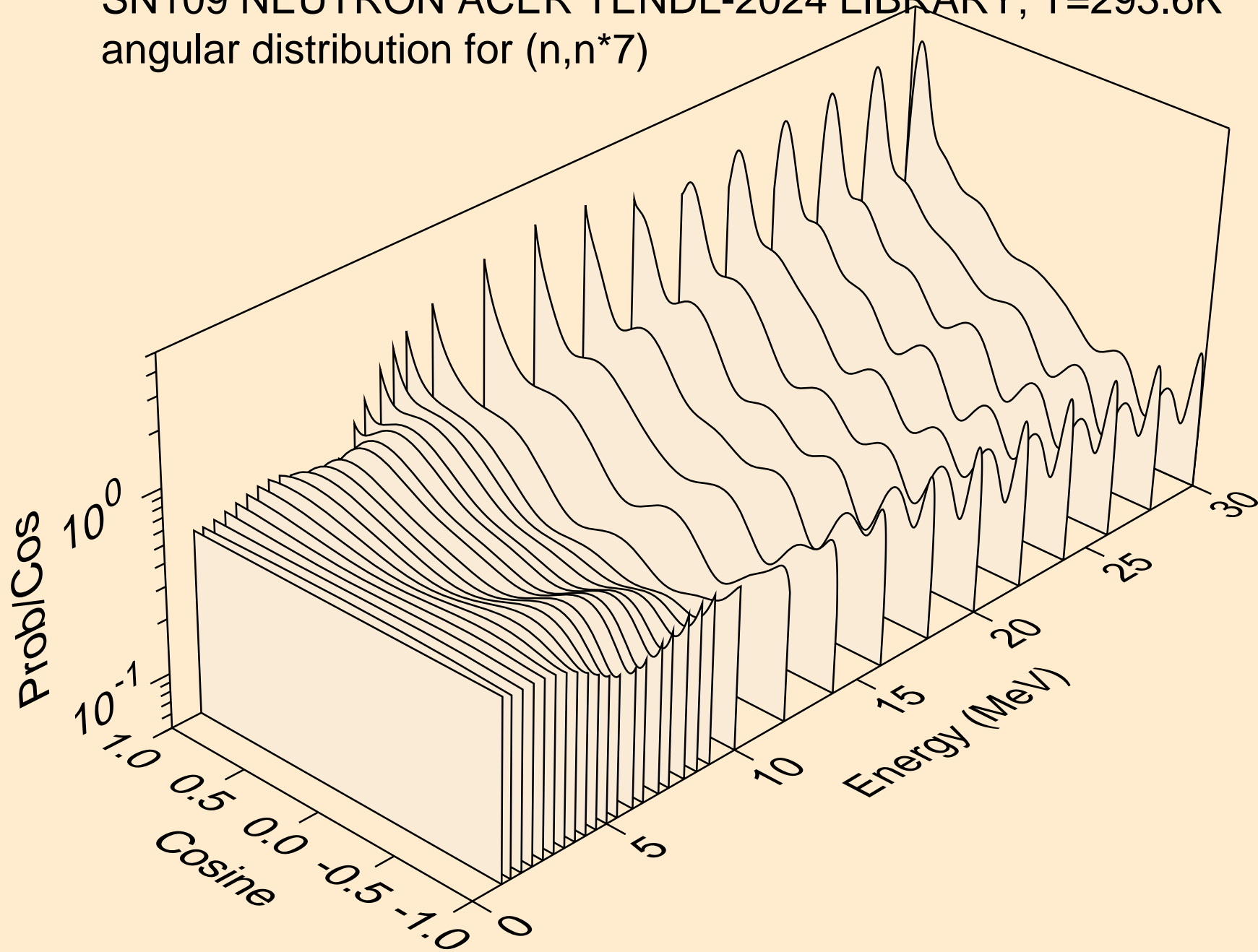

SN109 NEUTRON ACER TENDL-2024 LIBRARY; T=293.6K
angular distribution for (n,n*8)

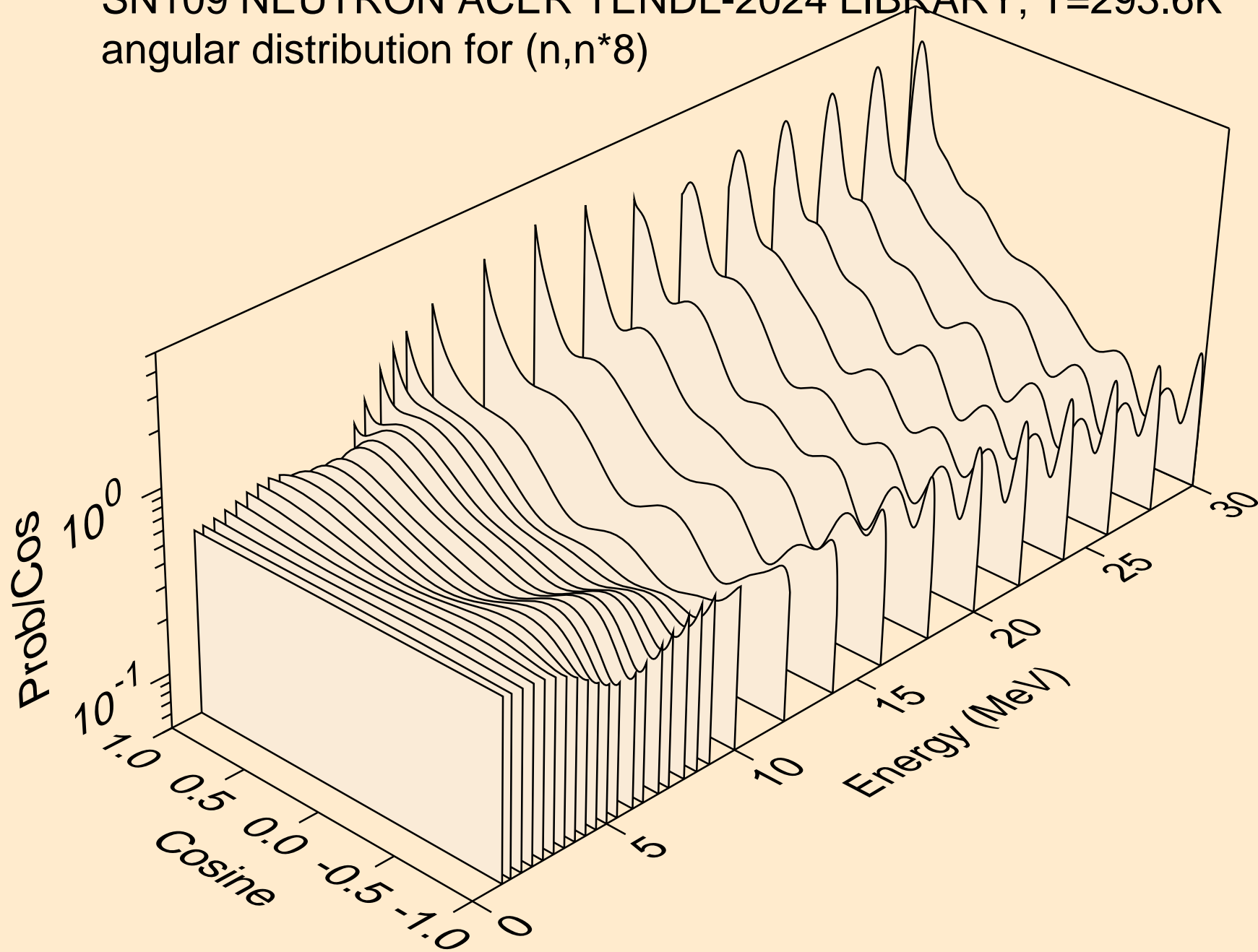

SN109 NEUTRON ACER TENDL-2024 LIBRARY; T=293.6K
angular distribution for (n,n*9)

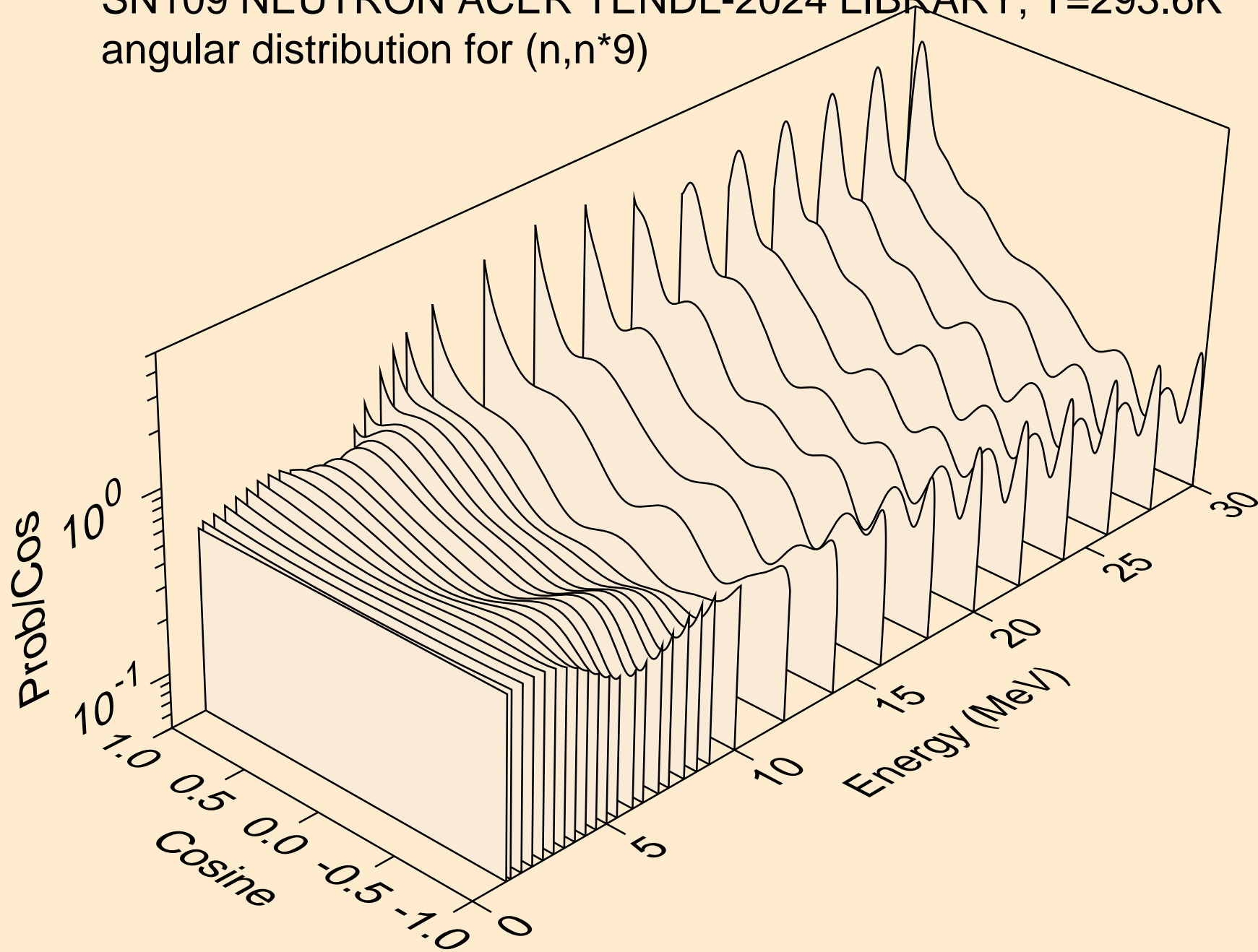

SN109 NEUTRON ACER TENDL-2024 LIBRARY; T=293.6K
angular distribution for (n,n*10)

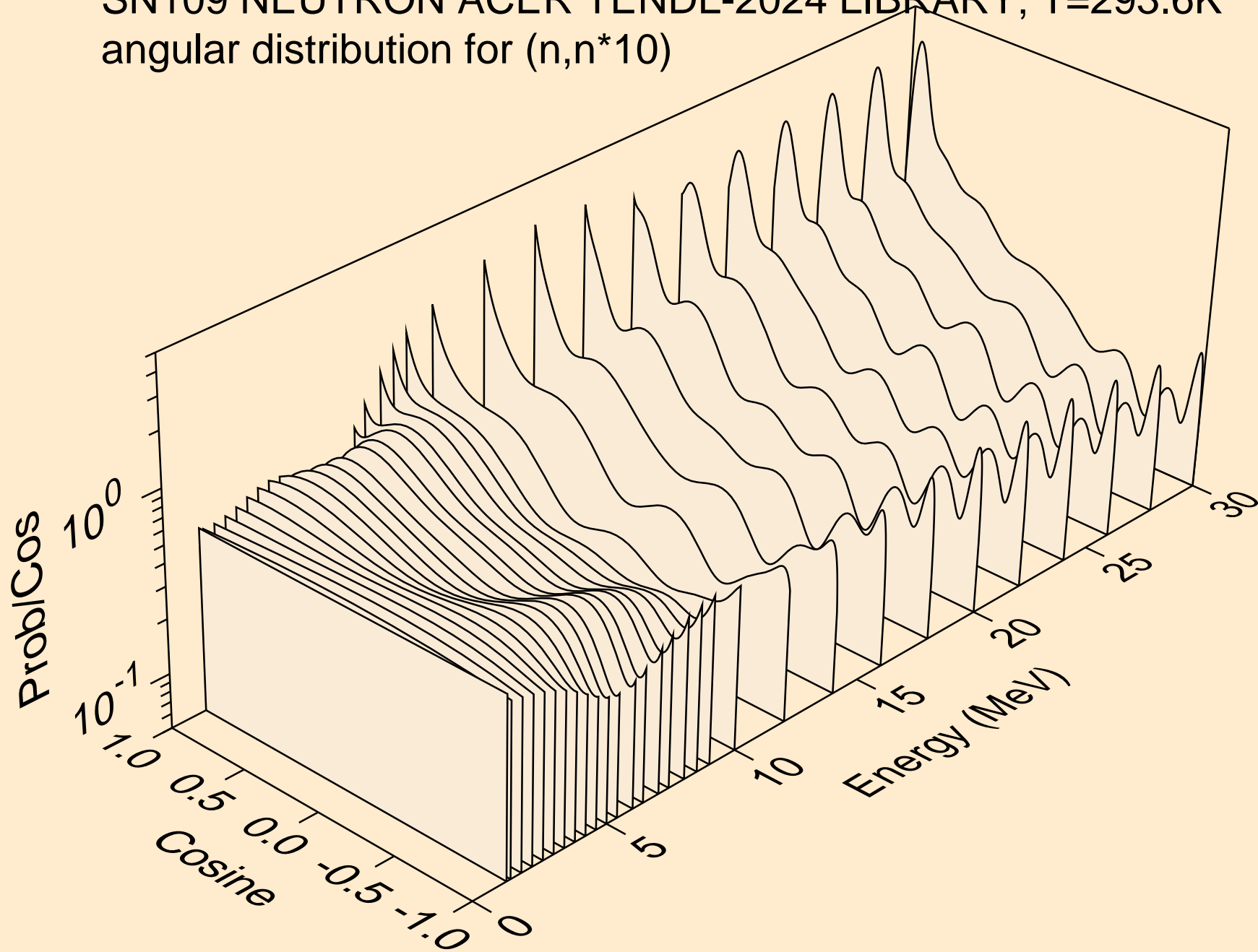

SN109 NEUTRON ACER TENDL-2024 LIBRARY; T=293.6K
angular distribution for (n,n*11)

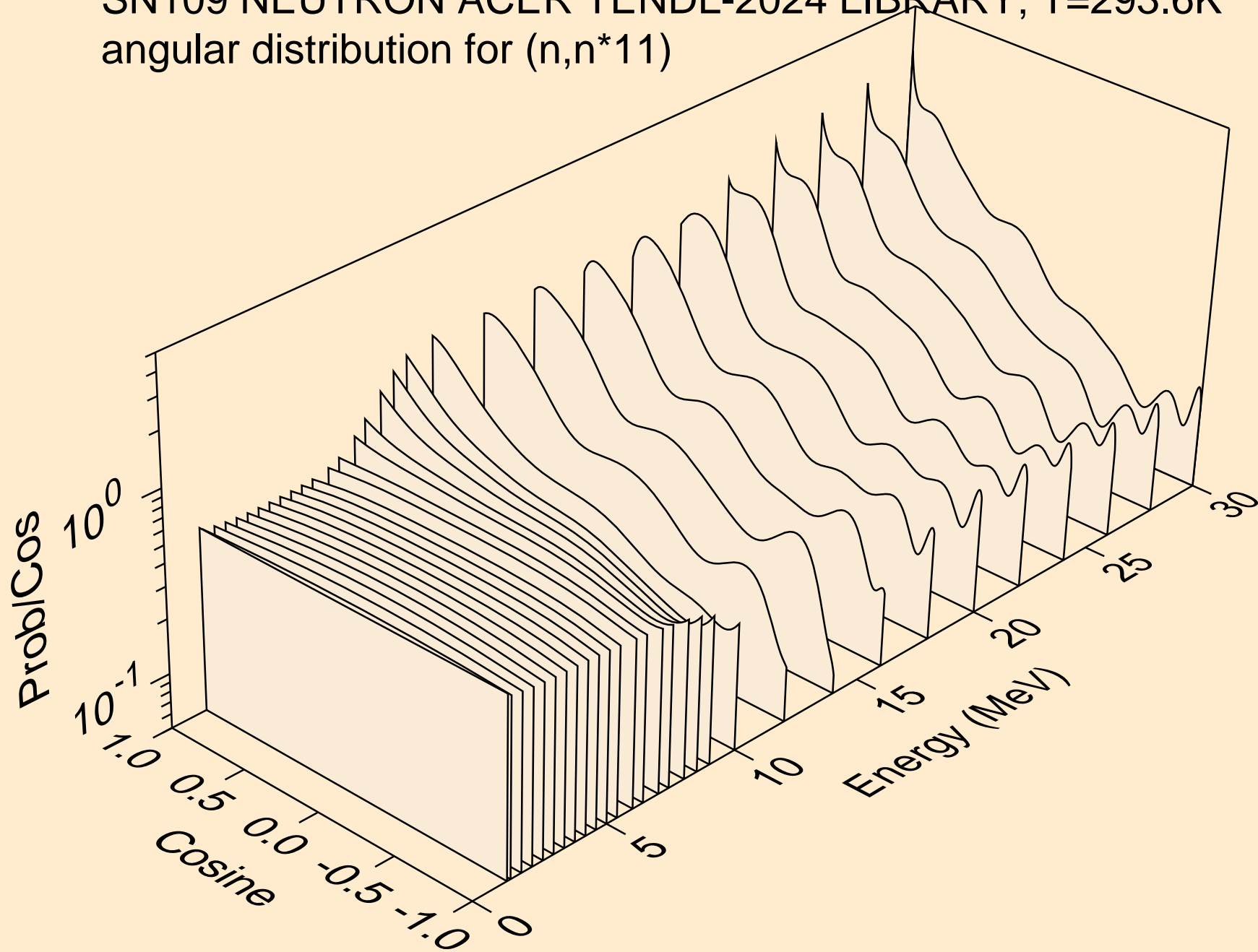

SN109 NEUTRON ACER TENDL-2024 LIBRARY; T=293.6K
angular distribution for (n,n*12)

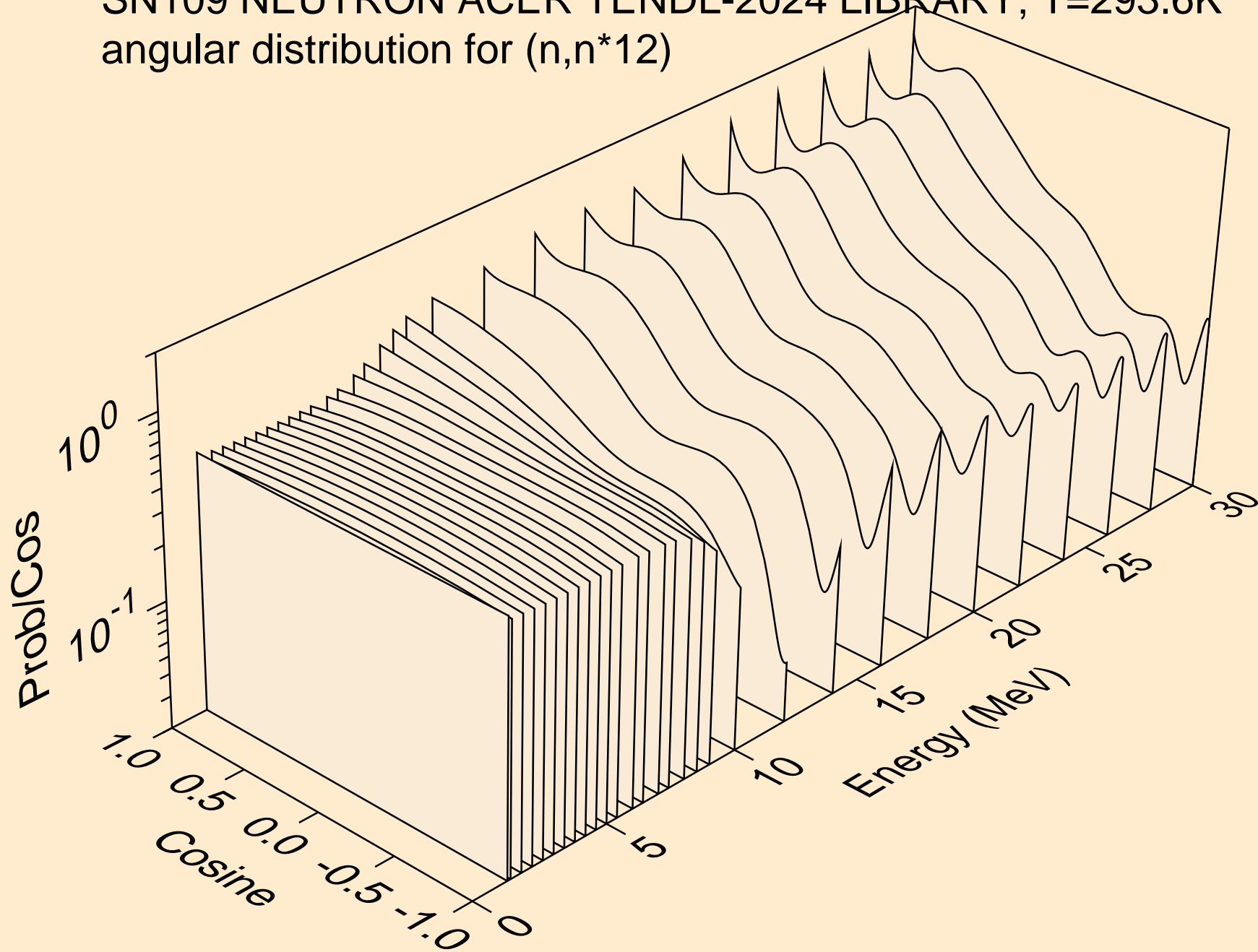

SN109 NEUTRON ACER TENDL-2024 LIBRARY; T=293.6K
angular distribution for (n,n*13)

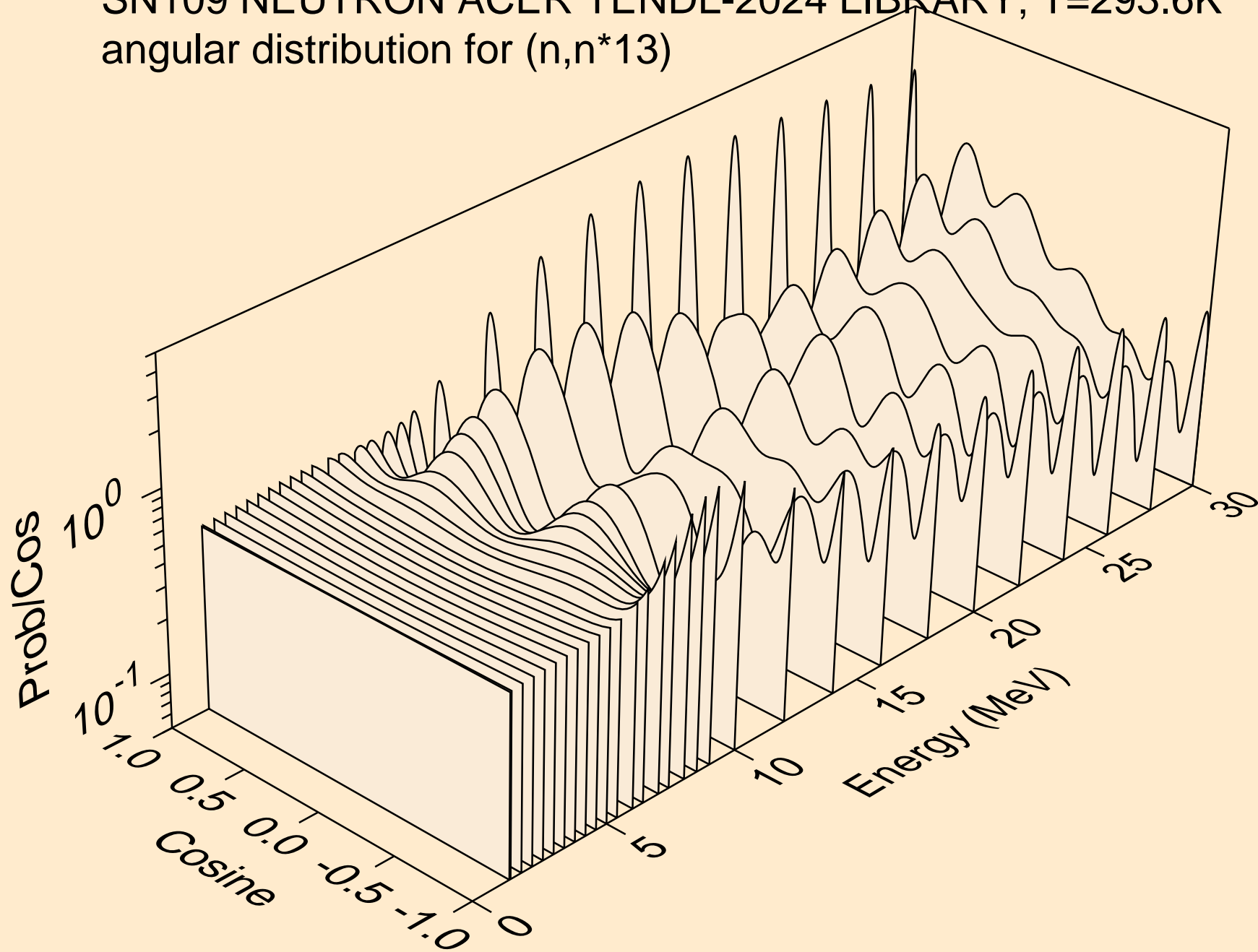

SN109 NEUTRON ACER TENDL-2024 LIBRARY; T=293.6K
angular distribution for (n,n*14)

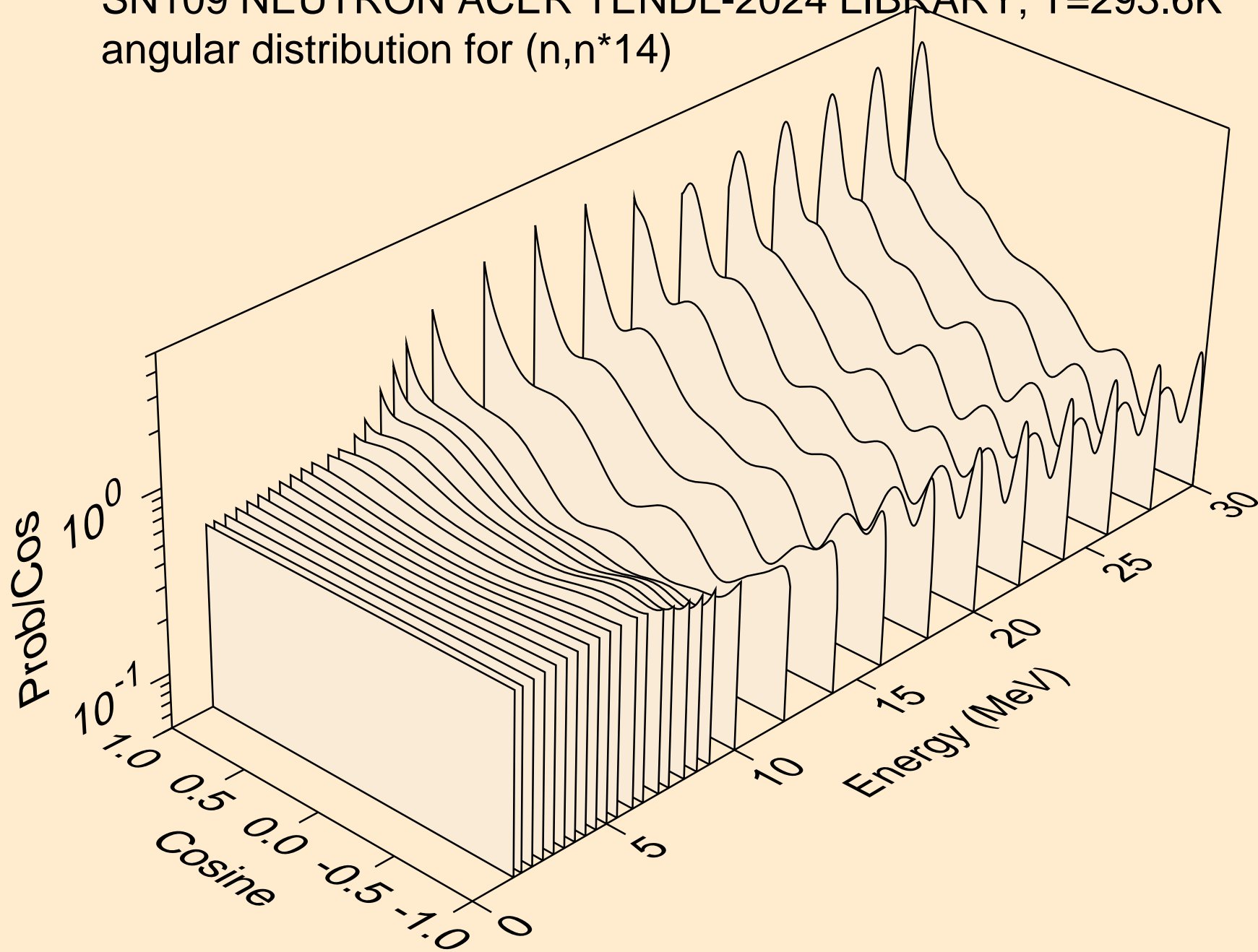

SN109 NEUTRON ACER TENDL-2024 LIBRARY; T=293.6K
angular distribution for (n,n*15)

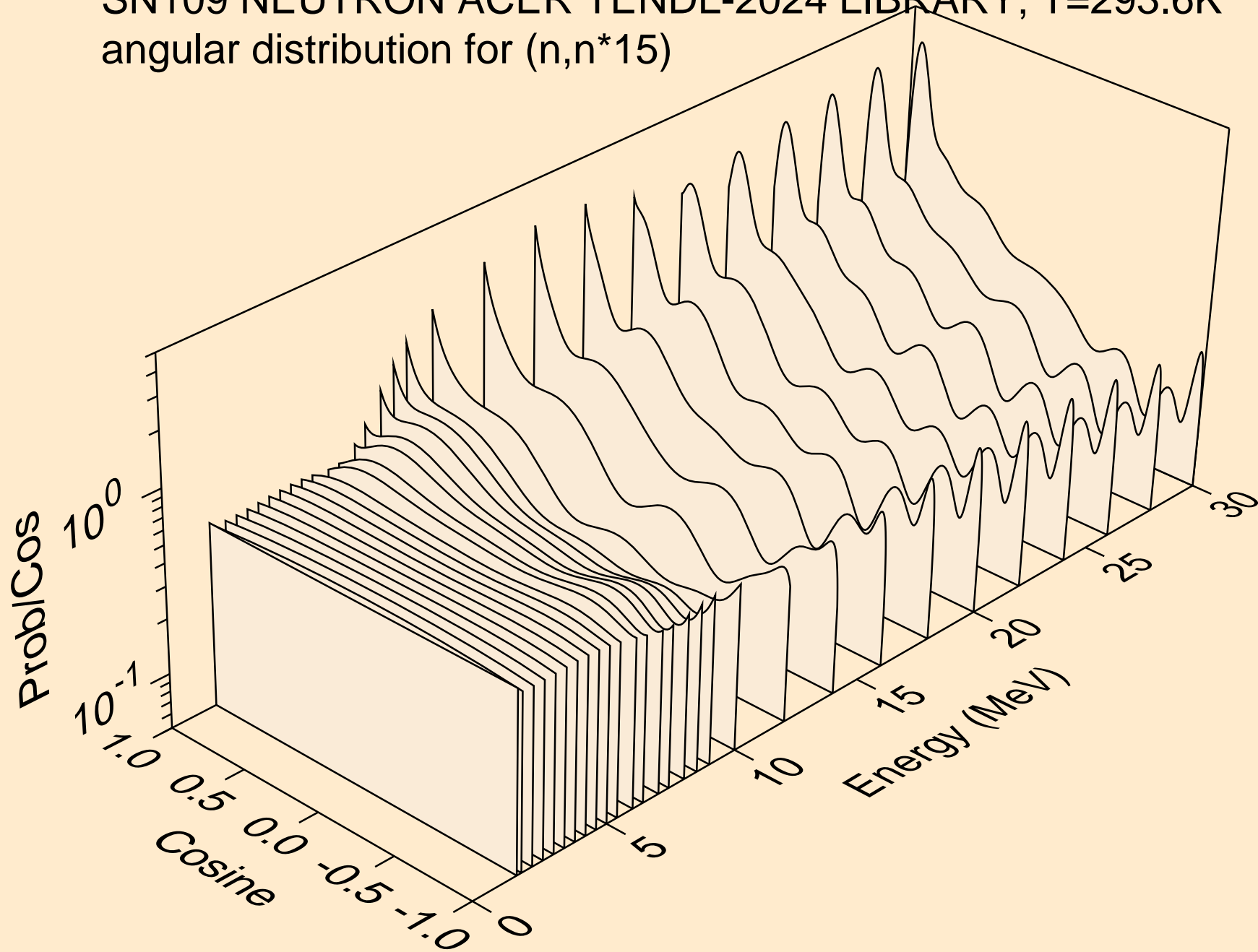

SN109 NEUTRON ACER TENDL-2024 LIBRARY; T=293.6K
angular distribution for (n,n*16)

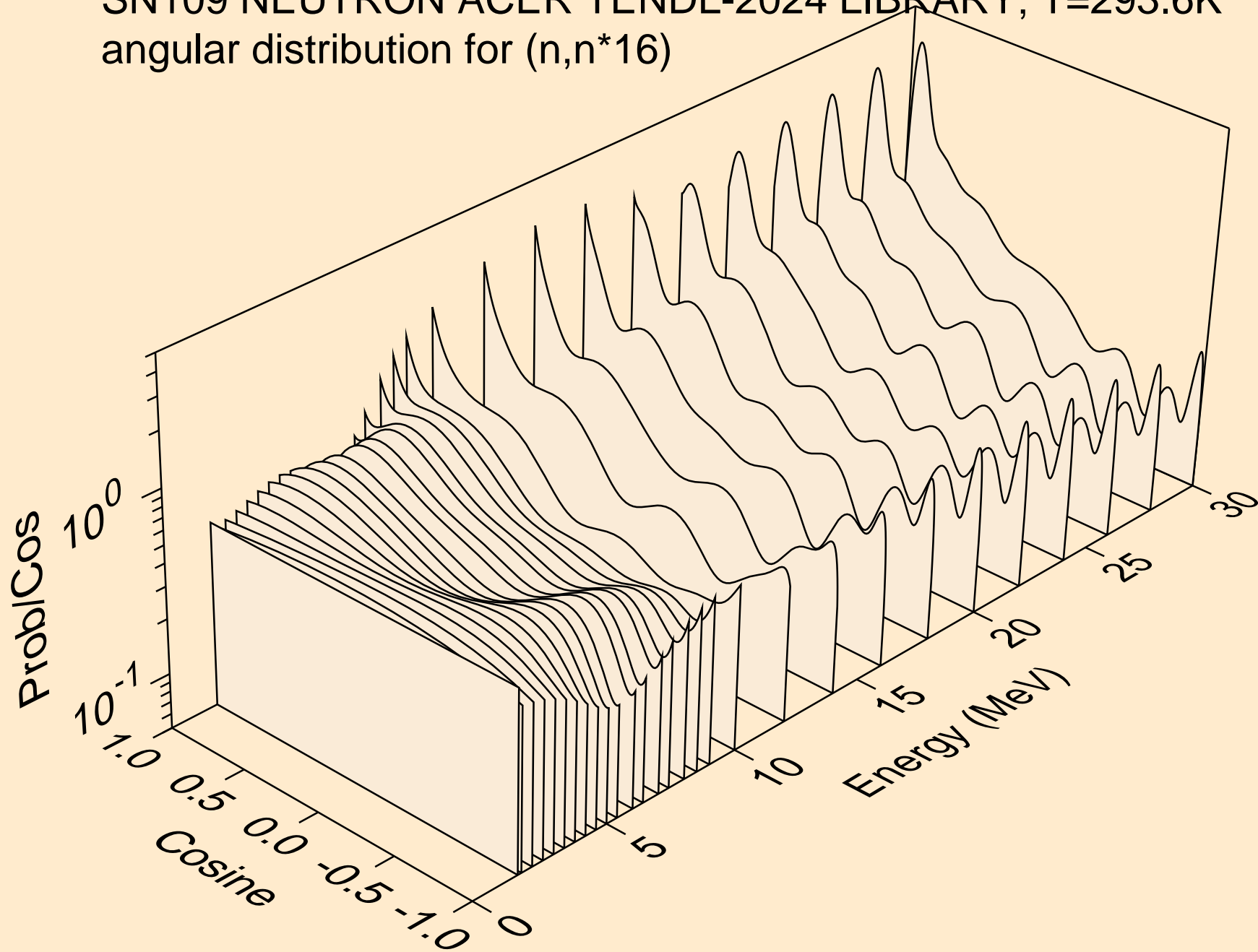

SN109 NEUTRON ACER TENDL-2024 LIBRARY; T=293.6K
angular distribution for (n,n*17)

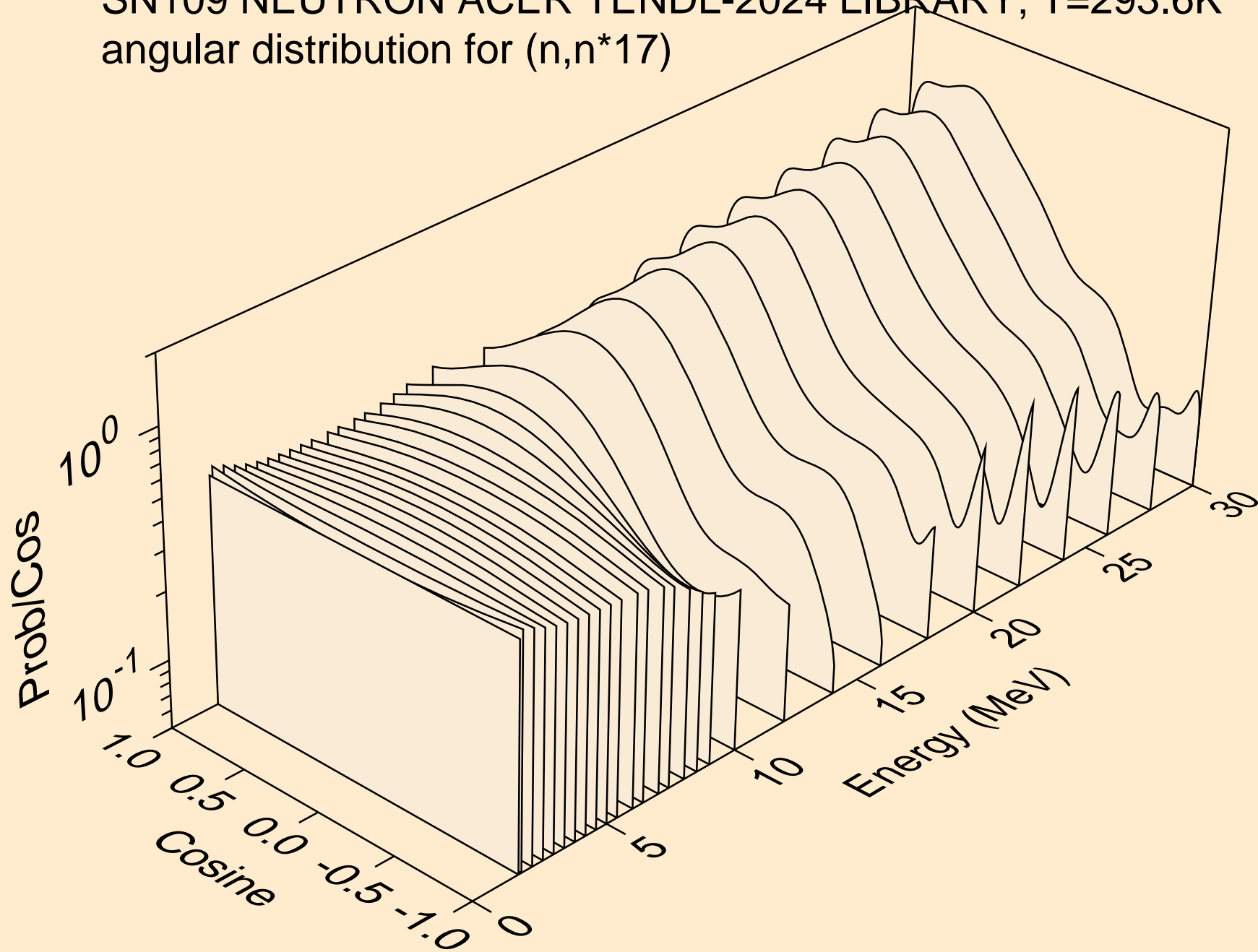

SN109 NEUTRON ACER TENDL-2024 LIBRARY; T=293.6K
angular distribution for (n,n*18)

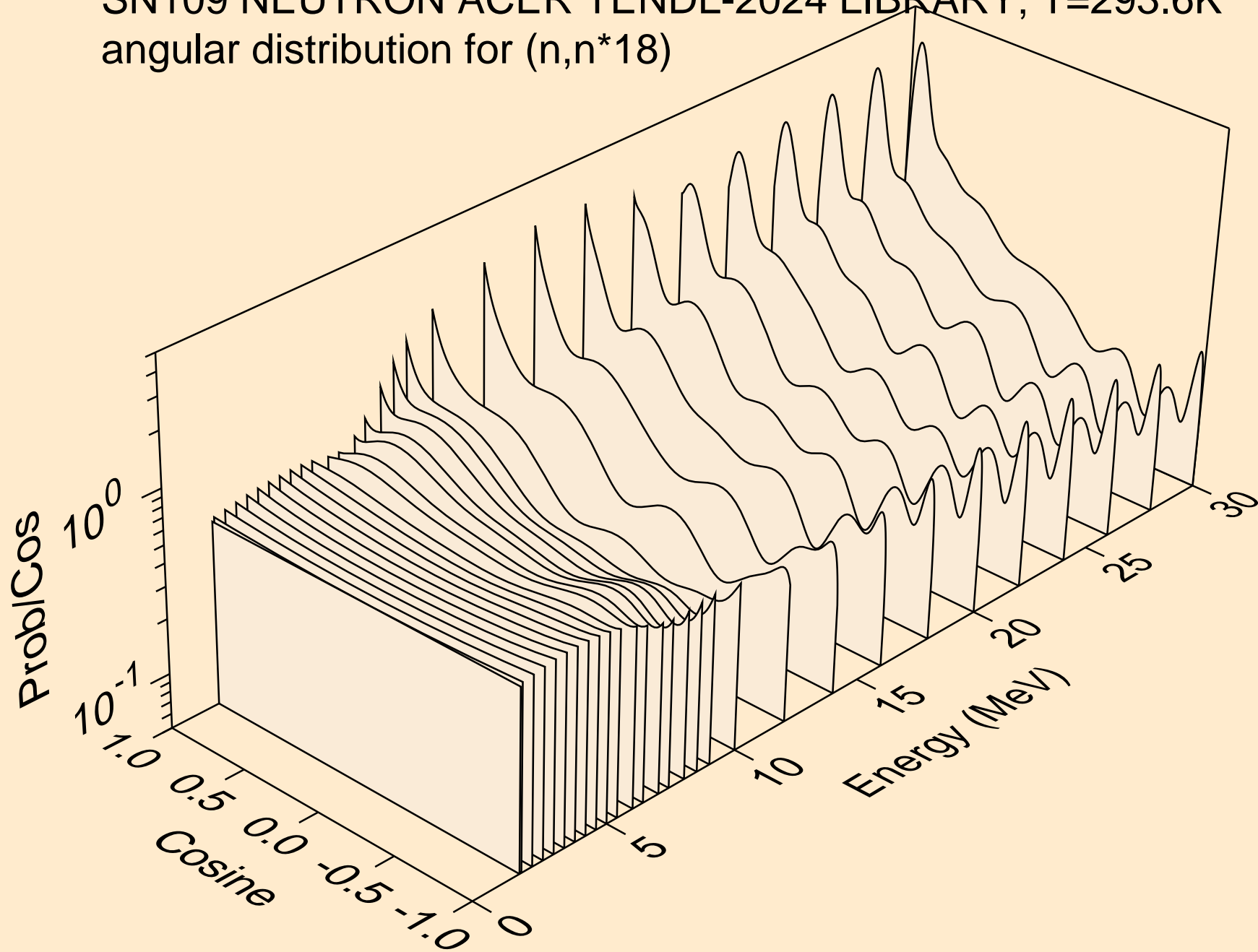

SN109 NEUTRON ACER TENDL-2024 LIBRARY; T=293.6K
angular distribution for (n,n*19)

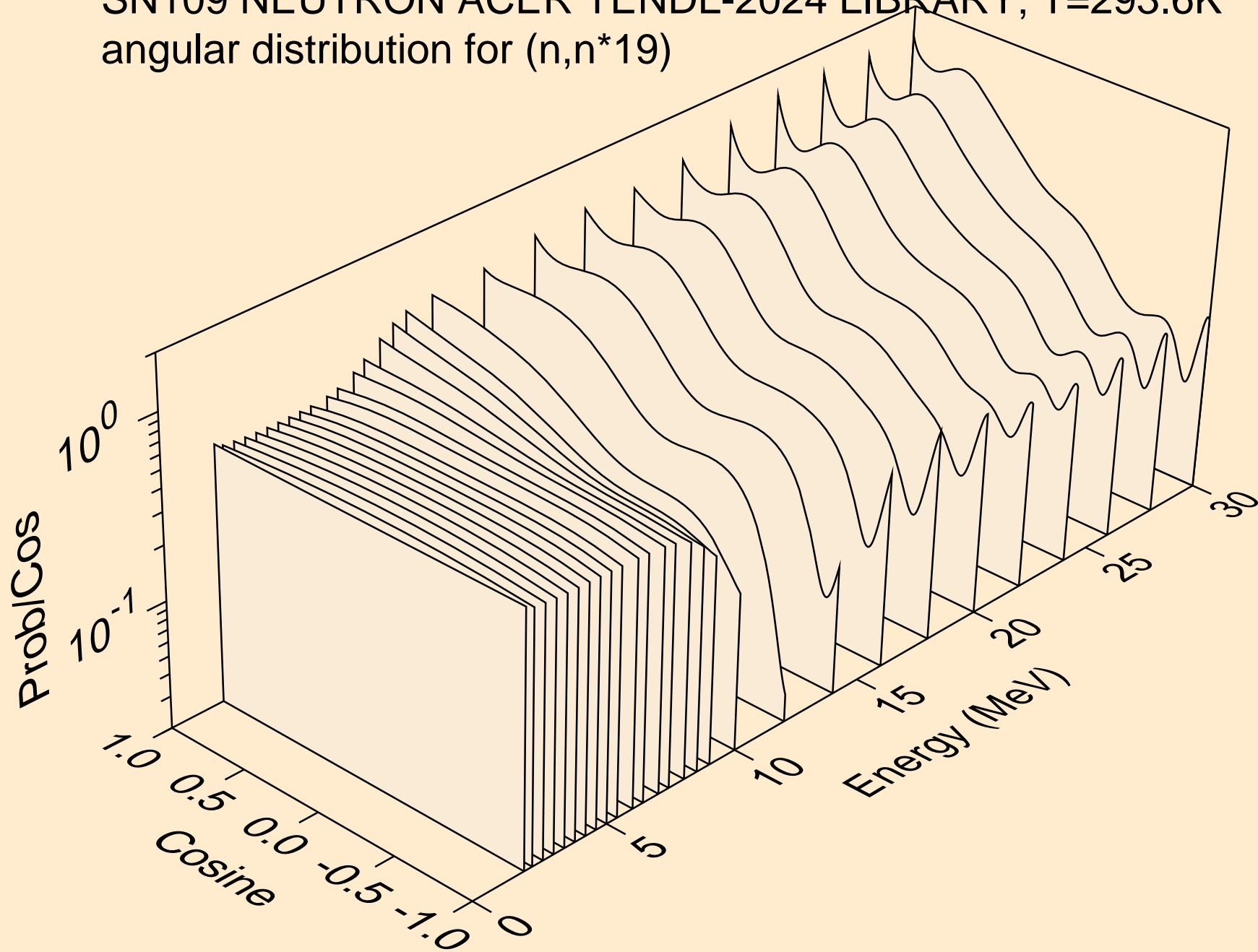

SN109 NEUTRON ACER TENDL-2024 LIBRARY; T=293.6K
angular distribution for (n,n*20)

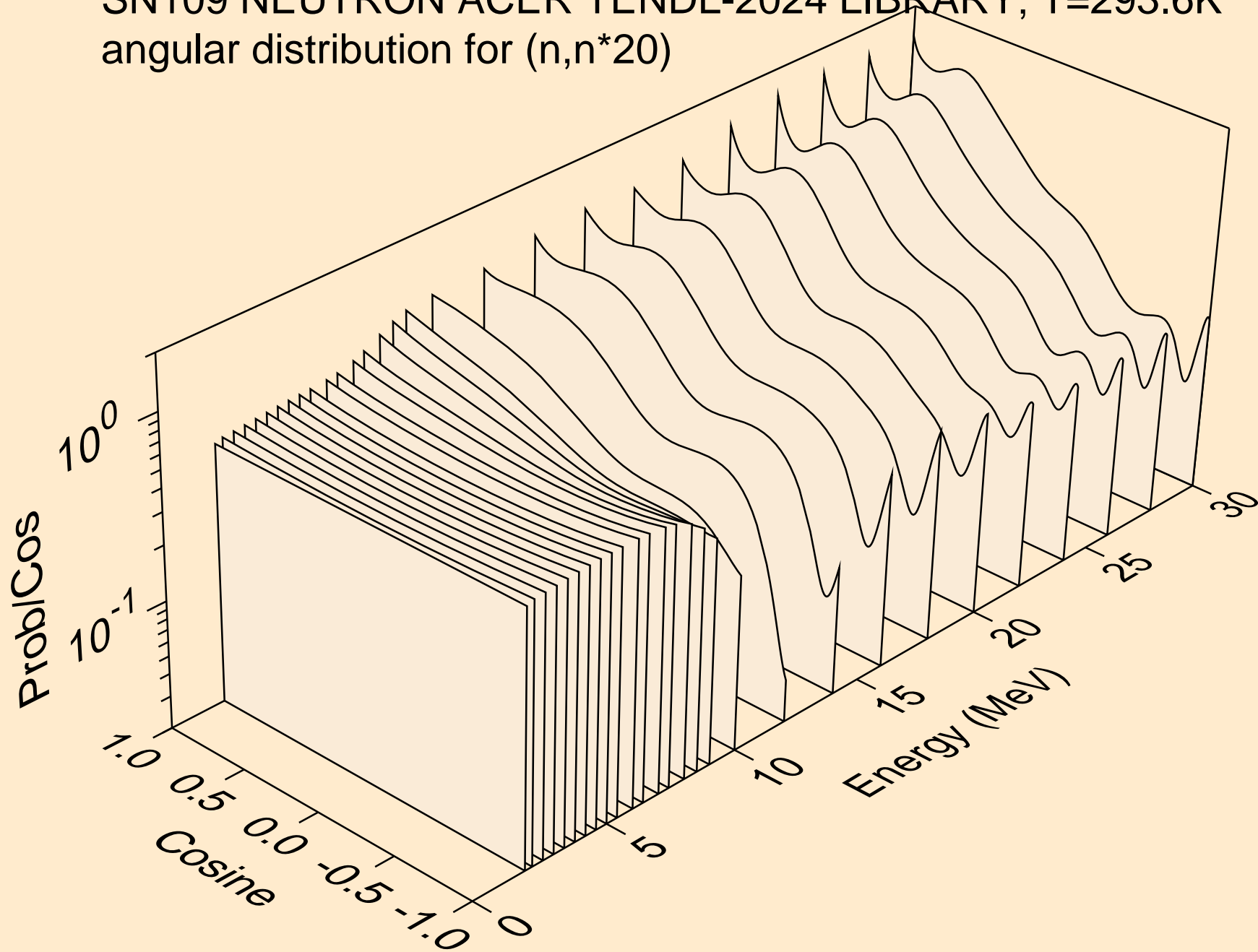

SN109 NEUTRON ACER TENDL-2024 LIBRARY; T=293.6K
angular distribution for (n,n*21)

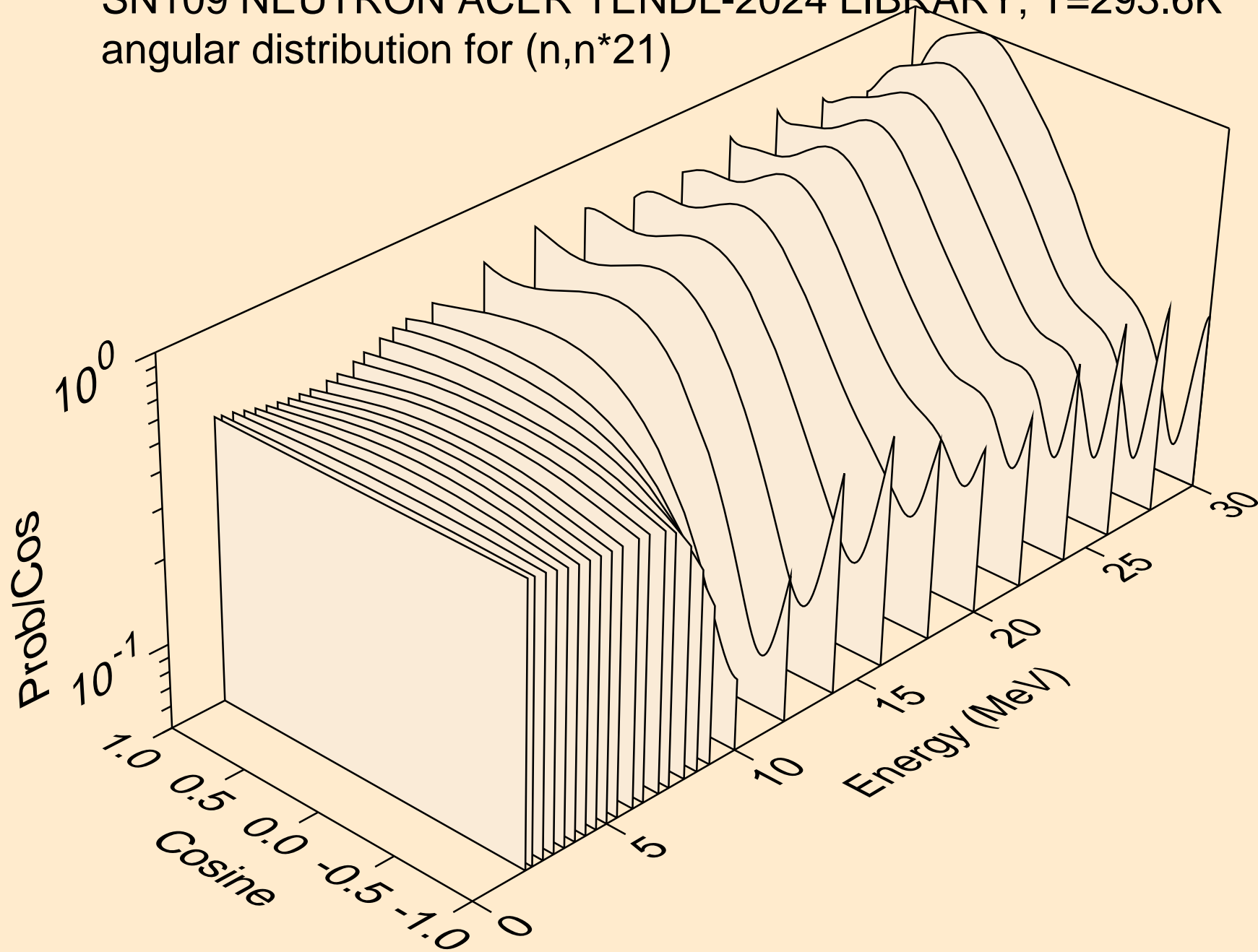

SN109 NEUTRON ACER TENDL-2024 LIBRARY; T=293.6K
angular distribution for (n,n*22)

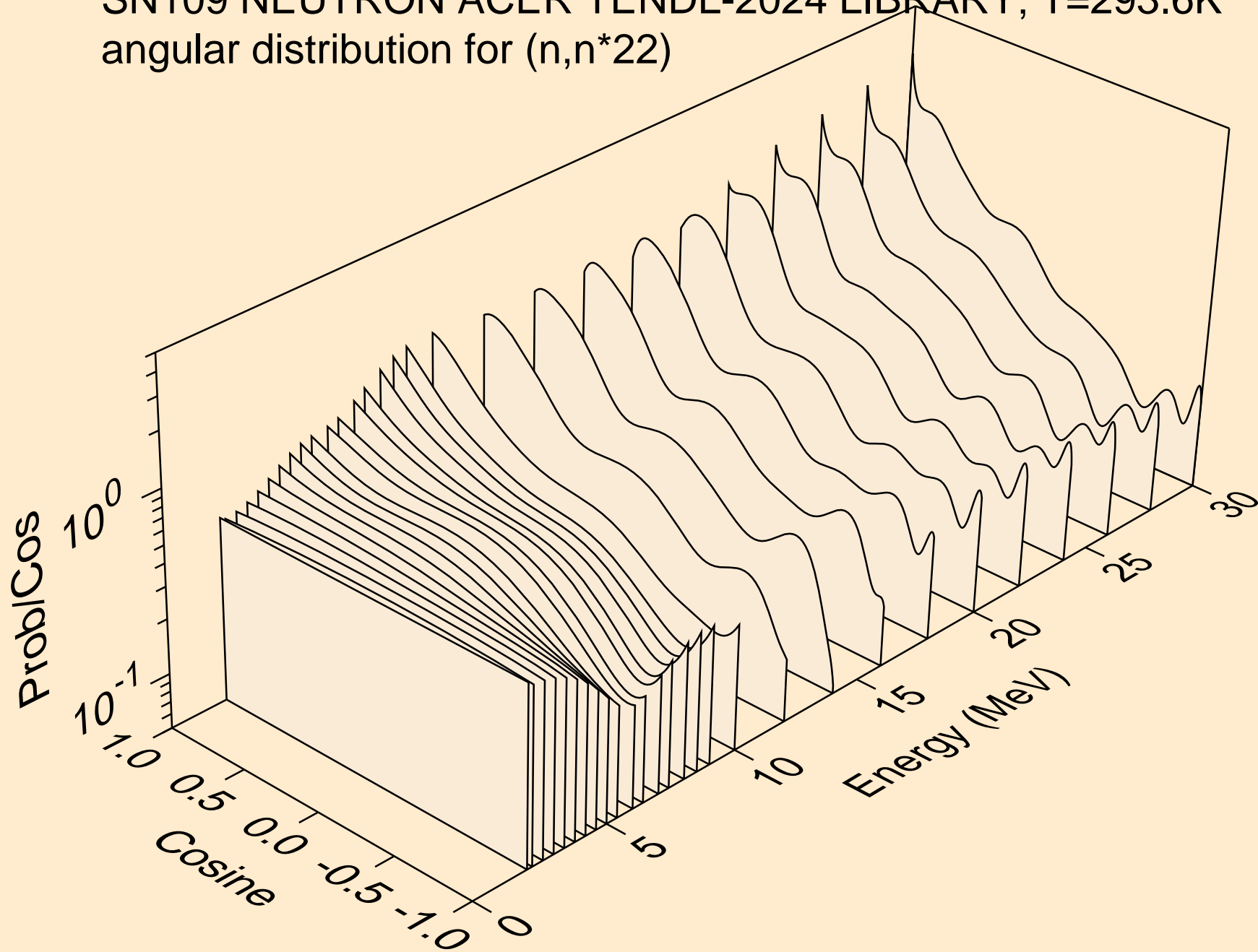

SN109 NEUTRON ACER TENDL-2024 LIBRARY; T=293.6K
angular distribution for (n,n*23)

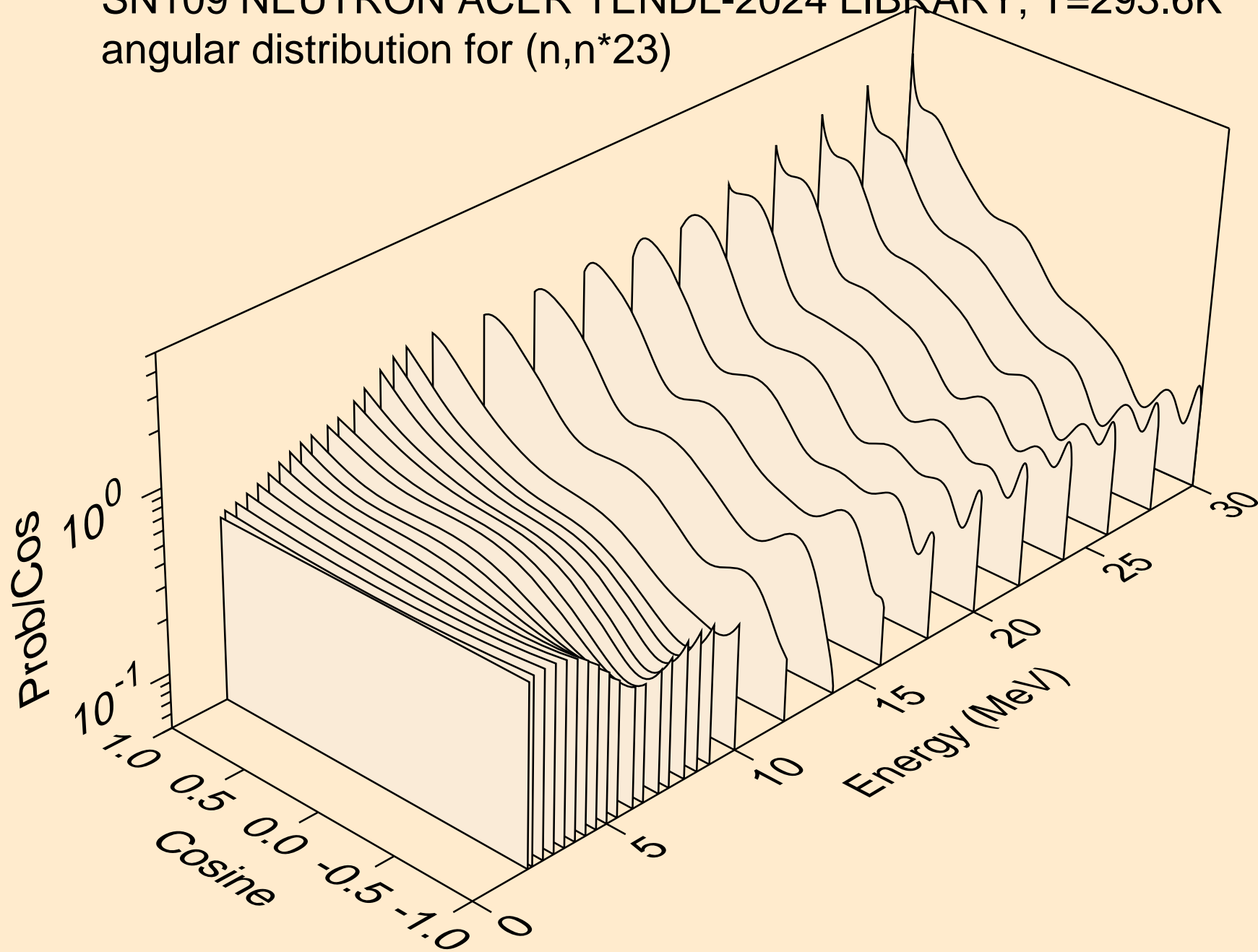

SN109 NEUTRON ACER TENDL-2024 LIBRARY; T=293.6K
angular distribution for (n,n*24)

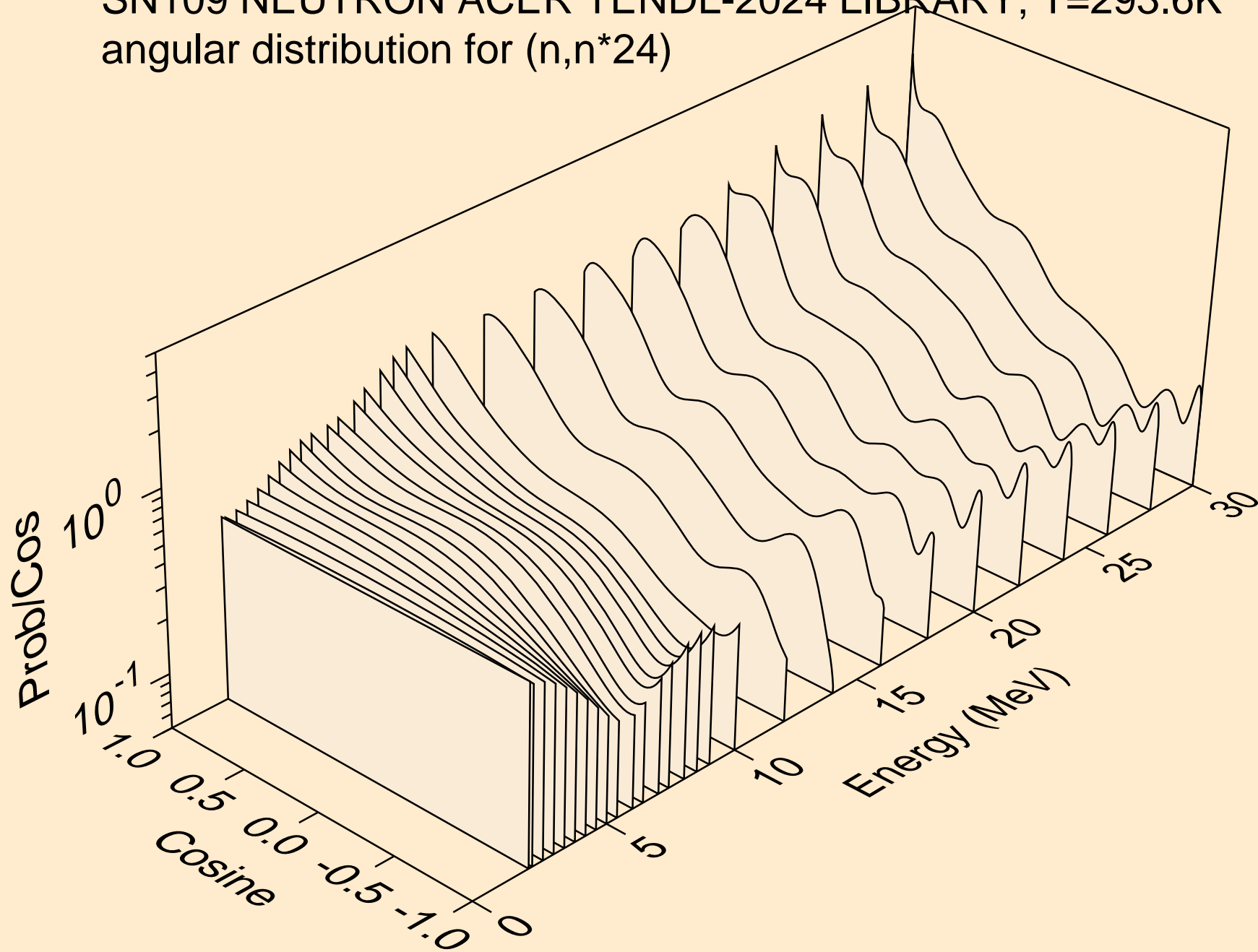

SN109 NEUTRON ACER TENDL-2024 LIBRARY; T=293.6K
angular distribution for (n,n*25)

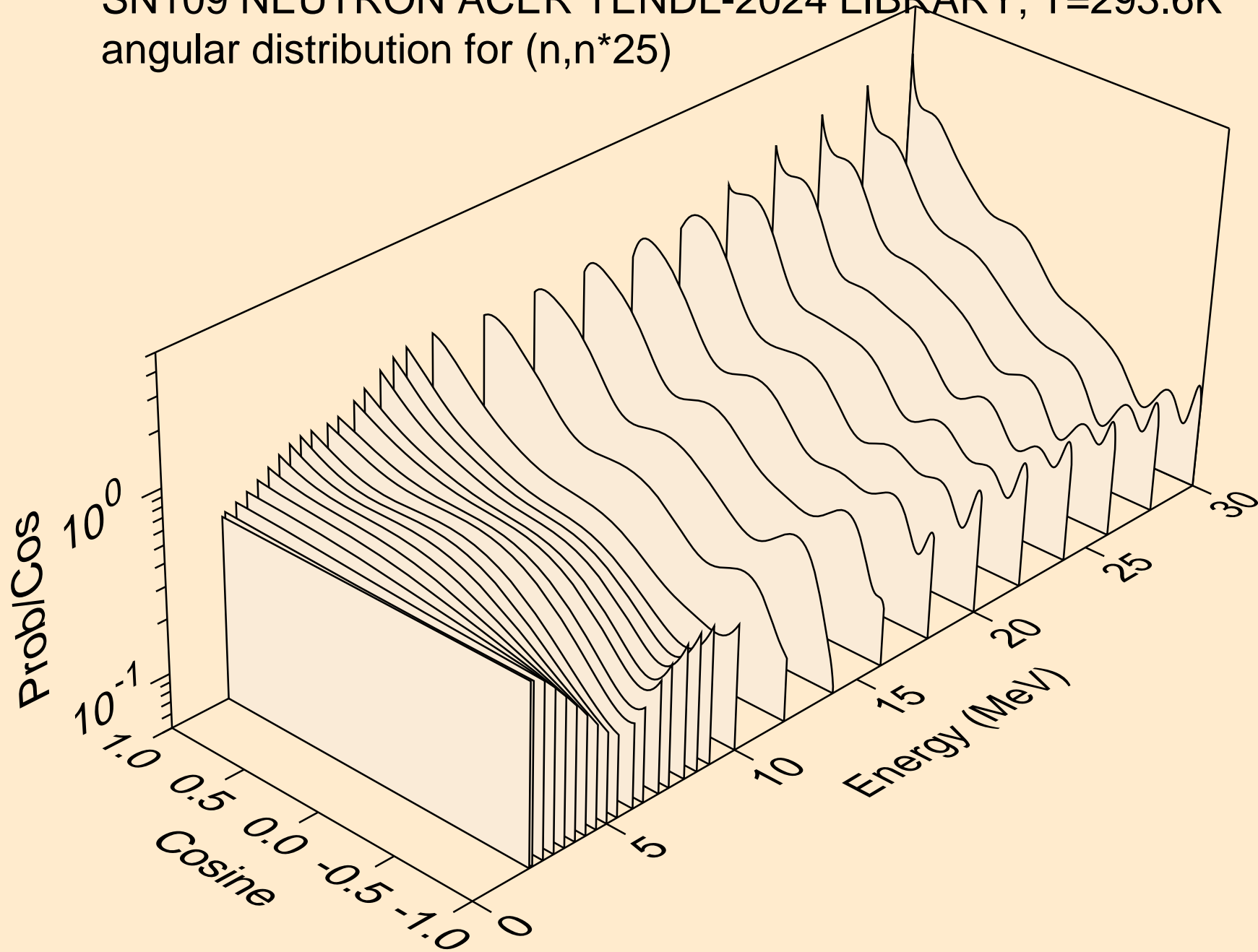

SN109 NEUTRON ACER TENDL-2024 LIBRARY; T=293.6K
angular distribution for (n,n*26)

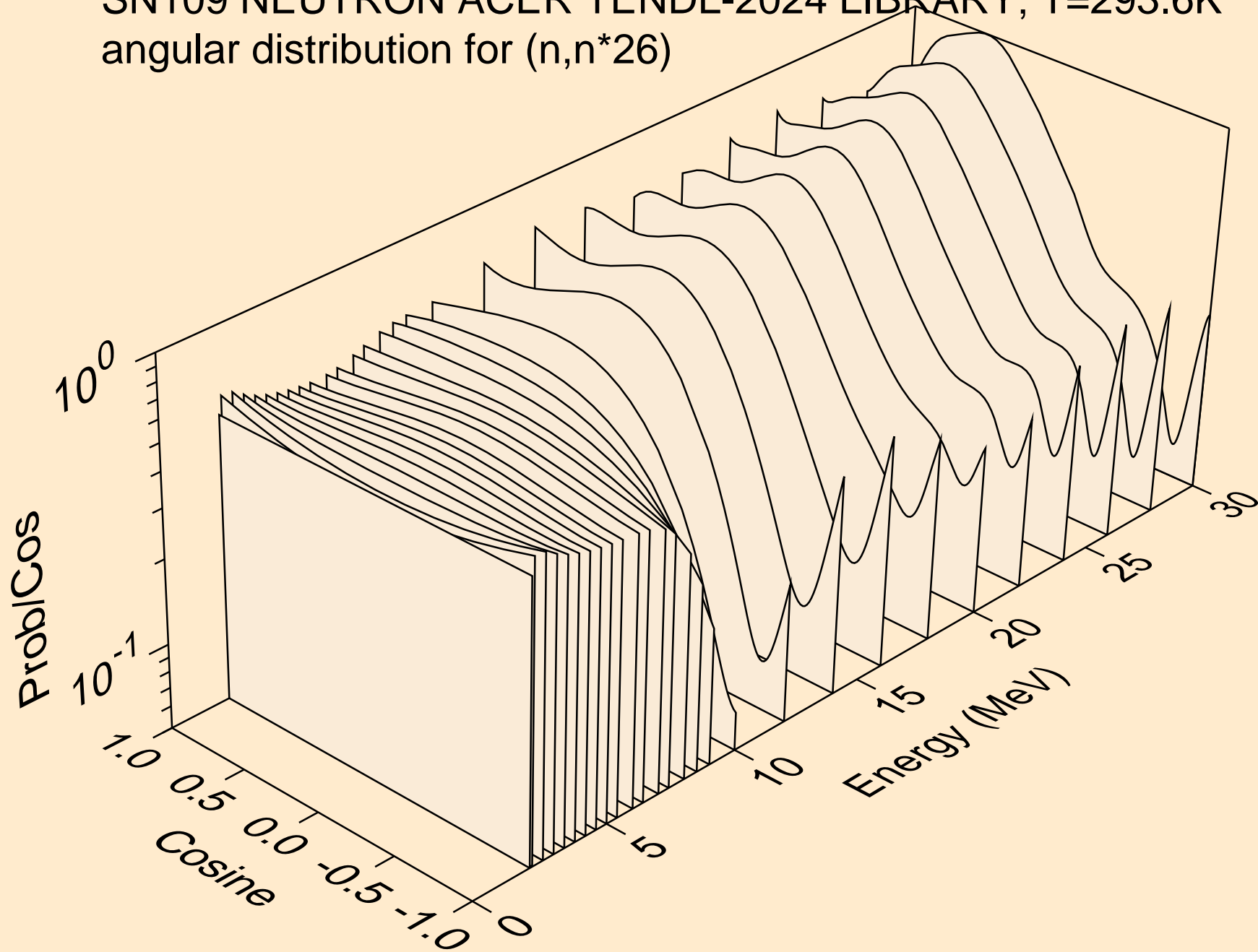

SN109 NEUTRON ACER TENDL-2024 LIBRARY; T=293.6K
angular distribution for (n,n*27)

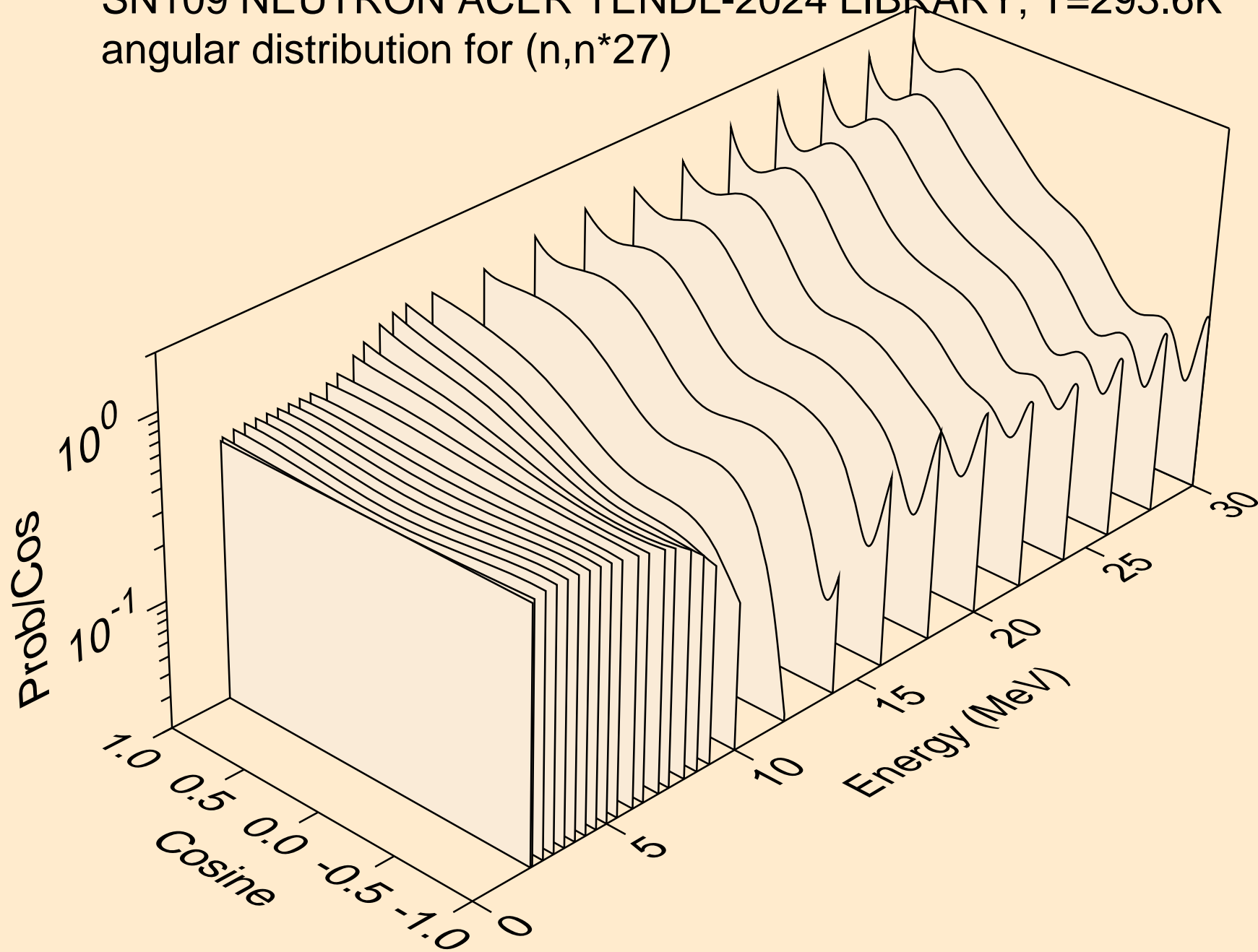

SN109 NEUTRON ACER TENDL-2024 LIBRARY; T=293.6K
angular distribution for (n,n*28)

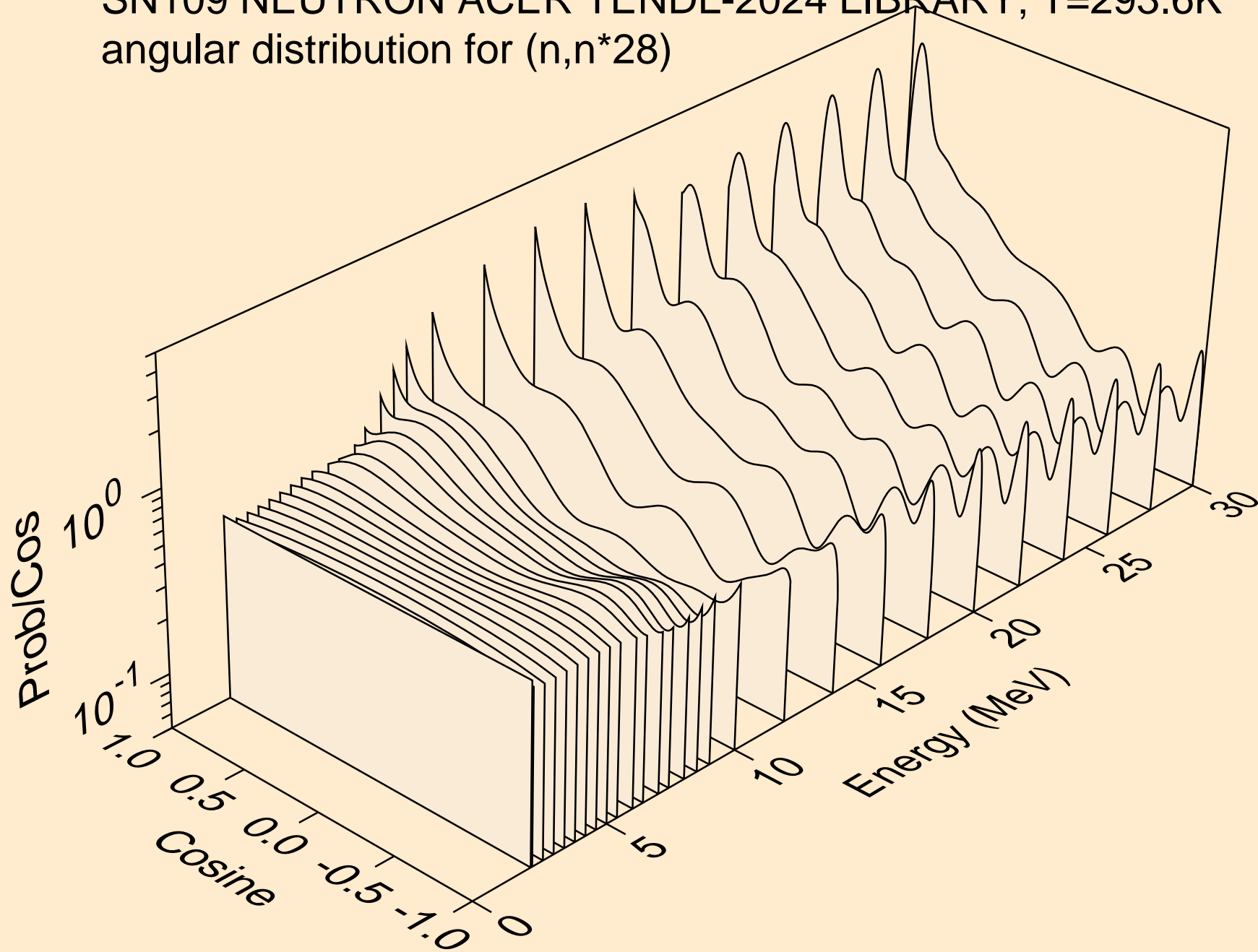

SN109 NEUTRON ACER TENDL-2024 LIBRARY; T=293.6K
angular distribution for (n,n*29)

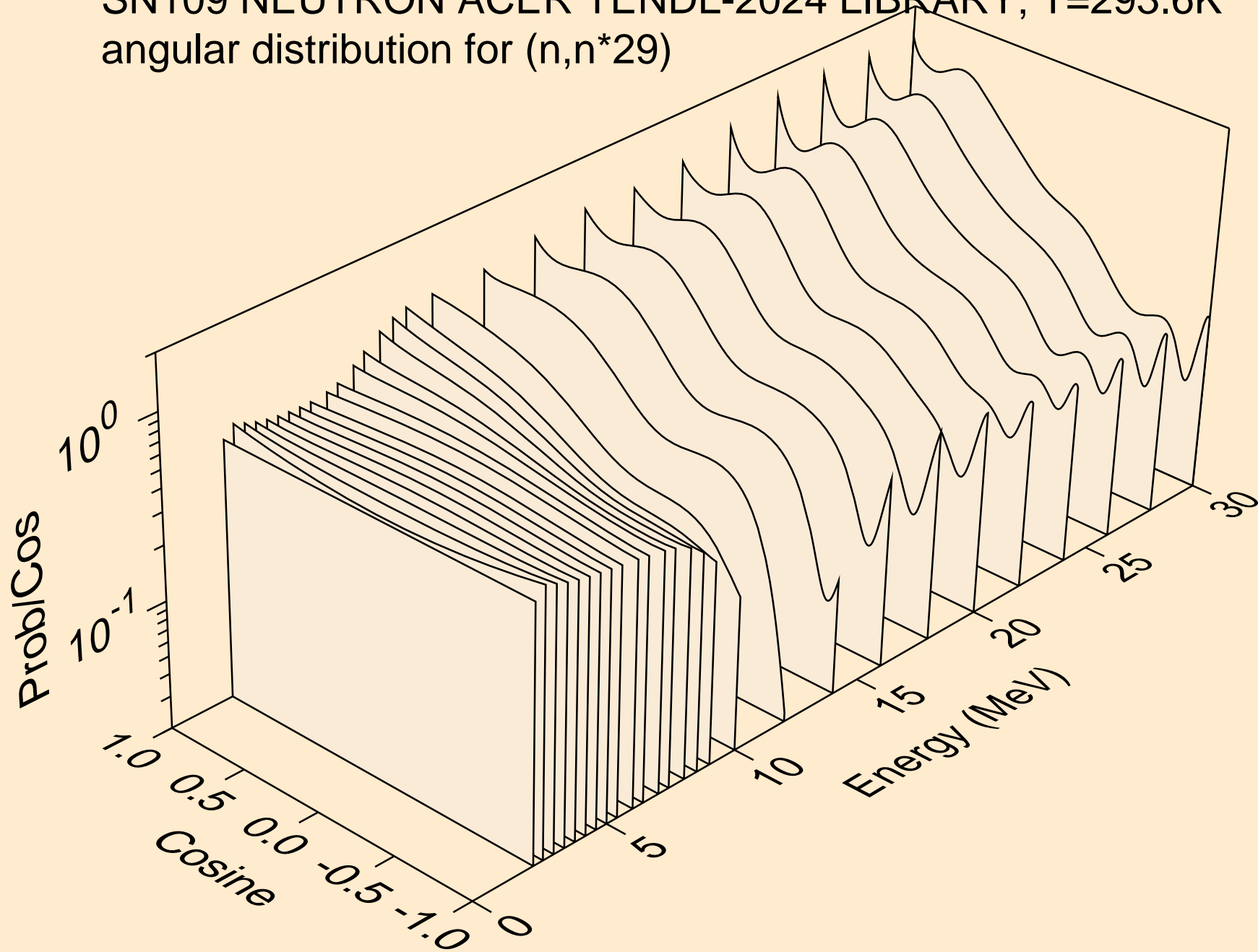

SN109 NEUTRON ACER TENDL-2024 LIBRARY; T=293.6K
angular distribution for (n,n*30)

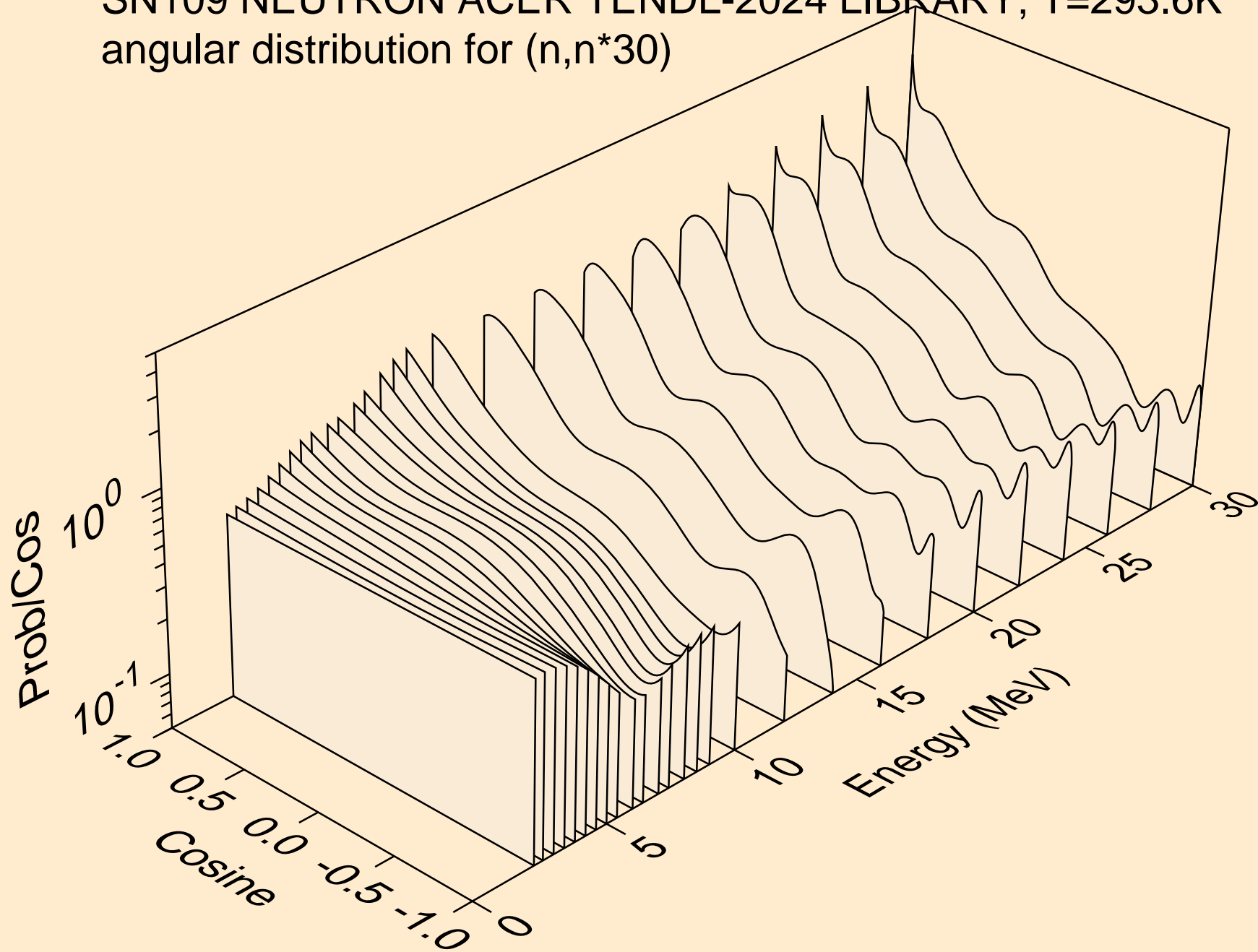

SN109 NEUTRON ACER TENDL-2024 LIBRARY; T=293.6K
Neutron emission for (n,x)

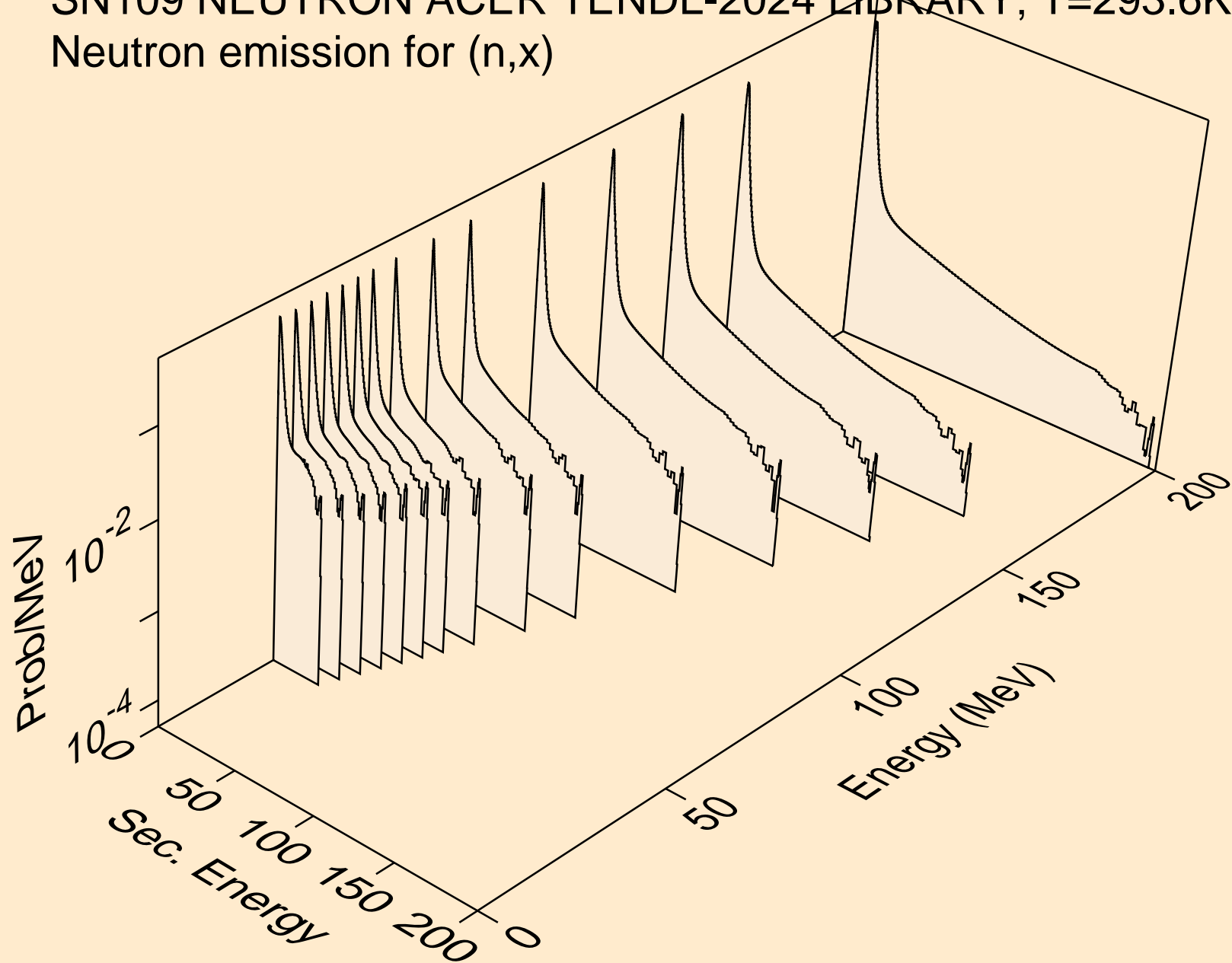

SN109 NEUTRON ACER TENDL-2024 LIBRARY; T=293.6K
Neutron emission for (n,2nd)

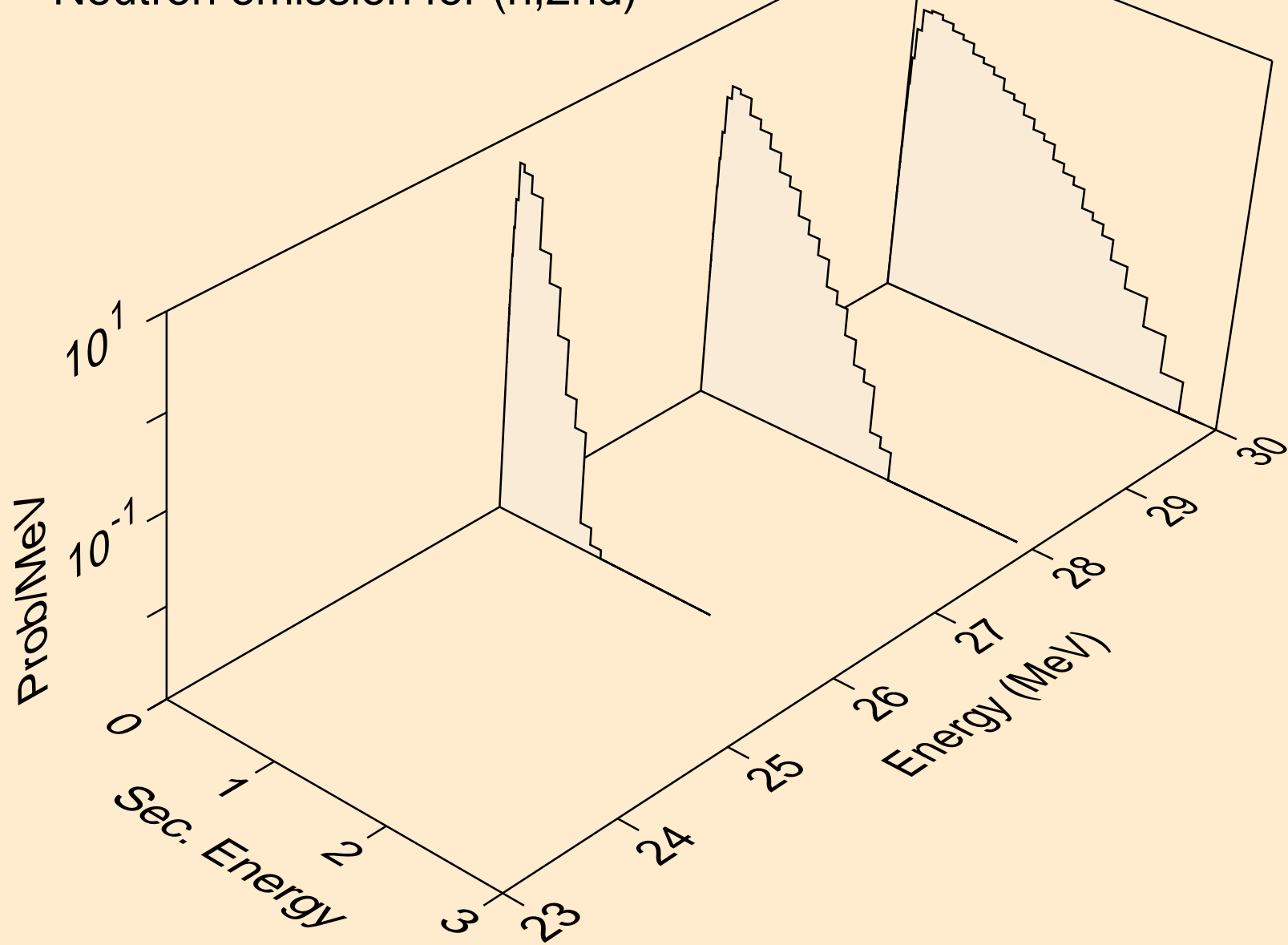

SN109 NEUTRON ACER TENDL-2024 LIBRARY; T=293.6K
Neutron emission for (n,2n)

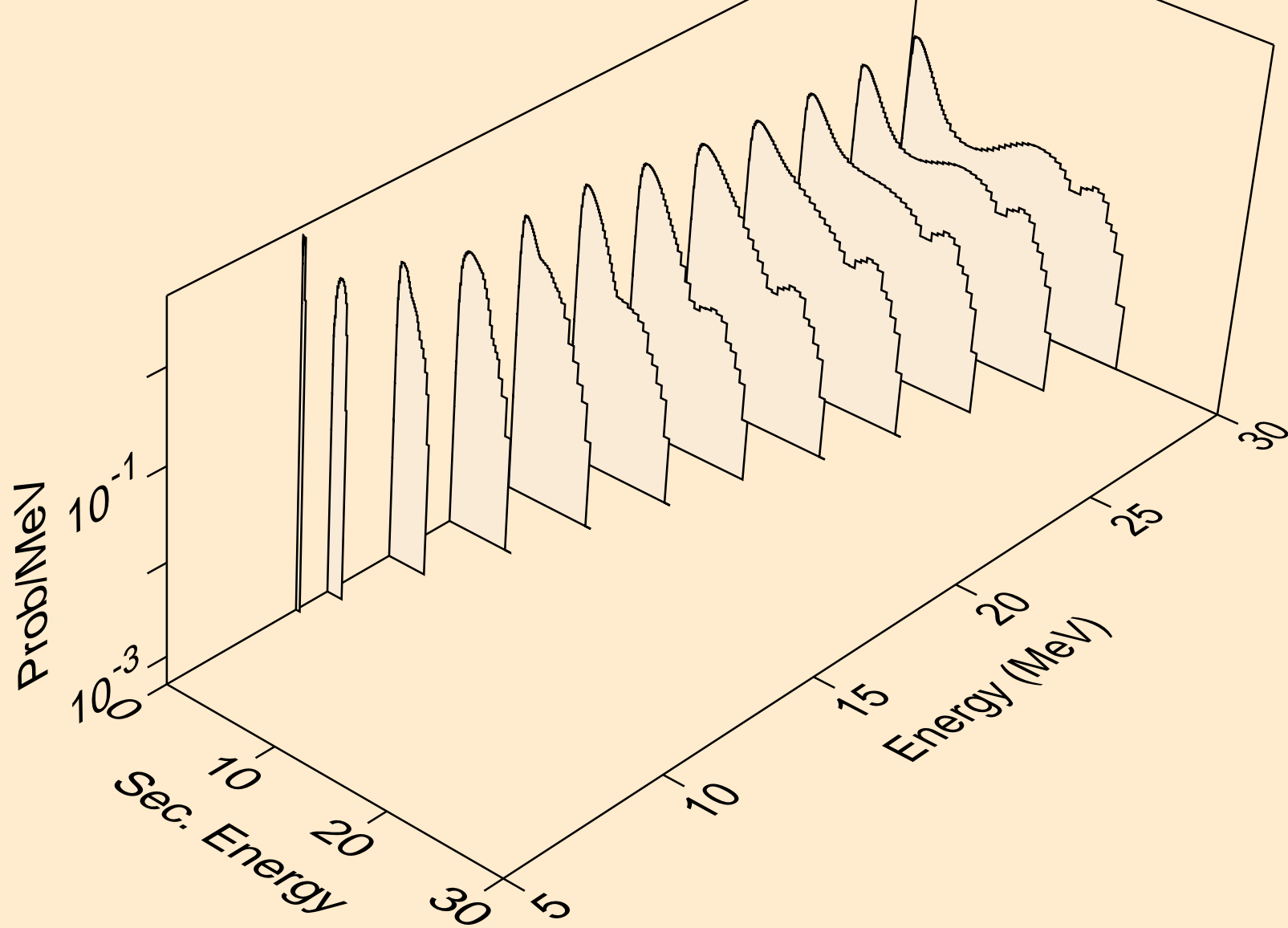

SN109 NEUTRON ACER TENDL-2024 LIBRARY; T=293.6K
Neutron emission for (n,3n)

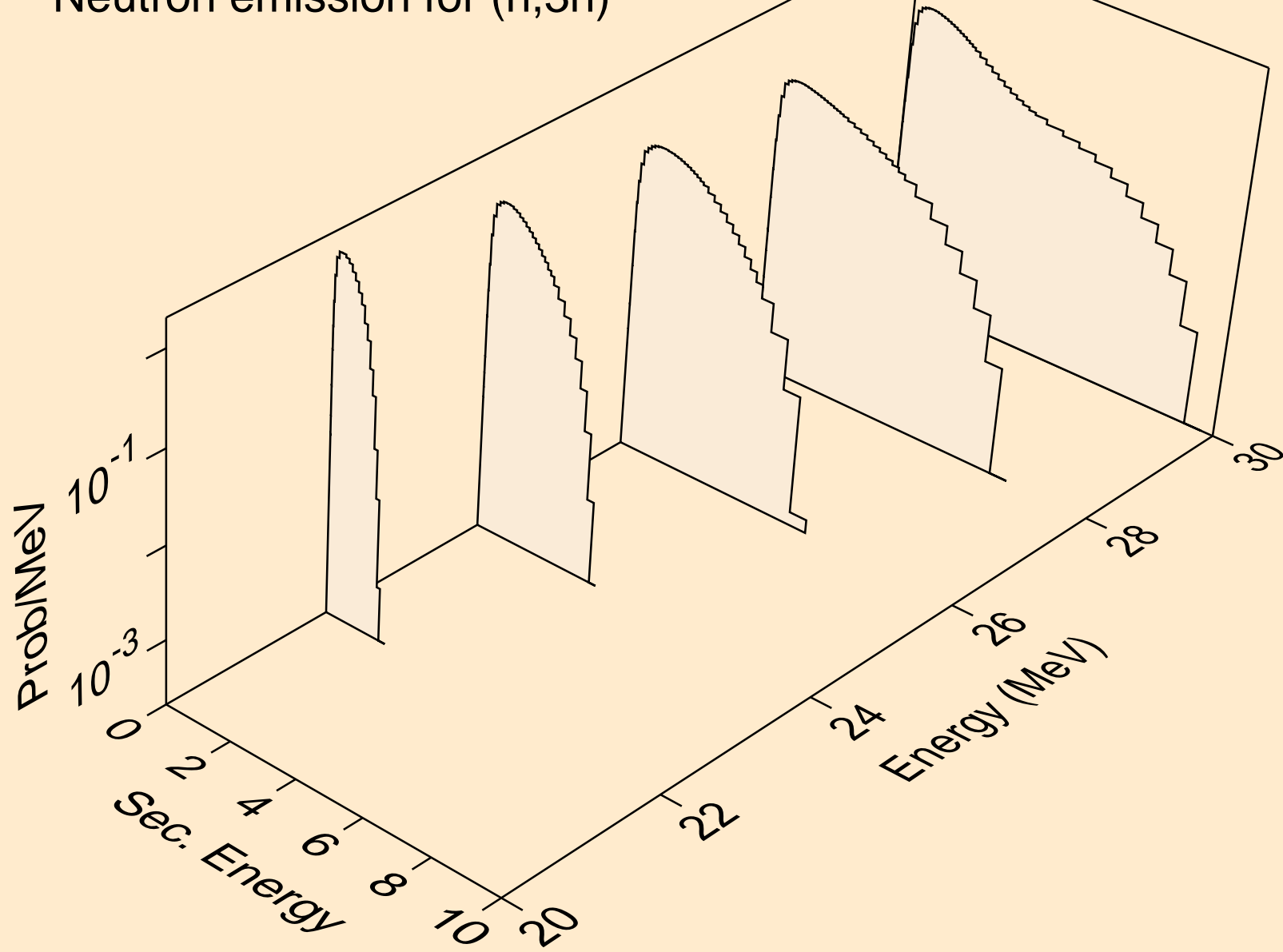

SN109 NEUTRON ACER TENDL-2024 LIBRARY; T=293.6K
Neutron emission for (n,n*)a

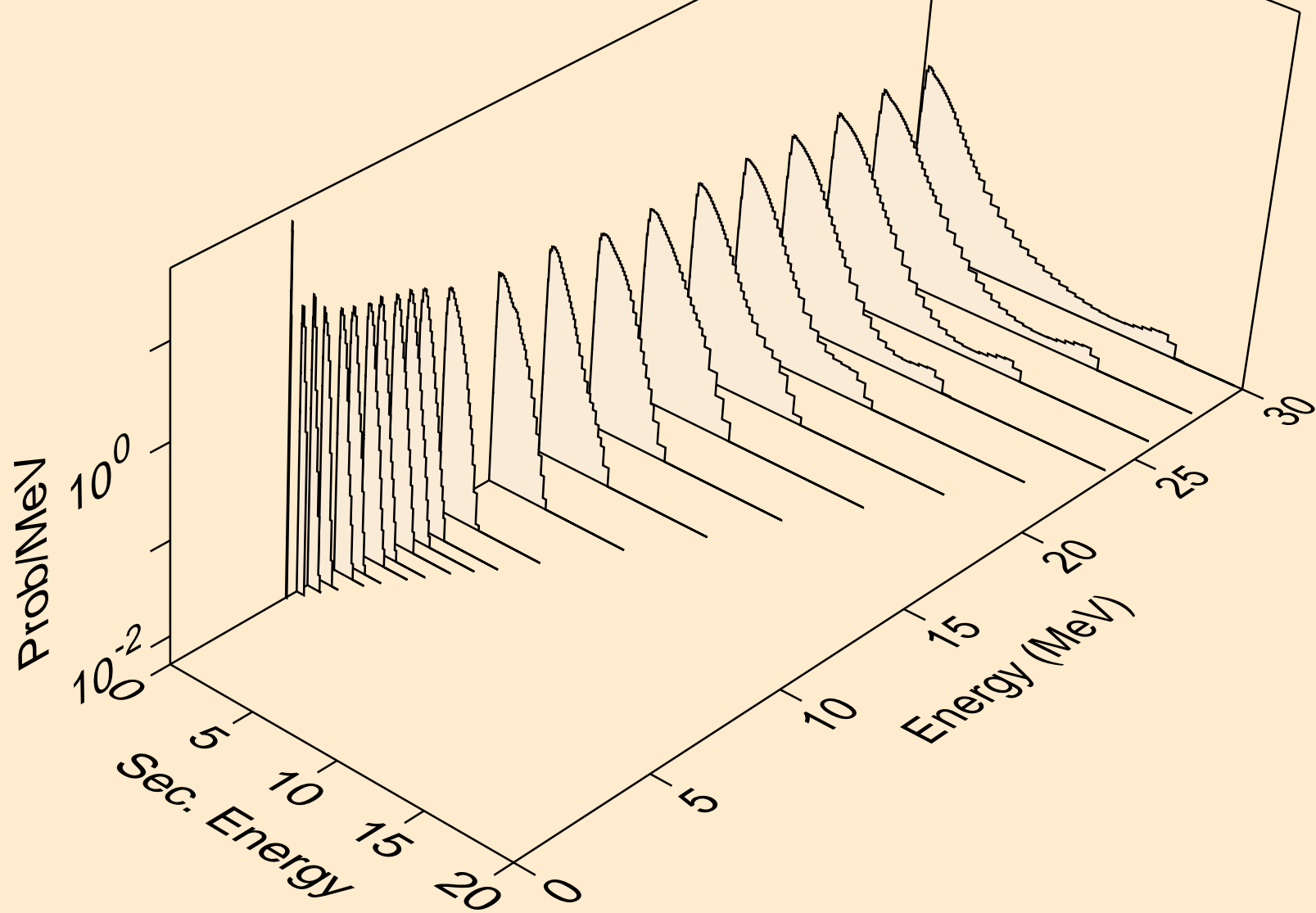

SN109 NEUTRON ACER TENDL-2024 LIBRARY; T=293.6K
Neutron emission for (n,2n)a

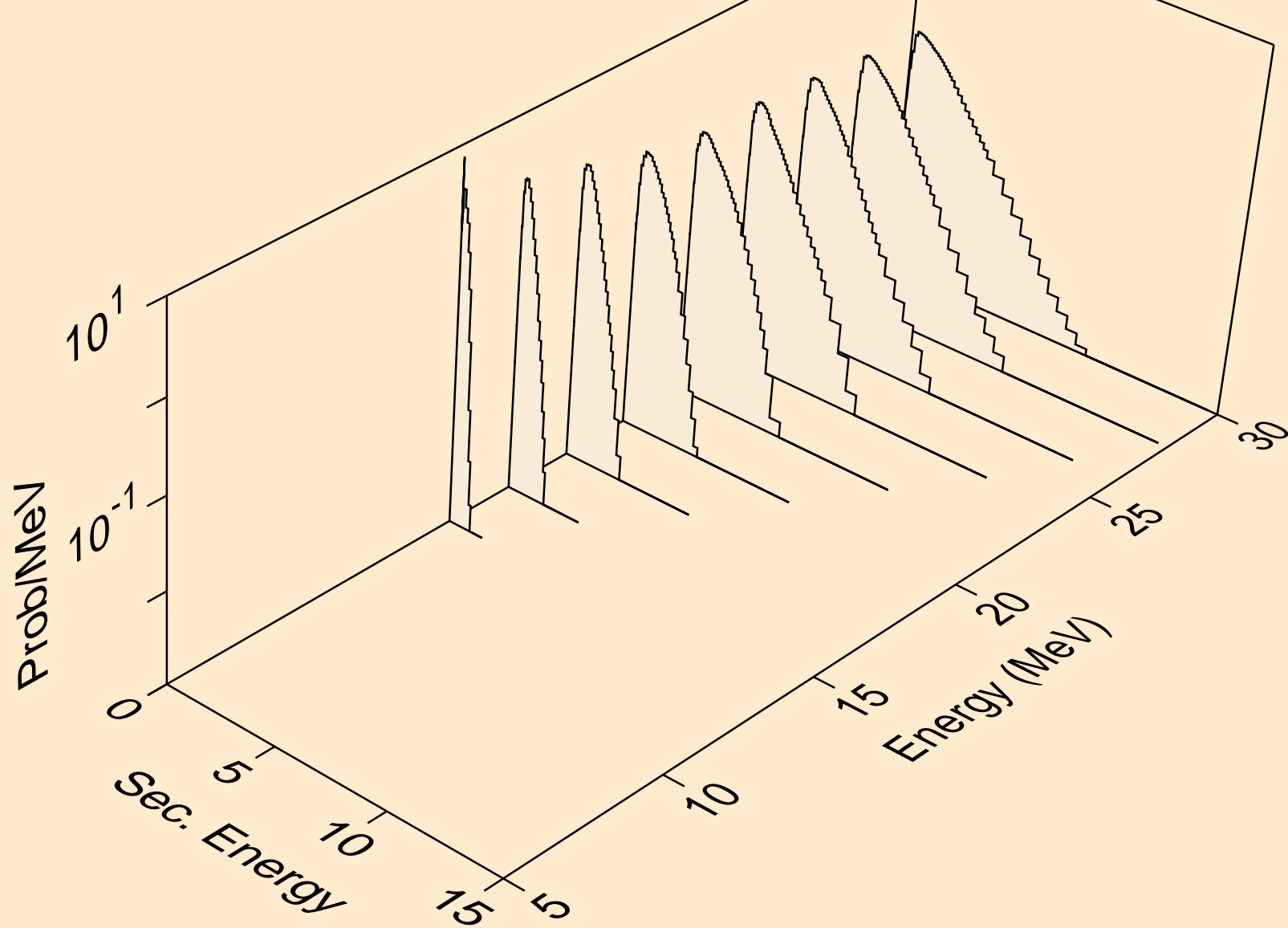

SN109 NEUTRON ACER TENDL-2024 LIBRARY; T=293.6K
Neutron emission for (n,3n)a

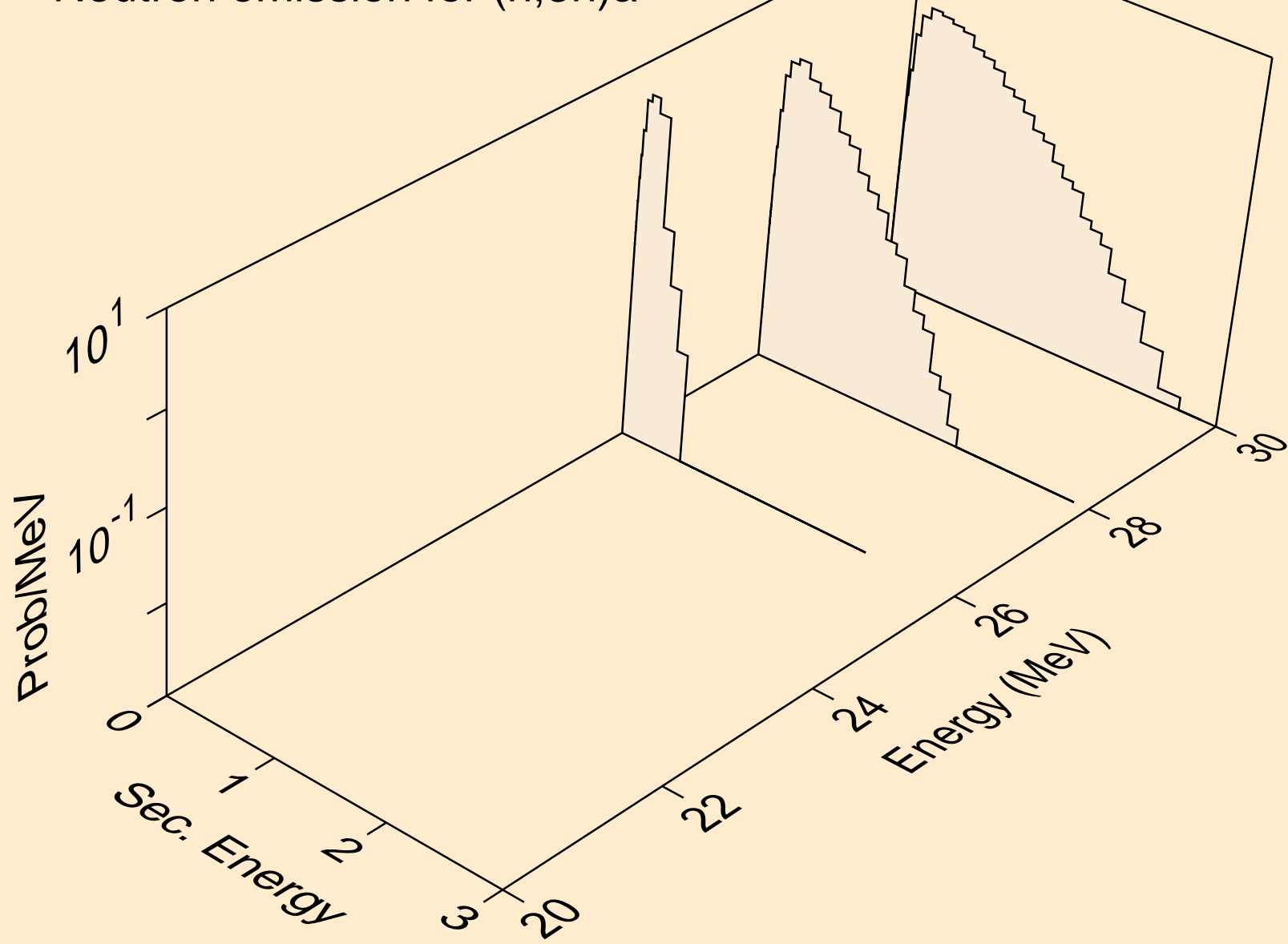

SN109 NEUTRON ACER TENDL-2024 LIBRARY; T=293.6K
Neutron emission for (n,n*)p

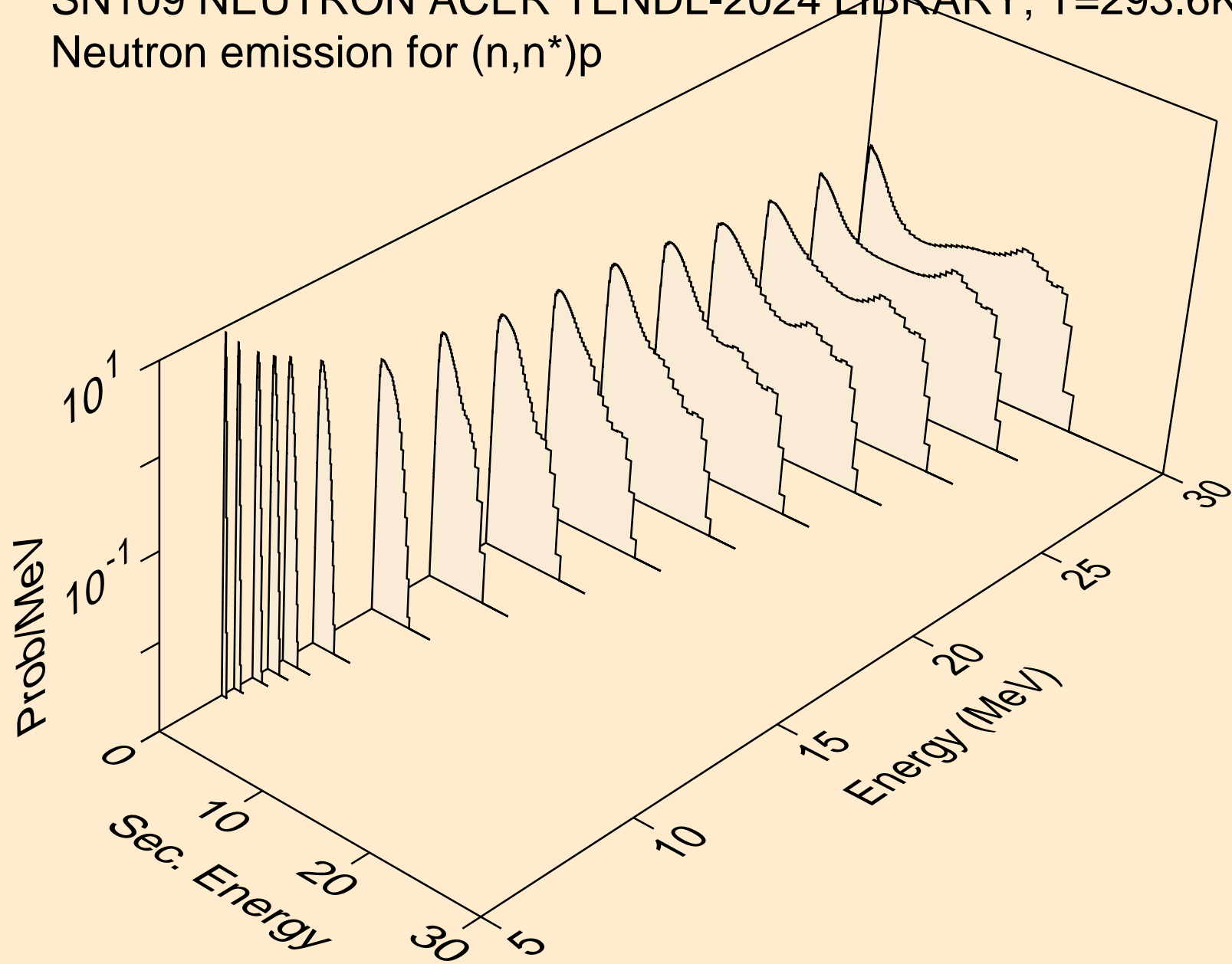

SN109 NEUTRON ACER TENDL-2024 LIBRARY; T=293.6K
Neutron emission for (n,n*)2a

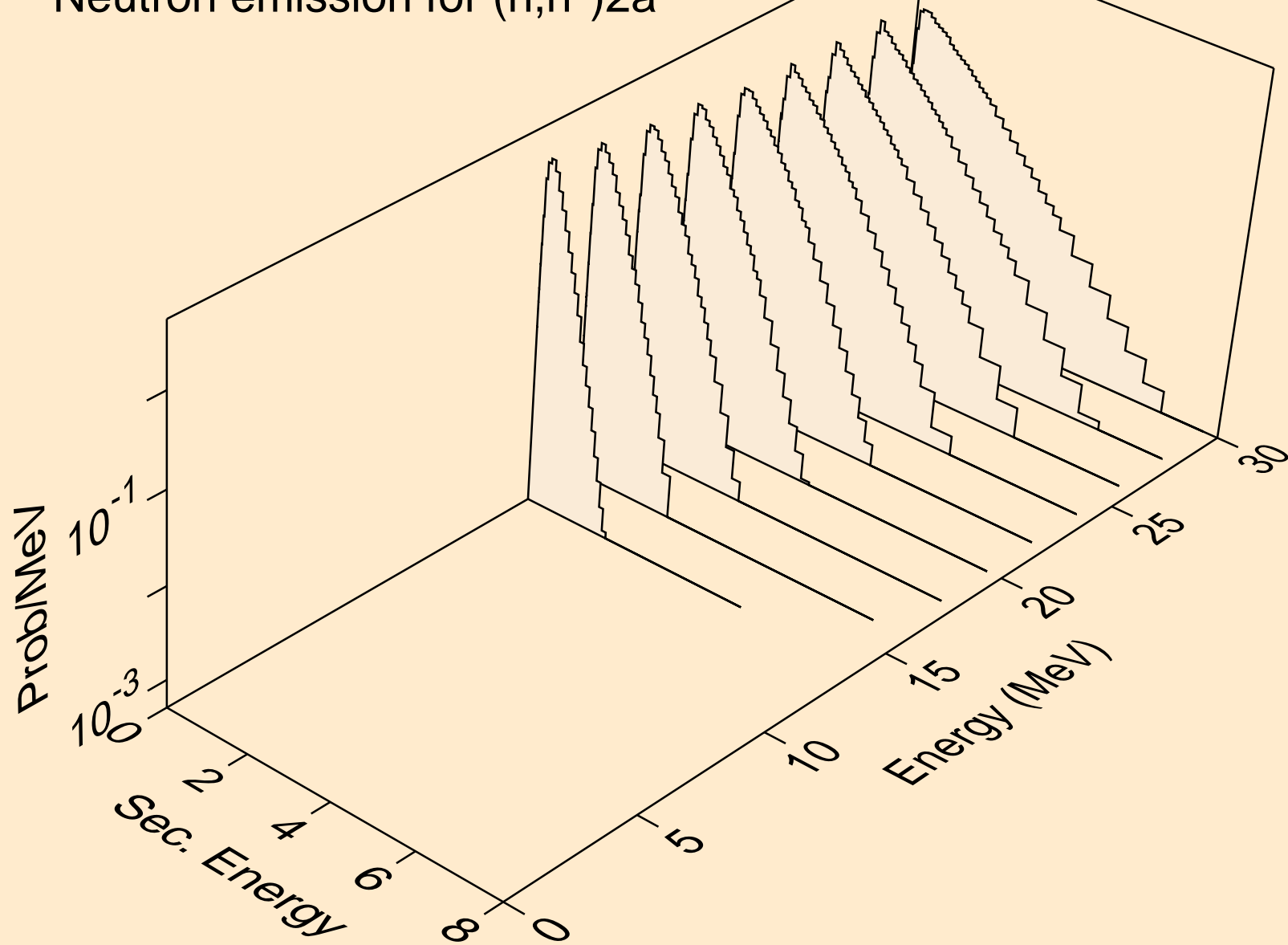

SN109 NEUTRON ACER TENDL-2024 LIBRARY; T=293.6K
Neutron emission for (n,2n)2a

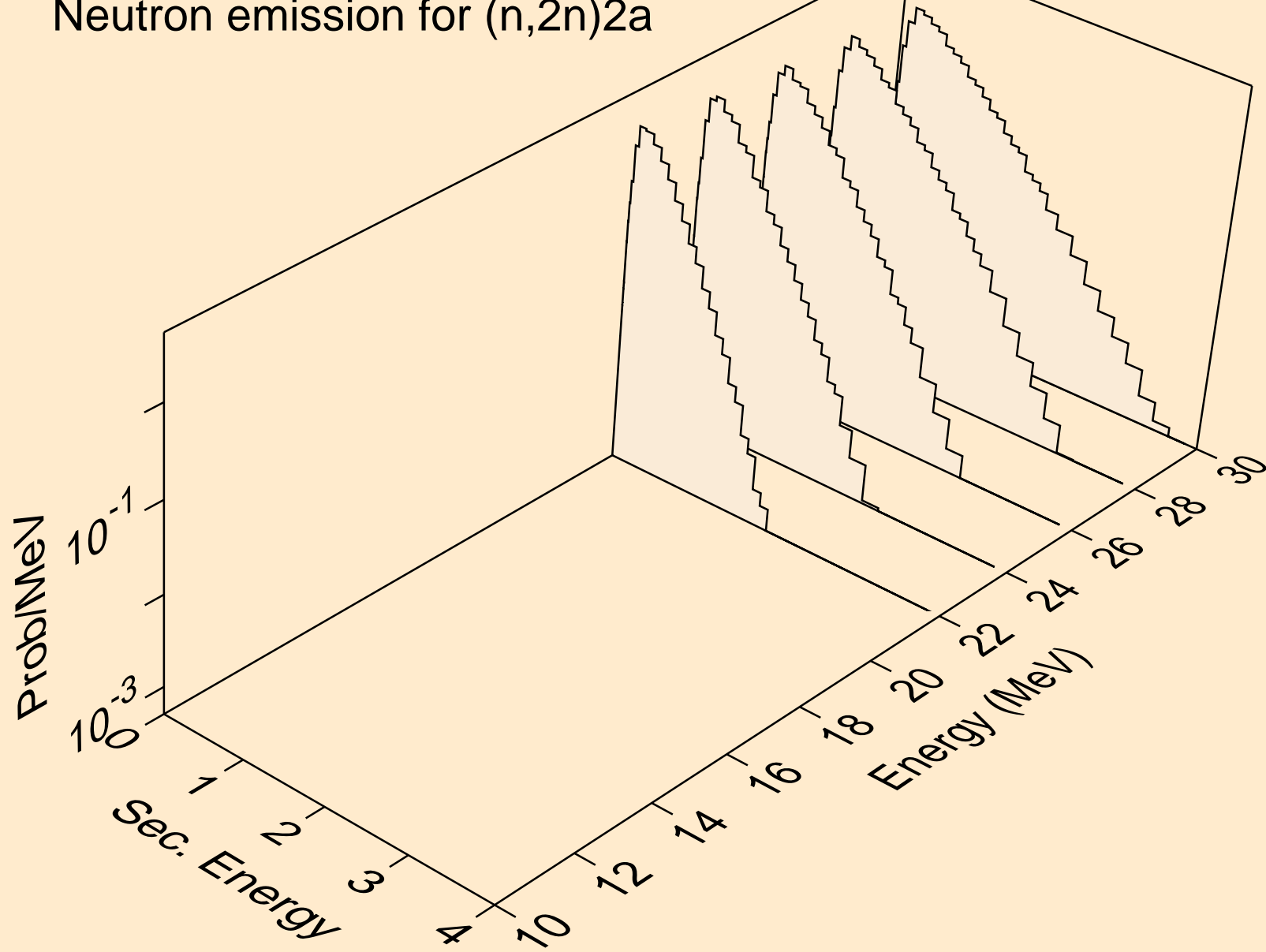

SN109 NEUTRON ACER TENDL-2024 LIBRARY; T=293.6K
Neutron emission for (n,n*)d

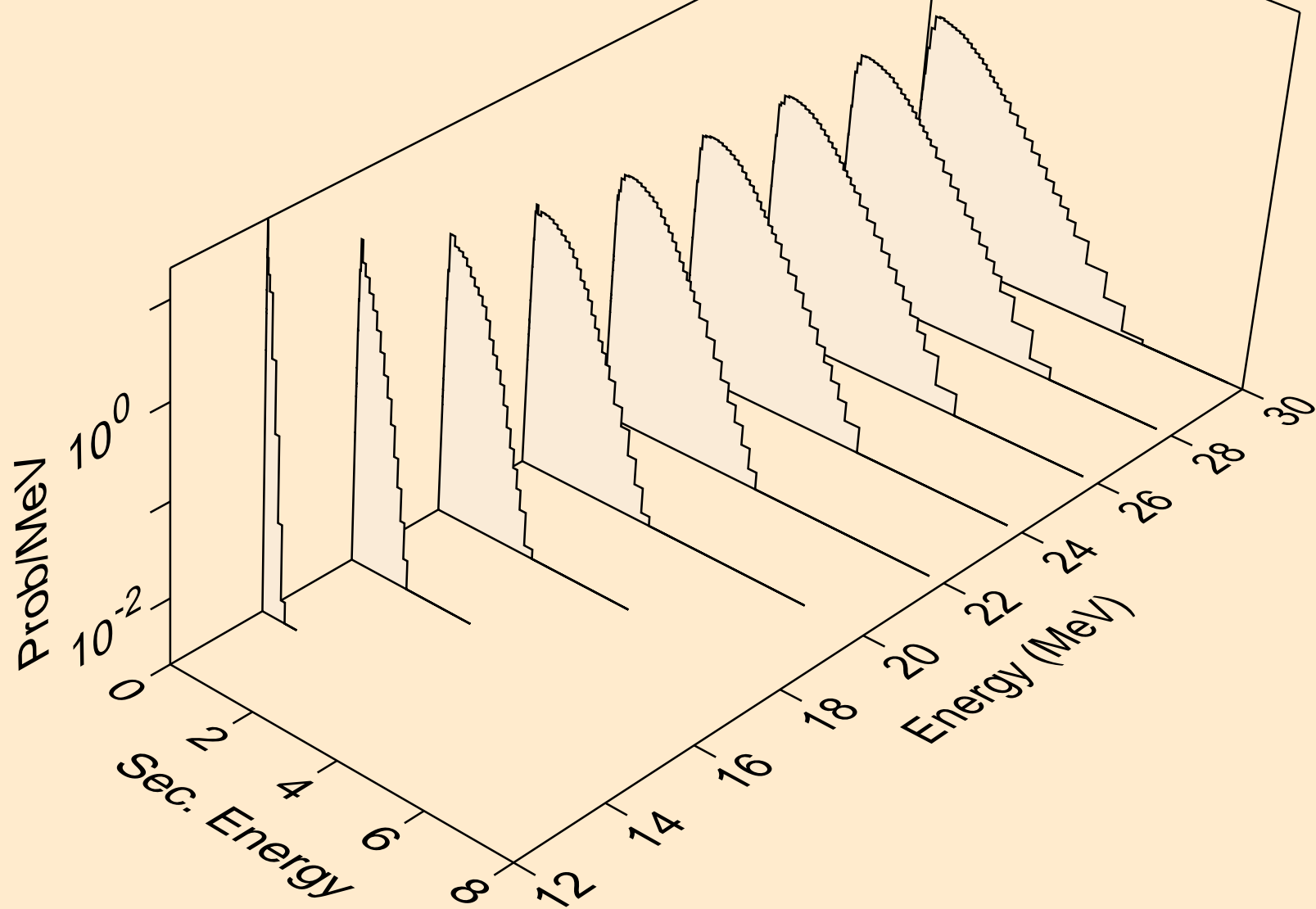

SN109 NEUTRON ACER TENDL-2024 LIBRARY; T=293.6K
Neutron emission for (n,n*)t

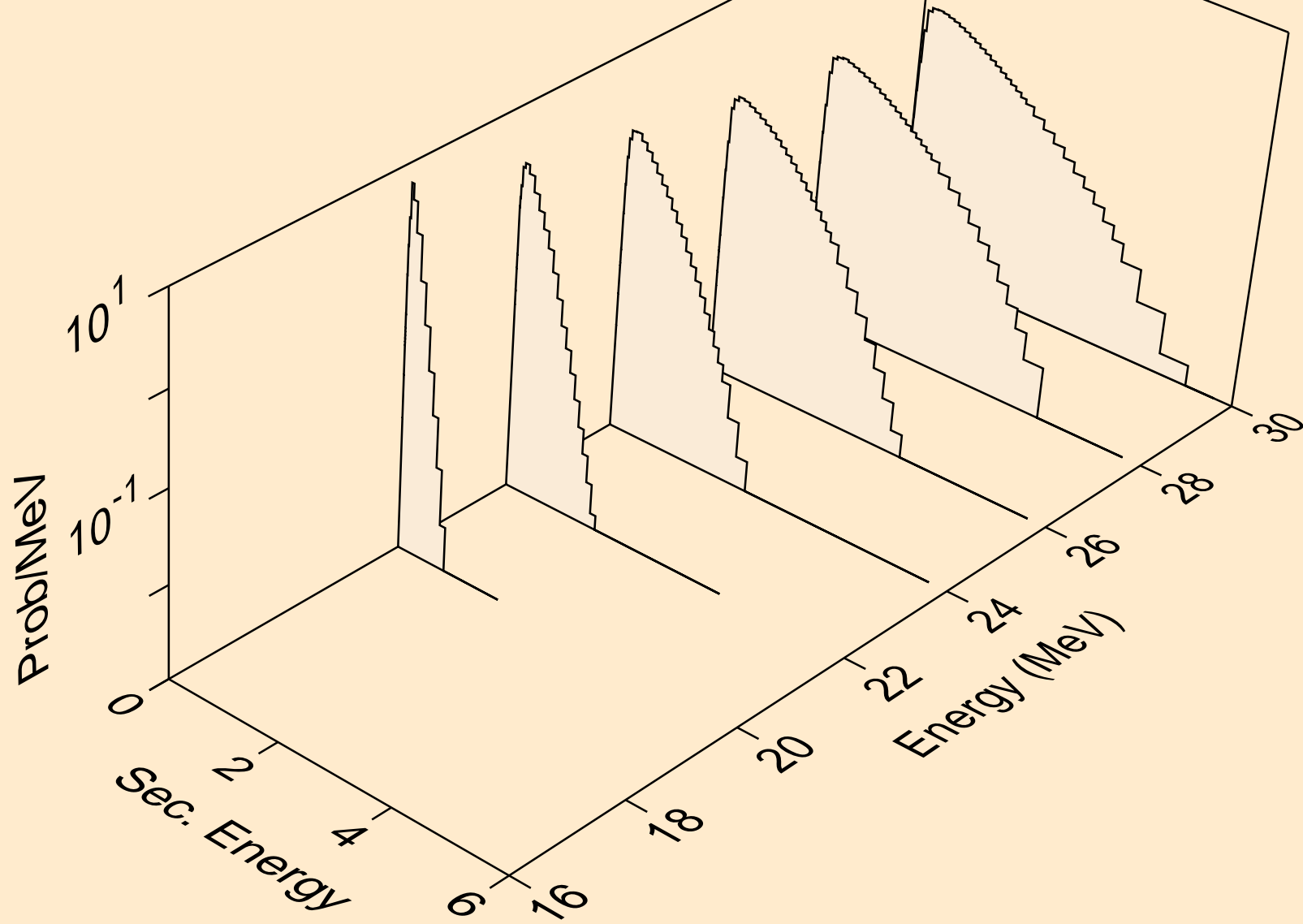

SN109 NEUTRON ACER TENDL-2024 LIBRARY; T=293.6K
Neutron emission for (n,n*)he3

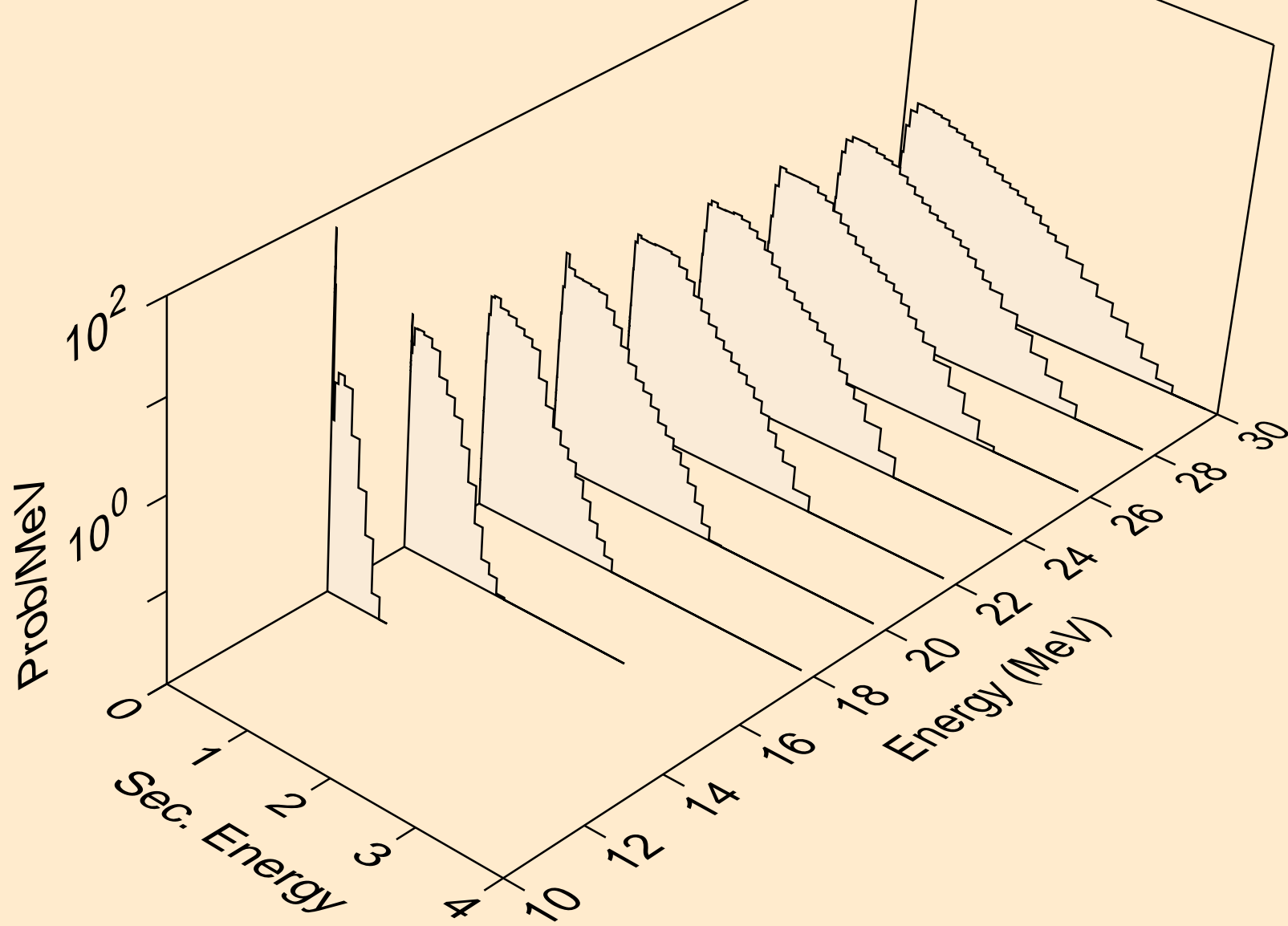

SN109 NEUTRON ACER TENDL-2024 LIBRARY; T=293.6K
Neutron emission for (n,2np)

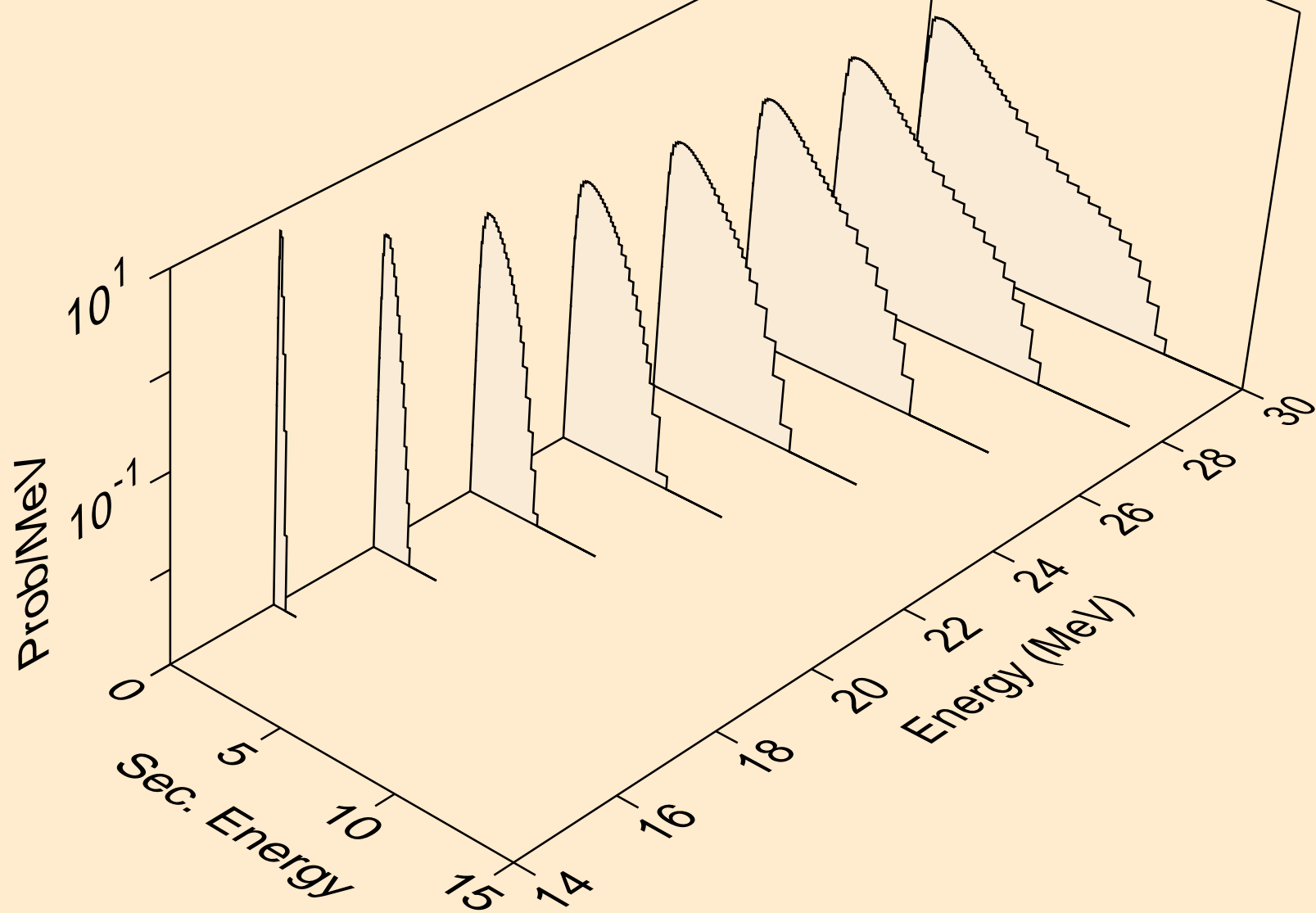

SN109 NEUTRON ACER TENDL-2024 LIBRARY; T=293.6K
Neutron emission for (n,3np)

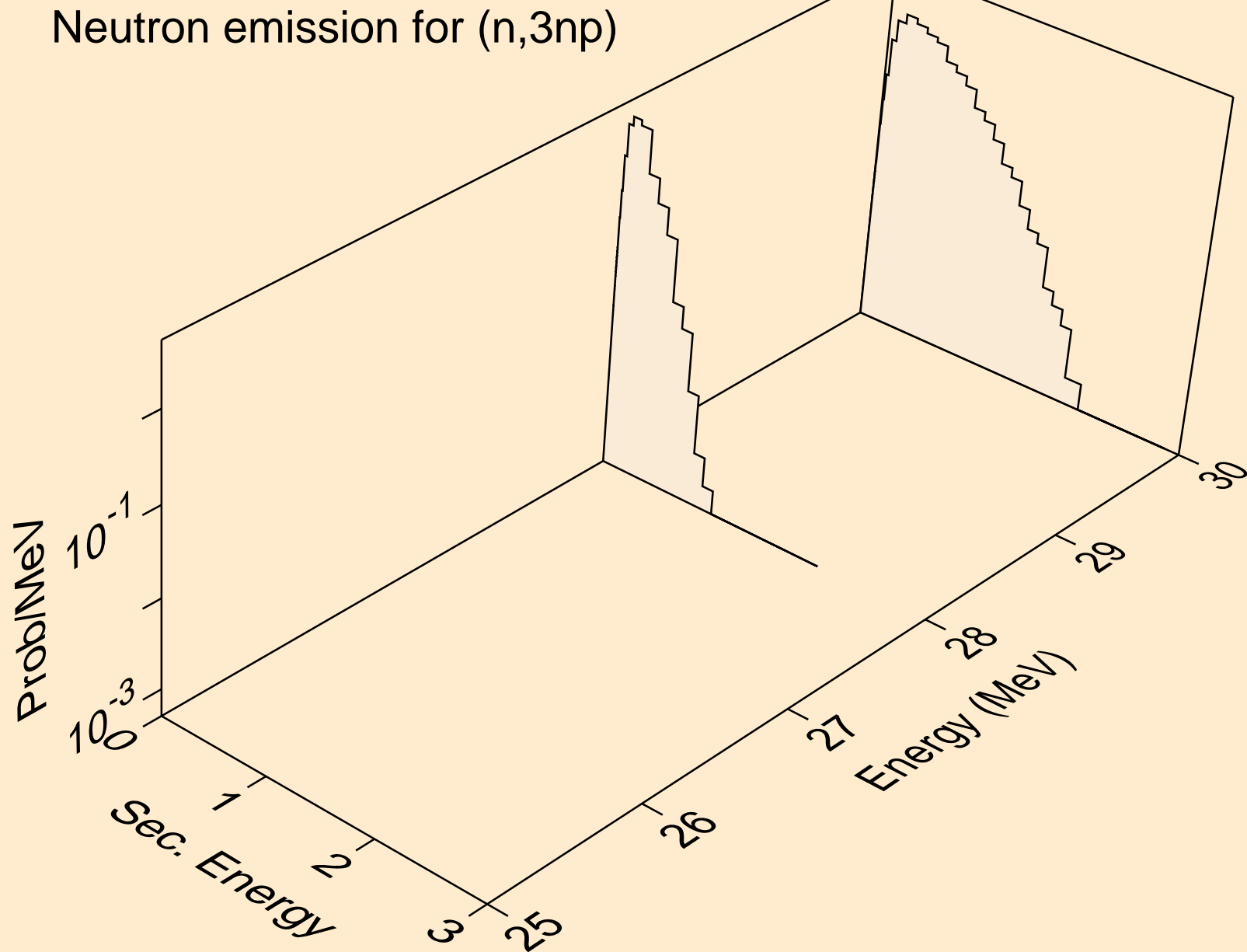

SN109 NEUTRON ACER TENDL-2024 LIBRARY; T=293.6K
Neutron emission for (n,n2p)

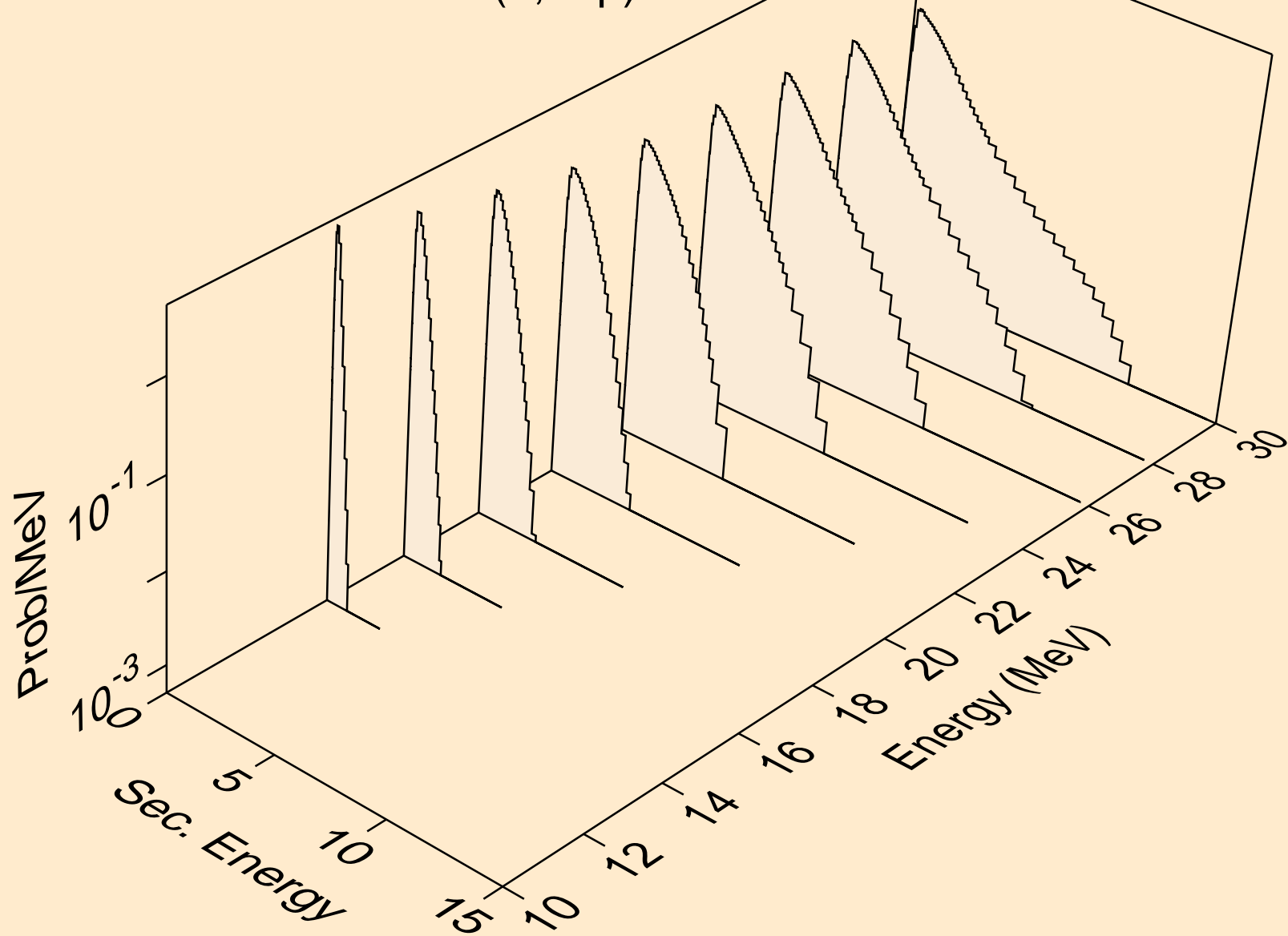

SN109 NEUTRON ACER TENDL-2024 LIBRARY; T=293.6K
Neutron emission for (n,npa)

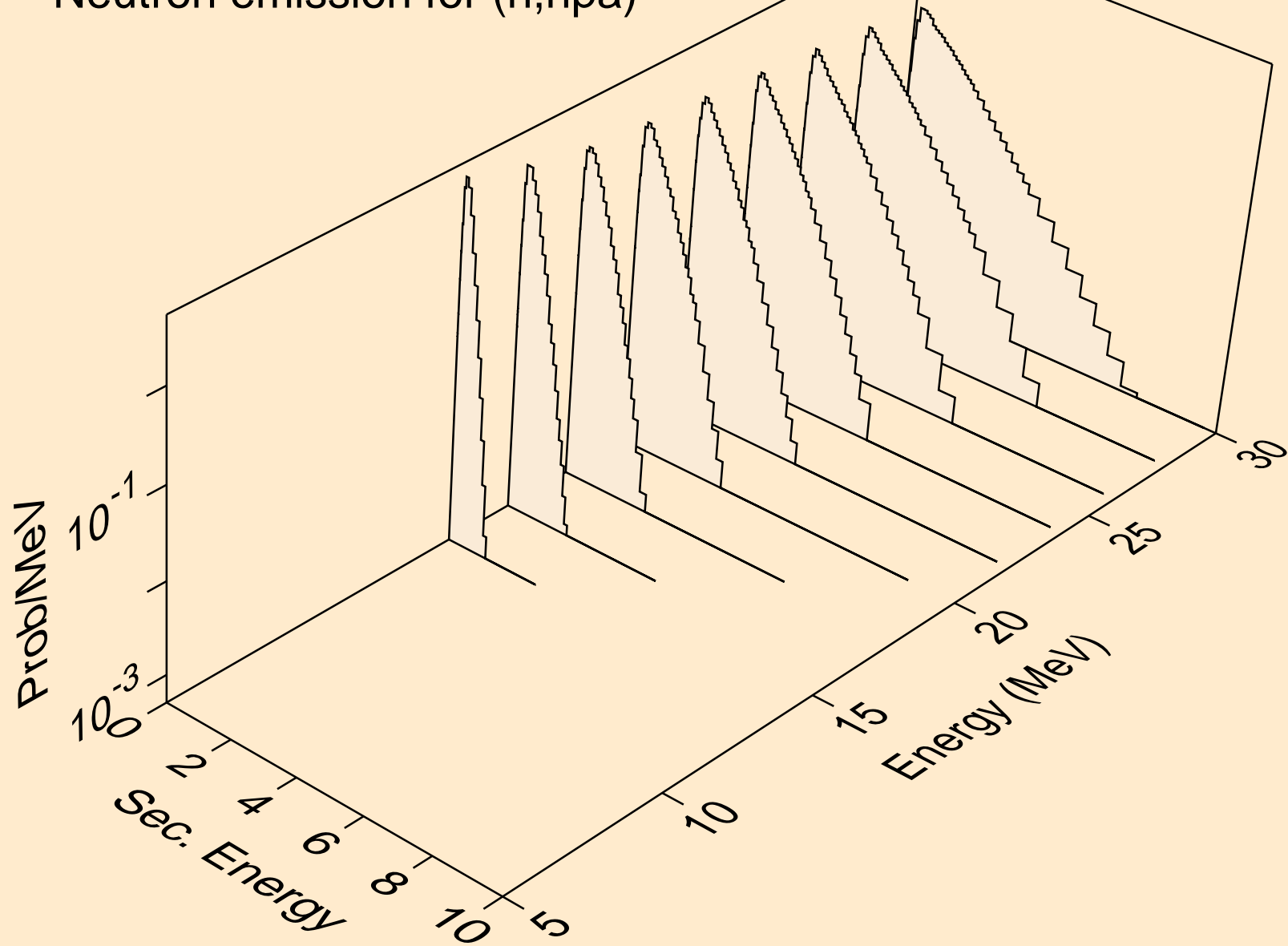

SN109 NEUTRON ACER TENDL-2024 LIBRARY; T=293.6K
Neutron emission for (n,n*c)

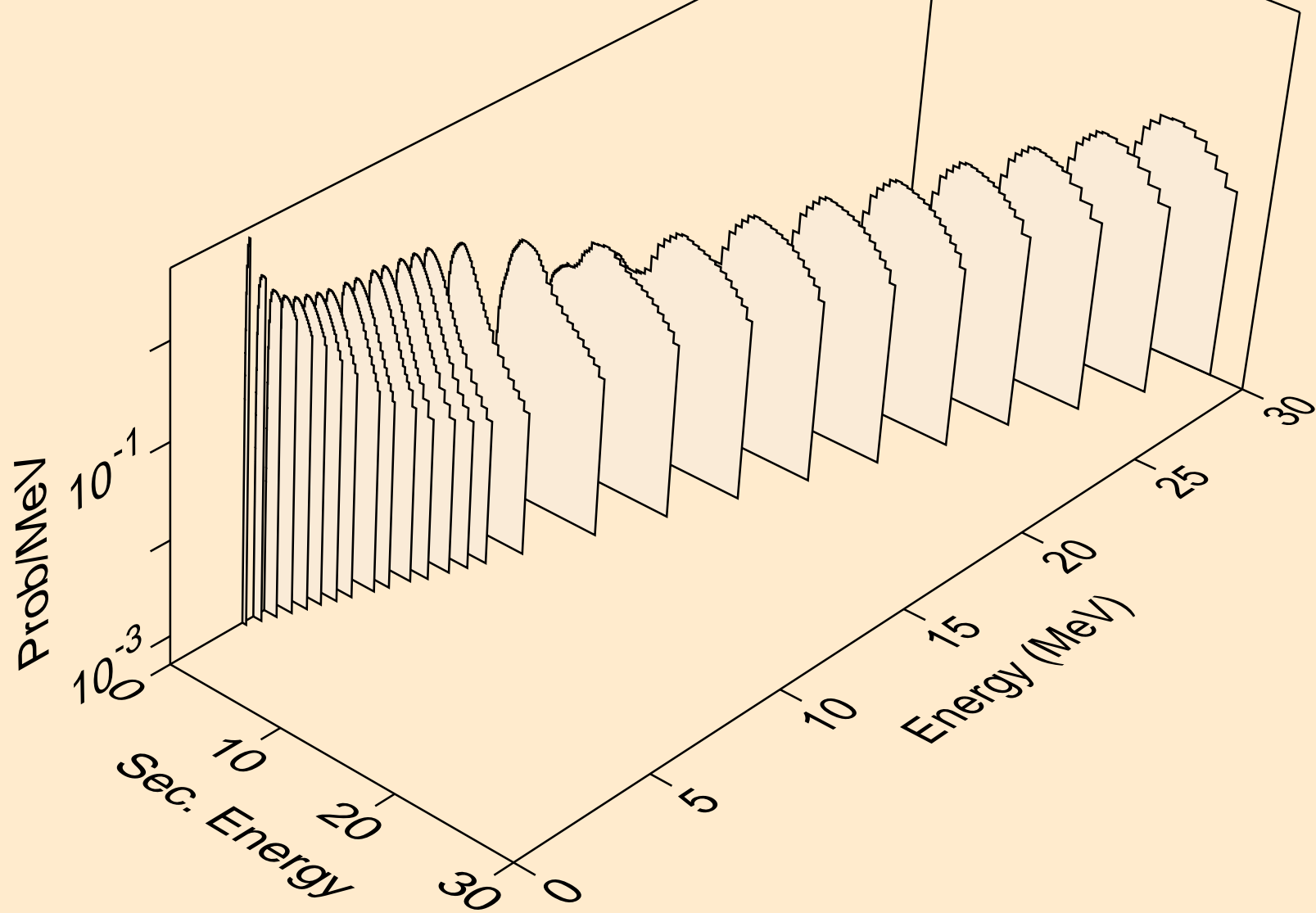

SN109 NEUTRON ACER TENDL-2024 LIBRARY; T=293.6K
Photon emission for (n,x)

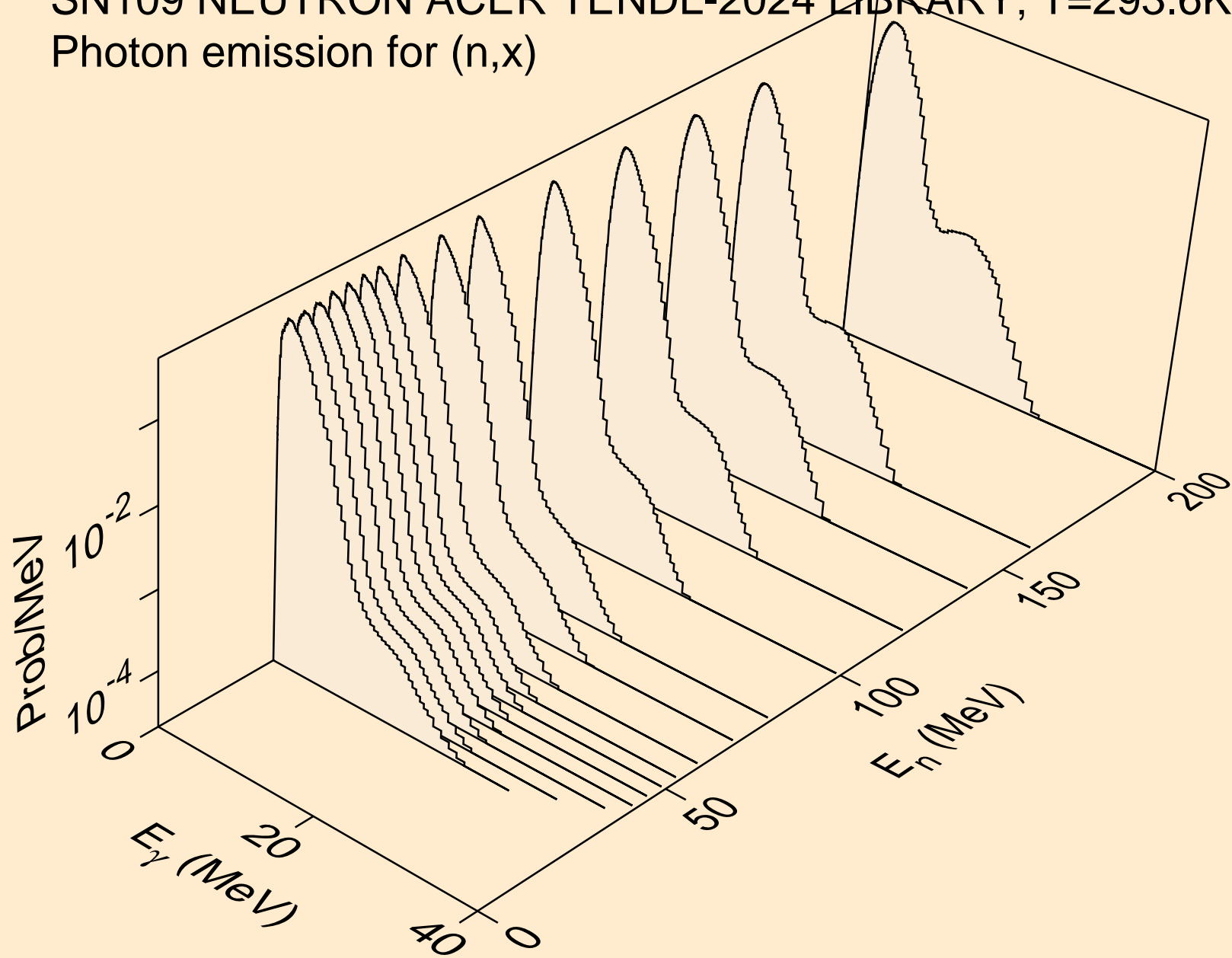

SN109 NEUTRON ACER TENDL-2024 LIBRARY; T=293.6K
Photon emission for (n,2nd)

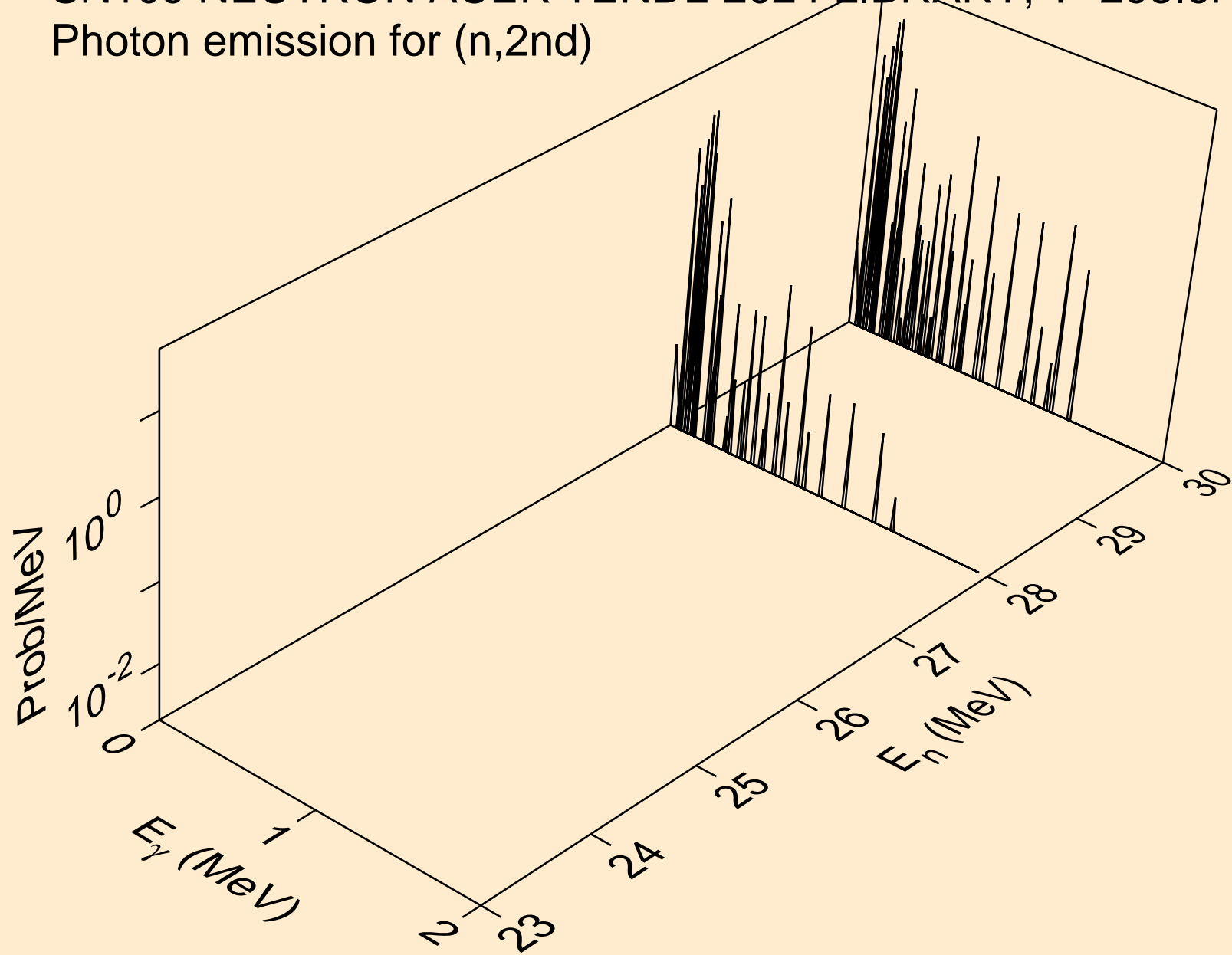

SN109 NEUTRON ACER TENDL-2024 LIBRARY; T=293.6K
Photon emission for (n,2n)

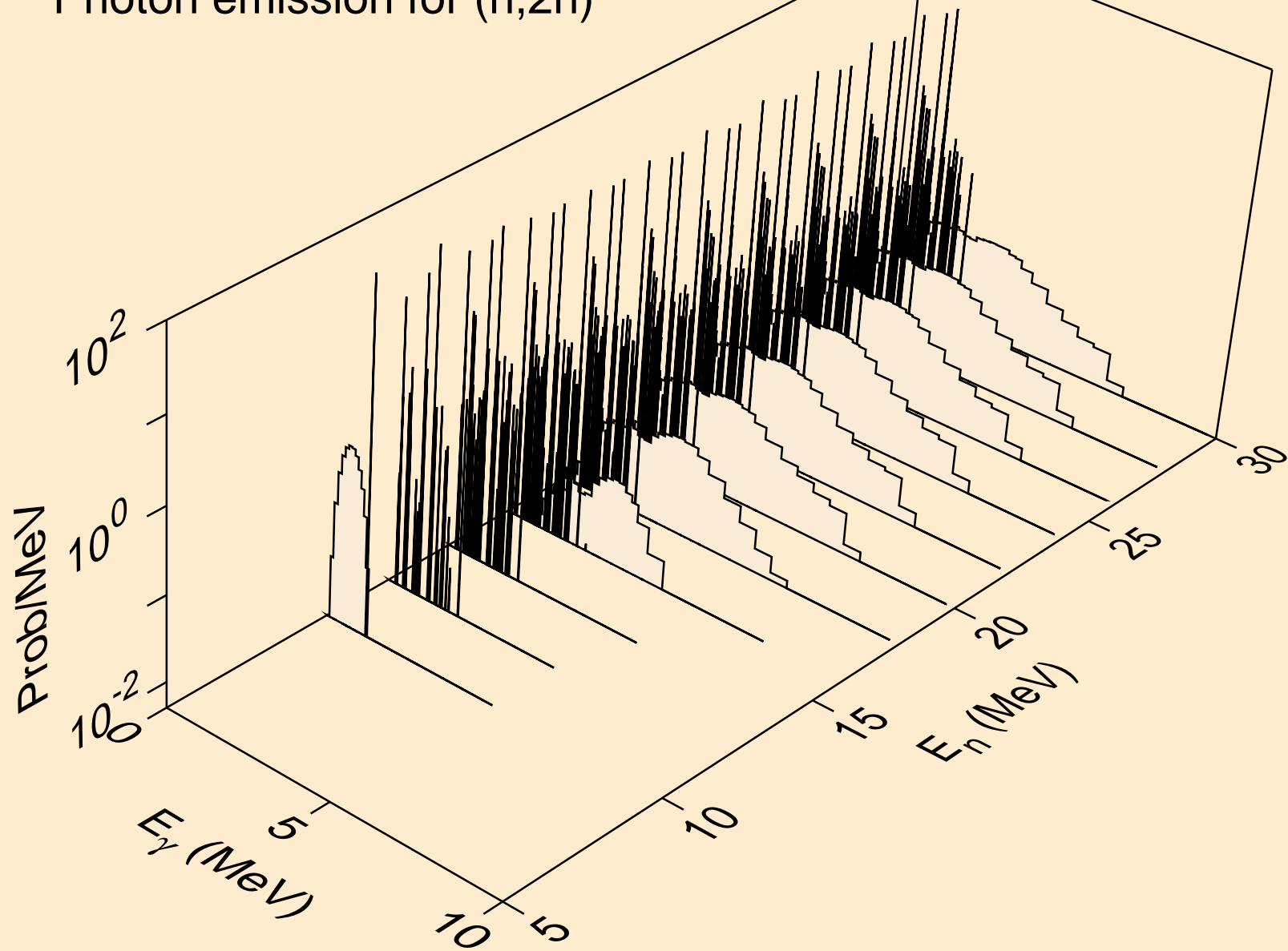

SN109 NEUTRON ACER TENDL-2024 LIBRARY; T=293.6K
Photon emission for (n,3n)

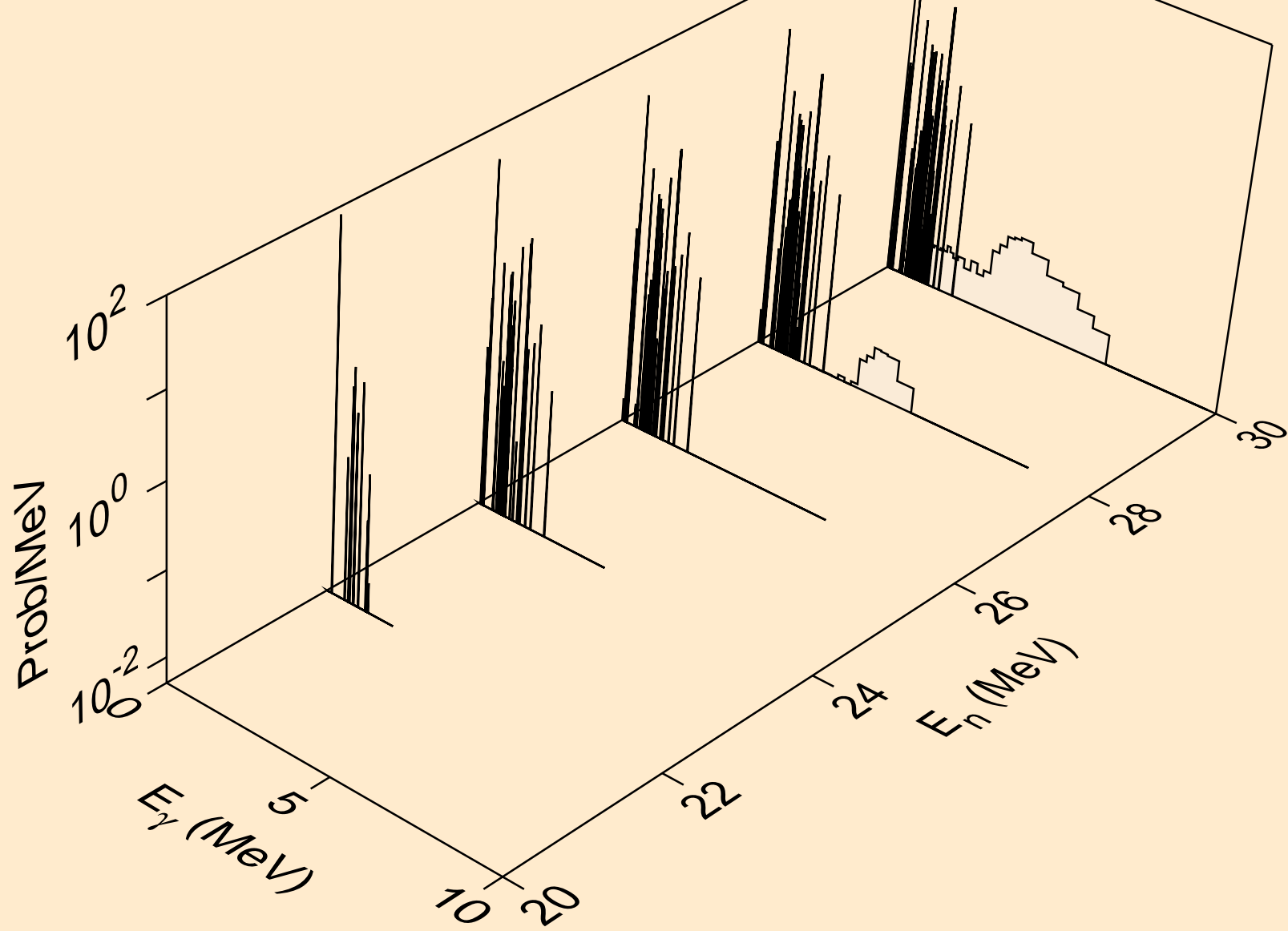

SN109 NEUTRON ACER TENDL-2024 LIBRARY; T=293.6K
Photon emission for (n,n*)a

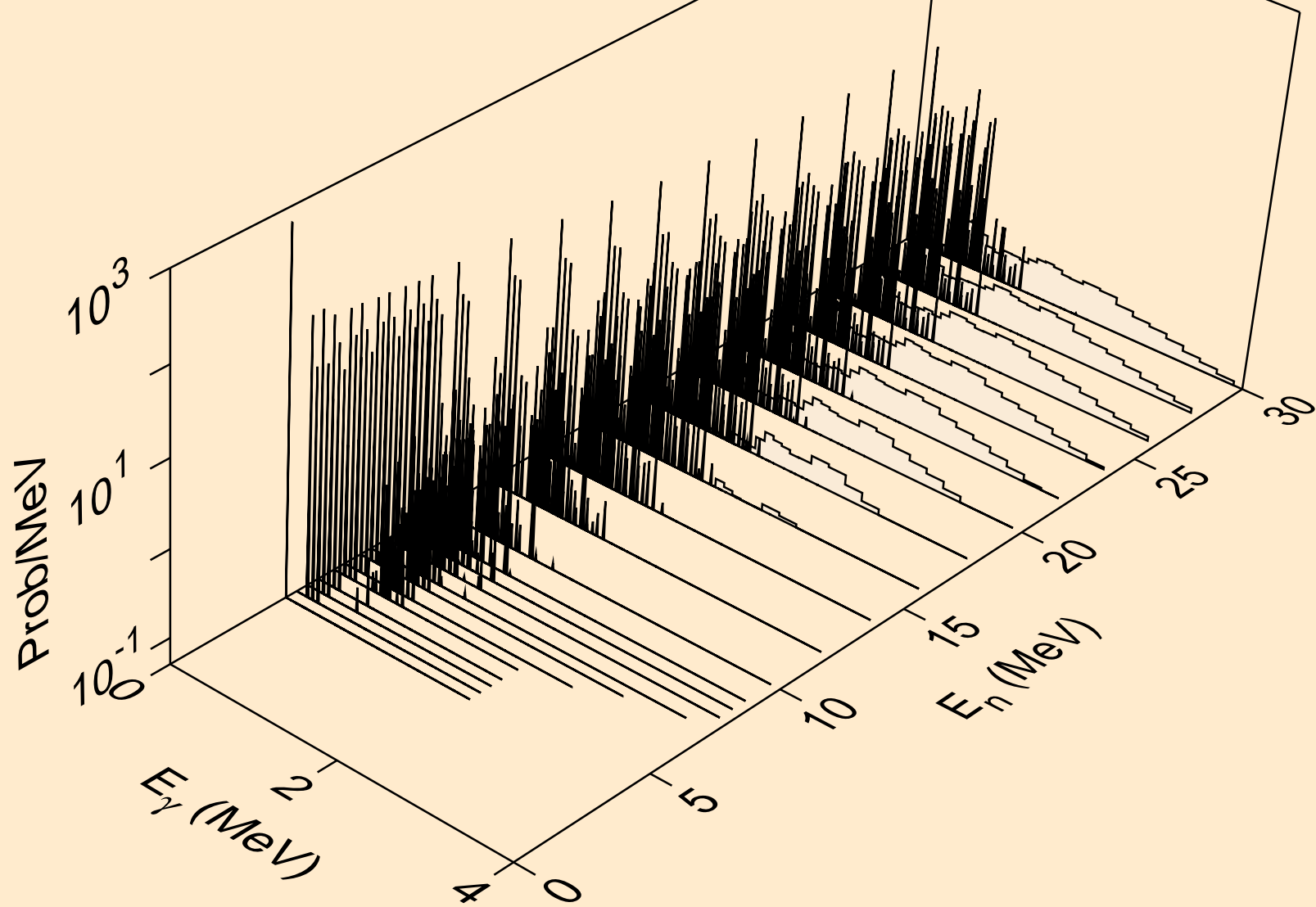

SN109 NEUTRON ACER TENDL-2024 LIBRARY; T=293.6K
Photon emission for (n,2n)a

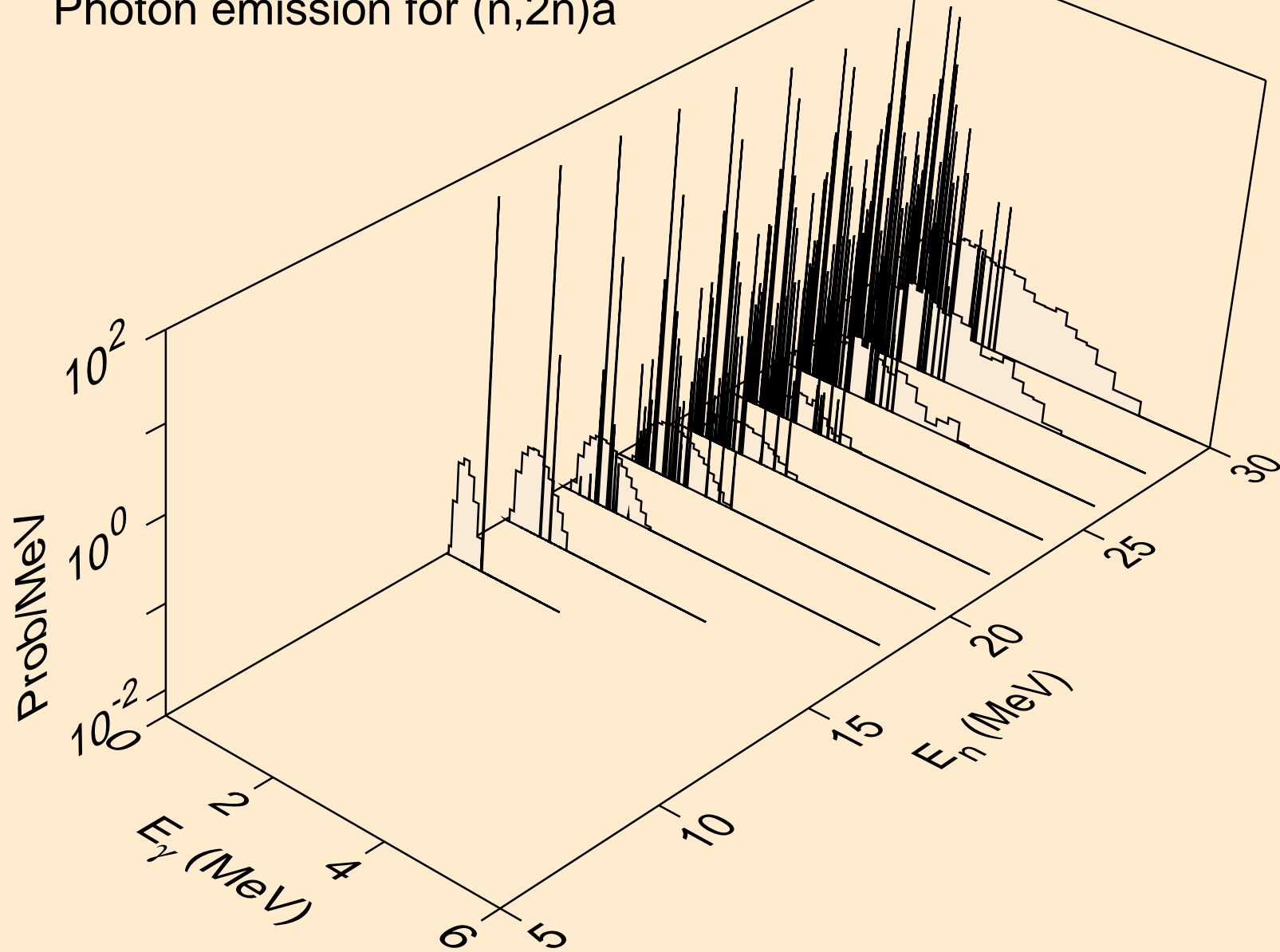

SN109 NEUTRON ACER TENDL-2024 LIBRARY; T=293.6K
Photon emission for (n,3n)a

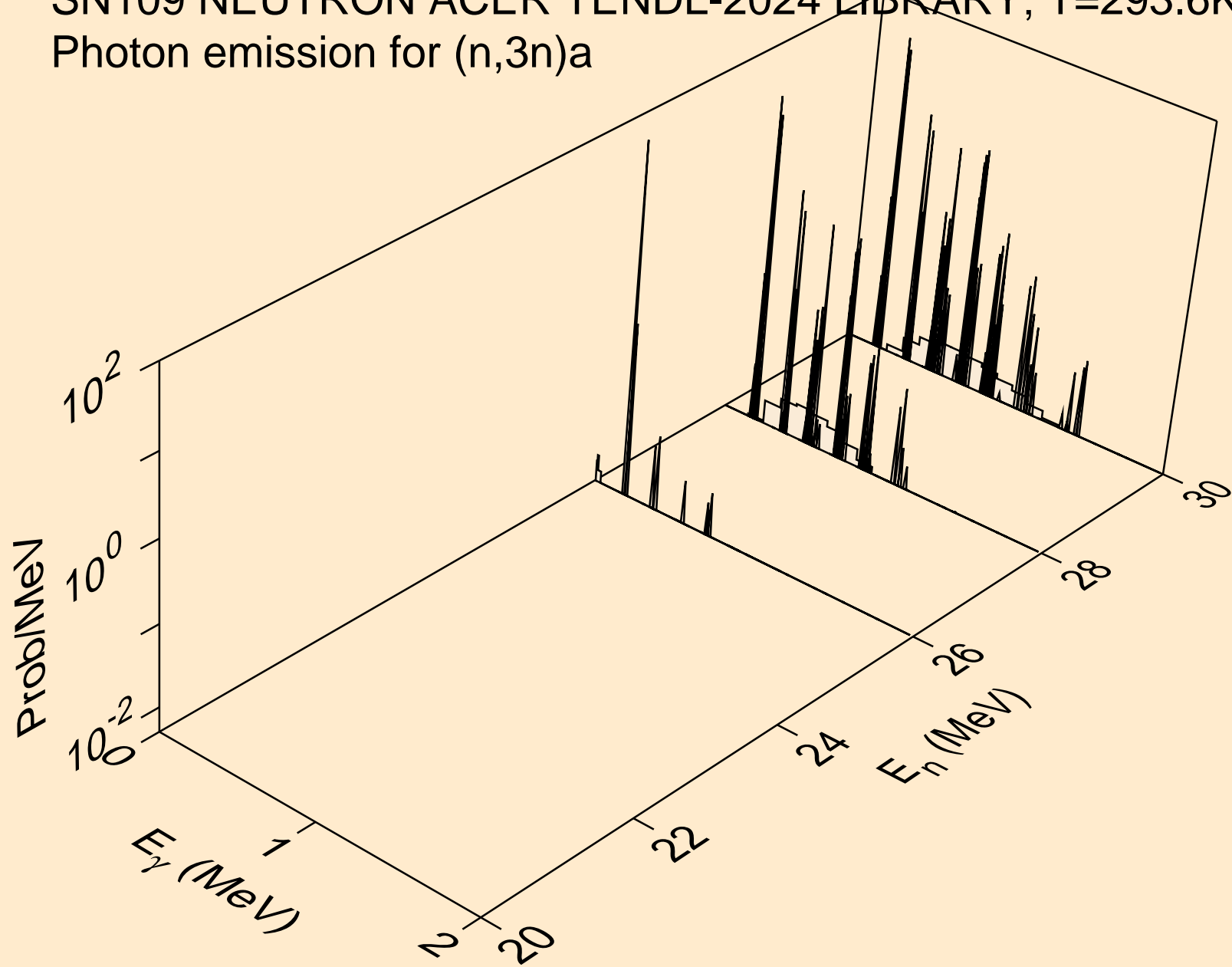

SN109 NEUTRON ACER TENDL-2024 LIBRARY; T=293.6K
Photon emission for (n,n*)p

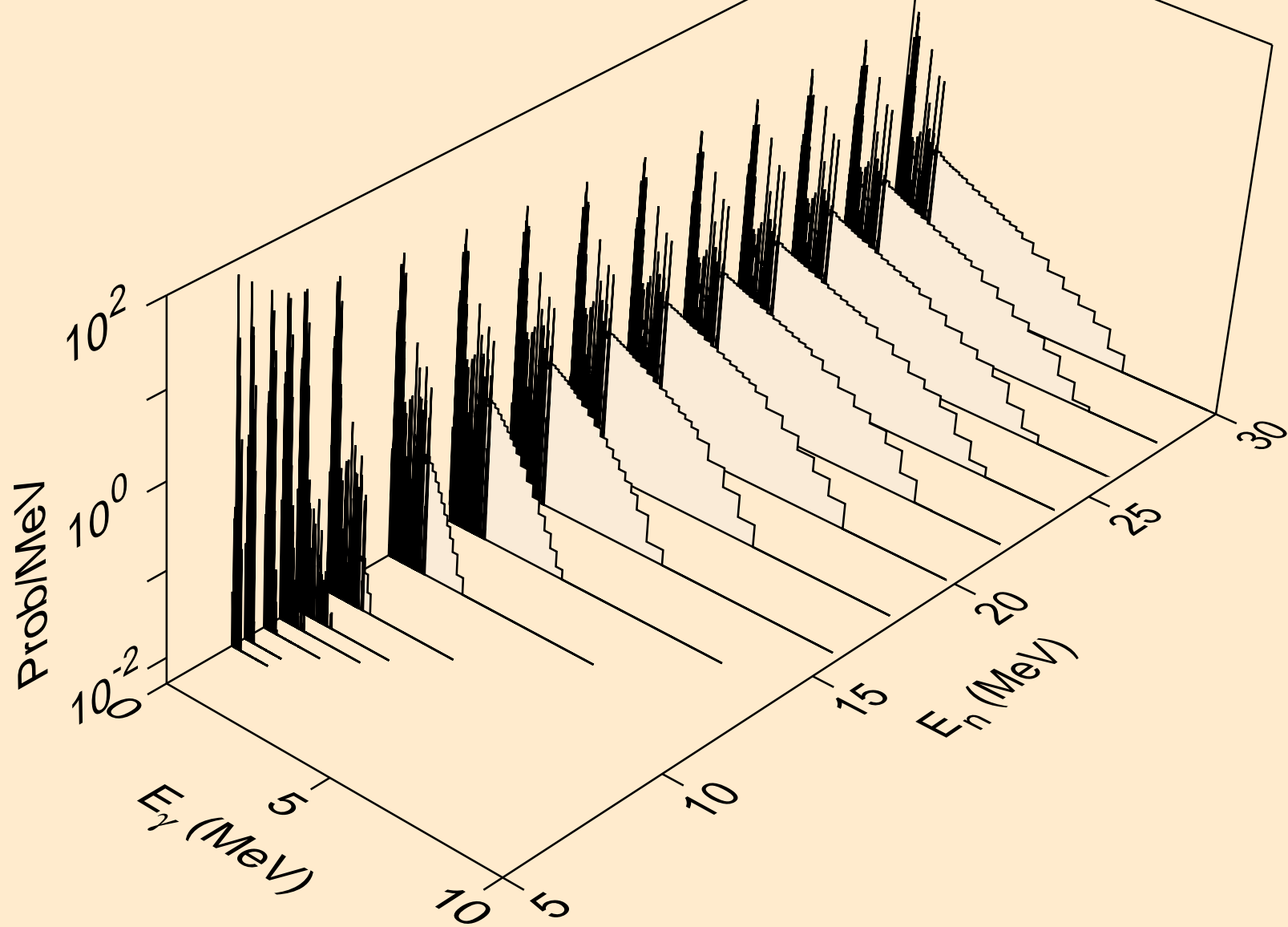

SN109 NEUTRON ACER TENDL-2024 LIBRARY; T=293.6K
Photon emission for (n,n*)2a

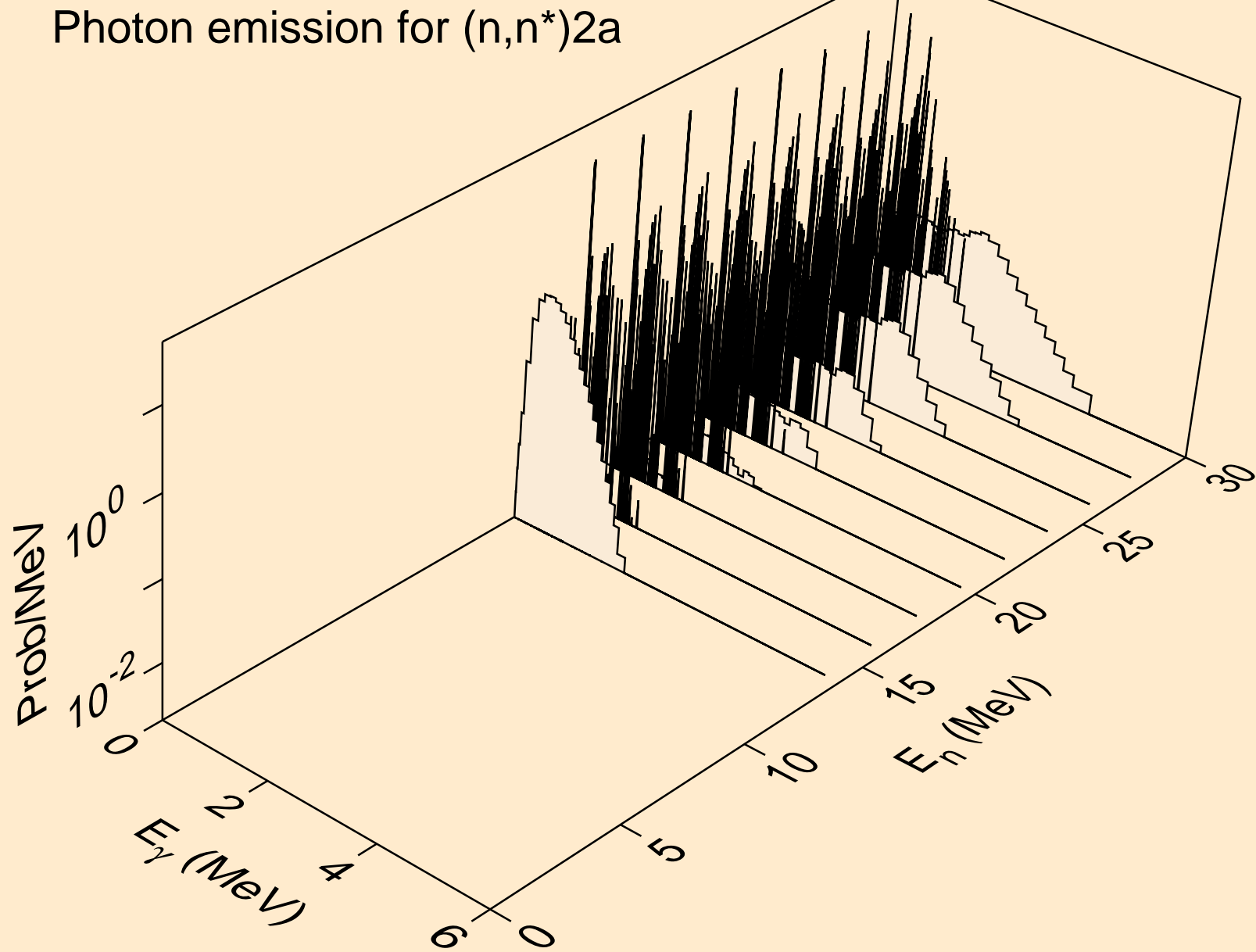

SN109 NEUTRON ACER TENDL-2024 LIBRARY; T=293.6K
Photon emission for (n,2n)2a

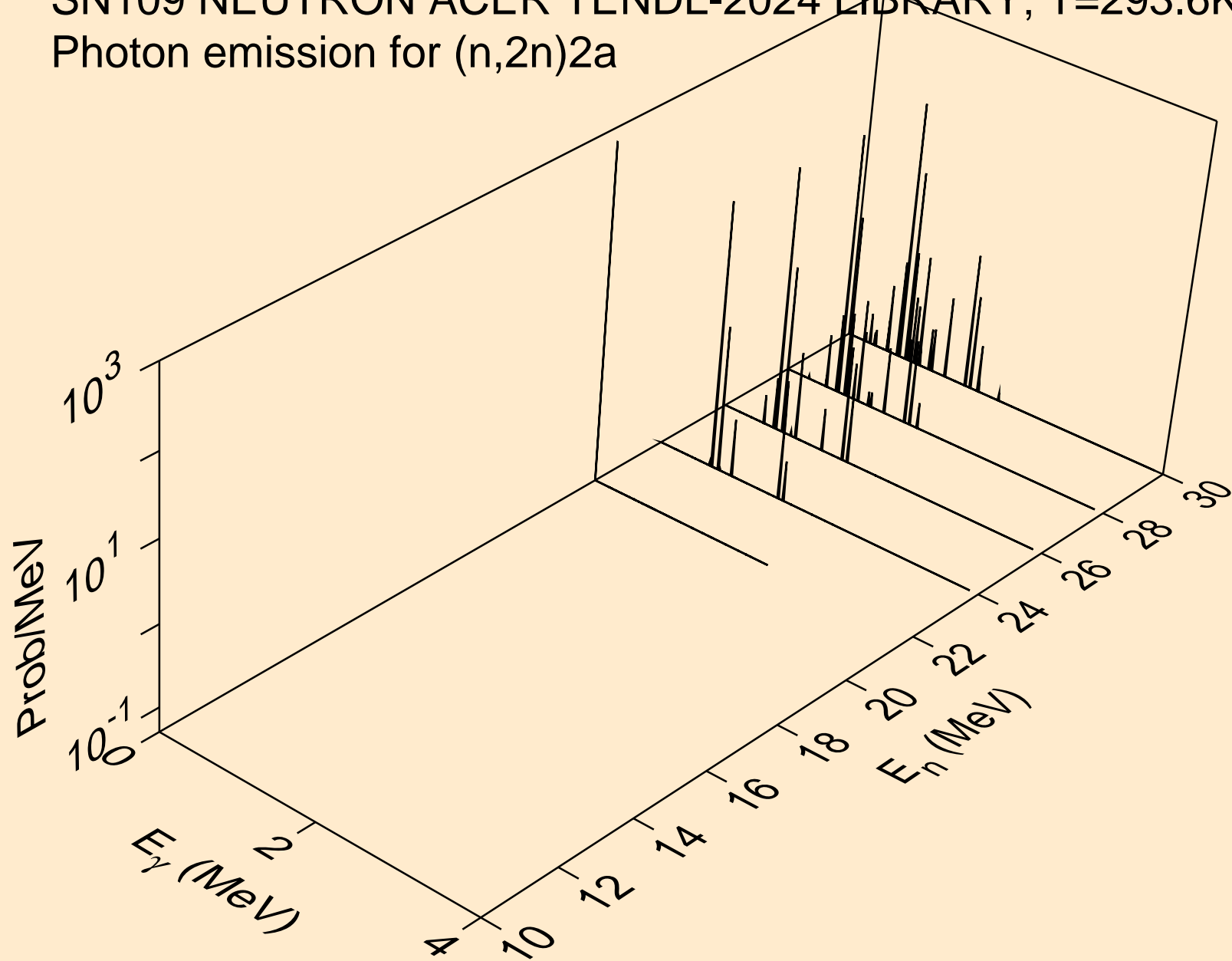

SN109 NEUTRON ACER TENDL-2024 LIBRARY; T=293.6K
Photon emission for (n,n*)d

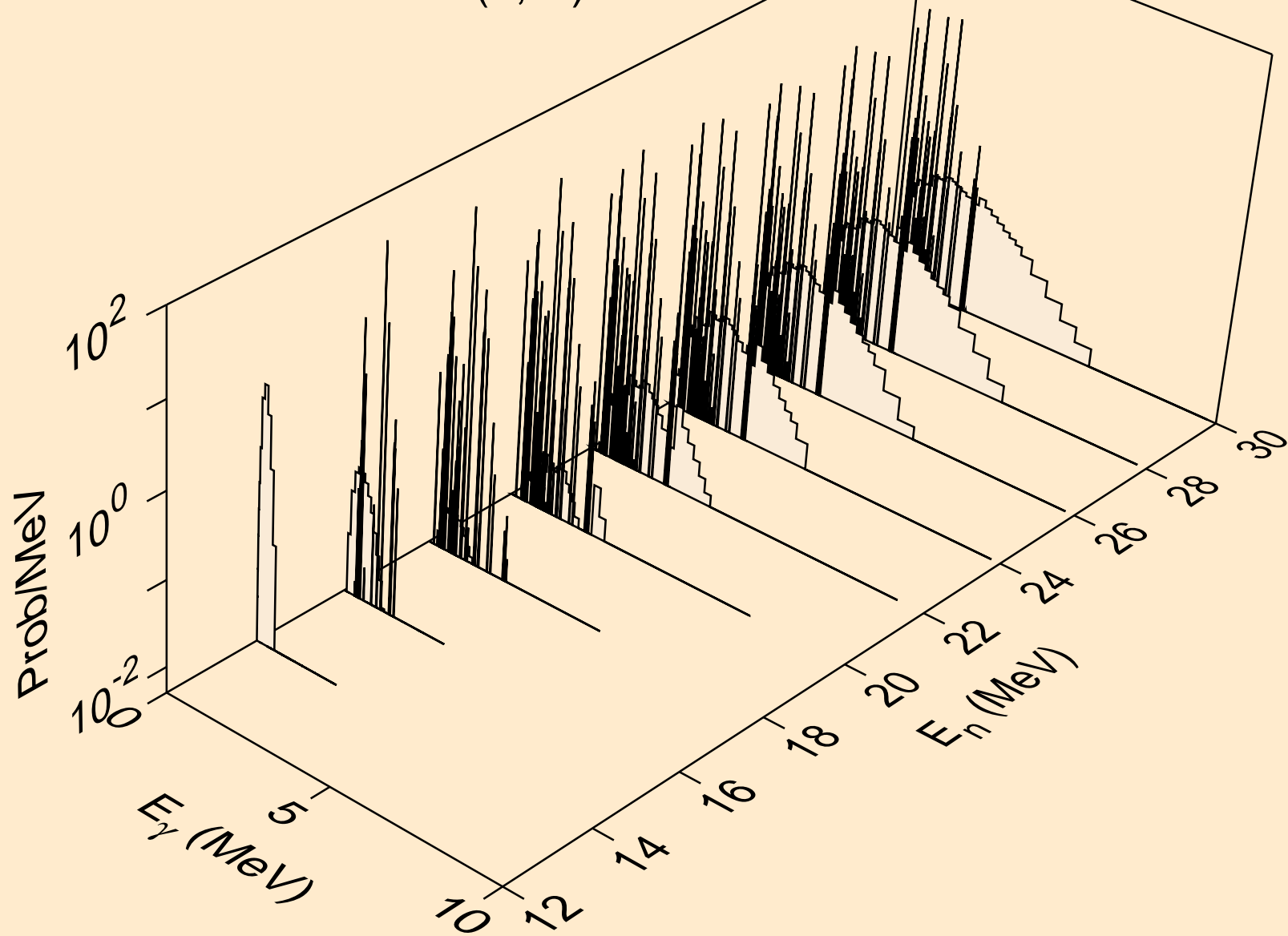

SN109 NEUTRON ACER TENDL-2024 LIBRARY; T=293.6K
Photon emission for (n,n*)t

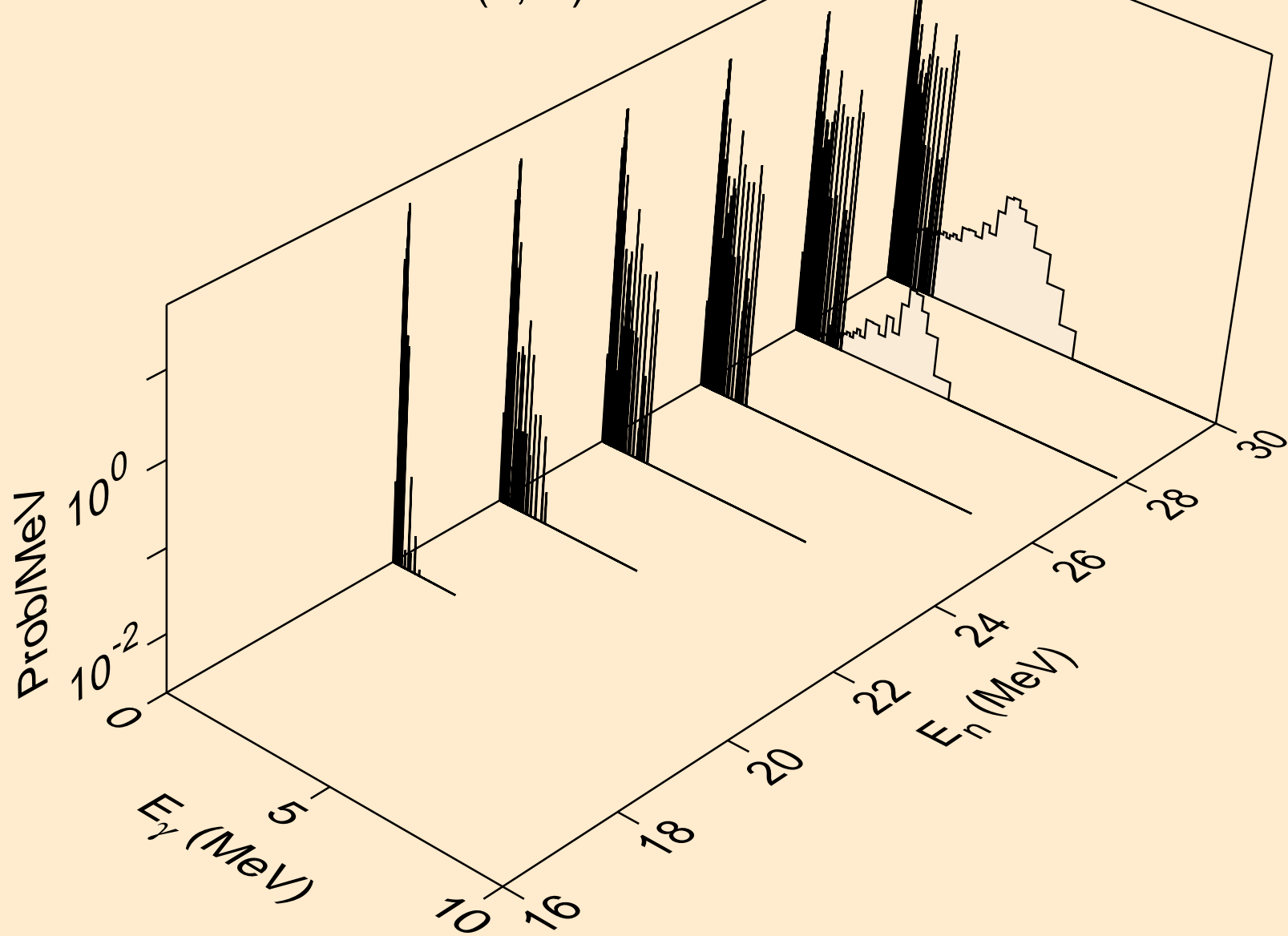

SN109 NEUTRON ACER TENDL-2024 LIBRARY; T=293.6K
Photon emission for (n,n*)he3

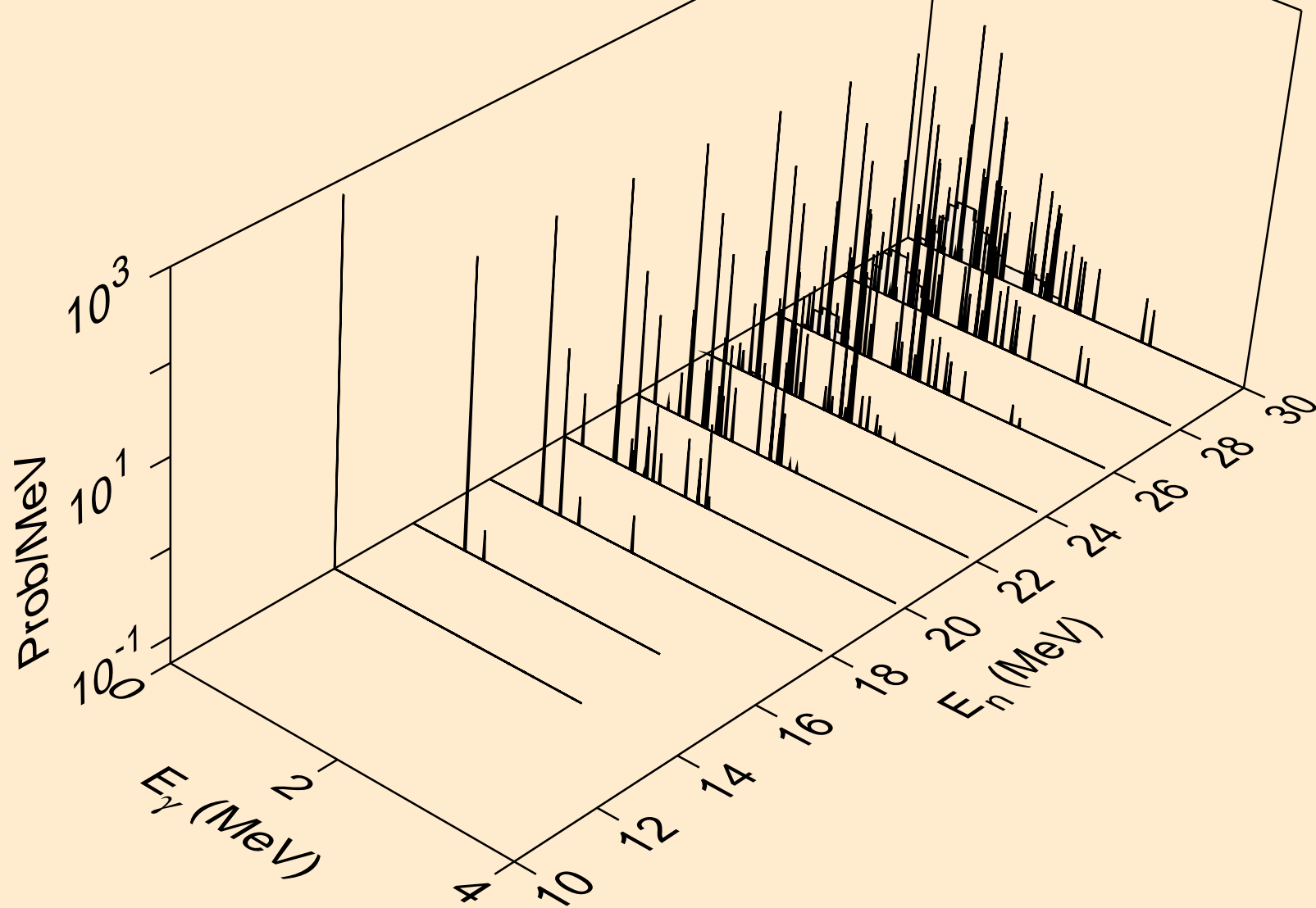

SN109 NEUTRON ACER TENDL-2024 LIBRARY; T=293.6K
Photon emission for (n,2np)

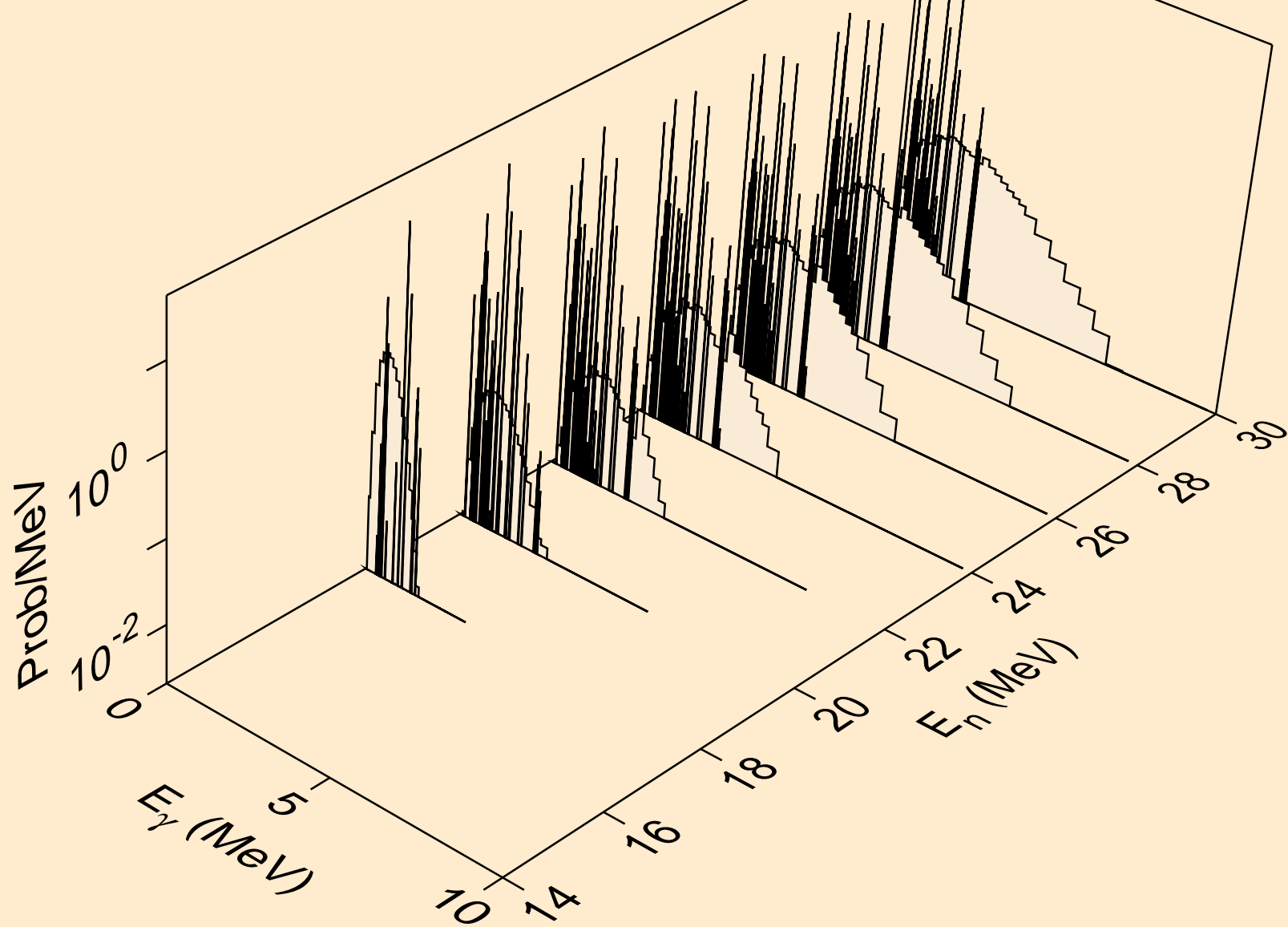

SN109 NEUTRON ACER TENDL-2024 LIBRARY; T=293.6K
Photon emission for (n,3np)

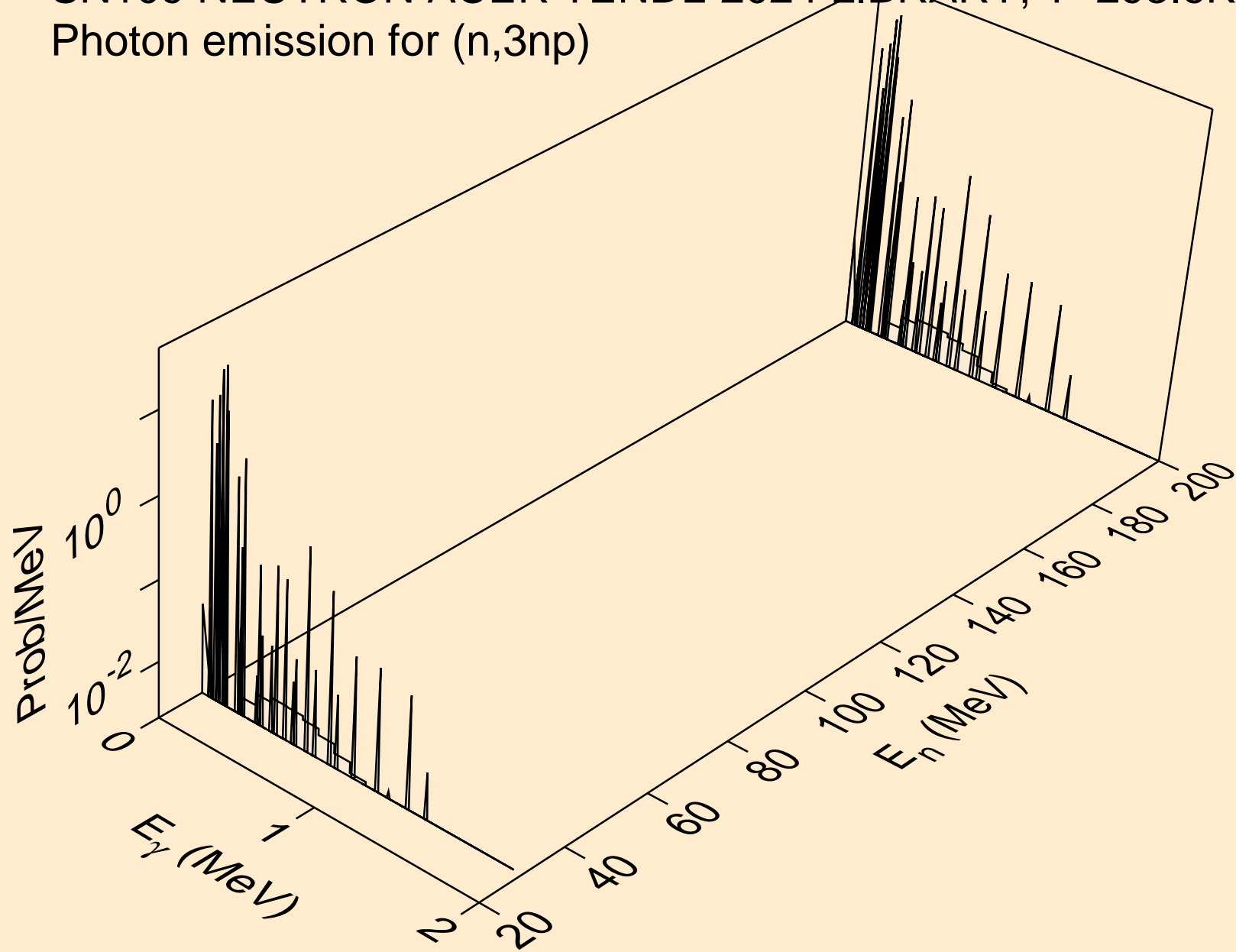

SN109 NEUTRON ACER TENDL-2024 LIBRARY; T=293.6K
Photon emission for (n,n2p)

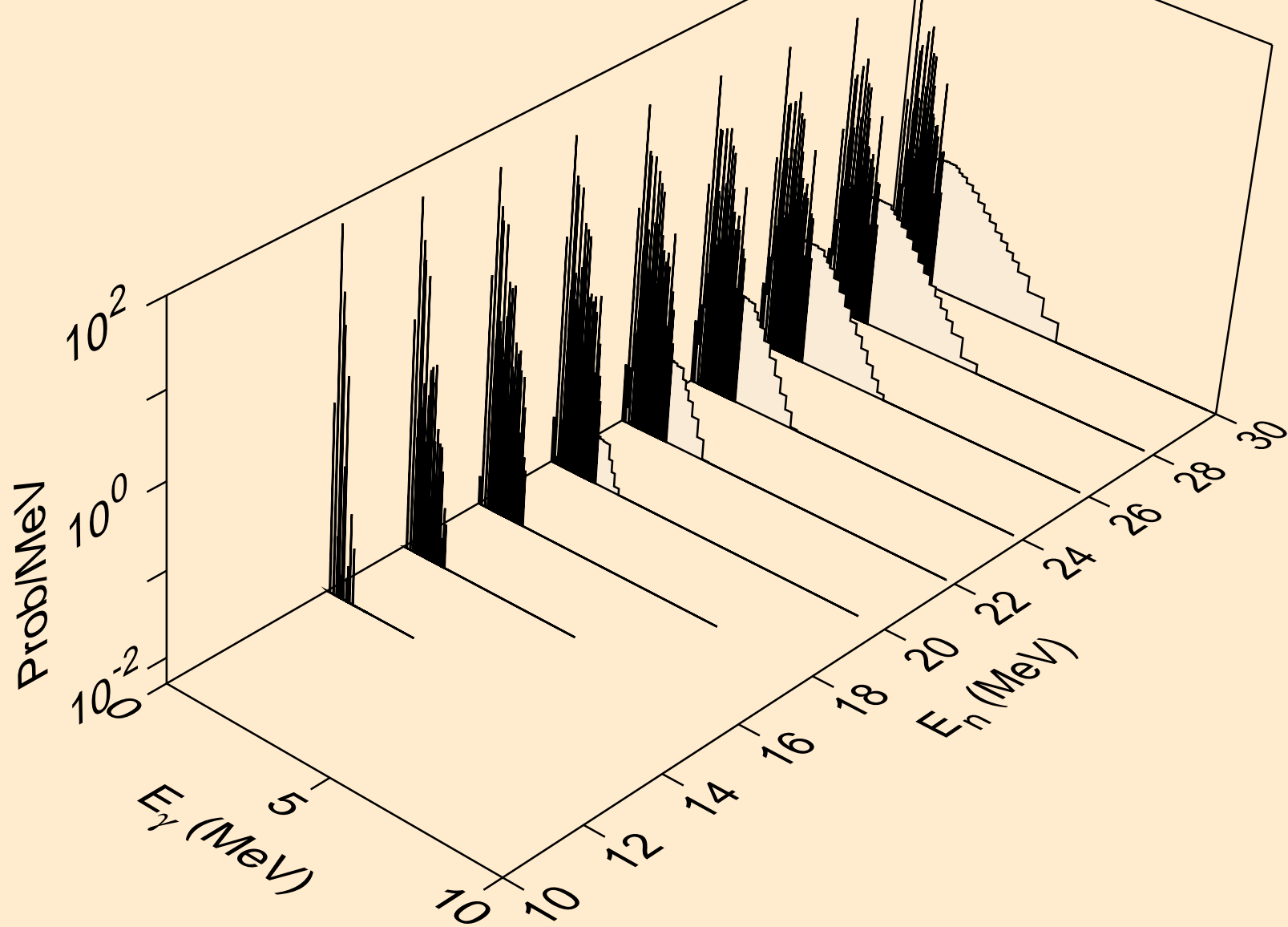

SN109 NEUTRON ACER TENDL-2024 LIBRARY; T=293.6K
Photon emission for (n,npa)

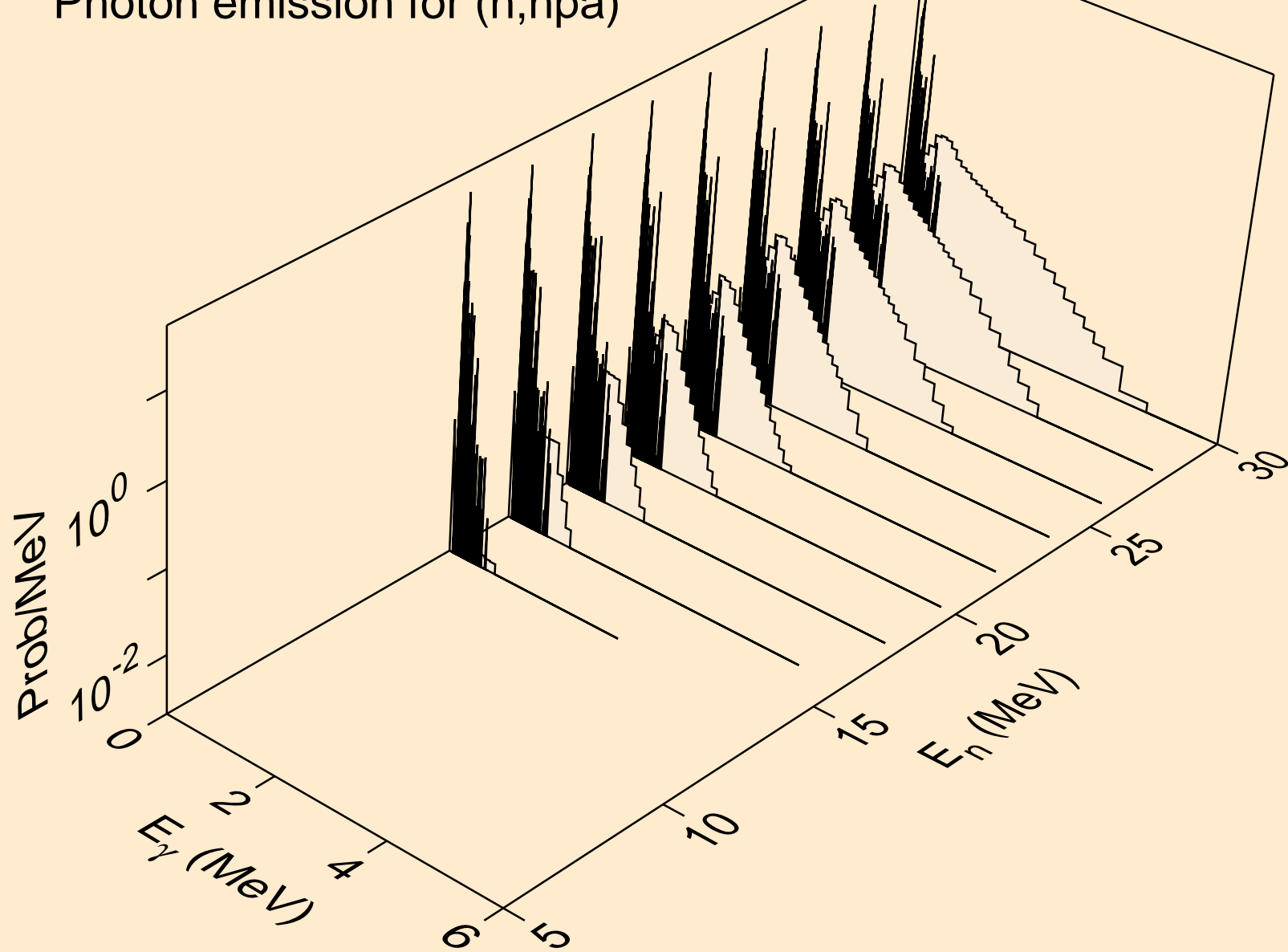

SN109 NEUTRON ACER TENDL-2024 LIBRARY; T=293.6K
Photon emission for (n,n*c)

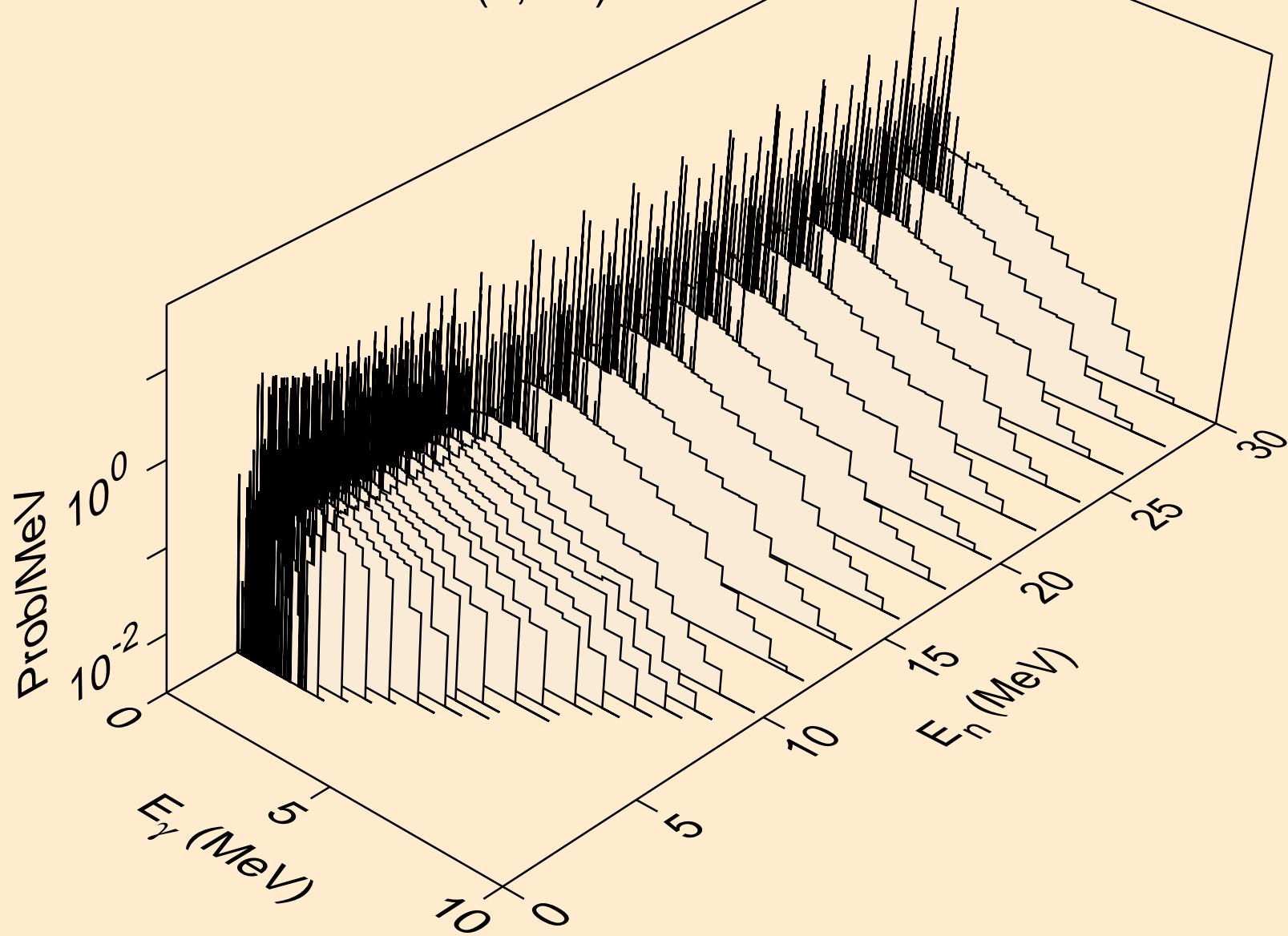

SN109 NEUTRON ACER TENDL-2024 LIBRARY; T=293.6K
Photon emission for (n,gma)

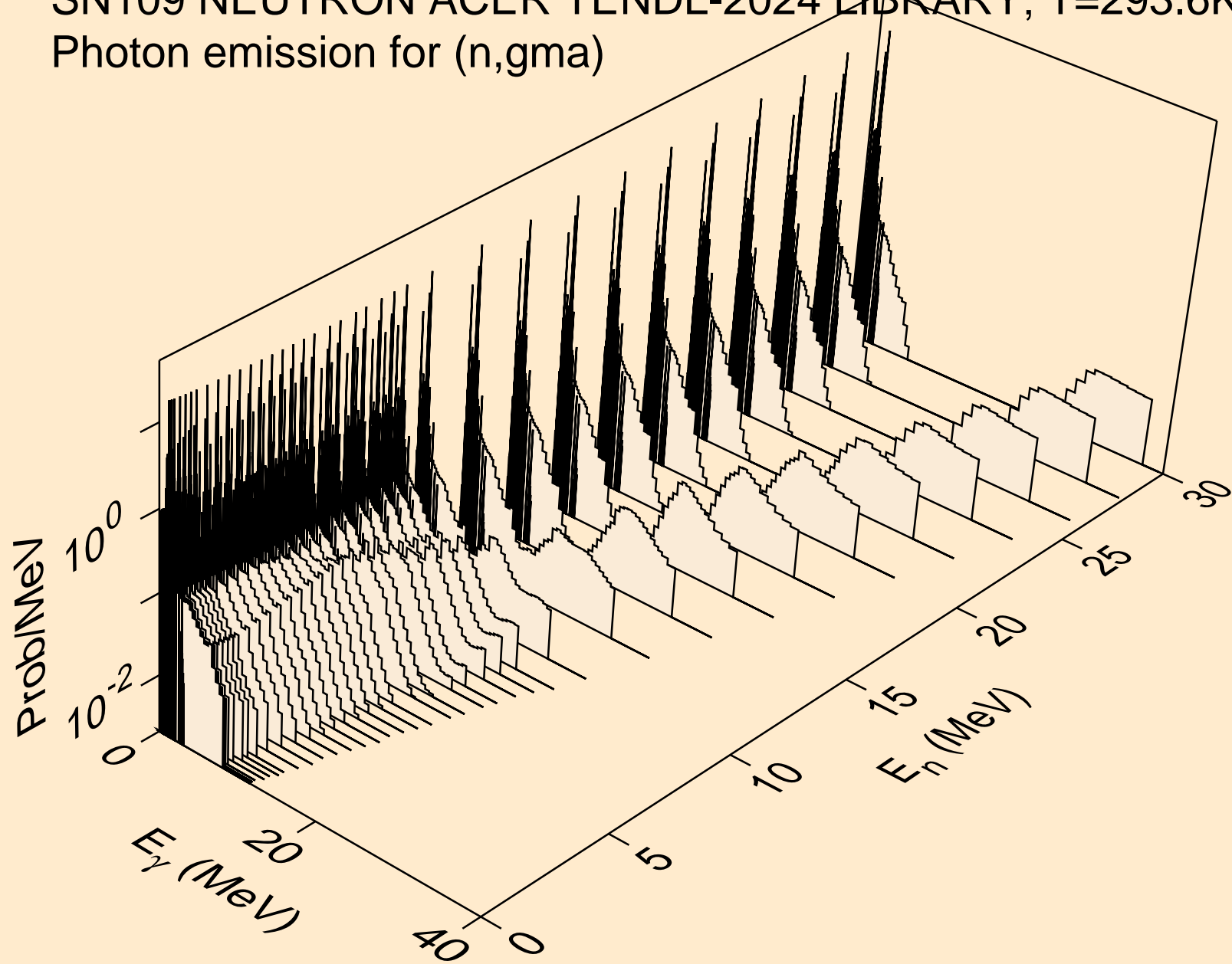

SN109 NEUTRON ACER TENDL-2024 LIBRARY; T=293.6K
Photon emission for (n,p)

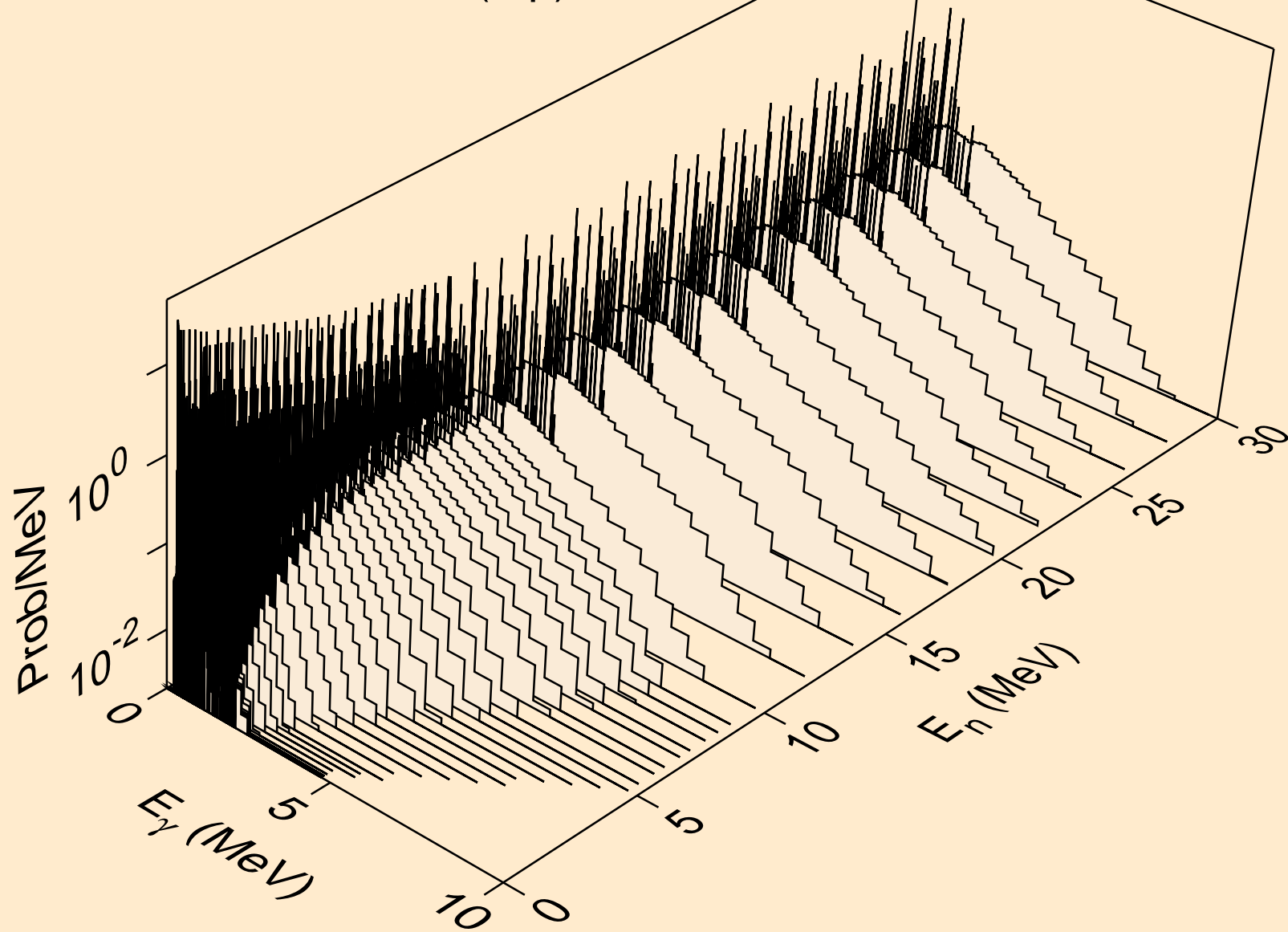

SN109 NEUTRON ACER TENDL-2024 LIBRARY; T=293.6K
Photon emission for (n,d)

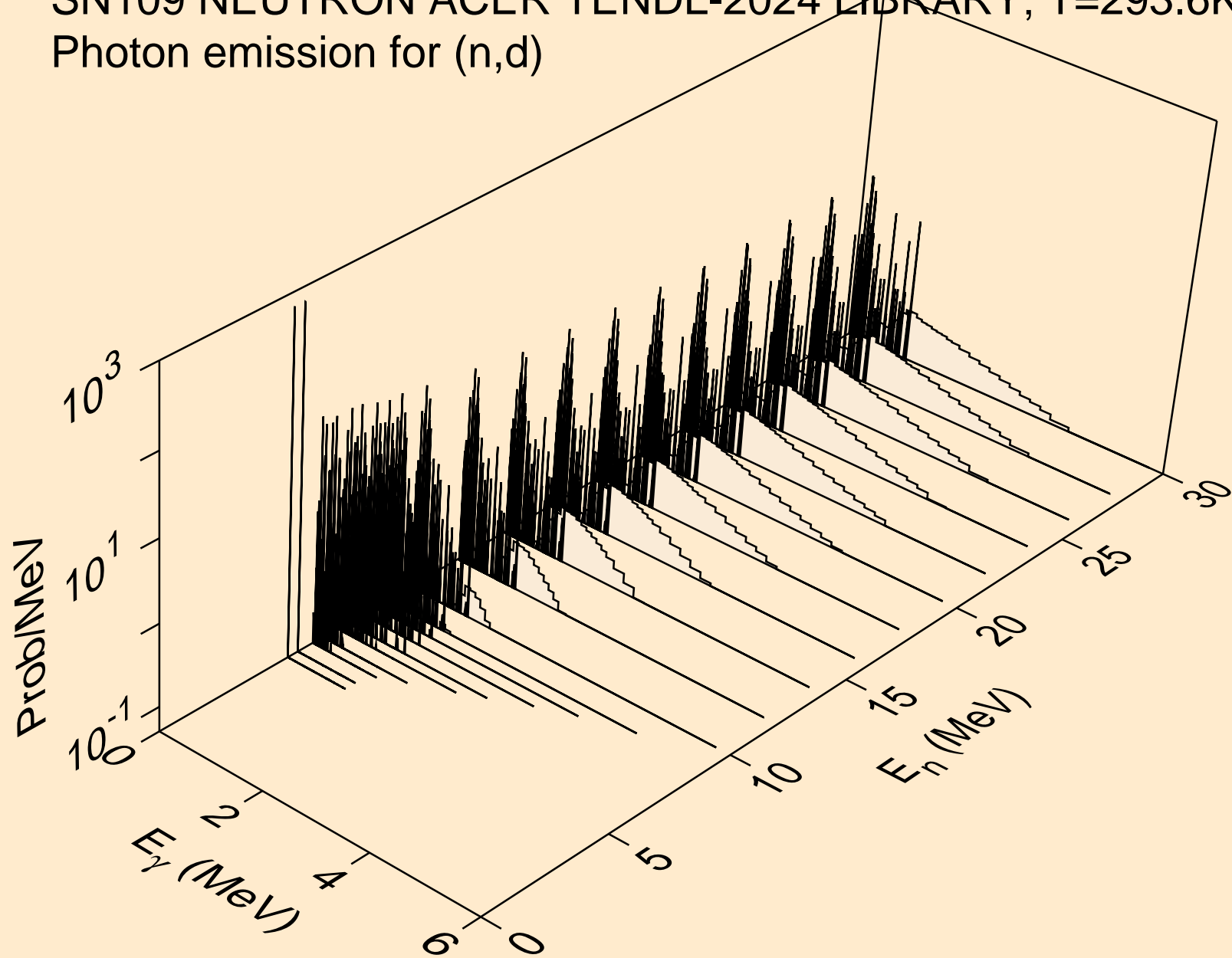

SN109 NEUTRON ACER TENDL-2024 LIBRARY; T=293.6K
Photon emission for (n,t)

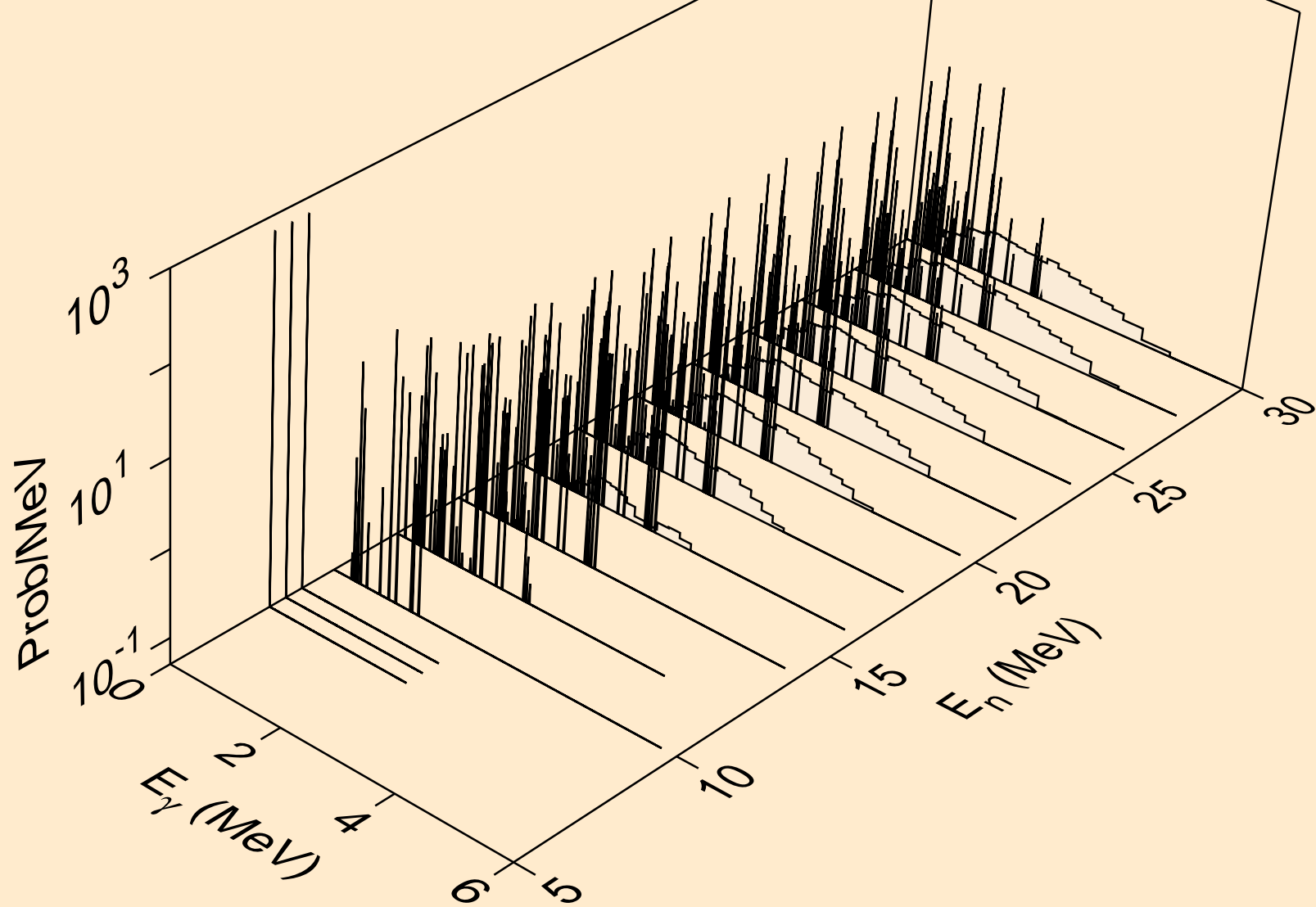

SN109 NEUTRON ACER TENDL-2024 LIBRARY; T=293.6K
Photon emission for (n,he3)

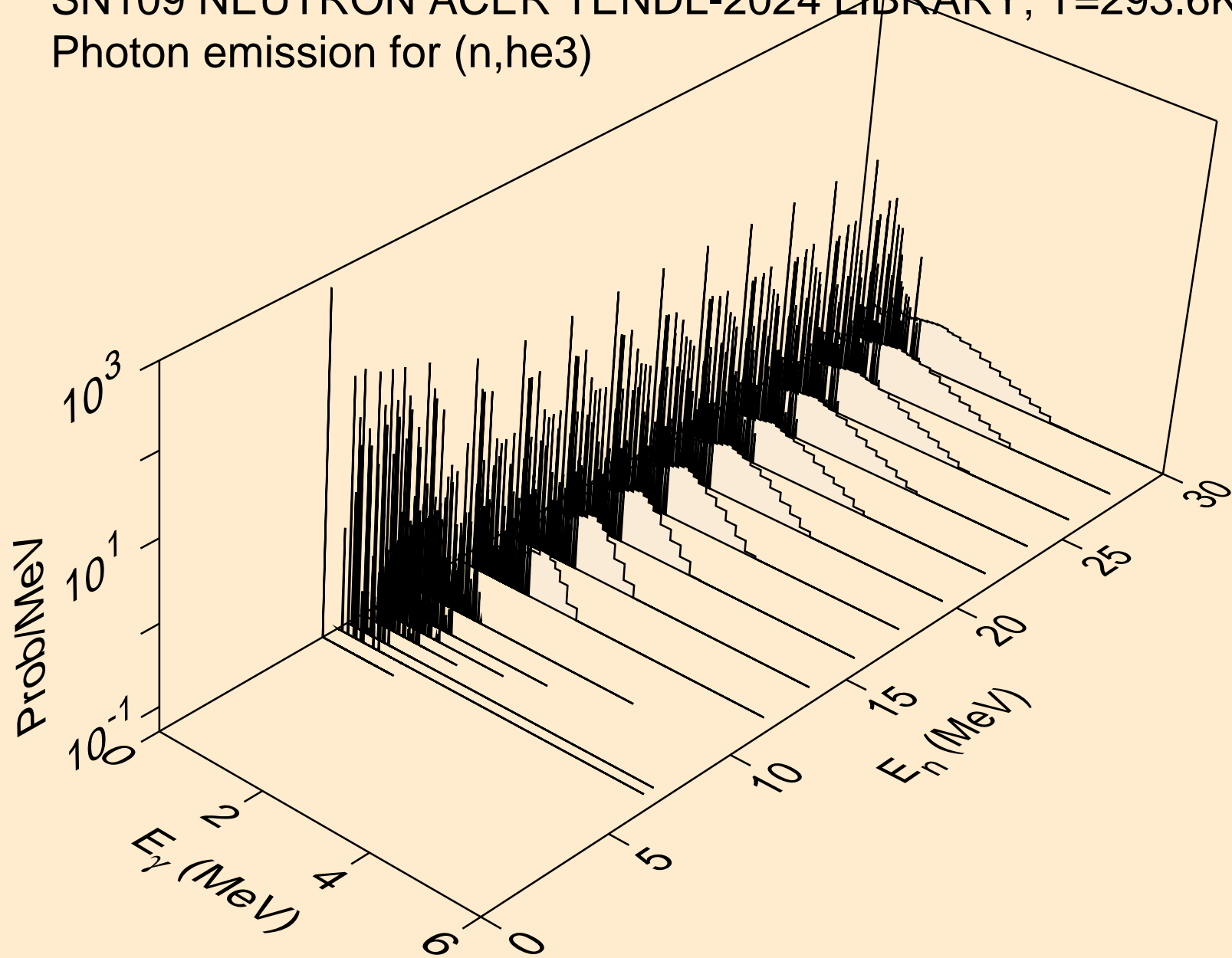

SN109 NEUTRON ACER TENDL-2024 LIBRARY; T=293.6K
Photon emission for (n,a)

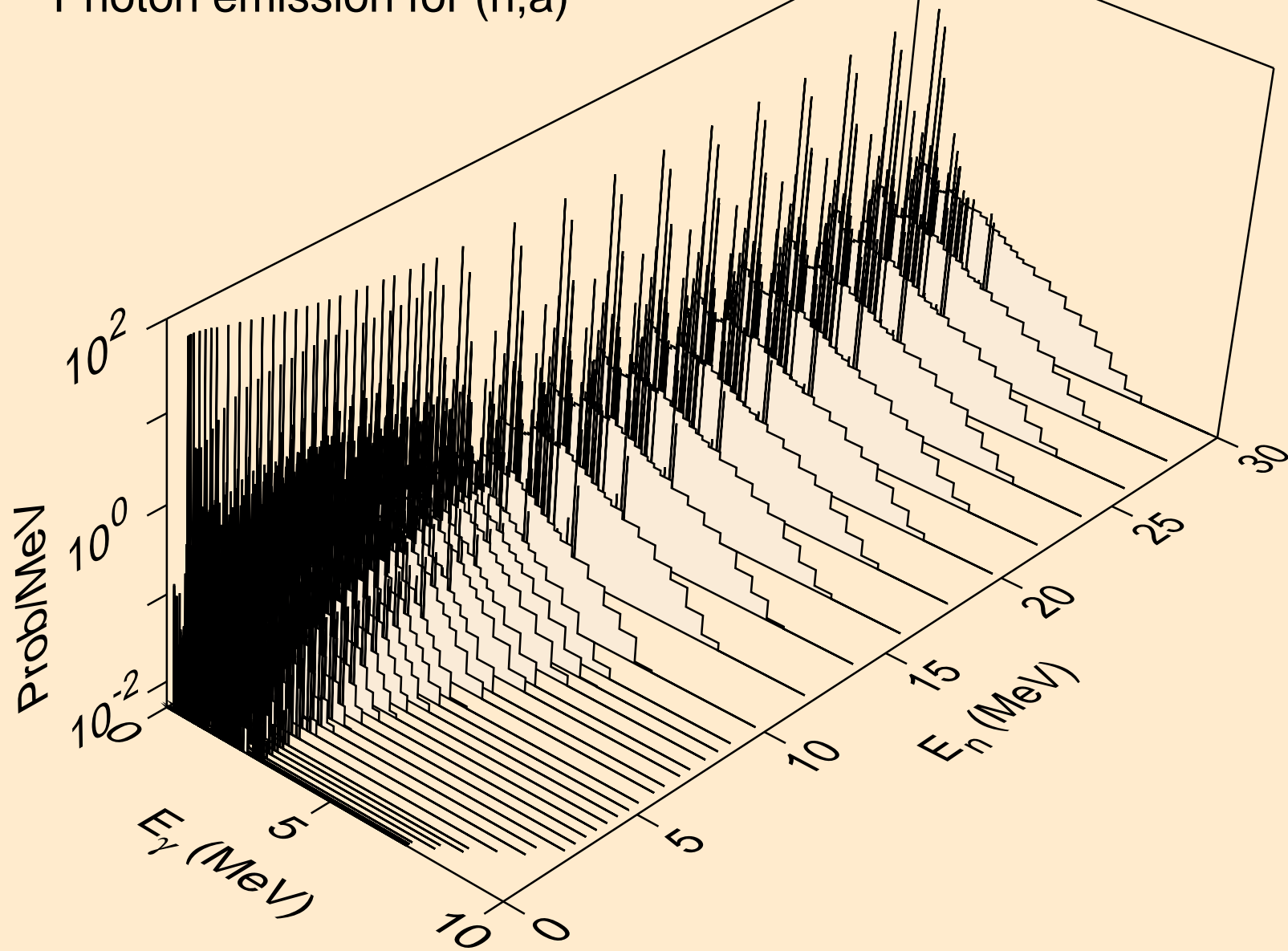

SN109 NEUTRON ACER TENDL-2024 LIBRARY; T=293.6K
Photon emission for (n,2a)

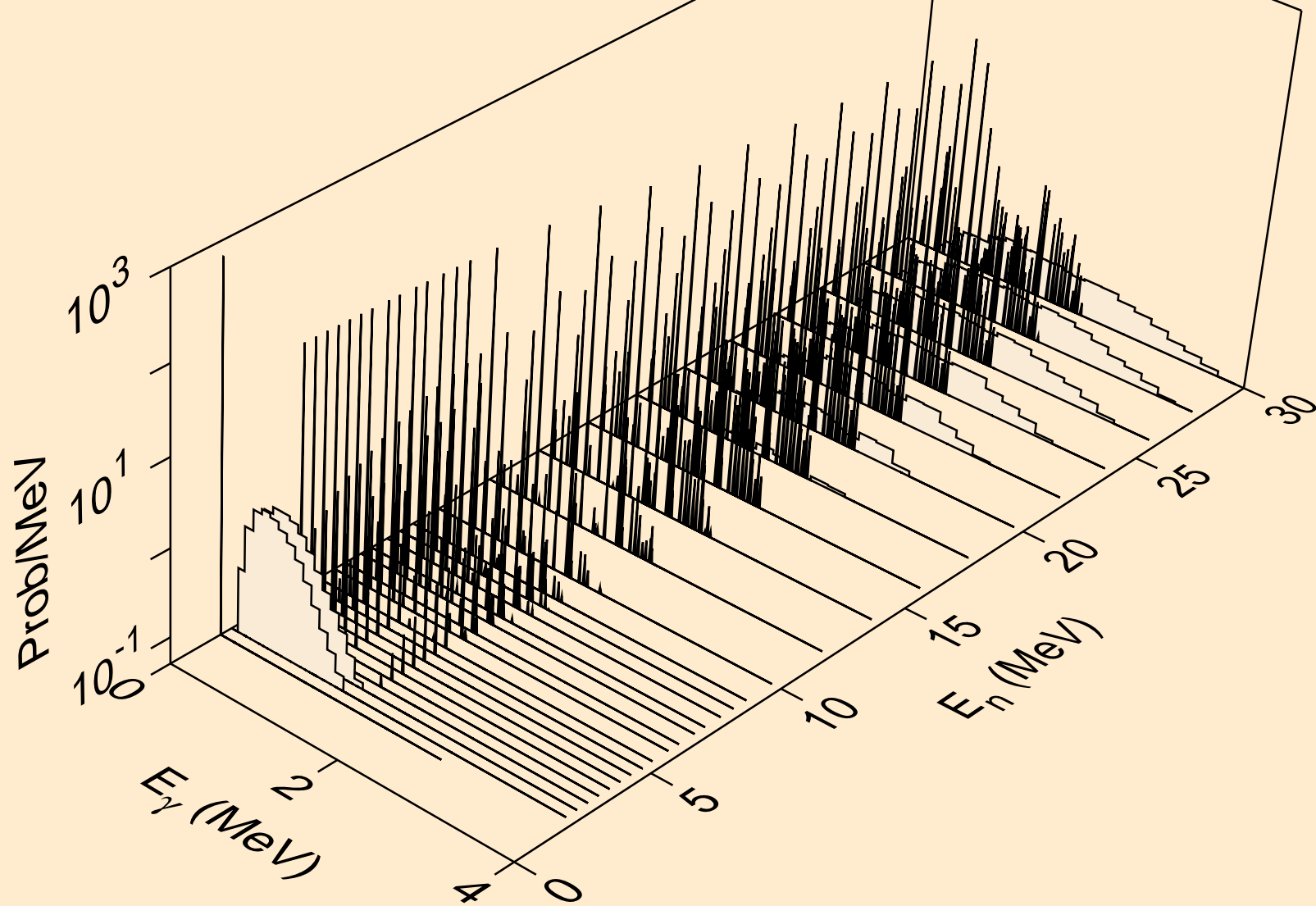

SN109 NEUTRON ACER TENDL-2024 LIBRARY; T=293.6K
Photon emission for (n,3a)

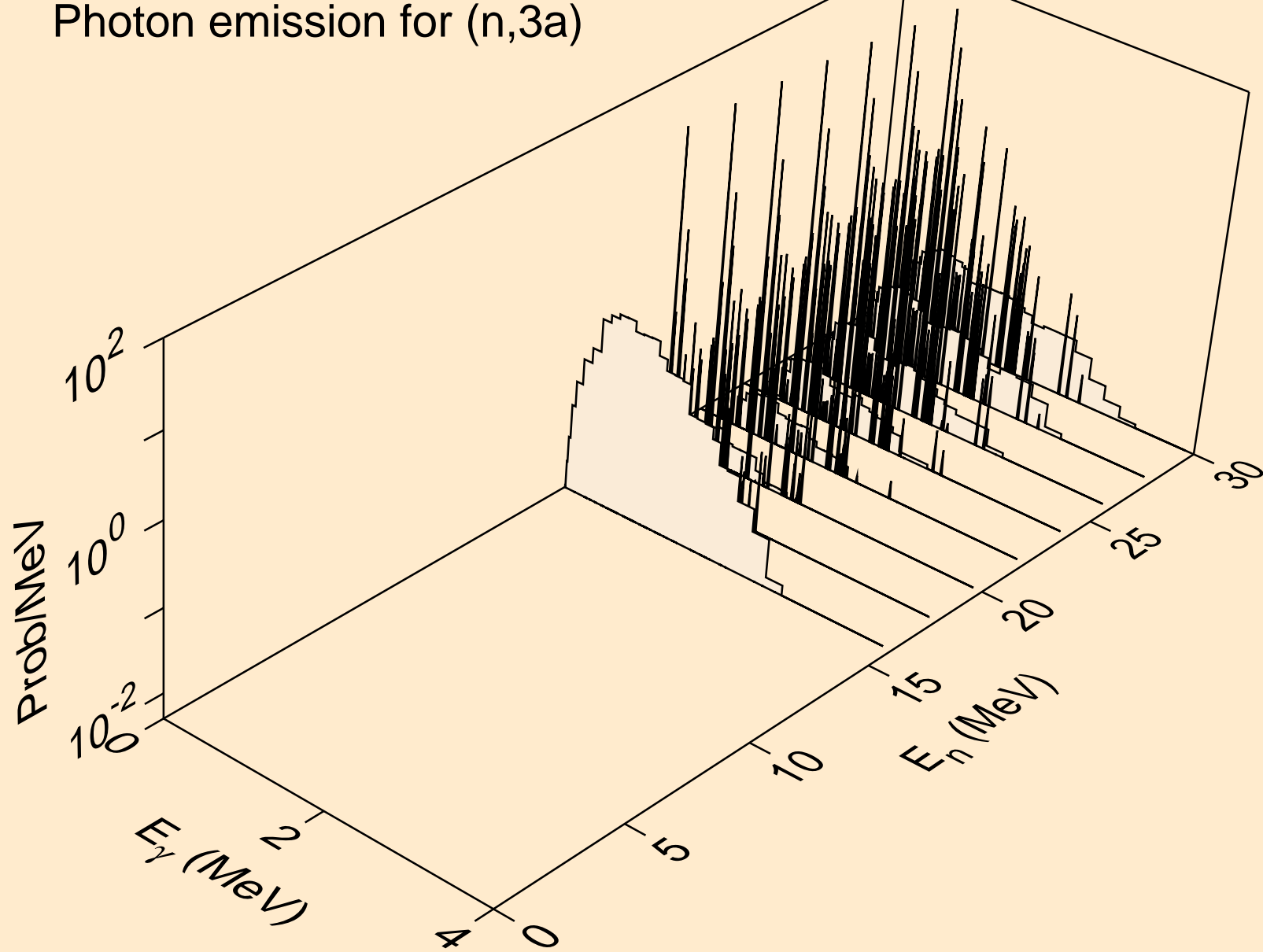

SN109 NEUTRON ACER TENDL-2024 LIBRARY; T=293.6K
Photon emission for (n,2p)

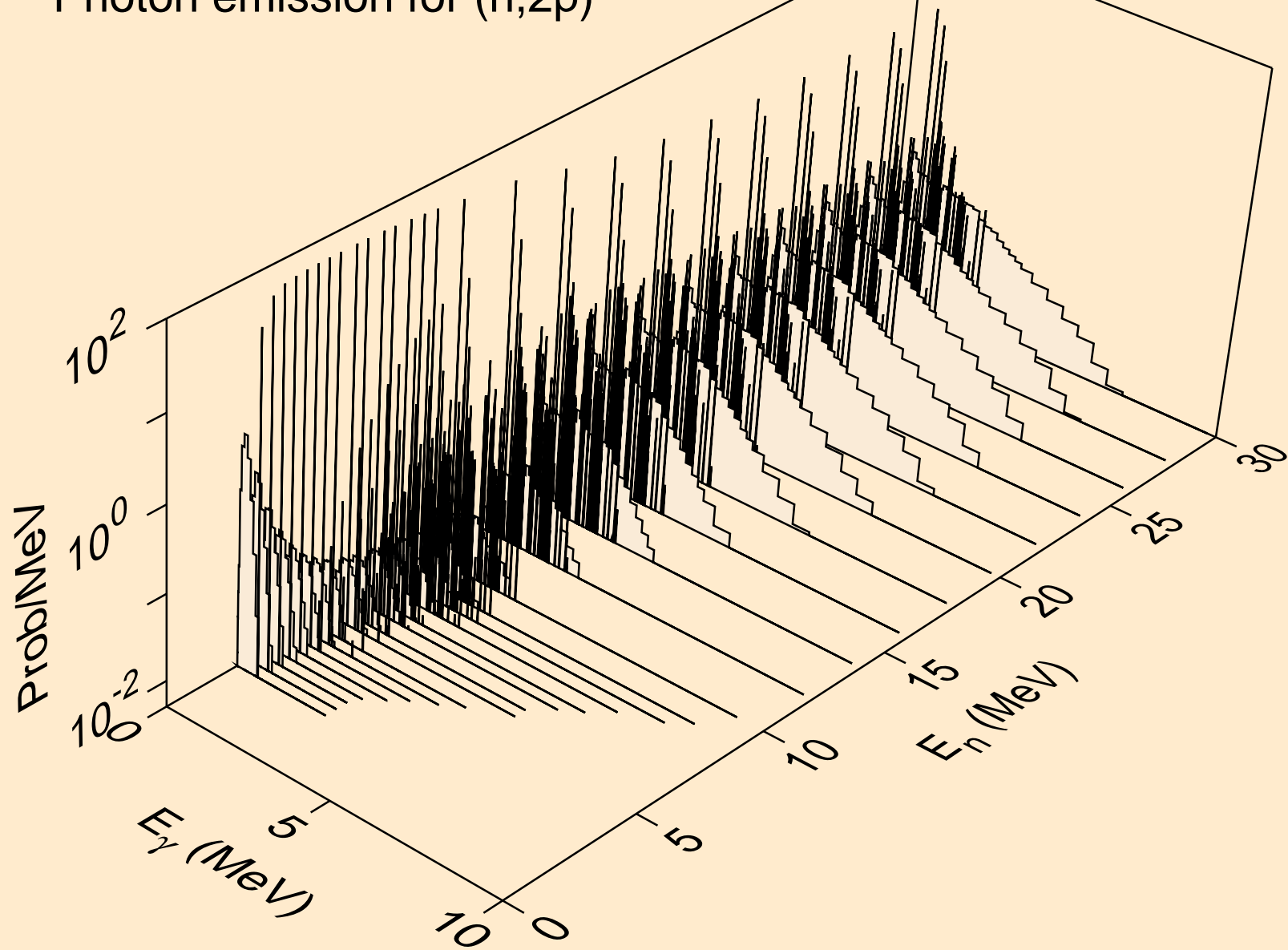

SN109 NEUTRON ACER TENDL-2024 LIBRARY; T=293.6K
Photon emission for (n,p)

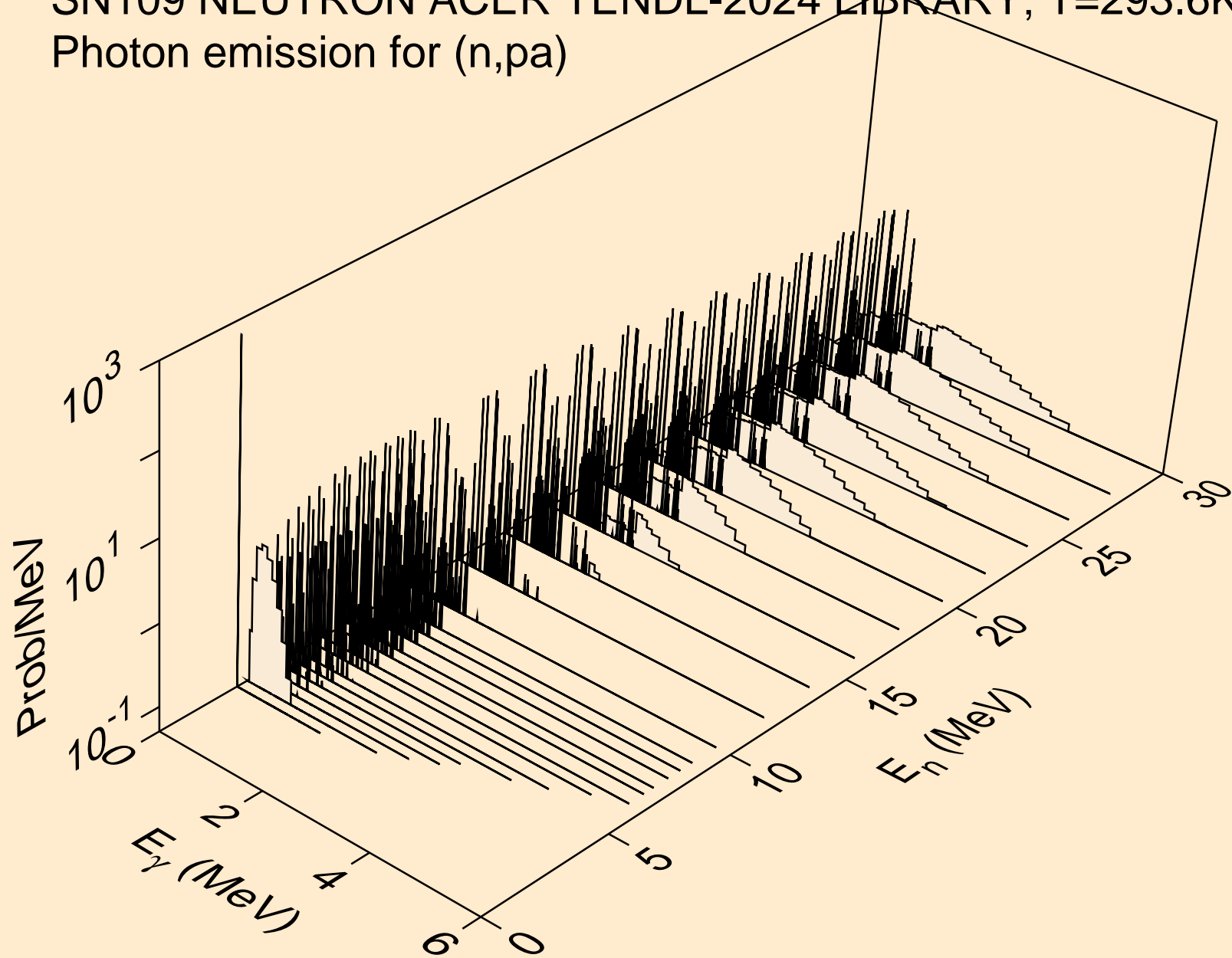

SN109 NEUTRON ACER TENDL-2024 LIBRARY; T=293.6K
Photon emission for (n,pd)

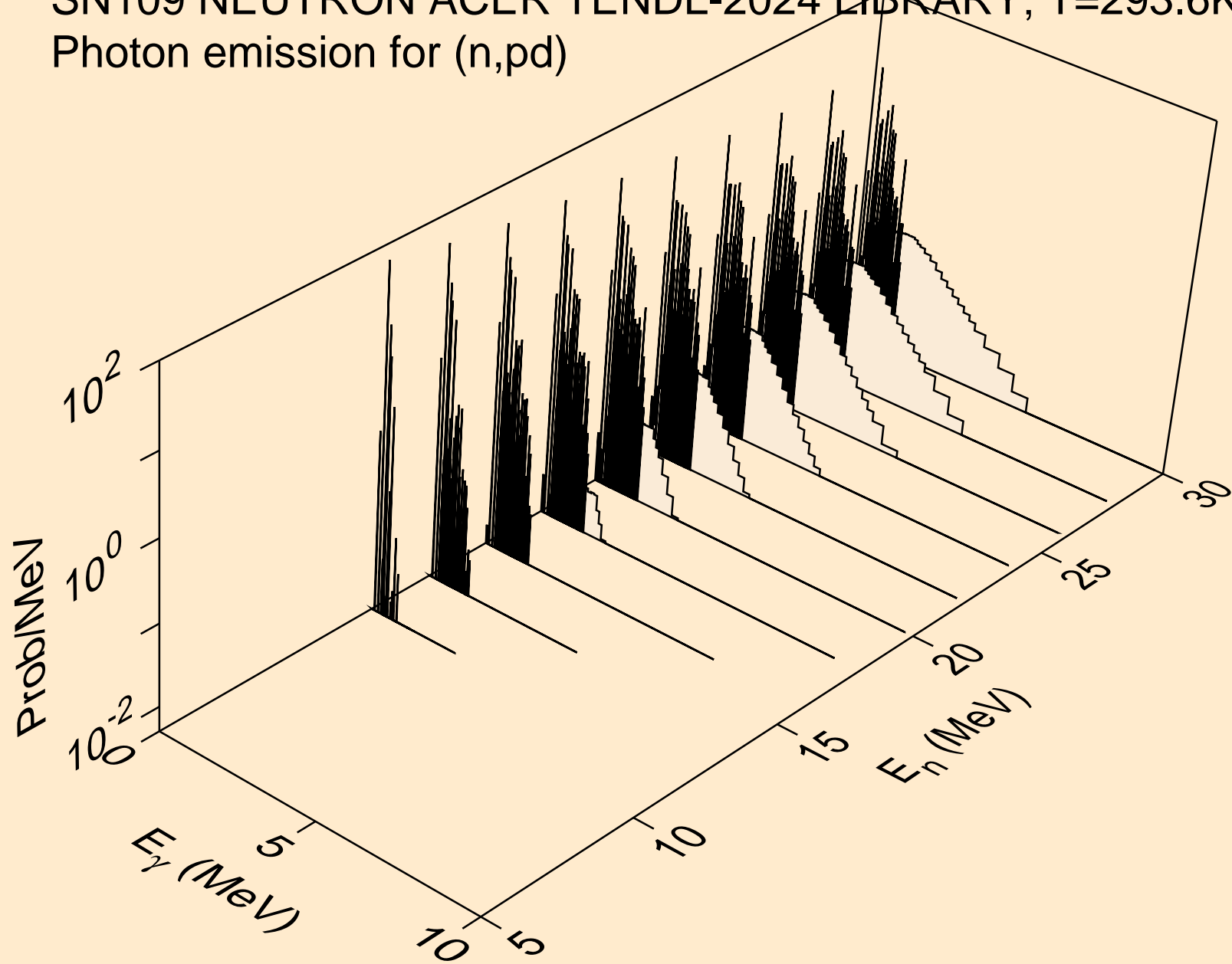

SN109 NEUTRON ACER TENDL-2024 LIBRARY; T=293.6K
Photon emission for (n,pt)

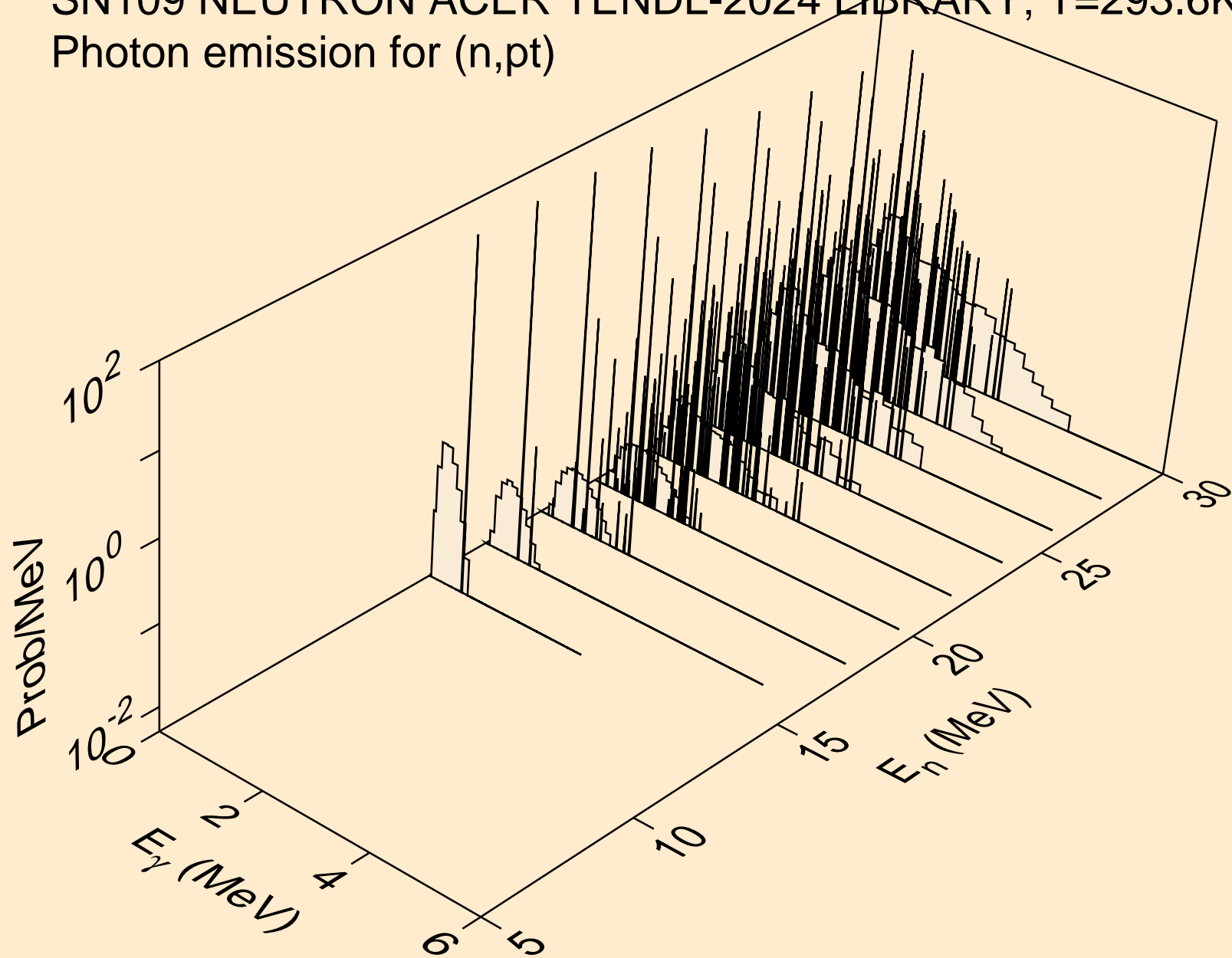

SN109 NEUTRON ACER TENDL-2024 LIBRARY; T=293.6K
Photon emission for (n,da)

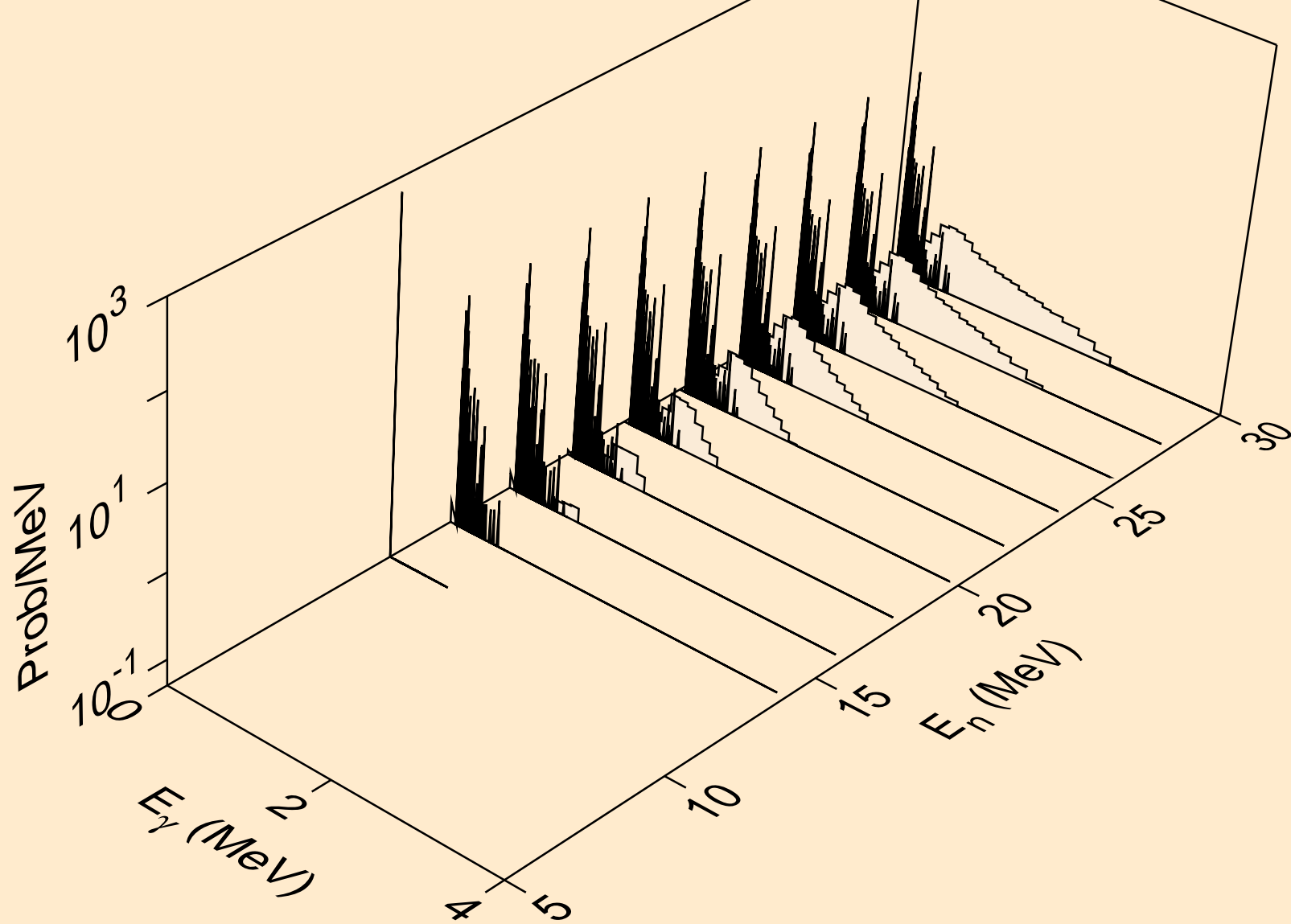

SN109 NEUTRON ACER TENDL-2024 LIBRARY; T=293.6K
thermal capture photon spectrum

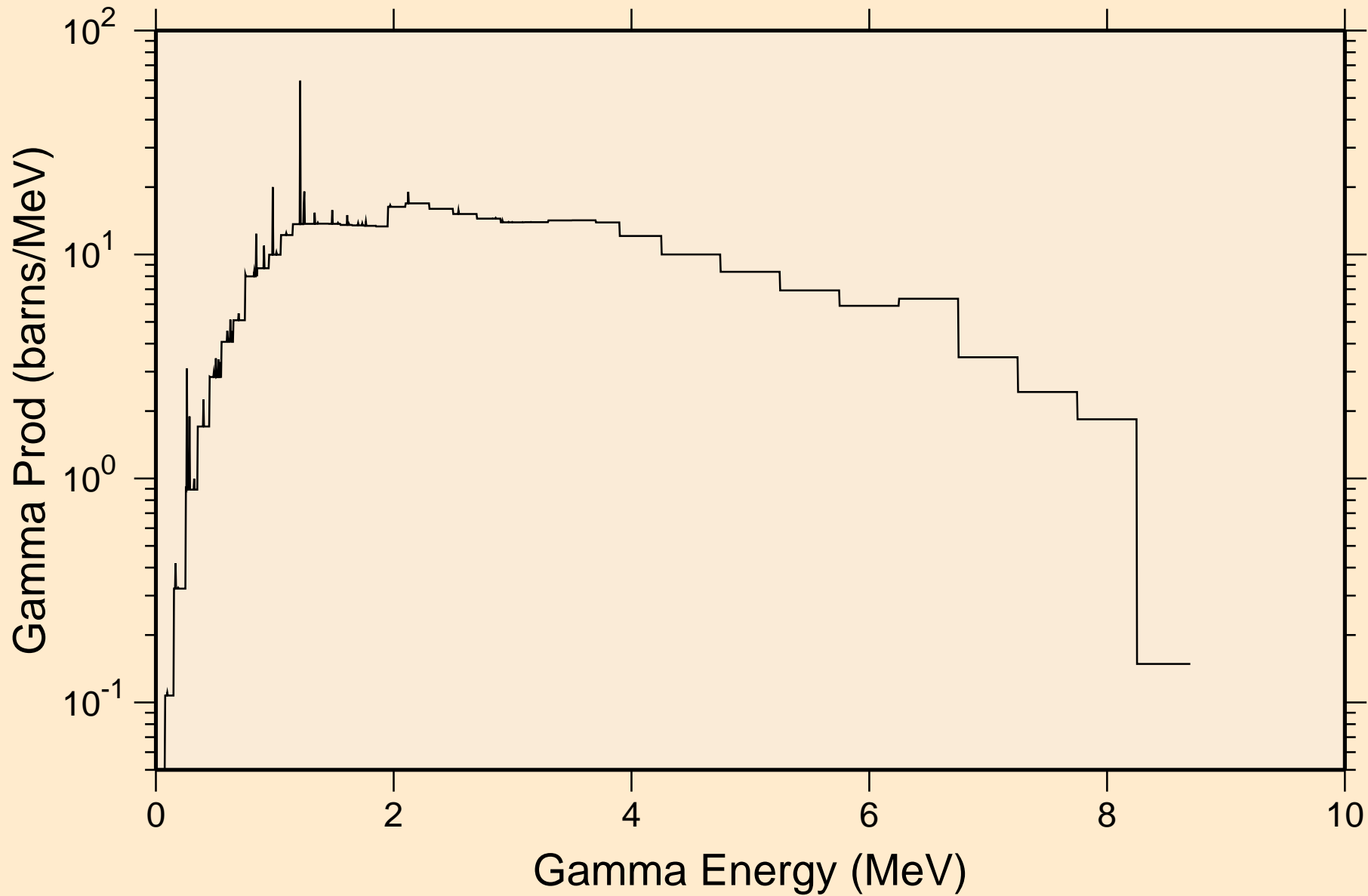

SN109 NEUTRON ACER TENDL-2024 LIBRARY; T=293.6K
14 MeV photon spectrum

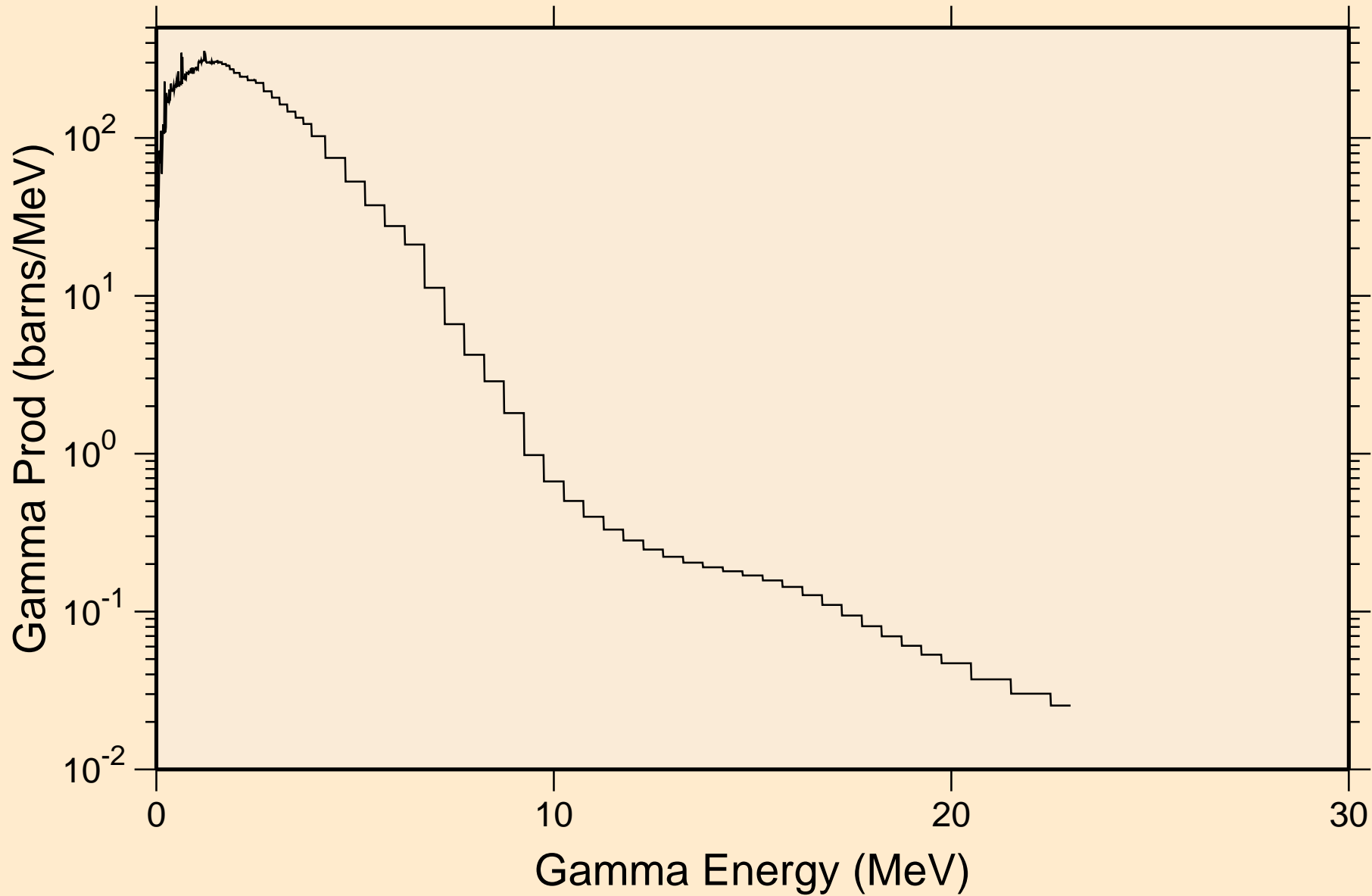

SN109 NEUTRON ACER TENDL-2024 LIBRARY; T=293.6K

Particle heating contributions

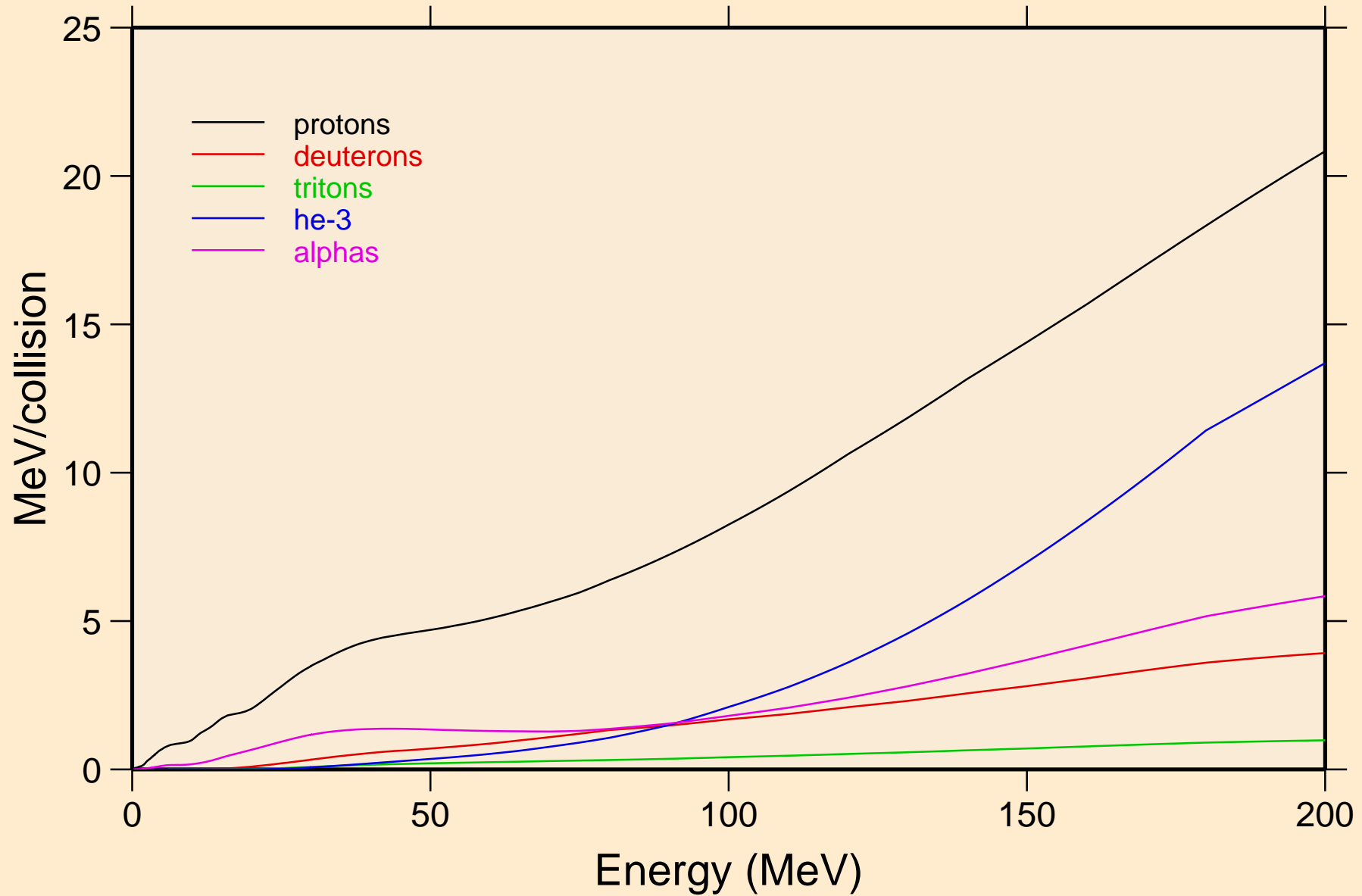

SN109 NEUTRON ACER TENDL-2024 LIBRARY; T=293.6K

Recoil Heating

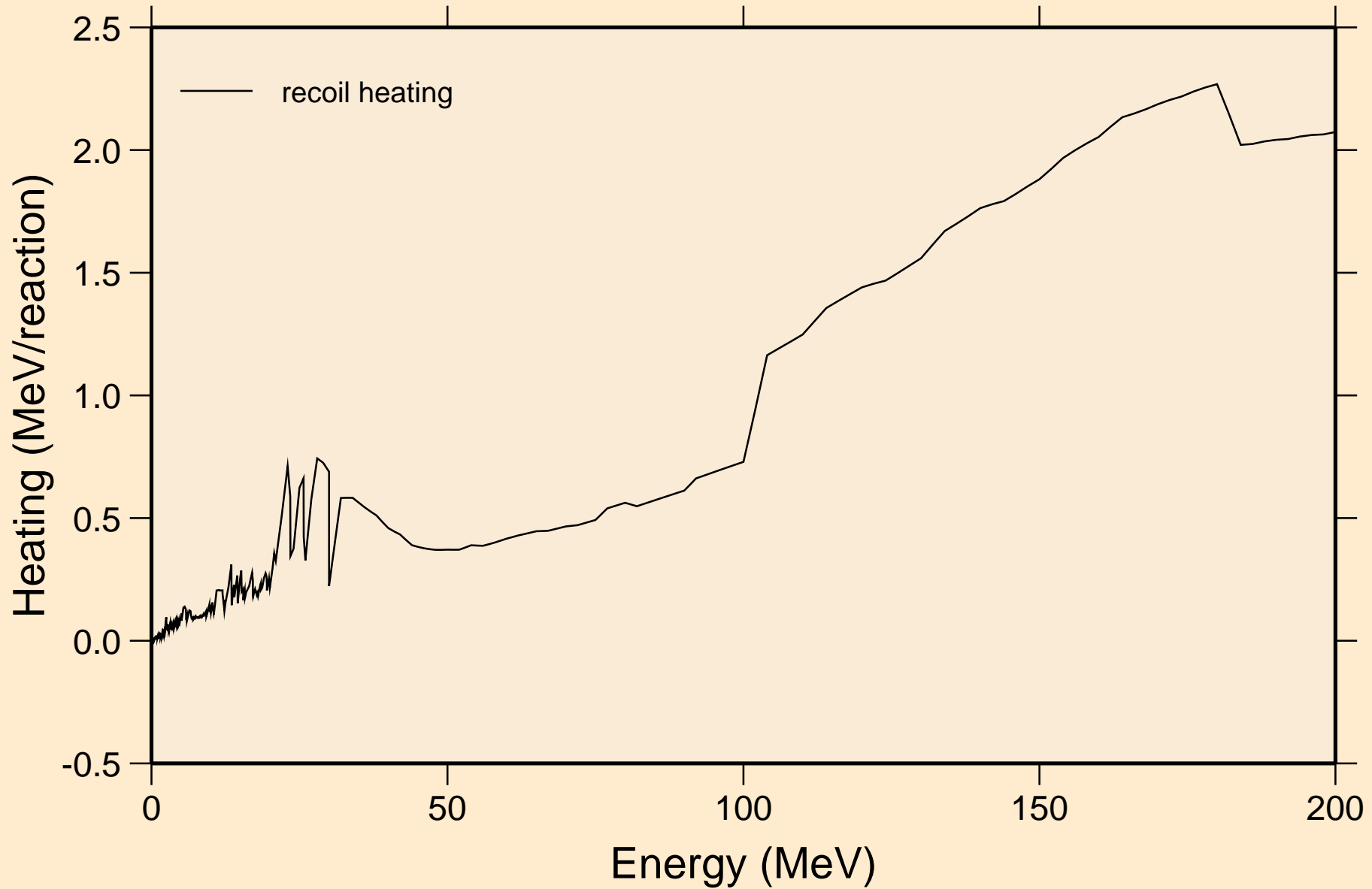

SN109 NEUTRON ACER TENDL-2024 LIBRARY; T=293.6K

Particle production cross sections

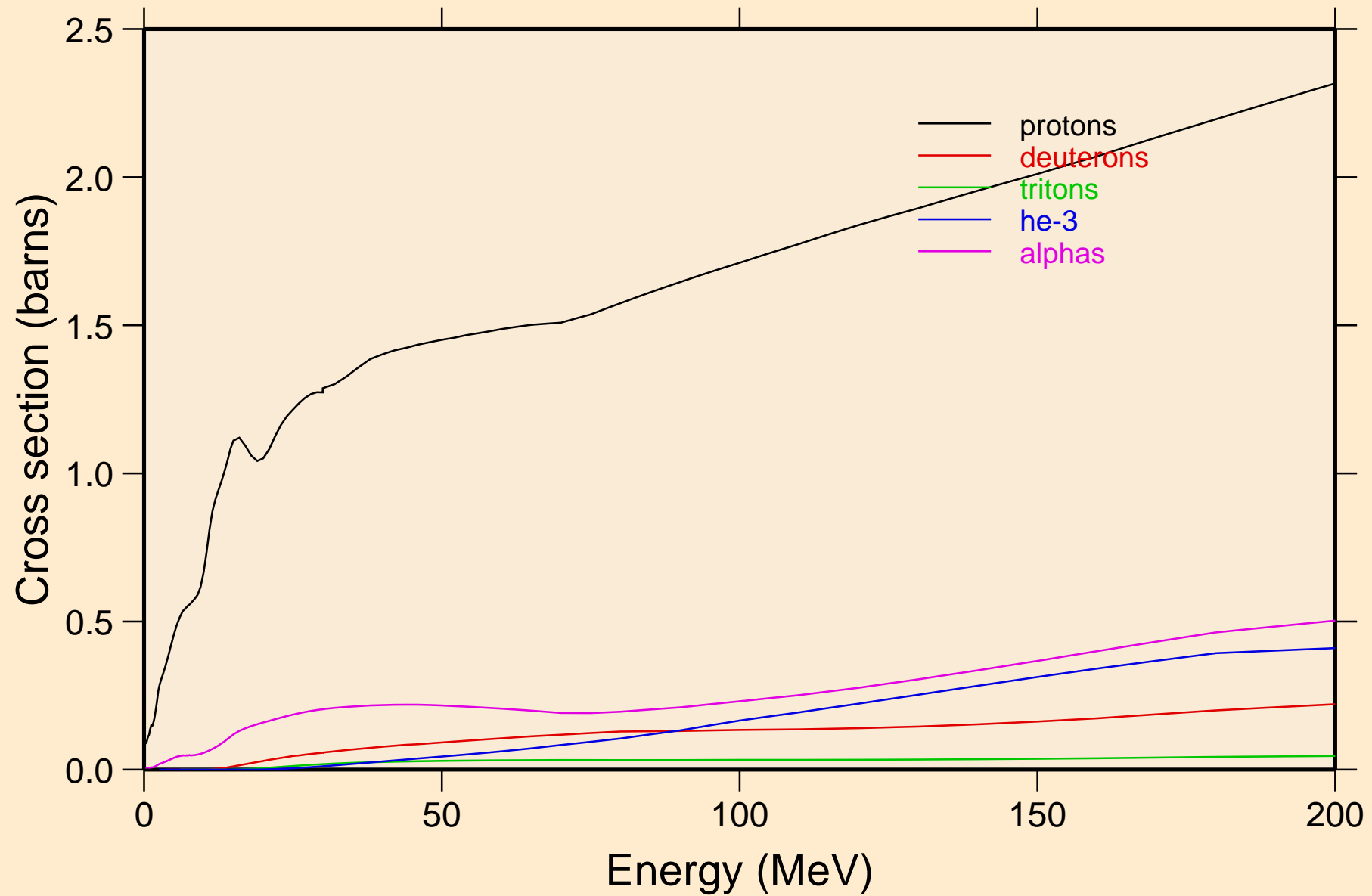

SN109 NEUTRON ACER TENDL-2024 LIBRARY; T=293.6K
protons from (n,x)

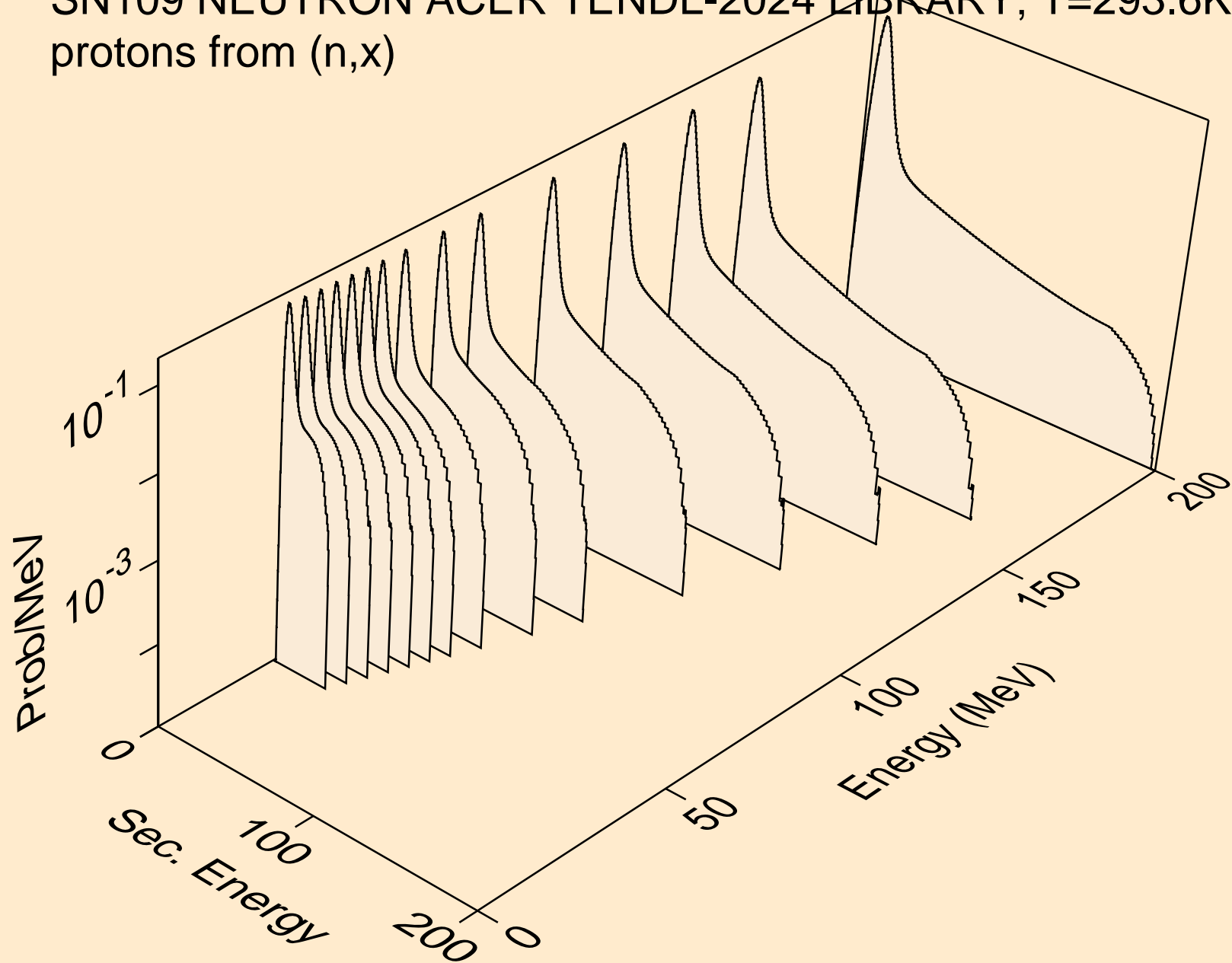

SN109 NEUTRON ACER TENDL-2024 LIBRARY; T=293.6K
protons from (n,n*)p

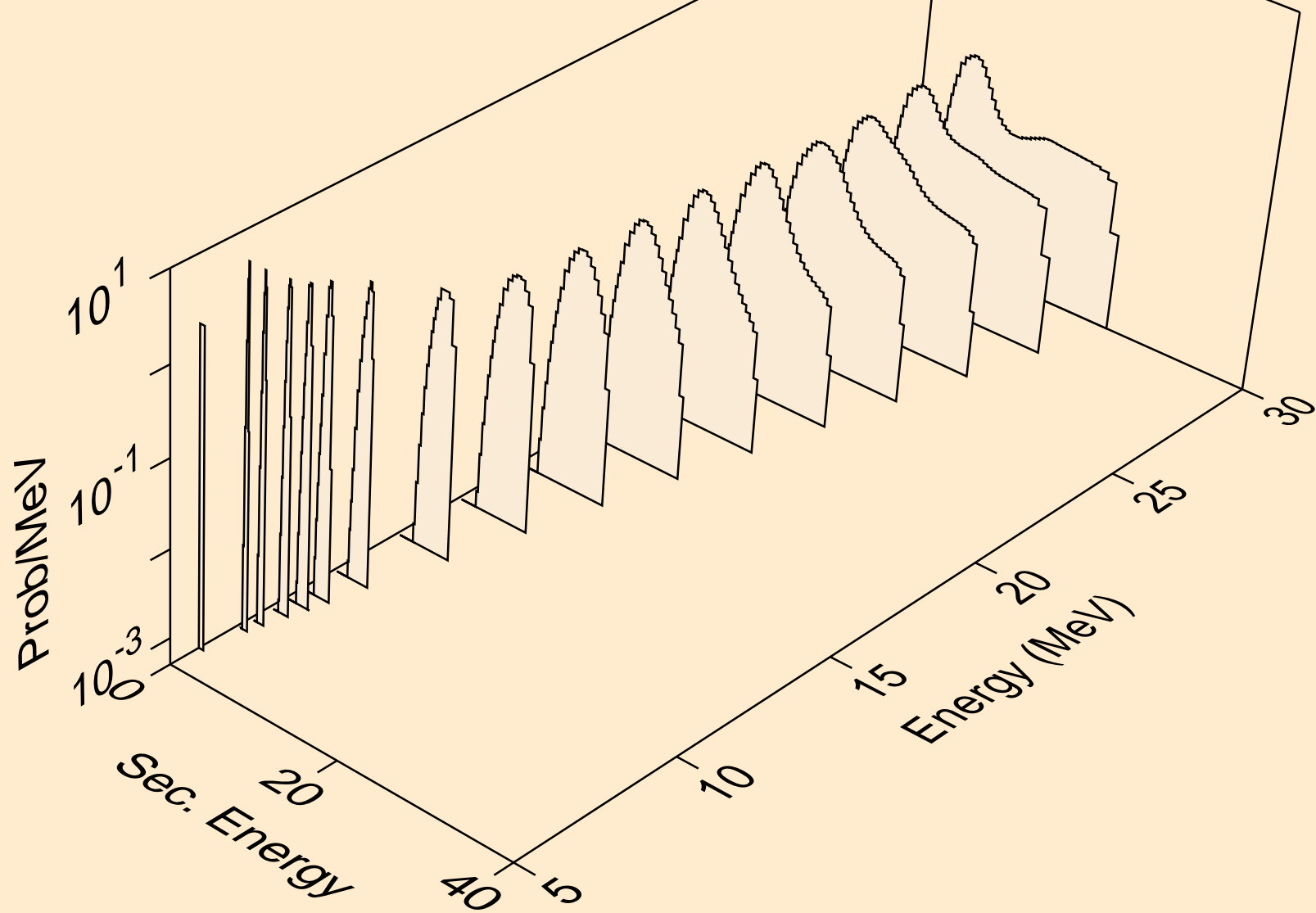

SN109 NEUTRON ACER TENDL-2024 LIBRARY; T=293.6K
protons from (n,2np)

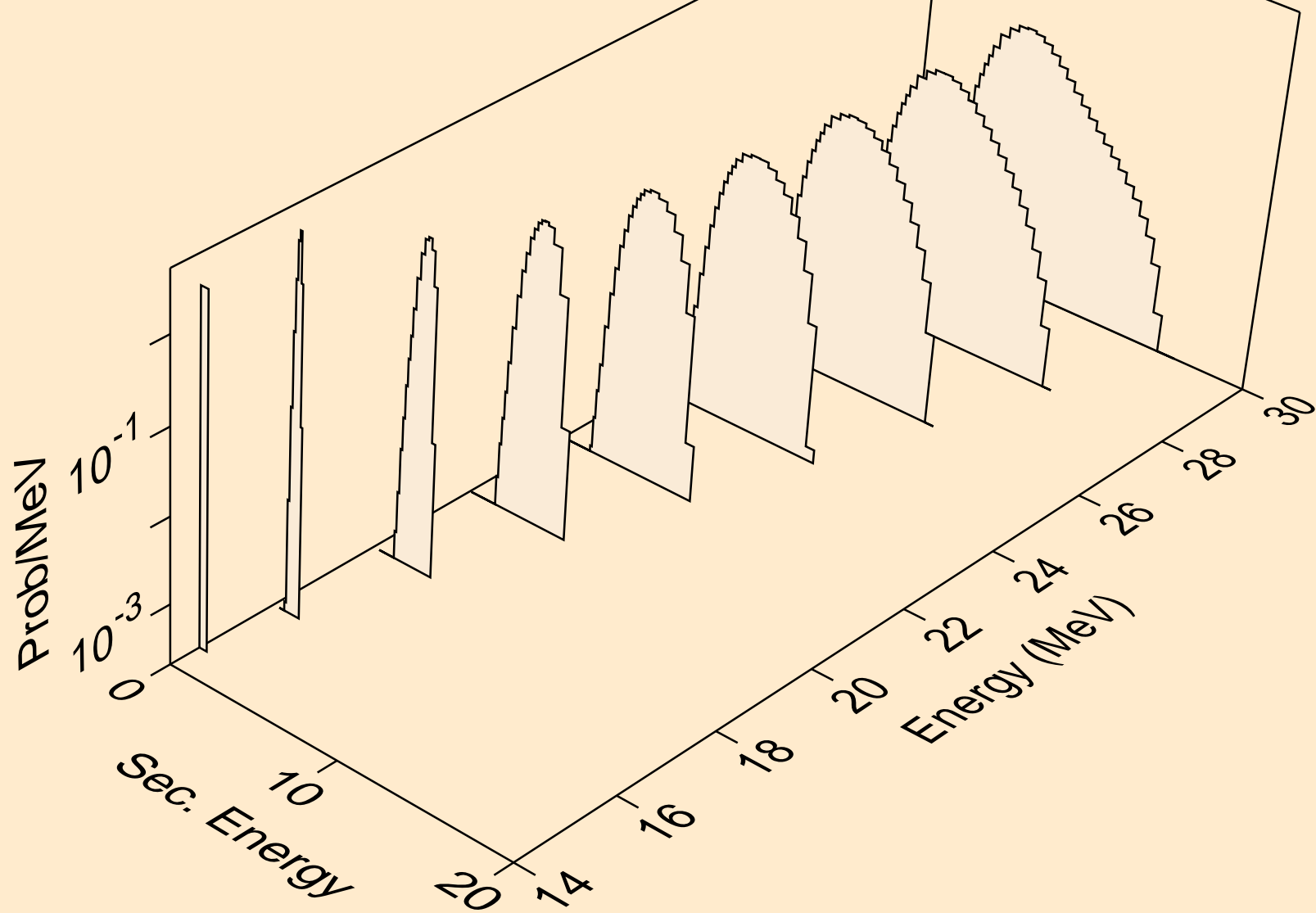

SN109 NEUTRON ACER TENDL-2024 LIBRARY; T=293.6K
protons from (n,3np)

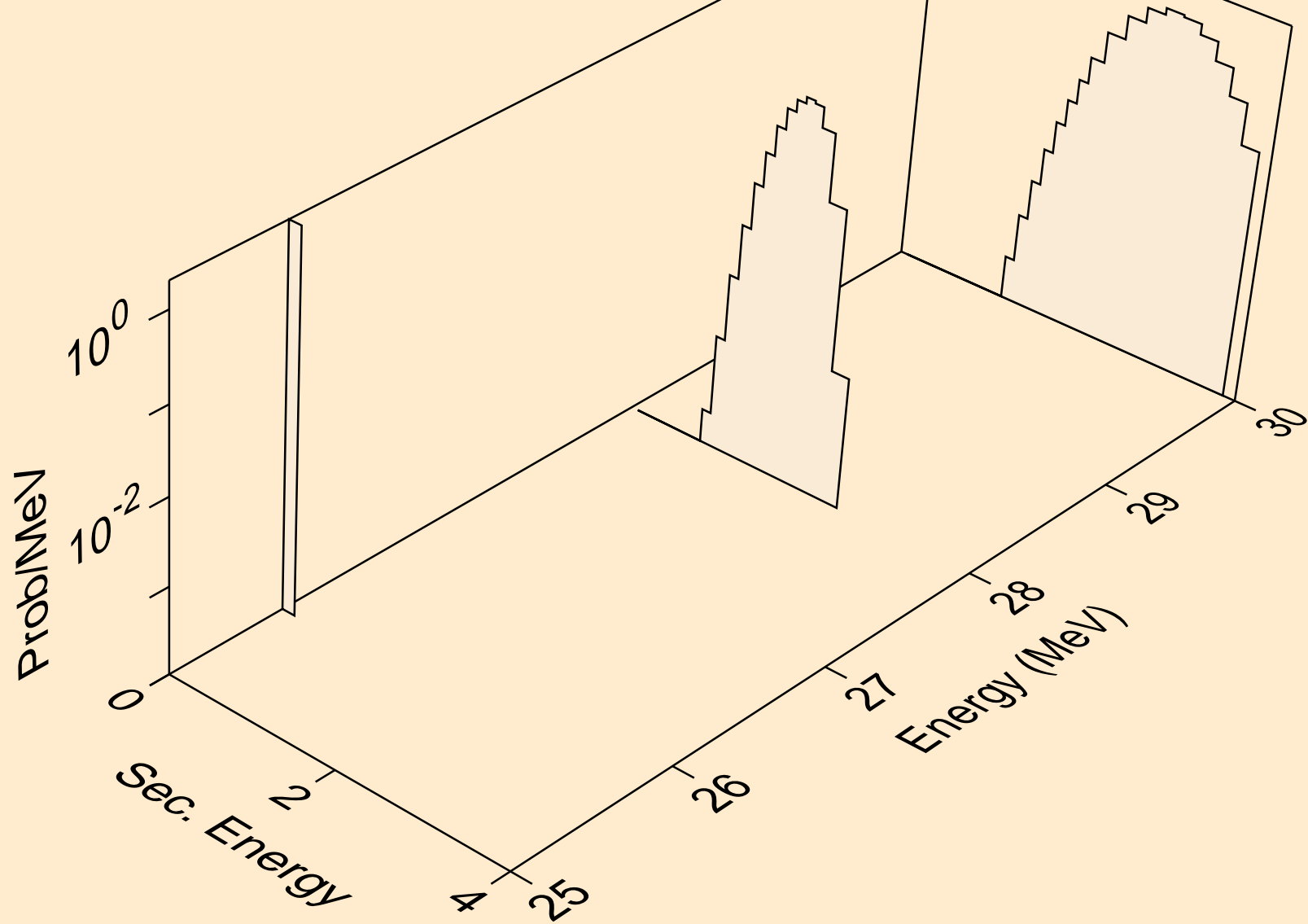

SN109 NEUTRON ACER TENDL-2024 LIBRARY; T=293.6K
protons from (n,n2p)

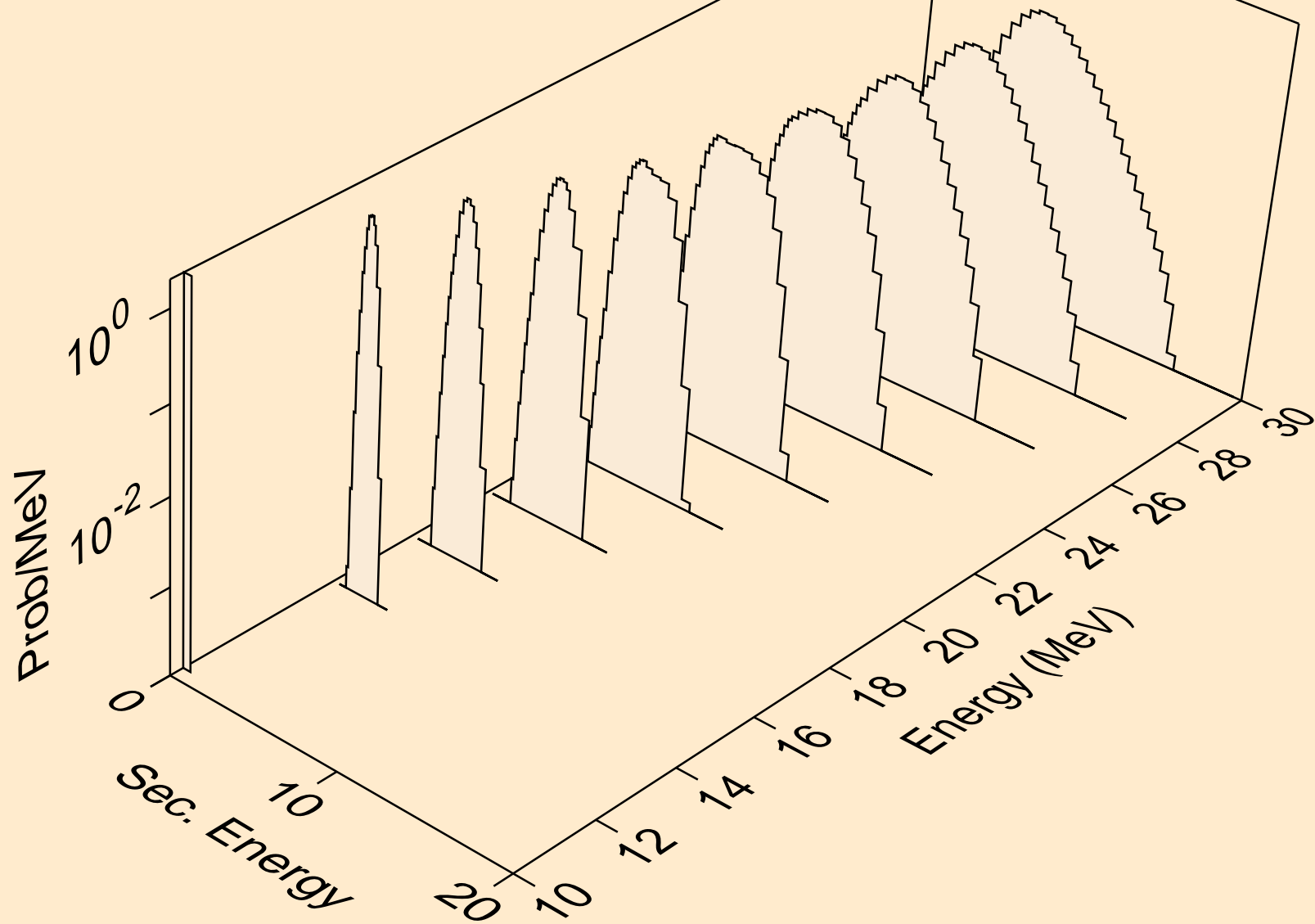

SN109 NEUTRON ACER TENDL-2024 LIBRARY; T=293.6K
protons from (n,npa)

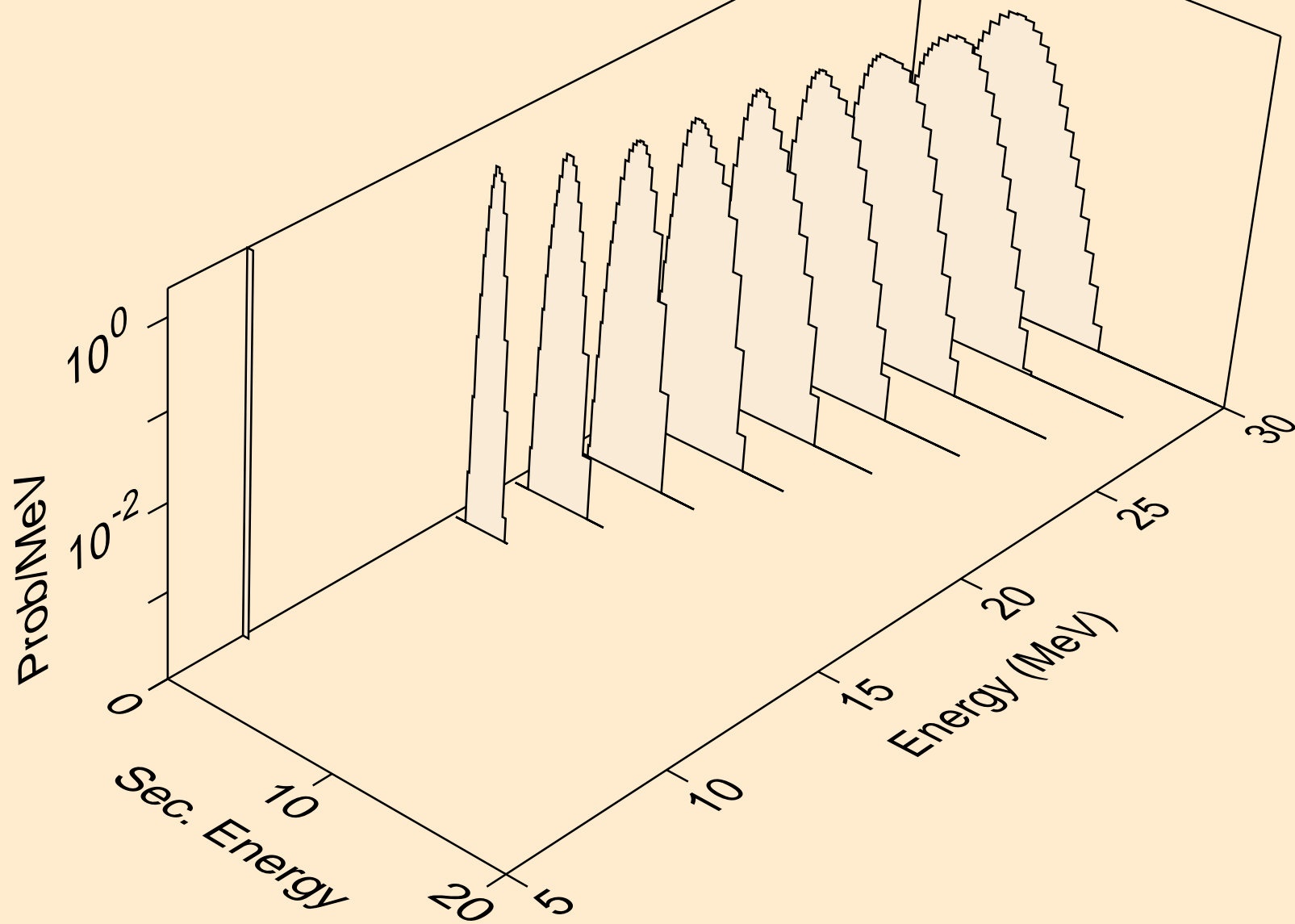

SN109 NEUTRON ACER TENDL-2024 LIBRARY; T=293.6K
protons from (n,p)

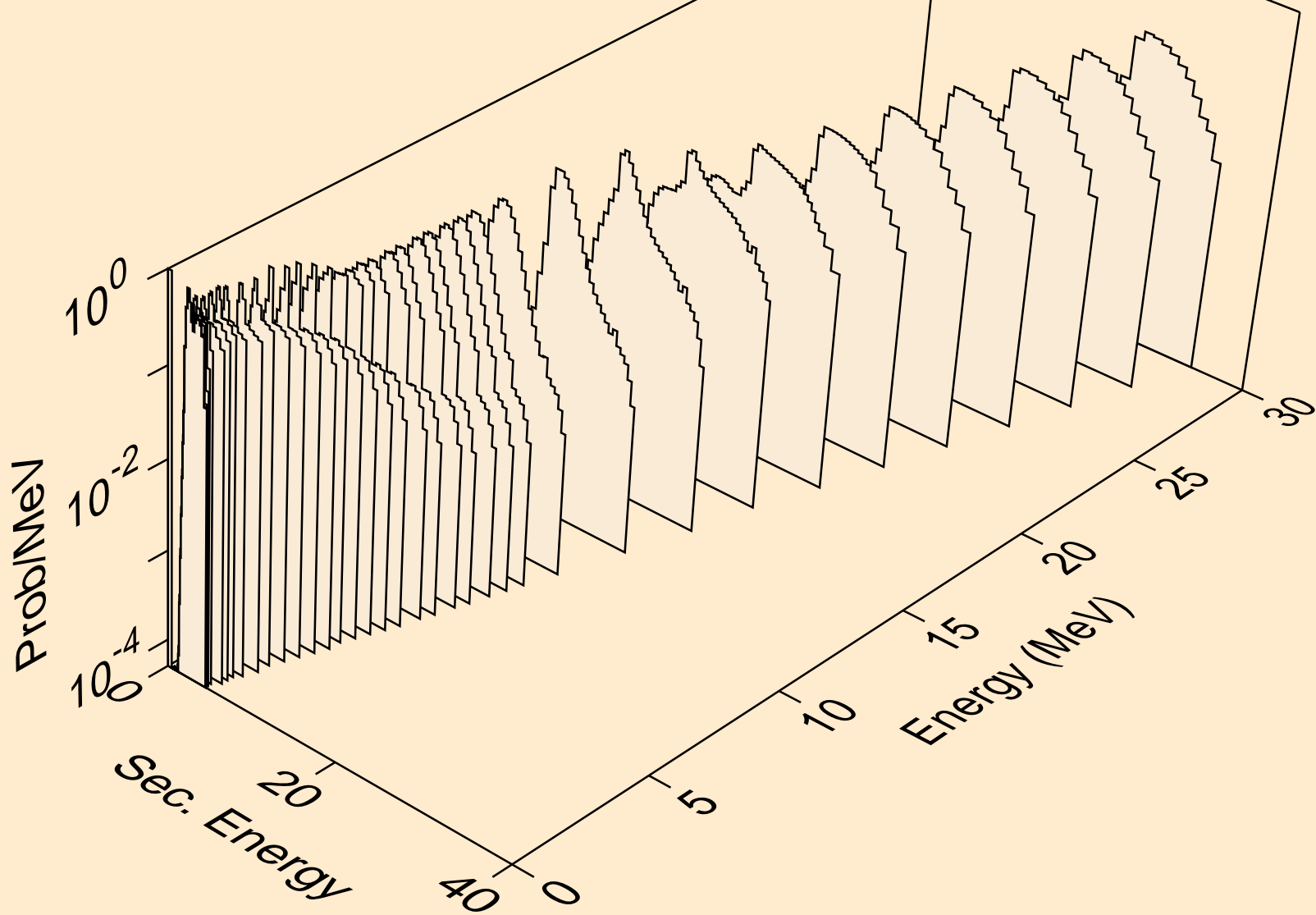

SN109 NEUTRON ACER TENDL-2024 LIBRARY; T=293.6K
protons from (n,2p)

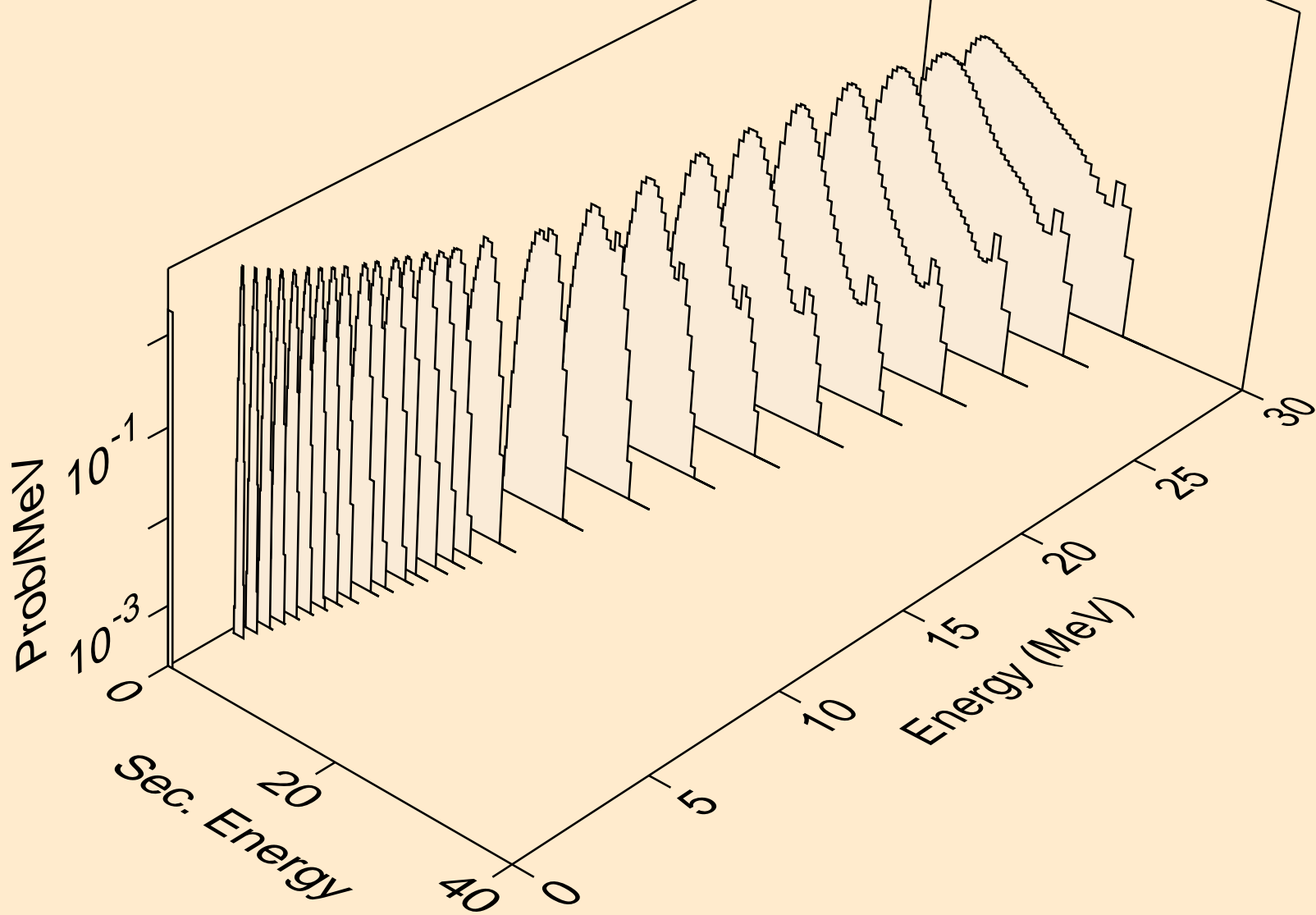

SN109 NEUTRON ACER TENDL-2024 LIBRARY; T=293.6K
protons from (n,p)

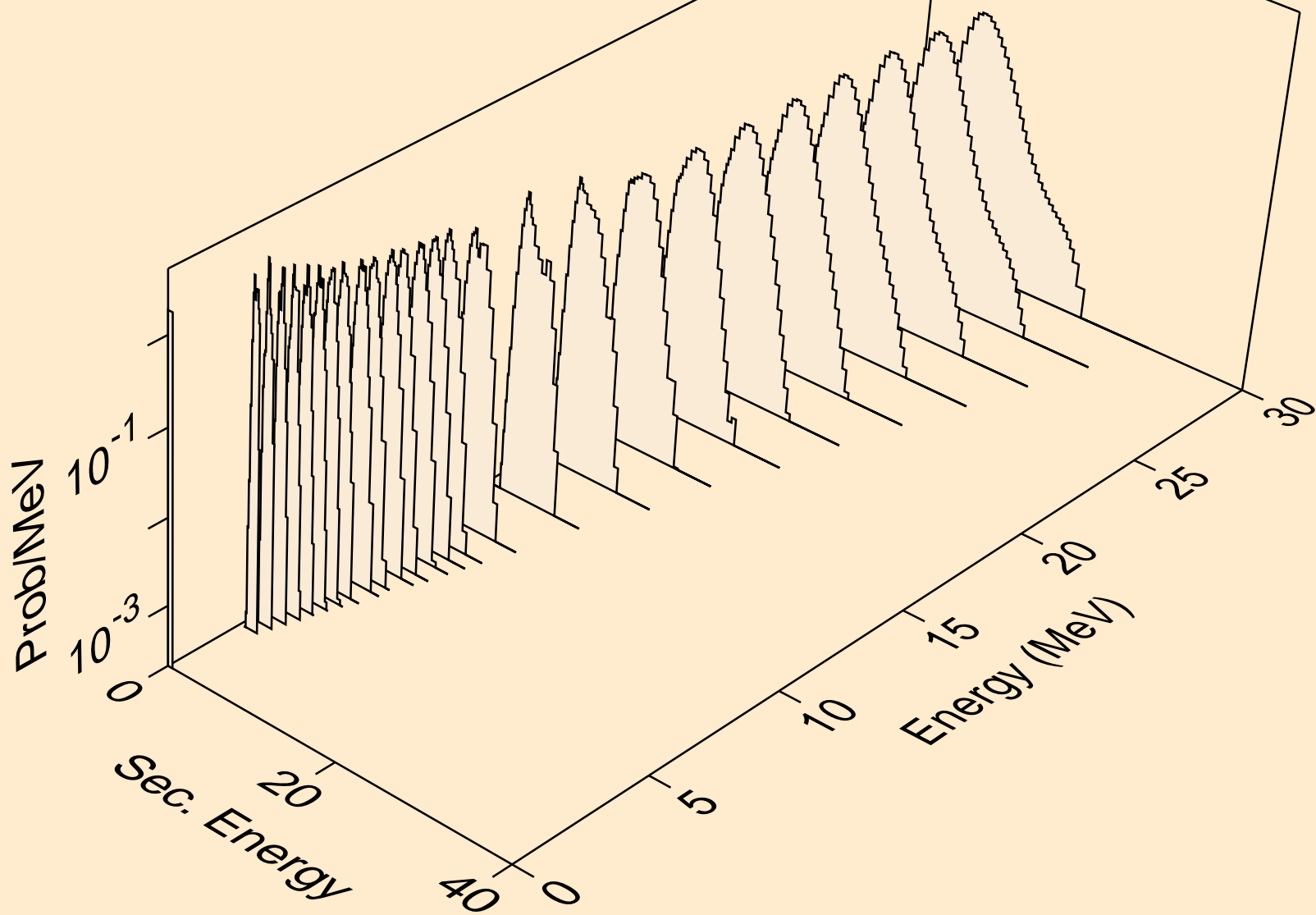

SN109 NEUTRON ACER TENDL-2024 LIBRARY; T=293.6K
protons from (n,pd)

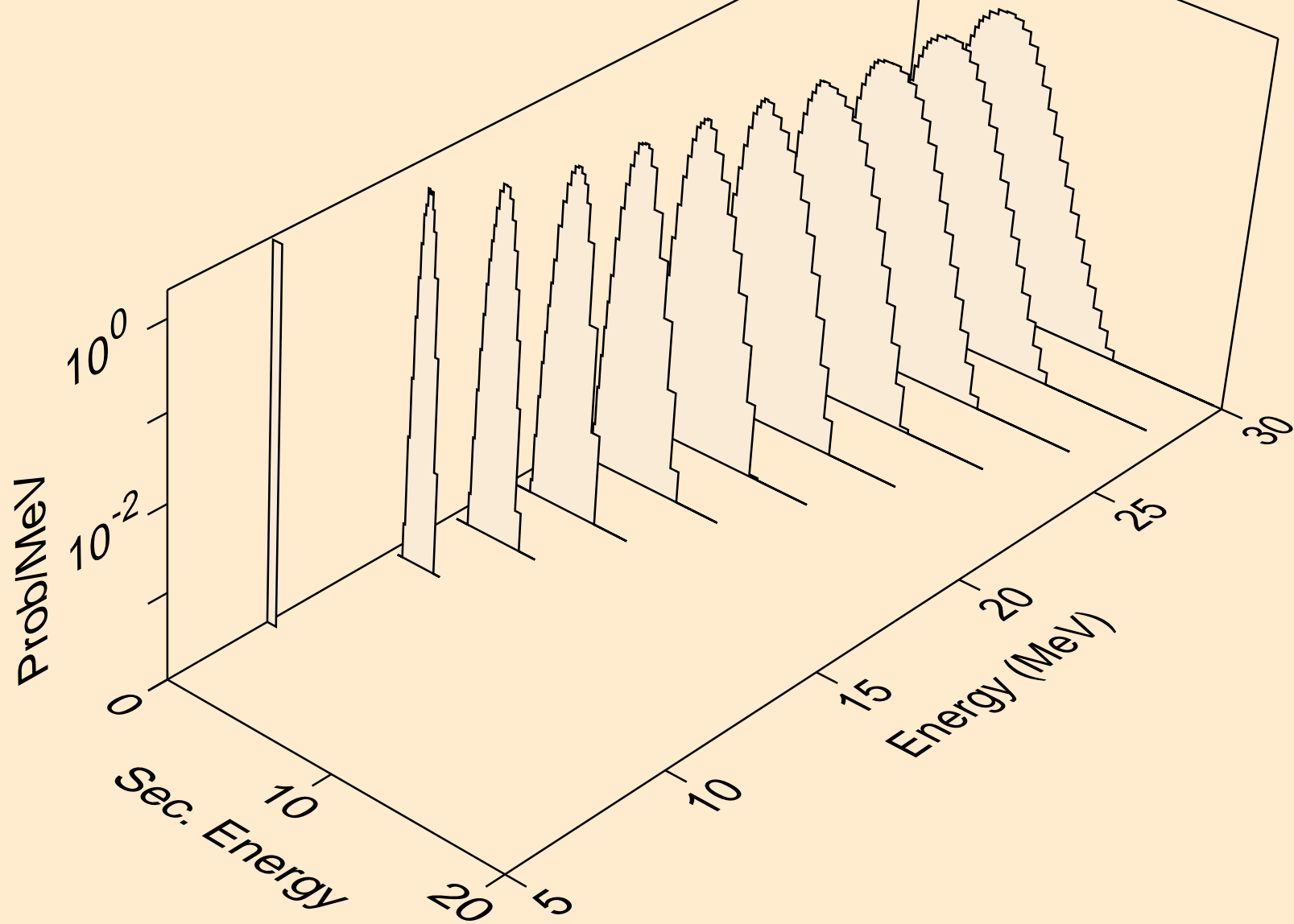

SN109 NEUTRON ACER TENDL-2024 LIBRARY; T=293.6K
protons from (n,pt)

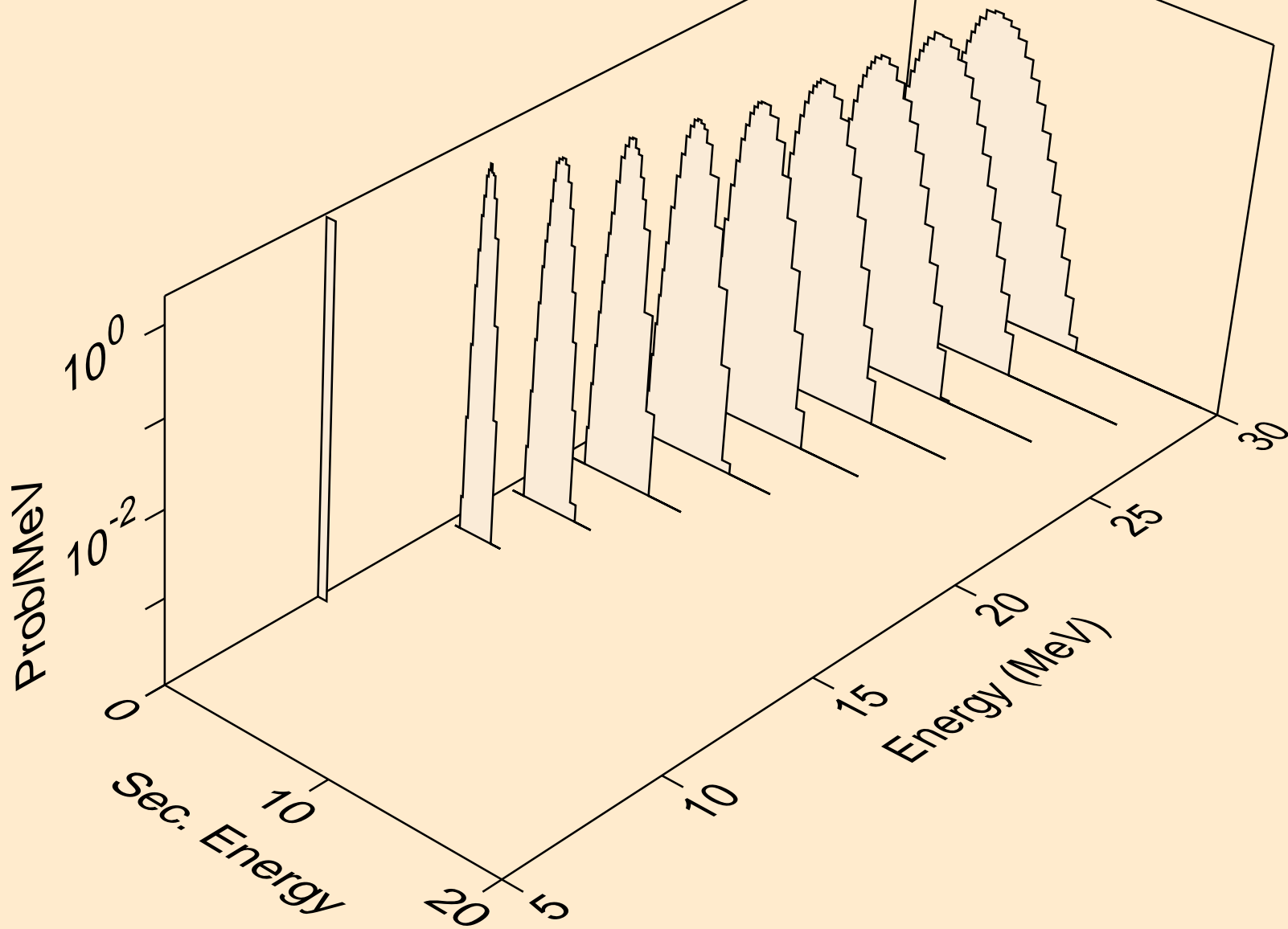

SN109 NEUTRON ACER TENDL-2024 LIBRARY; T=293.6K
deuterons from (n,x)

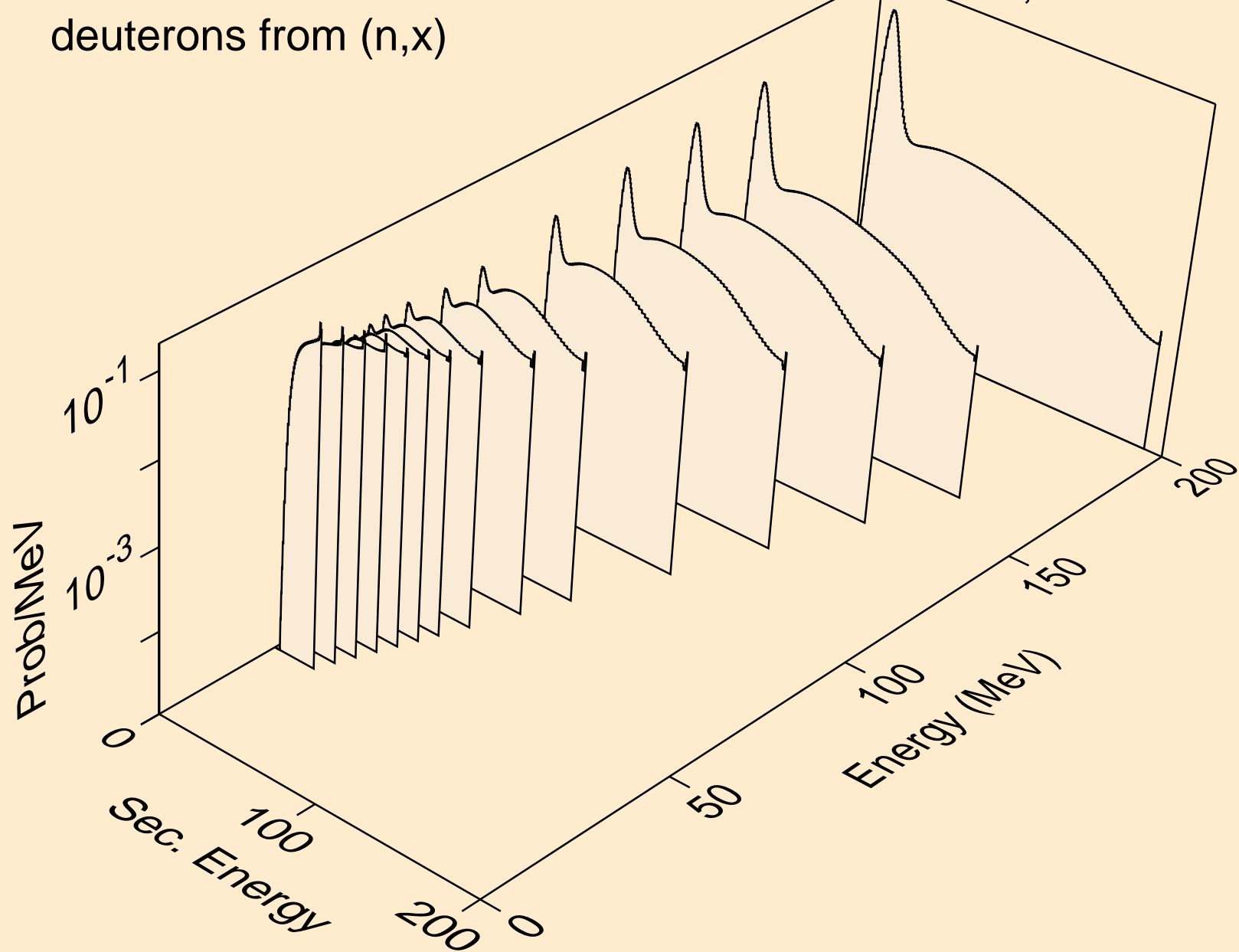

SN109 NEUTRON ACER TENDL-2024 LIBRARY; T=293.6K
deuterons from (n,2nd)

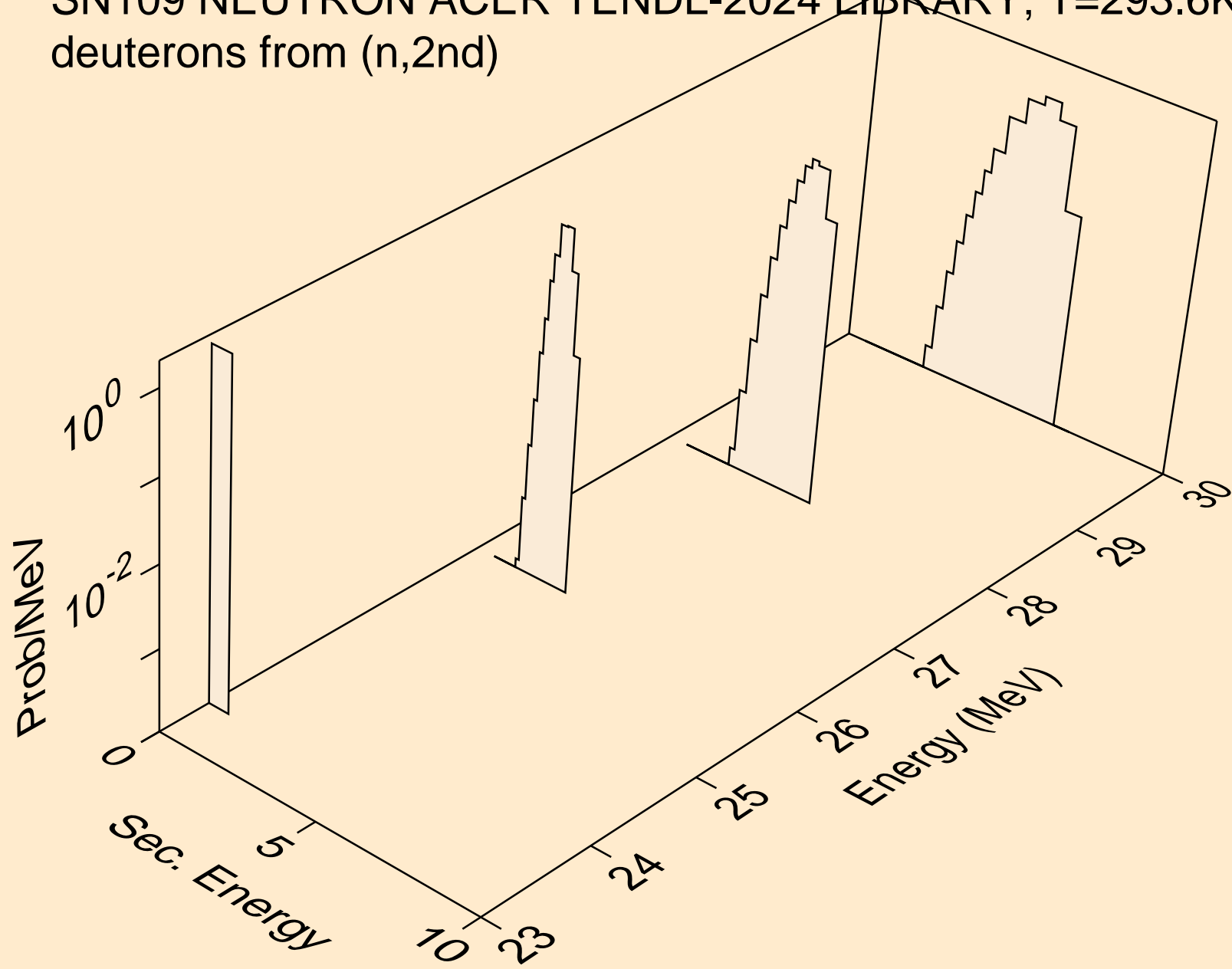

SN109 NEUTRON ACER TENDL-2024 LIBRARY; T=293.6K
deuterons from (n,n*)d

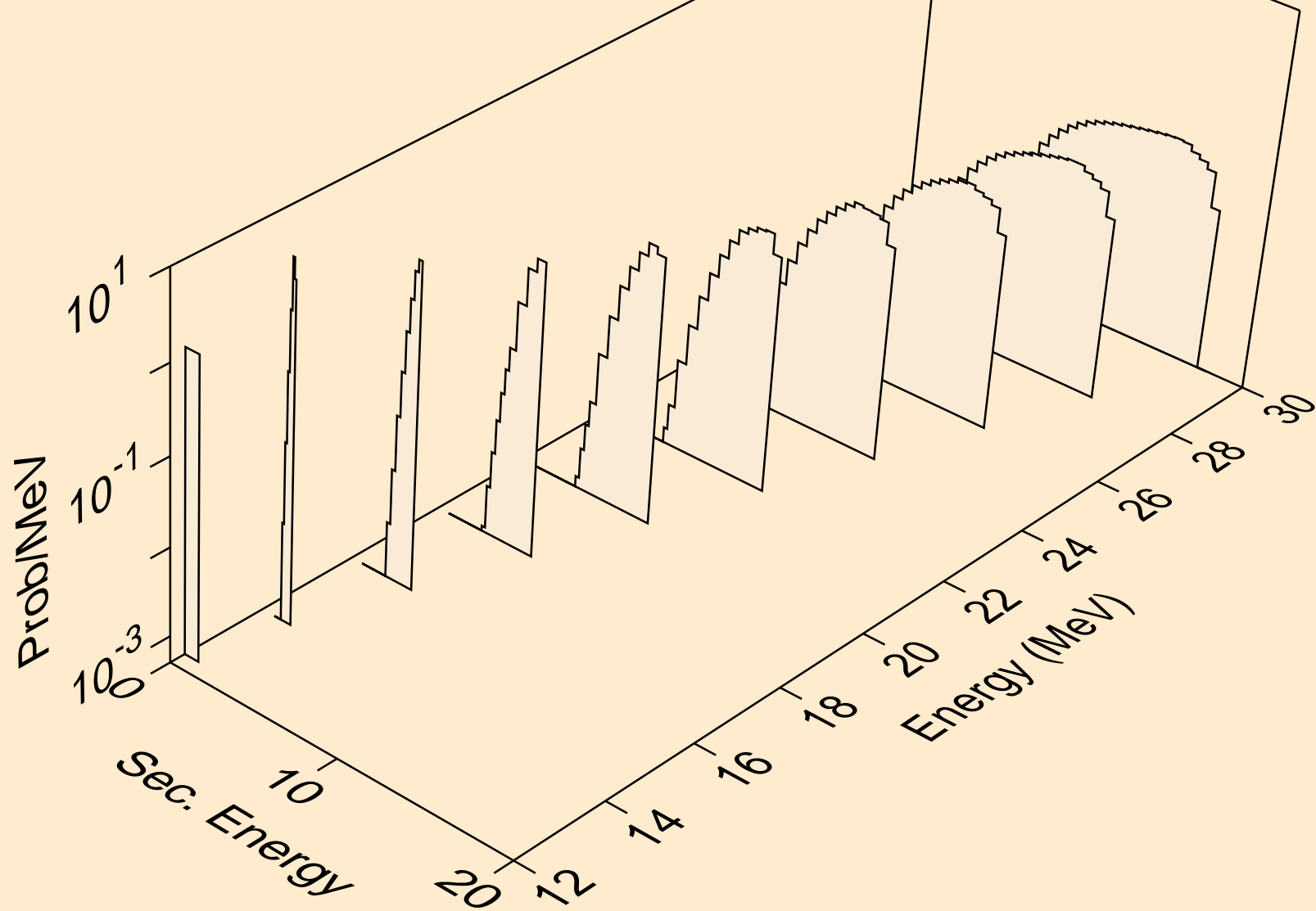

SN109 NEUTRON ACER TENDL-2024 LIBRARY; T=293.6K
deuterons from (n,d)

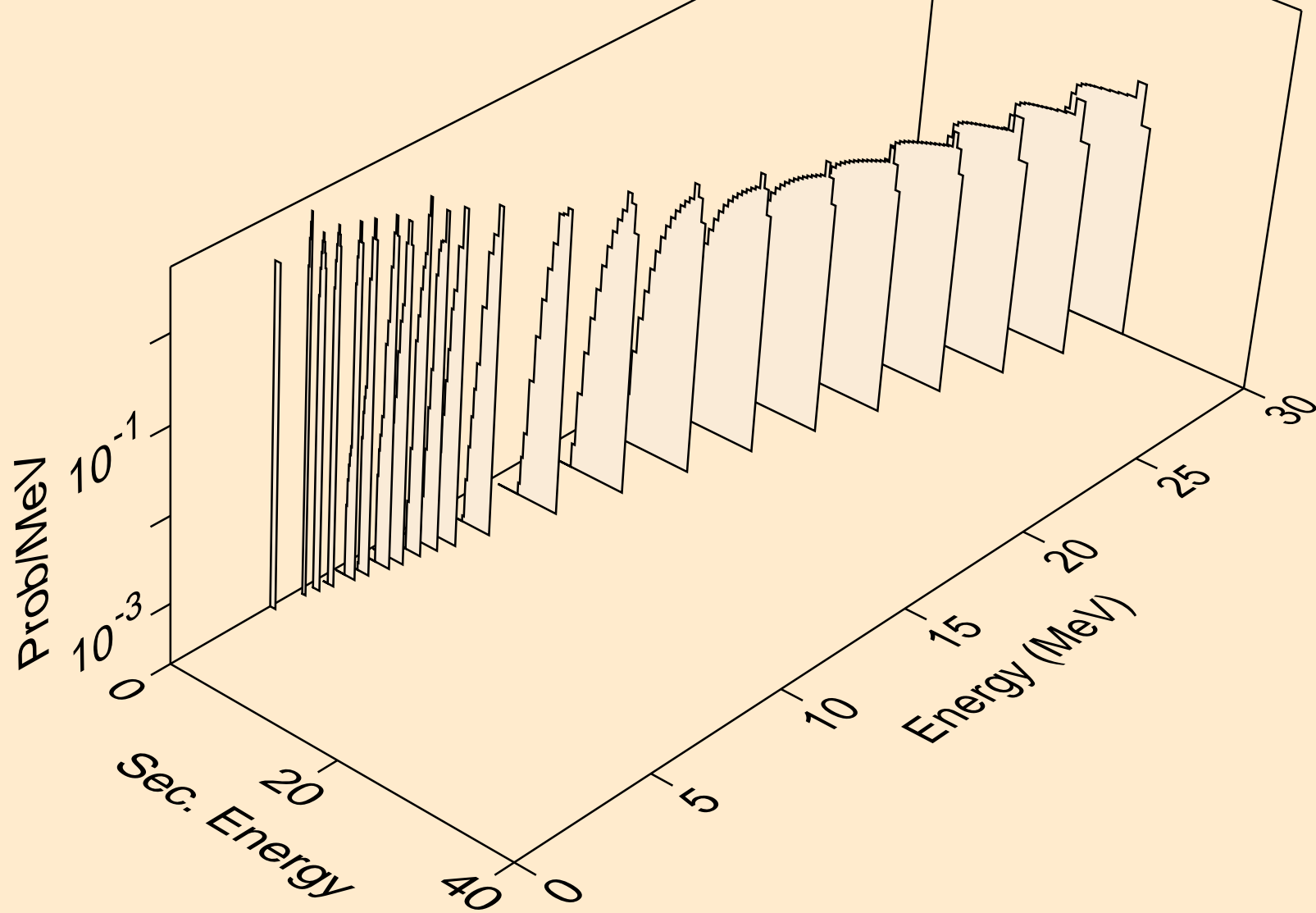

SN109 NEUTRON ACER TENDL-2024 LIBRARY; T=293.6K
deuterons from (n,pd)

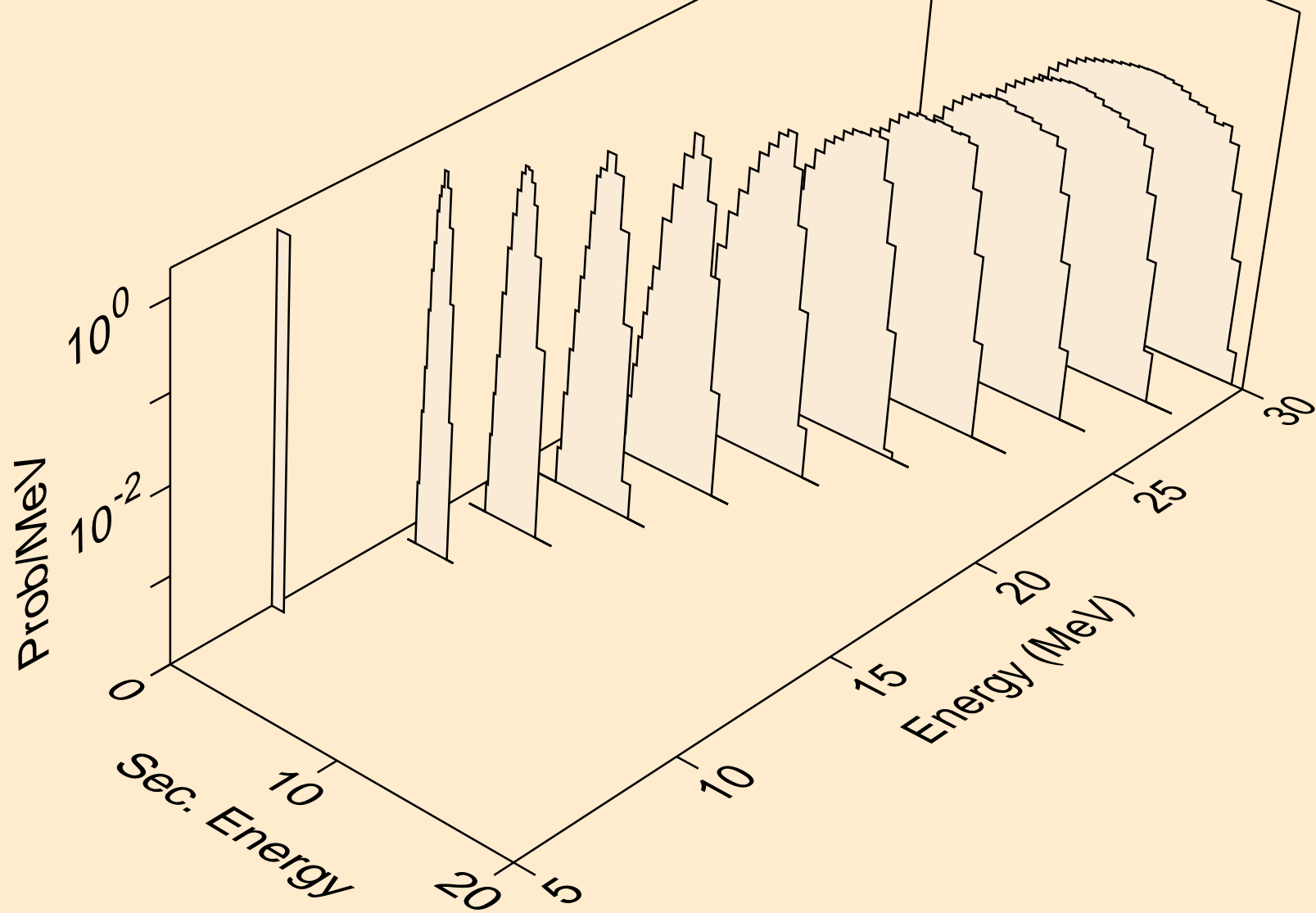

SN109 NEUTRON ACER TENDL-2024 LIBRARY; T=293.6K
deuterons from (n,da)

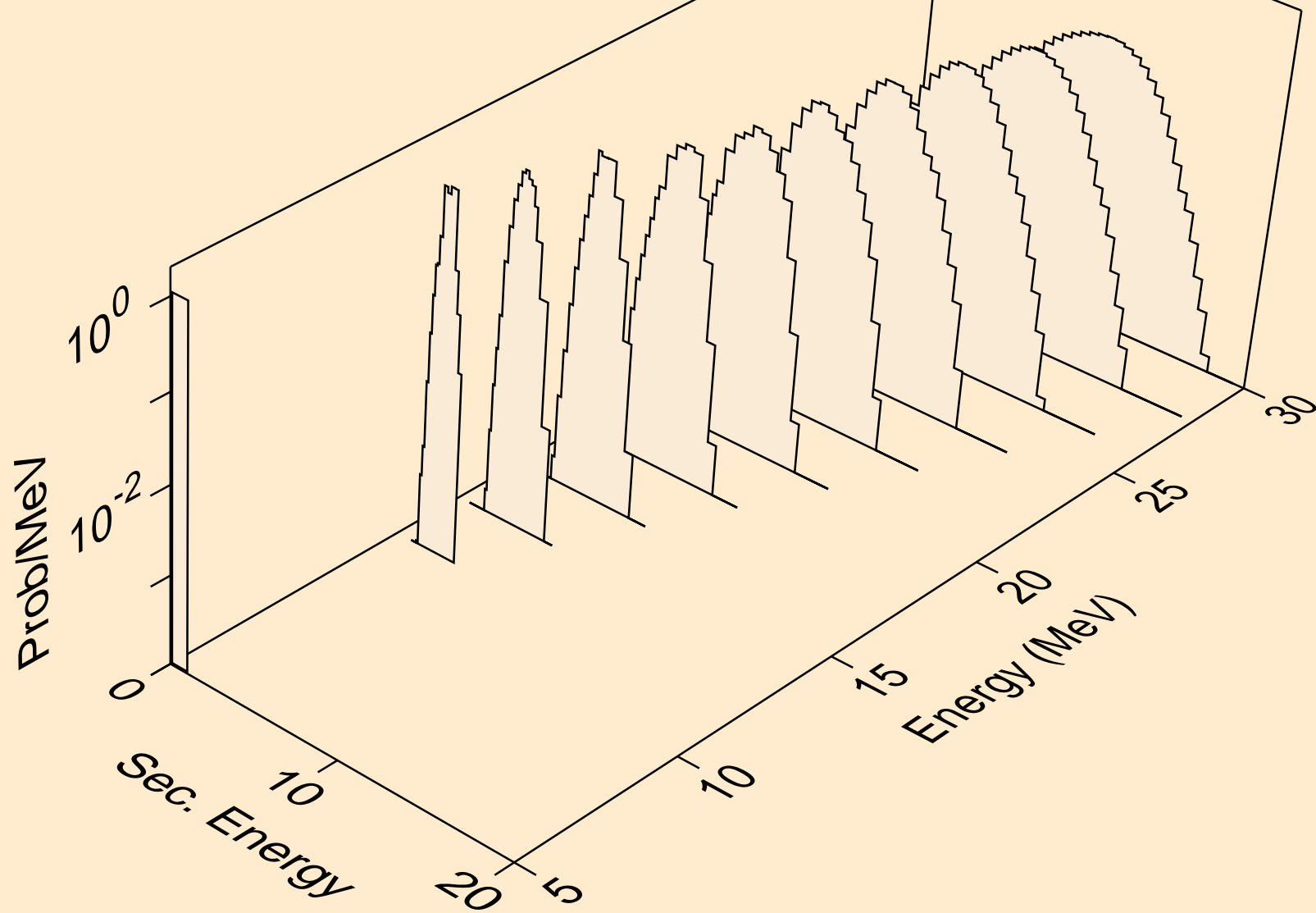

SN109 NEUTRON ACER TENDL-2024 LIBRARY; T=293.6K
tritons from (n,x)

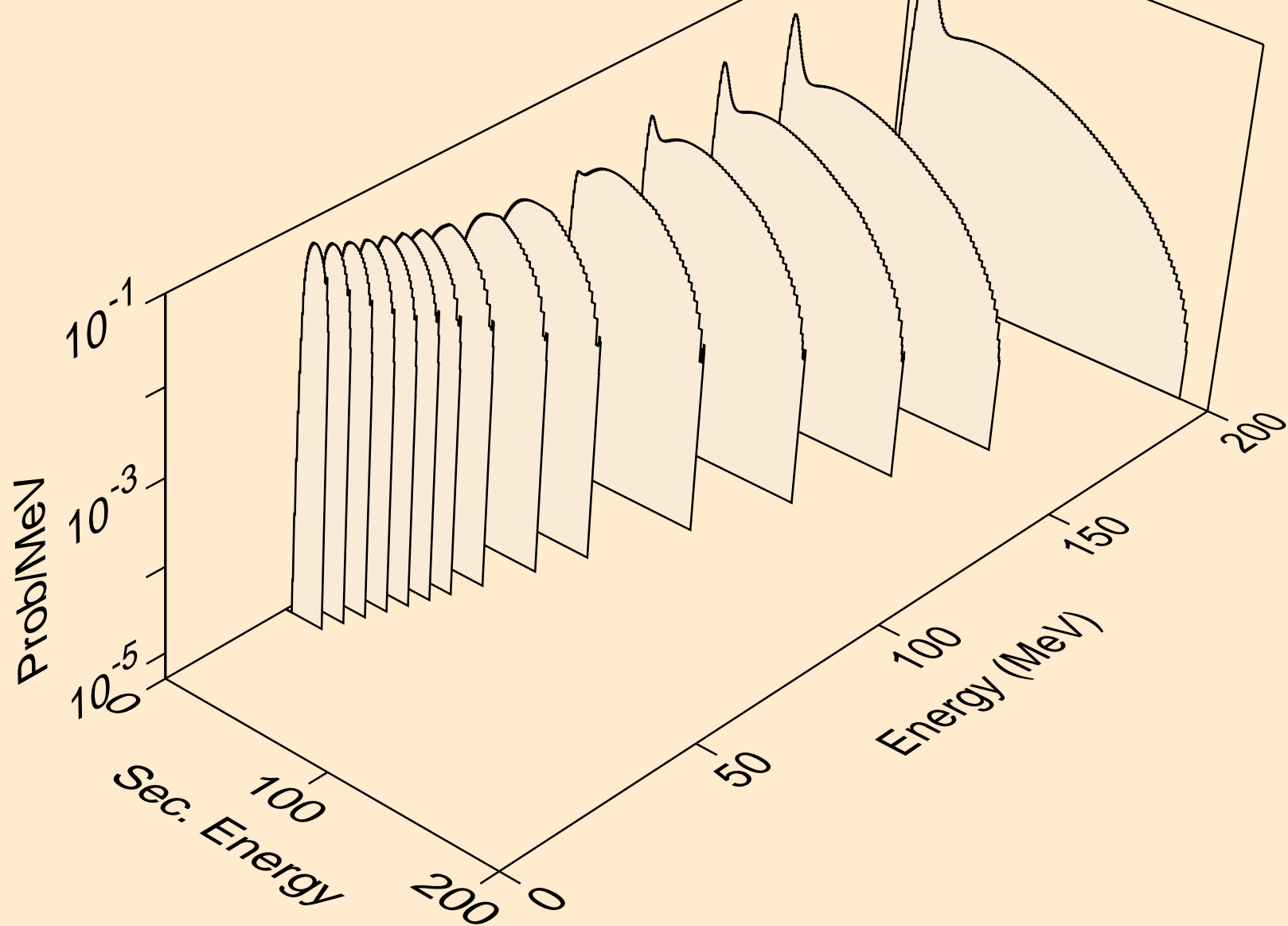

SN109 NEUTRON ACER TENDL-2024 LIBRARY; T=293.6K
tritons from (n,n*)t

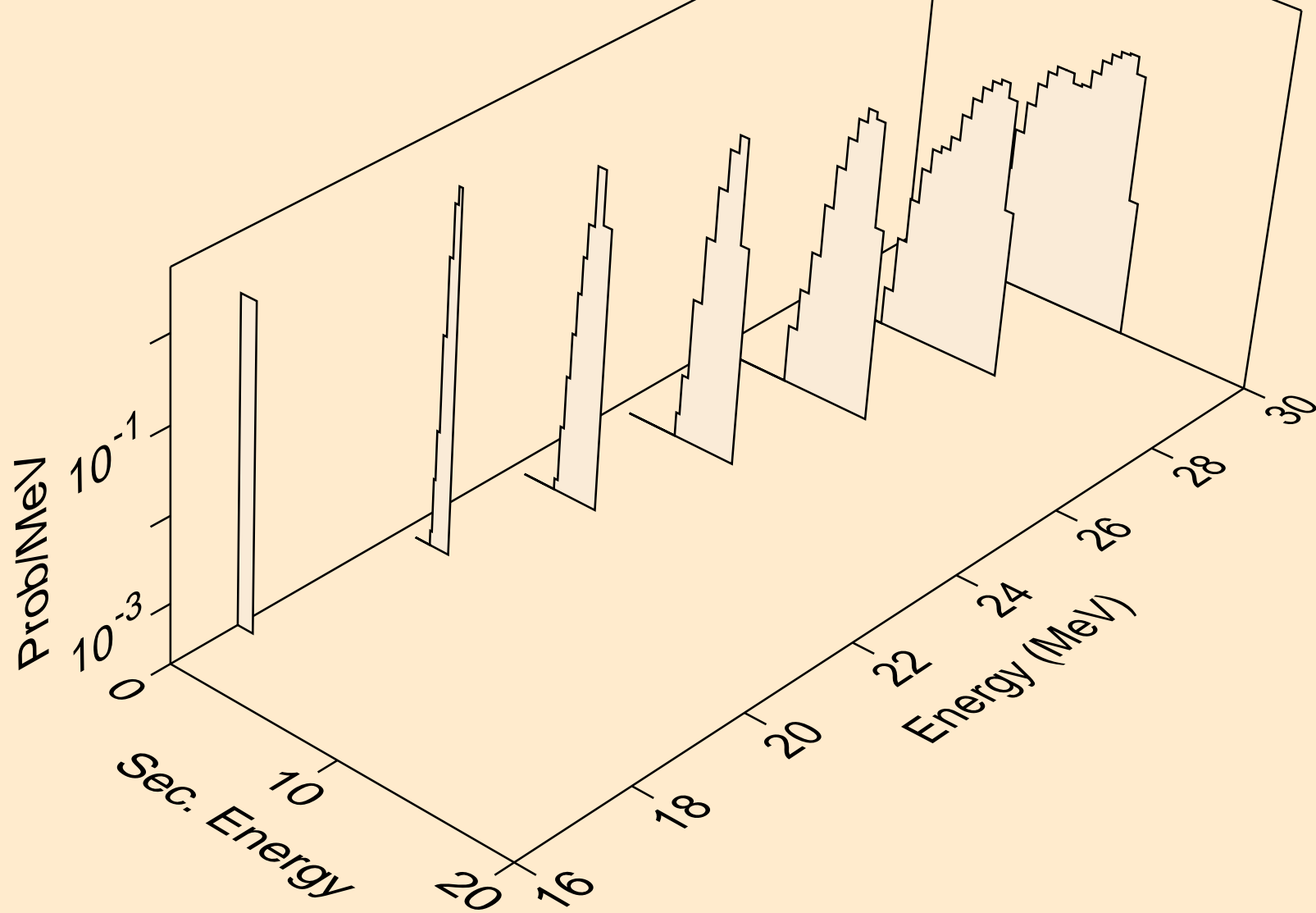

SN109 NEUTRON ACER TENDL-2024 LIBRARY; T=293.6K
tritons from (n,t)

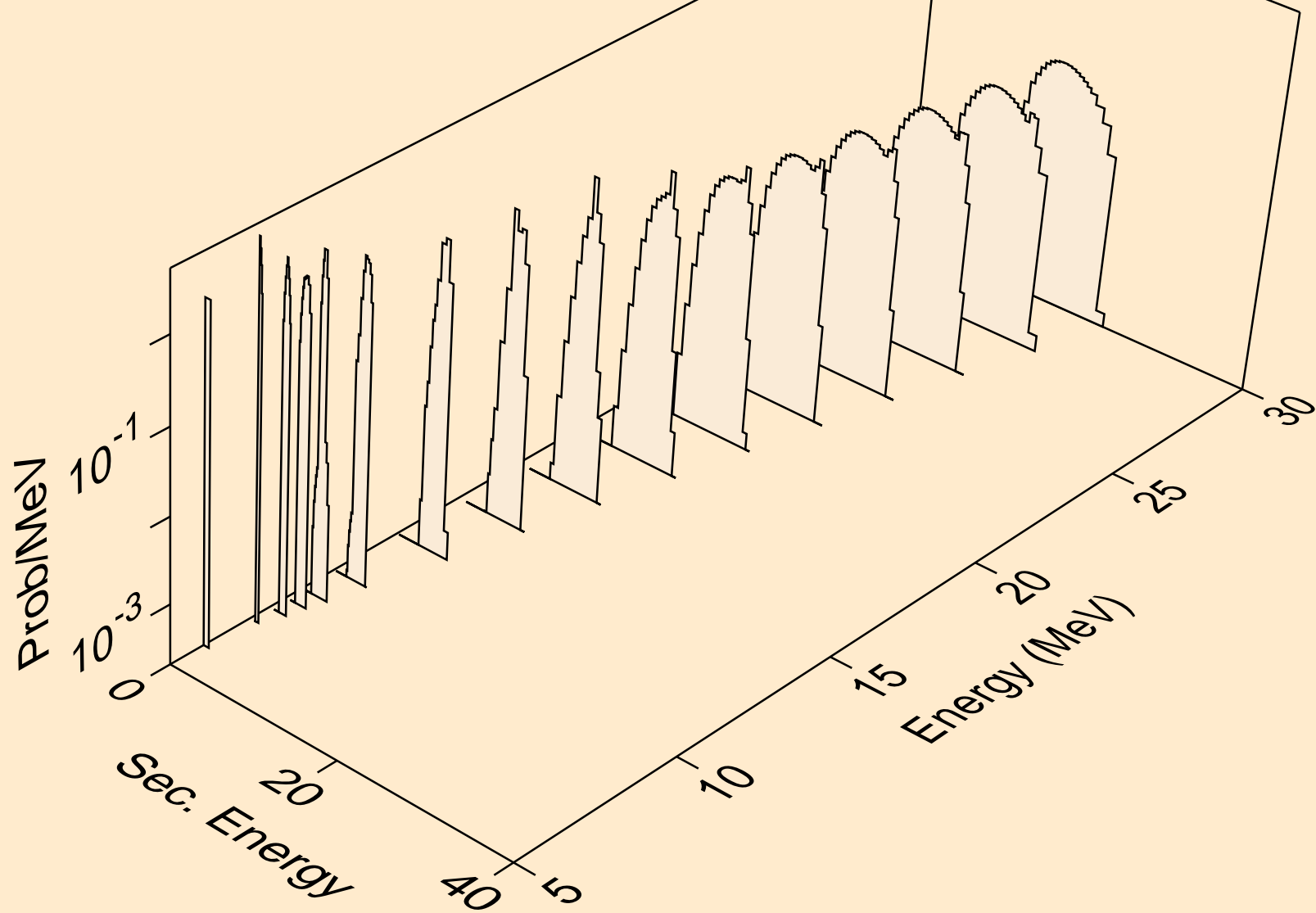

SN109 NEUTRON ACER TENDL-2024 LIBRARY; T=293.6K
tritons from (n,pt)

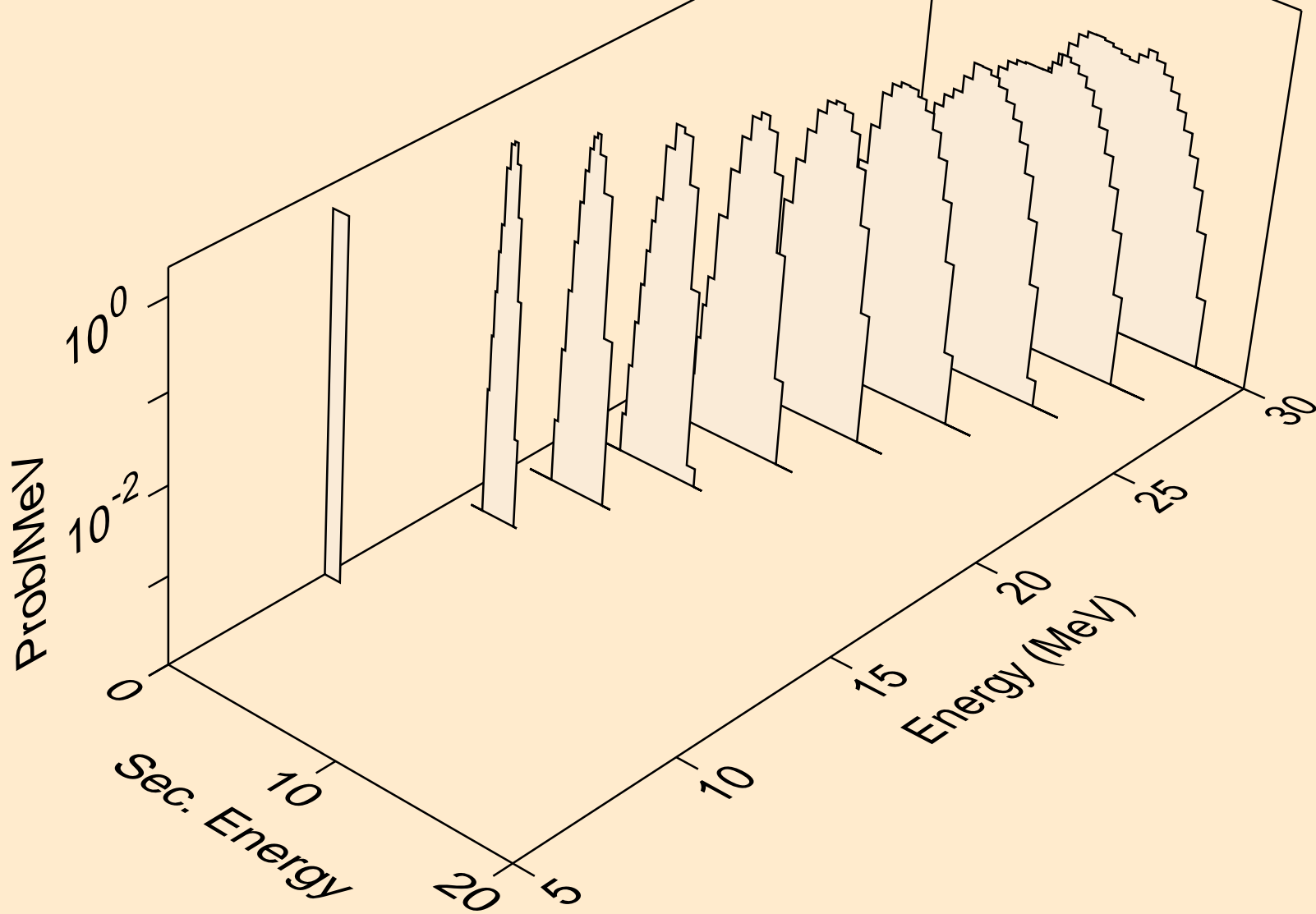

SN109 NEUTRON ACER TENDL-2024 LIBRARY; T=293.6K
he3s from (n,x)

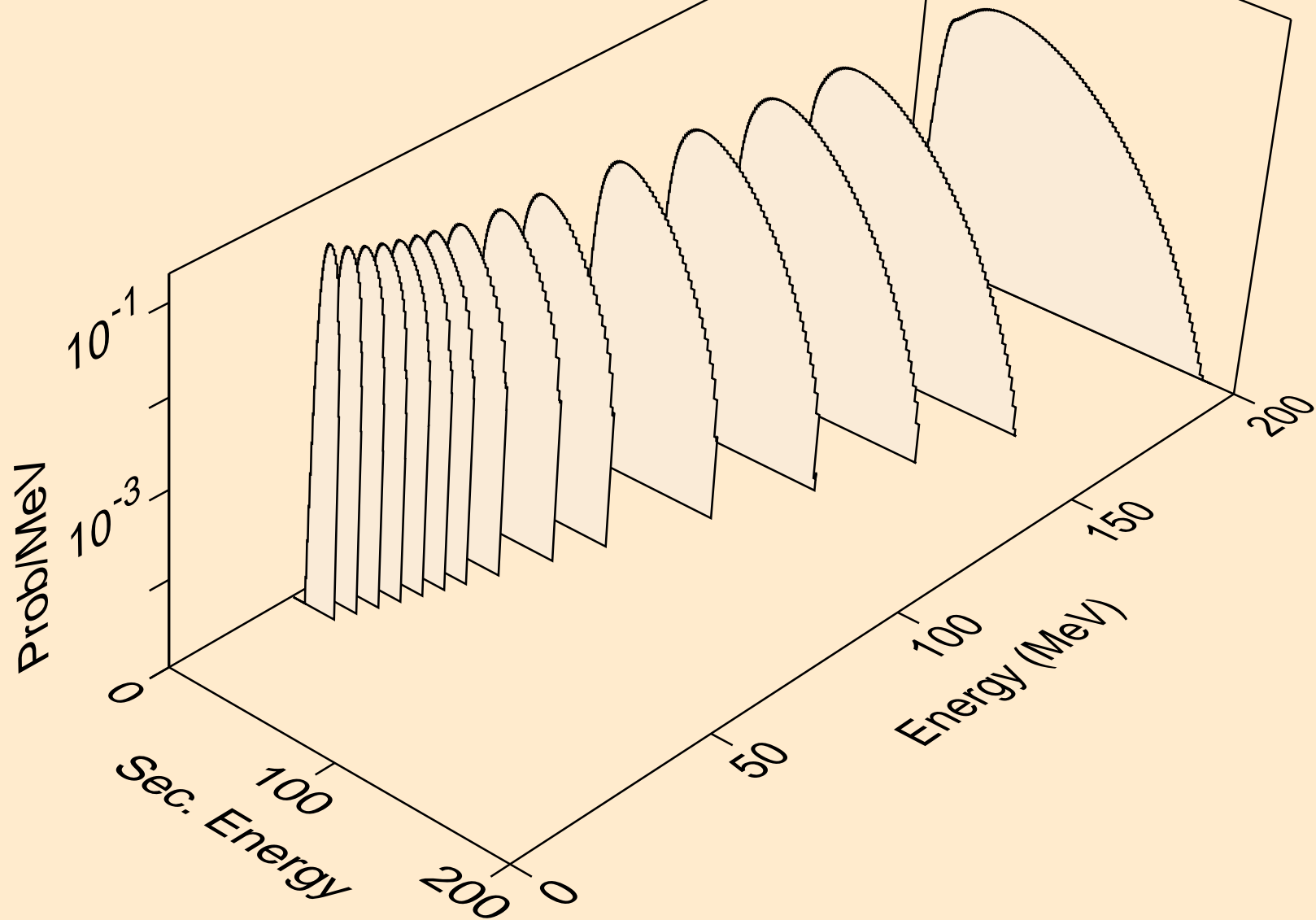

SN109 NEUTRON ACER TENDL-2024 LIBRARY; T=293.6K
he3s from (n,n*)he3

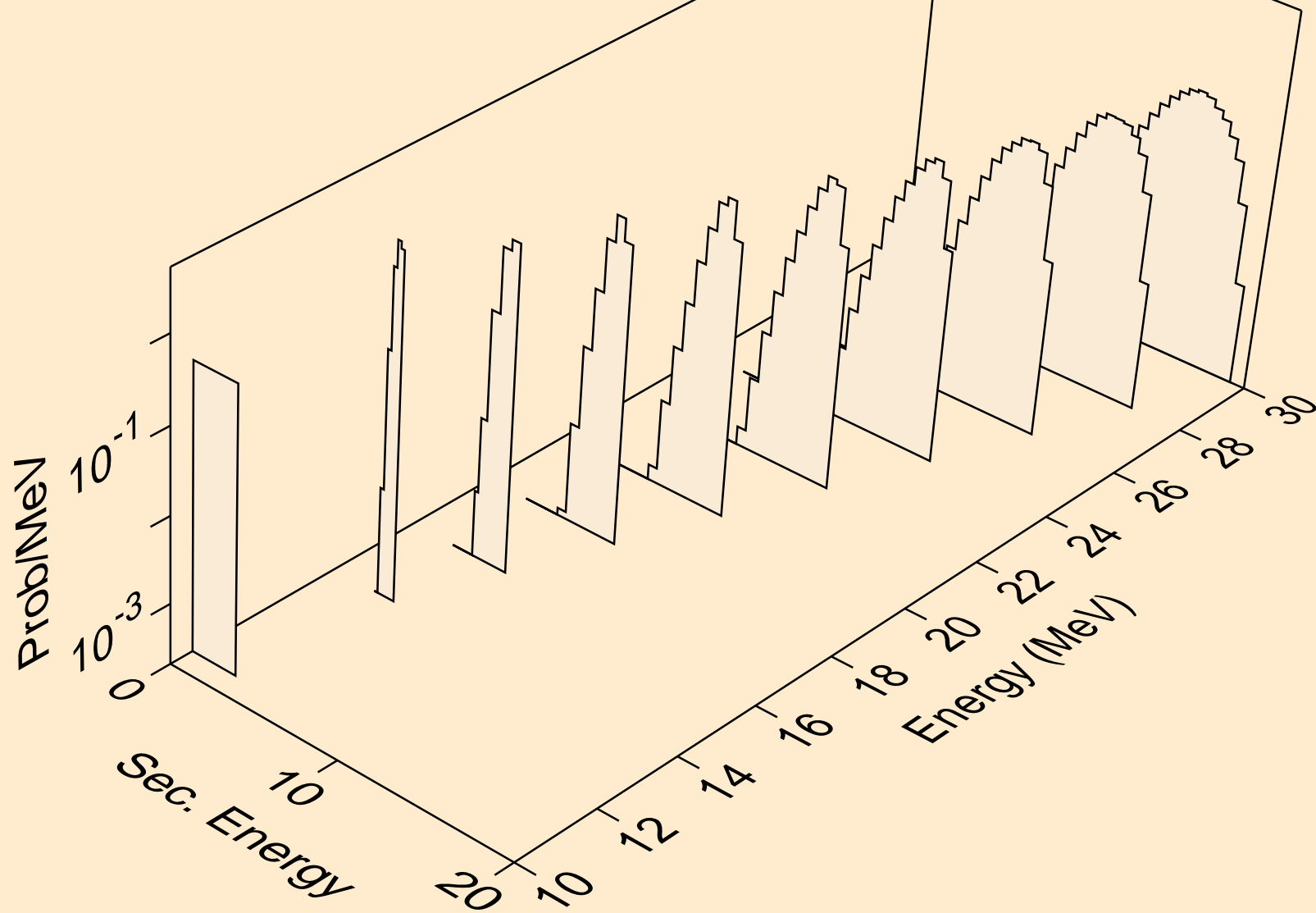

SN109 NEUTRON ACER TENDL-2024 LIBRARY; T=293.6K
he3s from (n,he3)

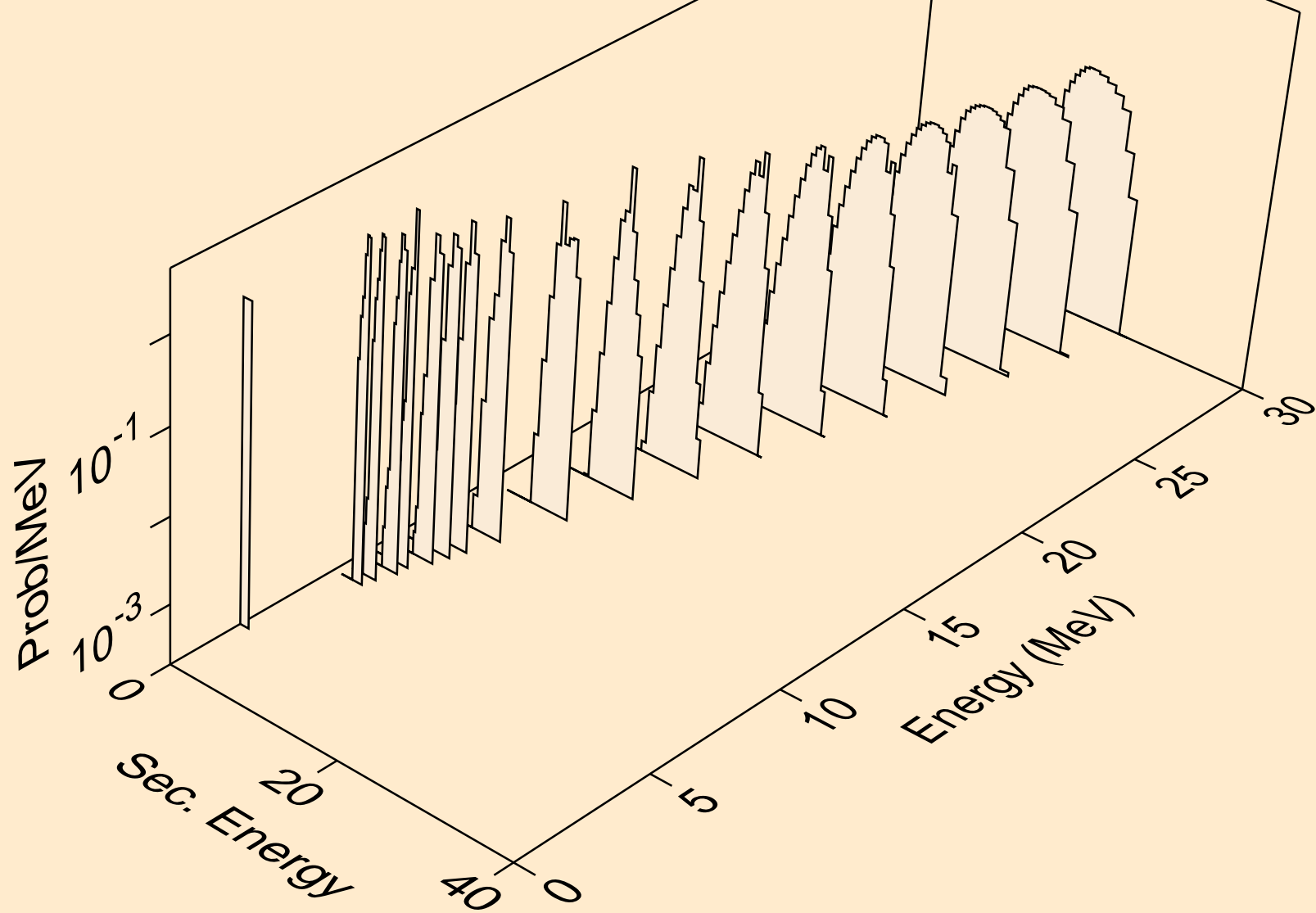

SN109 NEUTRON ACER TENDL-2024 LIBRARY; T=293.6K
alphas from (n,x)

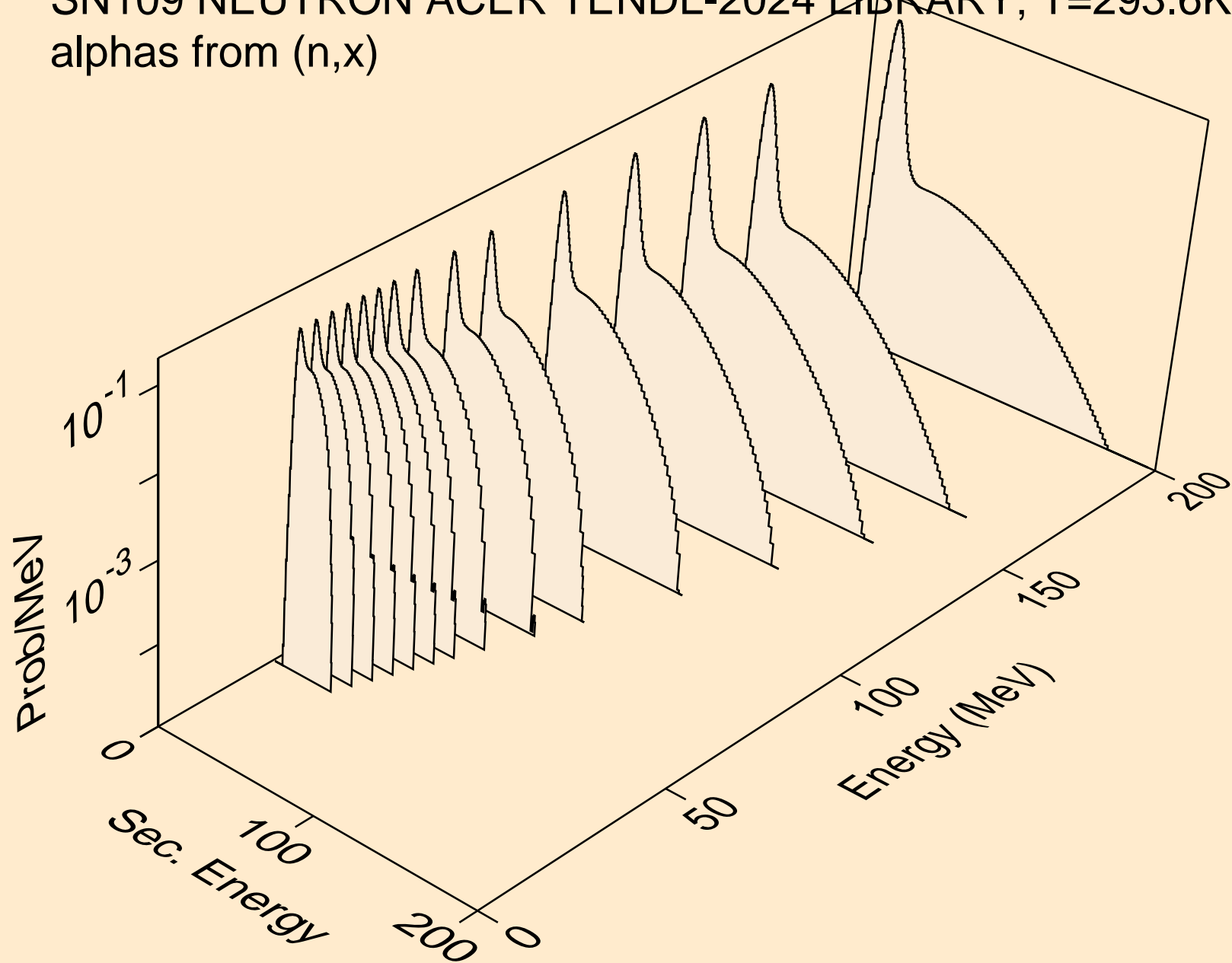

SN109 NEUTRON ACER TENDL-2024 LIBRARY; T=293.6K
alphas from (n,n*)a

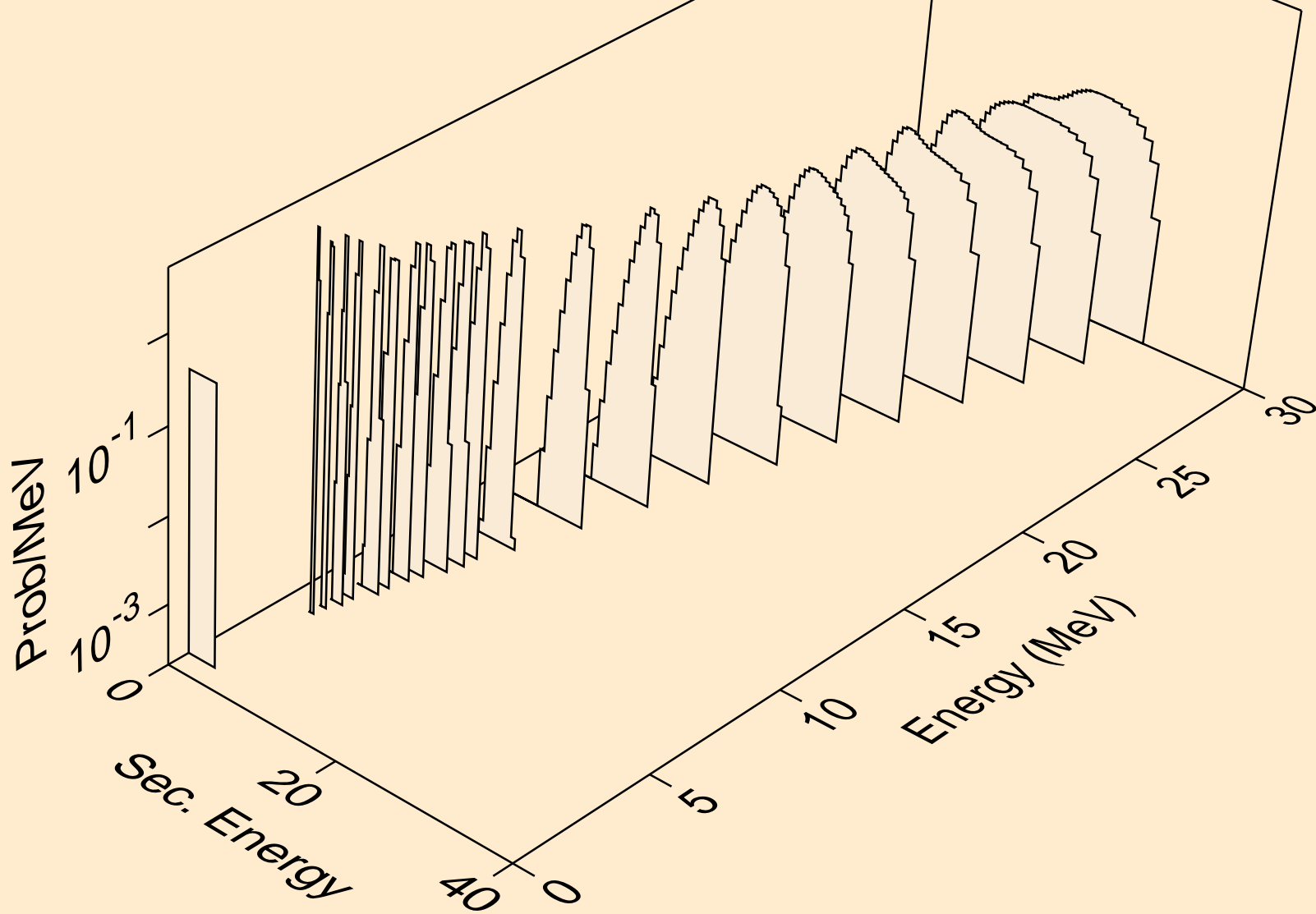

SN109 NEUTRON ACER TENDL-2024 LIBRARY; T=293.6K
alphas from (n,2n)a

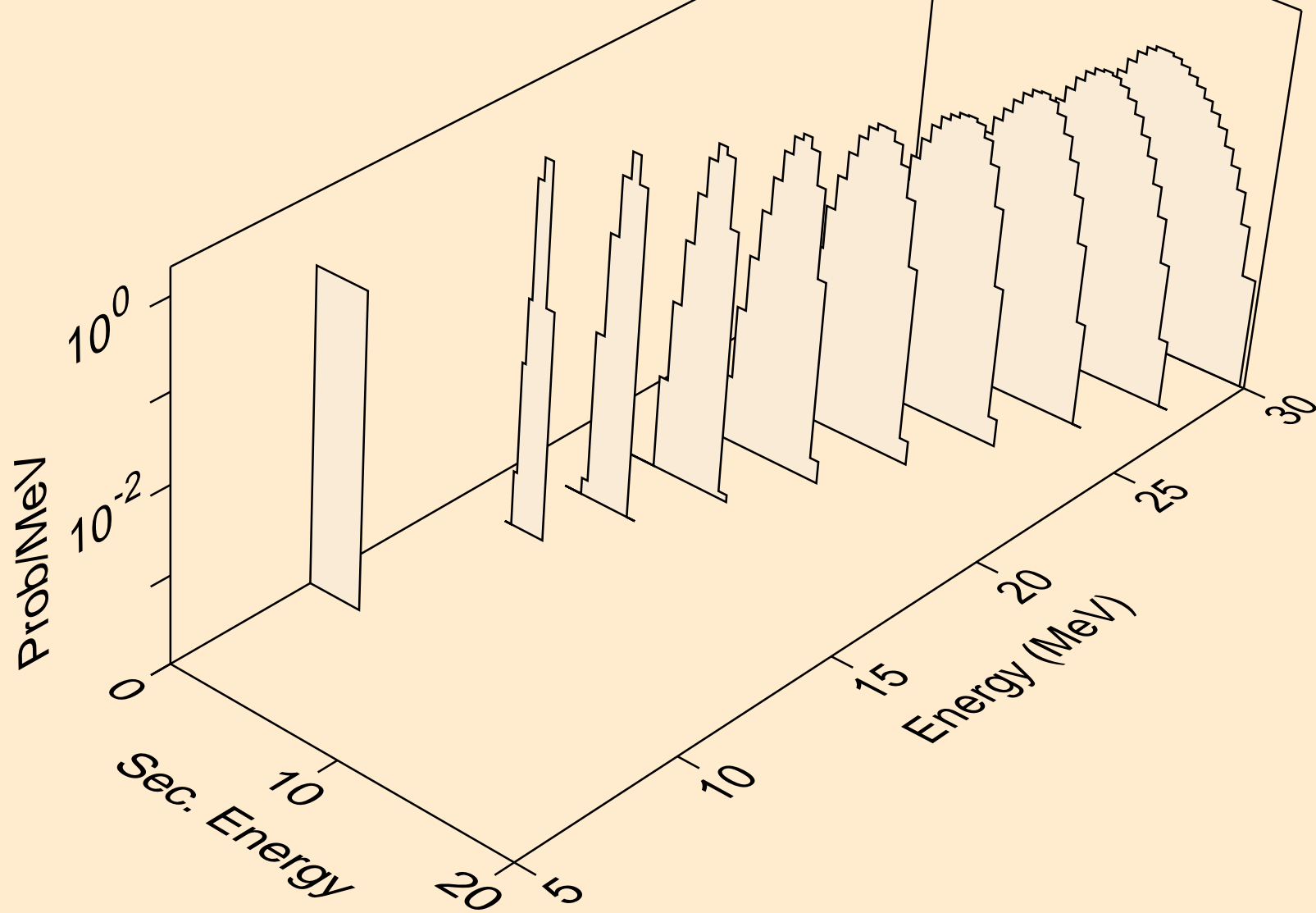

SN109 NEUTRON ACER TENDL-2024 LIBRARY; T=293.6K
alphas from (n,3n)a

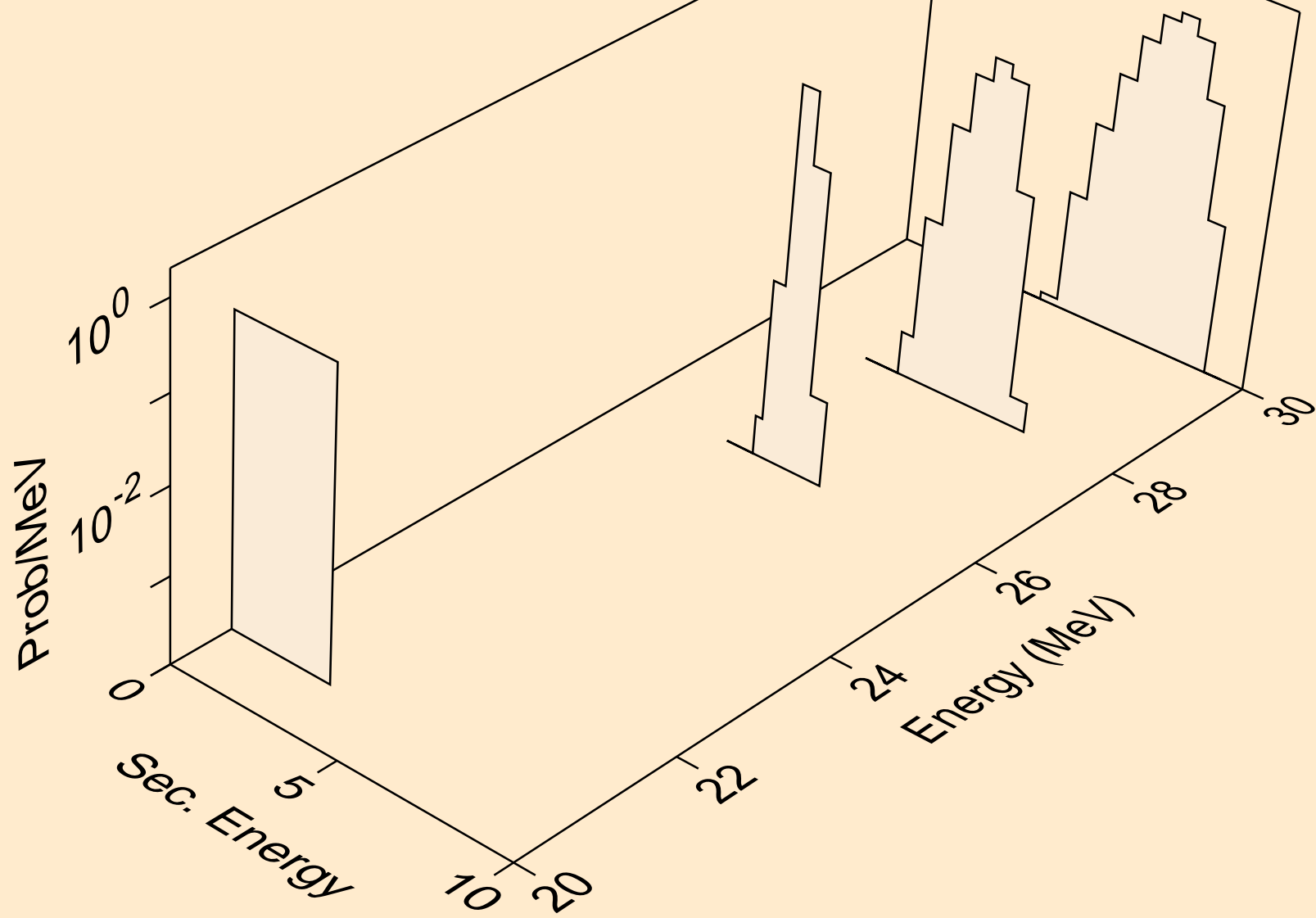

SN109 NEUTRON ACER TENDL-2024 LIBRARY; T=293.6K
alphas from (n,n*)2a

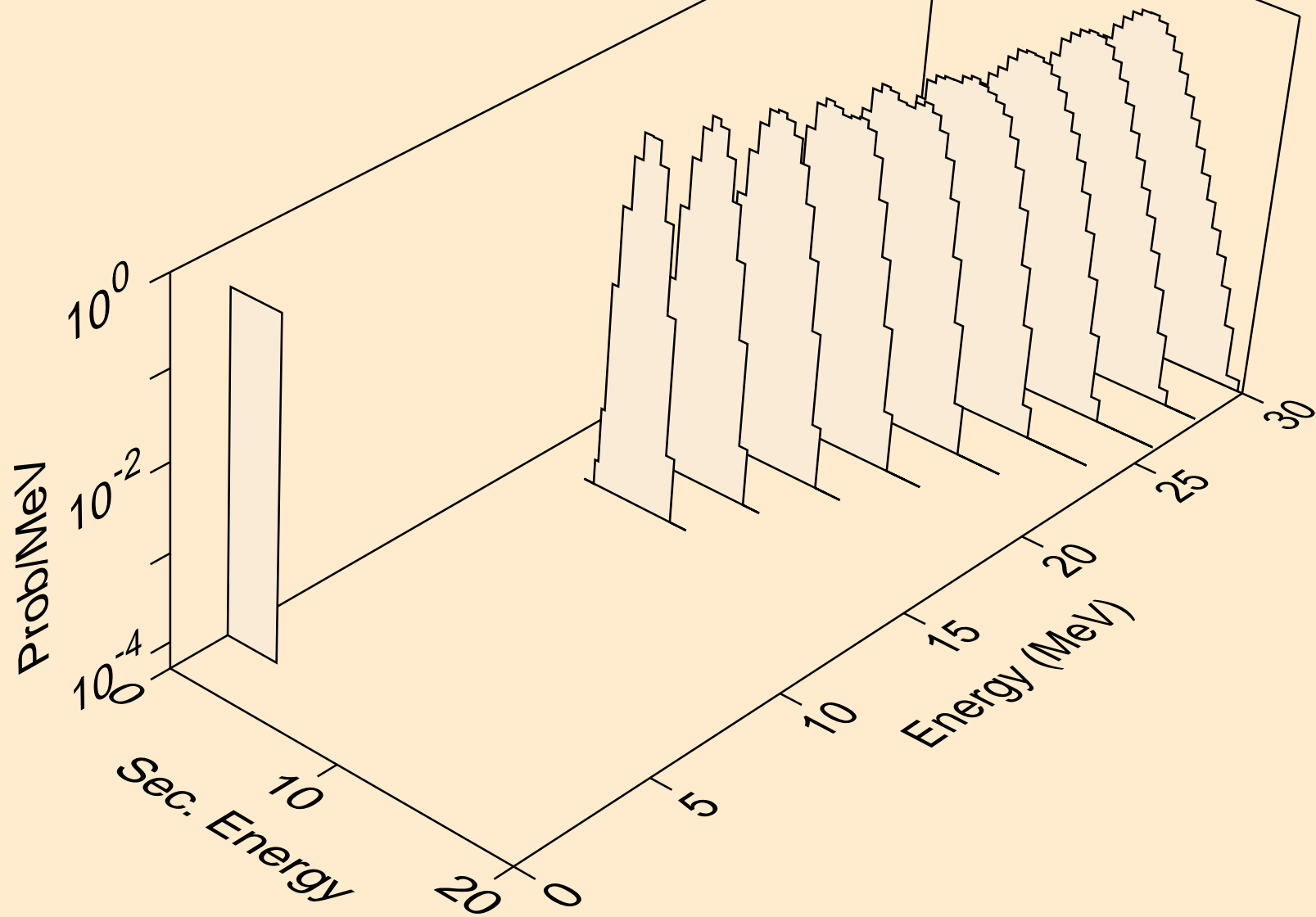

SN109 NEUTRON ACER TENDL-2024 LIBRARY; T=293.6K
alphas from (n,2n)2a

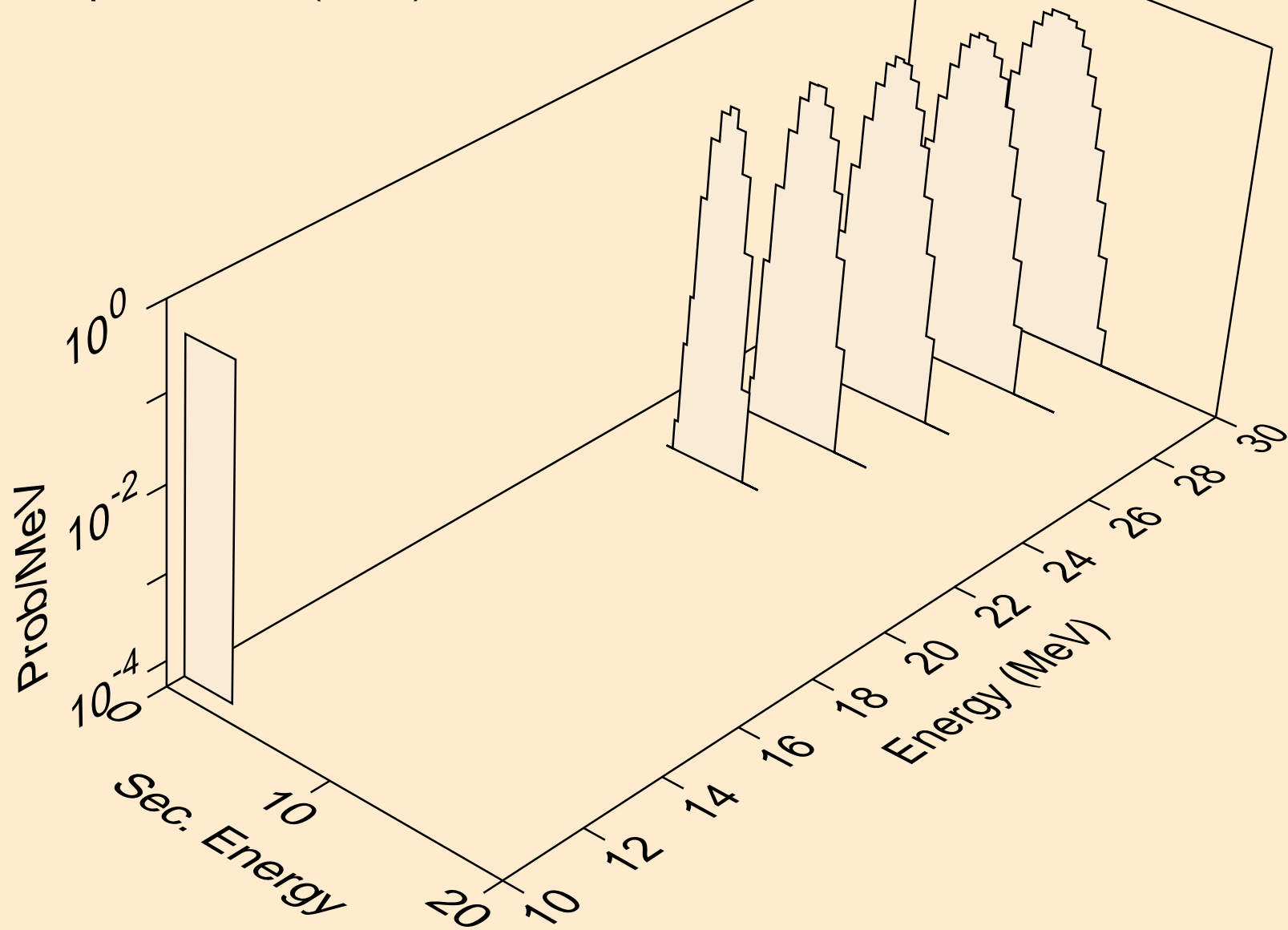

SN109 NEUTRON ACER TENDL-2024 LIBRARY; T=293.6K
alphas from (n,npa)

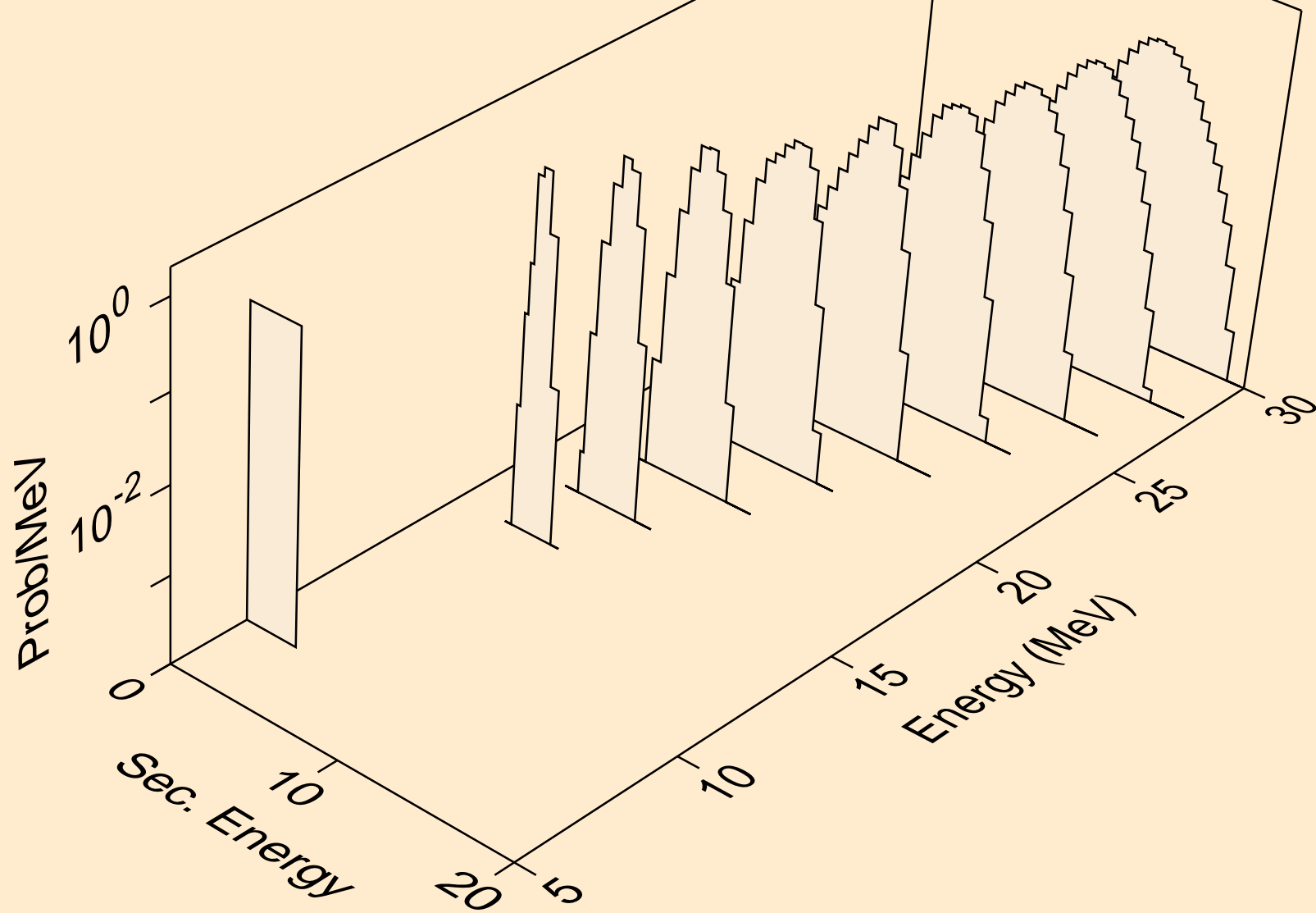

SN109 NEUTRON ACER TENDL-2024 LIBRARY; T=293.6K
alphas from (n,a)

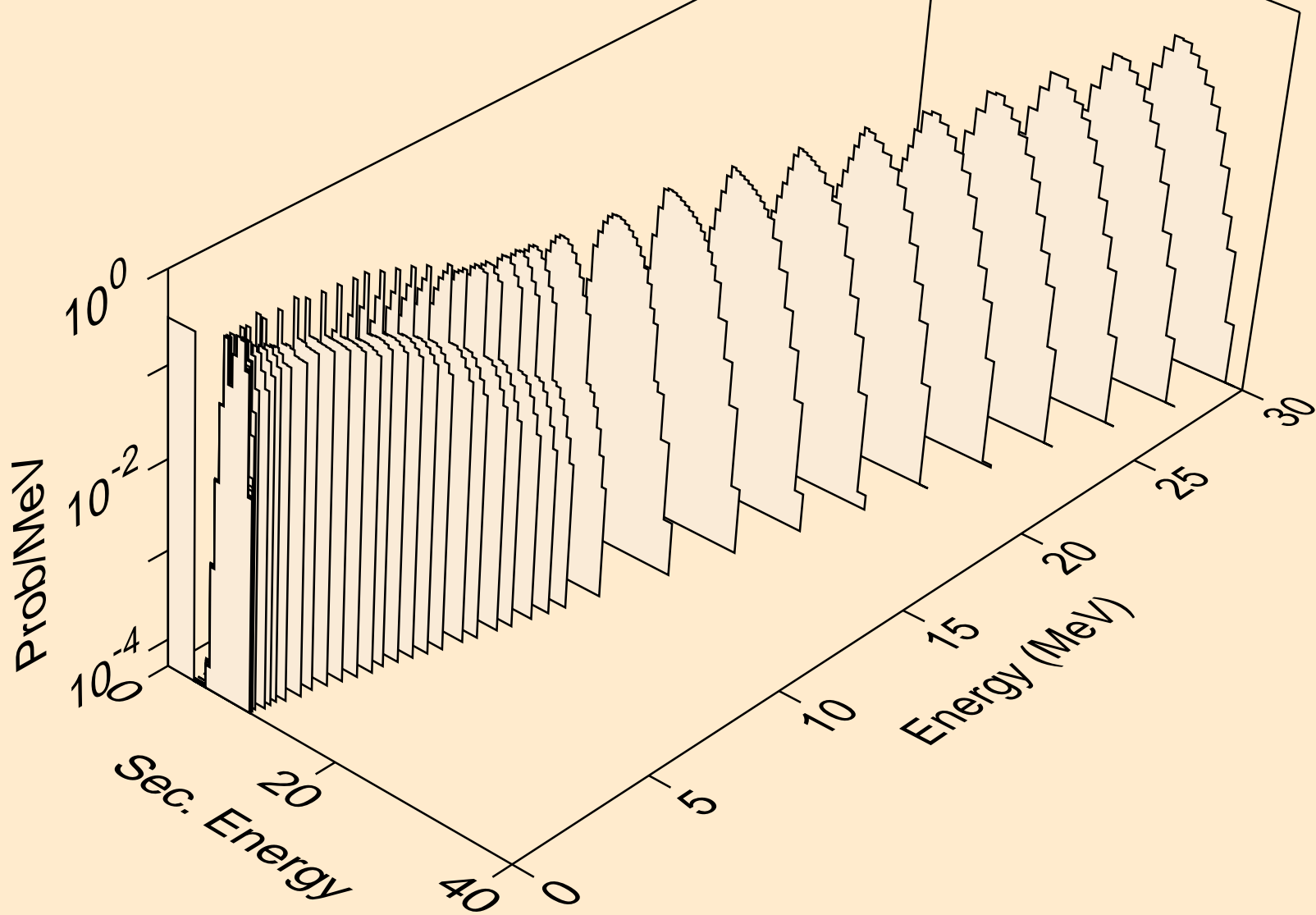

SN109 NEUTRON ACER TENDL-2024 LIBRARY; T=293.6K
alphas from (n,2a)

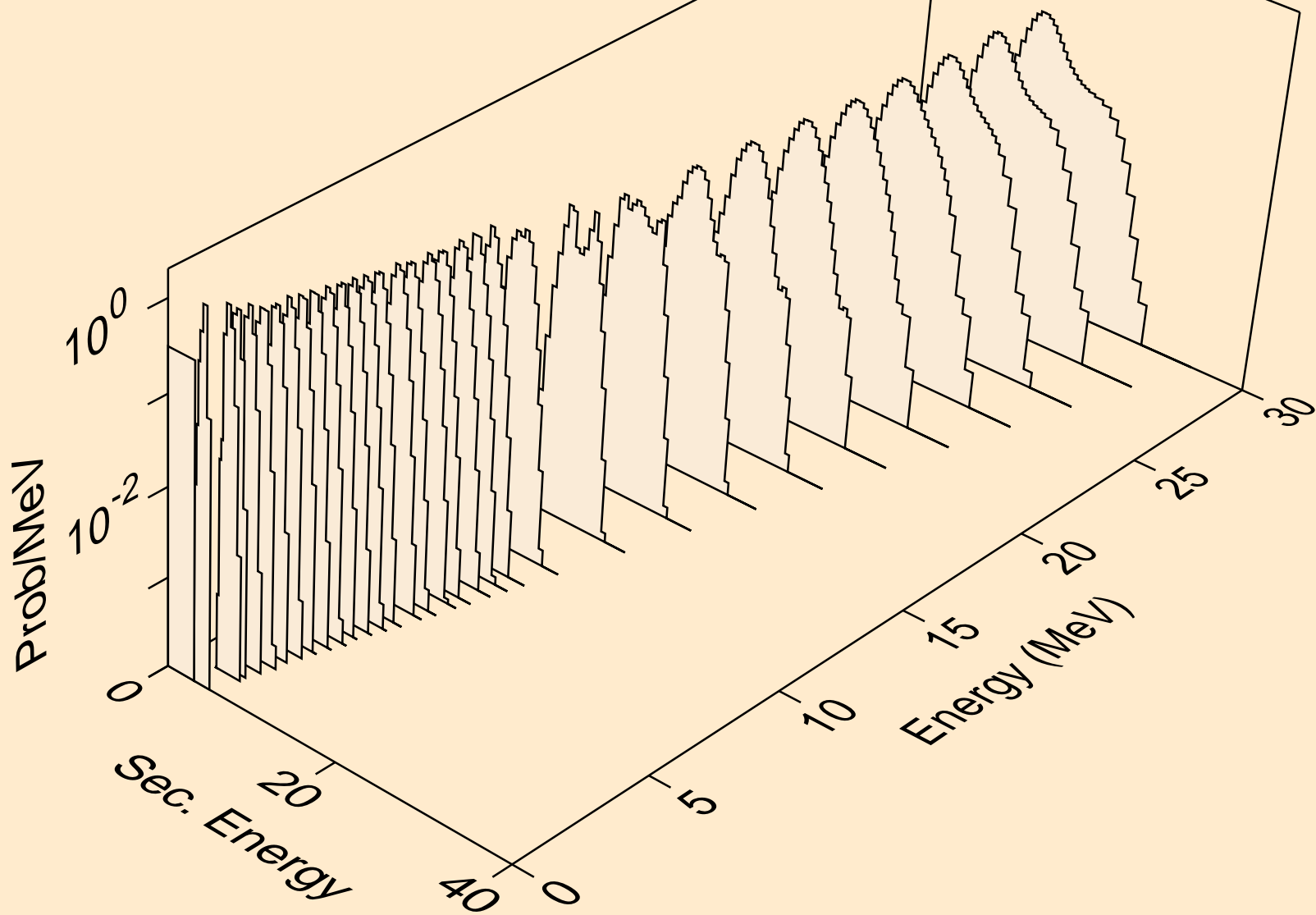

SN109 NEUTRON ACER TENDL-2024 LIBRARY; T=293.6K
alphas from (n,3a)

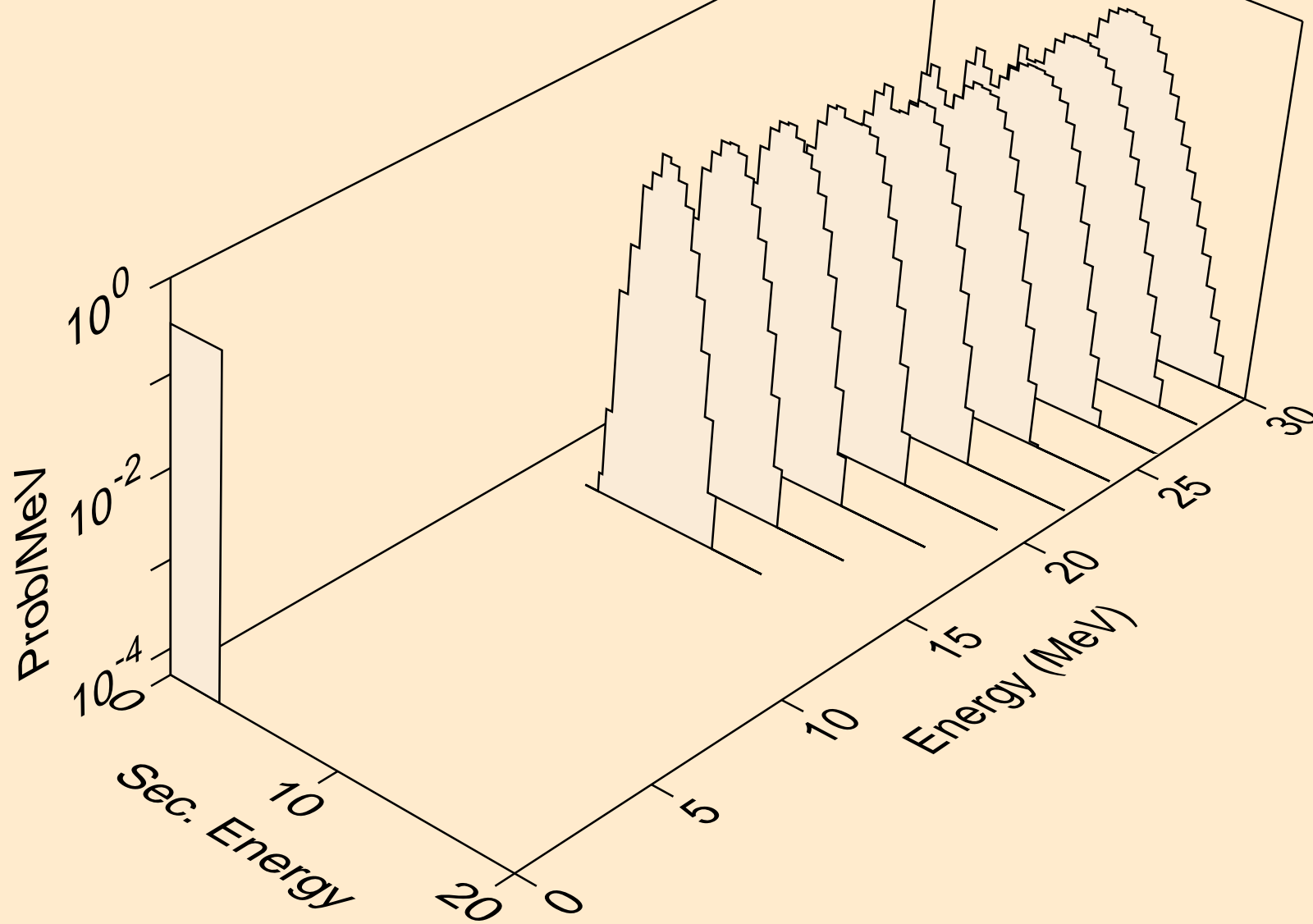

SN109 NEUTRON ACER TENDL-2024 LIBRARY; T=293.6K
alphas from (n,pa)

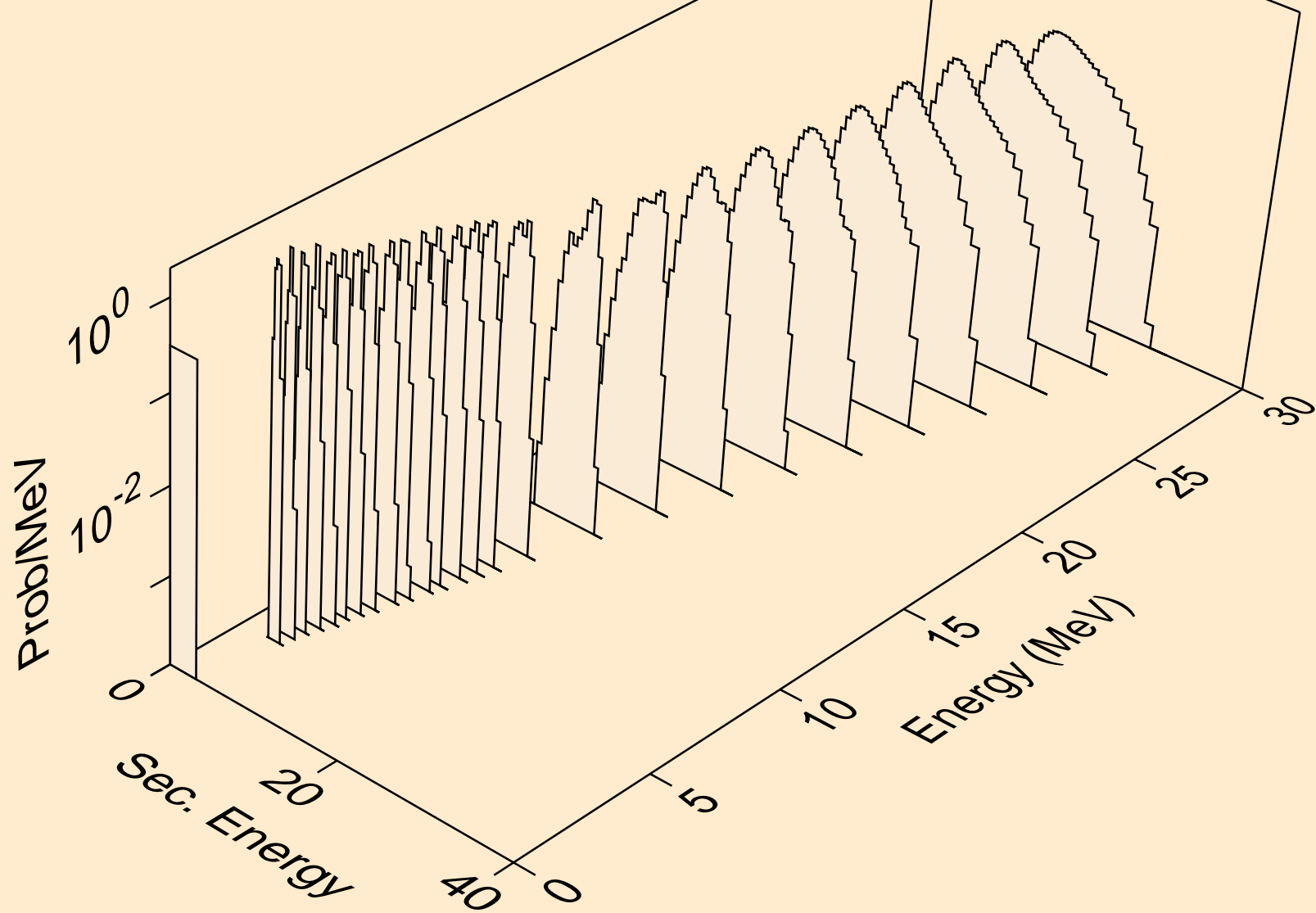

SN109 NEUTRON ACER TENDL-2024 LIBRARY; T=293.6K
alphas from (n,da)

