

SR077 NEUTRON ACER TENDL-2024 LIBRARY; T=293.6K

Principal cross sections

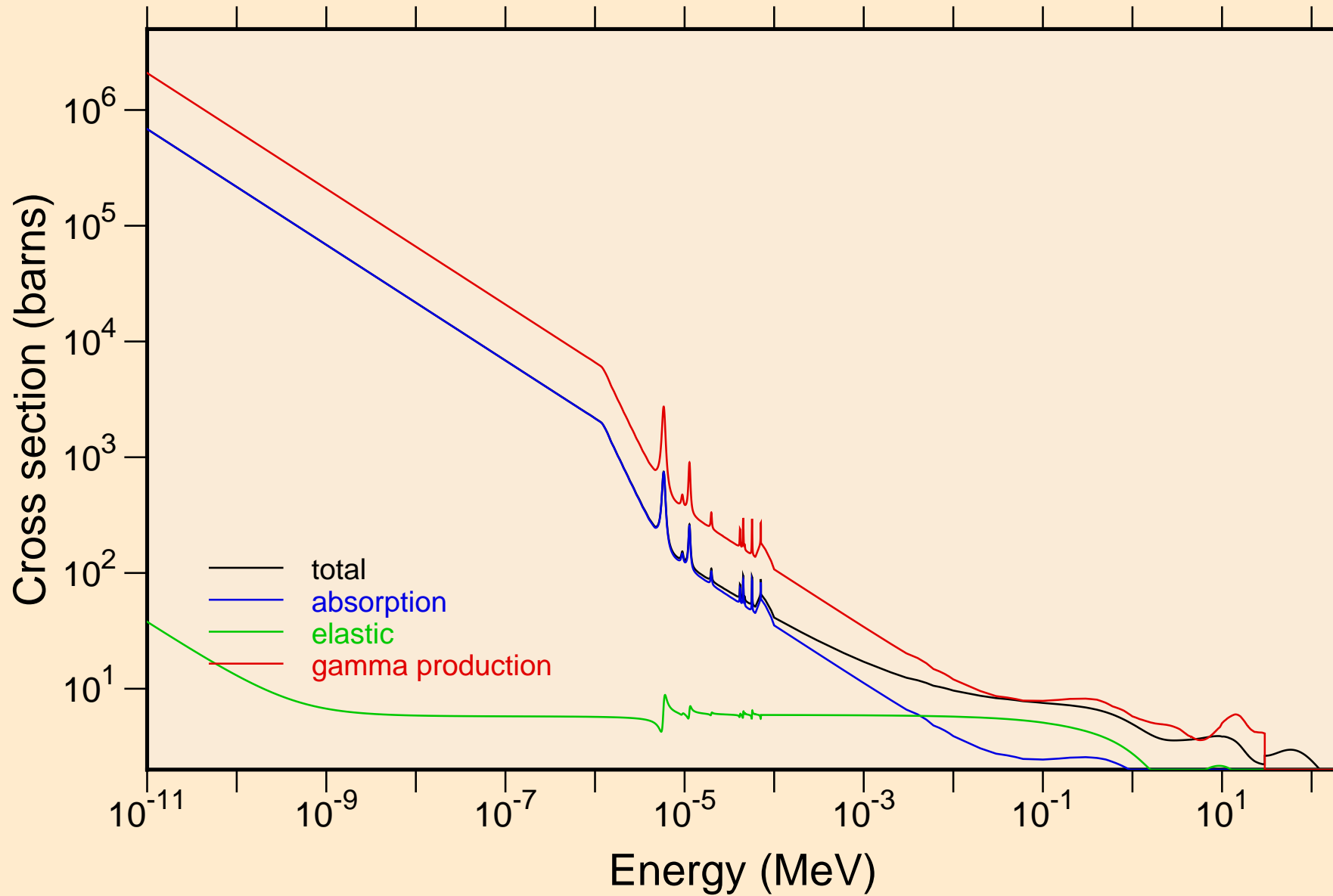

SR077 NEUTRON ACER TENDL-2024 LIBRARY; T=293.6K
resonance total cross section

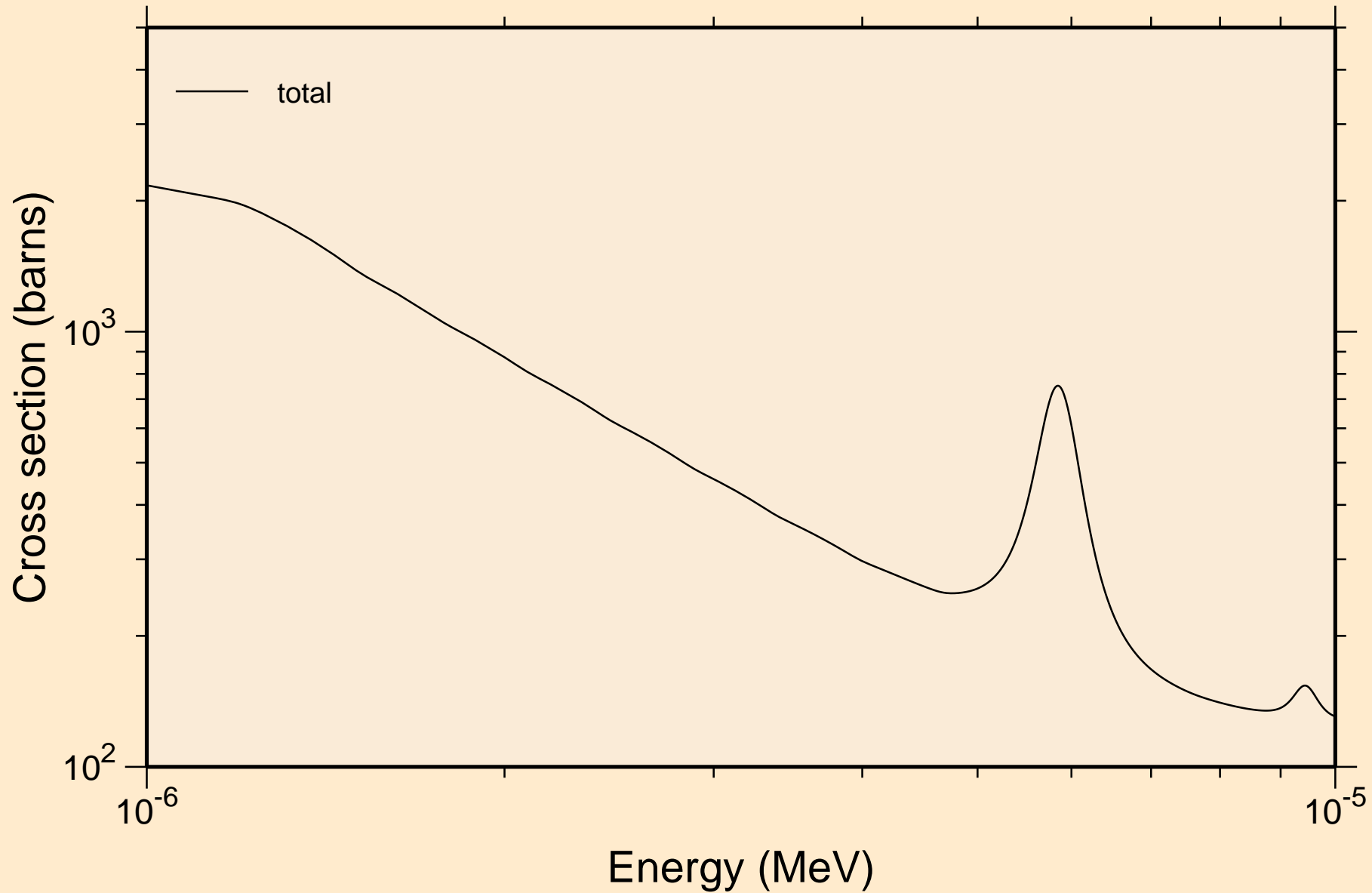

SR077 NEUTRON ACER TENDL-2024 LIBRARY; T=293.6K
resonance total cross section

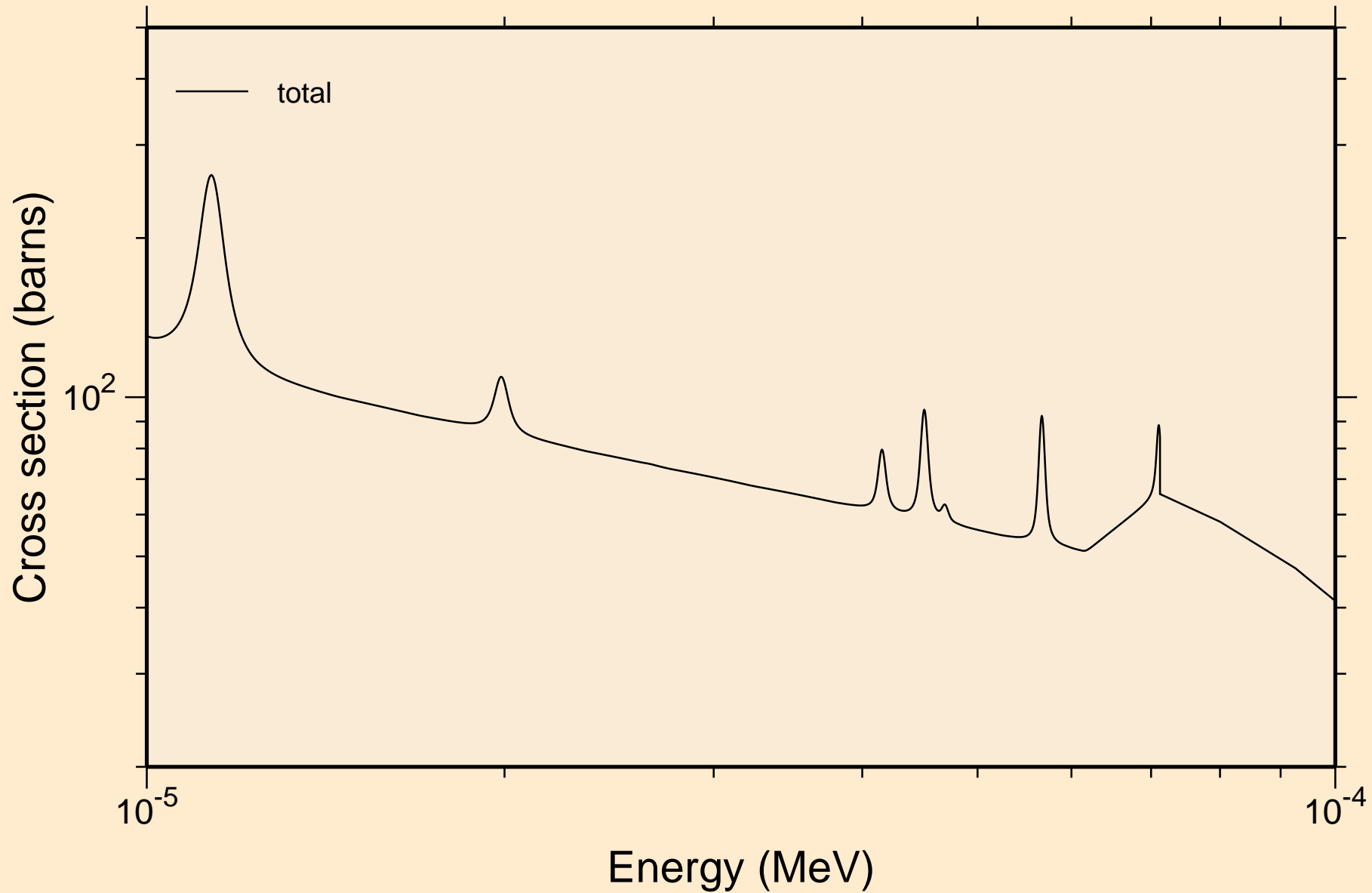

SR077 NEUTRON ACER TENDL-2024 LIBRARY; T=293.6K
resonance total cross section

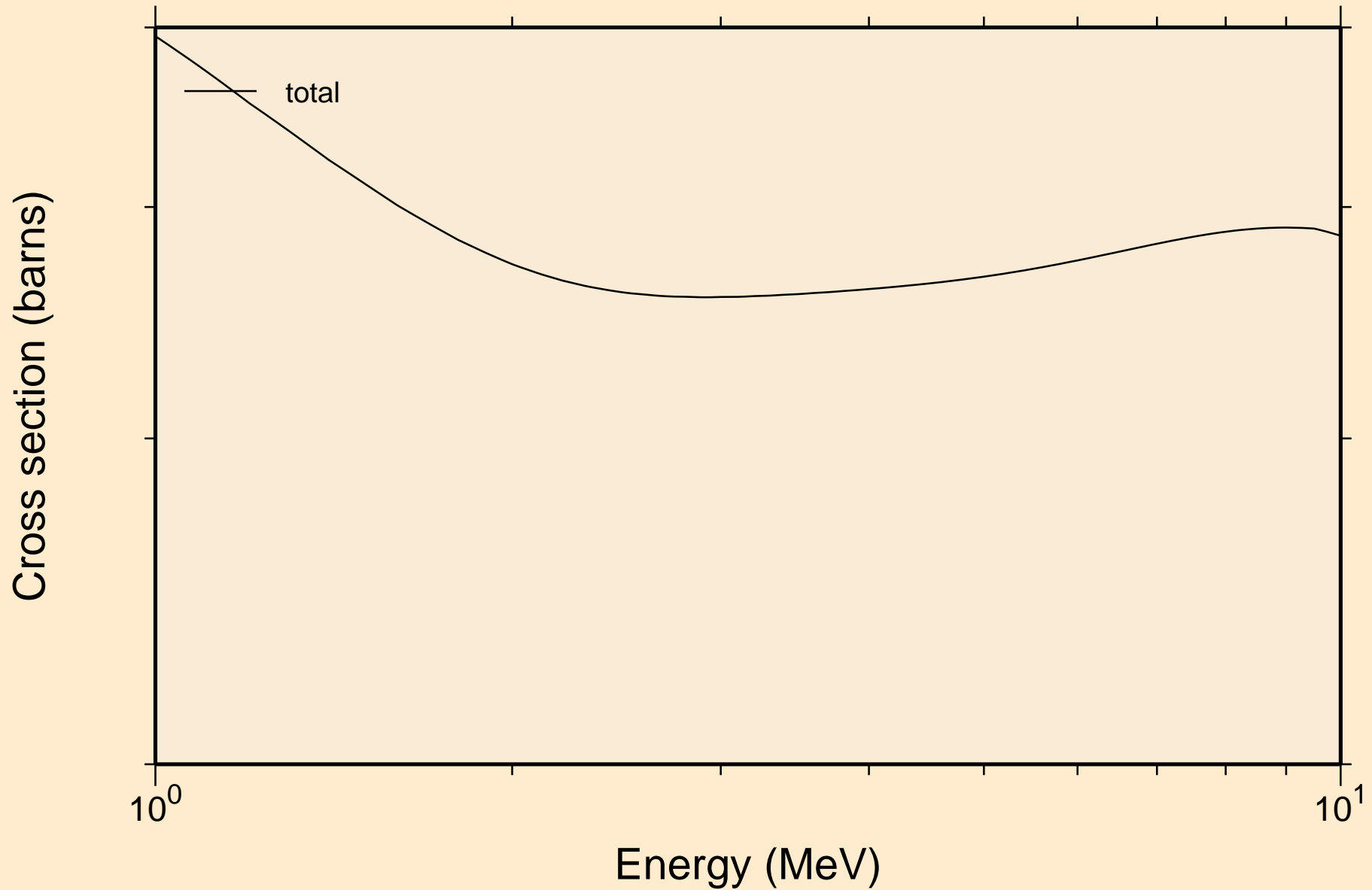

SR077 NEUTRON ACER TENDL-2024 LIBRARY; T=293.6K
resonance absorption cross sections

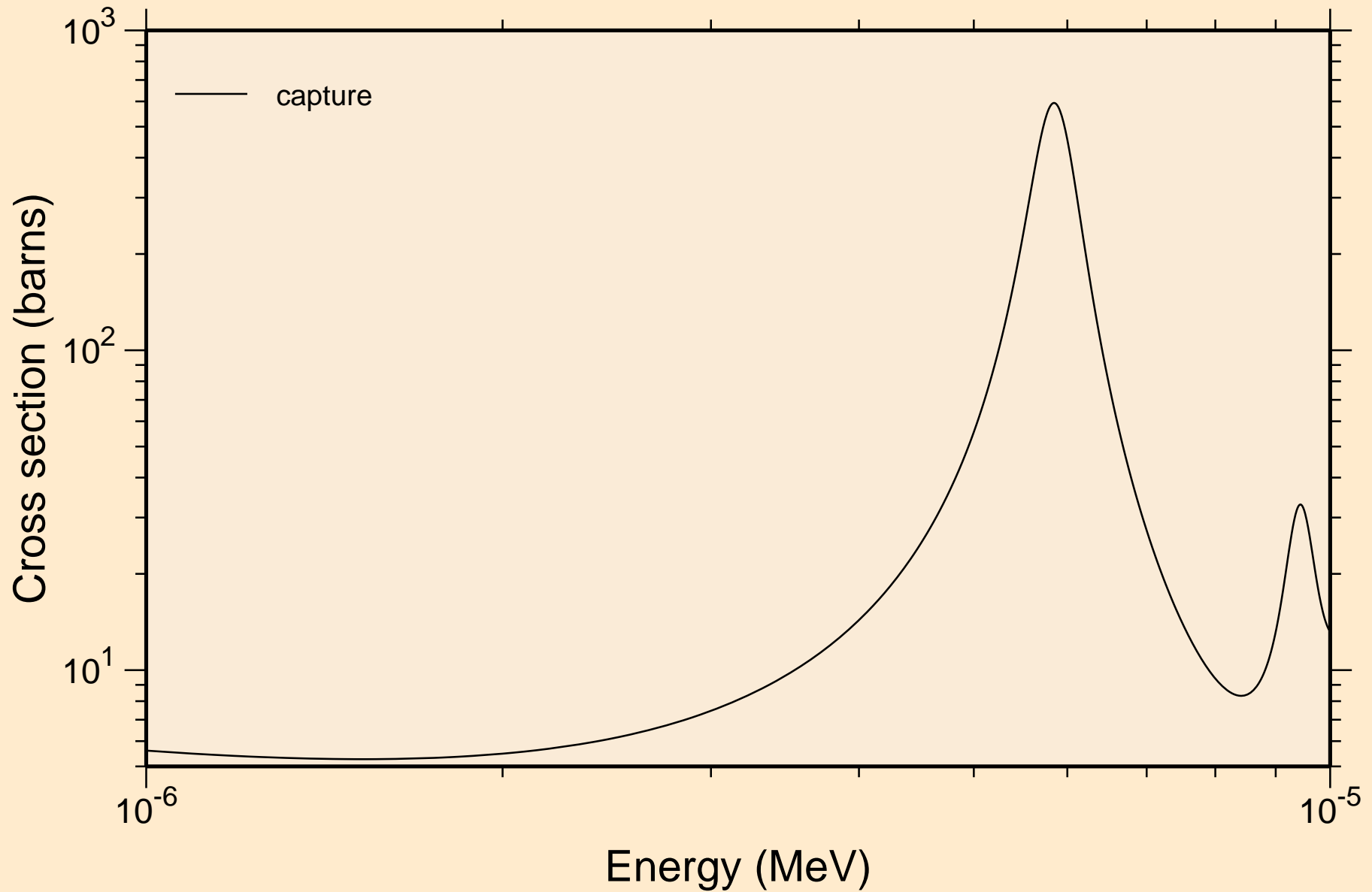

SR077 NEUTRON ACER TENDL-2024 LIBRARY; T=293.6K
resonance absorption cross sections

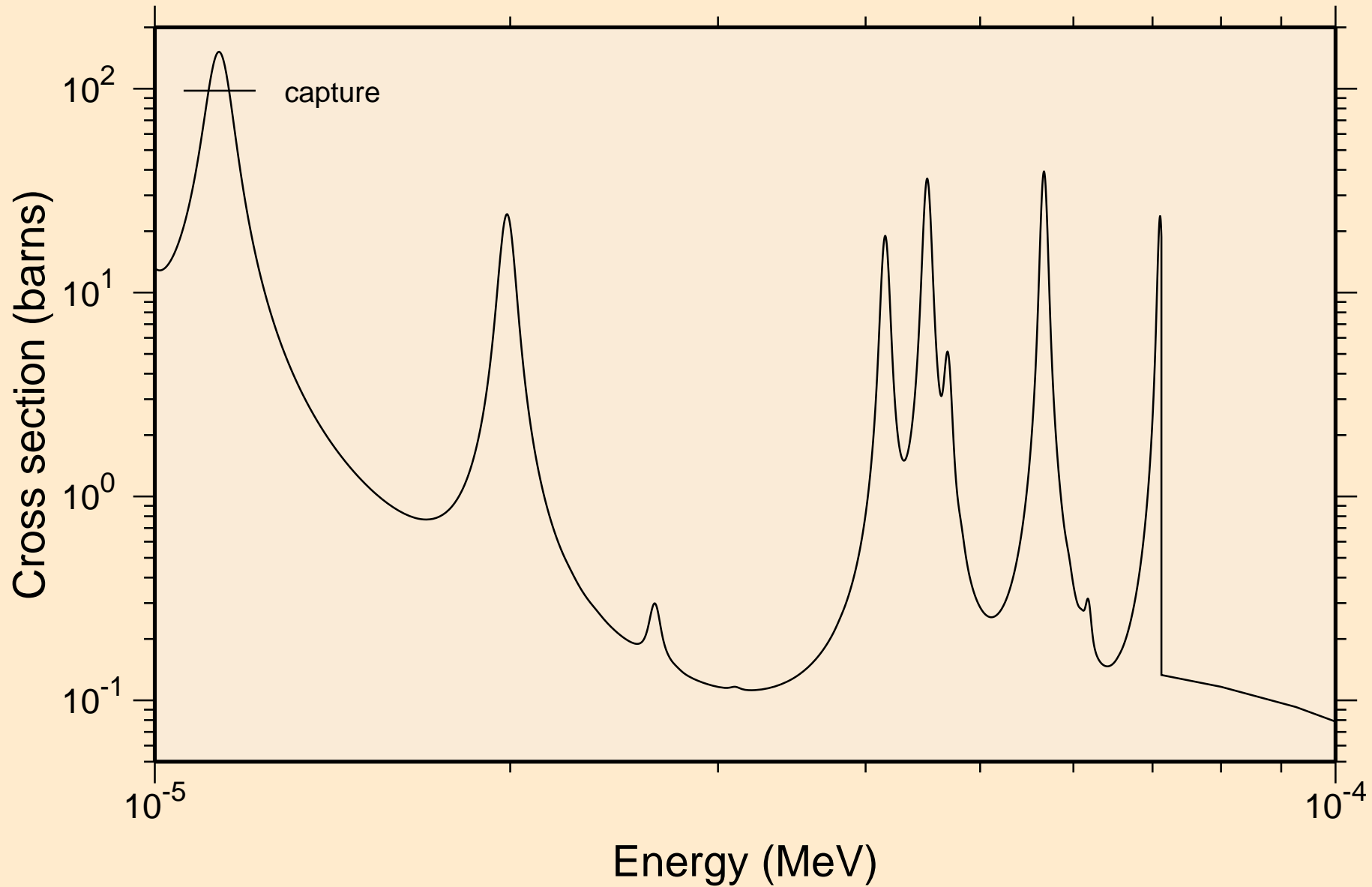

SR077 NEUTRON ACER TENDL-2024 LIBRARY; T=293.6K
resonance absorption cross sections

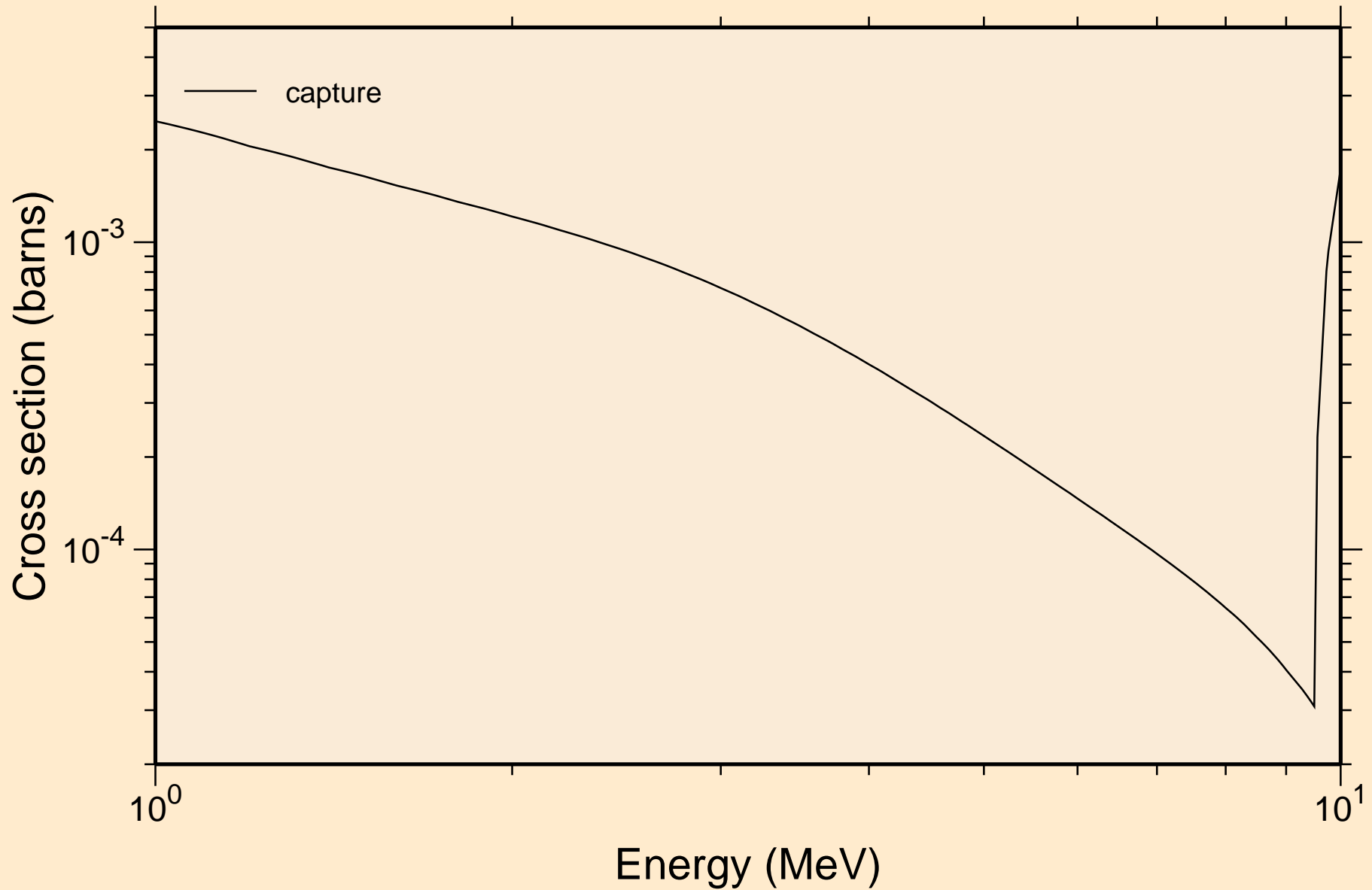

SR077 NEUTRON ACER TENDL-2024 LIBRARY; T=293.6K
Heating

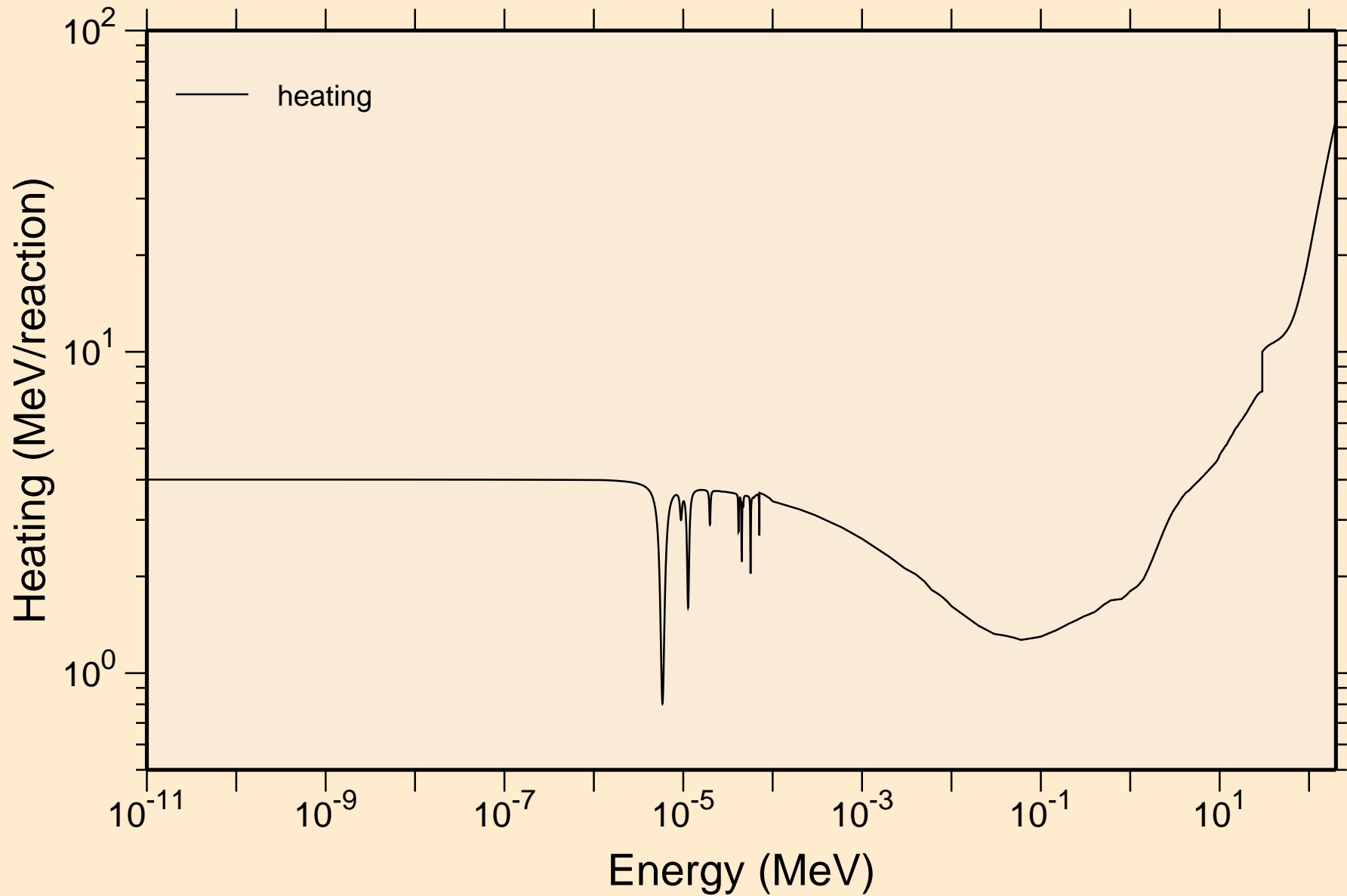

SR077 NEUTRON ACER TENDL-2024 LIBRARY; T=293.6K

Damage

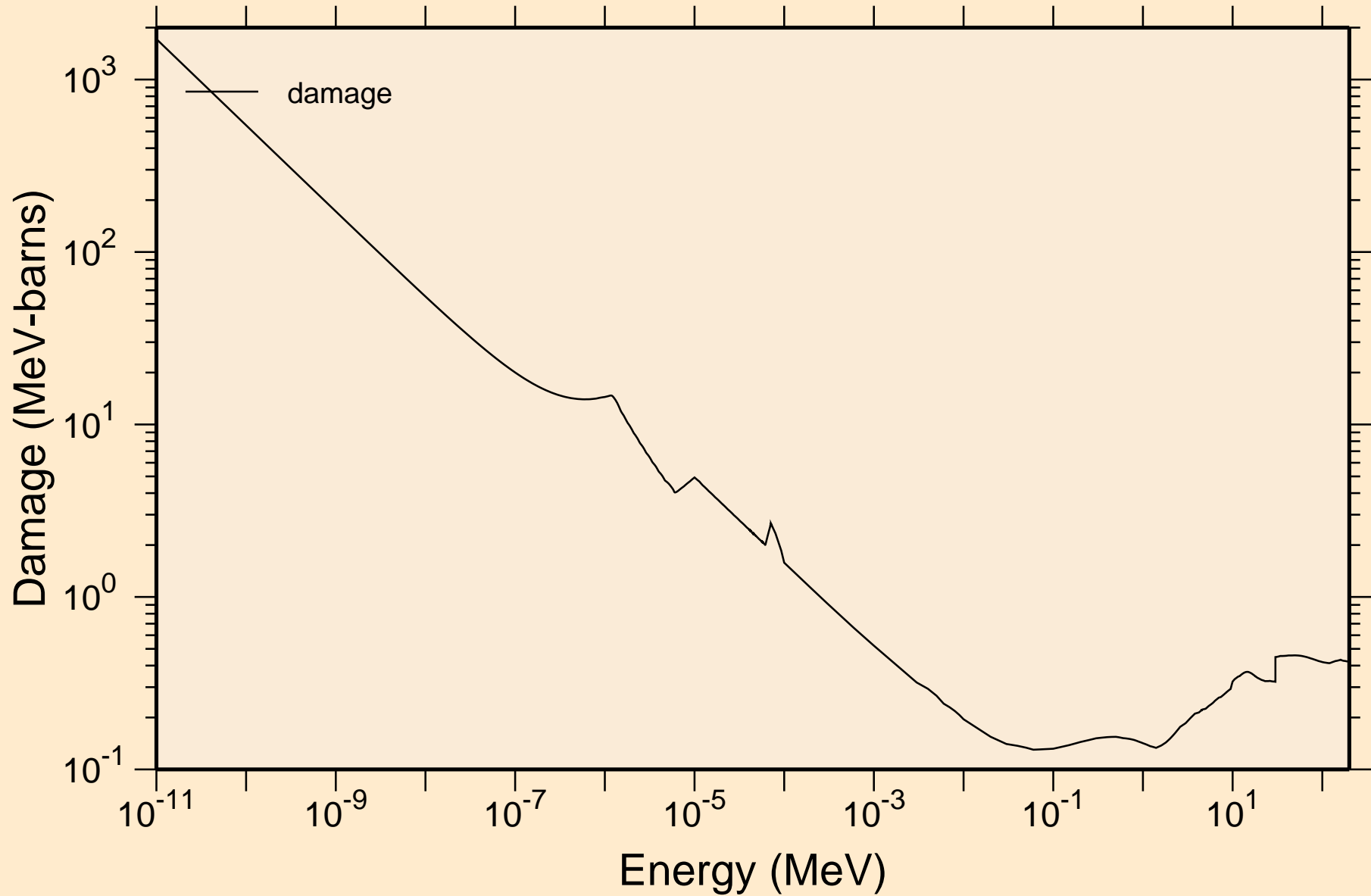

SR077 NEUTRON ACER TENDL-2024 LIBRARY; T=293.6K

Non-threshold reactions

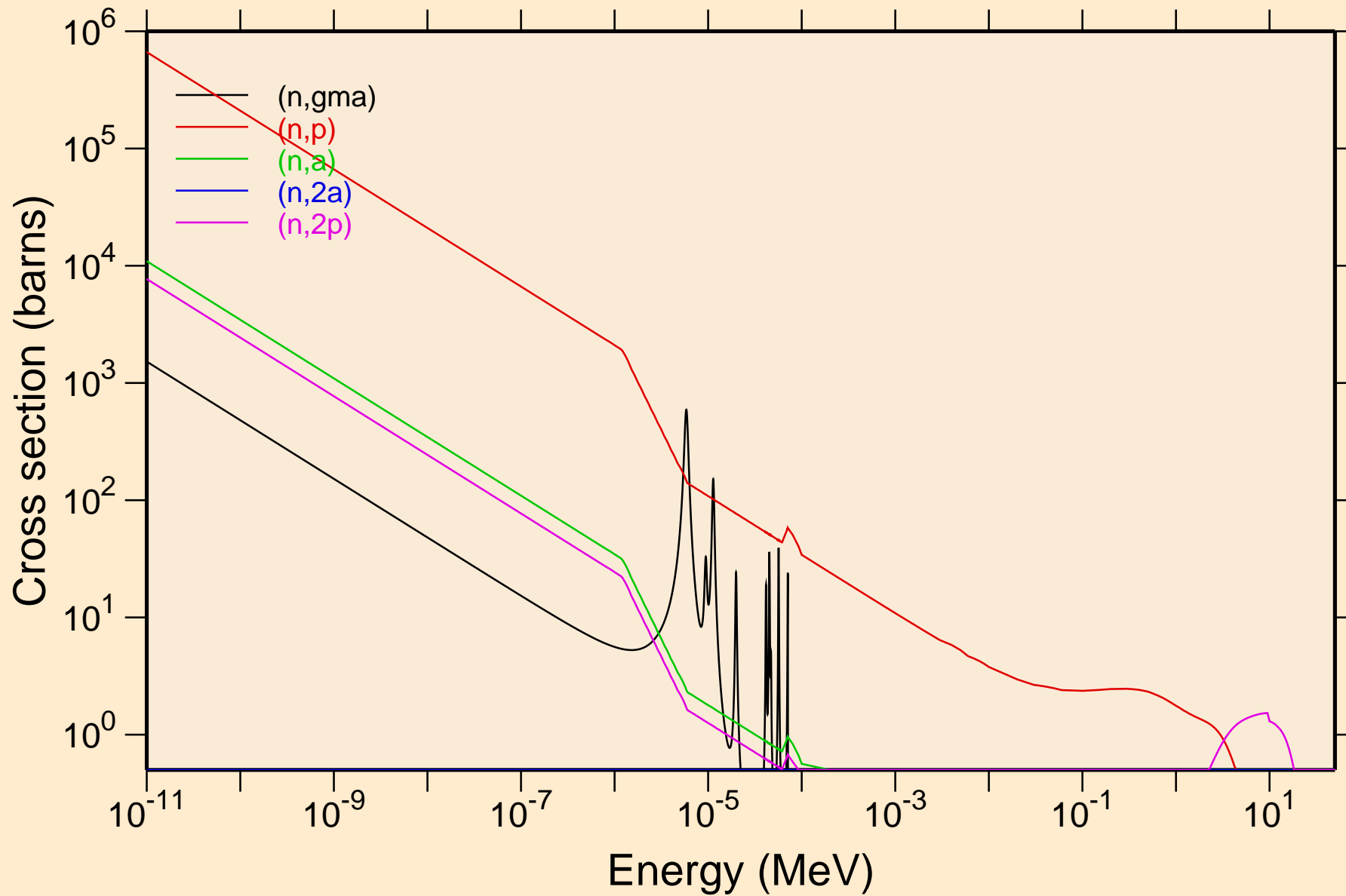

SR077 NEUTRON ACER TENDL-2024 LIBRARY; T=293.6K
Non-threshold reactions

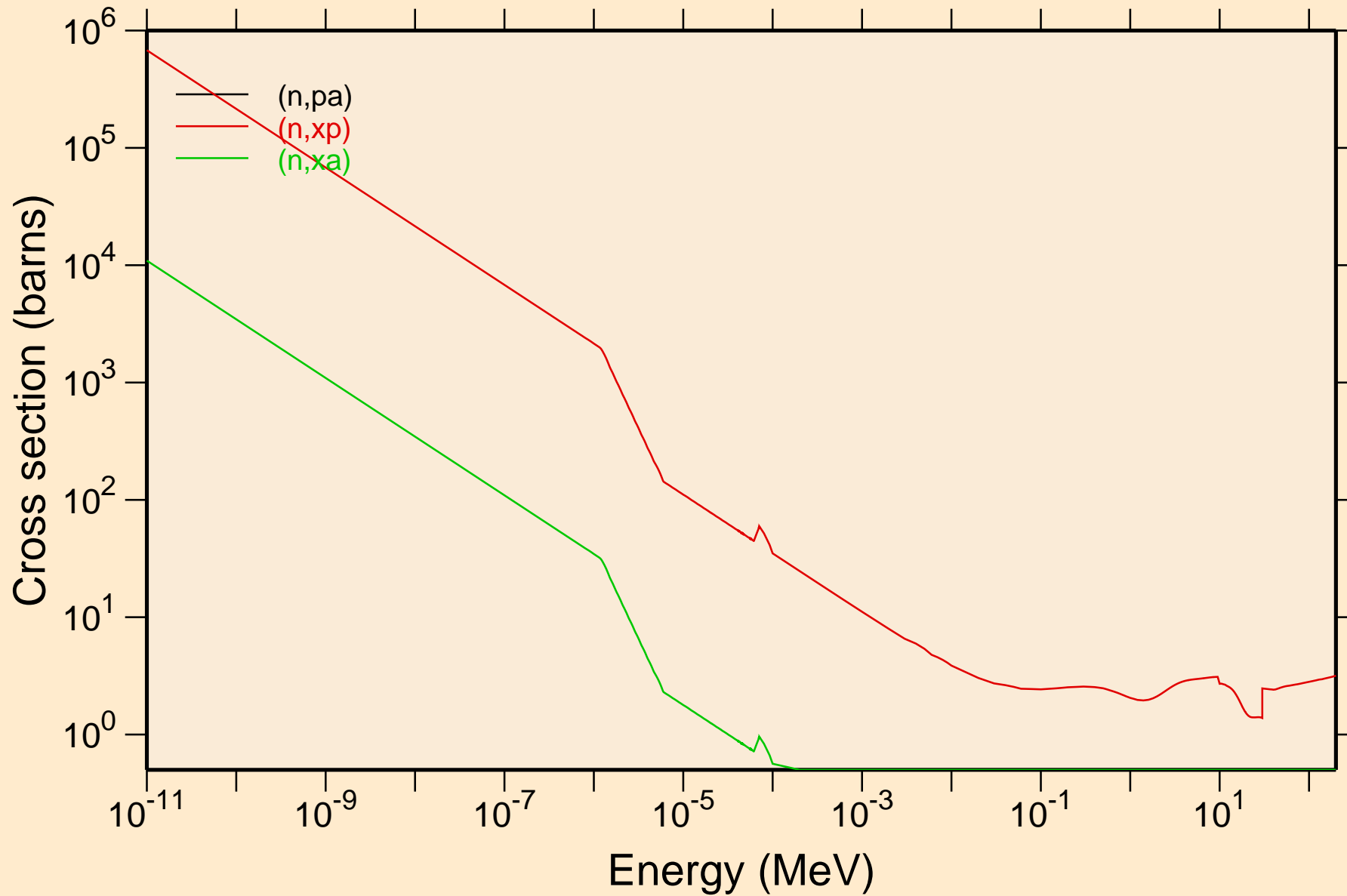

SR077 NEUTRON ACER TENDL-2024 LIBRARY; T=293.6K
Principal cross sections

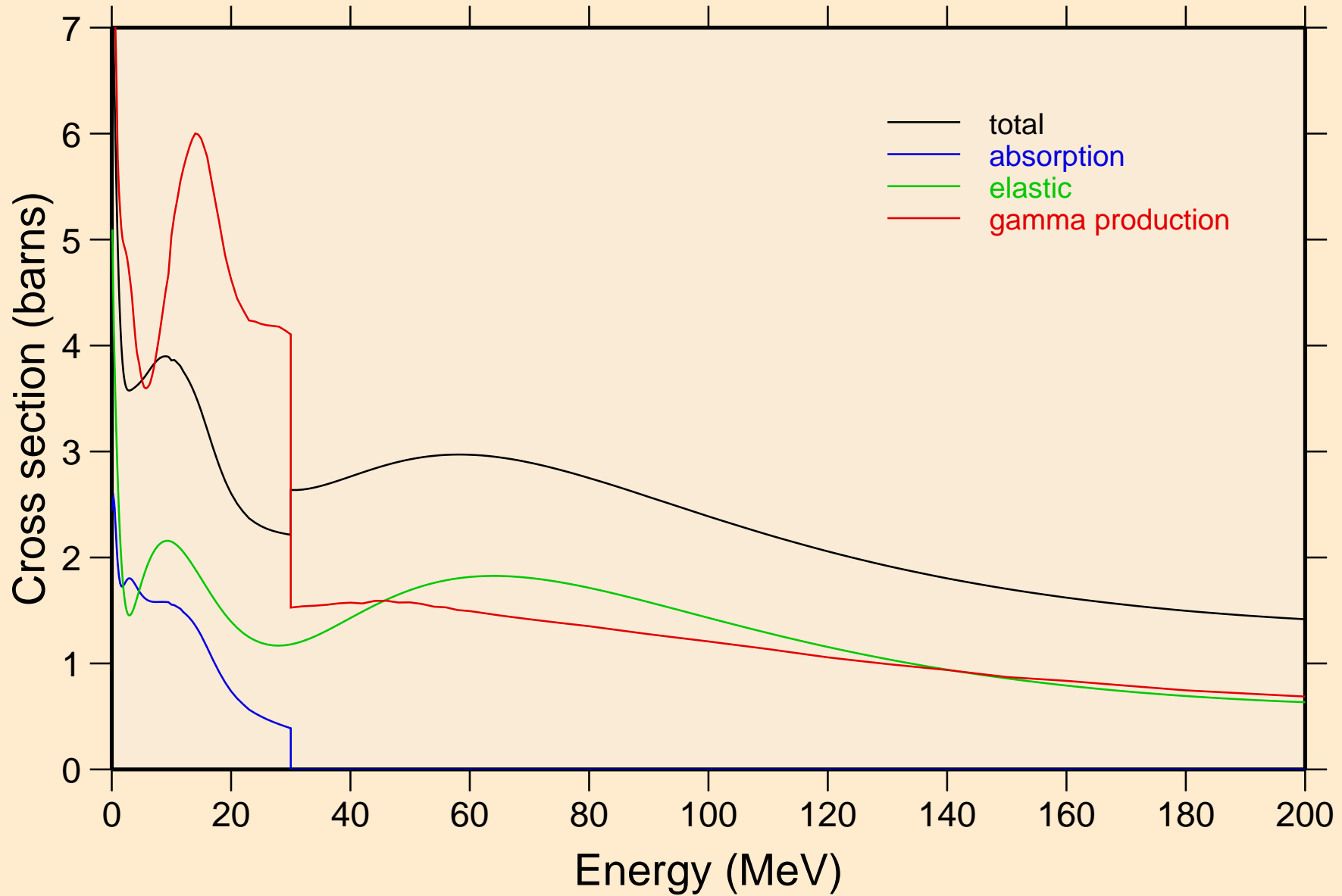

SR077 NEUTRON ACER TENDL-2024 LIBRARY; T=293.6K

Heating

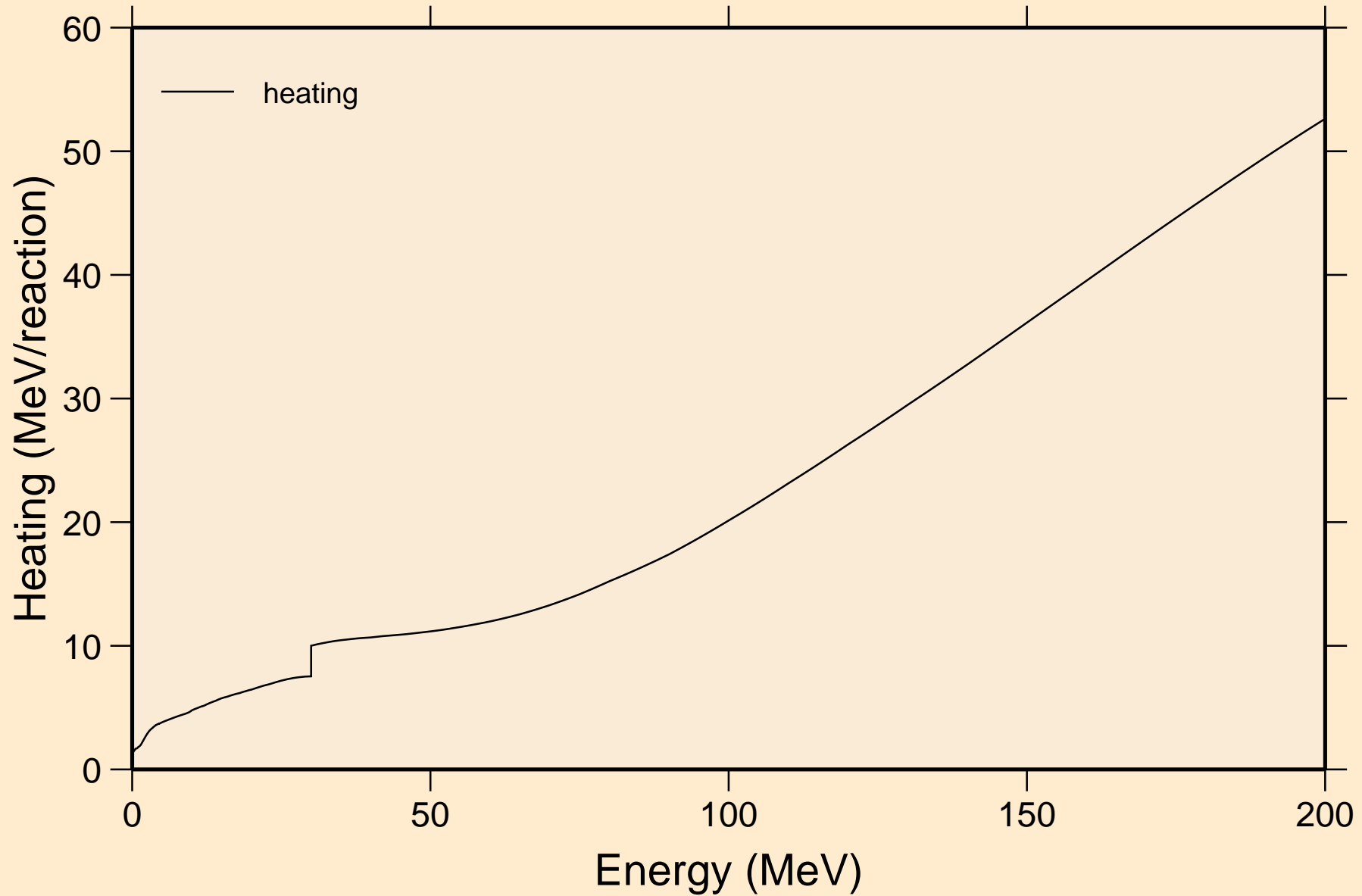

SR077 NEUTRON ACER TENDL-2024 LIBRARY; T=293.6K
Damage

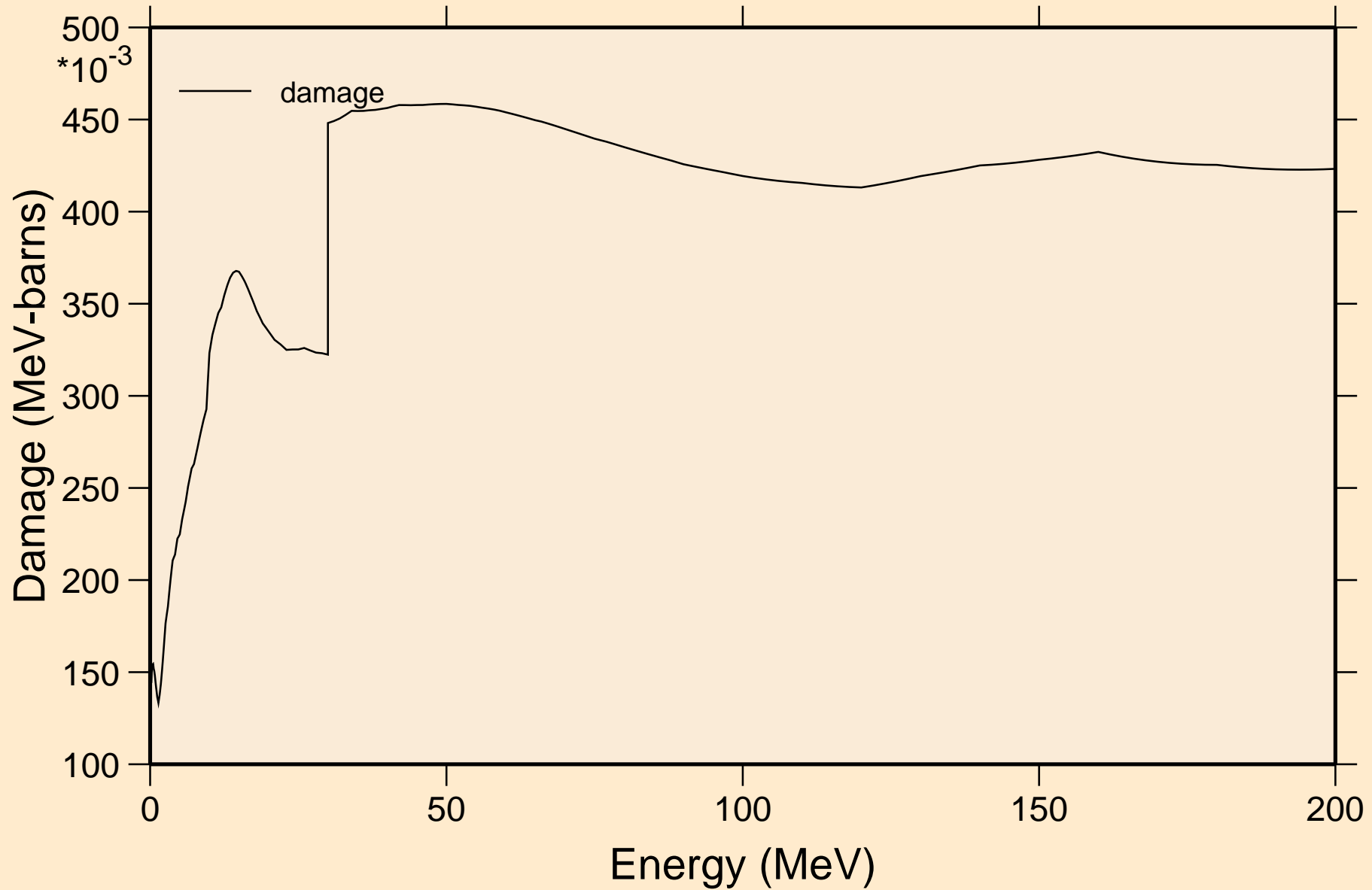

SR077 NEUTRON ACER TENDL-2024 LIBRARY; T=293.6K
Non-threshold reactions

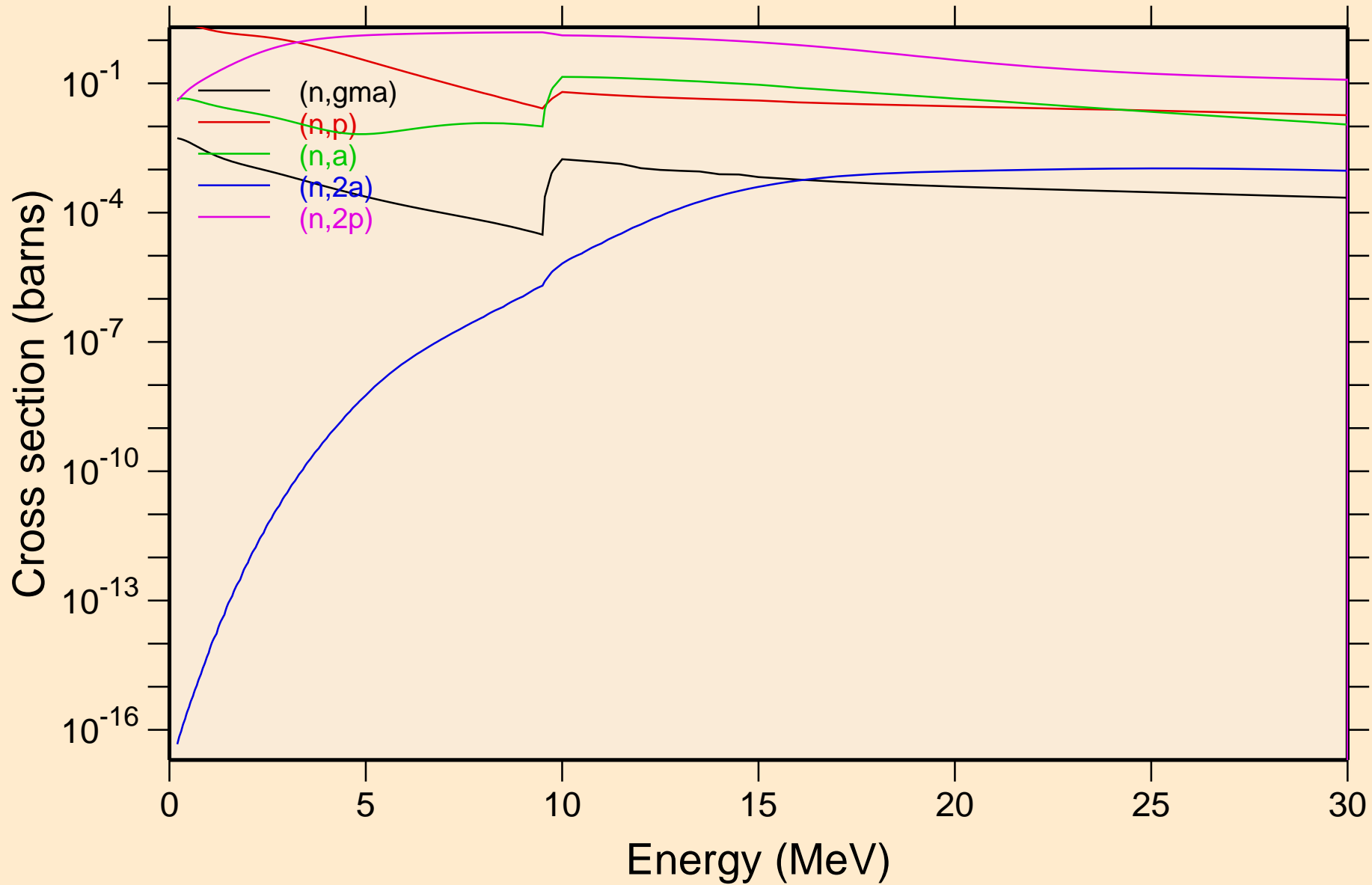

SR077 NEUTRON ACER TENDL-2024 LIBRARY; T=293.6K
Non-threshold reactions

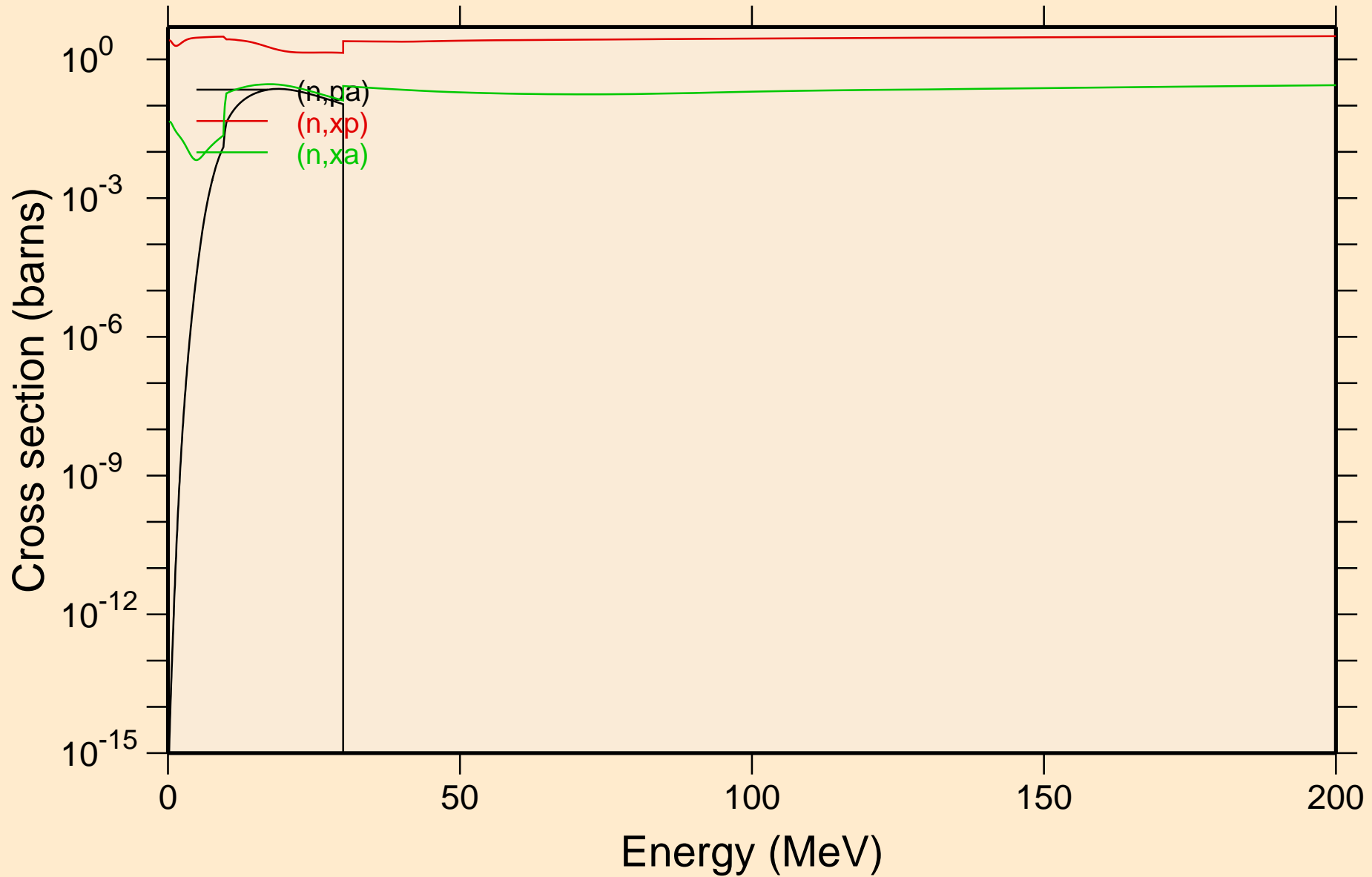

SR077 NEUTRON ACER TENDL-2024 LIBRARY; T=293.6K
Inelastic levels

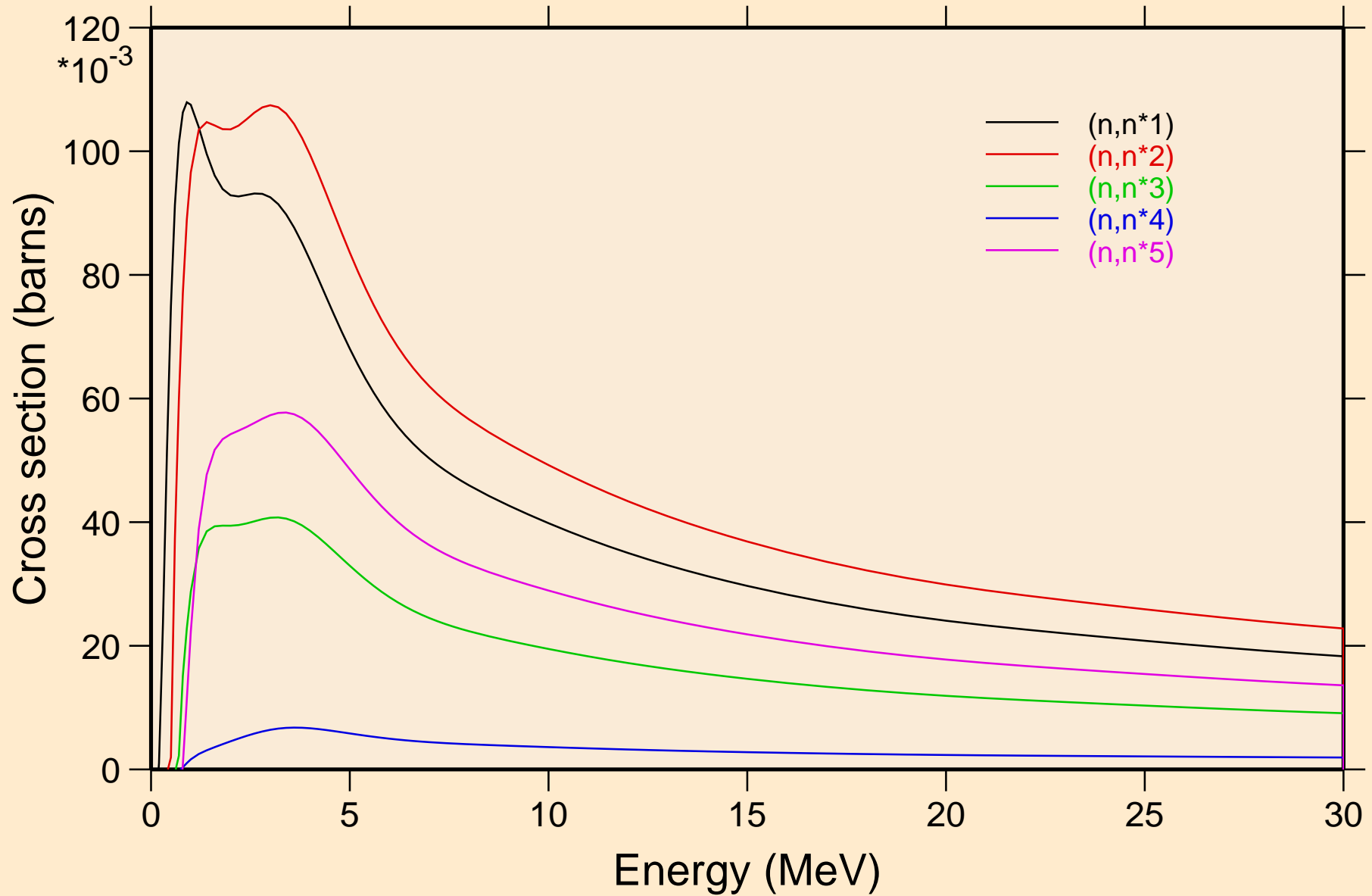

SR077 NEUTRON ACER TENDL-2024 LIBRARY; T=293.6K
Threshold reactions

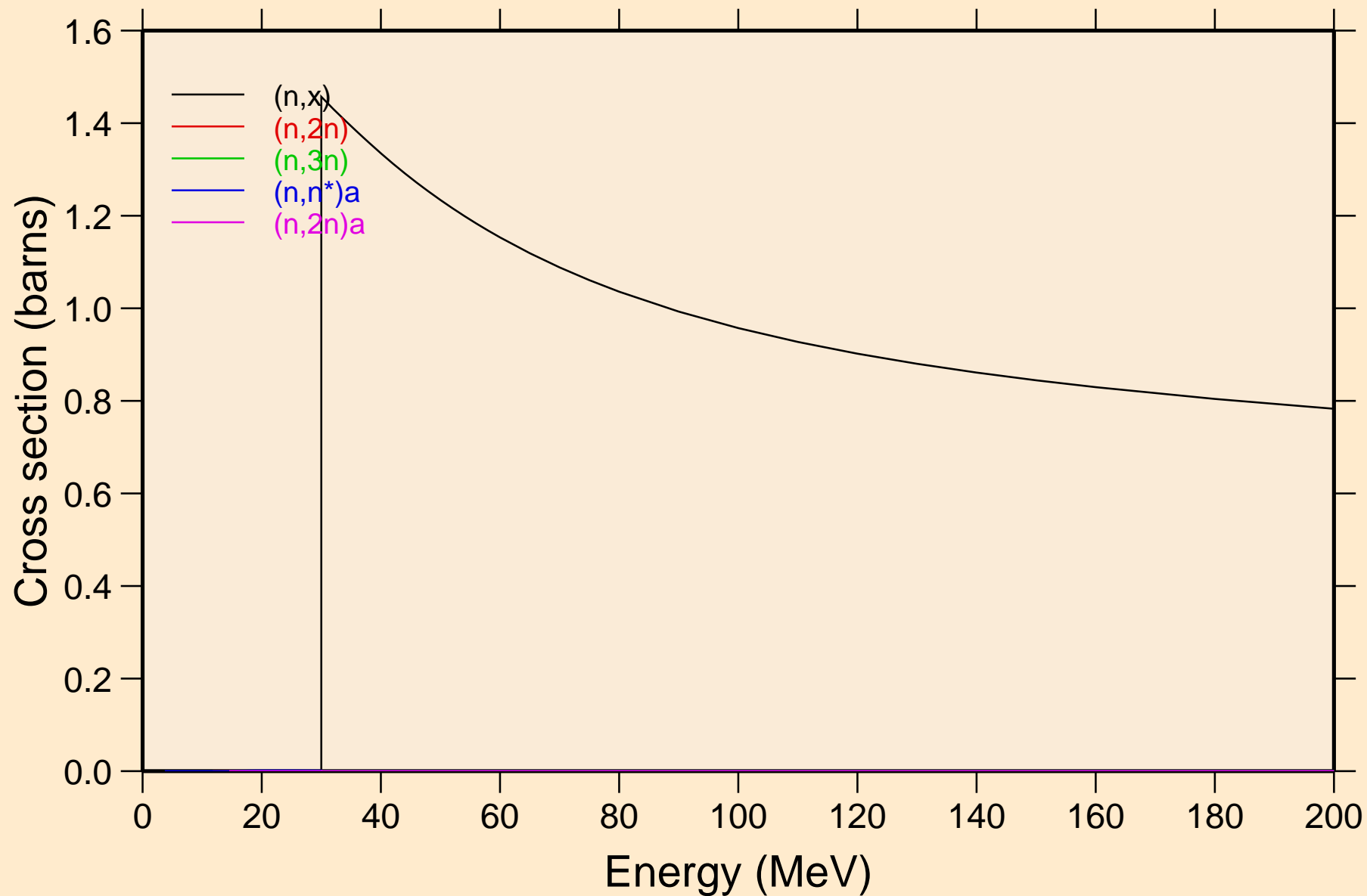

SR077 NEUTRON ACER TENDL-2024 LIBRARY; T=293.6K
Threshold reactions

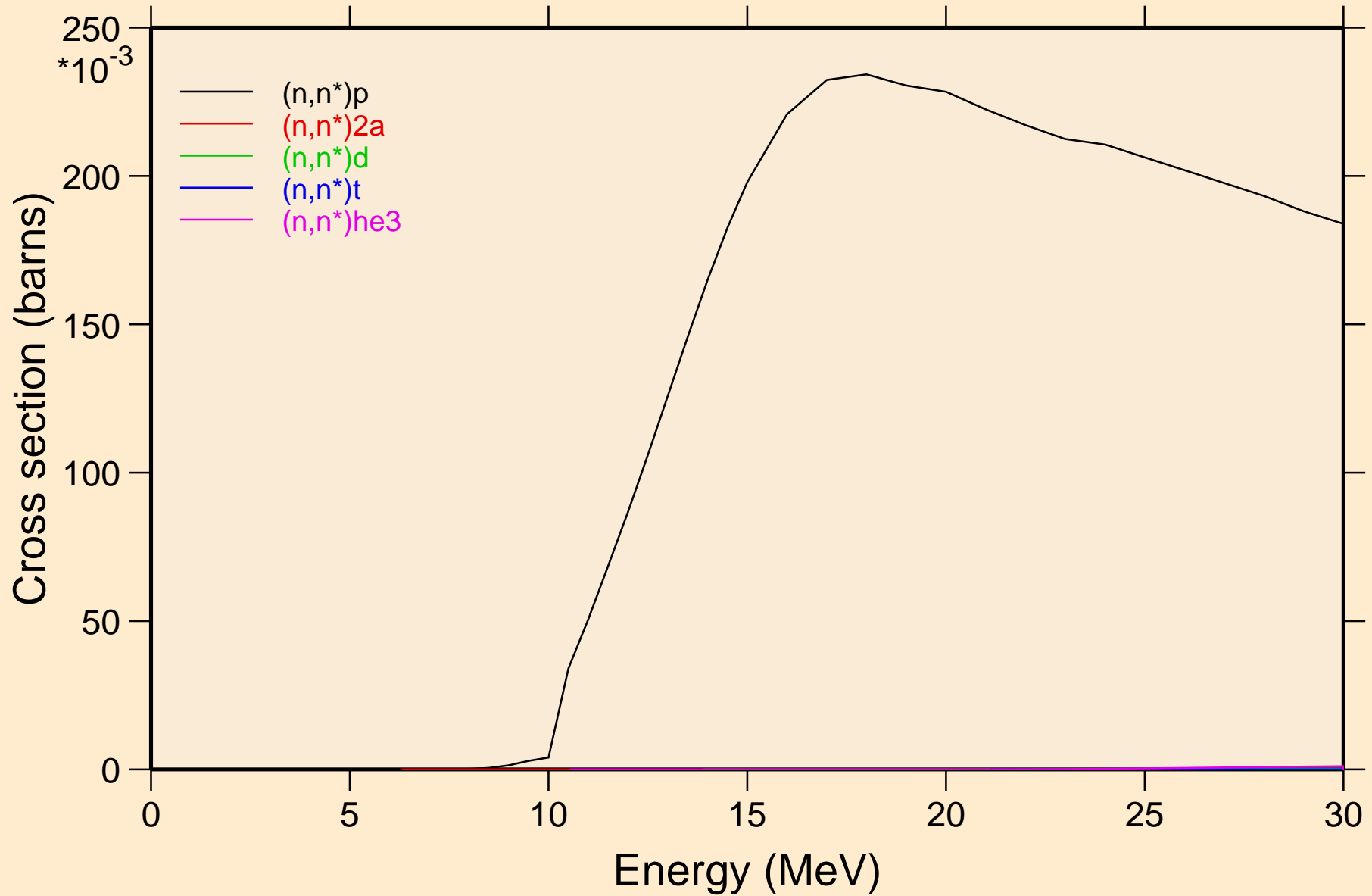

SR077 NEUTRON ACER TENDL-2024 LIBRARY; T=293.6K
Threshold reactions

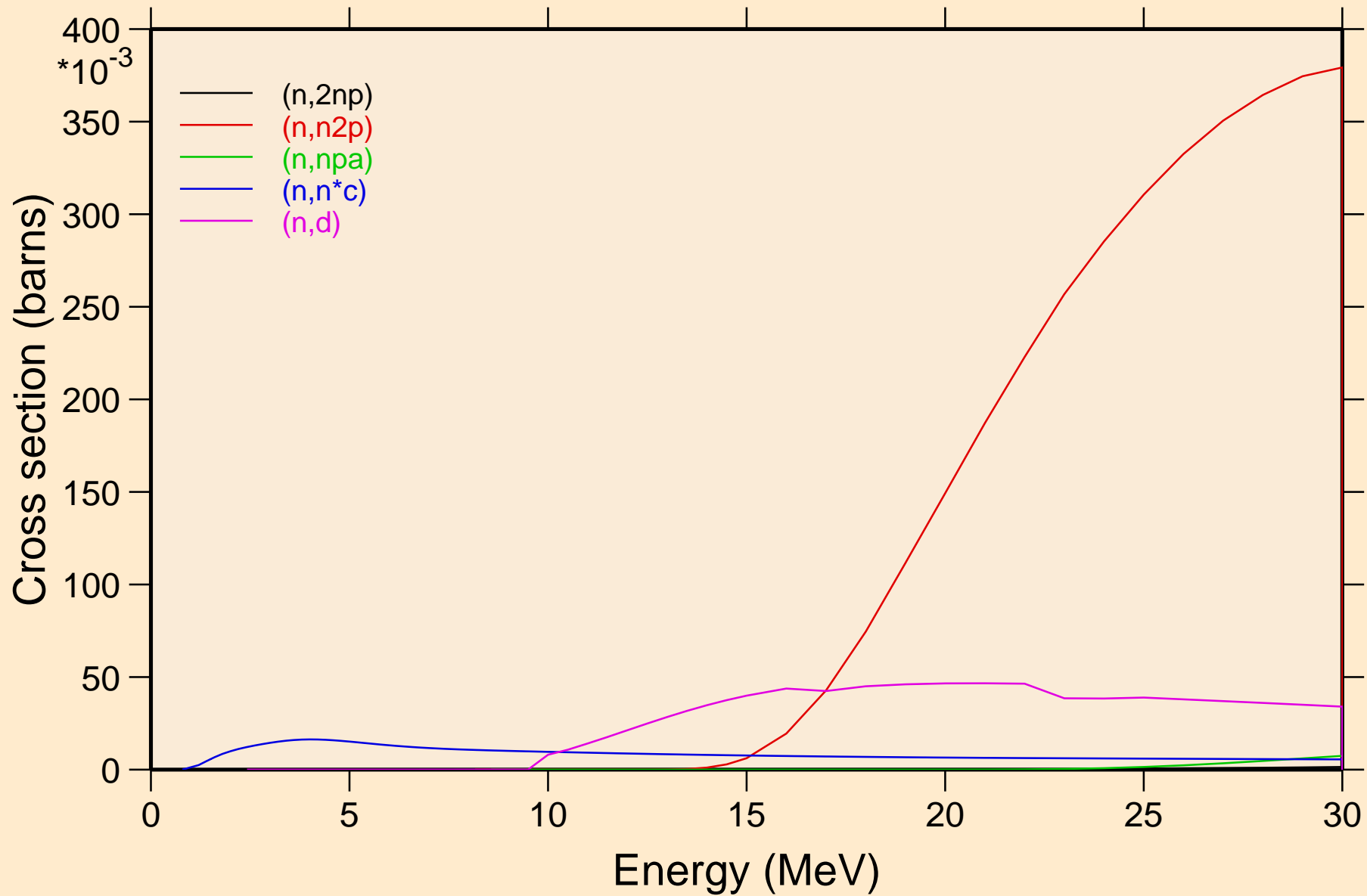

SR077 NEUTRON ACER TENDL-2024 LIBRARY; T=293.6K

Threshold reactions

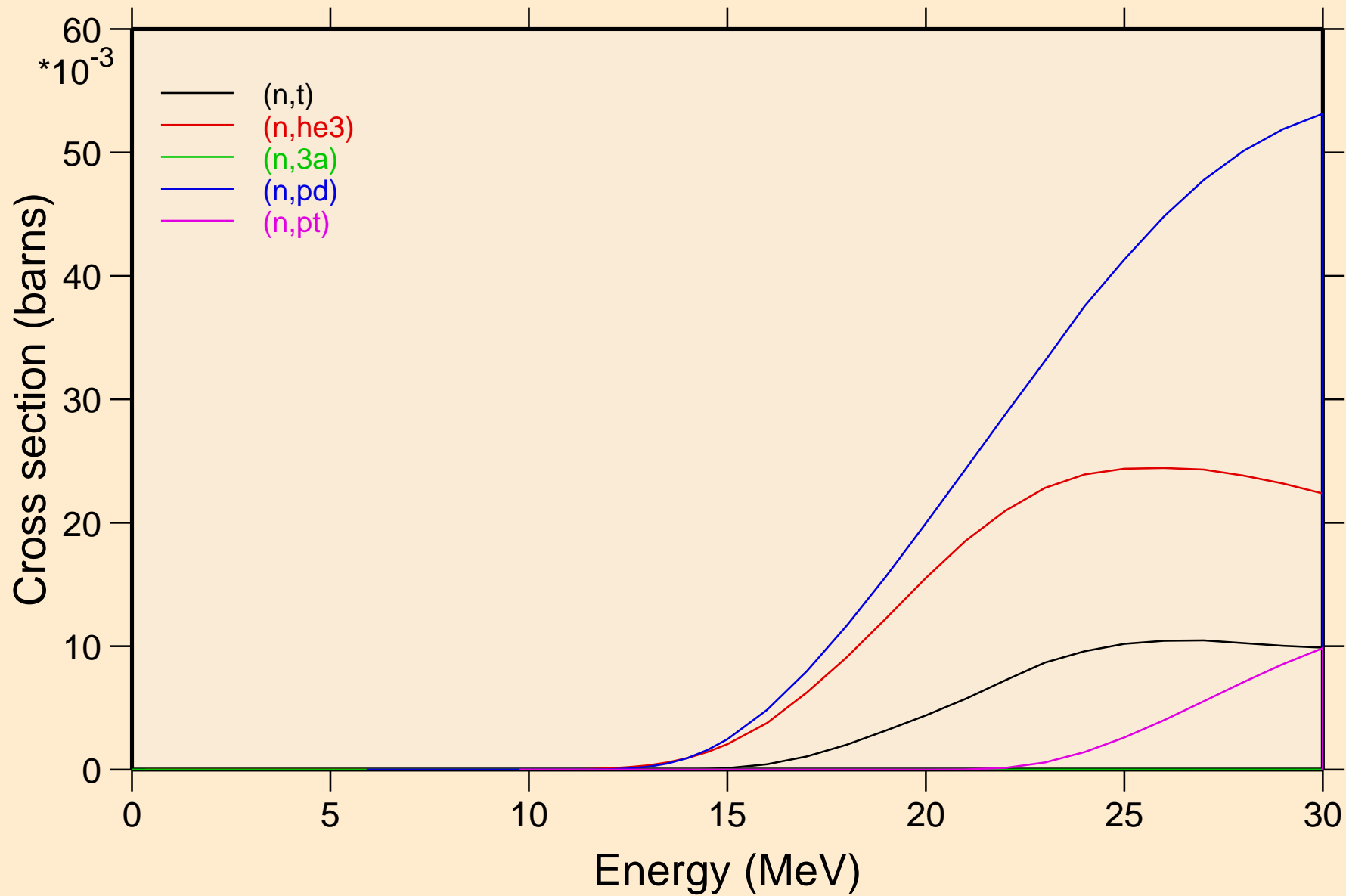

SR077 NEUTRON ACER TENDL-2024 LIBRARY; T=293.6K
Threshold reactions

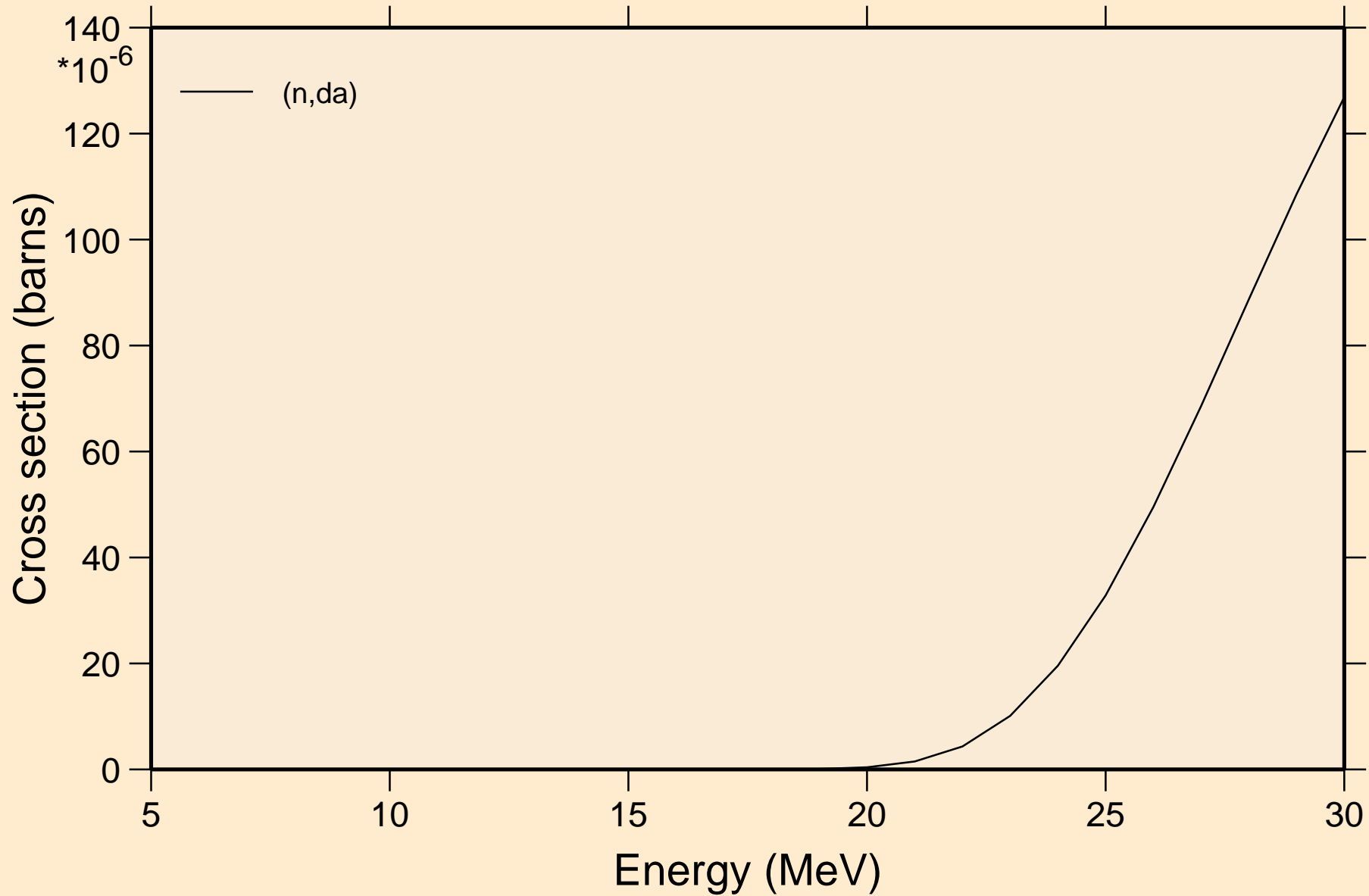

SR077 NEUTRON ACER TENDL-2024 LIBRARY; T=293.6K
Threshold reactions

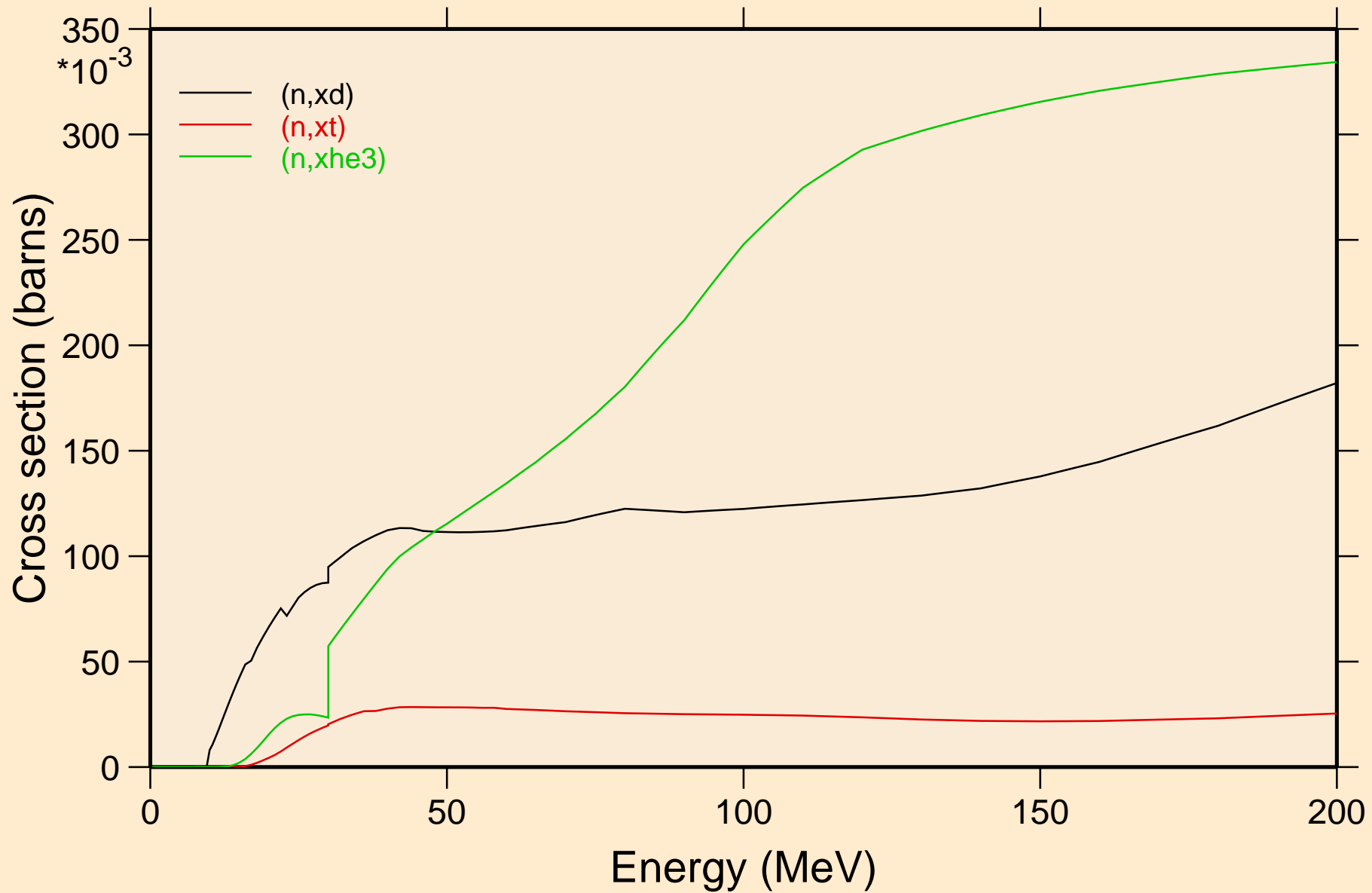

SR077 NEUTRON ACER TENDL-2024 LIBRARY; T=293.6K
angular distribution for elastic

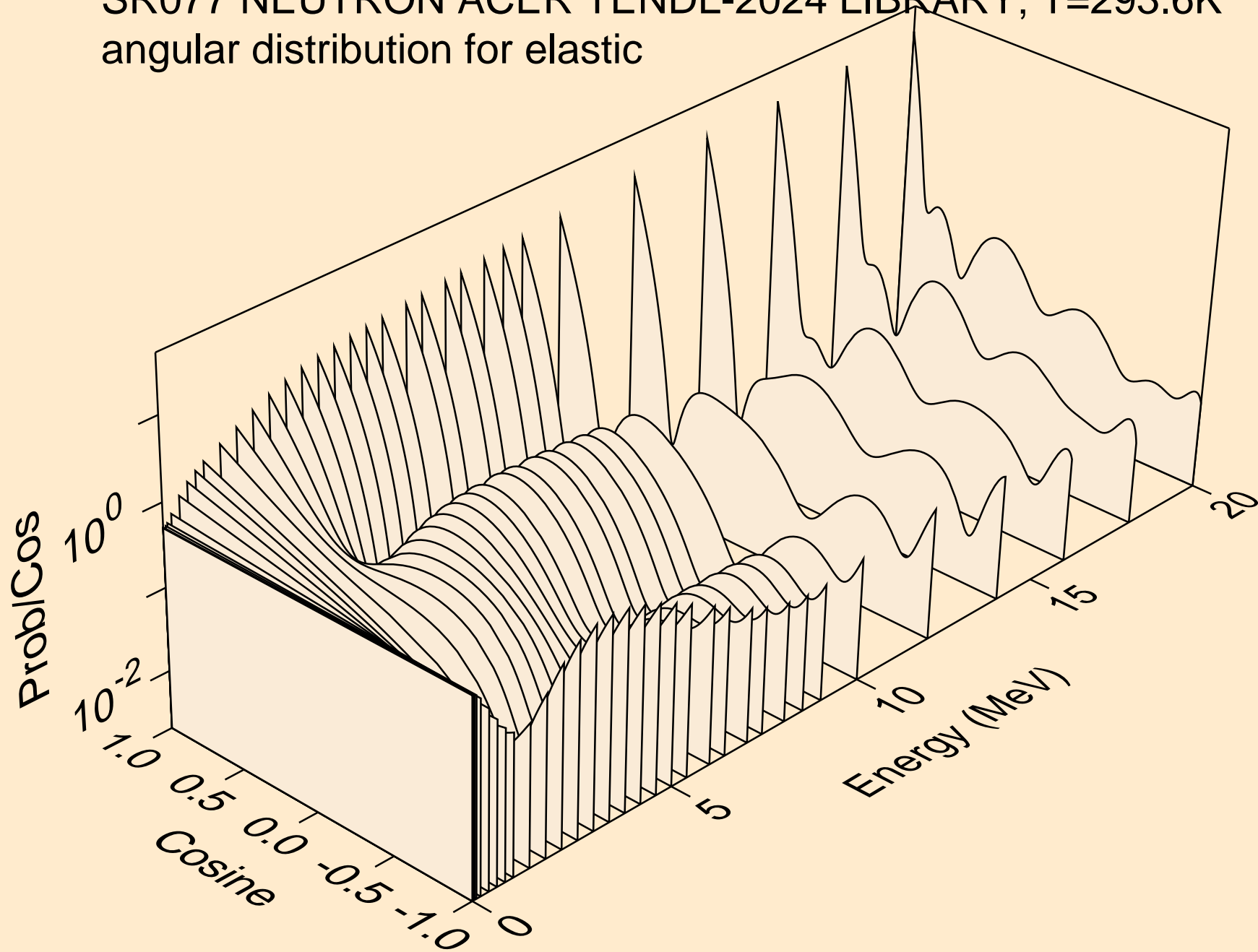

SR077 NEUTRON ACER TENDL-2024 LIBRARY; T=293.6K
angular distribution for elastic

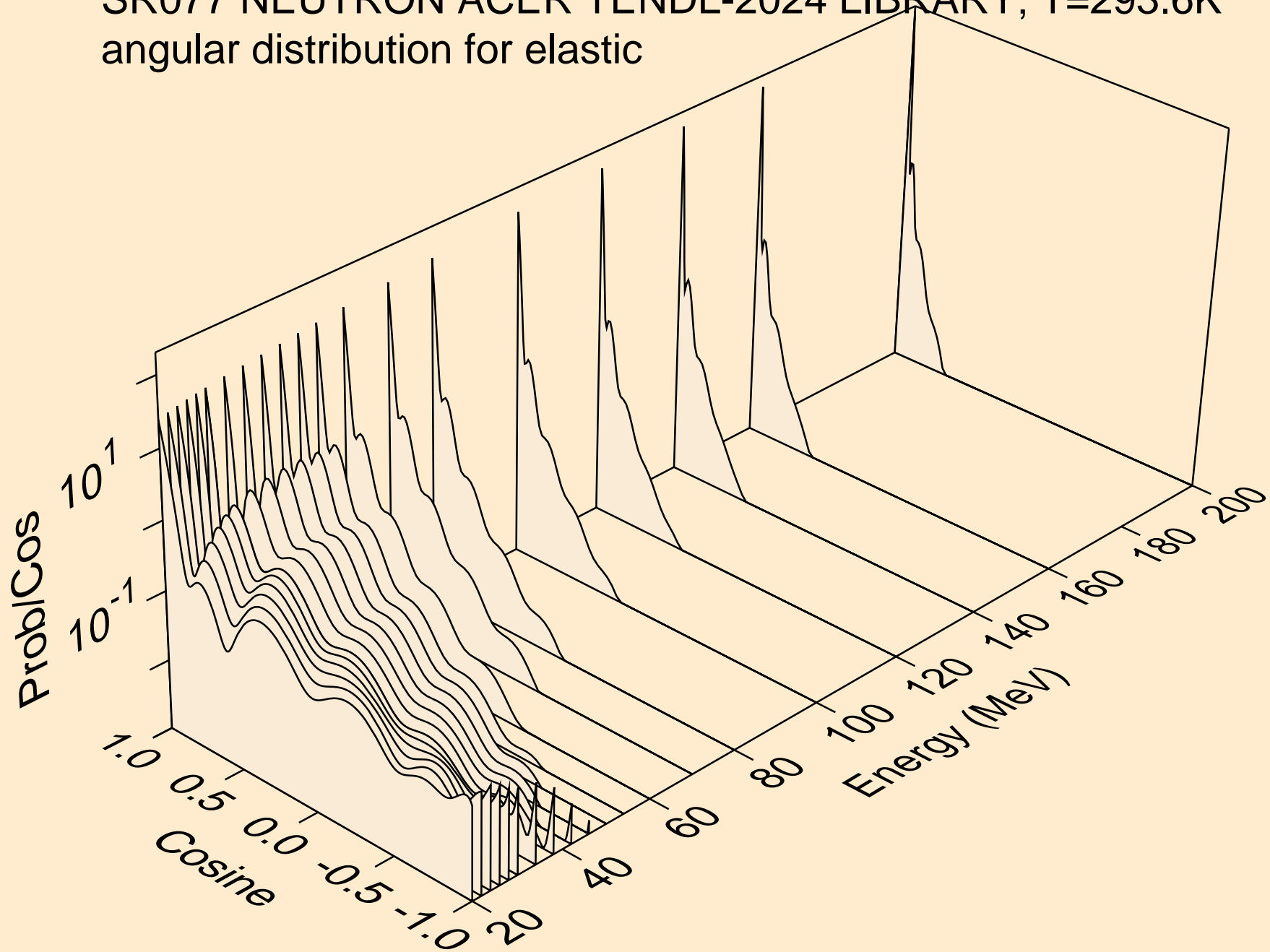

SR077 NEUTRON ACER TENDL-2024 LIBRARY; T=293.6K
angular distribution for (n,n*1)

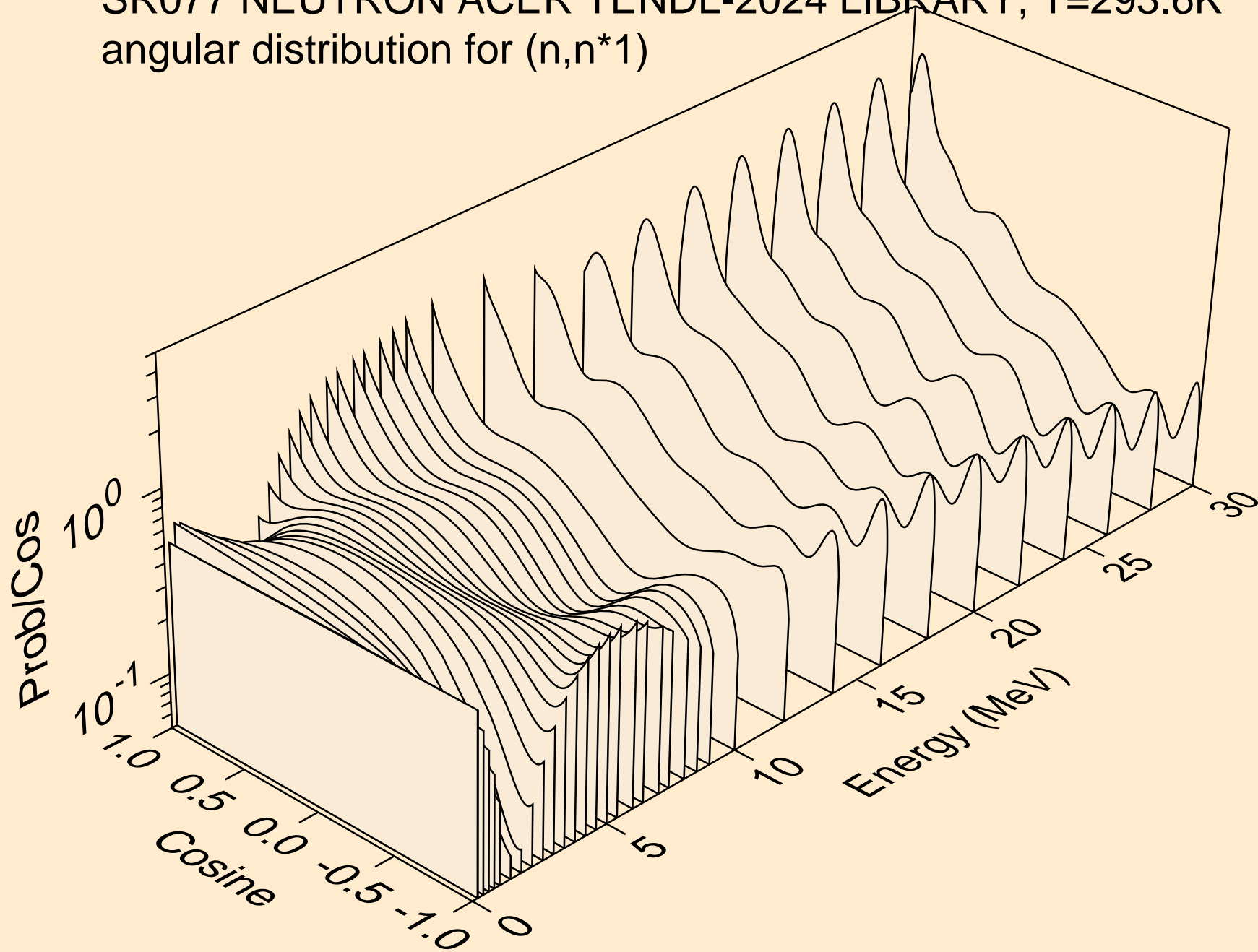

SR077 NEUTRON ACER TENDL-2024 LIBRARY; T=293.6K
angular distribution for (n,n*2)

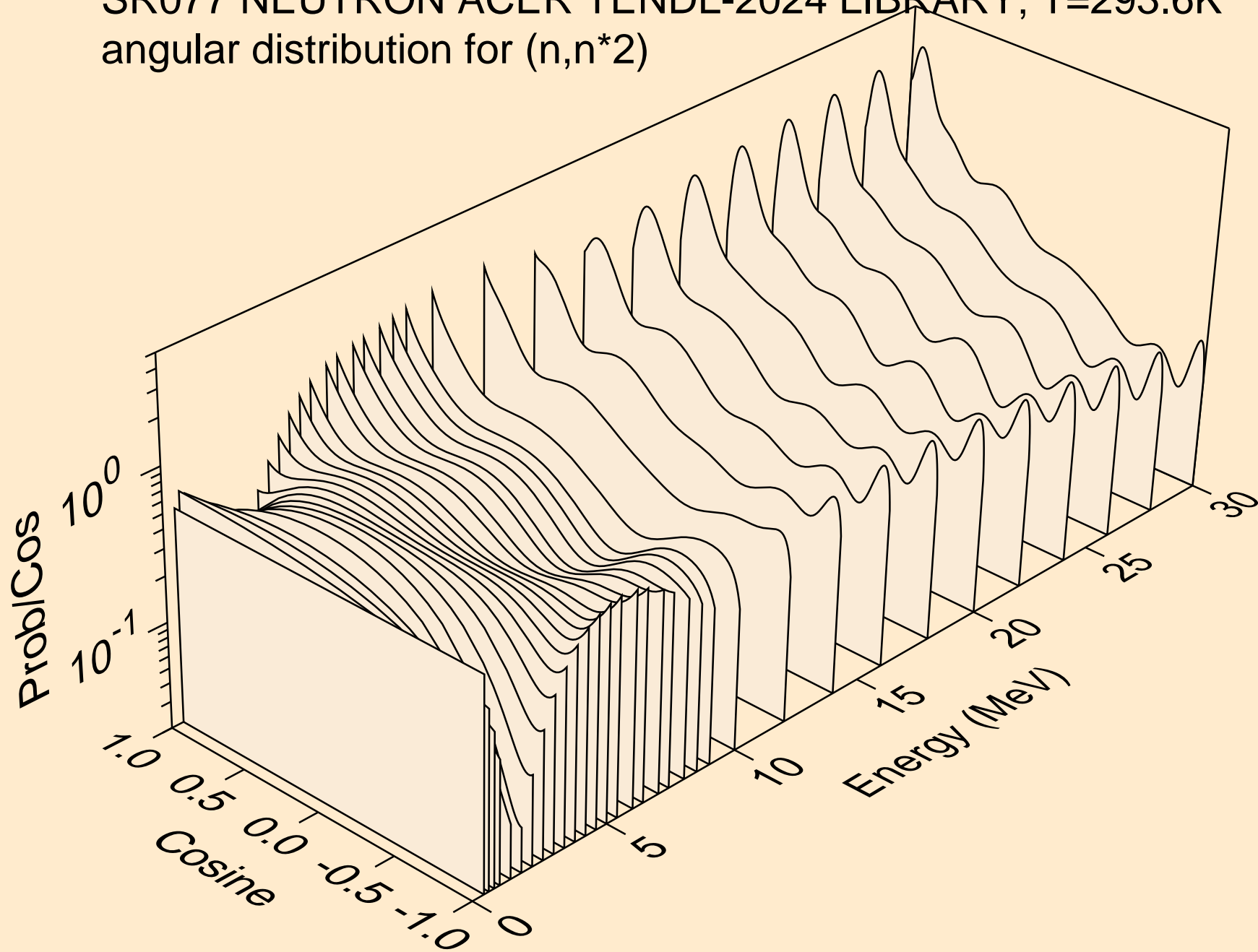

SR077 NEUTRON ACER TENDL-2024 LIBRARY; T=293.6K
angular distribution for (n,n*3)

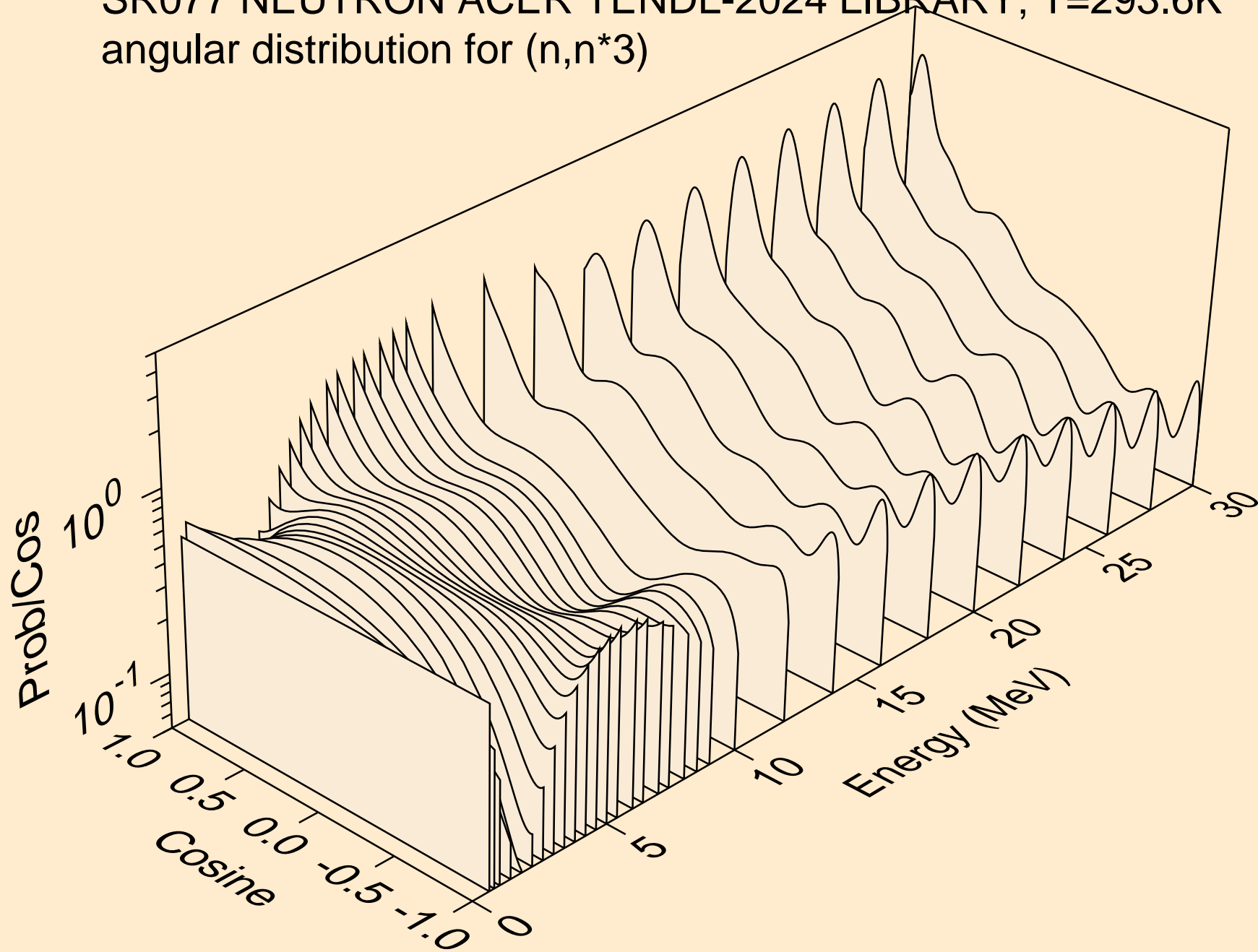

SR077 NEUTRON ACER TENDL-2024 LIBRARY; T=293.6K
angular distribution for (n,n*4)

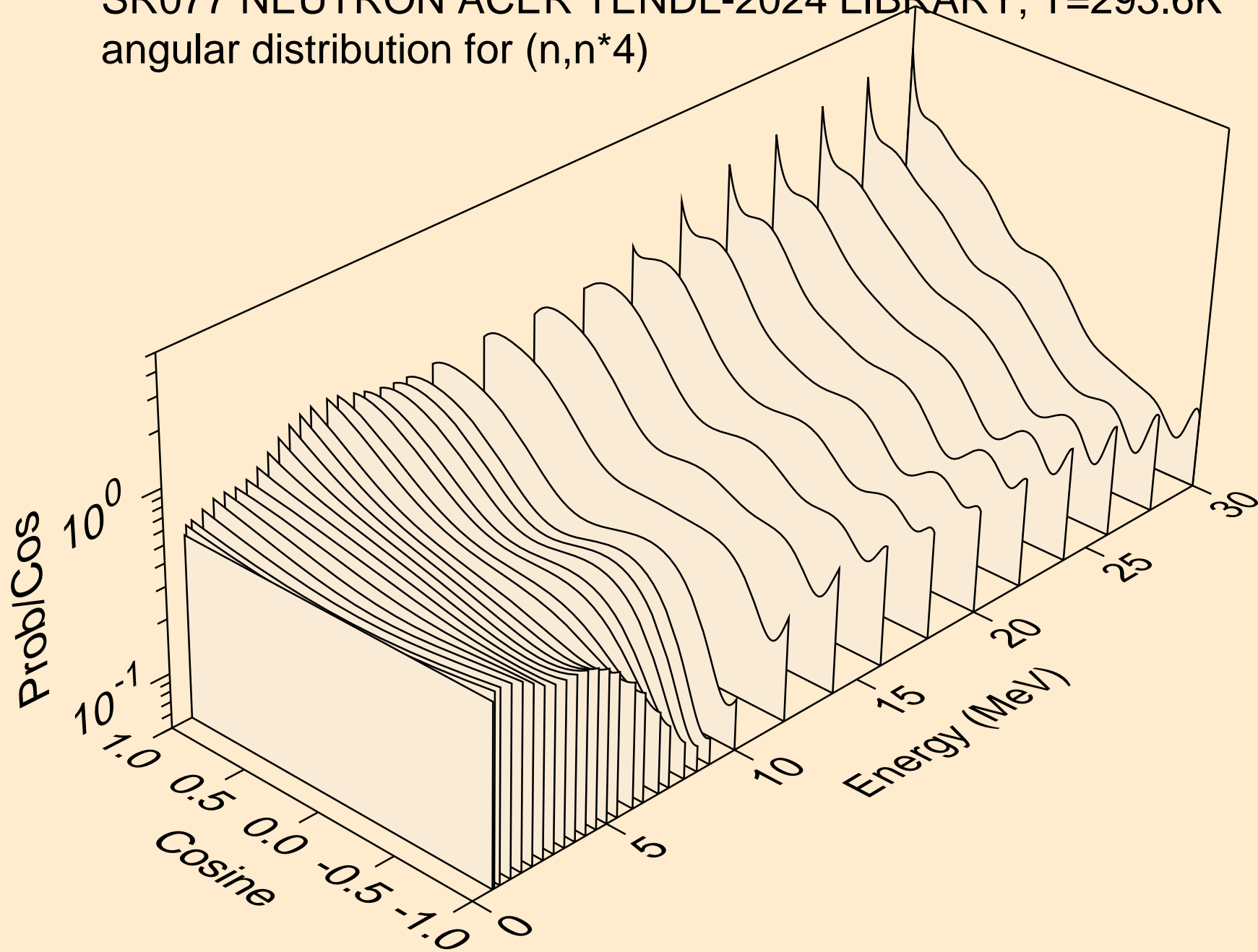

SR077 NEUTRON ACER TENDL-2024 LIBRARY; T=293.6K
angular distribution for (n,n*5)

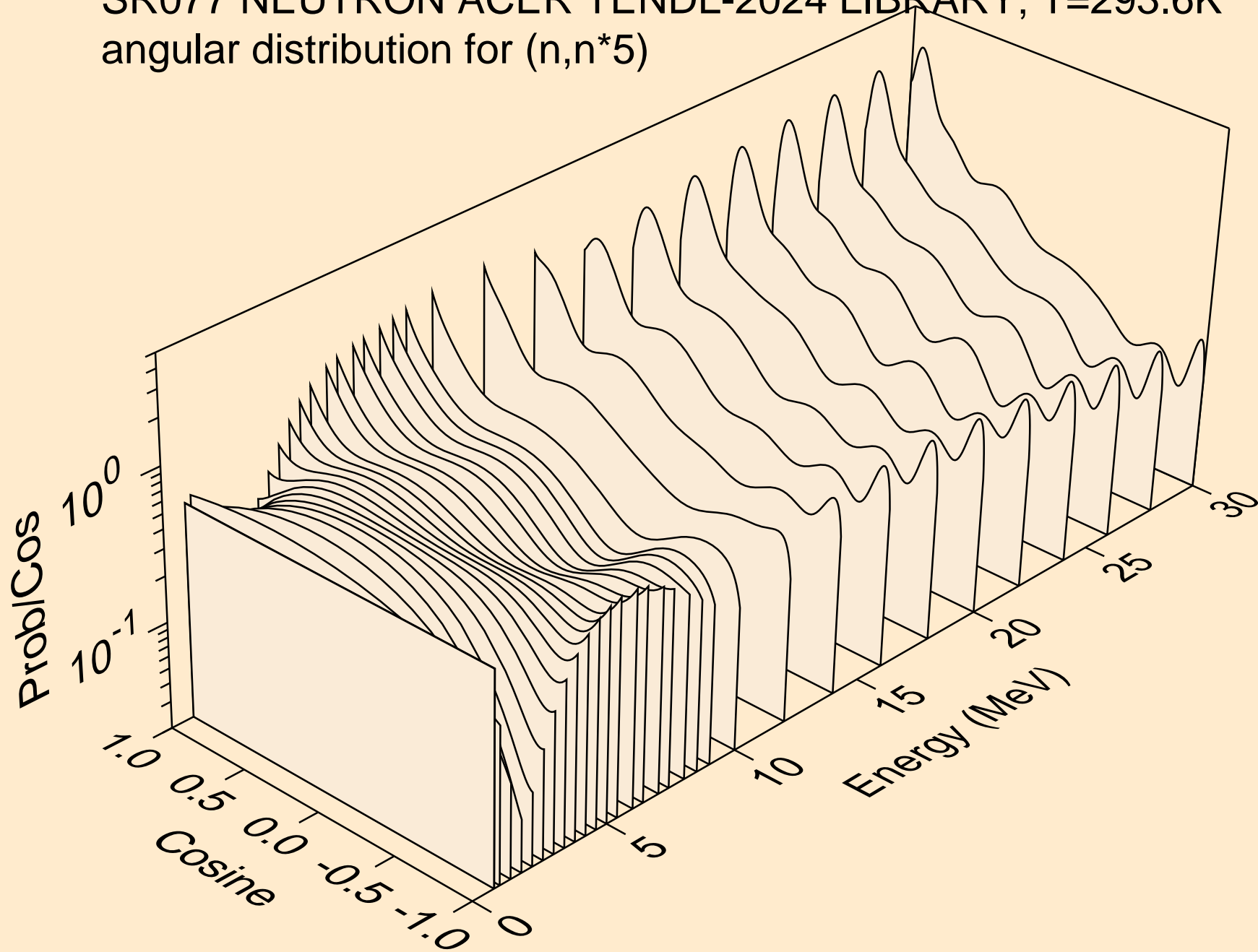

SR077 NEUTRON ACER TENDL-2024 LIBRARY; T=293.6K
Neutron emission for (n,x)

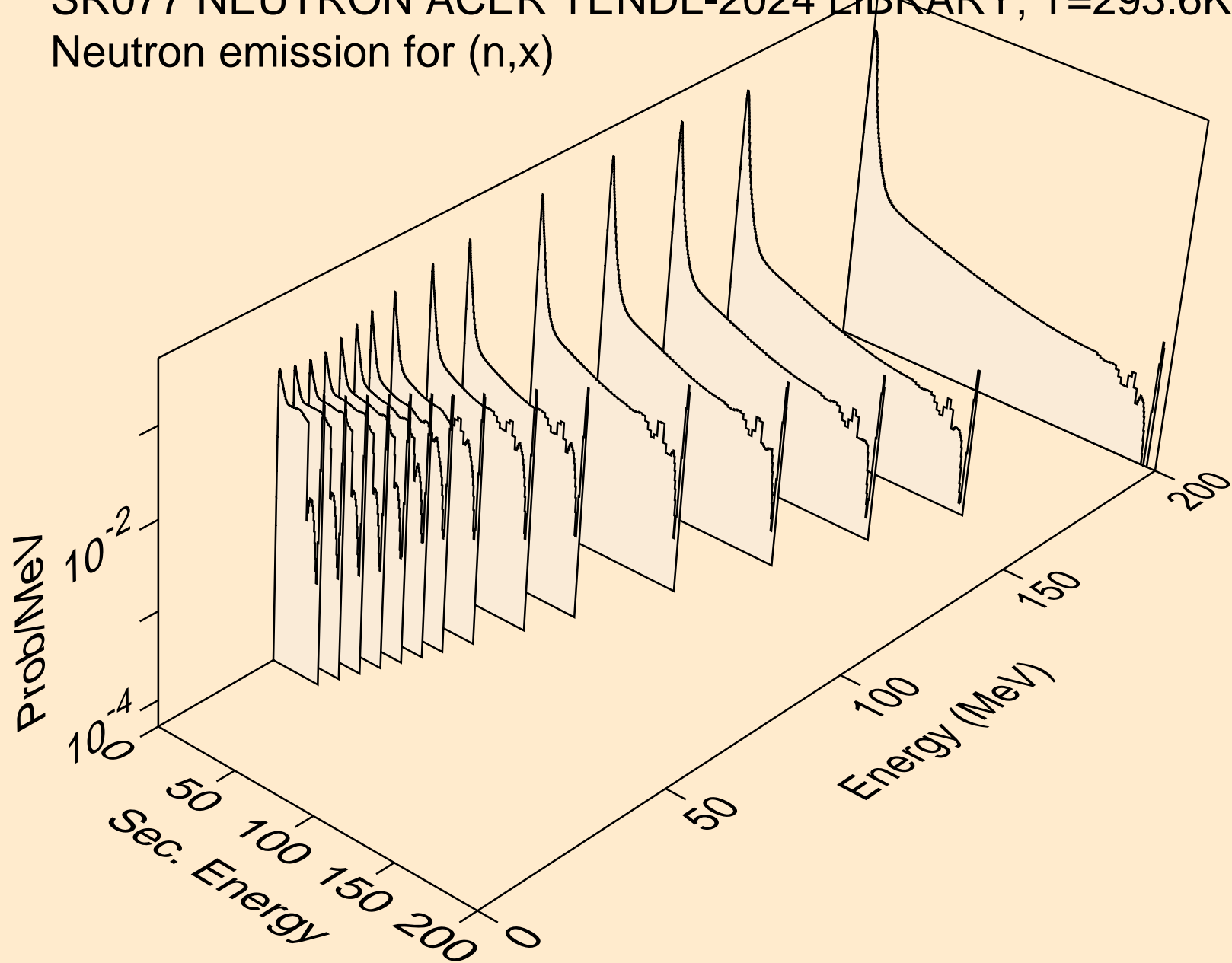

SR077 NEUTRON ACER TENDL-2024 LIBRARY; T=293.6K
Neutron emission for (n,2n)

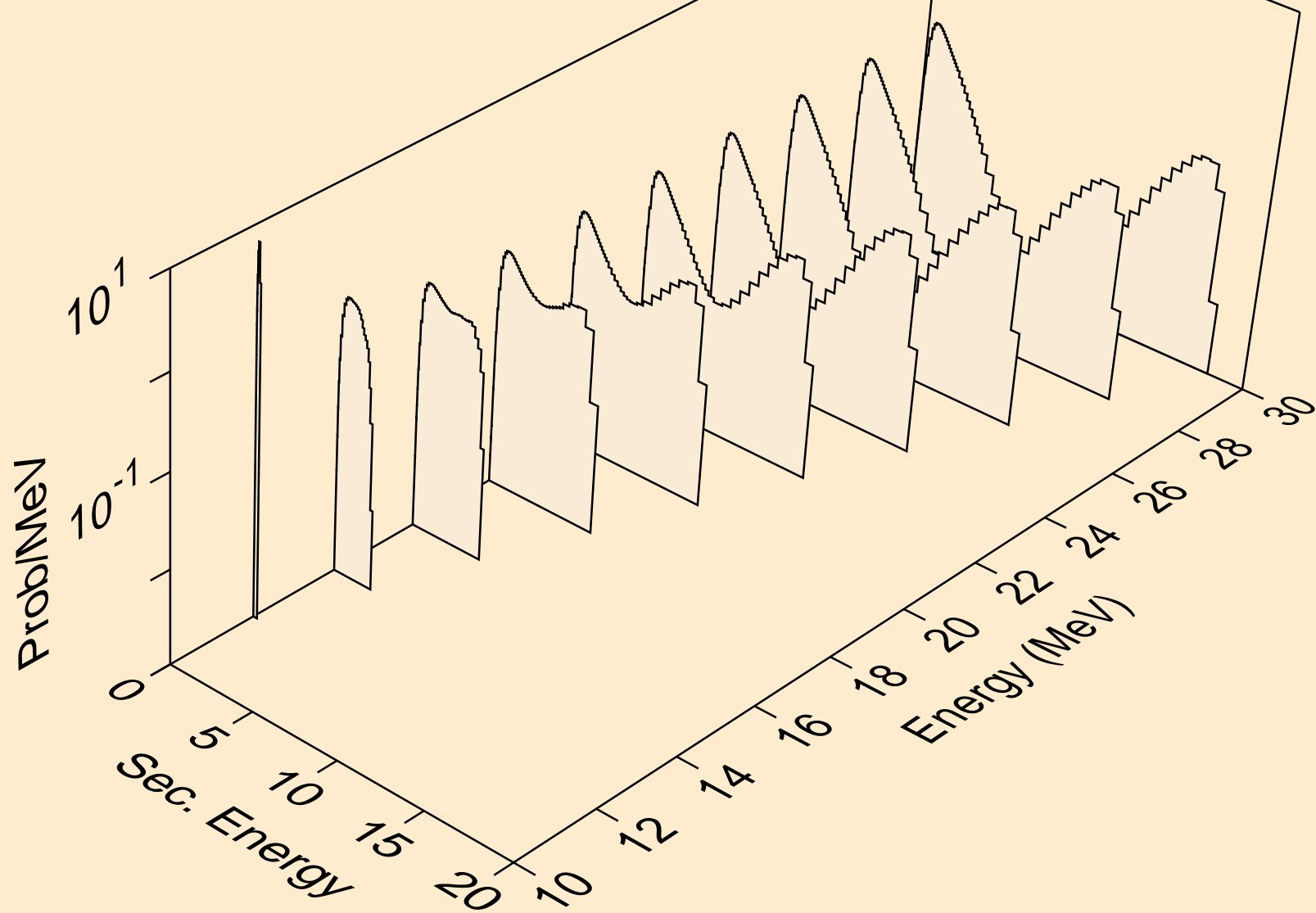

SR077 NEUTRON ACER TENDL-2024 LIBRARY; T=293.6K
Neutron emission for (n,3n)

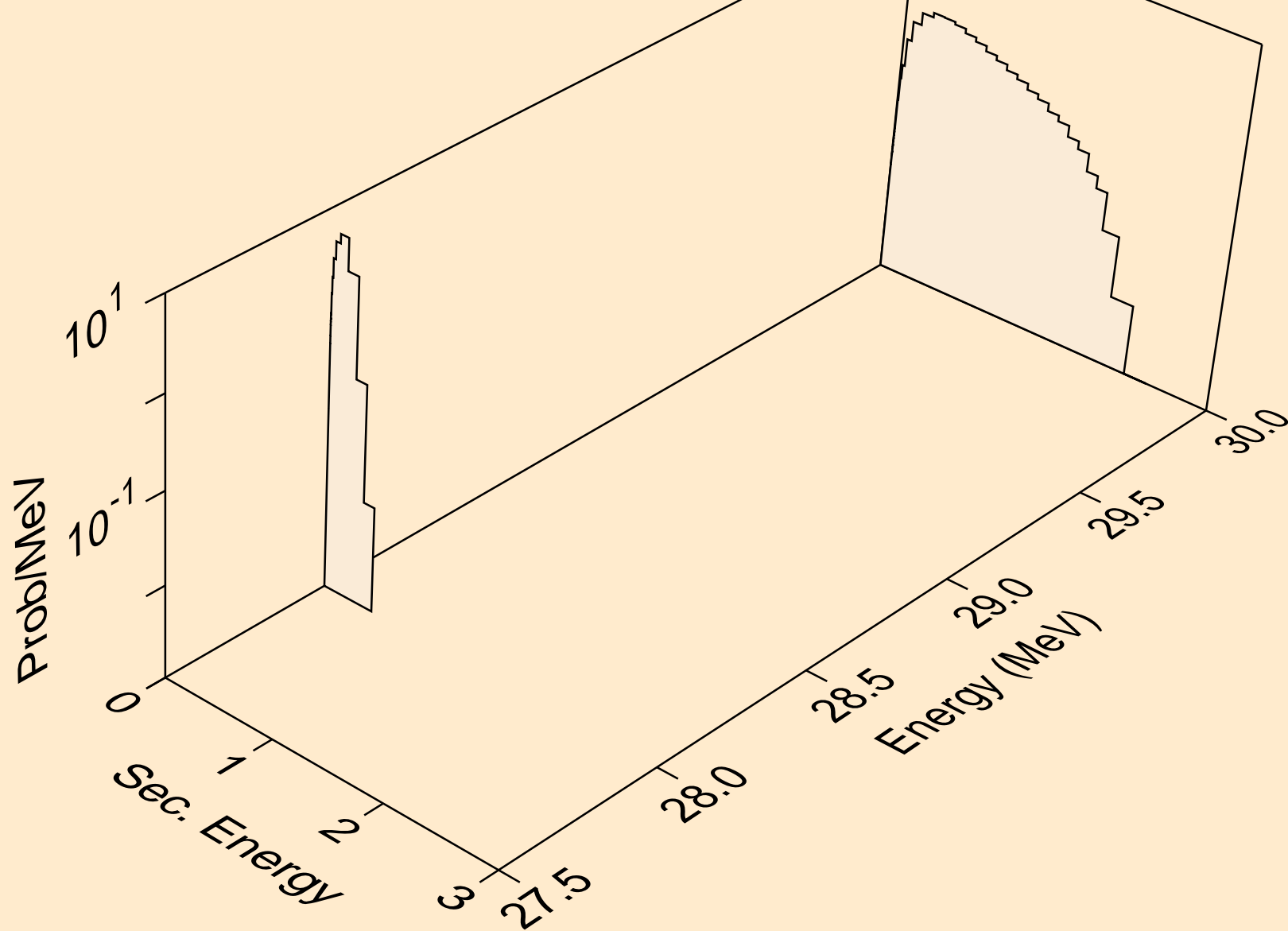

SR077 NEUTRON ACER TENDL-2024 LIBRARY; T=293.6K
Neutron emission for (n,n*)a

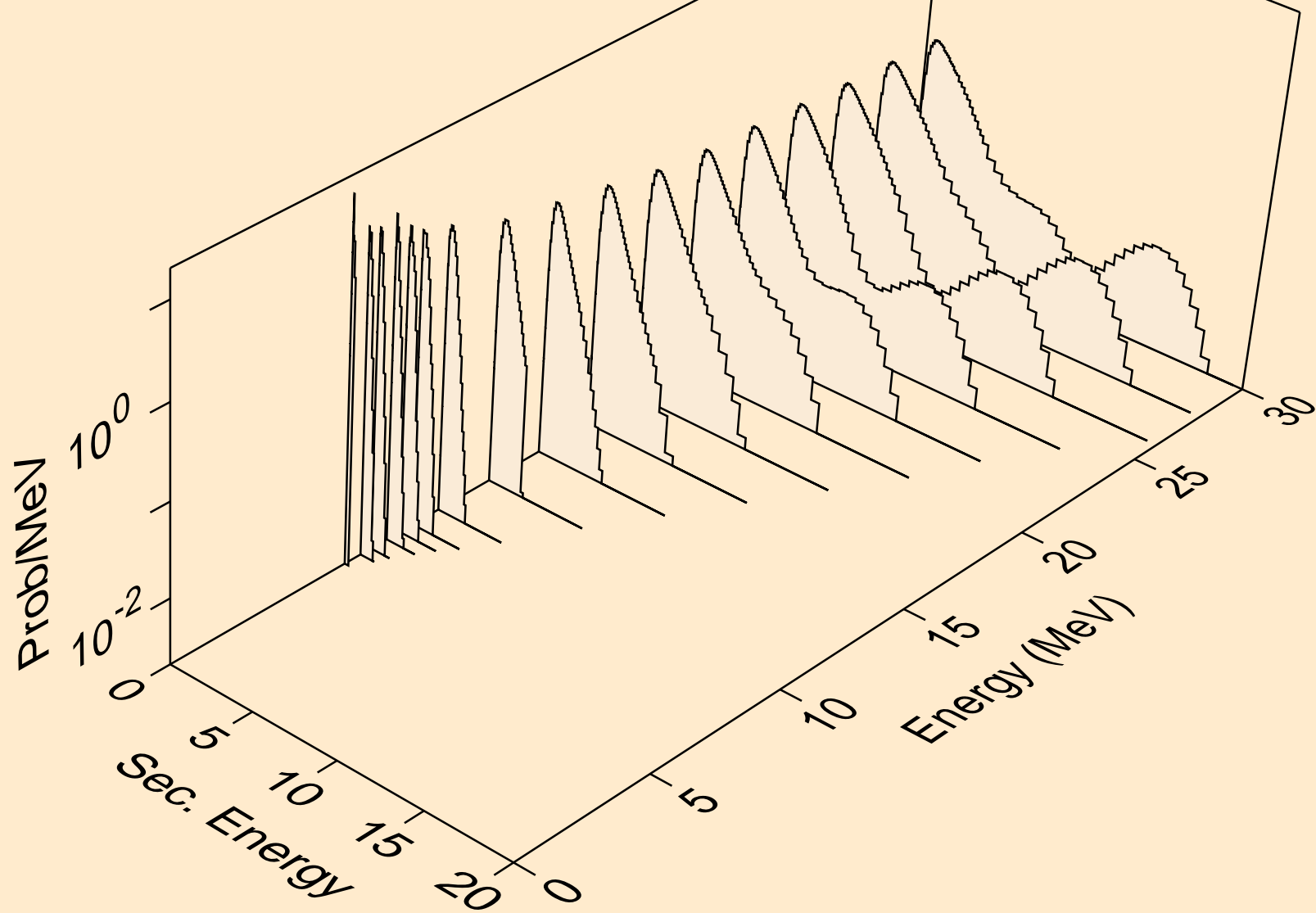

SR077 NEUTRON ACER TENDL-2024 LIBRARY; T=293.6K
Neutron emission for (n,2n)_a

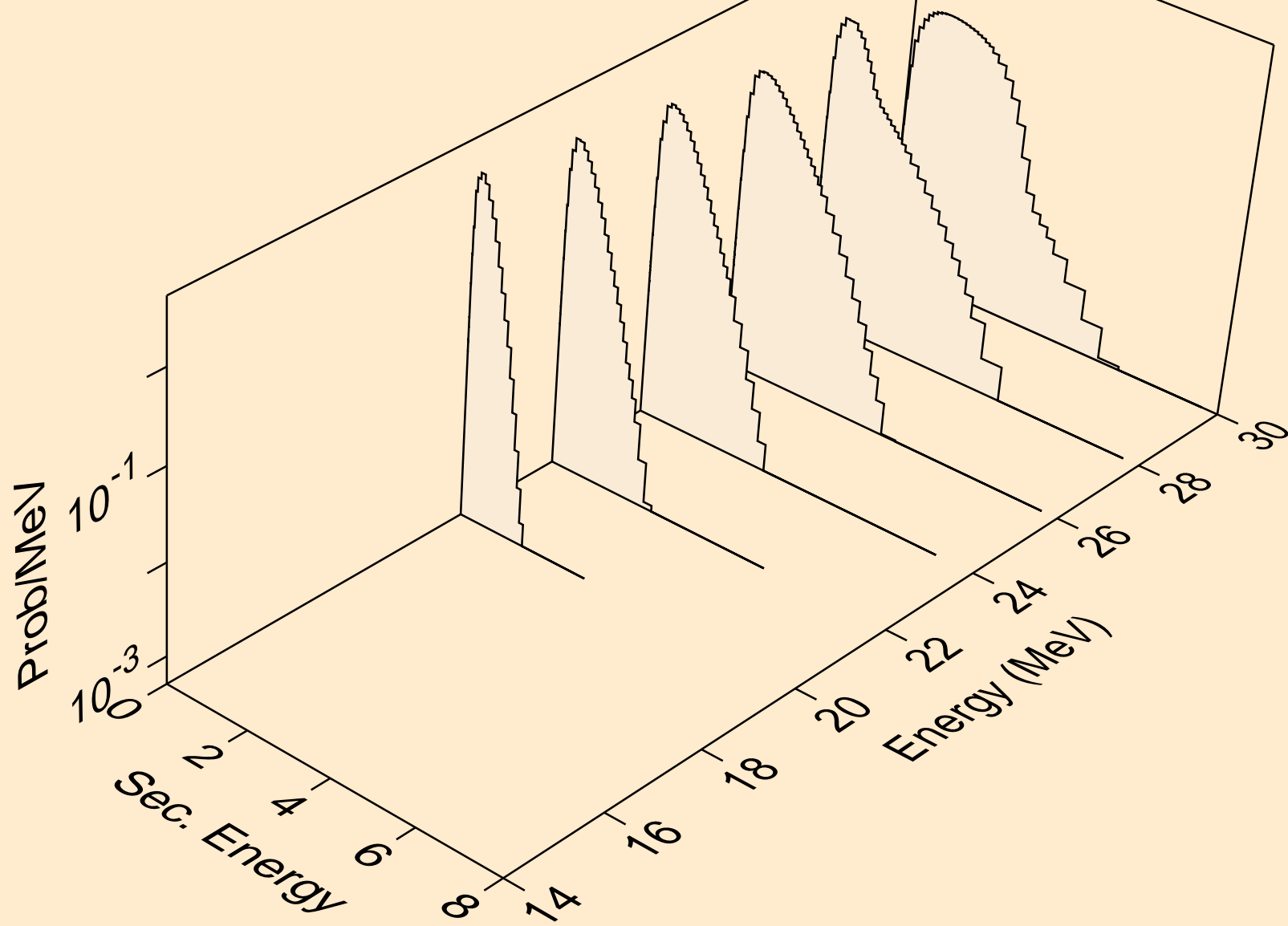

SR077 NEUTRON ACER TENDL-2024 LIBRARY; T=293.6K
Neutron emission for (n,n*)p

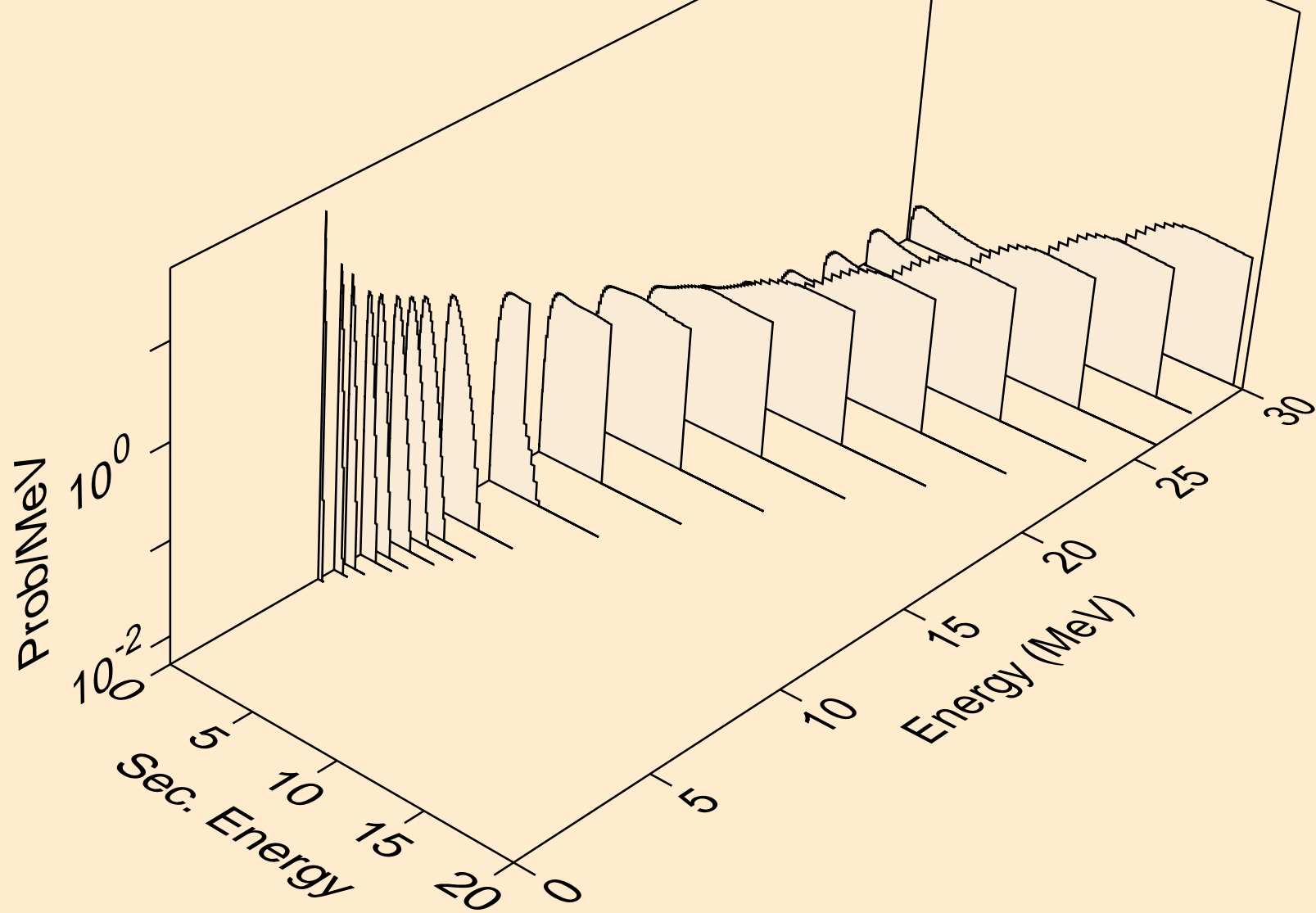

SR077 NEUTRON ACER TENDL-2024 LIBRARY; T=293.6K
Neutron emission for (n,n*)2a

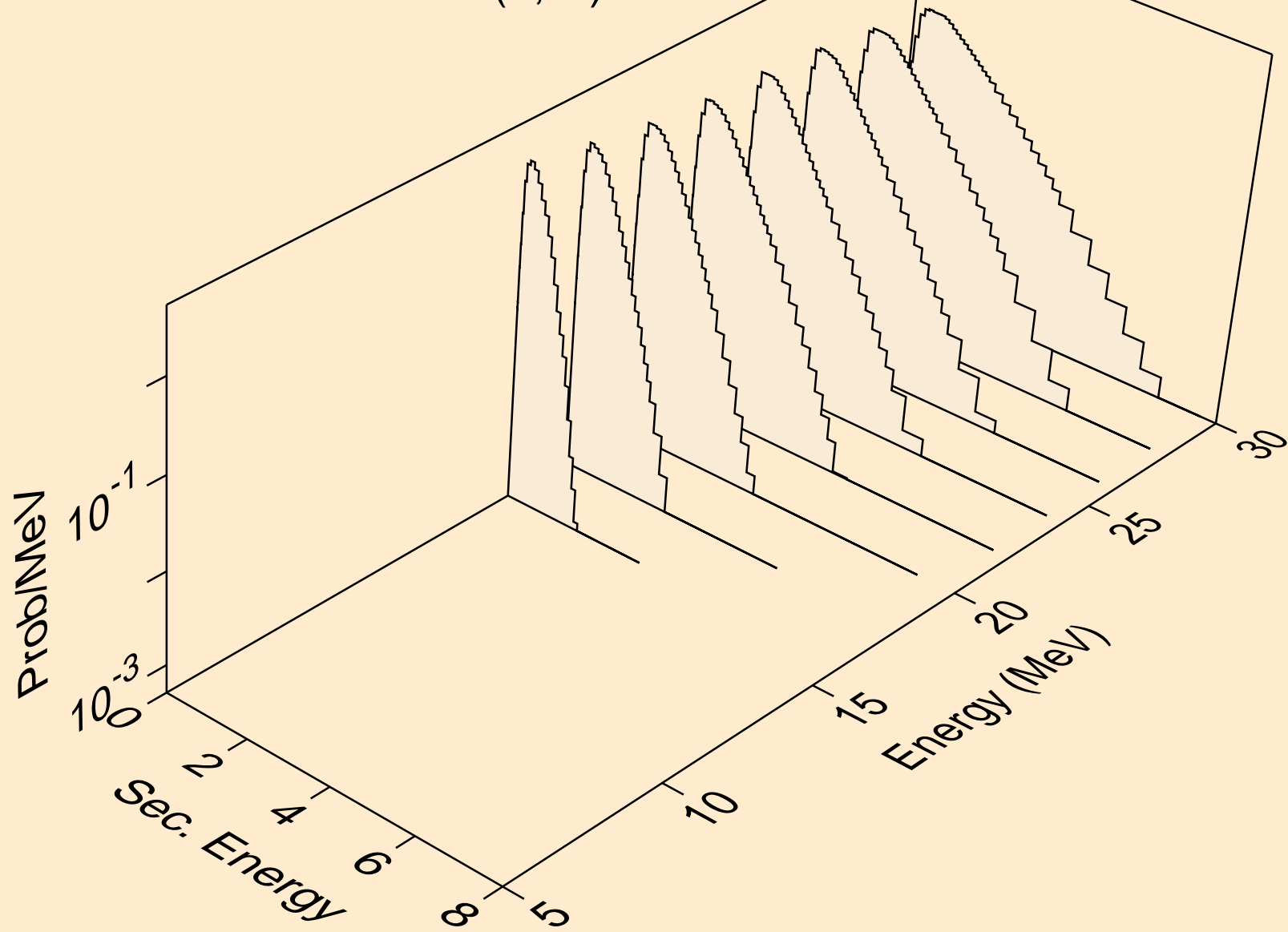

SR077 NEUTRON ACER TENDL-2024 LIBRARY; T=293.6K
Neutron emission for (n,n*)d

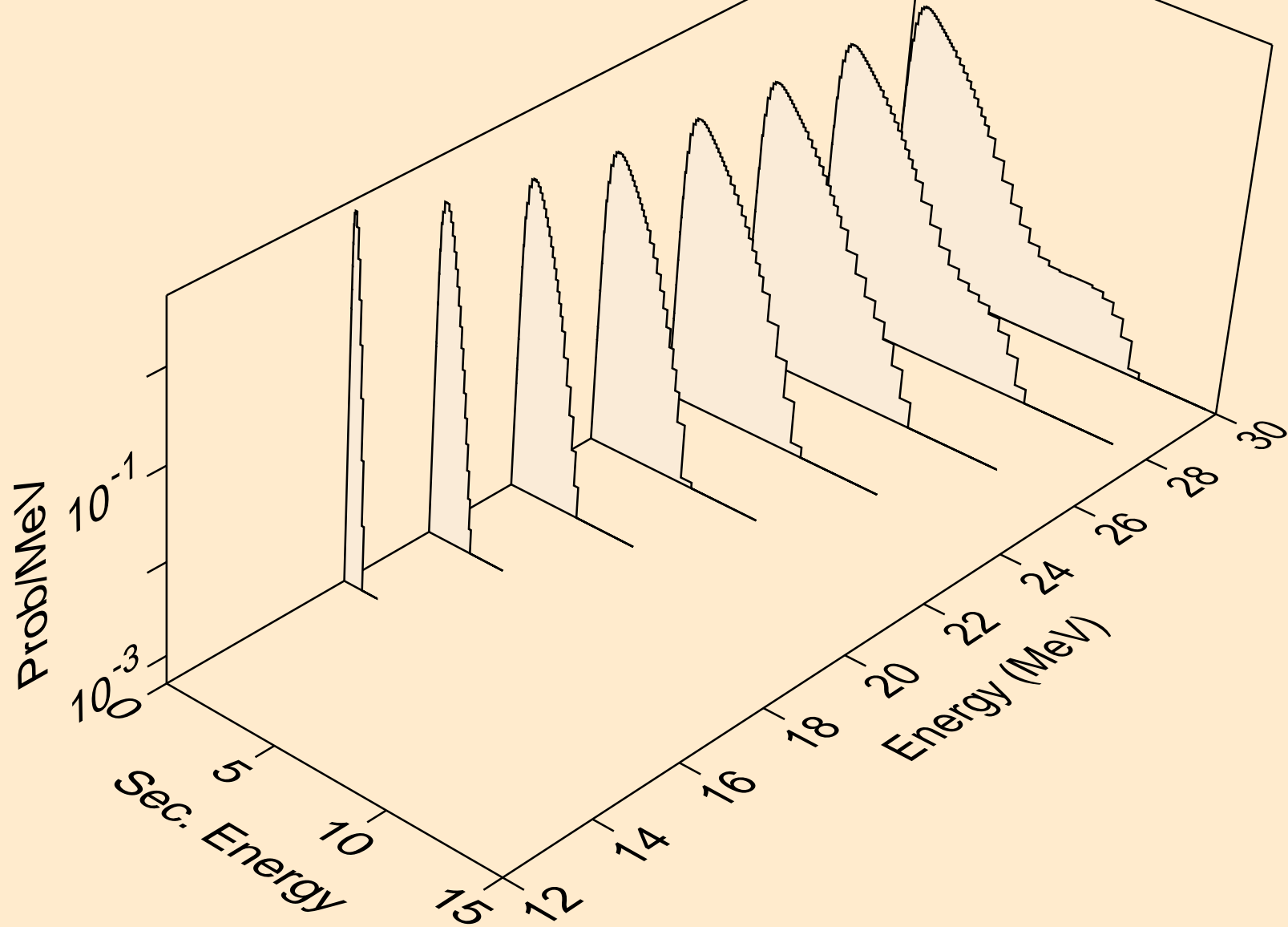

SR077 NEUTRON ACER TENDL-2024 LIBRARY; T=293.6K
Neutron emission for (n,n*)t

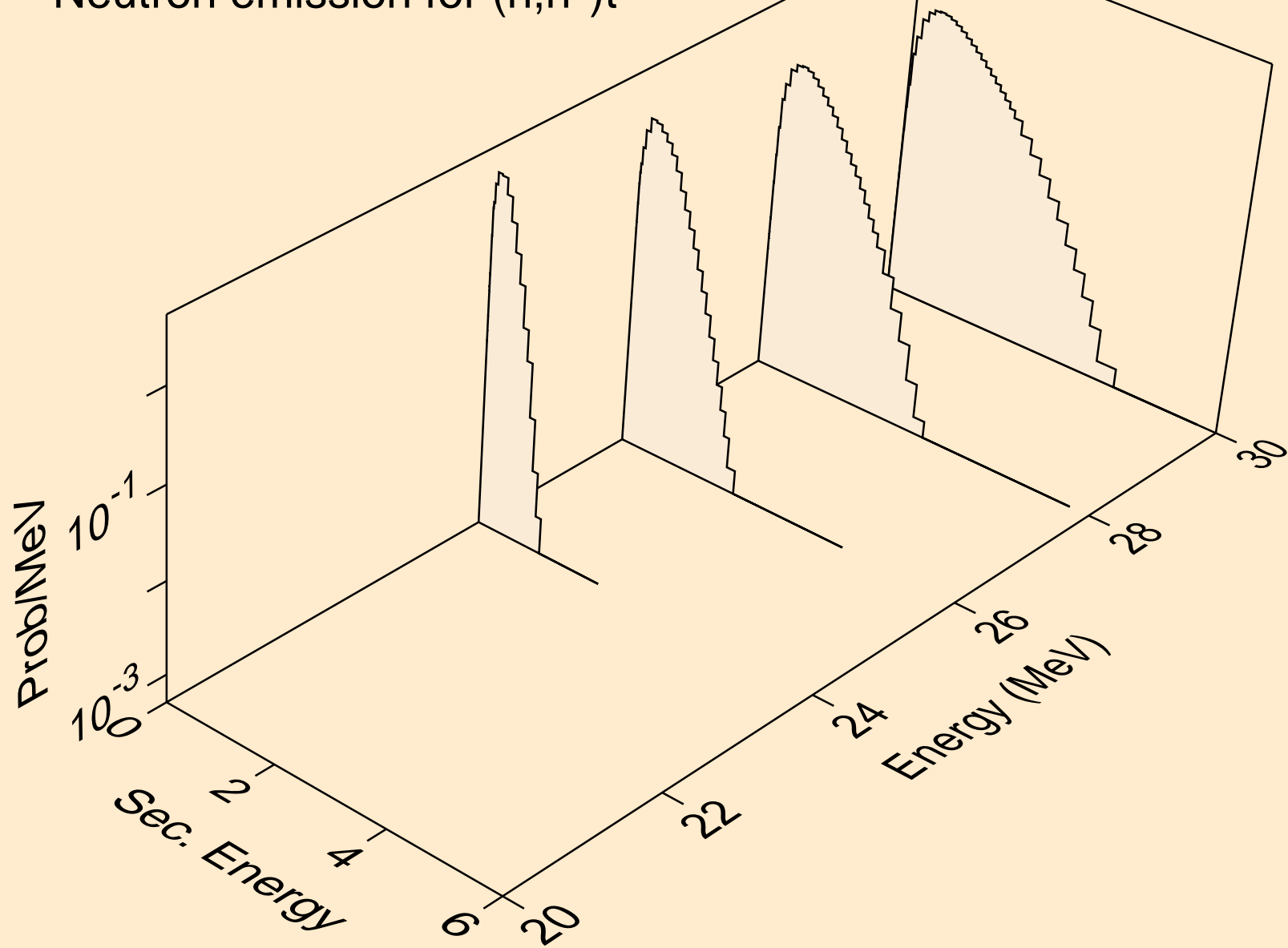

SR077 NEUTRON ACER TENDL-2024 LIBRARY; T=293.6K
Neutron emission for (n,n*)he3

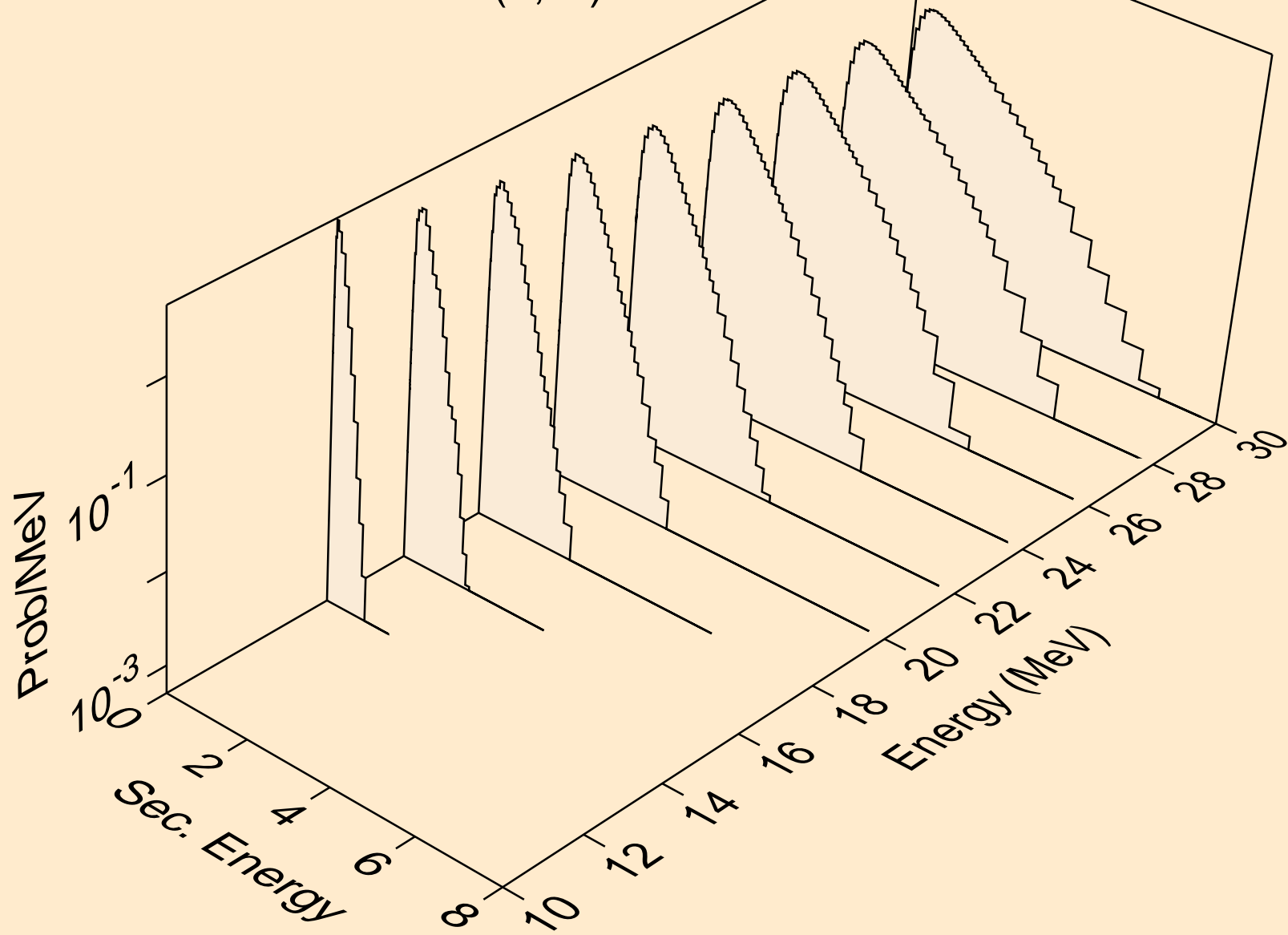

SR077 NEUTRON ACER TENDL-2024 LIBRARY; T=293.6K
Neutron emission for (n,2np)

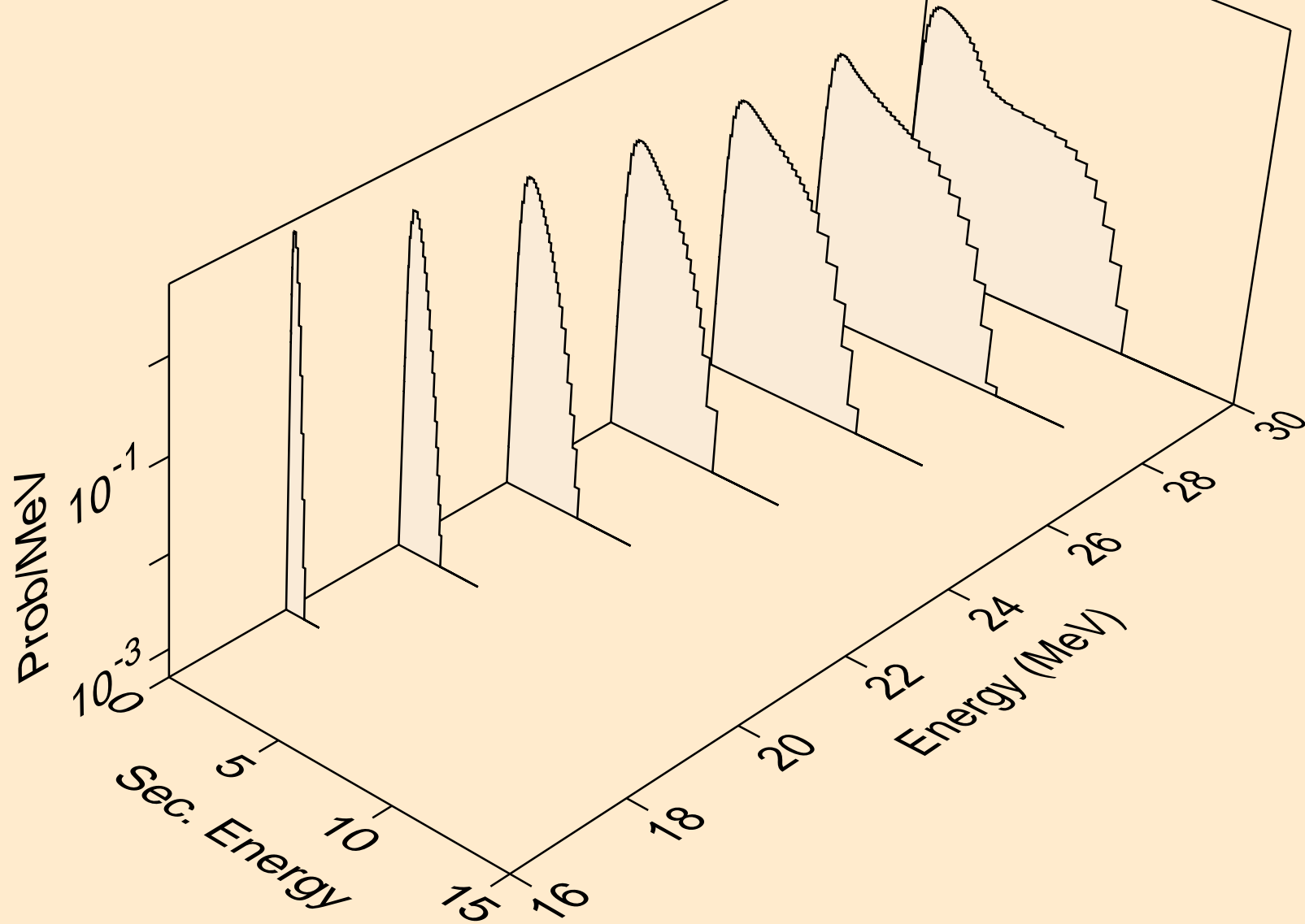

SR077 NEUTRON ACER TENDL-2024 LIBRARY; T=293.6K
Neutron emission for (n,n2p)

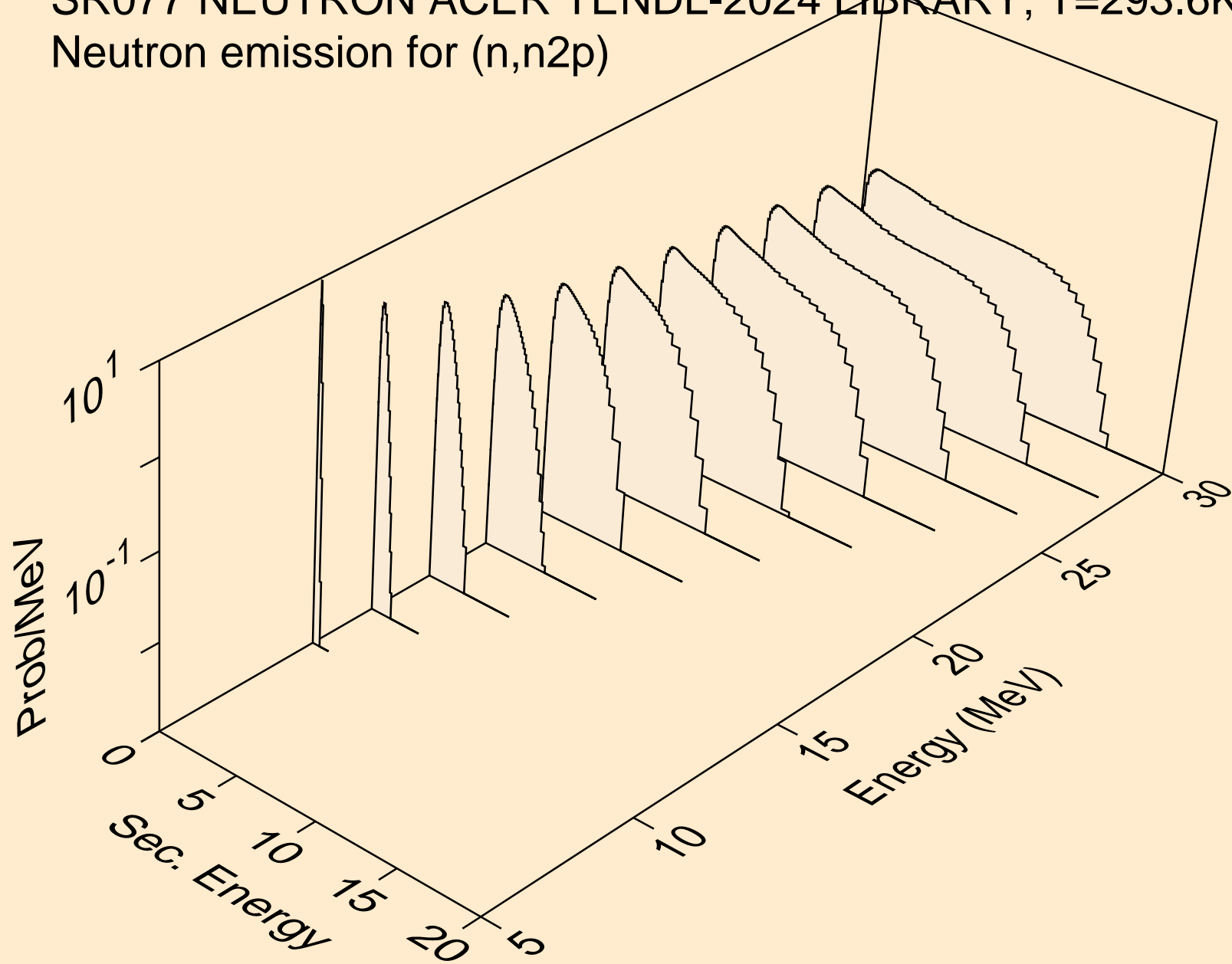

SR077 NEUTRON ACER TENDL-2024 LIBRARY; T=293.6K
Neutron emission for (n,npa)

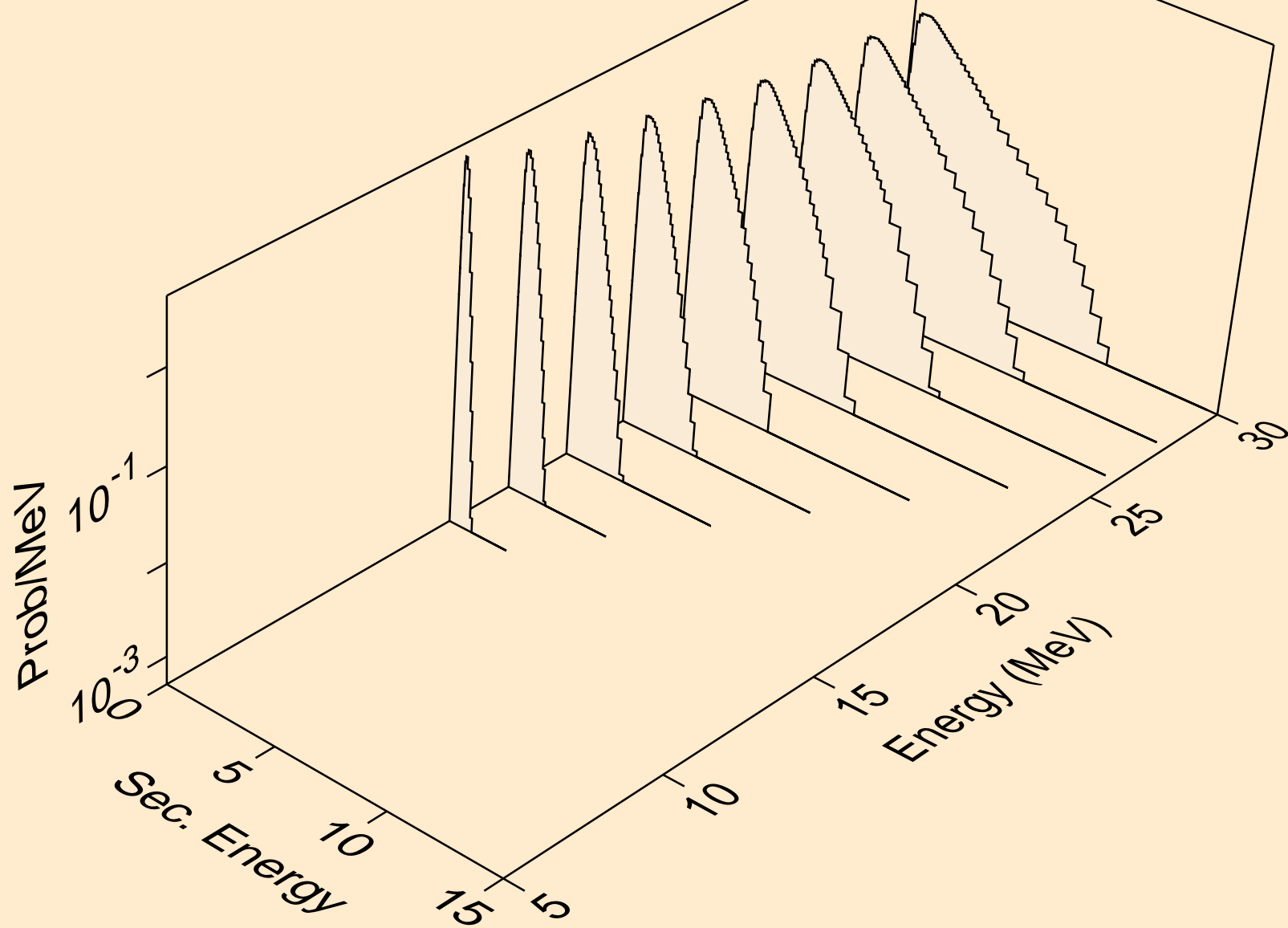

SR077 NEUTRON ACER TENDL-2024 LIBRARY; T=293.6K
Neutron emission for (n,n*c)

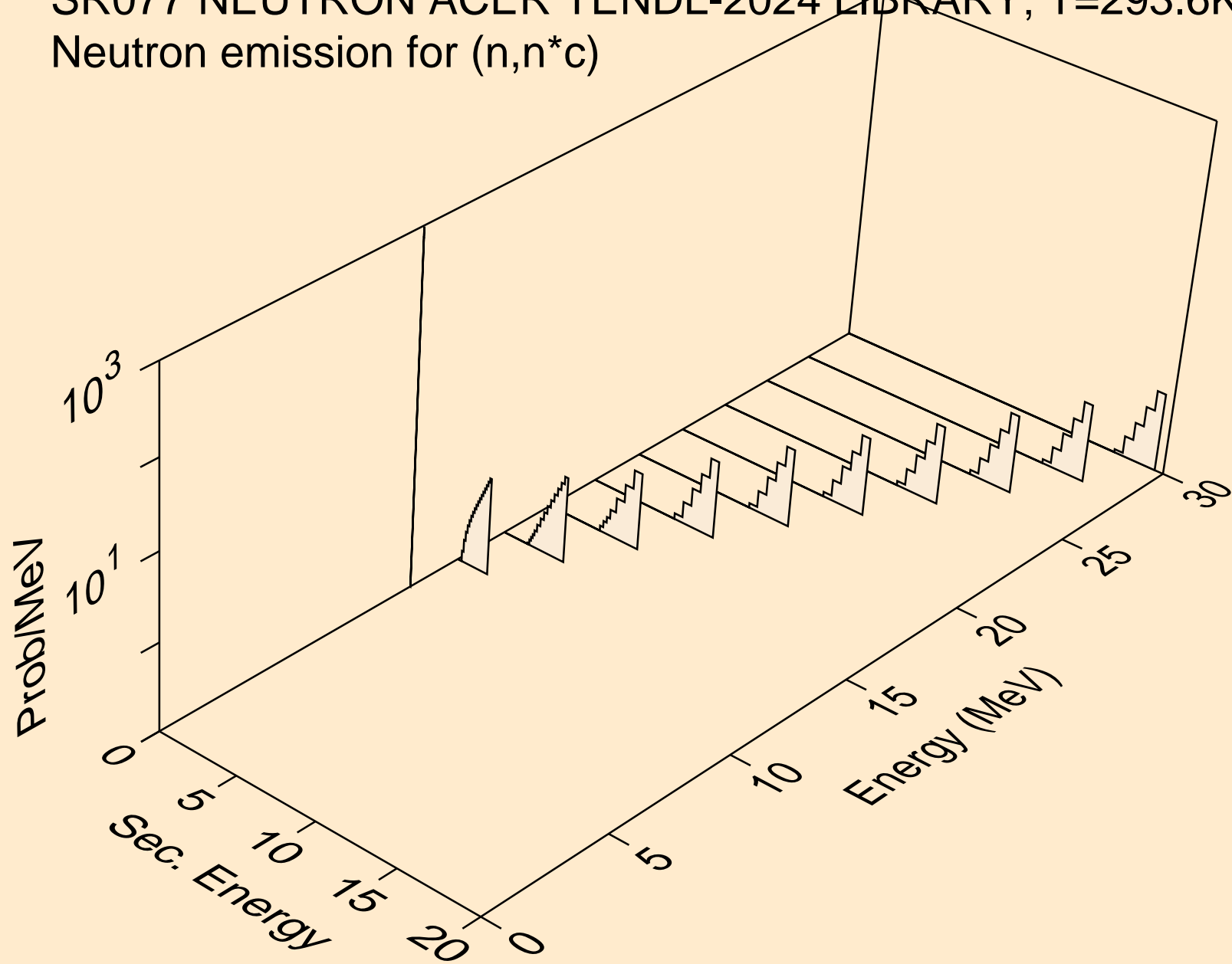

SR077 NEUTRON ACER TENDL-2024 LIBRARY; T=293.6K
Photon emission for (n,x)

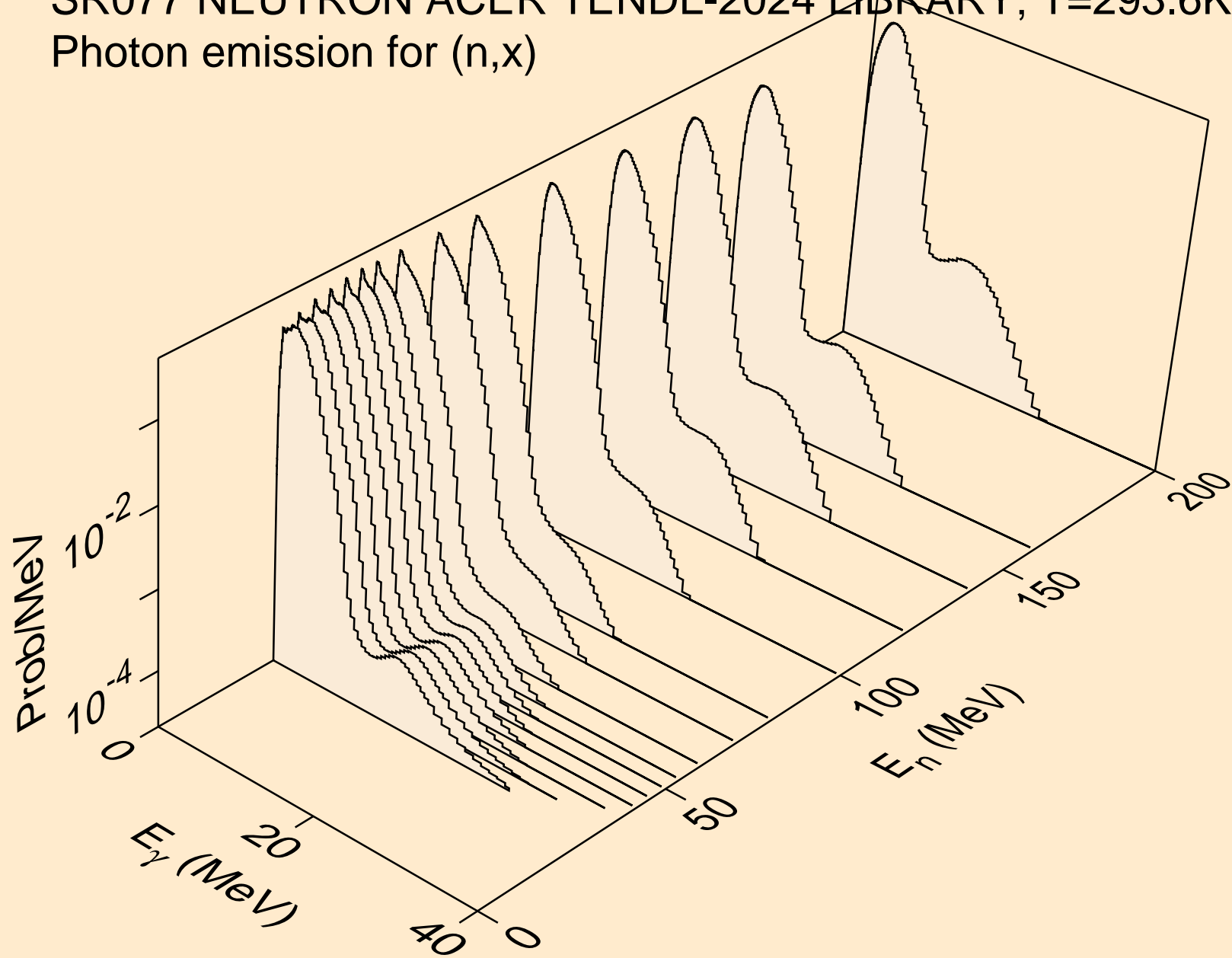

SR077 NEUTRON ACER TENDL-2024 LIBRARY; T=293.6K
Photon emission for (n,2n)

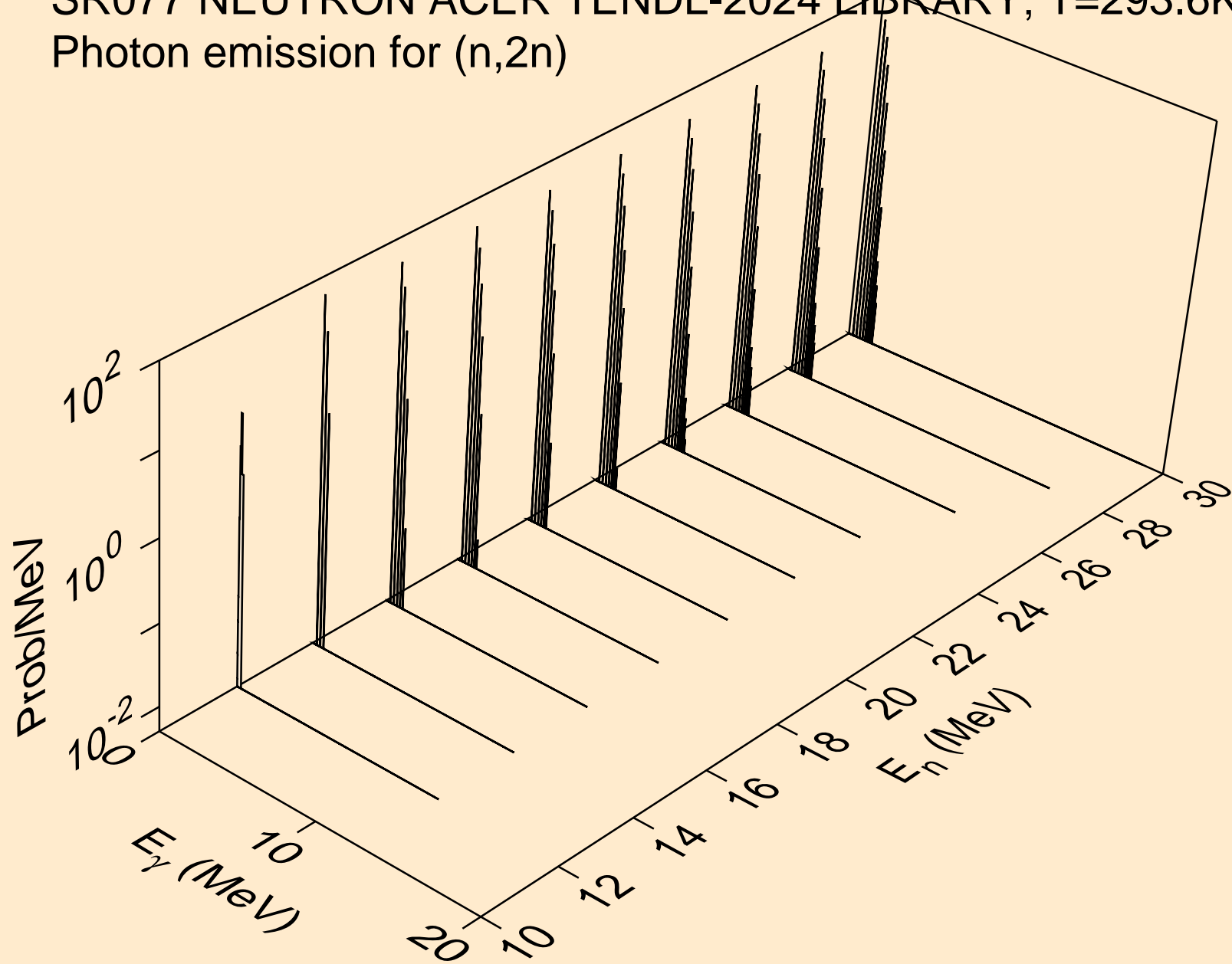

SR077 NEUTRON ACER TENDL-2024 LIBRARY; T=293.6K
Photon emission for (n,3n)

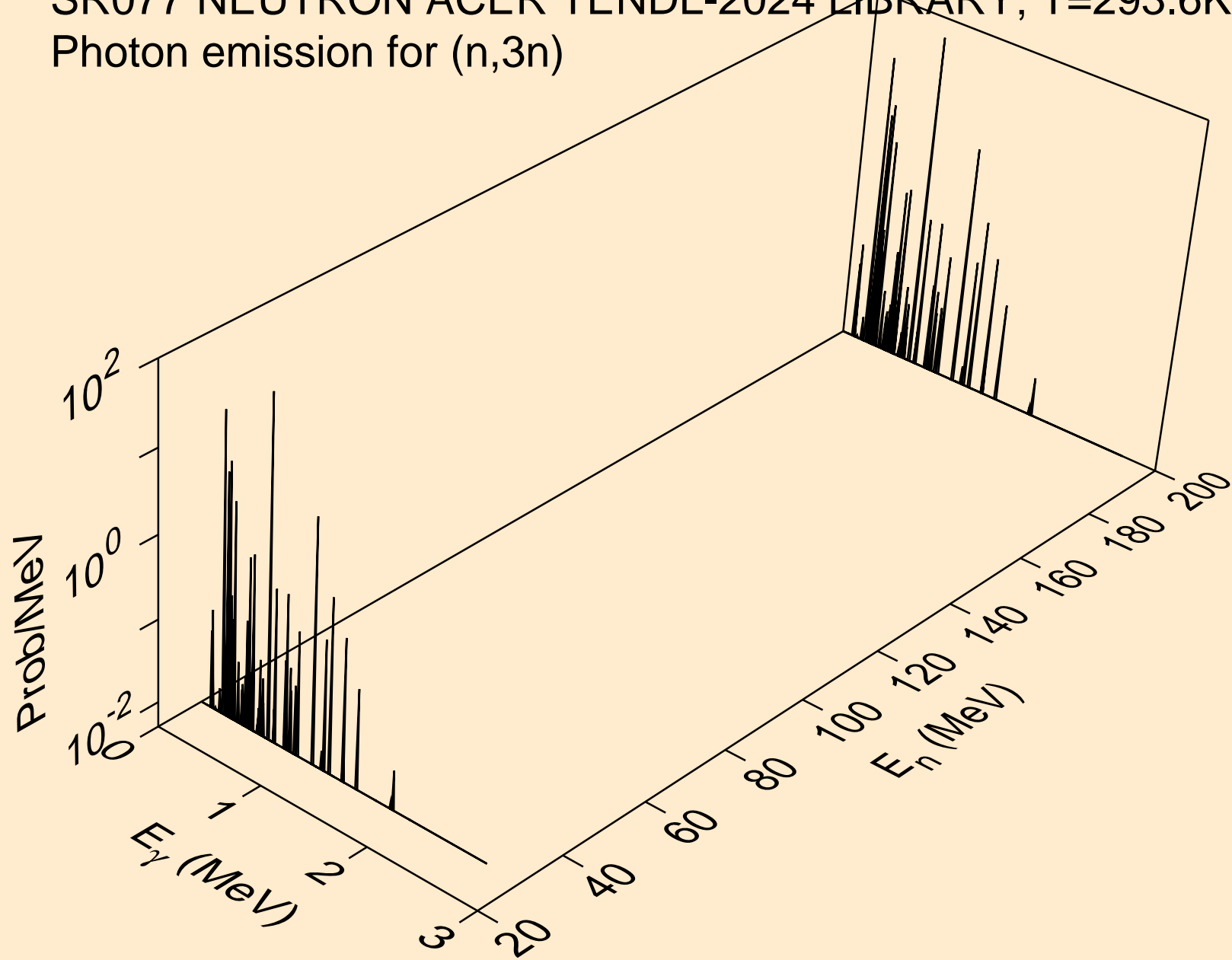

SR077 NEUTRON ACER TENDL-2024 LIBRARY; T=293.6K
Photon emission for (n,n*)a

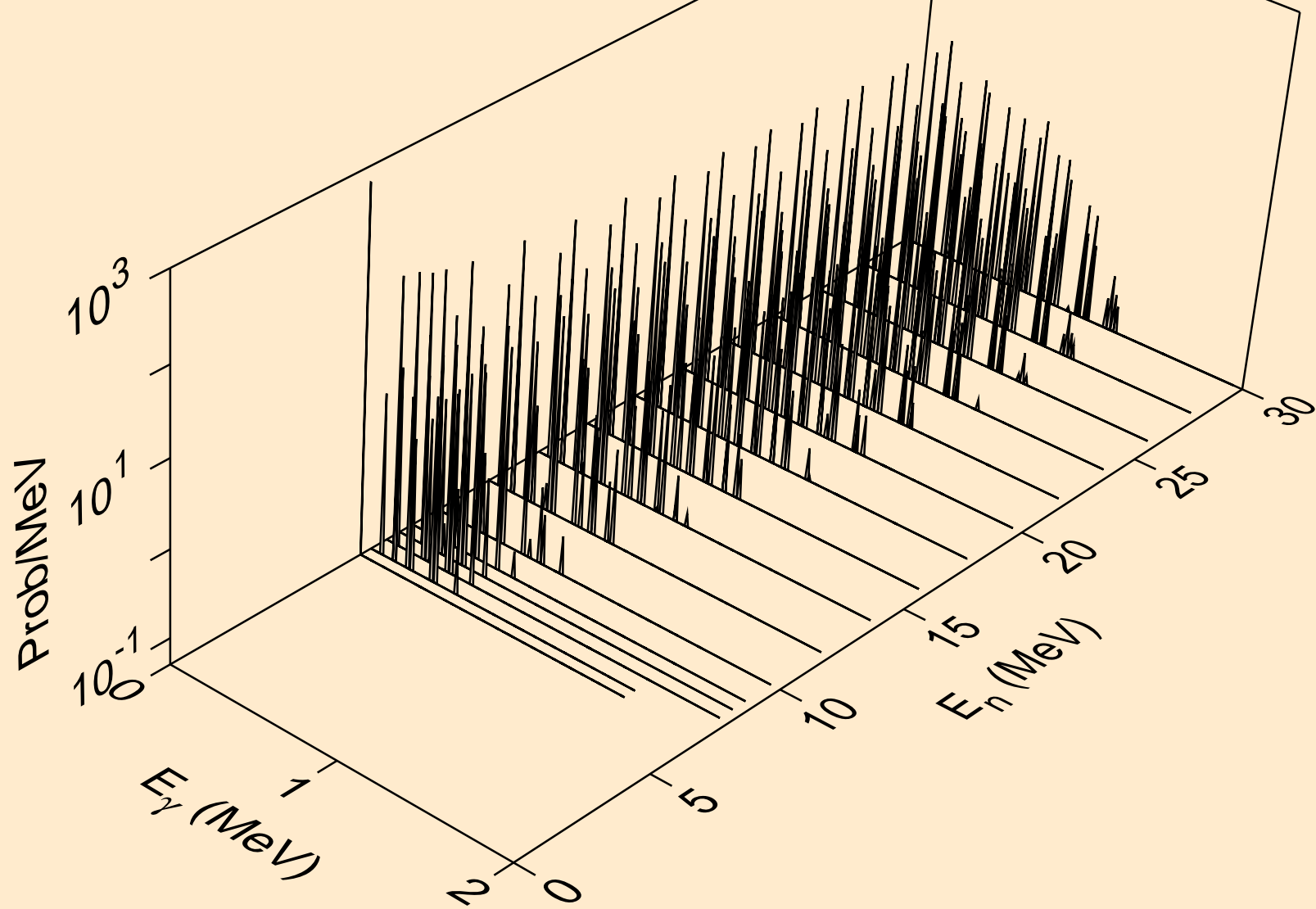

SR077 NEUTRON ACER TENDL-2024 LIBRARY; T=293.6K
Photon emission for (n,2n)a

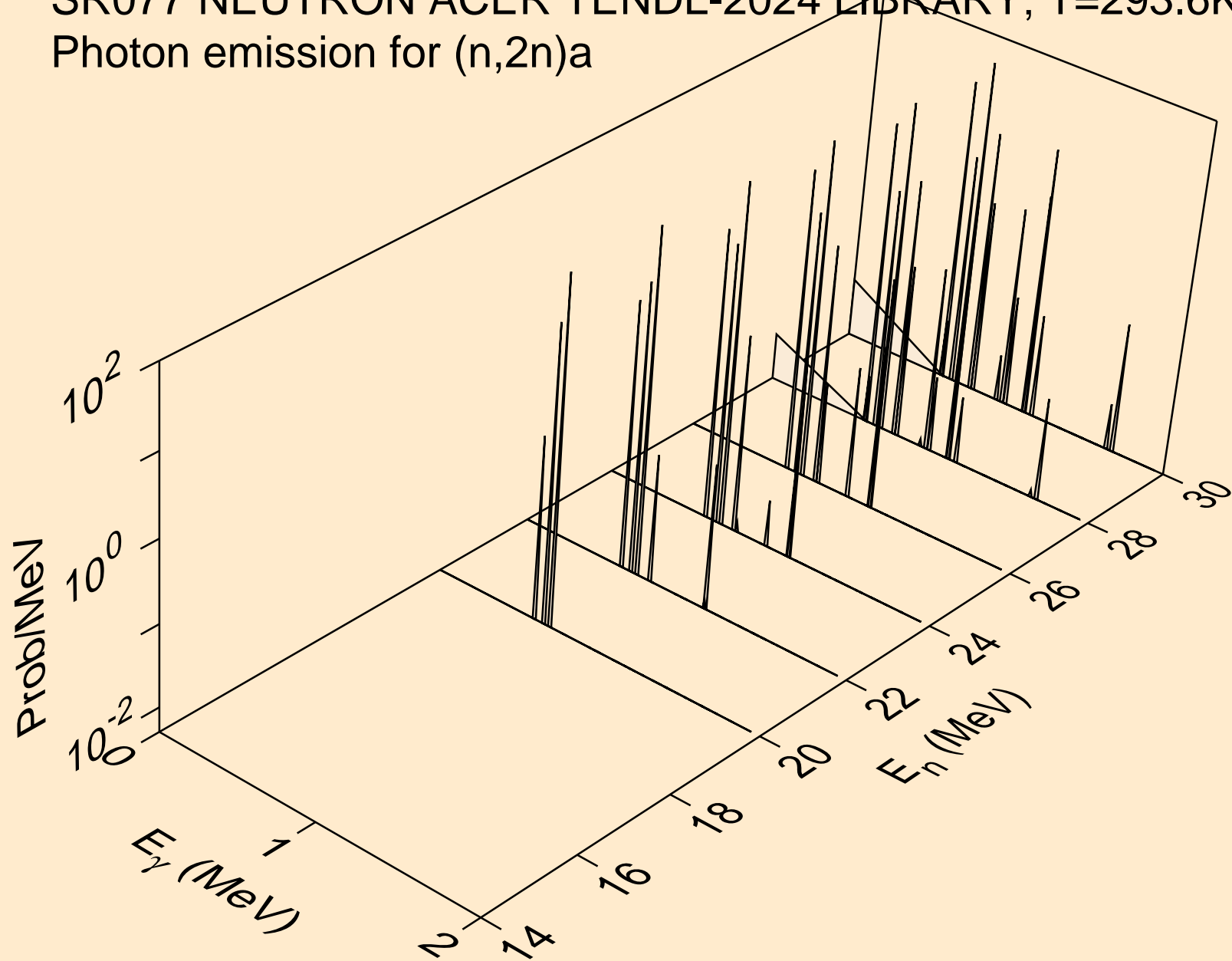

SR077 NEUTRON ACER TENDL-2024 LIBRARY; T=293.6K
Photon emission for (n,n*)p

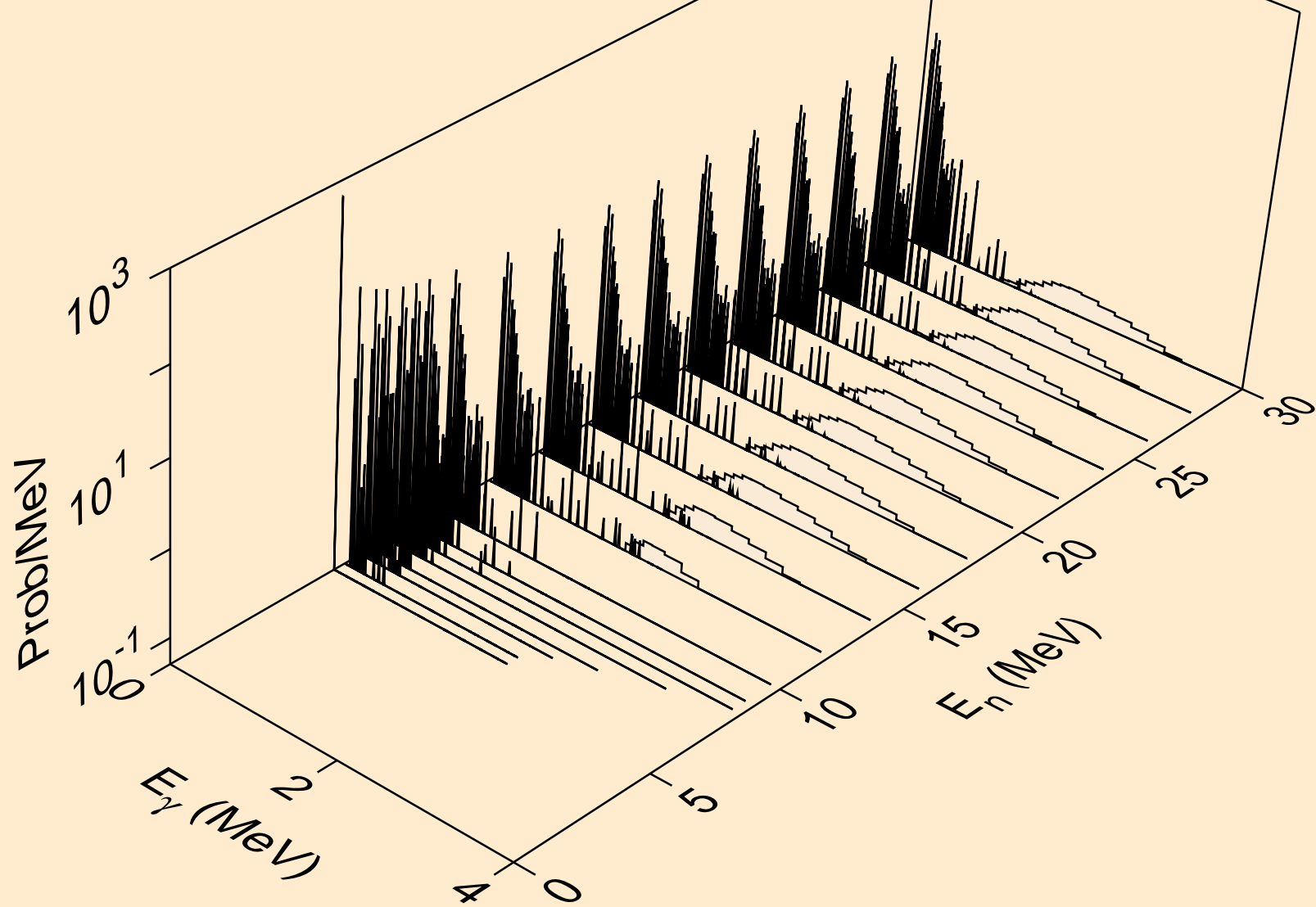

SR077 NEUTRON ACER TENDL-2024 LIBRARY; T=293.6K
Photon emission for (n,n*)2a

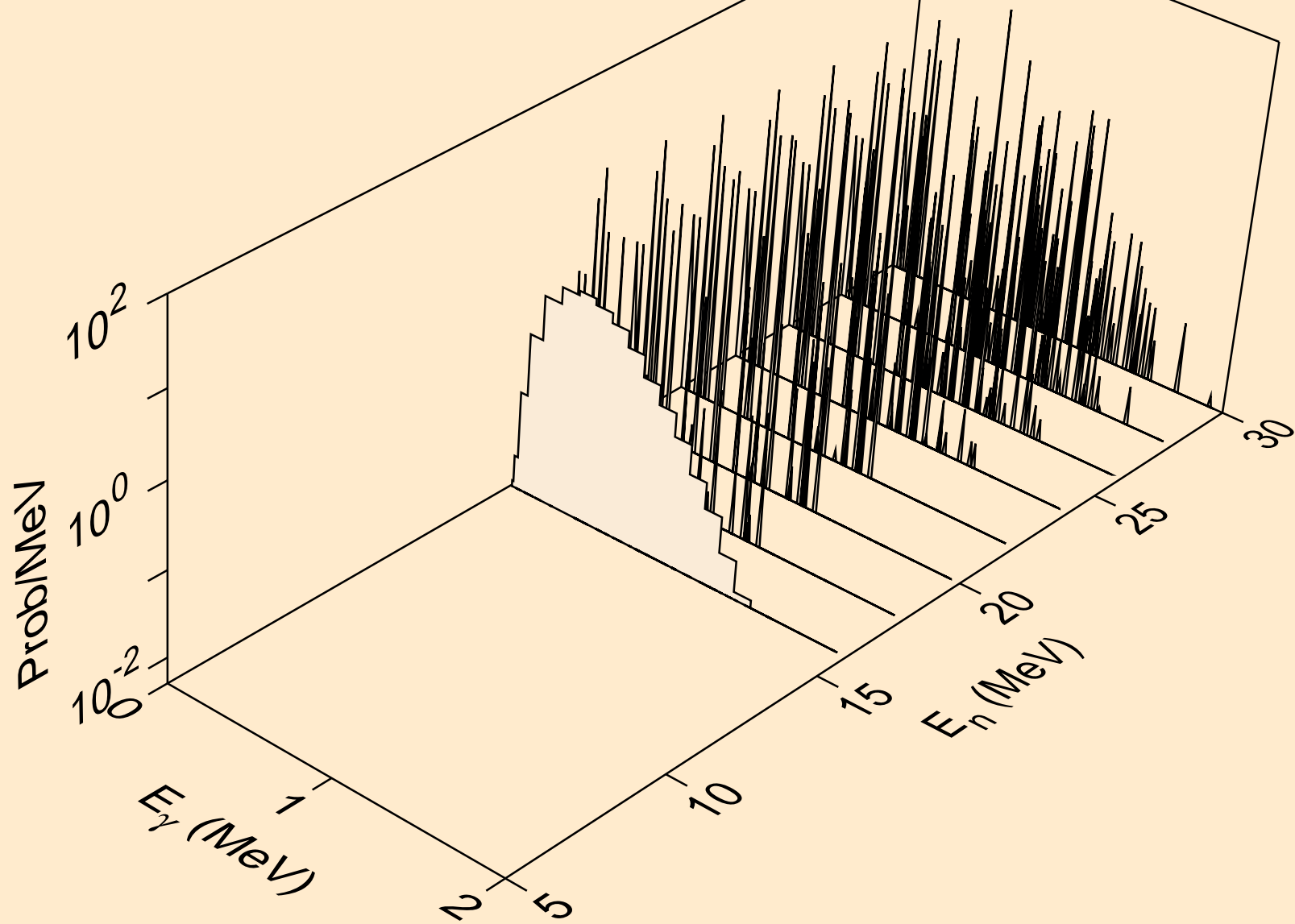

SR077 NEUTRON ACER TENDL-2024 LIBRARY; T=293.6K
Photon emission for (n,n*)d

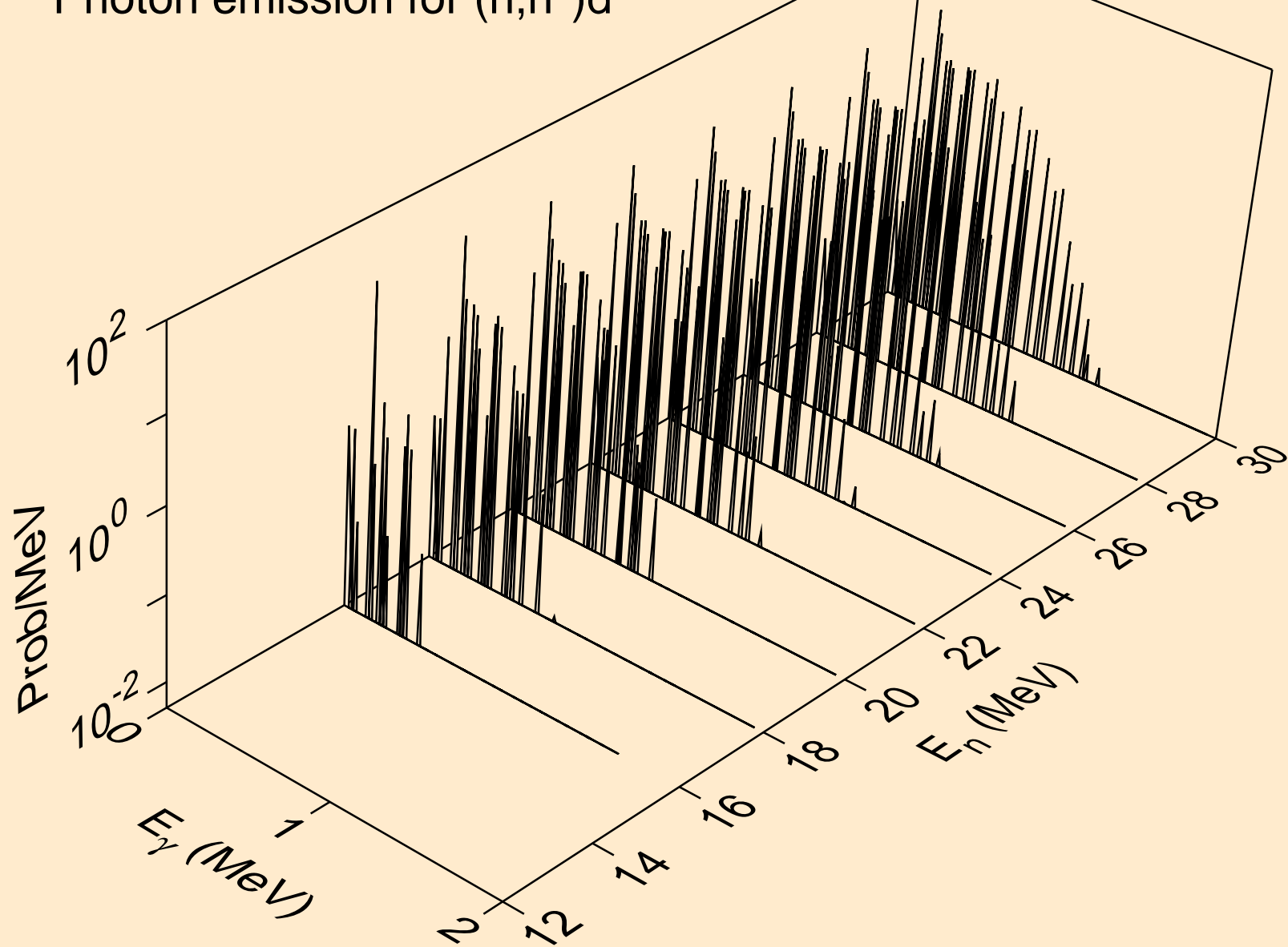

SR077 NEUTRON ACER TENDL-2024 LIBRARY; T=293.6K
Photon emission for (n,n*)t

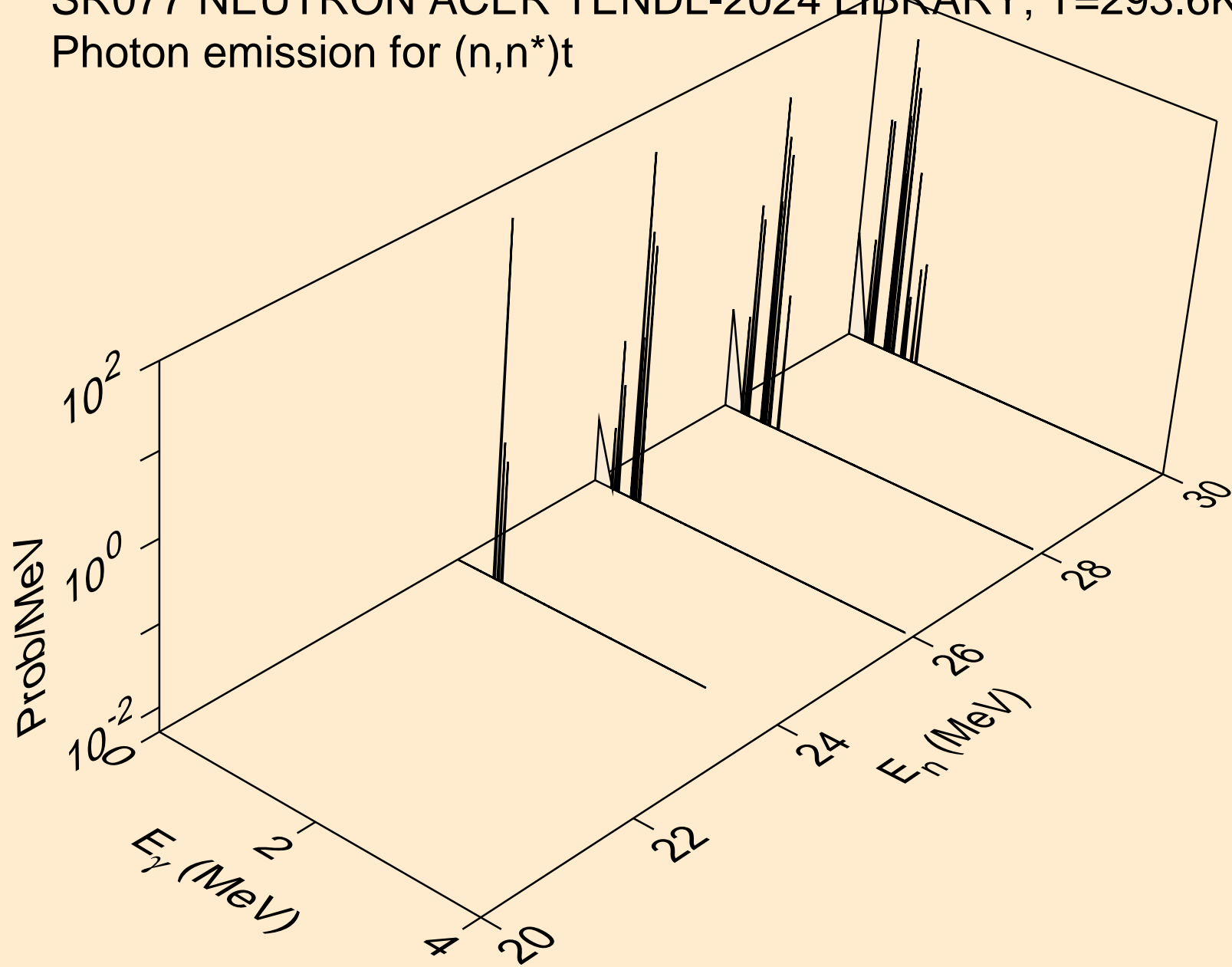

SR077 NEUTRON ACER TENDL-2024 LIBRARY; T=293.6K
Photon emission for (n,n*)he3

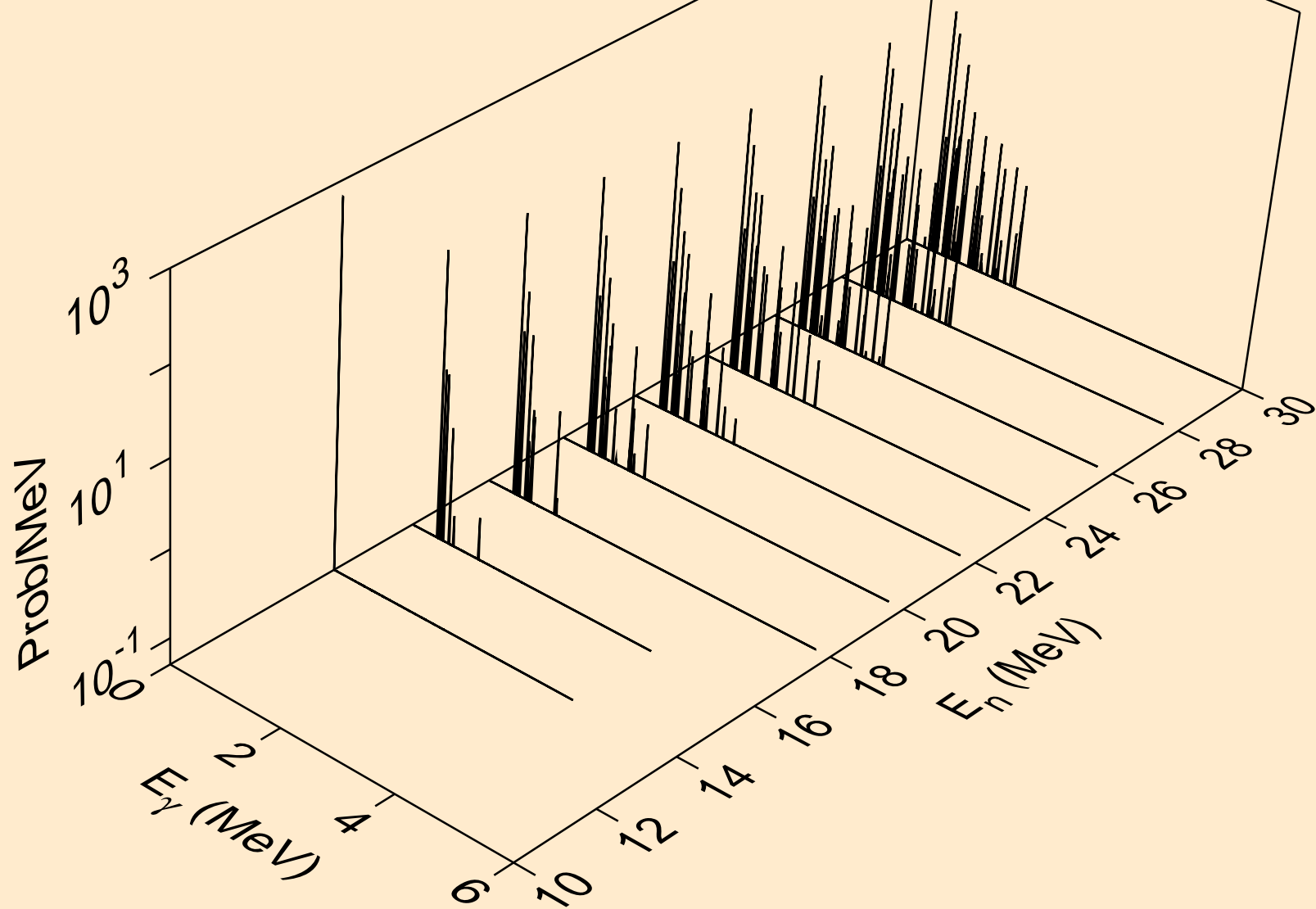

SR077 NEUTRON ACER TENDL-2024 LIBRARY; T=293.6K
Photon emission for (n,2np)

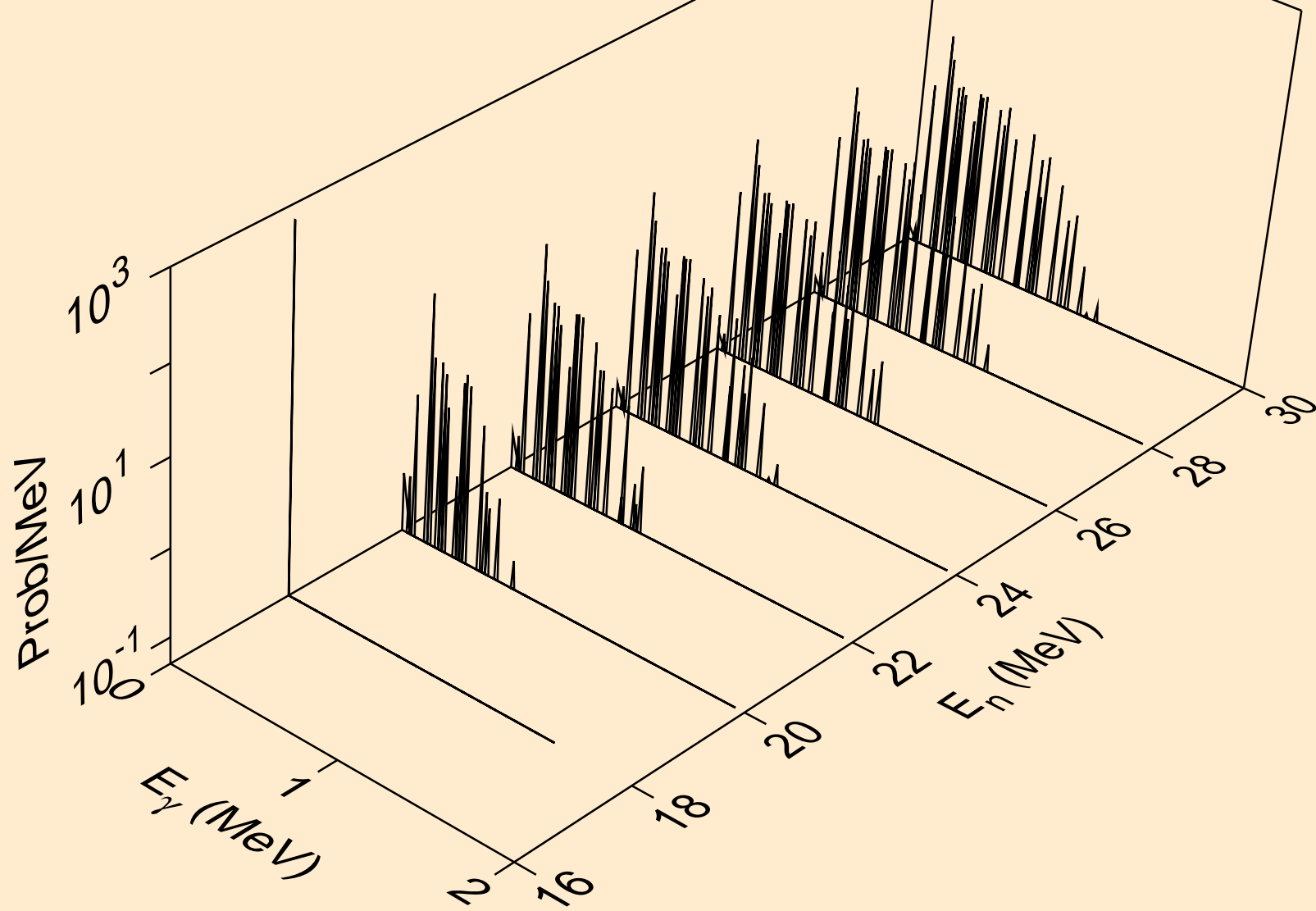

SR077 NEUTRON ACER TENDL-2024 LIBRARY; T=293.6K
Photon emission for (n,n2p)

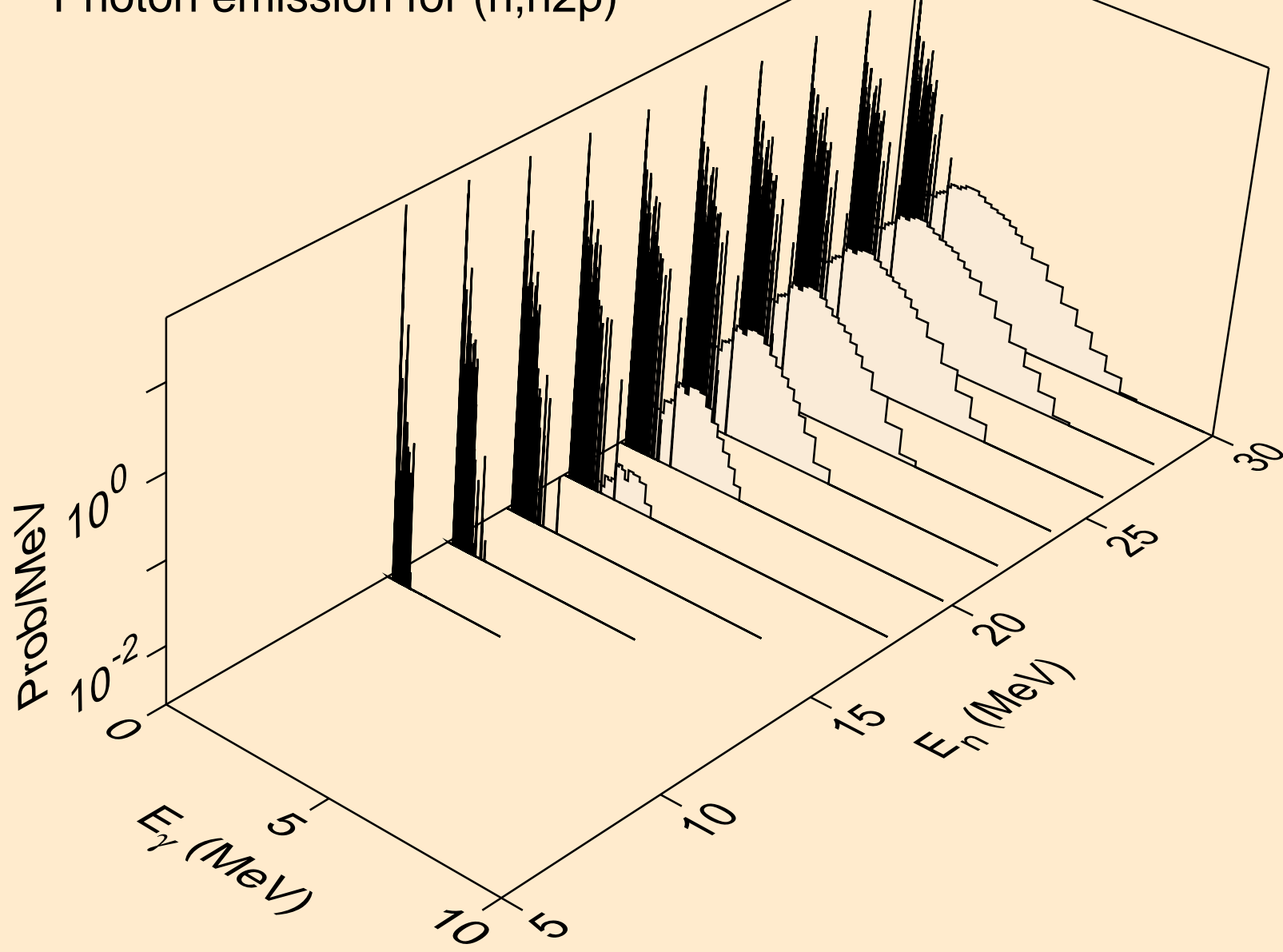

SR077 NEUTRON ACER TENDL-2024 LIBRARY; T=293.6K
Photon emission for (n,npa)

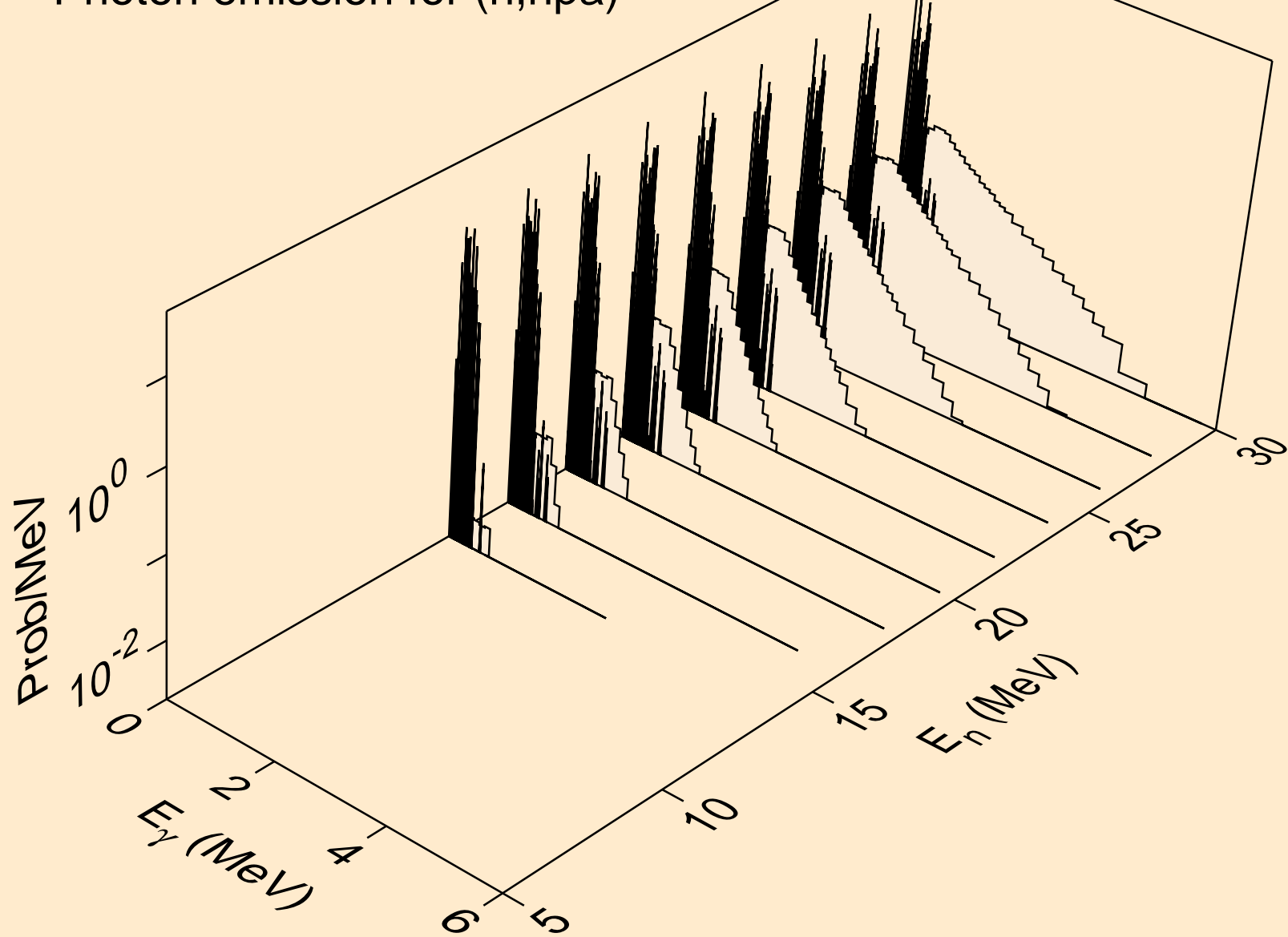

SR077 NEUTRON ACER TENDL-2024 LIBRARY; T=293.6K
Photon emission for (n,n*c)

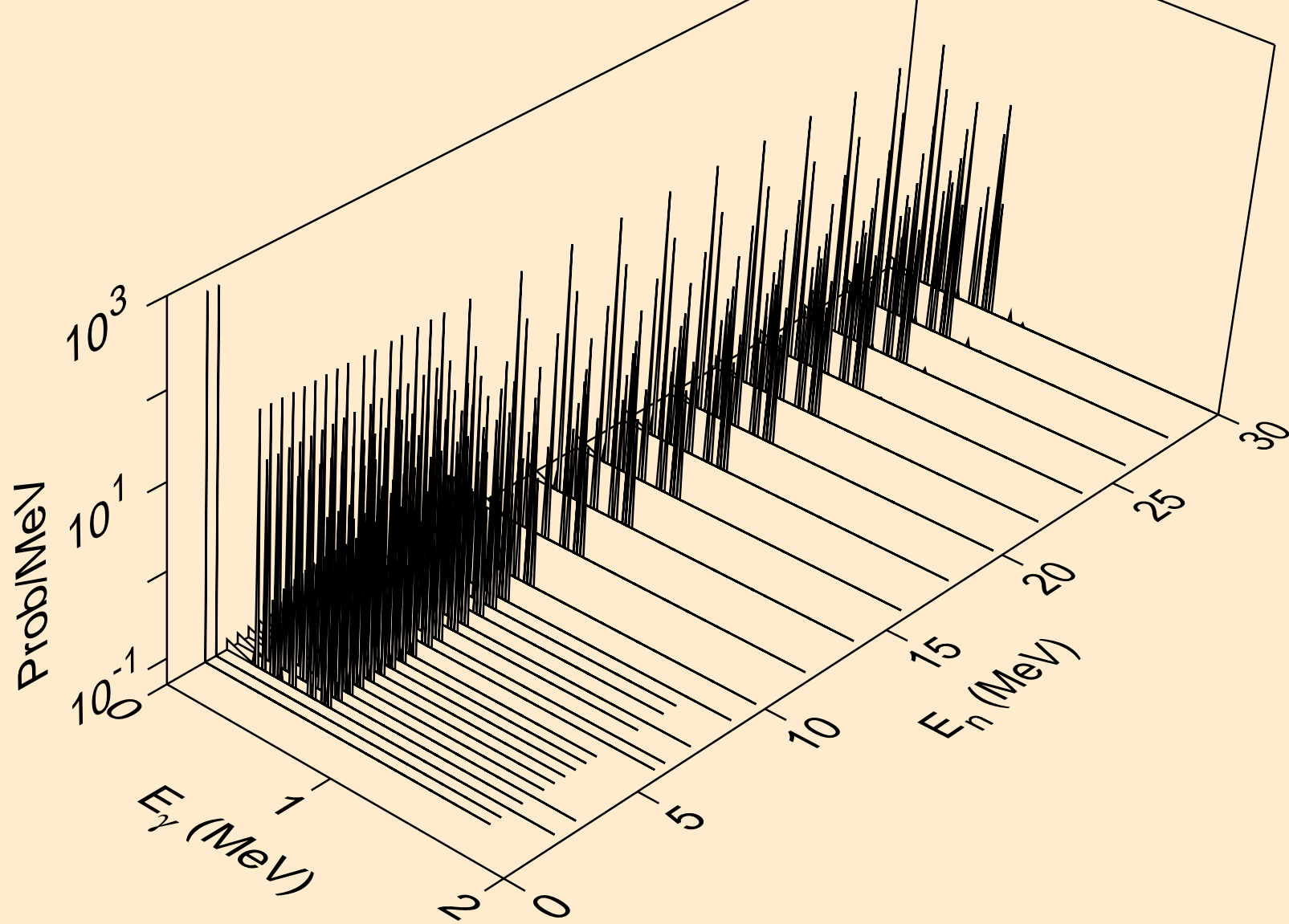

SR077 NEUTRON ACER TENDL-2024 LIBRARY; T=293.6K
Photon emission for (n,gma)

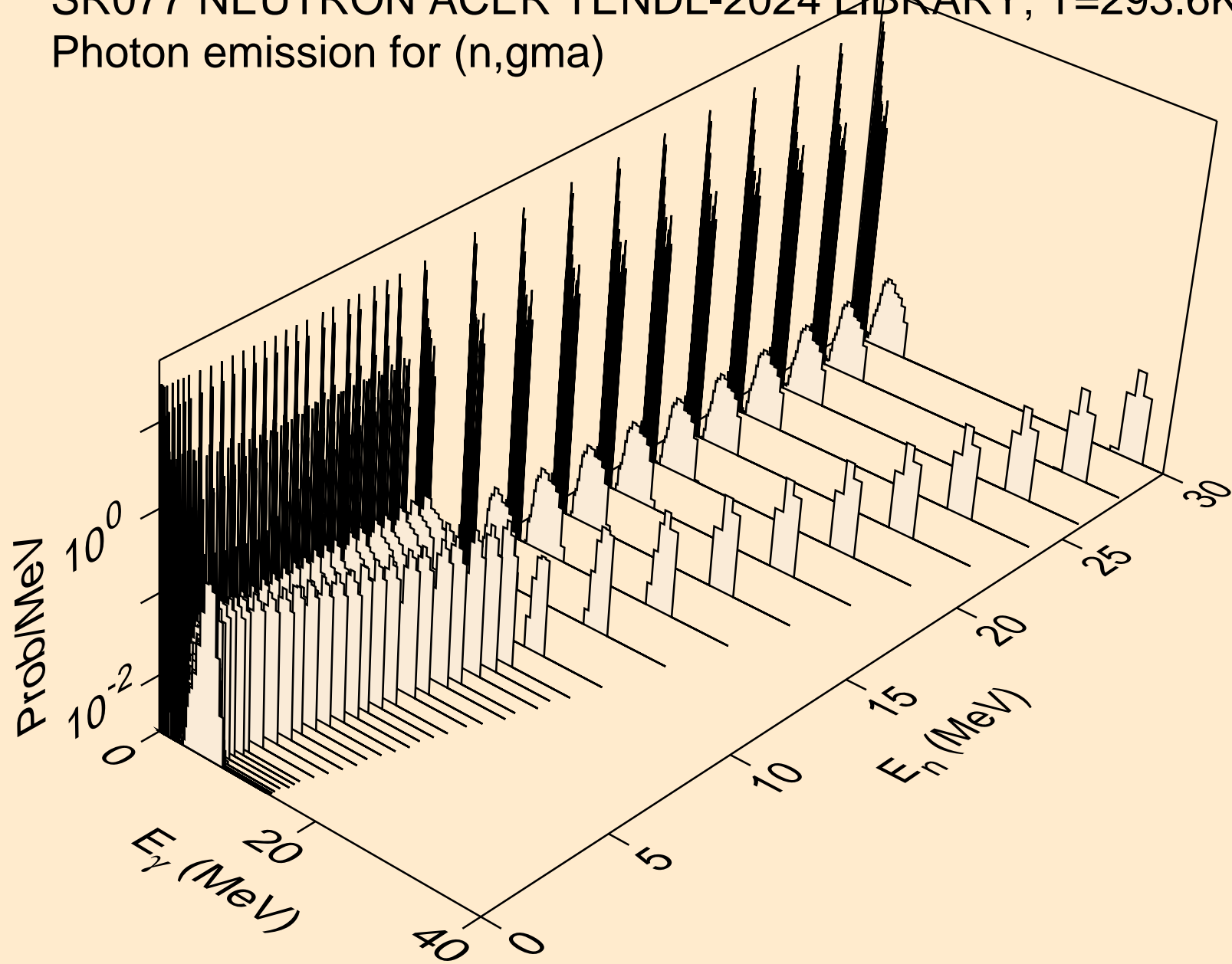

SR077 NEUTRON ACER TENDL-2024 LIBRARY; T=293.6K
Photon emission for (n,p)

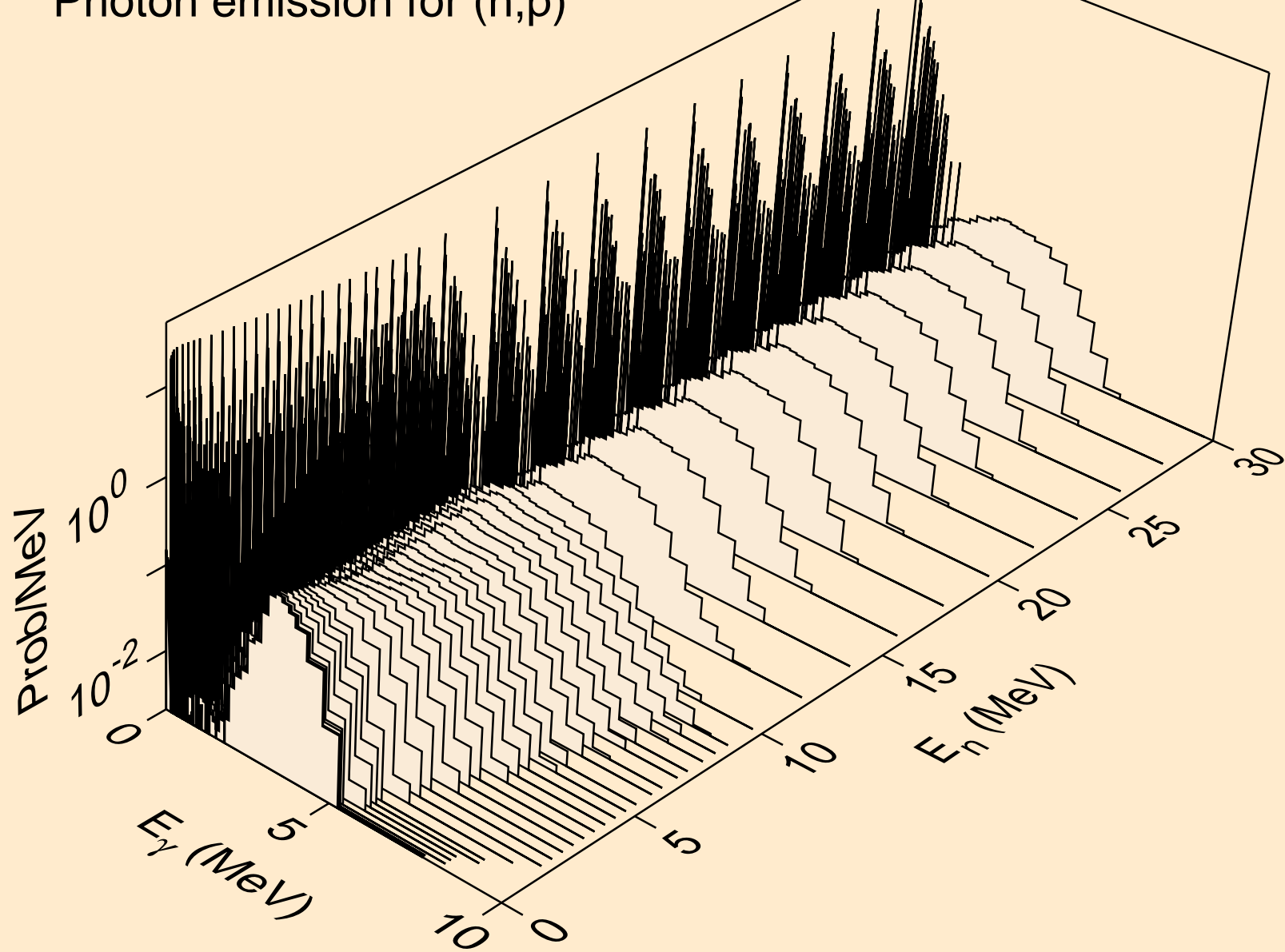

SR077 NEUTRON ACER TENDL-2024 LIBRARY; T=293.6K
Photon emission for (n,d)

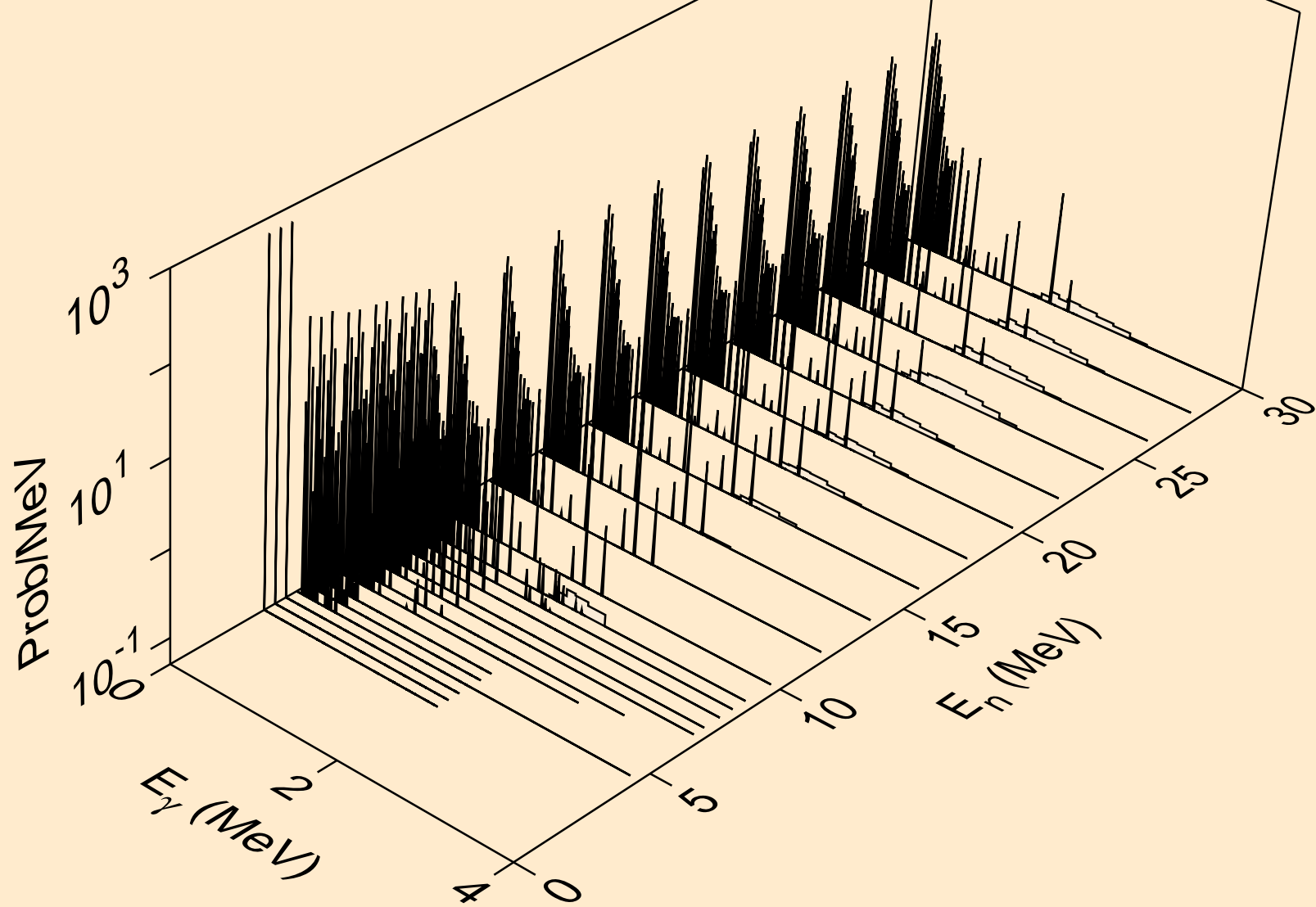

SR077 NEUTRON ACER TENDL-2024 LIBRARY; T=293.6K
Photon emission for (n,t)

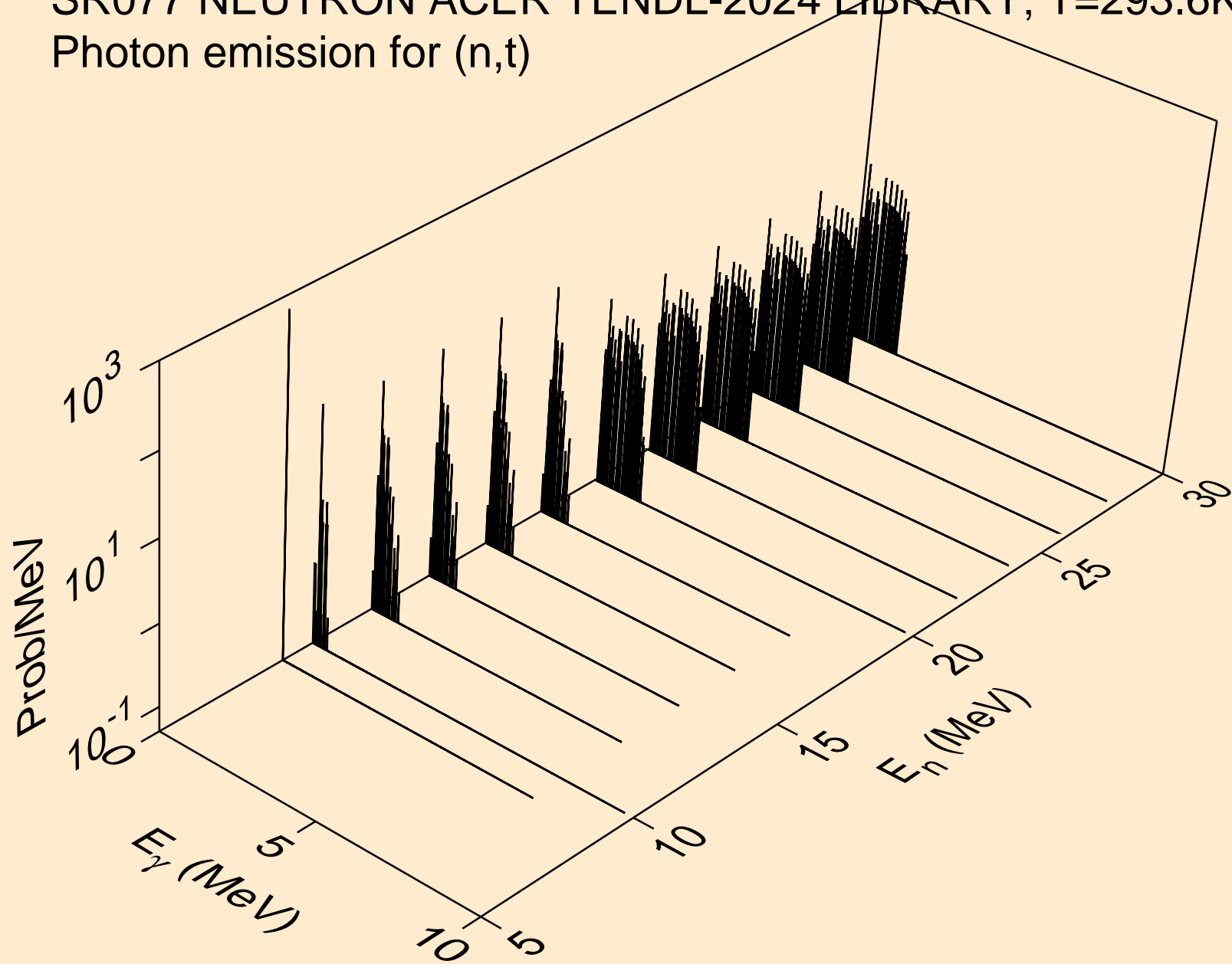

SR077 NEUTRON ACER TENDL-2024 LIBRARY; T=293.6K
Photon emission for (n,he3)

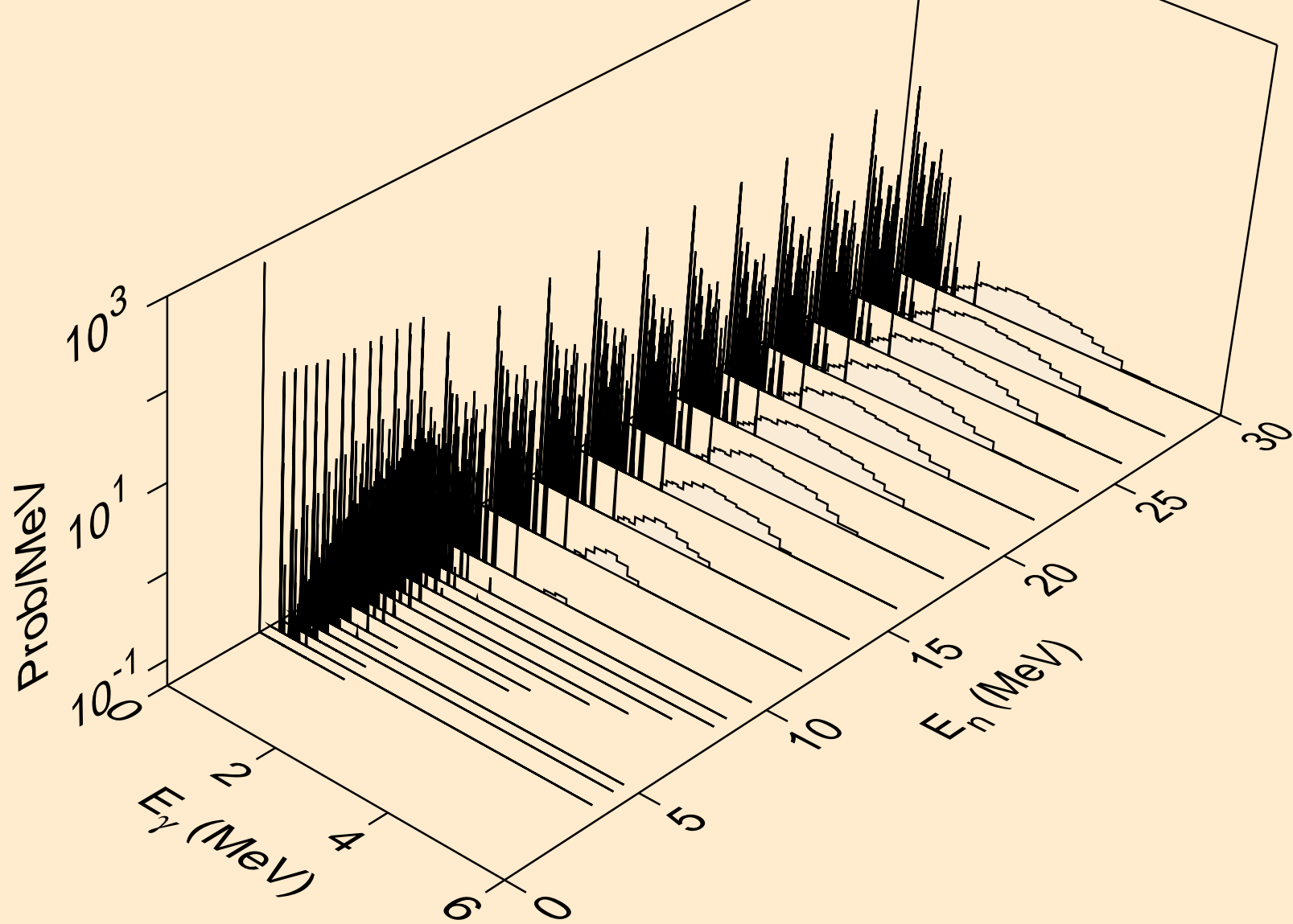

SR077 NEUTRON ACER TENDL-2024 LIBRARY; T=293.6K
Photon emission for (n,a)

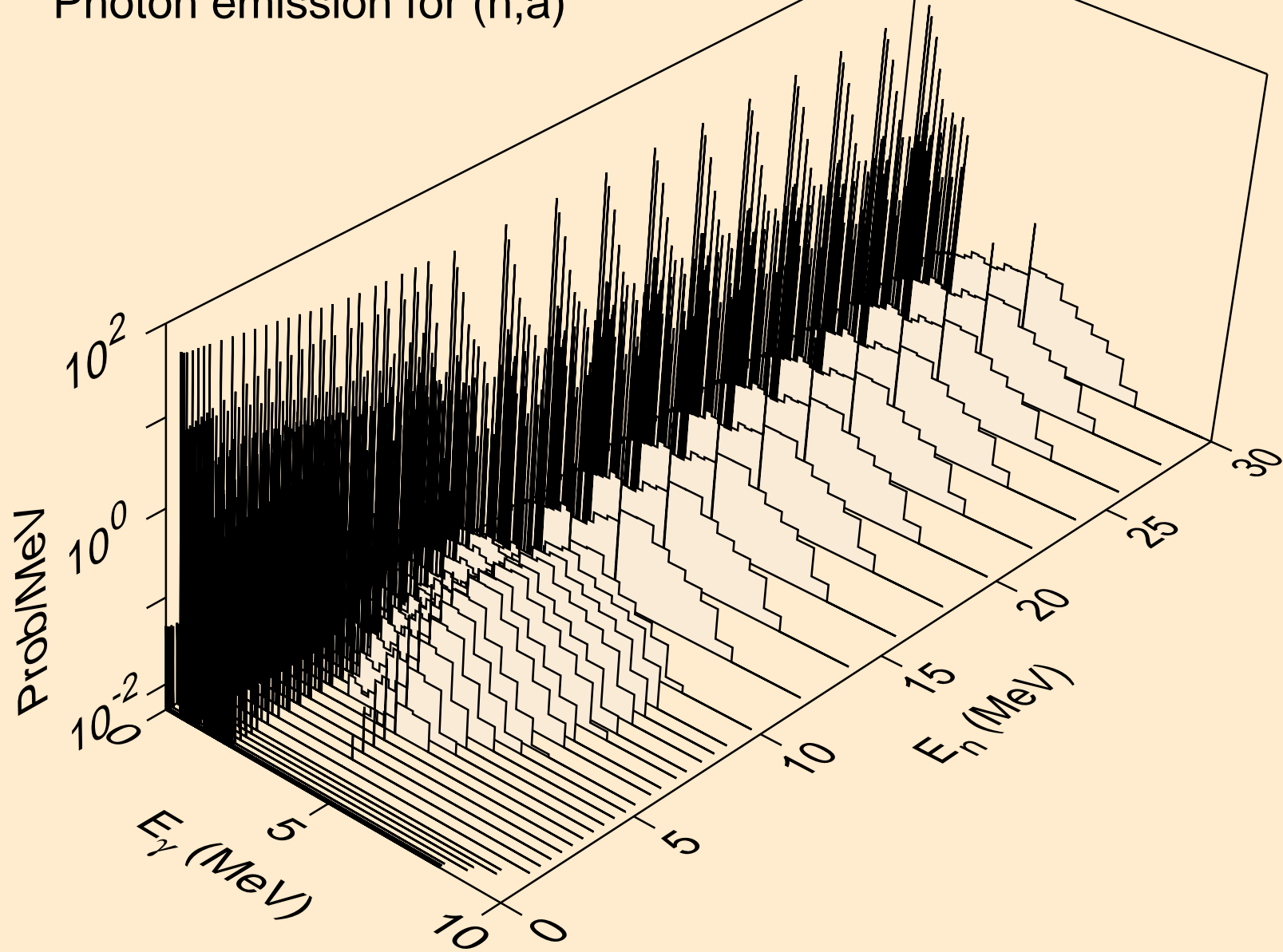

SR077 NEUTRON ACER TENDL-2024 LIBRARY; T=293.6K
Photon emission for (n,2a)

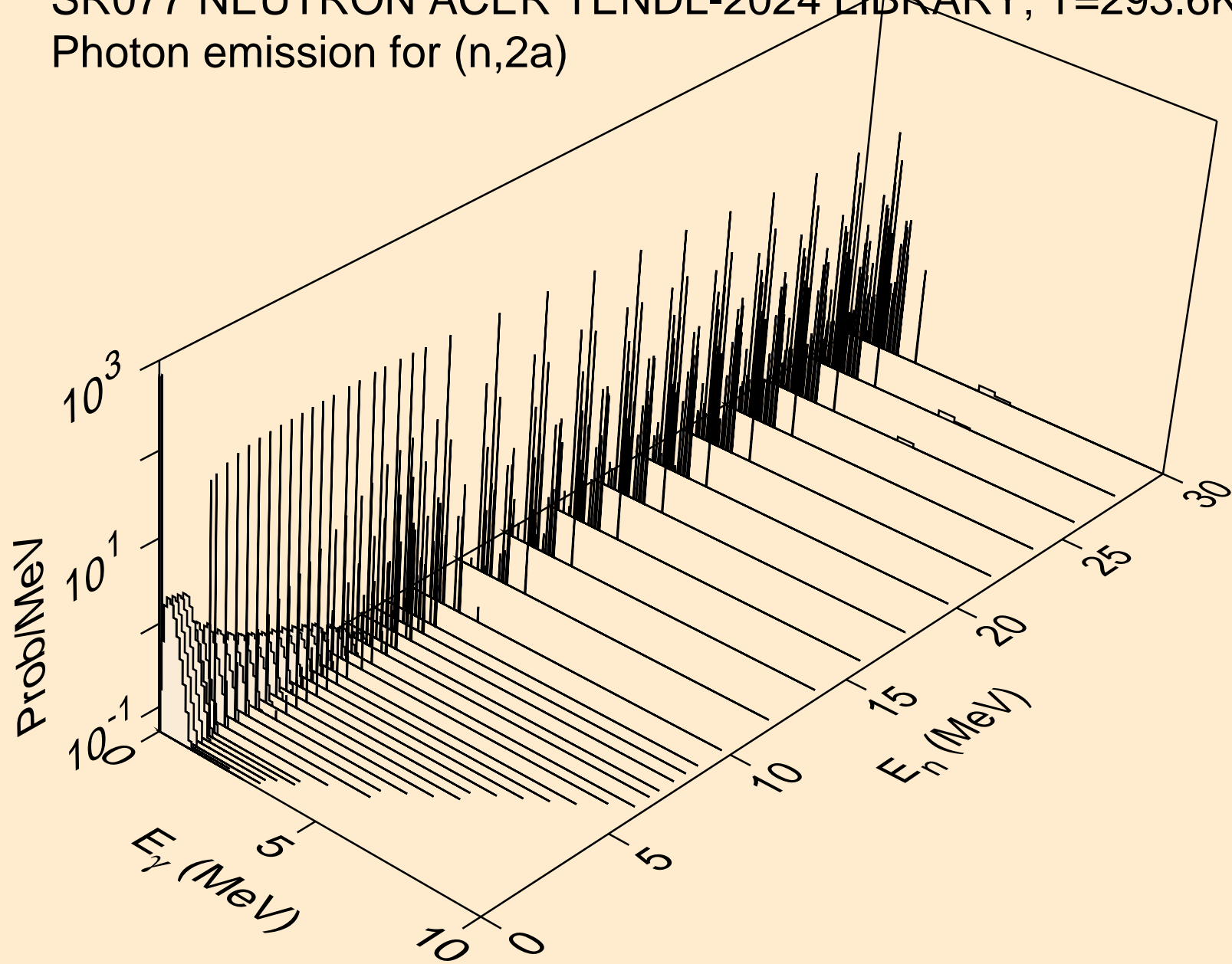

SR077 NEUTRON ACER TENDL-2024 LIBRARY; T=293.6K
Photon emission for (n,3a)

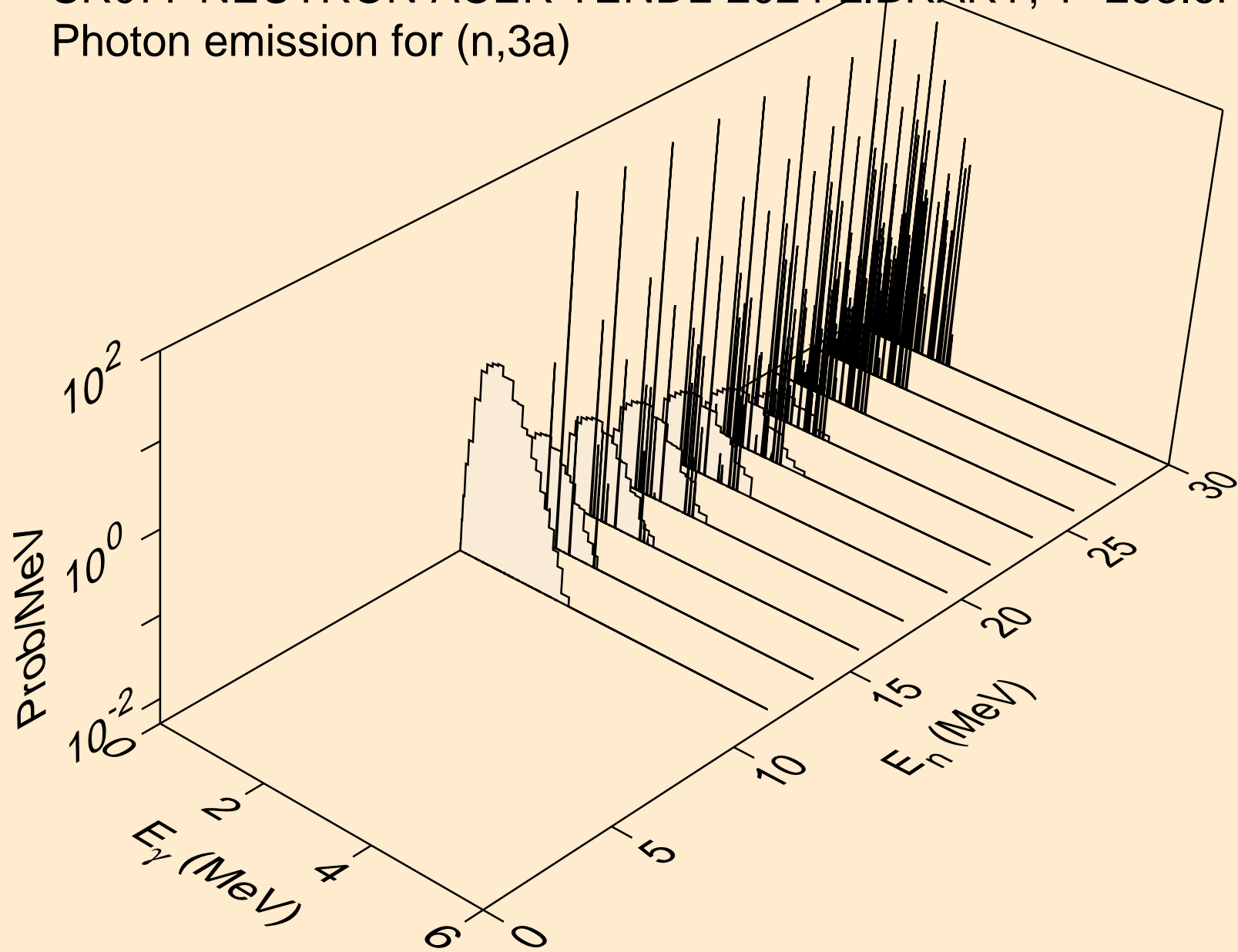

SR077 NEUTRON ACER TENDL-2024 LIBRARY; T=293.6K
Photon emission for (n,2p)

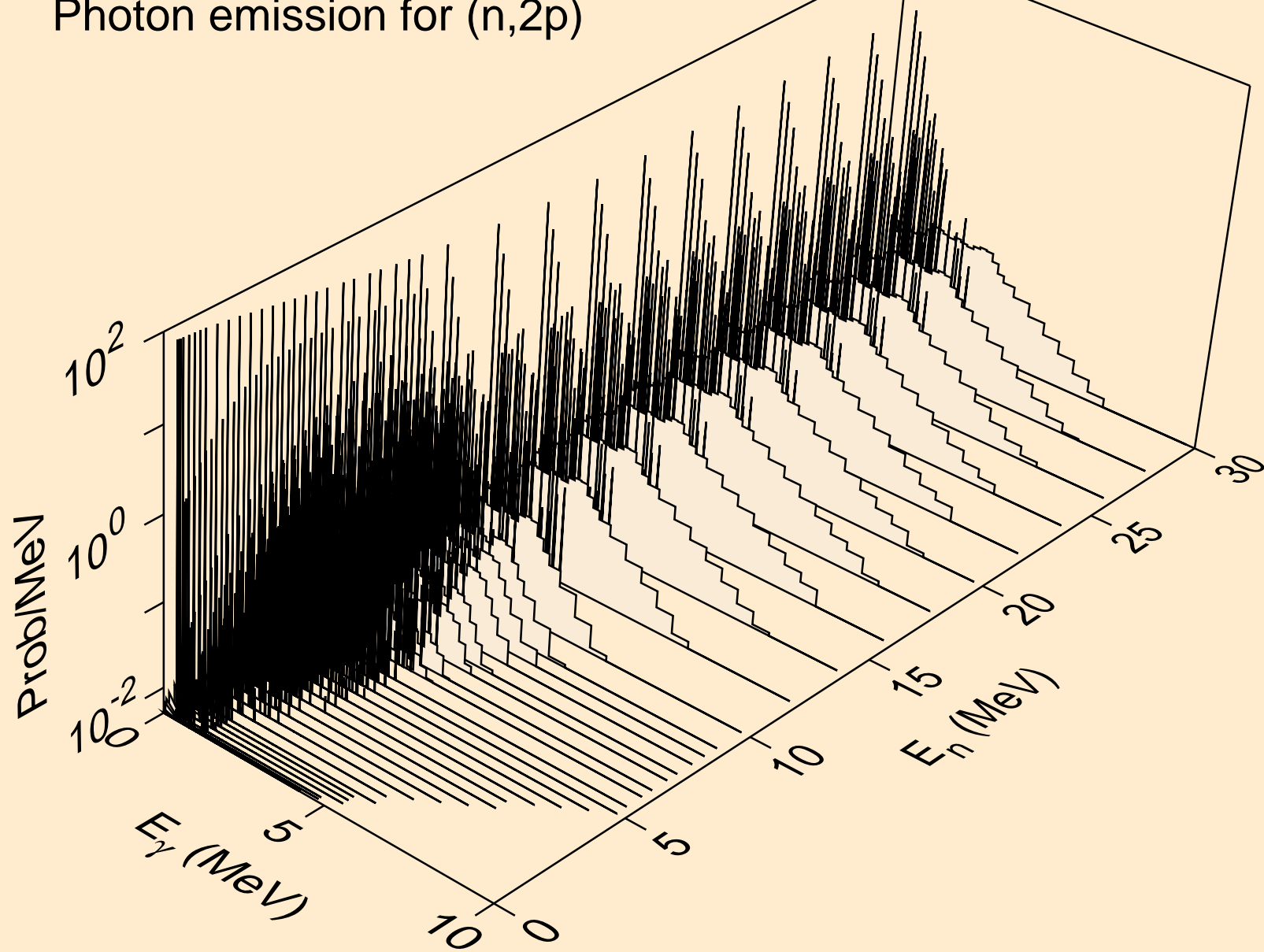

SR077 NEUTRON ACER TENDL-2024 LIBRARY; T=293.6K
Photon emission for (n,p)

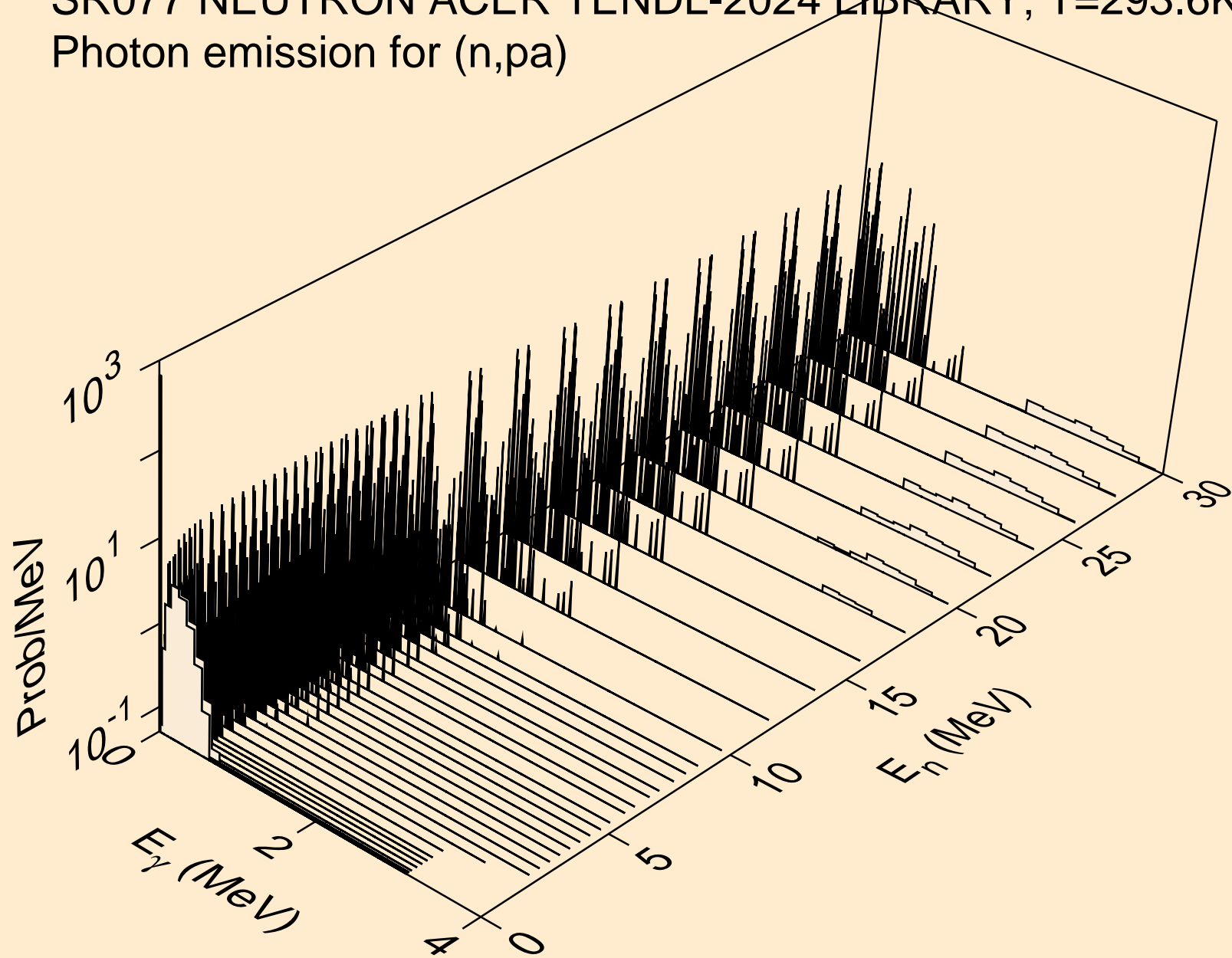

SR077 NEUTRON ACER TENDL-2024 LIBRARY; T=293.6K
Photon emission for (n,pd)

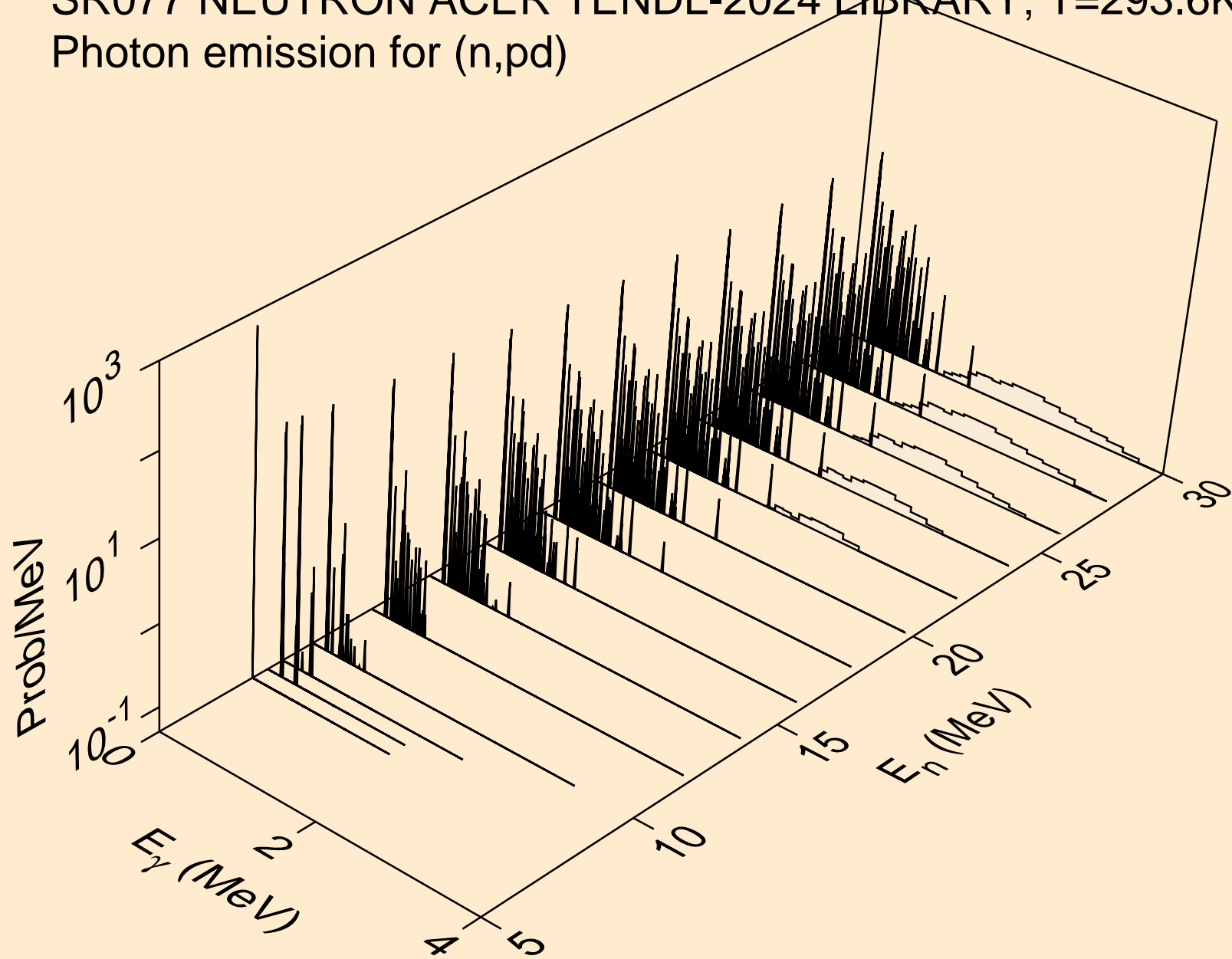

SR077 NEUTRON ACER TENDL-2024 LIBRARY; T=293.6K
Photon emission for (n,pt)

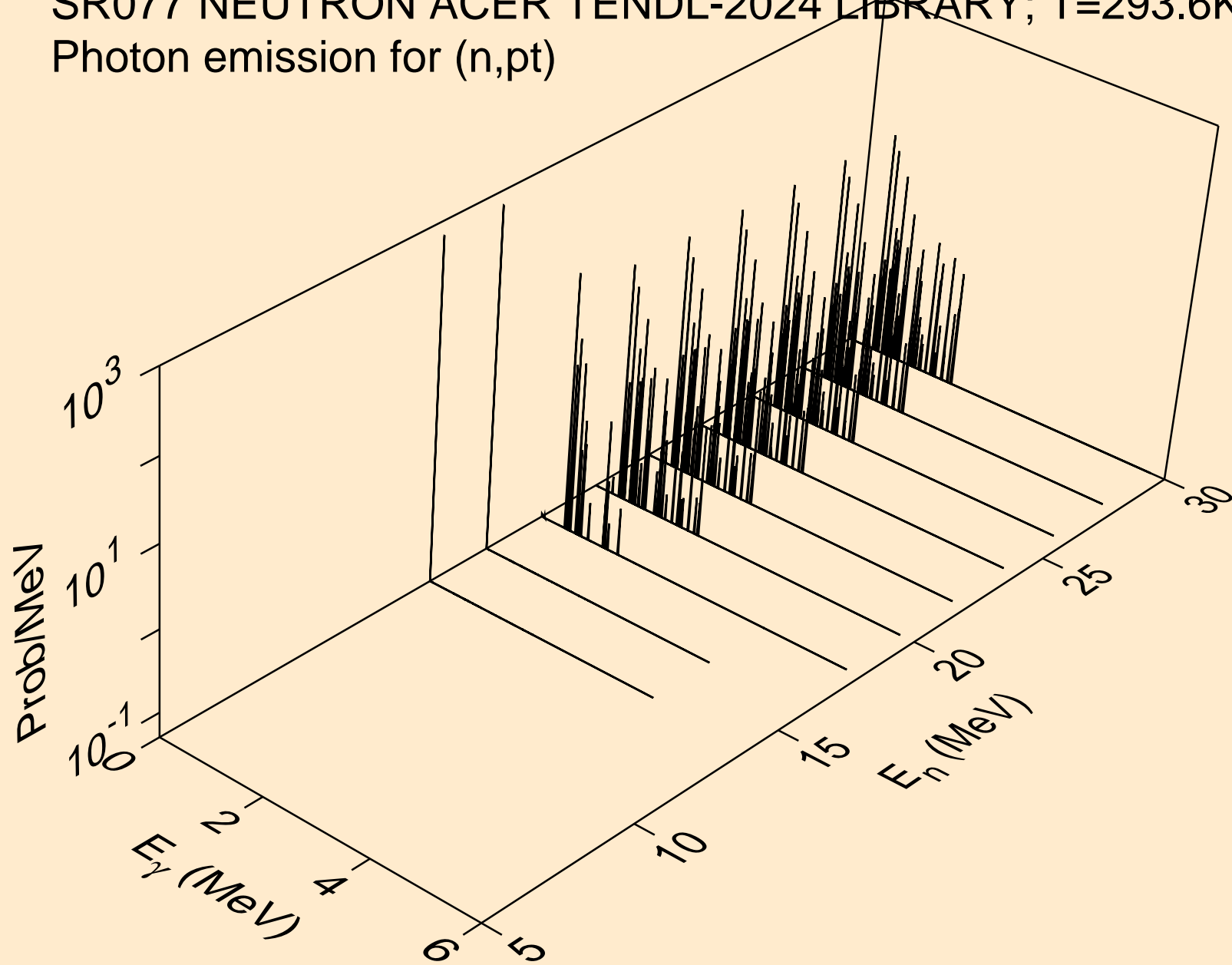

SR077 NEUTRON ACER TENDL-2024 LIBRARY; T=293.6K
Photon emission for (n,da)

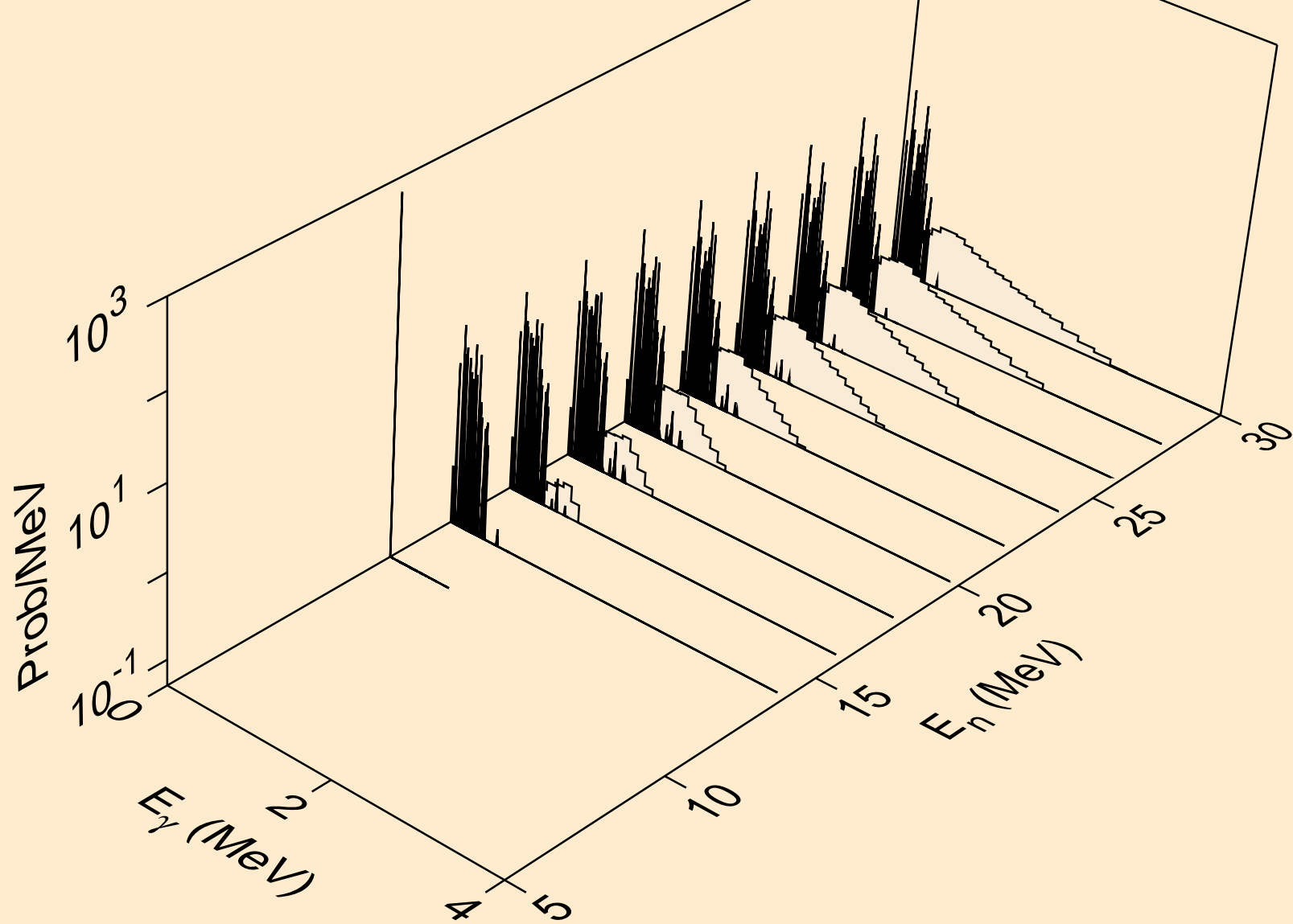

SR077 NEUTRON ACER TENDL-2024 LIBRARY; T=293.6K
thermal capture photon spectrum

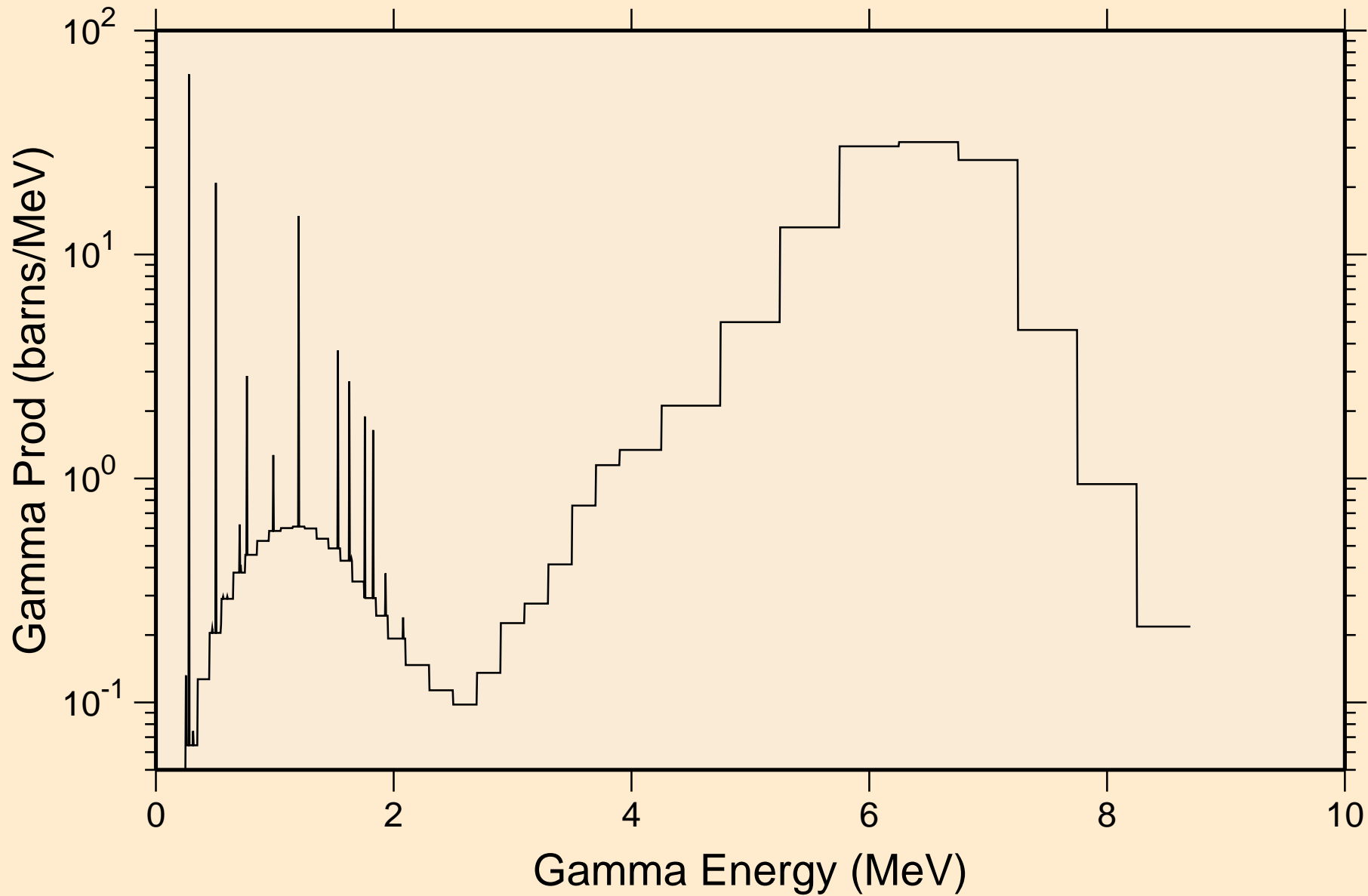

SR077 NEUTRON ACER TENDL-2024 LIBRARY; T=293.6K
14 MeV photon spectrum

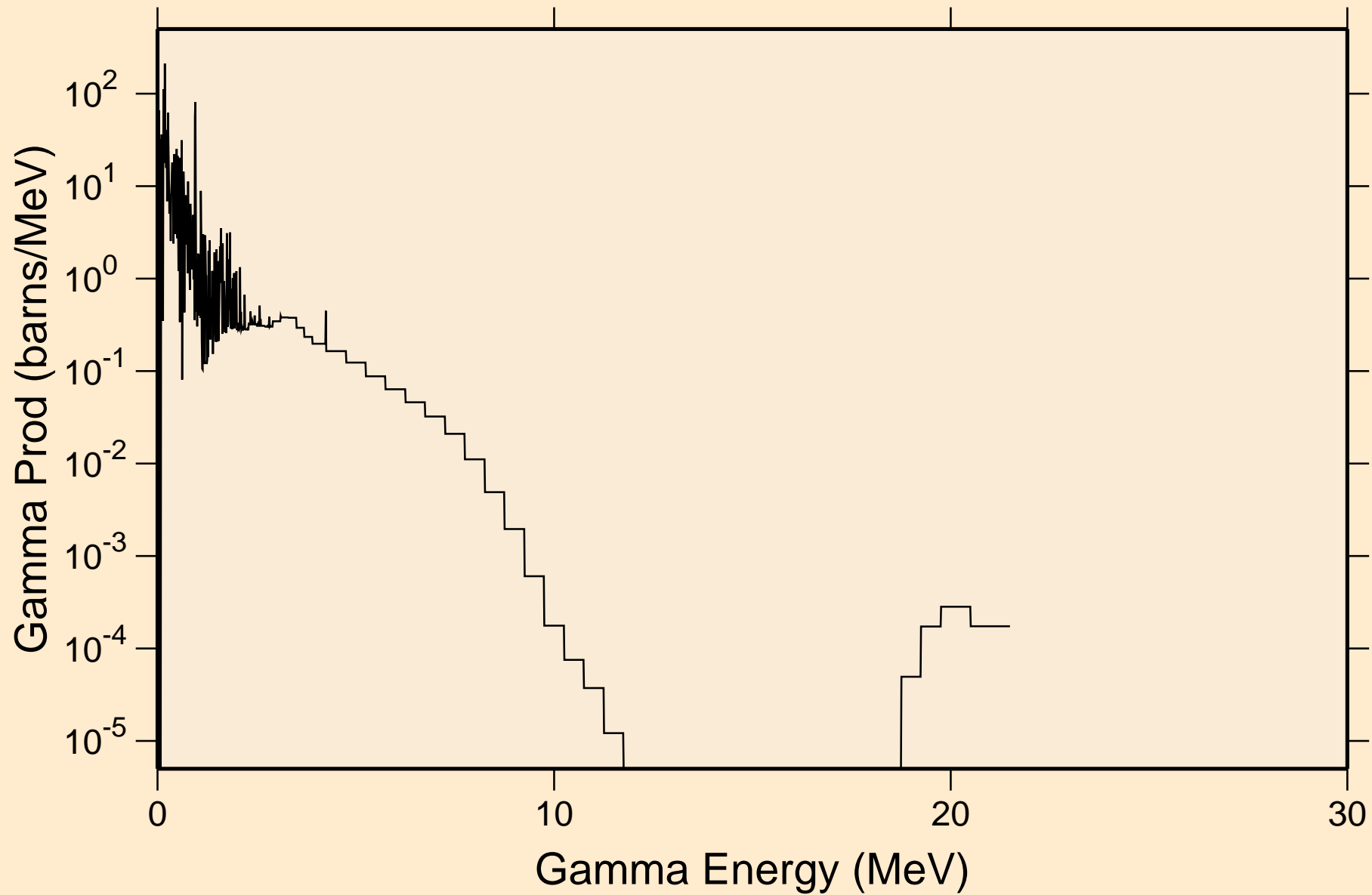

SR077 NEUTRON ACER TENDL-2024 LIBRARY; T=293.6K

Particle heating contributions

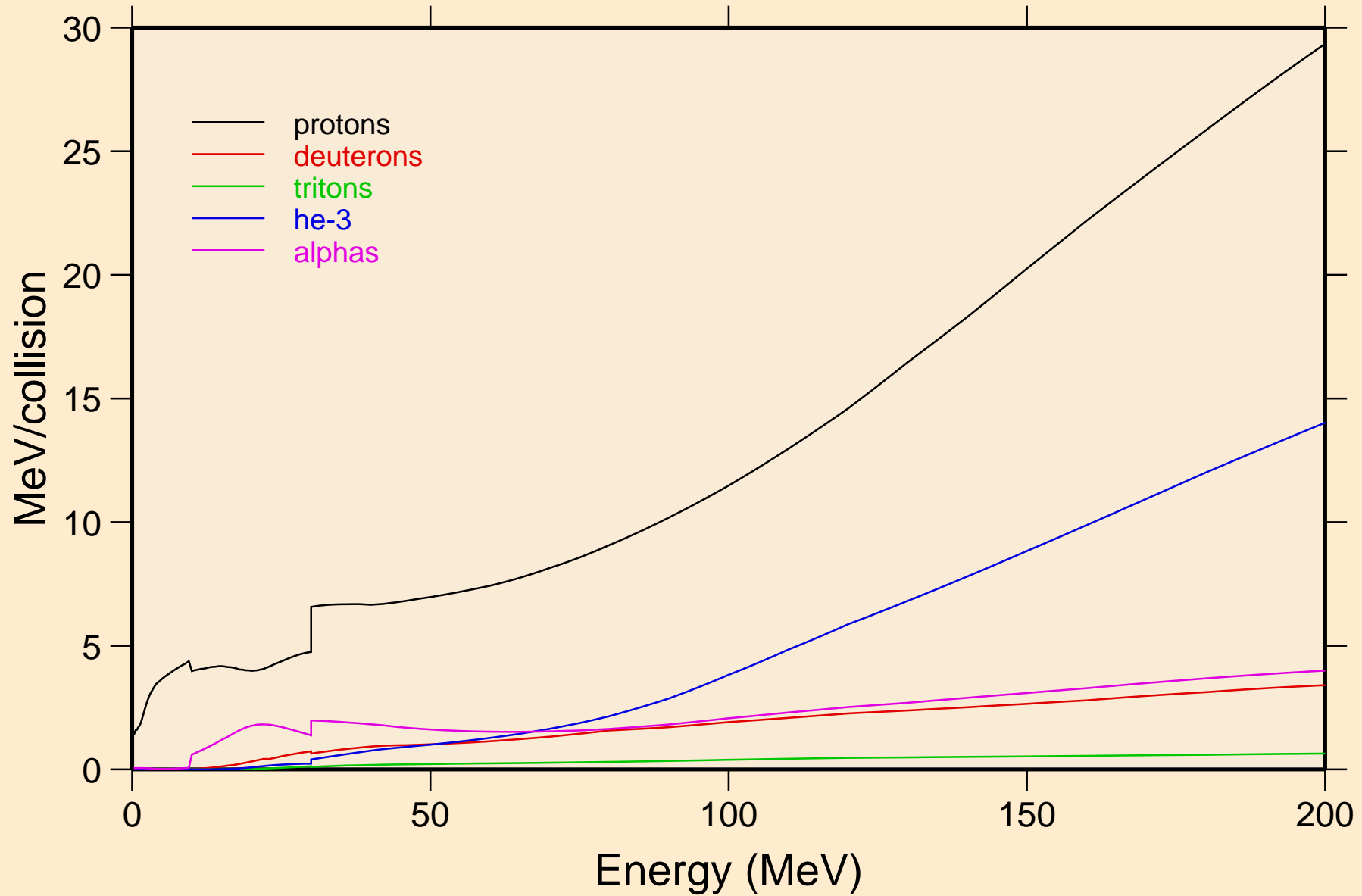

SR077 NEUTRON ACER TENDL-2024 LIBRARY; T=293.6K
Recoil Heating

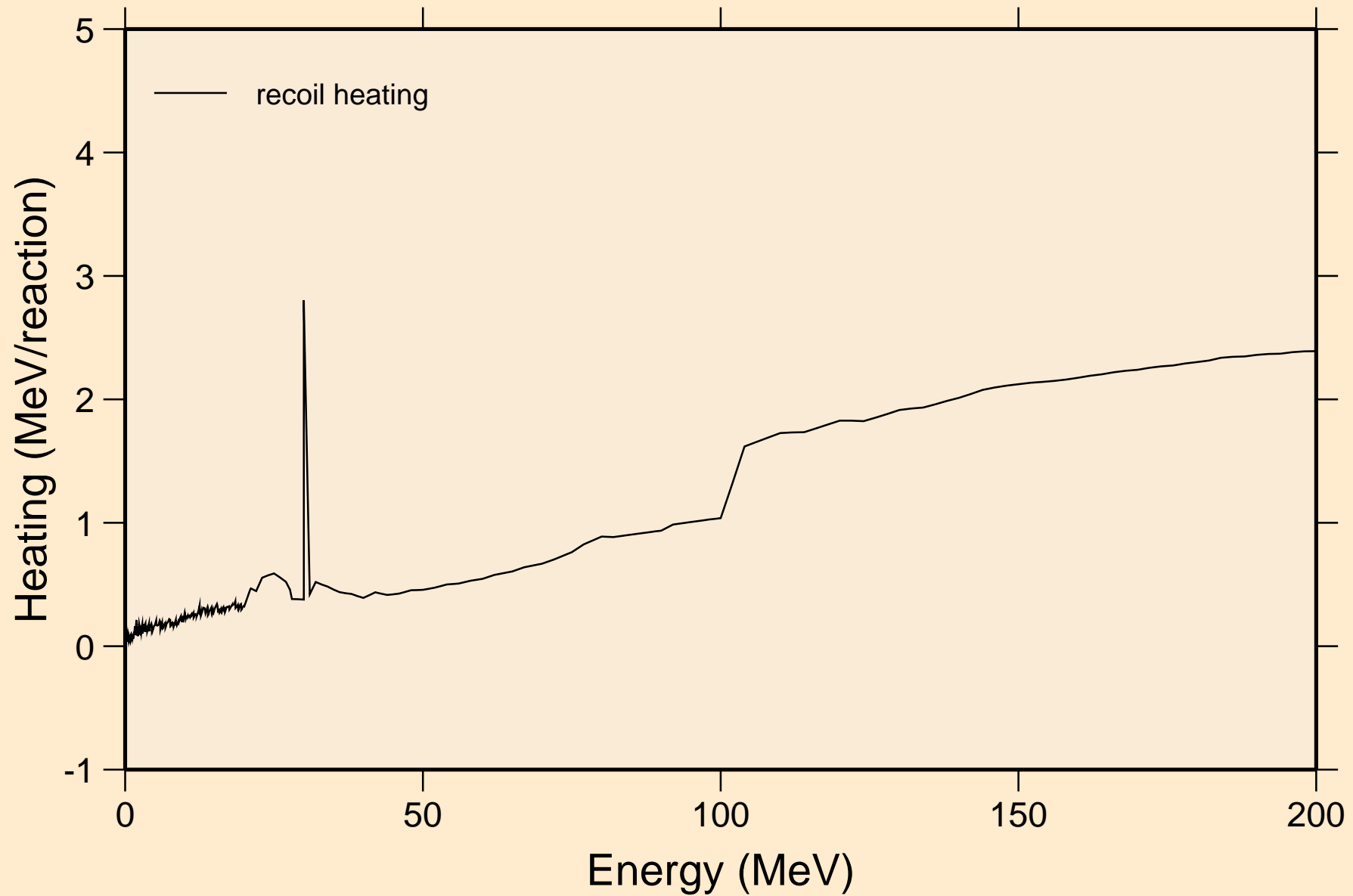

SR077 NEUTRON ACER TENDL-2024 LIBRARY; T=293.6K

Particle production cross sections

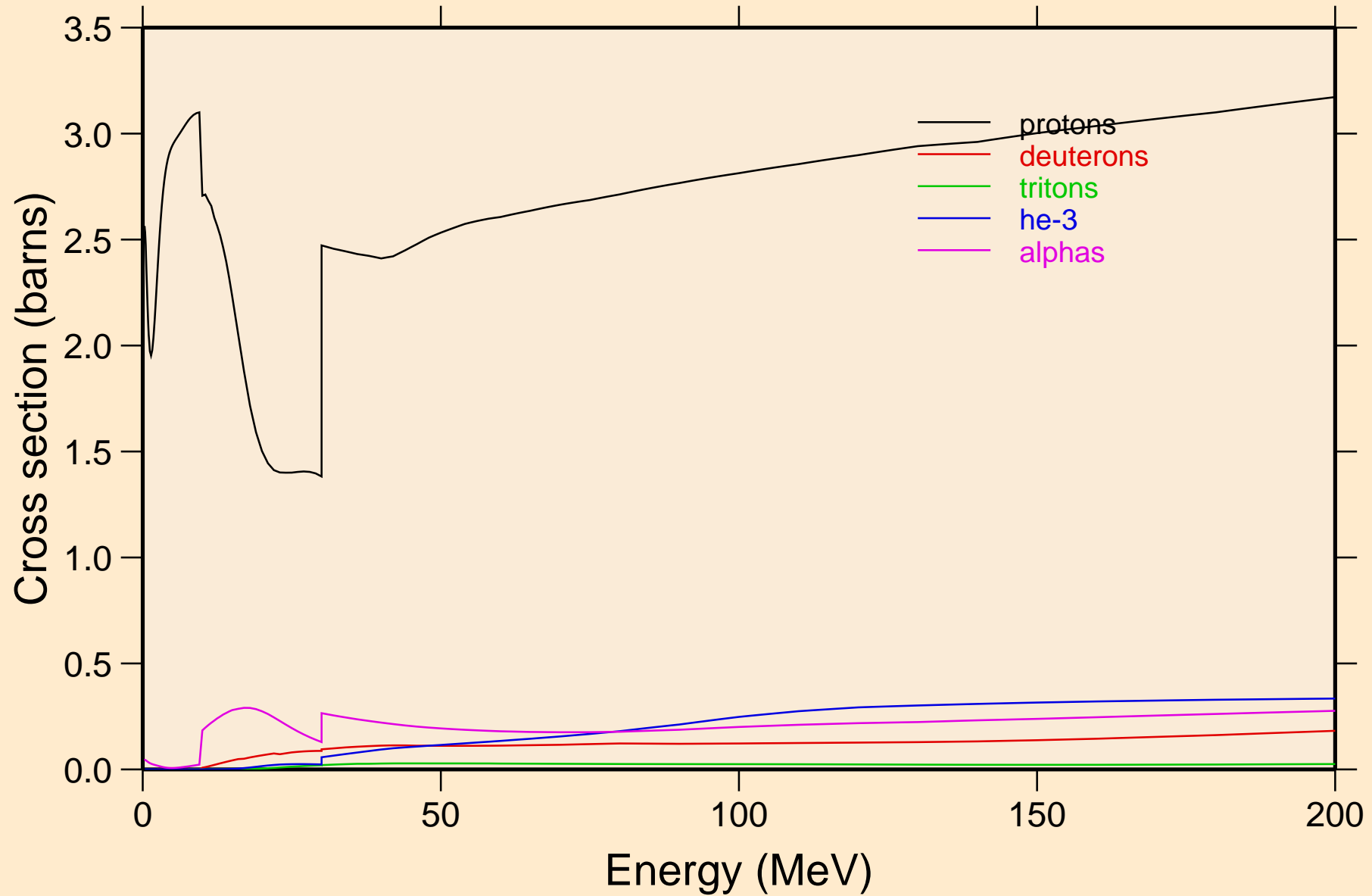

SR077 NEUTRON ACER TENDL-2024 LIBRARY; T=293.6K
protons from (n,x)

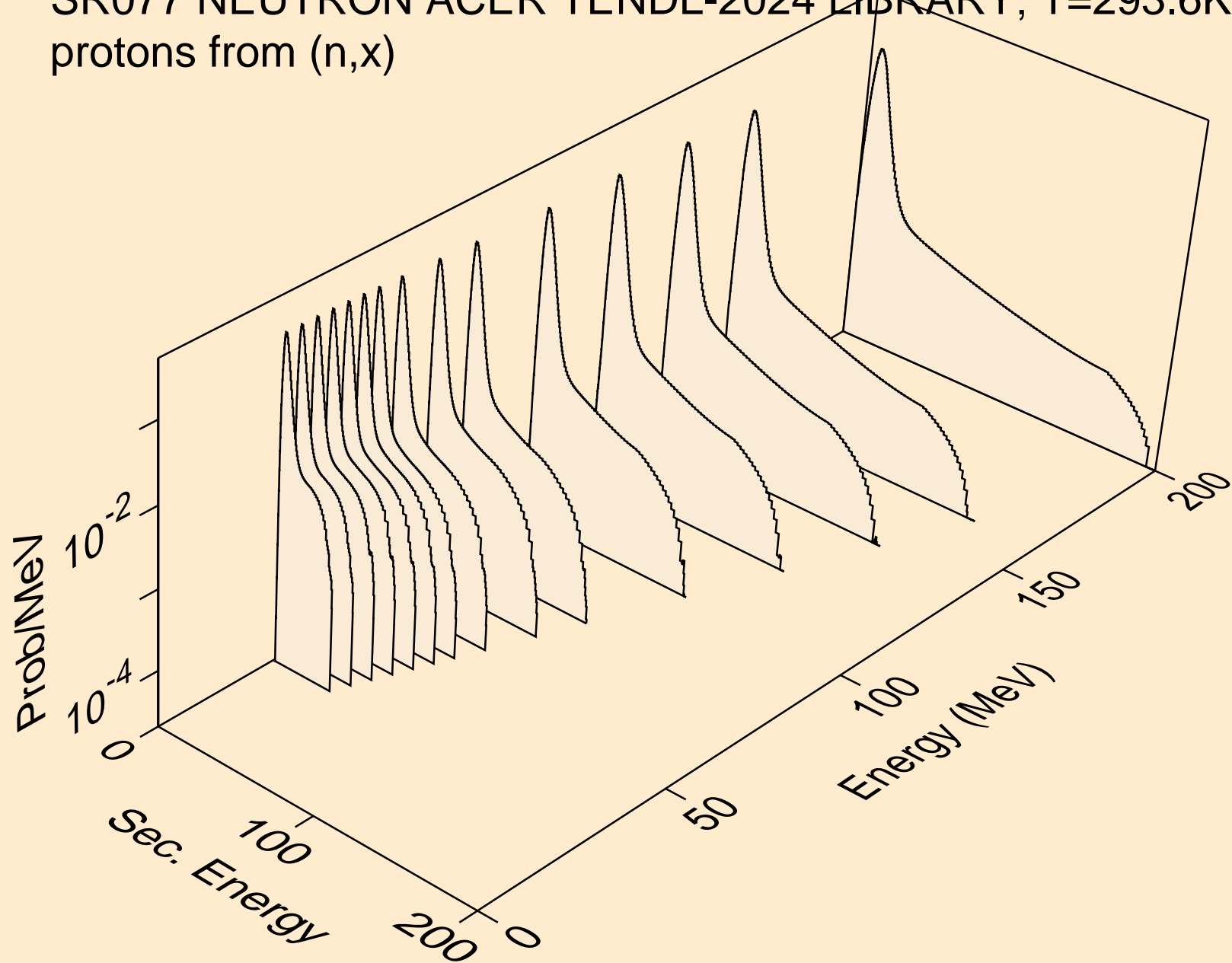

SR077 NEUTRON ACER TENDL-2024 LIBRARY; T=293.6K
protons from (n,n*)p

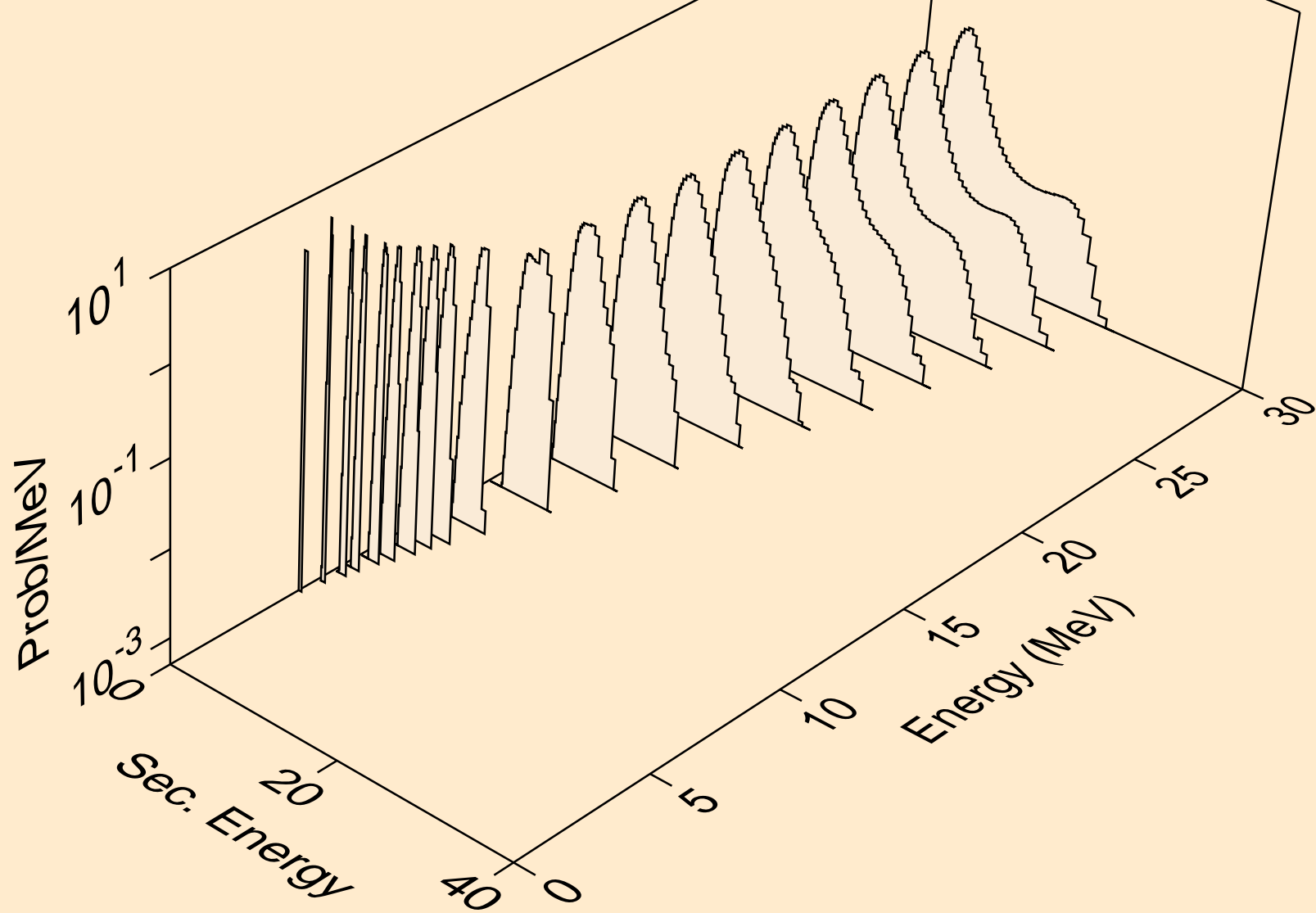

SR077 NEUTRON ACER TENDL-2024 LIBRARY; T=293.6K
protons from (n,2np)

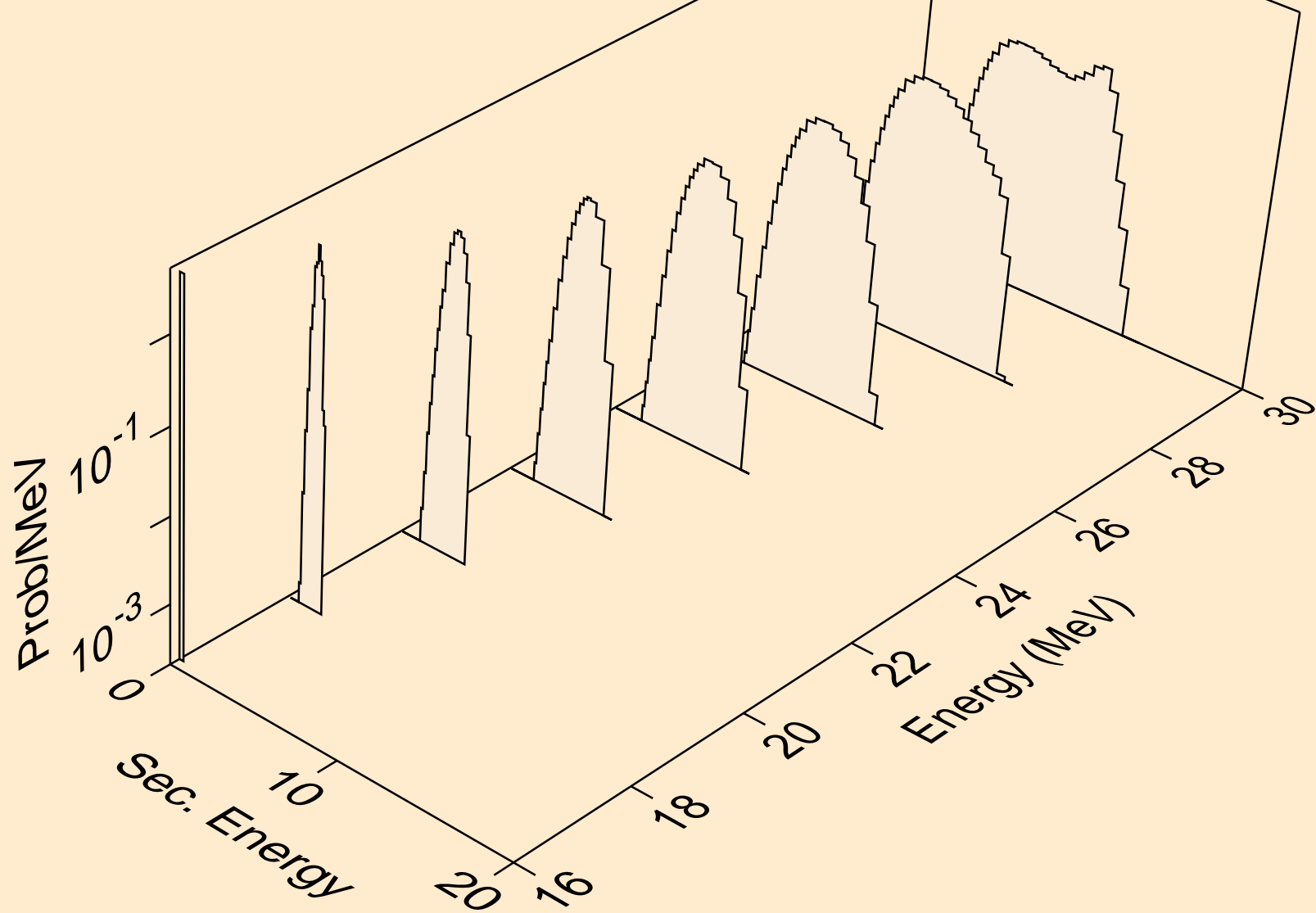

SR077 NEUTRON ACER TENDL-2024 LIBRARY; T=293.6K
protons from (n,n2p)

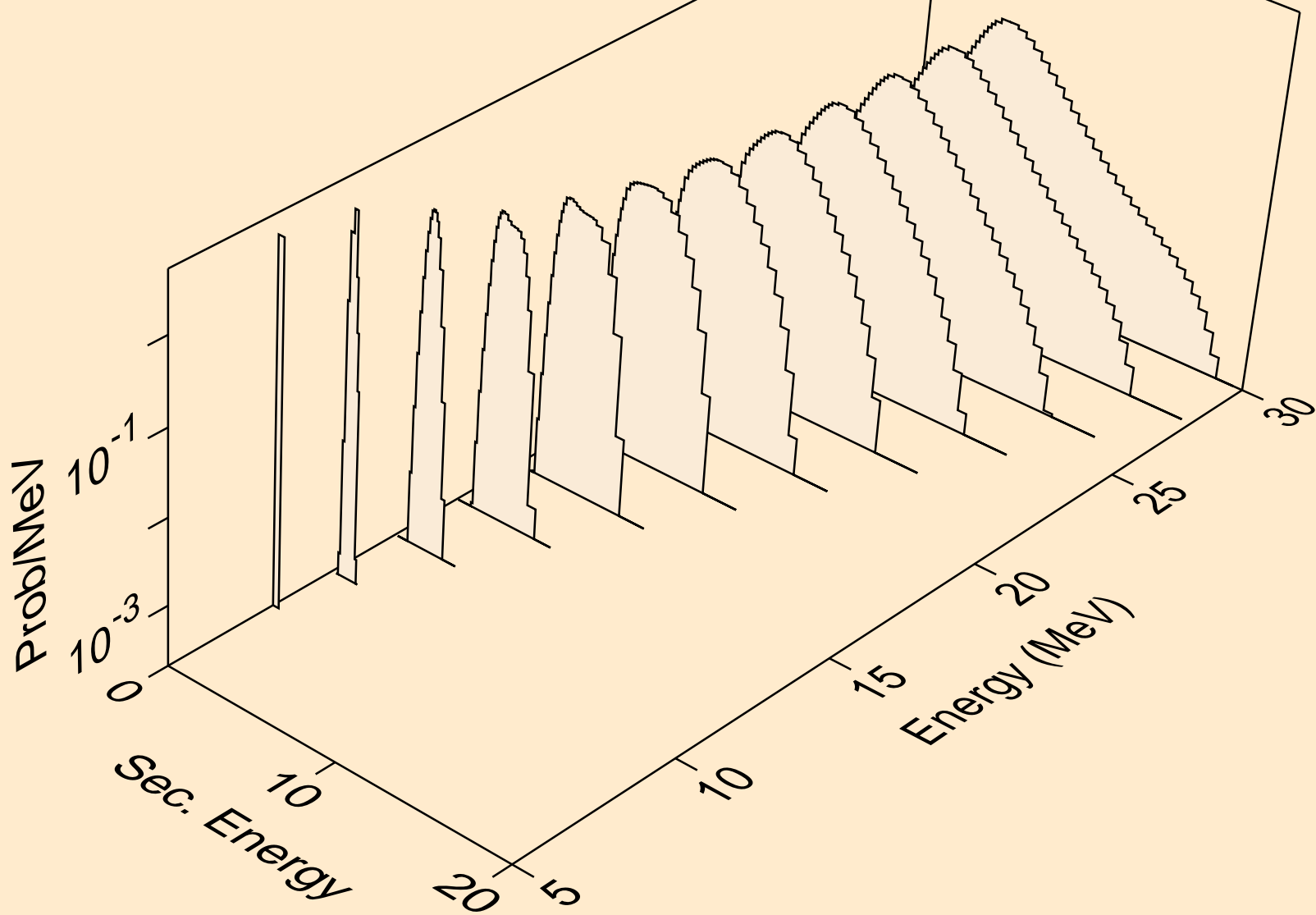

SR077 NEUTRON ACER TENDL-2024 LIBRARY; T=293.6K
protons from (n,npa)

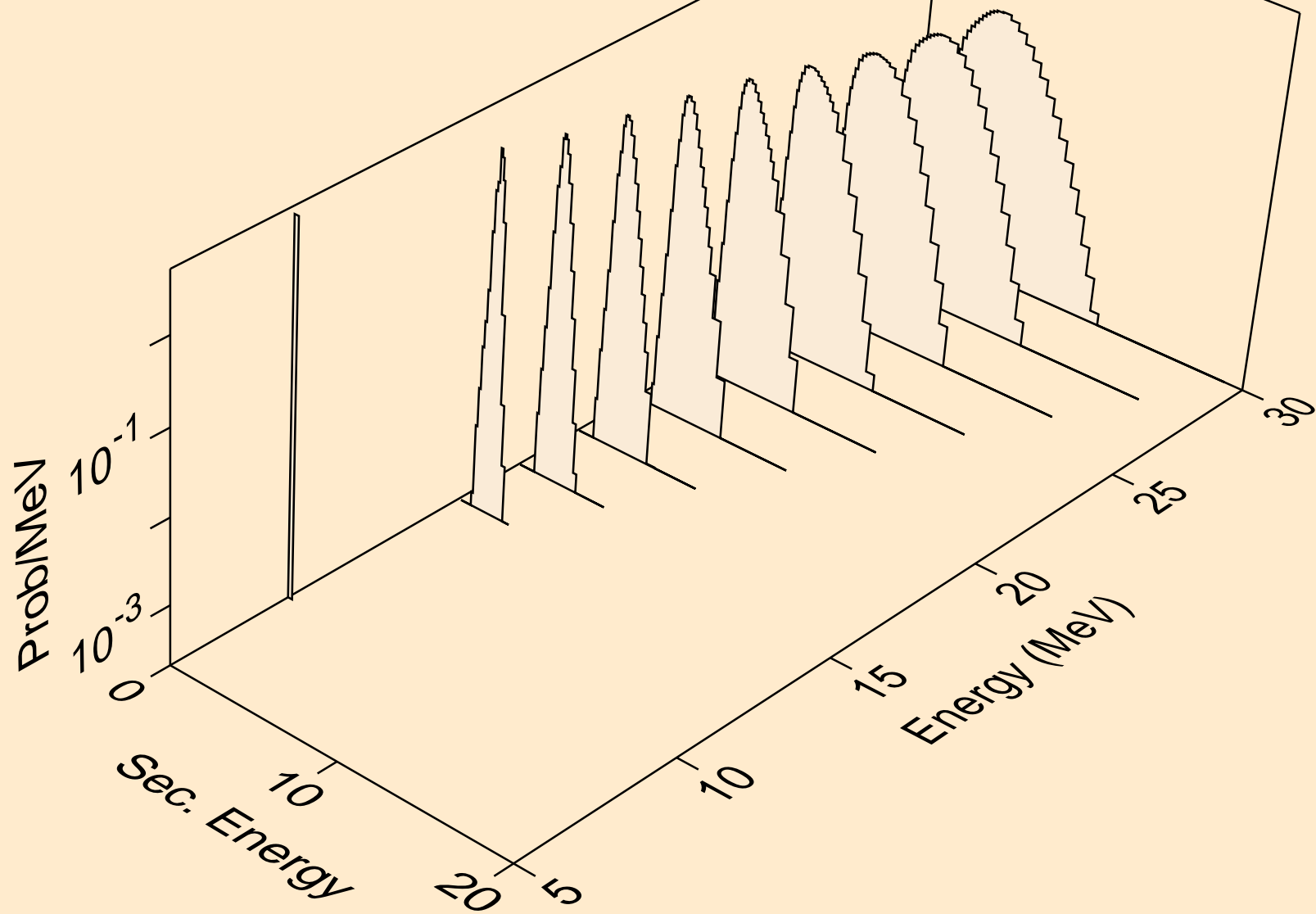

SR077 NEUTRON ACER TENDL-2024 LIBRARY; T=293.6K
protons from (n,p)

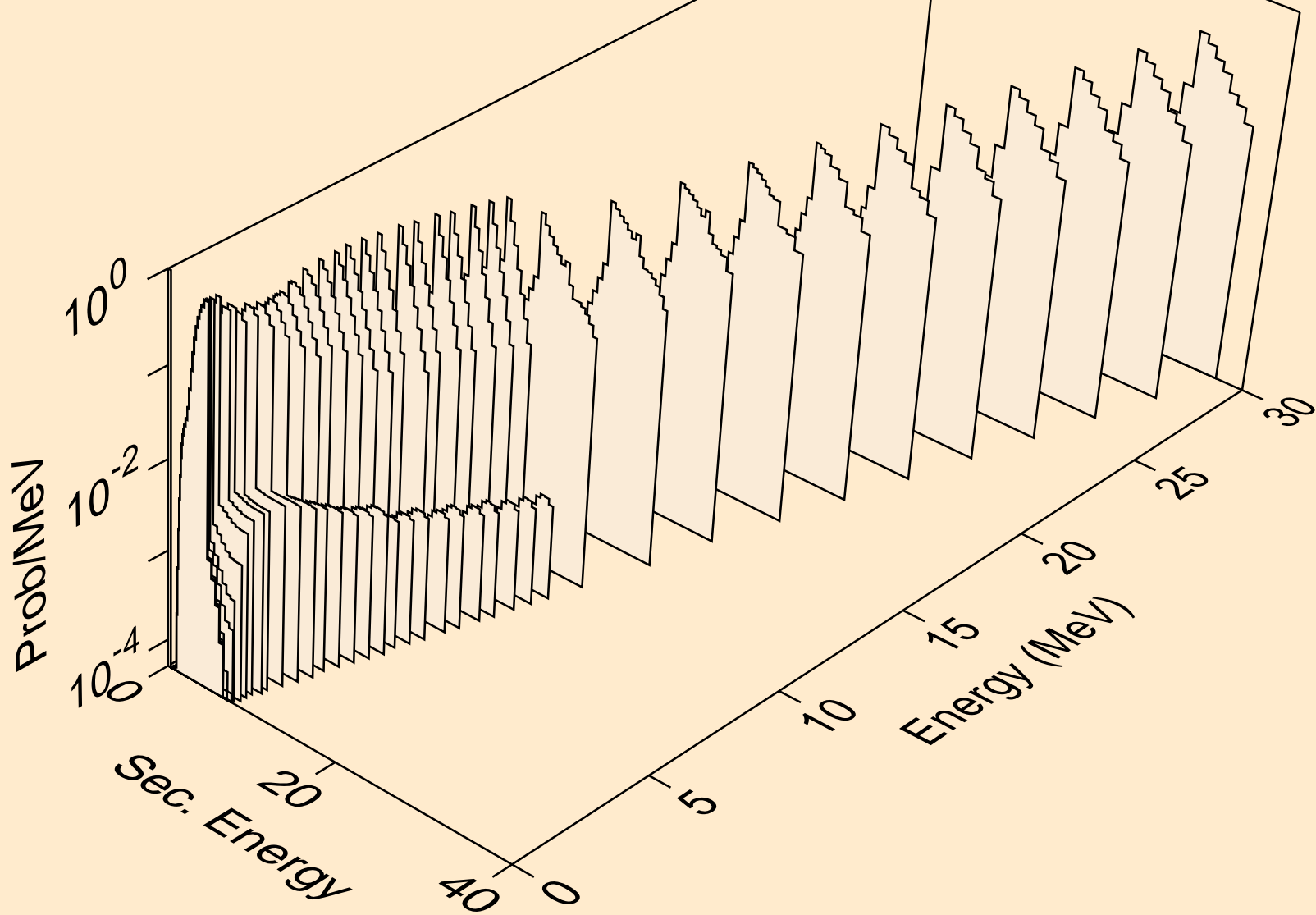

SR077 NEUTRON ACER TENDL-2024 LIBRARY; T=293.6K
protons from (n,2p)

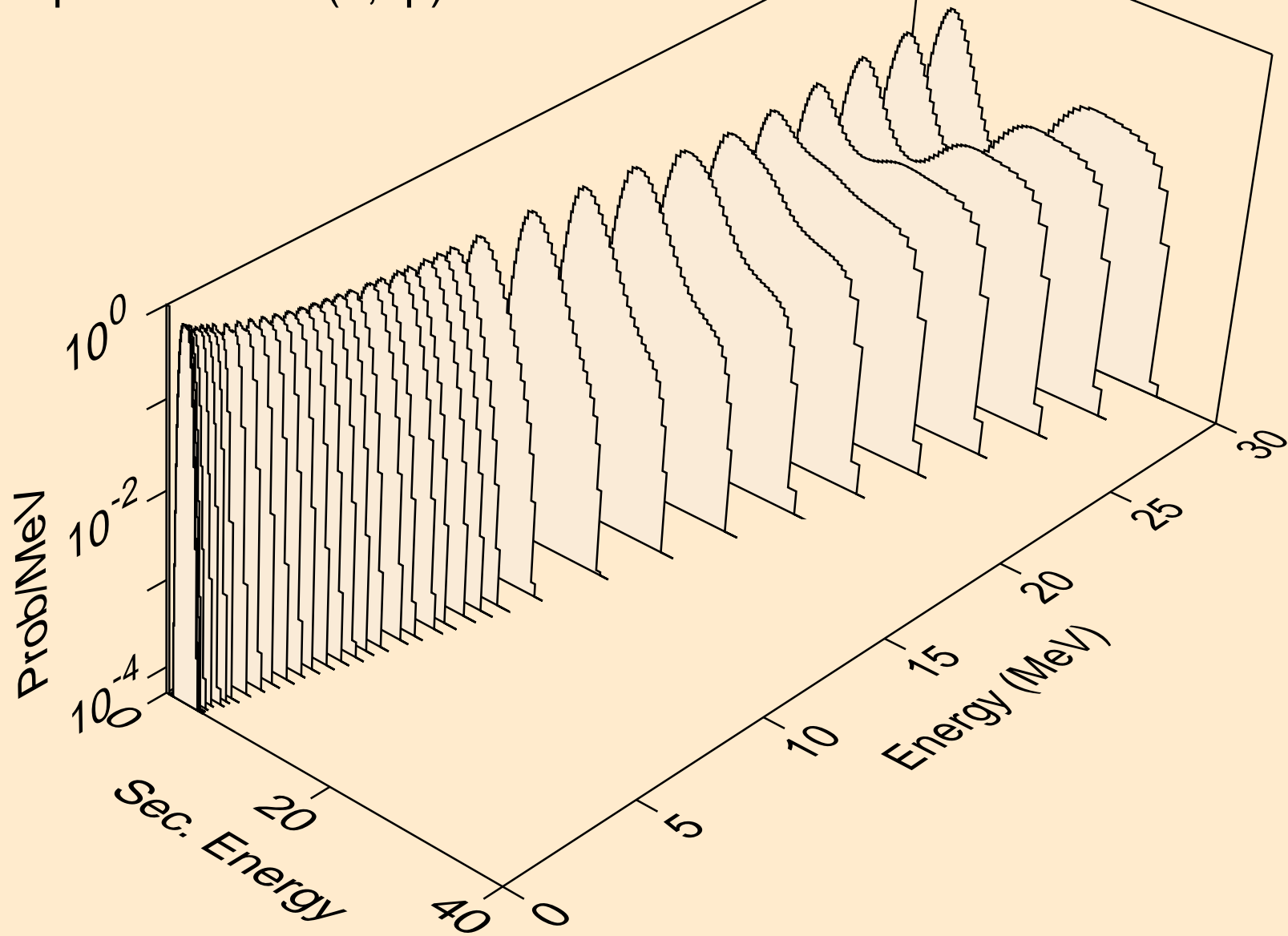

SR077 NEUTRON ACER TENDL-2024 LIBRARY; T=293.6K
protons from (n,p)

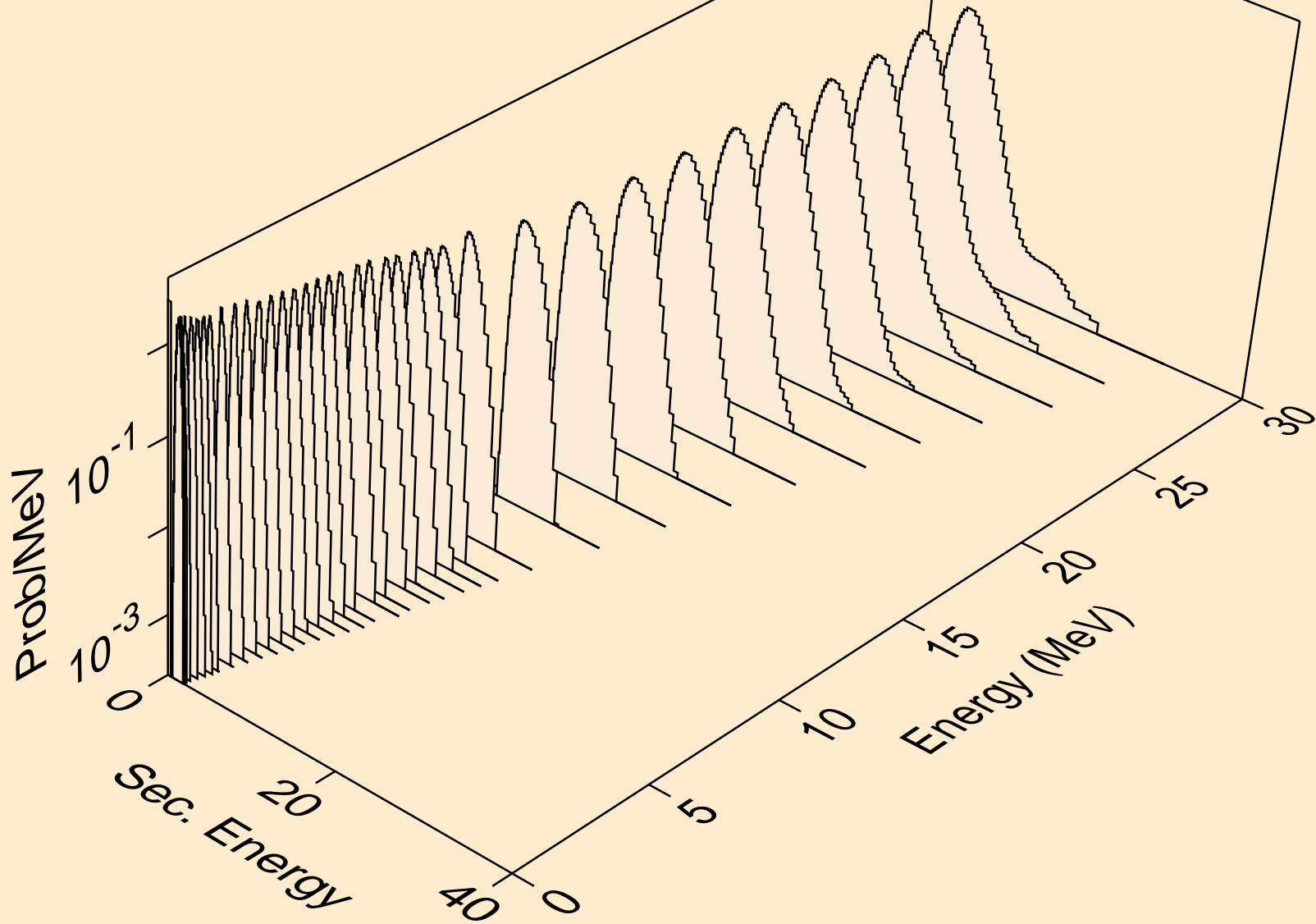

SR077 NEUTRON ACER TENDL-2024 LIBRARY; T=293.6K
protons from (n,pd)

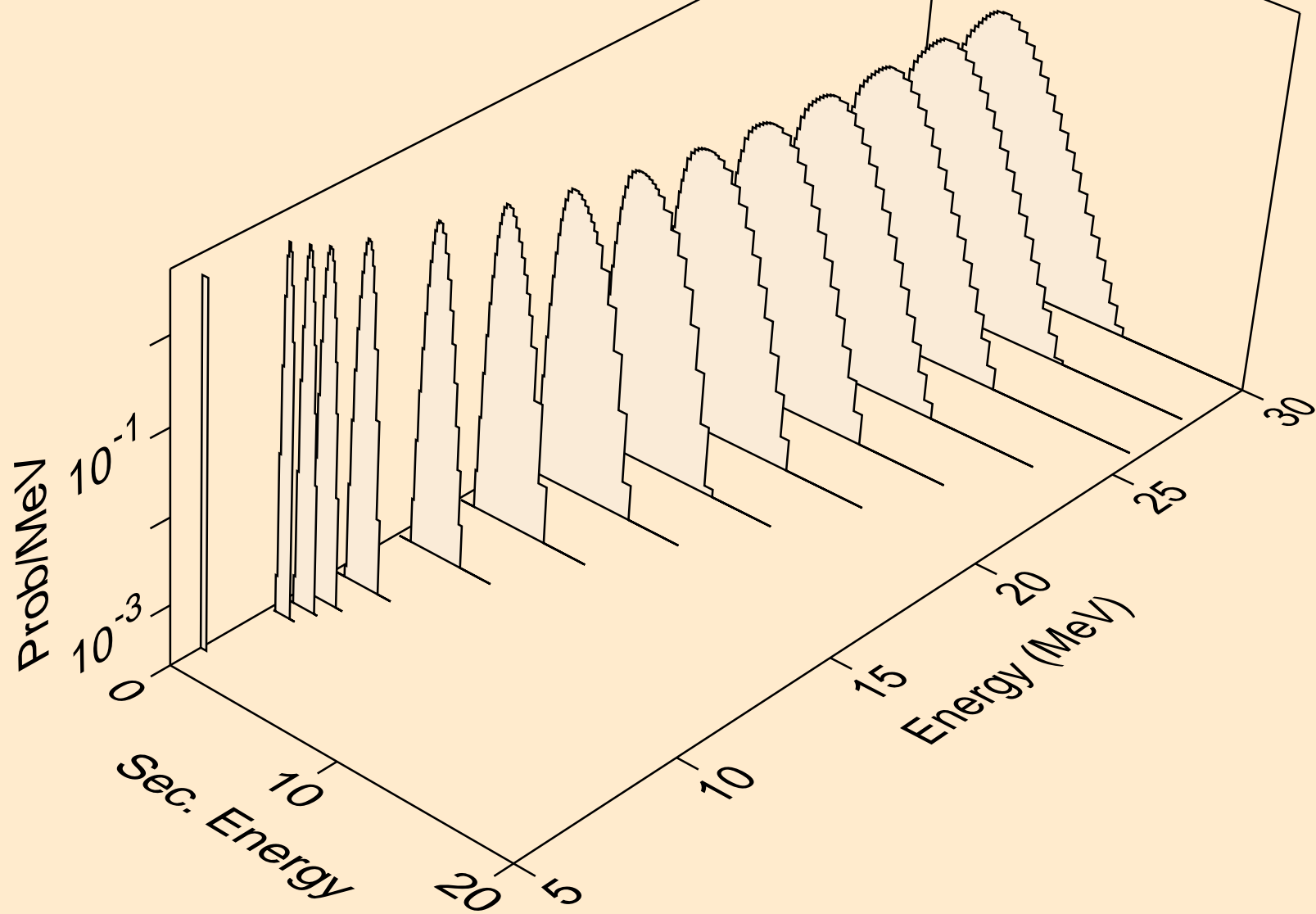

SR077 NEUTRON ACER TENDL-2024 LIBRARY; T=293.6K
protons from (n,pt)

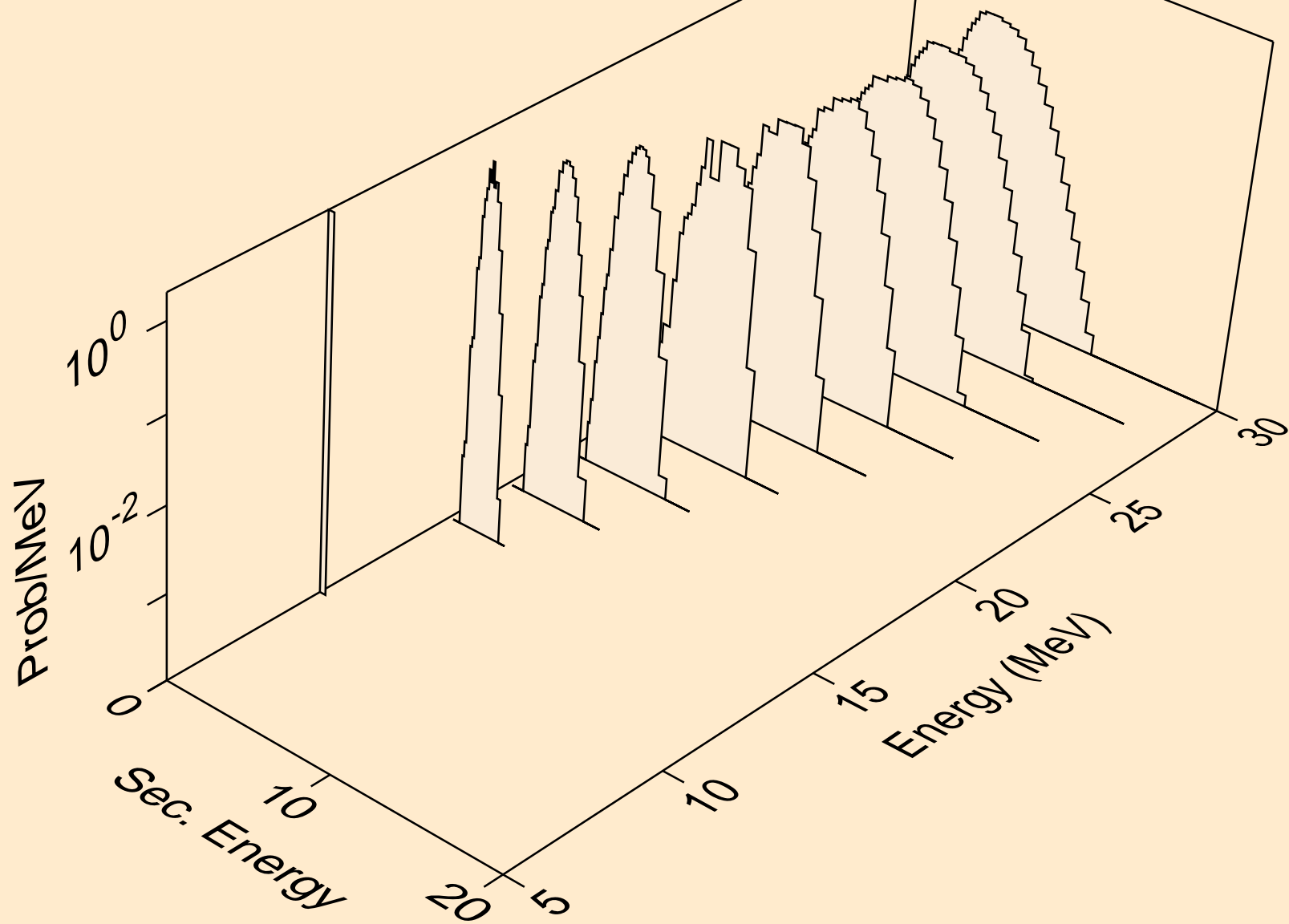

SR077 NEUTRON ACER TENDL-2024 LIBRARY; T=293.6K
deuterons from (n,x)



SR077 NEUTRON ACER TENDL-2024 LIBRARY; T=293.6K
deuterons from (n,n*)d

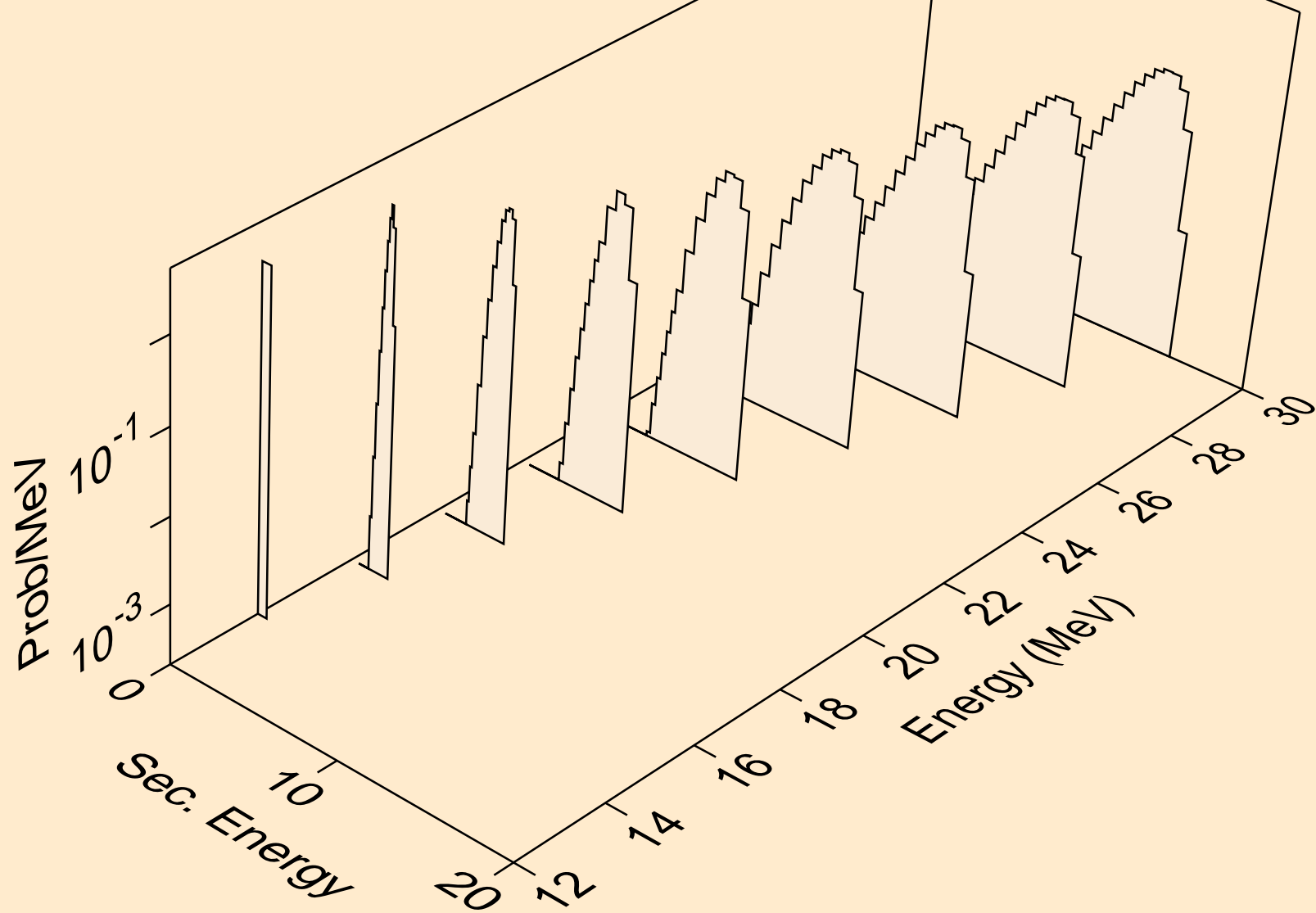

SR077 NEUTRON ACER TENDL-2024 LIBRARY; T=293.6K
deuterons from (n,d)

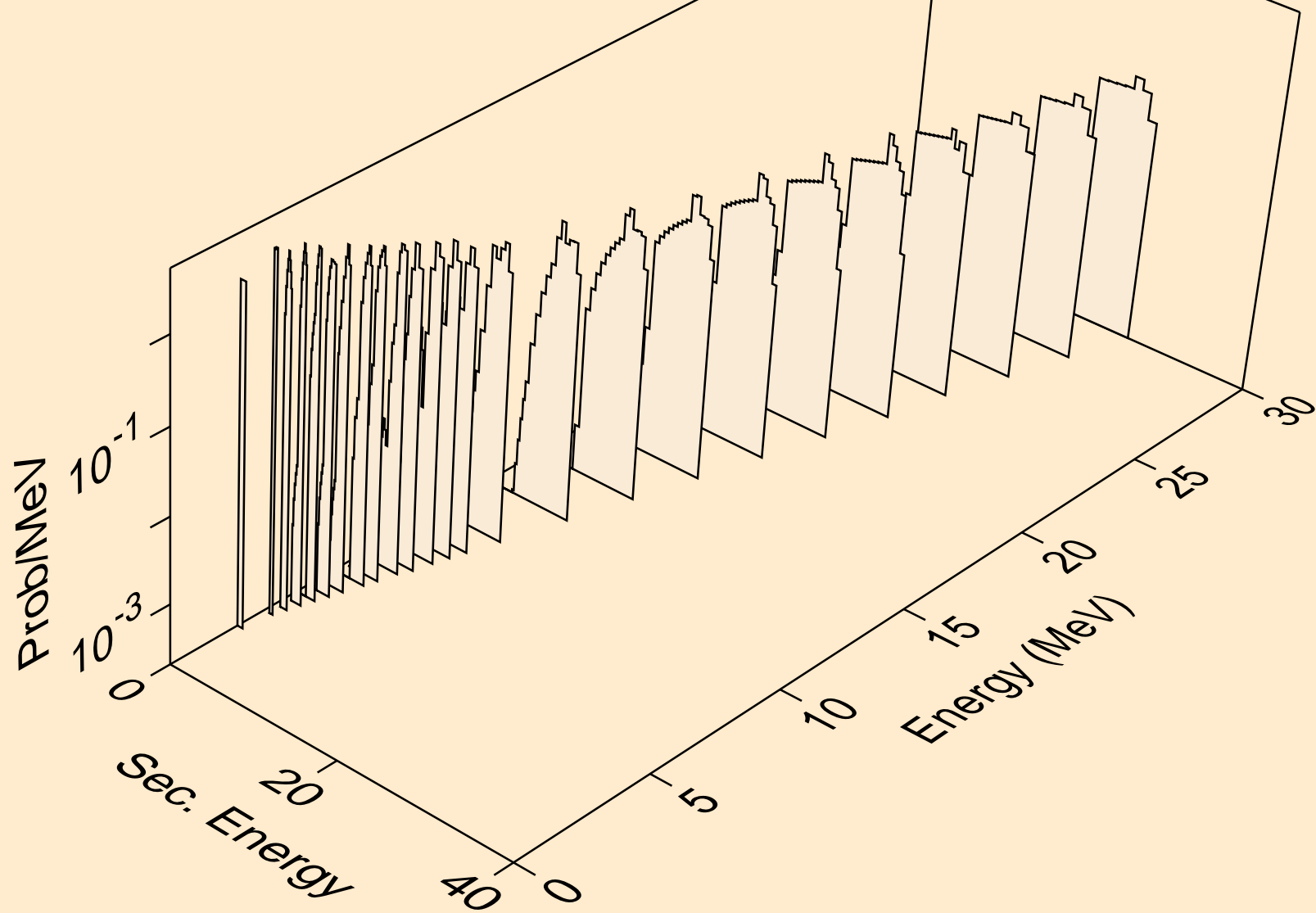

SR077 NEUTRON ACER TENDL-2024 LIBRARY; T=293.6K
deuterons from (n,pd)

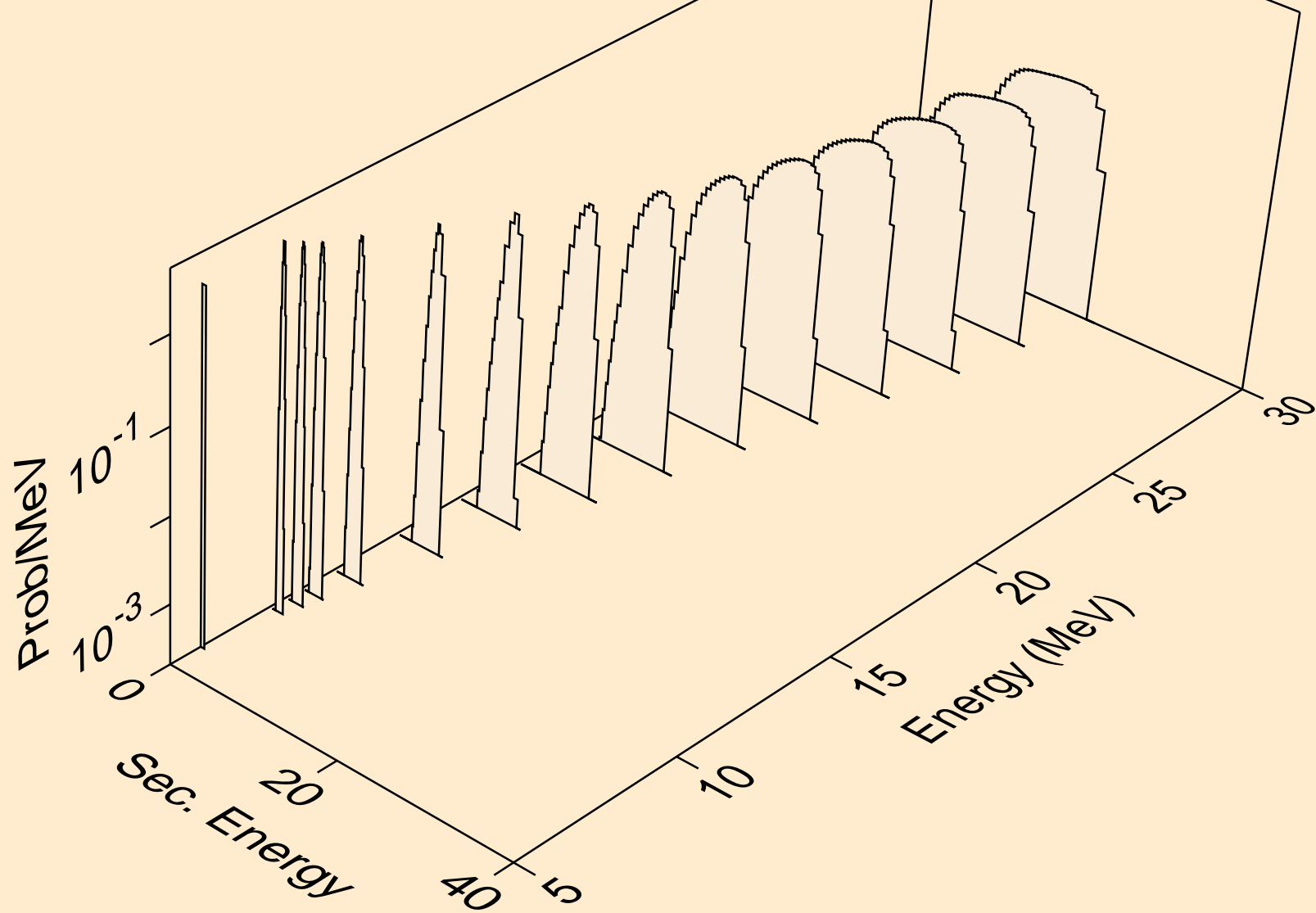

SR077 NEUTRON ACER TENDL-2024 LIBRARY; T=293.6K
deuterons from (n,da)

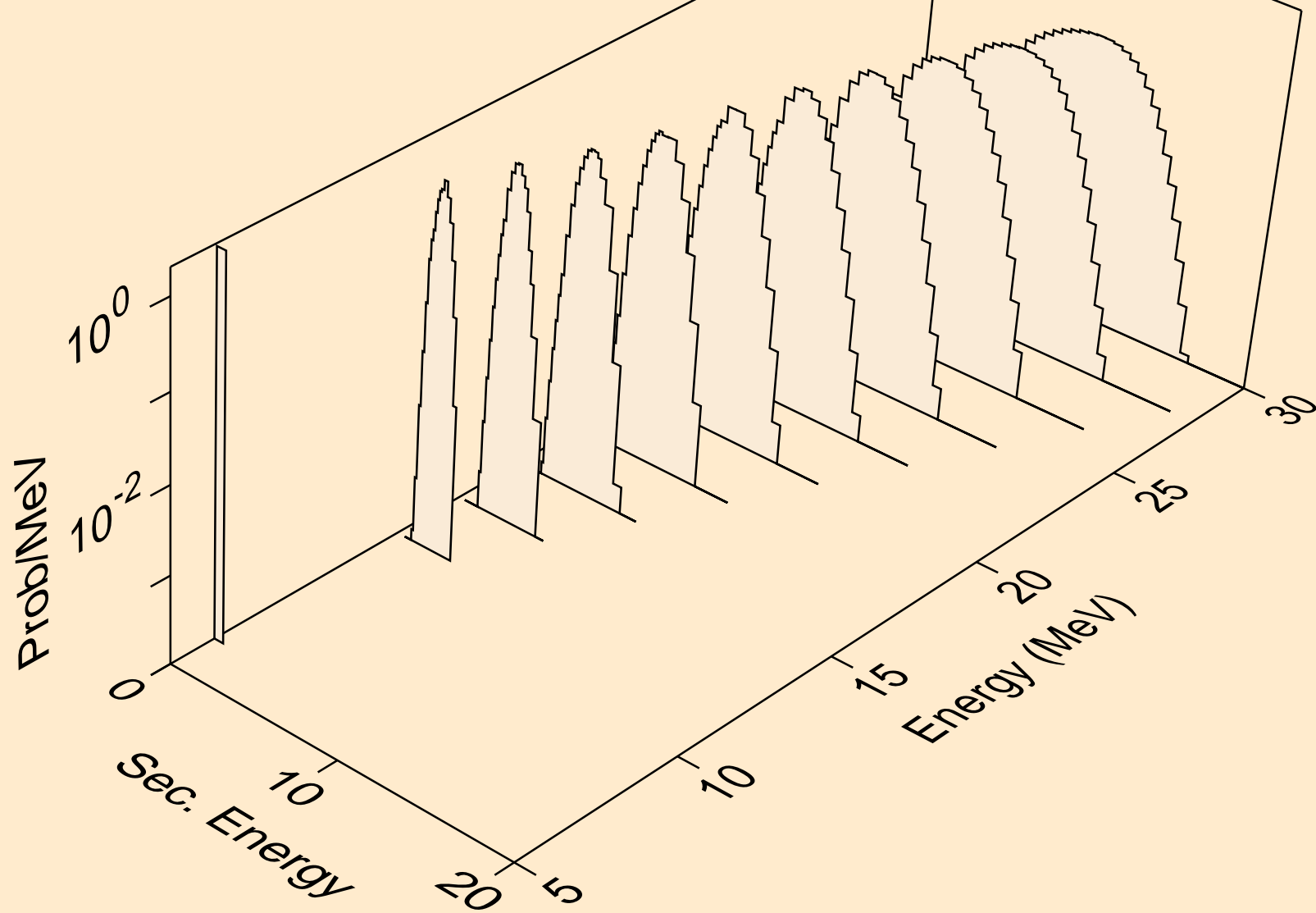

SR077 NEUTRON ACER TENDL-2024 LIBRARY; T=293.6K
tritons from (n,x)

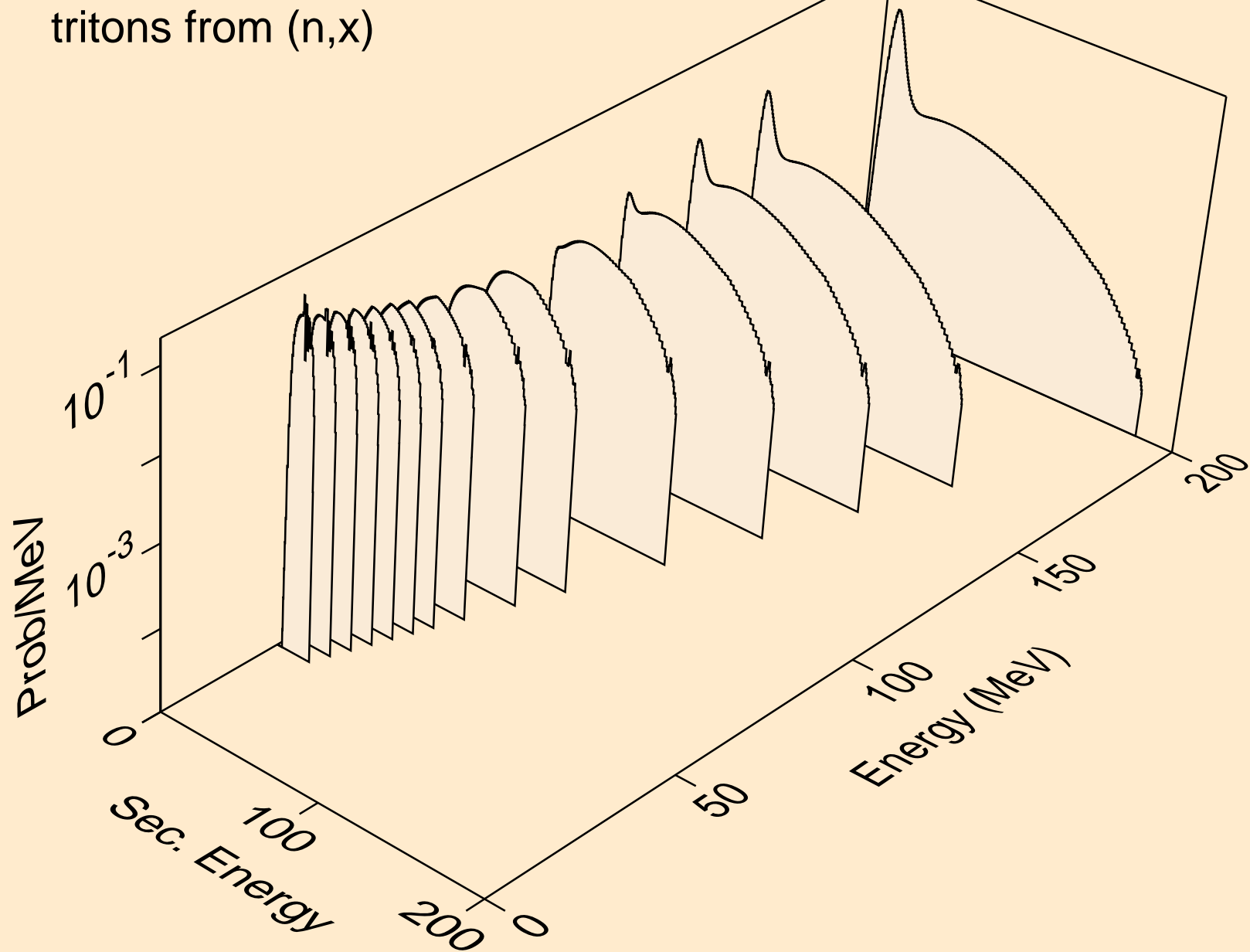

SR077 NEUTRON ACER TENDL-2024 LIBRARY; T=293.6K
tritons from (n,n*)t

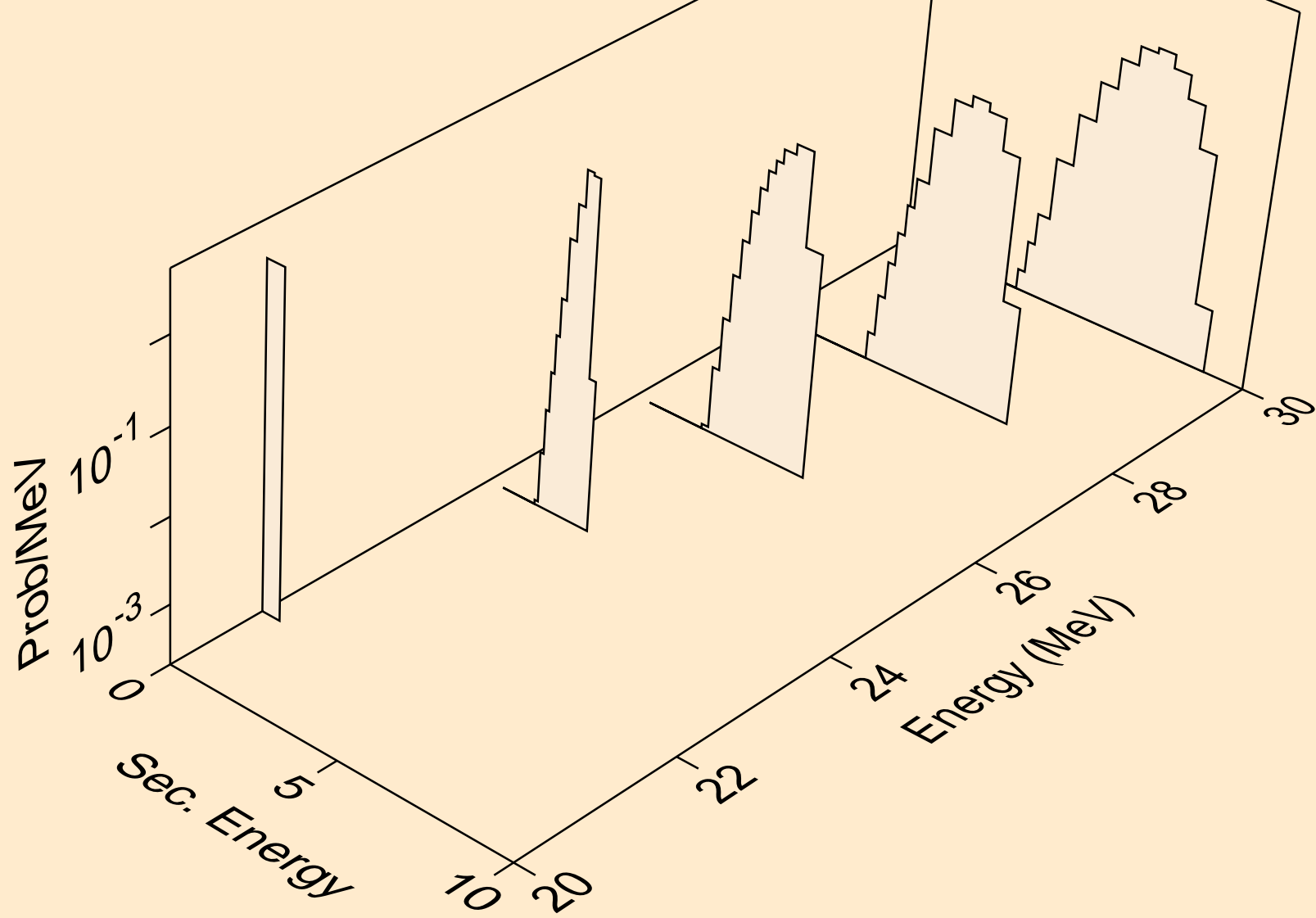

SR077 NEUTRON ACER TENDL-2024 LIBRARY; T=293.6K
tritons from (n,t)

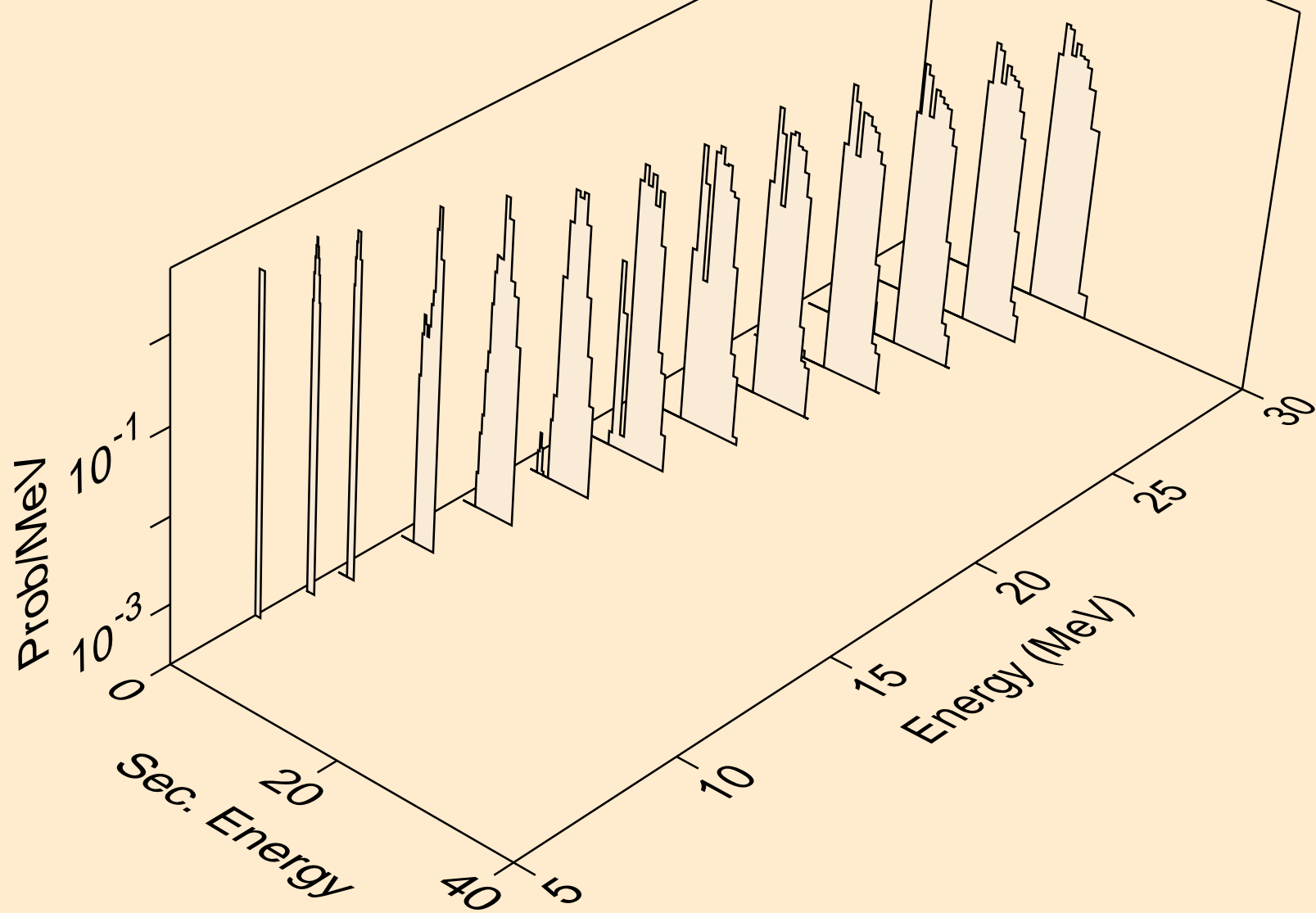

SR077 NEUTRON ACER TENDL-2024 LIBRARY; T=293.6K
tritons from (n,pt)

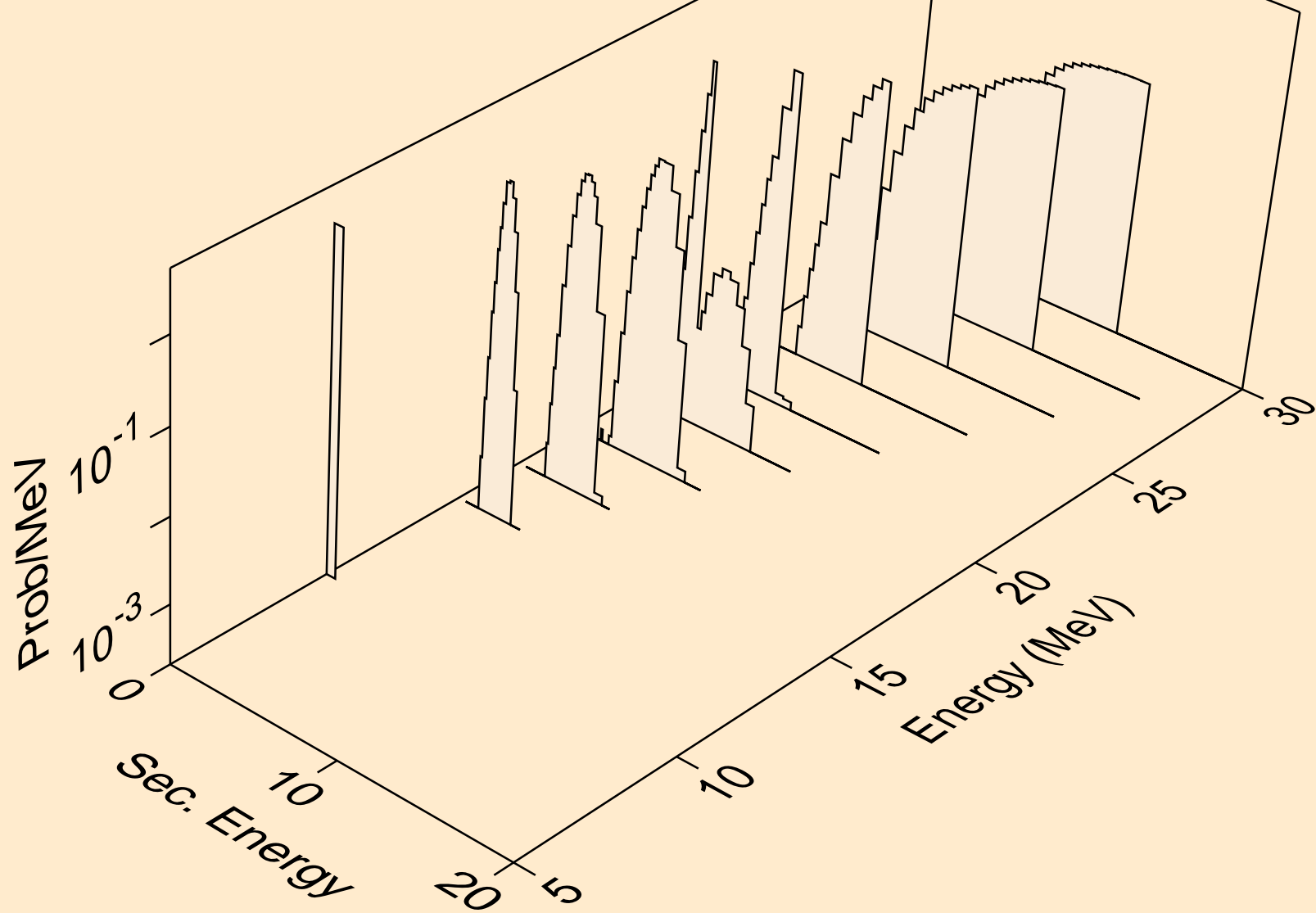

SR077 NEUTRON ACER TENDL-2024 LIBRARY; T=293.6K
he3s from (n,x)

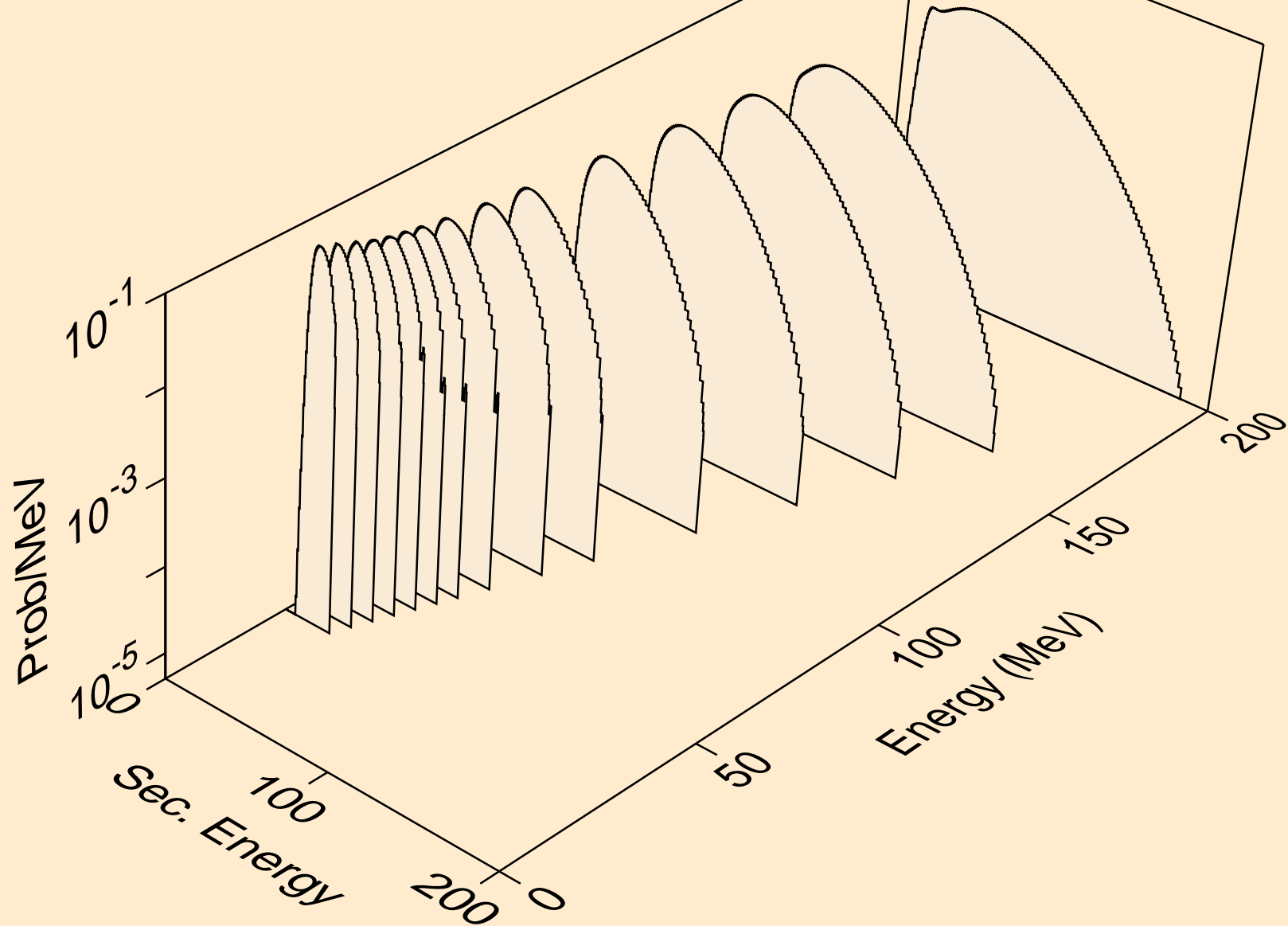

SR077 NEUTRON ACER TENDL-2024 LIBRARY; T=293.6K
he3s from (n,n*)he3

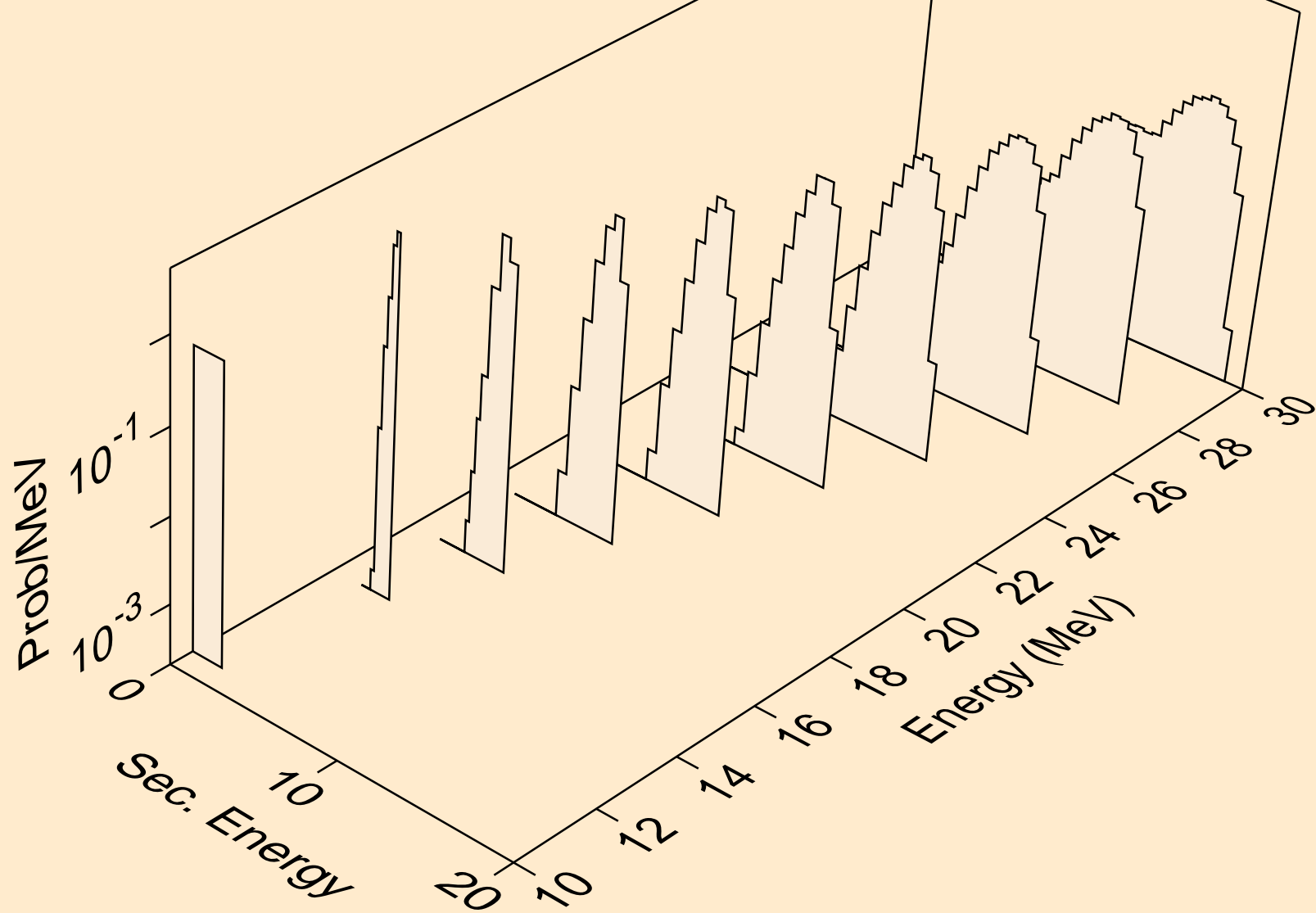

SR077 NEUTRON ACER TENDL-2024 LIBRARY; T=293.6K
he3s from (n,he3)

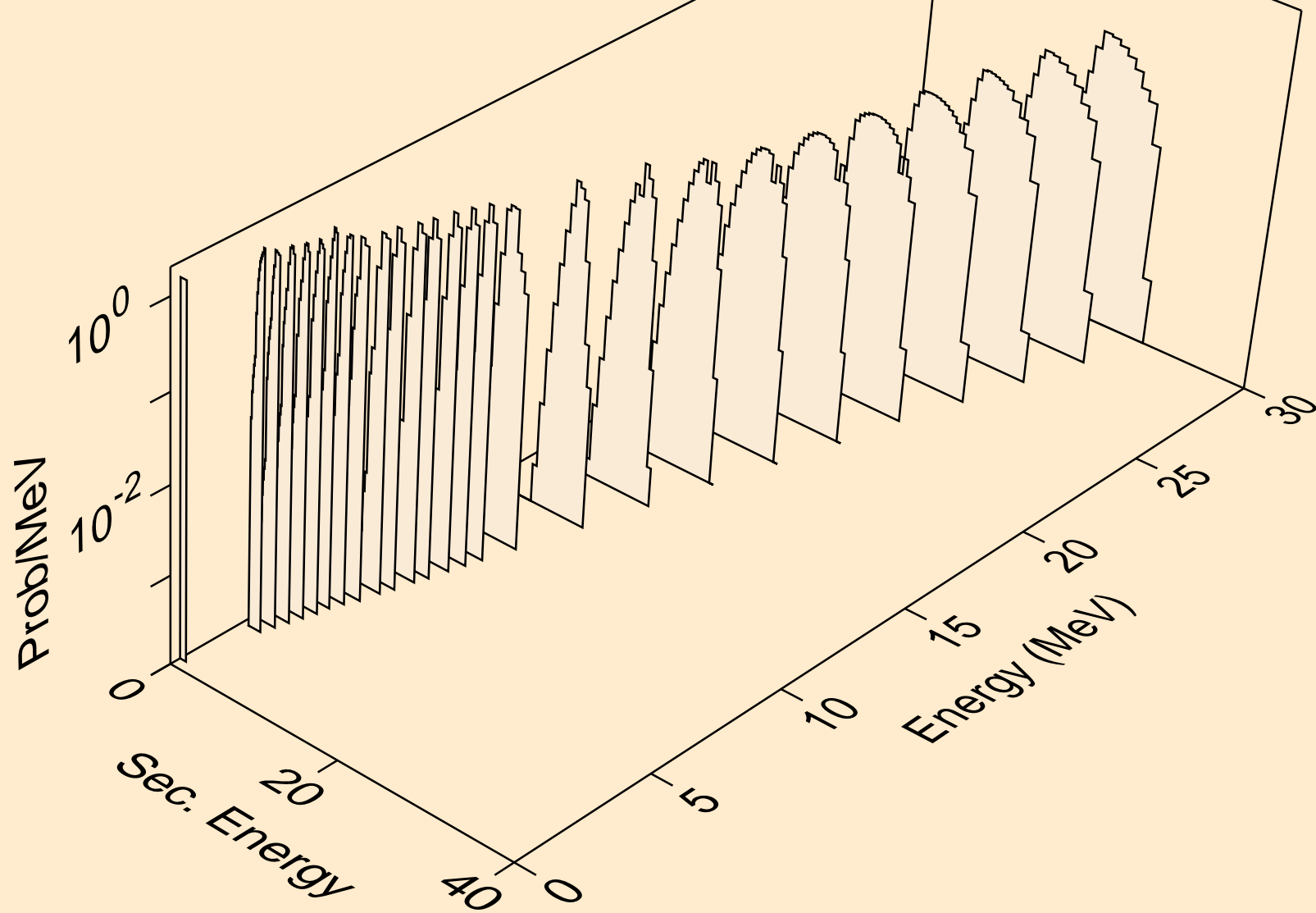

SR077 NEUTRON ACER TENDL-2024 LIBRARY; T=293.6K
alphas from (n,x)

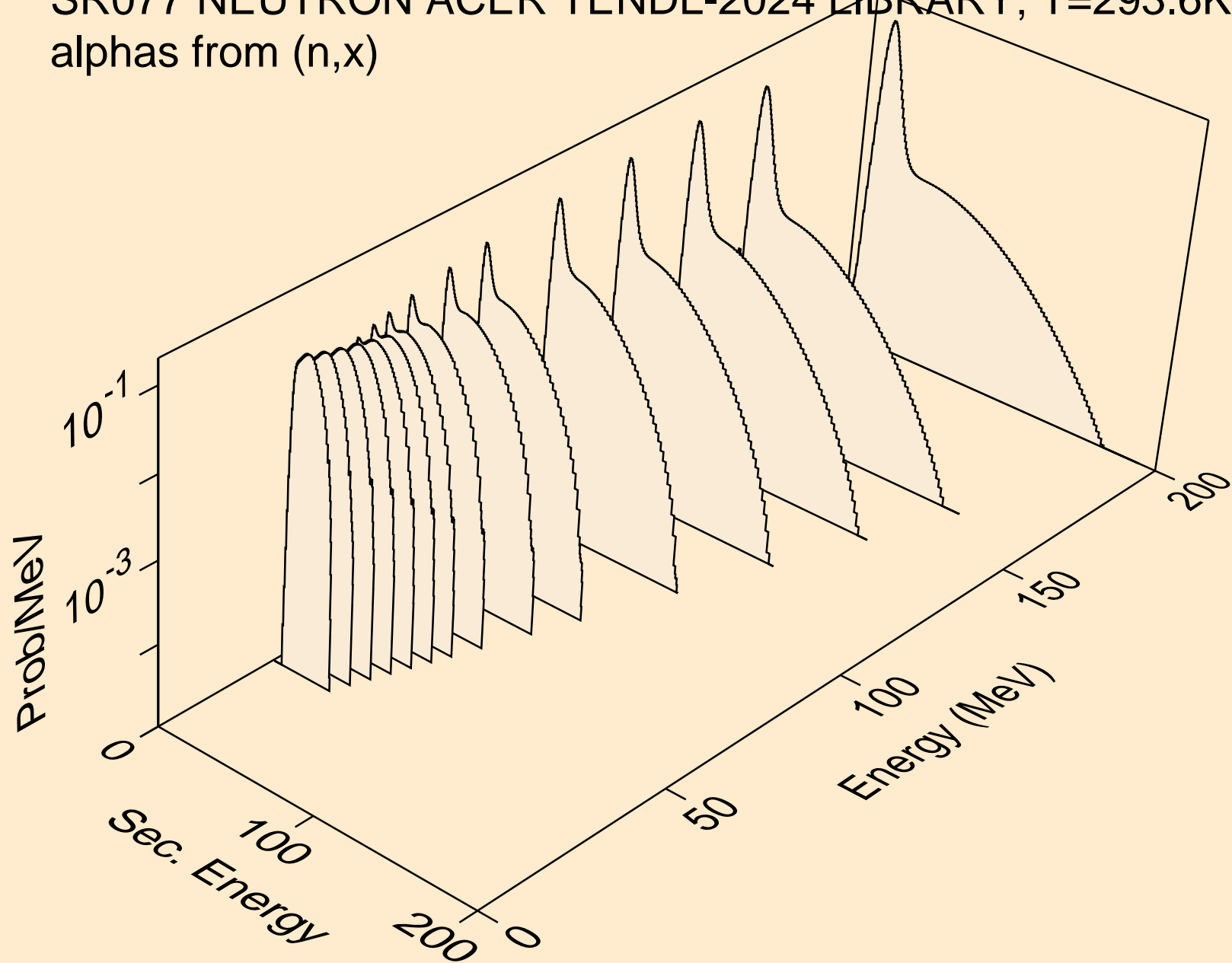

SR077 NEUTRON ACER TENDL-2024 LIBRARY; T=293.6K
alphas from (n,n*)a

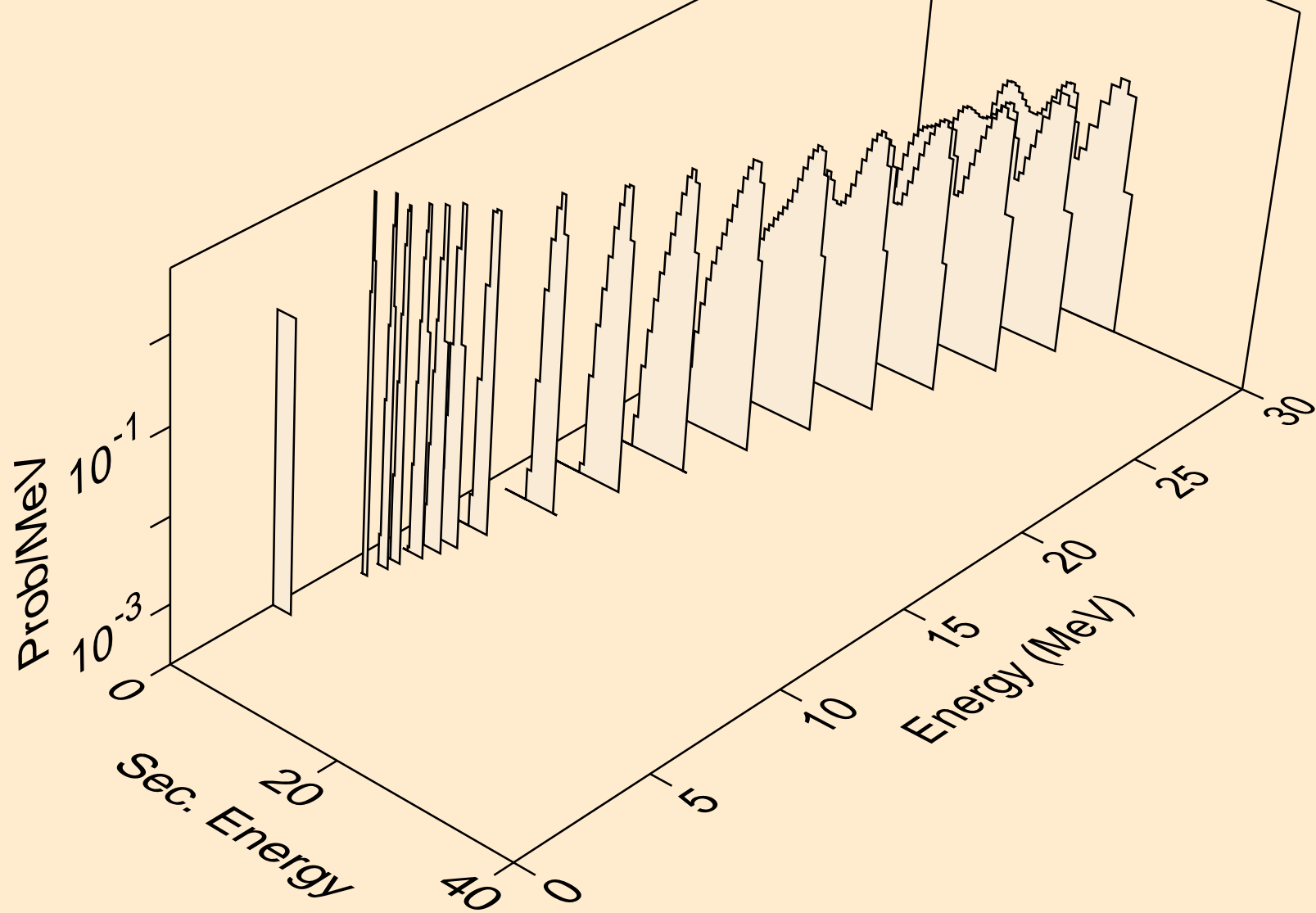

SR077 NEUTRON ACER TENDL-2024 LIBRARY; T=293.6K
alphas from (n,2n)a

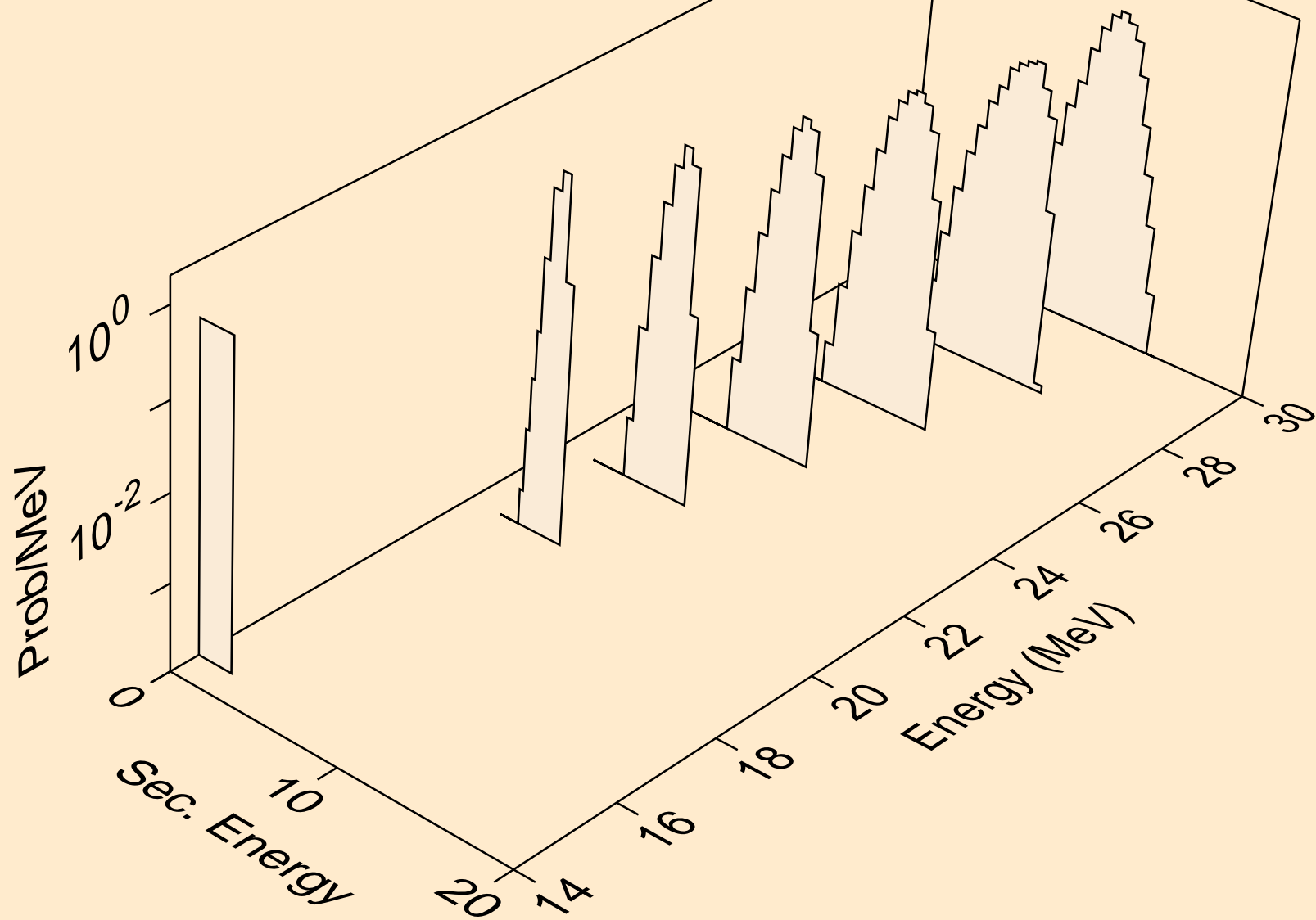

SR077 NEUTRON ACER TENDL-2024 LIBRARY; T=293.6K
alphas from (n,n*)2a

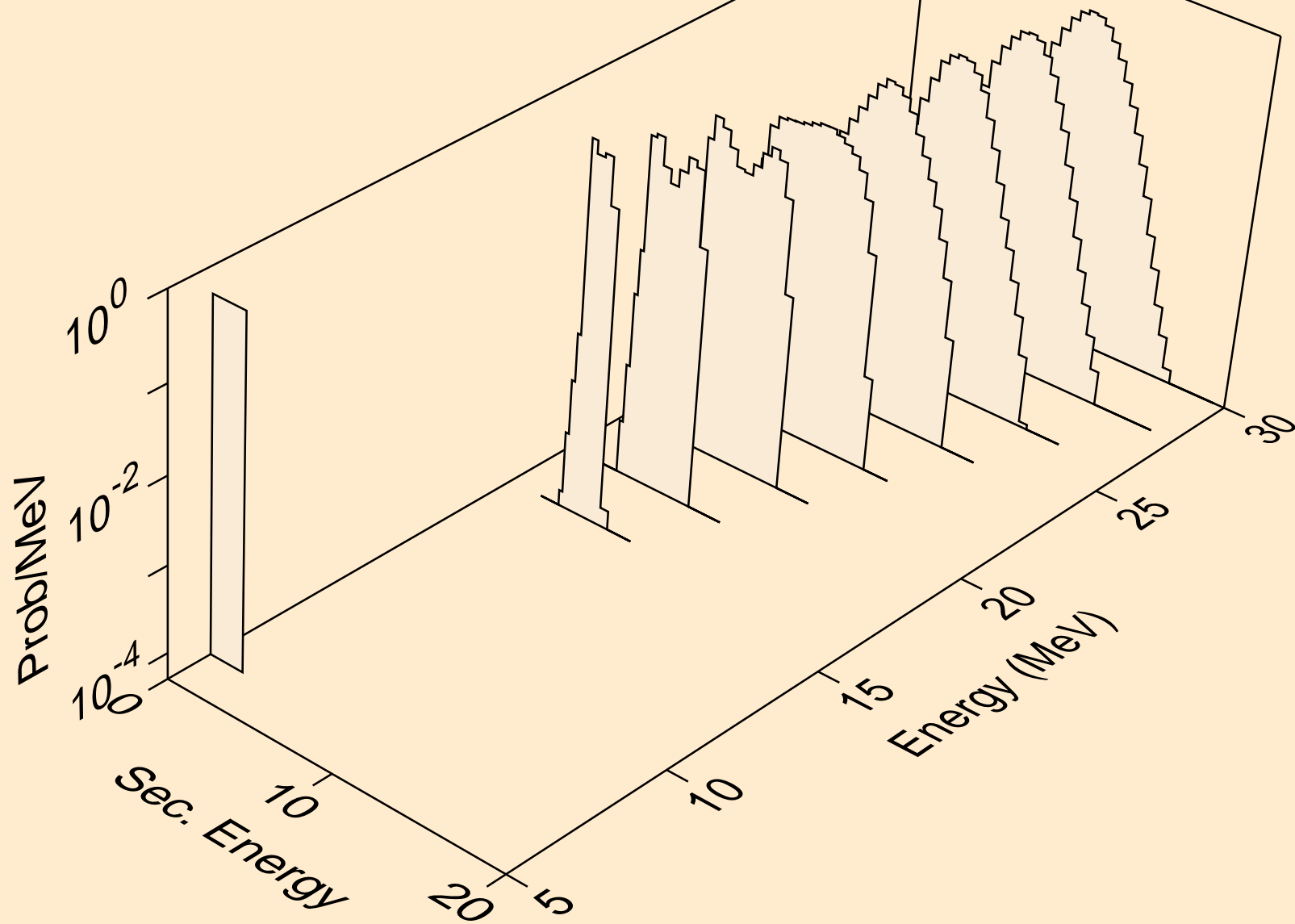

SR077 NEUTRON ACER TENDL-2024 LIBRARY; T=293.6K
alphas from (n,npa)

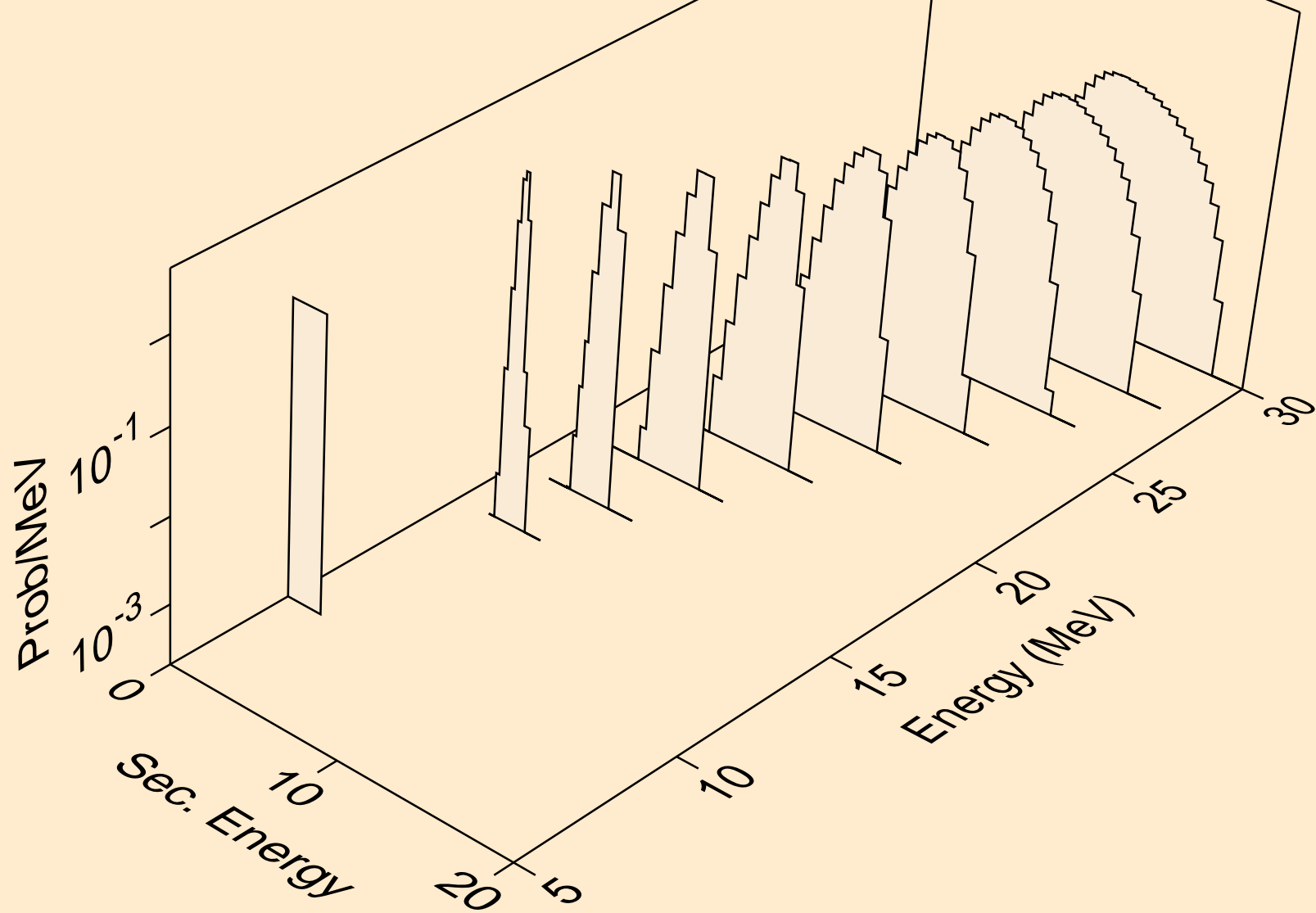

SR077 NEUTRON ACER TENDL-2024 LIBRARY; T=293.6K
alphas from (n,a)

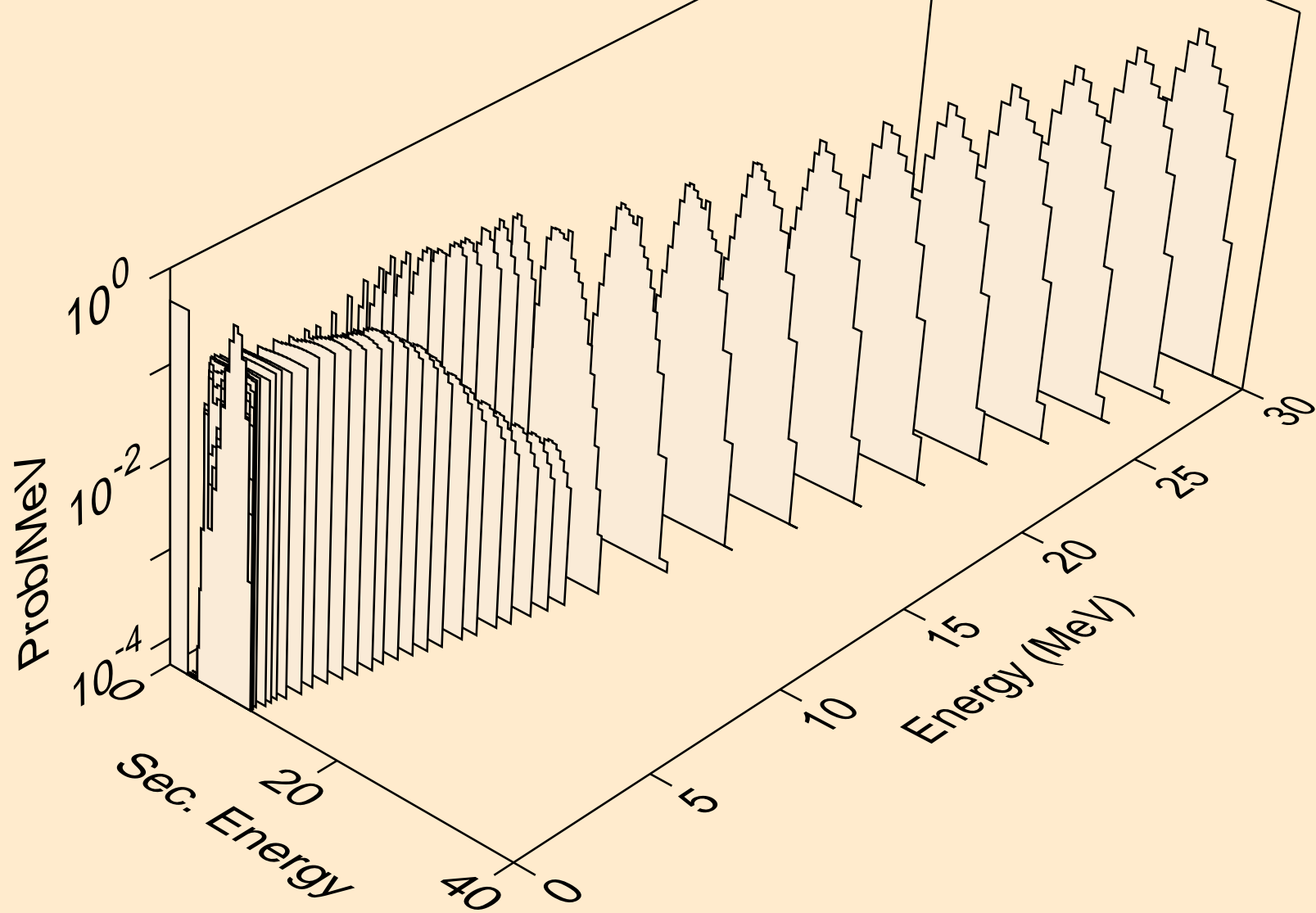

SR077 NEUTRON ACER TENDL-2024 LIBRARY; T=293.6K
alphas from (n,2a)

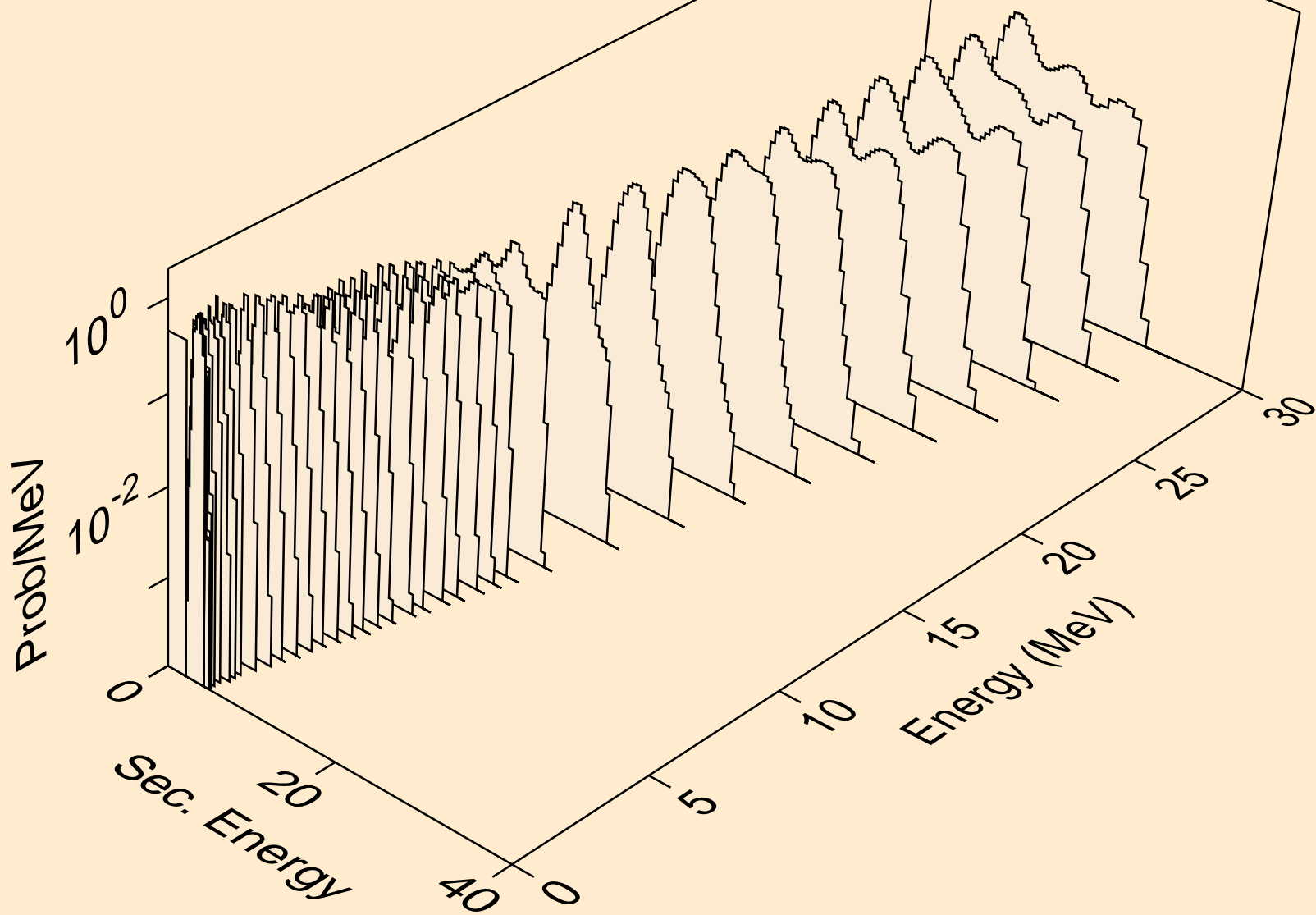

SR077 NEUTRON ACER TENDL-2024 LIBRARY; T=293.6K
alphas from (n,3a)

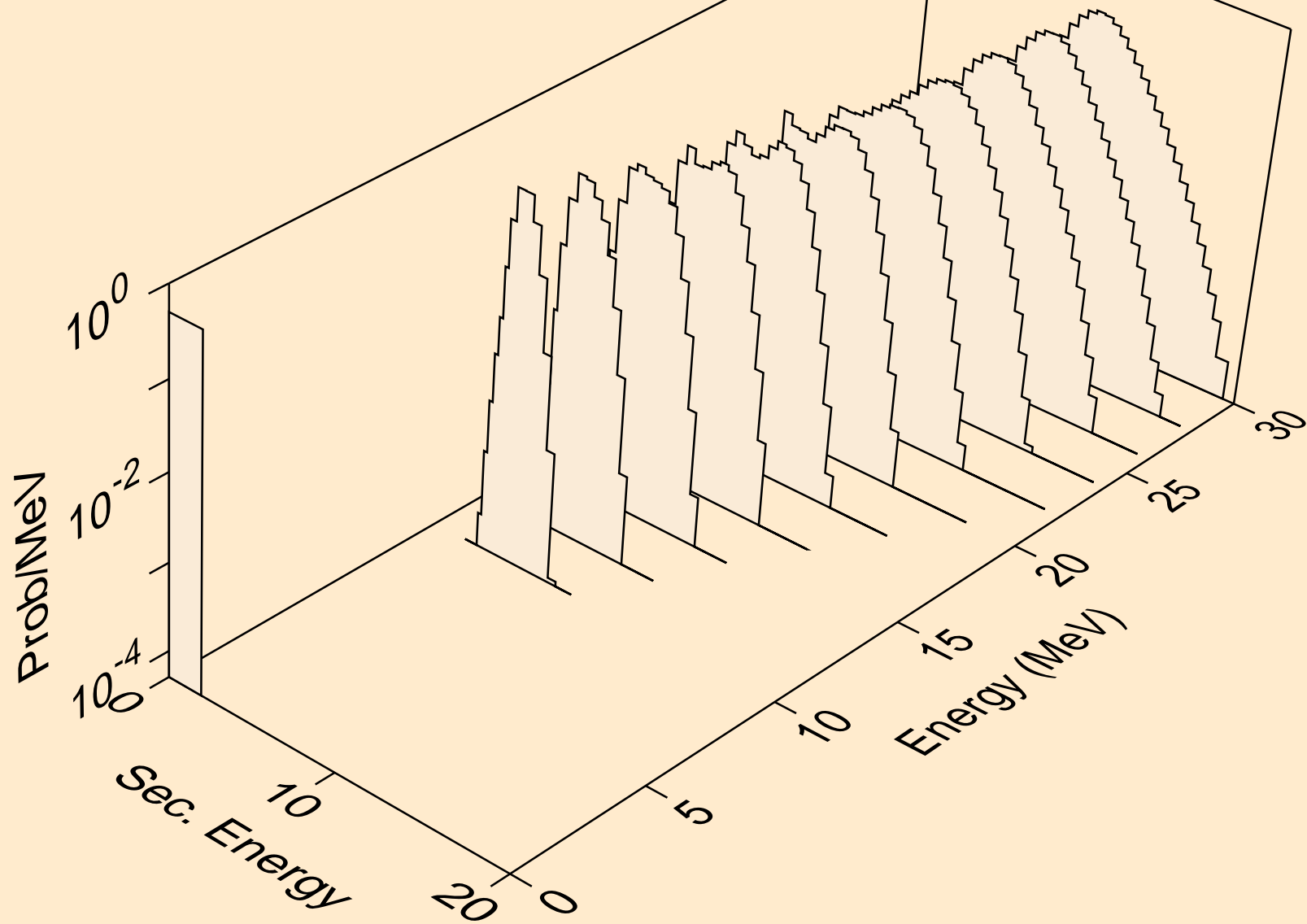

SR077 NEUTRON ACER TENDL-2024 LIBRARY; T=293.6K
alphas from (n,pa)

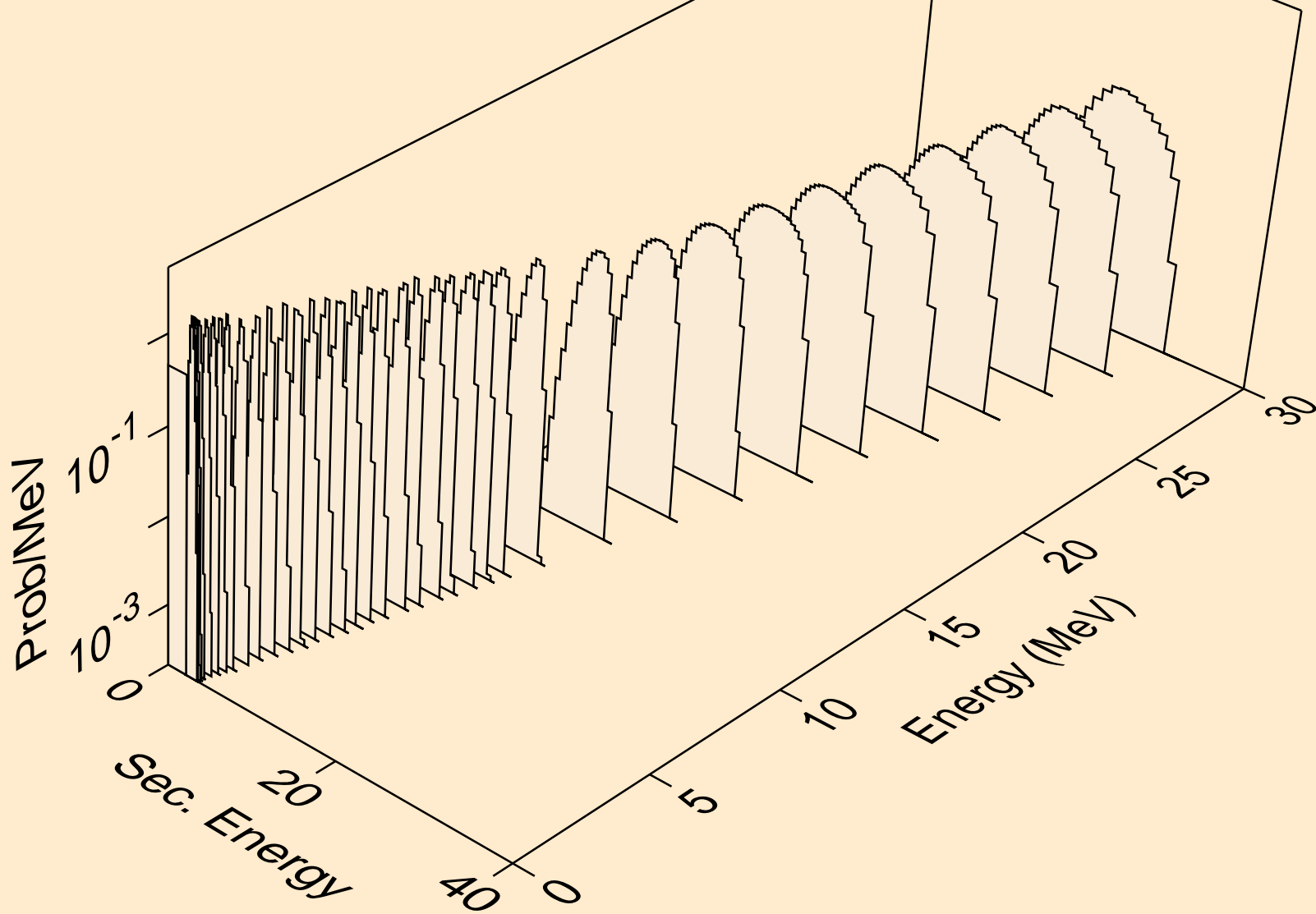

SR077 NEUTRON ACER TENDL-2024 LIBRARY; T=293.6K
alphas from (n,da)

