

TB165 NEUTRON ACER TENDL-2024 LIBRARY; T=293.6K

Principal cross sections

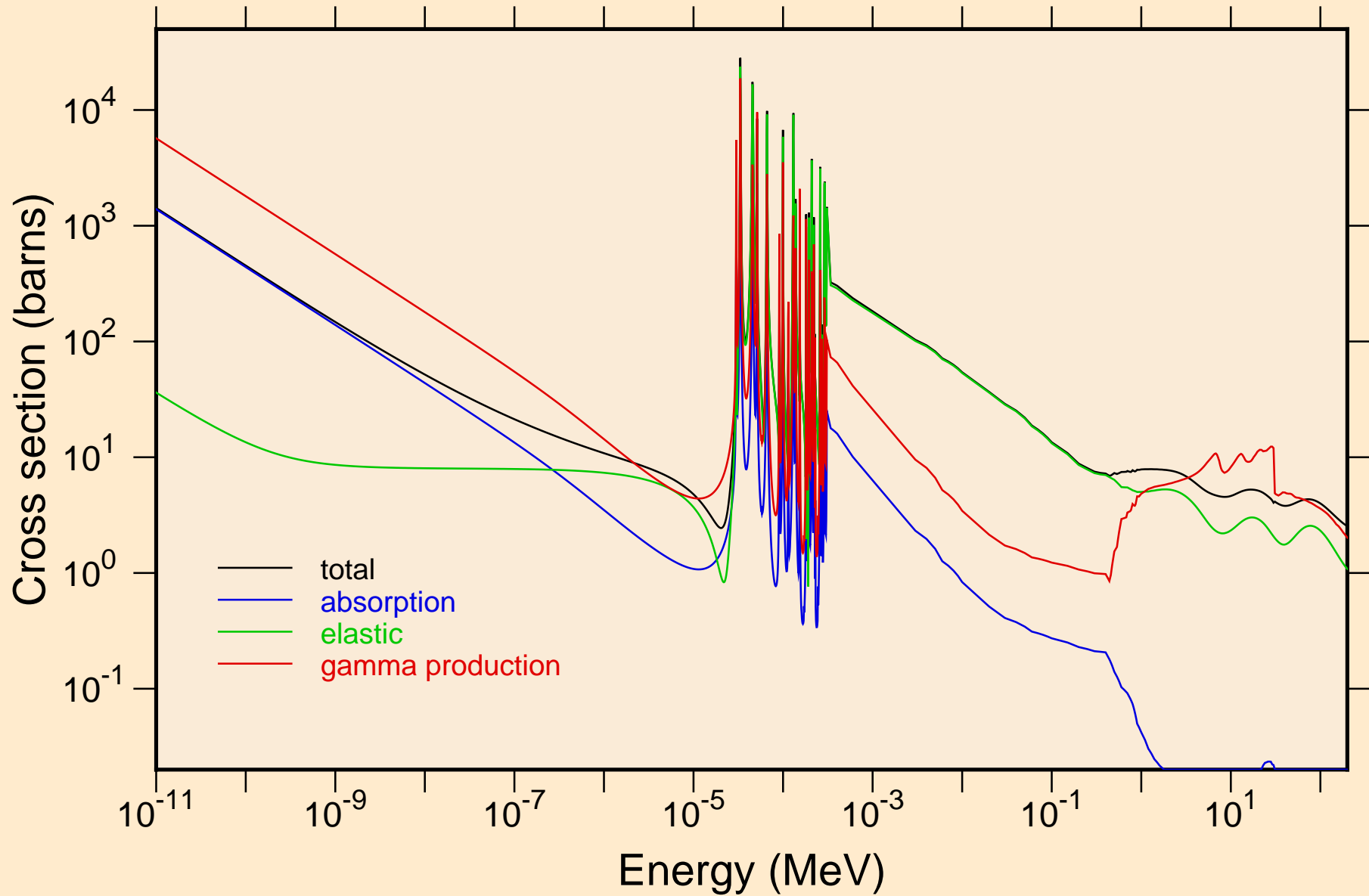

TB165 NEUTRON ACER TENDL-2024 LIBRARY; T=293.6K
resonance total cross section

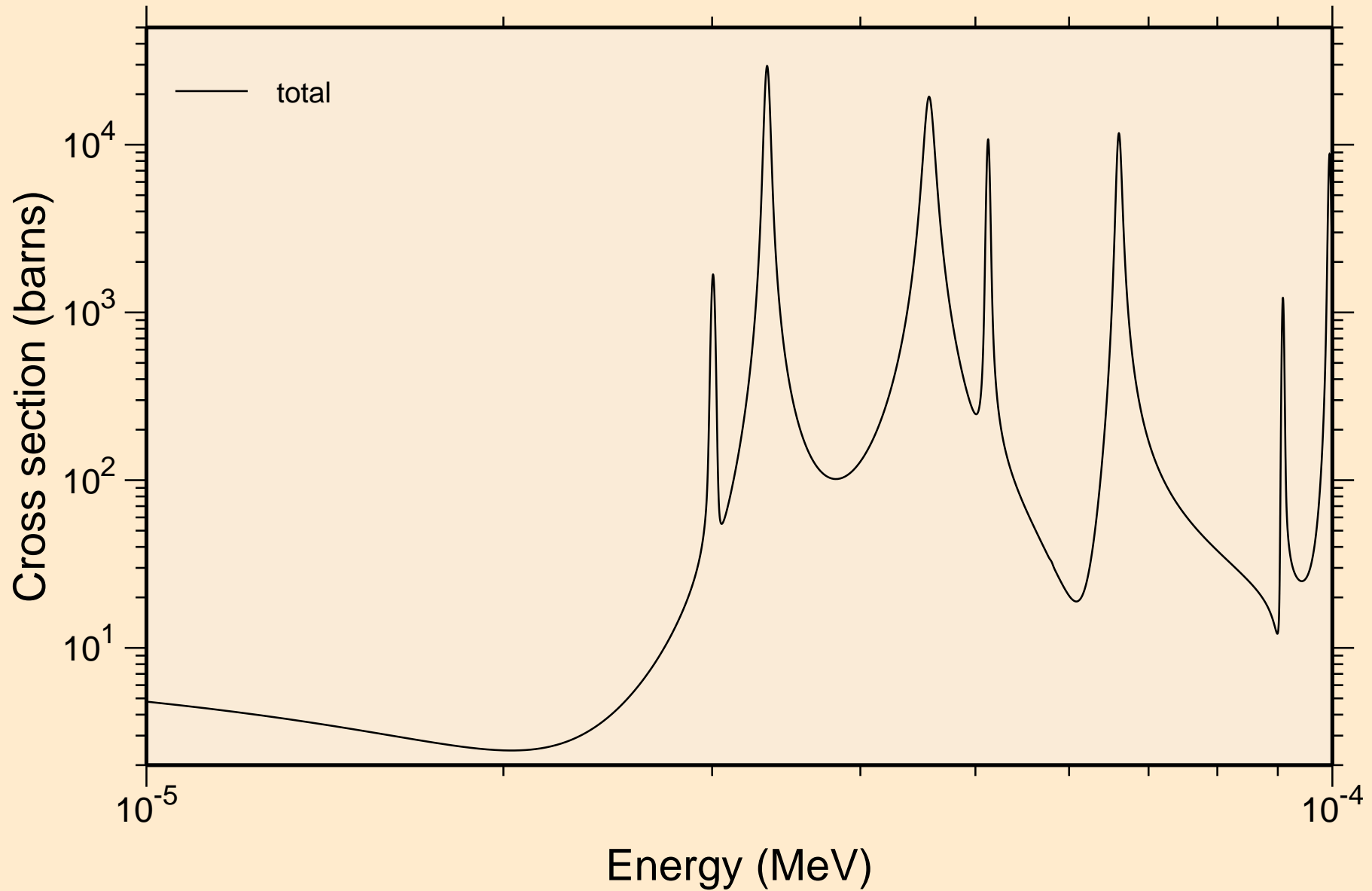

TB165 NEUTRON ACER TENDL-2024 LIBRARY; T=293.6K
resonance total cross section

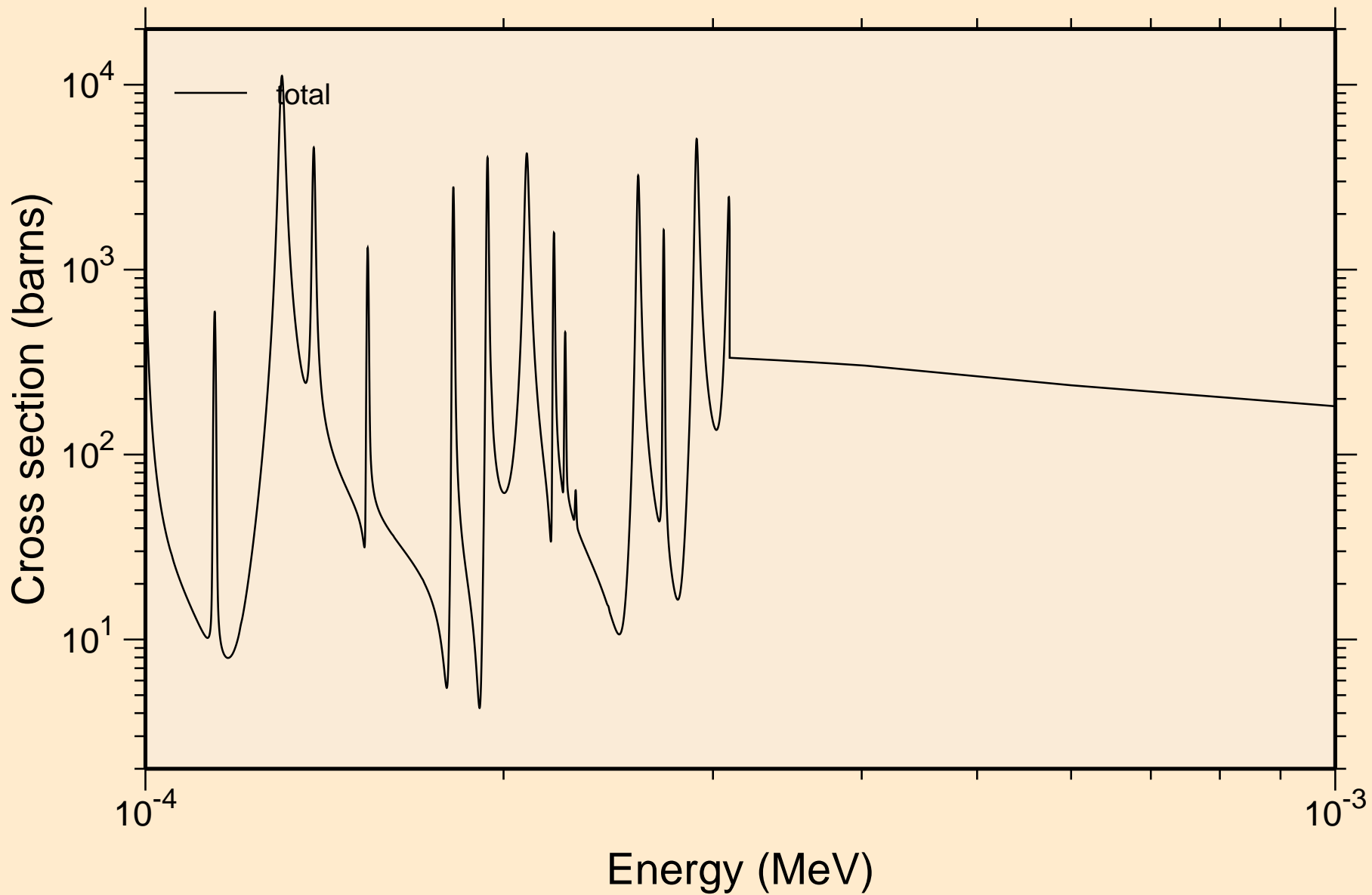

TB165 NEUTRON ACER TENDL-2024 LIBRARY; T=293.6K
resonance total cross section

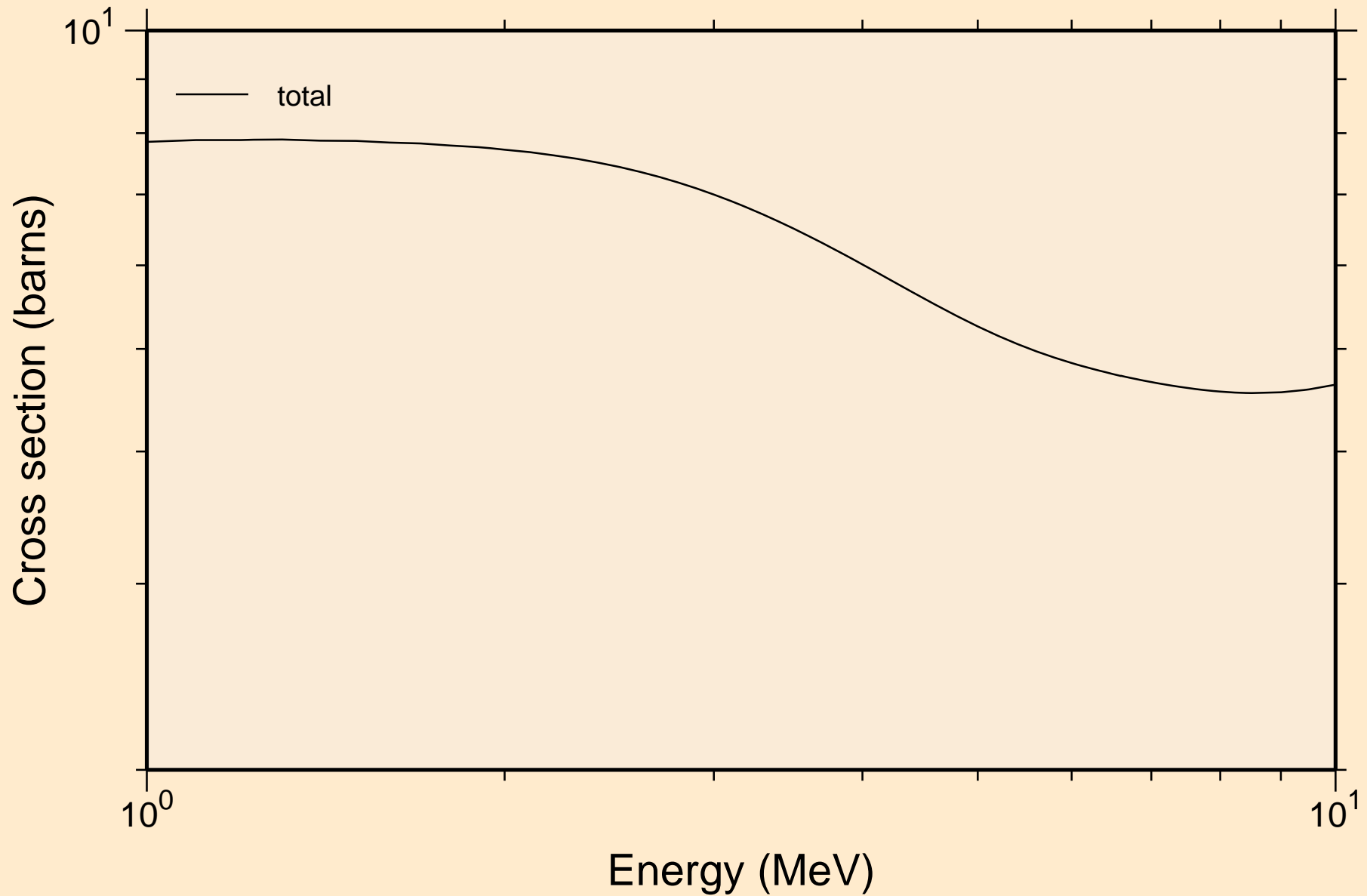

TB165 NEUTRON ACER TENDL-2024 LIBRARY; T=293.6K
resonance absorption cross sections

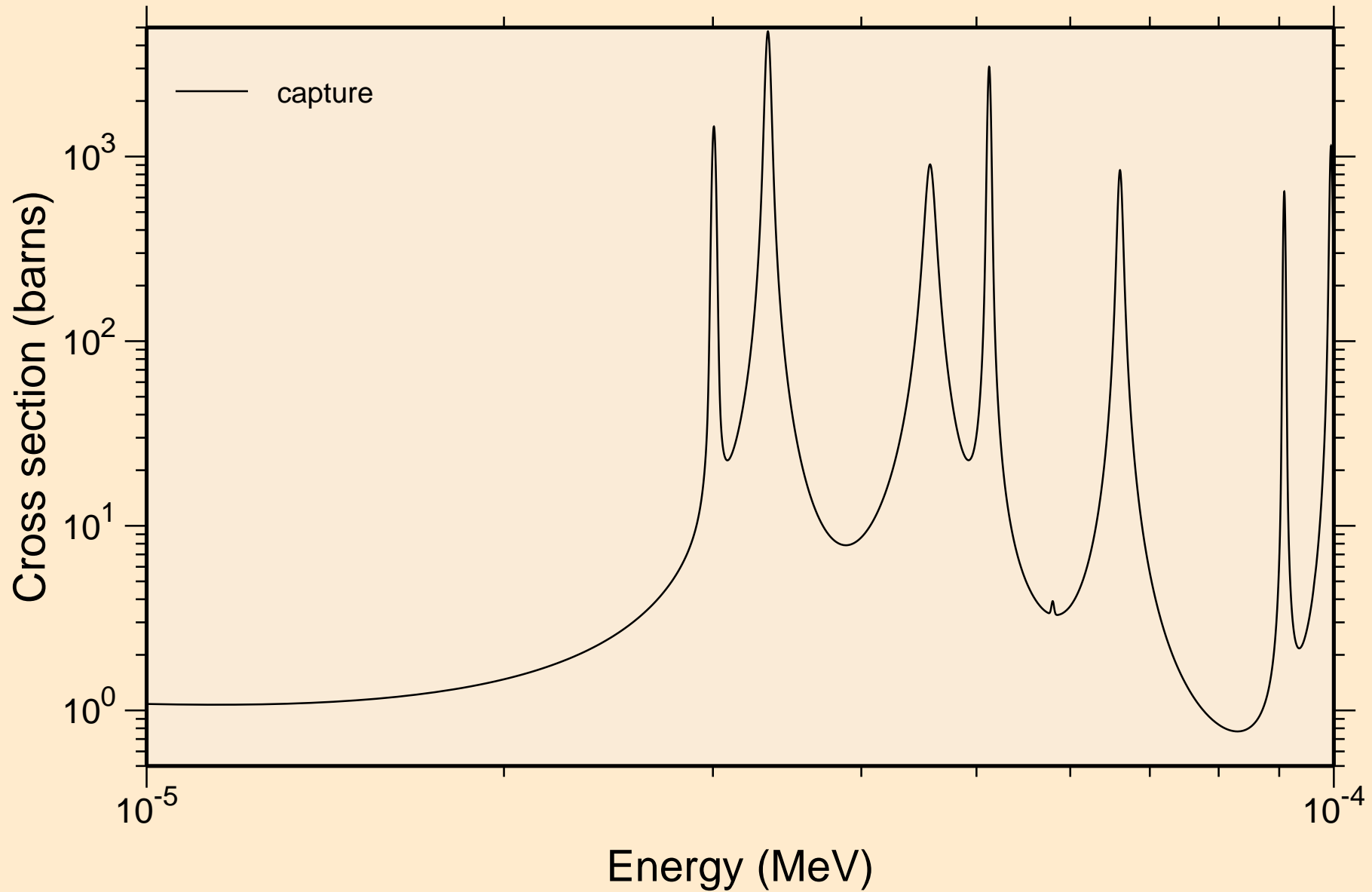

TB165 NEUTRON ACER TENDL-2024 LIBRARY; T=293.6K
resonance absorption cross sections

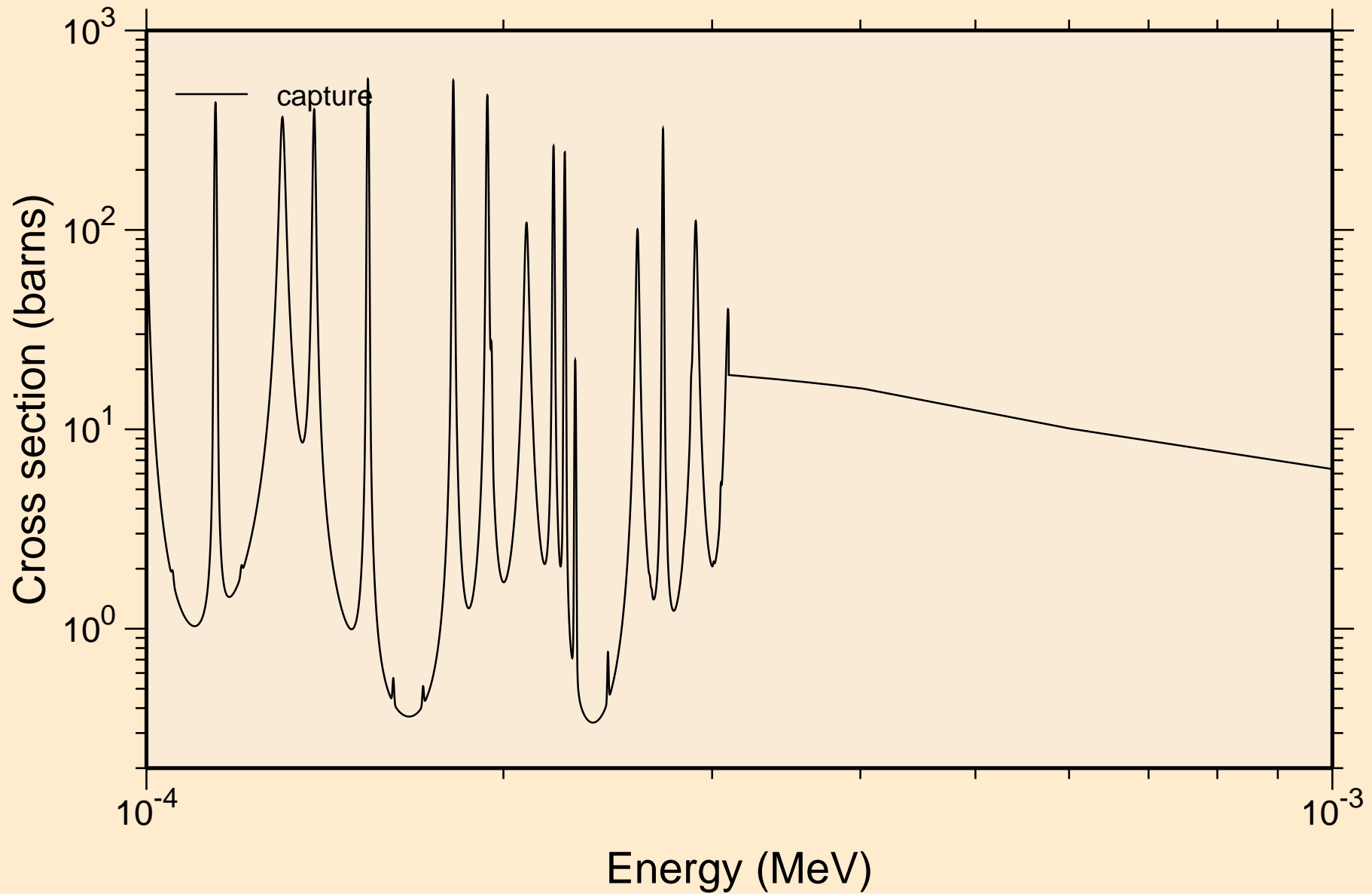

TB165 NEUTRON ACER TENDL-2024 LIBRARY; T=293.6K
resonance absorption cross sections

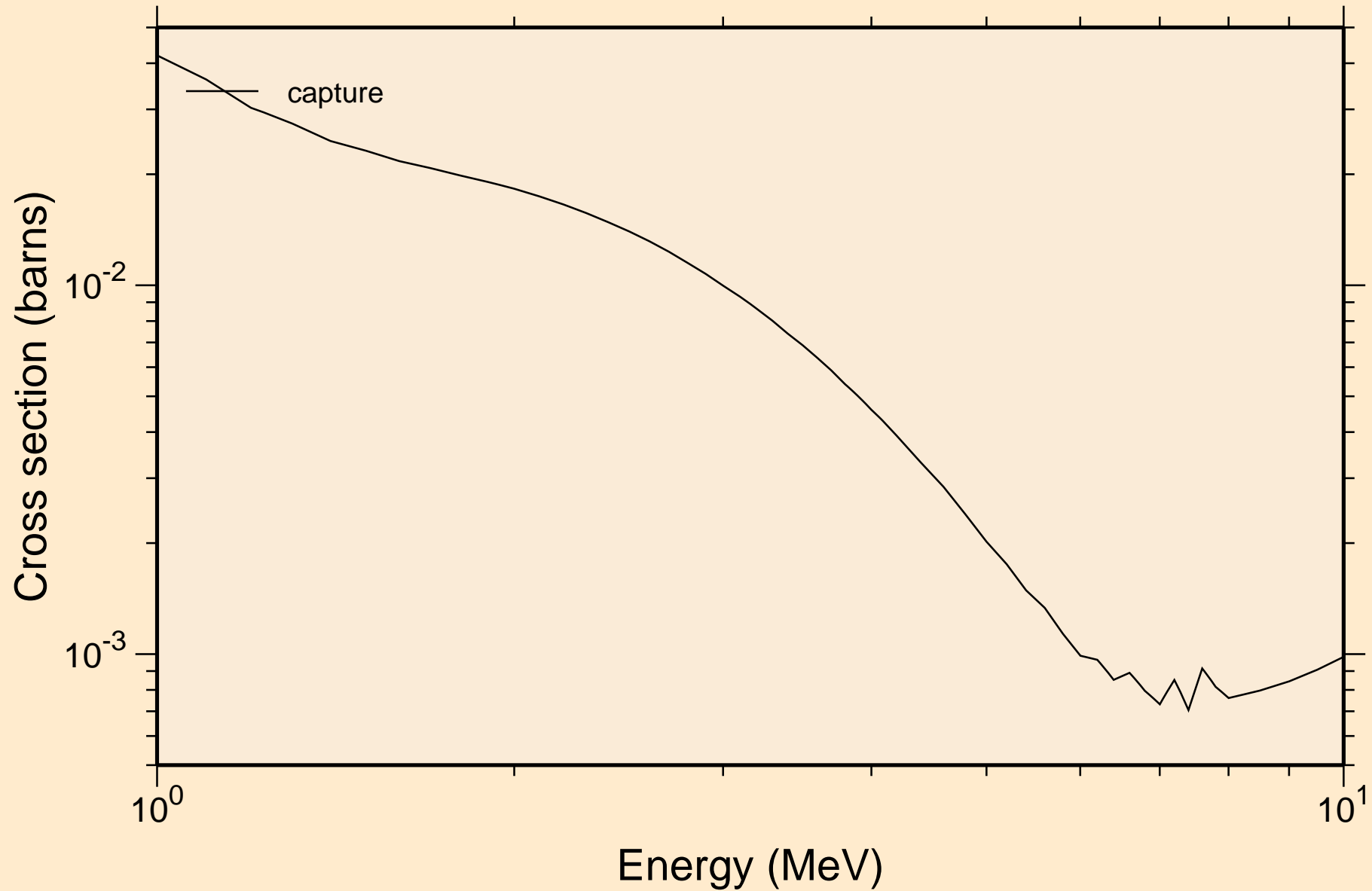

TB165 NEUTRON ACER TENDL-2024 LIBRARY; T=293.6K
Heating

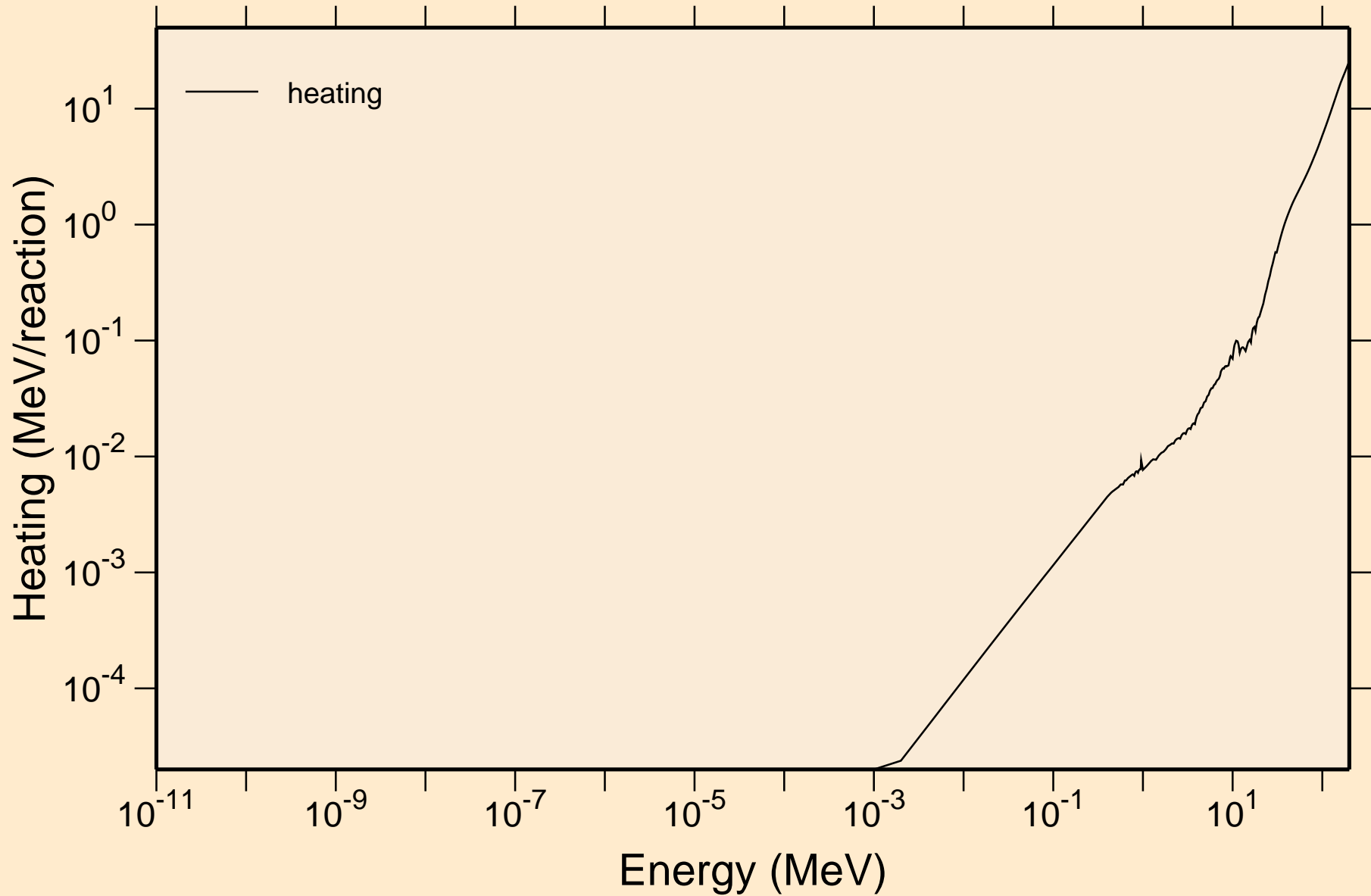

TB165 NEUTRON ACER TENDL-2024 LIBRARY; T=293.6K
Damage

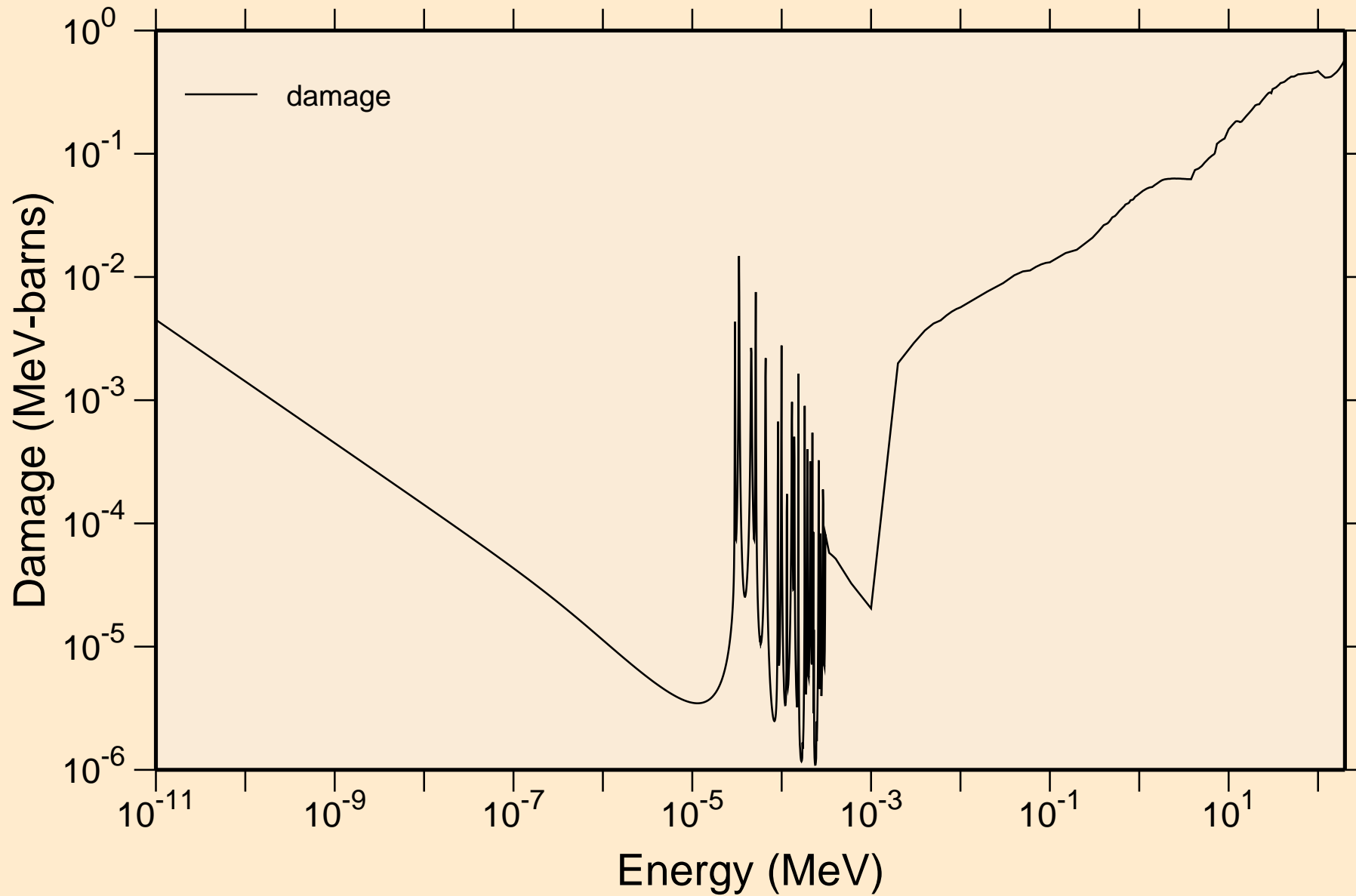

TB165 NEUTRON ACER TENDL-2024 LIBRARY; T=293.6K
Non-threshold reactions

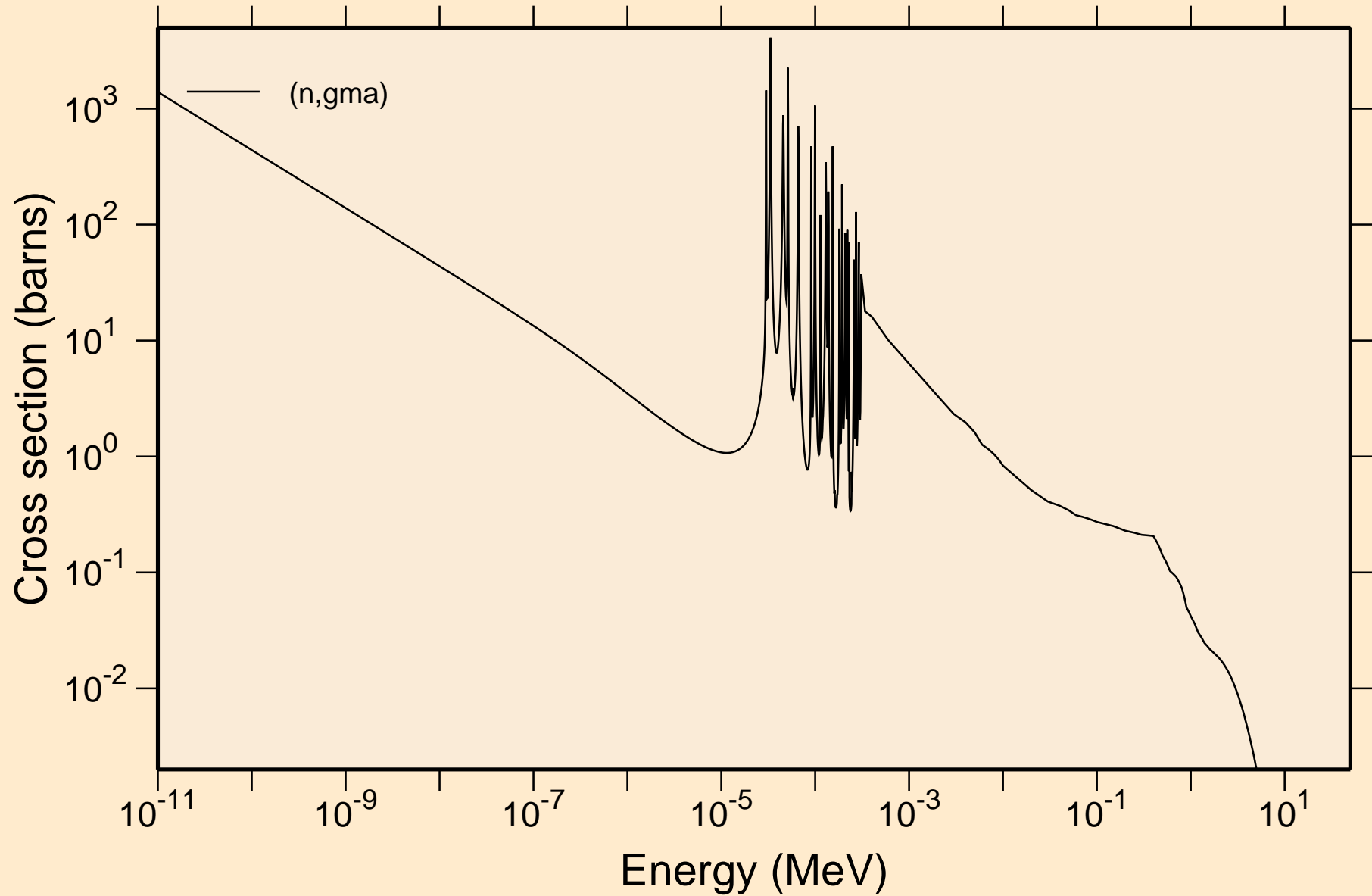

TB165 NEUTRON ACER TENDL-2024 LIBRARY; T=293.6K
Principal cross sections

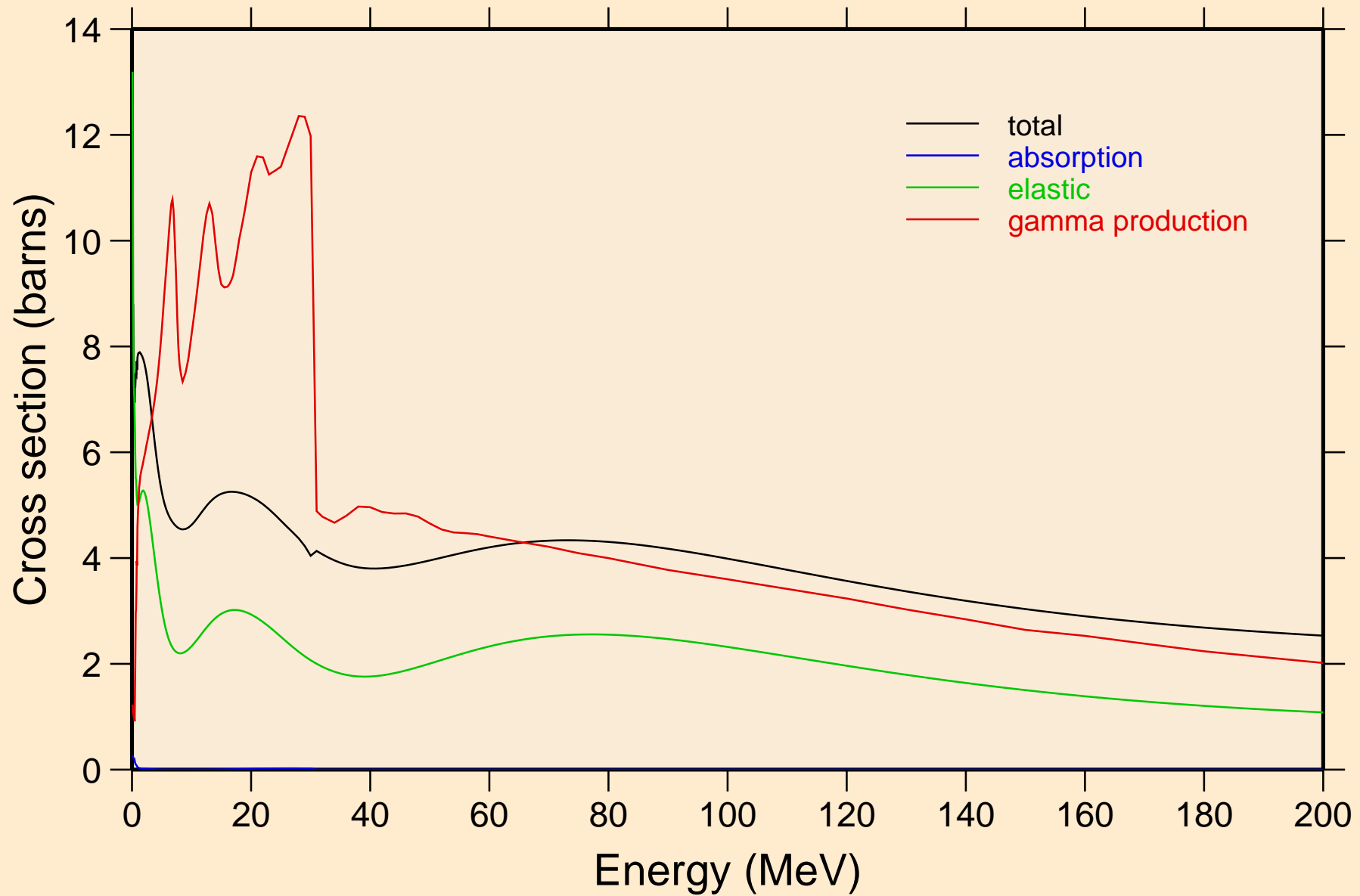

TB165 NEUTRON ACER TENDL-2024 LIBRARY; T=293.6K

Heating

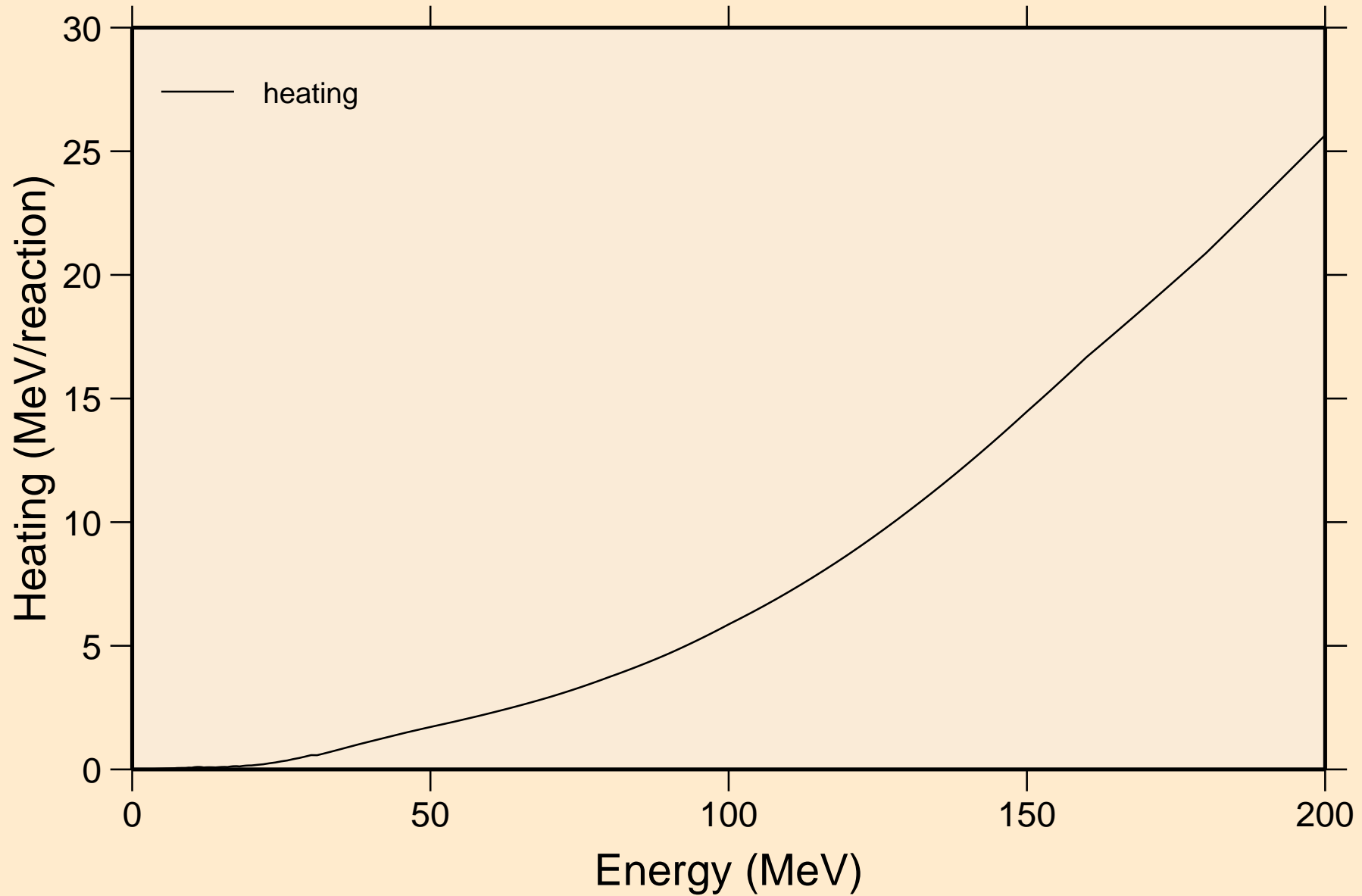

TB165 NEUTRON ACER TENDL-2024 LIBRARY; T=293.6K
Damage

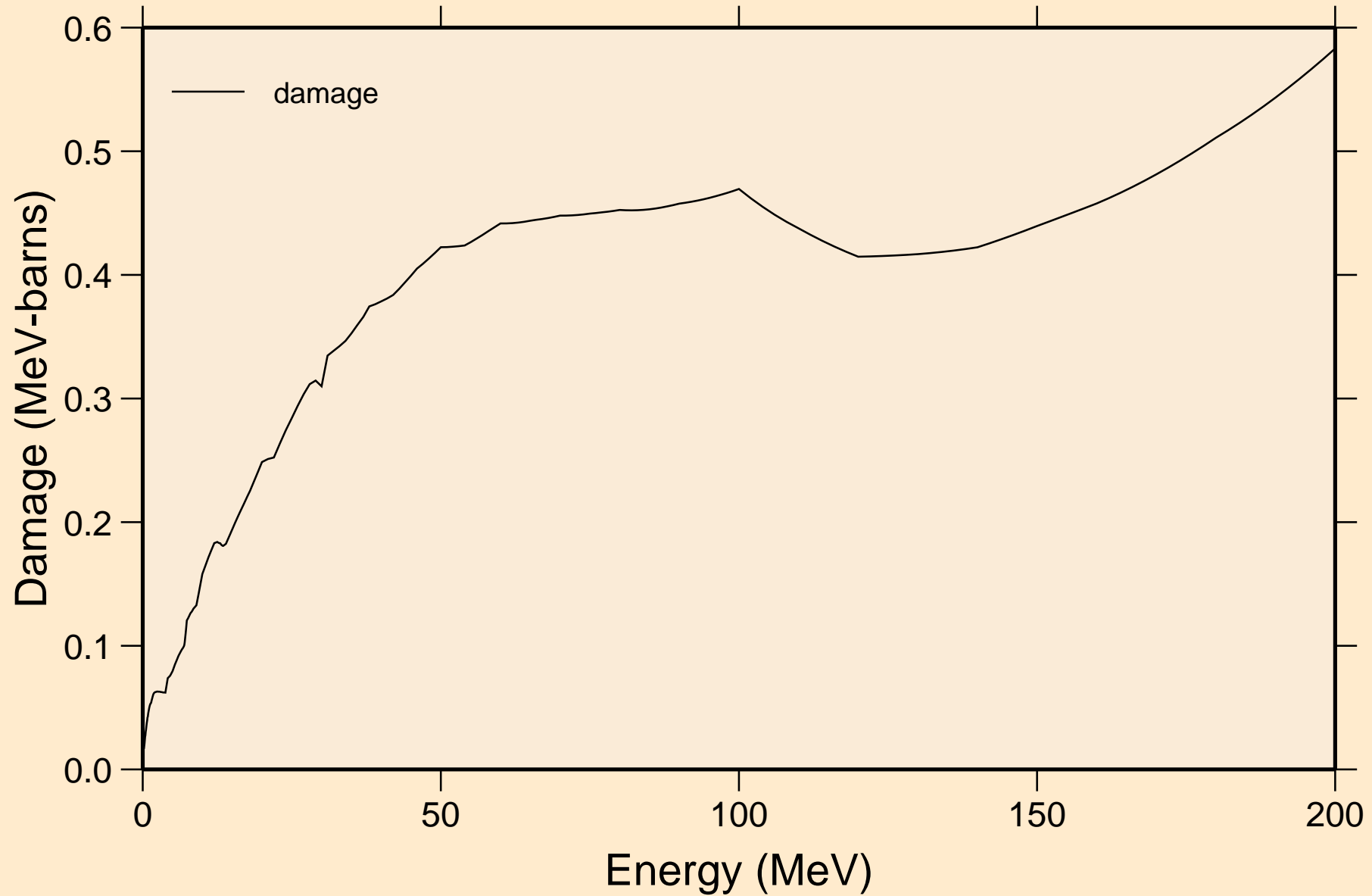

TB165 NEUTRON ACER TENDL-2024 LIBRARY; T=293.6K
Non-threshold reactions

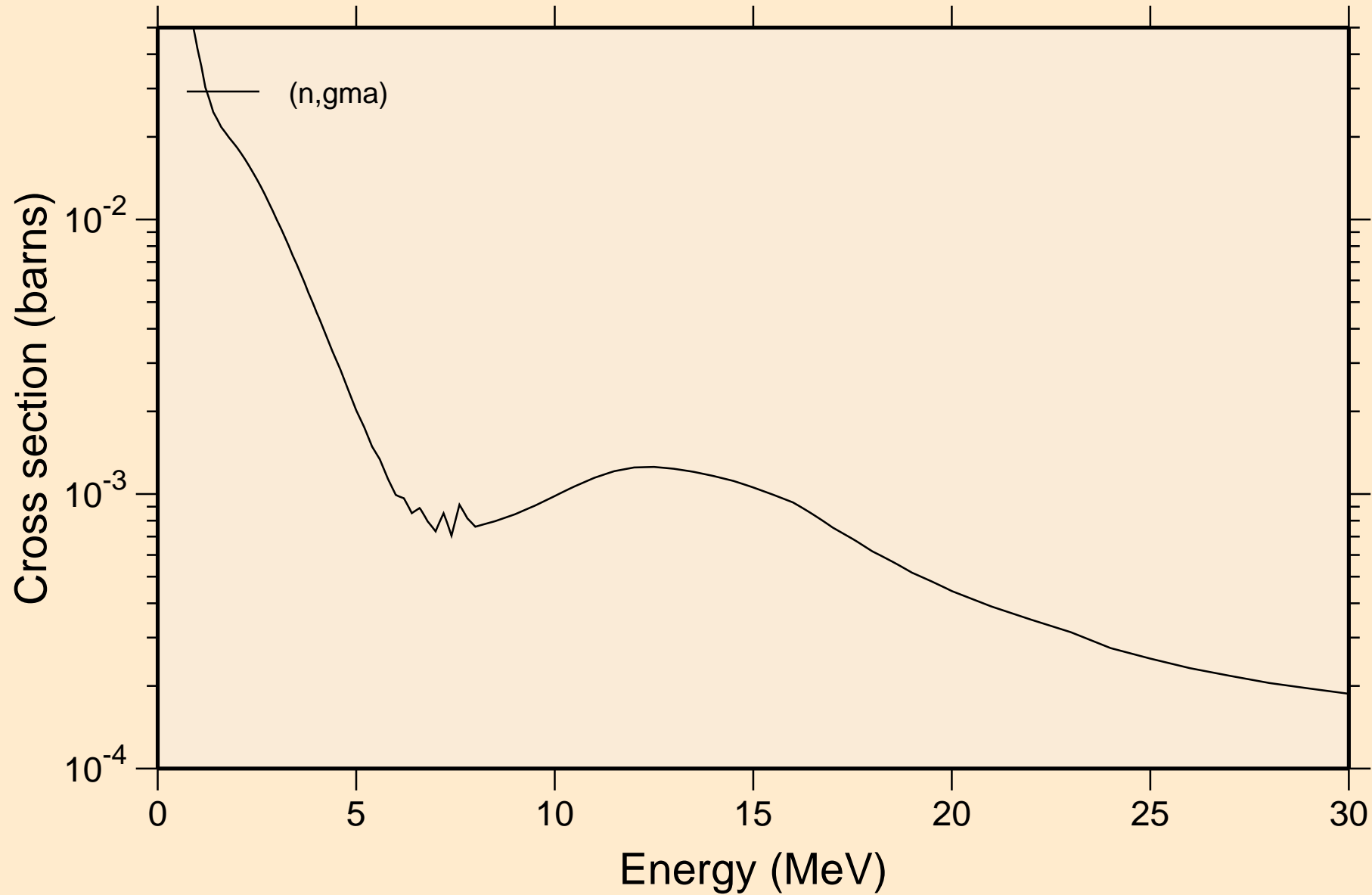

TB165 NEUTRON ACER TENDL-2024 LIBRARY; T=293.6K
Inelastic levels

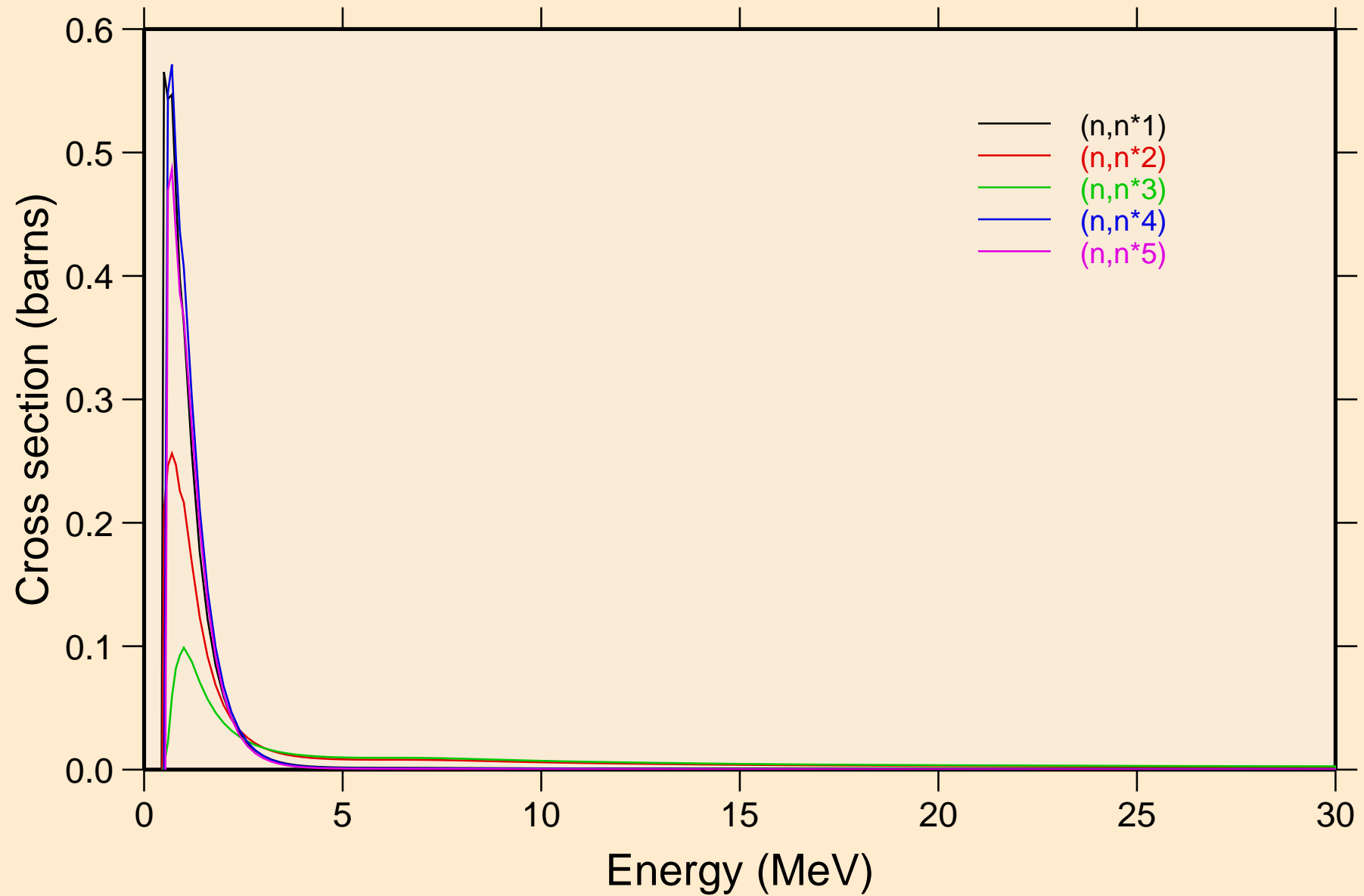

TB165 NEUTRON ACER TENDL-2024 LIBRARY; T=293.6K
Inelastic levels

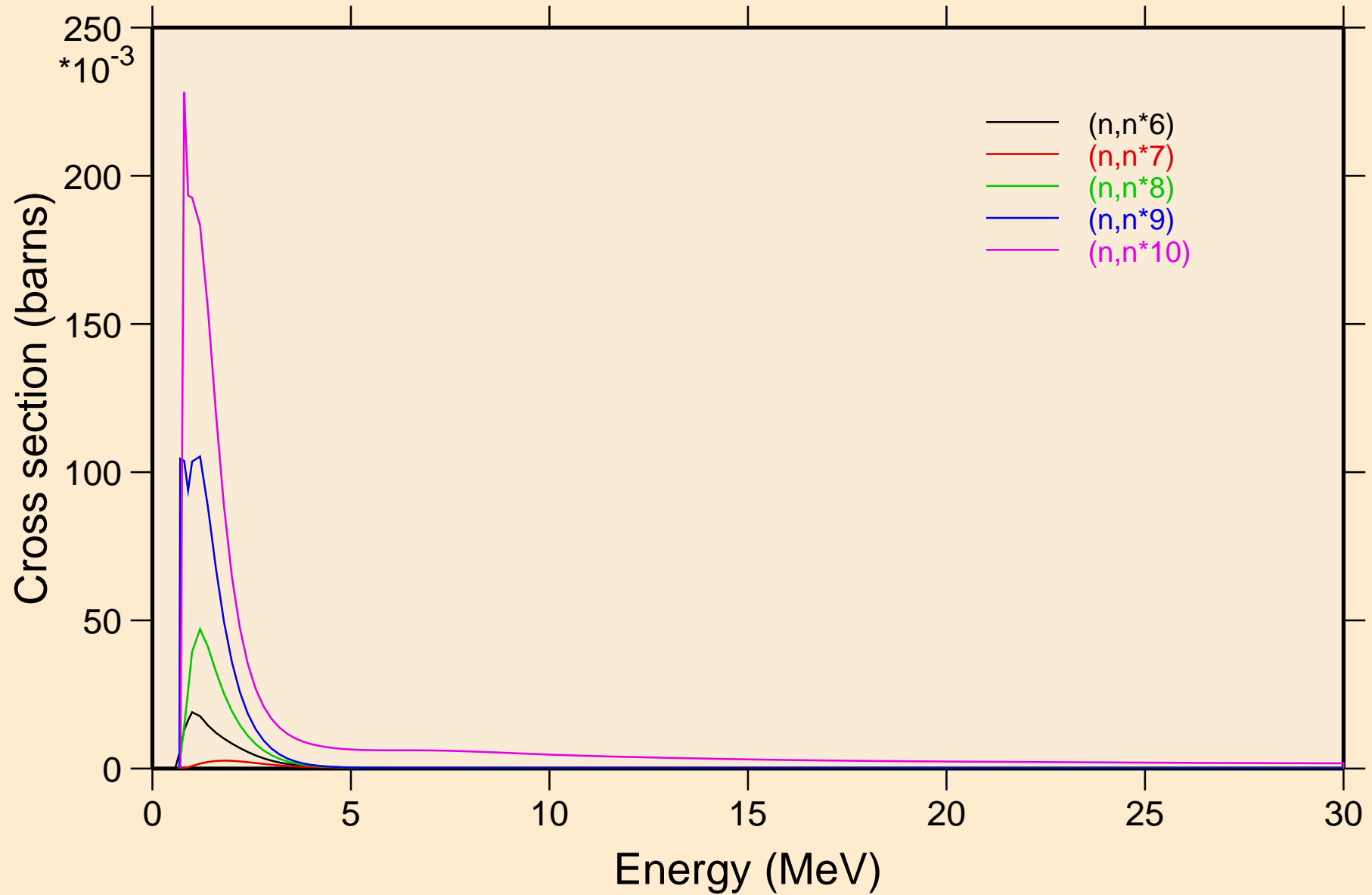

TB165 NEUTRON ACER TENDL-2024 LIBRARY; T=293.6K
Inelastic levels

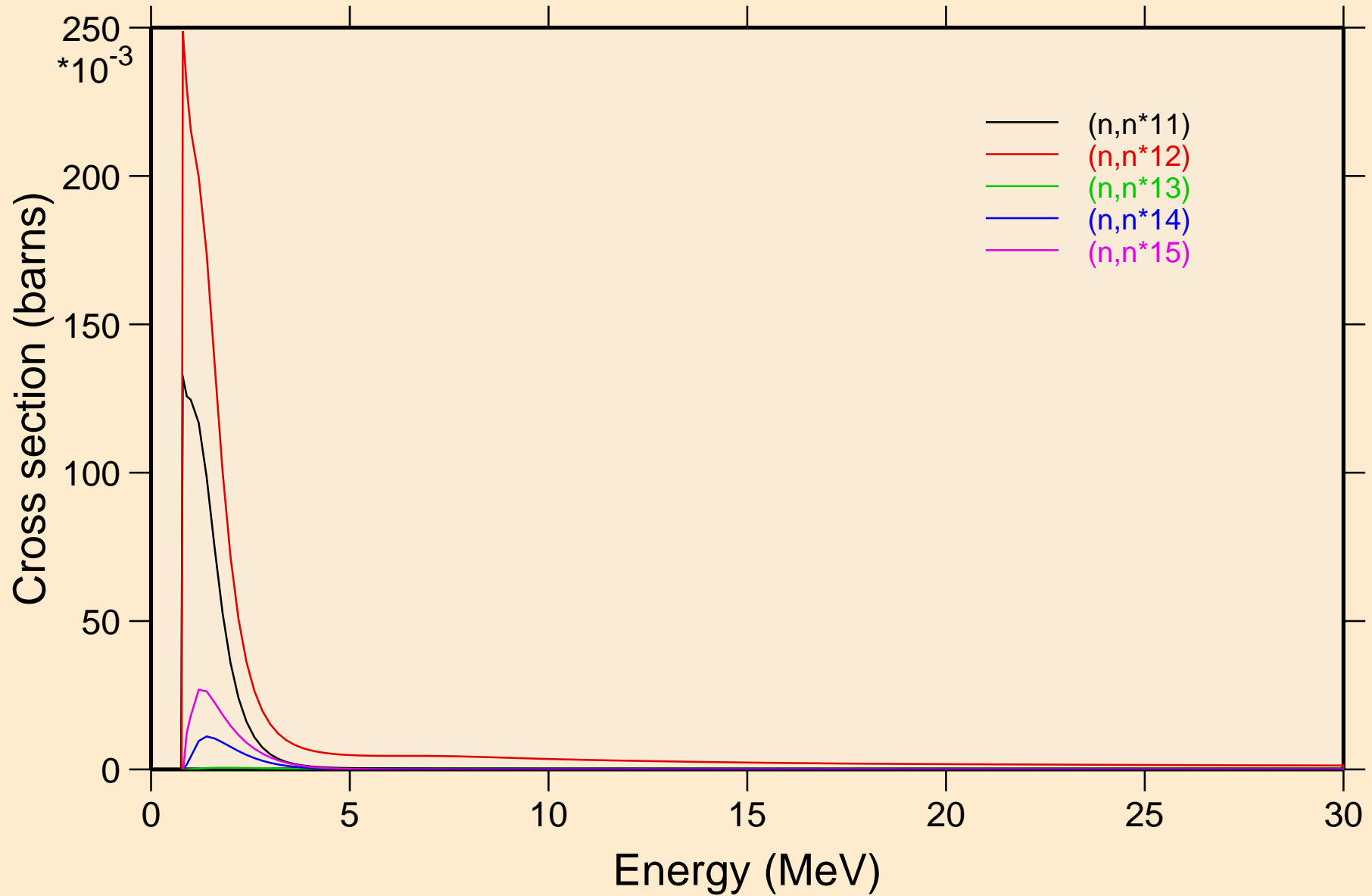

TB165 NEUTRON ACER TENDL-2024 LIBRARY; T=293.6K
Inelastic levels

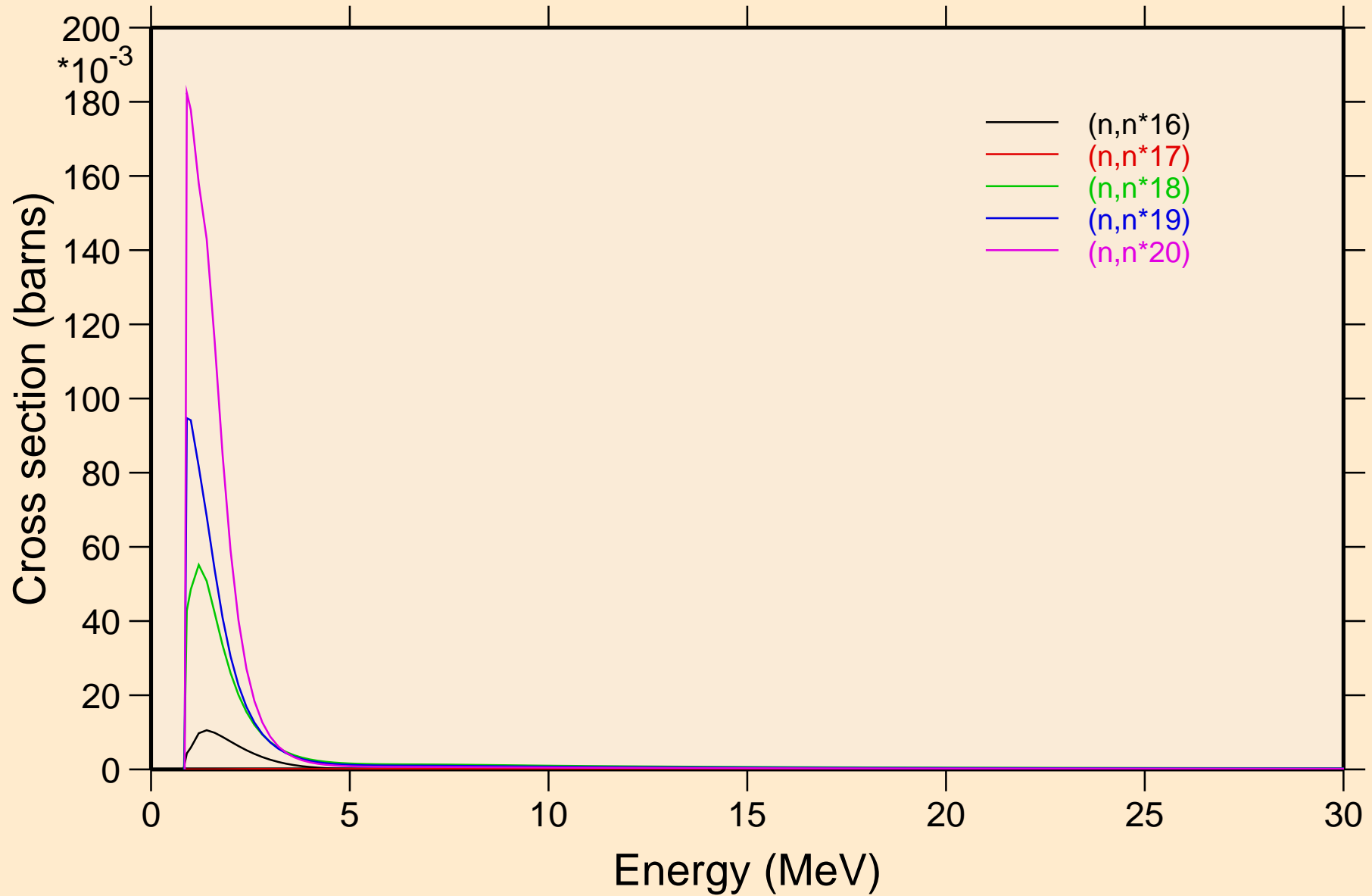

TB165 NEUTRON ACER TENDL-2024 LIBRARY; T=293.6K
Inelastic levels

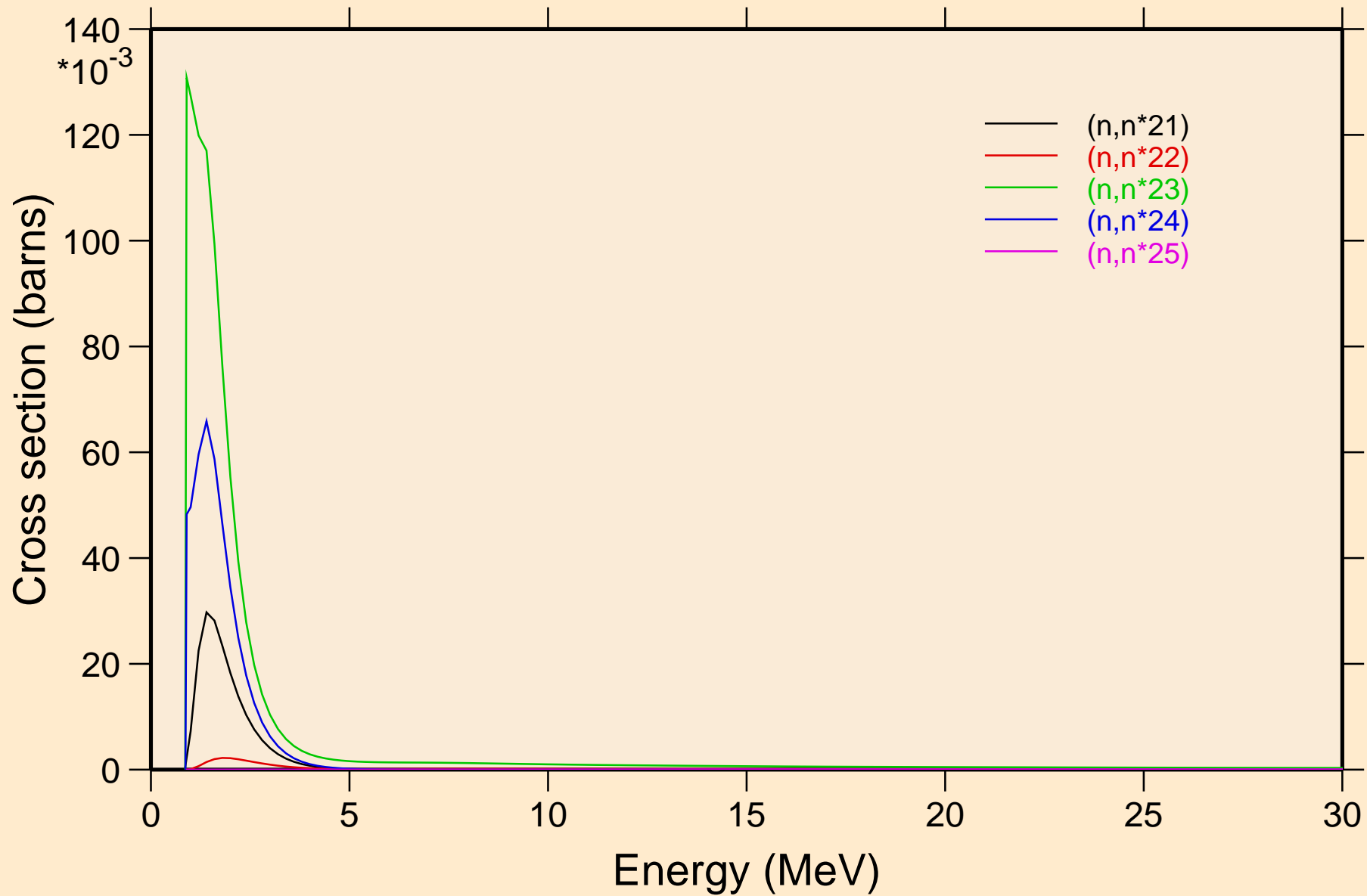

TB165 NEUTRON ACER TENDL-2024 LIBRARY; T=293.6K
Inelastic levels

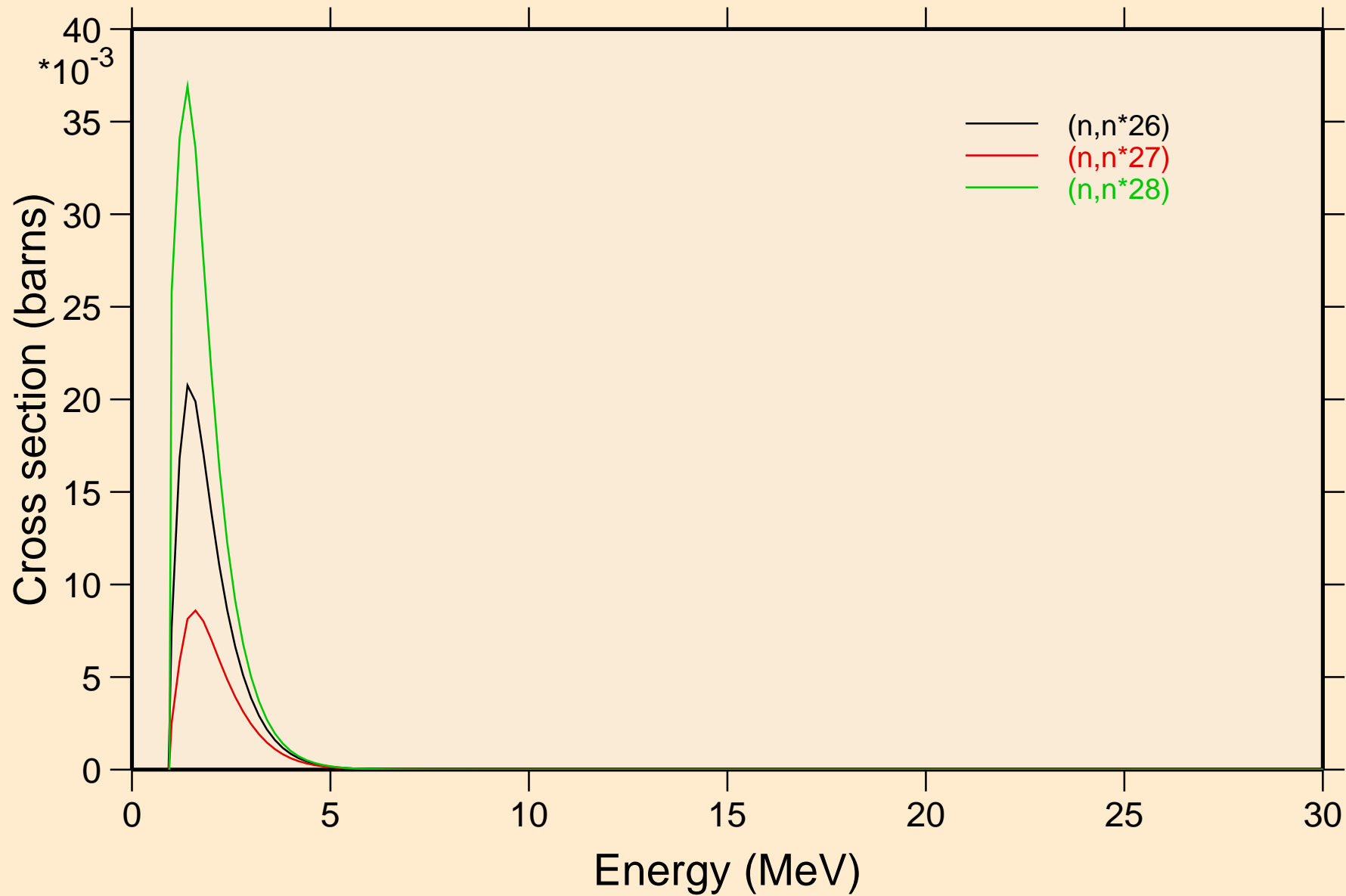

TB165 NEUTRON ACER TENDL-2024 LIBRARY; T=293.6K
Threshold reactions

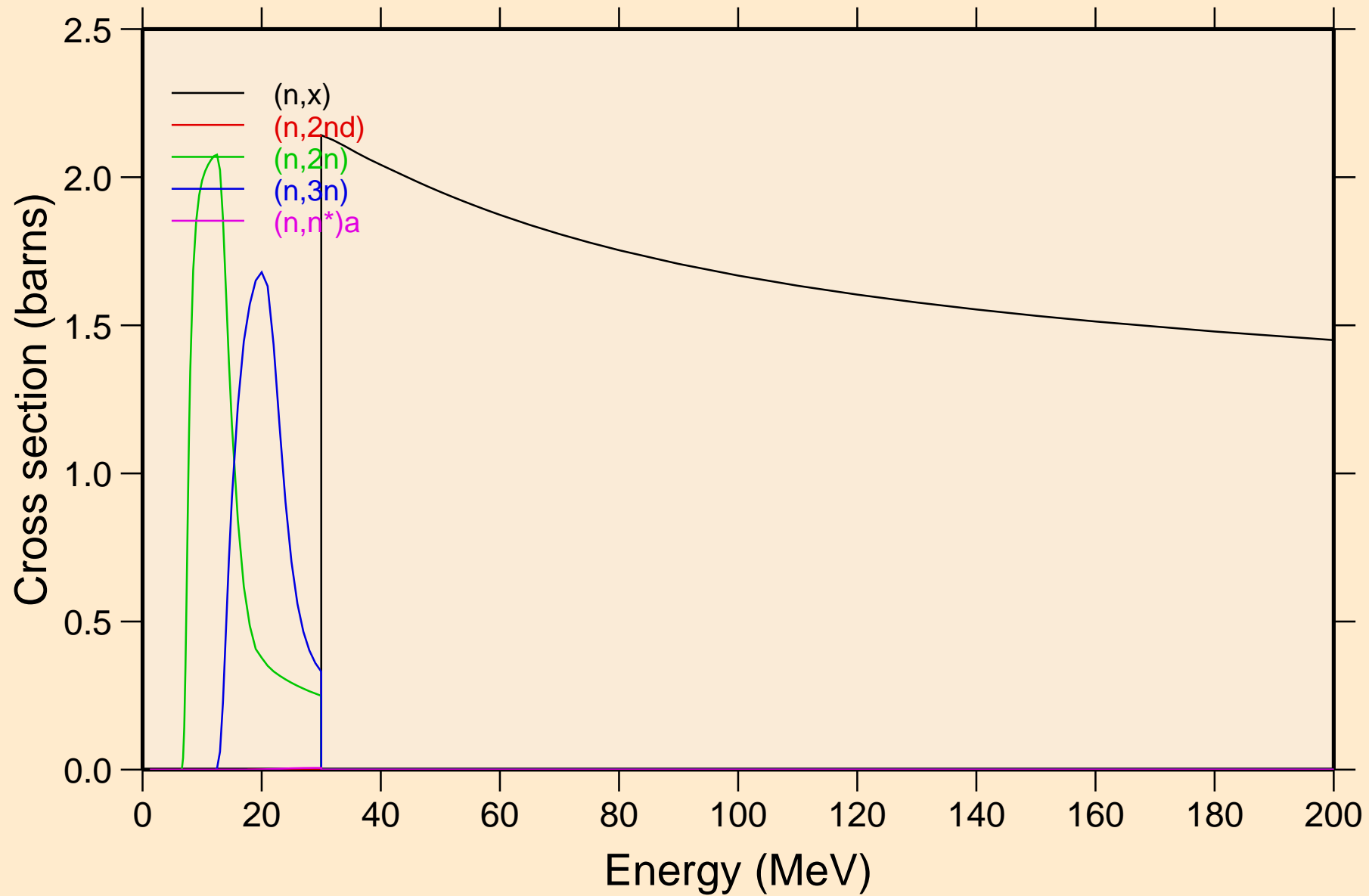

TB165 NEUTRON ACER TENDL-2024 LIBRARY; T=293.6K
Threshold reactions

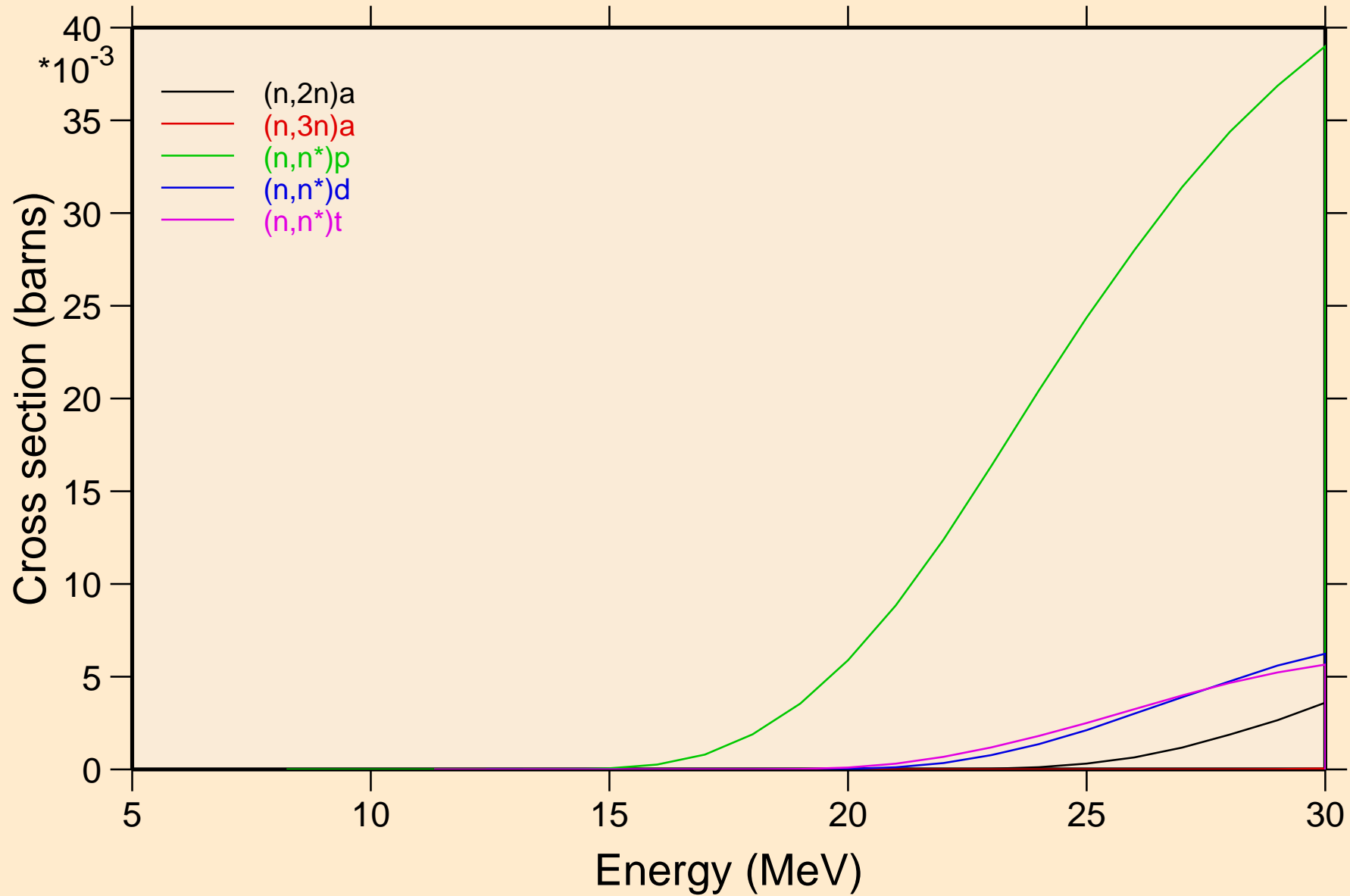

TB165 NEUTRON ACER TENDL-2024 LIBRARY; T=293.6K
Threshold reactions

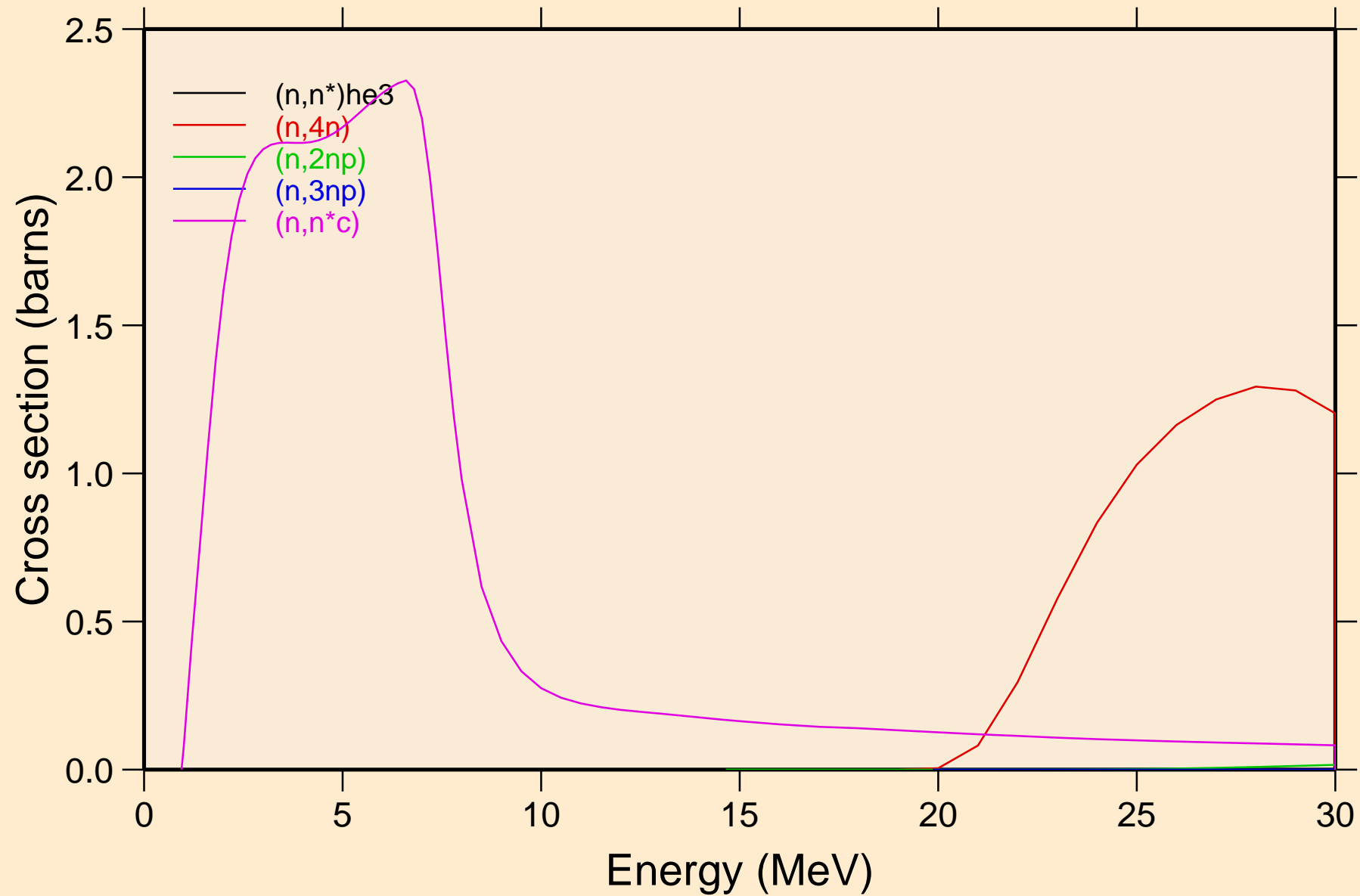

TB165 NEUTRON ACER TENDL-2024 LIBRARY; T=293.6K
Threshold reactions

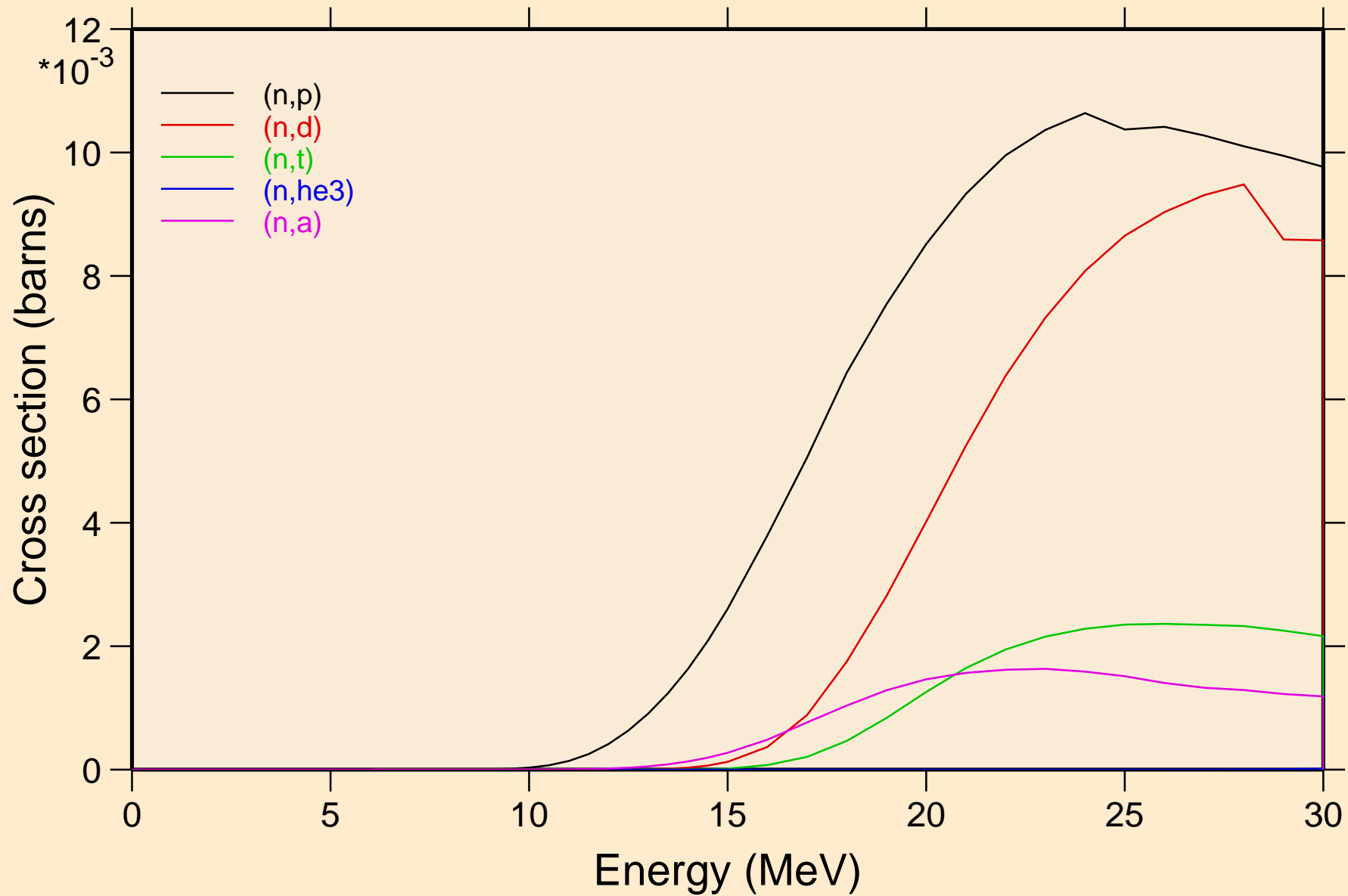

TB165 NEUTRON ACER TENDL-2024 LIBRARY; T=293.6K
Threshold reactions

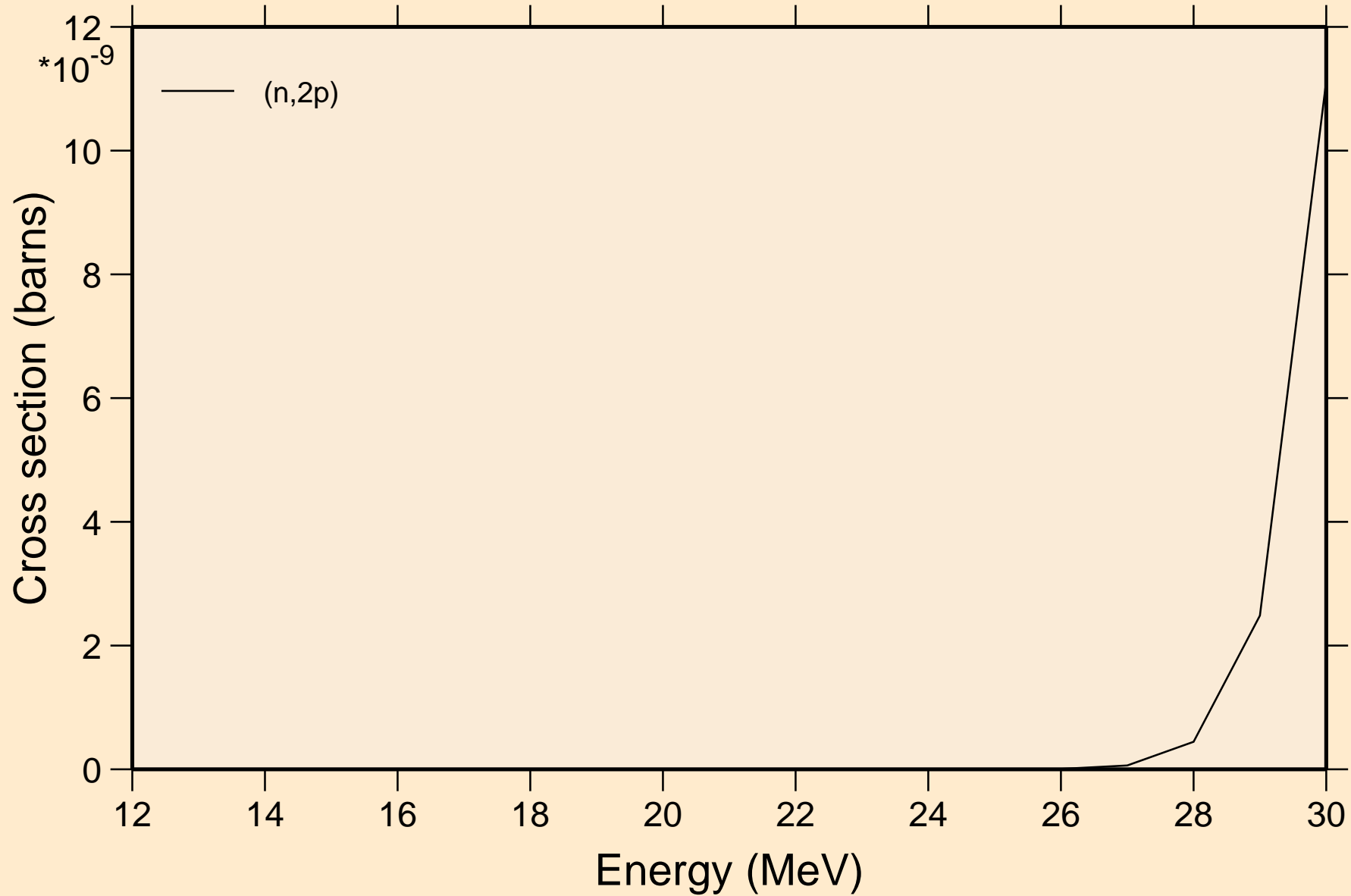

TB165 NEUTRON ACER TENDL-2024 LIBRARY; T=293.6K
Threshold reactions

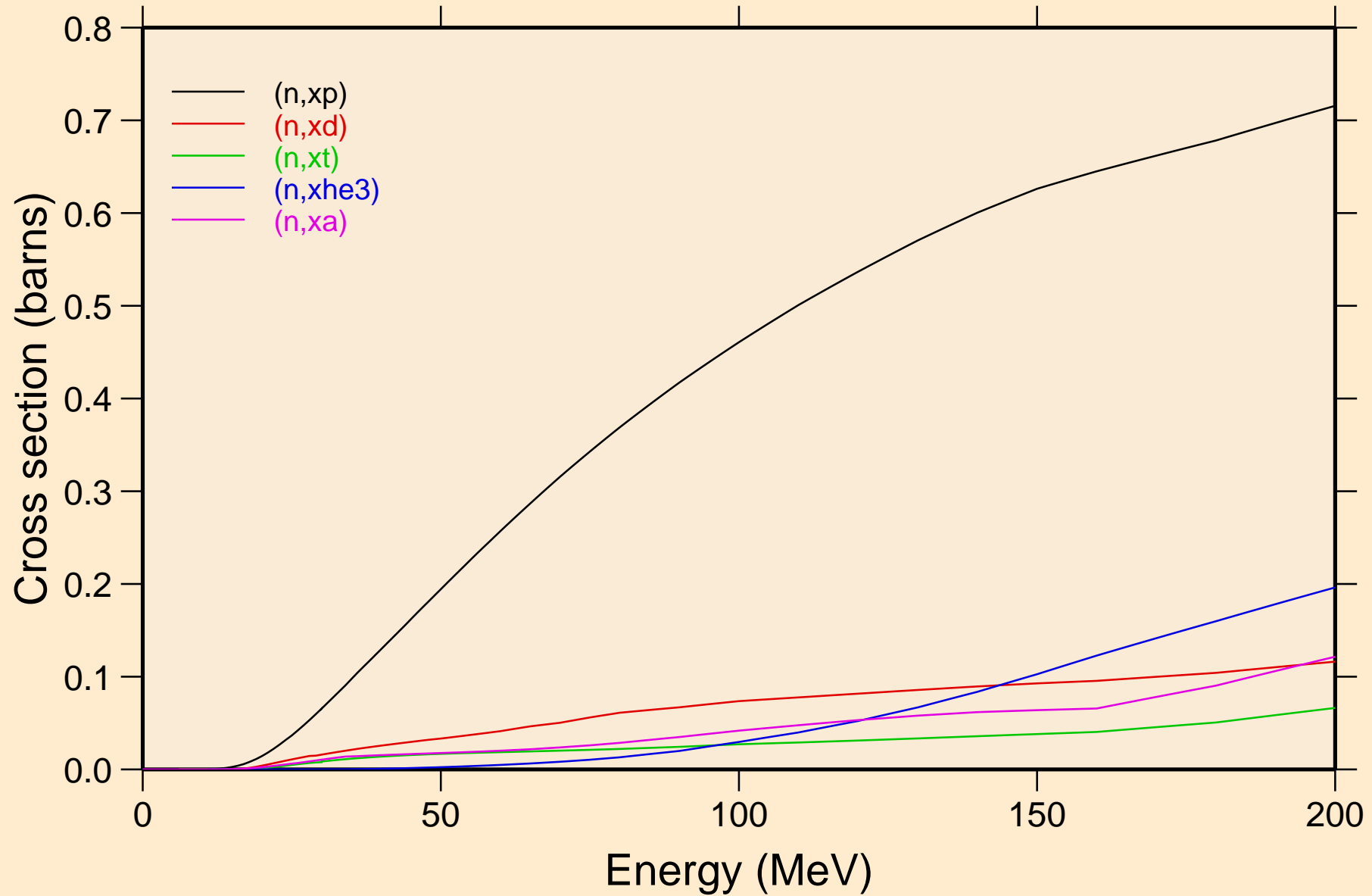

TB165 NEUTRON ACER TENDL-2024 LIBRARY; T=293.6K
angular distribution for elastic

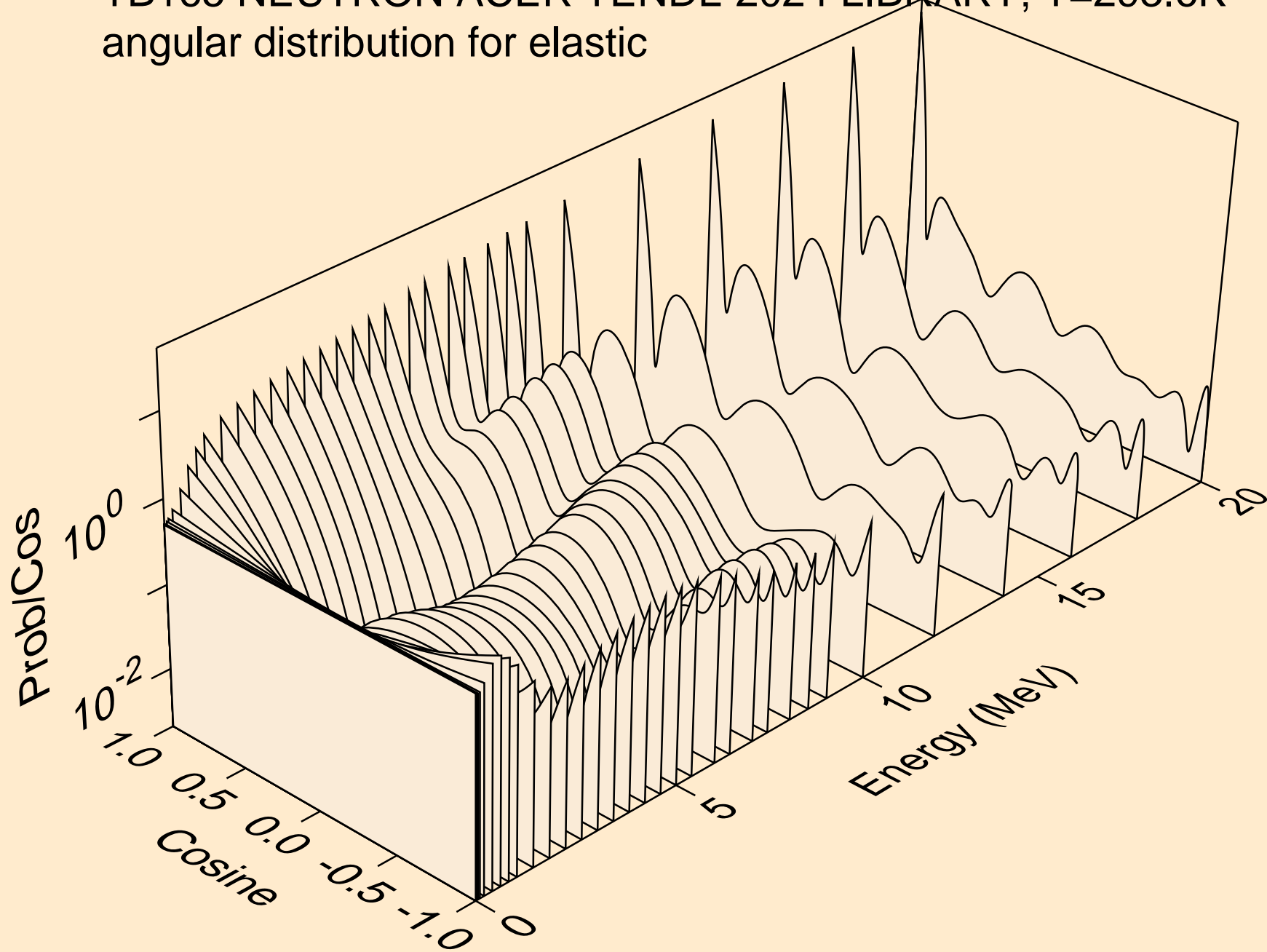

TB165 NEUTRON ACER TENDL-2024 LIBRARY; T=293.6K
angular distribution for elastic

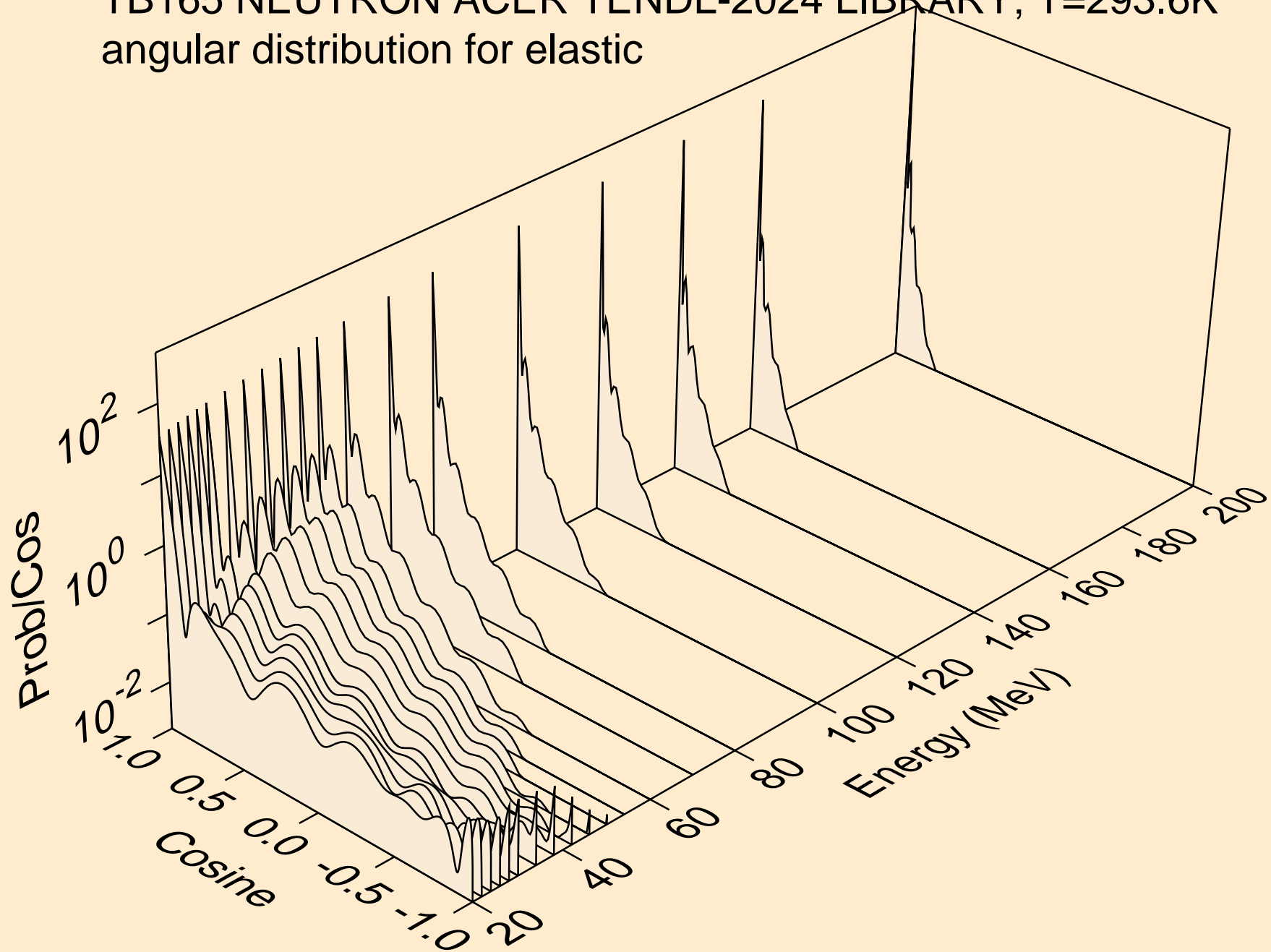

TB165 NEUTRON ACER TENDL-2024 LIBRARY; T=293.6K
angular distribution for (n,n*1)

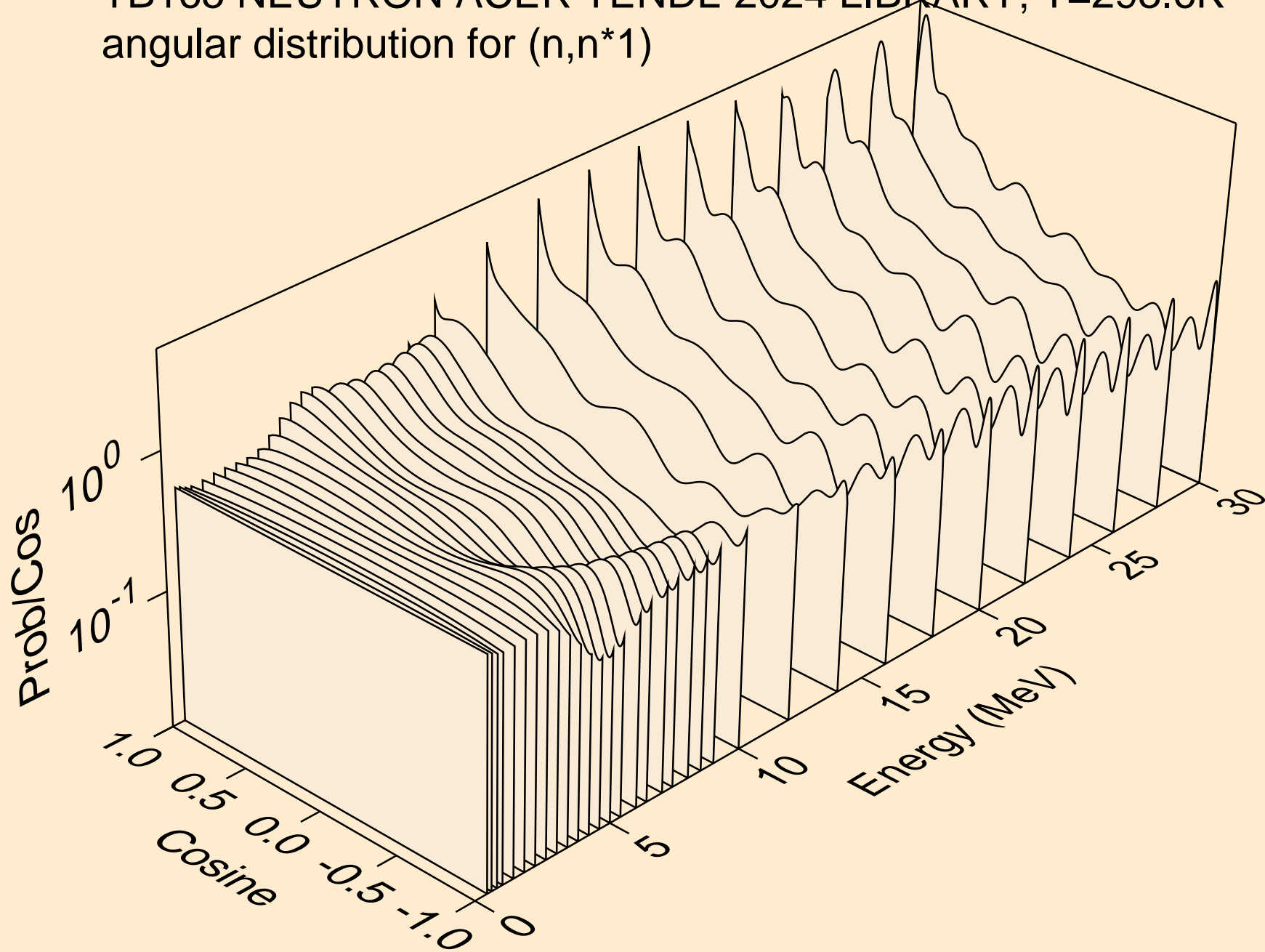

TB165 NEUTRON ACER TENDL-2024 LIBRARY; T=293.6K
angular distribution for (n,n*2)

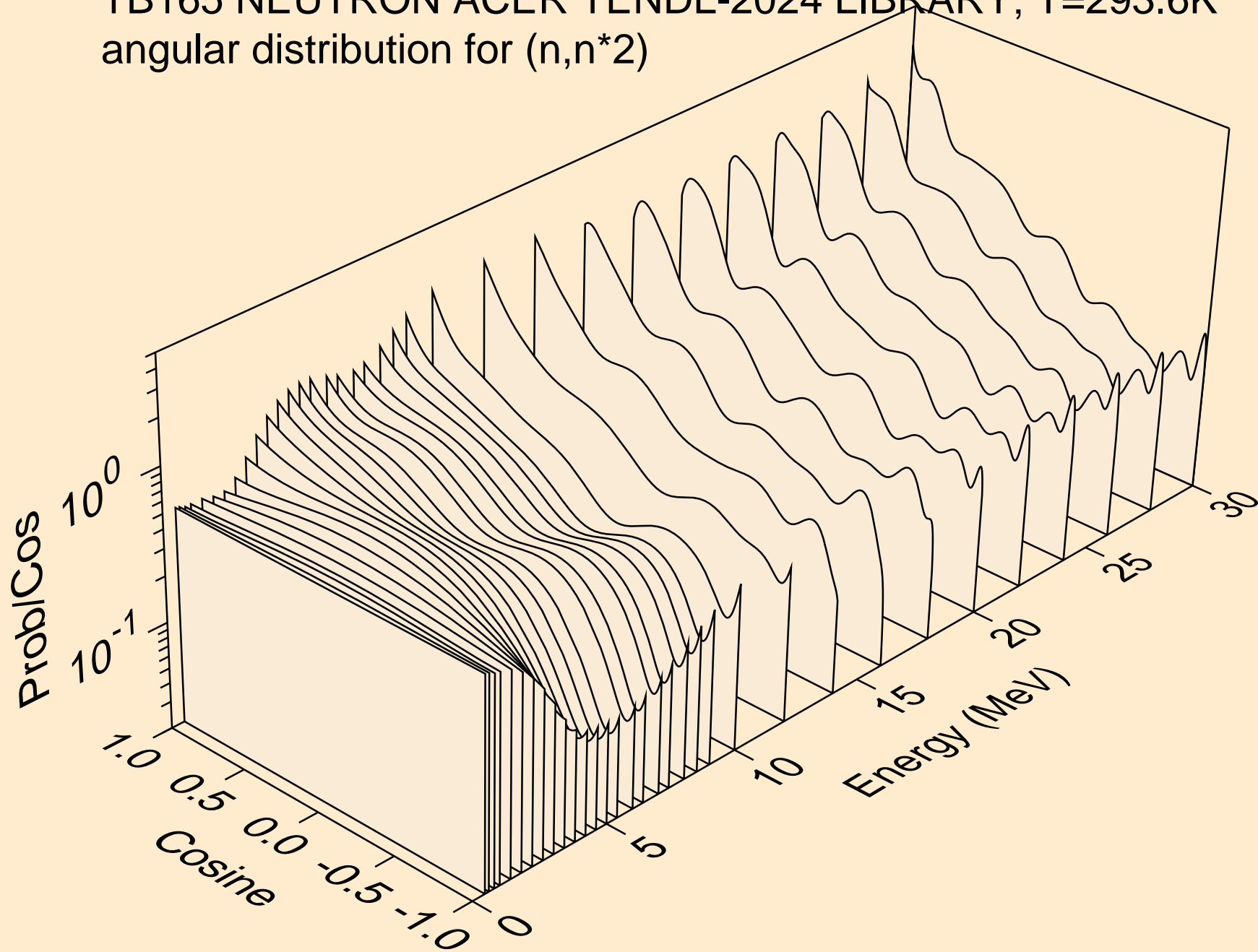

TB165 NEUTRON ACER TENDL-2024 LIBRARY; T=293.6K
angular distribution for (n,n*3)

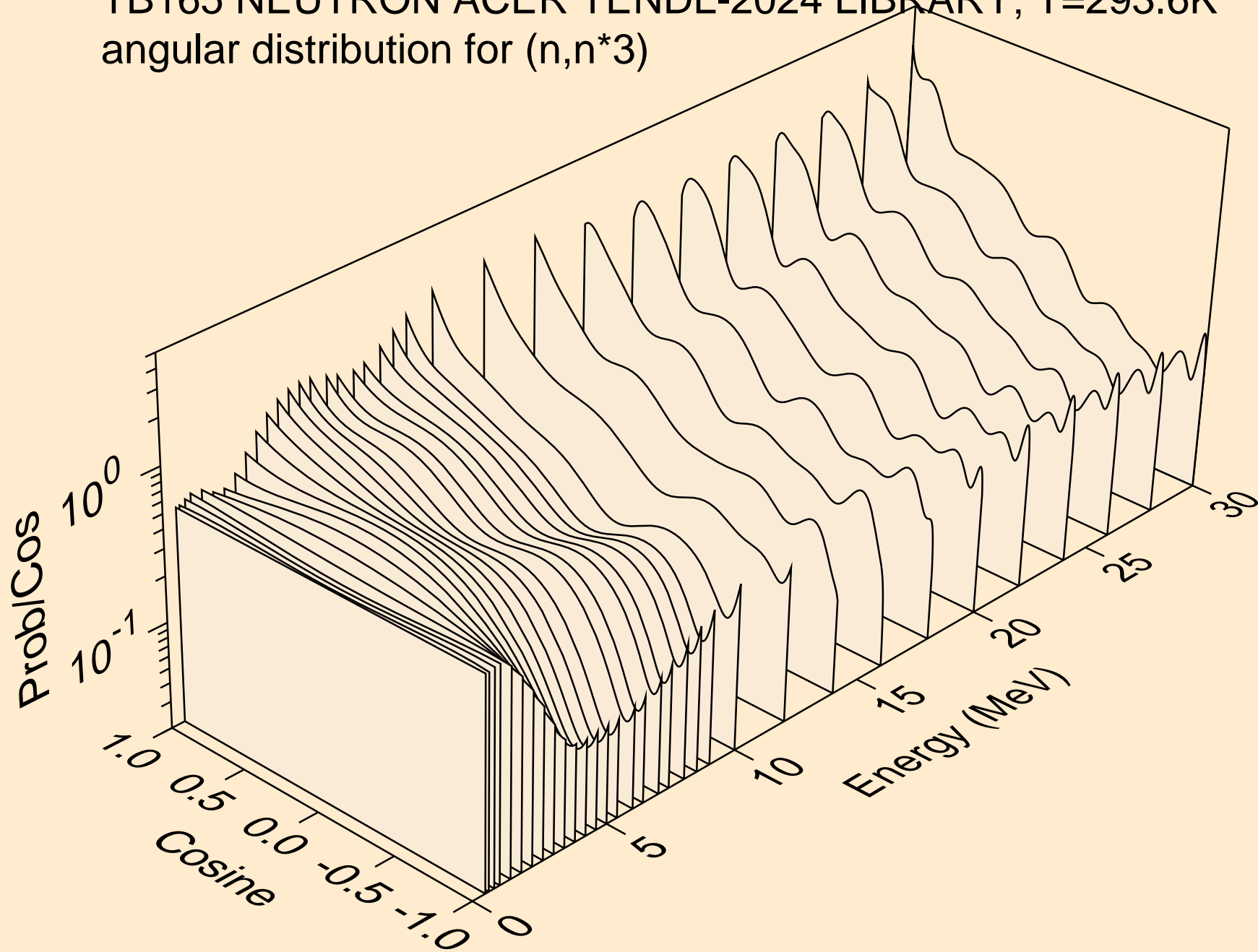

TB165 NEUTRON ACER TENDL-2024 LIBRARY; T=293.6K
angular distribution for (n,n*4)

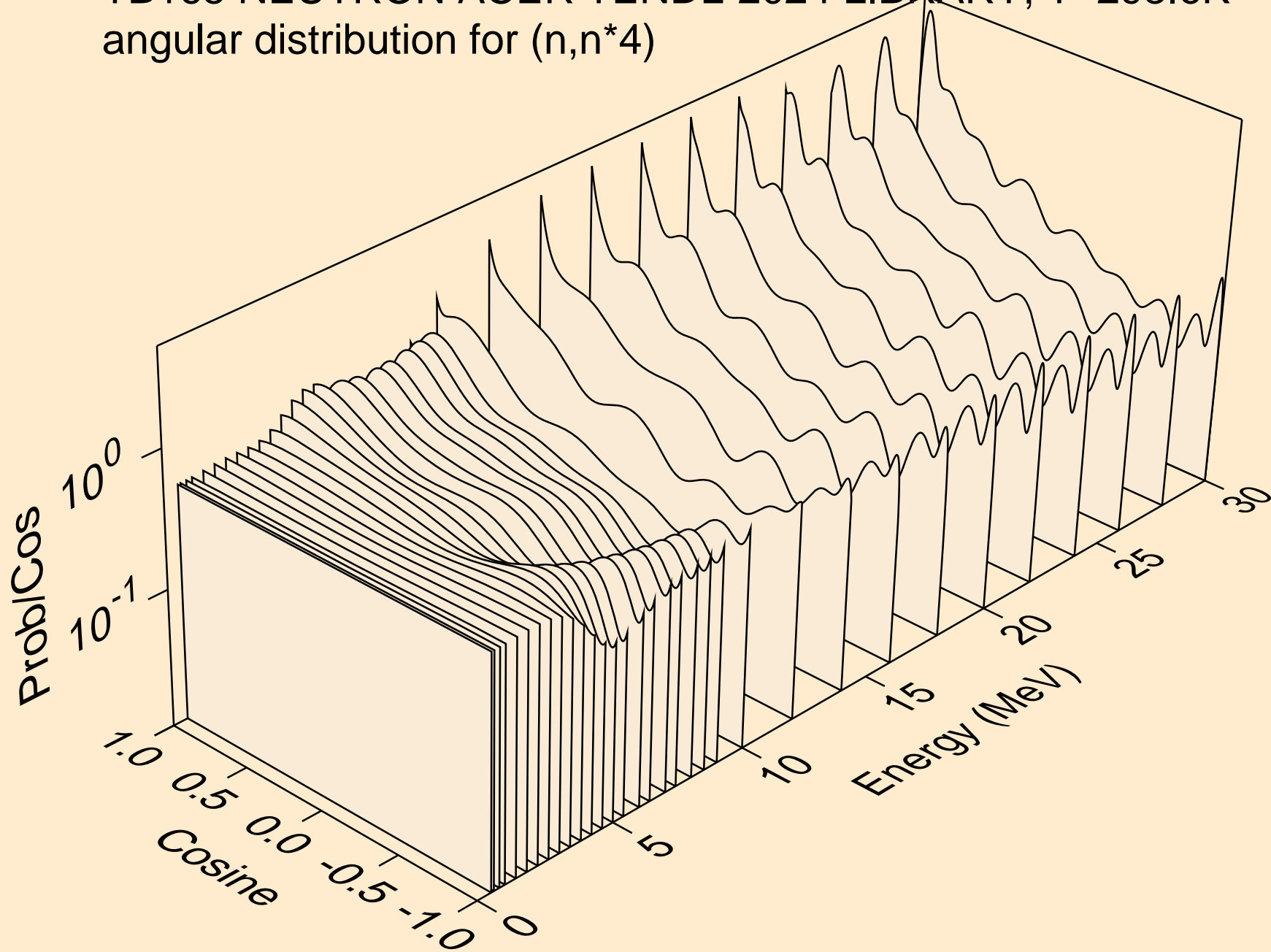

TB165 NEUTRON ACER TENDL-2024 LIBRARY; T=293.6K
angular distribution for (n,n*5)

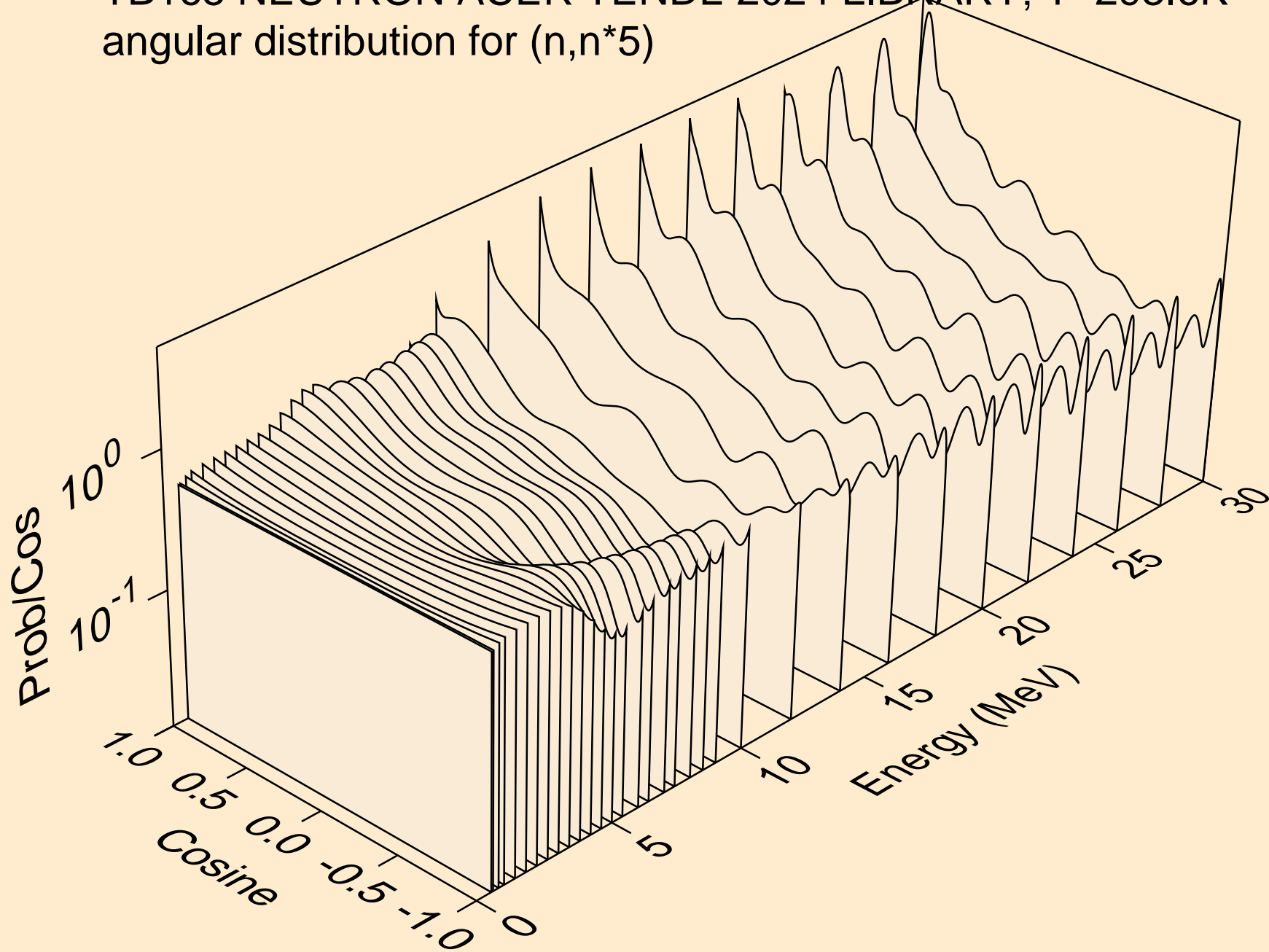

TB165 NEUTRON ACER TENDL-2024 LIBRARY; T=293.6K
angular distribution for (n,n*6)

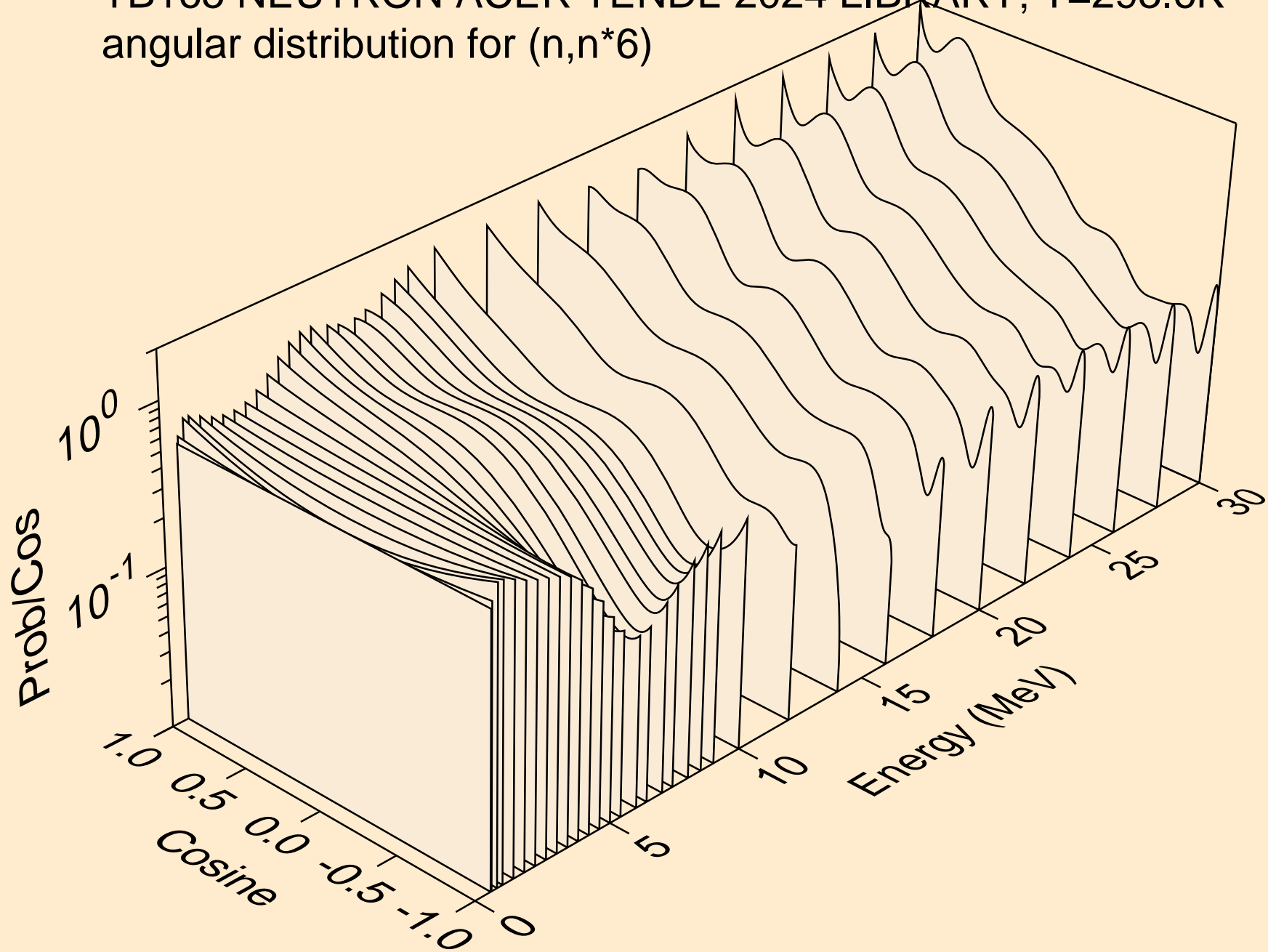

TB165 NEUTRON ACER TENDL-2024 LIBRARY; T=293.6K
angular distribution for (n,n*7)

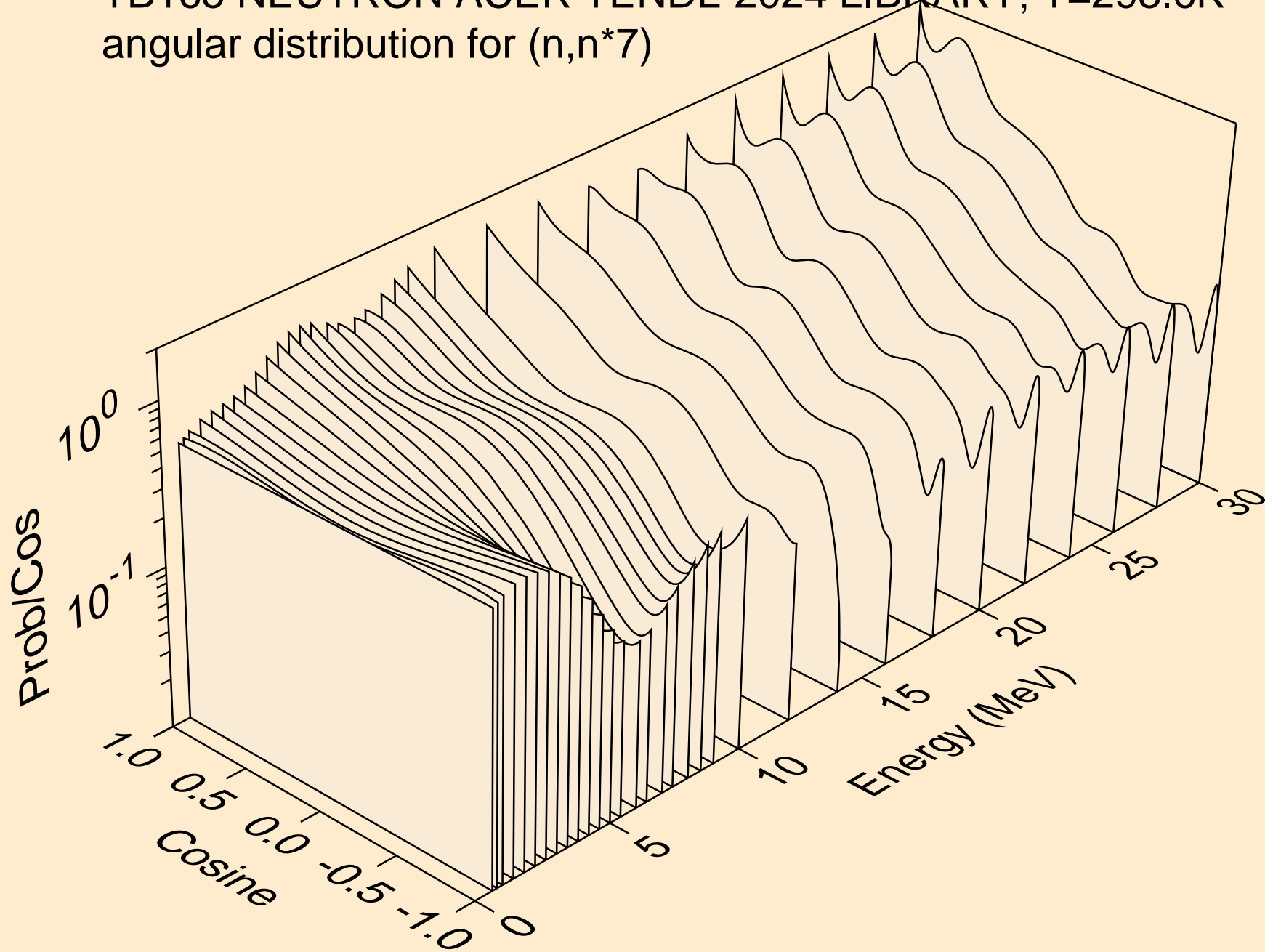

TB165 NEUTRON ACER TENDL-2024 LIBRARY; T=293.6K
angular distribution for (n,n*8)

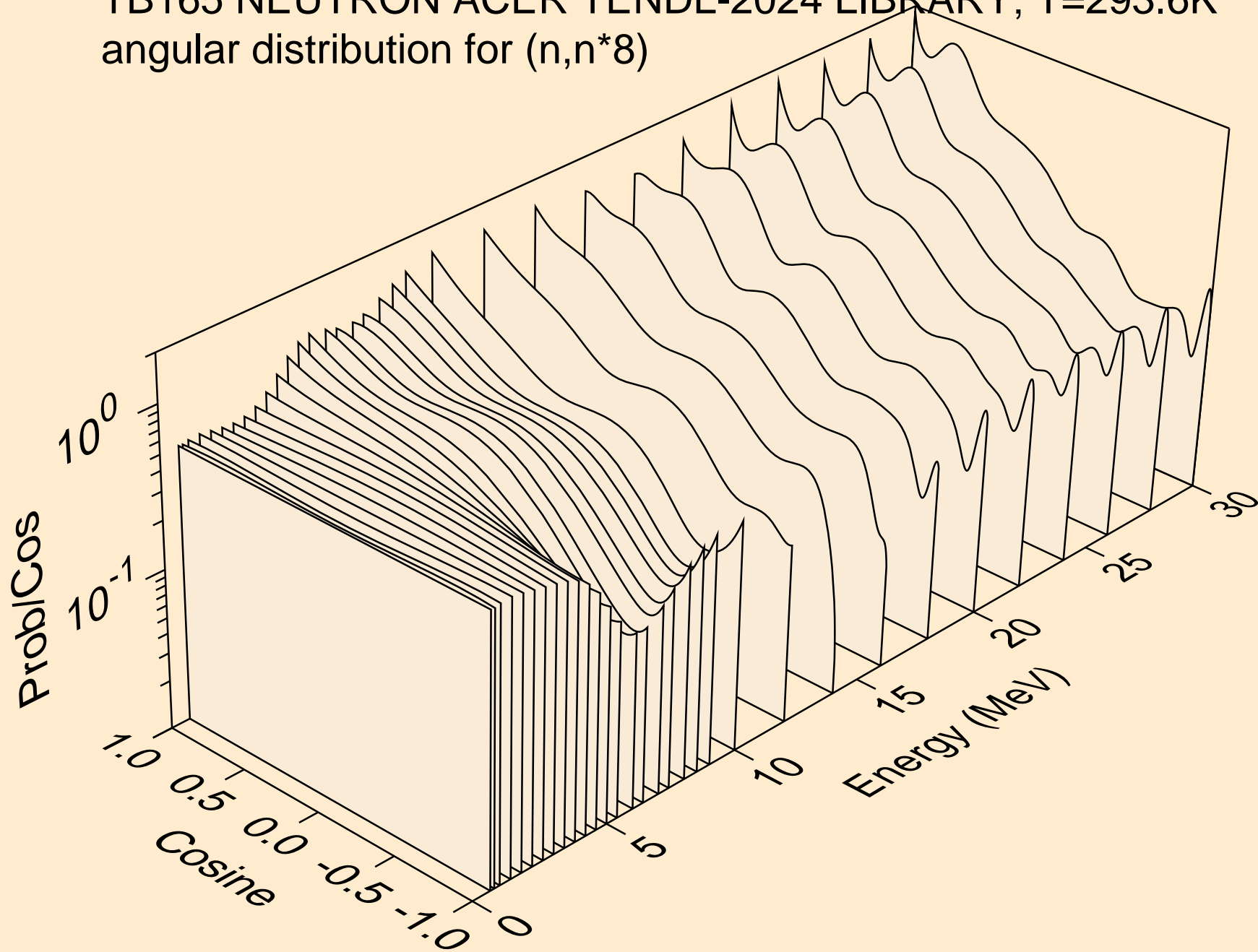

TB165 NEUTRON ACER TENDL-2024 LIBRARY; T=293.6K
angular distribution for (n,n*9)

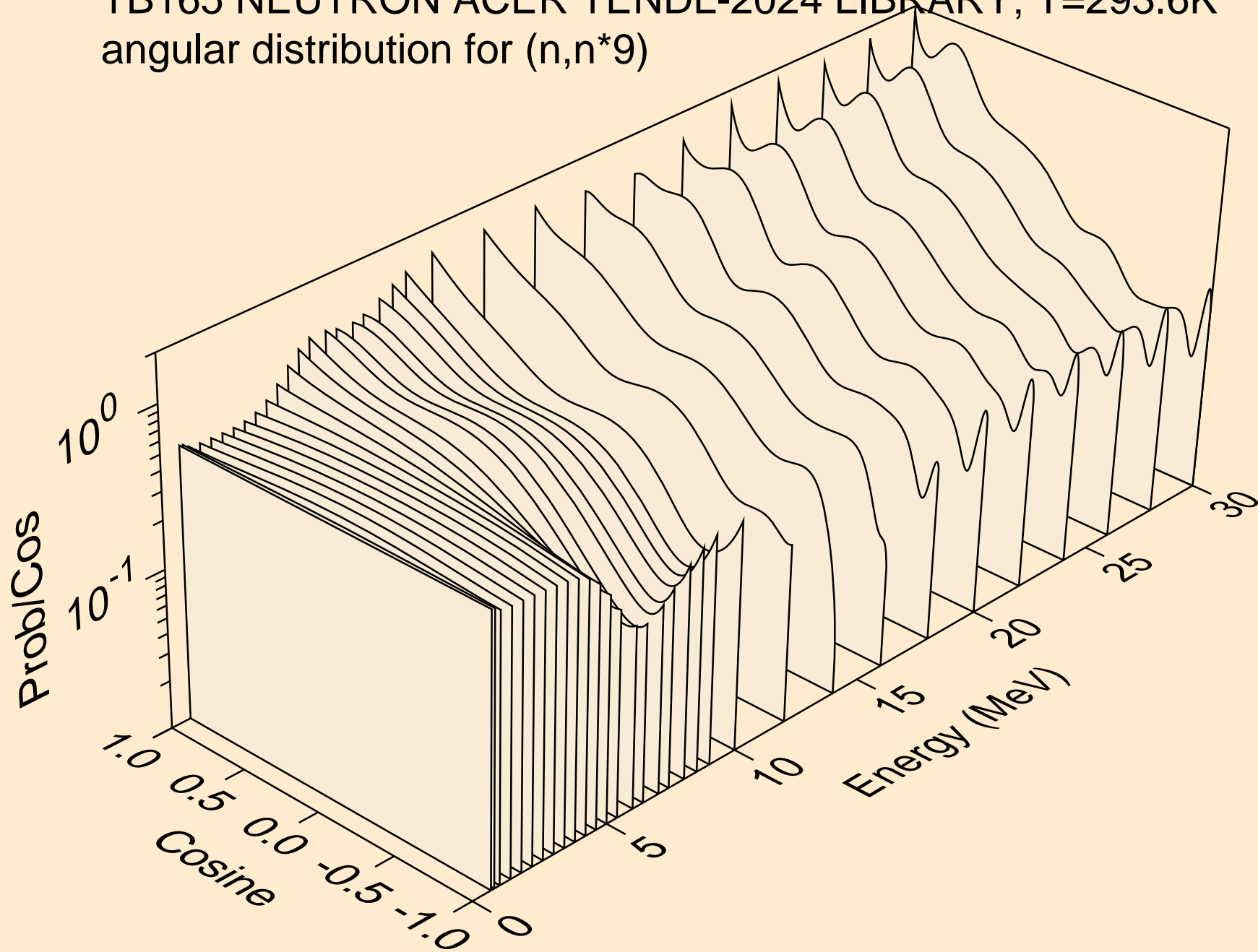

TB165 NEUTRON ACER TENDL-2024 LIBRARY; T=293.6K
angular distribution for (n,n*10)

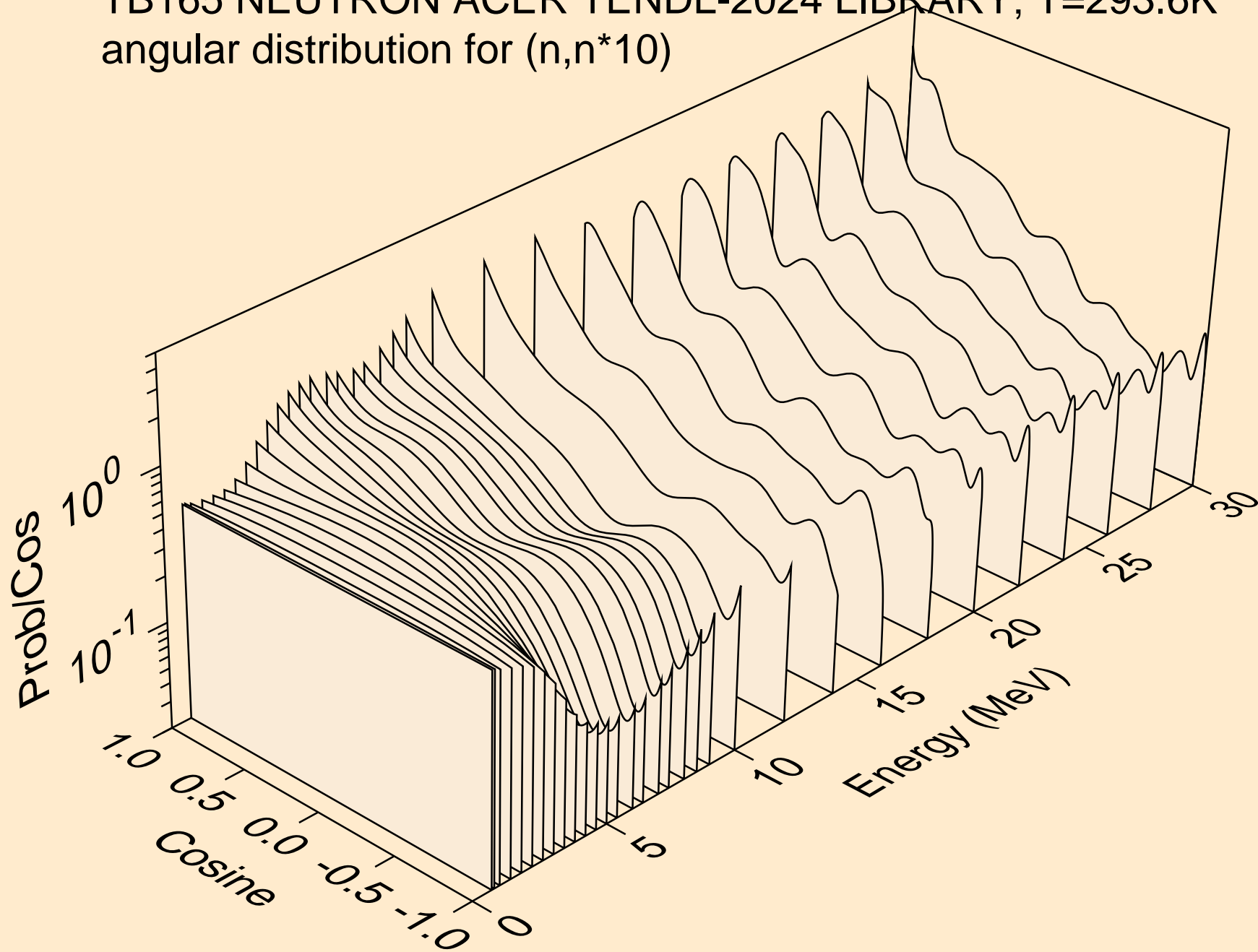

TB165 NEUTRON ACER TENDL-2024 LIBRARY; T=293.6K
angular distribution for (n,n*11)

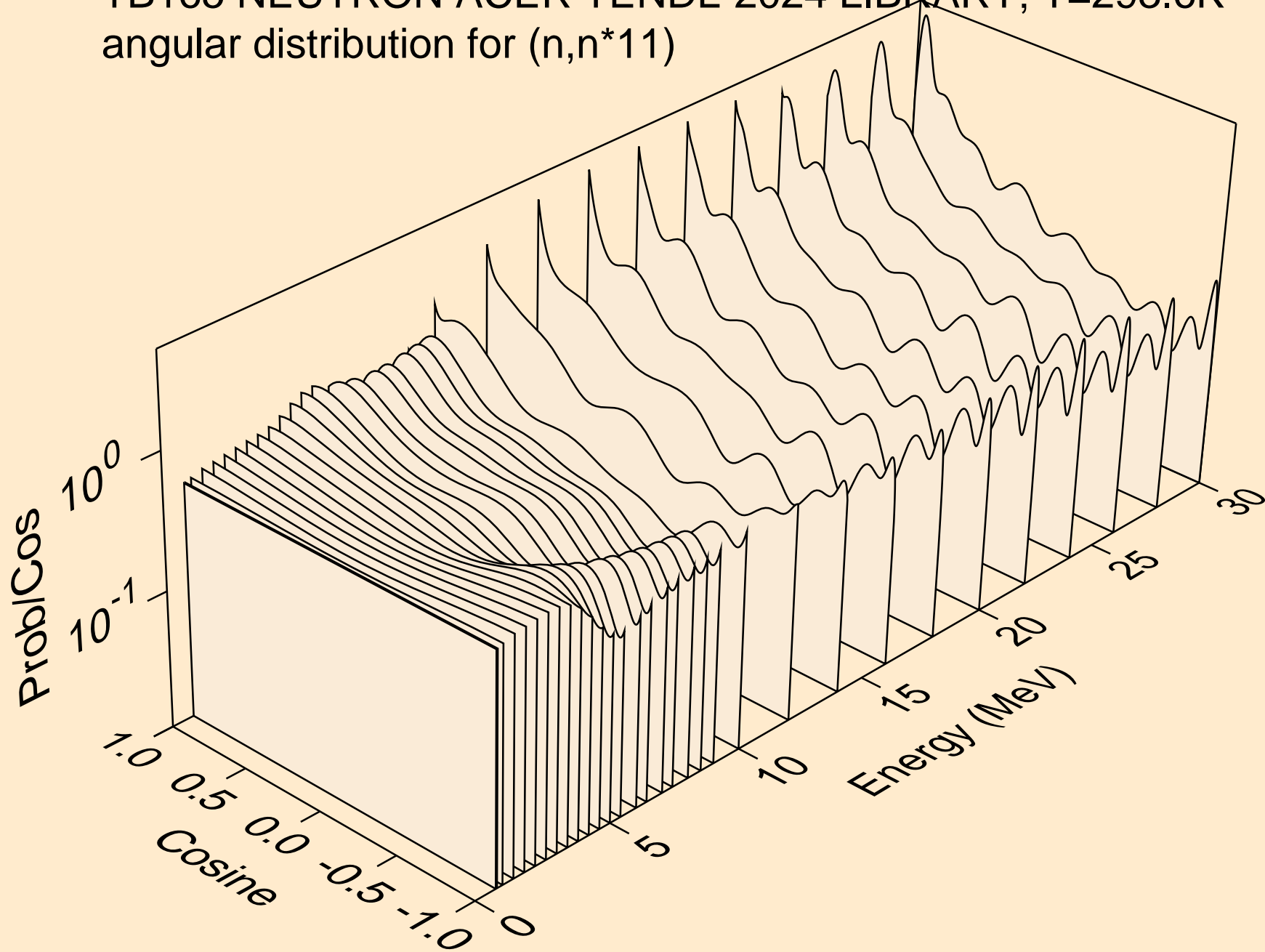

TB165 NEUTRON ACER TENDL-2024 LIBRARY; T=293.6K
angular distribution for (n,n*12)

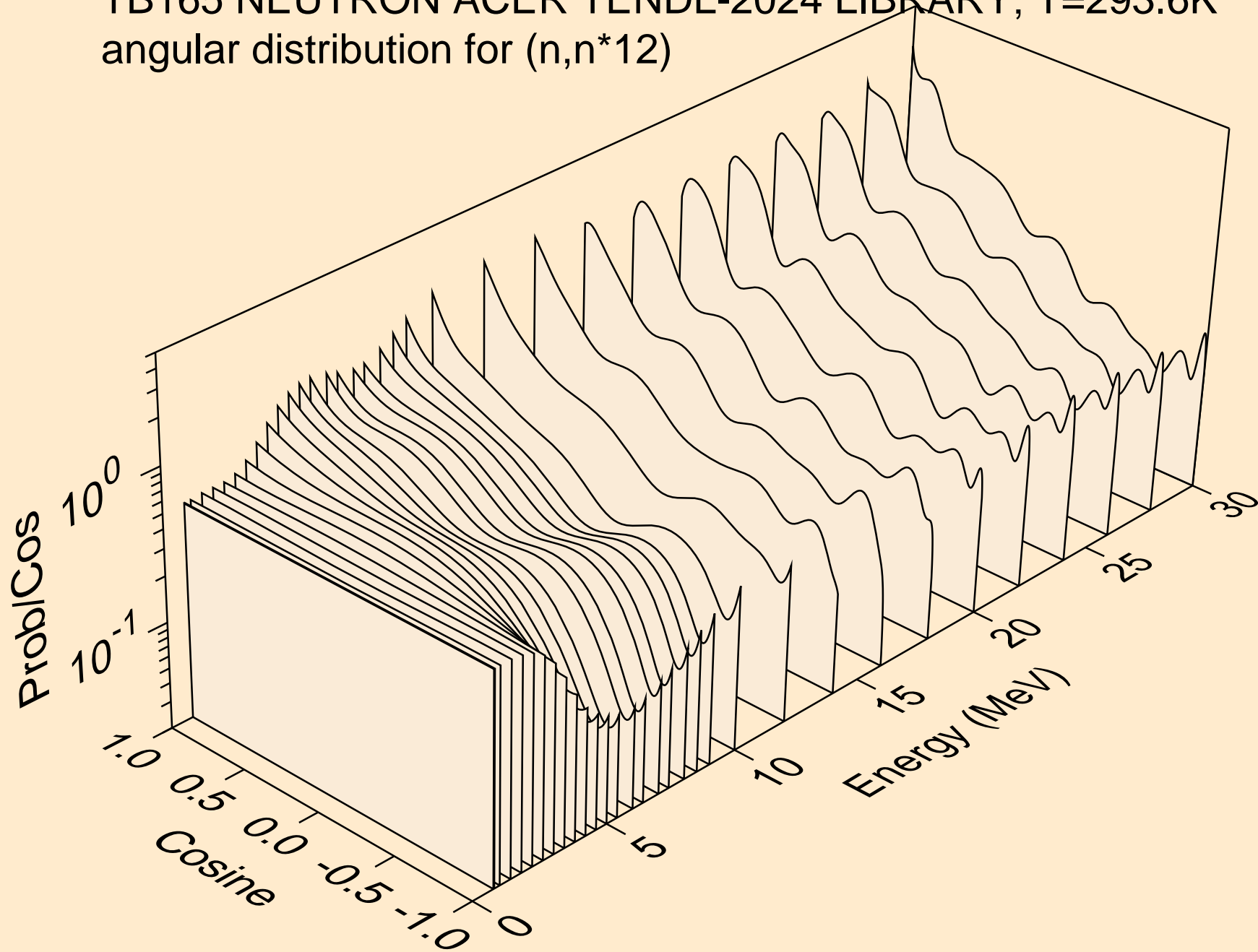

TB165 NEUTRON ACER TENDL-2024 LIBRARY; T=293.6K
angular distribution for (n,n*13)

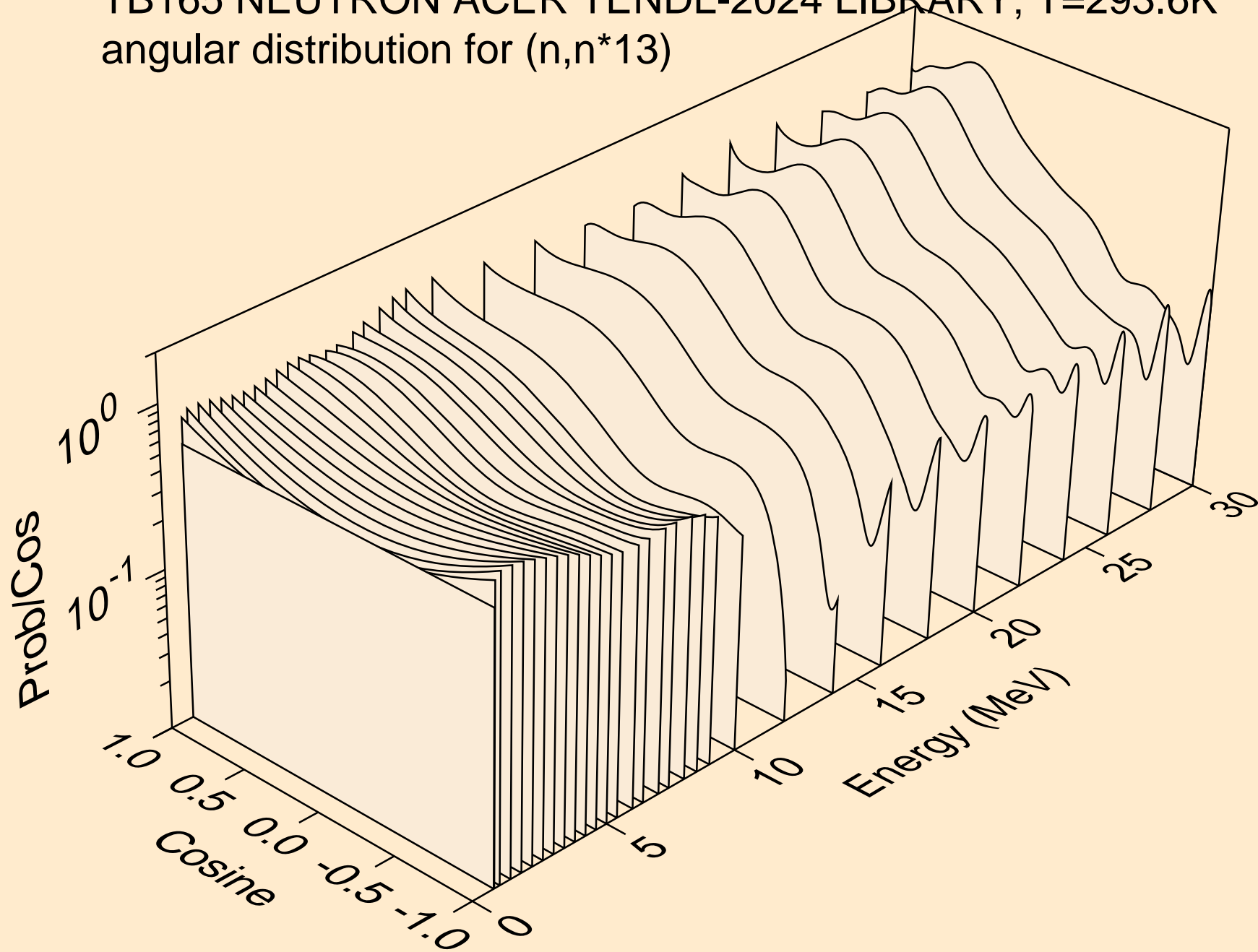

TB165 NEUTRON ACER TENDL-2024 LIBRARY; T=293.6K
angular distribution for (n,n*14)

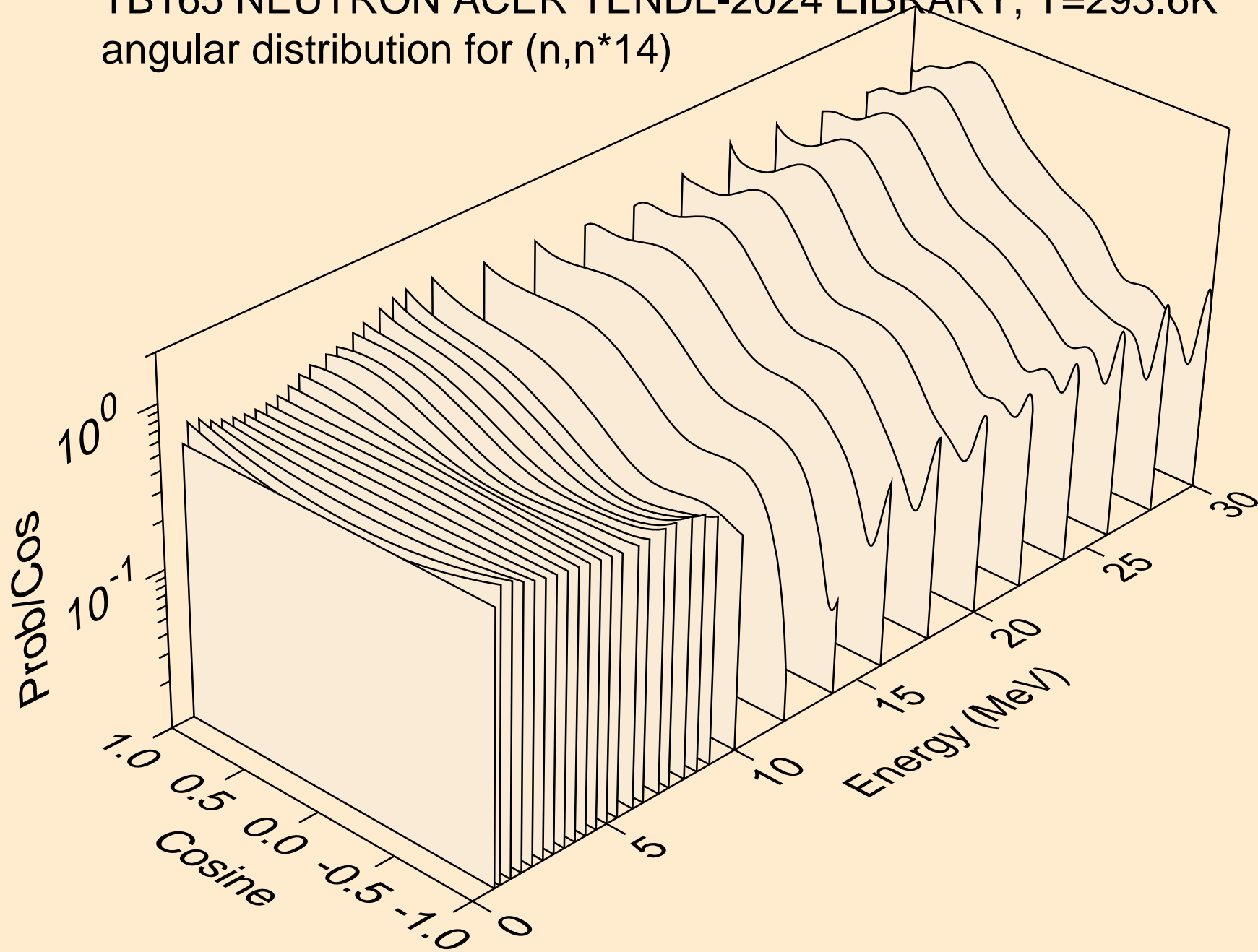

TB165 NEUTRON ACER TENDL-2024 LIBRARY; T=293.6K
angular distribution for (n,n*15)

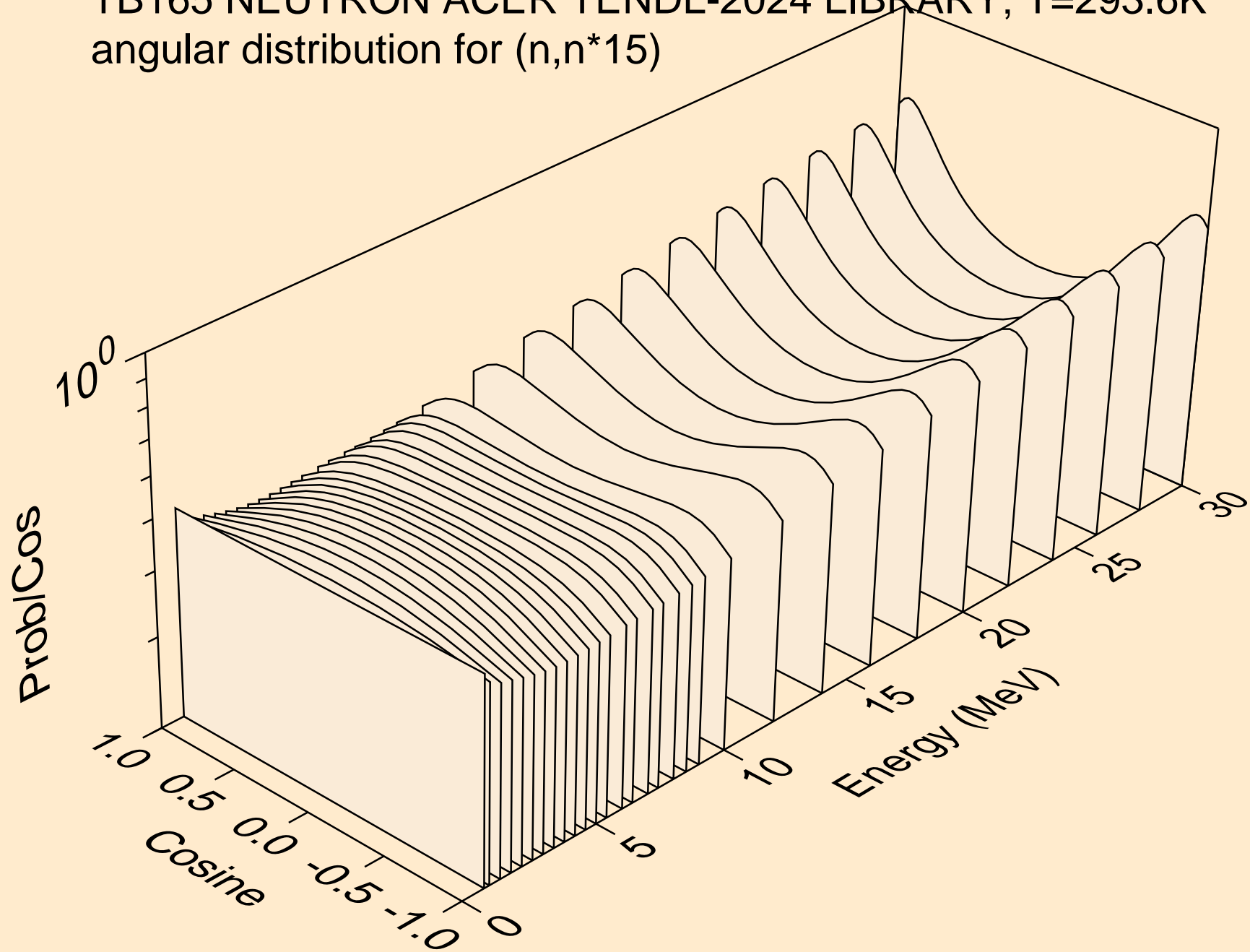

TB165 NEUTRON ACER TENDL-2024 LIBRARY; T=293.6K
angular distribution for (n,n*16)

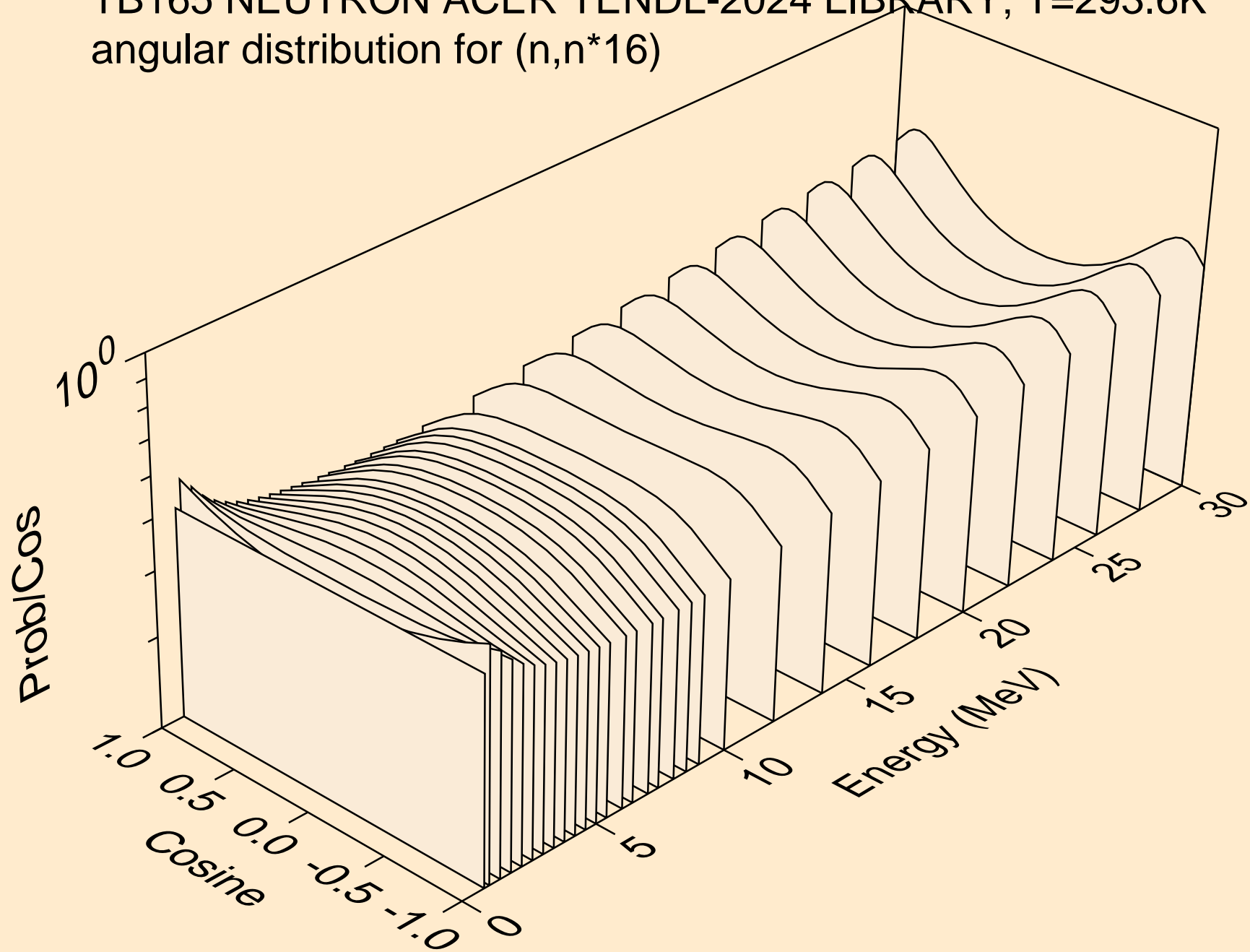

TB165 NEUTRON ACER TENDL-2024 LIBRARY; T=293.6K
angular distribution for (n,n*17)

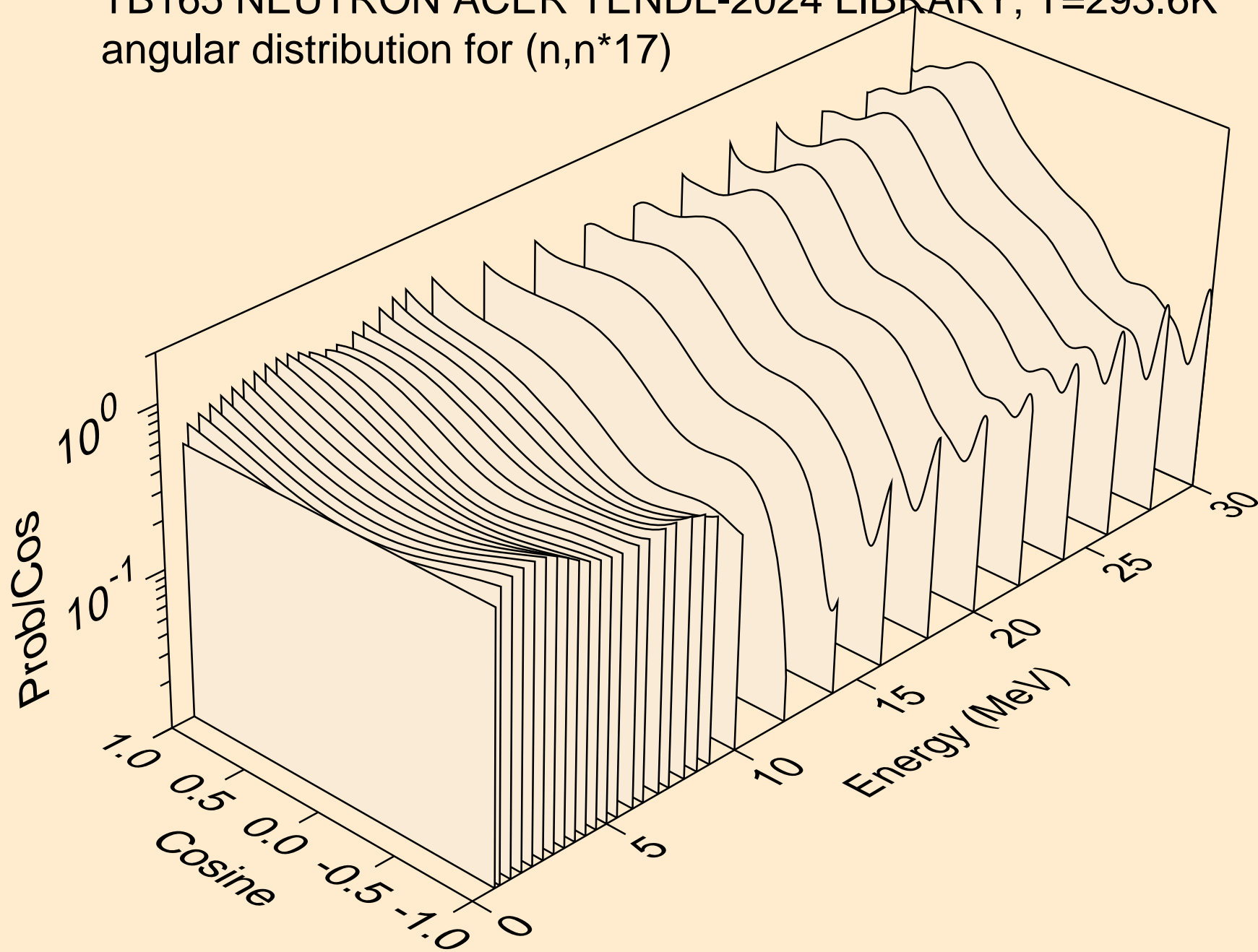

TB165 NEUTRON ACER TENDL-2024 LIBRARY; T=293.6K
angular distribution for (n,n*18)

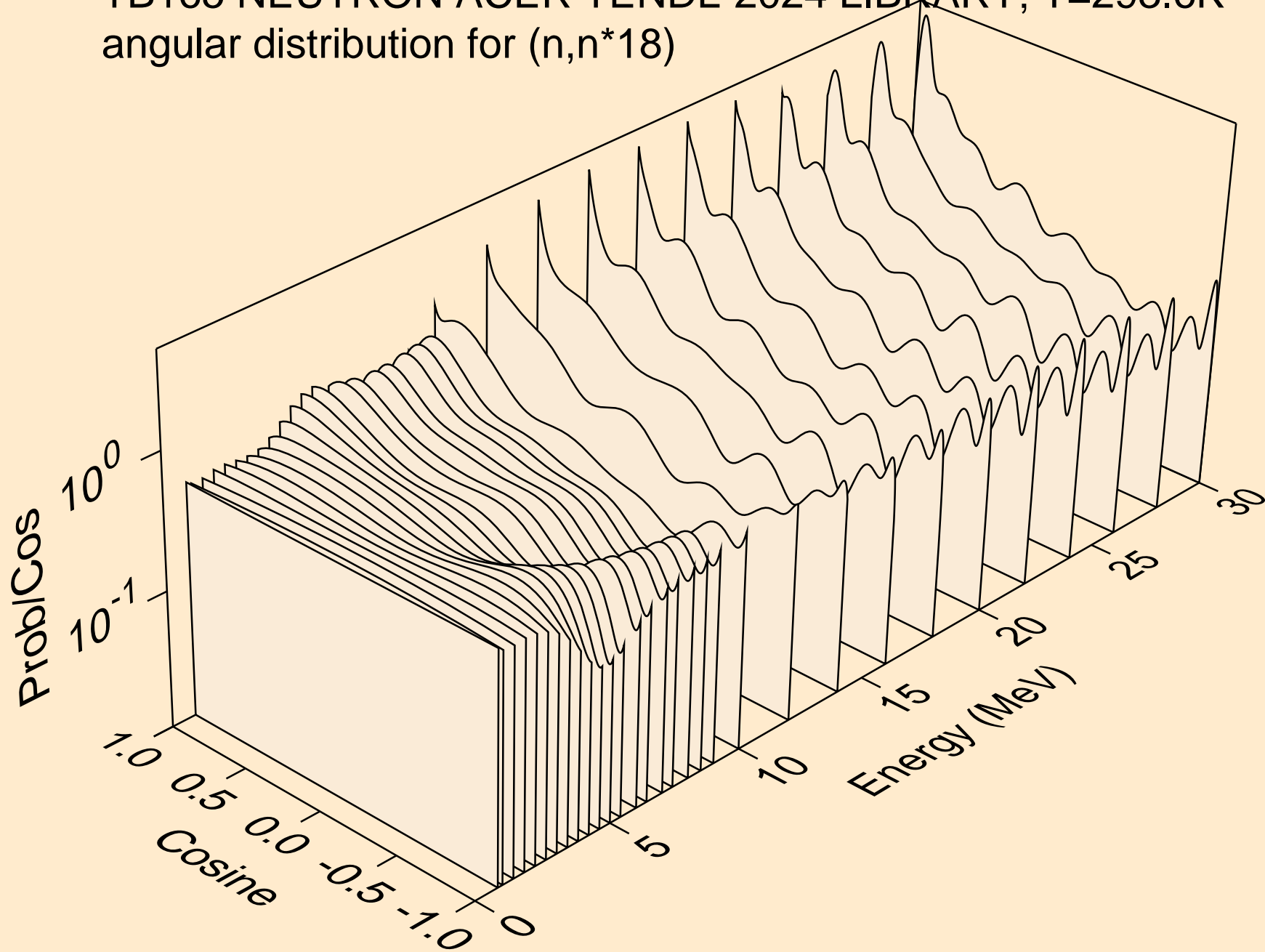

TB165 NEUTRON ACER TENDL-2024 LIBRARY; T=293.6K
angular distribution for (n,n*19)

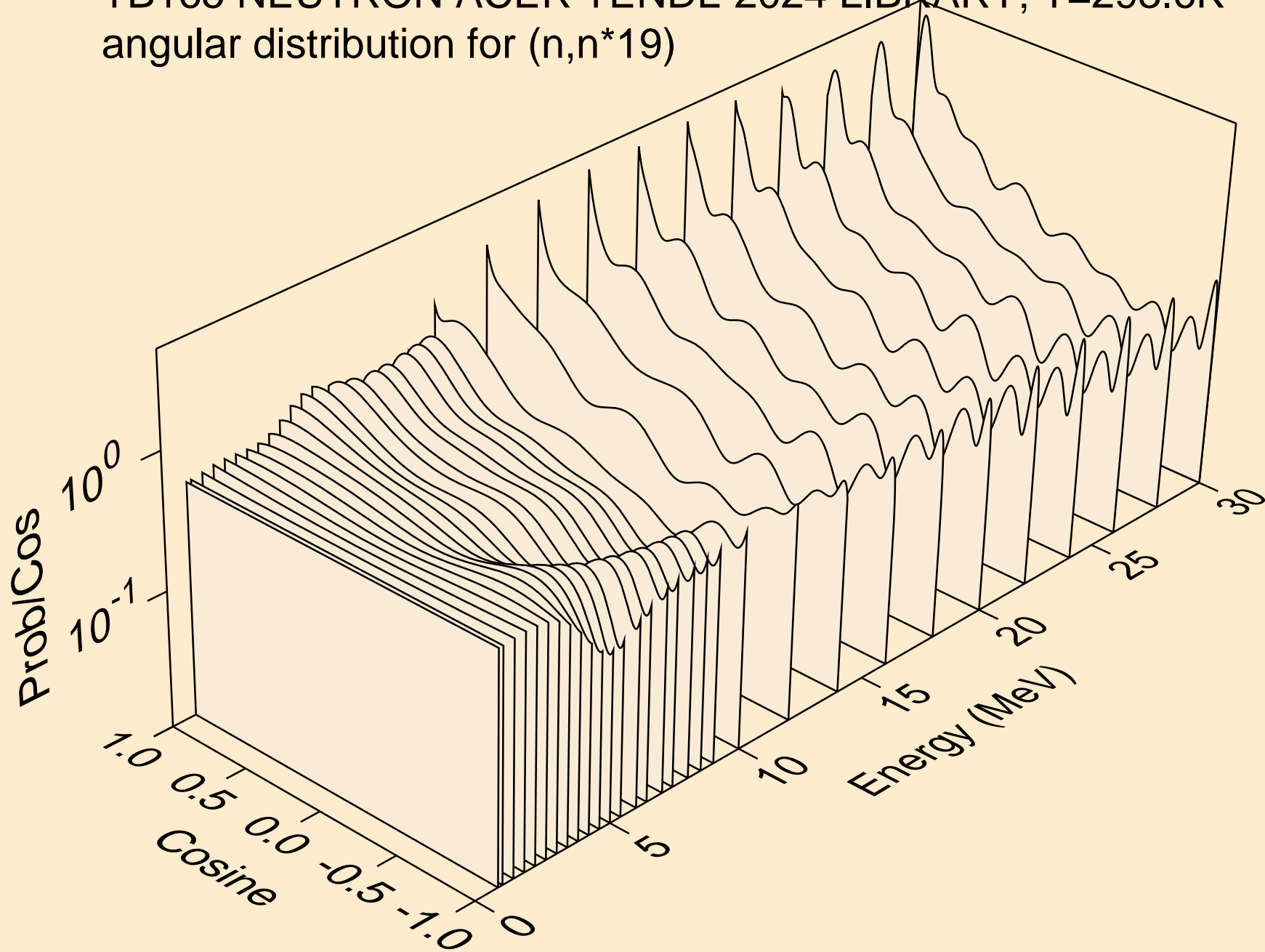

TB165 NEUTRON ACER TENDL-2024 LIBRARY; T=293.6K
angular distribution for (n,n*20)

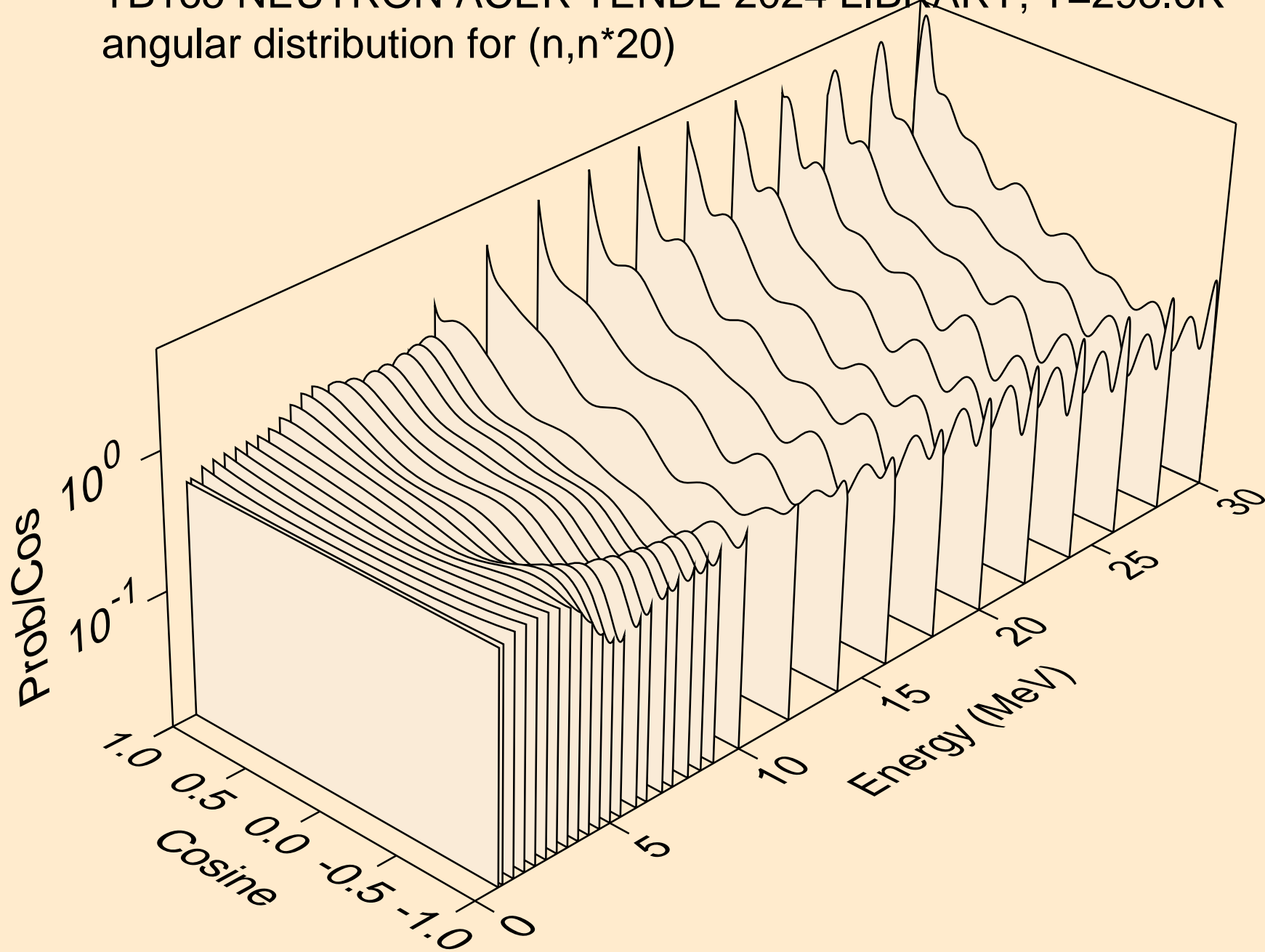

TB165 NEUTRON ACER TENDL-2024 LIBRARY; T=293.6K
angular distribution for (n,n*21)

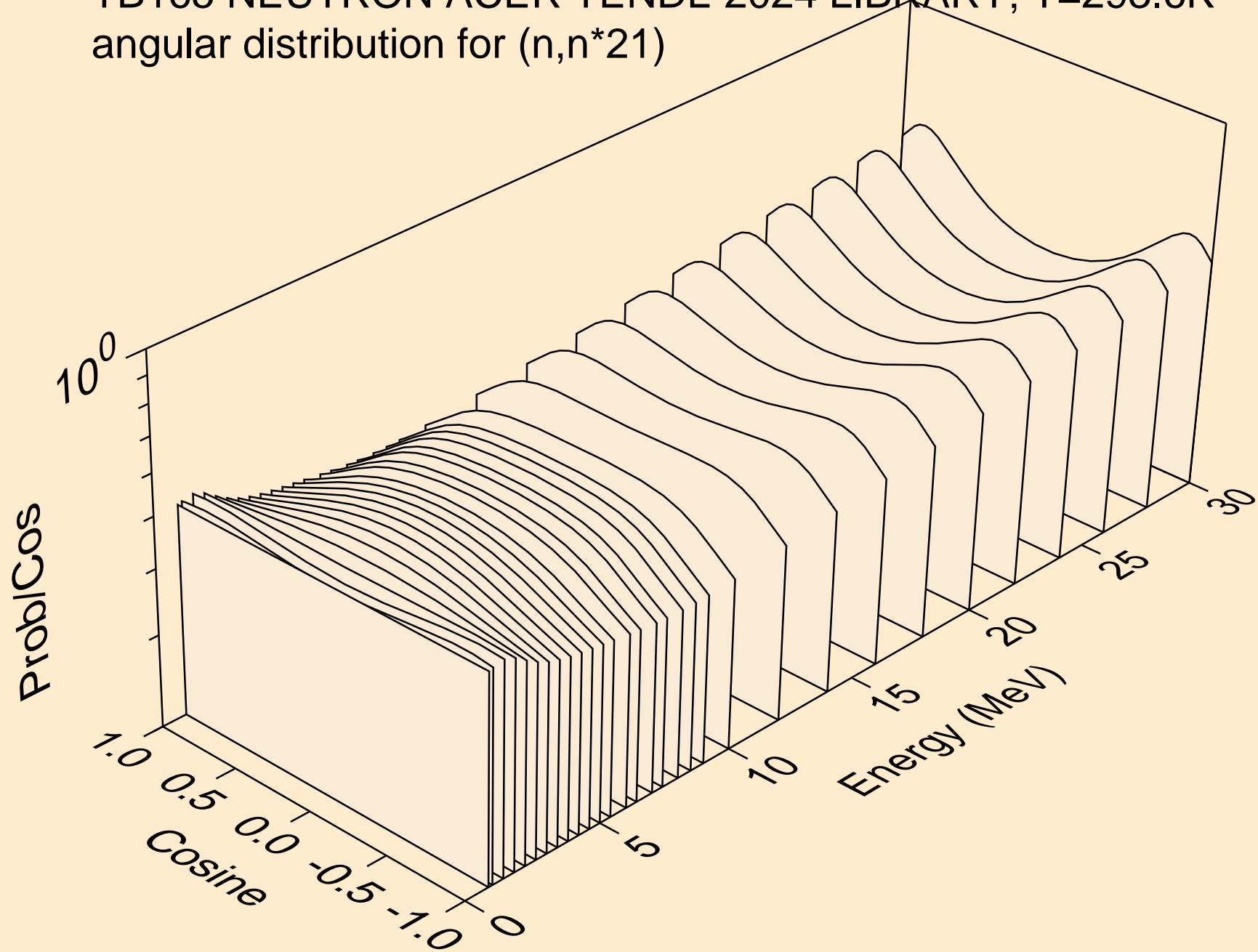

TB165 NEUTRON ACER TENDL-2024 LIBRARY; T=293.6K
angular distribution for (n,n*22)

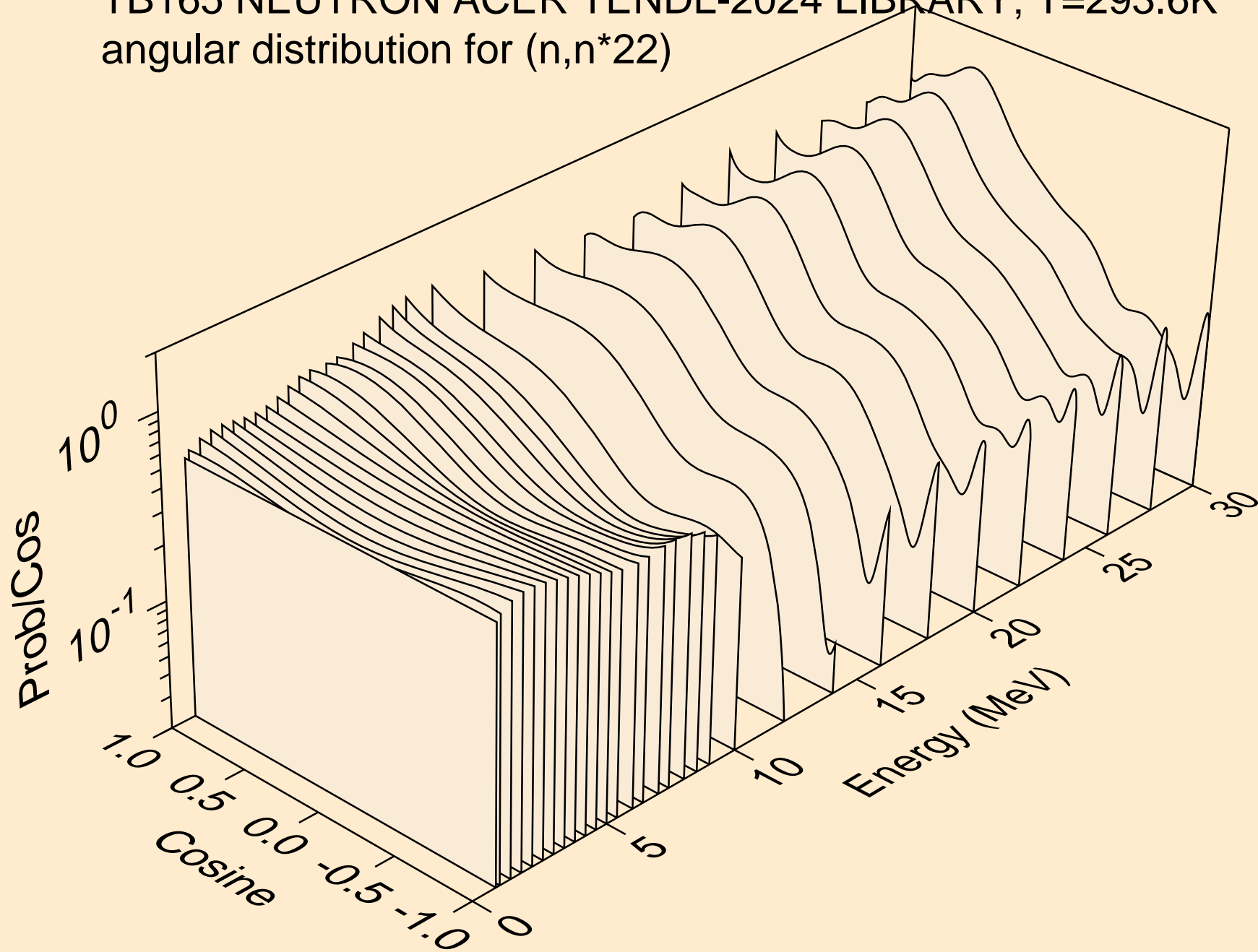

TB165 NEUTRON ACER TENDL-2024 LIBRARY; T=293.6K
angular distribution for (n,n*23)

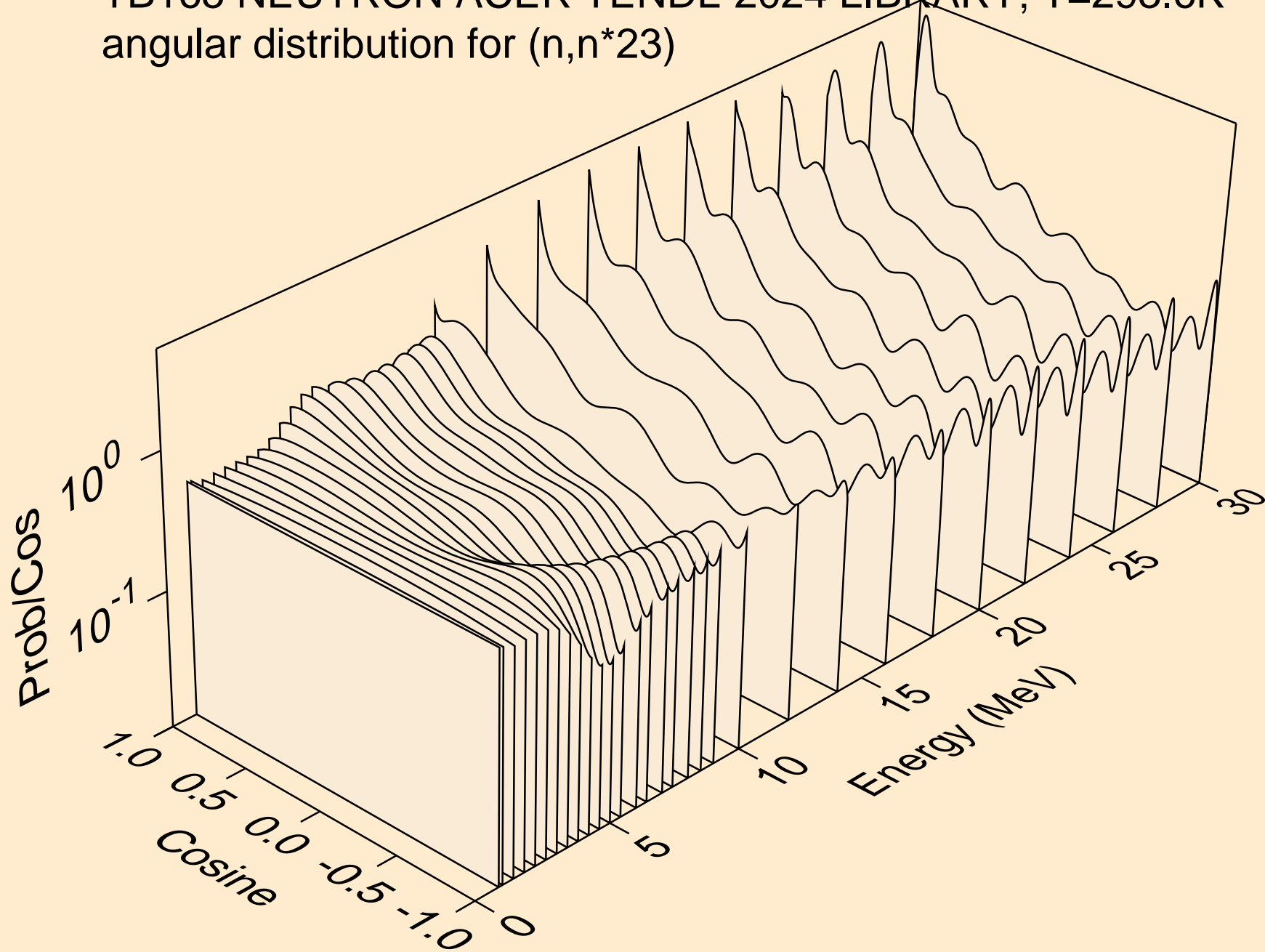

TB165 NEUTRON ACER TENDL-2024 LIBRARY; T=293.6K
angular distribution for (n,n*24)

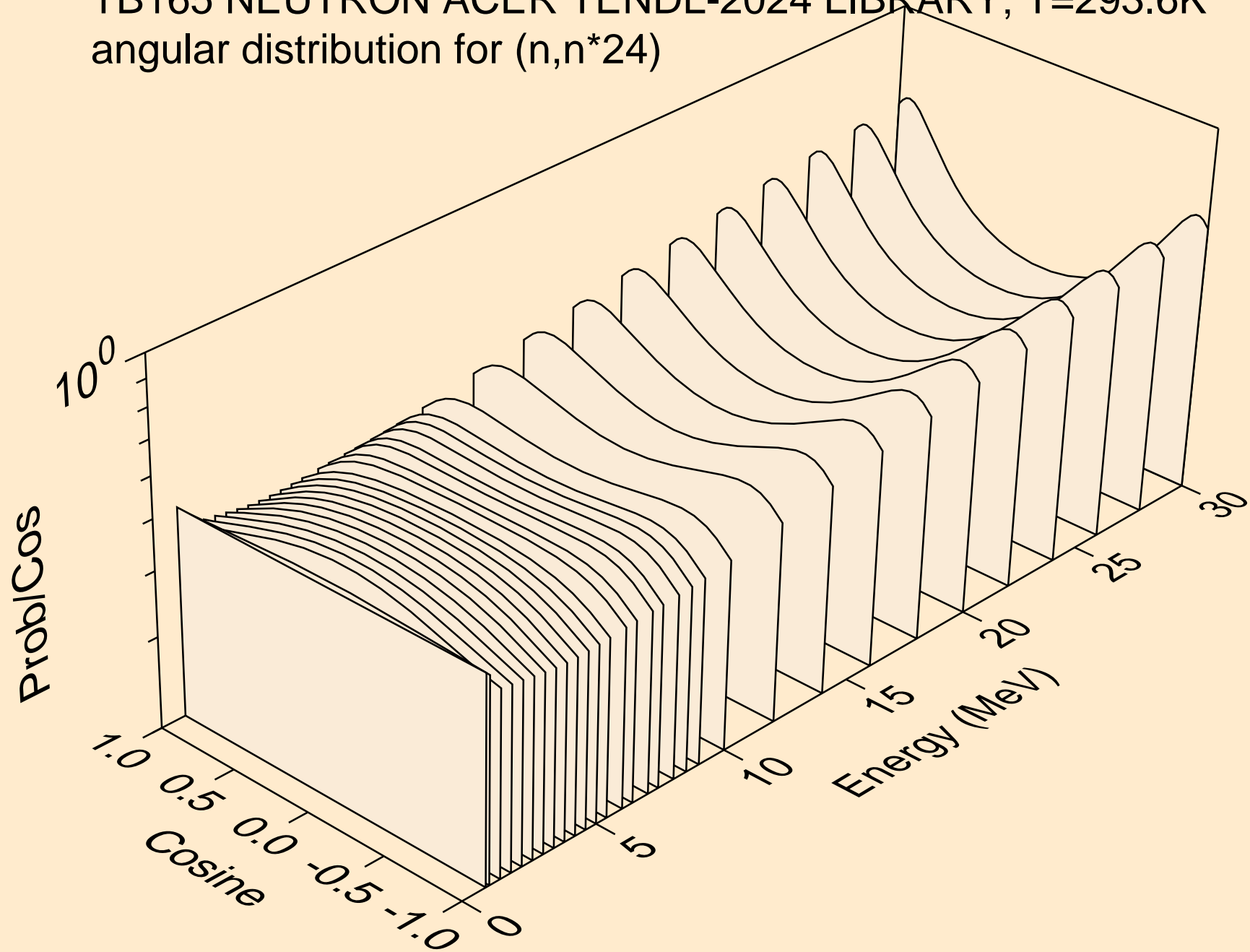

TB165 NEUTRON ACER TENDL-2024 LIBRARY; T=293.6K
angular distribution for (n,n*25)

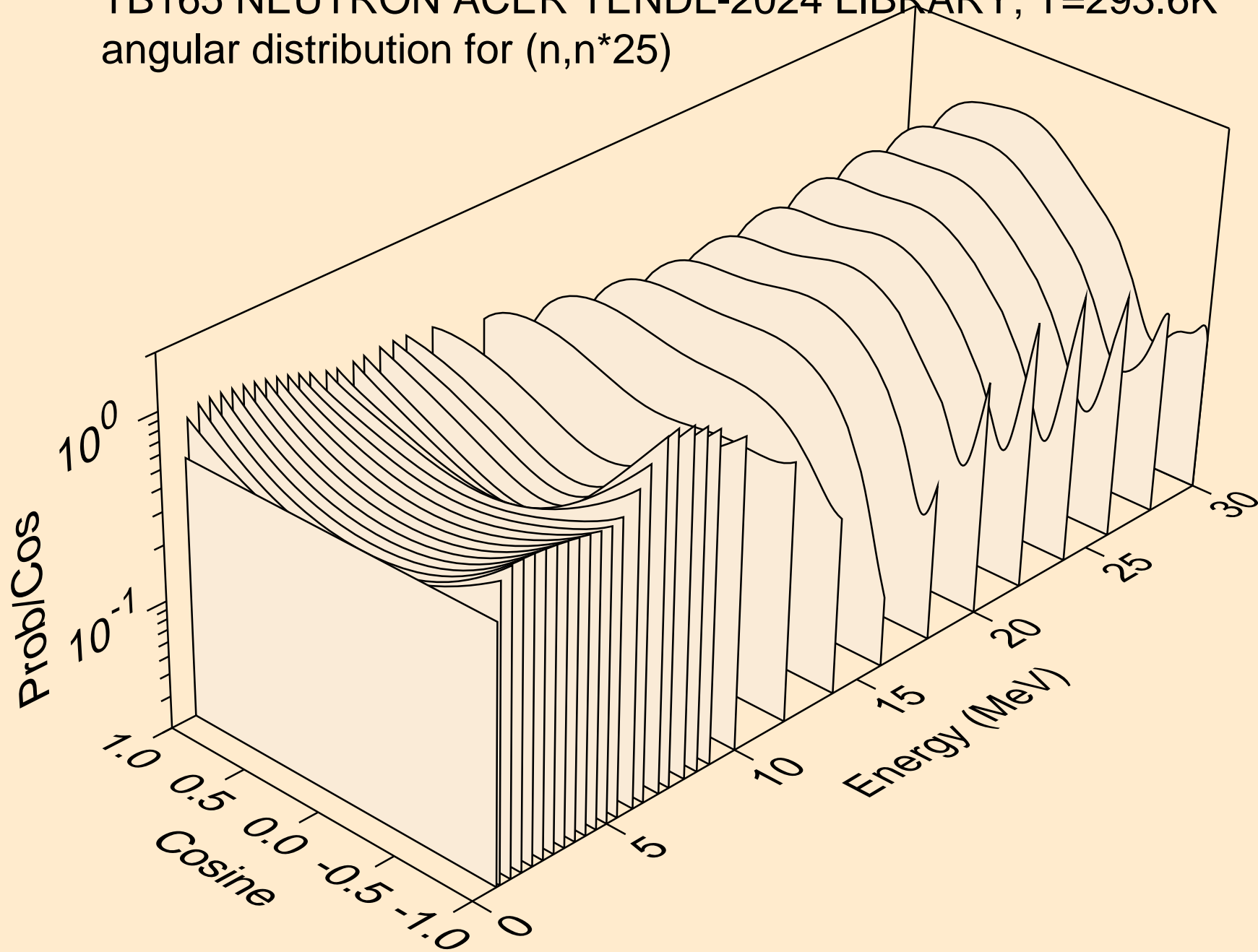

TB165 NEUTRON ACER TENDL-2024 LIBRARY; T=293.6K
angular distribution for (n,n*26)

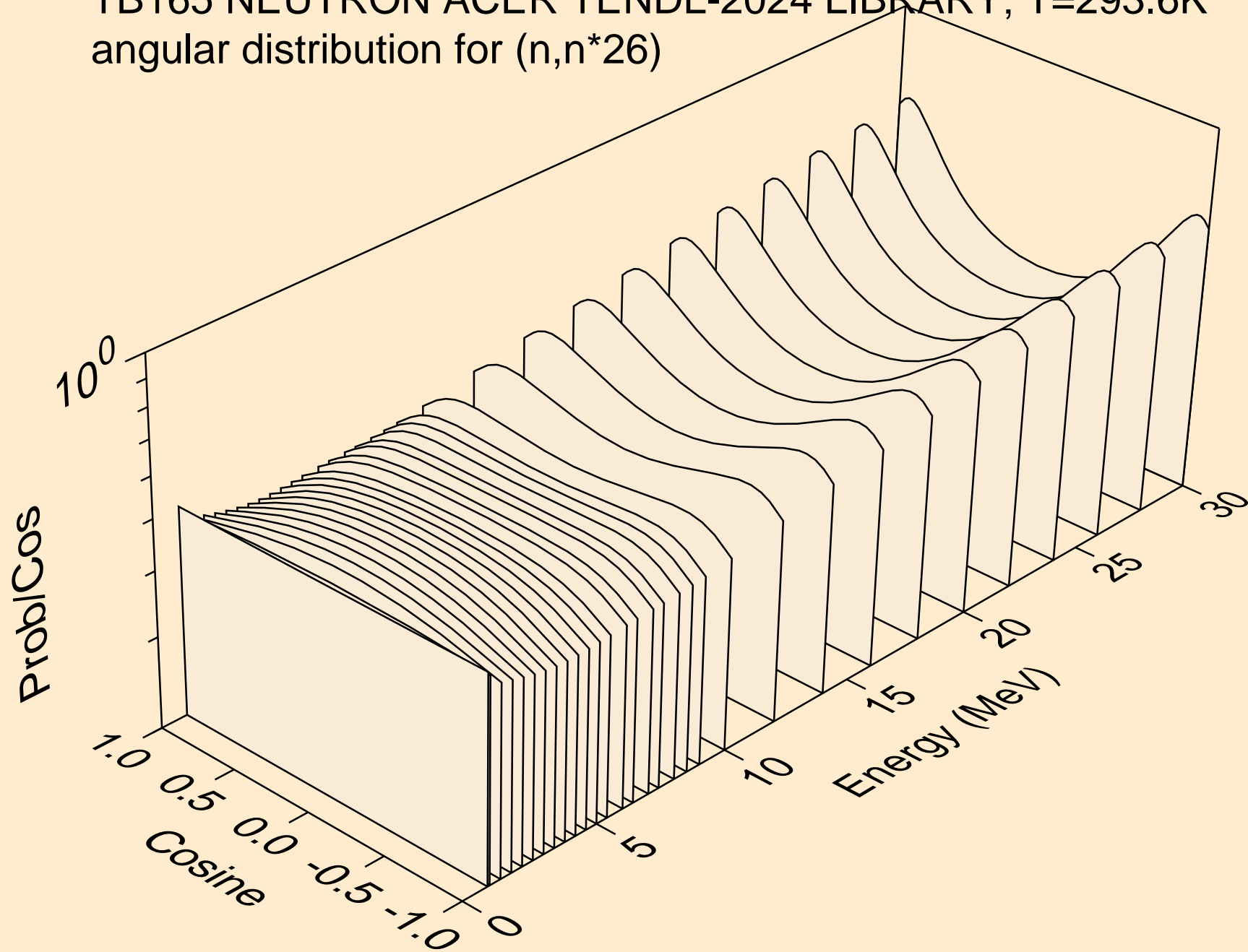

TB165 NEUTRON ACER TENDL-2024 LIBRARY; T=293.6K
angular distribution for (n,n*27)

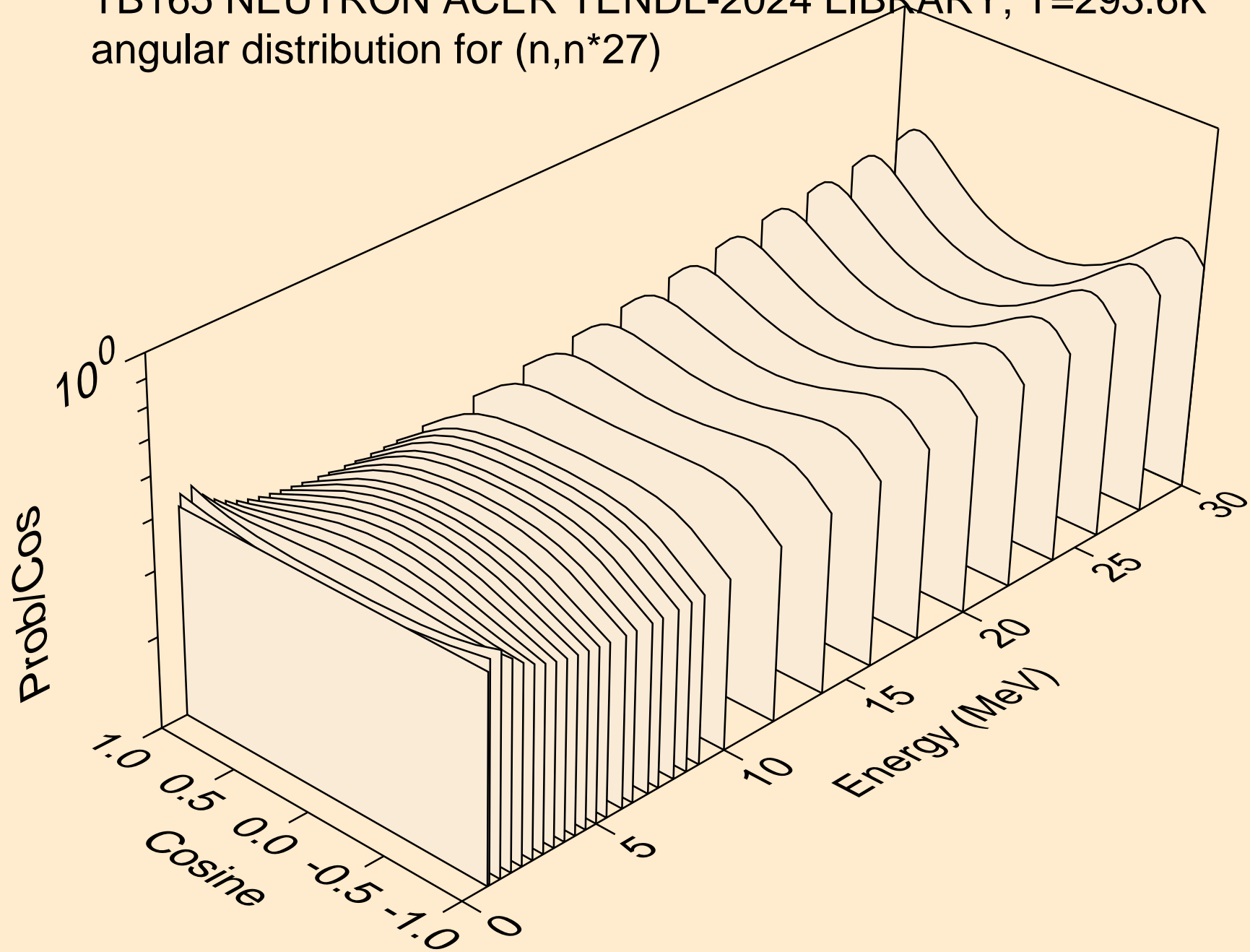

TB165 NEUTRON ACER TENDL-2024 LIBRARY; T=293.6K
angular distribution for (n,n*28)

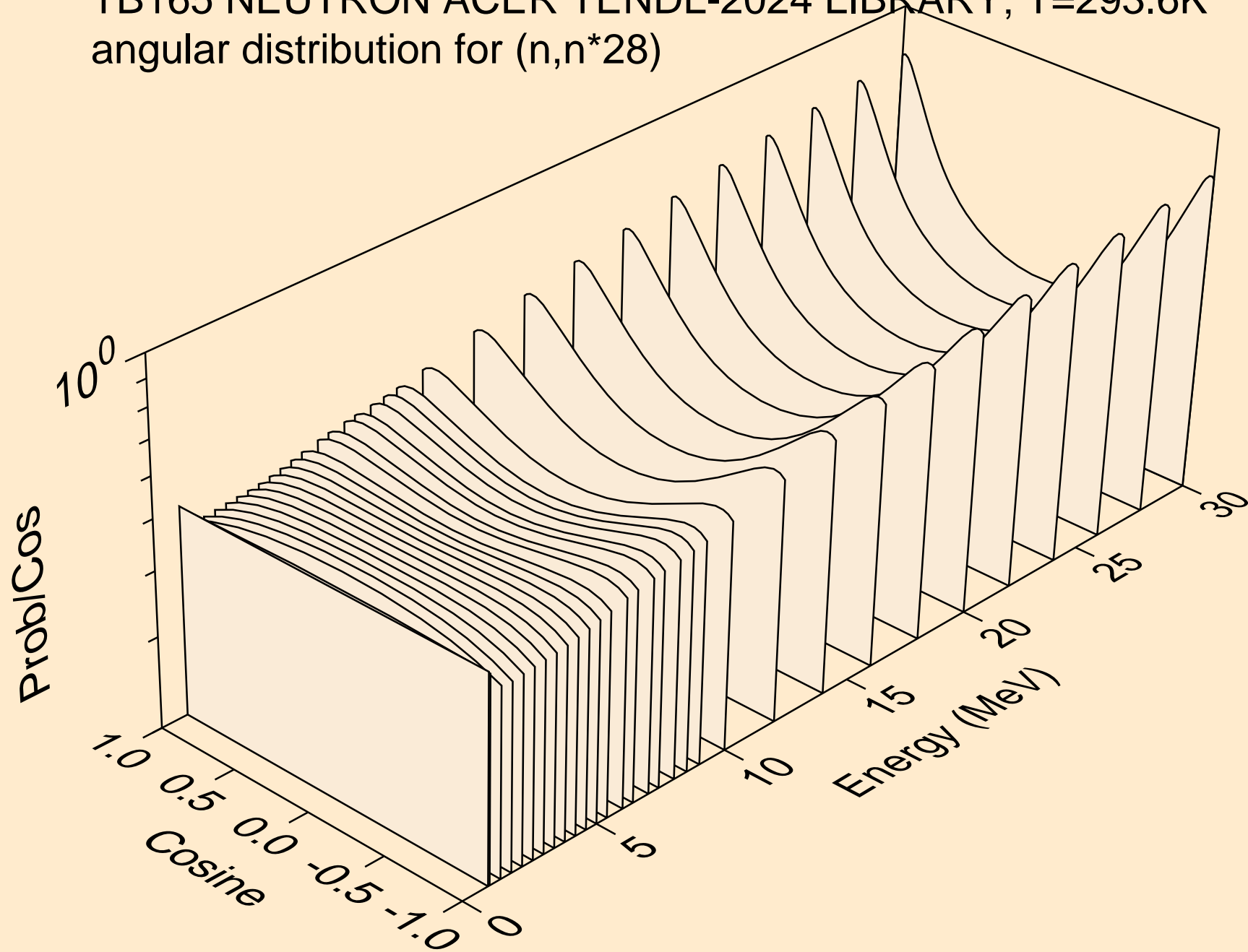

TB165 NEUTRON ACER TENDL-2024 LIBRARY; T=293.6K
Neutron emission for (n,x)

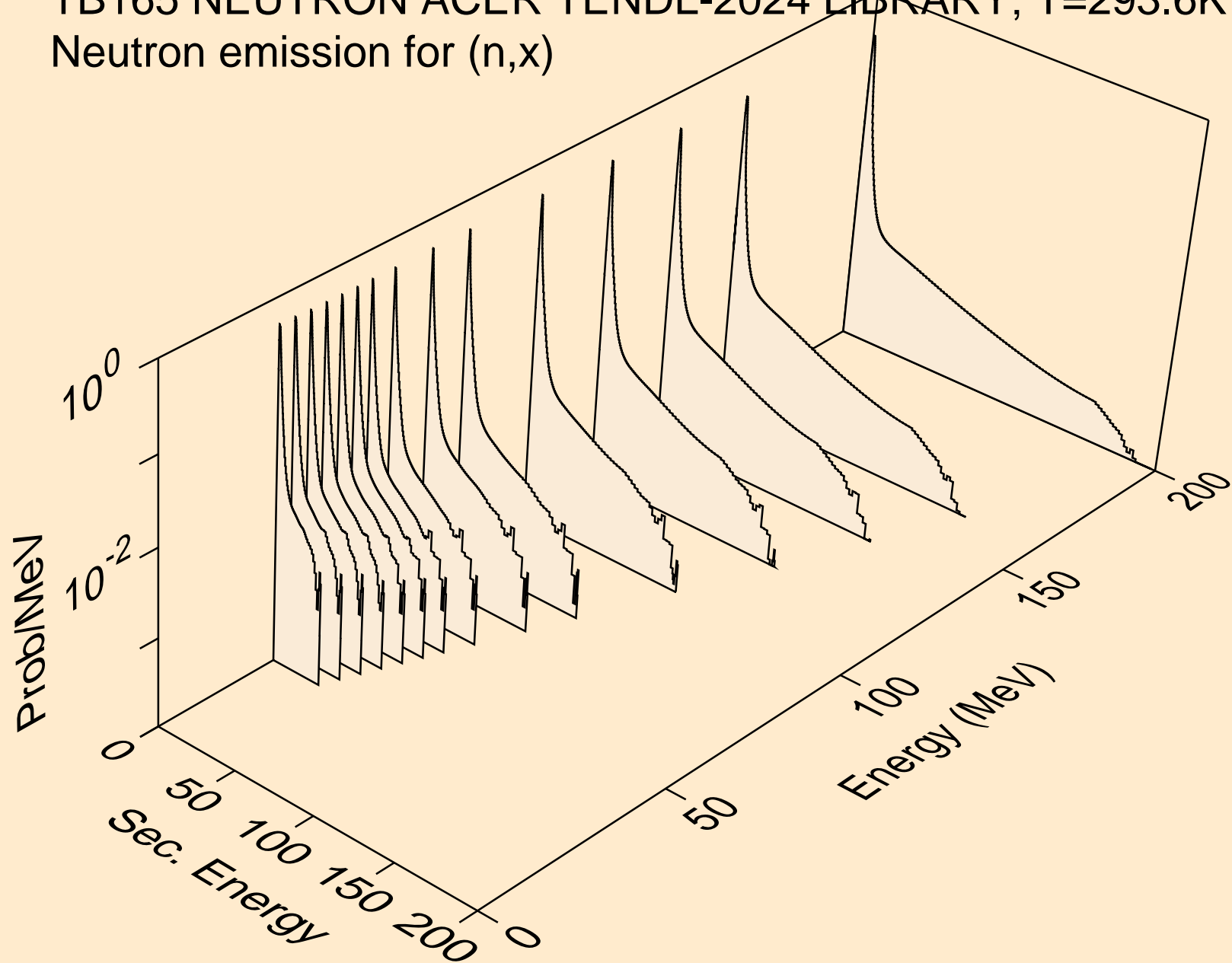

TB165 NEUTRON ACER TENDL-2024 LIBRARY; T=293.6K
Neutron emission for (n,2nd)

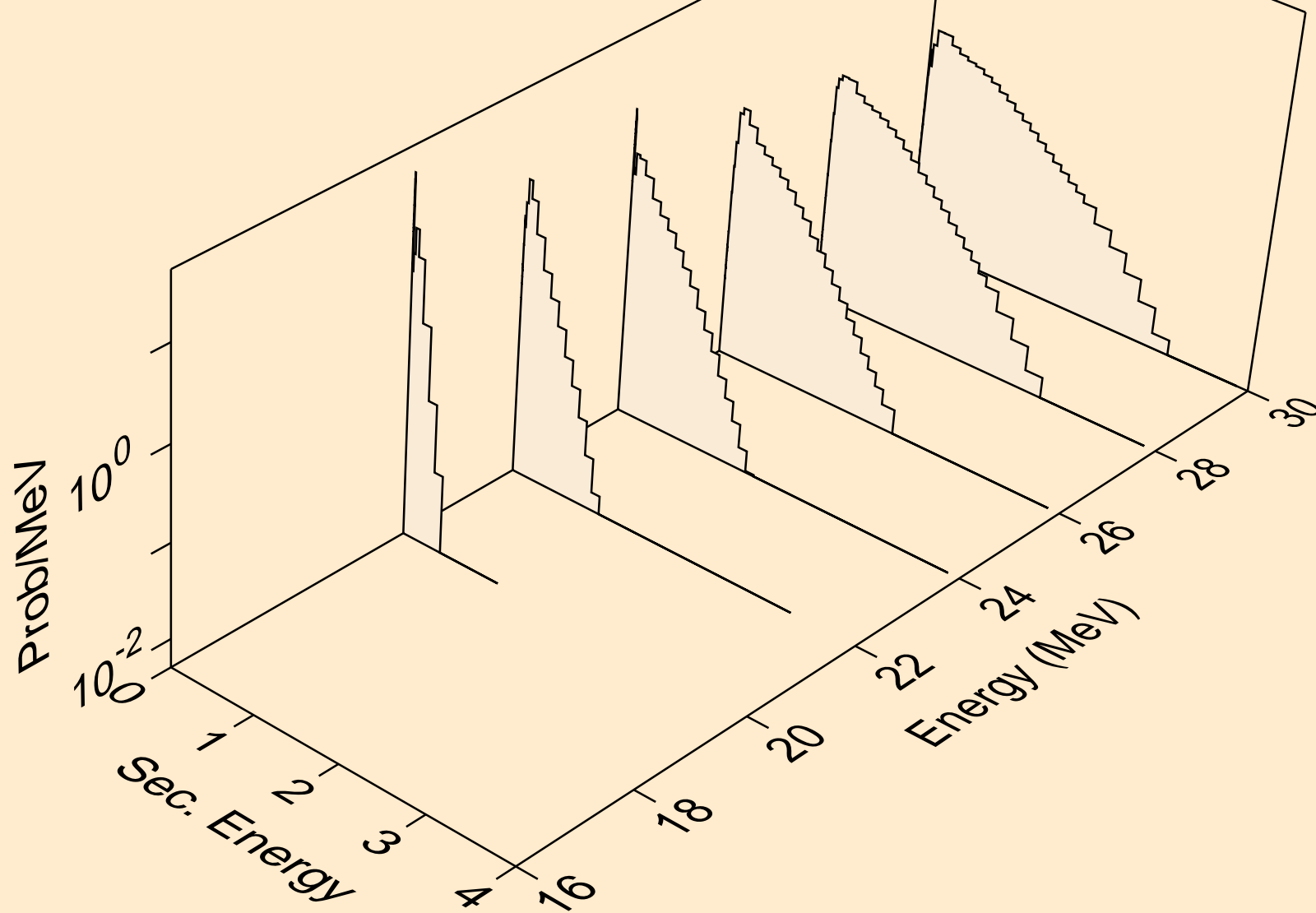

TB165 NEUTRON ACER TENDL-2024 LIBRARY; T=293.6K
Neutron emission for (n,2n)

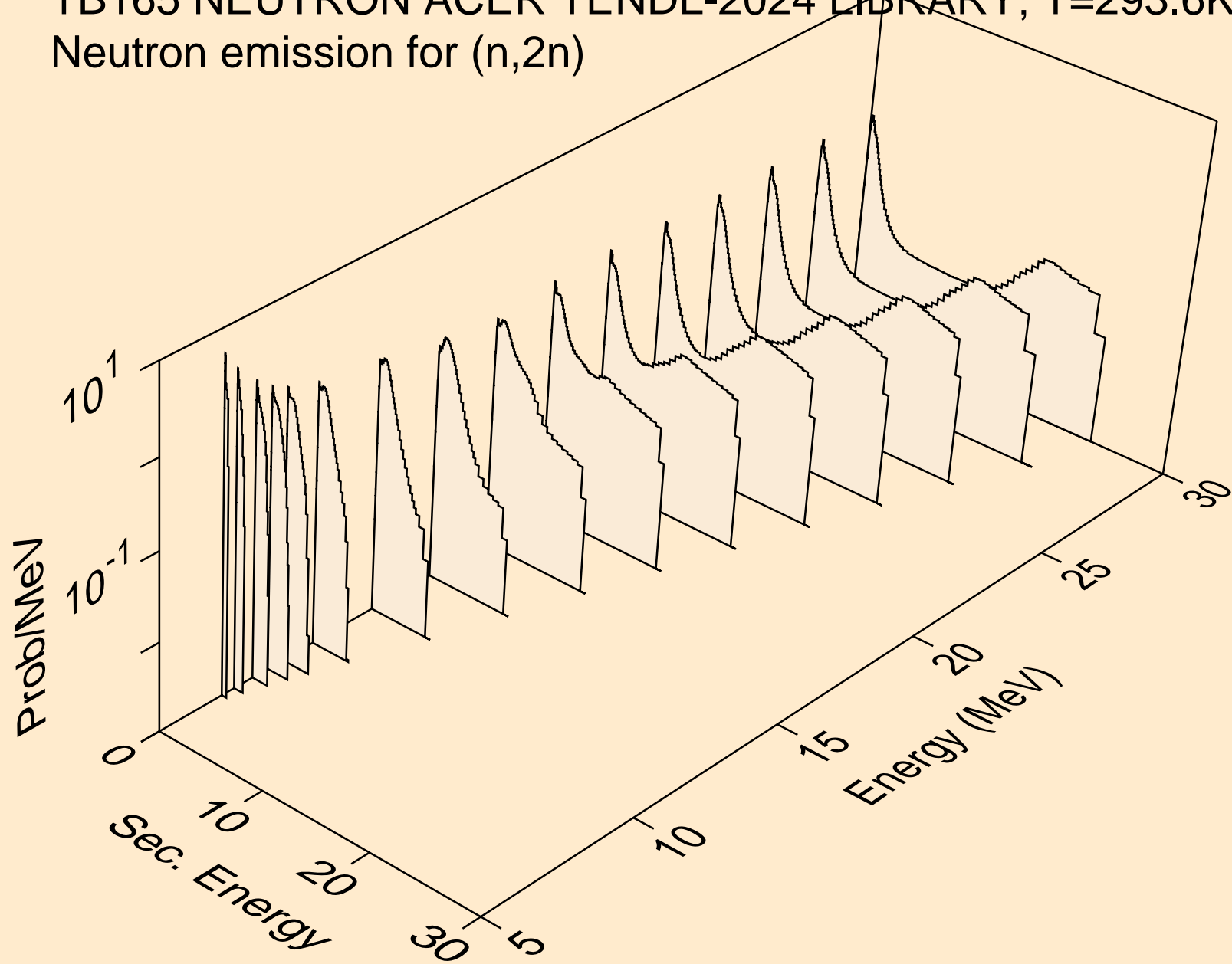

TB165 NEUTRON ACER TENDL-2024 LIBRARY; T=293.6K
Neutron emission for (n,3n)

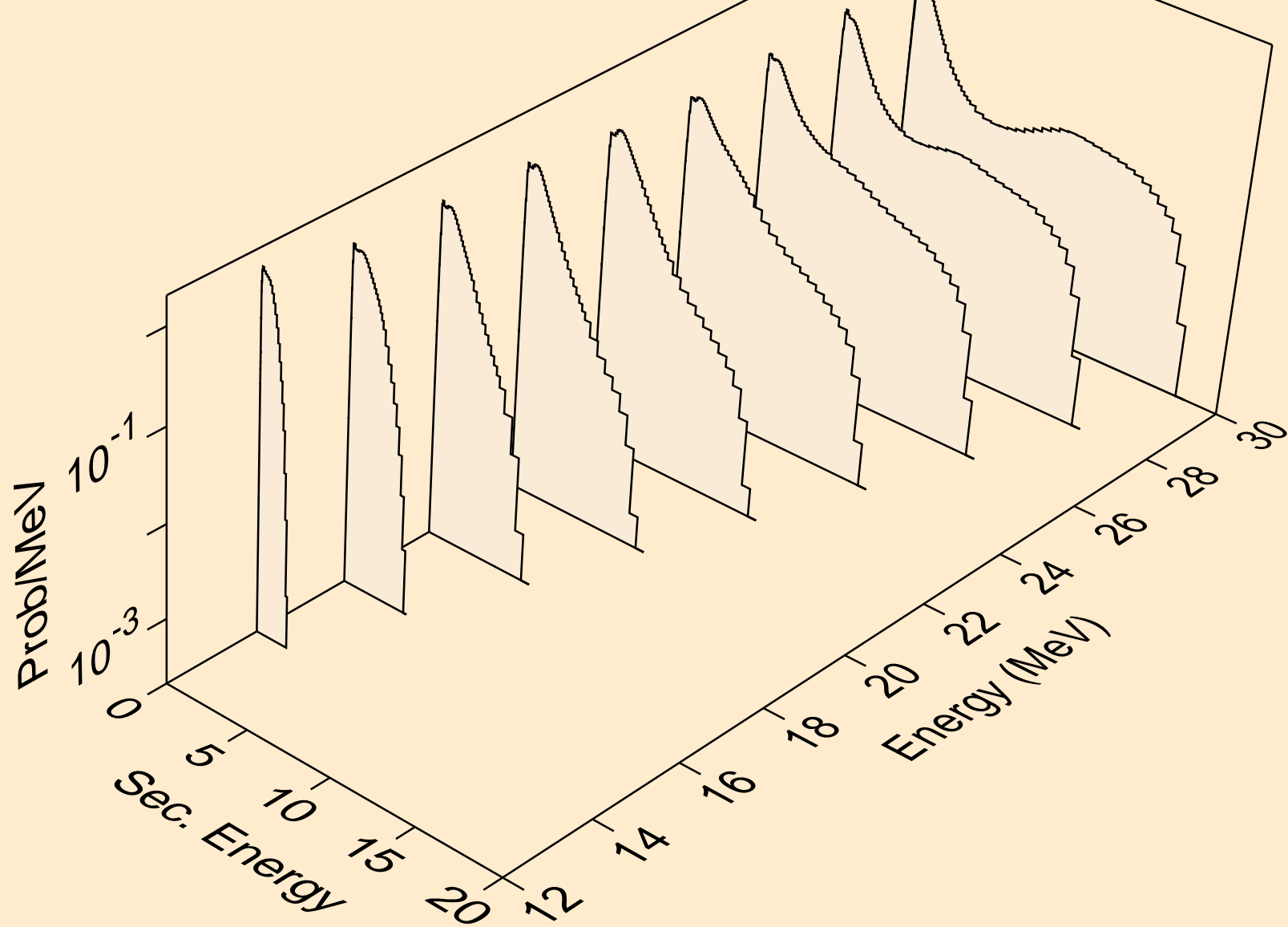

TB165 NEUTRON ACER TENDL-2024 LIBRARY; T=293.6K
Neutron emission for (n,n*)a

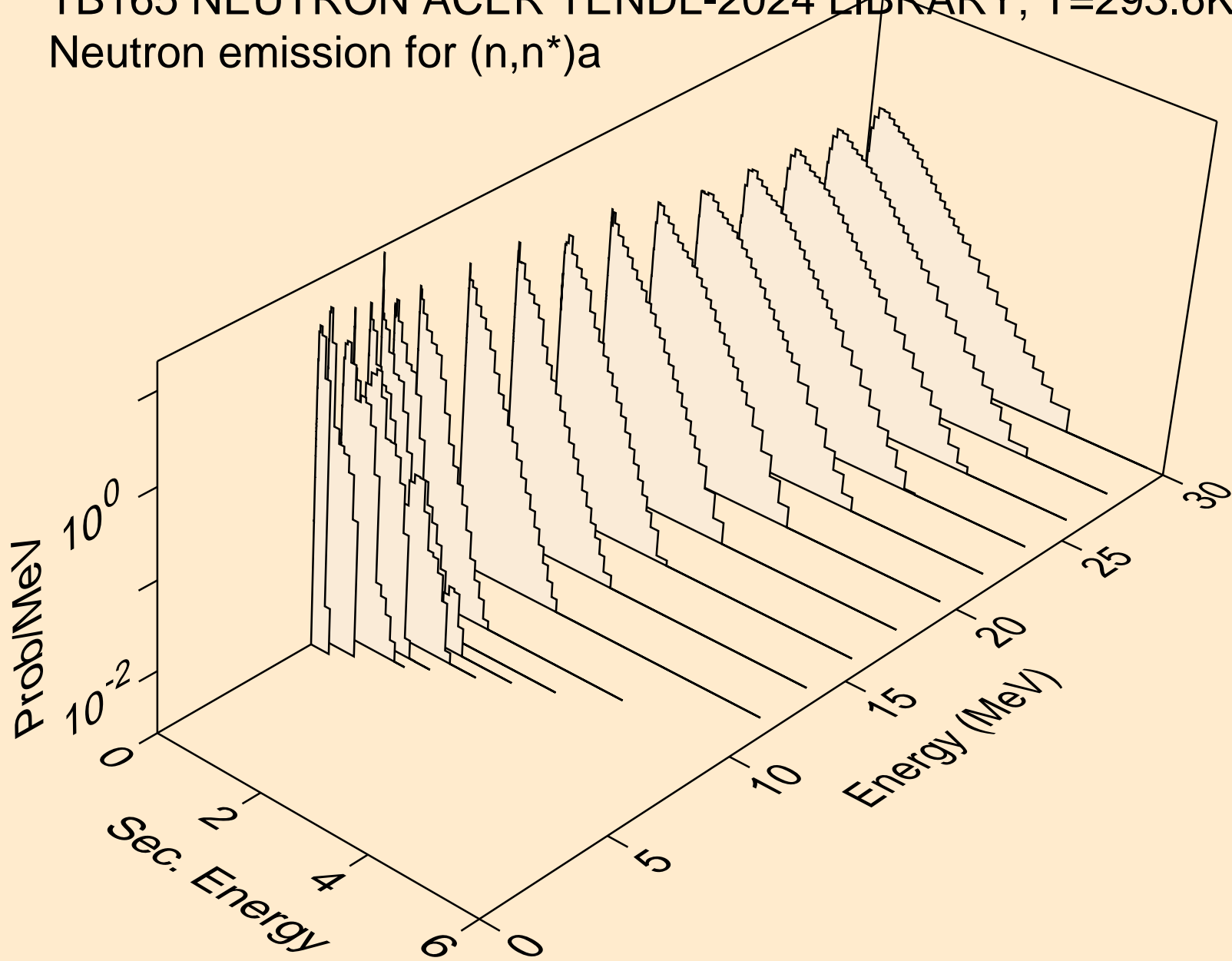

TB165 NEUTRON ACER TENDL-2024 LIBRARY; T=293.6K
Neutron emission for (n,2n)a

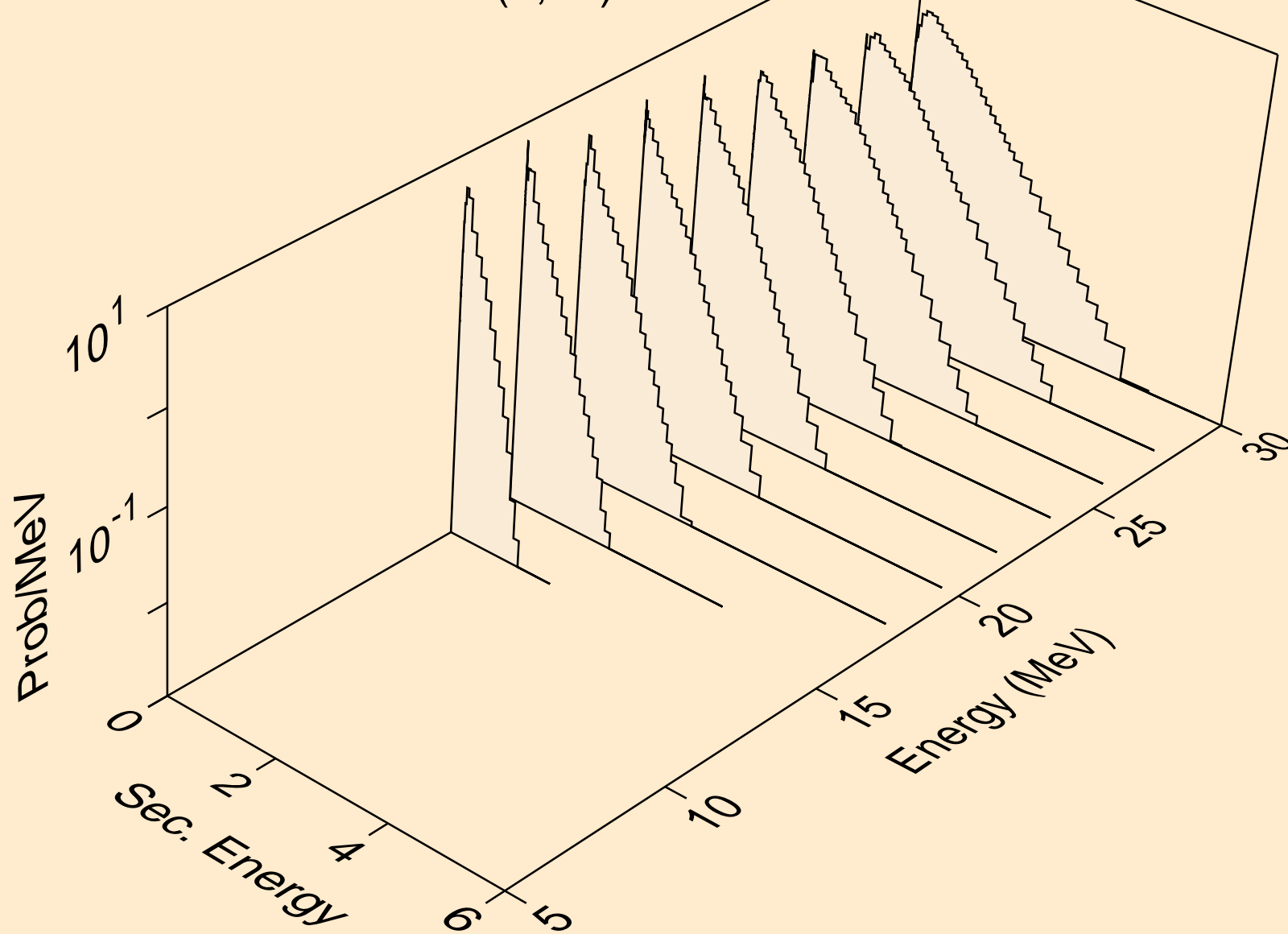

TB165 NEUTRON ACER TENDL-2024 LIBRARY; T=293.6K
Neutron emission for (n,3n)a

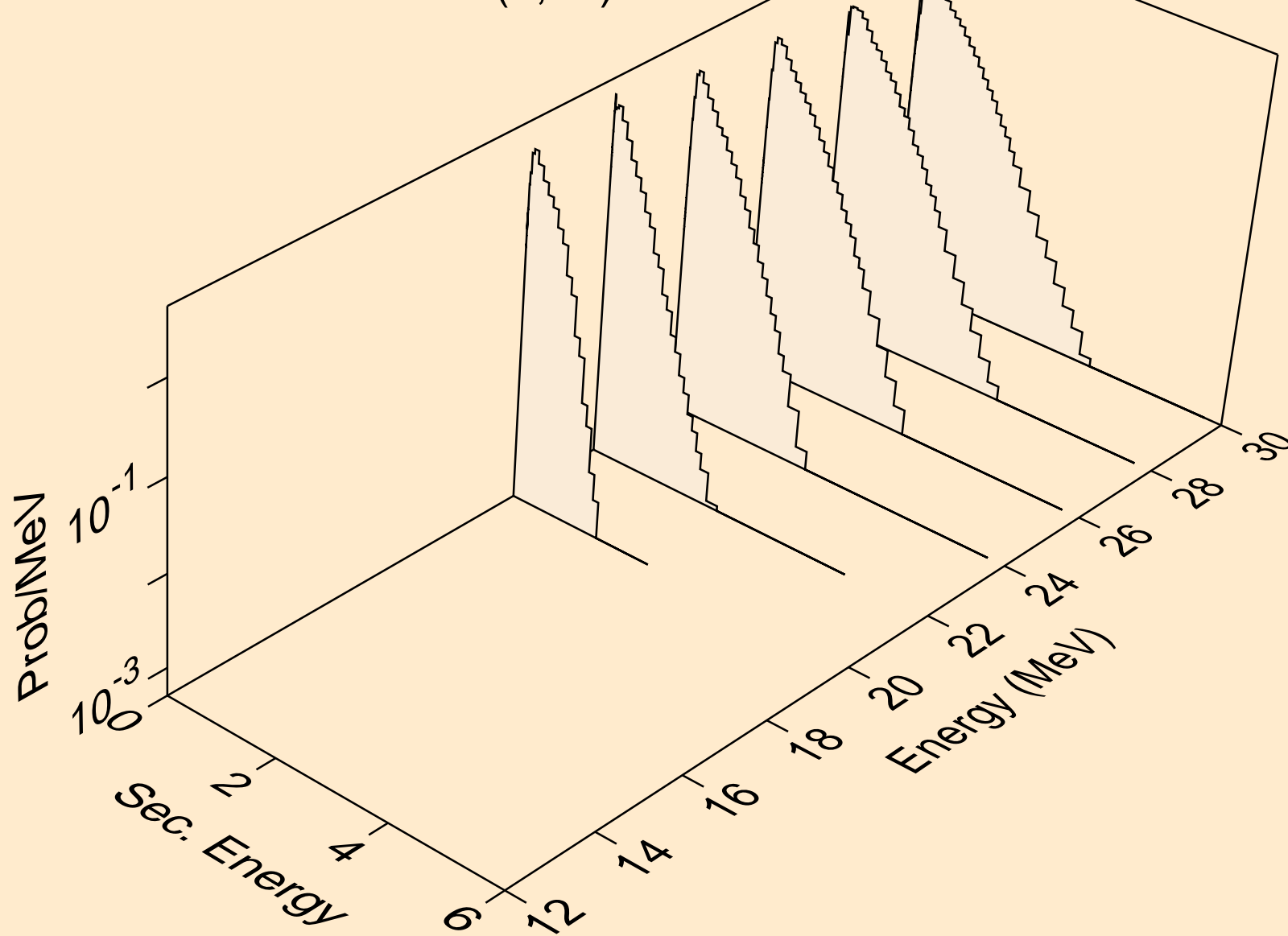

TB165 NEUTRON ACER TENDL-2024 LIBRARY; T=293.6K
Neutron emission for (n,n*)p

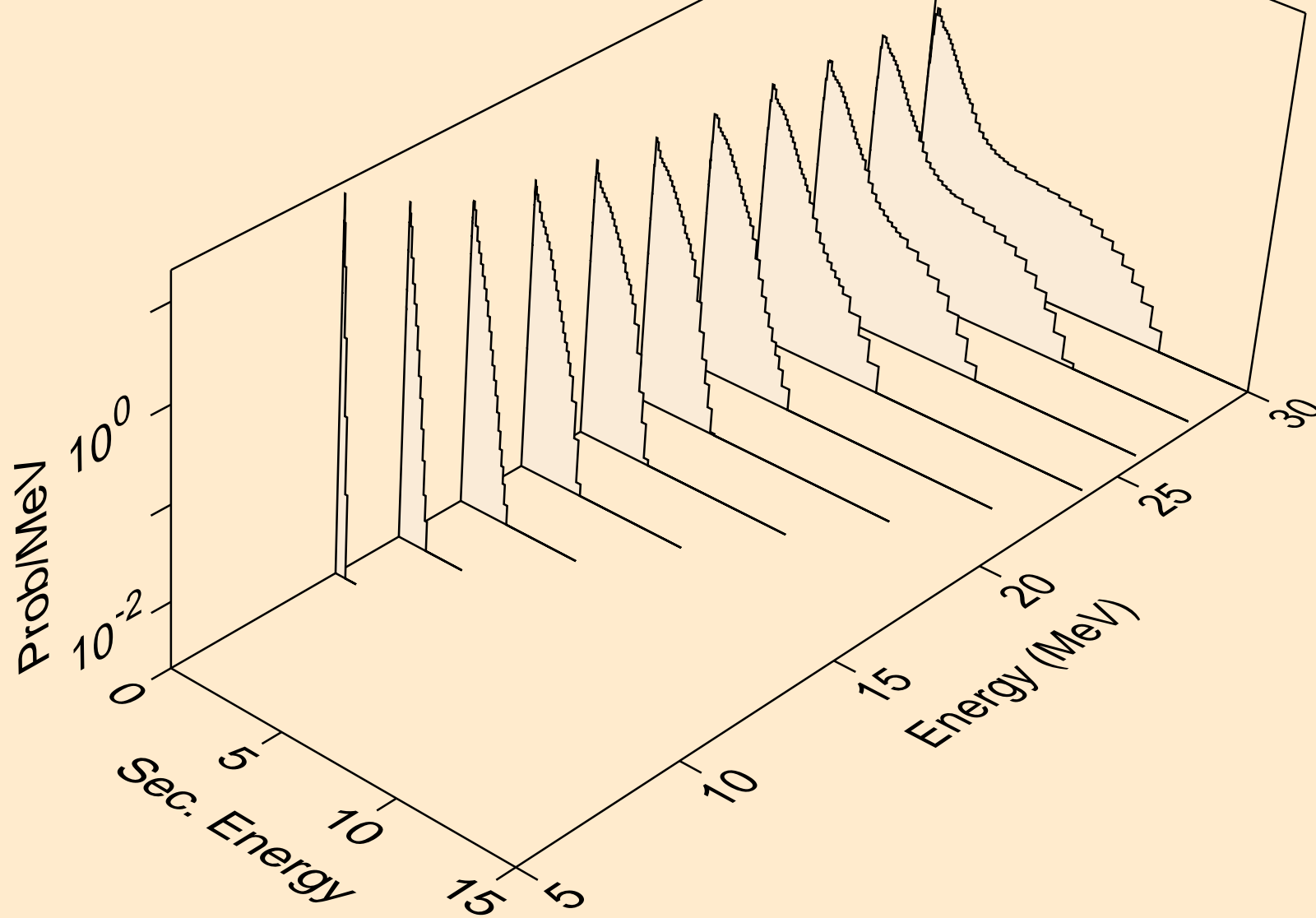

TB165 NEUTRON ACER TENDL-2024 LIBRARY; T=293.6K
Neutron emission for (n,n*)d

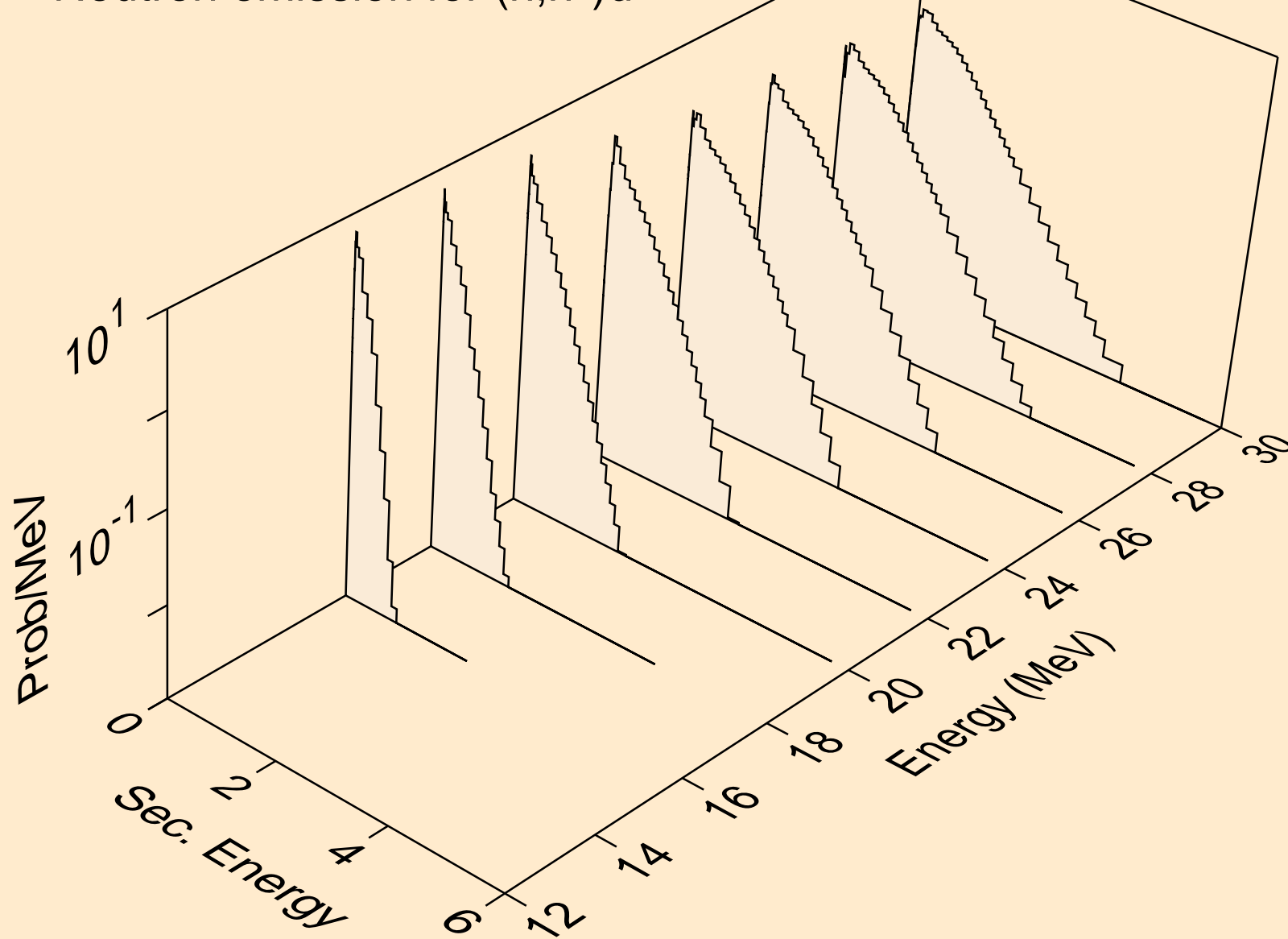

TB165 NEUTRON ACER TENDL-2024 LIBRARY; T=293.6K
Neutron emission for (n,n*)t

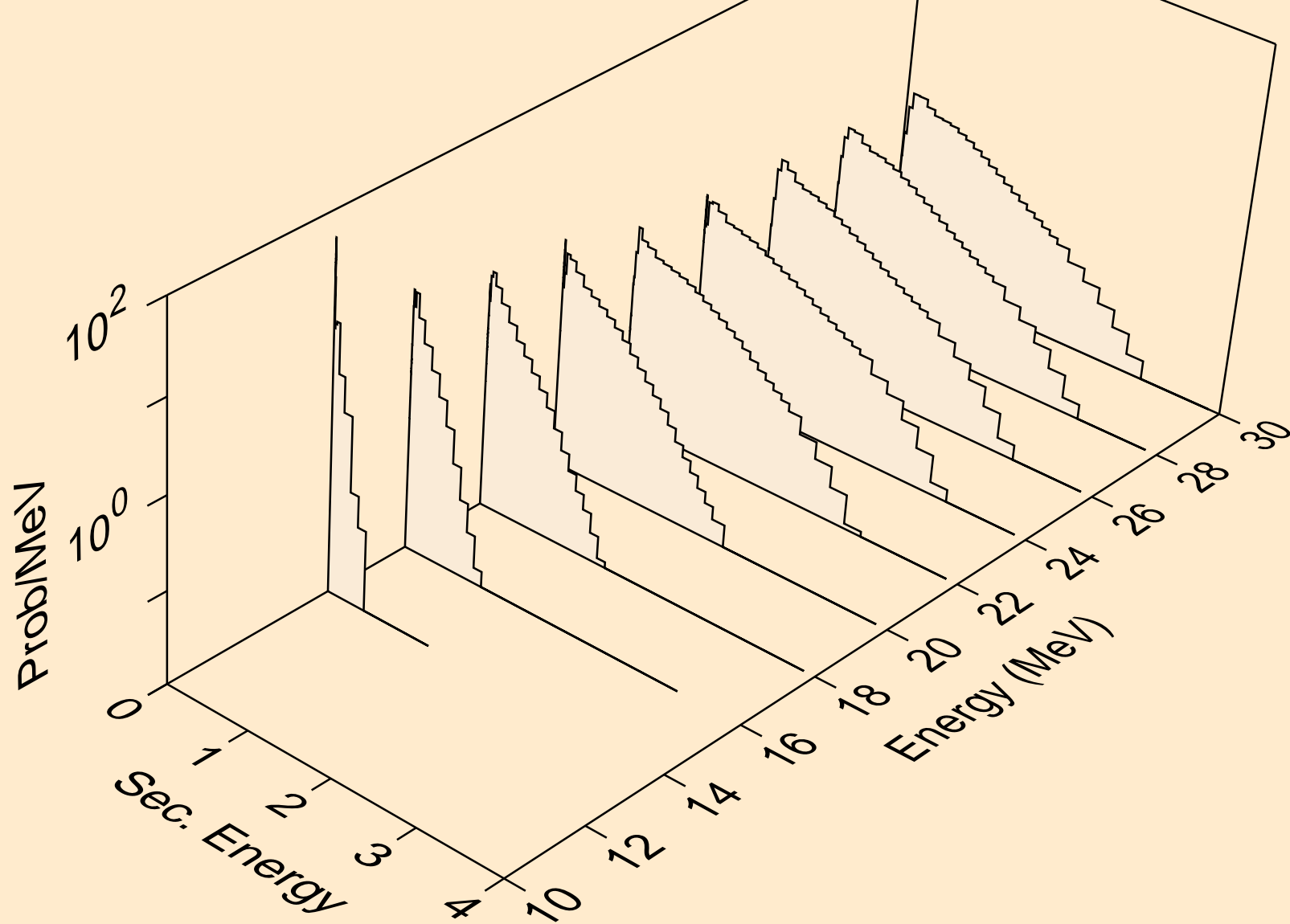

TB165 NEUTRON ACER TENDL-2024 LIBRARY; T=293.6K
Neutron emission for (n,n*)he3

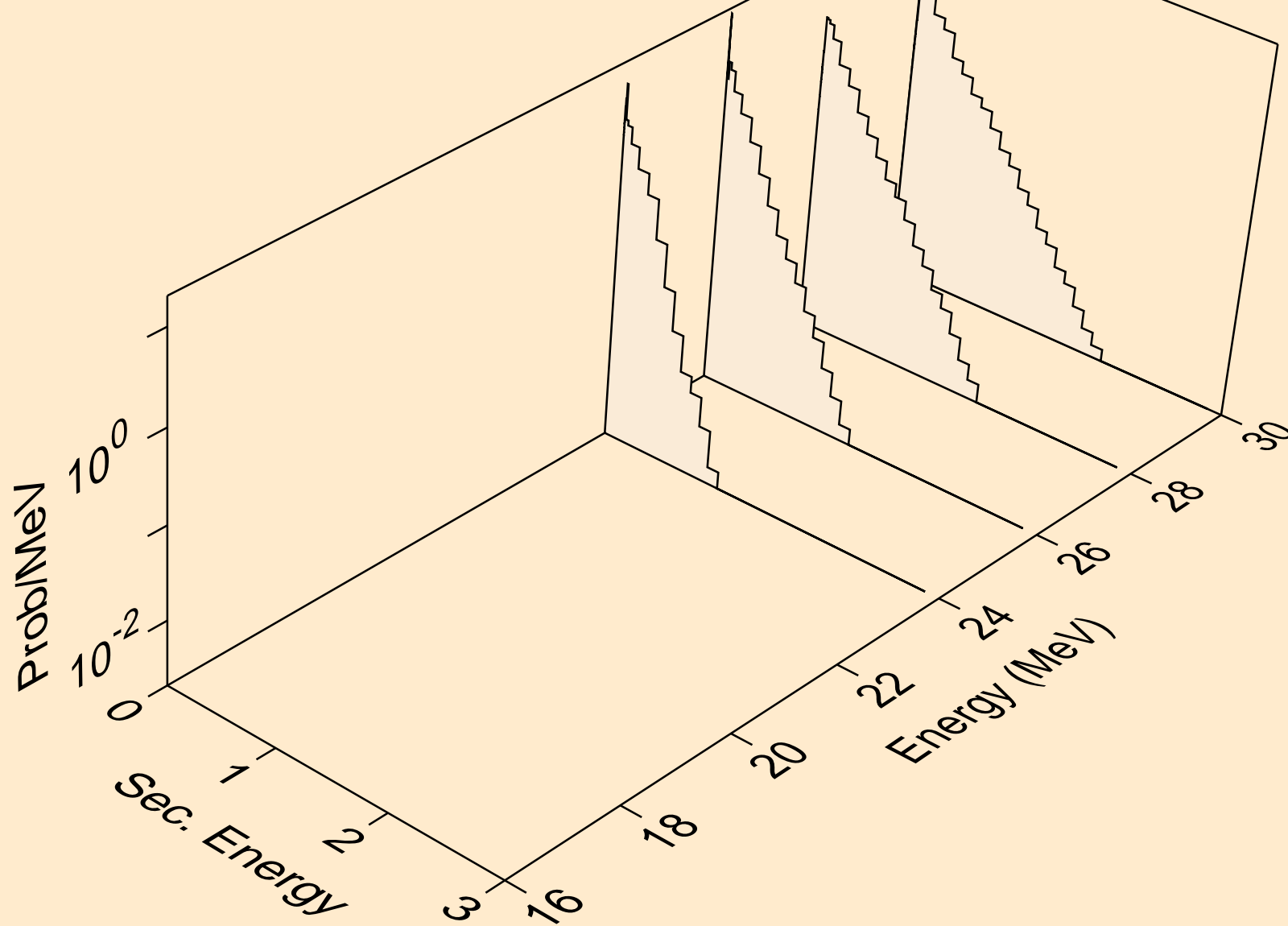

TB165 NEUTRON ACER TENDL-2024 LIBRARY; T=293.6K
Neutron emission for (n,4n)

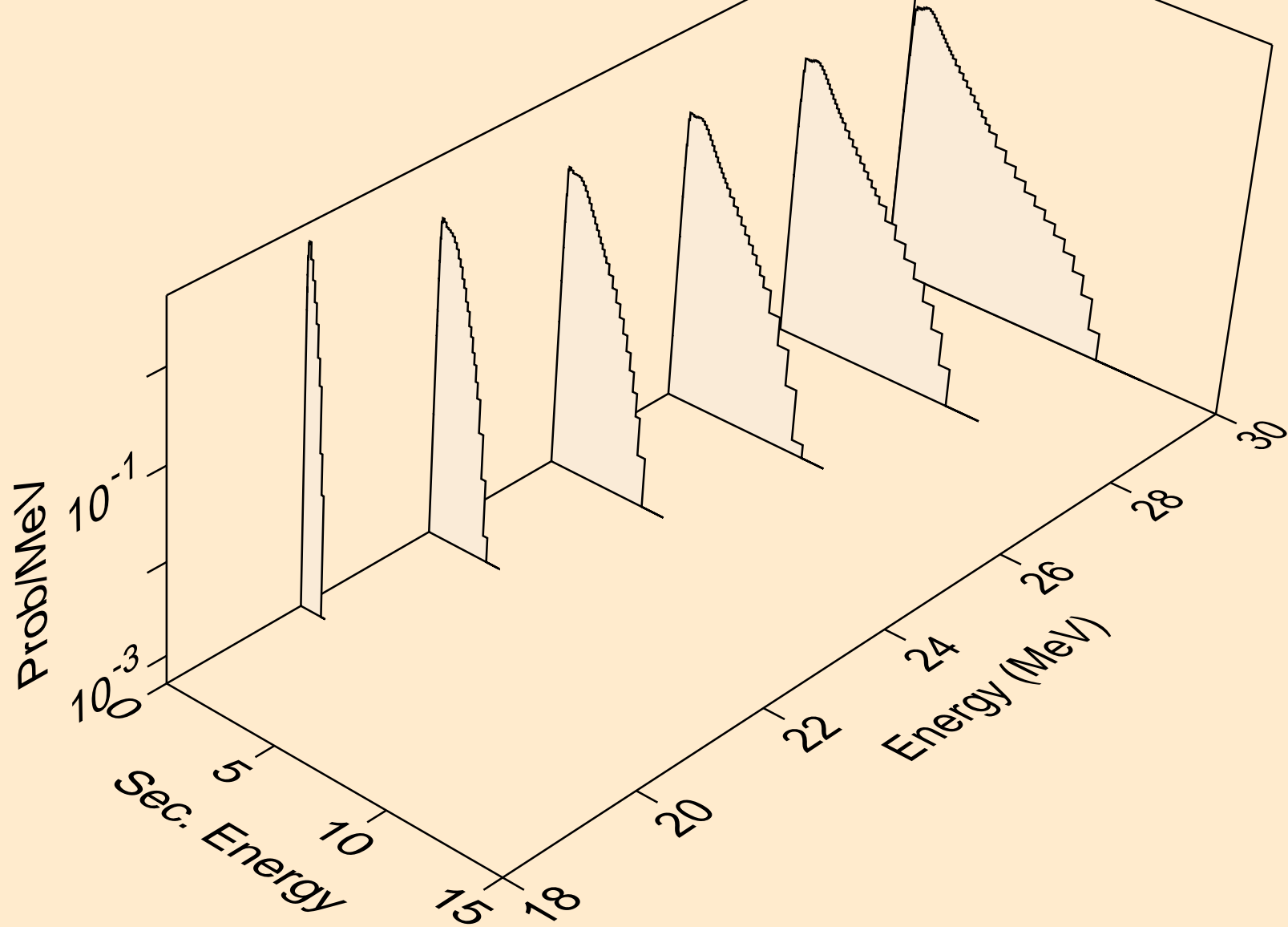

TB165 NEUTRON ACER TENDL-2024 LIBRARY; T=293.6K
Neutron emission for (n,2np)

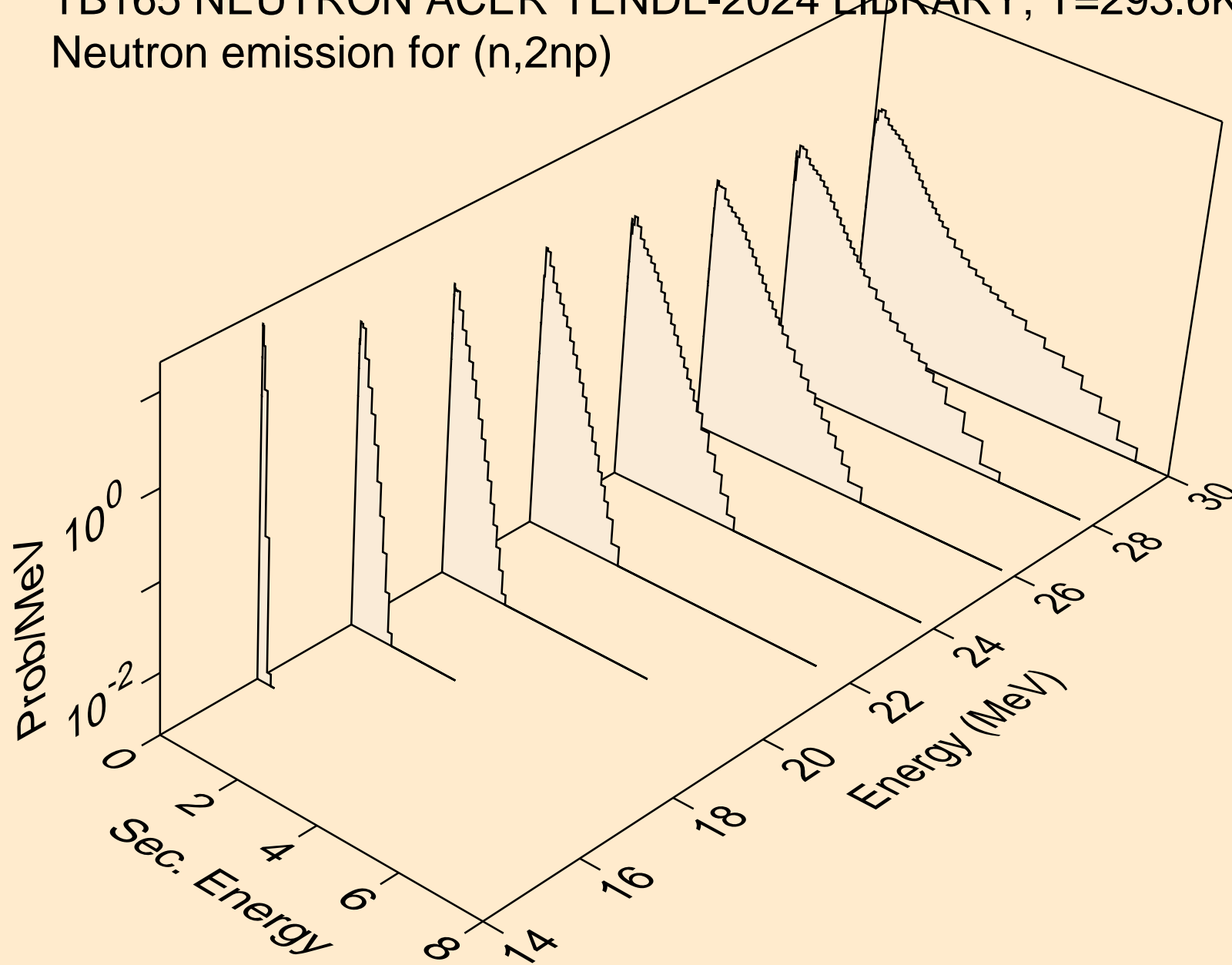

TB165 NEUTRON ACER TENDL-2024 LIBRARY; T=293.6K
Neutron emission for (n,3np)

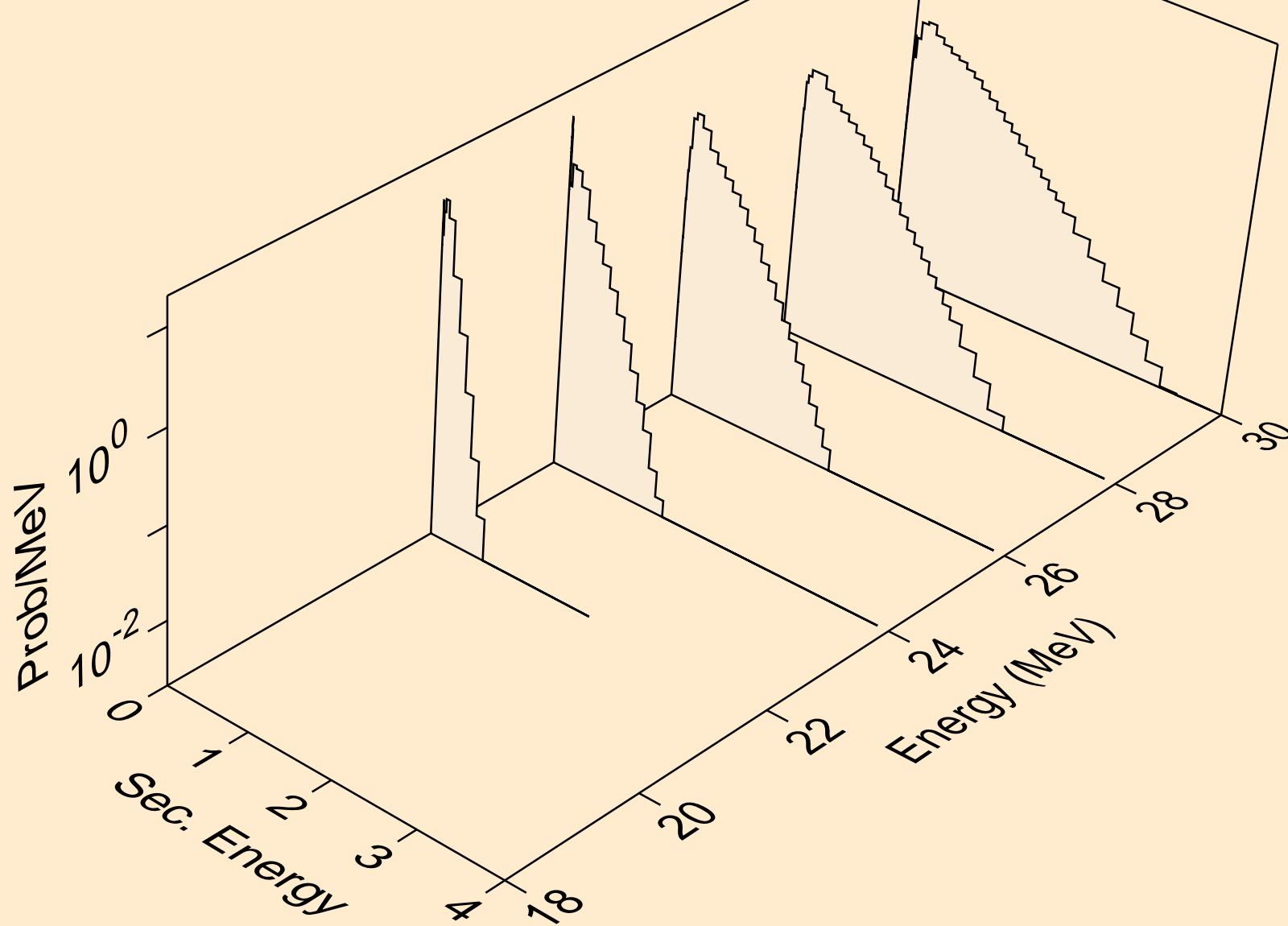

TB165 NEUTRON ACER TENDL-2024 LIBRARY; T=293.6K
Neutron emission for (n,n*c)

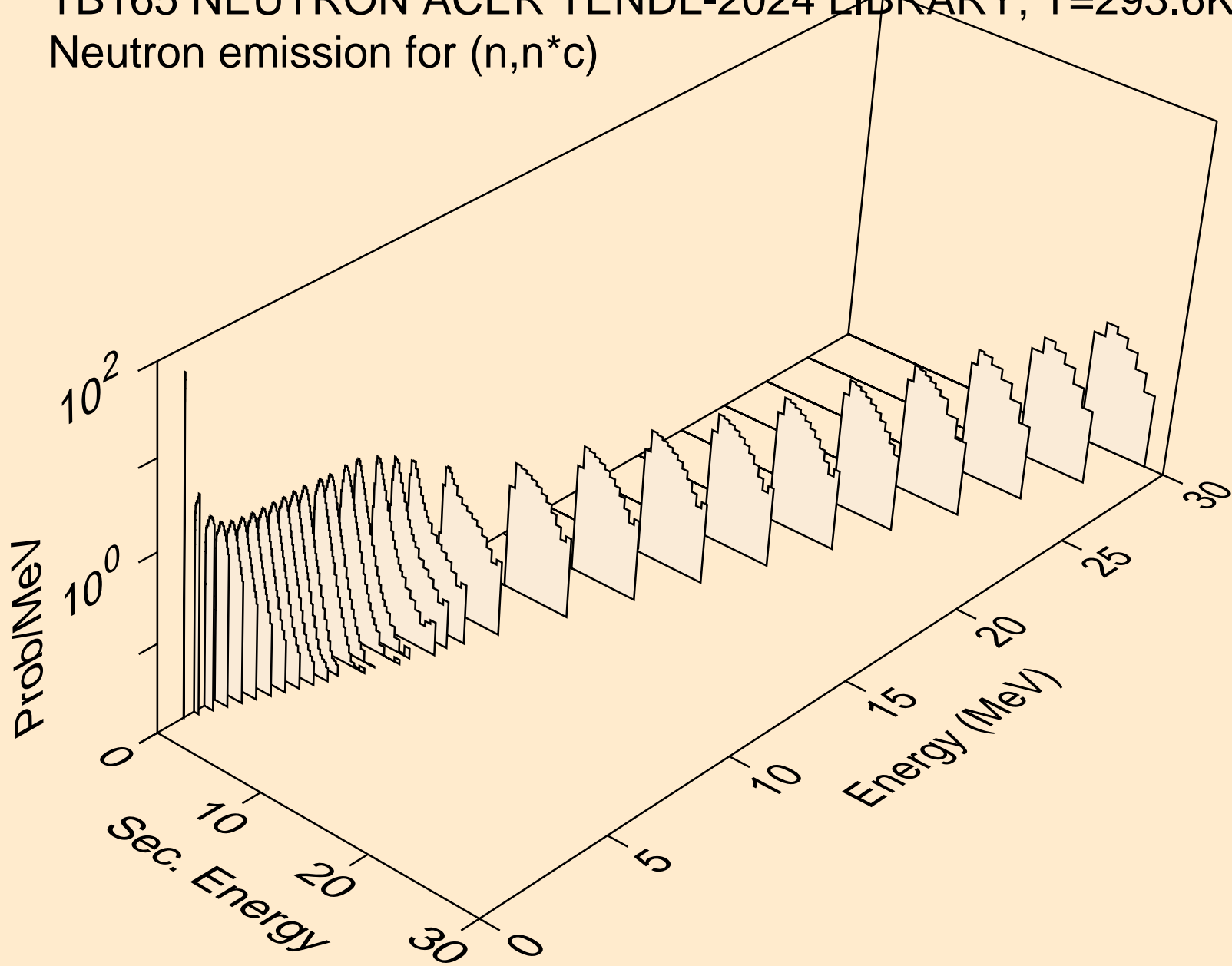

TB165 NEUTRON ACER TENDL-2024 LIBRARY; T=293.6K
Photon emission for (n,x)

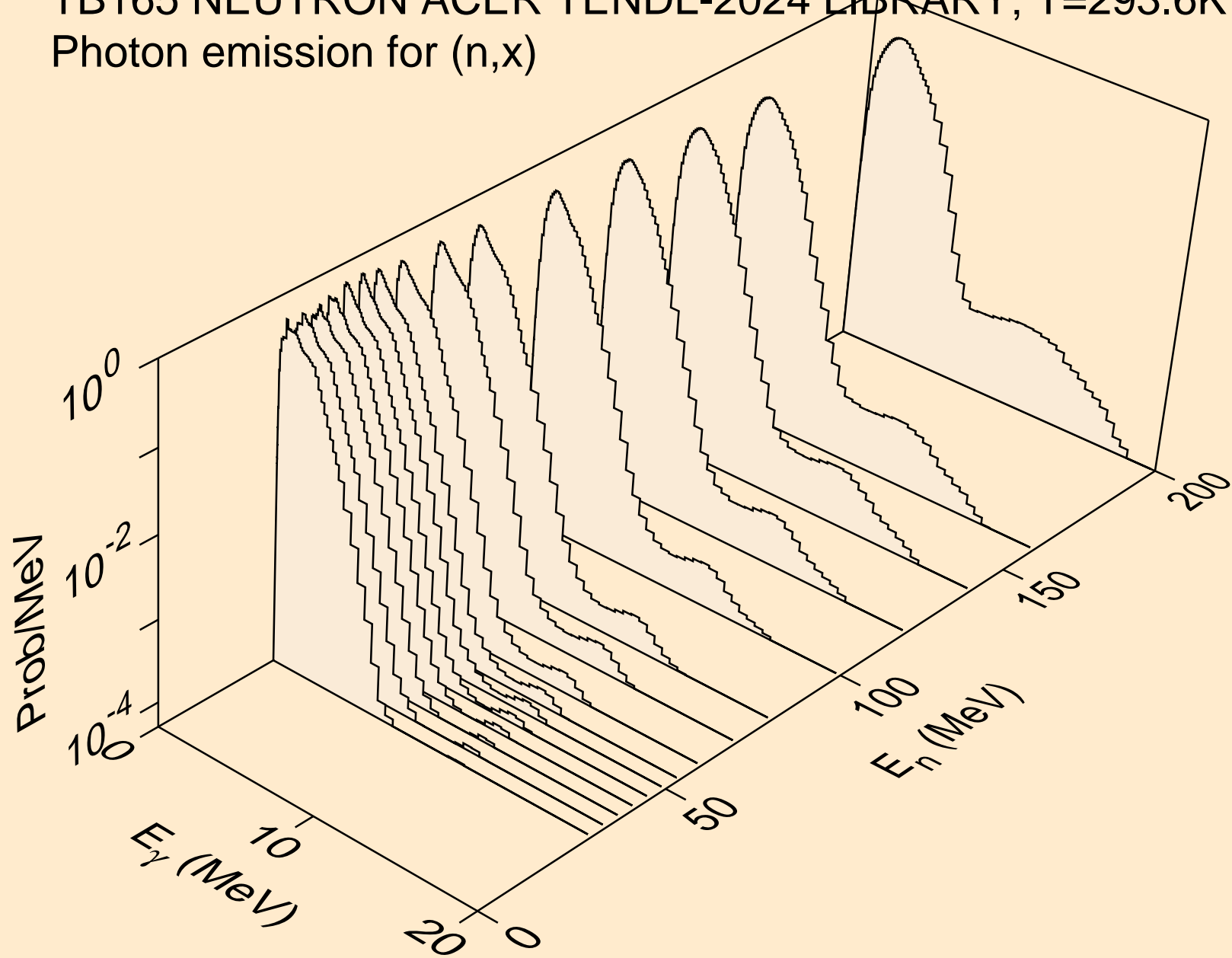

TB165 NEUTRON ACER TENDL-2024 LIBRARY; T=293.6K
Photon emission for (n,2nd)

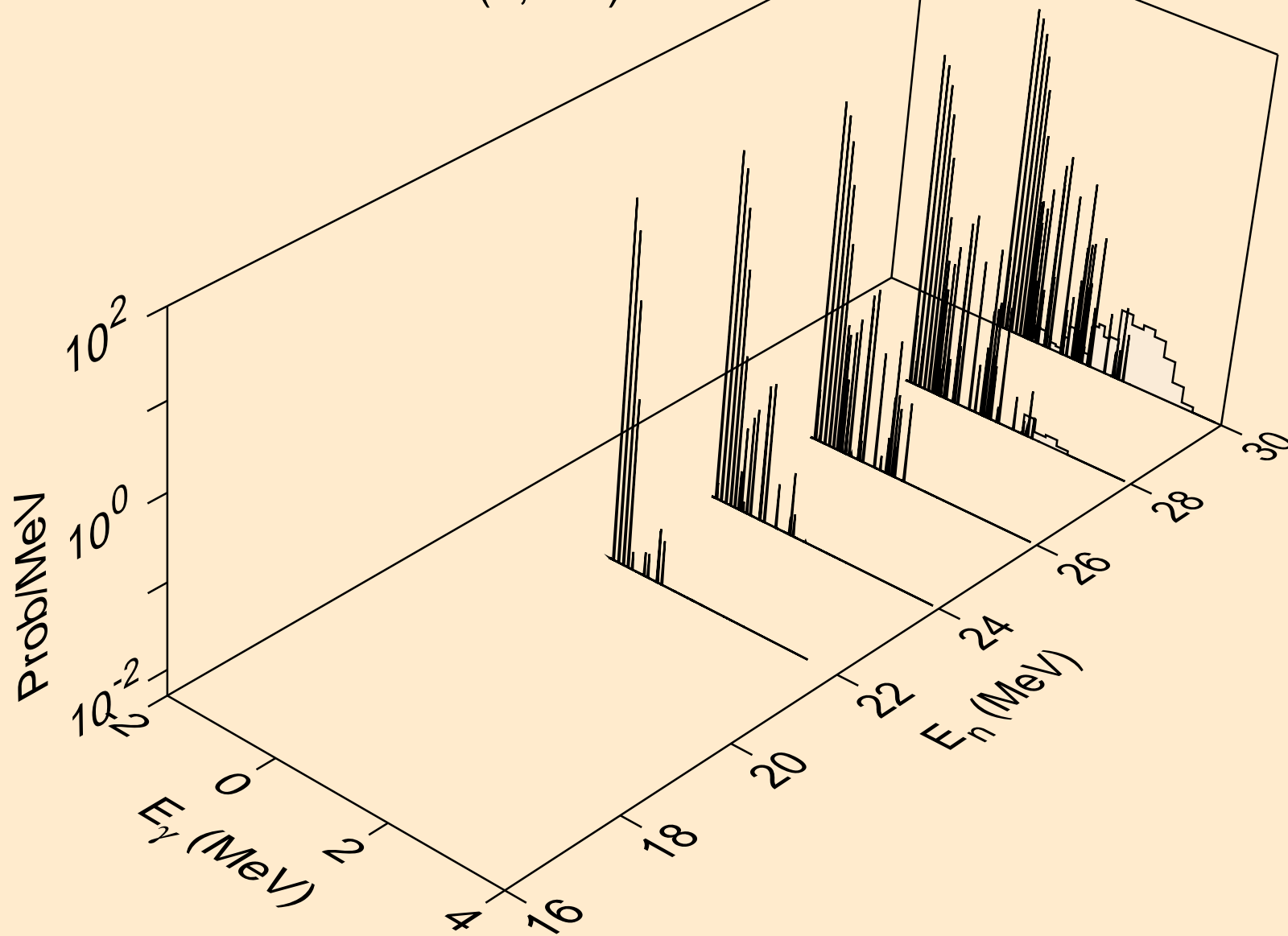

TB165 NEUTRON ACER TENDL-2024 LIBRARY; T=293.6K
Photon emission for (n,2n)

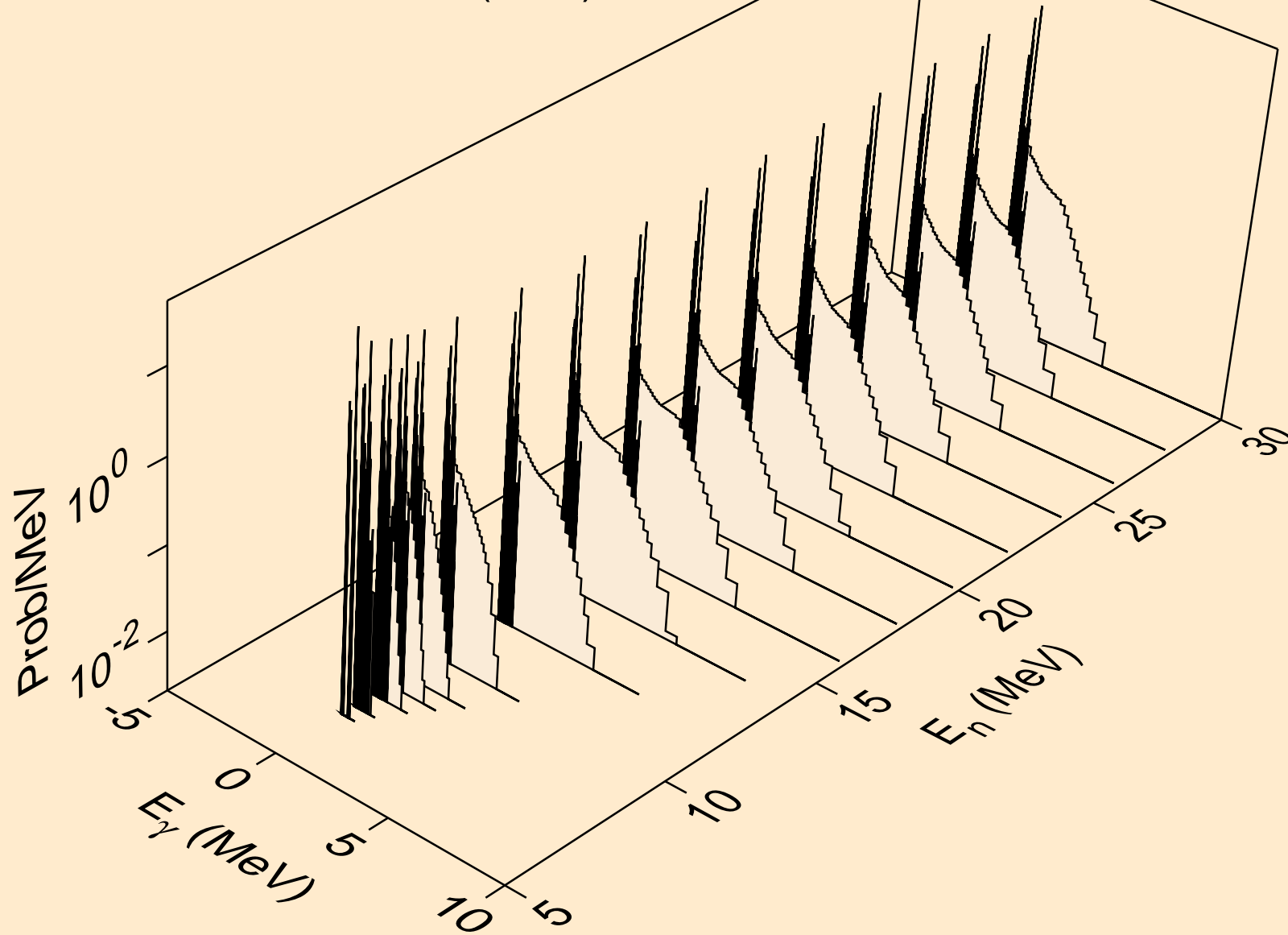

TB165 NEUTRON ACER TENDL-2024 LIBRARY; T=293.6K
Photon emission for (n,3n)

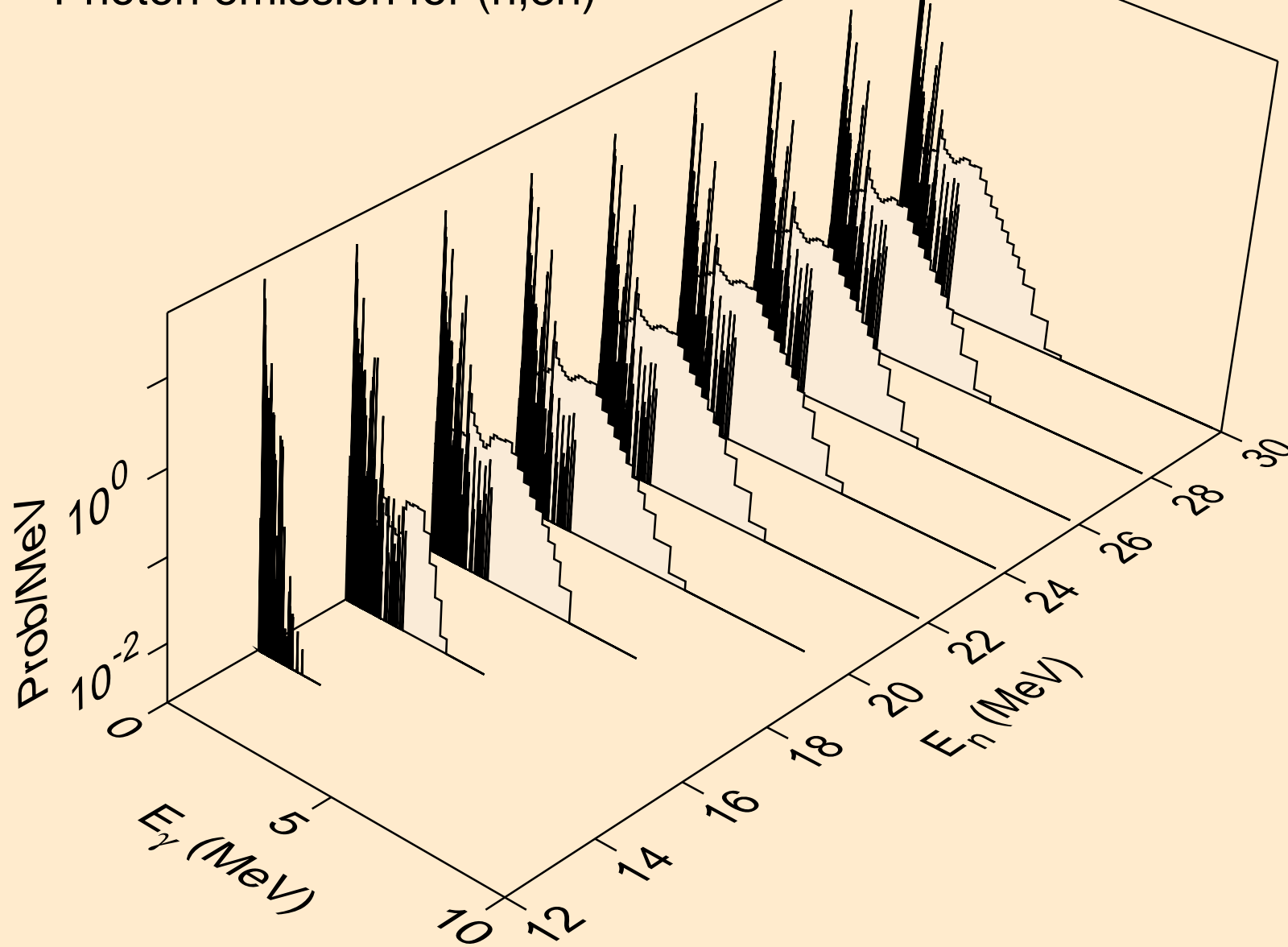

TB165 NEUTRON ACER TENDL-2024 LIBRARY; T=293.6K
Photon emission for (n,n*)a

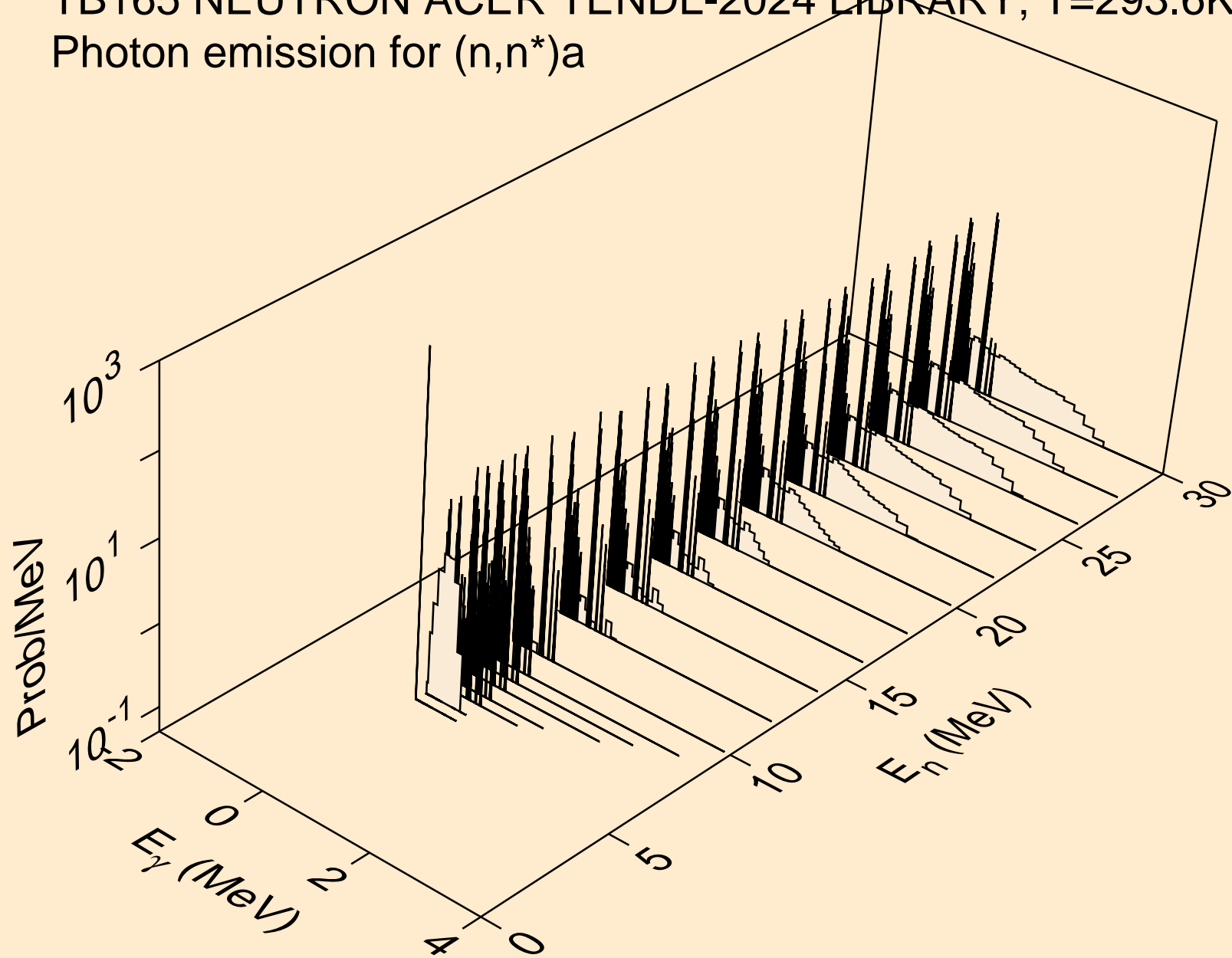

TB165 NEUTRON ACER TENDL-2024 LIBRARY; T=293.6K
Photon emission for (n,2n)a

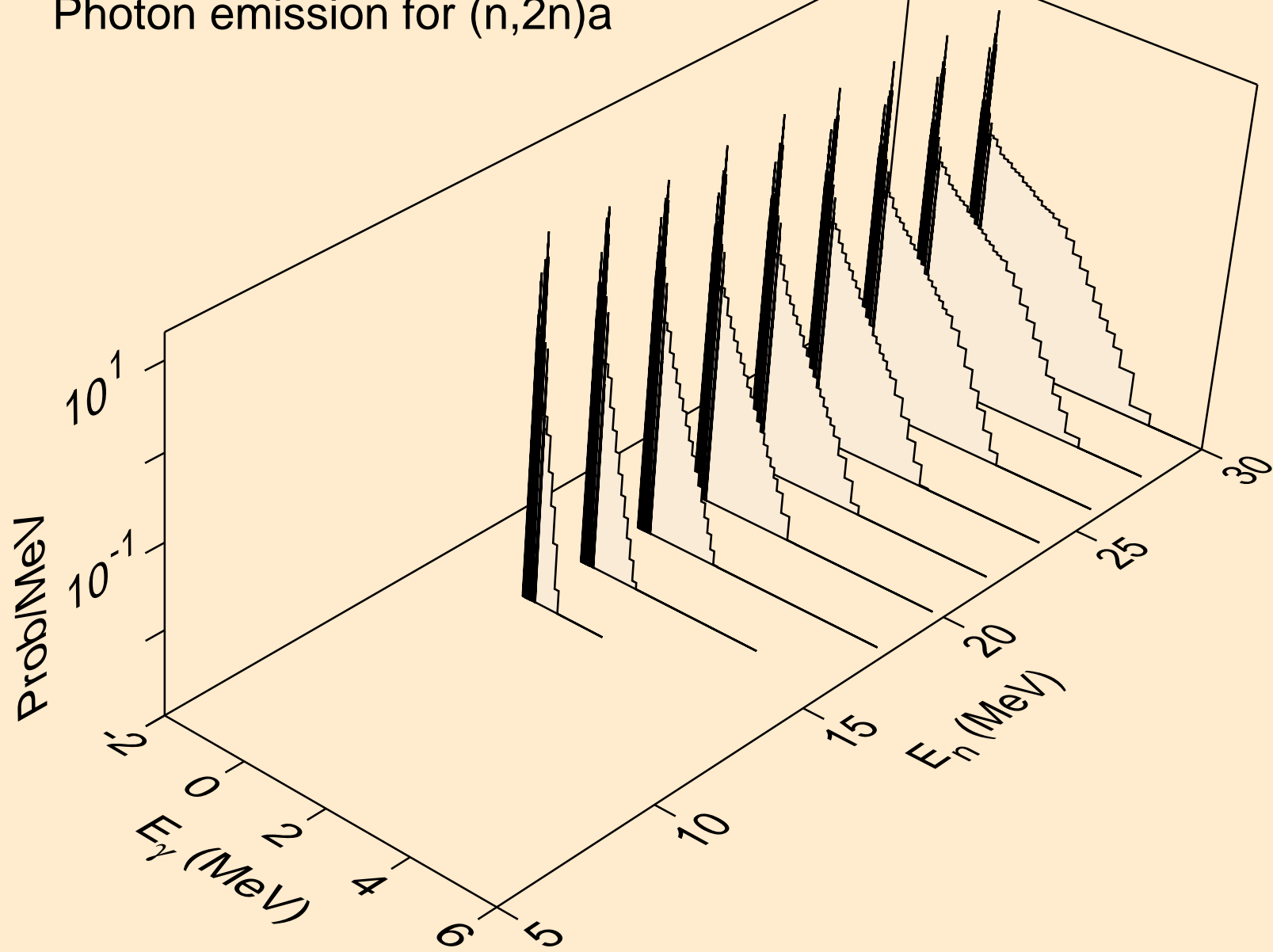

TB165 NEUTRON ACER TENDL-2024 LIBRARY; T=293.6K
Photon emission for (n,3n)a

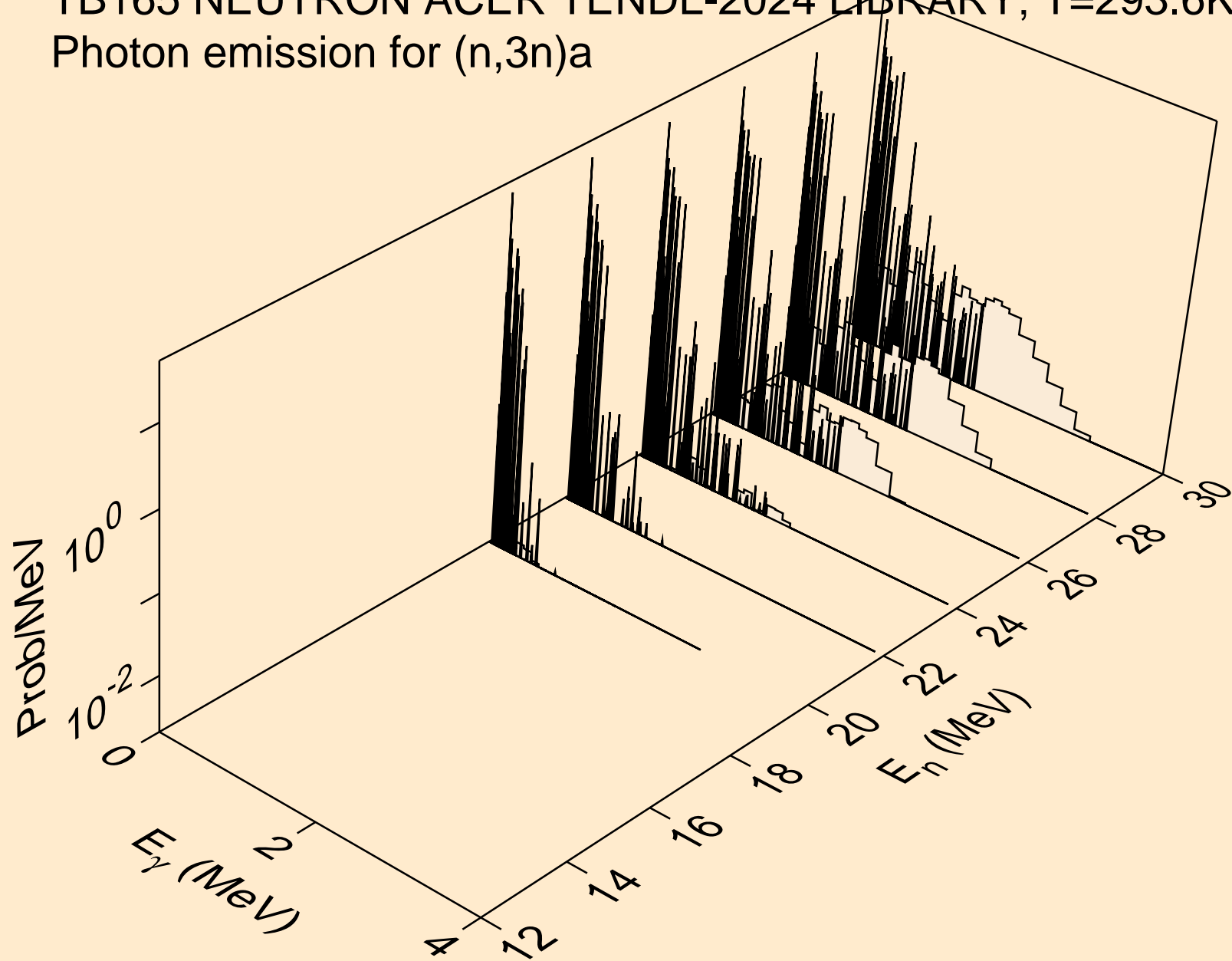

TB165 NEUTRON ACER TENDL-2024 LIBRARY; T=293.6K
Photon emission for (n,n*)p

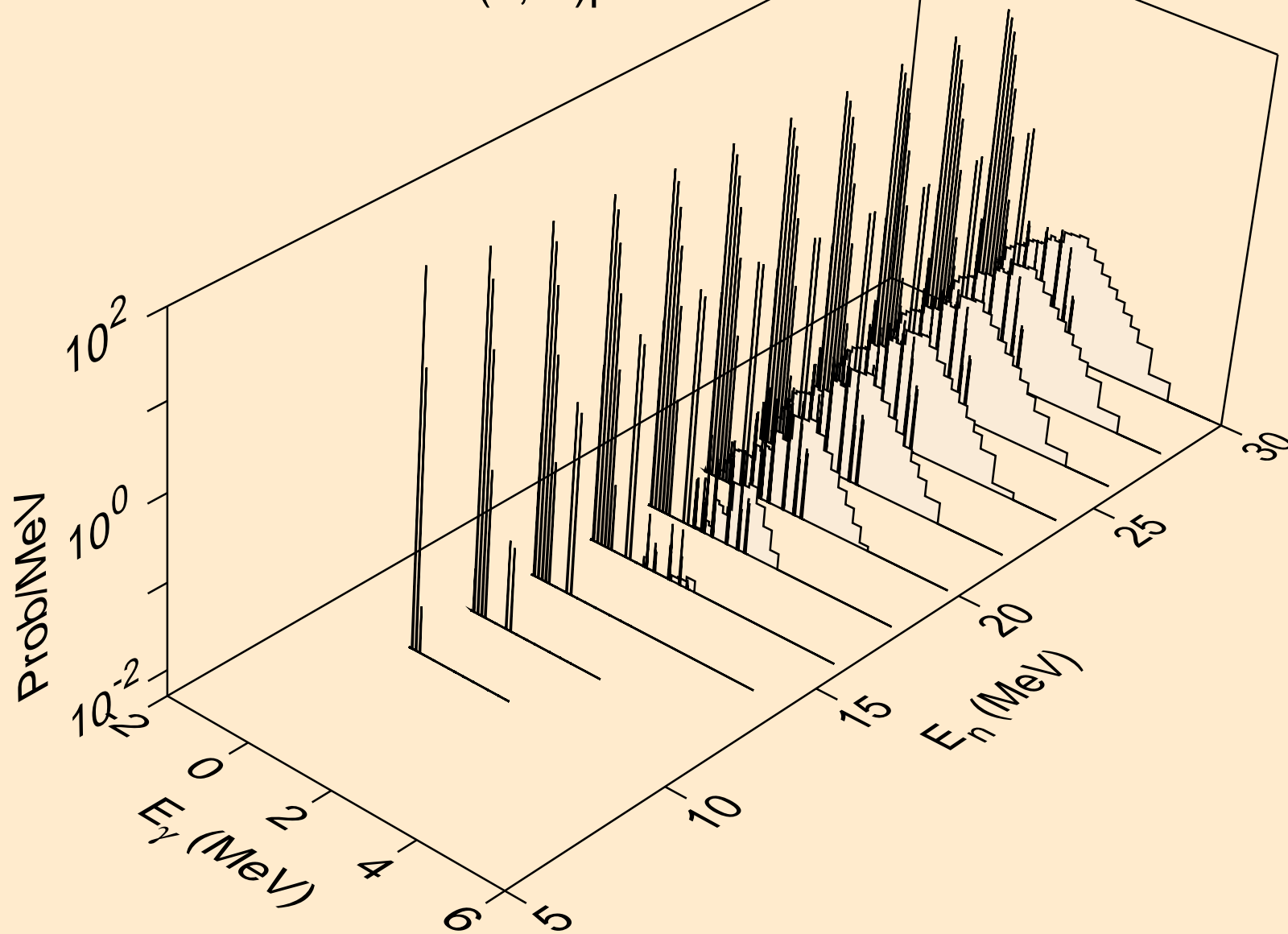

TB165 NEUTRON ACER TENDL-2024 LIBRARY; T=293.6K
Photon emission for (n,n*)d

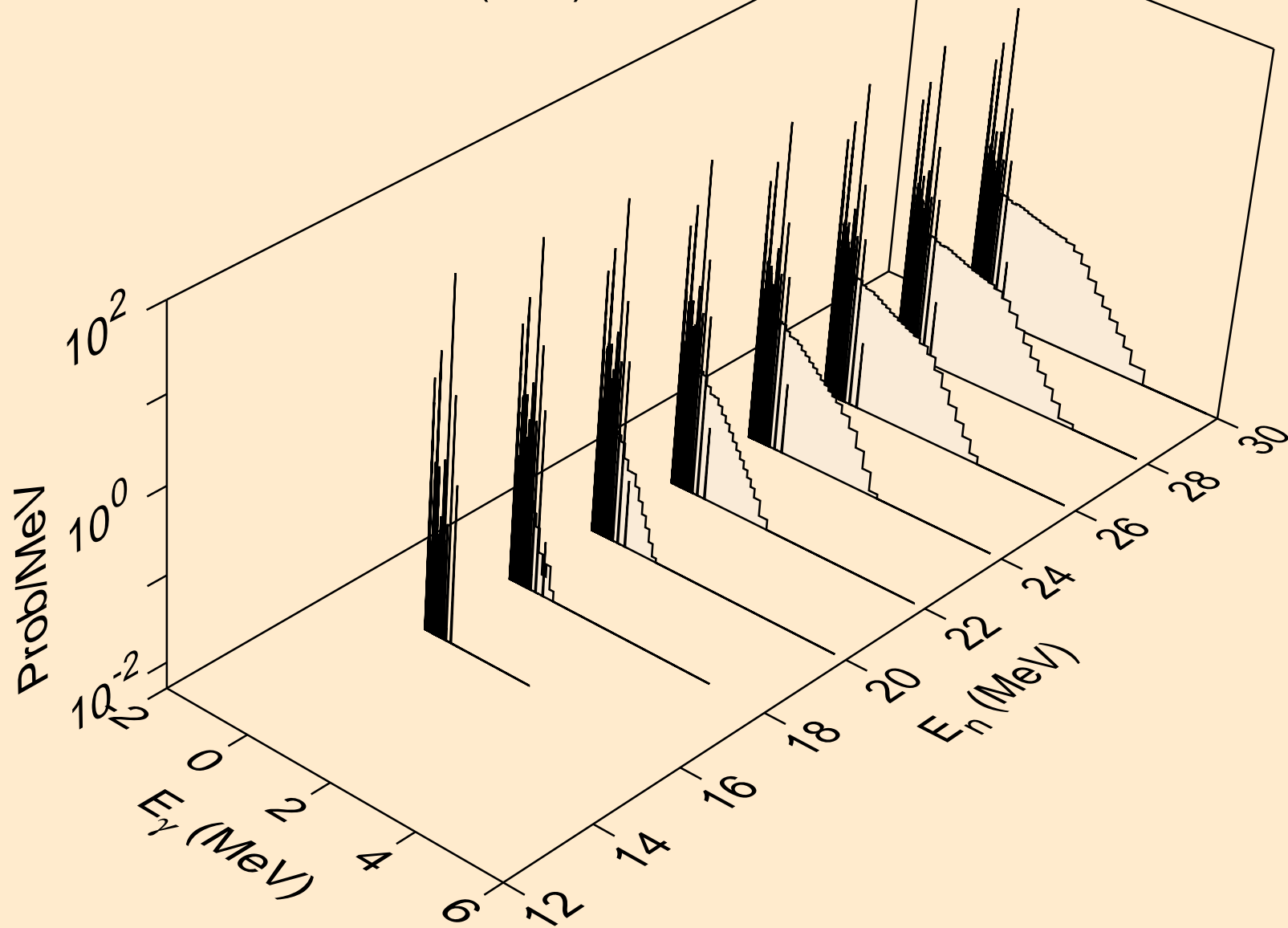

TB165 NEUTRON ACER TENDL-2024 LIBRARY; T=293.6K
Photon emission for (n,n*)t

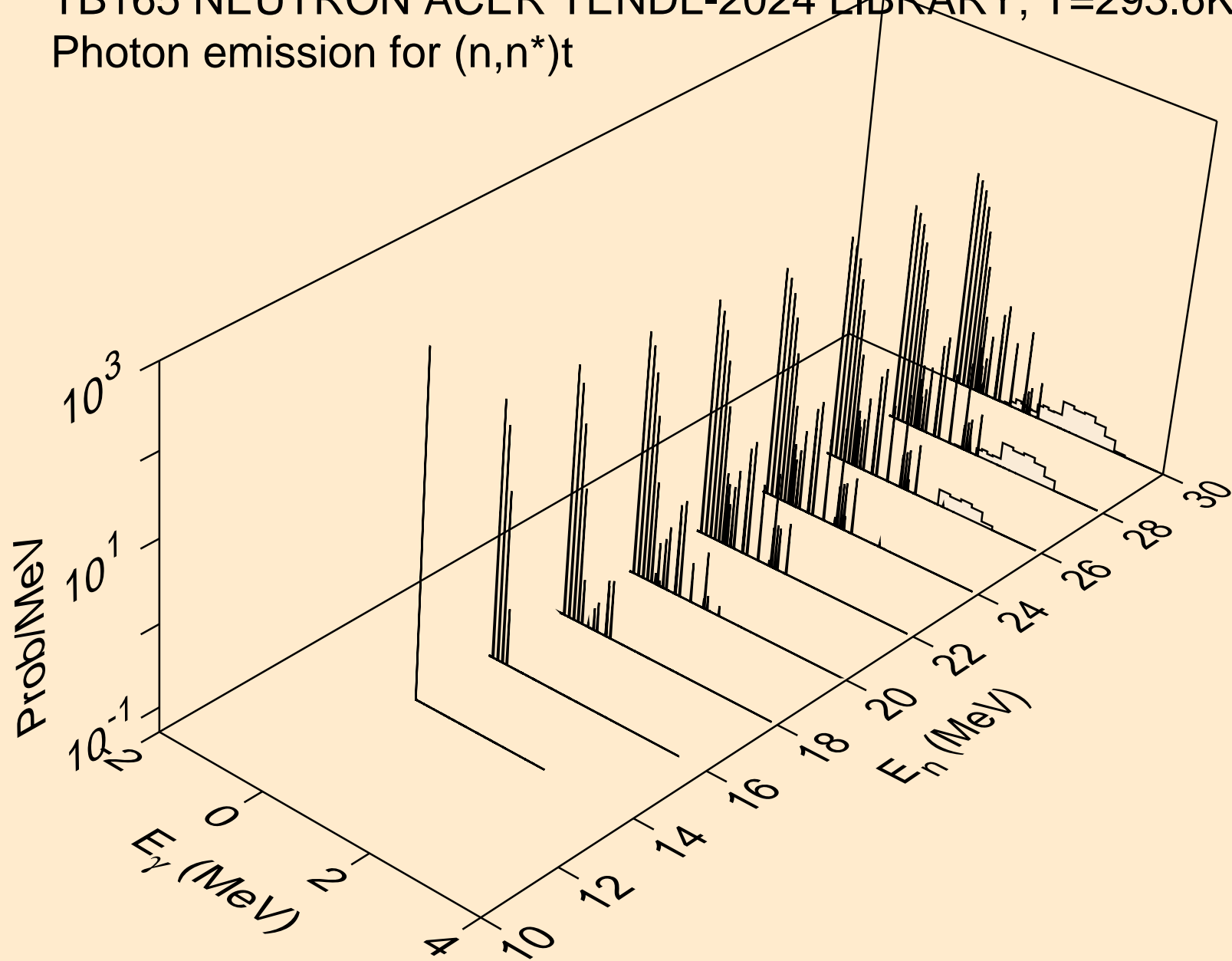

TB165 NEUTRON ACER TENDL-2024 LIBRARY; T=293.6K
Photon emission for (n,n*)he3

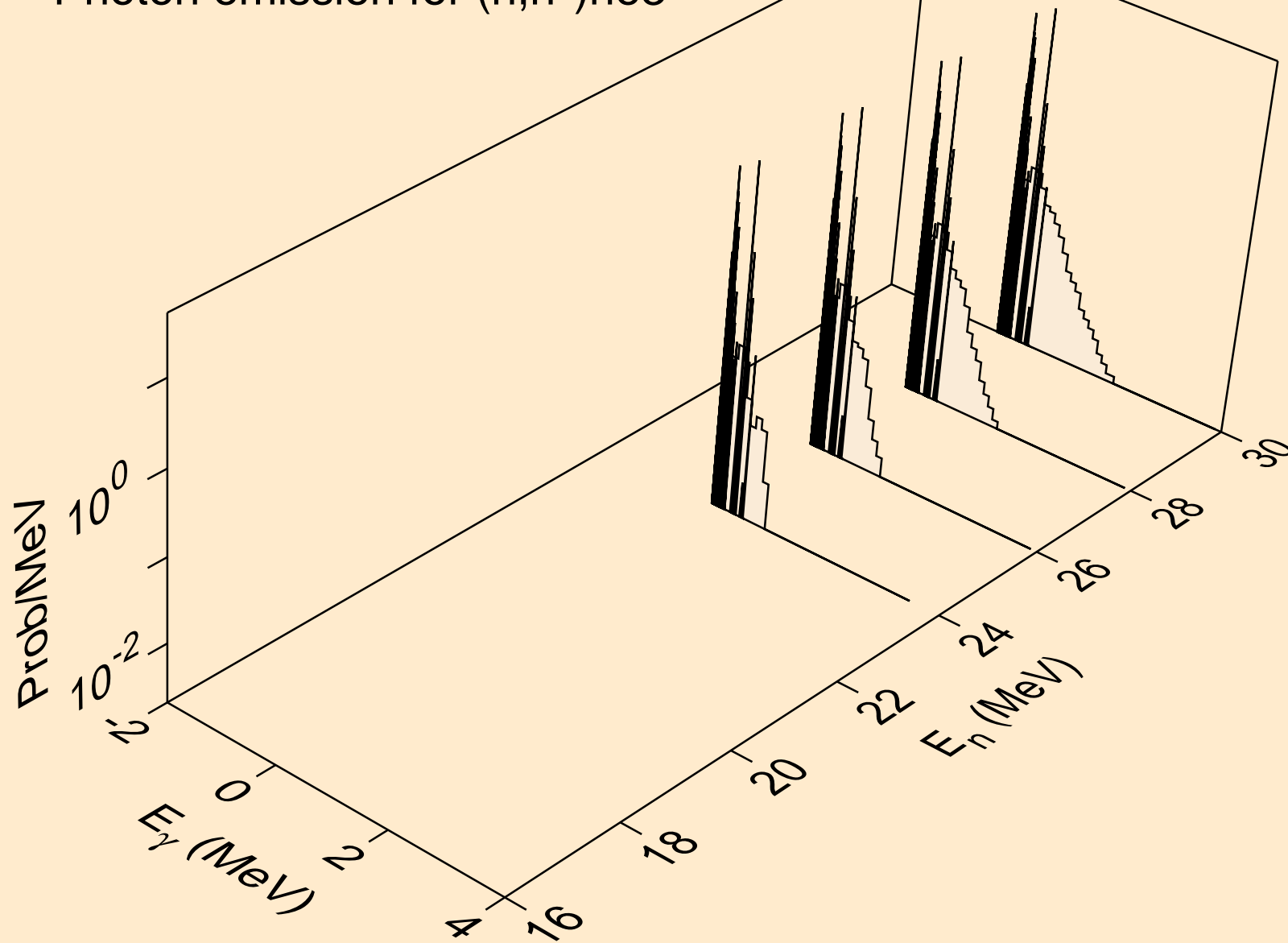

TB165 NEUTRON ACER TENDL-2024 LIBRARY; T=293.6K
Photon emission for (n,4n)

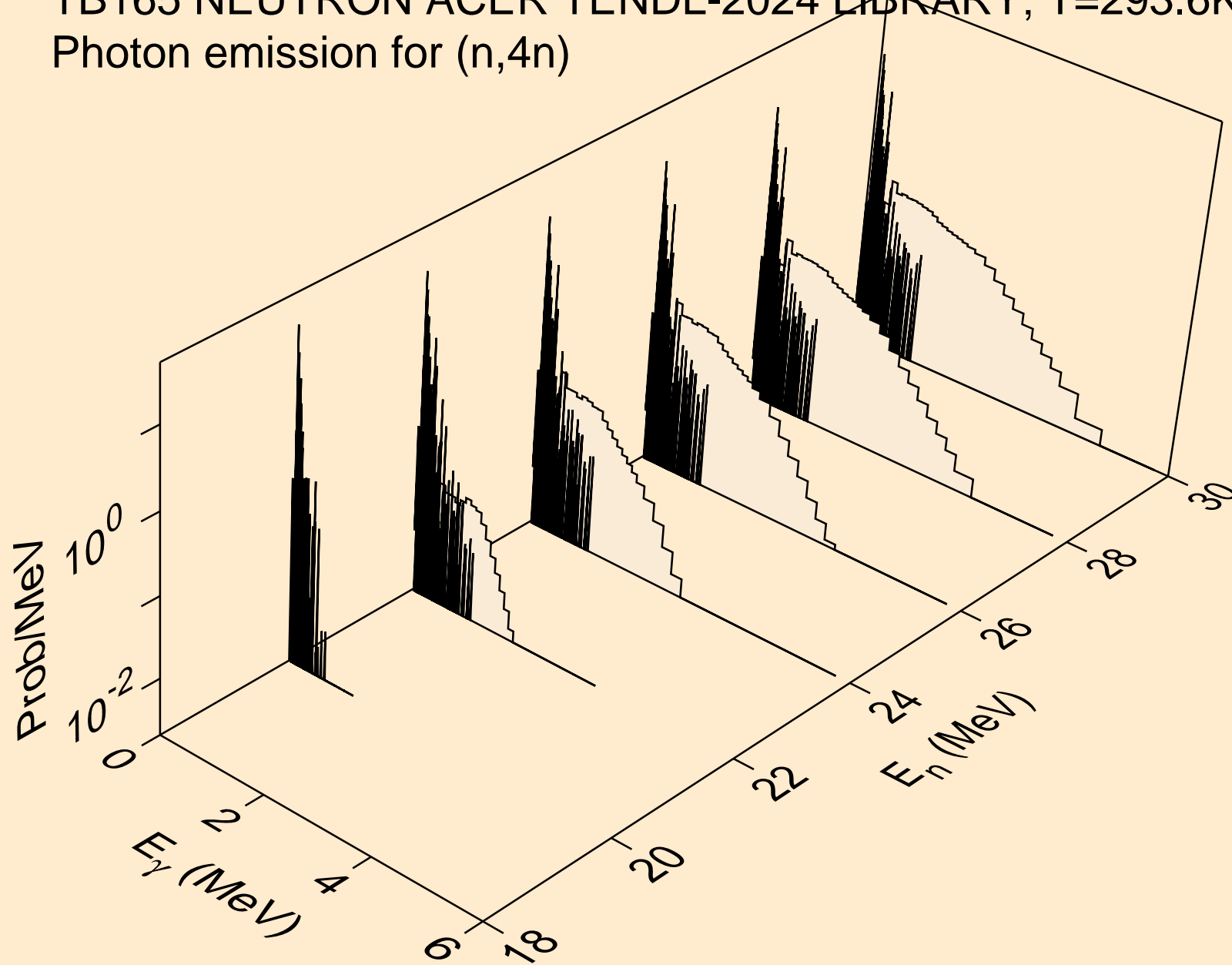

TB165 NEUTRON ACER TENDL-2024 LIBRARY; T=293.6K
Photon emission for (n,2np)

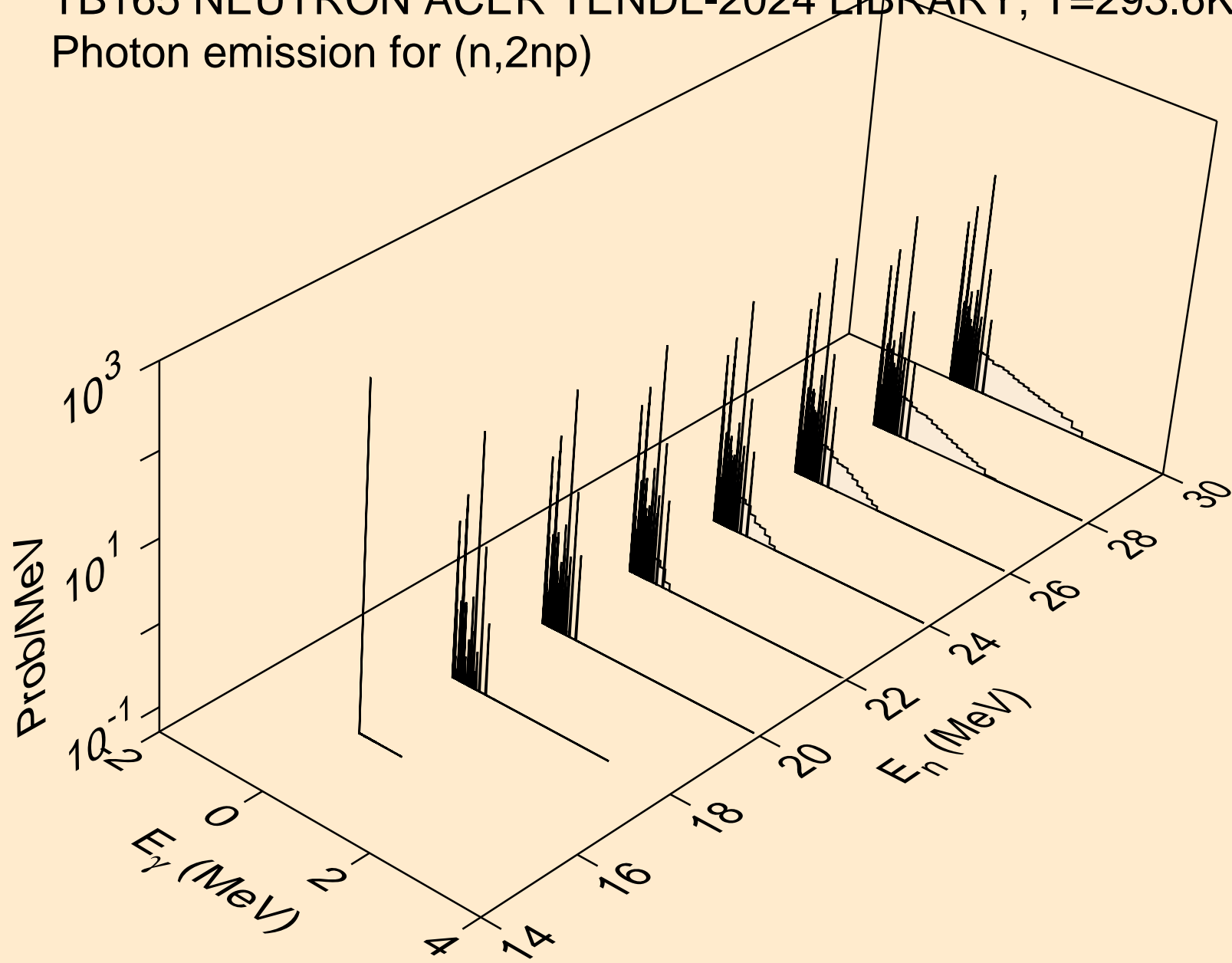

TB165 NEUTRON ACER TENDL-2024 LIBRARY; T=293.6K
Photon emission for (n,3np)

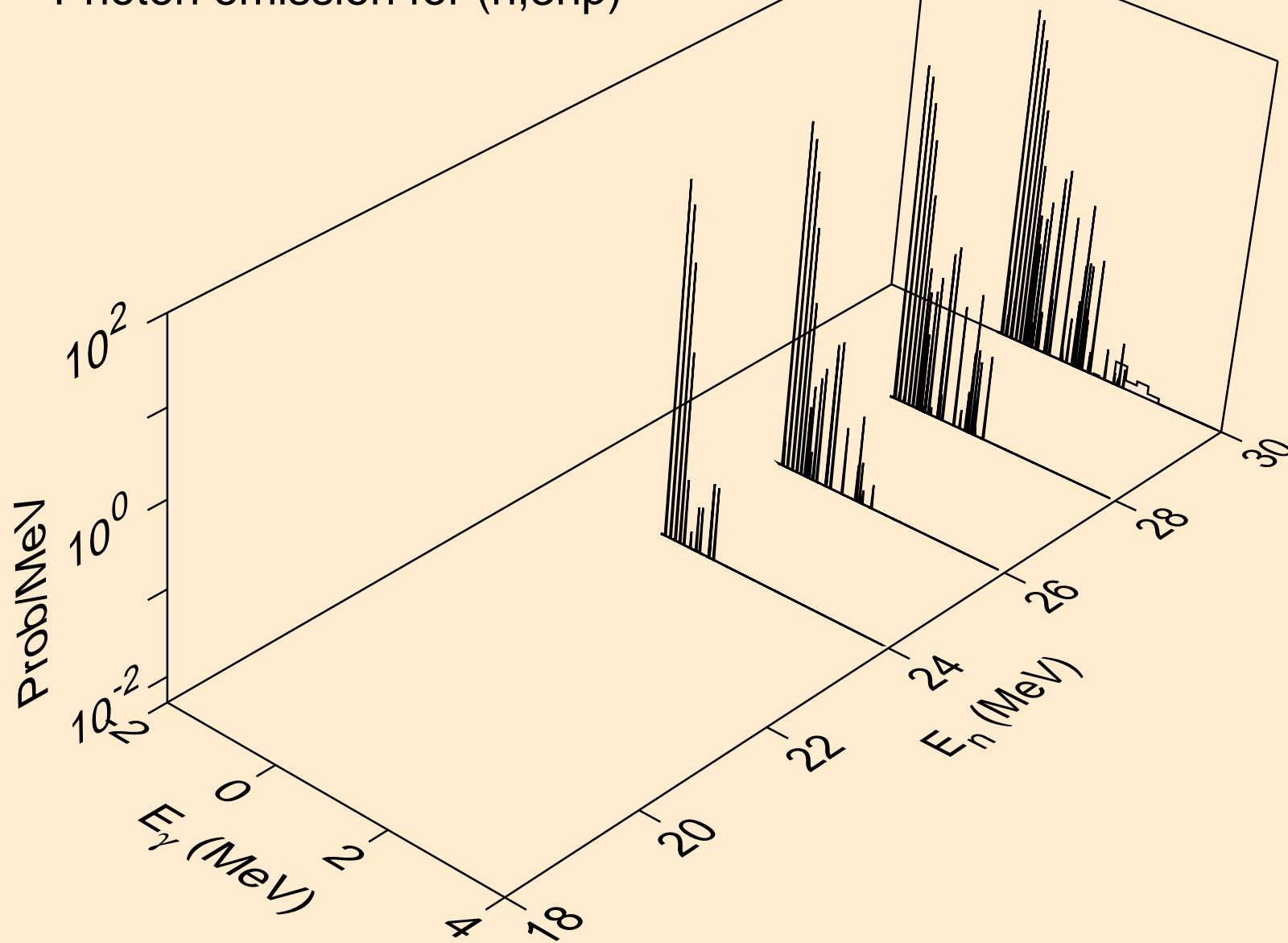

TB165 NEUTRON ACER TENDL-2024 LIBRARY; T=293.6K
Photon emission for (n,n*c)

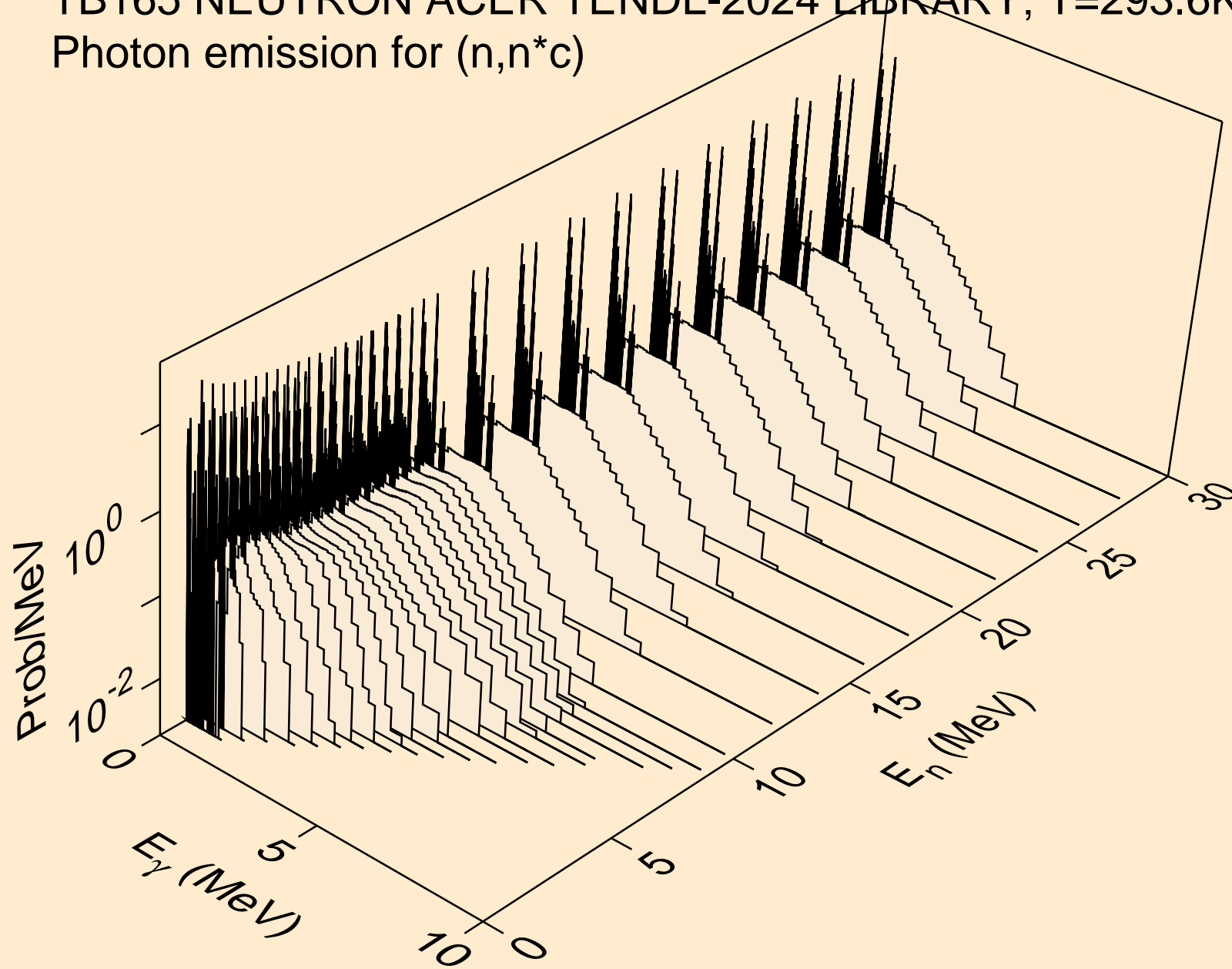

TB165 NEUTRON ACER TENDL-2024 LIBRARY; T=293.6K
Photon emission for (n,gma)

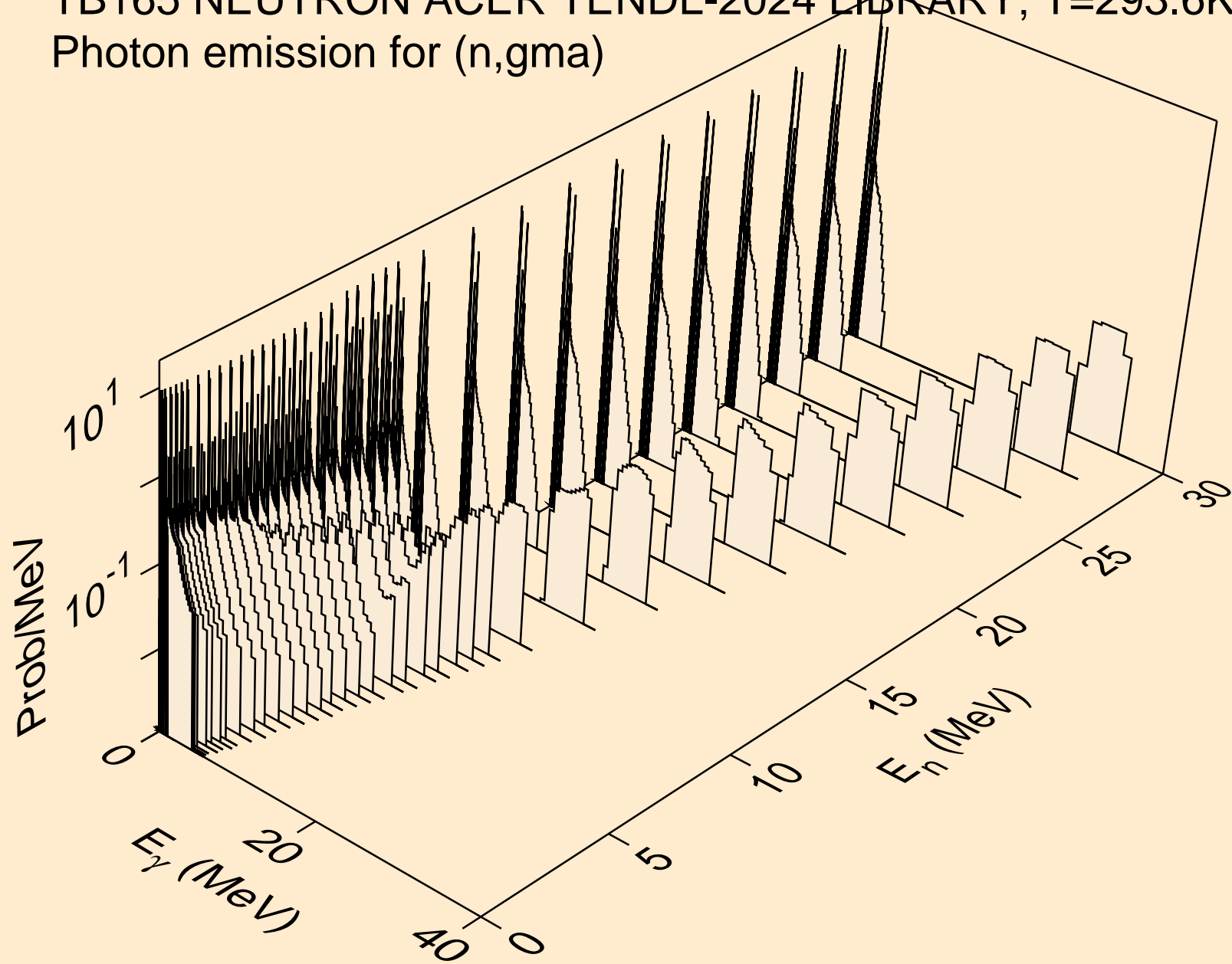

TB165 NEUTRON ACER TENDL-2024 LIBRARY; T=293.6K
Photon emission for (n,p)

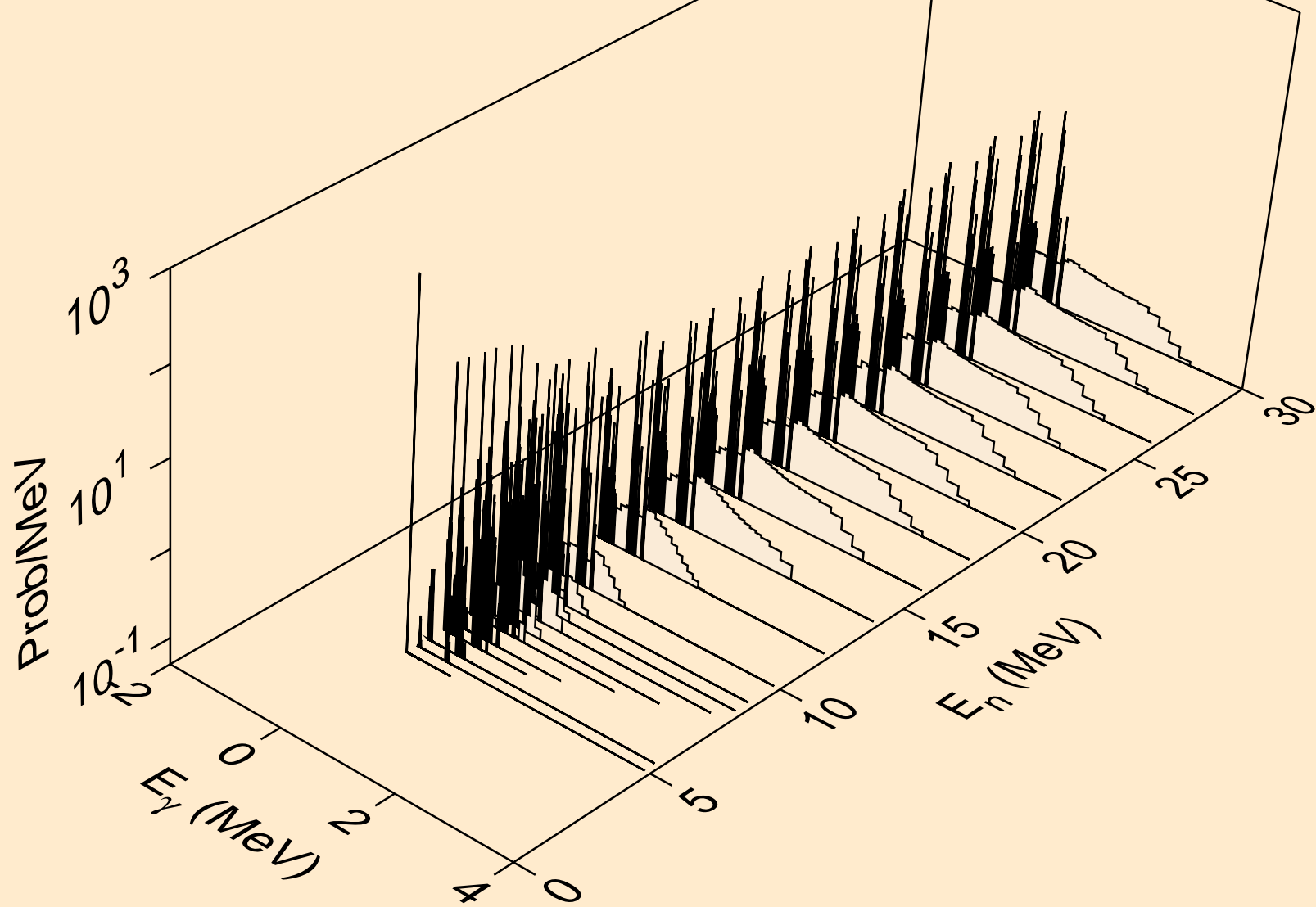

TB165 NEUTRON ACER TENDL-2024 LIBRARY; T=293.6K
Photon emission for (n,d)

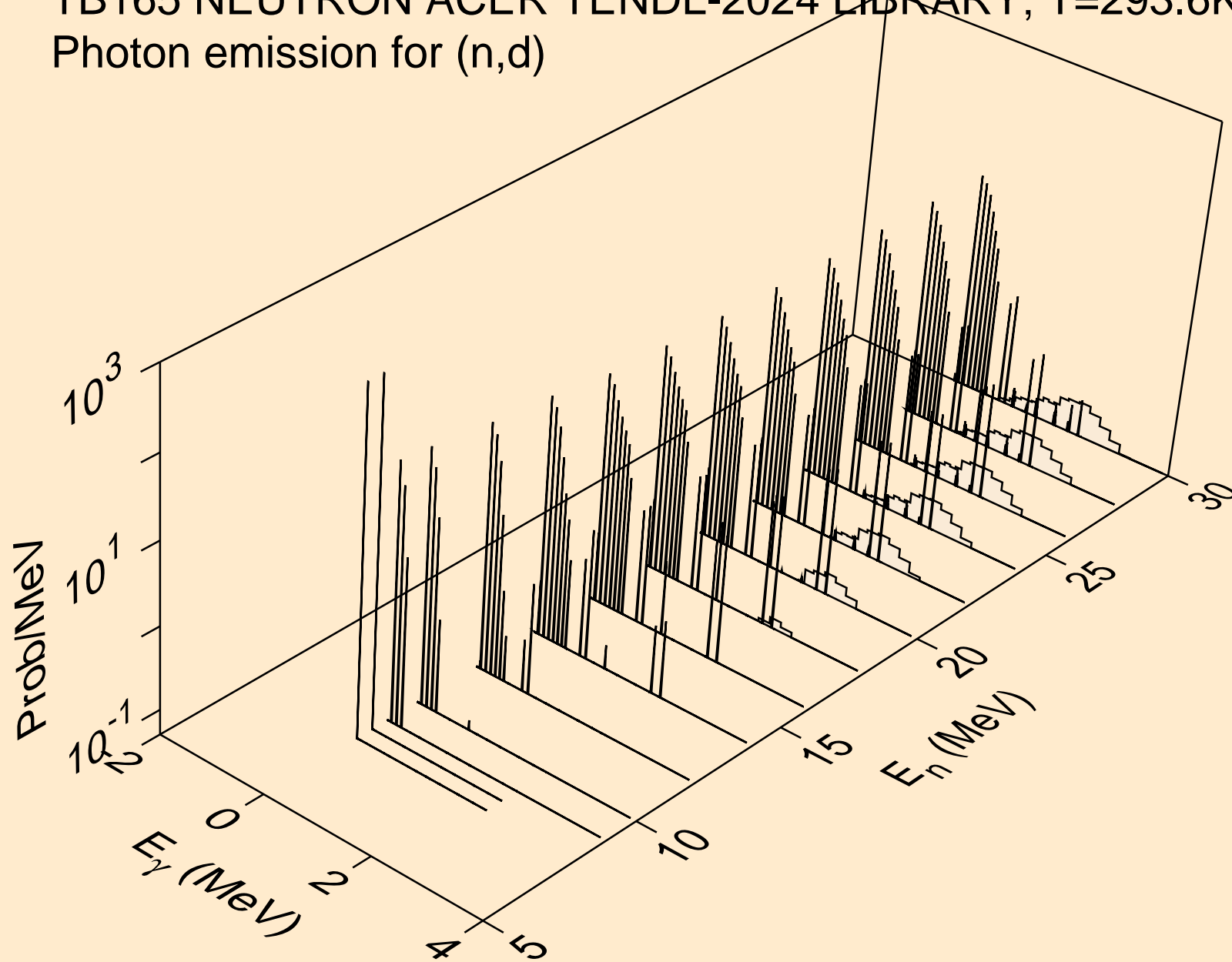

TB165 NEUTRON ACER TENDL-2024 LIBRARY; T=293.6K
Photon emission for (n,t)

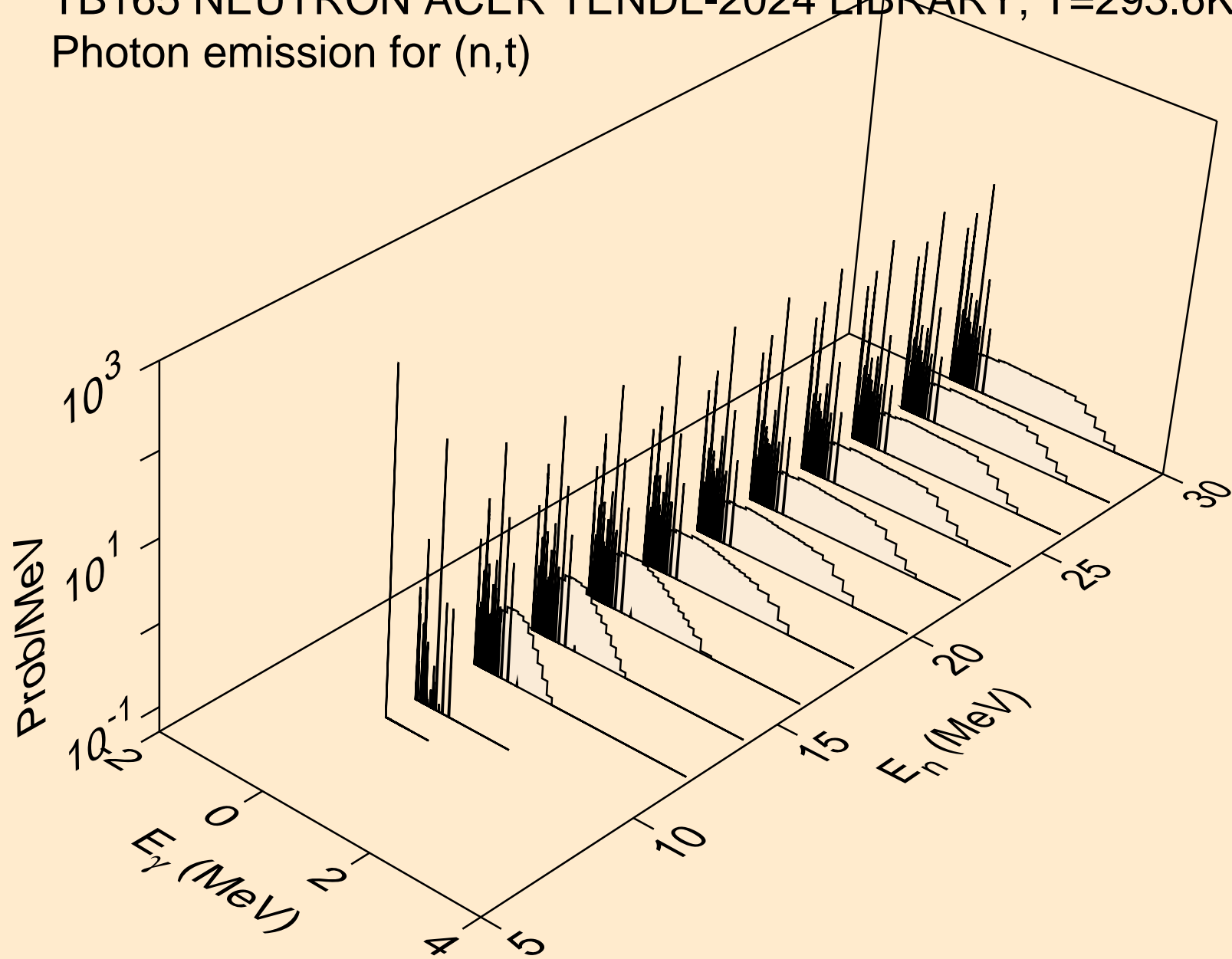

TB165 NEUTRON ACER TENDL-2024 LIBRARY; T=293.6K
Photon emission for (n,he3)

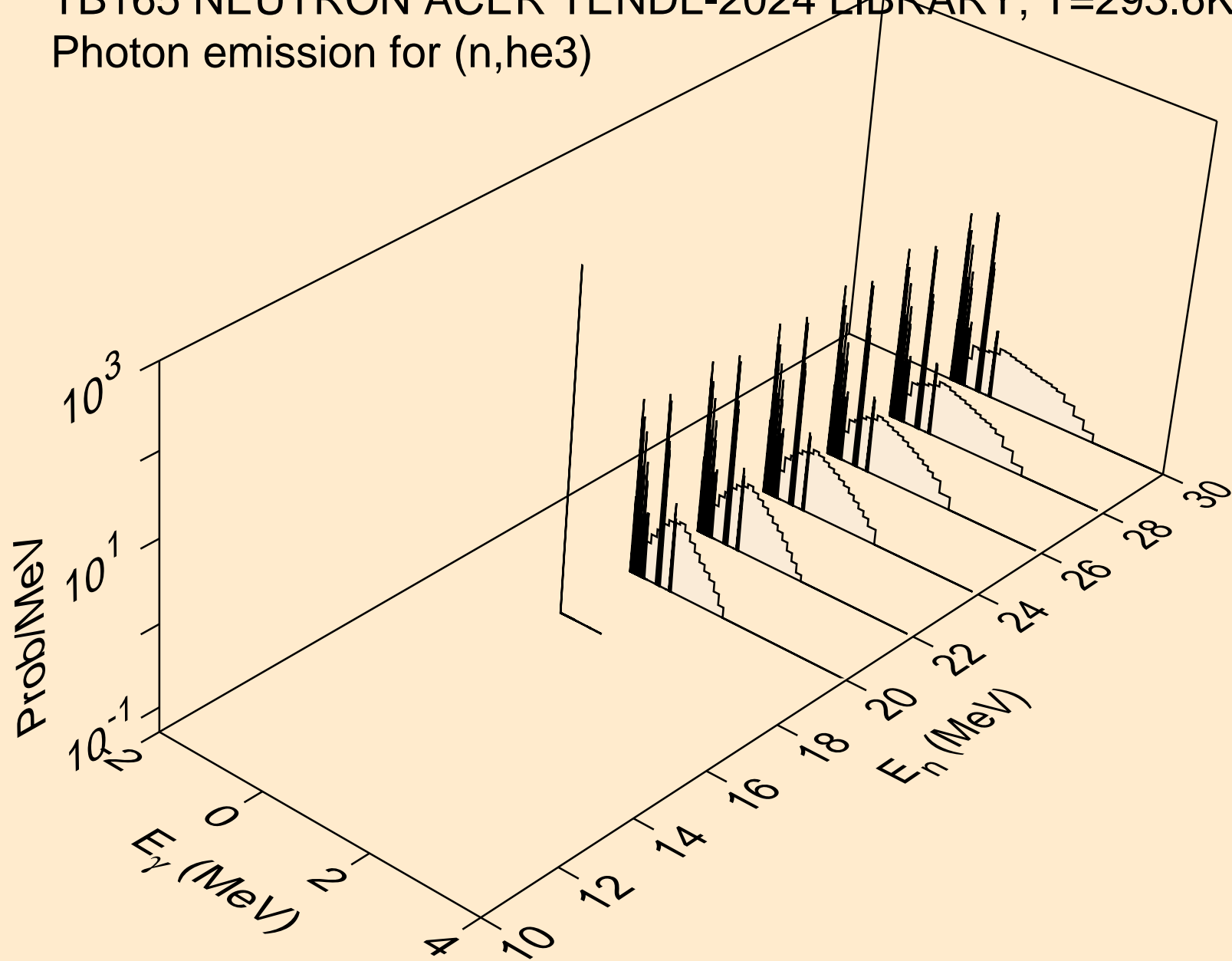

TB165 NEUTRON ACER TENDL-2024 LIBRARY; T=293.6K
Photon emission for (n,a)

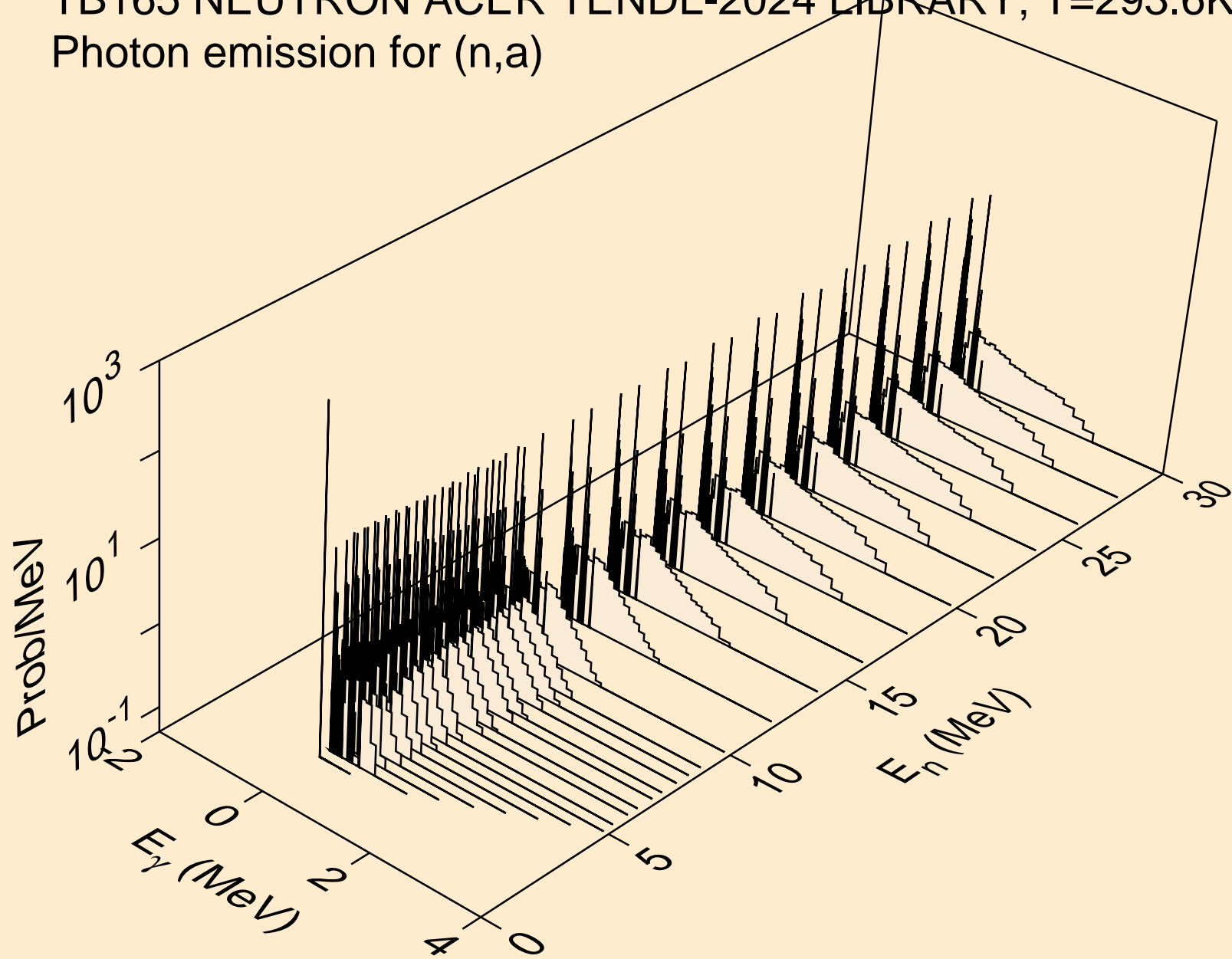

TB165 NEUTRON ACER TENDL-2024 LIBRARY; T=293.6K
Photon emission for (n,2p)

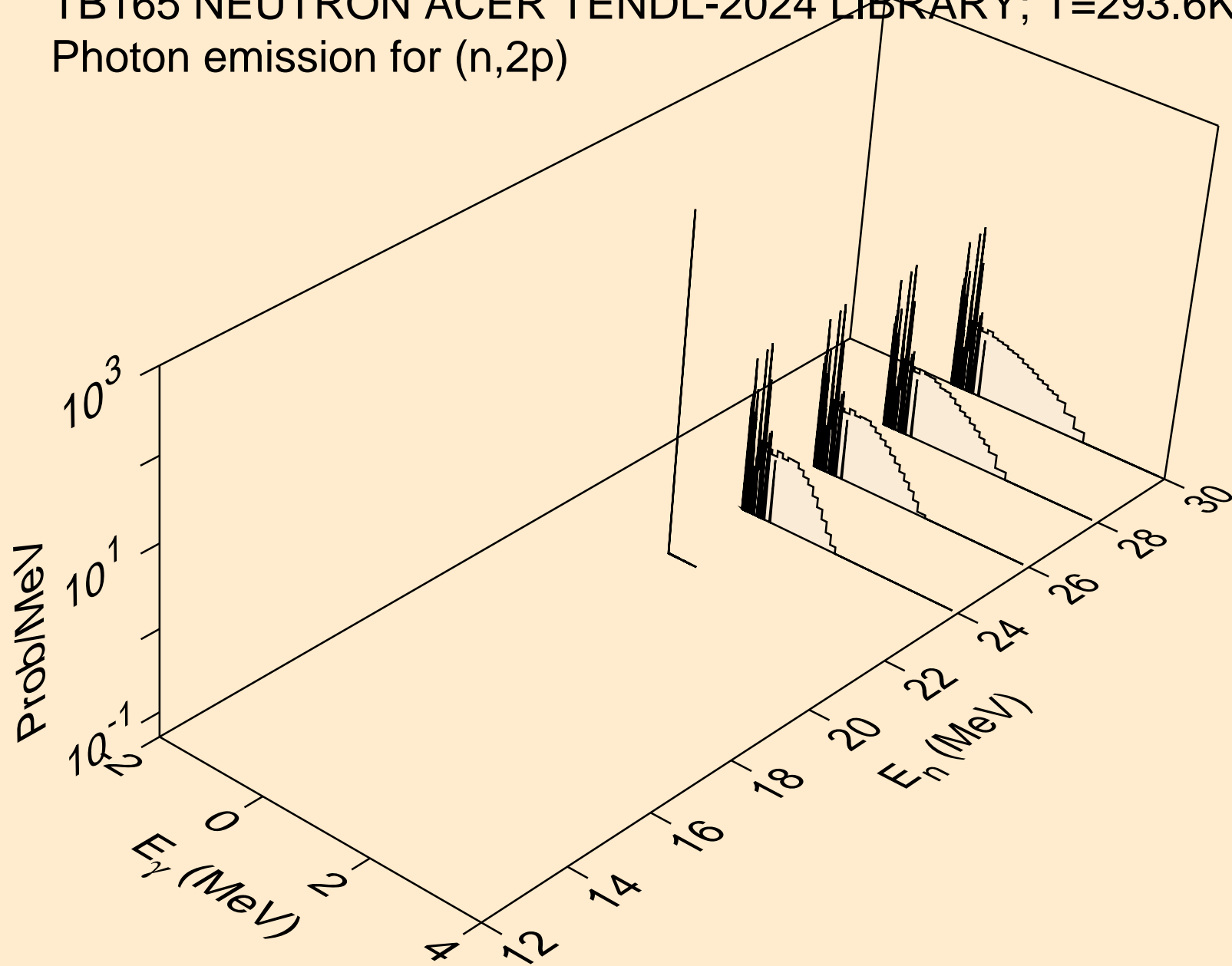

TB165 NEUTRON ACER TENDL-2024 LIBRARY; T=293.6K
thermal capture photon spectrum

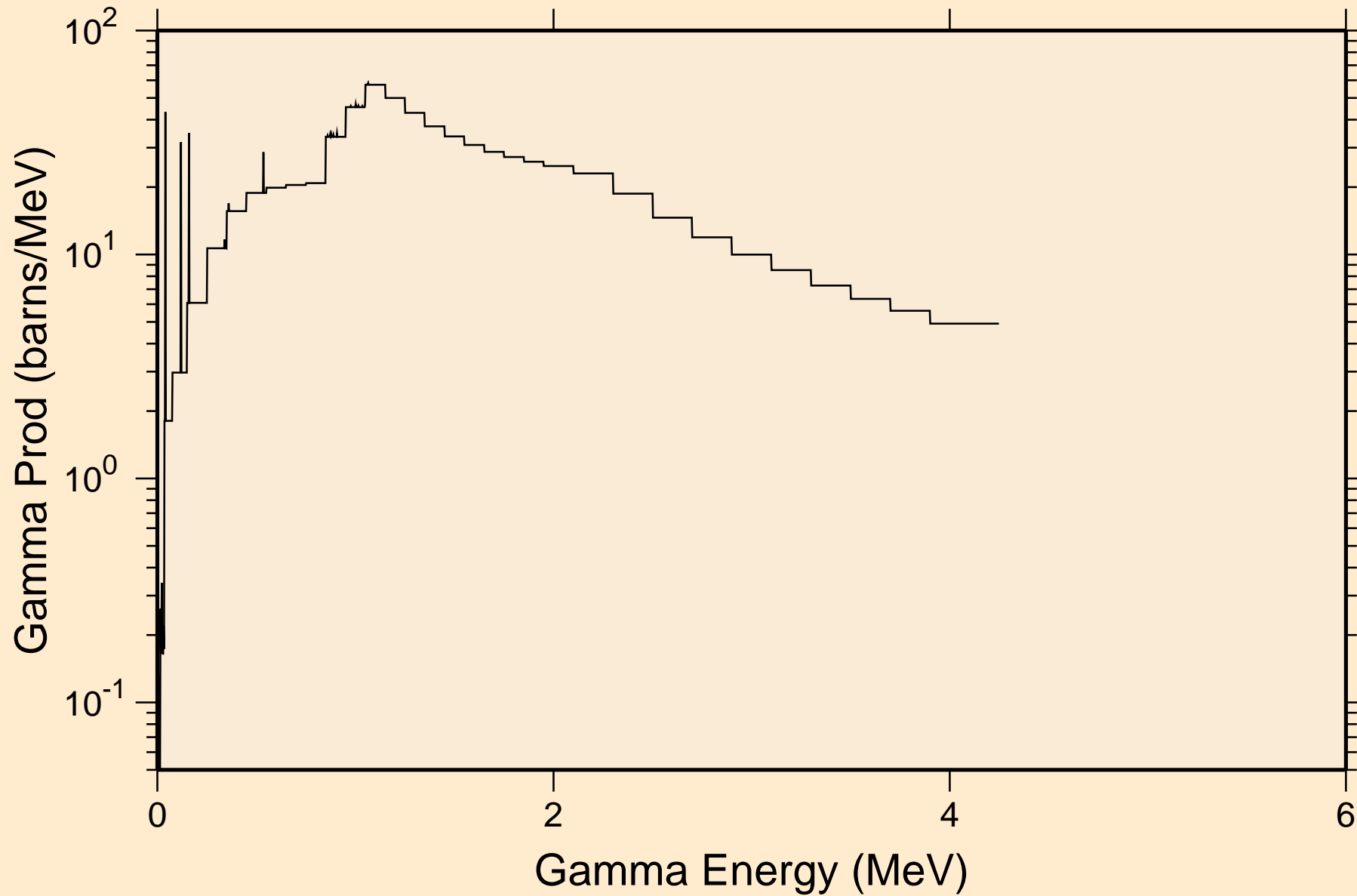

TB165 NEUTRON ACER TENDL-2024 LIBRARY; T=293.6K
14 MeV photon spectrum

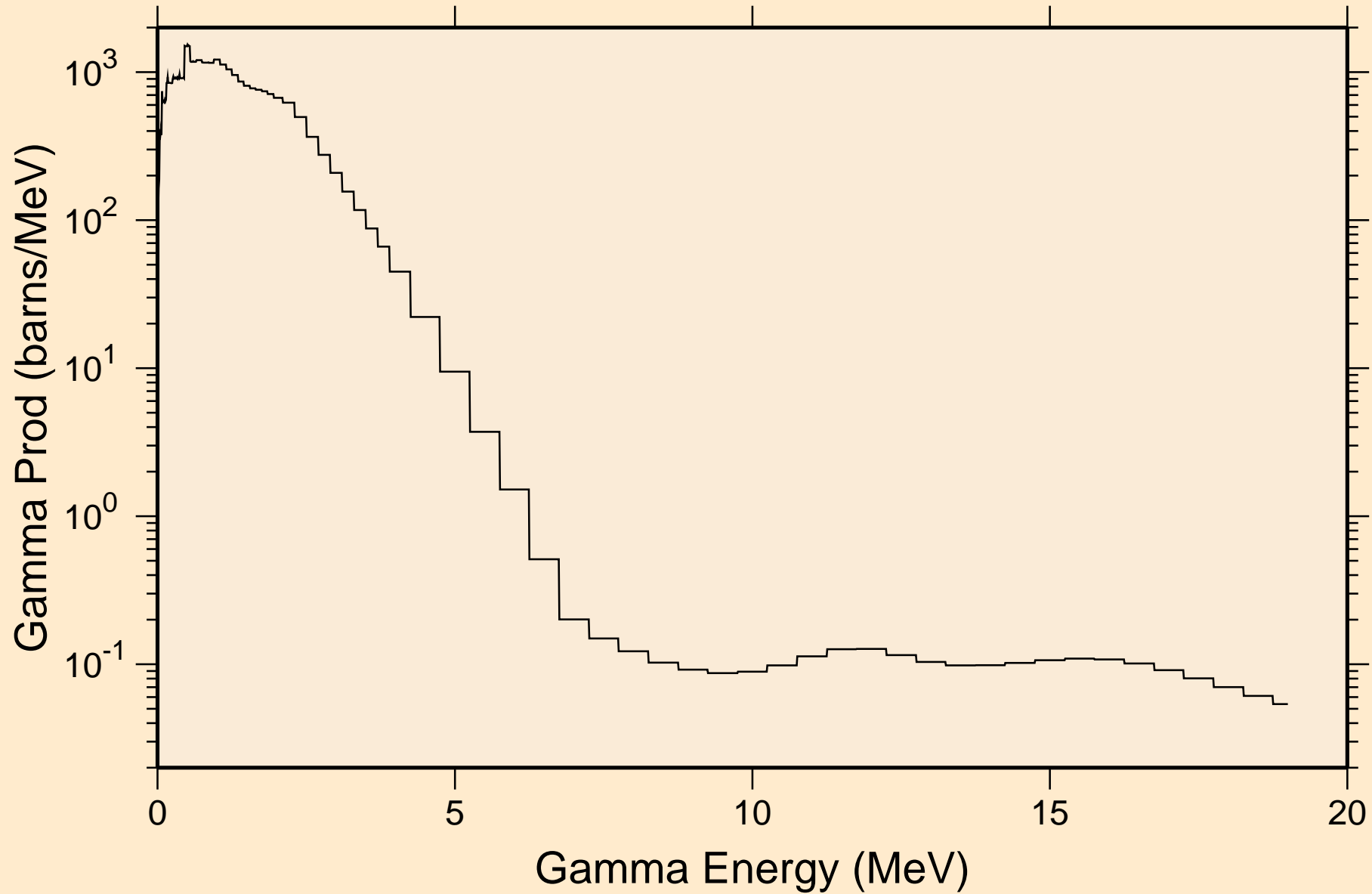

TB165 NEUTRON ACER TENDL-2024 LIBRARY; T=293.6K
Particle heating contributions

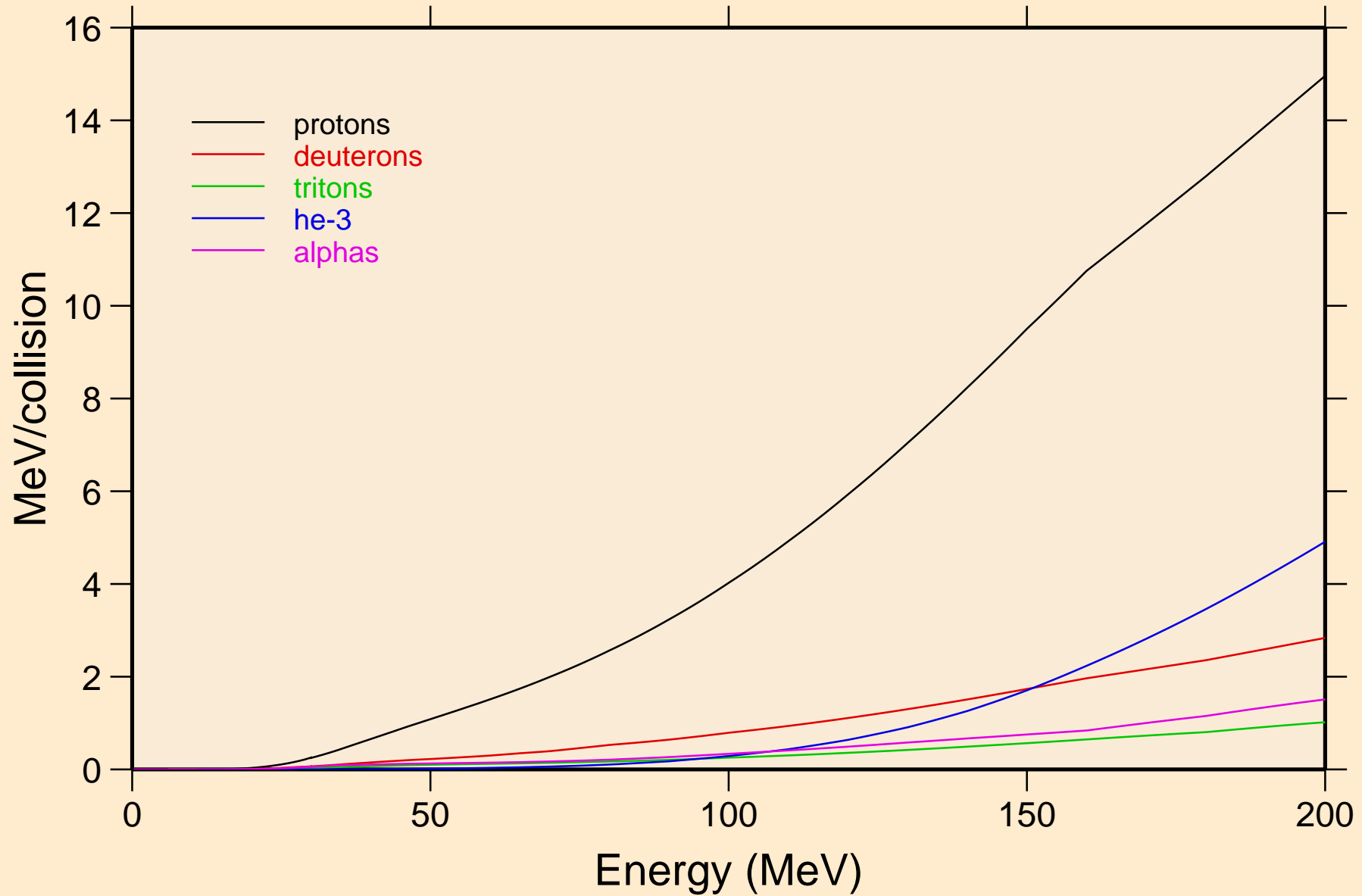

TB165 NEUTRON ACER TENDL-2024 LIBRARY; T=293.6K
Recoil Heating

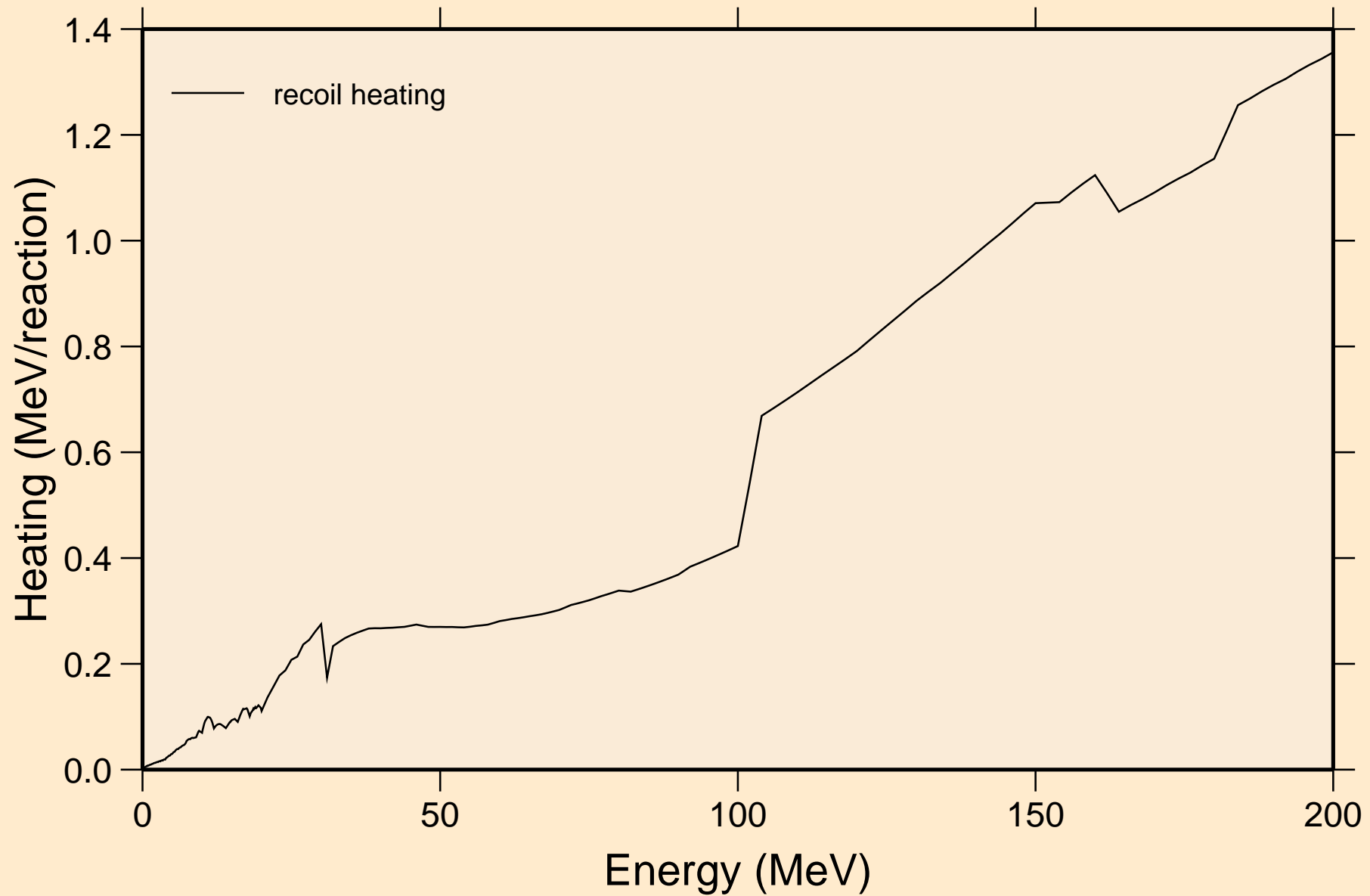

TB165 NEUTRON ACER TENDL-2024 LIBRARY; T=293.6K
Particle production cross sections

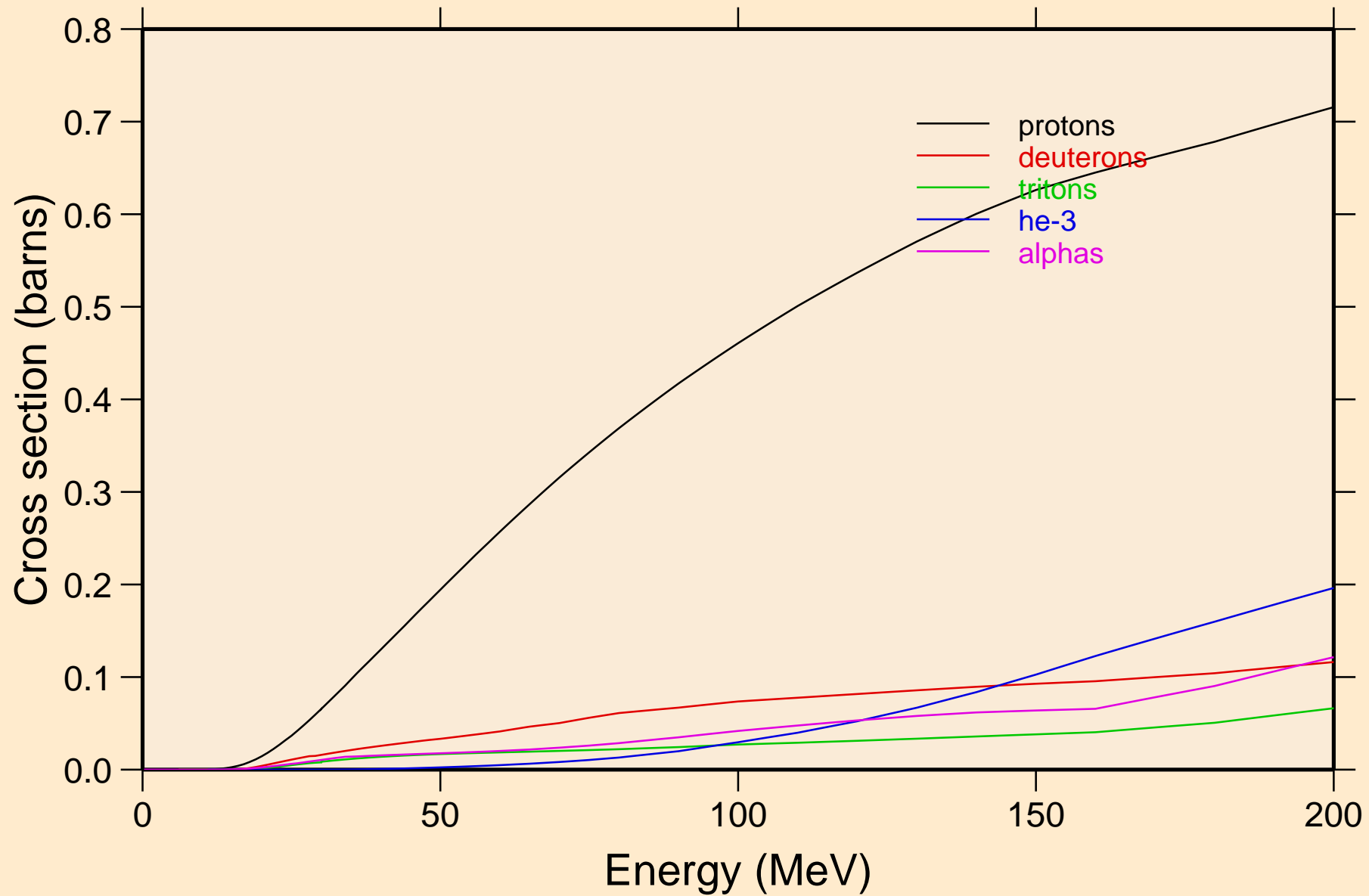

TB165 NEUTRON ACER TENDL-2024 LIBRARY; T=293.6K
protons from (n,x)

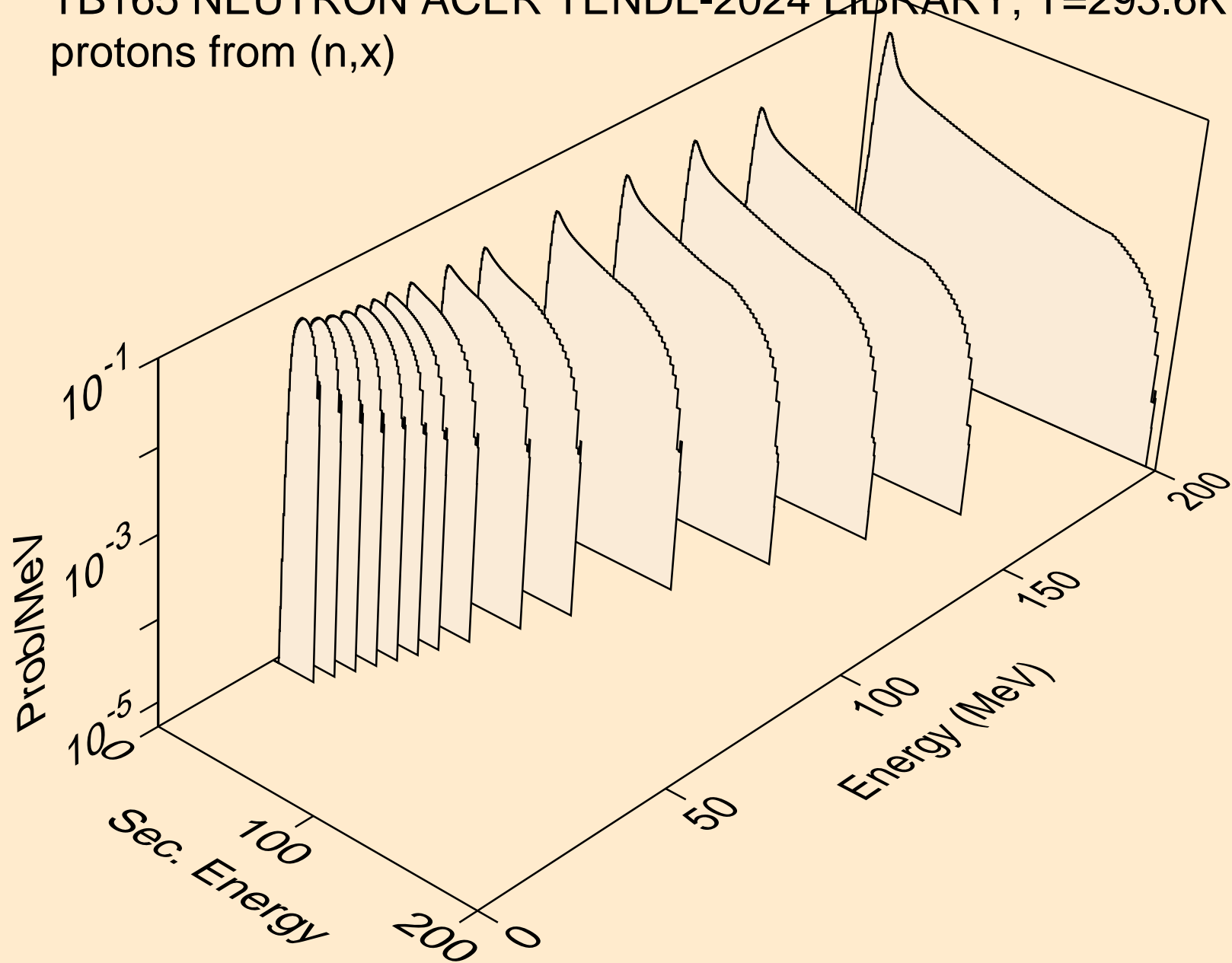

TB165 NEUTRON ACER TENDL-2024 LIBRARY; T=293.6K
protons from (n,n*)p

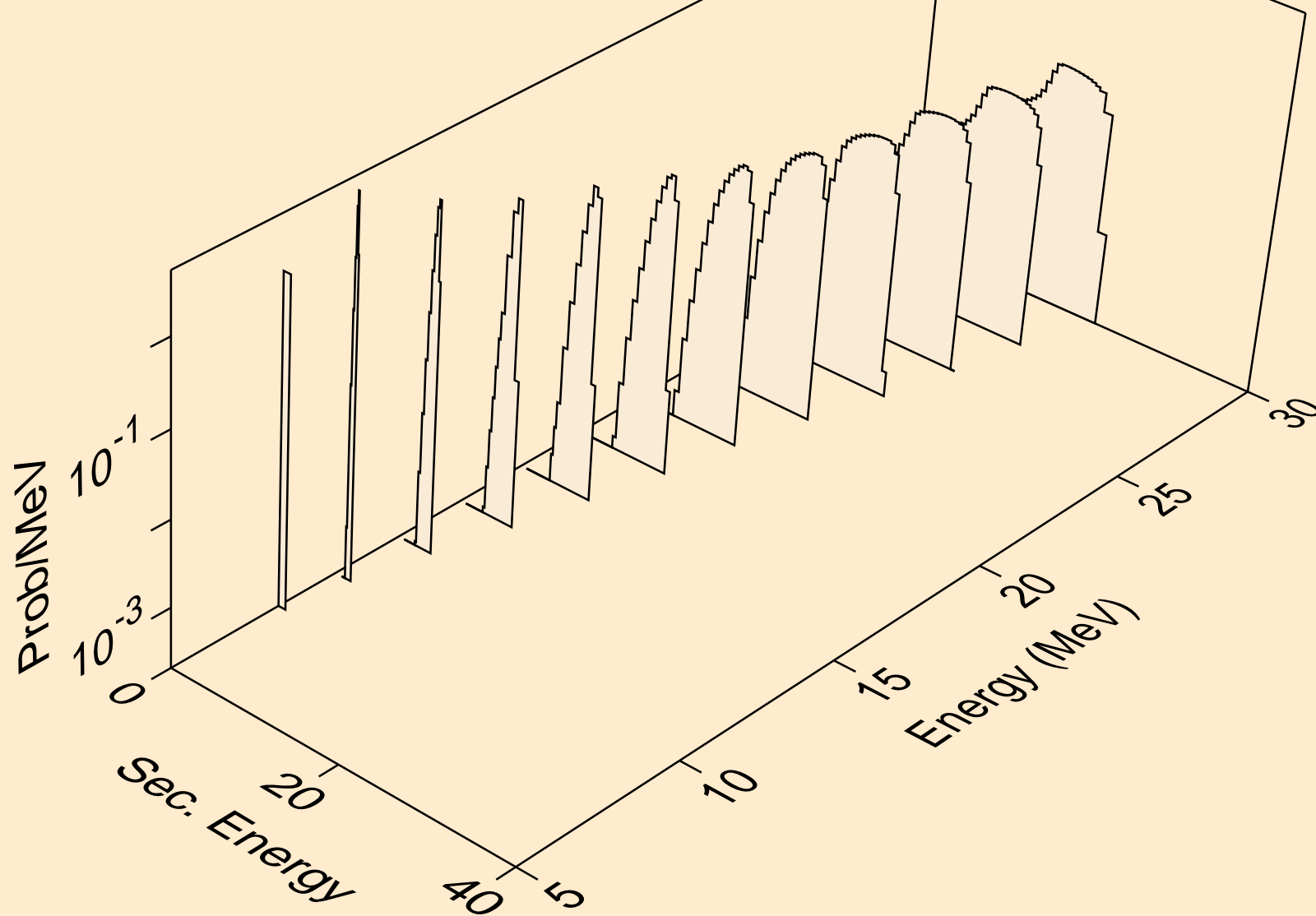

TB165 NEUTRON ACER TENDL-2024 LIBRARY; T=293.6K
protons from (n,2np)

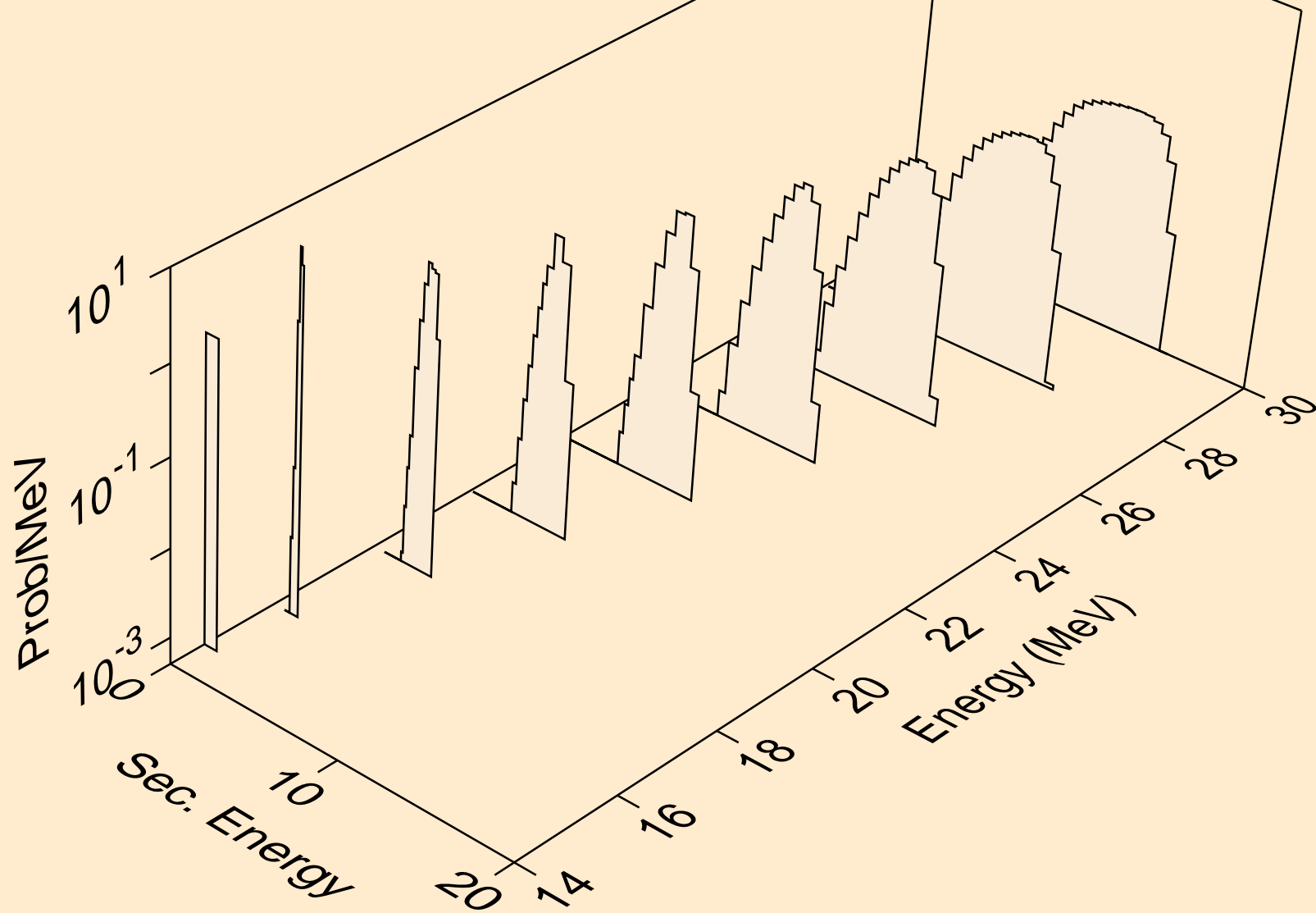

TB165 NEUTRON ACER TENDL-2024 LIBRARY; T=293.6K
protons from (n,3np)

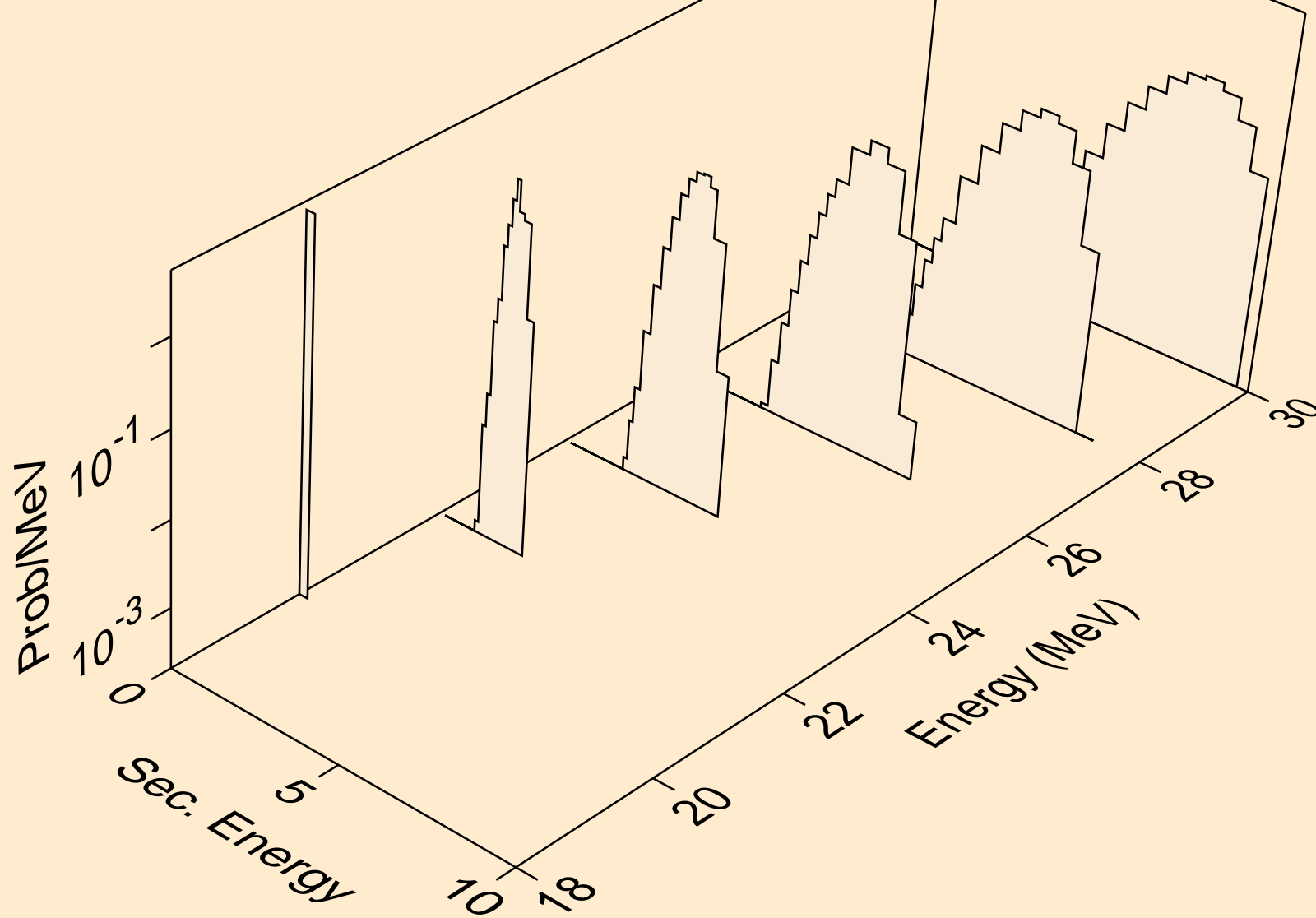

TB165 NEUTRON ACER TENDL-2024 LIBRARY; T=293.6K
protons from (n,p)

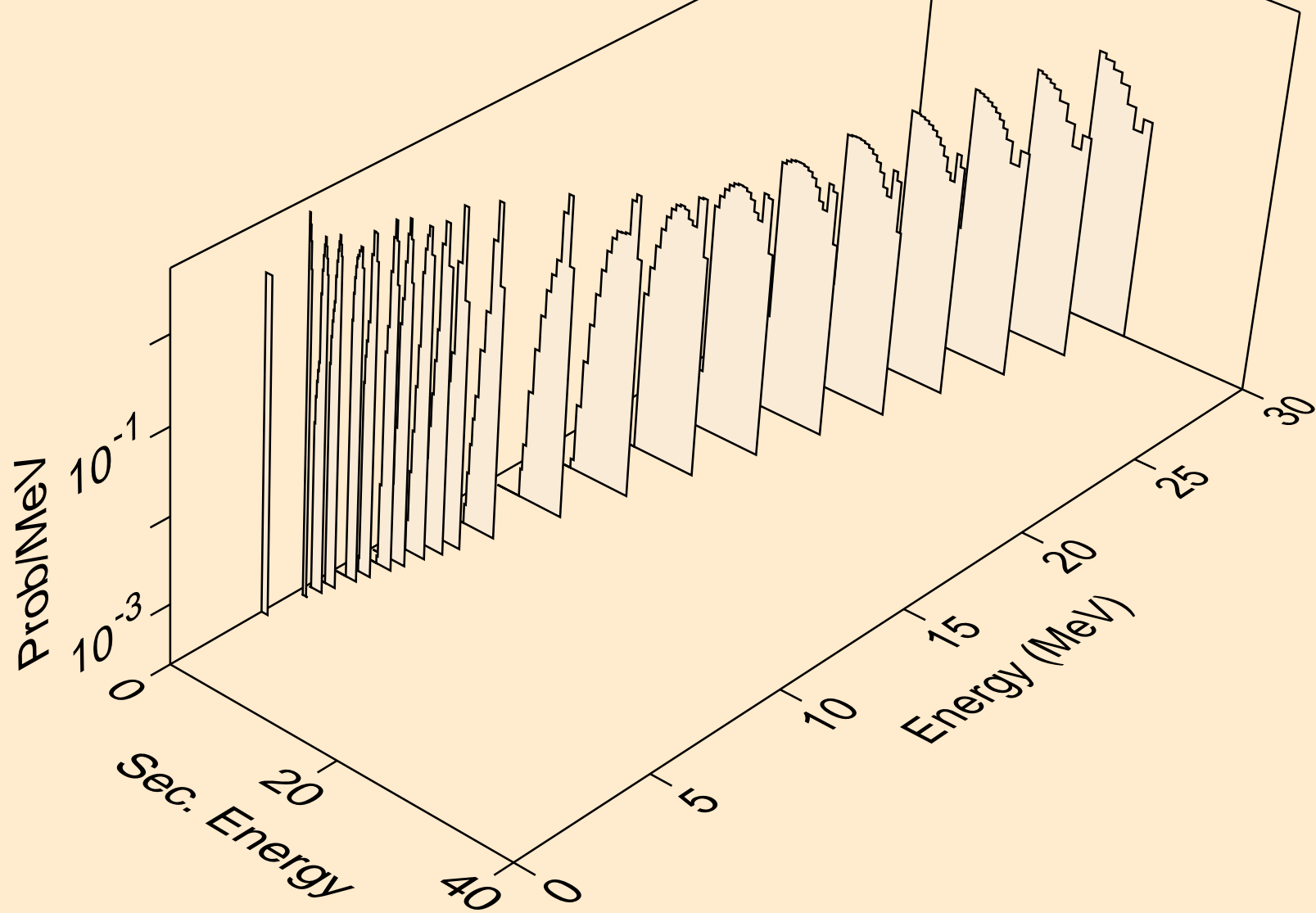

TB165 NEUTRON ACER TENDL-2024 LIBRARY; T=293.6K
protons from (n,2p)

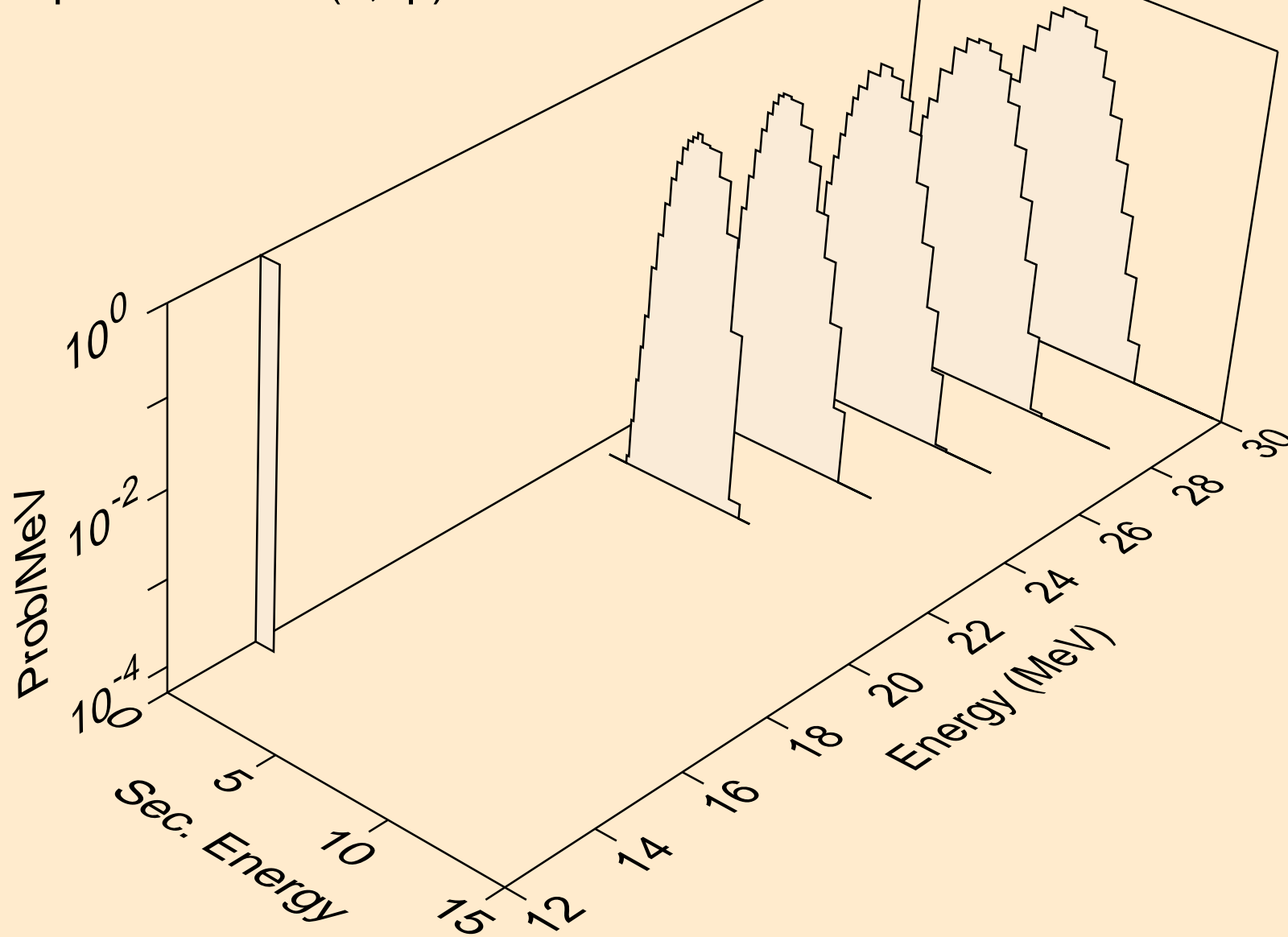

TB165 NEUTRON ACER TENDL-2024 LIBRARY; T=293.6K
deuterons from (n,x)

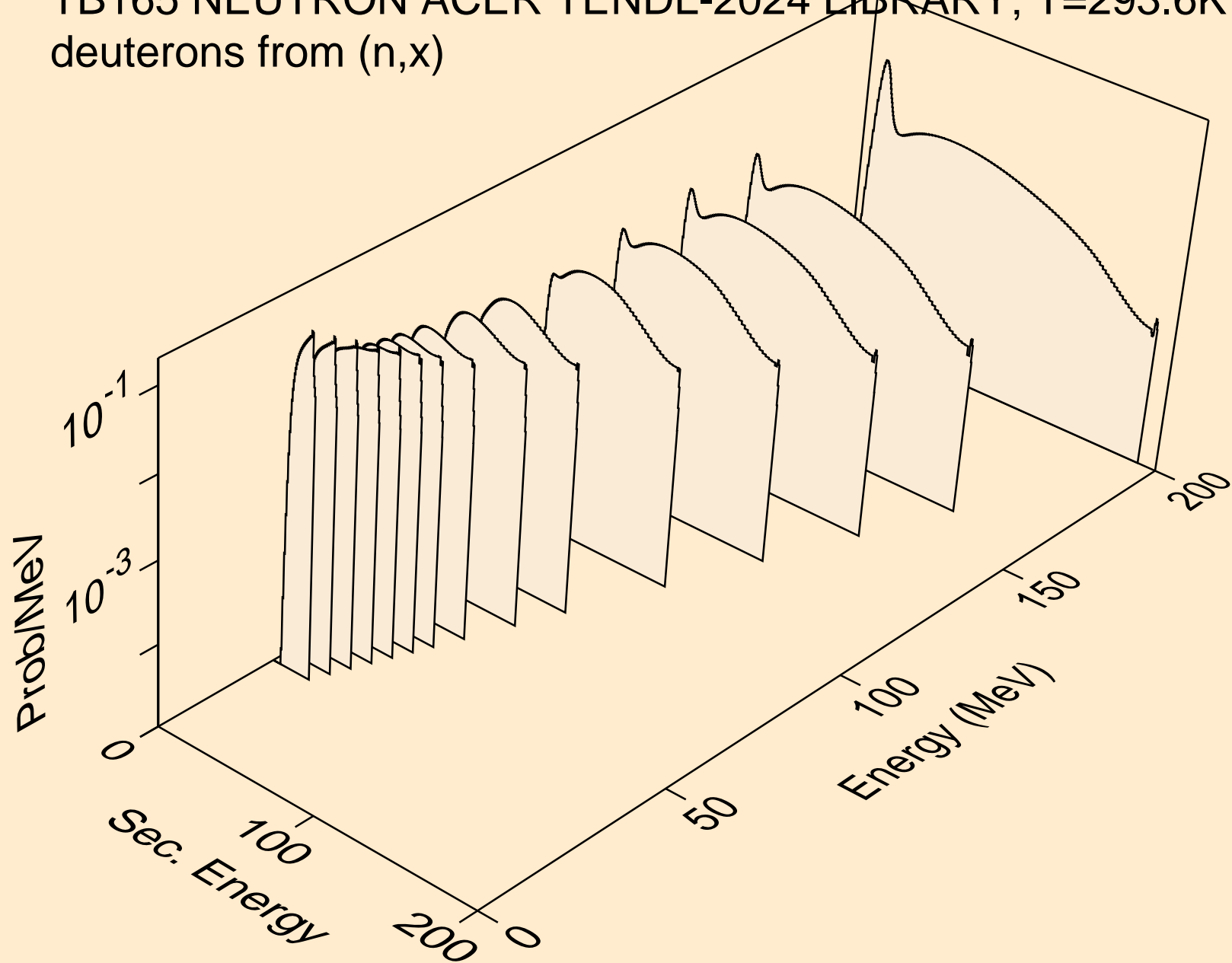

TB165 NEUTRON ACER TENDL-2024 LIBRARY; T=293.6K
deuterons from (n,2nd)

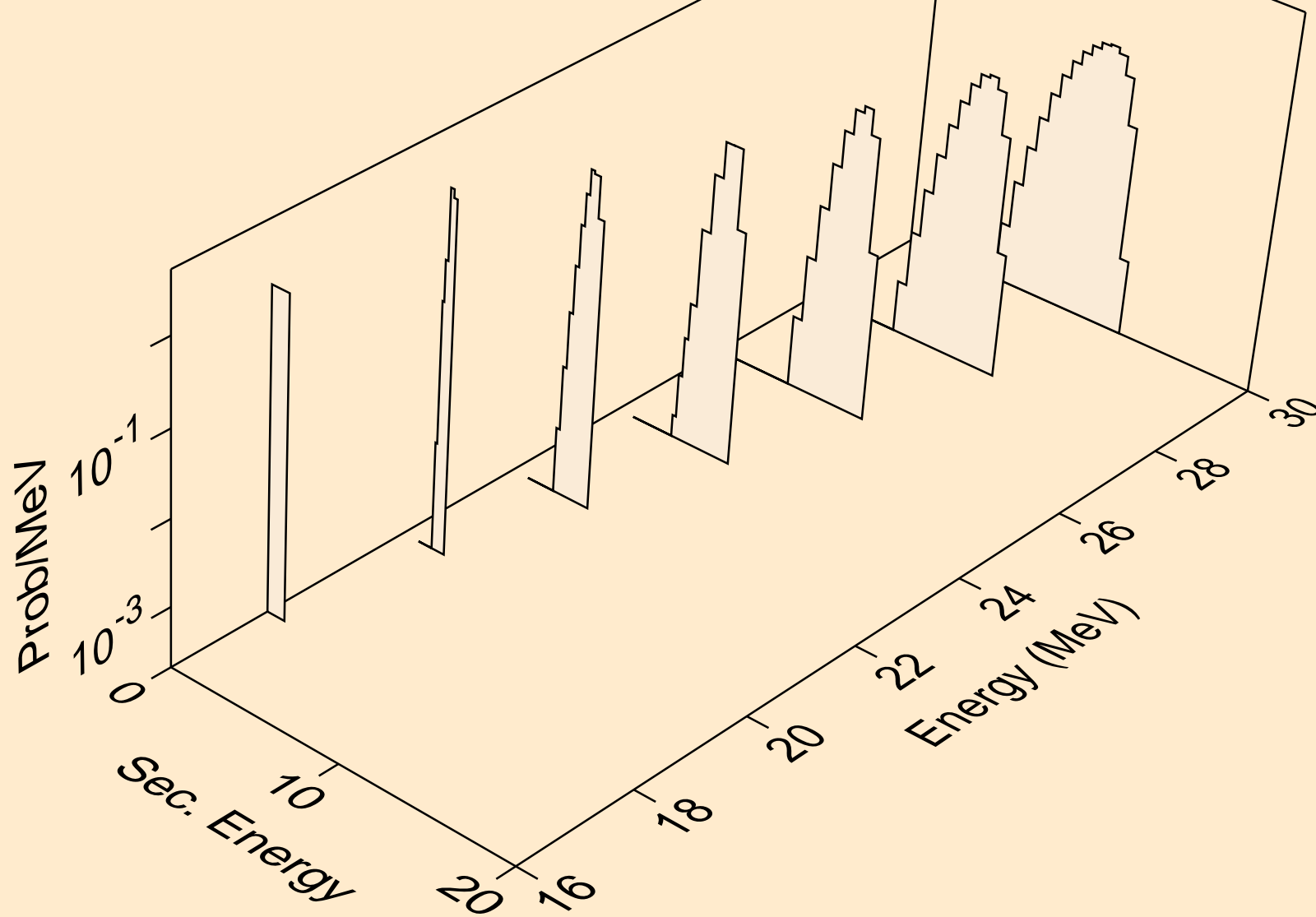

TB165 NEUTRON ACER TENDL-2024 LIBRARY; T=293.6K
deuterons from (n,n*)d

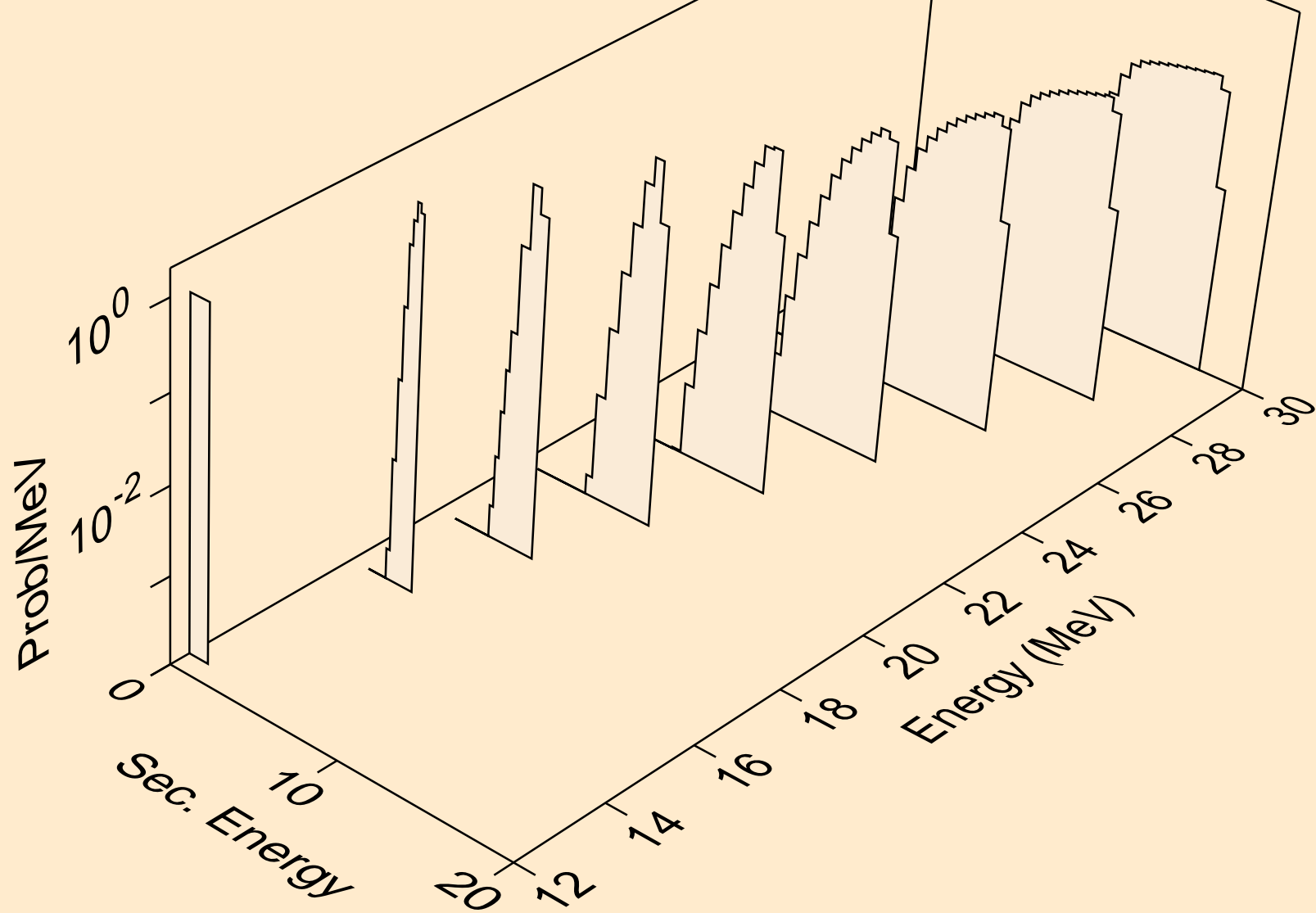

TB165 NEUTRON ACER TENDL-2024 LIBRARY; T=293.6K
deuterons from (n,d)

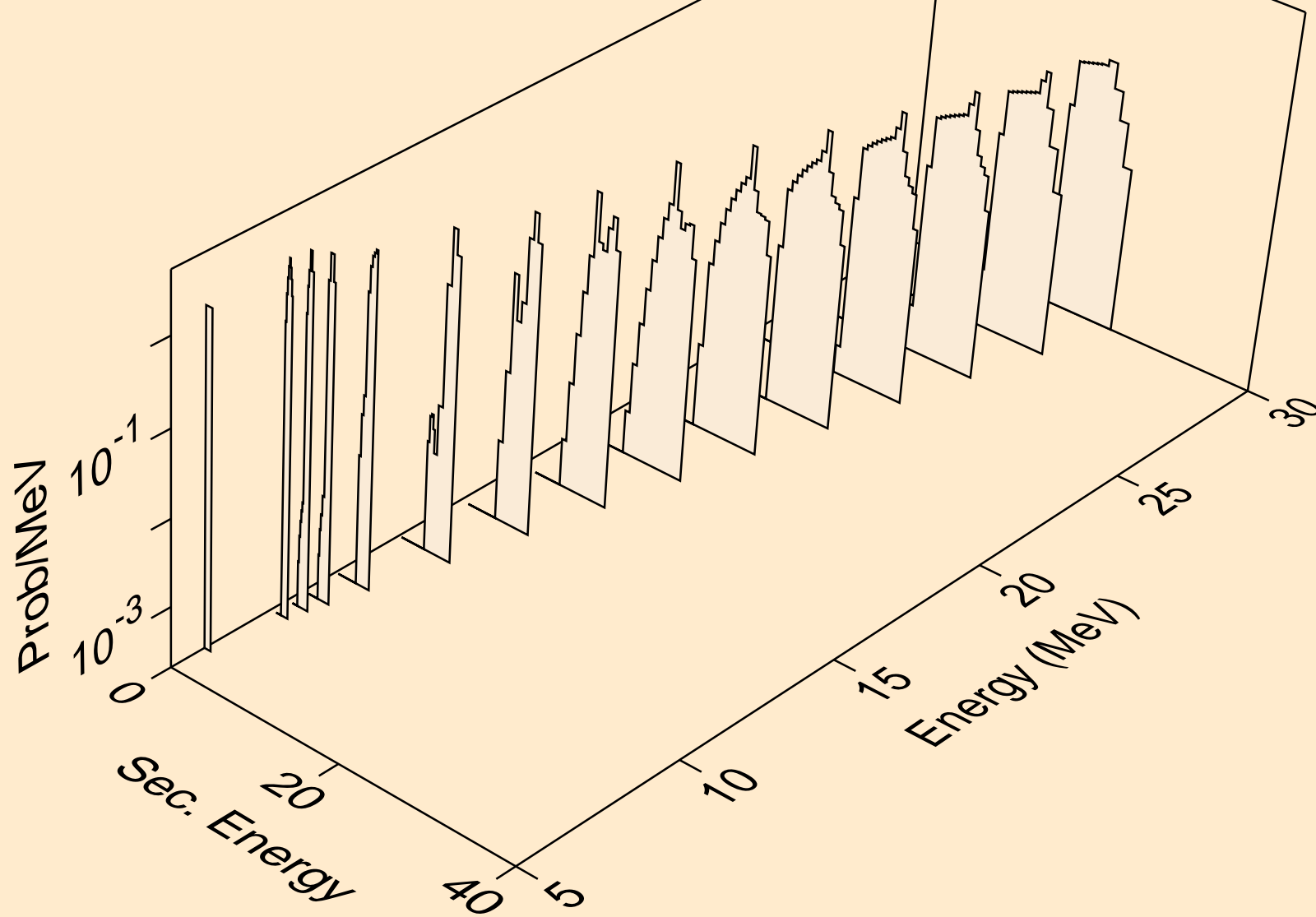

TB165 NEUTRON ACER TENDL-2024 LIBRARY; T=293.6K
tritons from (n,x)

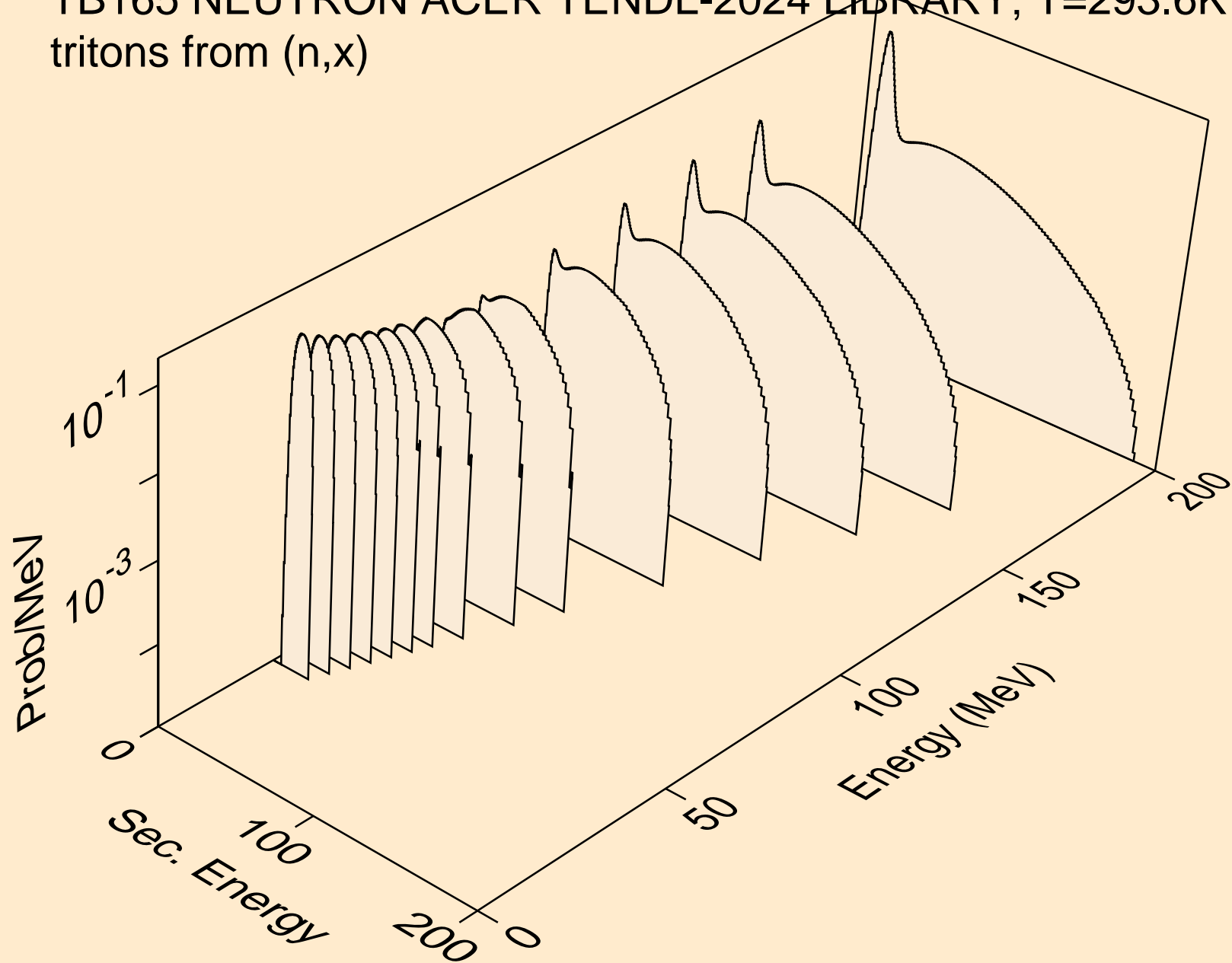

TB165 NEUTRON ACER TENDL-2024 LIBRARY; T=293.6K
tritons from (n,n*)t

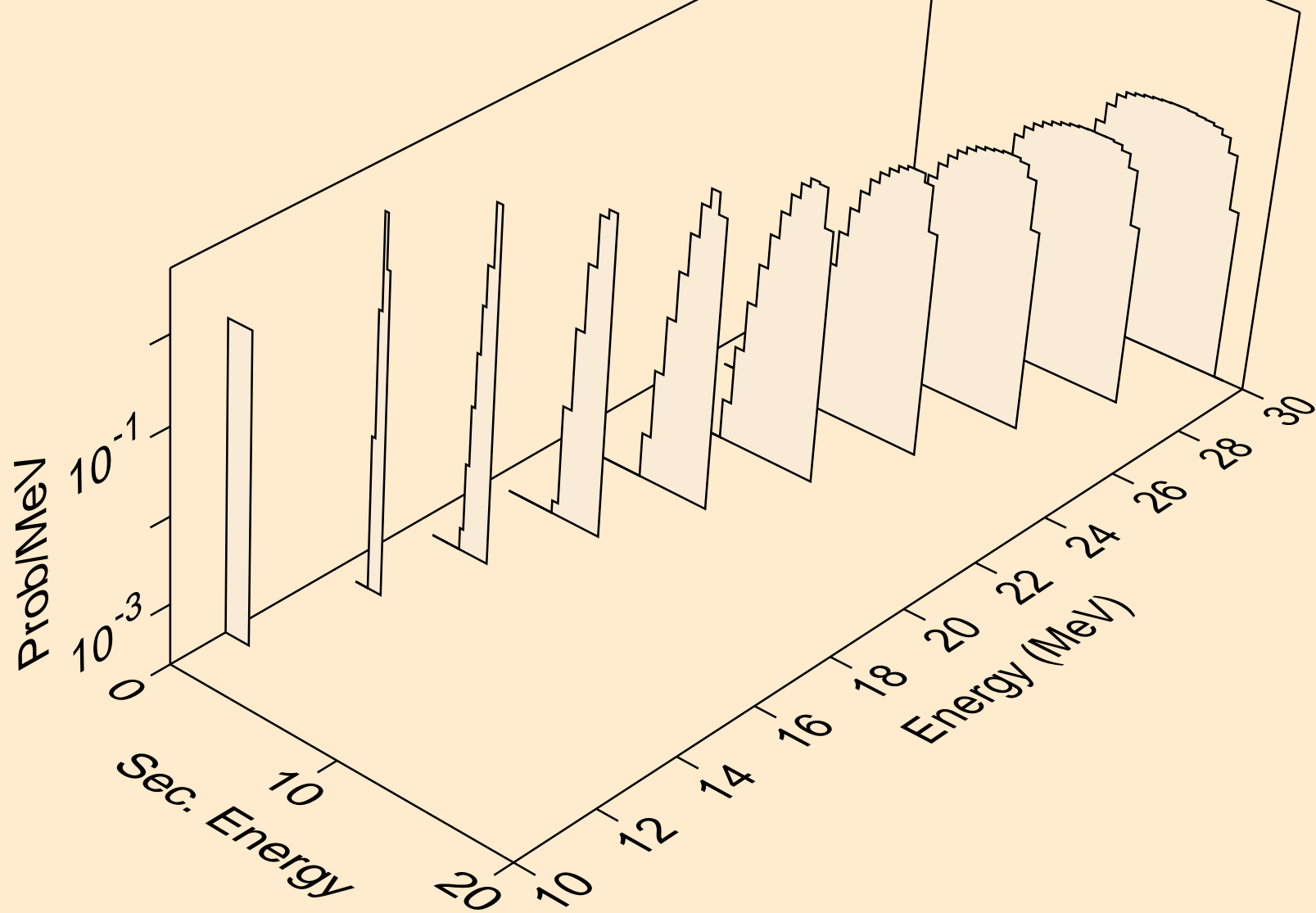

TB165 NEUTRON ACER TENDL-2024 LIBRARY; T=293.6K
tritons from (n,t)

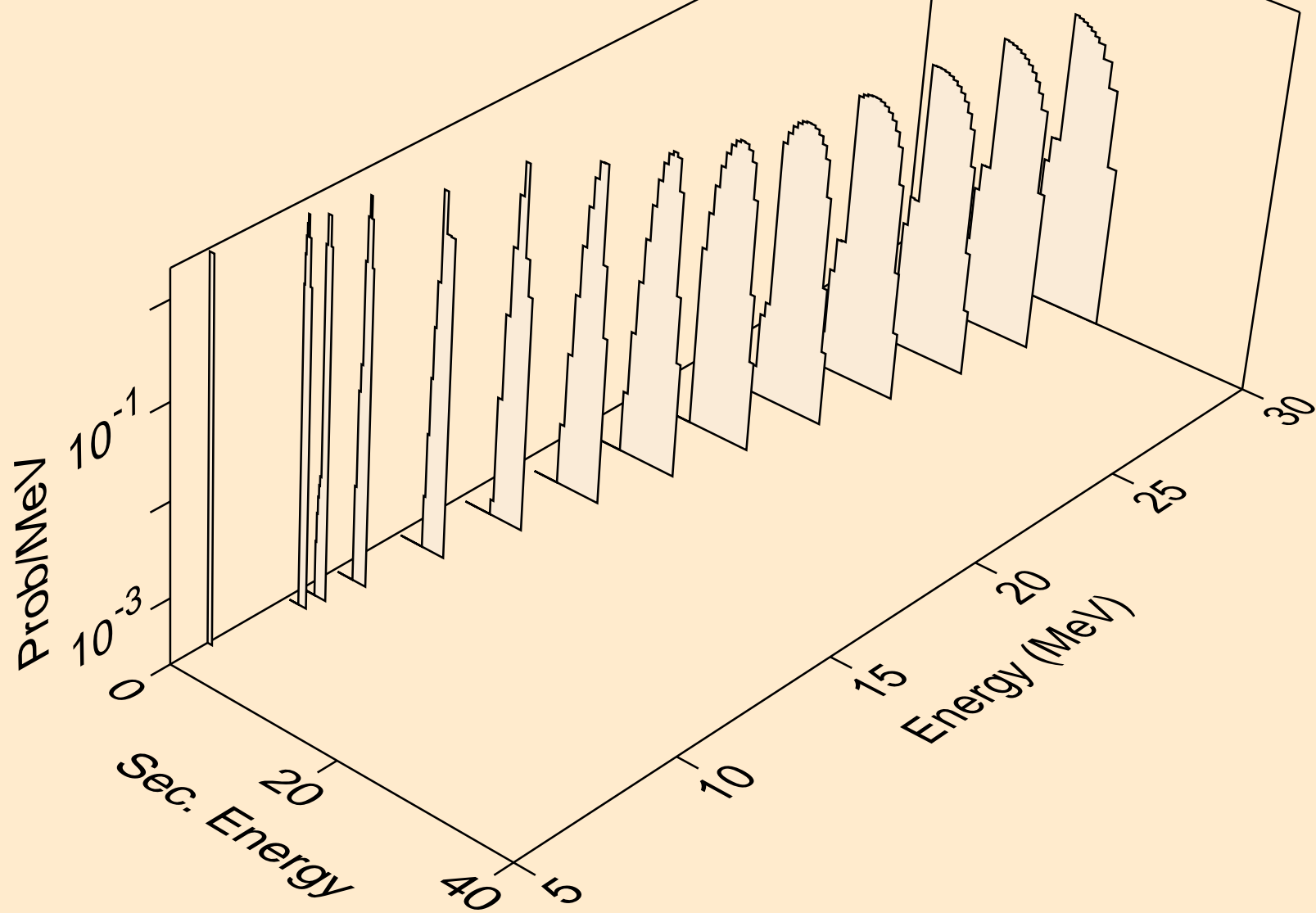

TB165 NEUTRON ACER TENDL-2024 LIBRARY; T=293.6K
he3s from (n,x)

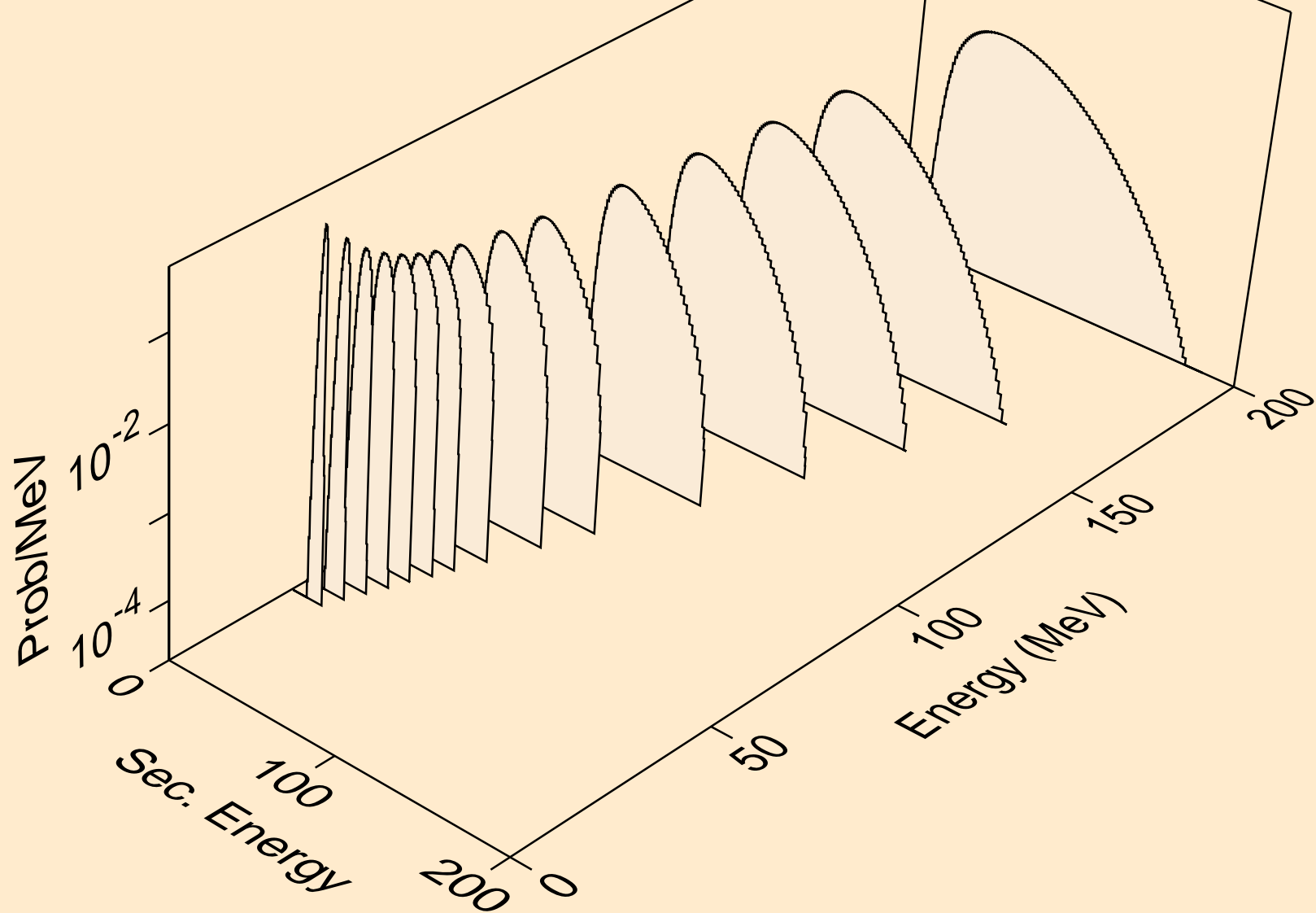

TB165 NEUTRON ACER TENDL-2024 LIBRARY; T=293.6K
he3s from (n,n*)he3

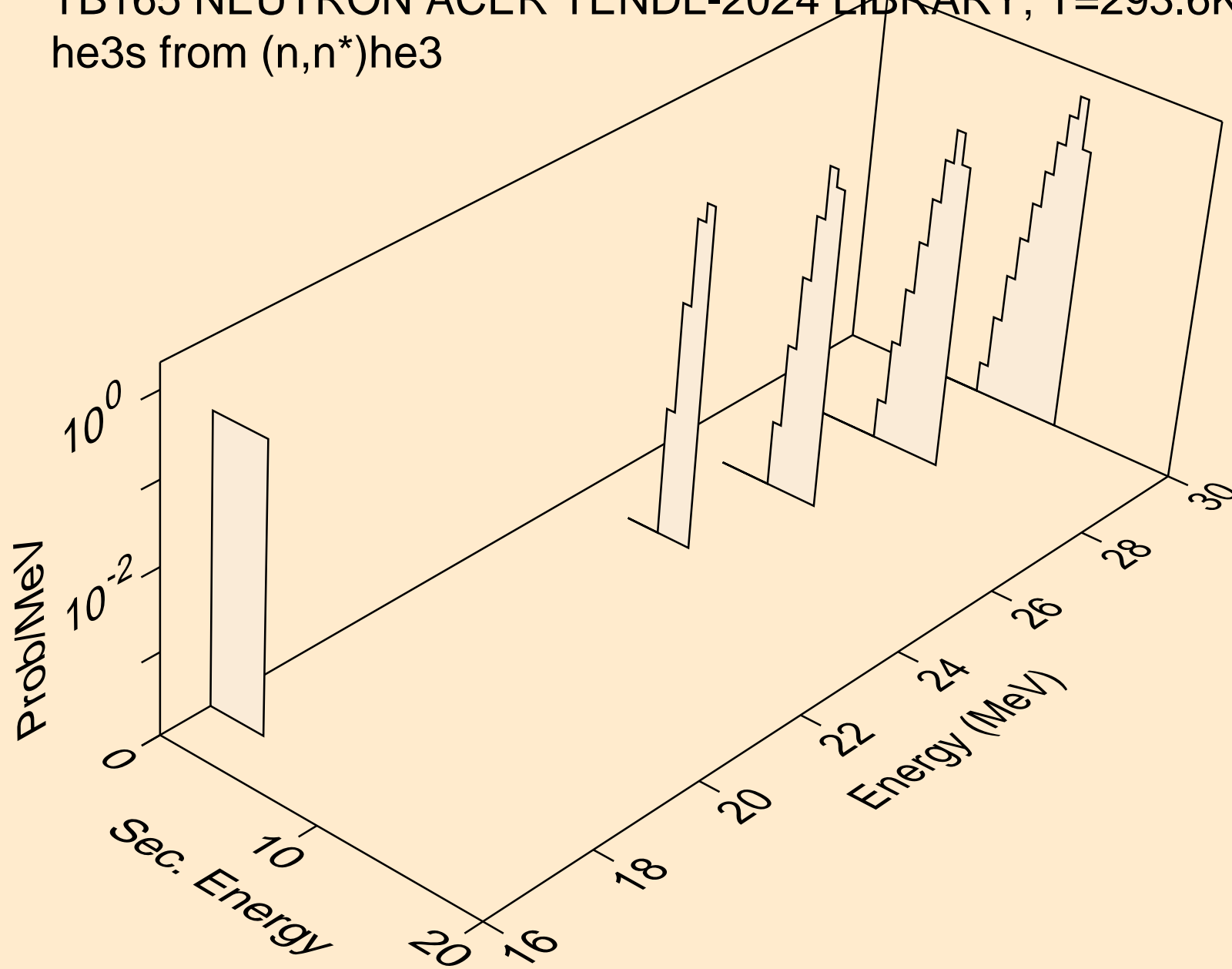

TB165 NEUTRON ACER TENDL-2024 LIBRARY; T=293.6K
he3s from (n,he3)

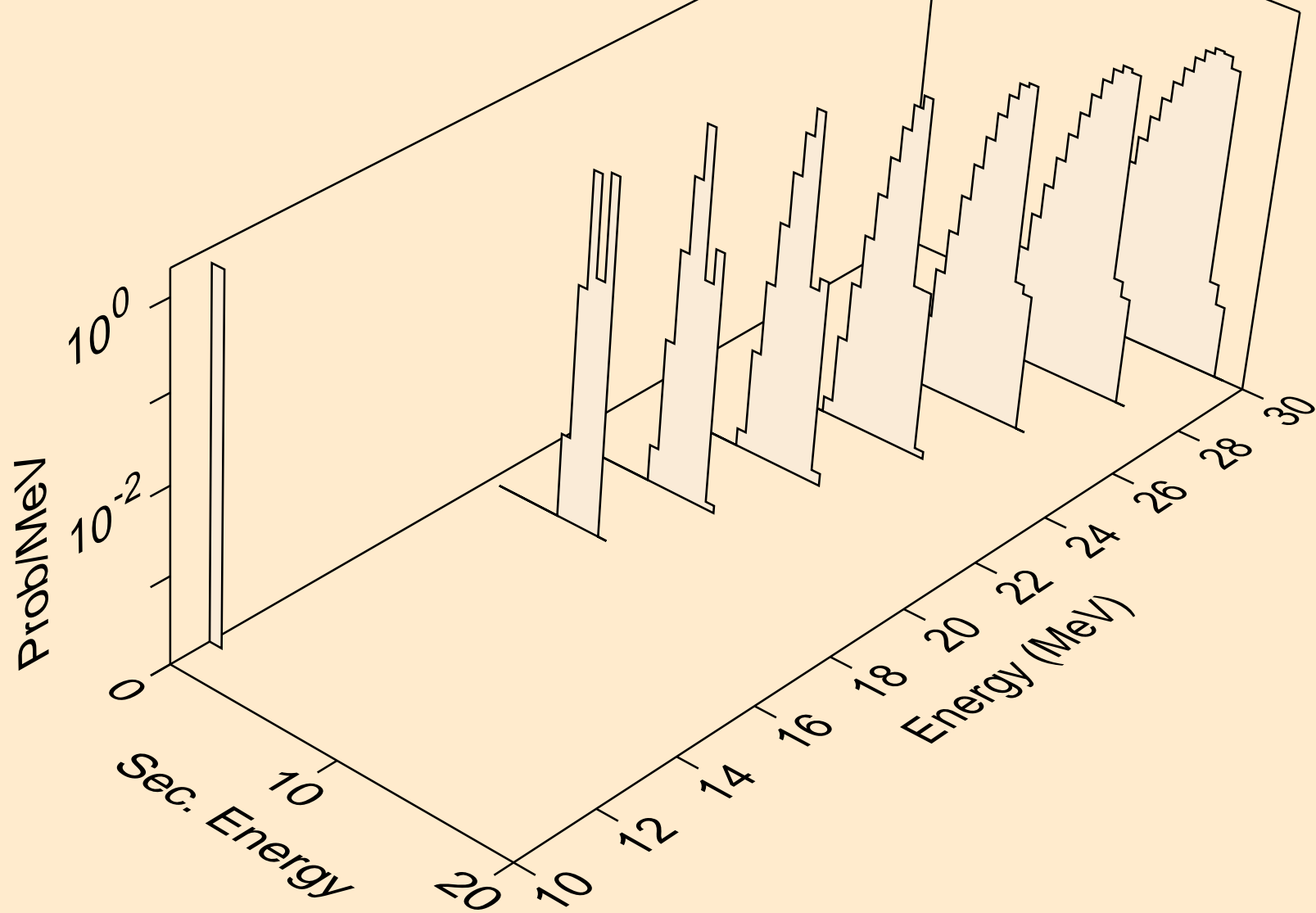

TB165 NEUTRON ACER TENDL-2024 LIBRARY; T=293.6K
alphas from (n,x)

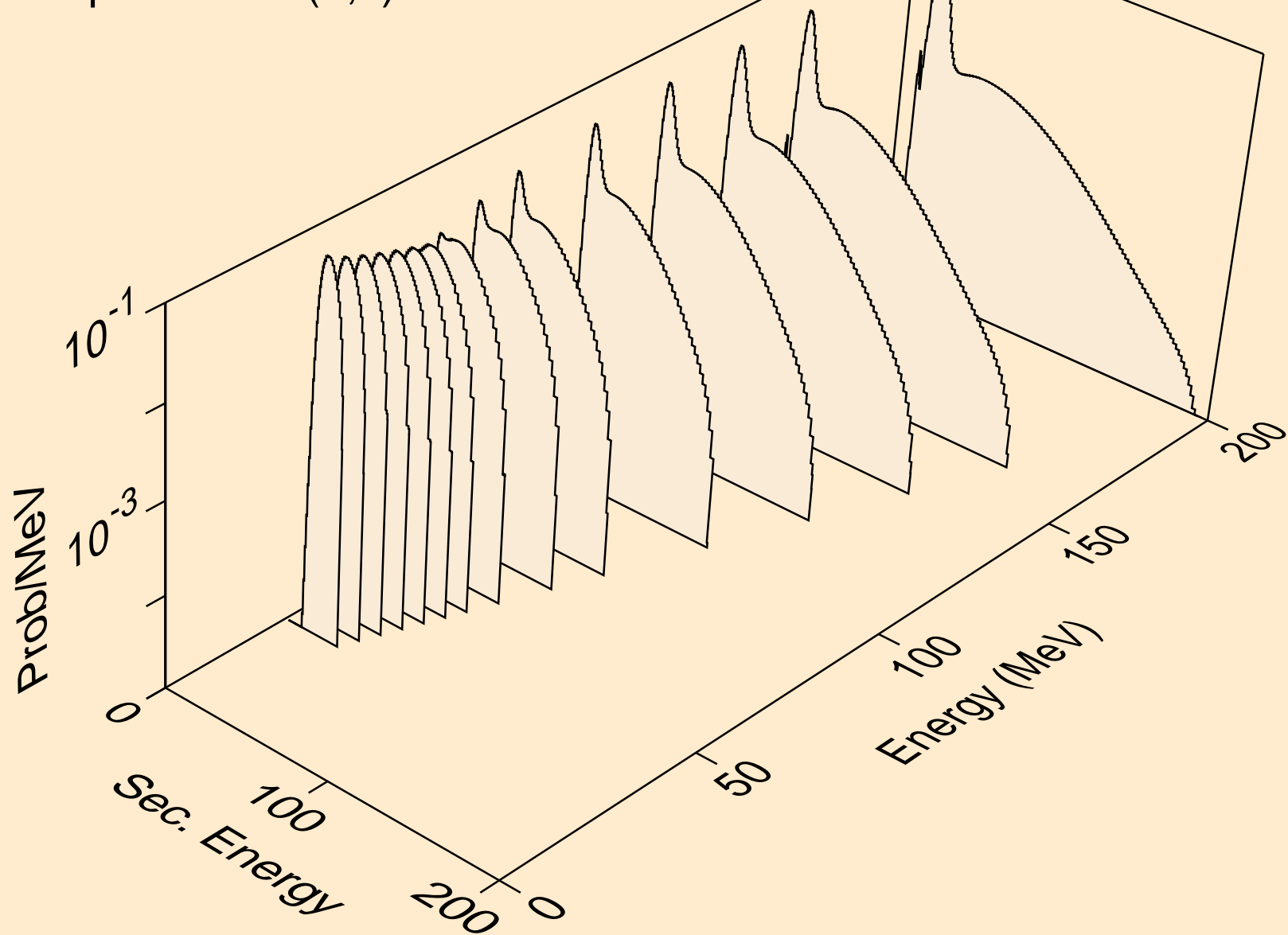

TB165 NEUTRON ACER TENDL-2024 LIBRARY; T=293.6K
alphas from (n,n*)a

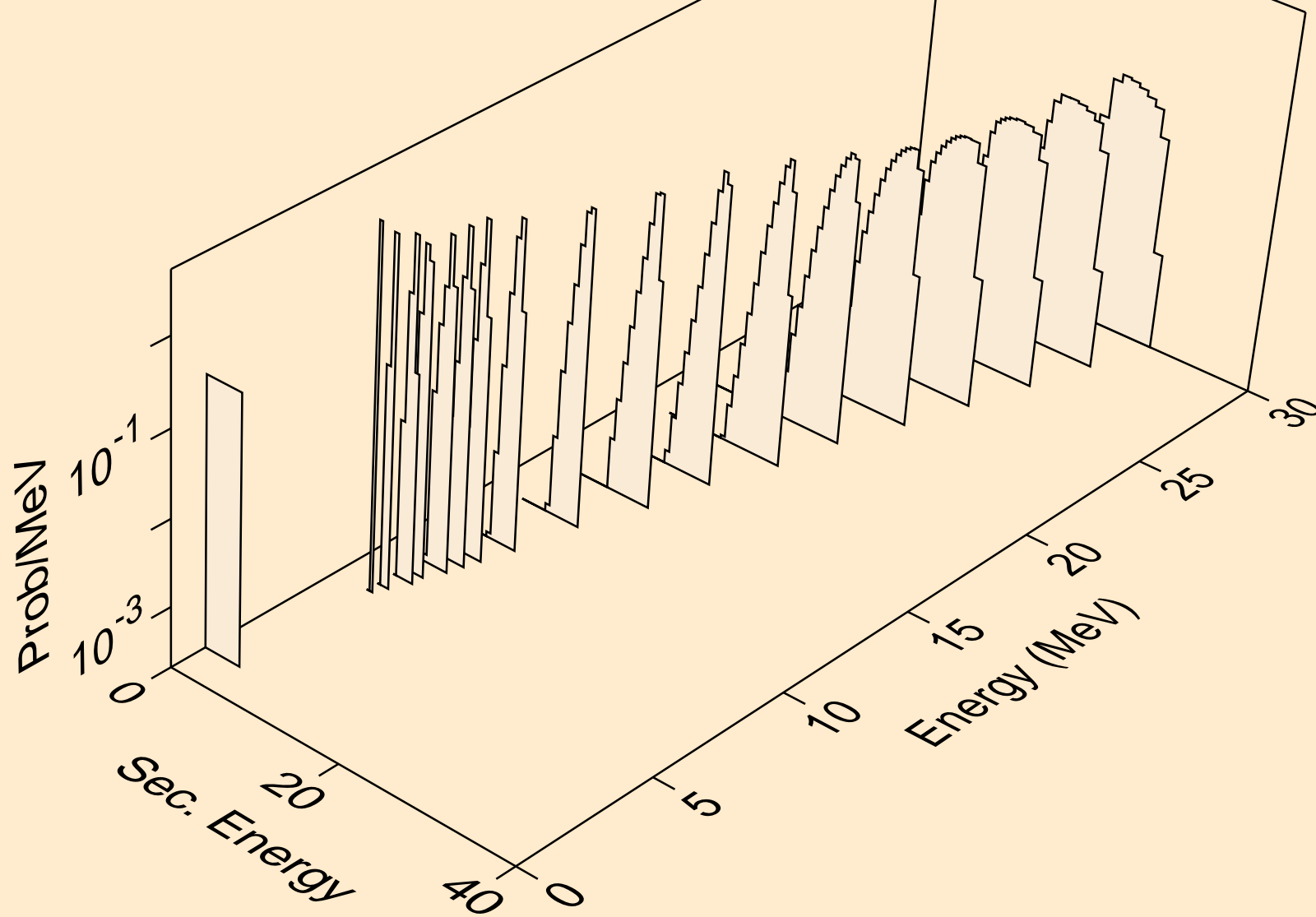

TB165 NEUTRON ACER TENDL-2024 LIBRARY; T=293.6K
alphas from (n,2n)a

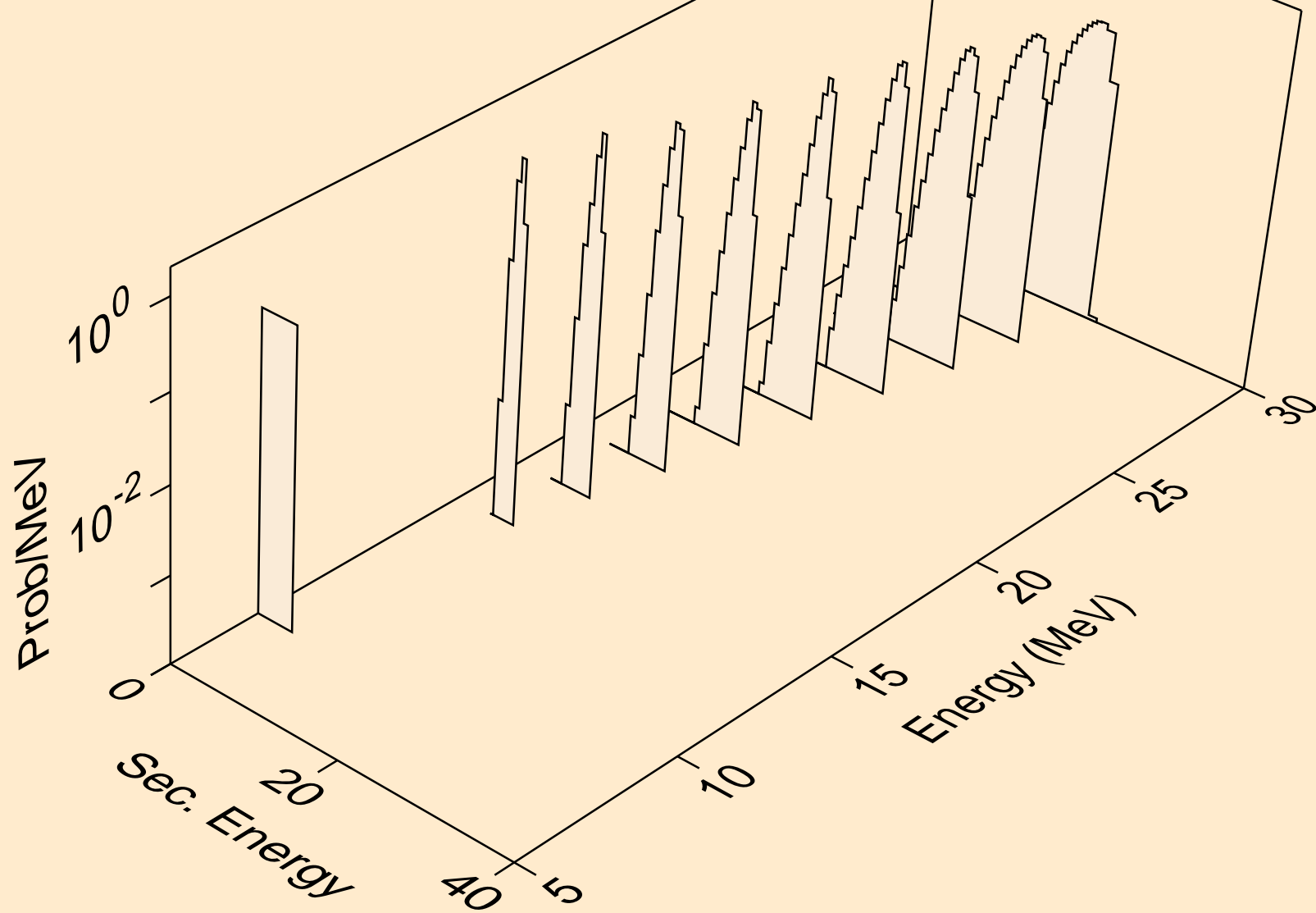

TB165 NEUTRON ACER TENDL-2024 LIBRARY; T=293.6K
alphas from (n,3n)a

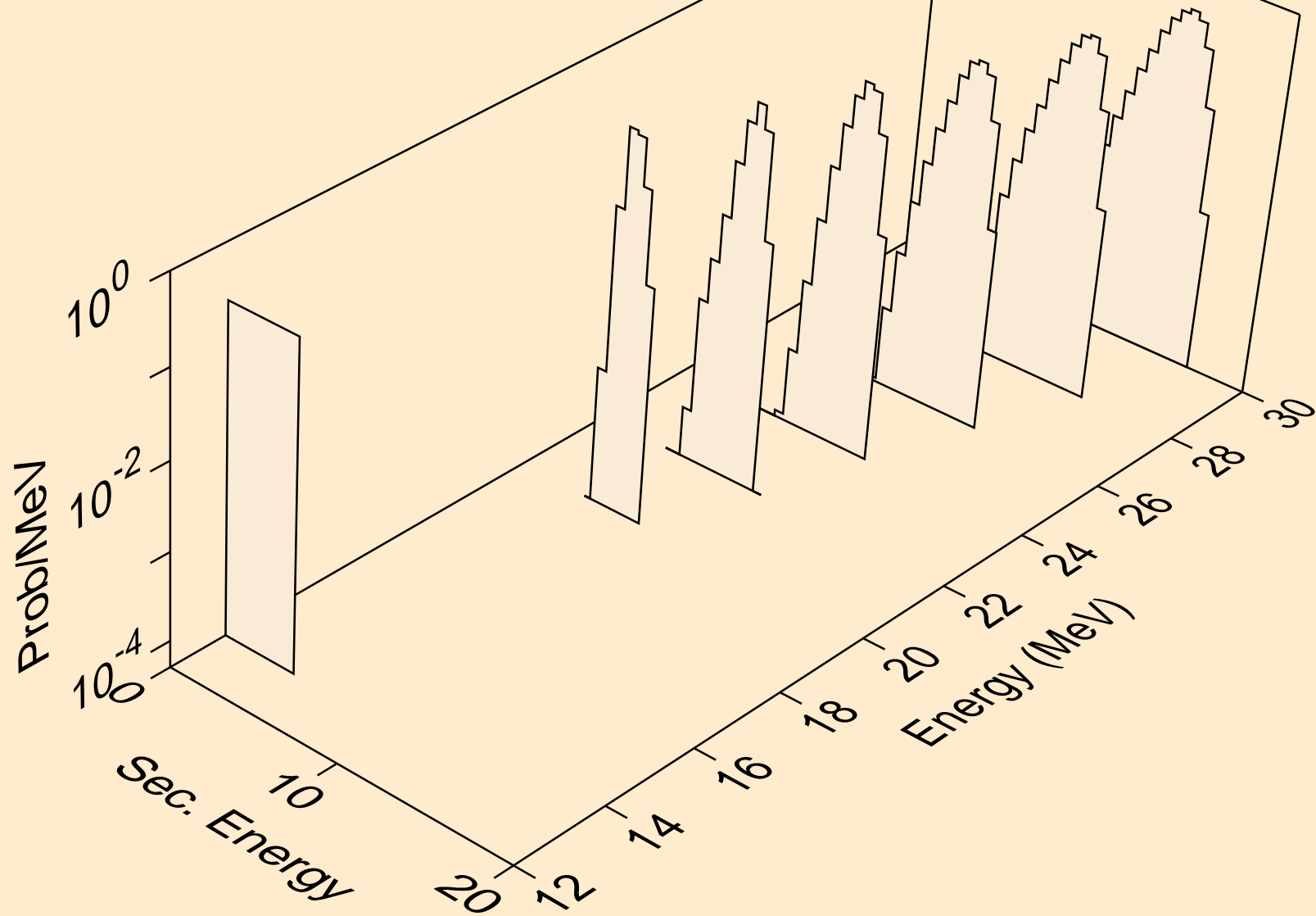

TB165 NEUTRON ACER TENDL-2024 LIBRARY; T=293.6K
alphas from (n,a)

