

TC091M NEUTRON ACER TENDL-2024 LIBRARY; T=293.6K  
Principal cross sections

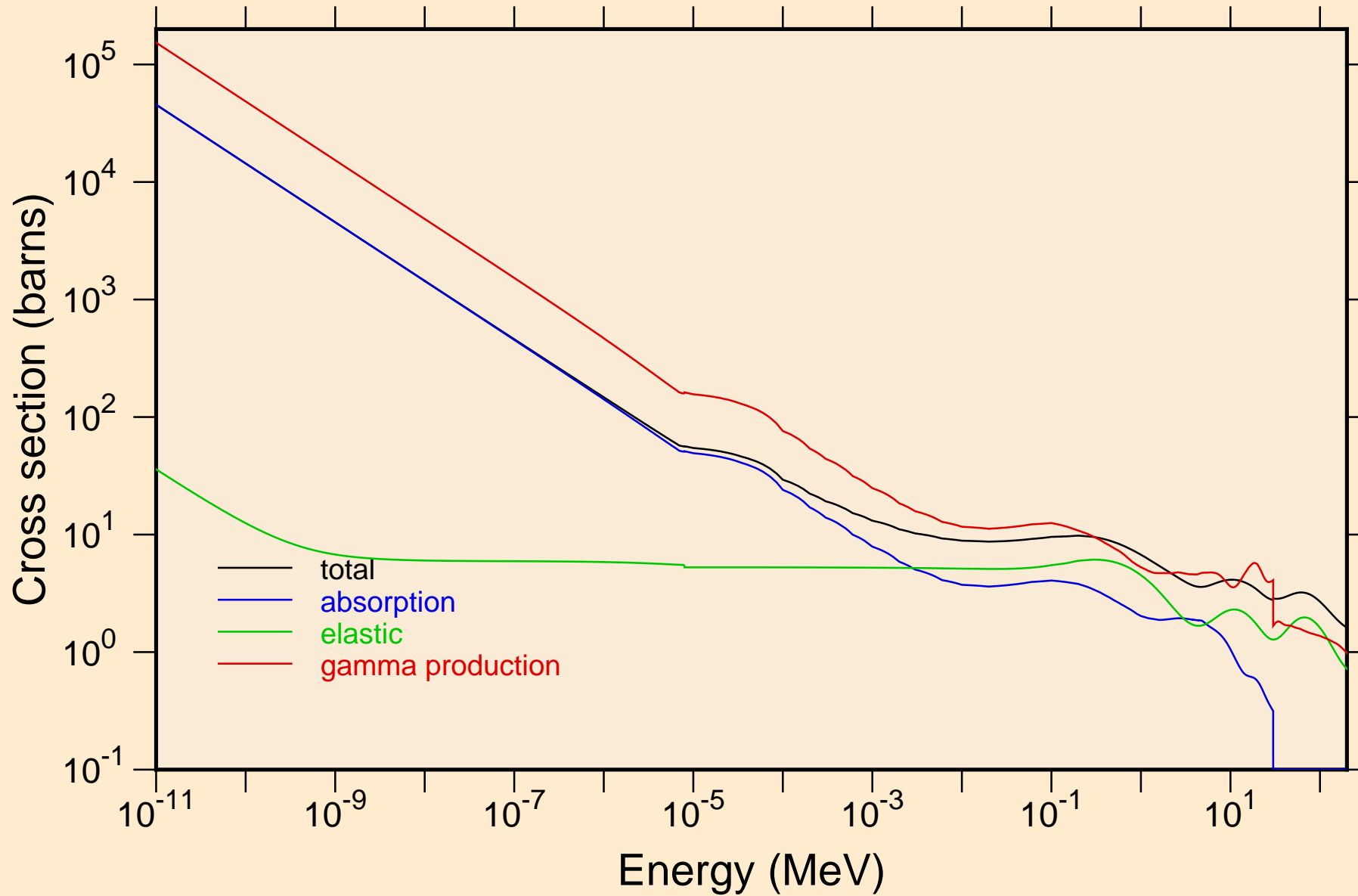

TC091M NEUTRON ACER TENDL-2024 LIBRARY; T=293.6K  
Heating

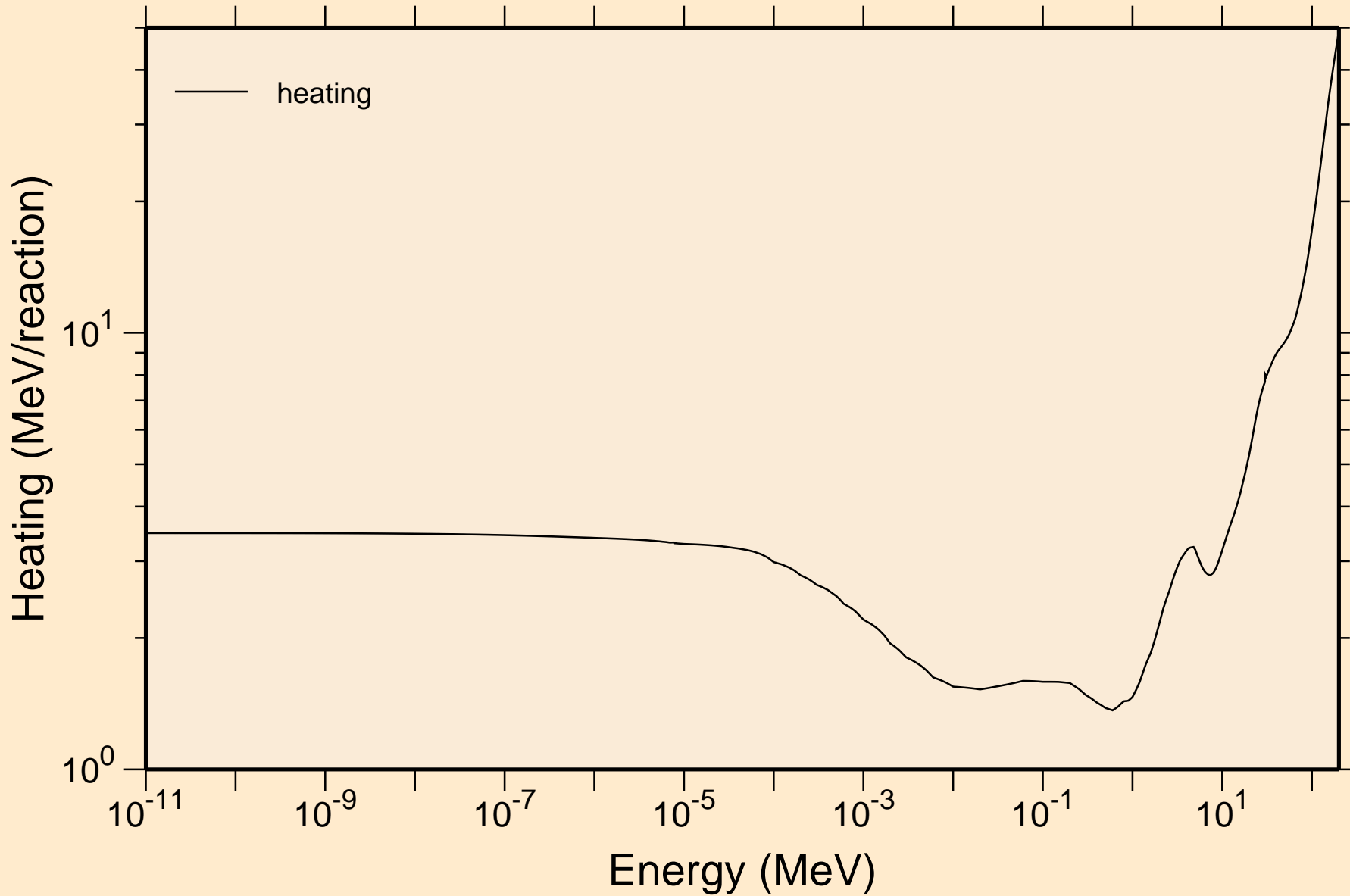

TC091M NEUTRON ACER TENDL-2024 LIBRARY; T=293.6K  
Damage

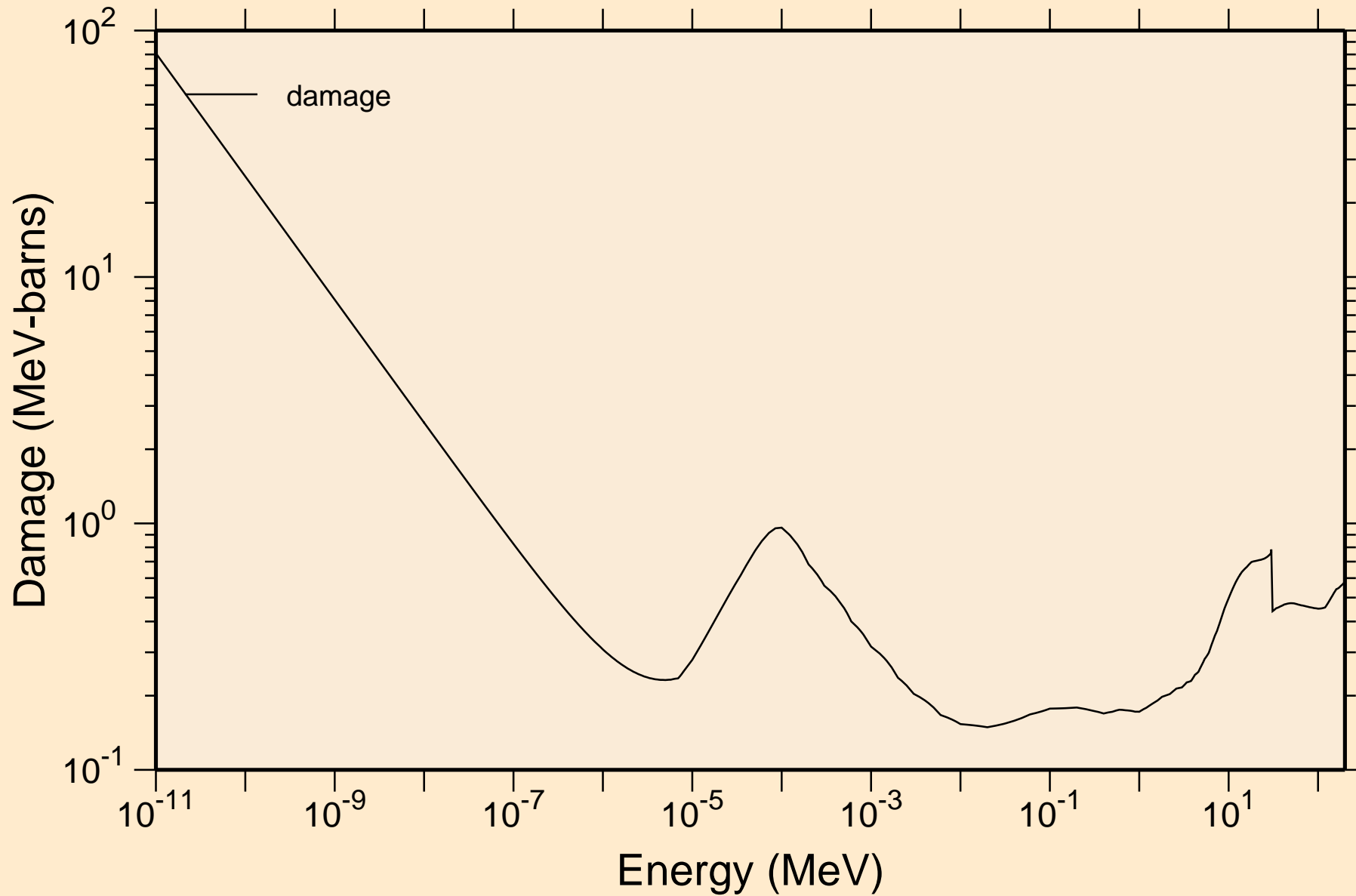

TC091M NEUTRON ACER TENDL-2024 LIBRARY; T=293.6K  
Non-threshold reactions

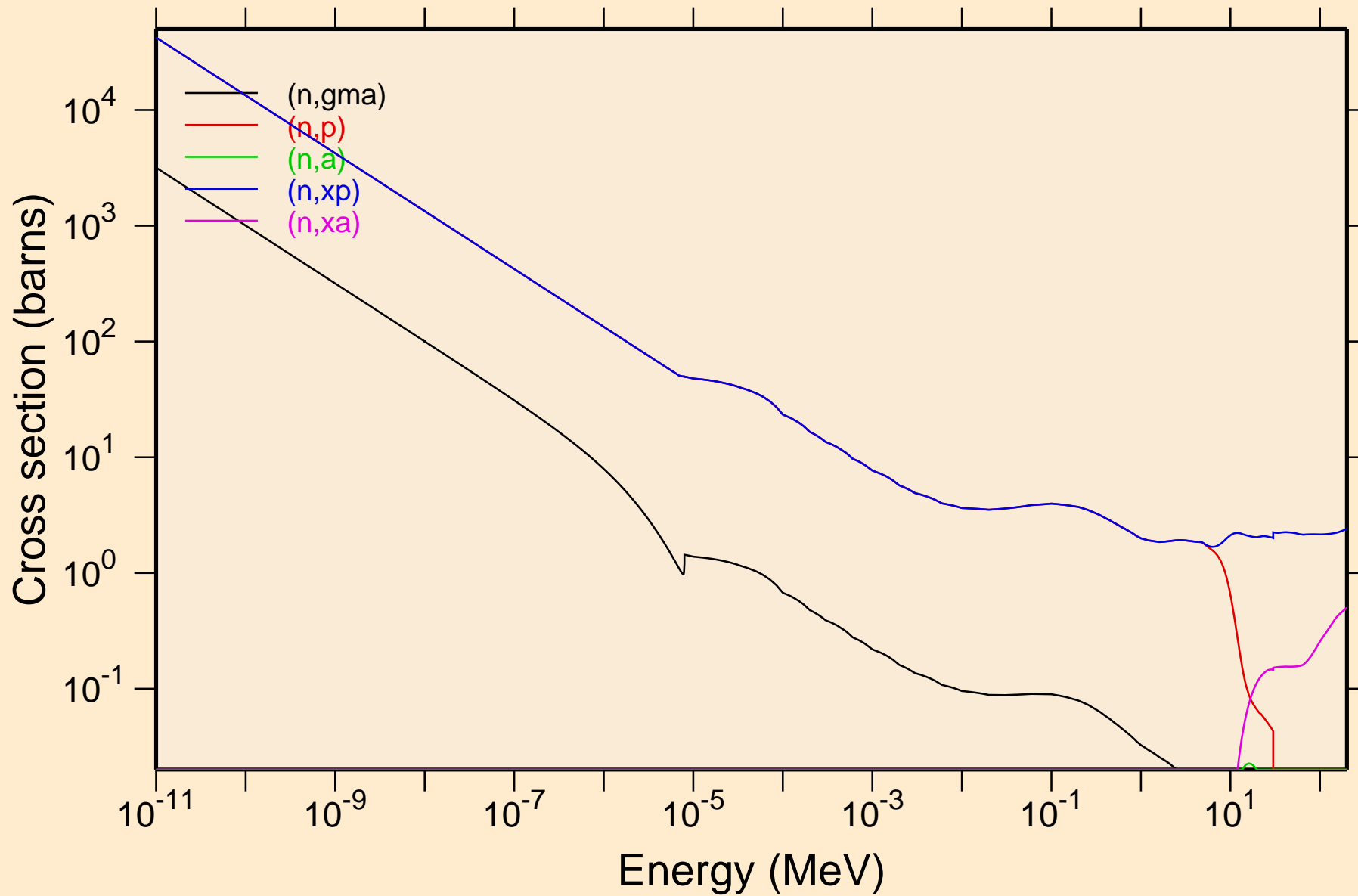

TC091M NEUTRON ACER TENDL-2024 LIBRARY; T=293.6K  
Principal cross sections

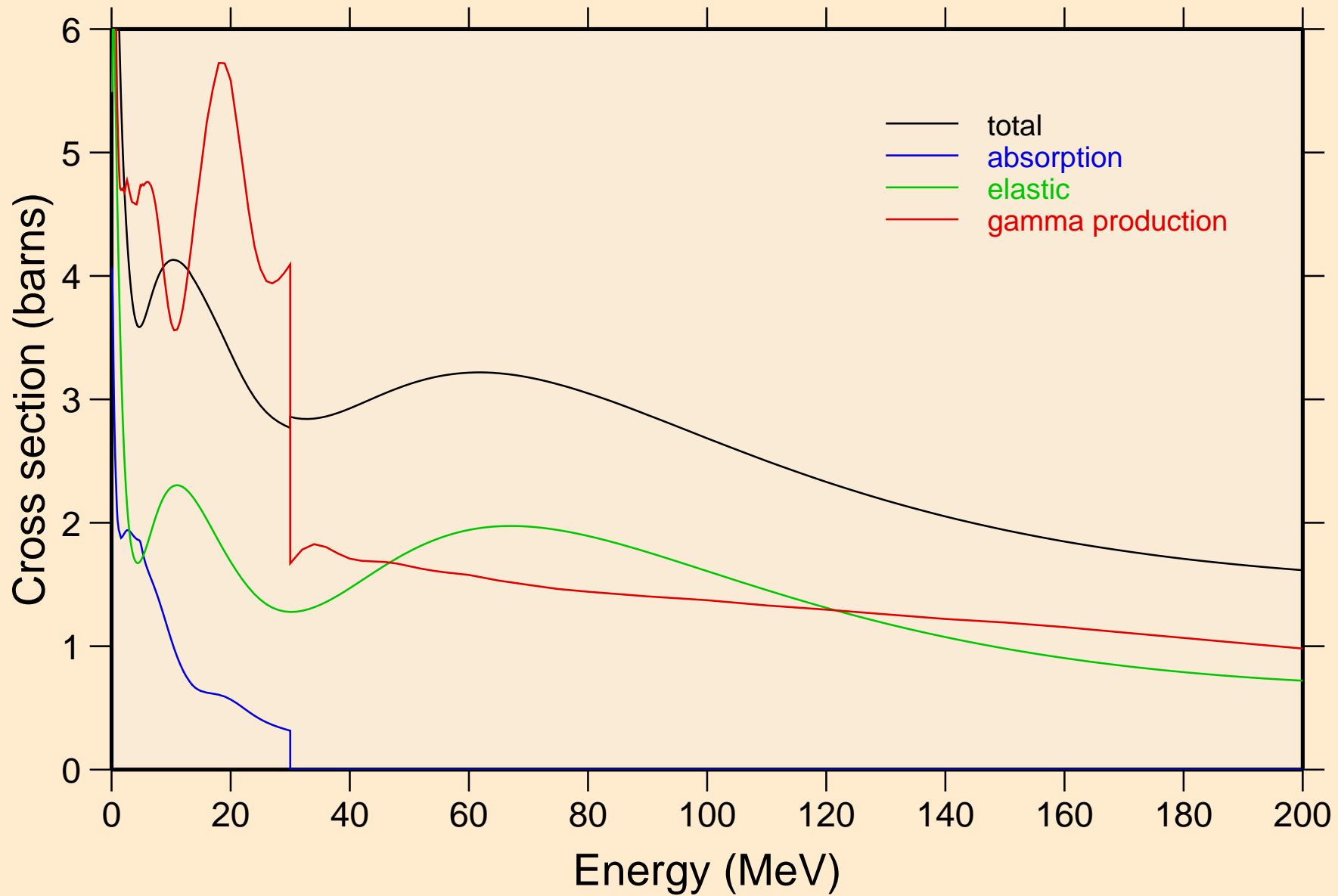

TC091M NEUTRON ACER TENDL-2024 LIBRARY; T=293.6K  
Heating

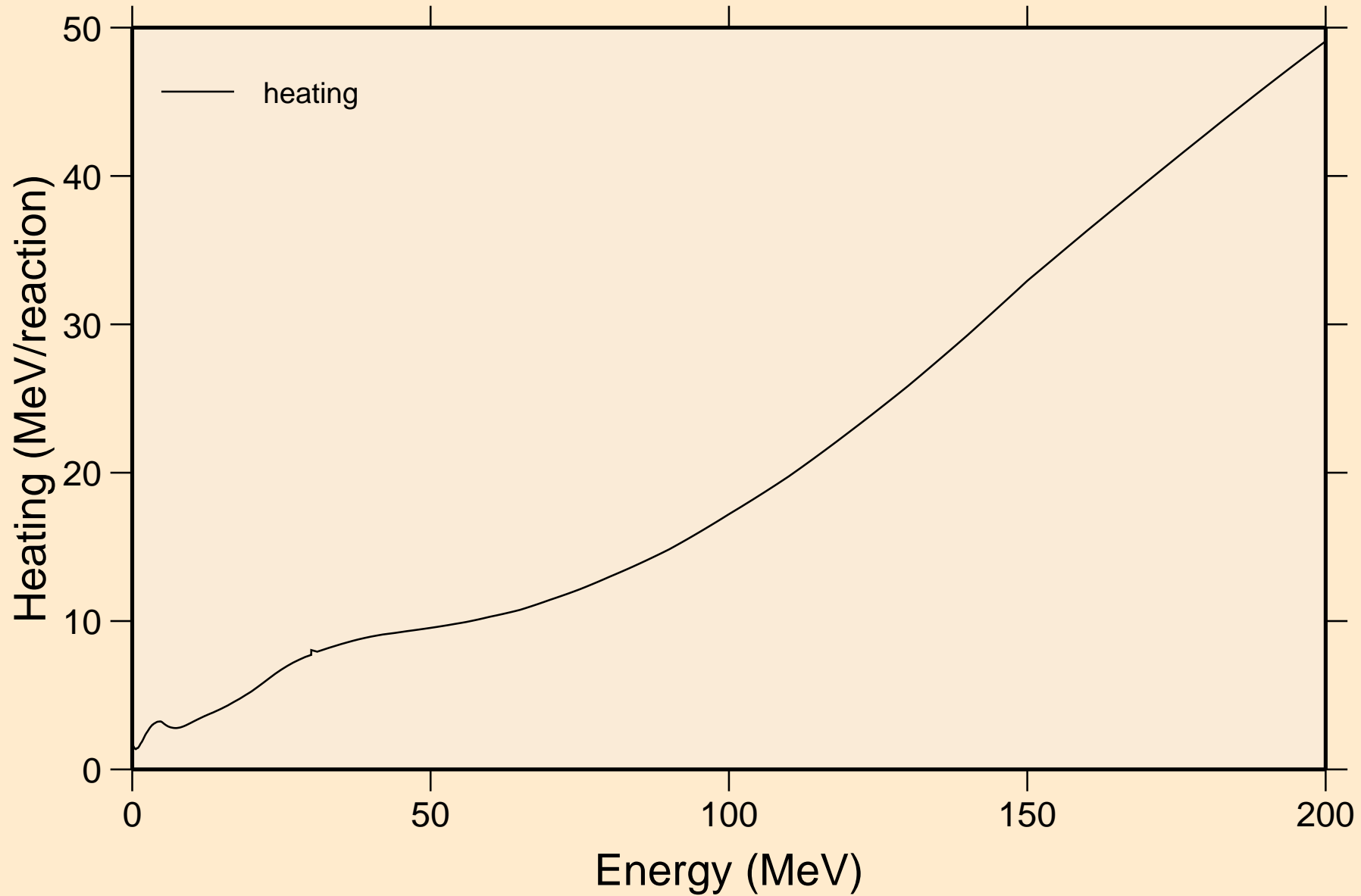

TC091M NEUTRON ACER TENDL-2024 LIBRARY; T=293.6K  
Damage

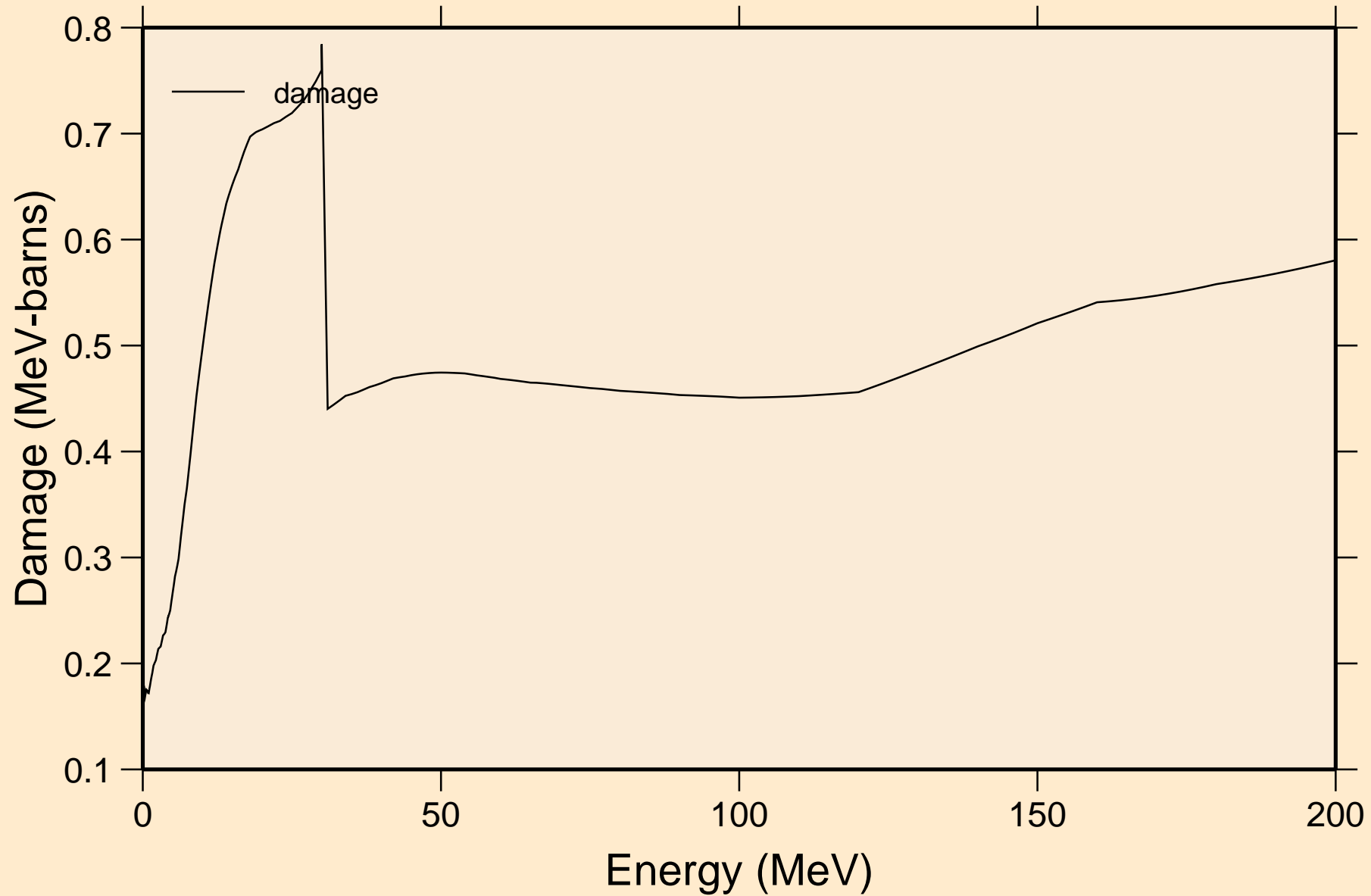

TC091M NEUTRON ACER TENDL-2024 LIBRARY; T=293.6K  
Non-threshold reactions

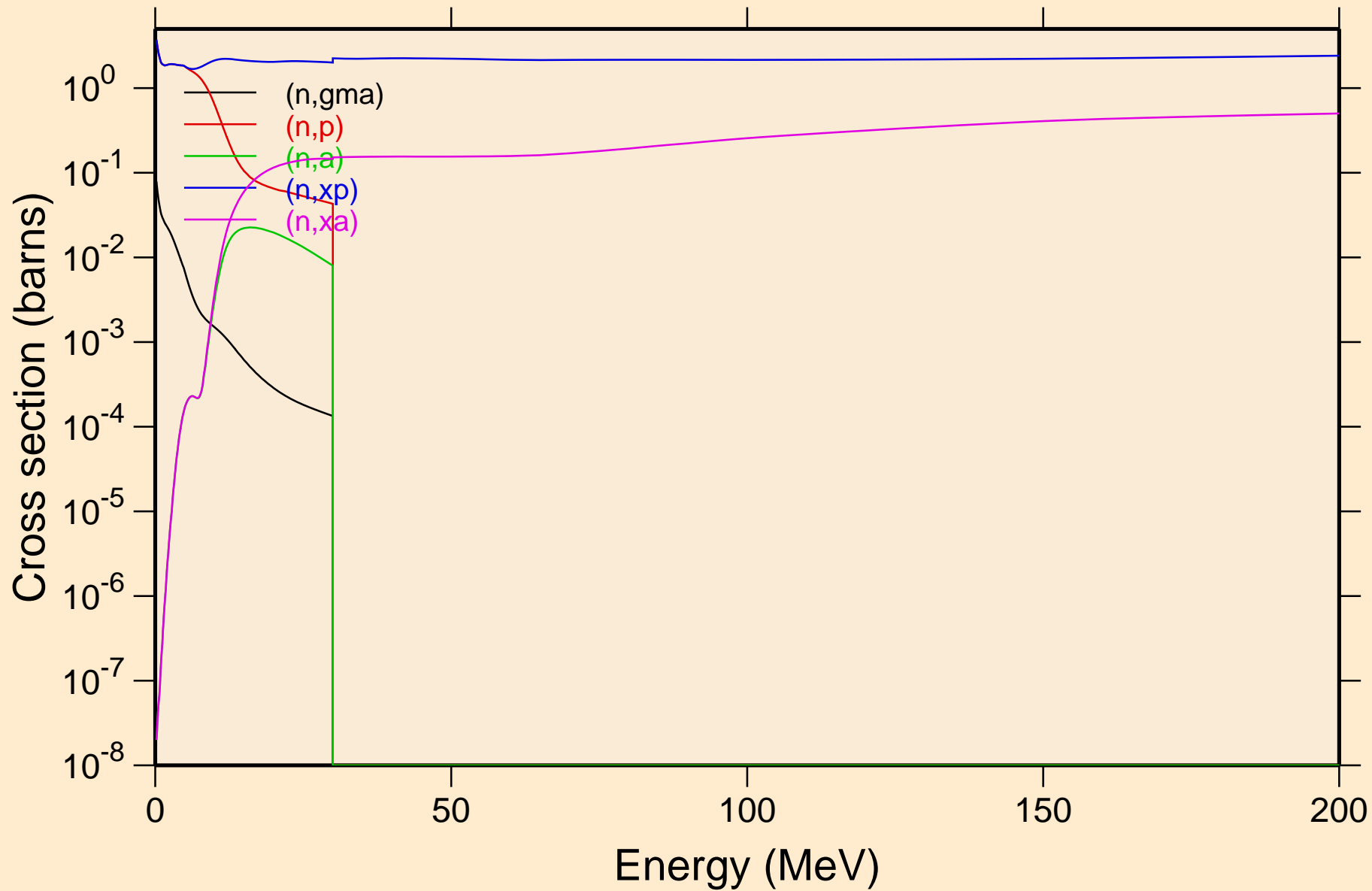

TC091M NEUTRON ACER TENDL-2024 LIBRARY; T=293.6K  
Inelastic levels

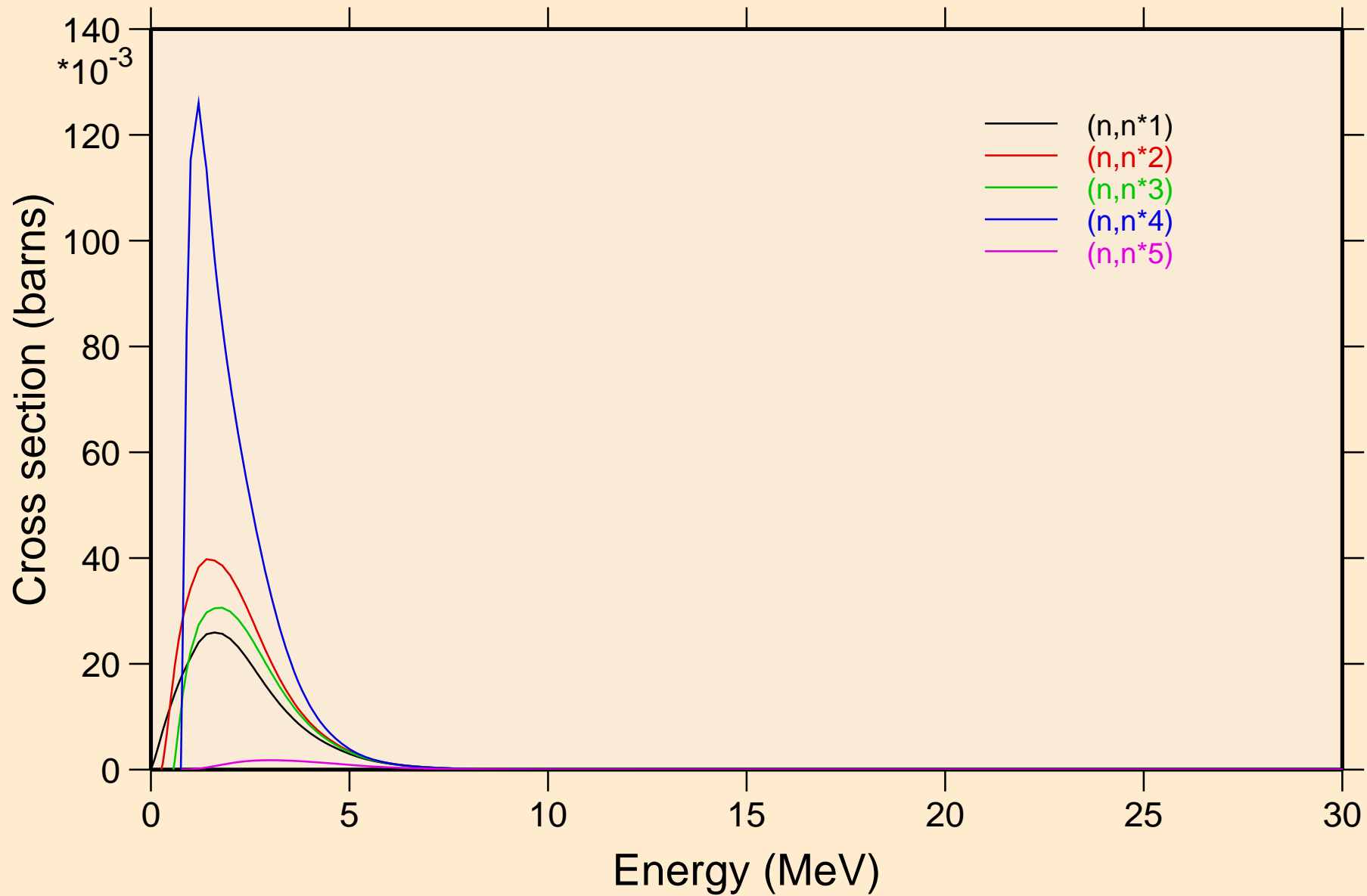

TC091M NEUTRON ACER TENDL-2024 LIBRARY; T=293.6K  
Inelastic levels

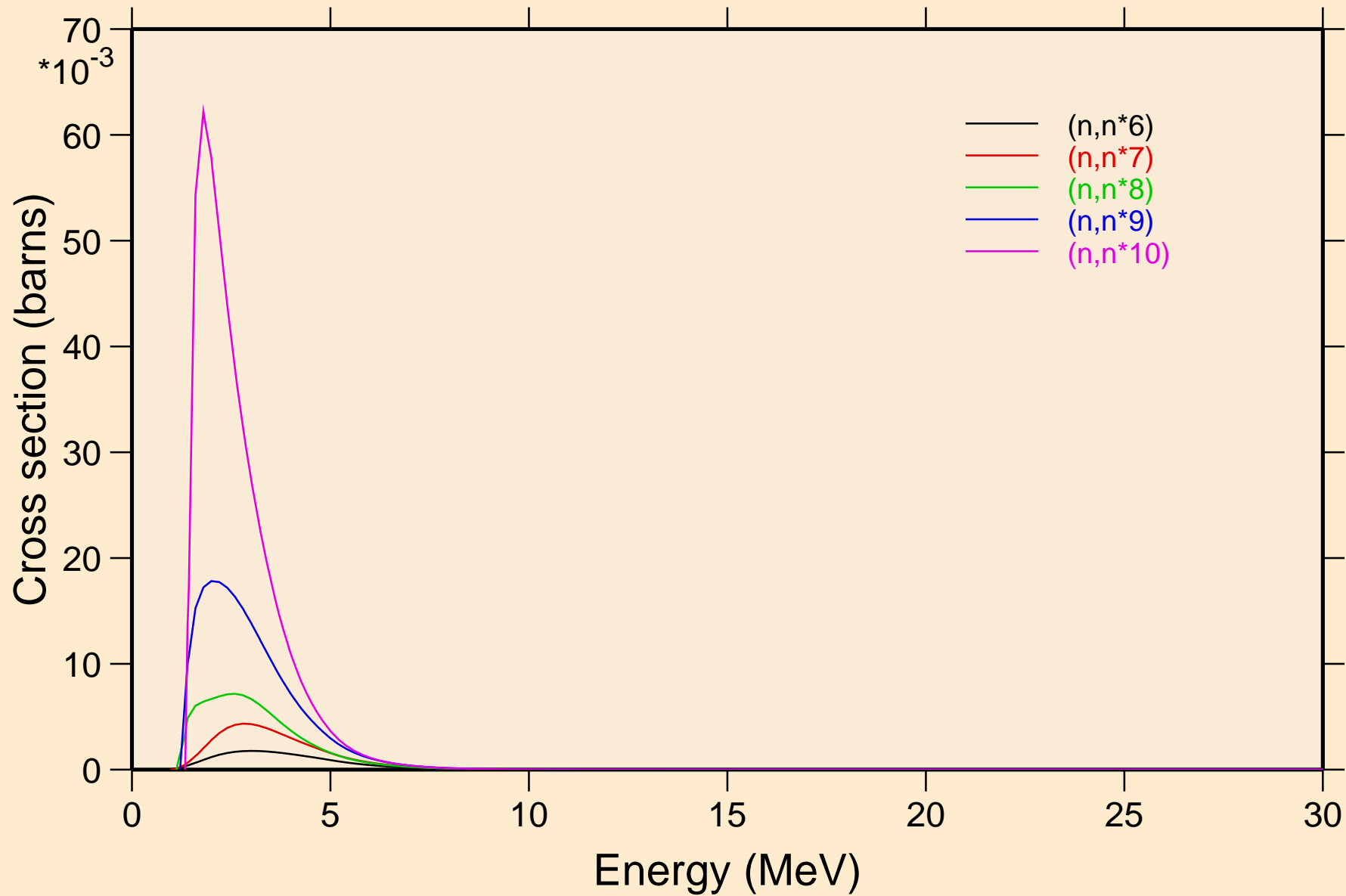

TC091M NEUTRON ACER TENDL-2024 LIBRARY; T=293.6K  
Inelastic levels

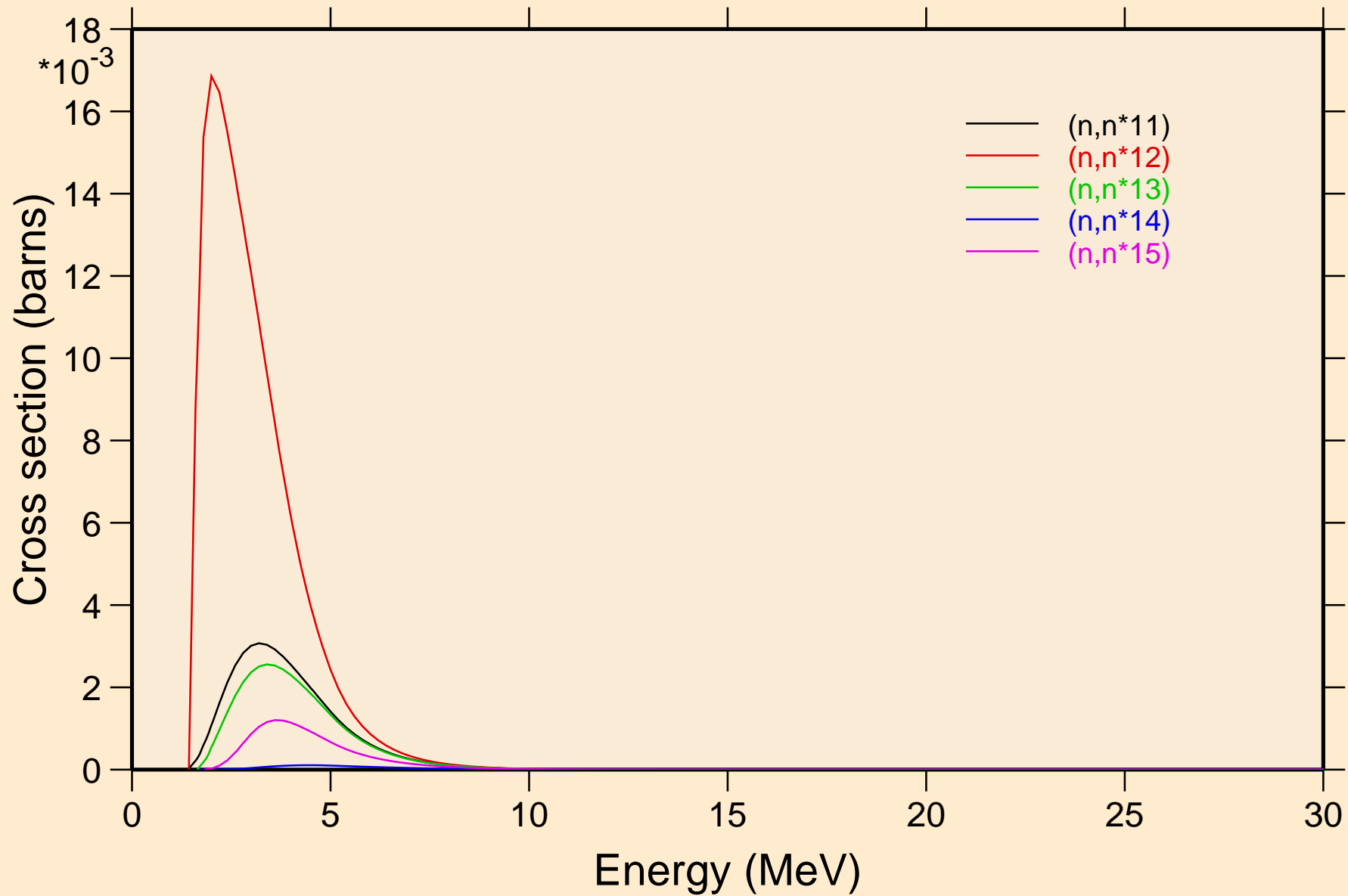

TC091M NEUTRON ACER TENDL-2024 LIBRARY; T=293.6K  
Inelastic levels

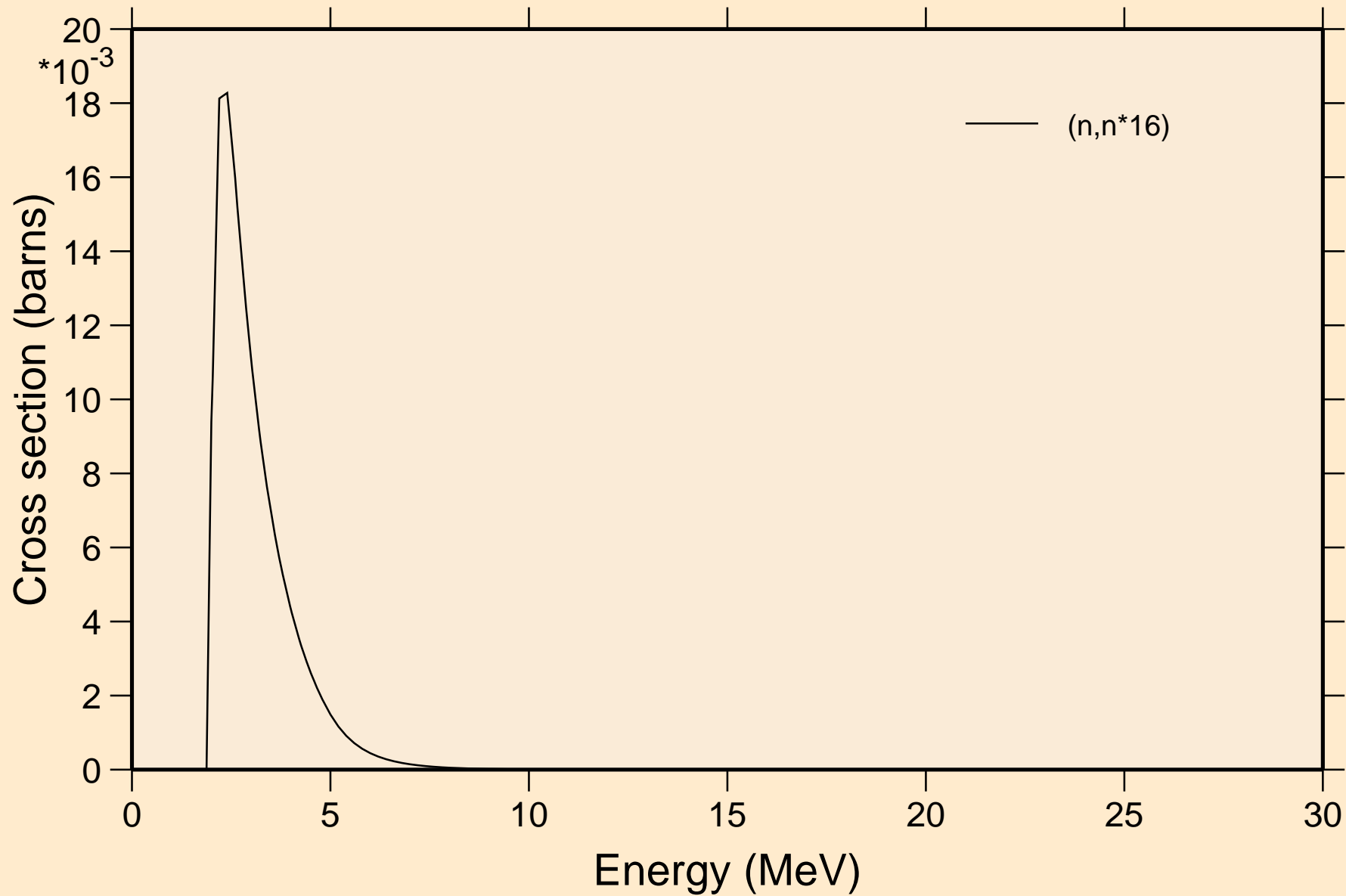

TC091M NEUTRON ACER TENDL-2024 LIBRARY; T=293.6K  
Threshold reactions

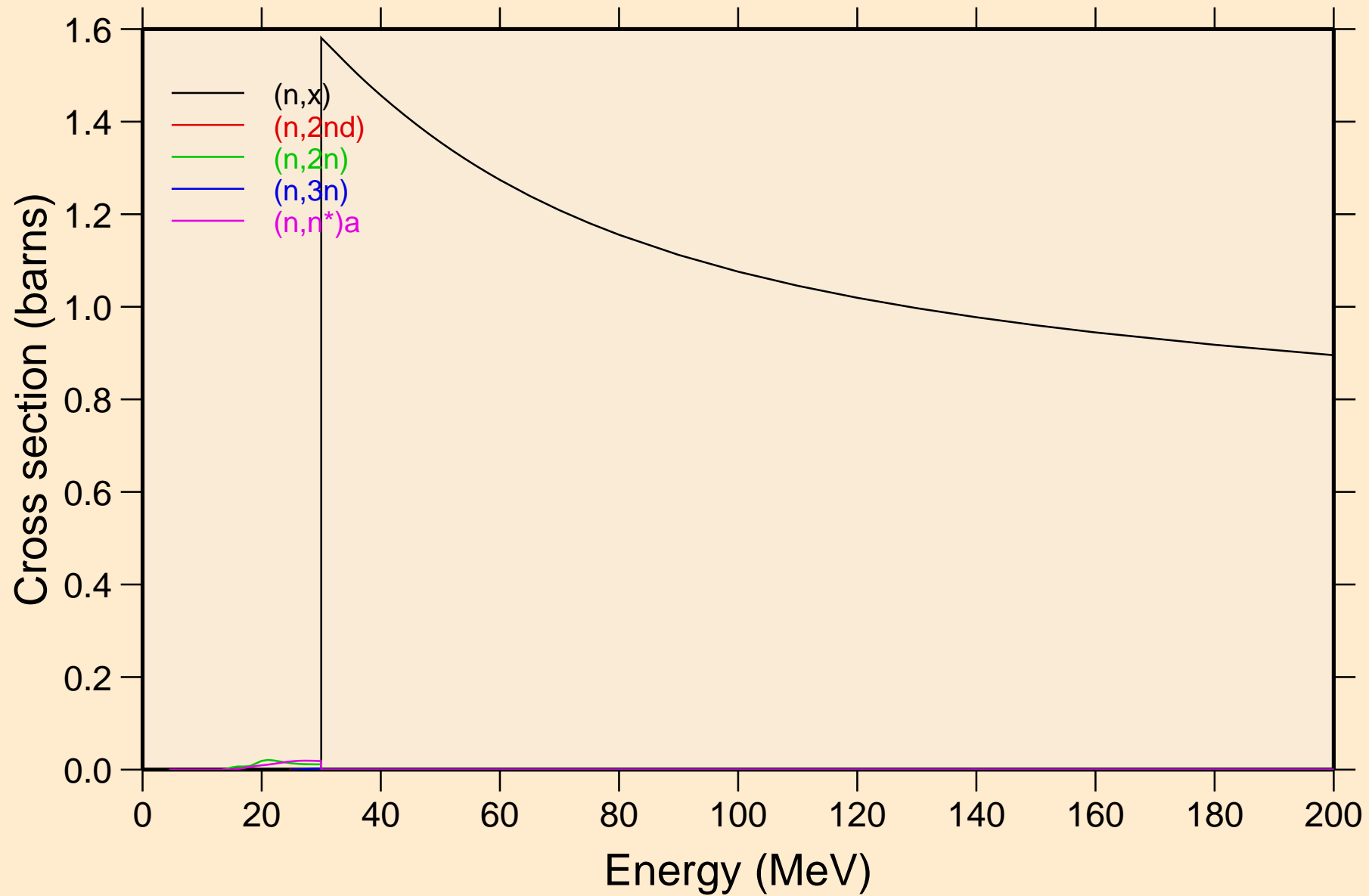

TC091M NEUTRON ACER TENDL-2024 LIBRARY; T=293.6K  
Threshold reactions

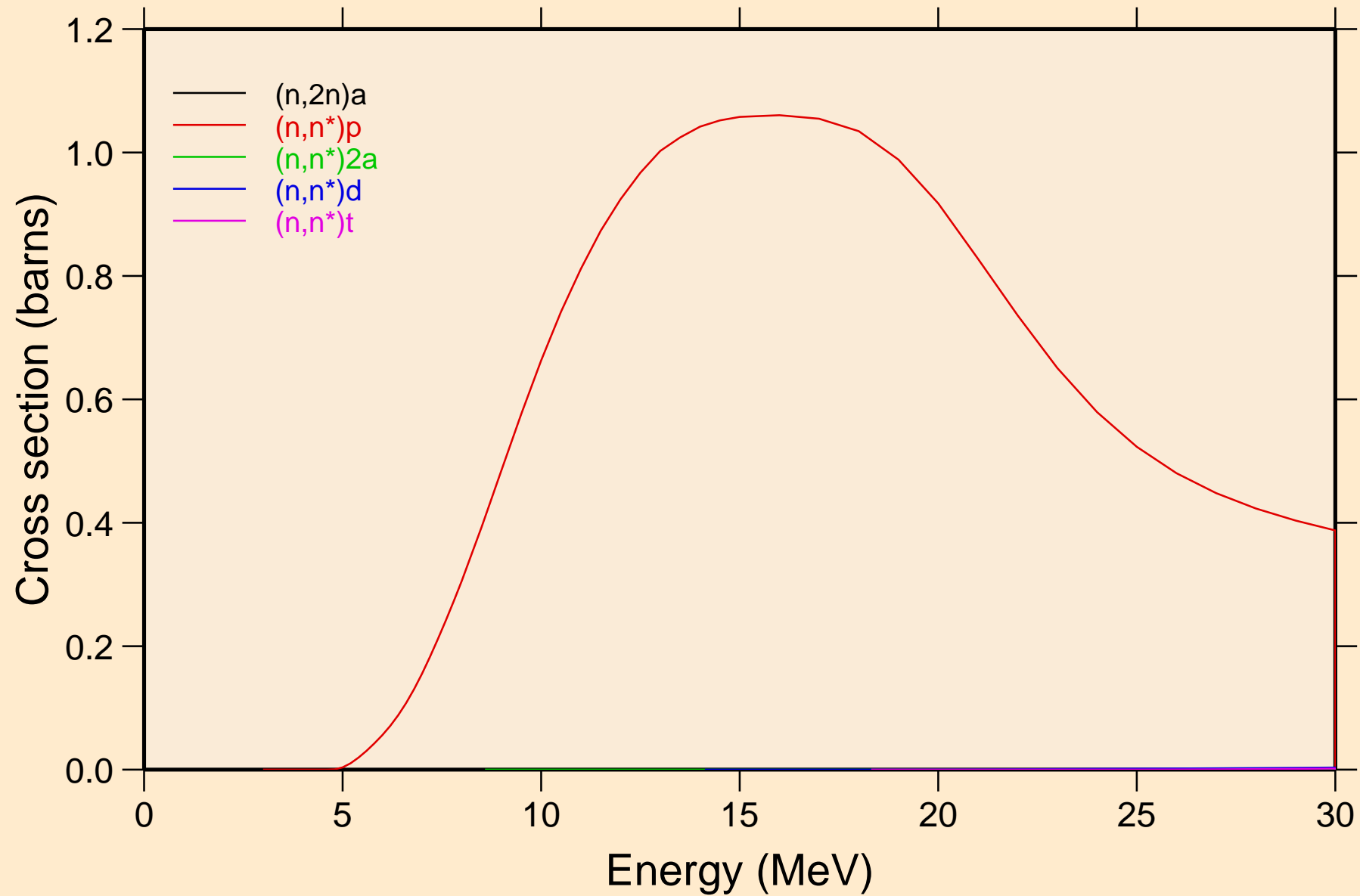

TC091M NEUTRON ACER TENDL-2024 LIBRARY; T=293.6K  
Threshold reactions

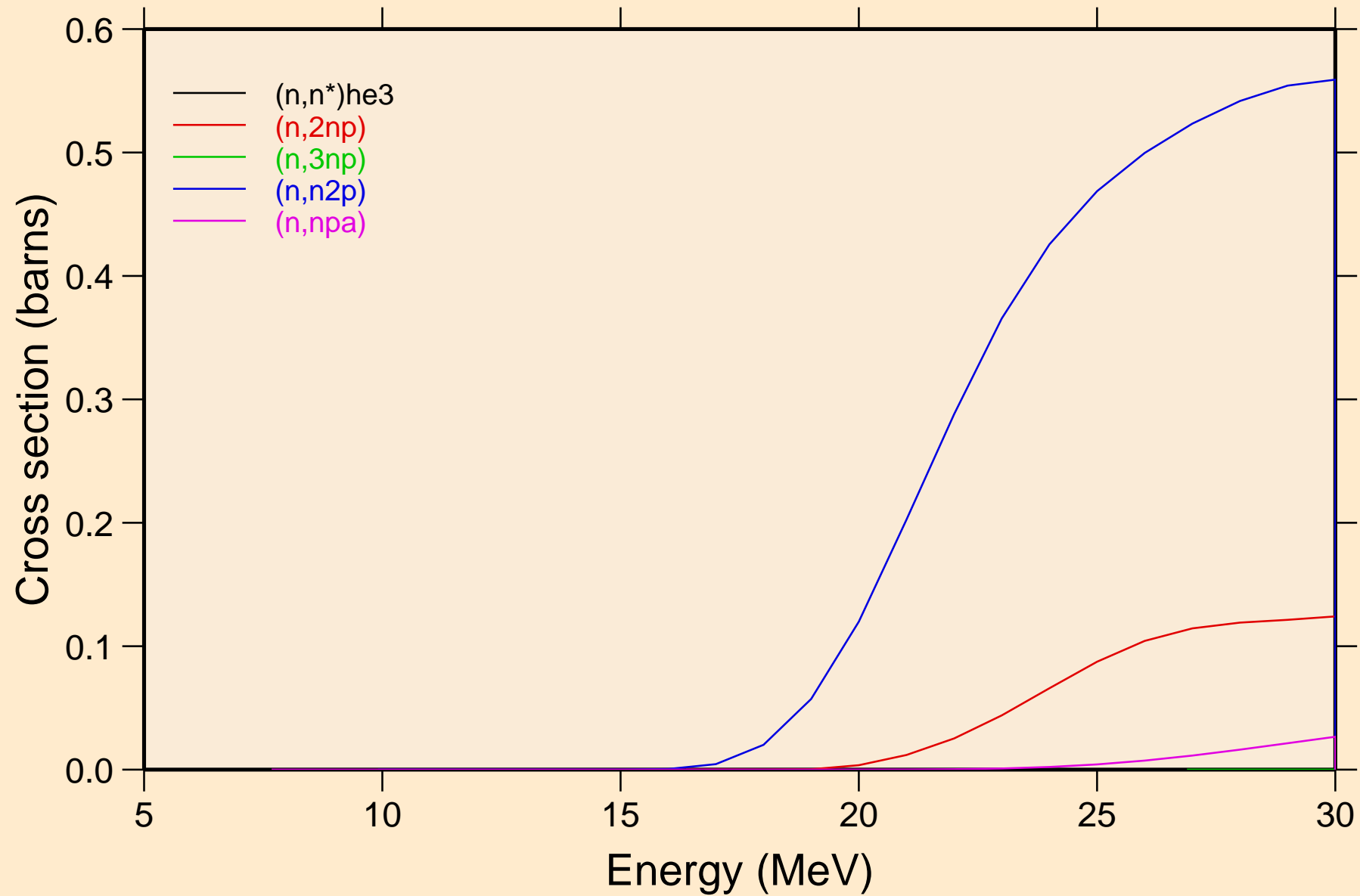

TC091M NEUTRON ACER TENDL-2024 LIBRARY; T=293.6K  
Threshold reactions

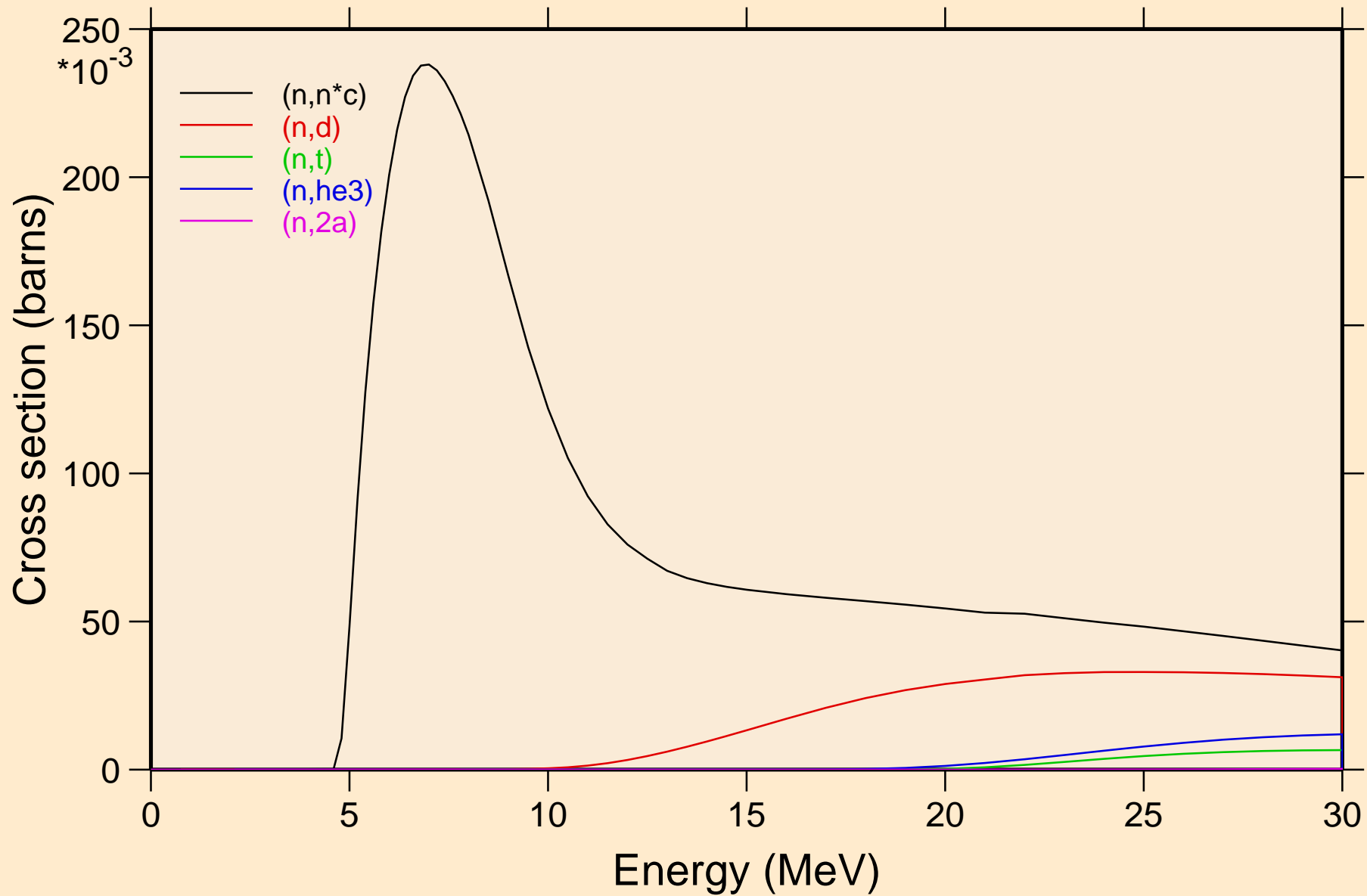

TC091M NEUTRON ACER TENDL-2024 LIBRARY; T=293.6K  
Threshold reactions

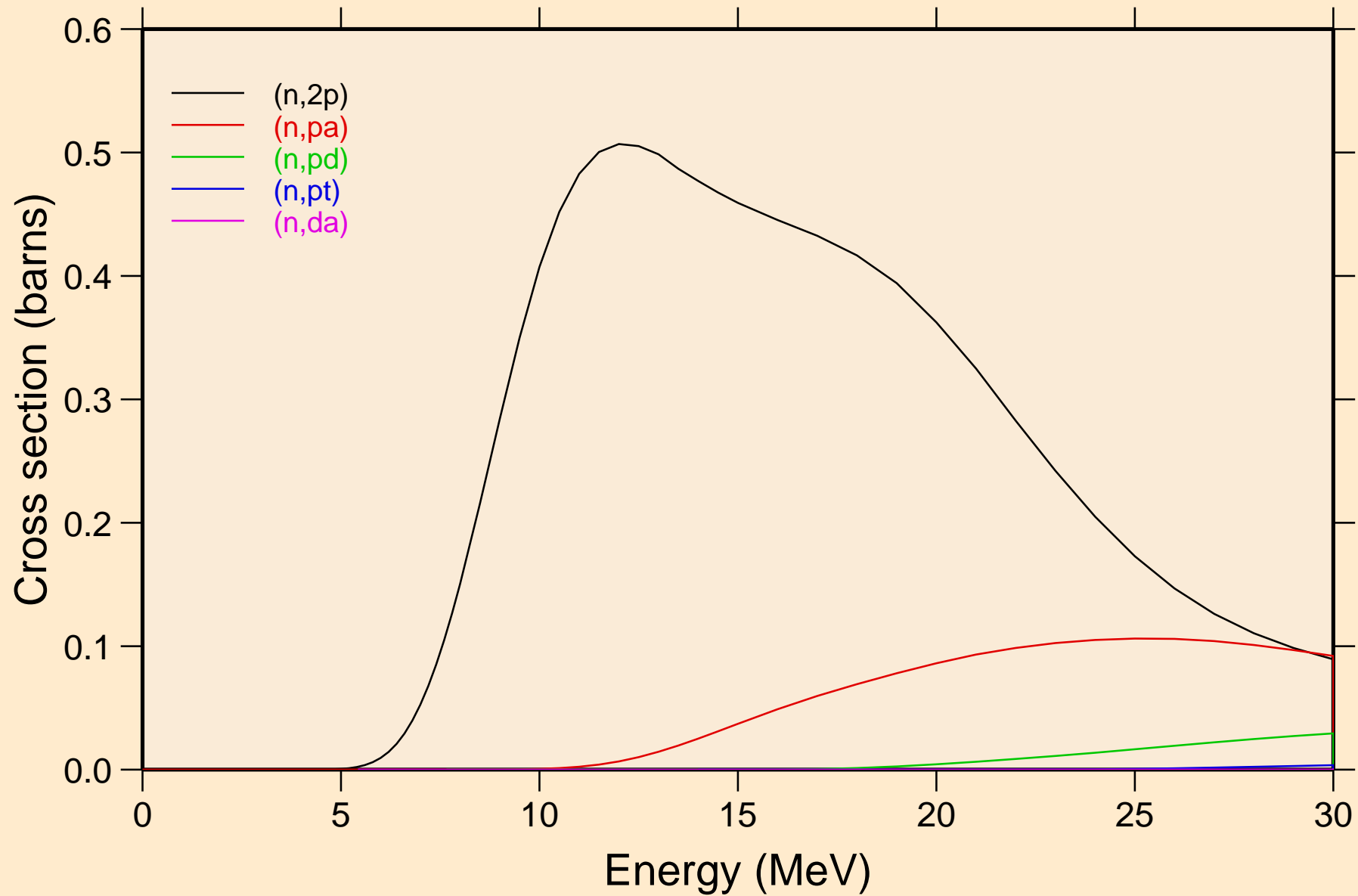

TC091M NEUTRON ACER TENDL-2024 LIBRARY; T=293.6K  
Threshold reactions

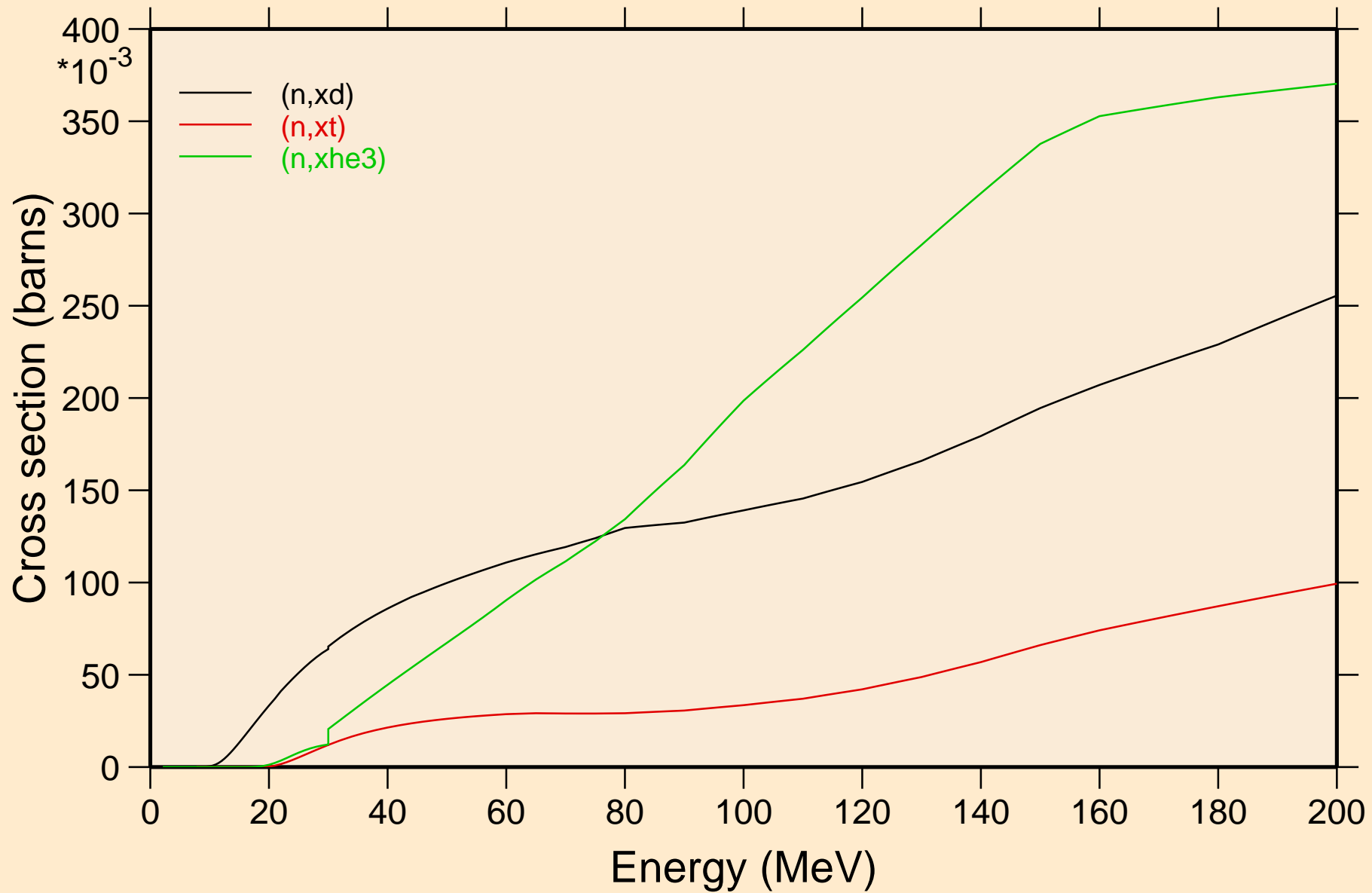

TC091M NEUTRON ACER TENDL-2024 LIBRARY; T=293.6K  
angular distribution for elastic

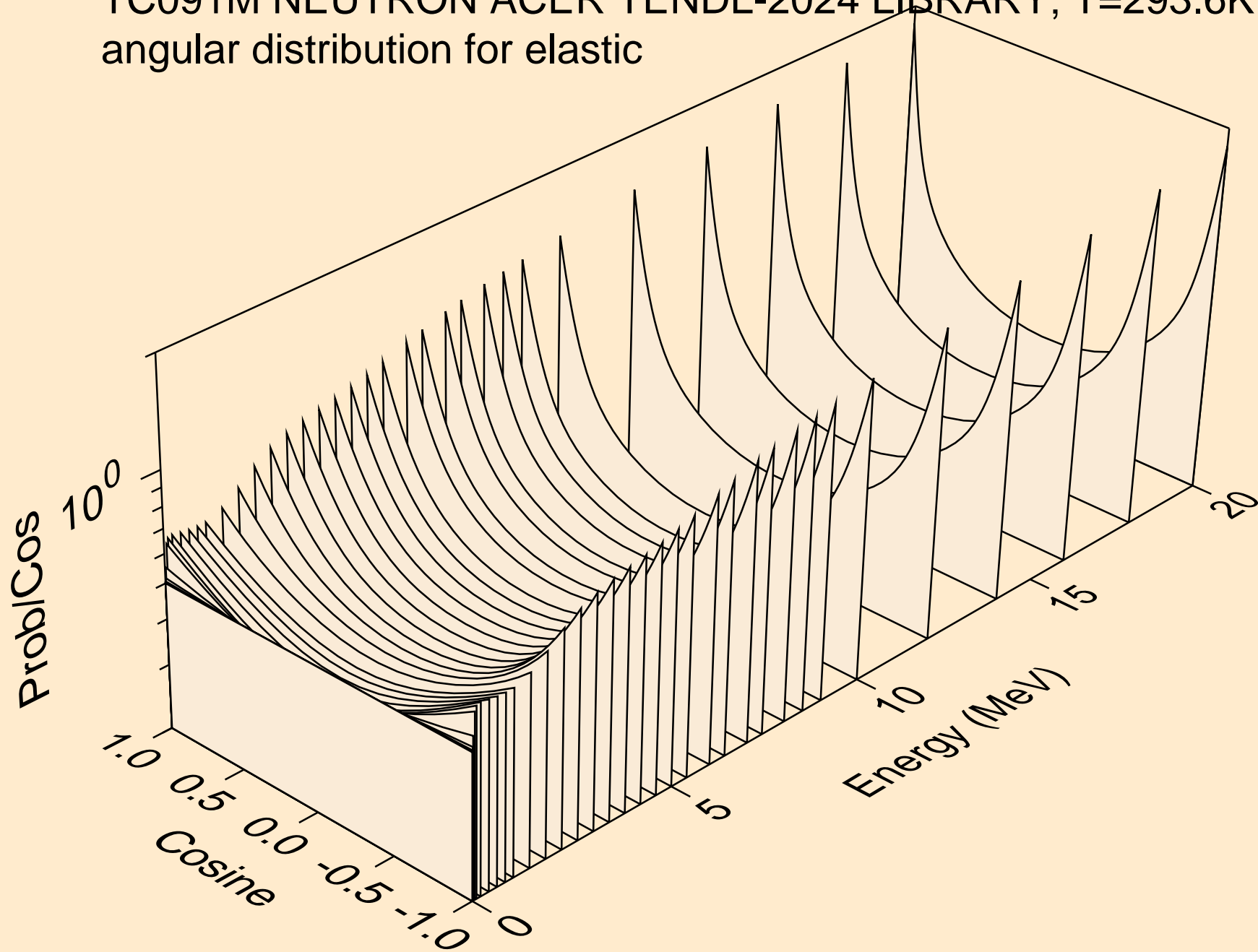

TC091M NEUTRON ACER TENDL-2024 LIBRARY; T=293.6K  
angular distribution for elastic

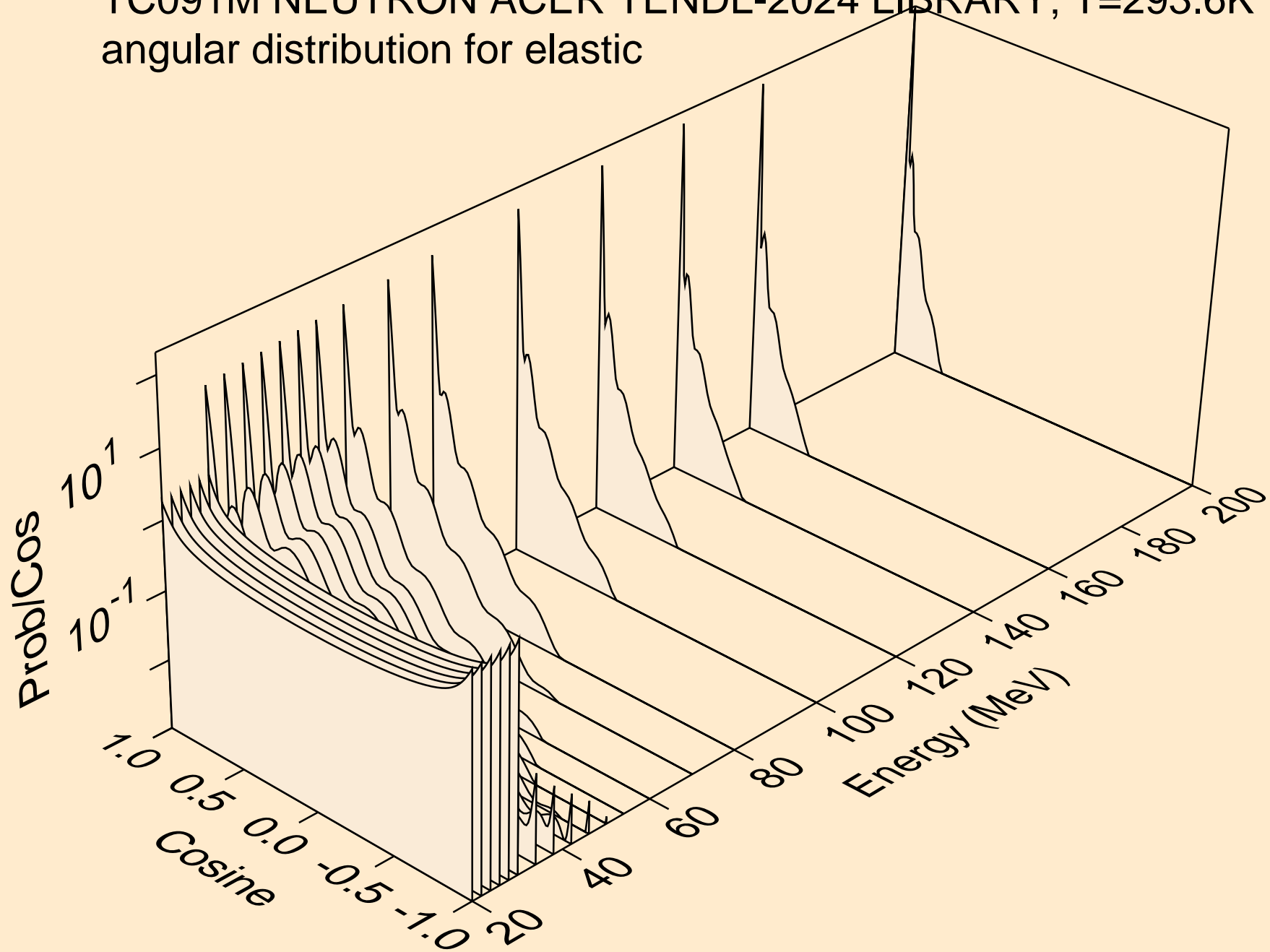

TC091M NEUTRON ACER TENDL-2024 LIBRARY; T=293.6K  
angular distribution for (n,n\*1)

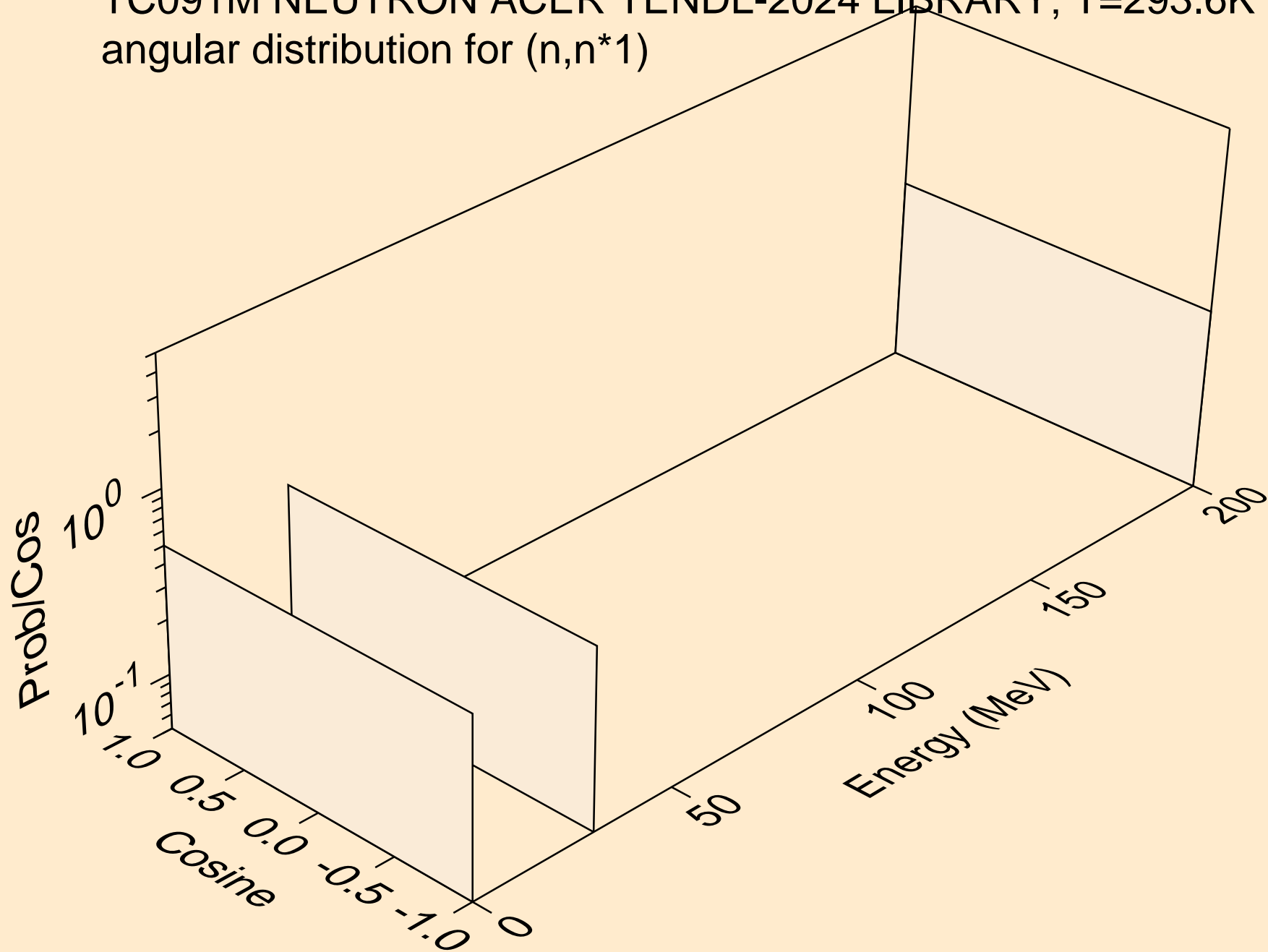

TC091M NEUTRON ACER TENDL-2024 LIBRARY; T=293.6K  
angular distribution for (n,n\*2)

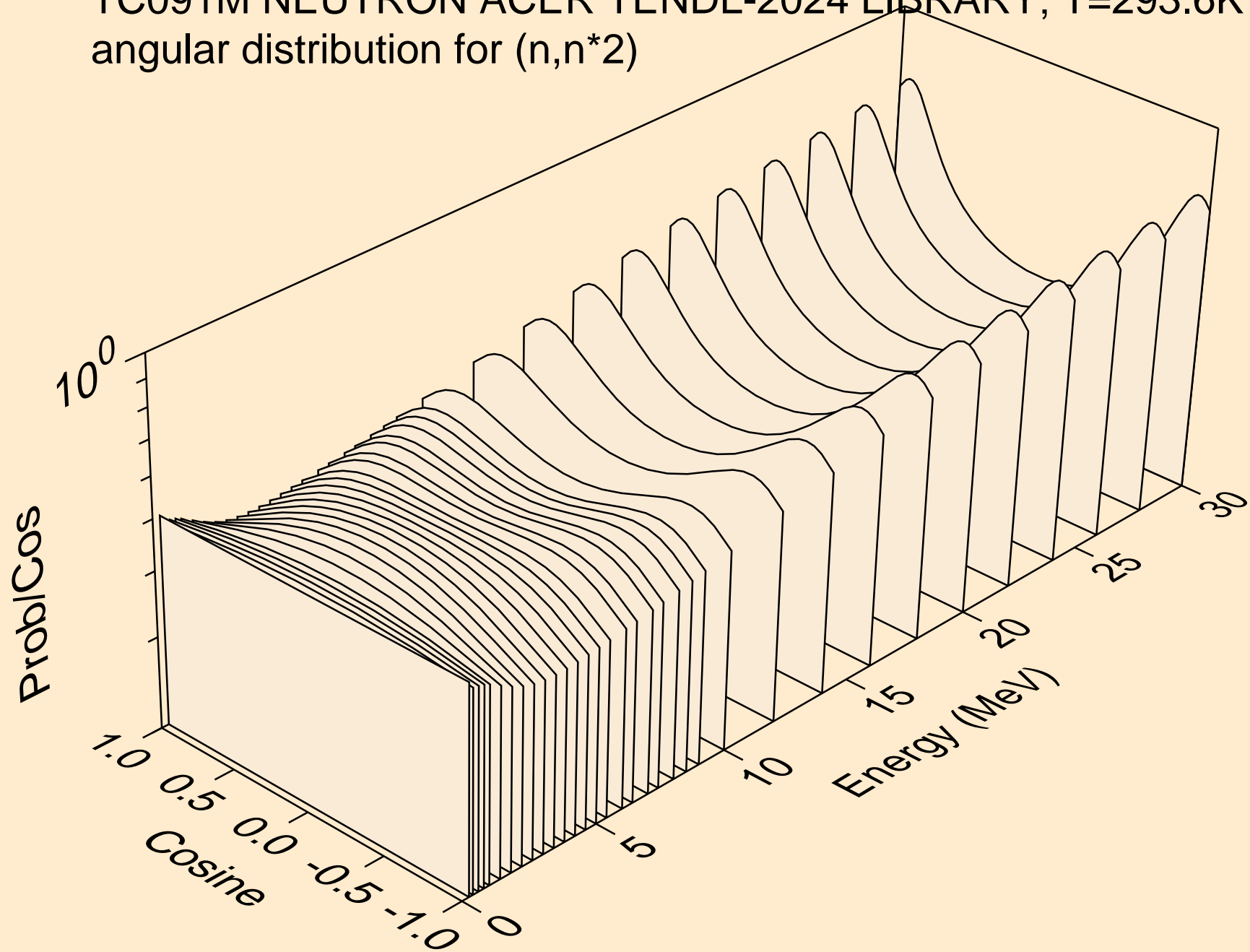

TC091M NEUTRON ACER TENDL-2024 LIBRARY; T=293.6K  
angular distribution for (n,n\*3)

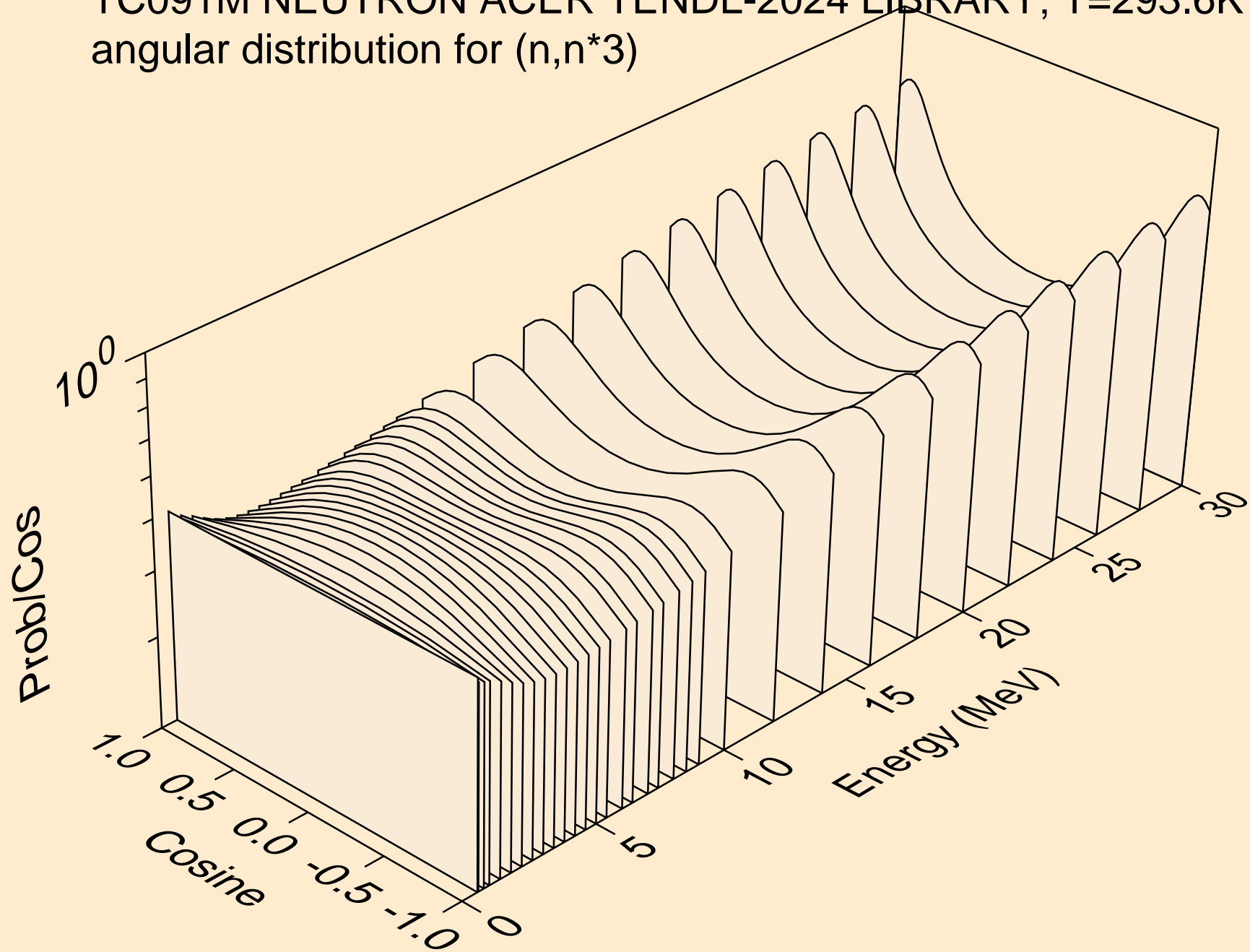

TC091M NEUTRON ACER TENDL-2024 LIBRARY; T=293.6K  
angular distribution for (n,n\*4)

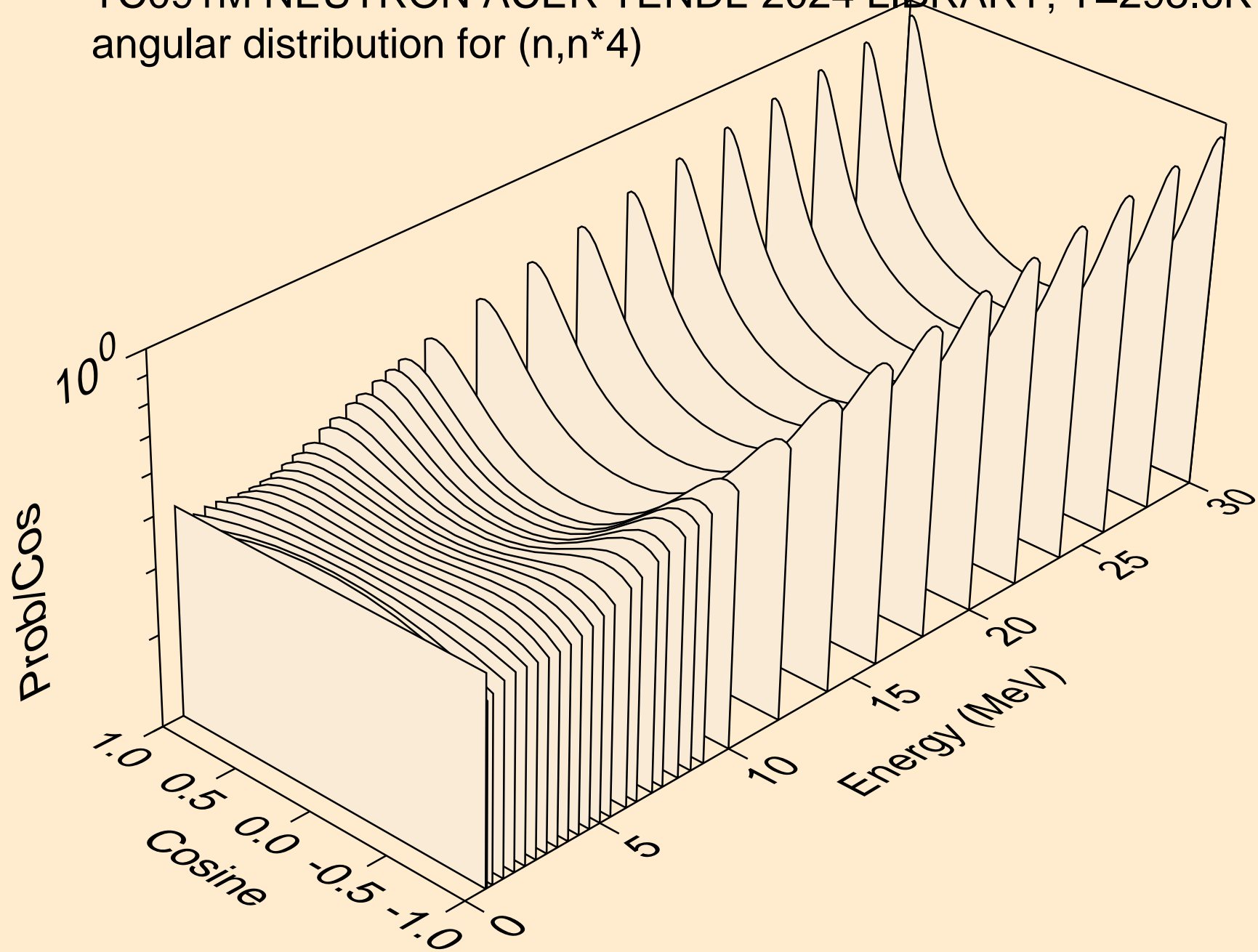

TC091M NEUTRON ACER TENDL-2024 LIBRARY; T=293.6K  
angular distribution for (n,n\*5)

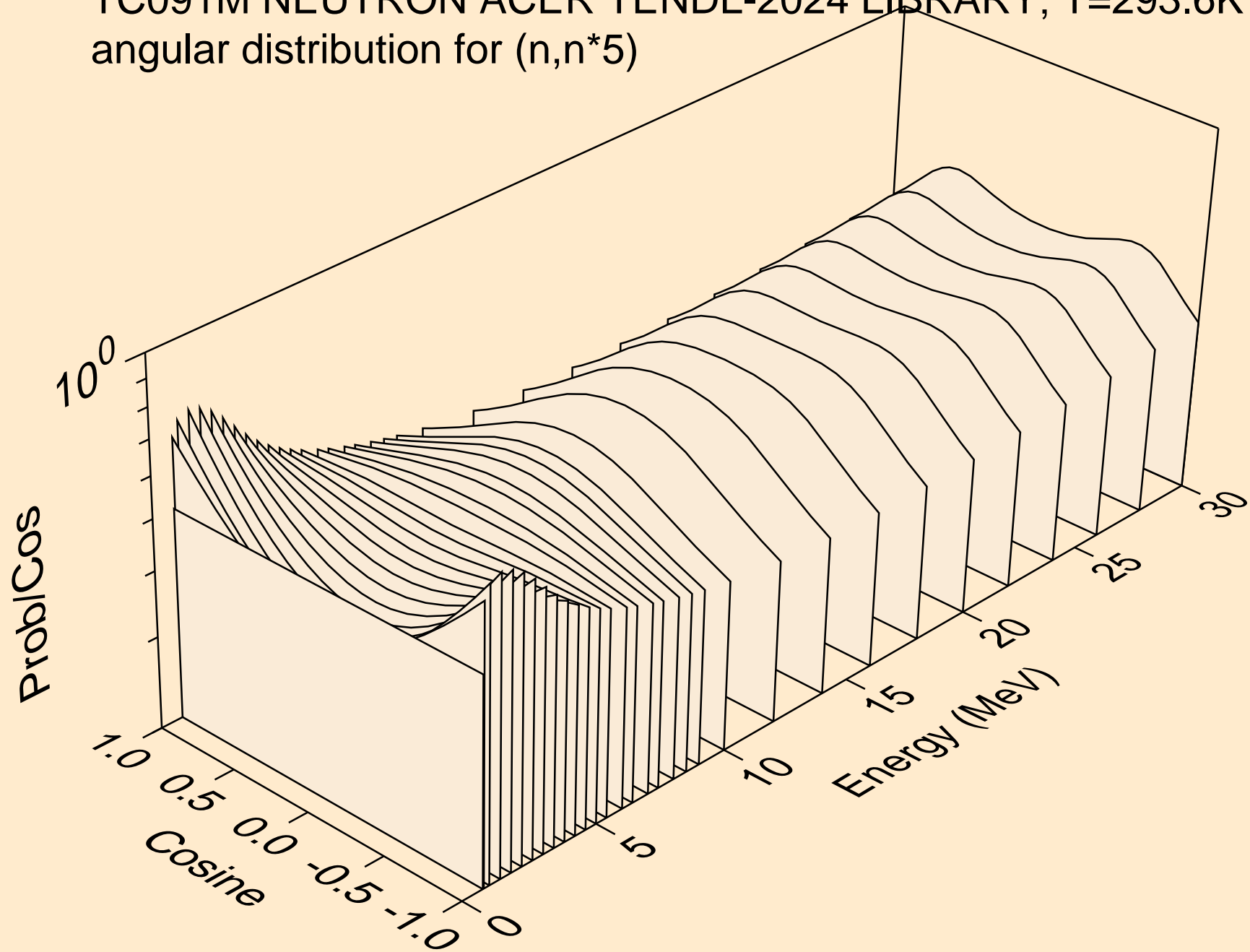

TC091M NEUTRON ACER TENDL-2024 LIBRARY; T=293.6K  
angular distribution for (n,n\*6)

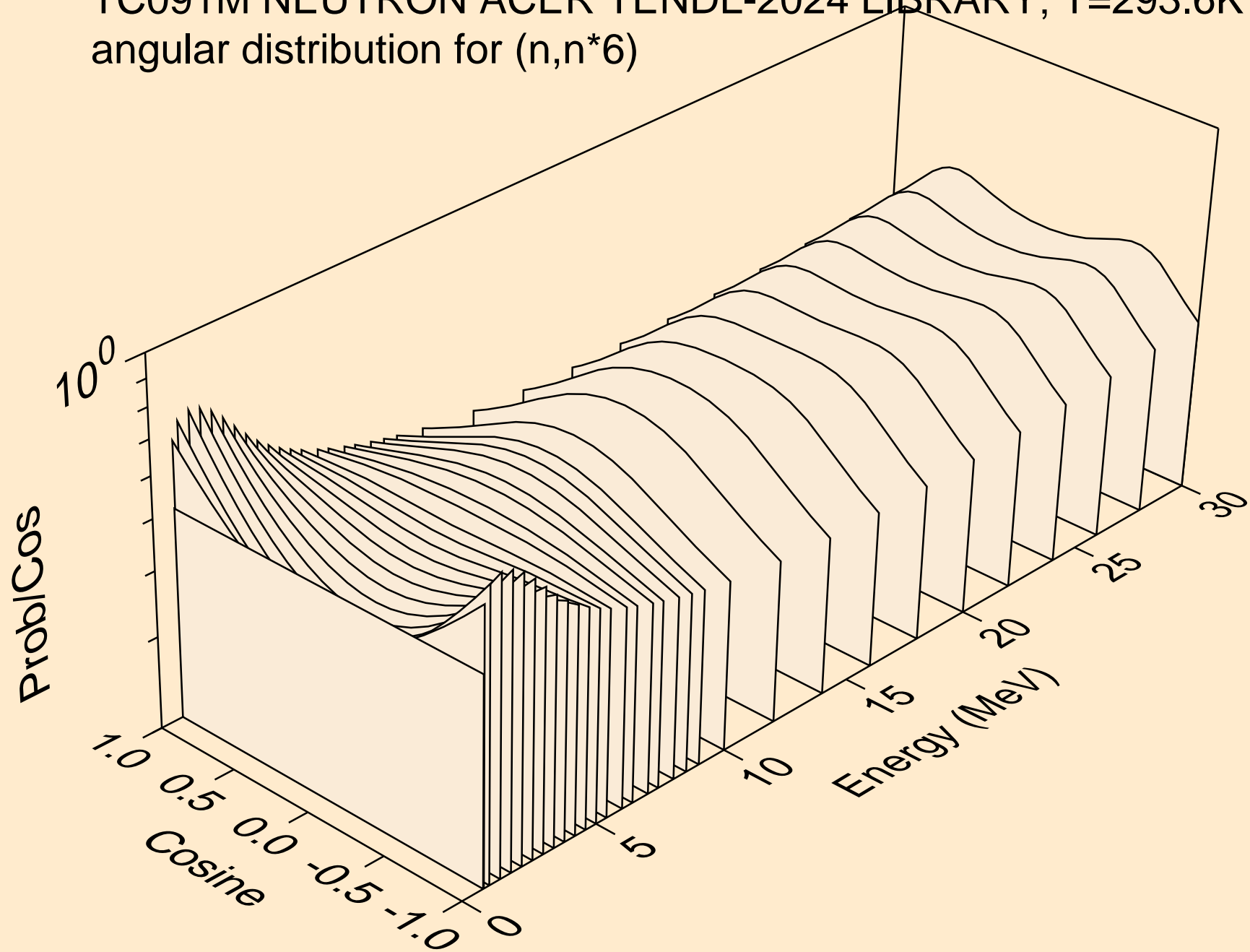

TC091M NEUTRON ACER TENDL-2024 LIBRARY; T=293.6K  
angular distribution for (n,n\*7)

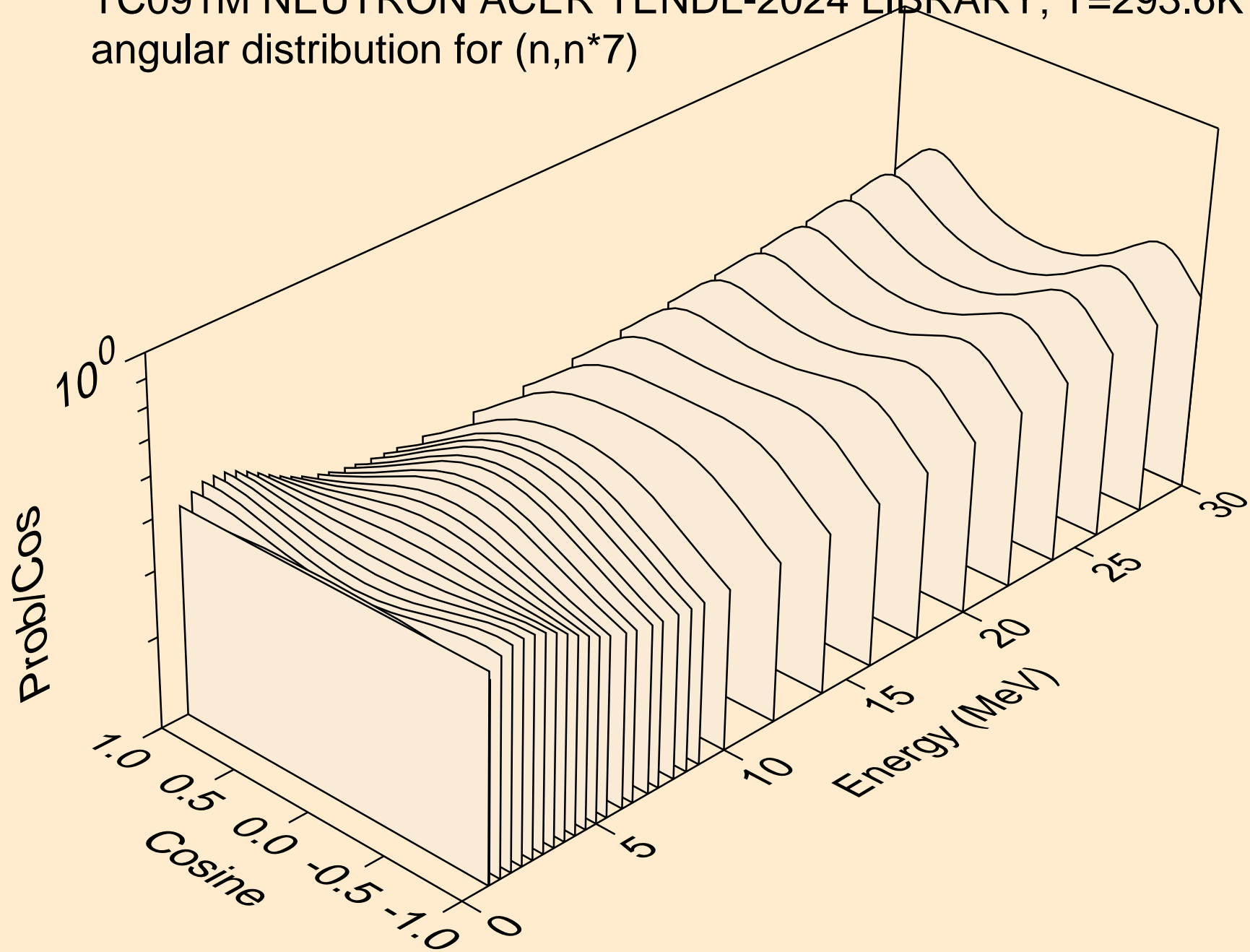

TC091M NEUTRON ACER TENDL-2024 LIBRARY; T=293.6K  
angular distribution for (n,n\*8)

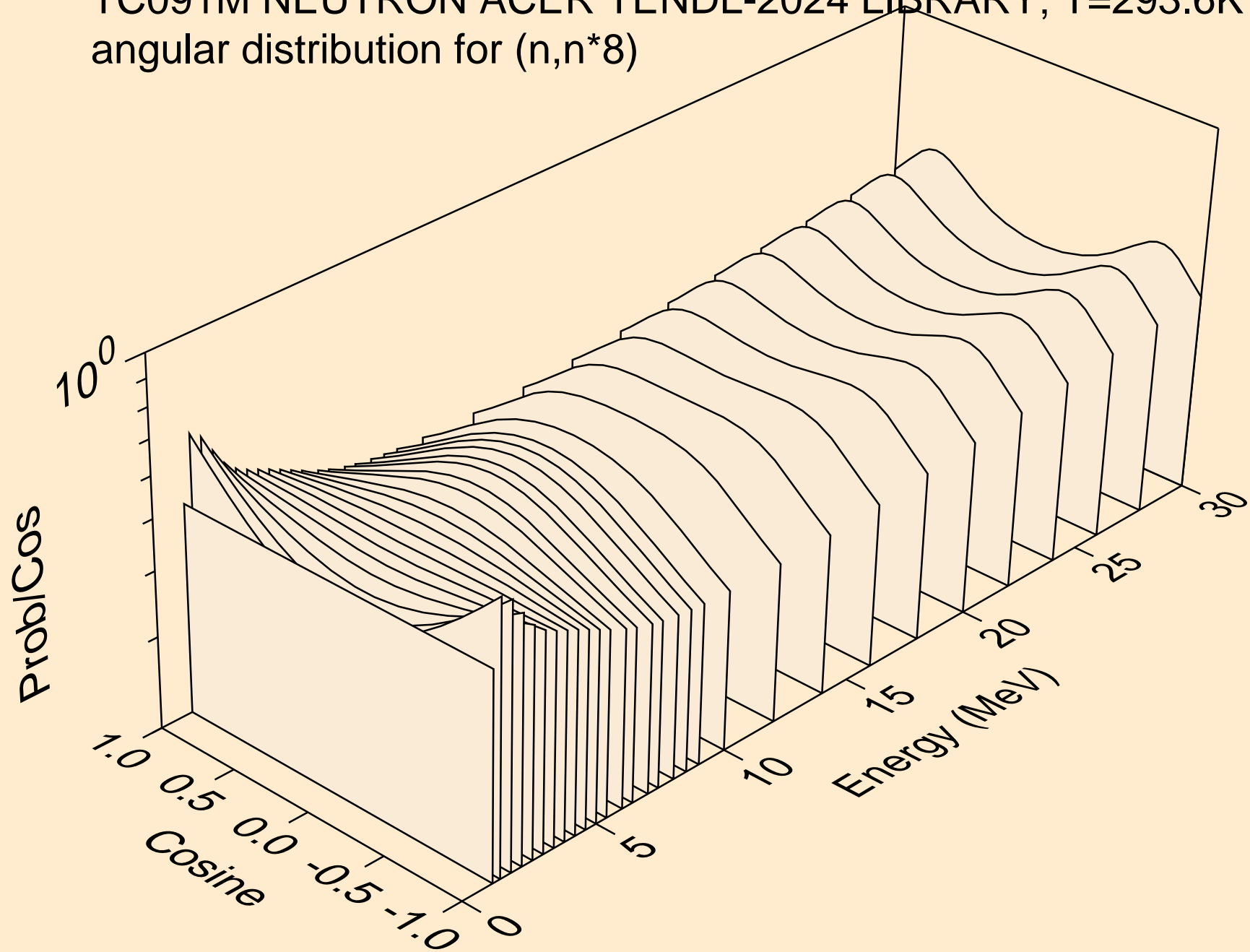

TC091M NEUTRON ACER TENDL-2024 LIBRARY; T=293.6K  
angular distribution for (n,n\*9)

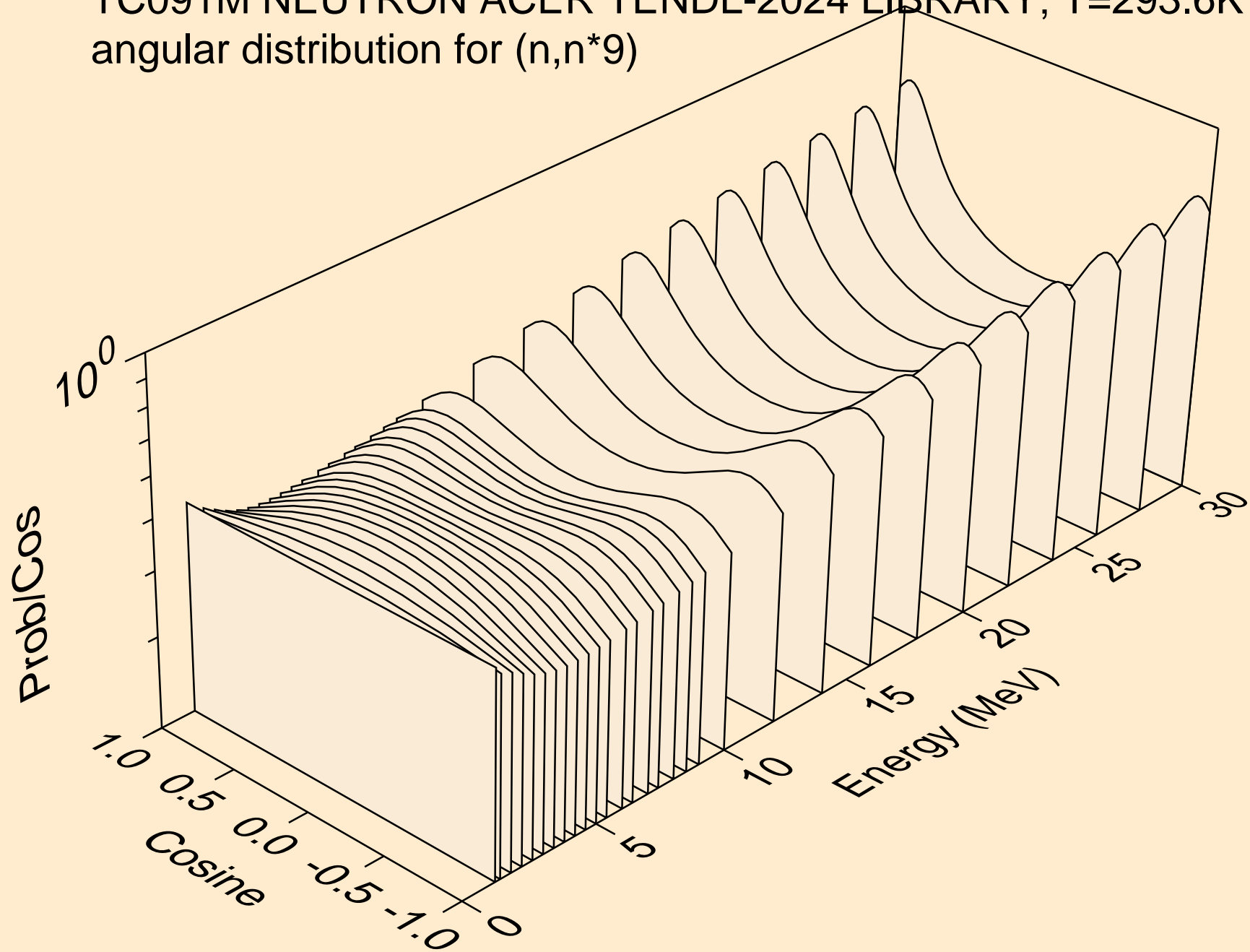

TC091M NEUTRON ACER TENDL-2024 LIBRARY; T=293.6K  
angular distribution for (n,n\*10)

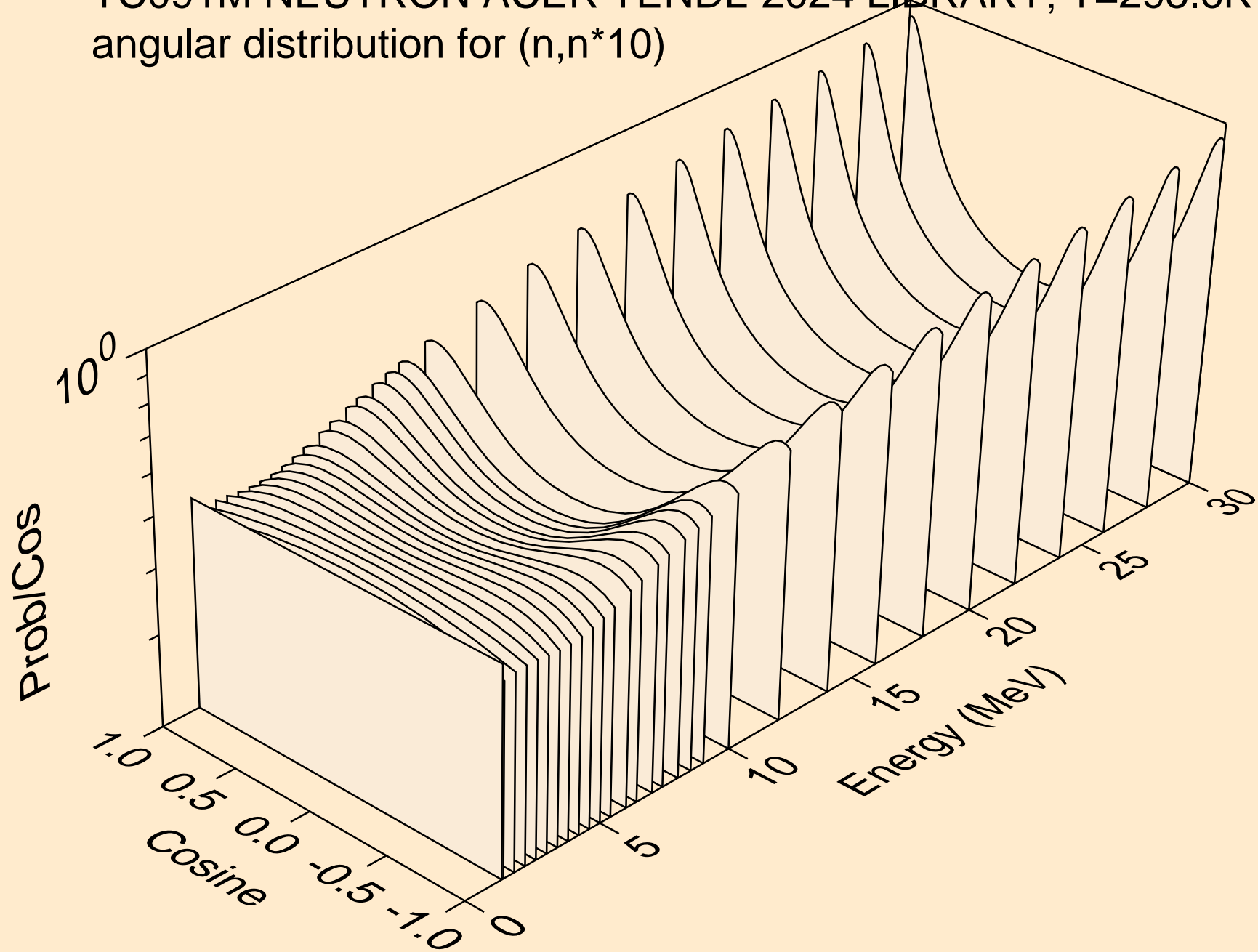

TC091M NEUTRON ACER TENDL-2024 LIBRARY; T=293.6K  
angular distribution for (n,n\*11)

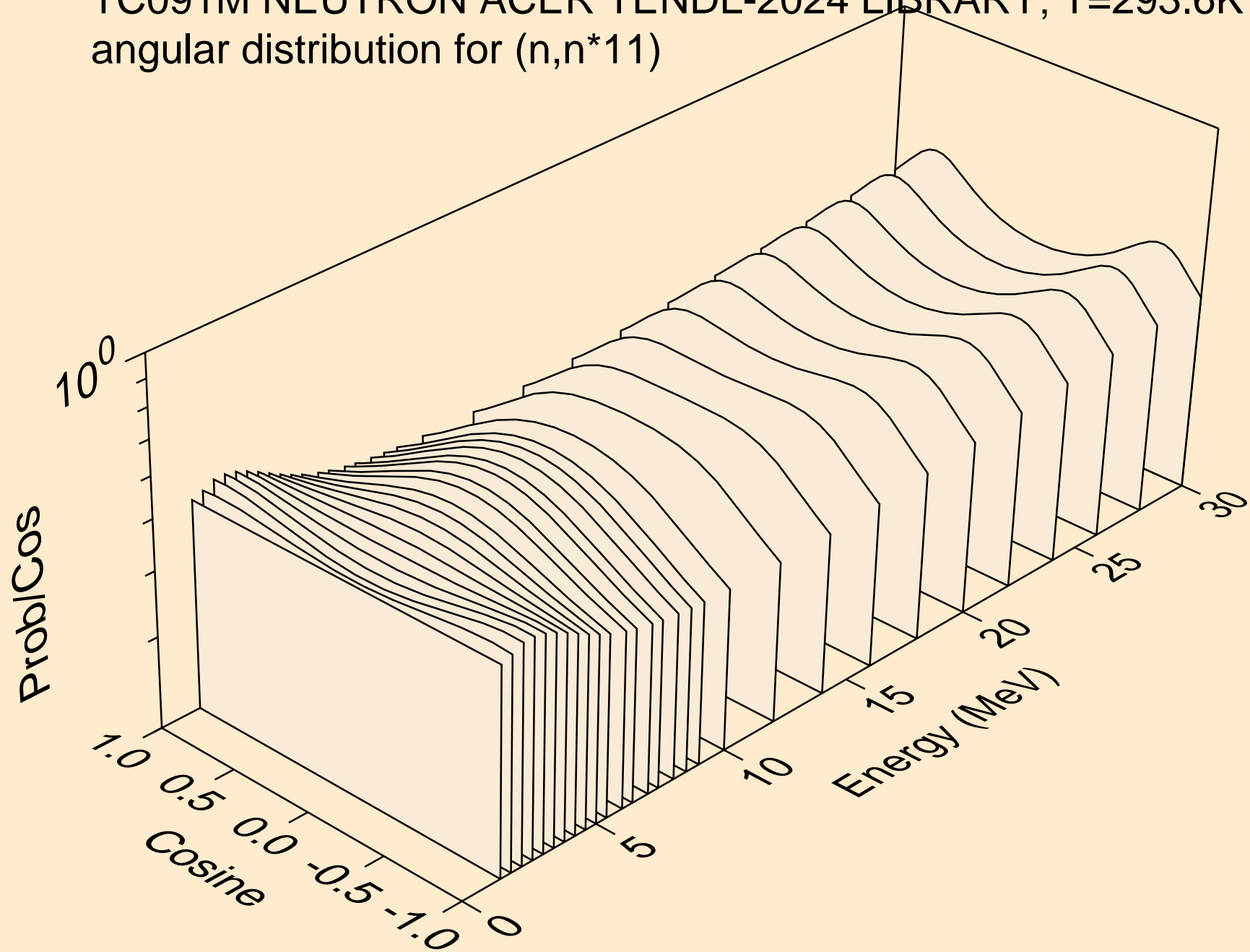

TC091M NEUTRON ACER TENDL-2024 LIBRARY; T=293.6K  
angular distribution for (n,n\*12)

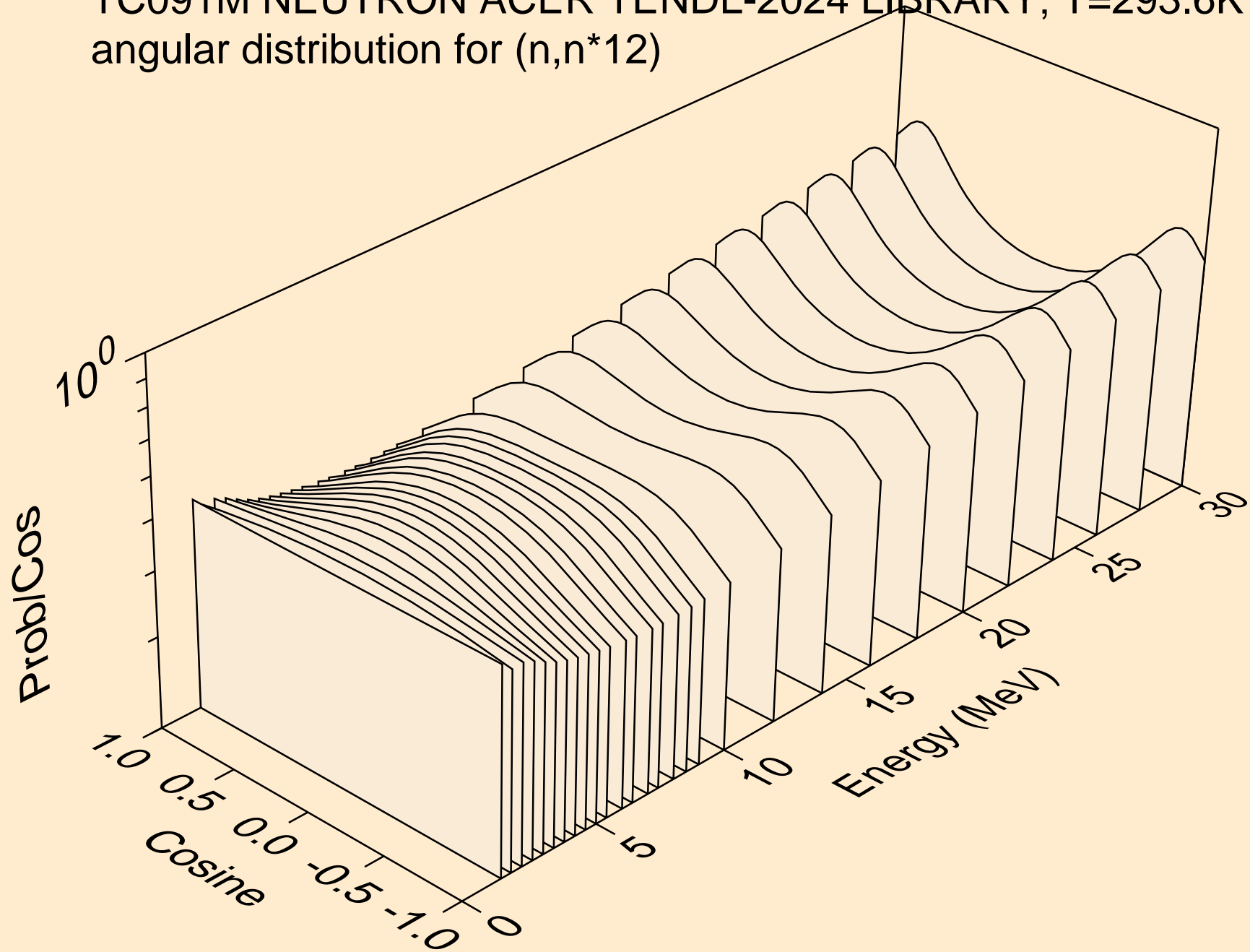

TC091M NEUTRON ACER TENDL-2024 LIBRARY; T=293.6K  
angular distribution for (n,n\*13)

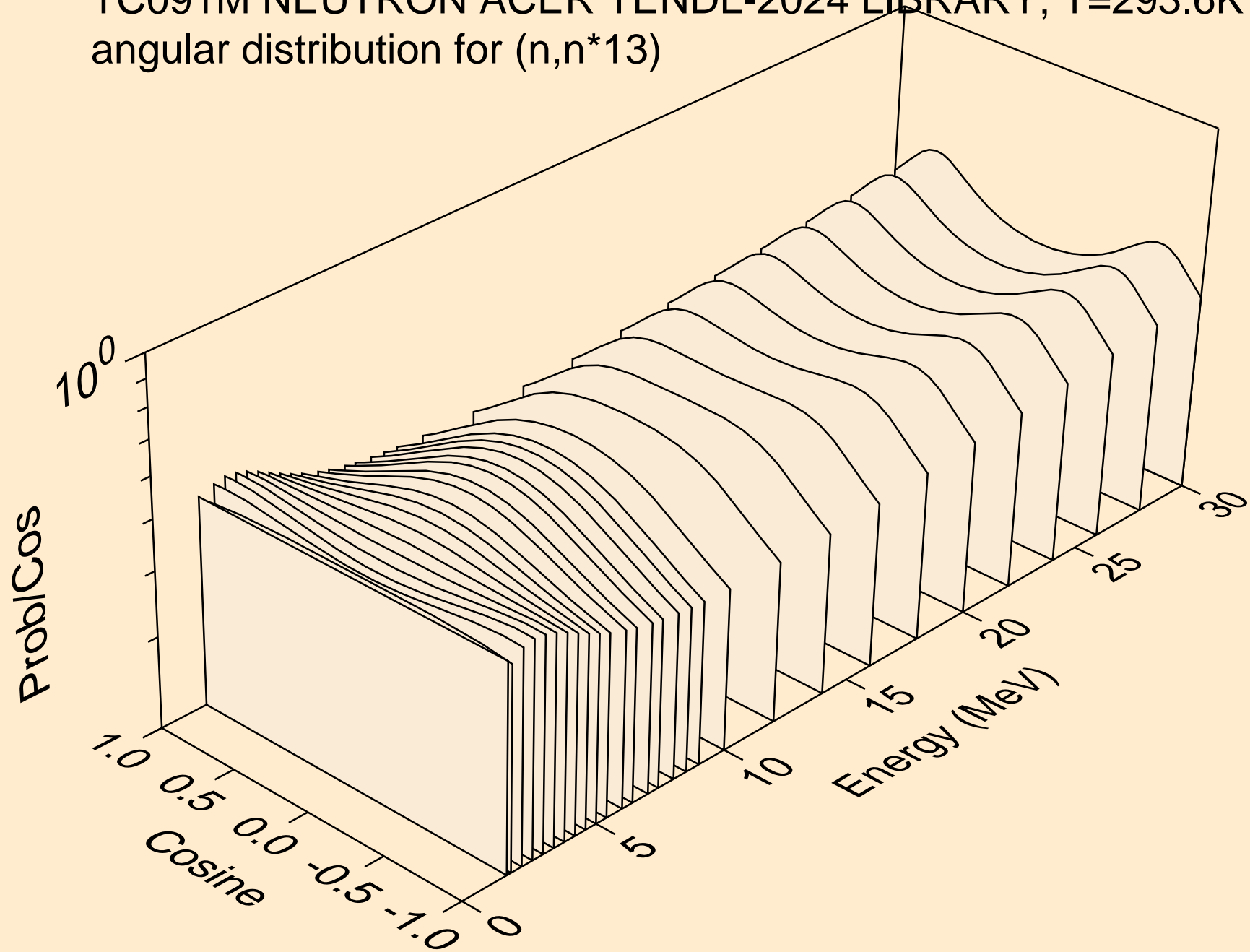

TC091M NEUTRON ACER TENDL-2024 LIBRARY; T=293.6K  
angular distribution for (n,n\*14)

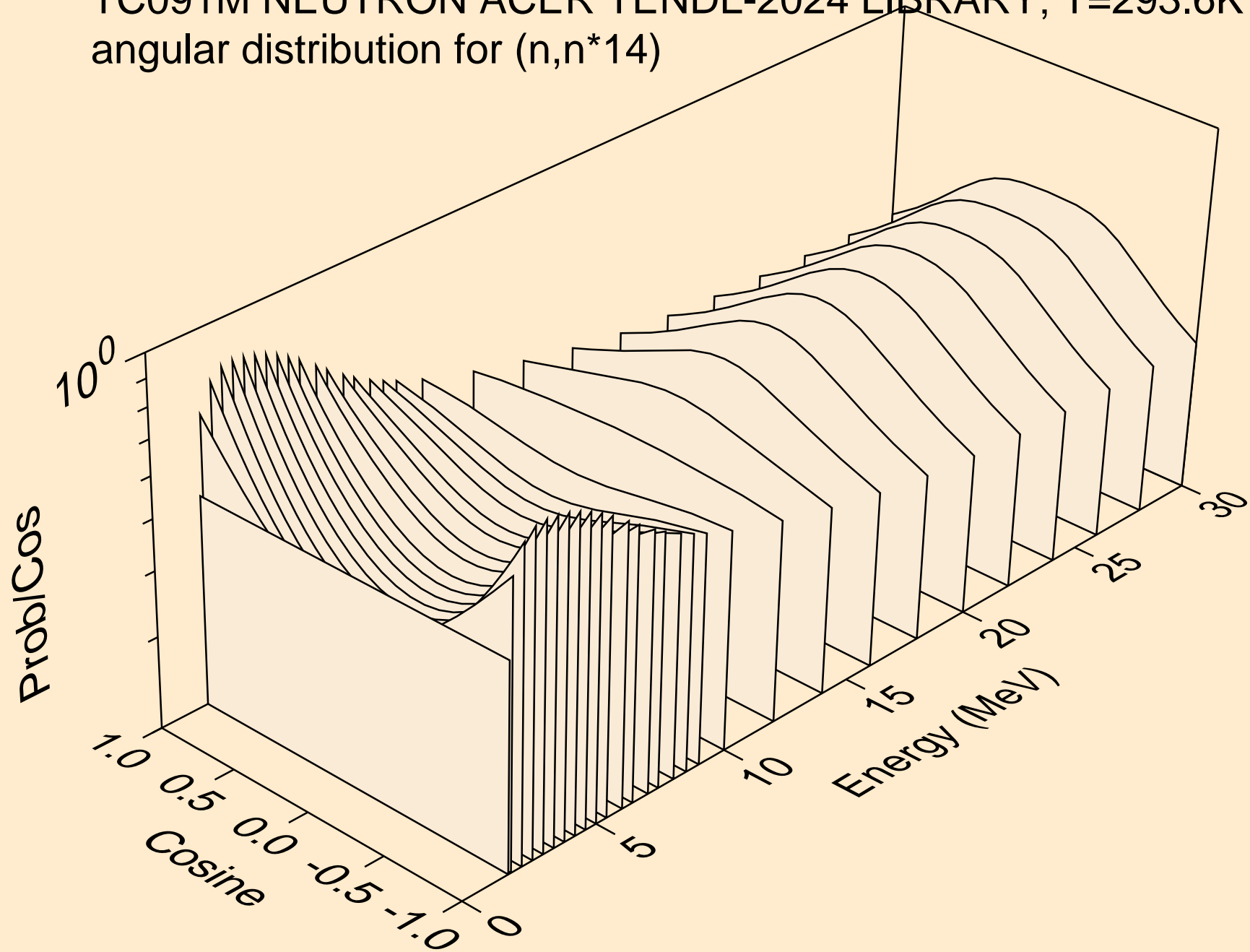

TC091M NEUTRON ACER TENDL-2024 LIBRARY; T=293.6K  
angular distribution for (n,n\*15)

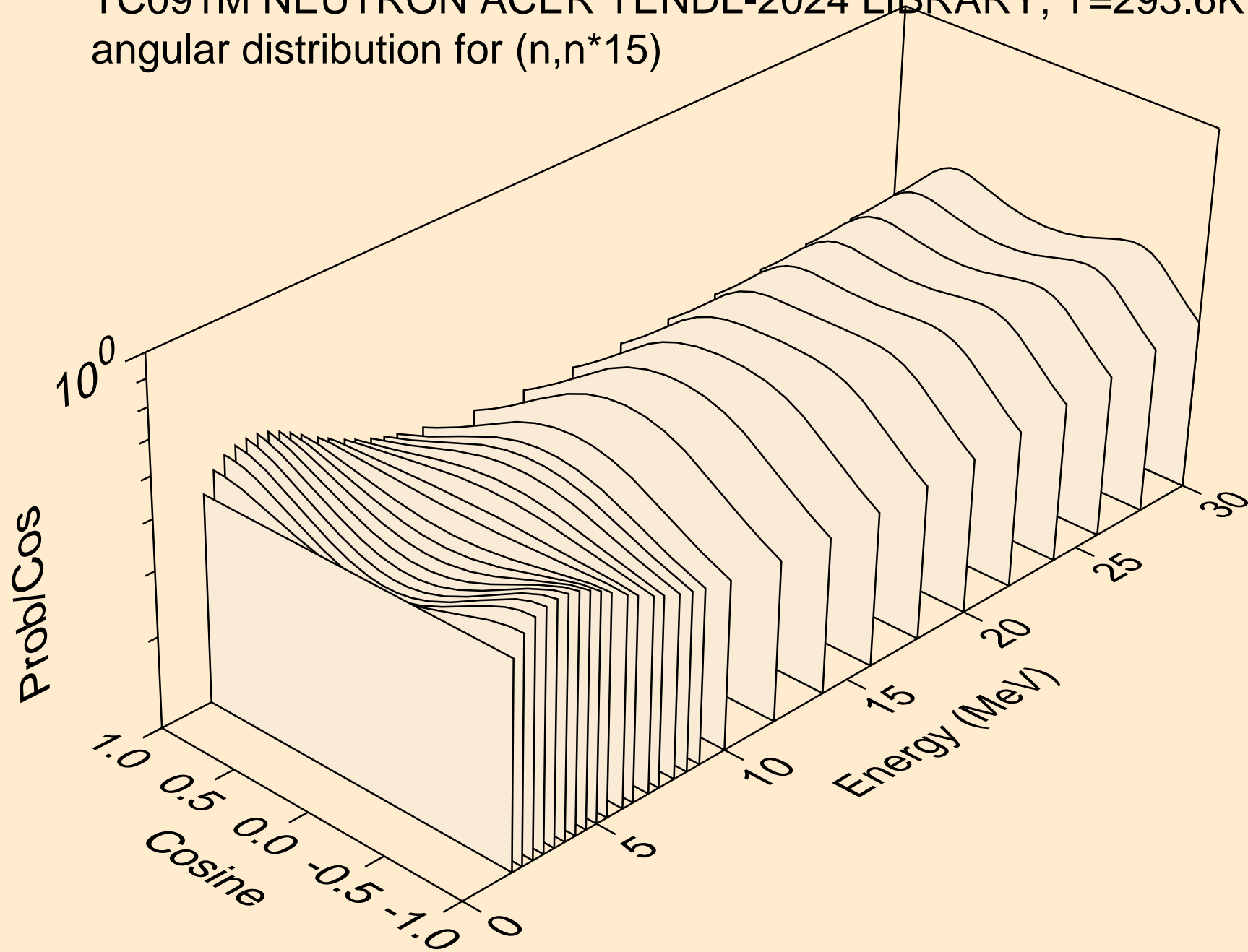

TC091M NEUTRON ACER TENDL-2024 LIBRARY; T=293.6K  
angular distribution for (n,n\*16)

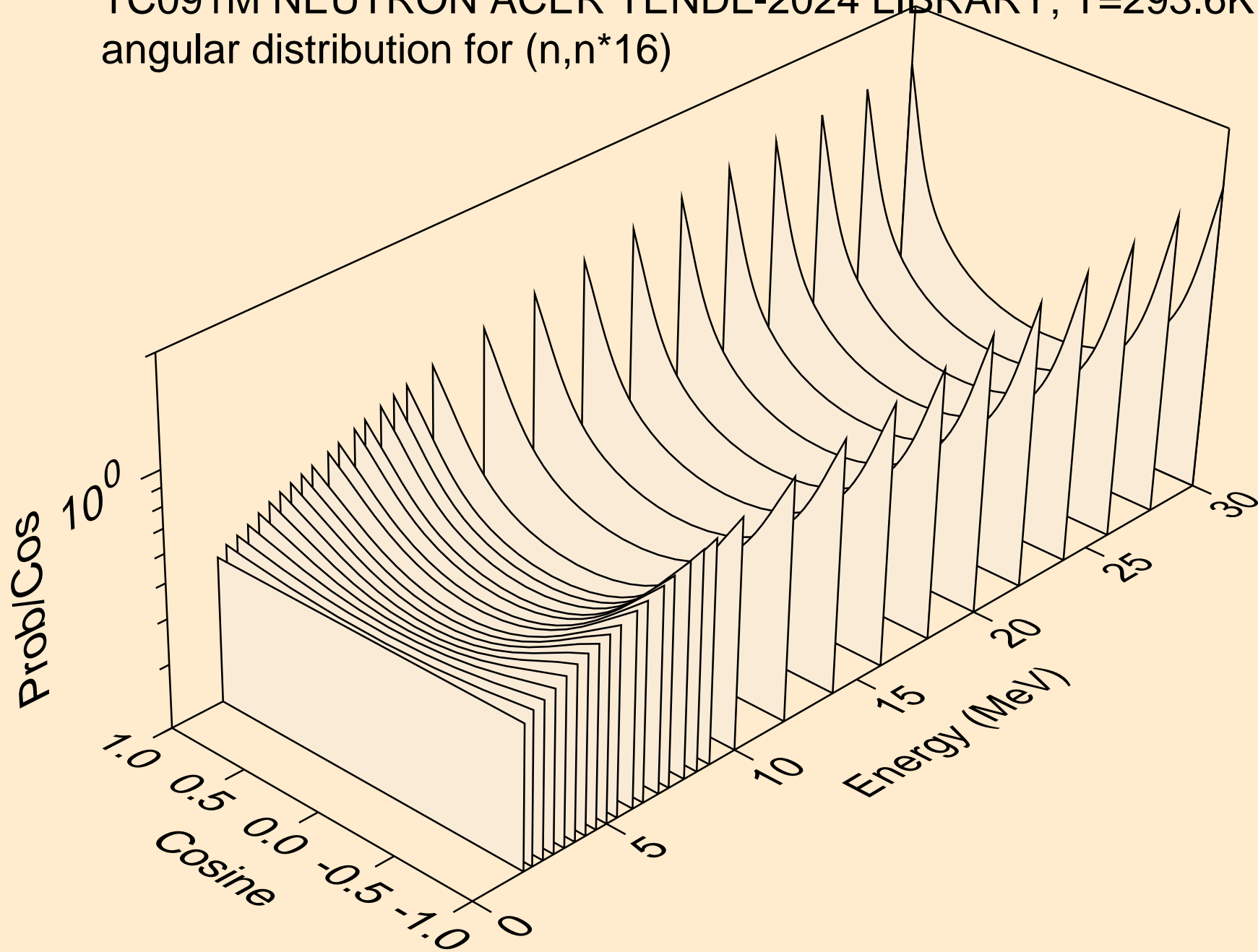

TC091M NEUTRON ACER TENDL-2024 LIBRARY; T=293.6K  
Neutron emission for (n,x)

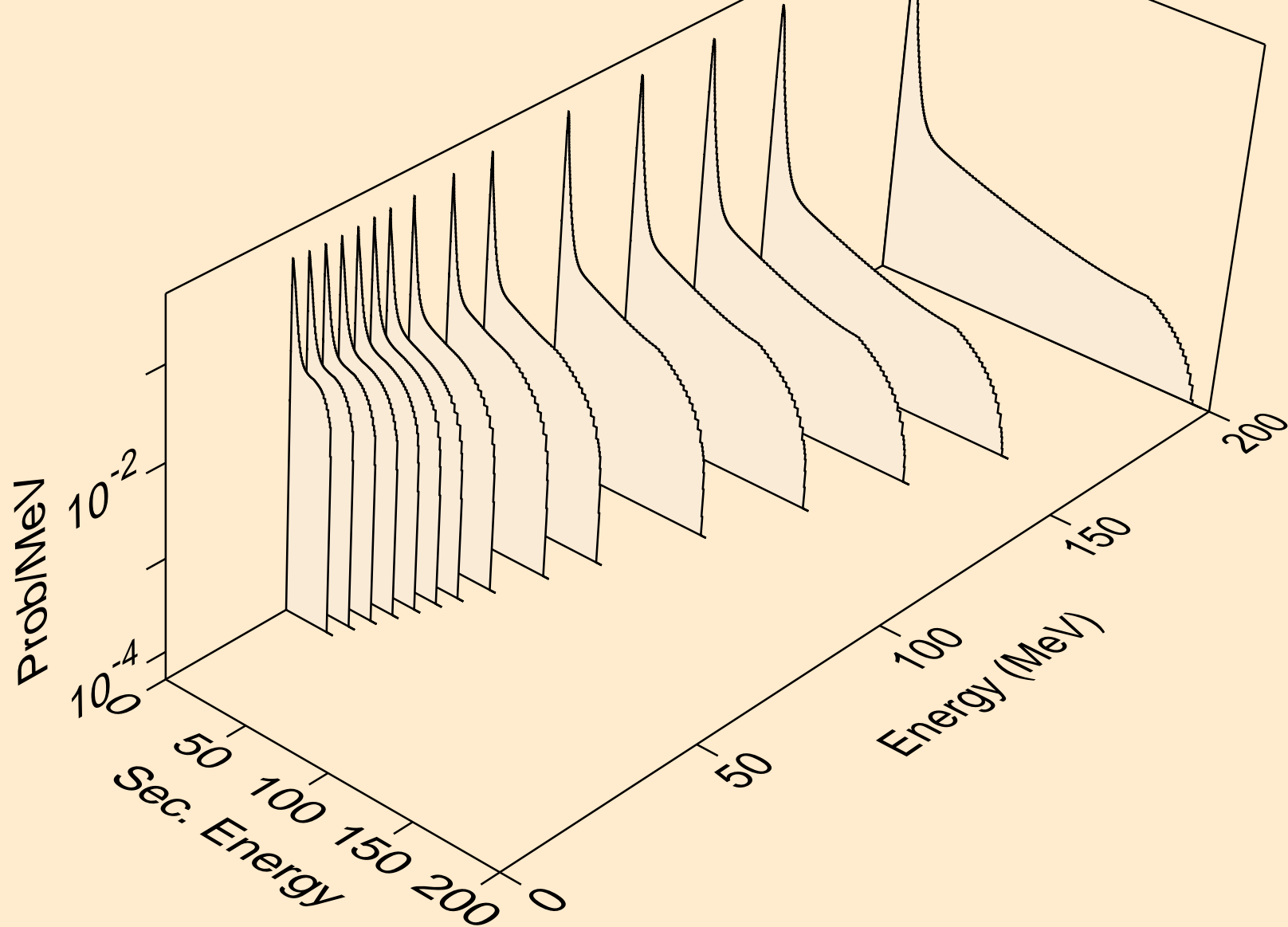

TC091M NEUTRON ACER TENDL-2024 LIBRARY; T=293.6K  
Neutron emission for (n,2nd)

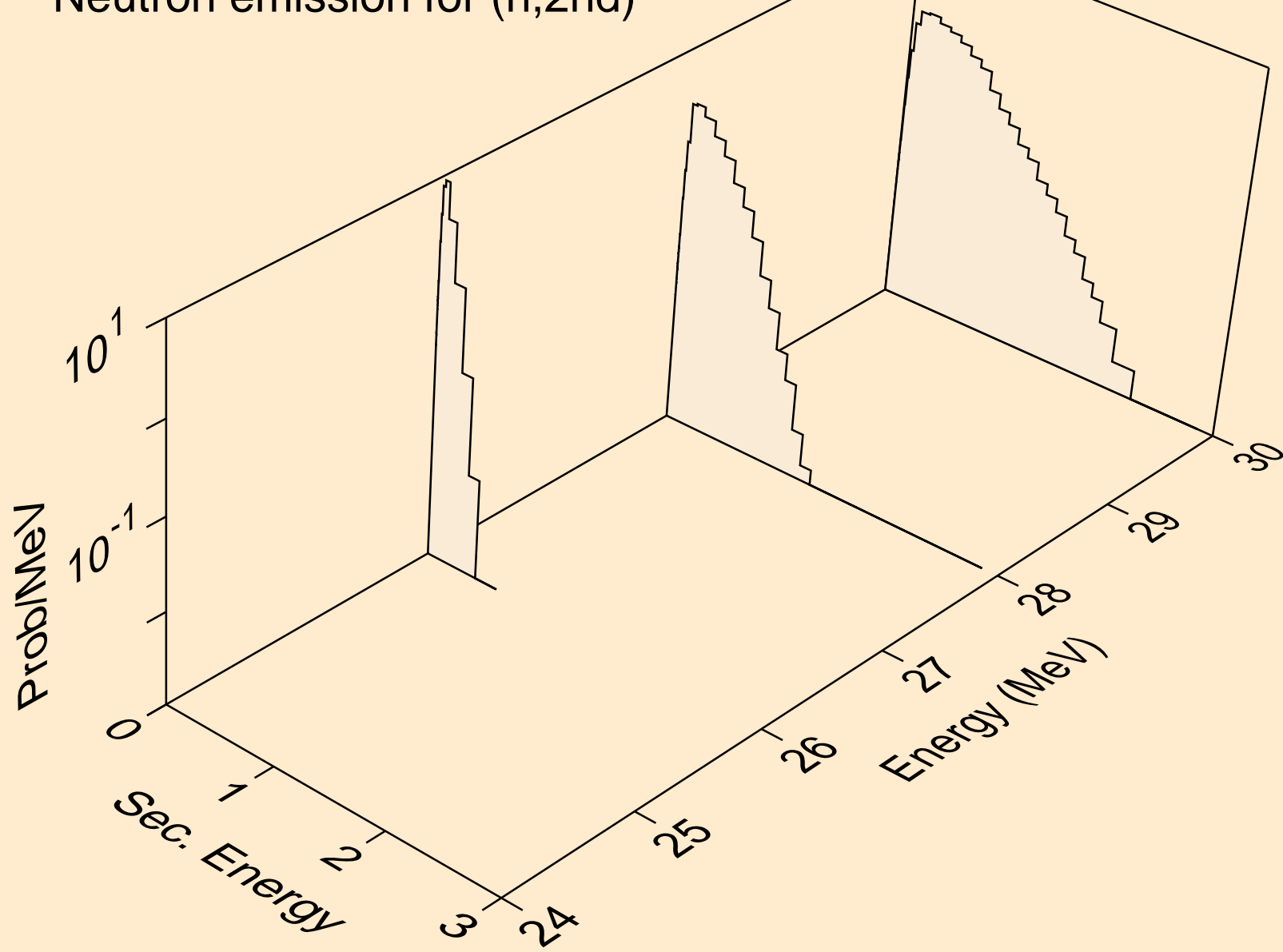

TC091M NEUTRON ACER TENDL-2024 LIBRARY; T=293.6K  
Neutron emission for (n,2n)

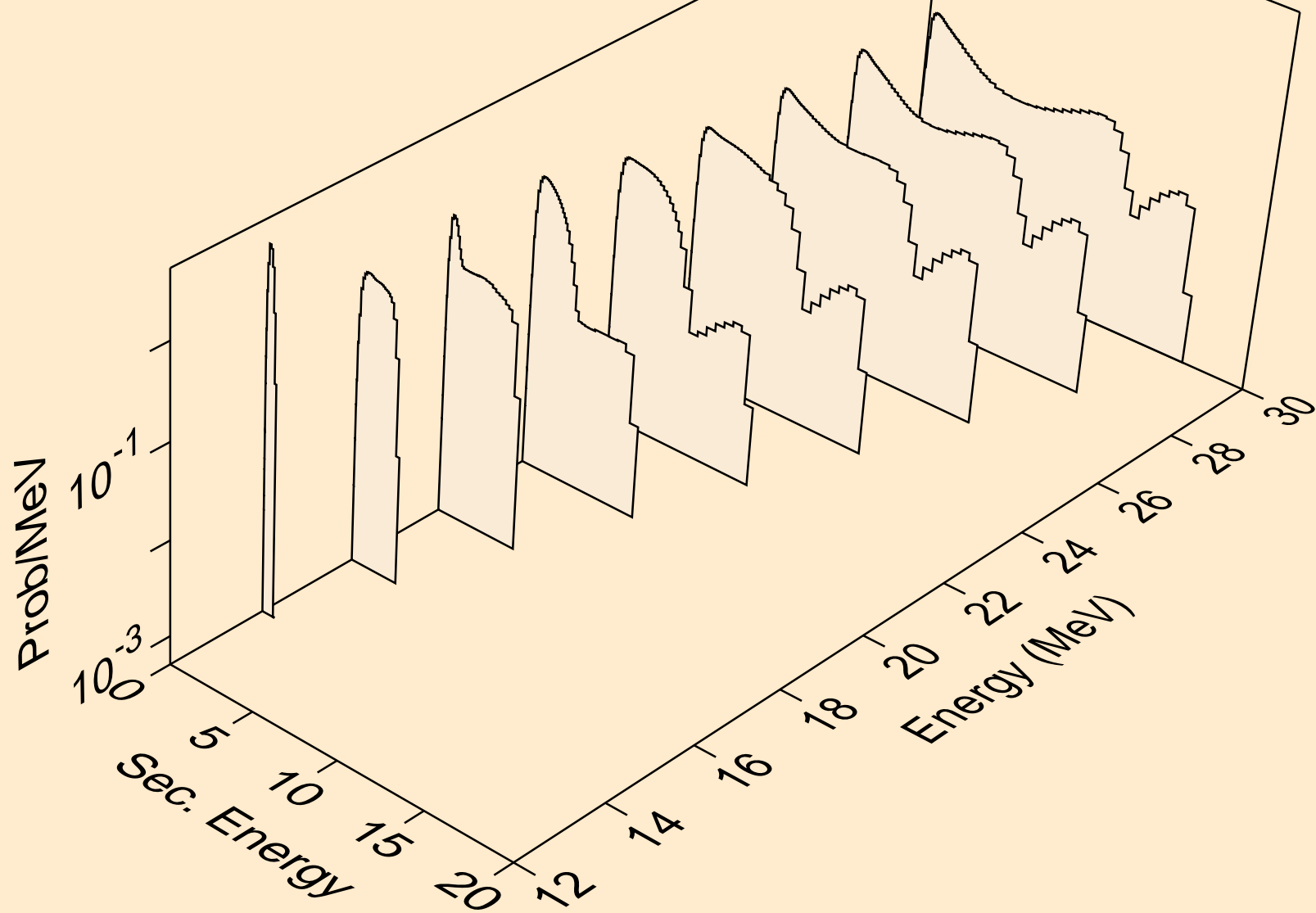

TC091M NEUTRON ACER TENDL-2024 LIBRARY; T=293.6K  
Neutron emission for (n,3n)

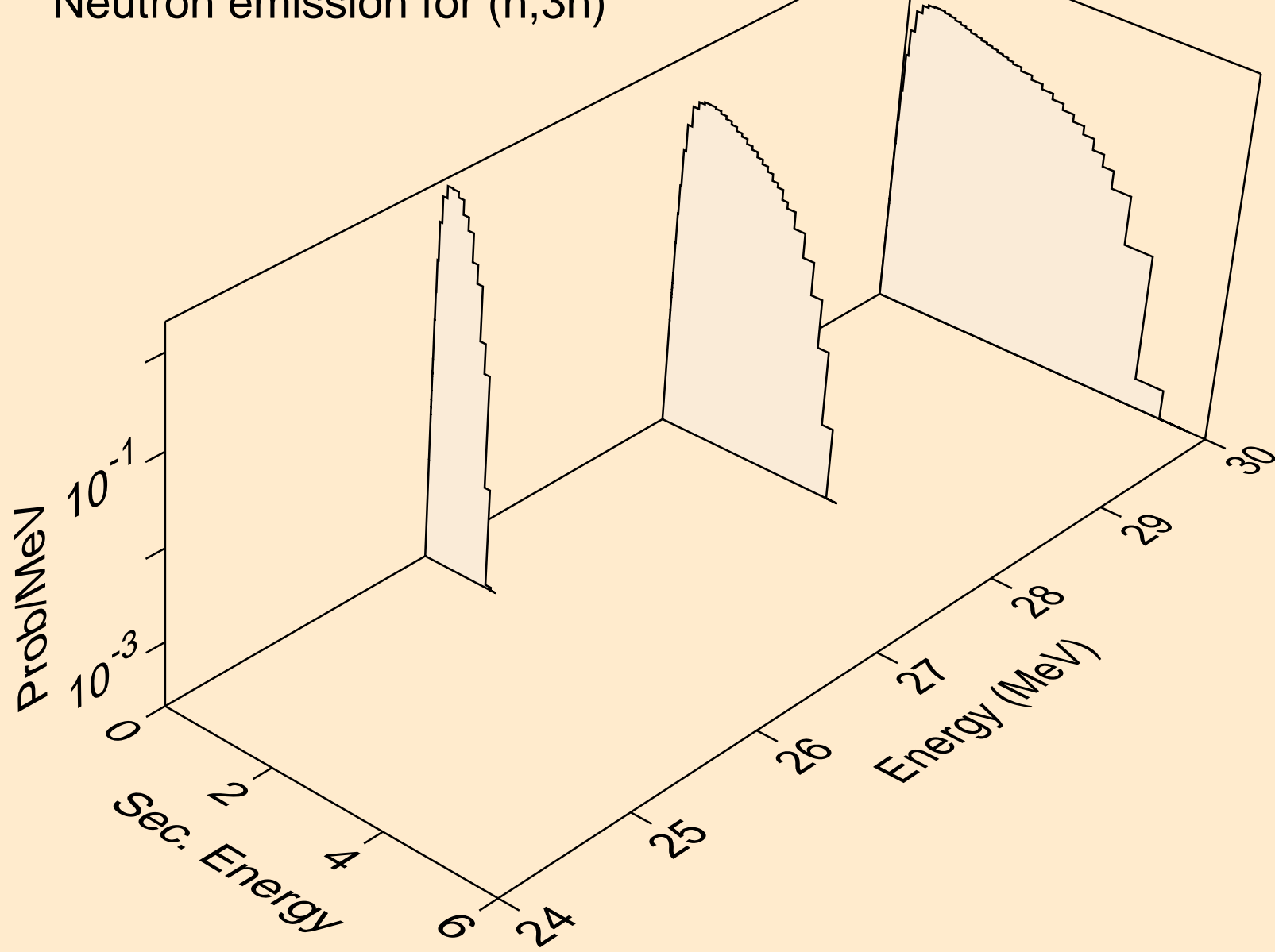

TC091M NEUTRON ACER TENDL-2024 LIBRARY; T=293.6K  
Neutron emission for (n,n\*)a

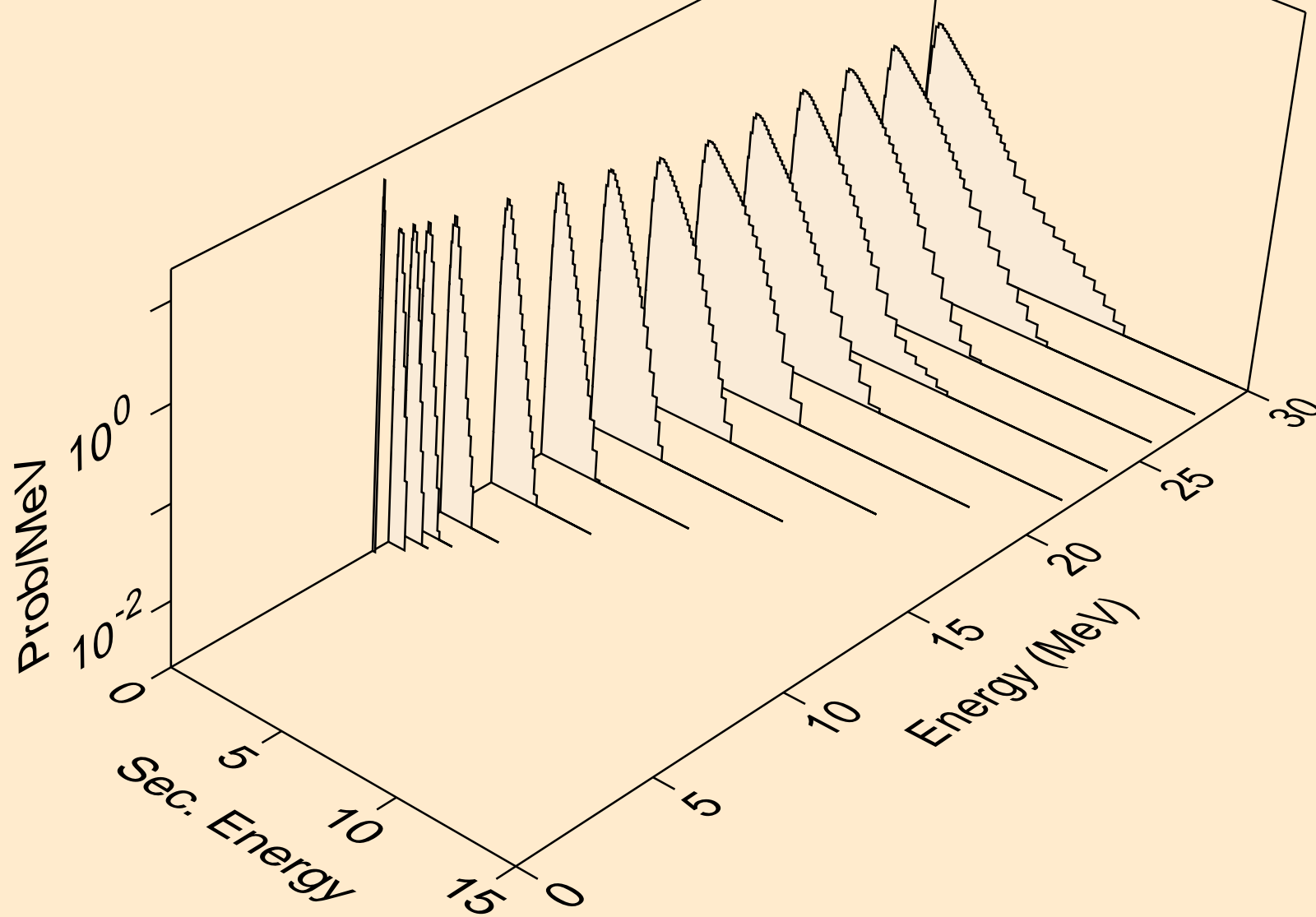

TC091M NEUTRON ACER TENDL-2024 LIBRARY; T=293.6K  
Neutron emission for (n,2n)a

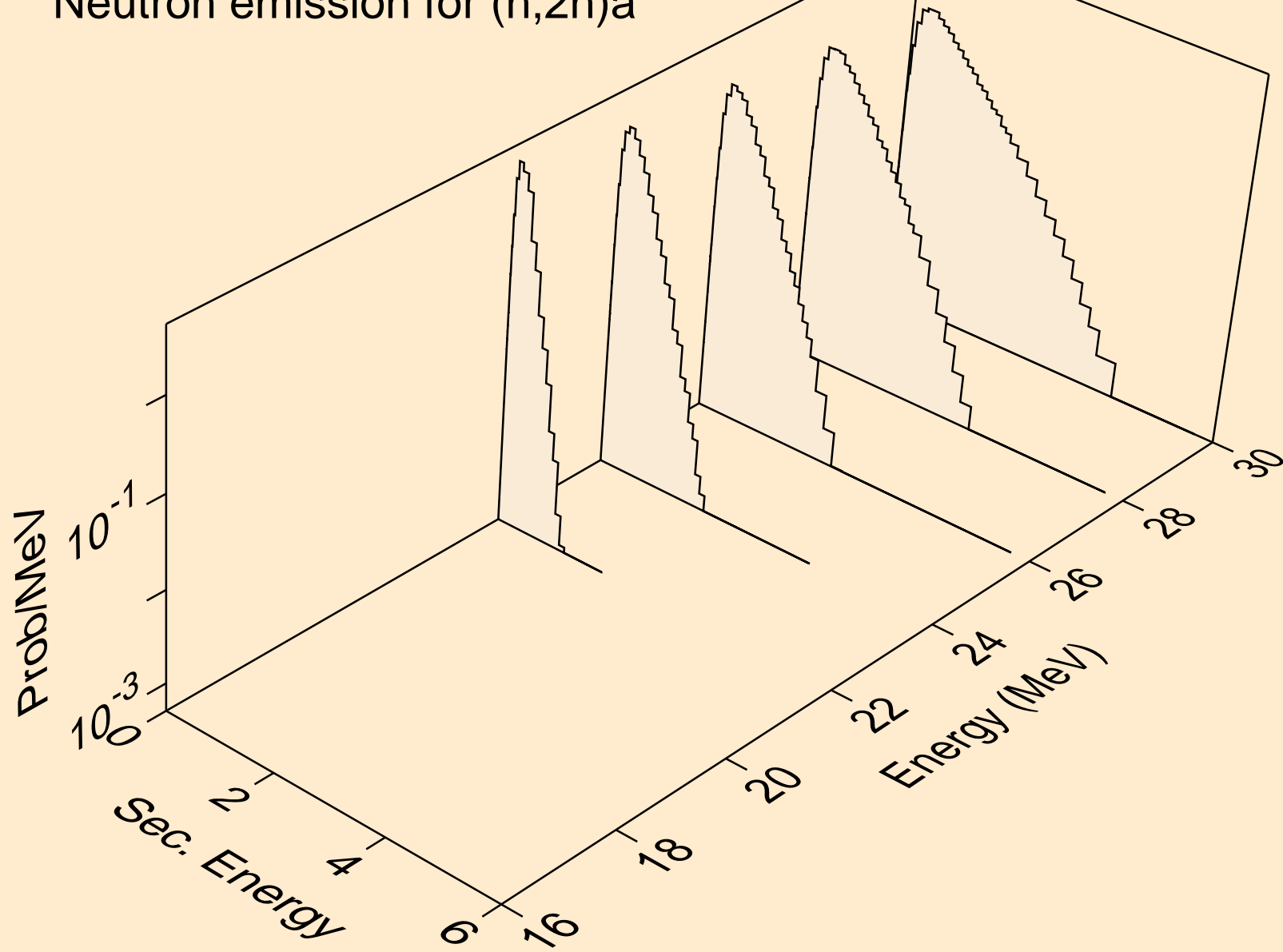

TC091M NEUTRON ACER TENDL-2024 LIBRARY; T=293.6K  
Neutron emission for (n,n\*)p

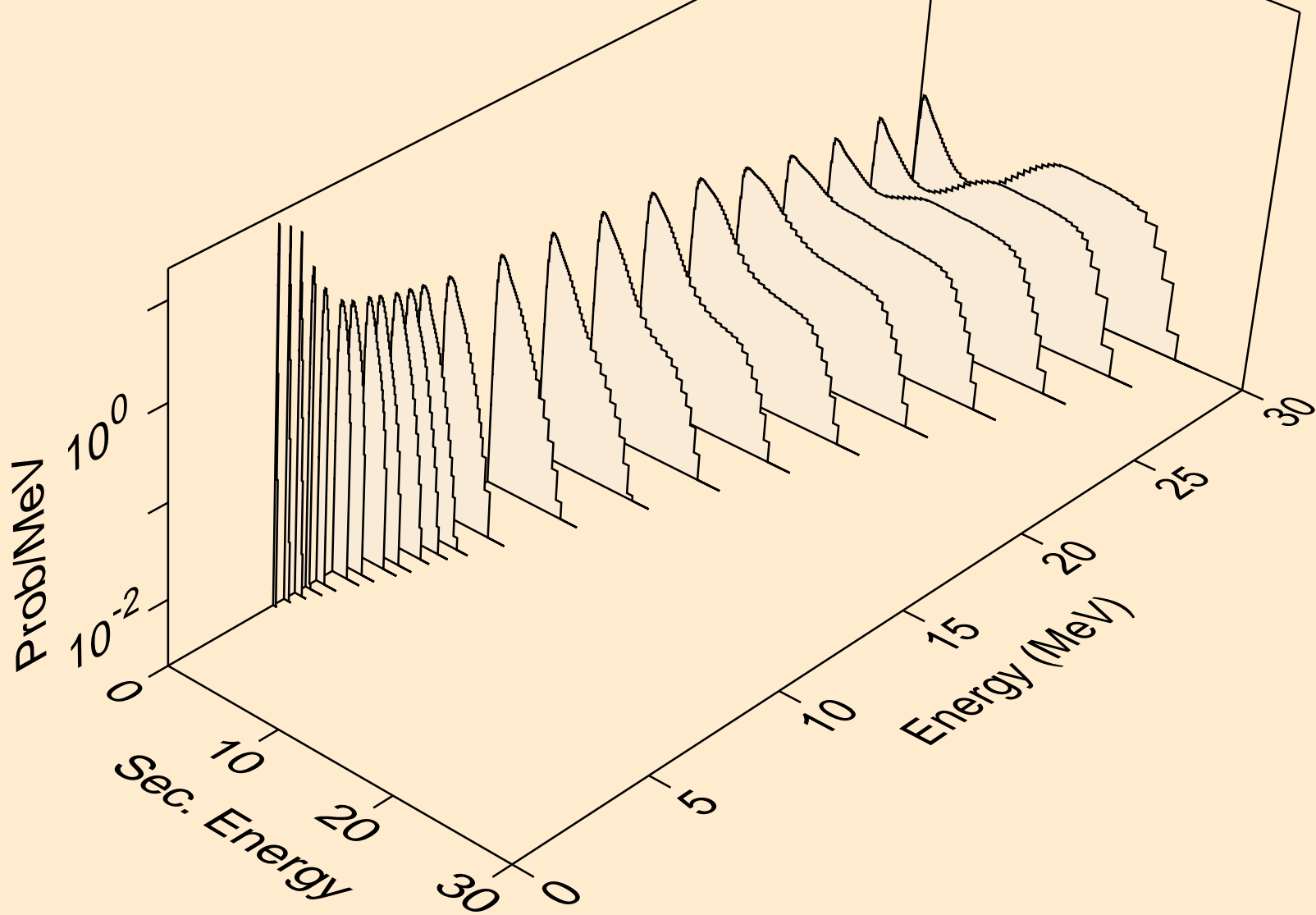

TC091M NEUTRON ACER TENDL-2024 LIBRARY; T=293.6K  
Neutron emission for (n,n\*)2a

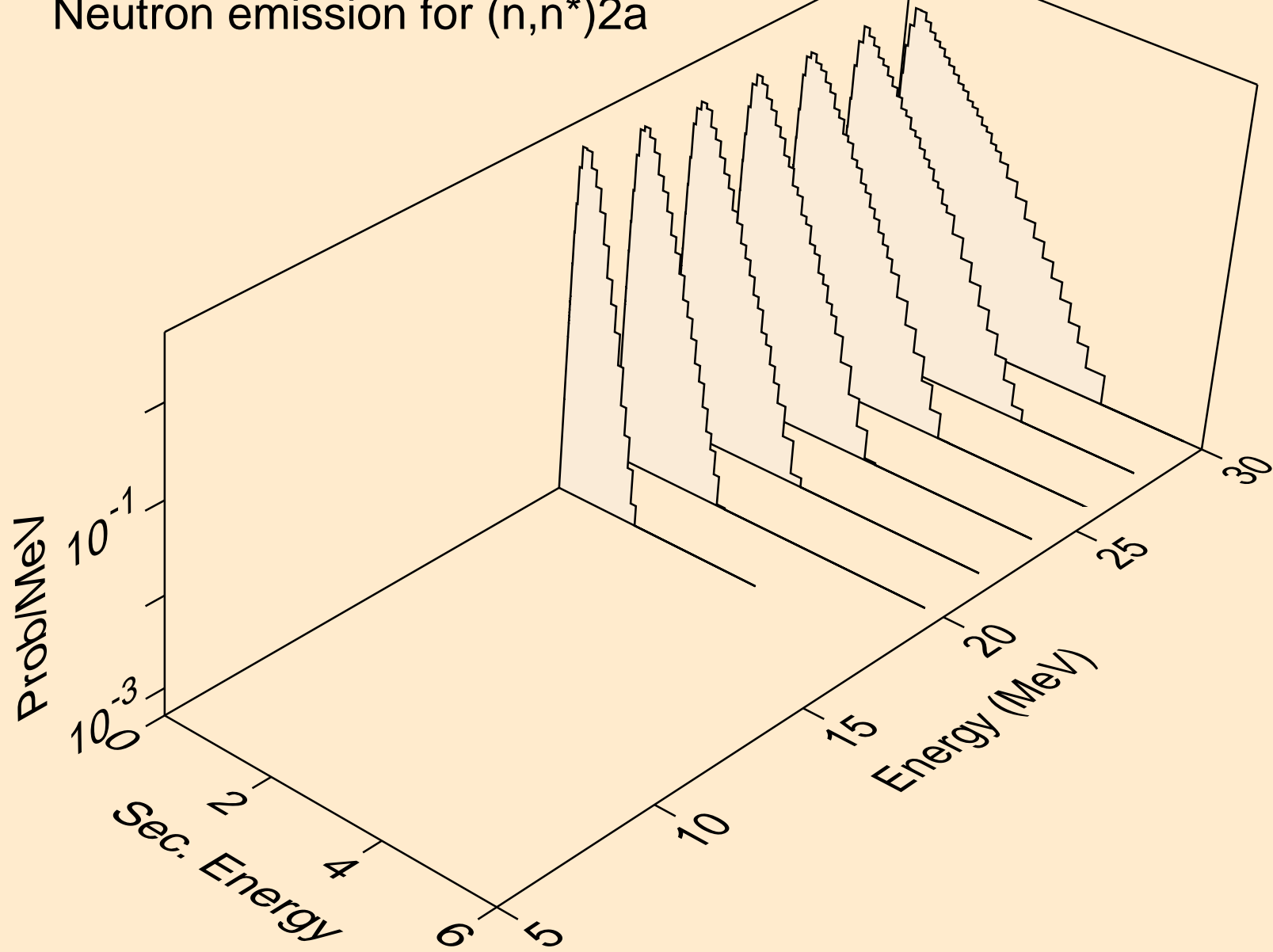

TC091M NEUTRON ACER TENDL-2024 LIBRARY; T=293.6K  
Neutron emission for (n,n\*)d

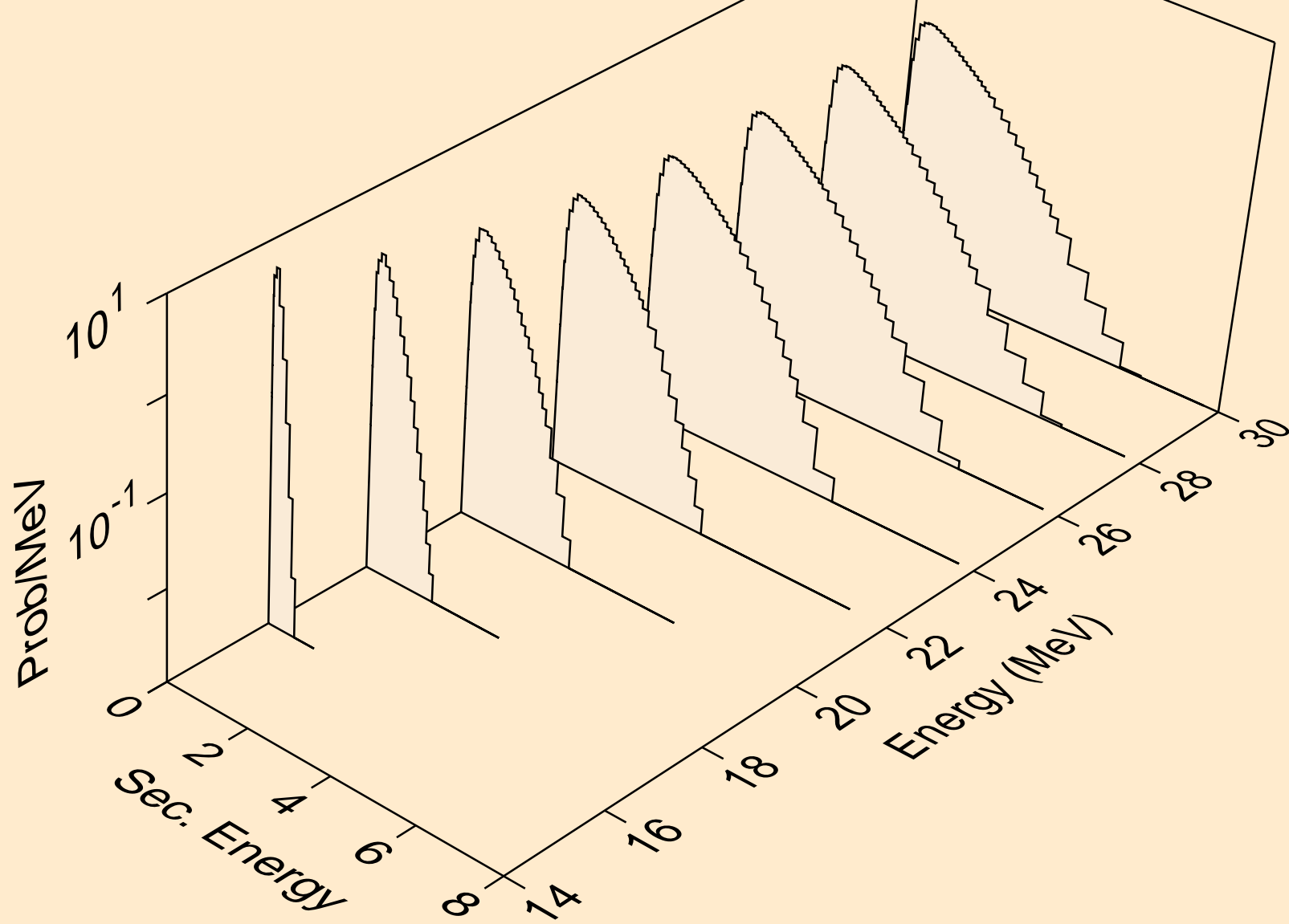

TC091M NEUTRON ACER TENDL-2024 LIBRARY; T=293.6K  
Neutron emission for (n,n\*)t

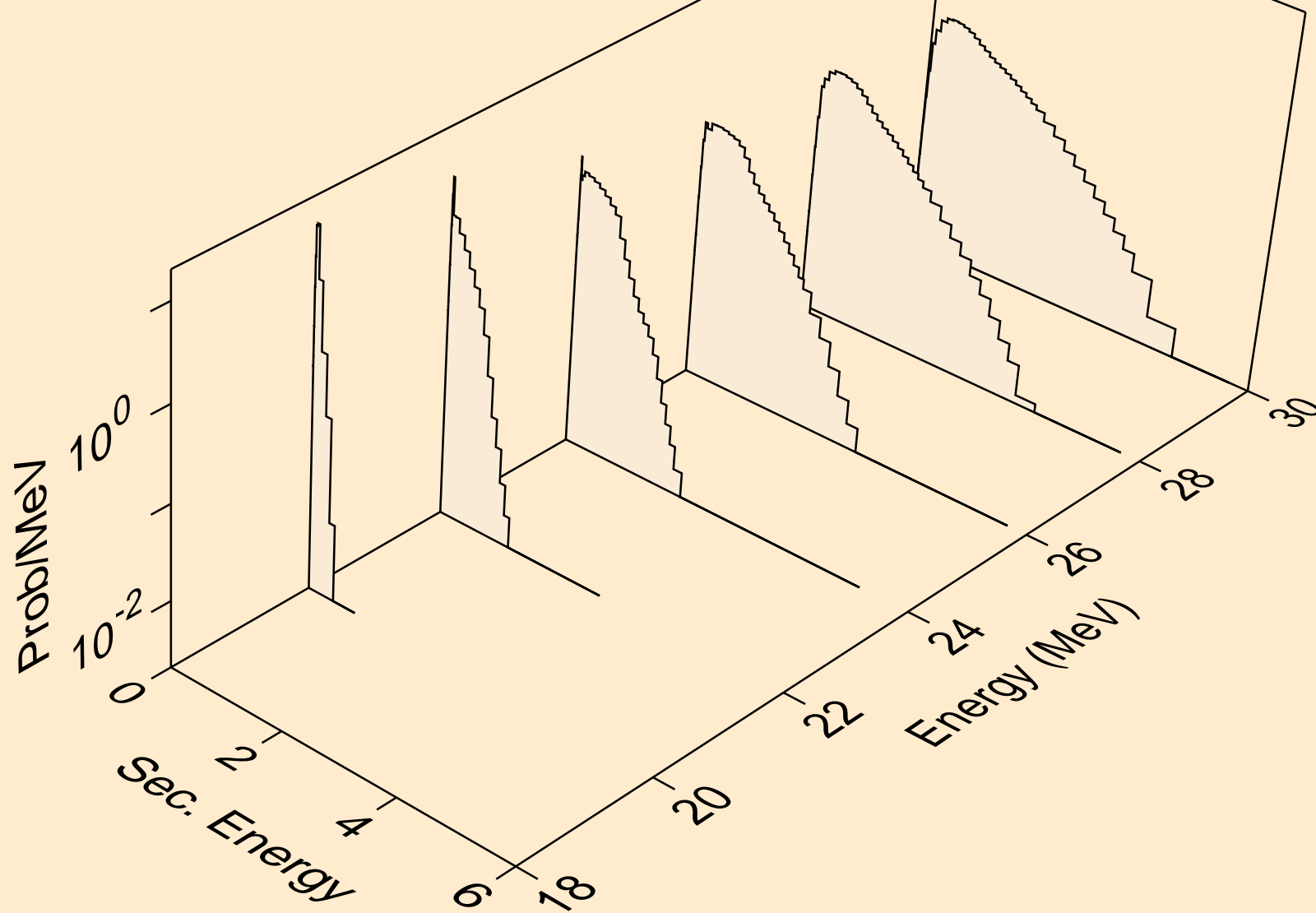

TC091M NEUTRON ACER TENDL-2024 LIBRARY; T=293.6K  
Neutron emission for (n,n\*)he3

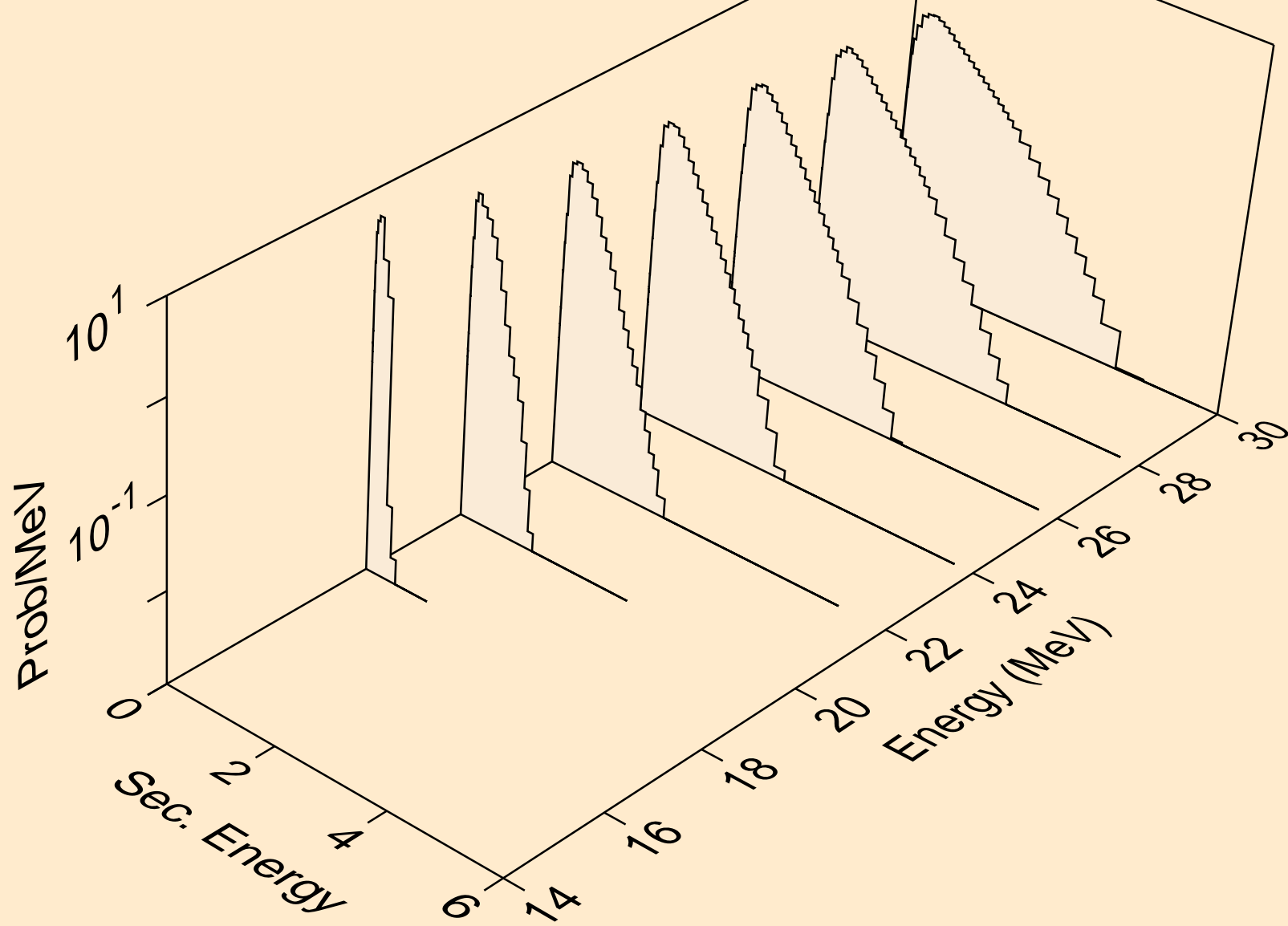

TC091M NEUTRON ACER TENDL-2024 LIBRARY; T=293.6K  
Neutron emission for (n,2np)

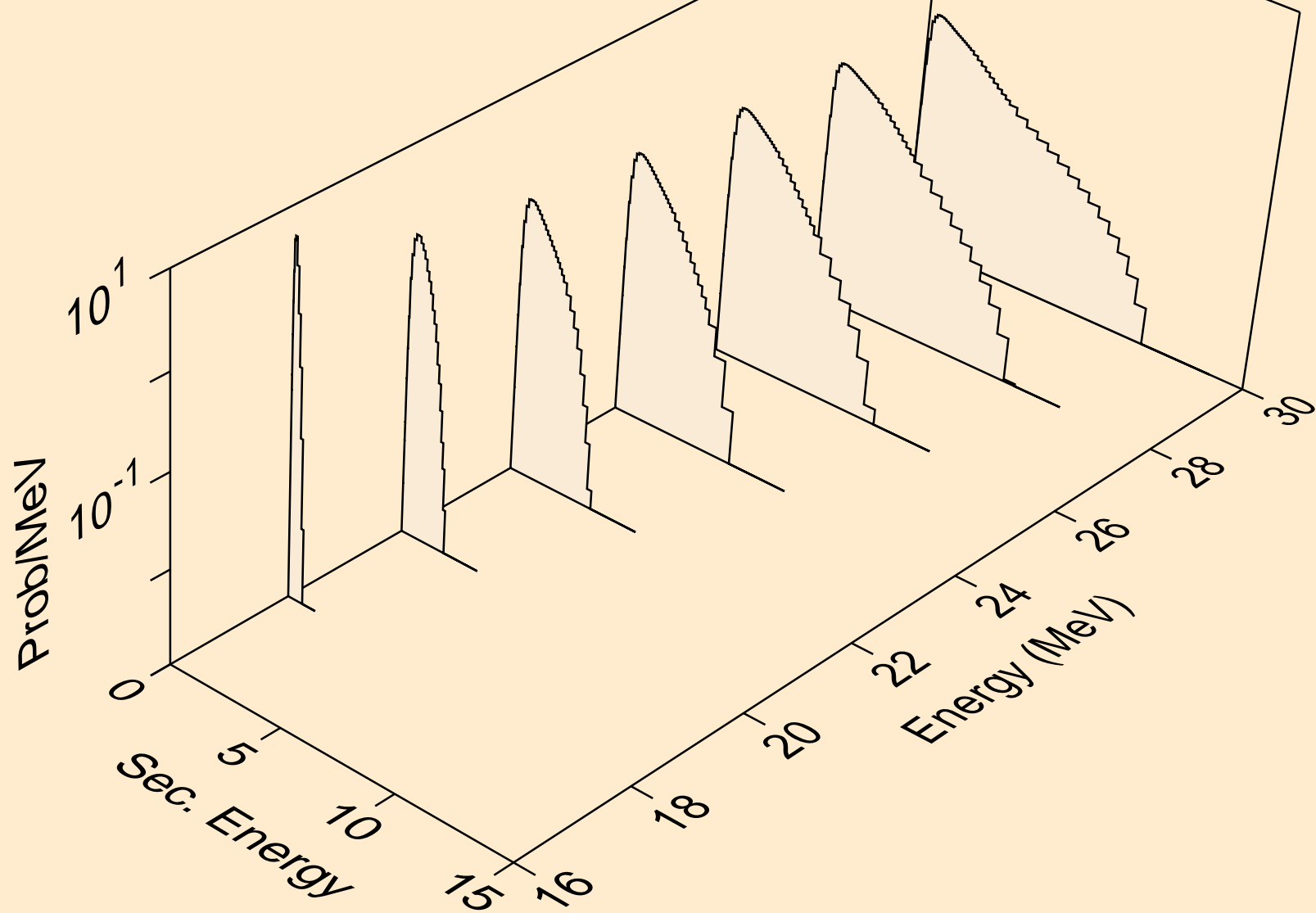

TC091M NEUTRON ACER TENDL-2024 LIBRARY; T=293.6K  
Neutron emission for (n,3np)

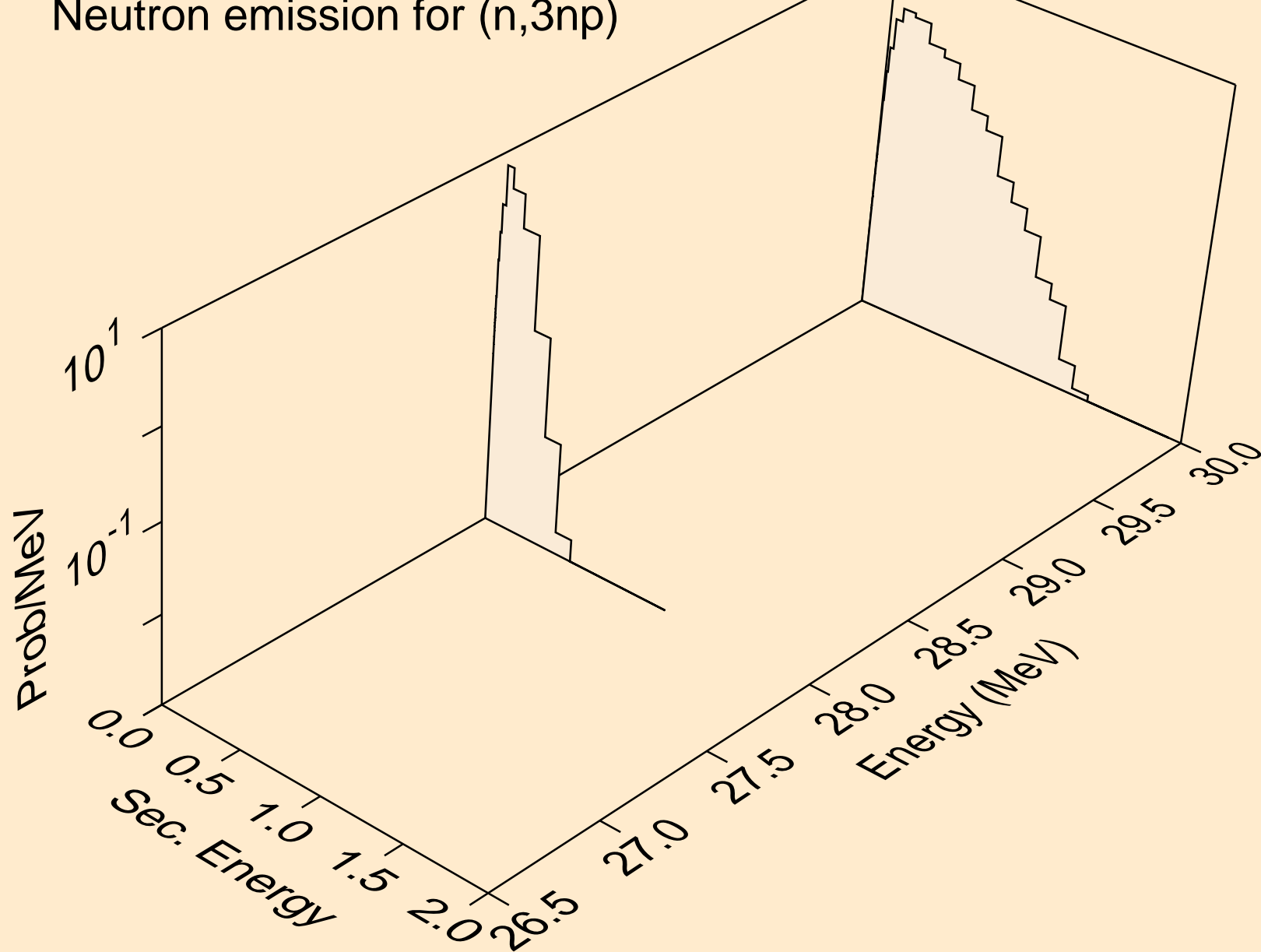

TC091M NEUTRON ACER TENDL-2024 LIBRARY; T=293.6K  
Neutron emission for (n,n2p)

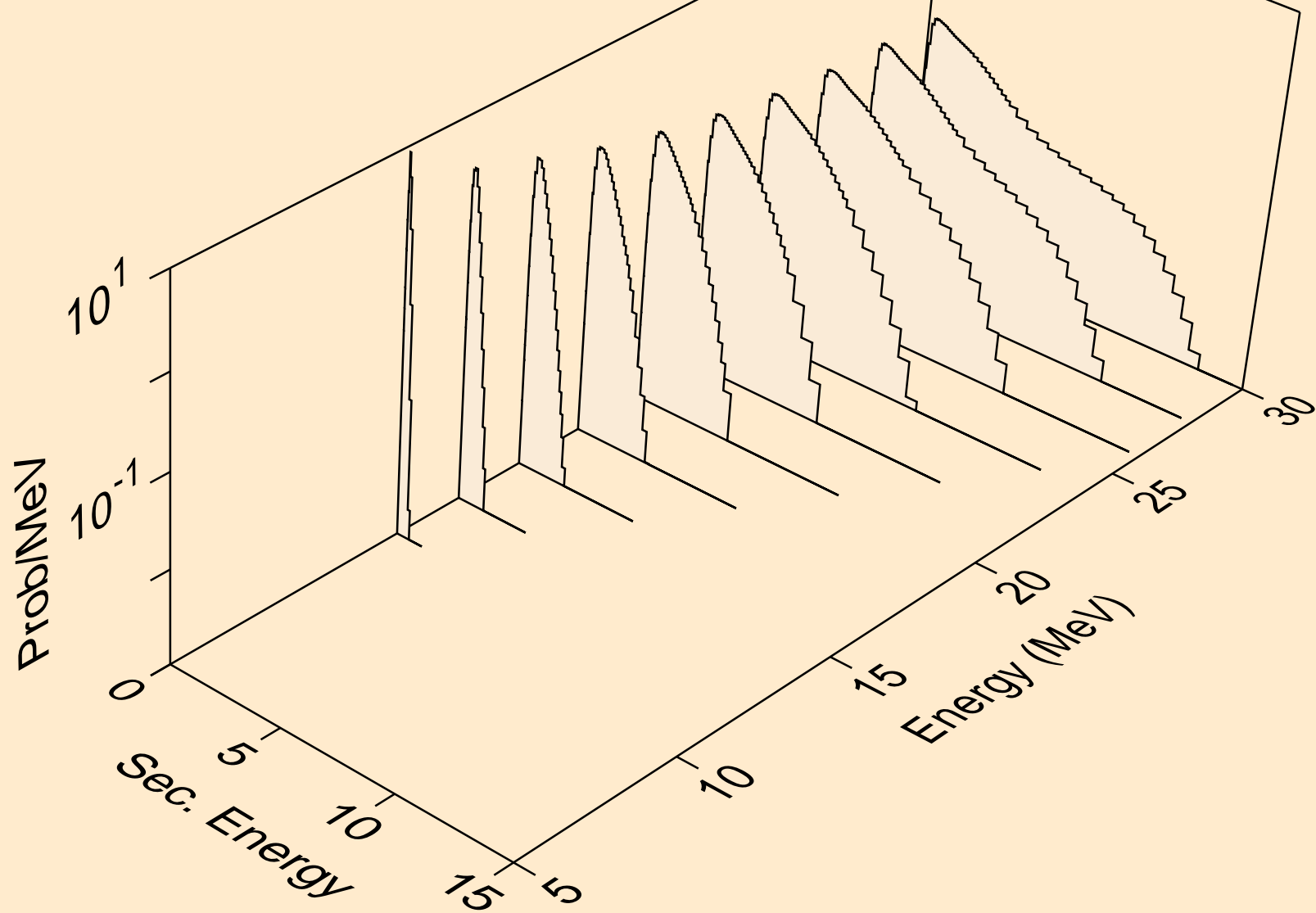

TC091M NEUTRON ACER TENDL-2024 LIBRARY; T=293.6K  
Neutron emission for (n,npa)

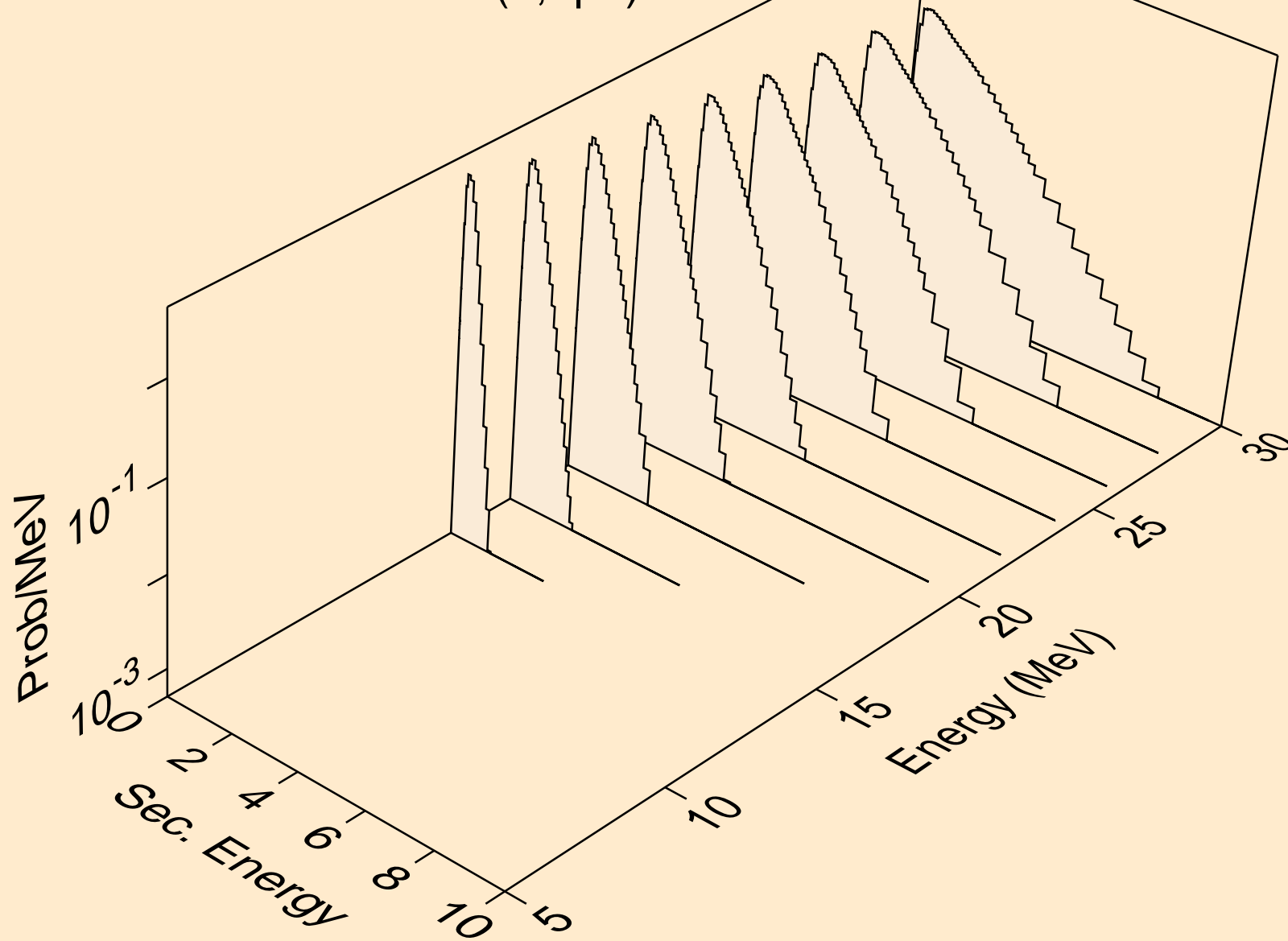

TC091M NEUTRON ACER TENDL-2024 LIBRARY; T=293.6K  
Neutron emission for (n,n\*c)

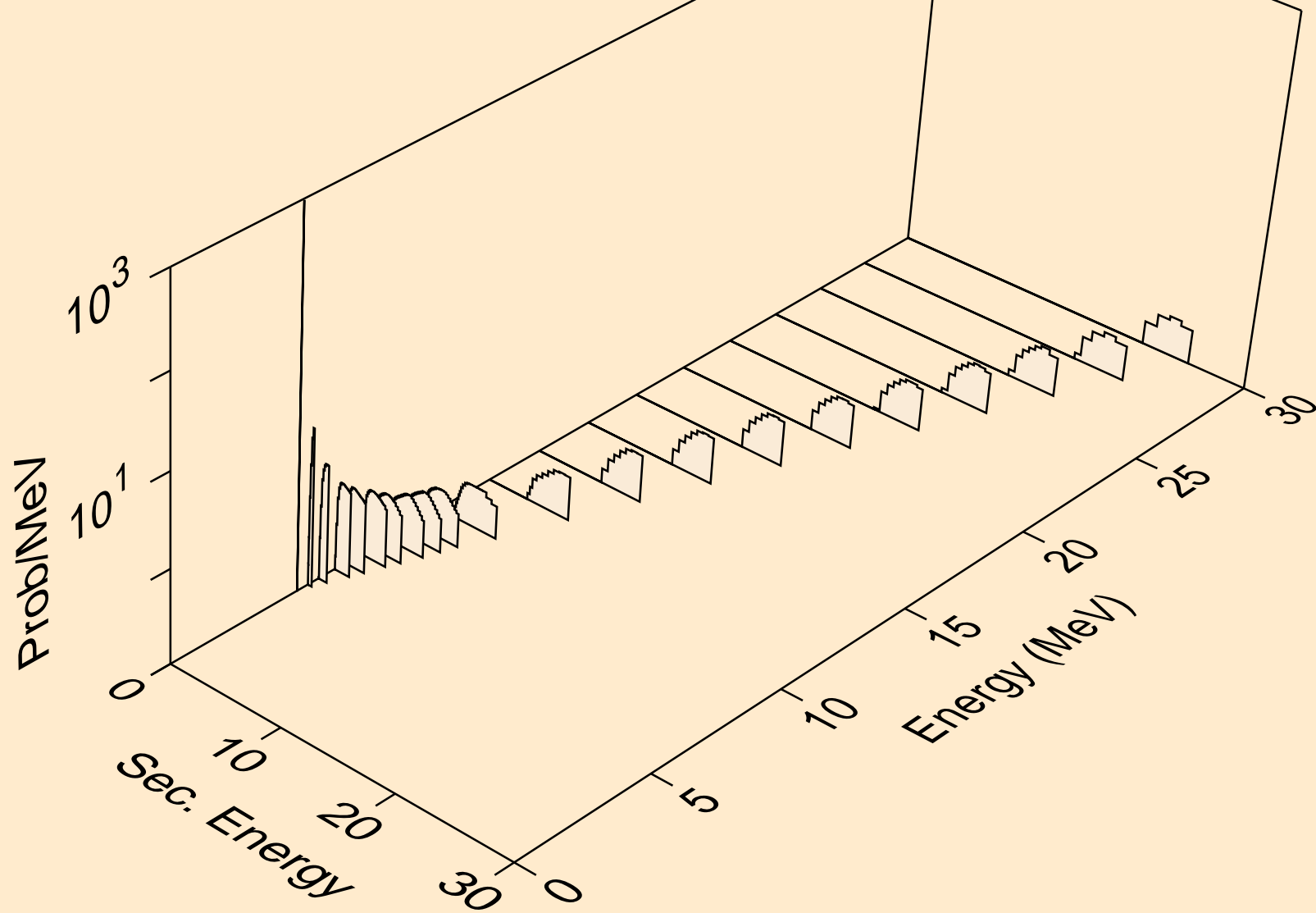

TC091M NEUTRON ACER TENDL-2024 LIBRARY; T=293.6K  
Photon emission for (n,x)

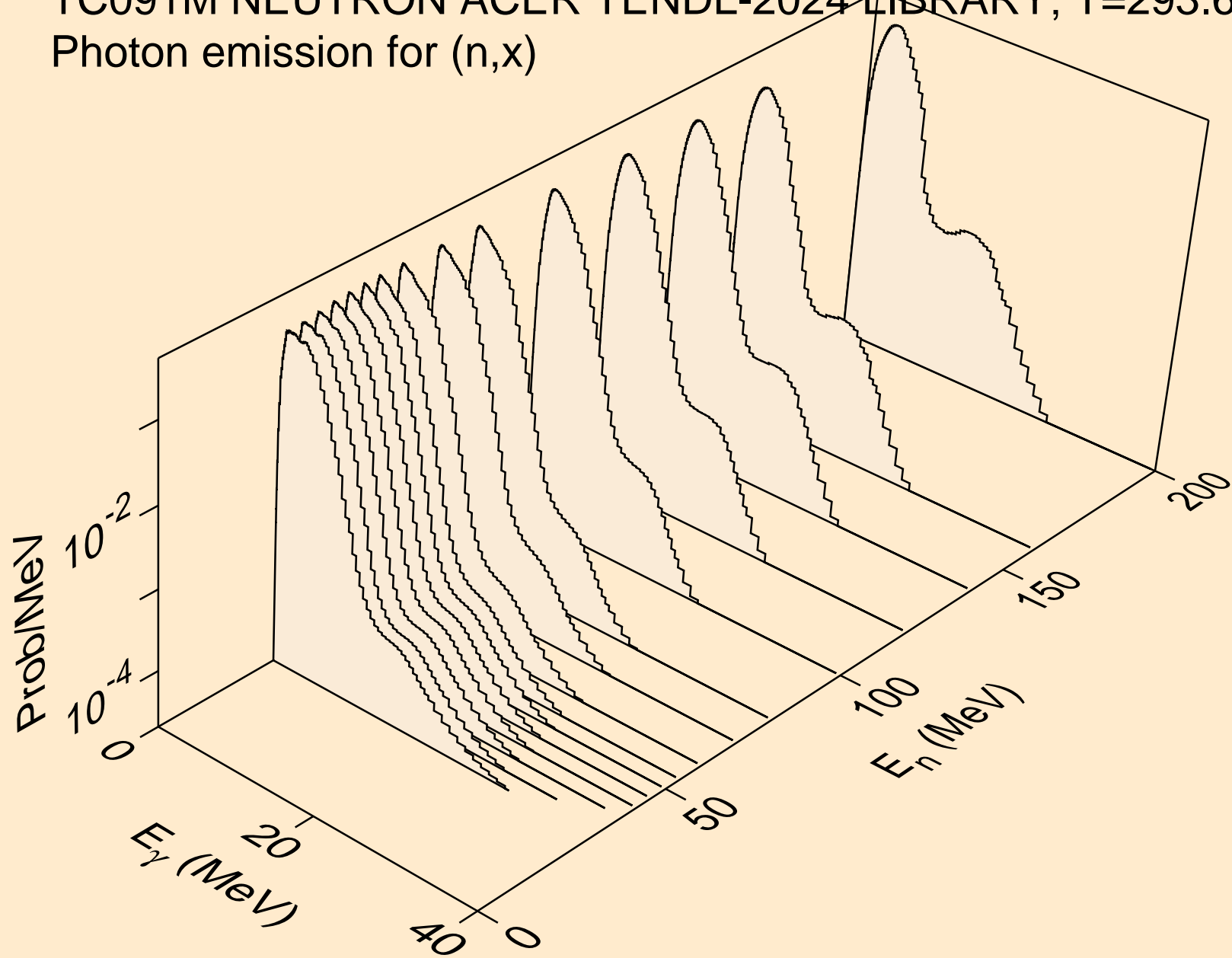

TC091M NEUTRON ACER TENDL-2024 LIBRARY; T=293.6K  
Photon emission for (n,2nd)

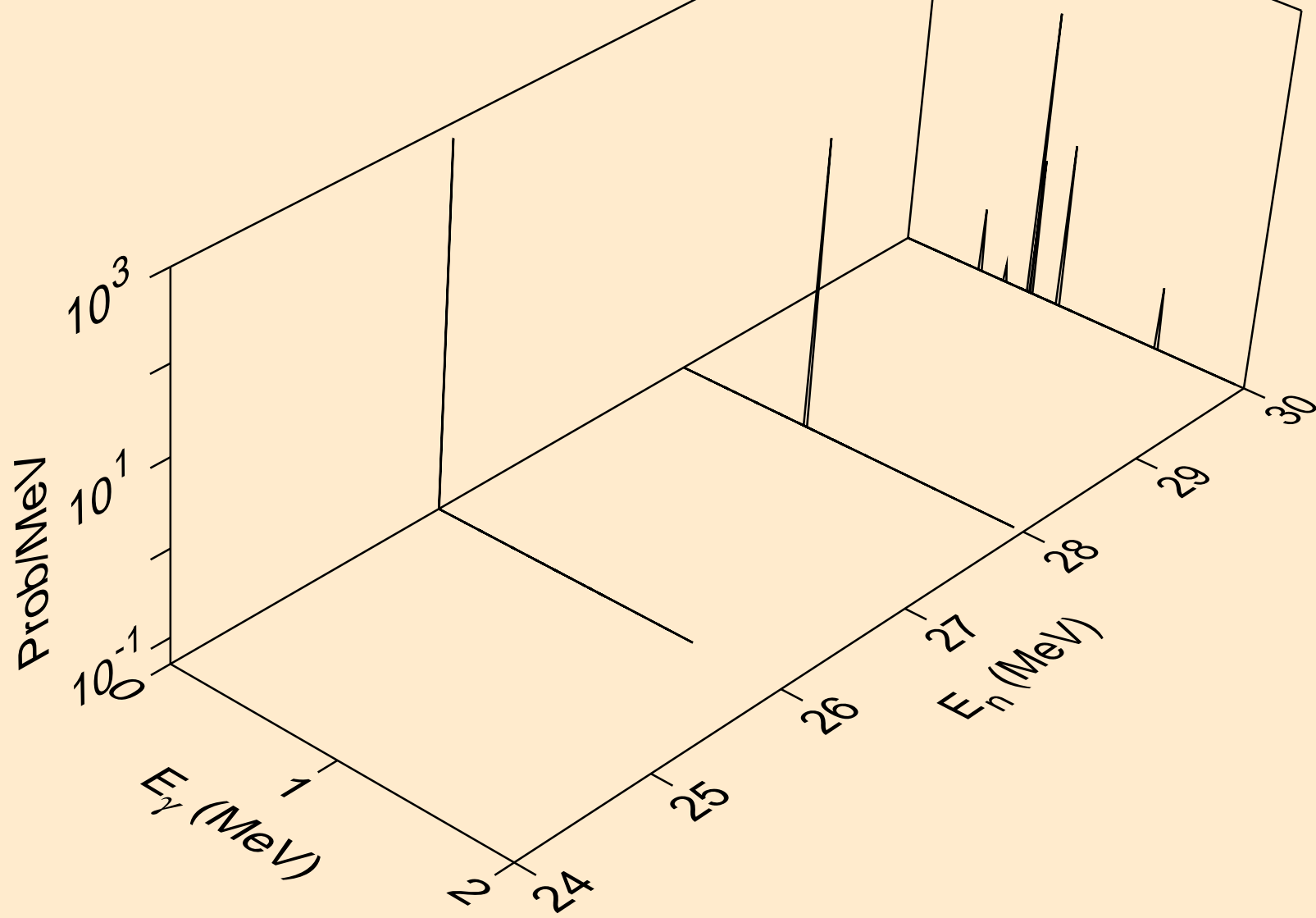

TC091M NEUTRON ACER TENDL-2024 LIBRARY; T=293.6K  
Photon emission for (n,2n)

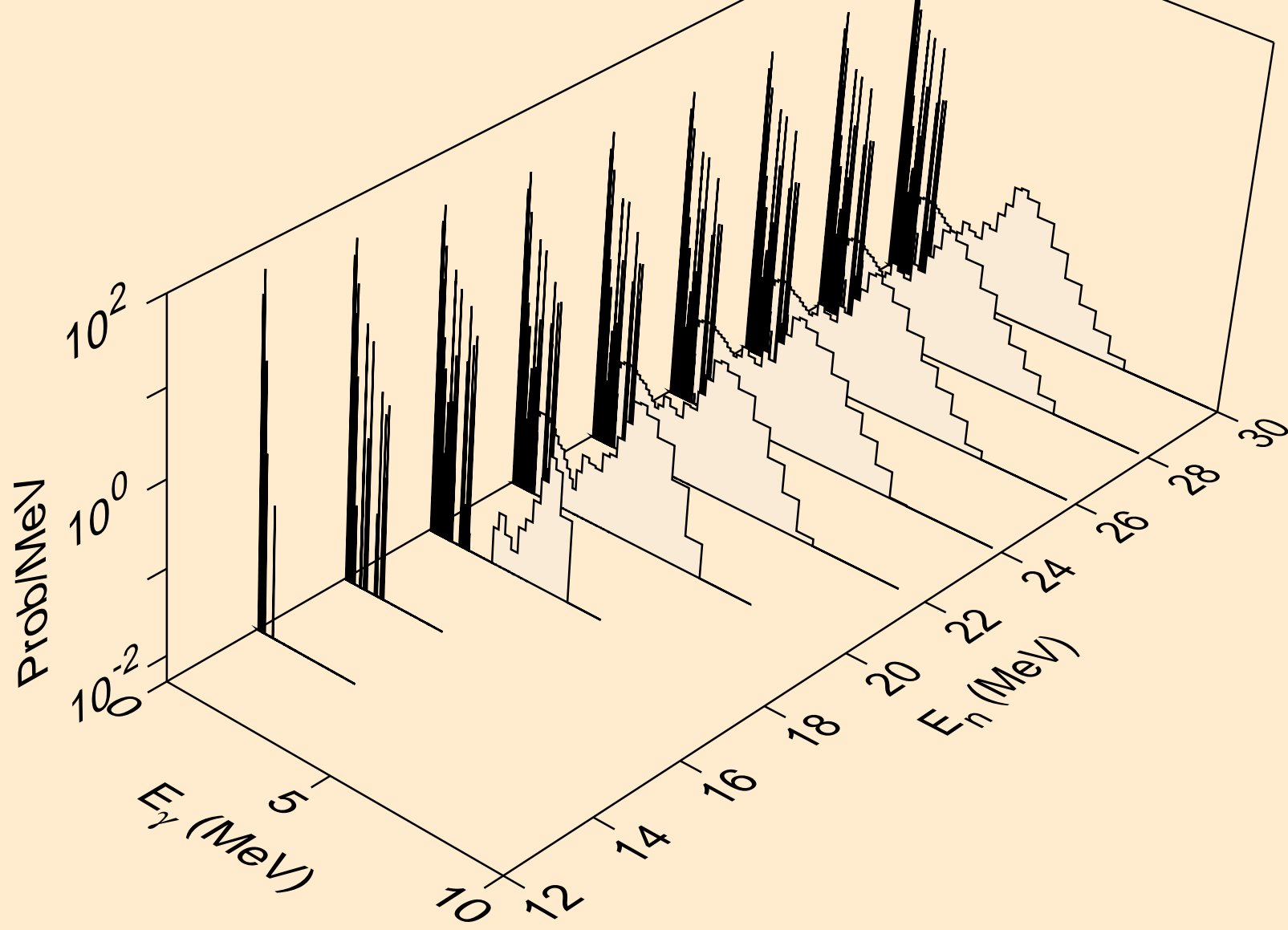

TC091M NEUTRON ACER TENDL-2024 LIBRARY; T=293.6K  
Photon emission for (n,3n)

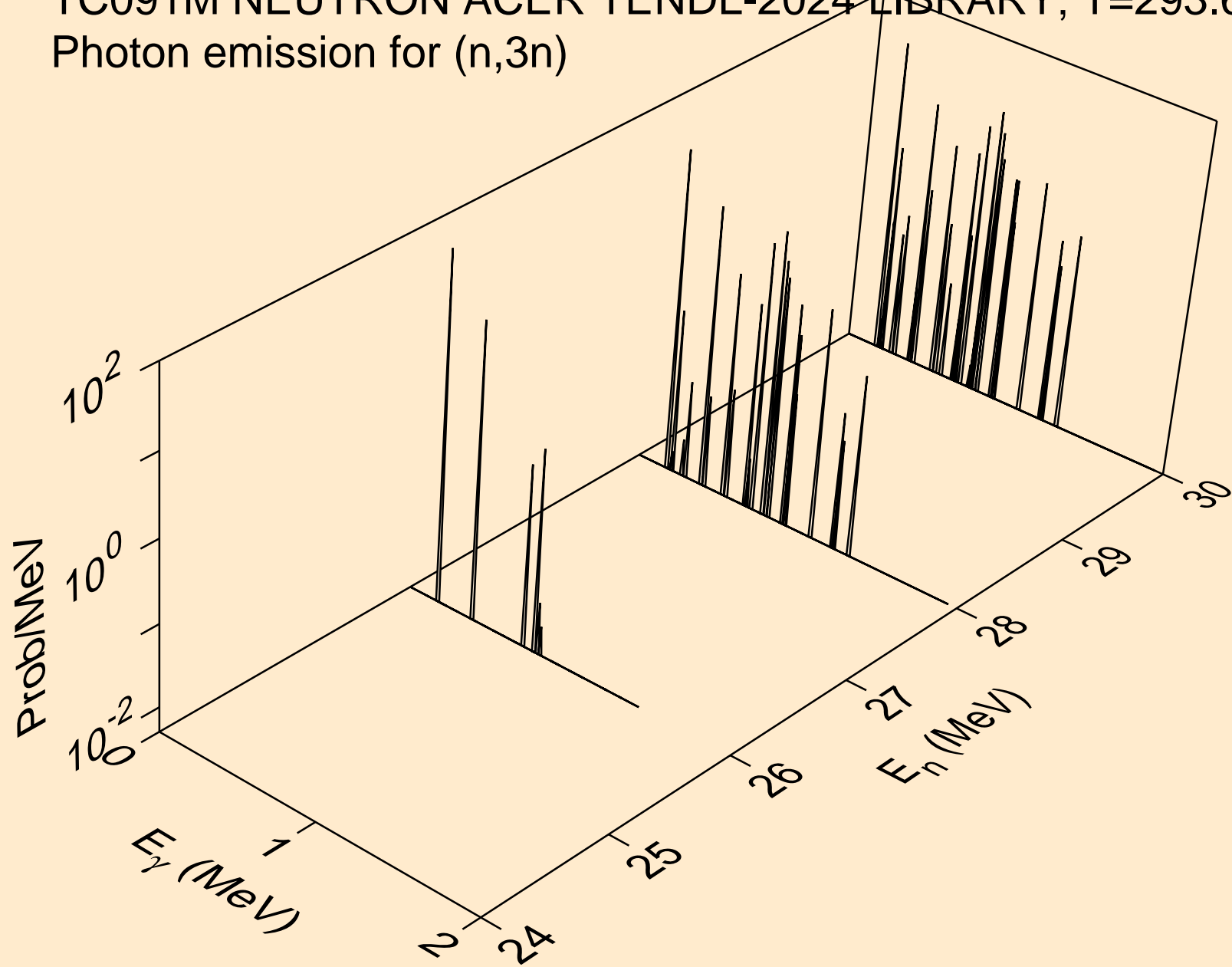

TC091M NEUTRON ACER TENDL-2024 LIBRARY; T=293.6K  
Photon emission for (n,n\*)a

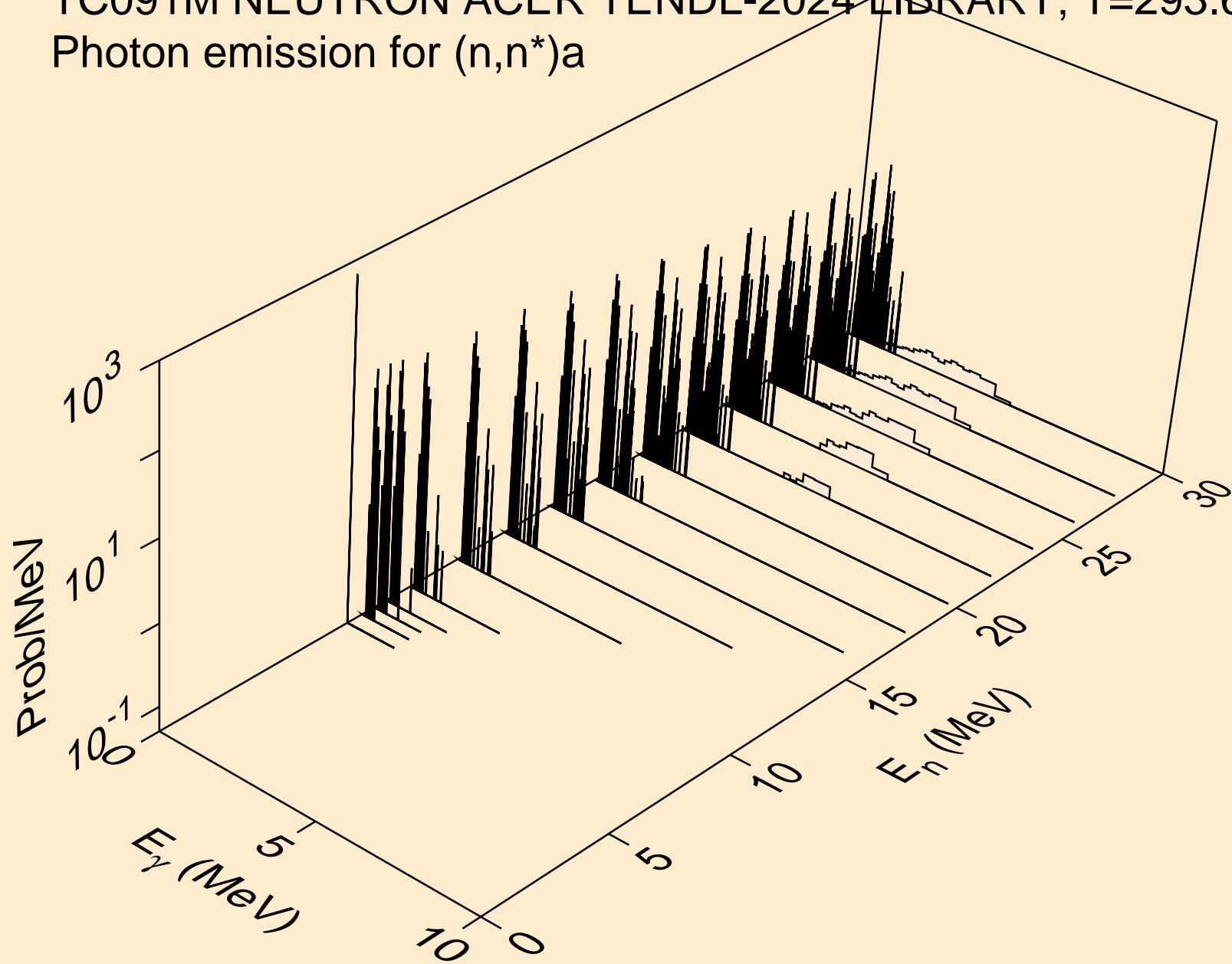

TC091M NEUTRON ACER TENDL-2024 LIBRARY; T=293.6K  
Photon emission for (n,2n)a

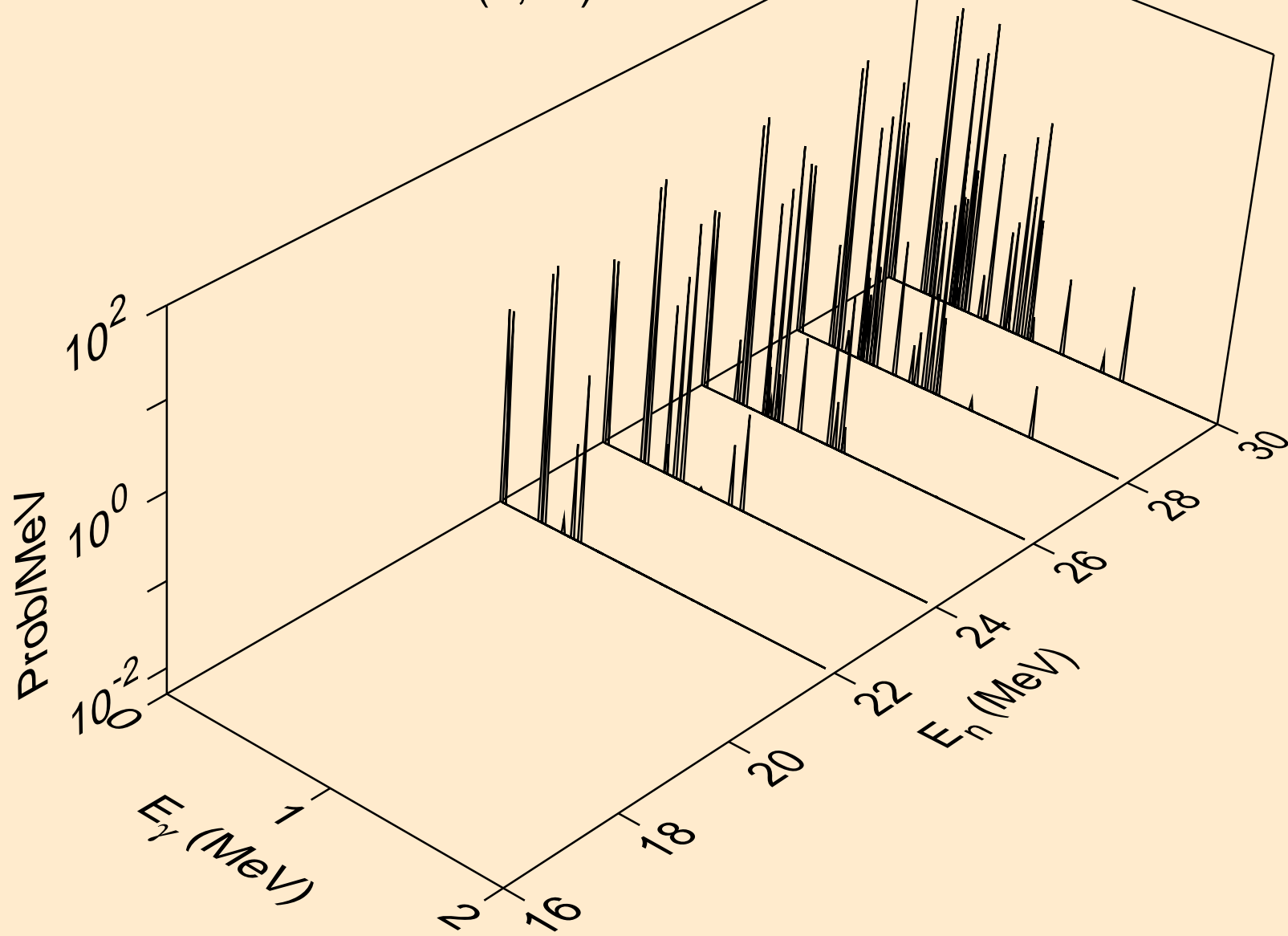

TC091M NEUTRON ACER TENDL-2024 LIBRARY; T=293.6K  
Photon emission for (n,n\*)p

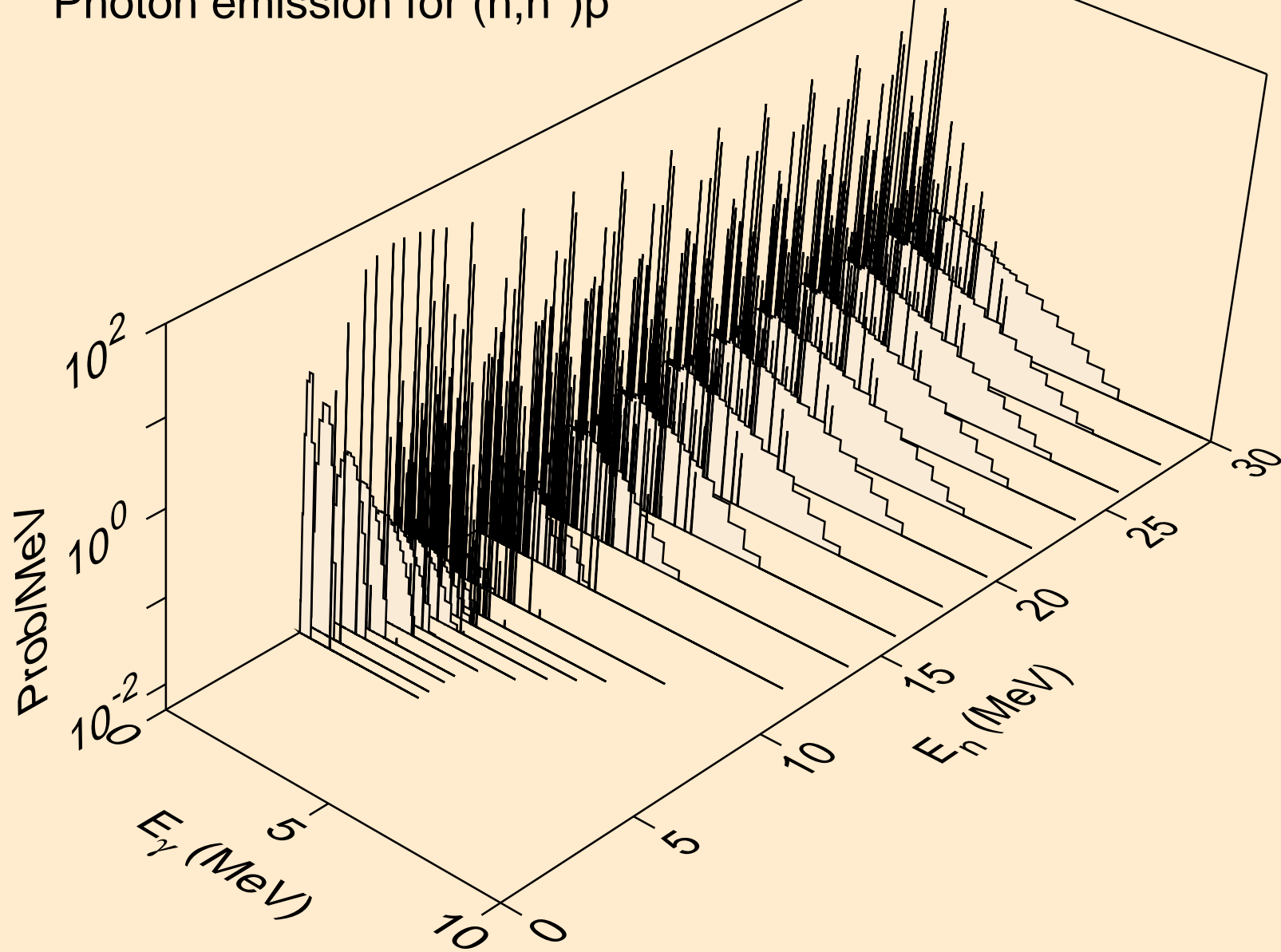

TC091M NEUTRON ACER TENDL-2024 LIBRARY; T=293.6K  
Photon emission for (n,n\*)2a

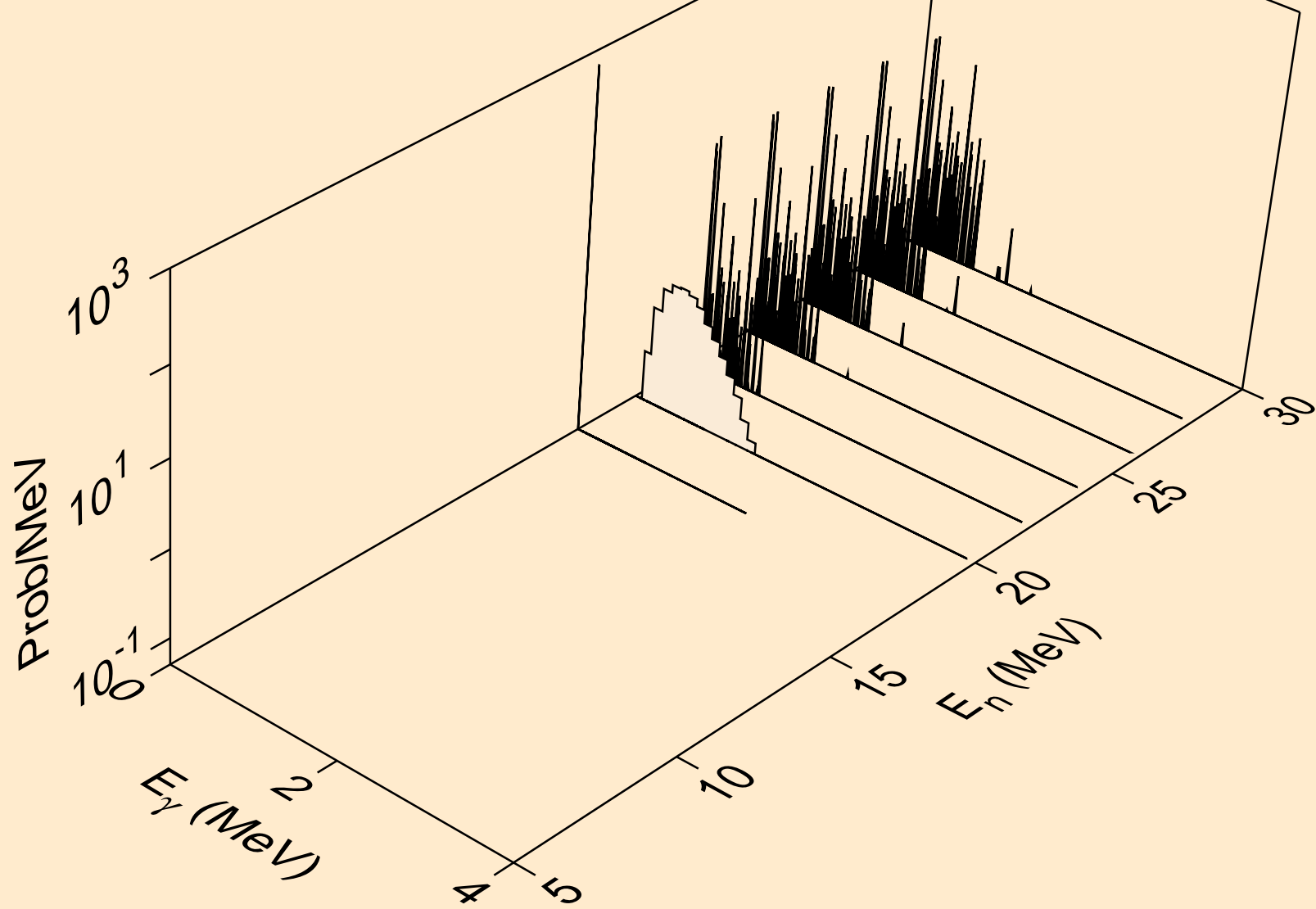

TC091M NEUTRON ACER TENDL-2024 LIBRARY; T=293.6K  
Photon emission for (n,n\*)d

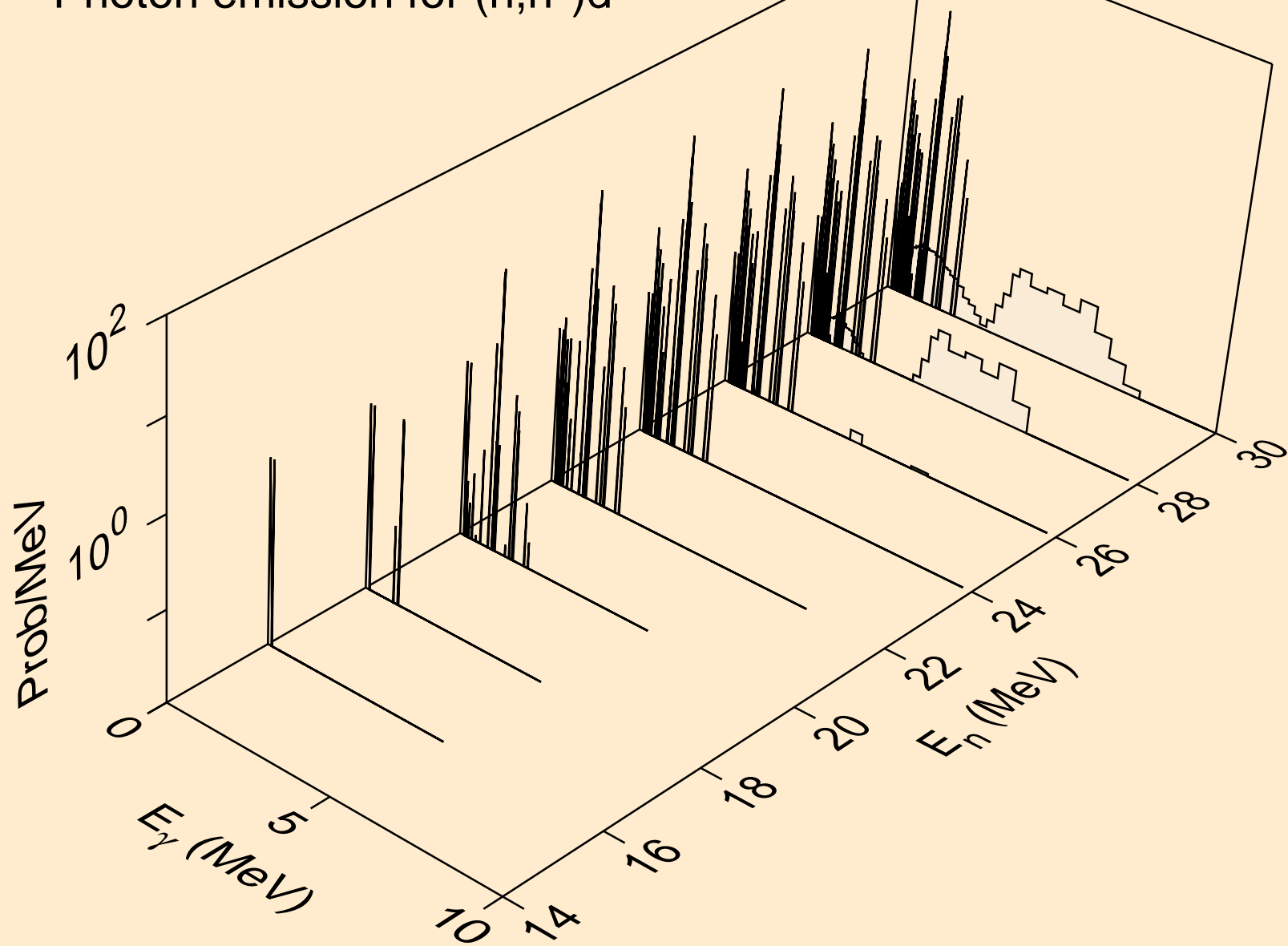

TC091M NEUTRON ACER TENDL-2024 LIBRARY; T=293.6K  
Photon emission for (n,n\*)t

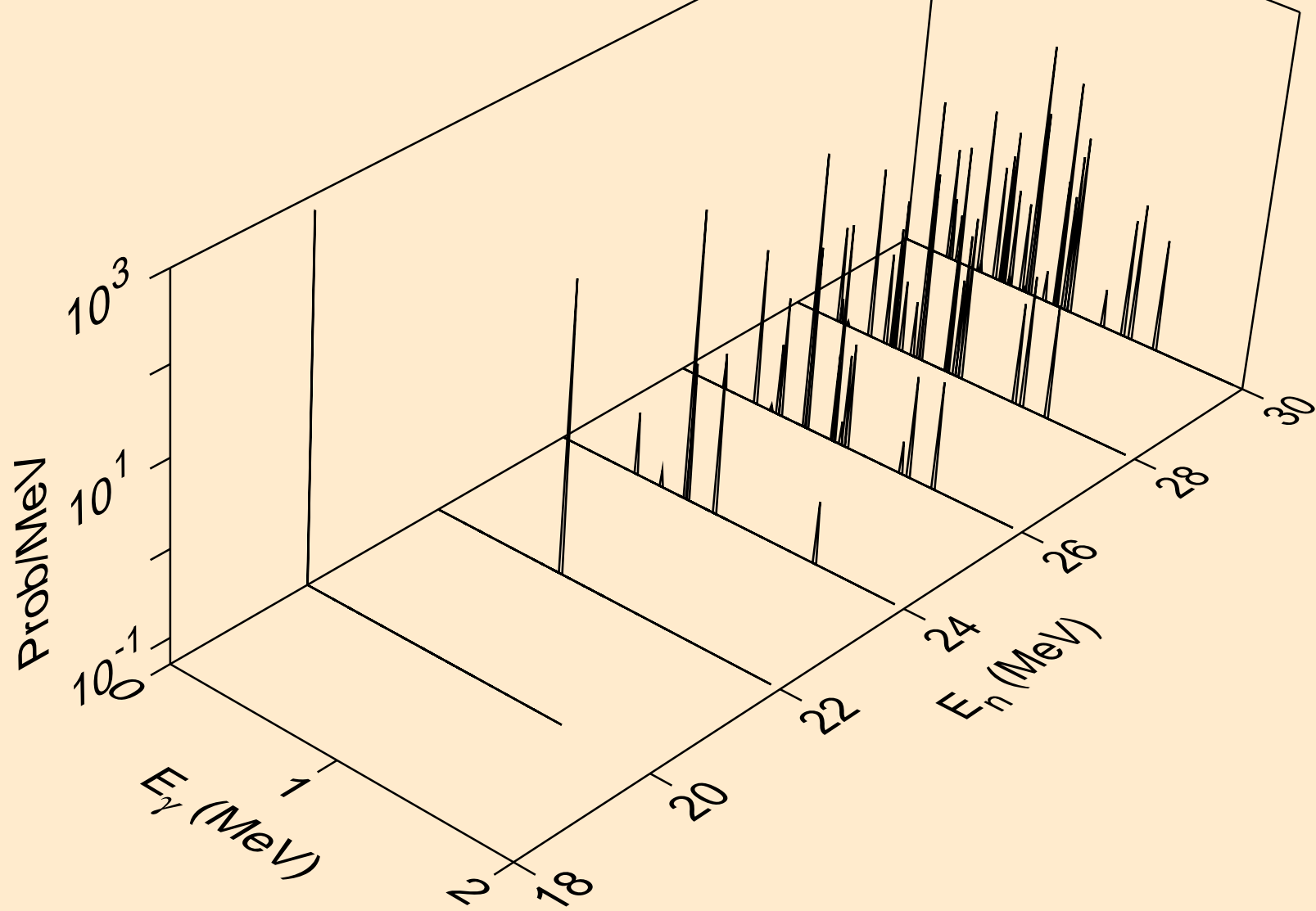

TC091M NEUTRON ACER TENDL-2024 LIBRARY; T=293.6K  
Photon emission for (n,n\*)he3

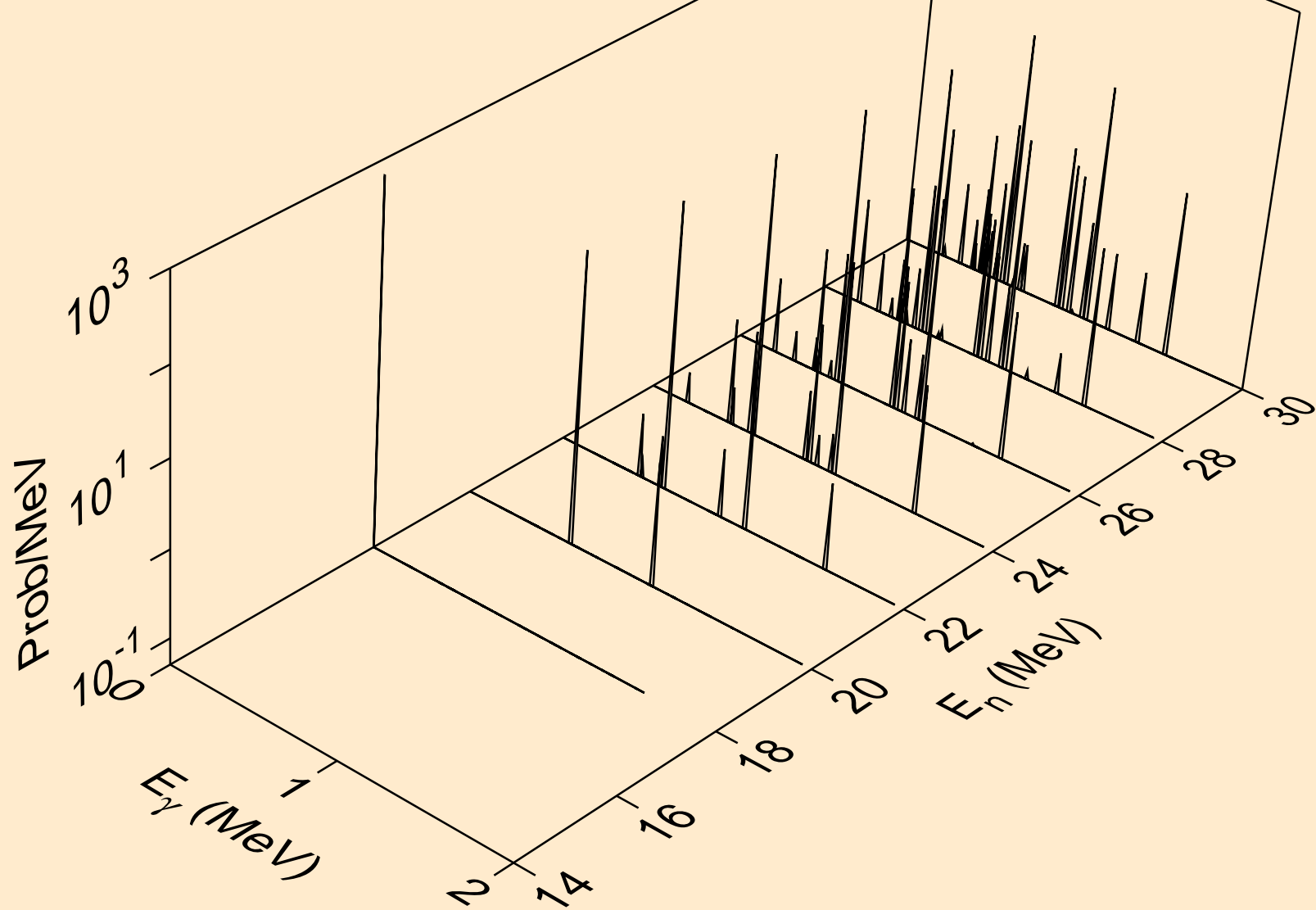

TC091M NEUTRON ACER TENDL-2024 LIBRARY; T=293.6K  
Photon emission for (n,2np)

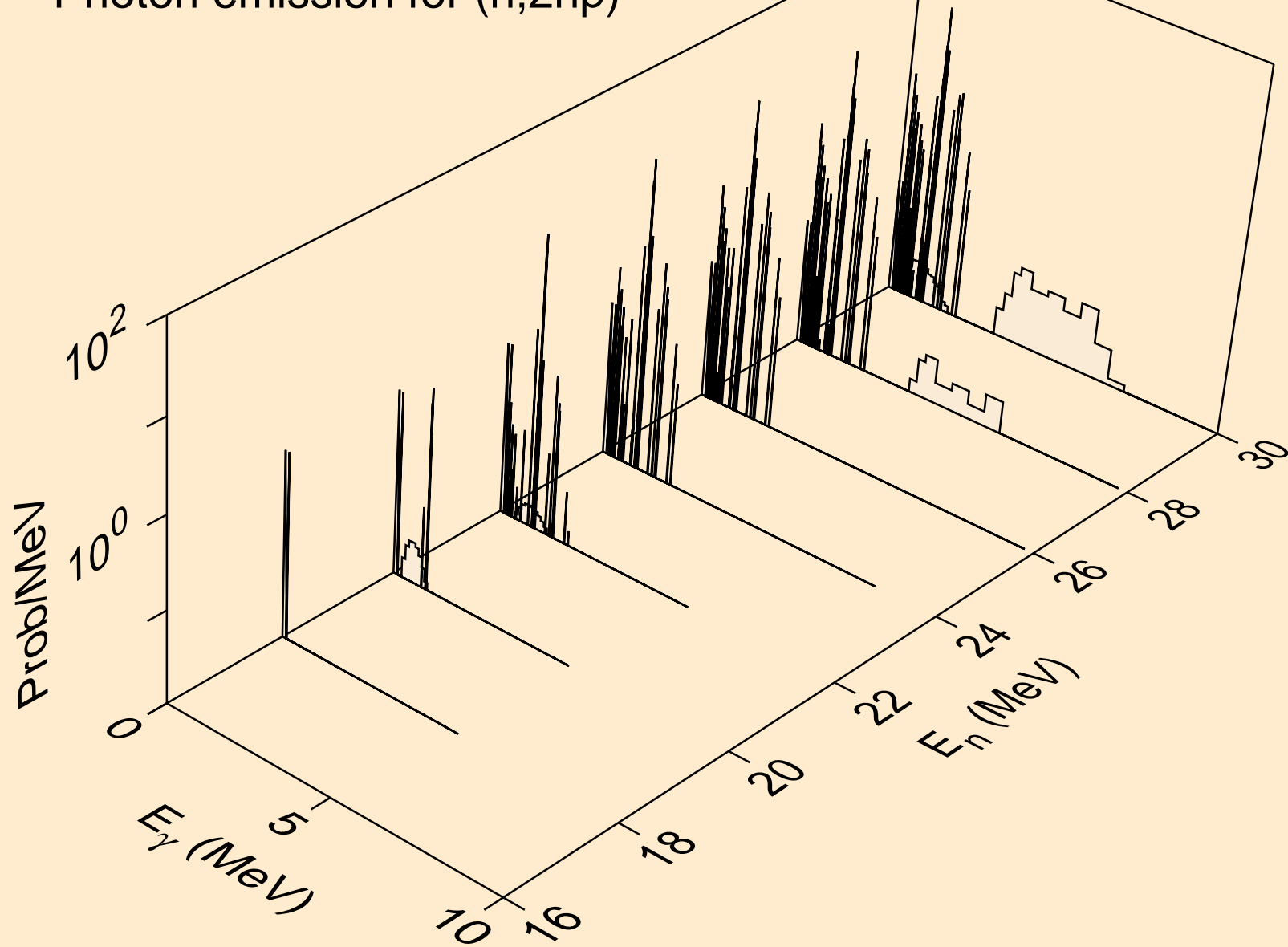

TC091M NEUTRON ACER TENDL-2024 LIBRARY; T=293.6K  
Photon emission for (n,3np)

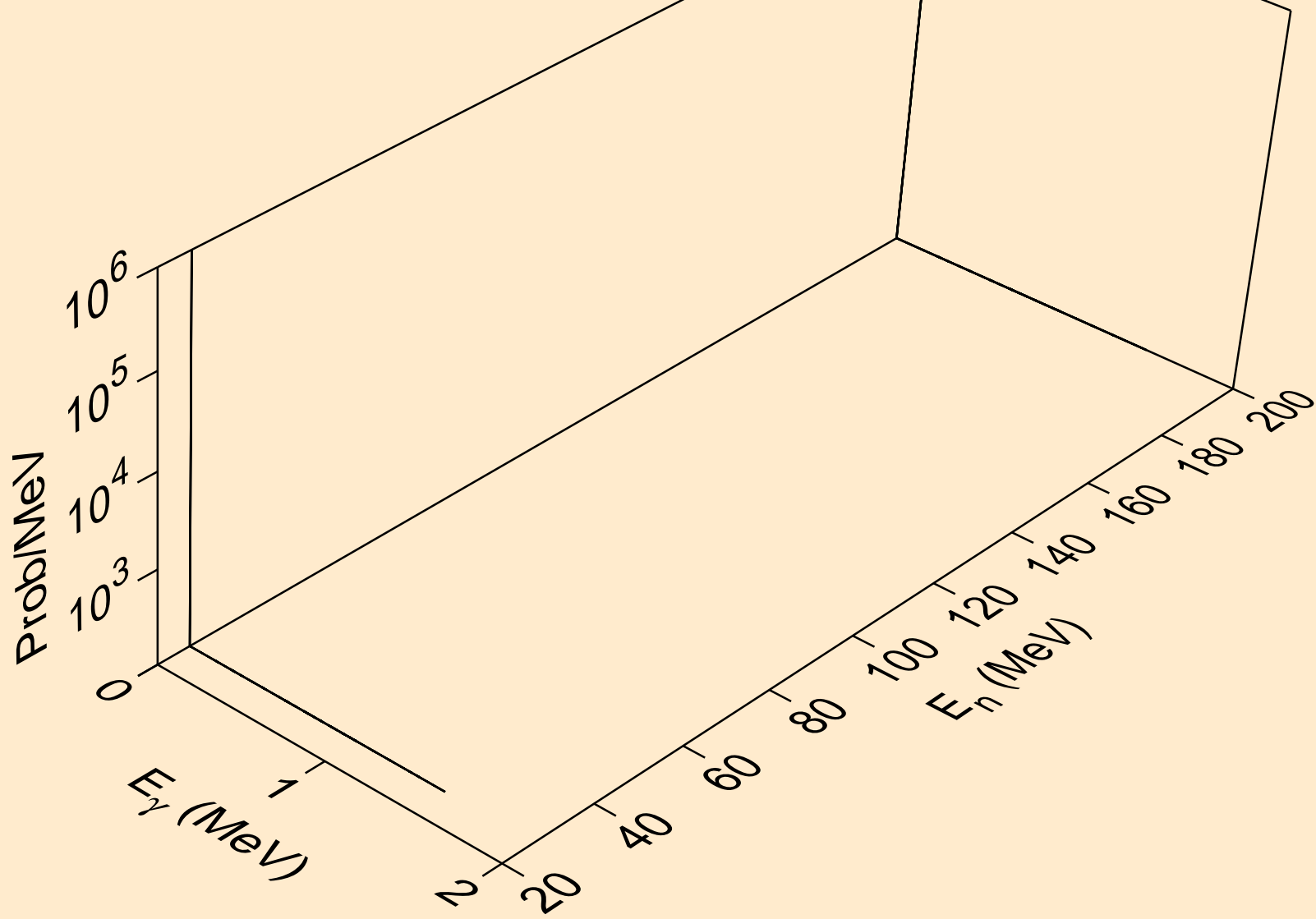

TC091M NEUTRON ACER TENDL-2024 LIBRARY; T=293.6K  
Photon emission for (n,n2p)

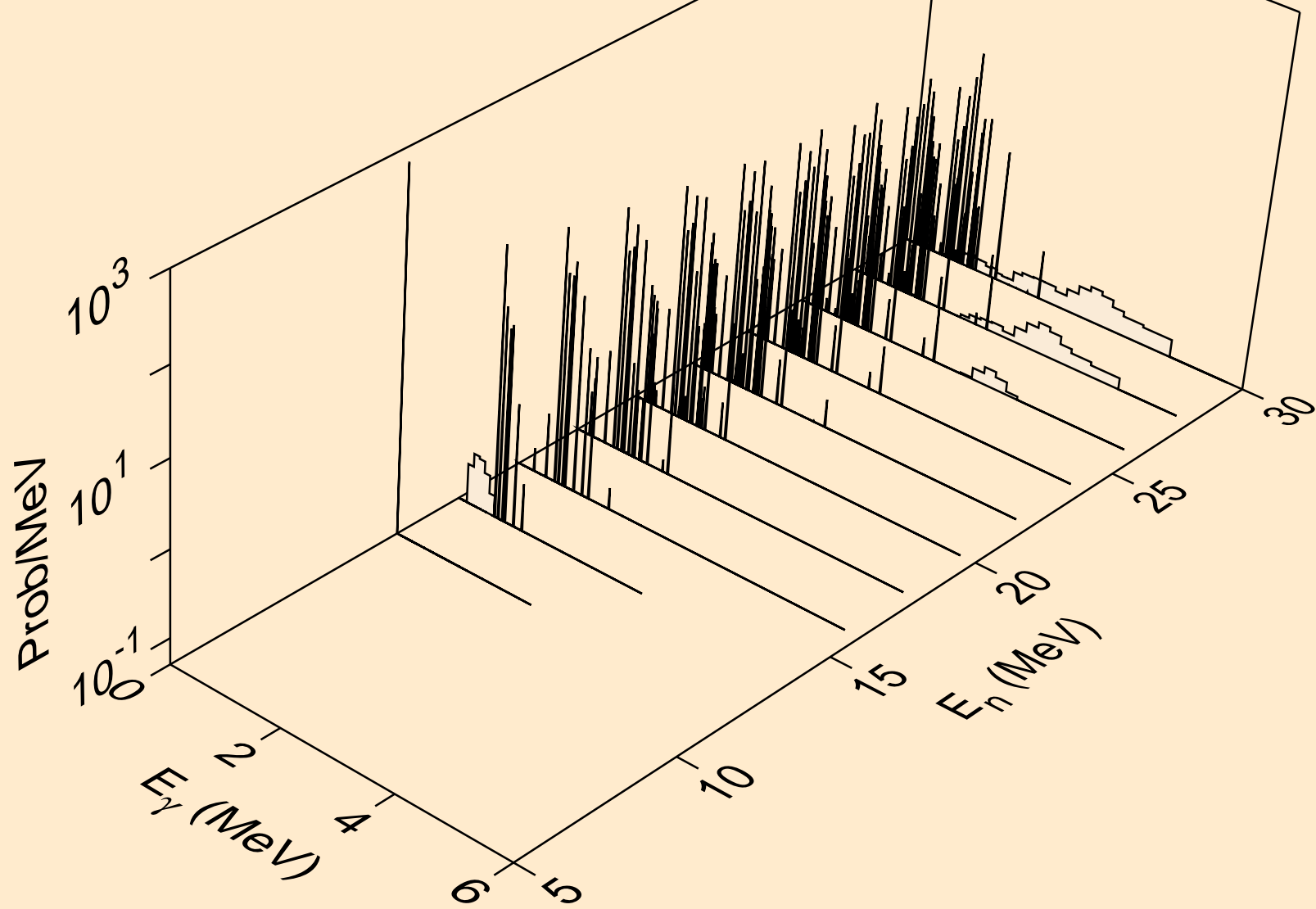

TC091M NEUTRON ACER TENDL-2024 LIBRARY; T=293.6K  
Photon emission for (n,npa)

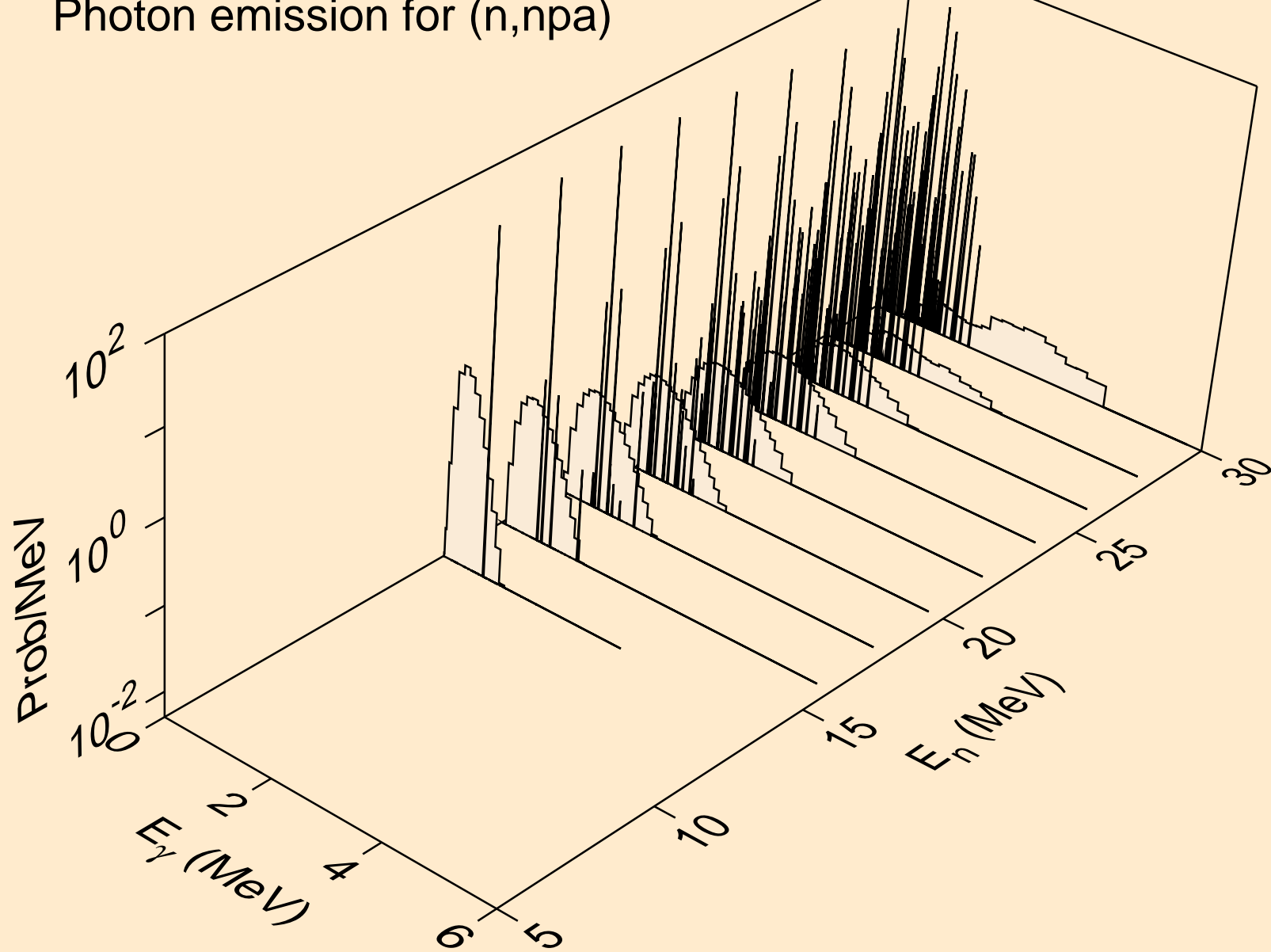

TC091M NEUTRON ACER TENDL-2024 LIBRARY; T=293.6K  
Photon emission for (n,n\*2)

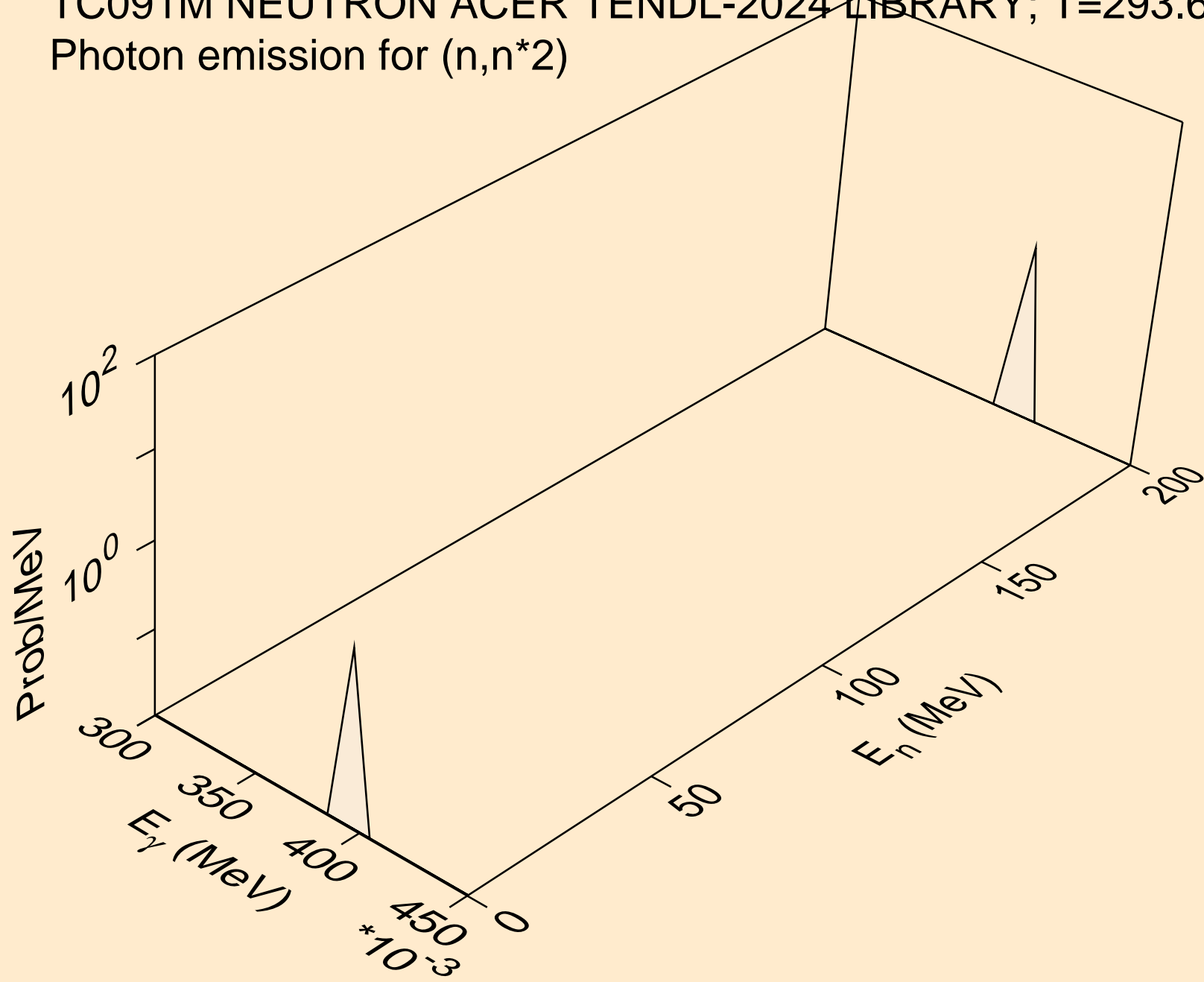

TC091M NEUTRON ACER TENDL-2024 LIBRARY; T=293.6K  
Photon emission for (n,n\*3)

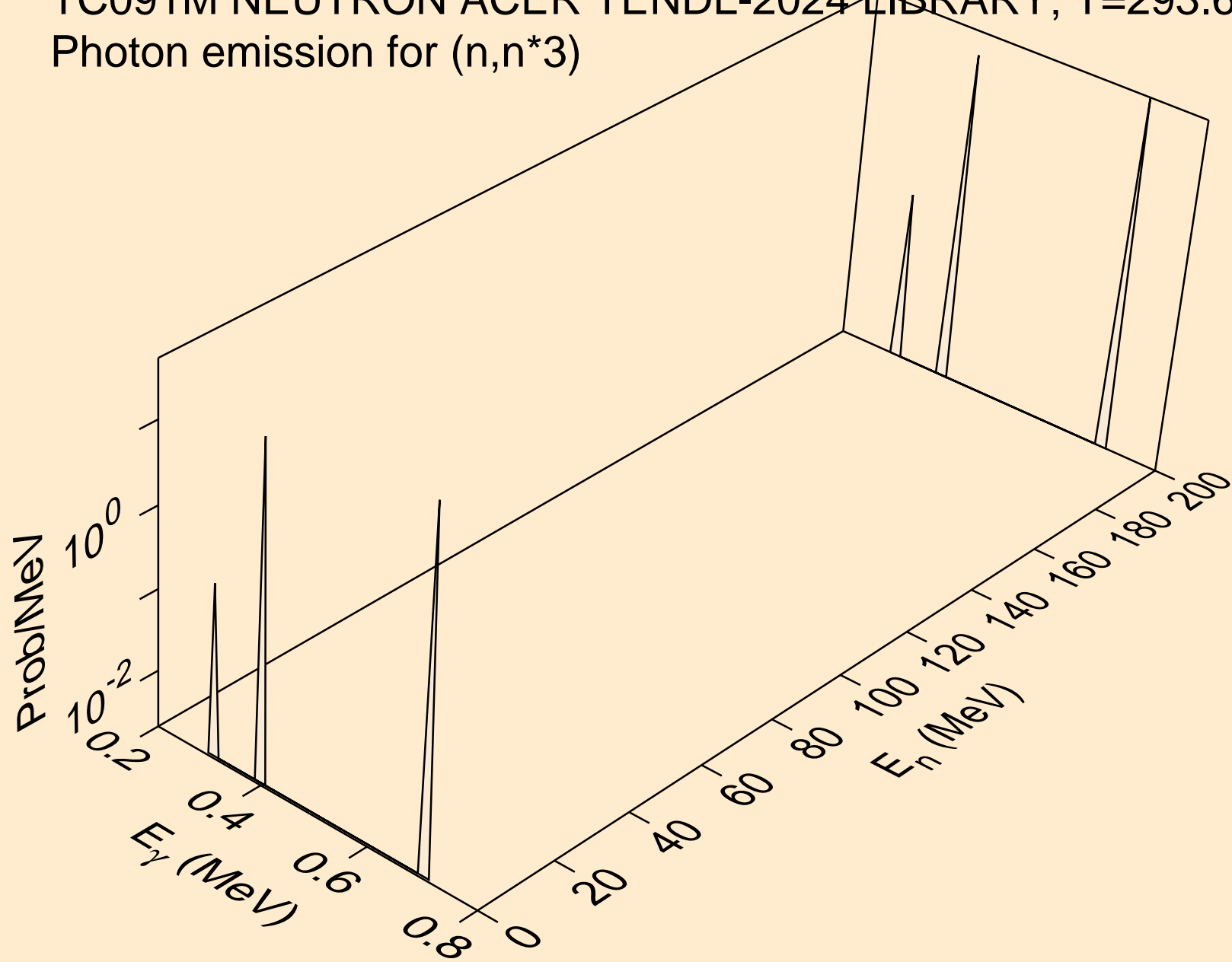

TC091M NEUTRON ACER TENDL-2024 LIBRARY; T=293.6K  
Photon emission for (n,n\*4)

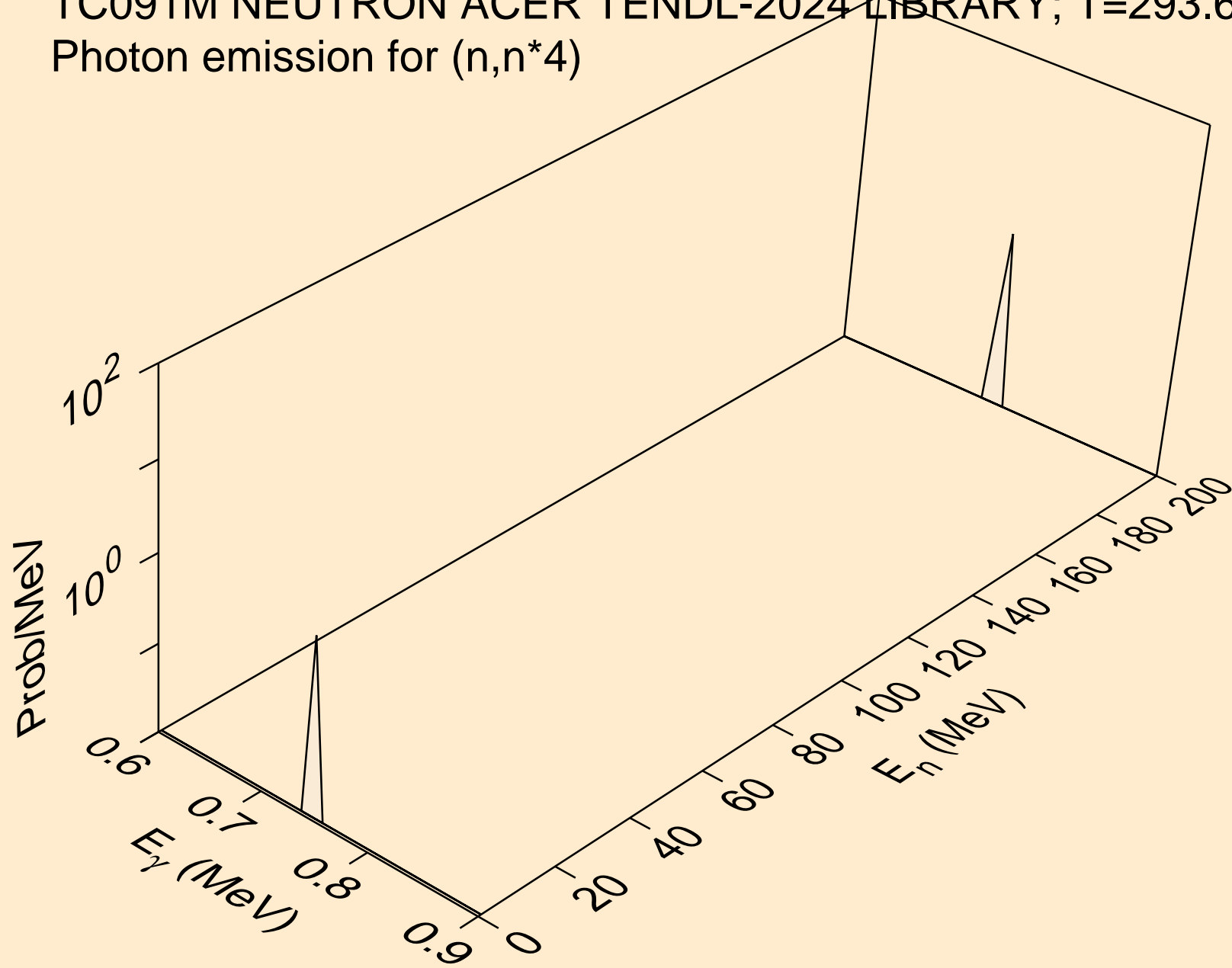

TC091M NEUTRON ACER TENDL-2024 LIBRARY; T=293.6K  
Photon emission for (n,n\*5)

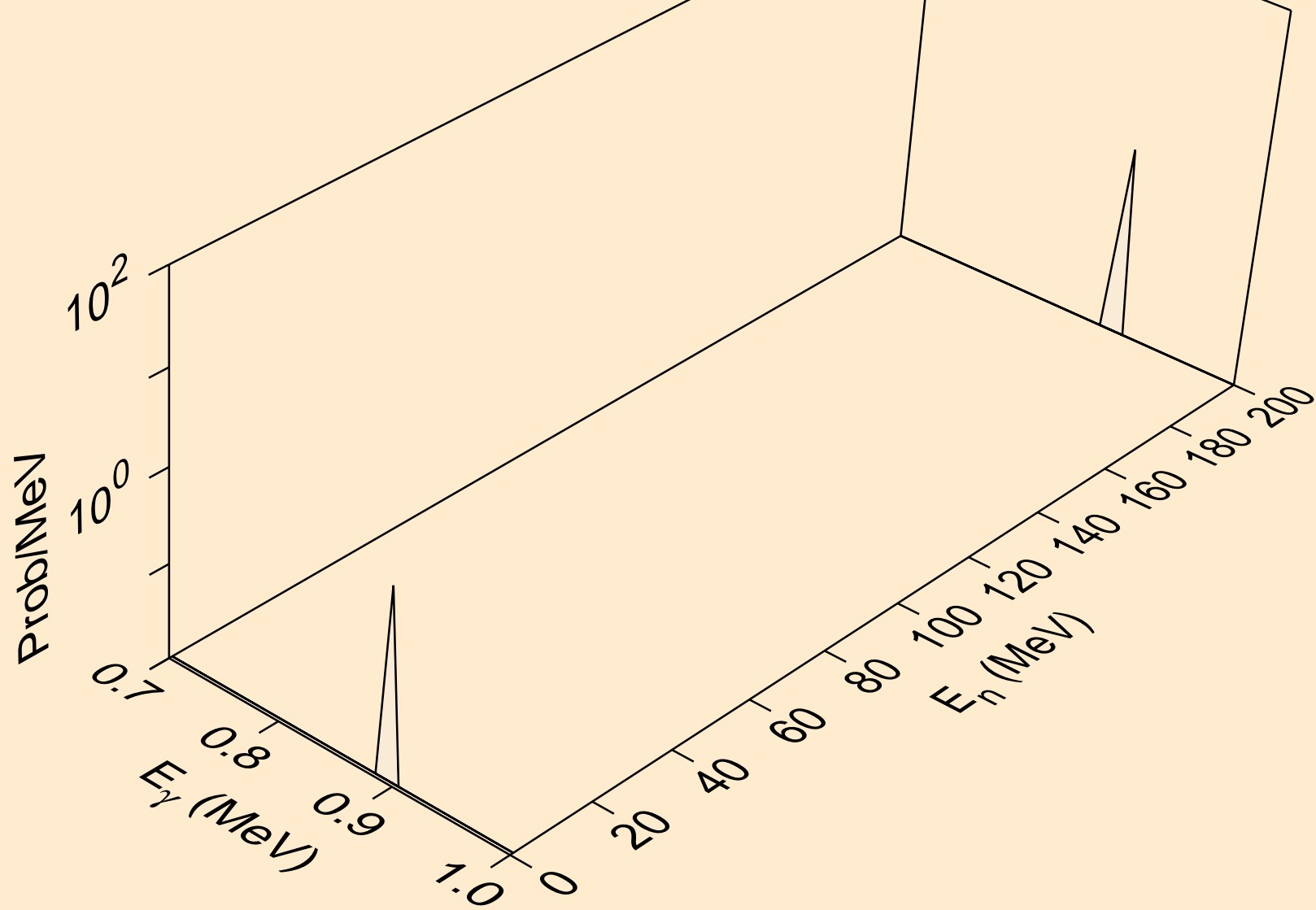

TC091M NEUTRON ACER TENDL-2024 LIBRARY; T=293.6K  
Photon emission for (n,n\*6)

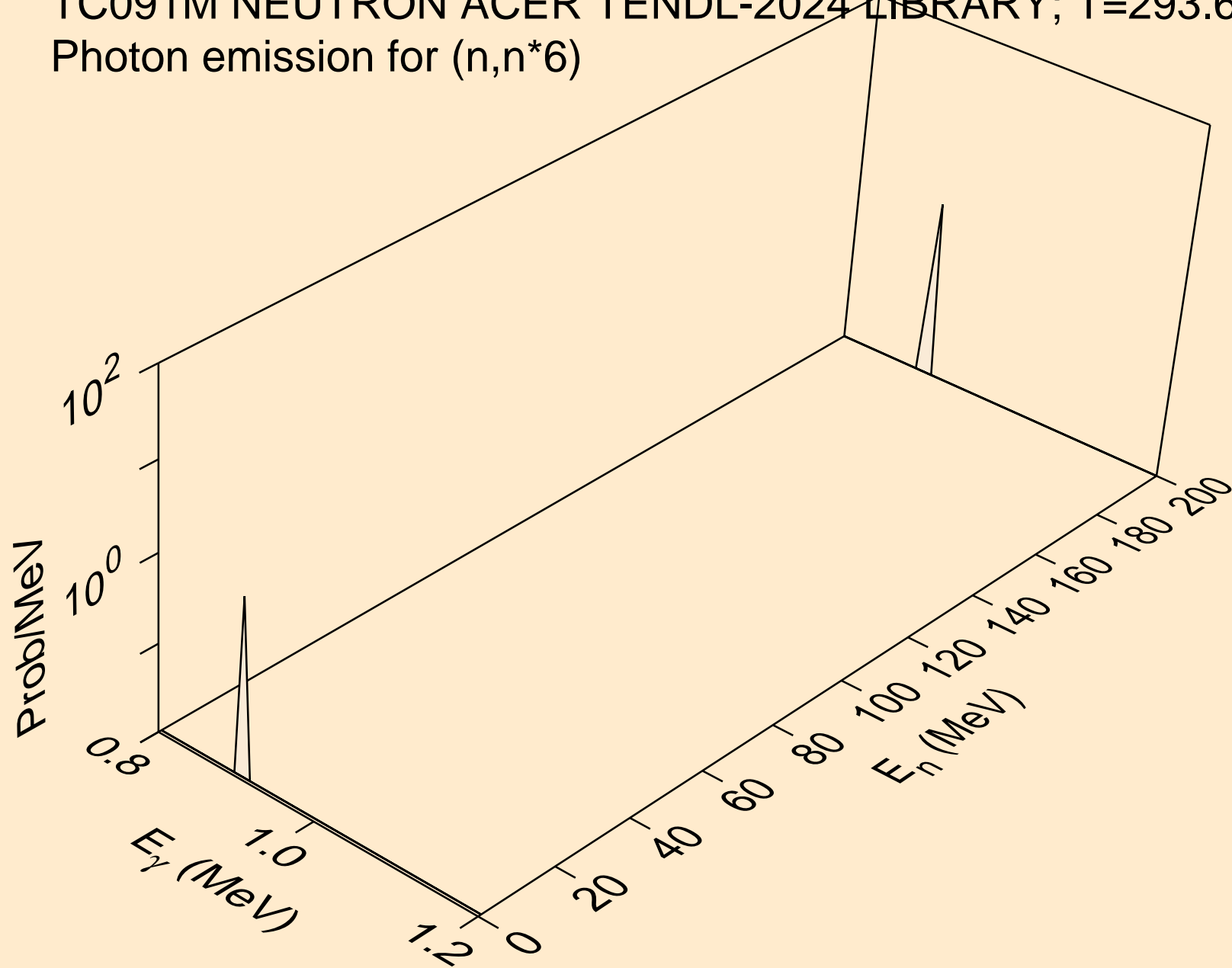

TC091M NEUTRON ACER TENDL-2024 LIBRARY; T=293.6K  
Photon emission for (n,n\*7)

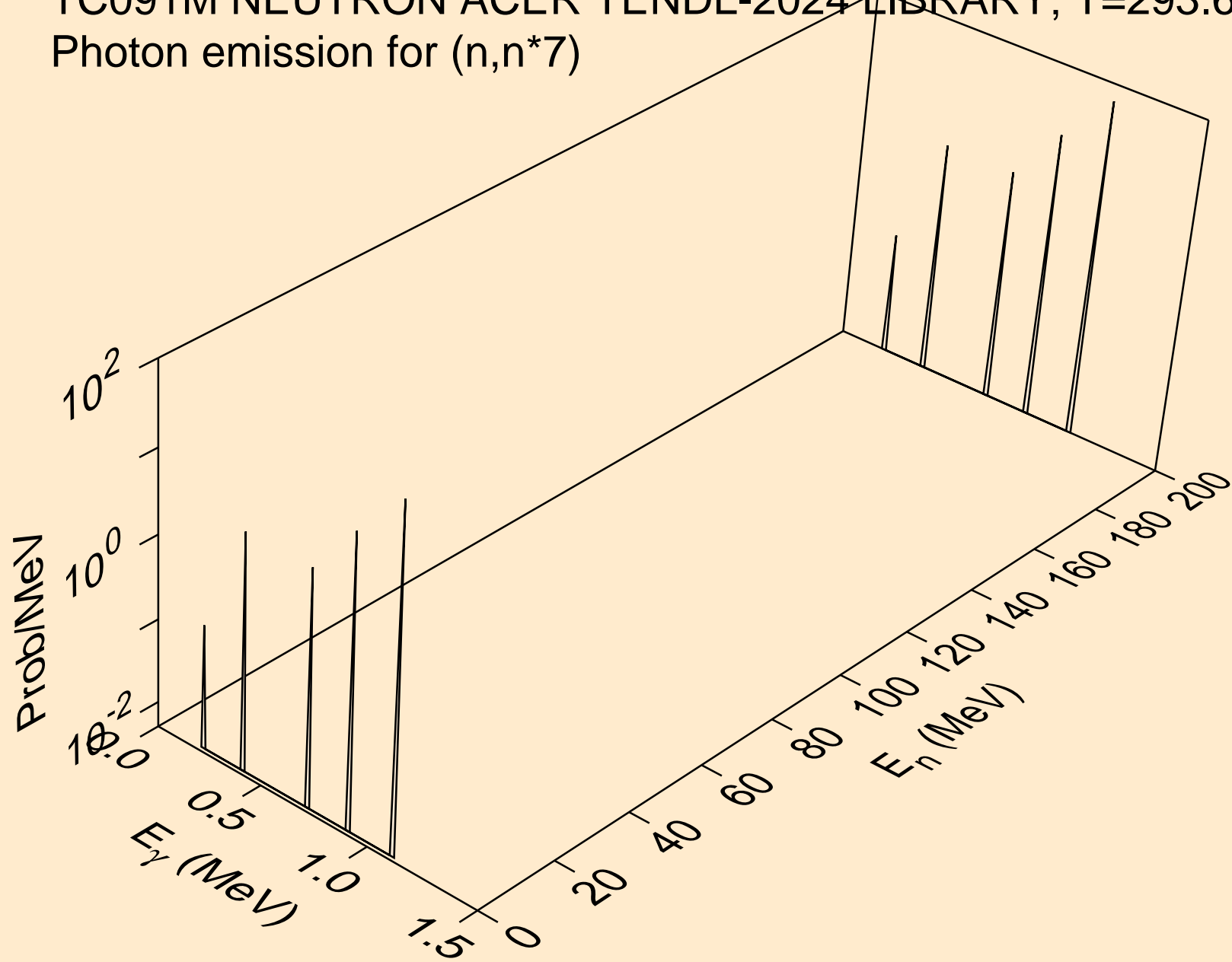

TC091M NEUTRON ACER TENDL-2024 LIBRARY; T=293.6K  
Photon emission for (n,n\*8)

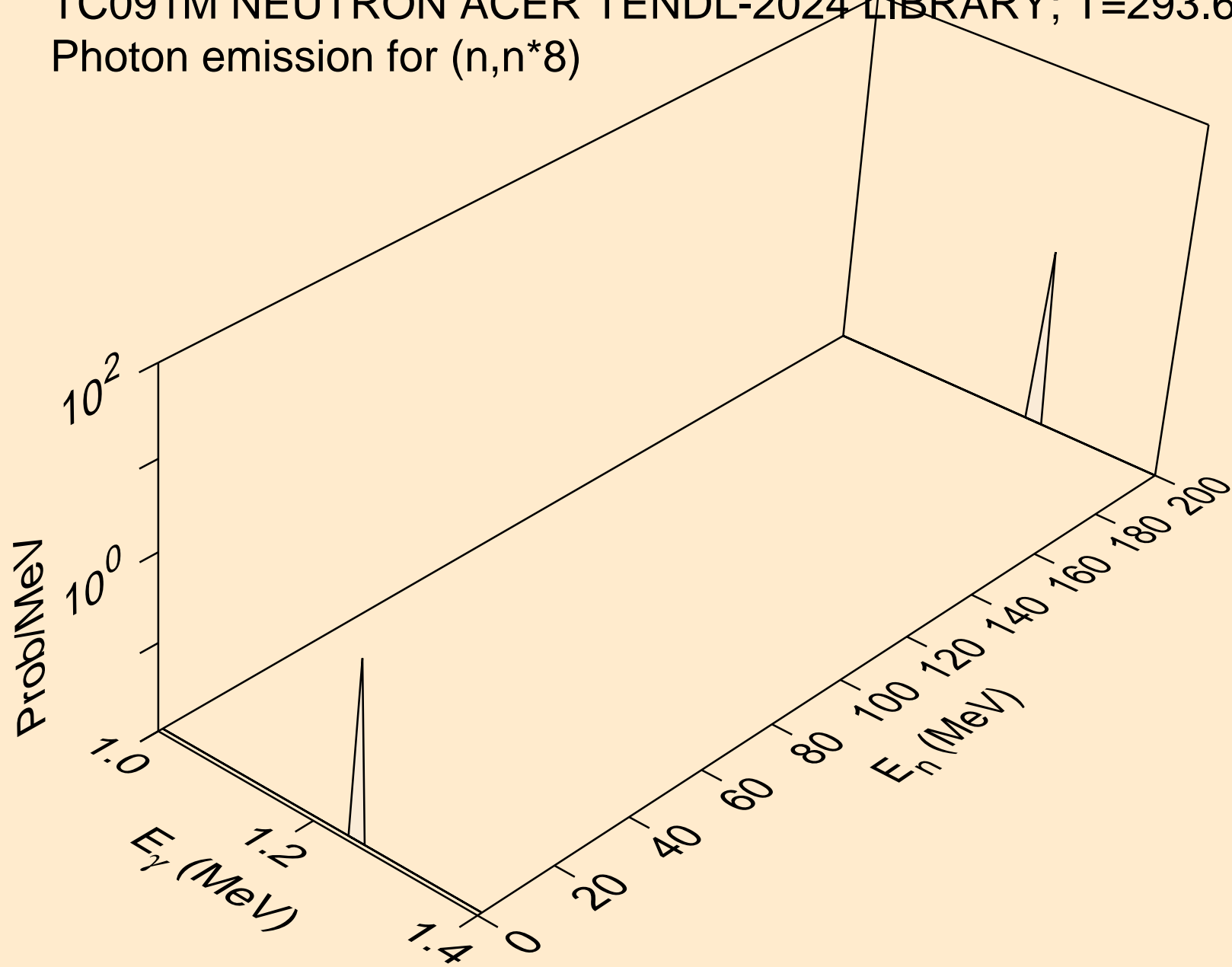

TC091M NEUTRON ACER TENDL-2024 LIBRARY; T=293.6K  
Photon emission for (n,n\*9)

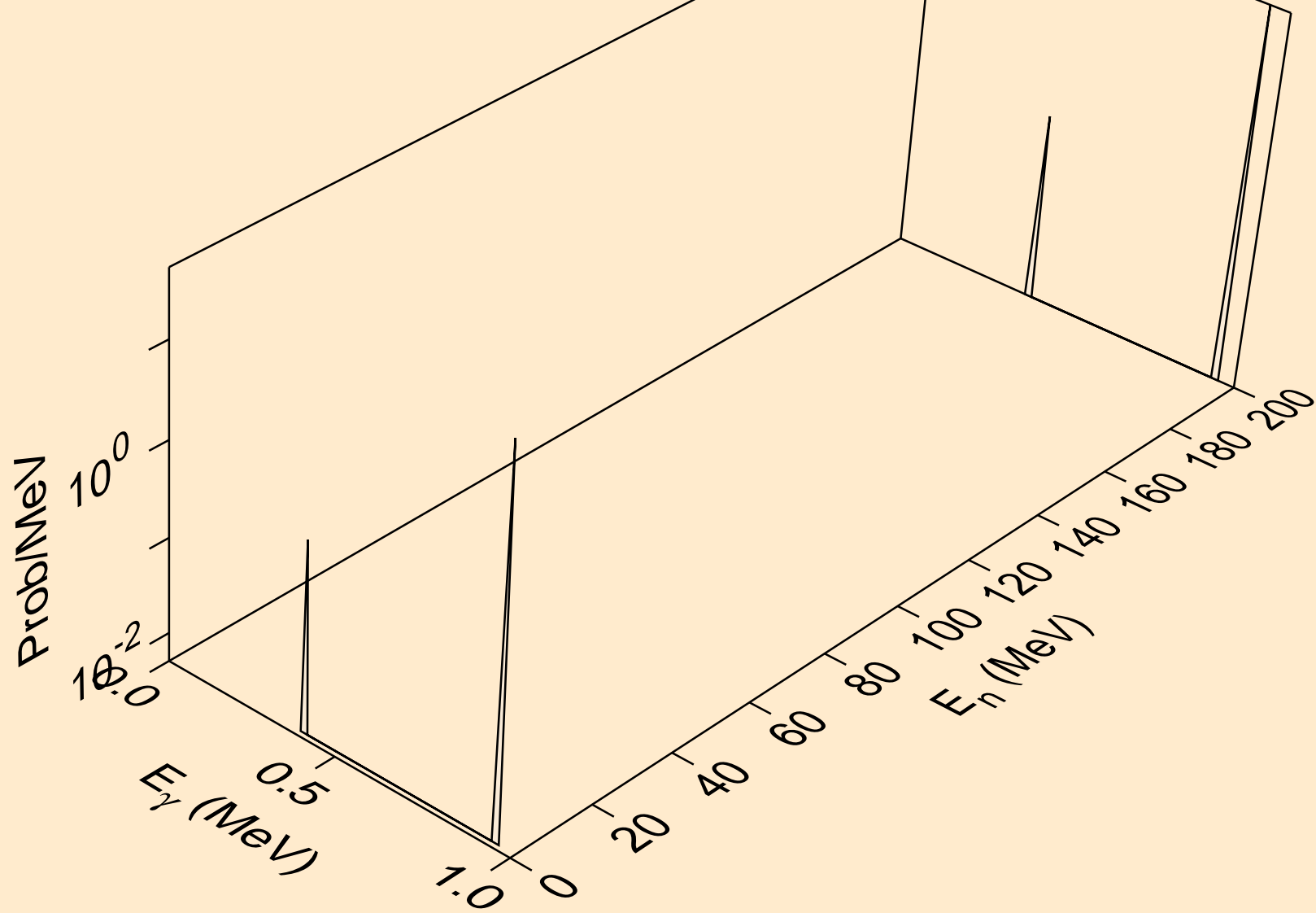

TC091M NEUTRON ACER TENDL-2024 LIBRARY; T=293.6K  
Photon emission for (n,n\*10)

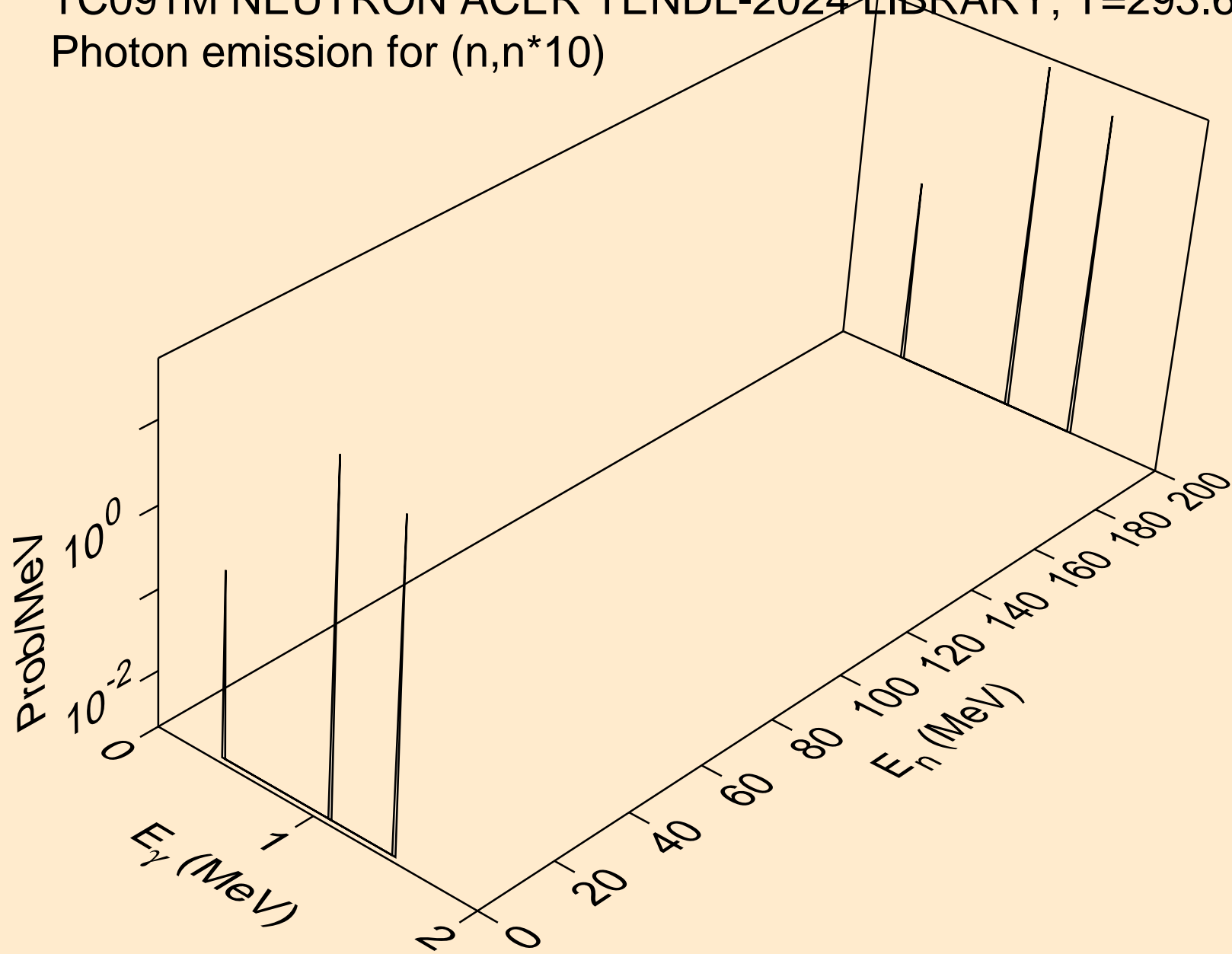

TC091M NEUTRON ACER TENDL-2024 LIBRARY; T=293.6K  
Photon emission for (n,n\*11)

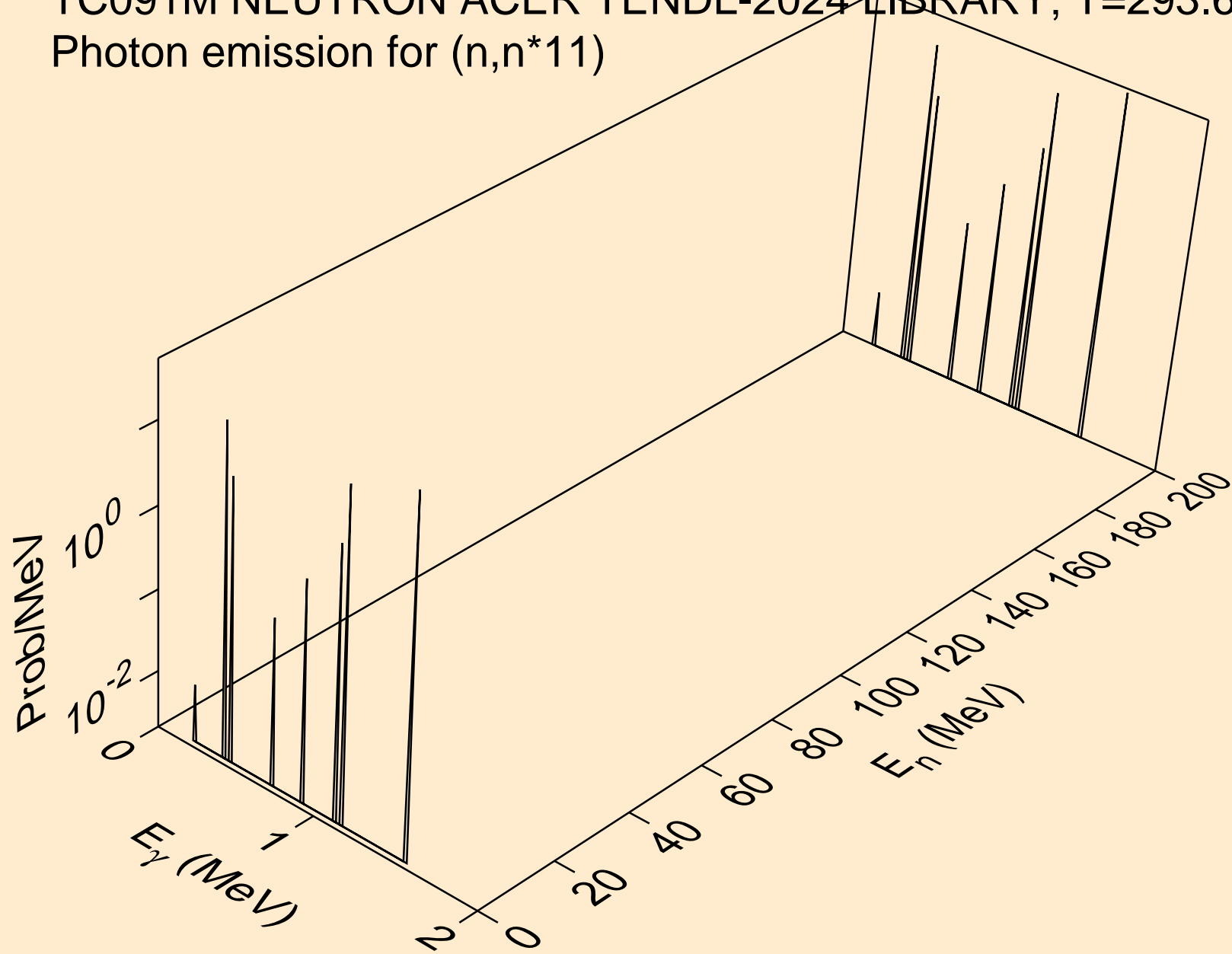

TC091M NEUTRON ACER TENDL-2024 LIBRARY; T=293.6K  
Photon emission for (n,n\*12)

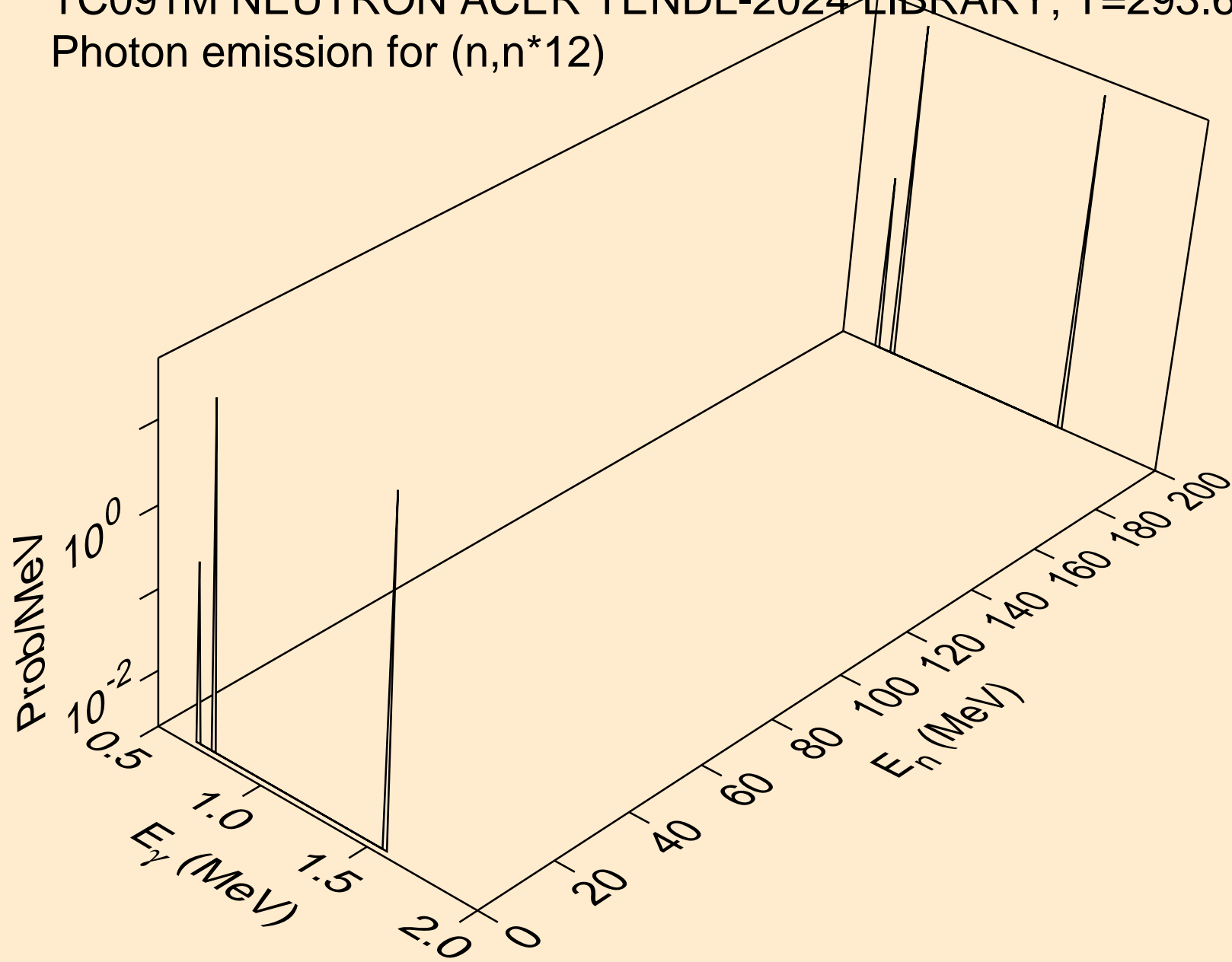

TC091M NEUTRON ACER TENDL-2024 LIBRARY; T=293.6K  
Photon emission for (n,n\*13)

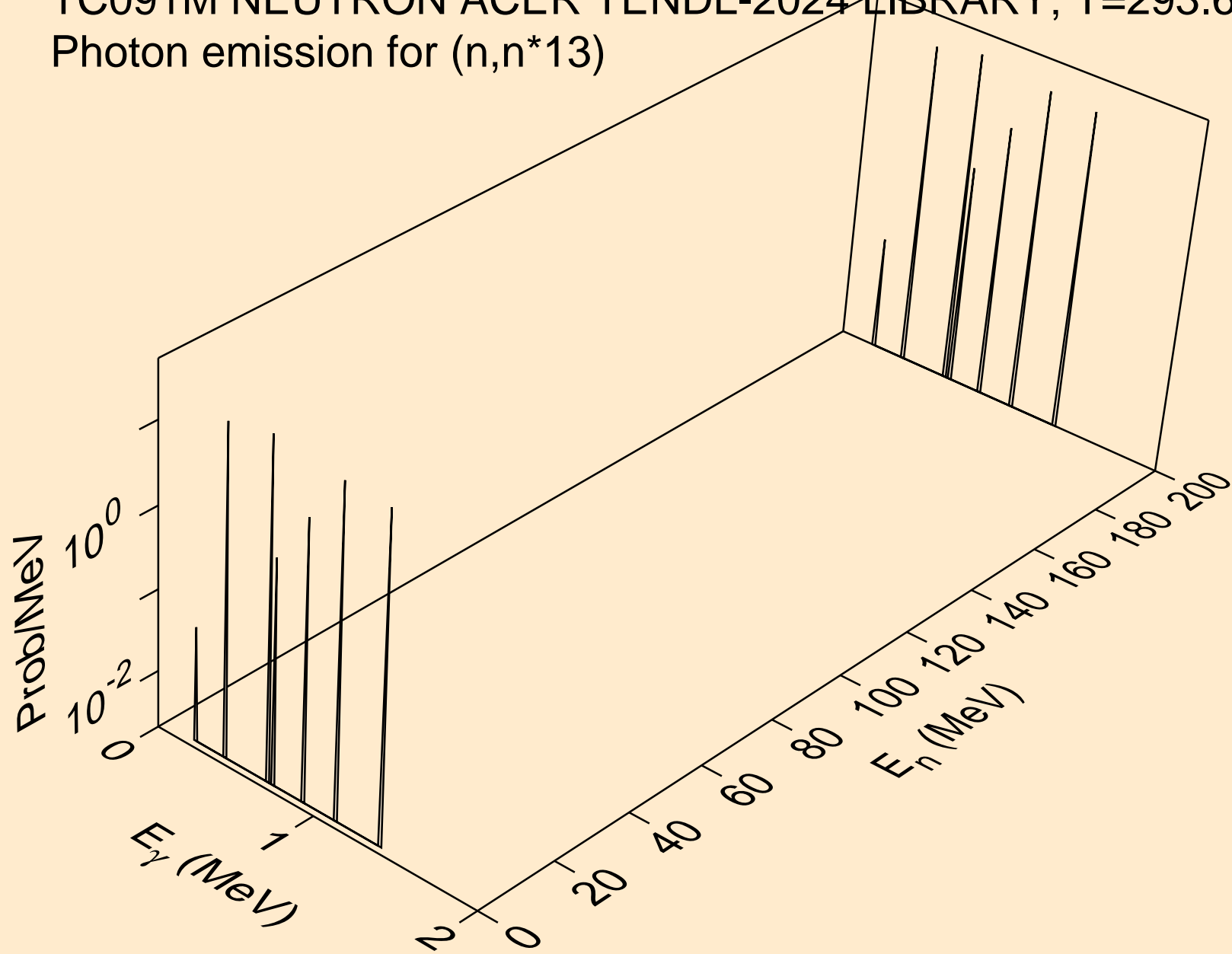

TC091M NEUTRON ACER TENDL-2024 LIBRARY; T=293.6K  
Photon emission for (n,n\*14)

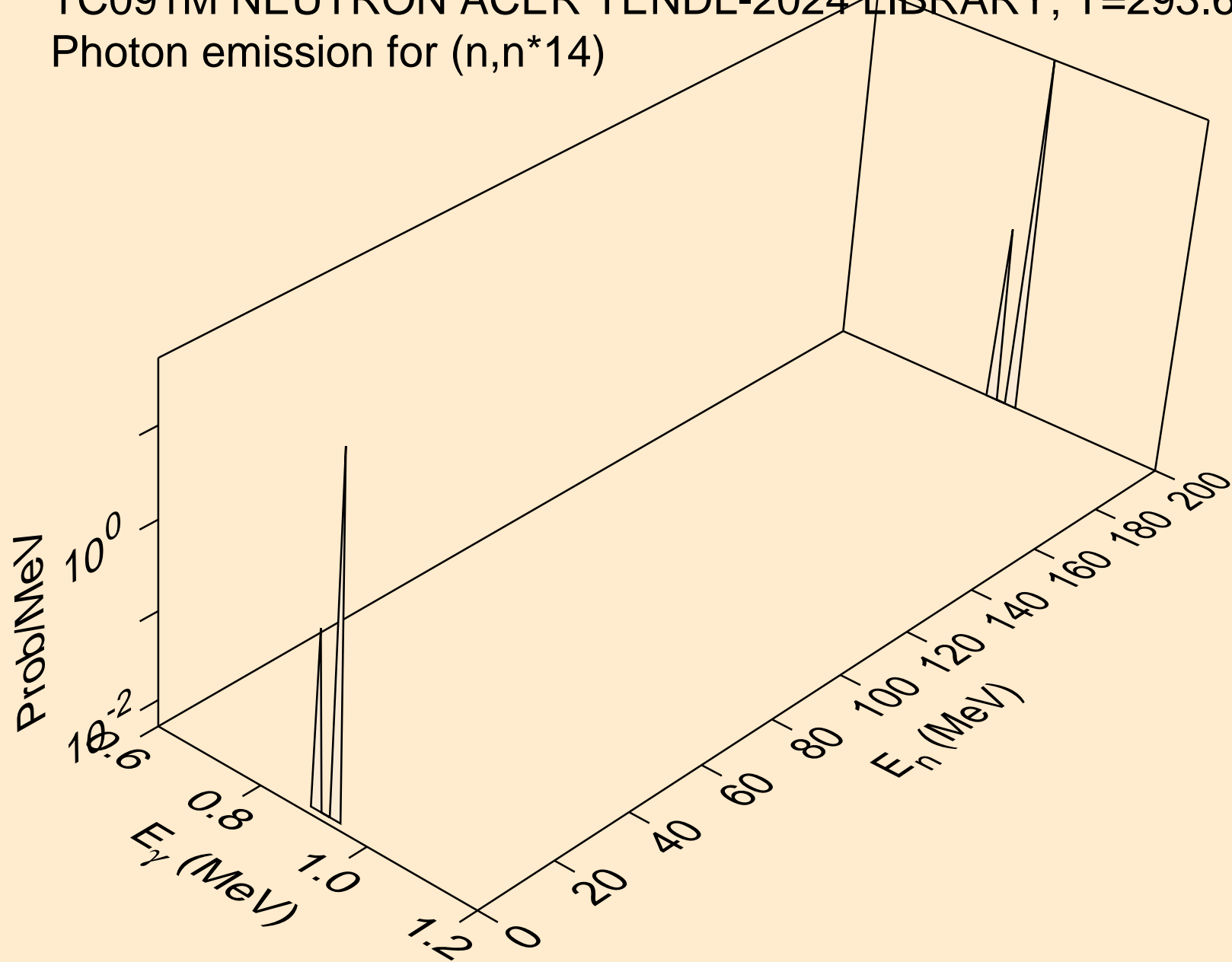

TC091M NEUTRON ACER TENDL-2024 LIBRARY; T=293.6K  
Photon emission for (n,n\*15)

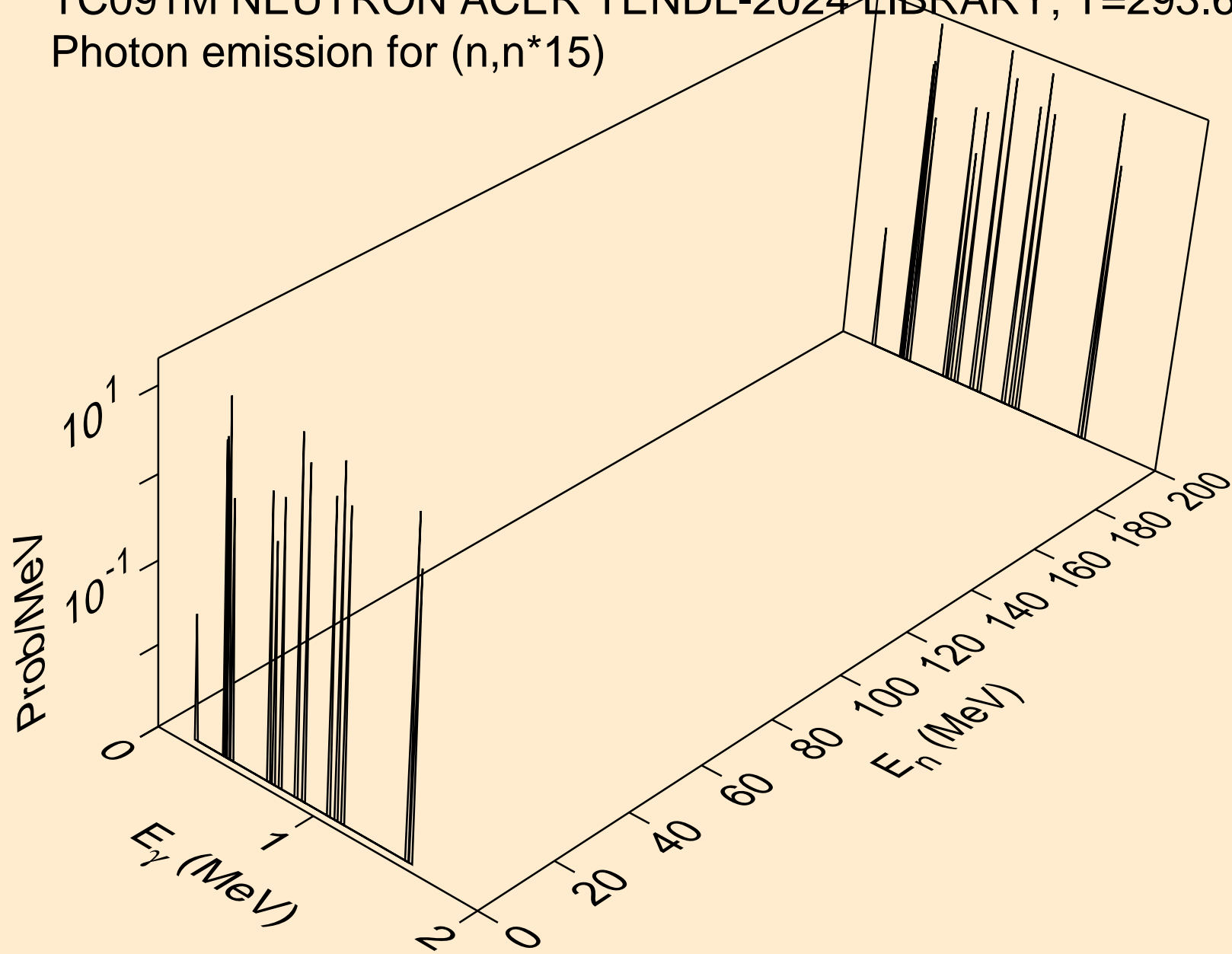

TC091M NEUTRON ACER TENDL-2024 LIBRARY; T=293.6K  
Photon emission for (n,n\*16)

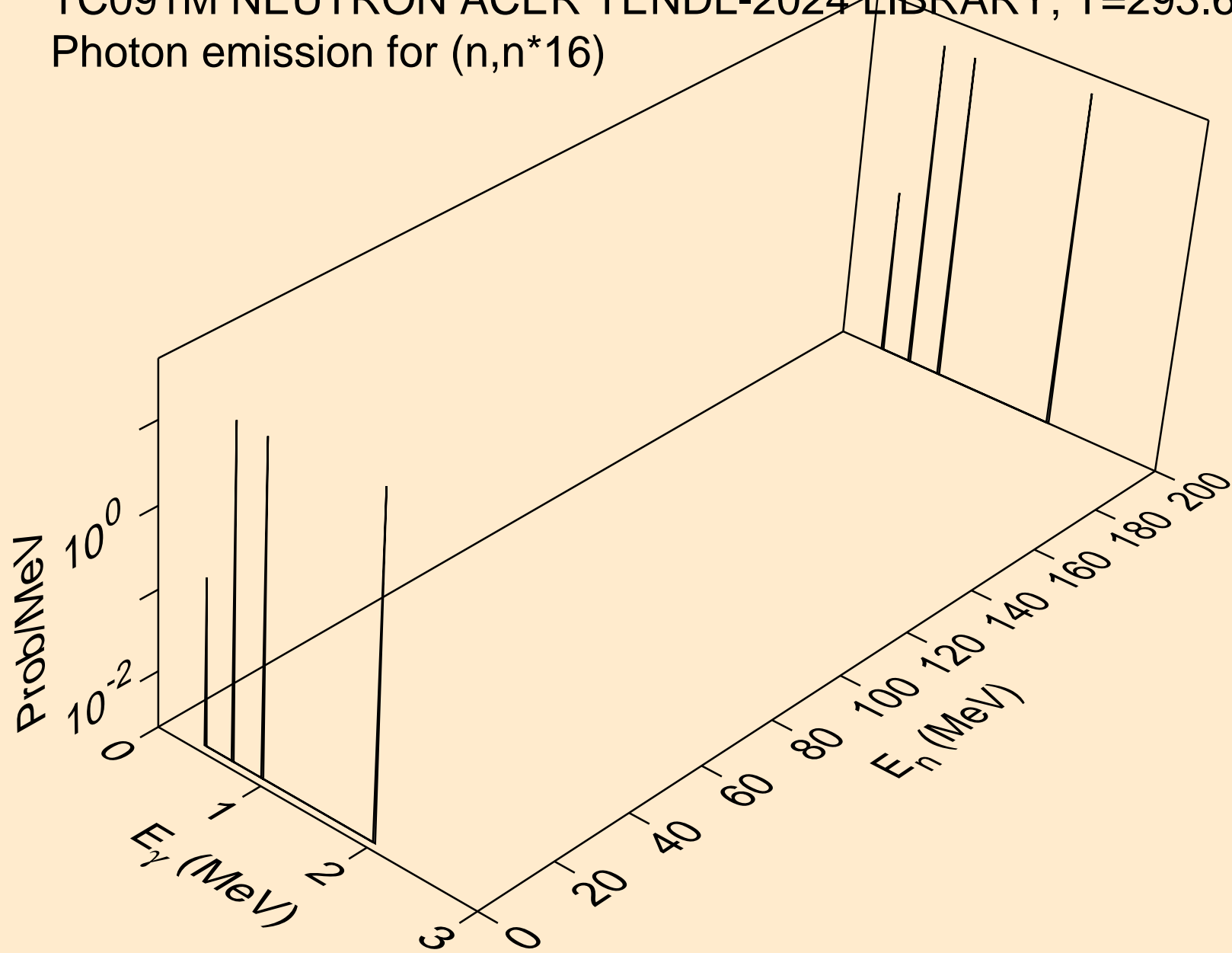

TC091M NEUTRON ACER TENDL-2024 LIBRARY; T=293.6K  
Photon emission for (n,n\*c)

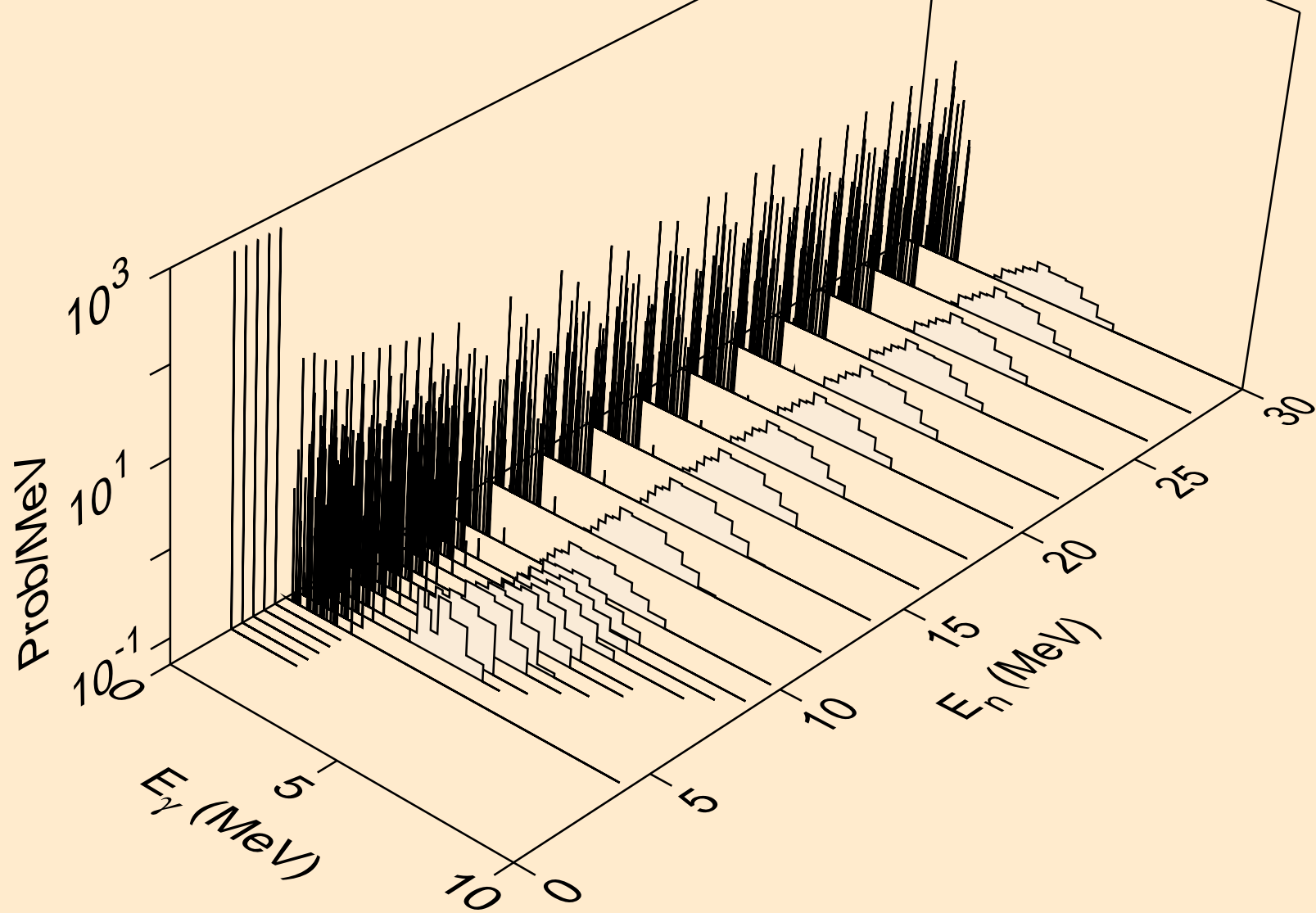

TC091M NEUTRON ACER TENDL-2024 LIBRARY; T=293.6K  
Photon emission for (n,gma)

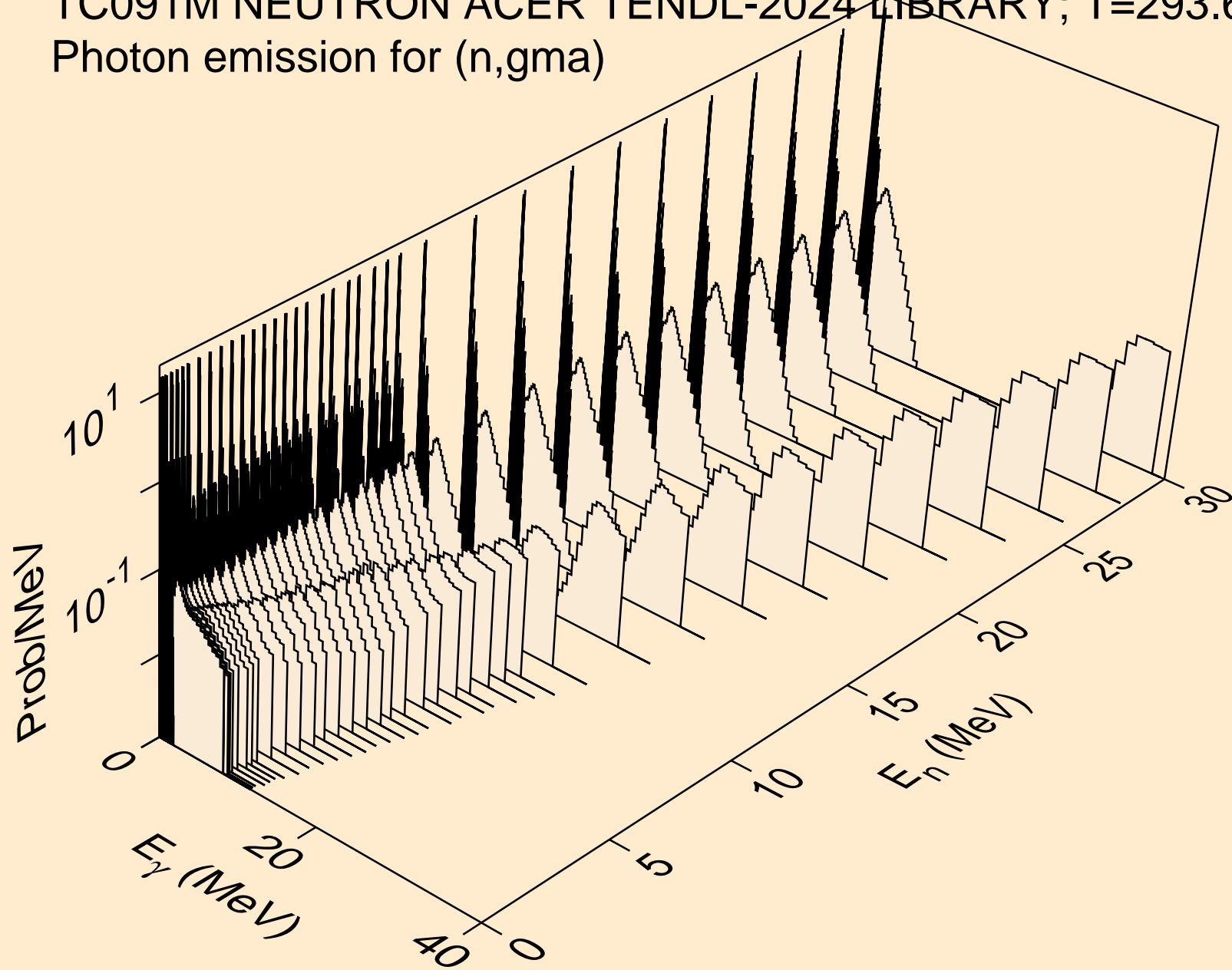

TC091M NEUTRON ACER TENDL-2024 LIBRARY; T=293.6K  
Photon emission for (n,p)

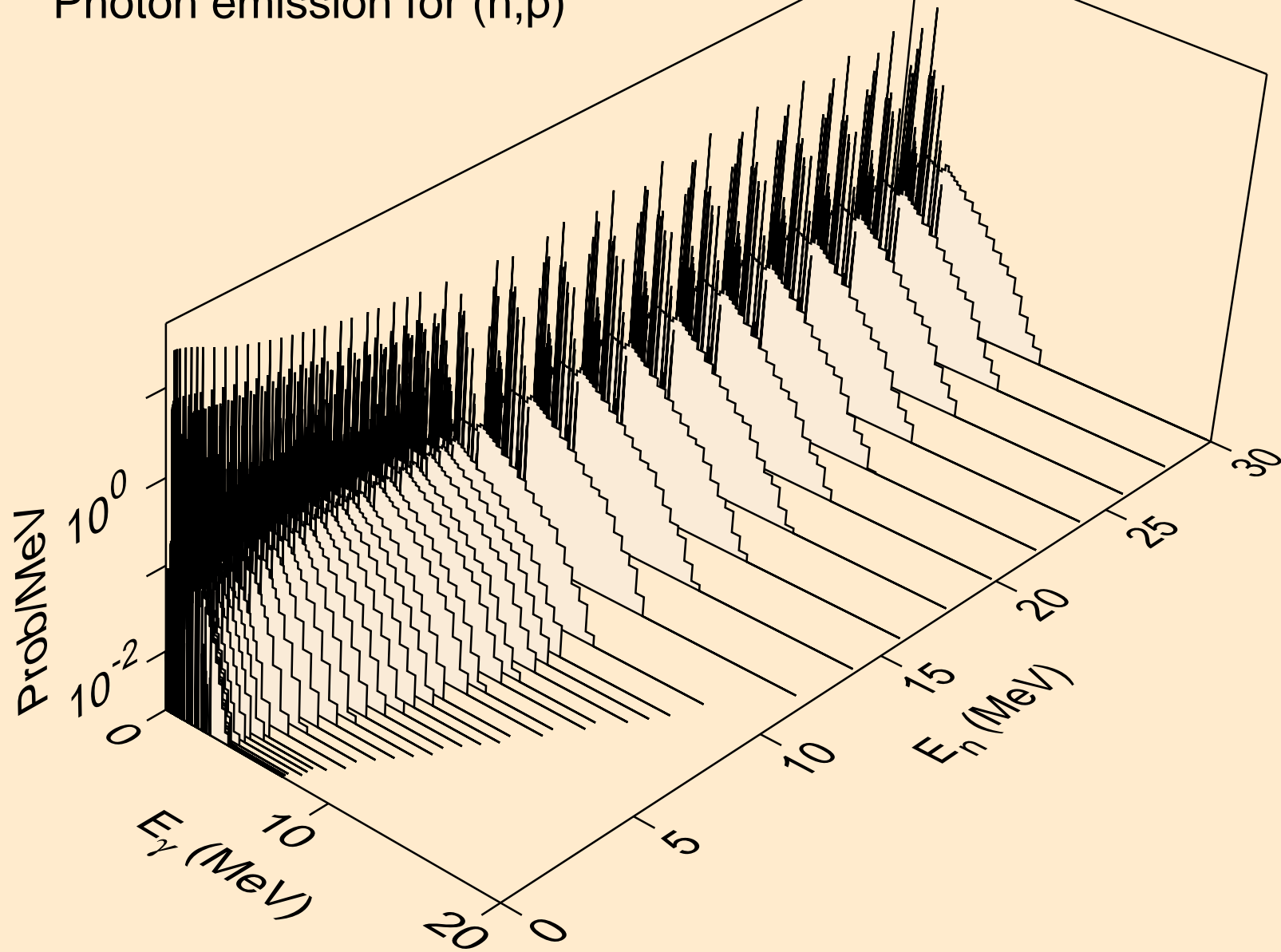

TC091M NEUTRON ACER TENDL-2024 LIBRARY; T=293.6K  
Photon emission for (n,d)

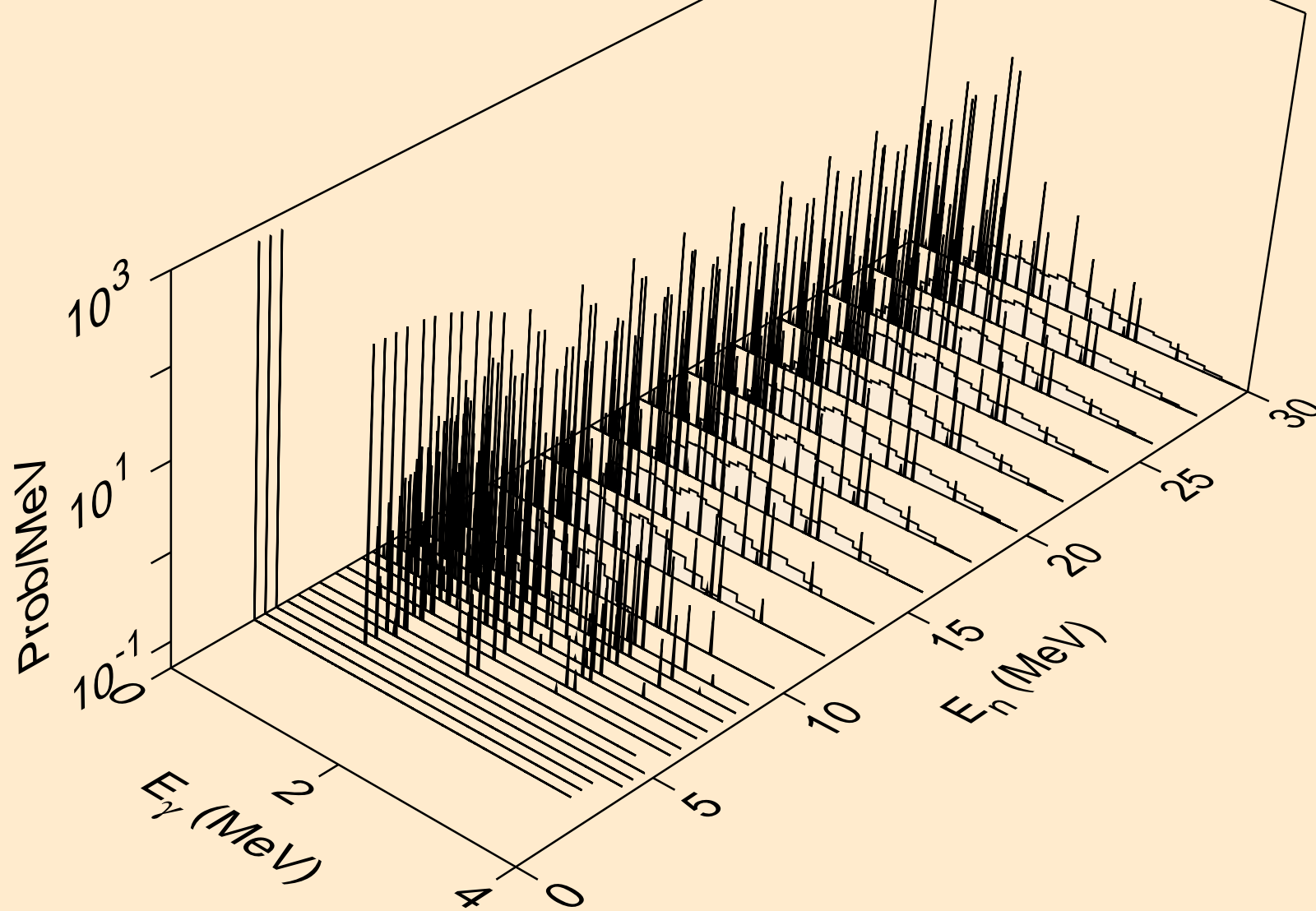

TC091M NEUTRON ACER TENDL-2024 LIBRARY; T=293.6K  
Photon emission for (n,t)

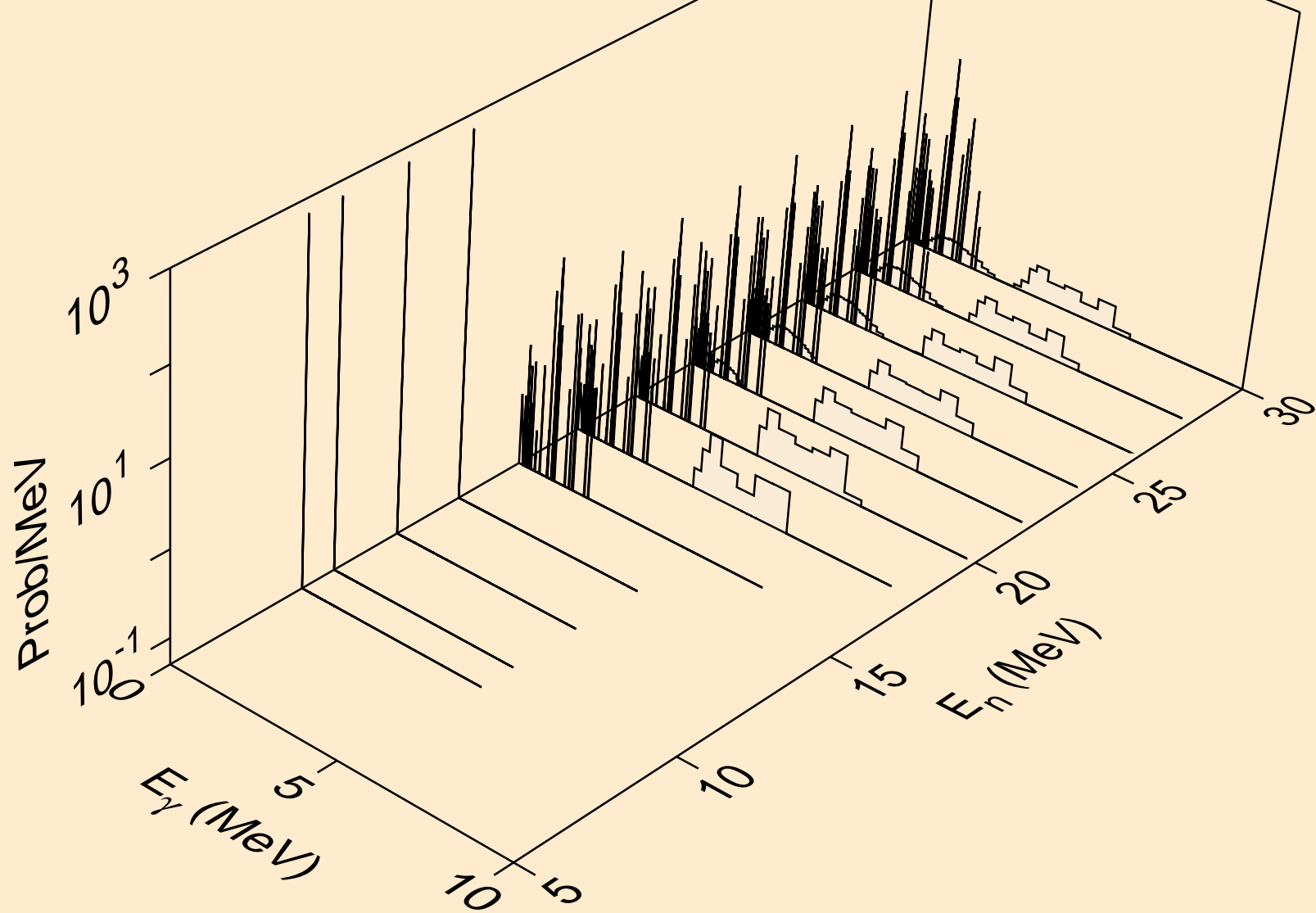

TC091M NEUTRON ACER TENDL-2024 LIBRARY; T=293.6K  
Photon emission for (n,he3)

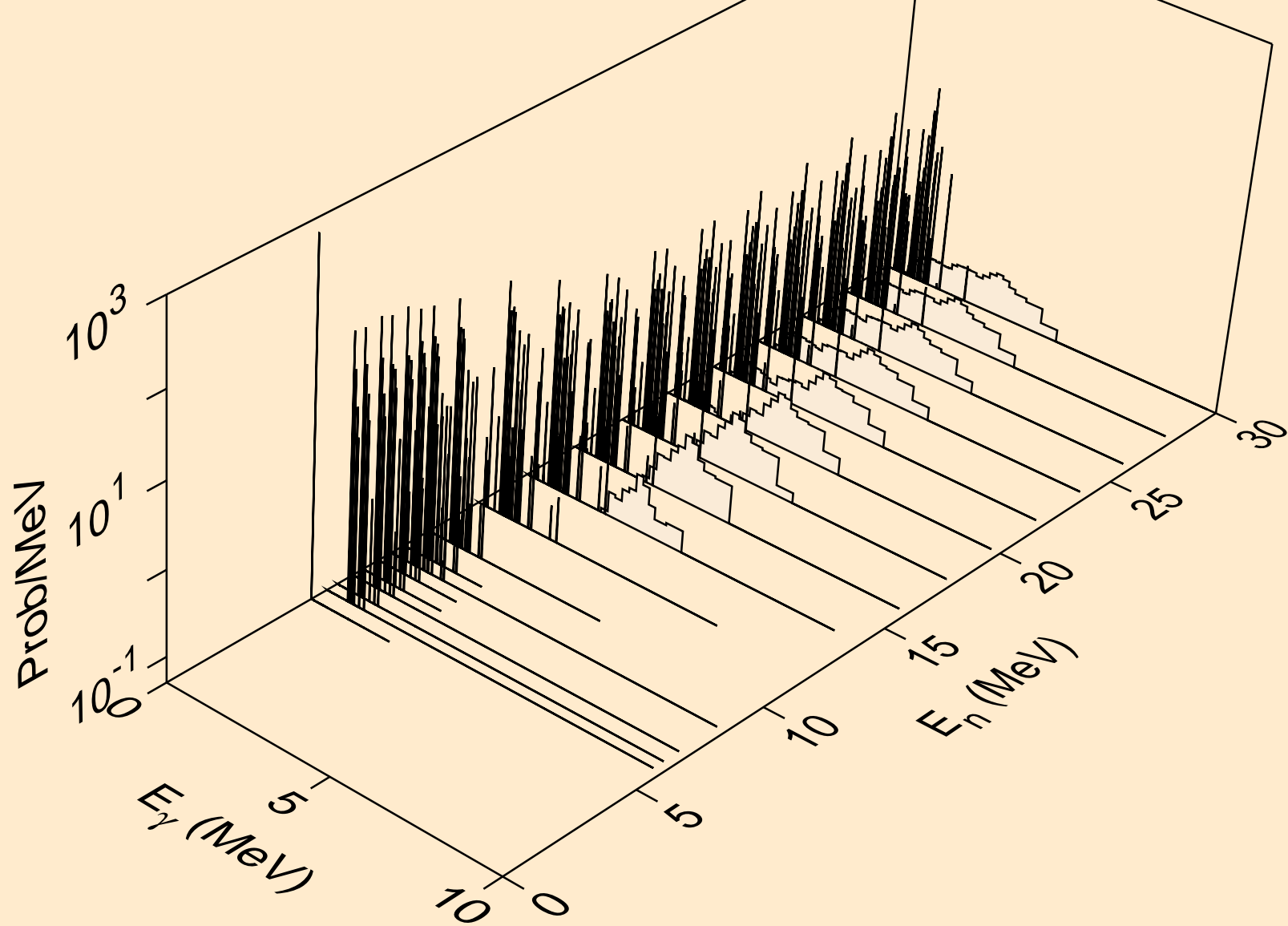

TC091M NEUTRON ACER TENDL-2024 LIBRARY; T=293.6K  
Photon emission for (n,a)

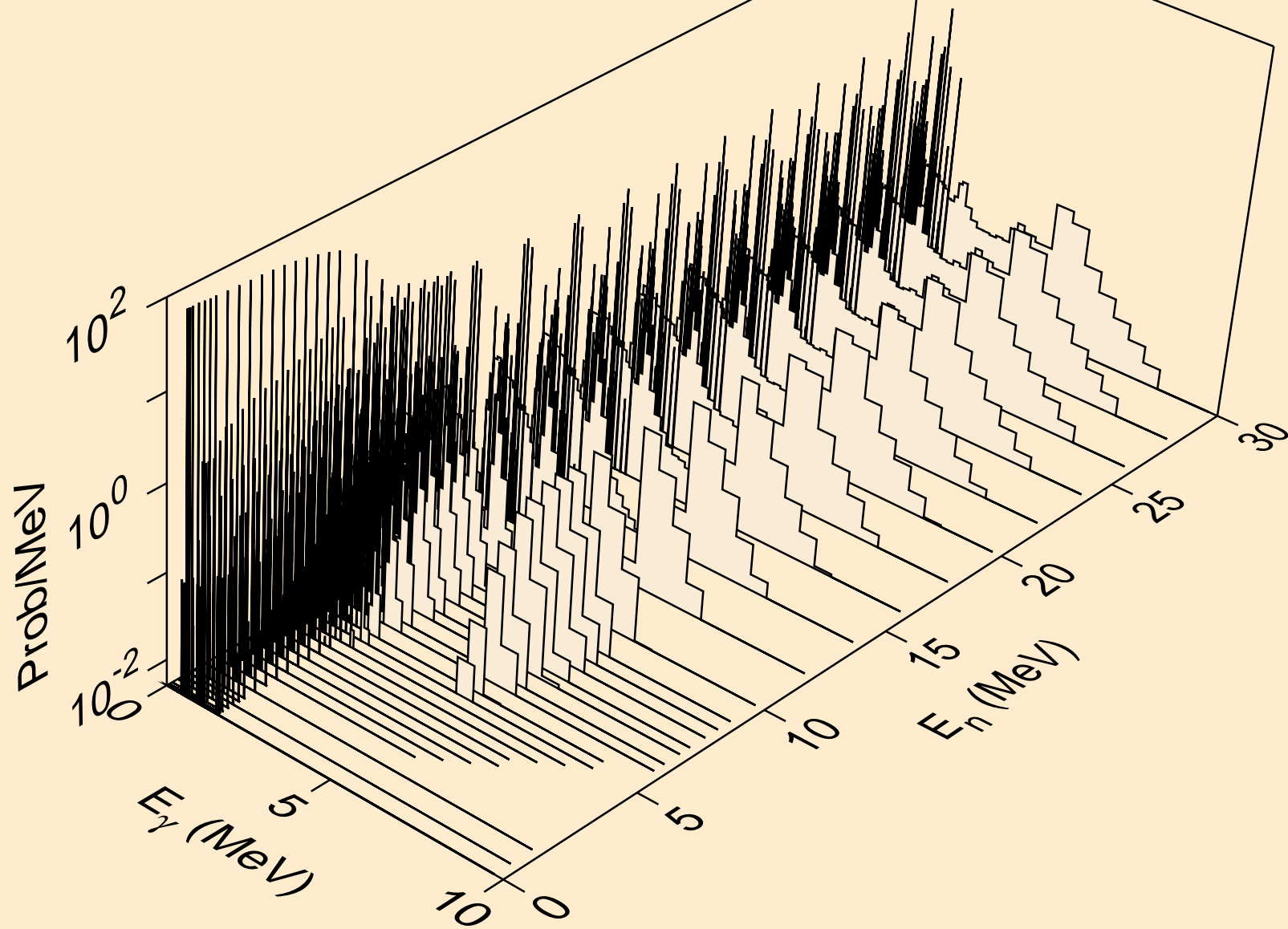

TC091M NEUTRON ACER TENDL-2024 LIBRARY; T=293.6K  
Photon emission for (n,2a)

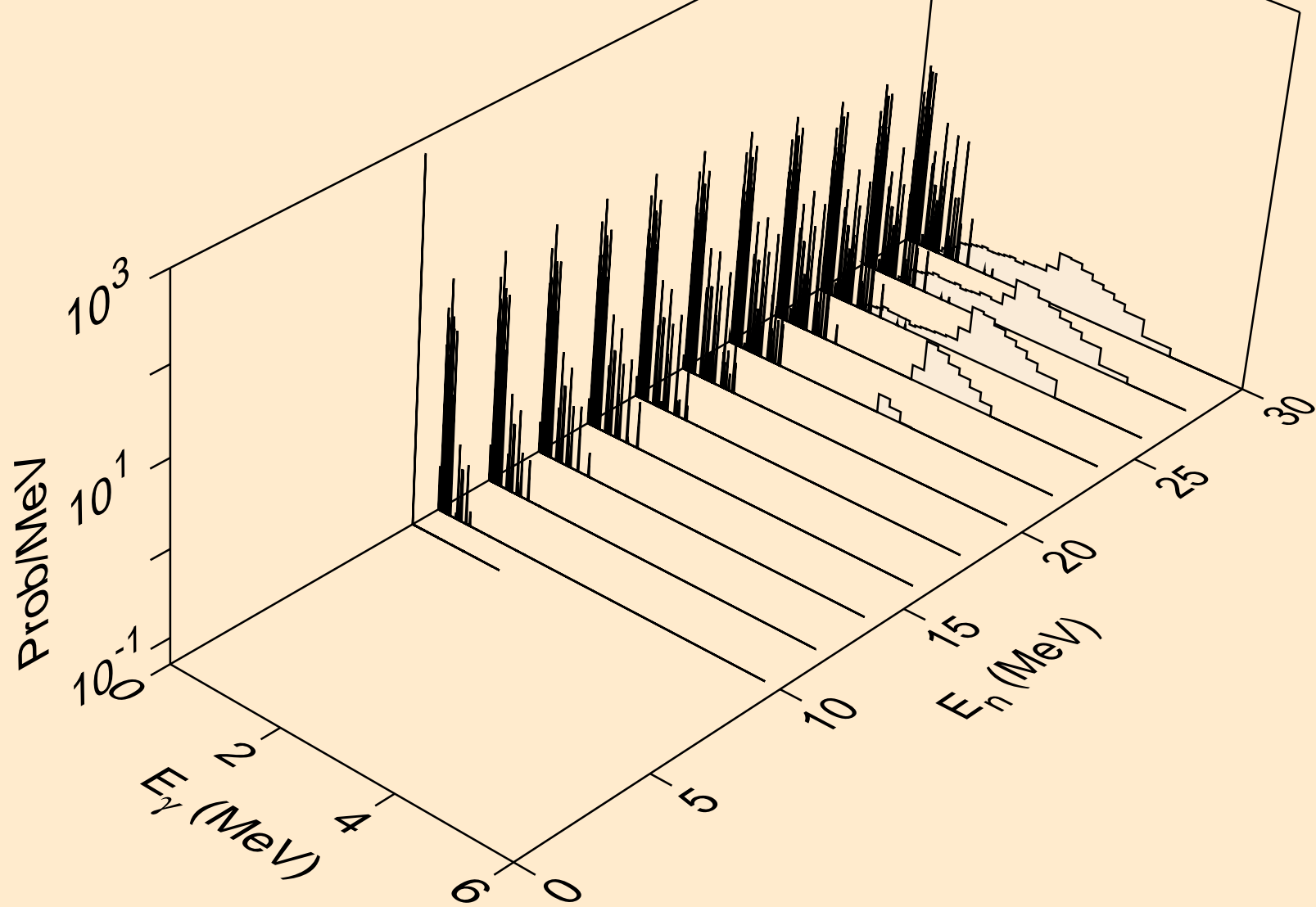

TC091M NEUTRON ACER TENDL-2024 LIBRARY; T=293.6K  
Photon emission for (n,2p)

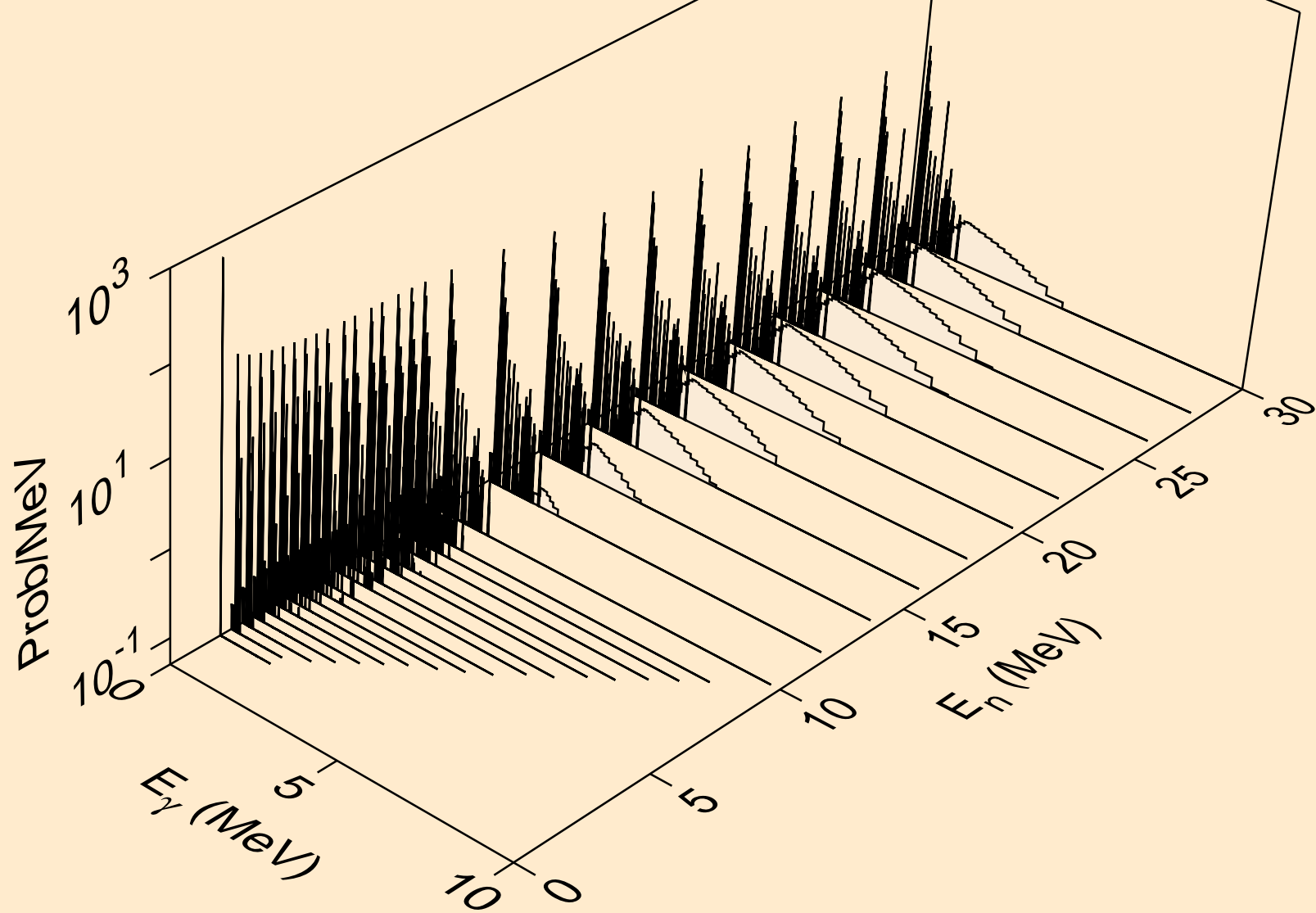

TC091M NEUTRON ACER TENDL-2024 LIBRARY; T=293.6K  
Photon emission for (n,p $\alpha$ )

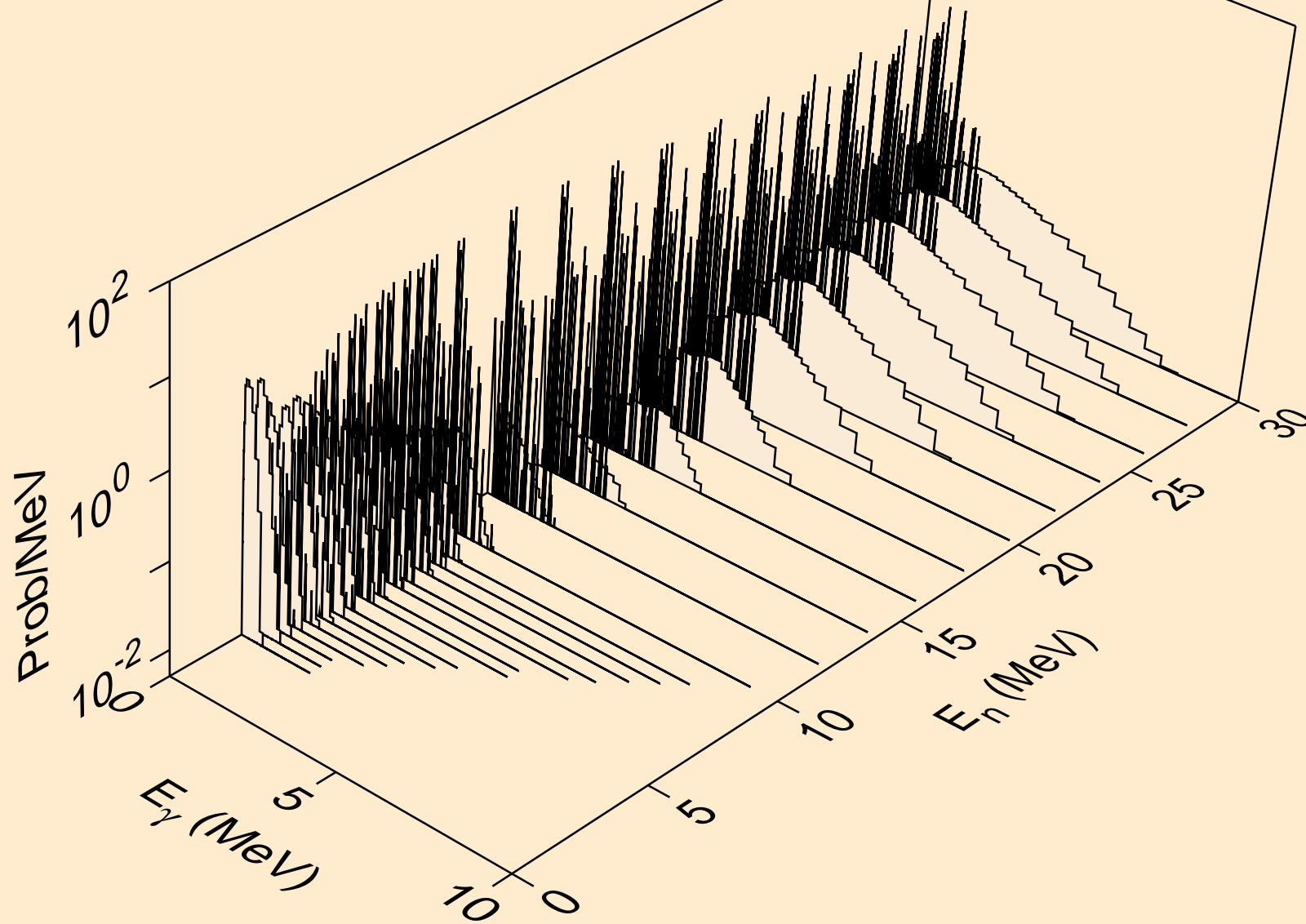

TC091M NEUTRON ACER TENDL-2024 LIBRARY; T=293.6K  
Photon emission for (n,pd)

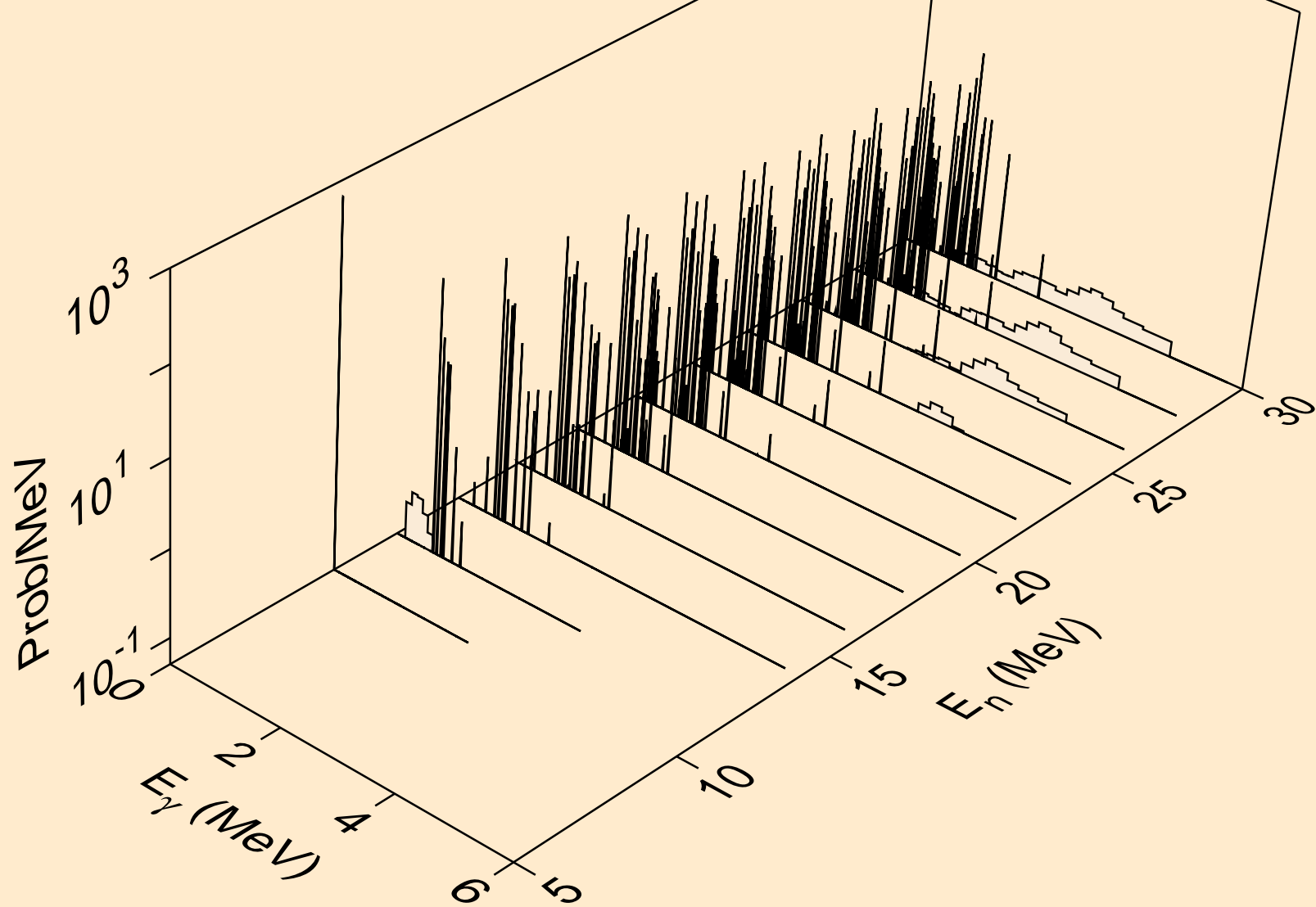

TC091M NEUTRON ACER TENDL-2024 LIBRARY; T=293.6K  
Photon emission for (n,pt)

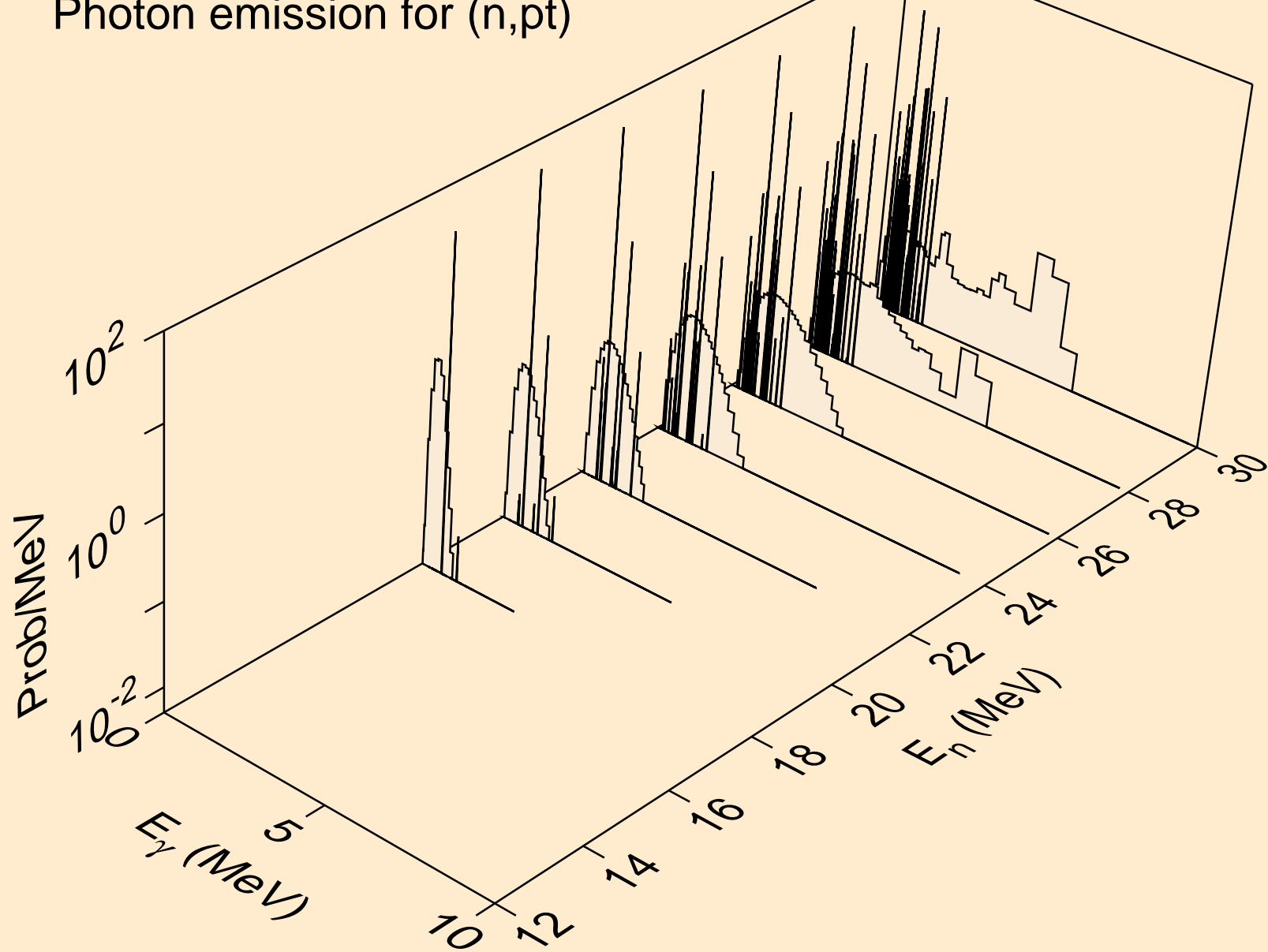

TC091M NEUTRON ACER TENDL-2024 LIBRARY; T=293.6K  
Photon emission for (n,da)

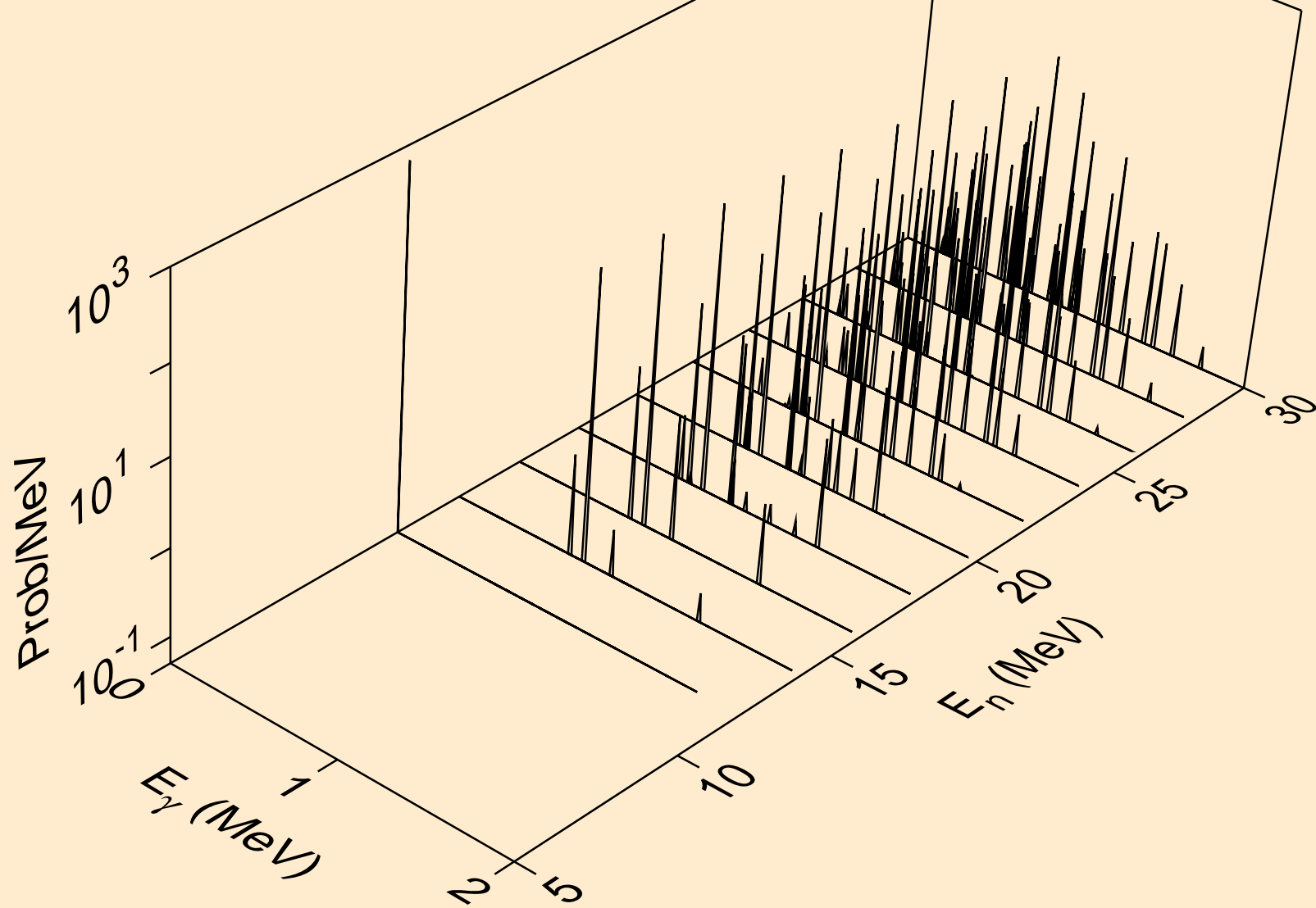

TC091M NEUTRON ACER TENDL-2024 LIBRARY; T=293.6K  
thermal capture photon spectrum

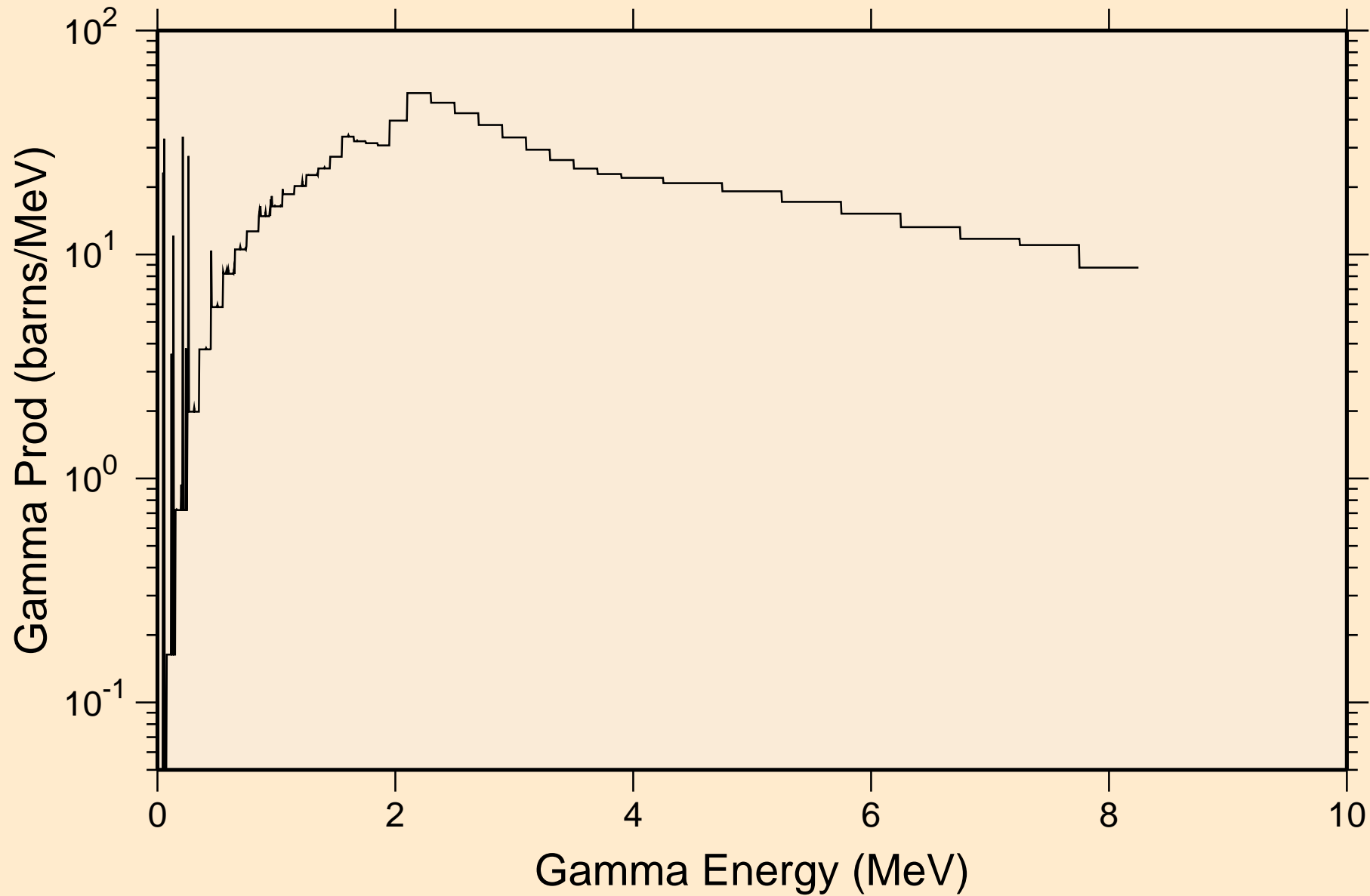

TC091M NEUTRON ACER TENDL-2024 LIBRARY; T=293.6K  
14 MeV photon spectrum

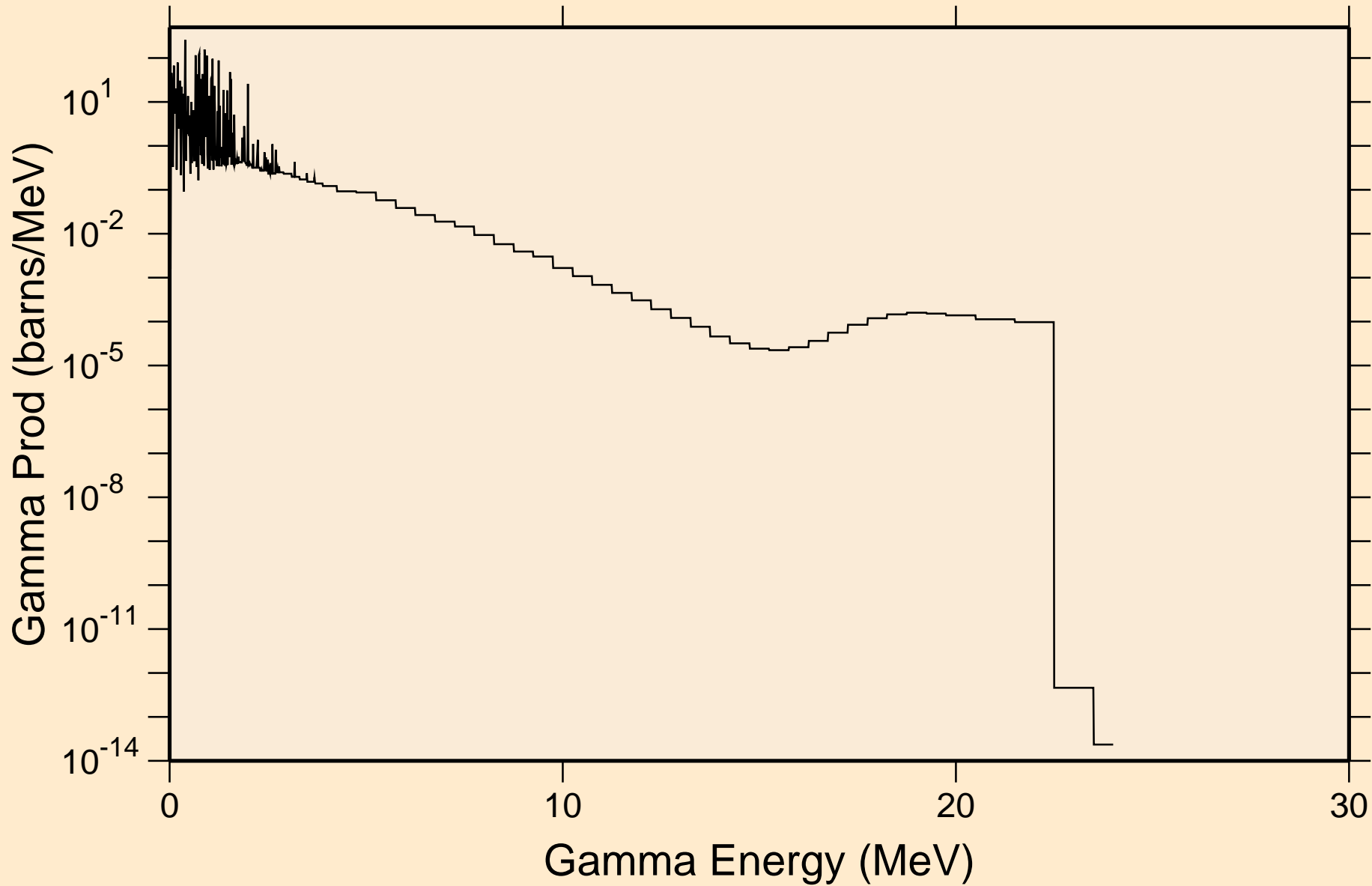

# TC091M NEUTRON ACER TENDL-2024 LIBRARY; T=293.6K

## Particle heating contributions

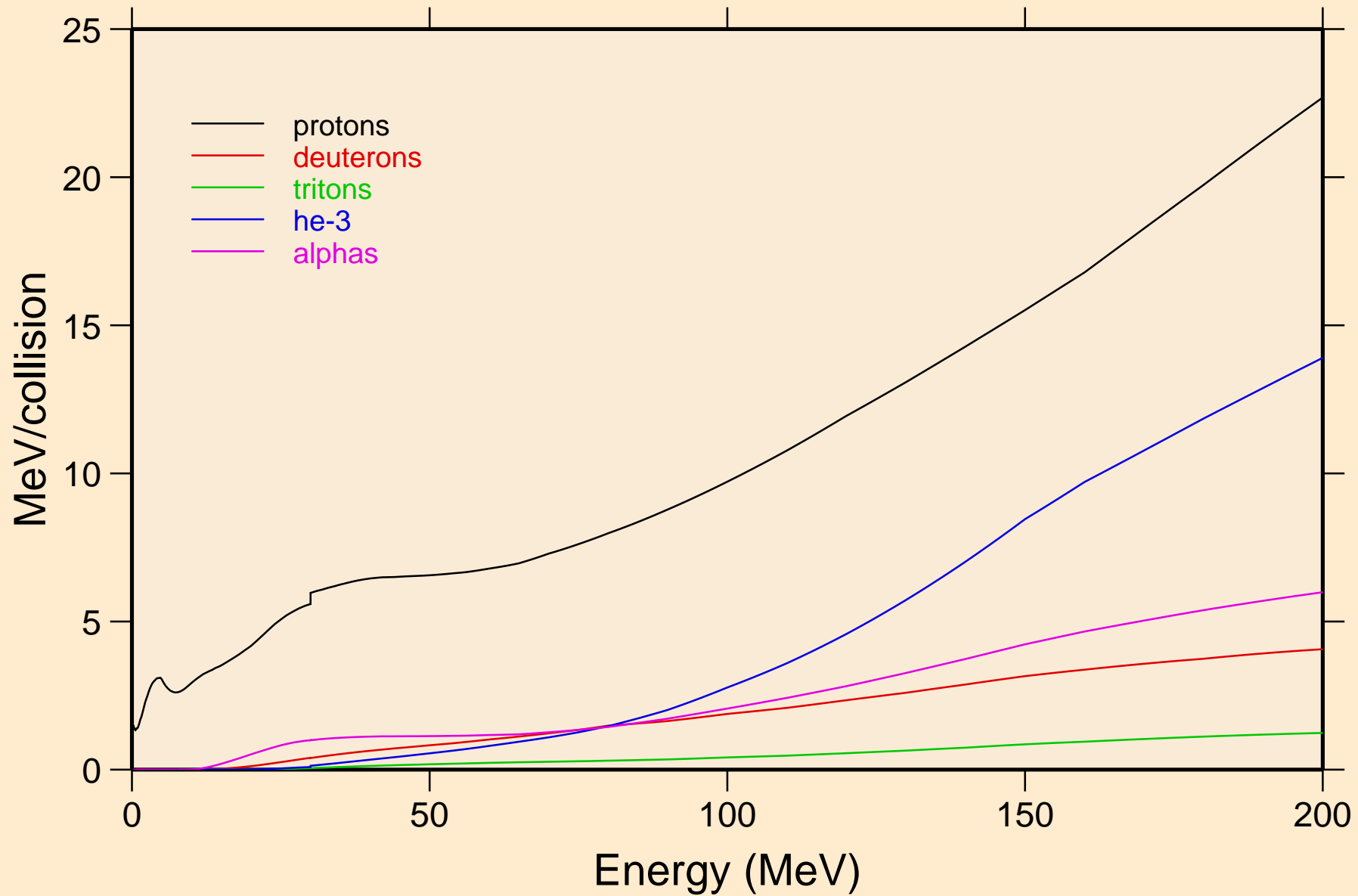

TC091M NEUTRON ACER TENDL-2024 LIBRARY; T=293.6K  
Recoil Heating

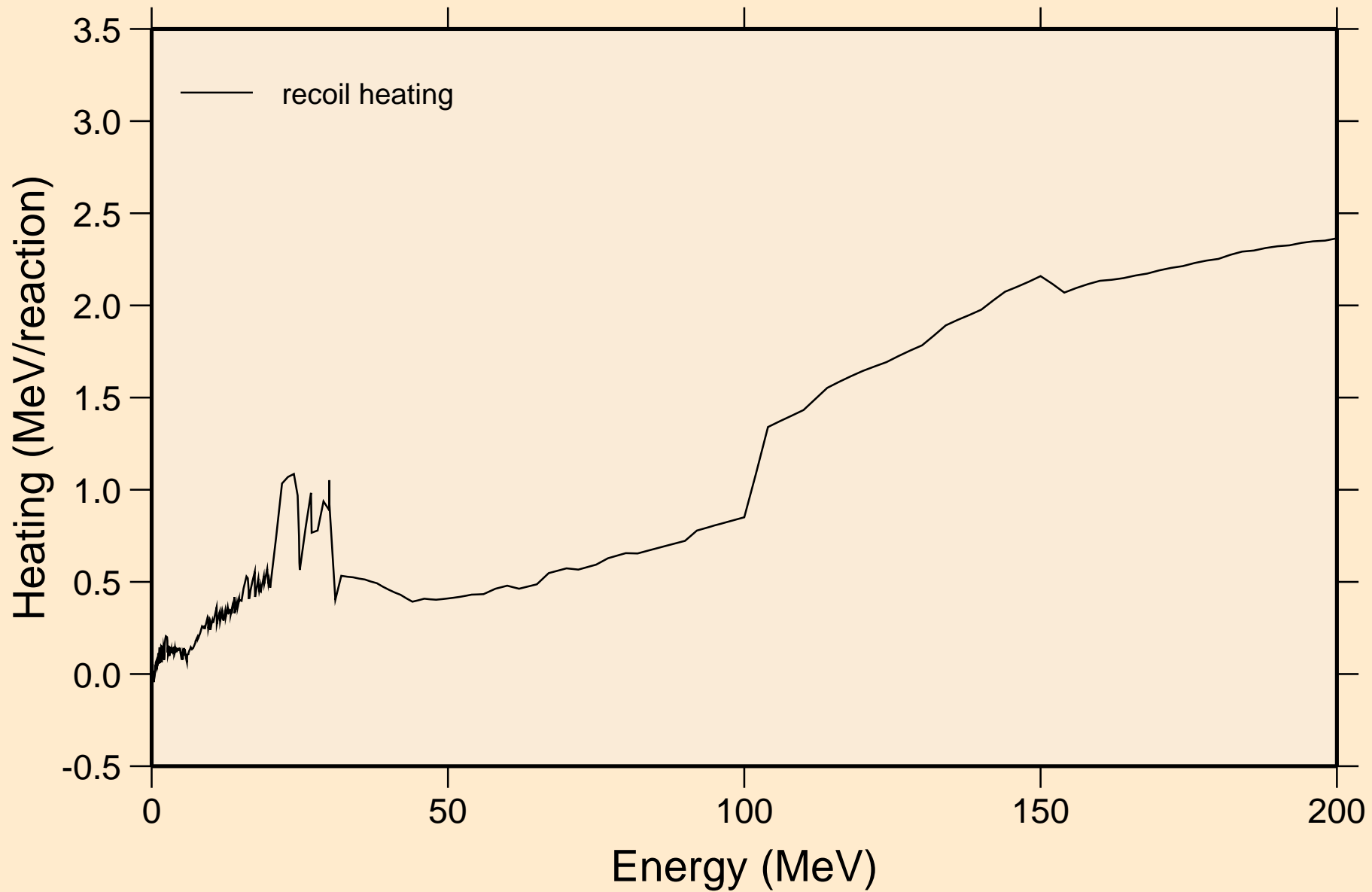

TC091M NEUTRON ACER TENDL-2024 LIBRARY; T=293.6K  
Particle production cross sections

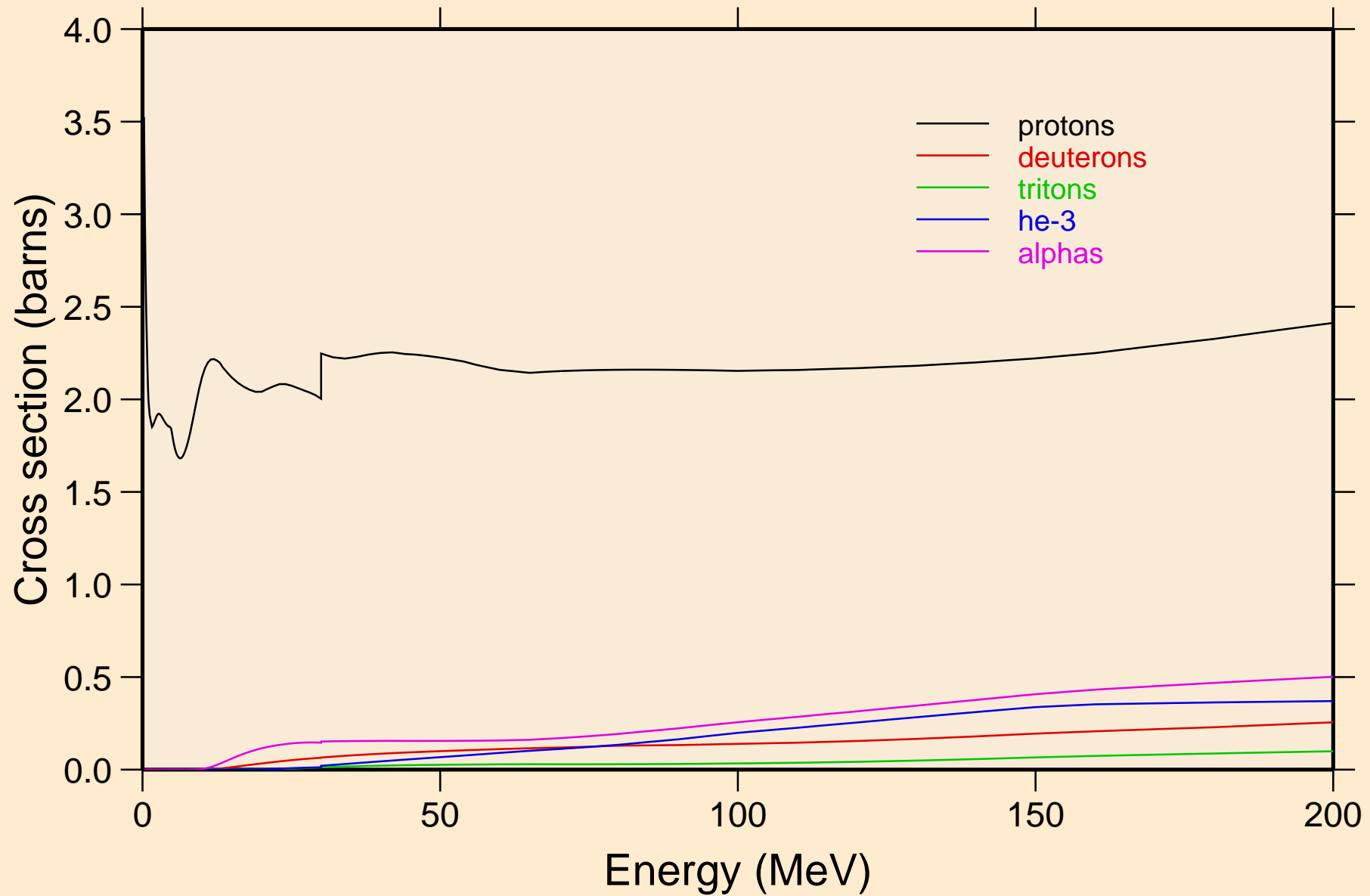

TC091M NEUTRON ACER TENDL-2024 LIBRARY; T=293.6K  
protons from (n,x)

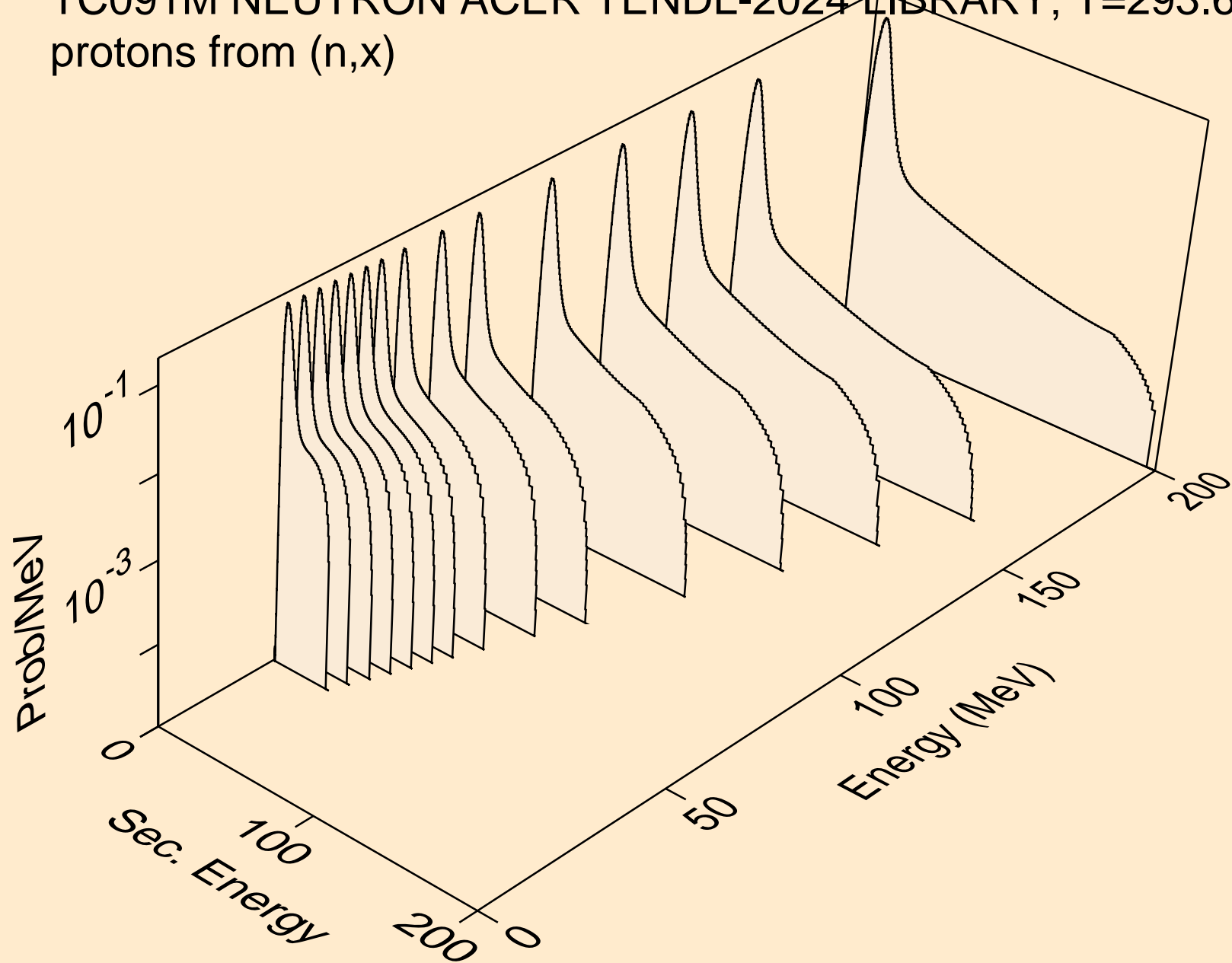

TC091M NEUTRON ACER TENDL-2024 LIBRARY; T=293.6K  
protons from (n,n\*)p

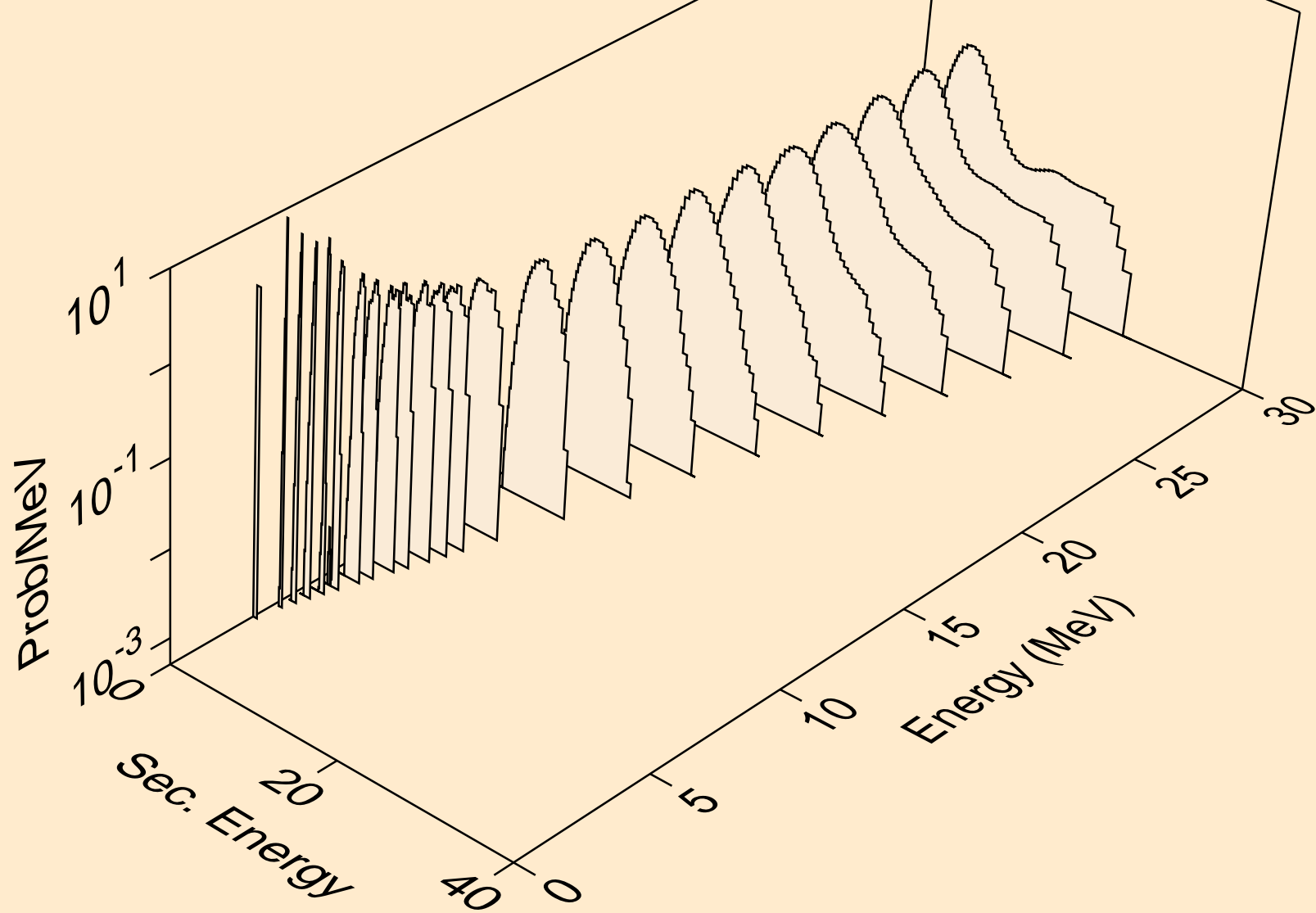

TC091M NEUTRON ACER TENDL-2024 LIBRARY; T=293.6K  
protons from (n,2np)

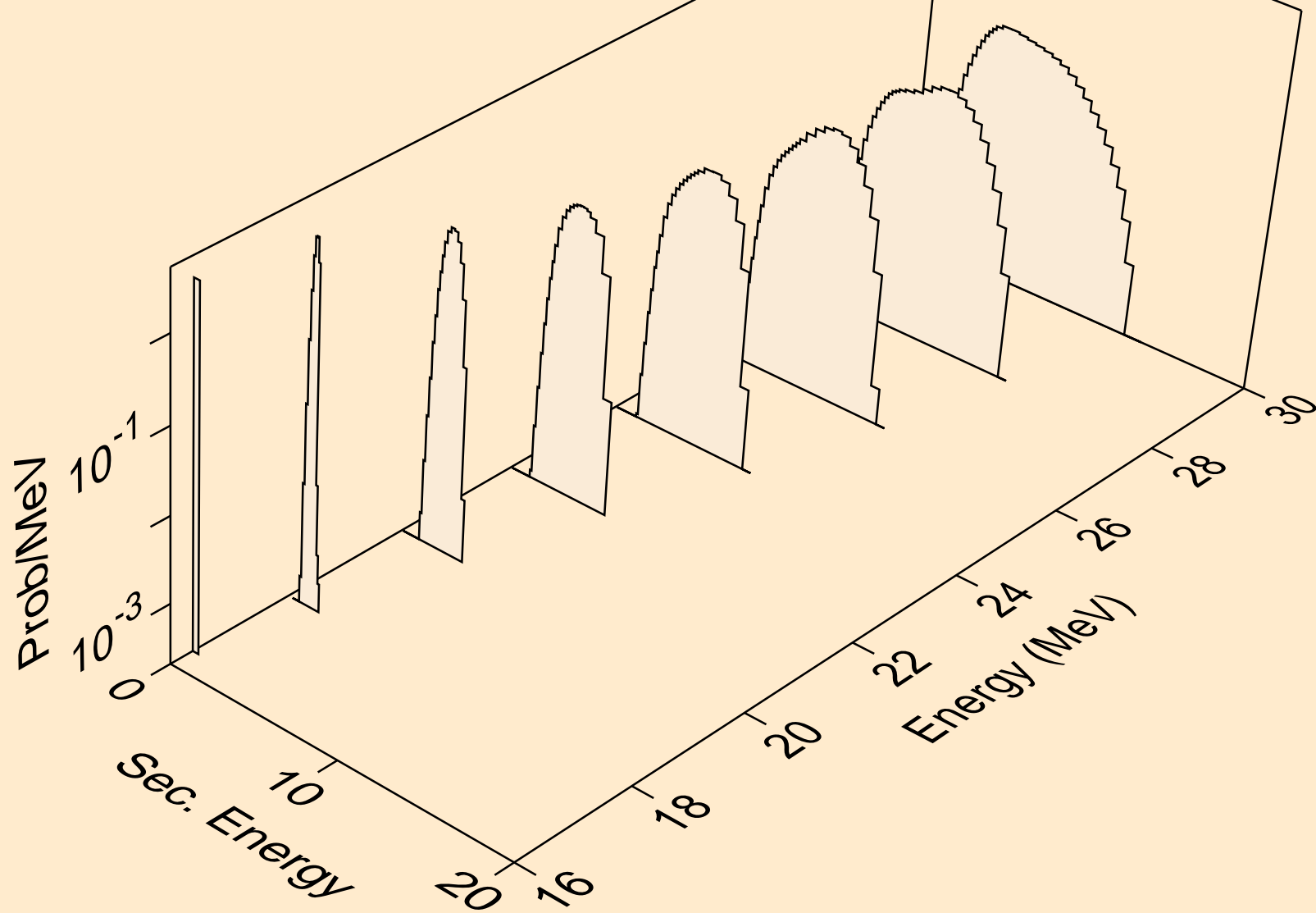

TC091M NEUTRON ACER TENDL-2024 LIBRARY; T=293.6K  
protons from (n,3np)

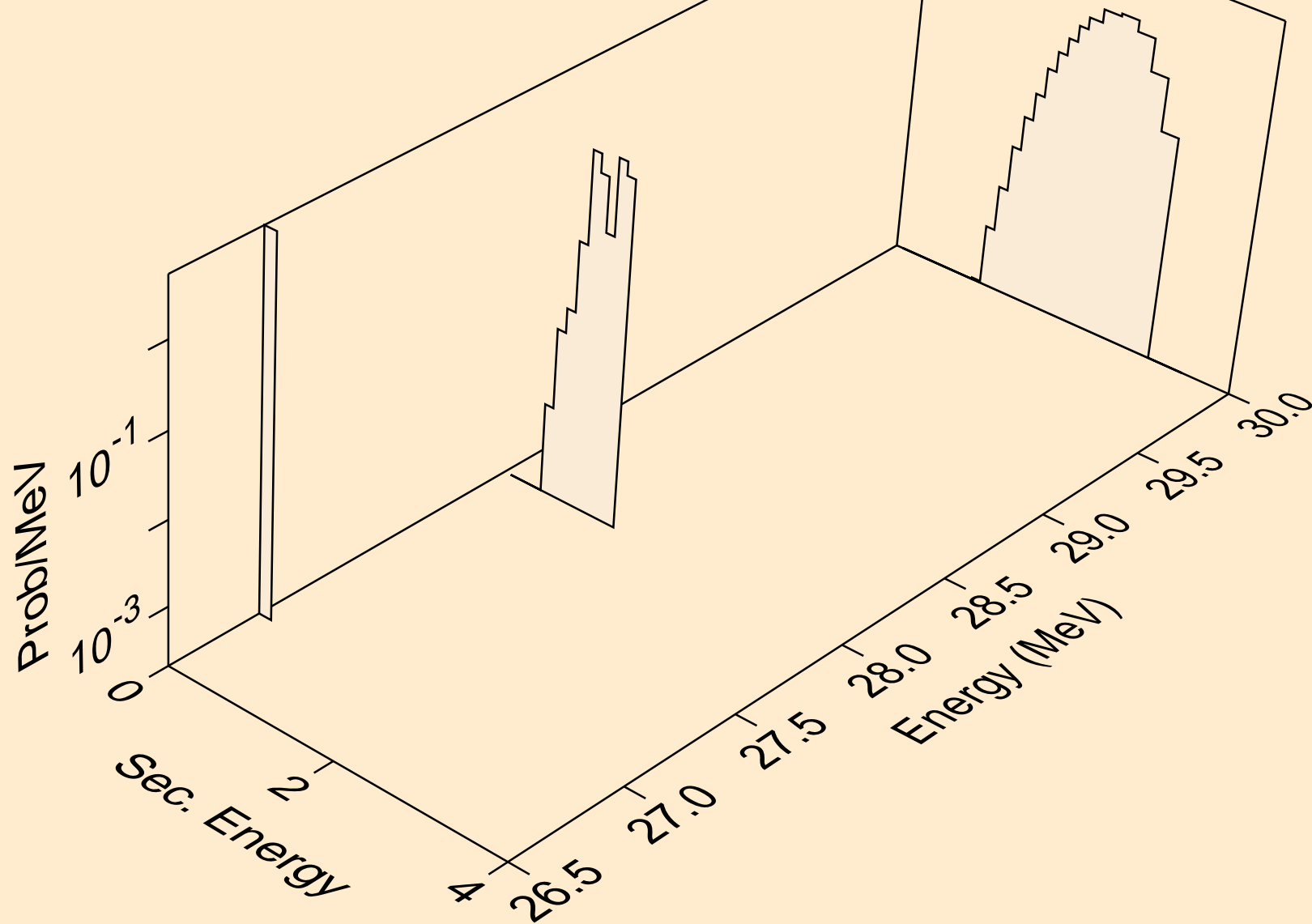

TC091M NEUTRON ACER TENDL-2024 LIBRARY; T=293.6K  
protons from (n,n2p)

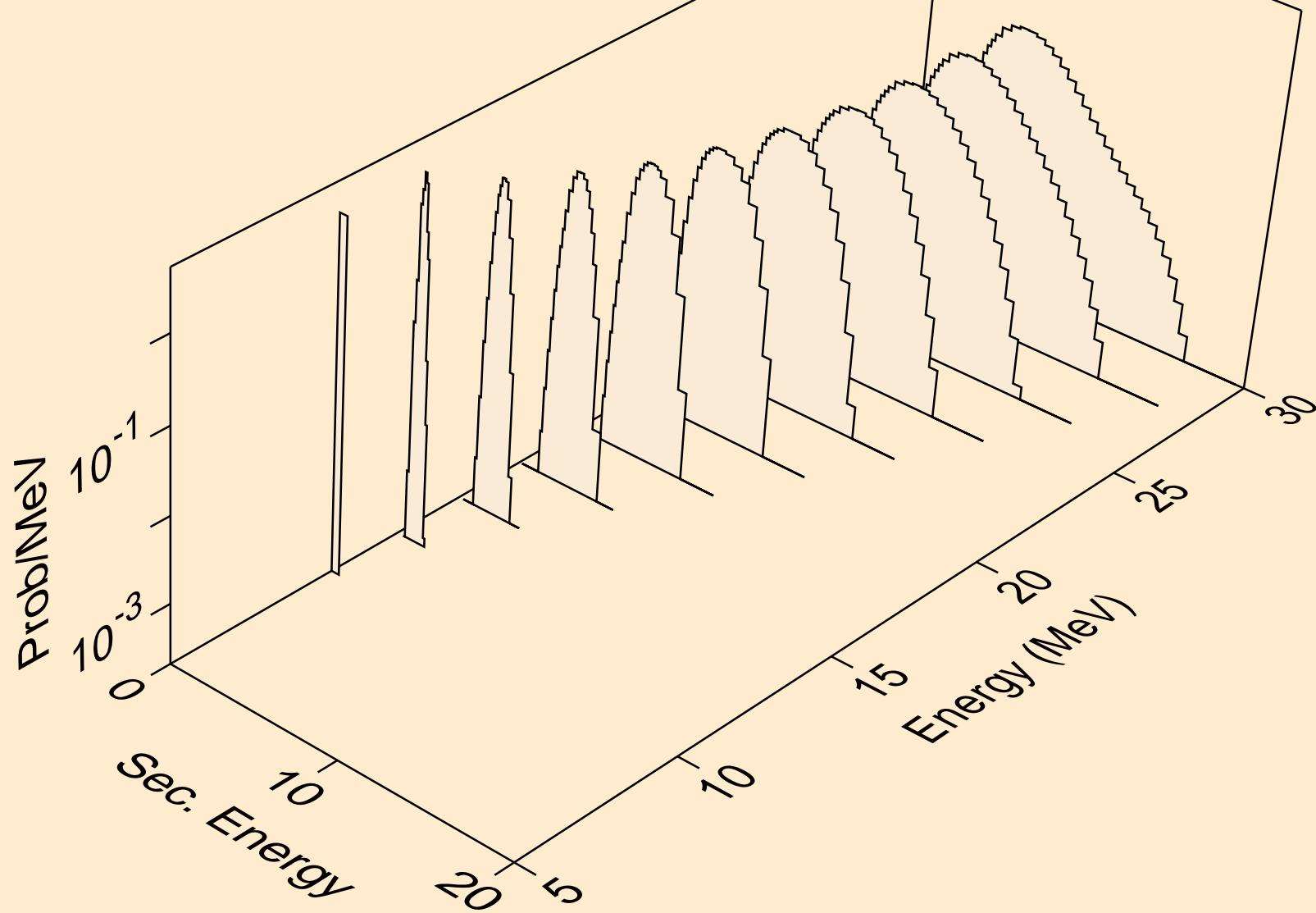

TC091M NEUTRON ACER TENDL-2024 LIBRARY; T=293.6K  
protons from (n,npa)

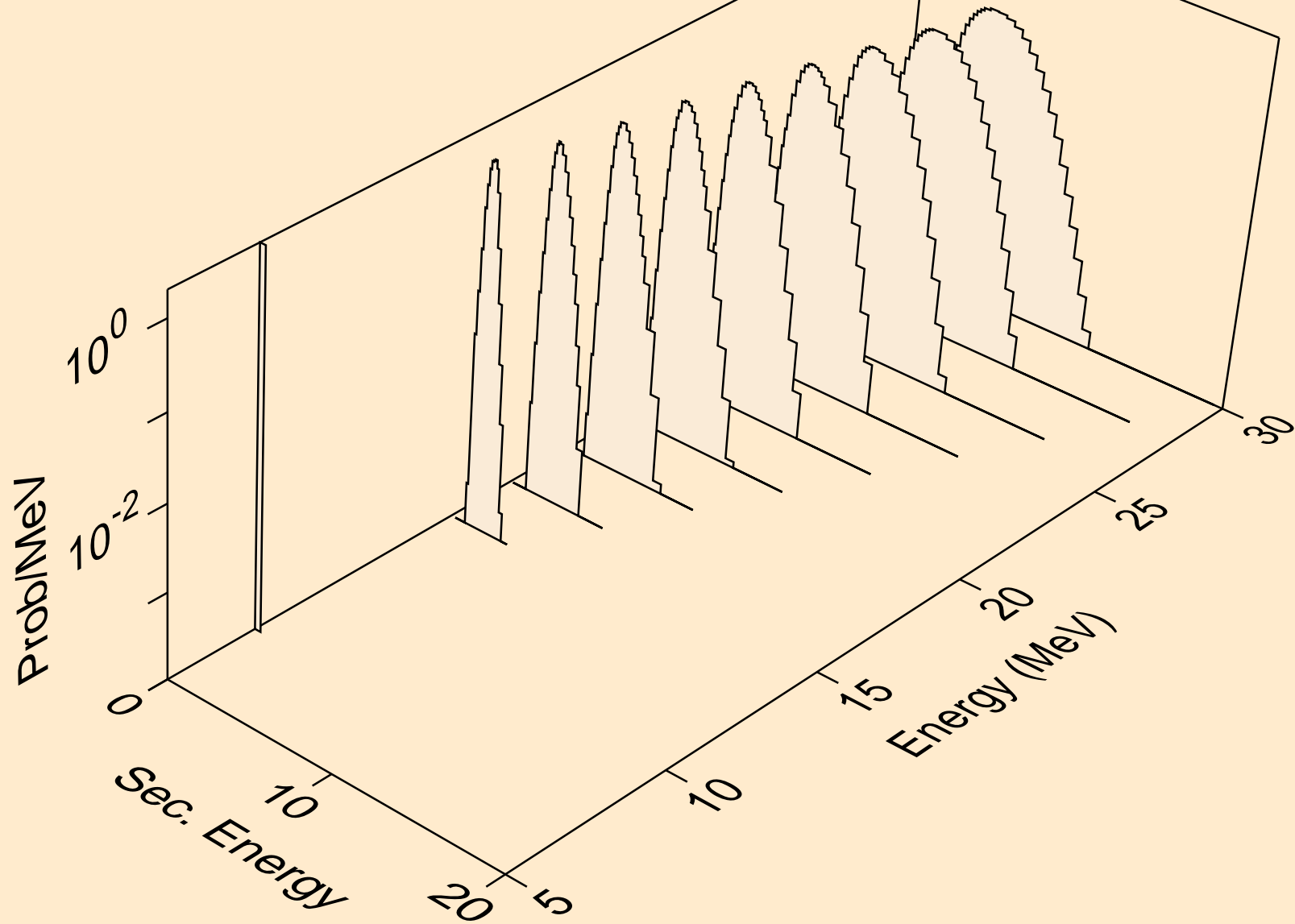

TC091M NEUTRON ACER TENDL-2024 LIBRARY; T=293.6K  
protons from (n,p)

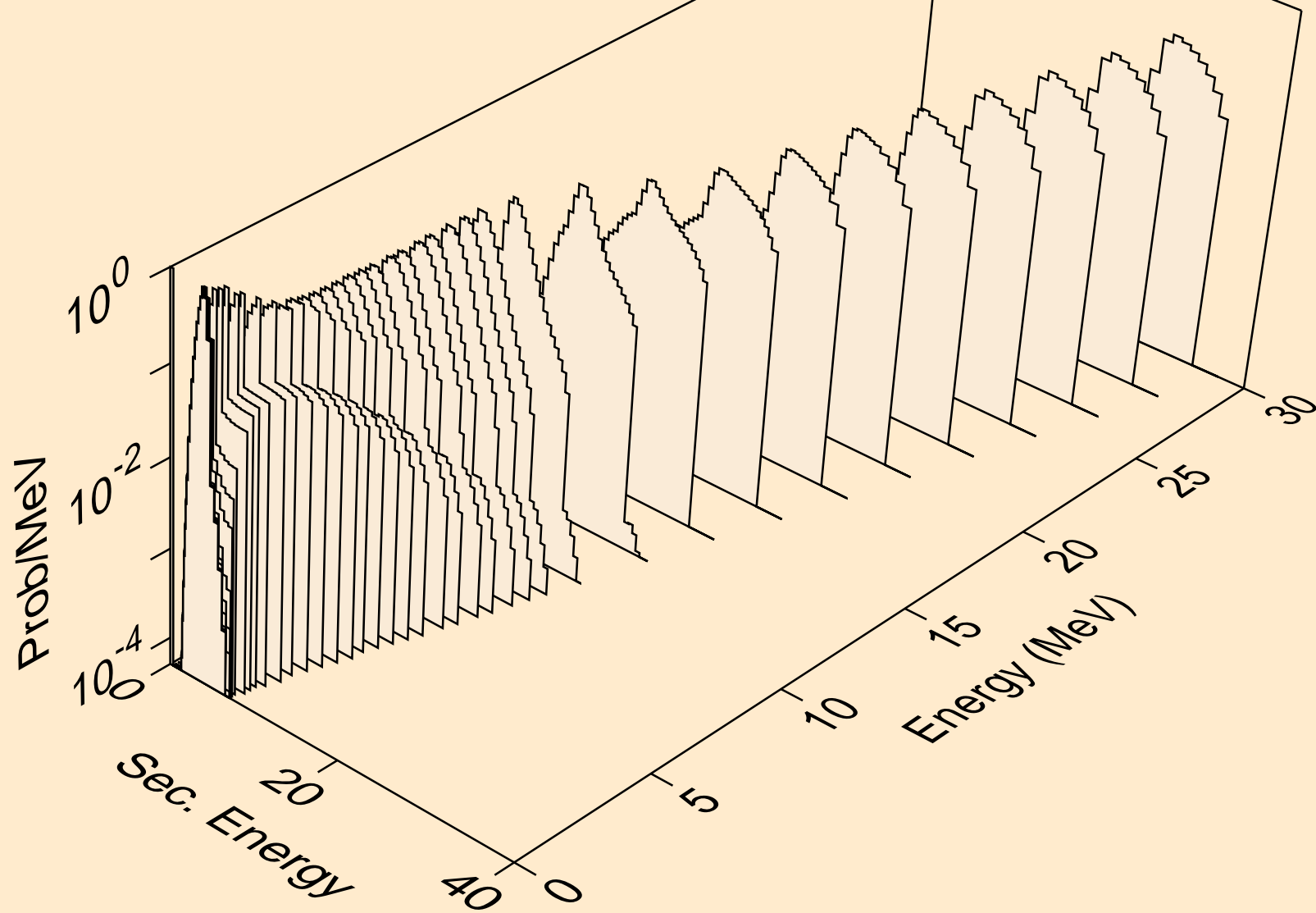

TC091M NEUTRON ACER TENDL-2024 LIBRARY; T=293.6K  
protons from (n,2p)

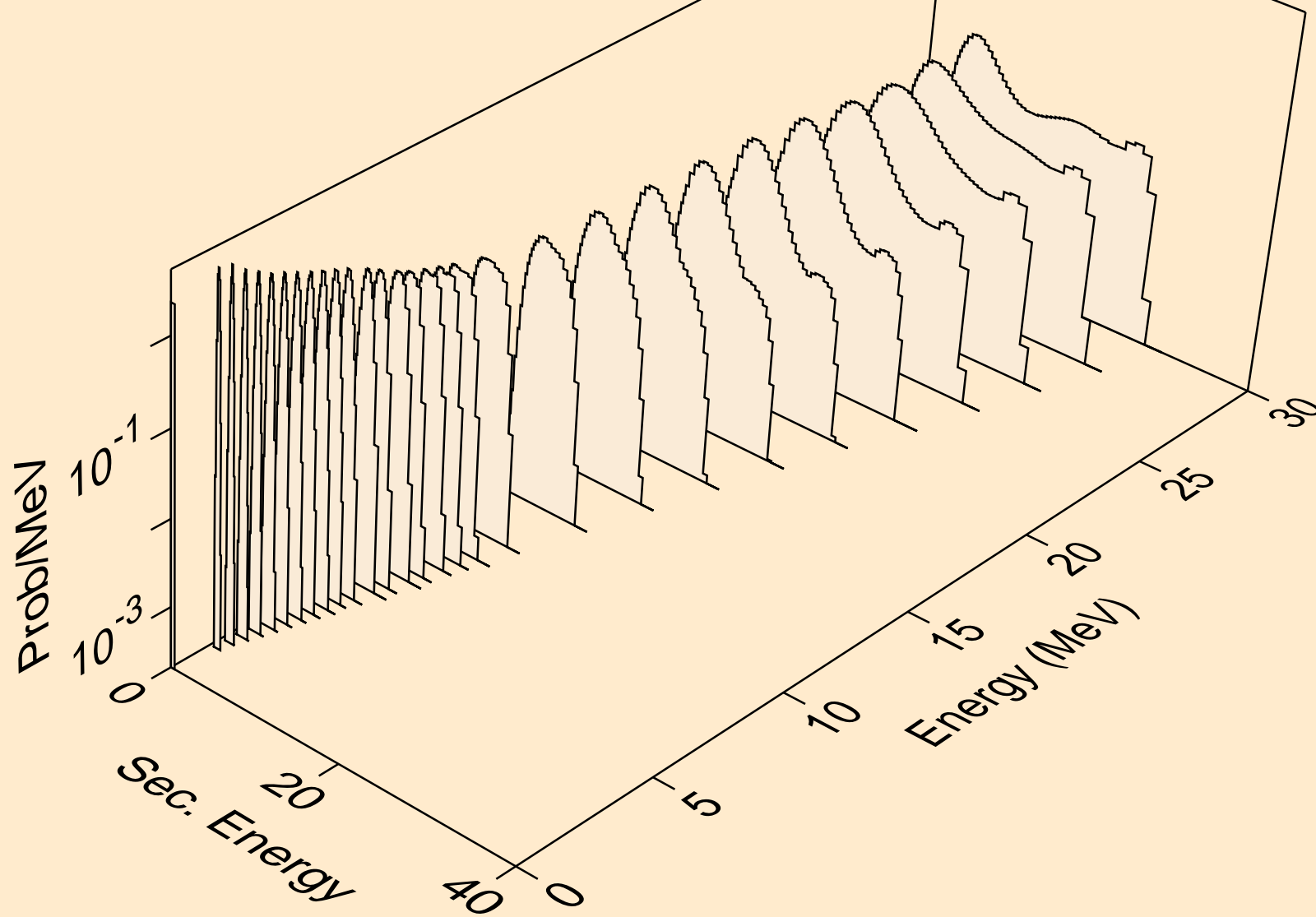

TC091M NEUTRON ACER TENDL-2024 LIBRARY; T=293.6K  
protons from (n,p)

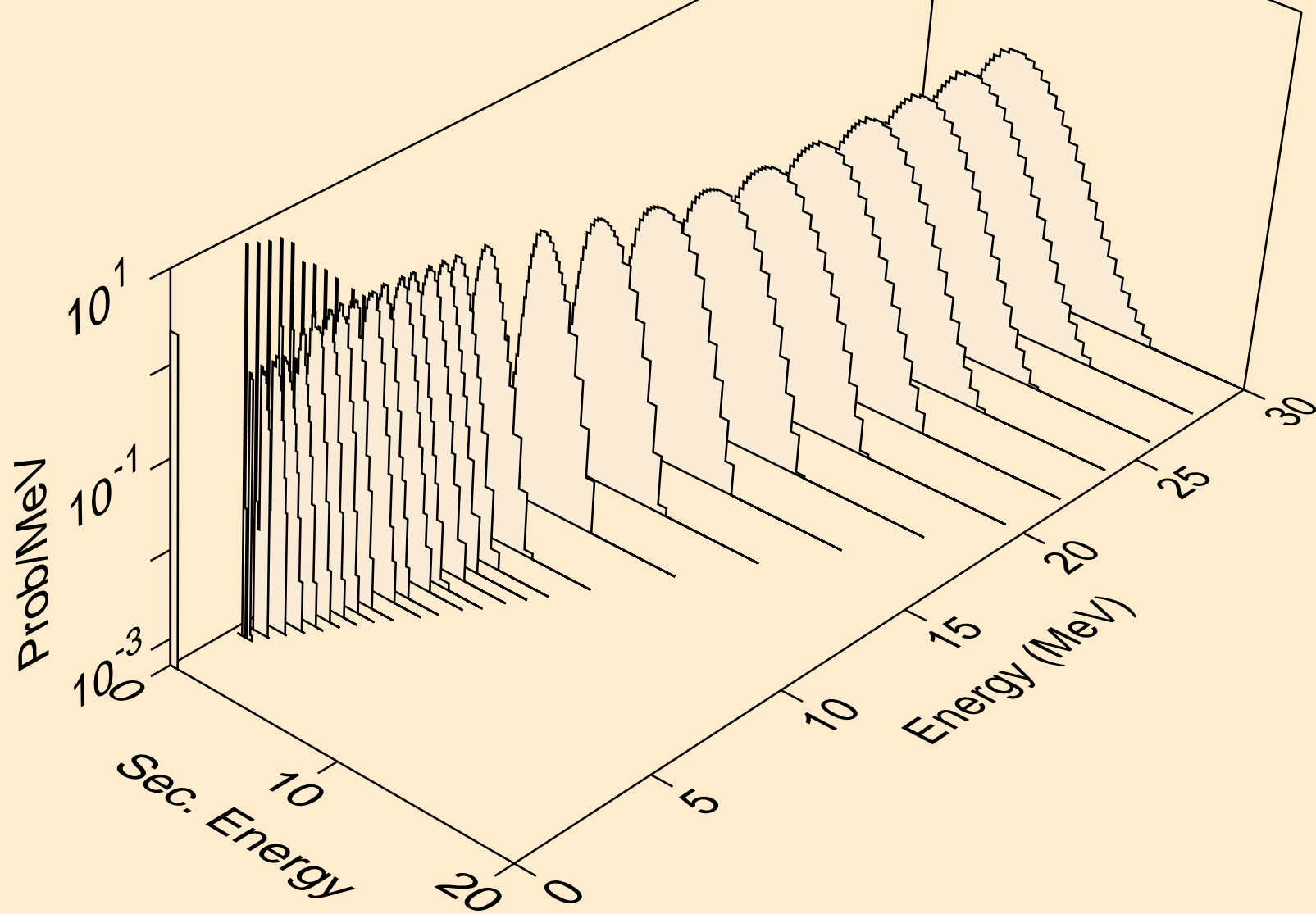

TC091M NEUTRON ACER TENDL-2024 LIBRARY; T=293.6K  
protons from (n,pd)

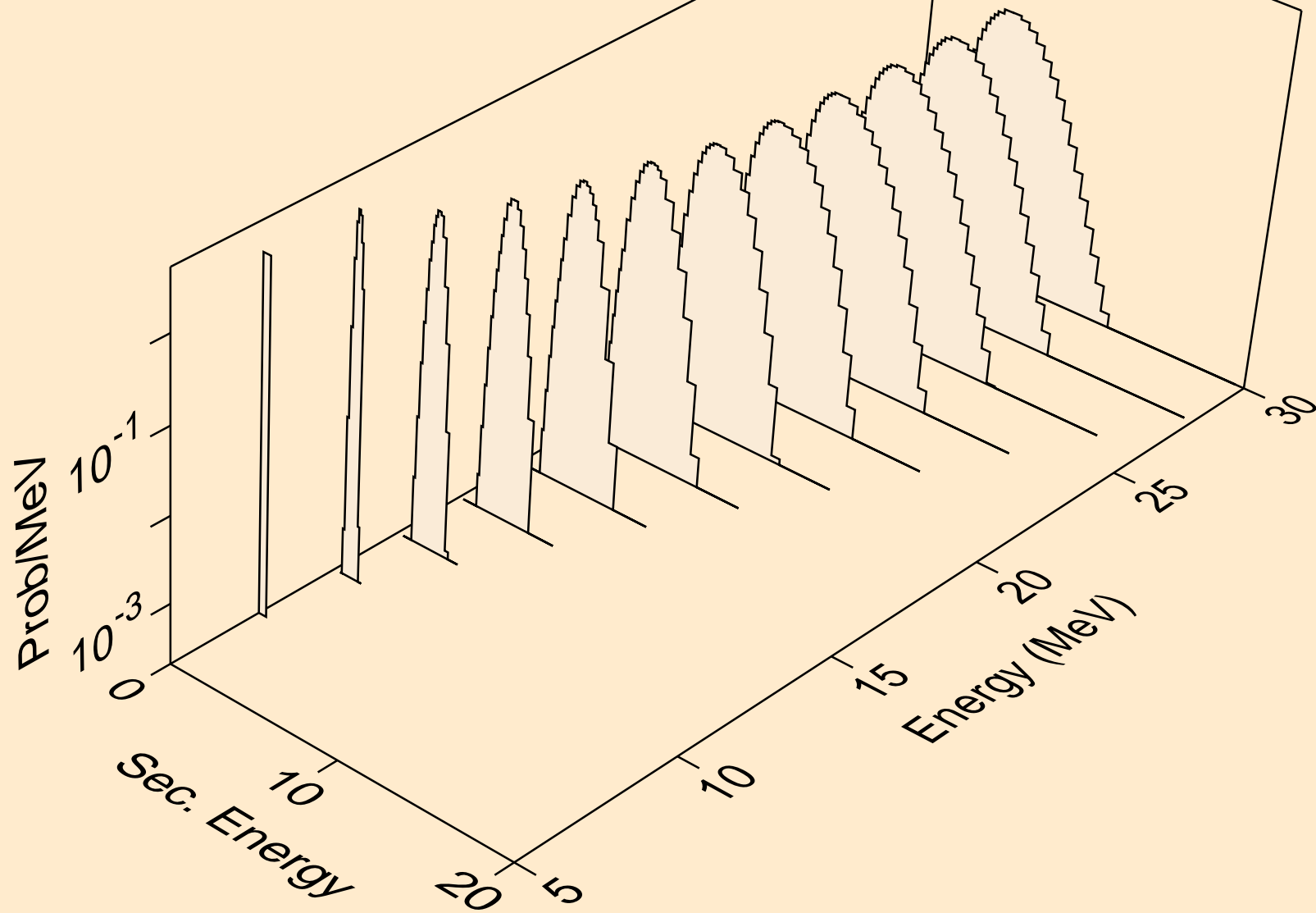

TC091M NEUTRON ACER TENDL-2024 LIBRARY; T=293.6K  
protons from (n,pt)

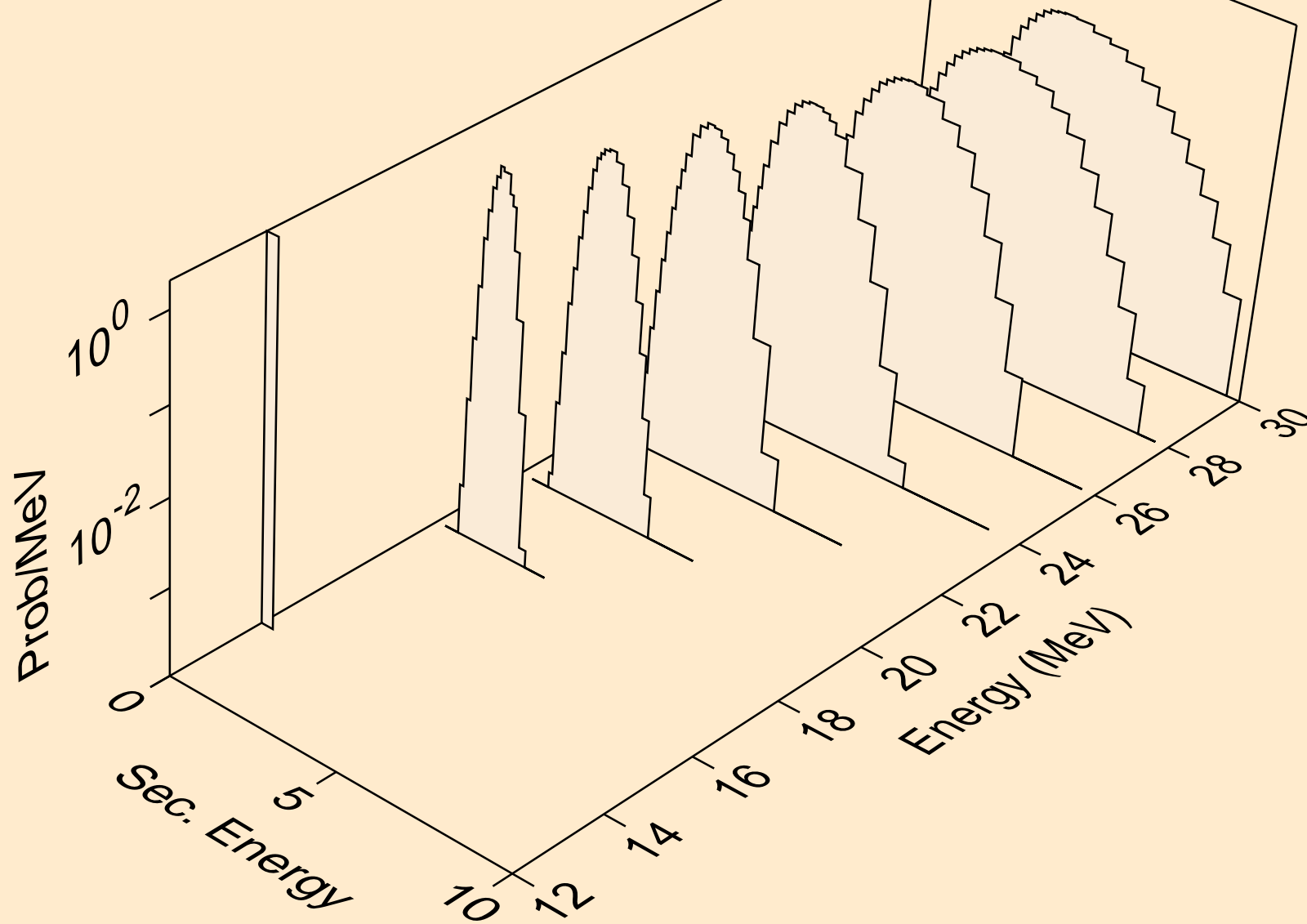

TC091M NEUTRON ACER TENDL-2024 LIBRARY; T=293.6K  
deuterons from (n,x)

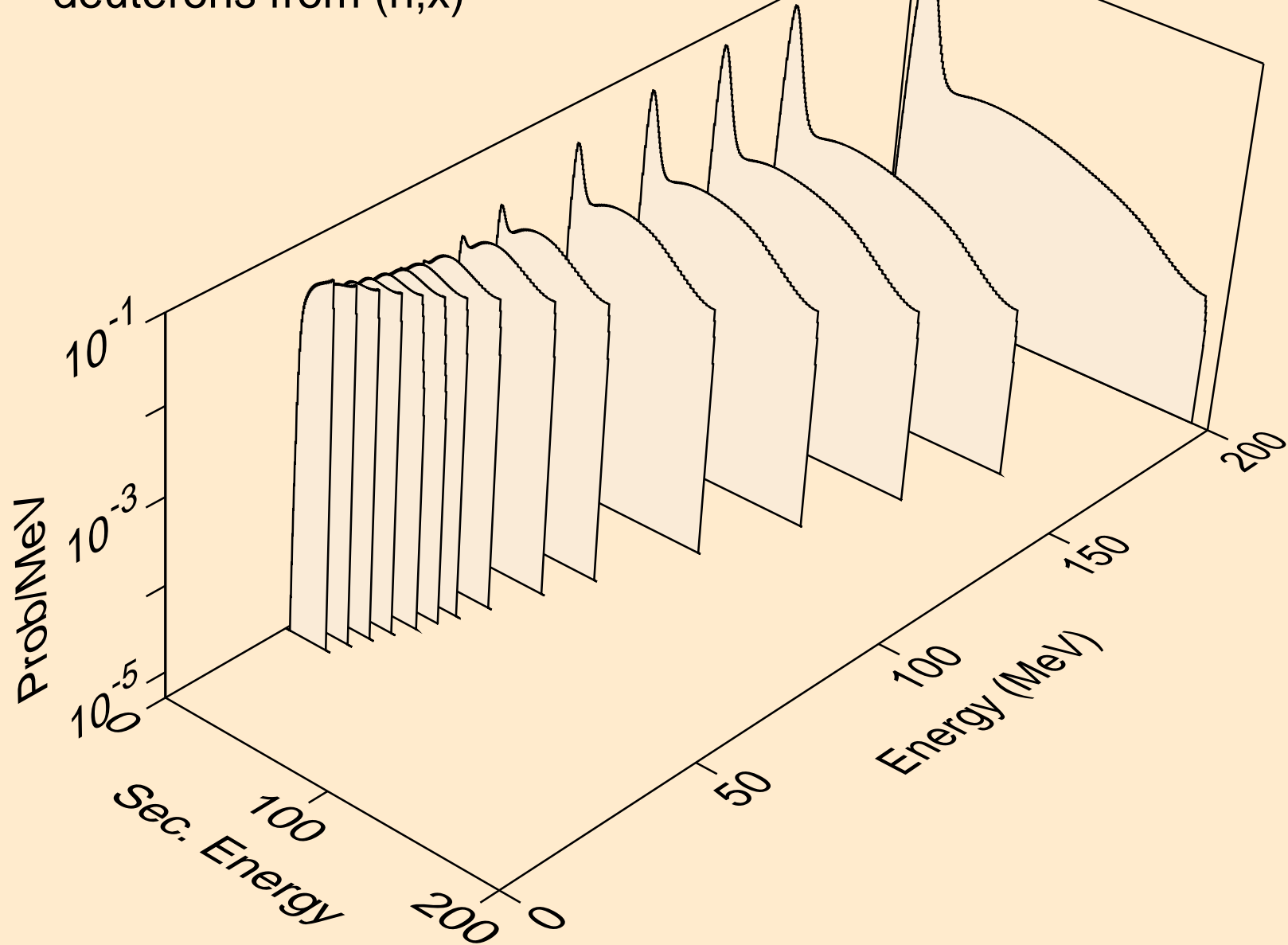

TC091M NEUTRON ACER TENDL-2024 LIBRARY; T=293.6K  
deuterons from (n,2nd)

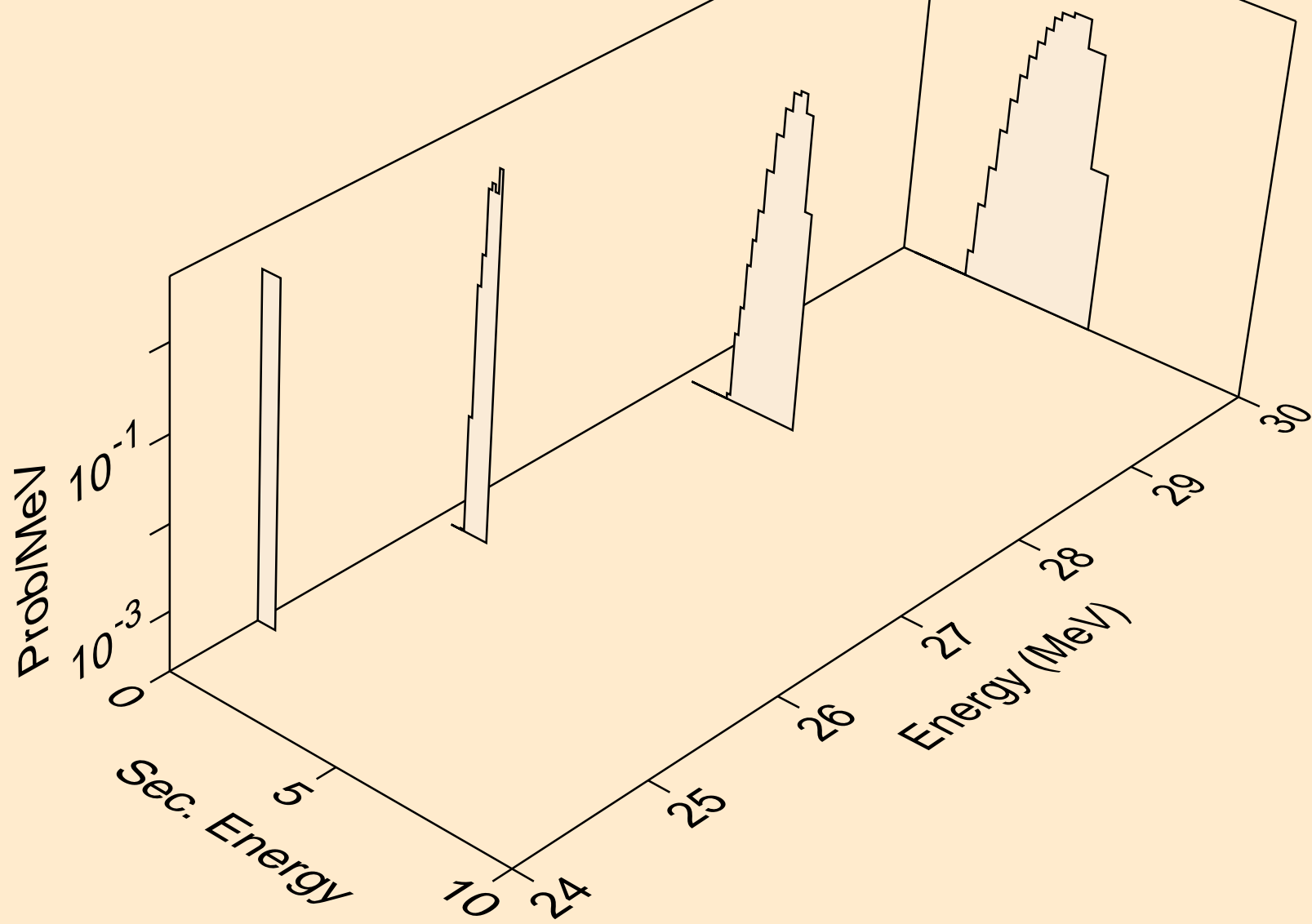

TC091M NEUTRON ACER TENDL-2024 LIBRARY; T=293.6K  
deuterons from (n,n\*)d

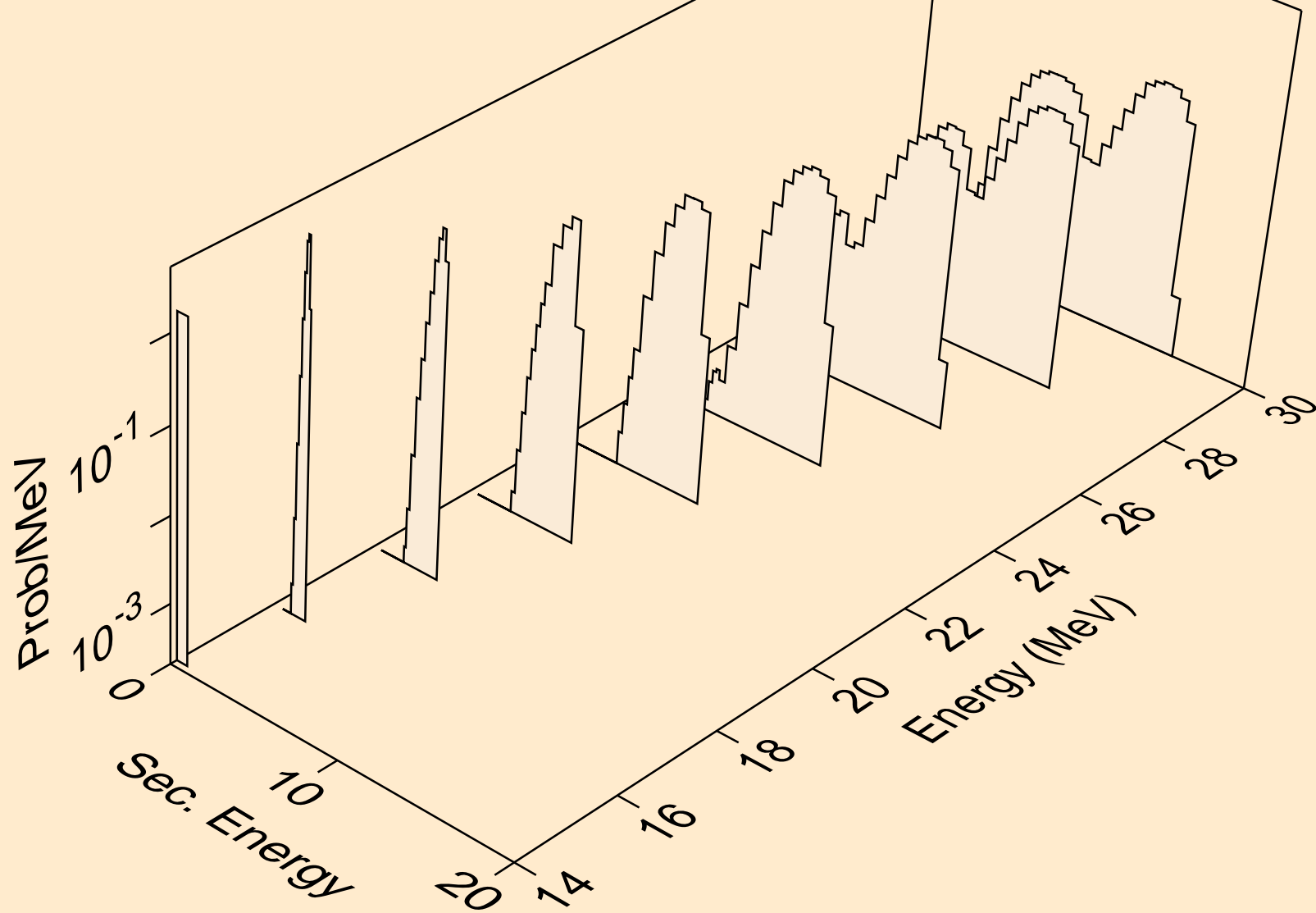

TC091M NEUTRON ACER TENDL-2024 LIBRARY; T=293.6K  
deuterons from (n,d)

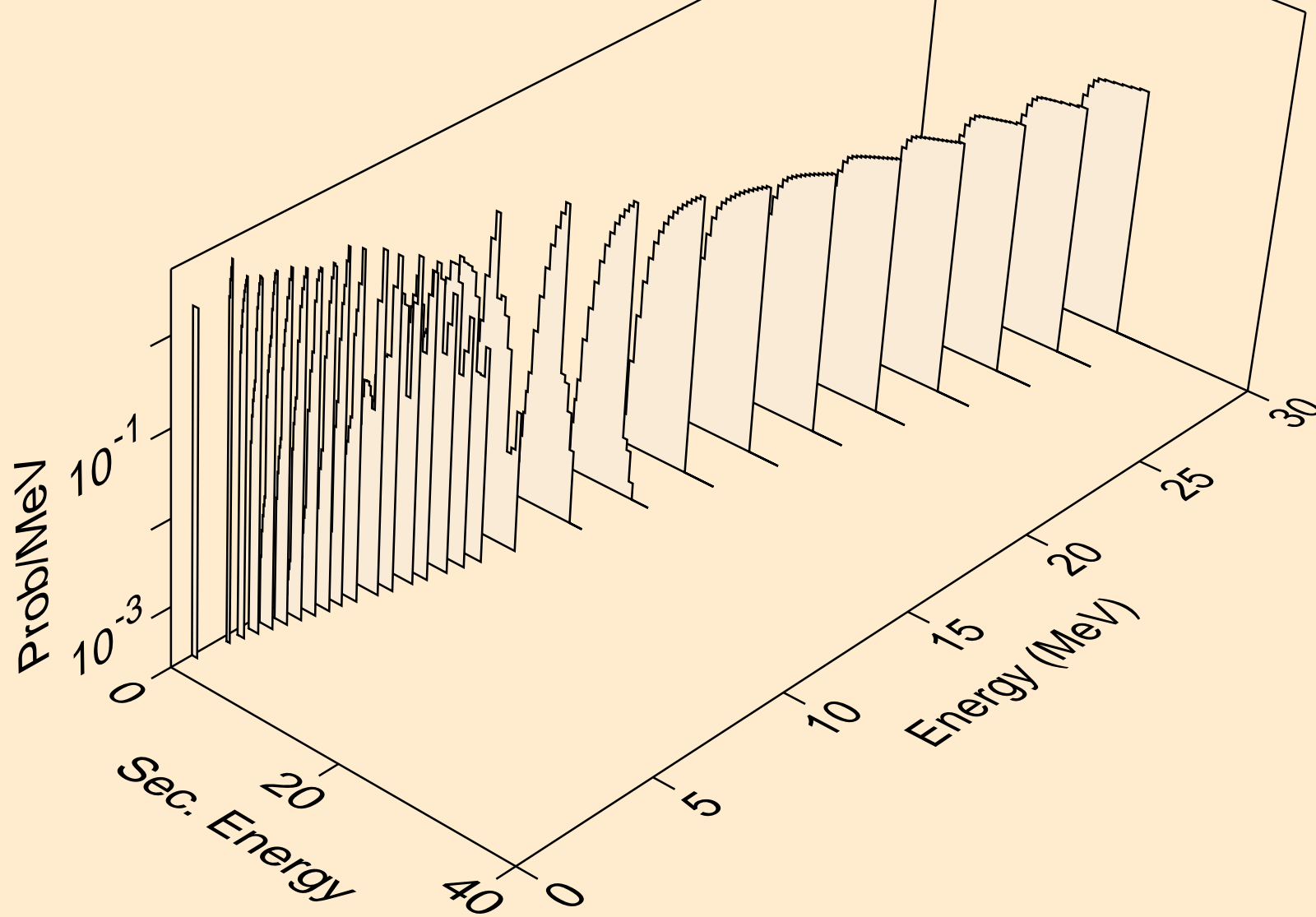

TC091M NEUTRON ACER TENDL-2024 LIBRARY; T=293.6K  
deuterons from (n,pd)

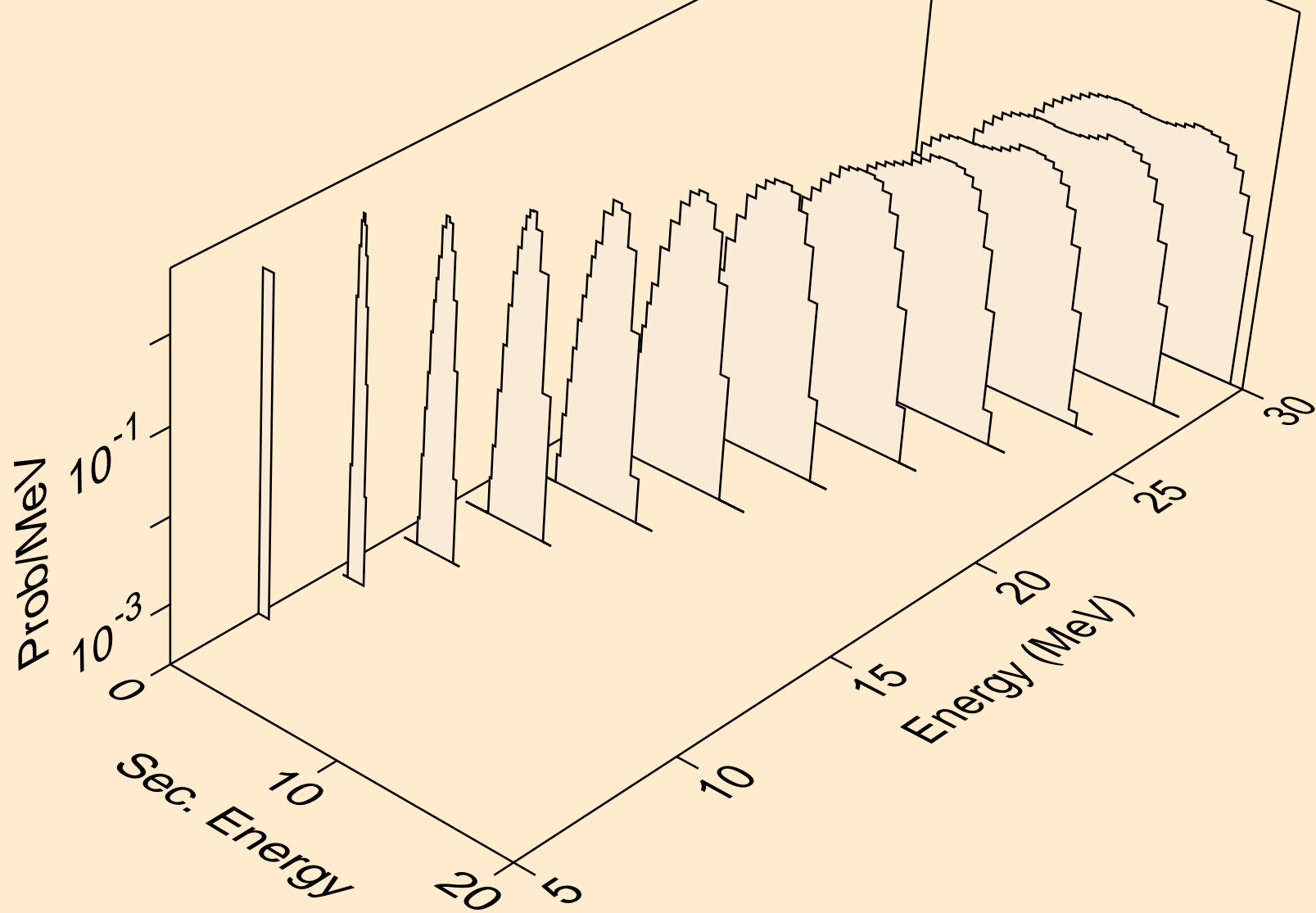

TC091M NEUTRON ACER TENDL-2024 LIBRARY; T=293.6K  
deuterons from (n,da)

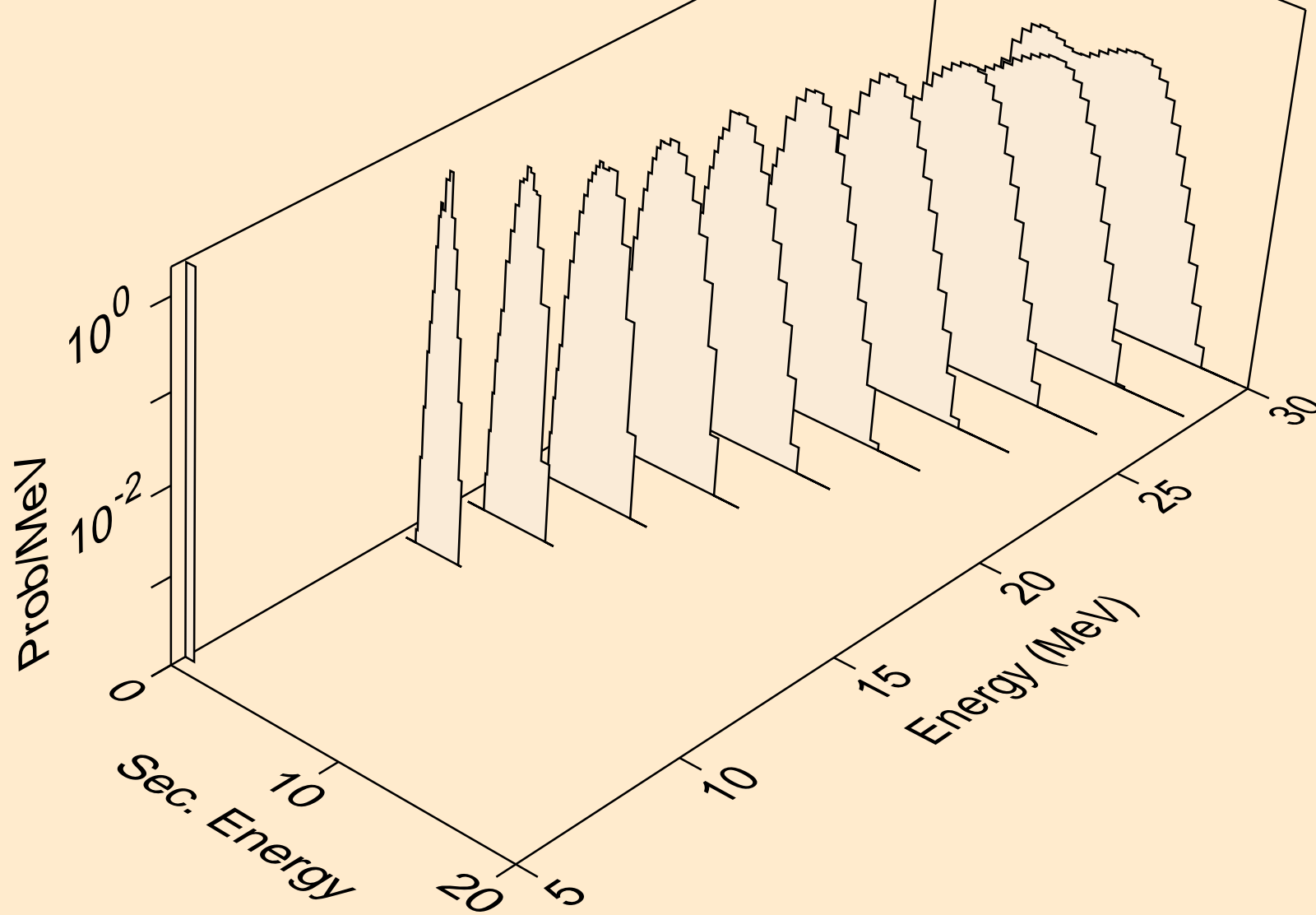

TC091M NEUTRON ACER TENDL-2024 LIBRARY; T=293.6K  
tritons from (n,x)

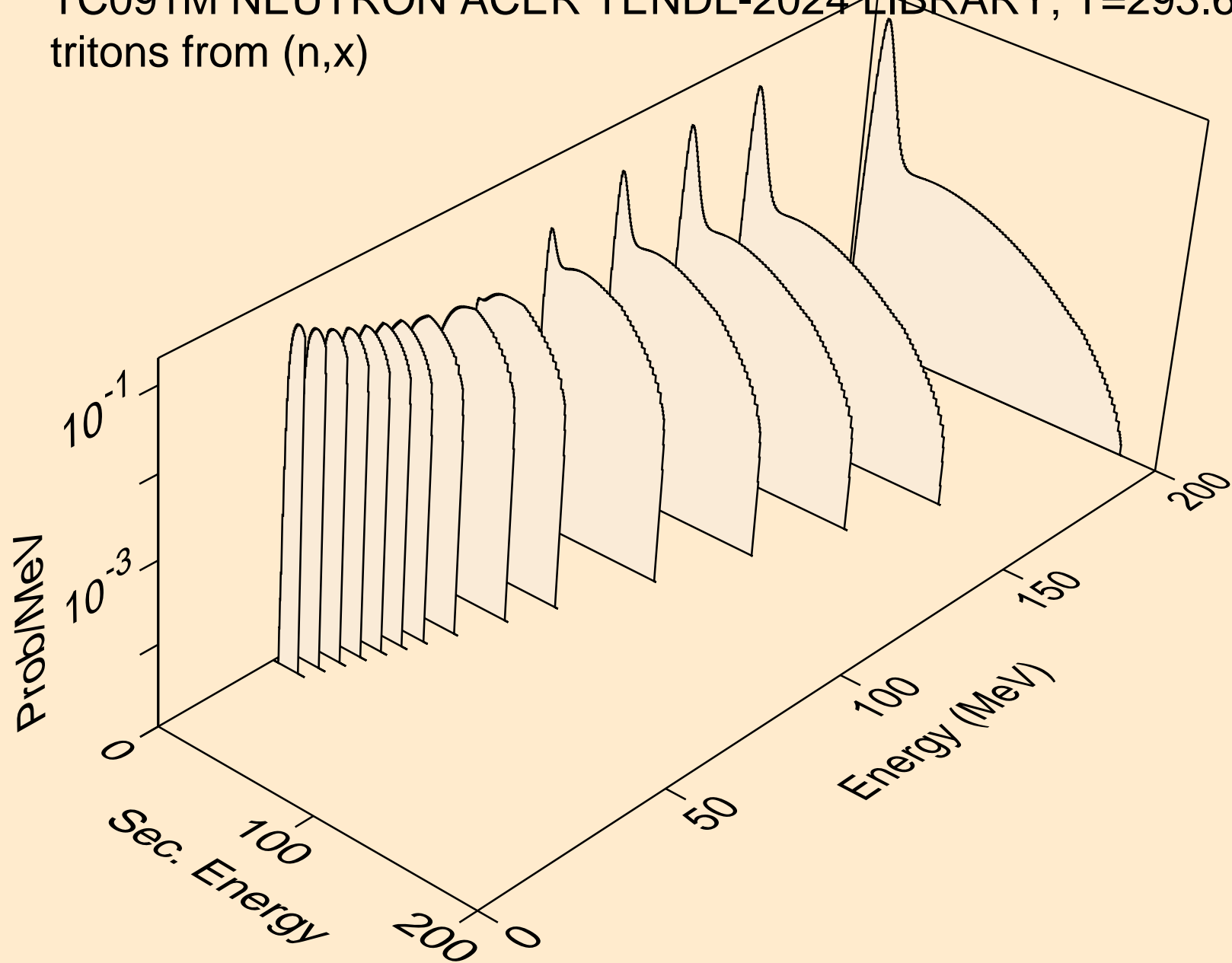

TC091M NEUTRON ACER TENDL-2024 LIBRARY; T=293.6K  
tritons from (n,n\*)t

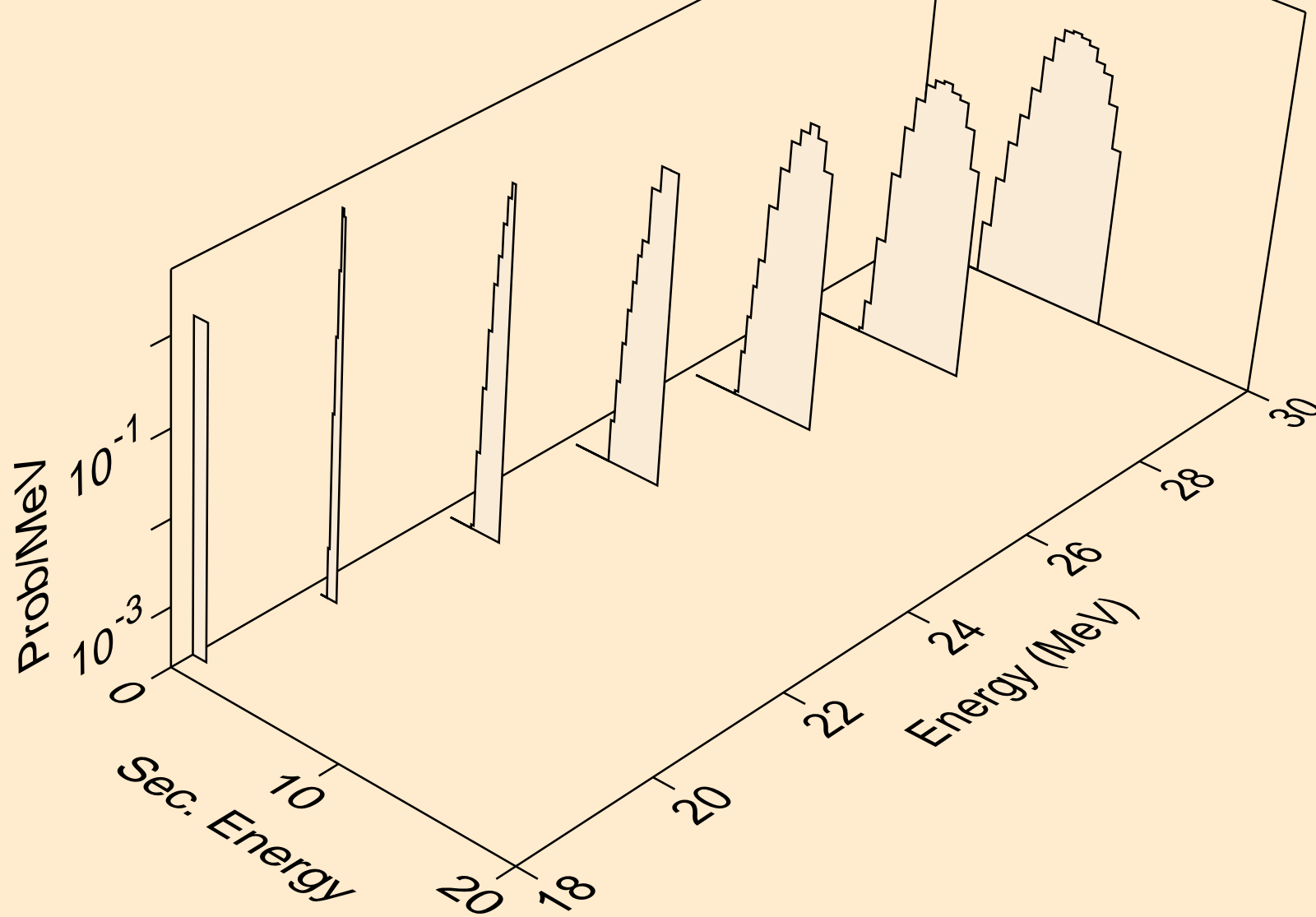

TC091M NEUTRON ACER TENDL-2024 LIBRARY; T=293.6K  
tritons from (n,t)

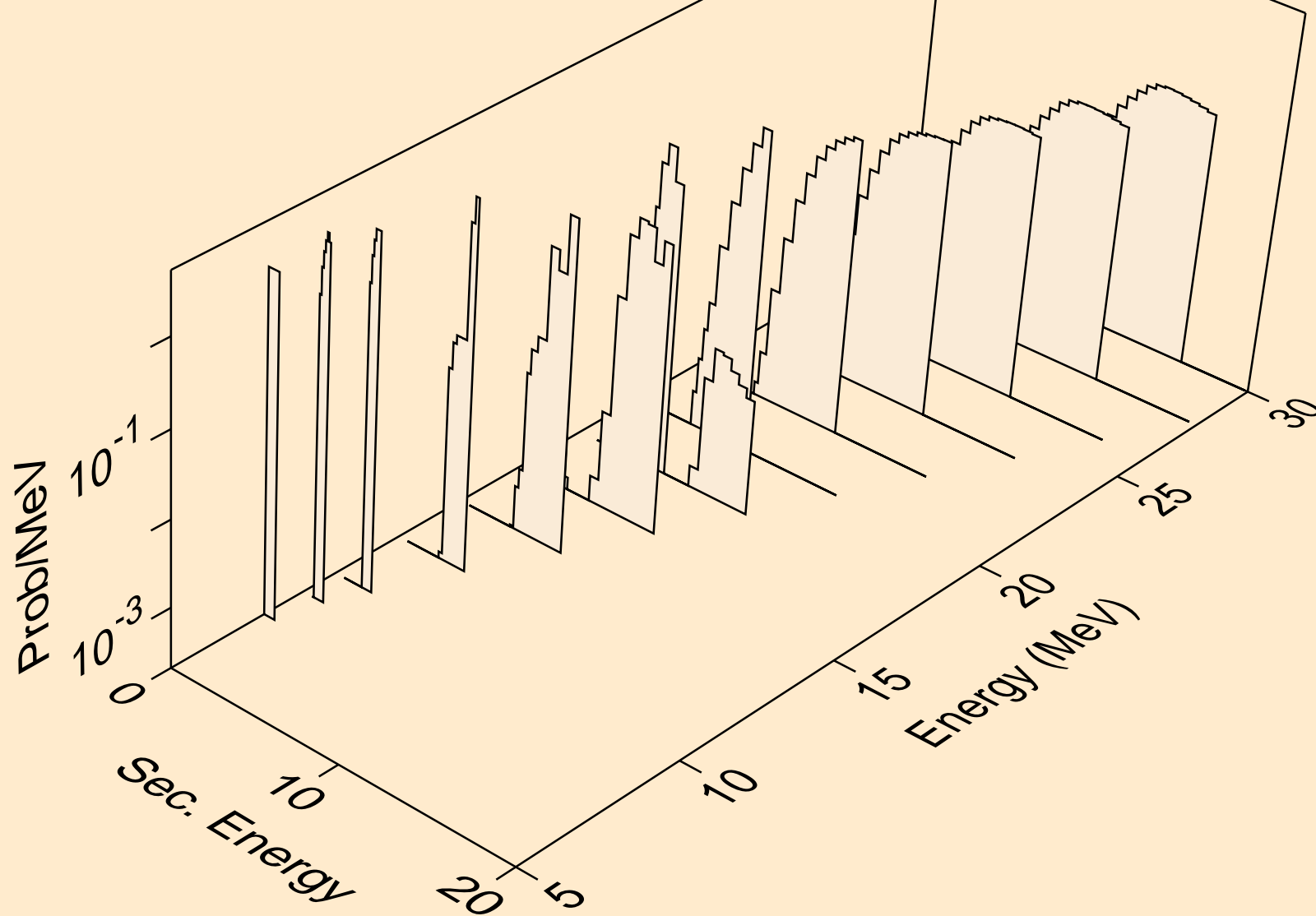

TC091M NEUTRON ACER TENDL-2024 LIBRARY; T=293.6K  
tritons from (n,pt)

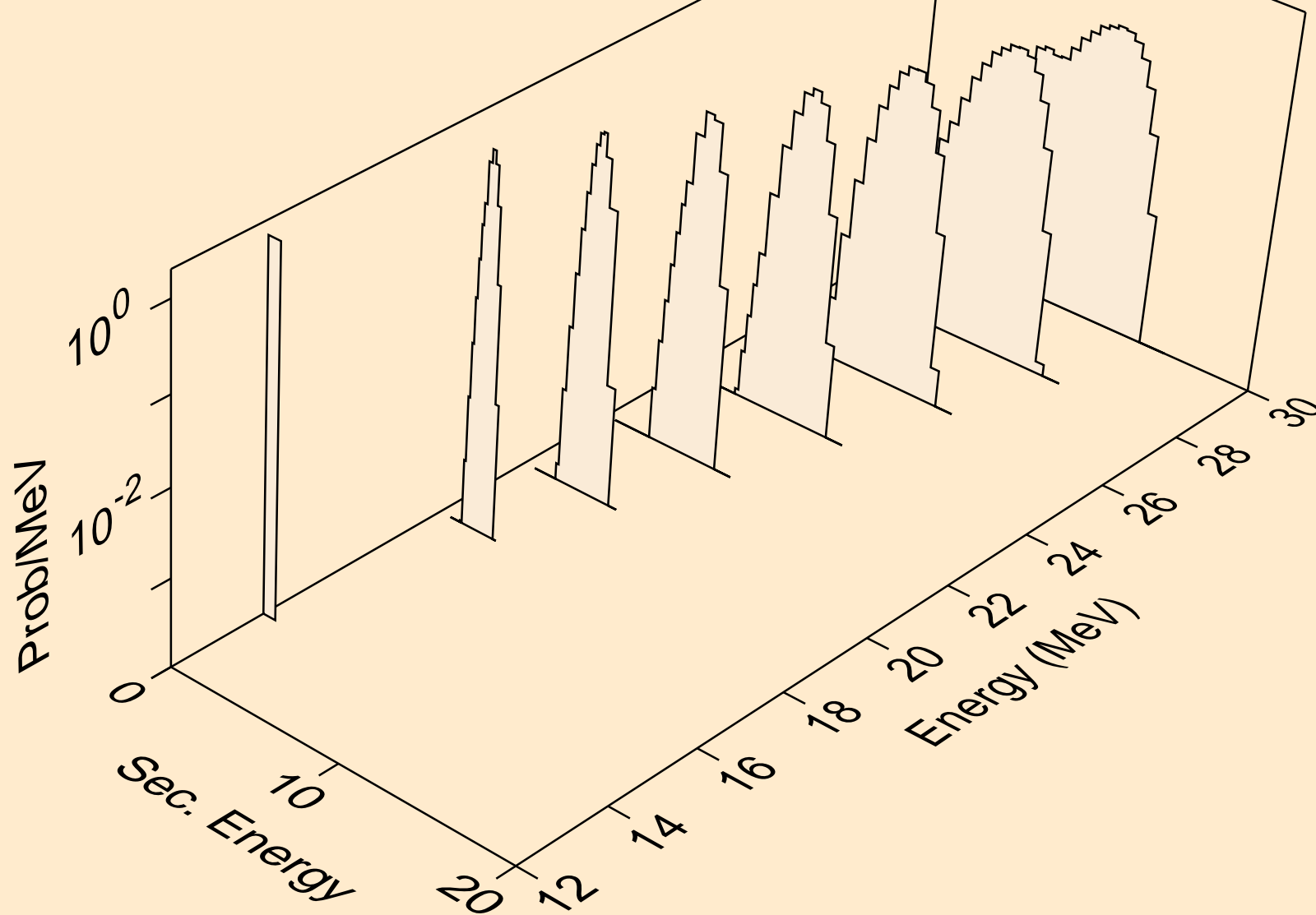

TC091M NEUTRON ACER TENDL-2024 LIBRARY; T=293.6K  
he3s from (n,x)

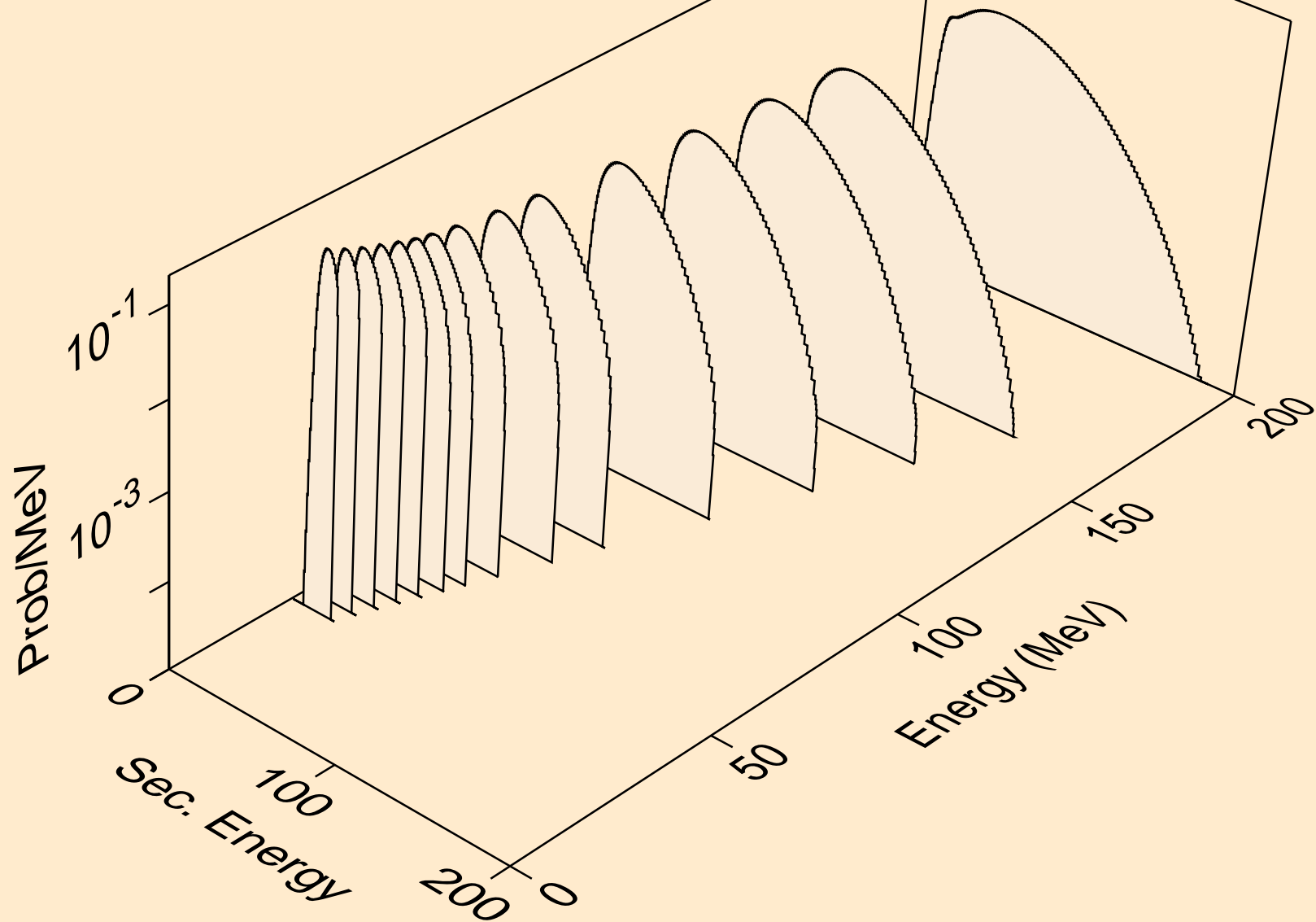

TC091M NEUTRON ACER TENDL-2024 LIBRARY; T=293.6K  
he3s from (n,n\*)he3

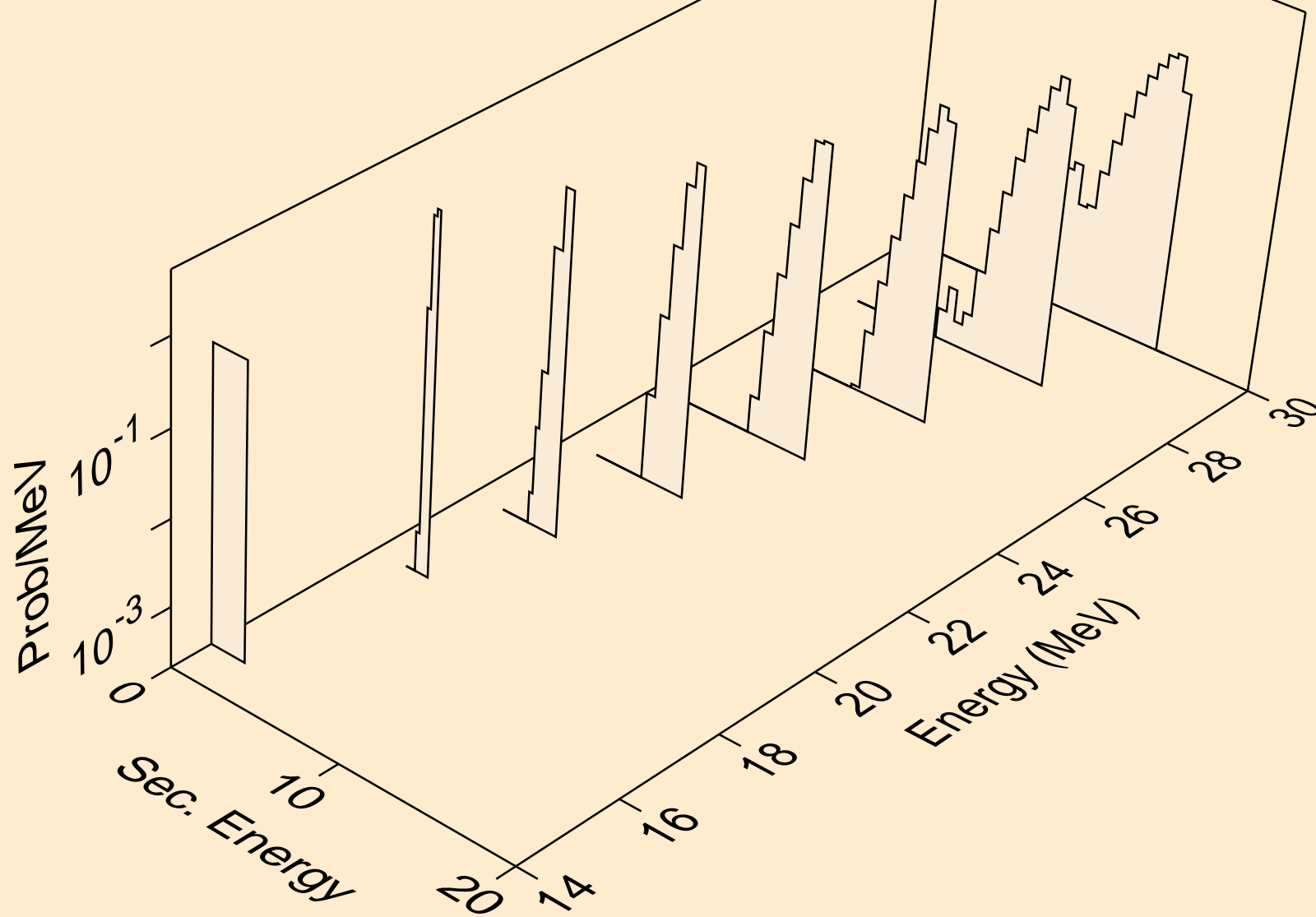

TC091M NEUTRON ACER TENDL-2024 LIBRARY; T=293.6K  
he3s from (n,he3)

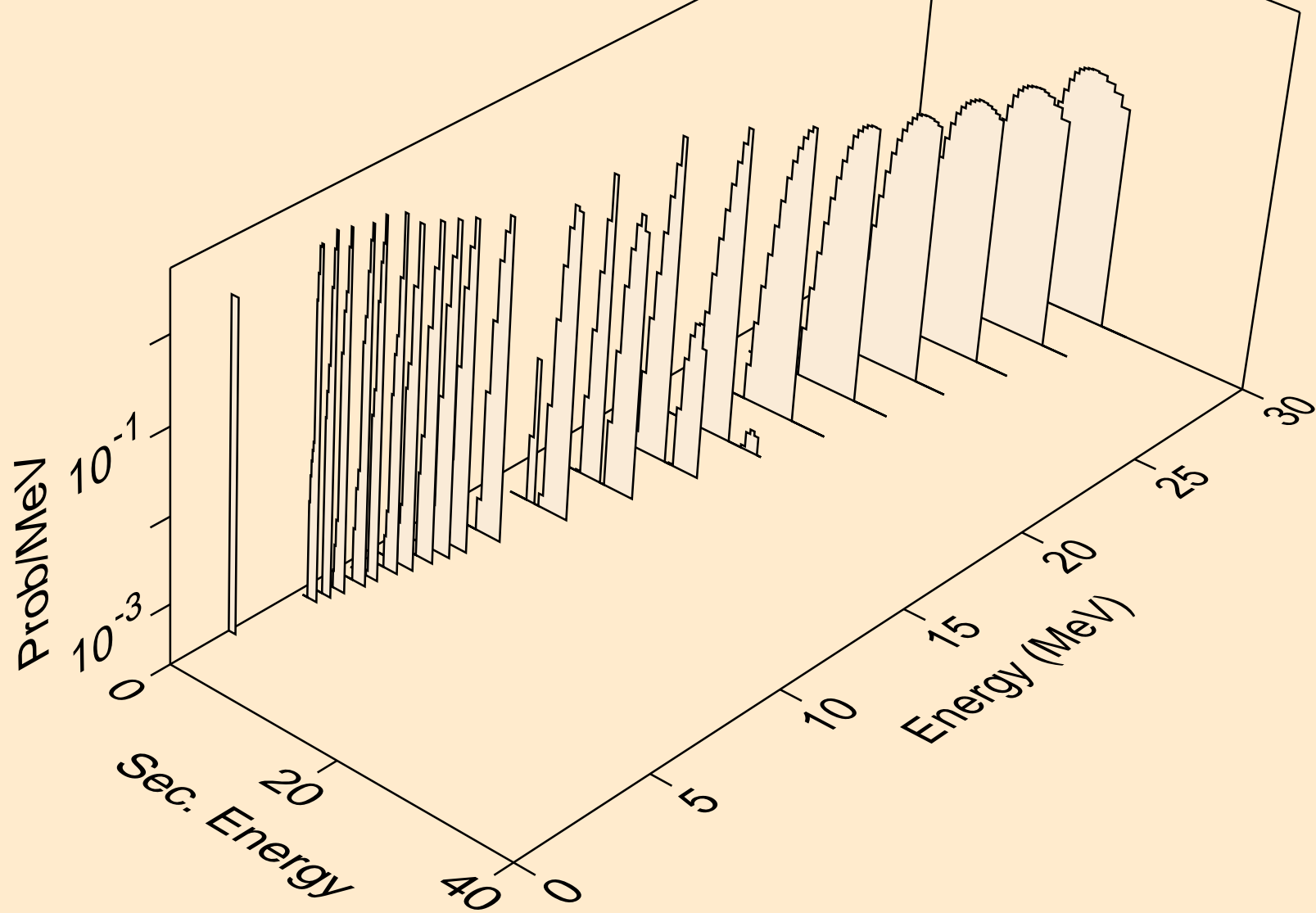

TC091M NEUTRON ACER TENDL-2024 LIBRARY; T=293.6K  
alphas from (n,x)

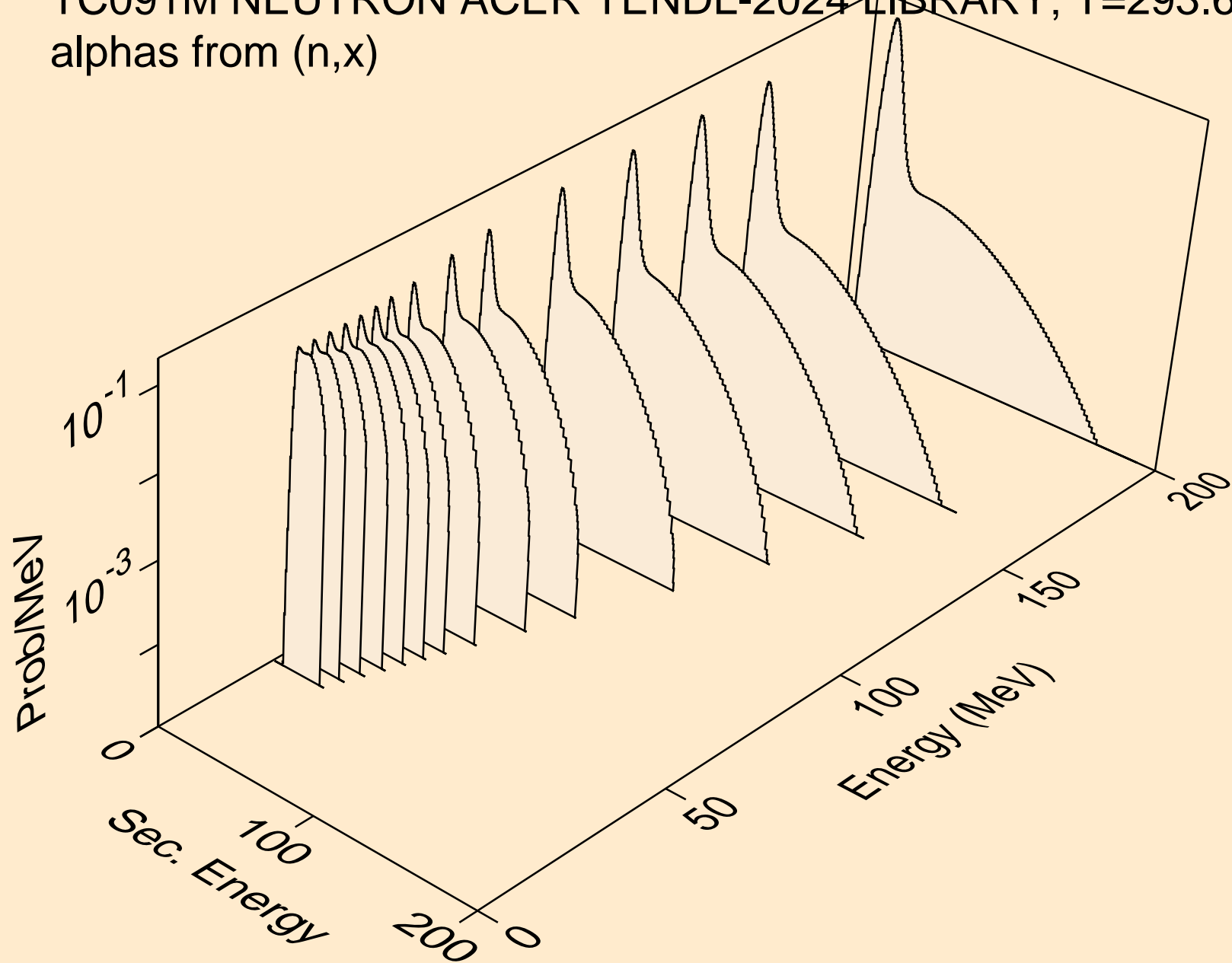

TC091M NEUTRON ACER TENDL-2024 LIBRARY; T=293.6K  
alphas from (n,n\*)a

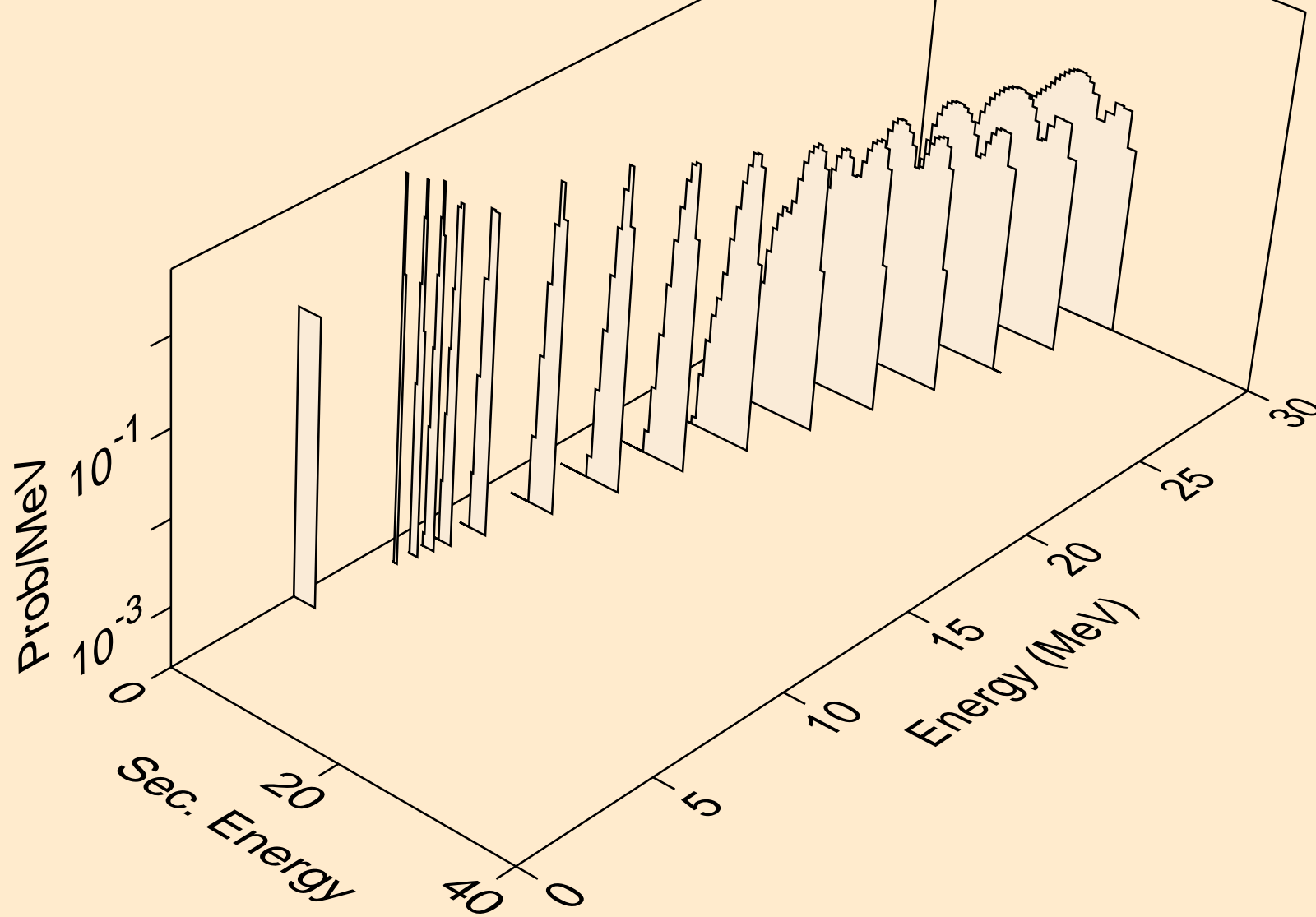

TC091M NEUTRON ACER TENDL-2024 LIBRARY; T=293.6K  
alphas from (n,2n)a

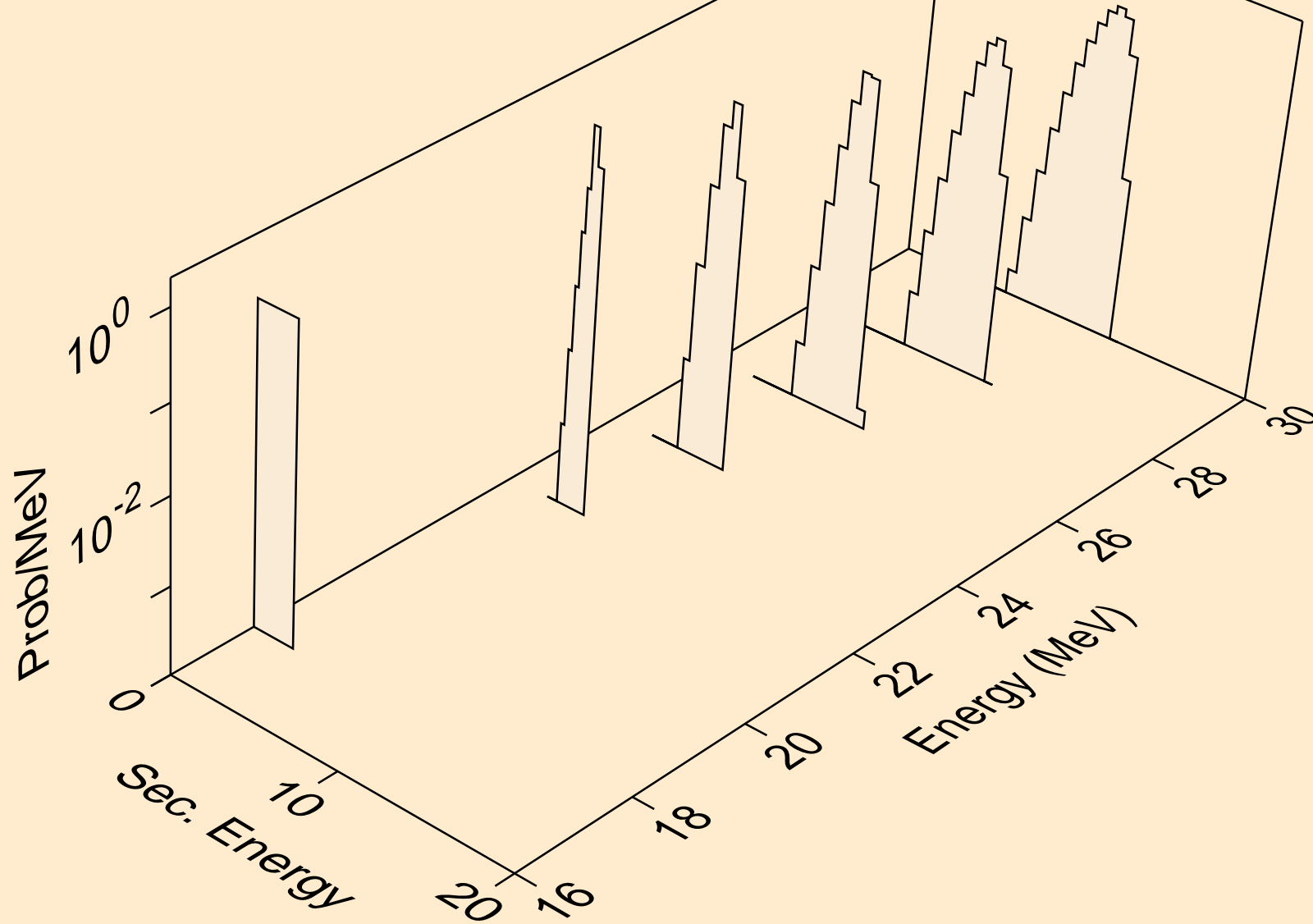

TC091M NEUTRON ACER TENDL-2024 LIBRARY; T=293.6K  
alphas from (n,n\*)2a

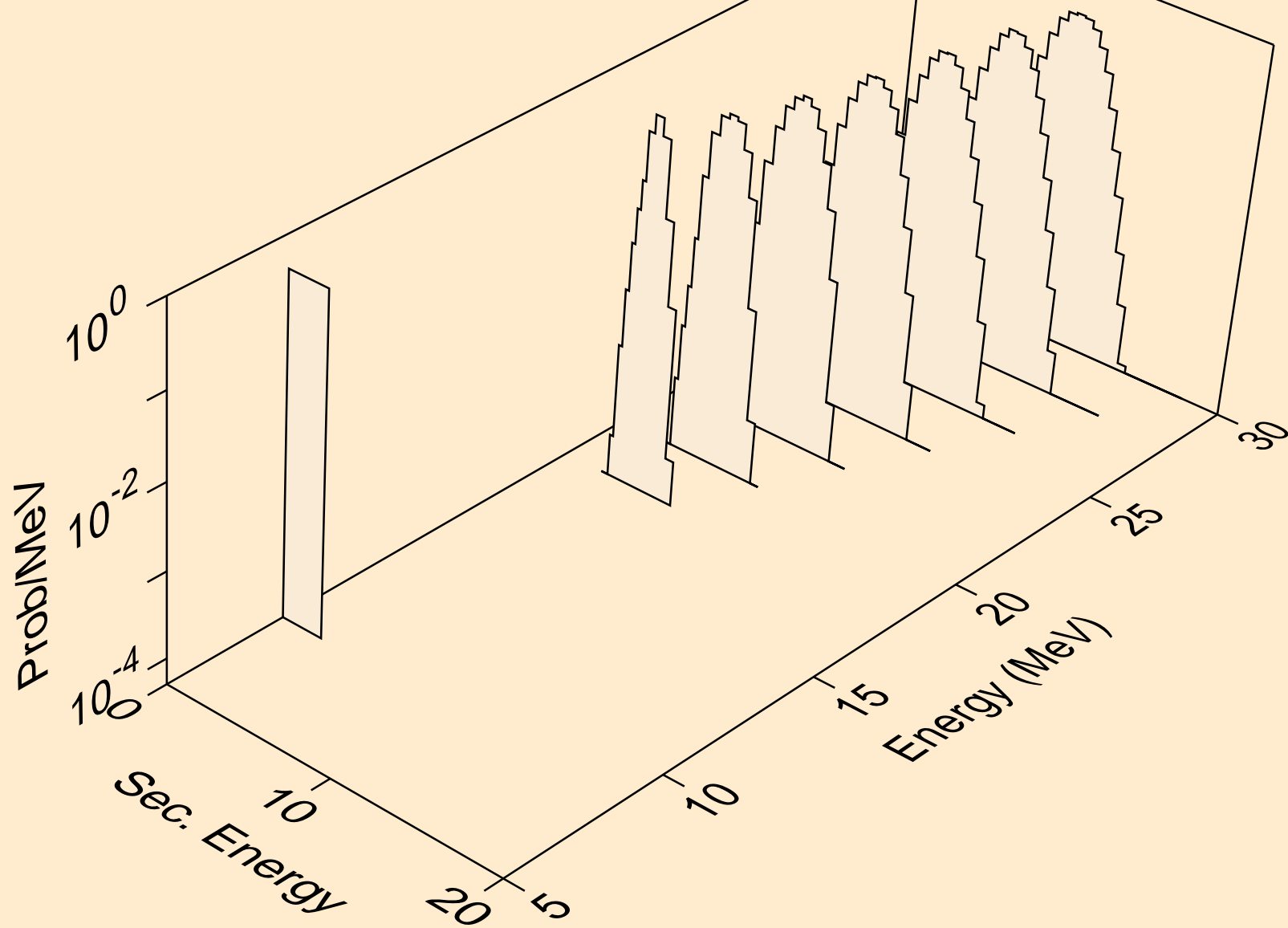

TC091M NEUTRON ACER TENDL-2024 LIBRARY; T=293.6K  
alphas from (n,npa)

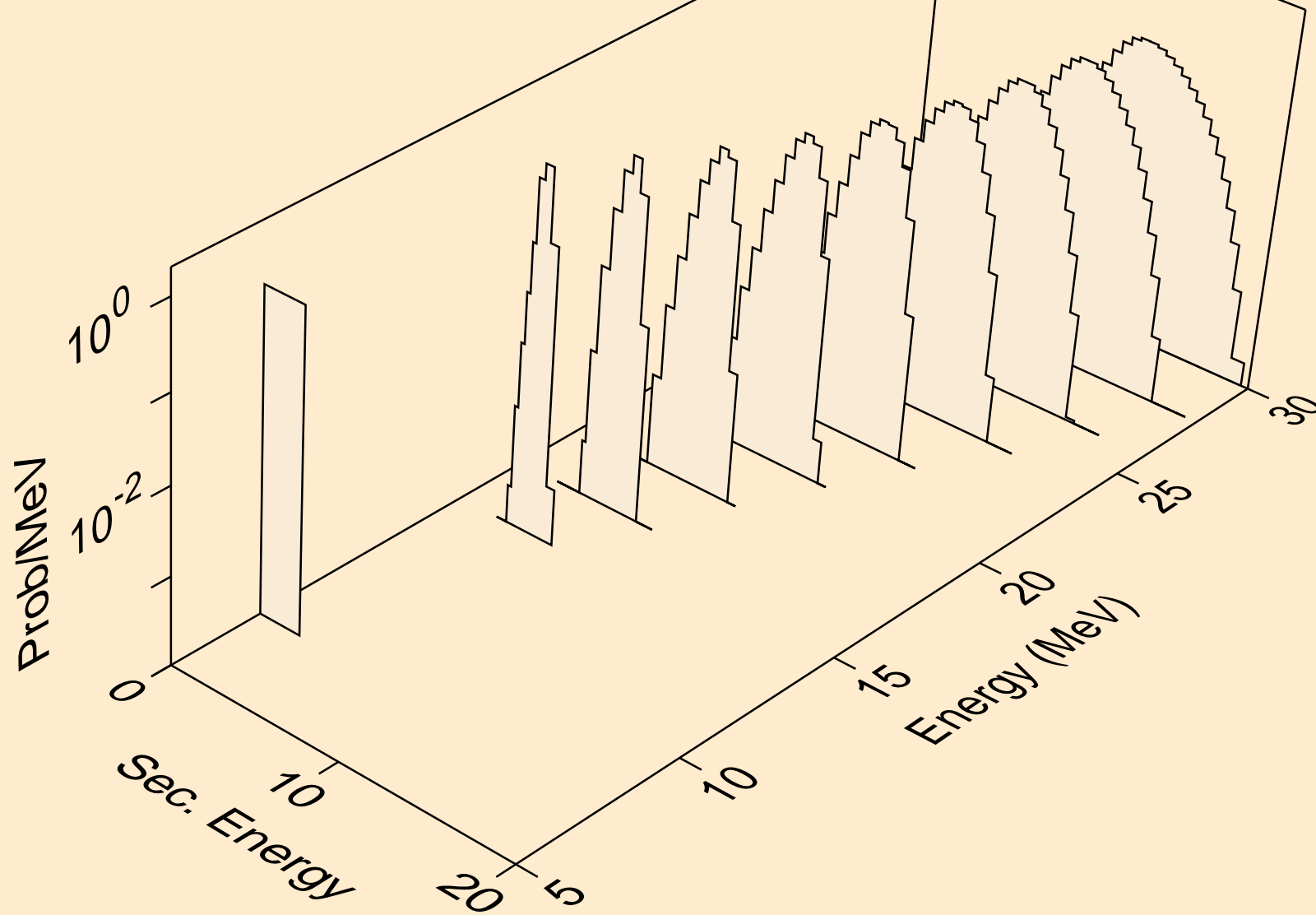

TC091M NEUTRON ACER TENDL-2024 LIBRARY; T=293.6K  
alphas from (n,a)

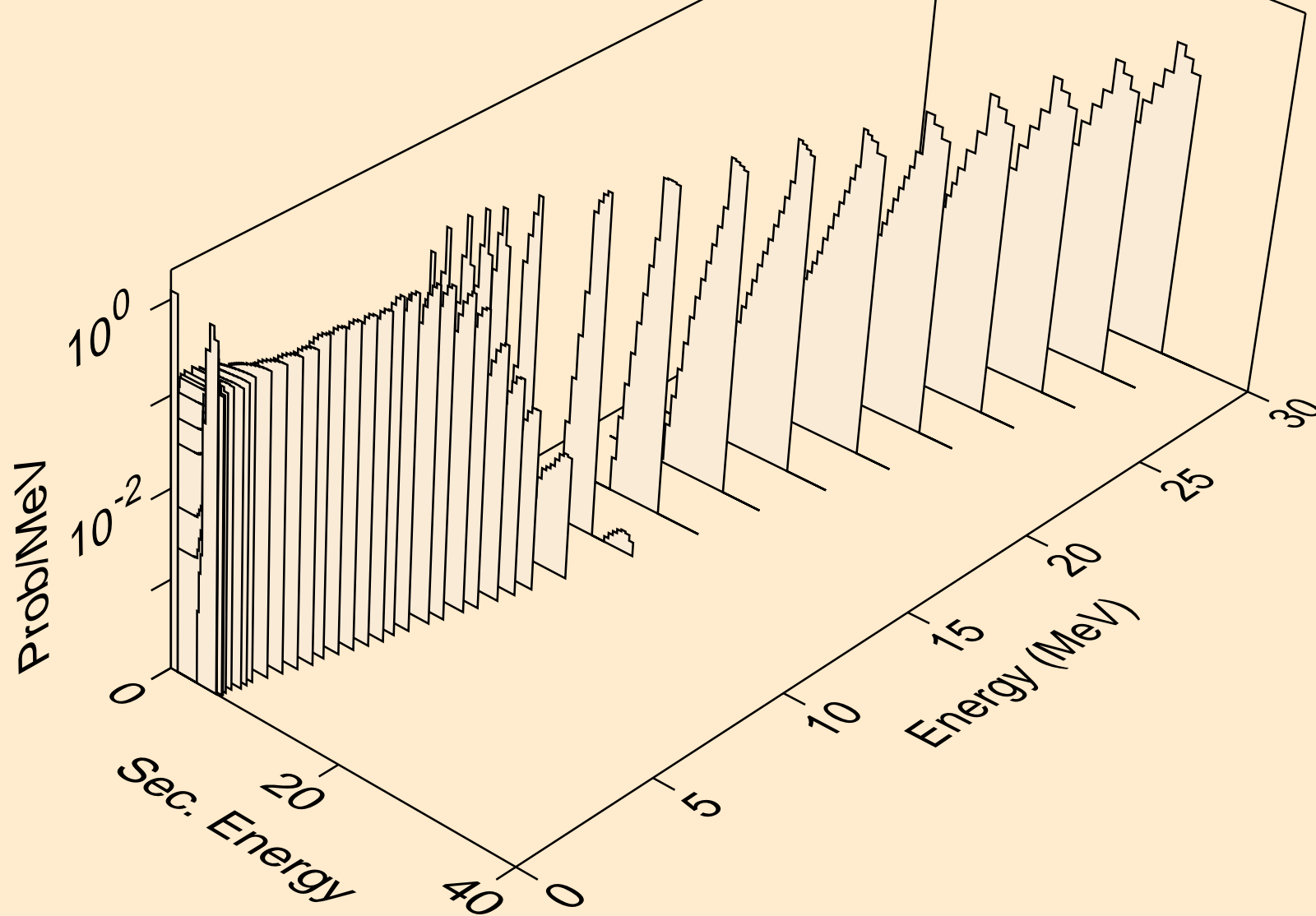

TC091M NEUTRON ACER TENDL-2024 LIBRARY; T=293.6K  
alphas from (n,2a)

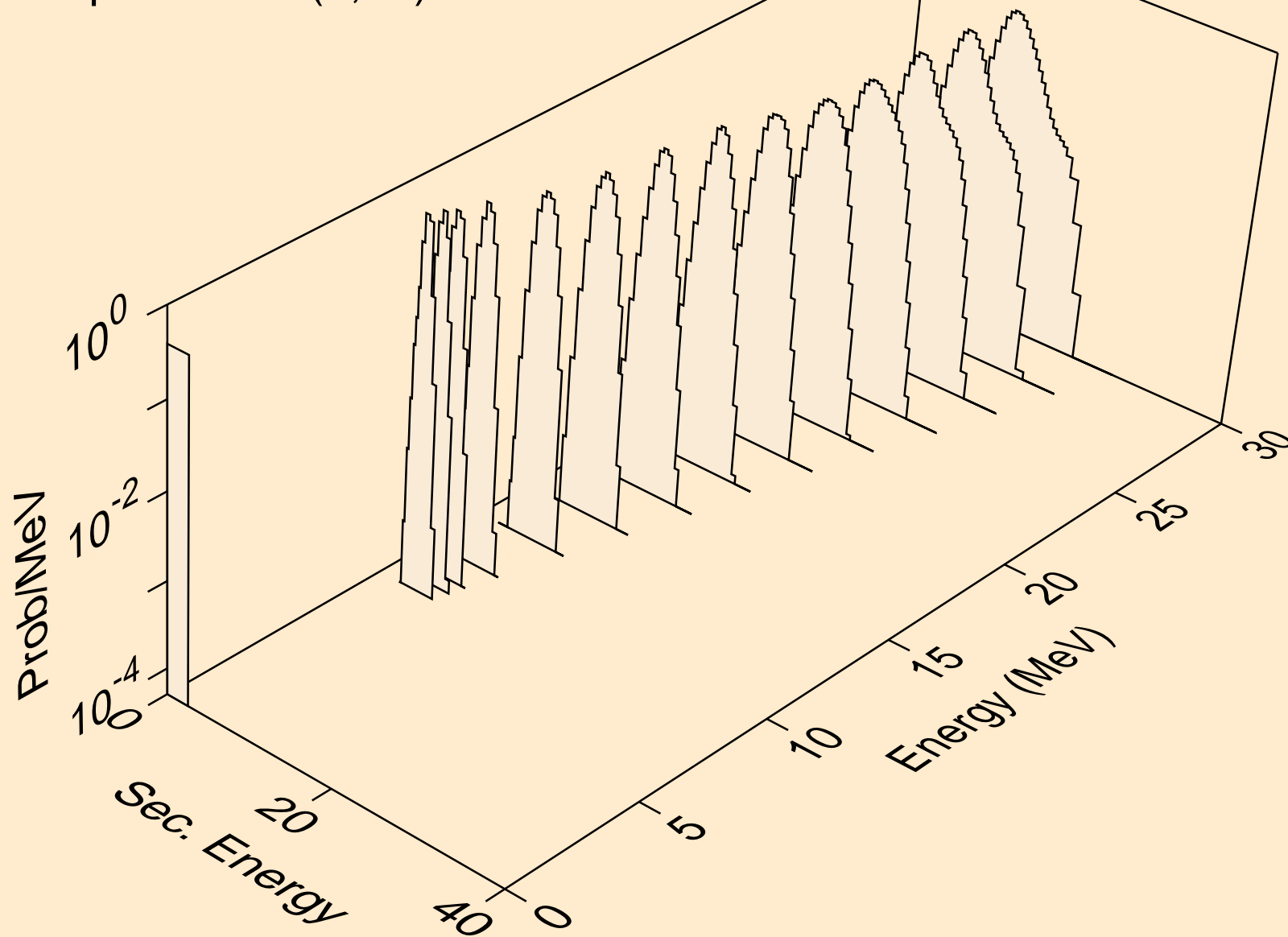

TC091M NEUTRON ACER TENDL-2024 LIBRARY; T=293.6K  
alphas from (n,pa)

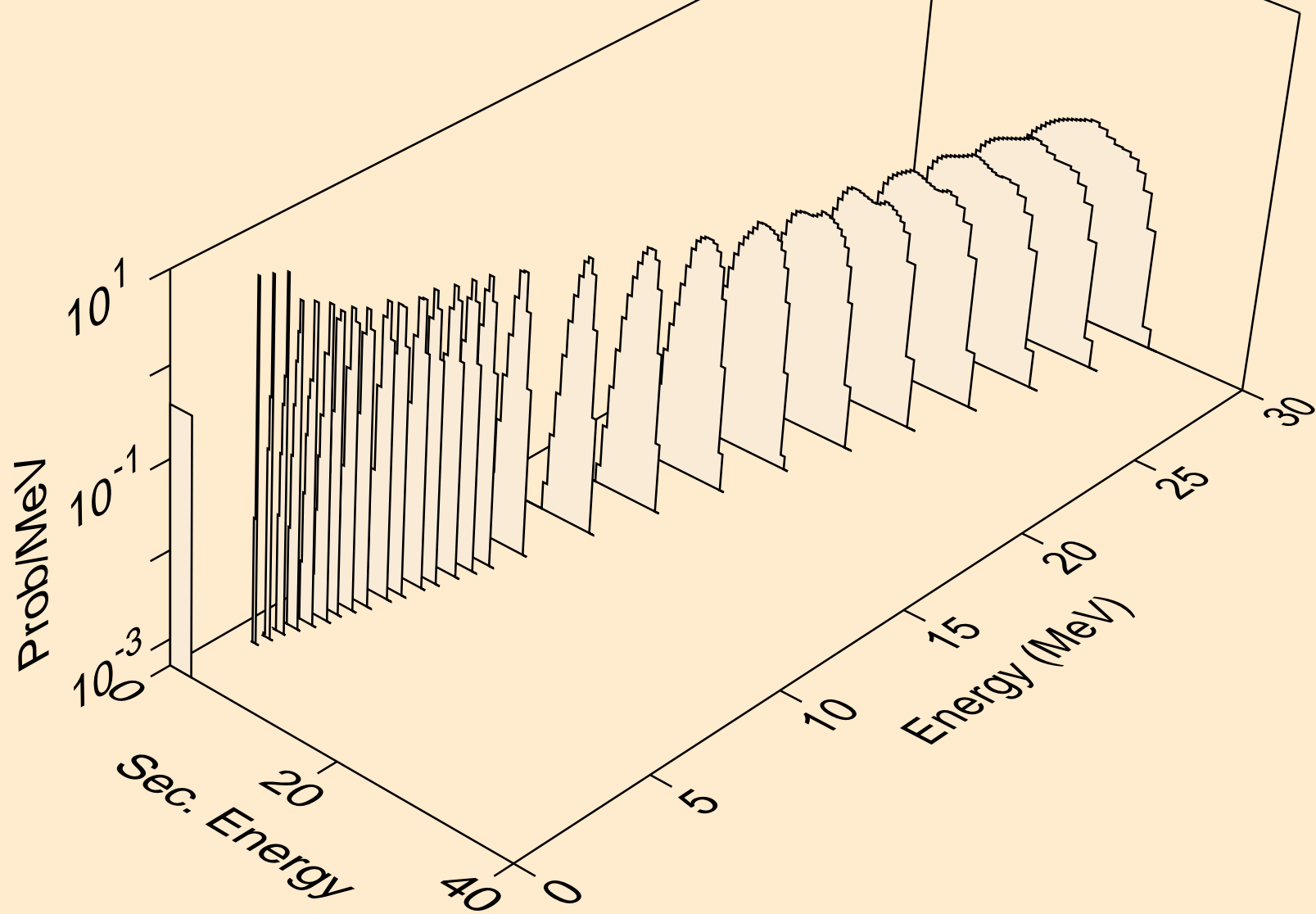

TC091M NEUTRON ACER TENDL-2024 LIBRARY; T=293.6K  
alphas from (n,da)

