

# TE113 NEUTRON ACER TENDL-2024 LIBRARY; T=293.6K

## Principal cross sections

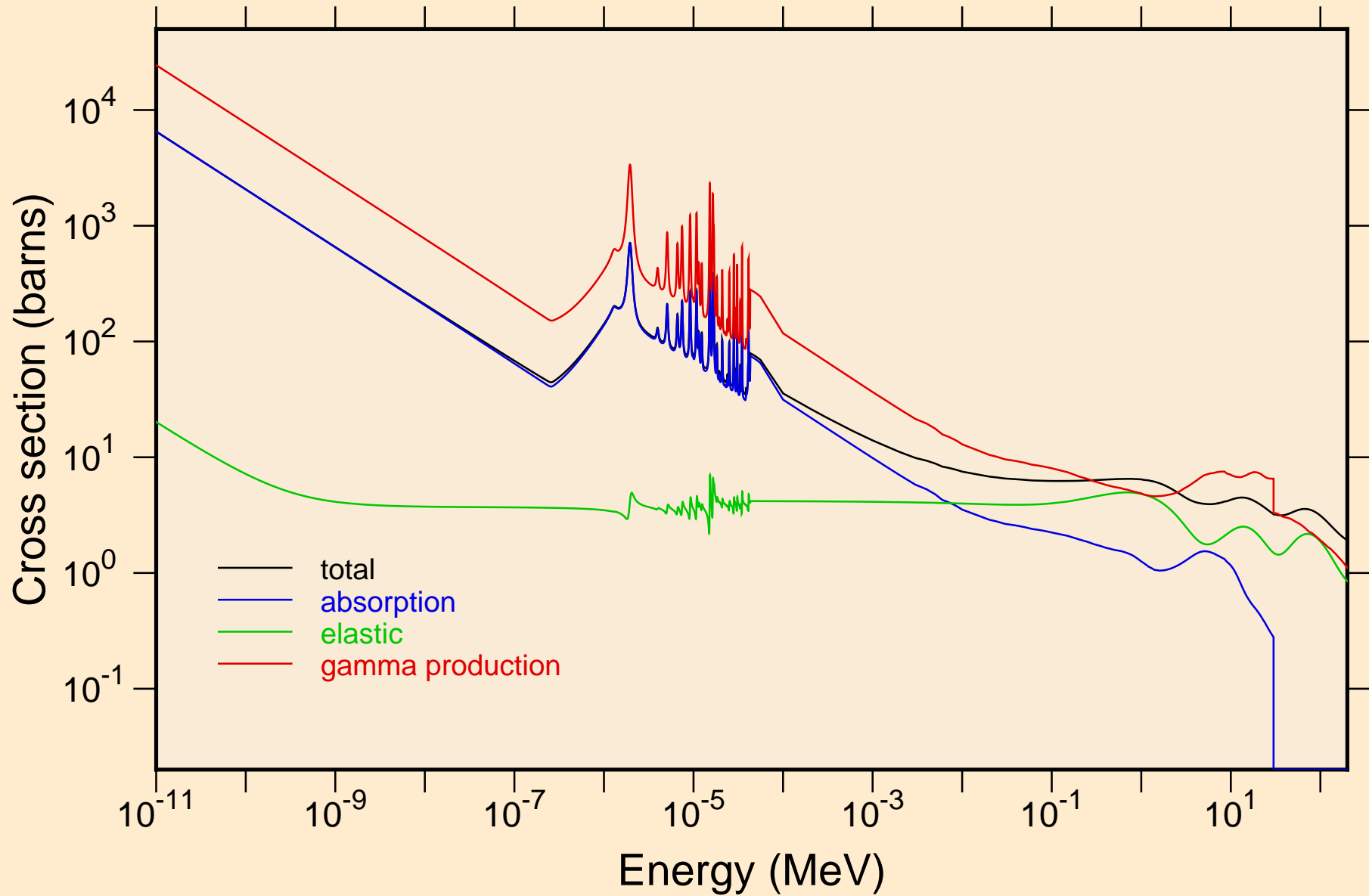

TE113 NEUTRON ACER TENDL-2024 LIBRARY; T=293.6K  
resonance total cross section

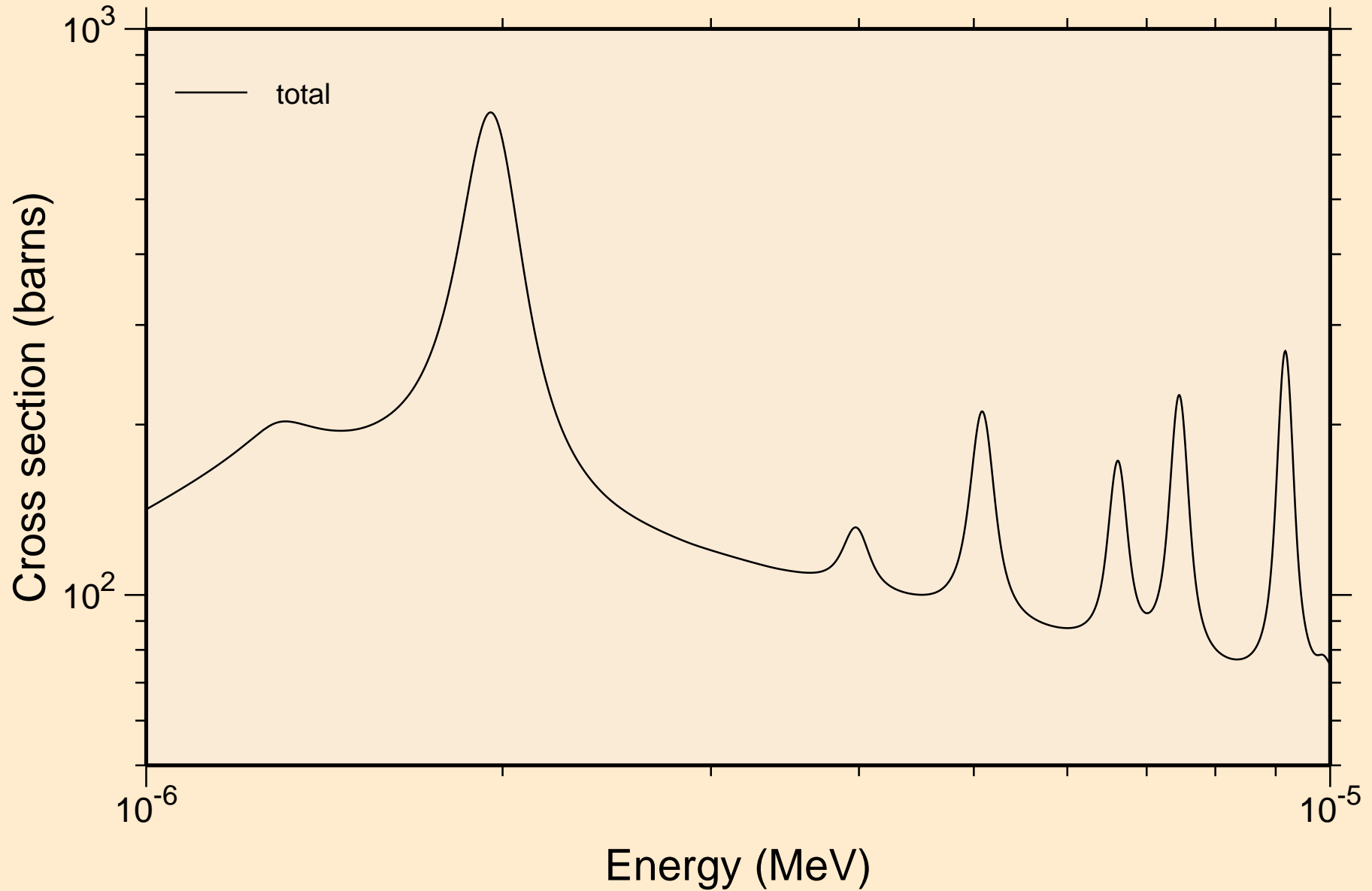

TE113 NEUTRON ACER TENDL-2024 LIBRARY; T=293.6K  
resonance total cross section

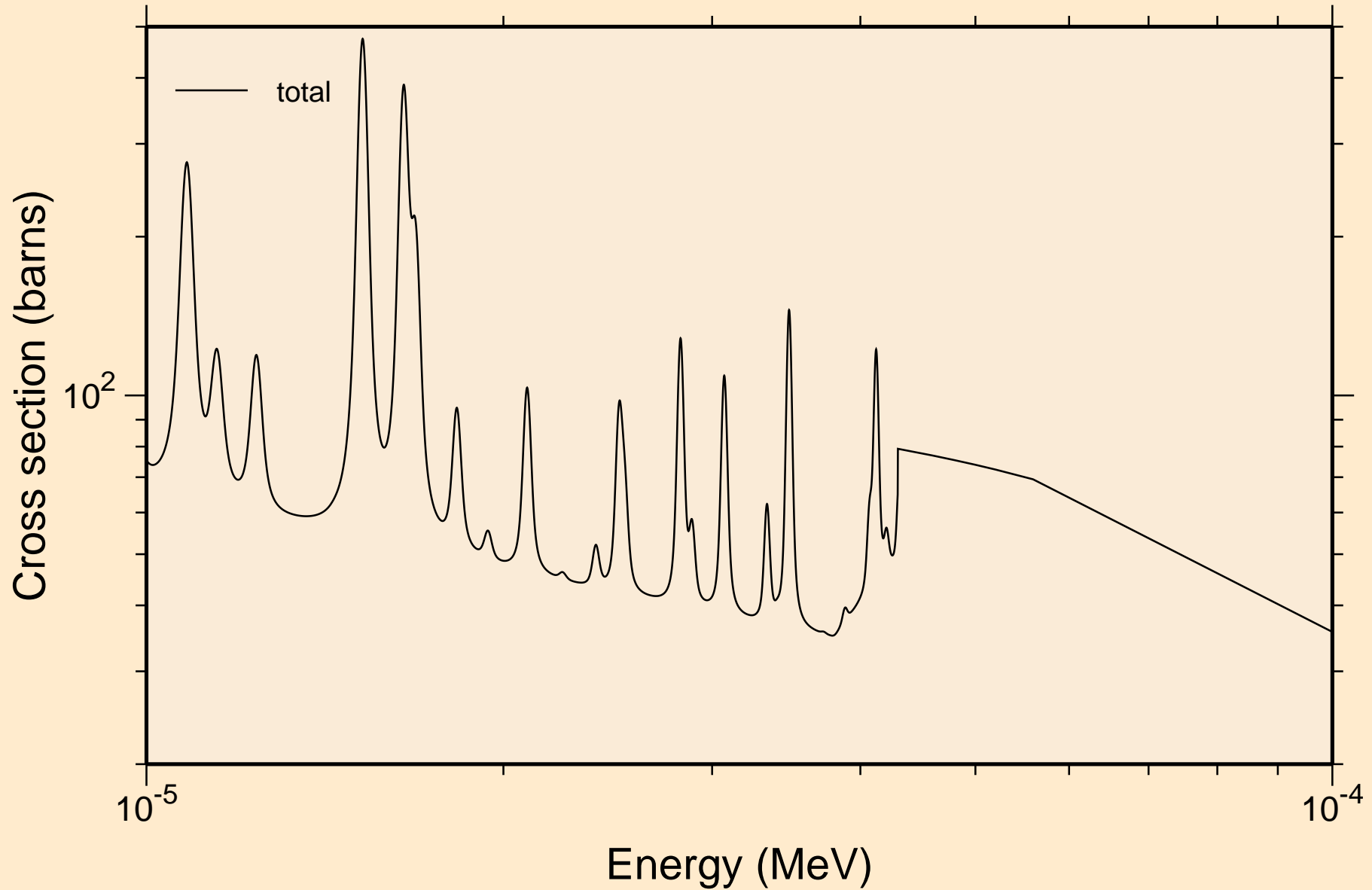

TE113 NEUTRON ACER TENDL-2024 LIBRARY; T=293.6K  
resonance total cross section

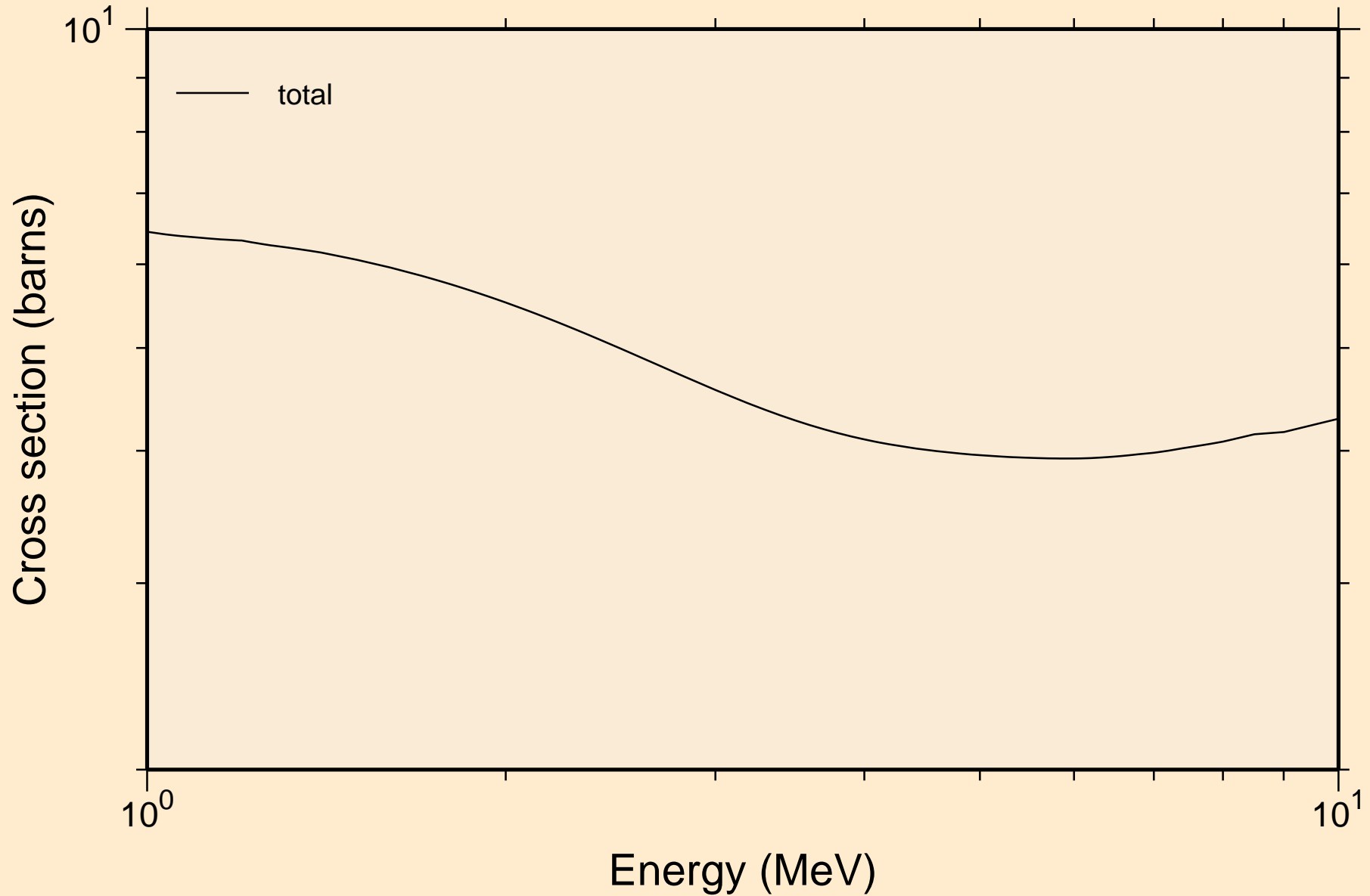

TE113 NEUTRON ACER TENDL-2024 LIBRARY; T=293.6K  
resonance absorption cross sections

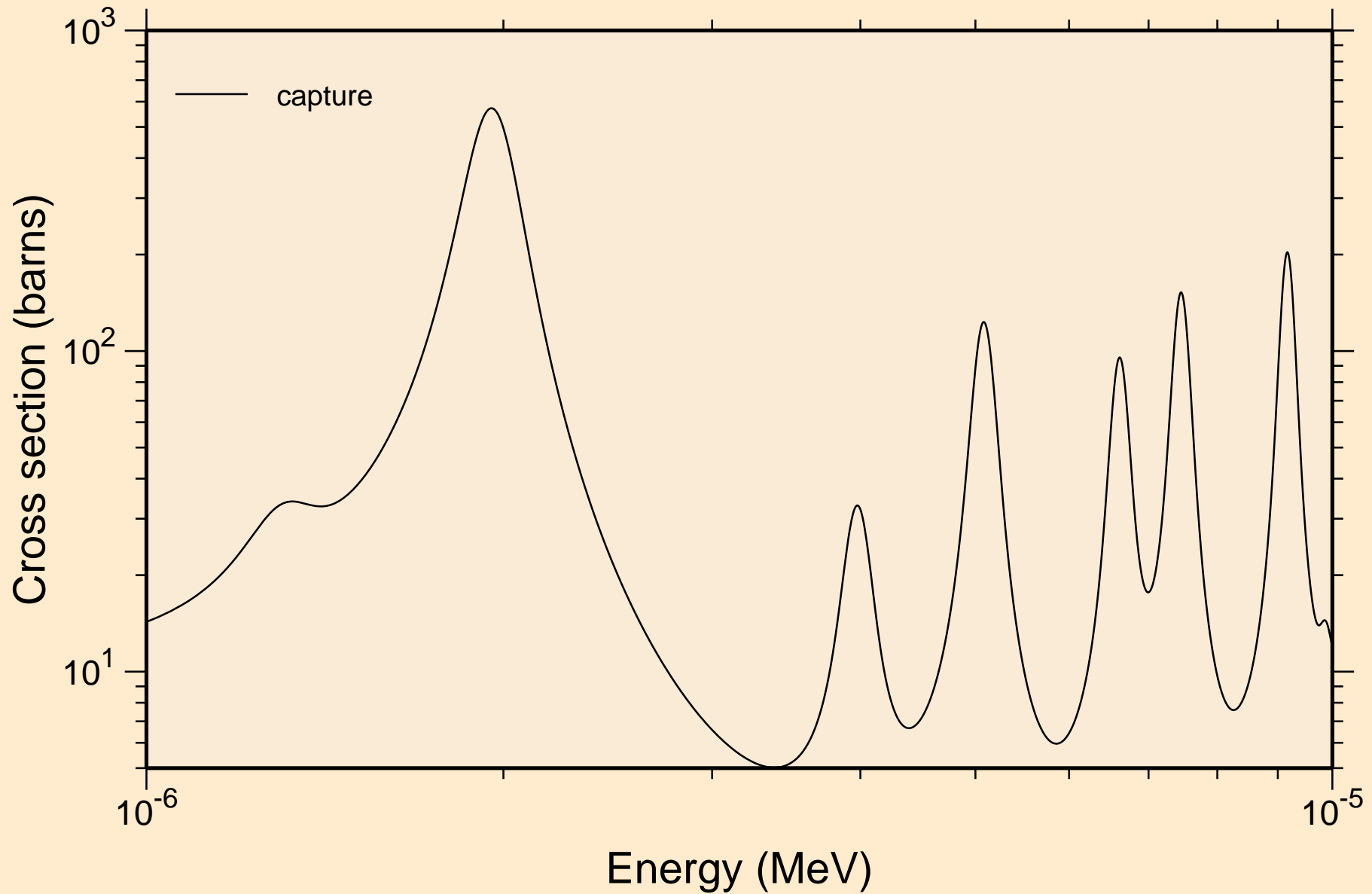

TE113 NEUTRON ACER TENDL-2024 LIBRARY; T=293.6K  
resonance absorption cross sections

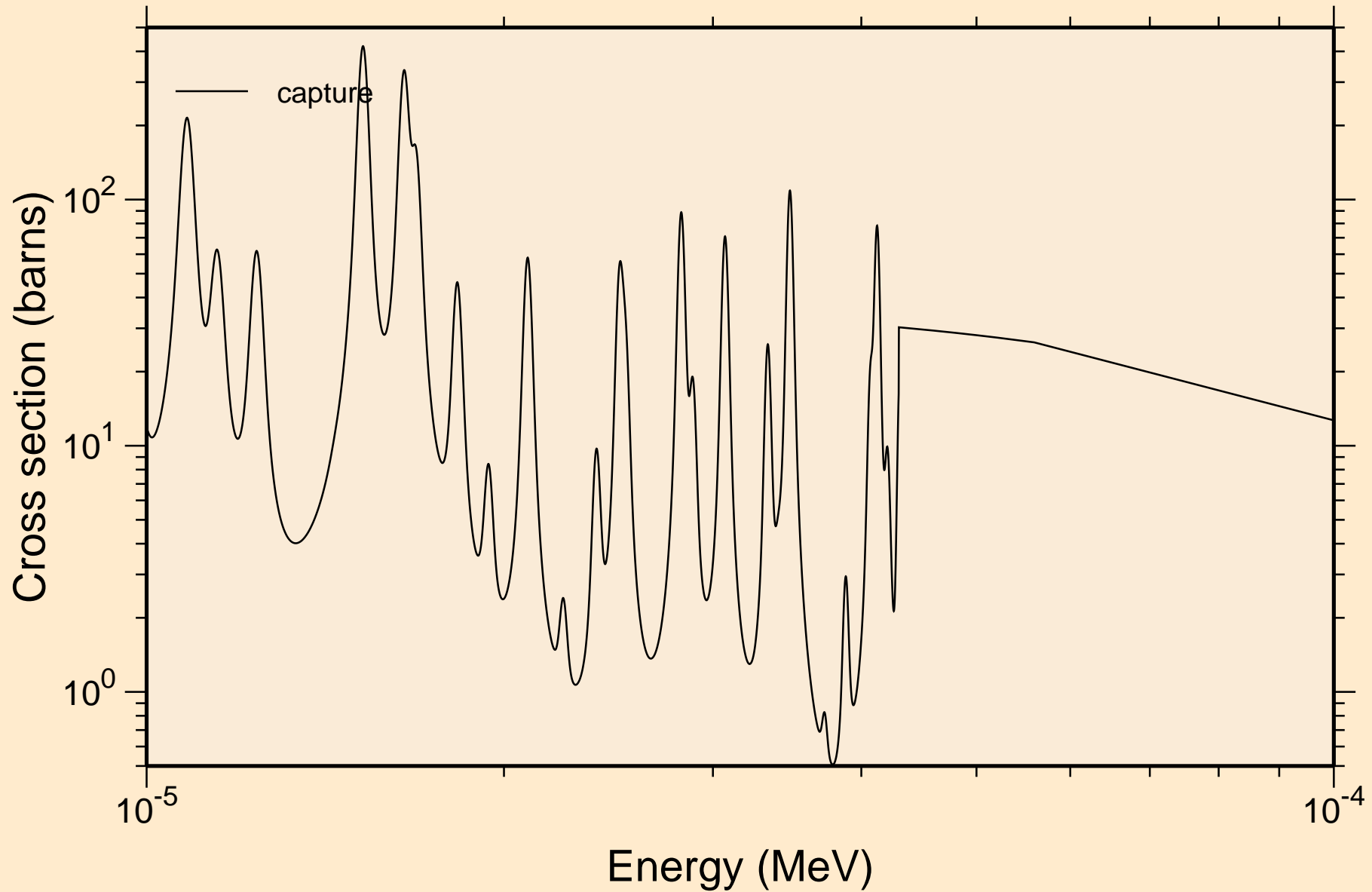

TE113 NEUTRON ACER TENDL-2024 LIBRARY; T=293.6K  
resonance absorption cross sections

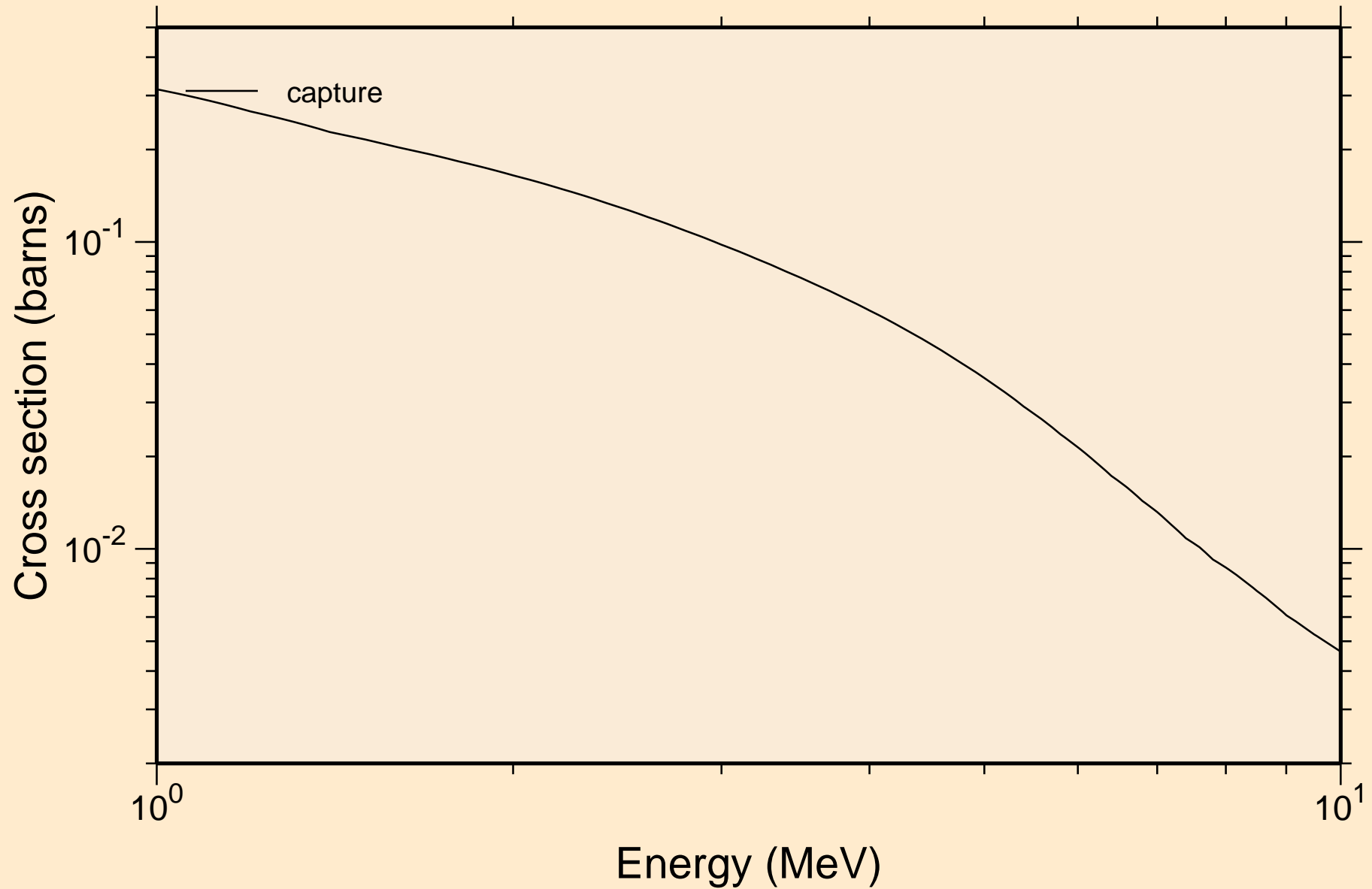

TE113 NEUTRON ACER TENDL-2024 LIBRARY; T=293.6K  
Heating

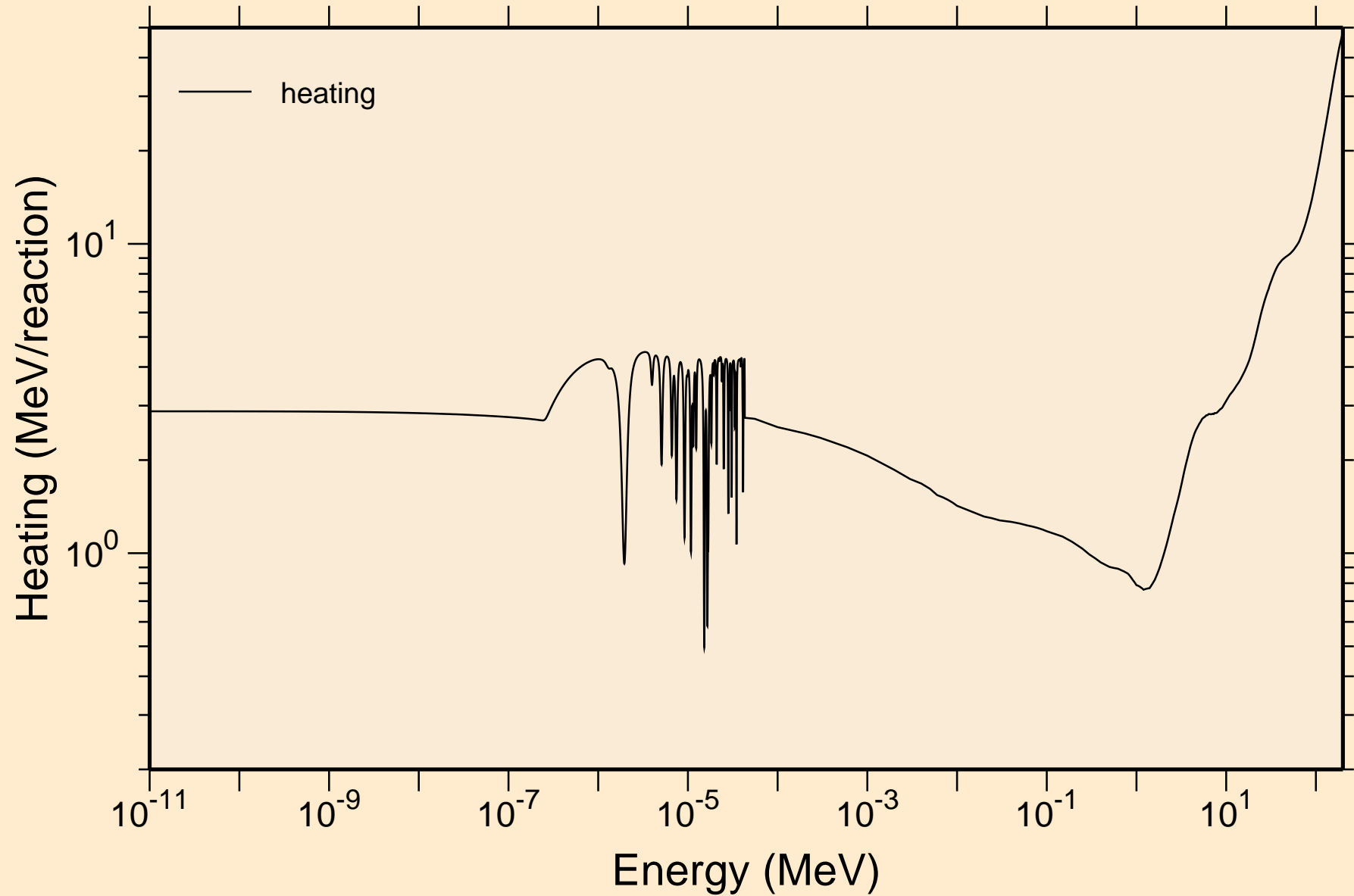

TE113 NEUTRON ACER TENDL-2024 LIBRARY; T=293.6K  
Damage

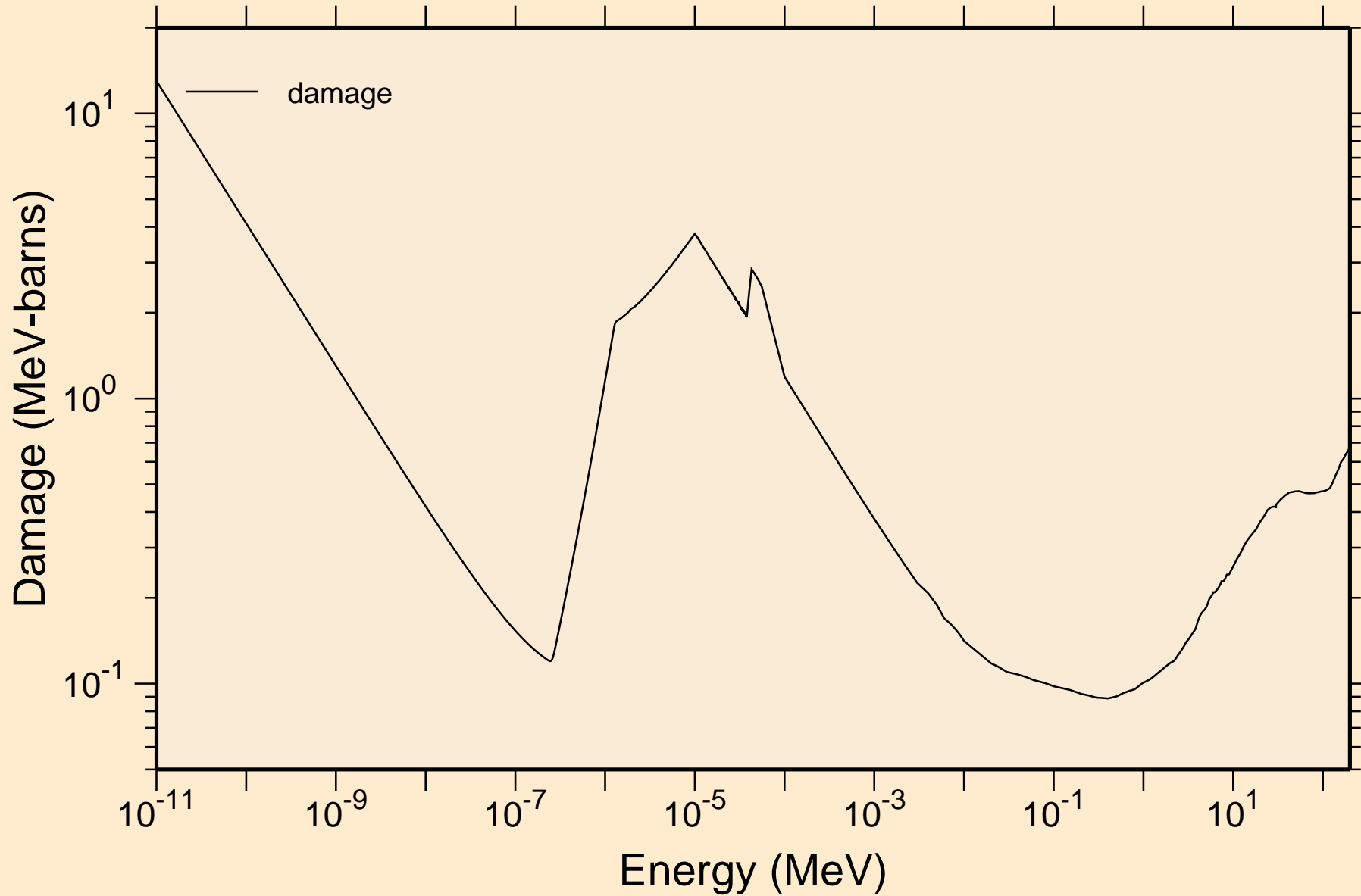

TE113 NEUTRON ACER TENDL-2024 LIBRARY; T=293.6K  
Non-threshold reactions

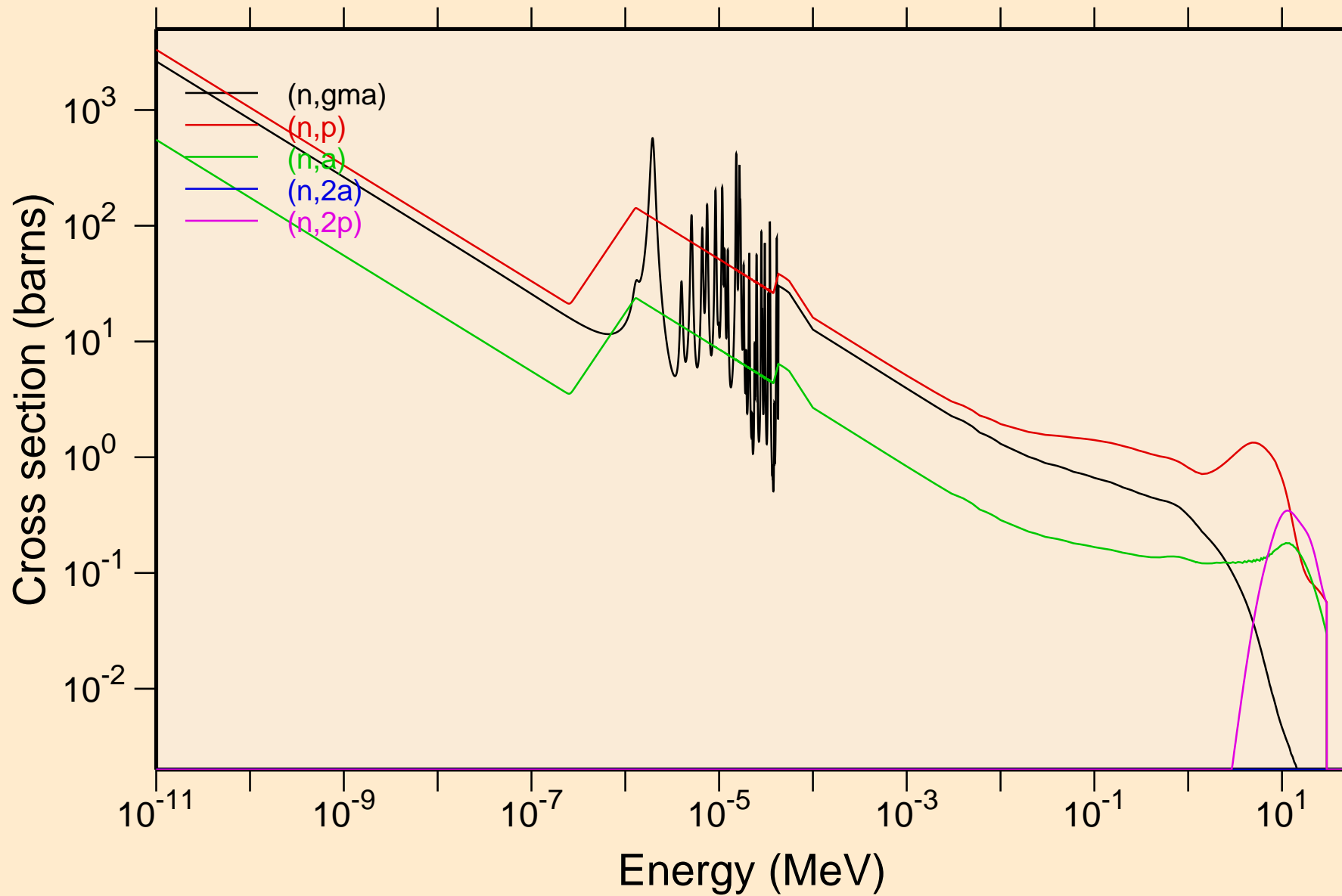

TE113 NEUTRON ACER TENDL-2024 LIBRARY; T=293.6K  
Non-threshold reactions

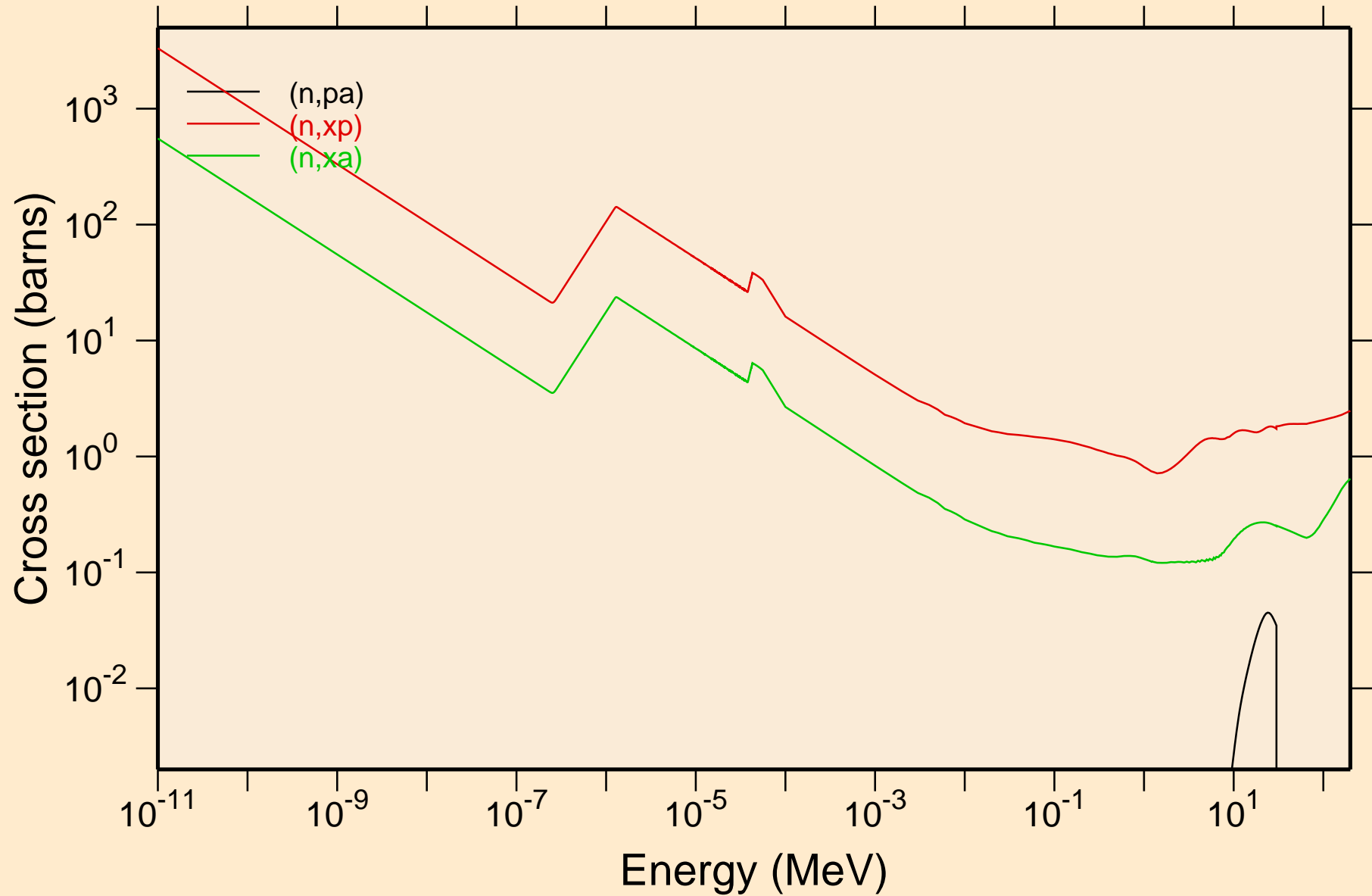

# TE113 NEUTRON ACER TENDL-2024 LIBRARY; T=293.6K

## Principal cross sections

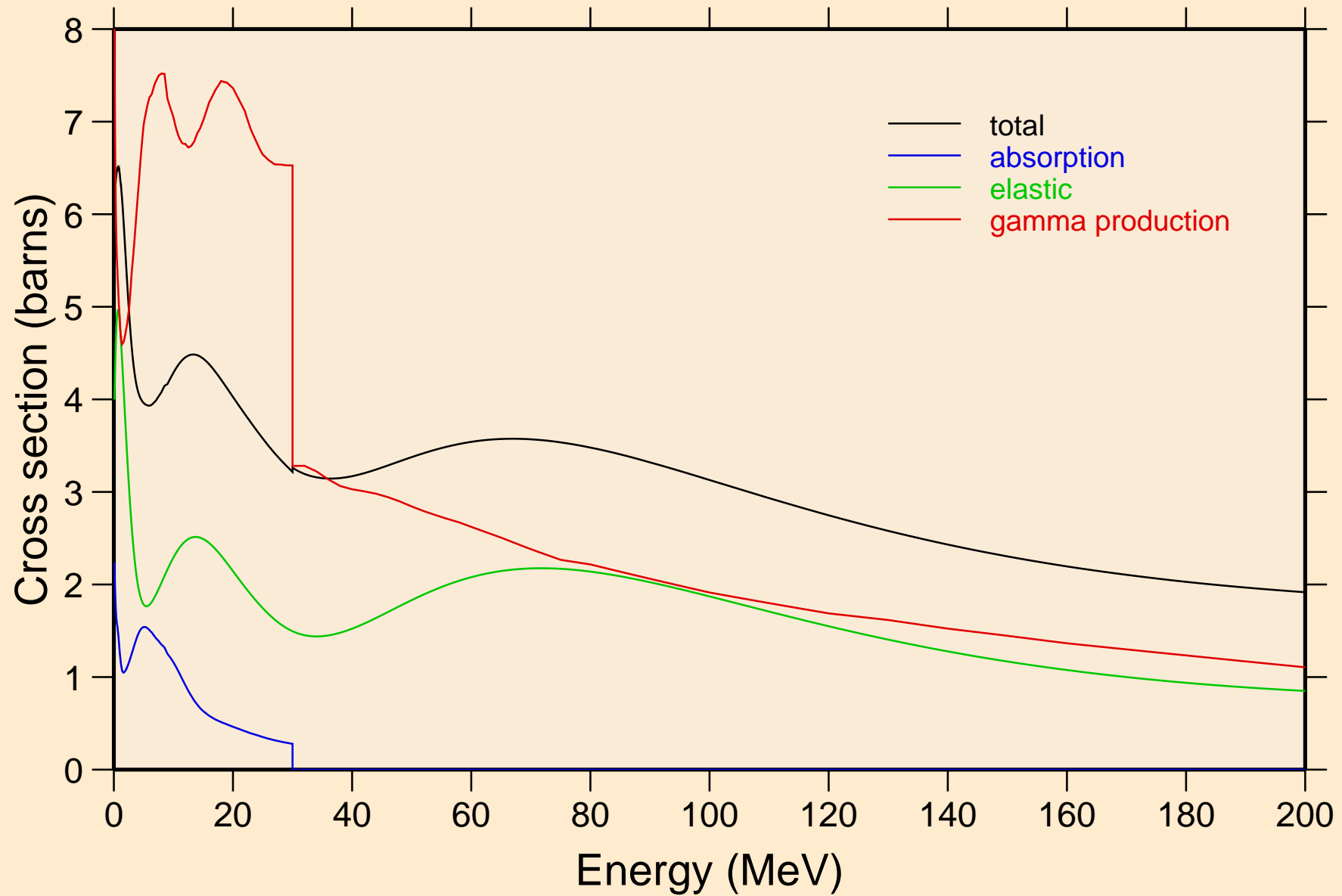

# TE113 NEUTRON ACER TENDL-2024 LIBRARY; T=293.6K

## Heating

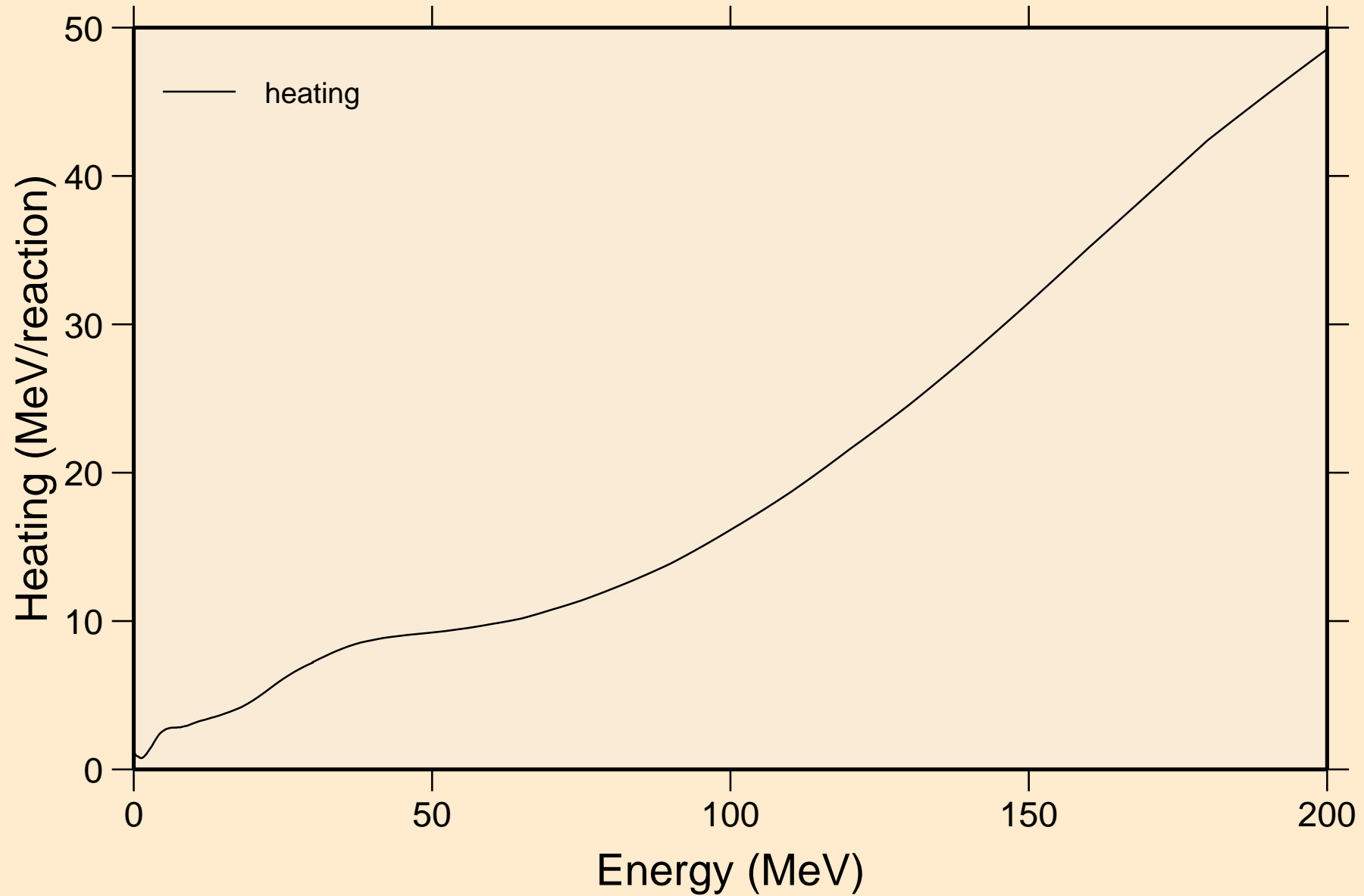

TE113 NEUTRON ACER TENDL-2024 LIBRARY; T=293.6K  
Damage

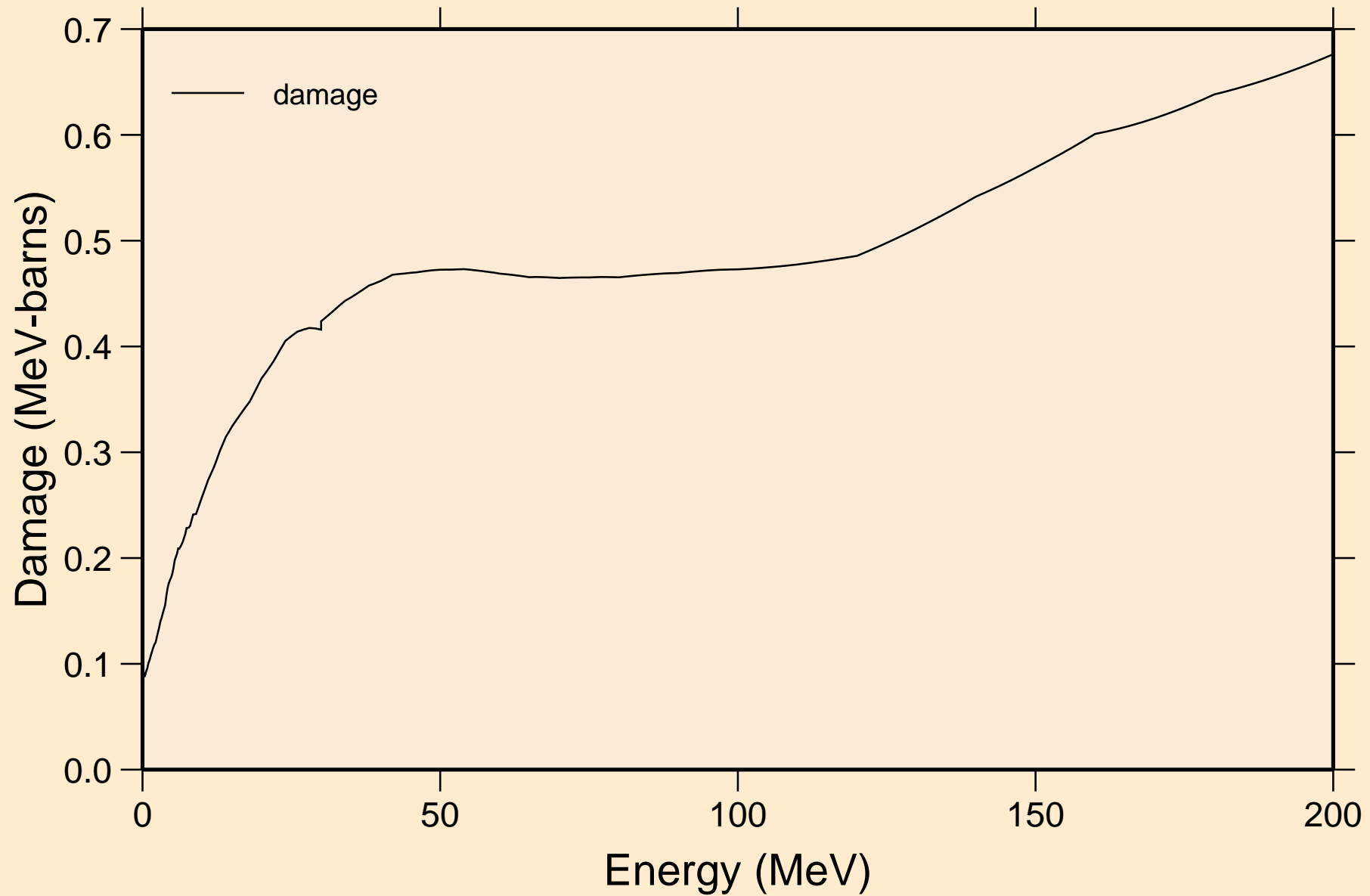

TE113 NEUTRON ACER TENDL-2024 LIBRARY; T=293.6K  
Non-threshold reactions

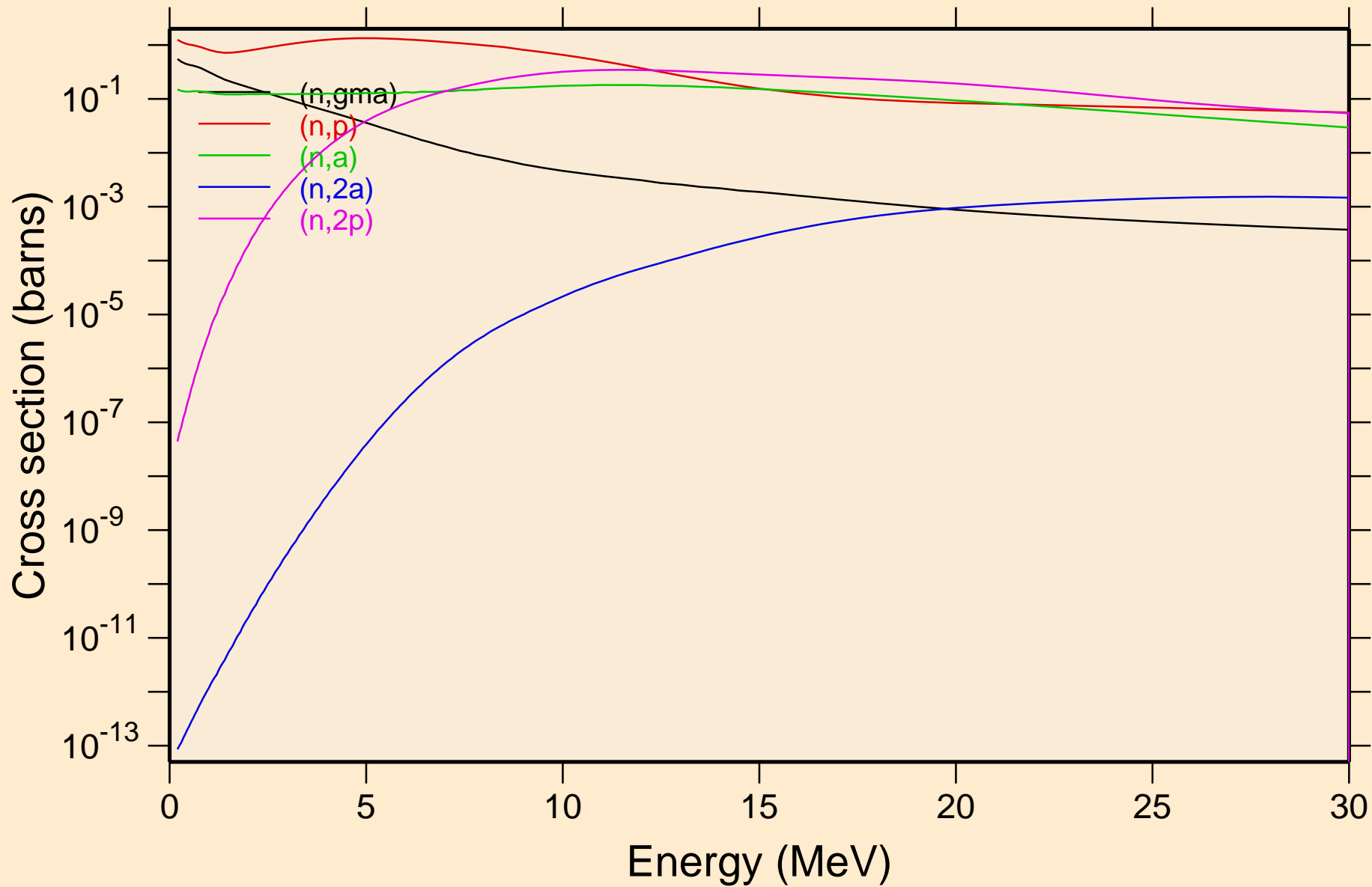

TE113 NEUTRON ACER TENDL-2024 LIBRARY; T=293.6K  
Non-threshold reactions

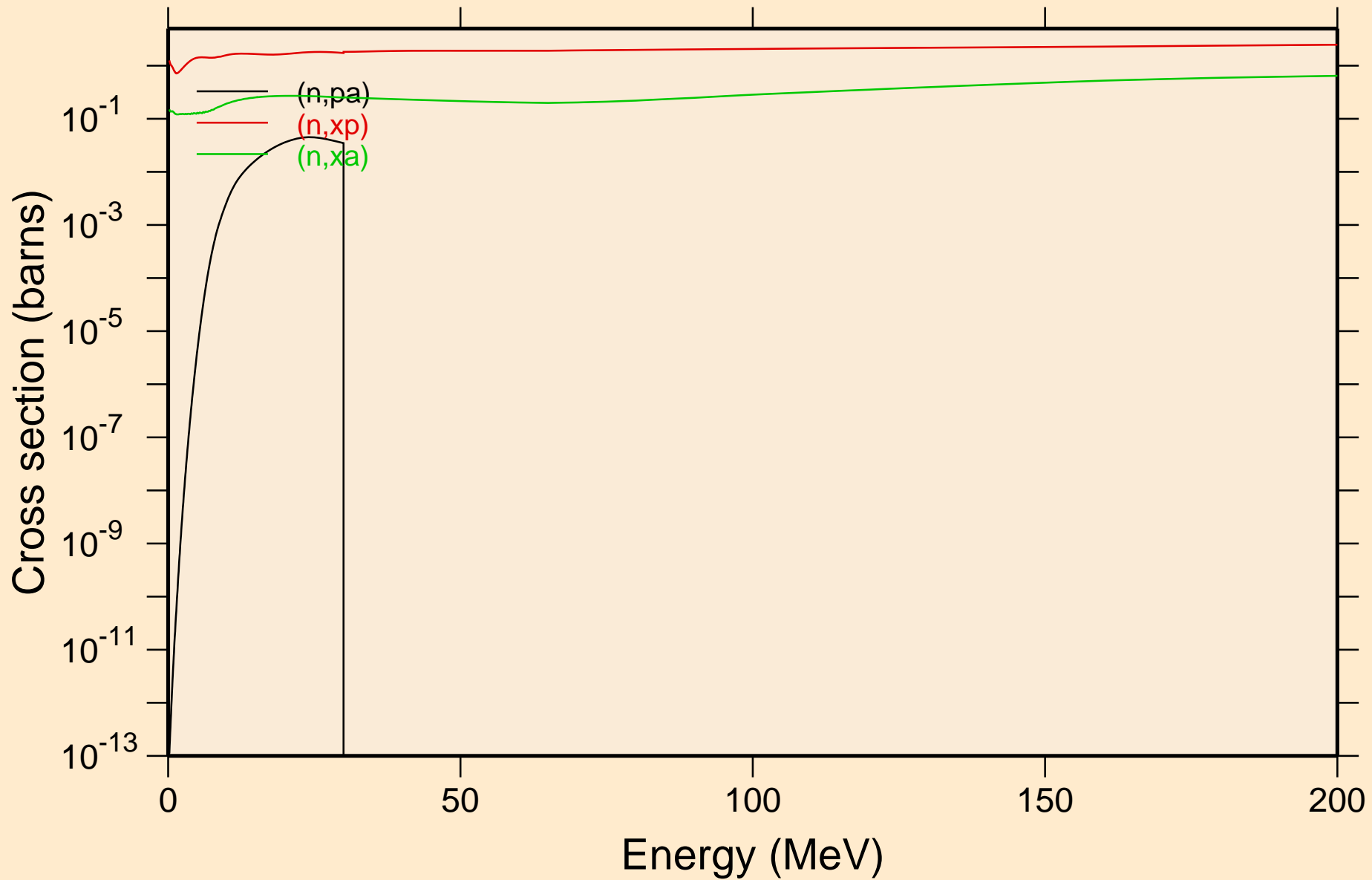

TE113 NEUTRON ACER TENDL-2024 LIBRARY; T=293.6K  
Inelastic levels

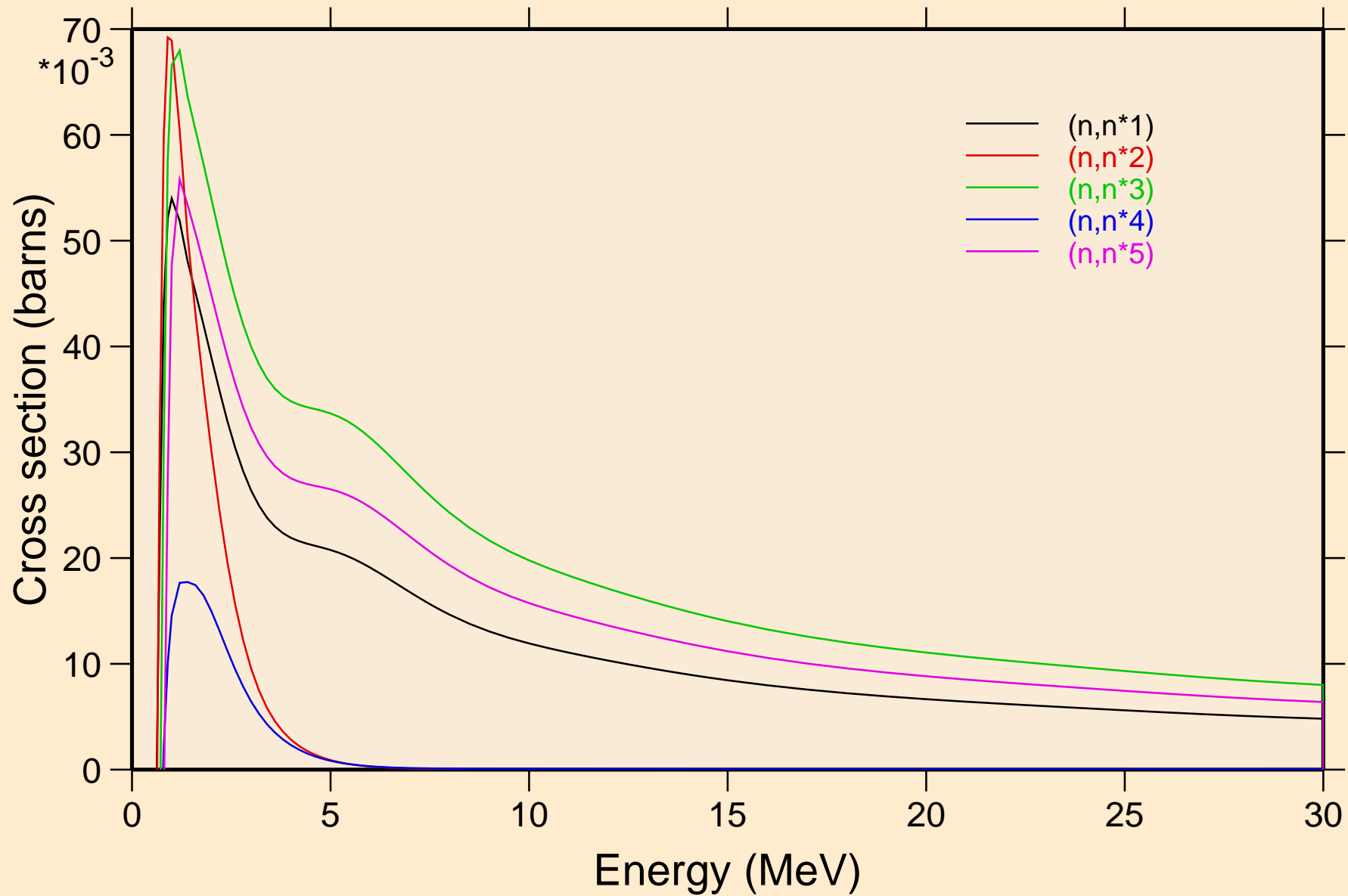

TE113 NEUTRON ACER TENDL-2024 LIBRARY; T=293.6K  
Inelastic levels

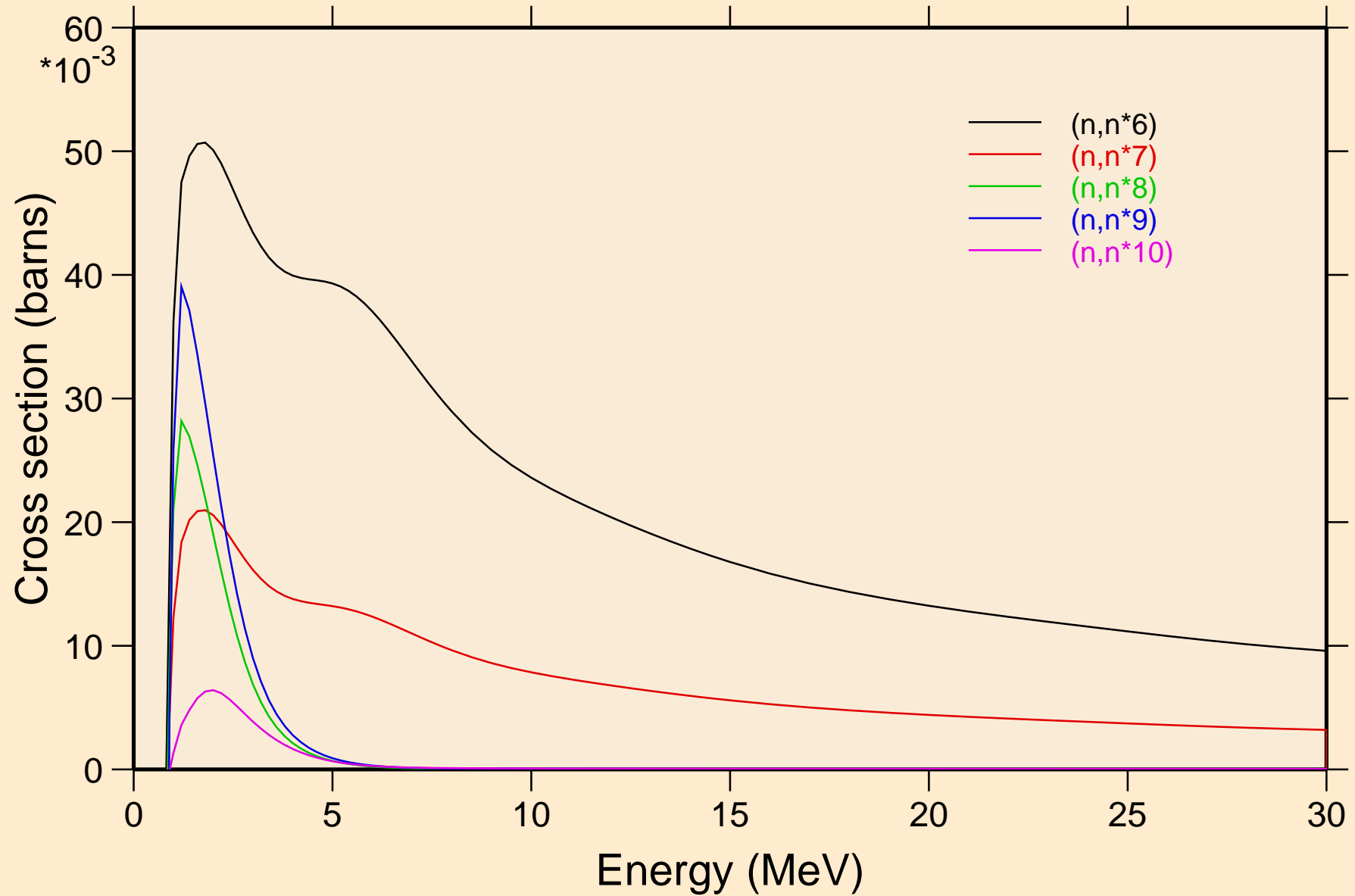

TE113 NEUTRON ACER TENDL-2024 LIBRARY; T=293.6K  
Inelastic levels

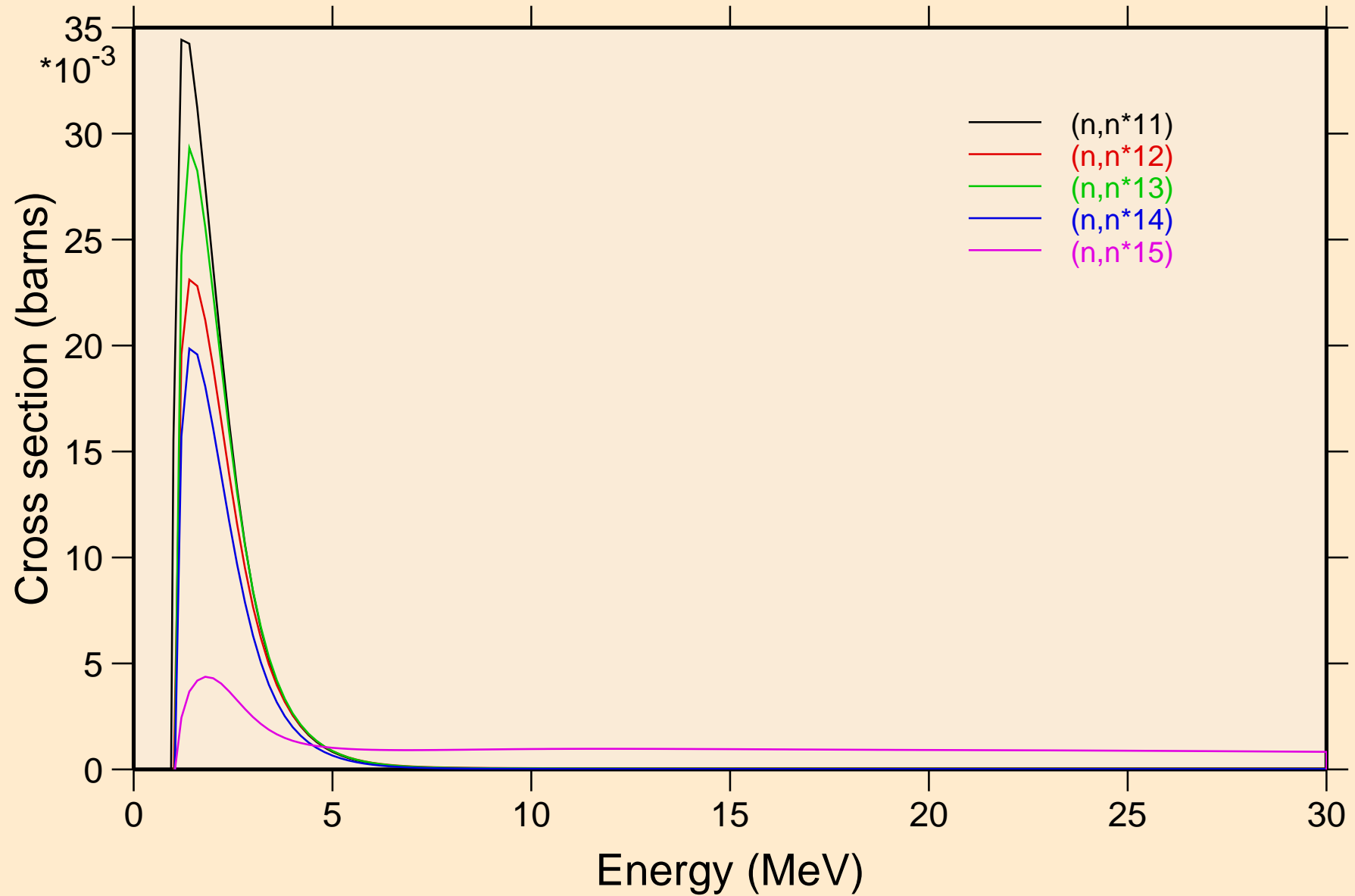

TE113 NEUTRON ACER TENDL-2024 LIBRARY; T=293.6K  
Inelastic levels

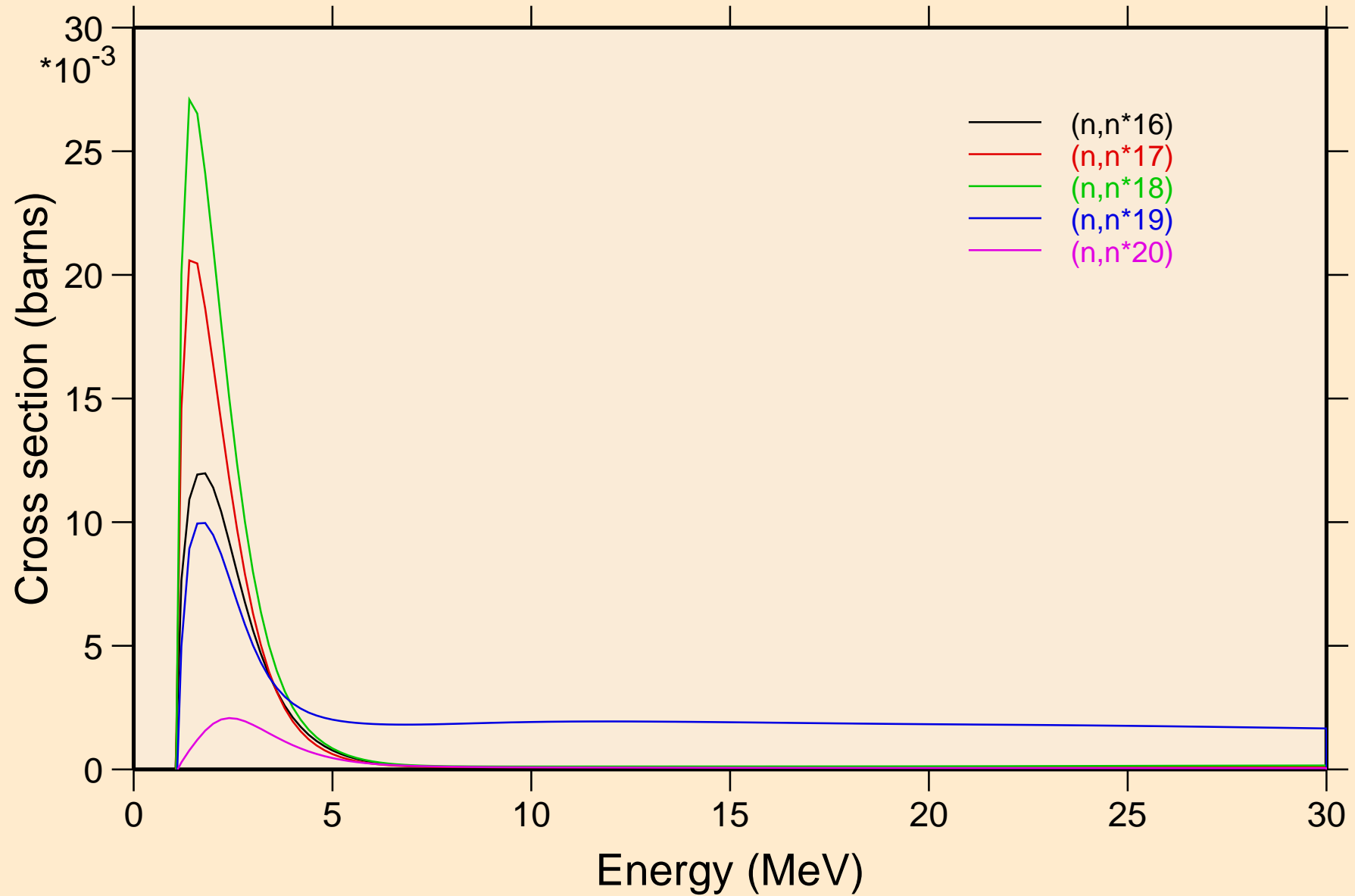

TE113 NEUTRON ACER TENDL-2024 LIBRARY; T=293.6K  
Inelastic levels

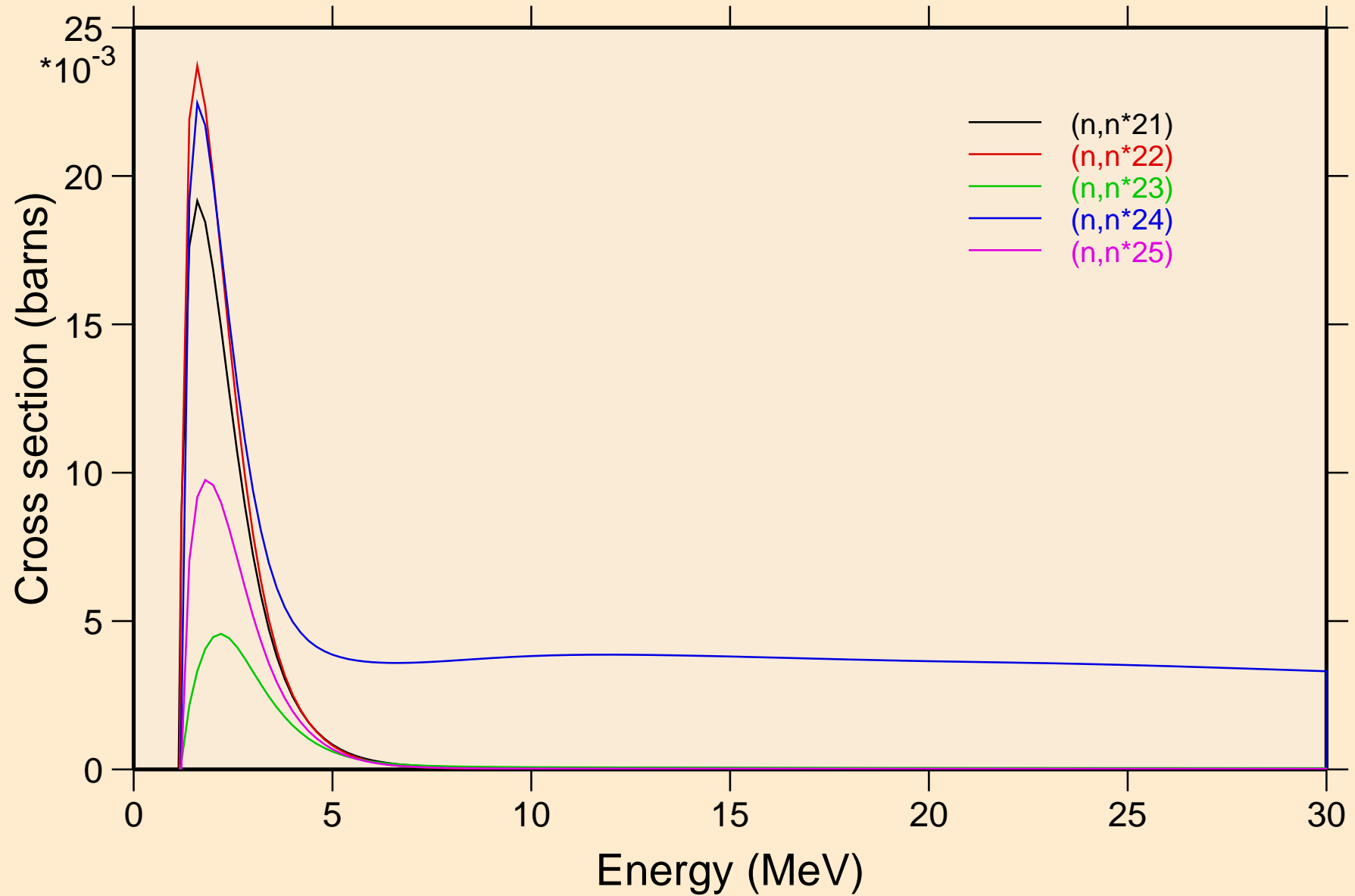

TE113 NEUTRON ACER TENDL-2024 LIBRARY; T=293.6K  
Inelastic levels

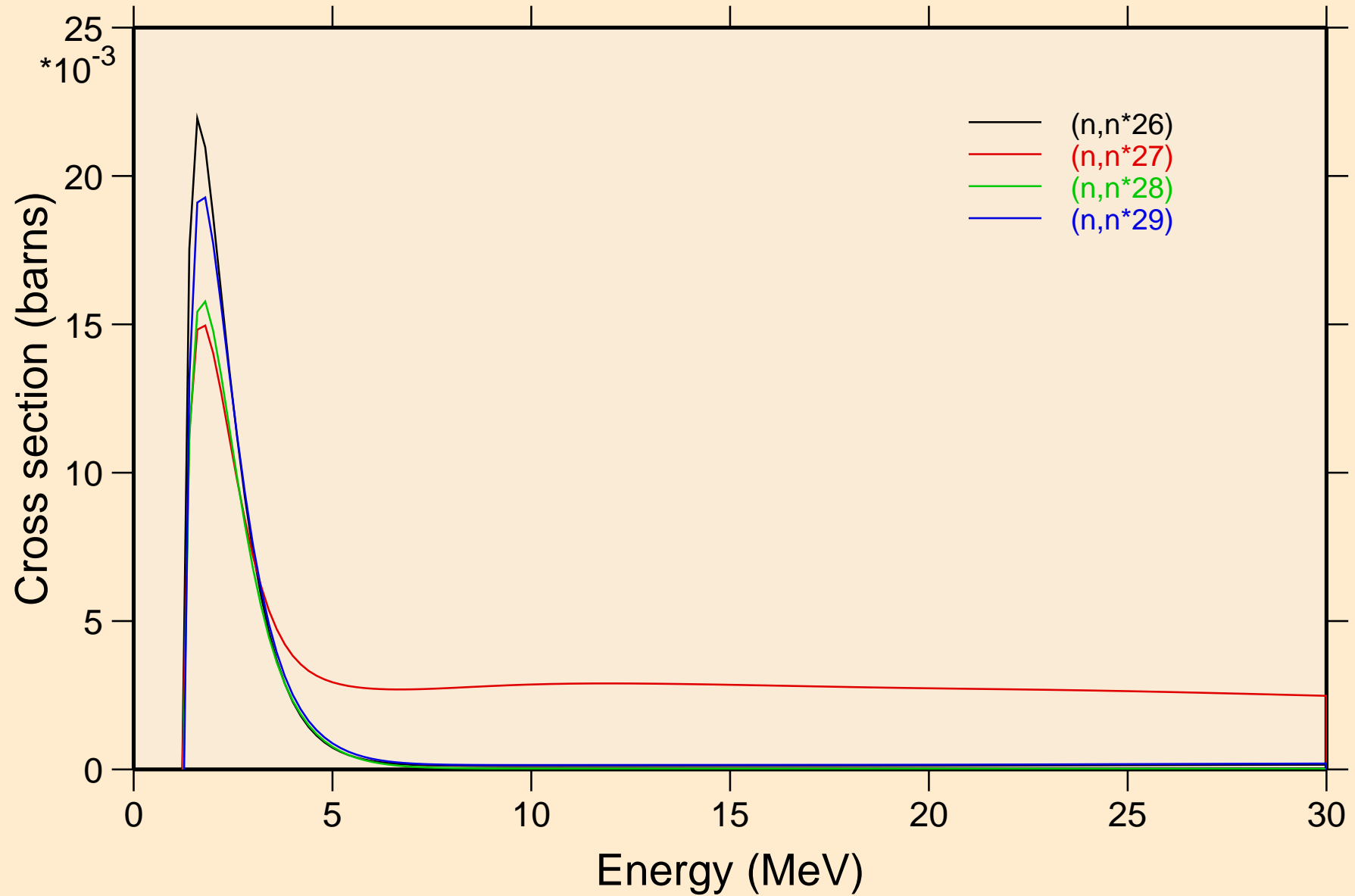

TE113 NEUTRON ACER TENDL-2024 LIBRARY; T=293.6K  
Threshold reactions

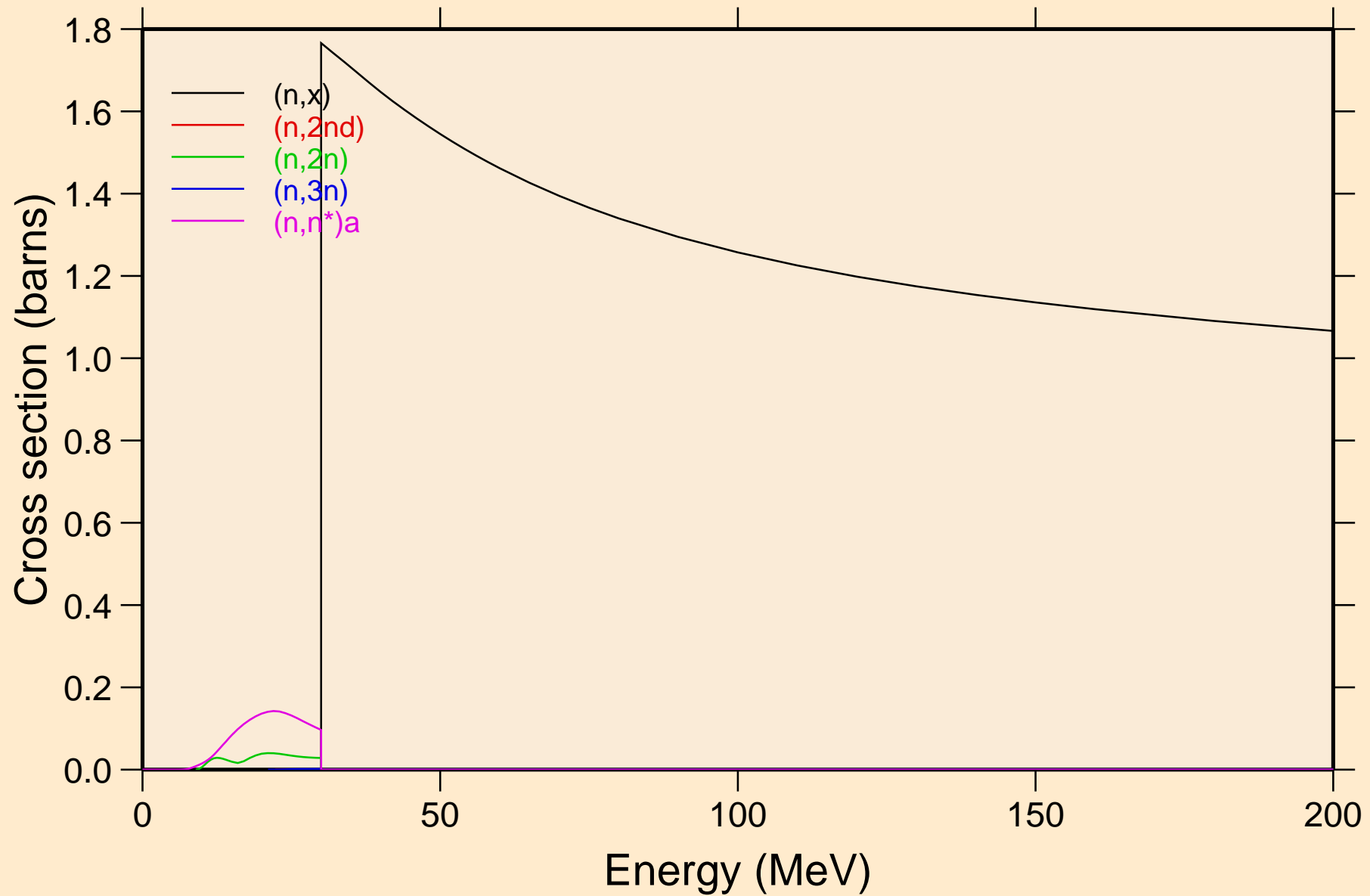

TE113 NEUTRON ACER TENDL-2024 LIBRARY; T=293.6K  
Threshold reactions

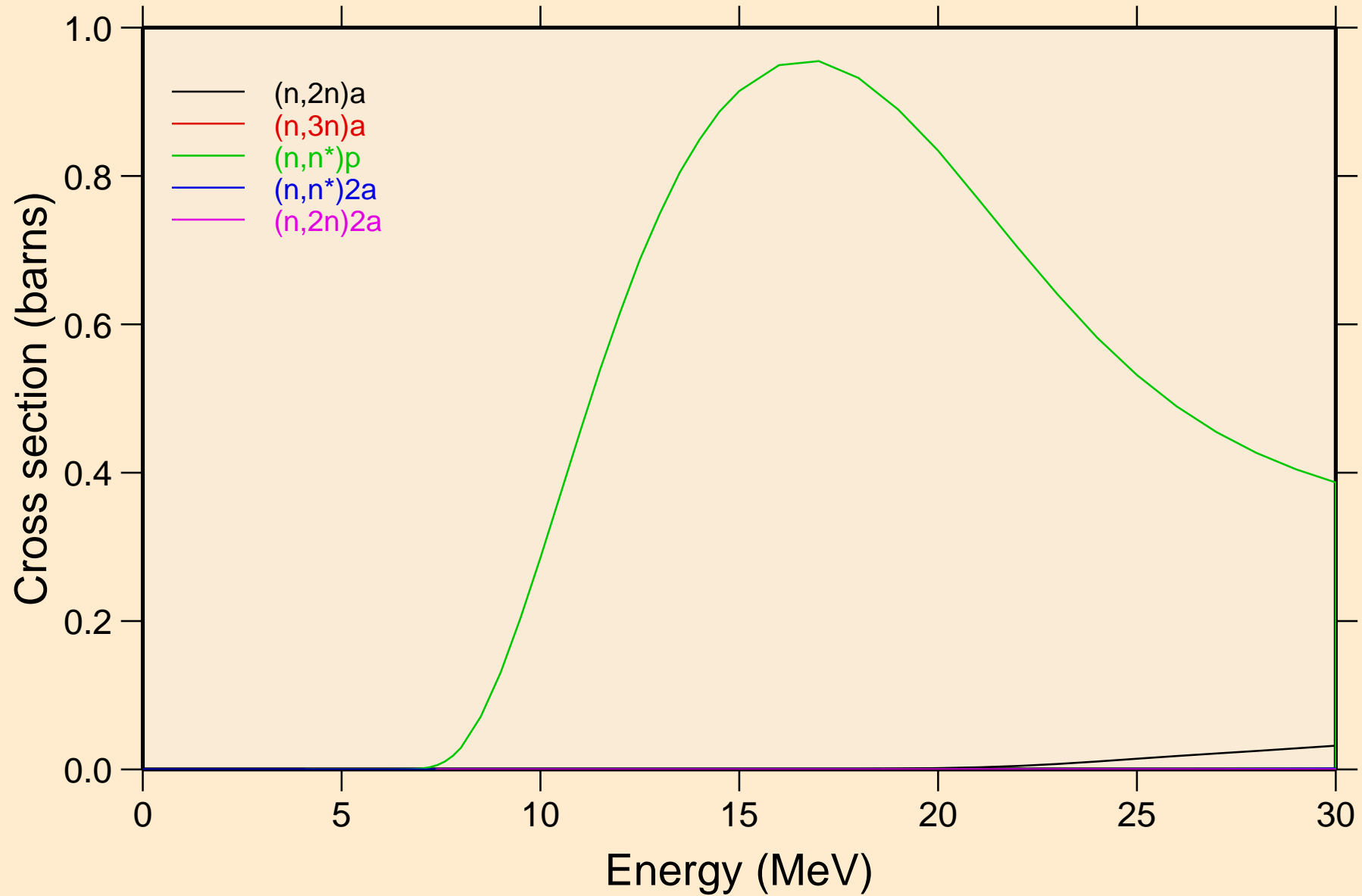

TE113 NEUTRON ACER TENDL-2024 LIBRARY; T=293.6K  
Threshold reactions

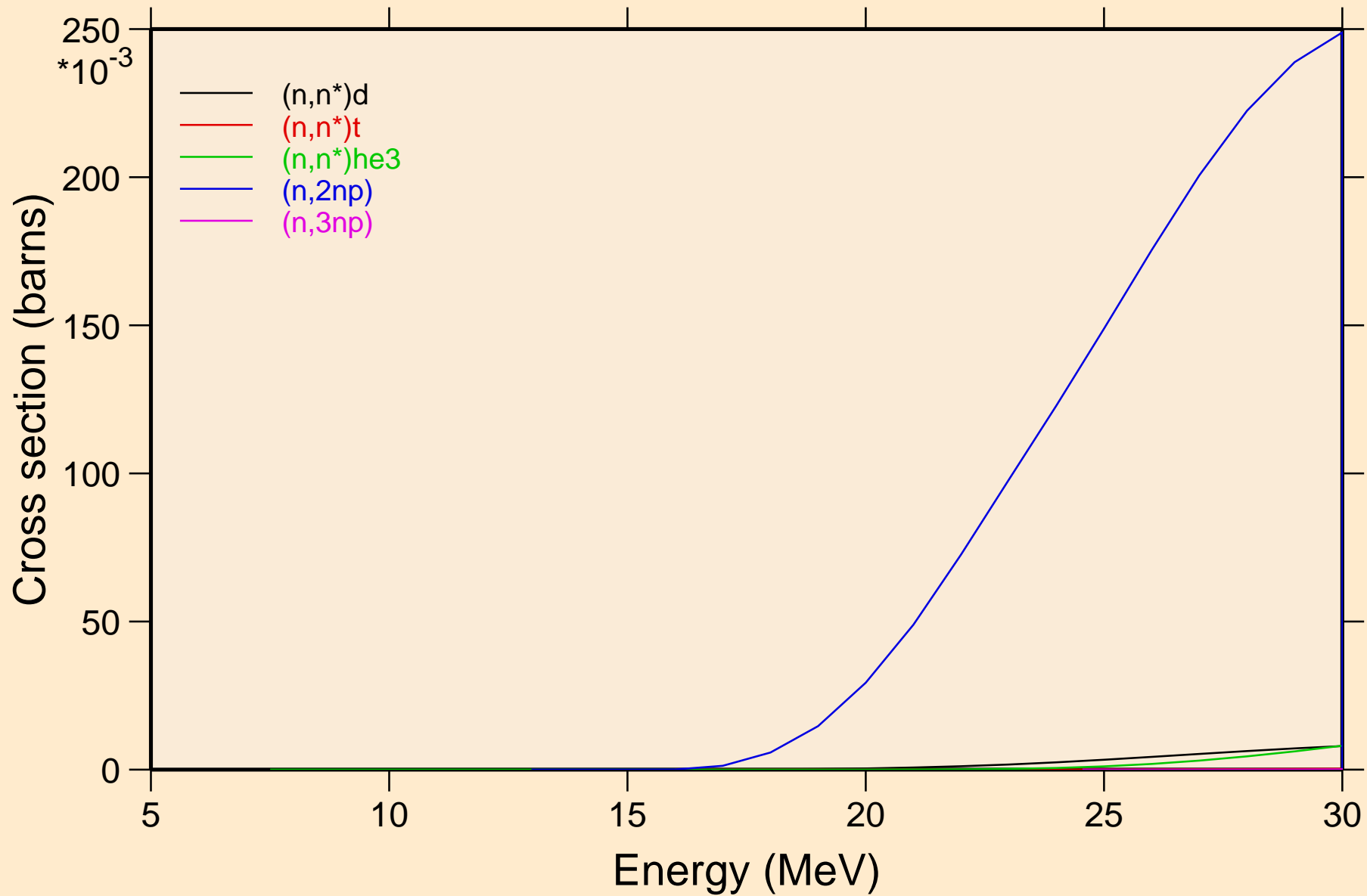

TE113 NEUTRON ACER TENDL-2024 LIBRARY; T=293.6K  
Threshold reactions

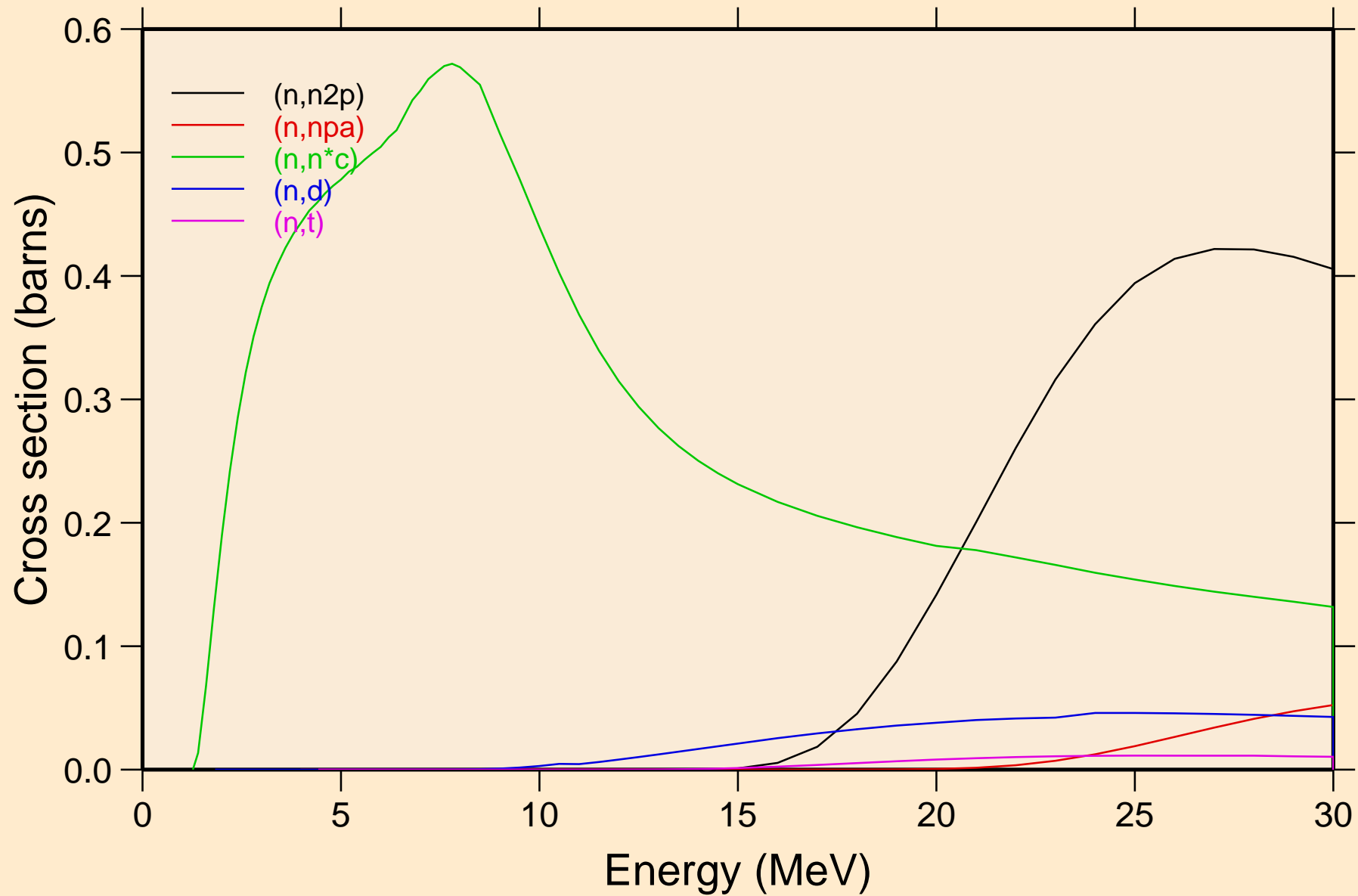

TE113 NEUTRON ACER TENDL-2024 LIBRARY; T=293.6K  
Threshold reactions

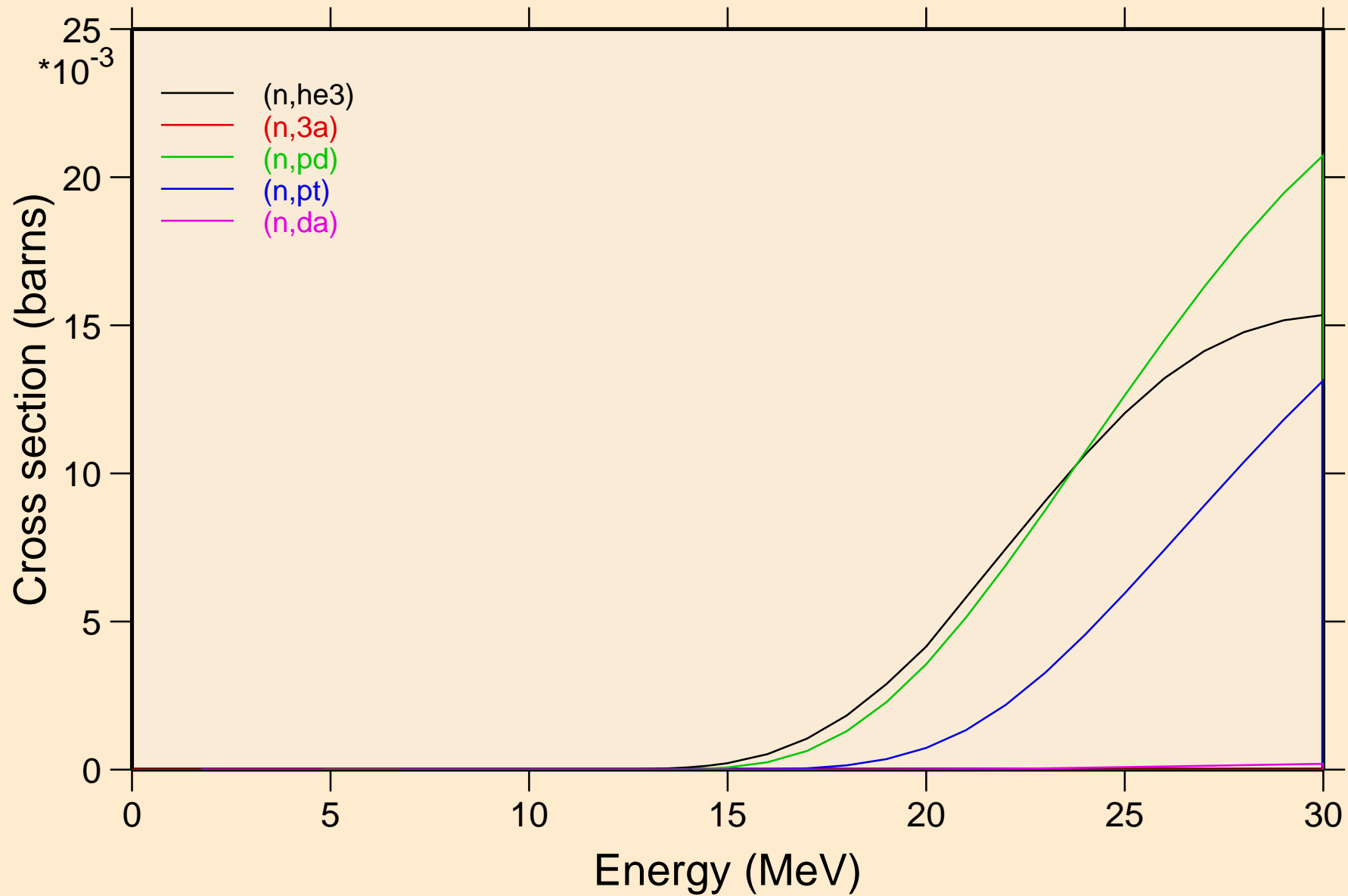

TE113 NEUTRON ACER TENDL-2024 LIBRARY; T=293.6K  
Threshold reactions

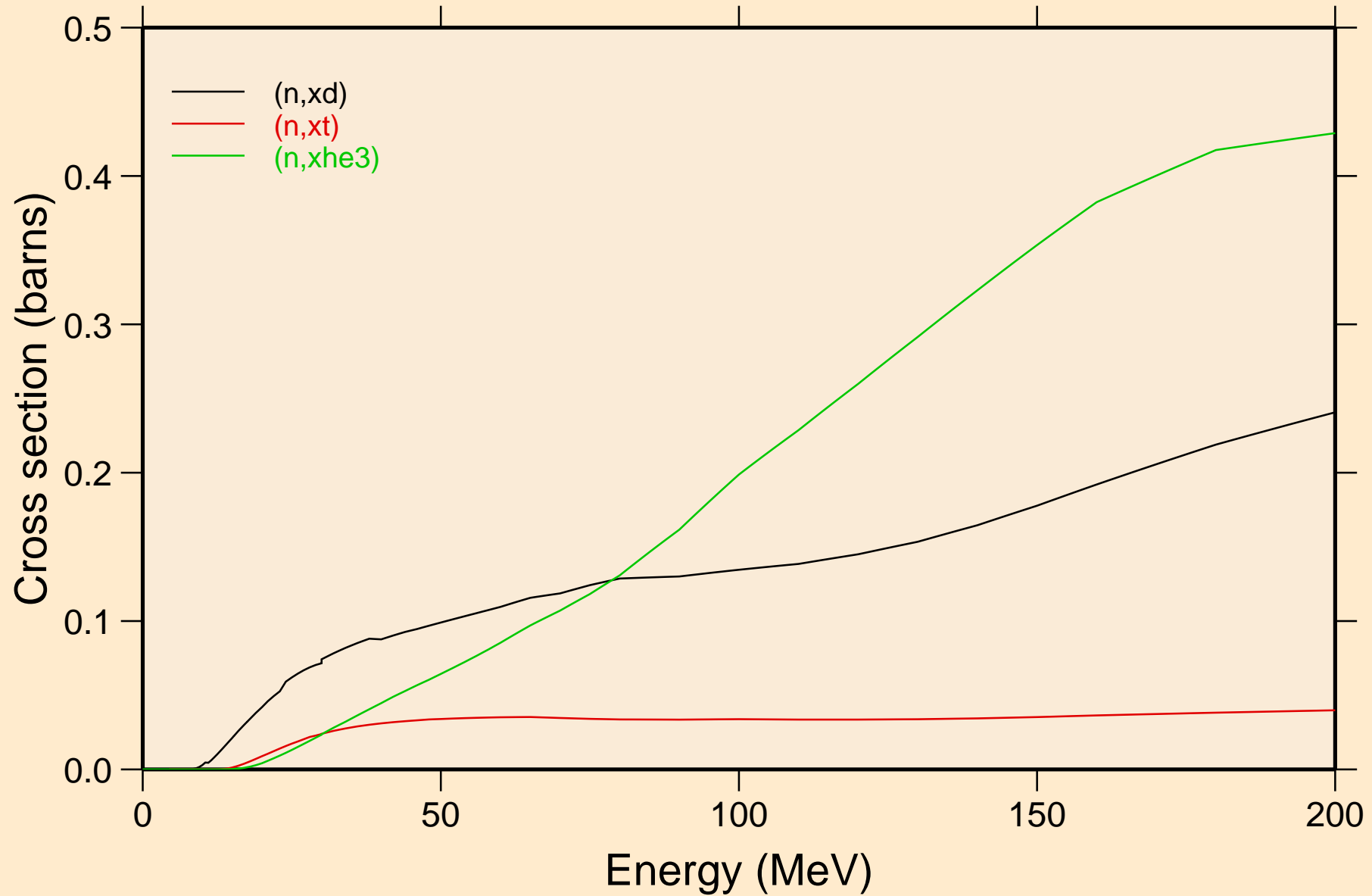

TE113 NEUTRON ACER TENDL-2024 LIBRARY; T=293.6K  
angular distribution for elastic

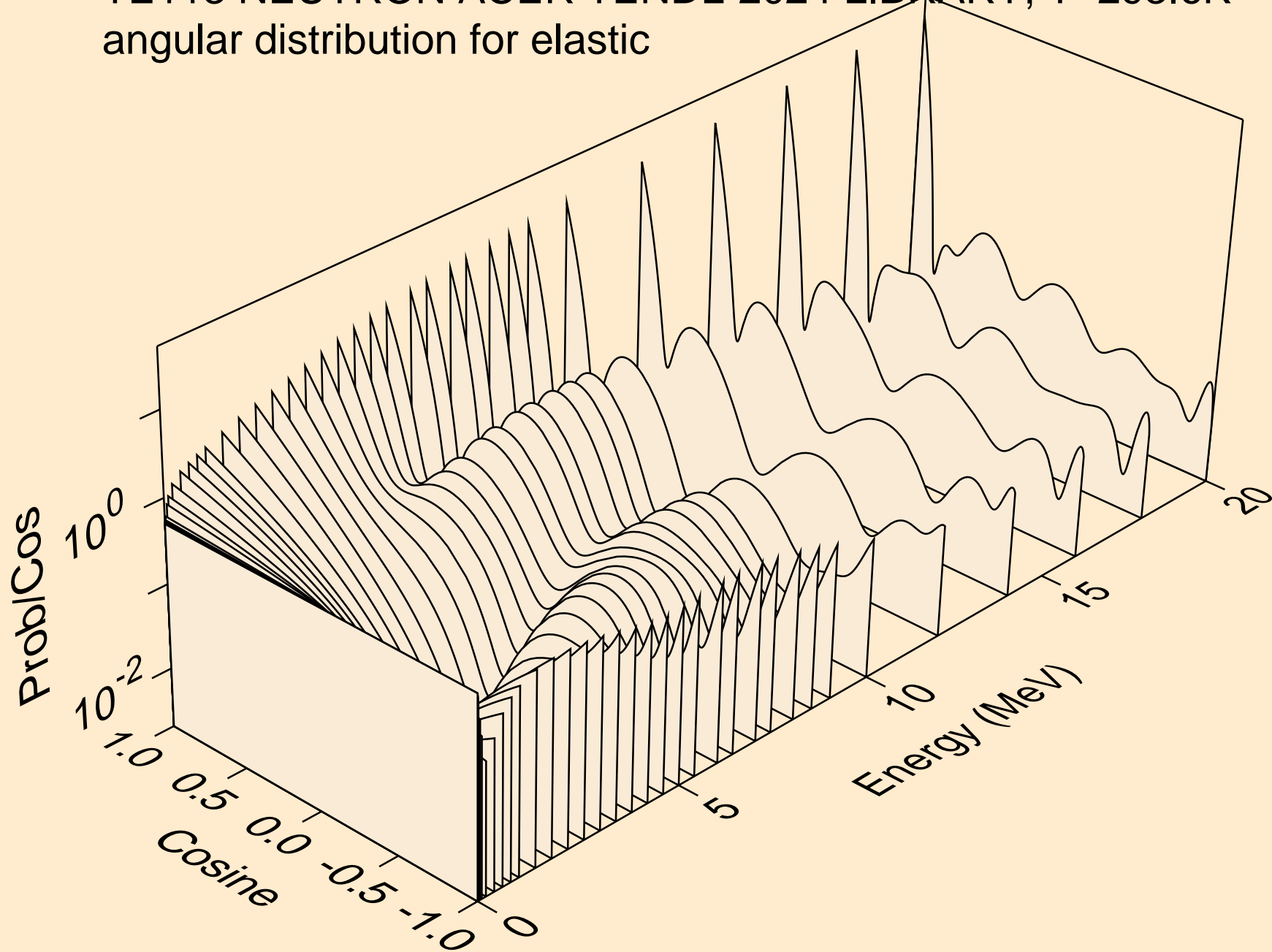

TE113 NEUTRON ACER TENDL-2024 LIBRARY; T=293.6K  
angular distribution for elastic

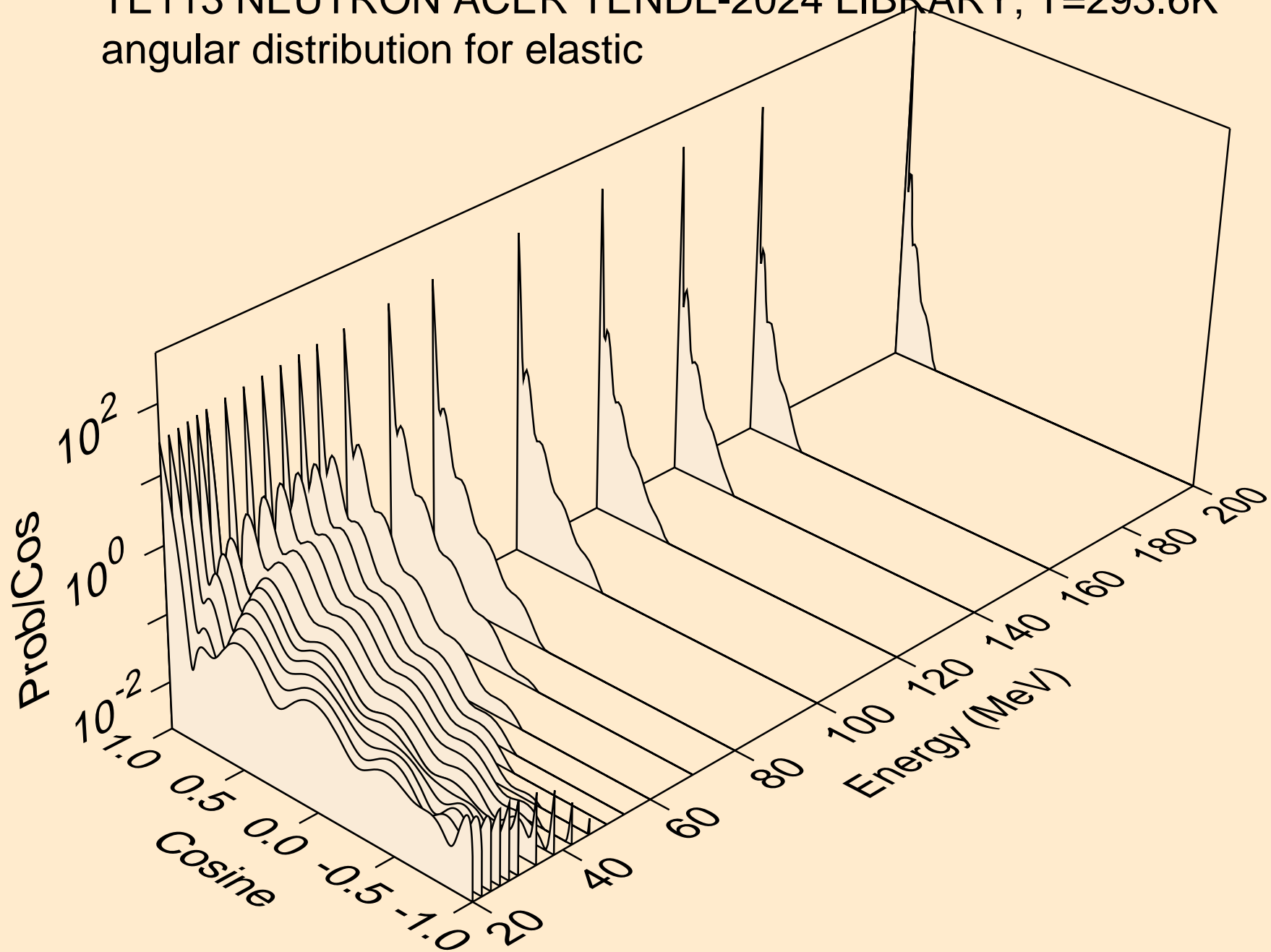

TE113 NEUTRON ACER TENDL-2024 LIBRARY; T=293.6K  
angular distribution for (n,n\*1)

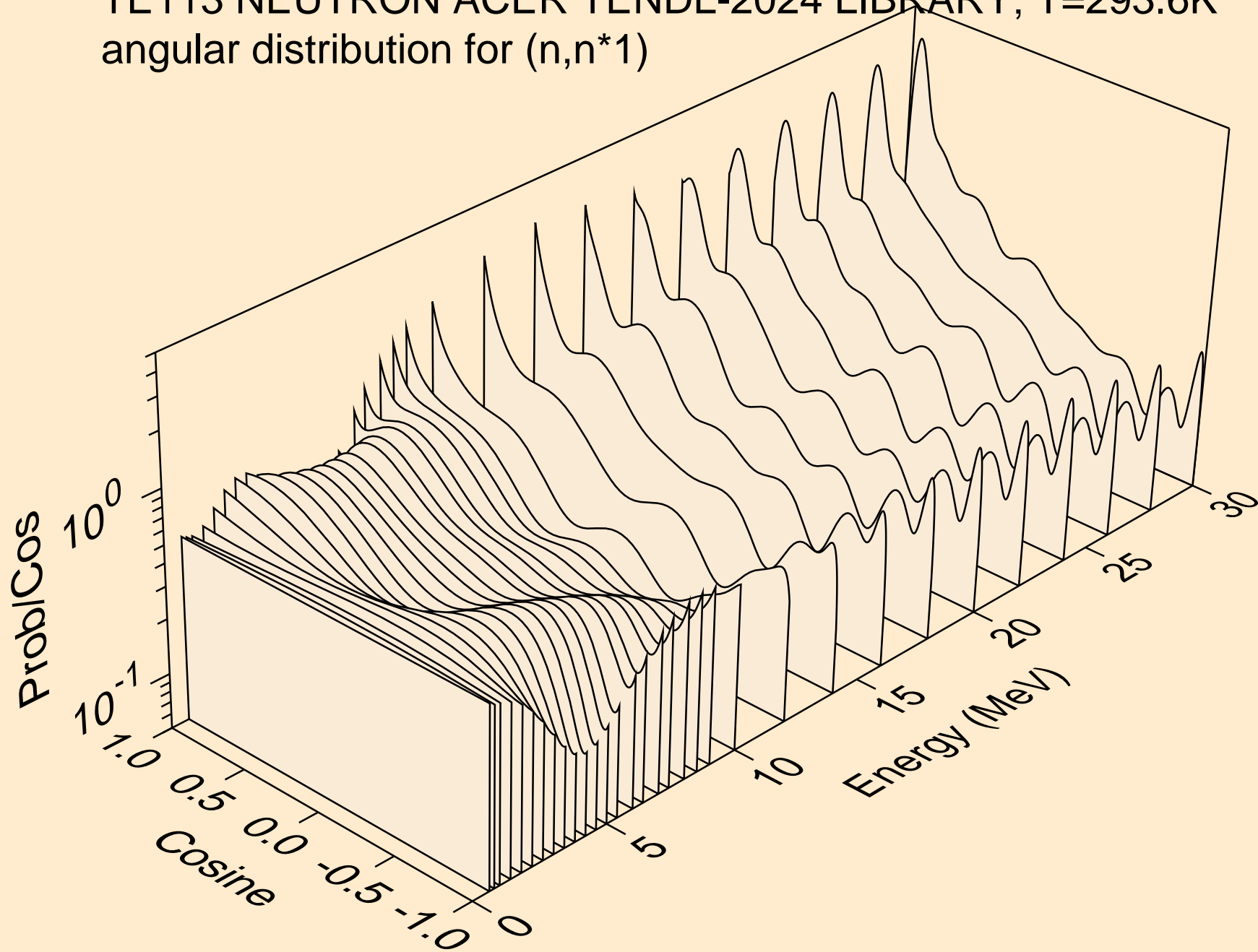

TE113 NEUTRON ACER TENDL-2024 LIBRARY; T=293.6K  
angular distribution for (n,n\*2)

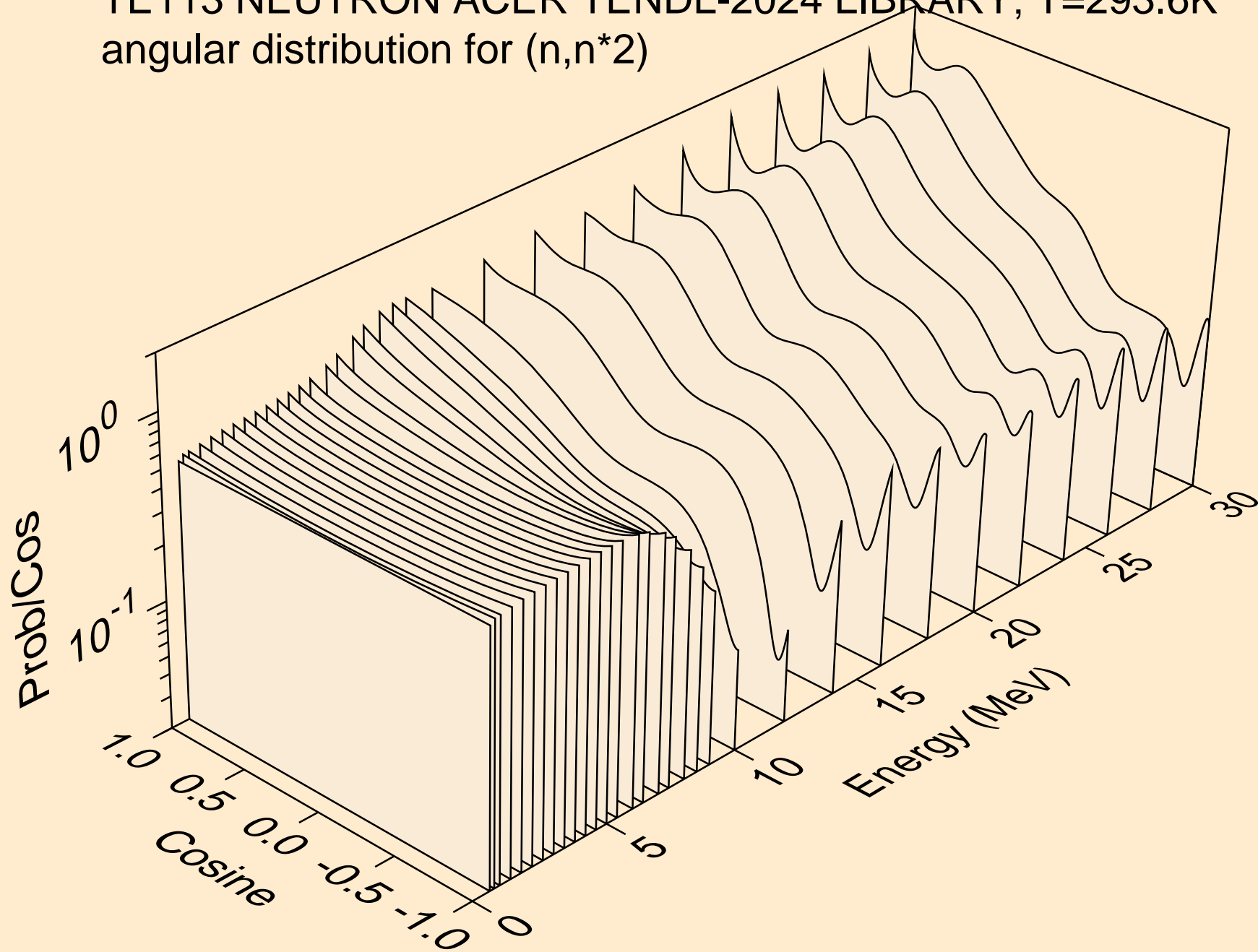

TE113 NEUTRON ACER TENDL-2024 LIBRARY; T=293.6K  
angular distribution for (n,n\*3)

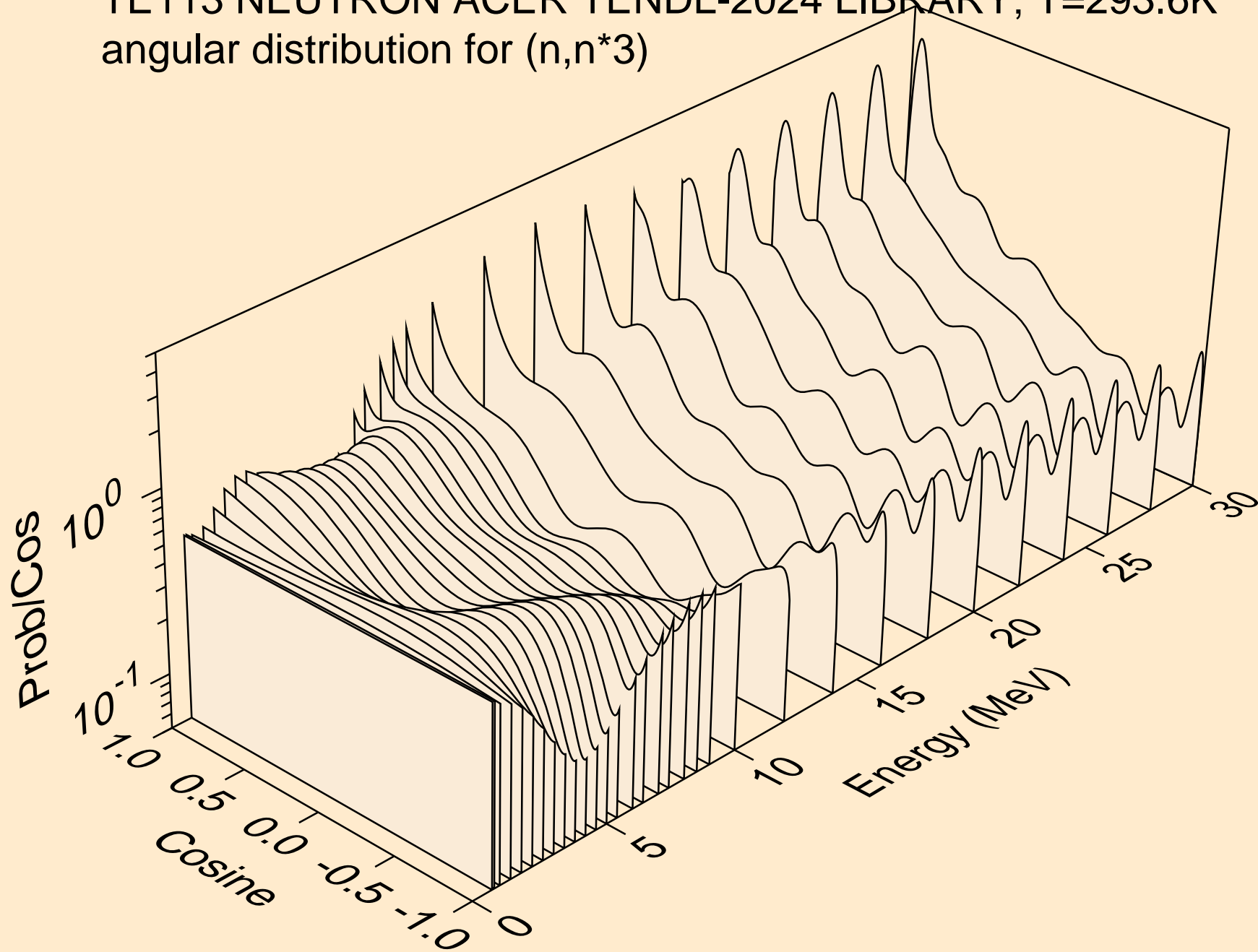

TE113 NEUTRON ACER TENDL-2024 LIBRARY; T=293.6K  
angular distribution for (n,n\*4)

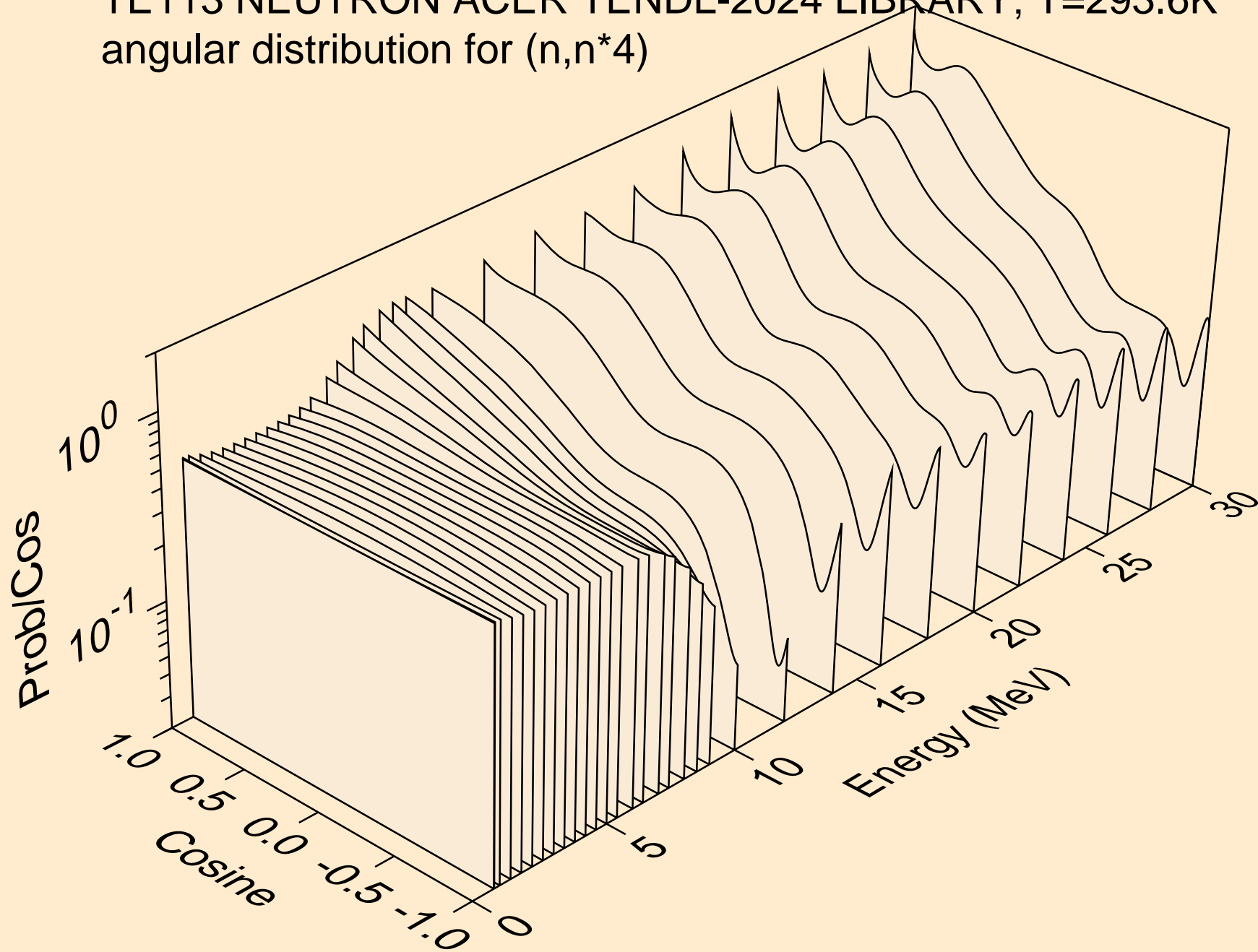

TE113 NEUTRON ACER TENDL-2024 LIBRARY; T=293.6K  
angular distribution for (n,n\*5)

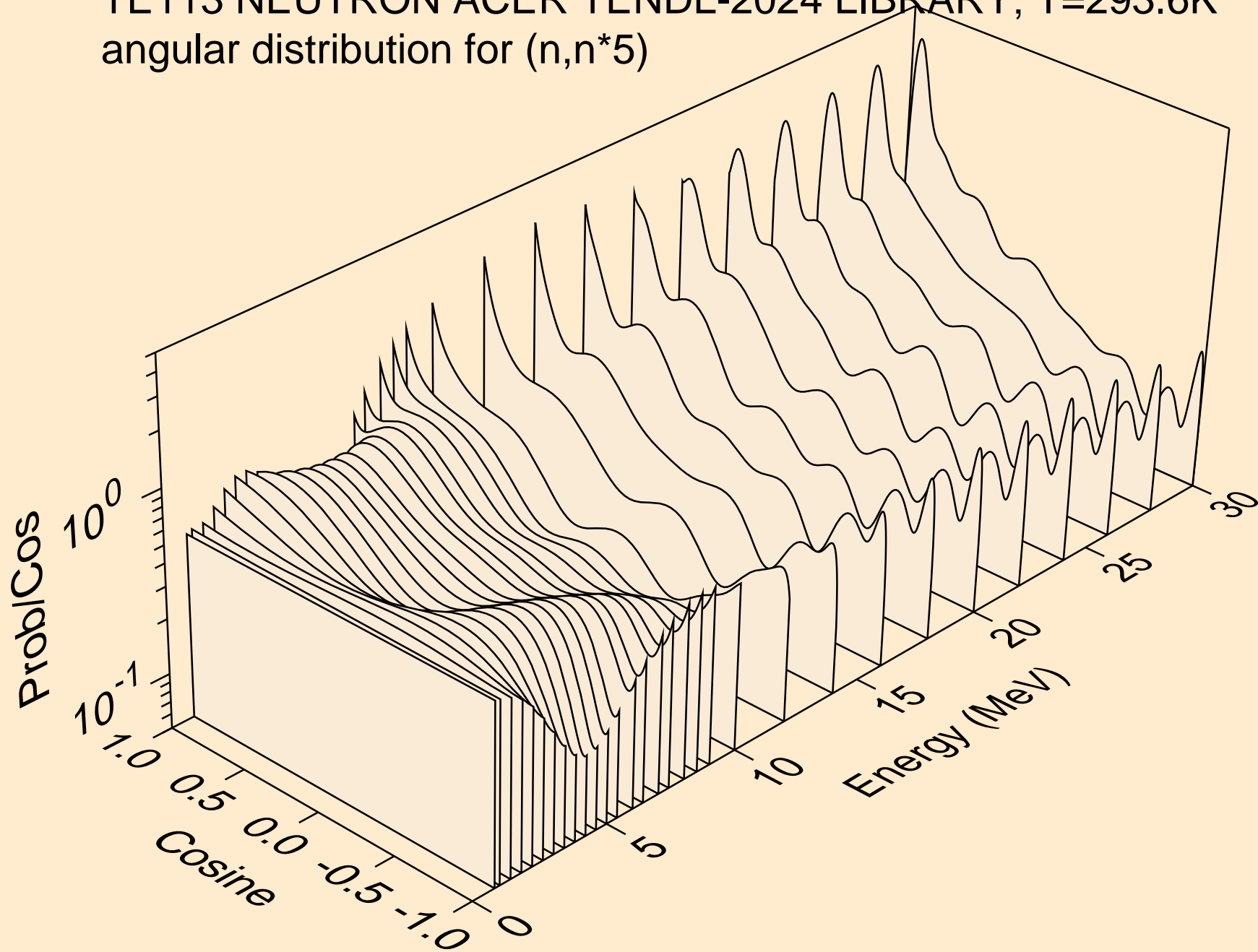

TE113 NEUTRON ACER TENDL-2024 LIBRARY; T=293.6K  
angular distribution for (n,n\*6)

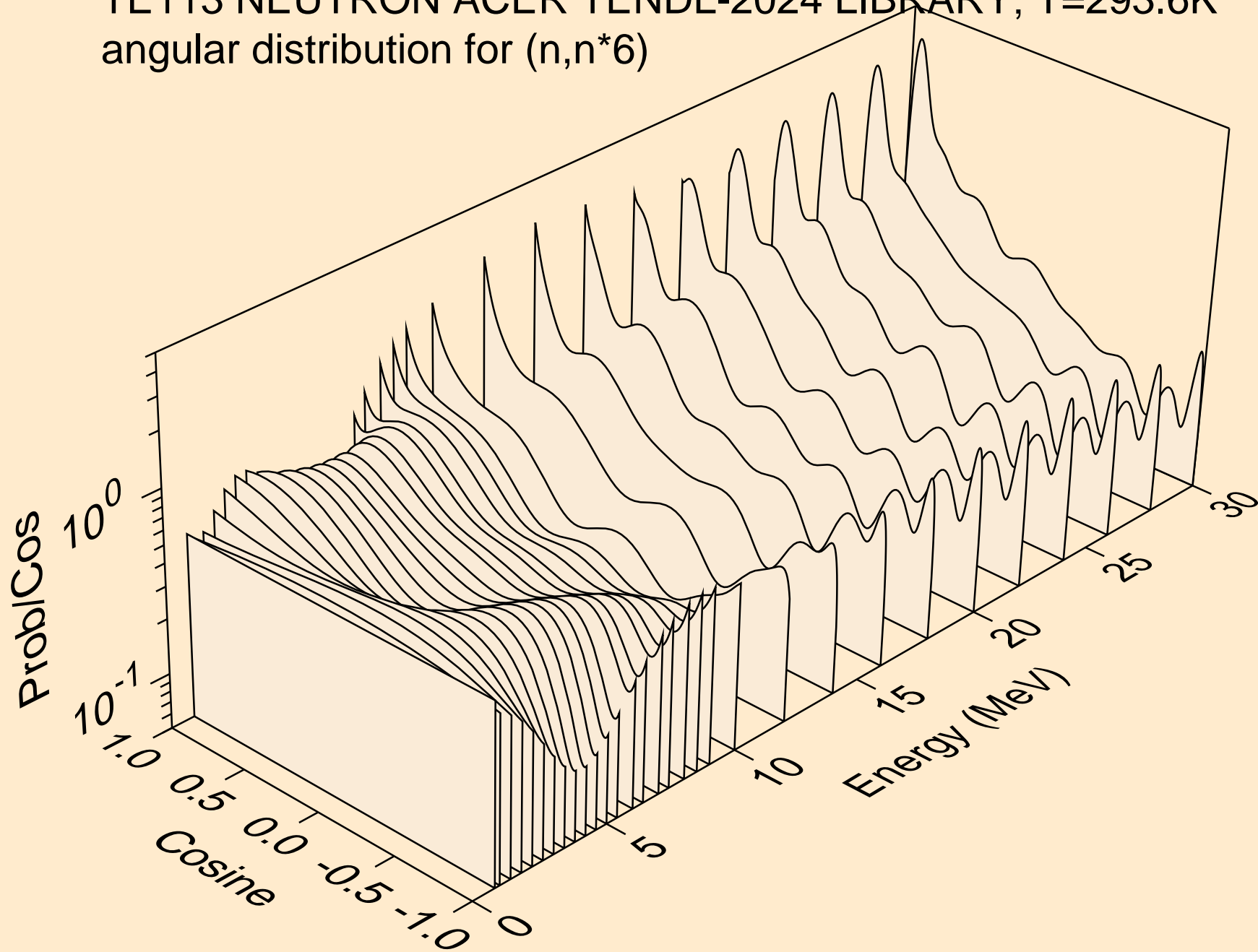

TE113 NEUTRON ACER TENDL-2024 LIBRARY; T=293.6K  
angular distribution for (n,n\*7)

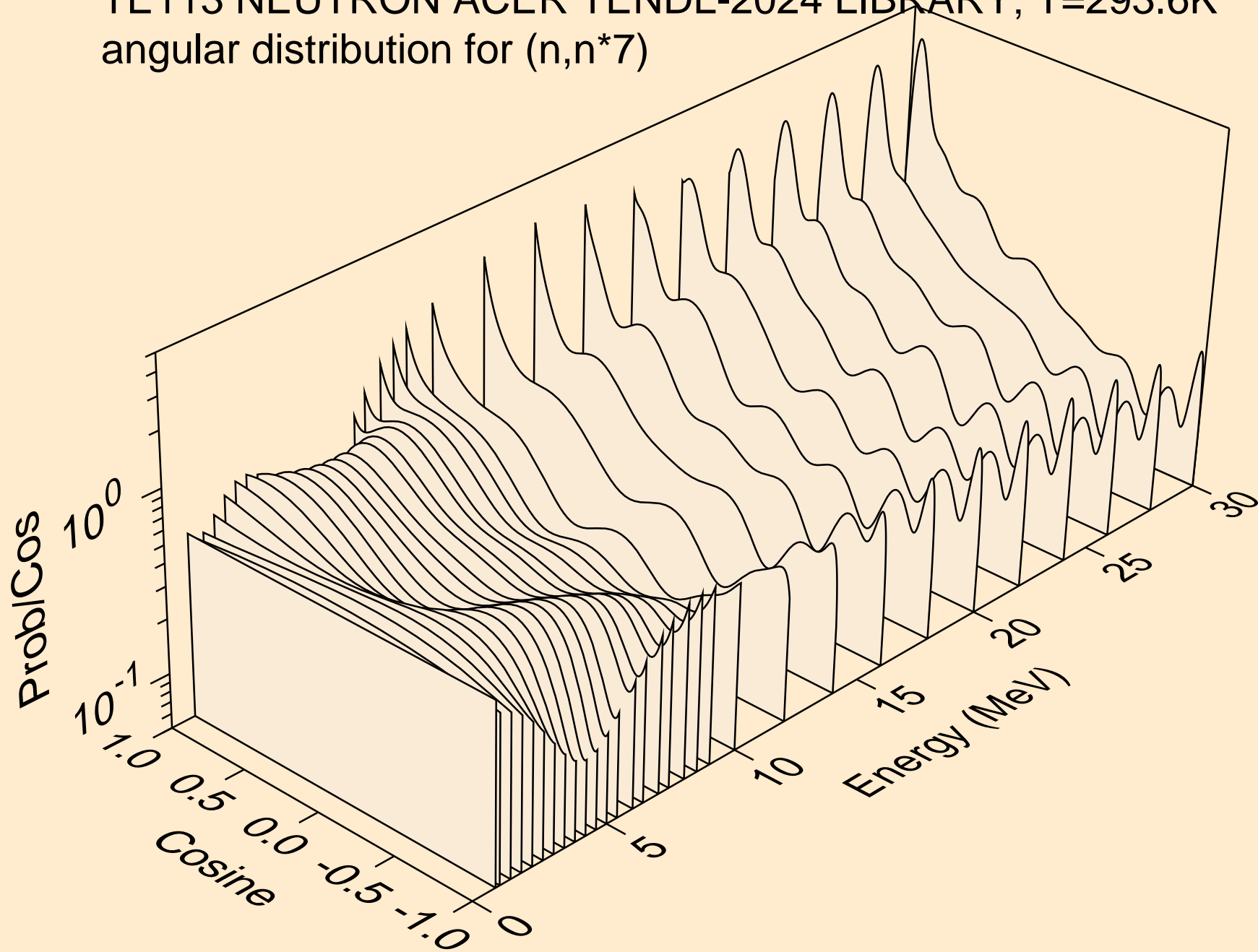

TE113 NEUTRON ACER TENDL-2024 LIBRARY; T=293.6K  
angular distribution for (n,n\*8)

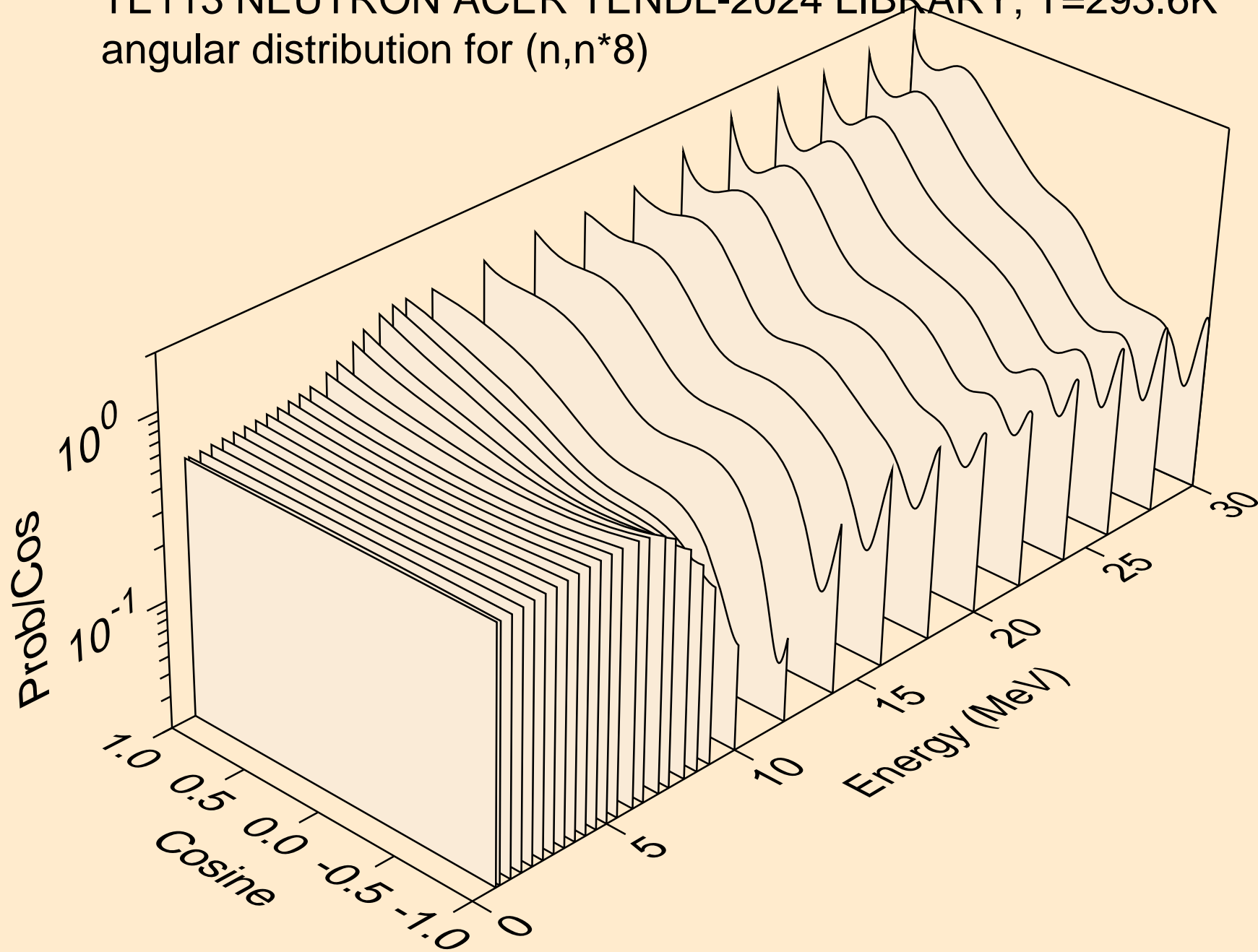

TE113 NEUTRON ACER TENDL-2024 LIBRARY; T=293.6K  
angular distribution for (n,n\*9)

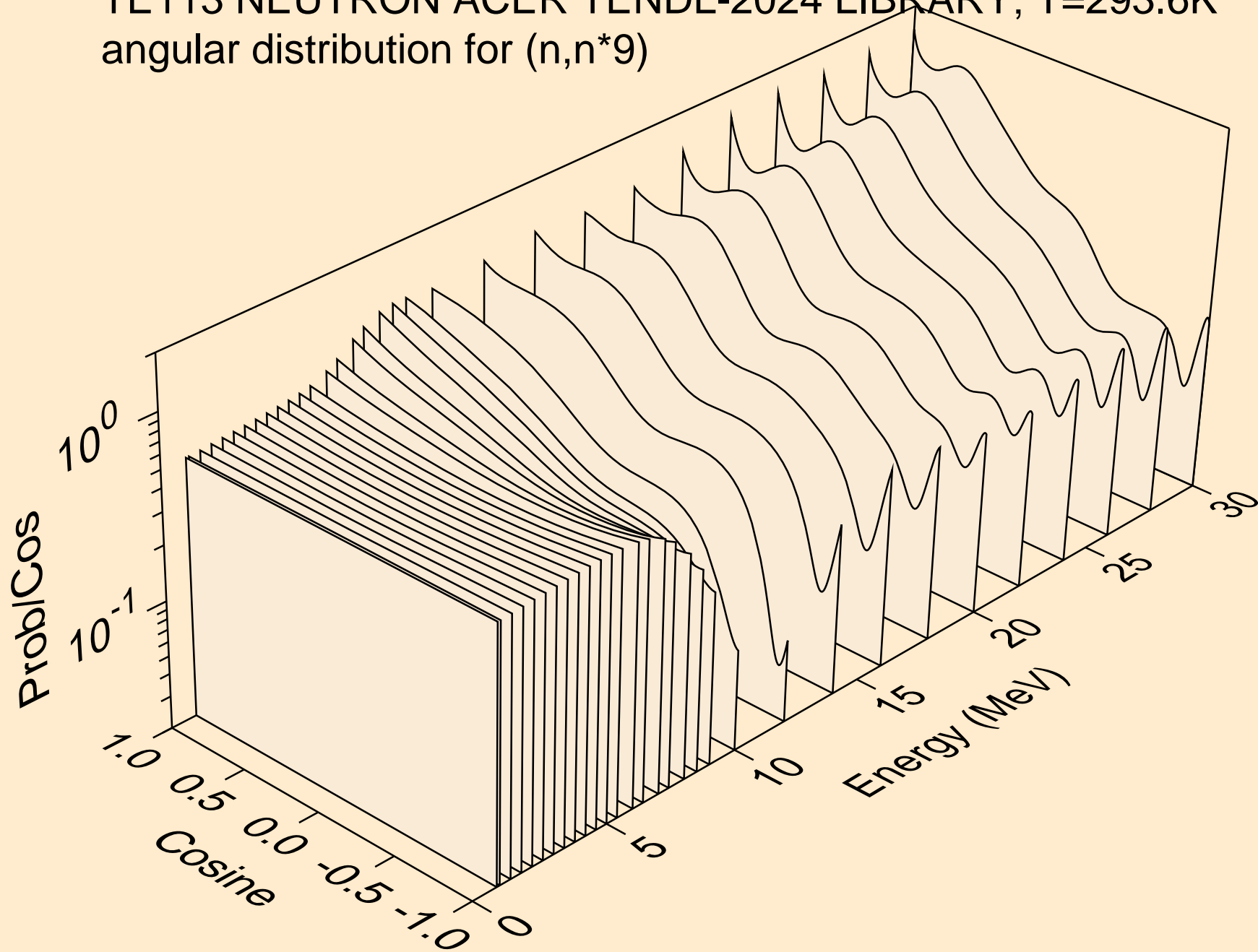

TE113 NEUTRON ACER TENDL-2024 LIBRARY; T=293.6K  
angular distribution for (n,n\*10)

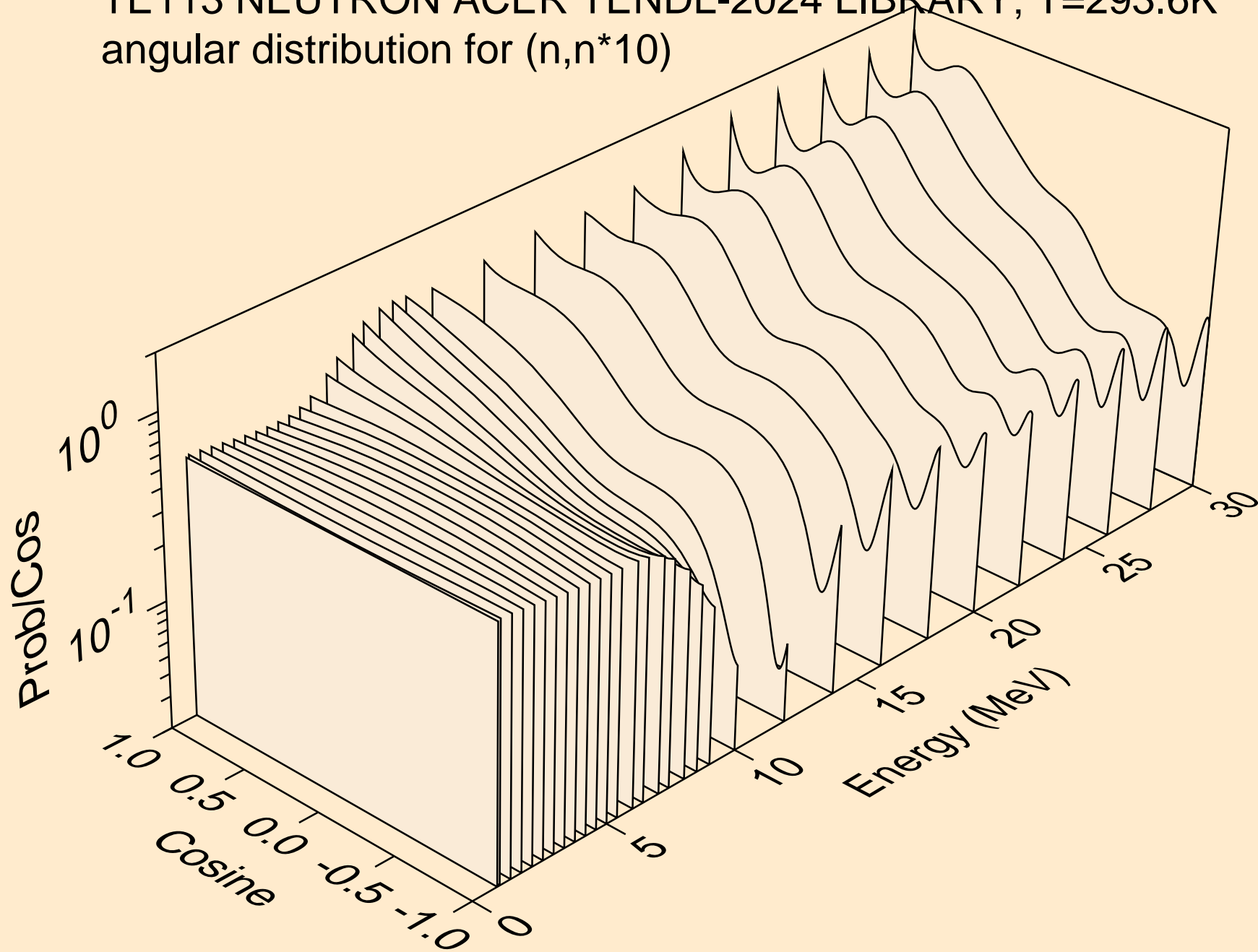

TE113 NEUTRON ACER TENDL-2024 LIBRARY; T=293.6K  
angular distribution for (n,n\*11)

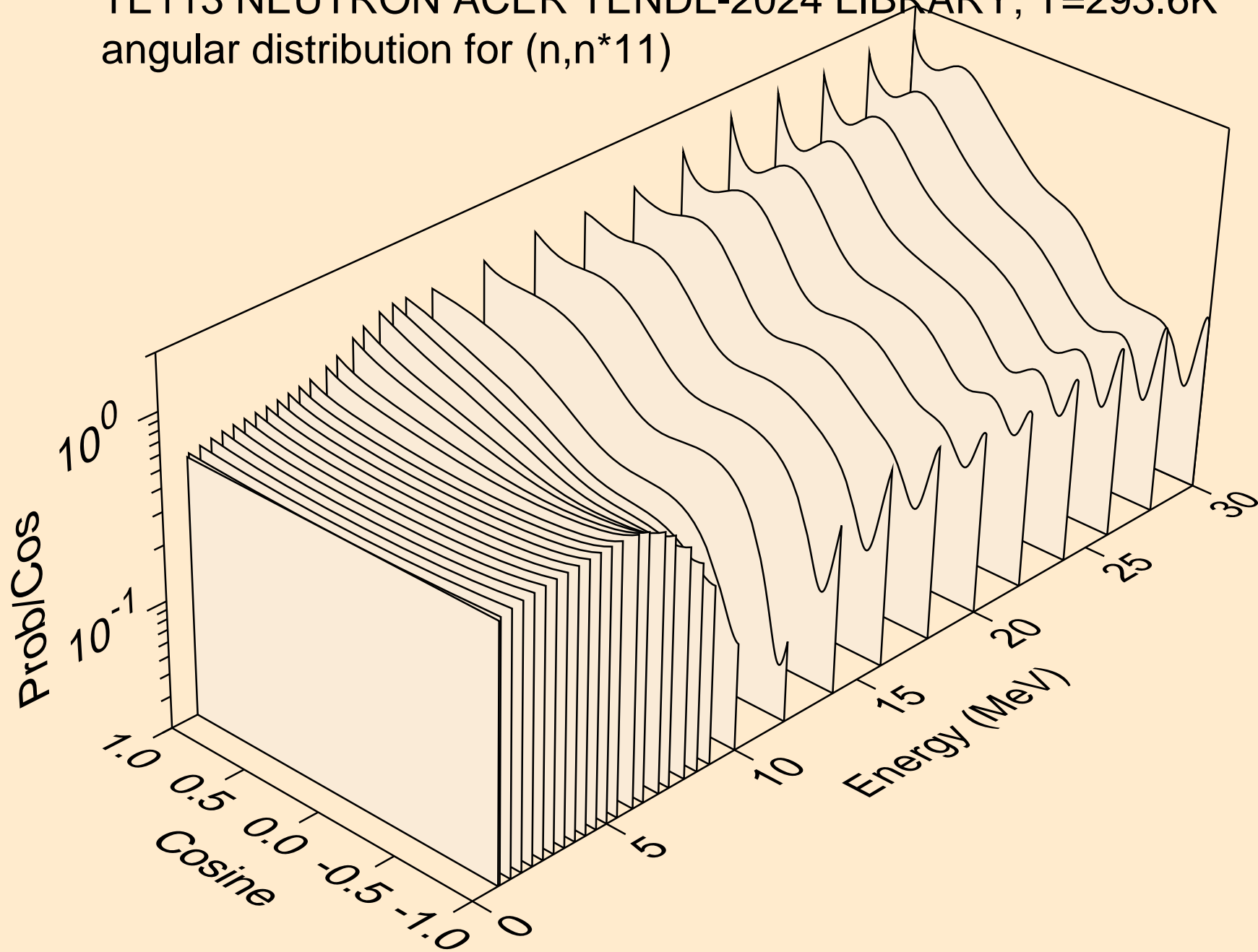

TE113 NEUTRON ACER TENDL-2024 LIBRARY; T=293.6K  
angular distribution for (n,n\*12)

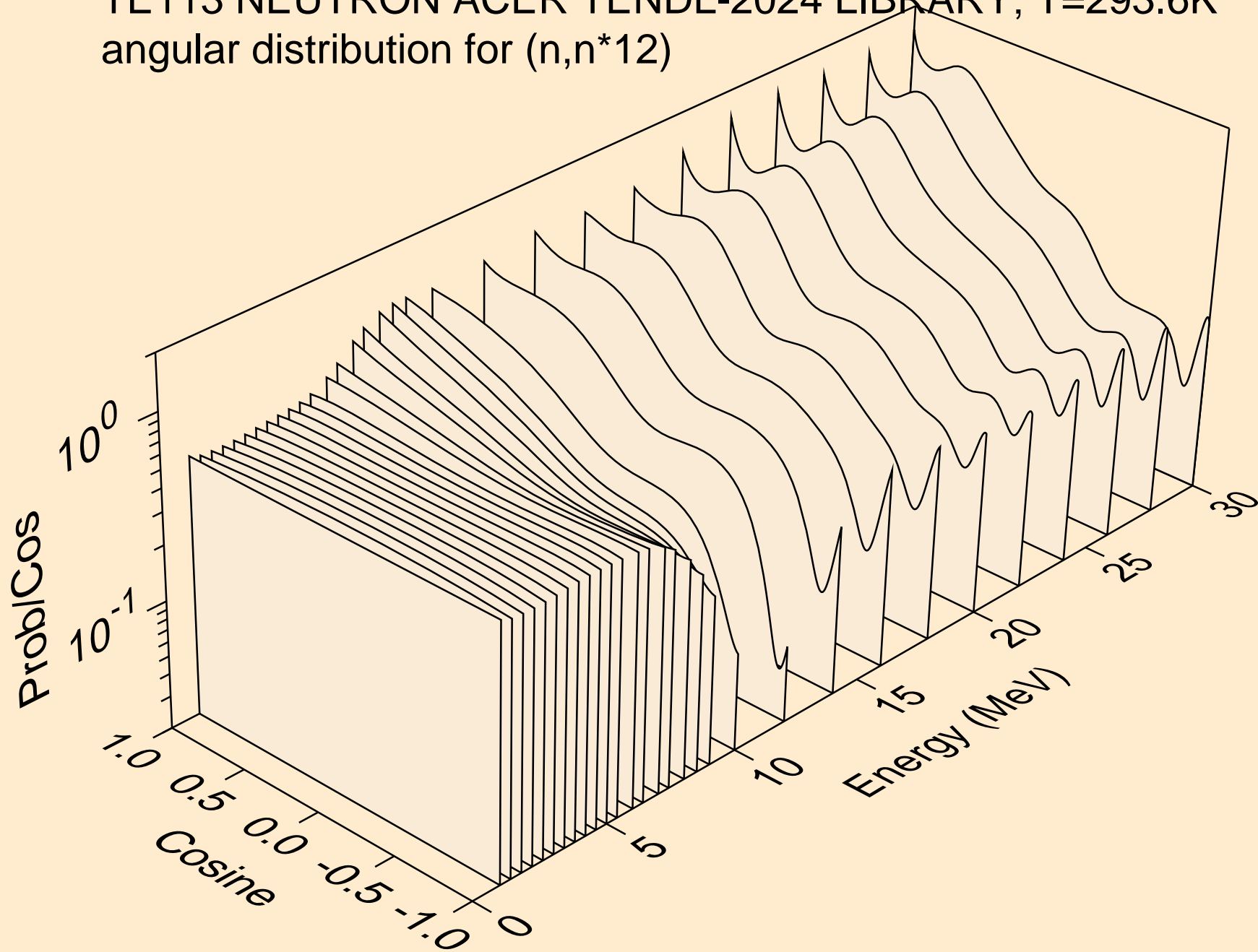

TE113 NEUTRON ACER TENDL-2024 LIBRARY; T=293.6K  
angular distribution for (n,n\*13)

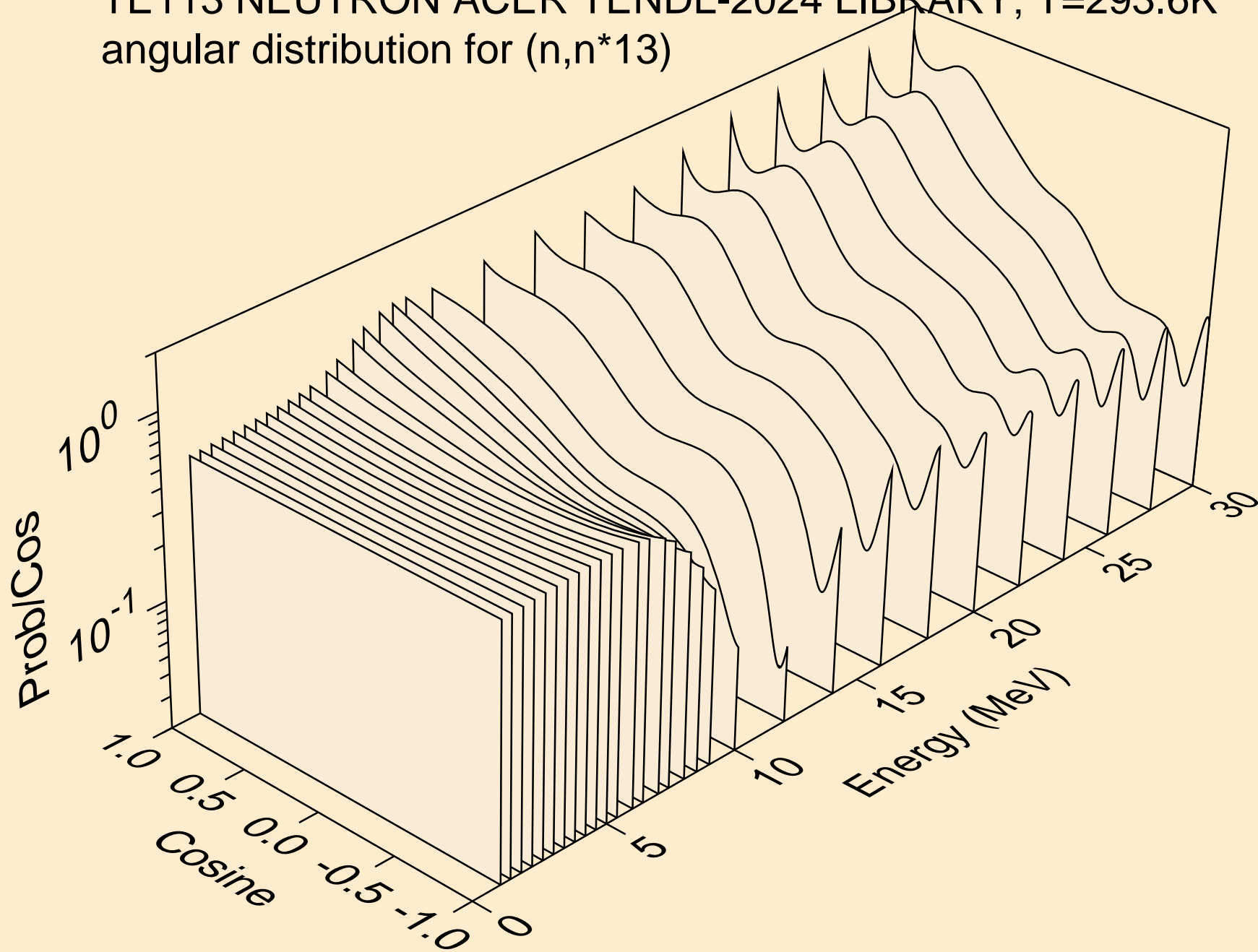

TE113 NEUTRON ACER TENDL-2024 LIBRARY; T=293.6K  
angular distribution for (n,n\*14)

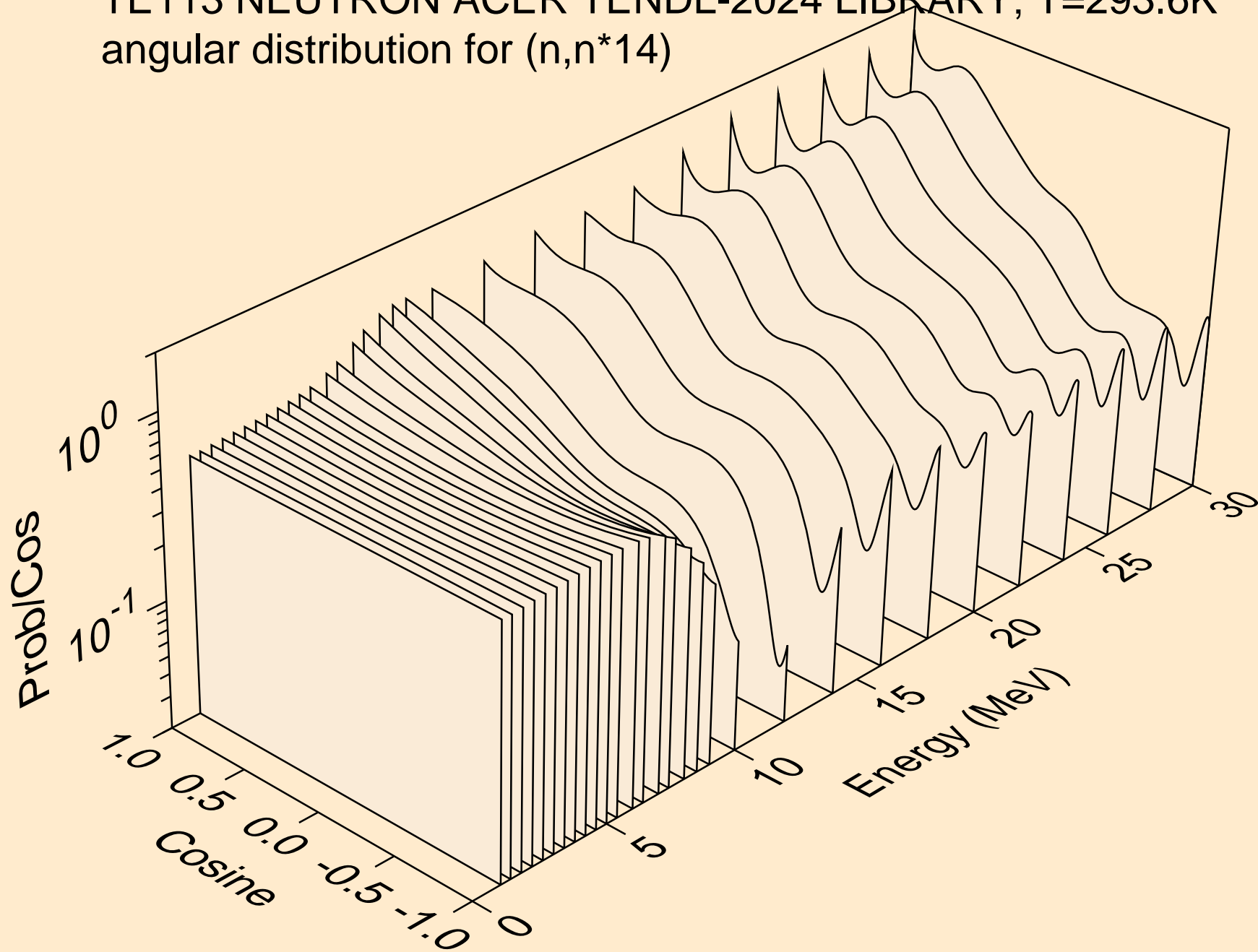

TE113 NEUTRON ACER TENDL-2024 LIBRARY; T=293.6K  
angular distribution for (n,n\*15)

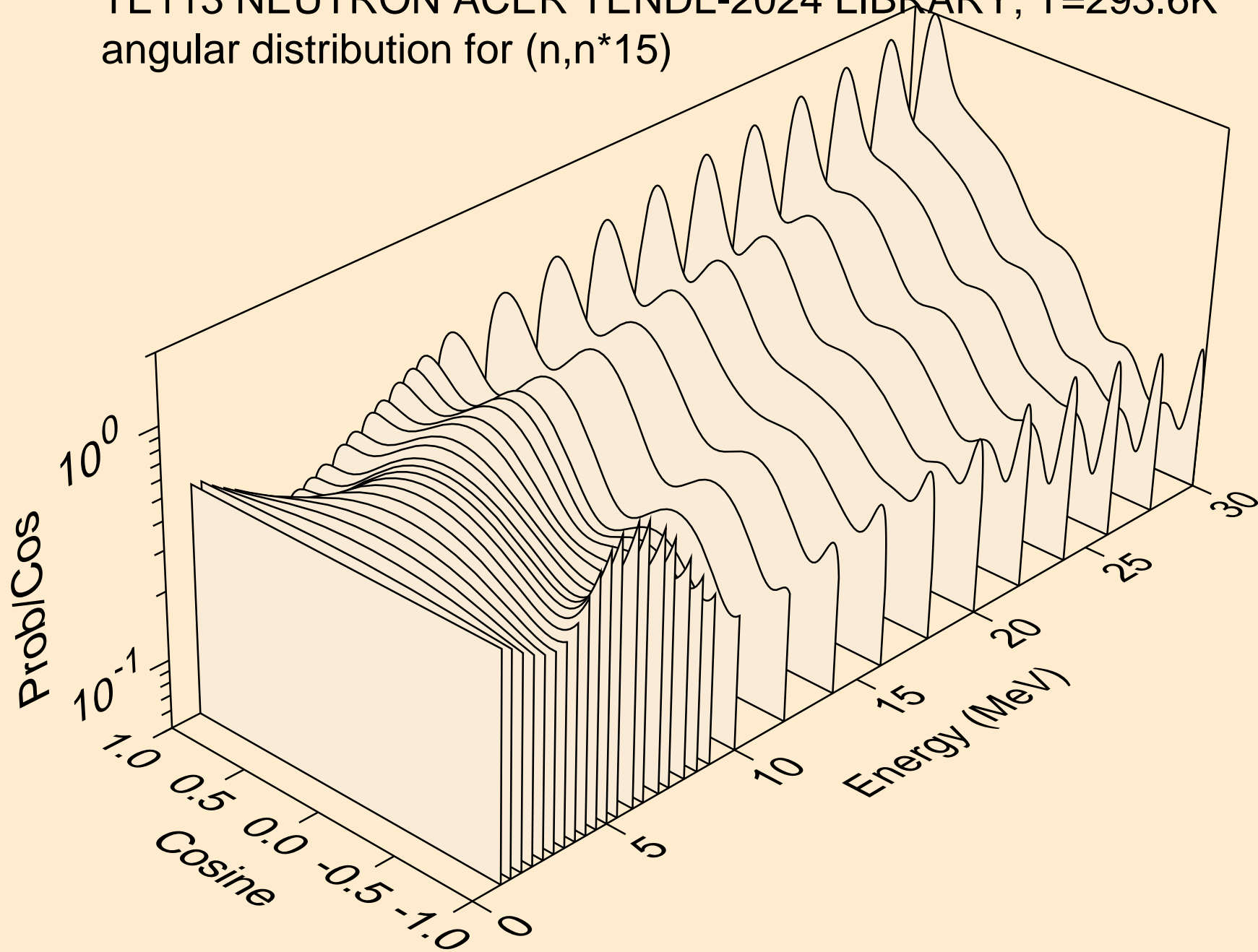

TE113 NEUTRON ACER TENDL-2024 LIBRARY; T=293.6K  
angular distribution for (n,n\*16)

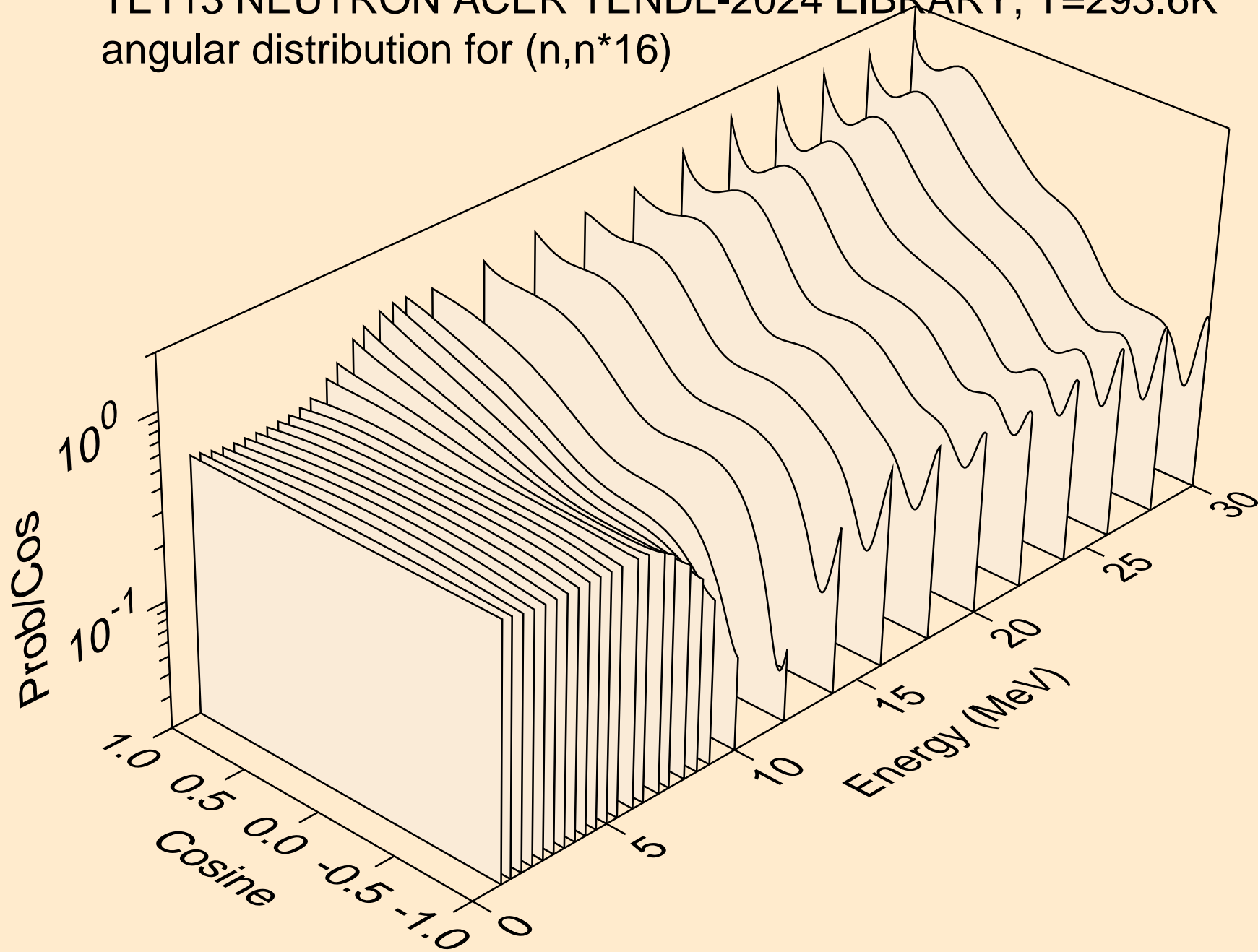

TE113 NEUTRON ACER TENDL-2024 LIBRARY; T=293.6K  
angular distribution for (n,n\*17)

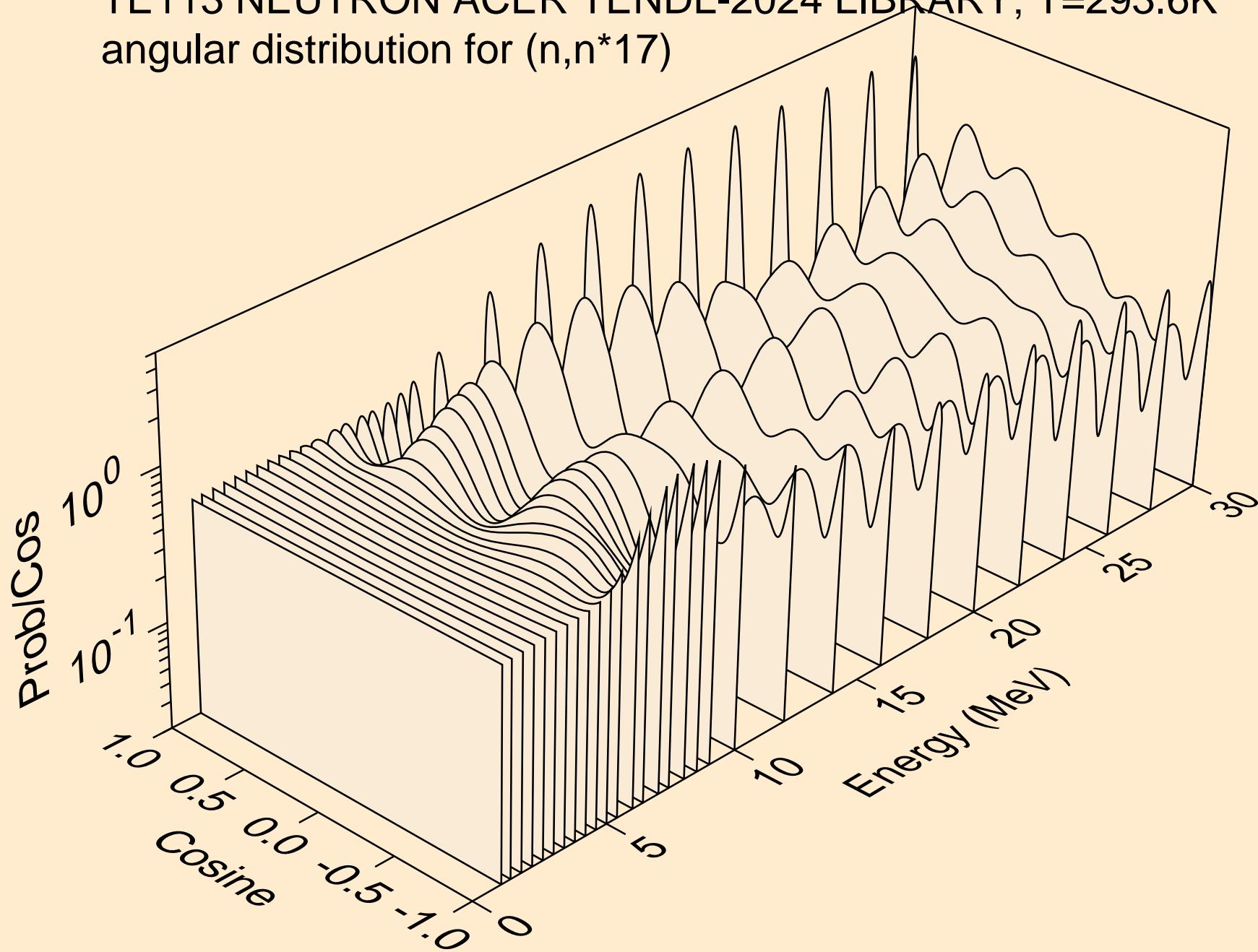

TE113 NEUTRON ACER TENDL-2024 LIBRARY; T=293.6K  
angular distribution for (n,n\*18)

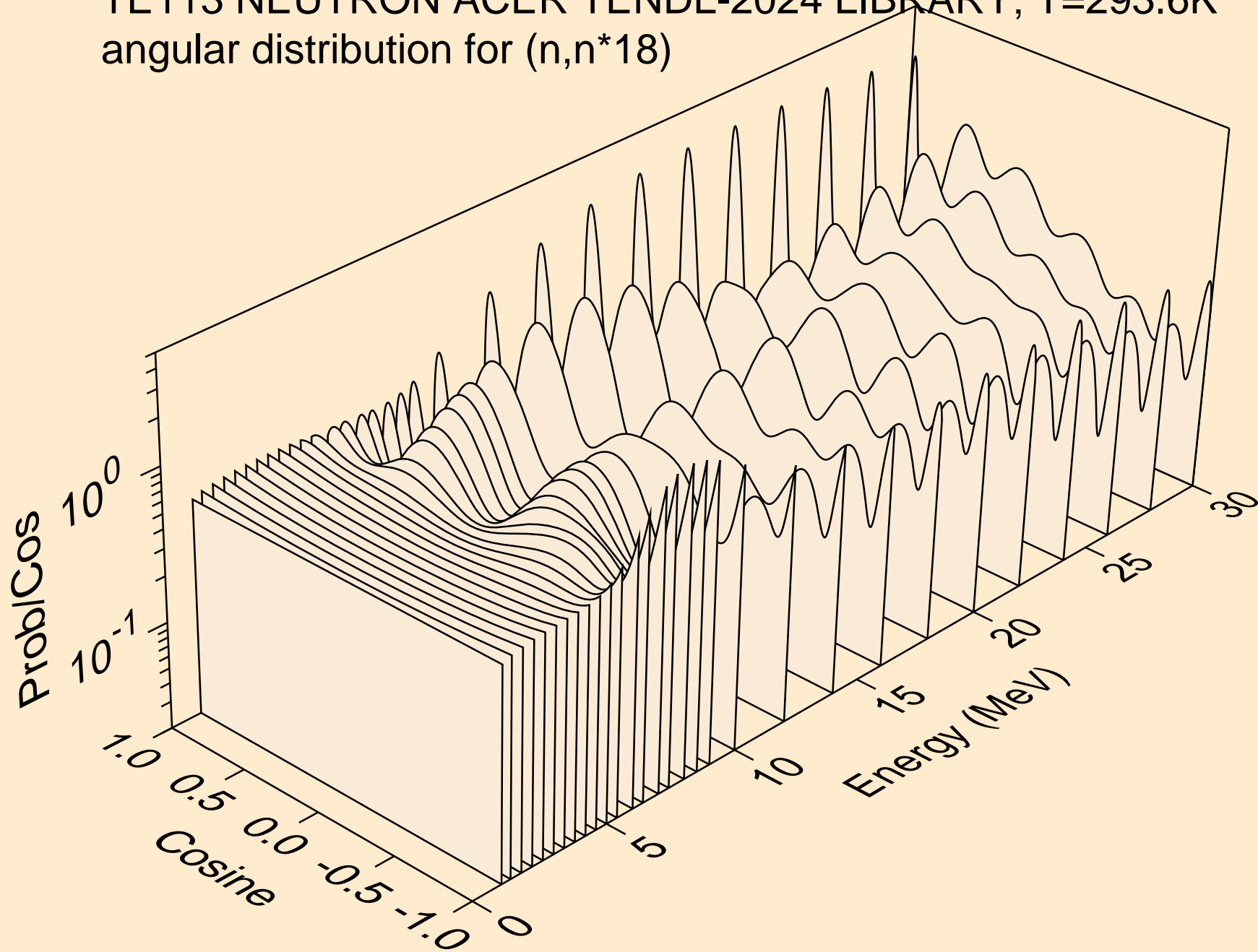

TE113 NEUTRON ACER TENDL-2024 LIBRARY; T=293.6K  
angular distribution for (n,n\*19)

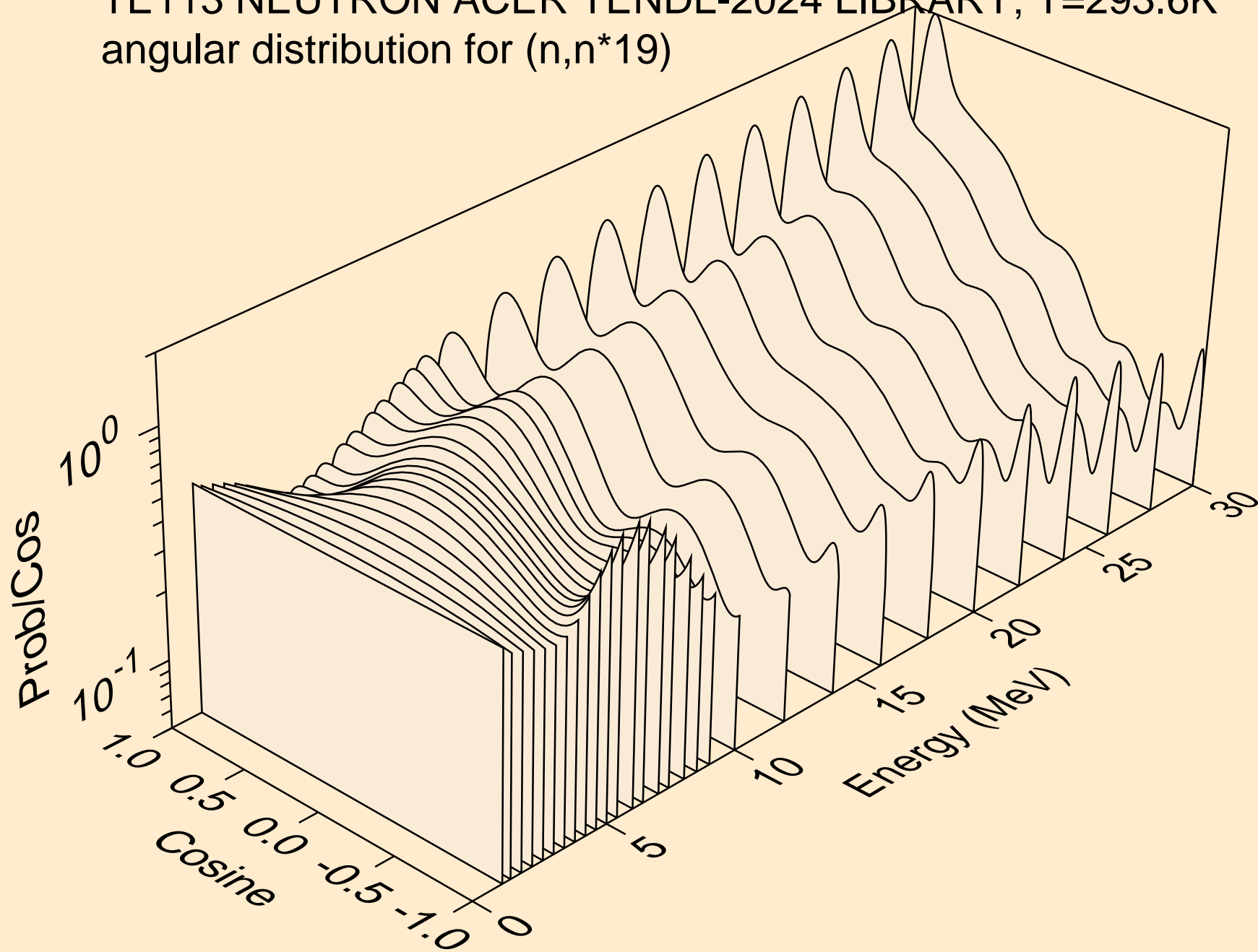

TE113 NEUTRON ACER TENDL-2024 LIBRARY; T=293.6K  
angular distribution for (n,n\*20)

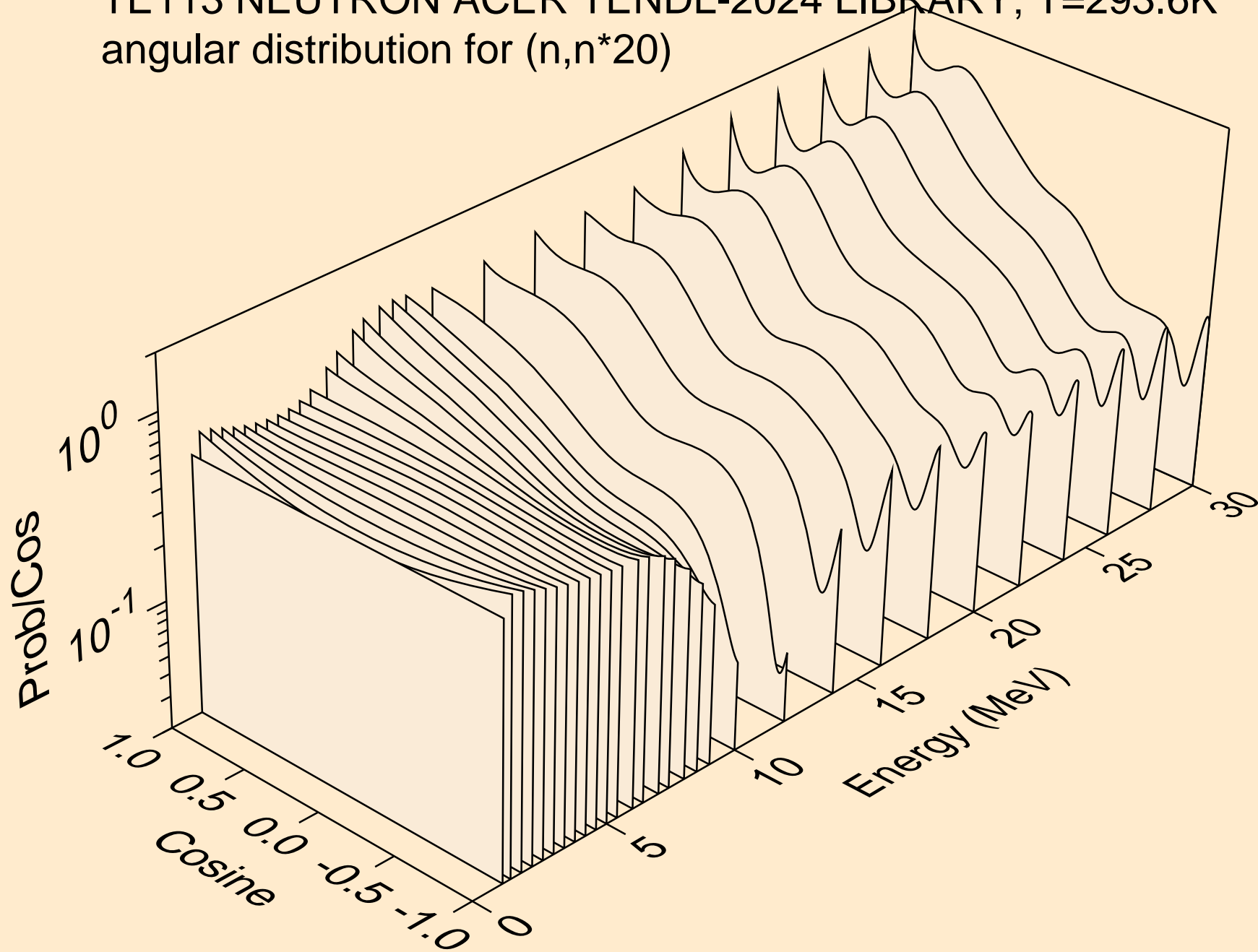

TE113 NEUTRON ACER TENDL-2024 LIBRARY; T=293.6K  
angular distribution for (n,n\*21)

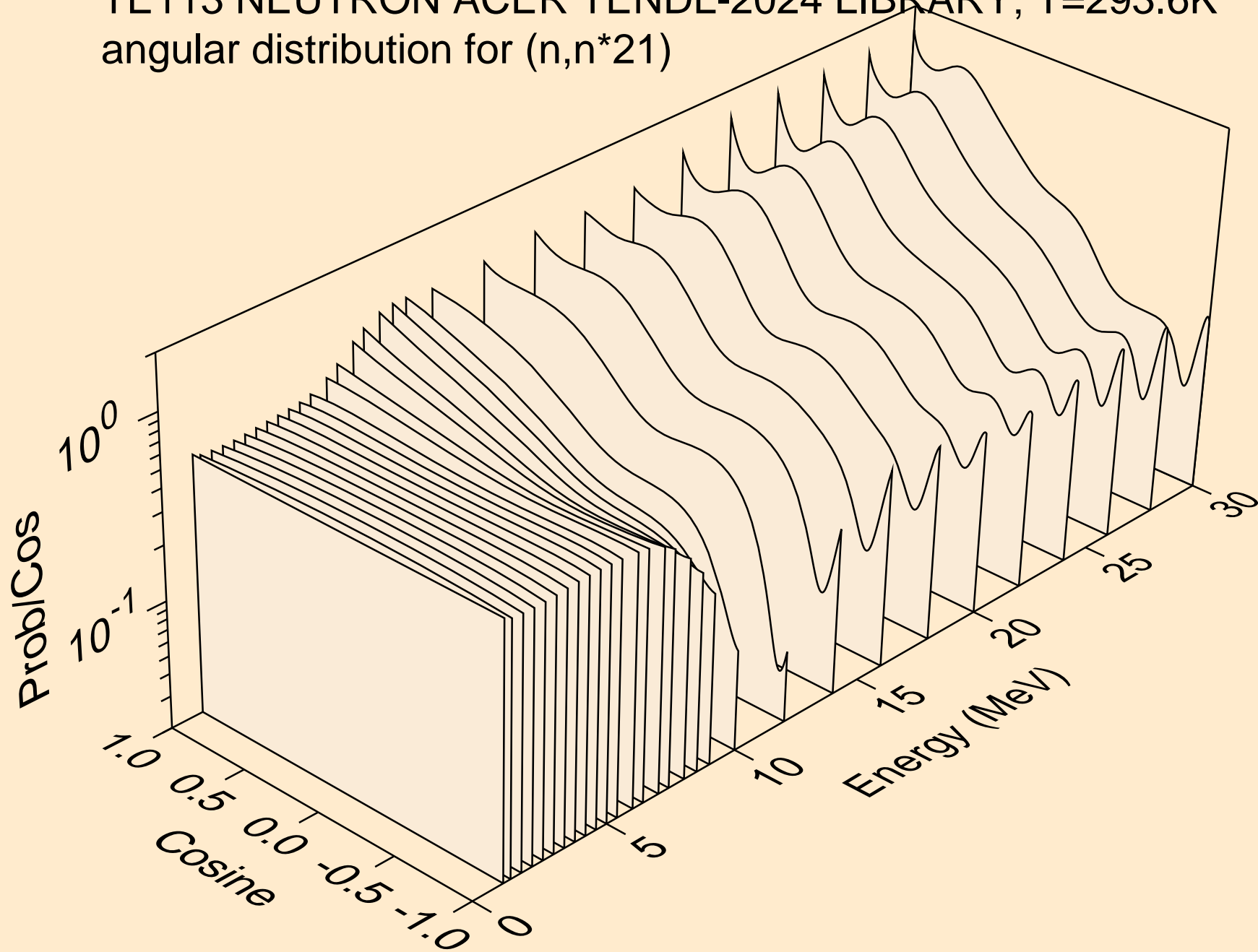

TE113 NEUTRON ACER TENDL-2024 LIBRARY; T=293.6K  
angular distribution for (n,n\*22)

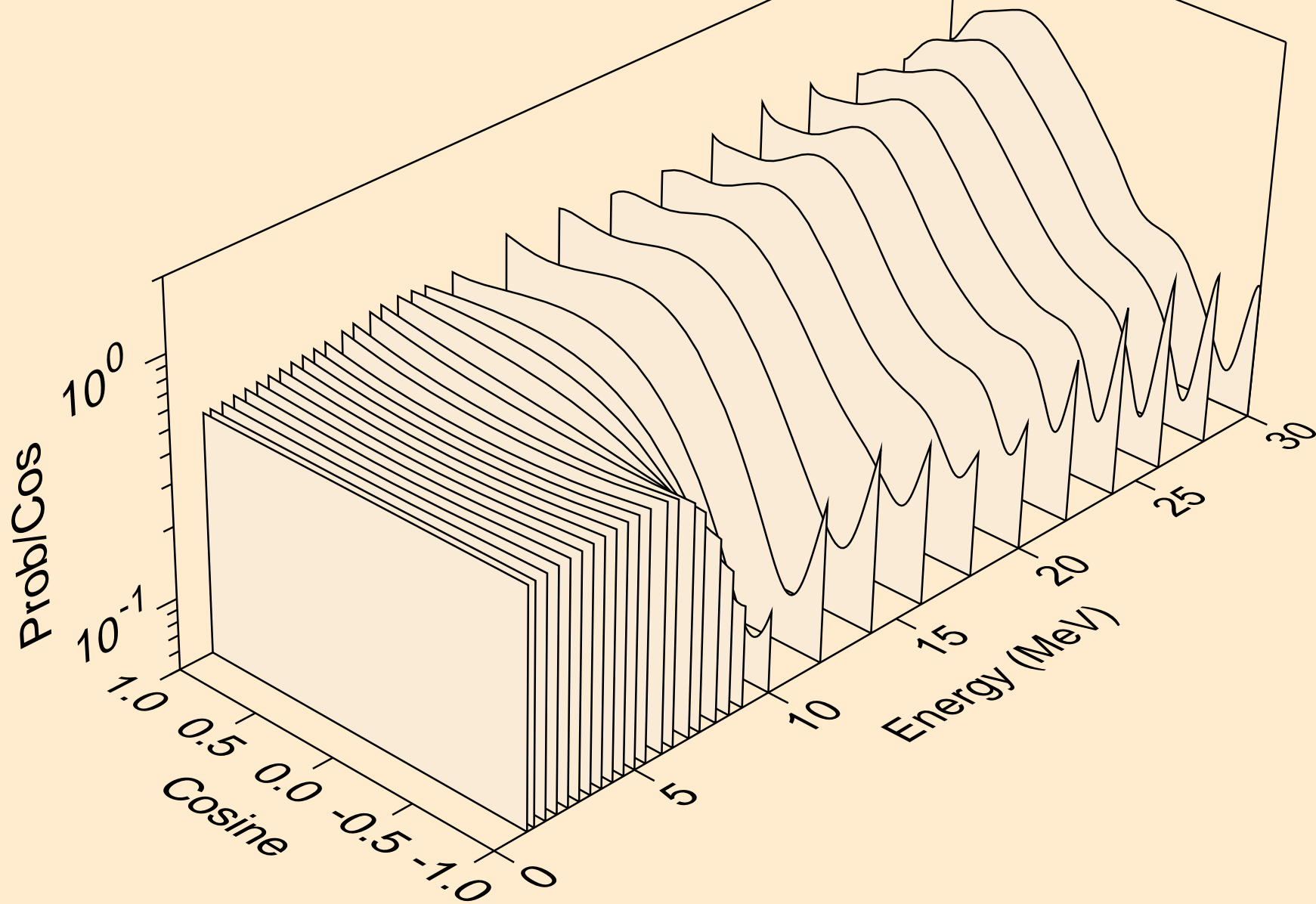

TE113 NEUTRON ACER TENDL-2024 LIBRARY; T=293.6K  
angular distribution for (n,n\*23)

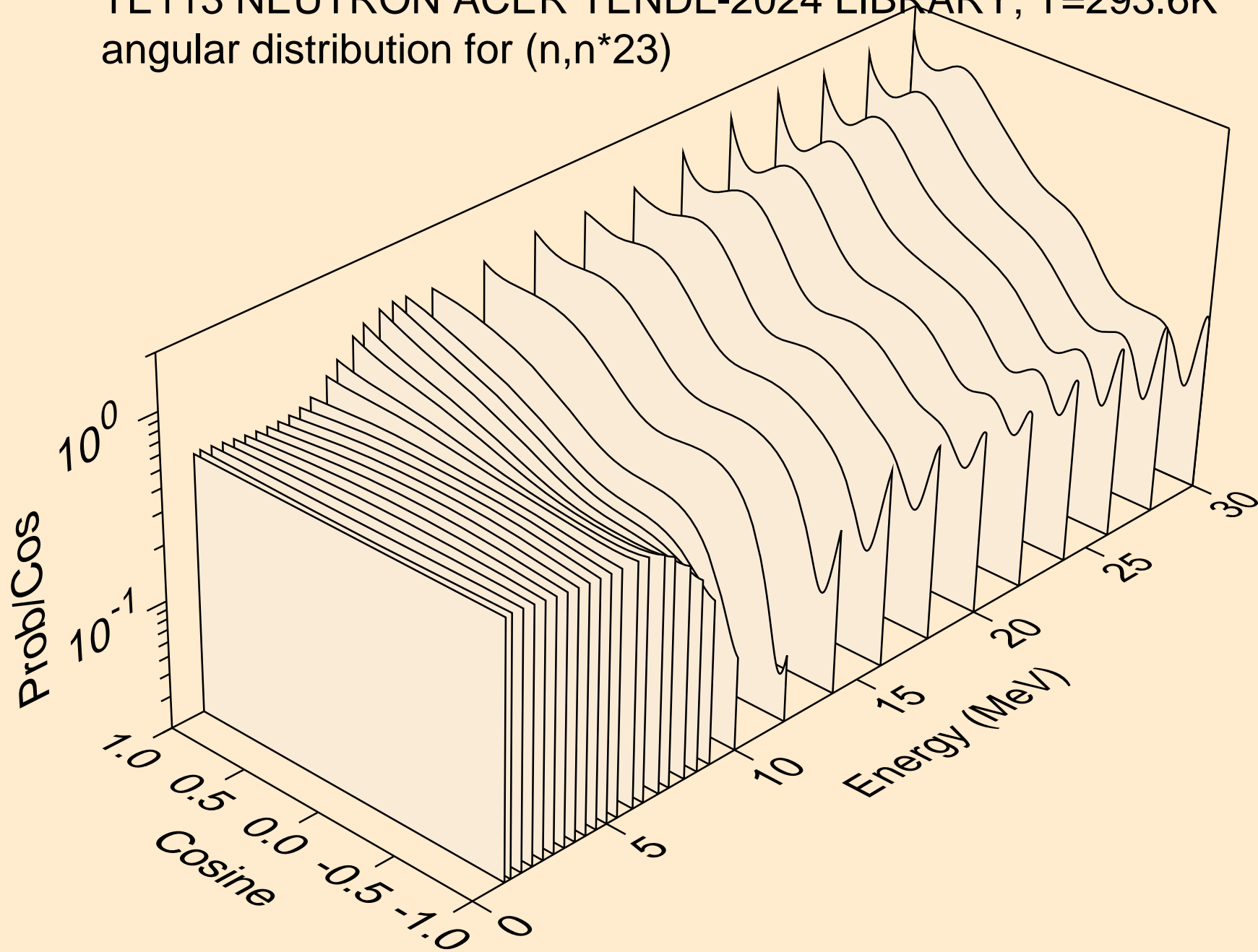

TE113 NEUTRON ACER TENDL-2024 LIBRARY; T=293.6K  
angular distribution for (n,n\*24)

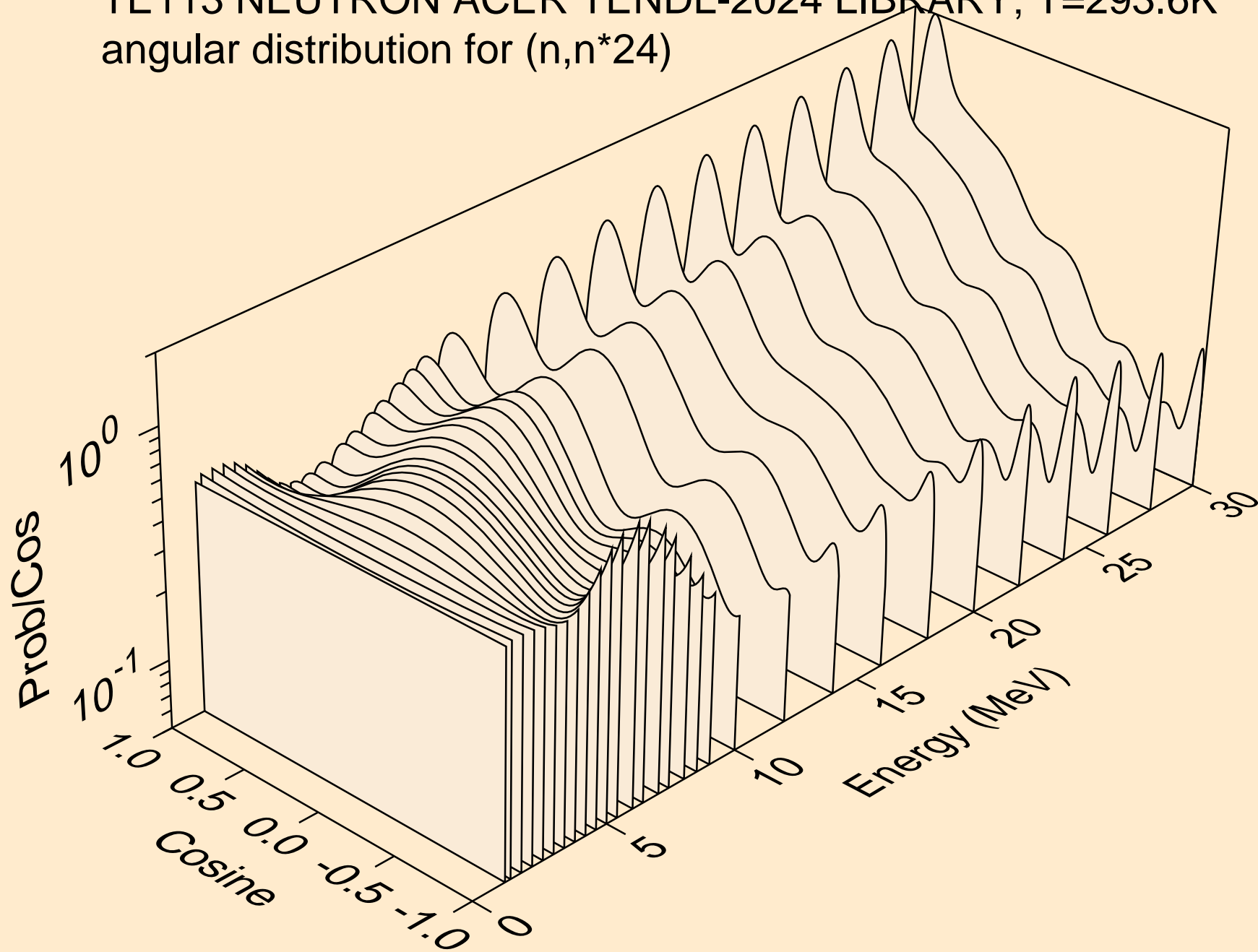

TE113 NEUTRON ACER TENDL-2024 LIBRARY; T=293.6K  
angular distribution for (n,n\*25)

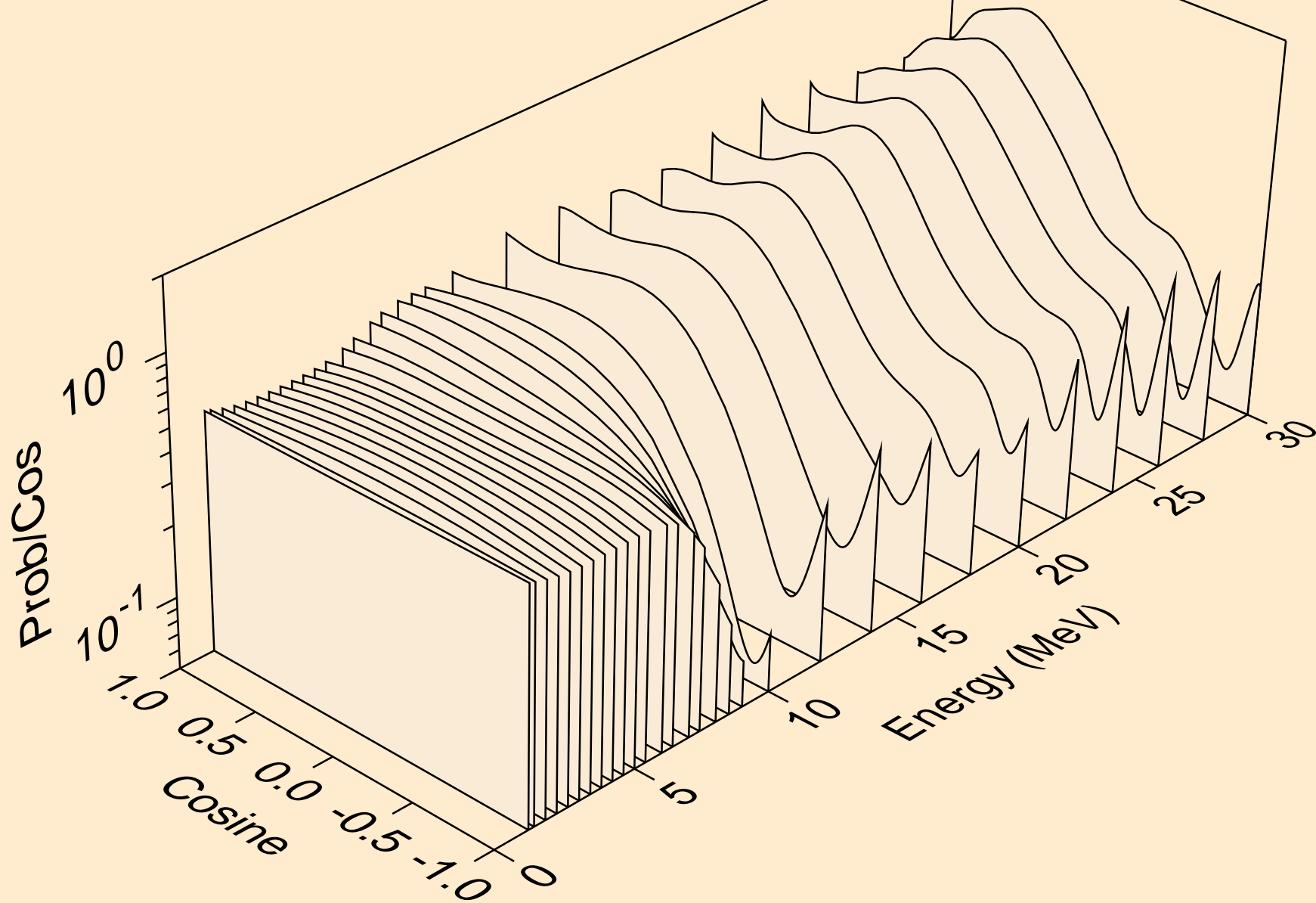

TE113 NEUTRON ACER TENDL-2024 LIBRARY; T=293.6K  
angular distribution for (n,n\*26)

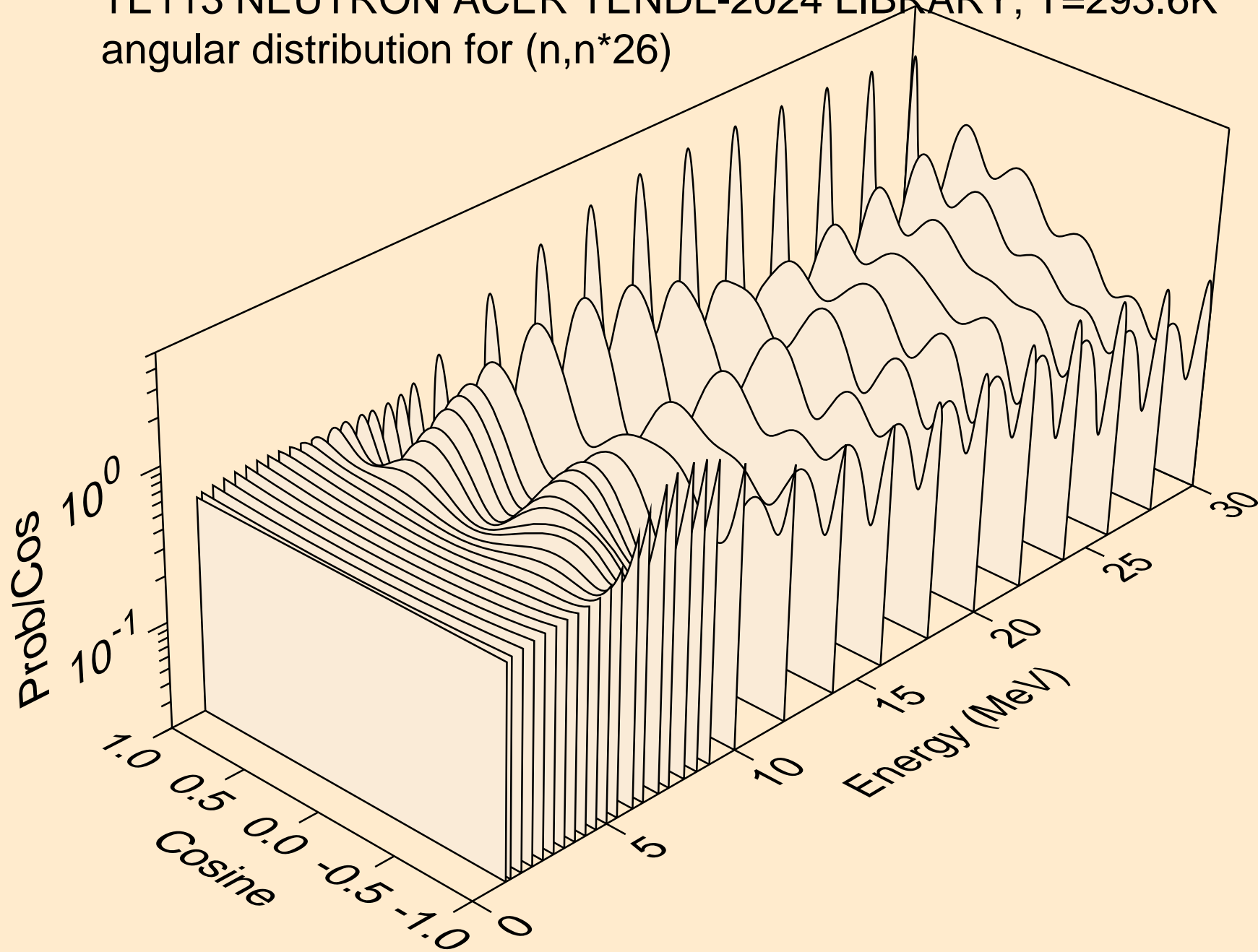

TE113 NEUTRON ACER TENDL-2024 LIBRARY; T=293.6K  
angular distribution for (n,n\*27)

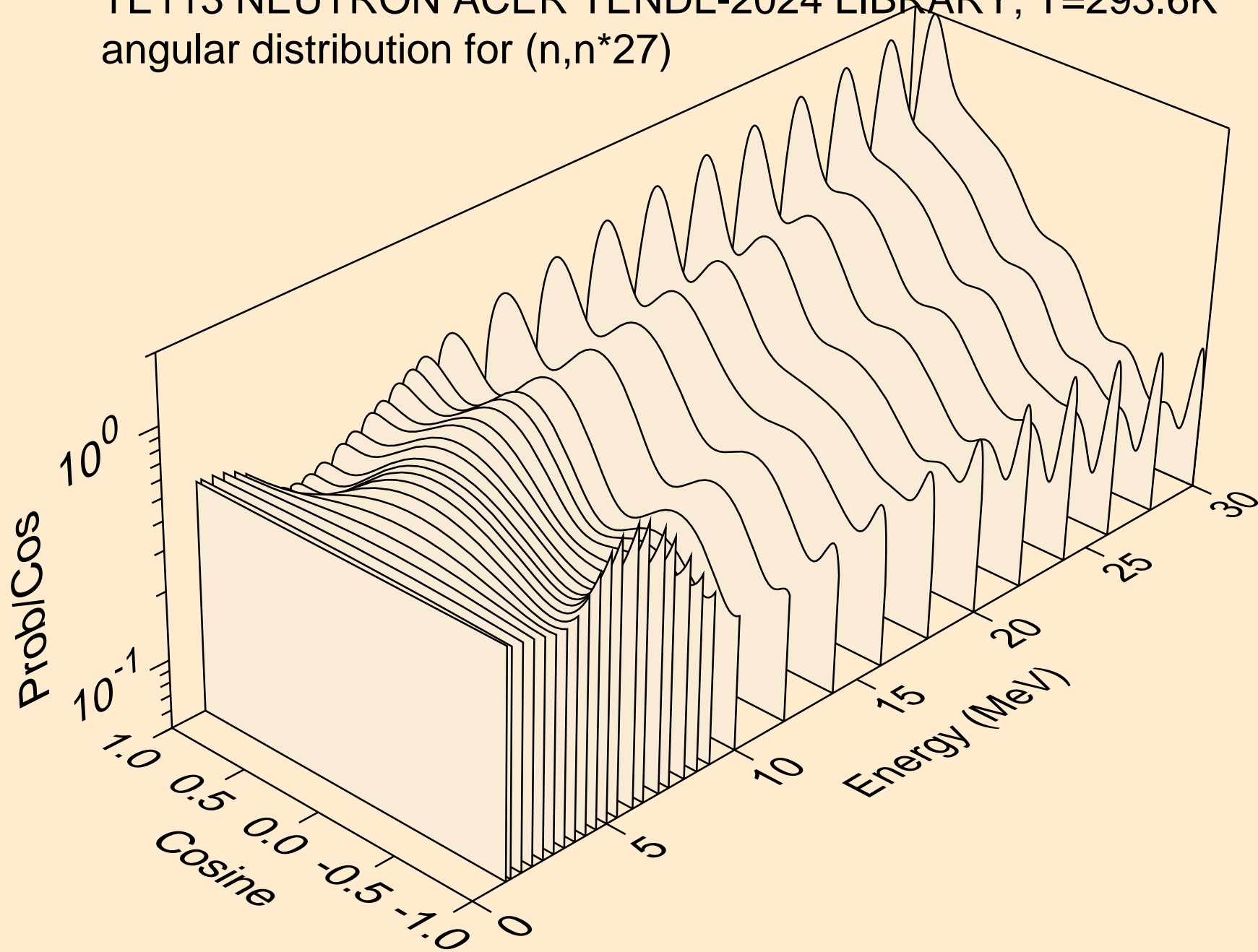

TE113 NEUTRON ACER TENDL-2024 LIBRARY; T=293.6K  
angular distribution for (n,n\*28)

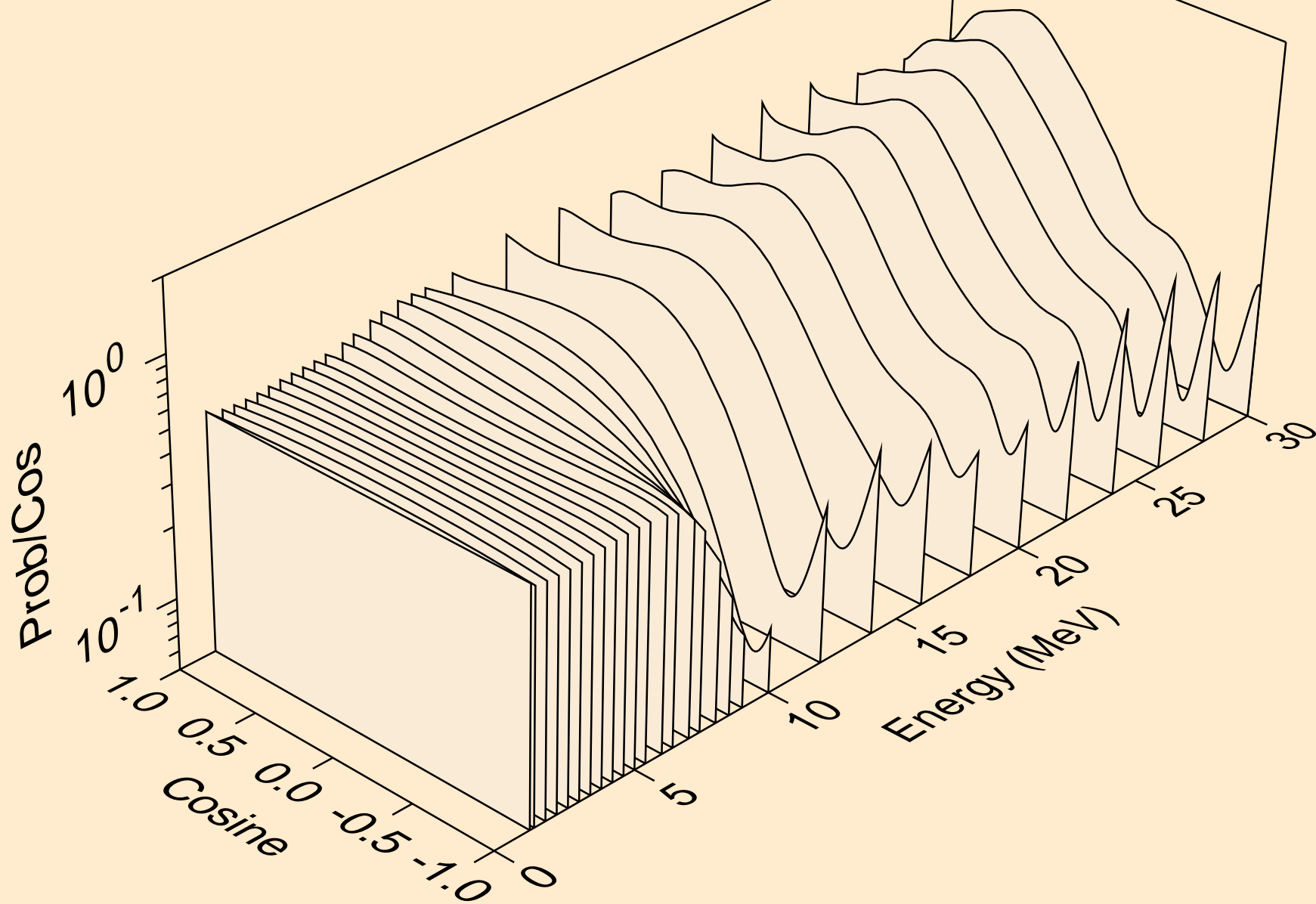

TE113 NEUTRON ACER TENDL-2024 LIBRARY; T=293.6K  
angular distribution for (n,n\*29)

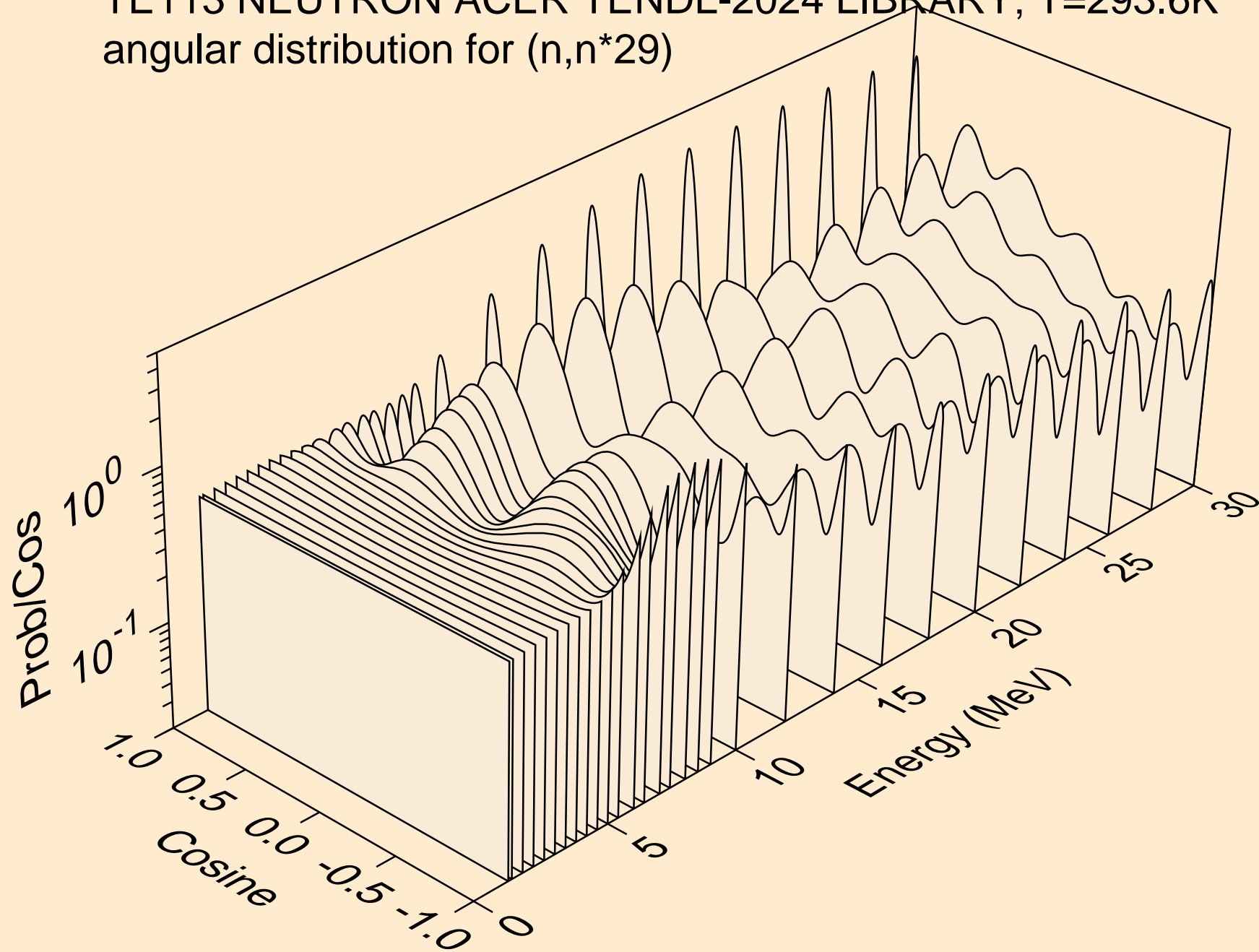

TE113 NEUTRON ACER TENDL-2024 LIBRARY; T=293.6K  
Neutron emission for (n,x)

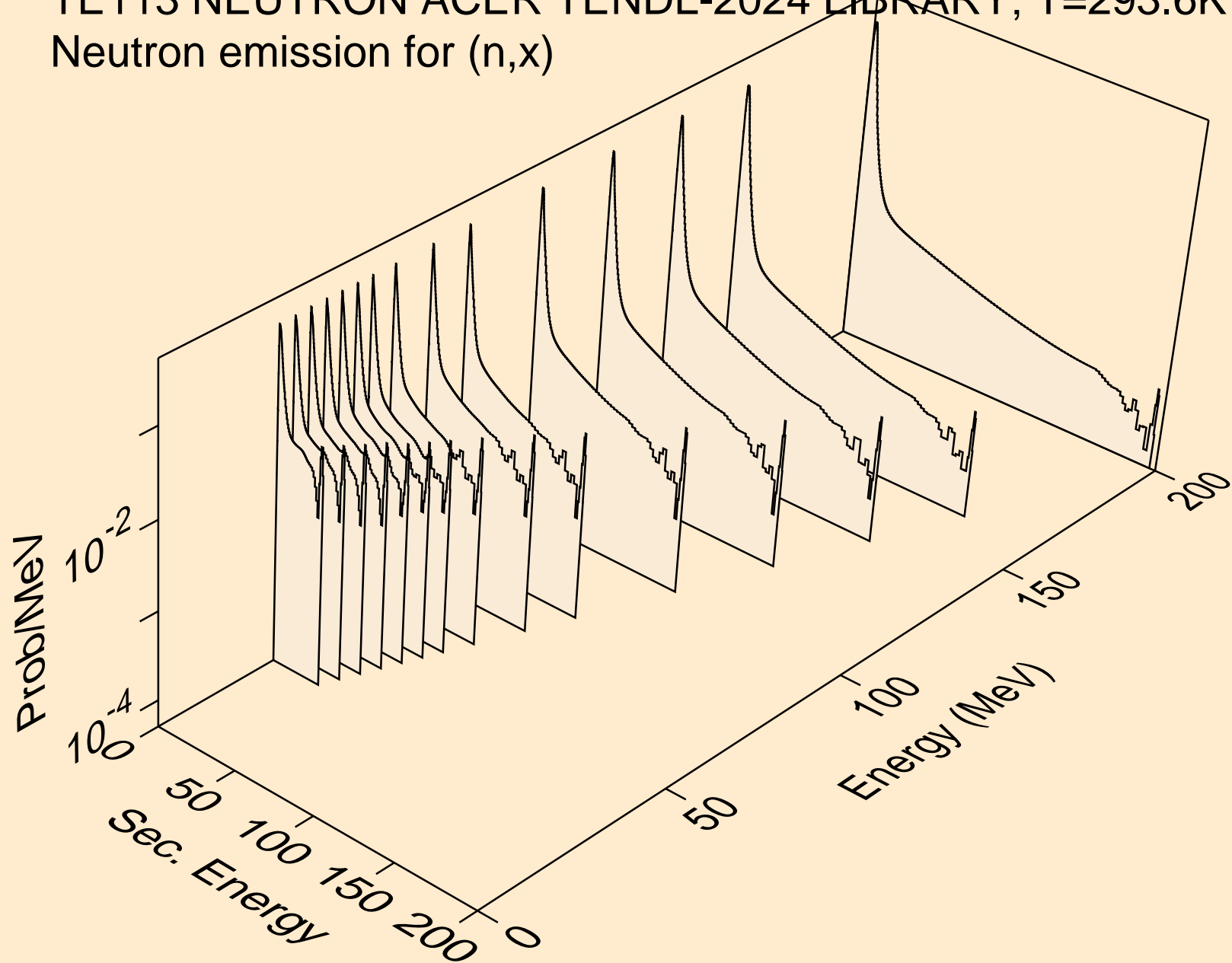

TE113 NEUTRON ACER TENDL-2024 LIBRARY; T=293.6K  
Neutron emission for (n,2nd)

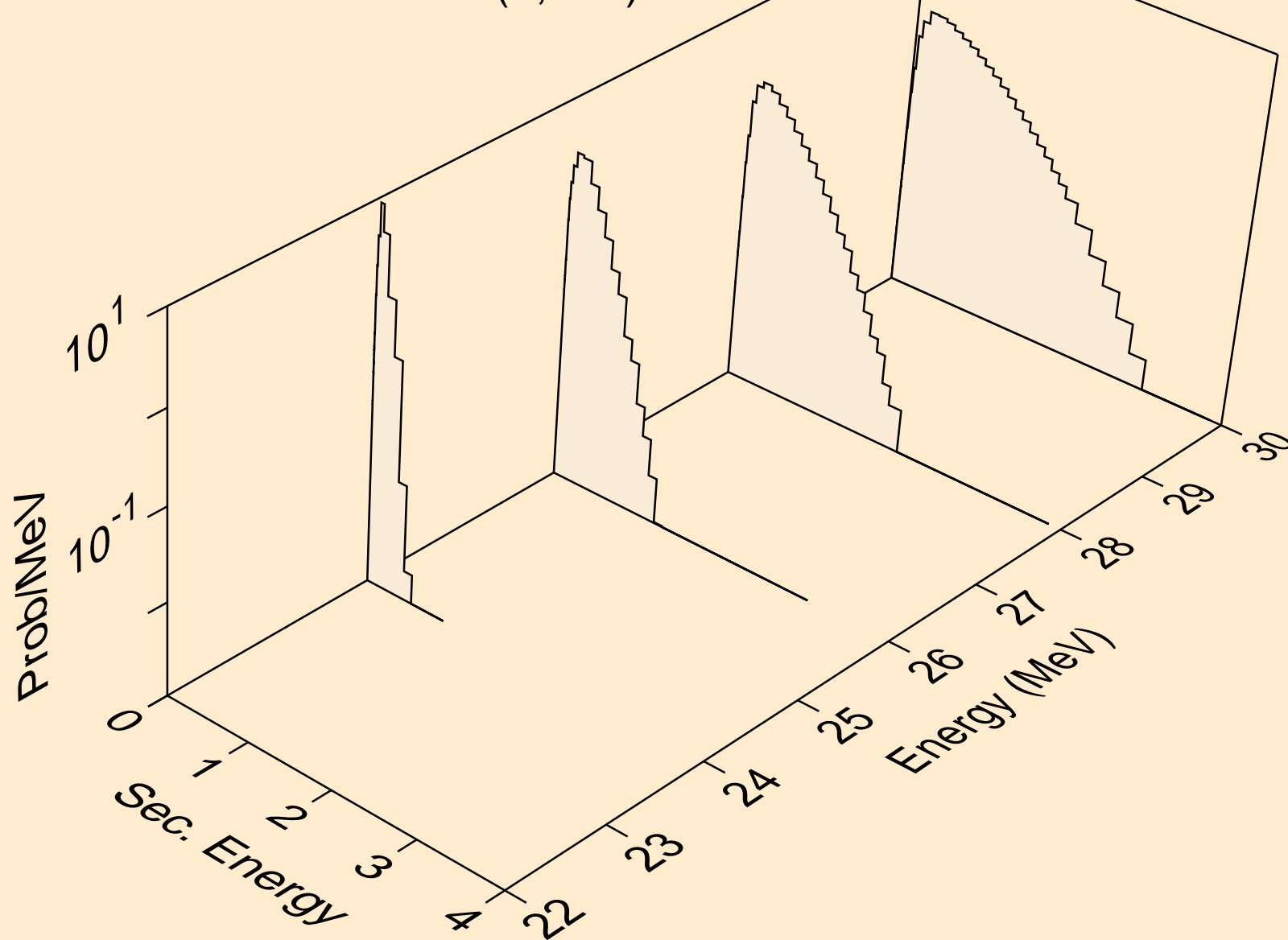

TE113 NEUTRON ACER TENDL-2024 LIBRARY; T=293.6K  
Neutron emission for (n,2n)

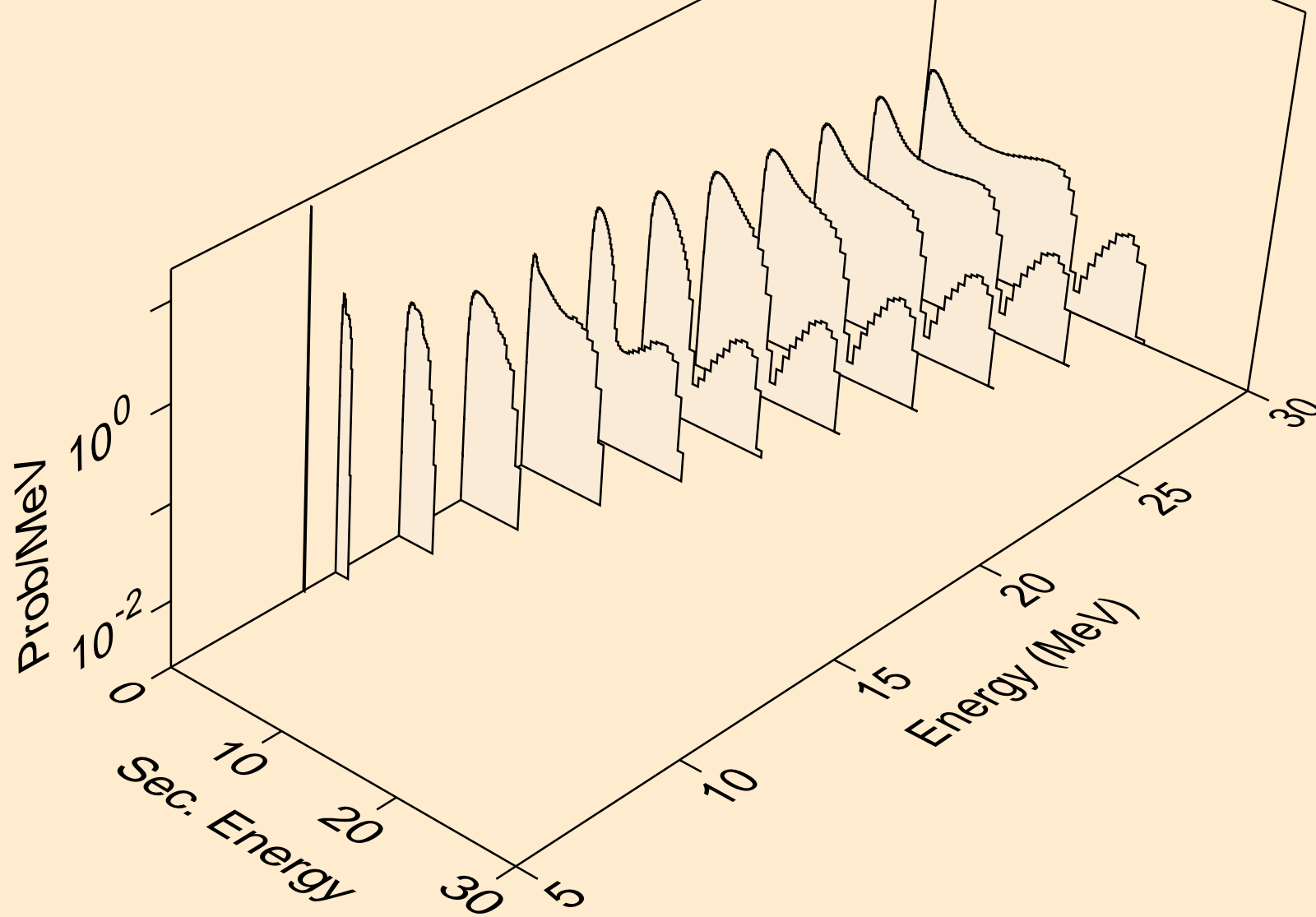

TE113 NEUTRON ACER TENDL-2024 LIBRARY; T=293.6K  
Neutron emission for (n,3n)

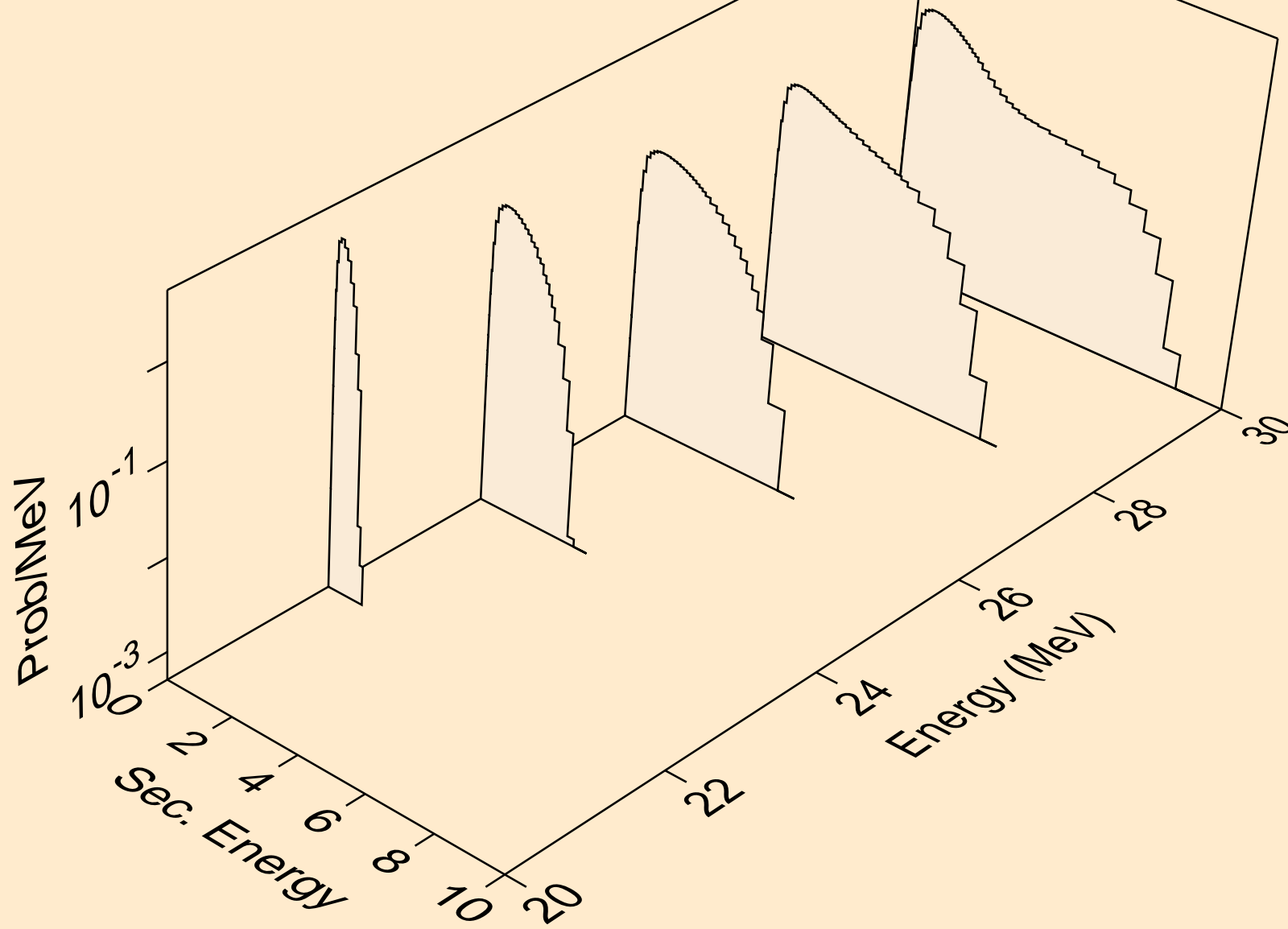

TE113 NEUTRON ACER TENDL-2024 LIBRARY; T=293.6K  
Neutron emission for (n,n\*)a

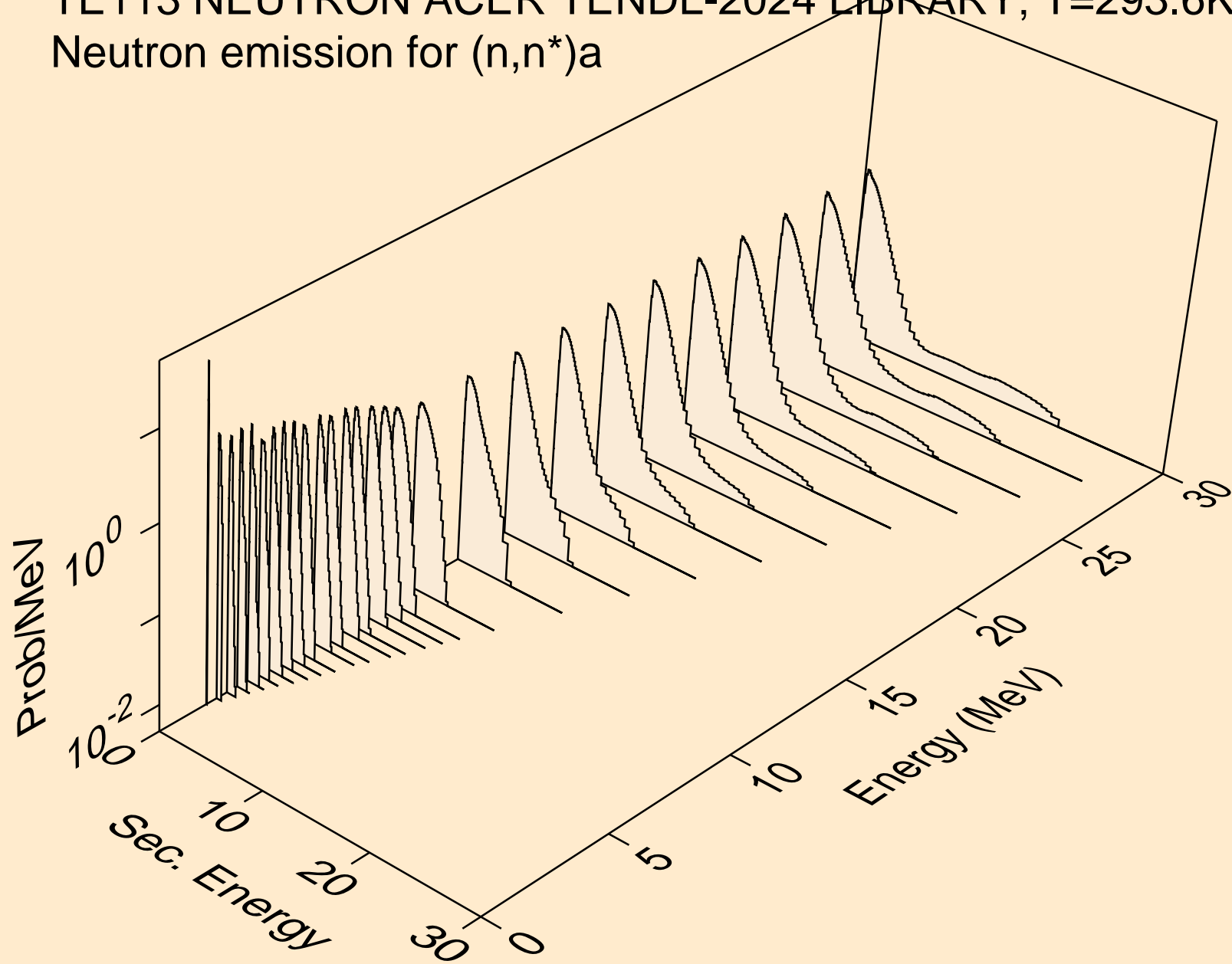

TE113 NEUTRON ACER TENDL-2024 LIBRARY; T=293.6K  
Neutron emission for (n,2n)<sub>a</sub>

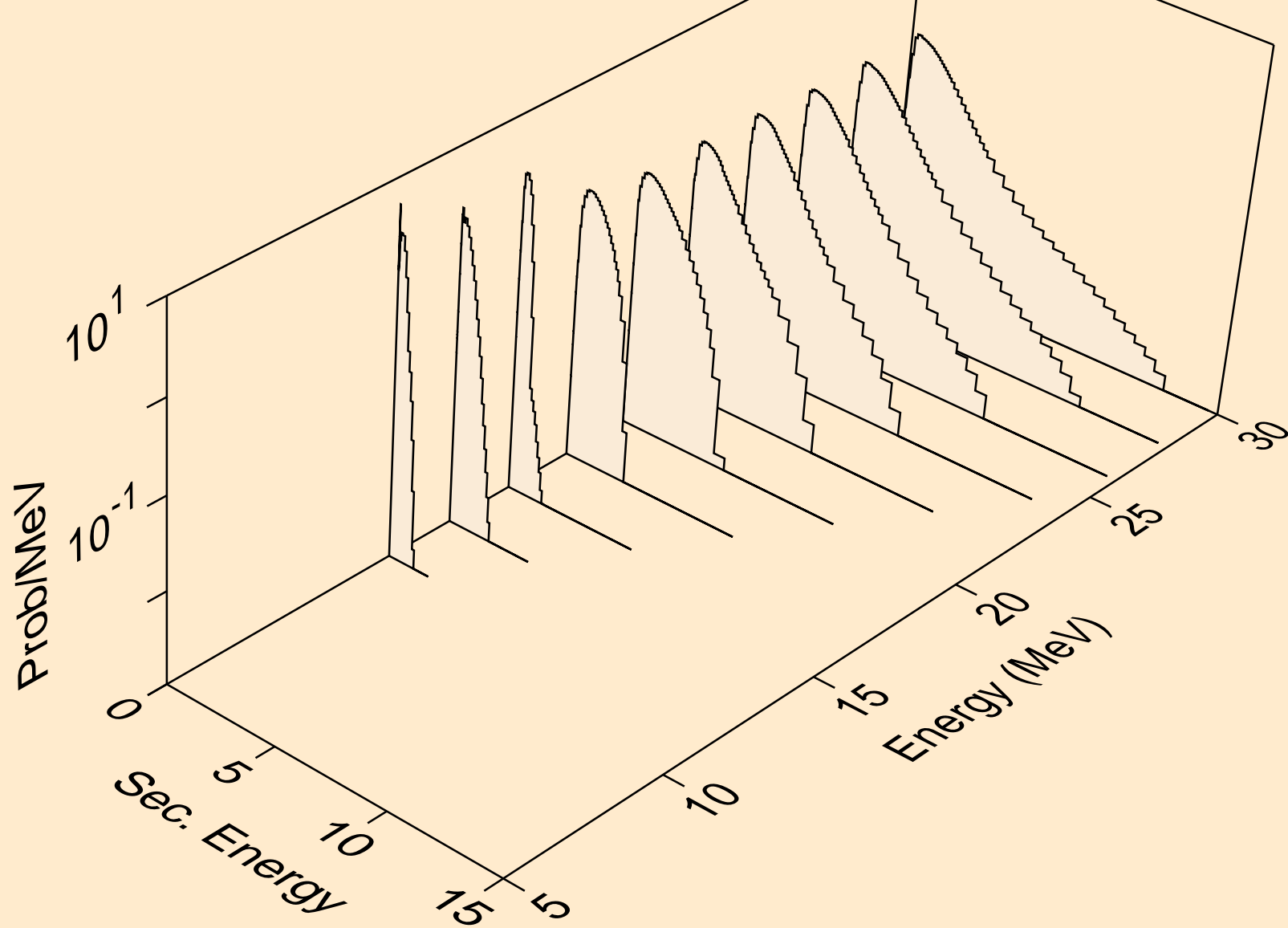

TE113 NEUTRON ACER TENDL-2024 LIBRARY; T=293.6K  
Neutron emission for (n,3n)a

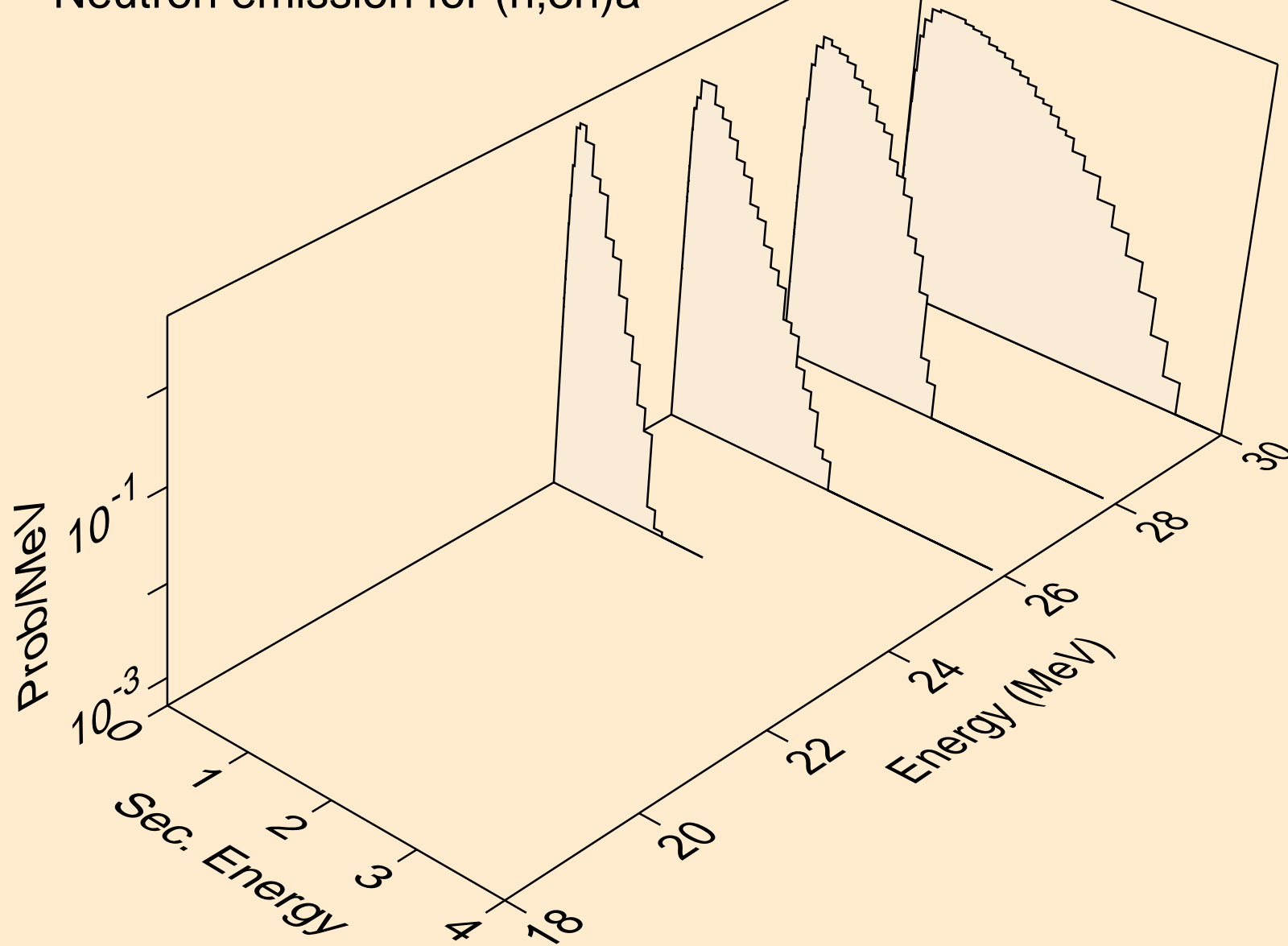

TE113 NEUTRON ACER TENDL-2024 LIBRARY; T=293.6K  
Neutron emission for (n,n\*)p

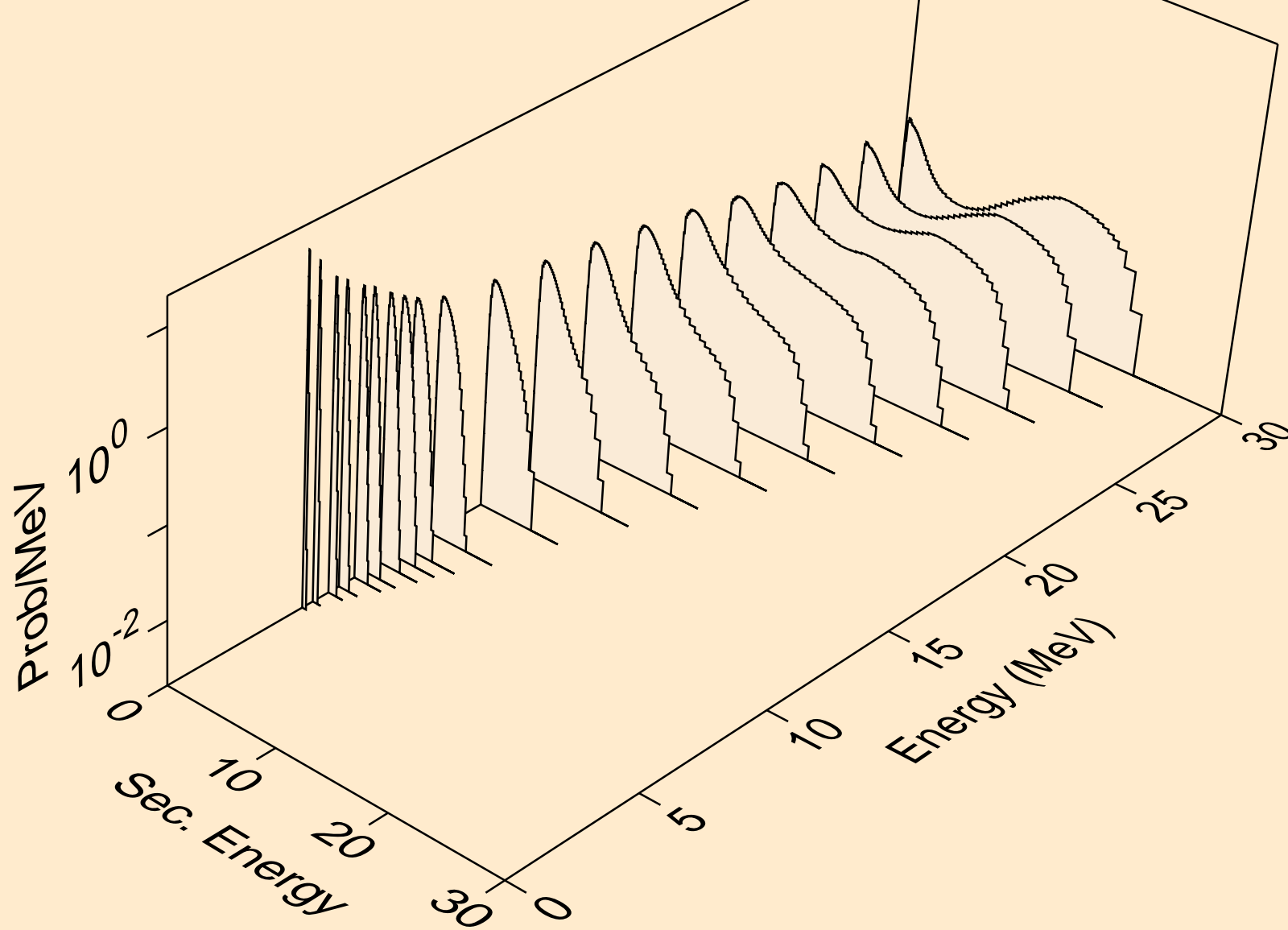

TE113 NEUTRON ACER TENDL-2024 LIBRARY; T=293.6K  
Neutron emission for (n,n\*)2a

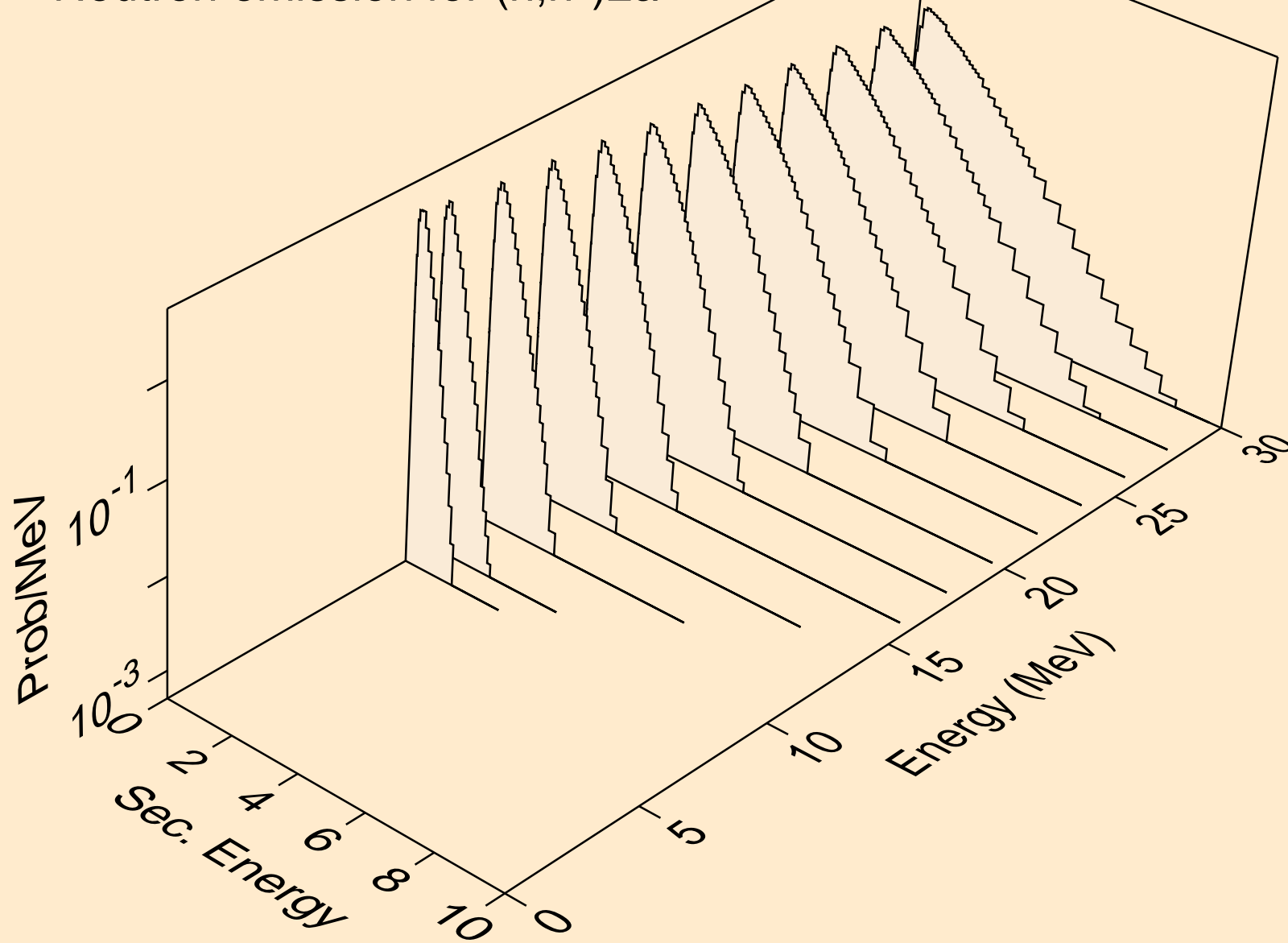

TE113 NEUTRON ACER TENDL-2024 LIBRARY; T=293.6K  
Neutron emission for (n,2n)2a

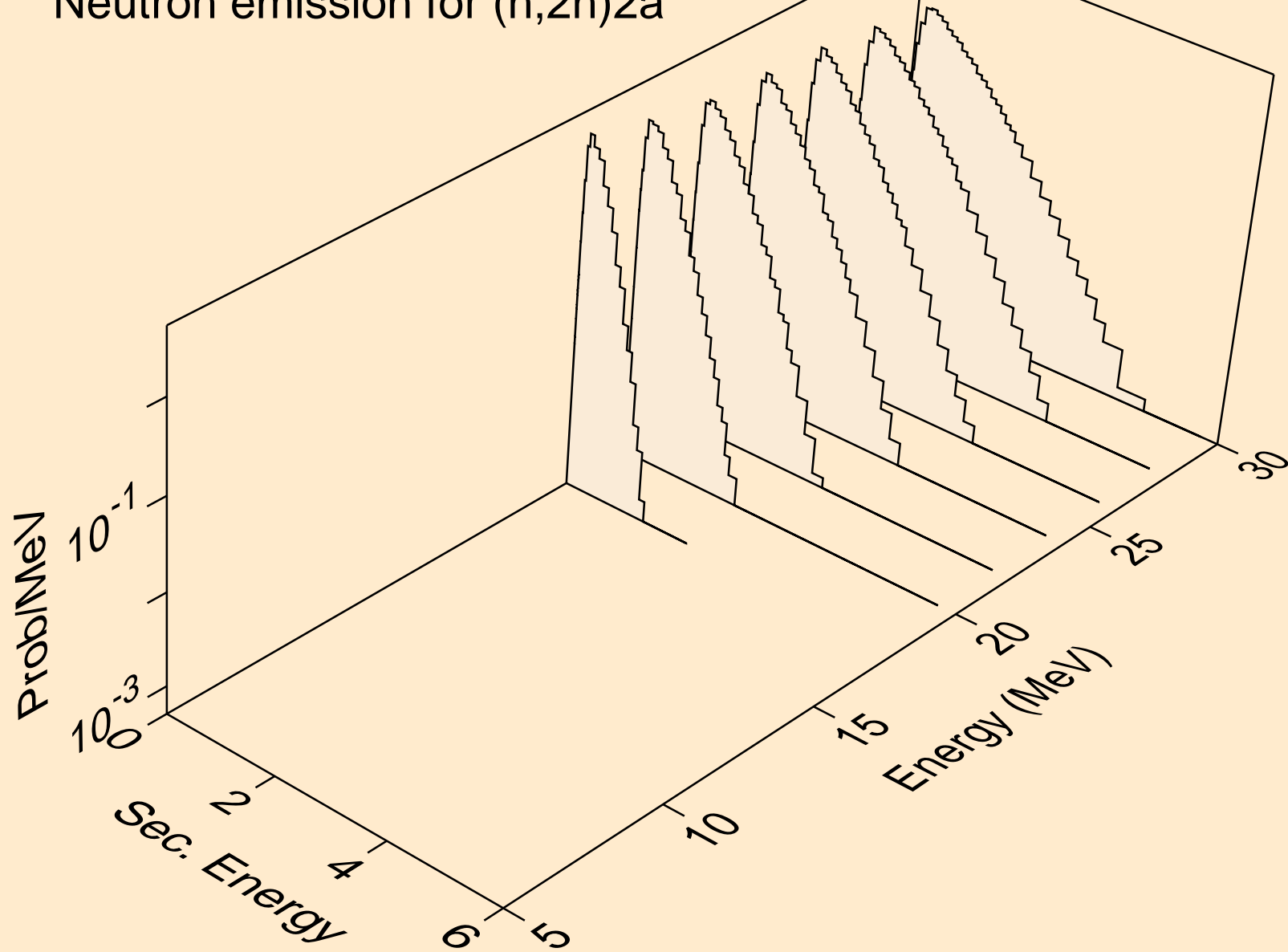

TE113 NEUTRON ACER TENDL-2024 LIBRARY; T=293.6K  
Neutron emission for (n,n\*)d

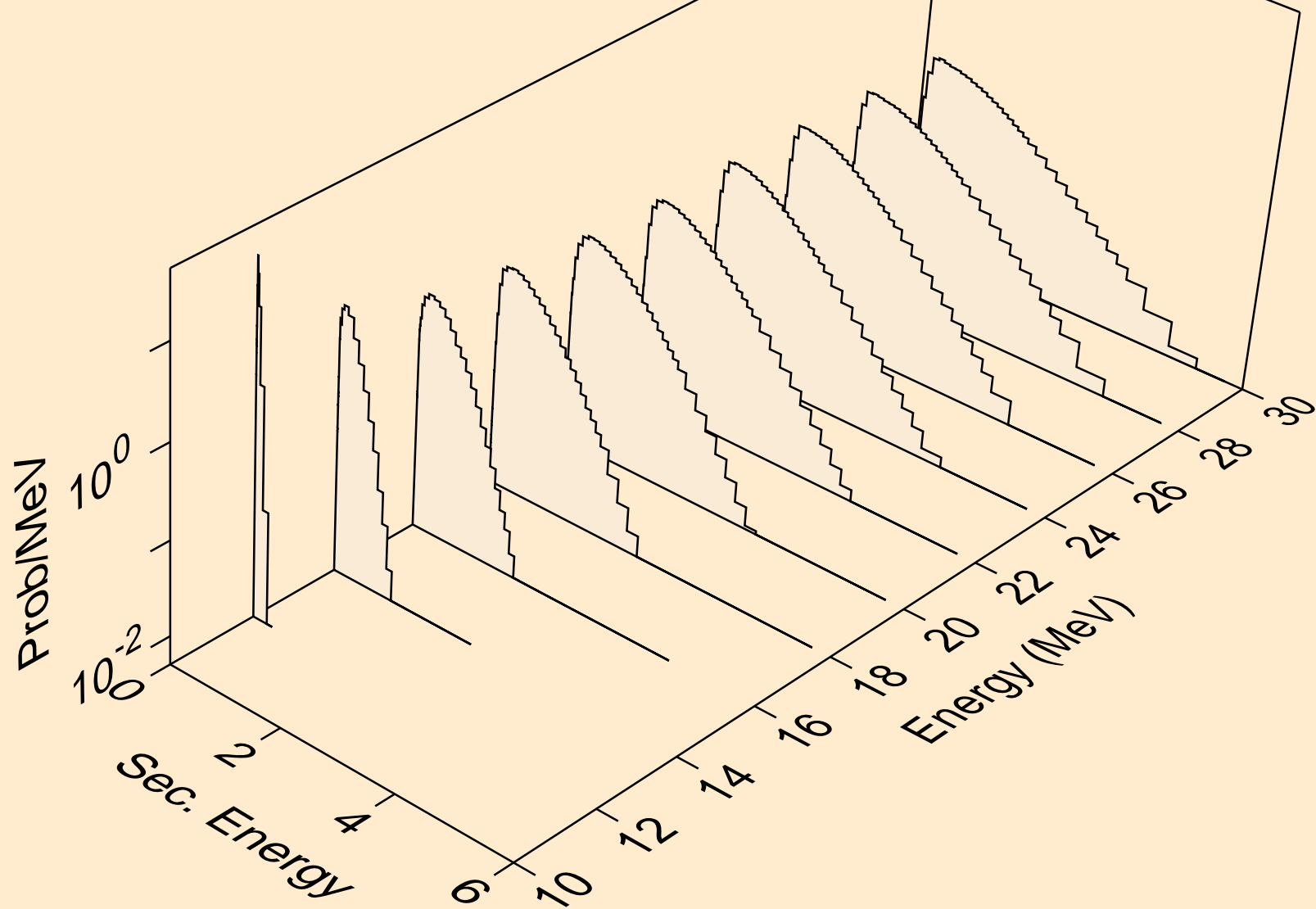

TE113 NEUTRON ACER TENDL-2024 LIBRARY; T=293.6K  
Neutron emission for (n,n\*)t

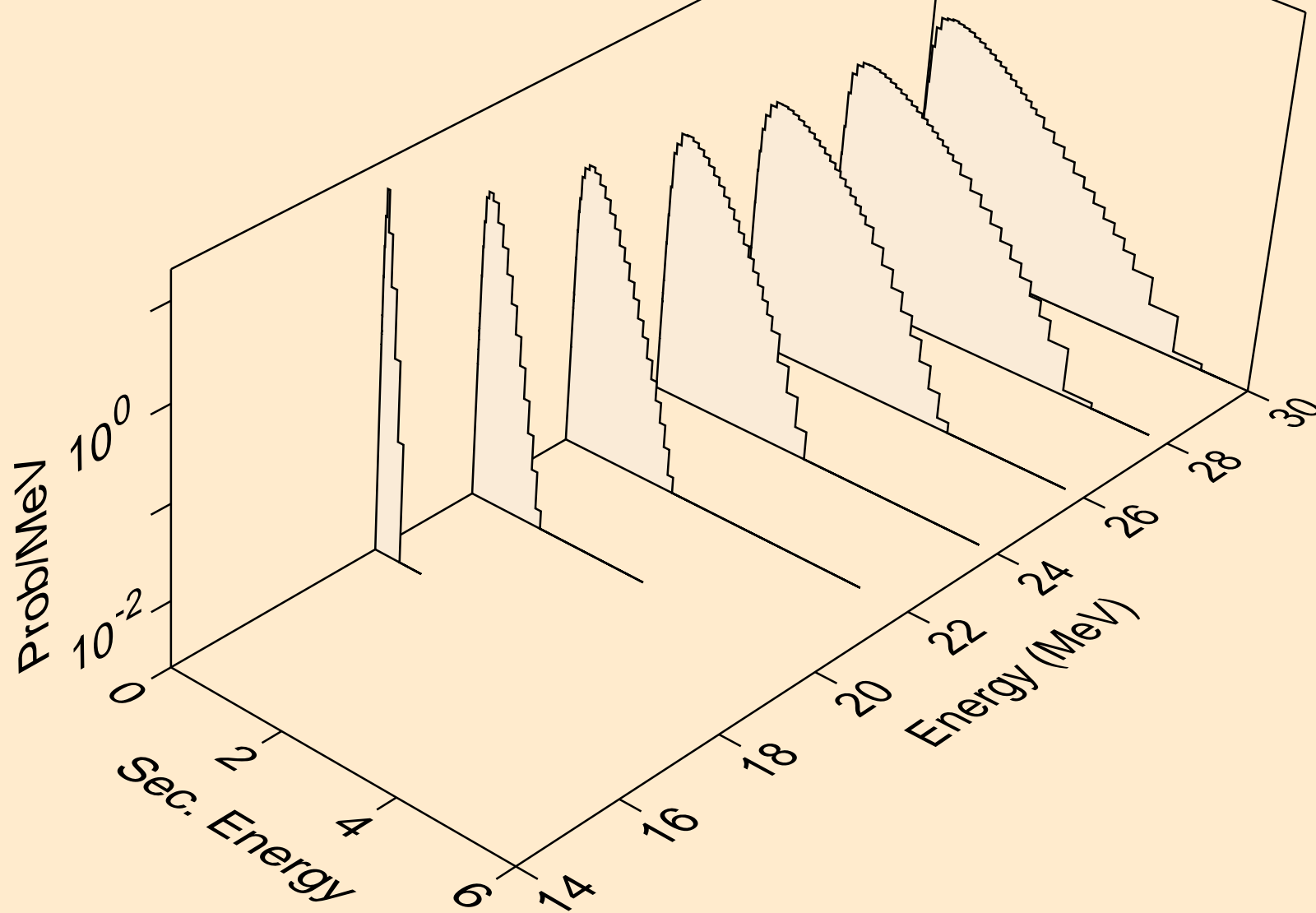

TE113 NEUTRON ACER TENDL-2024 LIBRARY; T=293.6K  
Neutron emission for (n,n\*)he3

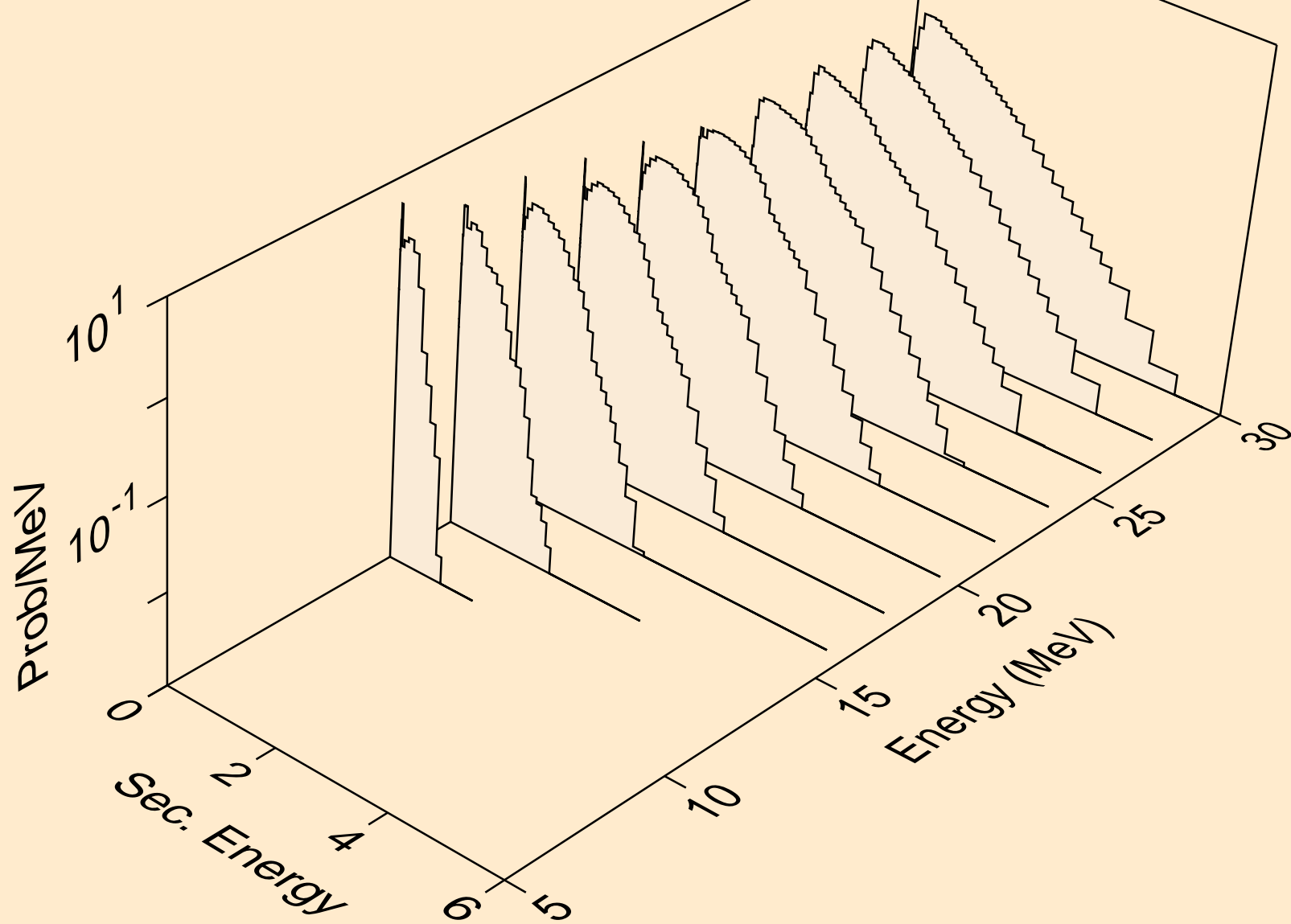

TE113 NEUTRON ACER TENDL-2024 LIBRARY; T=293.6K  
Neutron emission for (n,2np)

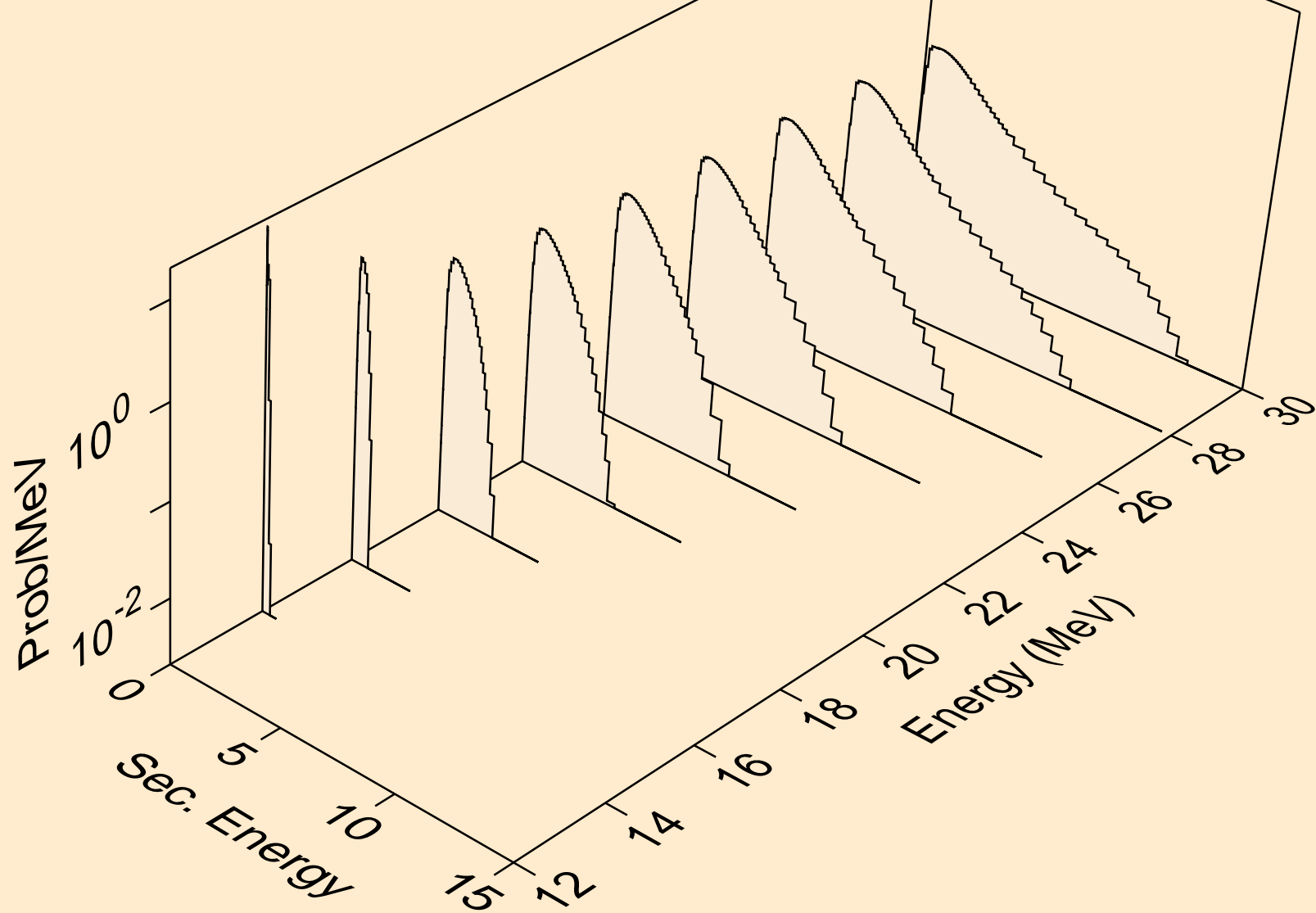

TE113 NEUTRON ACER TENDL-2024 LIBRARY; T=293.6K  
Neutron emission for (n,3np)

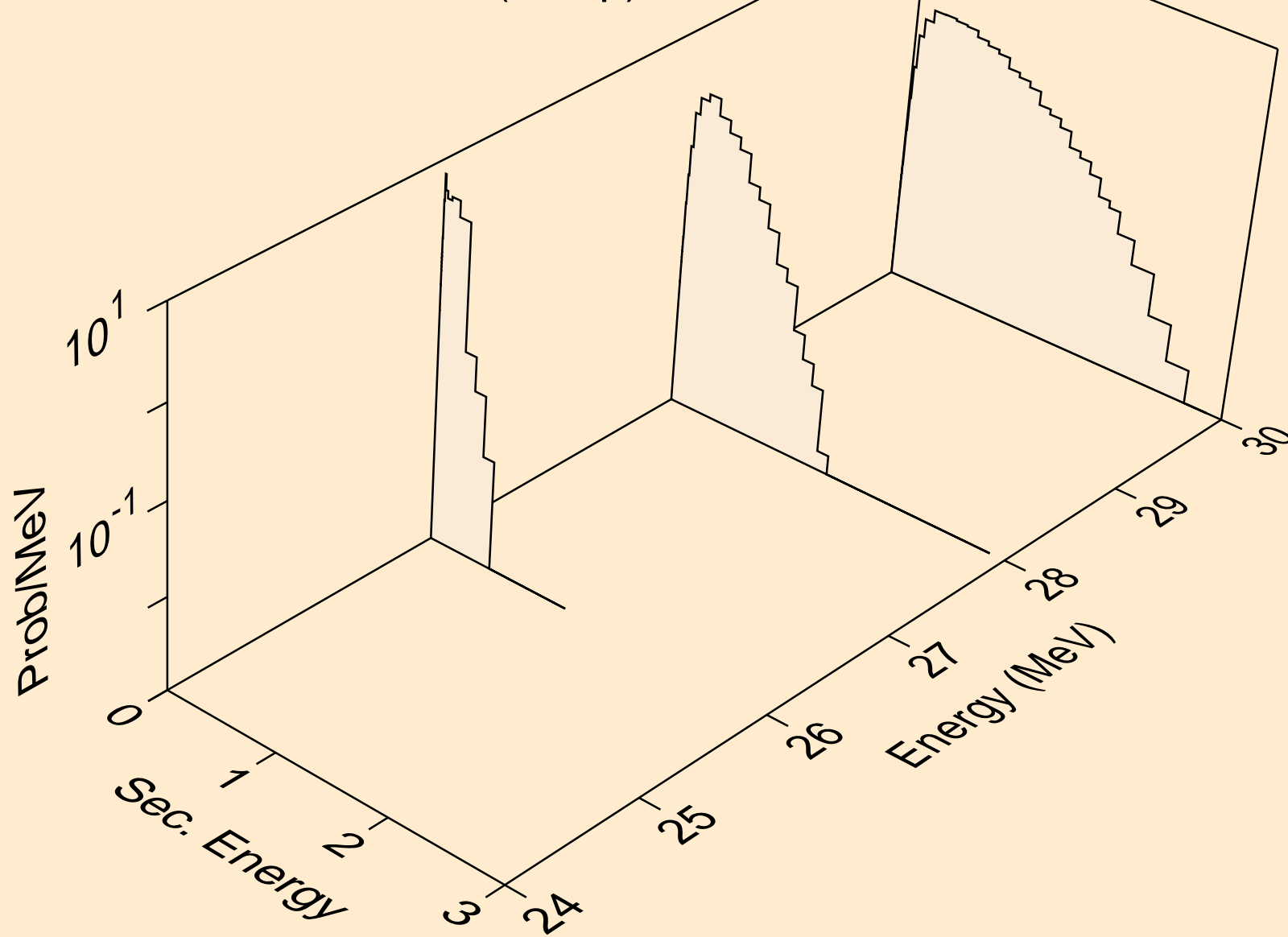

TE113 NEUTRON ACER TENDL-2024 LIBRARY; T=293.6K  
Neutron emission for (n,n2p)

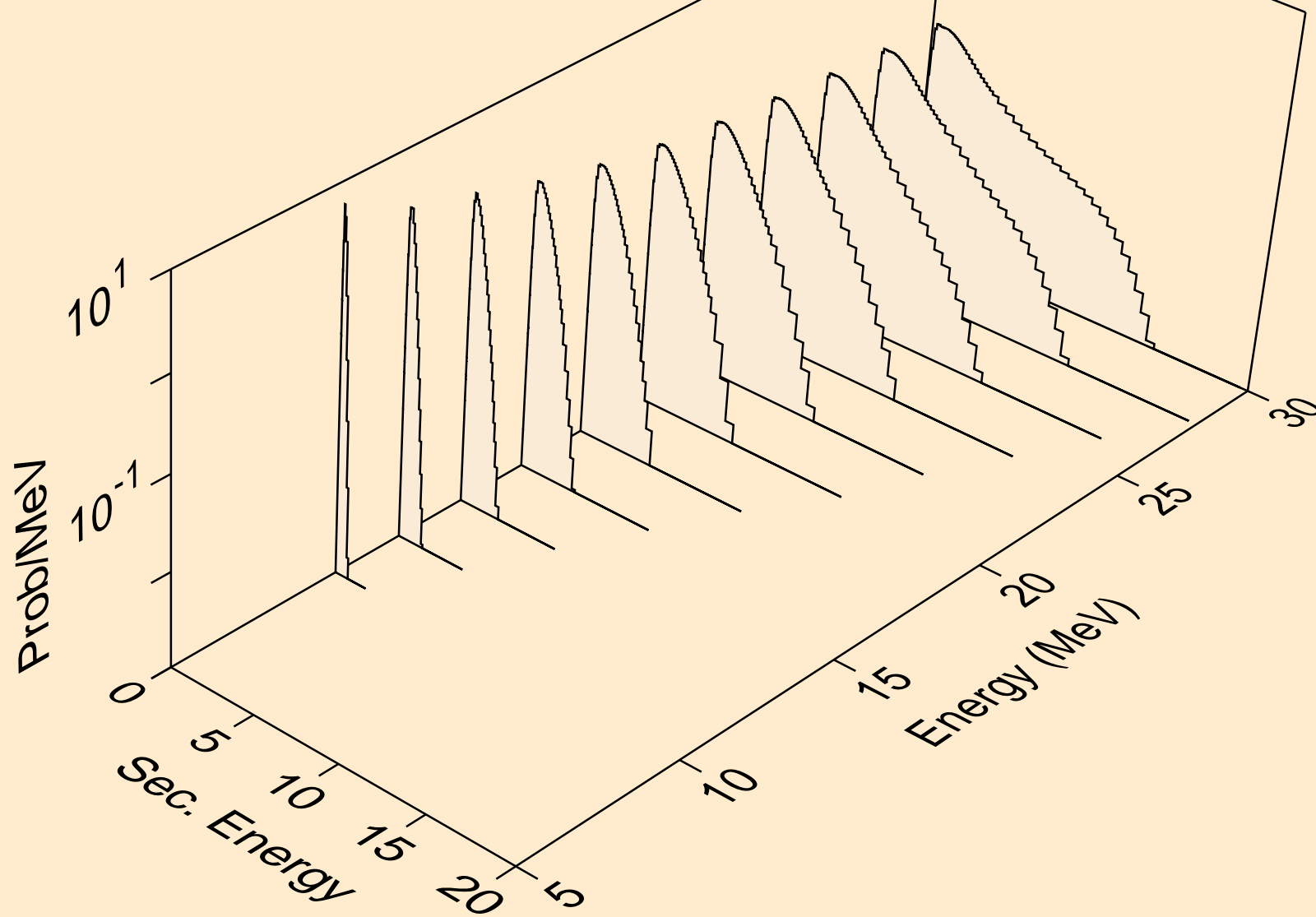

TE113 NEUTRON ACER TENDL-2024 LIBRARY; T=293.6K  
Neutron emission for (n,npa)

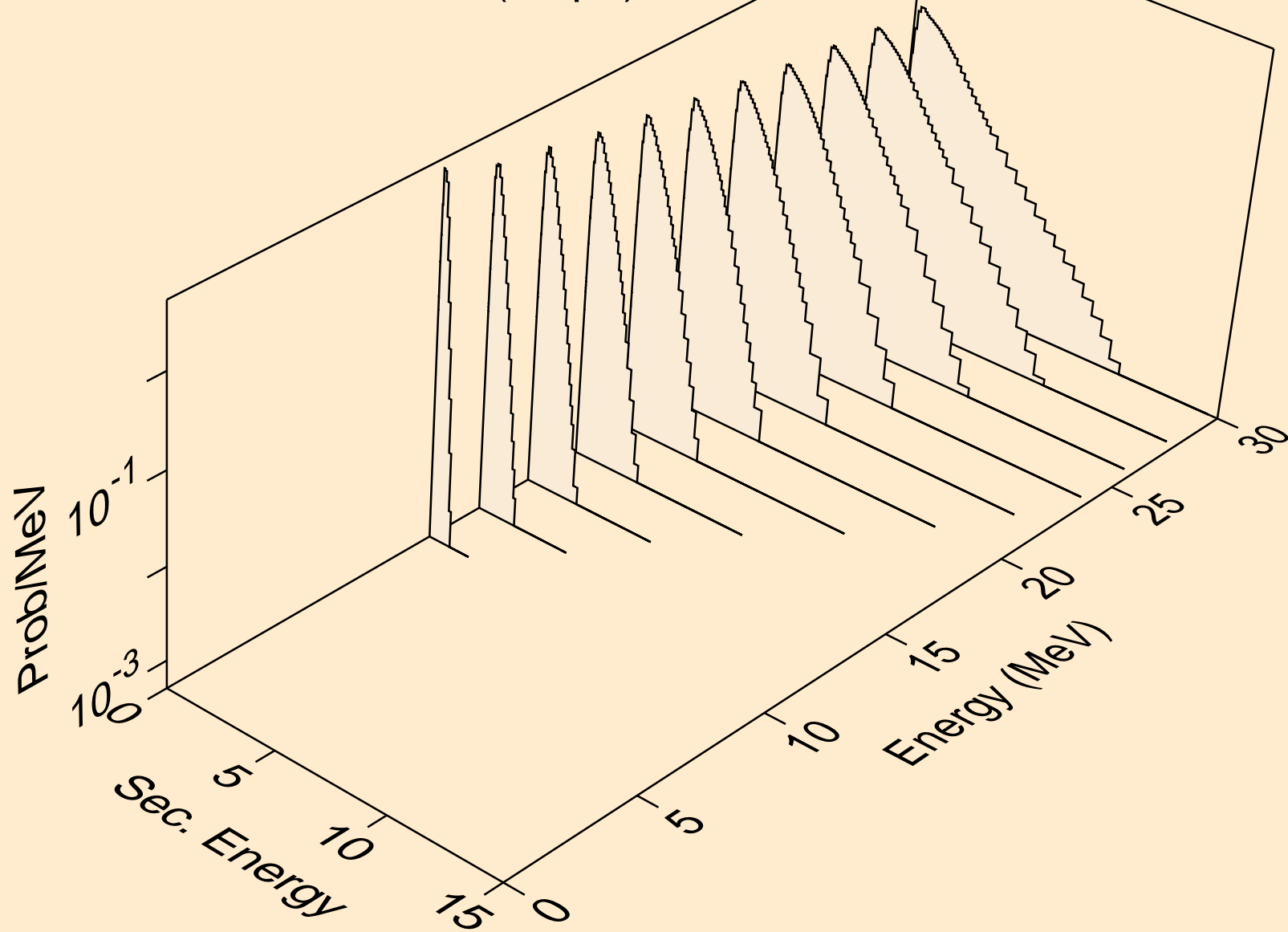

TE113 NEUTRON ACER TENDL-2024 LIBRARY; T=293.6K  
Neutron emission for (n,n\*c)

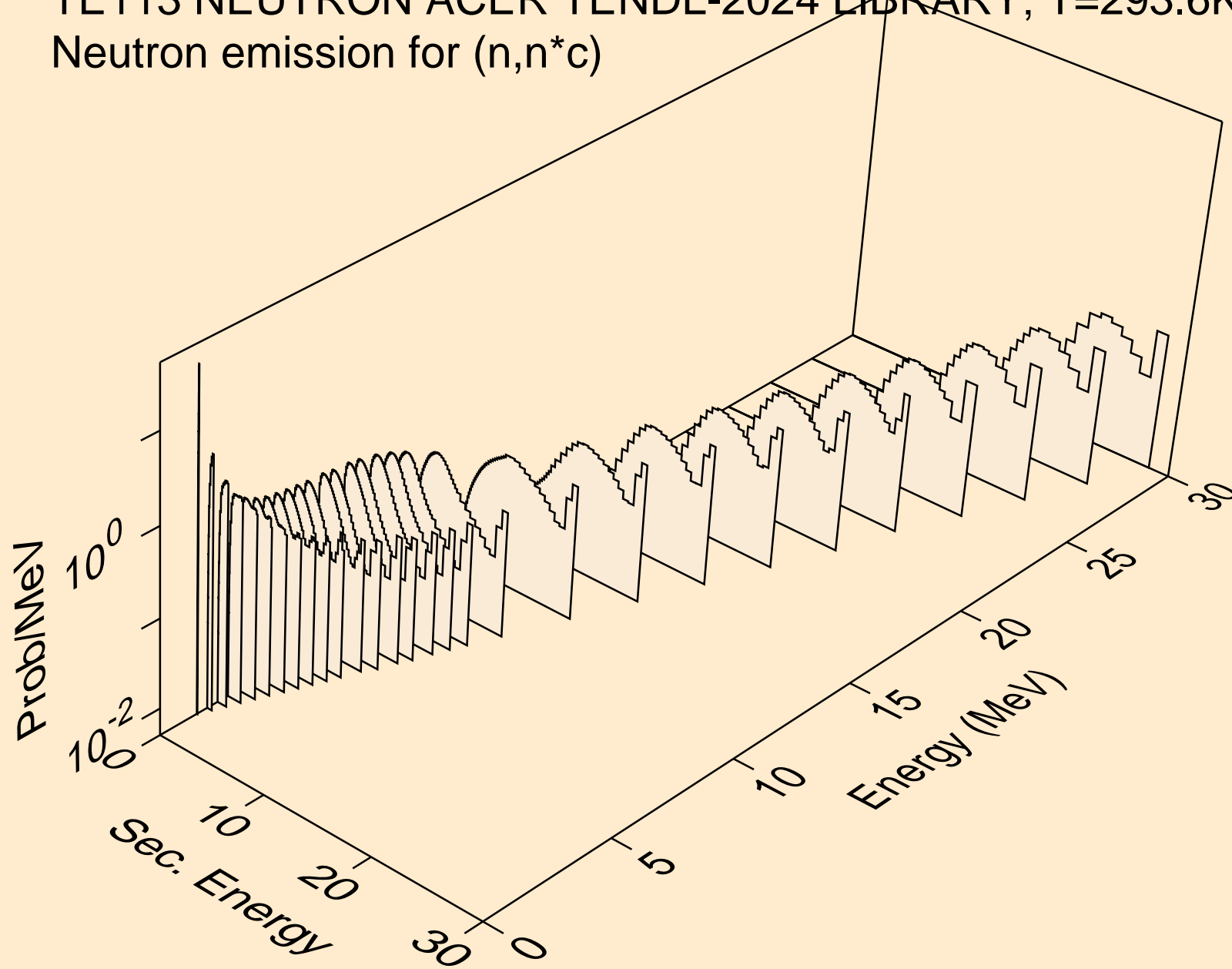

TE113 NEUTRON ACER TENDL-2024 LIBRARY; T=293.6K  
Photon emission for (n,x)

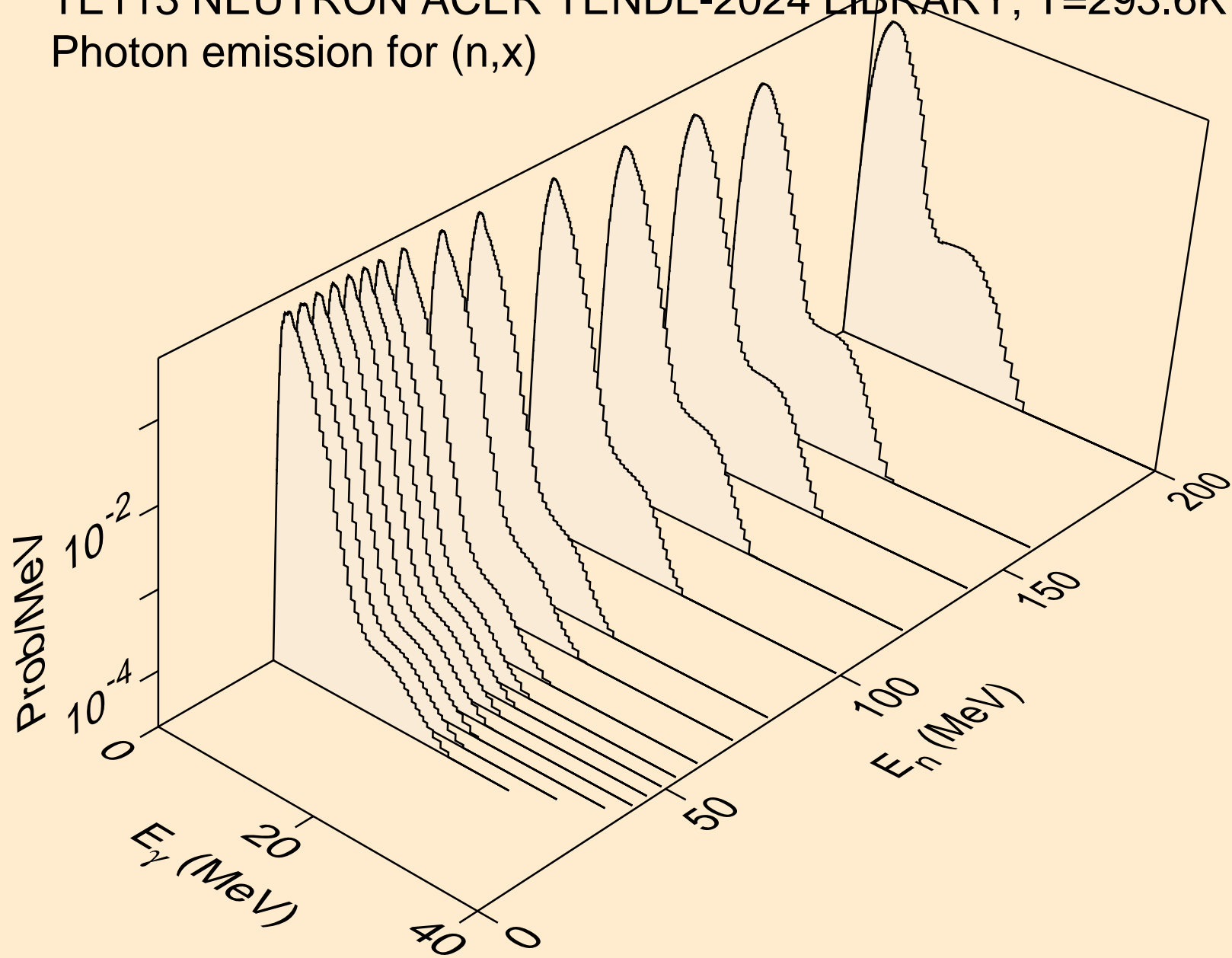

TE113 NEUTRON ACER TENDL-2024 LIBRARY; T=293.6K  
Photon emission for (n,2nd)

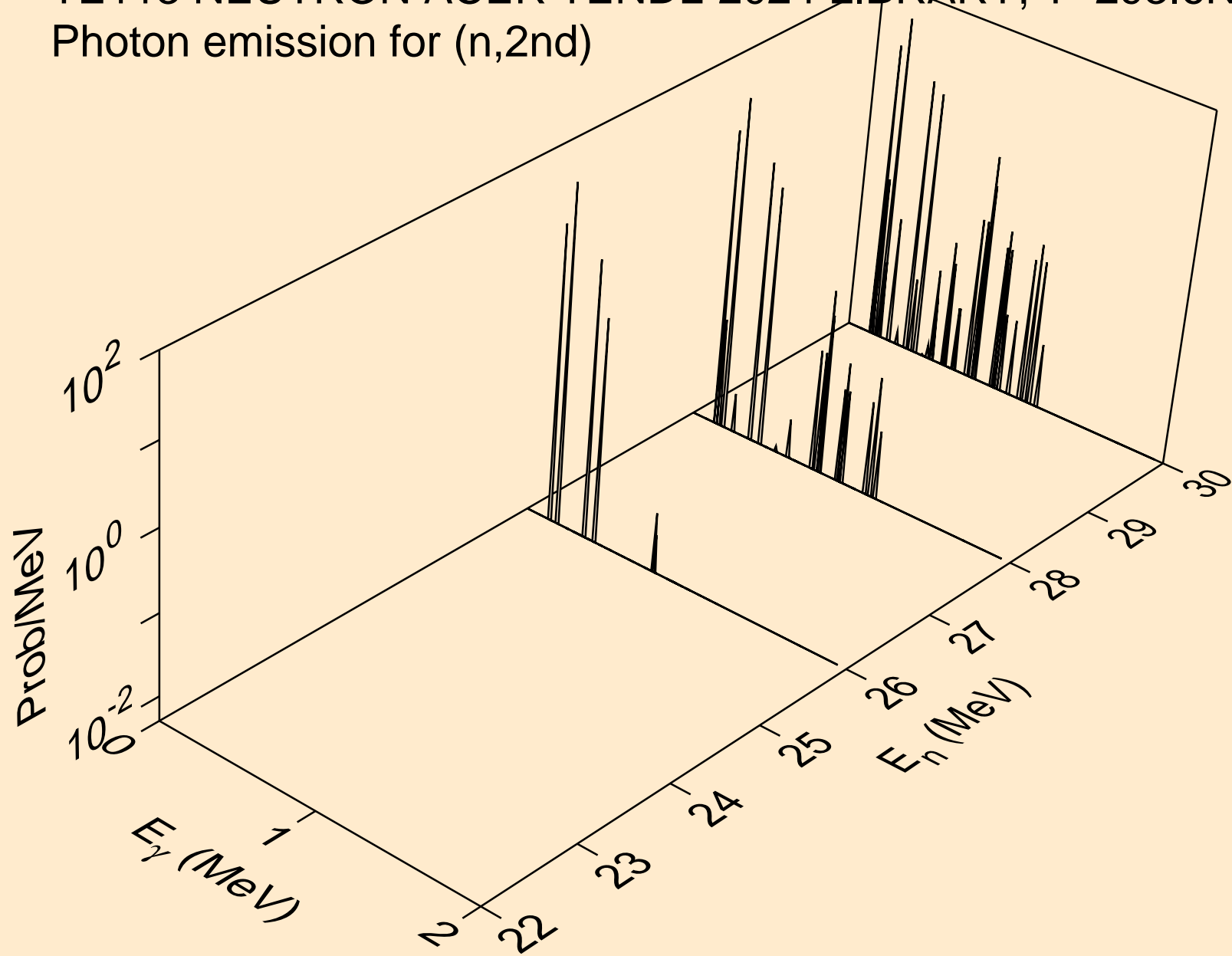

TE113 NEUTRON ACER TENDL-2024 LIBRARY; T=293.6K  
Photon emission for (n,2n)

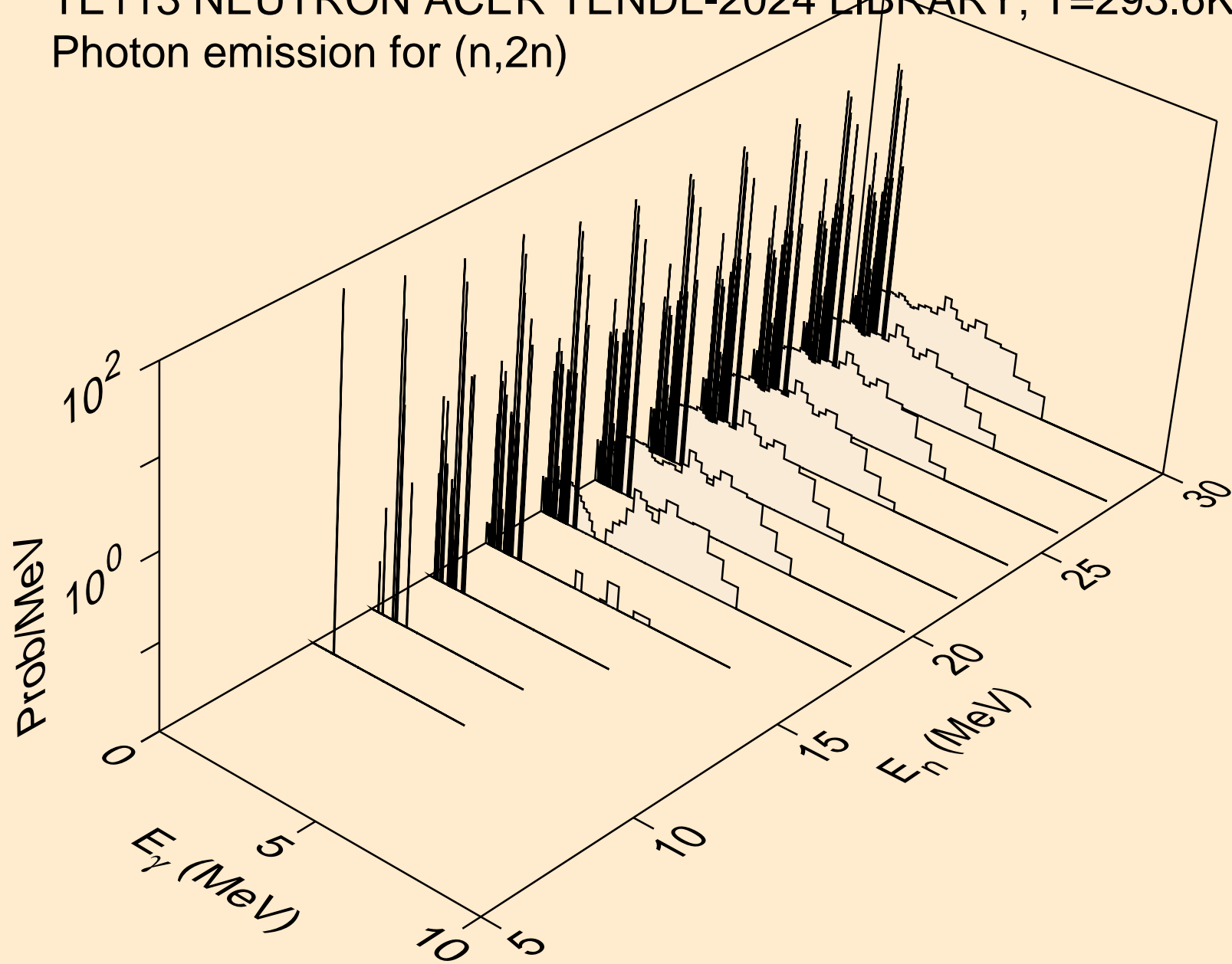

TE113 NEUTRON ACER TENDL-2024 LIBRARY; T=293.6K  
Photon emission for (n,3n)

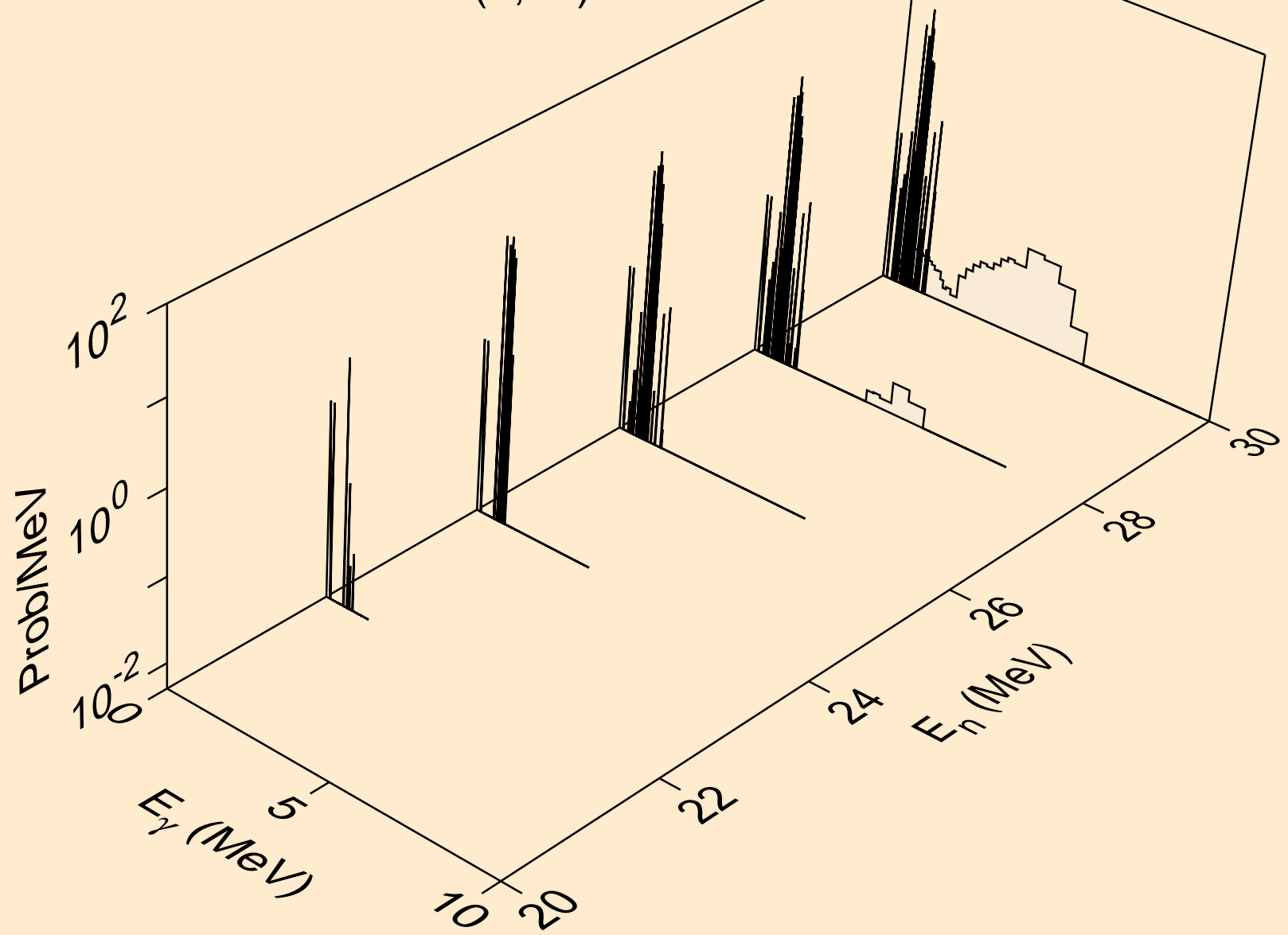

TE113 NEUTRON ACER TENDL-2024 LIBRARY; T=293.6K  
Photon emission for (n,n\*)a

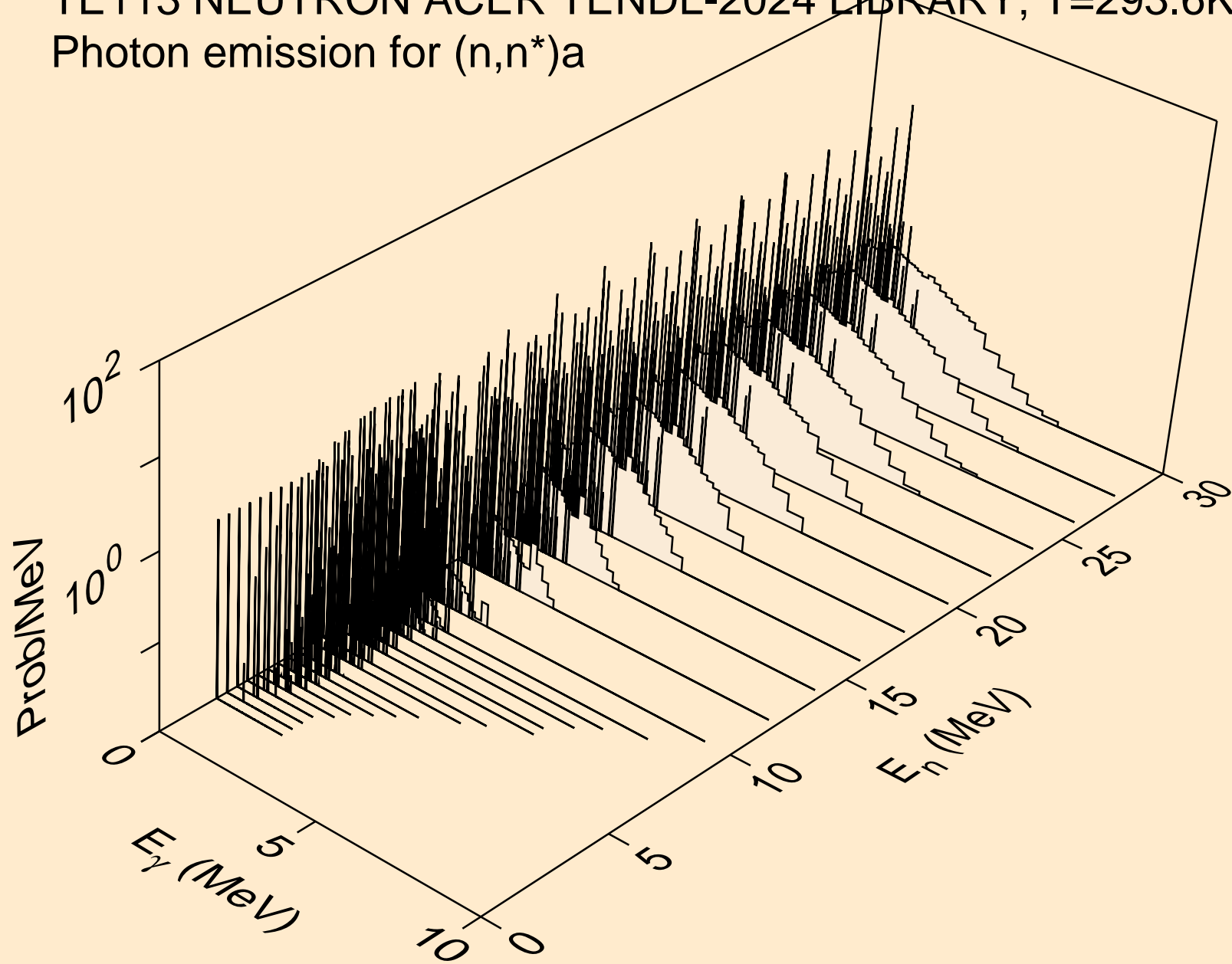

TE113 NEUTRON ACER TENDL-2024 LIBRARY; T=293.6K  
Photon emission for (n,2n)a

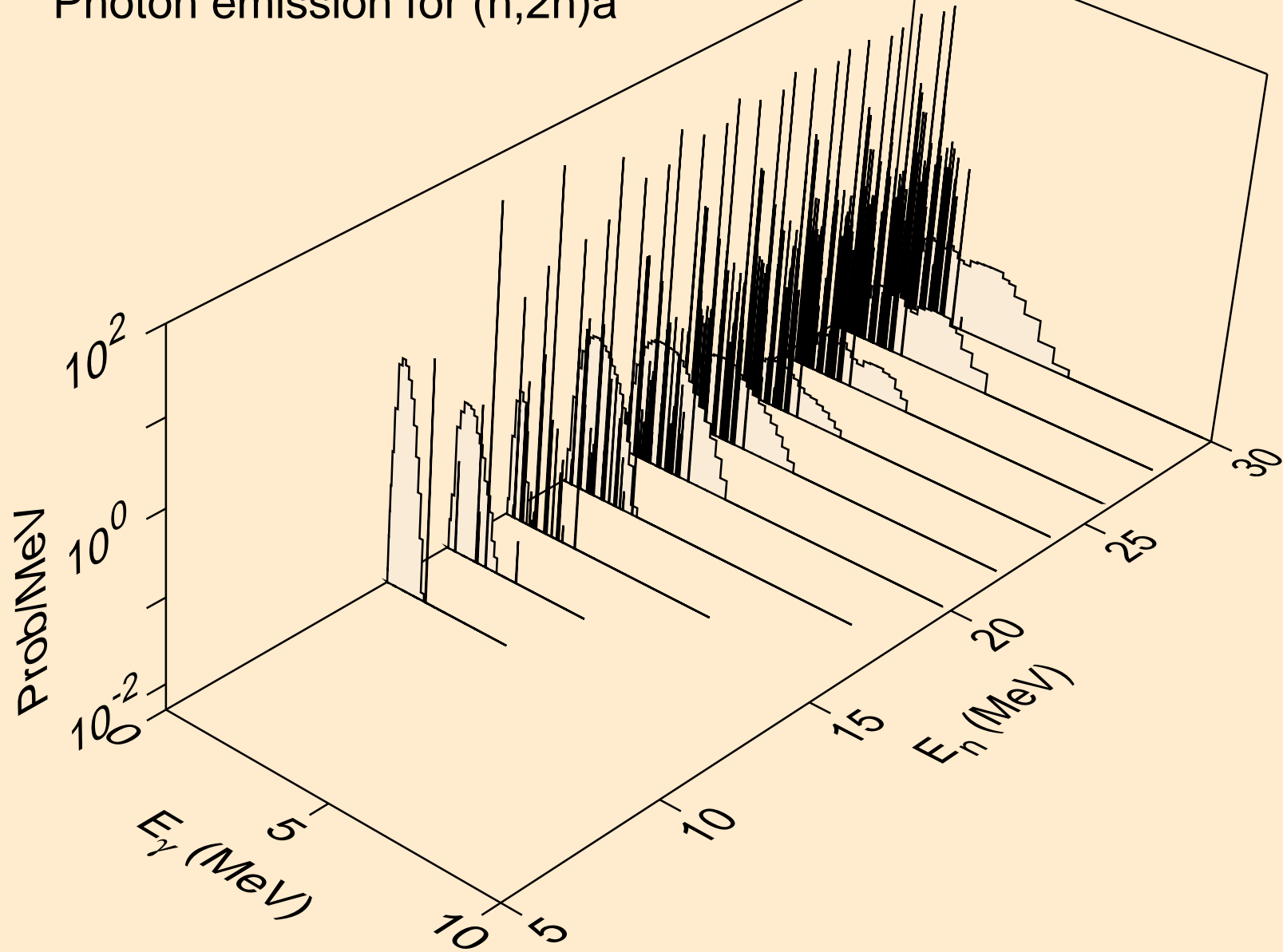

TE113 NEUTRON ACER TENDL-2024 LIBRARY; T=293.6K  
Photon emission for (n,3n)a

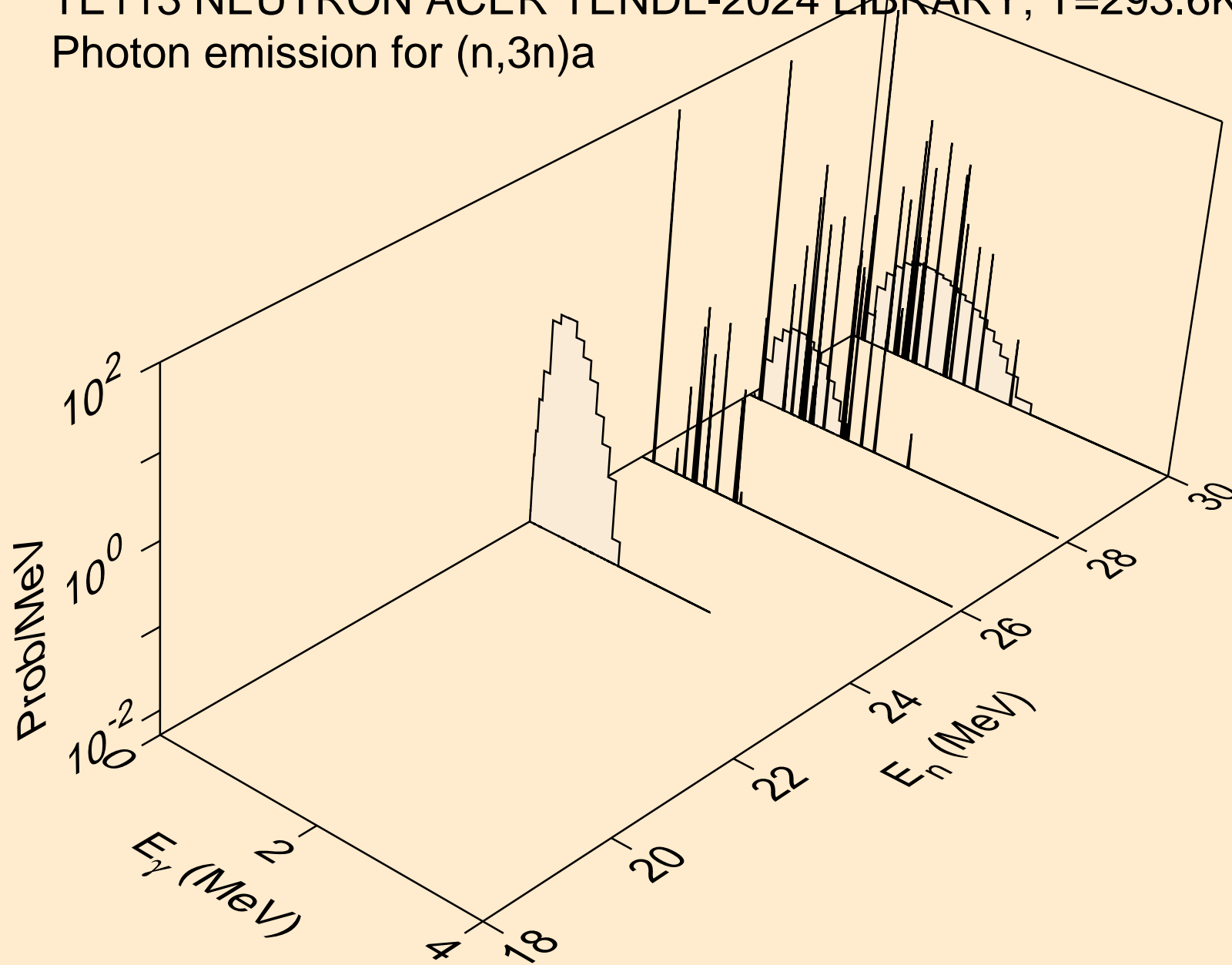

TE113 NEUTRON ACER TENDL-2024 LIBRARY; T=293.6K  
Photon emission for (n,n\*)p

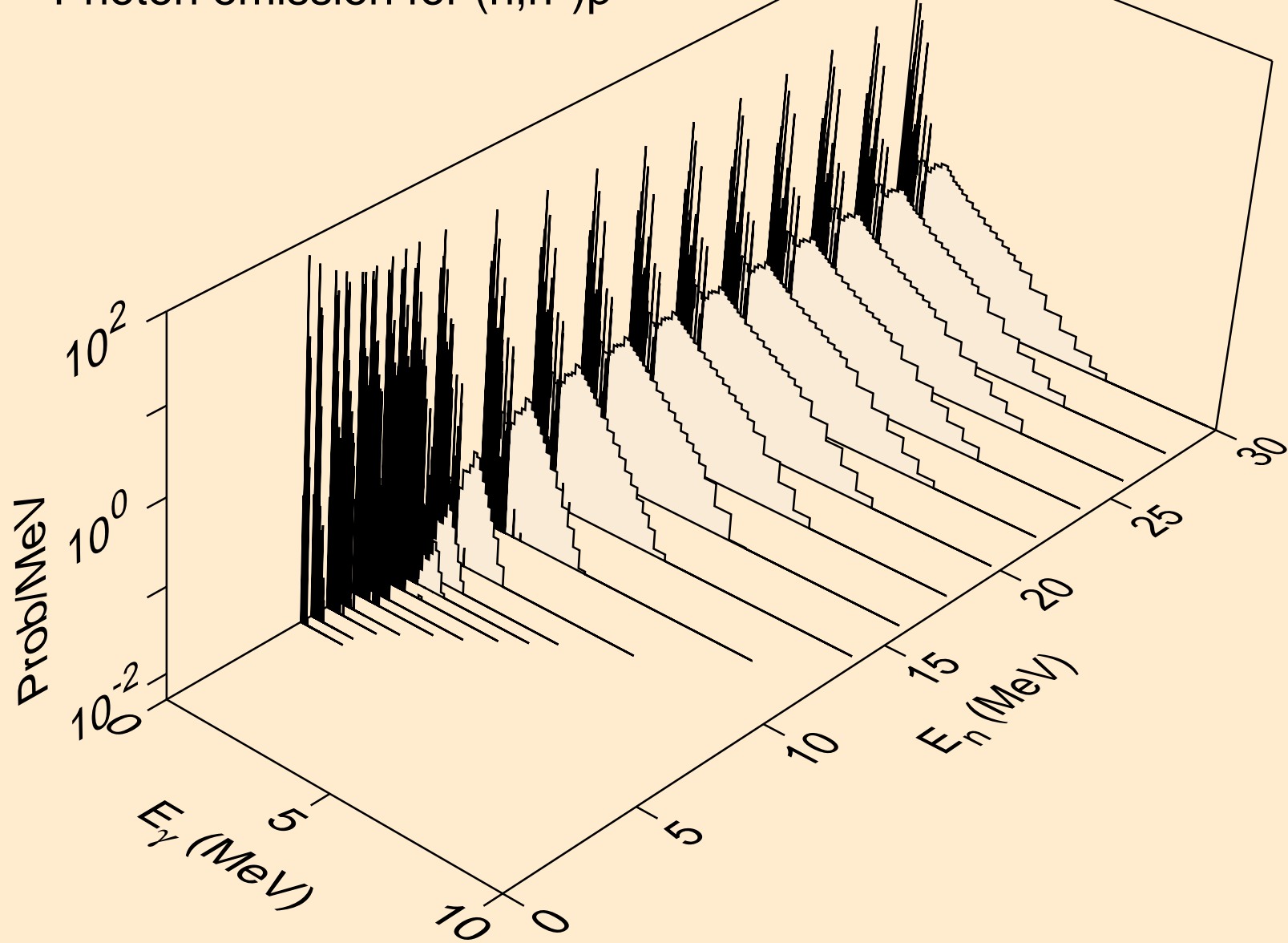

TE113 NEUTRON ACER TENDL-2024 LIBRARY; T=293.6K  
Photon emission for (n,n\*)2a

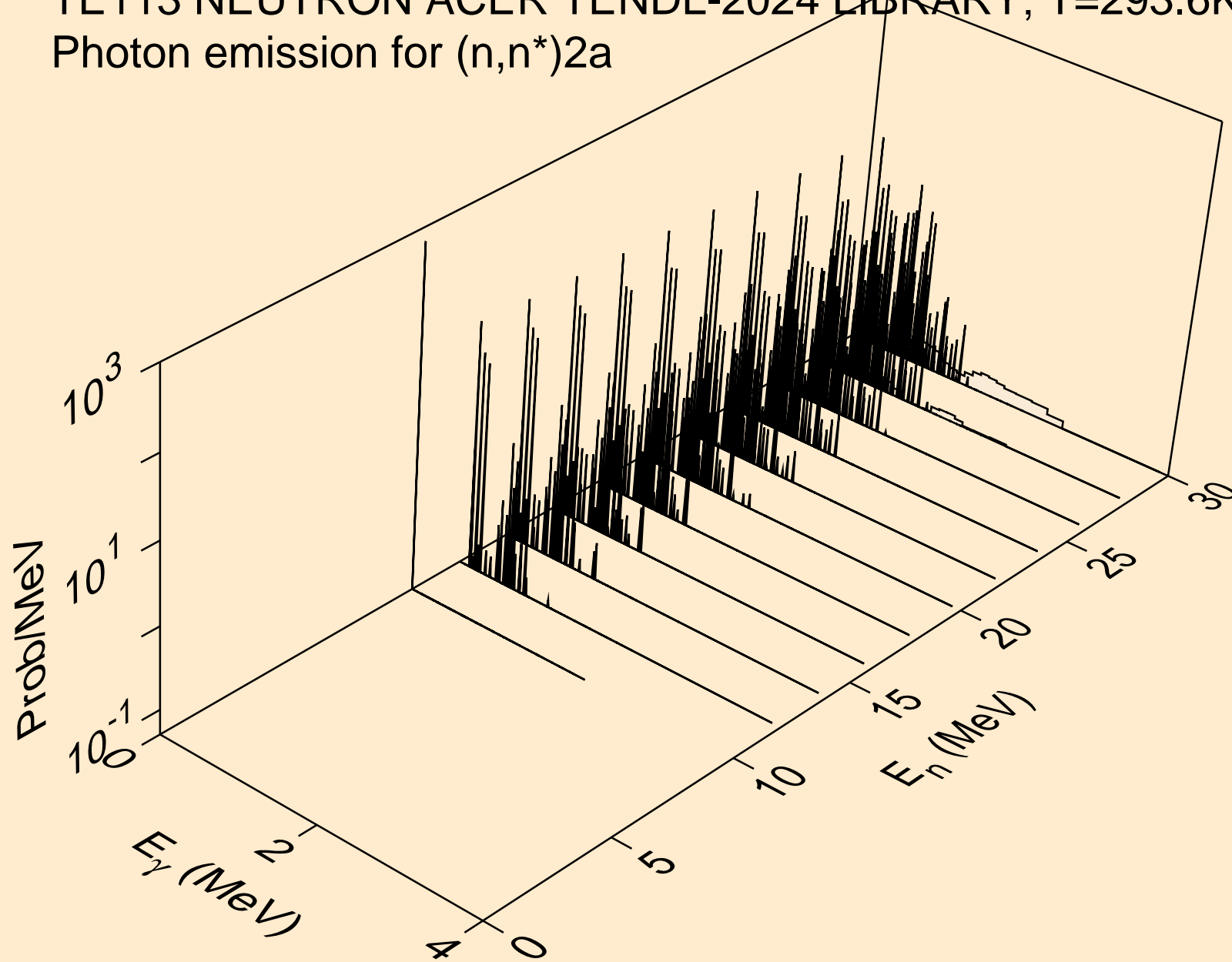

TE113 NEUTRON ACER TENDL-2024 LIBRARY; T=293.6K  
Photon emission for (n,2n)2a

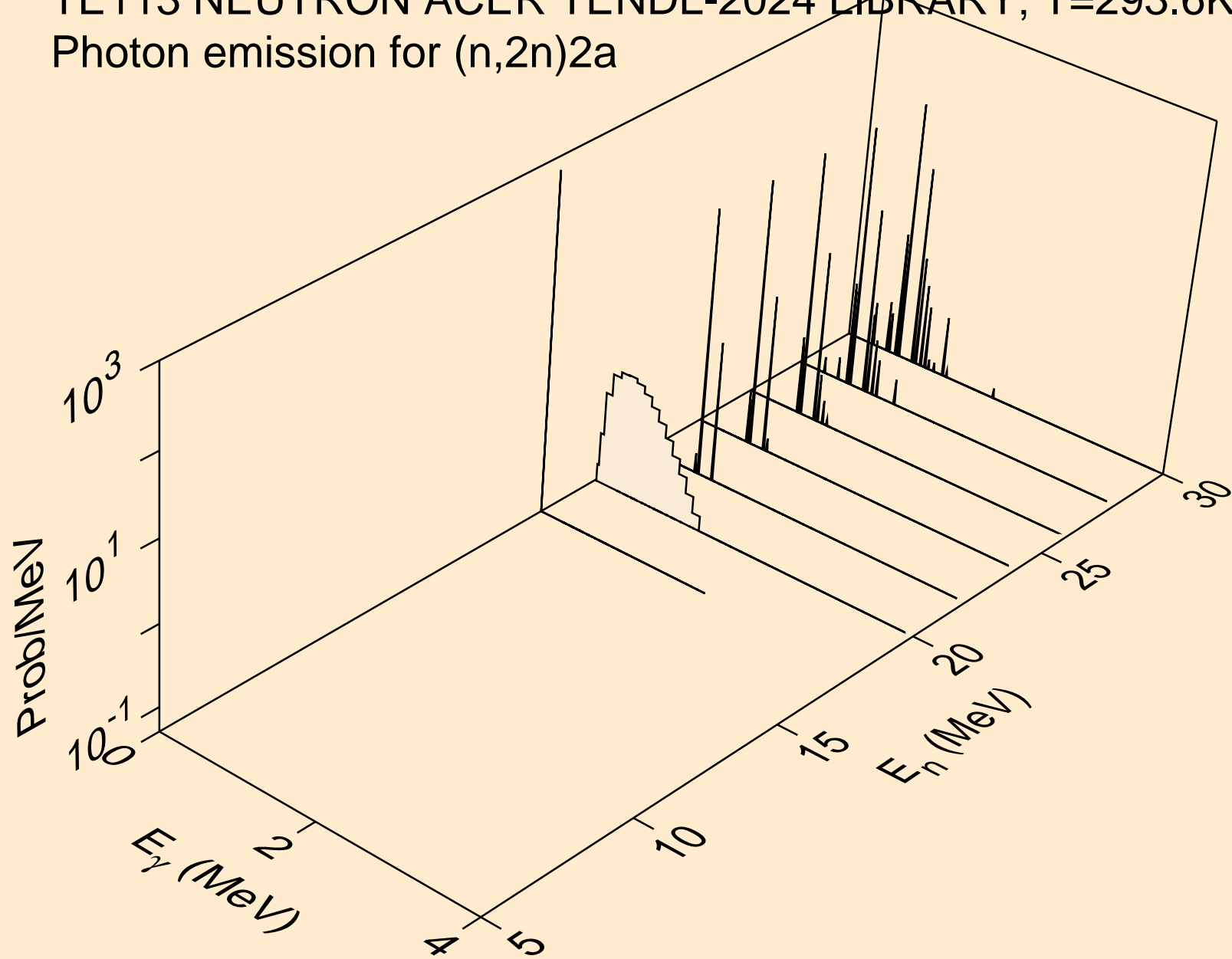

TE113 NEUTRON ACER TENDL-2024 LIBRARY; T=293.6K  
Photon emission for (n,n\*)d

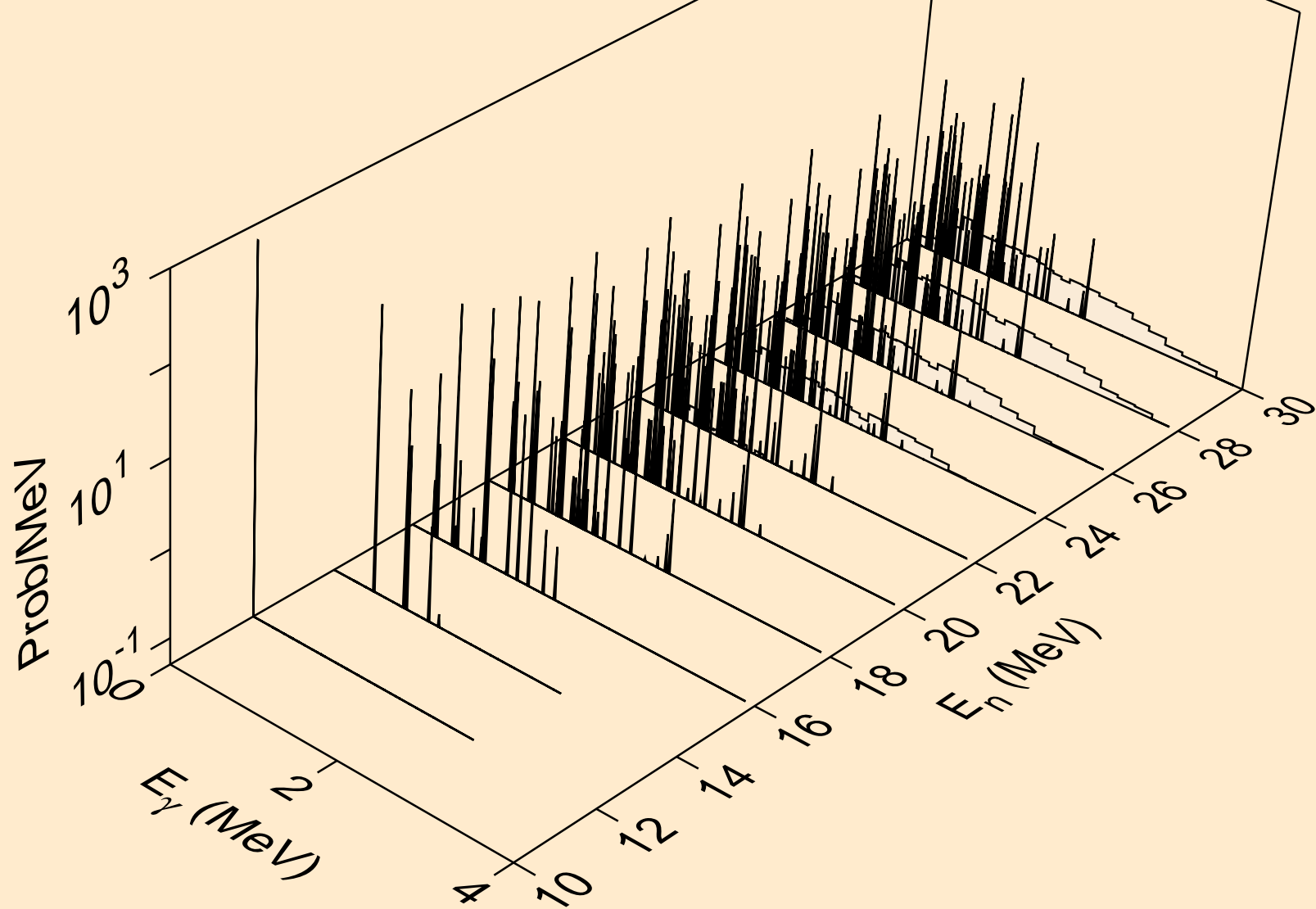

TE113 NEUTRON ACER TENDL-2024 LIBRARY; T=293.6K  
Photon emission for (n,n\*)t

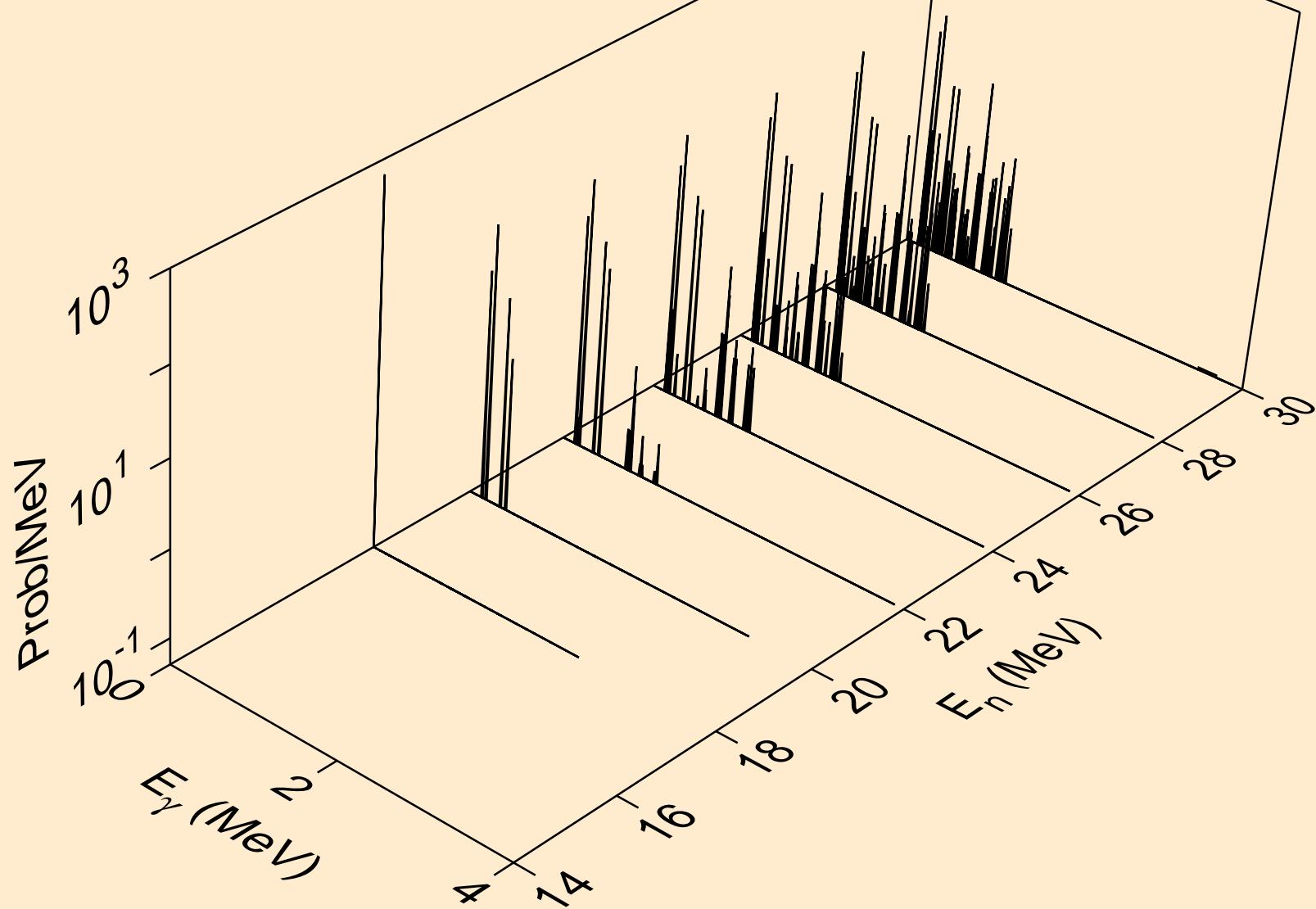

TE113 NEUTRON ACER TENDL-2024 LIBRARY; T=293.6K  
Photon emission for (n,n\*)he3

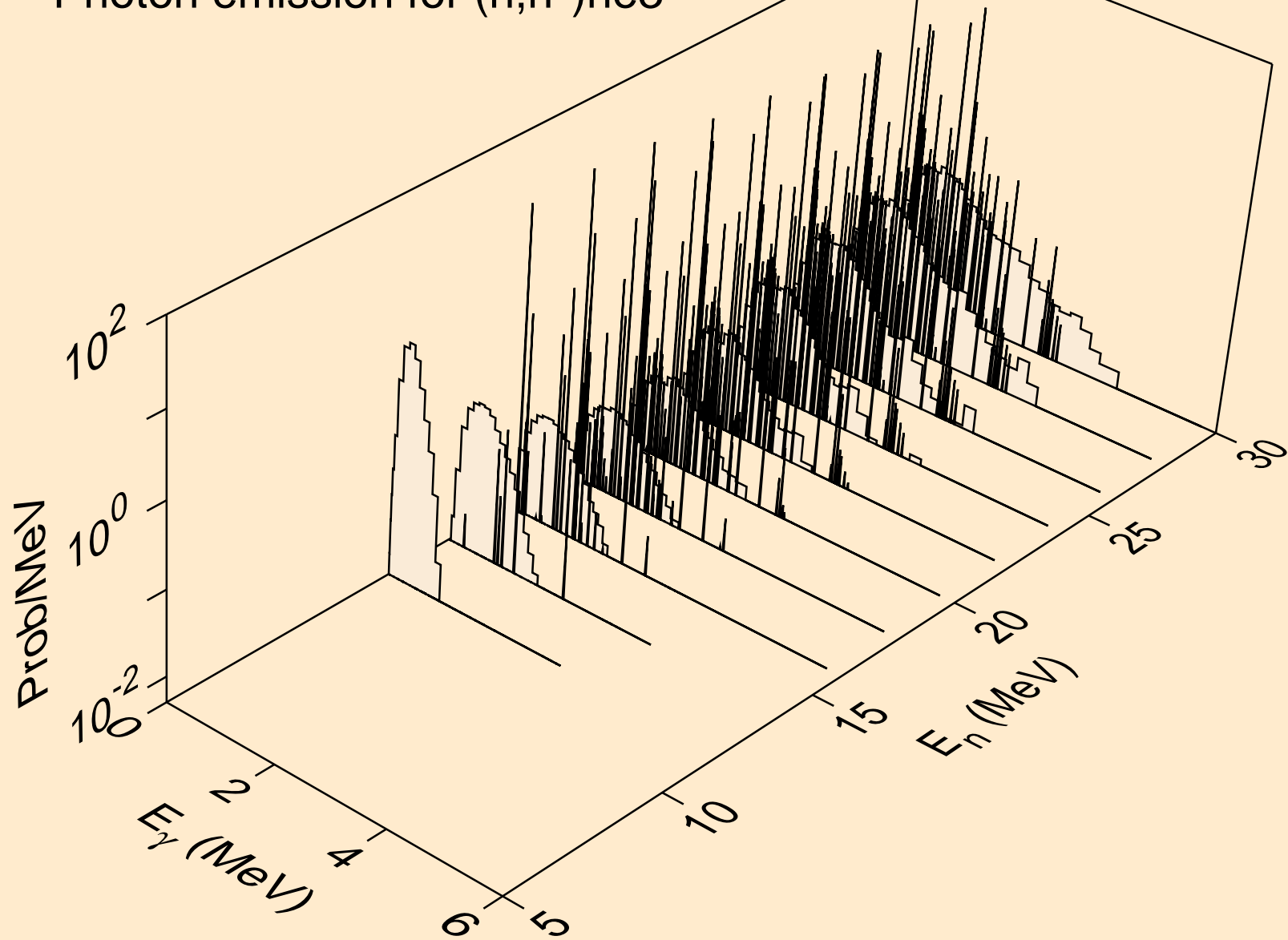

TE113 NEUTRON ACER TENDL-2024 LIBRARY; T=293.6K  
Photon emission for (n,2np)

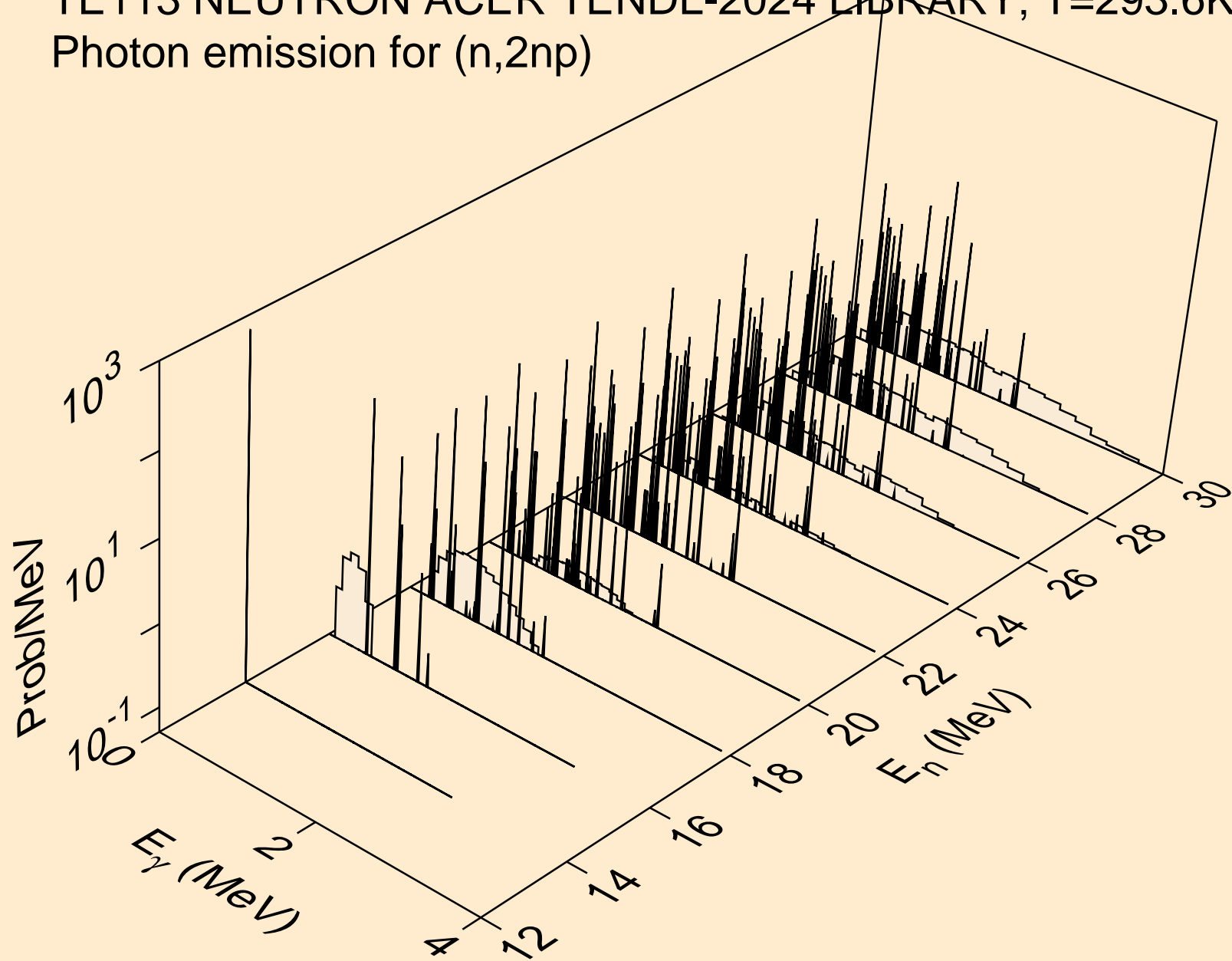

TE113 NEUTRON ACER TENDL-2024 LIBRARY; T=293.6K  
Photon emission for (n,3np)

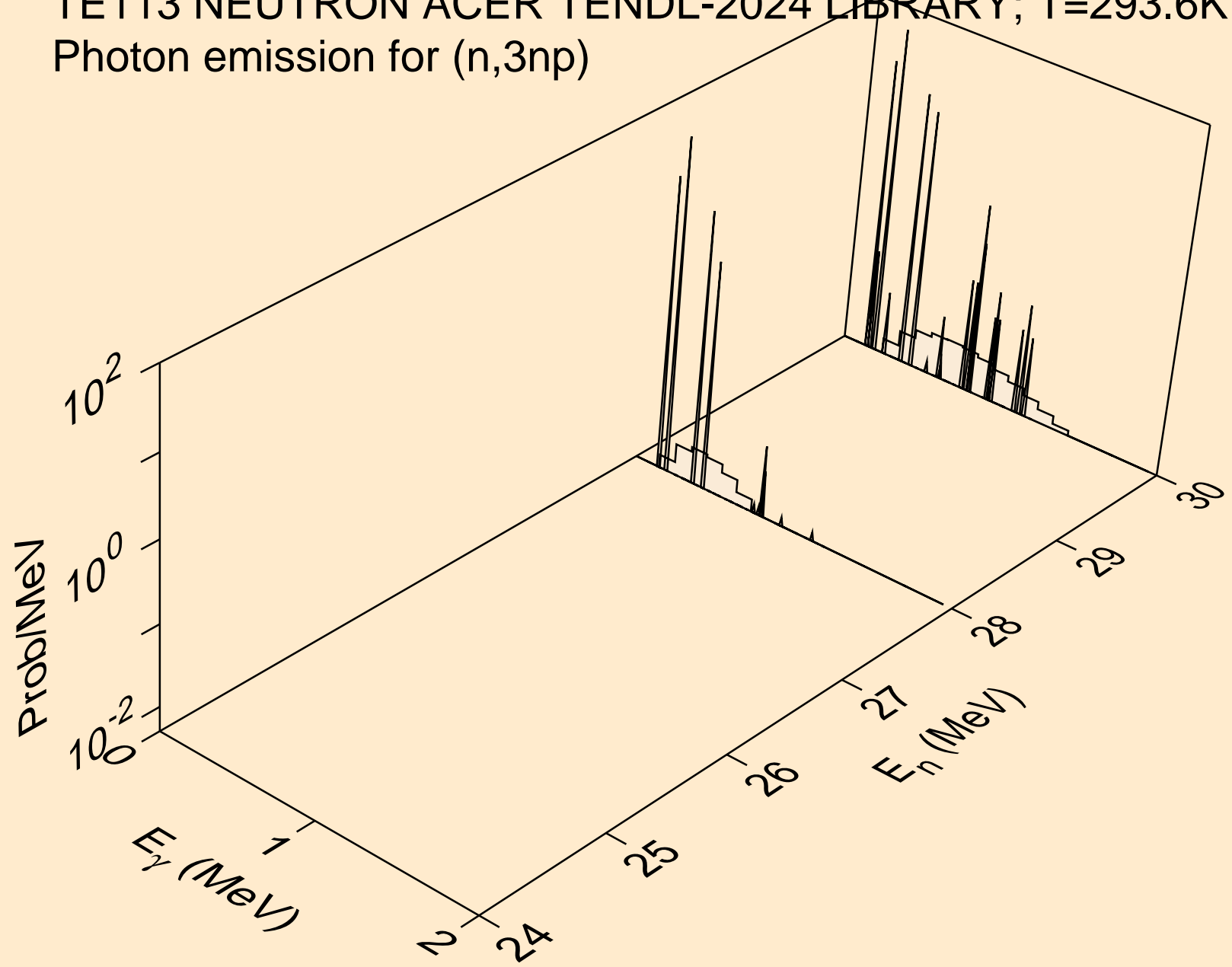

TE113 NEUTRON ACER TENDL-2024 LIBRARY; T=293.6K  
Photon emission for (n,n2p)

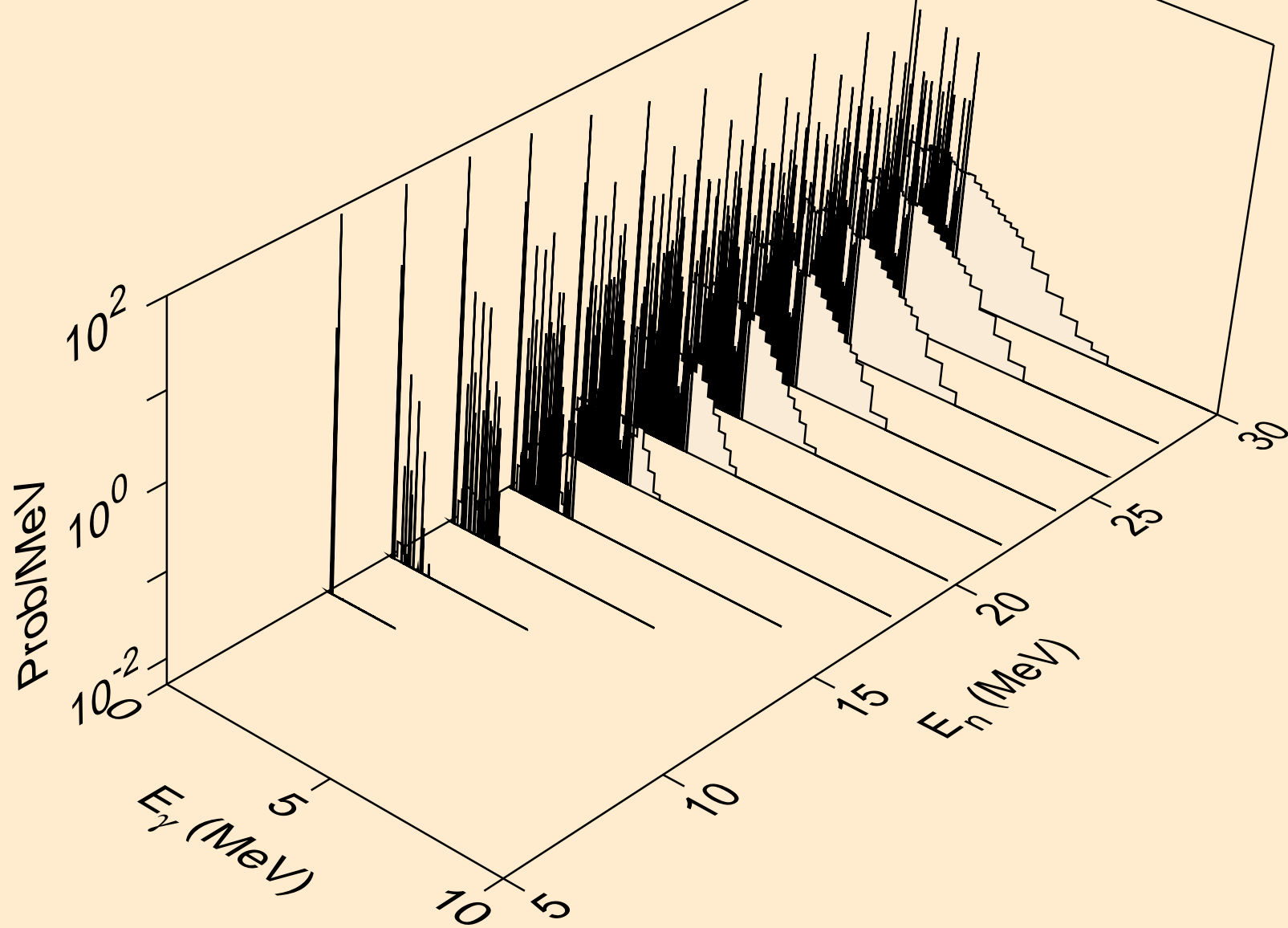

TE113 NEUTRON ACER TENDL-2024 LIBRARY; T=293.6K  
Photon emission for (n,npa)

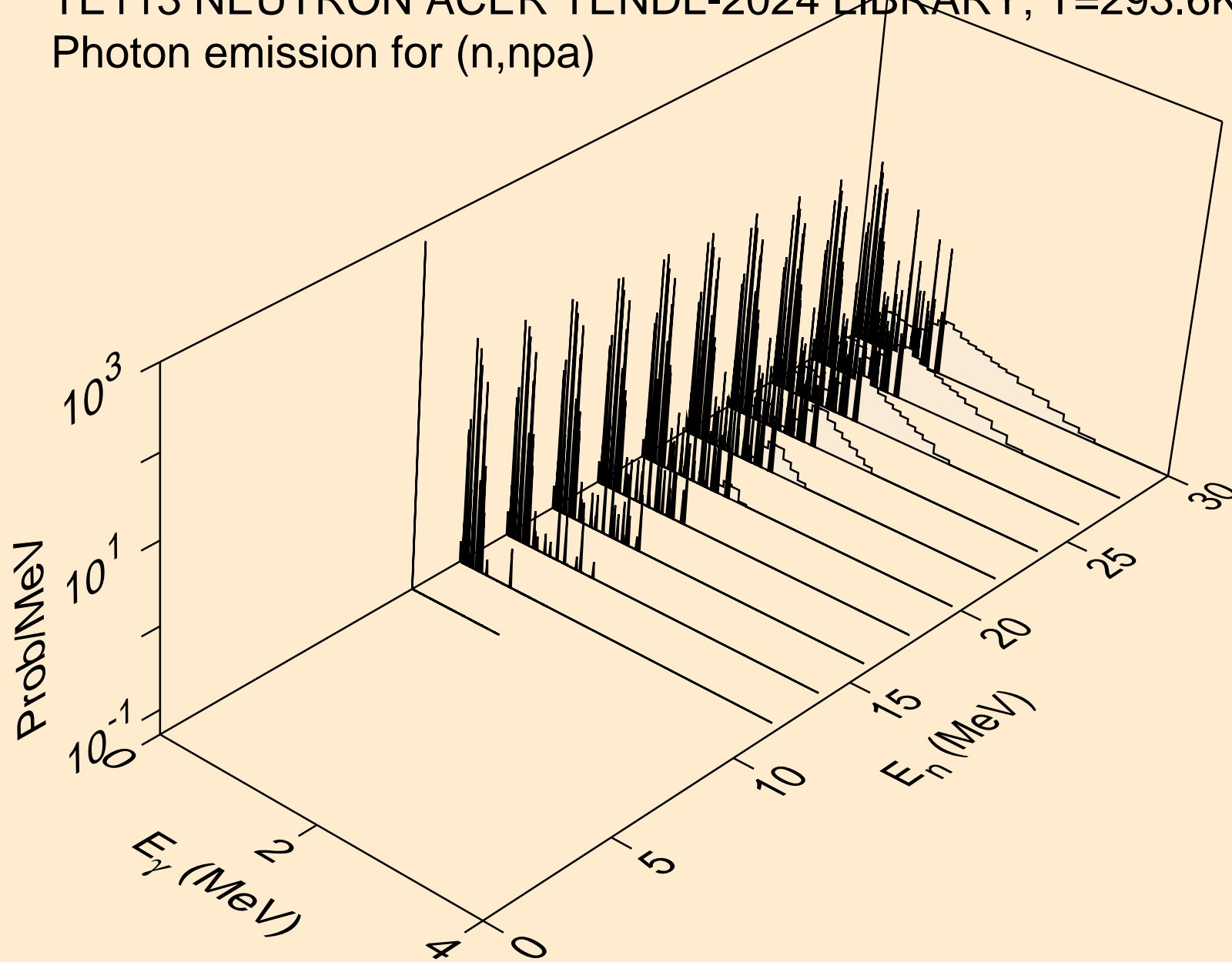

TE113 NEUTRON ACER TENDL-2024 LIBRARY; T=293.6K  
Photon emission for (n,n\*c)

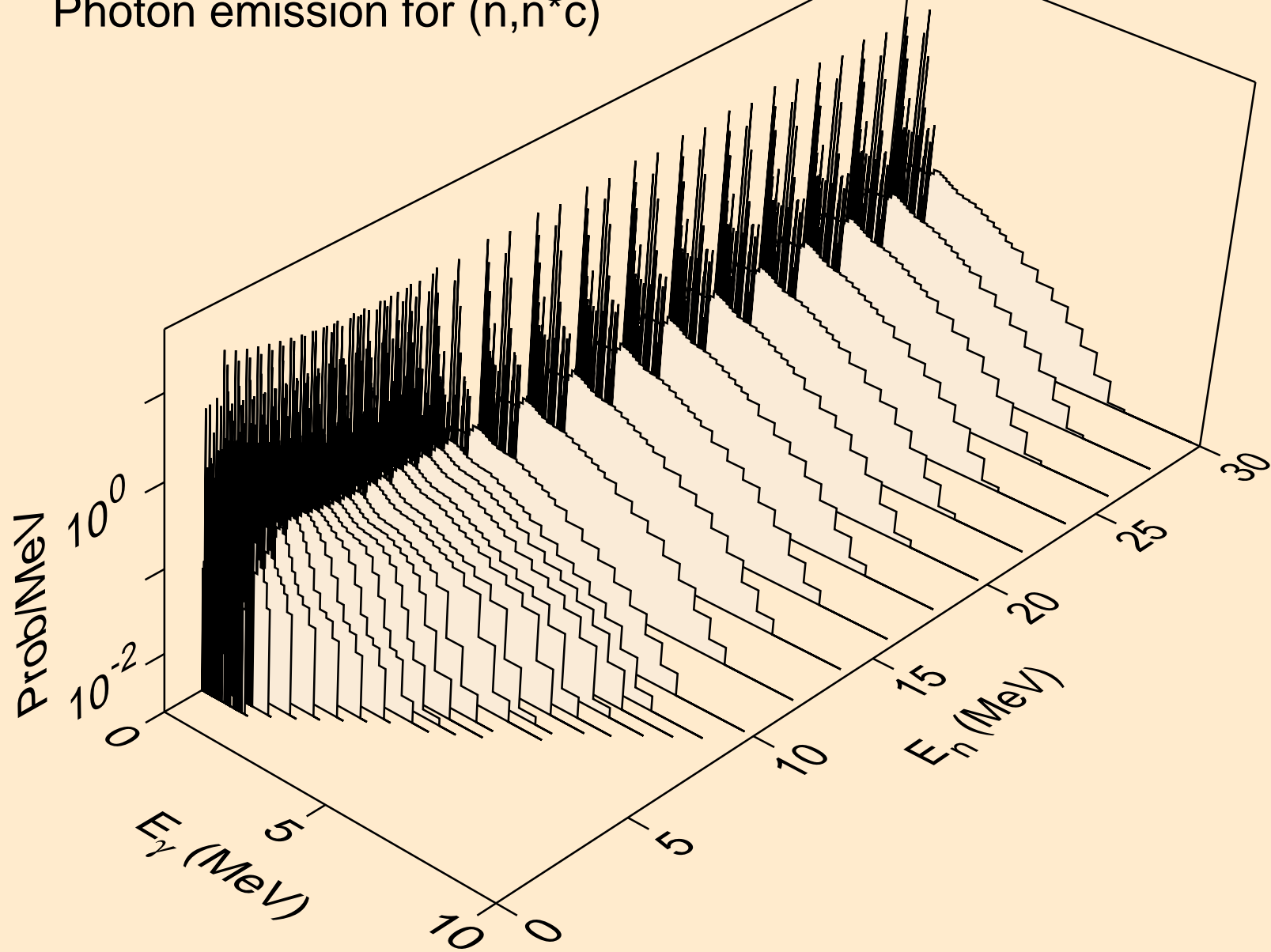

TE113 NEUTRON ACER TENDL-2024 LIBRARY; T=293.6K  
Photon emission for (n,gma)

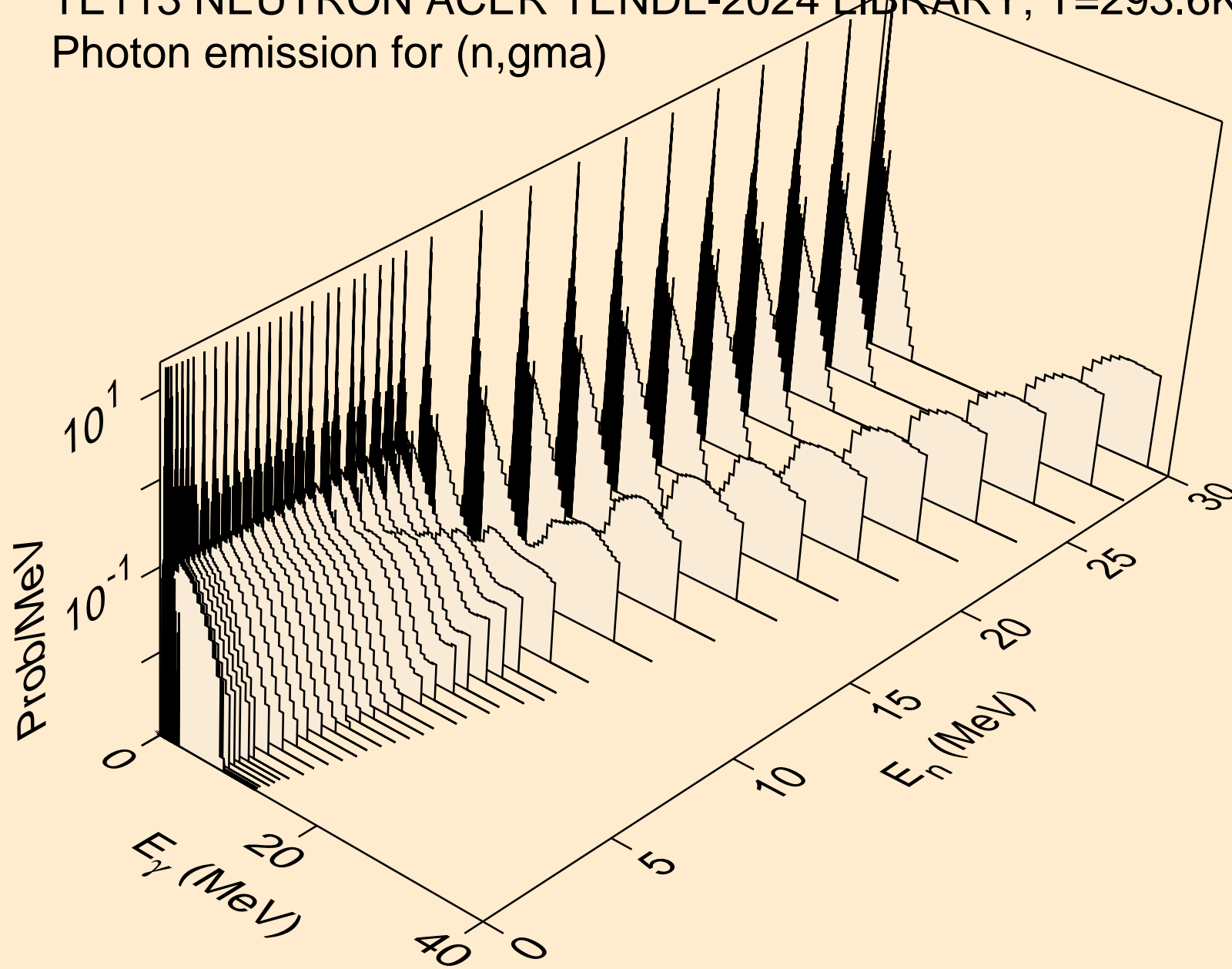

TE113 NEUTRON ACER TENDL-2024 LIBRARY; T=293.6K  
Photon emission for (n,p)

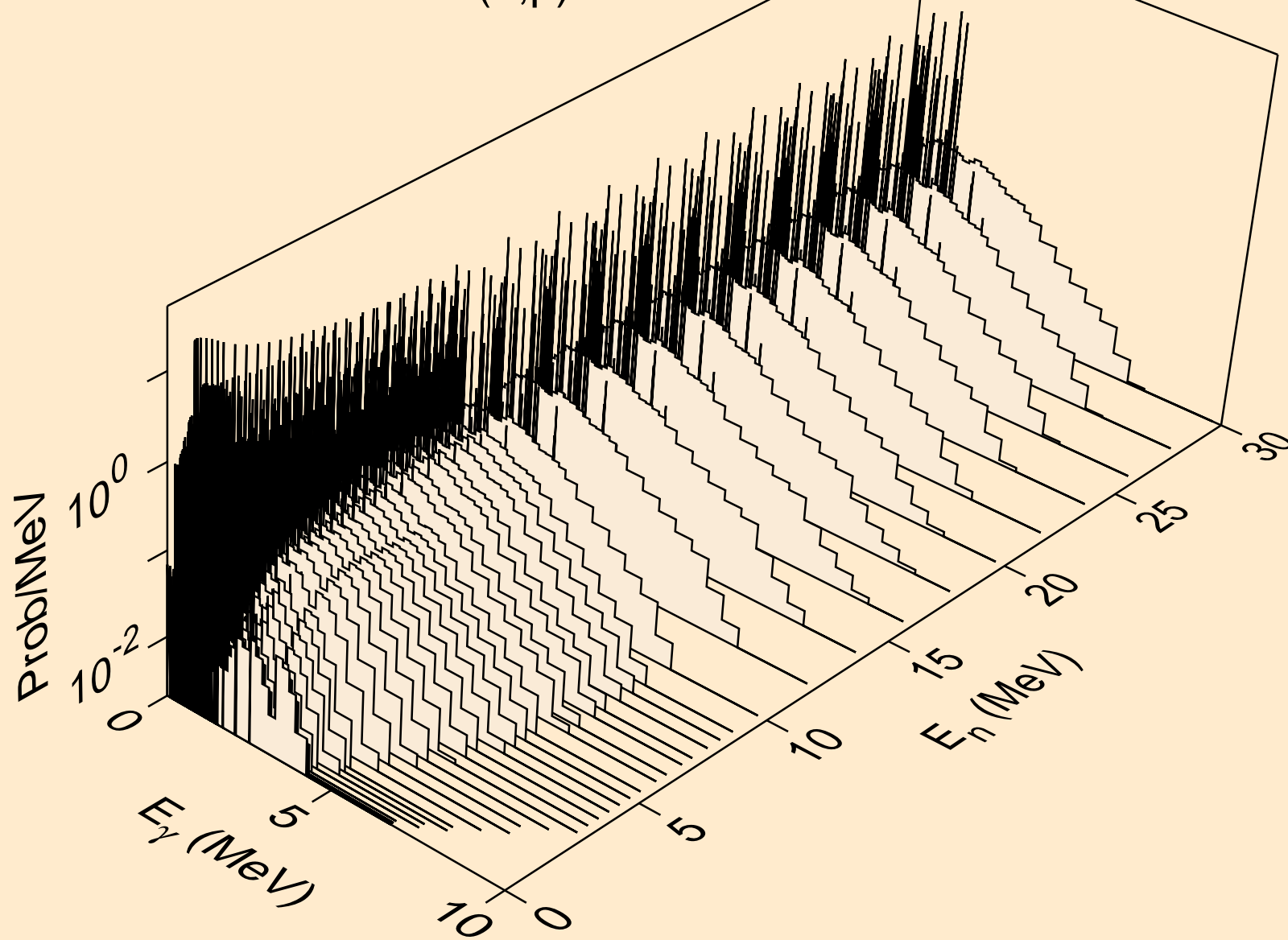

TE113 NEUTRON ACER TENDL-2024 LIBRARY; T=293.6K  
Photon emission for (n,d)

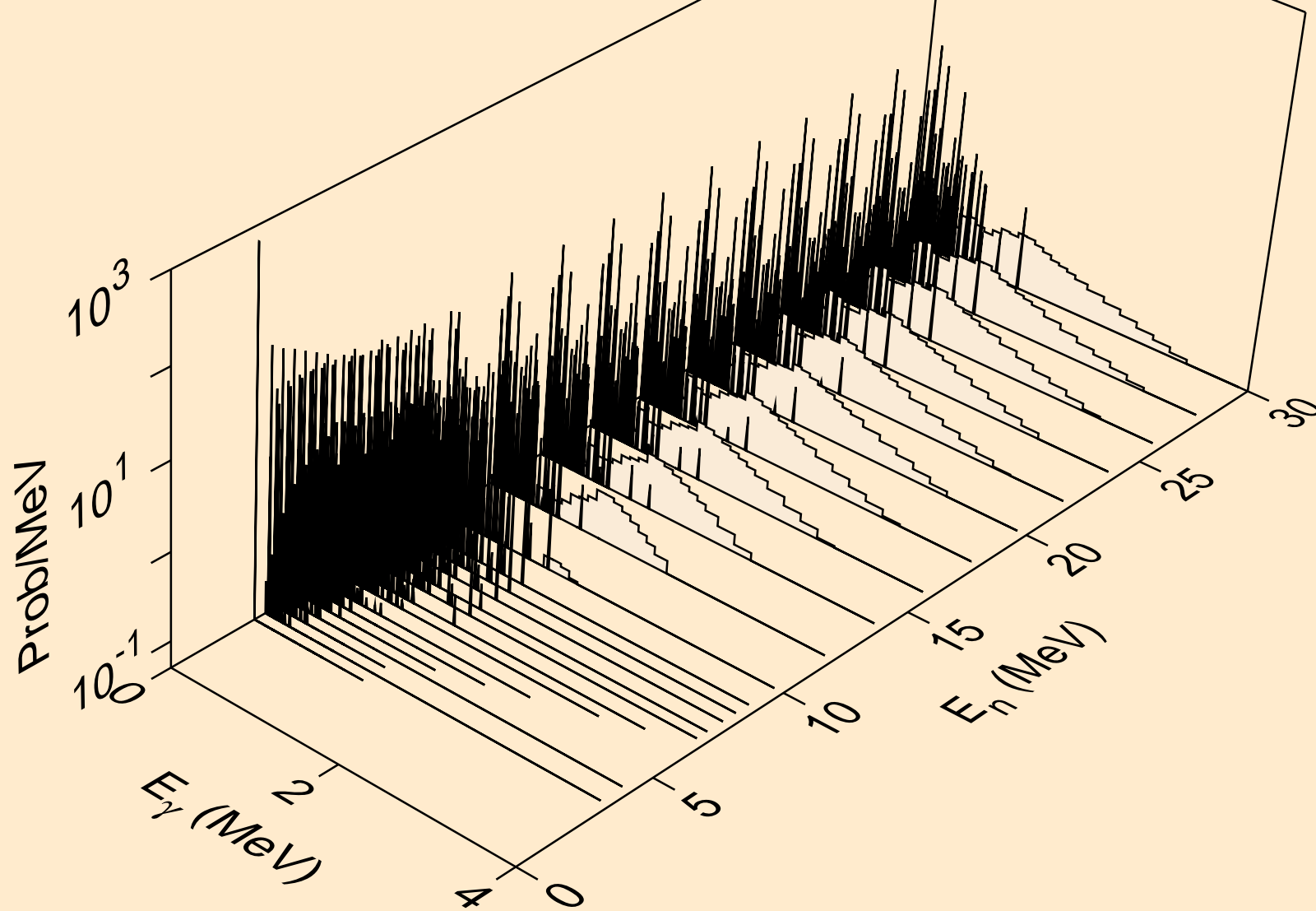

TE113 NEUTRON ACER TENDL-2024 LIBRARY; T=293.6K  
Photon emission for (n,t)

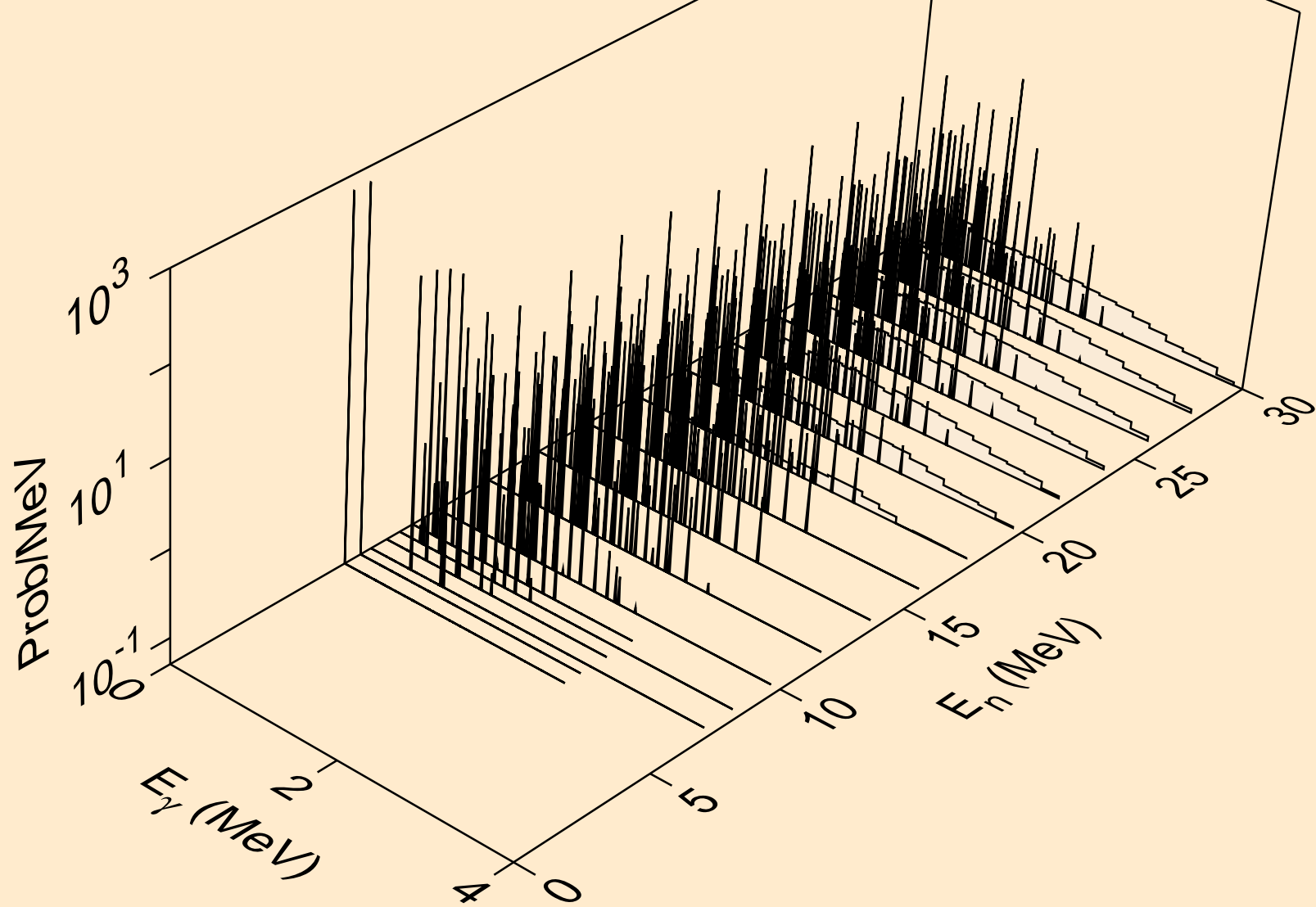

TE113 NEUTRON ACER TENDL-2024 LIBRARY; T=293.6K  
Photon emission for (n,he3)

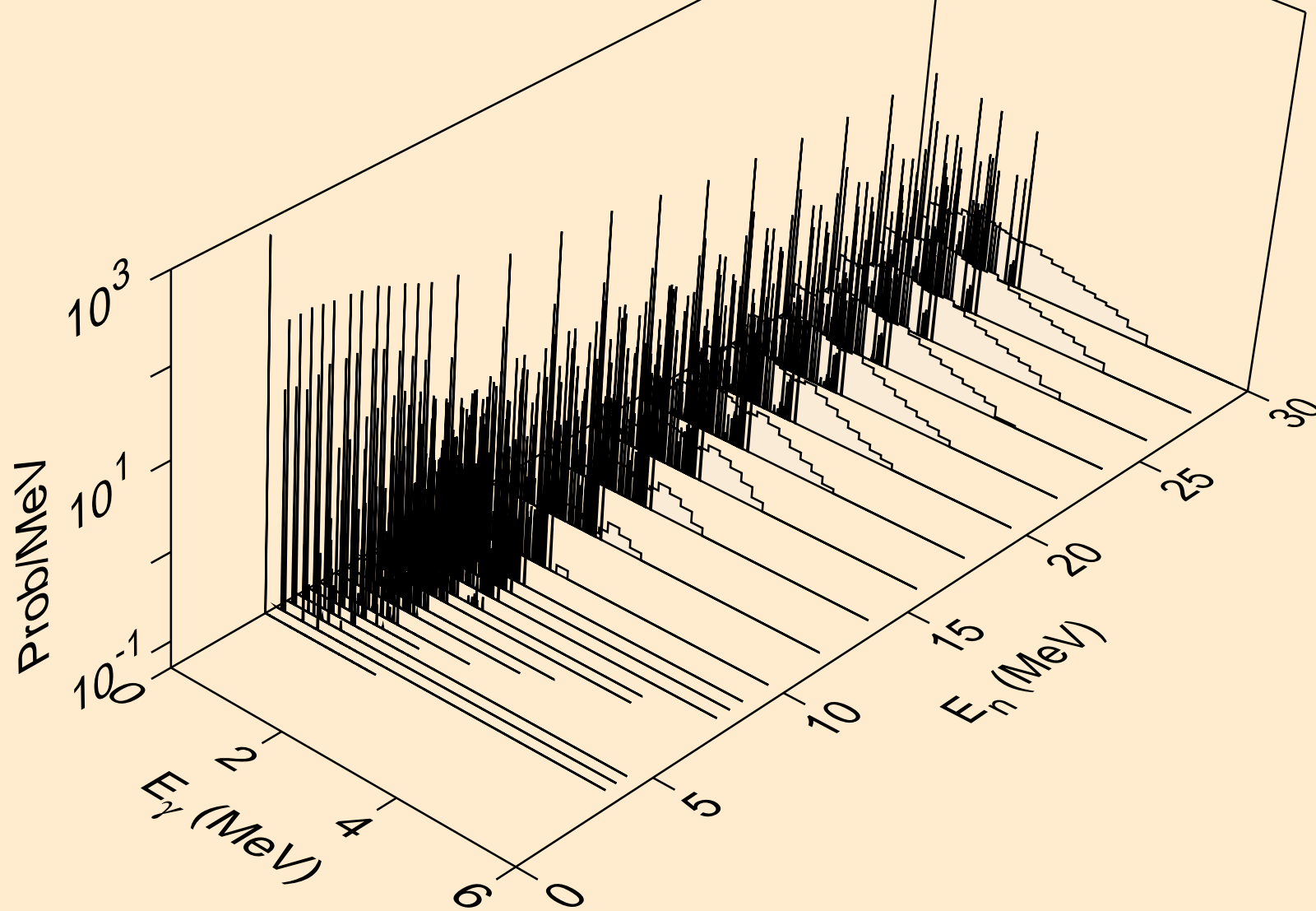

TE113 NEUTRON ACER TENDL-2024 LIBRARY; T=293.6K  
Photon emission for (n,a)

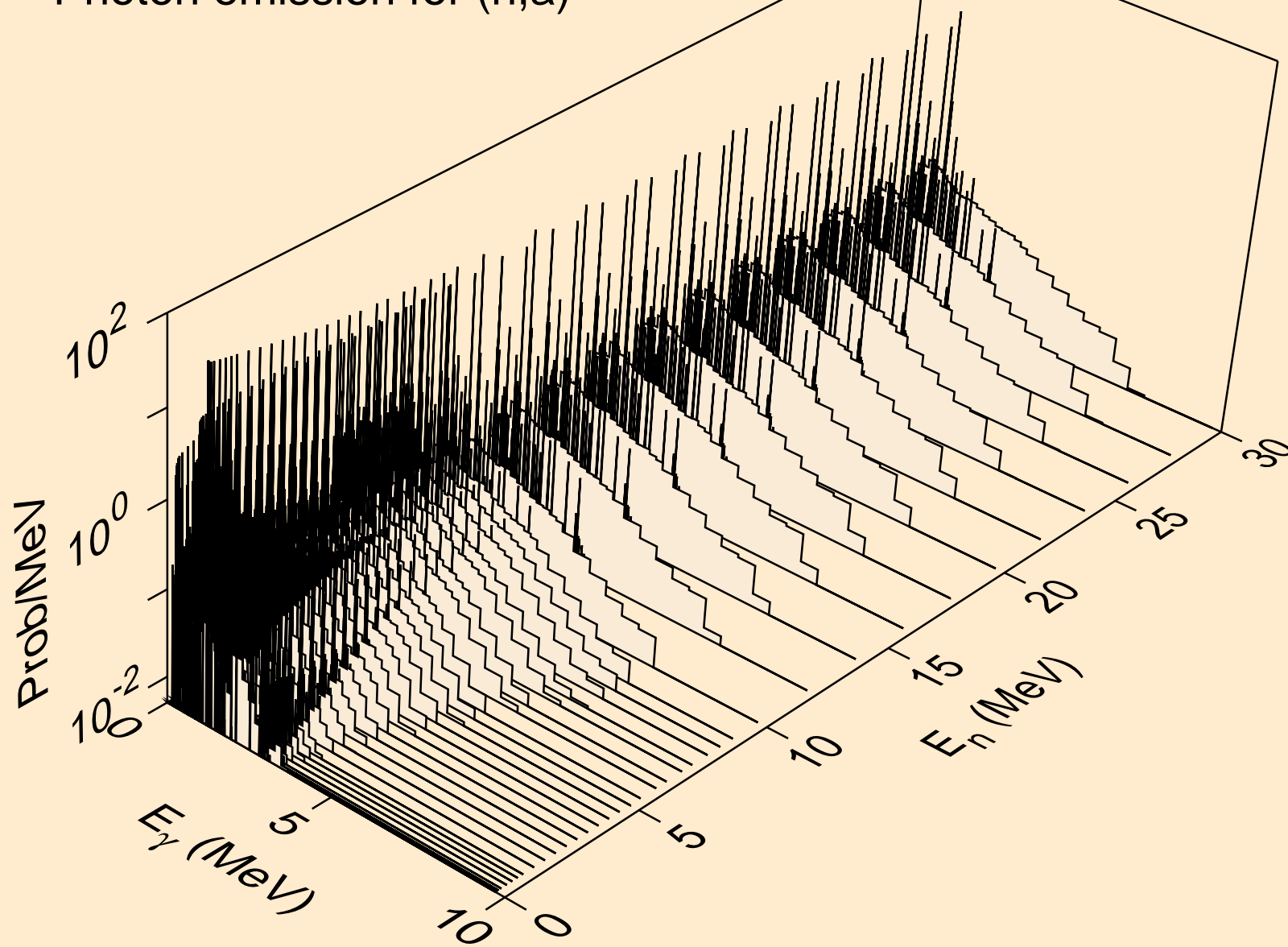

TE113 NEUTRON ACER TENDL-2024 LIBRARY; T=293.6K  
Photon emission for (n,2a)

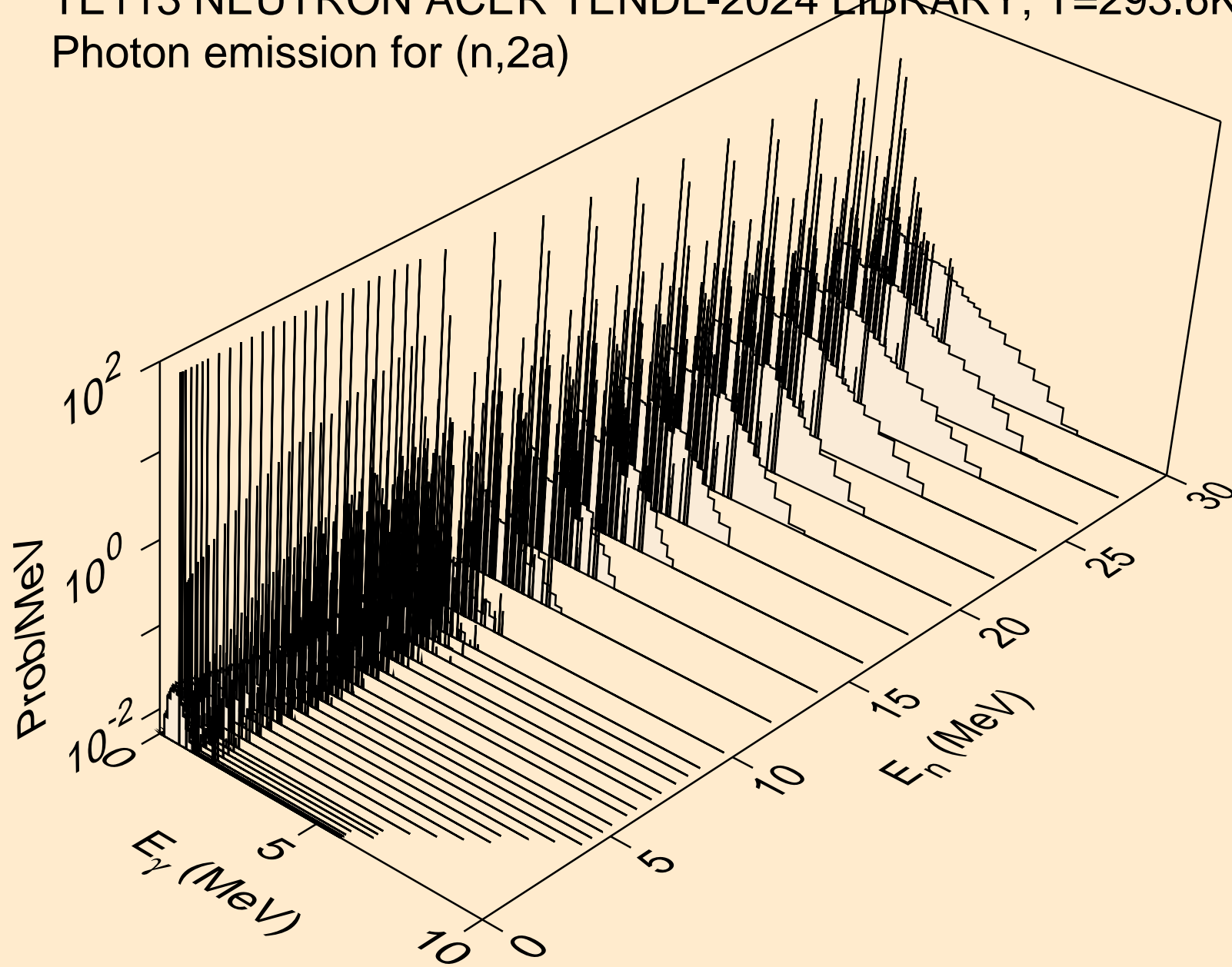

TE113 NEUTRON ACER TENDL-2024 LIBRARY; T=293.6K  
Photon emission for (n,3a)

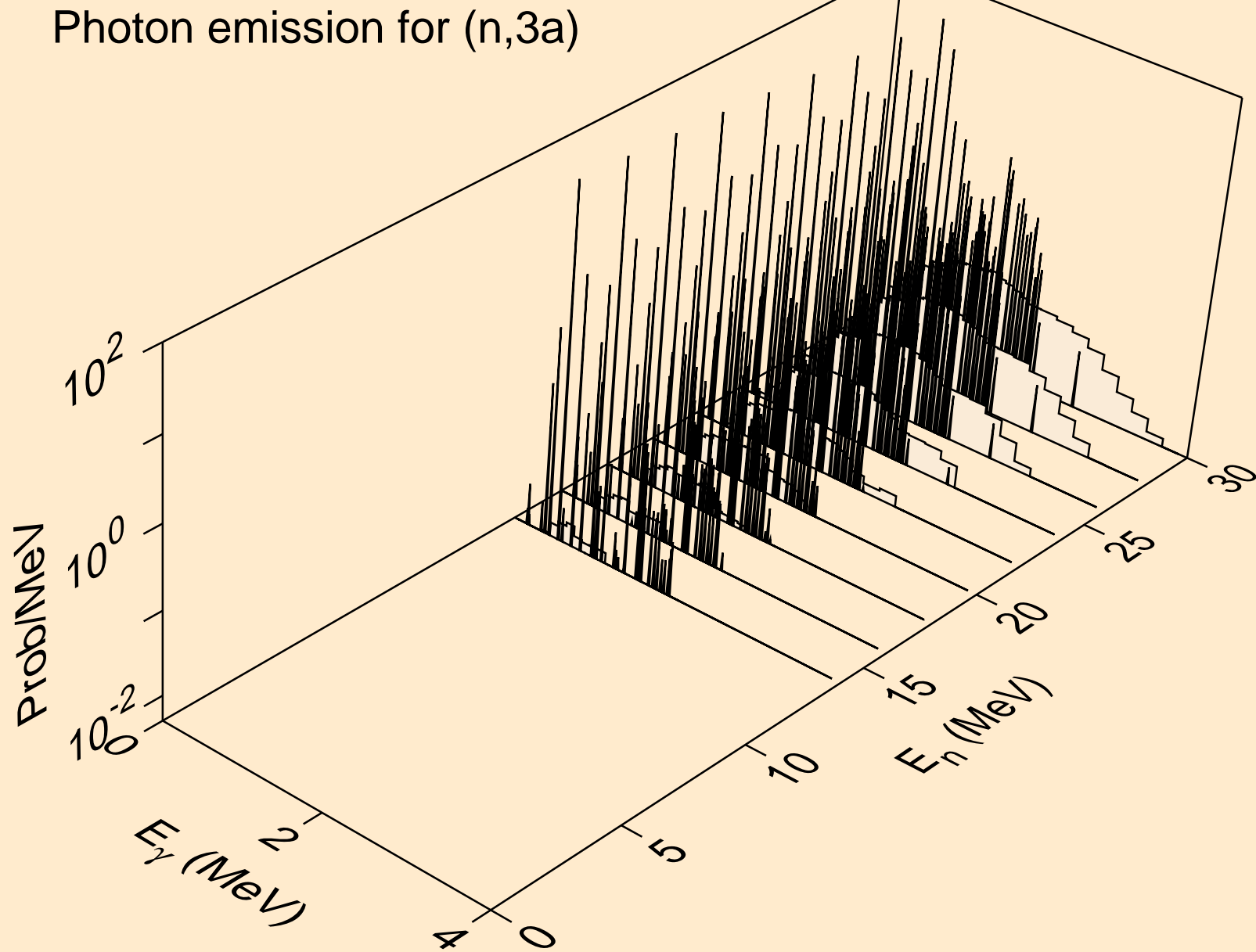

TE113 NEUTRON ACER TENDL-2024 LIBRARY; T=293.6K  
Photon emission for (n,2p)

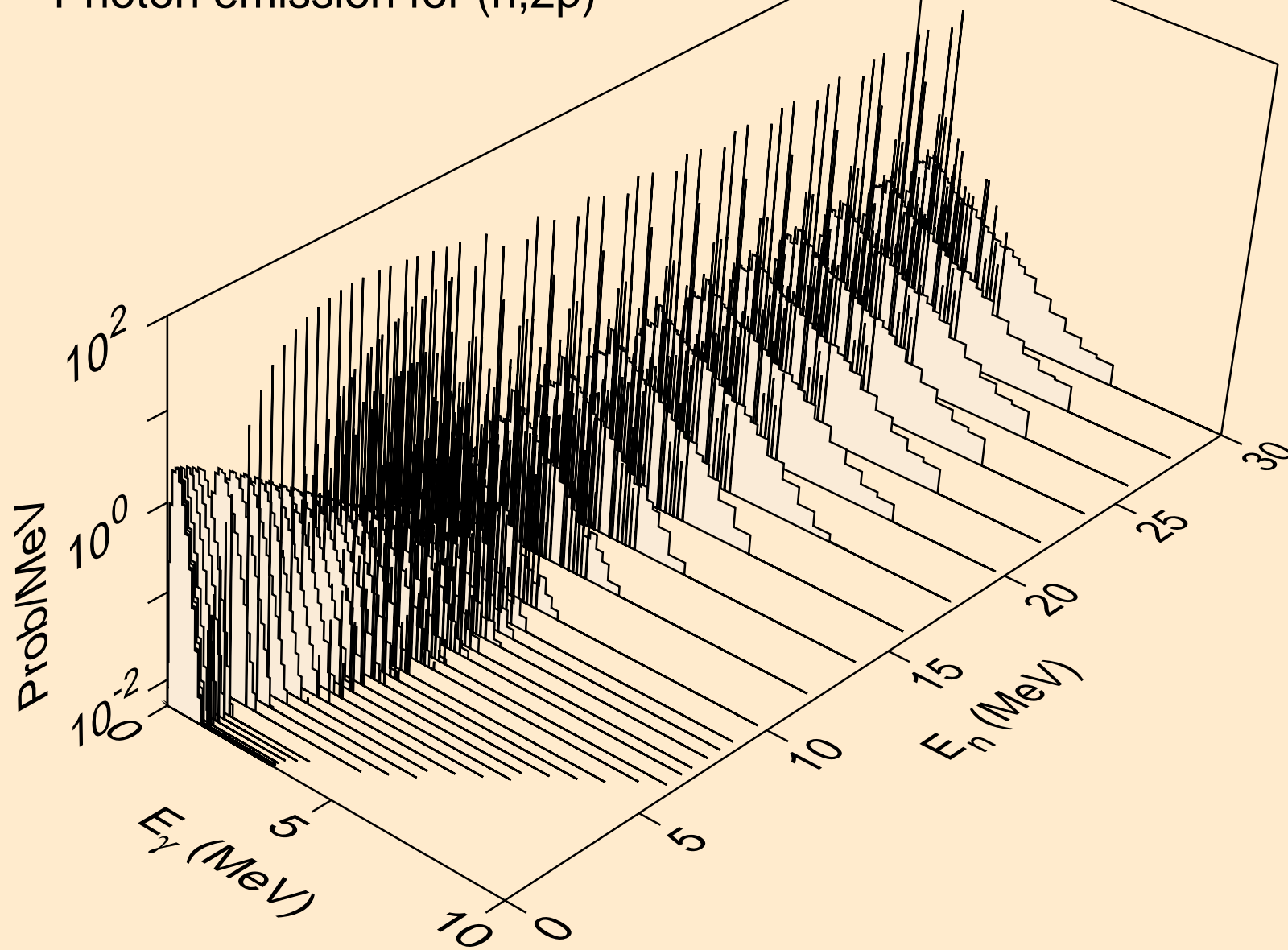

TE113 NEUTRON ACER TENDL-2024 LIBRARY; T=293.6K  
Photon emission for (n,p $\alpha$ )

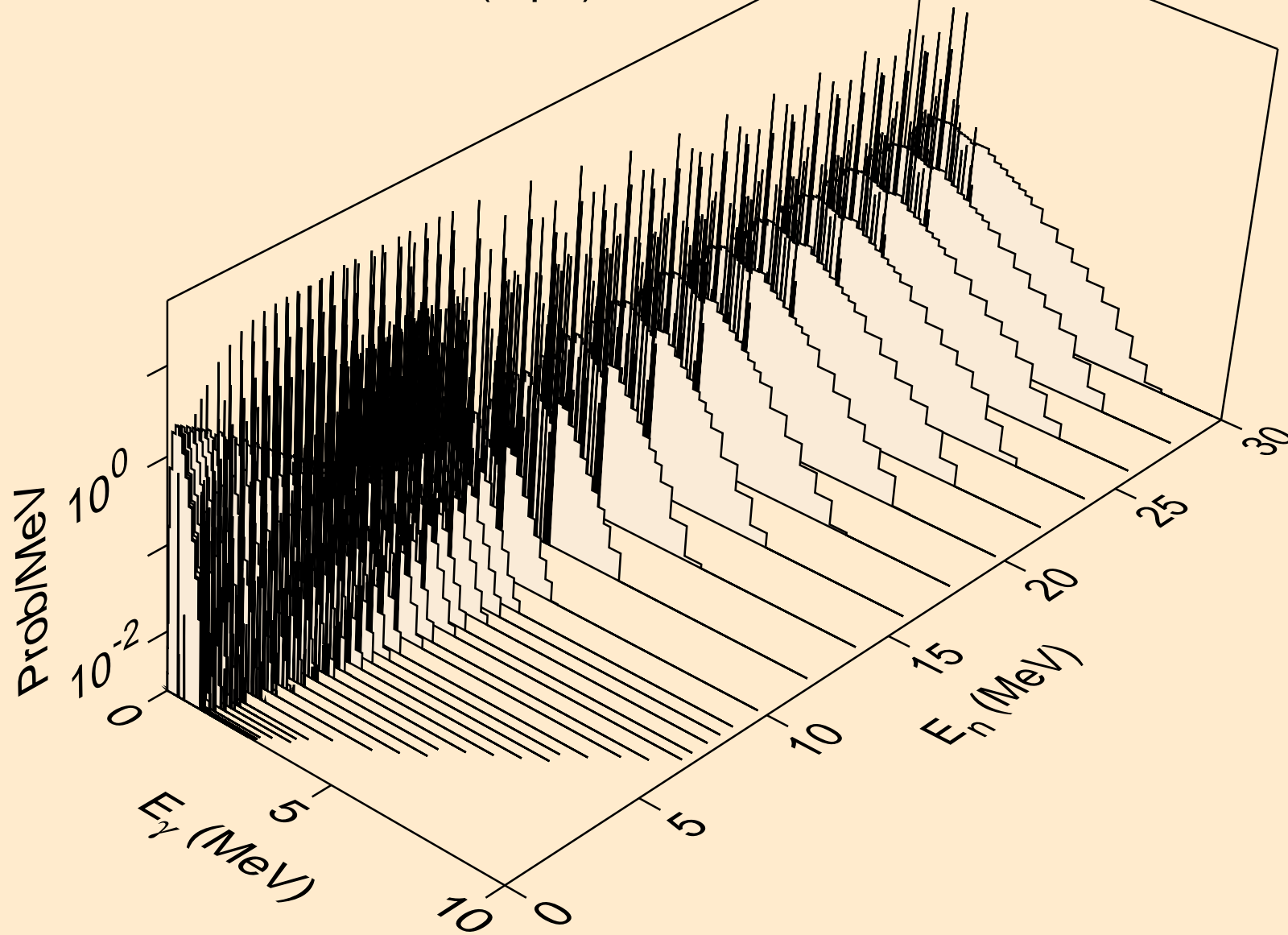

TE113 NEUTRON ACER TENDL-2024 LIBRARY; T=293.6K  
Photon emission for (n,pd)

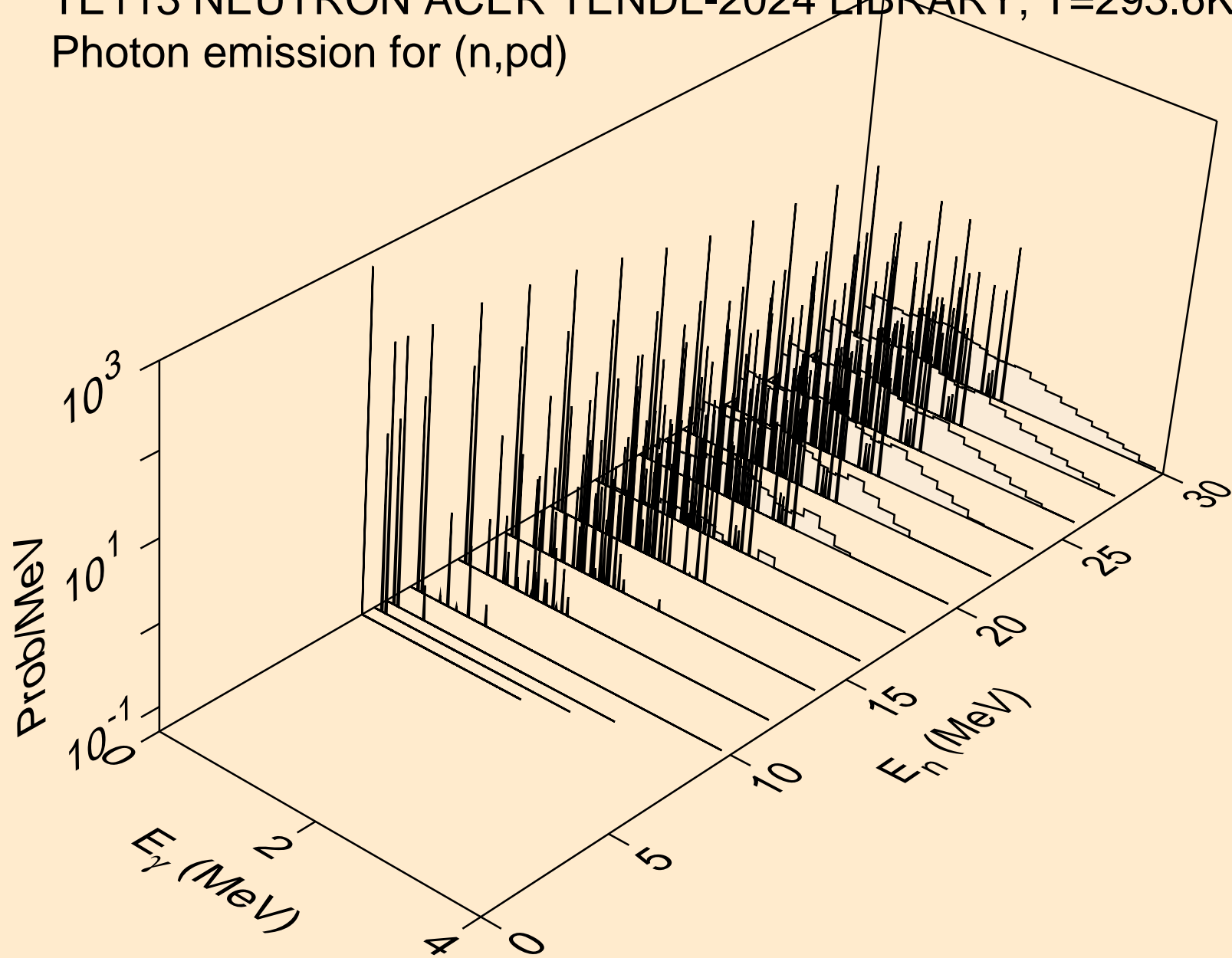

TE113 NEUTRON ACER TENDL-2024 LIBRARY; T=293.6K  
Photon emission for (n,pt)

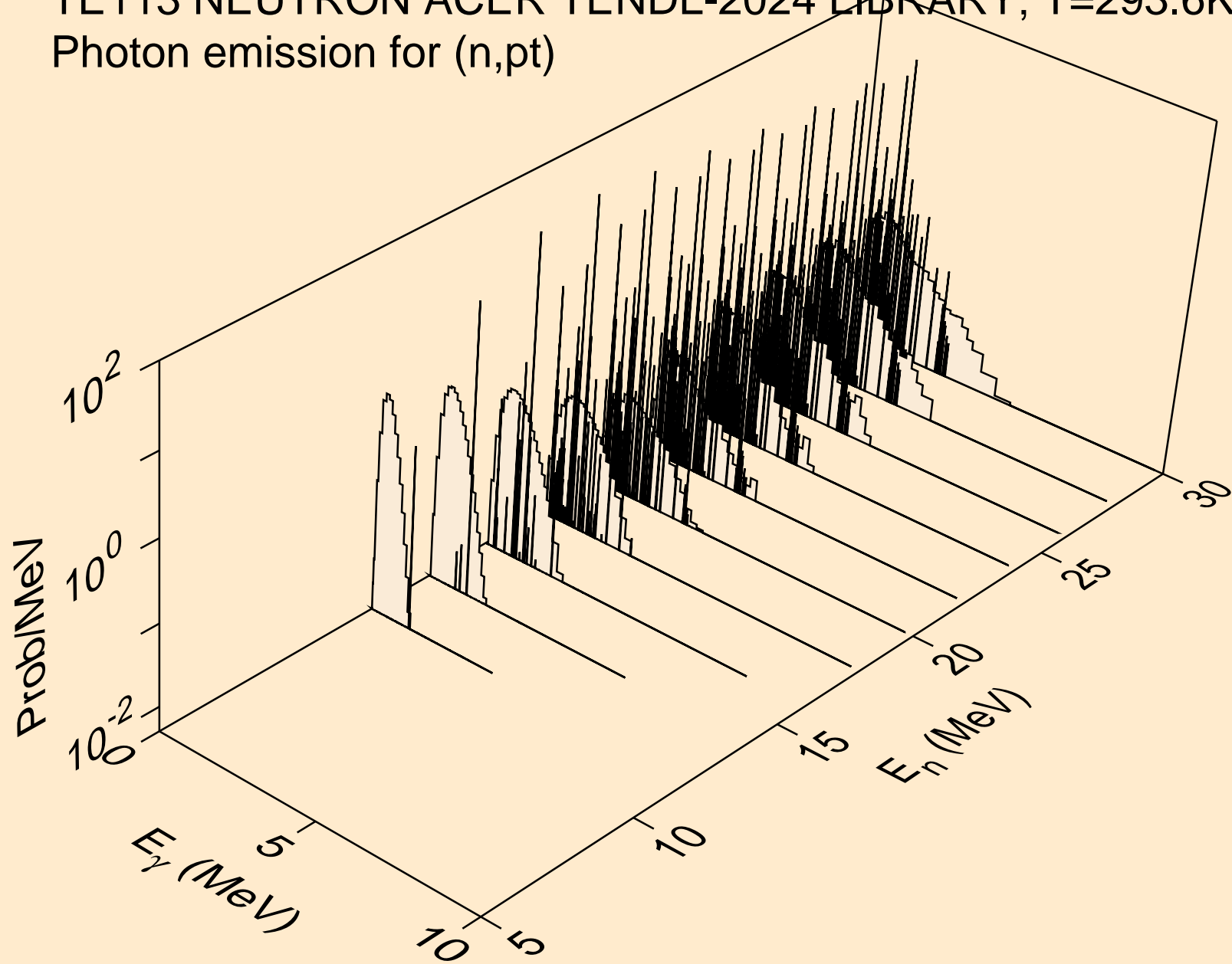

TE113 NEUTRON ACER TENDL-2024 LIBRARY; T=293.6K  
Photon emission for (n,da)

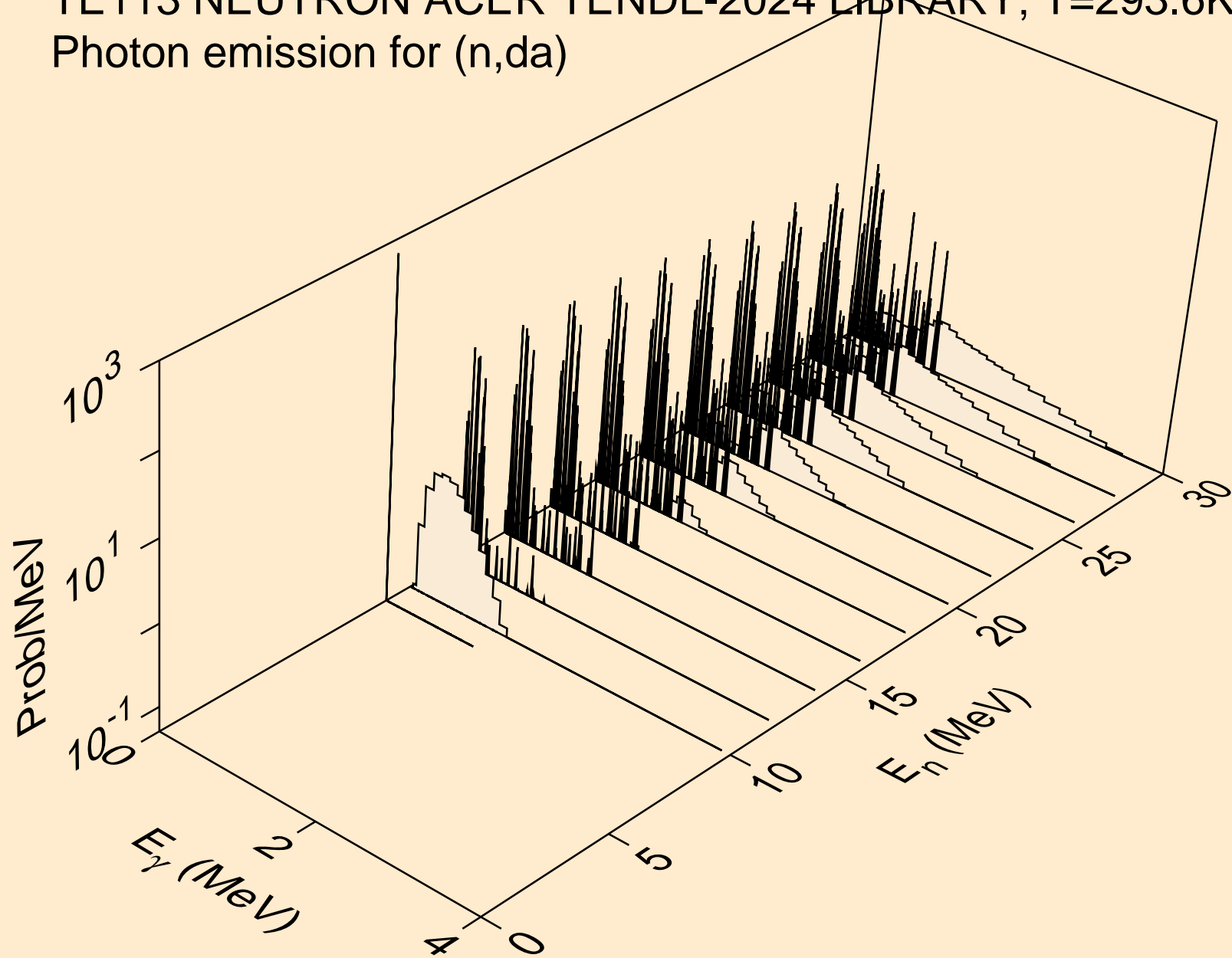

TE113 NEUTRON ACER TENDL-2024 LIBRARY; T=293.6K  
thermal capture photon spectrum

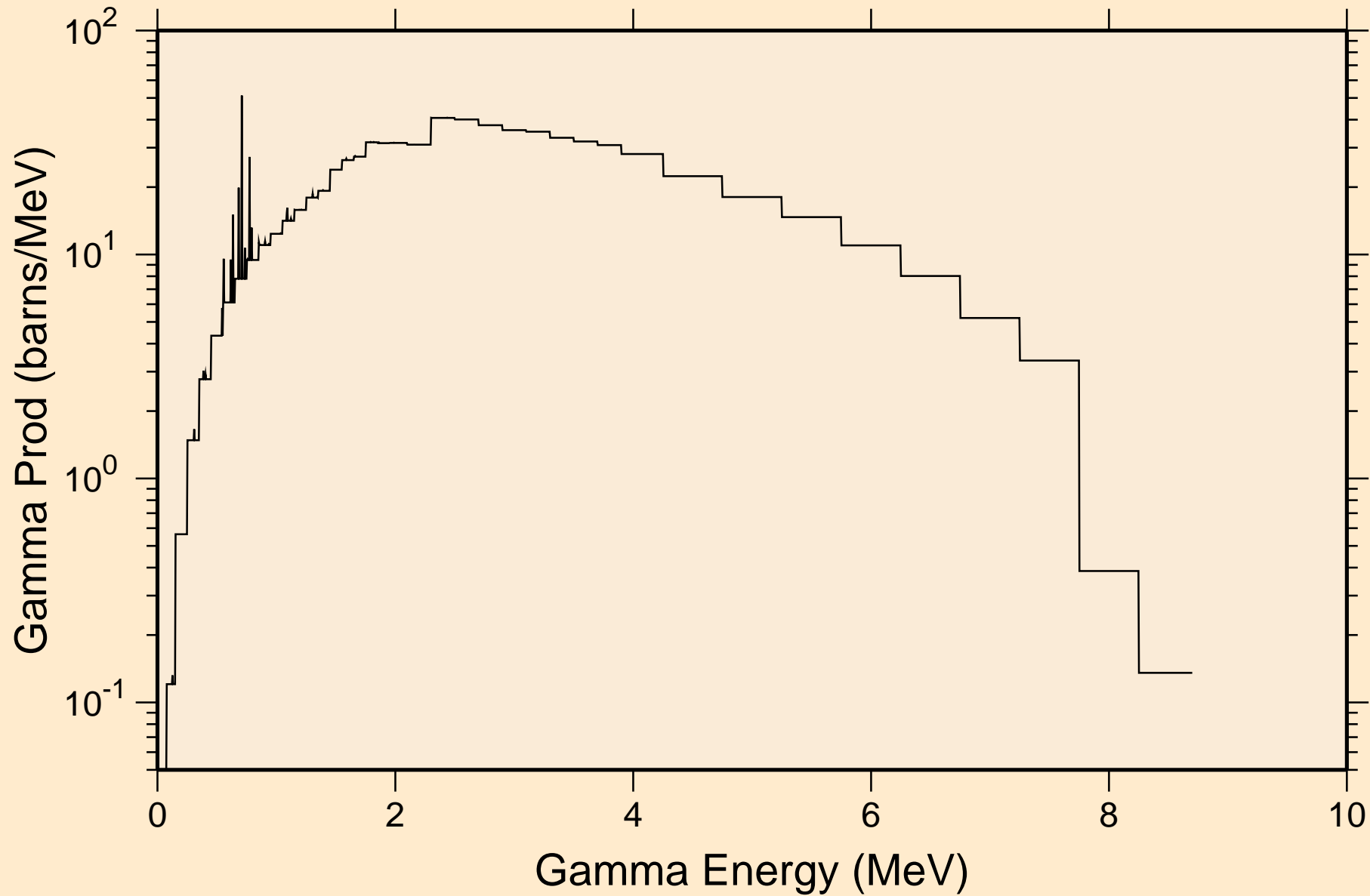

TE113 NEUTRON ACER TENDL-2024 LIBRARY; T=293.6K  
14 MeV photon spectrum

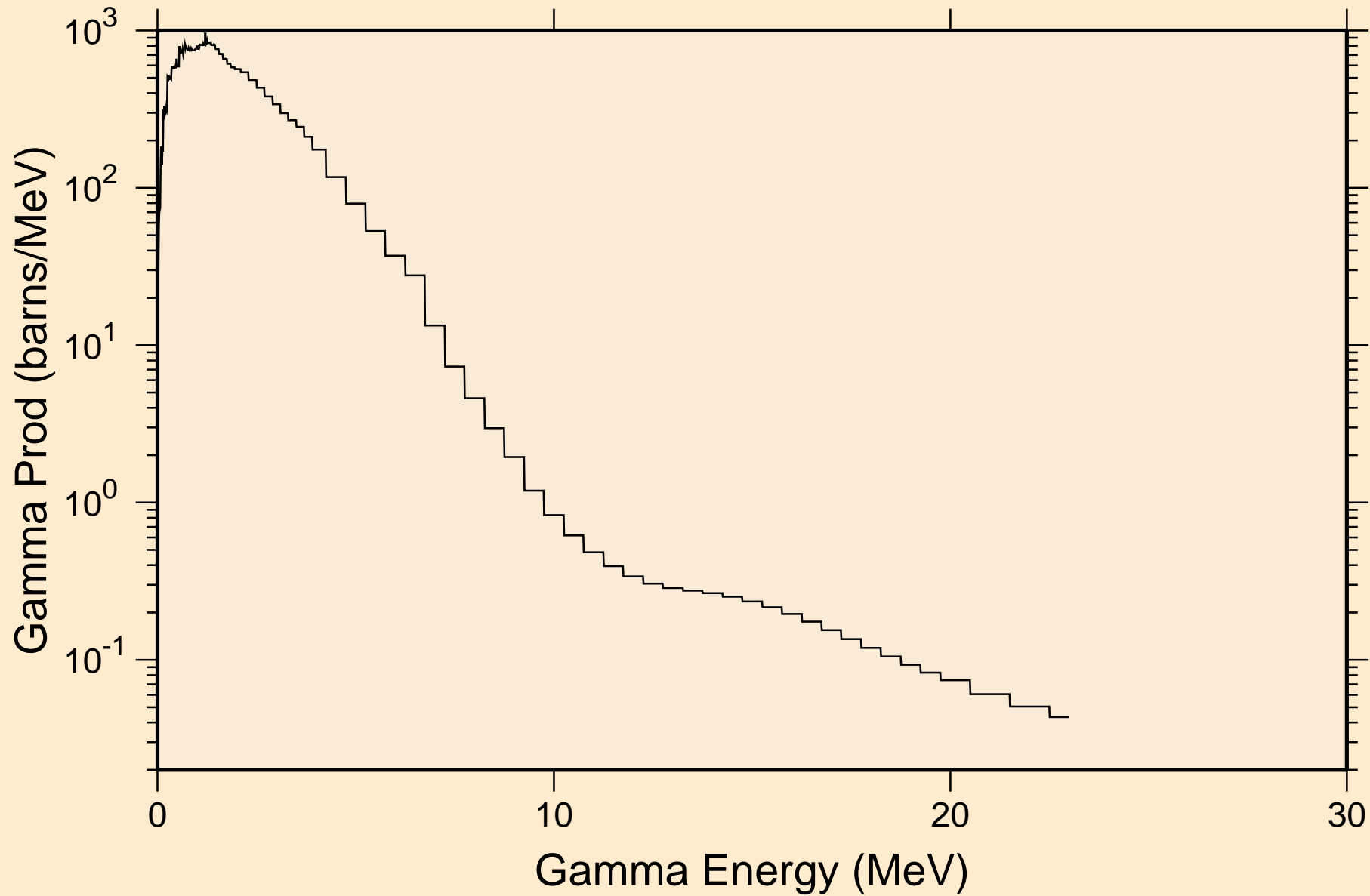

# TE113 NEUTRON ACER TENDL-2024 LIBRARY; T=293.6K

## Particle heating contributions

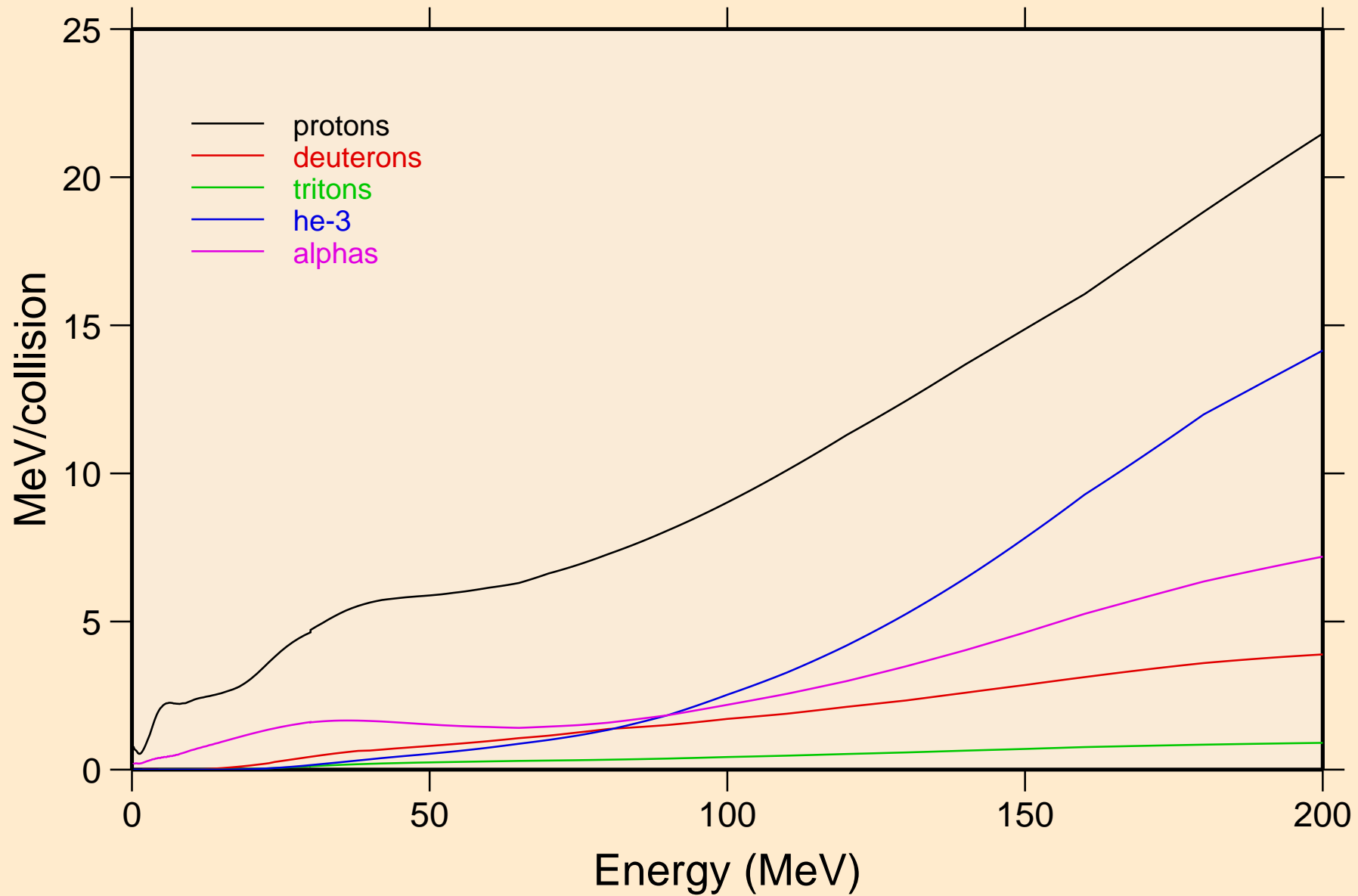

TE113 NEUTRON ACER TENDL-2024 LIBRARY; T=293.6K  
Recoil Heating

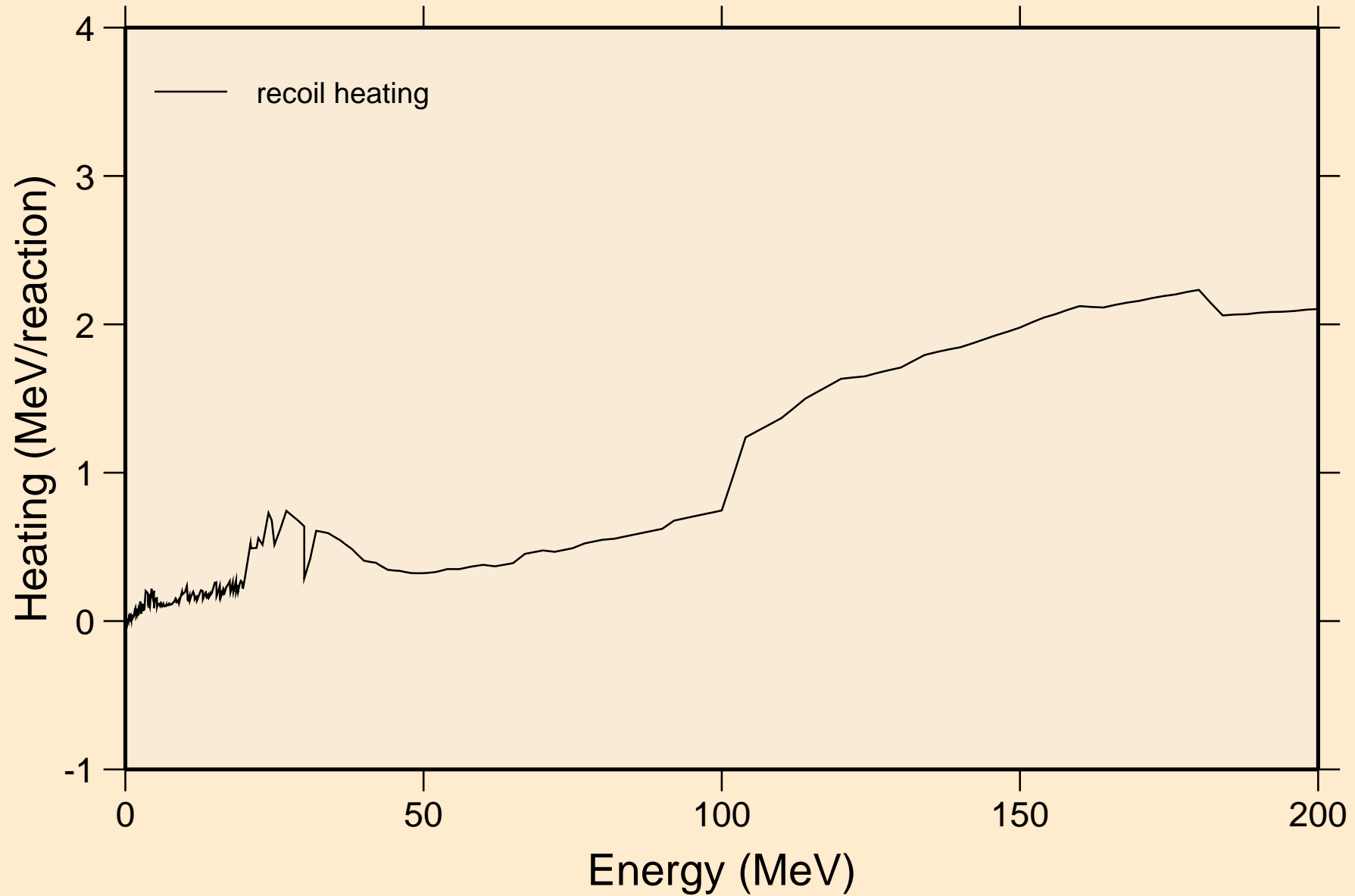

TE113 NEUTRON ACER TENDL-2024 LIBRARY; T=293.6K  
Particle production cross sections

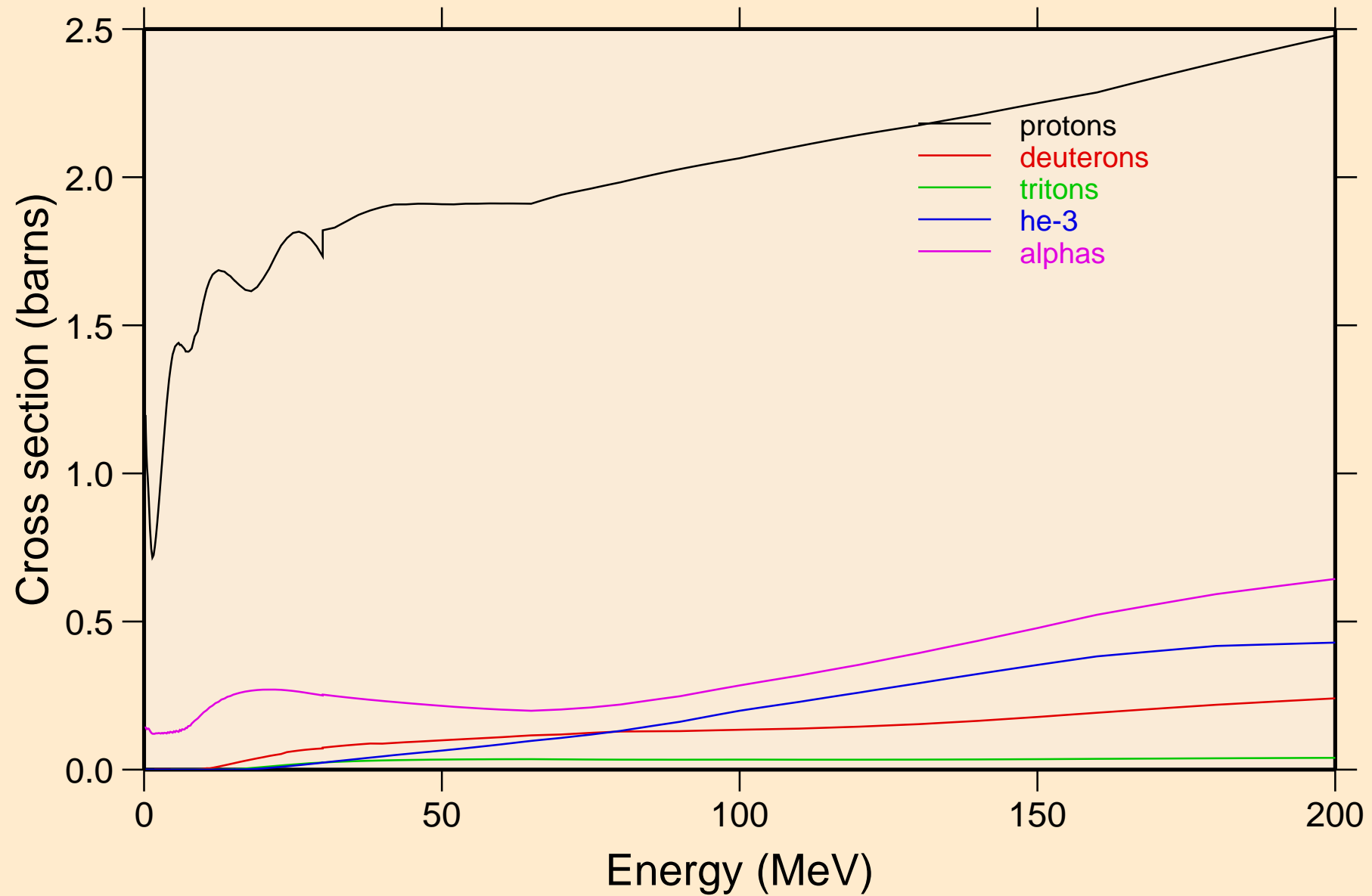

TE113 NEUTRON ACER TENDL-2024 LIBRARY; T=293.6K  
protons from (n,x)

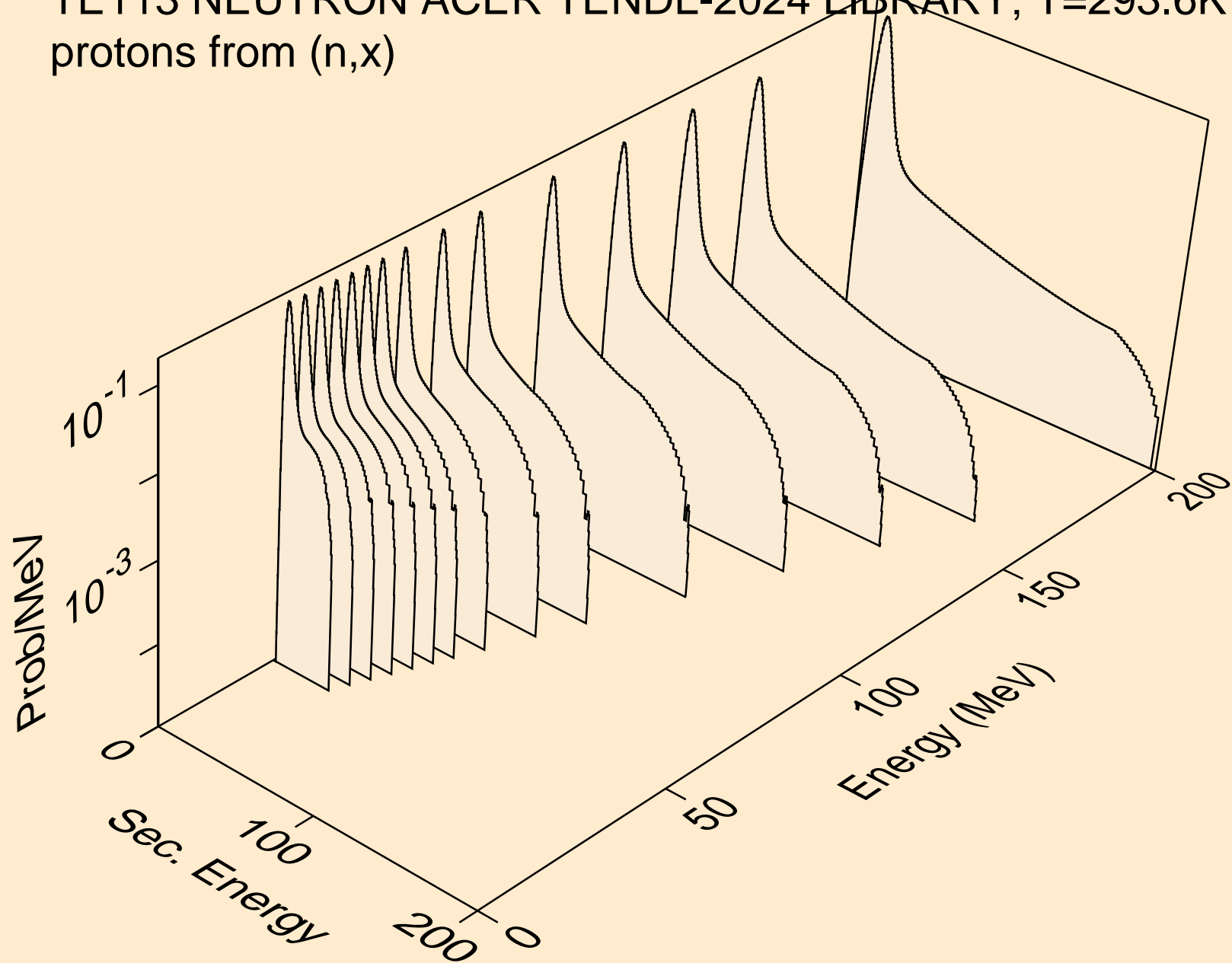

TE113 NEUTRON ACER TENDL-2024 LIBRARY; T=293.6K  
protons from (n,n\*)p

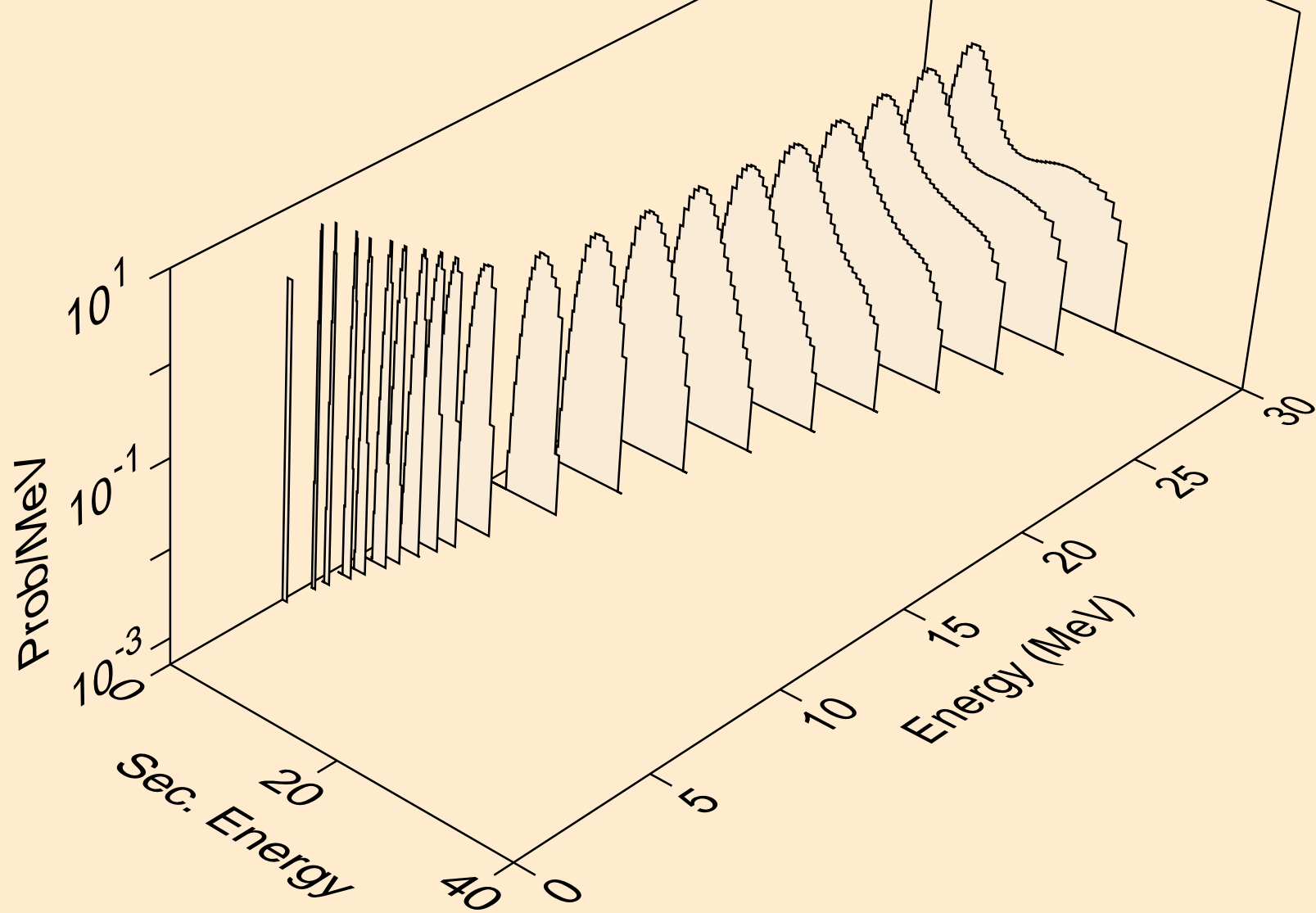

TE113 NEUTRON ACER TENDL-2024 LIBRARY; T=293.6K  
protons from (n,2np)

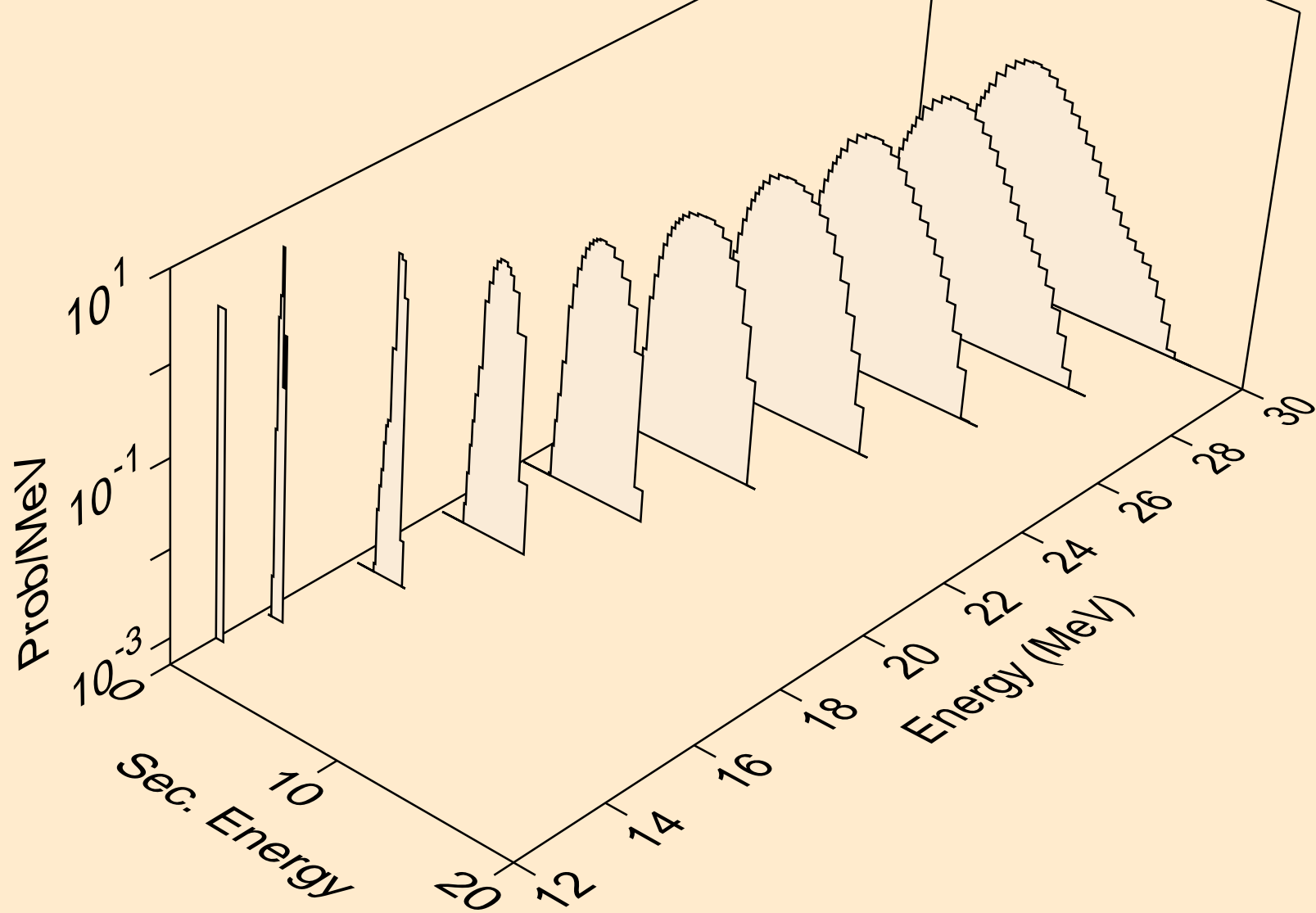

TE113 NEUTRON ACER TENDL-2024 LIBRARY; T=293.6K  
protons from (n,3np)

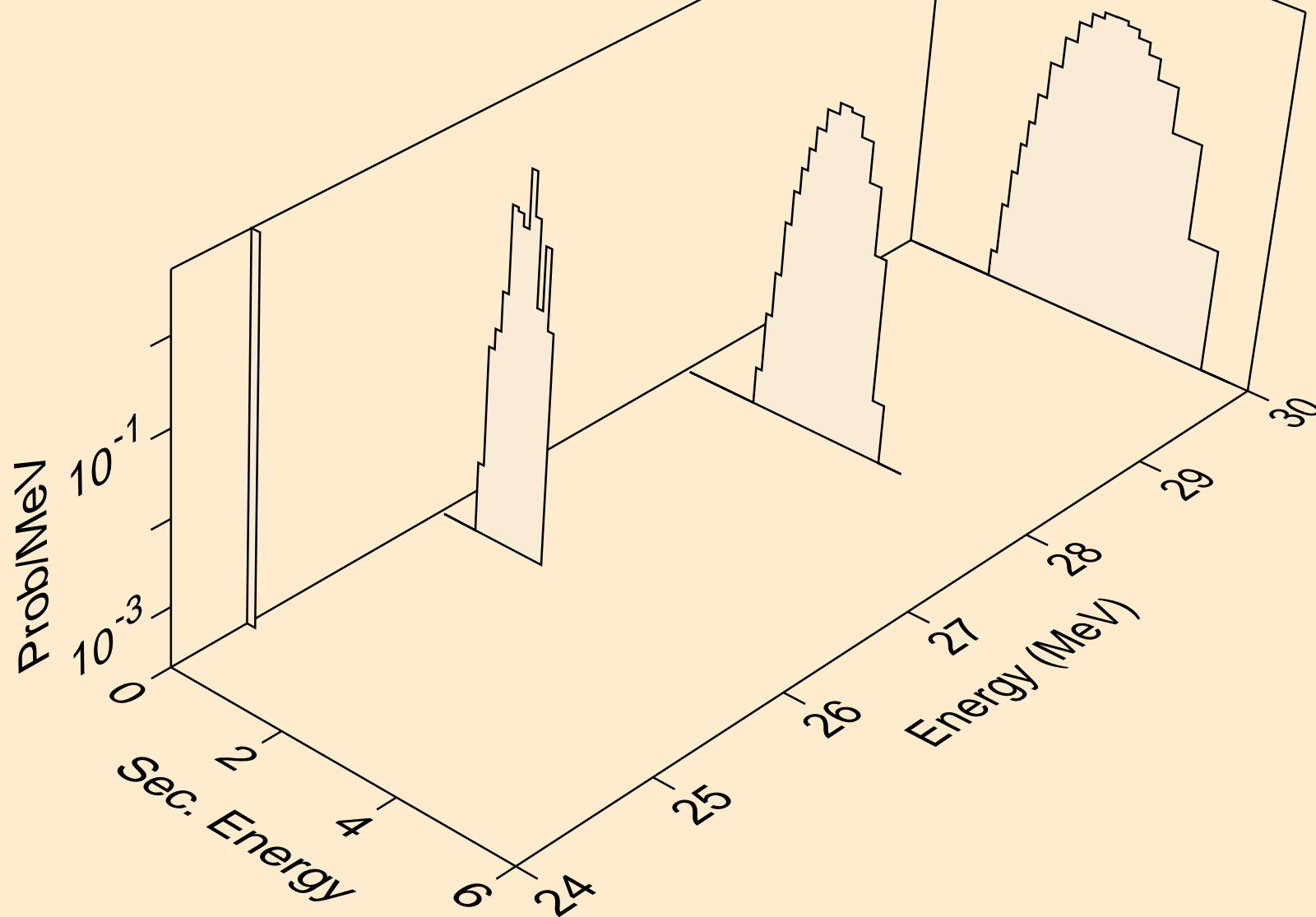

TE113 NEUTRON ACER TENDL-2024 LIBRARY; T=293.6K  
protons from (n,n2p)

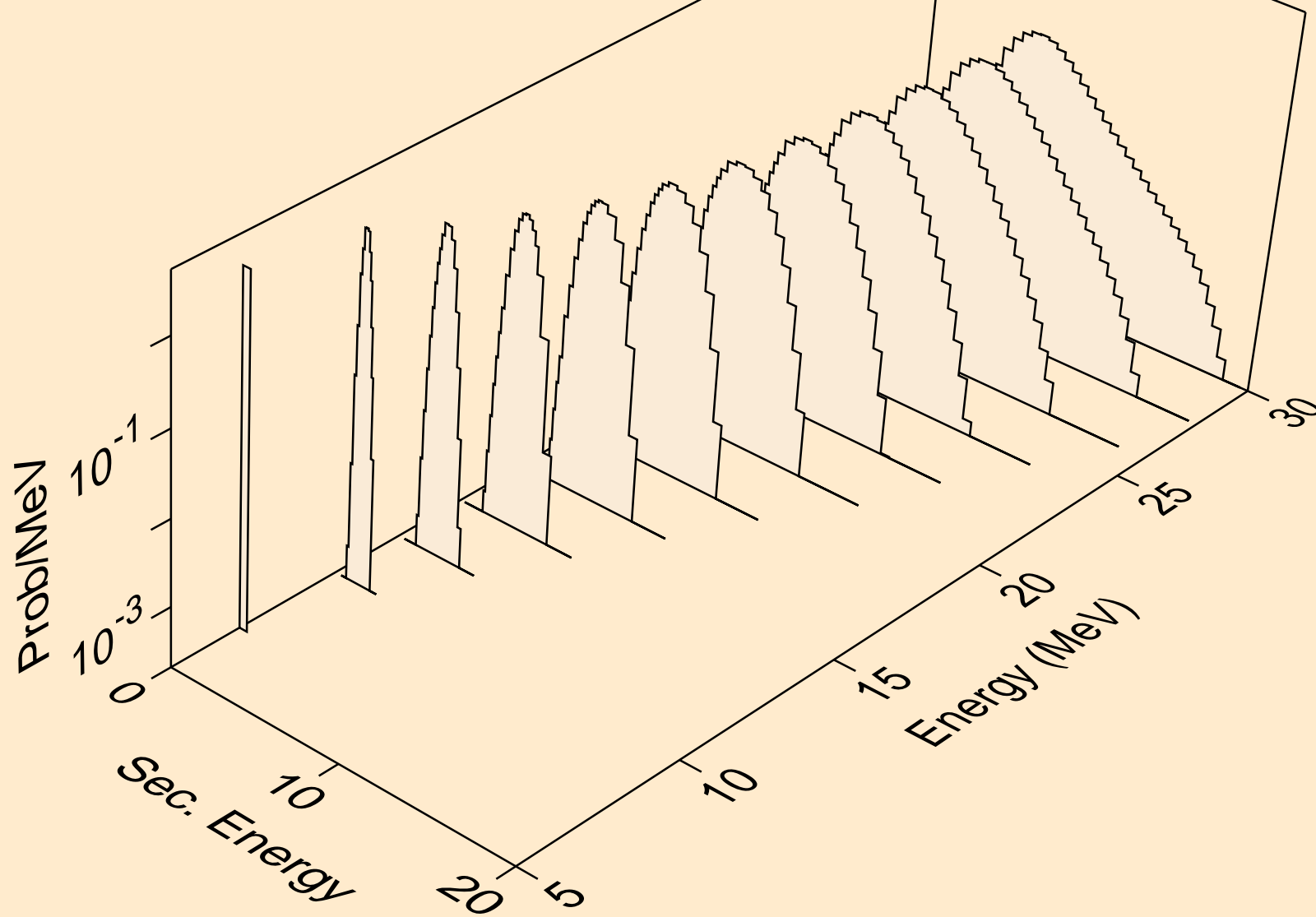

TE113 NEUTRON ACER TENDL-2024 LIBRARY; T=293.6K  
protons from (n,npa)

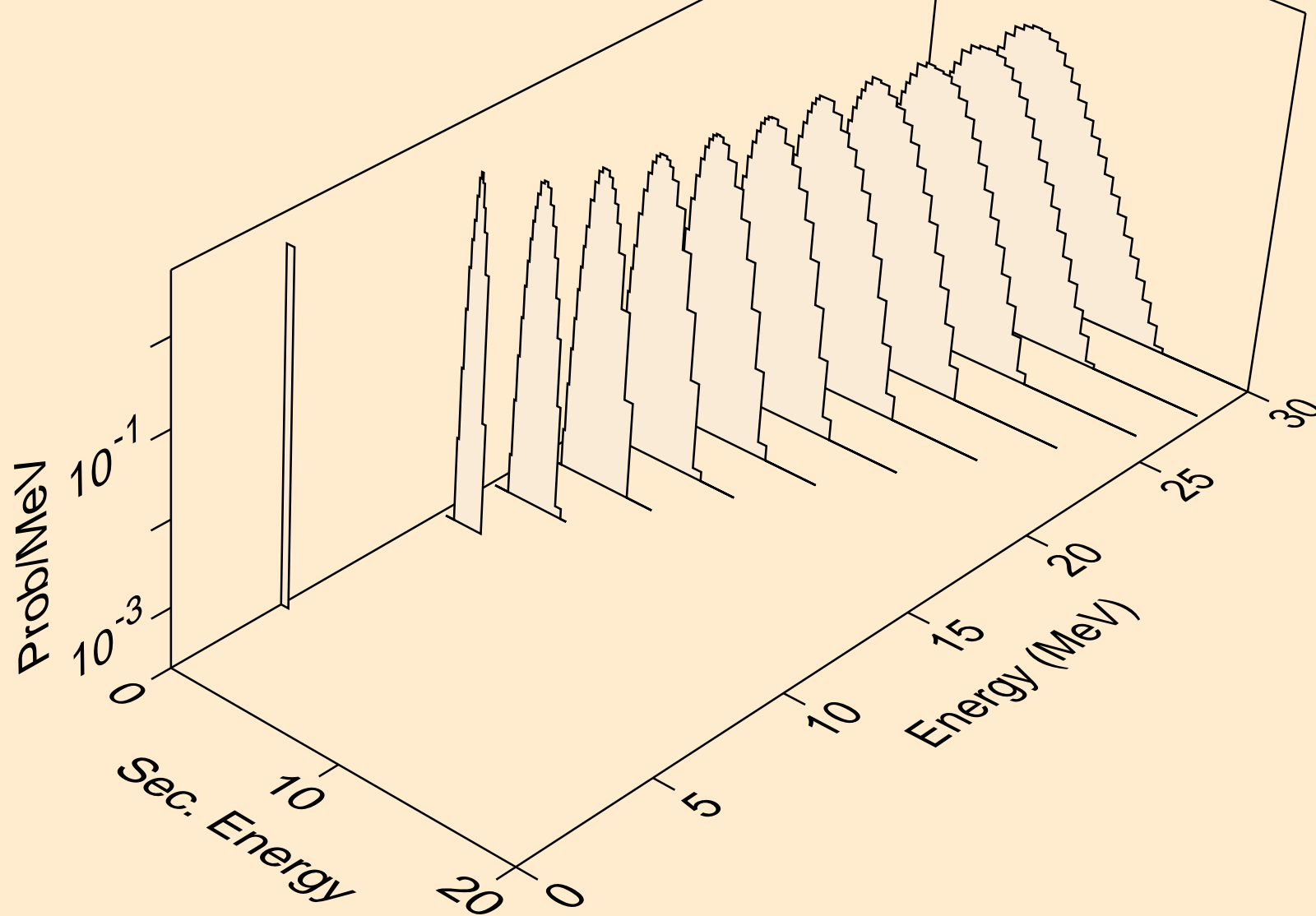

TE113 NEUTRON ACER TENDL-2024 LIBRARY; T=293.6K  
protons from (n,p)

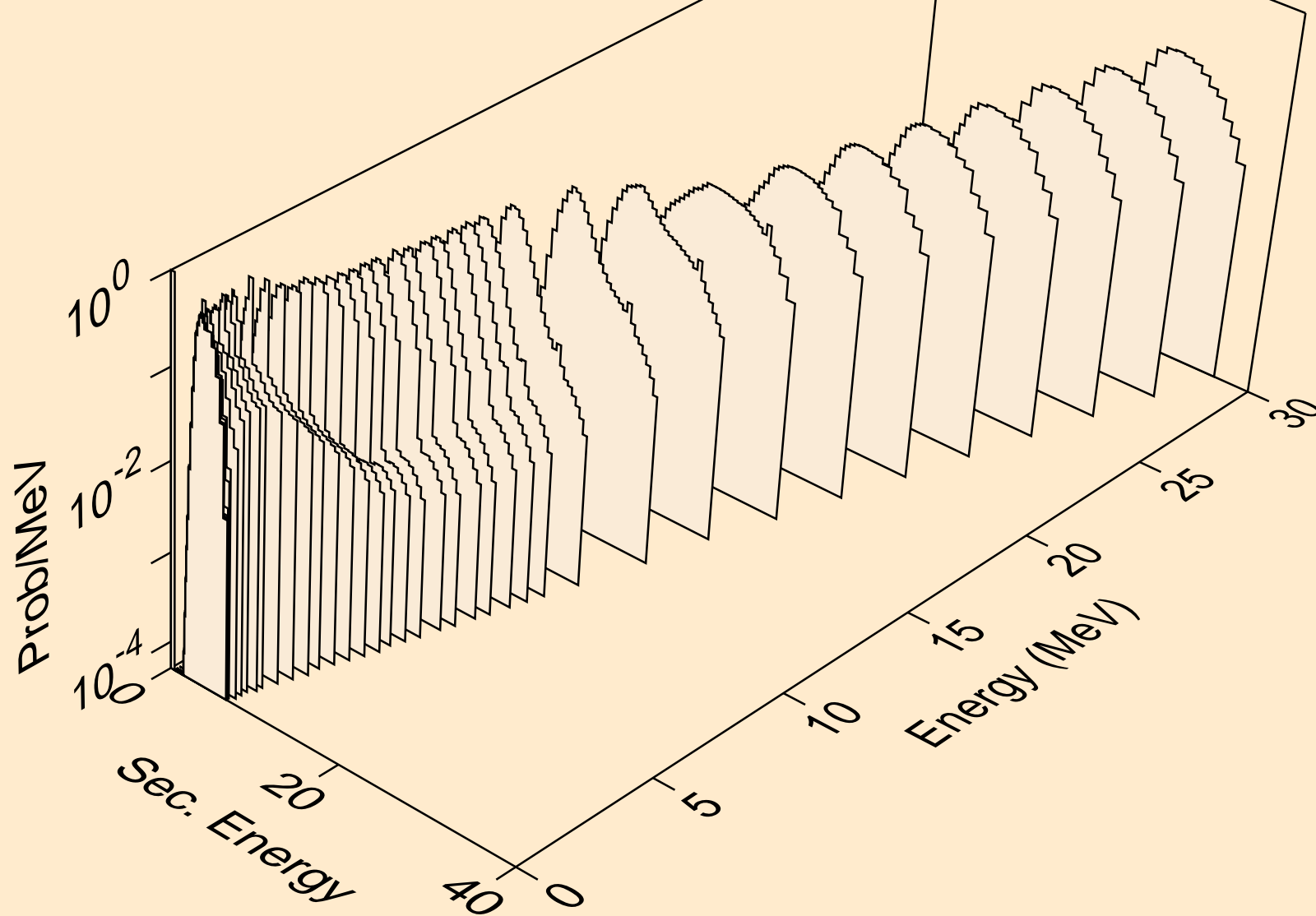

TE113 NEUTRON ACER TENDL-2024 LIBRARY; T=293.6K  
protons from (n,2p)

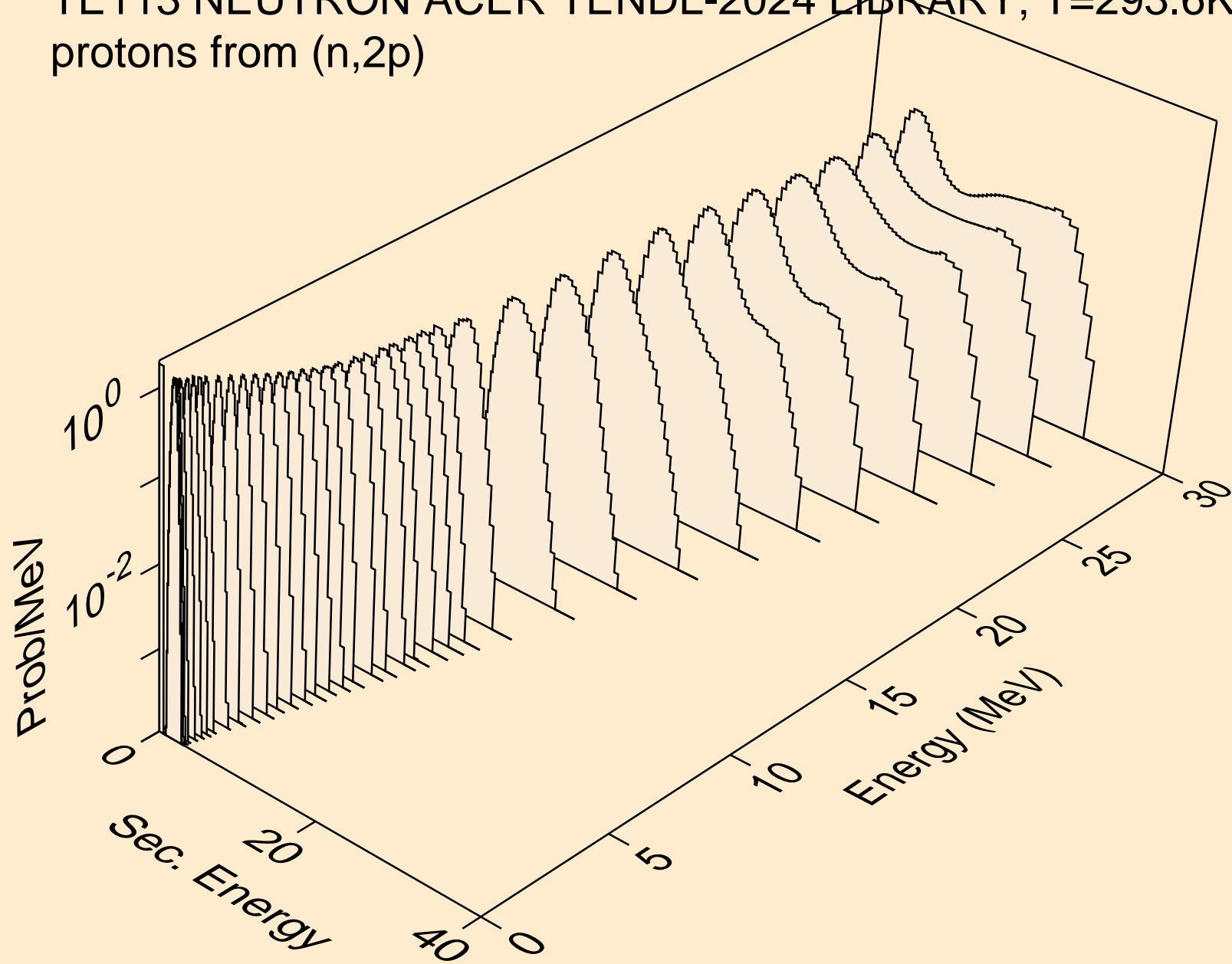

TE113 NEUTRON ACER TENDL-2024 LIBRARY; T=293.6K  
protons from (n,p)

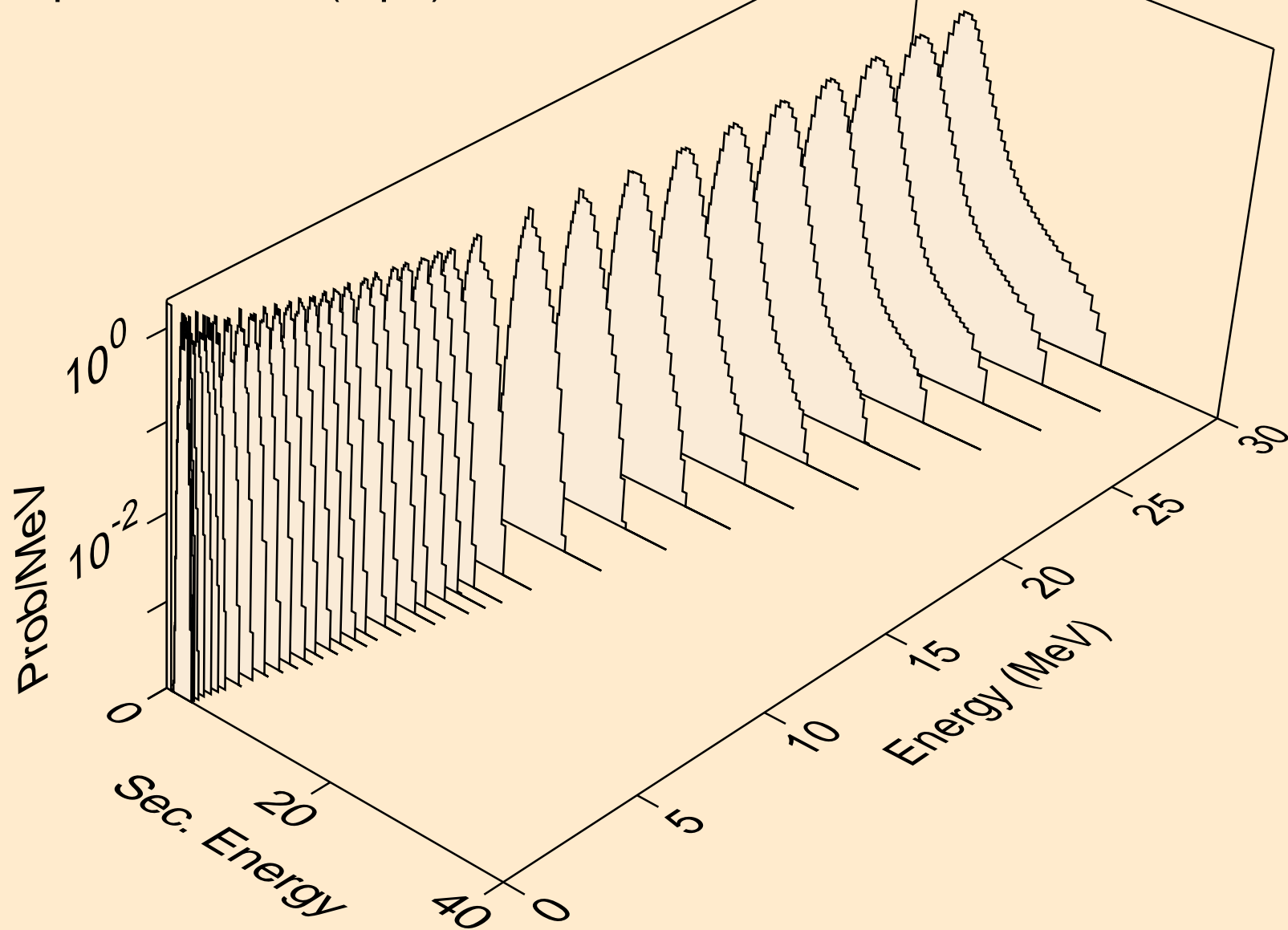

TE113 NEUTRON ACER TENDL-2024 LIBRARY; T=293.6K  
protons from (n,pd)

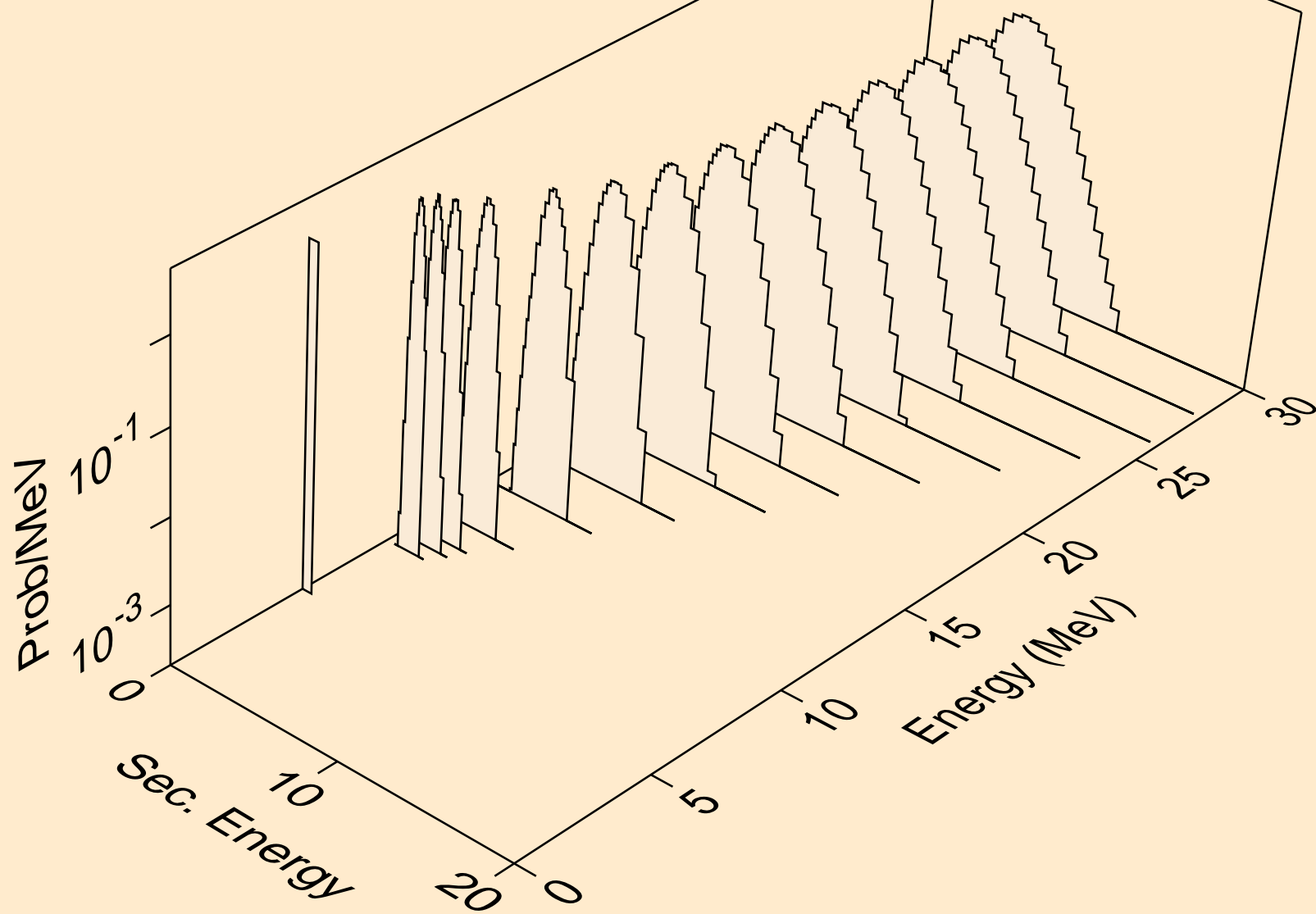

TE113 NEUTRON ACER TENDL-2024 LIBRARY; T=293.6K  
protons from (n,pt)

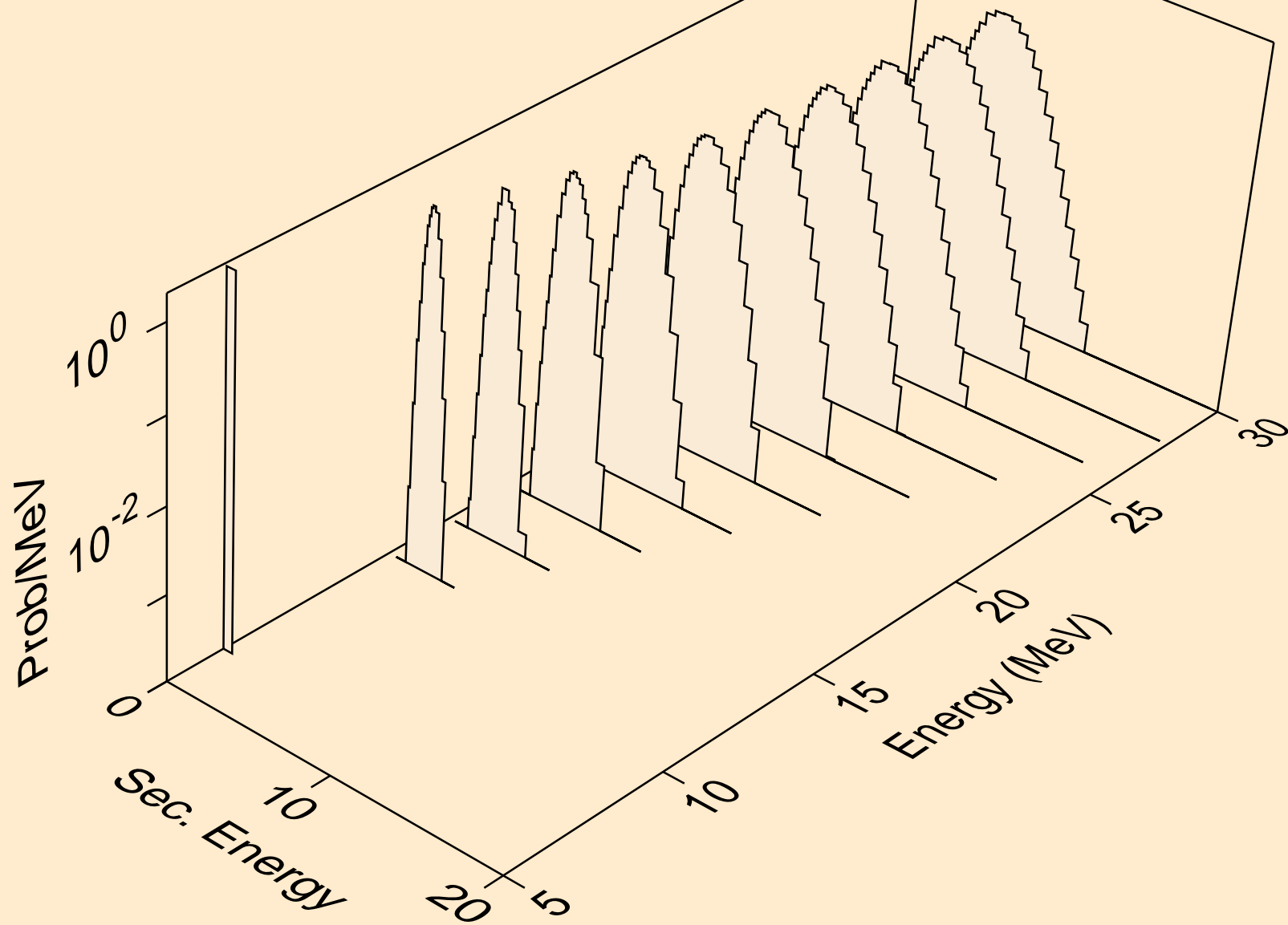

TE113 NEUTRON ACER TENDL-2024 LIBRARY; T=293.6K  
deuterons from (n,x)

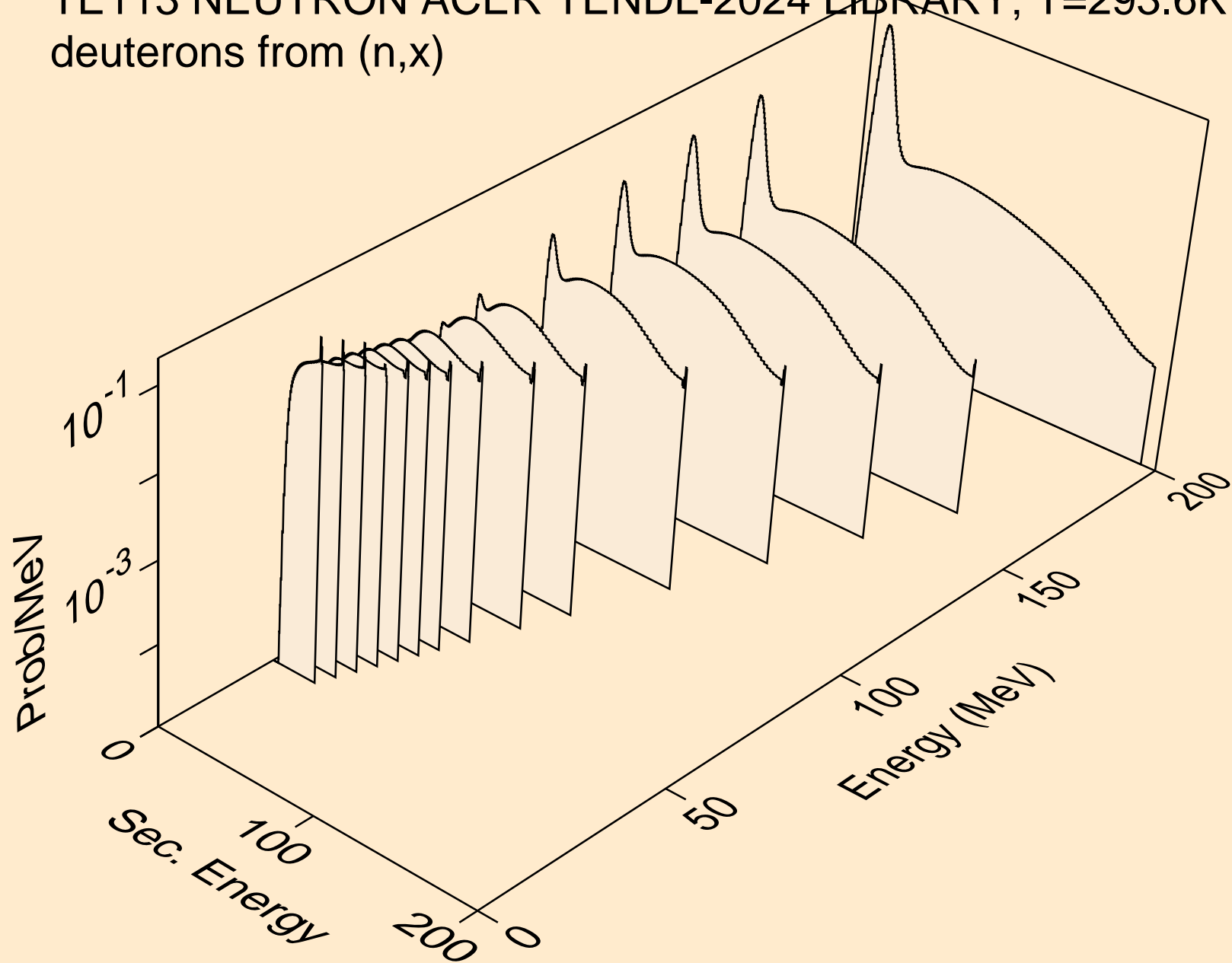

TE113 NEUTRON ACER TENDL-2024 LIBRARY; T=293.6K  
deuterons from (n,2nd)

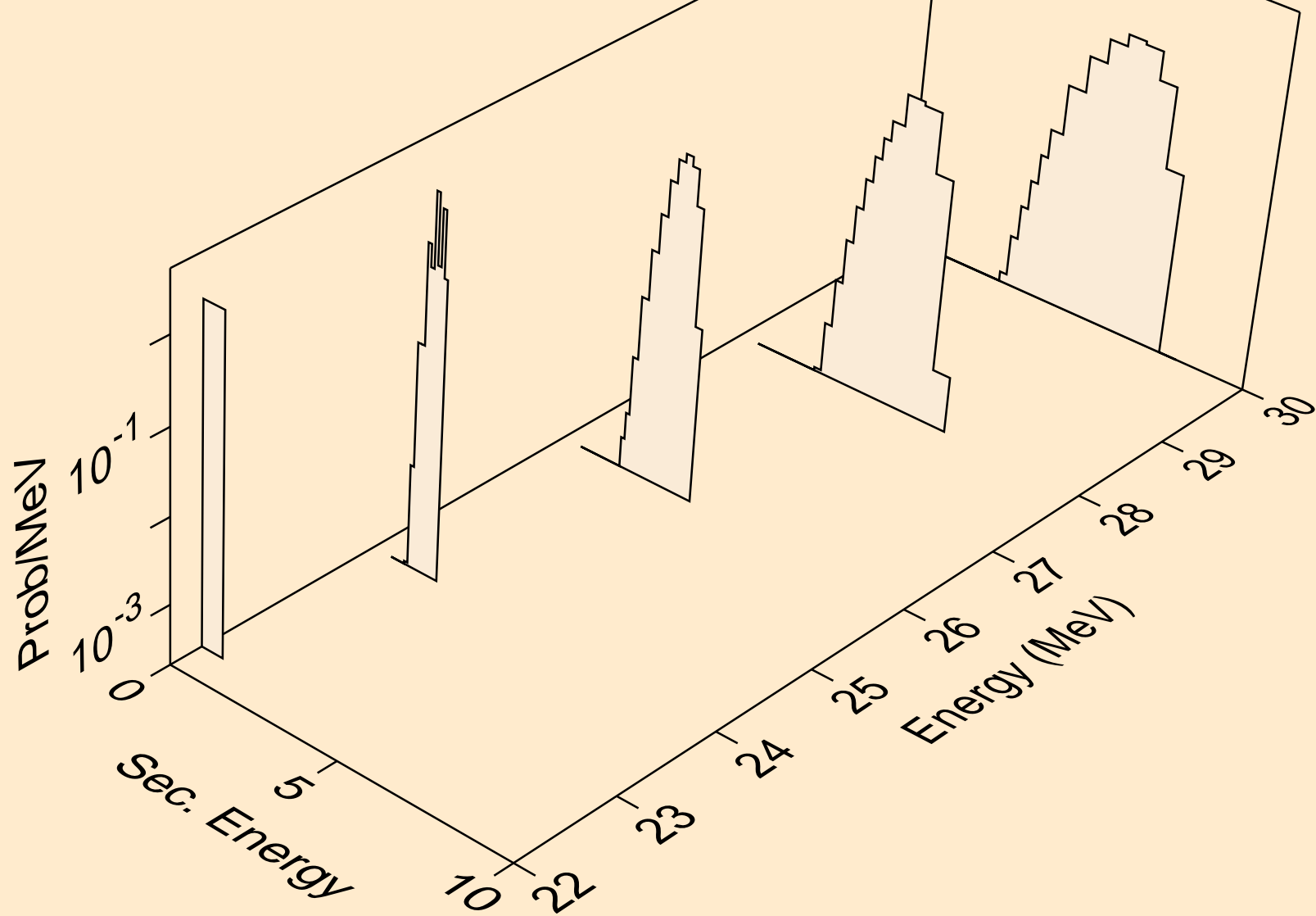

TE113 NEUTRON ACER TENDL-2024 LIBRARY; T=293.6K  
deuterons from (n,n\*)d

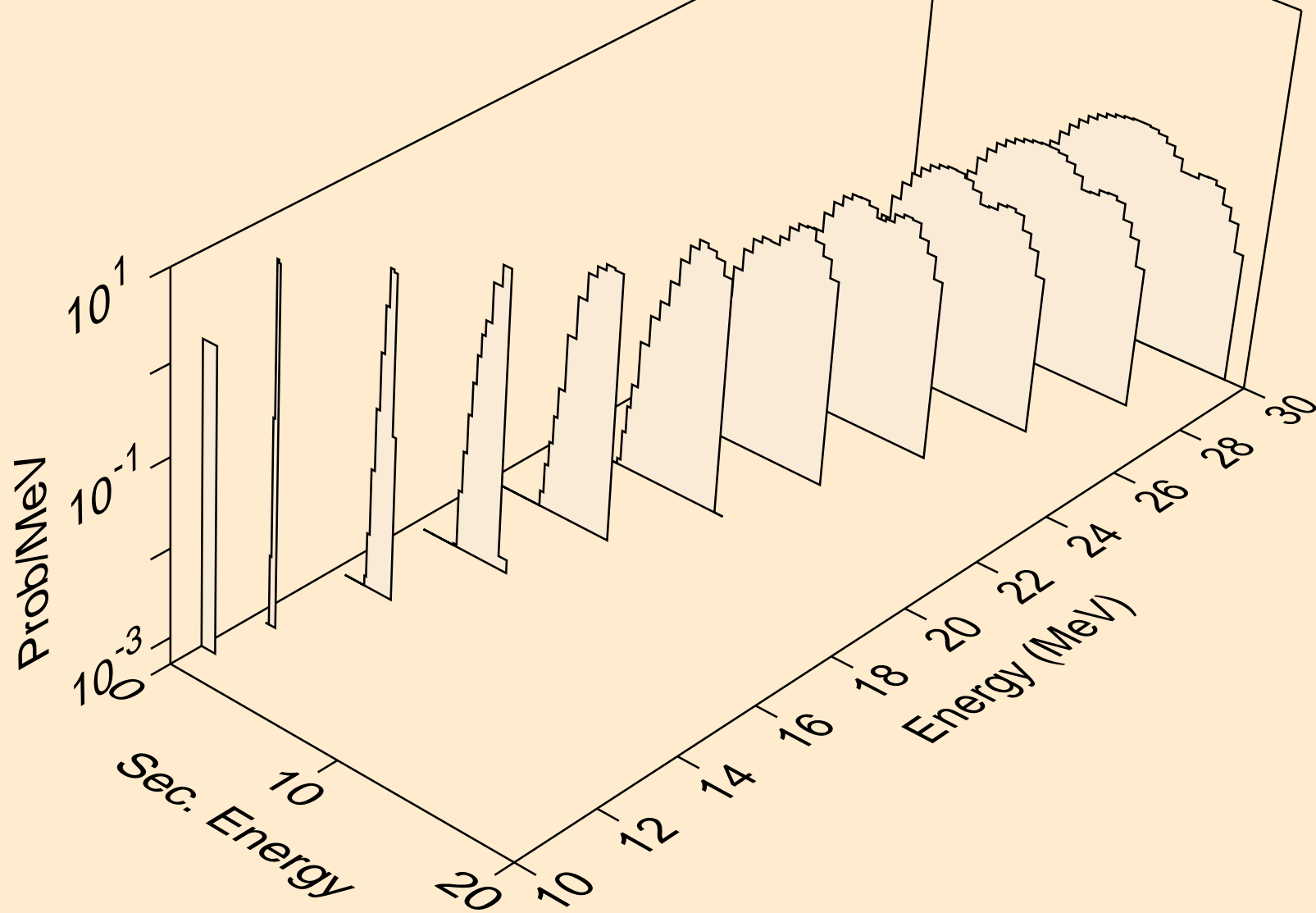

TE113 NEUTRON ACER TENDL-2024 LIBRARY; T=293.6K  
deuterons from (n,d)

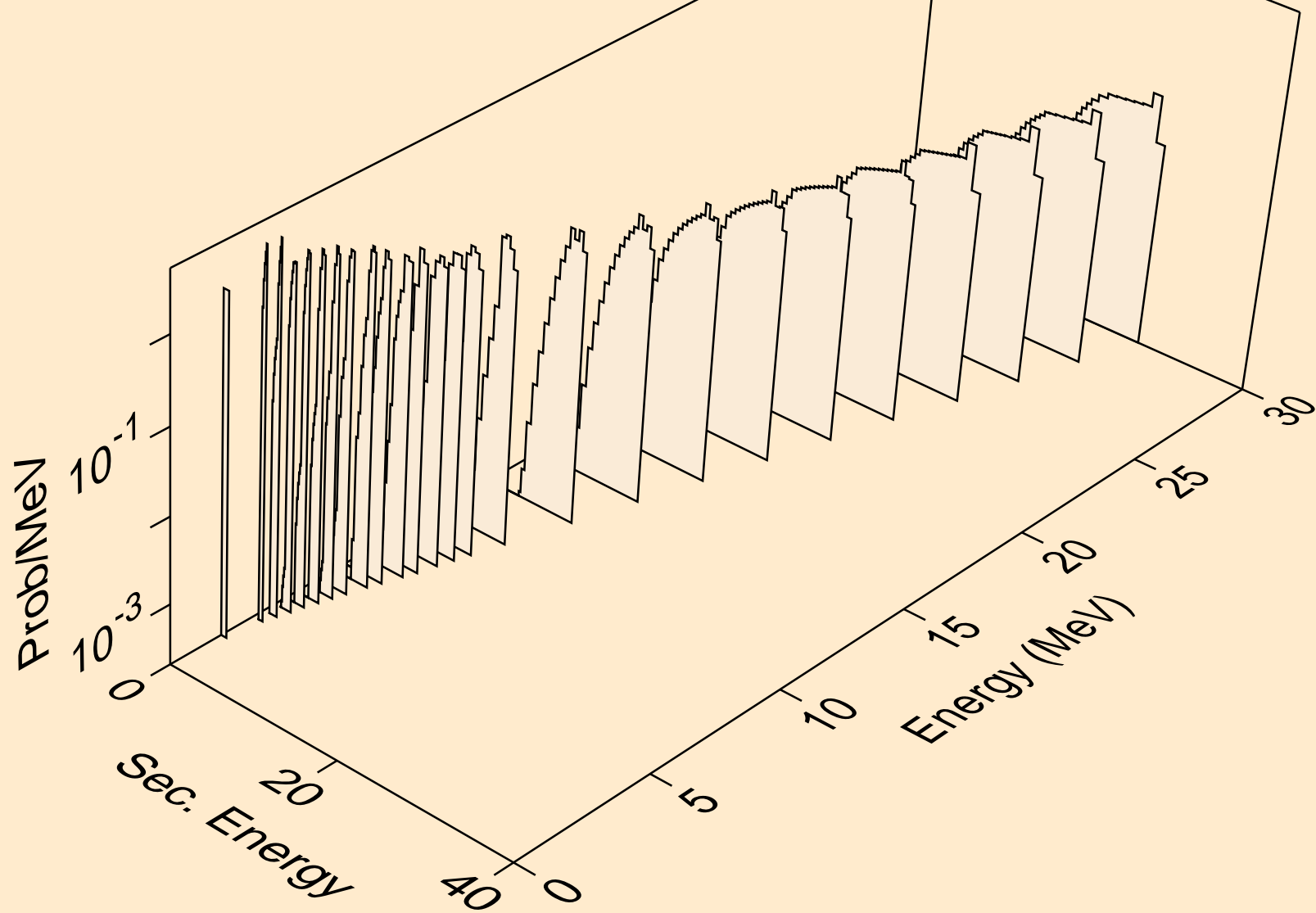

TE113 NEUTRON ACER TENDL-2024 LIBRARY; T=293.6K  
deuterons from (n,pd)

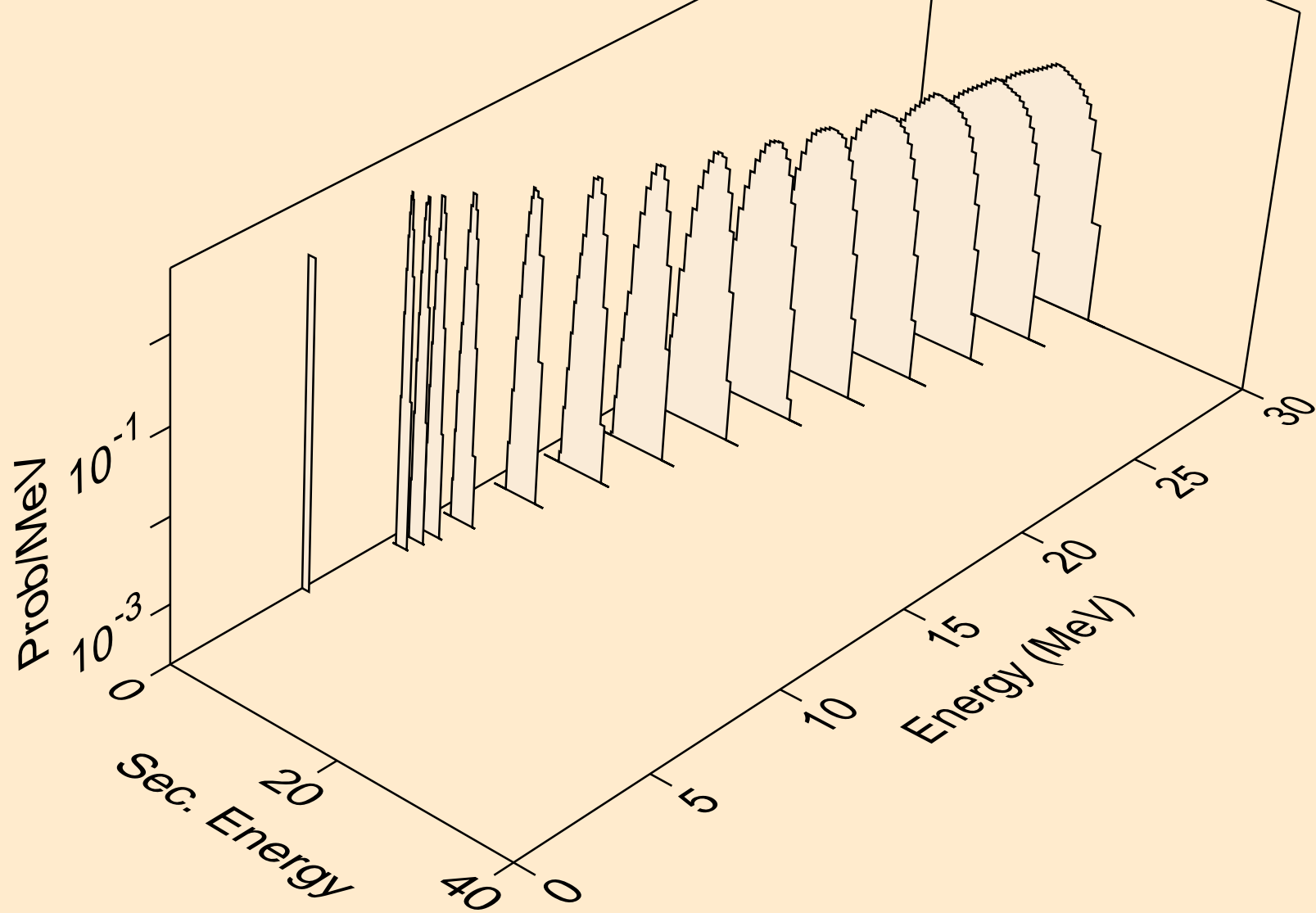

TE113 NEUTRON ACER TENDL-2024 LIBRARY; T=293.6K  
deuterons from (n,da)

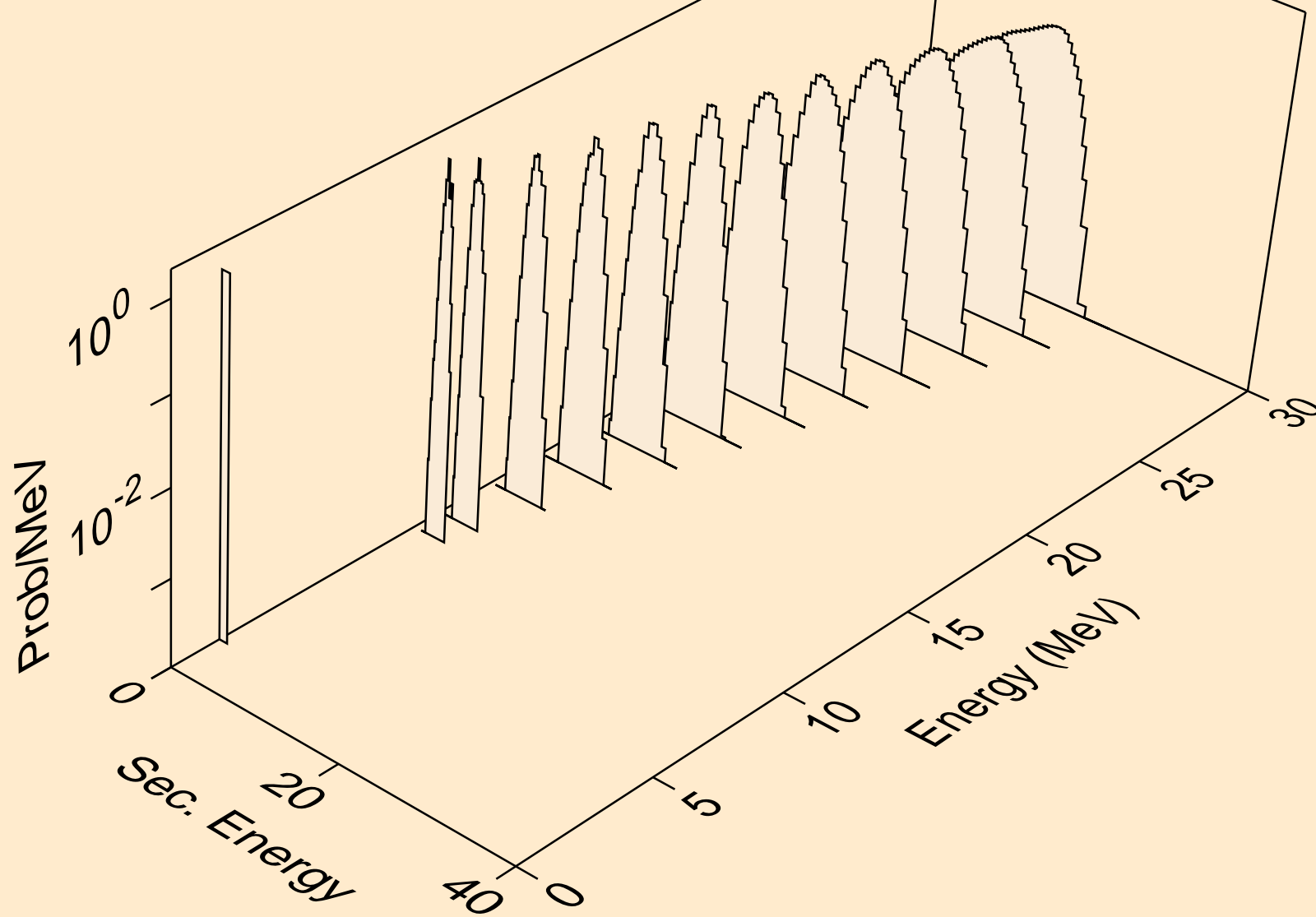

TE113 NEUTRON ACER TENDL-2024 LIBRARY; T=293.6K  
tritons from (n,x)

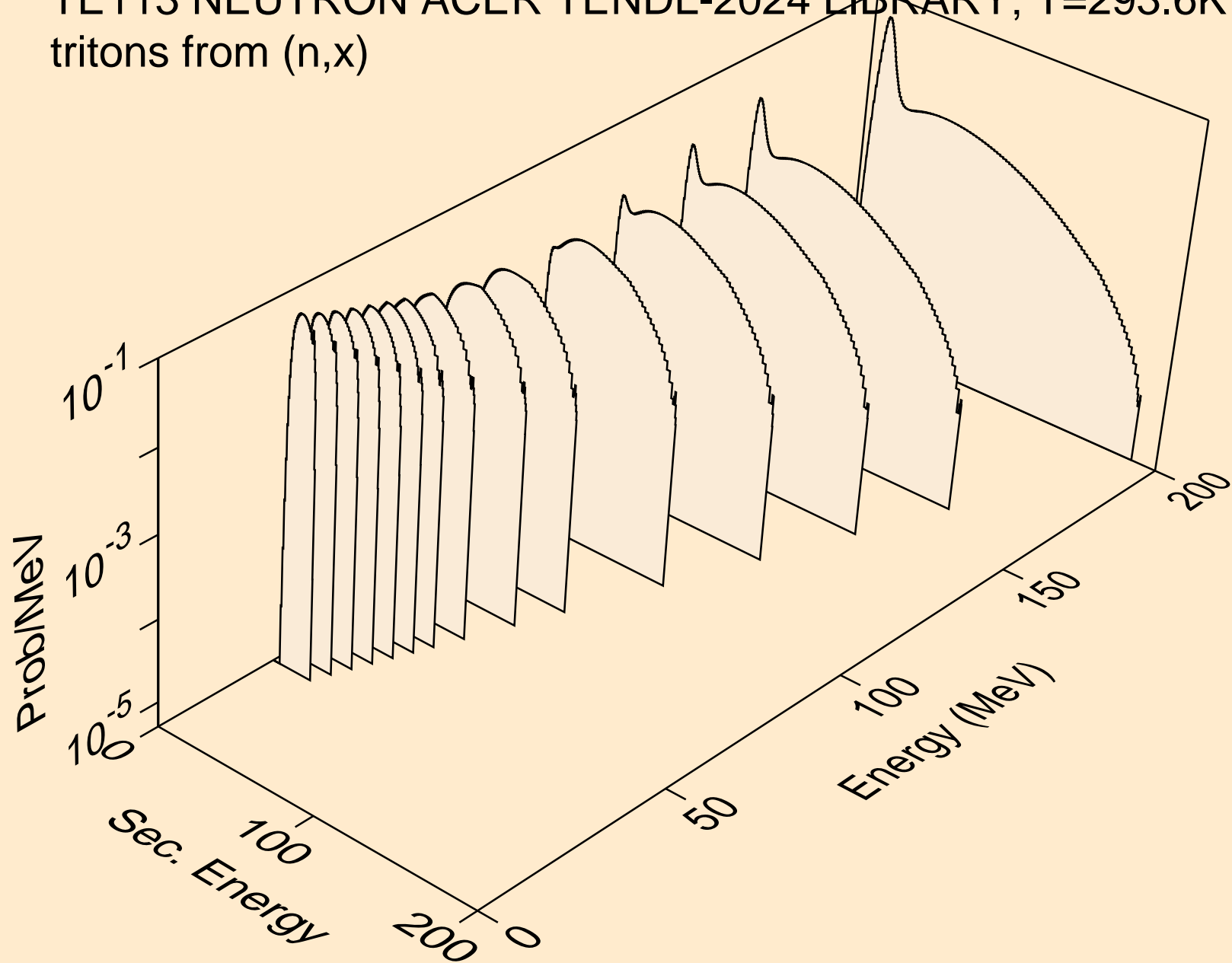

TE113 NEUTRON ACER TENDL-2024 LIBRARY; T=293.6K  
tritons from (n,n\*)t

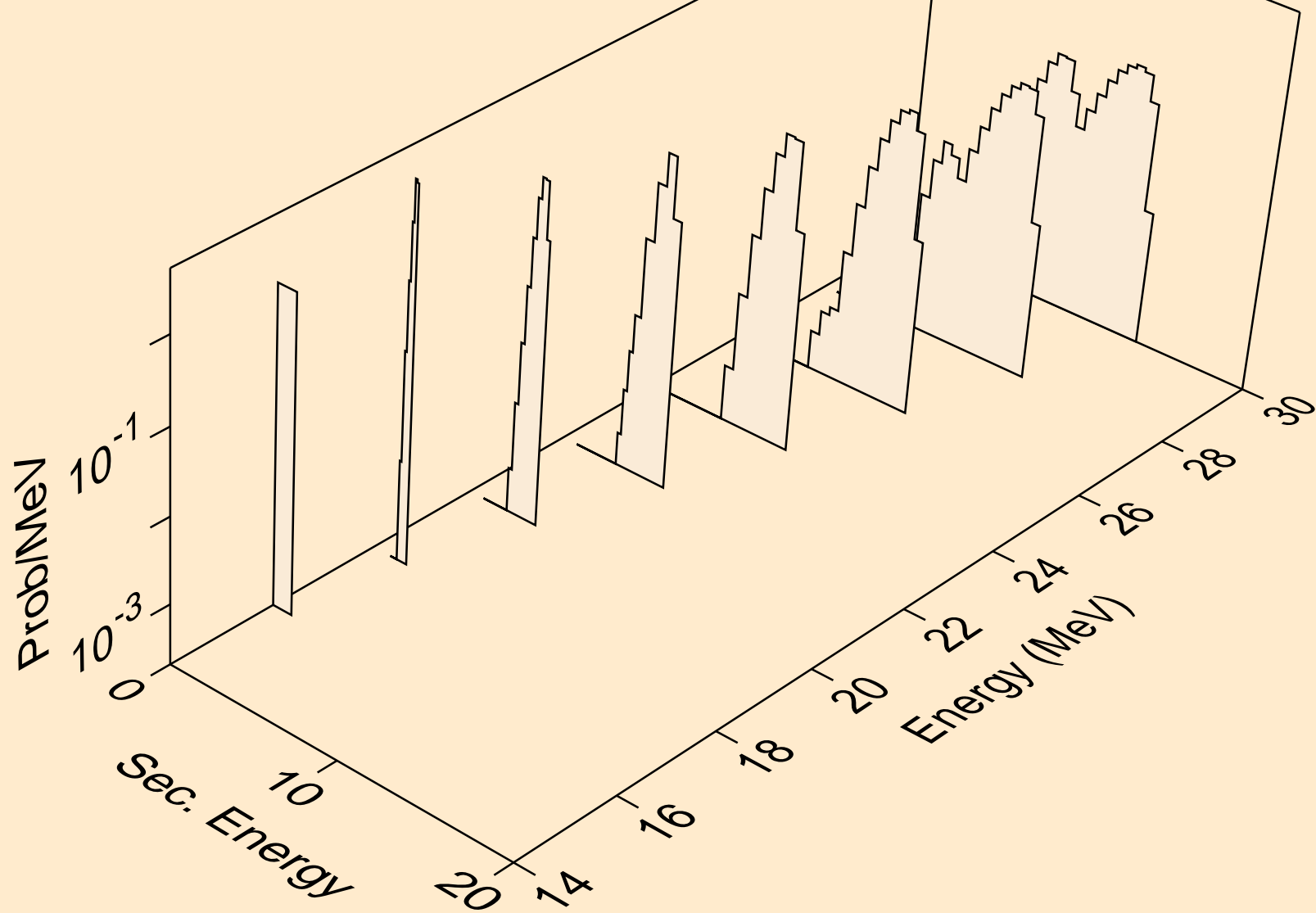

TE113 NEUTRON ACER TENDL-2024 LIBRARY; T=293.6K  
tritons from (n,t)

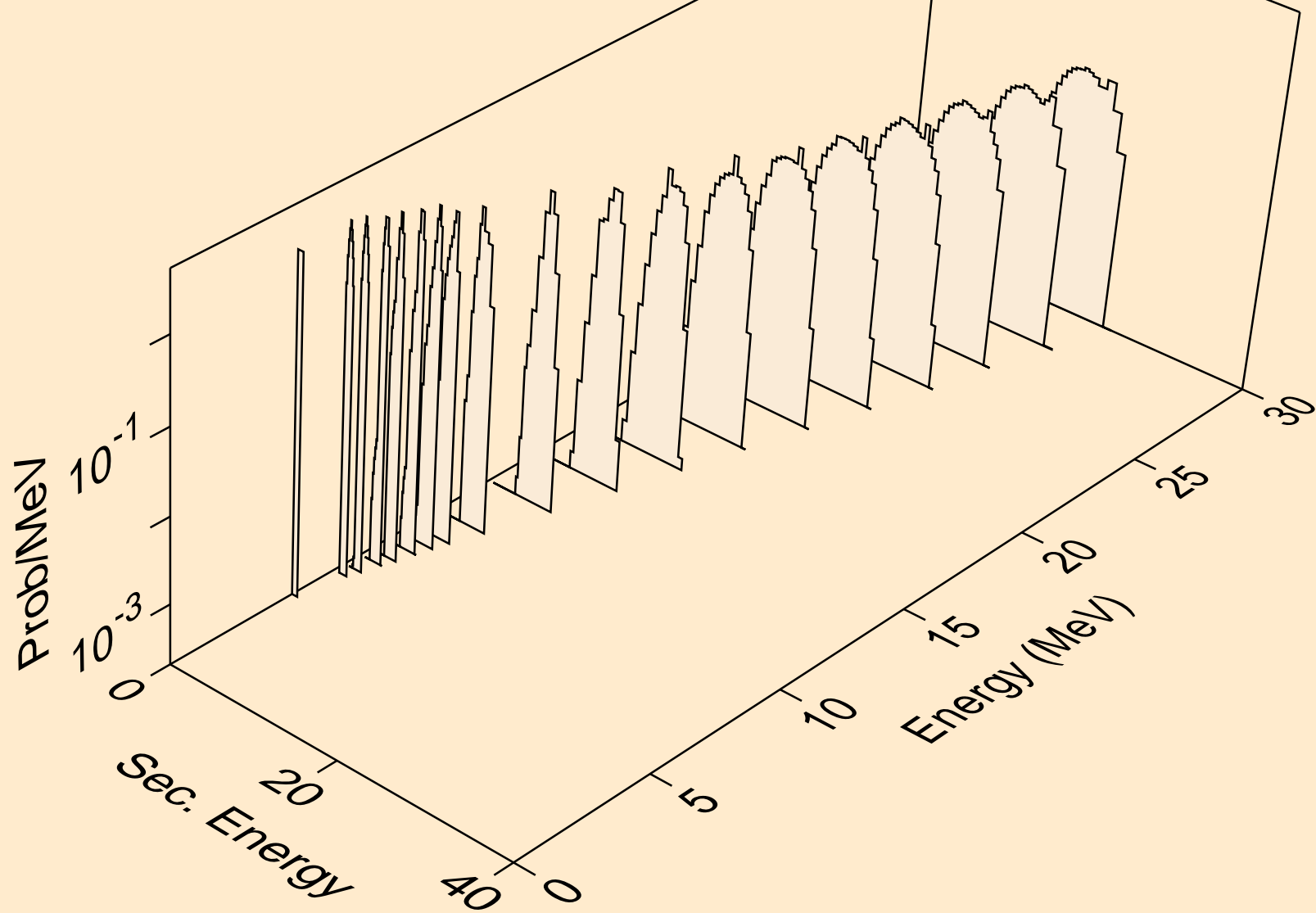

TE113 NEUTRON ACER TENDL-2024 LIBRARY; T=293.6K  
tritons from (n,pt)

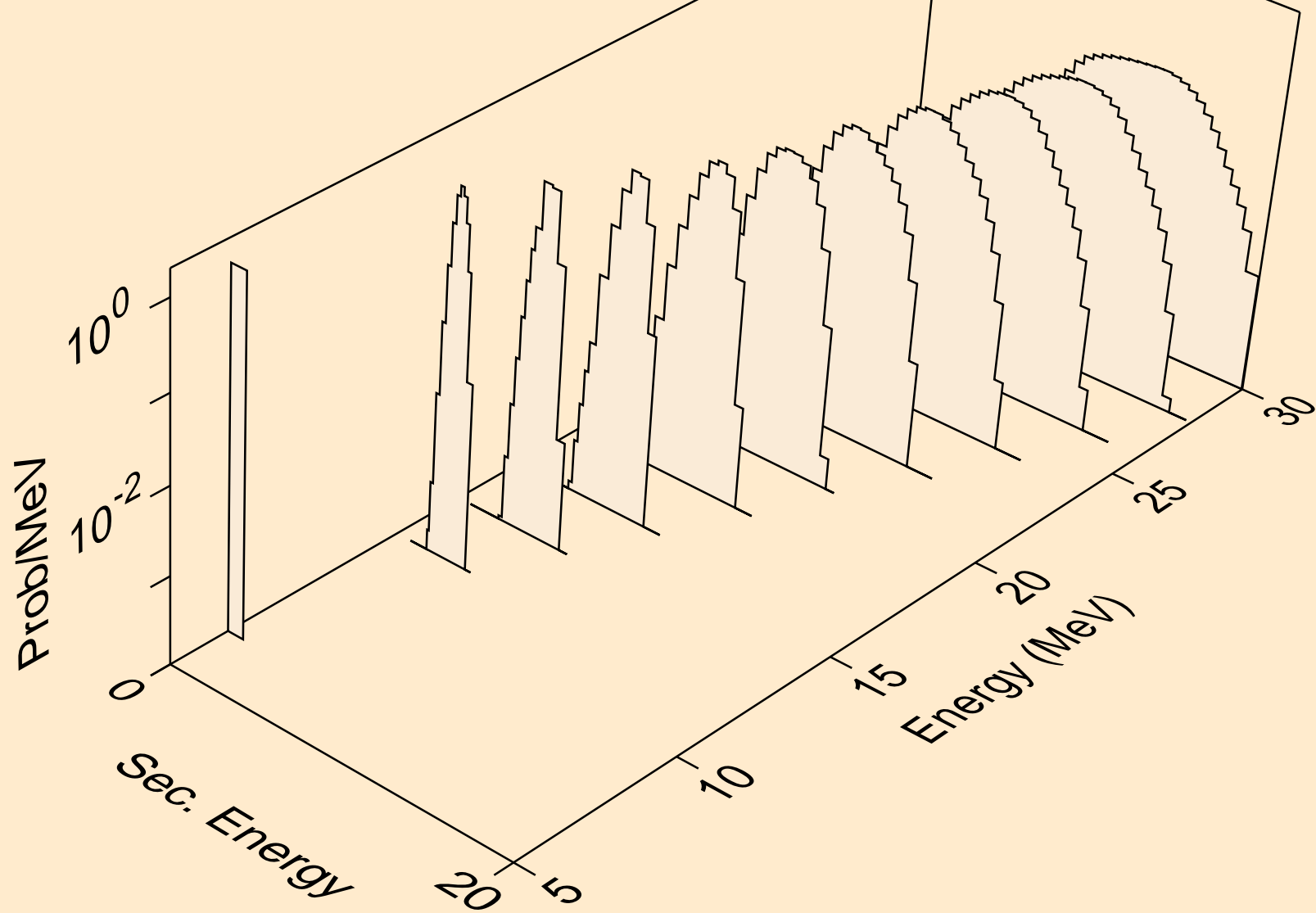

TE113 NEUTRON ACER TENDL-2024 LIBRARY; T=293.6K  
he3s from (n,x)

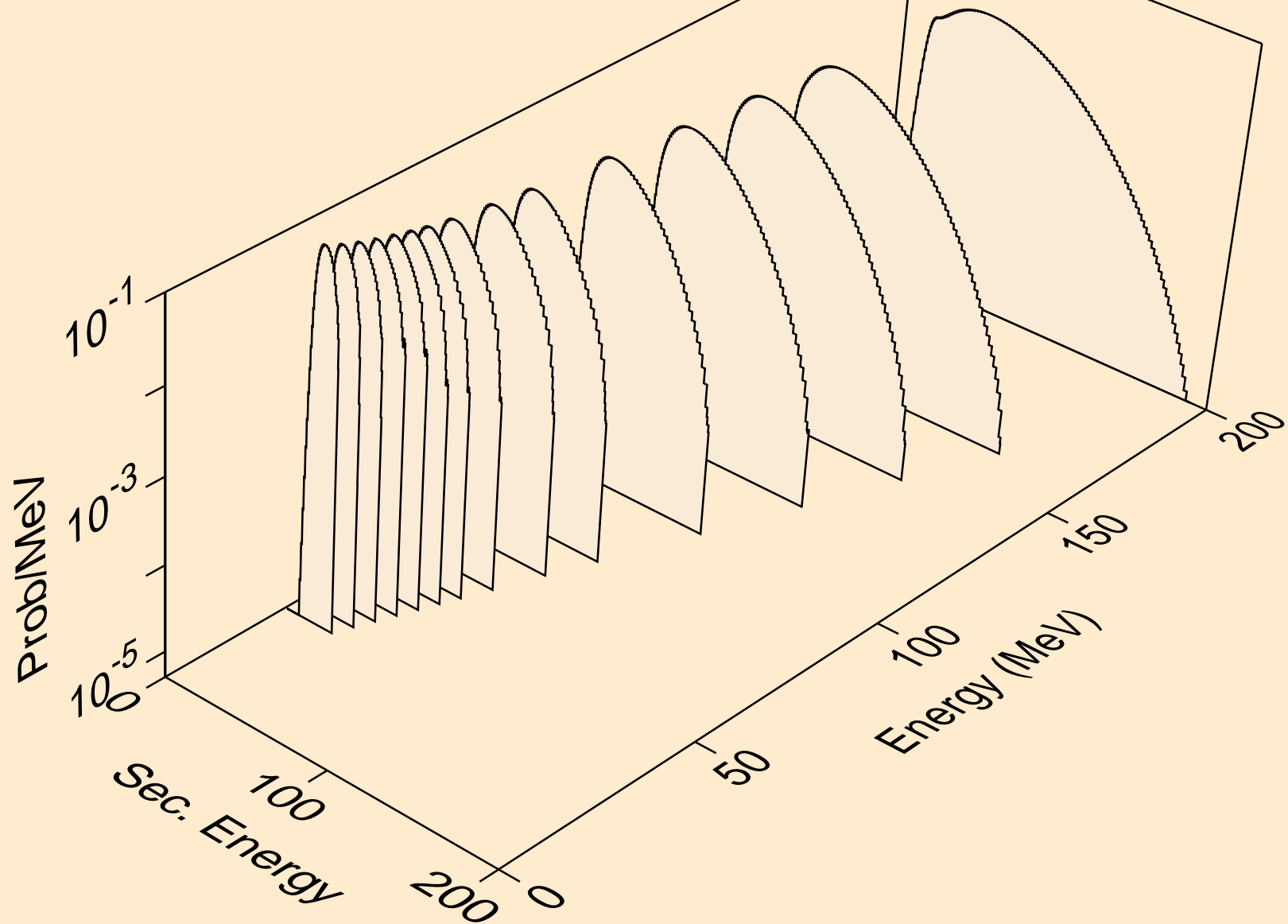

TE113 NEUTRON ACER TENDL-2024 LIBRARY; T=293.6K  
he3s from (n,n\*)he3

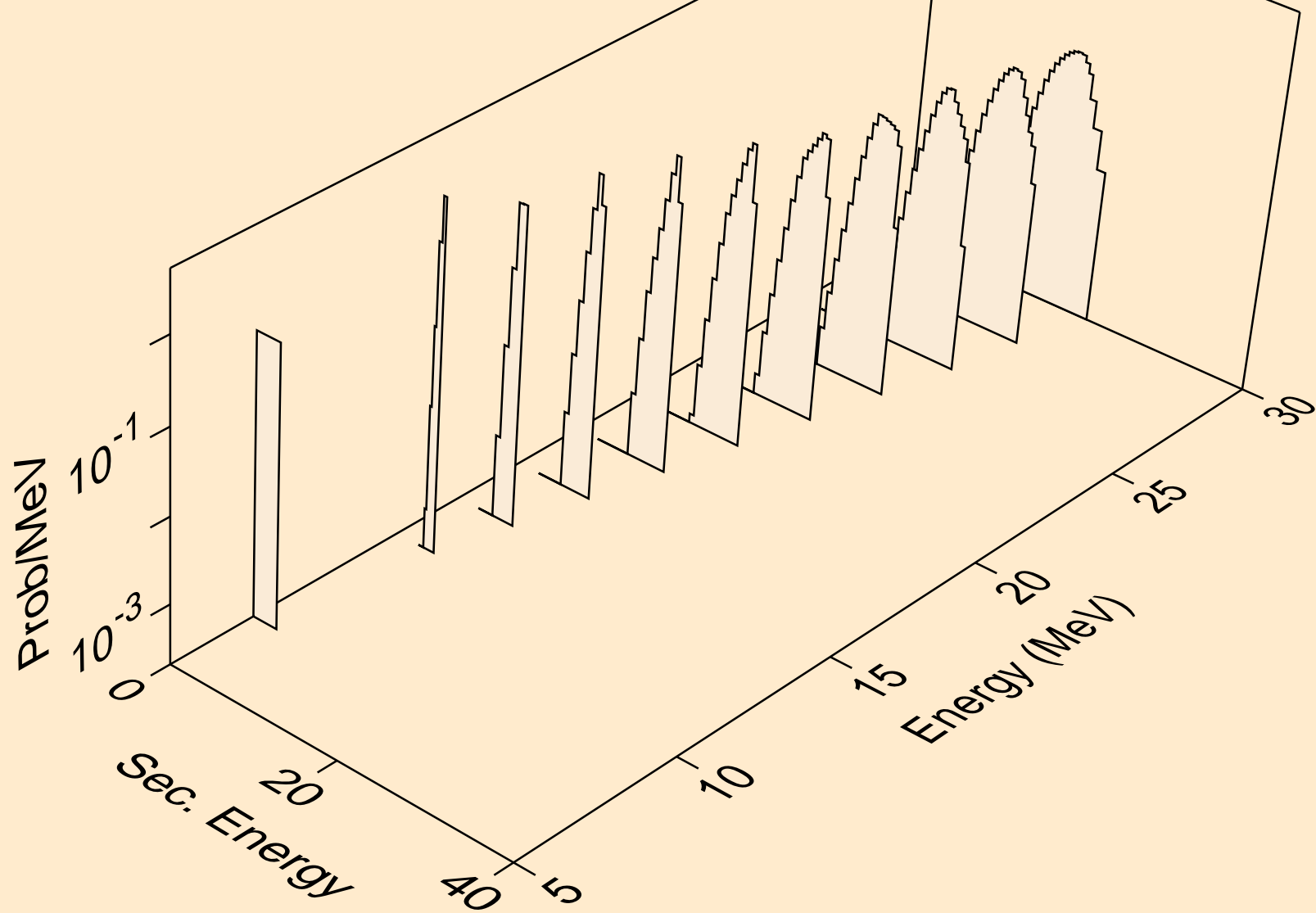

TE113 NEUTRON ACER TENDL-2024 LIBRARY; T=293.6K  
he3s from (n,he3)

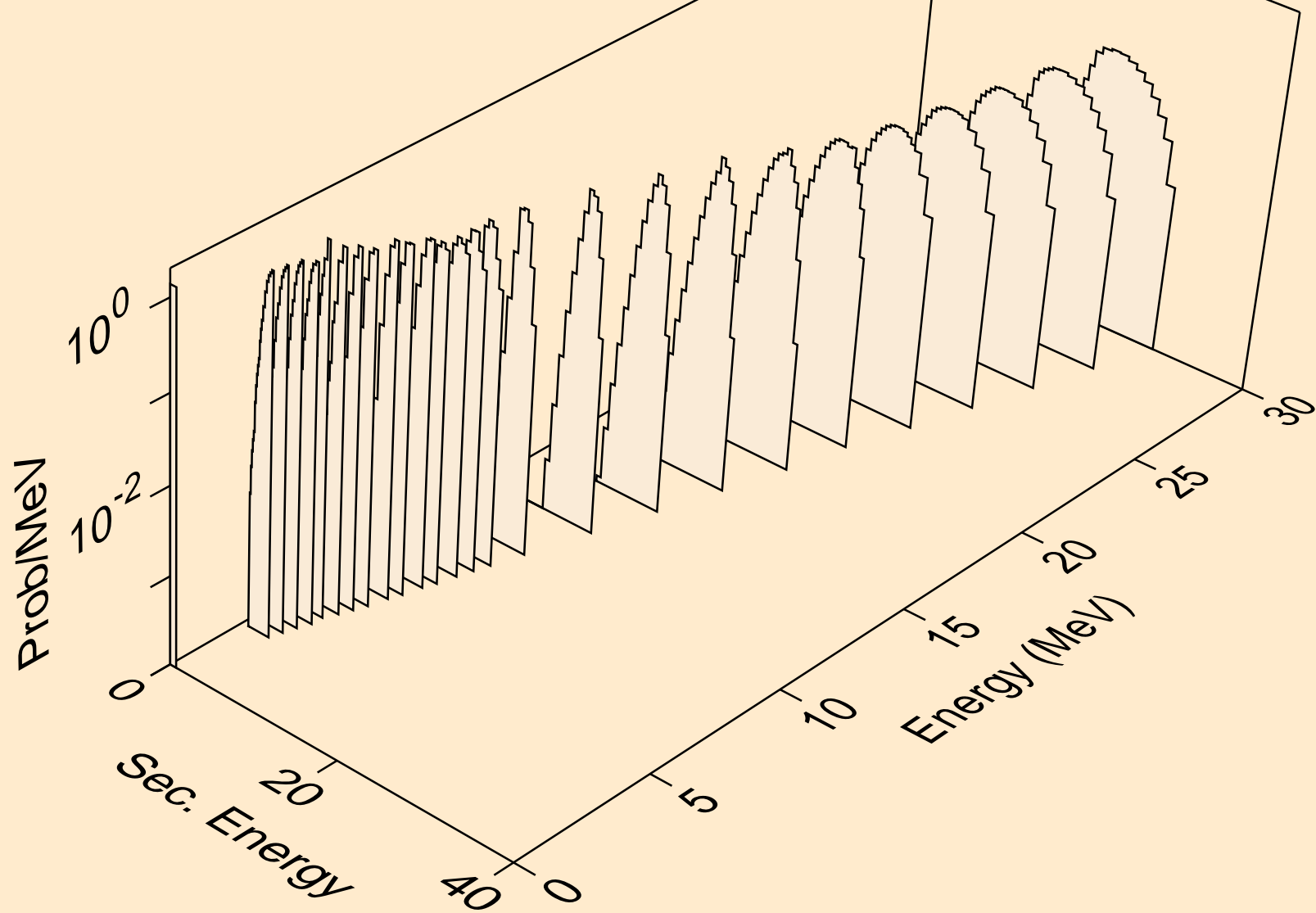

TE113 NEUTRON ACER TENDL-2024 LIBRARY; T=293.6K  
alphas from (n,x)

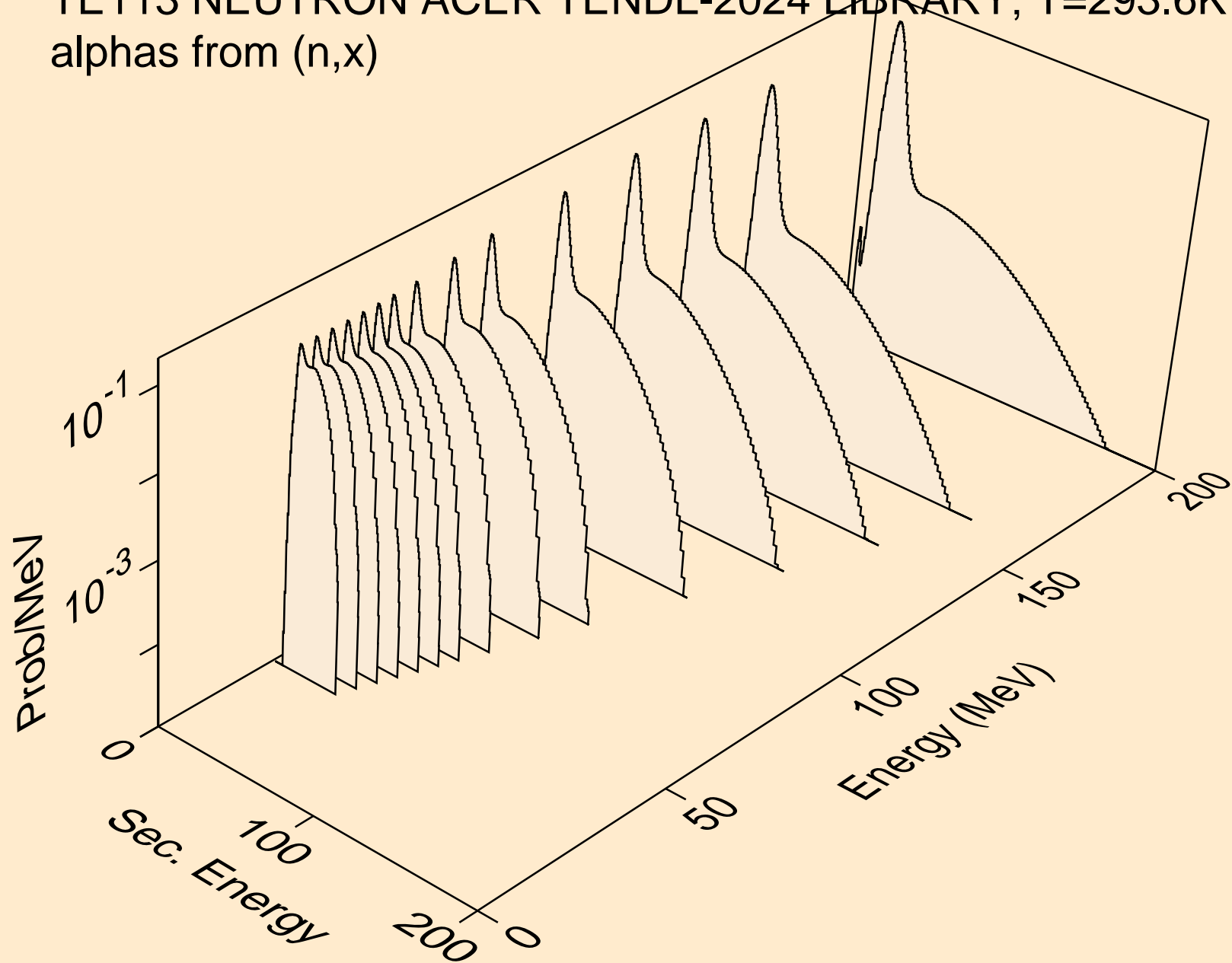

TE113 NEUTRON ACER TENDL-2024 LIBRARY; T=293.6K  
alphas from (n,n\*)a

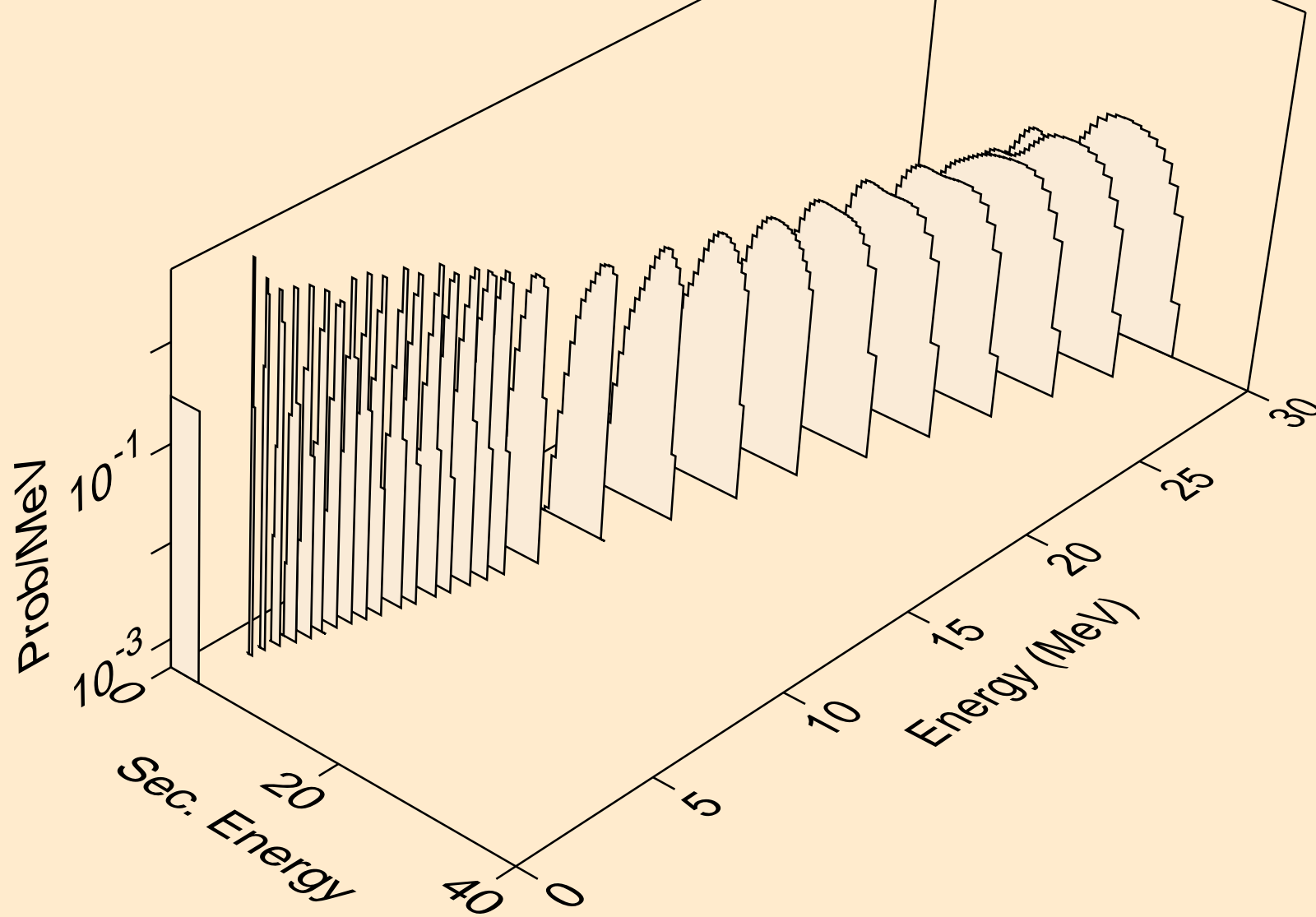

TE113 NEUTRON ACER TENDL-2024 LIBRARY; T=293.6K  
alphas from (n,2n)a

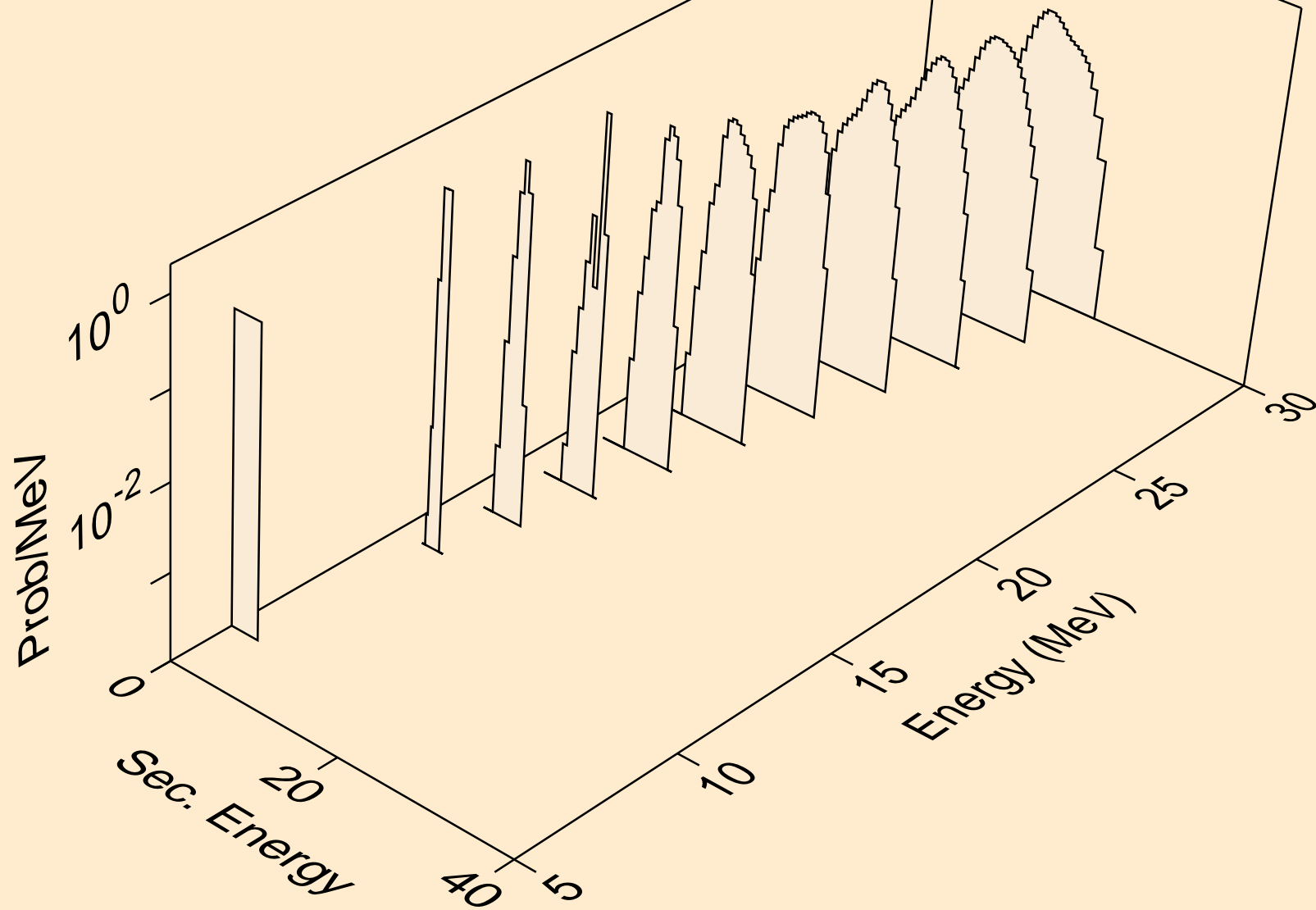

TE113 NEUTRON ACER TENDL-2024 LIBRARY; T=293.6K  
alphas from (n,3n)a

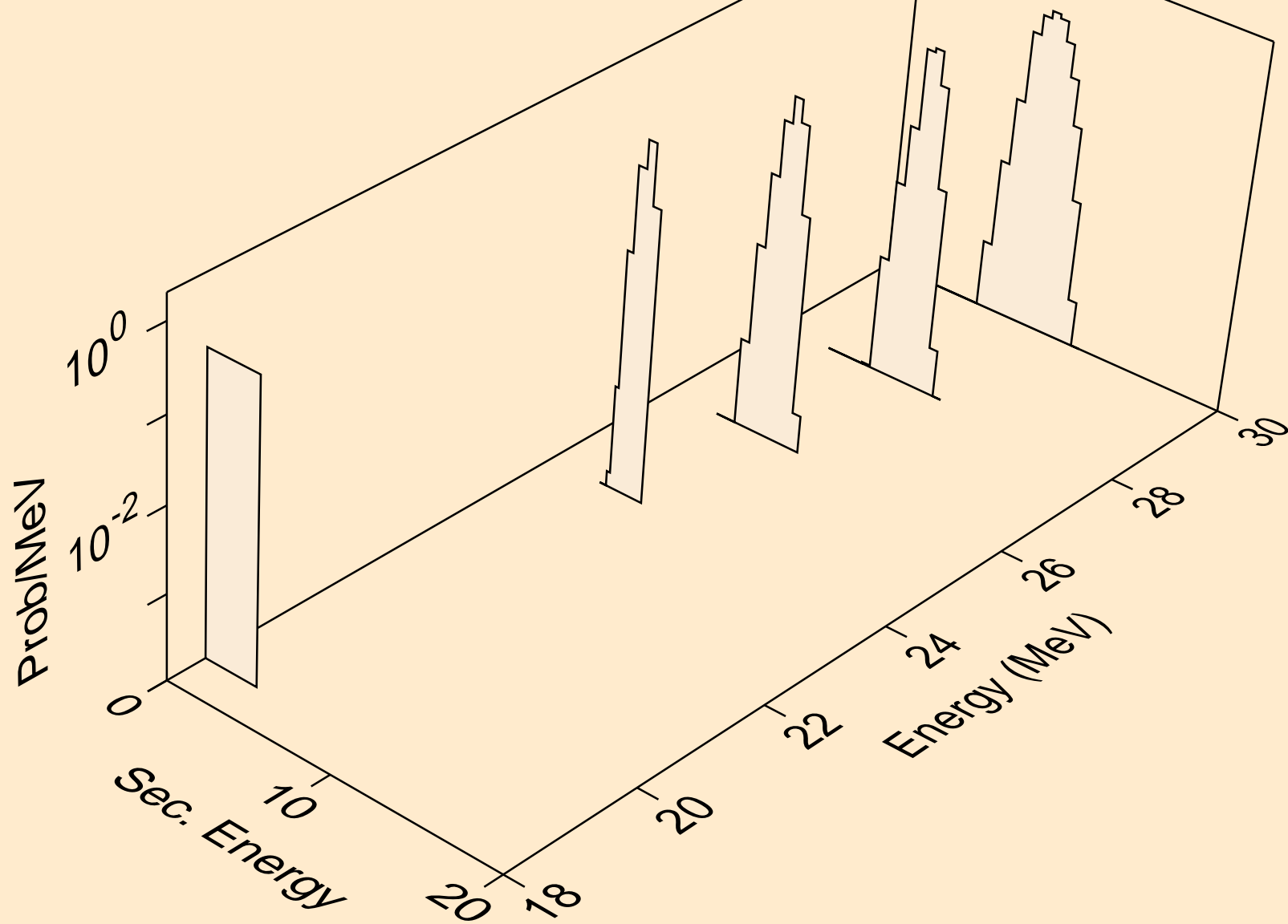

TE113 NEUTRON ACER TENDL-2024 LIBRARY; T=293.6K  
alphas from (n,n\*)2a

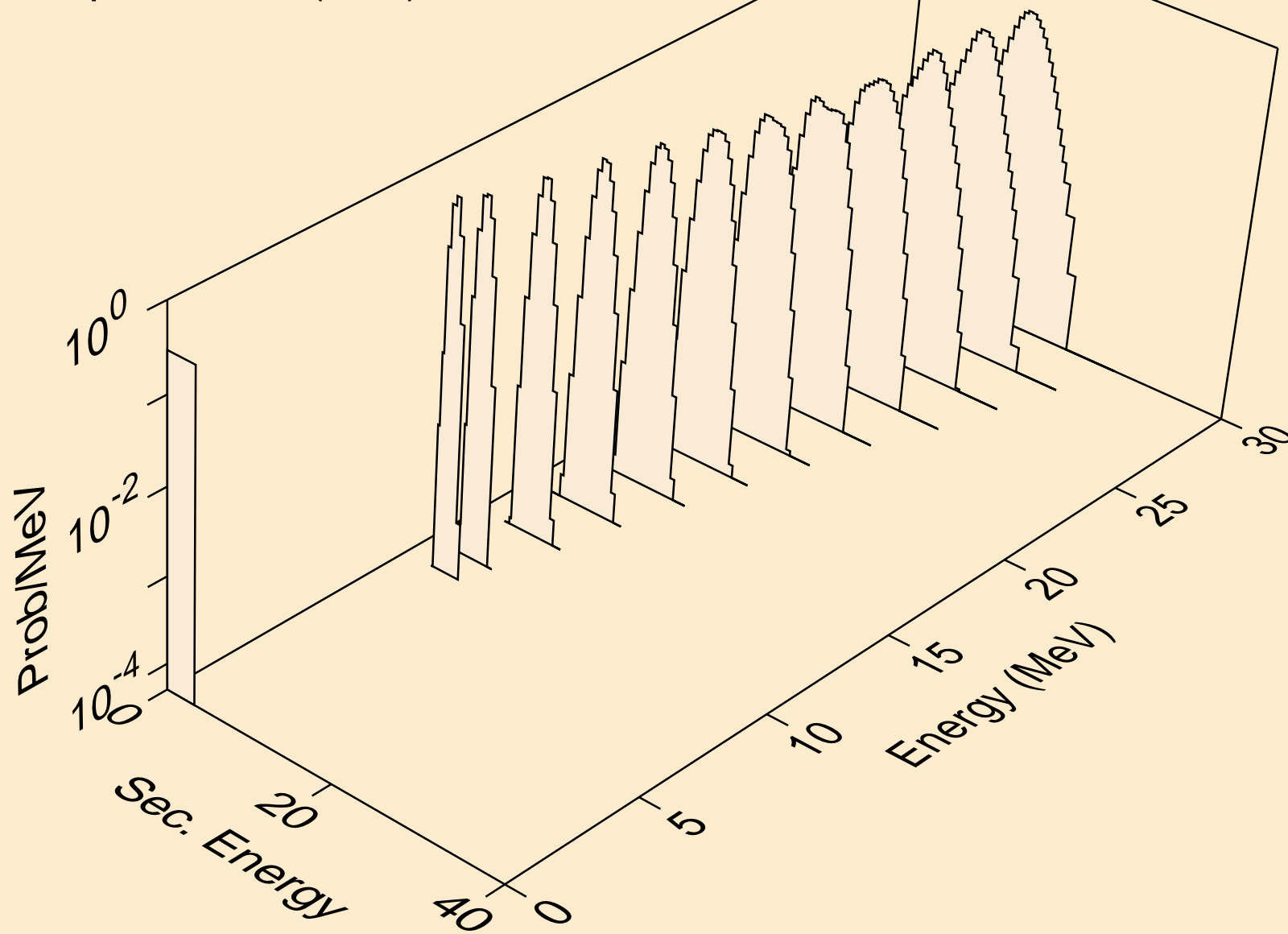

TE113 NEUTRON ACER TENDL-2024 LIBRARY; T=293.6K  
alphas from (n,2n)2a

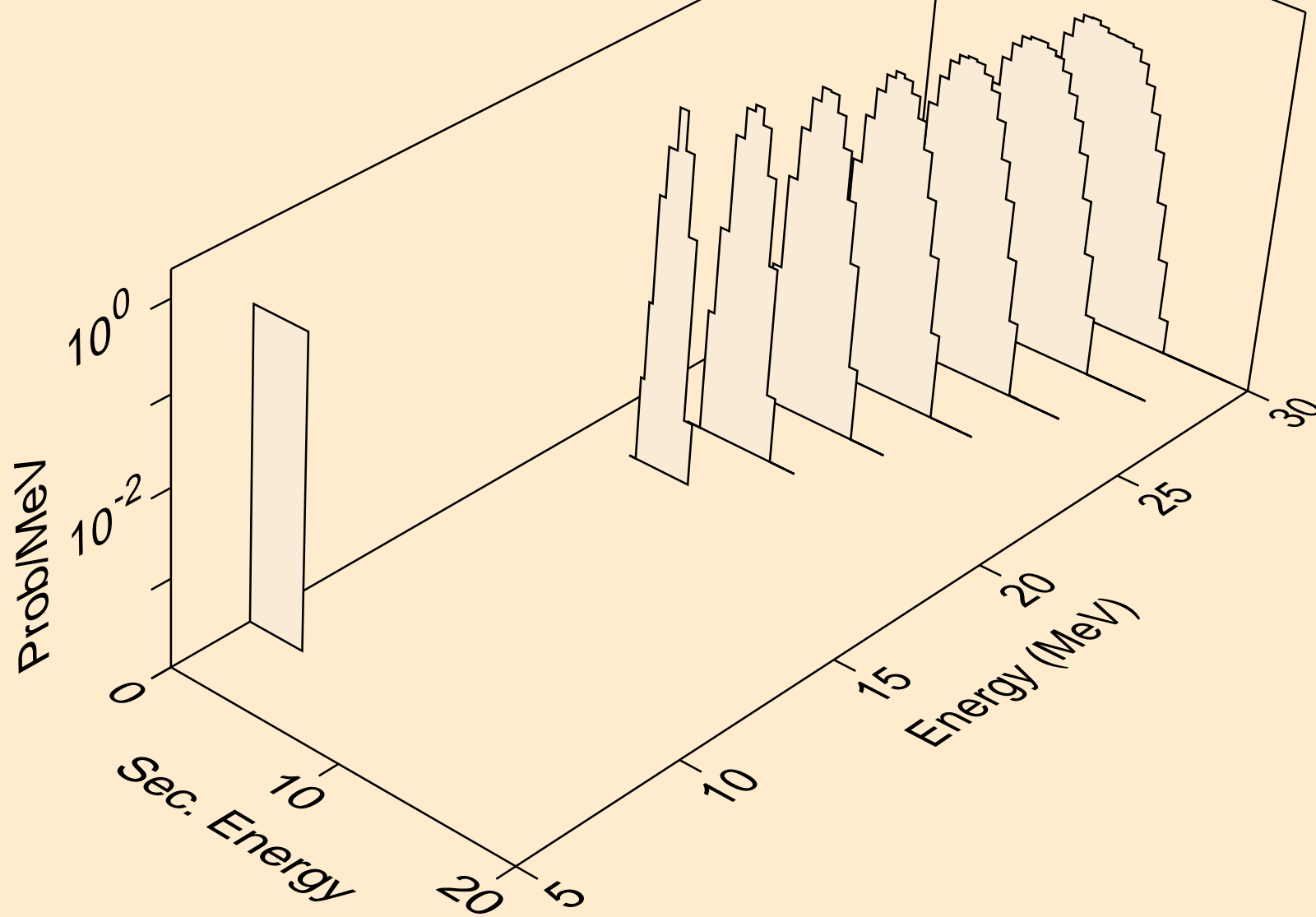

TE113 NEUTRON ACER TENDL-2024 LIBRARY; T=293.6K  
alphas from (n,npa)

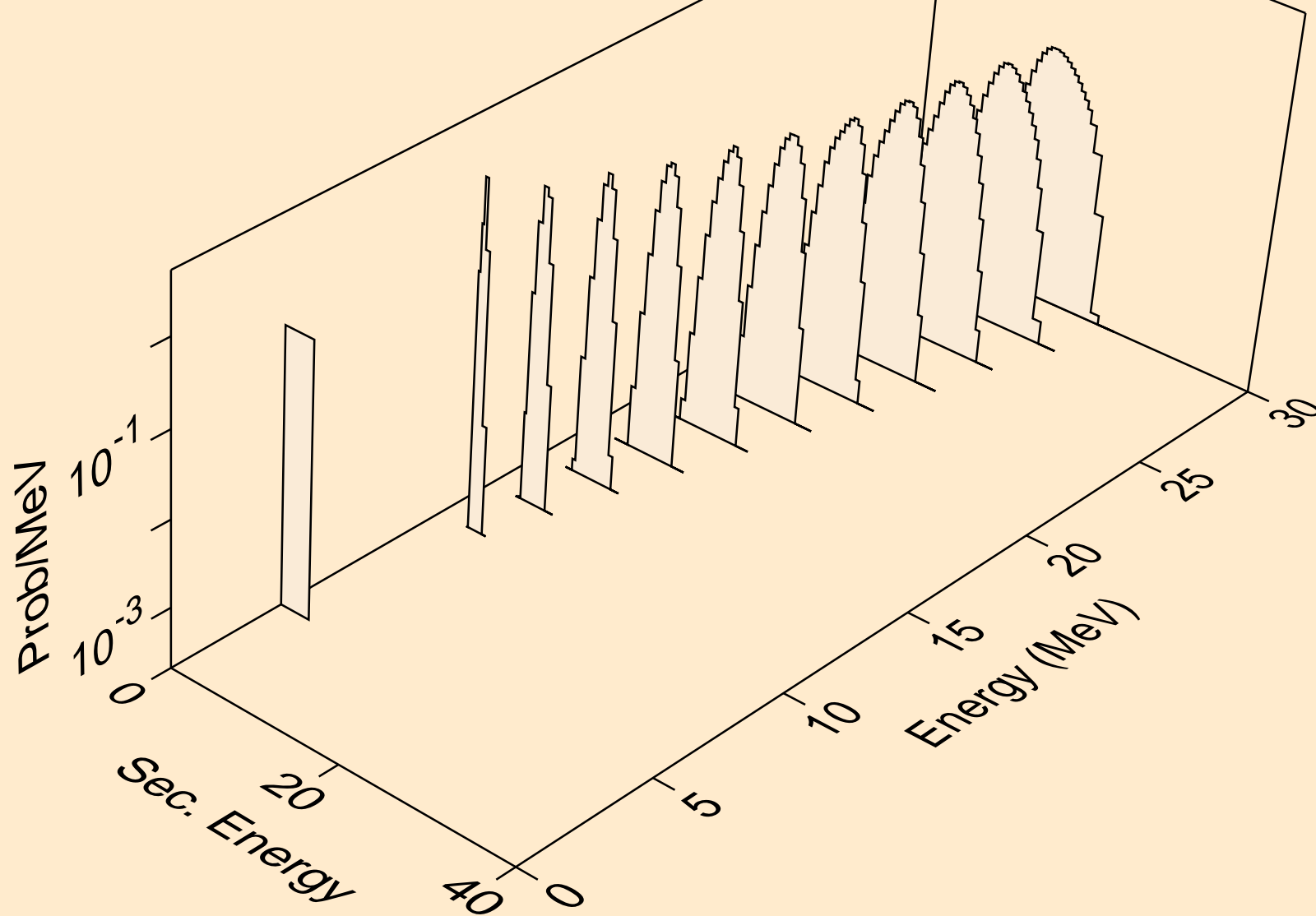

TE113 NEUTRON ACER TENDL-2024 LIBRARY; T=293.6K  
alphas from (n,a)

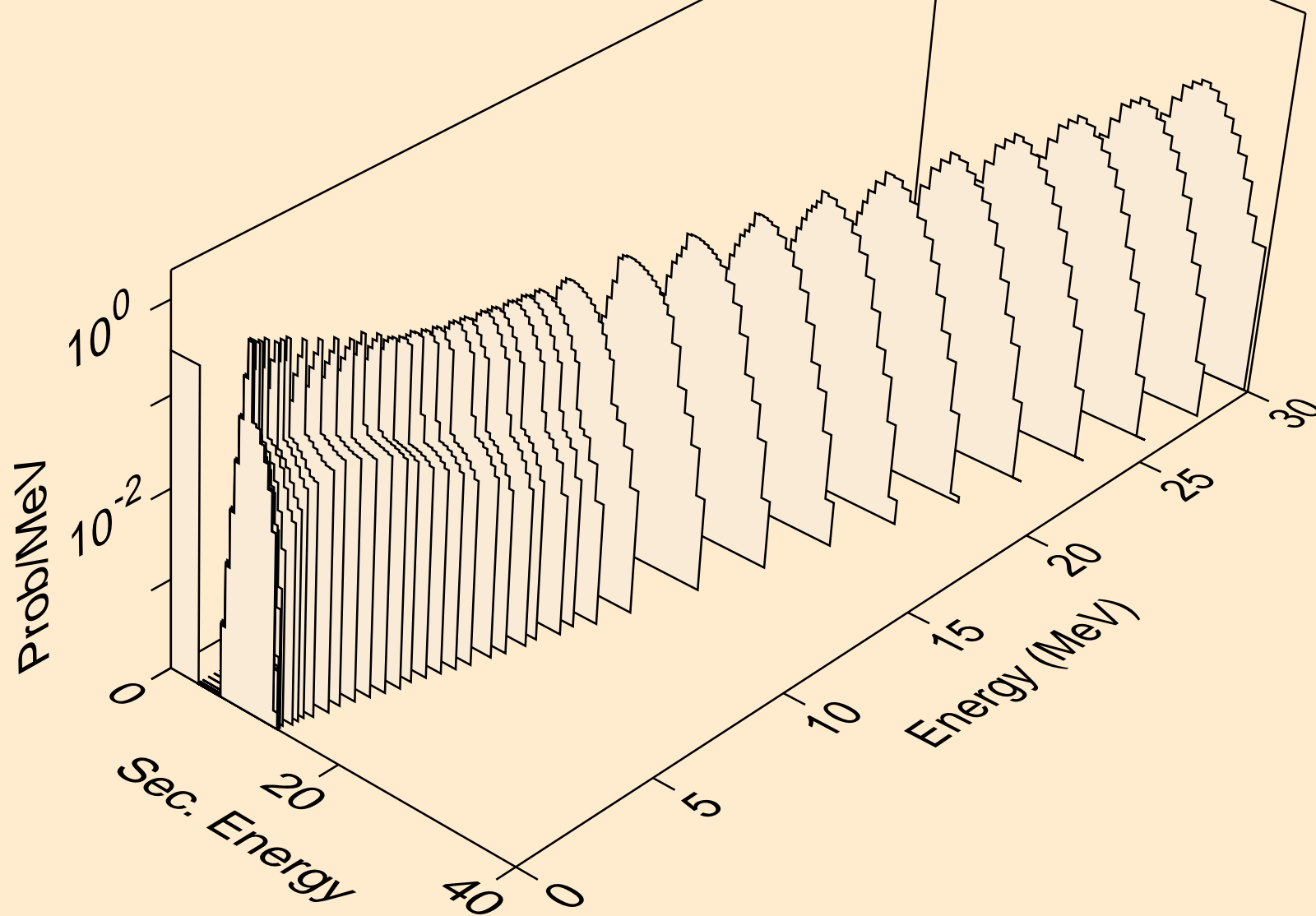

TE113 NEUTRON ACER TENDL-2024 LIBRARY; T=293.6K  
alphas from (n,2a)

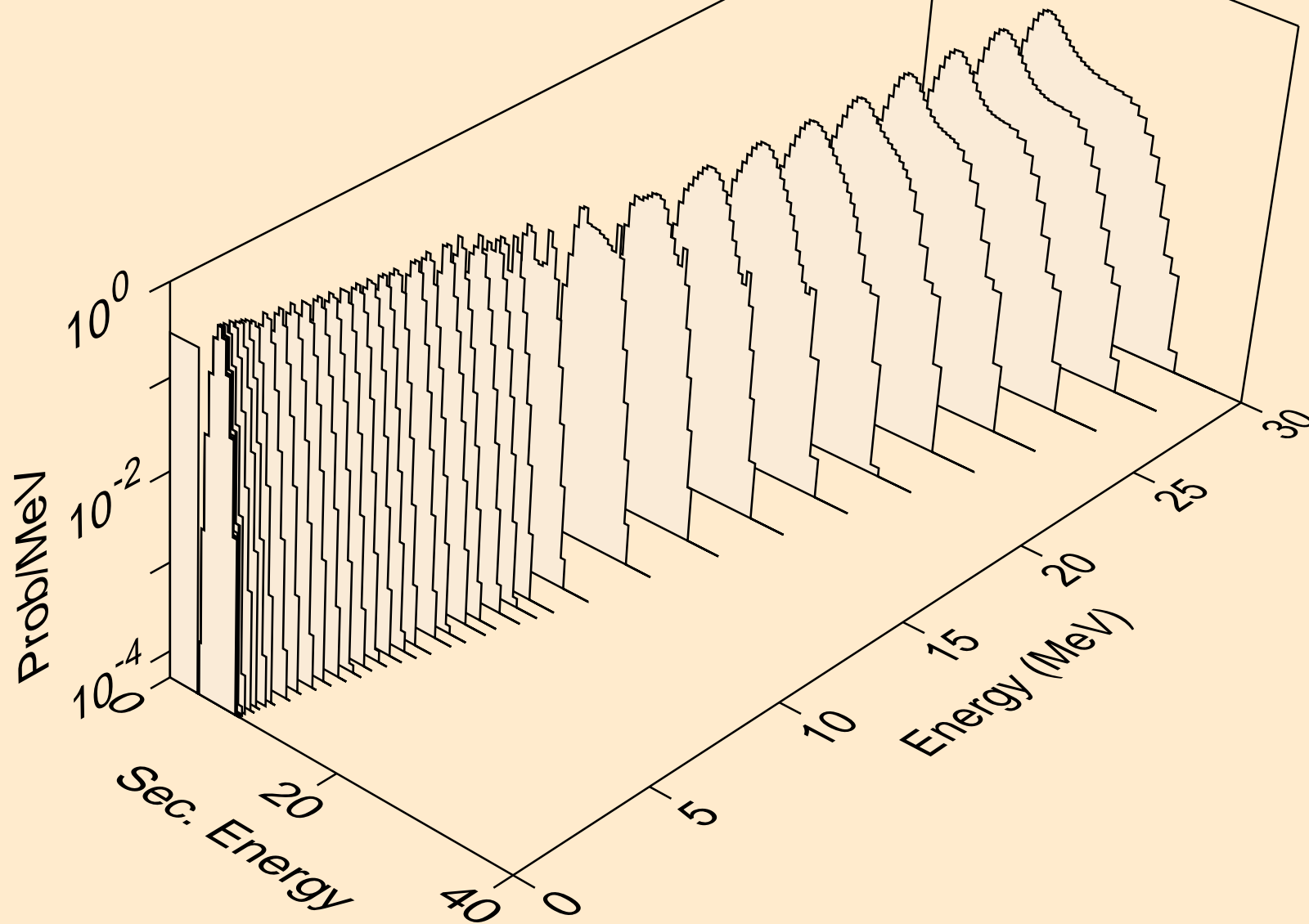

TE113 NEUTRON ACER TENDL-2024 LIBRARY; T=293.6K  
alphas from (n,3a)

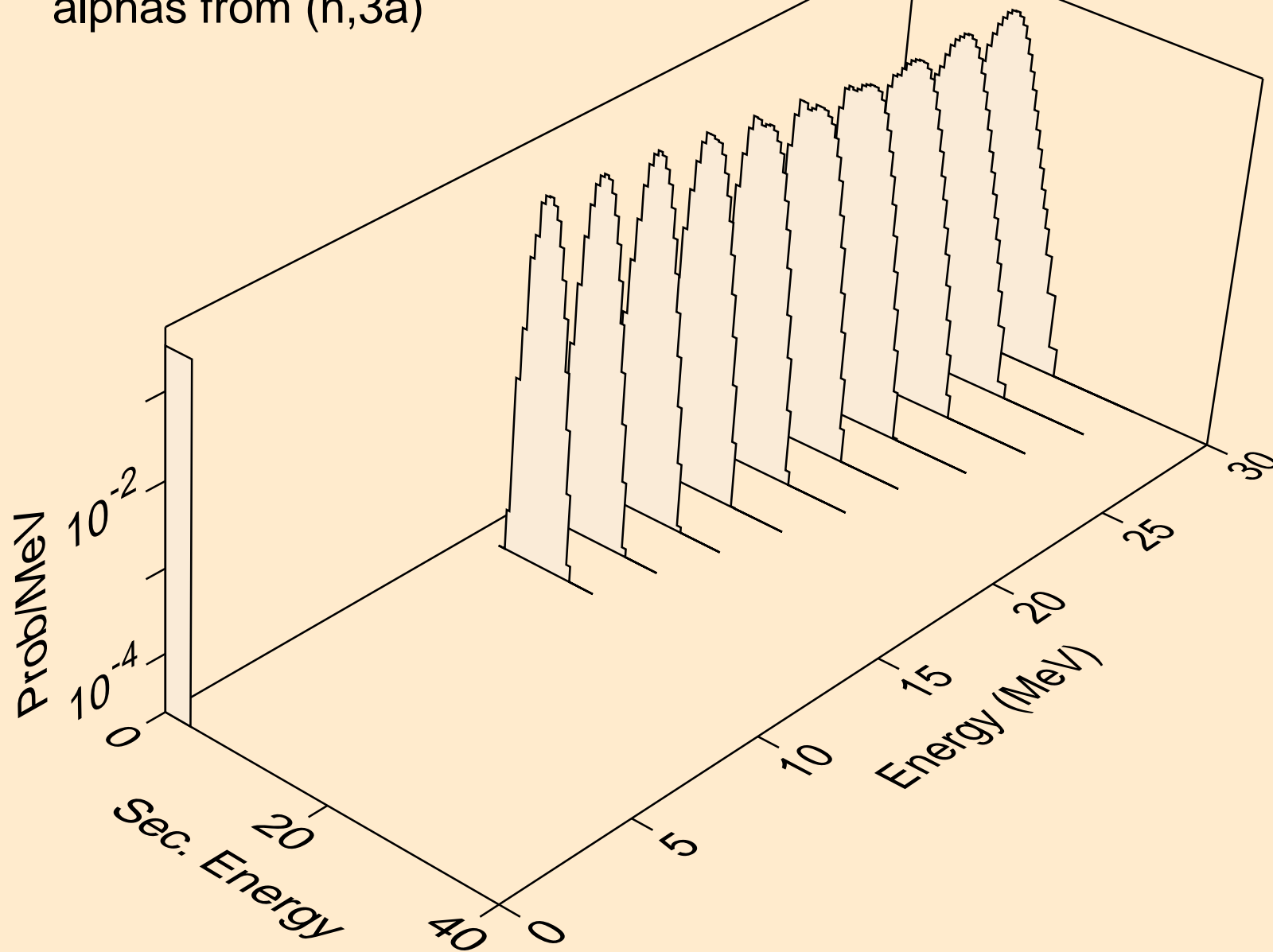

TE113 NEUTRON ACER TENDL-2024 LIBRARY; T=293.6K  
alphas from (n,pa)

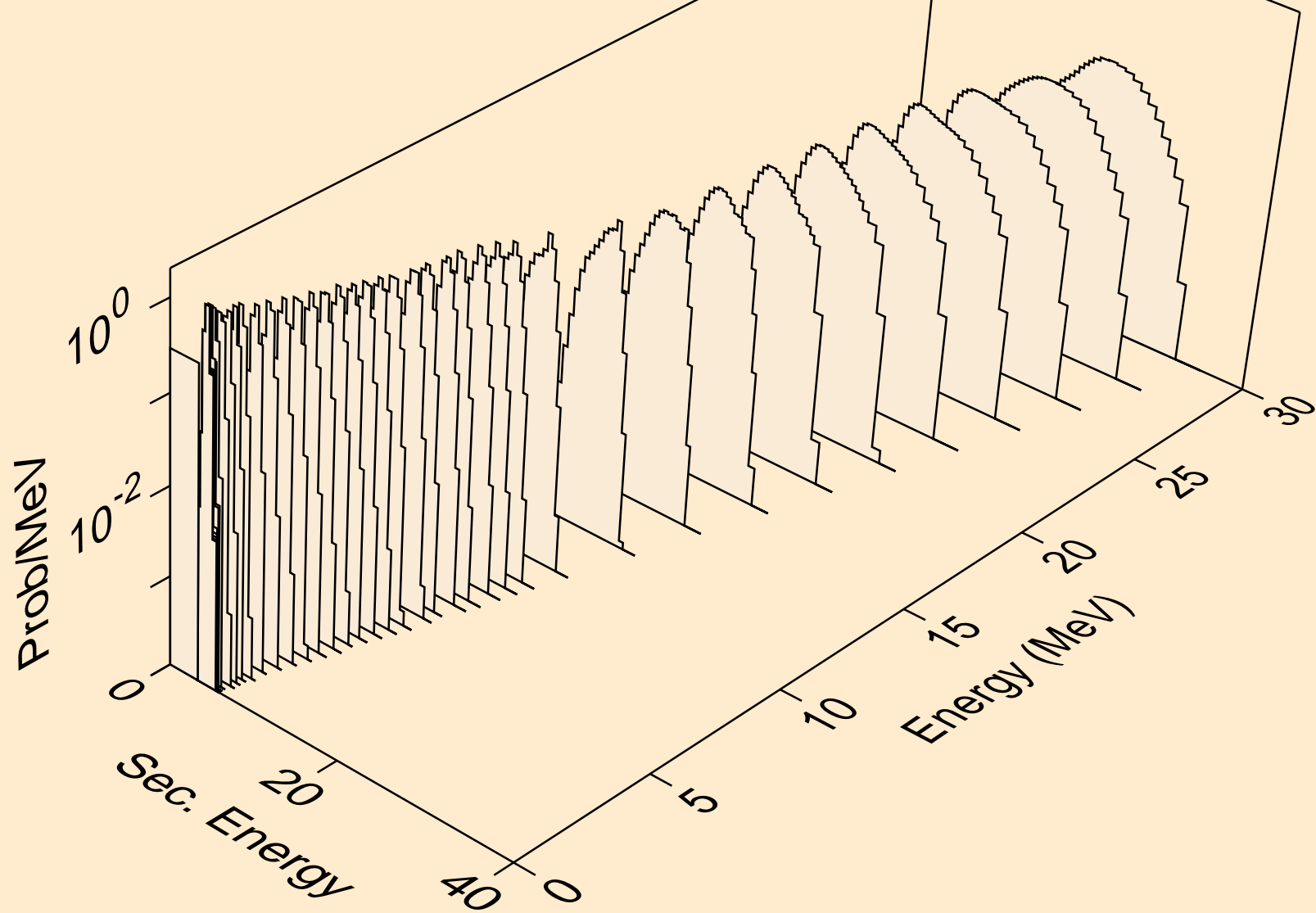

TE113 NEUTRON ACER TENDL-2024 LIBRARY; T=293.6K  
alphas from (n,da)

