

# TH234 NEUTRON ACER TENDL-2024 LIBRARY; T=293.6K

## Principal cross sections

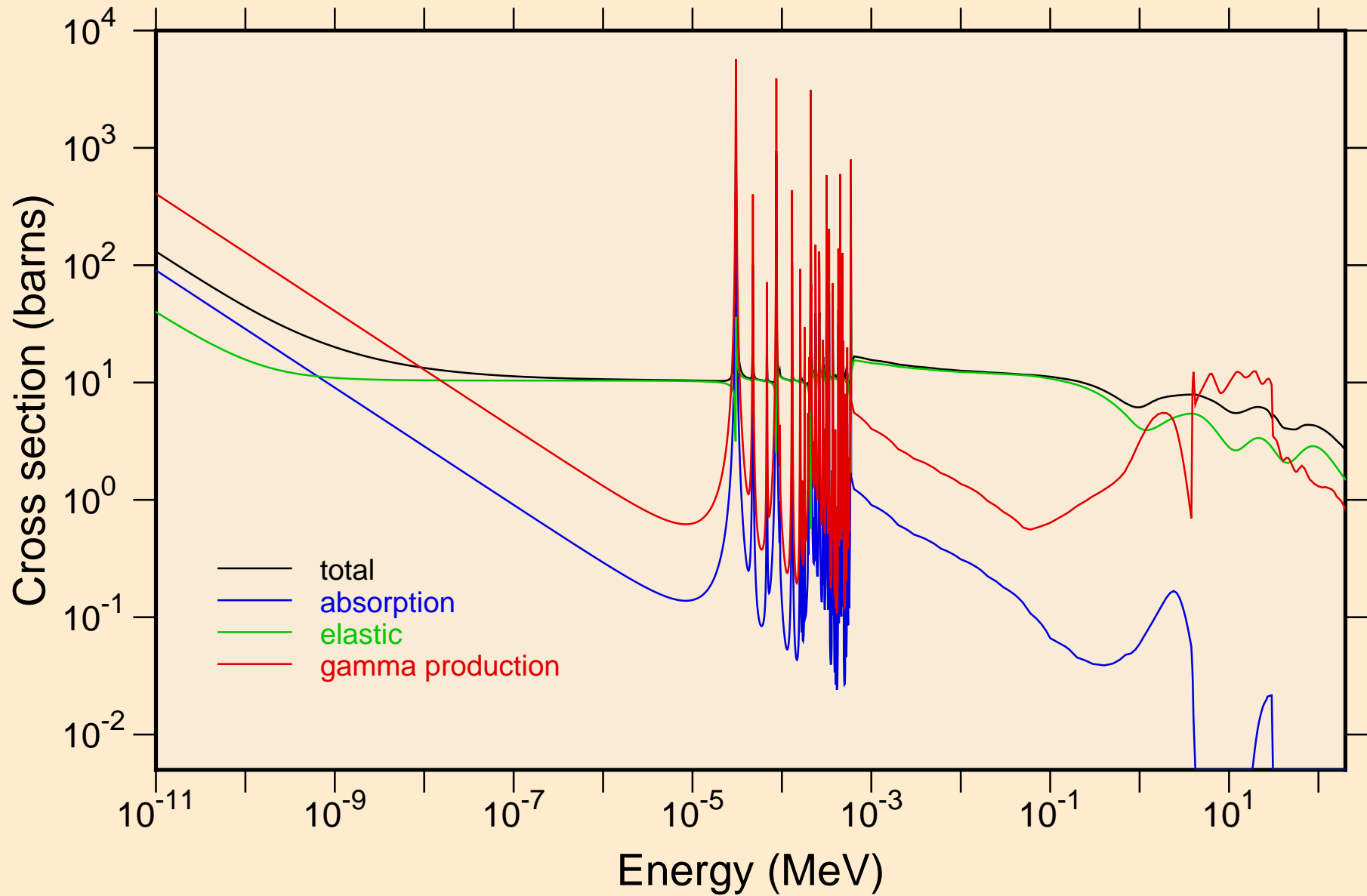

TH234 NEUTRON ACER TENDL-2024 LIBRARY; T=293.6K  
resonance total cross section

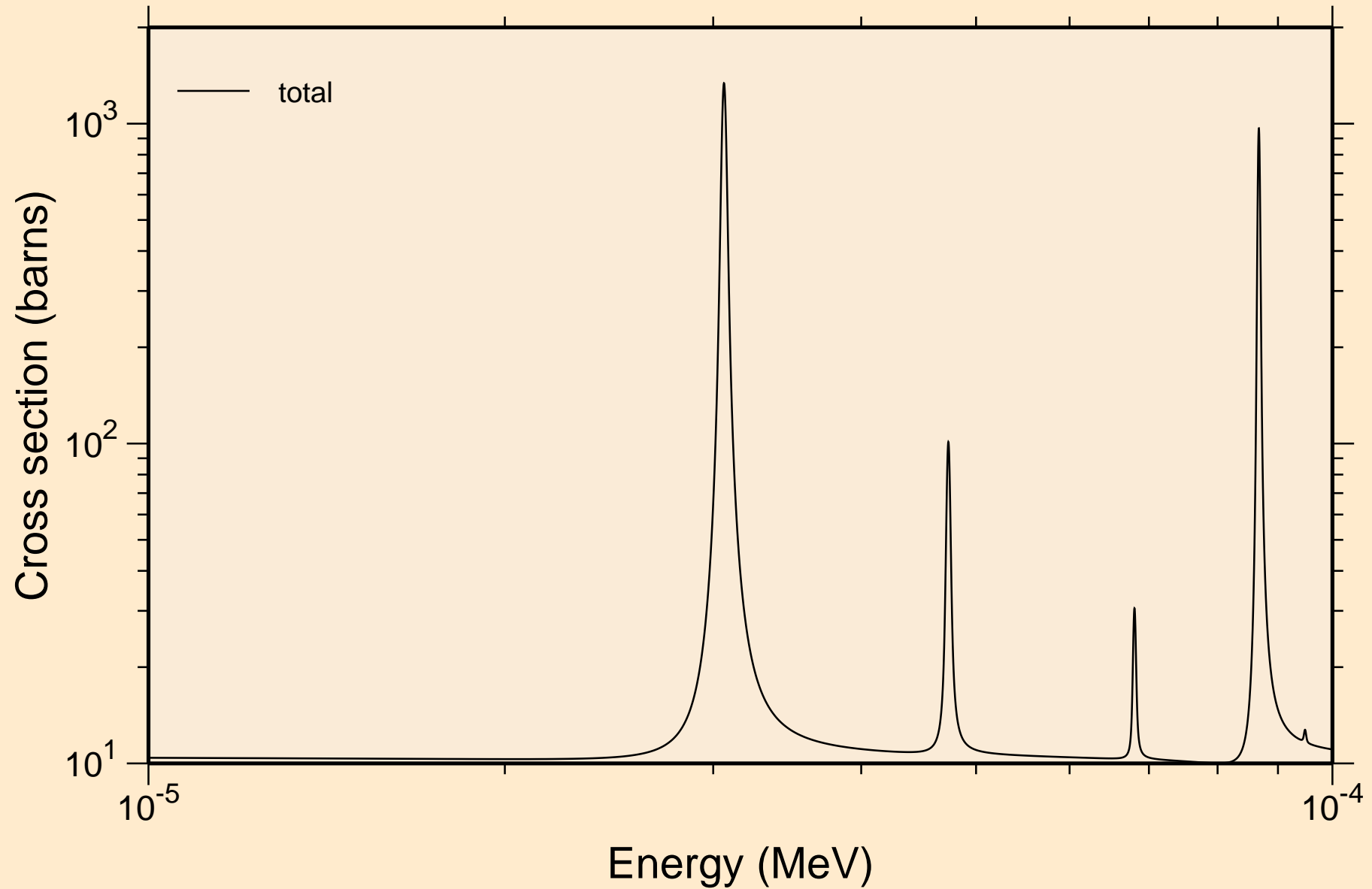

TH234 NEUTRON ACER TENDL-2024 LIBRARY; T=293.6K  
resonance total cross section

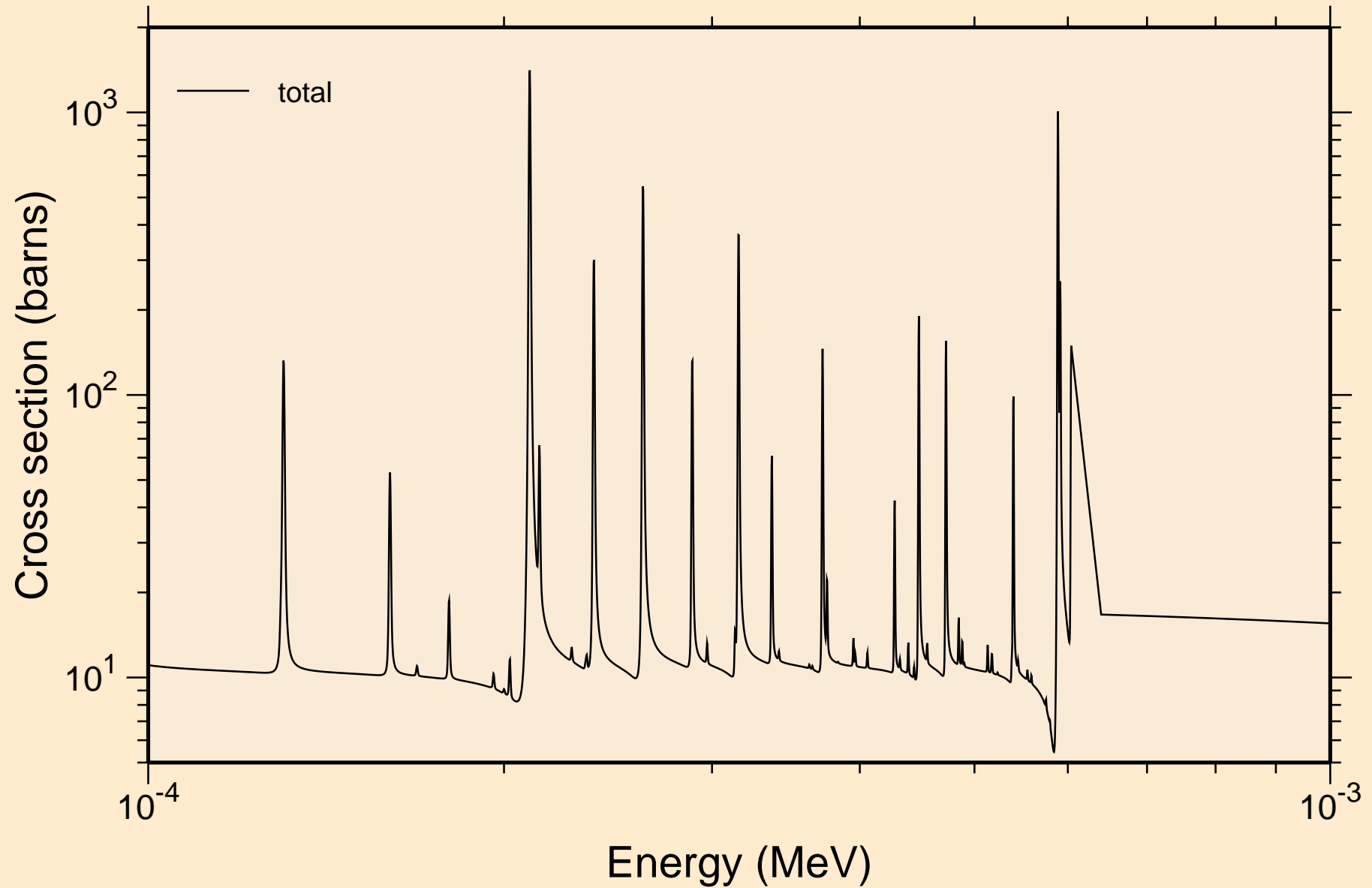

TH234 NEUTRON ACER TENDL-2024 LIBRARY; T=293.6K  
resonance total cross section

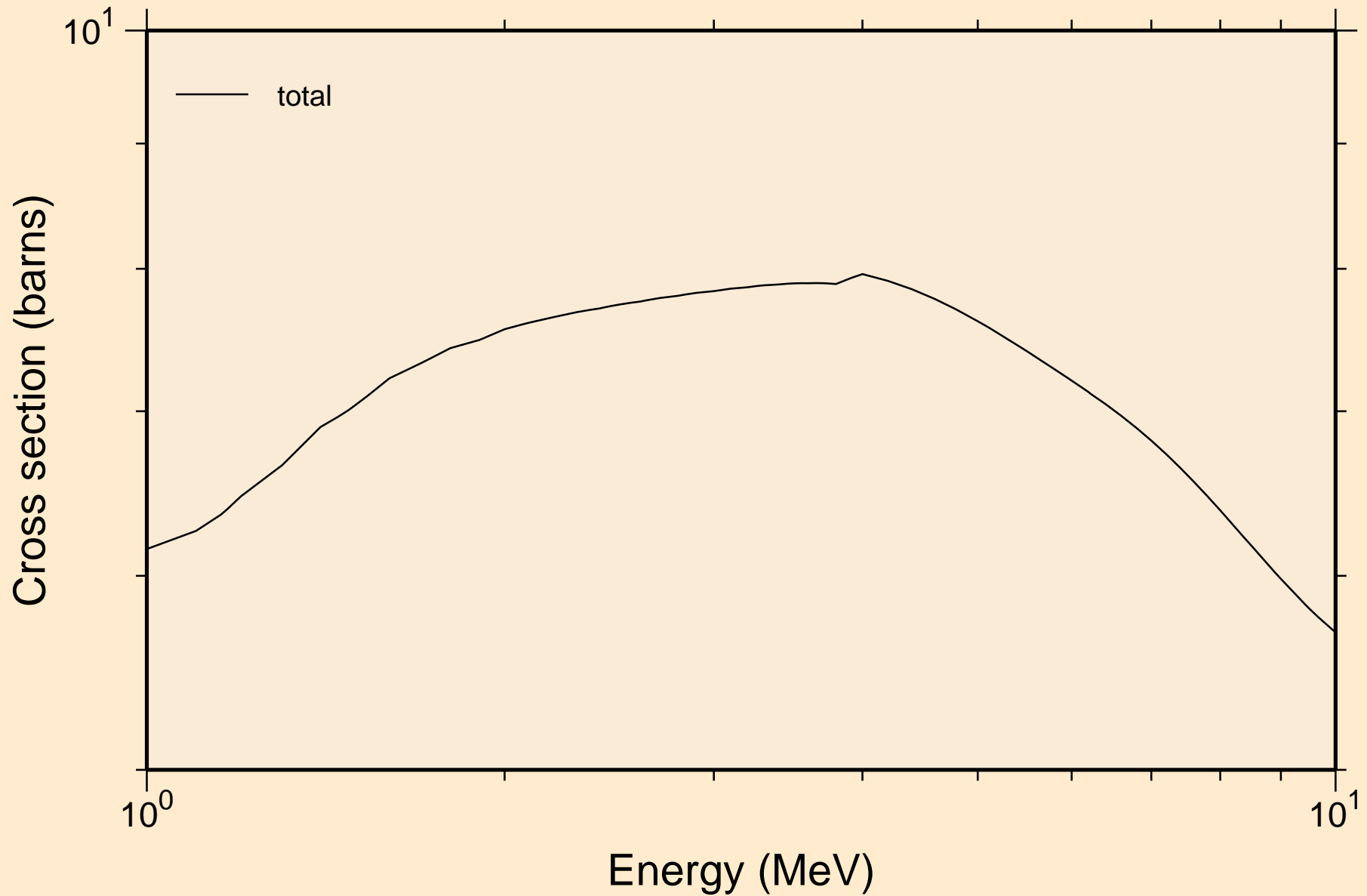

TH234 NEUTRON ACER TENDL-2024 LIBRARY; T=293.6K  
resonance absorption cross sections

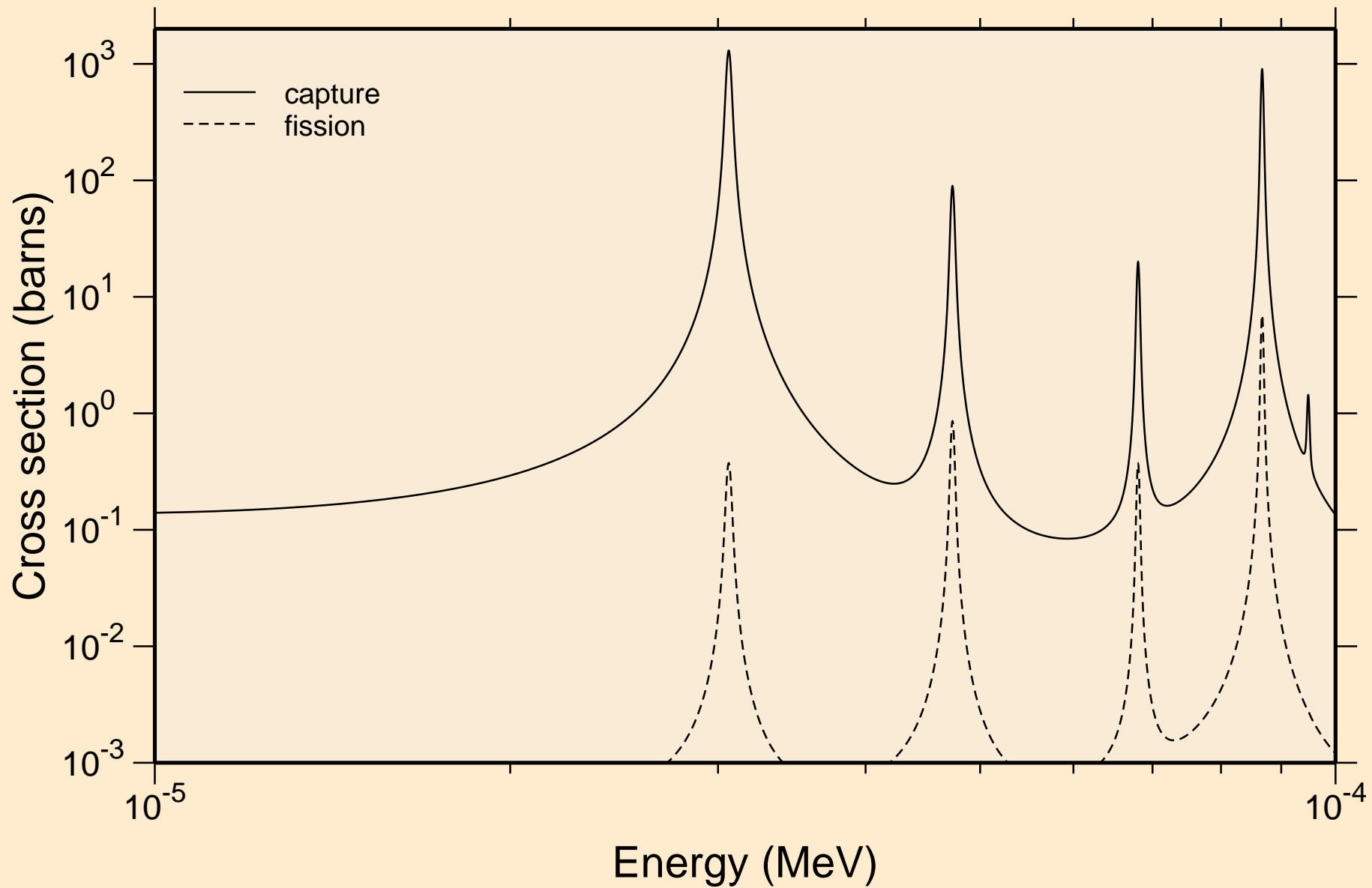

TH234 NEUTRON ACER TENDL-2024 LIBRARY; T=293.6K  
resonance absorption cross sections

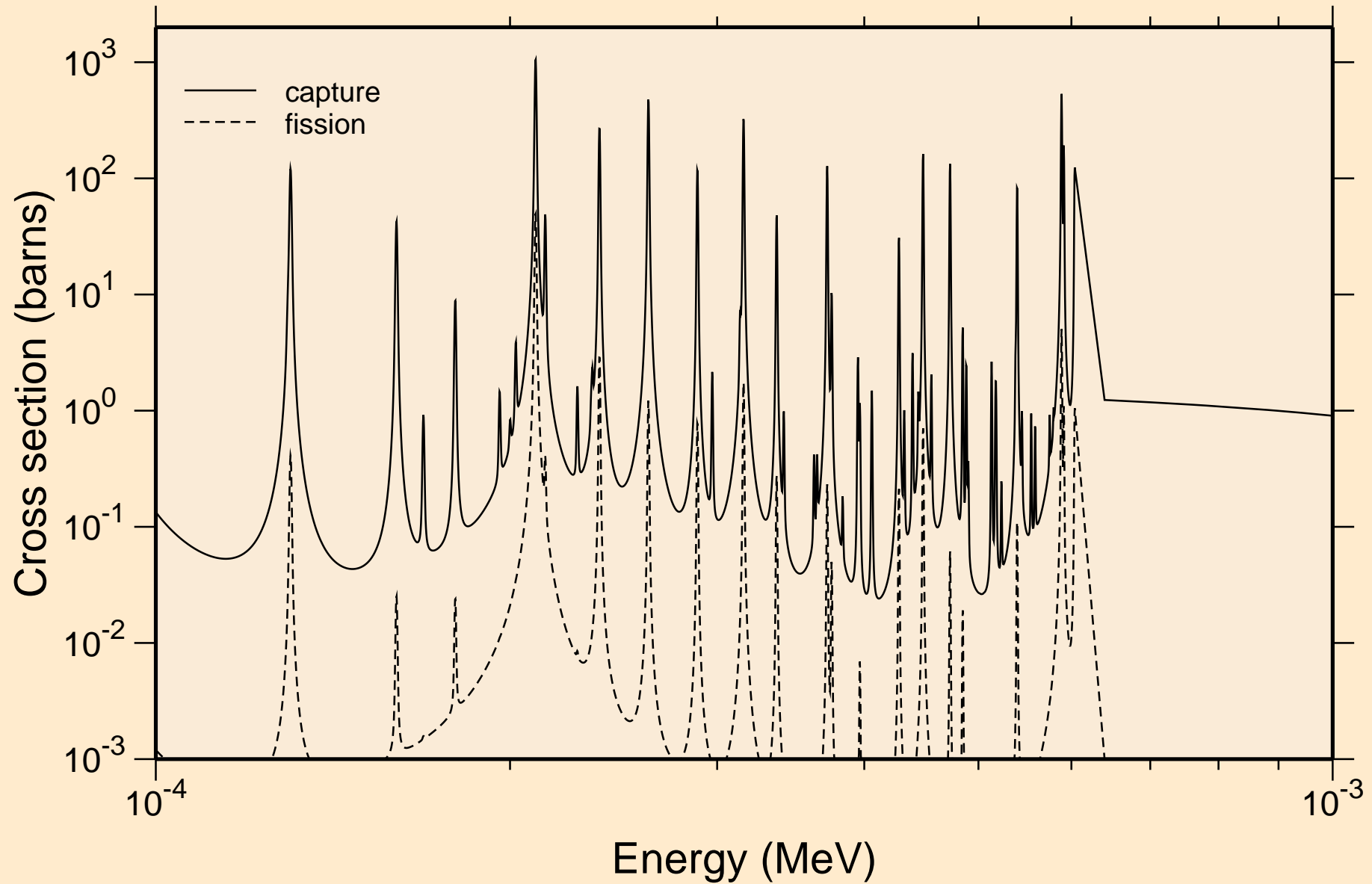

TH234 NEUTRON ACER TENDL-2024 LIBRARY; T=293.6K  
resonance absorption cross sections

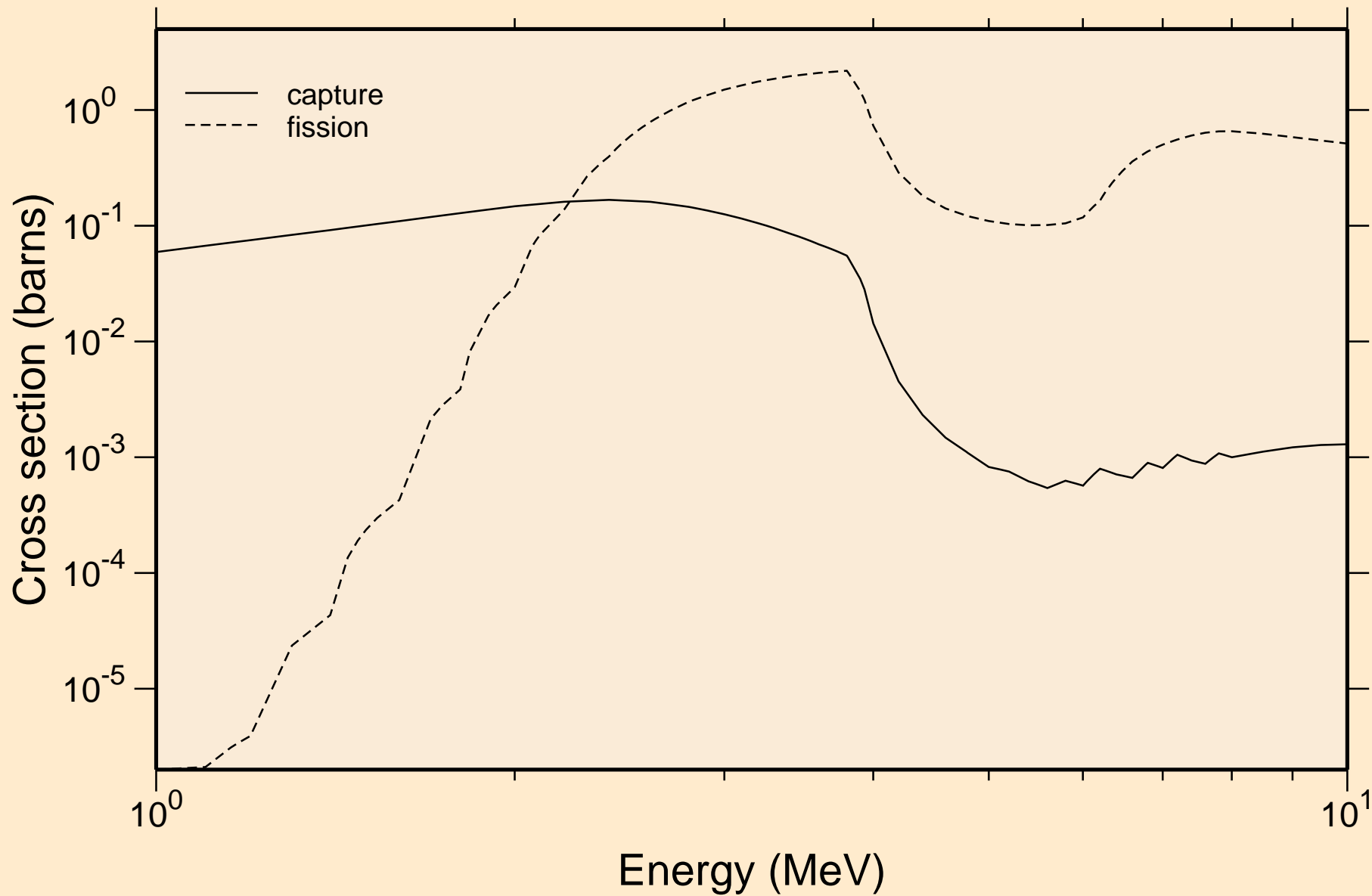

TH234 NEUTRON ACER TENDL-2024 LIBRARY; T=293.6K  
Heating

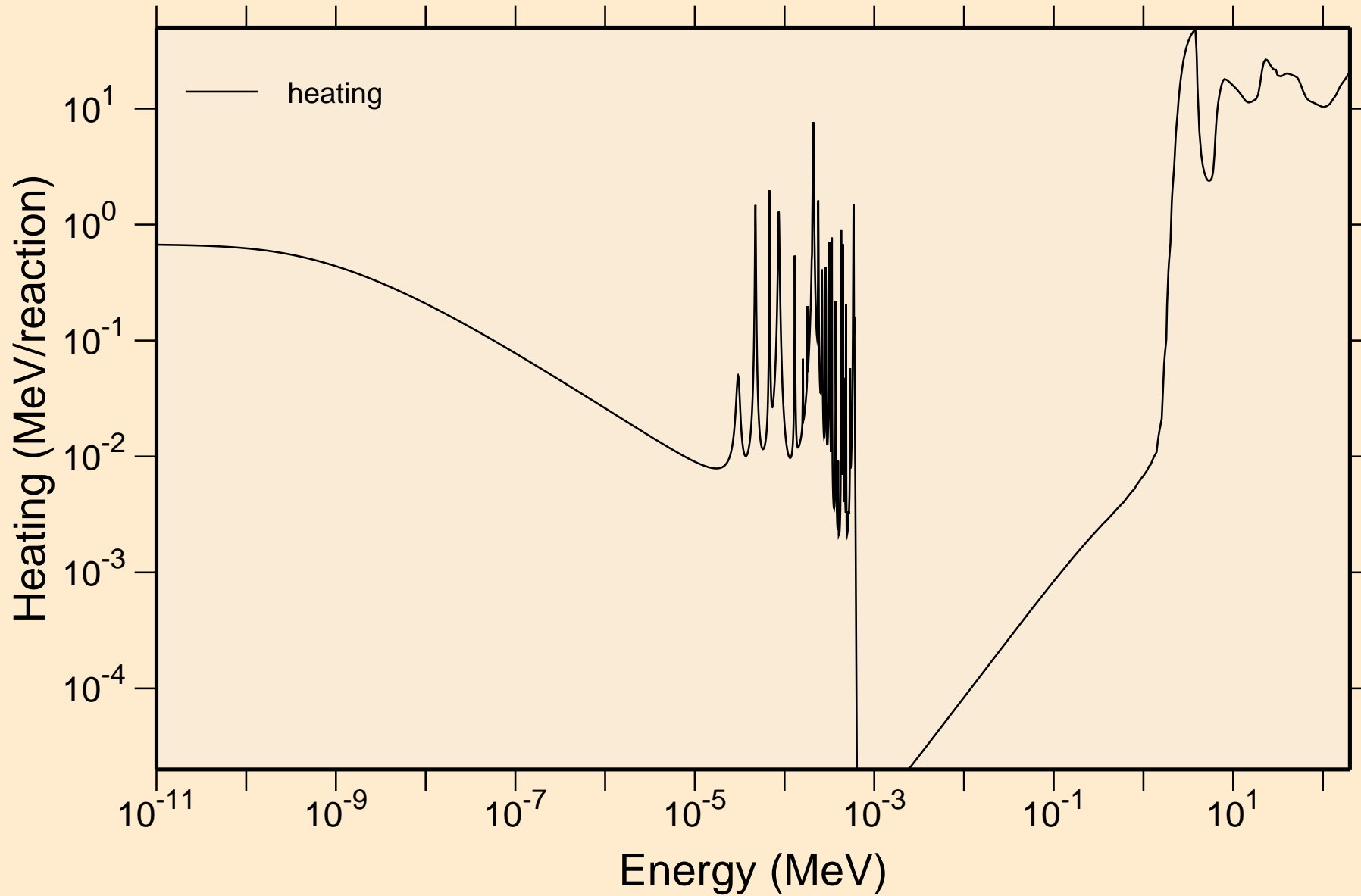

TH234 NEUTRON ACER TENDL-2024 LIBRARY; T=293.6K  
Damage

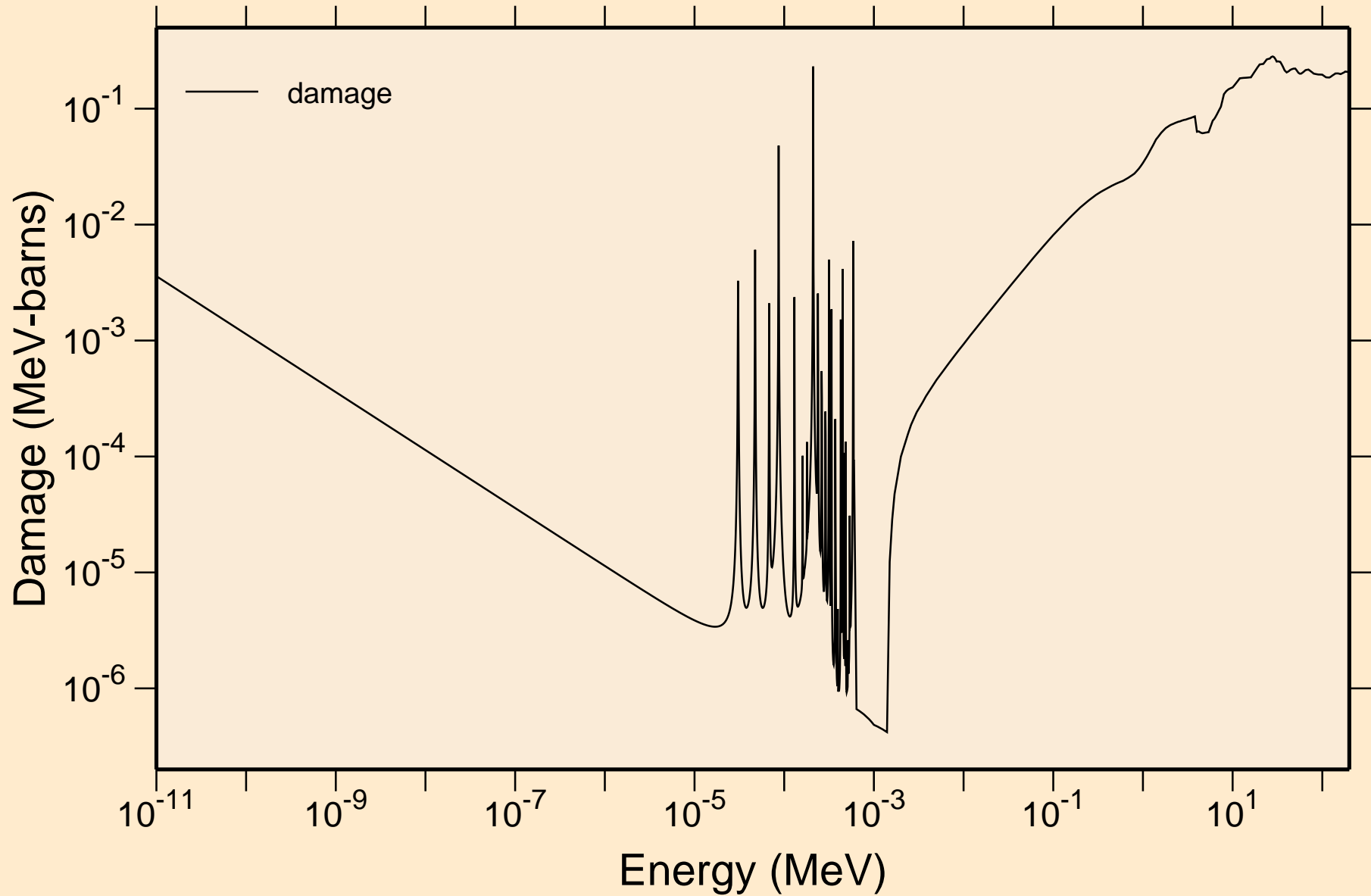

TH234 NEUTRON ACER TENDL-2024 LIBRARY; T=293.6K  
Non-threshold reactions

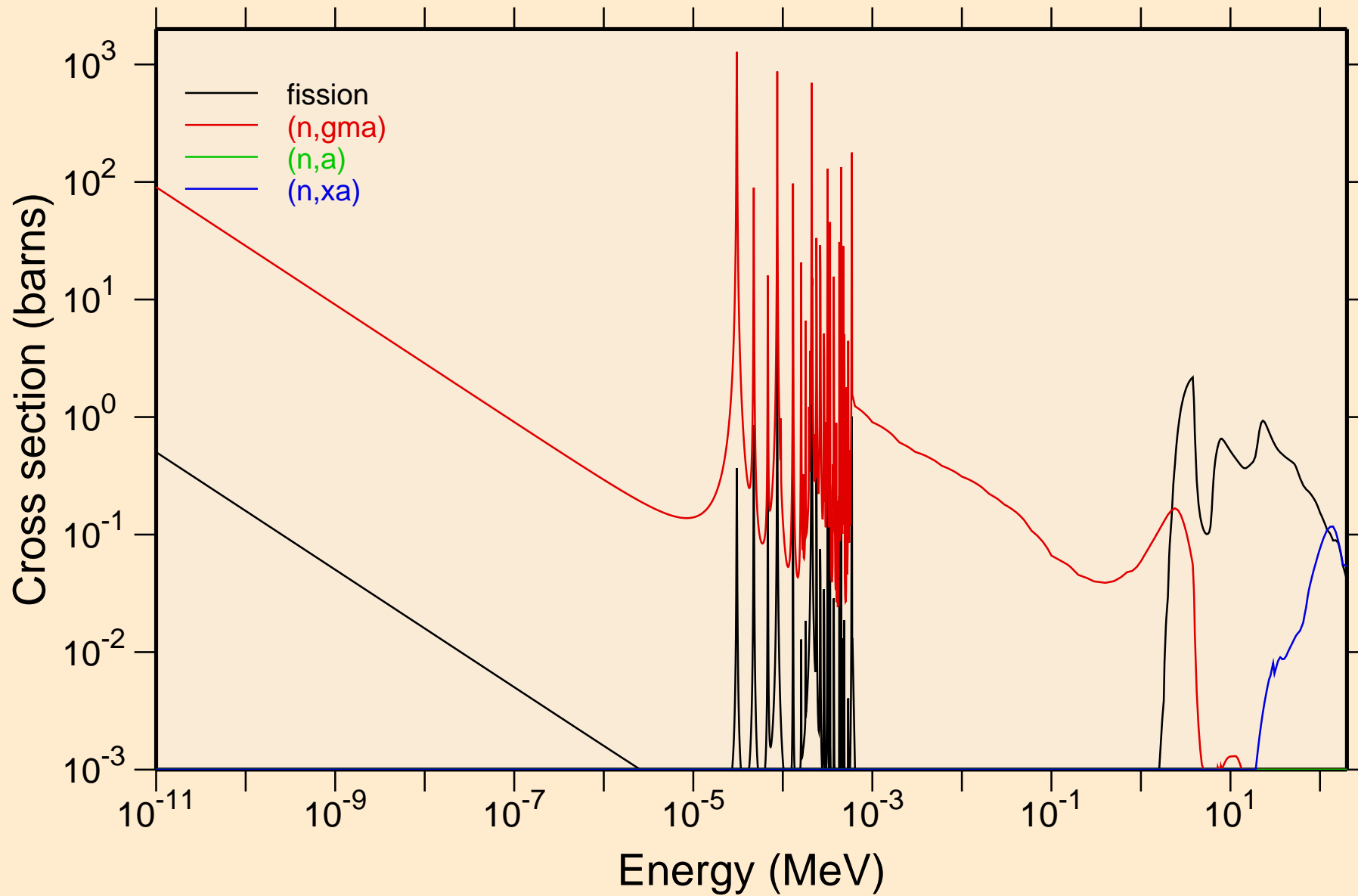

# TH234 NEUTRON ACER TENDL-2024 LIBRARY; T=293.6K

## Principal cross sections

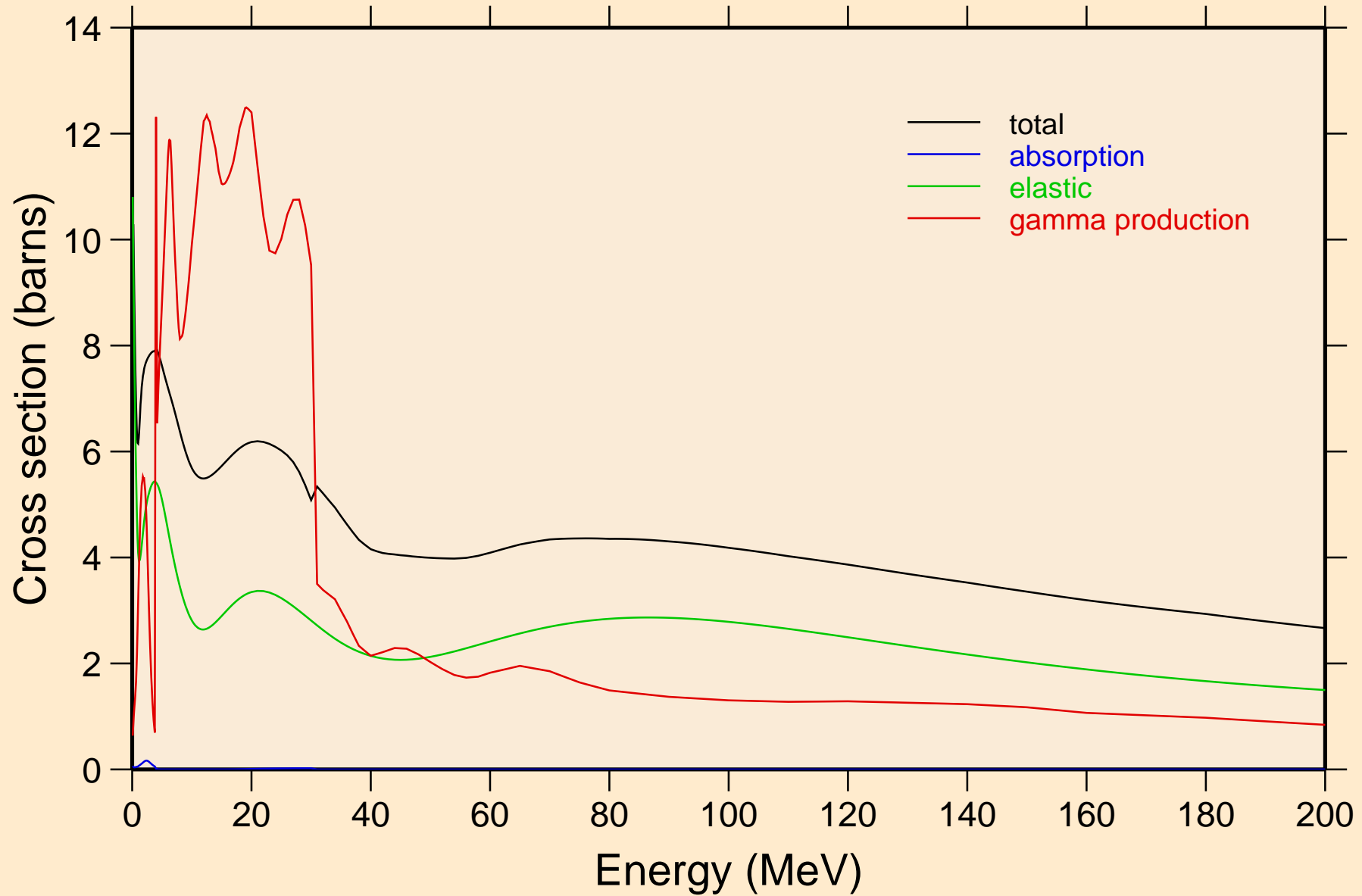

# TH234 NEUTRON ACER TENDL-2024 LIBRARY; T=293.6K

## Heating

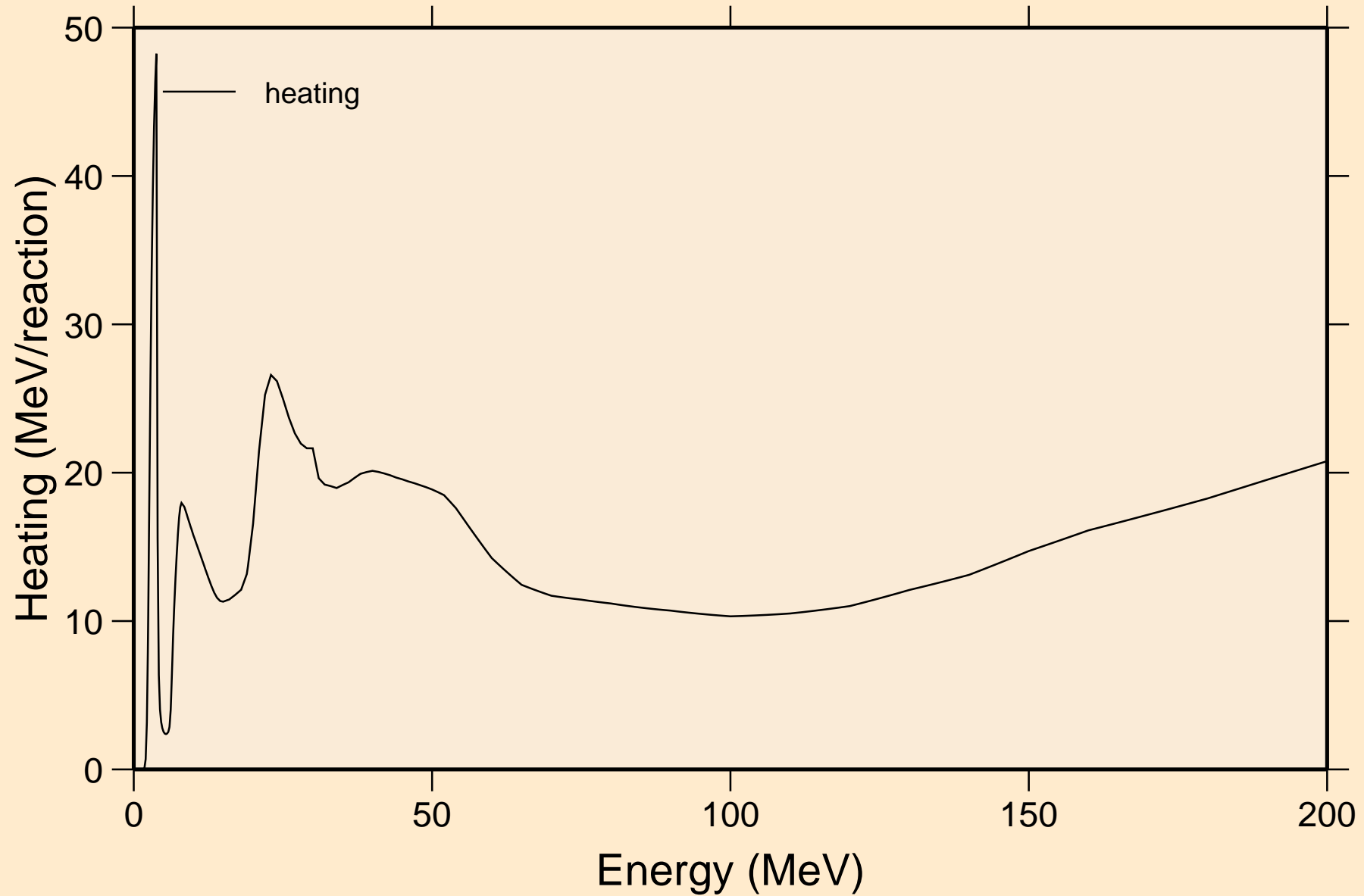

TH234 NEUTRON ACER TENDL-2024 LIBRARY; T=293.6K  
Damage

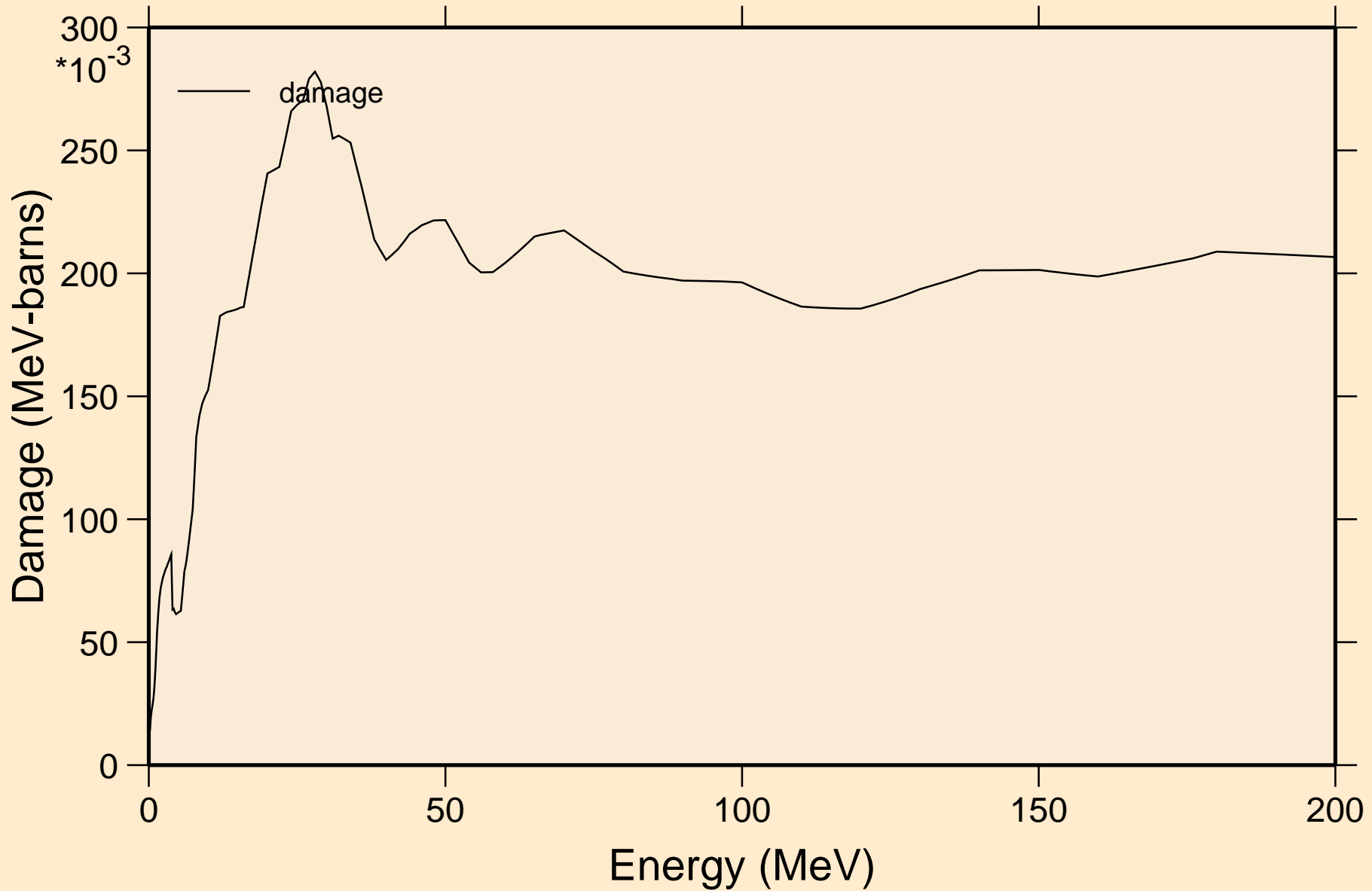

TH234 NEUTRON ACER TENDL-2024 LIBRARY; T=293.6K  
Non-threshold reactions

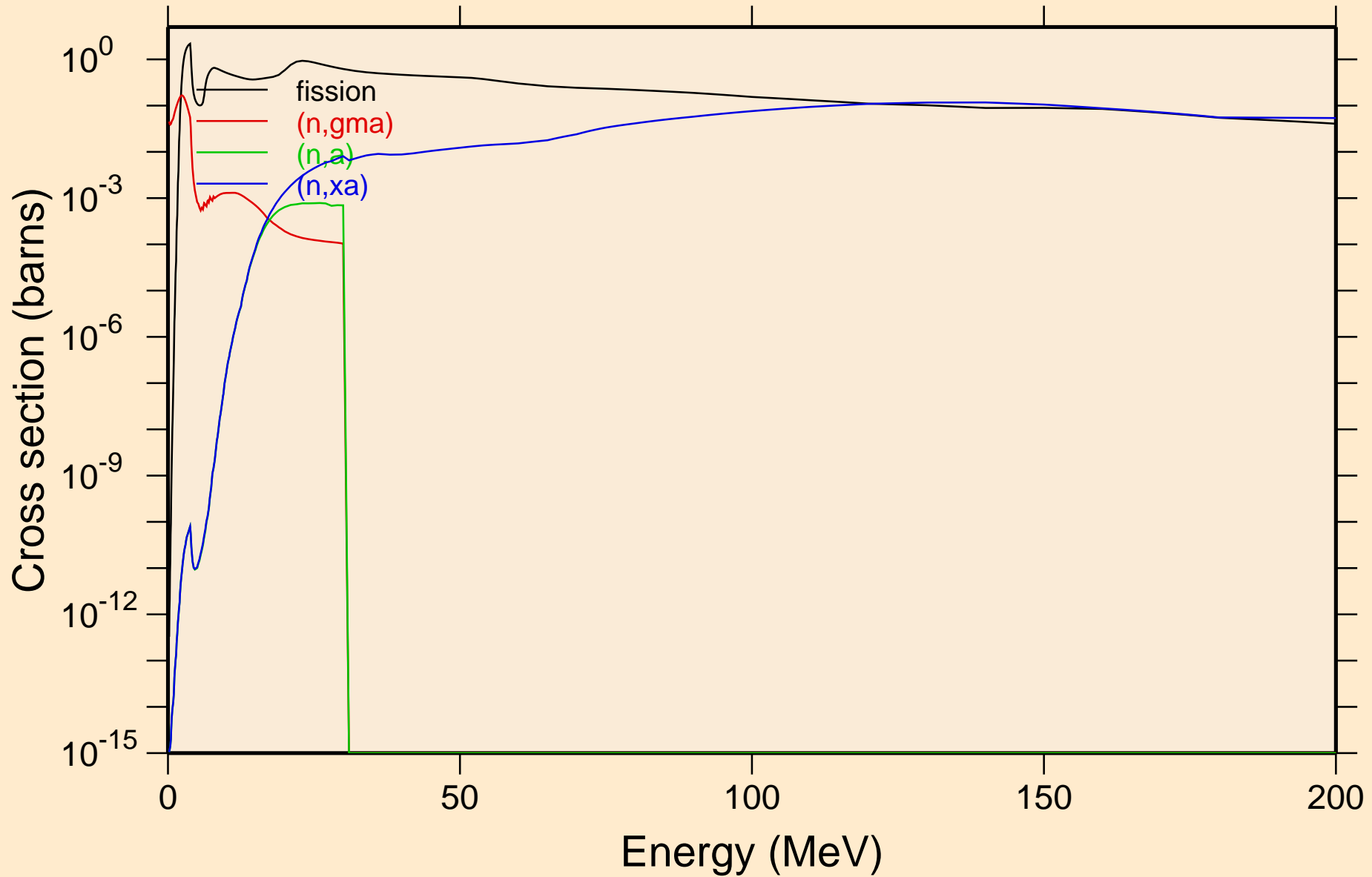

TH234 NEUTRON ACER TENDL-2024 LIBRARY; T=293.6K  
Inelastic levels

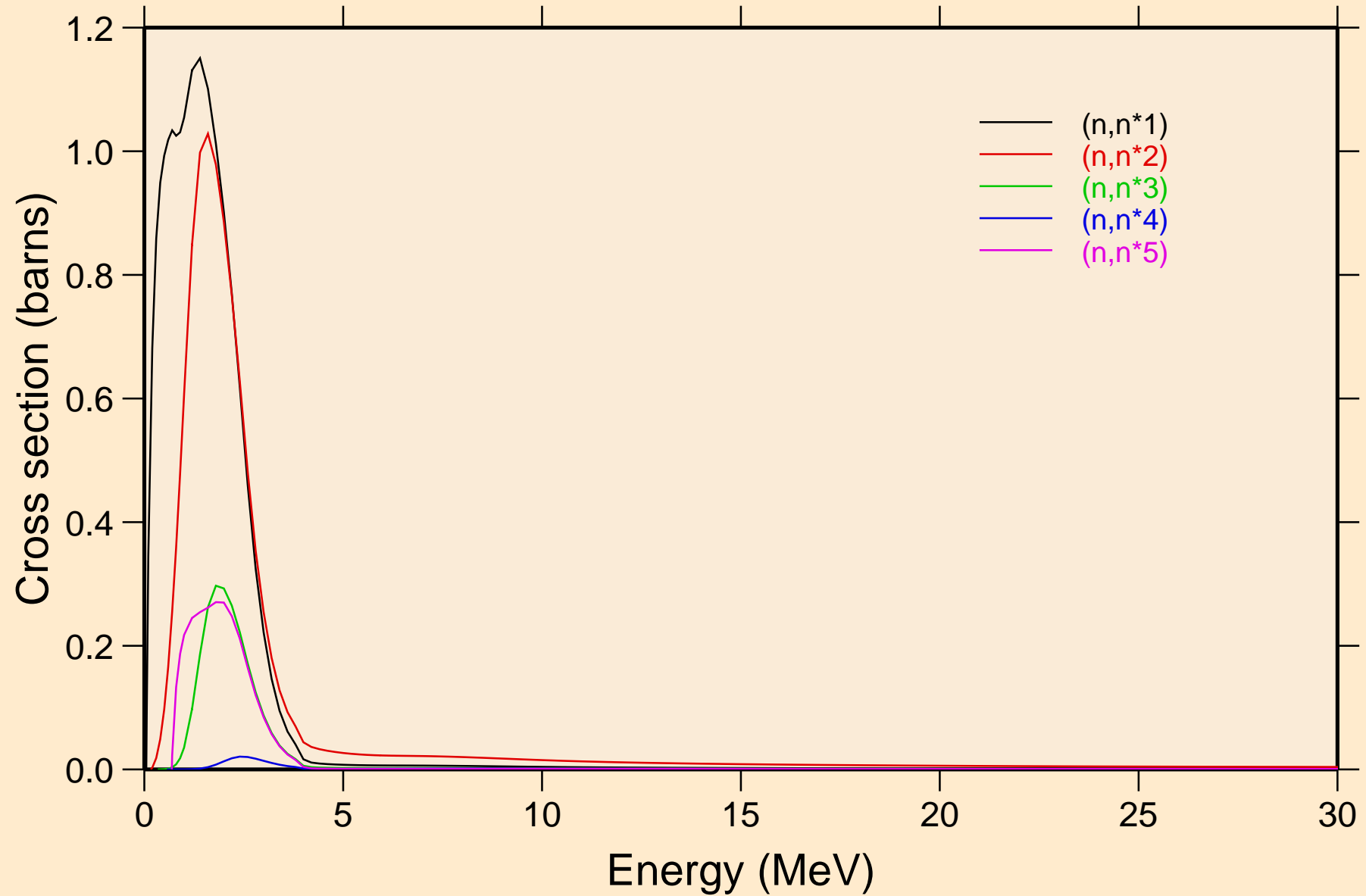

TH234 NEUTRON ACER TENDL-2024 LIBRARY; T=293.6K  
Inelastic levels

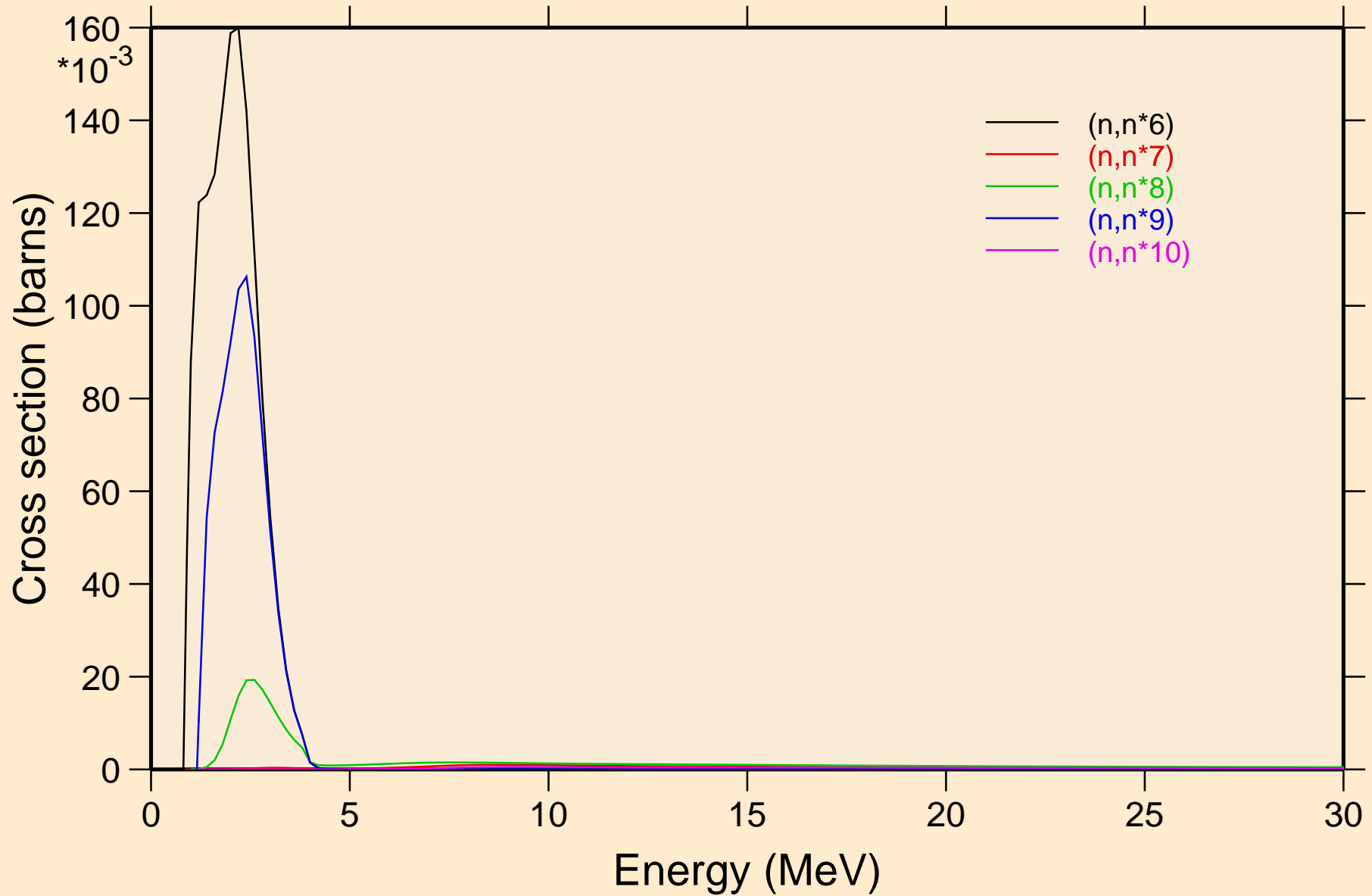

TH234 NEUTRON ACER TENDL-2024 LIBRARY; T=293.6K  
Inelastic levels

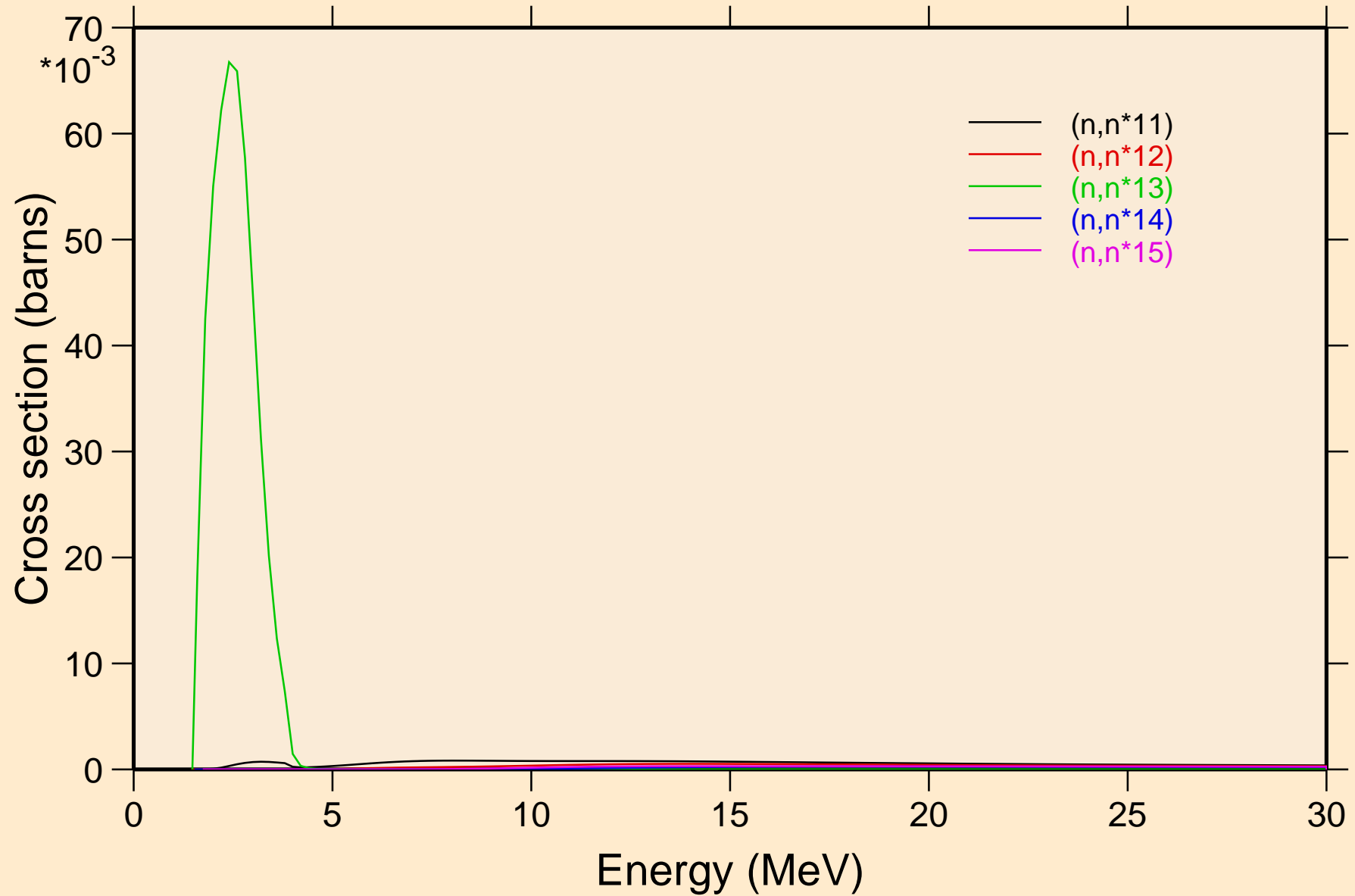

TH234 NEUTRON ACER TENDL-2024 LIBRARY; T=293.6K  
Inelastic levels

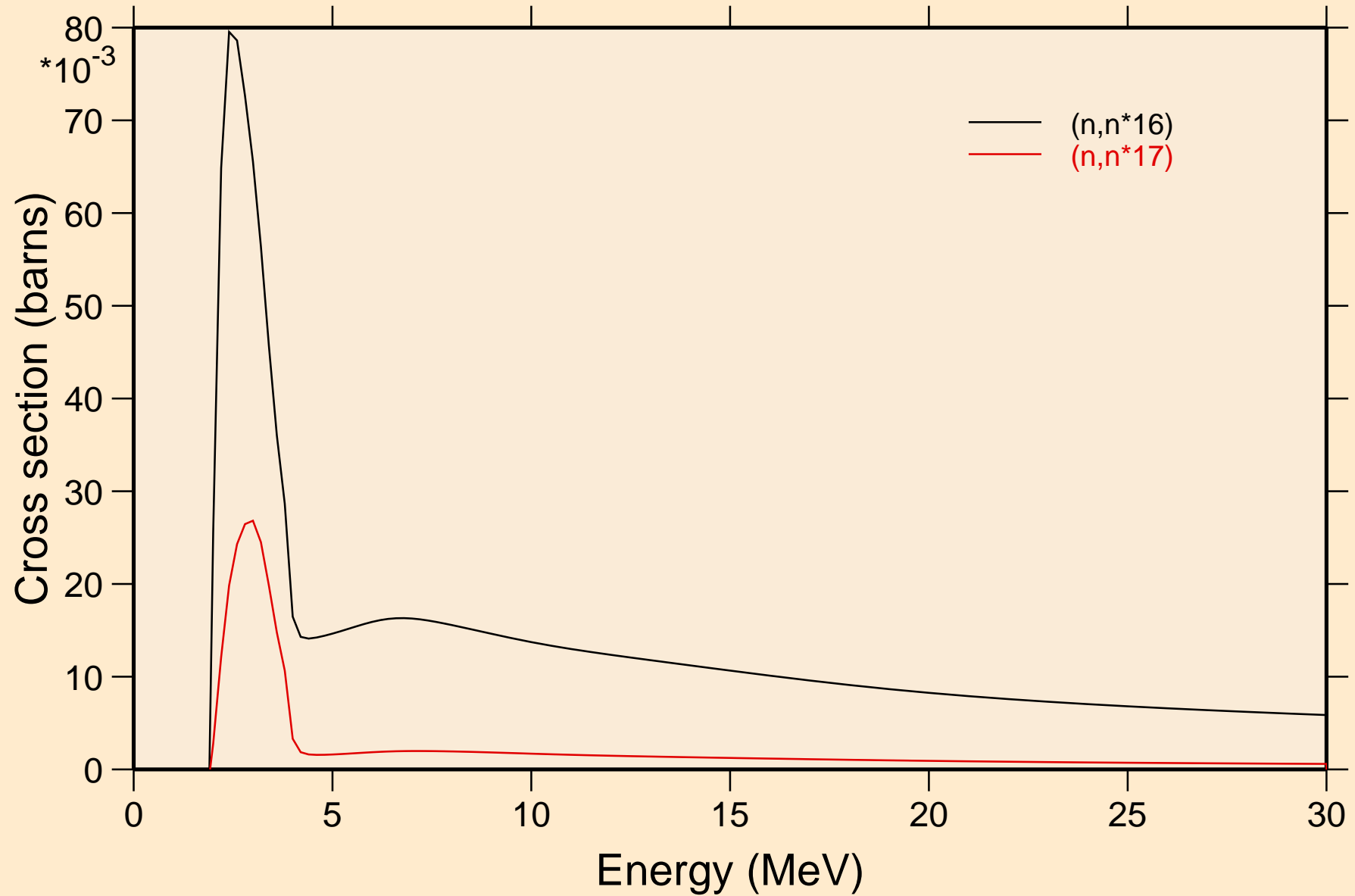

# TH234 NEUTRON ACER TENDL-2024 LIBRARY; T=293.6K

## Threshold reactions

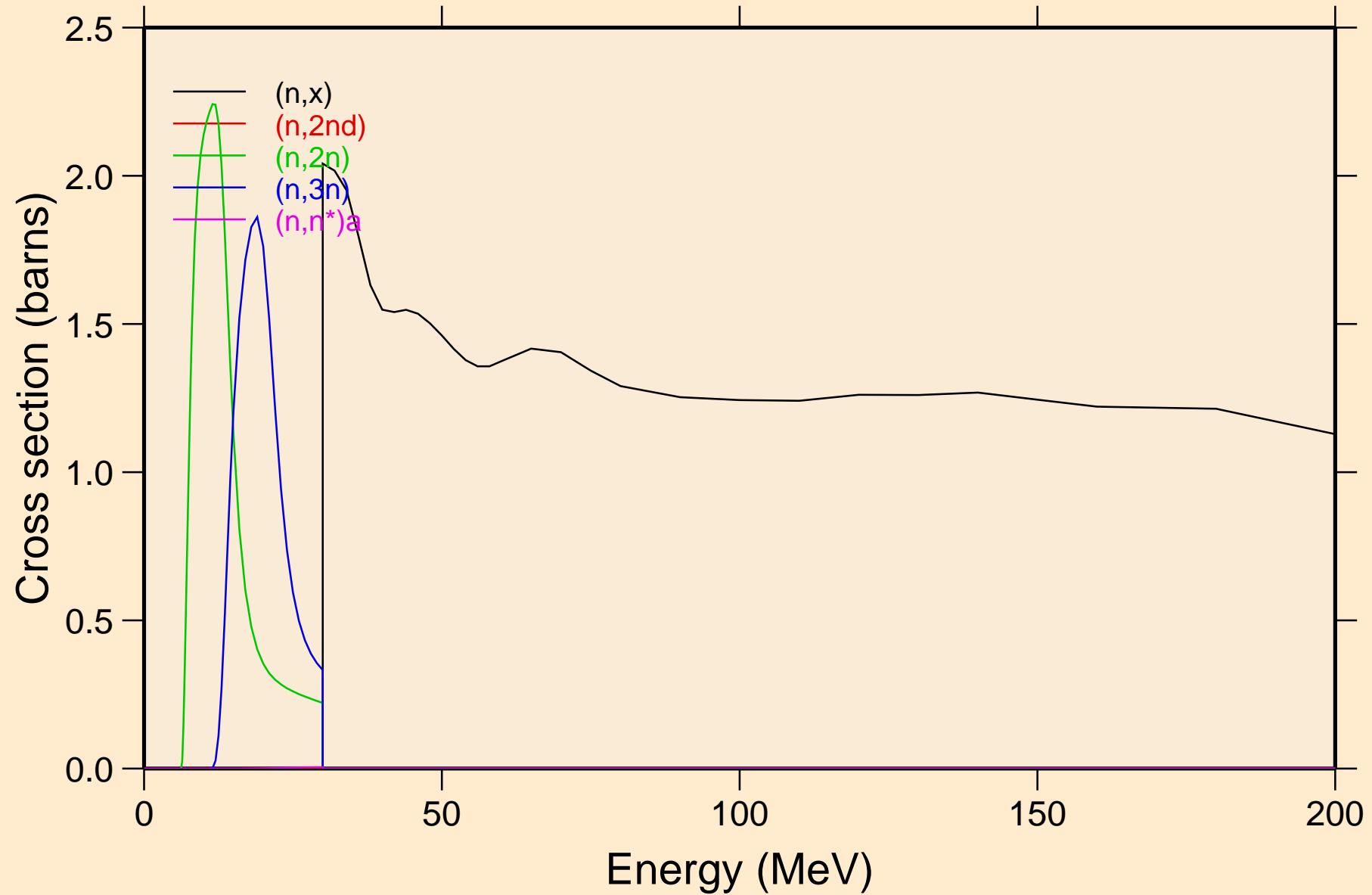

TH234 NEUTRON ACER TENDL-2024 LIBRARY; T=293.6K  
Threshold reactions

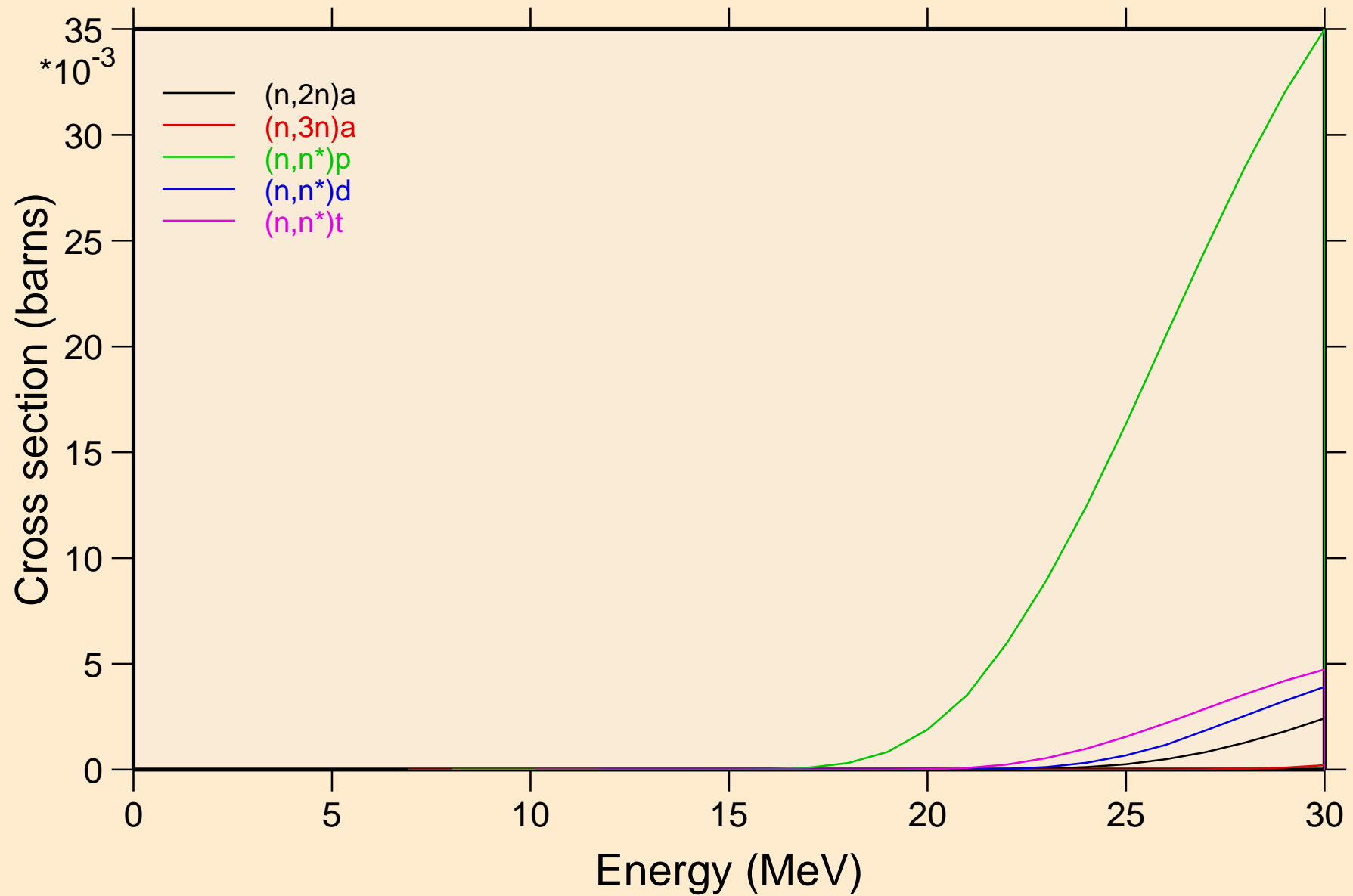

TH234 NEUTRON ACER TENDL-2024 LIBRARY; T=293.6K  
Threshold reactions

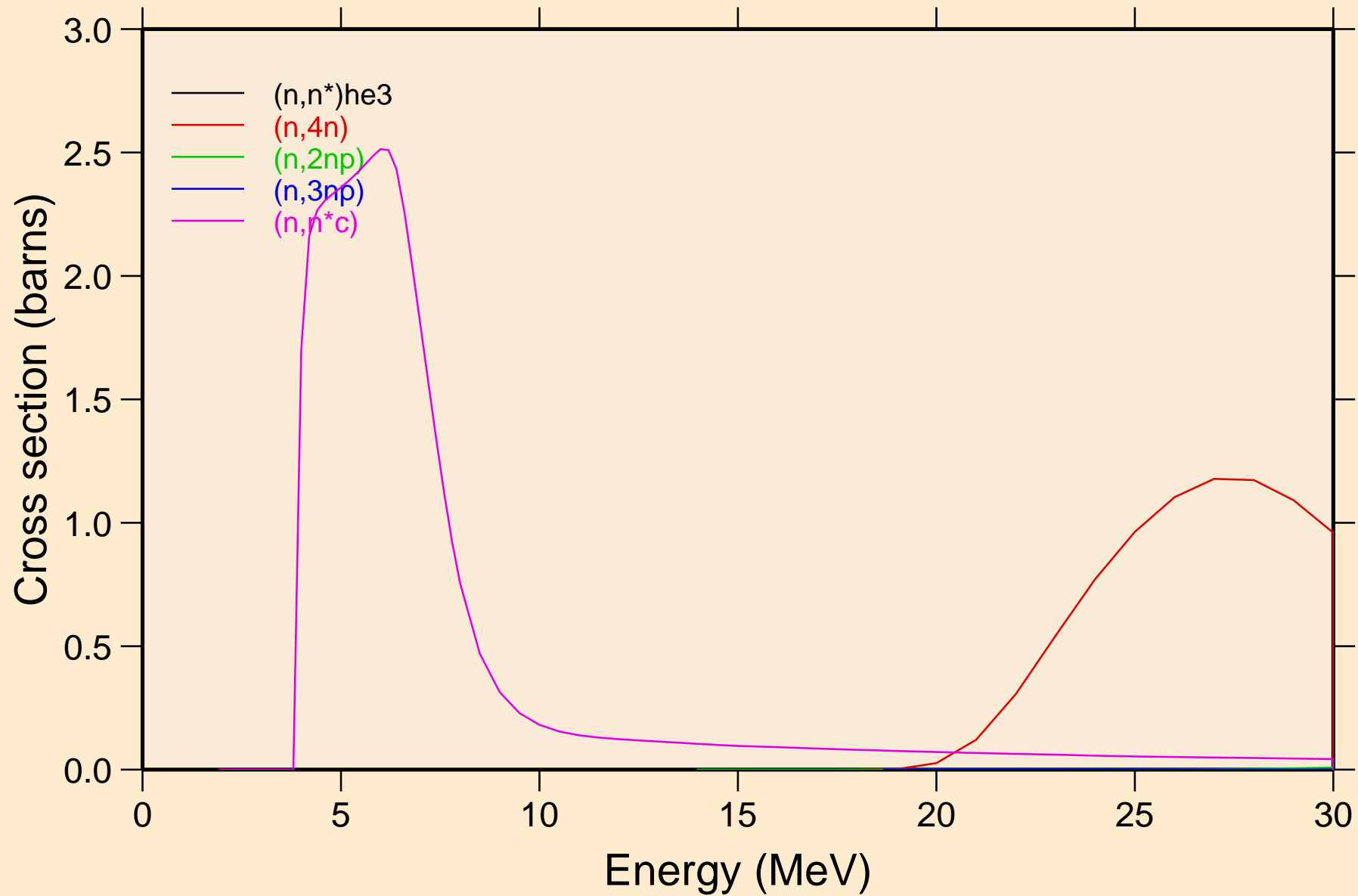

TH234 NEUTRON ACER TENDL-2024 LIBRARY; T=293.6K  
Threshold reactions

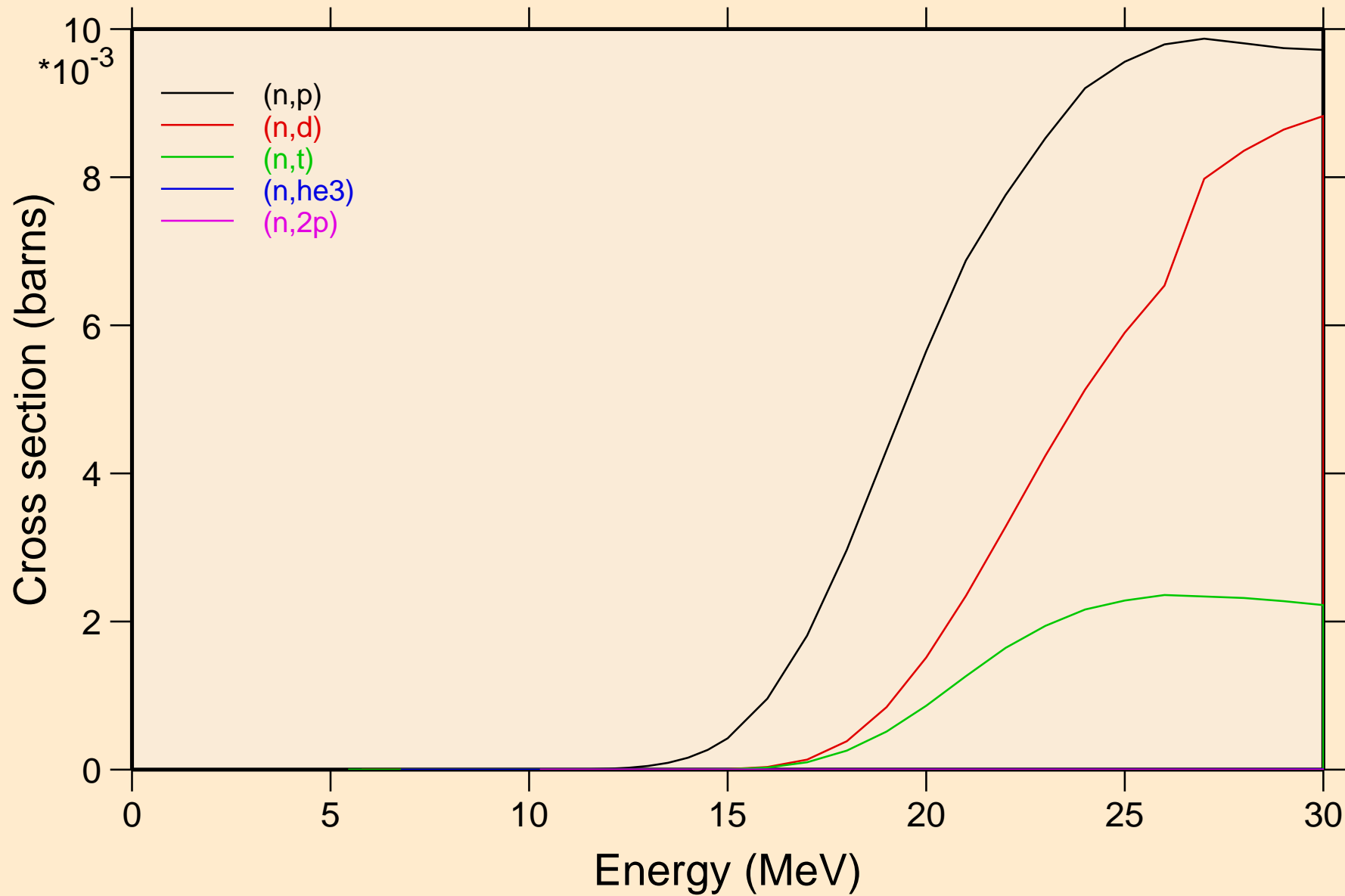

TH234 NEUTRON ACER TENDL-2024 LIBRARY; T=293.6K  
Threshold reactions

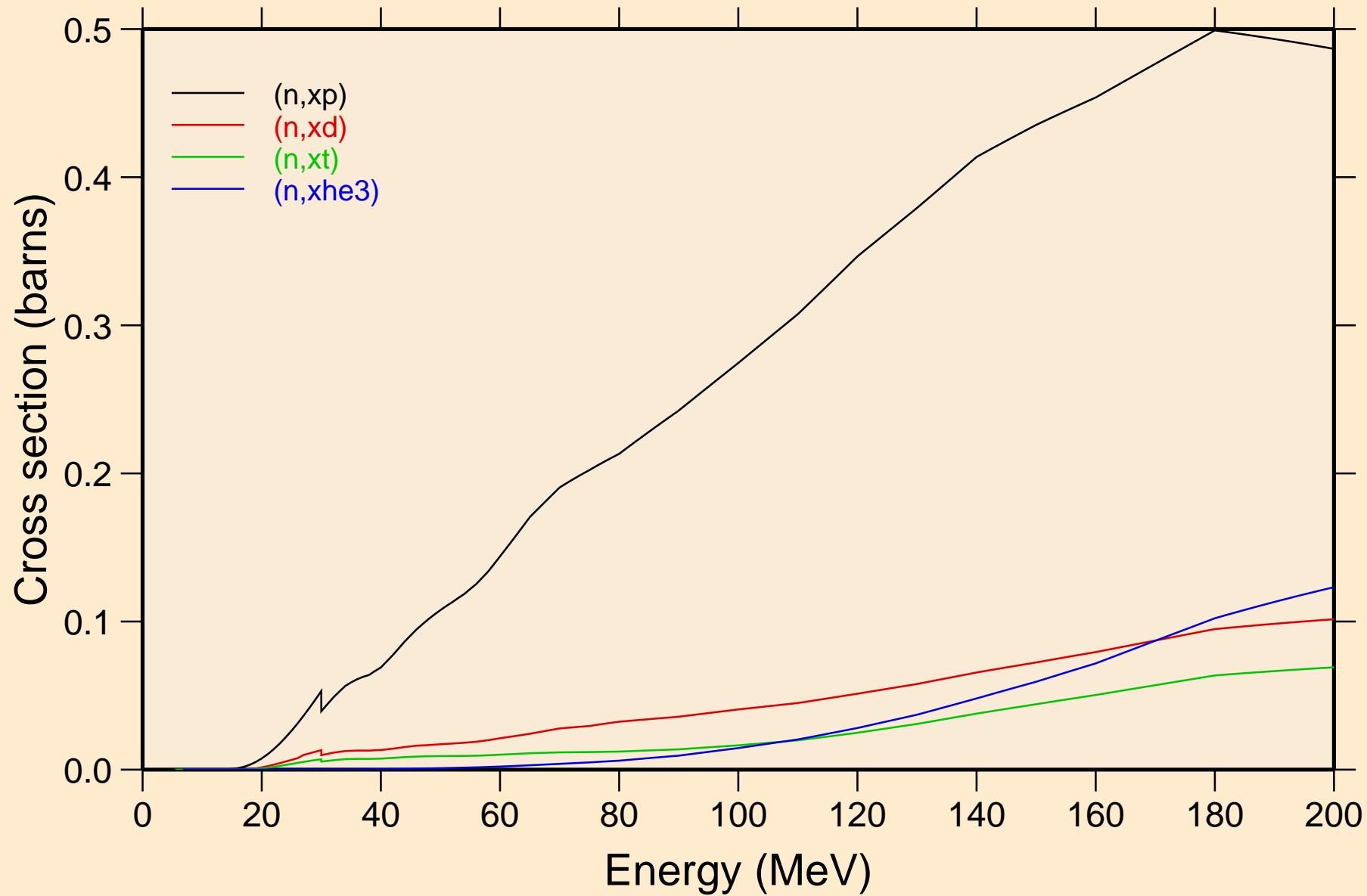

TH234 NEUTRON ACER TENDL-2024 LIBRARY; T=293.6K  
angular distribution for elastic

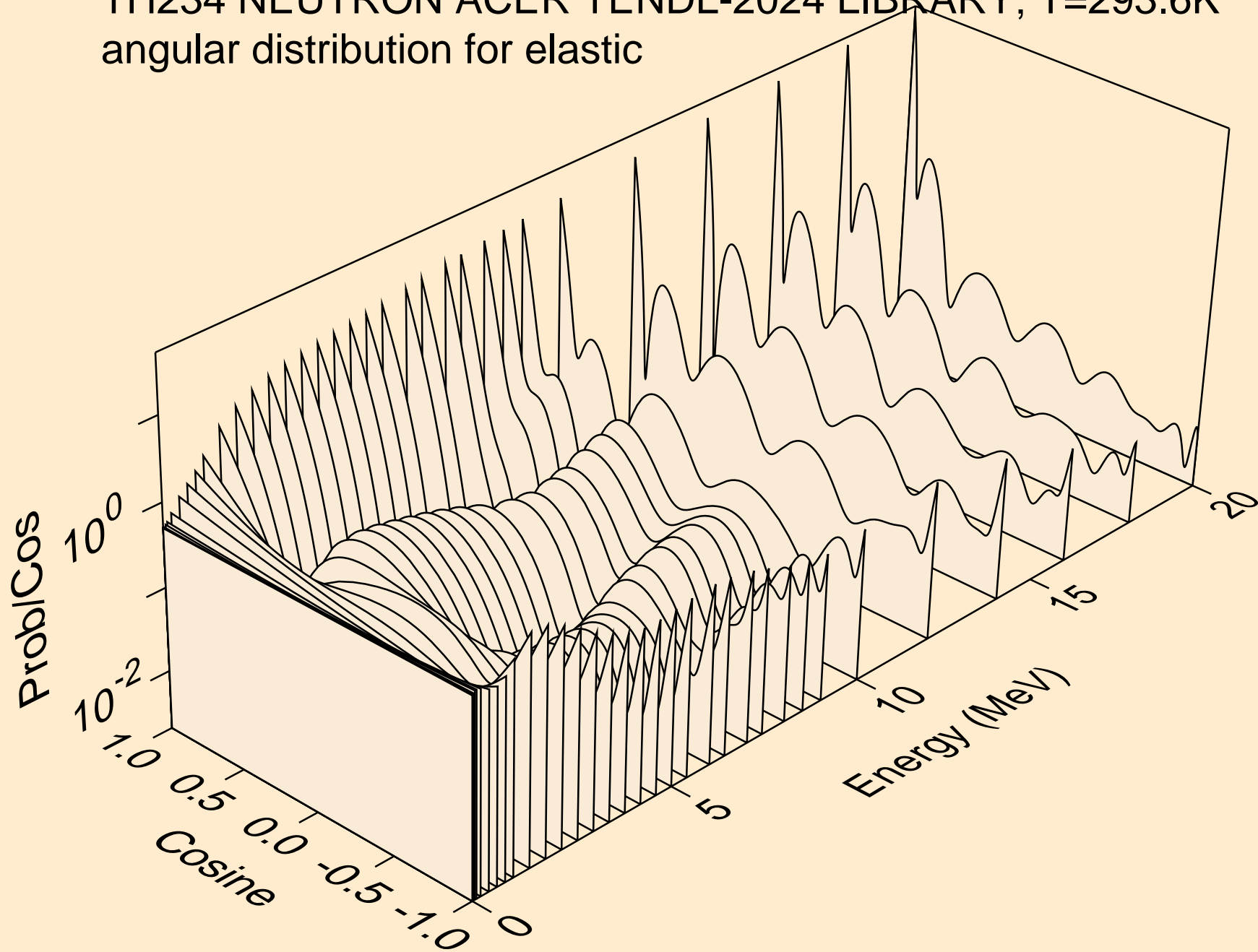

TH234 NEUTRON ACER TENDL-2024 LIBRARY; T=293.6K  
angular distribution for elastic

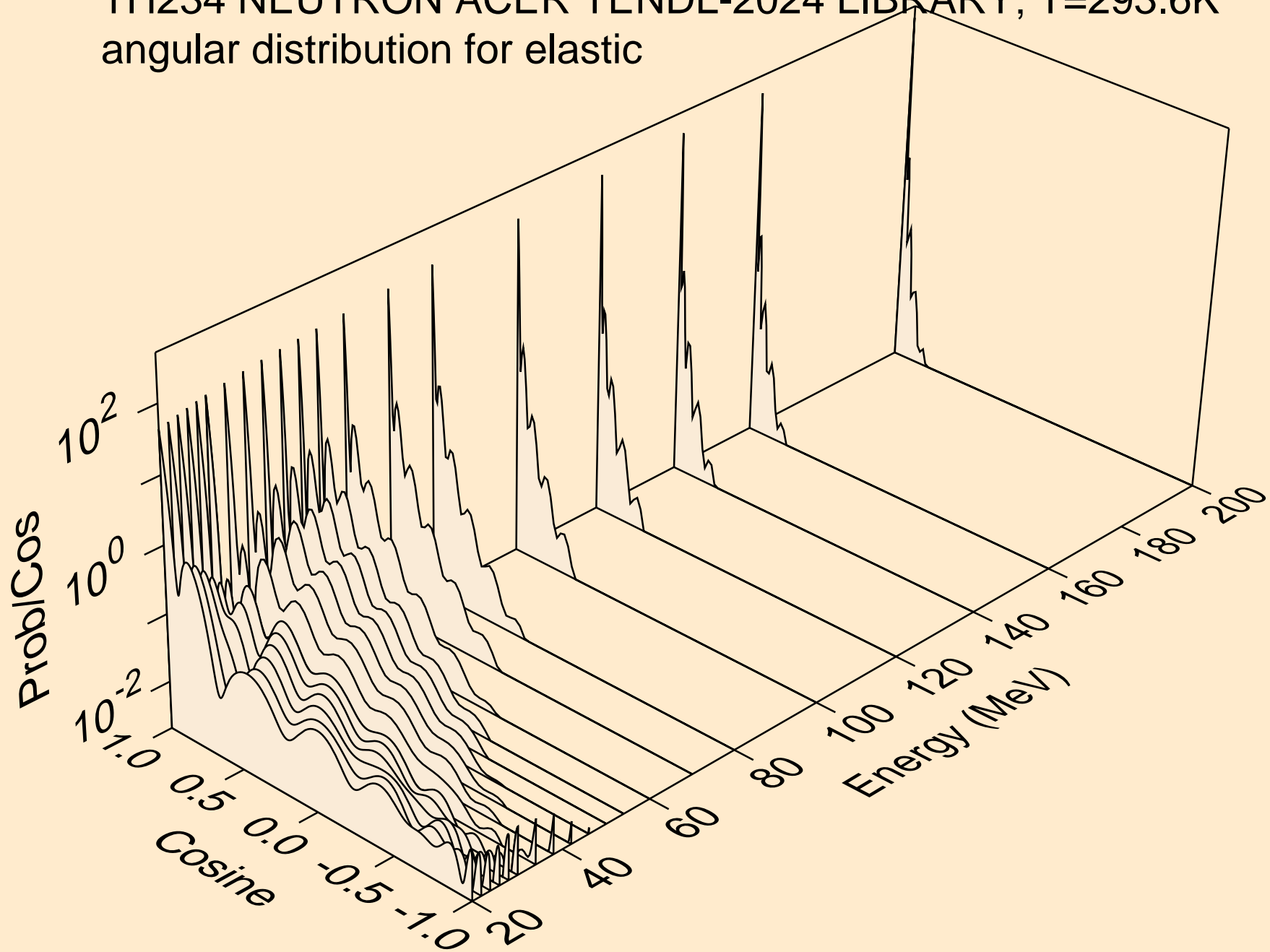

TH234 NEUTRON ACER TENDL-2024 LIBRARY; T=293.6K  
angular distribution for (n,n\*1)

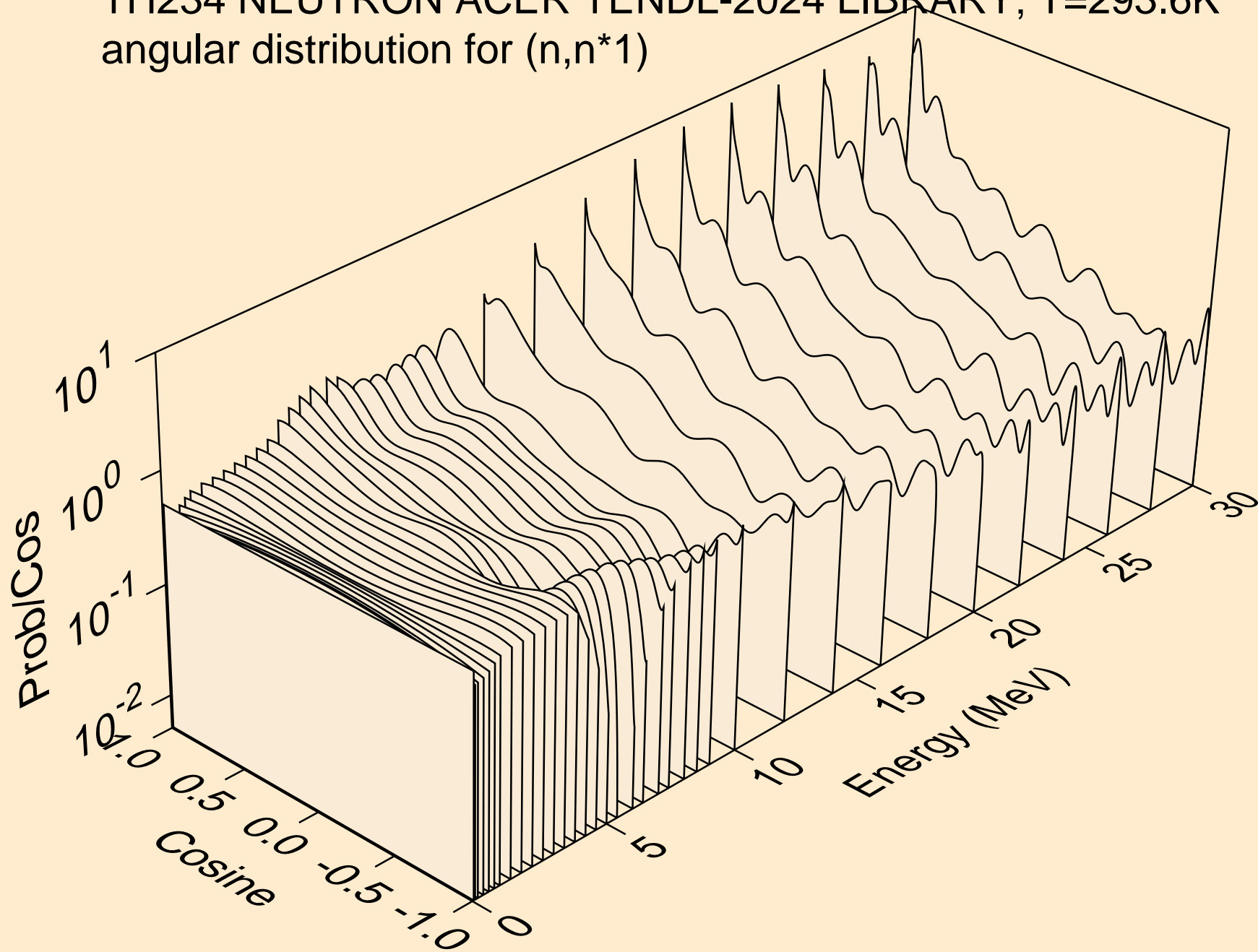

TH234 NEUTRON ACER TENDL-2024 LIBRARY; T=293.6K  
angular distribution for (n,n\*2)

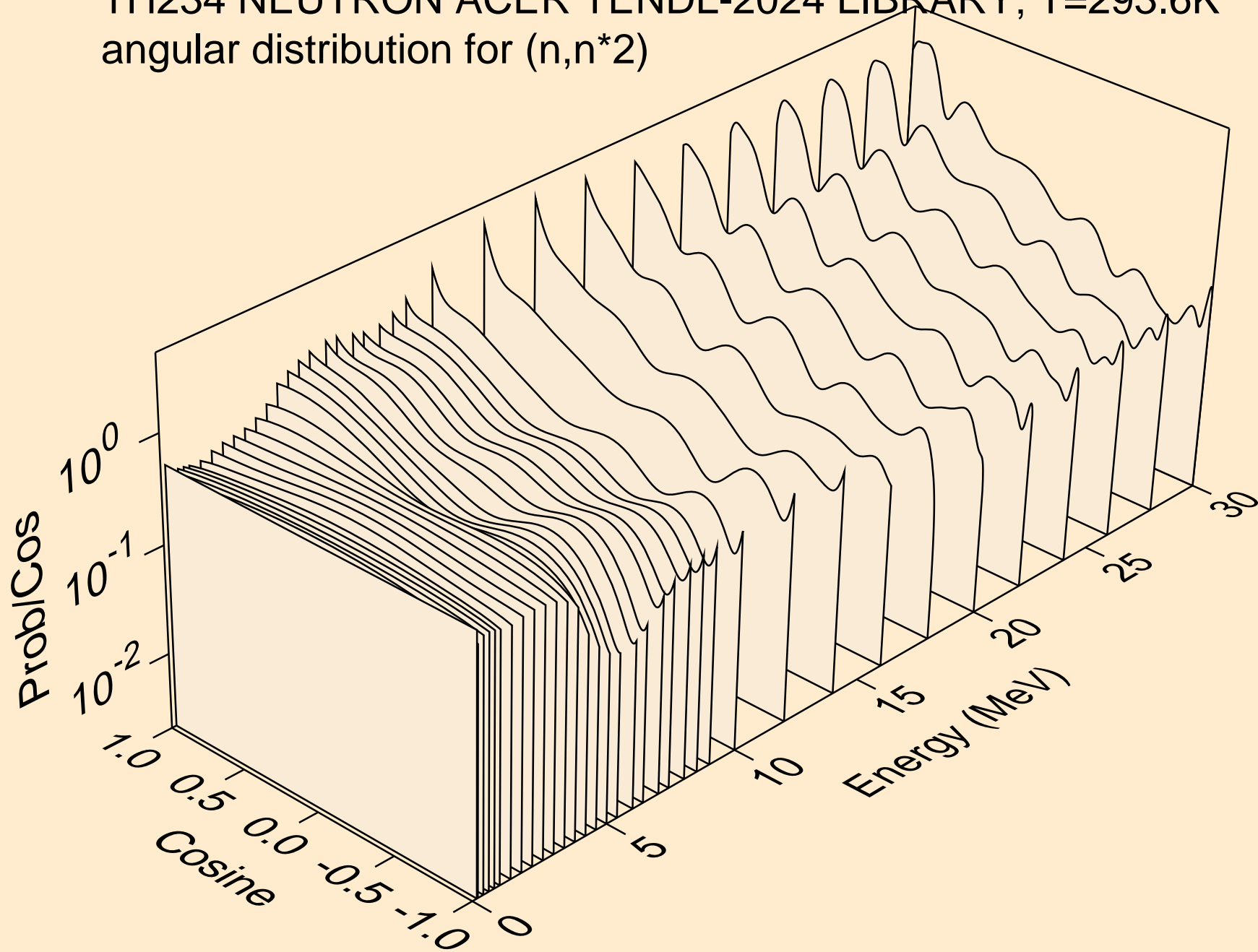

TH234 NEUTRON ACER TENDL-2024 LIBRARY; T=293.6K  
angular distribution for (n,n\*3)

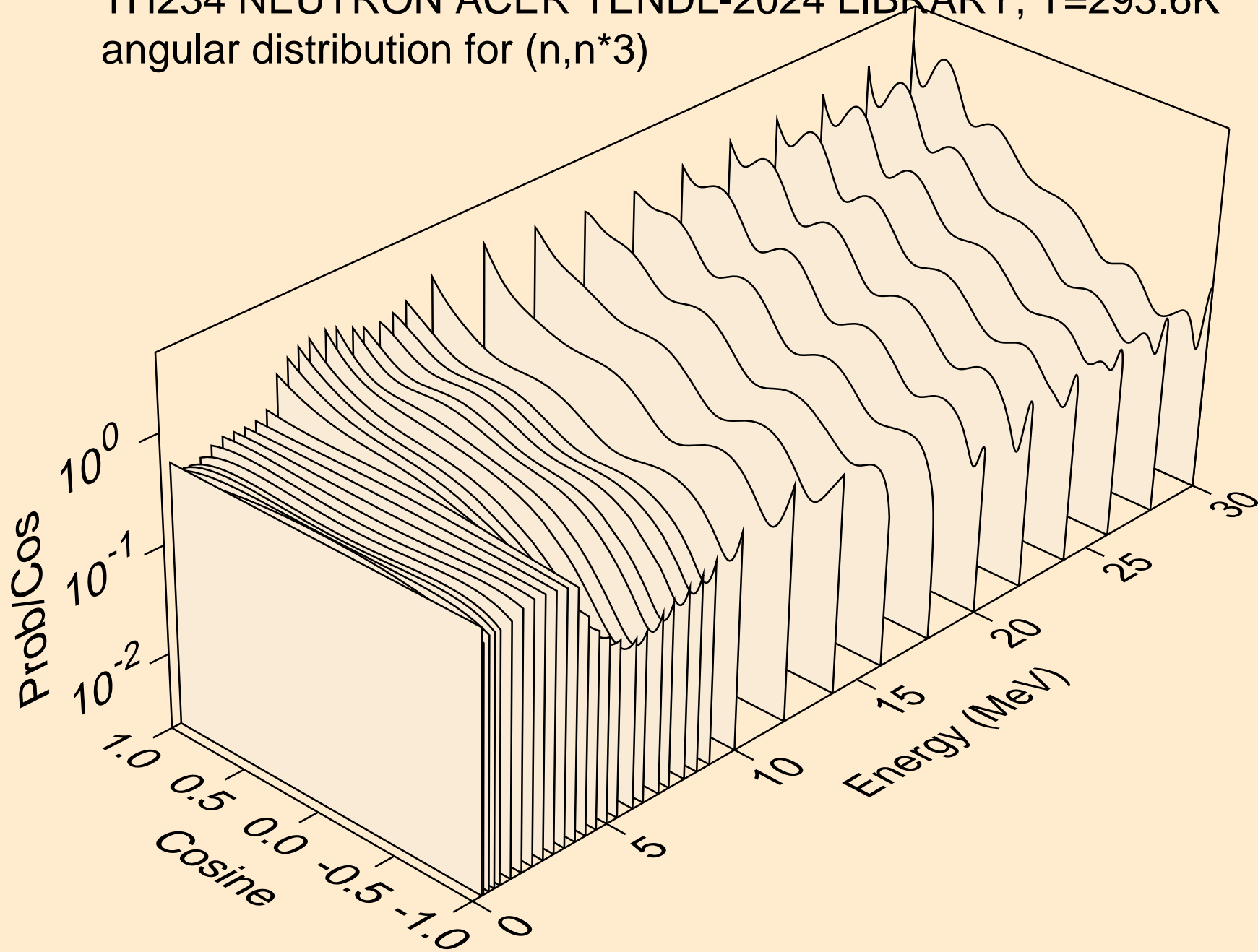

TH234 NEUTRON ACER TENDL-2024 LIBRARY; T=293.6K  
angular distribution for (n,n\*4)

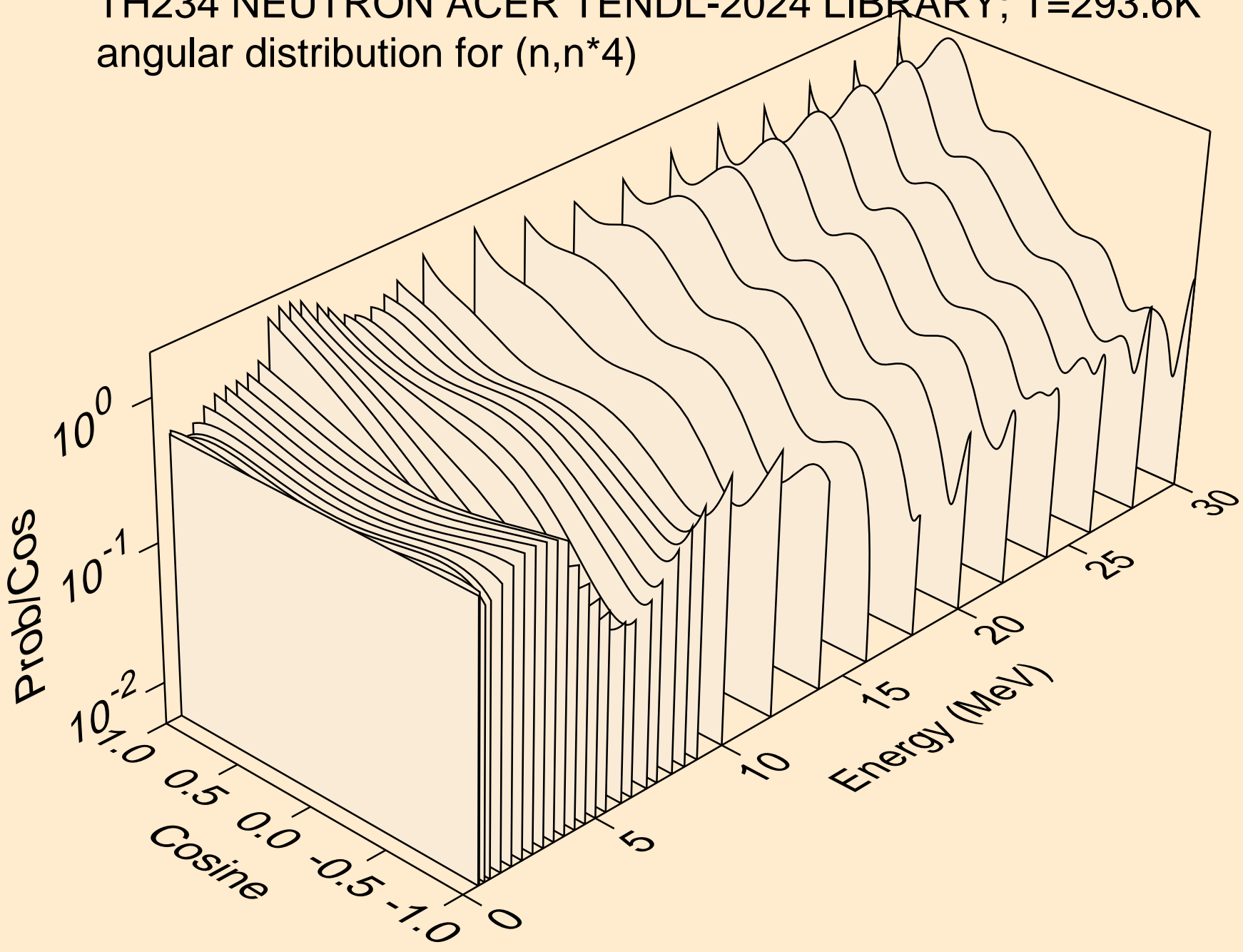

TH234 NEUTRON ACER TENDL-2024 LIBRARY; T=293.6K  
angular distribution for (n,n\*5)

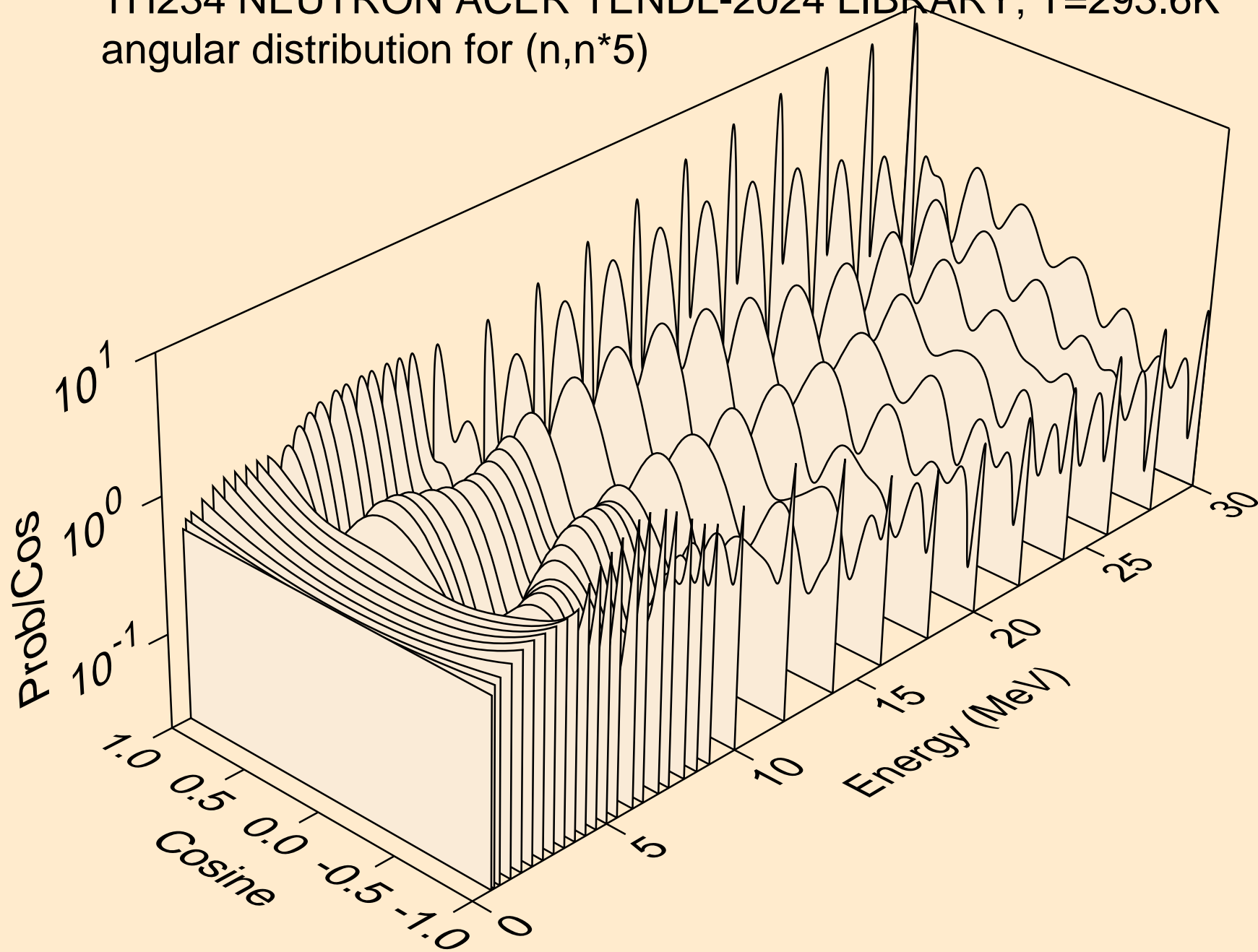

TH234 NEUTRON ACER TENDL-2024 LIBRARY; T=293.6K  
angular distribution for (n,n\*6)

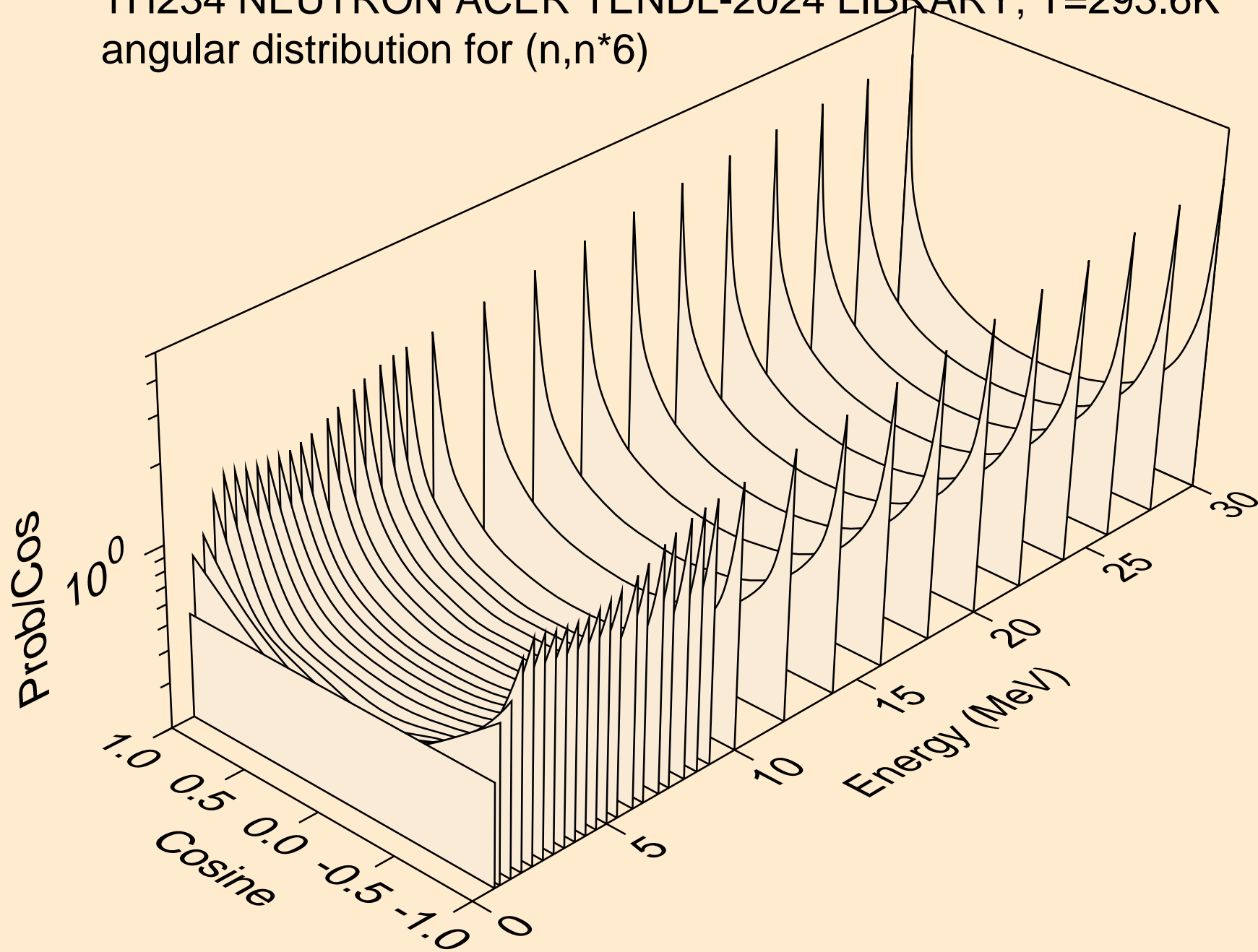

TH234 NEUTRON ACER TENDL-2024 LIBRARY; T=293.6K  
angular distribution for (n,n\*7)

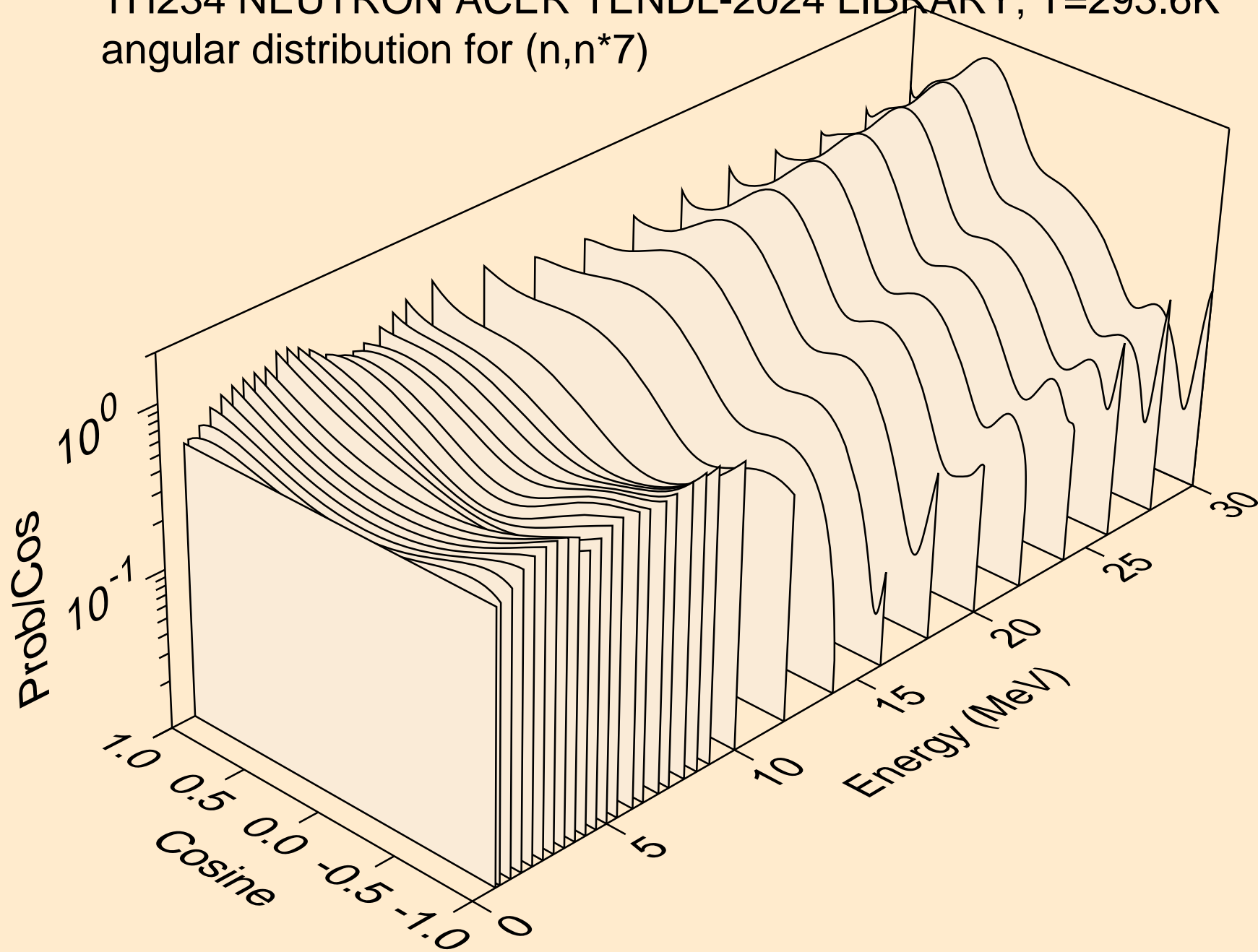

TH234 NEUTRON ACER TENDL-2024 LIBRARY; T=293.6K  
angular distribution for (n,n\*8)

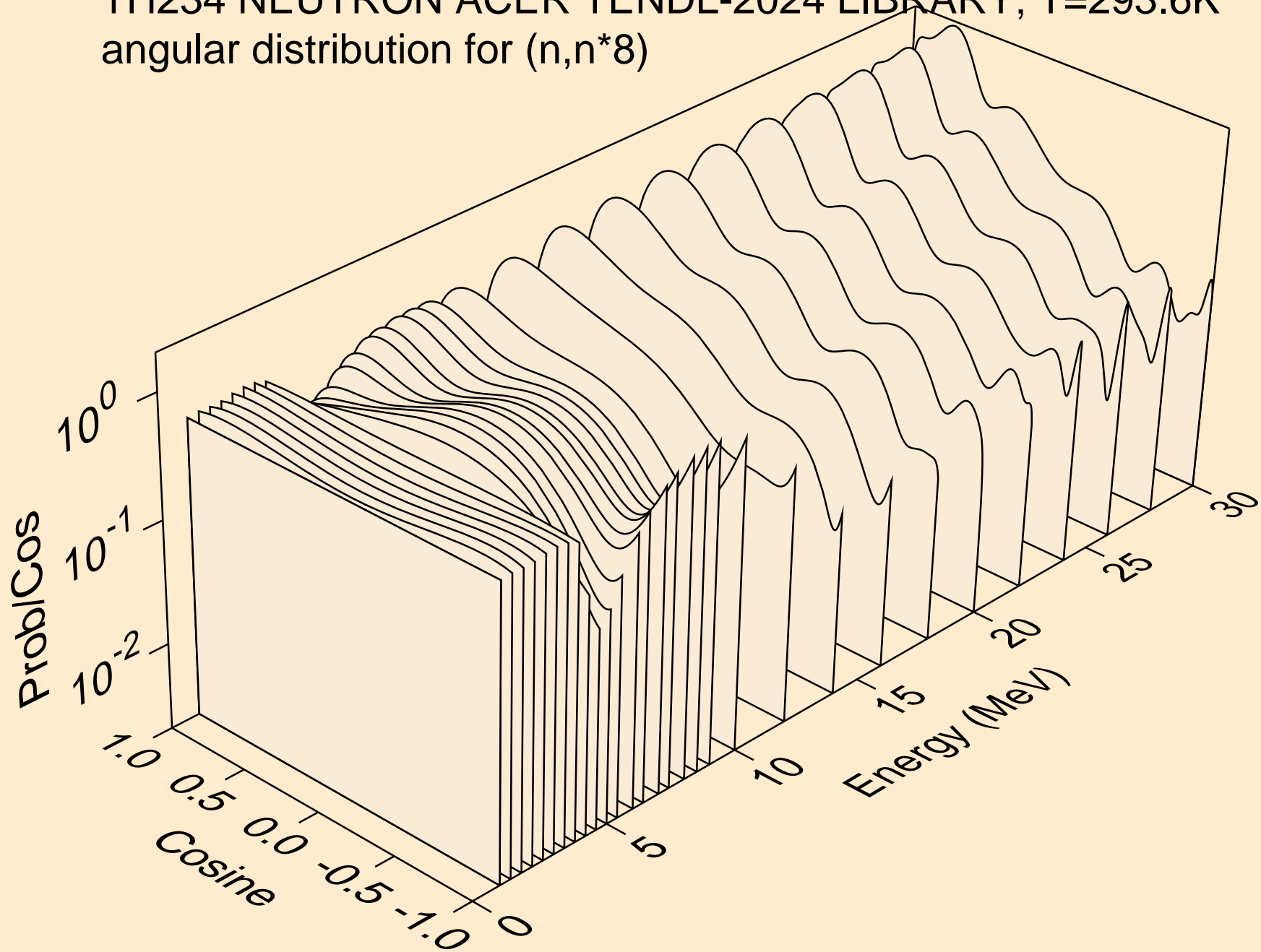

TH234 NEUTRON ACER TENDL-2024 LIBRARY; T=293.6K  
angular distribution for (n,n\*9)

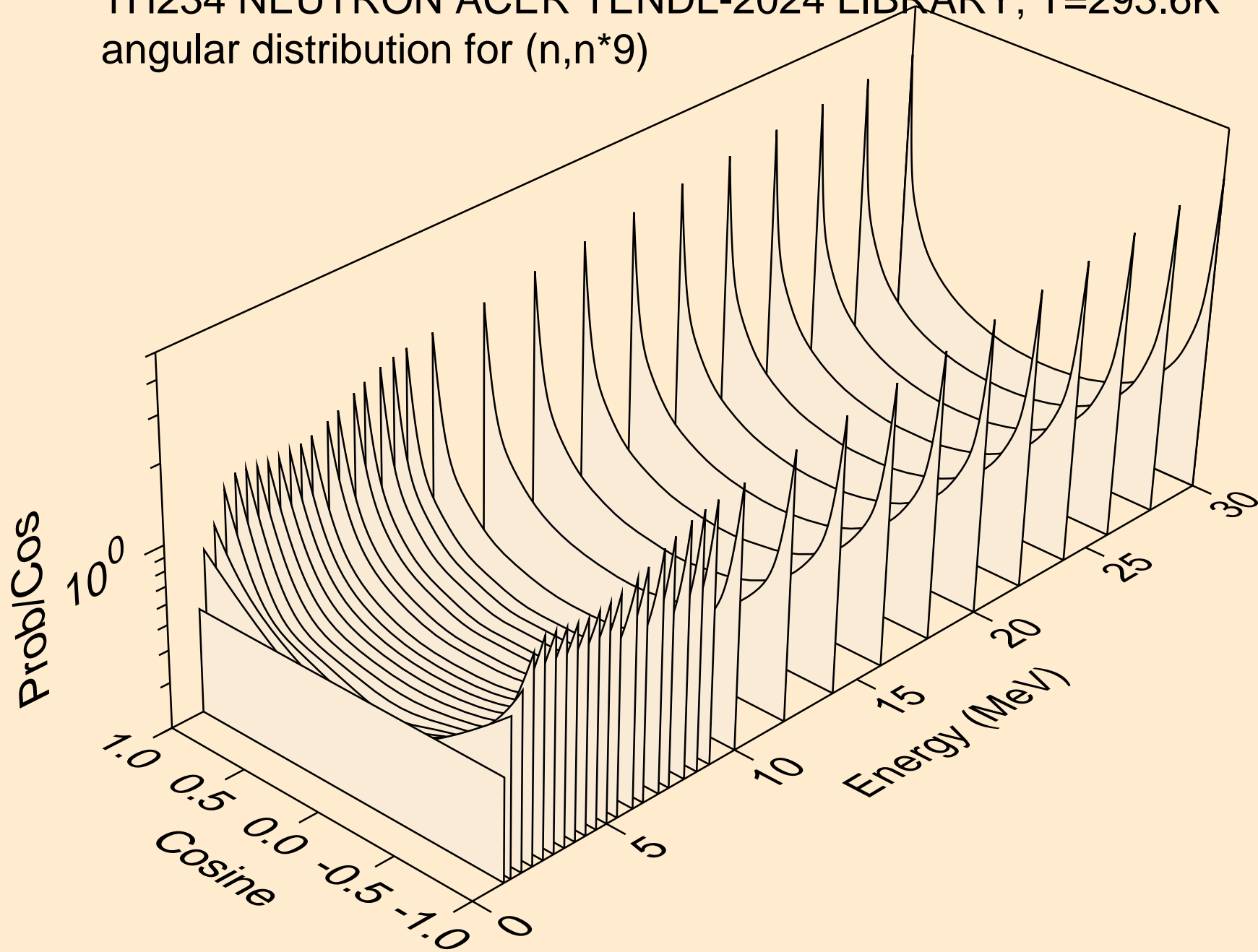

TH234 NEUTRON ACER TENDL-2024 LIBRARY; T=293.6K  
angular distribution for (n,n\*10)

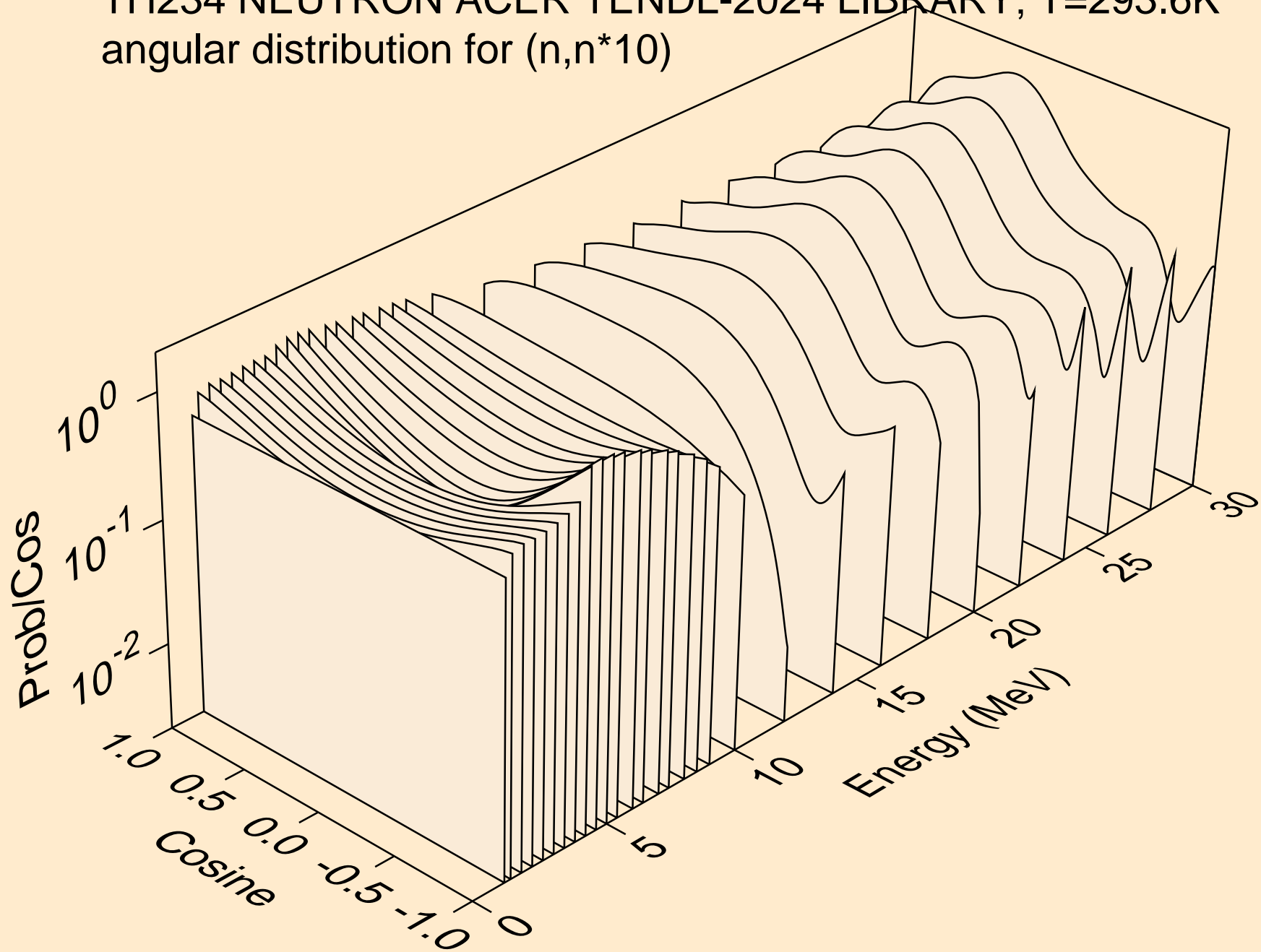

TH234 NEUTRON ACER TENDL-2024 LIBRARY; T=293.6K  
angular distribution for (n,n\*11)

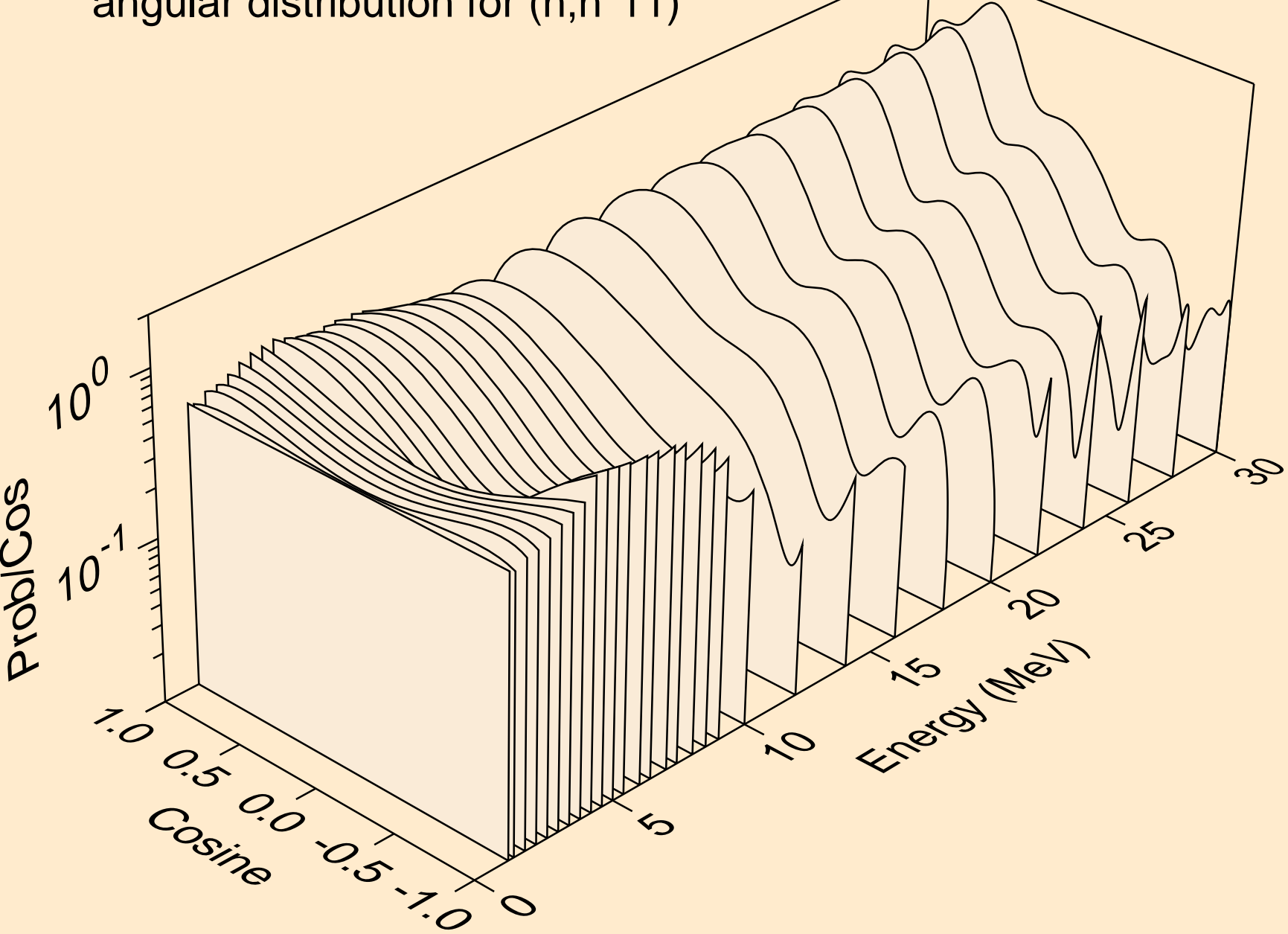

TH234 NEUTRON ACER TENDL-2024 LIBRARY; T=293.6K  
angular distribution for (n,n\*12)

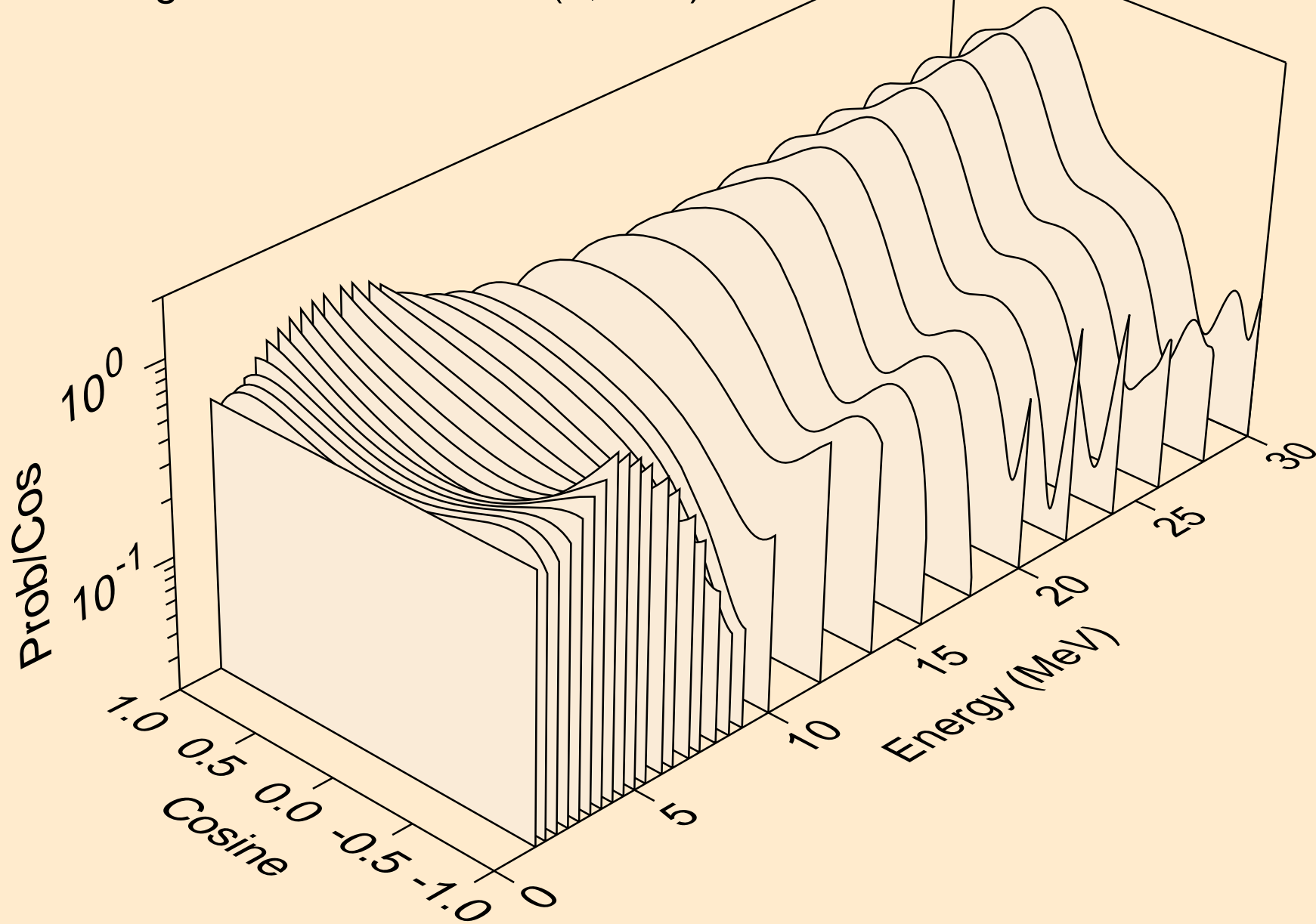

TH234 NEUTRON ACER TENDL-2024 LIBRARY; T=293.6K  
angular distribution for (n,n\*13)

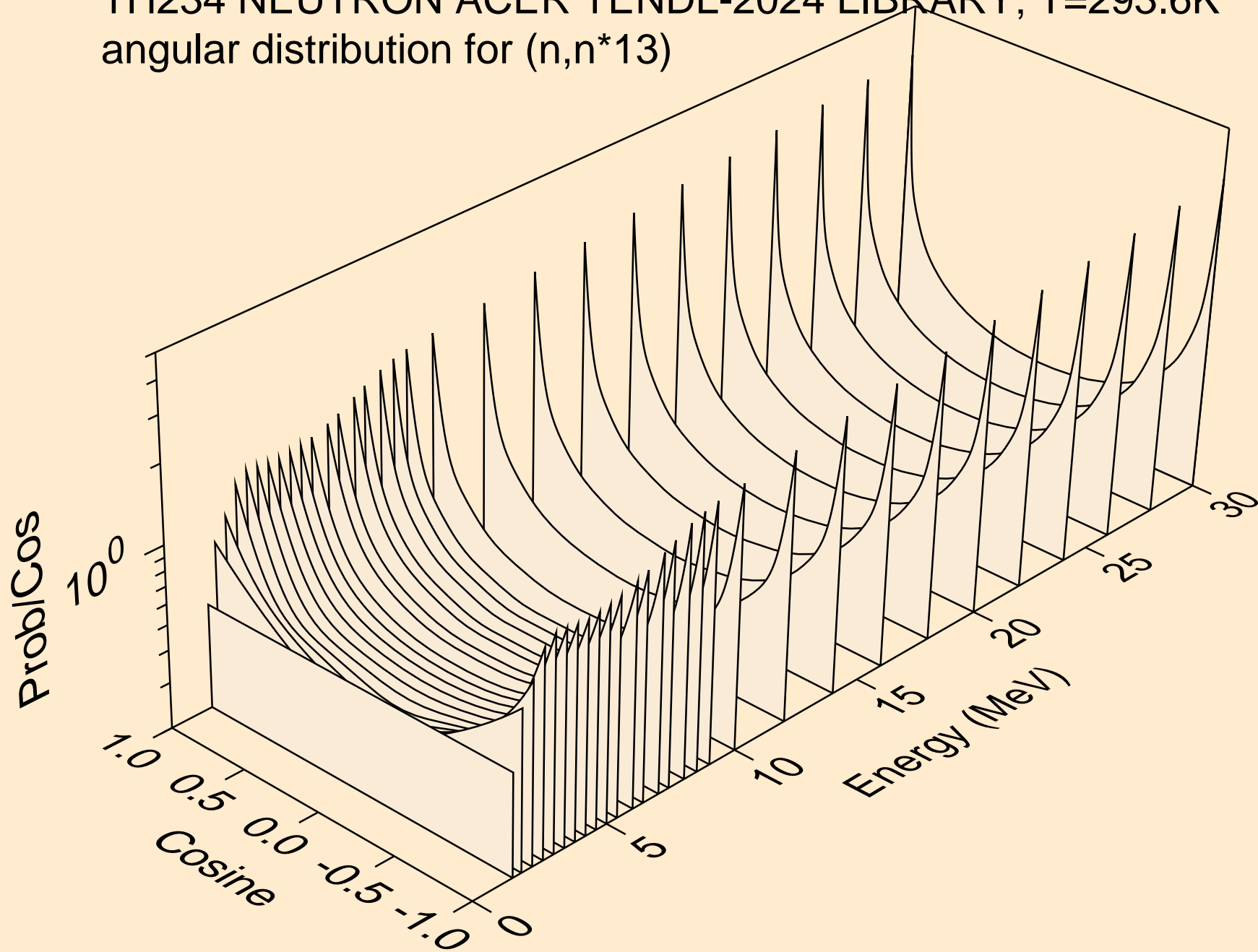

TH234 NEUTRON ACER TENDL-2024 LIBRARY; T=293.6K  
angular distribution for (n,n\*14)

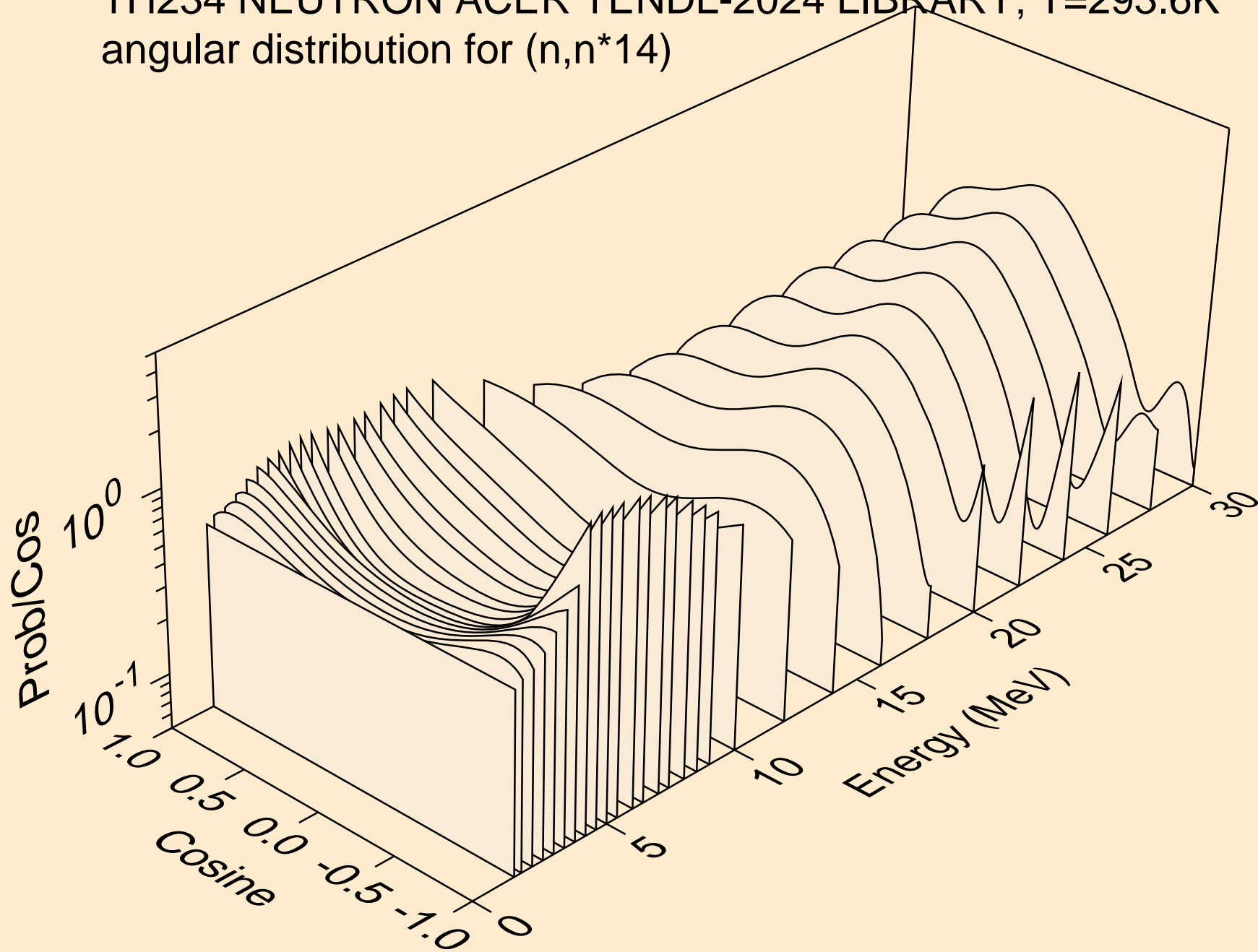

TH234 NEUTRON ACER TENDL-2024 LIBRARY; T=293.6K  
angular distribution for (n,n\*15)

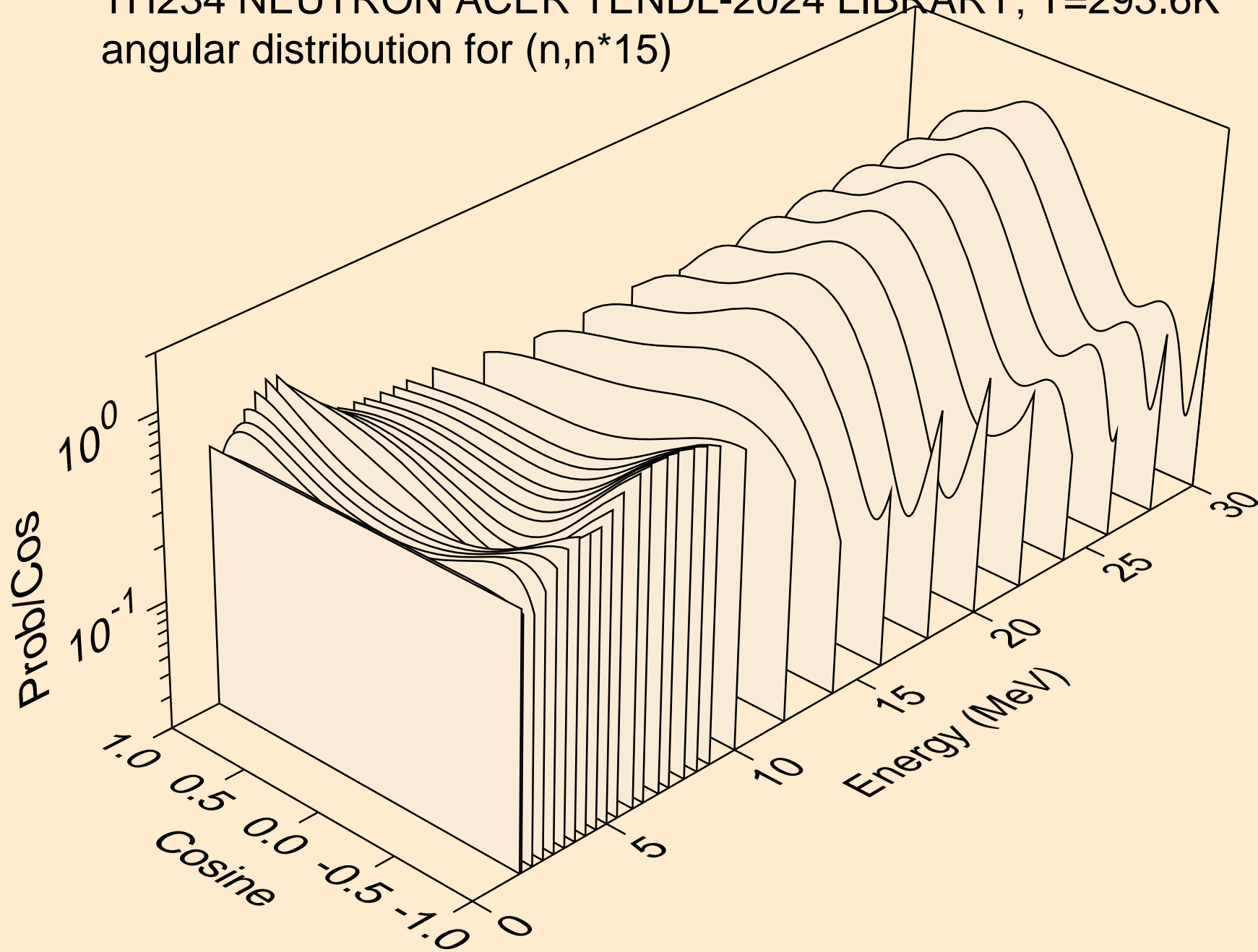

TH234 NEUTRON ACER TENDL-2024 LIBRARY; T=293.6K  
angular distribution for (n,n\*16)

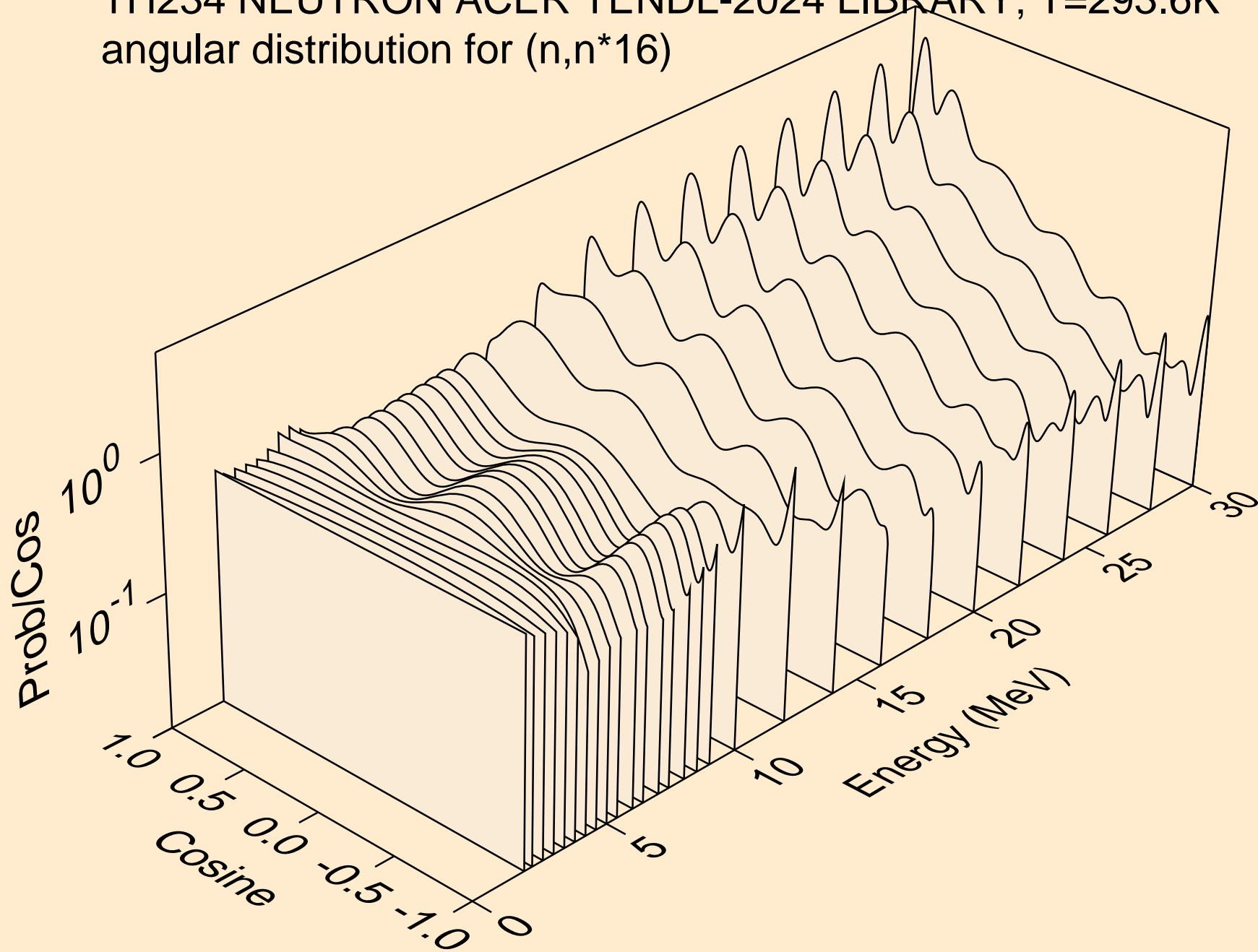

TH234 NEUTRON ACER TENDL-2024 LIBRARY; T=293.6K  
angular distribution for (n,n\*17)

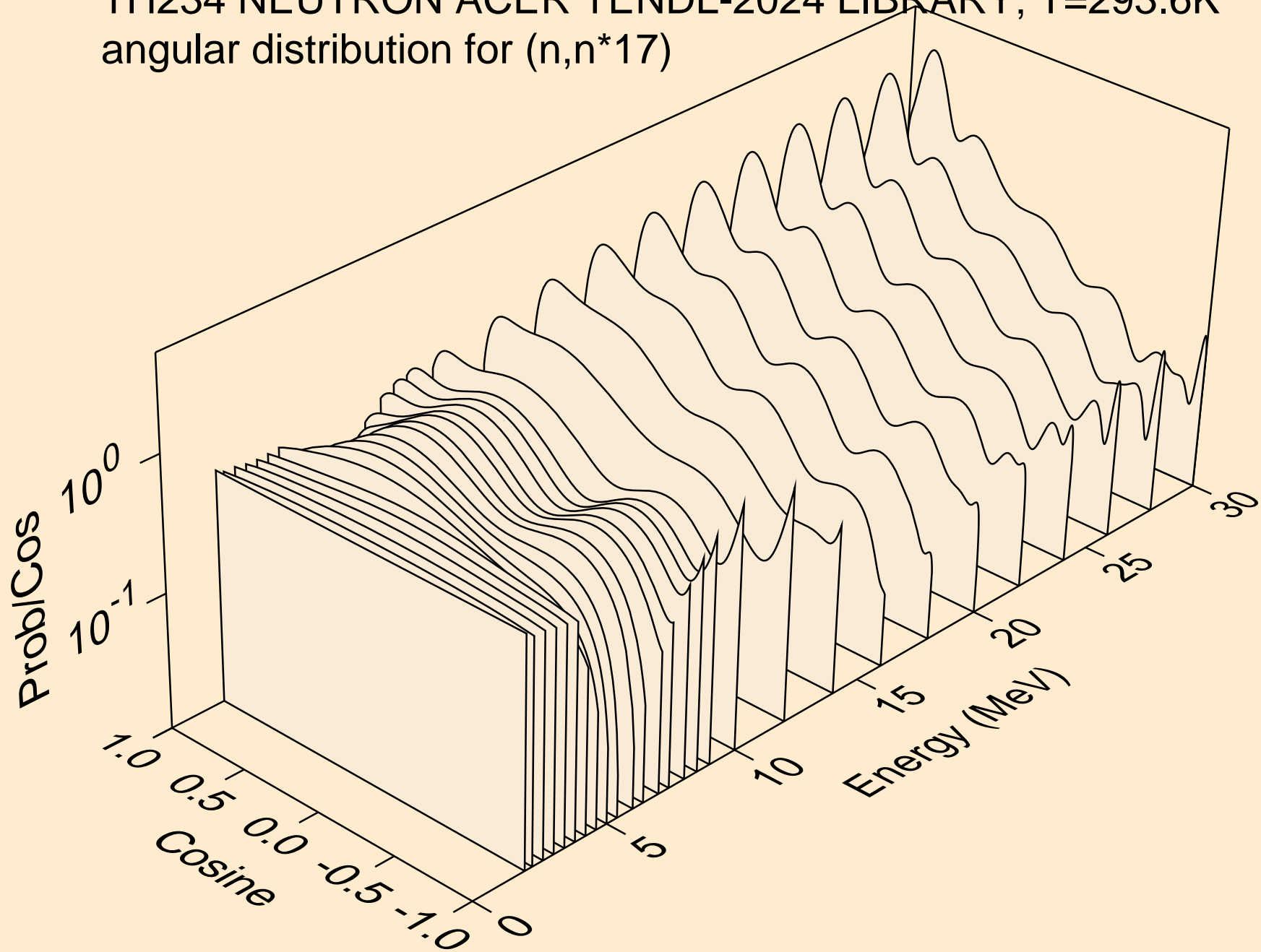

TH234 NEUTRON ACER TENDL-2024 LIBRARY; T=293.6K  
Total fission nubar

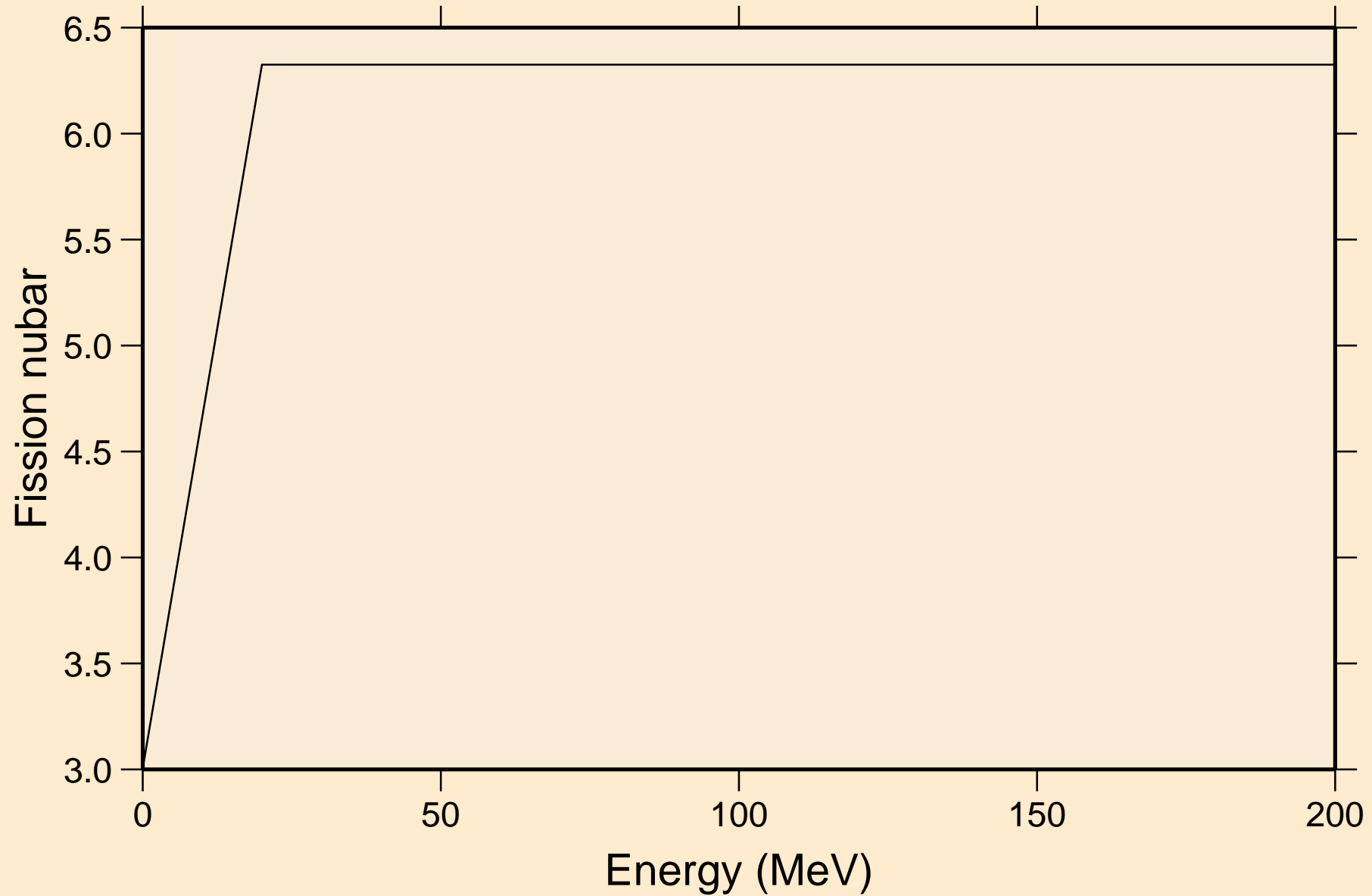

TH234 NEUTRON ACER TENDL-2024 LIBRARY; T=293.6K  
Neutron emission for (n,x)

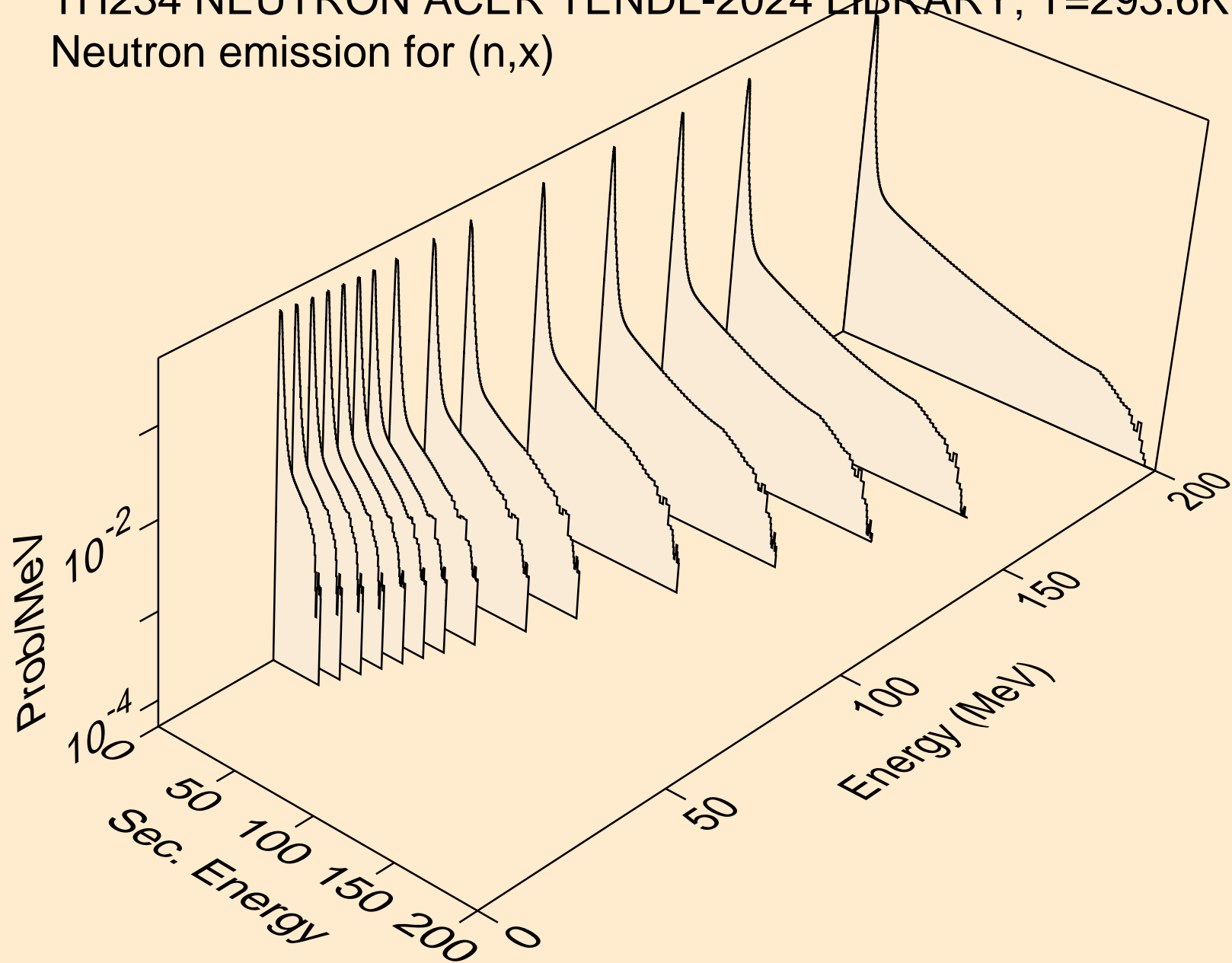

TH234 NEUTRON ACER TENDL-2024 LIBRARY; T=293.6K  
Neutron emission for (n,2nd)

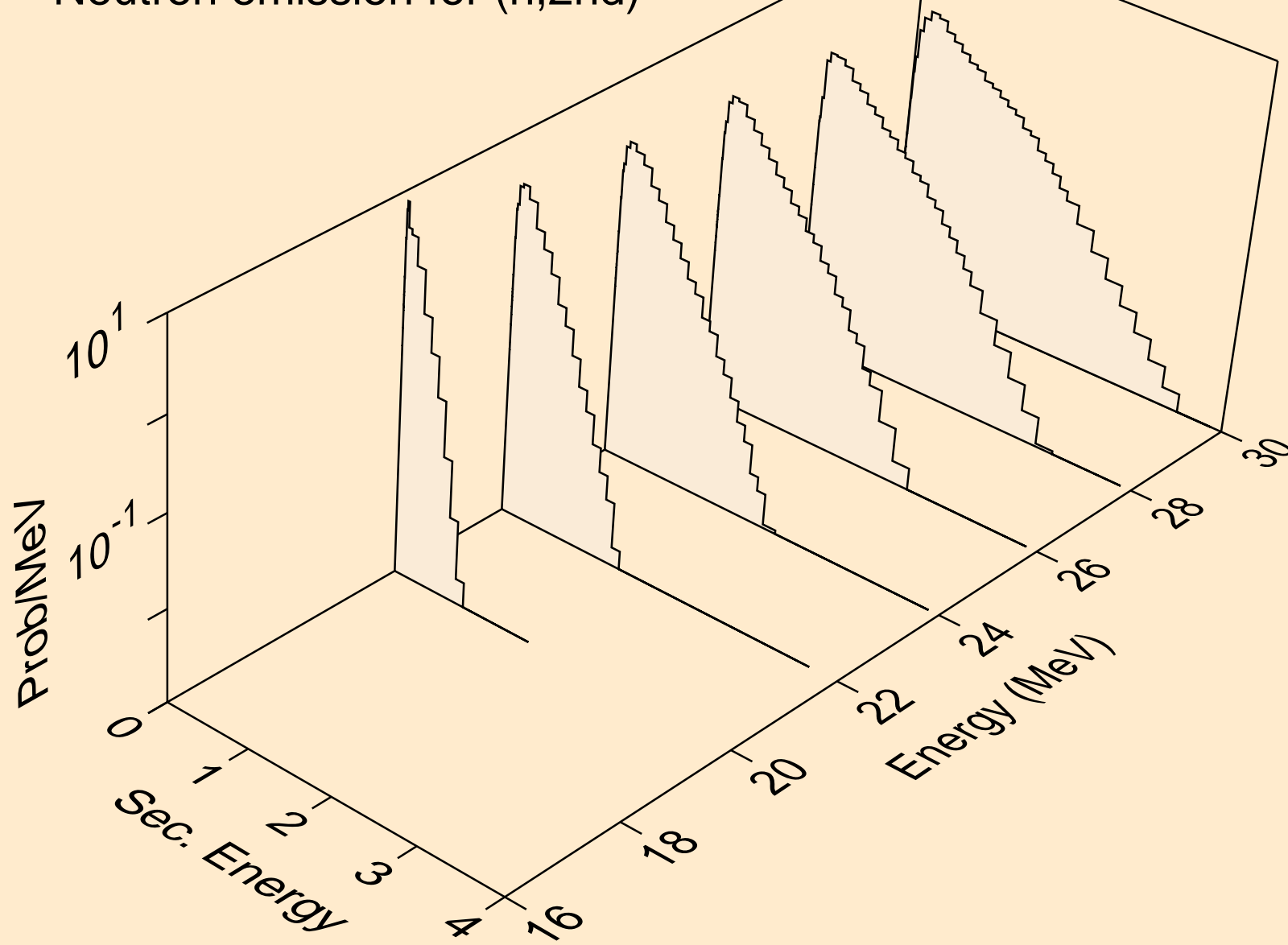

TH234 NEUTRON ACER TENDL-2024 LIBRARY; T=293.6K  
Neutron emission for (n,2n)

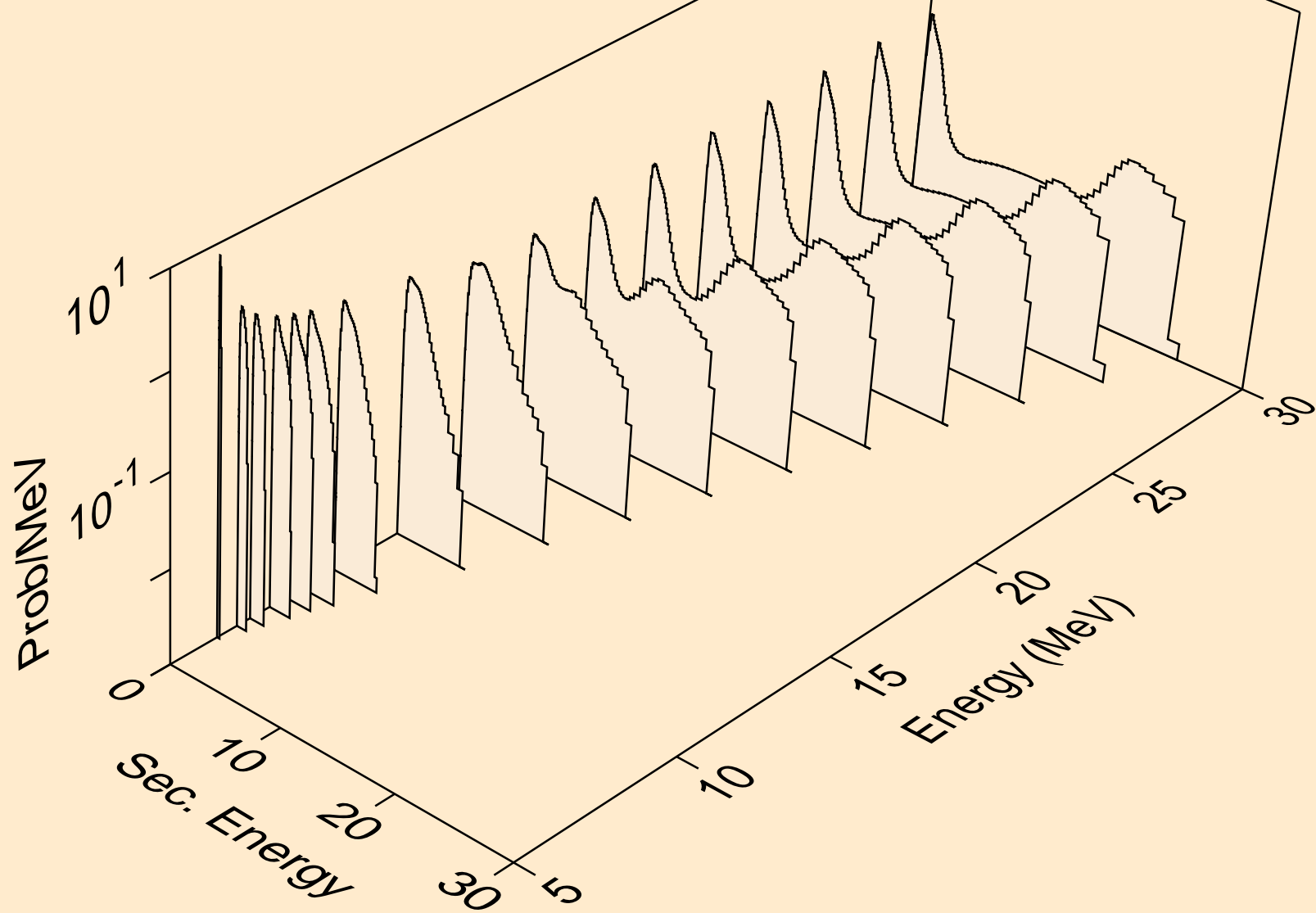

TH234 NEUTRON ACER TENDL-2024 LIBRARY; T=293.6K  
Neutron emission for (n,3n)

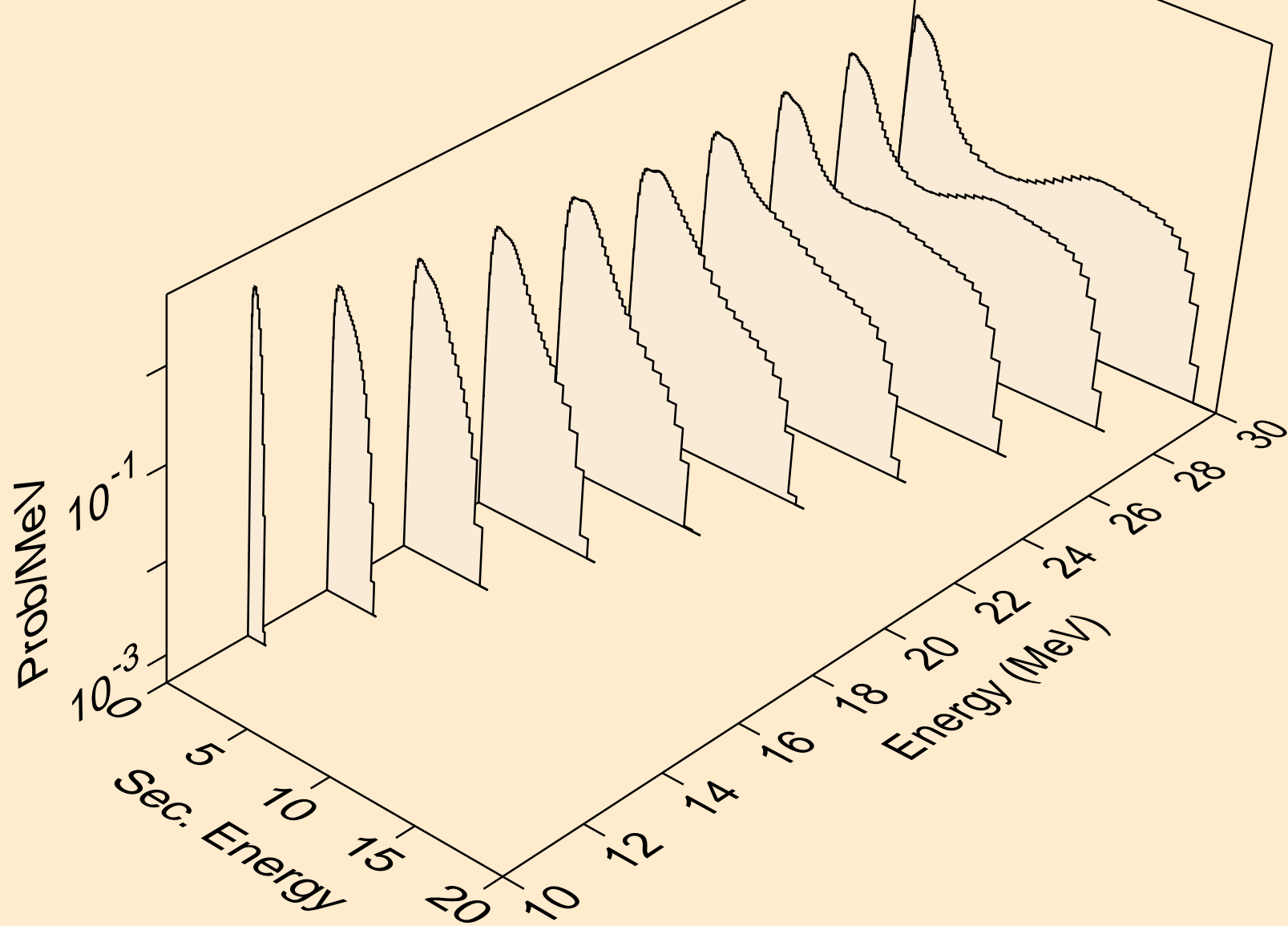

TH234 NEUTRON ACER TENDL-2024 LIBRARY; T=293.6K  
Neutron emission for fission

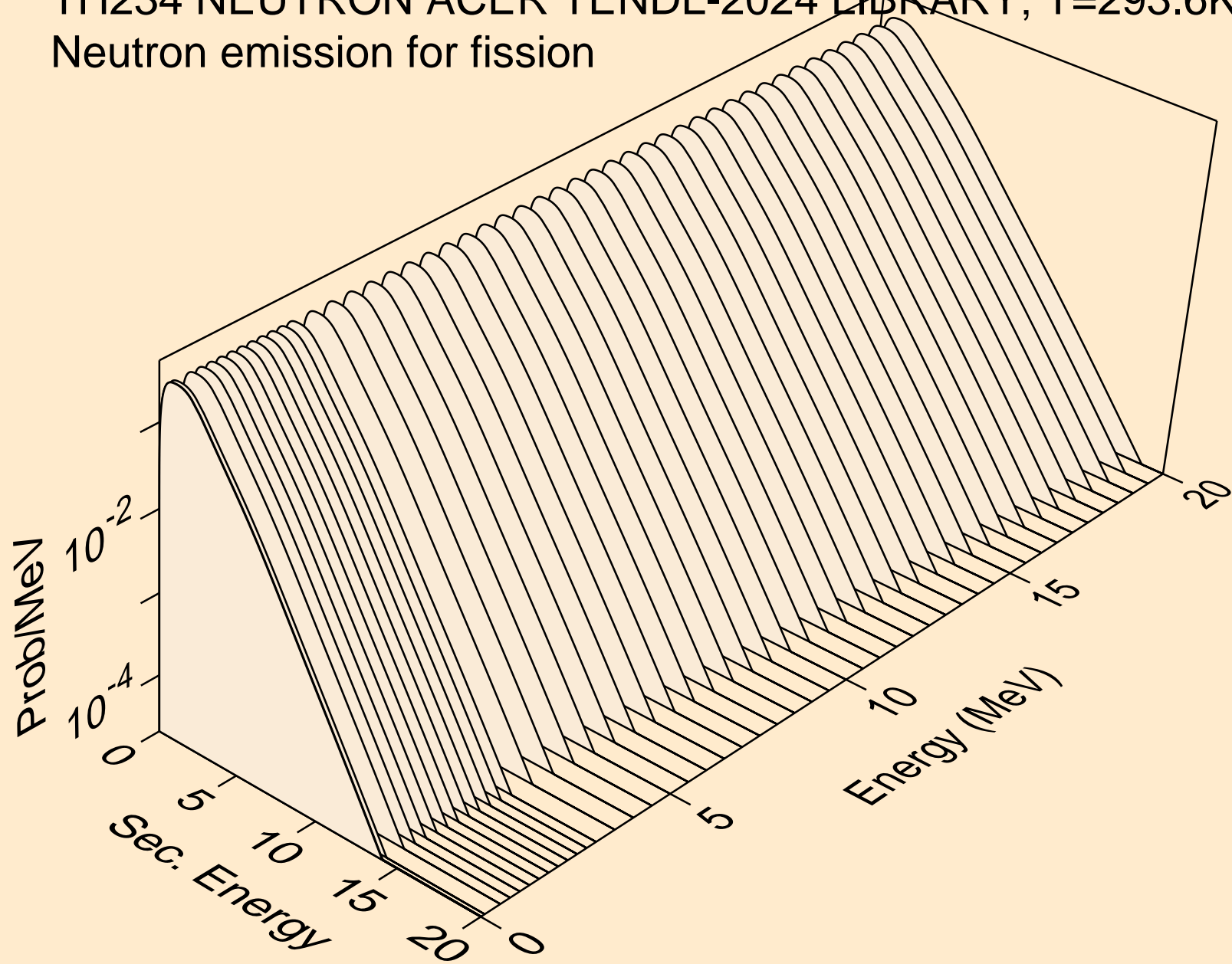

TH234 NEUTRON ACER TENDL-2024 LIBRARY; T=293.6K  
Neutron emission for (n,n\*)a

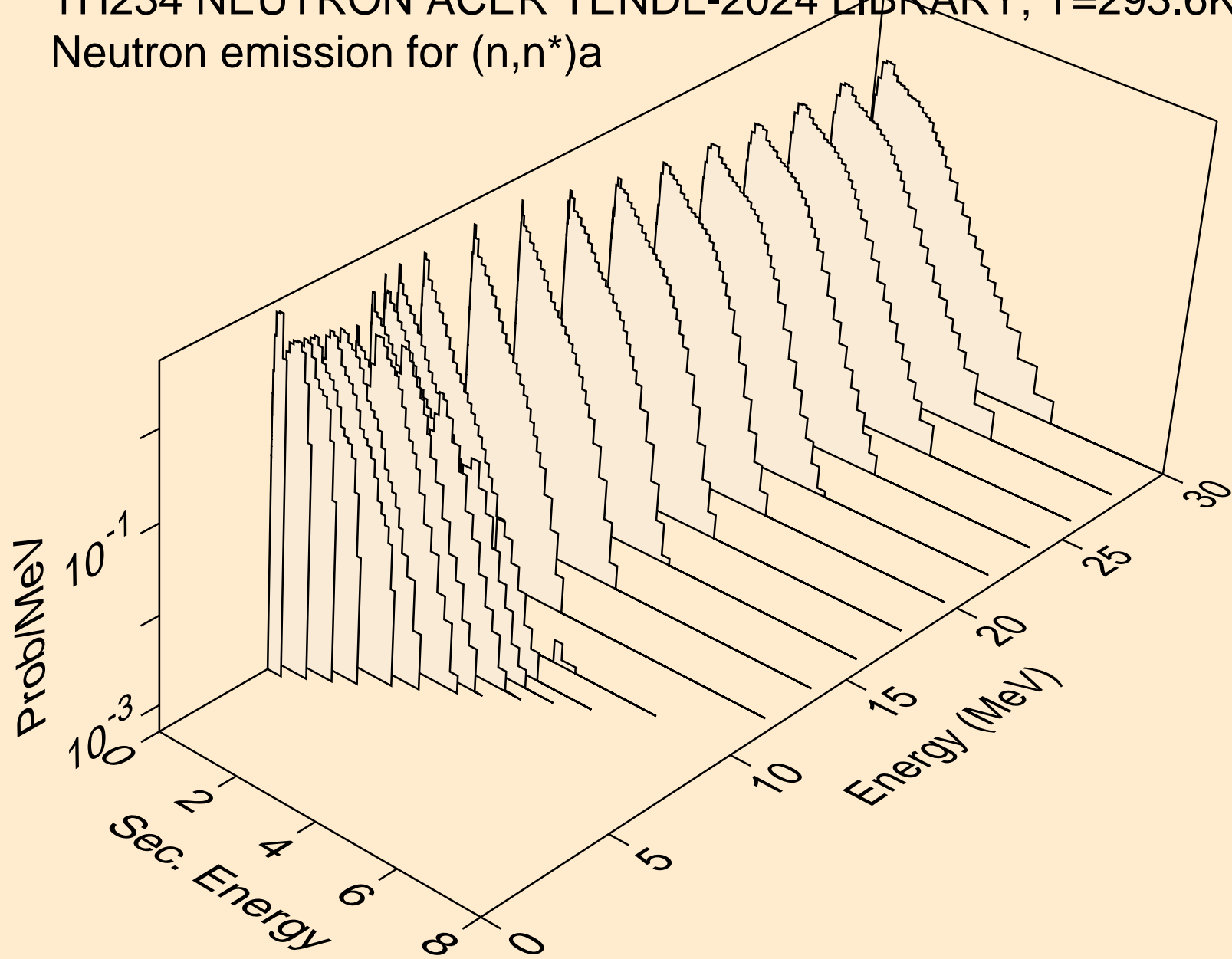

TH234 NEUTRON ACER TENDL-2024 LIBRARY; T=293.6K  
Neutron emission for (n,2n)<sub>a</sub>

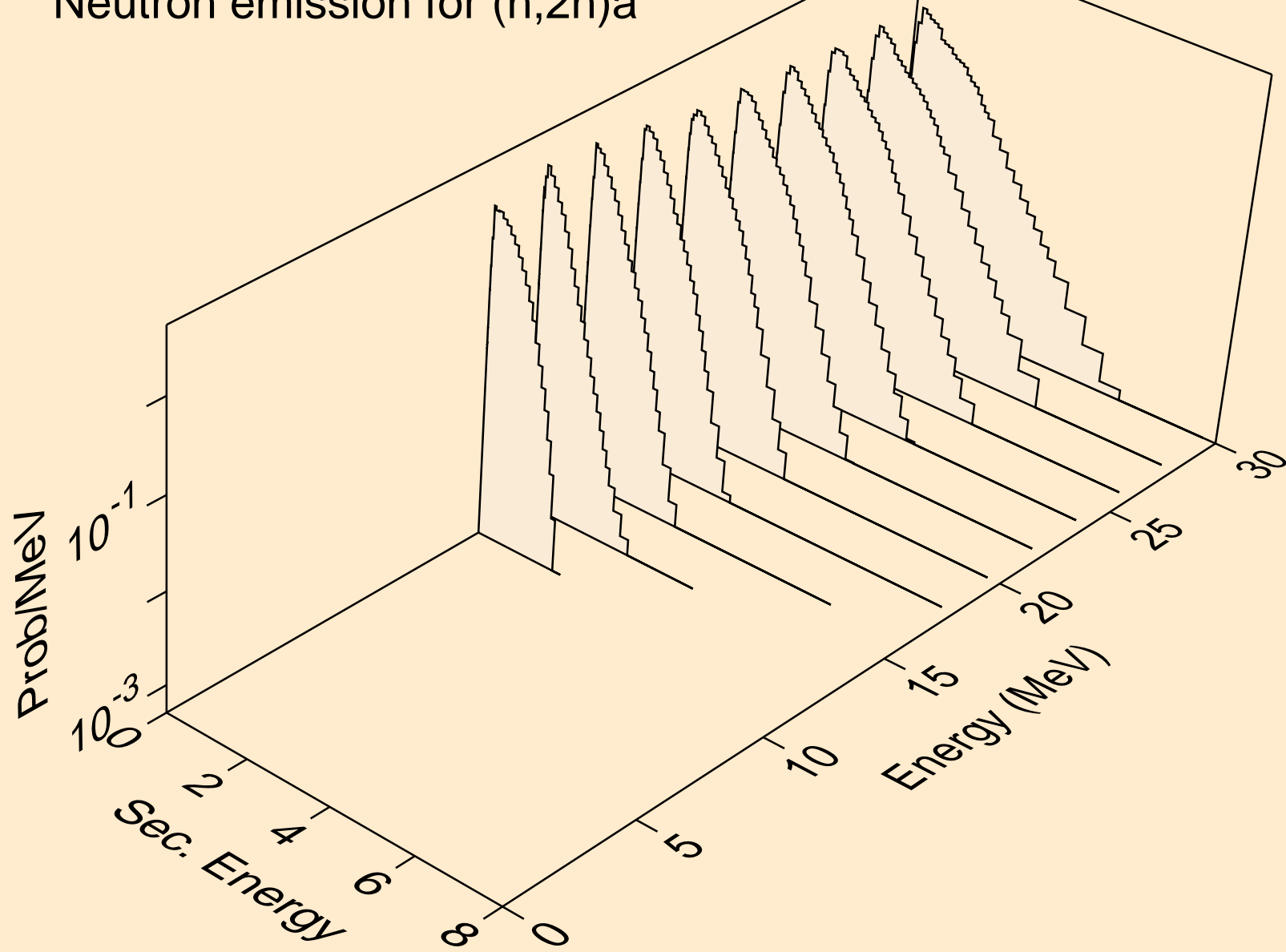

TH234 NEUTRON ACER TENDL-2024 LIBRARY; T=293.6K  
Neutron emission for (n,3n)a

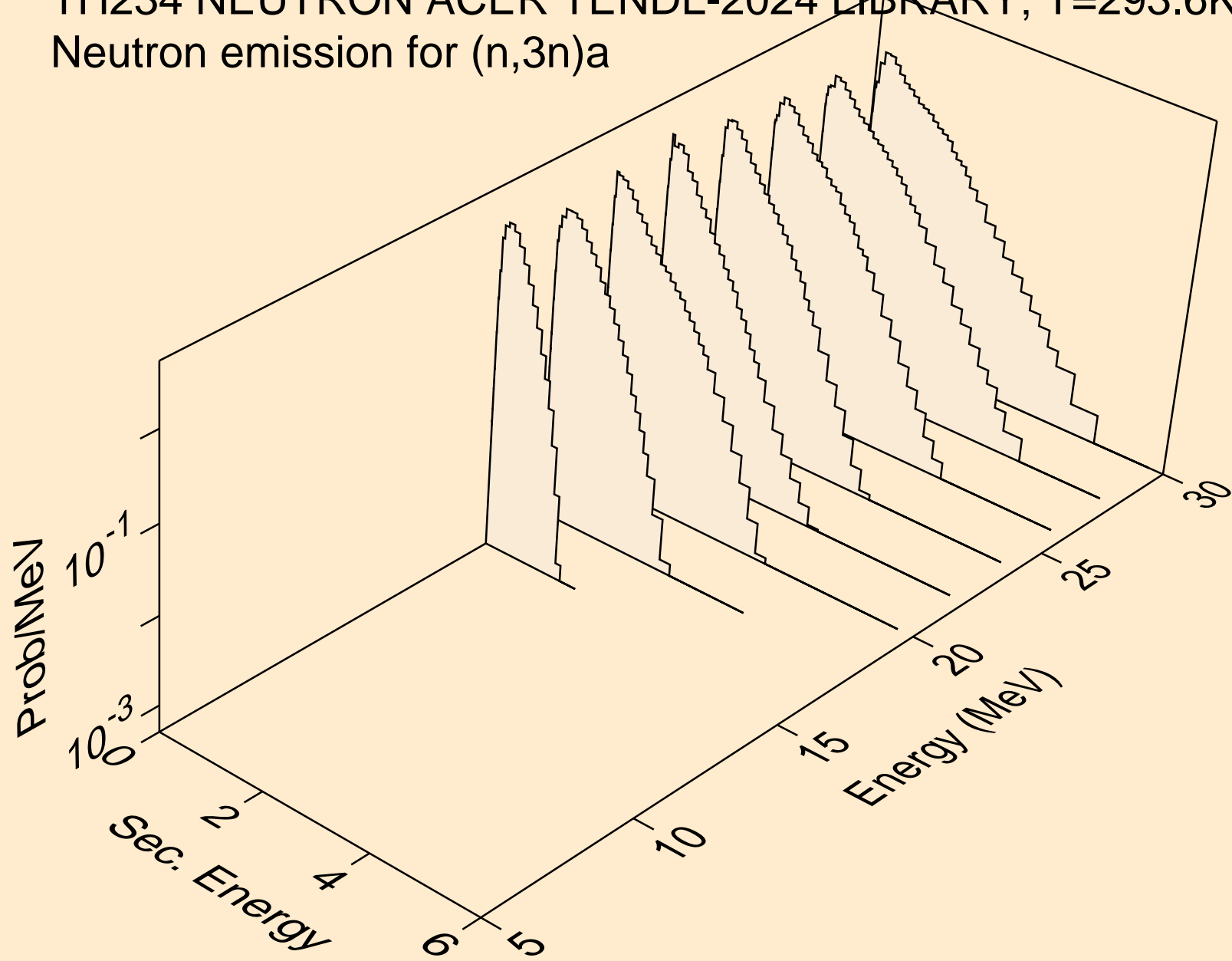

TH234 NEUTRON ACER TENDL-2024 LIBRARY; T=293.6K  
Neutron emission for (n,n\*)p

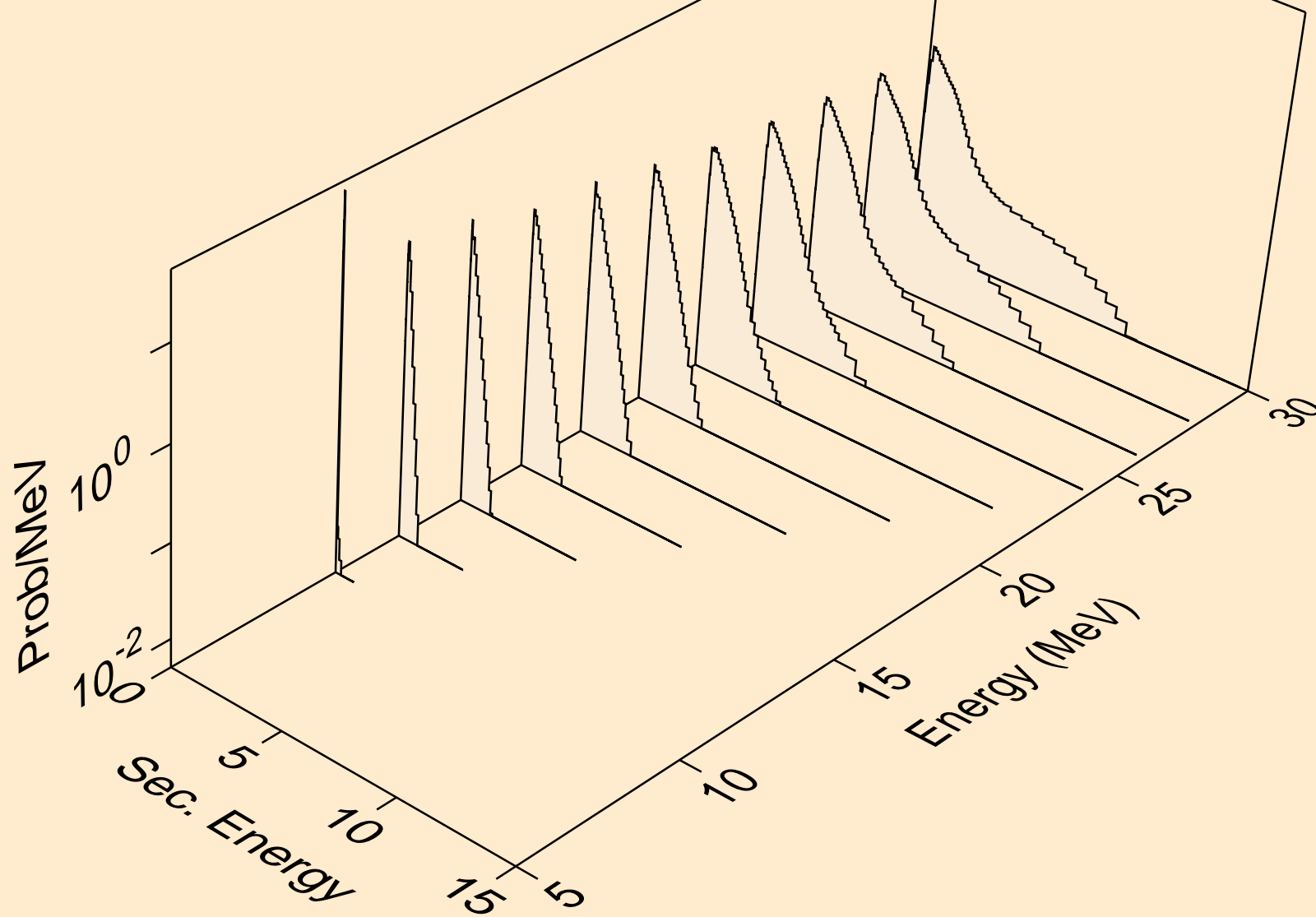

TH234 NEUTRON ACER TENDL-2024 LIBRARY; T=293.6K  
Neutron emission for (n,n\*)d

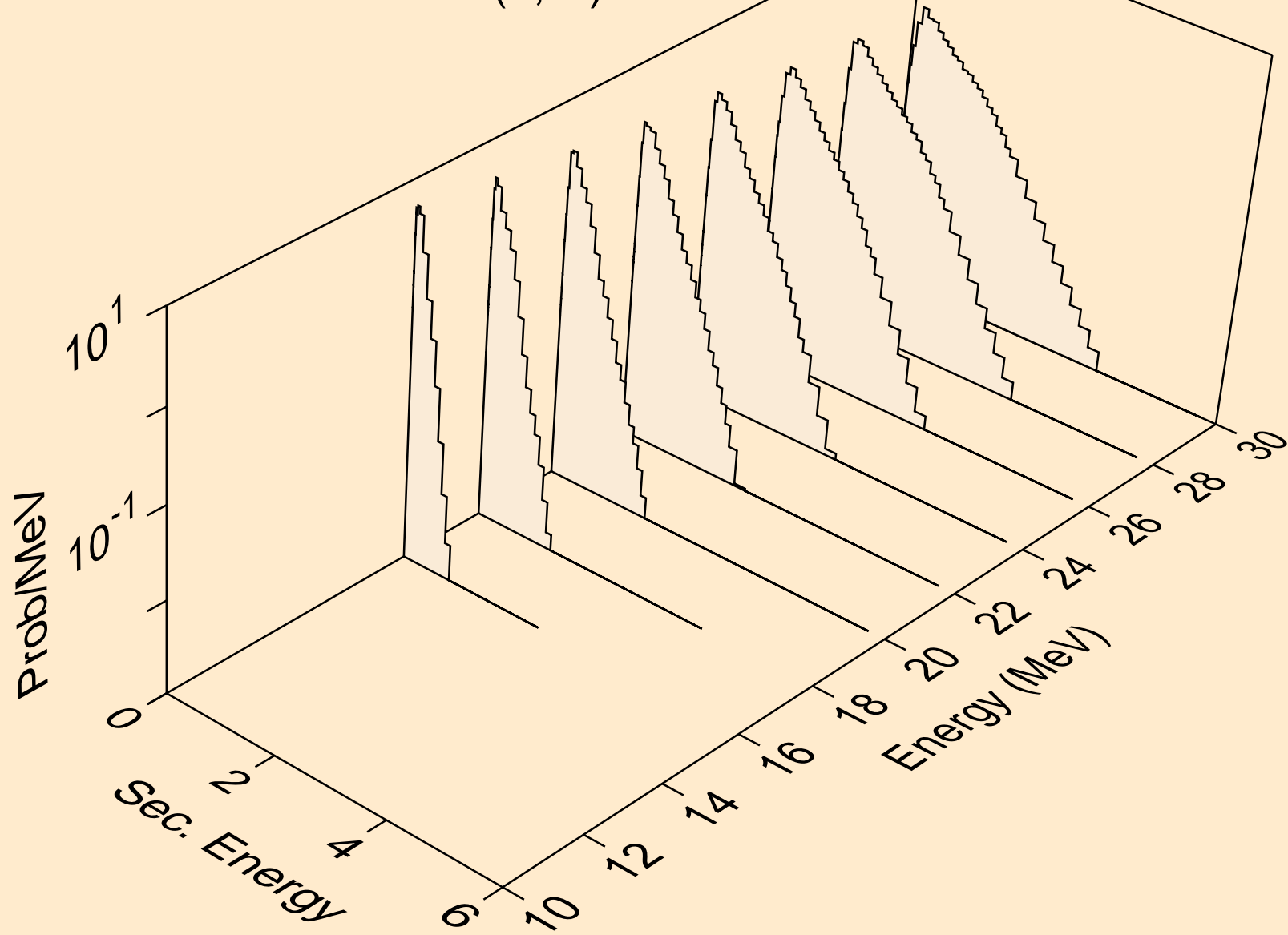

TH234 NEUTRON ACER TENDL-2024 LIBRARY; T=293.6K  
Neutron emission for (n,n\*)t

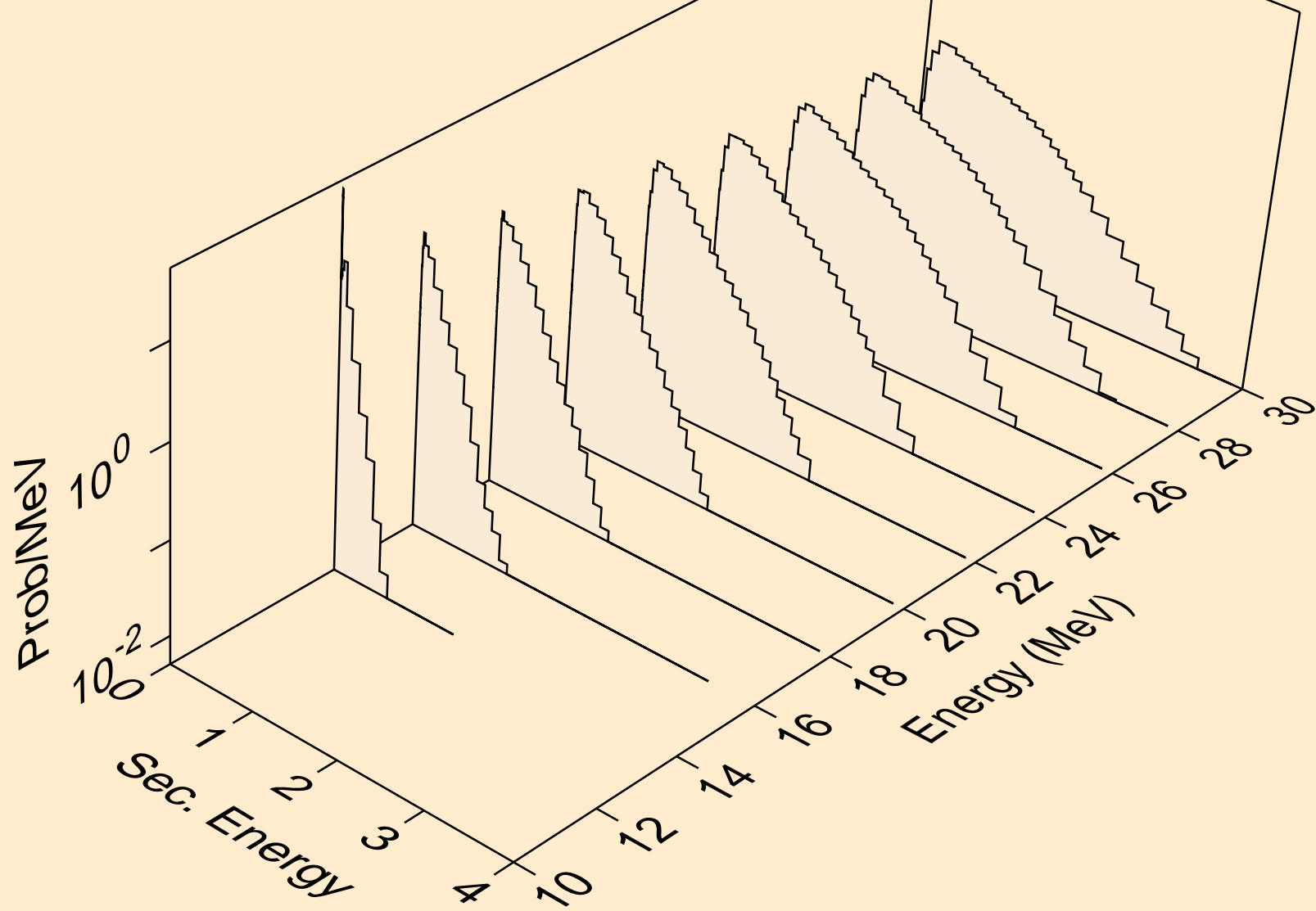

TH234 NEUTRON ACER TENDL-2024 LIBRARY; T=293.6K  
Neutron emission for (n,n\*)he3

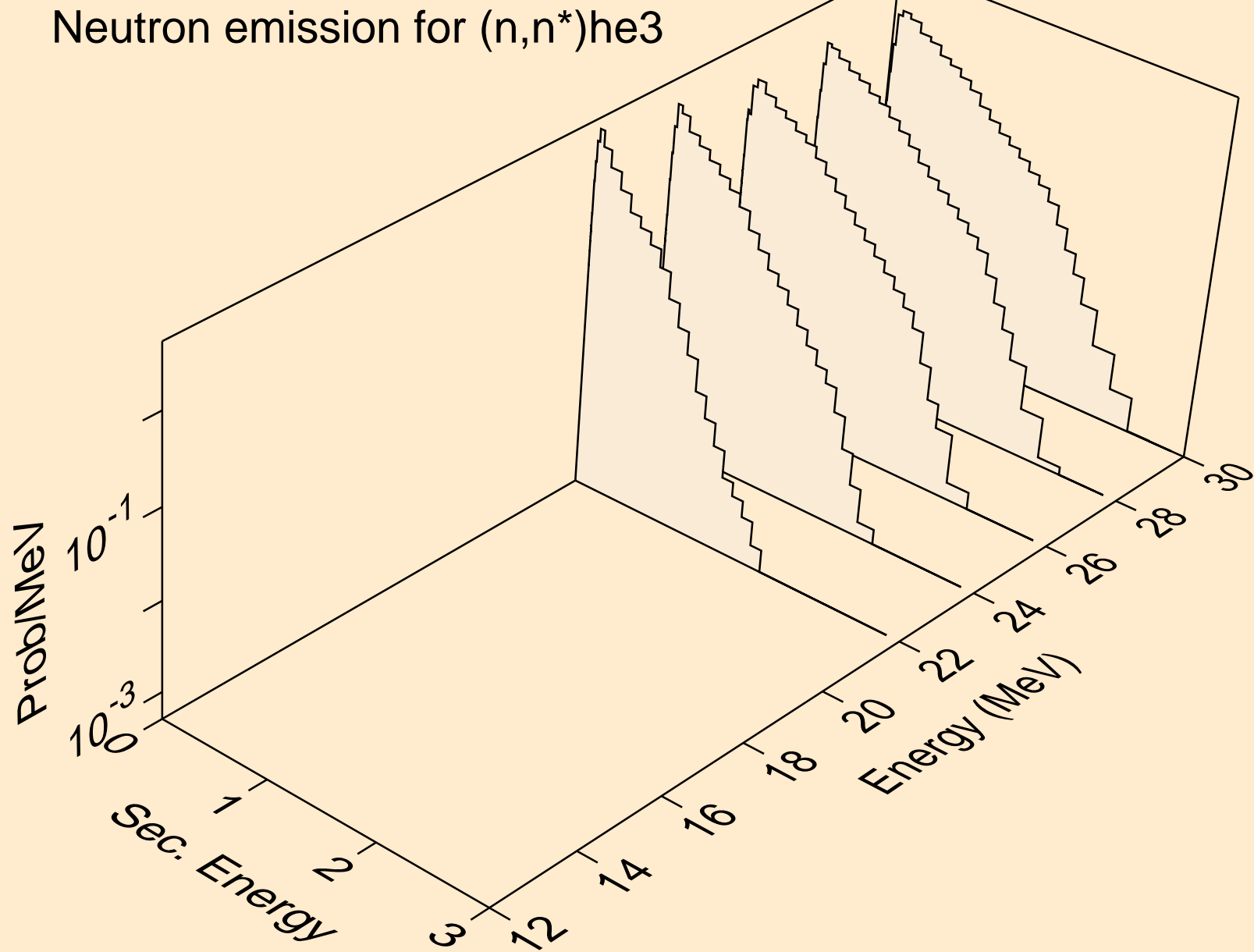

TH234 NEUTRON ACER TENDL-2024 LIBRARY; T=293.6K  
Neutron emission for (n,4n)

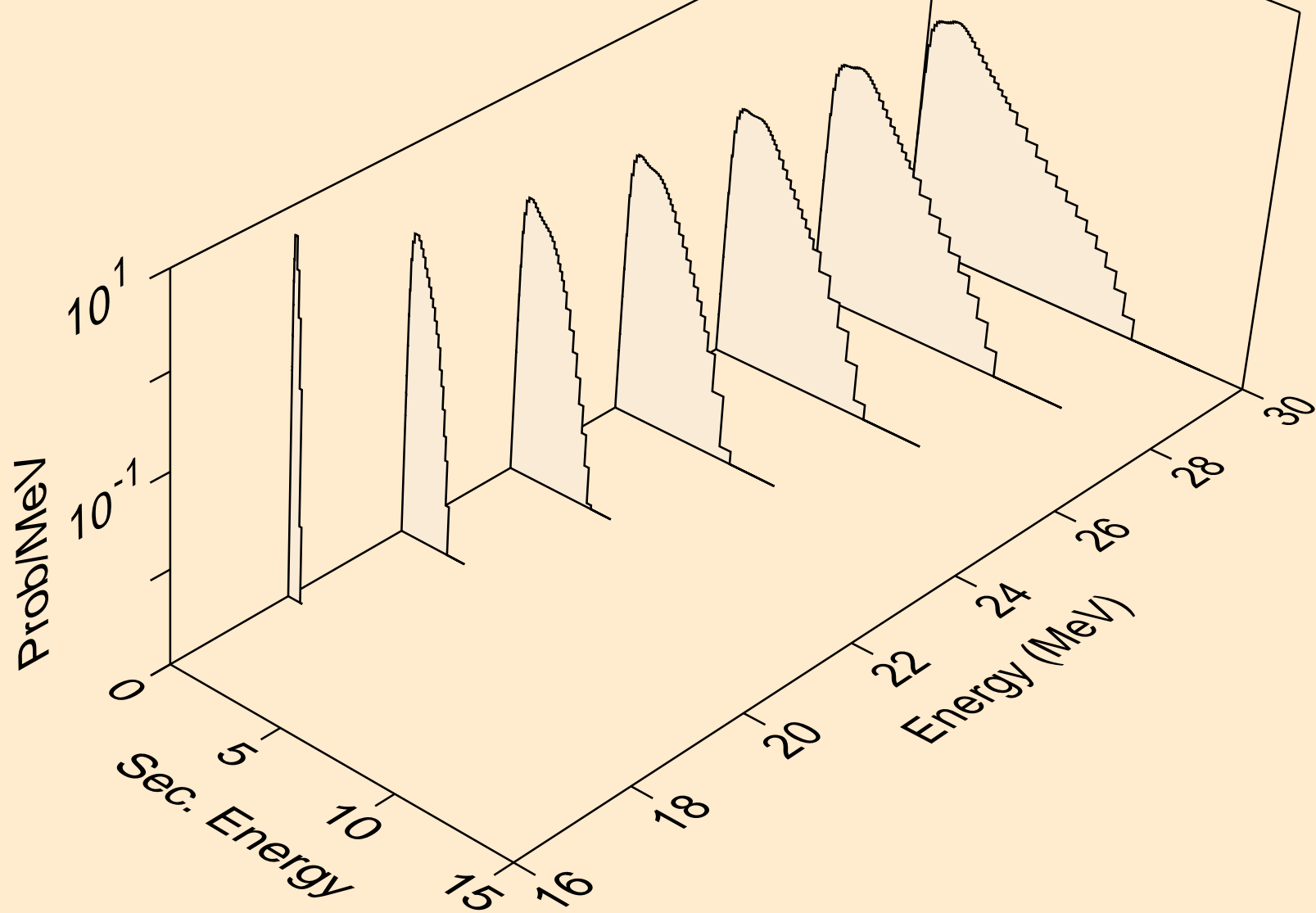

TH234 NEUTRON ACER TENDL-2024 LIBRARY; T=293.6K  
Neutron emission for (n,2np)

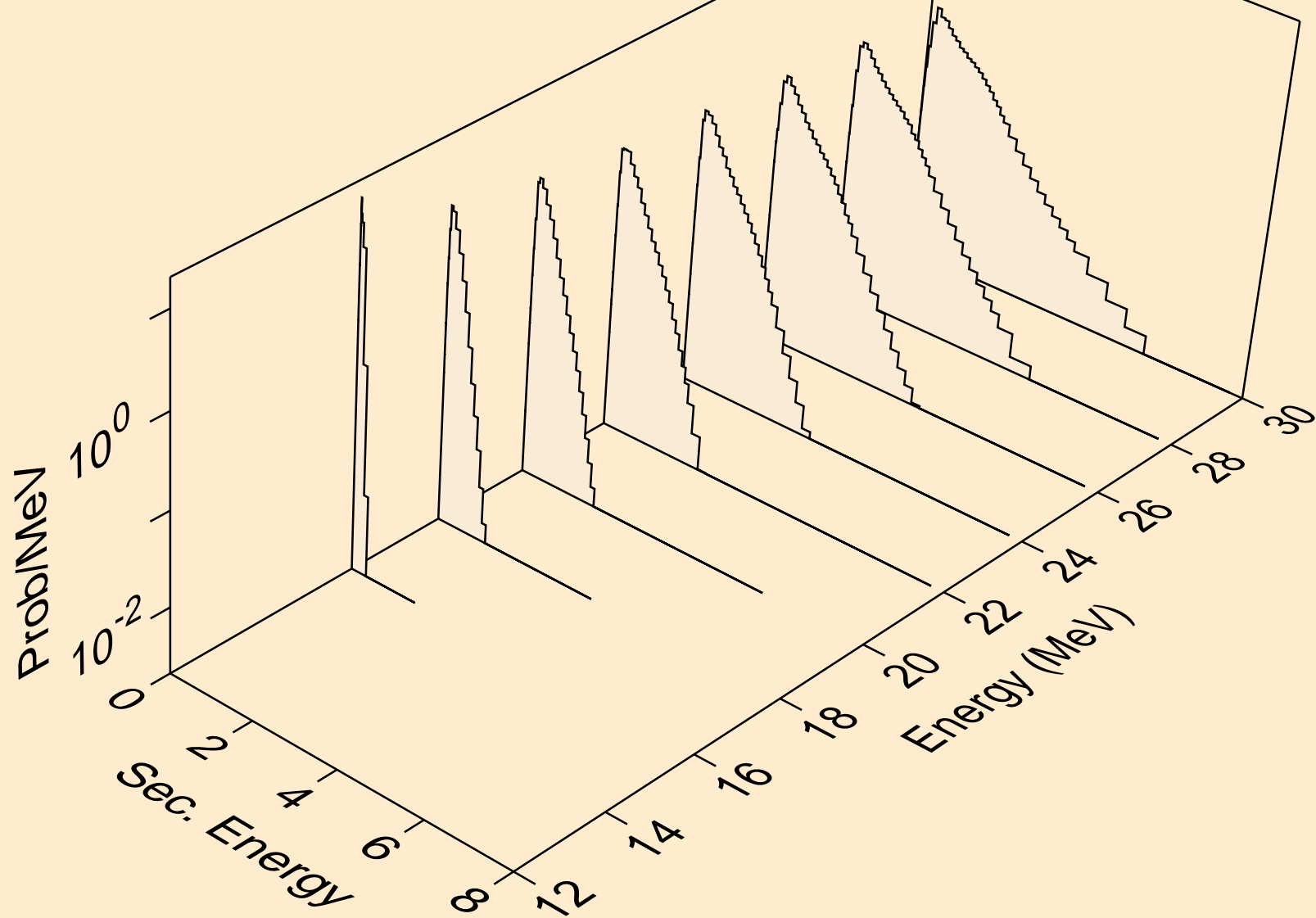

TH234 NEUTRON ACER TENDL-2024 LIBRARY; T=293.6K  
Neutron emission for (n,3np)

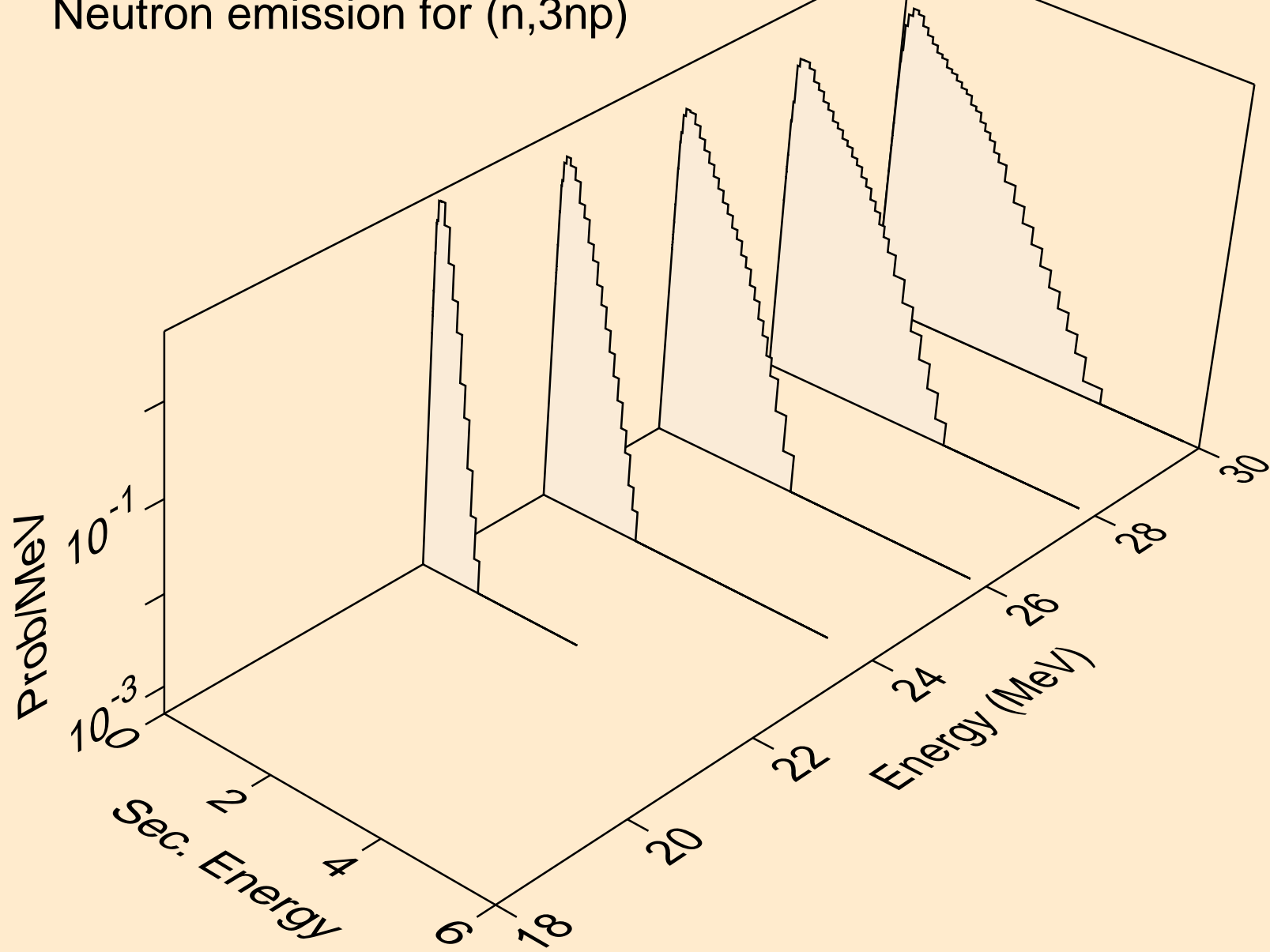

TH234 NEUTRON ACER TENDL-2024 LIBRARY; T=293.6K  
Neutron emission for (n,n\*c)

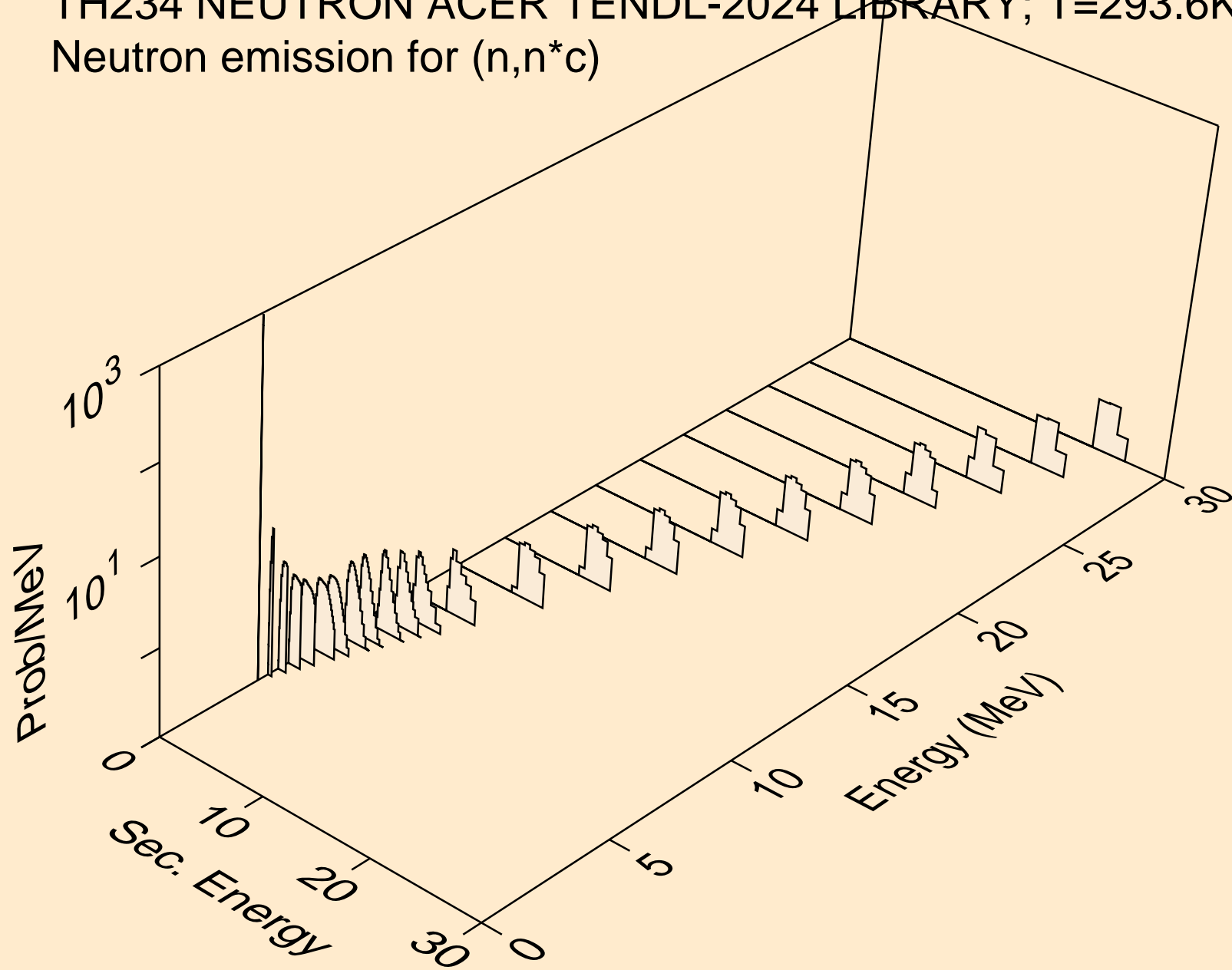

TH234 NEUTRON ACER TENDL-2024 LIBRARY; T=293.6K  
Delayed nubar

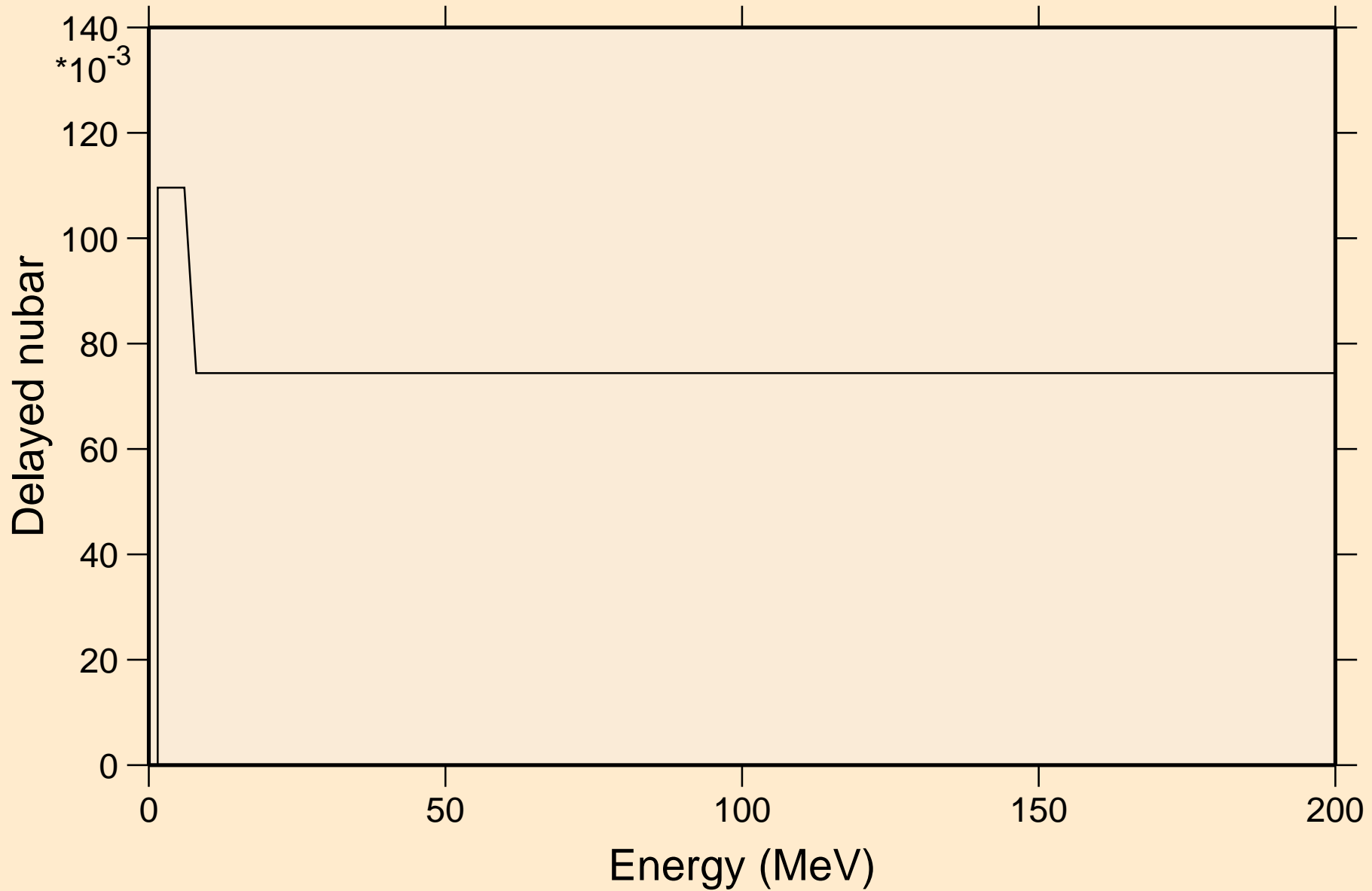

# TH234 NEUTRON ACER TENDL-2024 LIBRARY; T=293.6K

## Delayed neutron spectra

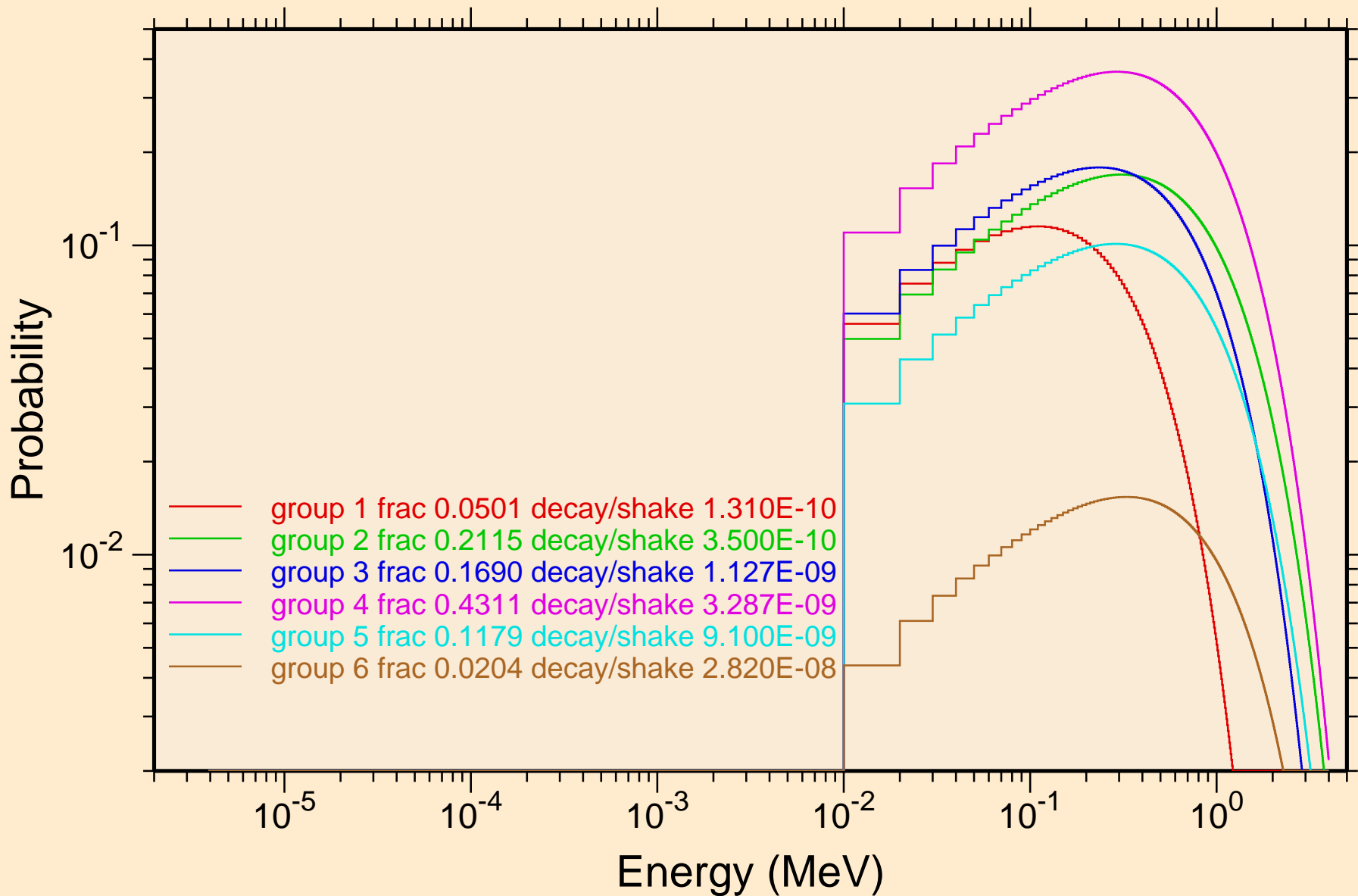

TH234 NEUTRON ACER TENDL-2024 LIBRARY; T=293.6K  
Photon emission for (n,x)

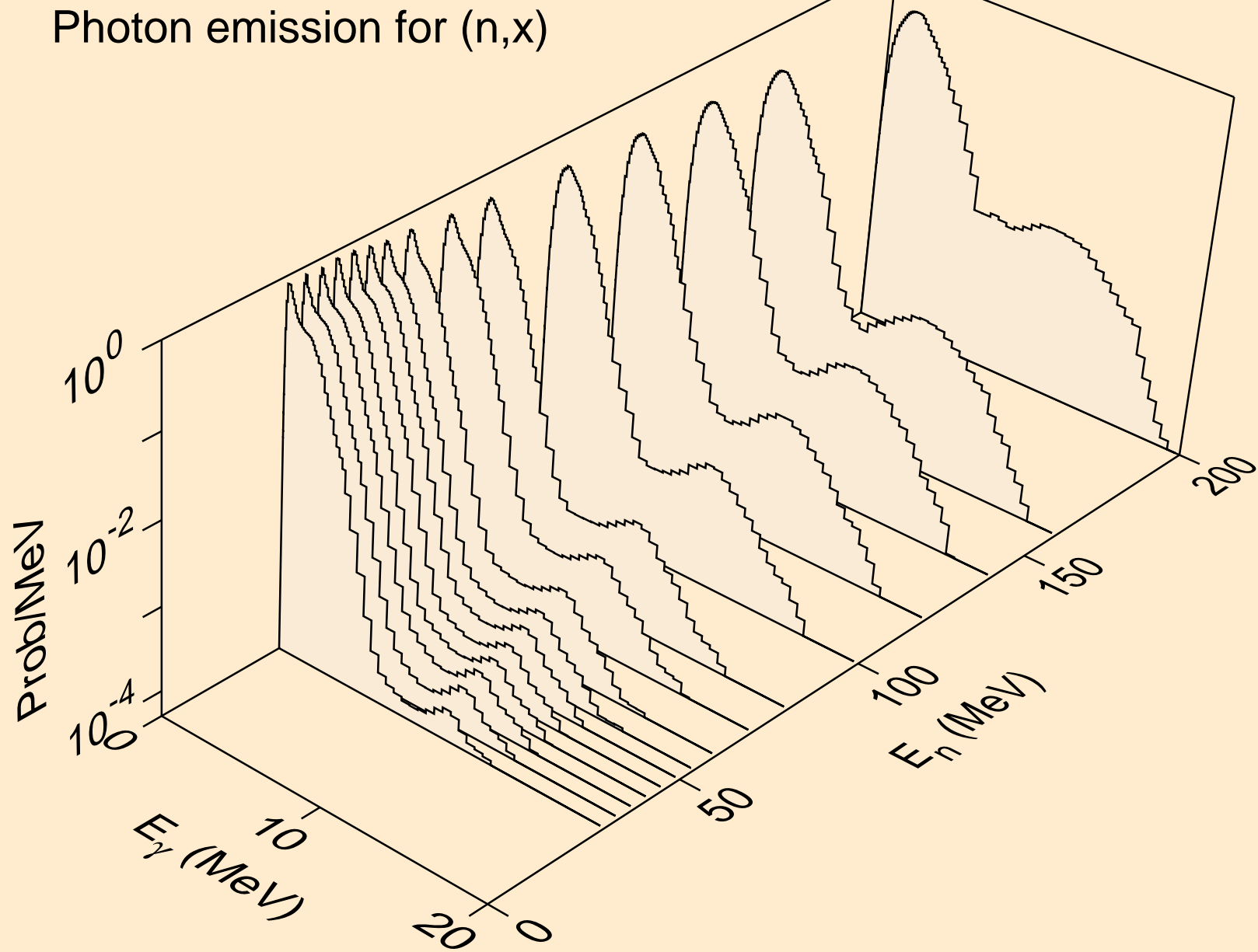

TH234 NEUTRON ACER TENDL-2024 LIBRARY; T=293.6K  
Photon emission for (n,2nd)

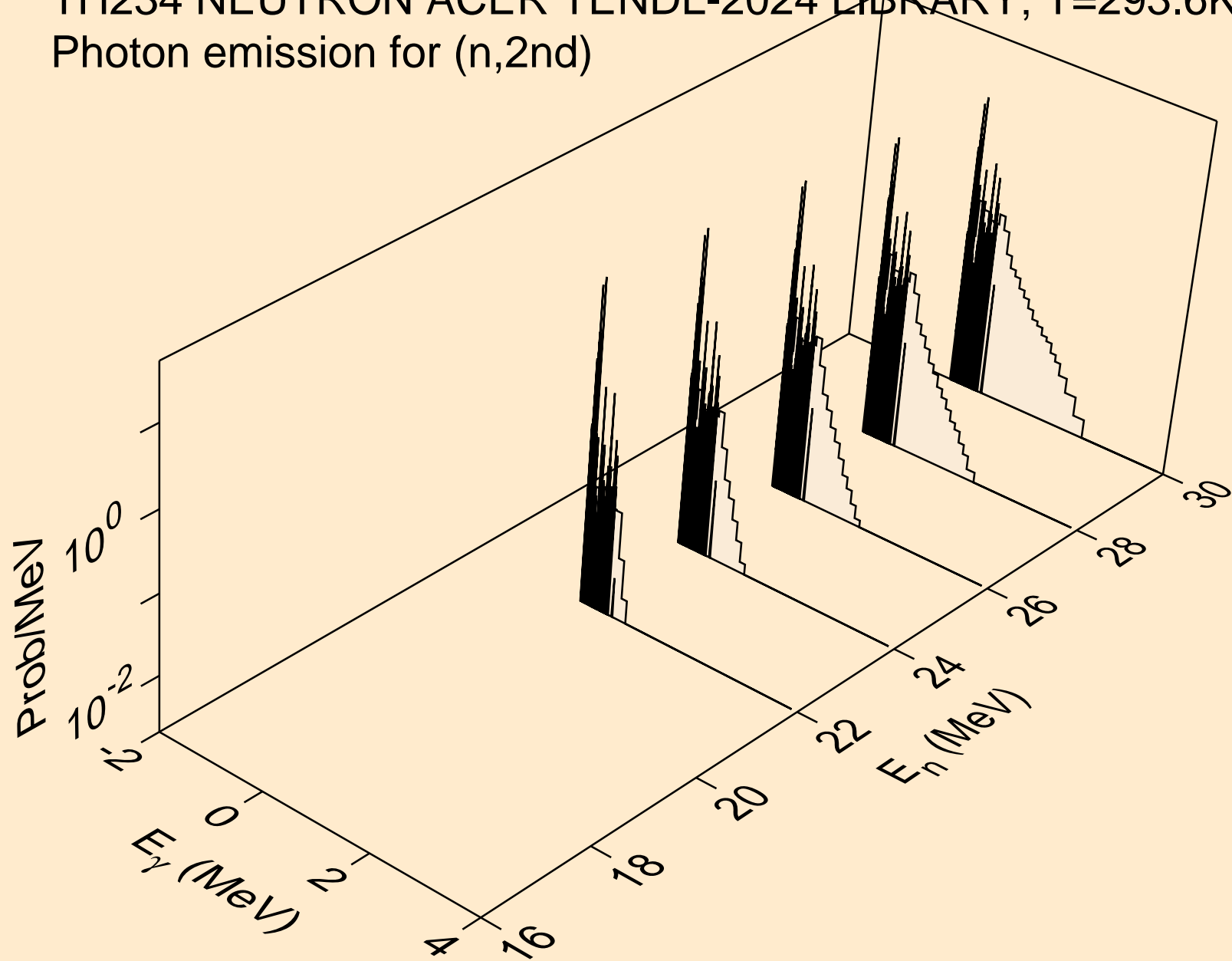

TH234 NEUTRON ACER TENDL-2024 LIBRARY; T=293.6K  
Photon emission for (n,2n)

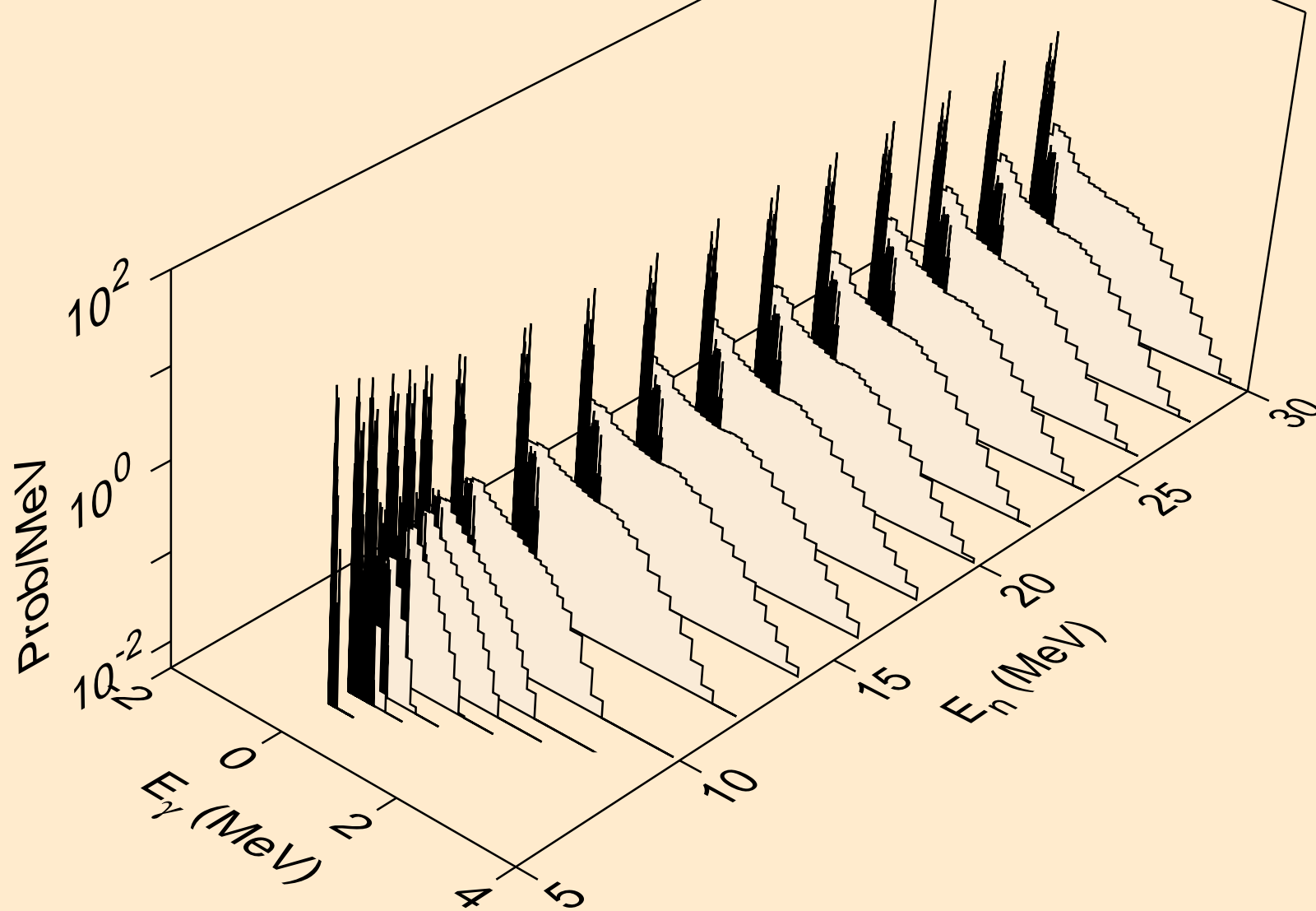

TH234 NEUTRON ACER TENDL-2024 LIBRARY; T=293.6K  
Photon emission for (n,3n)

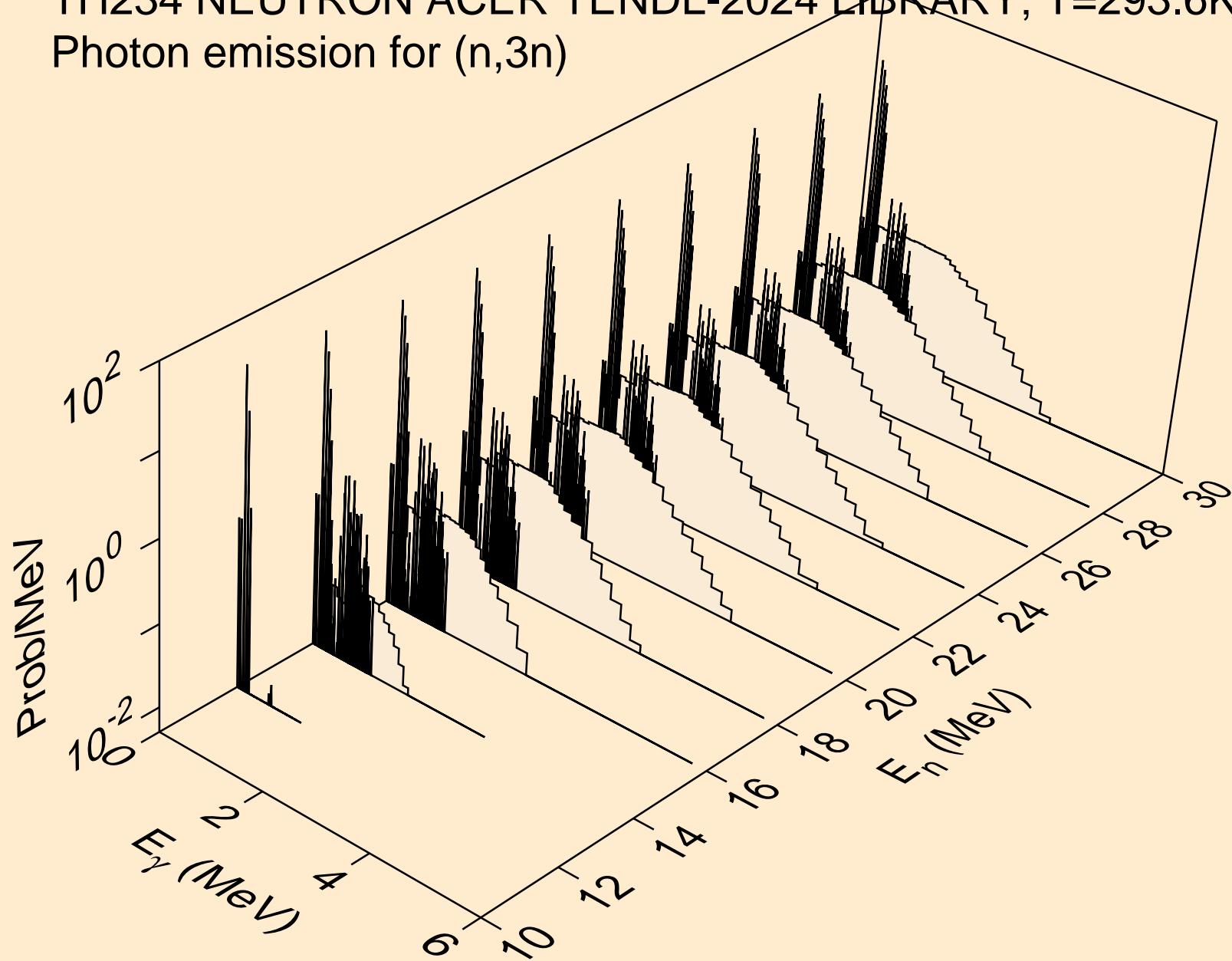

TH234 NEUTRON ACER TENDL-2024 LIBRARY; T=293.6K  
Photon emission for (n,n\*)a

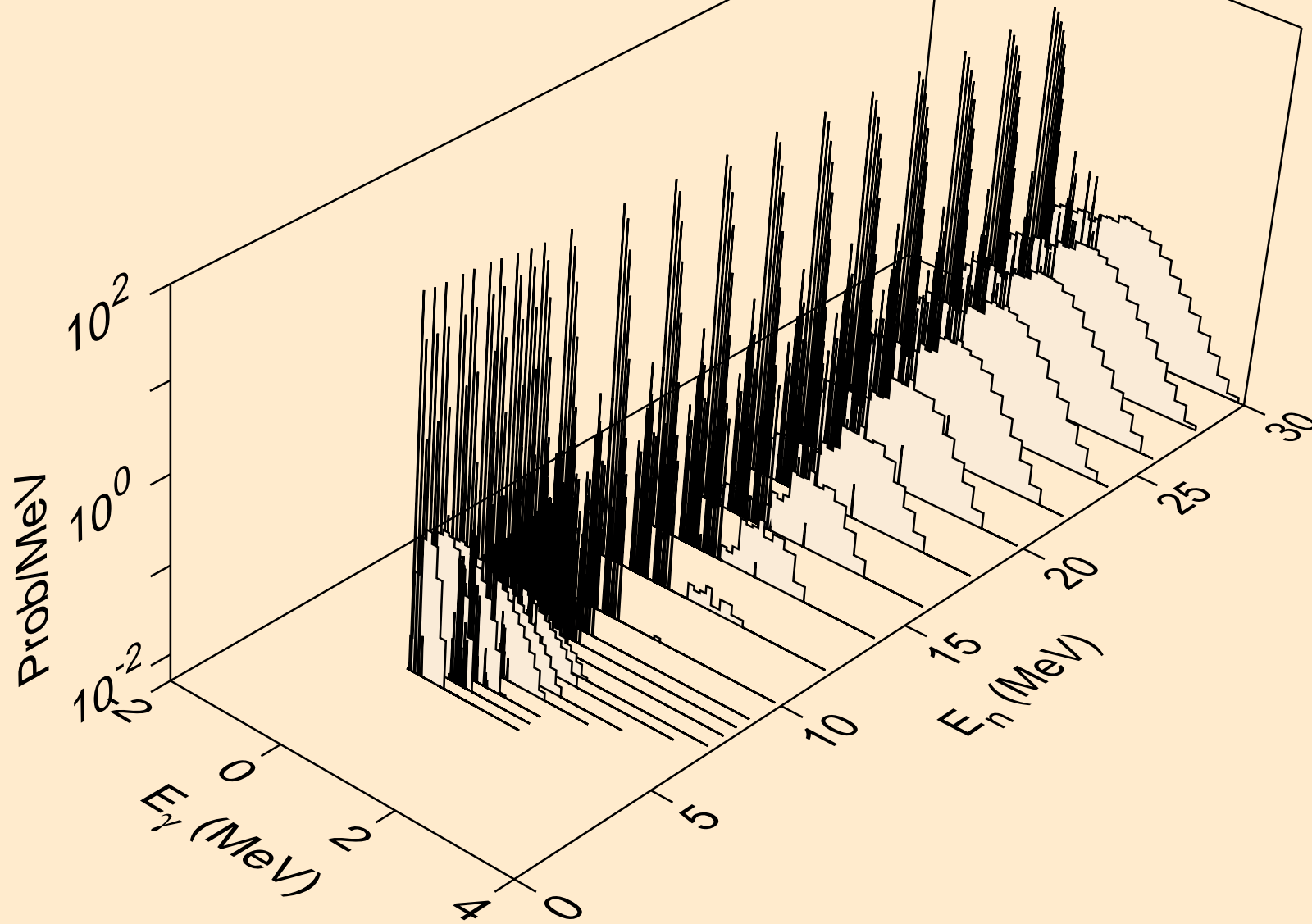

TH234 NEUTRON ACER TENDL-2024 LIBRARY; T=293.6K  
Photon emission for (n,2n)a

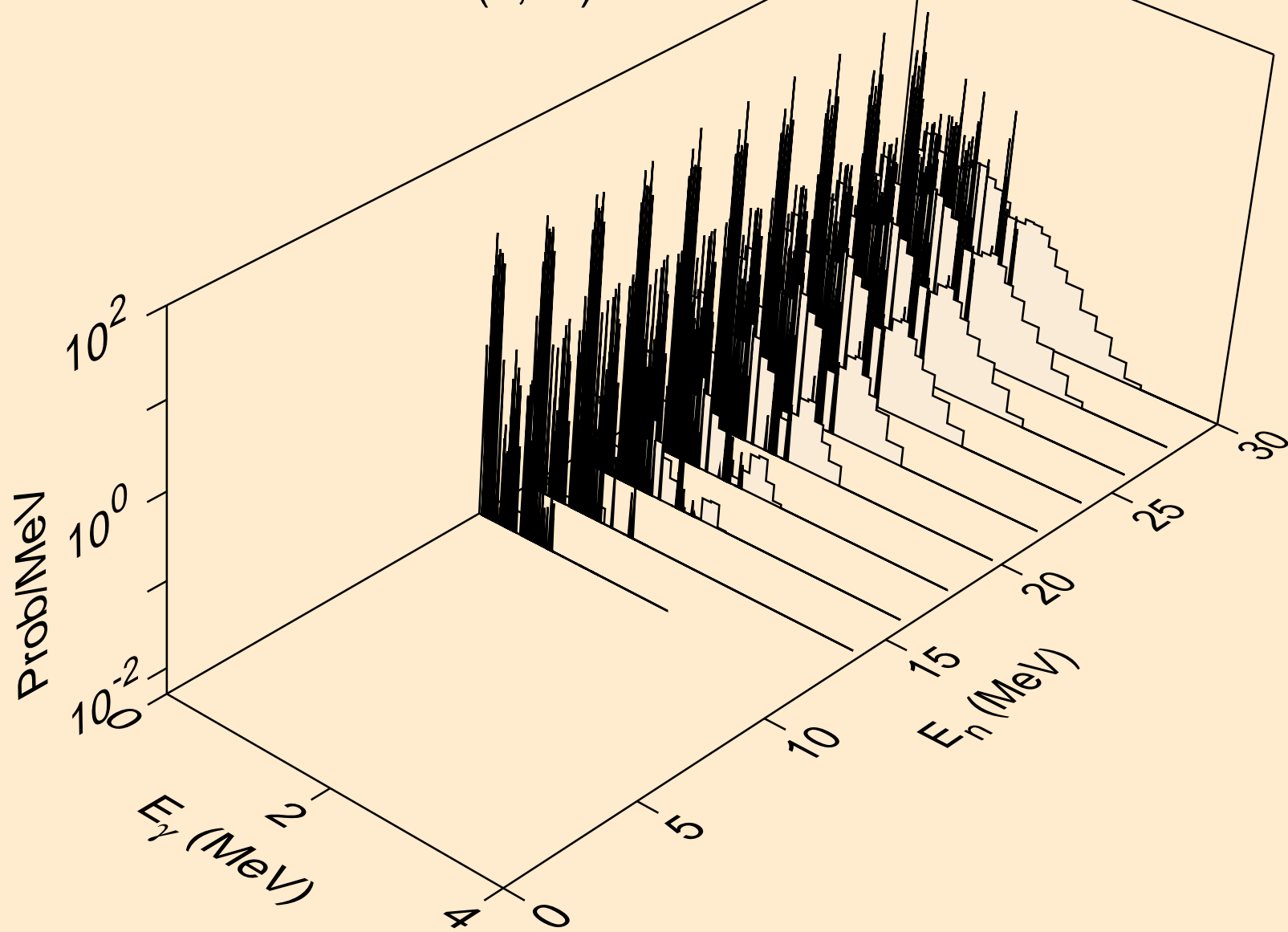

TH234 NEUTRON ACER TENDL-2024 LIBRARY; T=293.6K  
Photon emission for (n,3n)a

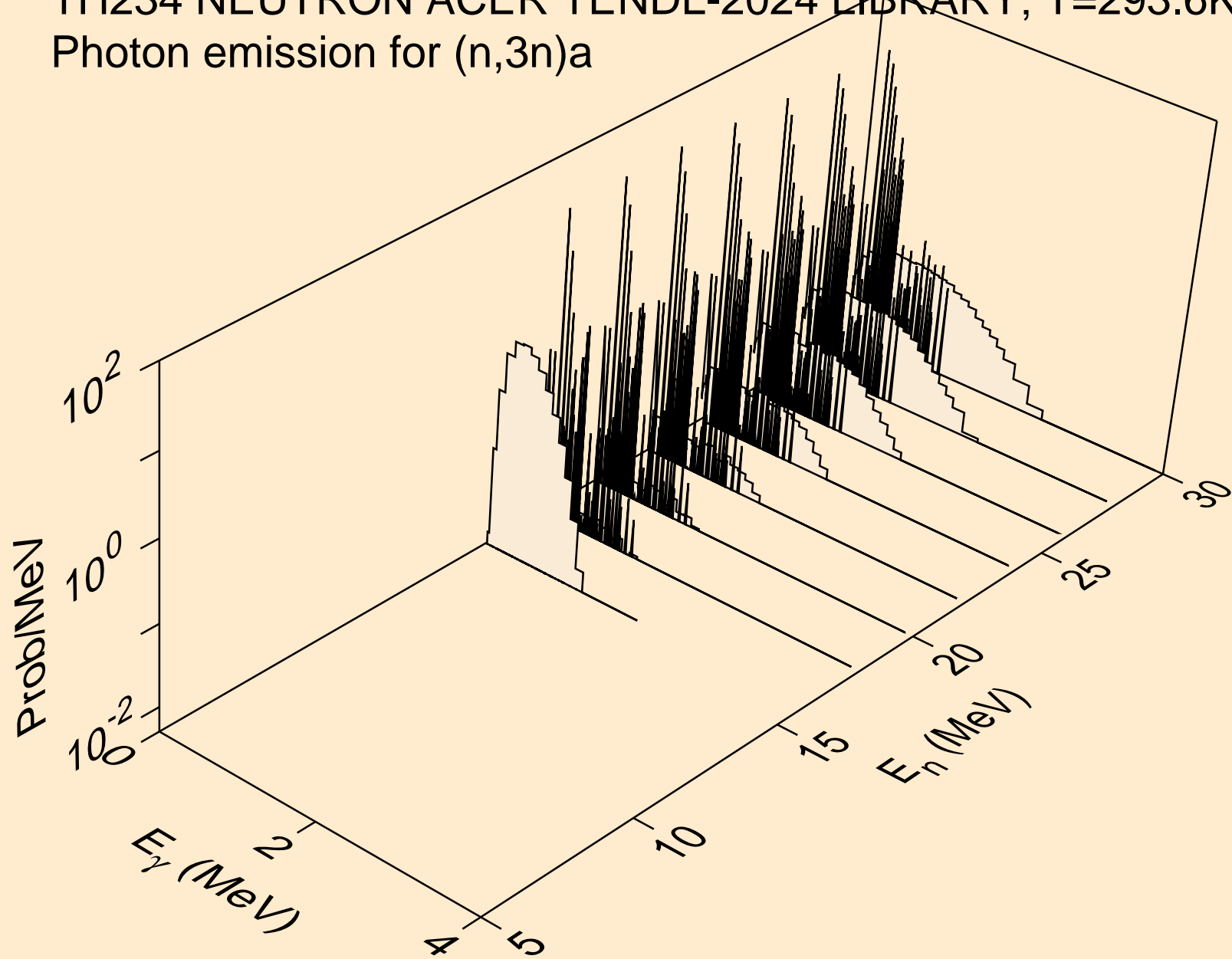

TH234 NEUTRON ACER TENDL-2024 LIBRARY; T=293.6K  
Photon emission for (n,n\*)p

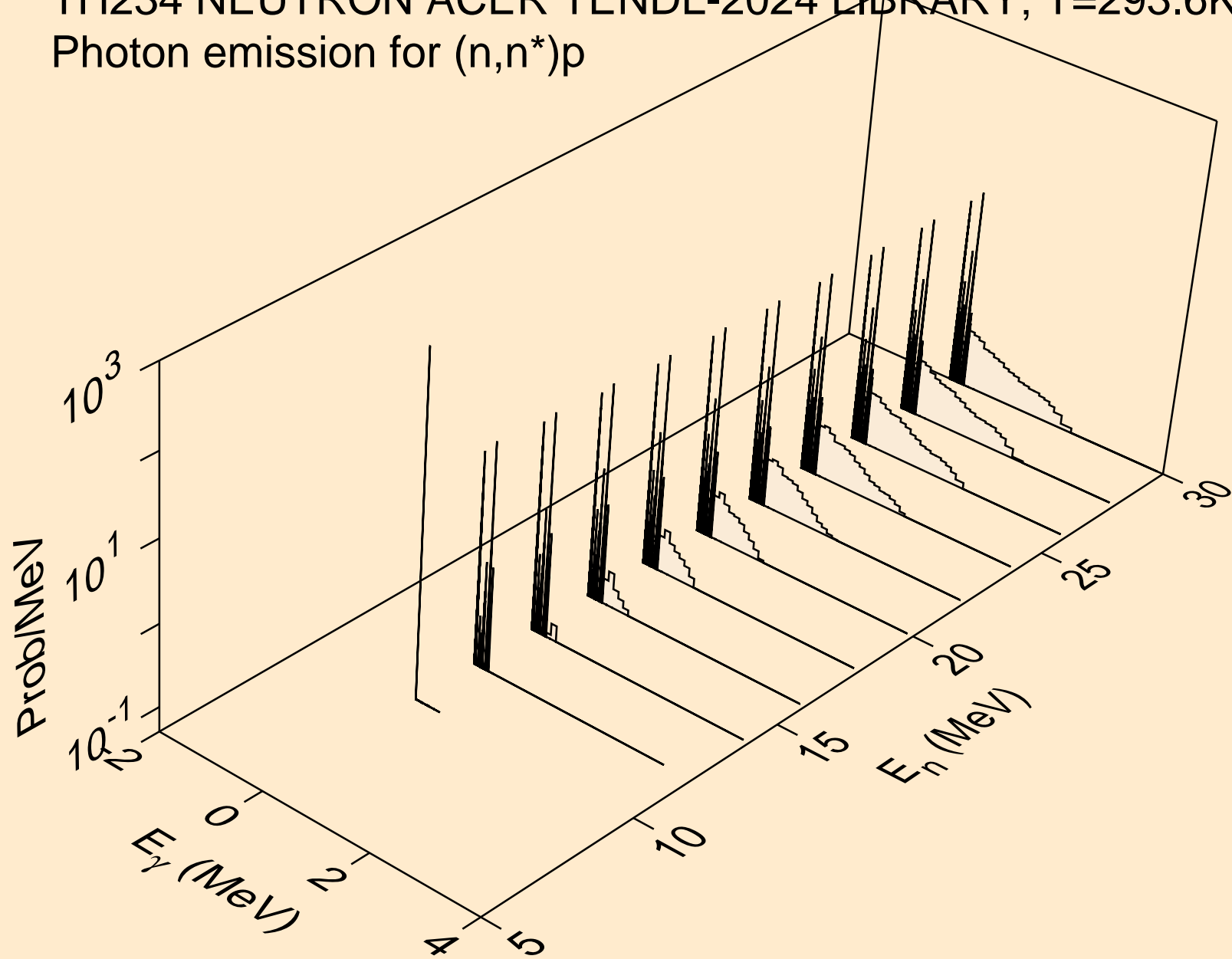

TH234 NEUTRON ACER TENDL-2024 LIBRARY; T=293.6K  
Photon emission for (n,n\*)d

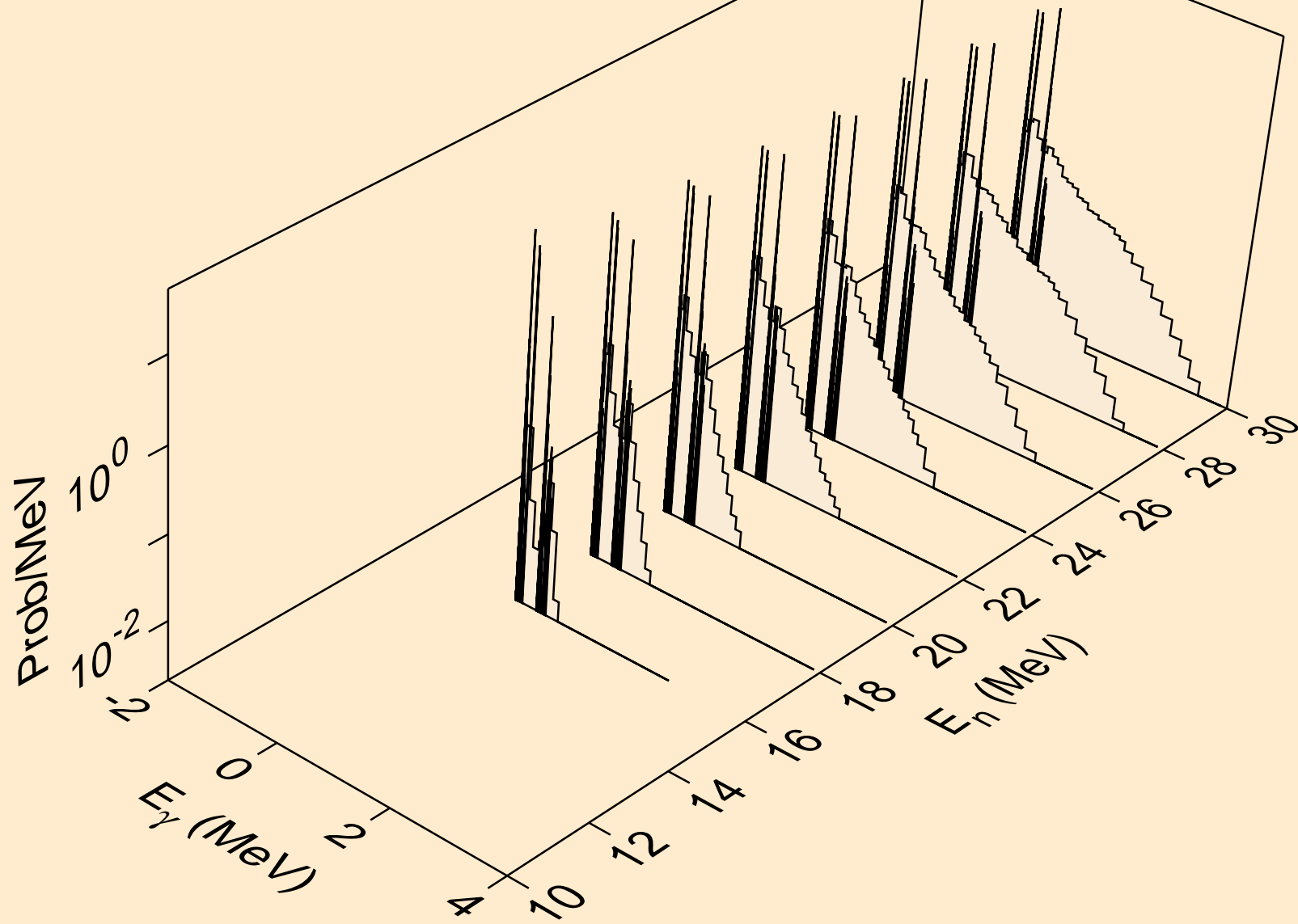

TH234 NEUTRON ACER TENDL-2024 LIBRARY; T=293.6K  
Photon emission for (n,n\*)t

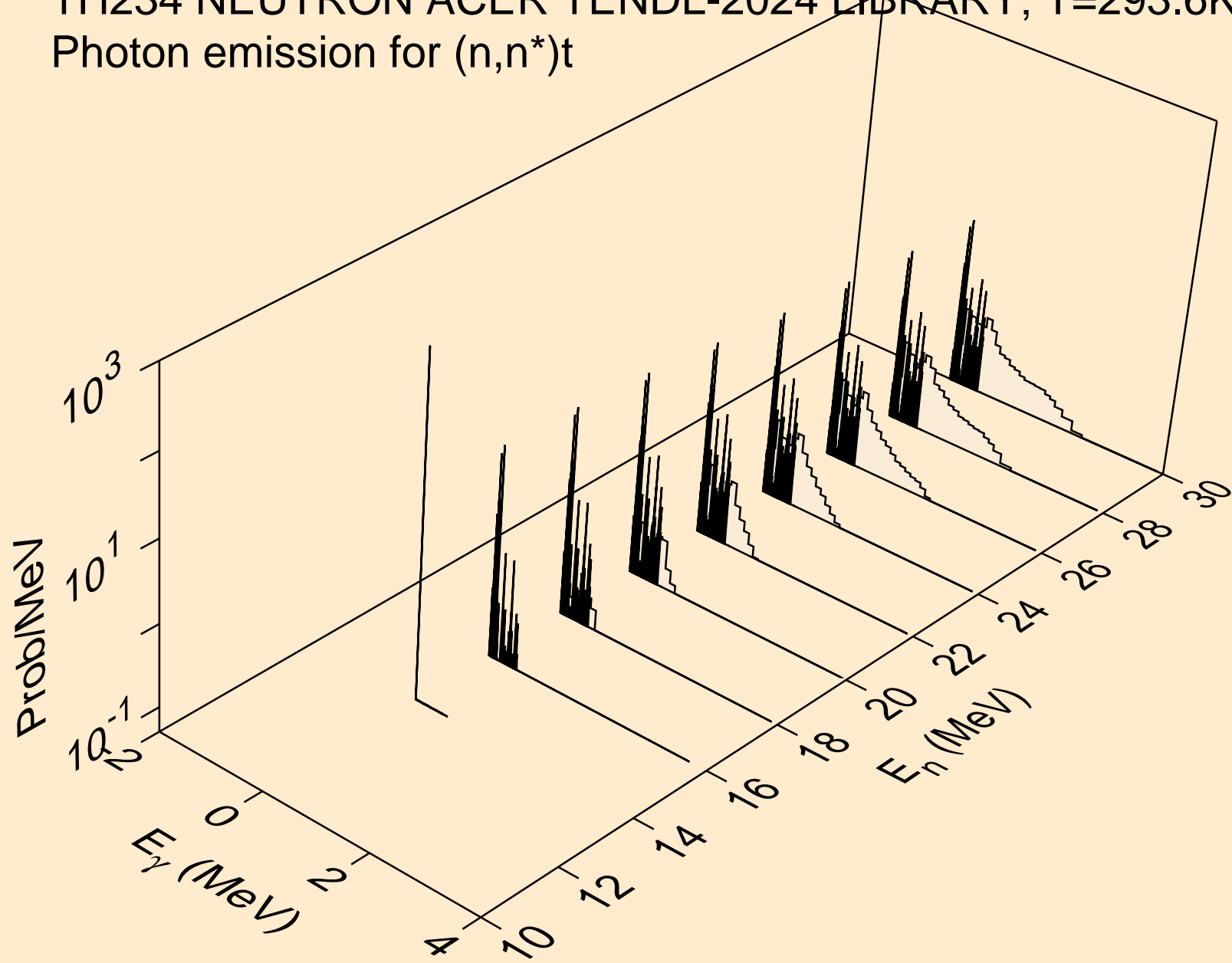

TH234 NEUTRON ACER TENDL-2024 LIBRARY; T=293.6K  
Photon emission for (n,n\*)he3

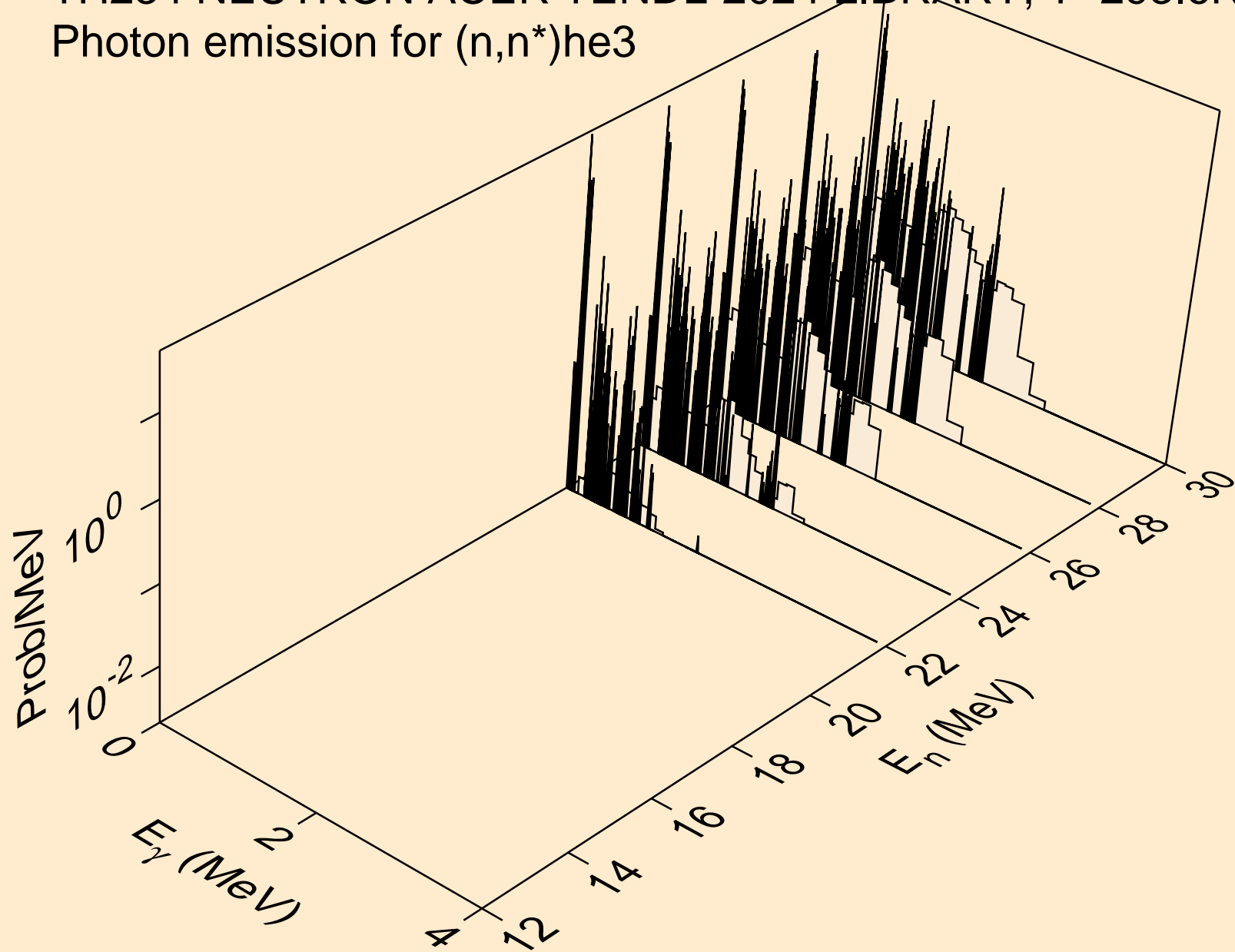

TH234 NEUTRON ACER TENDL-2024 LIBRARY; T=293.6K  
Photon emission for (n,4n)

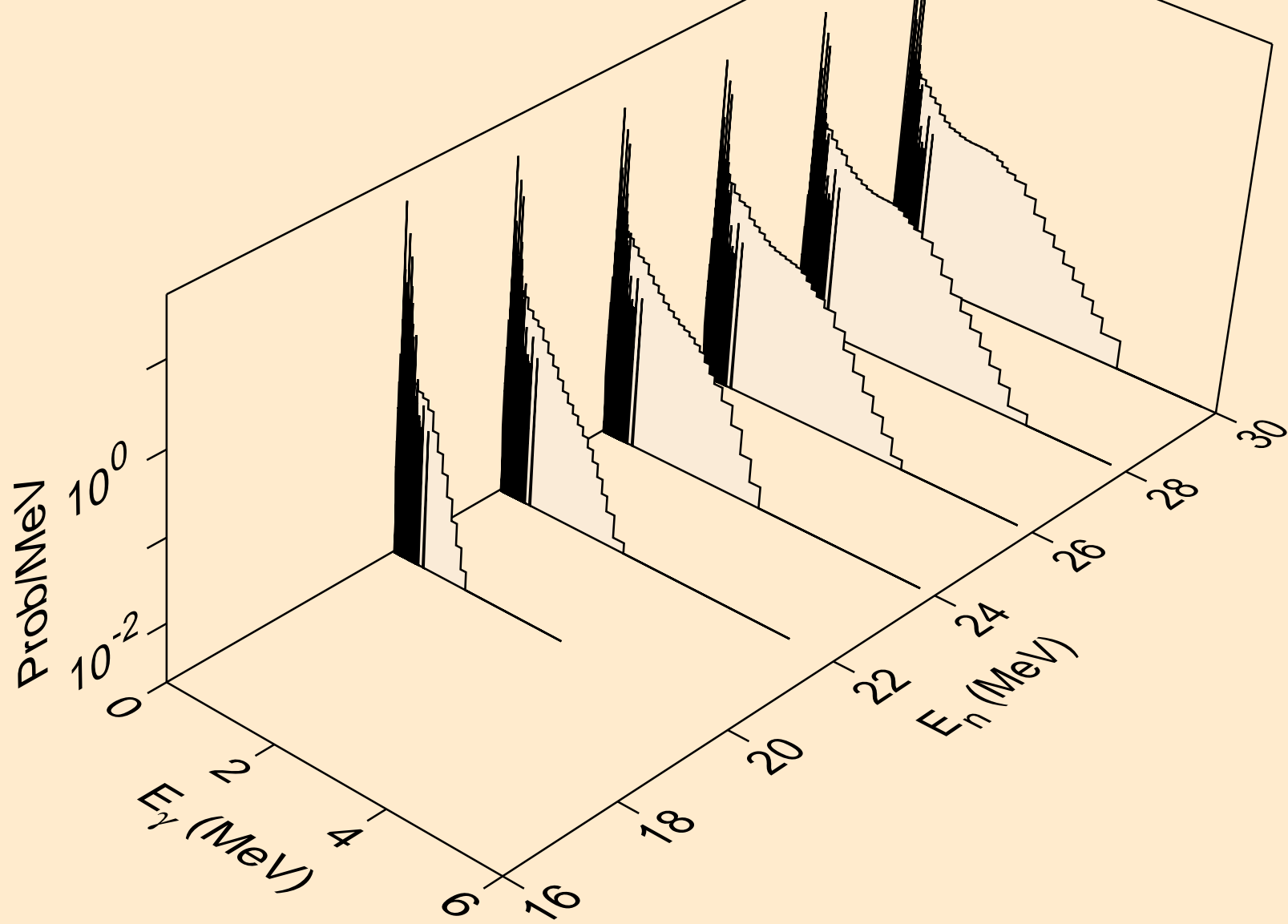

TH234 NEUTRON ACER TENDL-2024 LIBRARY; T=293.6K  
Photon emission for (n,2np)

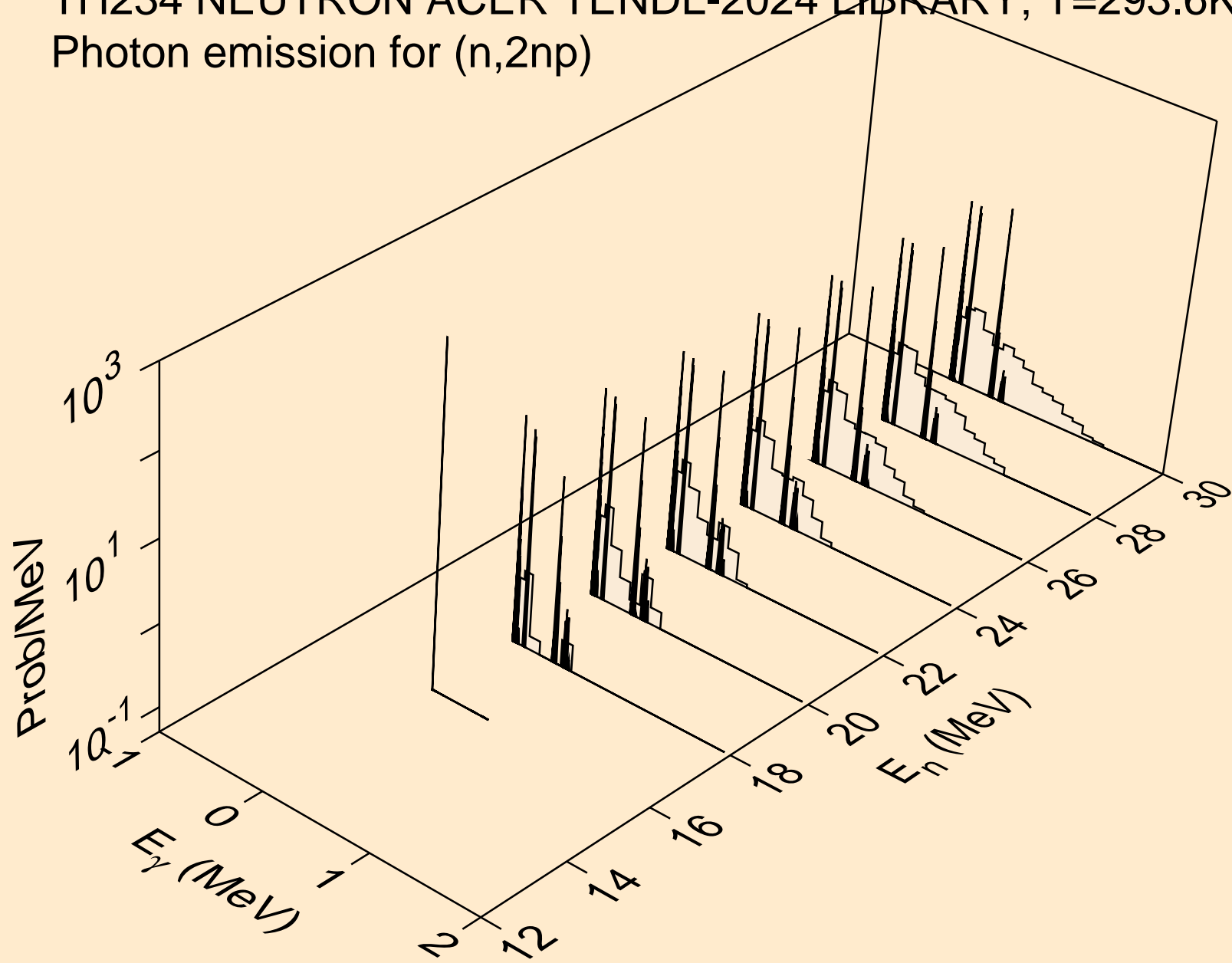

TH234 NEUTRON ACER TENDL-2024 LIBRARY; T=293.6K  
Photon emission for (n,3np)

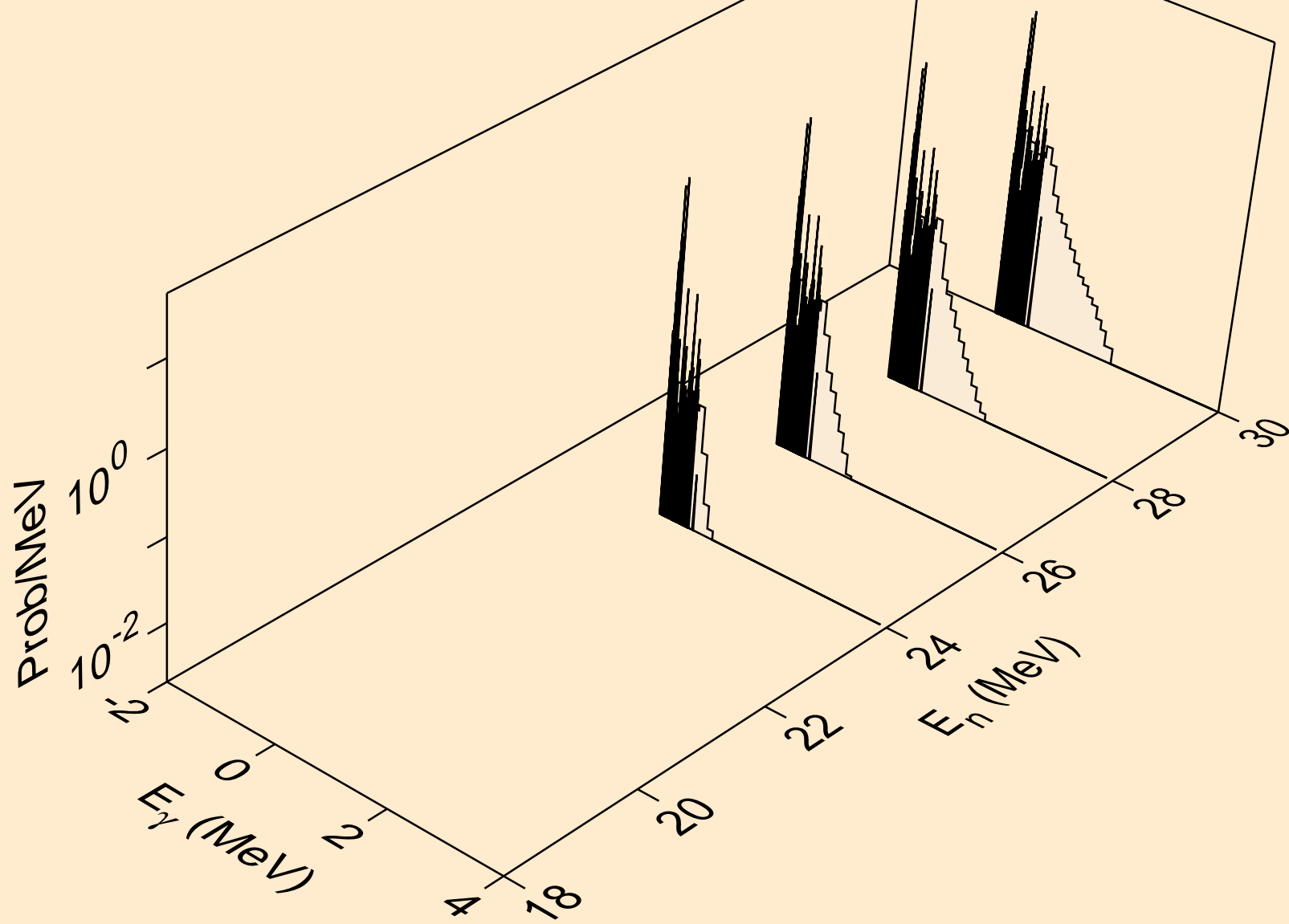

TH234 NEUTRON ACER TENDL-2024 LIBRARY; T=293.6K  
Photon emission for (n,n\*c)

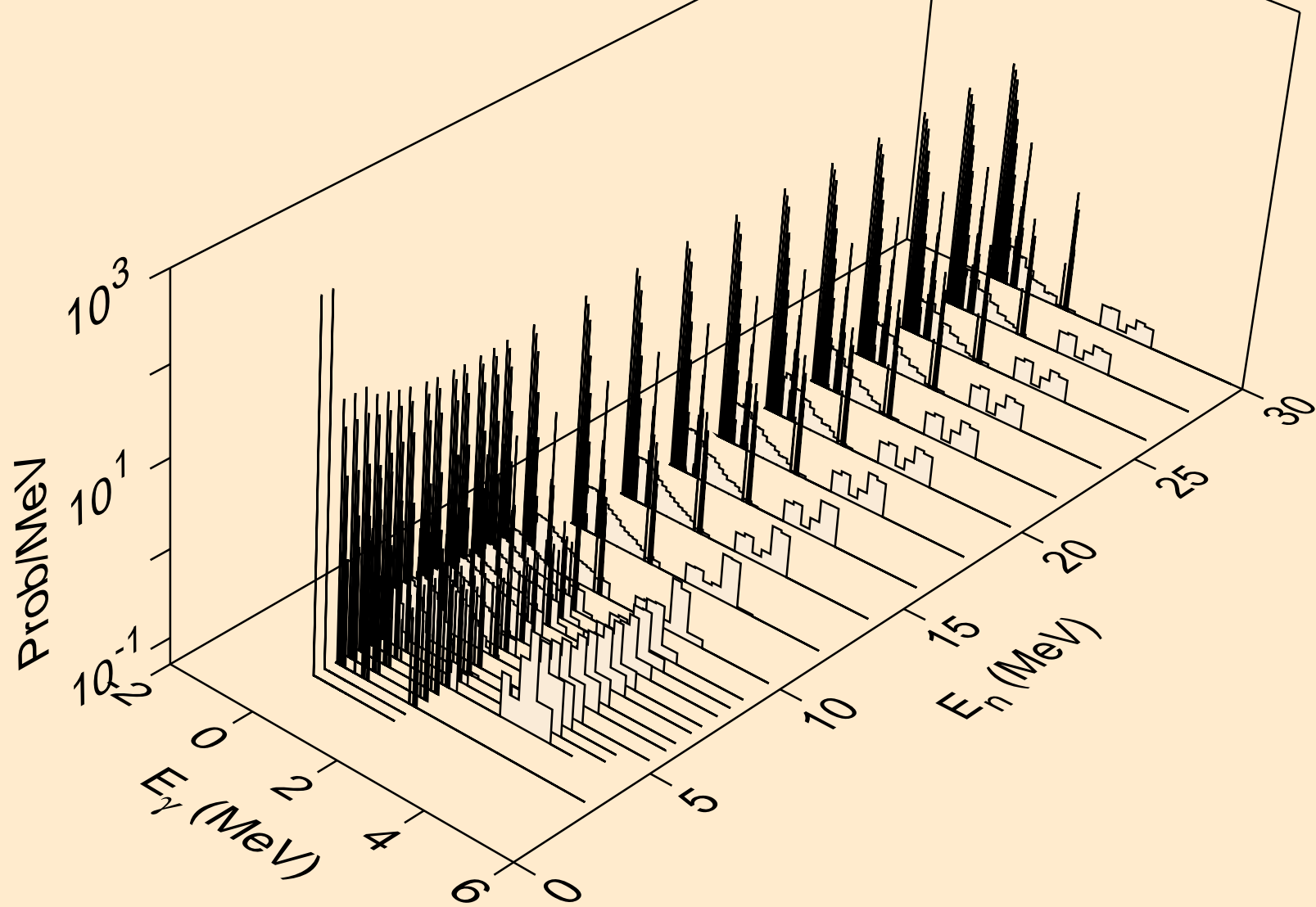

TH234 NEUTRON ACER TENDL-2024 LIBRARY; T=293.6K  
Photon emission for (n,gma)

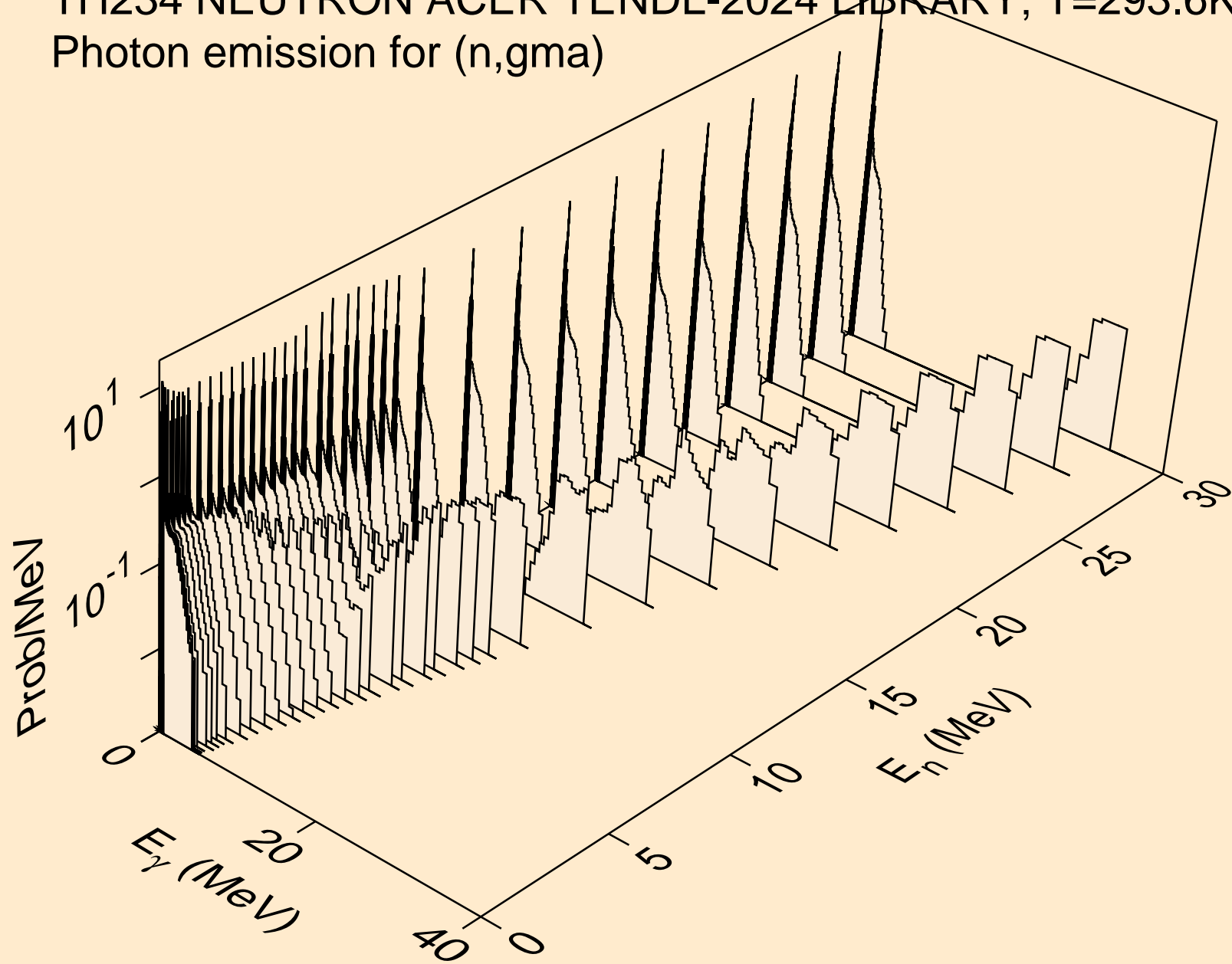

TH234 NEUTRON ACER TENDL-2024 LIBRARY; T=293.6K  
Photon emission for (n,p)

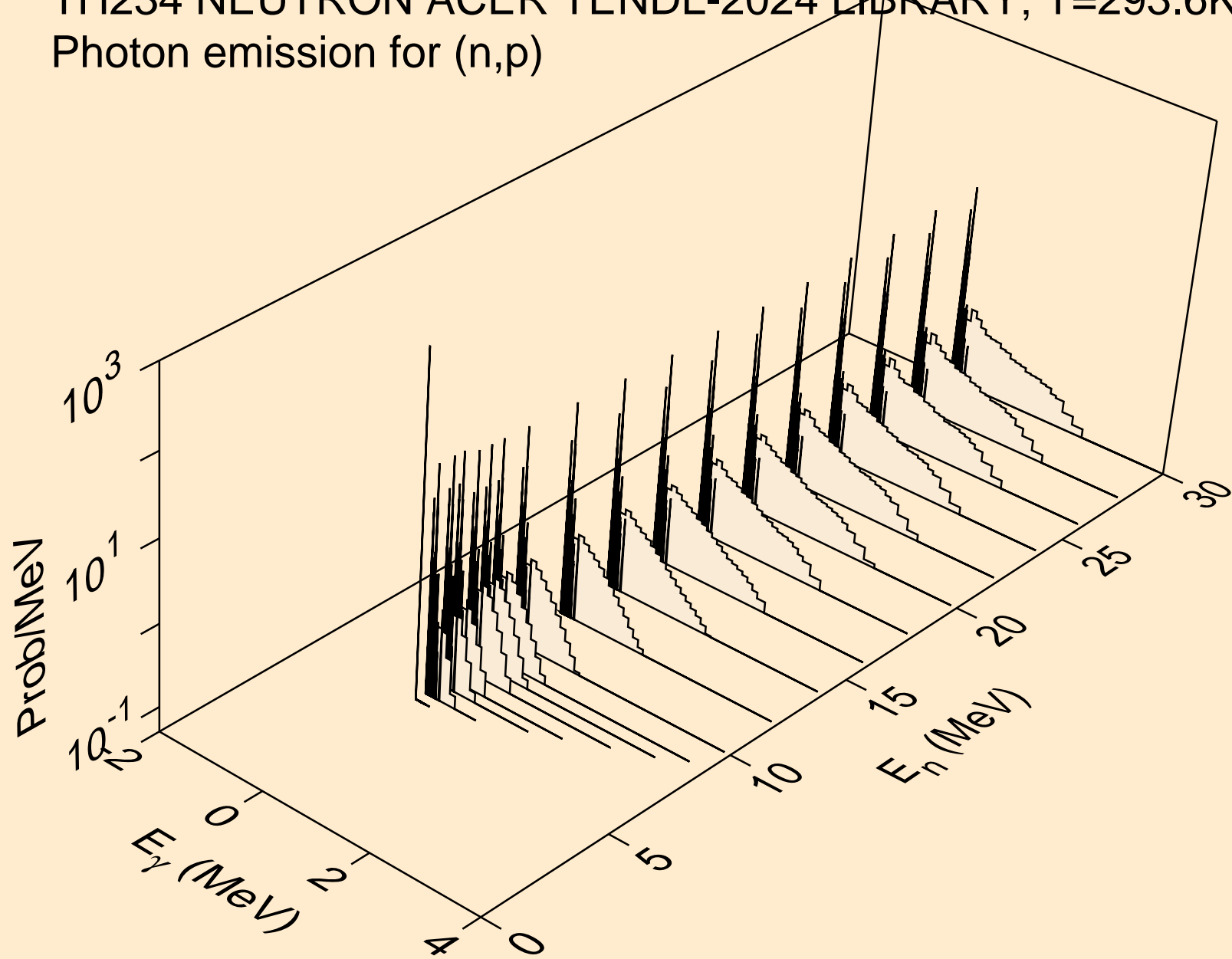

TH234 NEUTRON ACER TENDL-2024 LIBRARY; T=293.6K  
Photon emission for (n,d)

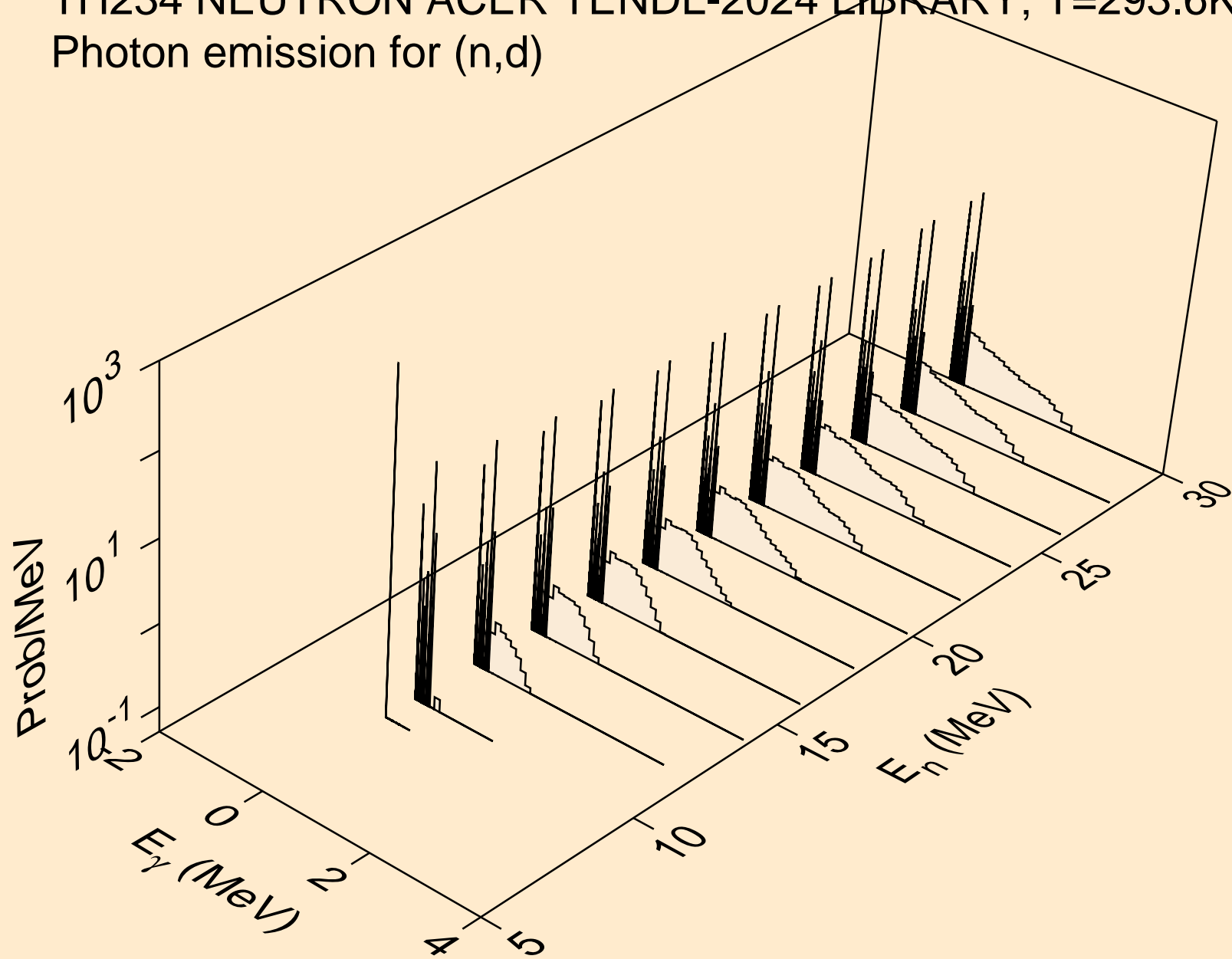

TH234 NEUTRON ACER TENDL-2024 LIBRARY; T=293.6K  
Photon emission for (n,t)

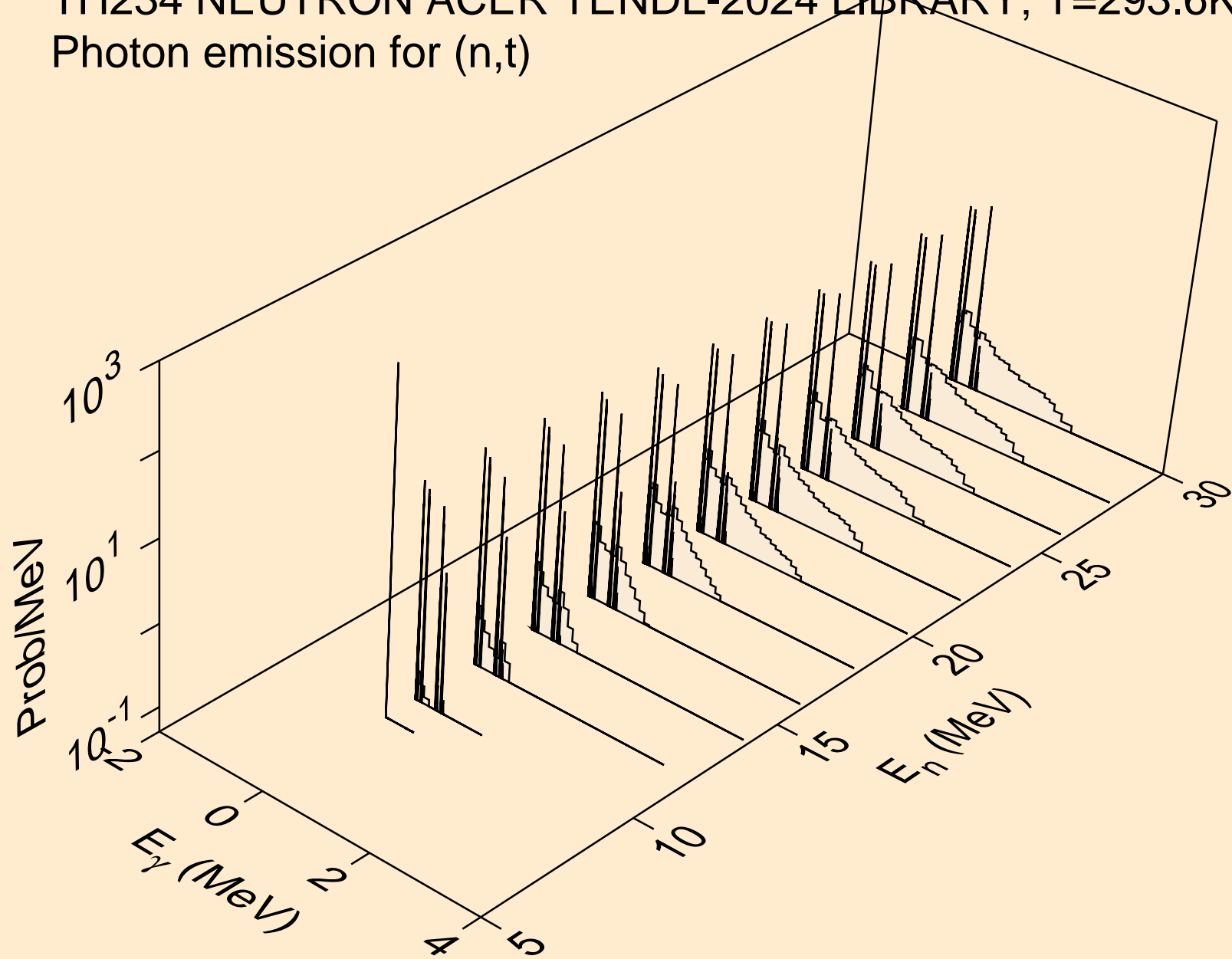

TH234 NEUTRON ACER TENDL-2024 LIBRARY; T=293.6K  
Photon emission for (n,he3)

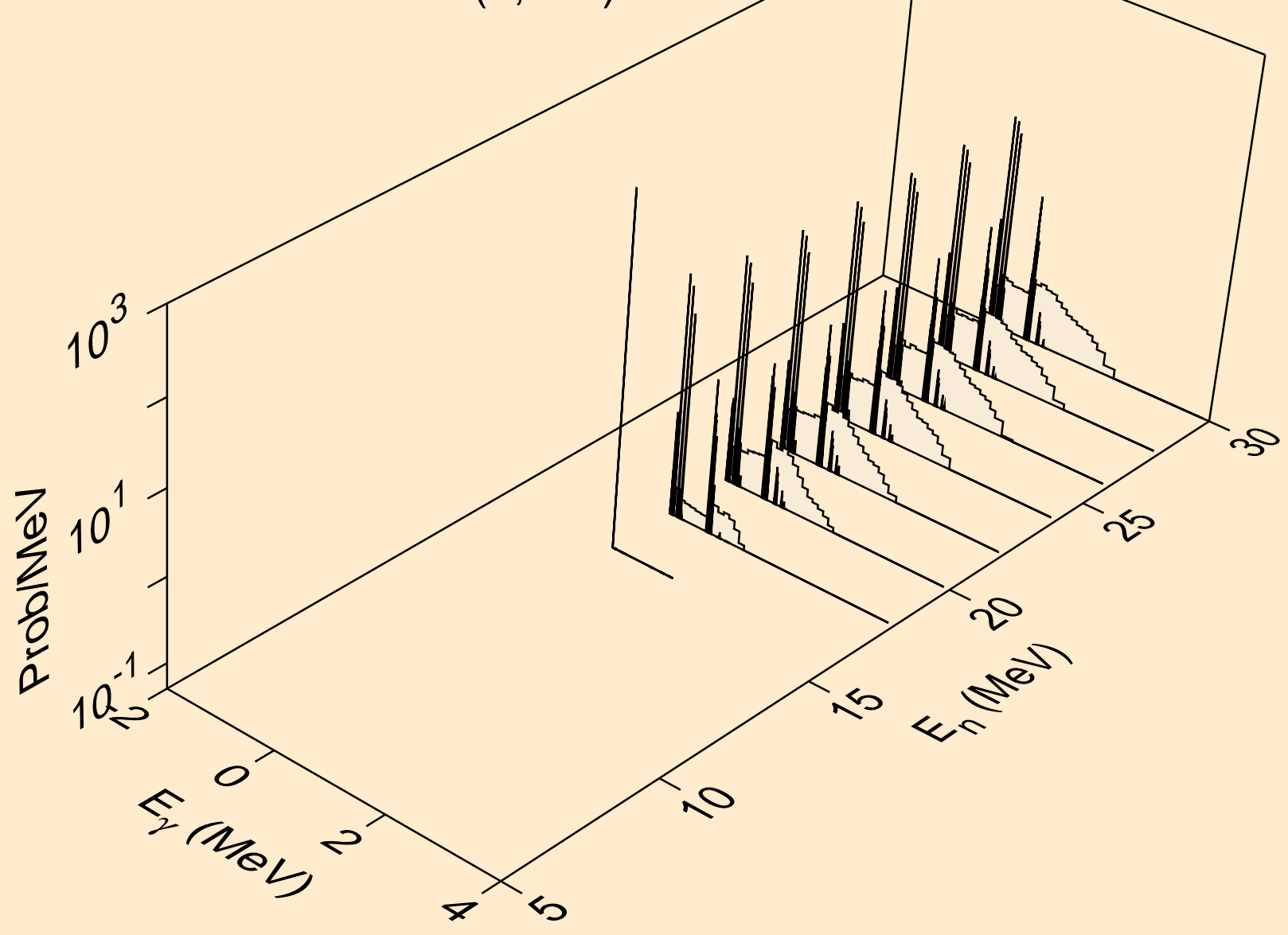

TH234 NEUTRON ACER TENDL-2024 LIBRARY; T=293.6K  
Photon emission for (n,a)

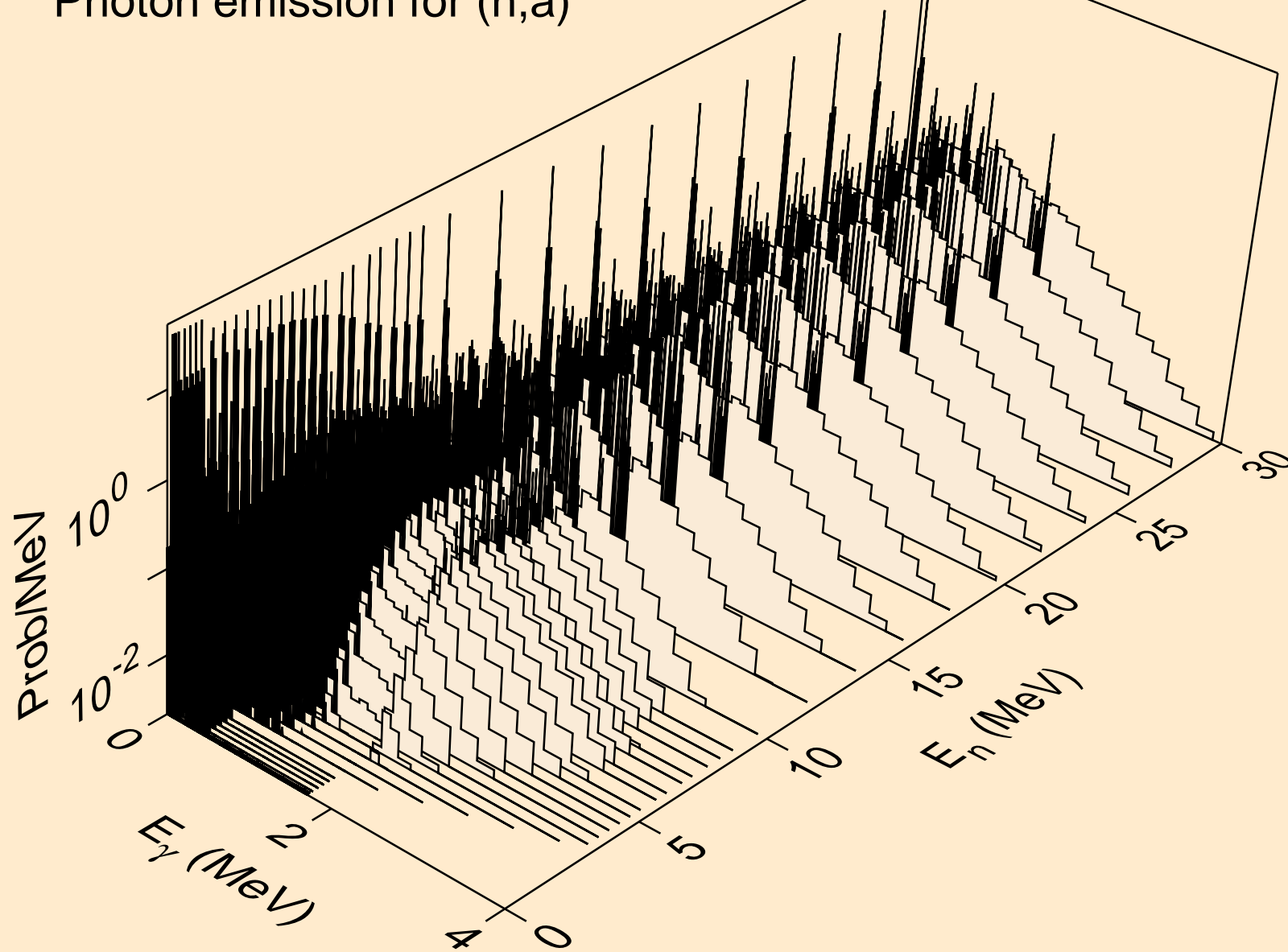

TH234 NEUTRON ACER TENDL-2024 LIBRARY; T=293.6K  
Photon emission for (n,2p)

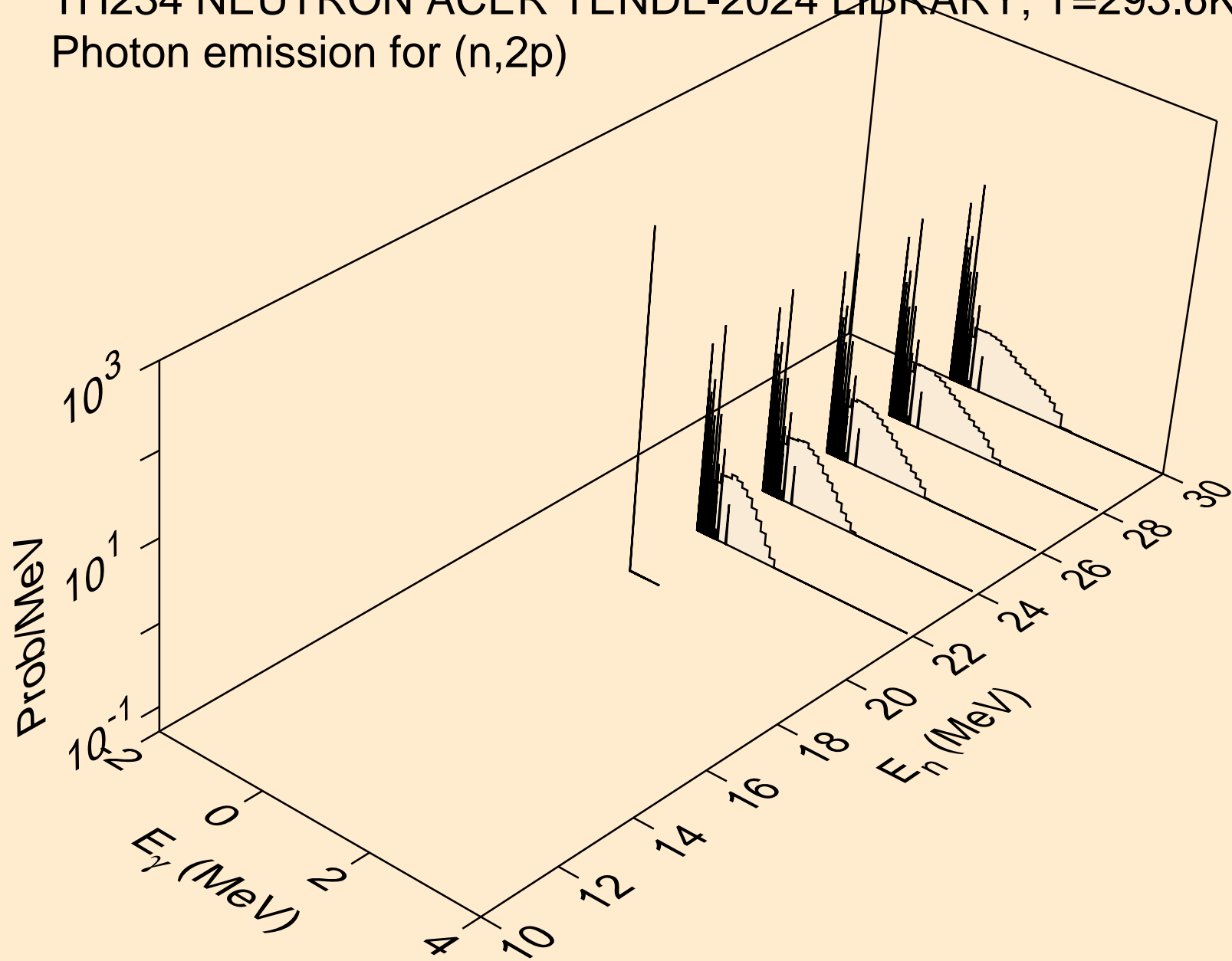

TH234 NEUTRON ACER TENDL-2024 LIBRARY; T=293.6K  
thermal capture photon spectrum

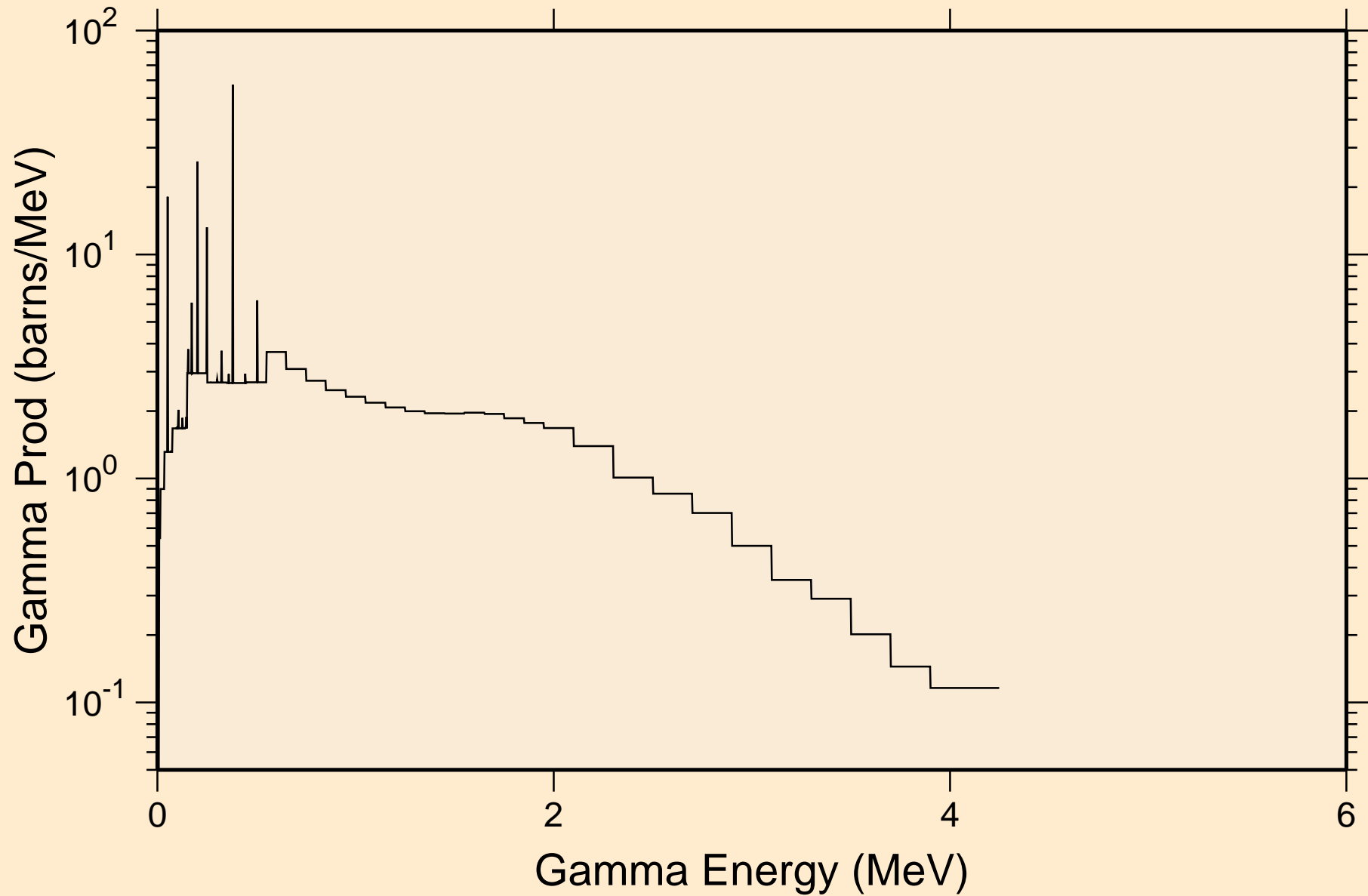

TH234 NEUTRON ACER TENDL-2024 LIBRARY; T=293.6K  
14 MeV photon spectrum

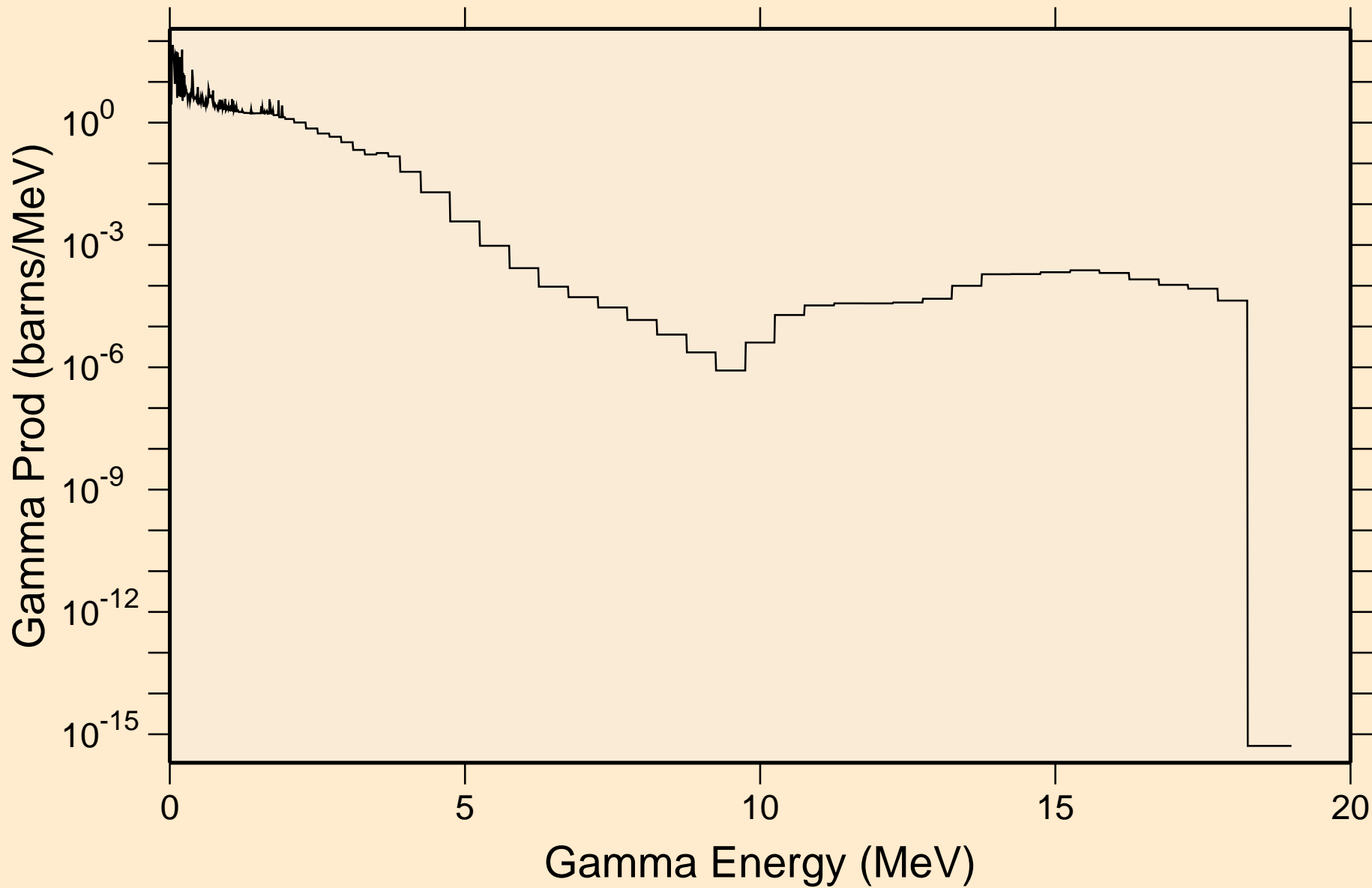

# TH234 NEUTRON ACER TENDL-2024 LIBRARY; T=293.6K

## Particle heating contributions

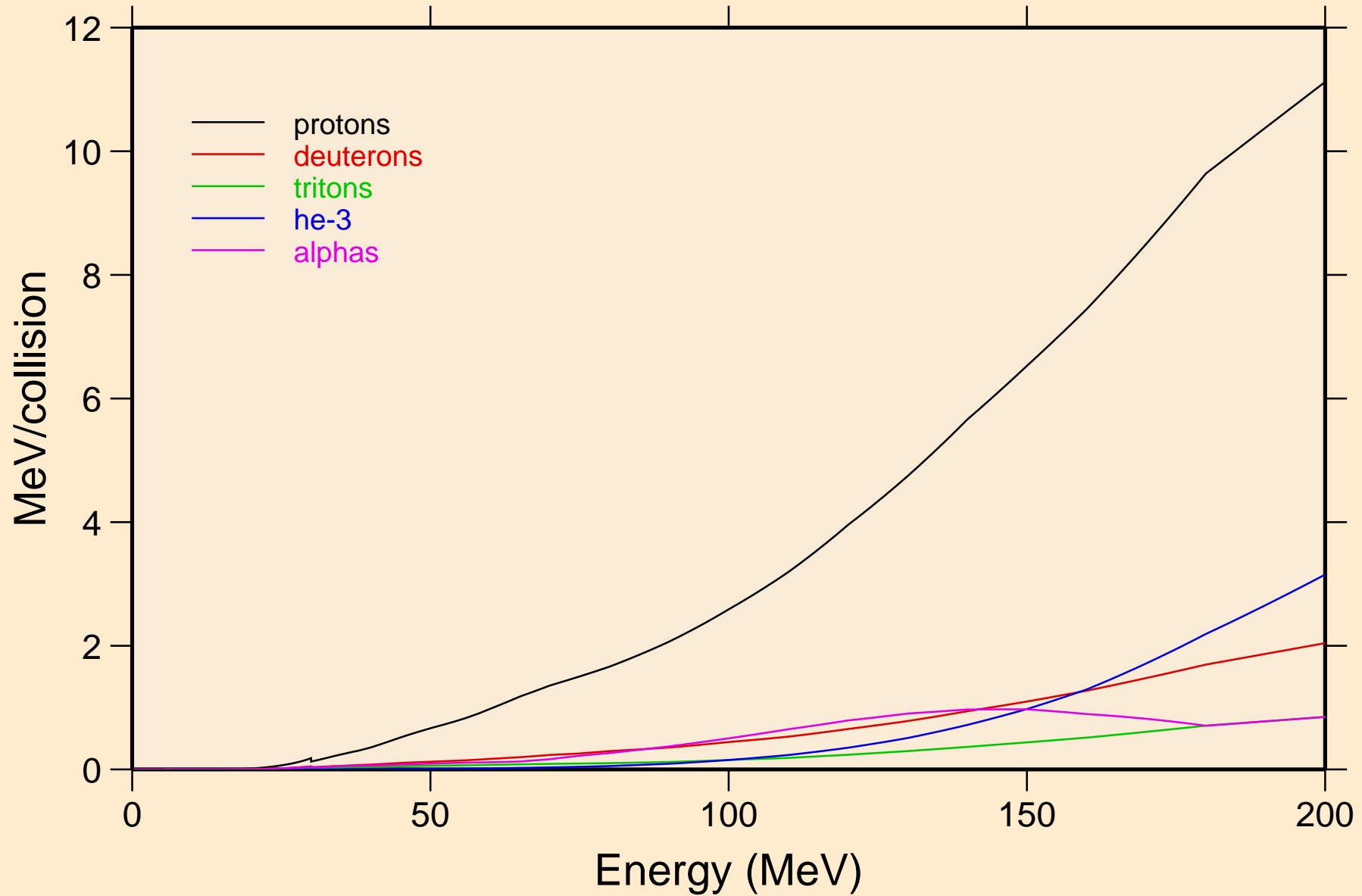

TH234 NEUTRON ACER TENDL-2024 LIBRARY; T=293.6K  
Recoil Heating

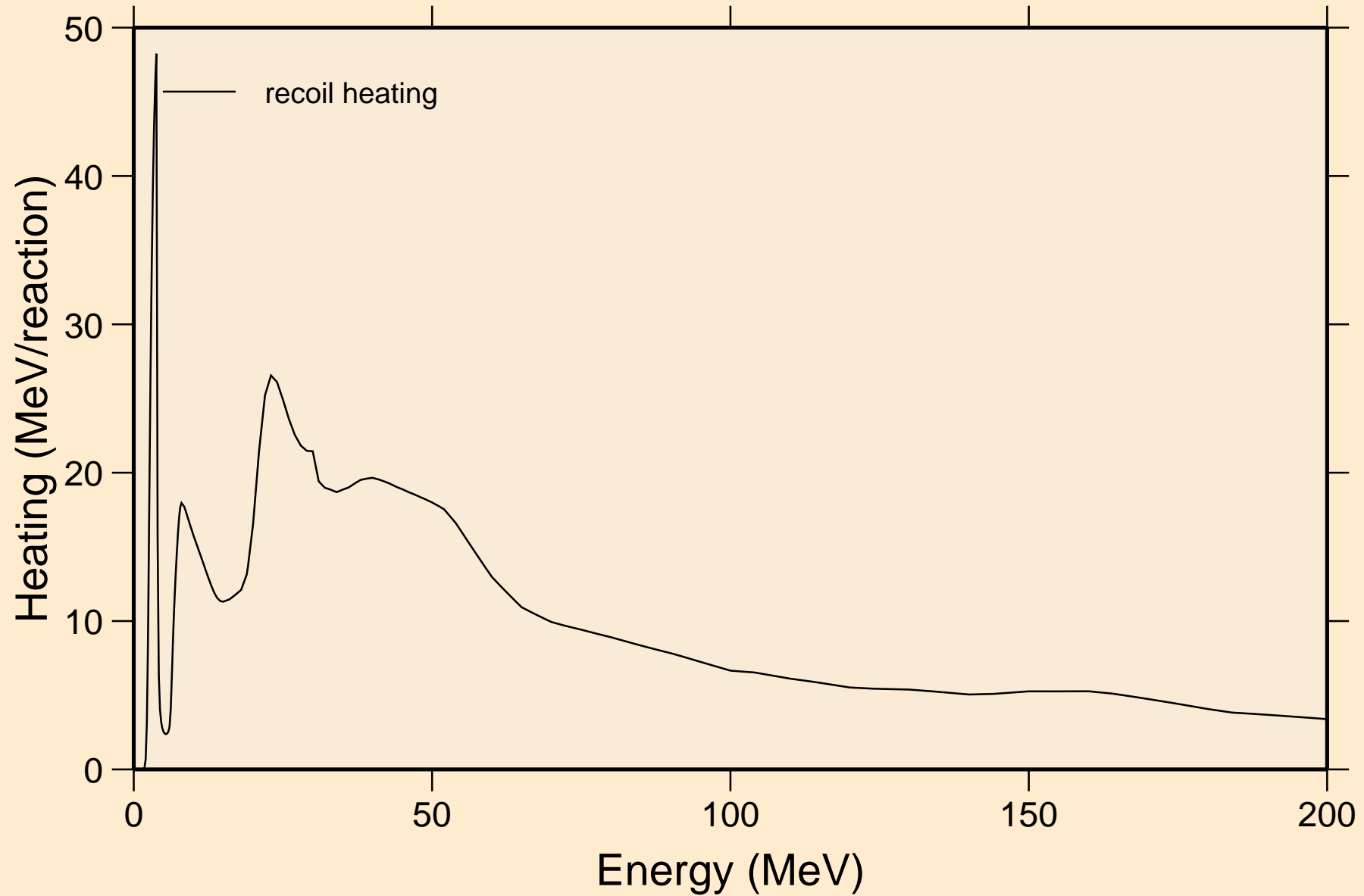

TH234 NEUTRON ACER TENDL-2024 LIBRARY; T=293.6K  
Particle production cross sections

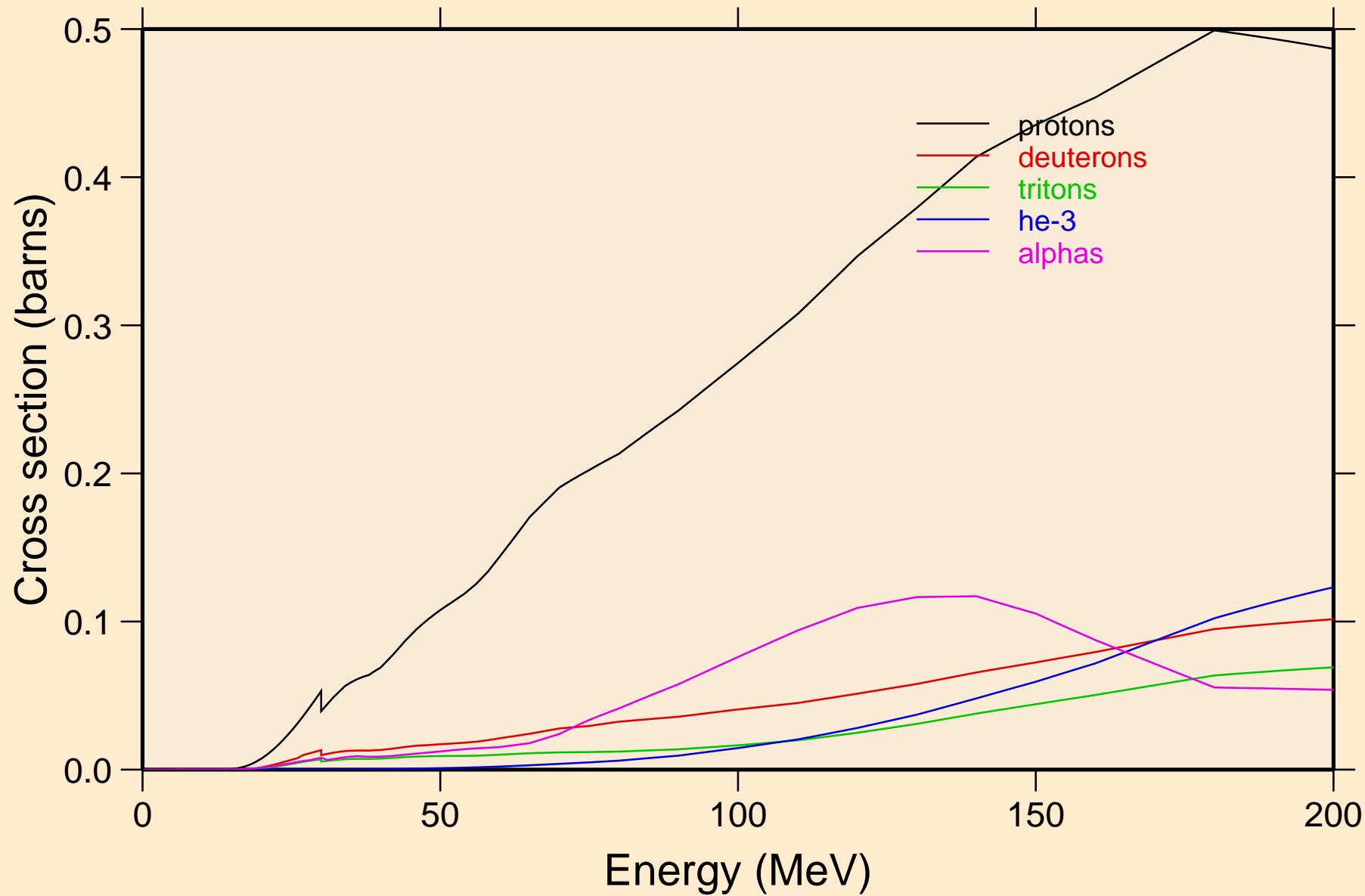

TH234 NEUTRON ACER TENDL-2024 LIBRARY; T=293.6K  
protons from (n,x)

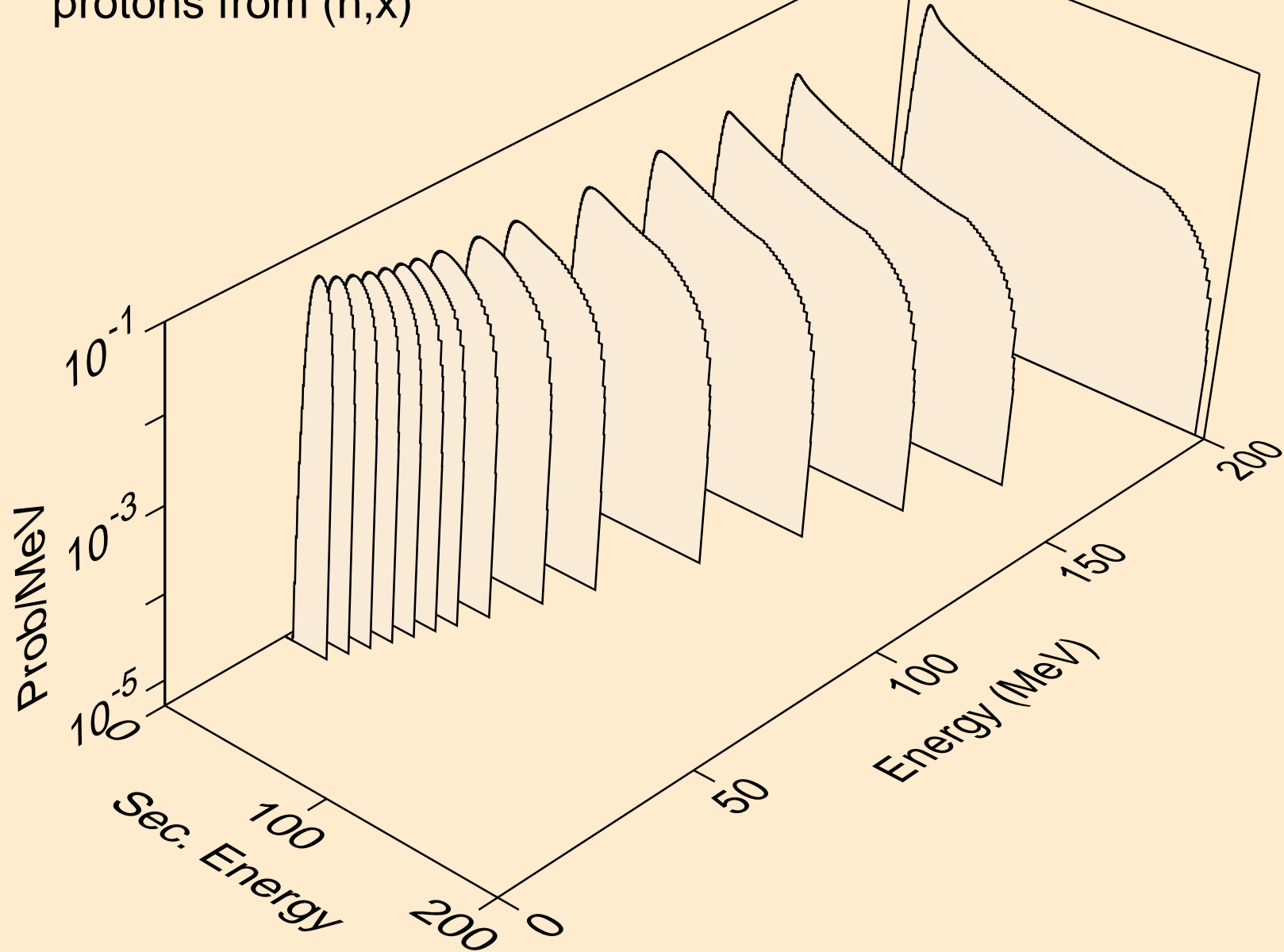

TH234 NEUTRON ACER TENDL-2024 LIBRARY; T=293.6K  
protons from (n,n\*)p

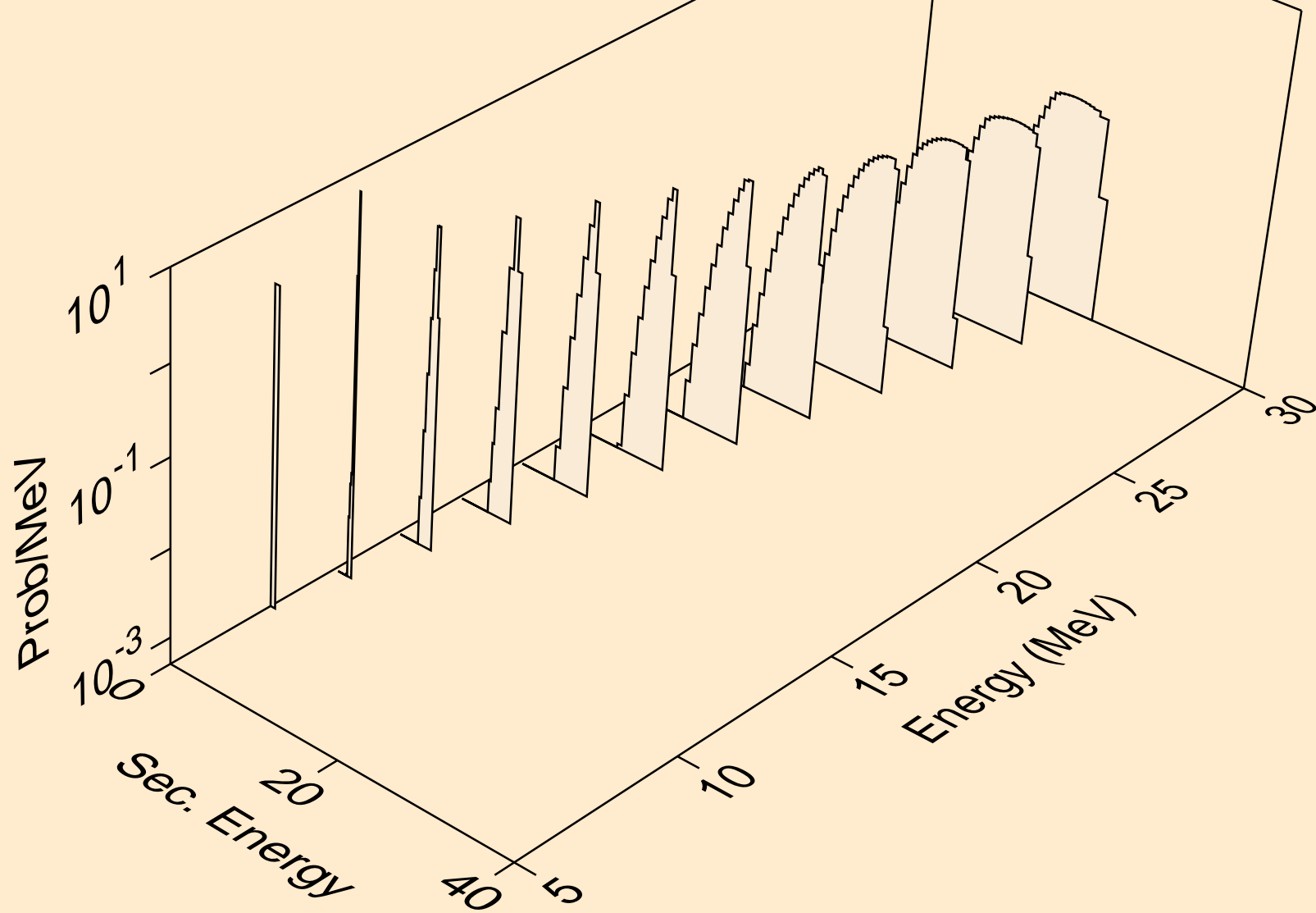

TH234 NEUTRON ACER TENDL-2024 LIBRARY; T=293.6K  
protons from (n,2np)

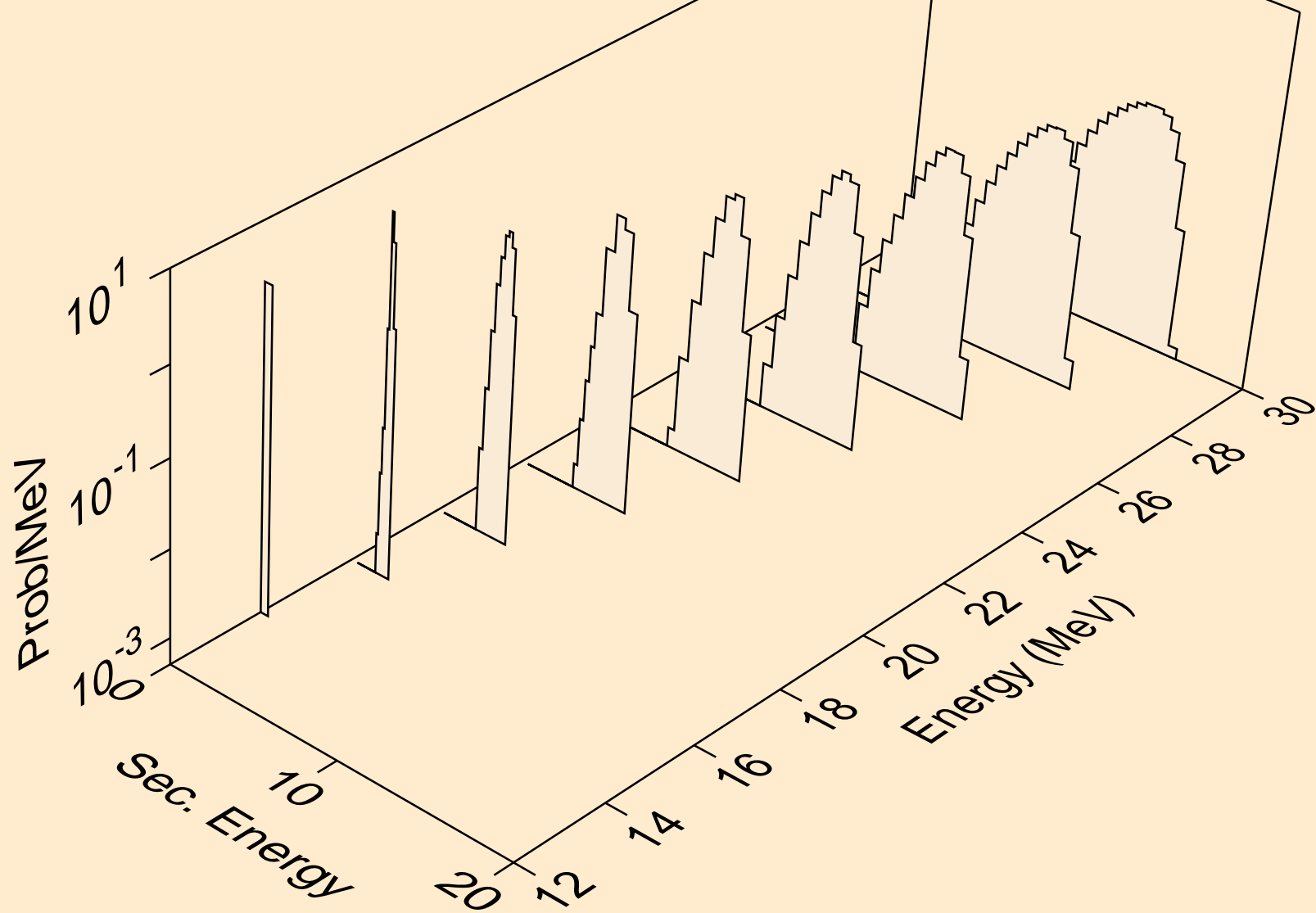

TH234 NEUTRON ACER TENDL-2024 LIBRARY; T=293.6K  
protons from (n,3np)

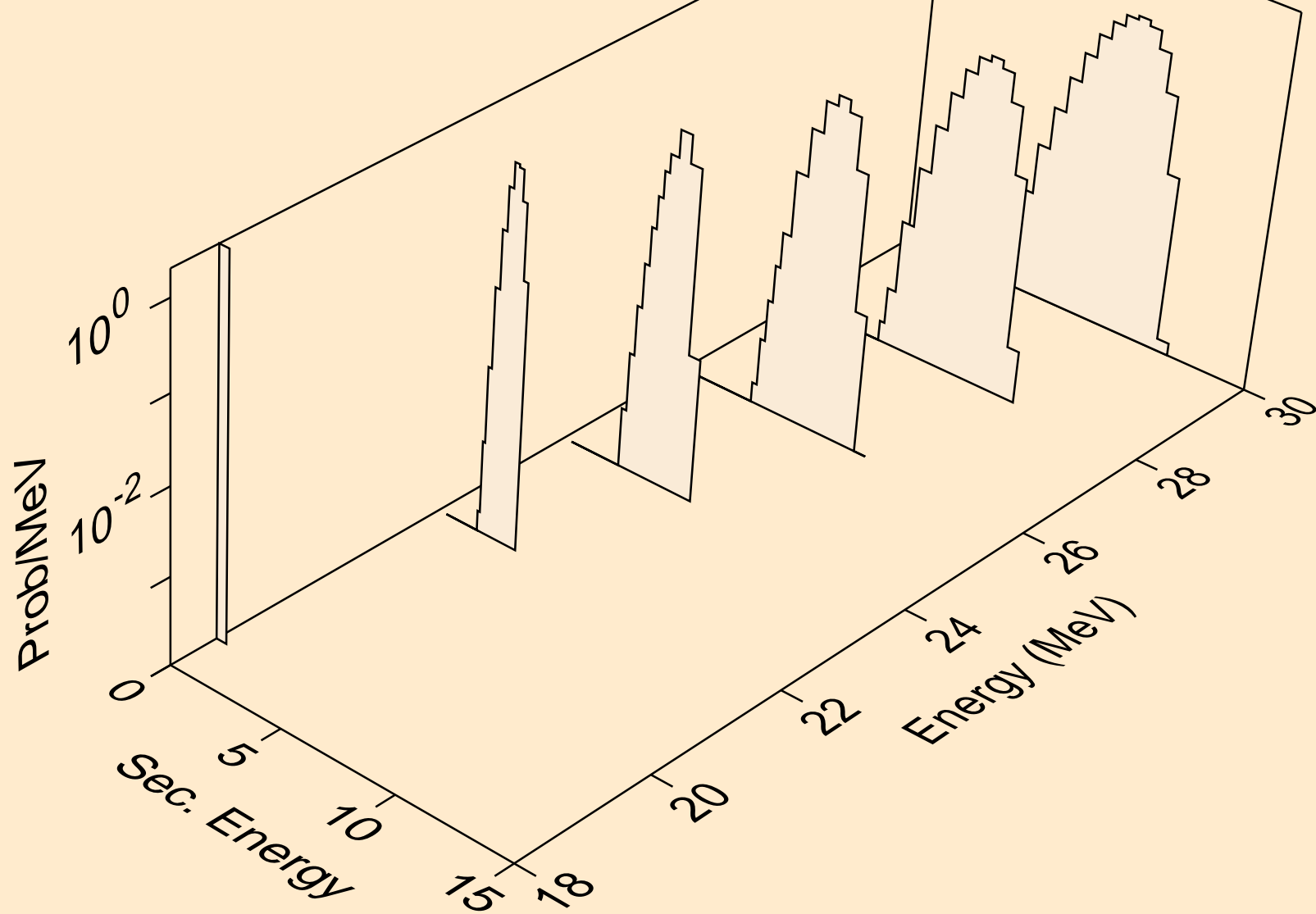

TH234 NEUTRON ACER TENDL-2024 LIBRARY; T=293.6K  
protons from (n,p)

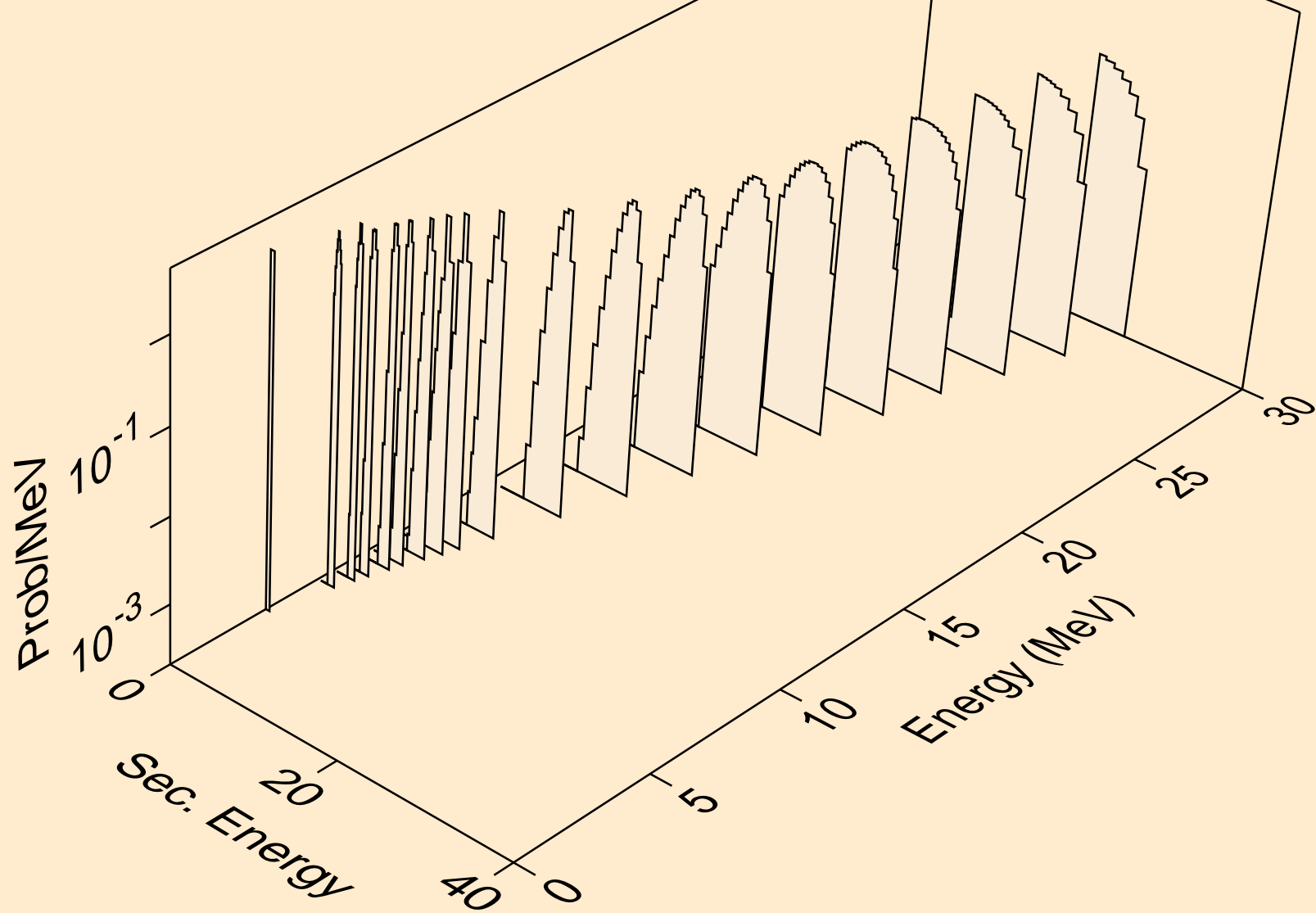

TH234 NEUTRON ACER TENDL-2024 LIBRARY; T=293.6K  
protons from (n,2p)

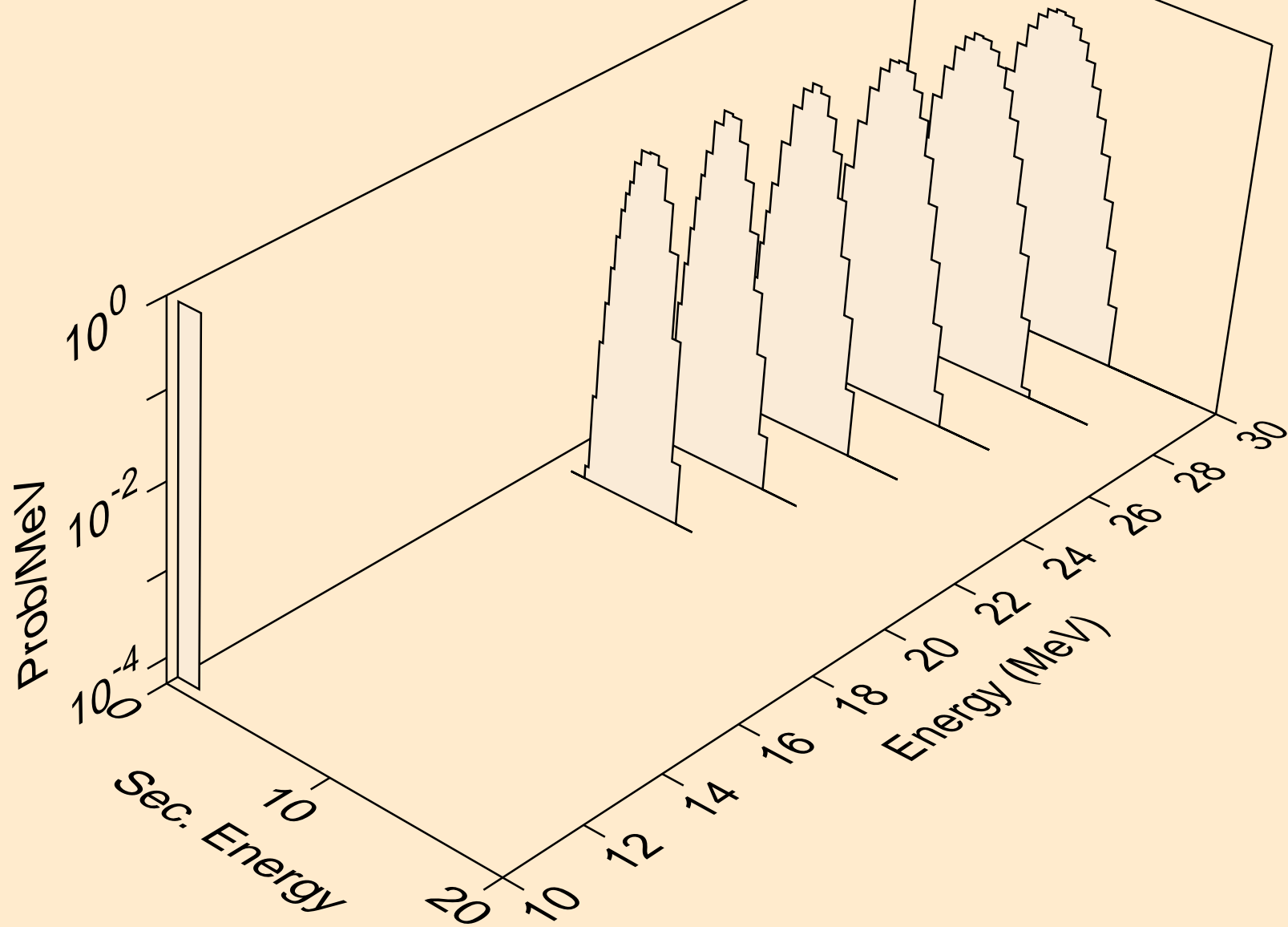

TH234 NEUTRON ACER TENDL-2024 LIBRARY; T=293.6K  
deuterons from (n,x)

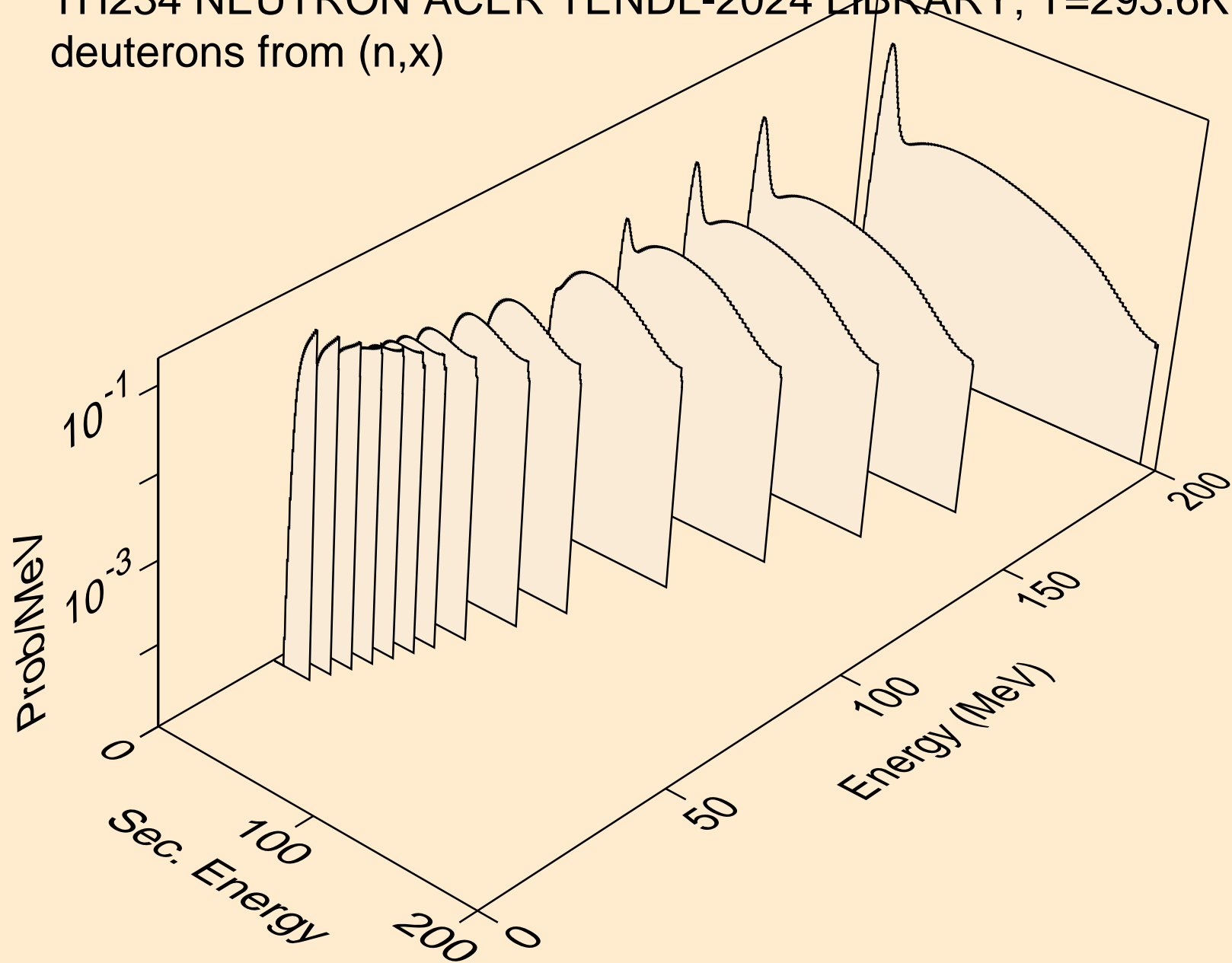

TH234 NEUTRON ACER TENDL-2024 LIBRARY; T=293.6K  
deuterons from (n,2nd)

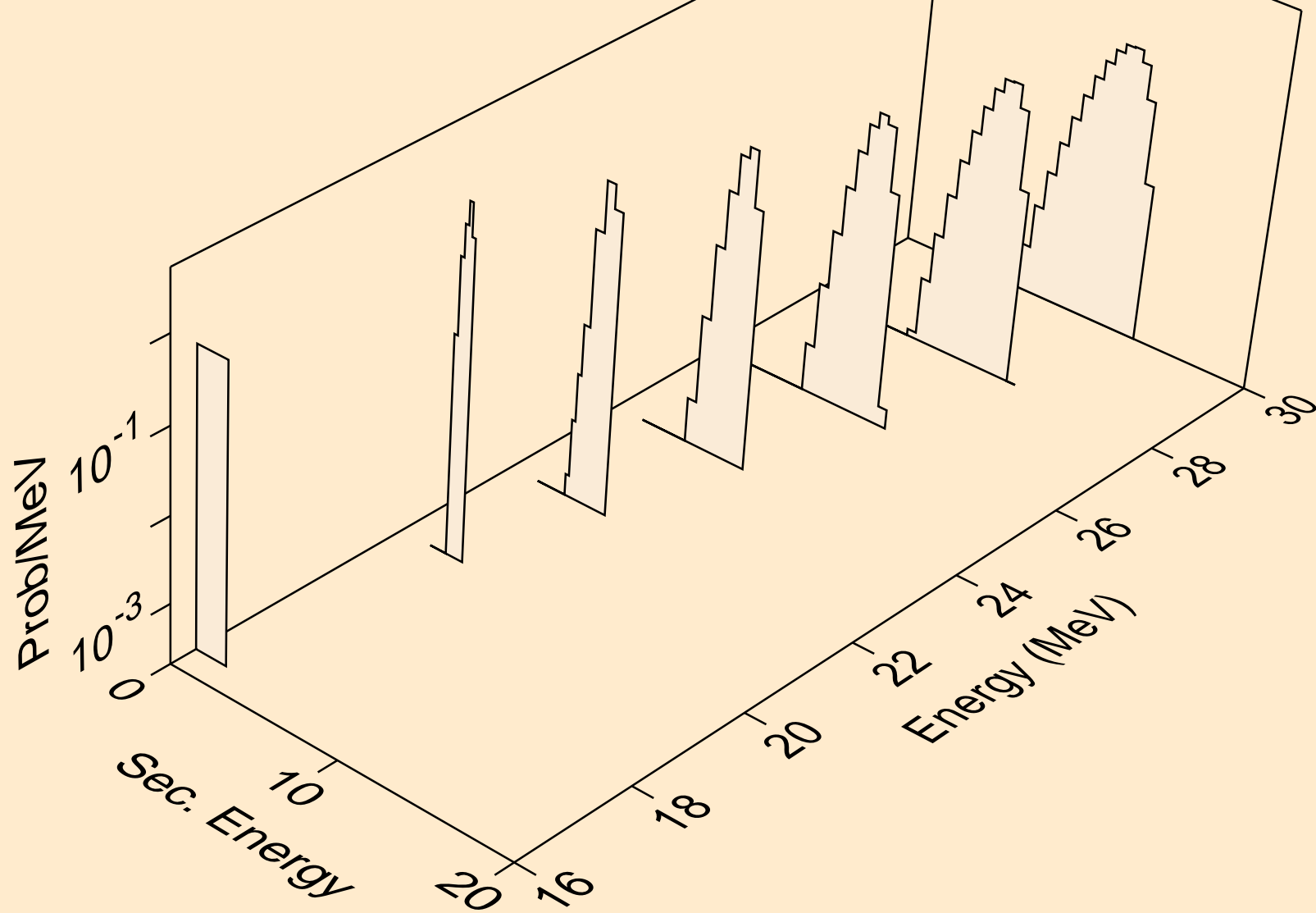

TH234 NEUTRON ACER TENDL-2024 LIBRARY; T=293.6K  
deuterons from (n,n\*)d

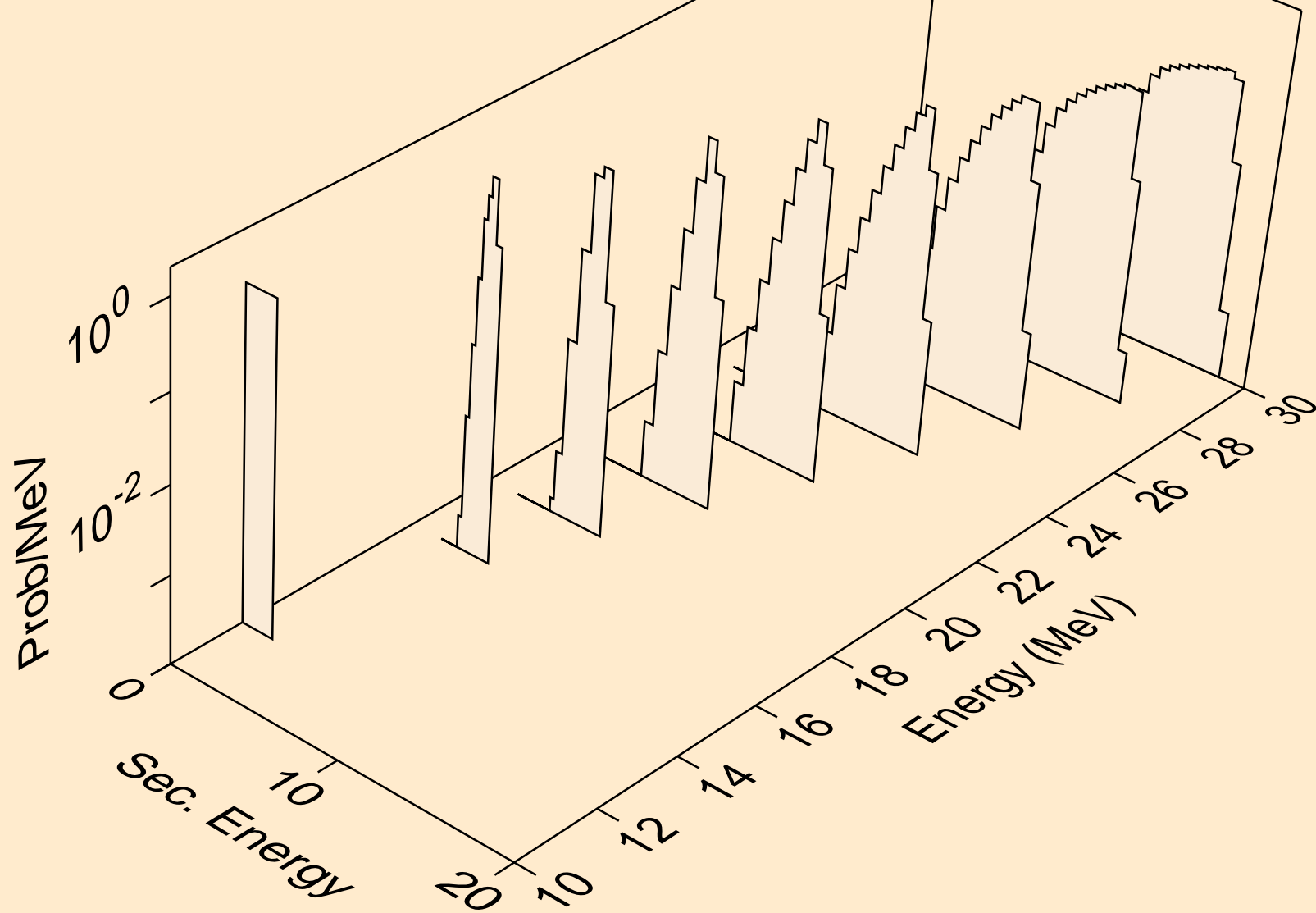

TH234 NEUTRON ACER TENDL-2024 LIBRARY; T=293.6K  
deuterons from (n,d)

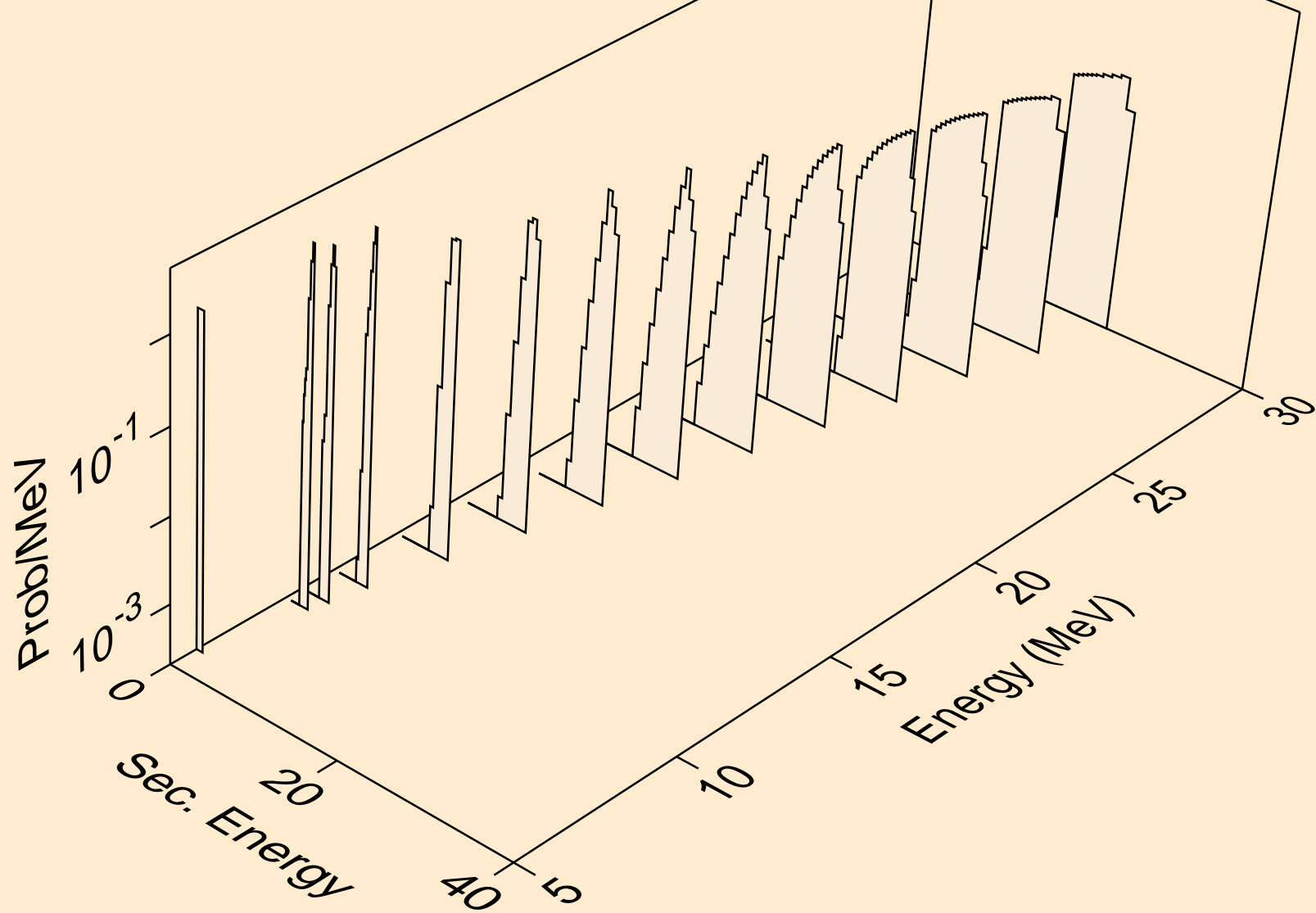

TH234 NEUTRON ACER TENDL-2024 LIBRARY; T=293.6K  
tritons from (n,x)

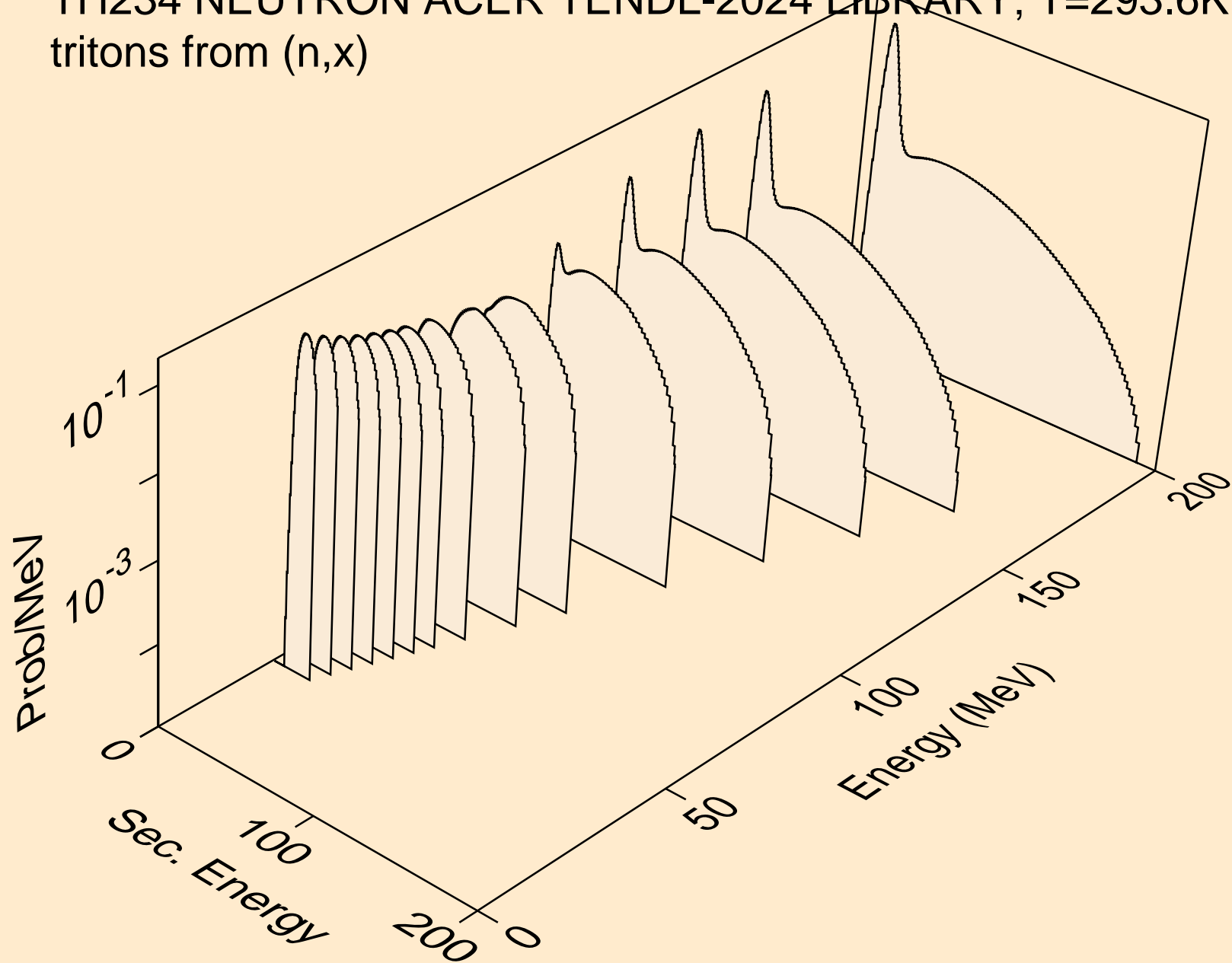

TH234 NEUTRON ACER TENDL-2024 LIBRARY; T=293.6K  
tritons from (n,n\*)t

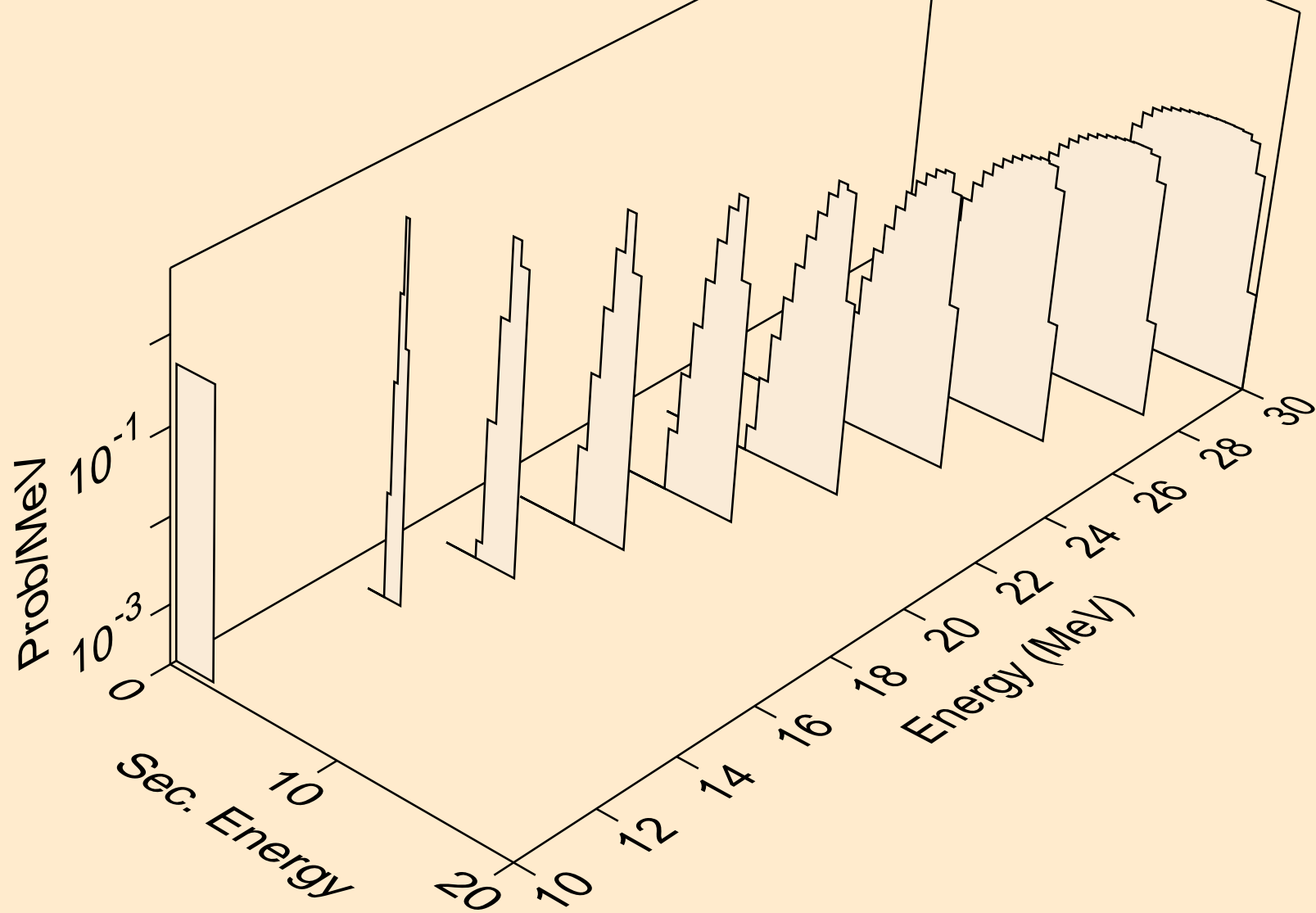

TH234 NEUTRON ACER TENDL-2024 LIBRARY; T=293.6K  
tritons from (n,t)

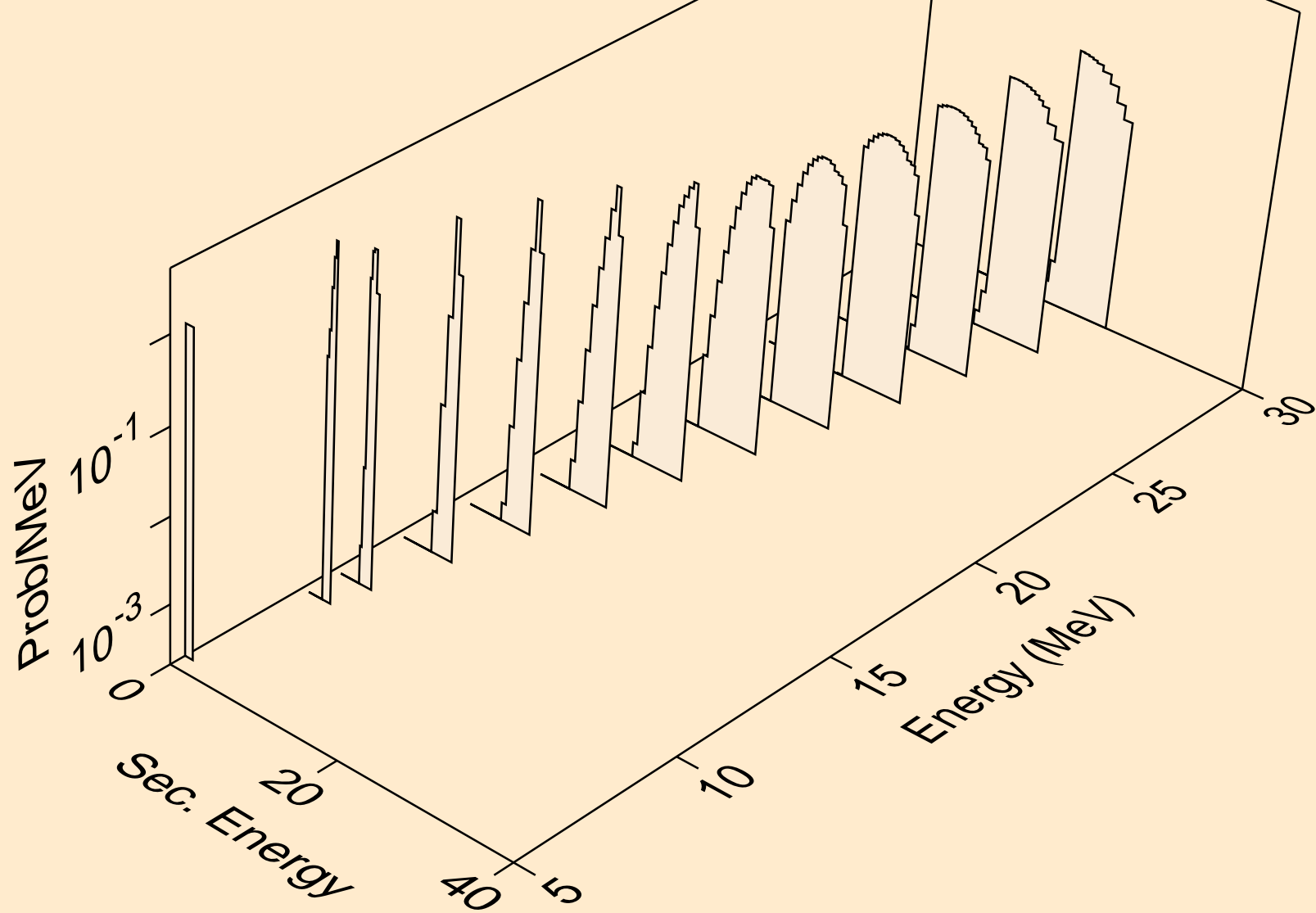

TH234 NEUTRON ACER TENDL-2024 LIBRARY; T=293.6K  
he3s from (n,x)

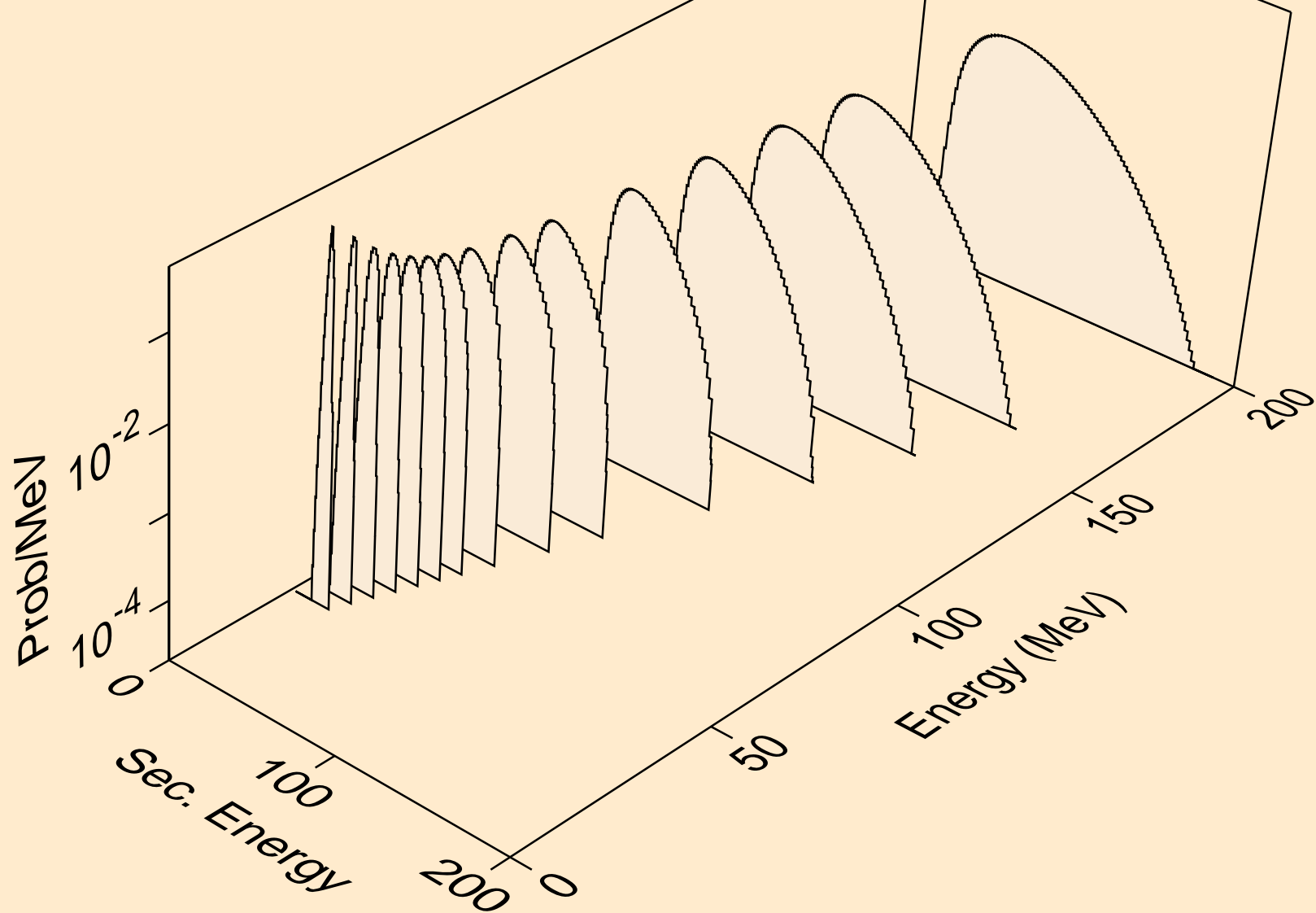

TH234 NEUTRON ACER TENDL-2024 LIBRARY; T=293.6K  
he3s from (n,n\*)he3

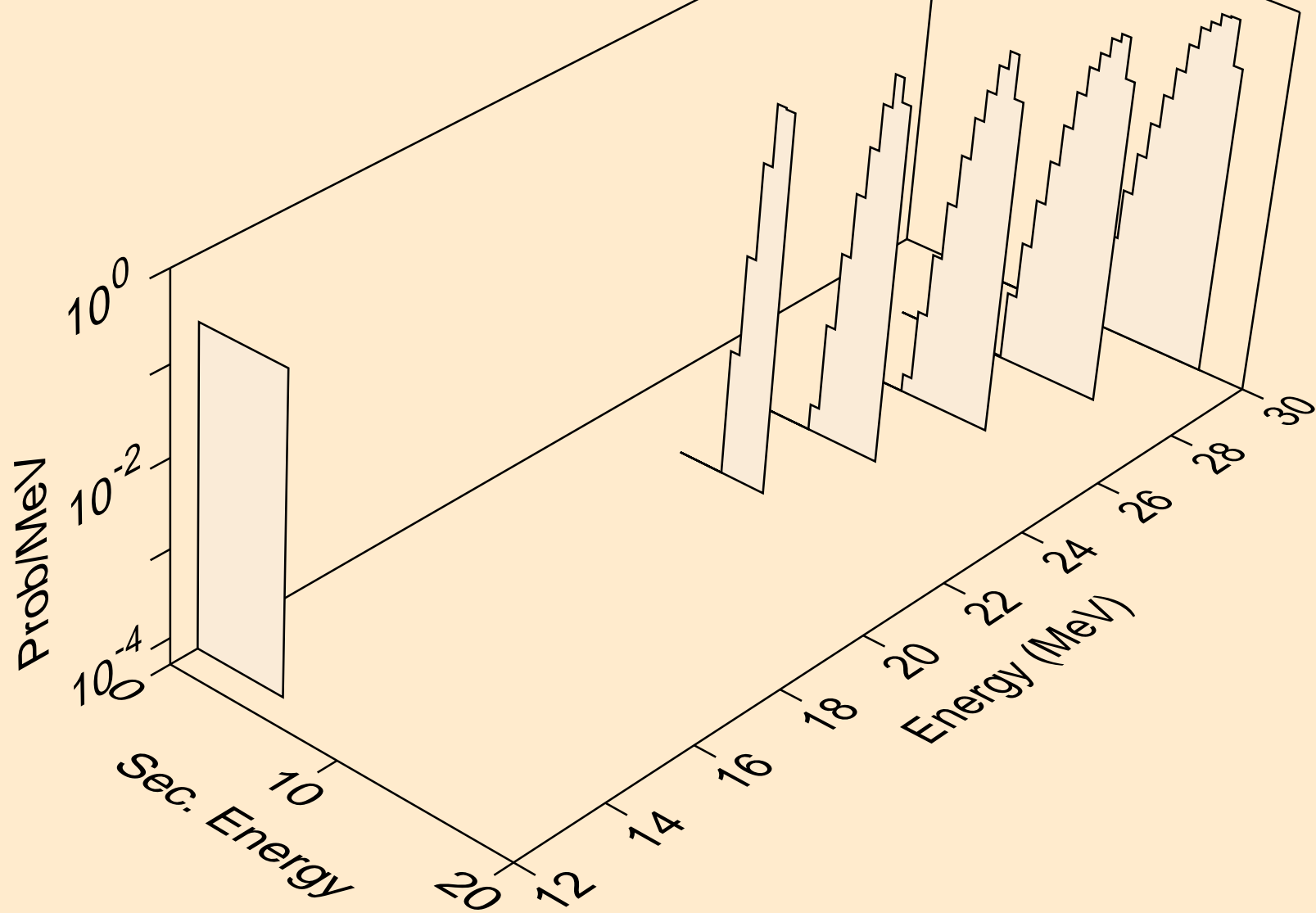

TH234 NEUTRON ACER TENDL-2024 LIBRARY; T=293.6K  
he3s from (n,he3)

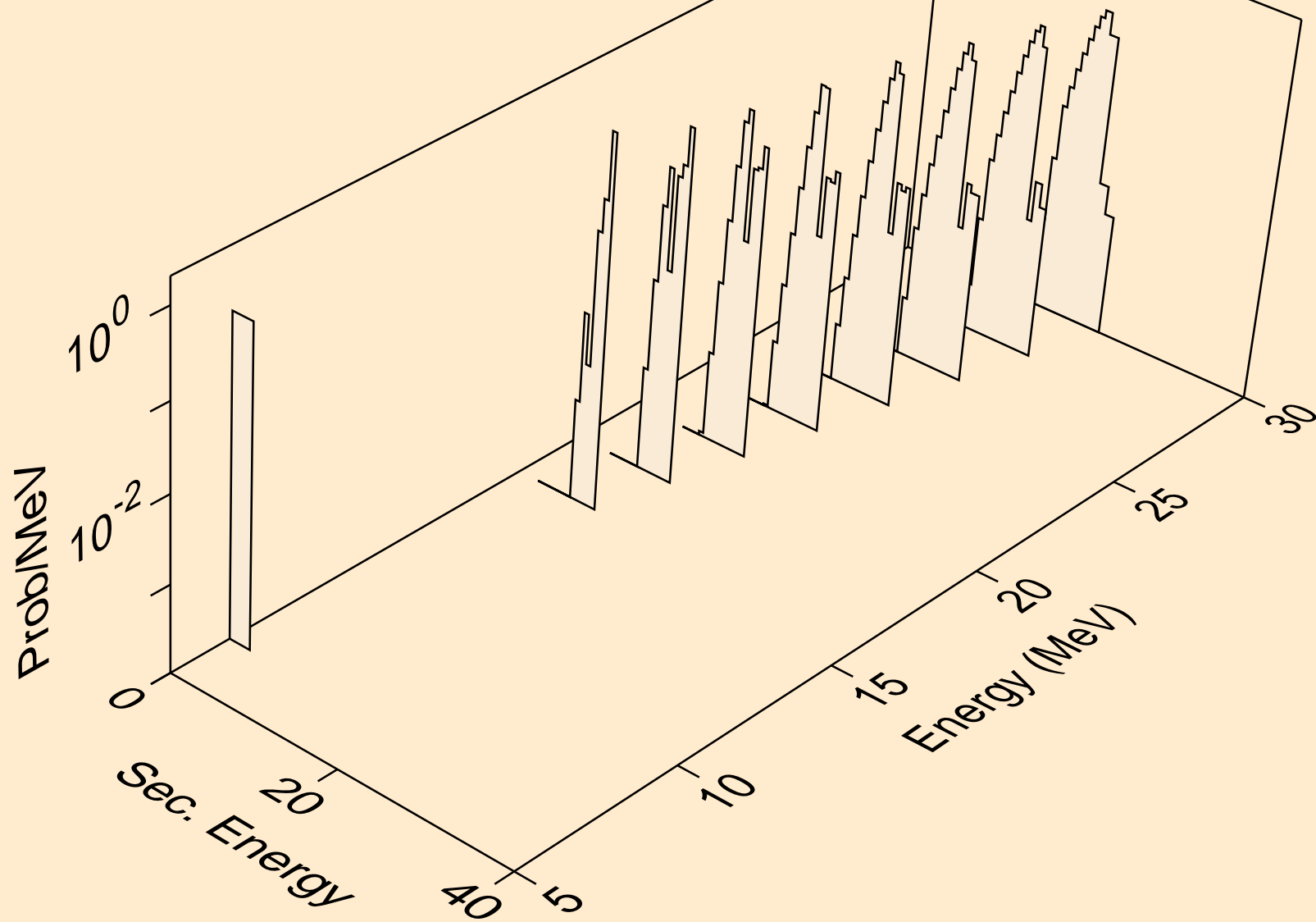

TH234 NEUTRON ACER TENDL-2024 LIBRARY; T=293.6K  
alphas from (n,x)

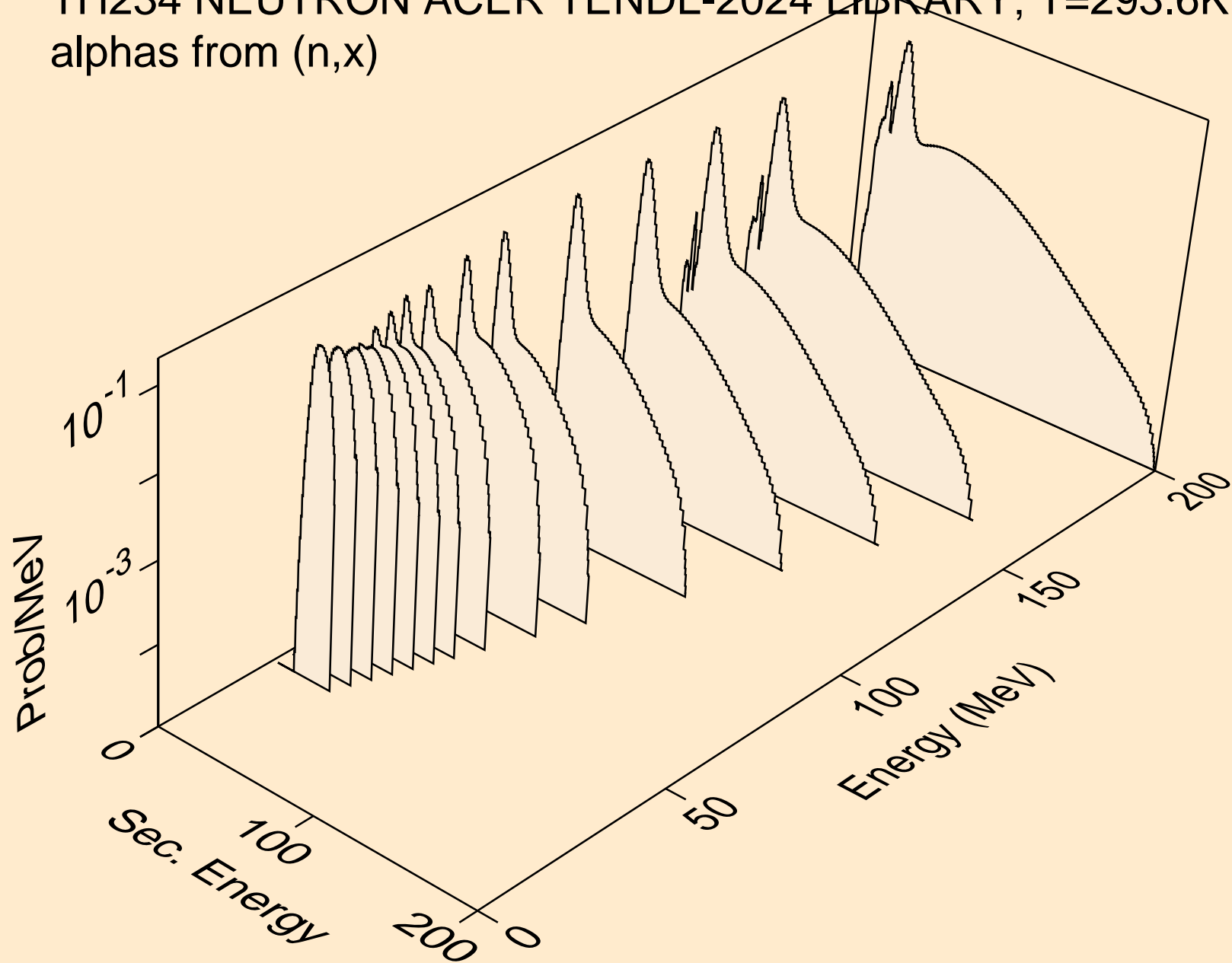

TH234 NEUTRON ACER TENDL-2024 LIBRARY; T=293.6K  
alphas from (n,n\*)a

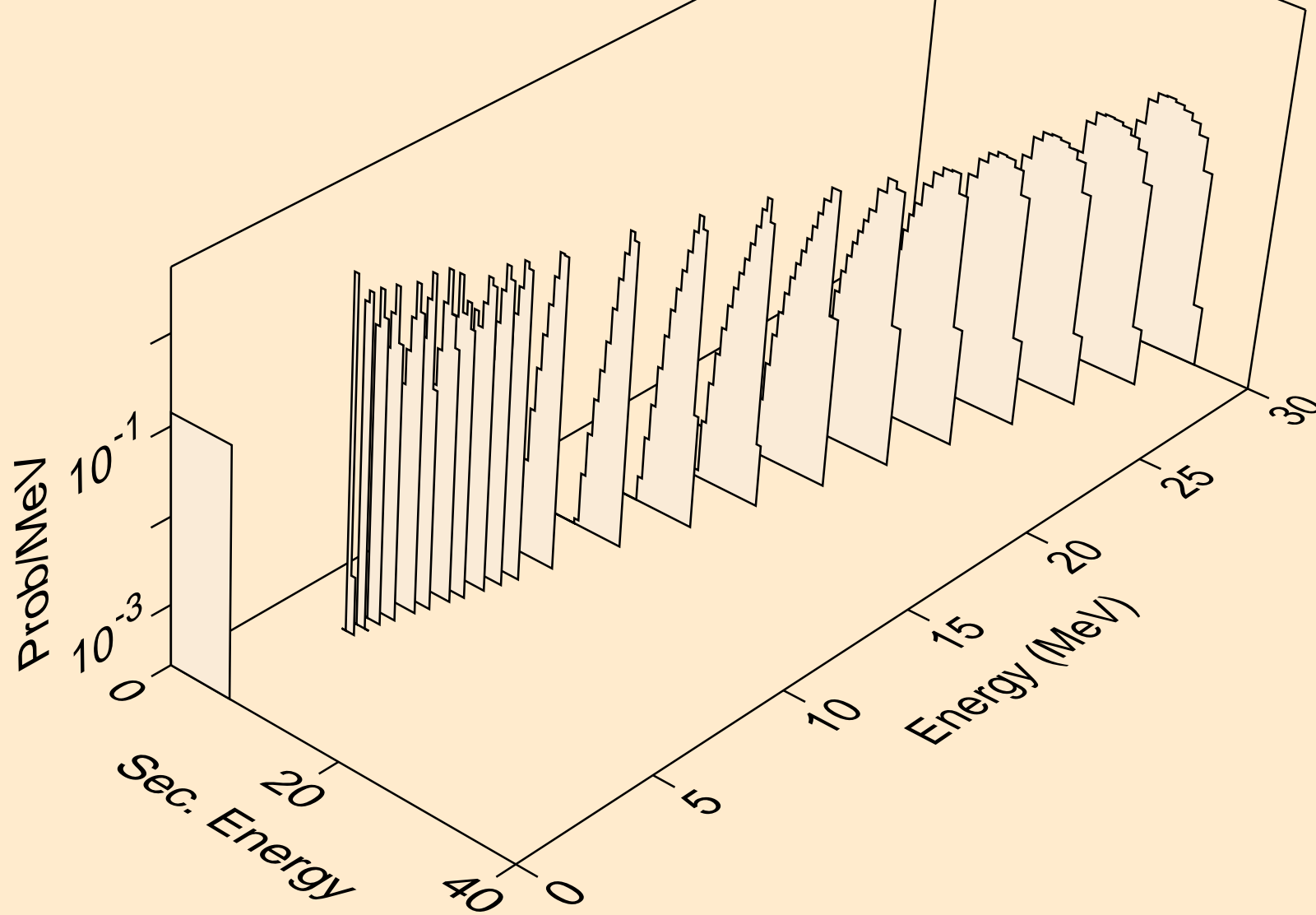

TH234 NEUTRON ACER TENDL-2024 LIBRARY; T=293.6K  
alphas from (n,2n)a

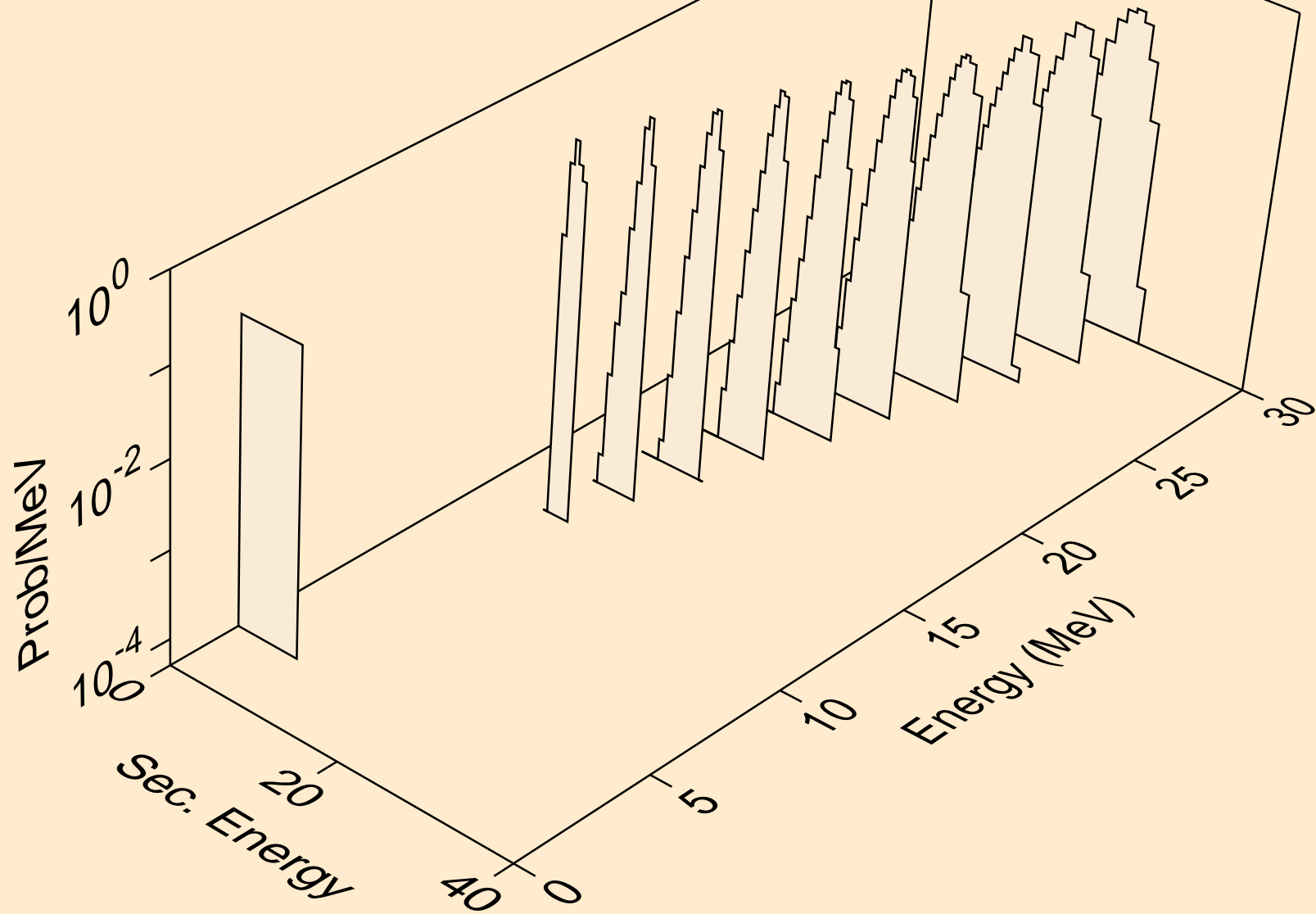

TH234 NEUTRON ACER TENDL-2024 LIBRARY; T=293.6K  
alphas from (n,3n)a

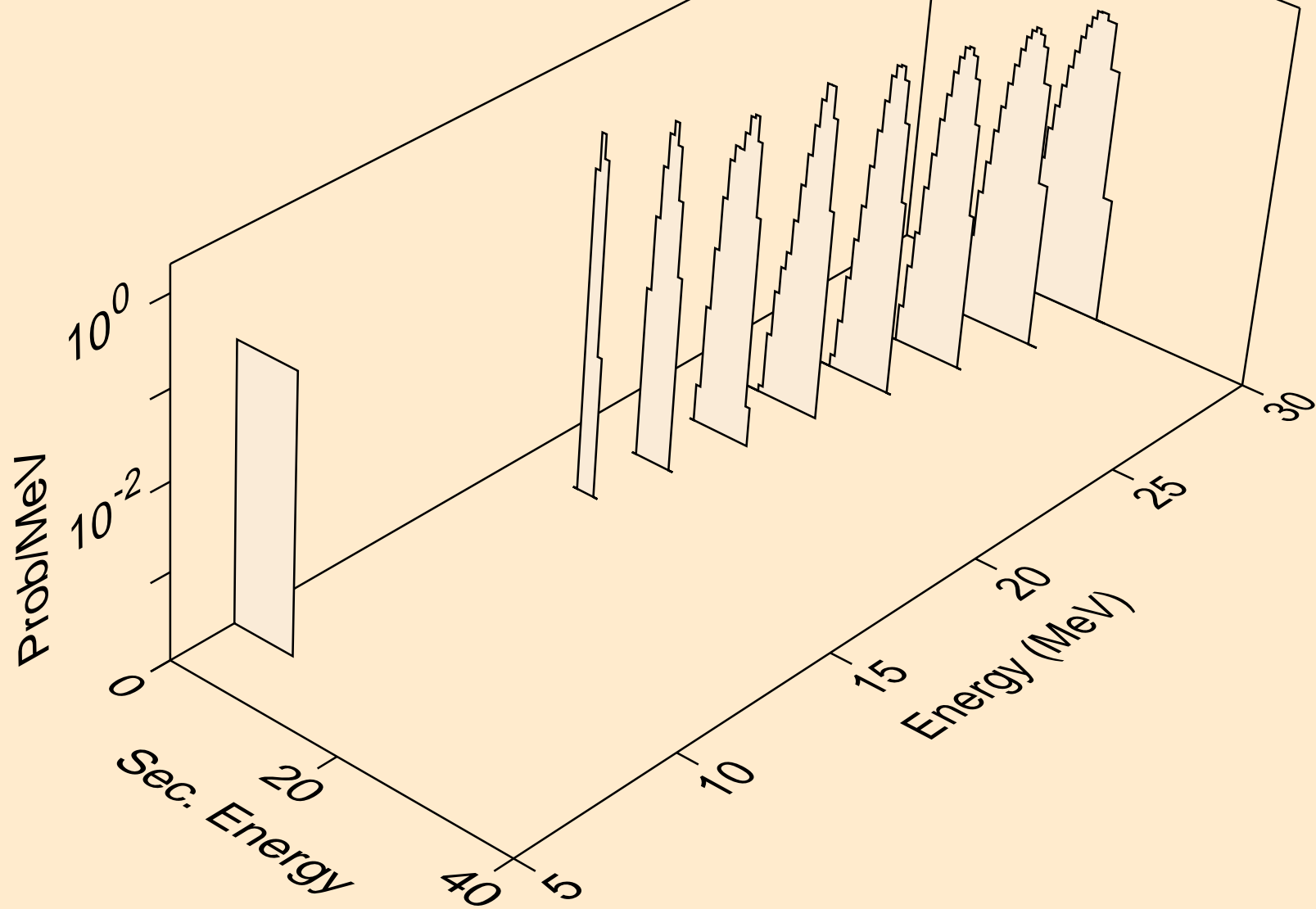

TH234 NEUTRON ACER TENDL-2024 LIBRARY; T=293.6K  
alphas from (n,a)

