

TL197 NEUTRON ACER TENDL-2024 LIBRARY; T=293.6K
Principal cross sections

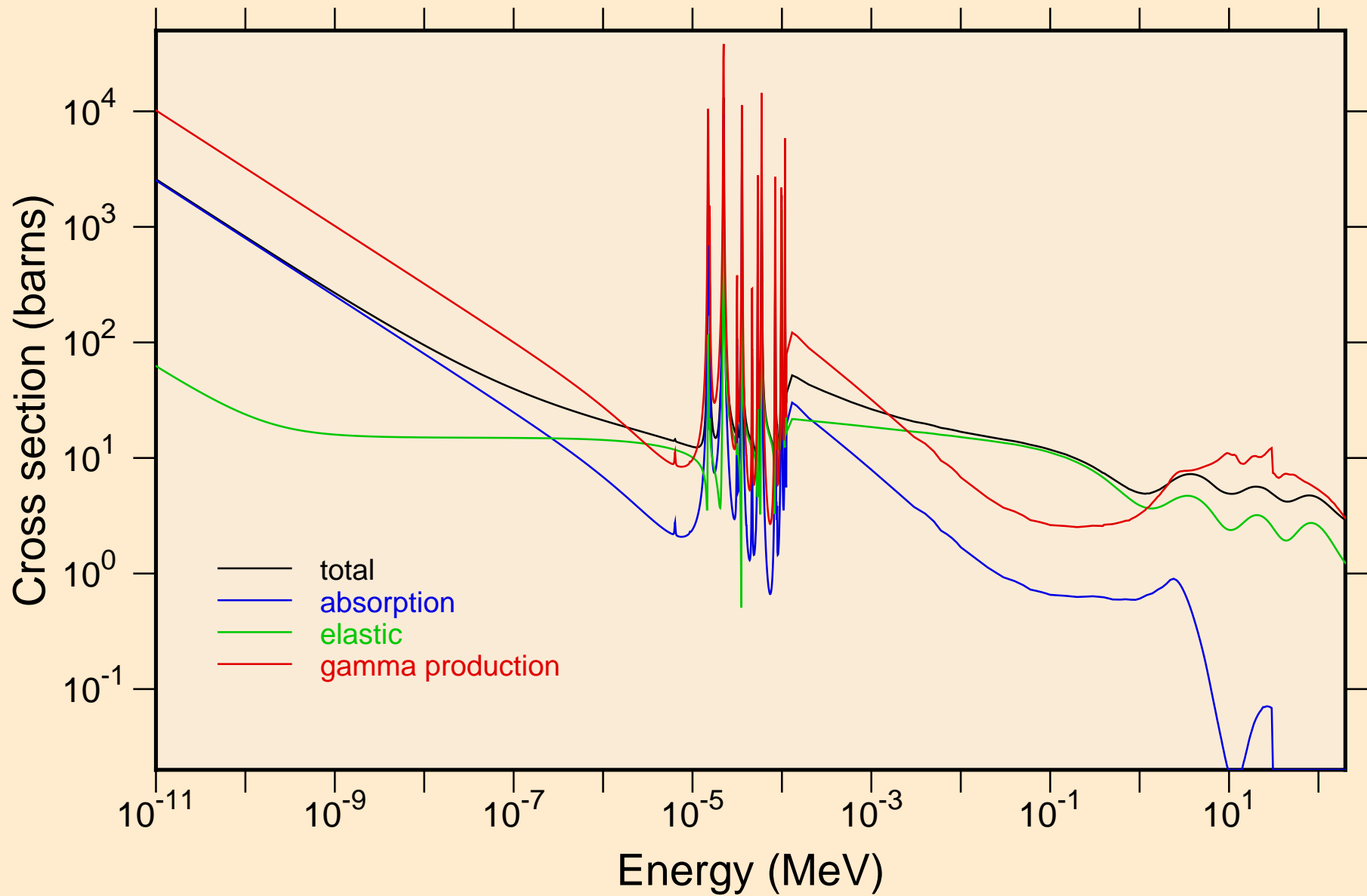

TL197 NEUTRON ACER TENDL-2024 LIBRARY; T=293.6K
resonance total cross section

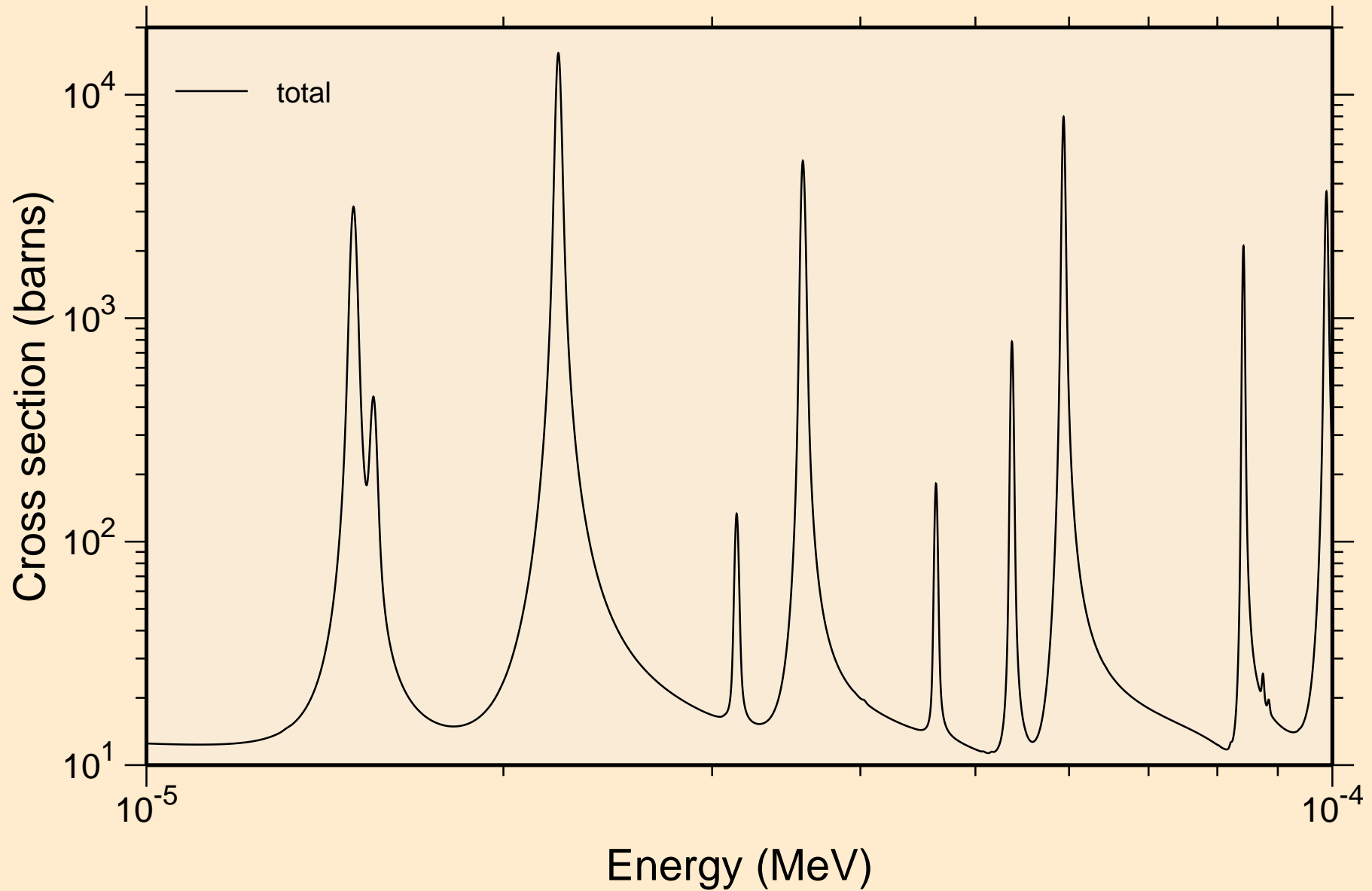

TL197 NEUTRON ACER TENDL-2024 LIBRARY; T=293.6K
resonance total cross section

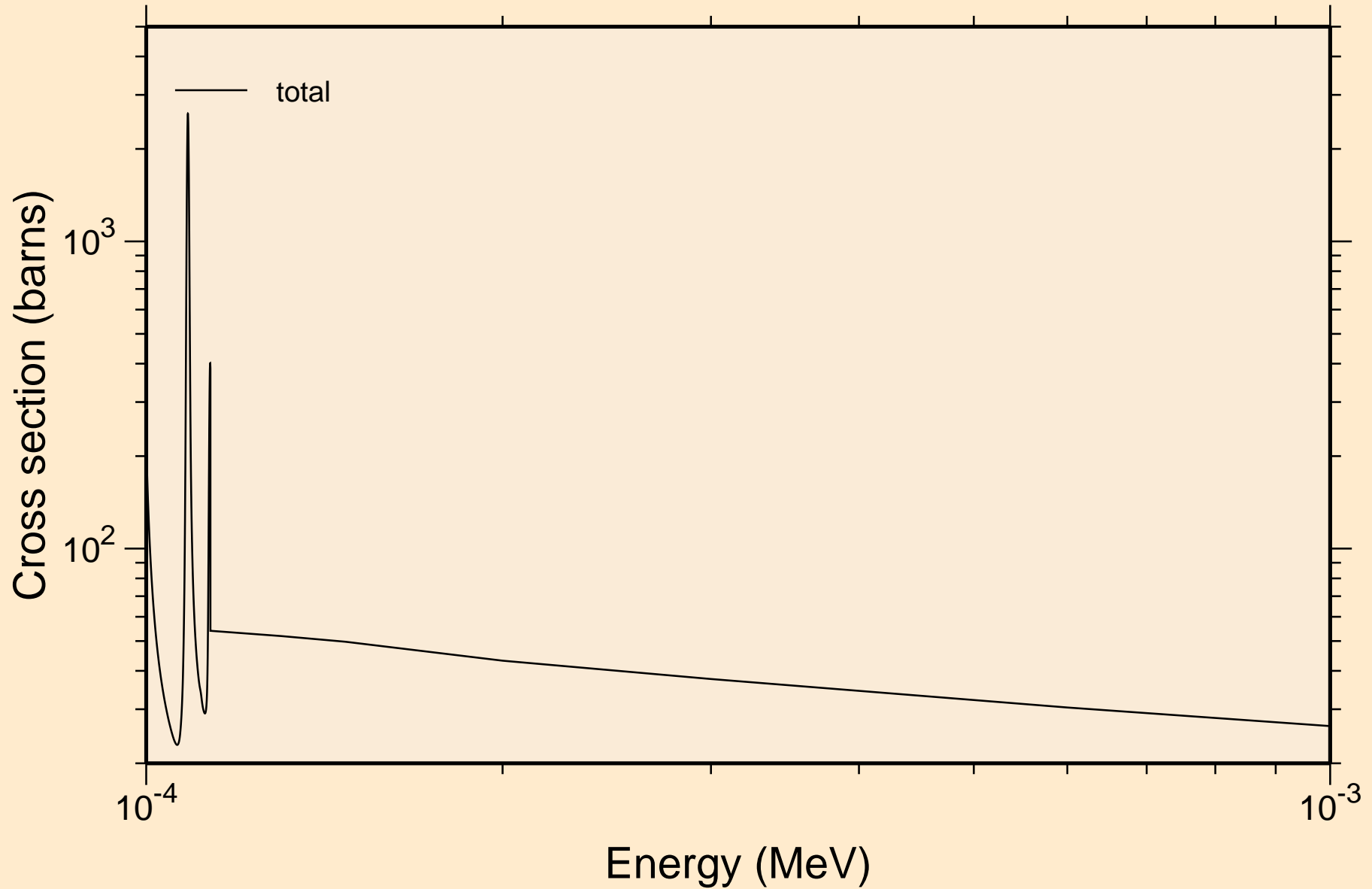

TL197 NEUTRON ACER TENDL-2024 LIBRARY; T=293.6K
resonance total cross section

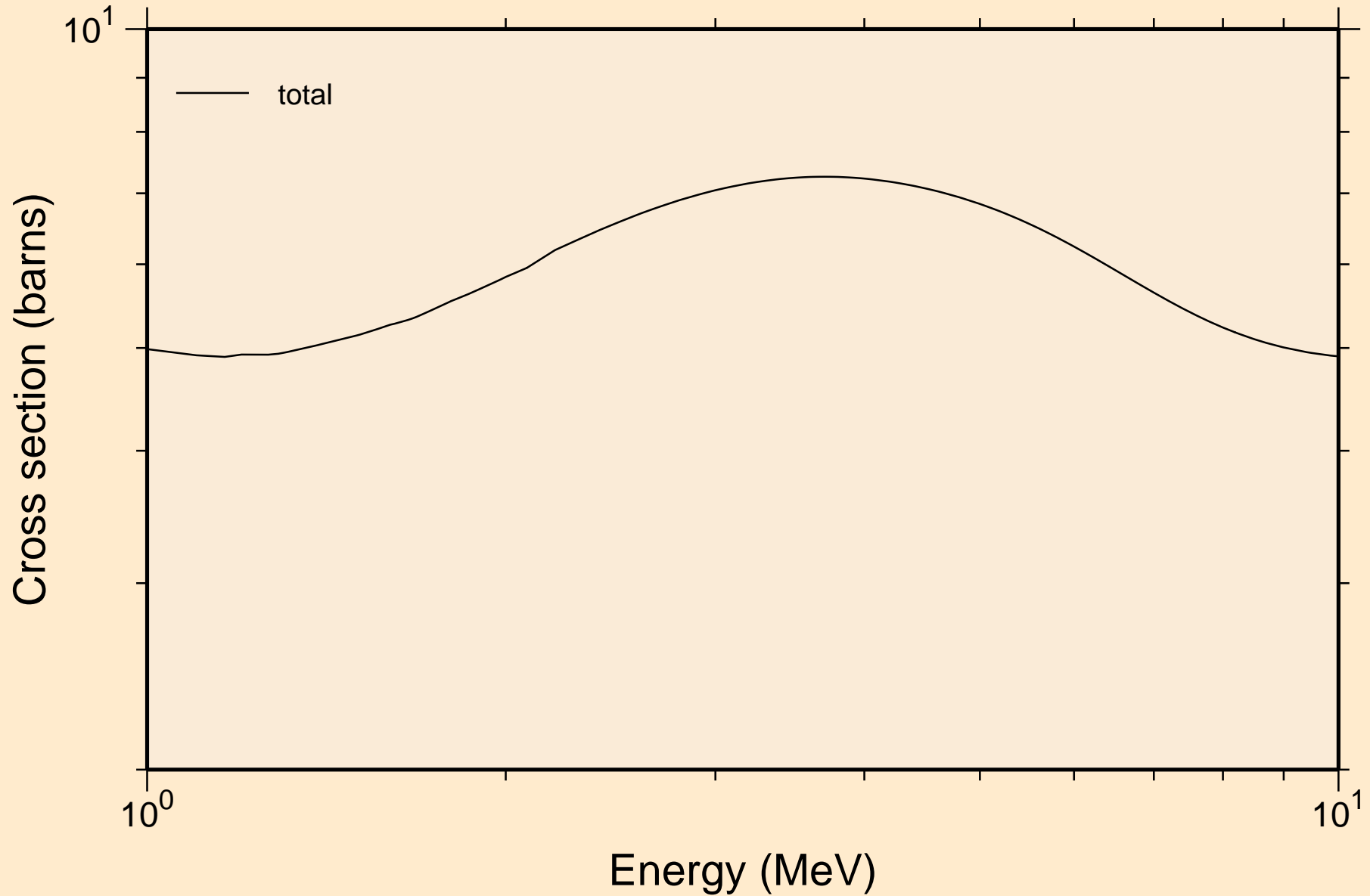

TL197 NEUTRON ACER TENDL-2024 LIBRARY; T=293.6K
resonance absorption cross sections

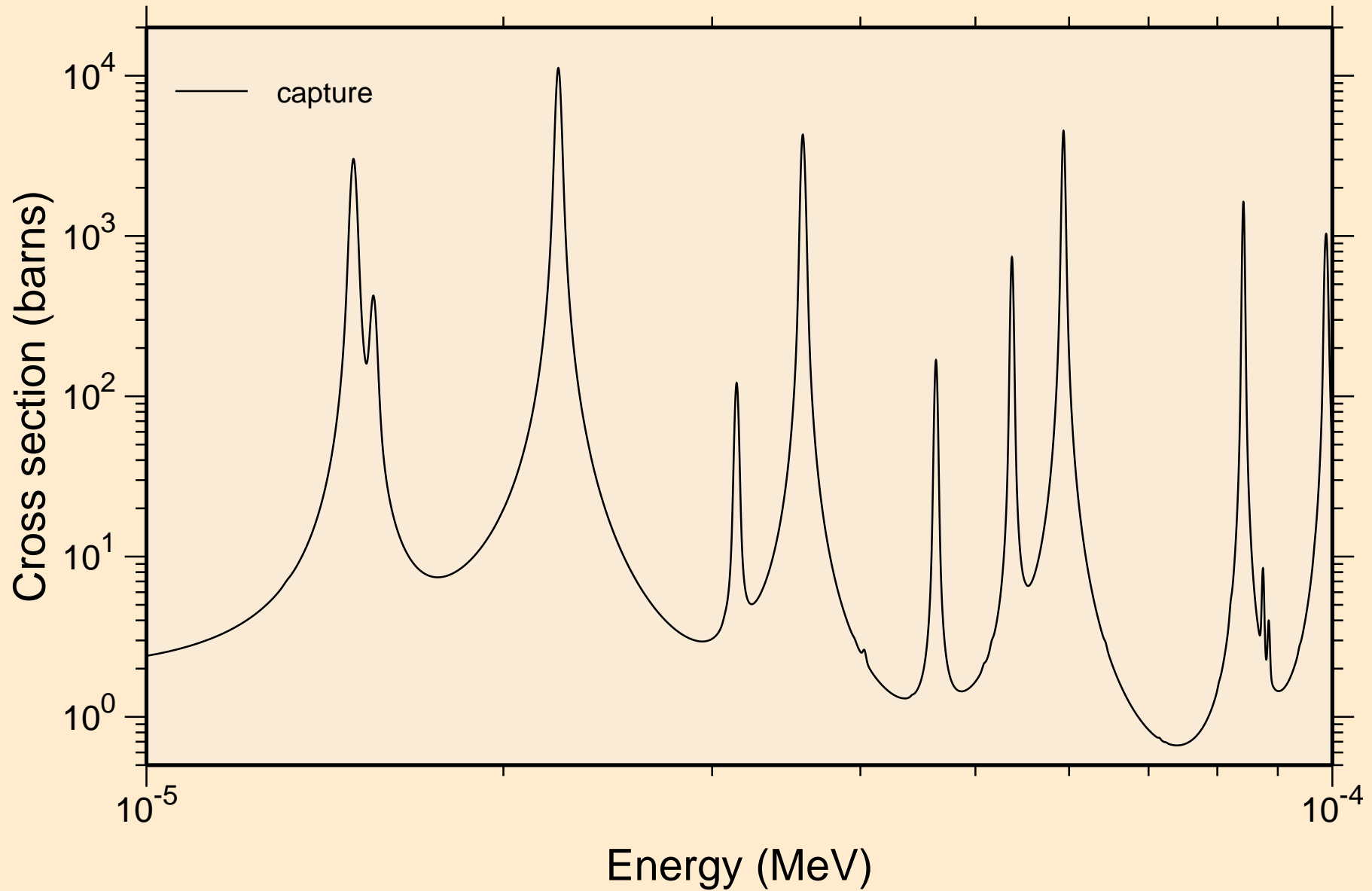

TL197 NEUTRON ACER TENDL-2024 LIBRARY; T=293.6K
resonance absorption cross sections

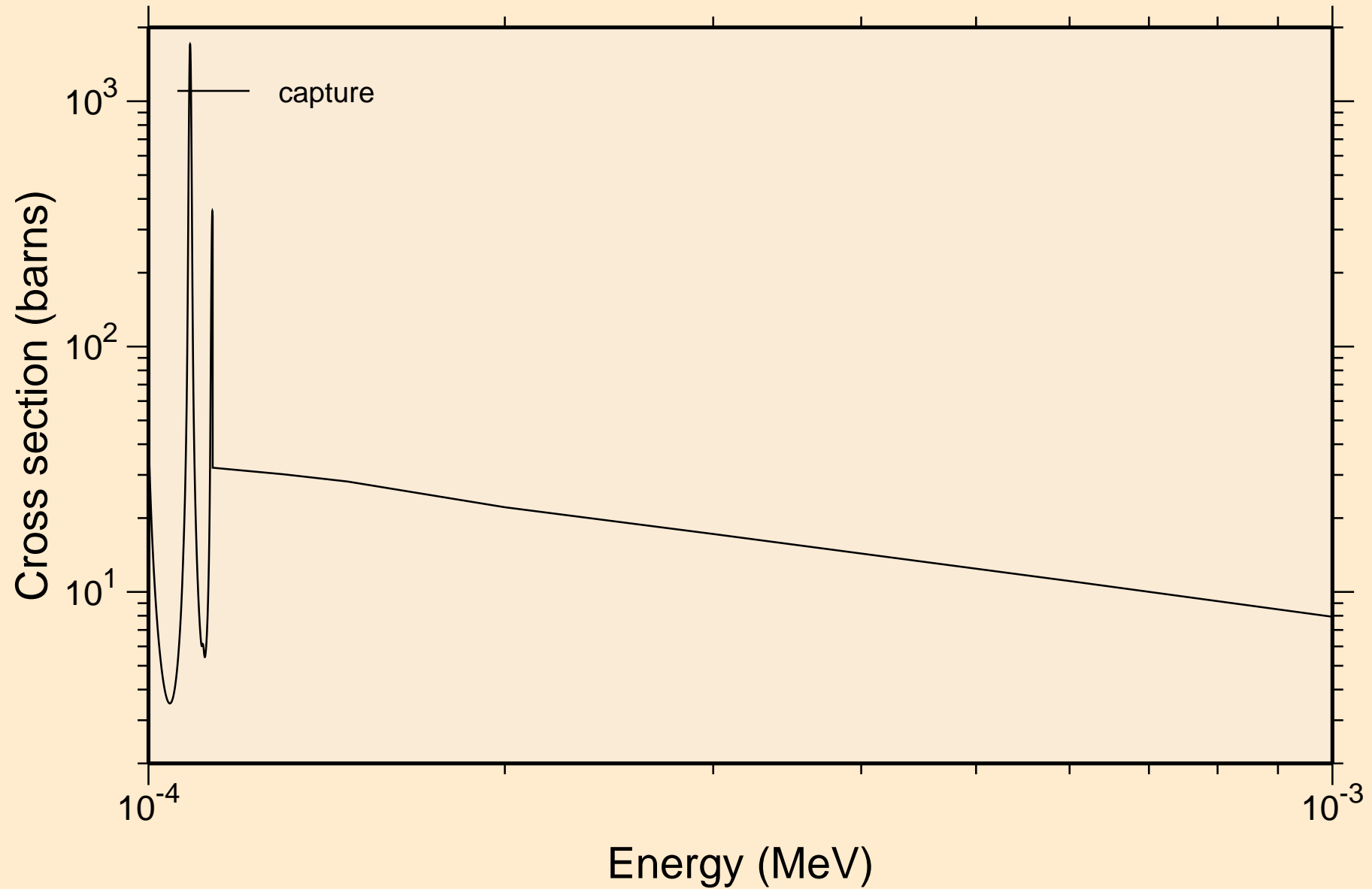

TL197 NEUTRON ACER TENDL-2024 LIBRARY; T=293.6K
resonance absorption cross sections

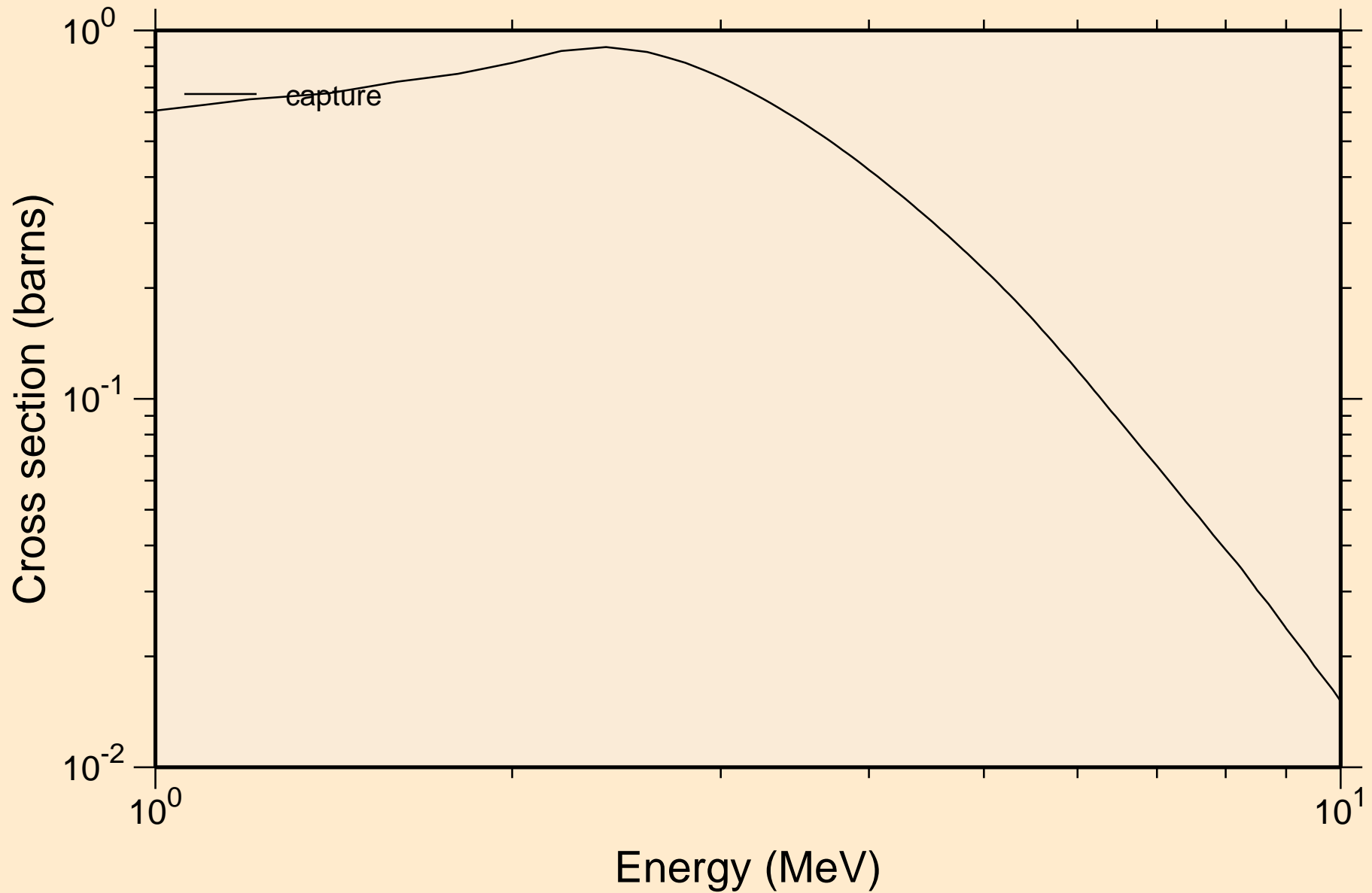

TL197 NEUTRON ACER TENDL-2024 LIBRARY; T=293.6K
Heating

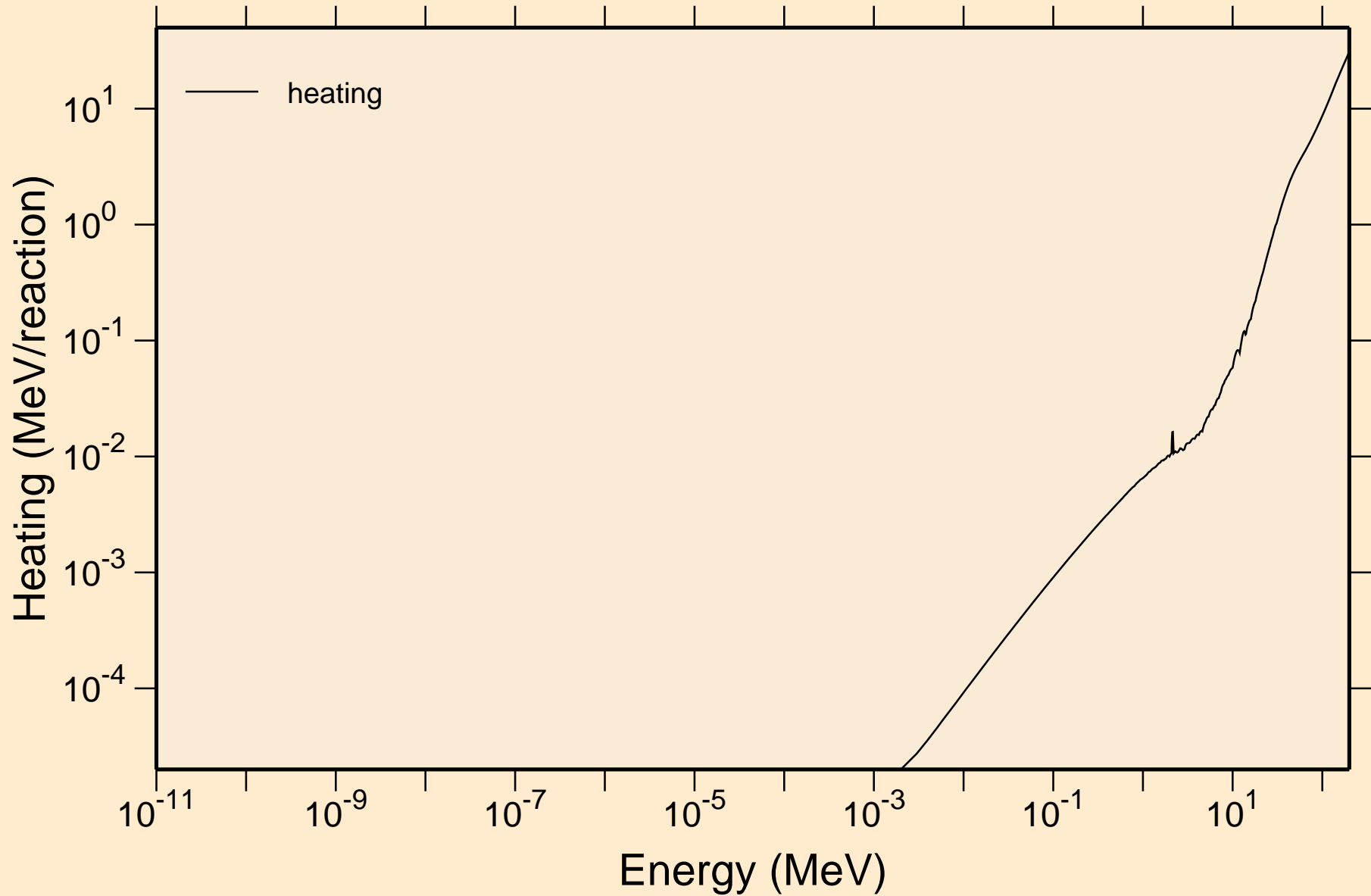

TL197 NEUTRON ACER TENDL-2024 LIBRARY; T=293.6K
Damage

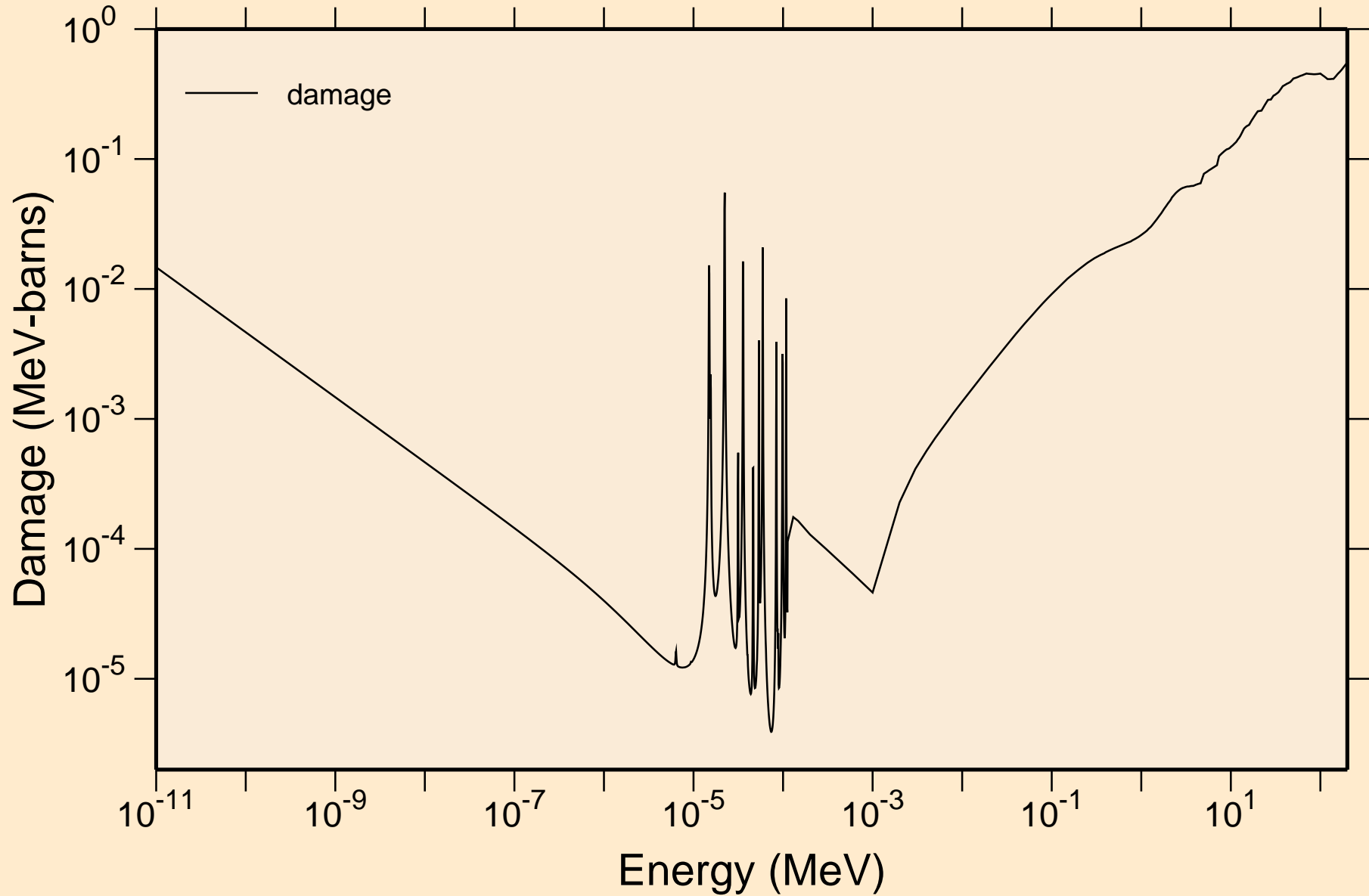

TL197 NEUTRON ACER TENDL-2024 LIBRARY; T=293.6K
Non-threshold reactions

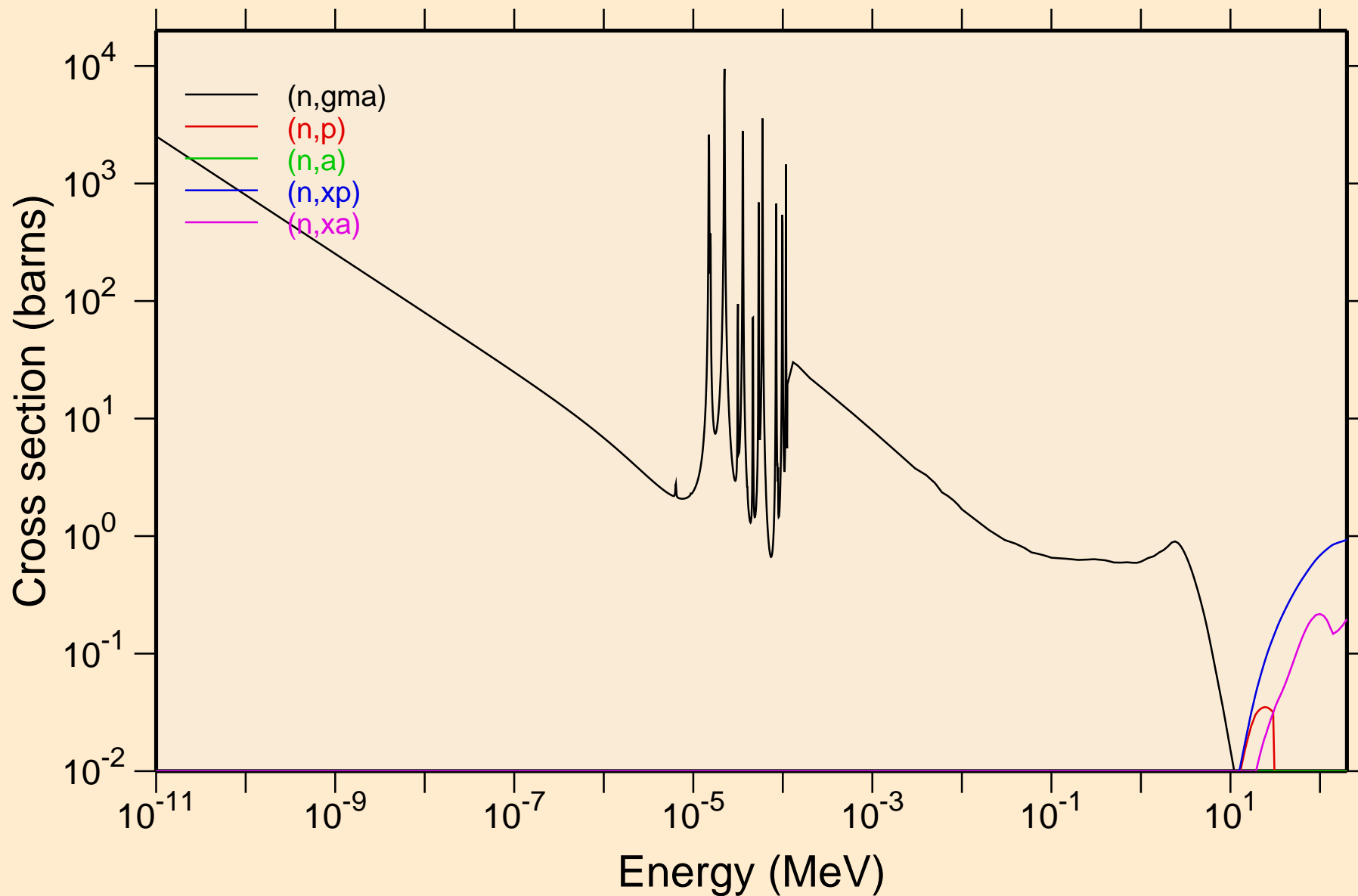

TL197 NEUTRON ACER TENDL-2024 LIBRARY; T=293.6K
Principal cross sections

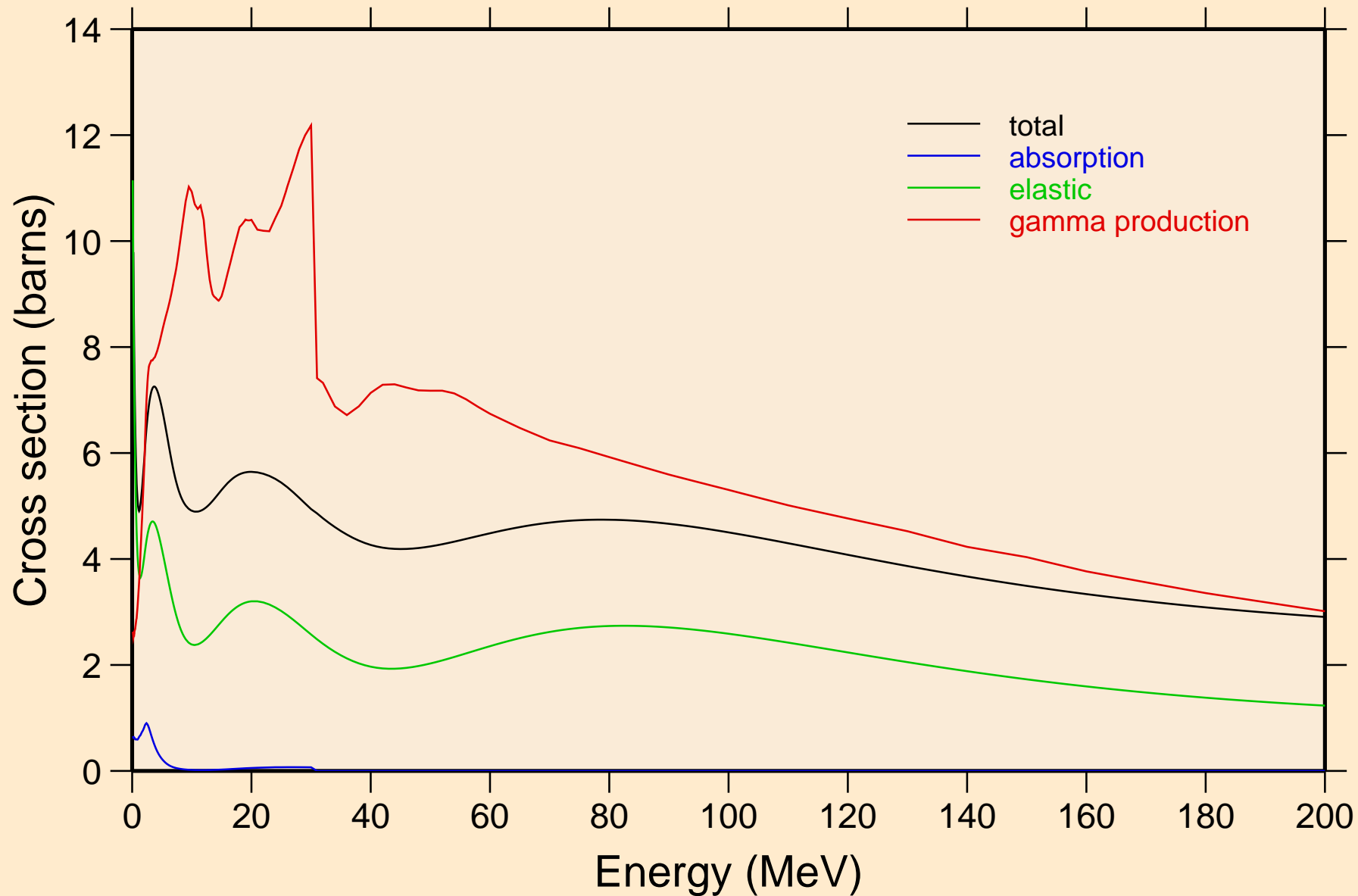

TL197 NEUTRON ACER TENDL-2024 LIBRARY; T=293.6K
Heating

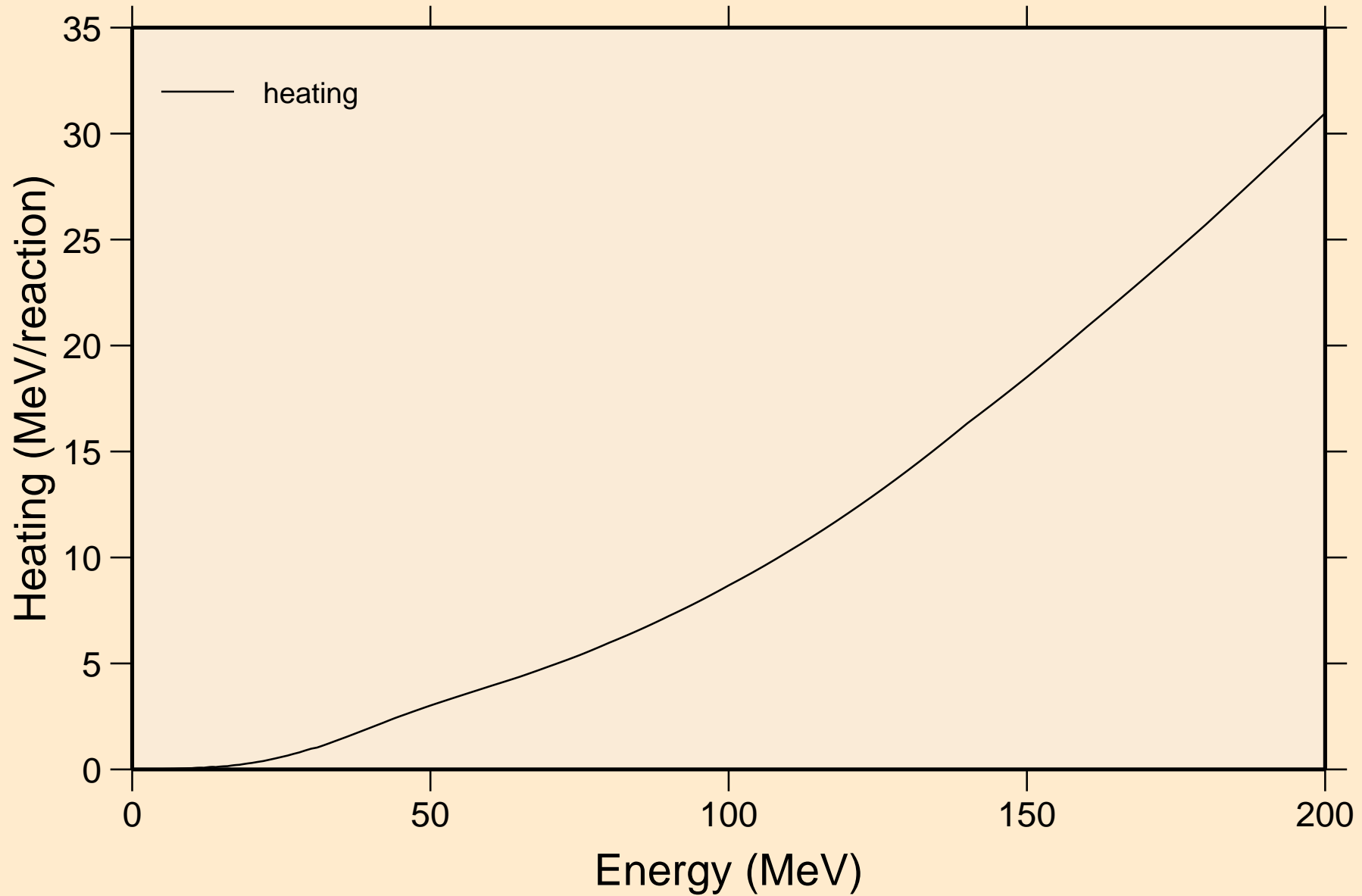

TL197 NEUTRON ACER TENDL-2024 LIBRARY; T=293.6K
Damage

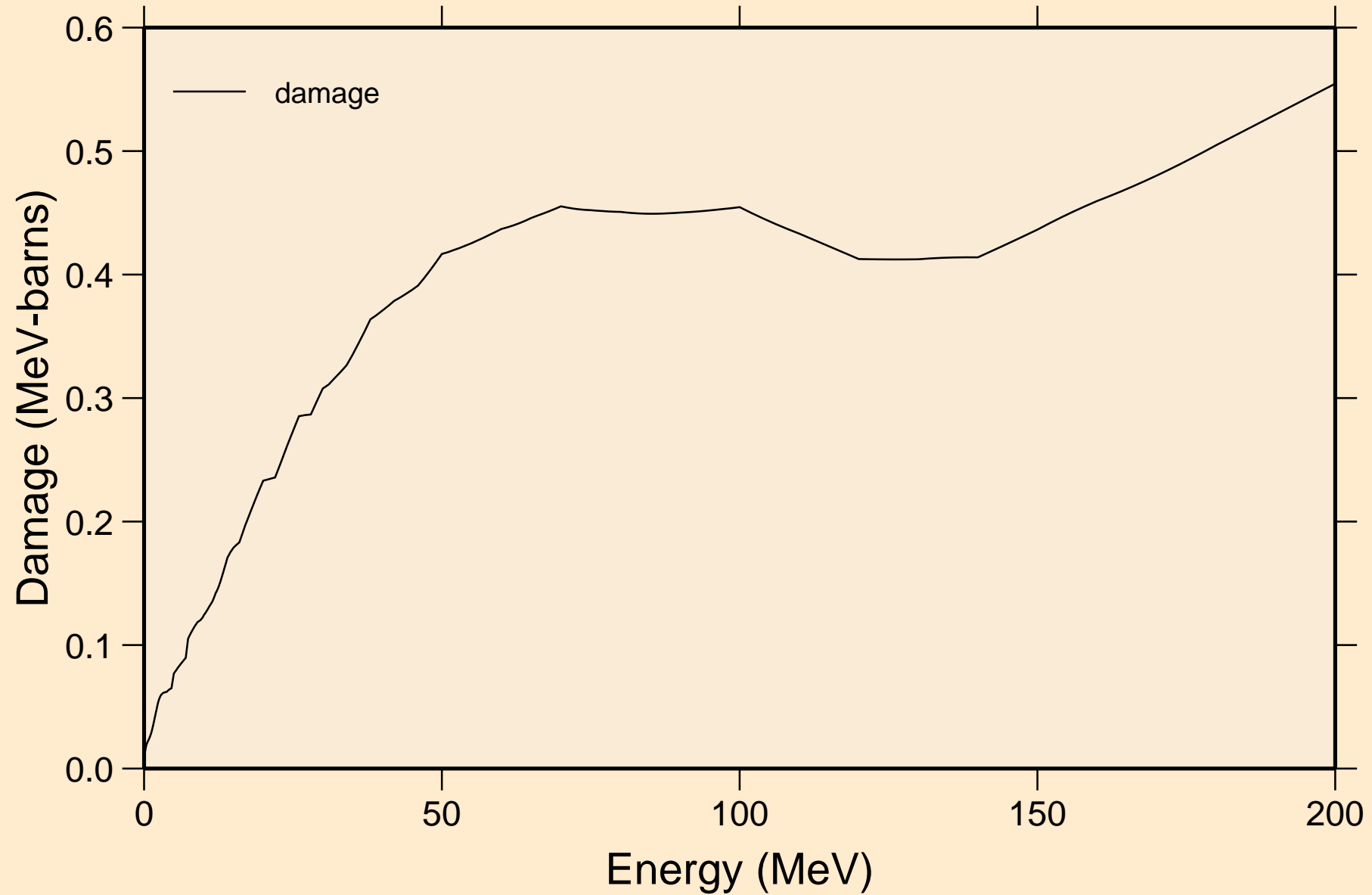

TL197 NEUTRON ACER TENDL-2024 LIBRARY; T=293.6K
Non-threshold reactions

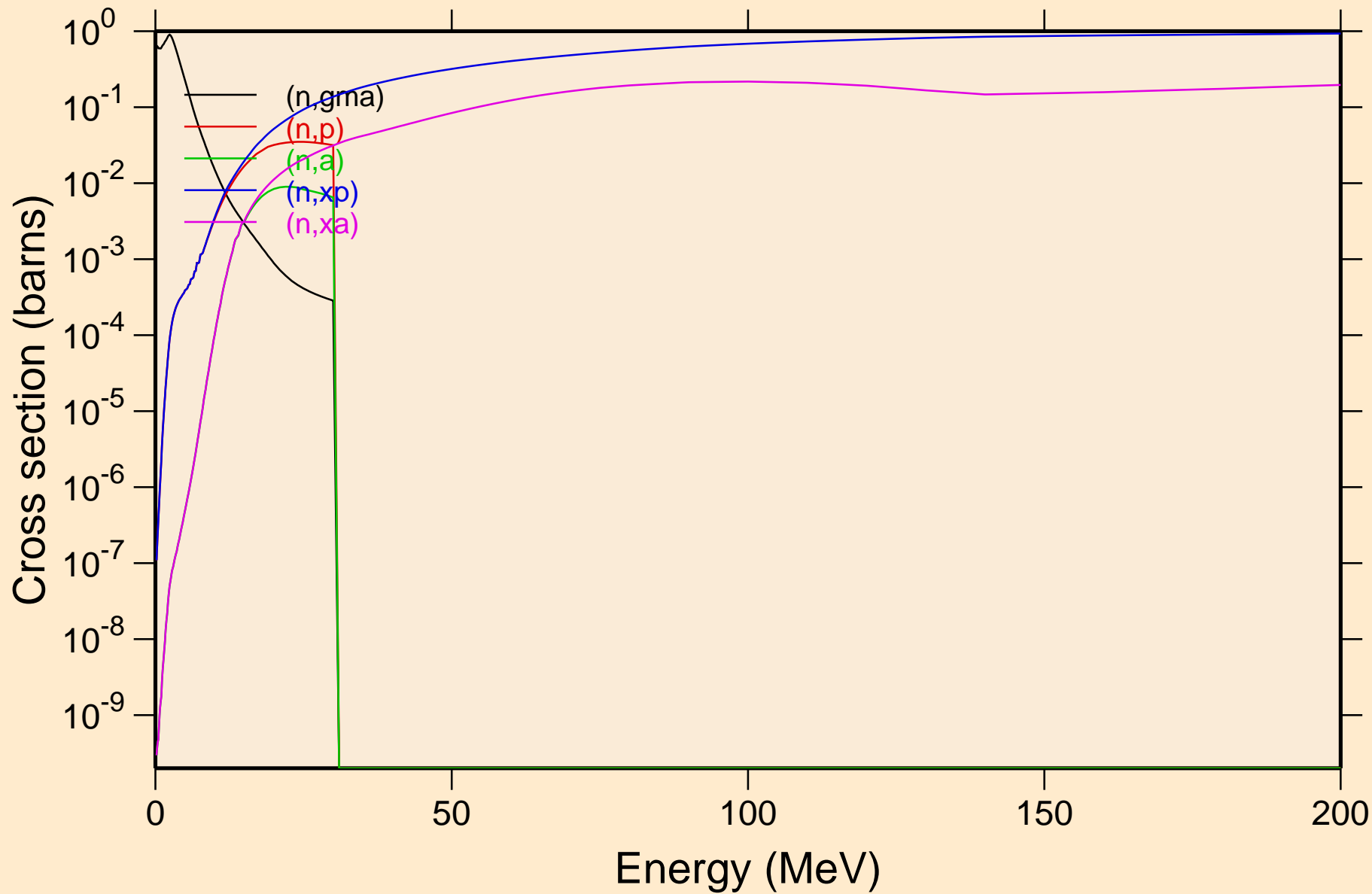

TL197 NEUTRON ACER TENDL-2024 LIBRARY; T=293.6K
Inelastic levels

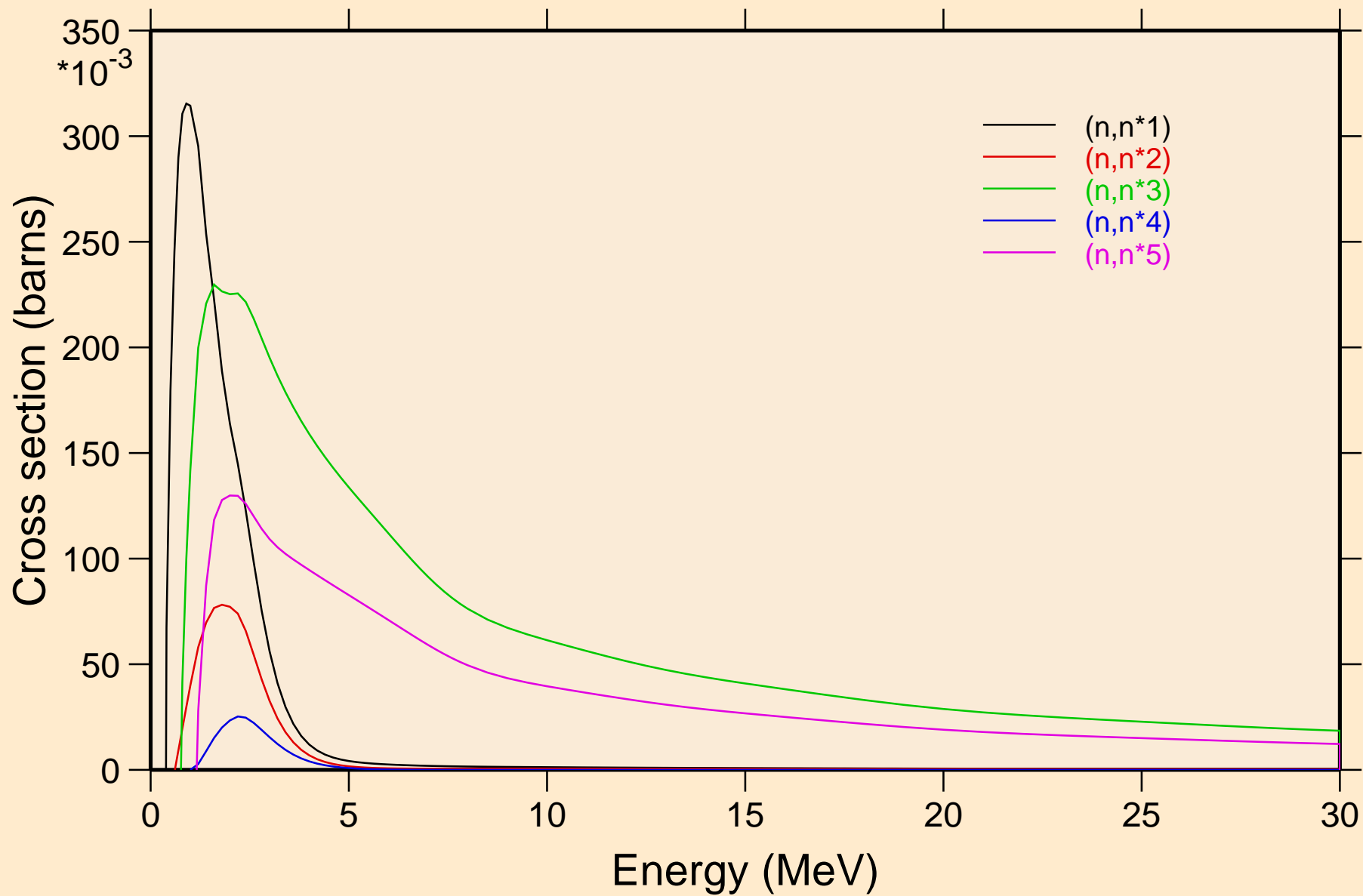

TL197 NEUTRON ACER TENDL-2024 LIBRARY; T=293.6K
Inelastic levels

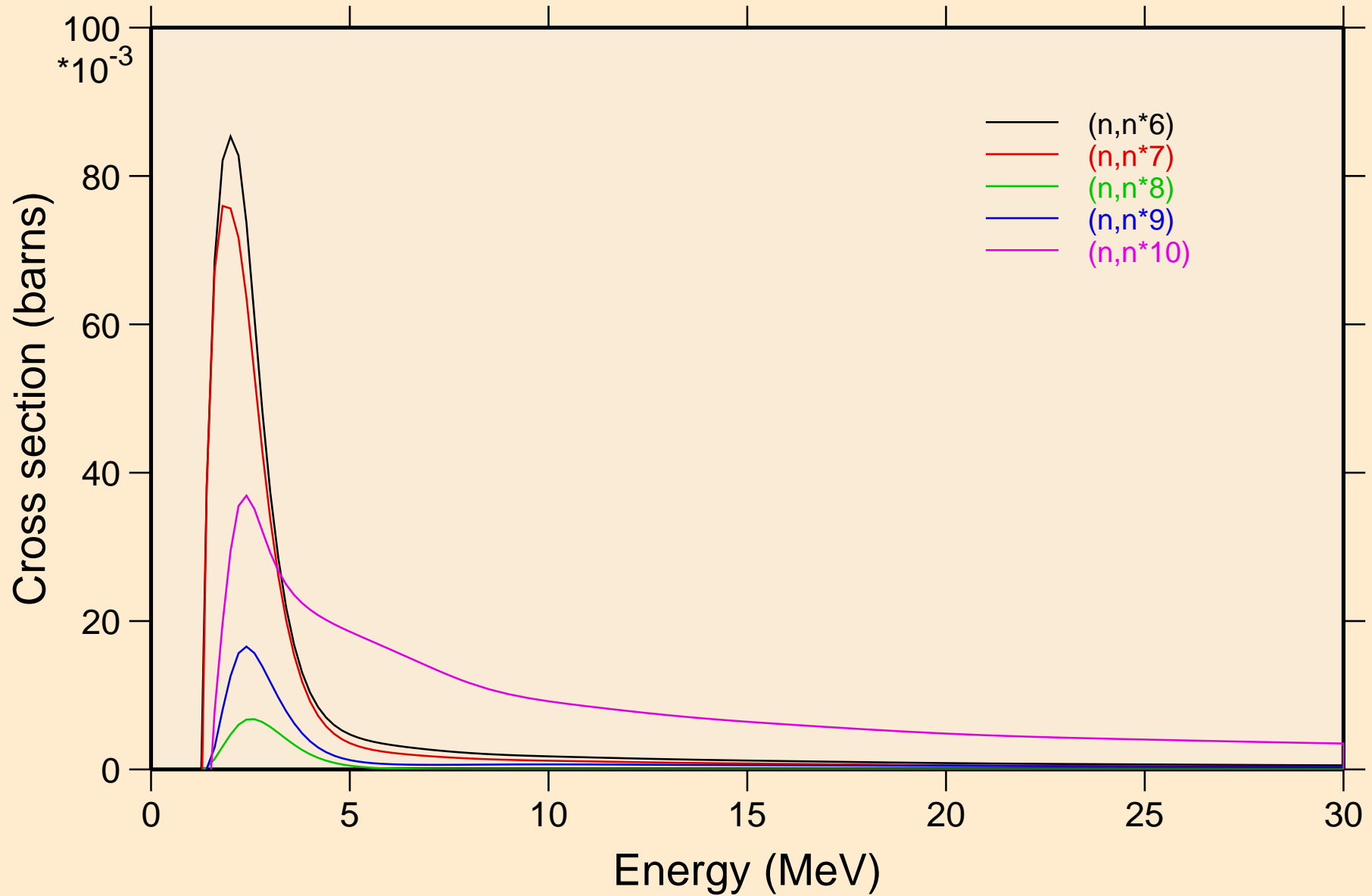

TL197 NEUTRON ACER TENDL-2024 LIBRARY; T=293.6K
Inelastic levels

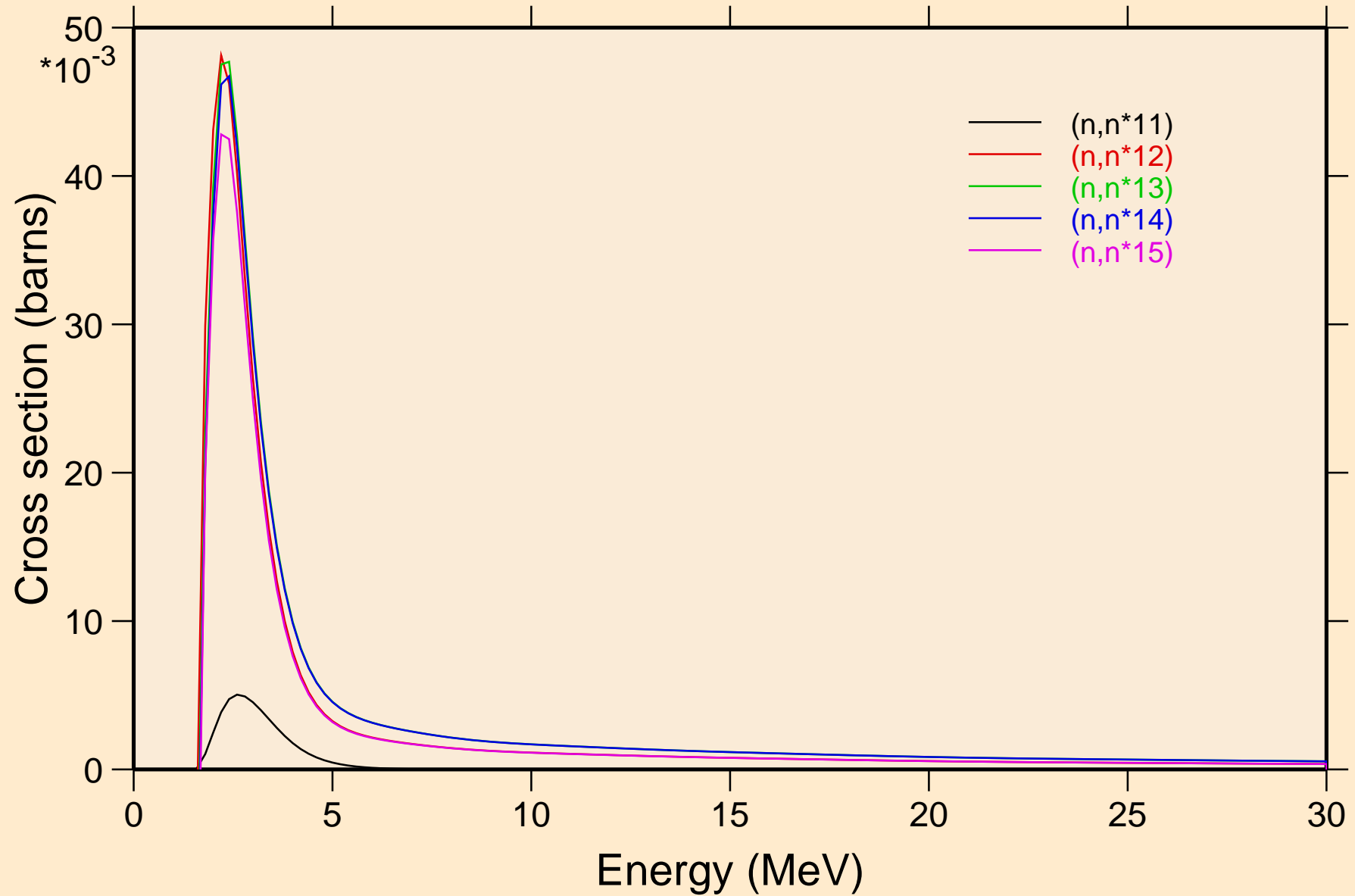

TL197 NEUTRON ACER TENDL-2024 LIBRARY; T=293.6K
Inelastic levels

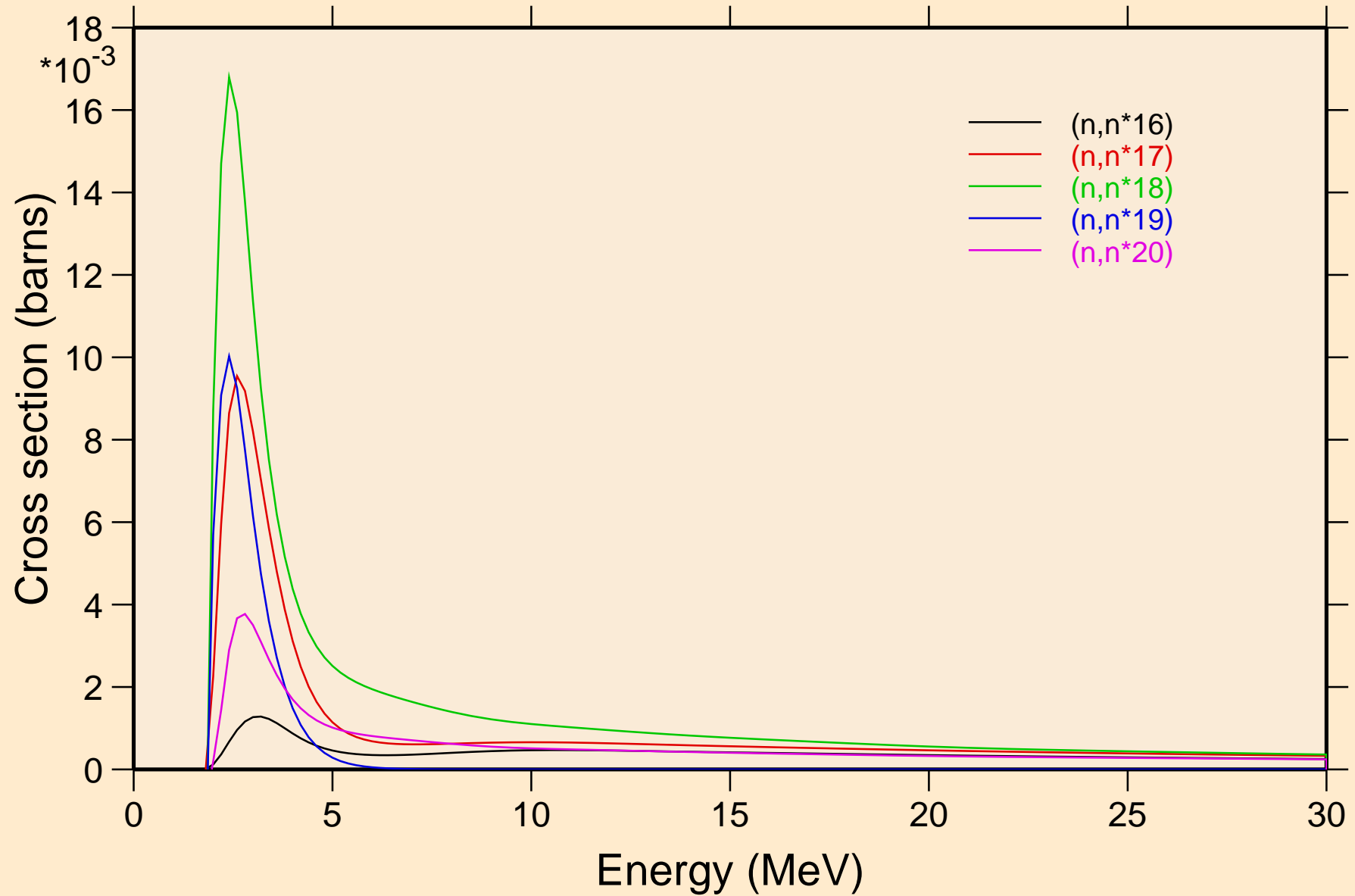

TL197 NEUTRON ACER TENDL-2024 LIBRARY; T=293.6K
Inelastic levels

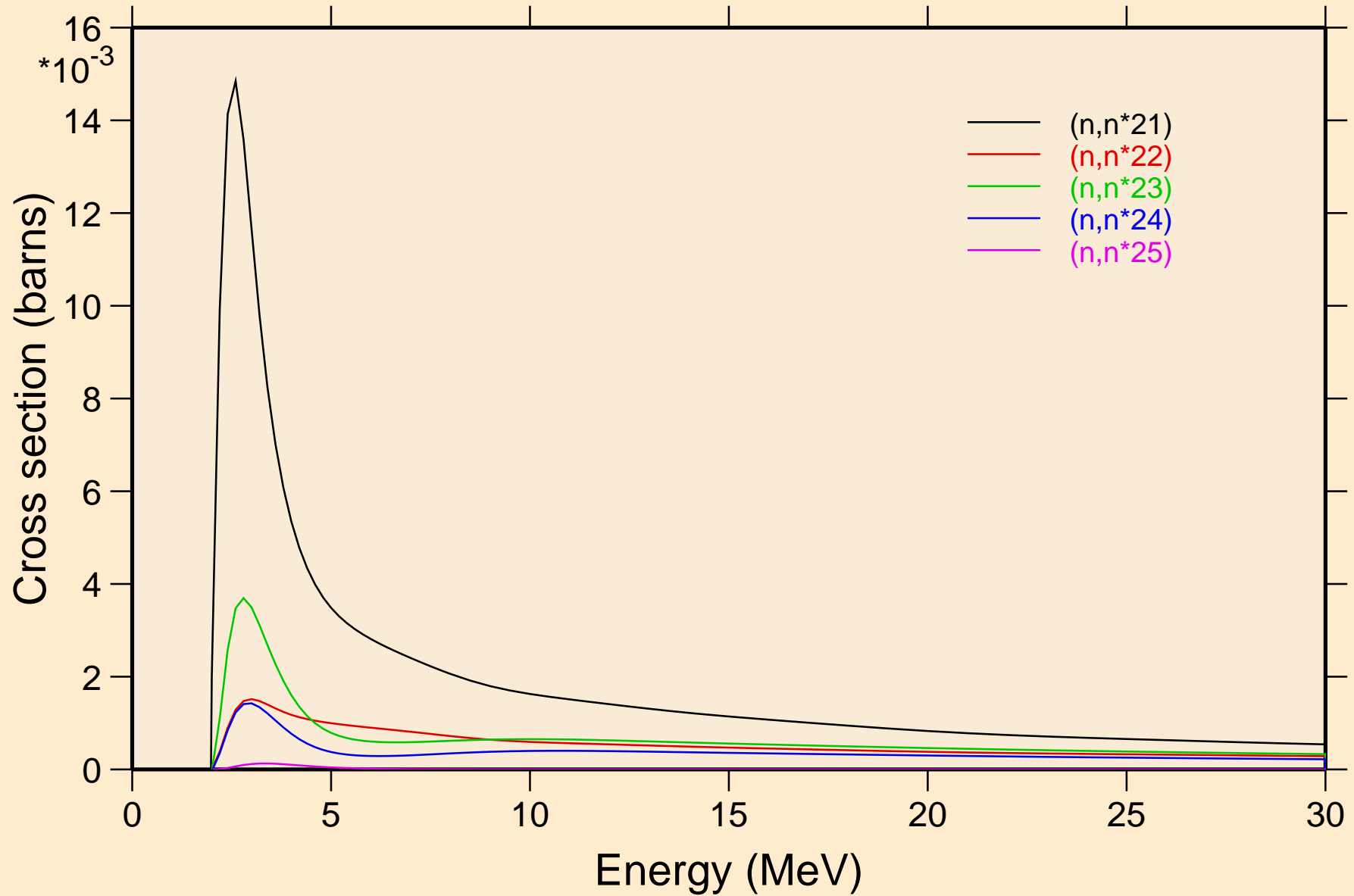

TL197 NEUTRON ACER TENDL-2024 LIBRARY; T=293.6K
Inelastic levels

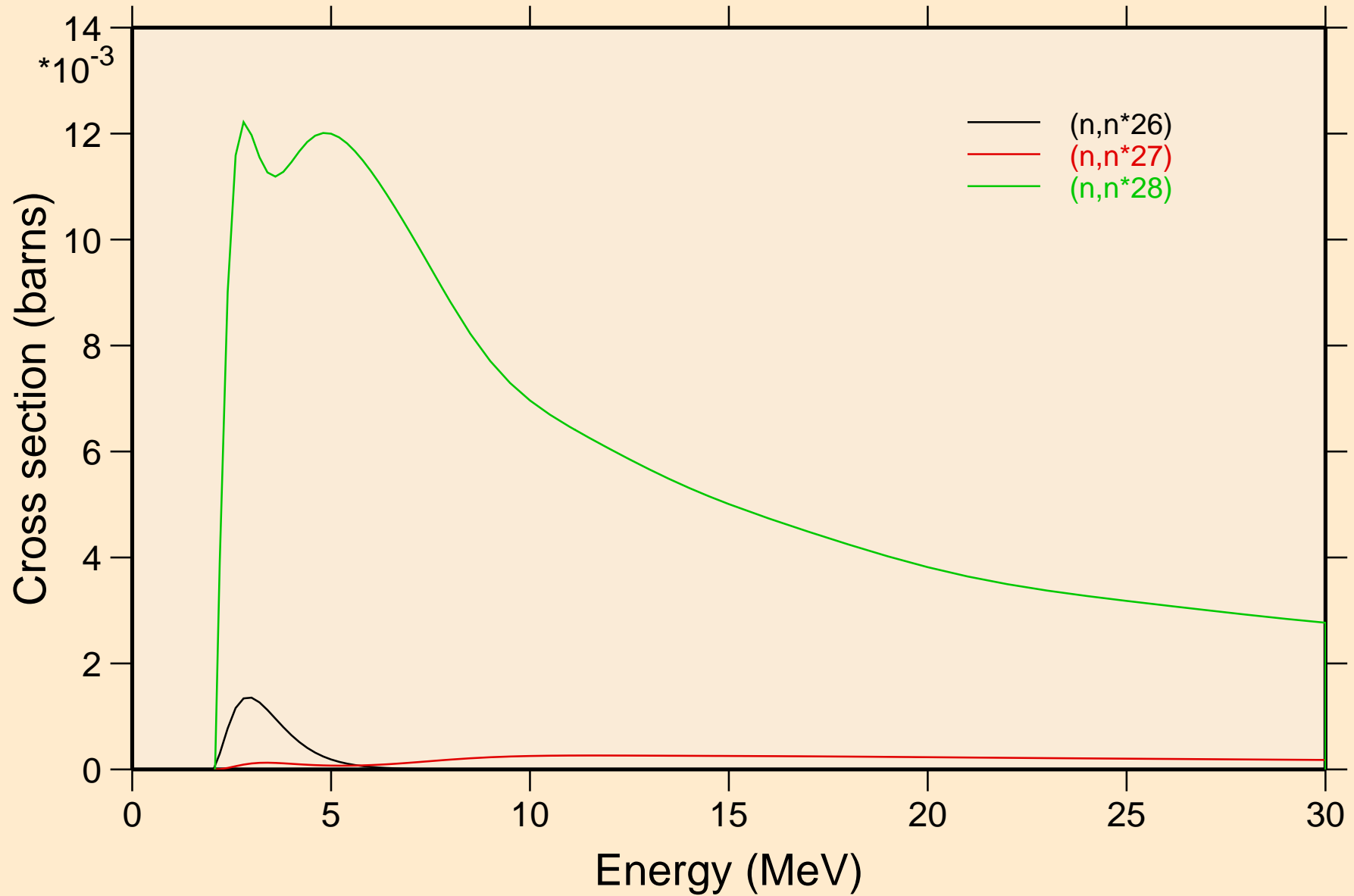

TL197 NEUTRON ACER TENDL-2024 LIBRARY; T=293.6K
Threshold reactions

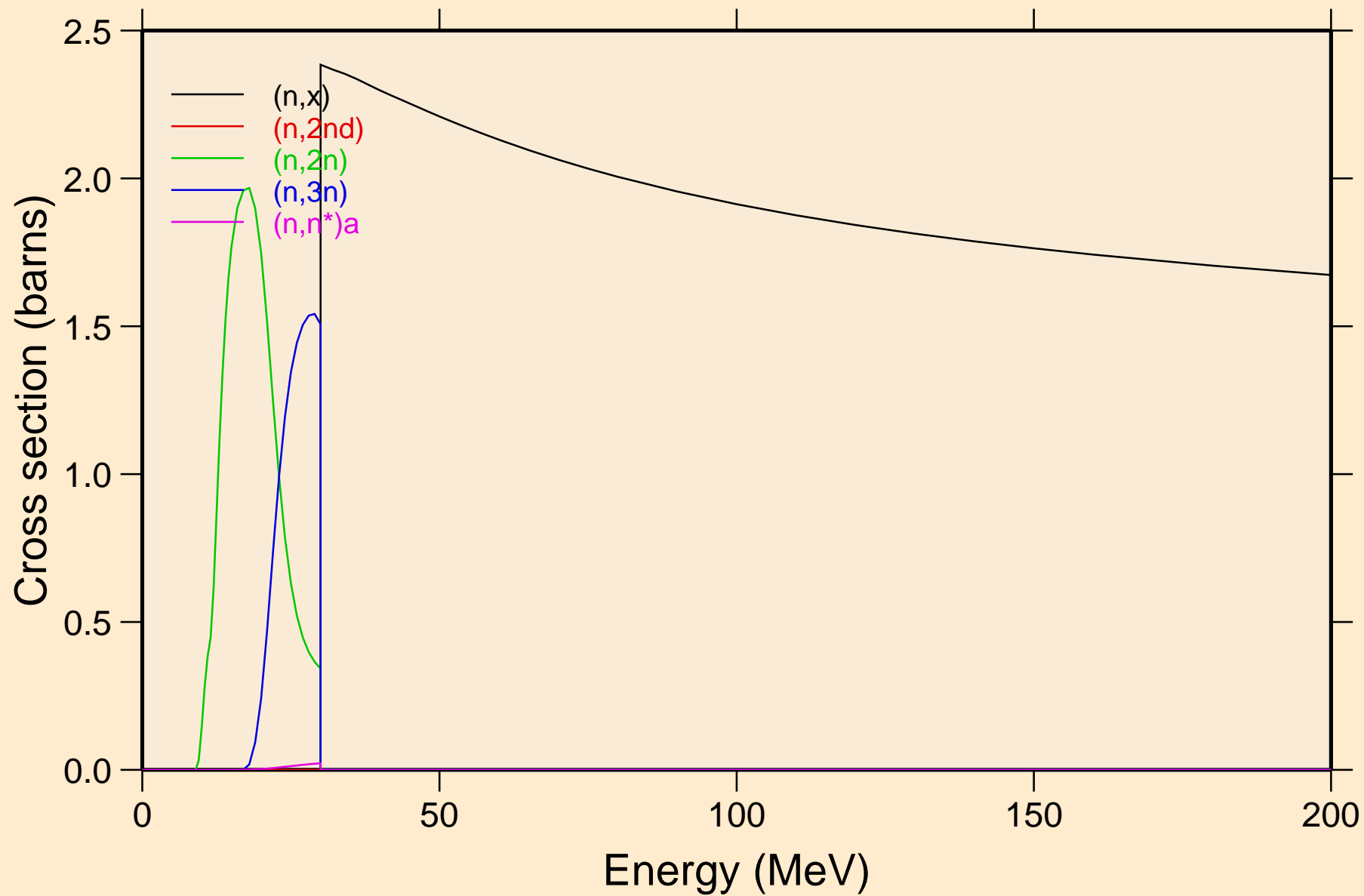

TL197 NEUTRON ACER TENDL-2024 LIBRARY; T=293.6K
Threshold reactions

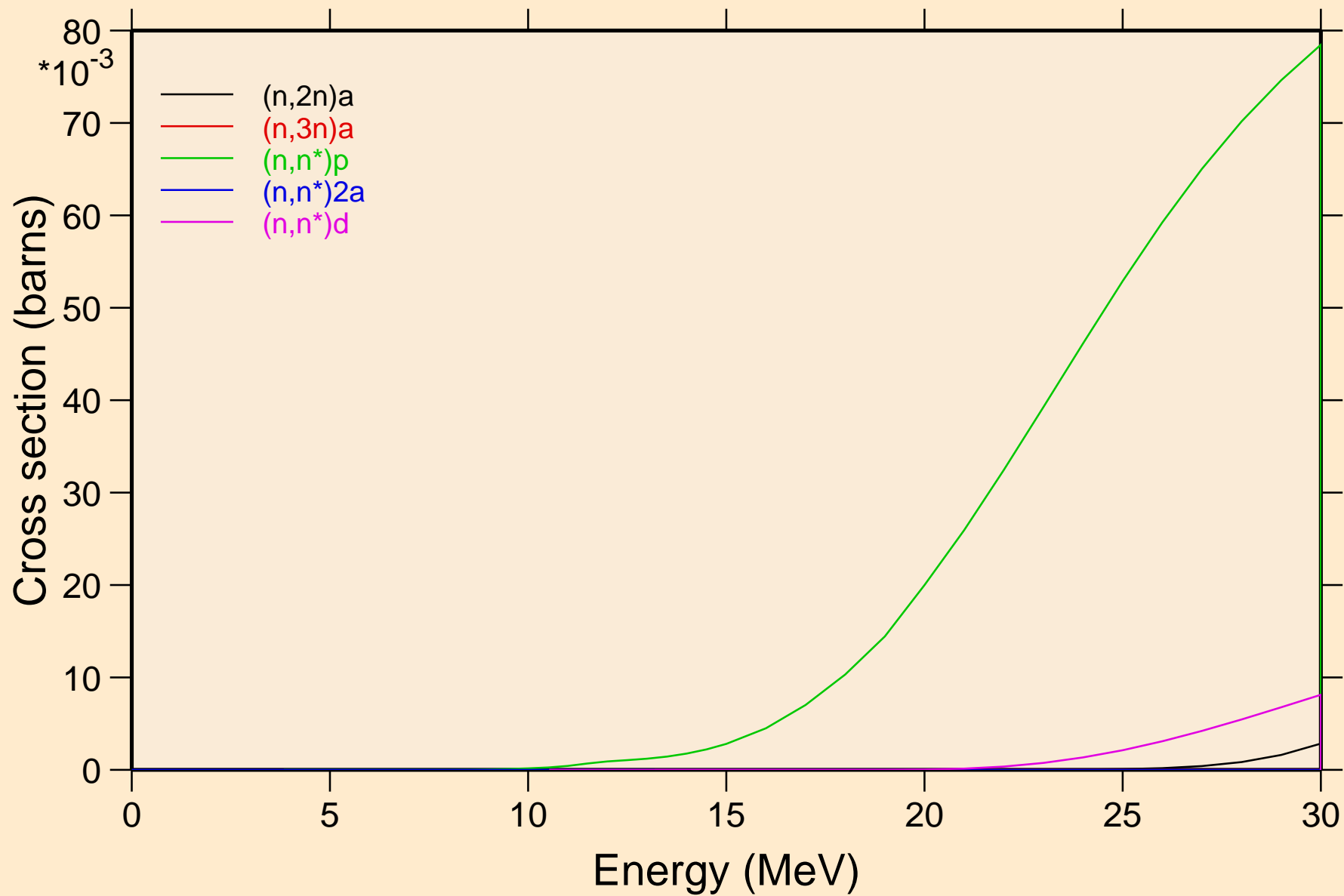

TL197 NEUTRON ACER TENDL-2024 LIBRARY; T=293.6K
Threshold reactions

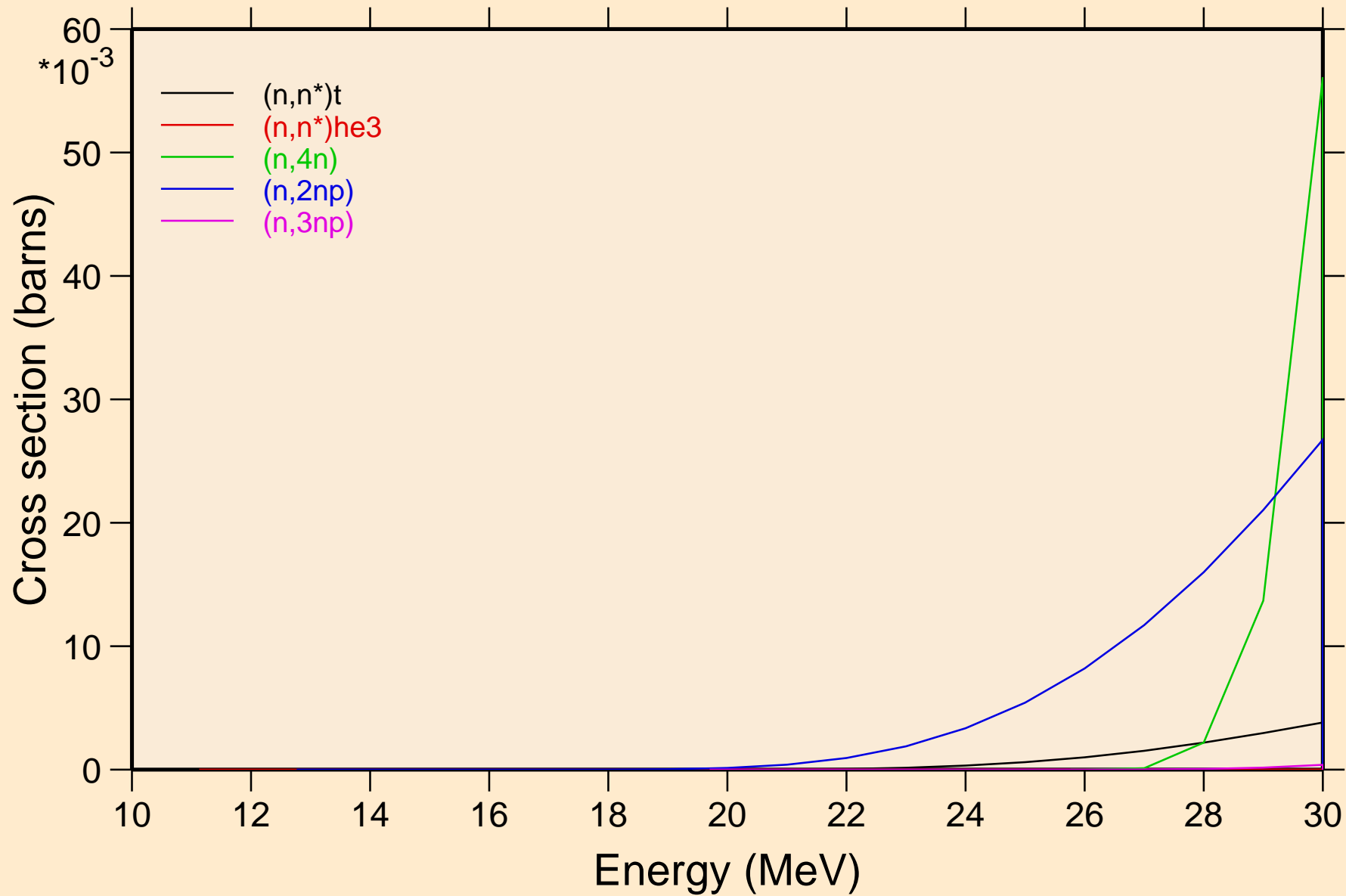

TL197 NEUTRON ACER TENDL-2024 LIBRARY; T=293.6K
Threshold reactions

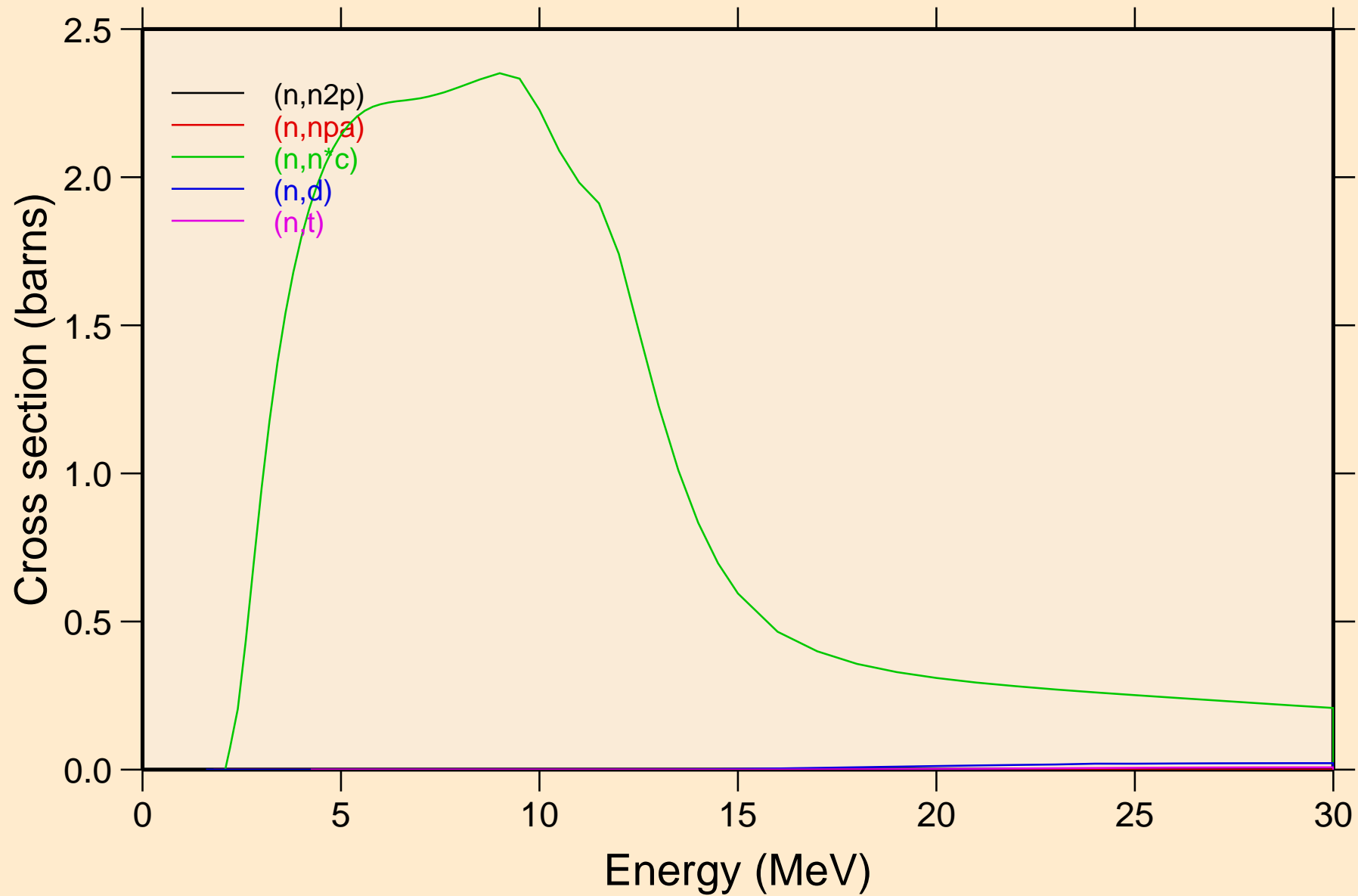

TL197 NEUTRON ACER TENDL-2024 LIBRARY; T=293.6K
Threshold reactions

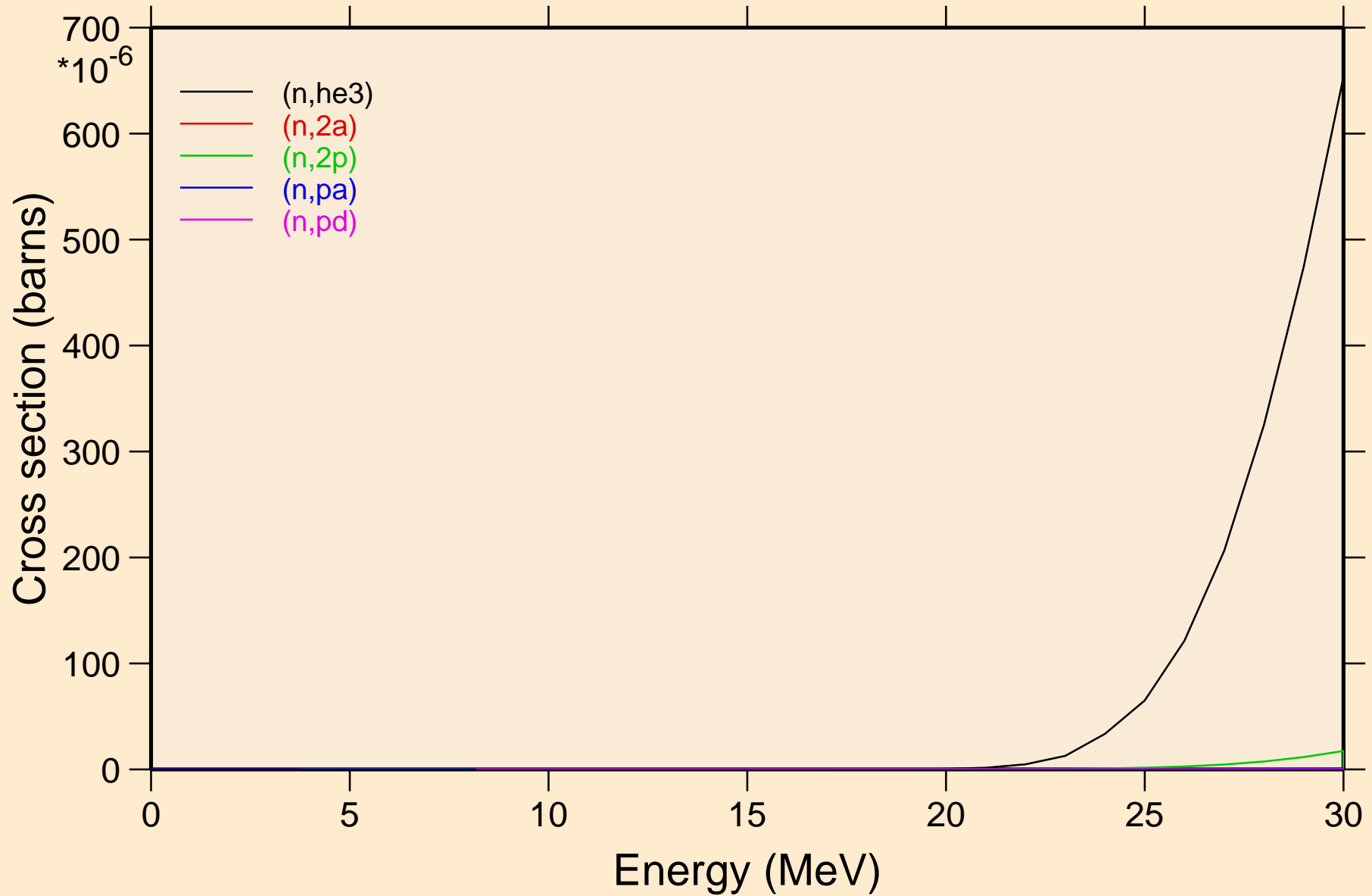

TL197 NEUTRON ACER TENDL-2024 LIBRARY; T=293.6K
Threshold reactions

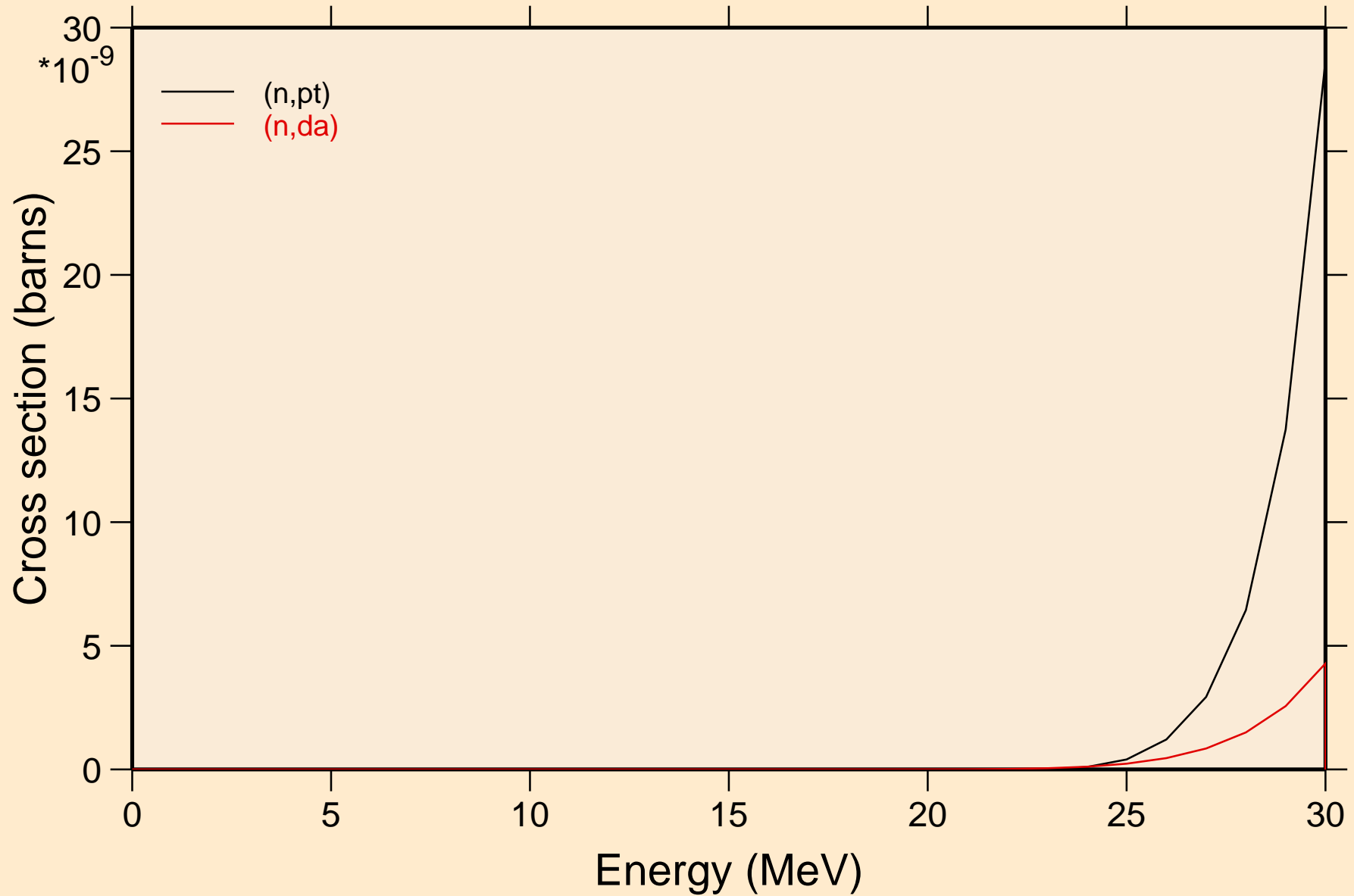

TL197 NEUTRON ACER TENDL-2024 LIBRARY; T=293.6K
Threshold reactions

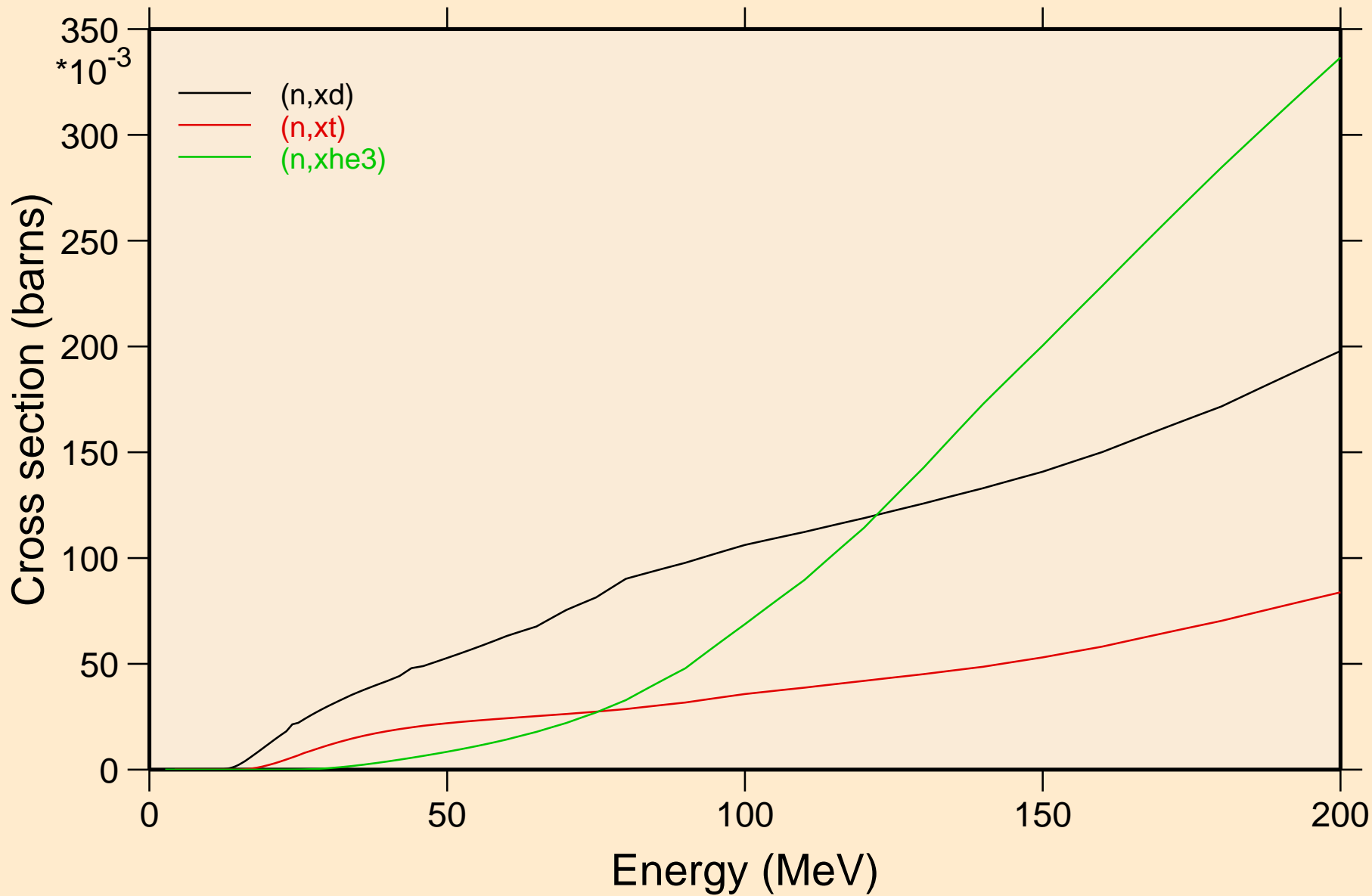

TL197 NEUTRON ACER TENDL-2024 LIBRARY; T=293.6K
angular distribution for elastic

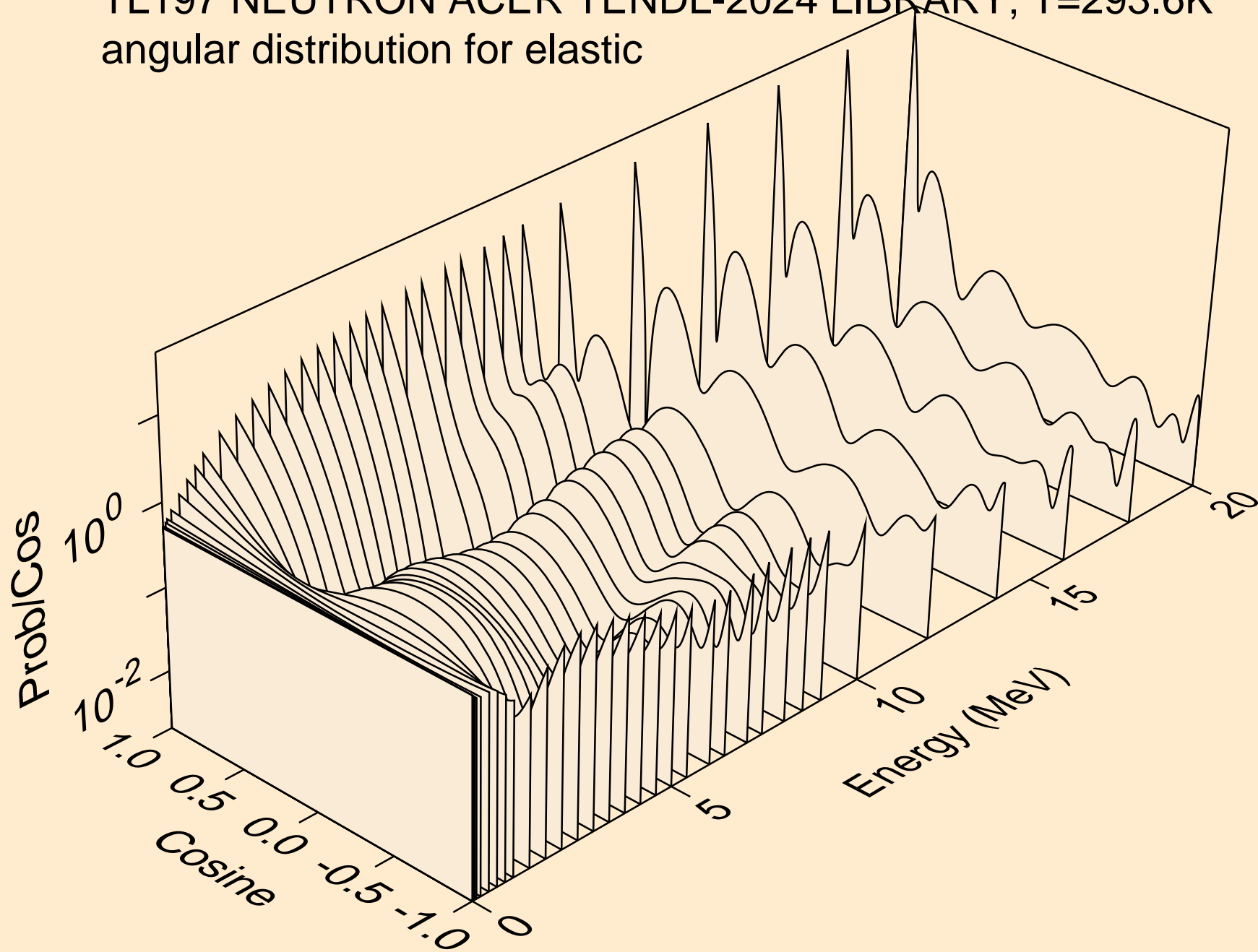

TL197 NEUTRON ACER TENDL-2024 LIBRARY; T=293.6K
angular distribution for elastic

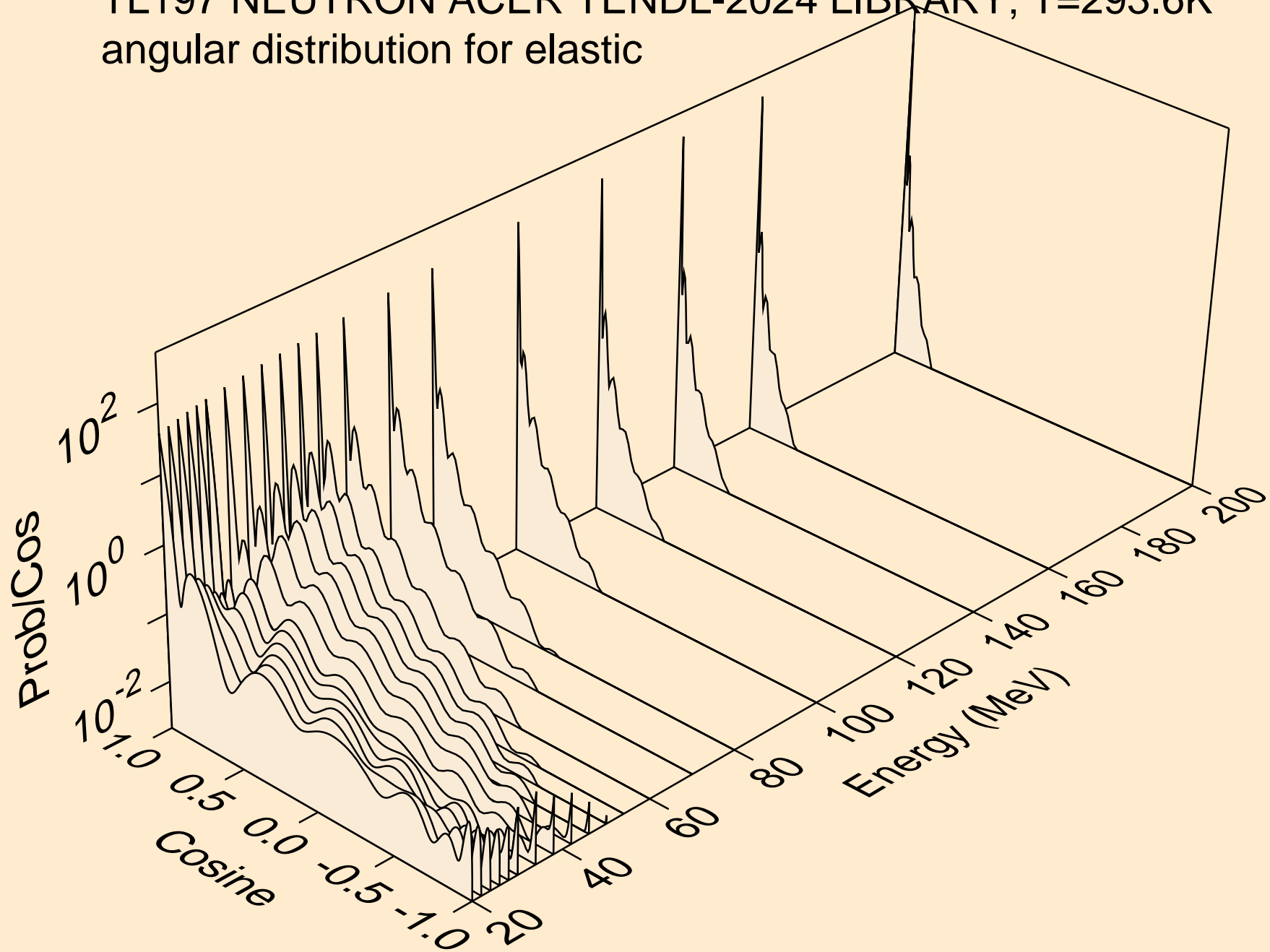

TL197 NEUTRON ACER TENDL-2024 LIBRARY; T=293.6K
angular distribution for (n,n*1)

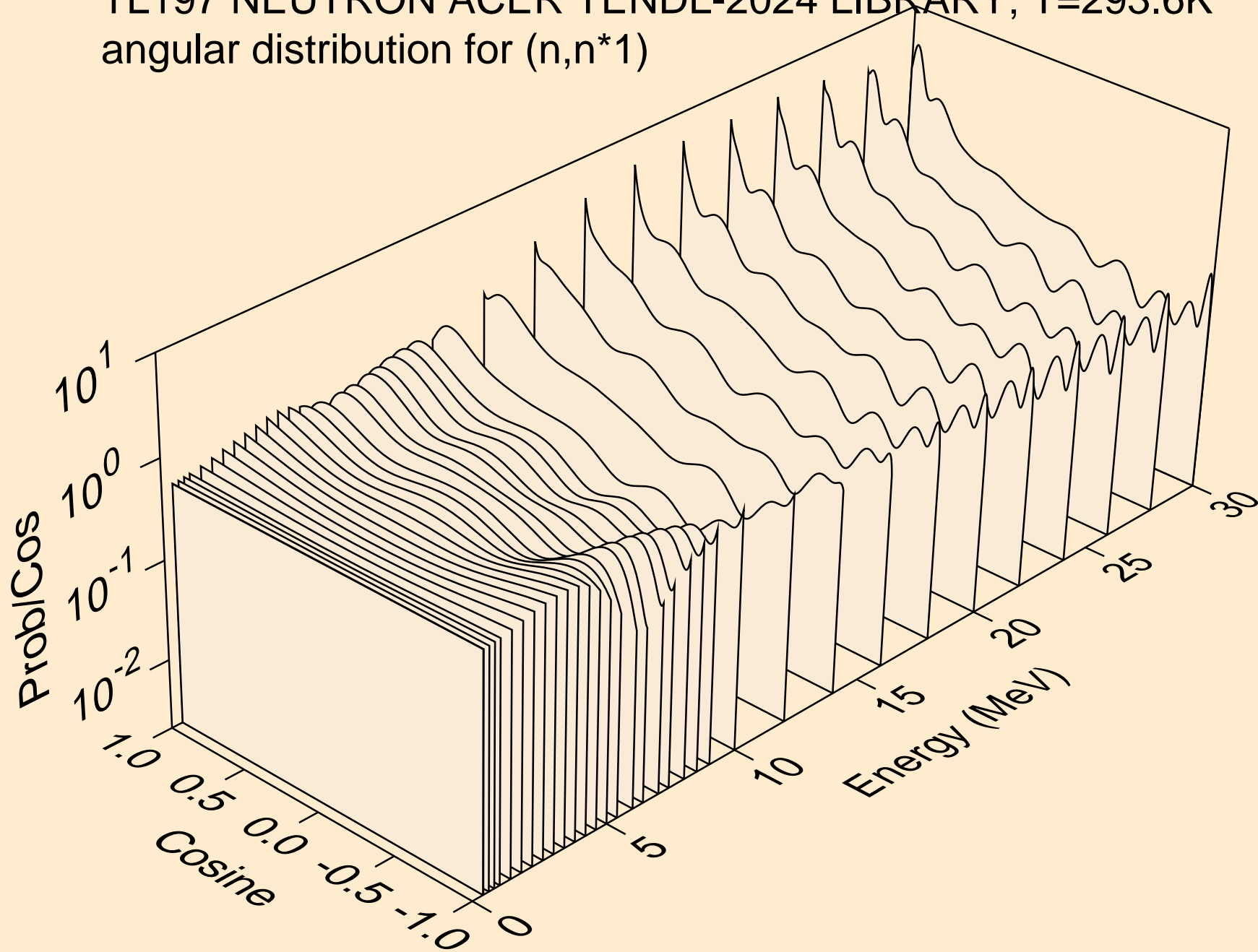

TL197 NEUTRON ACER TENDL-2024 LIBRARY; T=293.6K
angular distribution for (n,n*2)

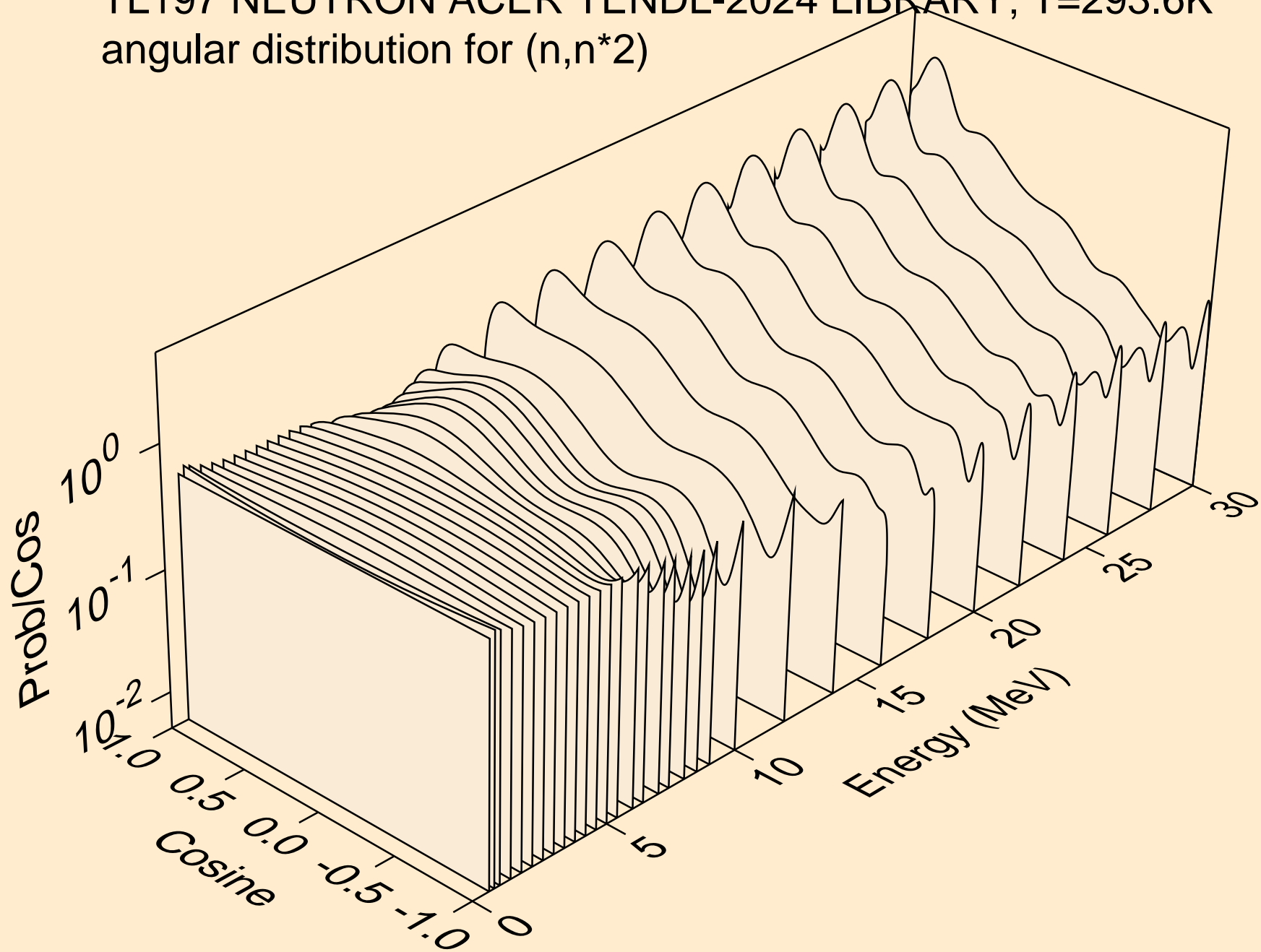

TL197 NEUTRON ACER TENDL-2024 LIBRARY; T=293.6K
angular distribution for (n,n*3)

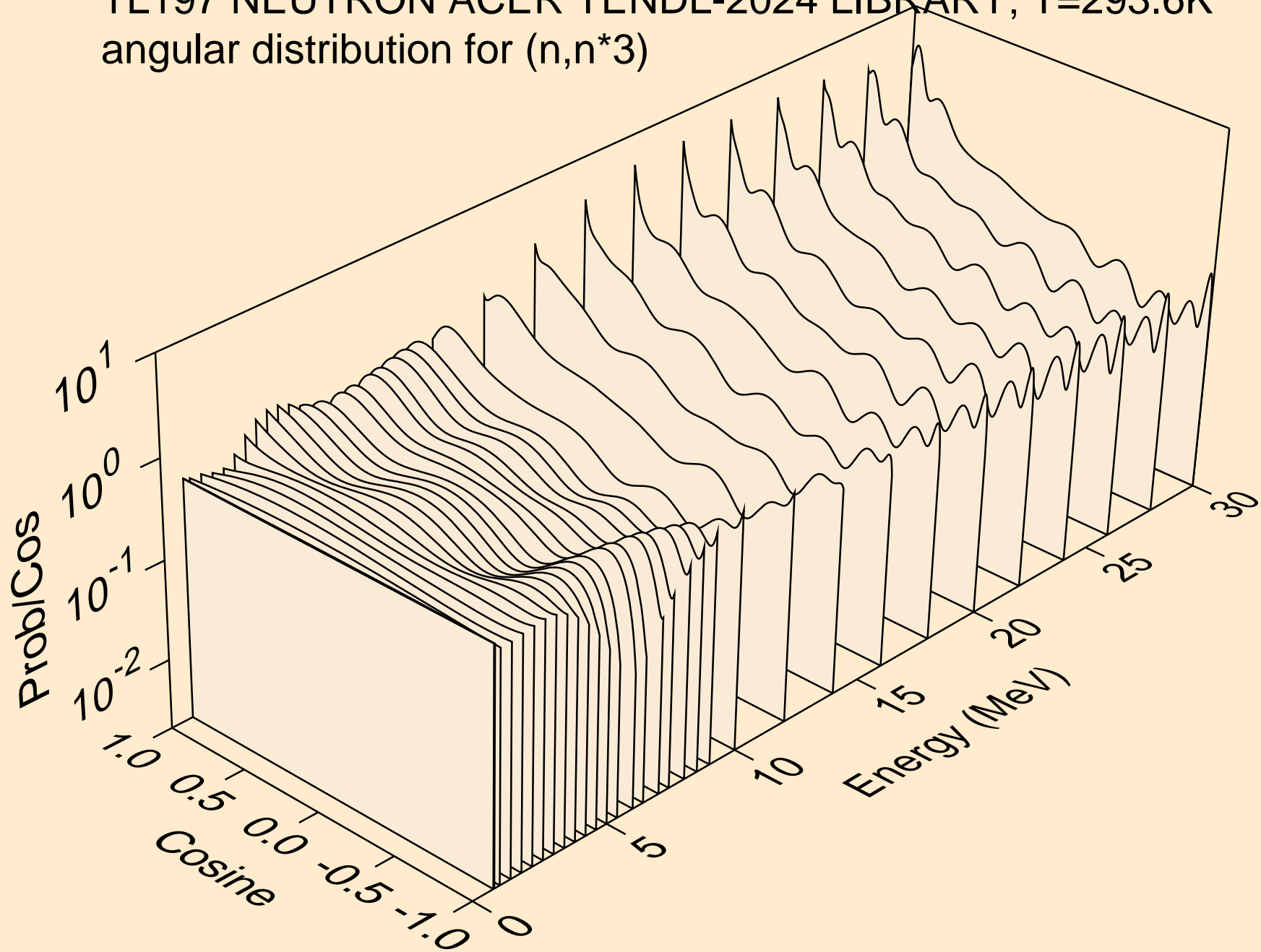

TL197 NEUTRON ACER TENDL-2024 LIBRARY; T=293.6K
angular distribution for (n,n*4)

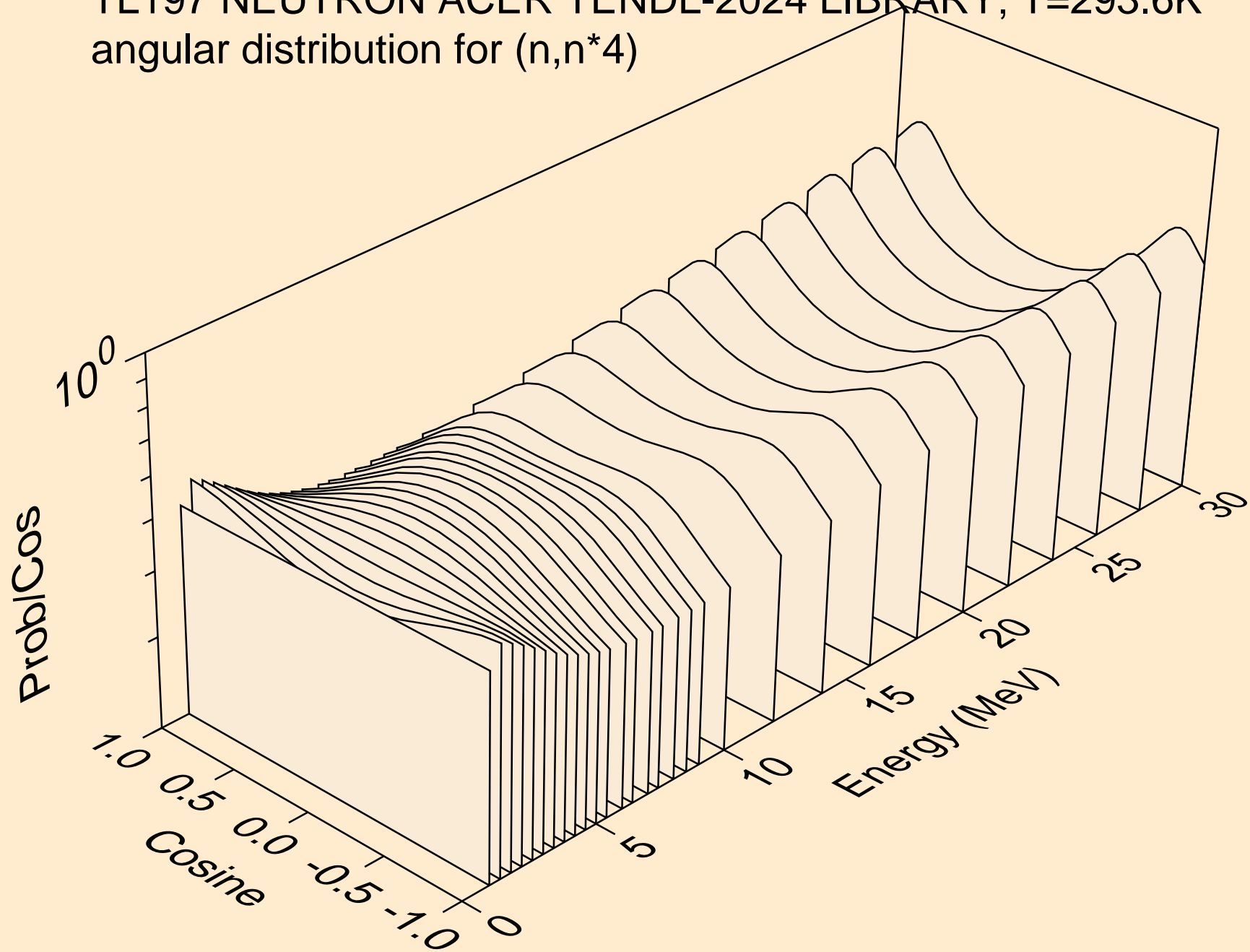

TL197 NEUTRON ACER TENDL-2024 LIBRARY; T=293.6K
angular distribution for (n,n*5)

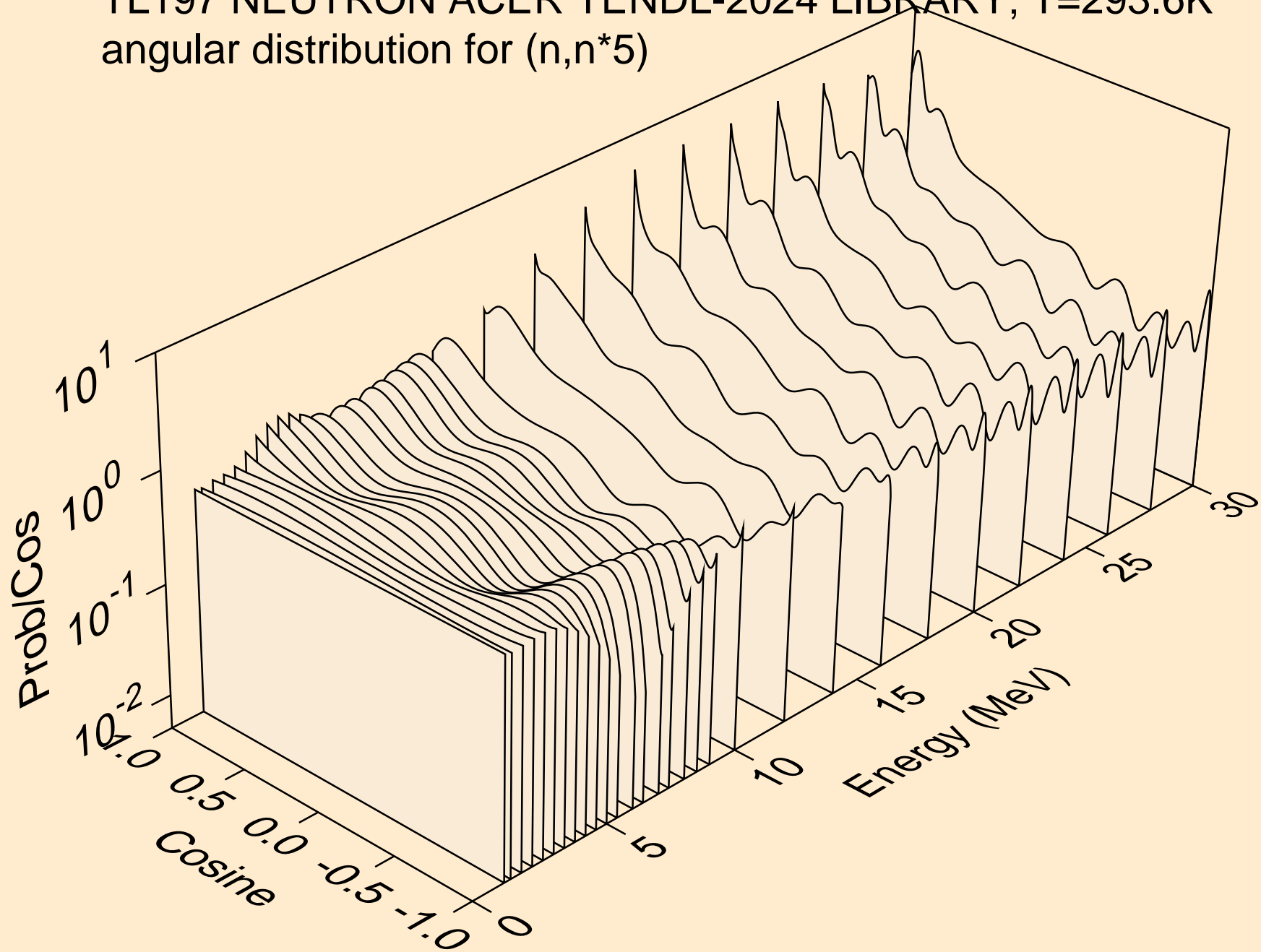

TL197 NEUTRON ACER TENDL-2024 LIBRARY; T=293.6K
angular distribution for (n,n*6)

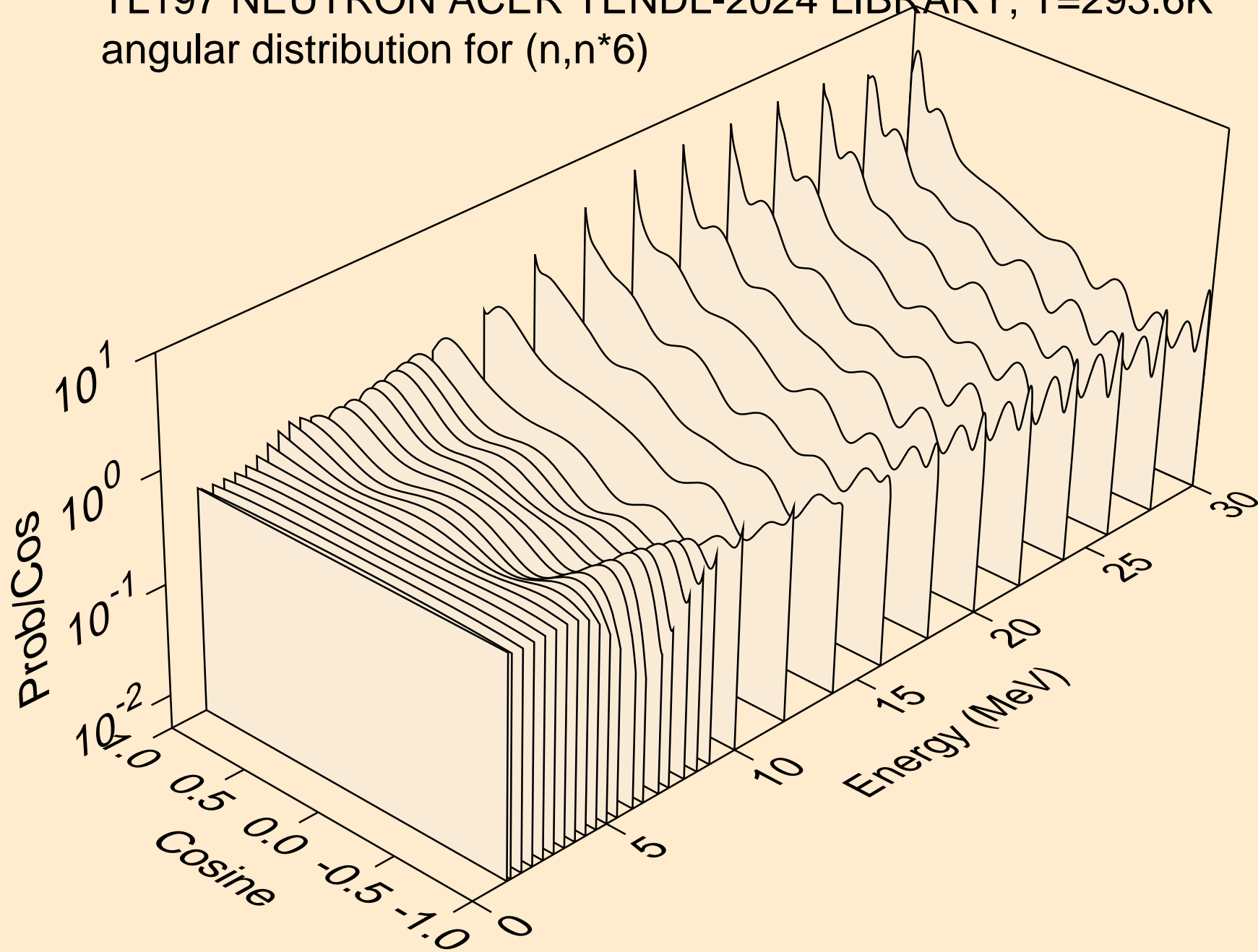

TL197 NEUTRON ACER TENDL-2024 LIBRARY; T=293.6K
angular distribution for (n,n*7)

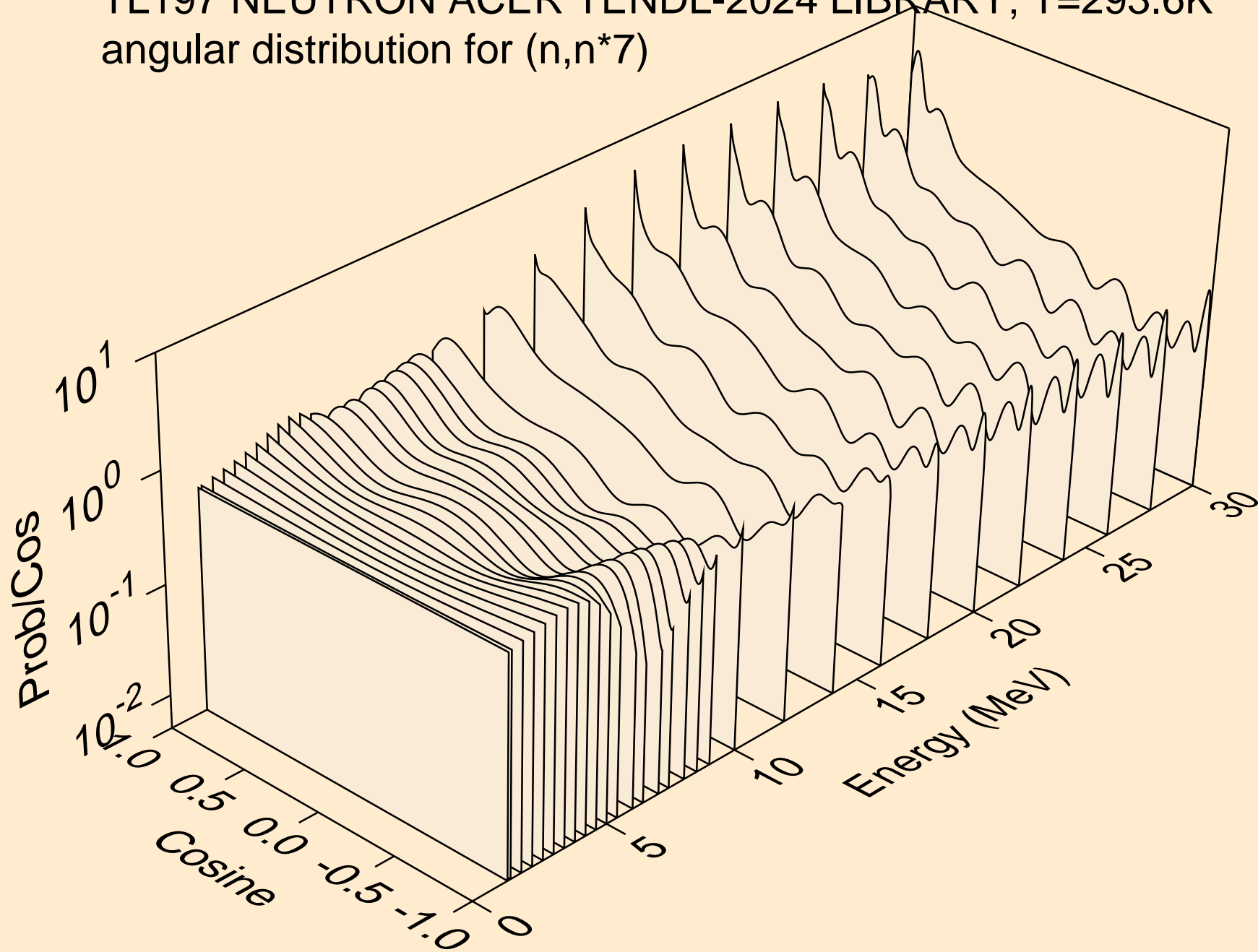

TL197 NEUTRON ACER TENDL-2024 LIBRARY; T=293.6K
angular distribution for (n,n*8)

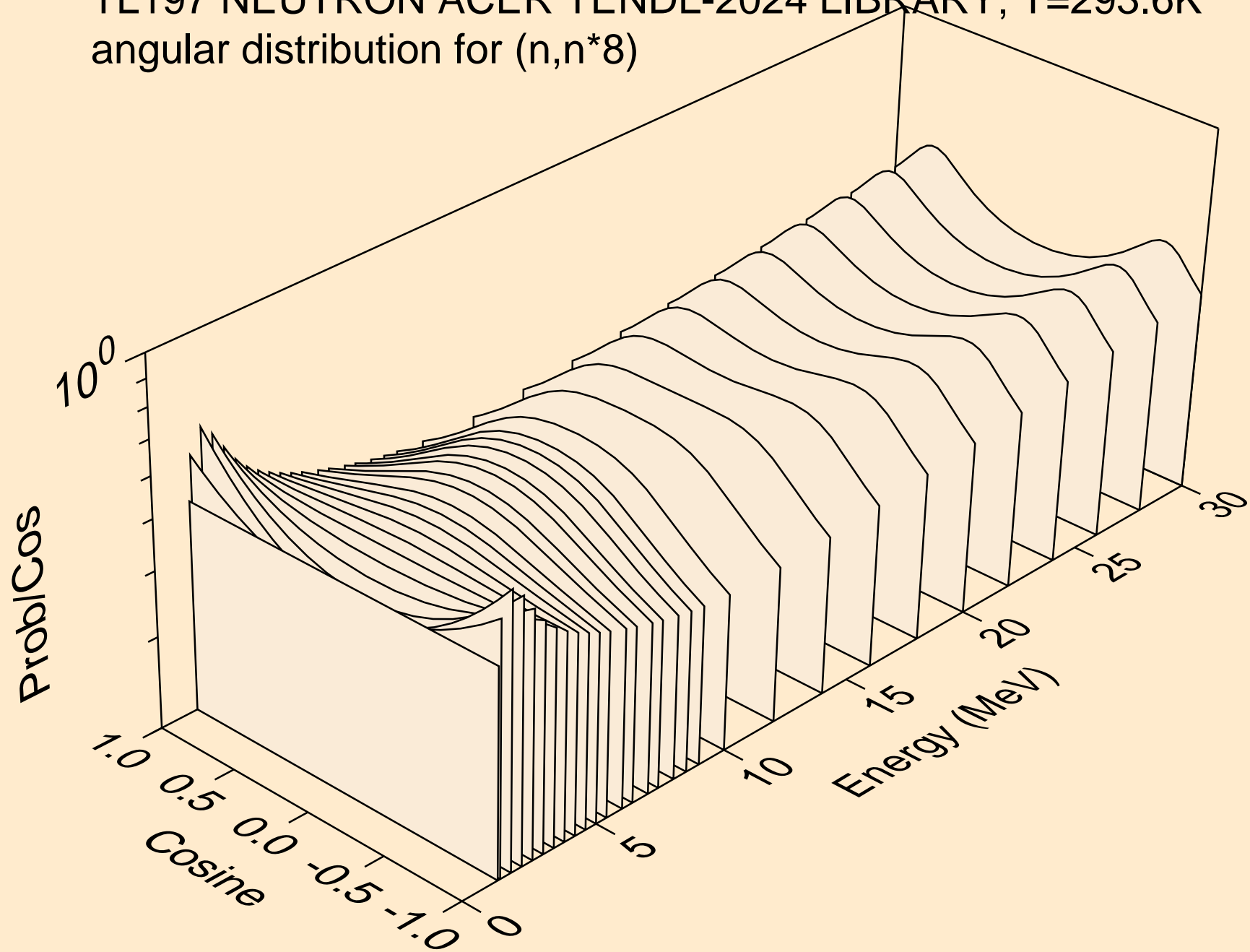

TL197 NEUTRON ACER TENDL-2024 LIBRARY; T=293.6K
angular distribution for (n,n*9)

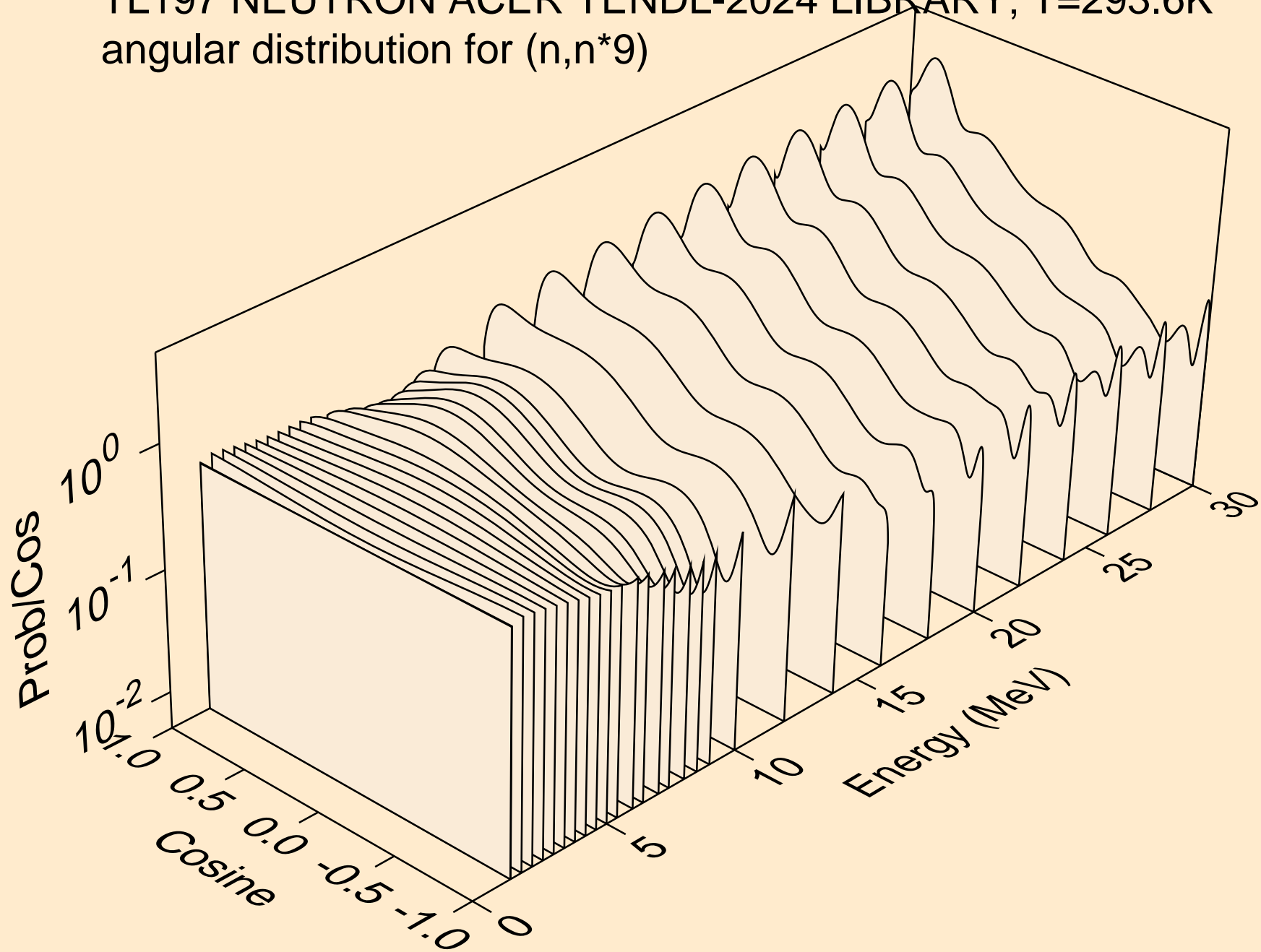

TL197 NEUTRON ACER TENDL-2024 LIBRARY; T=293.6K
angular distribution for (n,n*10)

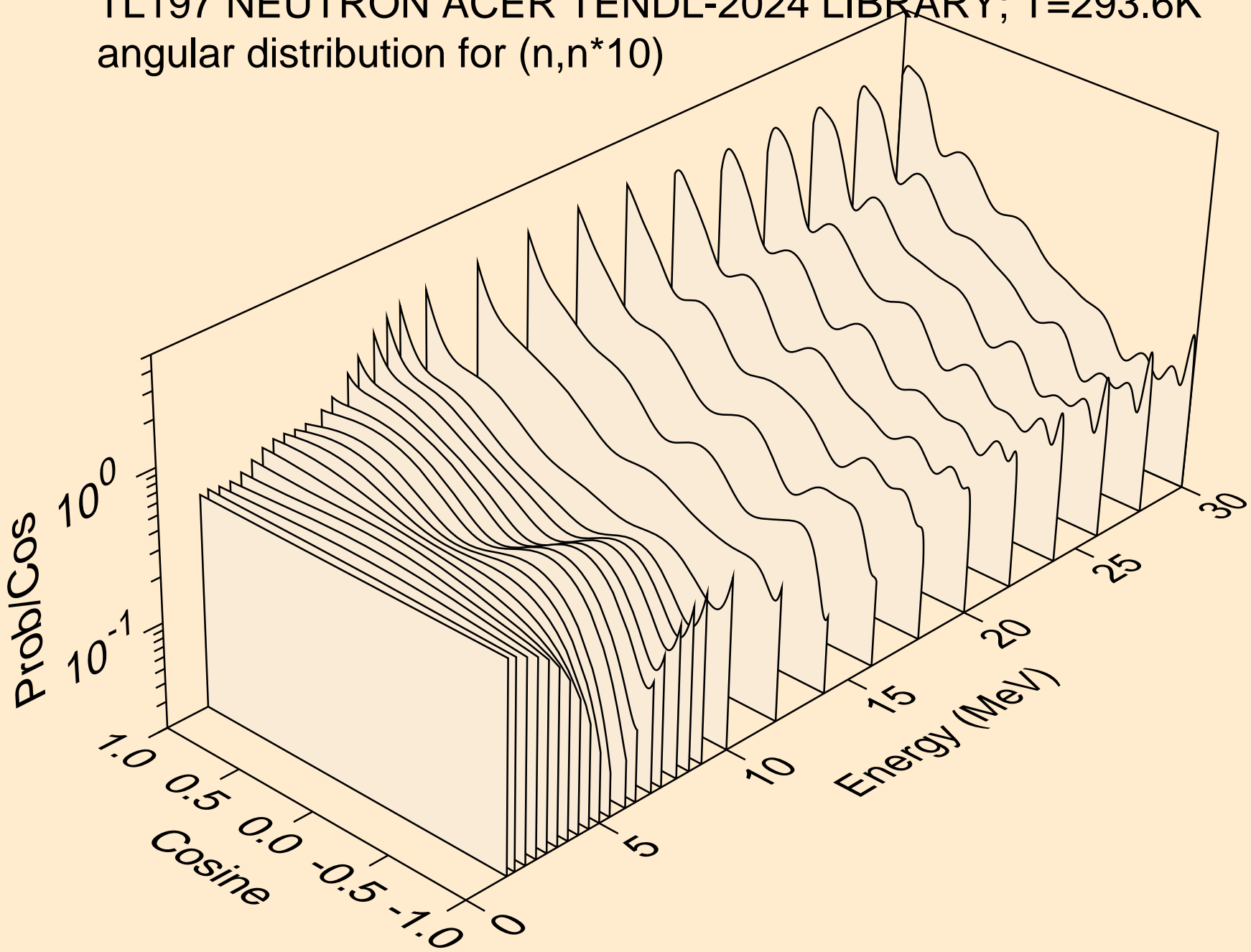

TL197 NEUTRON ACER TENDL-2024 LIBRARY; T=293.6K
angular distribution for (n,n*11)

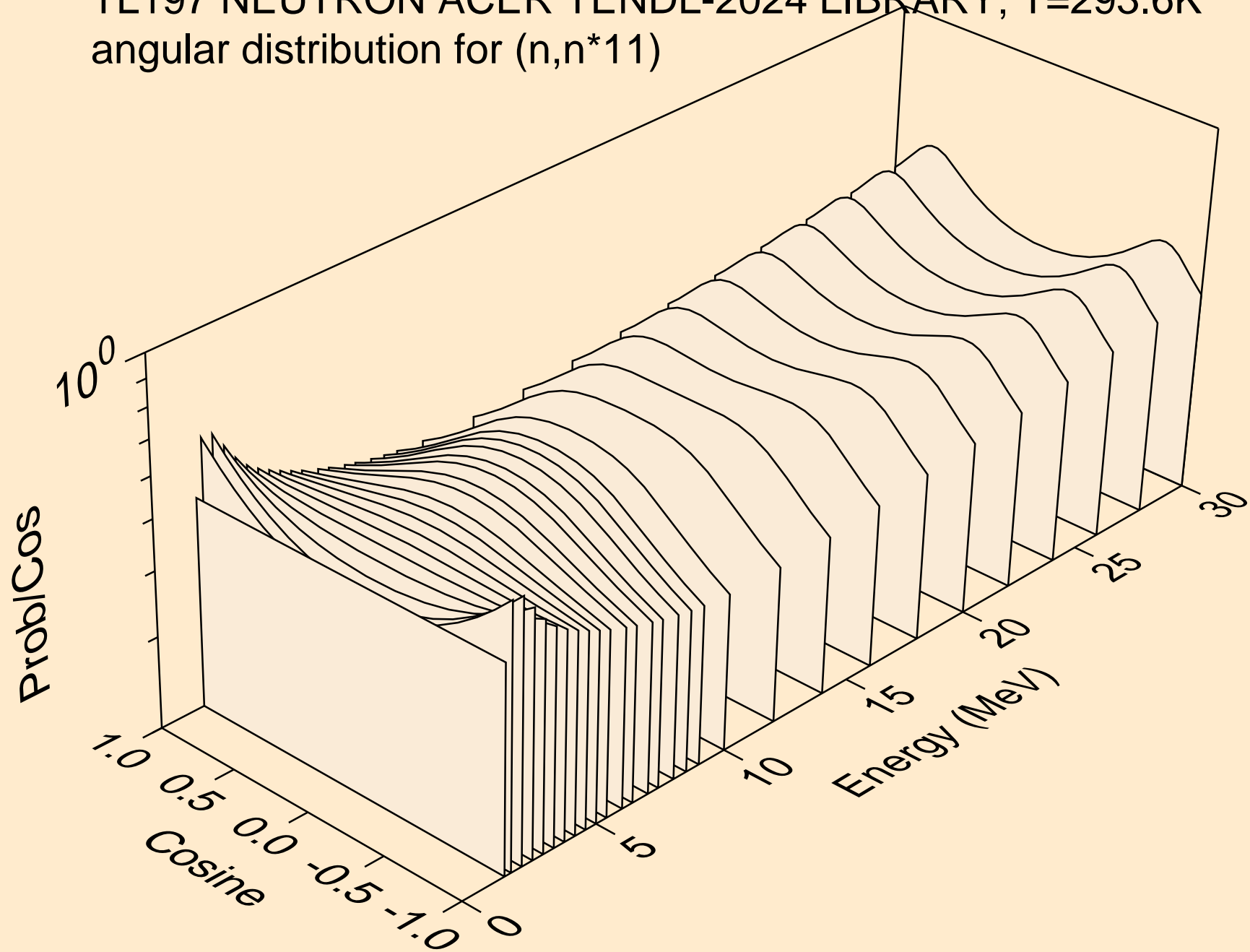

TL197 NEUTRON ACER TENDL-2024 LIBRARY; T=293.6K
angular distribution for (n,n*12)

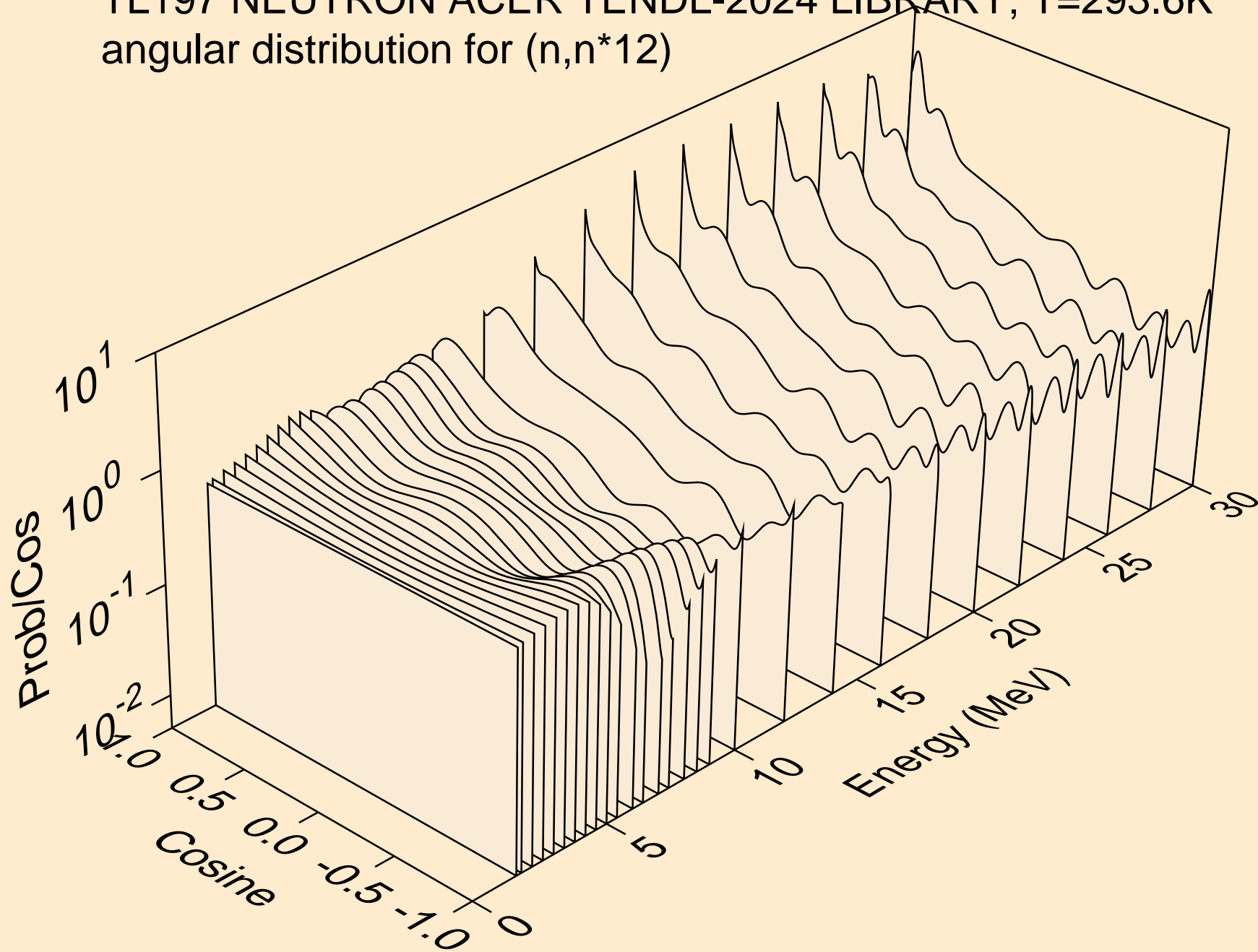

TL197 NEUTRON ACER TENDL-2024 LIBRARY; T=293.6K
angular distribution for (n,n*13)

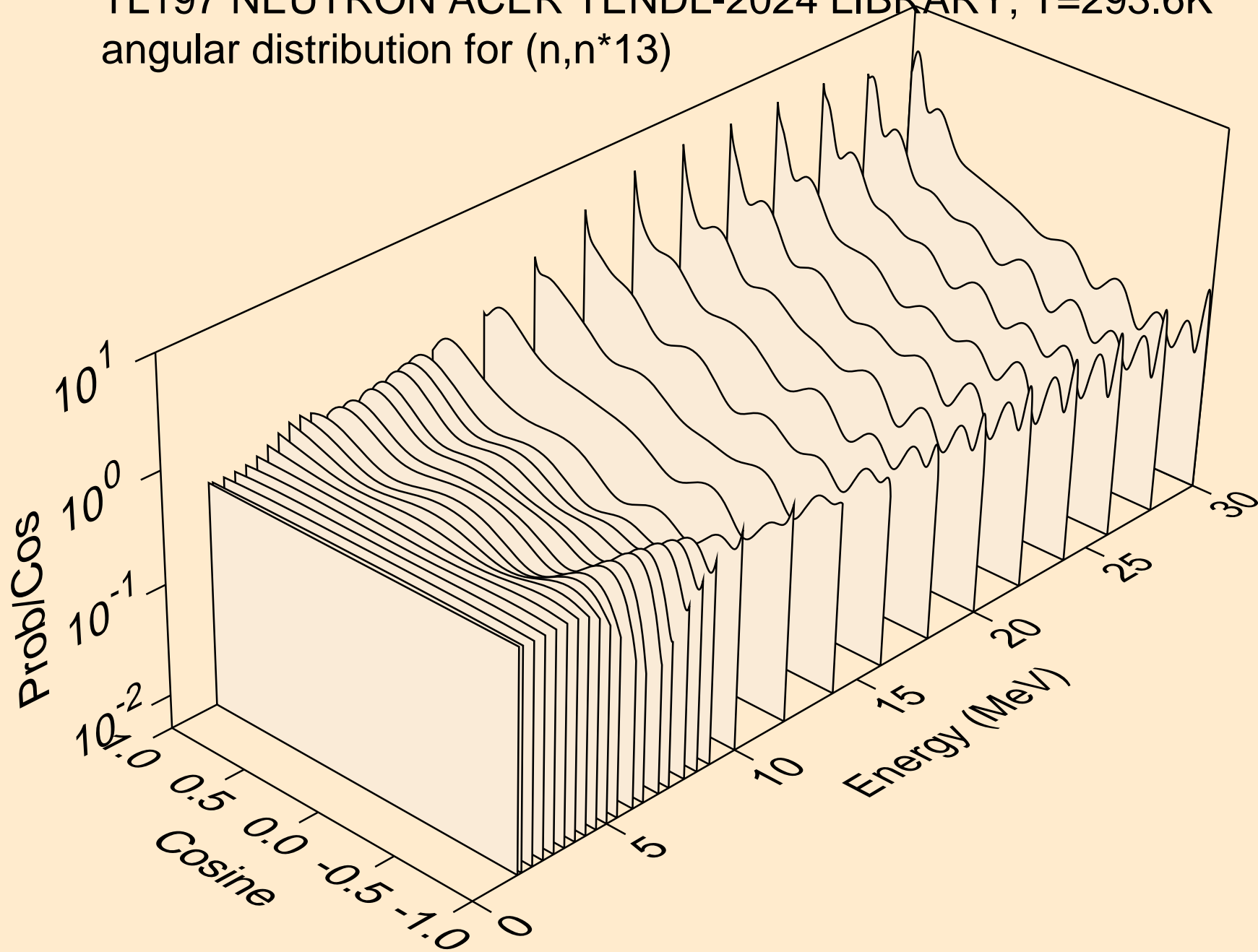

TL197 NEUTRON ACER TENDL-2024 LIBRARY; T=293.6K
angular distribution for (n,n*14)

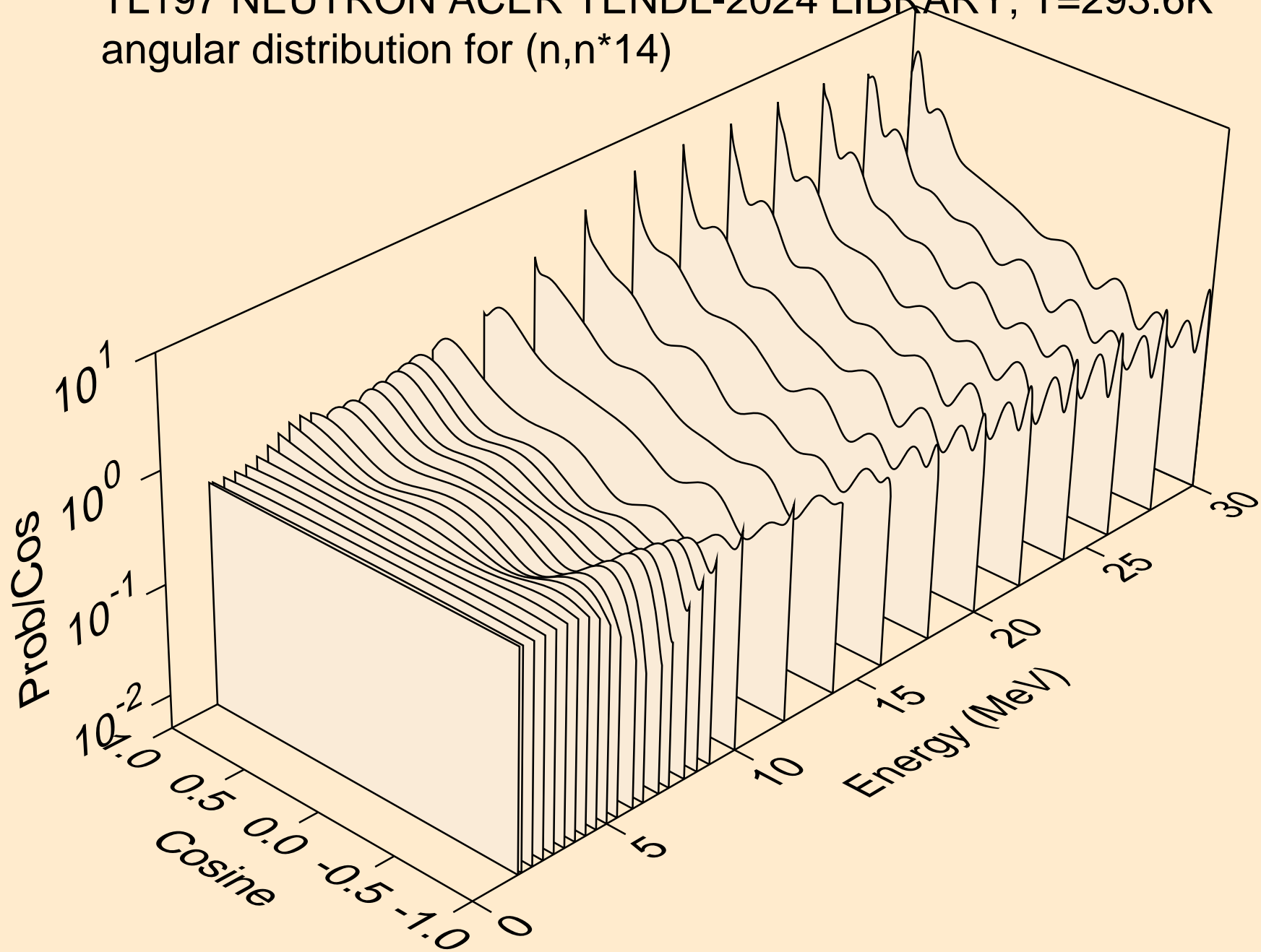

TL197 NEUTRON ACER TENDL-2024 LIBRARY; T=293.6K
angular distribution for (n,n*15)

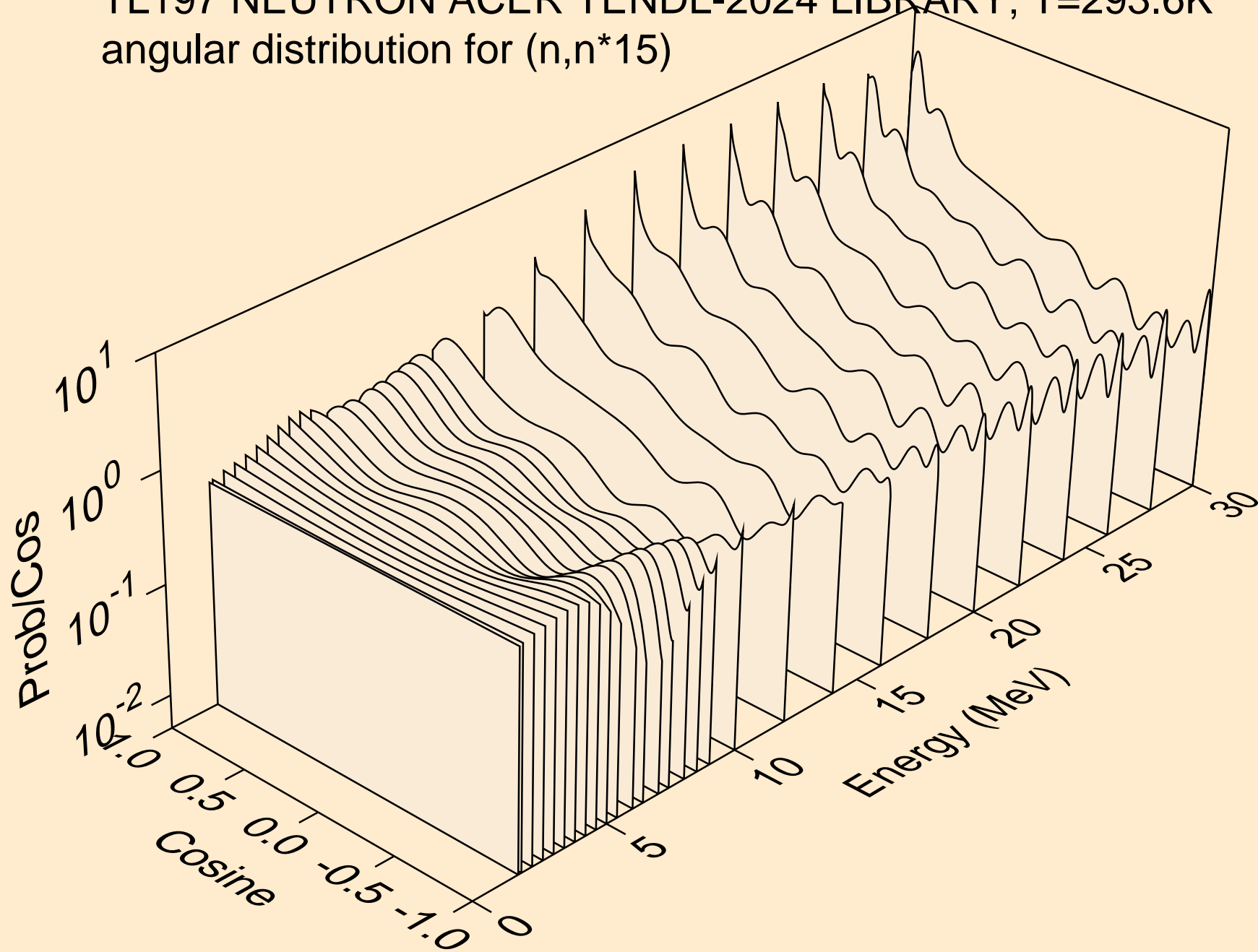

TL197 NEUTRON ACER TENDL-2024 LIBRARY; T=293.6K
angular distribution for (n,n*16)

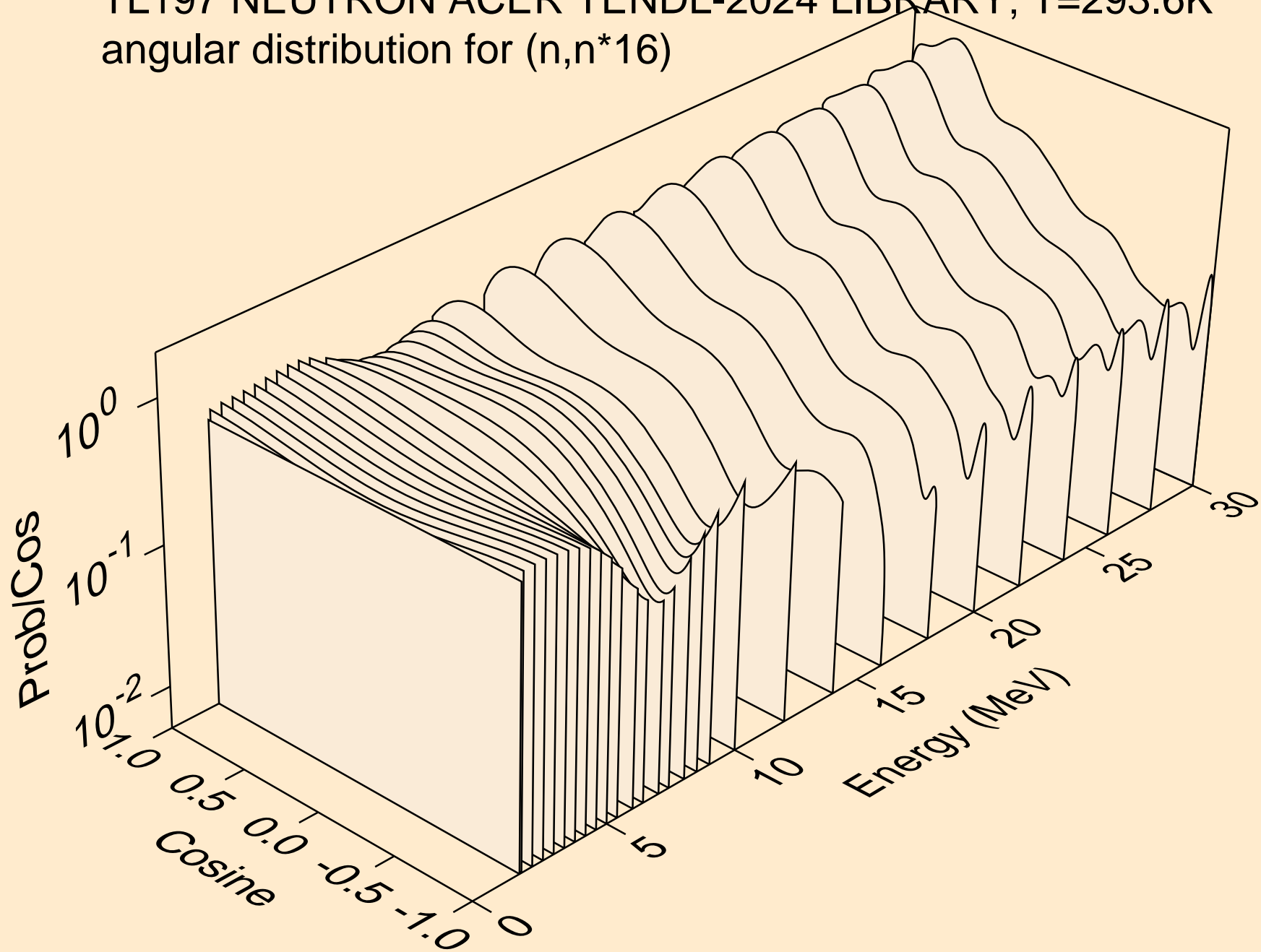

TL197 NEUTRON ACER TENDL-2024 LIBRARY; T=293.6K
angular distribution for (n,n*17)

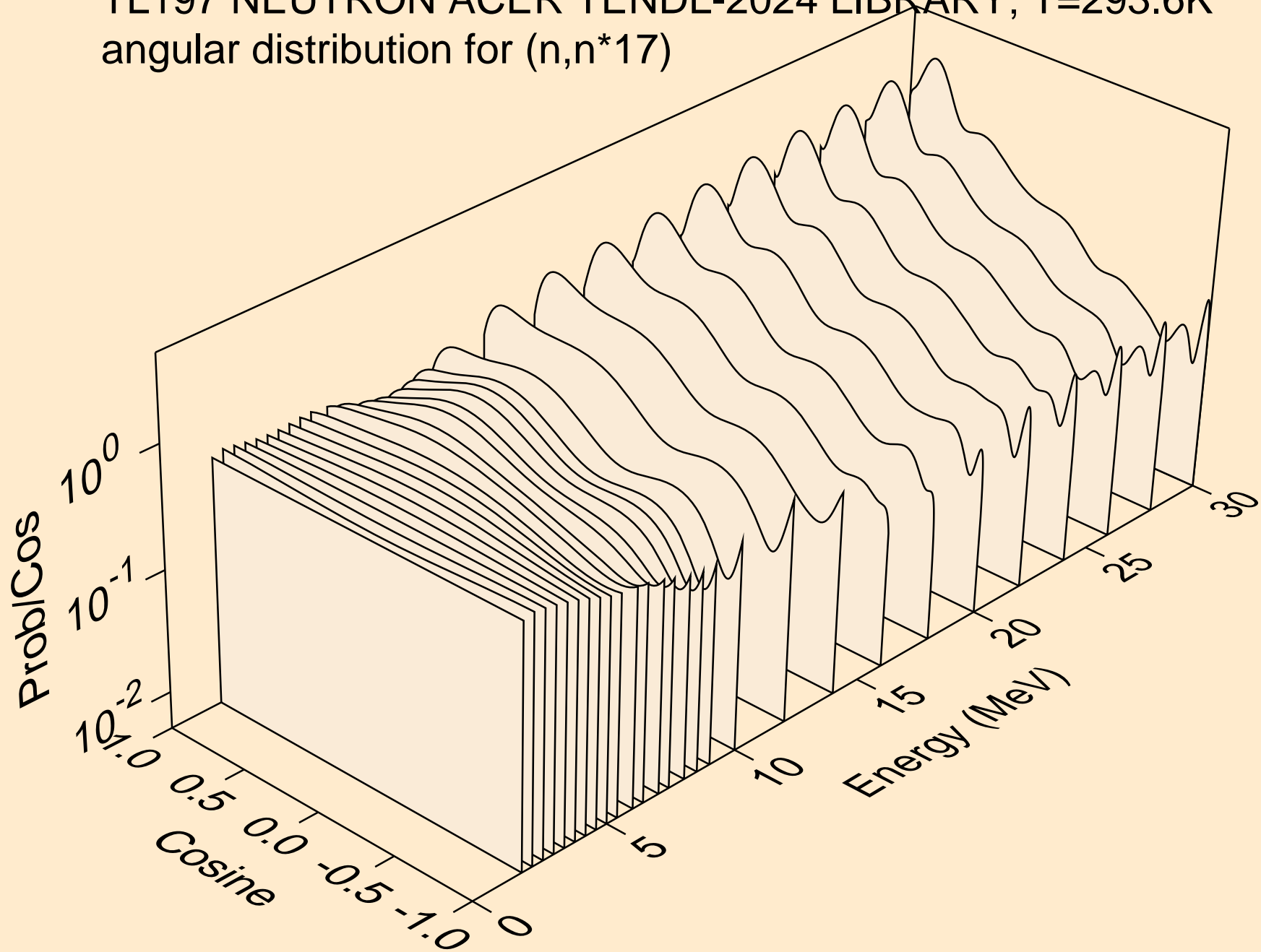

TL197 NEUTRON ACER TENDL-2024 LIBRARY; T=293.6K
angular distribution for (n,n*18)

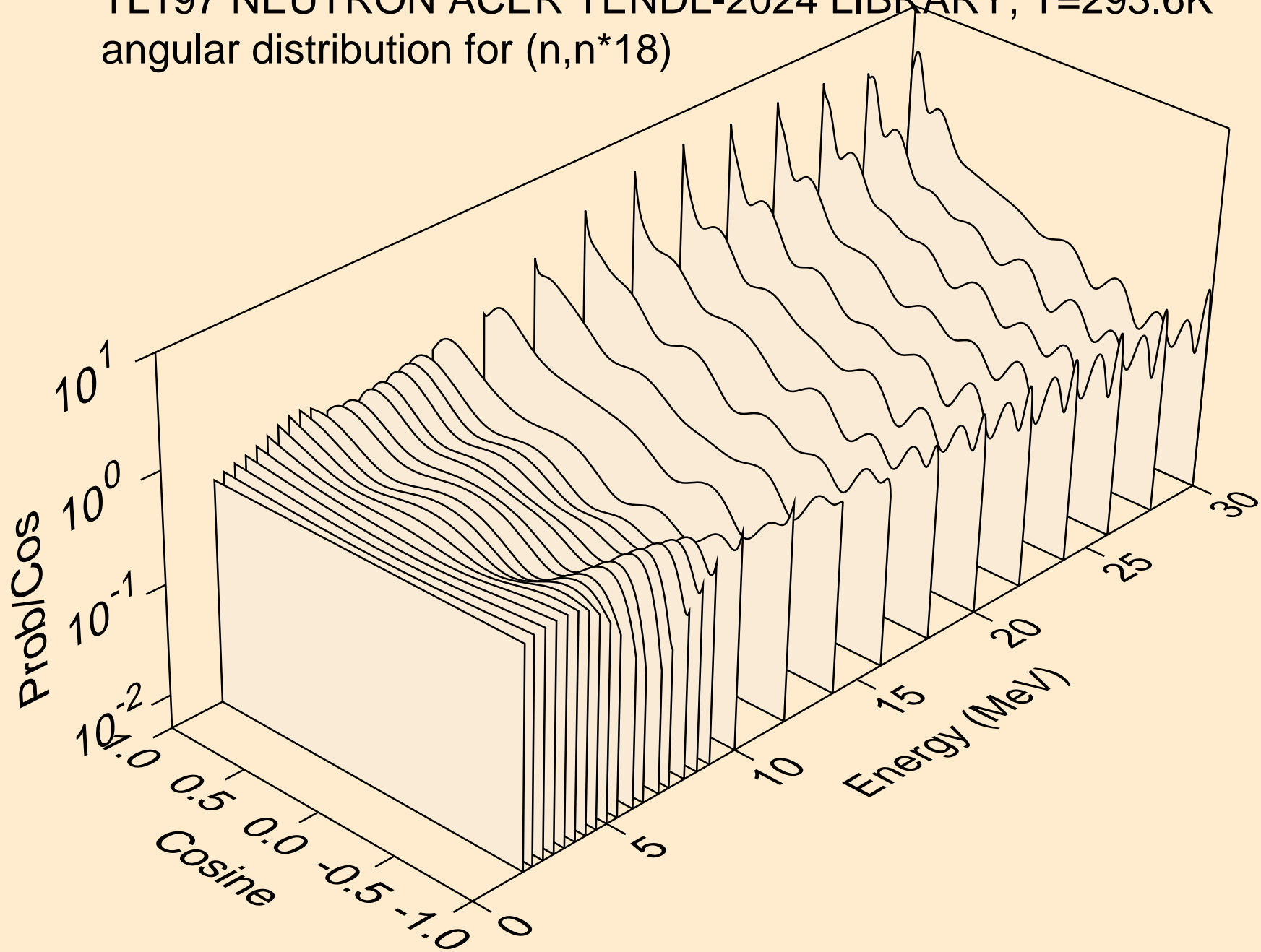

TL197 NEUTRON ACER TENDL-2024 LIBRARY; T=293.6K
angular distribution for (n,n*19)

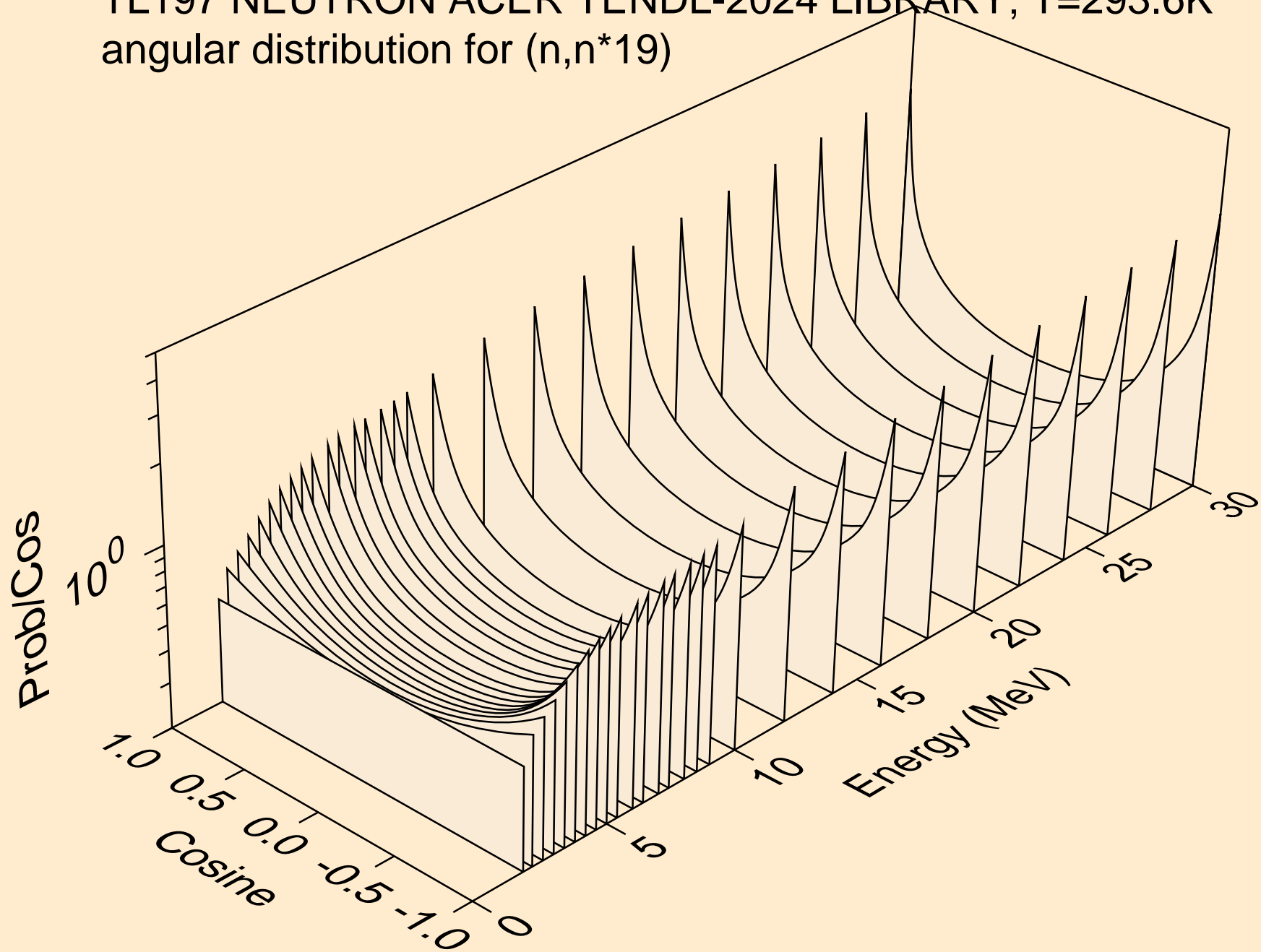

TL197 NEUTRON ACER TENDL-2024 LIBRARY; T=293.6K
angular distribution for (n,n*20)

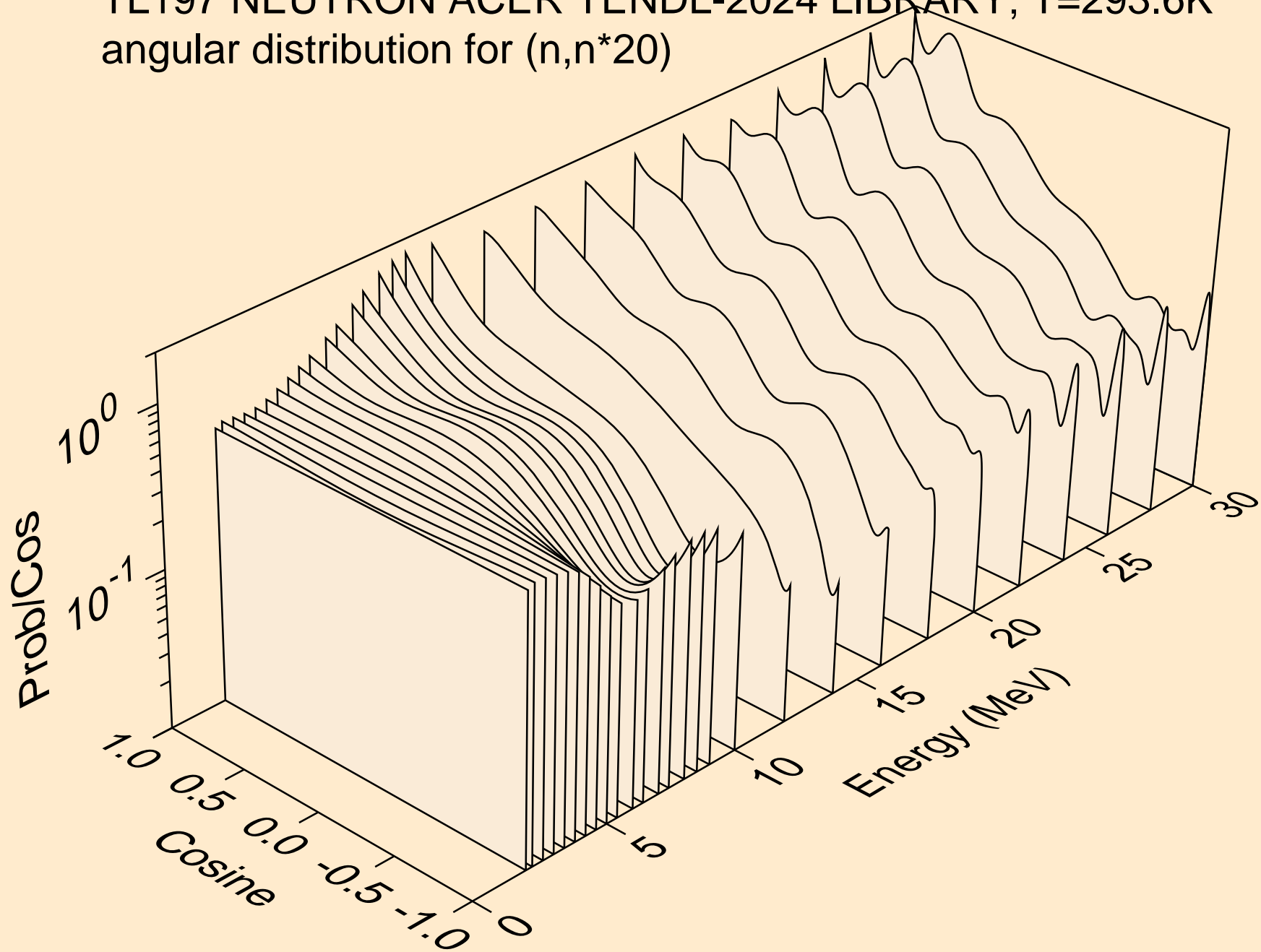

TL197 NEUTRON ACER TENDL-2024 LIBRARY; T=293.6K
angular distribution for (n,n*21)

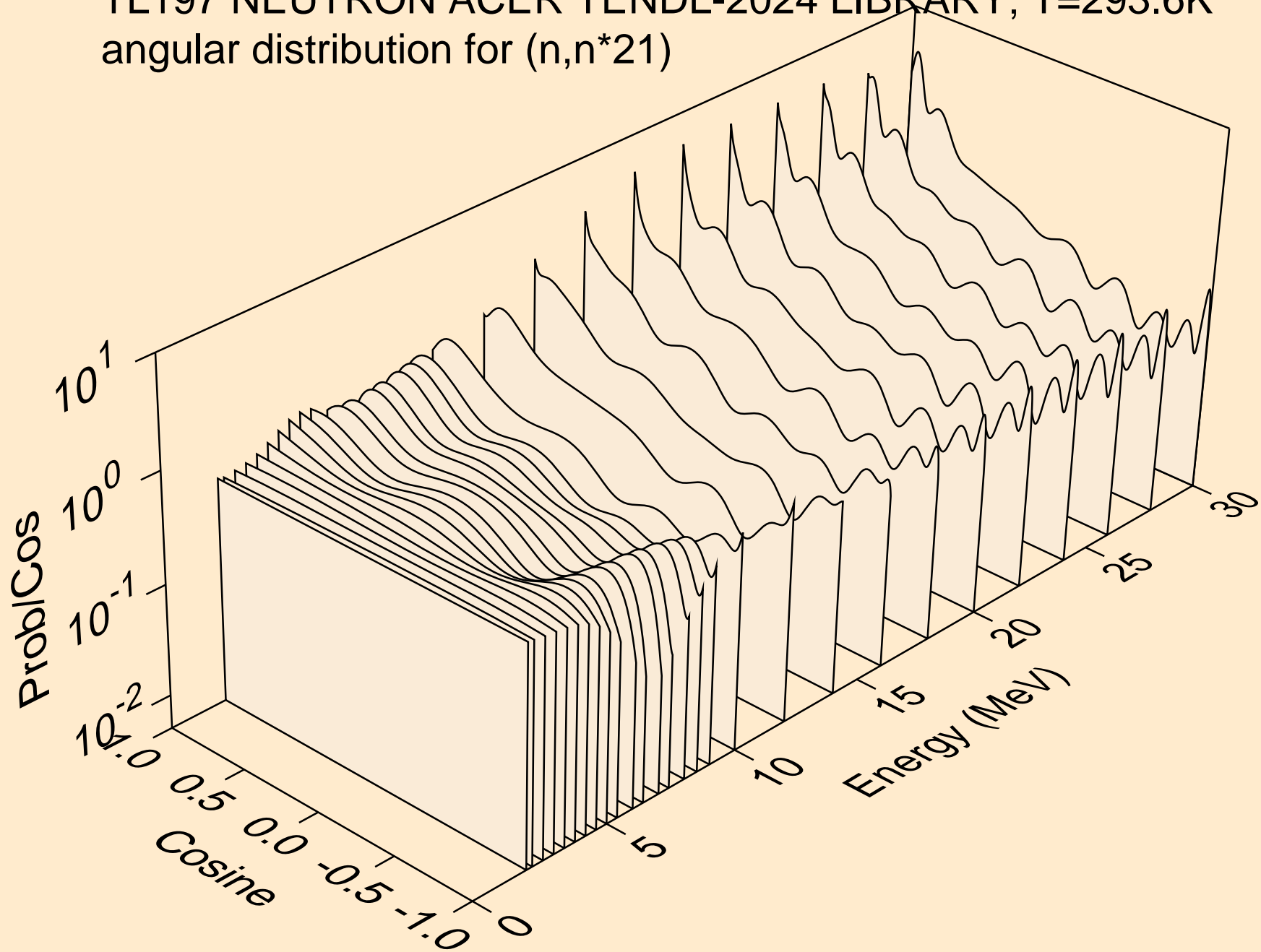

TL197 NEUTRON ACER TENDL-2024 LIBRARY; T=293.6K
angular distribution for (n,n*22)

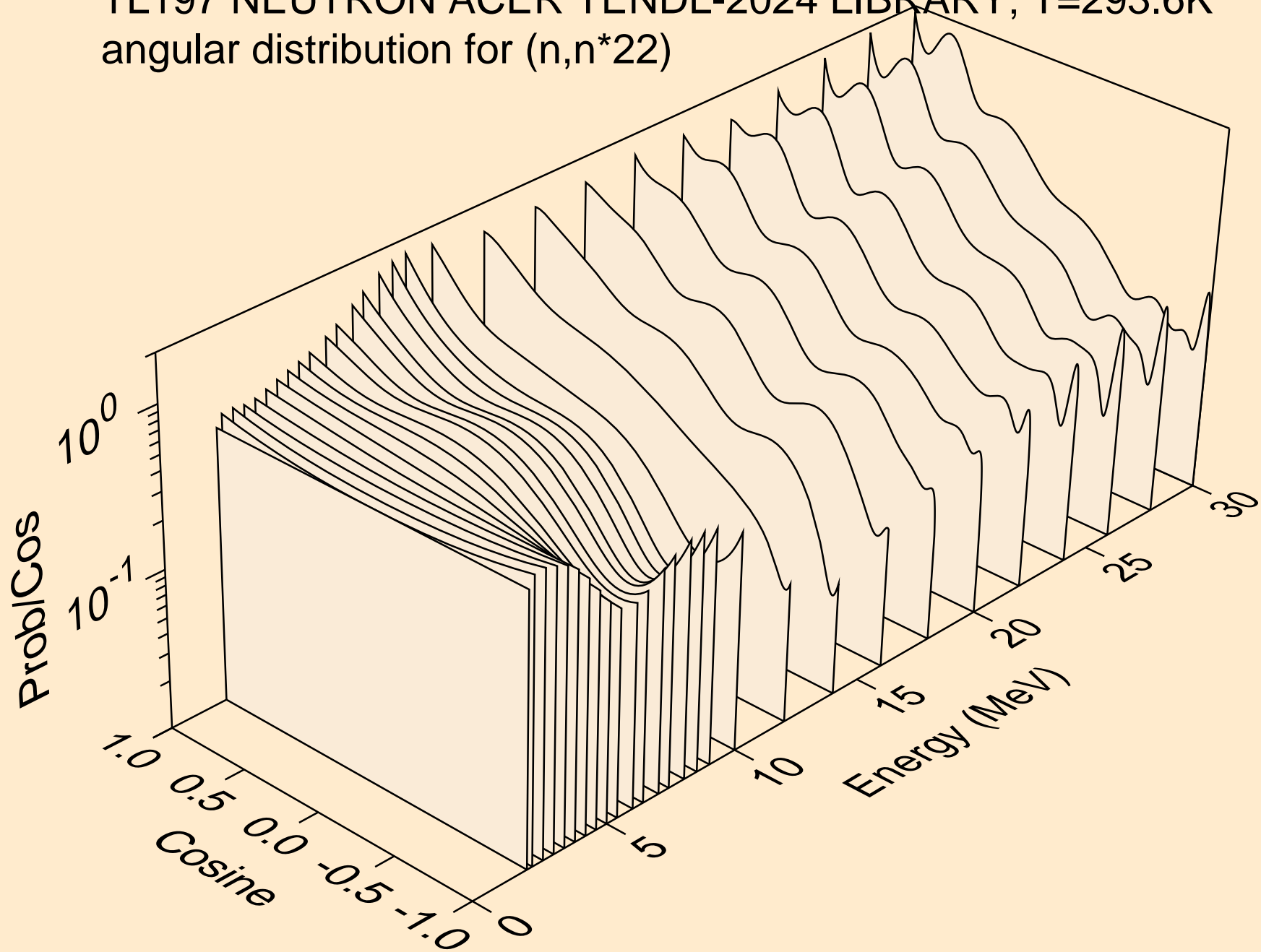

TL197 NEUTRON ACER TENDL-2024 LIBRARY; T=293.6K
angular distribution for (n,n*23)

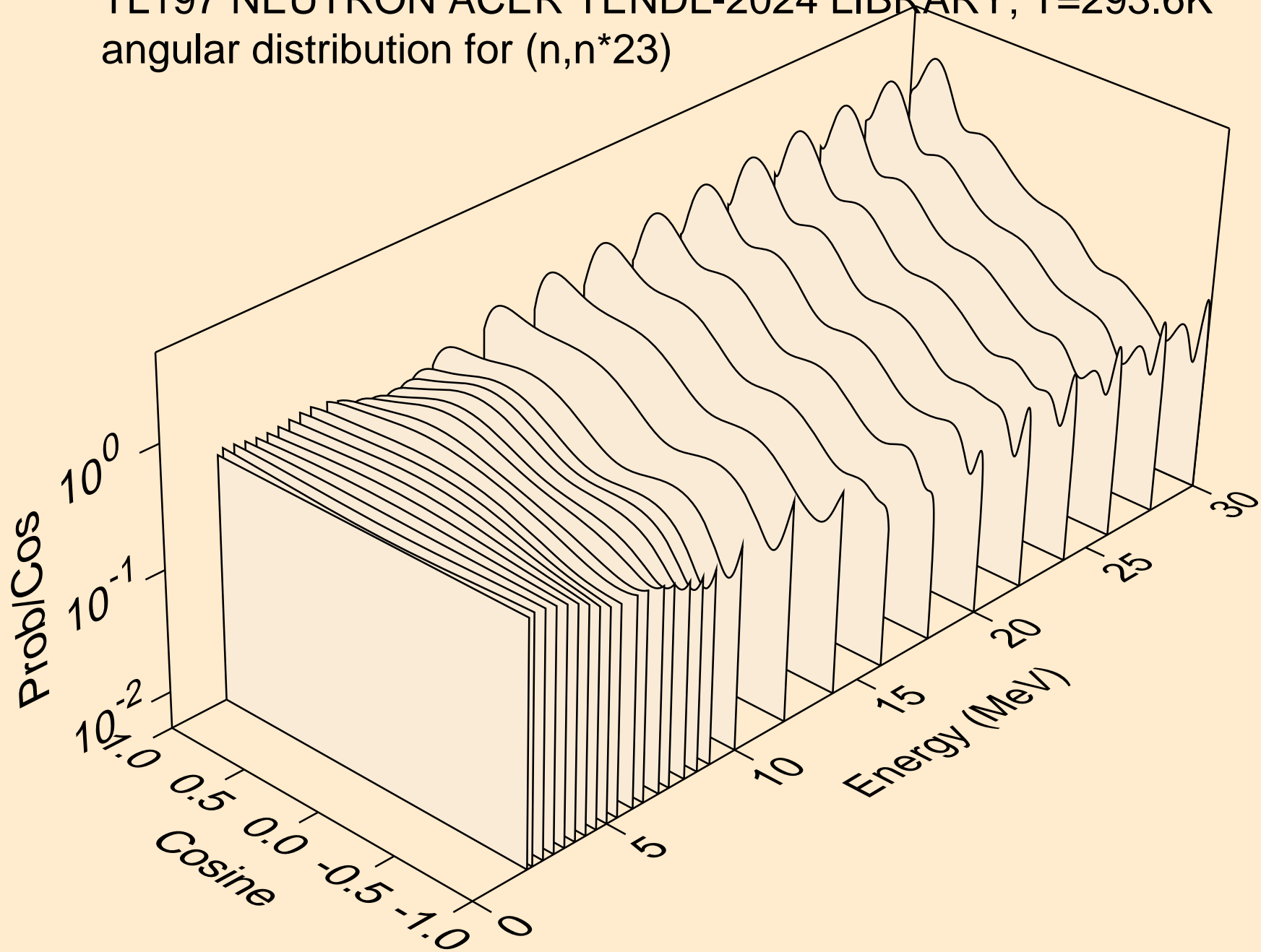

TL197 NEUTRON ACER TENDL-2024 LIBRARY; T=293.6K
angular distribution for (n,n*24)

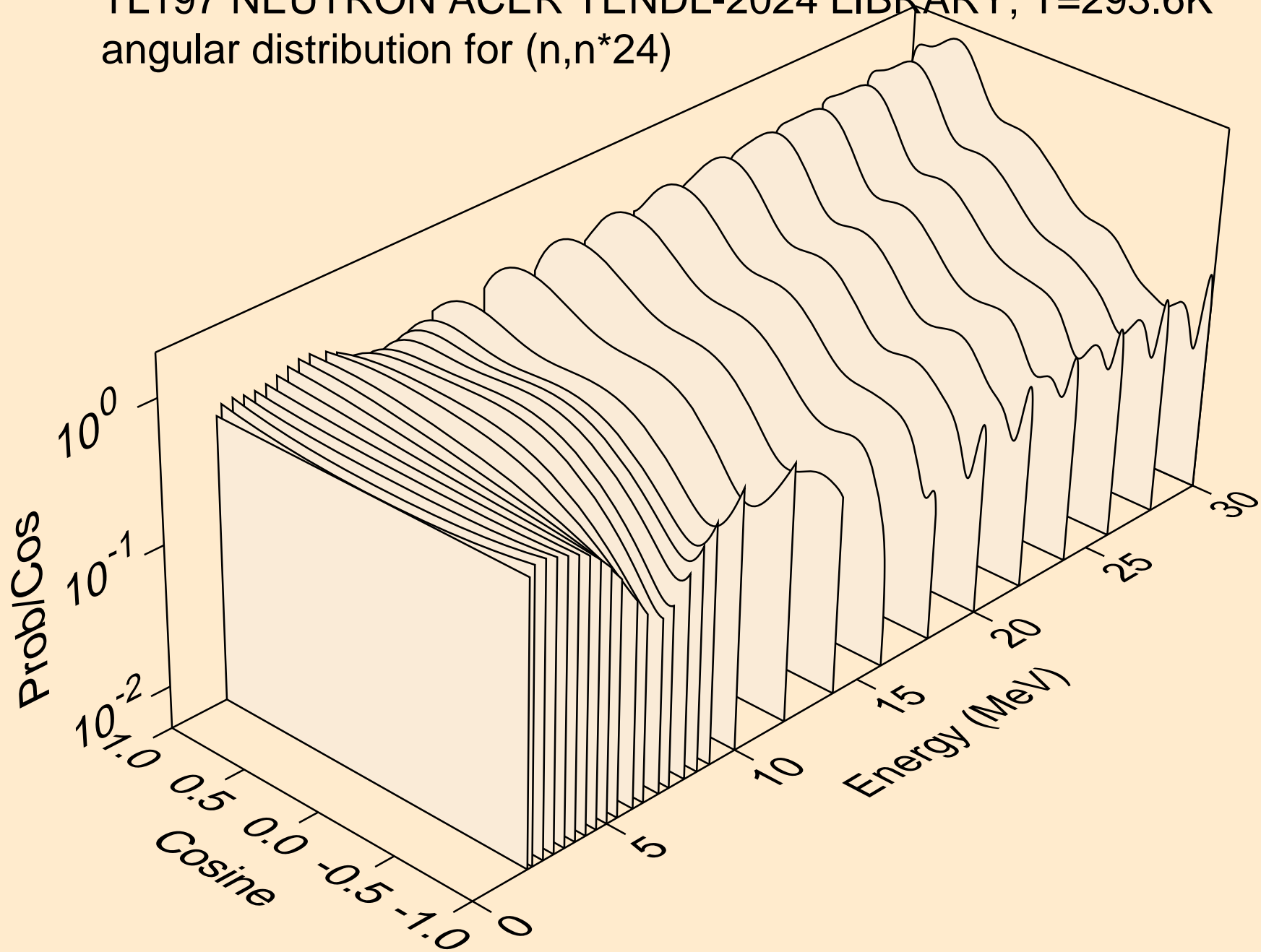

TL197 NEUTRON ACER TENDL-2024 LIBRARY; T=293.6K
angular distribution for (n,n*25)

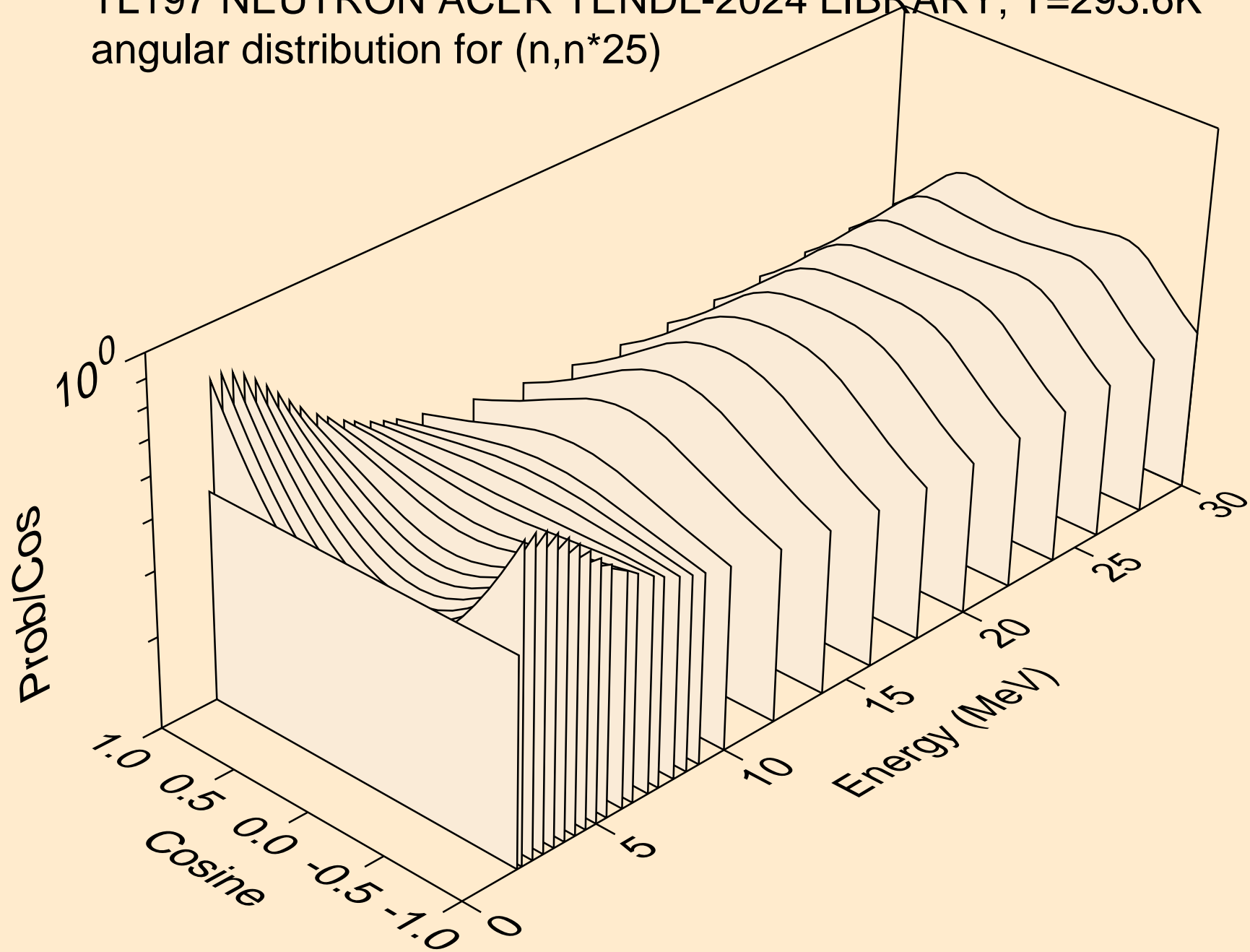

TL197 NEUTRON ACER TENDL-2024 LIBRARY; T=293.6K
angular distribution for (n,n*26)

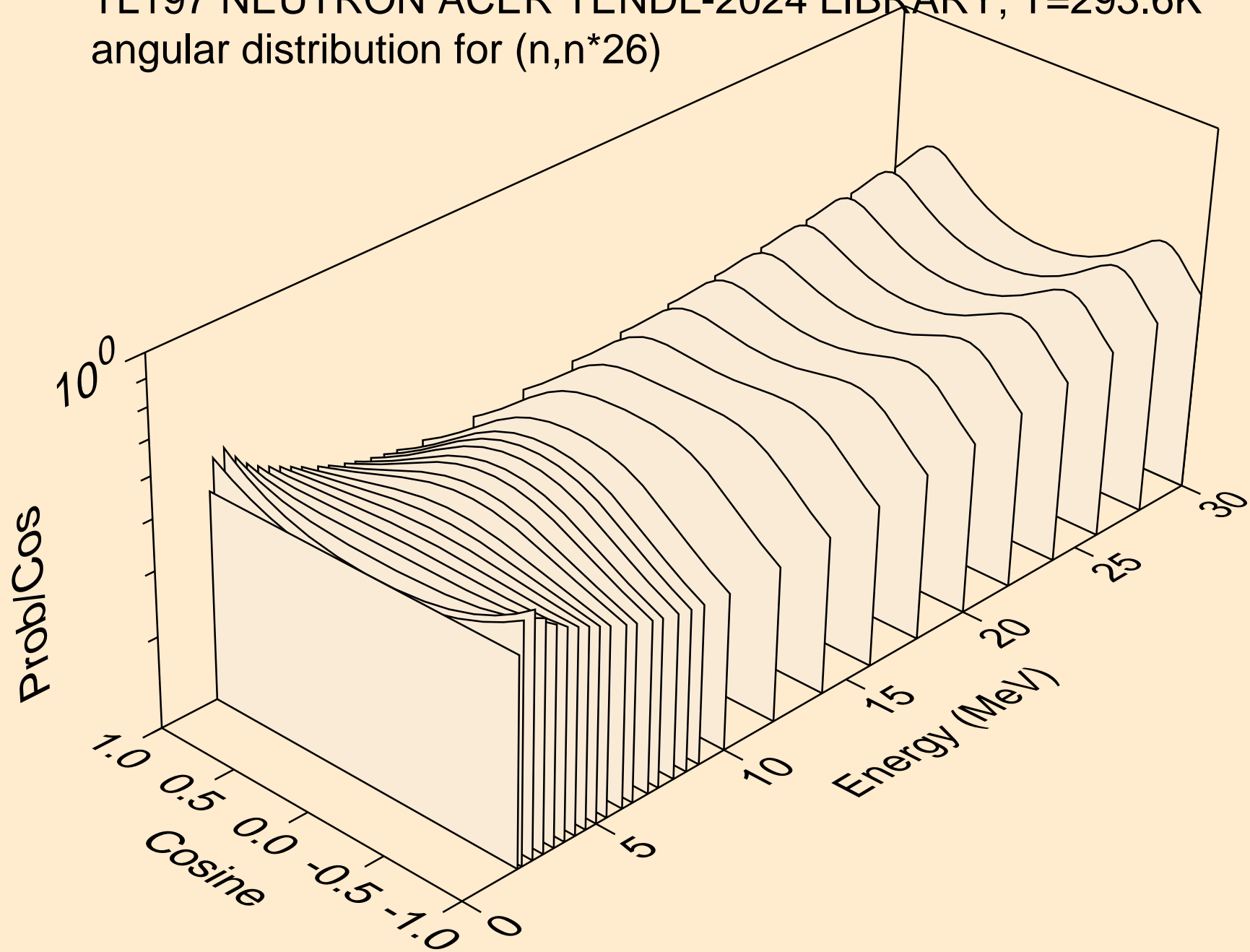

TL197 NEUTRON ACER TENDL-2024 LIBRARY; T=293.6K
angular distribution for (n,n*27)

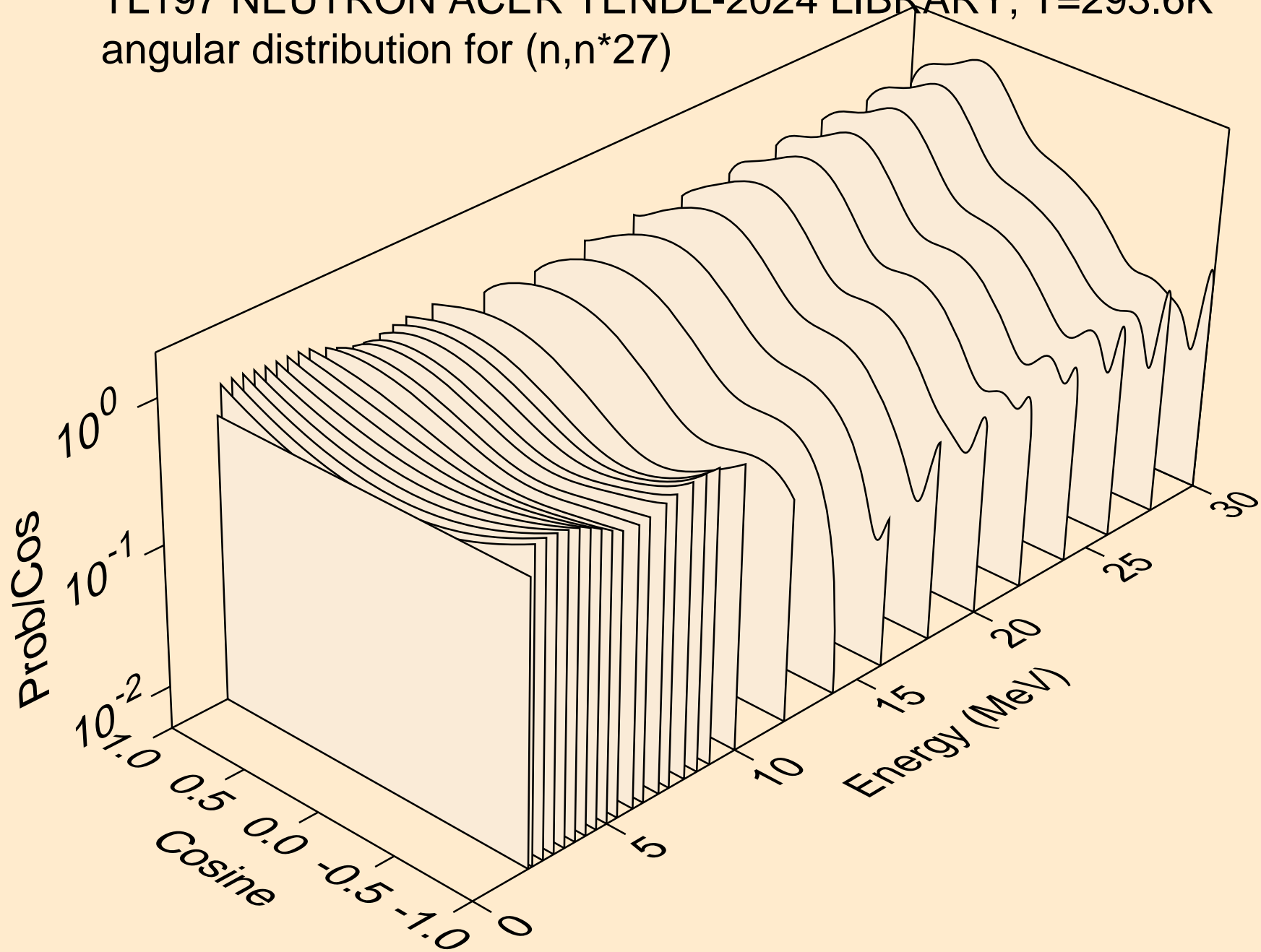

TL197 NEUTRON ACER TENDL-2024 LIBRARY; T=293.6K
angular distribution for (n,n*28)

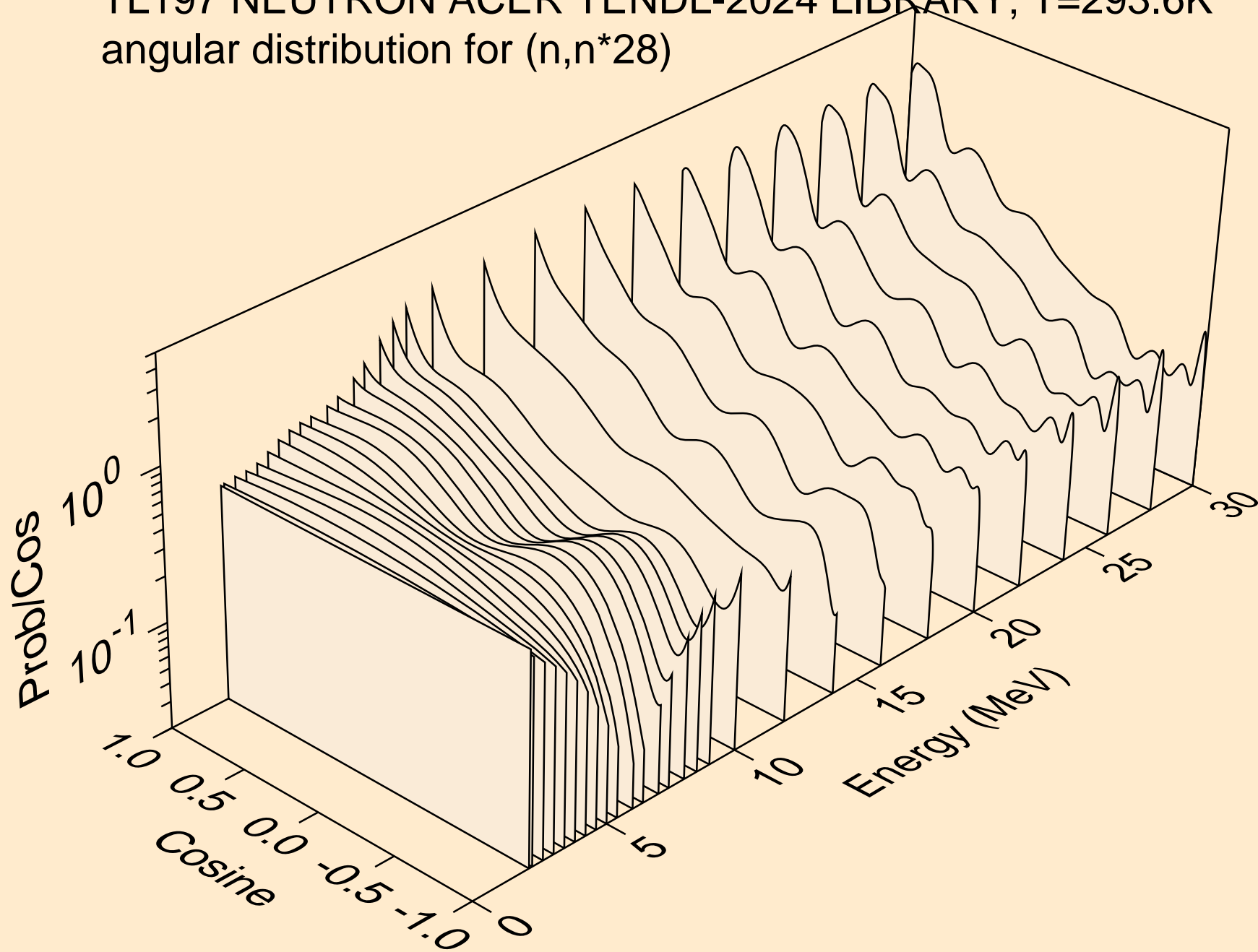

TL197 NEUTRON ACER TENDL-2024 LIBRARY; T=293.6K
Neutron emission for (n,x)

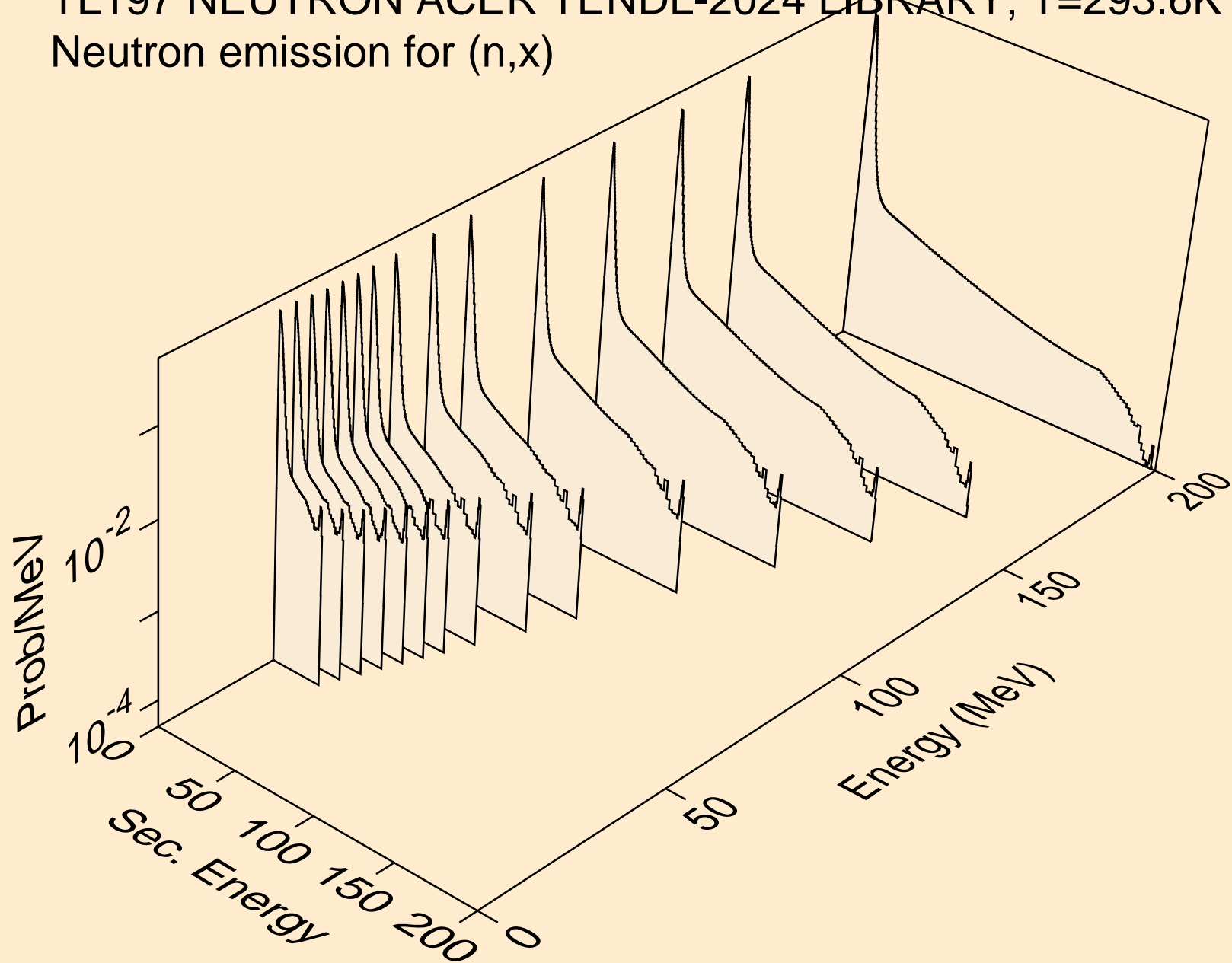

TL197 NEUTRON ACER TENDL-2024 LIBRARY; T=293.6K
Neutron emission for (n,2nd)

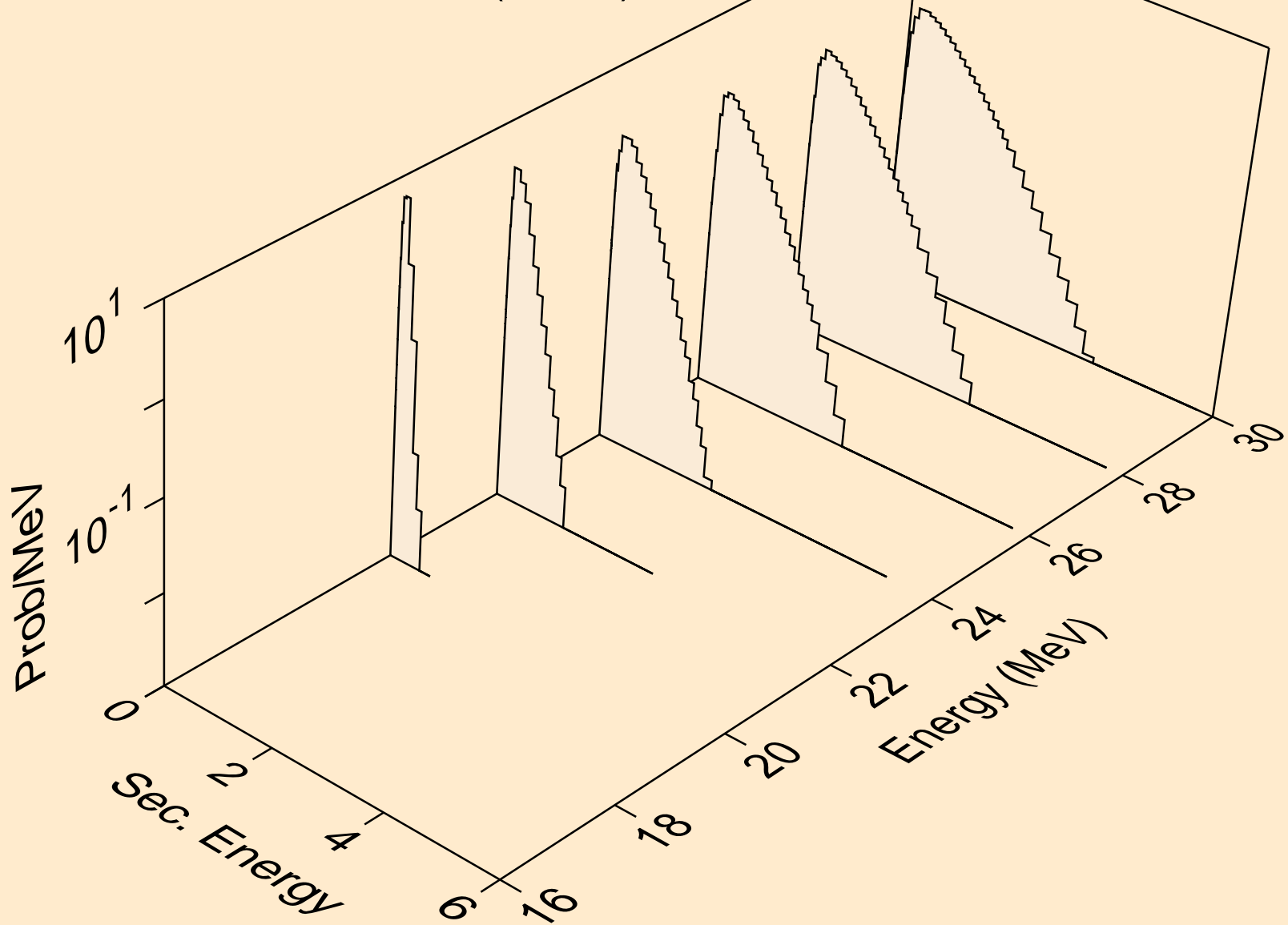

TL197 NEUTRON ACER TENDL-2024 LIBRARY; T=293.6K
Neutron emission for (n,2n)

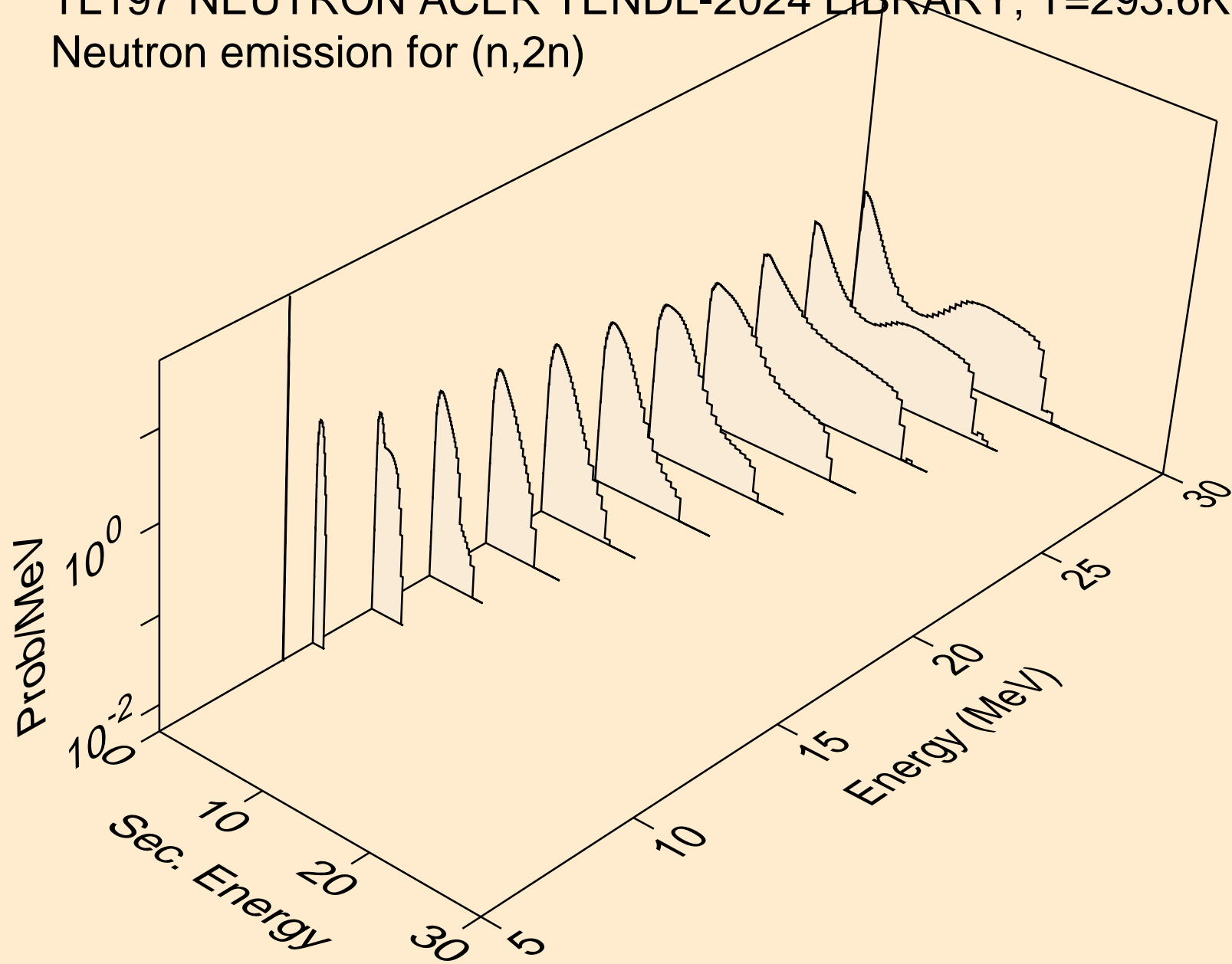

TL197 NEUTRON ACER TENDL-2024 LIBRARY; T=293.6K
Neutron emission for (n,3n)

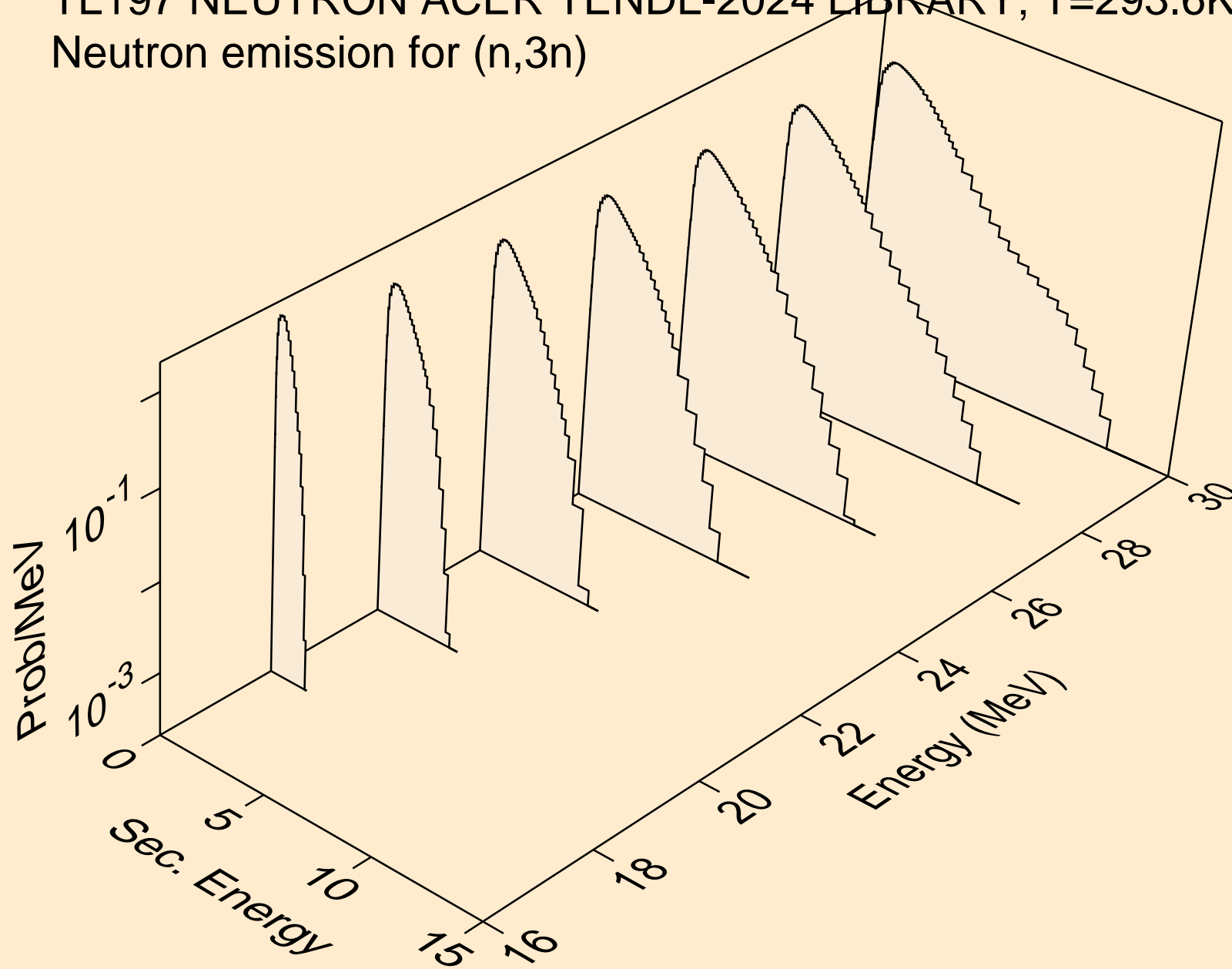

TL197 NEUTRON ACER TENDL-2024 LIBRARY; T=293.6K
Neutron emission for (n,n*)a

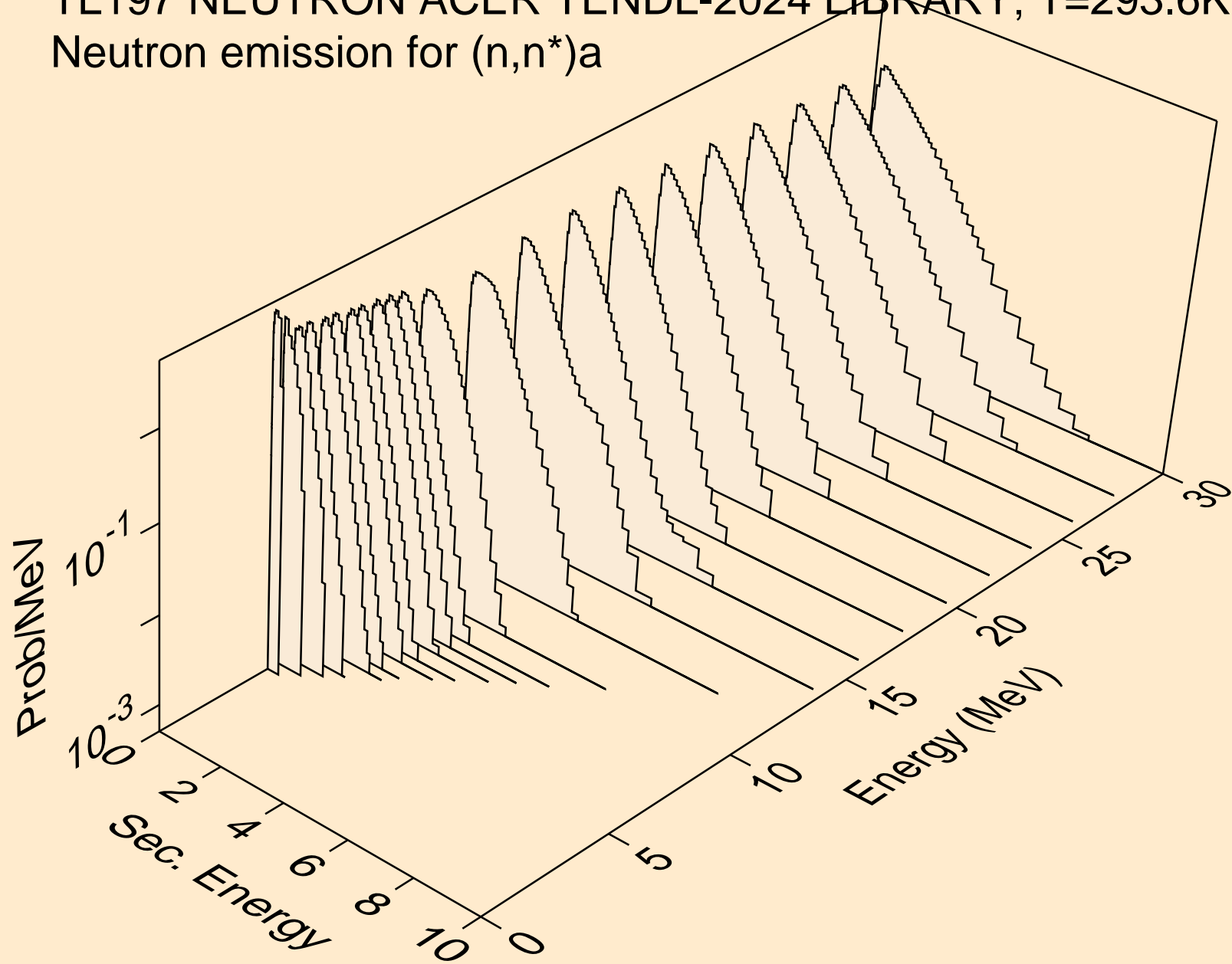

TL197 NEUTRON ACER TENDL-2024 LIBRARY; T=293.6K
Neutron emission for (n,2n)_a

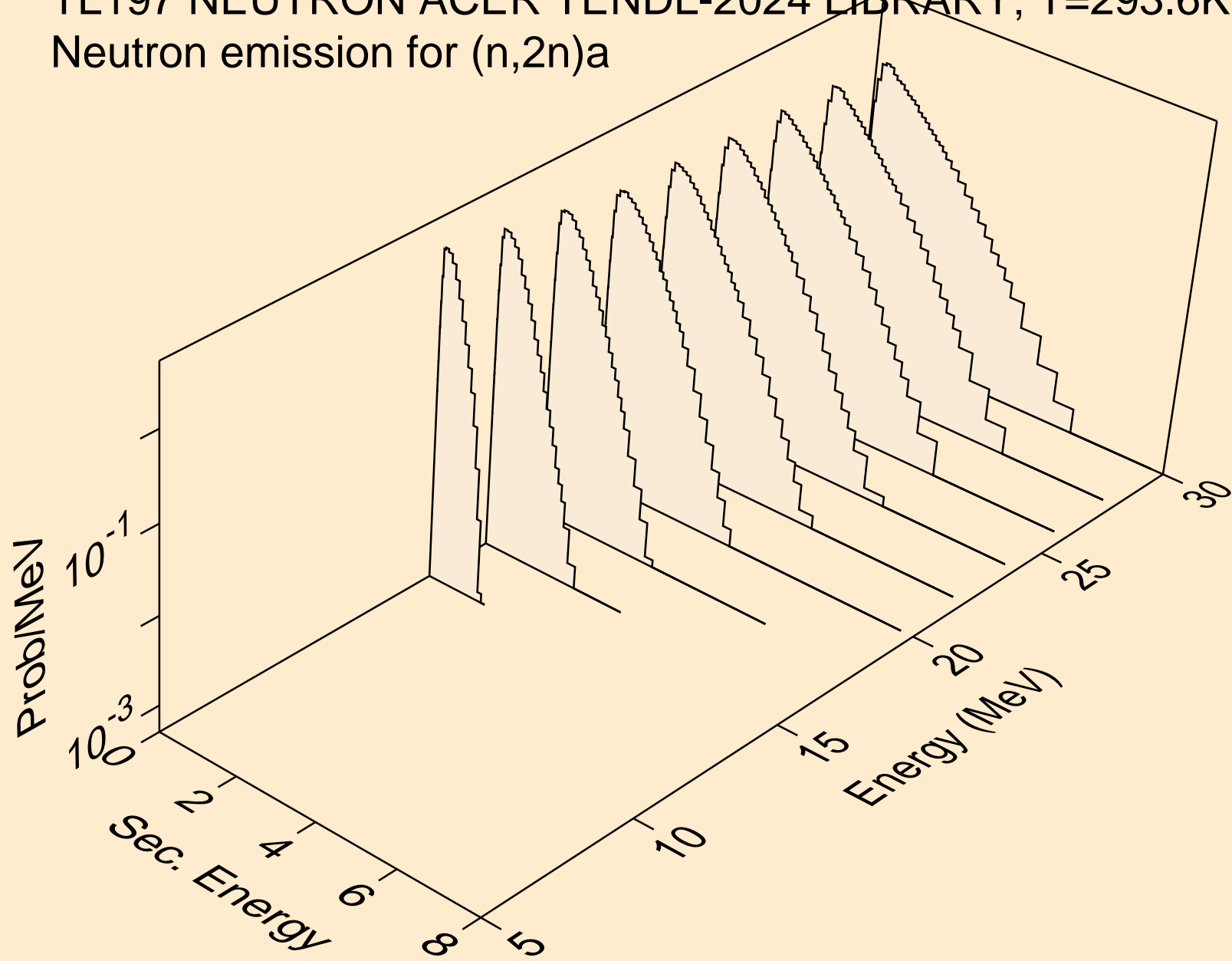

TL197 NEUTRON ACER TENDL-2024 LIBRARY; T=293.6K
Neutron emission for (n,3n)a

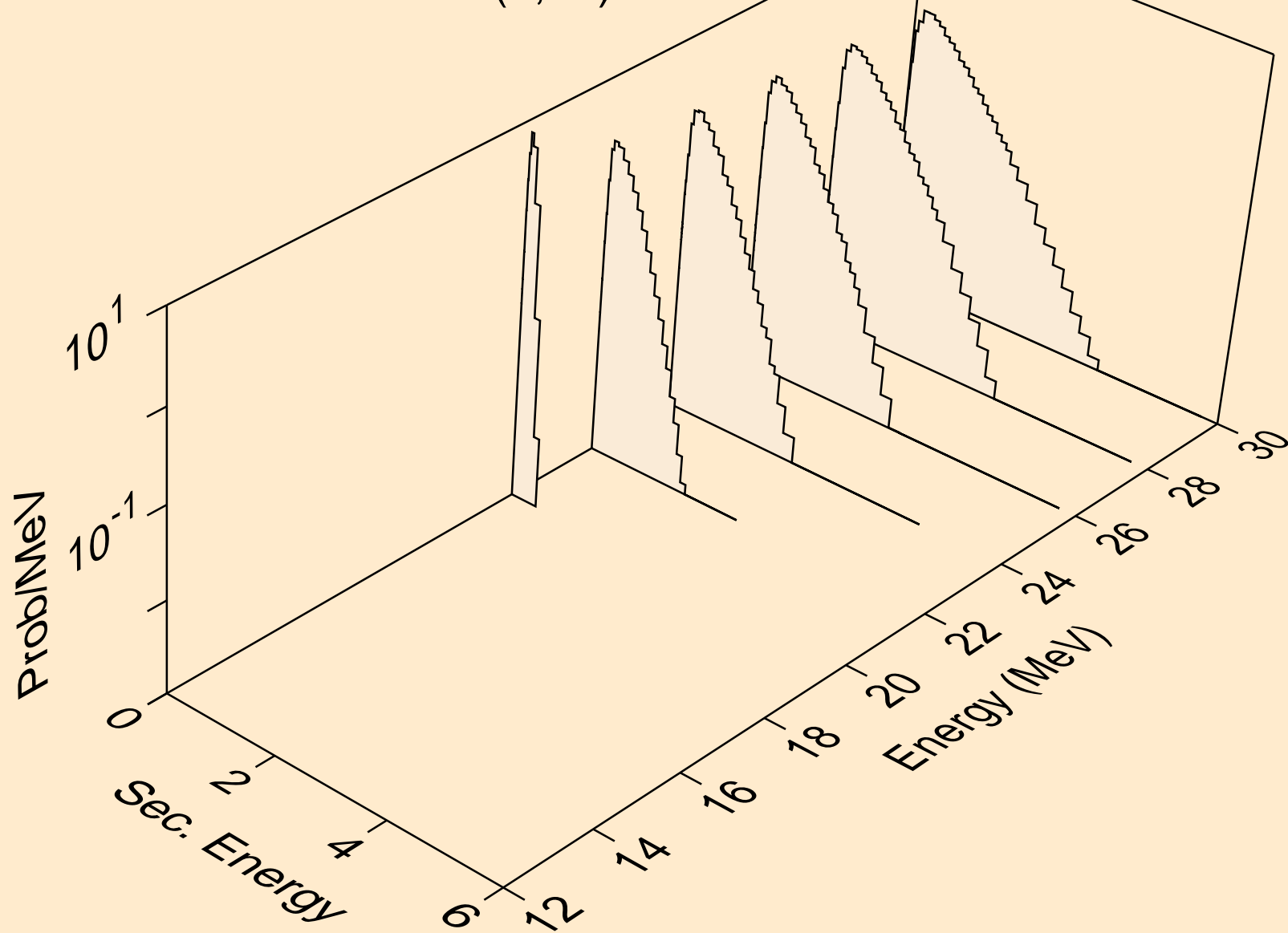

TL197 NEUTRON ACER TENDL-2024 LIBRARY; T=293.6K
Neutron emission for (n,n*)p

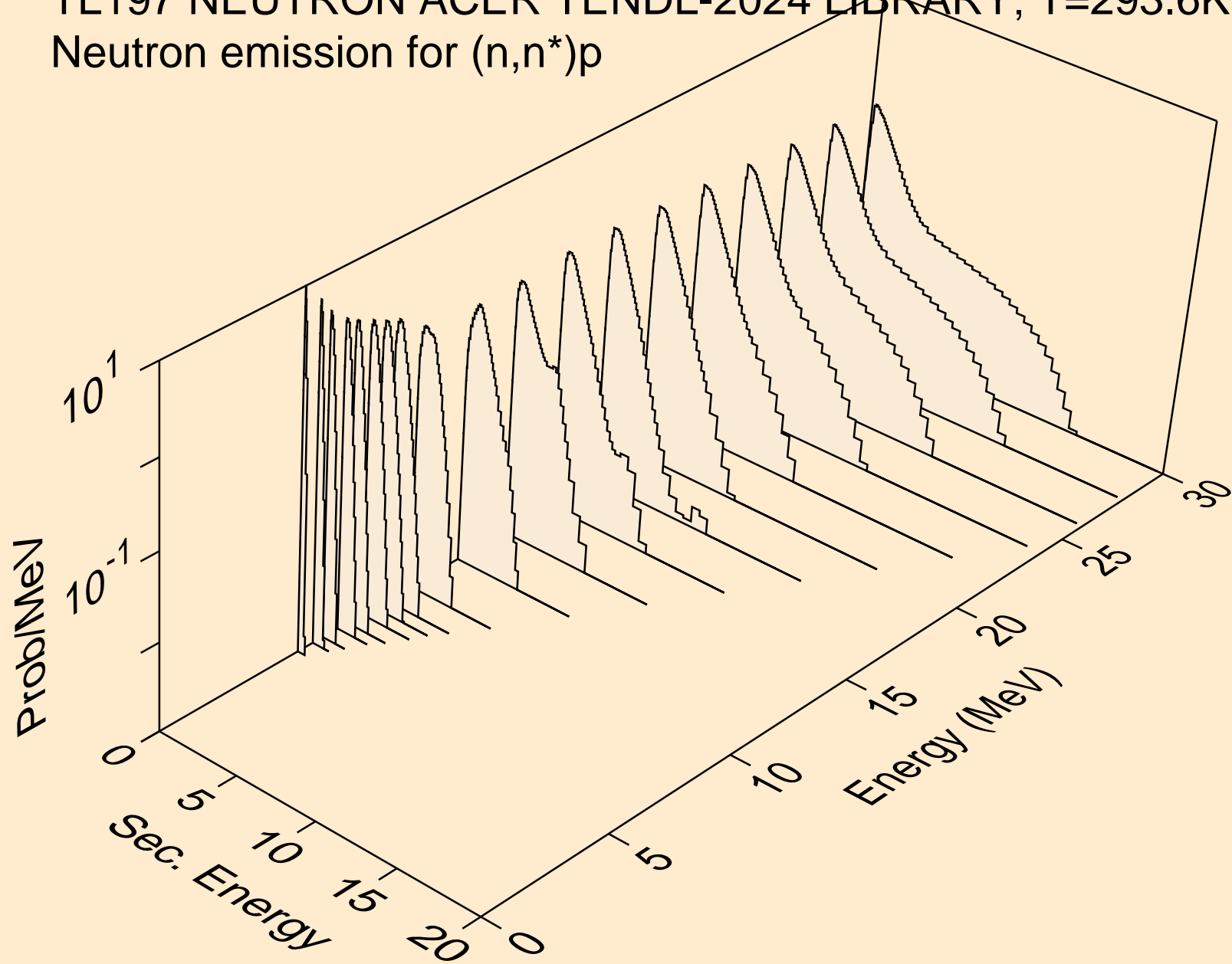

TL197 NEUTRON ACER TENDL-2024 LIBRARY; T=293.6K
Neutron emission for (n,n*)2a

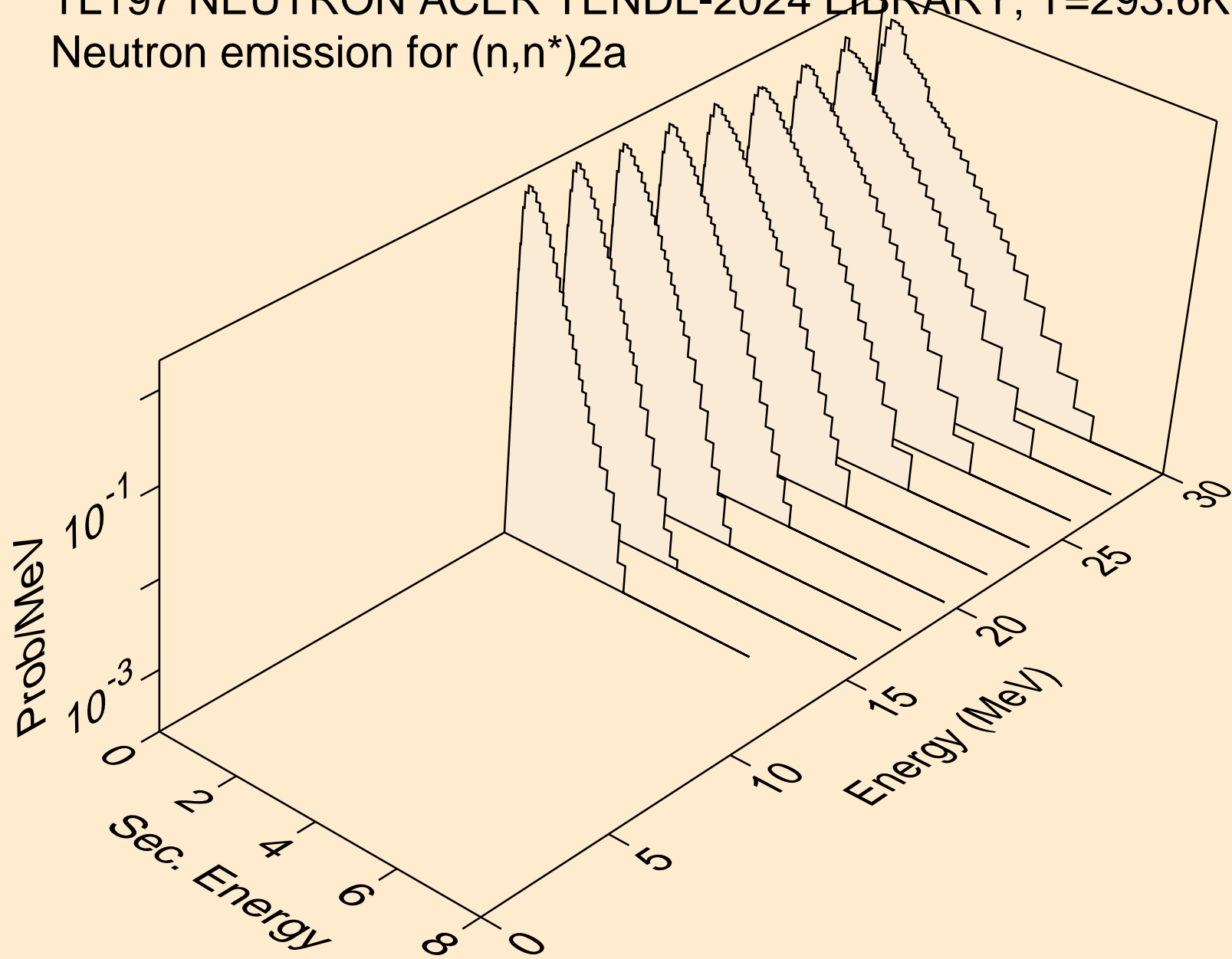

TL197 NEUTRON ACER TENDL-2024 LIBRARY; T=293.6K
Neutron emission for (n,n*)d

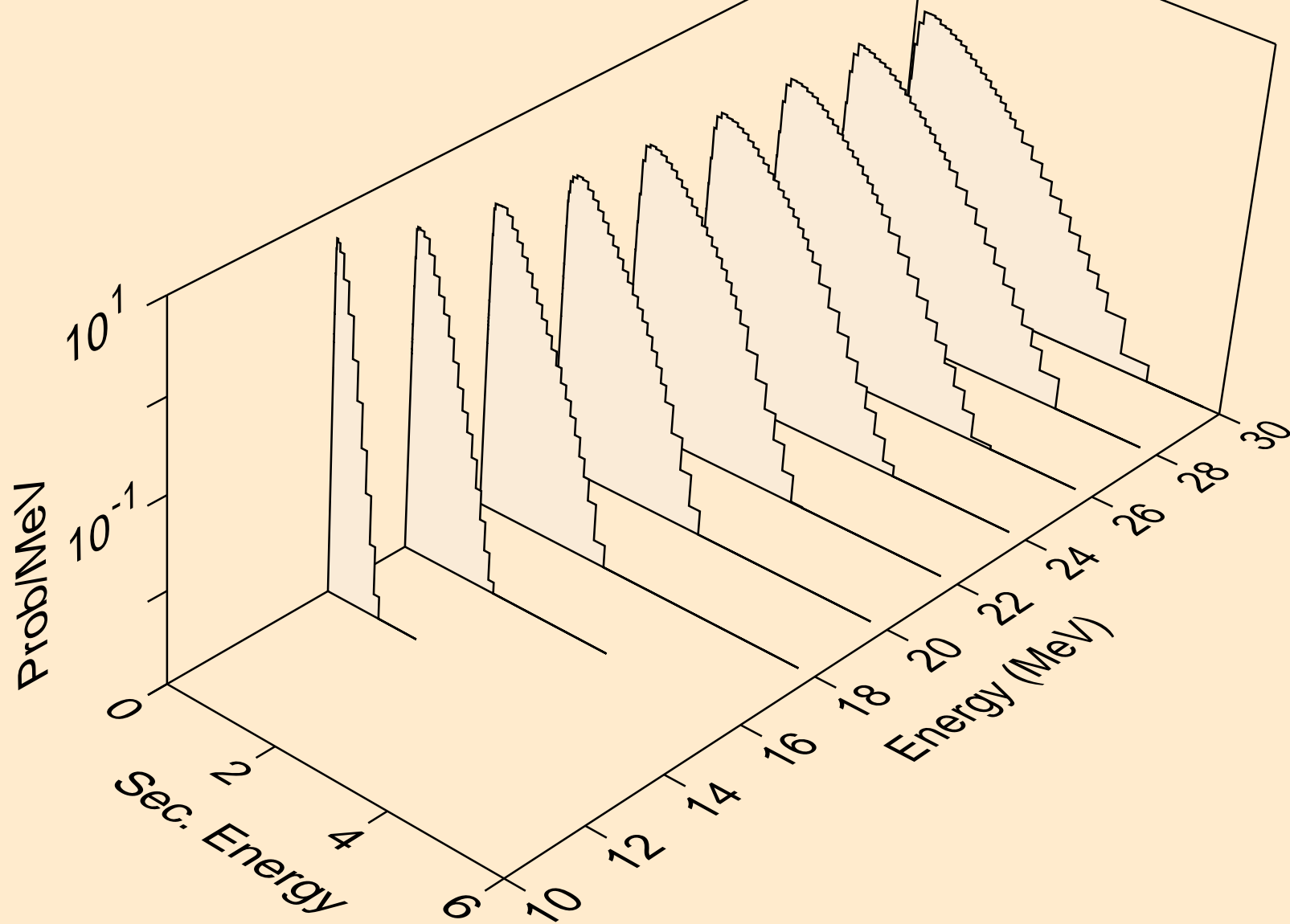

TL197 NEUTRON ACER TENDL-2024 LIBRARY; T=293.6K
Neutron emission for (n,n*)t

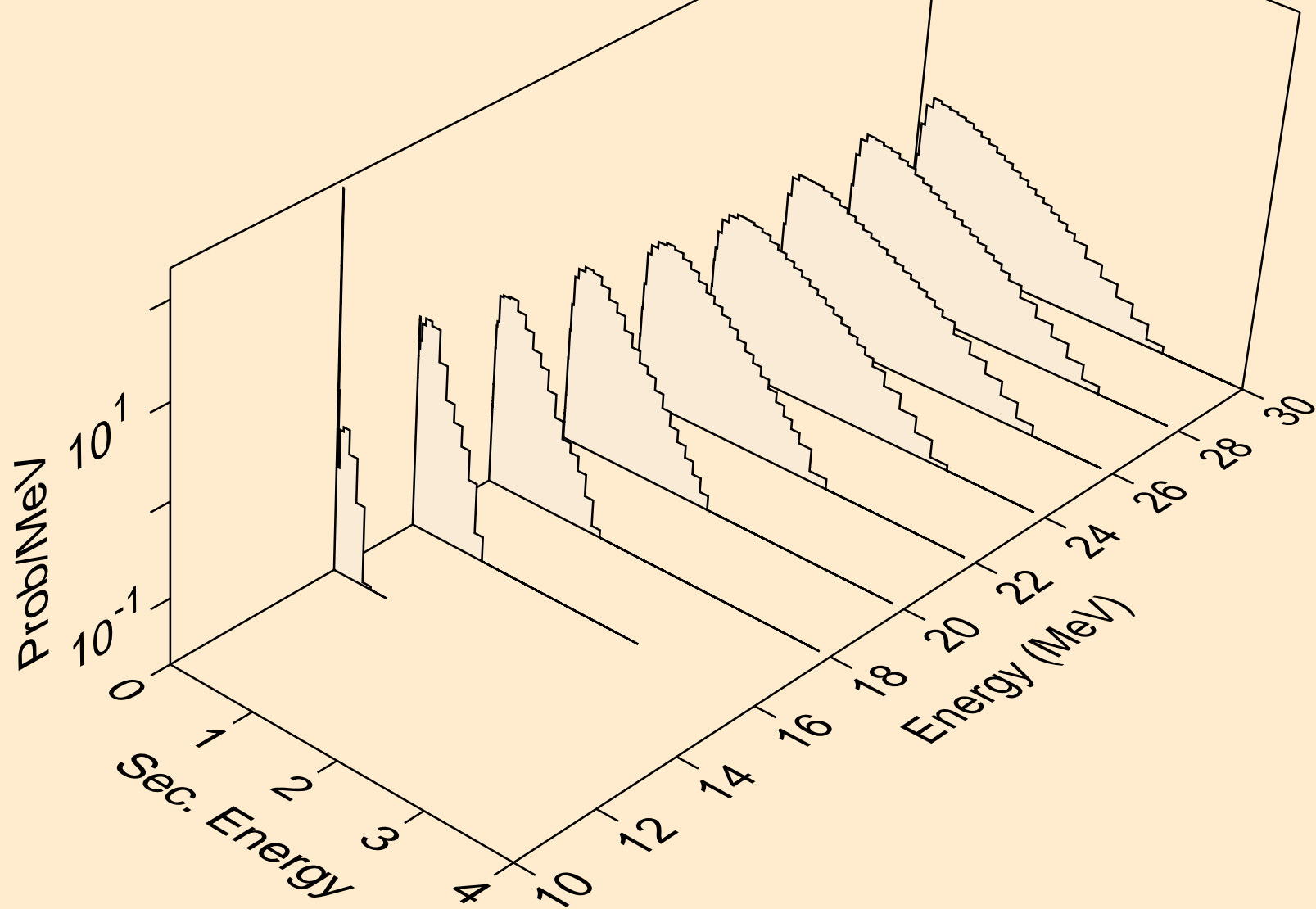

TL197 NEUTRON ACER TENDL-2024 LIBRARY; T=293.6K
Neutron emission for (n,n*)he3

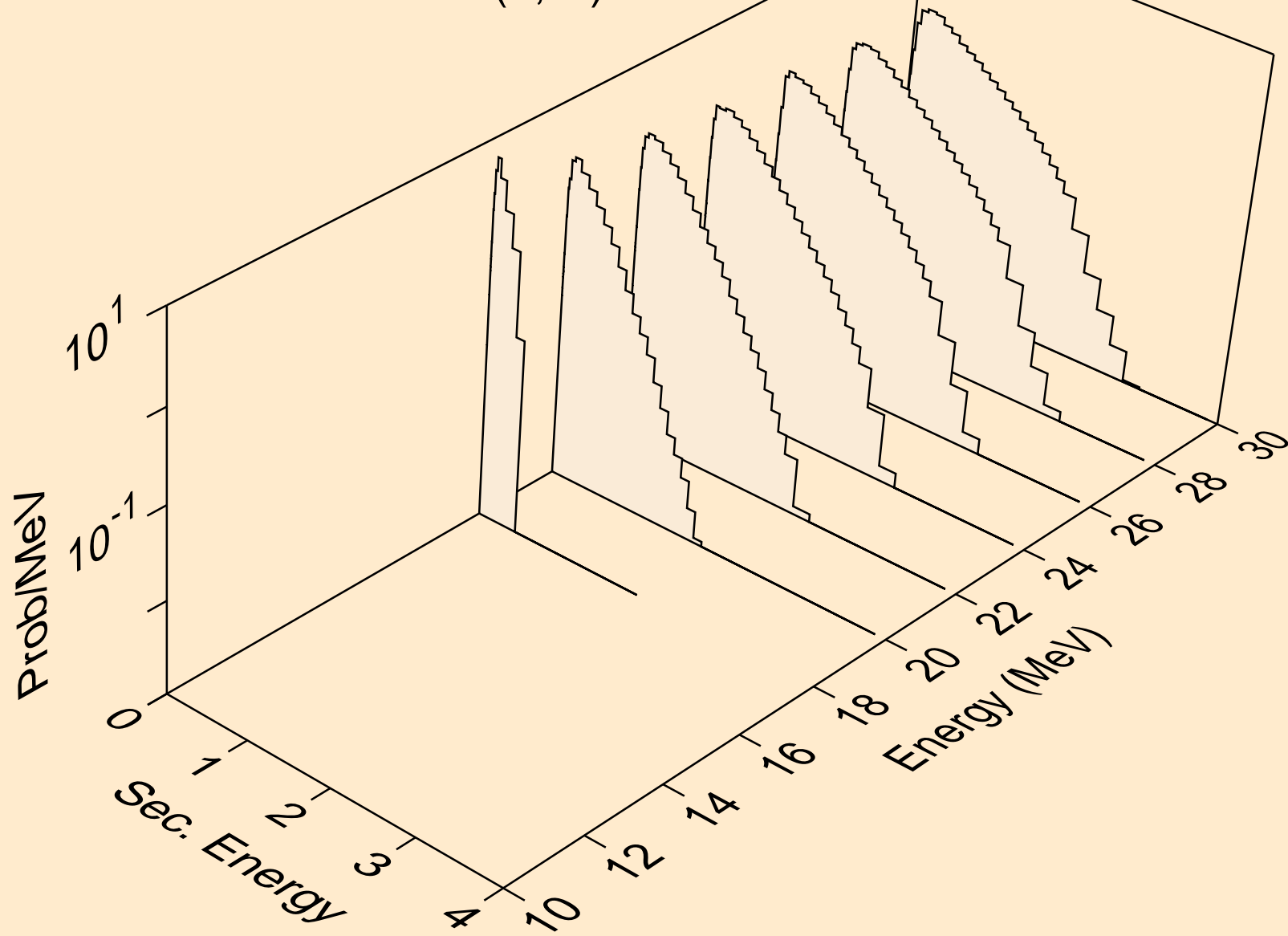

TL197 NEUTRON ACER TENDL-2024 LIBRARY; T=293.6K
Neutron emission for (n,4n)

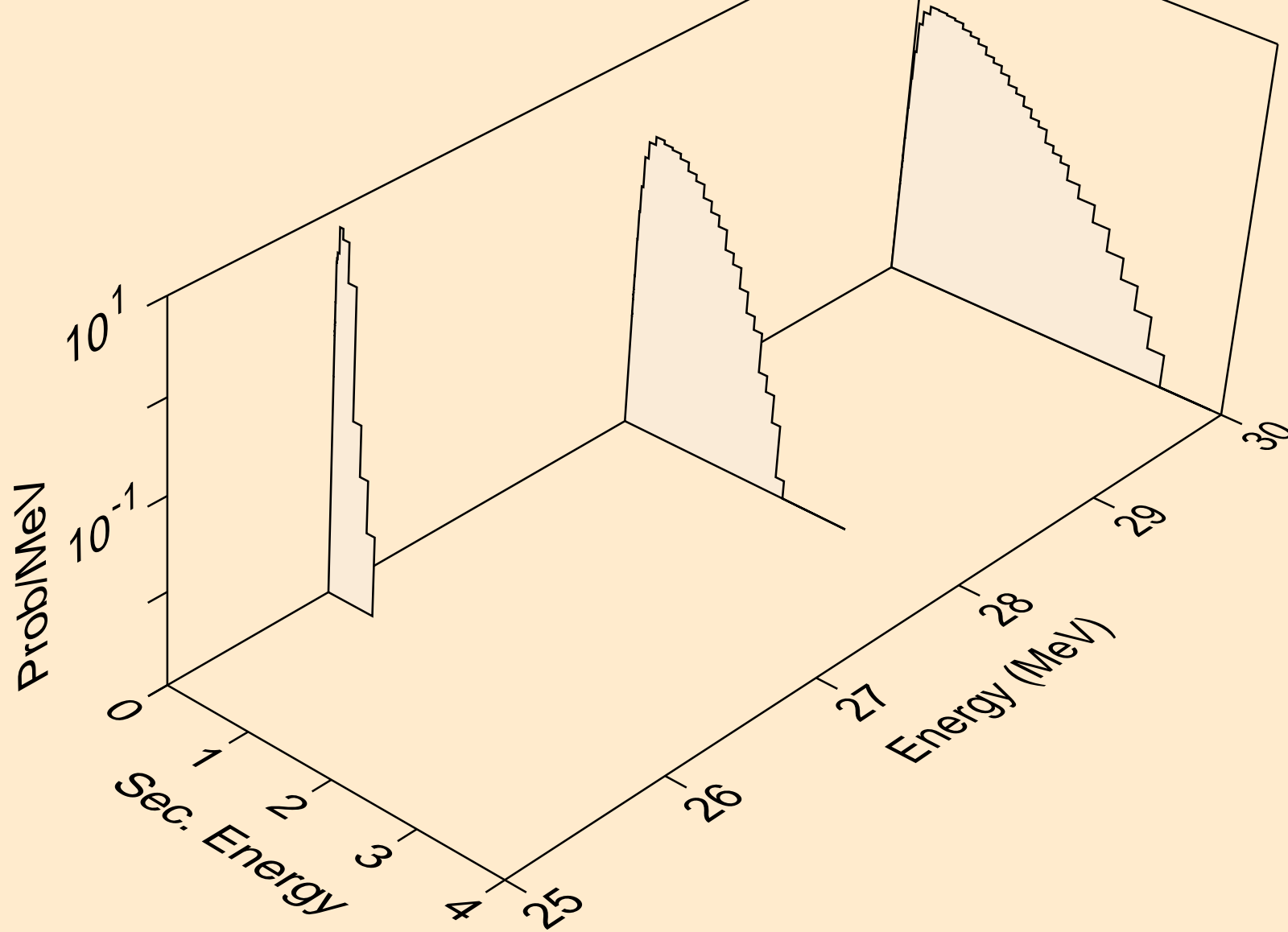

TL197 NEUTRON ACER TENDL-2024 LIBRARY; T=293.6K
Neutron emission for (n,2np)

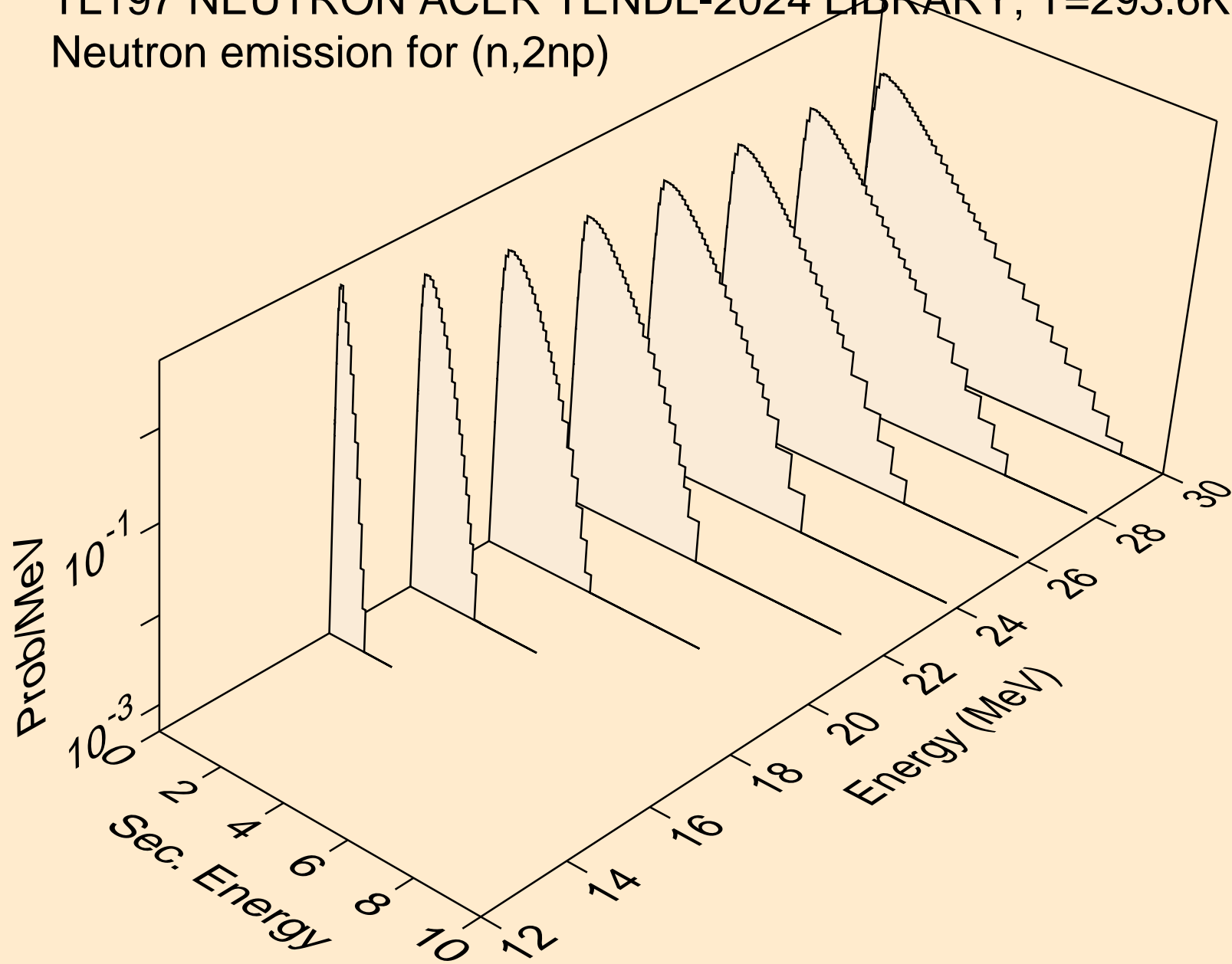

TL197 NEUTRON ACER TENDL-2024 LIBRARY; T=293.6K
Neutron emission for (n,3np)

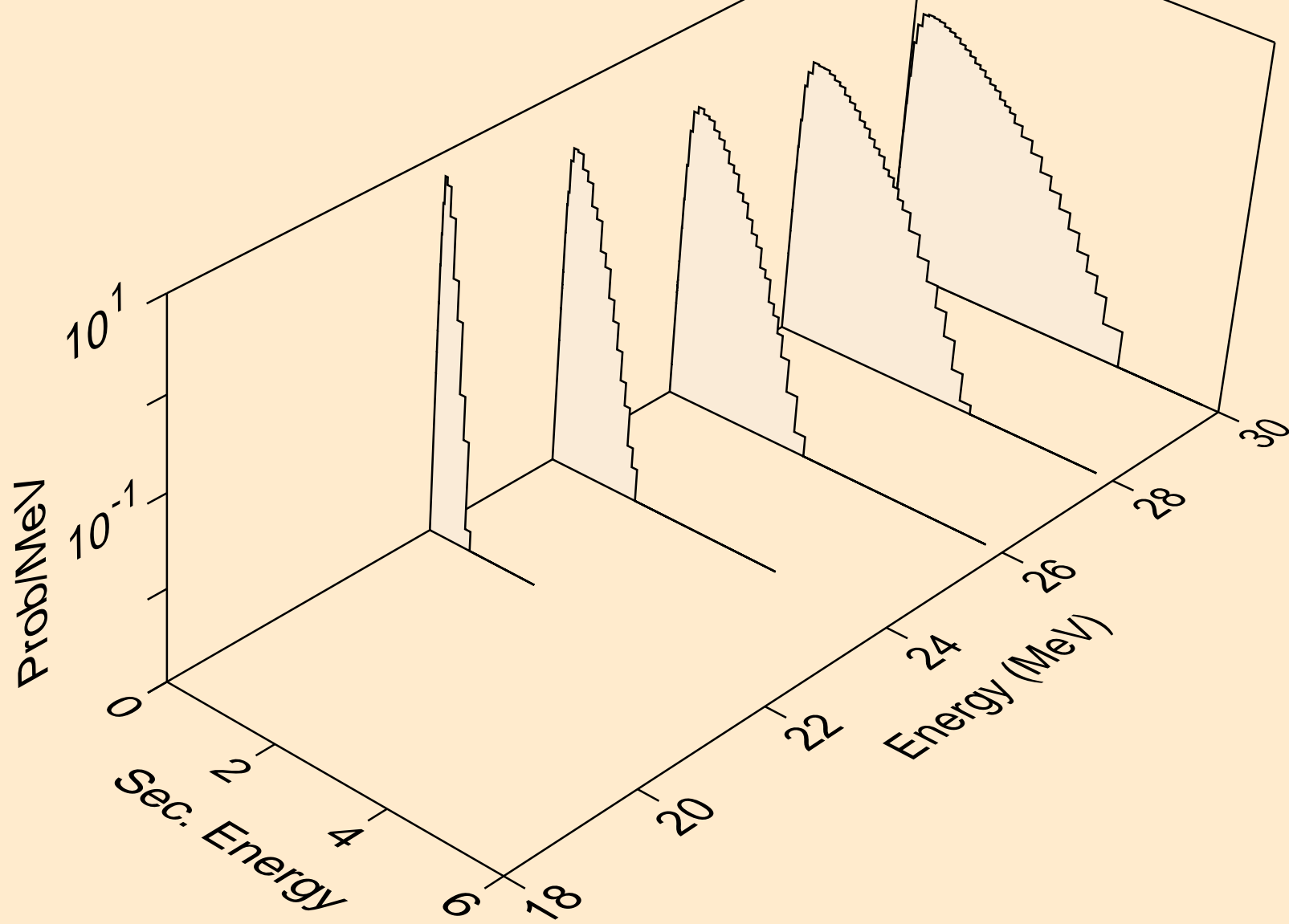

TL197 NEUTRON ACER TENDL-2024 LIBRARY; T=293.6K
Neutron emission for (n,n2p)

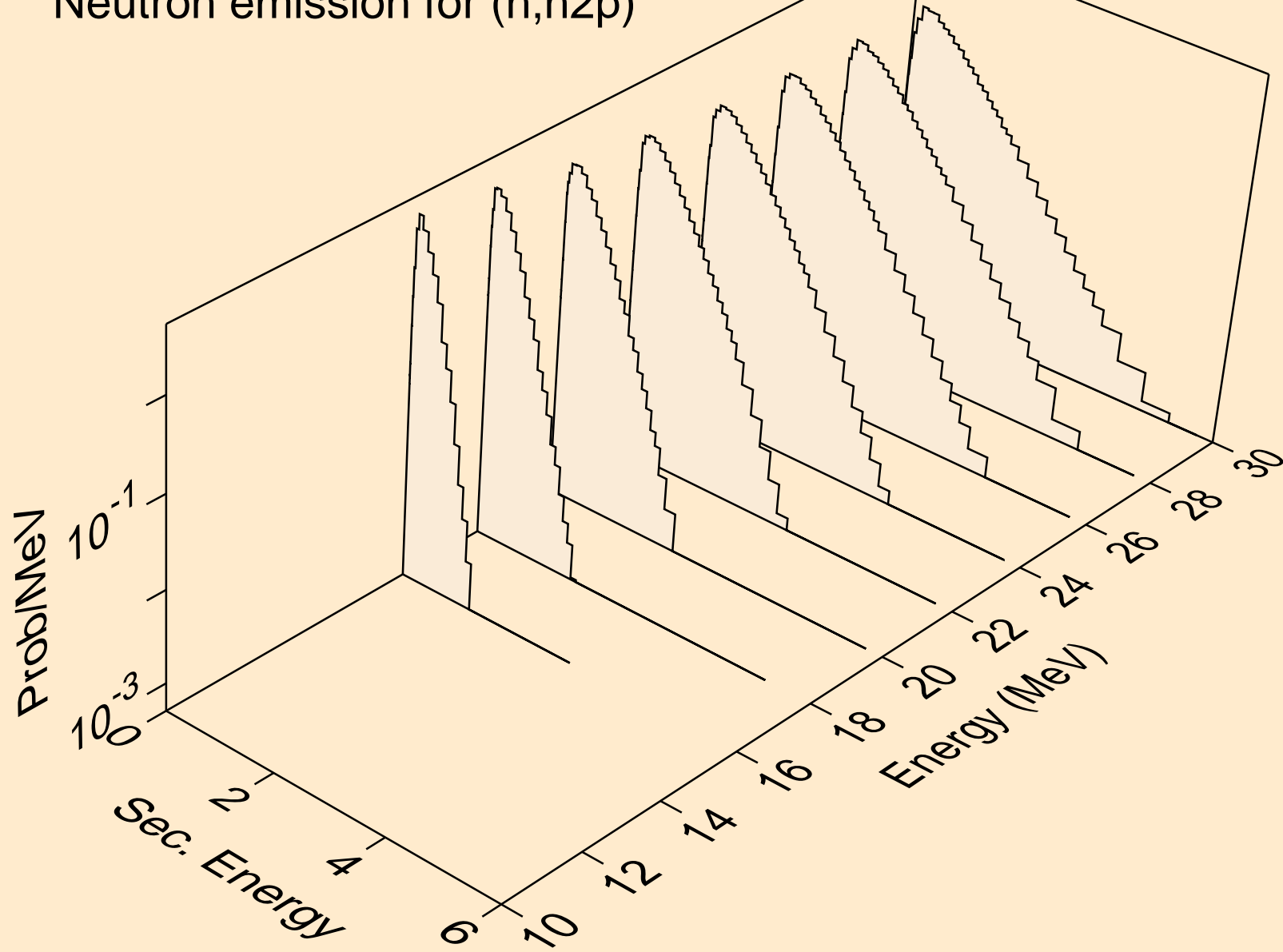

TL197 NEUTRON ACER TENDL-2024 LIBRARY; T=293.6K
Neutron emission for (n,npa)

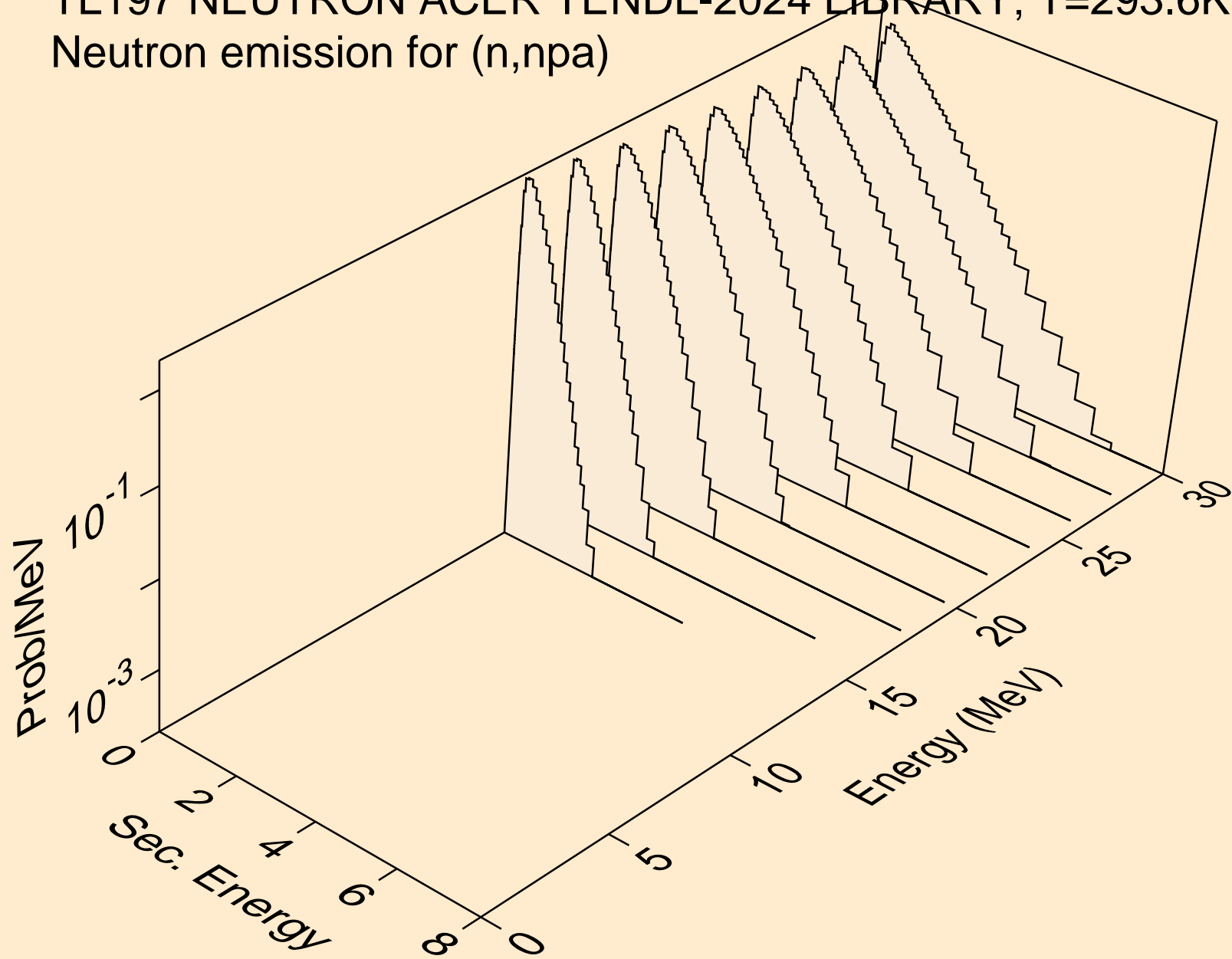

TL197 NEUTRON ACER TENDL-2024 LIBRARY; T=293.6K
Neutron emission for (n,n*c)

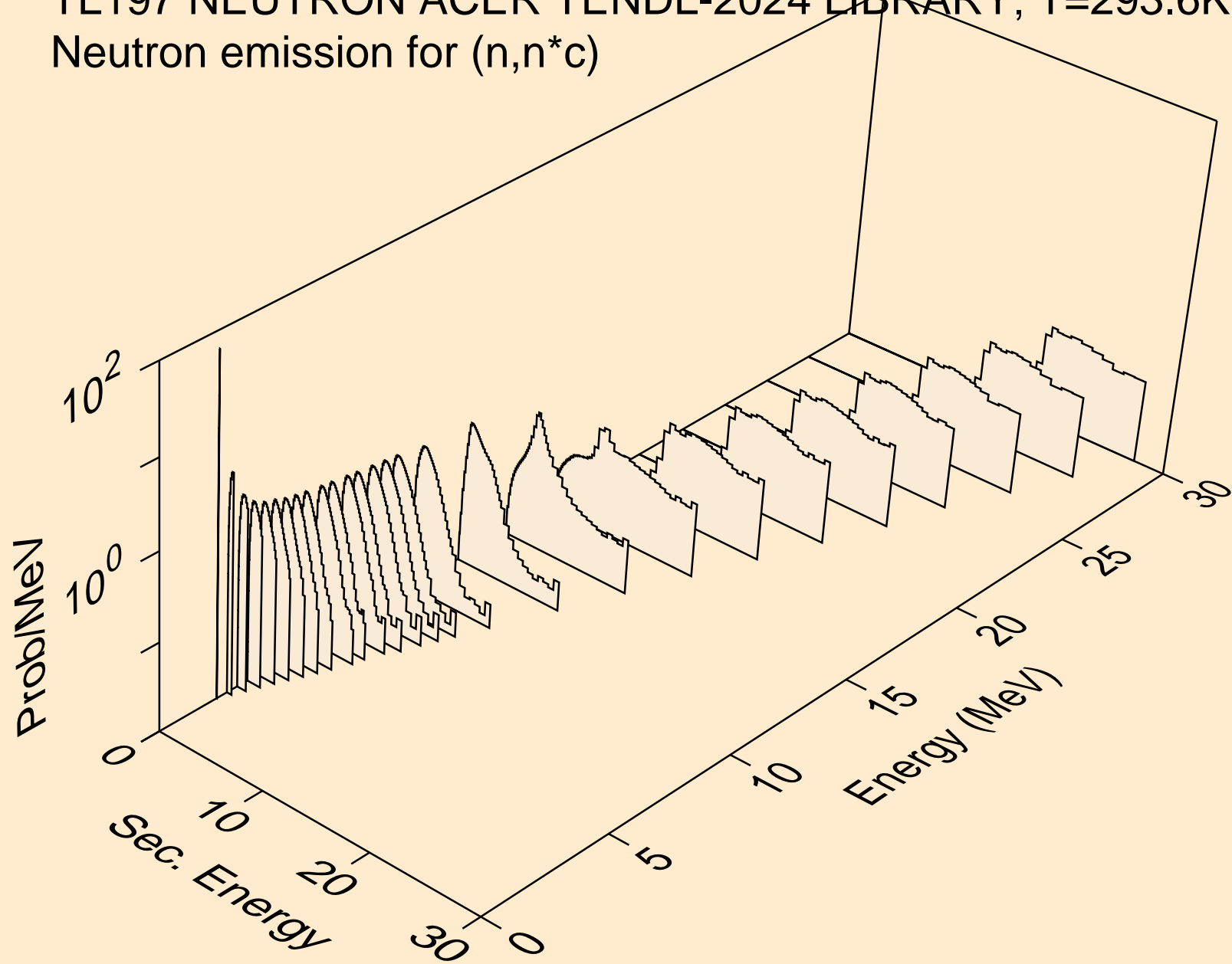

TL197 NEUTRON ACER TENDL-2024 LIBRARY; T=293.6K
Photon emission for (n,x)

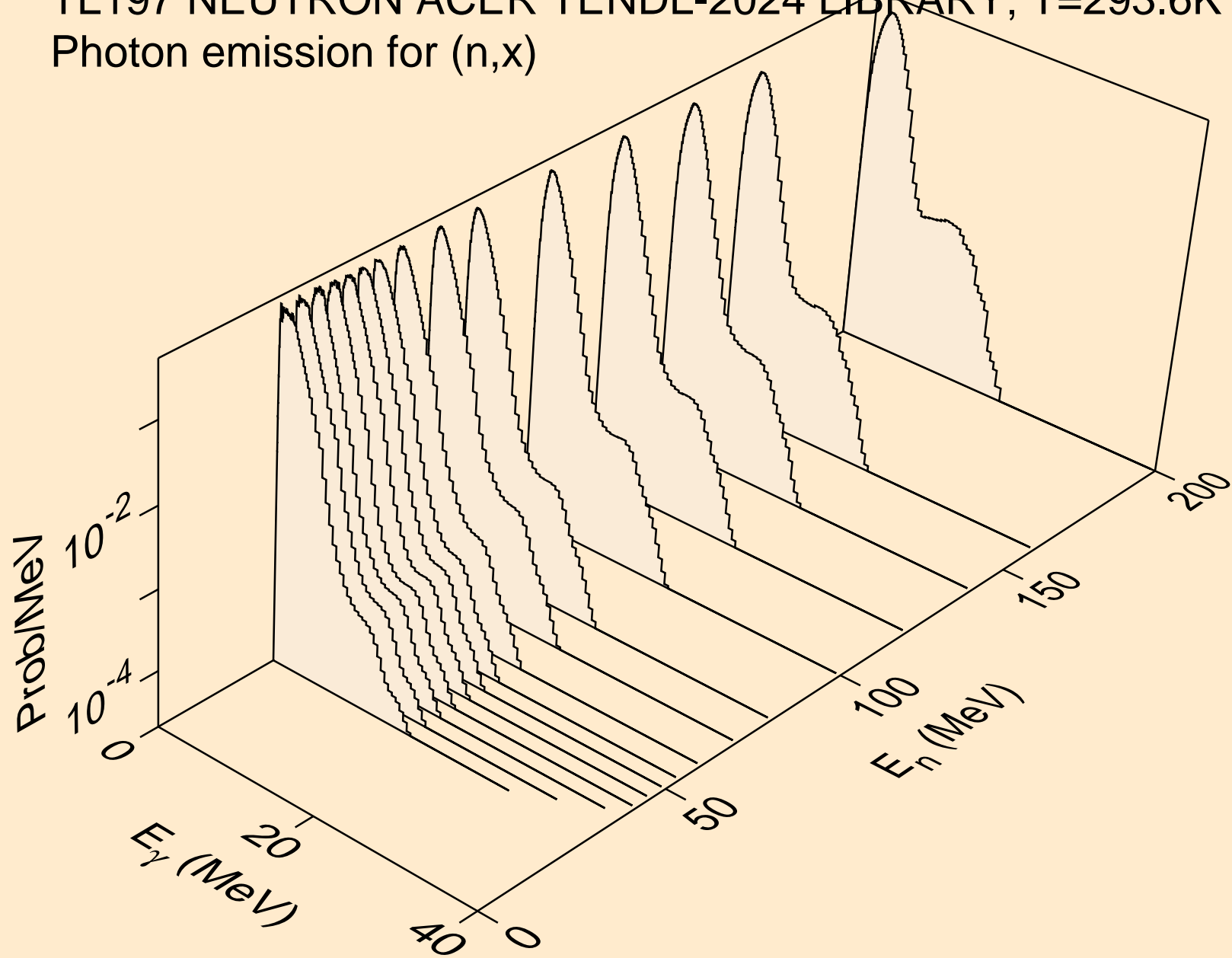

TL197 NEUTRON ACER TENDL-2024 LIBRARY; T=293.6K
Photon emission for (n,2nd)

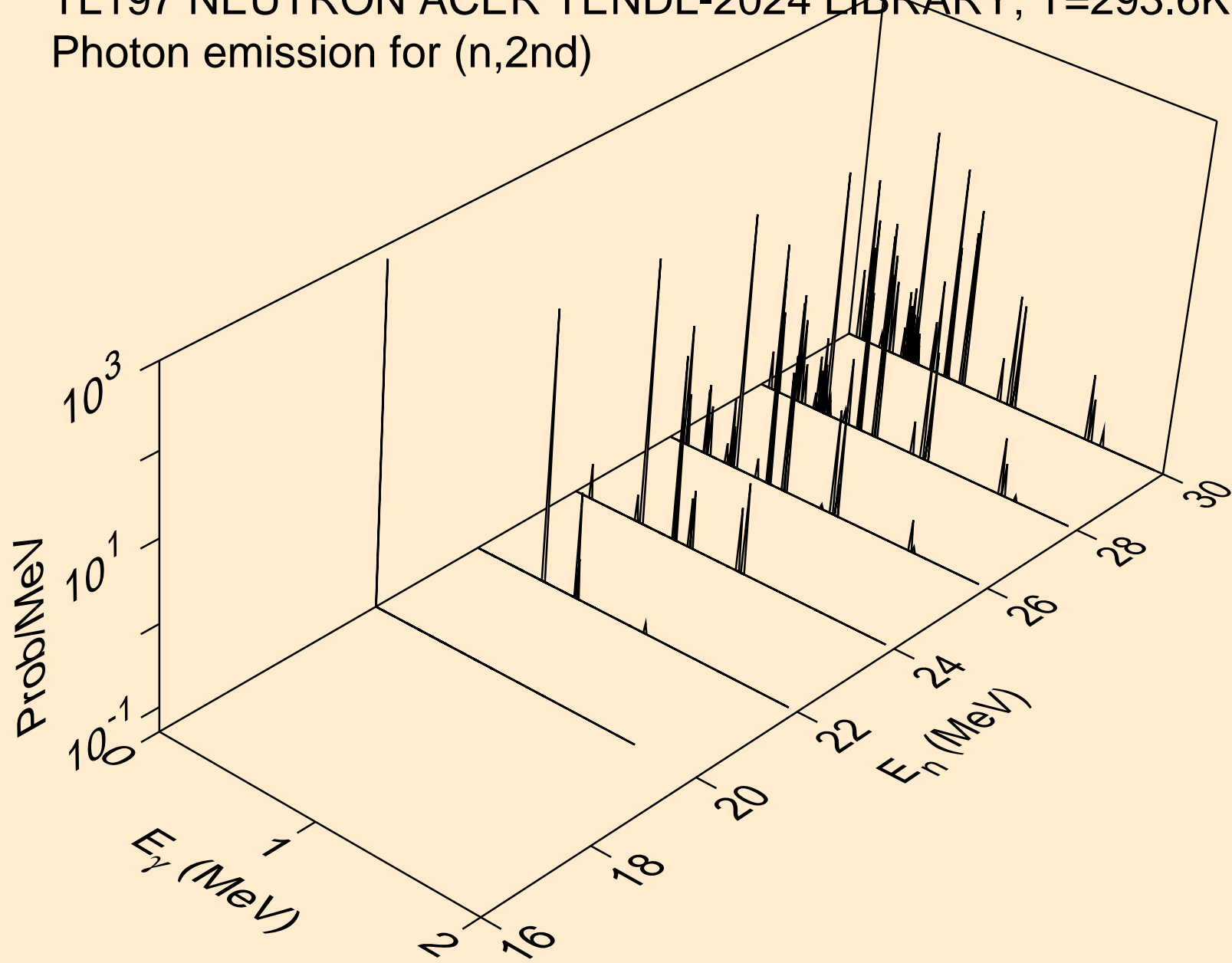

TL197 NEUTRON ACER TENDL-2024 LIBRARY; T=293.6K
Photon emission for (n,2n)

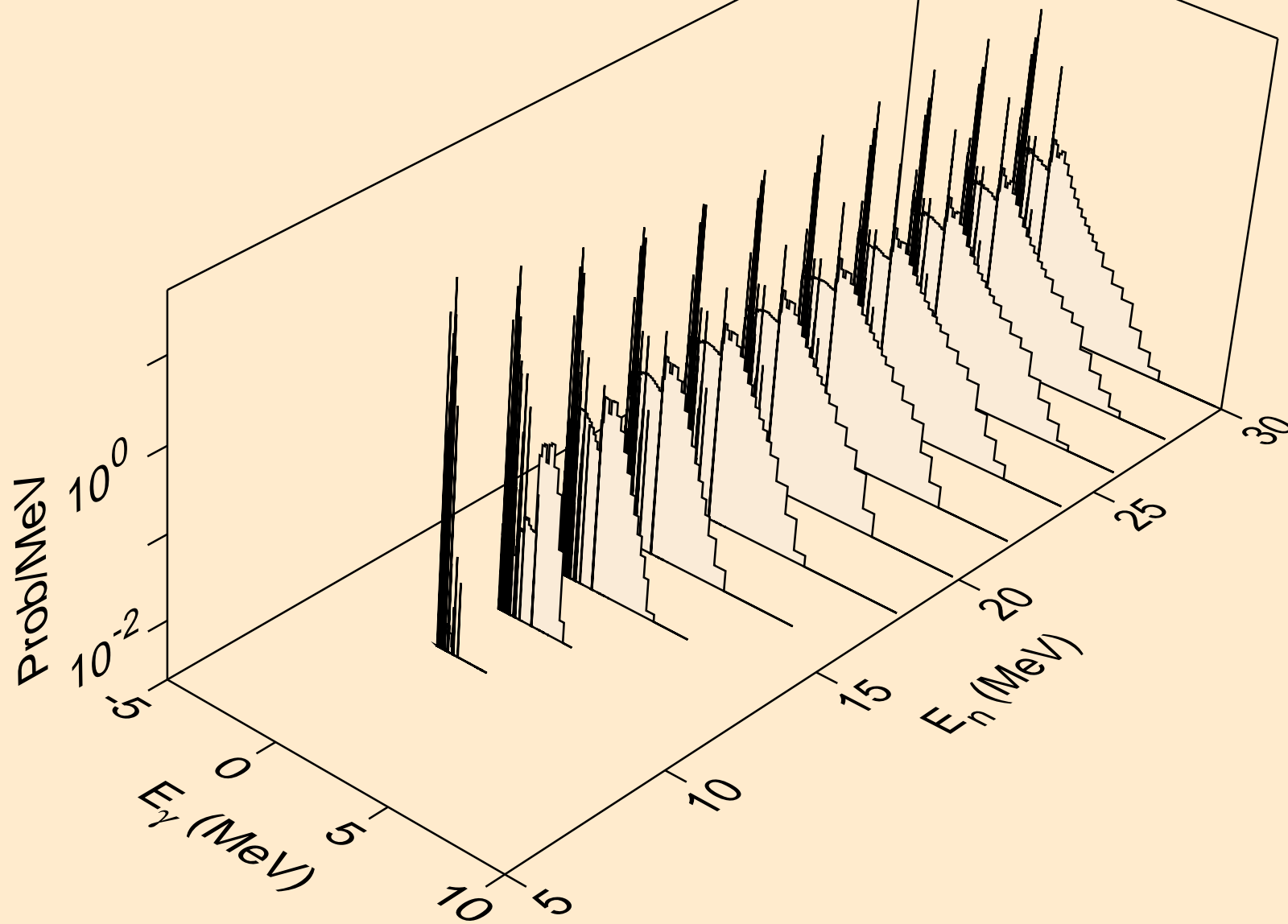

TL197 NEUTRON ACER TENDL-2024 LIBRARY; T=293.6K
Photon emission for (n,3n)

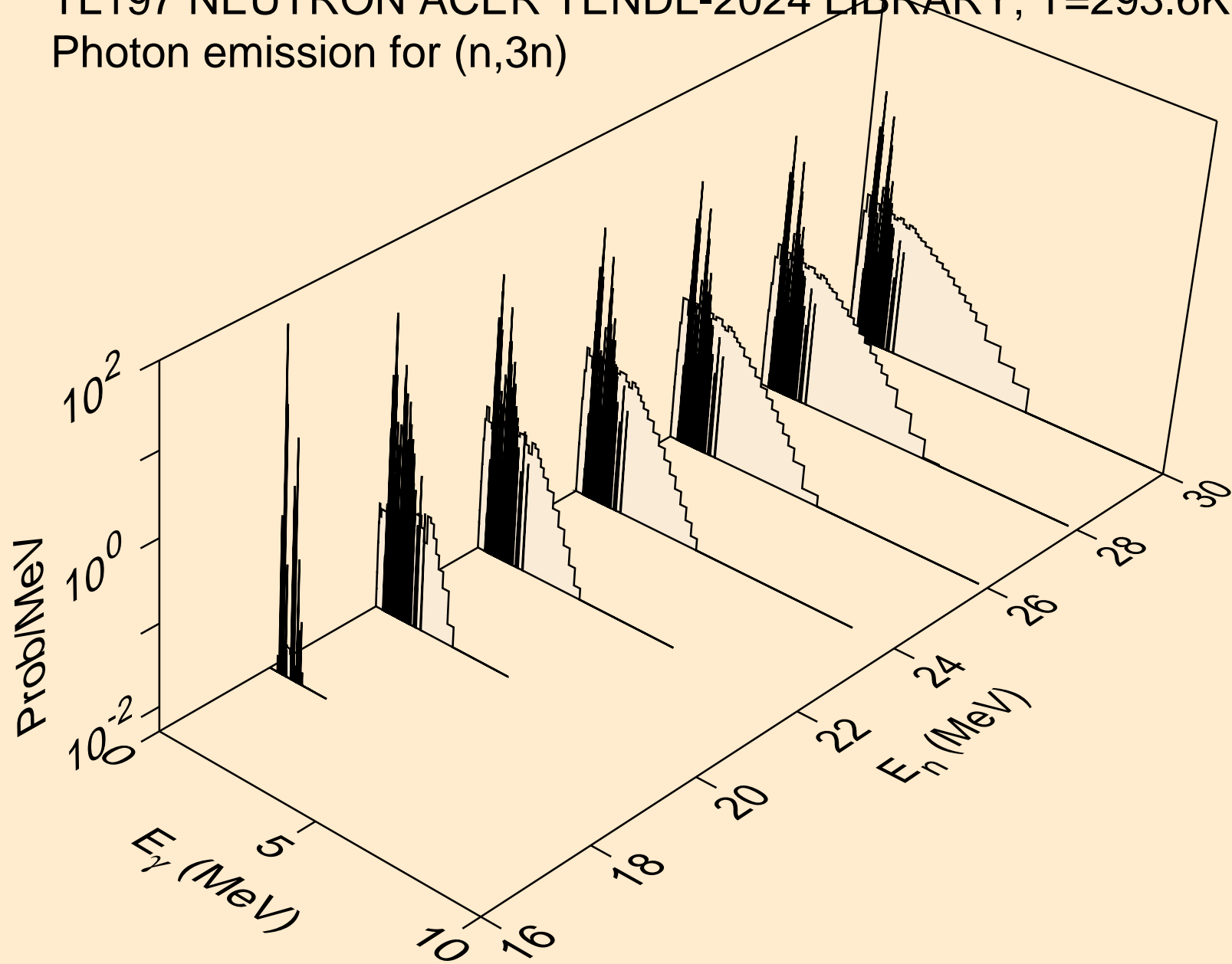

TL197 NEUTRON ACER TENDL-2024 LIBRARY; T=293.6K
Photon emission for (n,n*)a

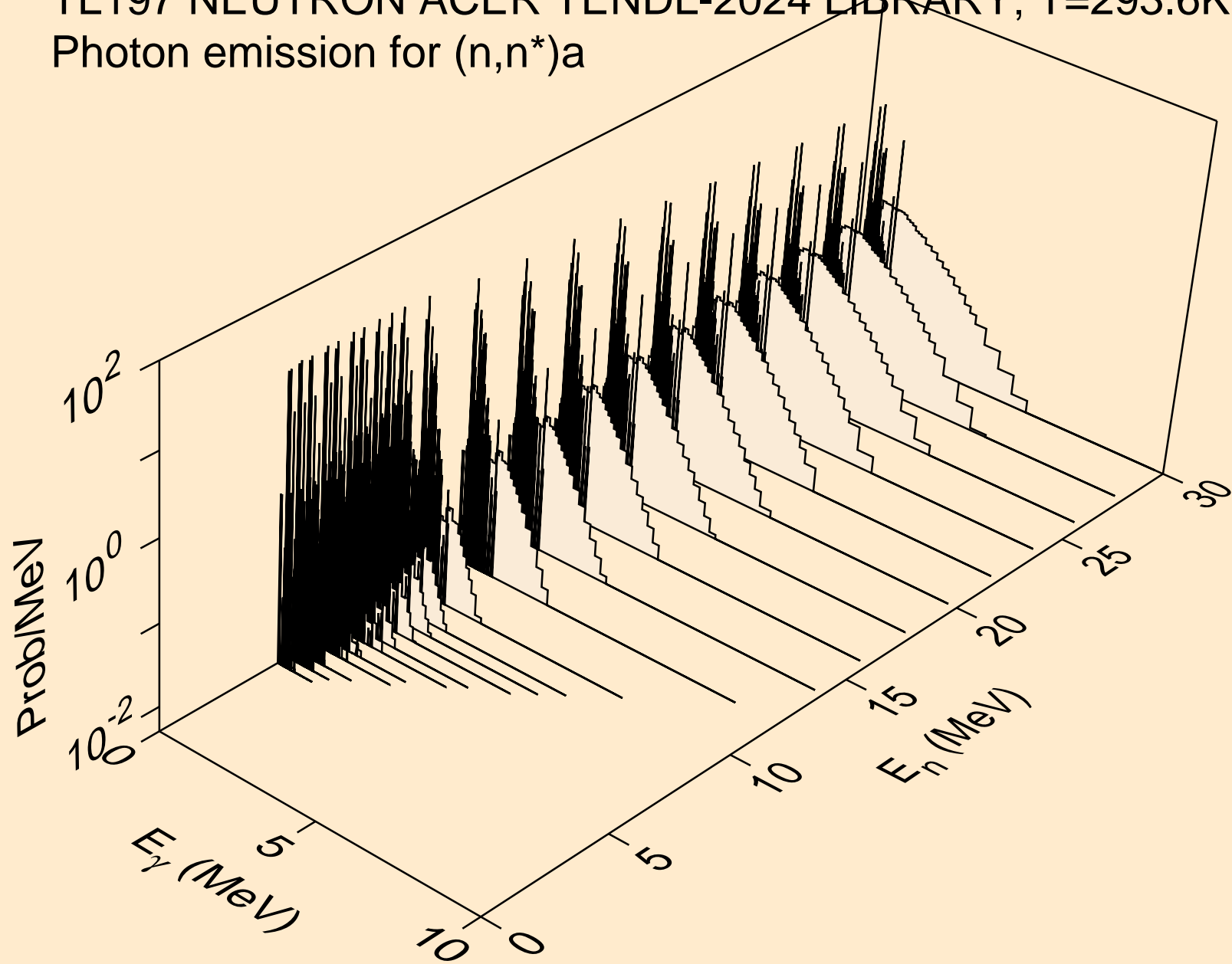

TL197 NEUTRON ACER TENDL-2024 LIBRARY; T=293.6K
Photon emission for (n,2n)a

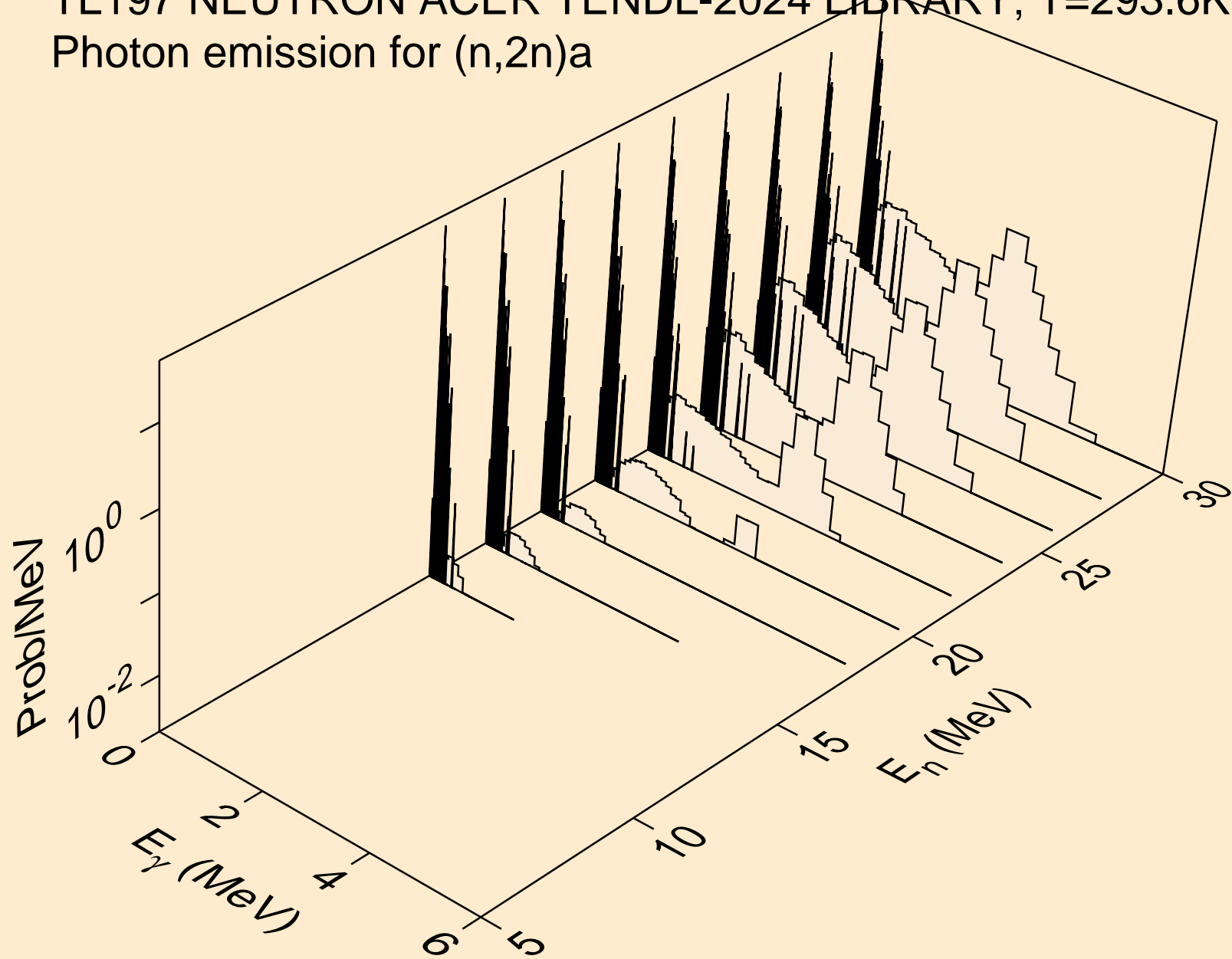

TL197 NEUTRON ACER TENDL-2024 LIBRARY; T=293.6K
Photon emission for (n,3n)a

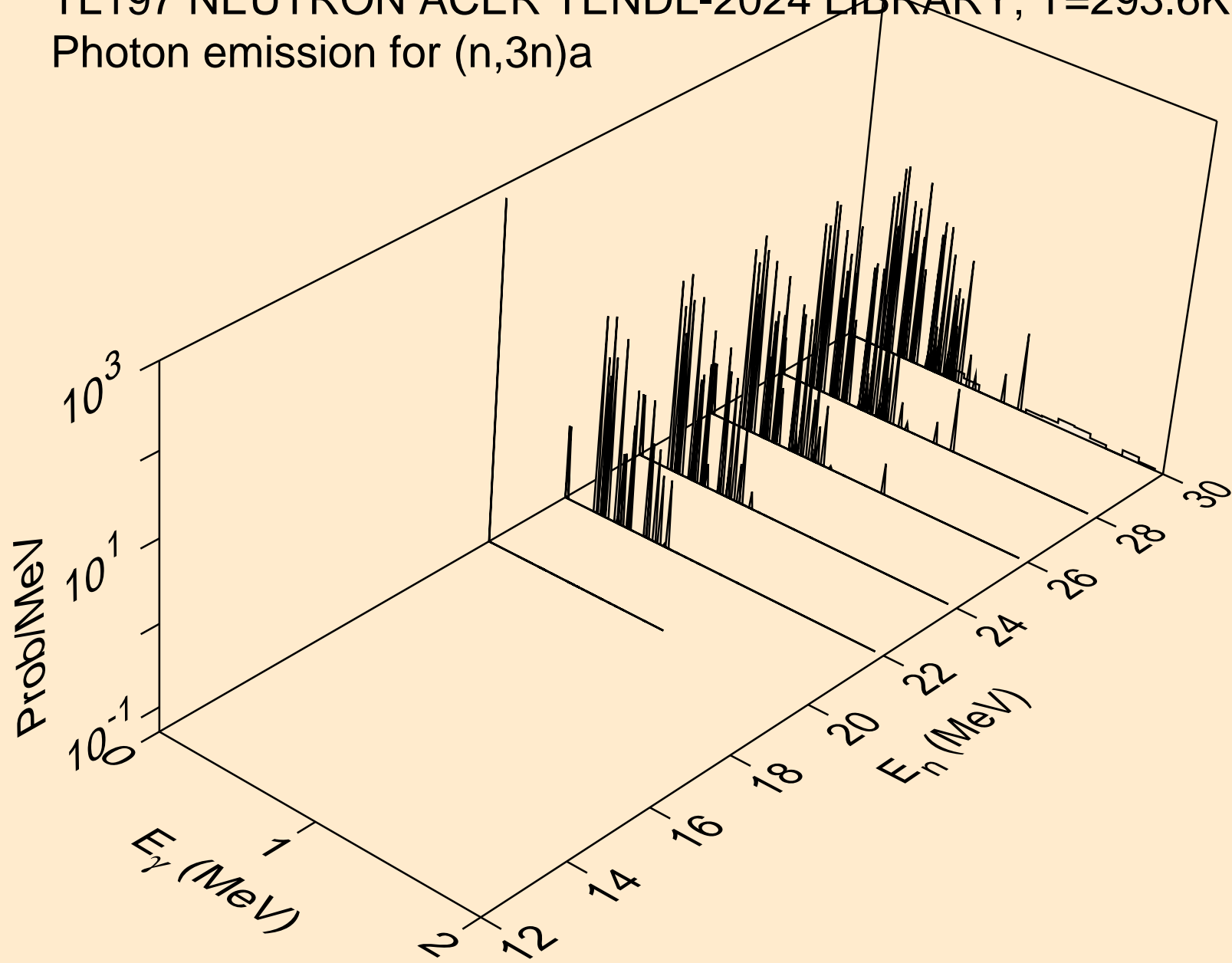

TL197 NEUTRON ACER TENDL-2024 LIBRARY; T=293.6K
Photon emission for (n,n*)p

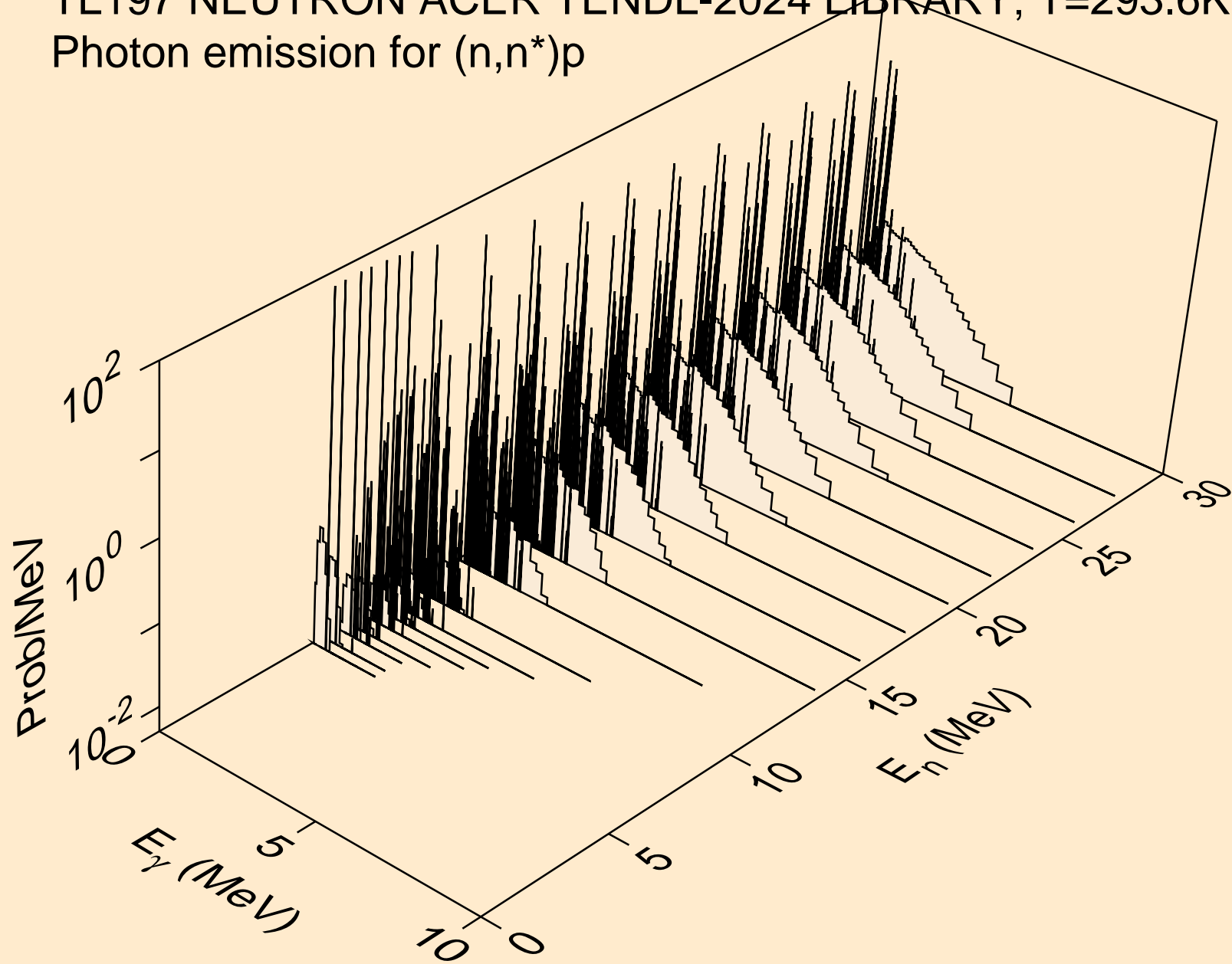

TL197 NEUTRON ACER TENDL-2024 LIBRARY; T=293.6K
Photon emission for (n,n*)2a

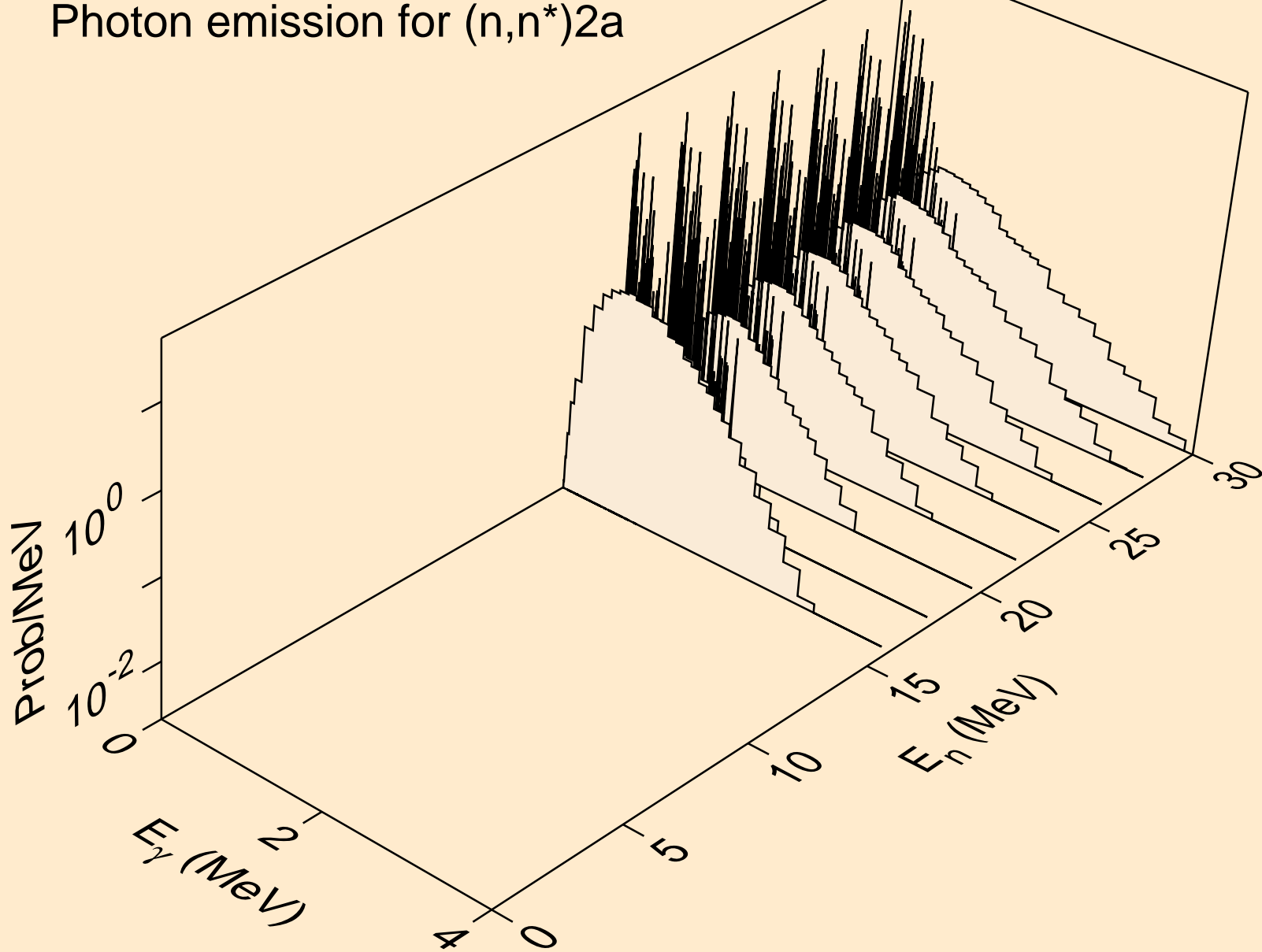

TL197 NEUTRON ACER TENDL-2024 LIBRARY; T=293.6K
Photon emission for (n,n*)d

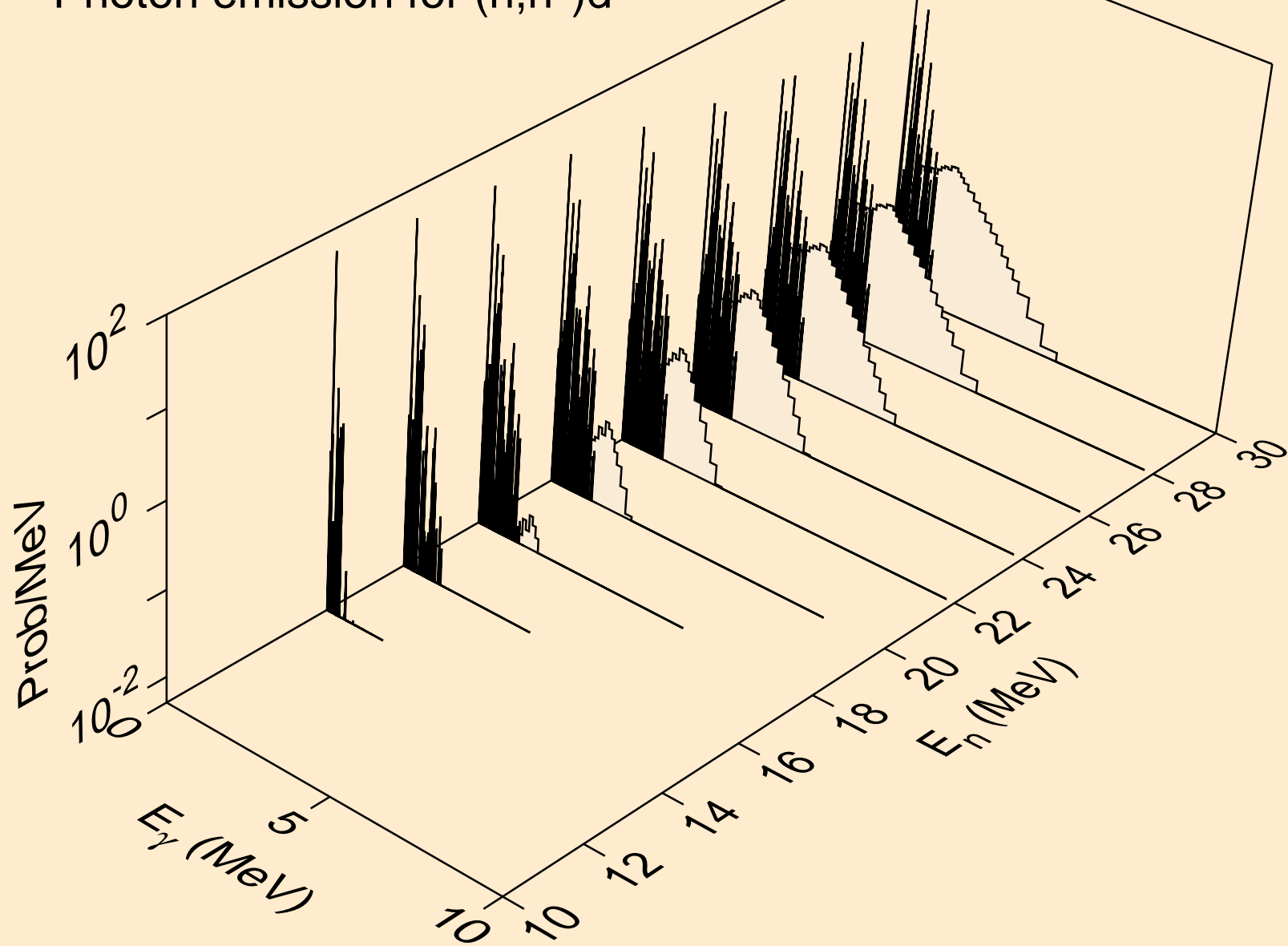

TL197 NEUTRON ACER TENDL-2024 LIBRARY; T=293.6K
Photon emission for (n,n*)t

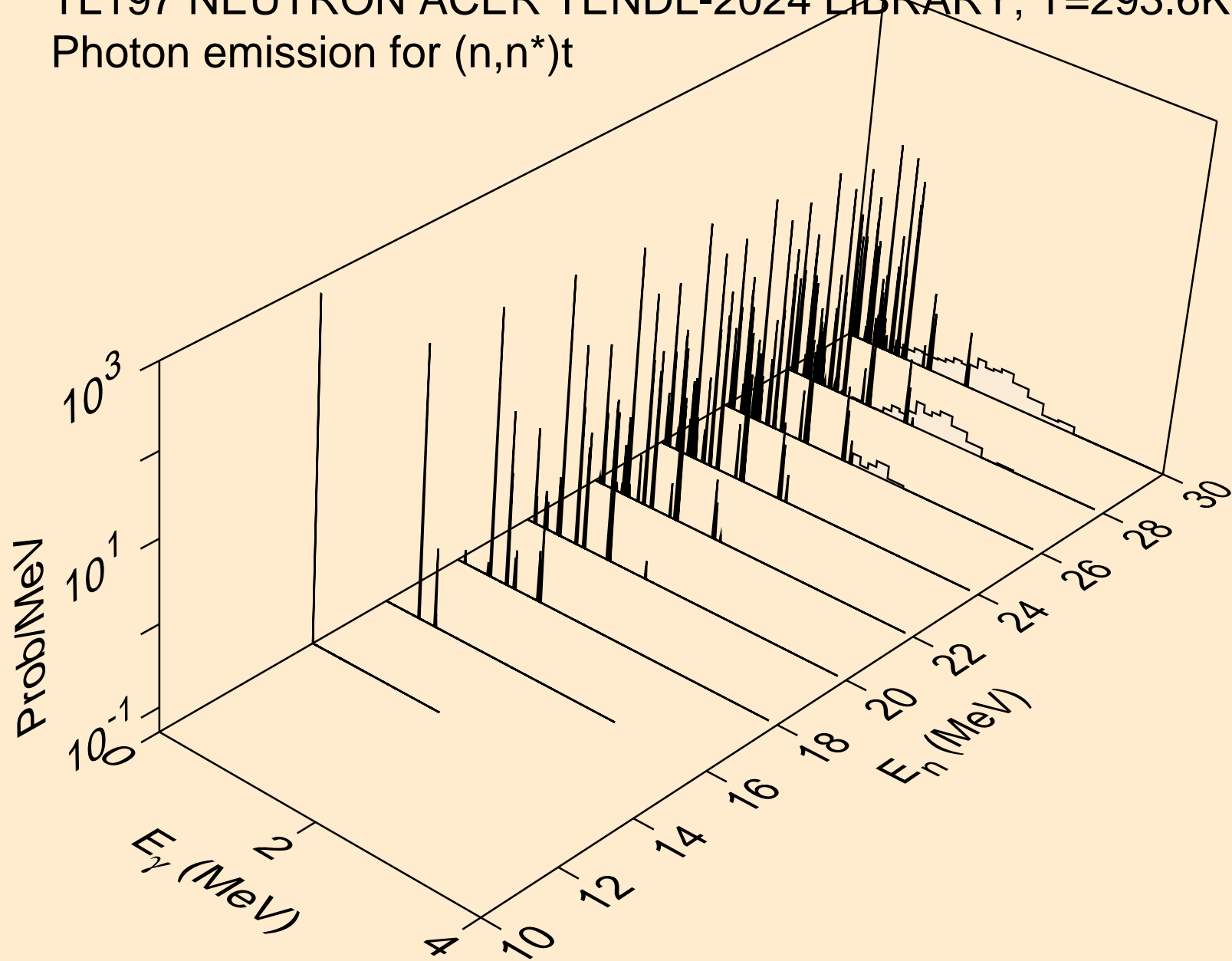

TL197 NEUTRON ACER TENDL-2024 LIBRARY; T=293.6K
Photon emission for (n,n*)he3

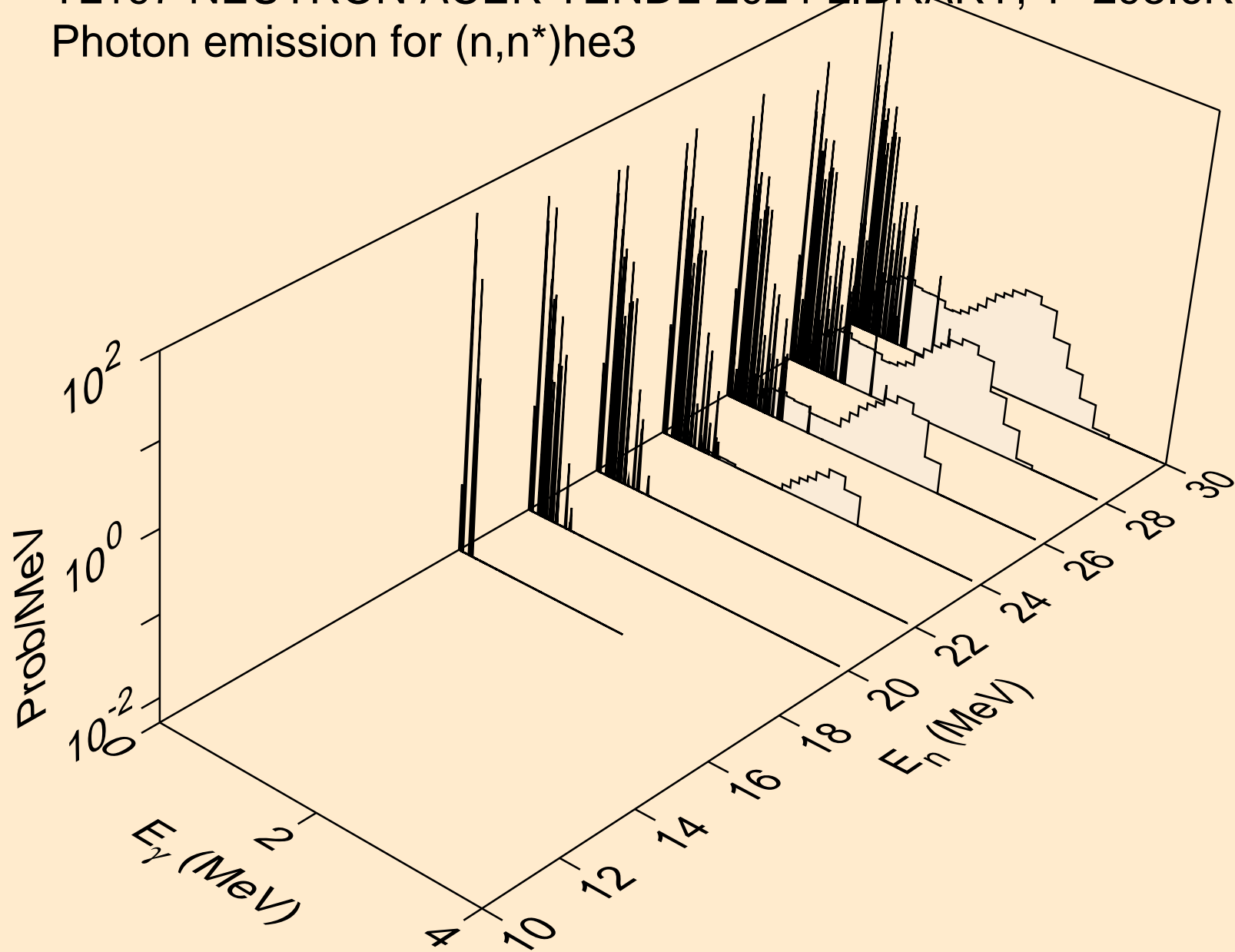

TL197 NEUTRON ACER TENDL-2024 LIBRARY; T=293.6K
Photon emission for (n,4n)

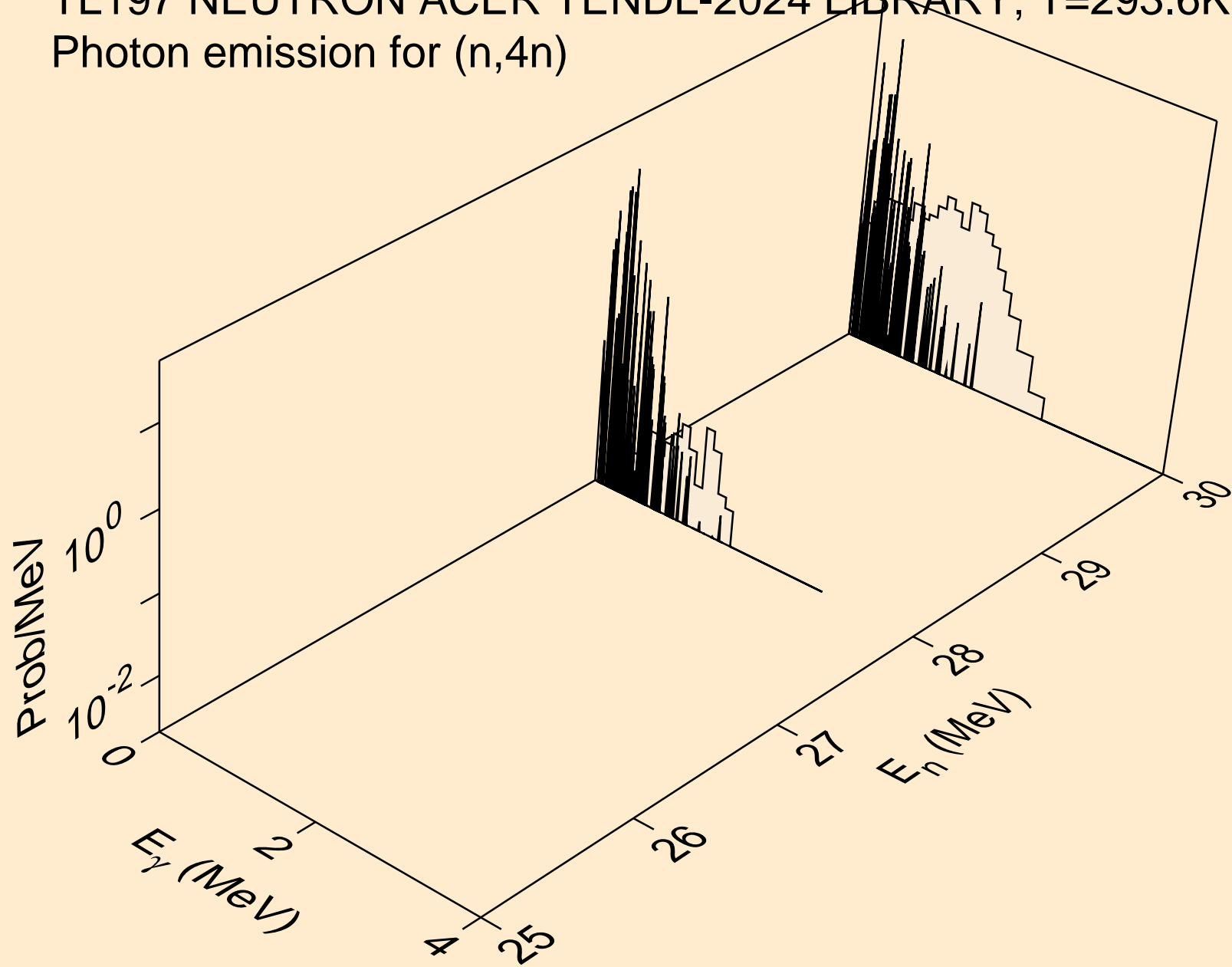

TL197 NEUTRON ACER TENDL-2024 LIBRARY; T=293.6K
Photon emission for (n,2np)

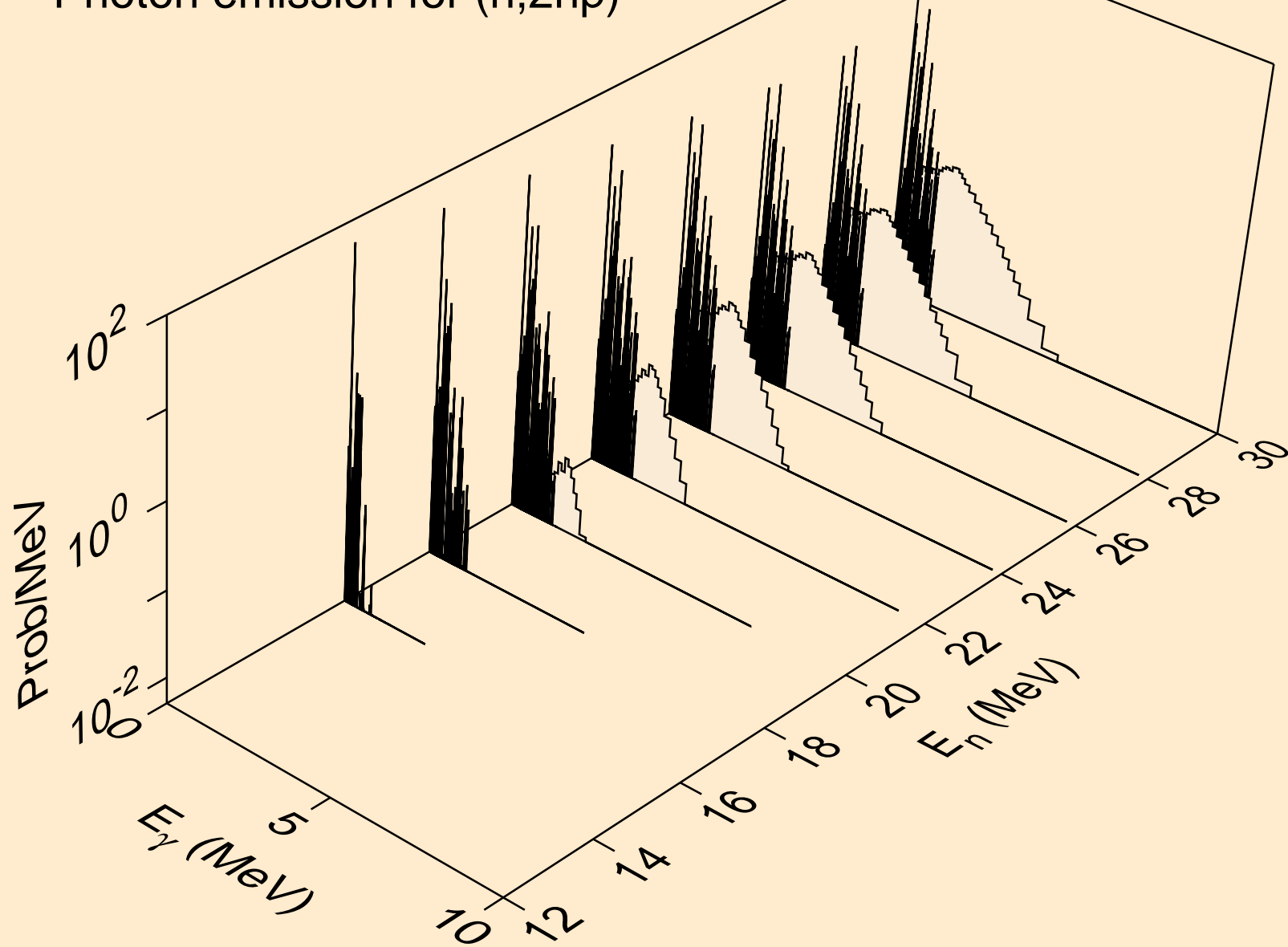

TL197 NEUTRON ACER TENDL-2024 LIBRARY; T=293.6K
Photon emission for (n,3np)

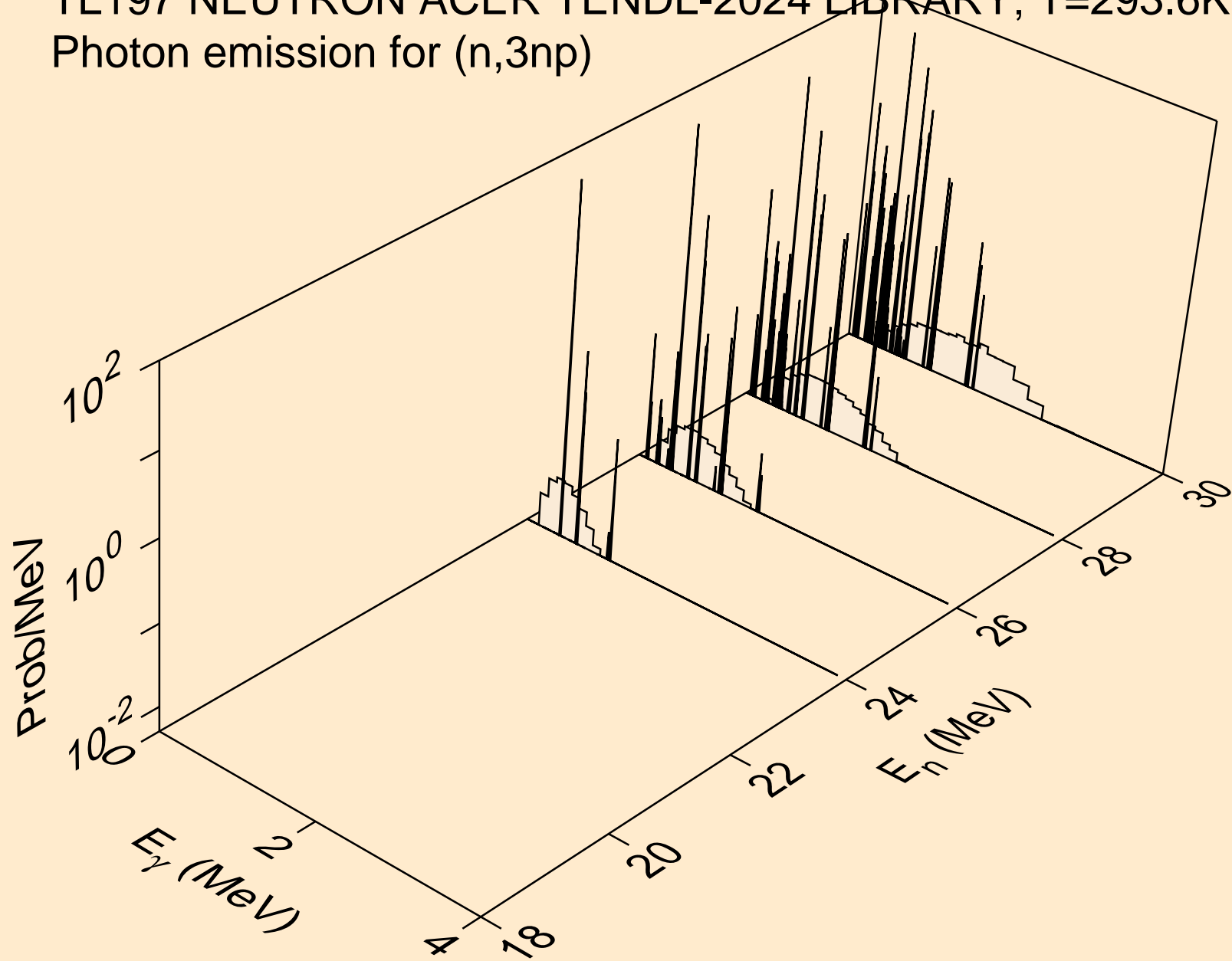

TL197 NEUTRON ACER TENDL-2024 LIBRARY; T=293.6K
Photon emission for (n,n2p)

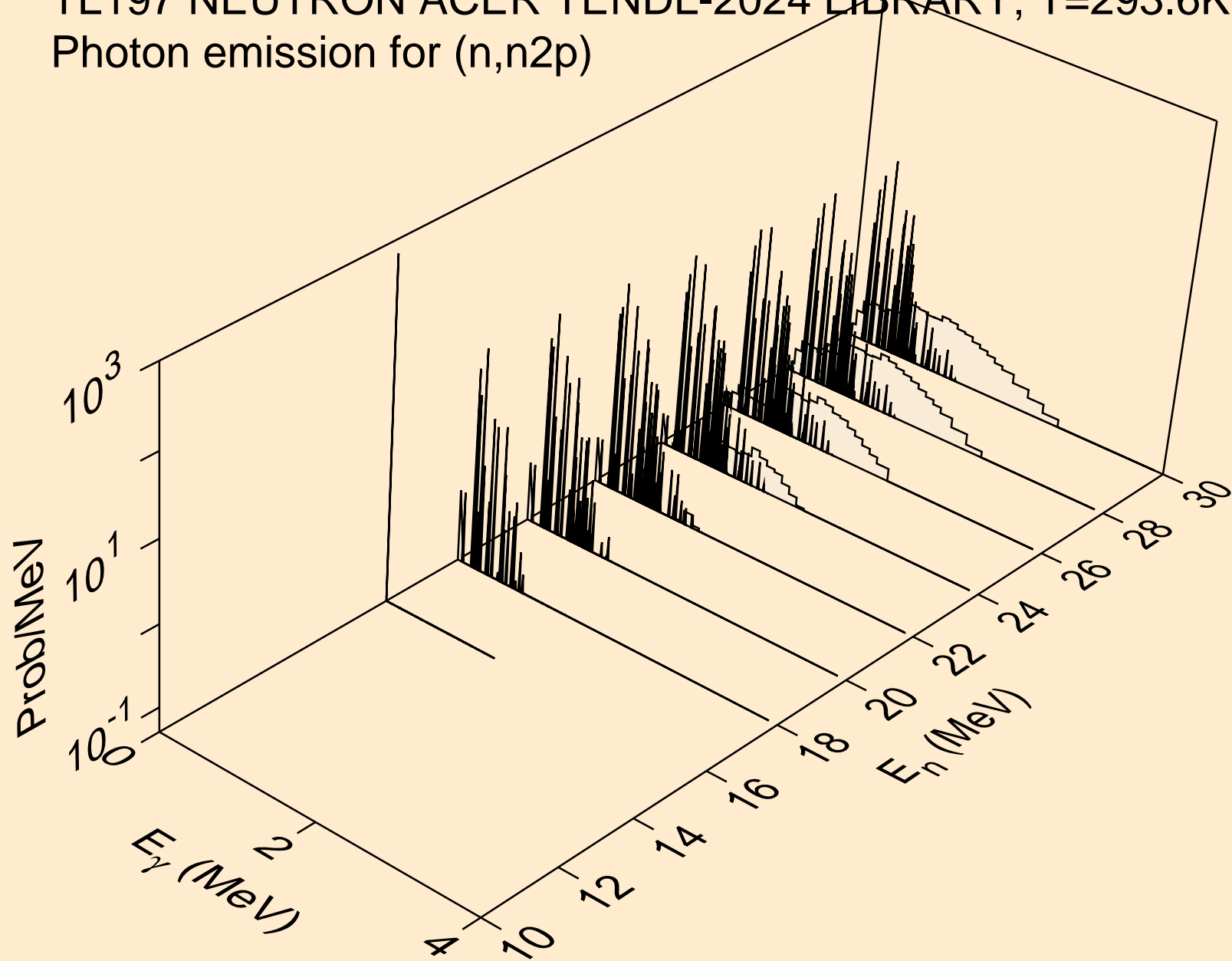

TL197 NEUTRON ACER TENDL-2024 LIBRARY; T=293.6K
Photon emission for (n,npa)

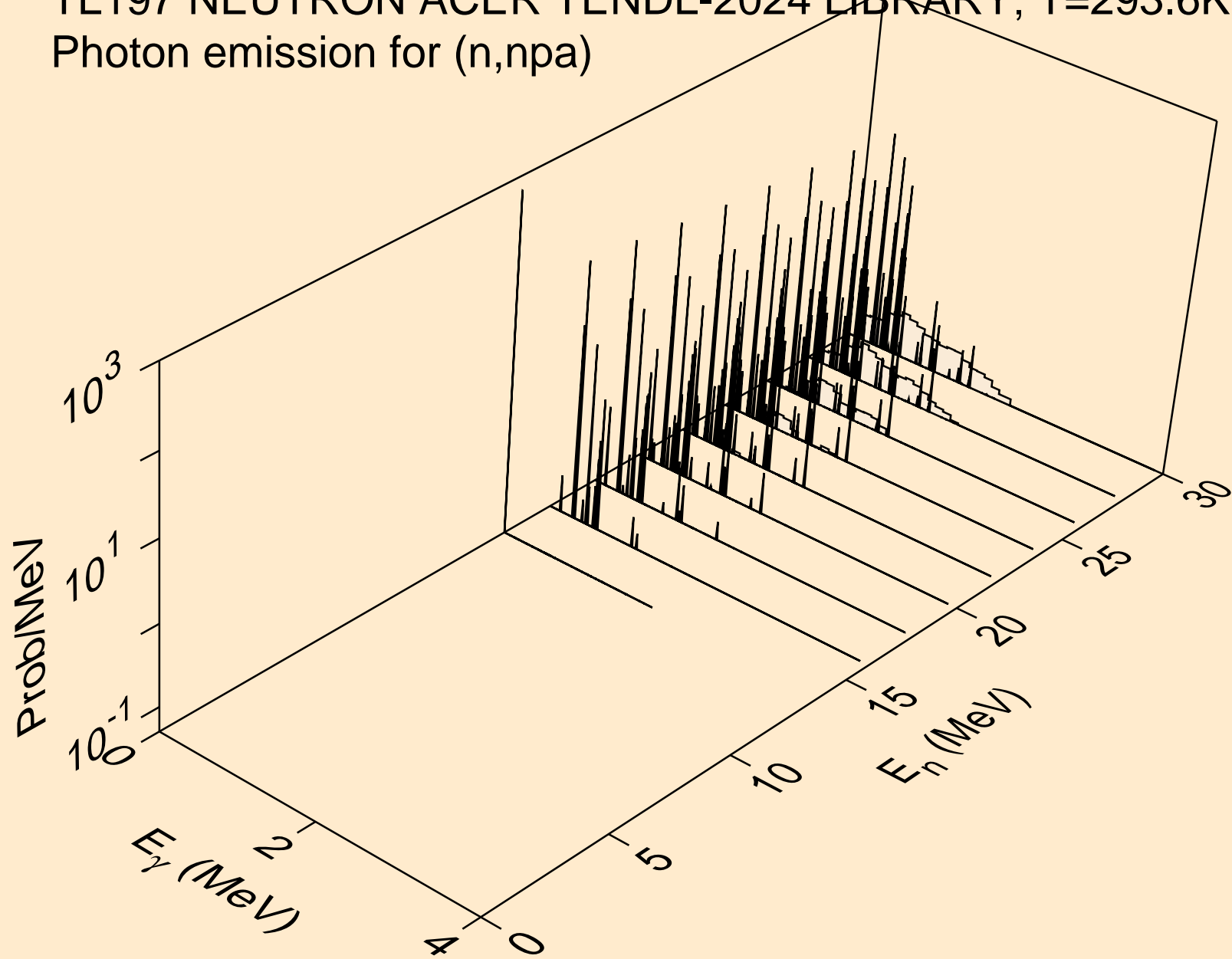

TL197 NEUTRON ACER TENDL-2024 LIBRARY; T=293.6K
Photon emission for (n,n*c)

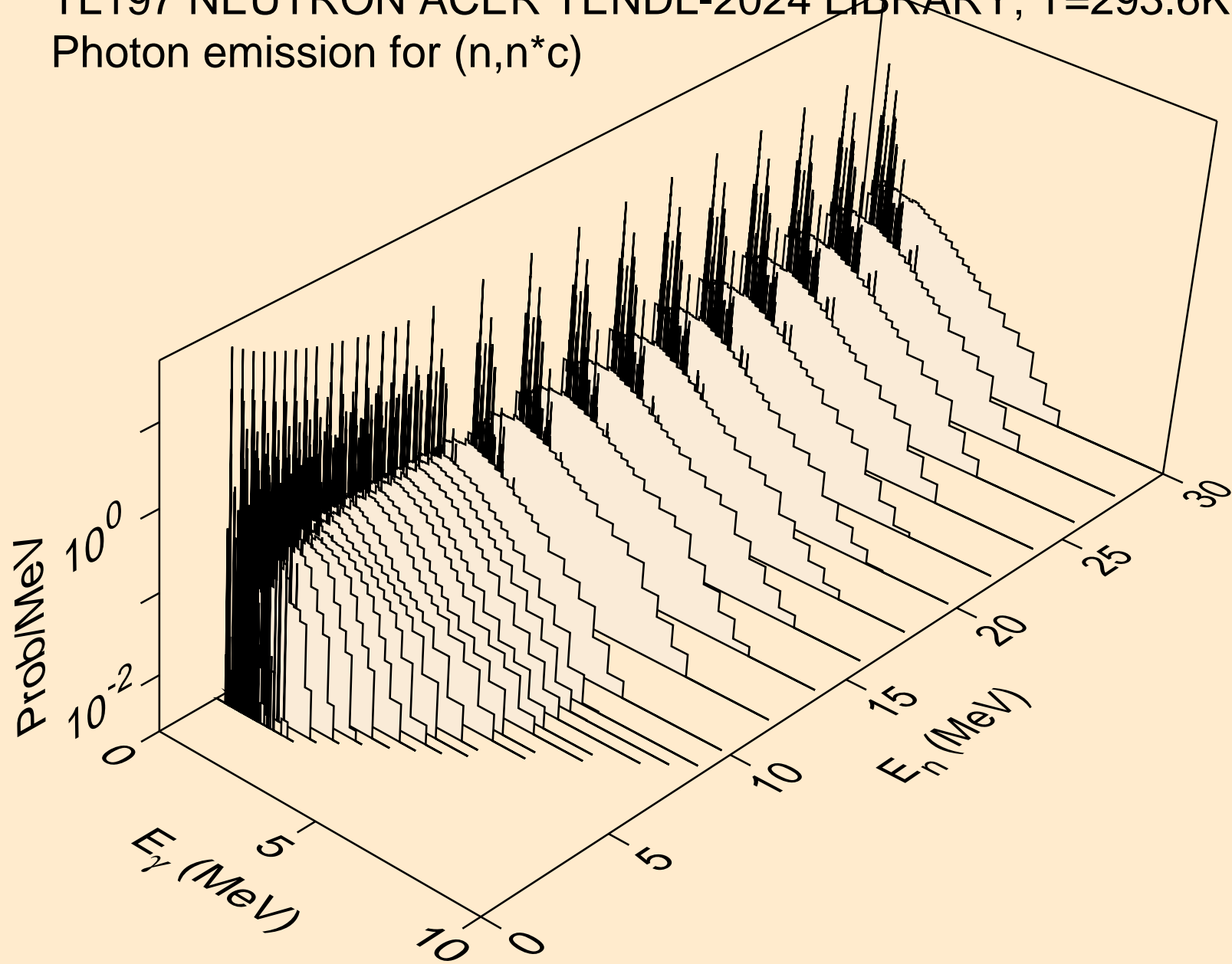

TL197 NEUTRON ACER TENDL-2024 LIBRARY; T=293.6K
Photon emission for (n,gma)

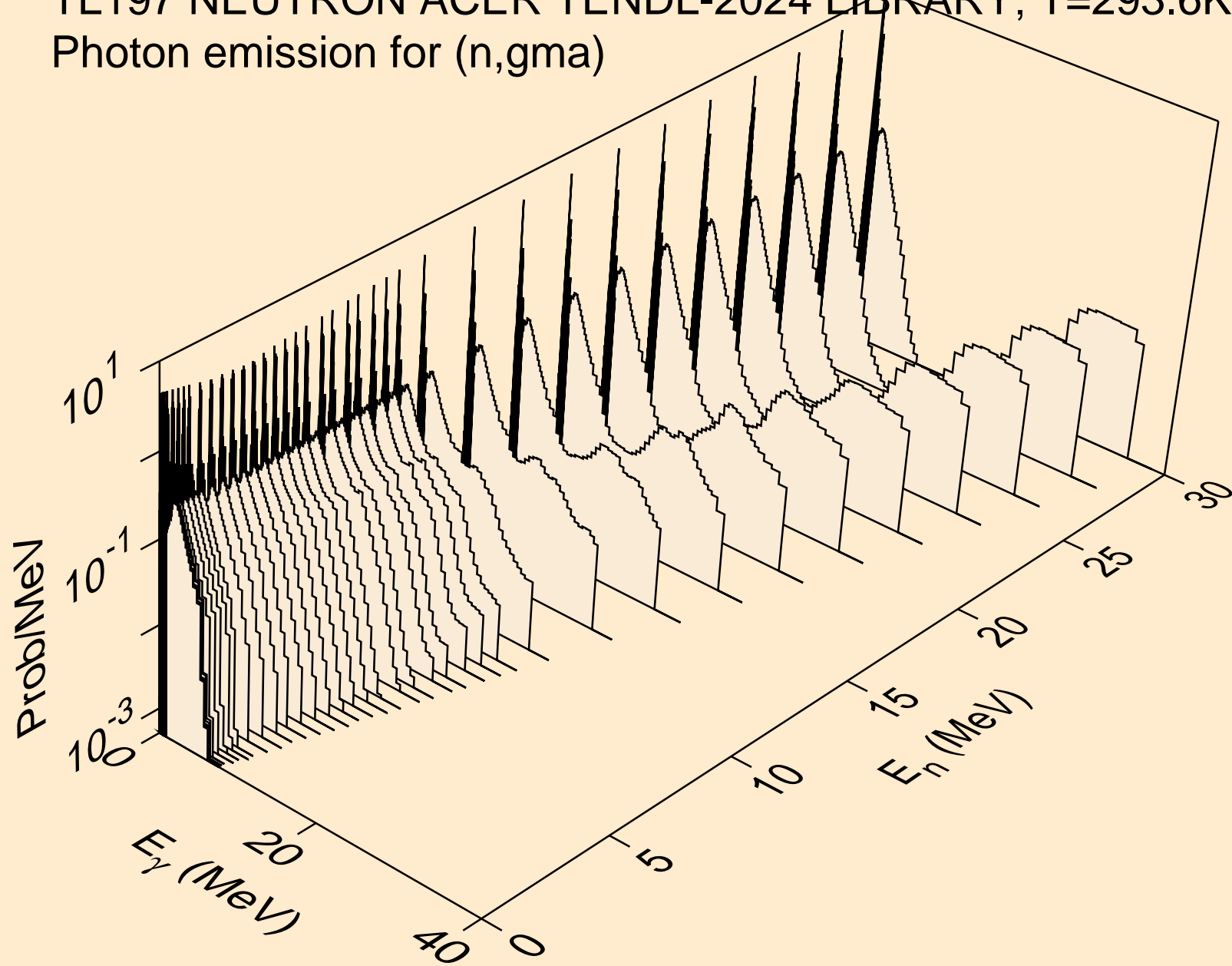

TL197 NEUTRON ACER TENDL-2024 LIBRARY; T=293.6K
Photon emission for (n,p)

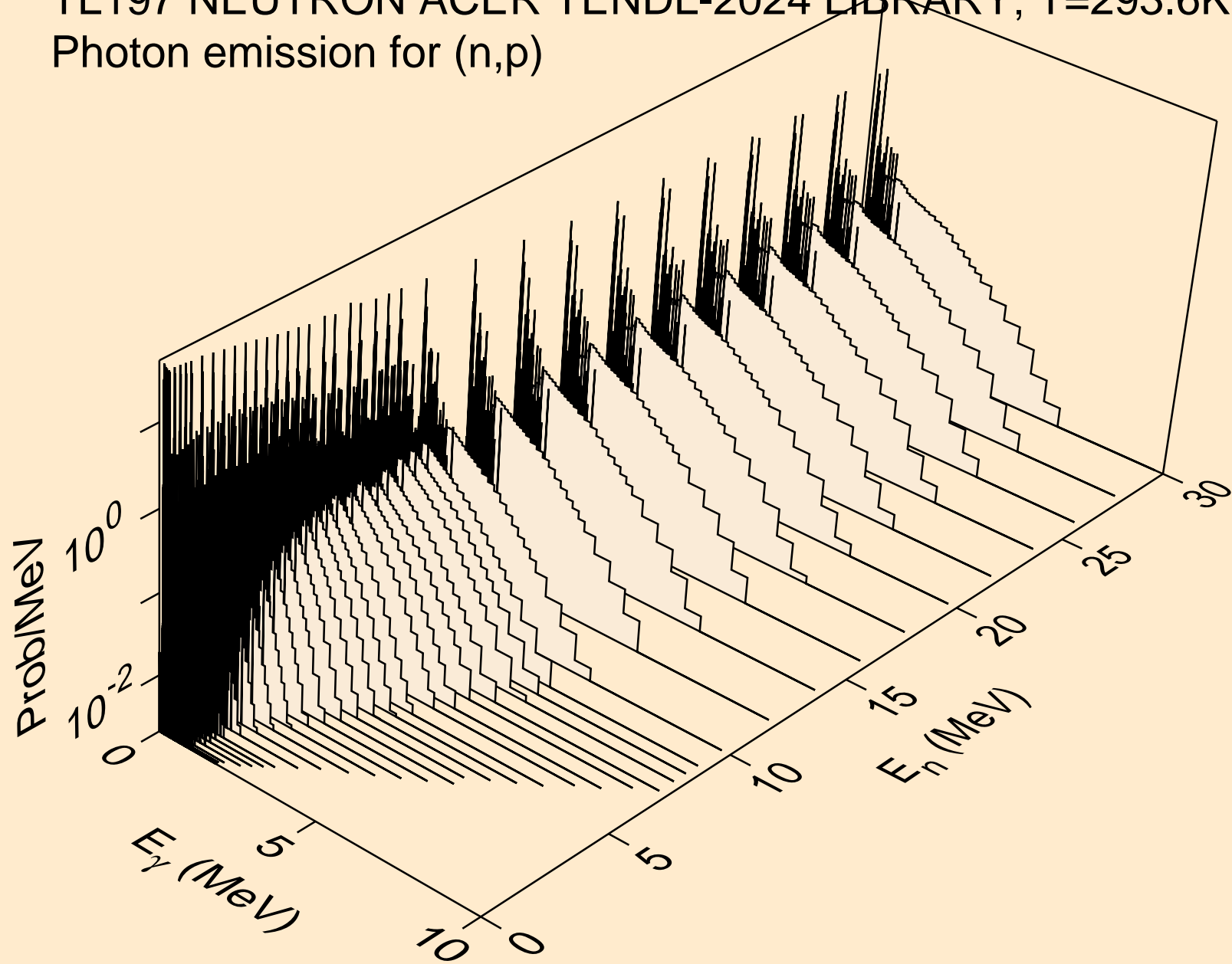

TL197 NEUTRON ACER TENDL-2024 LIBRARY; T=293.6K
Photon emission for (n,d)

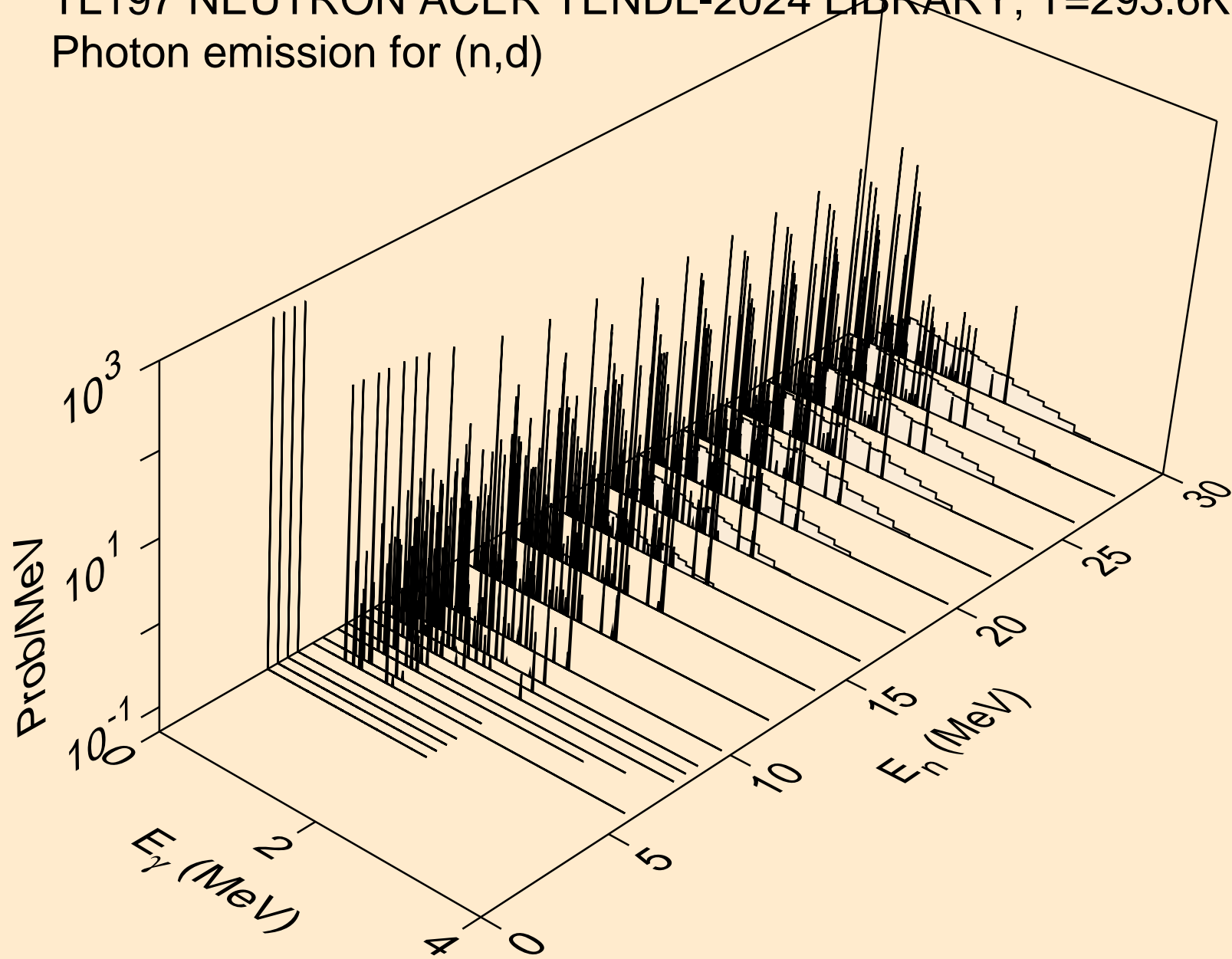

TL197 NEUTRON ACER TENDL-2024 LIBRARY; T=293.6K
Photon emission for (n,t)

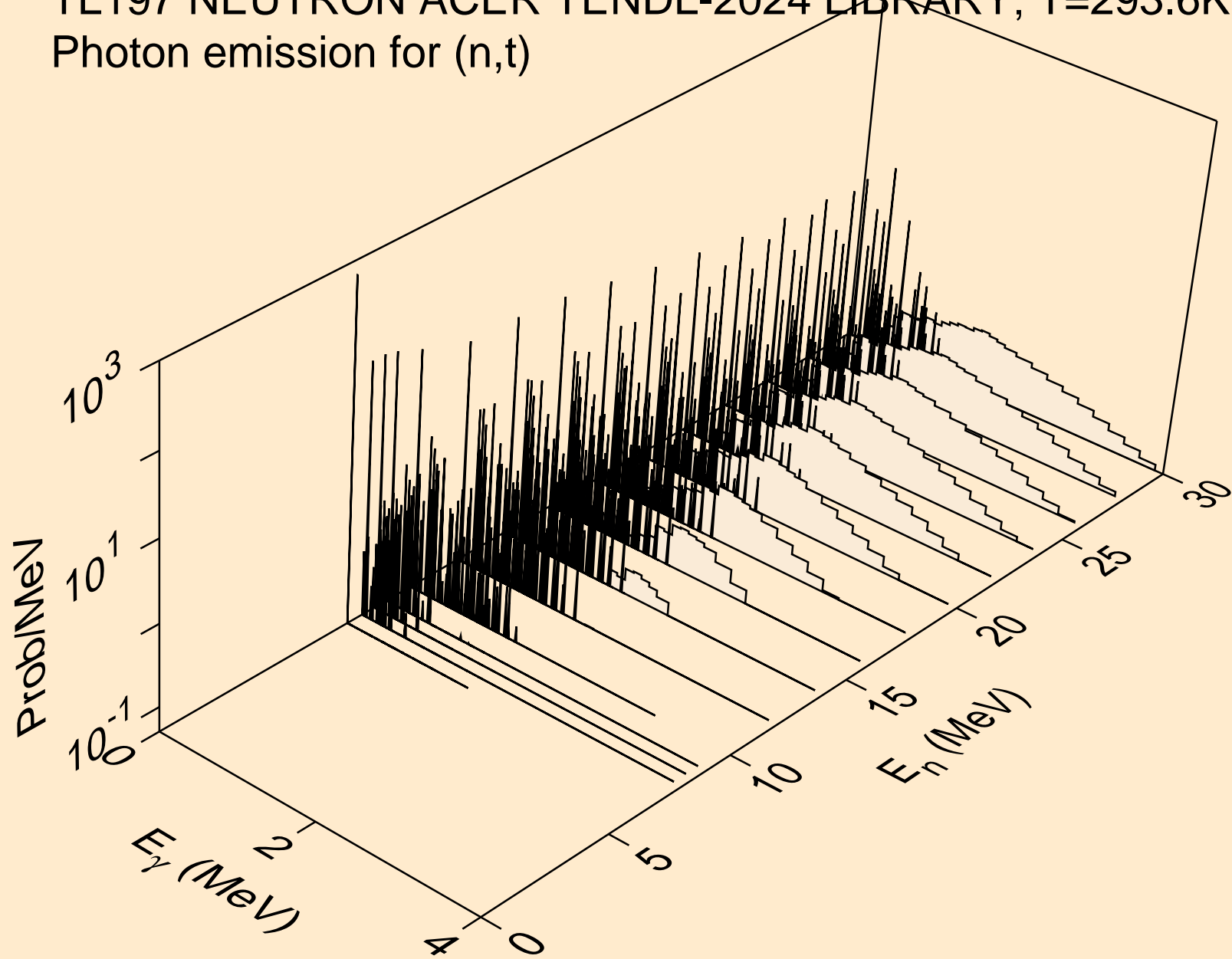

TL197 NEUTRON ACER TENDL-2024 LIBRARY; T=293.6K
Photon emission for (n,he3)

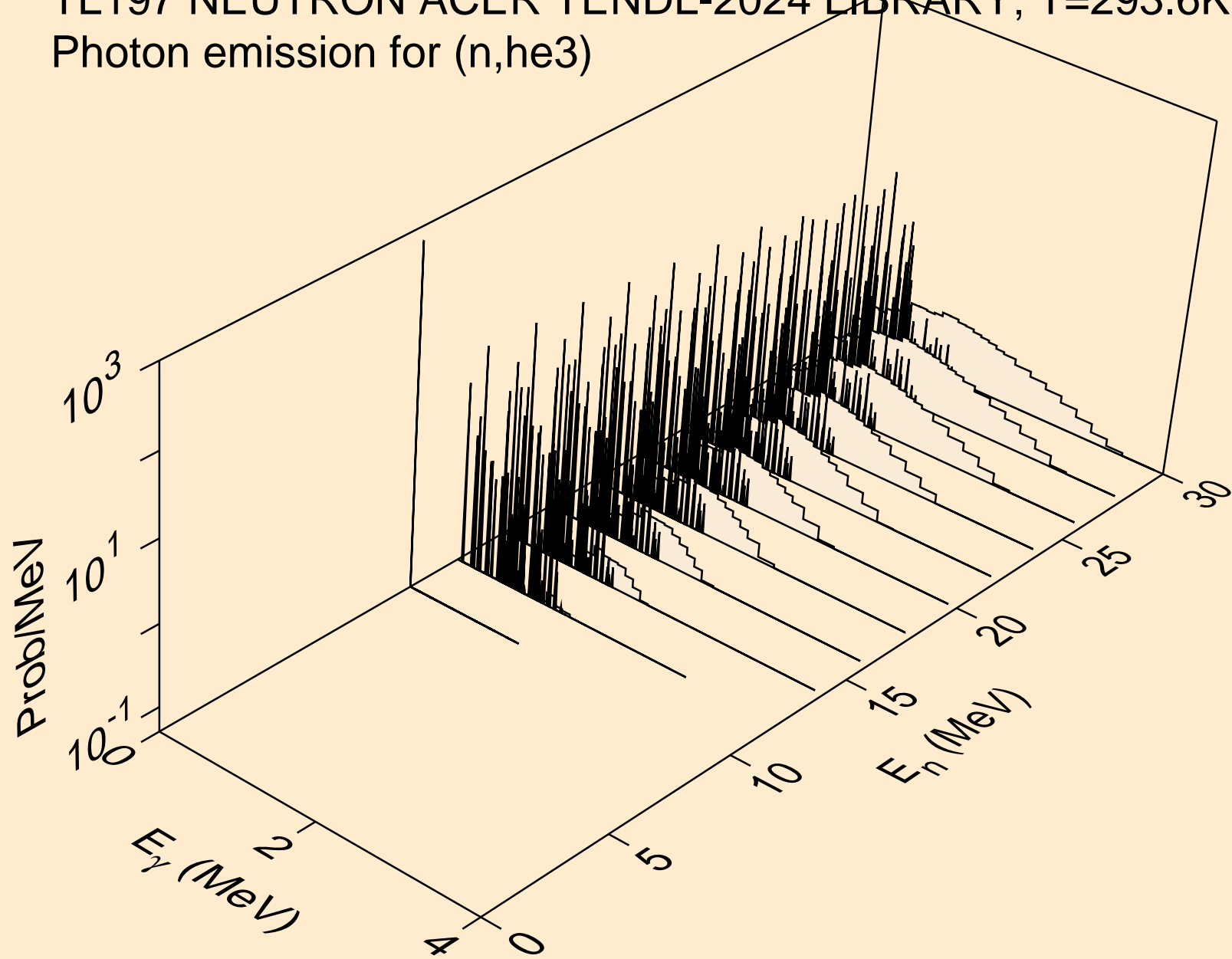

TL197 NEUTRON ACER TENDL-2024 LIBRARY; T=293.6K
Photon emission for (n,a)

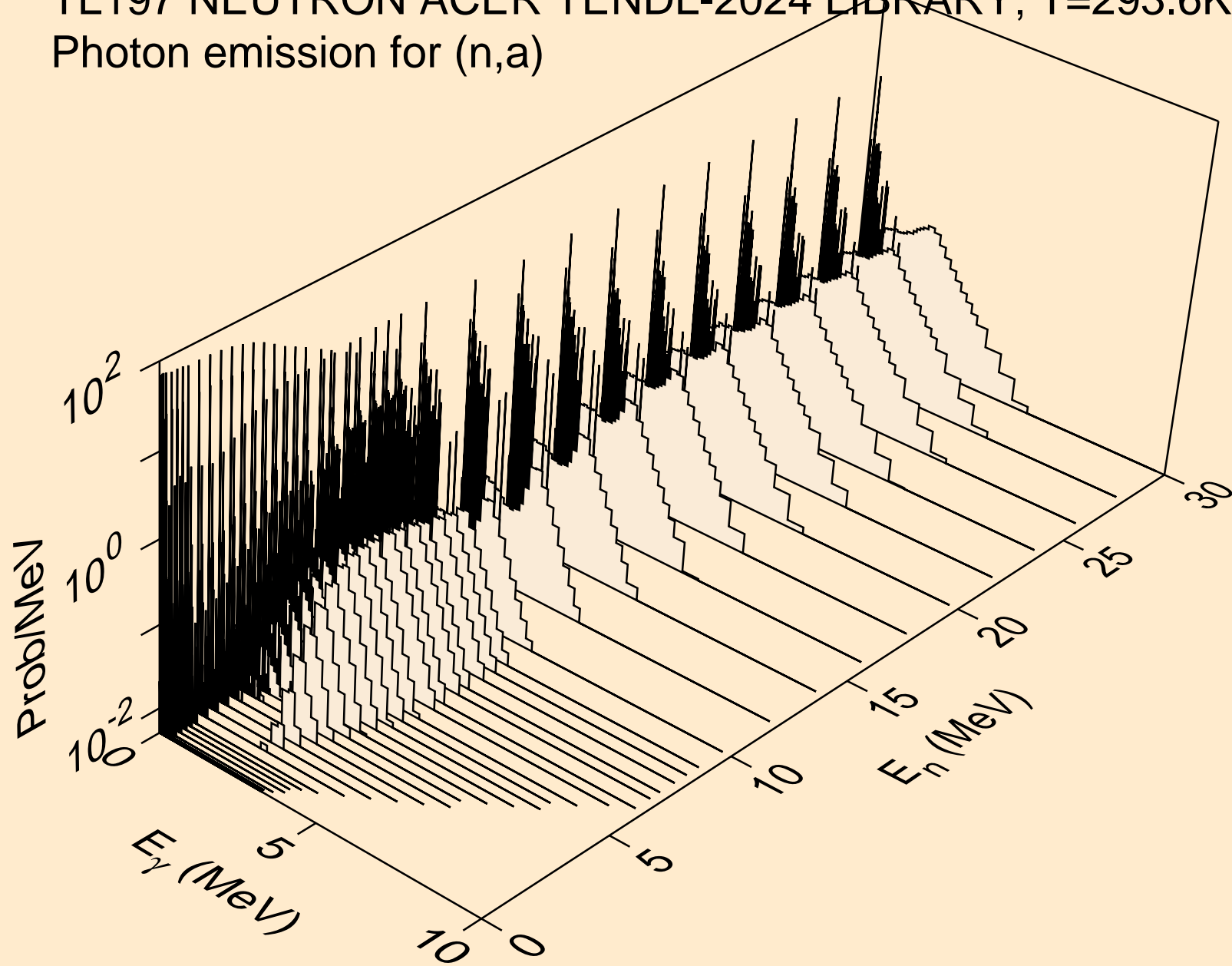

TL197 NEUTRON ACER TENDL-2024 LIBRARY; T=293.6K
Photon emission for (n,2a)

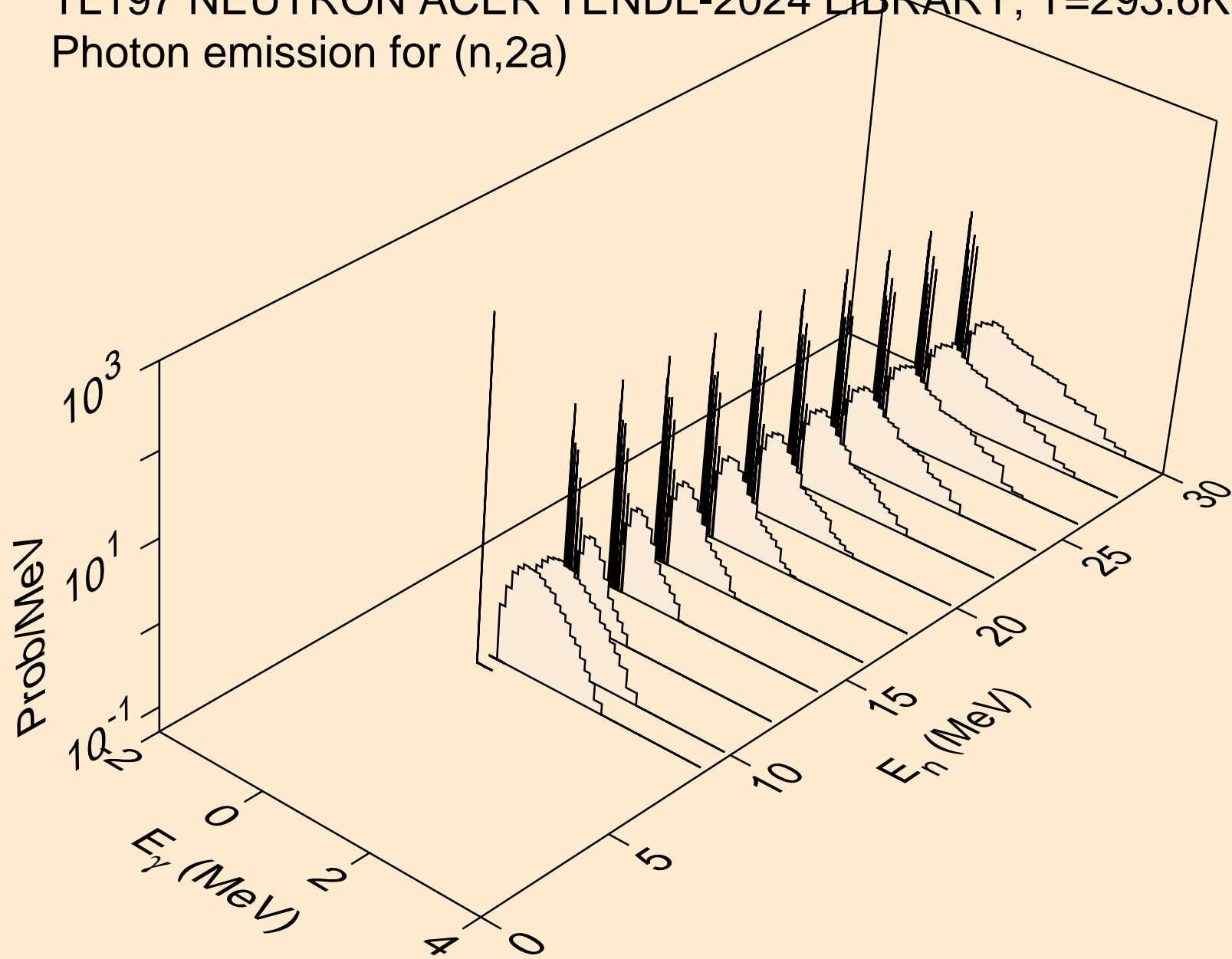

TL197 NEUTRON ACER TENDL-2024 LIBRARY; T=293.6K
Photon emission for (n,2p)

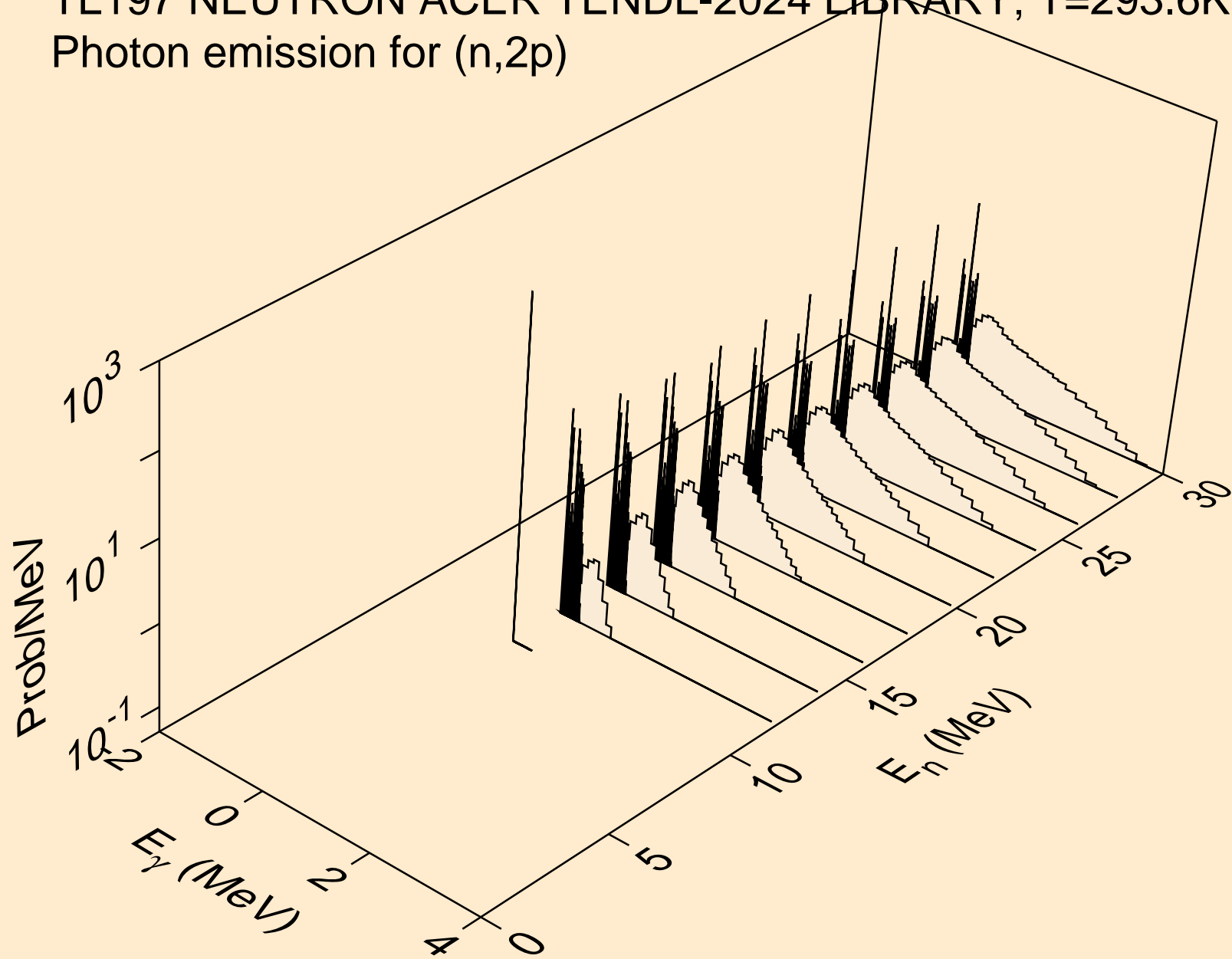

TL197 NEUTRON ACER TENDL-2024 LIBRARY; T=293.6K
Photon emission for (n,p α)

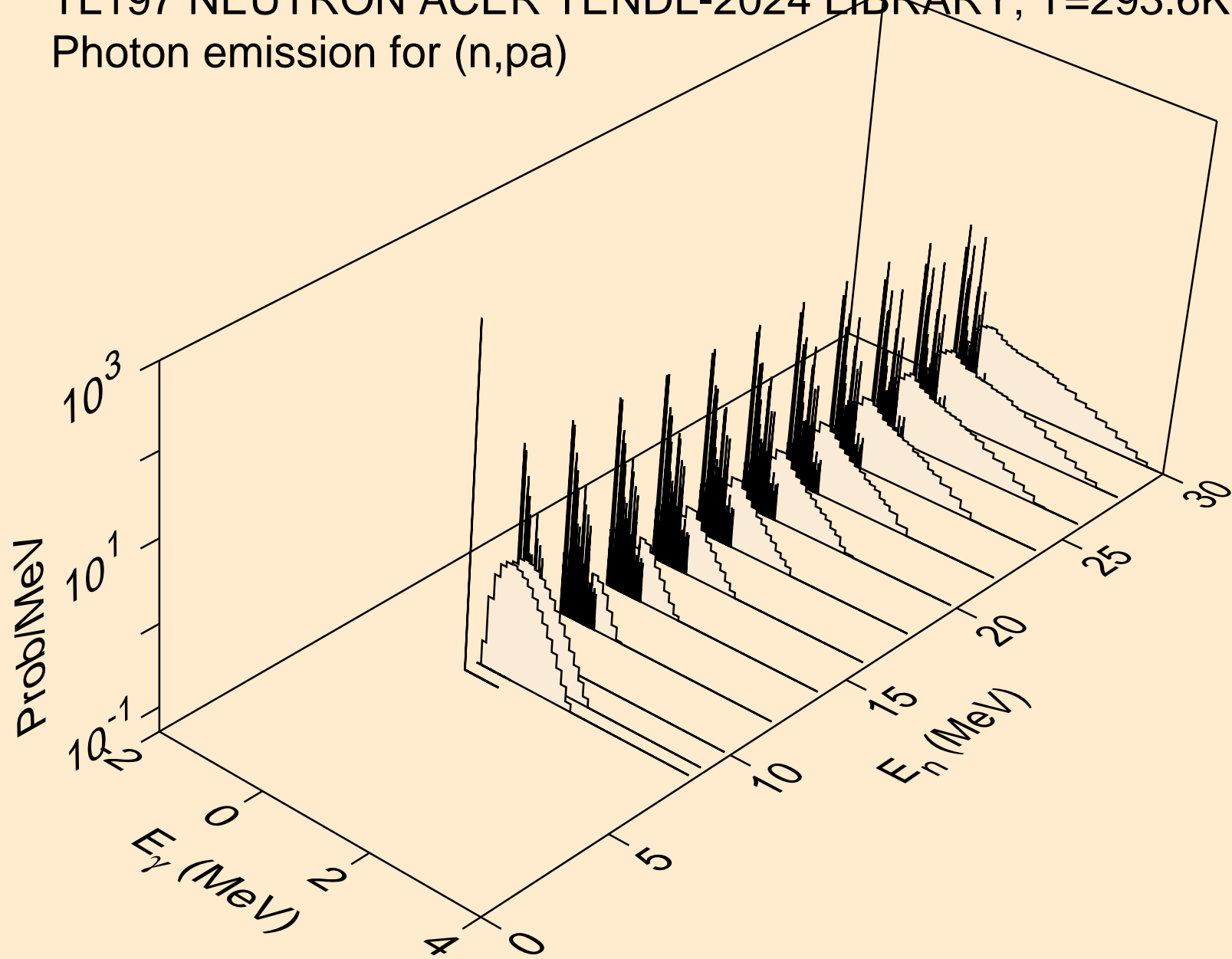

TL197 NEUTRON ACER TENDL-2024 LIBRARY; T=293.6K
Photon emission for (n,pd)

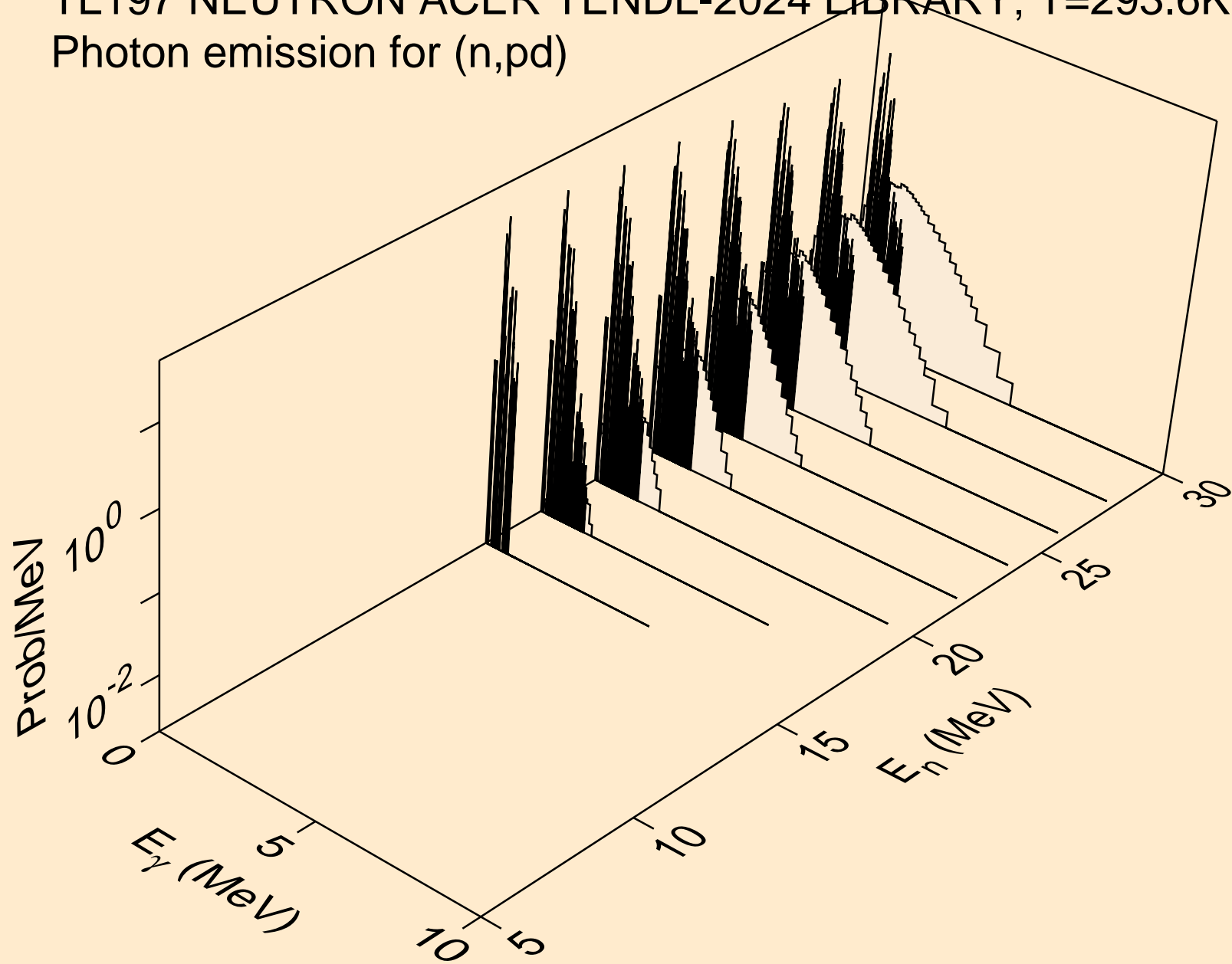

TL197 NEUTRON ACER TENDL-2024 LIBRARY; T=293.6K
Photon emission for (n,pt)

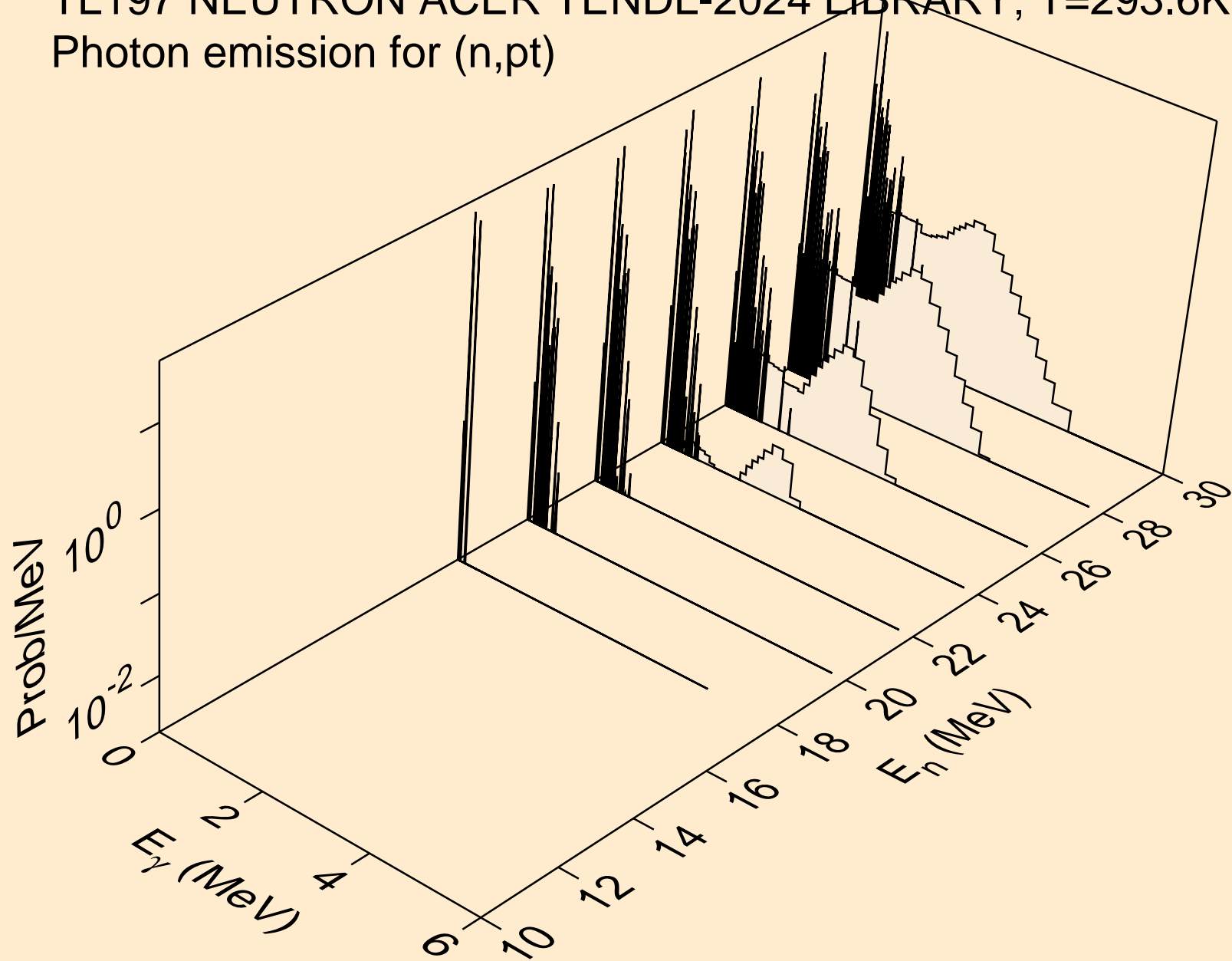

TL197 NEUTRON ACER TENDL-2024 LIBRARY; T=293.6K
Photon emission for (n,da)

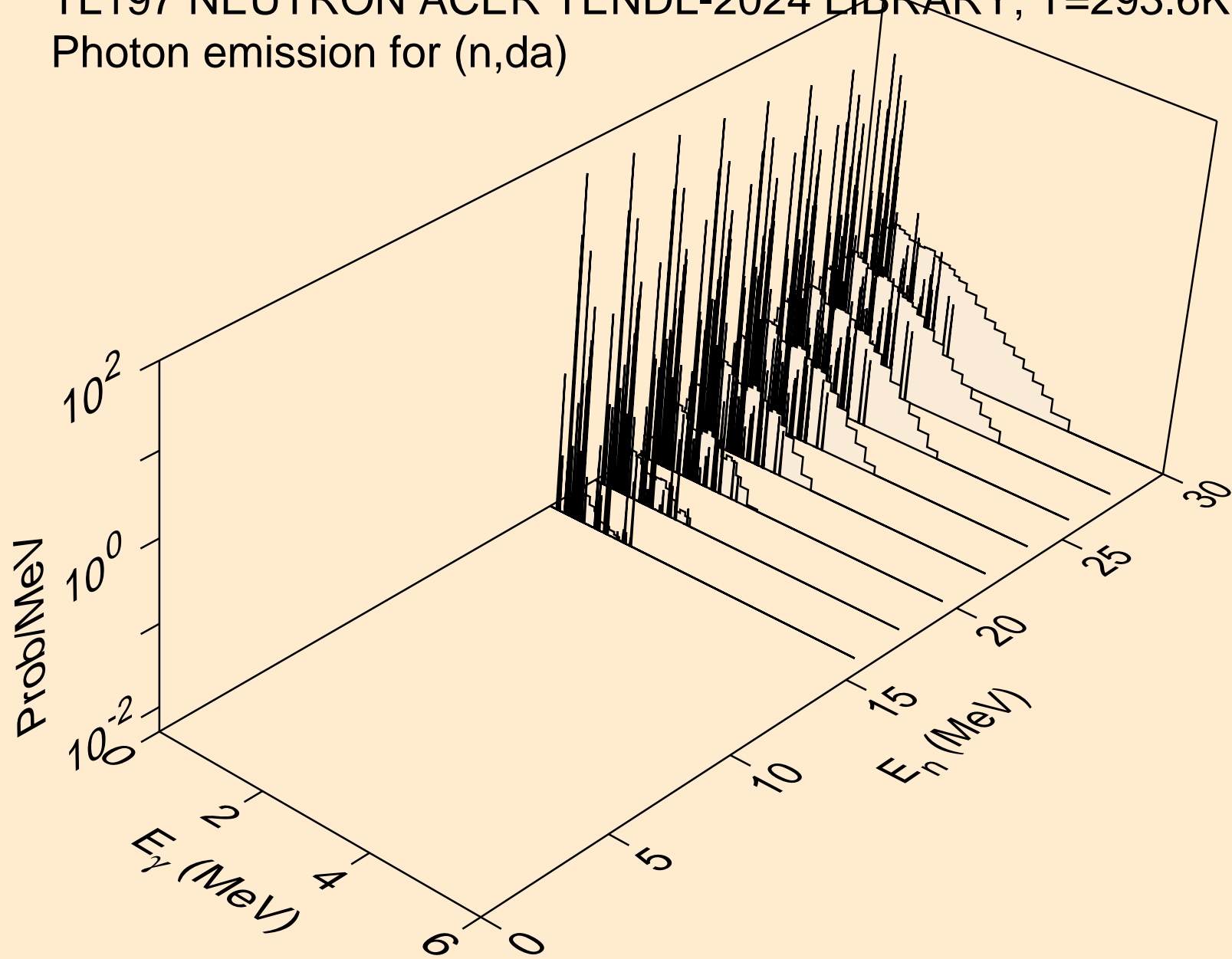

TL197 NEUTRON ACER TENDL-2024 LIBRARY; T=293.6K
thermal capture photon spectrum

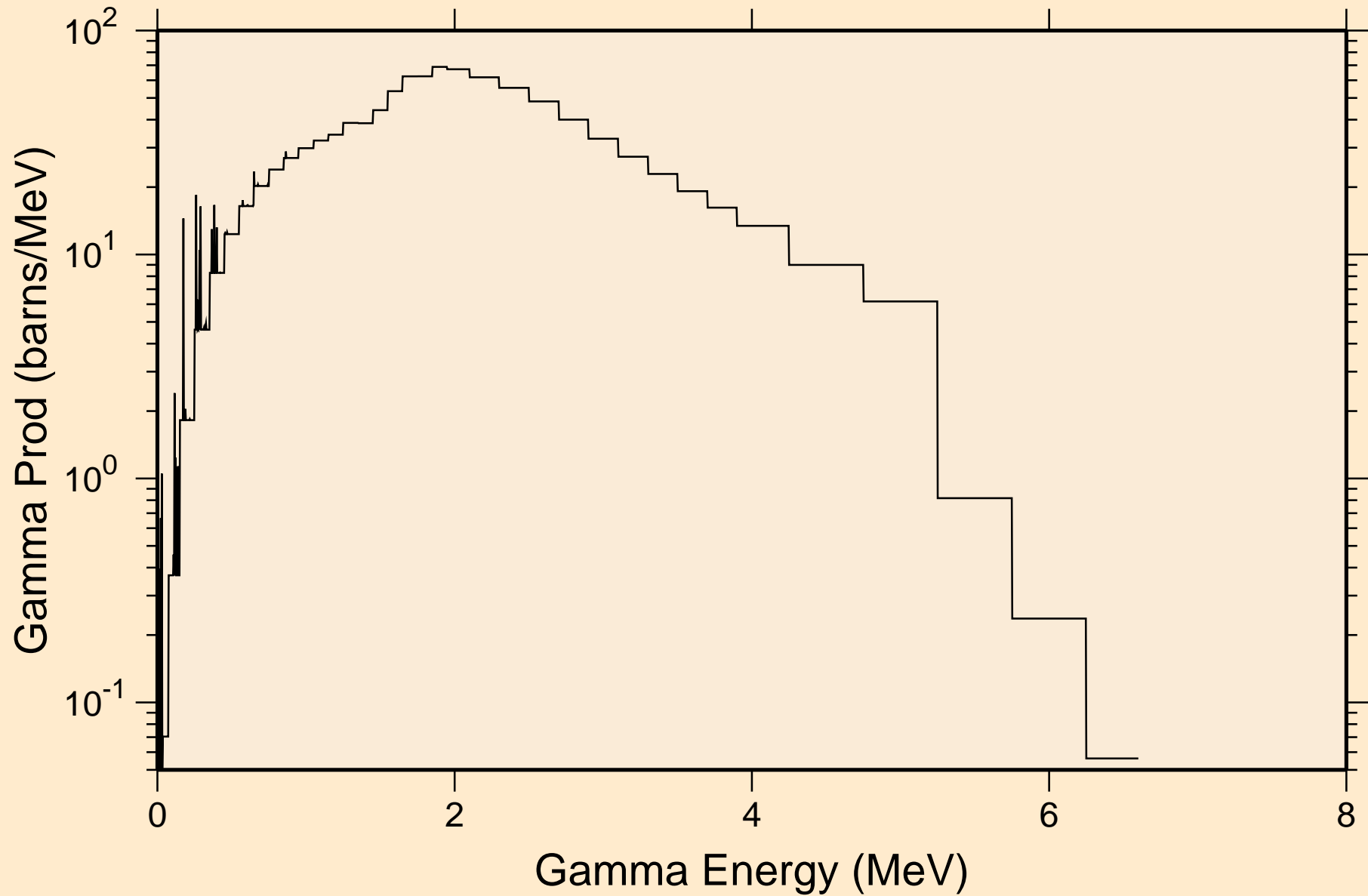

TL197 NEUTRON ACER TENDL-2024 LIBRARY; T=293.6K
14 MeV photon spectrum

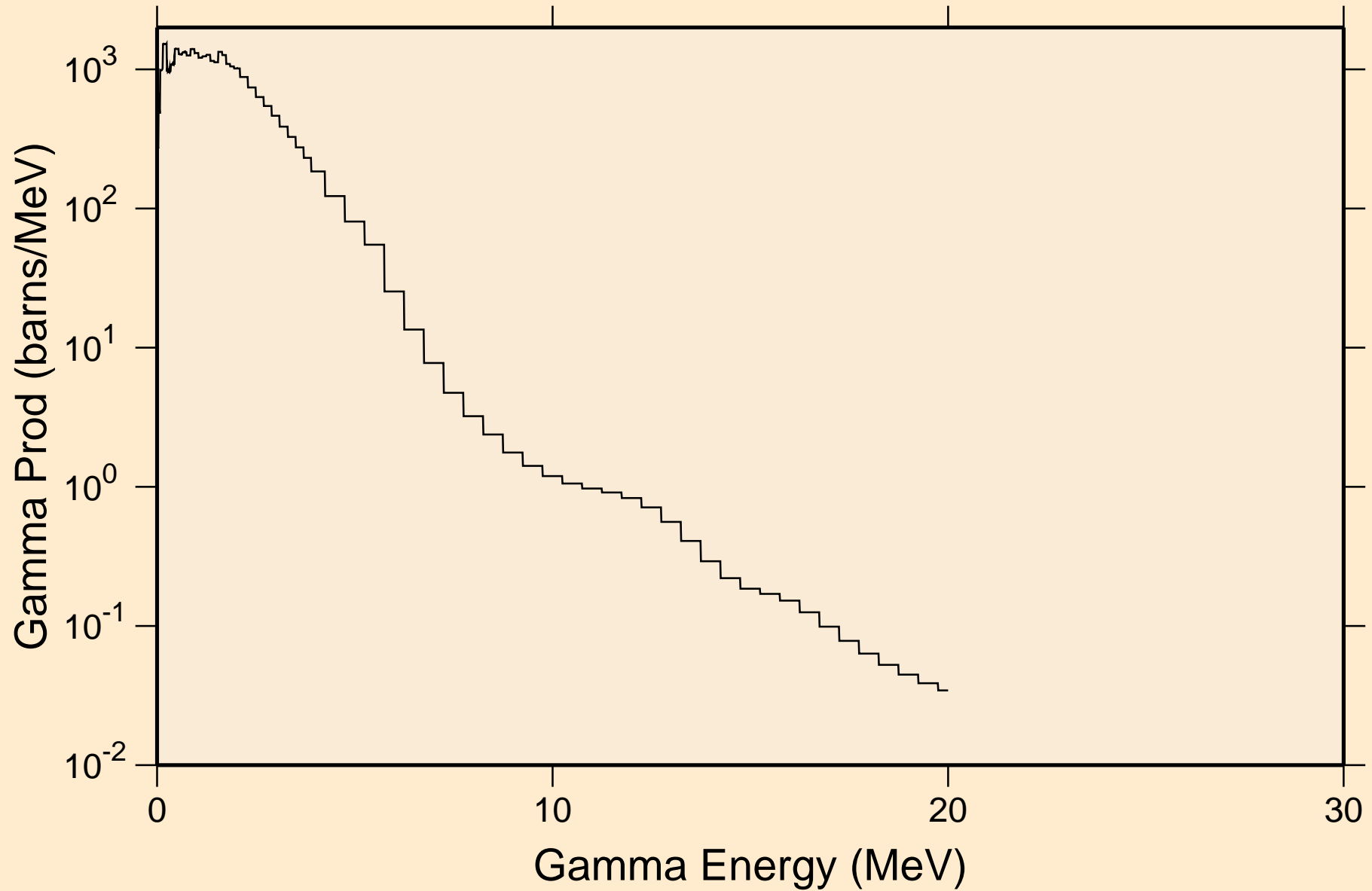

TL197 NEUTRON ACER TENDL-2024 LIBRARY; T=293.6K
Particle heating contributions

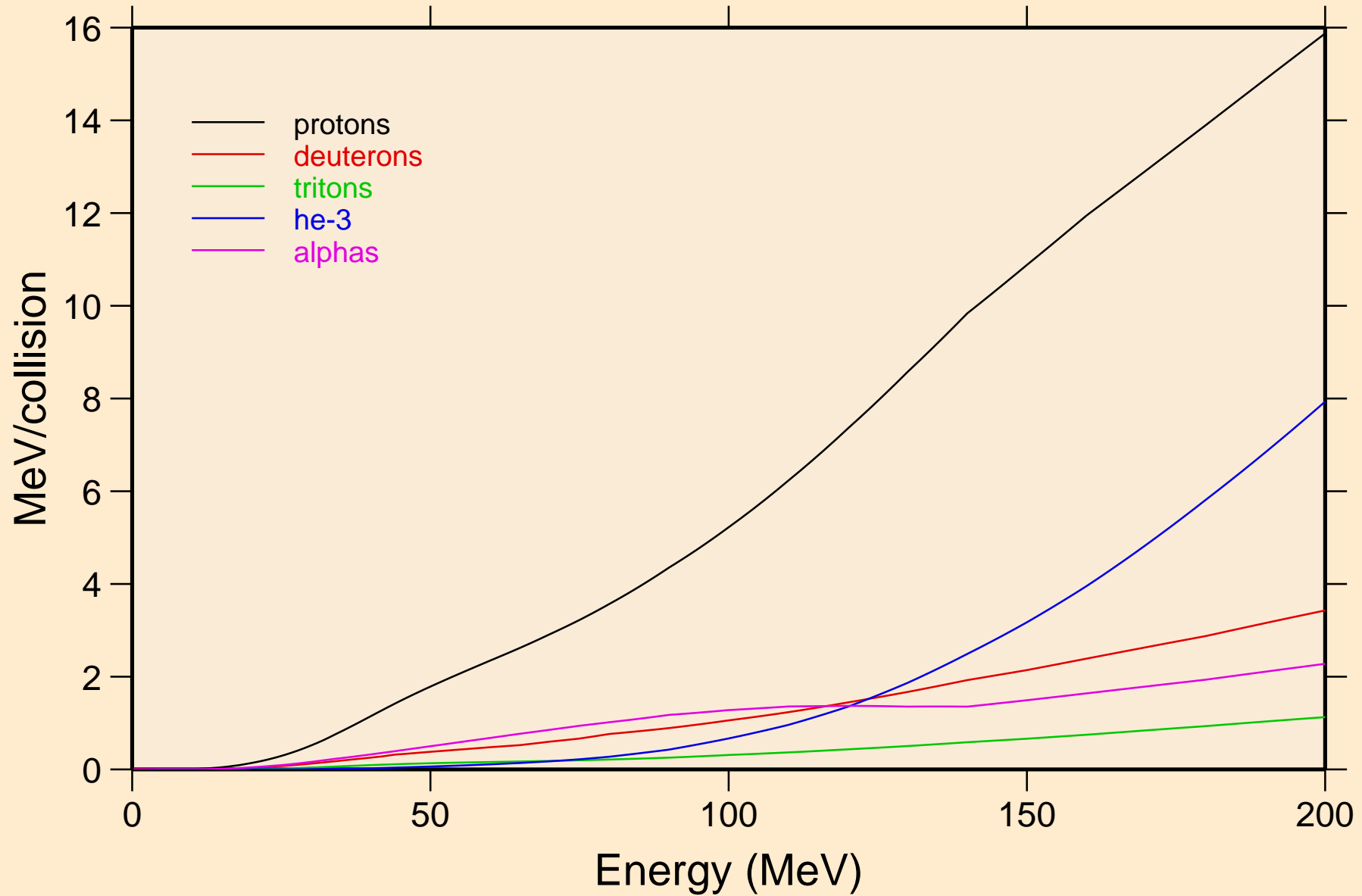

TL197 NEUTRON ACER TENDL-2024 LIBRARY; T=293.6K
Recoil Heating

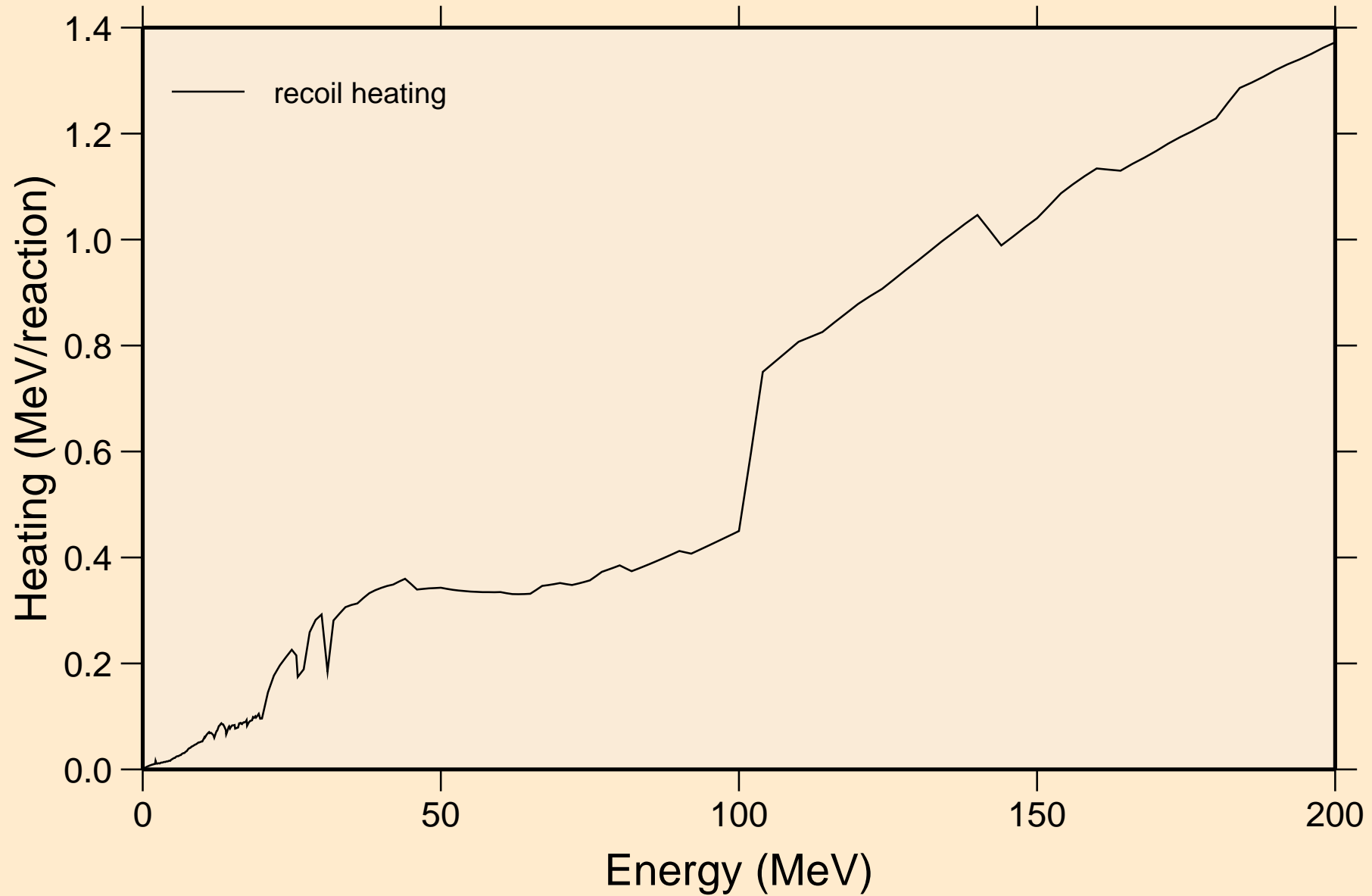

TL197 NEUTRON ACER TENDL-2024 LIBRARY; T=293.6K
Particle production cross sections

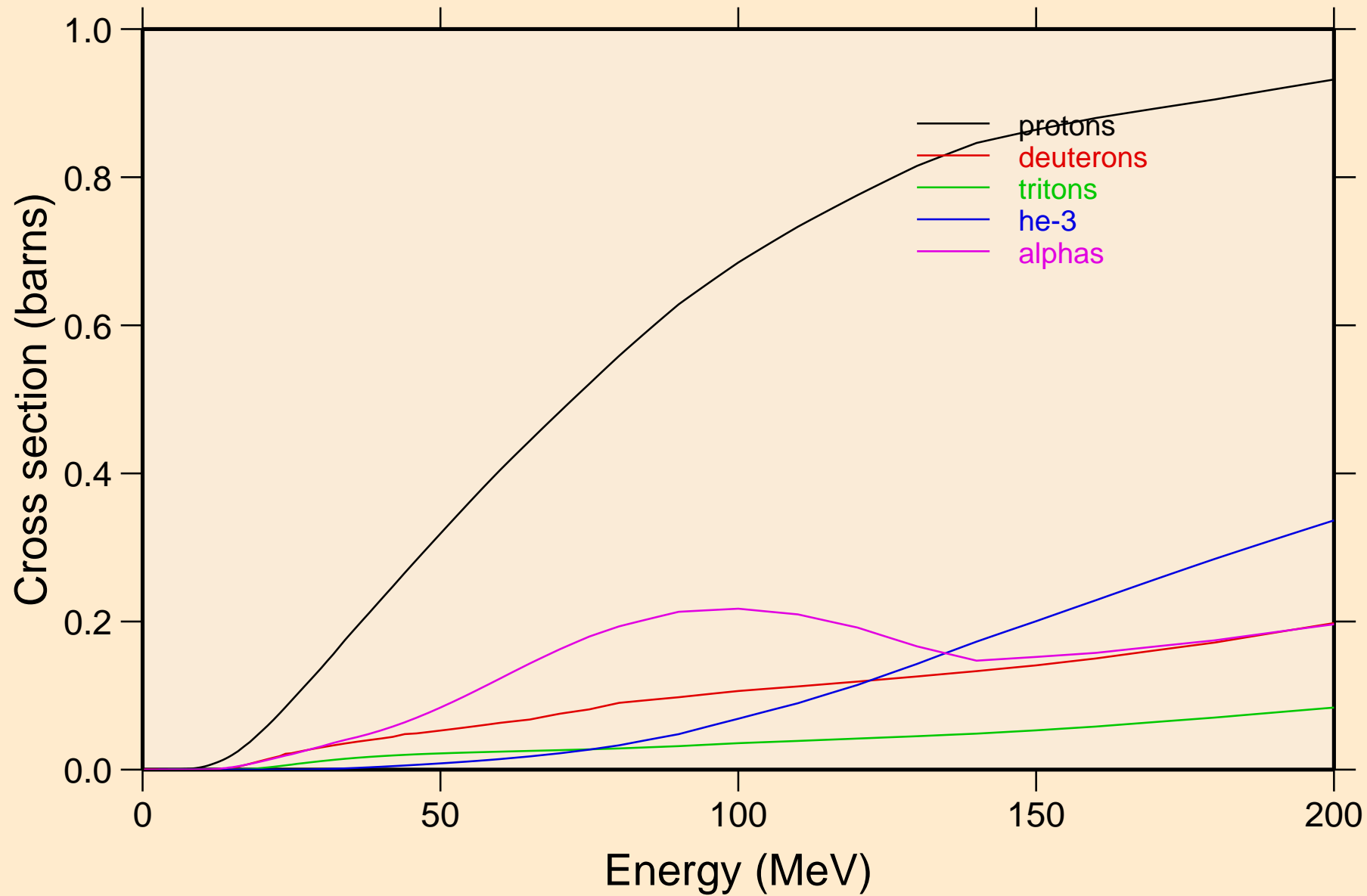

TL197 NEUTRON ACER TENDL-2024 LIBRARY; T=293.6K
protons from (n,x)

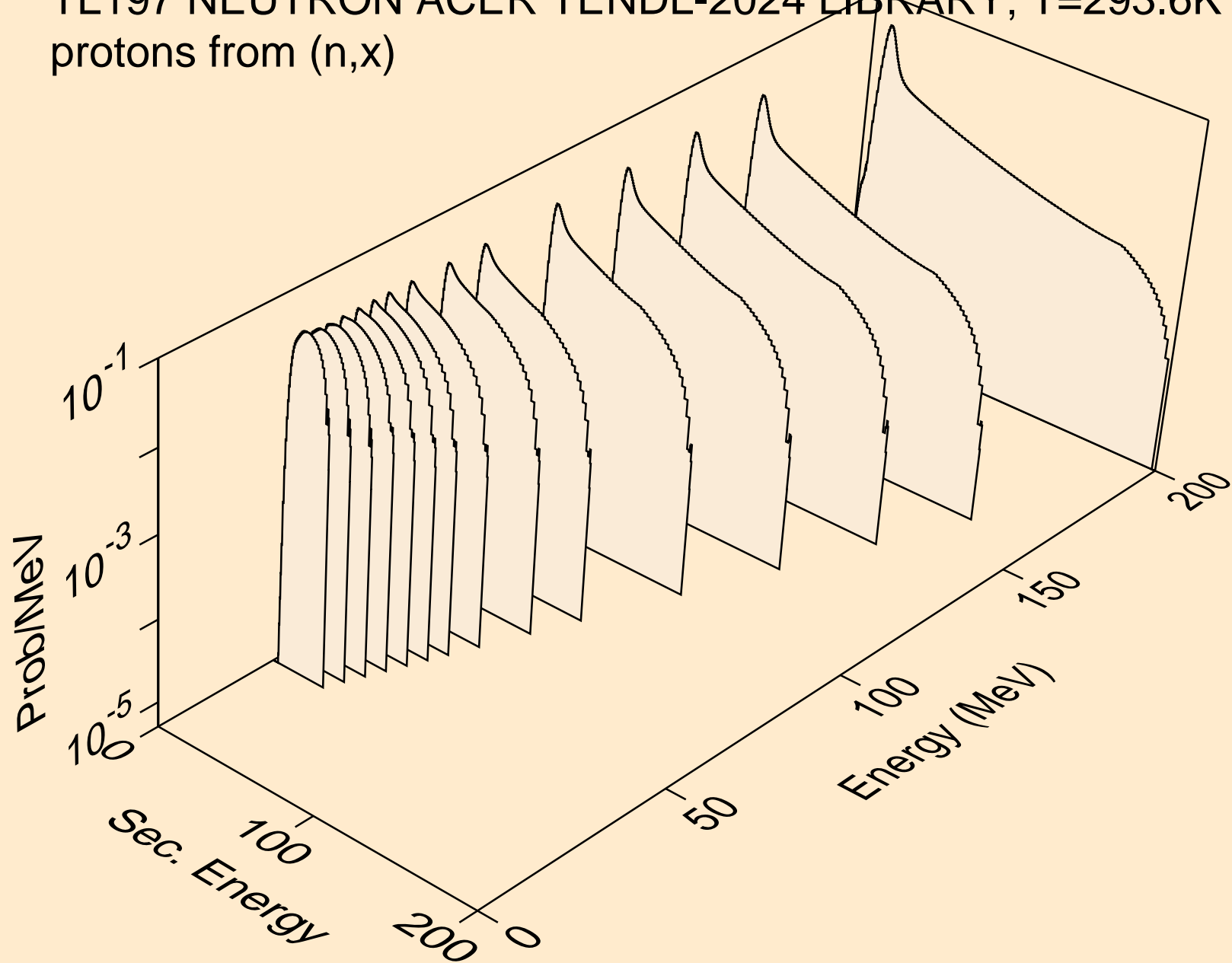

TL197 NEUTRON ACER TENDL-2024 LIBRARY; T=293.6K
protons from (n,n*)p

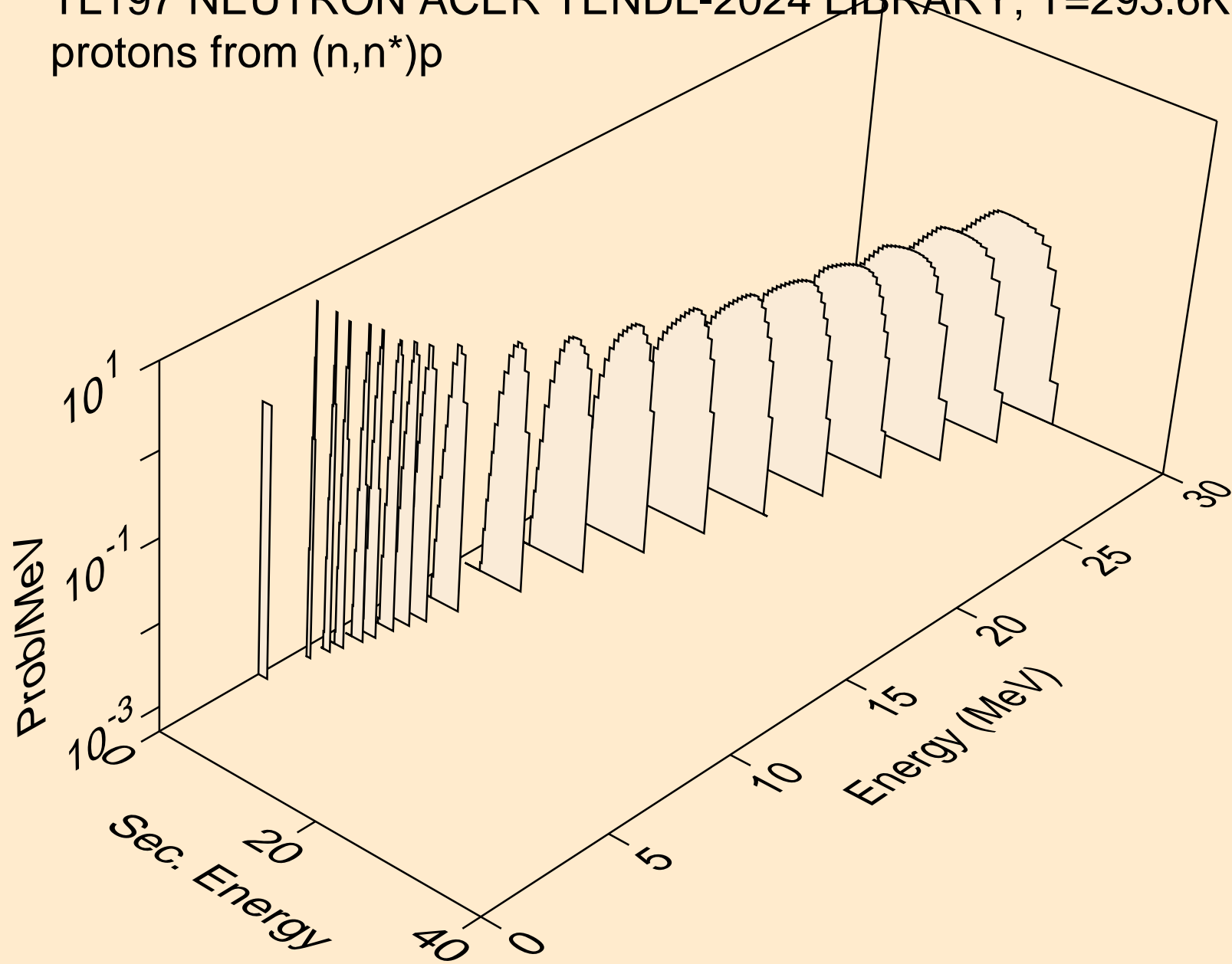

TL197 NEUTRON ACER TENDL-2024 LIBRARY; T=293.6K
protons from (n,2np)

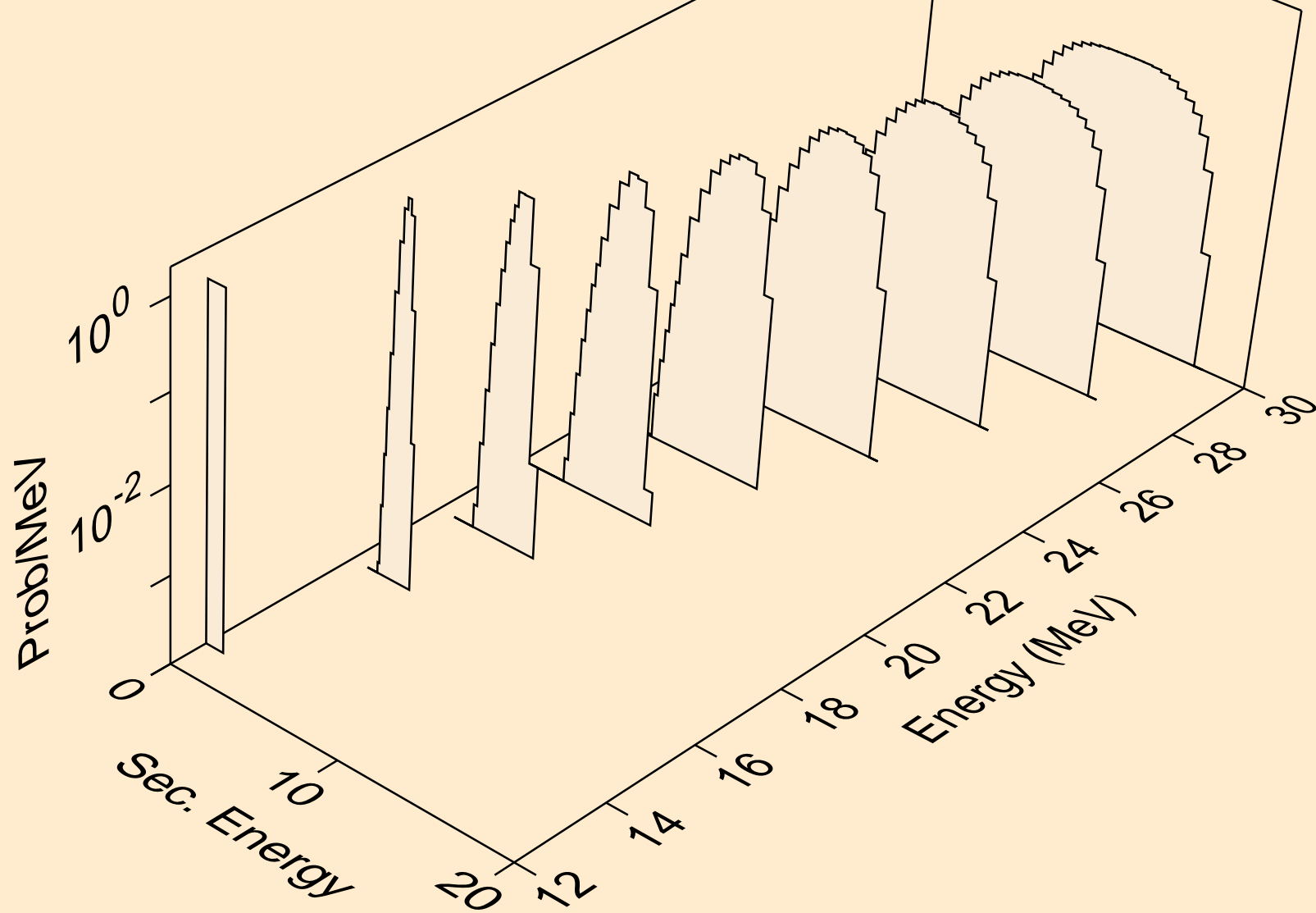

TL197 NEUTRON ACER TENDL-2024 LIBRARY; T=293.6K
protons from (n,3np)

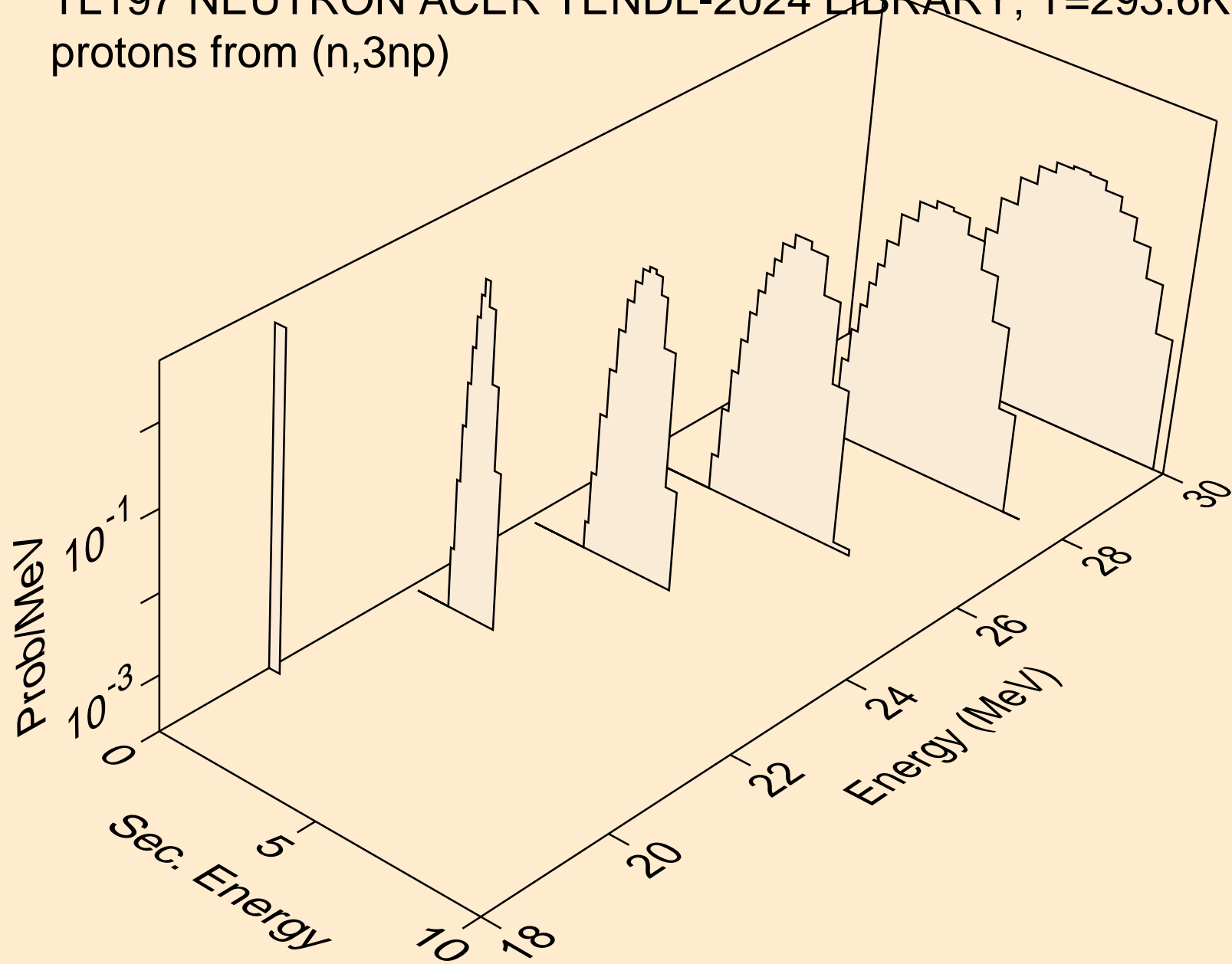

TL197 NEUTRON ACER TENDL-2024 LIBRARY; T=293.6K
protons from (n,n2p)

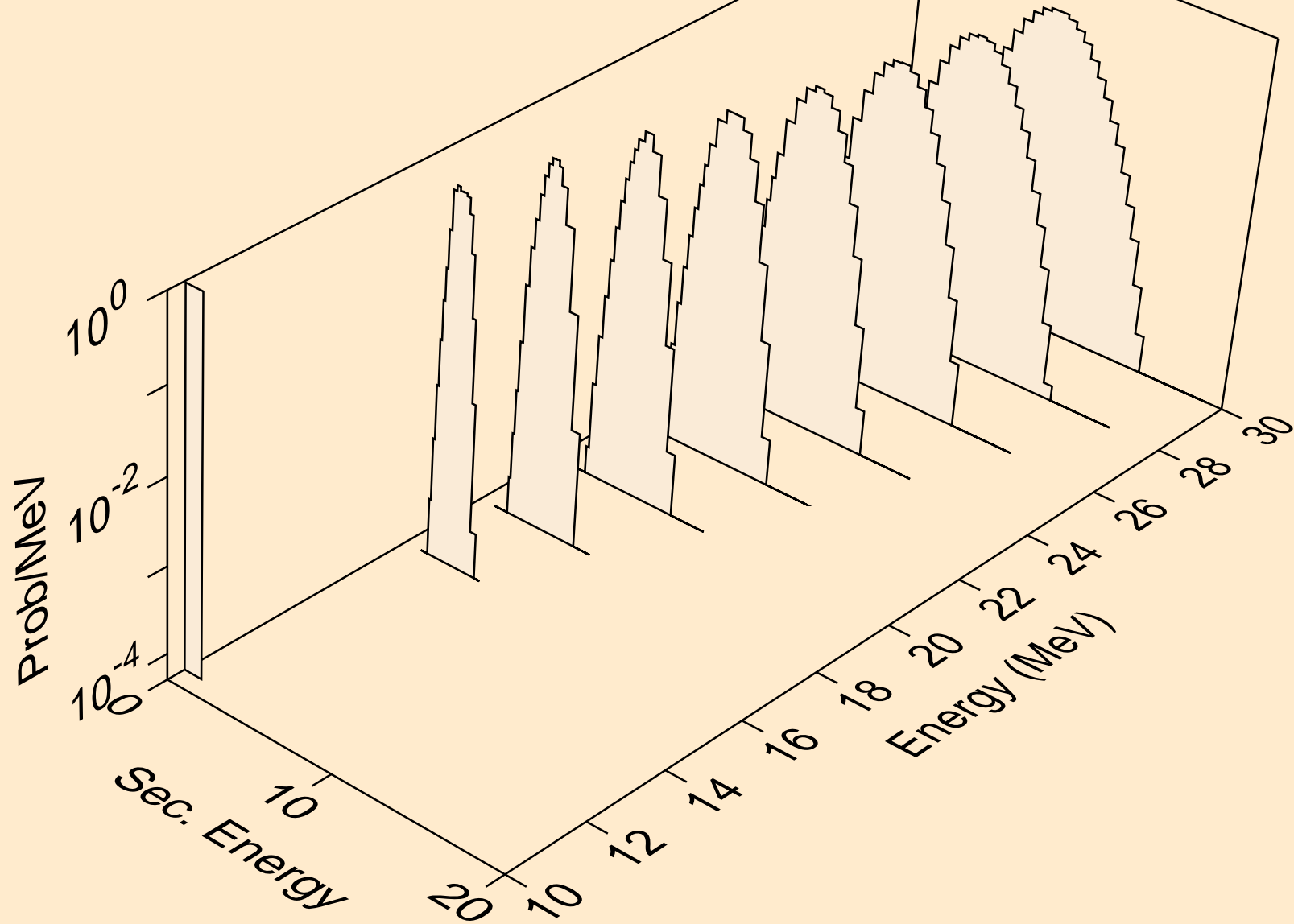

TL197 NEUTRON ACER TENDL-2024 LIBRARY; T=293.6K
protons from (n,npa)

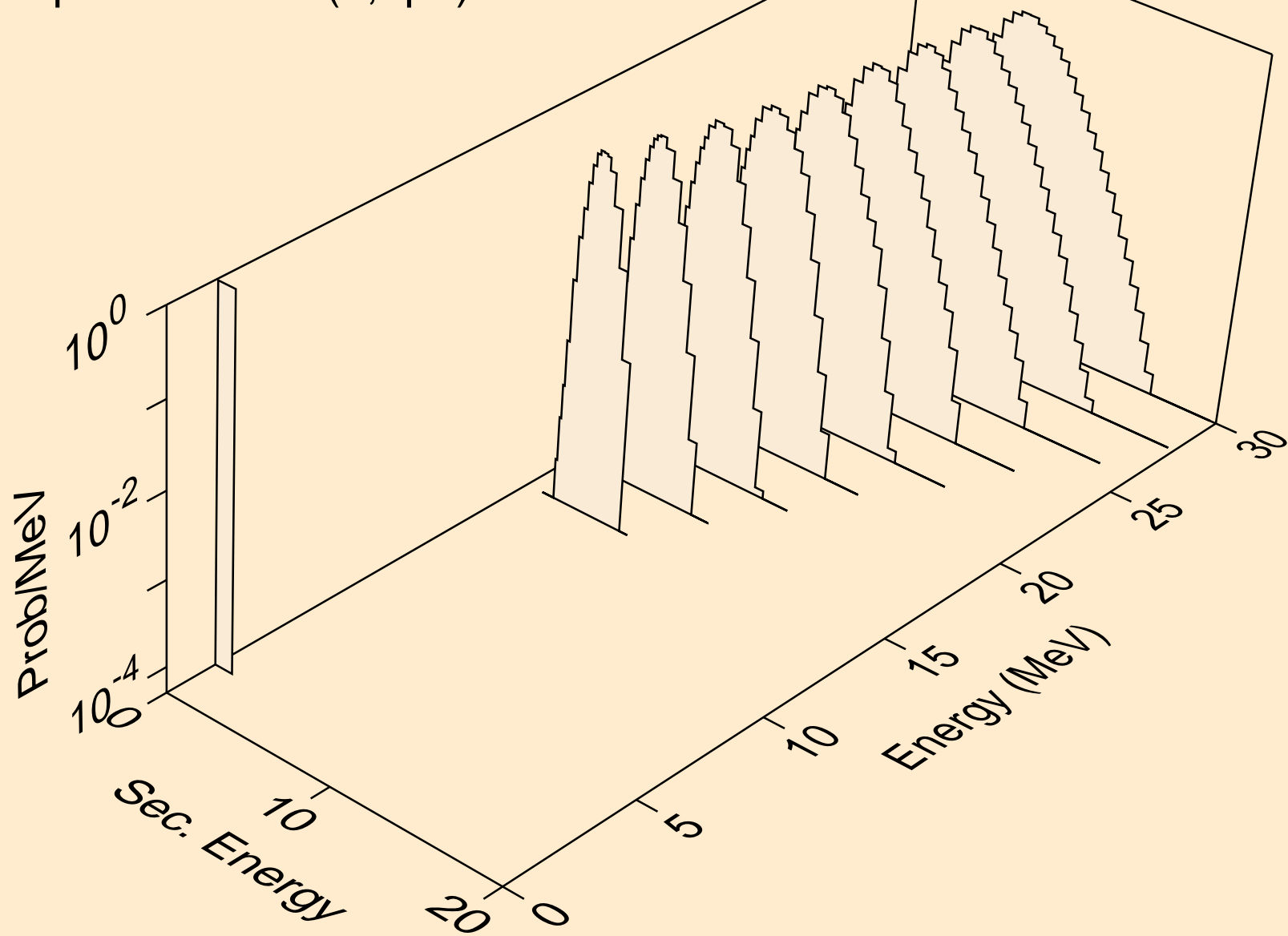

TL197 NEUTRON ACER TENDL-2024 LIBRARY; T=293.6K
protons from (n,p)

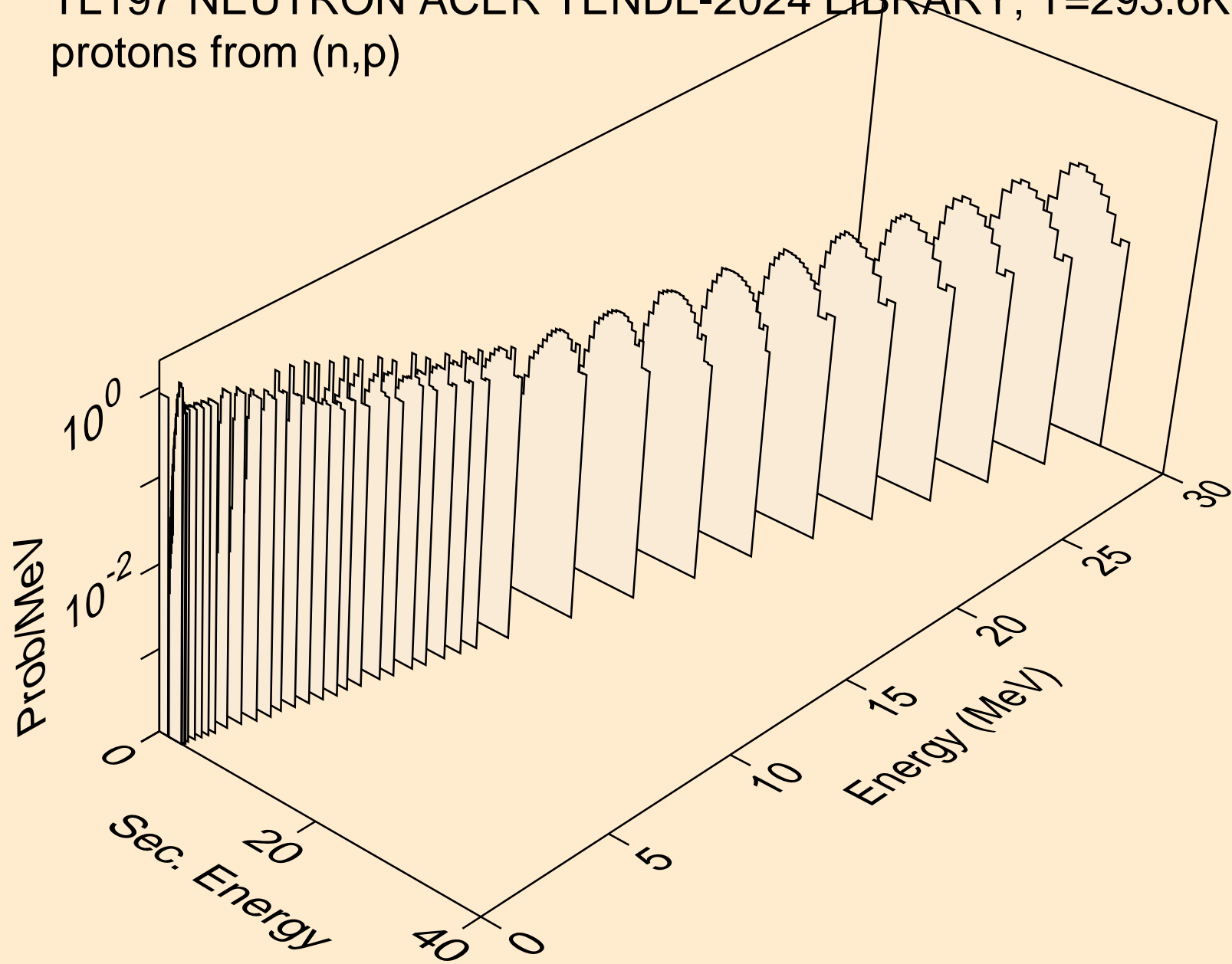

TL197 NEUTRON ACER TENDL-2024 LIBRARY; T=293.6K
protons from (n,2p)

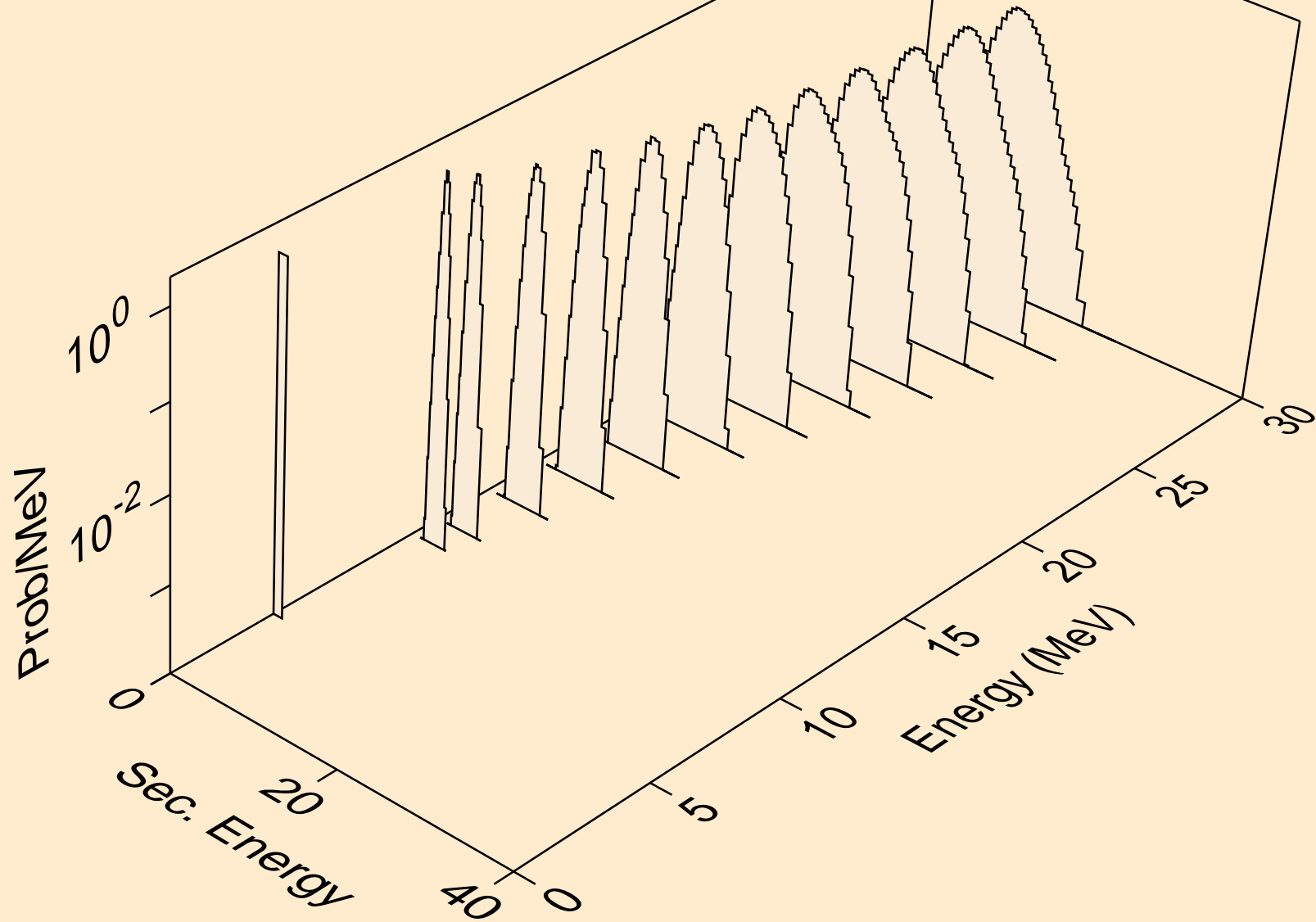

TL197 NEUTRON ACER TENDL-2024 LIBRARY; T=293.6K
protons from (n,p)

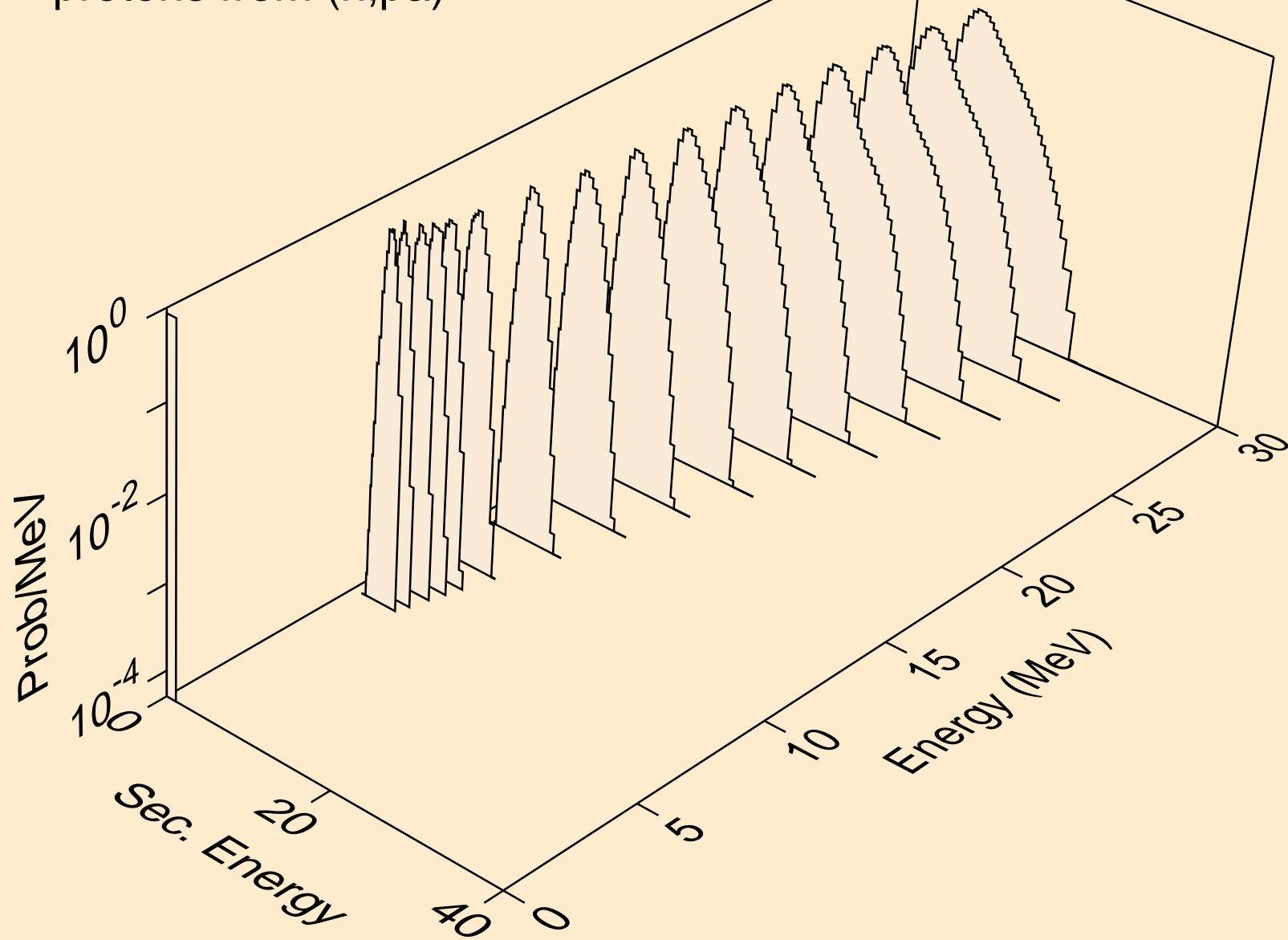

TL197 NEUTRON ACER TENDL-2024 LIBRARY; T=293.6K
protons from (n,pd)

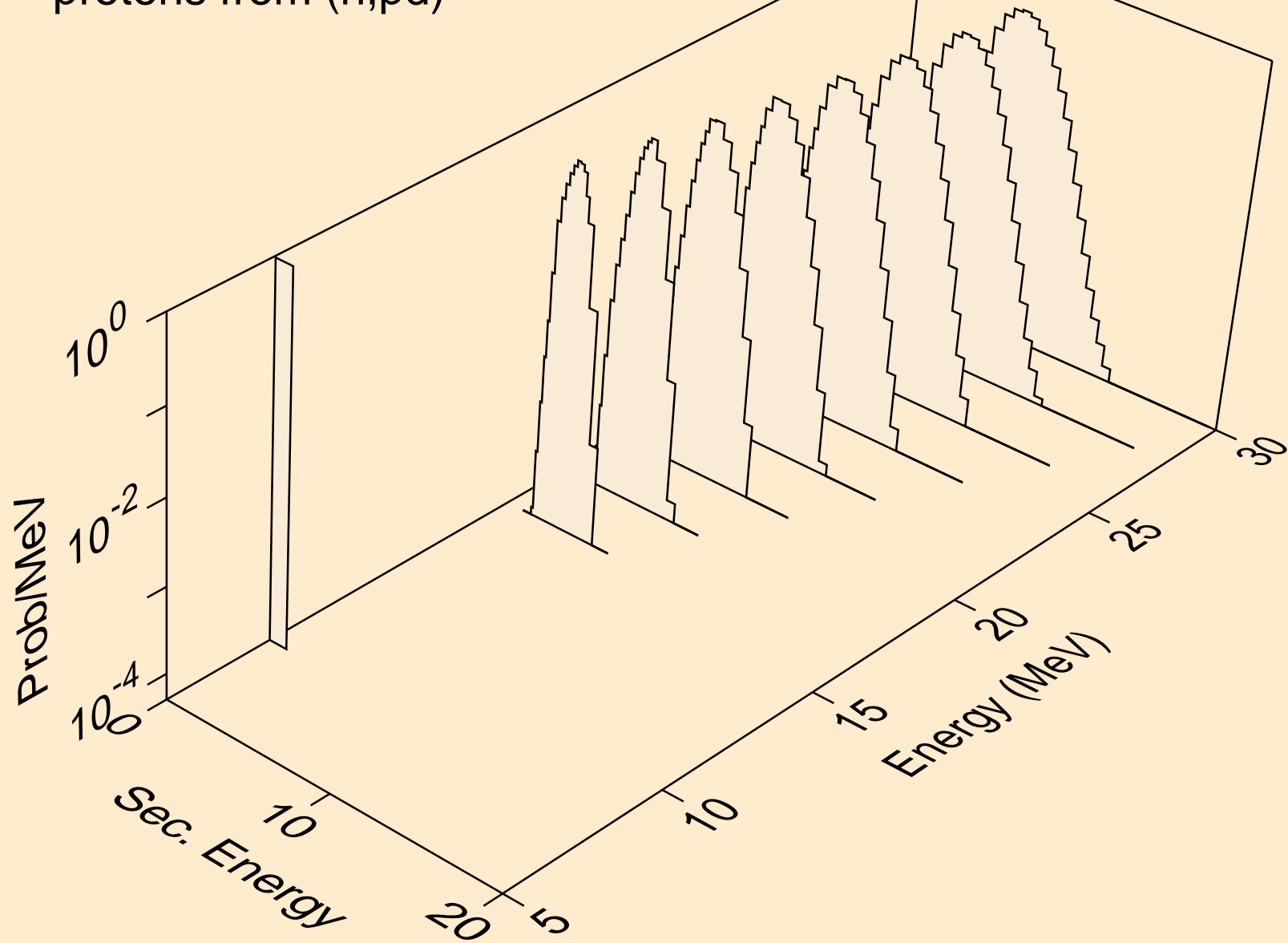

TL197 NEUTRON ACER TENDL-2024 LIBRARY; T=293.6K
protons from (n,pt)

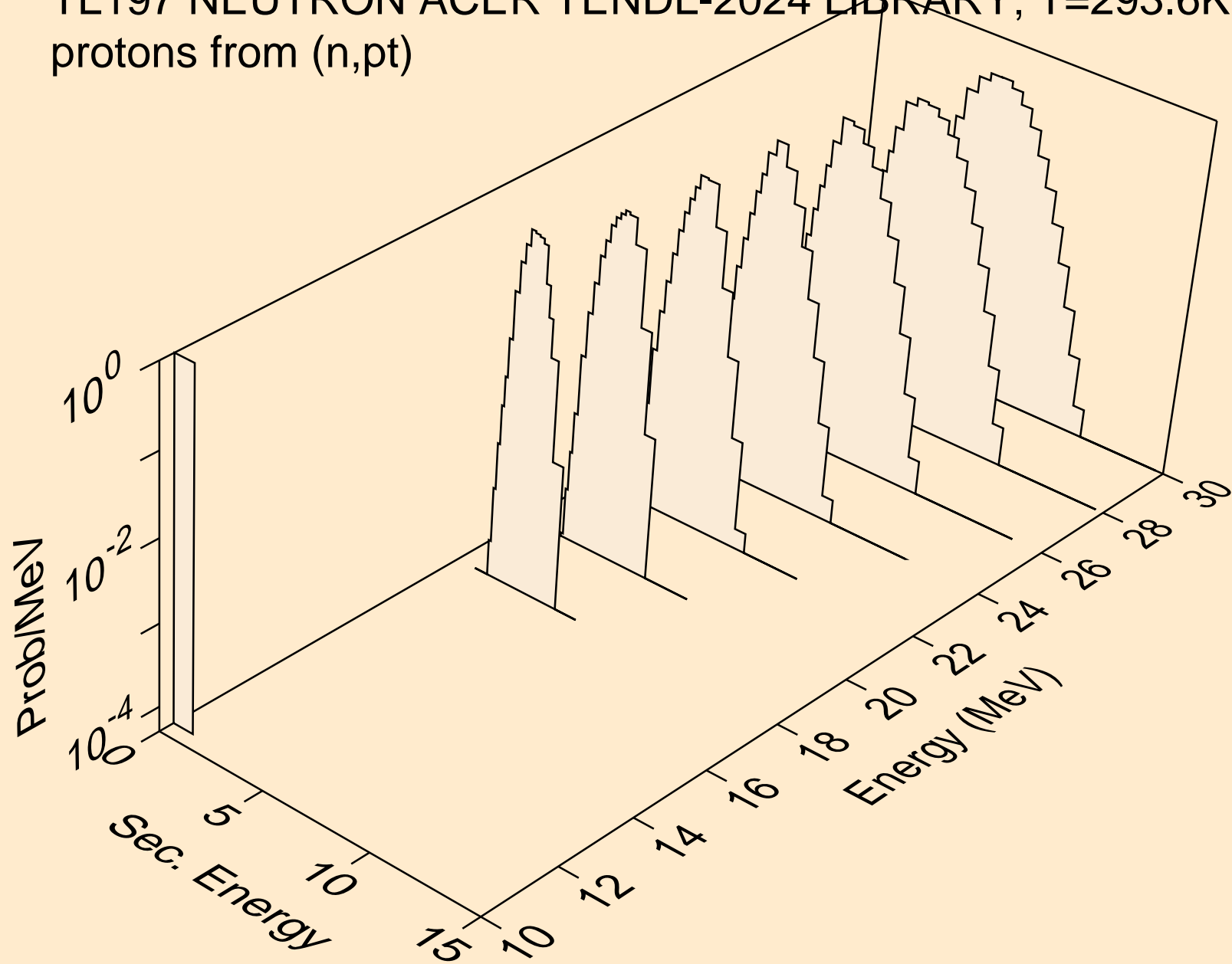

TL197 NEUTRON ACER TENDL-2024 LIBRARY; T=293.6K
deuterons from (n,x)

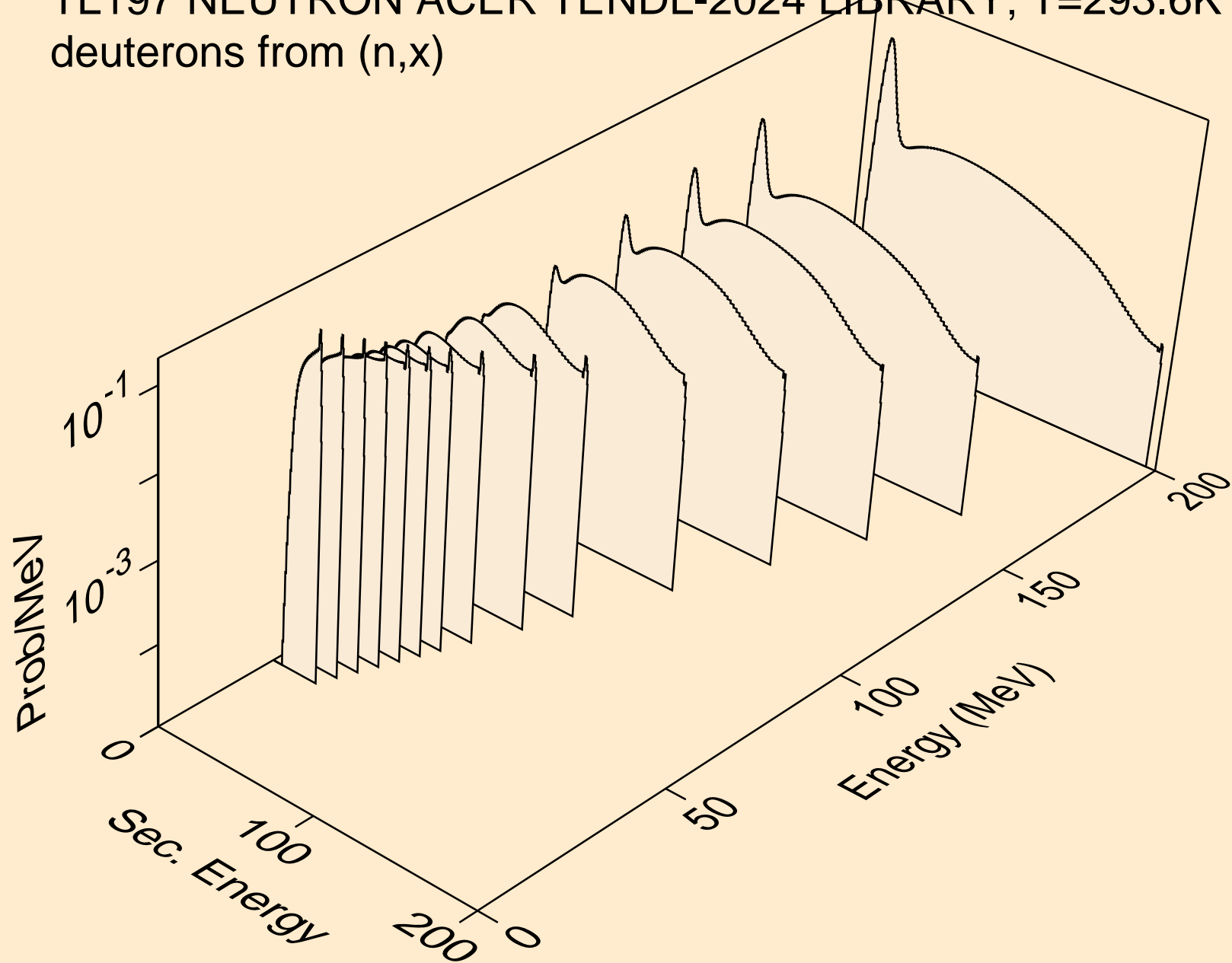

TL197 NEUTRON ACER TENDL-2024 LIBRARY; T=293.6K
deuterons from (n,2nd)

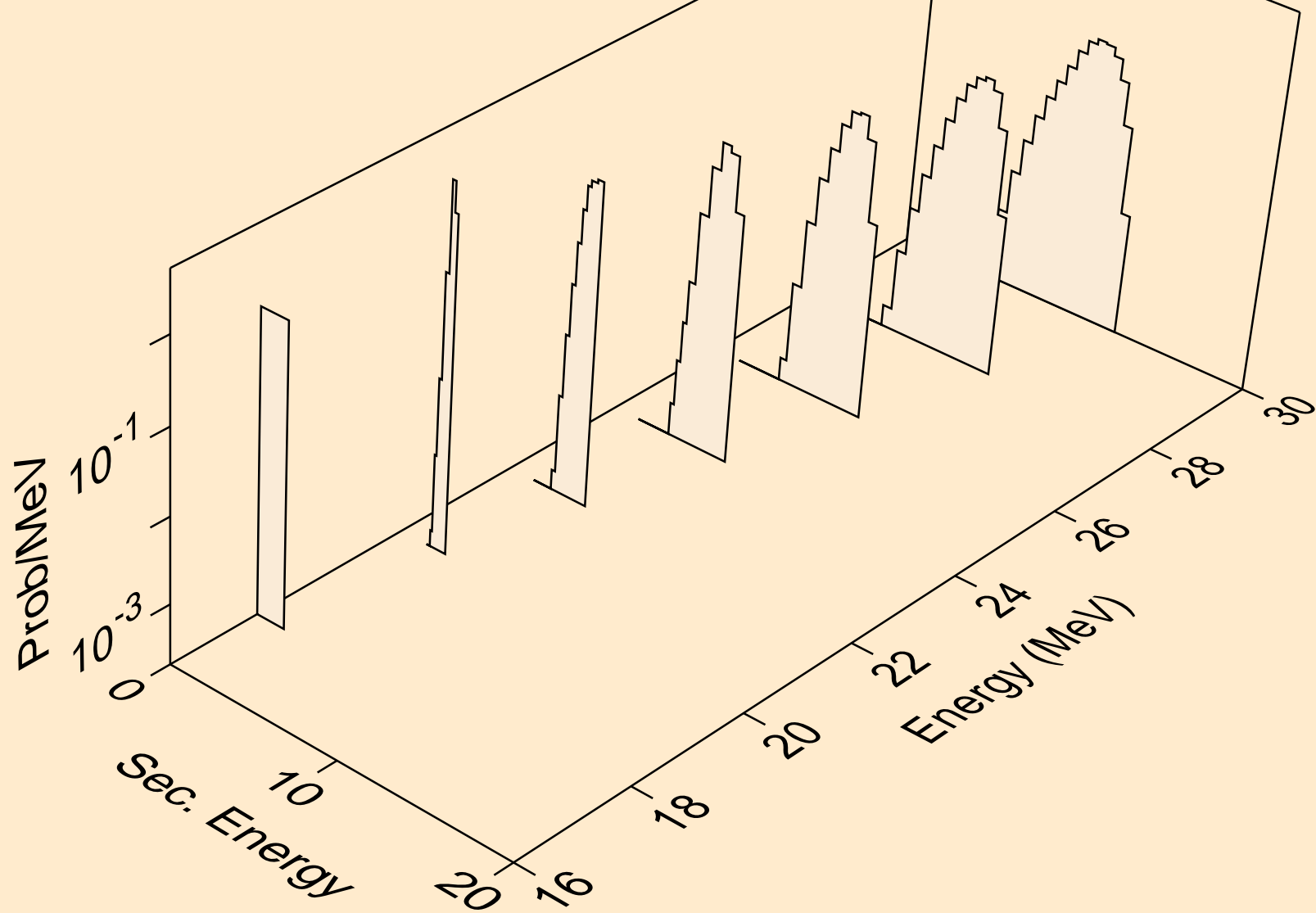

TL197 NEUTRON ACER TENDL-2024 LIBRARY; T=293.6K
deuterons from (n,n*)d

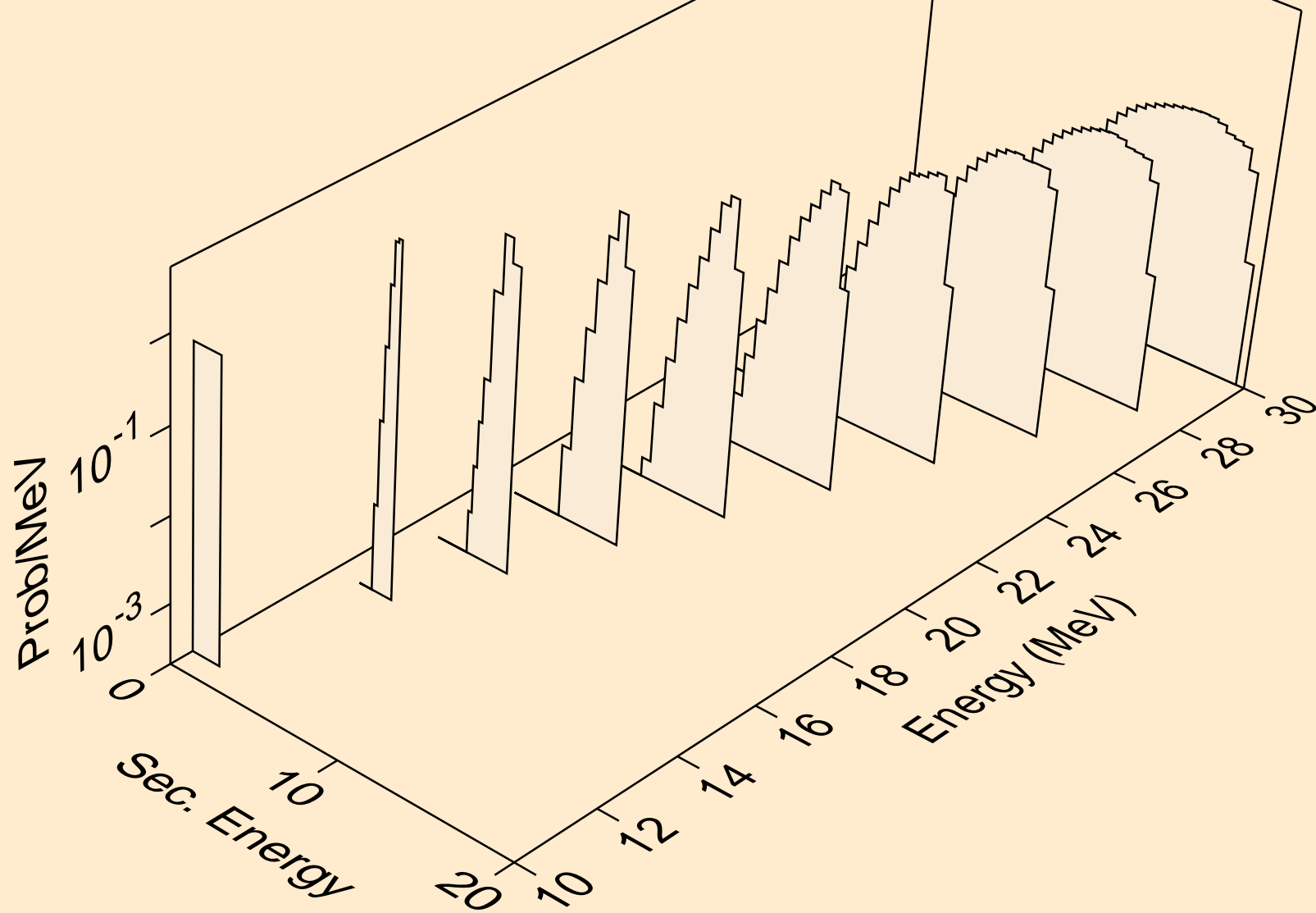

TL197 NEUTRON ACER TENDL-2024 LIBRARY; T=293.6K
deuterons from (n,d)

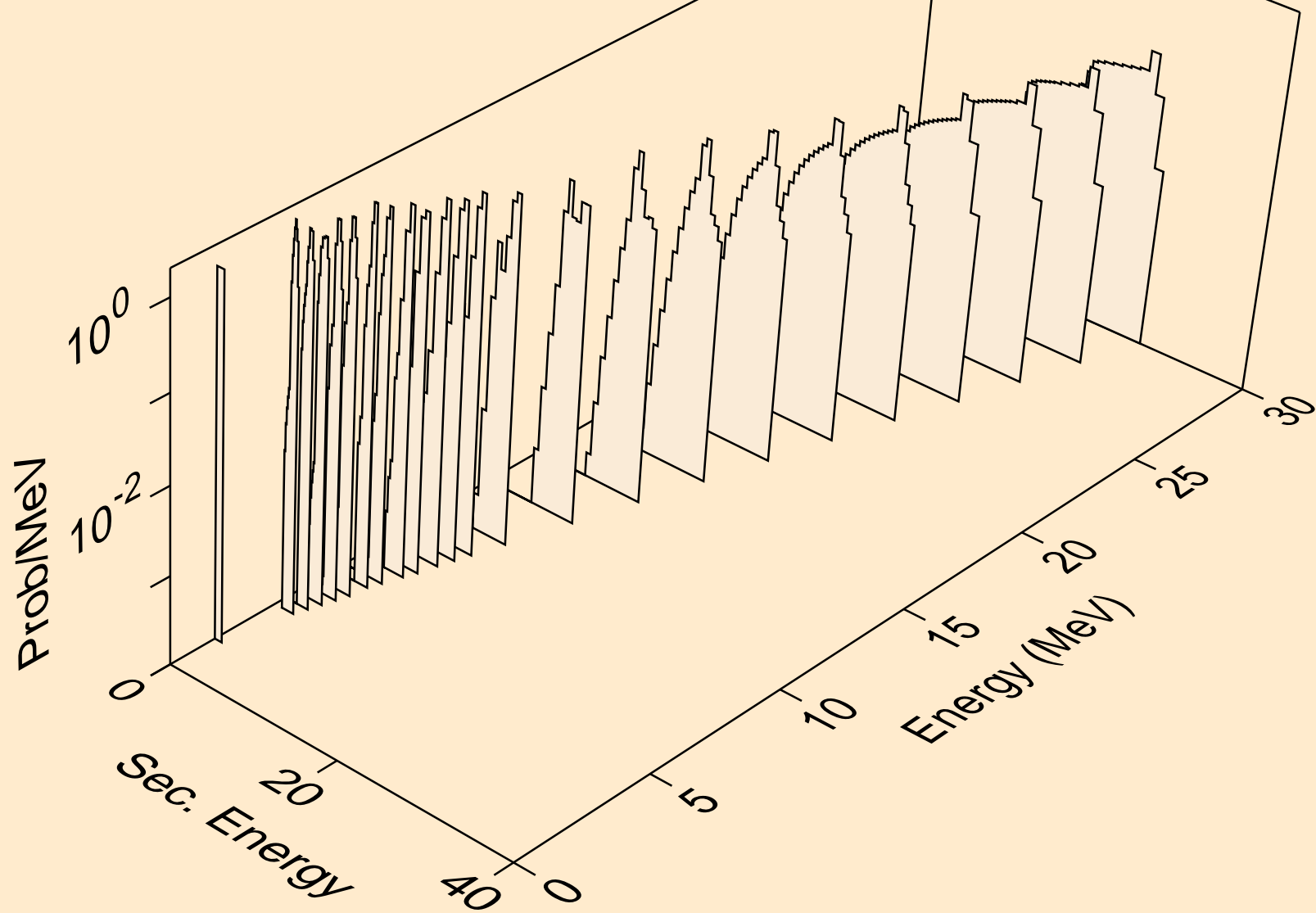

TL197 NEUTRON ACER TENDL-2024 LIBRARY; T=293.6K
deuterons from (n,pd)

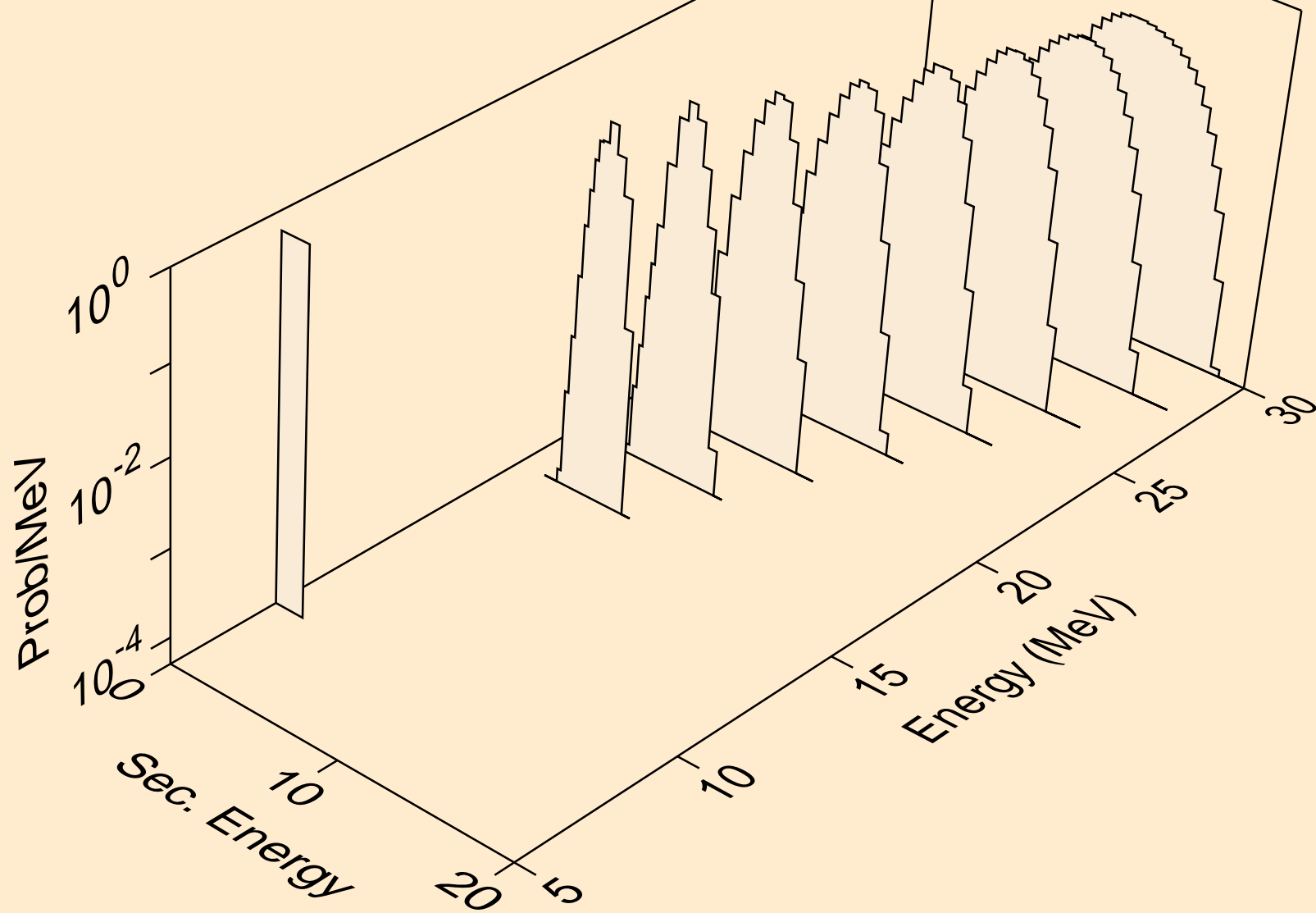

TL197 NEUTRON ACER TENDL-2024 LIBRARY; T=293.6K
deuterons from (n,da)

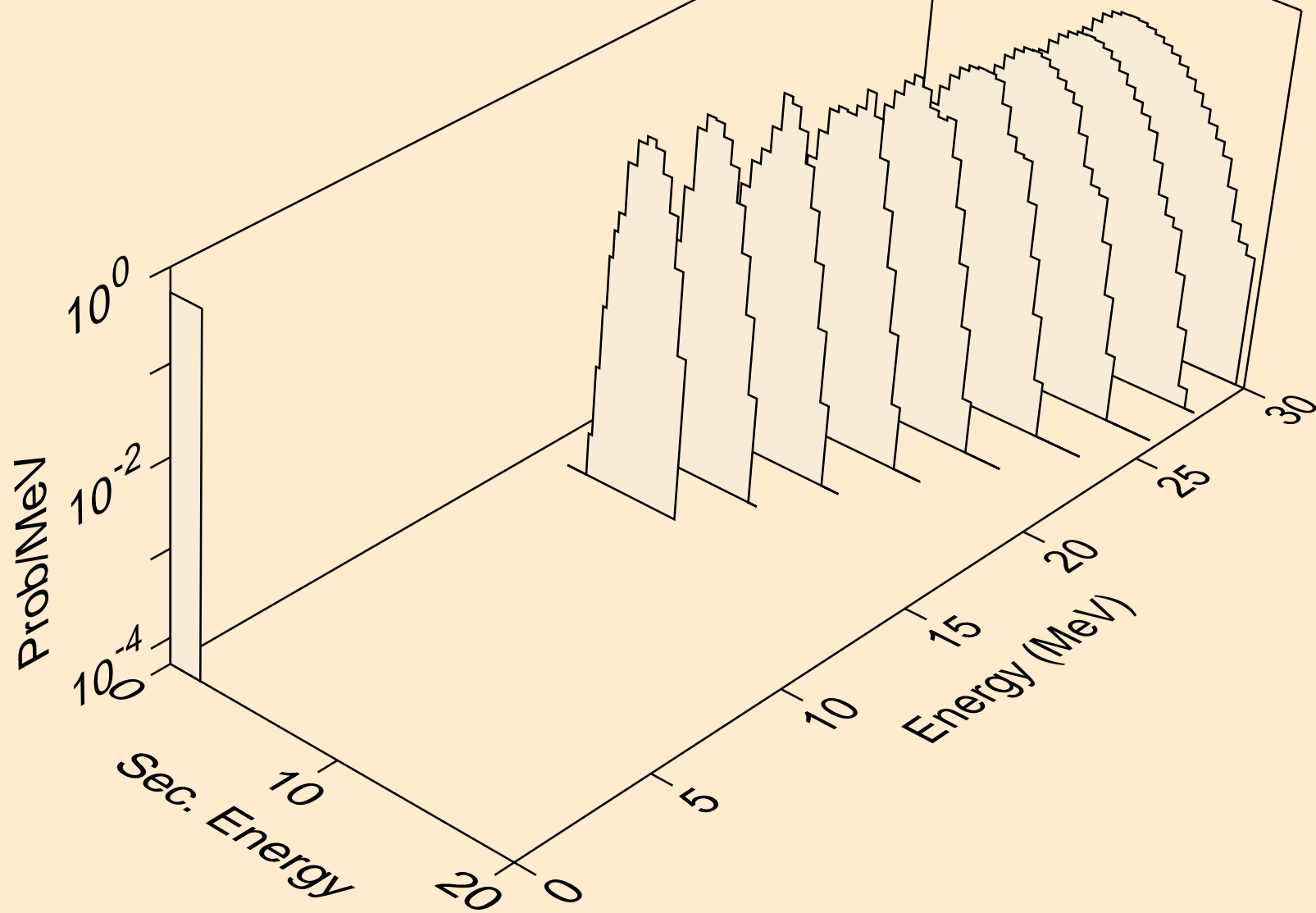

TL197 NEUTRON ACER TENDL-2024 LIBRARY; T=293.6K
tritons from (n,x)

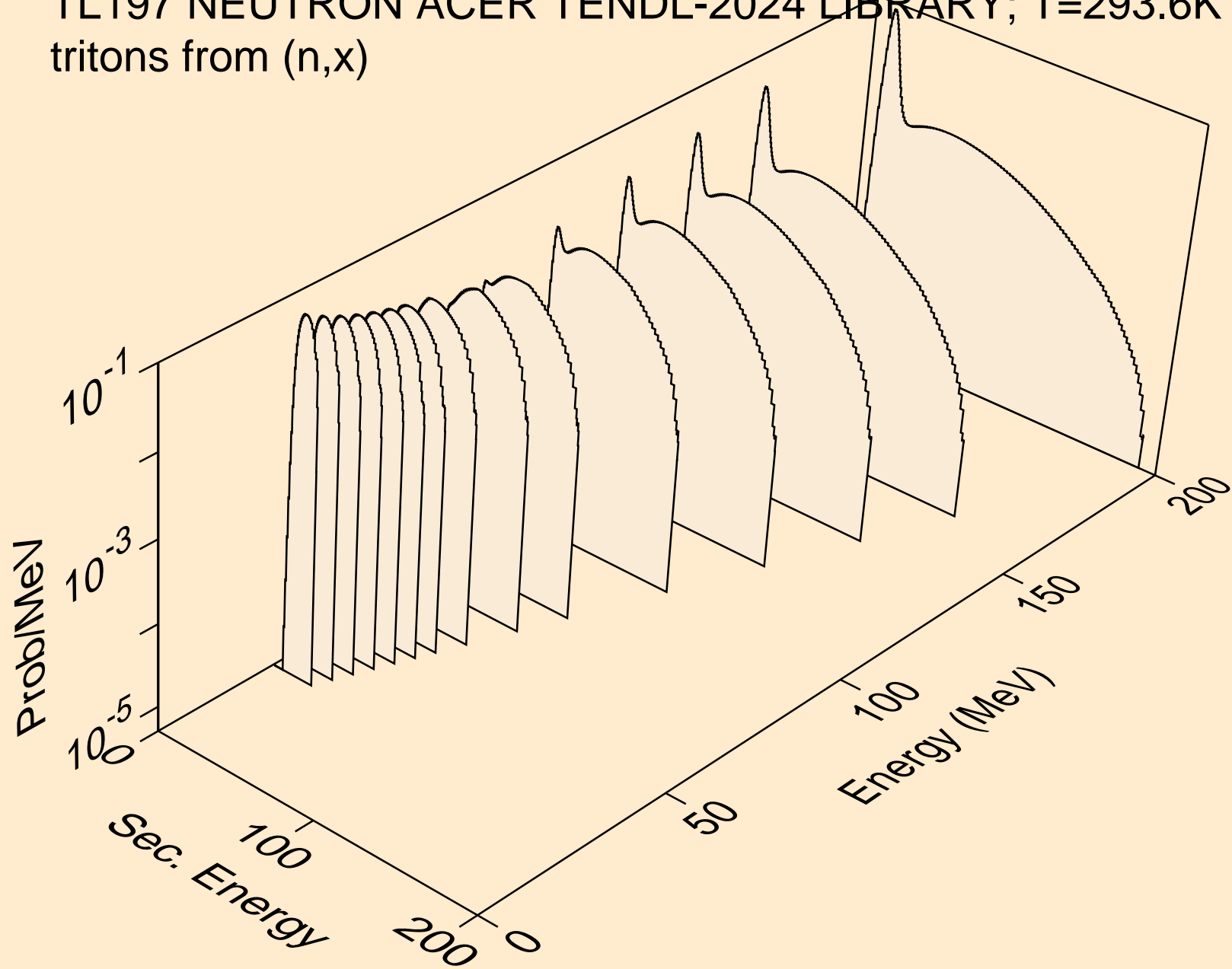

TL197 NEUTRON ACER TENDL-2024 LIBRARY; T=293.6K
tritons from (n,n*)t

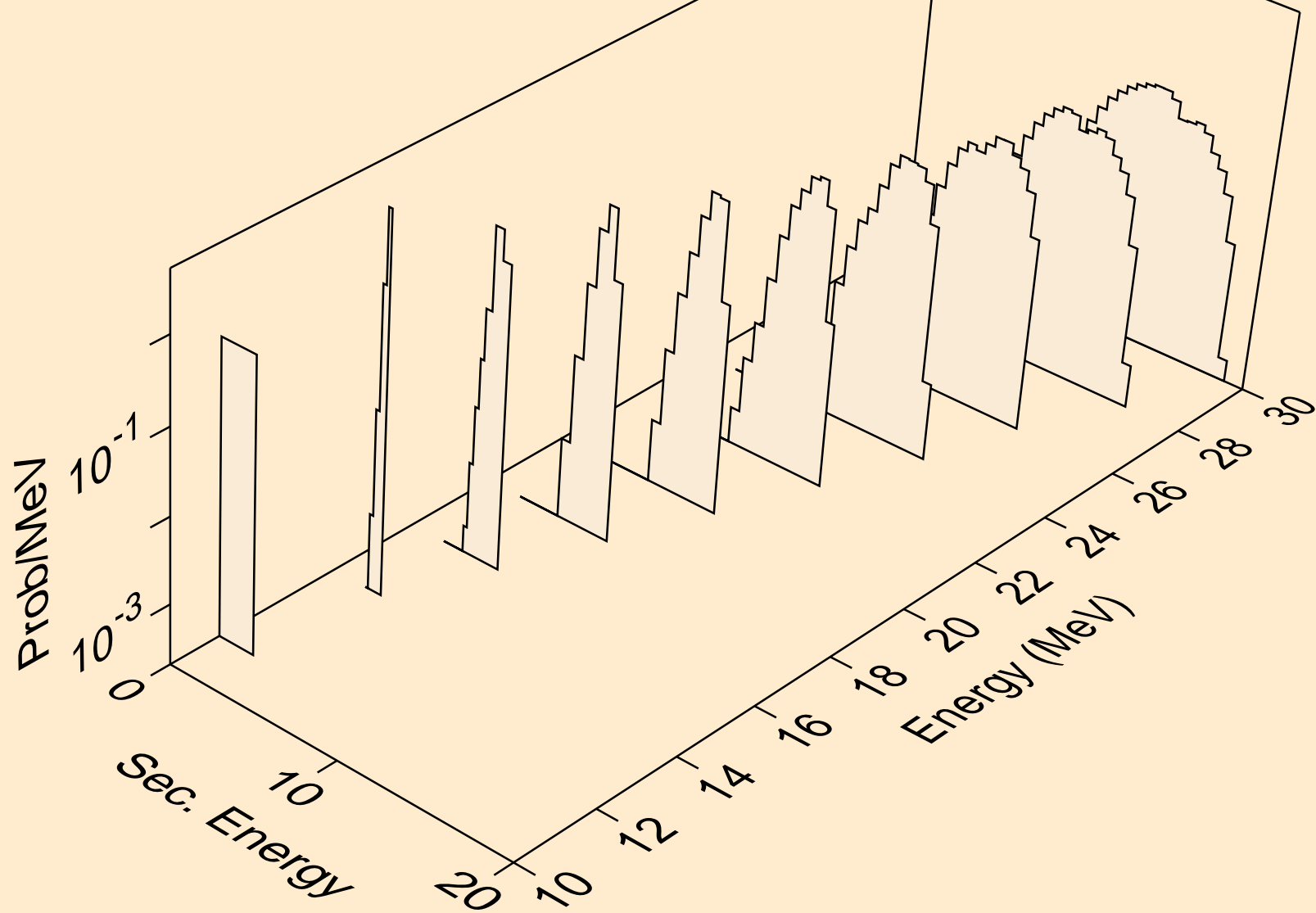

TL197 NEUTRON ACER TENDL-2024 LIBRARY; T=293.6K
tritons from (n,t)

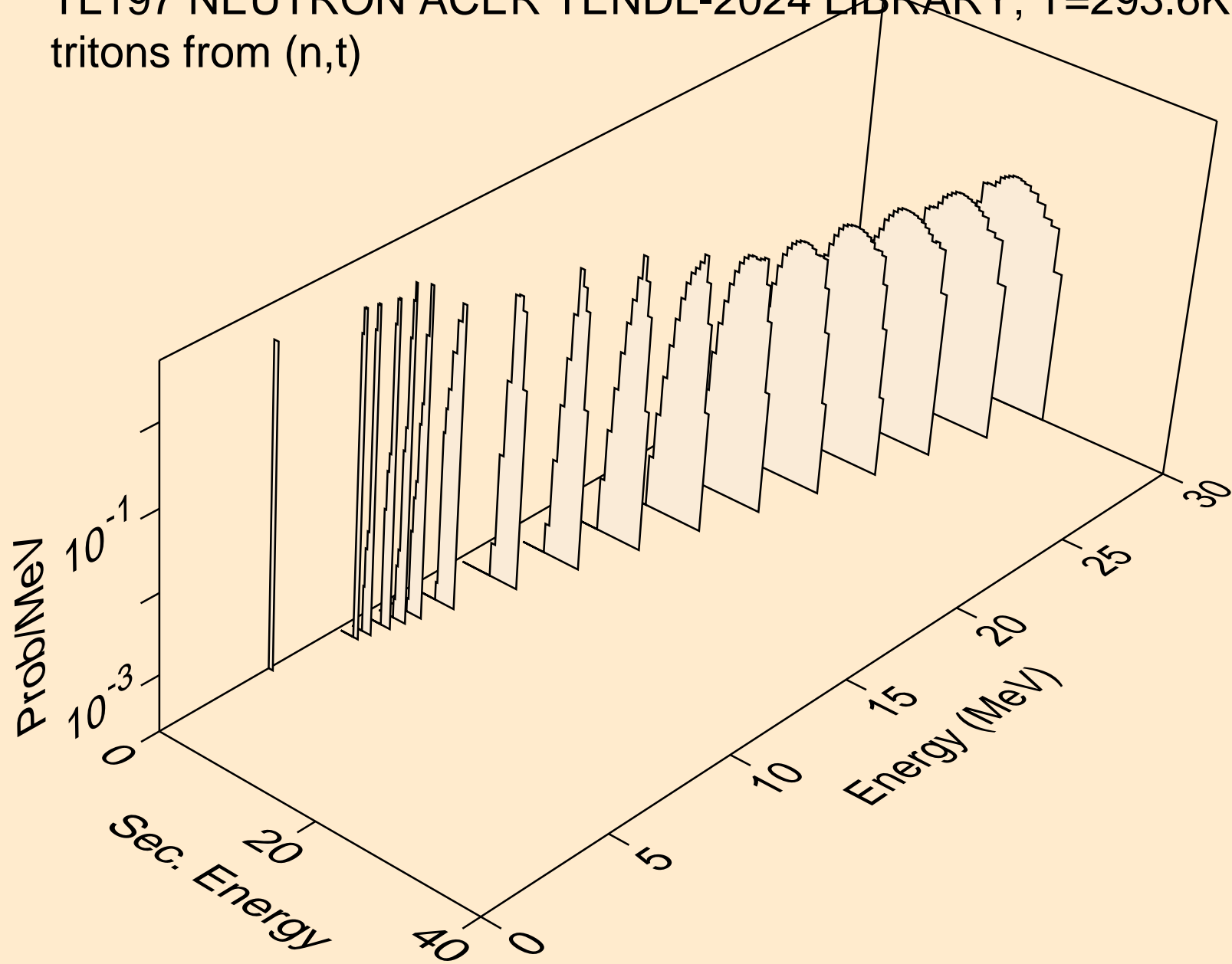

TL197 NEUTRON ACER TENDL-2024 LIBRARY; T=293.6K
tritons from (n,pt)

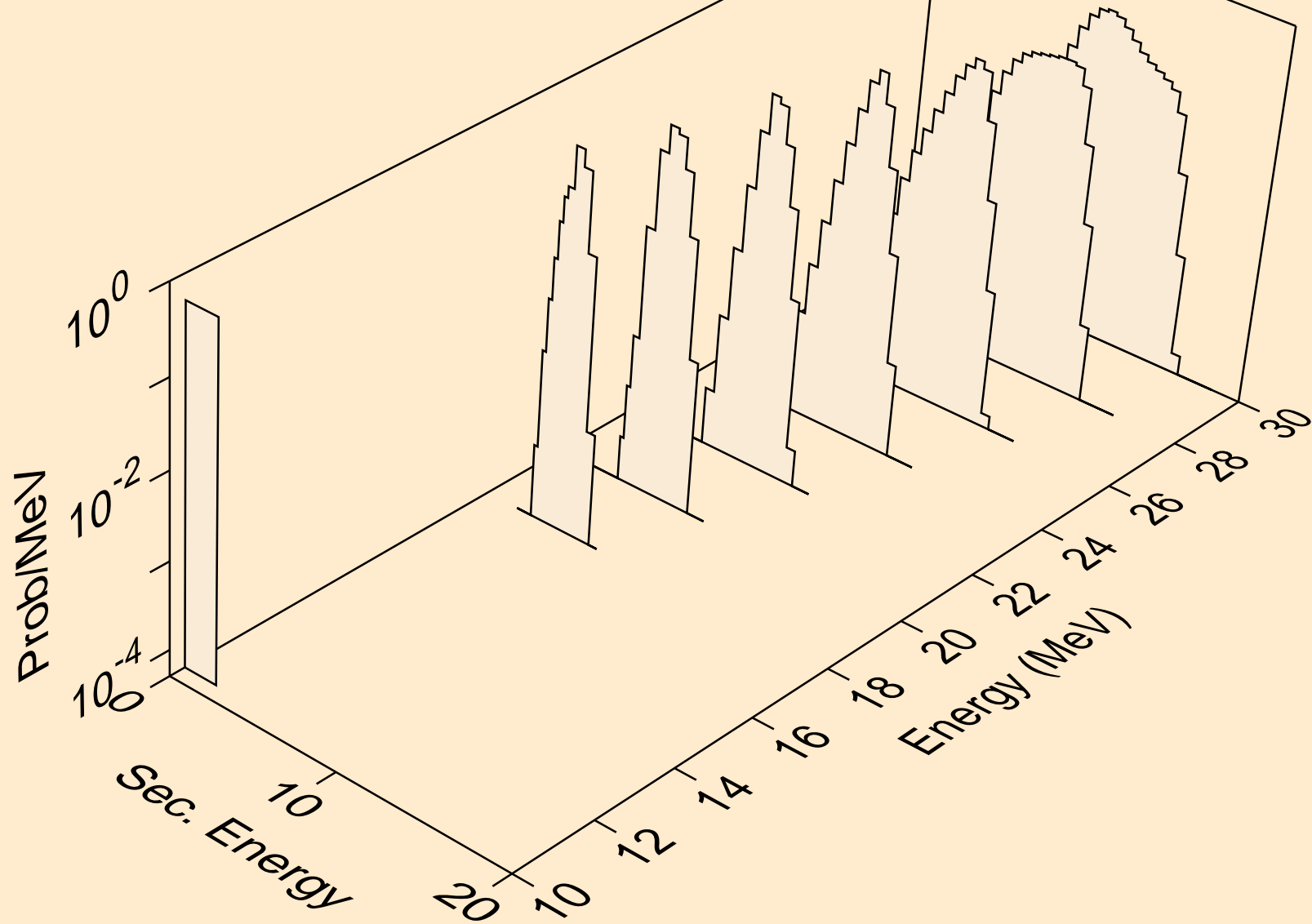

TL197 NEUTRON ACER TENDL-2024 LIBRARY; T=293.6K
he3s from (n,x)

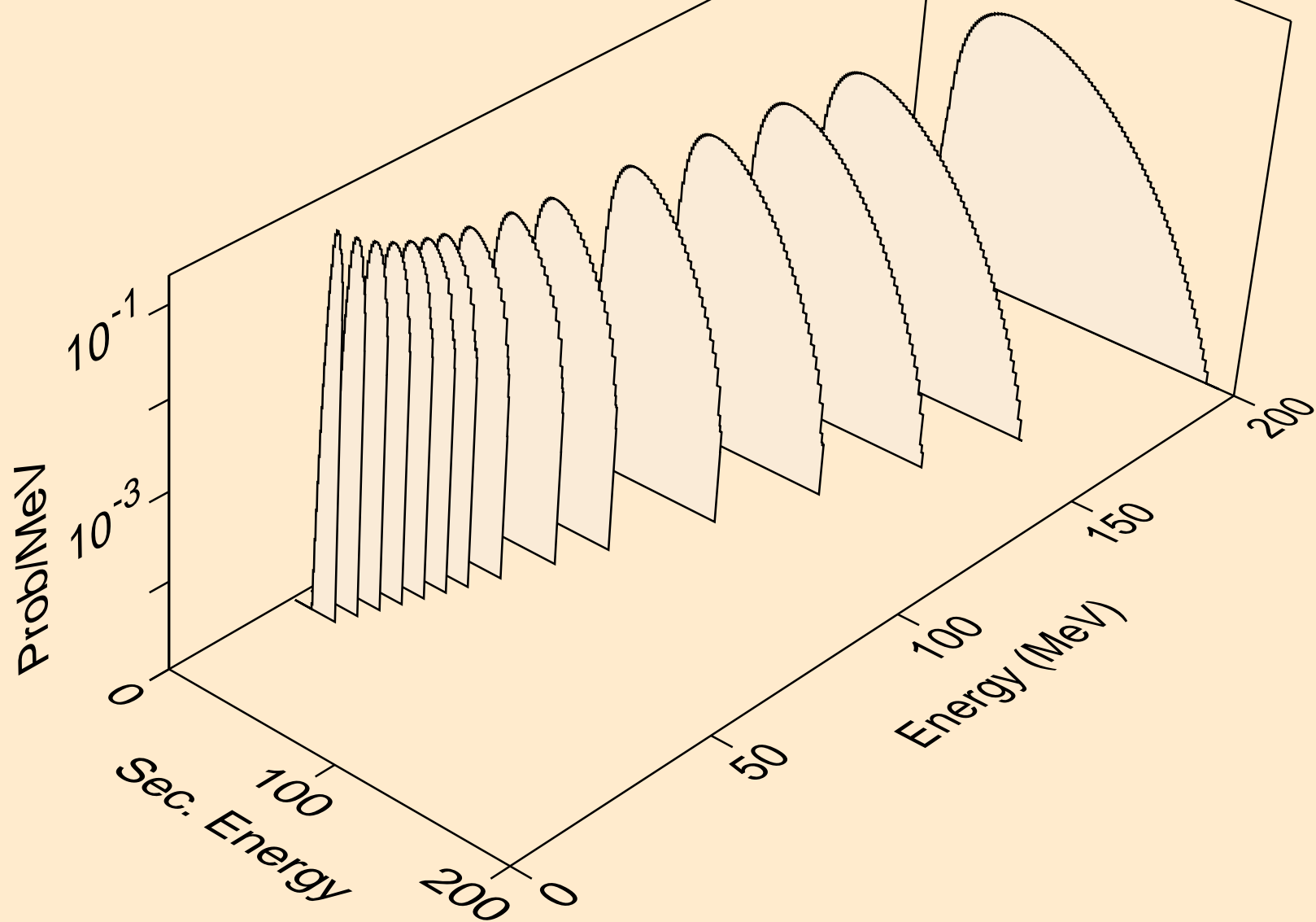

TL197 NEUTRON ACER TENDL-2024 LIBRARY; T=293.6K
he3s from (n,n*)he3

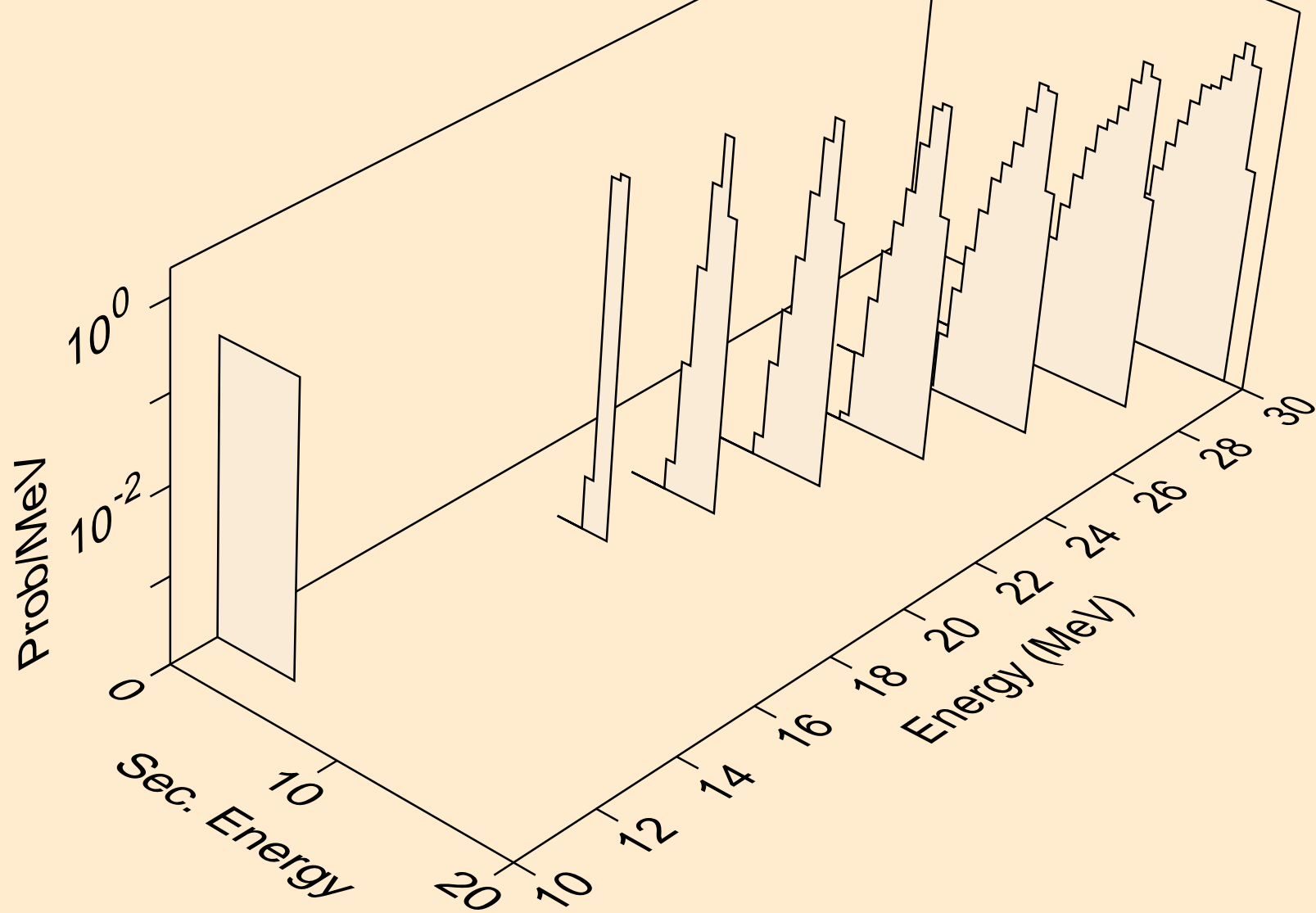

TL197 NEUTRON ACER TENDL-2024 LIBRARY; T=293.6K
he3s from (n,he3)

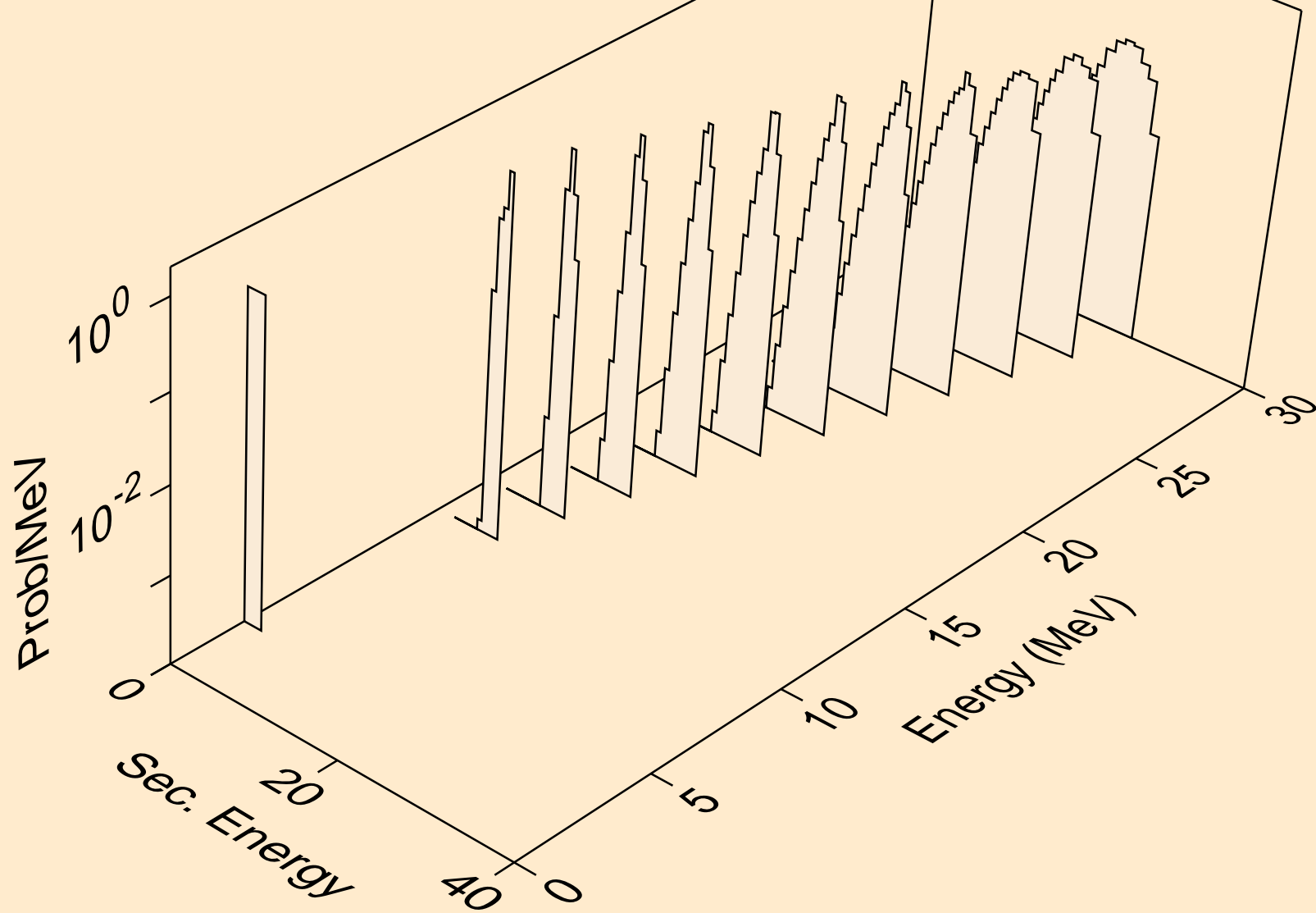

TL197 NEUTRON ACER TENDL-2024 LIBRARY; T=293.6K
alphas from (n,x)

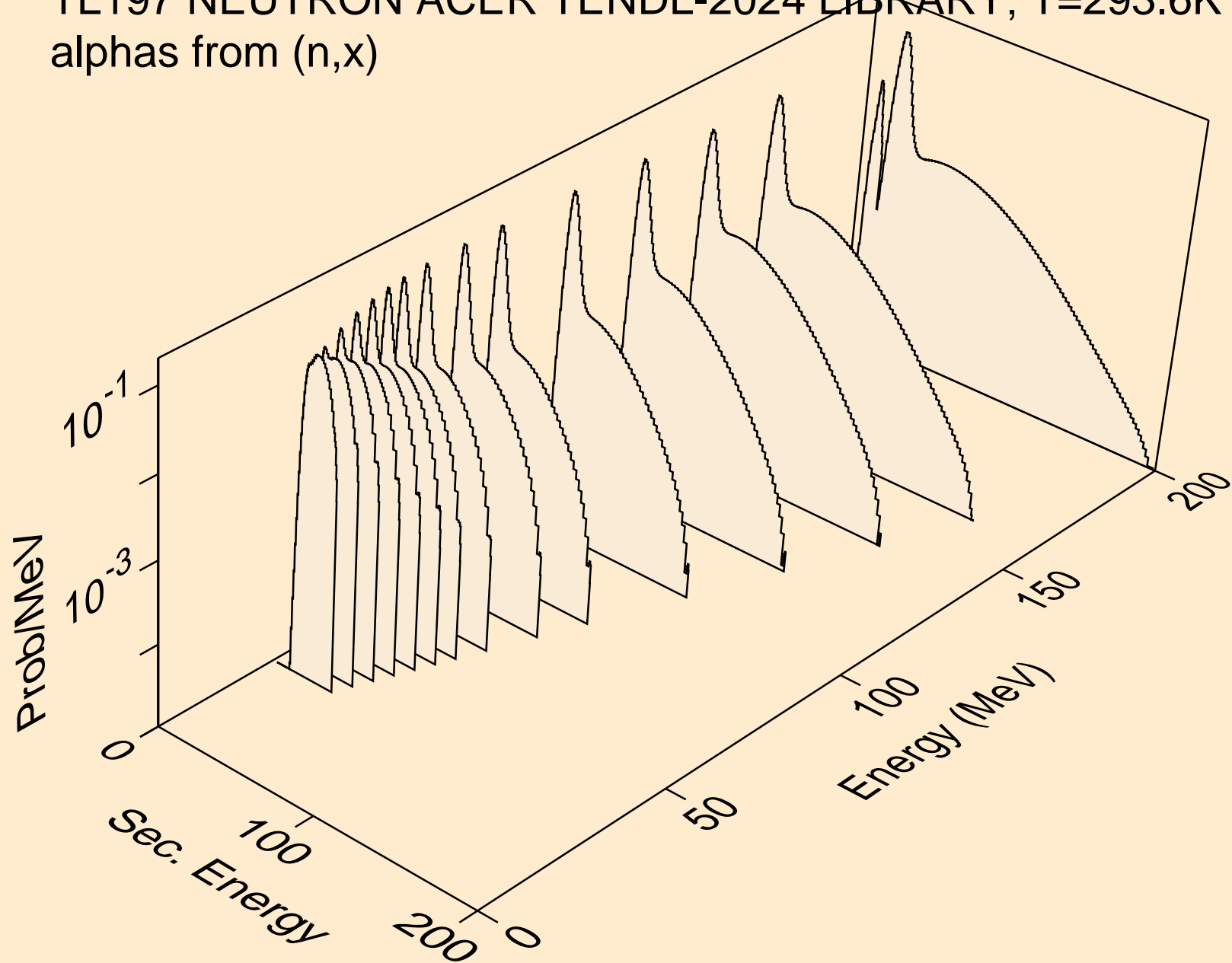

TL197 NEUTRON ACER TENDL-2024 LIBRARY; T=293.6K
alphas from (n,n*)a

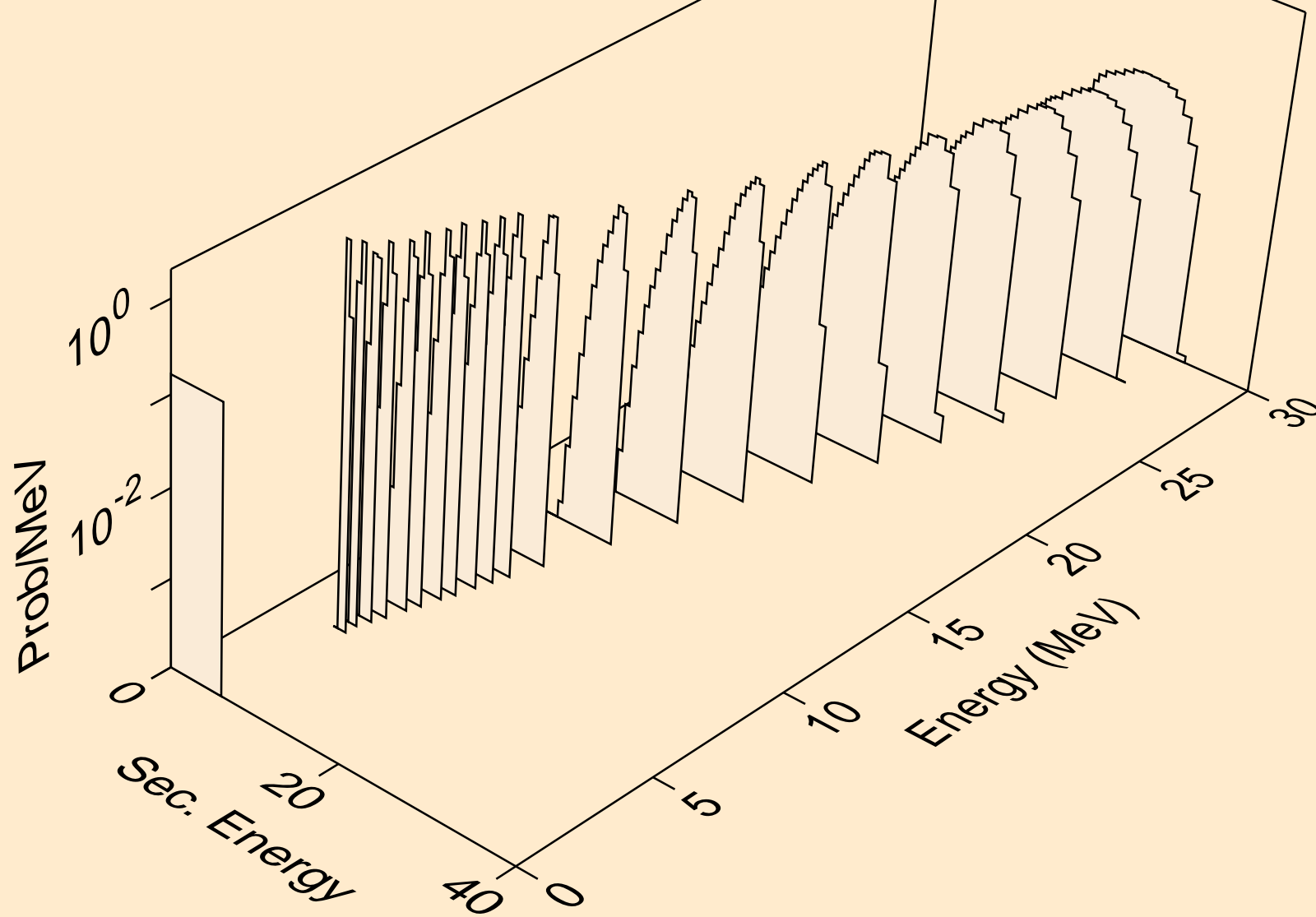

TL197 NEUTRON ACER TENDL-2024 LIBRARY; T=293.6K
alphas from (n,2n)a

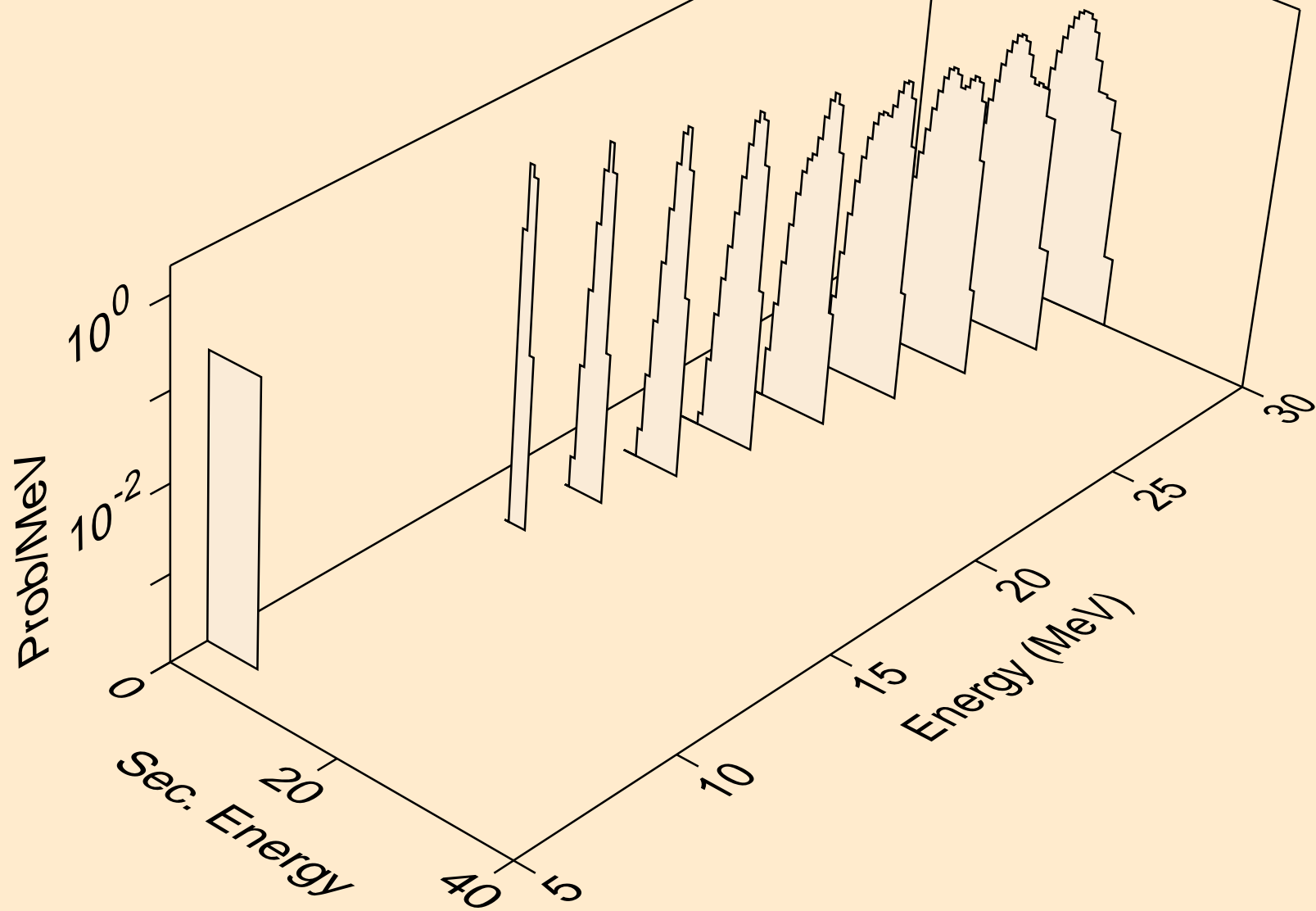

TL197 NEUTRON ACER TENDL-2024 LIBRARY; T=293.6K
alphas from (n,3n)a

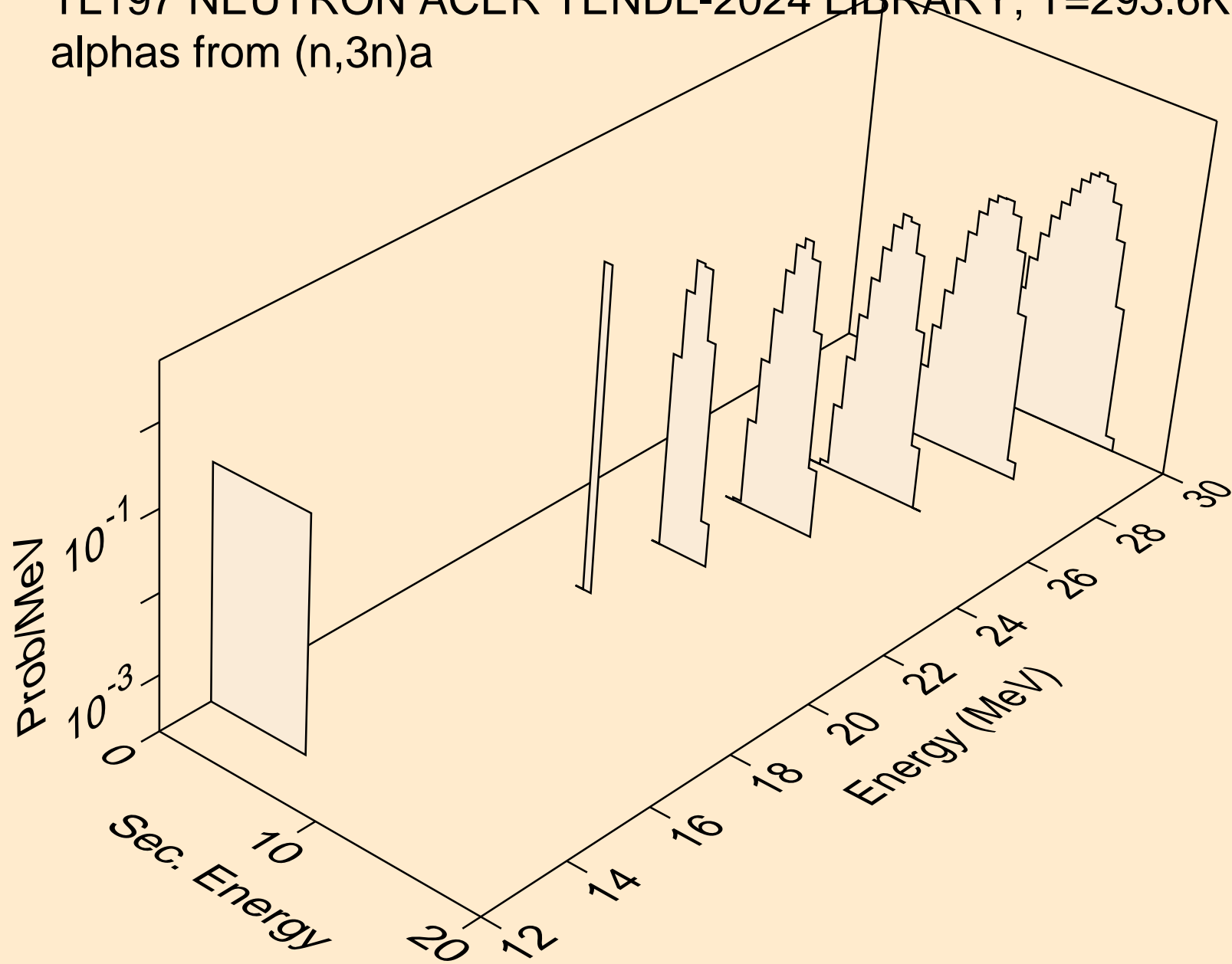

TL197 NEUTRON ACER TENDL-2024 LIBRARY; T=293.6K
alphas from (n,n*)2a

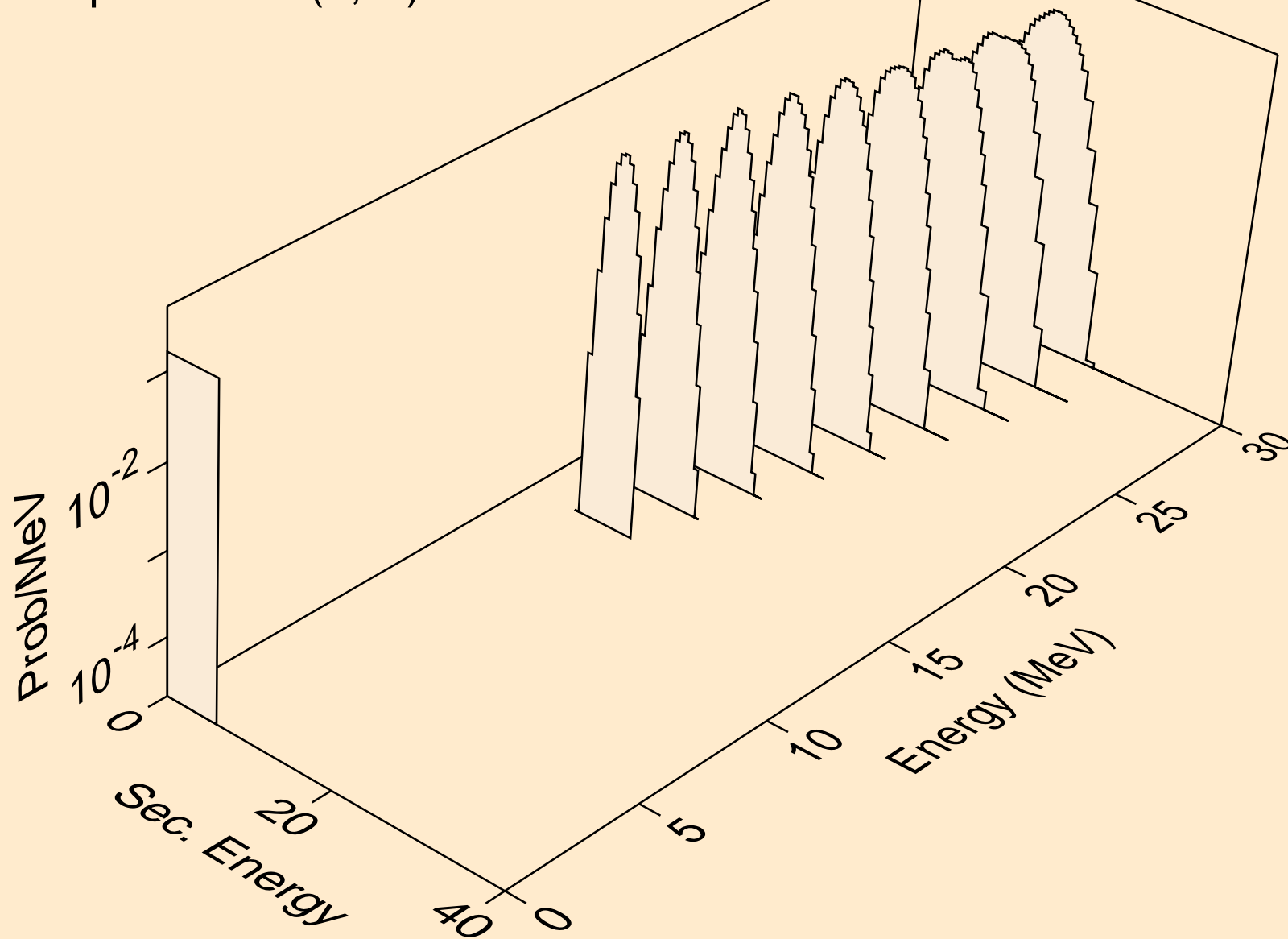

TL197 NEUTRON ACER TENDL-2024 LIBRARY; T=293.6K
alphas from (n,npa)

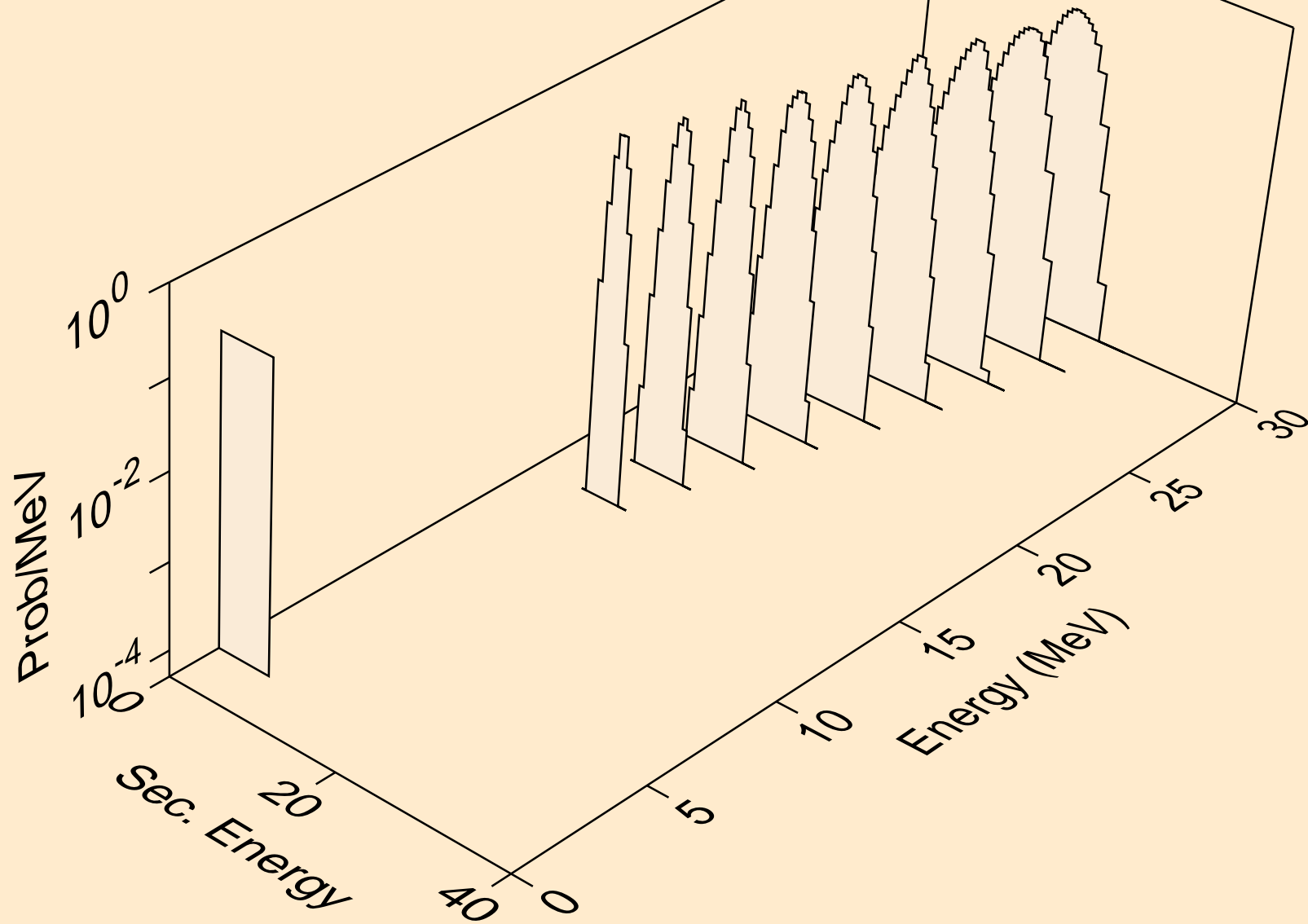

TL197 NEUTRON ACER TENDL-2024 LIBRARY; T=293.6K
alphas from (n,a)

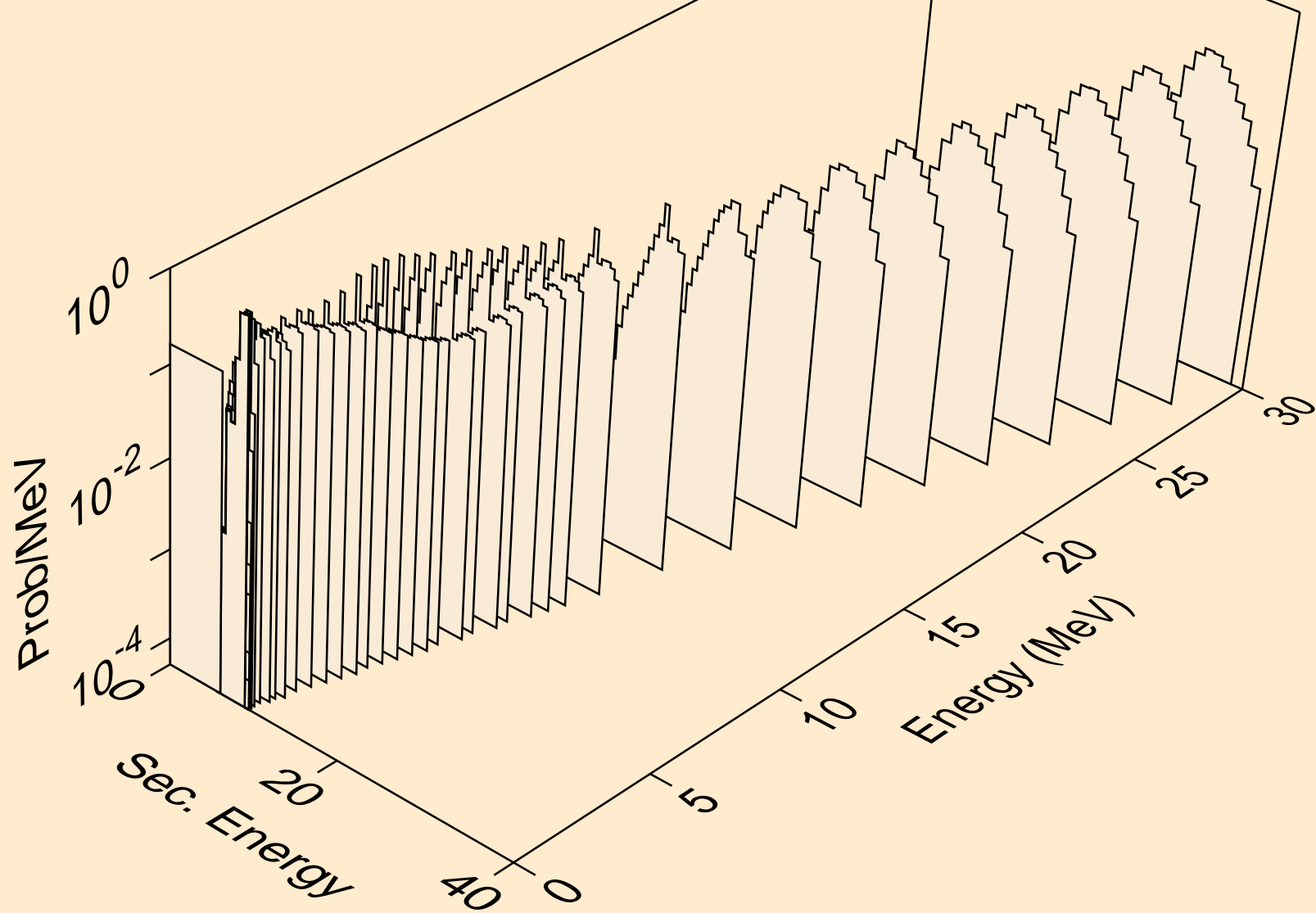

TL197 NEUTRON ACER TENDL-2024 LIBRARY; T=293.6K
alphas from (n,2a)

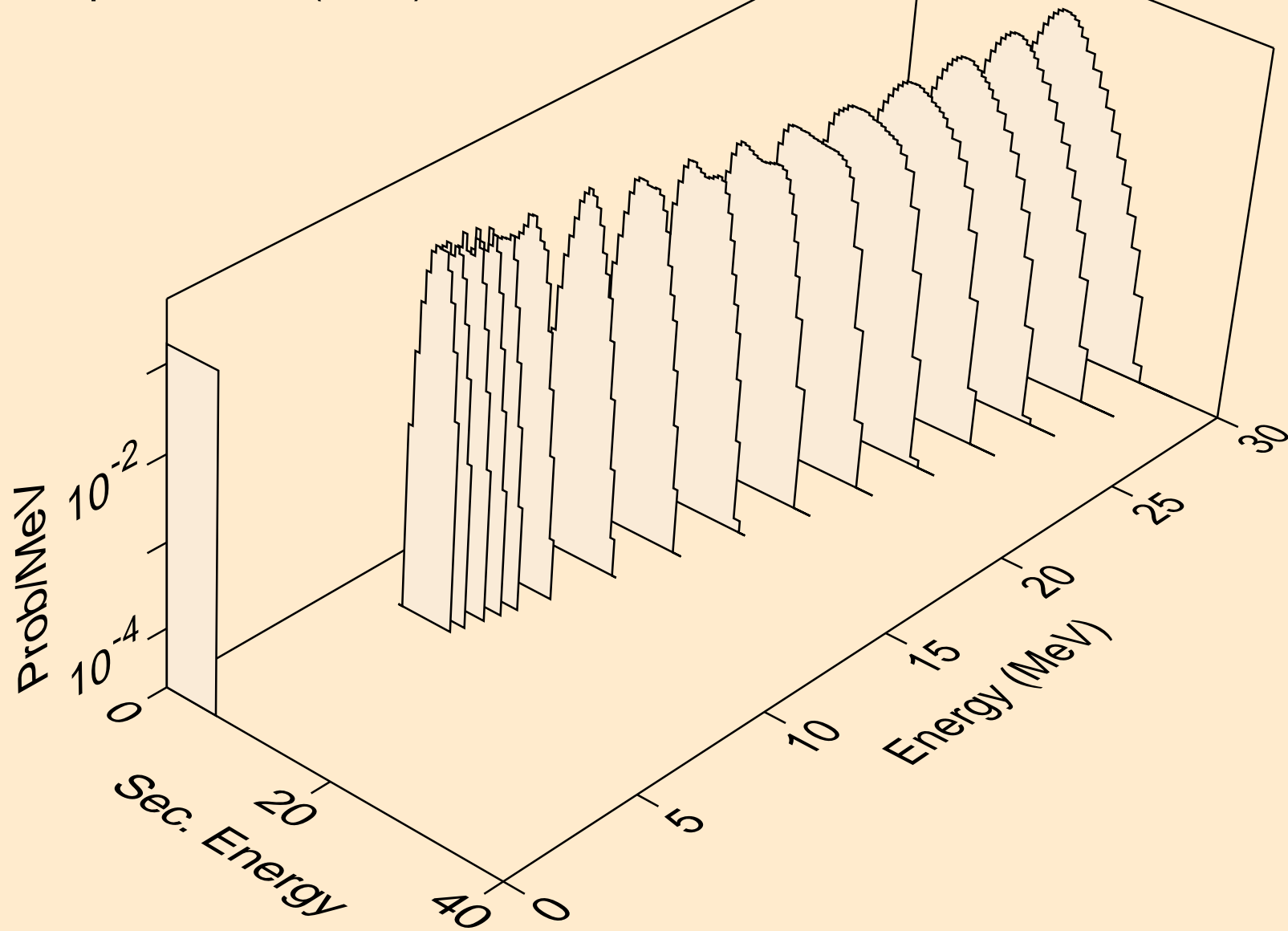

TL197 NEUTRON ACER TENDL-2024 LIBRARY; T=293.6K
alphas from (n,pa)

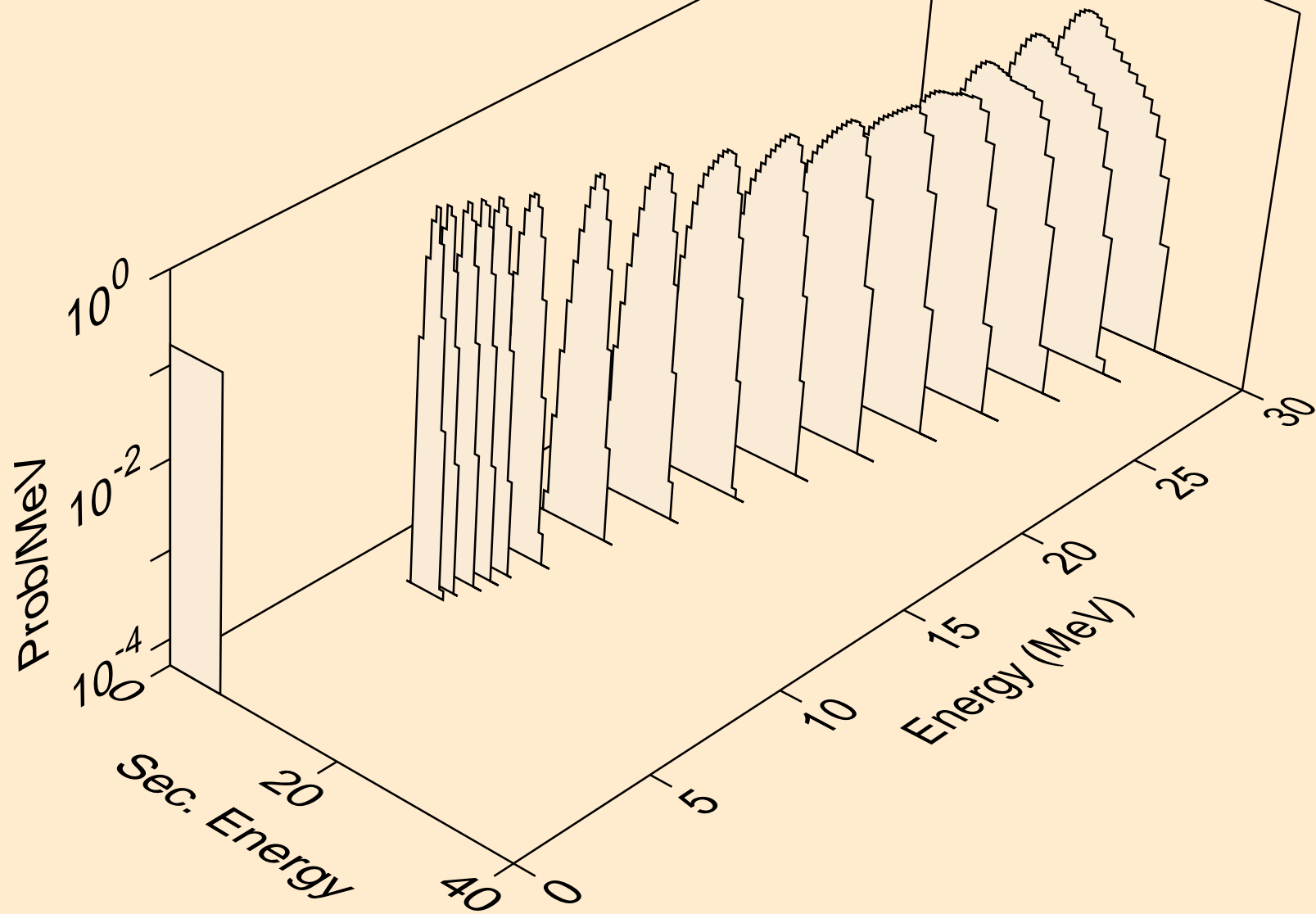

TL197 NEUTRON ACER TENDL-2024 LIBRARY; T=293.6K
alphas from (n,da)

