

TM153M NEUTRON ACER TENDL-2024 LIBRARY; T=293.6K
Principal cross sections

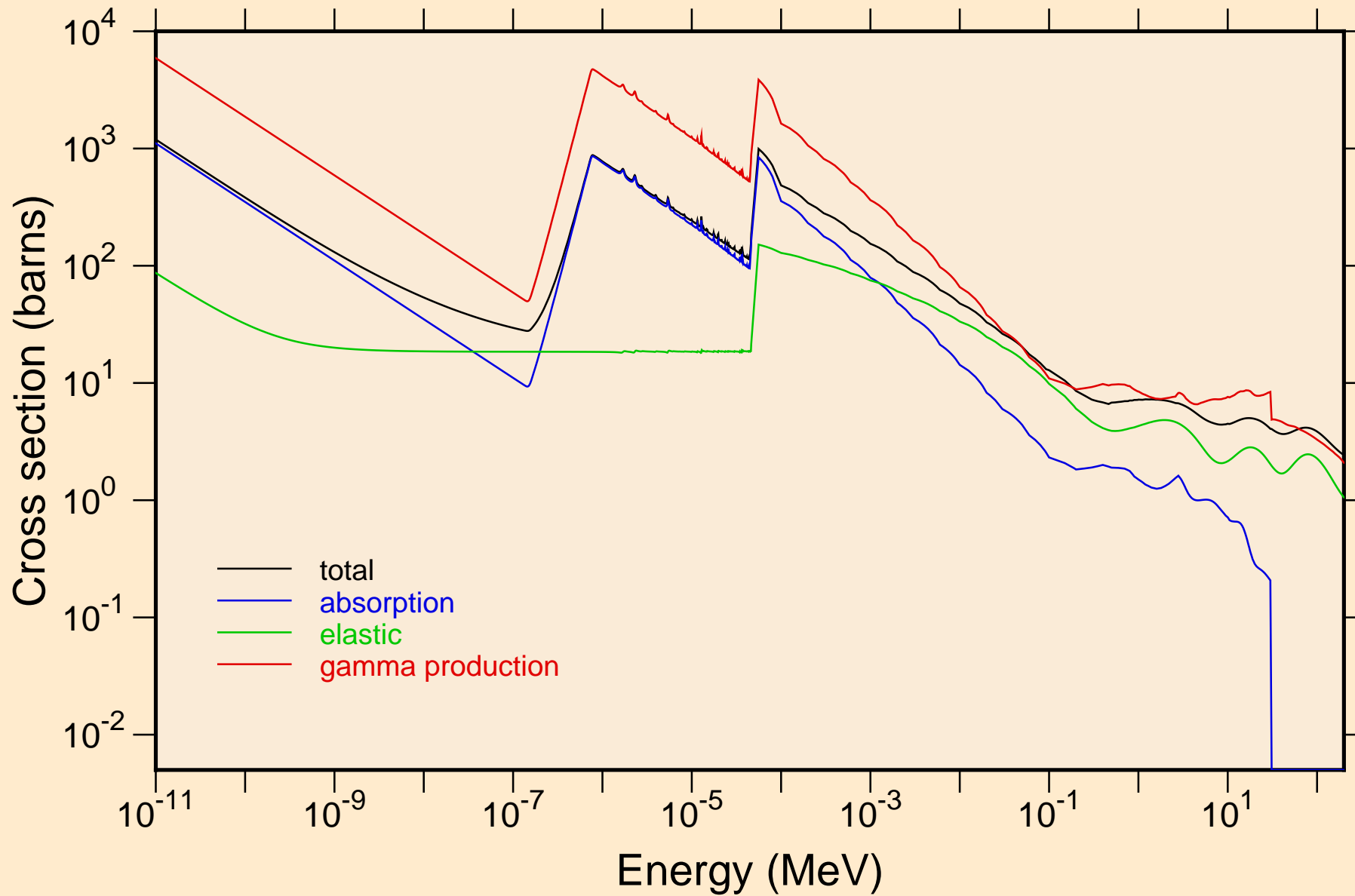

TM153M NEUTRON ACER TENDL-2024 LIBRARY; T=293.6K
resonance total cross section

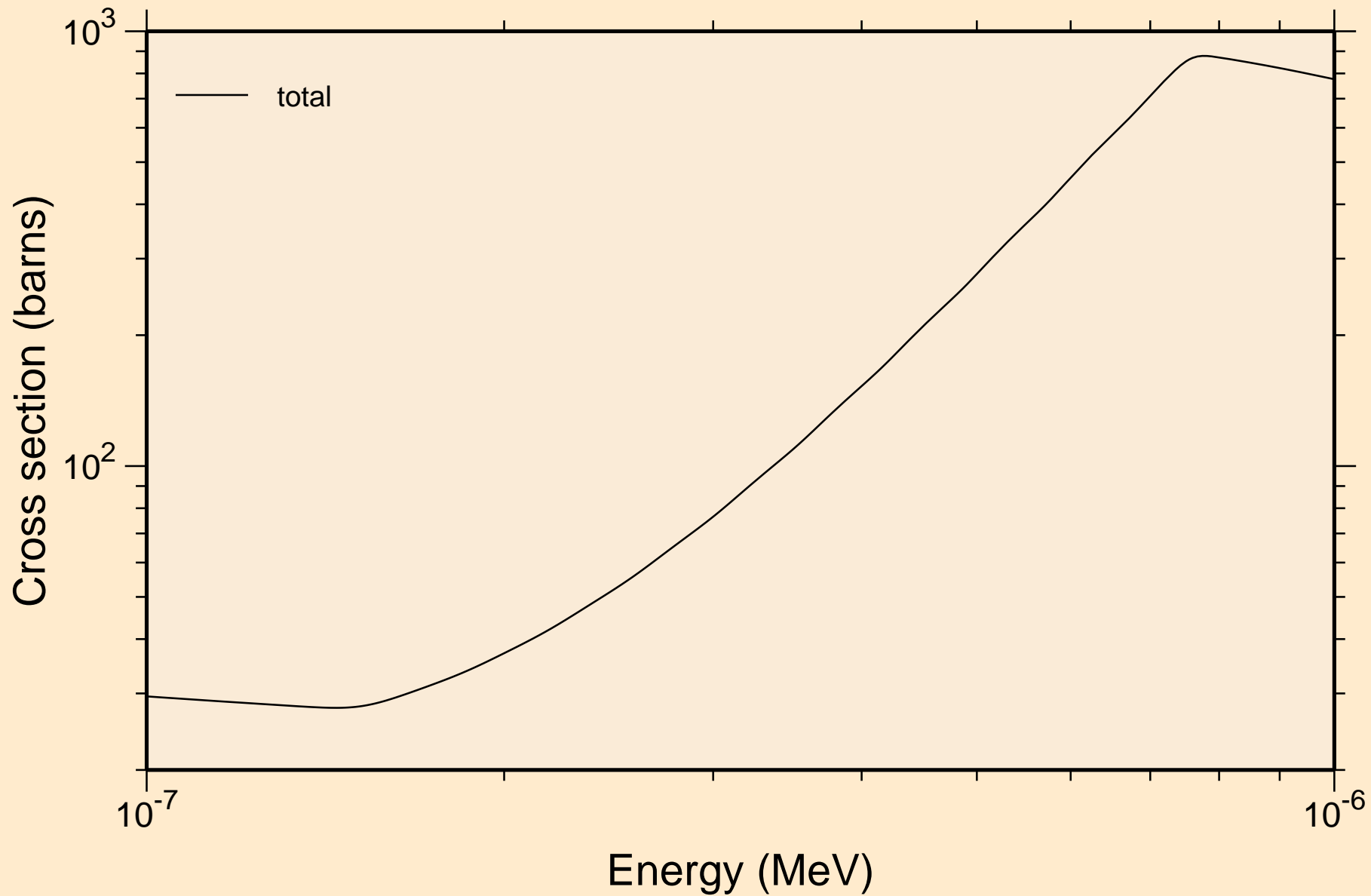

TM153M NEUTRON ACER TENDL-2024 LIBRARY; T=293.6K
resonance total cross section

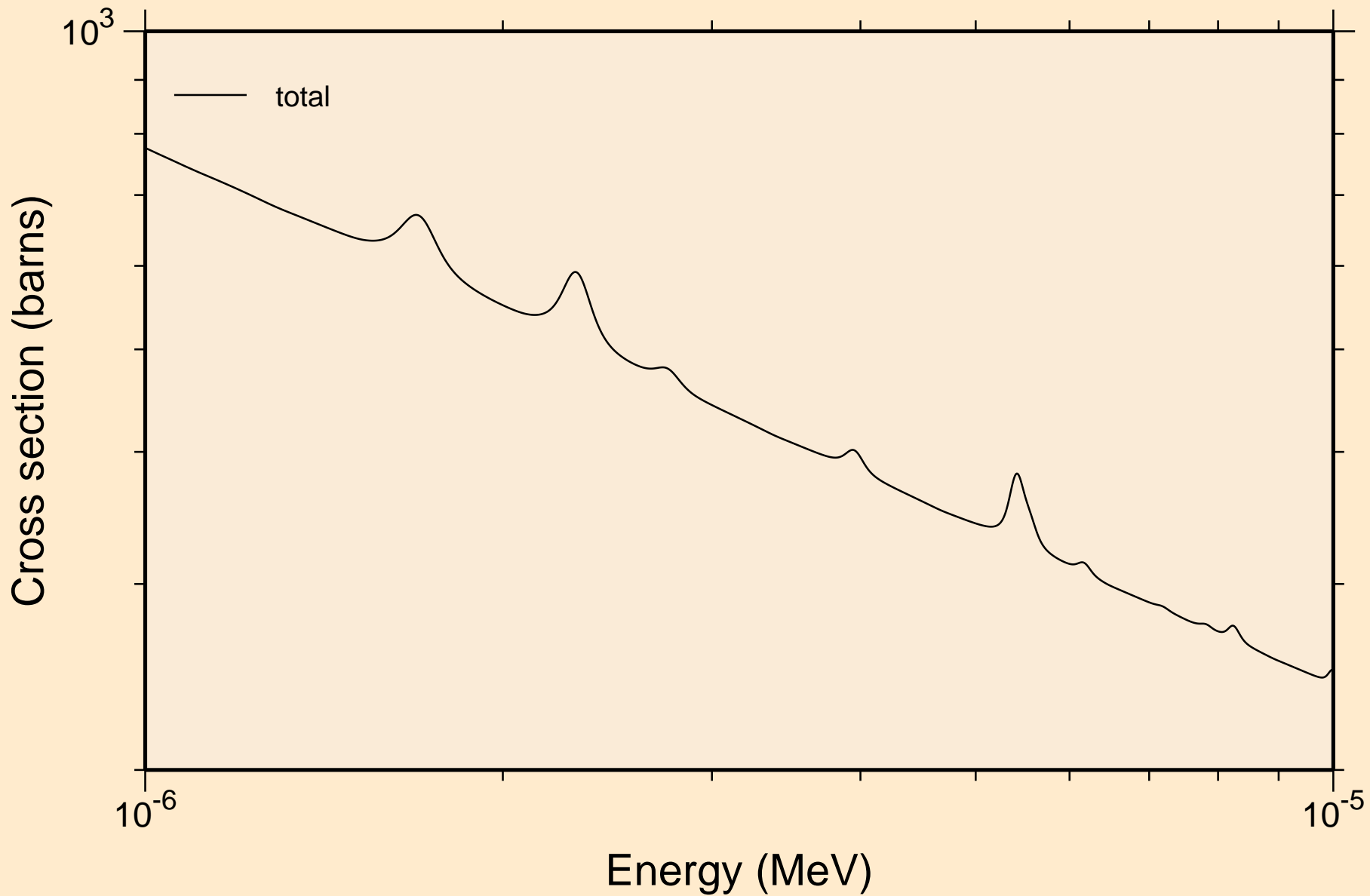

TM153M NEUTRON ACER TENDL-2024 LIBRARY; T=293.6K
resonance total cross section

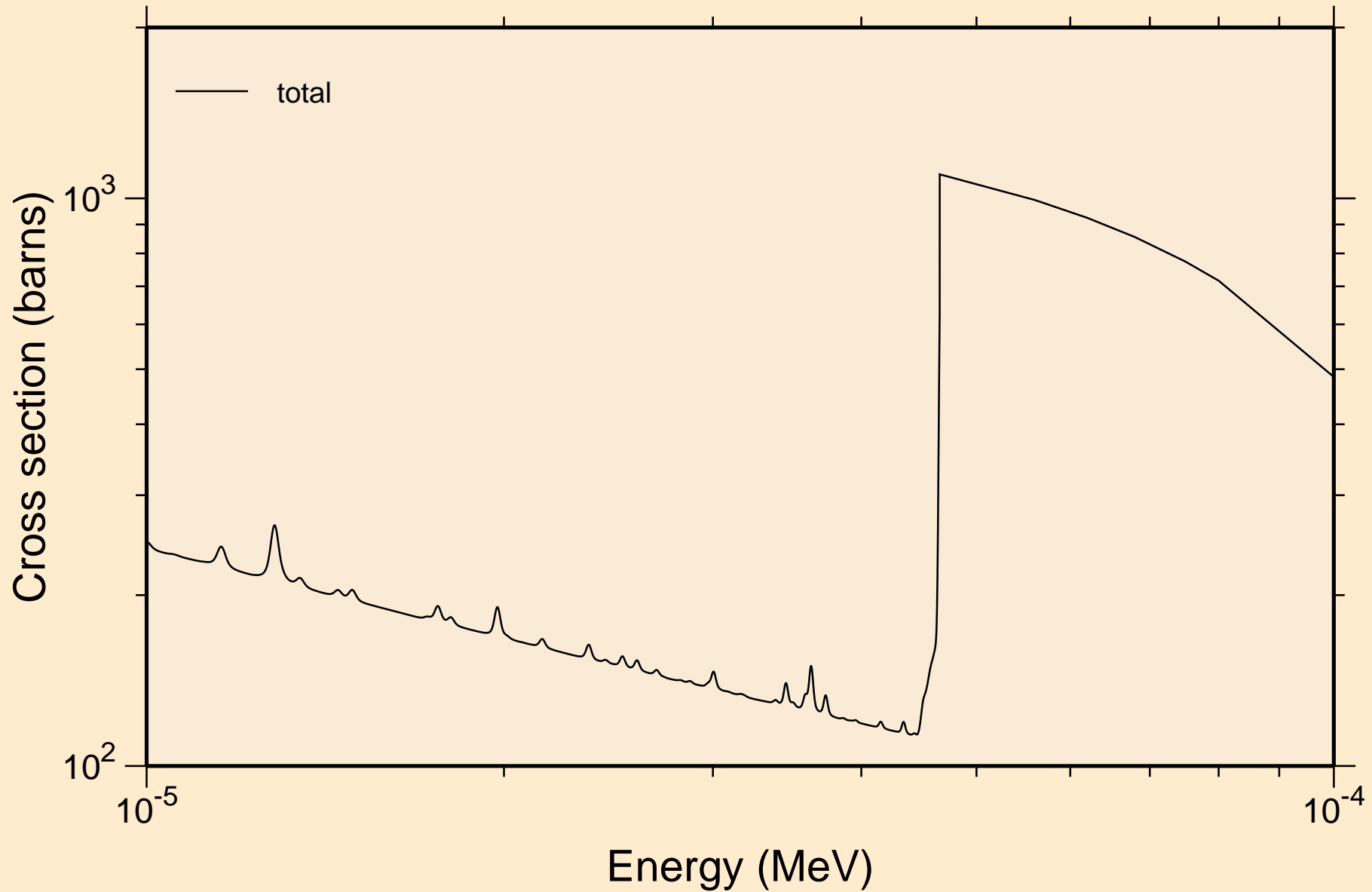

TM153M NEUTRON ACER TENDL-2024 LIBRARY; T=293.6K
resonance total cross section

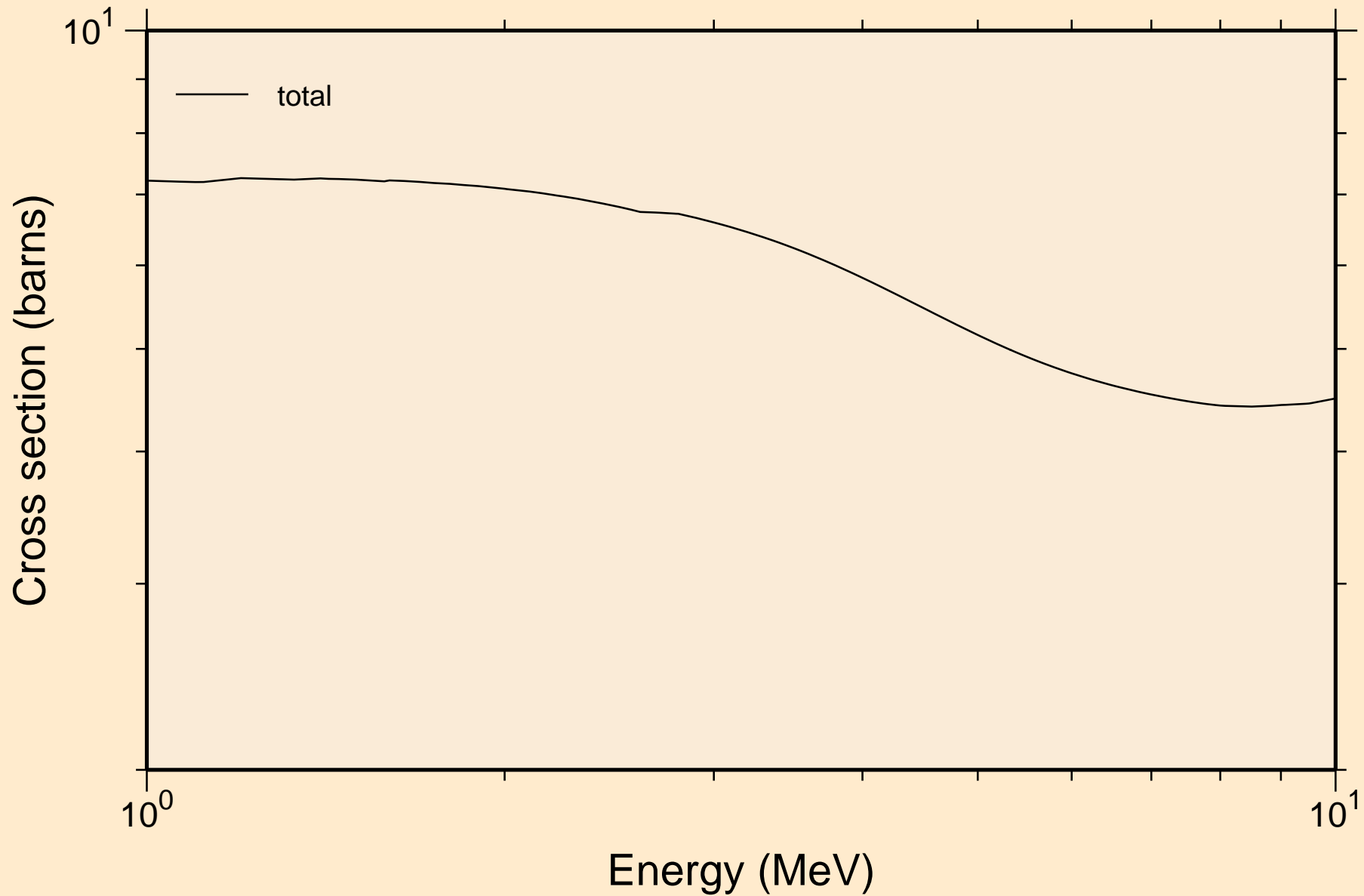

TM153M NEUTRON ACER TENDL-2024 LIBRARY; T=293.6K
resonance absorption cross sections

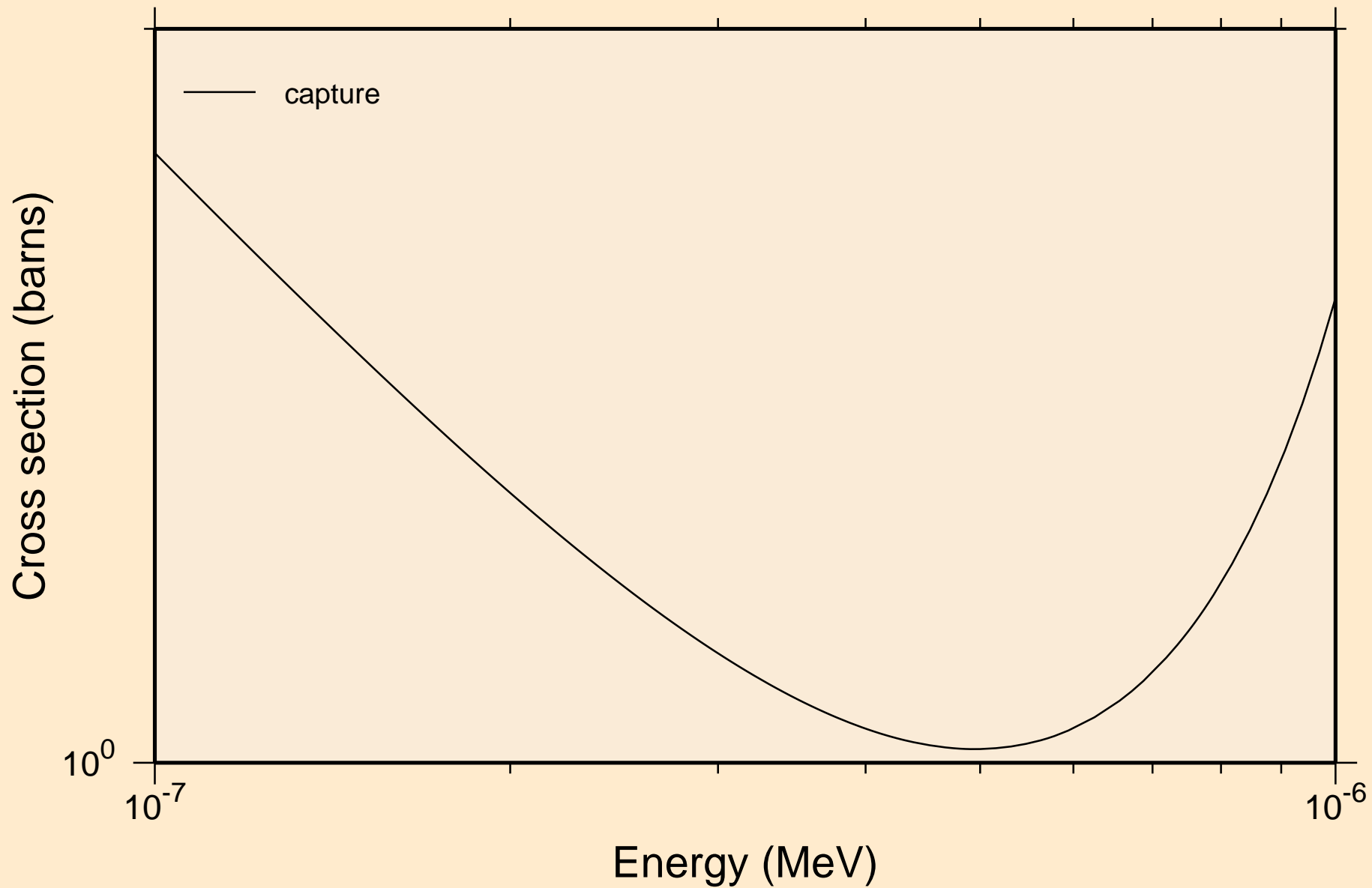

TM153M NEUTRON ACER TENDL-2024 LIBRARY; T=293.6K
resonance absorption cross sections

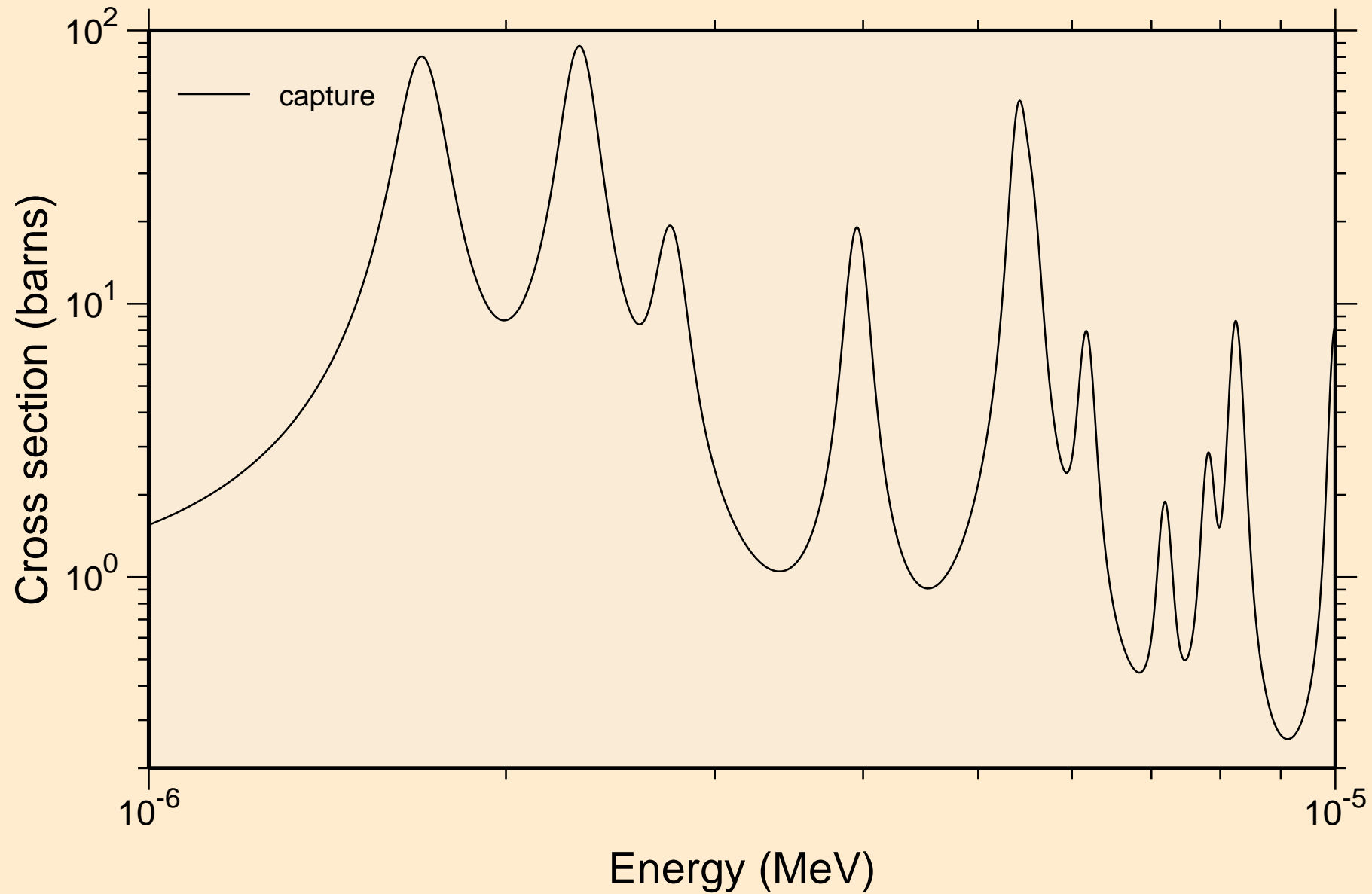

TM153M NEUTRON ACER TENDL-2024 LIBRARY; T=293.6K
resonance absorption cross sections

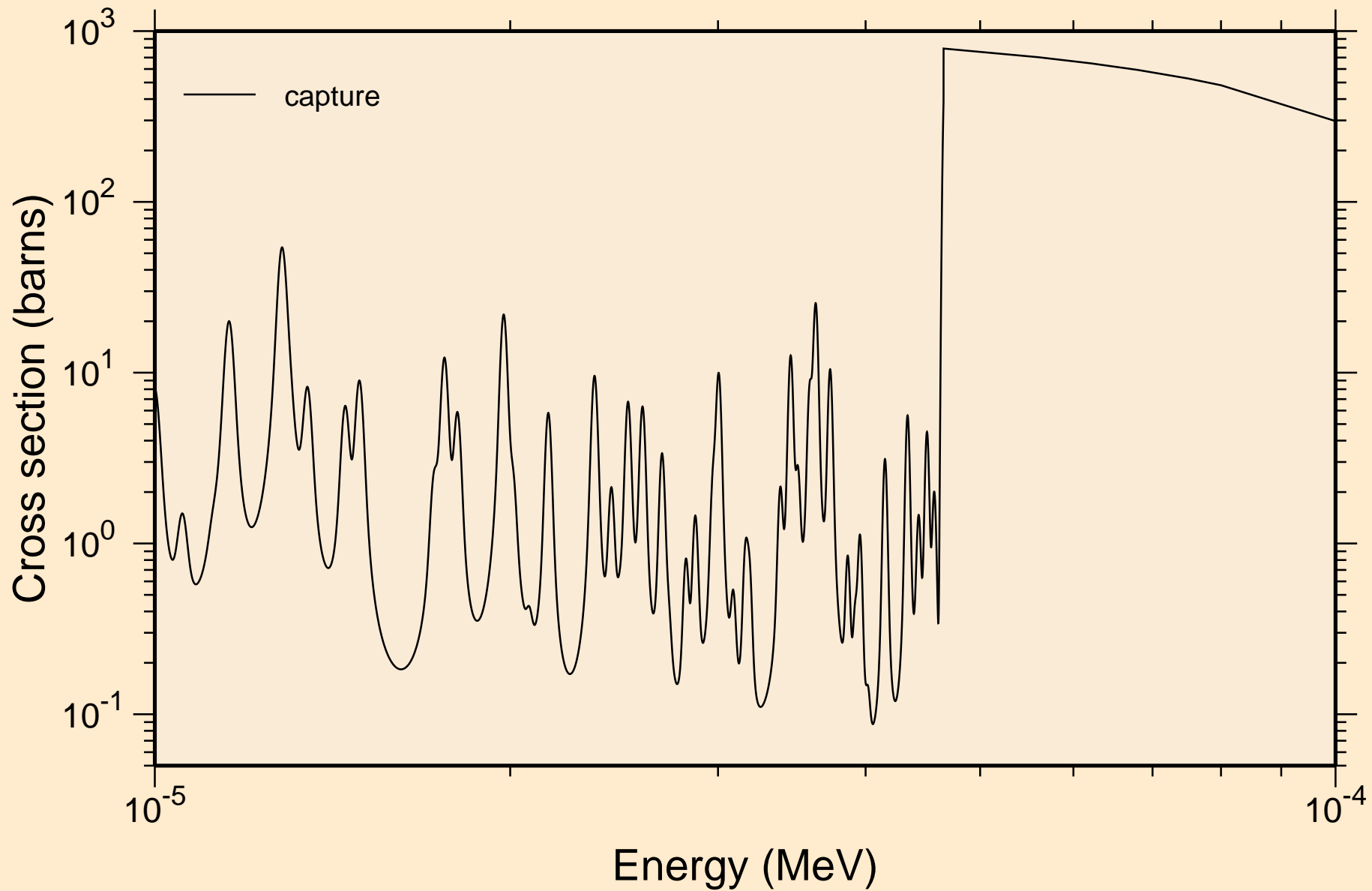

TM153M NEUTRON ACER TENDL-2024 LIBRARY; T=293.6K
resonance absorption cross sections

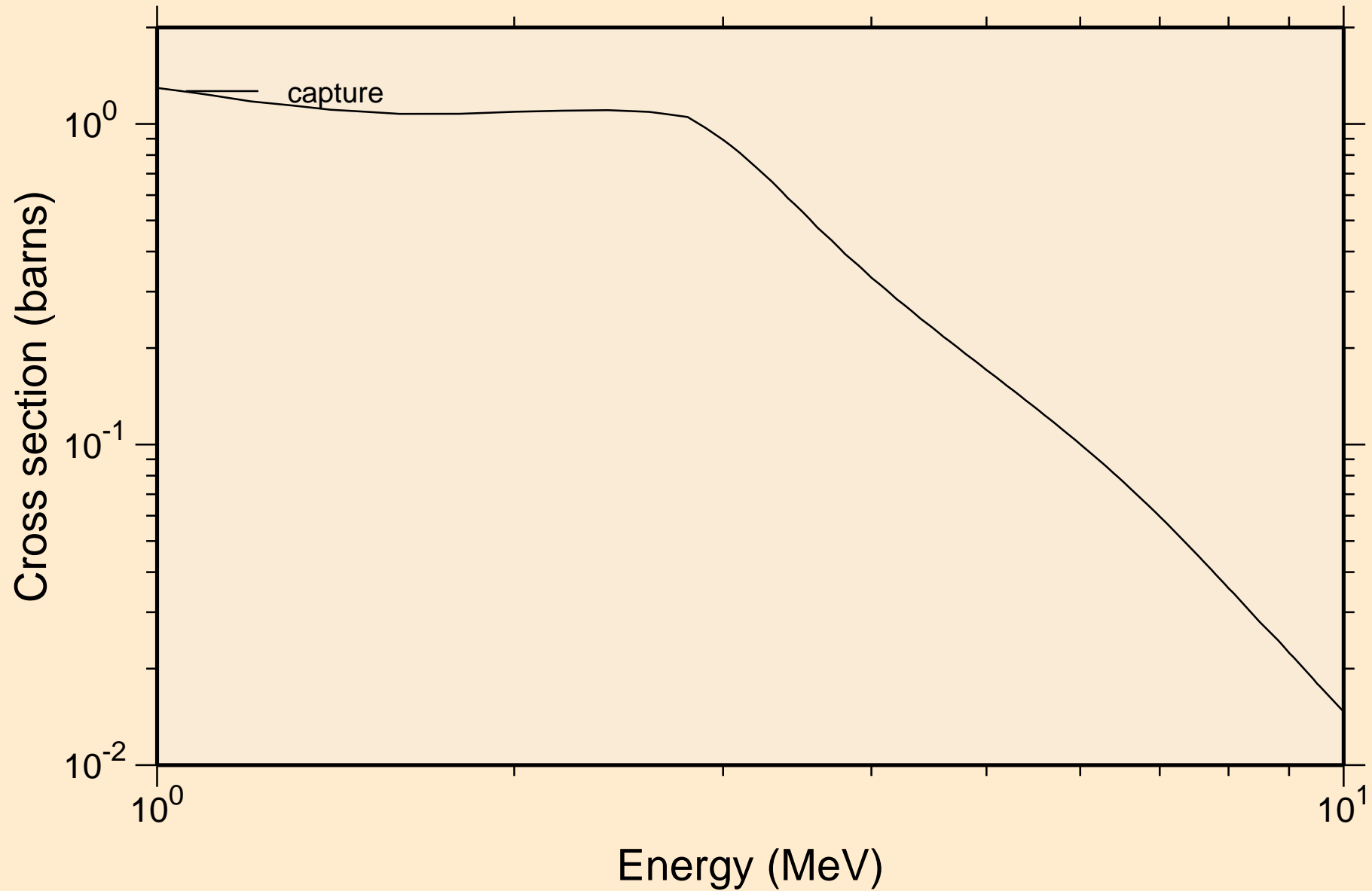

TM153M NEUTRON ACER TENDL-2024 LIBRARY; T=293.6K
Heating

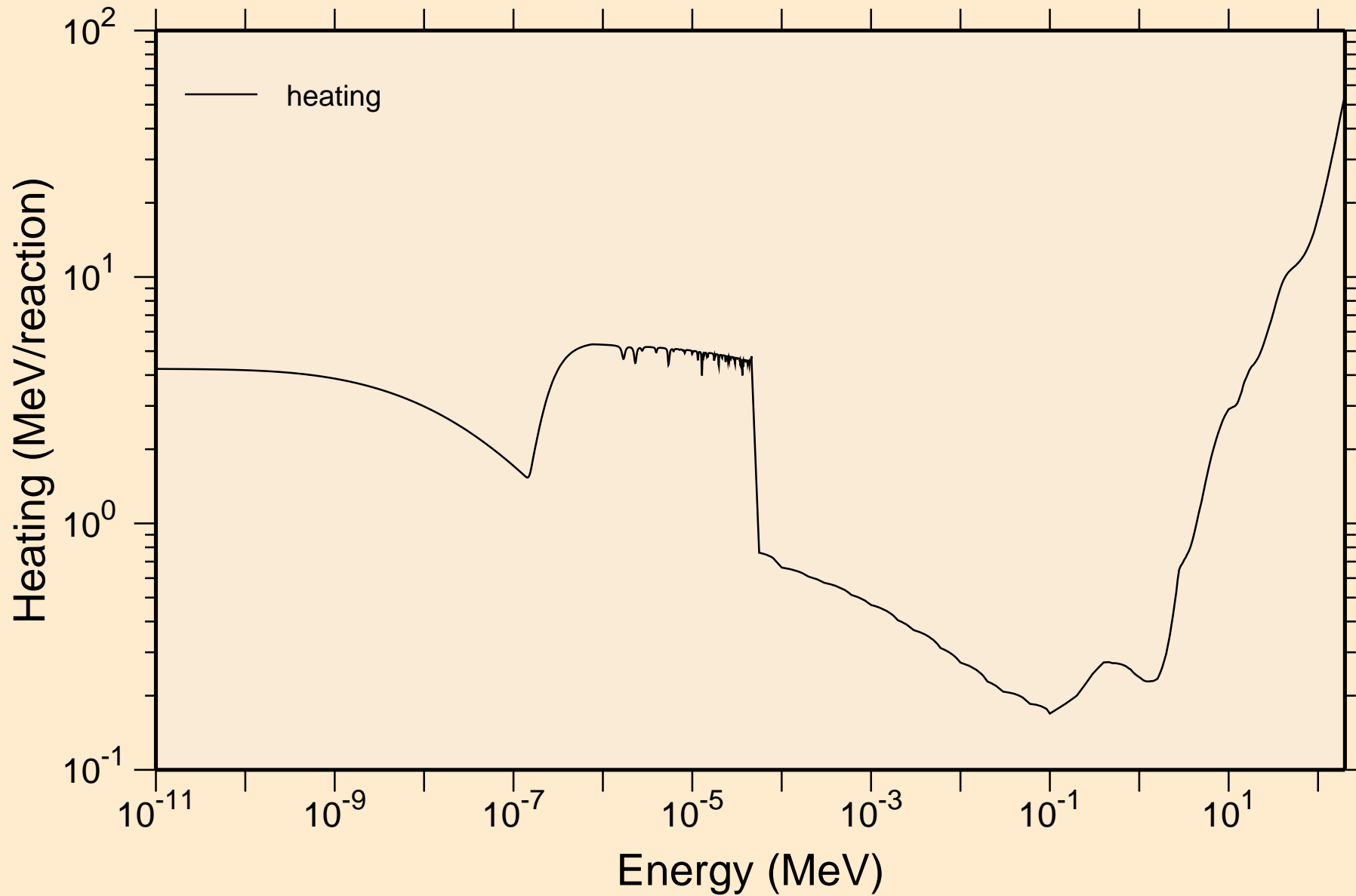

TM153M NEUTRON ACER TENDL-2024 LIBRARY; T=293.6K
Damage

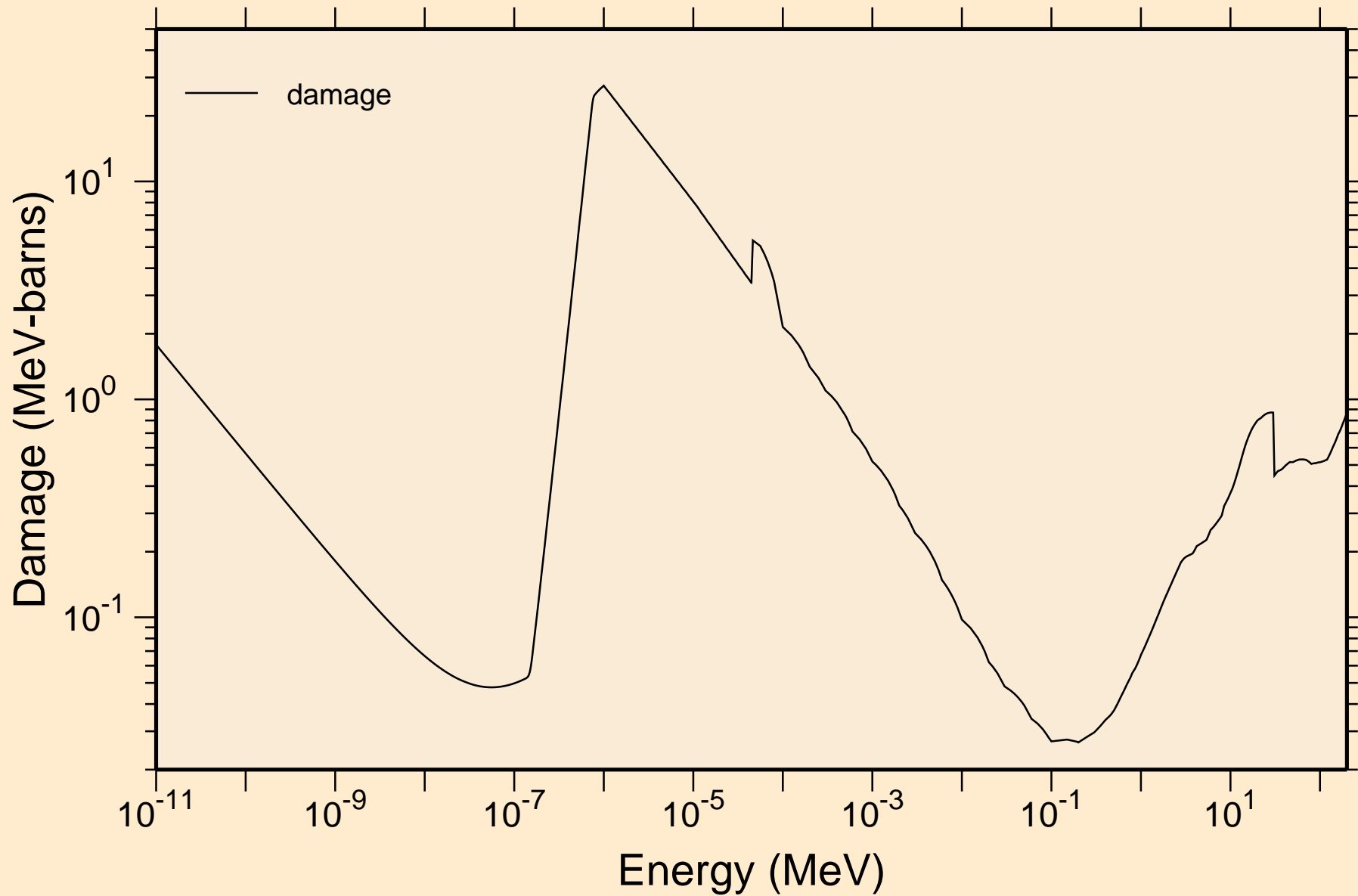

TM153M NEUTRON ACER TENDL-2024 LIBRARY; T=293.6K
Non-threshold reactions

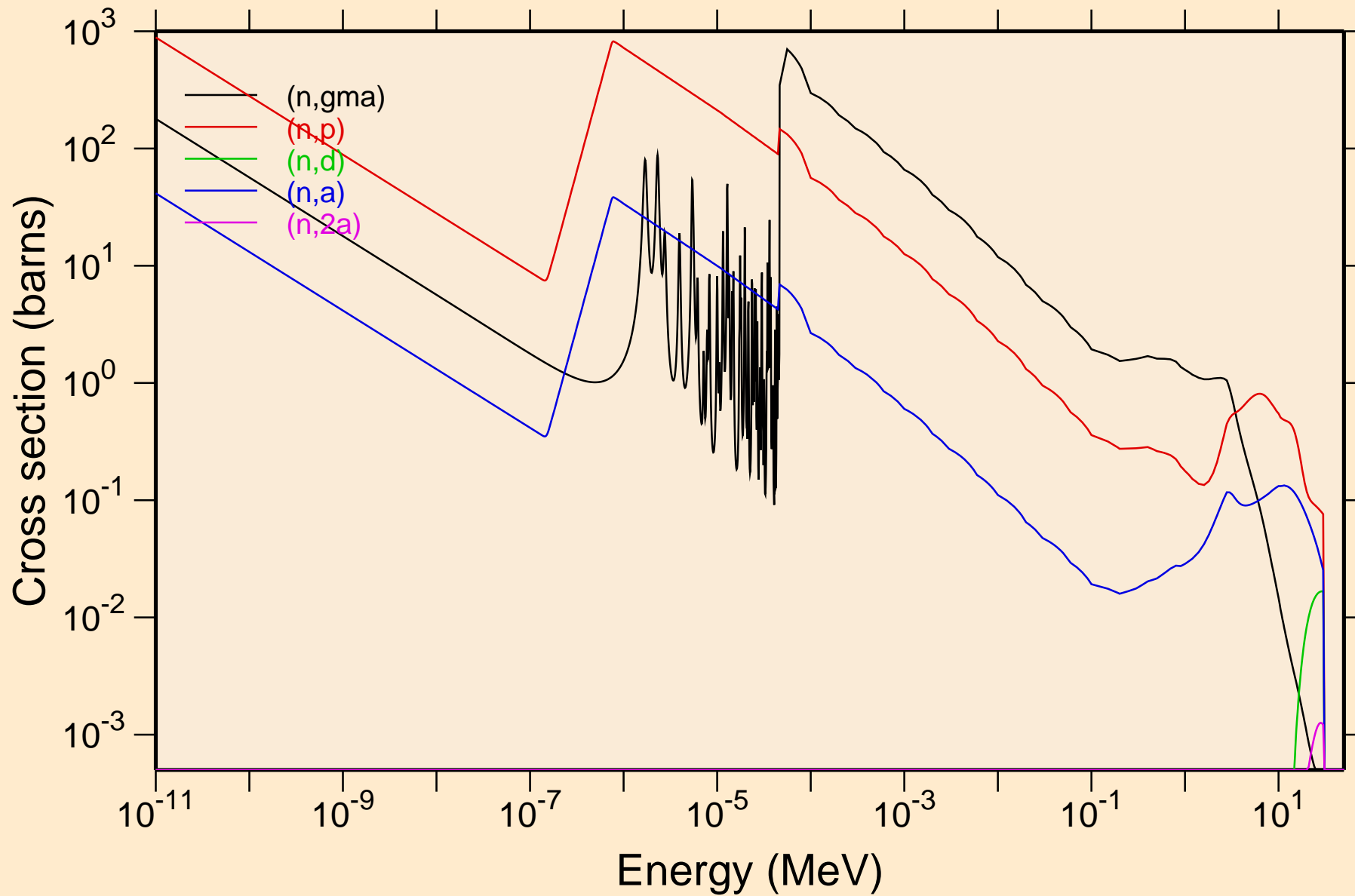

TM153M NEUTRON ACER TENDL-2024 LIBRARY; T=293.6K
Non-threshold reactions

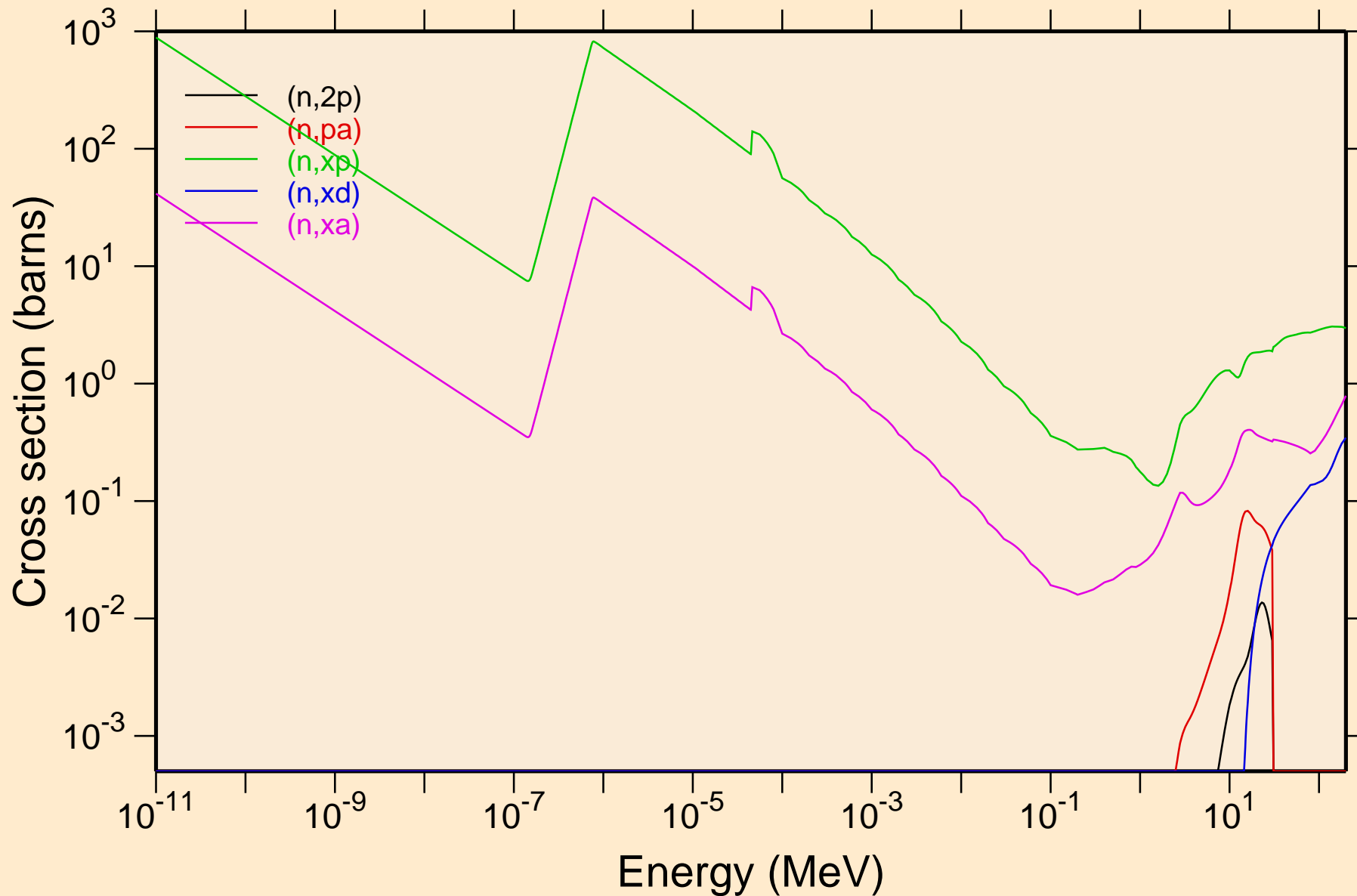

TM153M NEUTRON ACER TENDL-2024 LIBRARY; T=293.6K
Principal cross sections

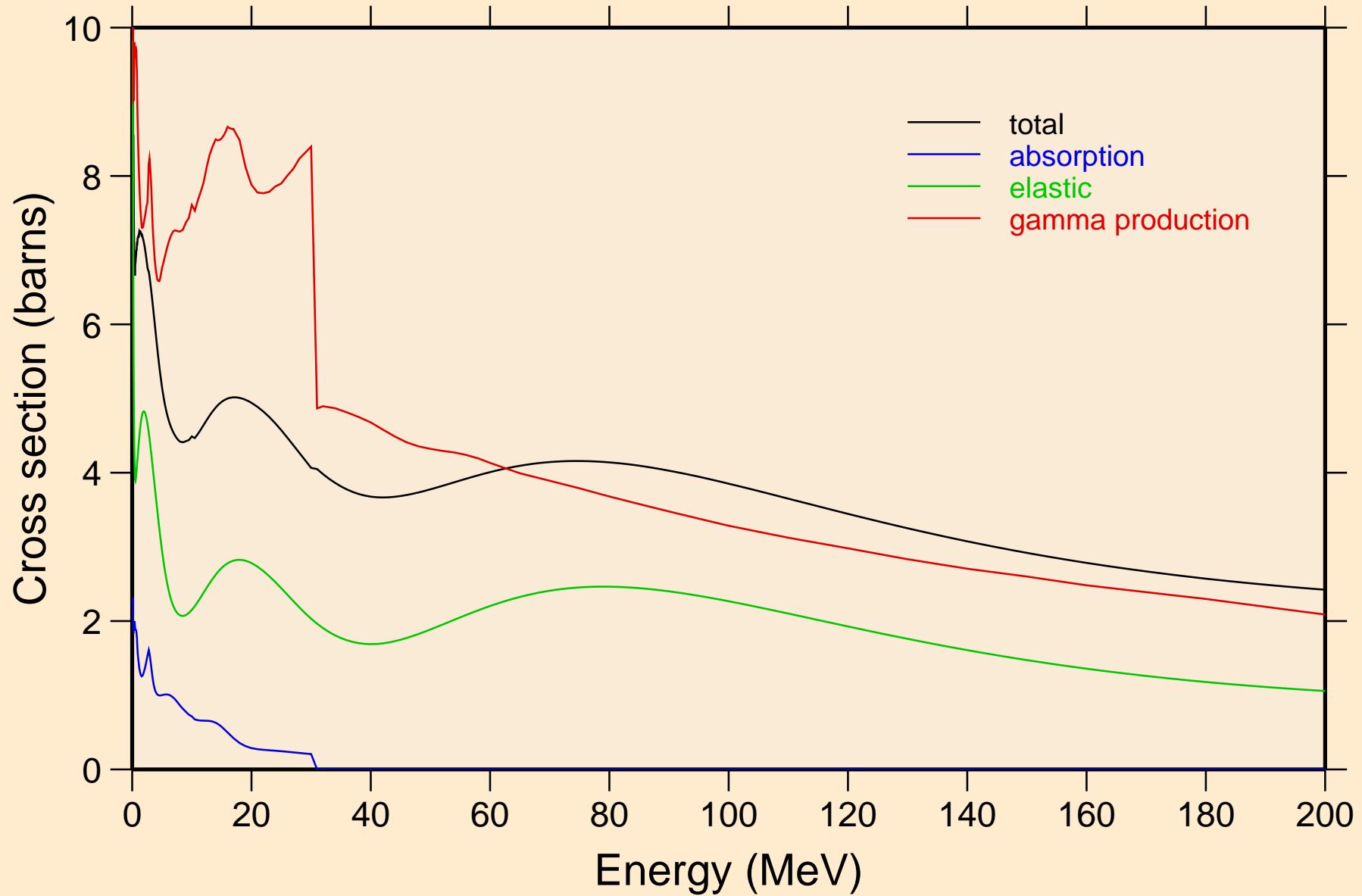

TM153M NEUTRON ACER TENDL-2024 LIBRARY; T=293.6K
Heating

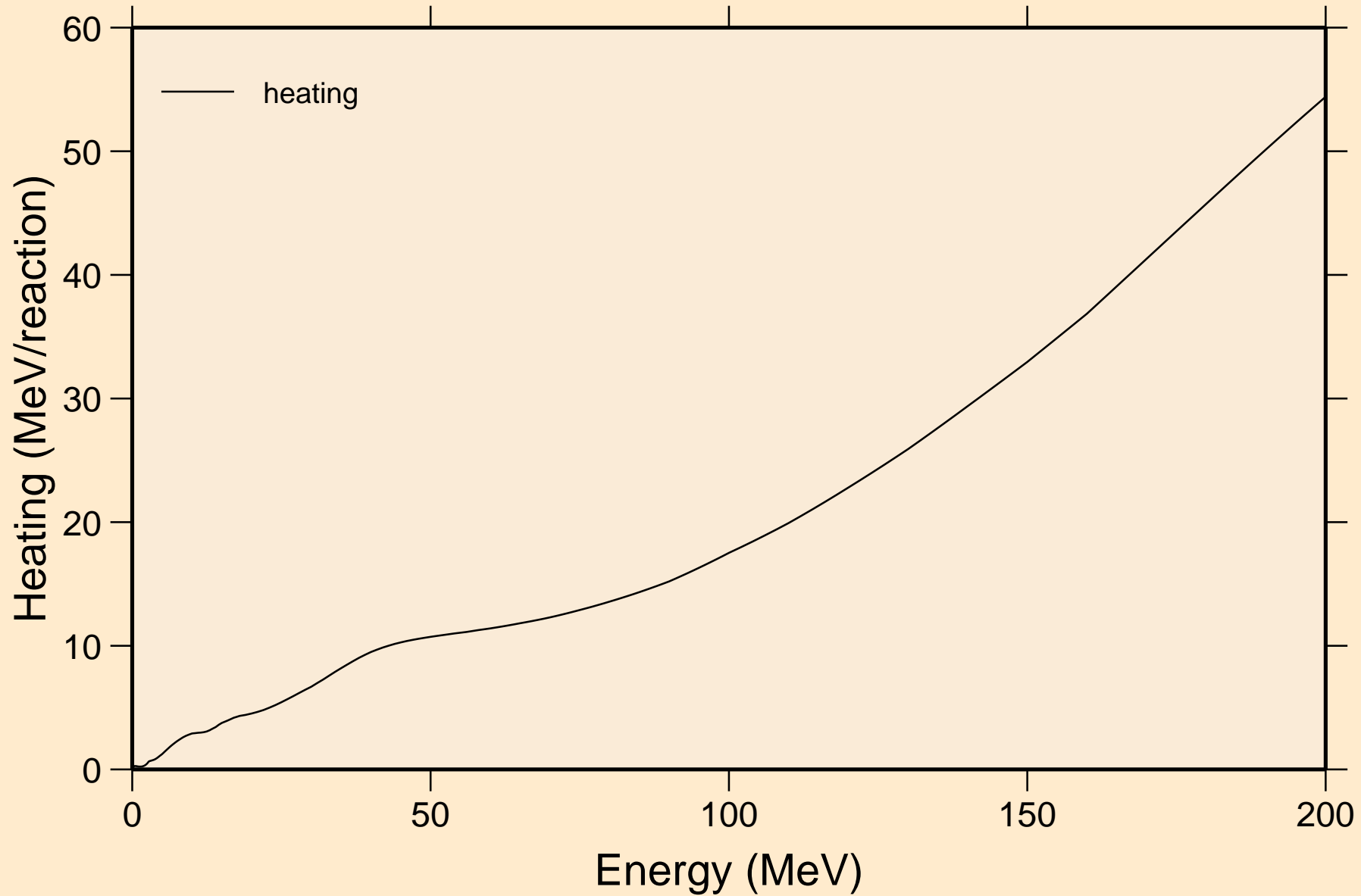

TM153M NEUTRON ACER TENDL-2024 LIBRARY; T=293.6K
Damage

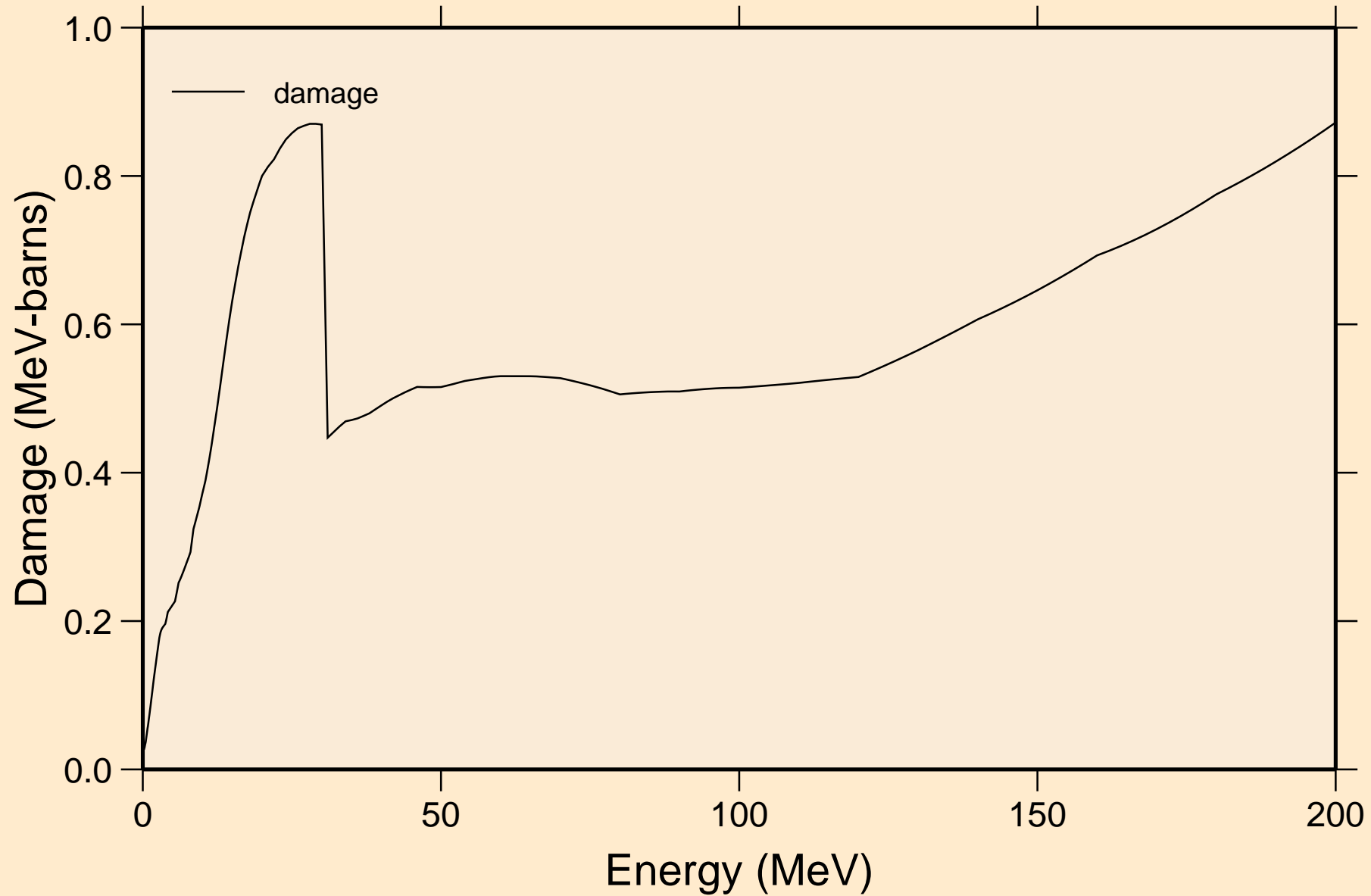

TM153M NEUTRON ACER TENDL-2024 LIBRARY; T=293.6K
Non-threshold reactions

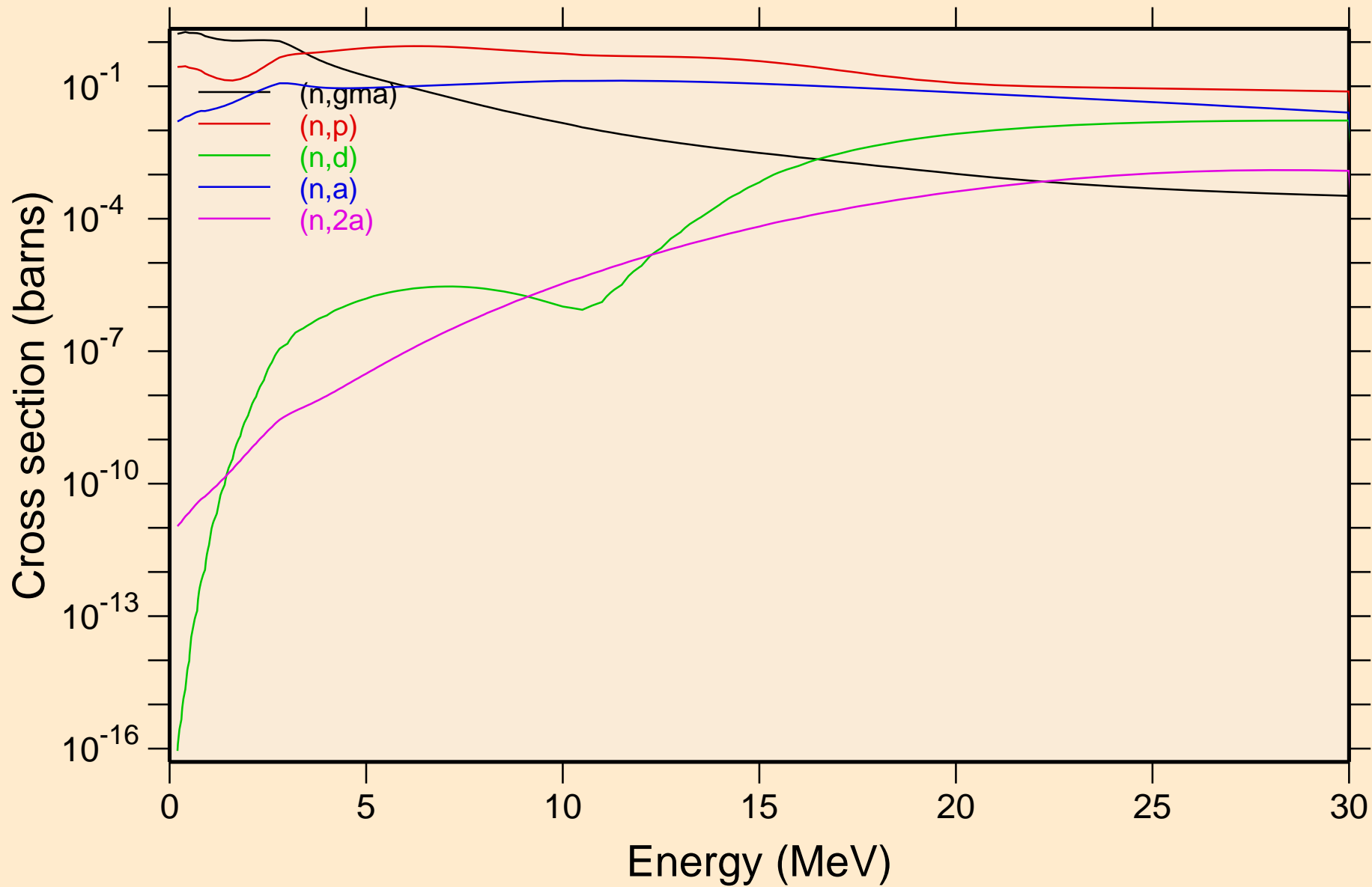

TM153M NEUTRON ACER TENDL-2024 LIBRARY; T=293.6K
Non-threshold reactions

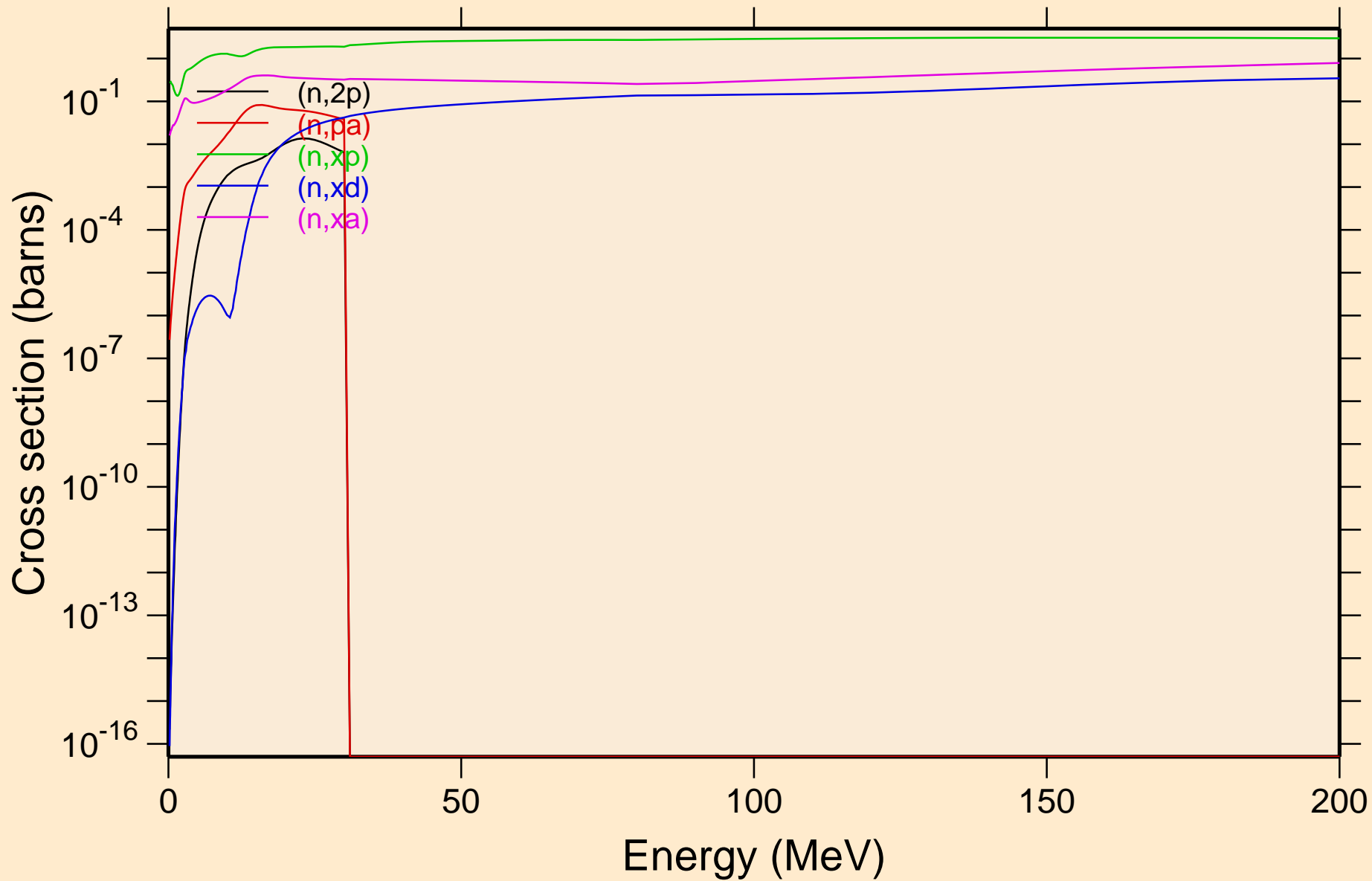

TM153M NEUTRON ACER TENDL-2024 LIBRARY; T=293.6K
Inelastic levels

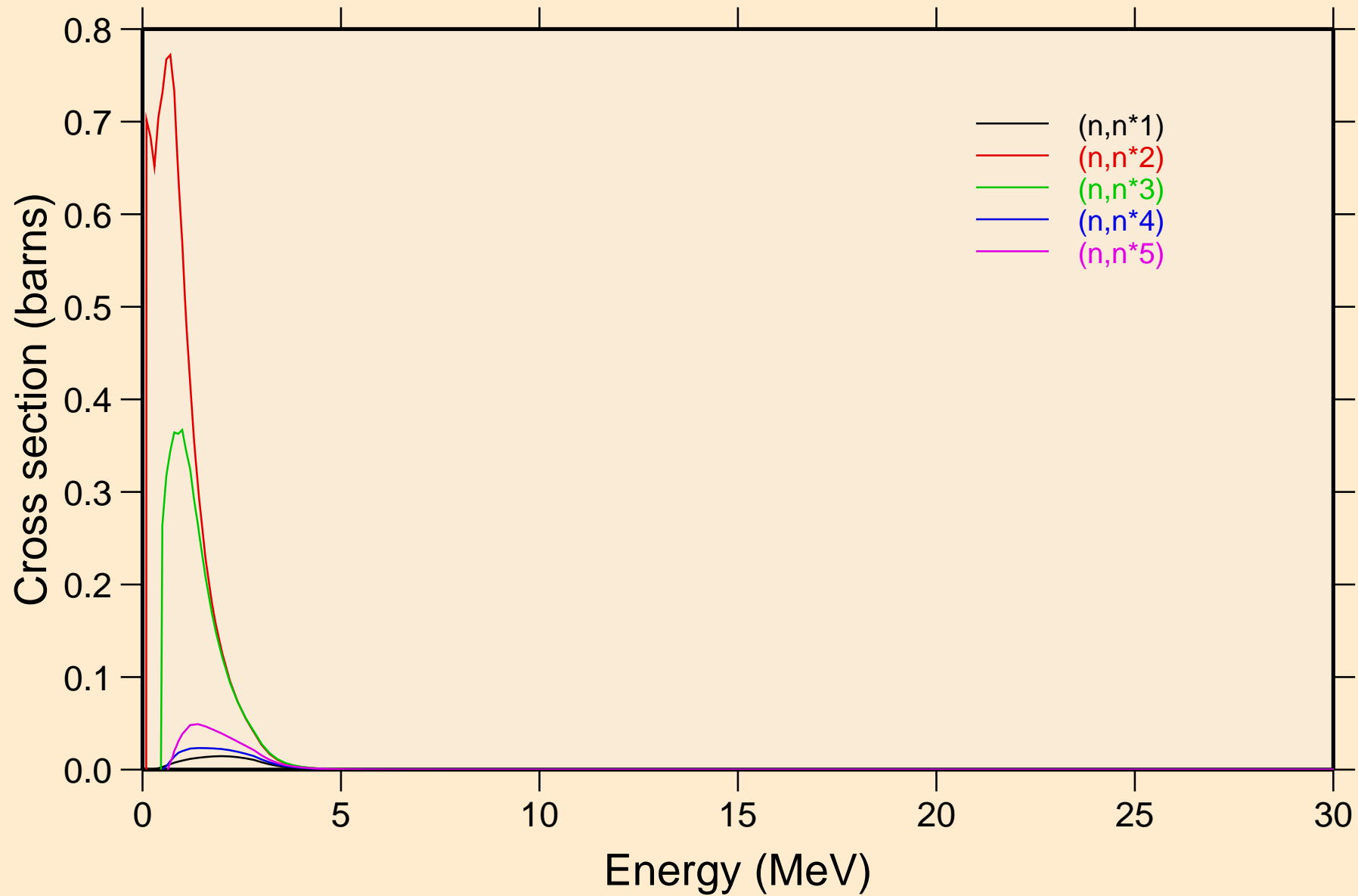

TM153M NEUTRON ACER TENDL-2024 LIBRARY; T=293.6K
Inelastic levels

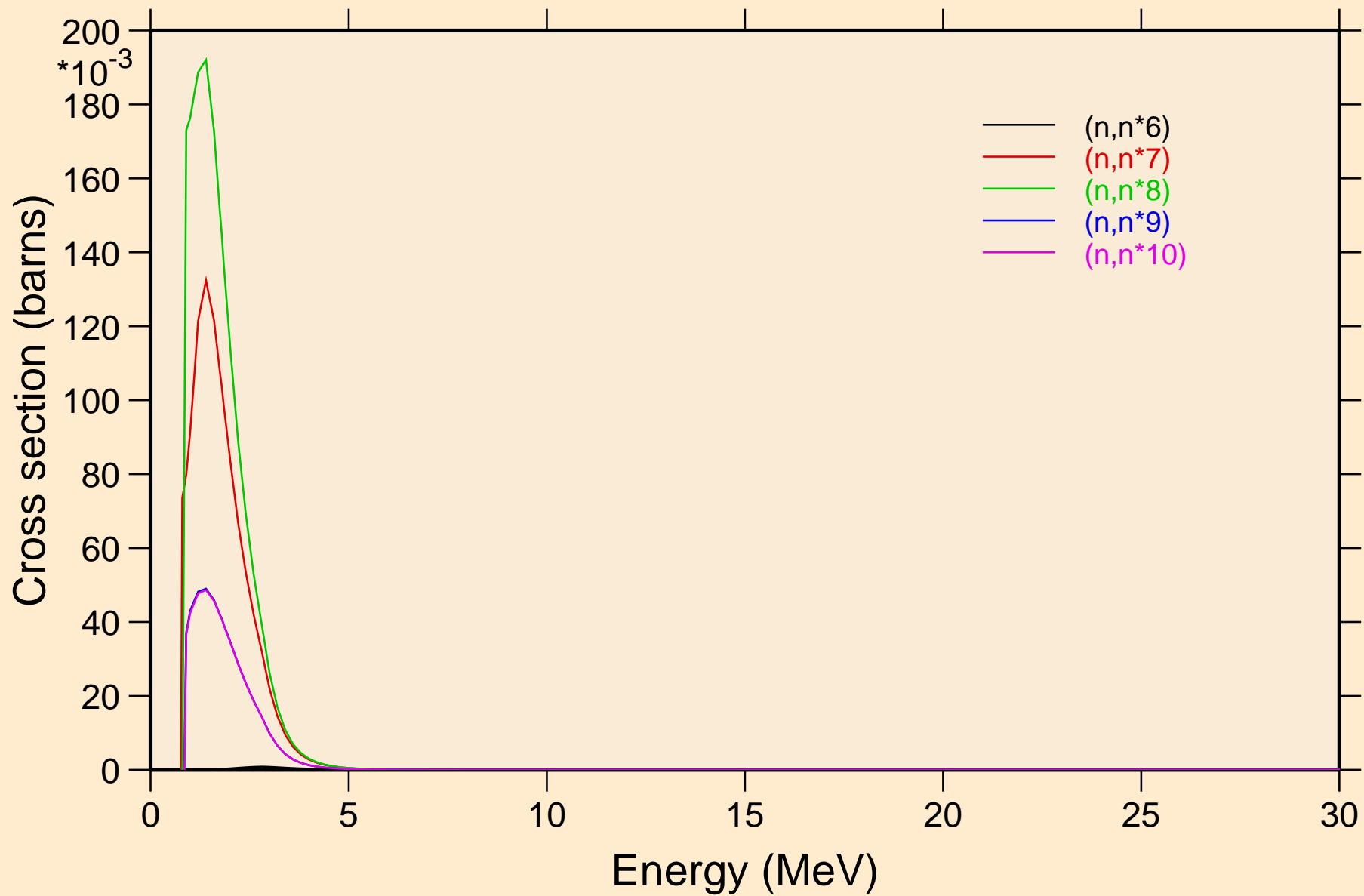

TM153M NEUTRON ACER TENDL-2024 LIBRARY; T=293.6K
Inelastic levels

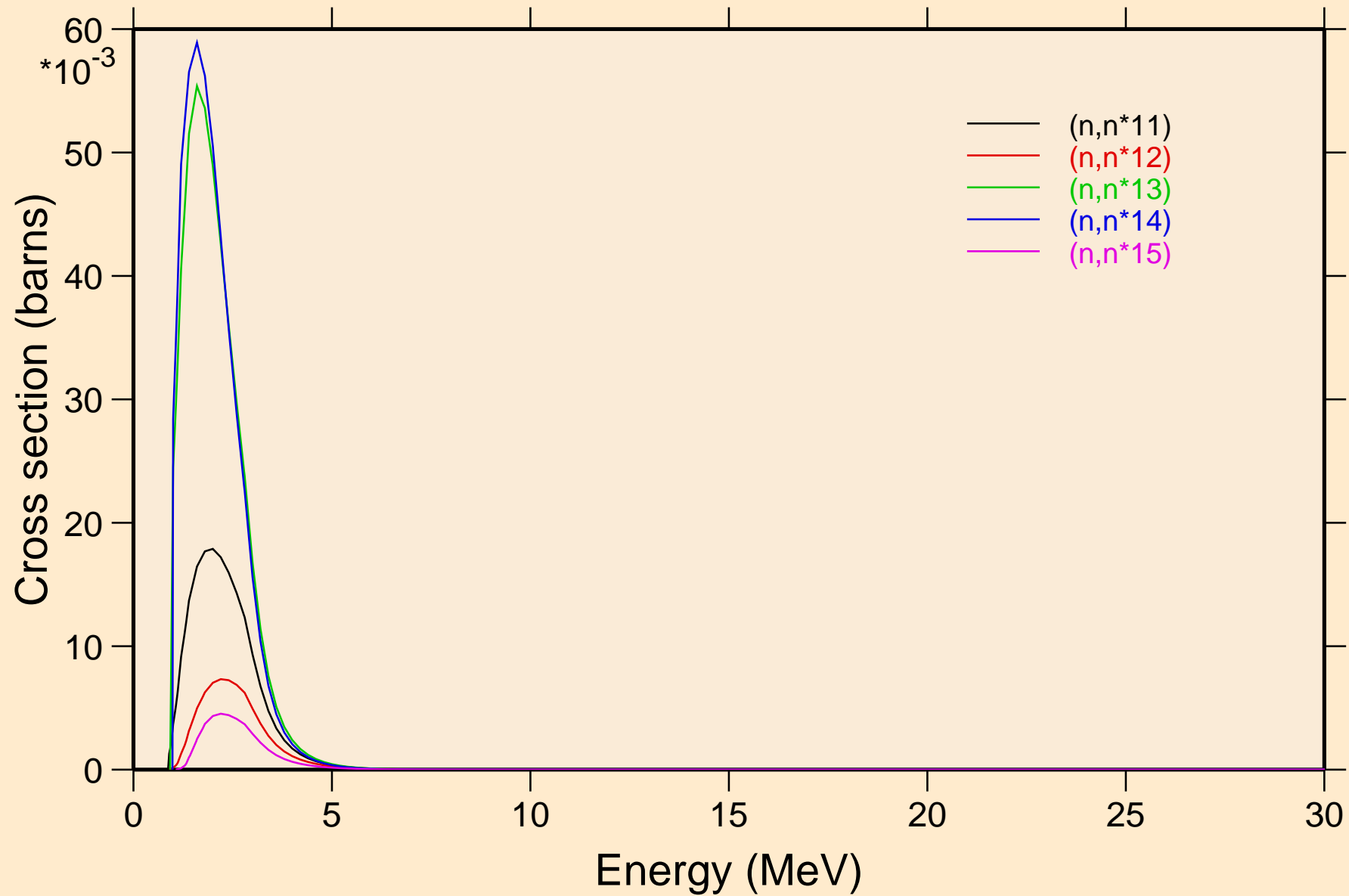

TM153M NEUTRON ACER TENDL-2024 LIBRARY; T=293.6K
Inelastic levels

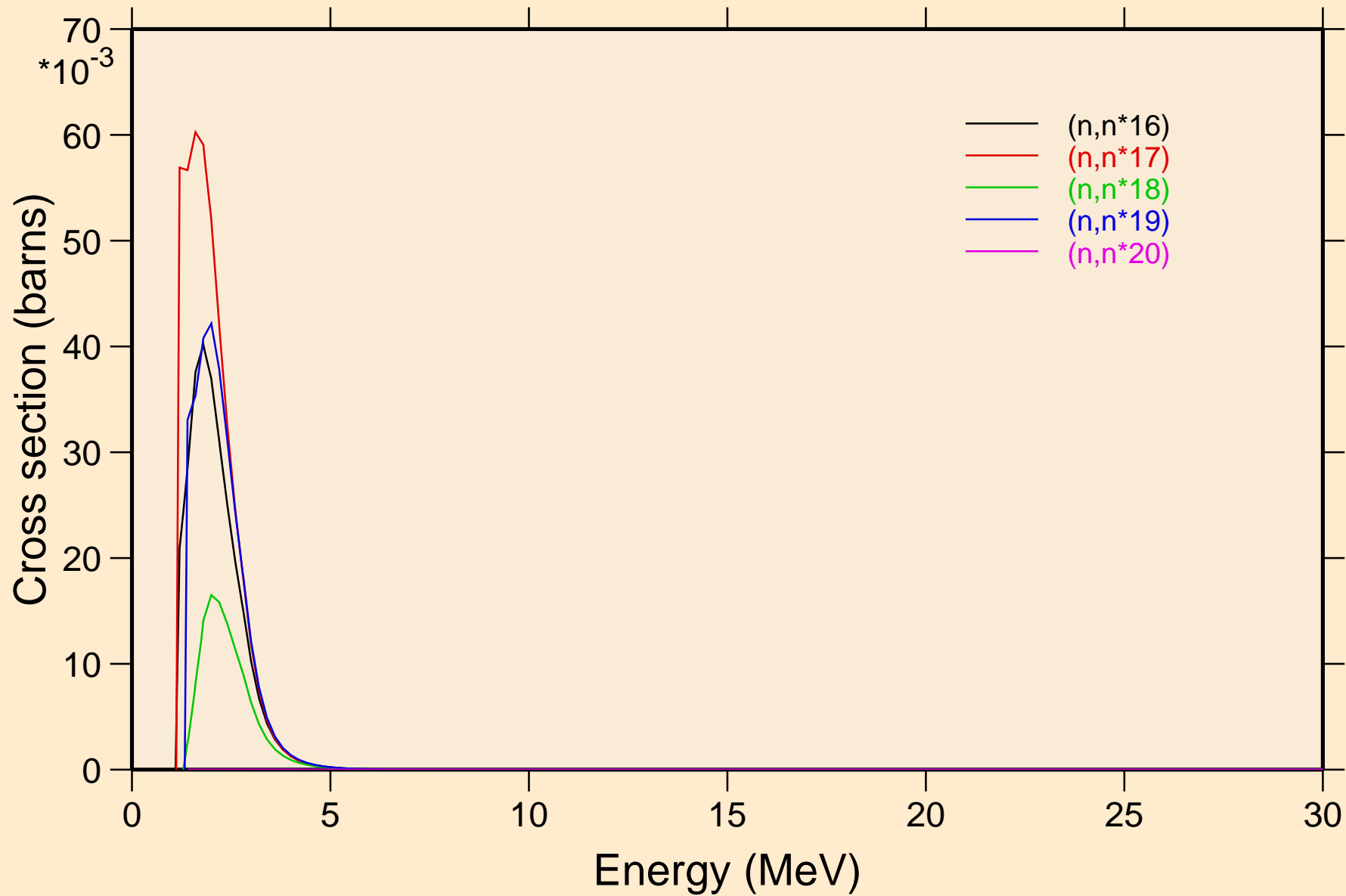

TM153M NEUTRON ACER TENDL-2024 LIBRARY; T=293.6K
Inelastic levels

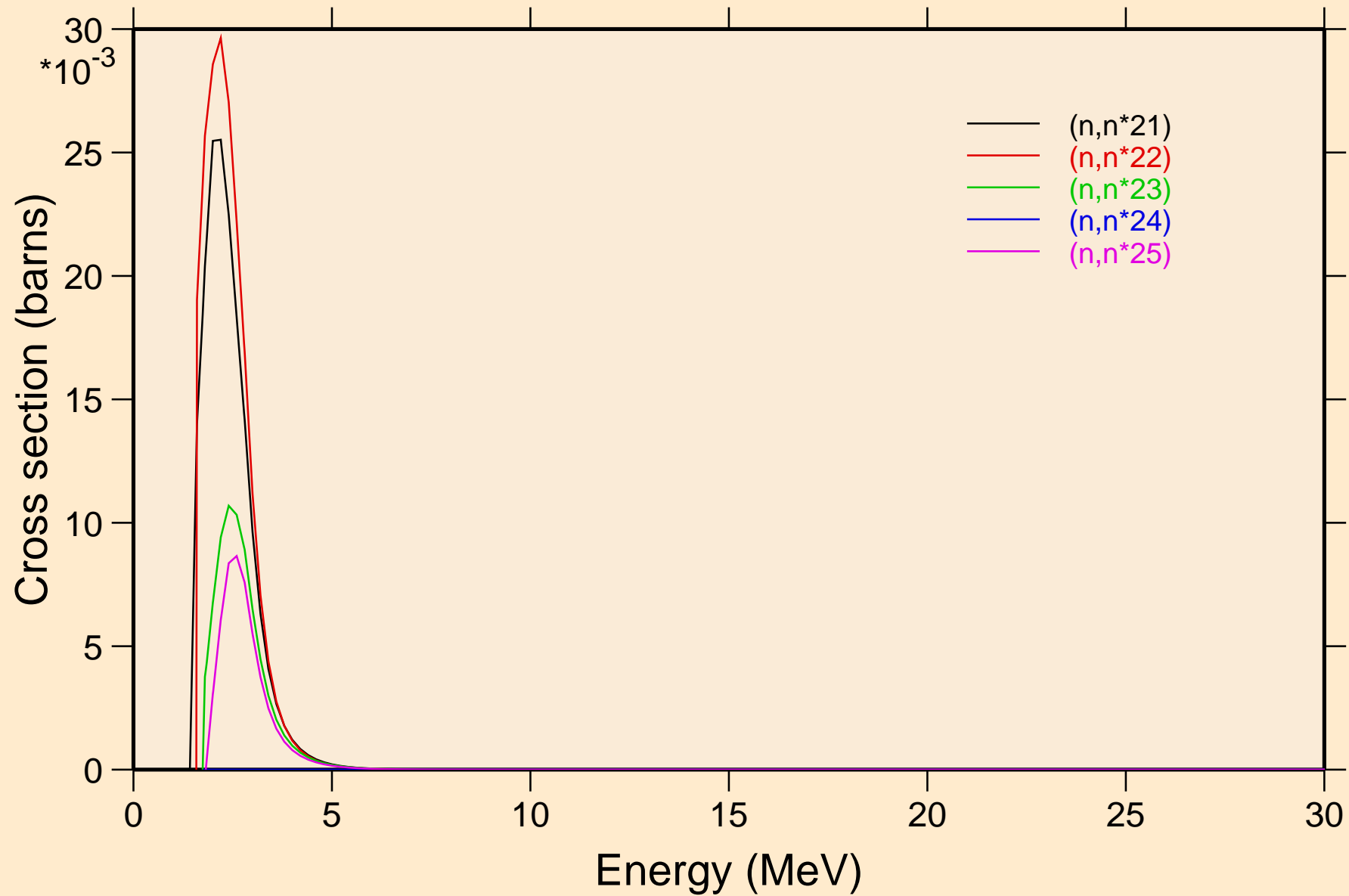

TM153M NEUTRON ACER TENDL-2024 LIBRARY; T=293.6K
Inelastic levels

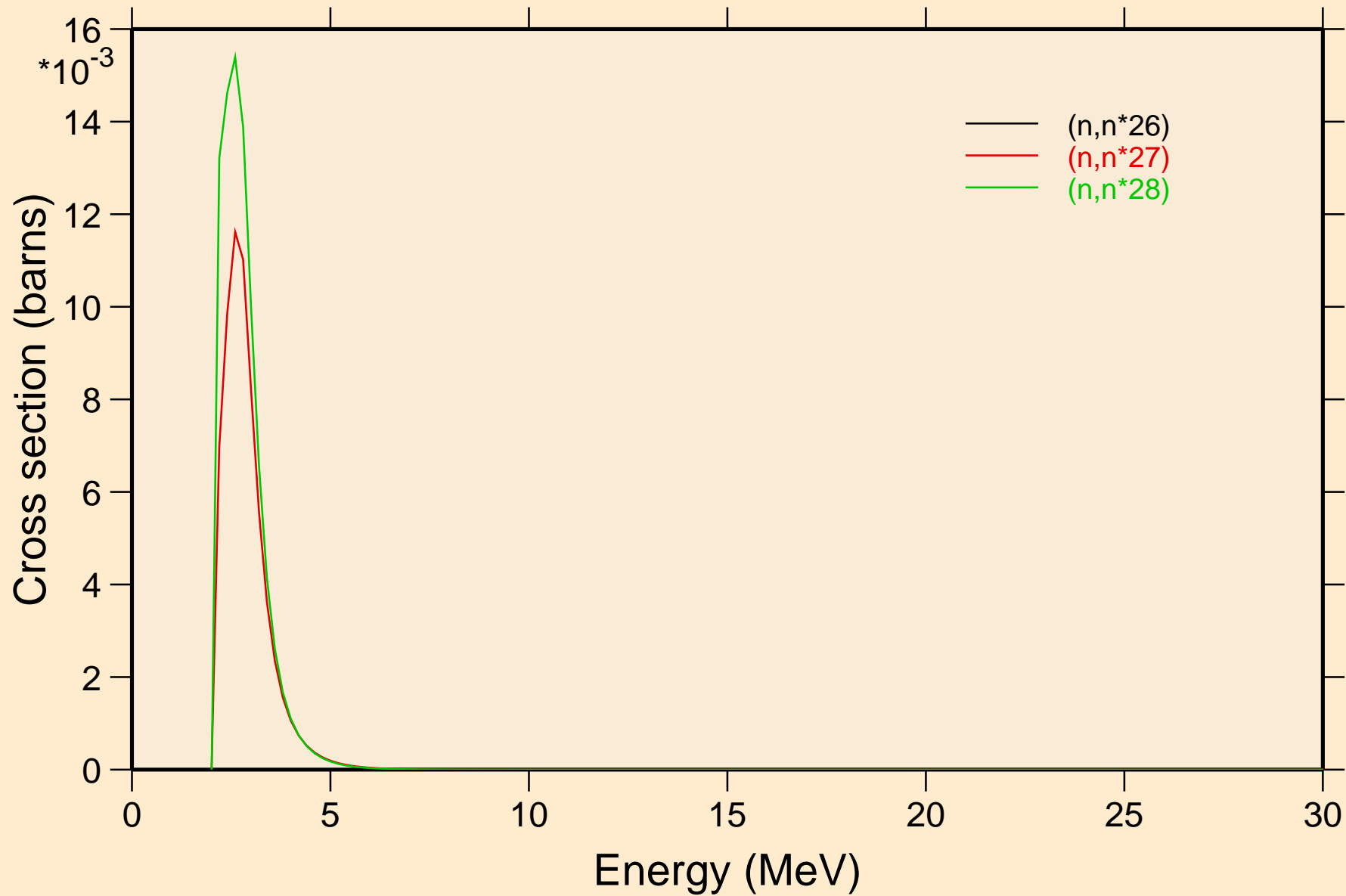

TM153M NEUTRON ACER TENDL-2024 LIBRARY; T=293.6K
Threshold reactions

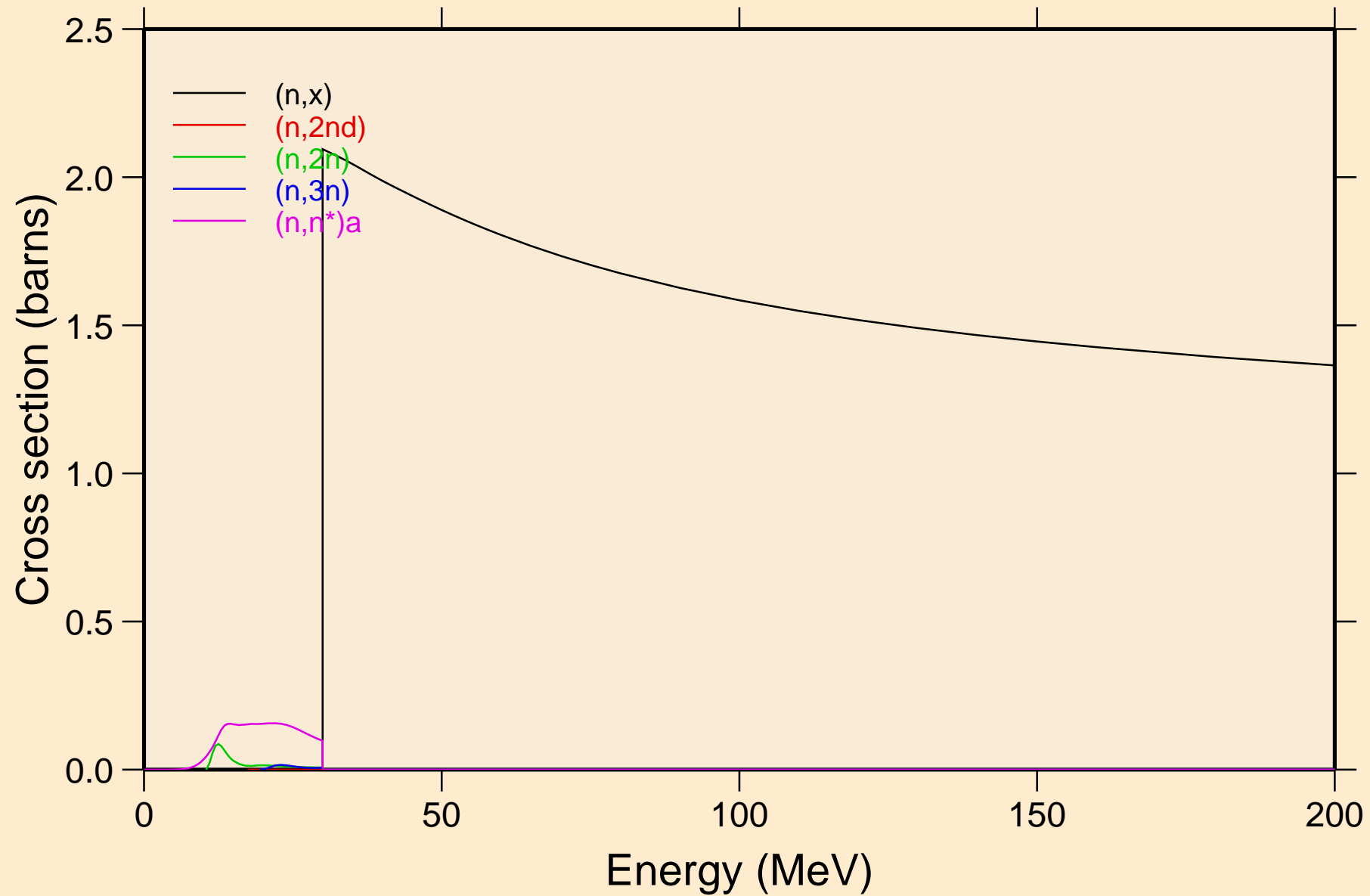

TM153M NEUTRON ACER TENDL-2024 LIBRARY; T=293.6K
Threshold reactions

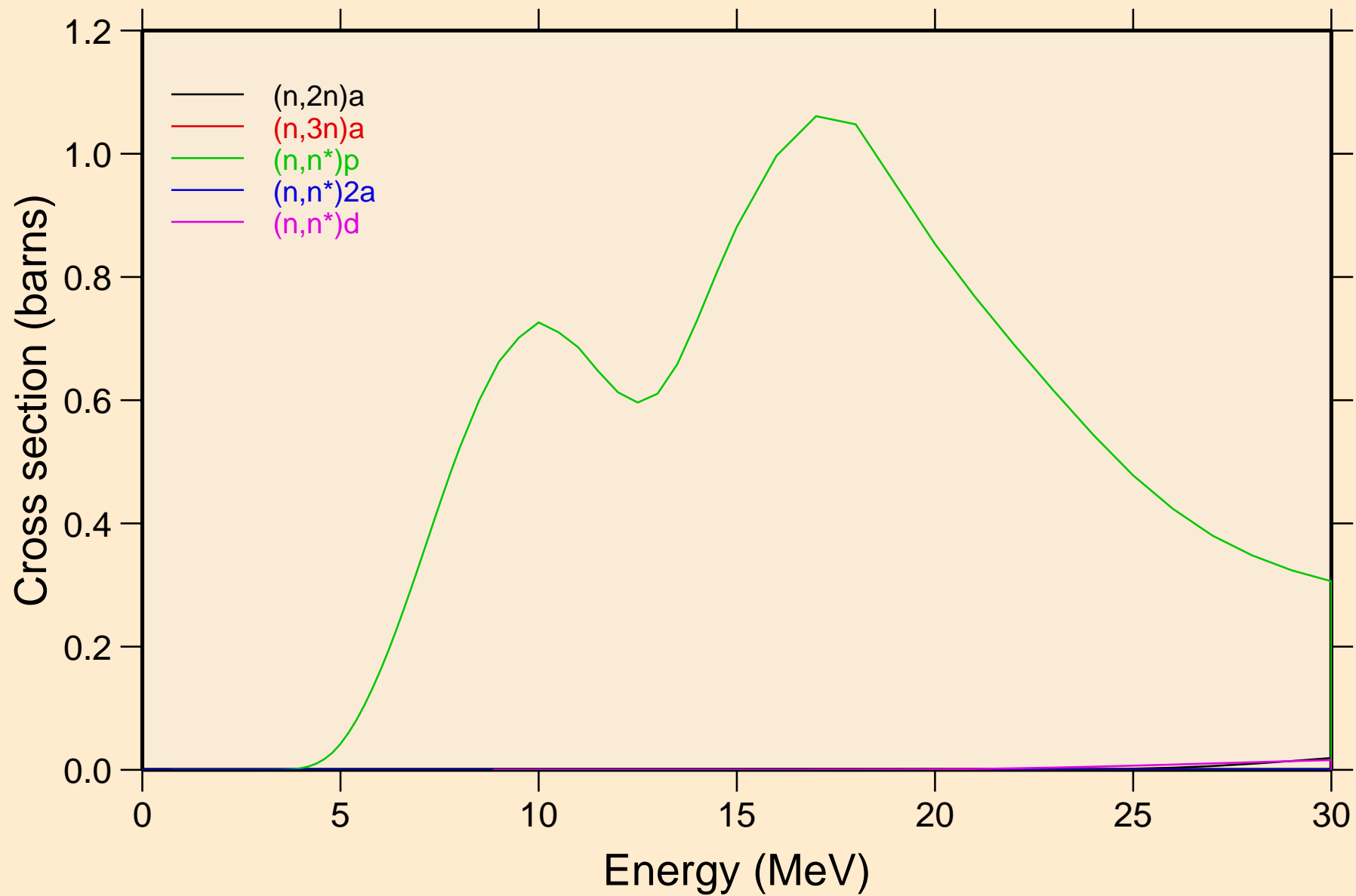

TM153M NEUTRON ACER TENDL-2024 LIBRARY; T=293.6K
Threshold reactions

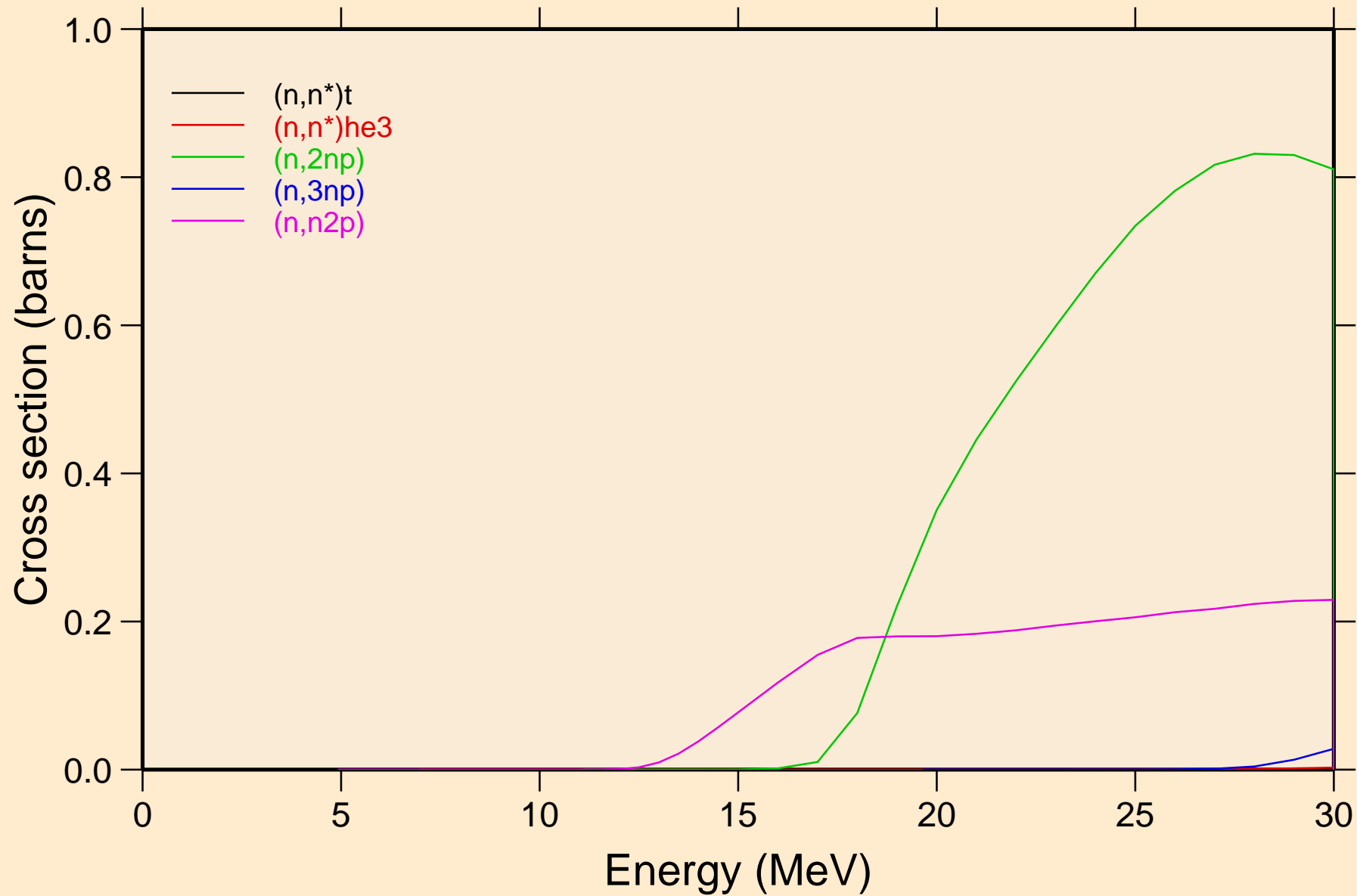

TM153M NEUTRON ACER TENDL-2024 LIBRARY; T=293.6K
Threshold reactions

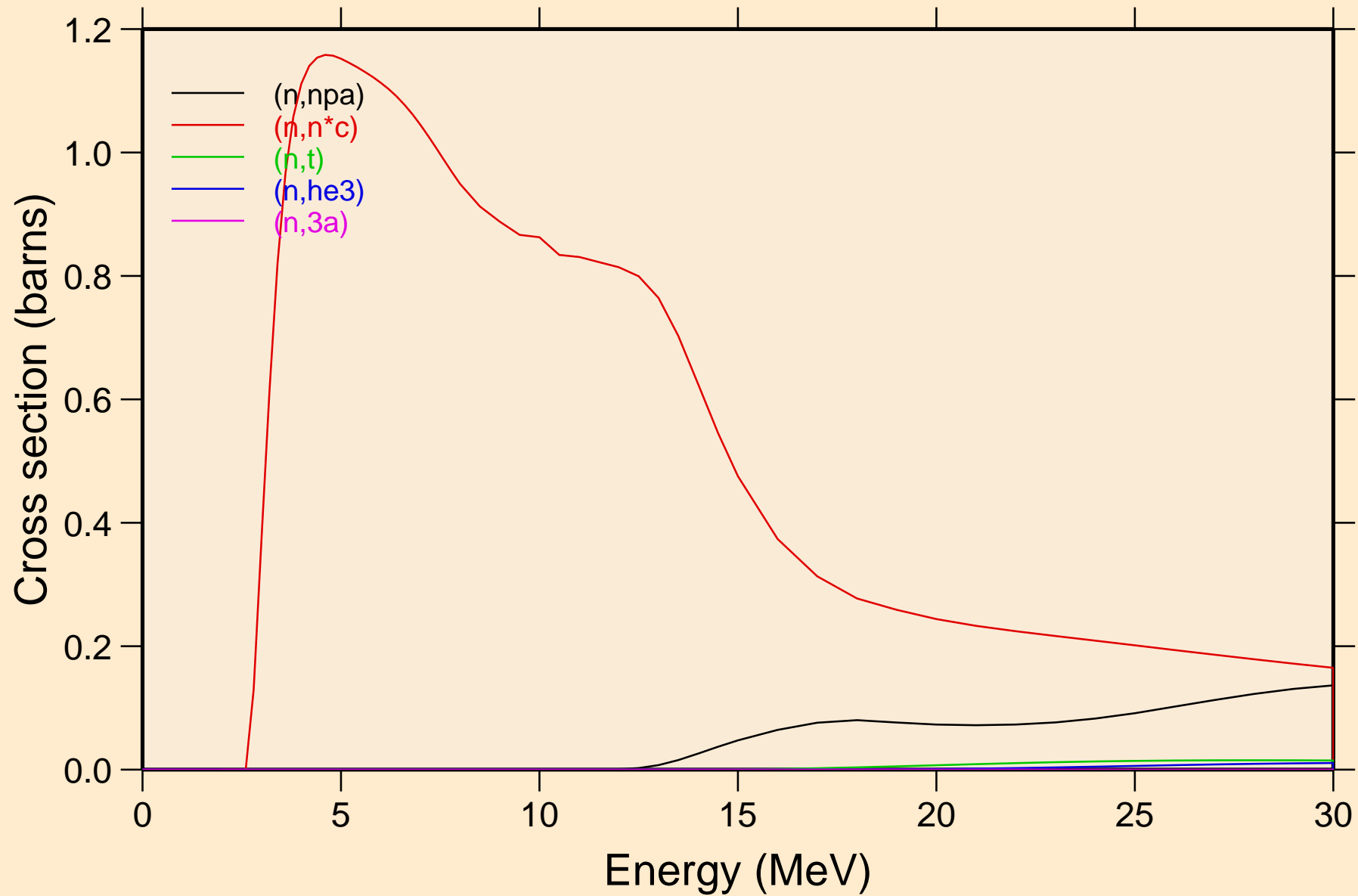

TM153M NEUTRON ACER TENDL-2024 LIBRARY; T=293.6K
Threshold reactions

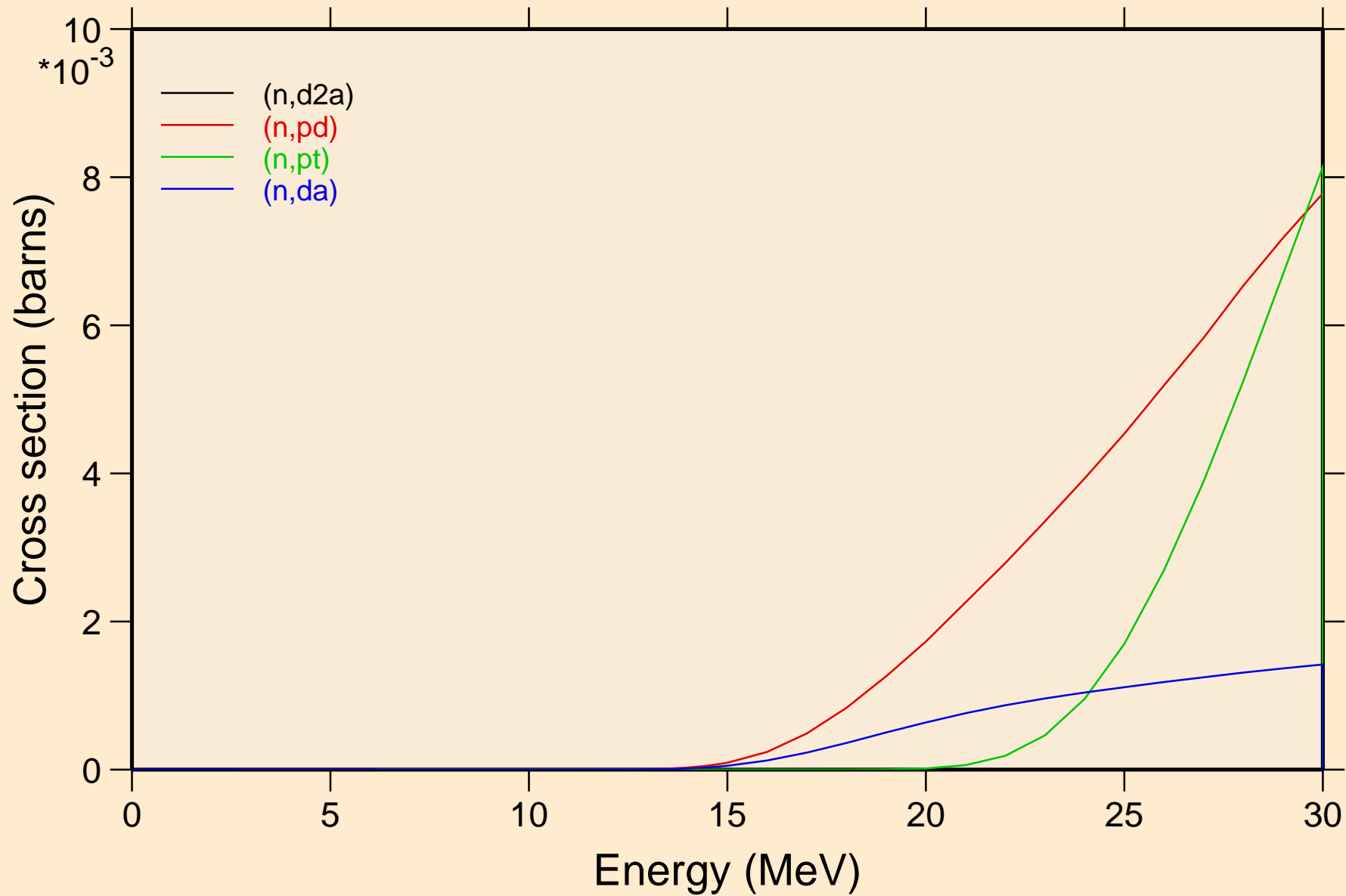

TM153M NEUTRON ACER TENDL-2024 LIBRARY; T=293.6K
Threshold reactions

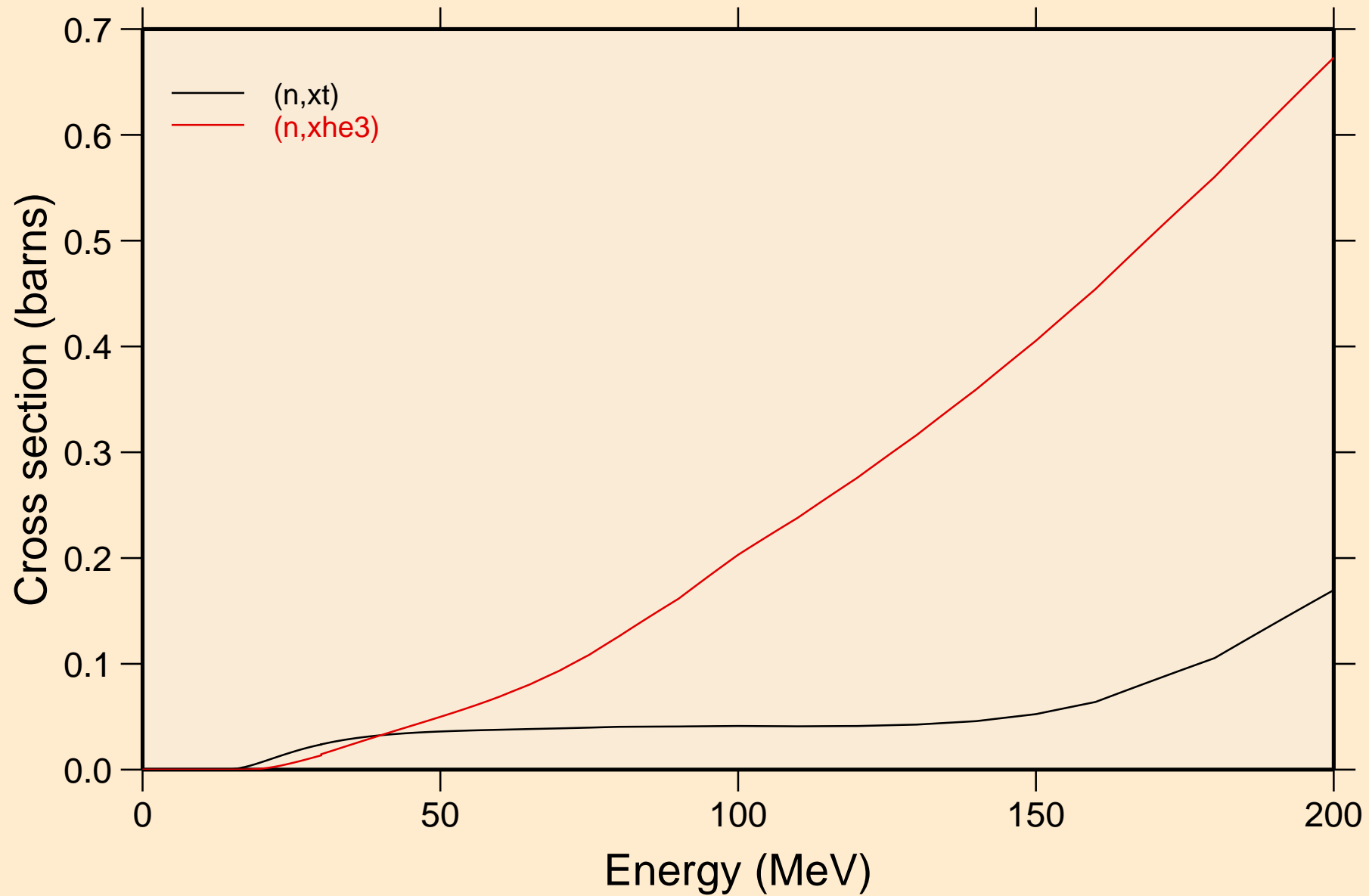

TM153M NEUTRON ACER TENDL-2024 LIBRARY; T=293.6K
angular distribution for elastic

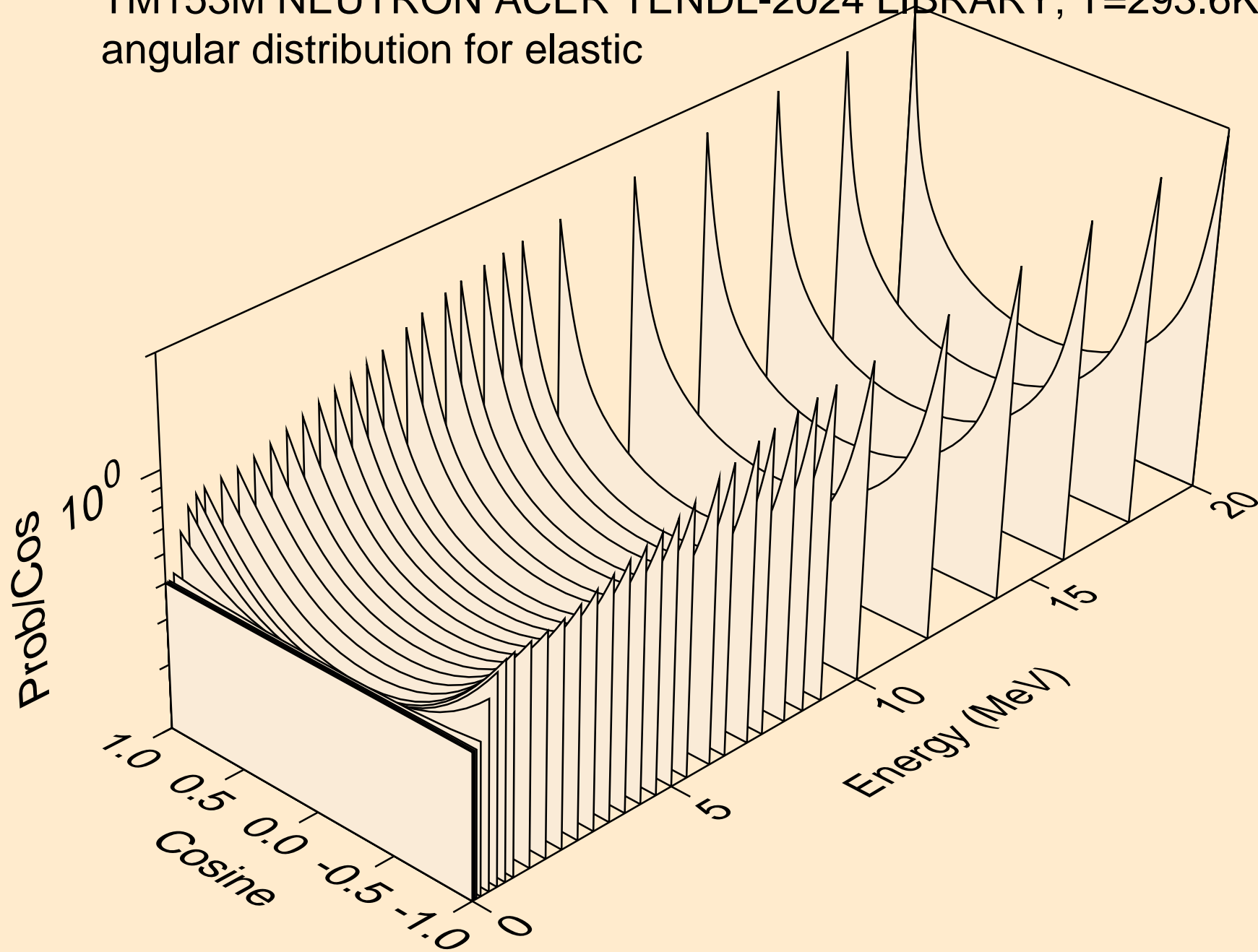

TM153M NEUTRON ACER TENDL-2024 LIBRARY; T=293.6K
angular distribution for elastic

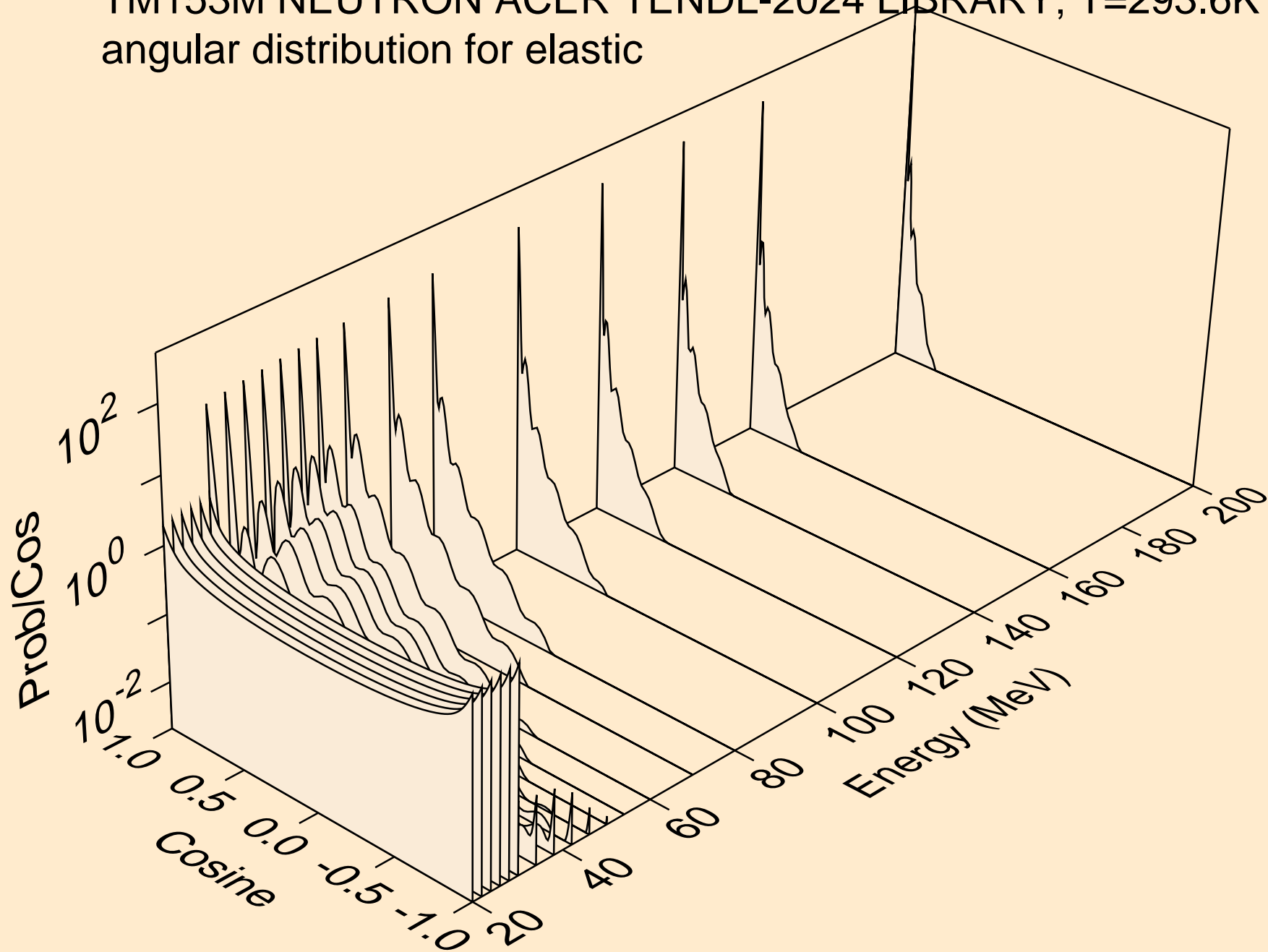

TM153M NEUTRON ACER TENDL-2024 LIBRARY; T=293.6K
angular distribution for (n,n*1)

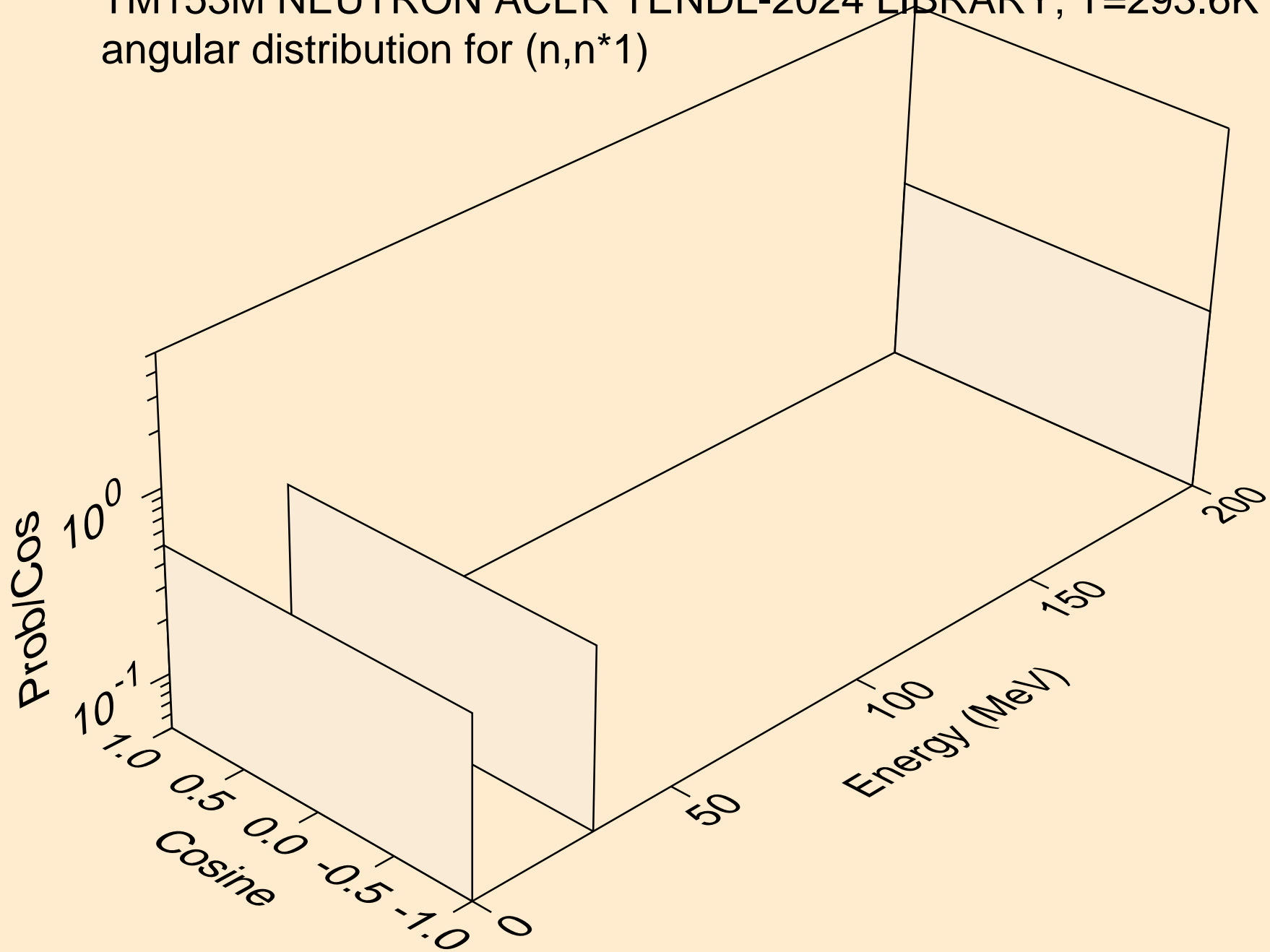

TM153M NEUTRON ACER TENDL-2024 LIBRARY; T=293.6K
angular distribution for (n,n*2)

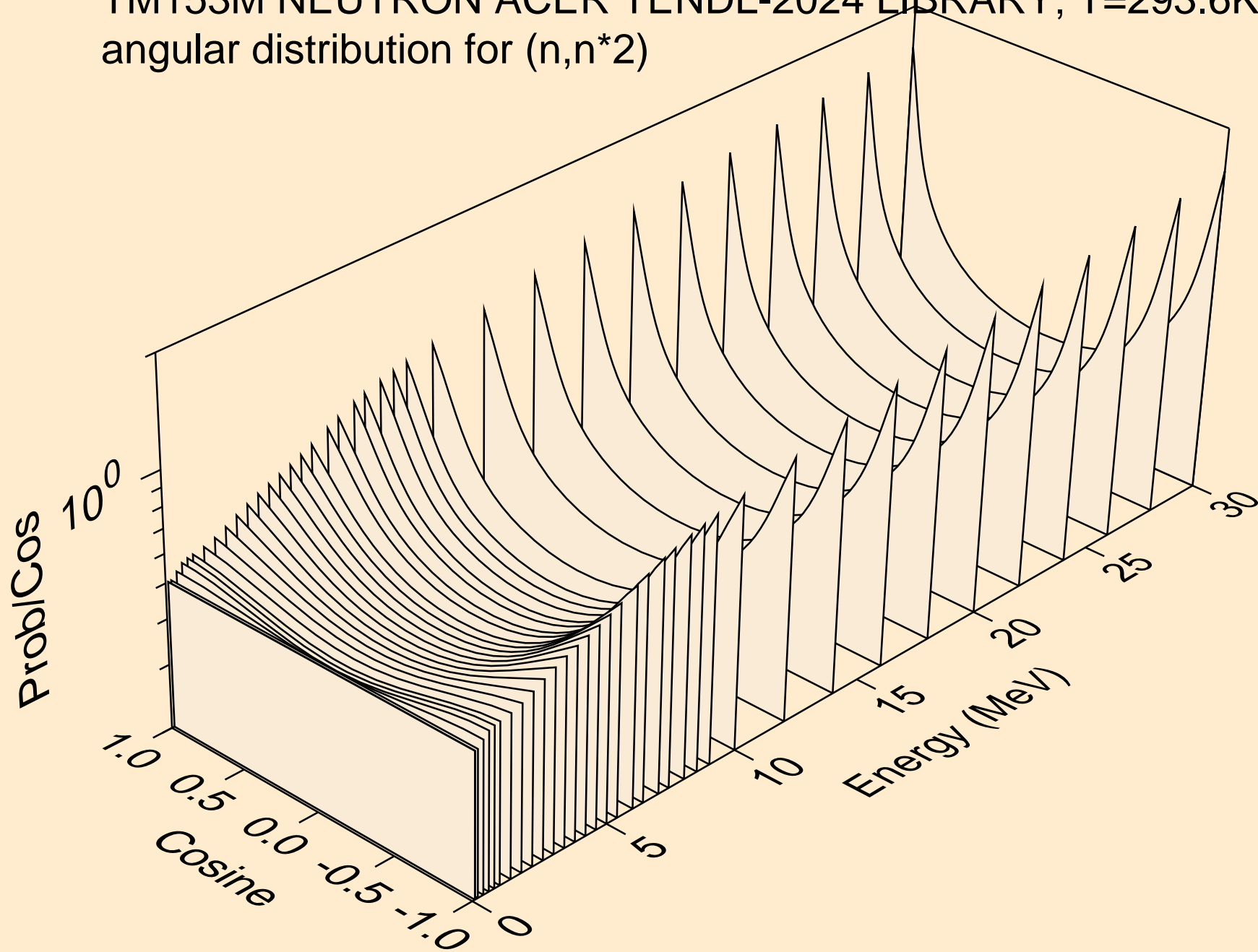

TM153M NEUTRON ACER TENDL-2024 LIBRARY; T=293.6K
angular distribution for (n,n*3)

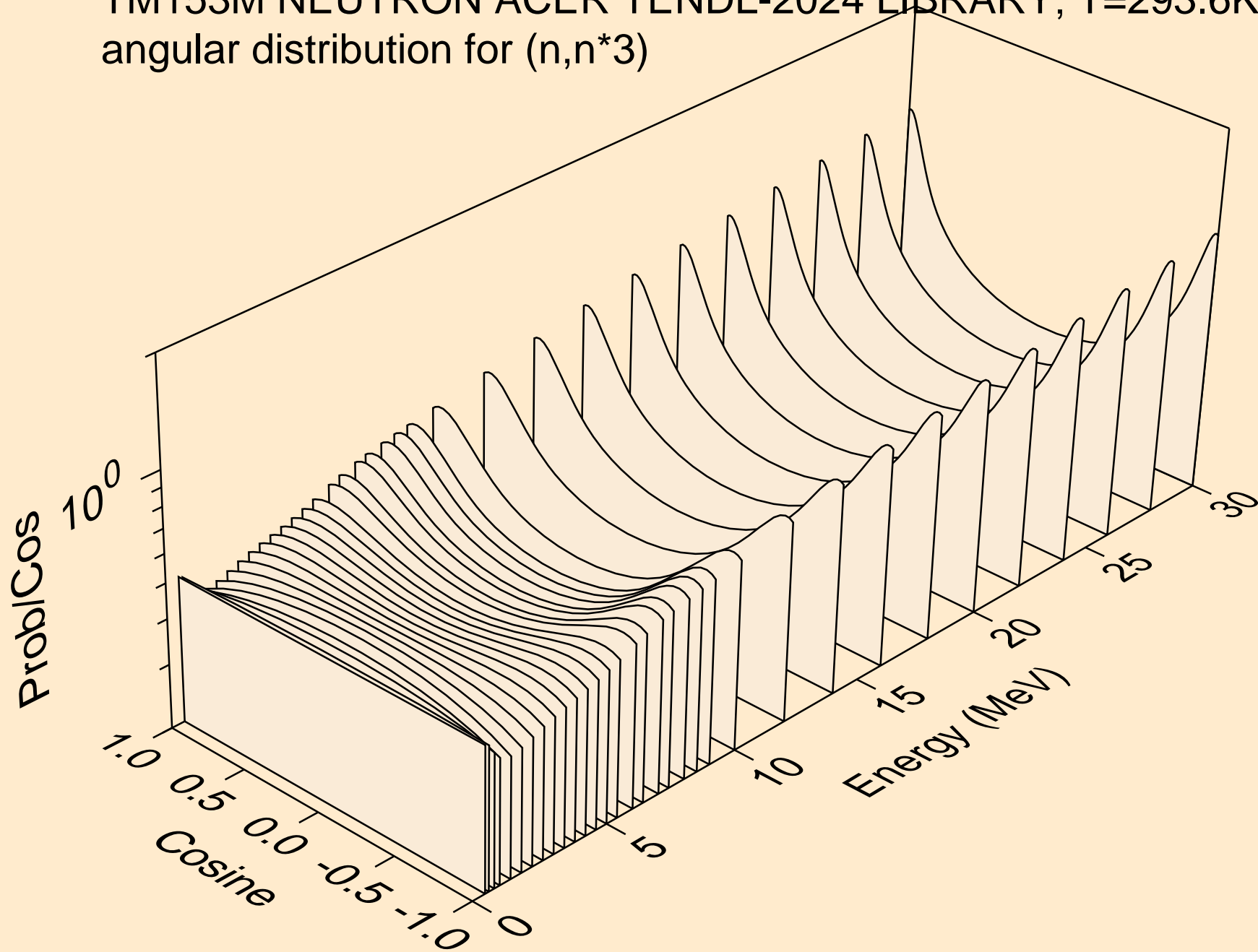

TM153M NEUTRON ACER TENDL-2024 LIBRARY; T=293.6K
angular distribution for (n,n*4)

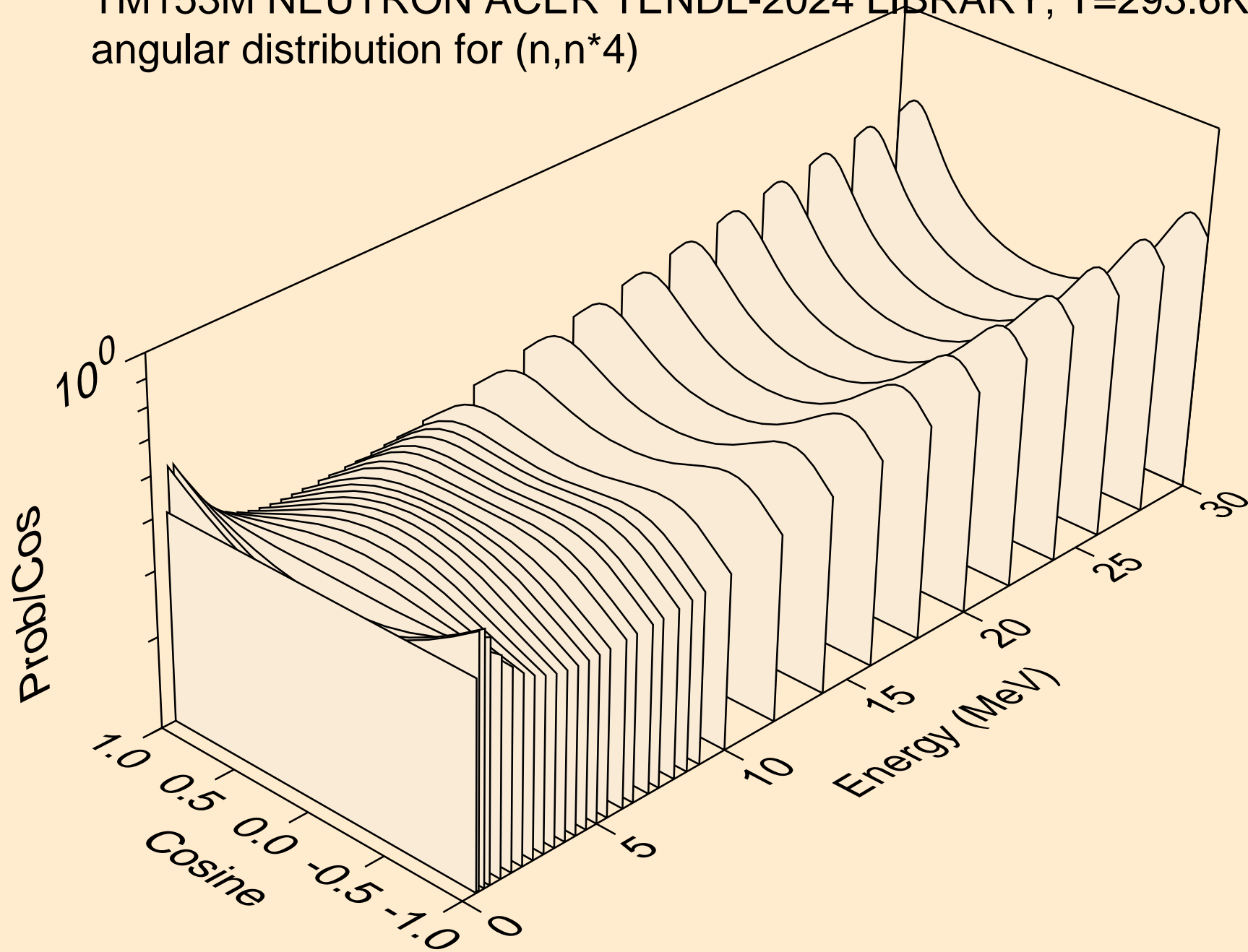

TM153M NEUTRON ACER TENDL-2024 LIBRARY; T=293.6K
angular distribution for (n,n*5)

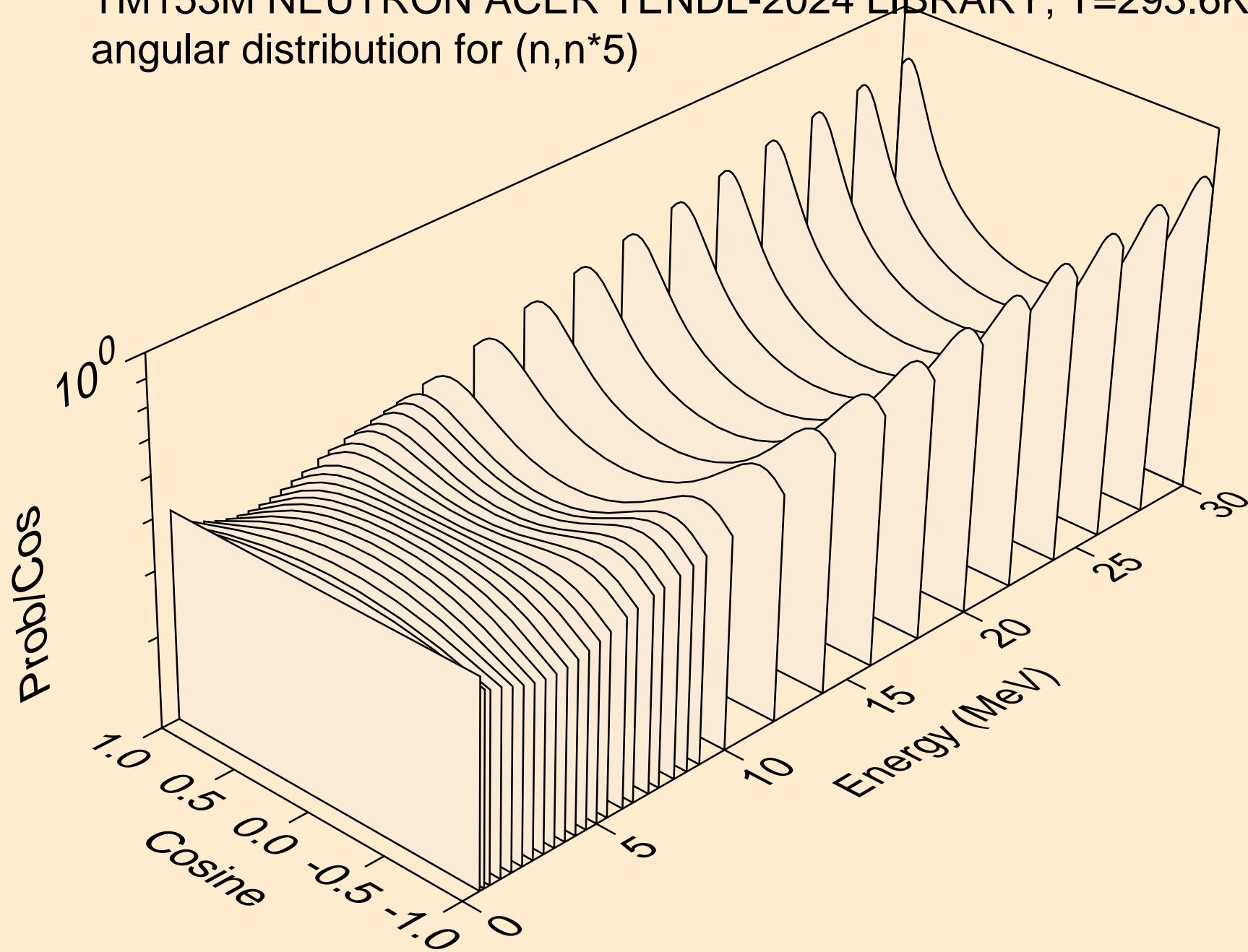

TM153M NEUTRON ACER TENDL-2024 LIBRARY; T=293.6K
angular distribution for (n,n*6)

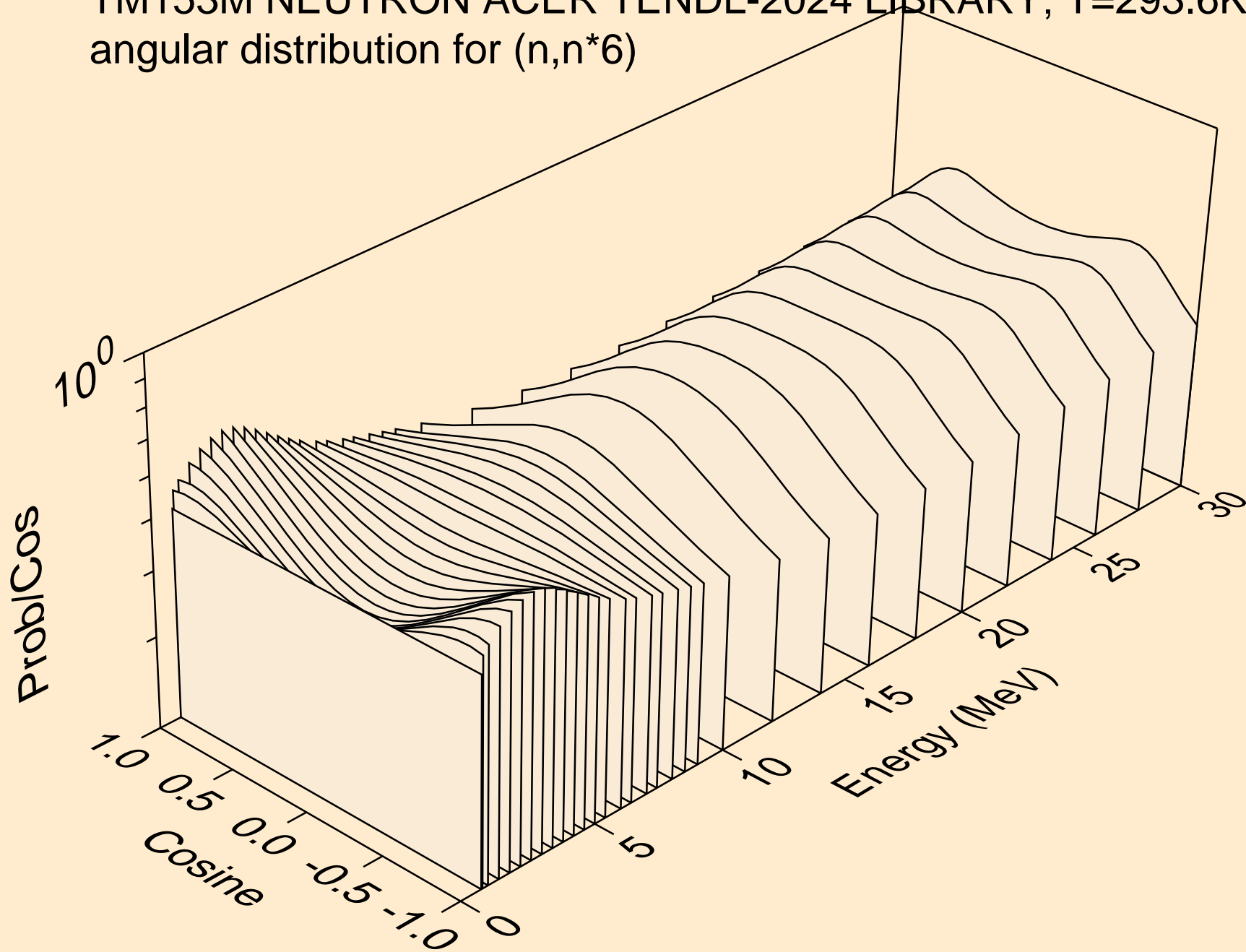

TM153M NEUTRON ACER TENDL-2024 LIBRARY; T=293.6K
angular distribution for (n,n*7)

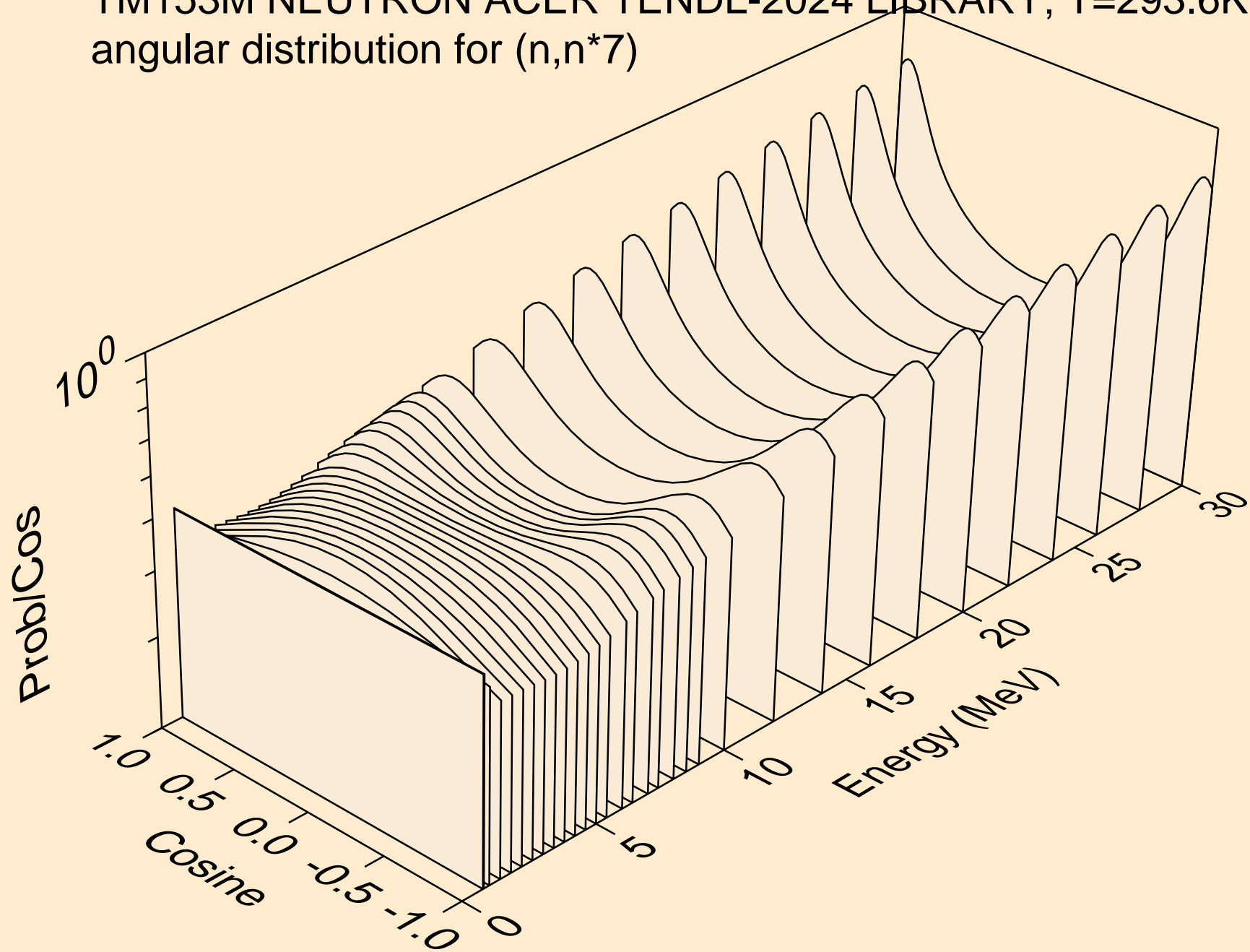

TM153M NEUTRON ACER TENDL-2024 LIBRARY; T=293.6K
angular distribution for (n,n*8)

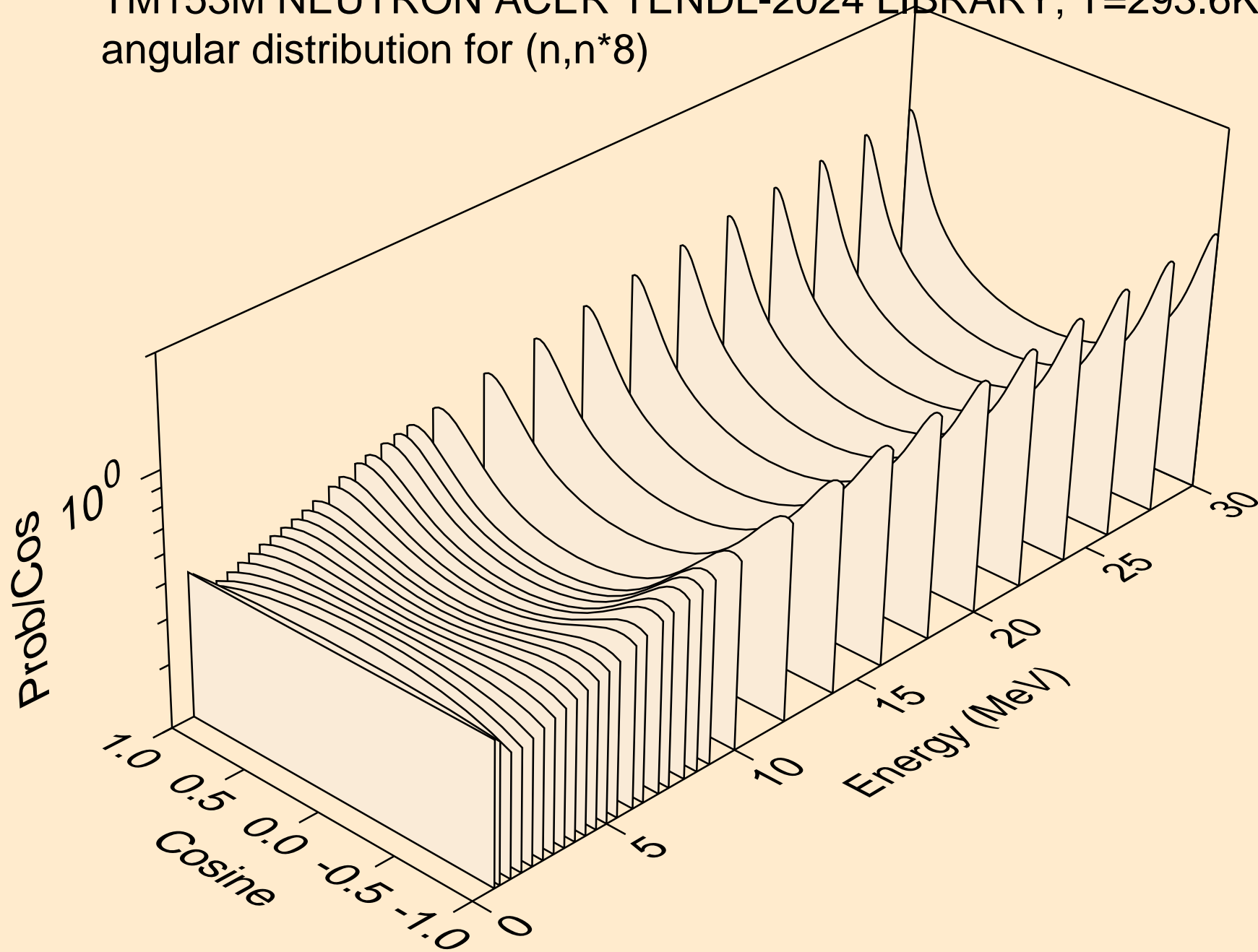

TM153M NEUTRON ACER TENDL-2024 LIBRARY; T=293.6K
angular distribution for (n,n*9)

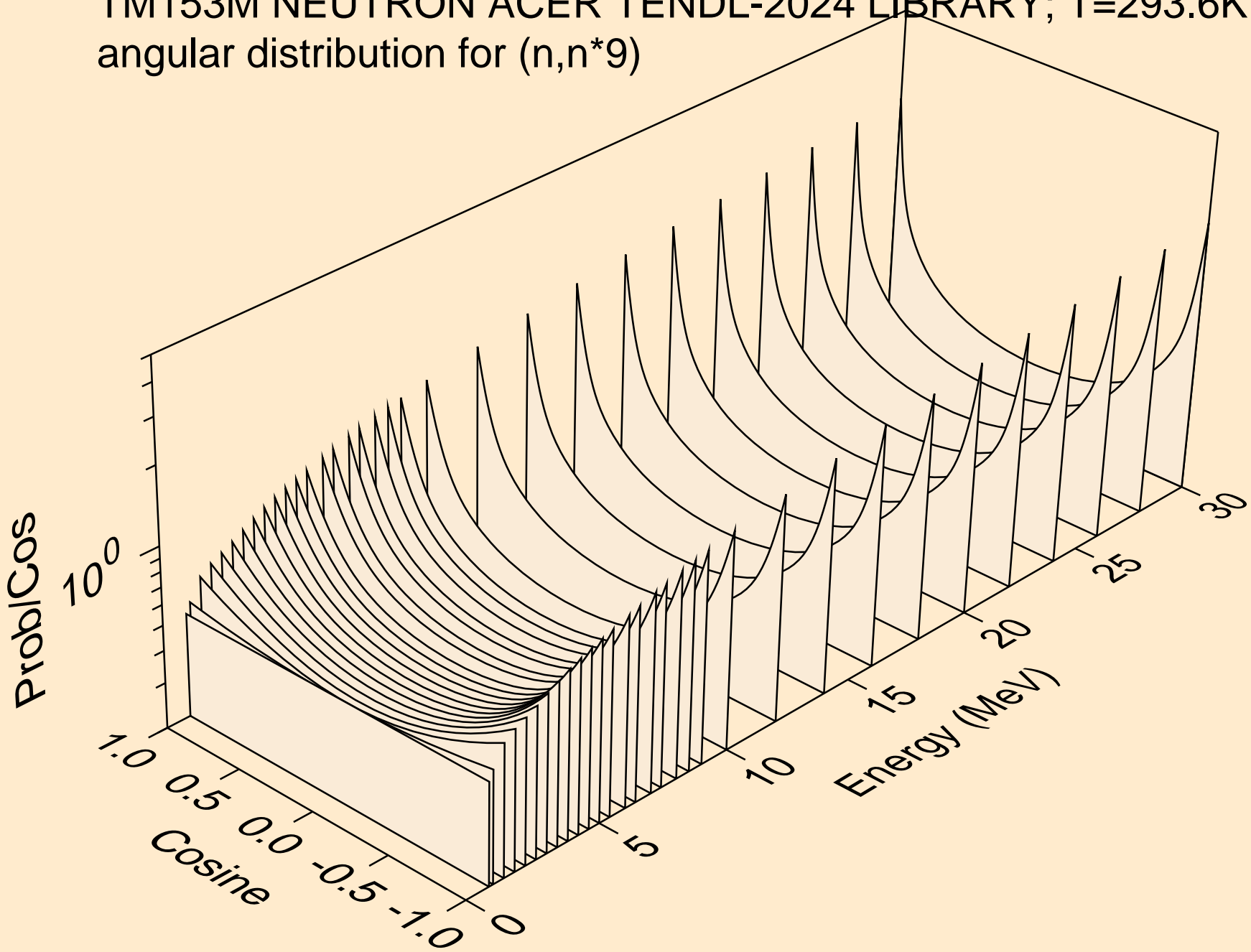

TM153M NEUTRON ACER TENDL-2024 LIBRARY; T=293.6K
angular distribution for (n,n*10)

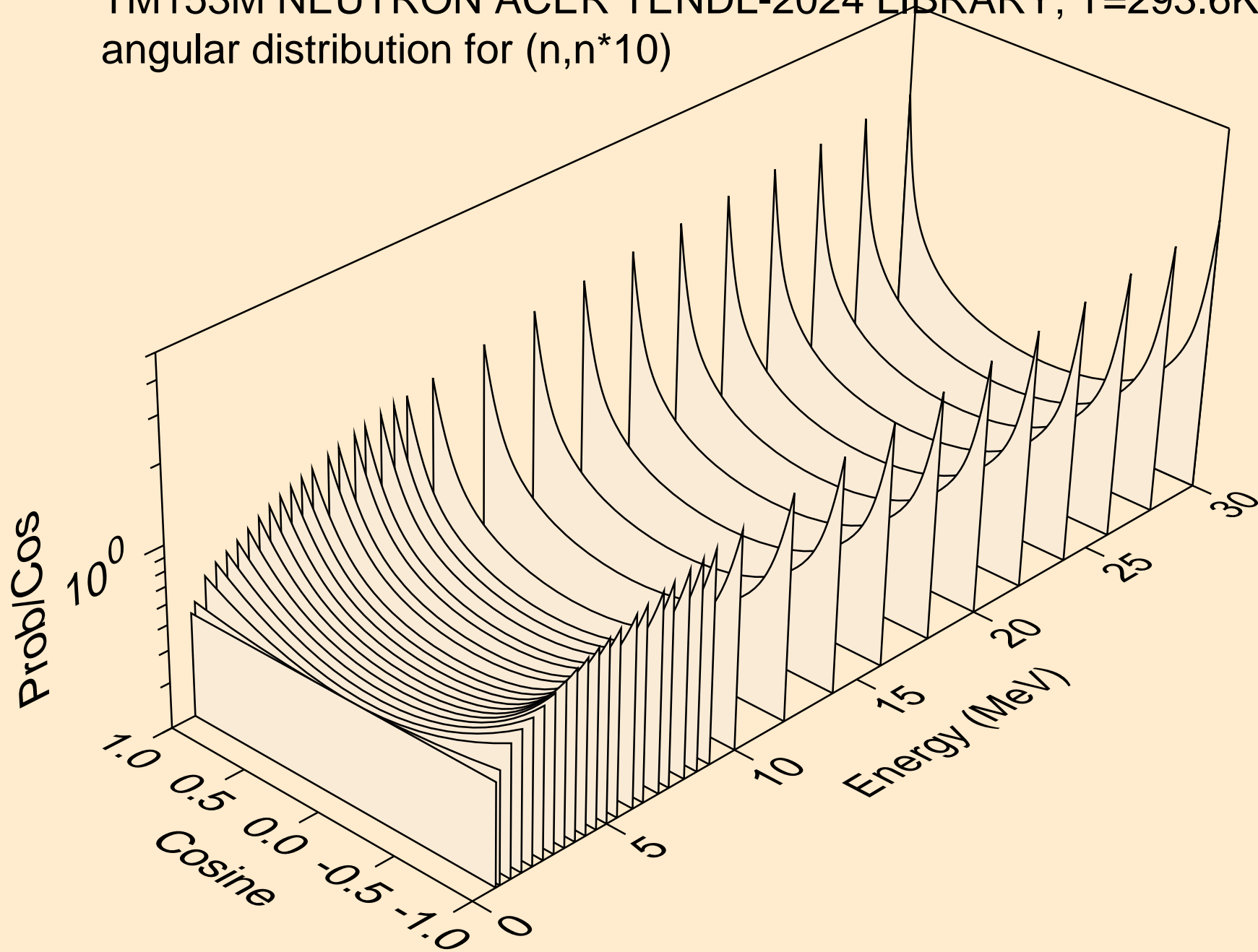

TM153M NEUTRON ACER TENDL-2024 LIBRARY; T=293.6K
angular distribution for (n,n*11)

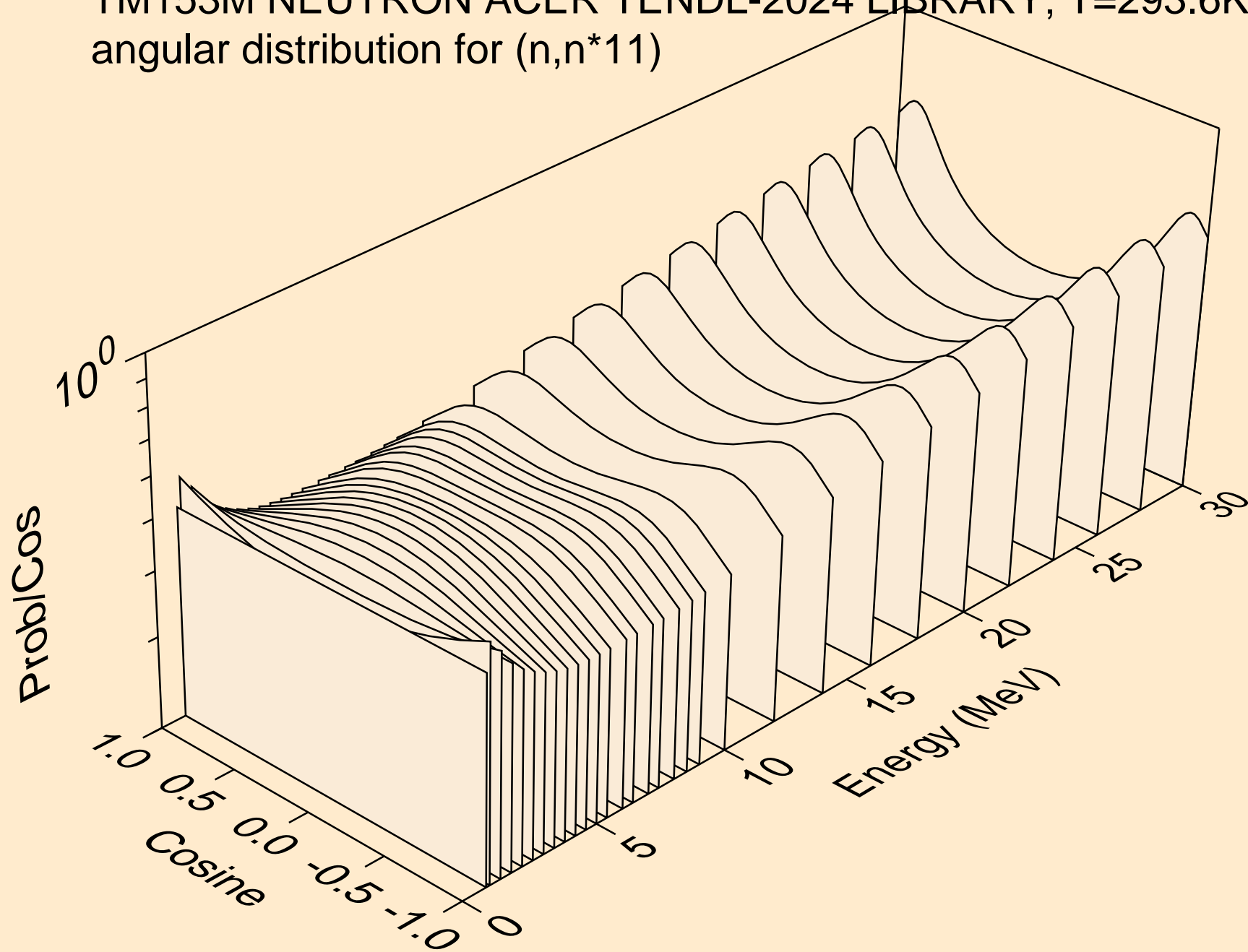

TM153M NEUTRON ACER TENDL-2024 LIBRARY; T=293.6K
angular distribution for (n,n*12)

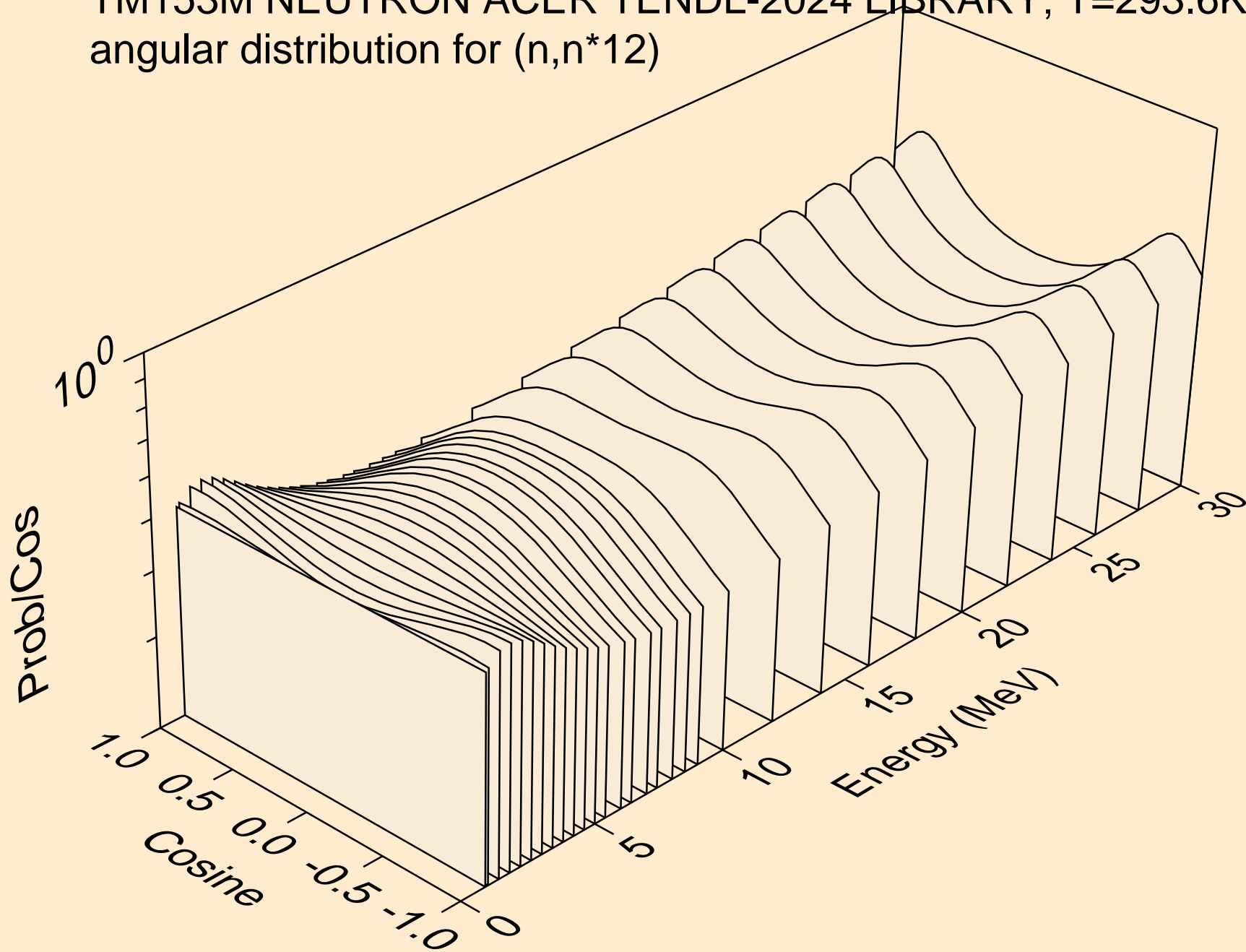

TM153M NEUTRON ACER TENDL-2024 LIBRARY; T=293.6K
angular distribution for (n,n*13)

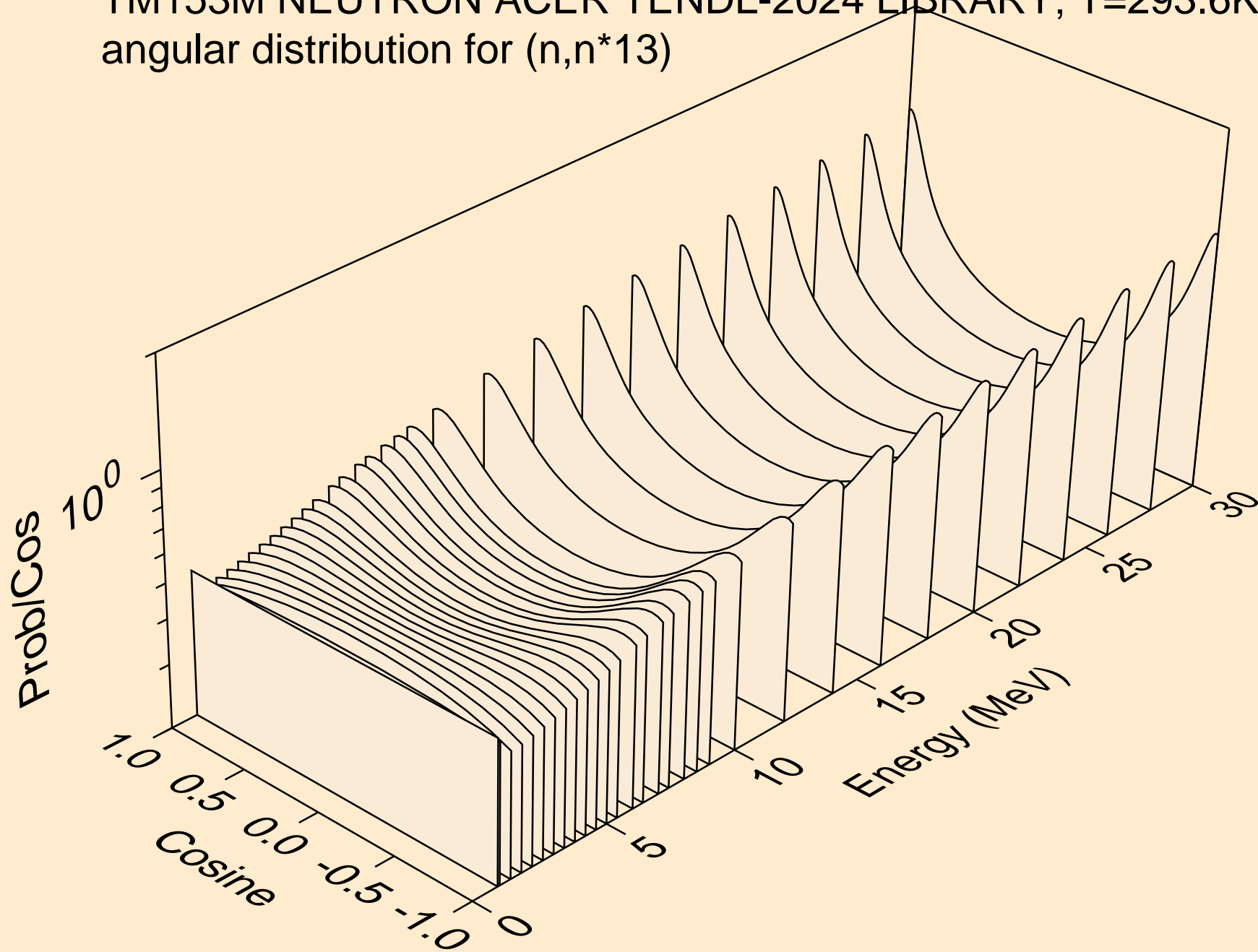

TM153M NEUTRON ACER TENDL-2024 LIBRARY; T=293.6K
angular distribution for (n,n*14)

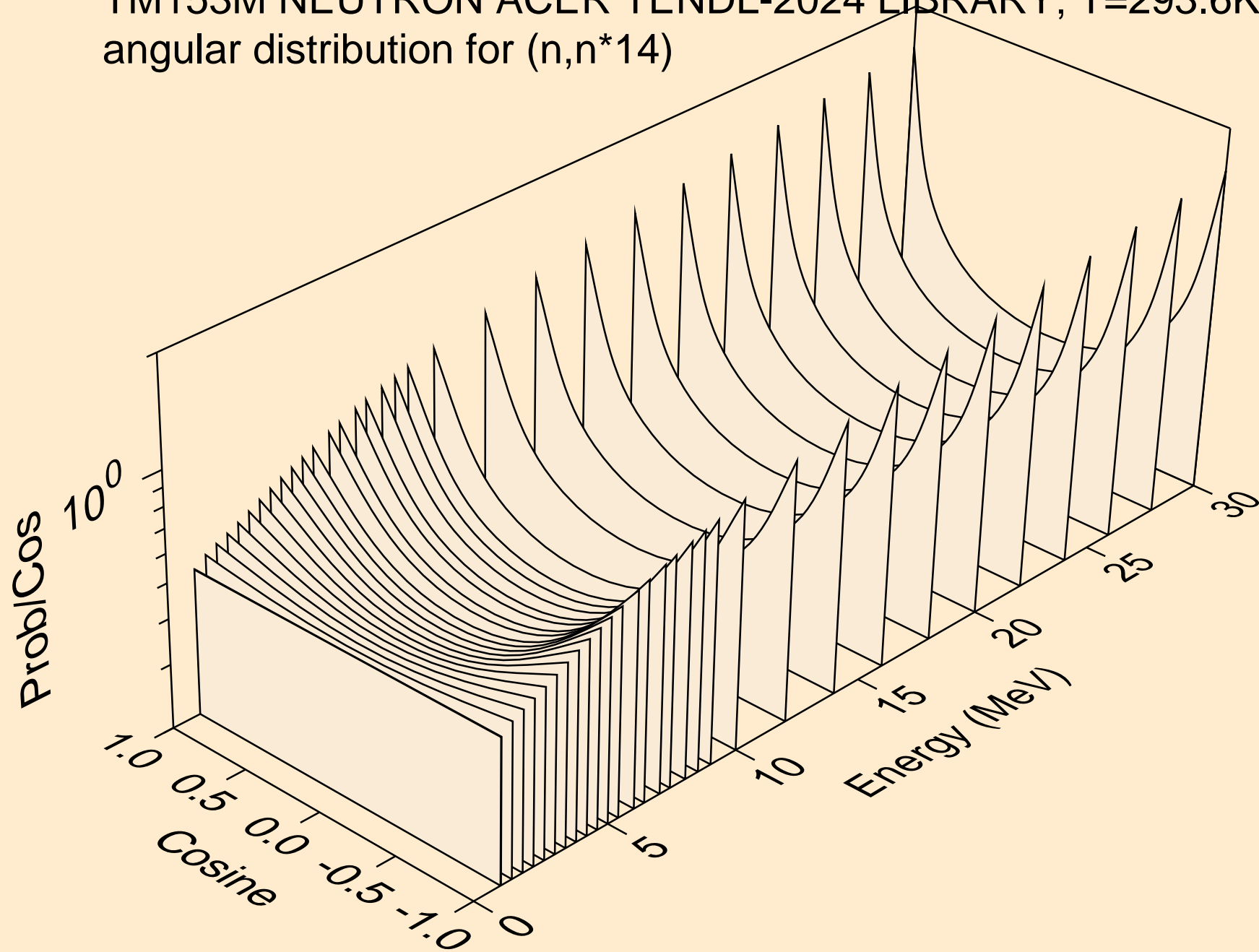

TM153M NEUTRON ACER TENDL-2024 LIBRARY; T=293.6K
angular distribution for (n,n*15)

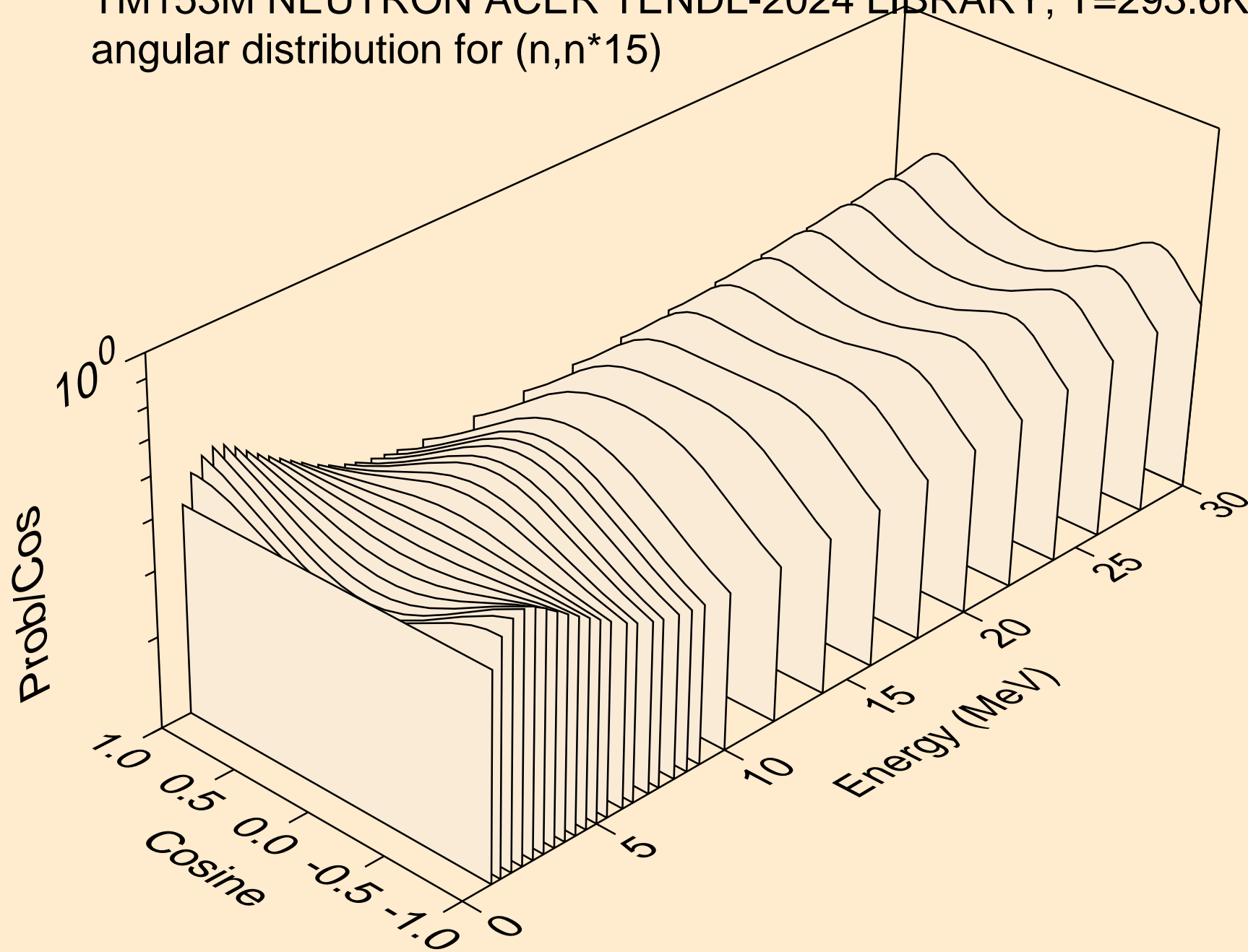

TM153M NEUTRON ACER TENDL-2024 LIBRARY; T=293.6K
angular distribution for (n,n*16)

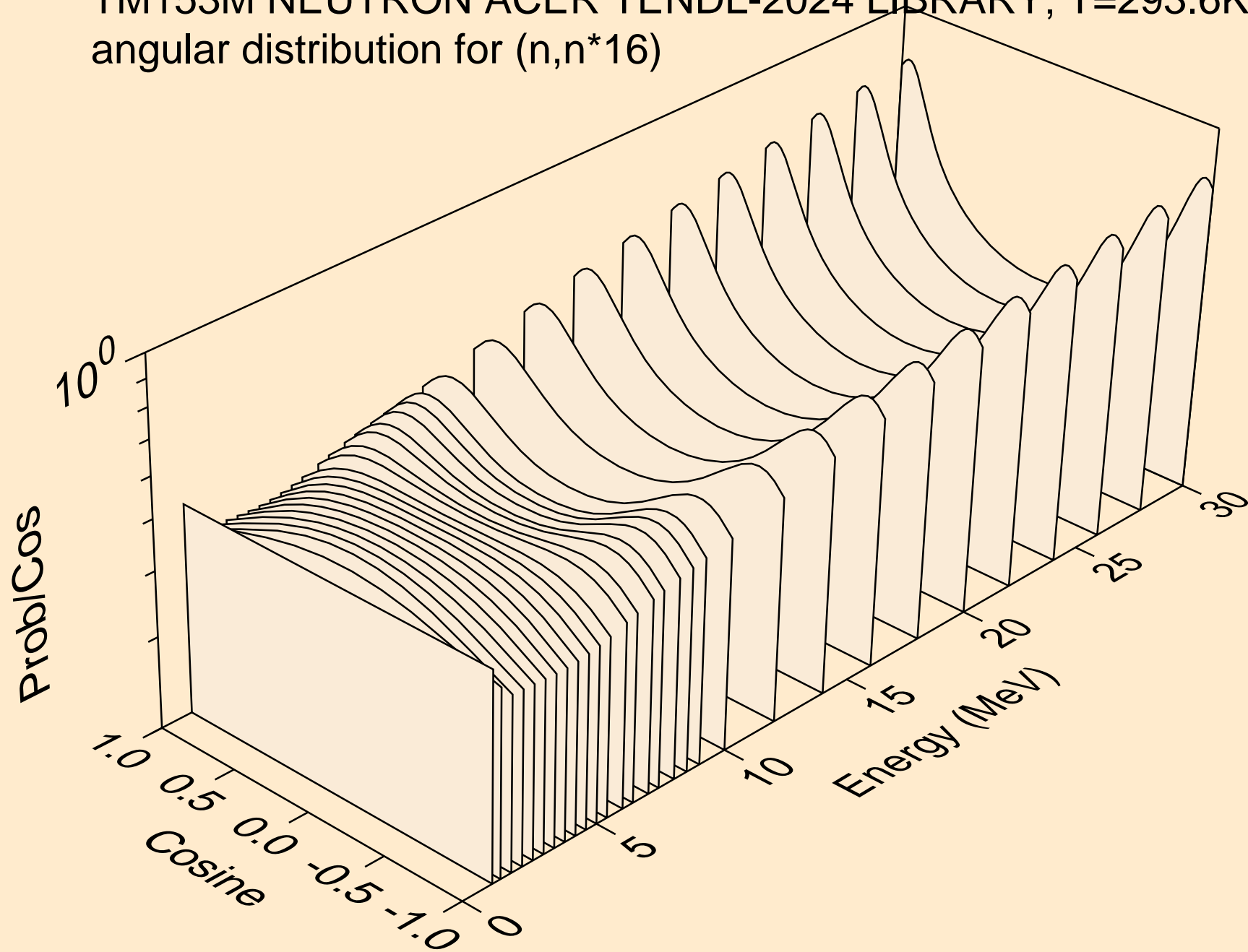

TM153M NEUTRON ACER TENDL-2024 LIBRARY; T=293.6K
angular distribution for (n,n*17)

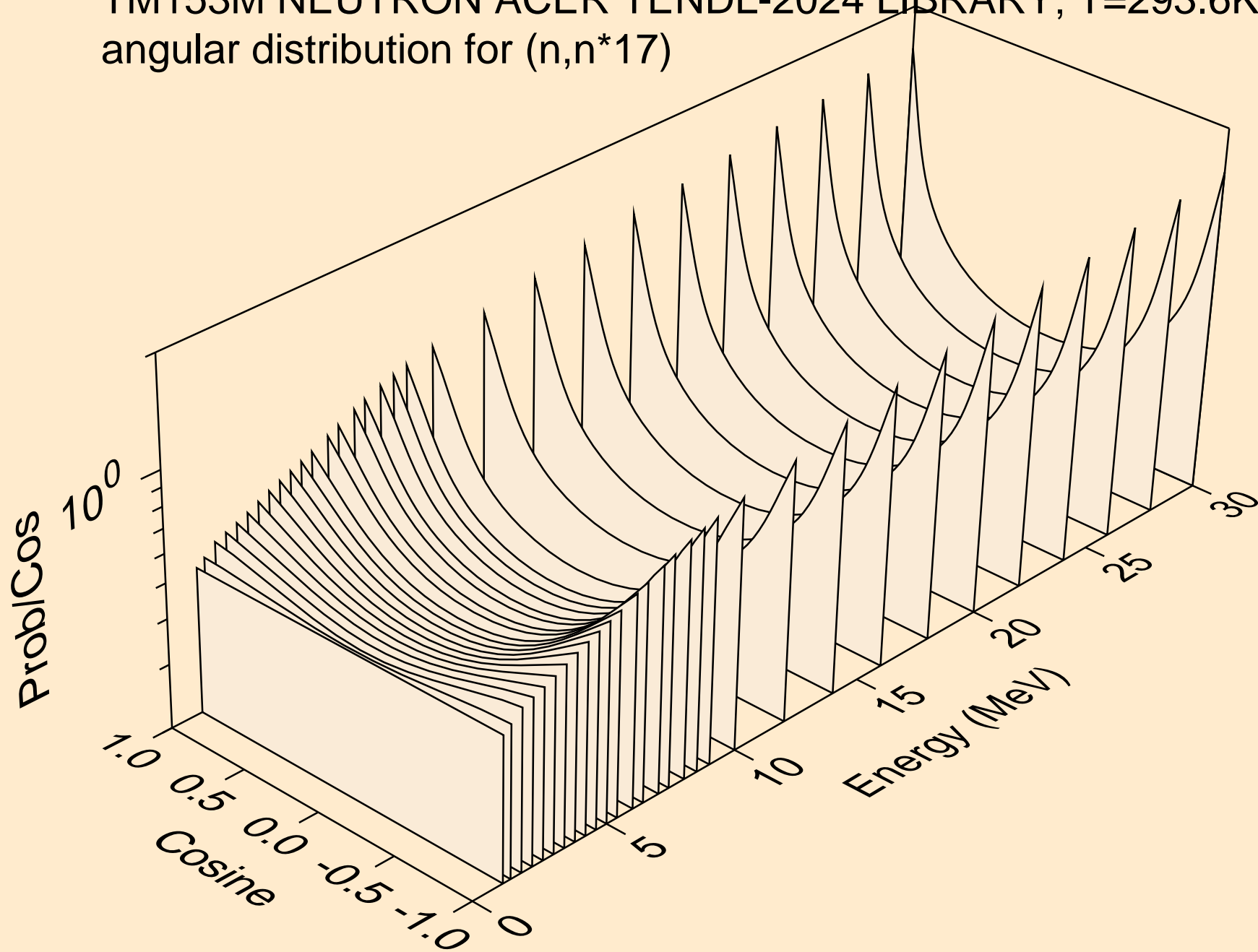

TM153M NEUTRON ACER TENDL-2024 LIBRARY; T=293.6K
angular distribution for (n,n*18)

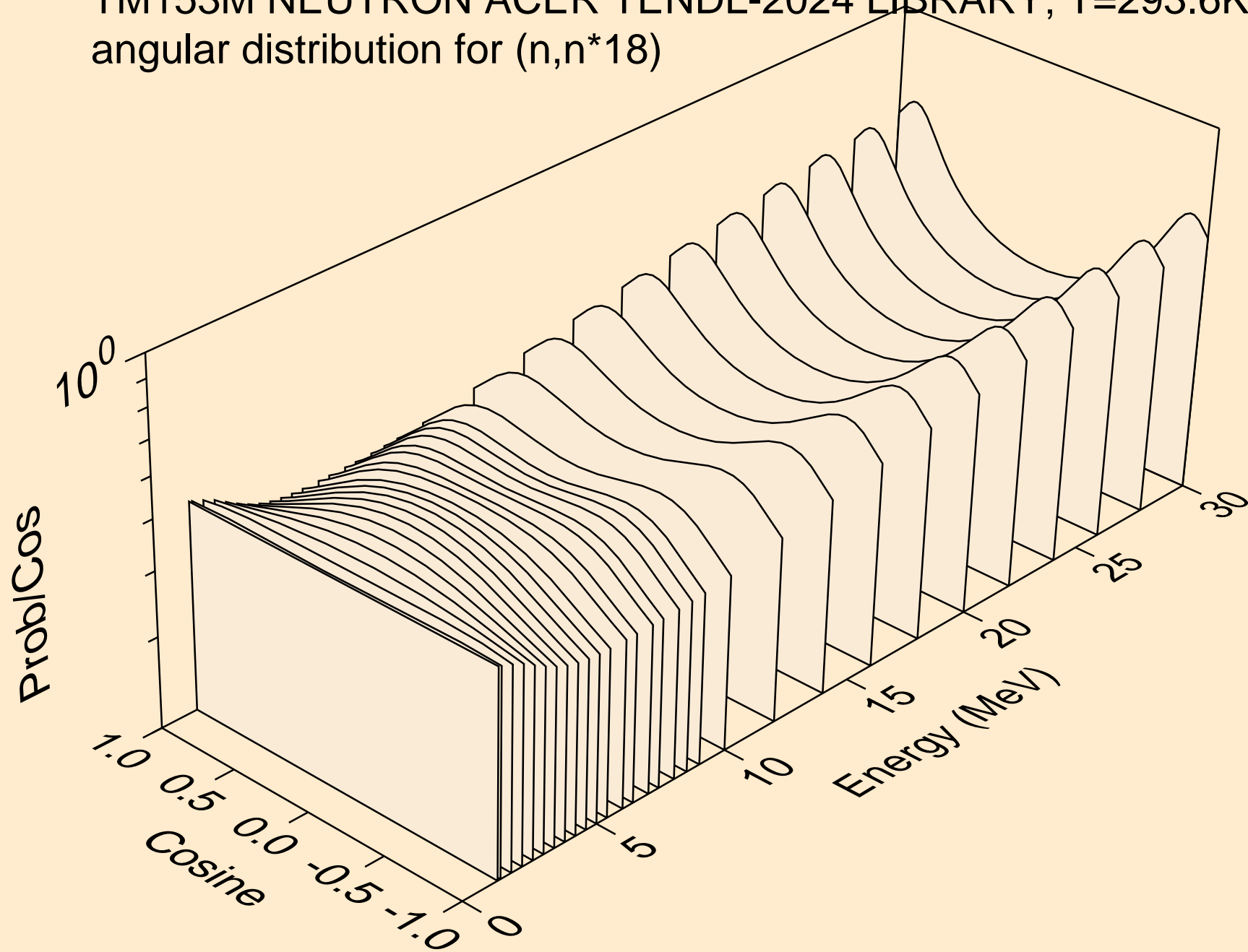

TM153M NEUTRON ACER TENDL-2024 LIBRARY; T=293.6K
angular distribution for (n,n*19)

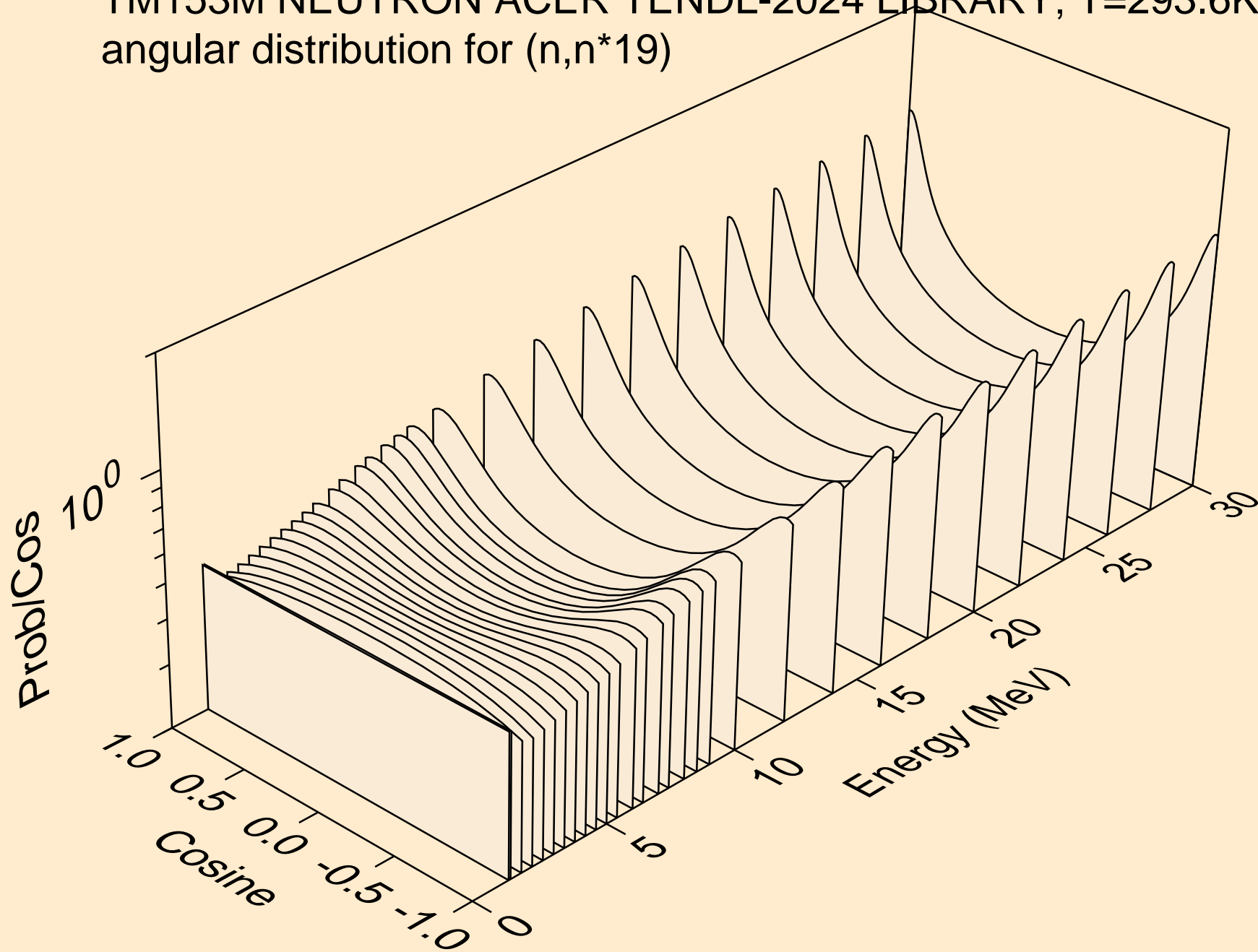

TM153M NEUTRON ACER TENDL-2024 LIBRARY; T=293.6K
angular distribution for (n,n*20)

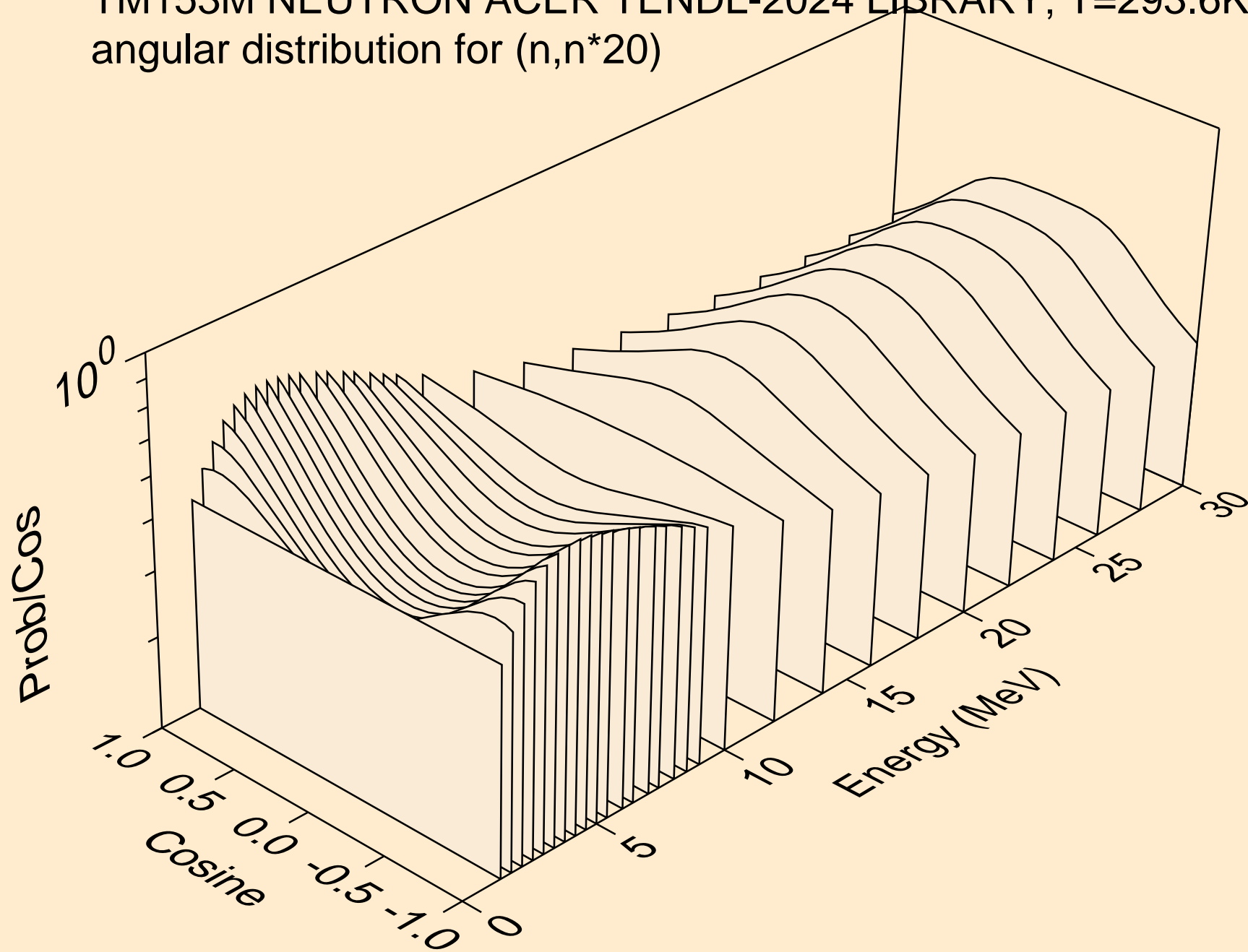

TM153M NEUTRON ACER TENDL-2024 LIBRARY; T=293.6K
angular distribution for (n,n*21)

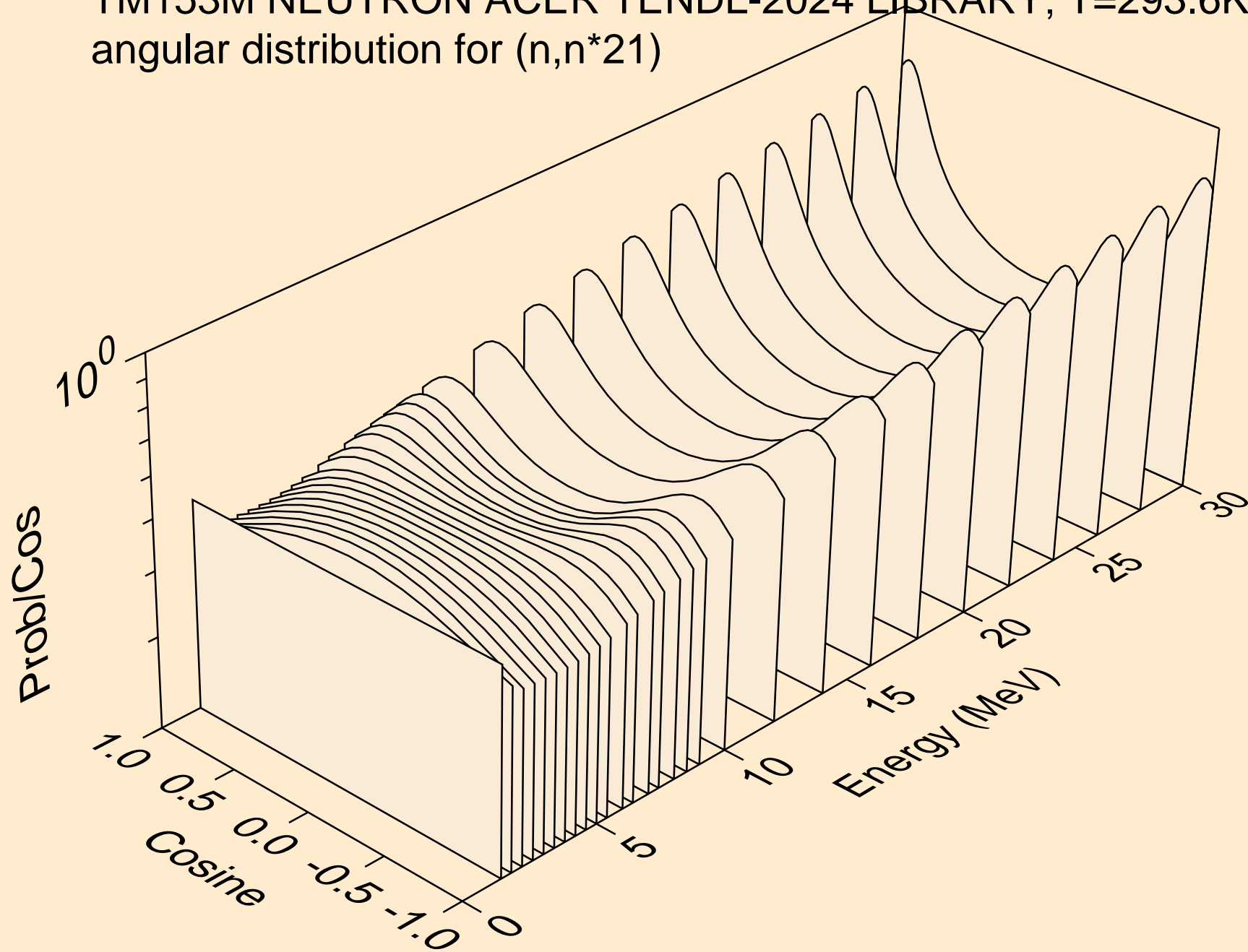

TM153M NEUTRON ACER TENDL-2024 LIBRARY; T=293.6K
angular distribution for (n,n*22)

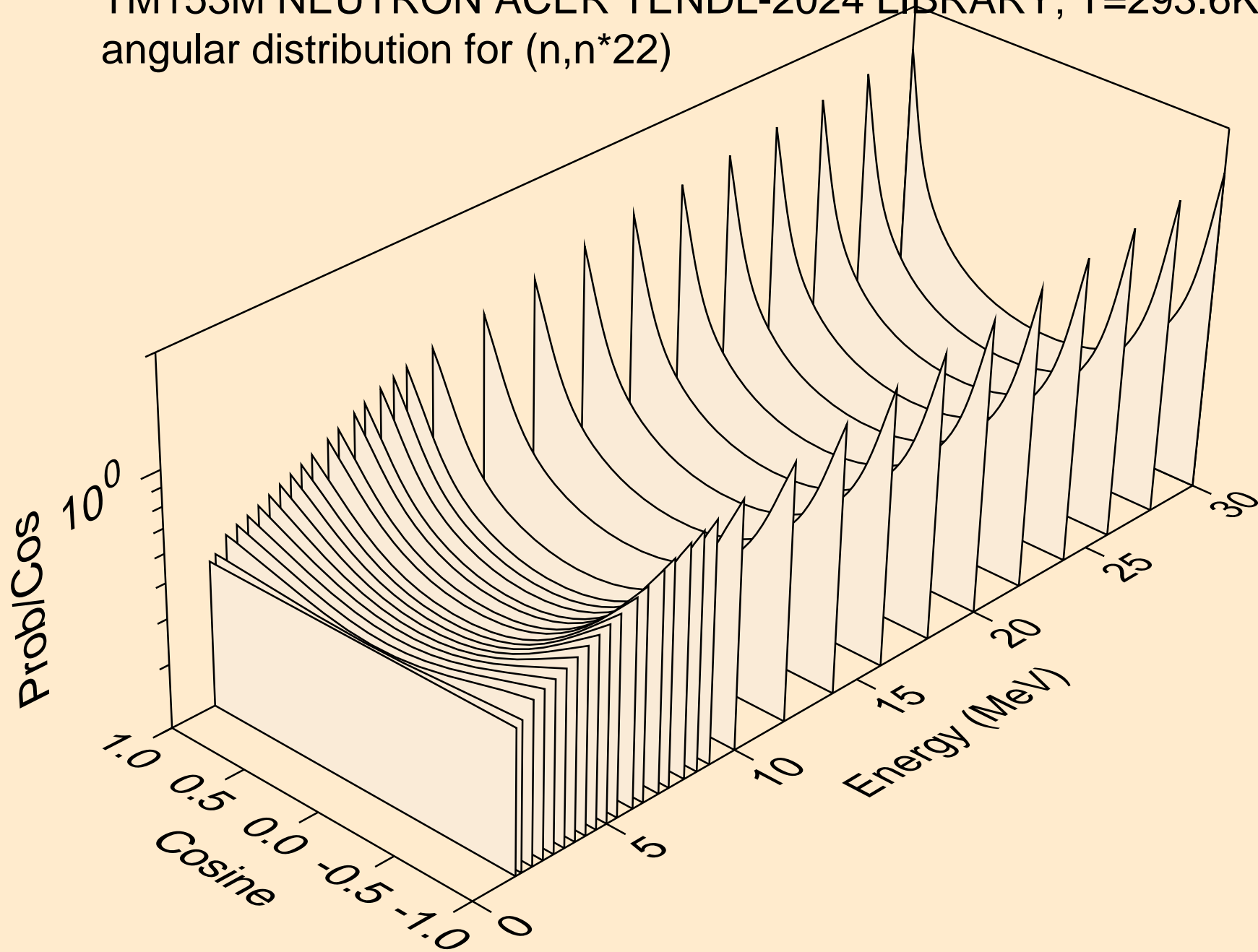

TM153M NEUTRON ACER TENDL-2024 LIBRARY; T=293.6K
angular distribution for (n,n*23)

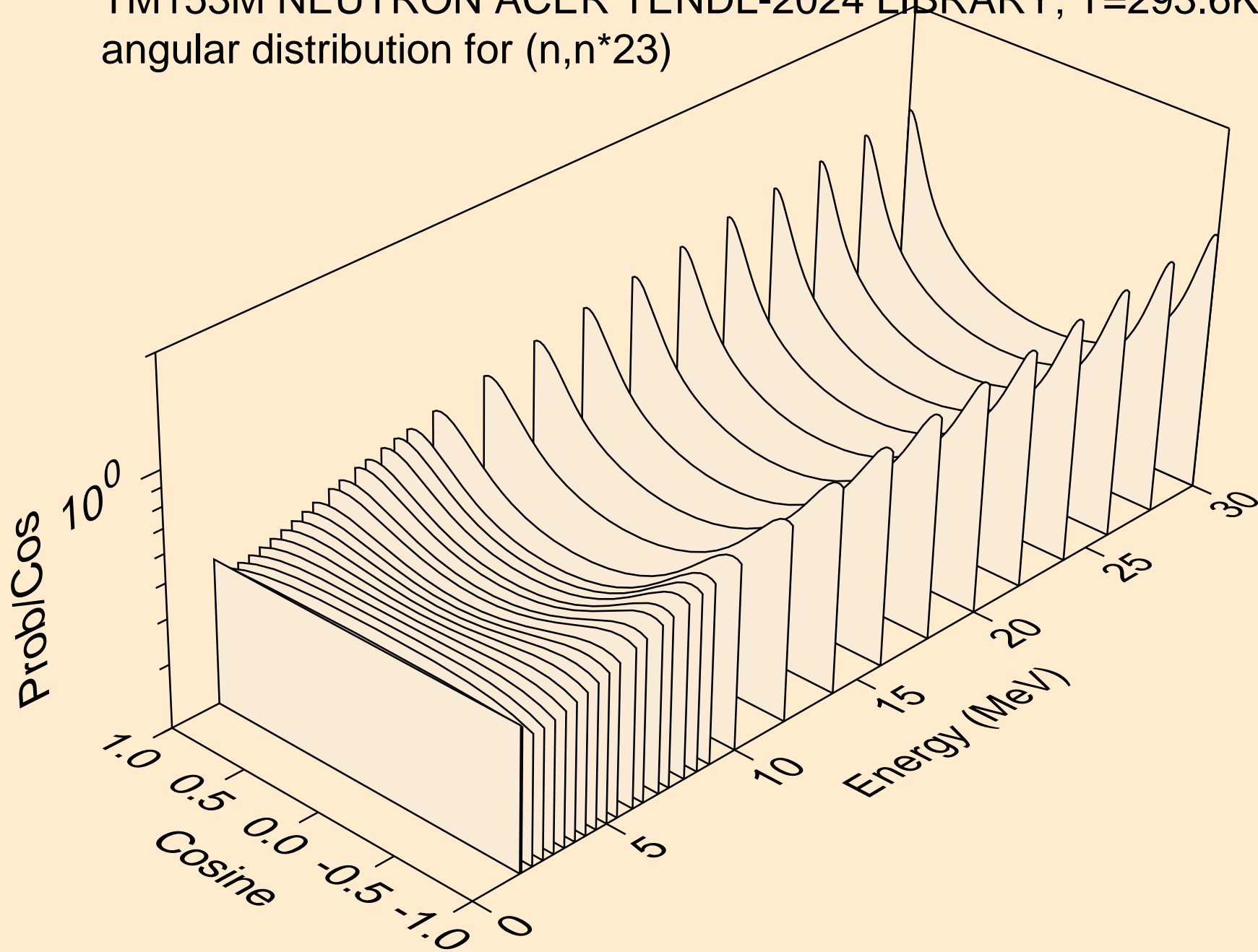

TM153M NEUTRON ACER TENDL-2024 LIBRARY; T=293.6K
angular distribution for (n,n*24)

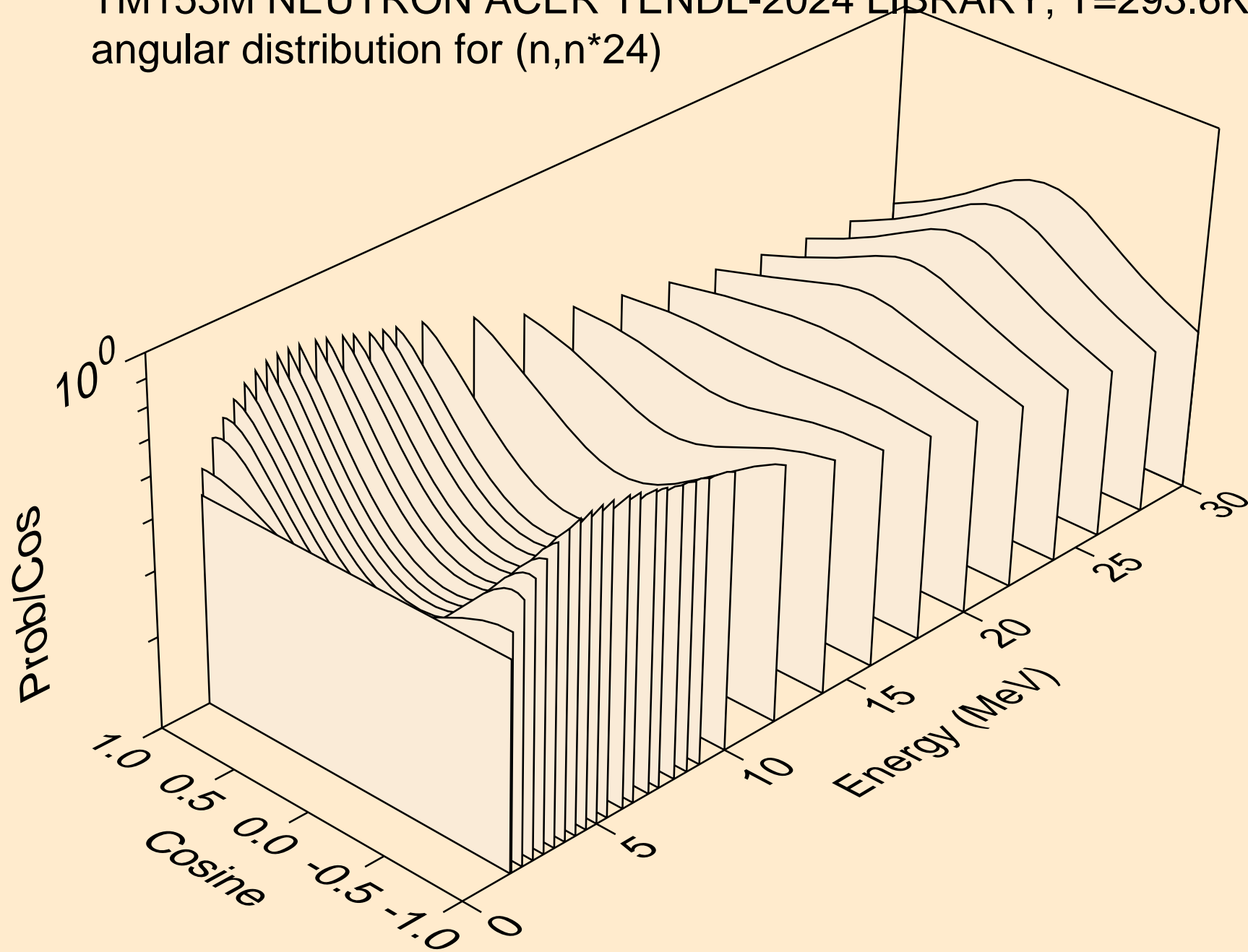

TM153M NEUTRON ACER TENDL-2024 LIBRARY; T=293.6K
angular distribution for (n,n*25)

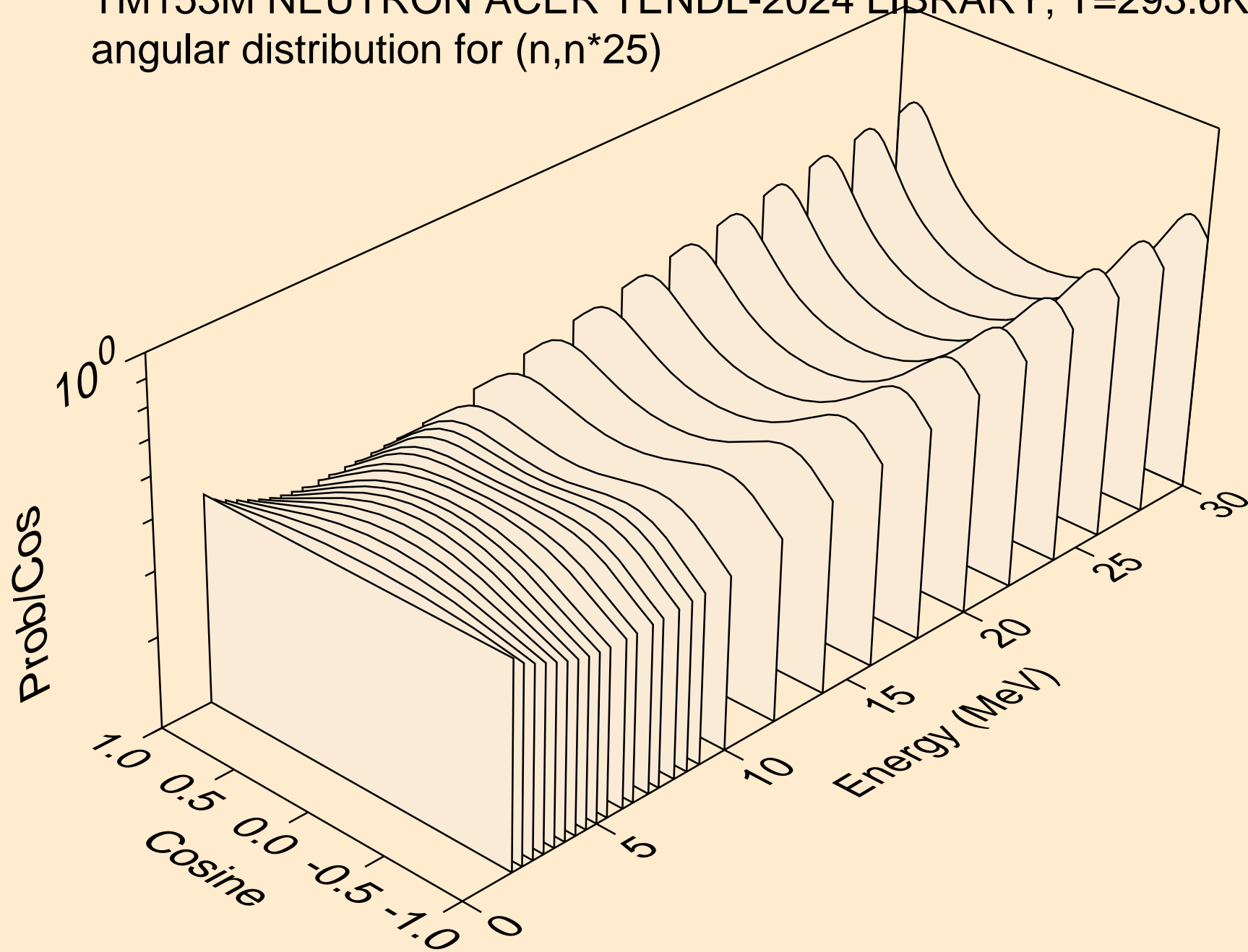

TM153M NEUTRON ACER TENDL-2024 LIBRARY; T=293.6K
angular distribution for (n,n*26)

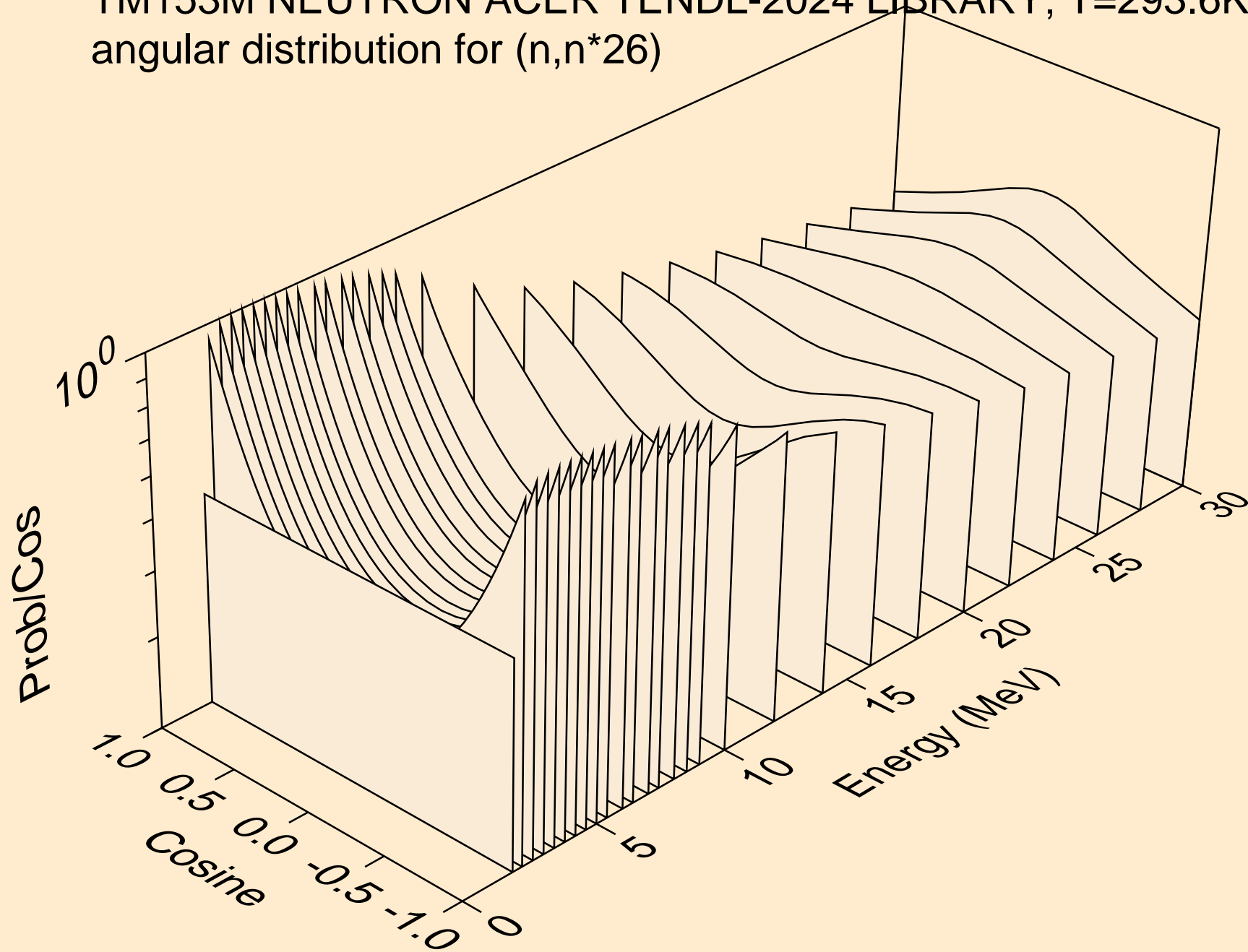

TM153M NEUTRON ACER TENDL-2024 LIBRARY; T=293.6K
angular distribution for (n,n*27)

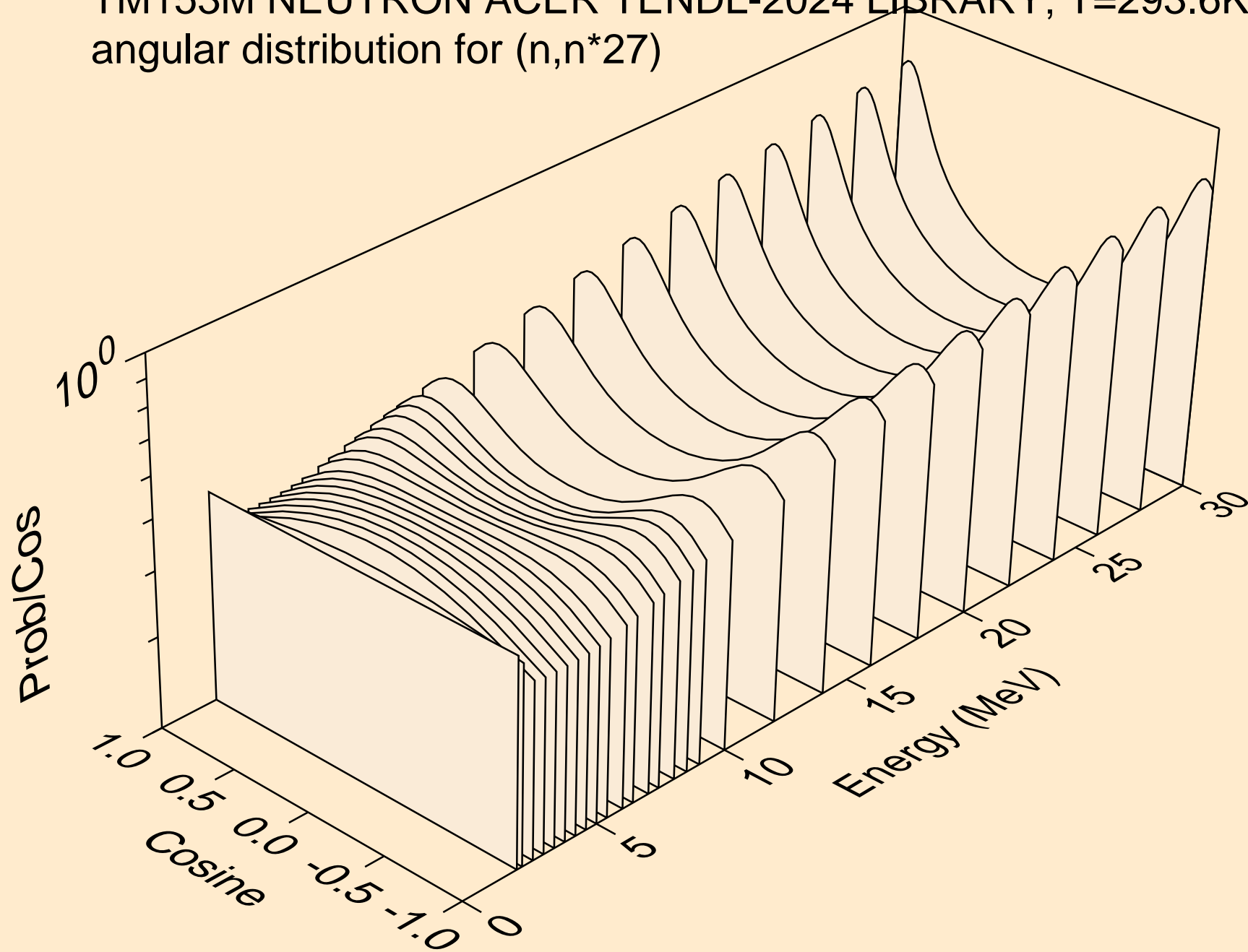

TM153M NEUTRON ACER TENDL-2024 LIBRARY; T=293.6K
angular distribution for (n,n*28)

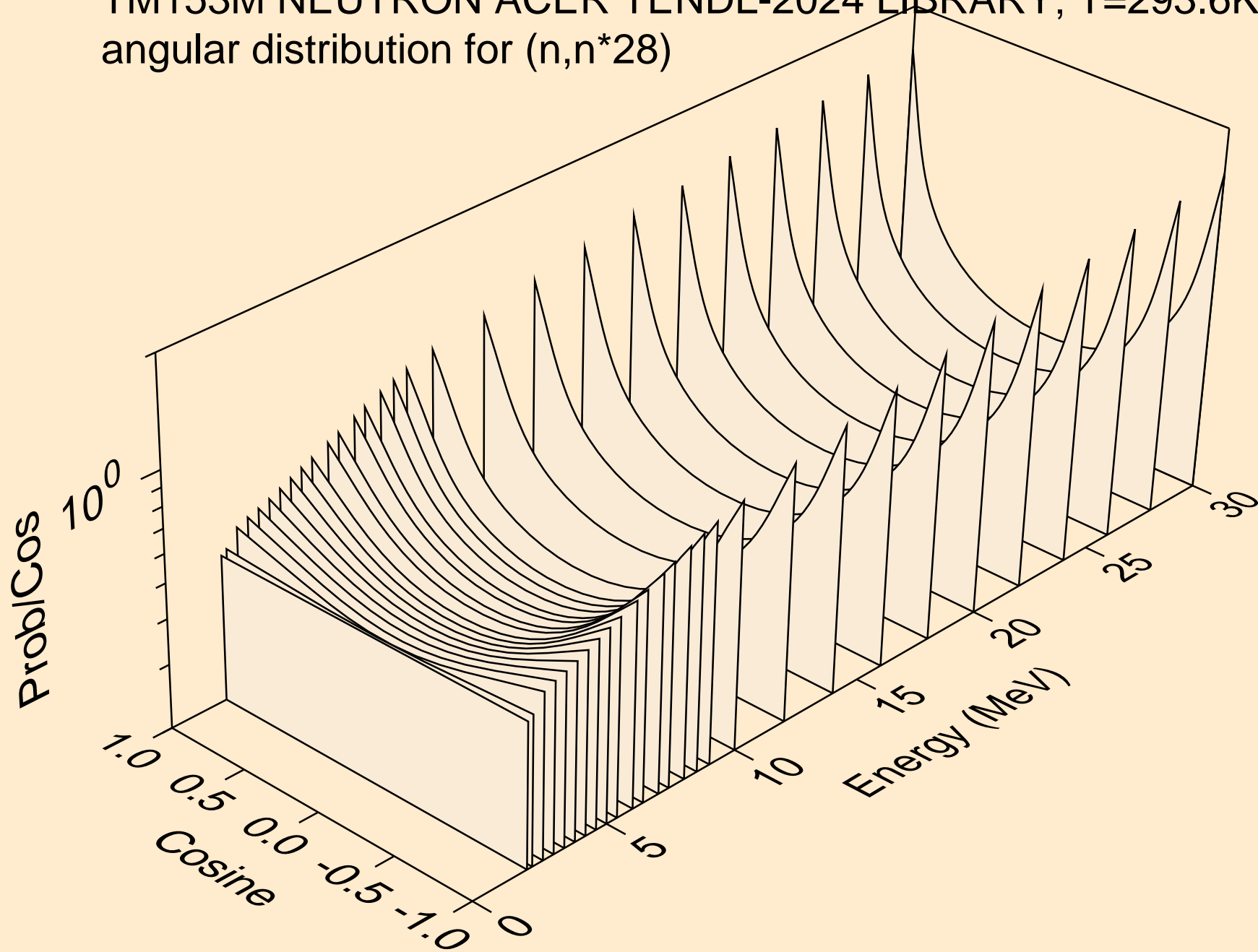

TM153M NEUTRON ACER TENDL-2024 LIBRARY; T=293.6K
Neutron emission for (n,x)

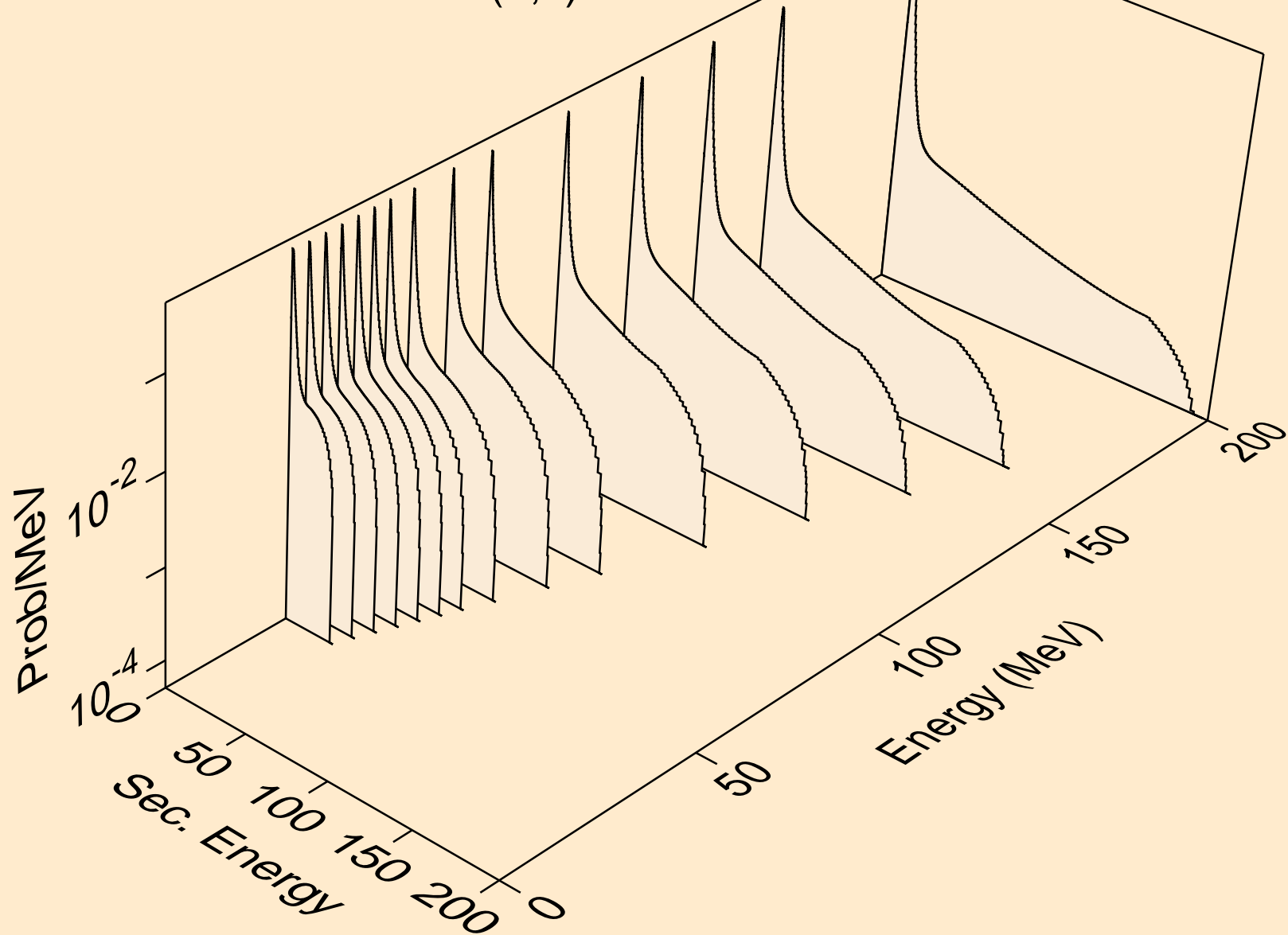

TM153M NEUTRON ACER TENDL-2024 LIBRARY; T=293.6K
Neutron emission for (n,2nd)

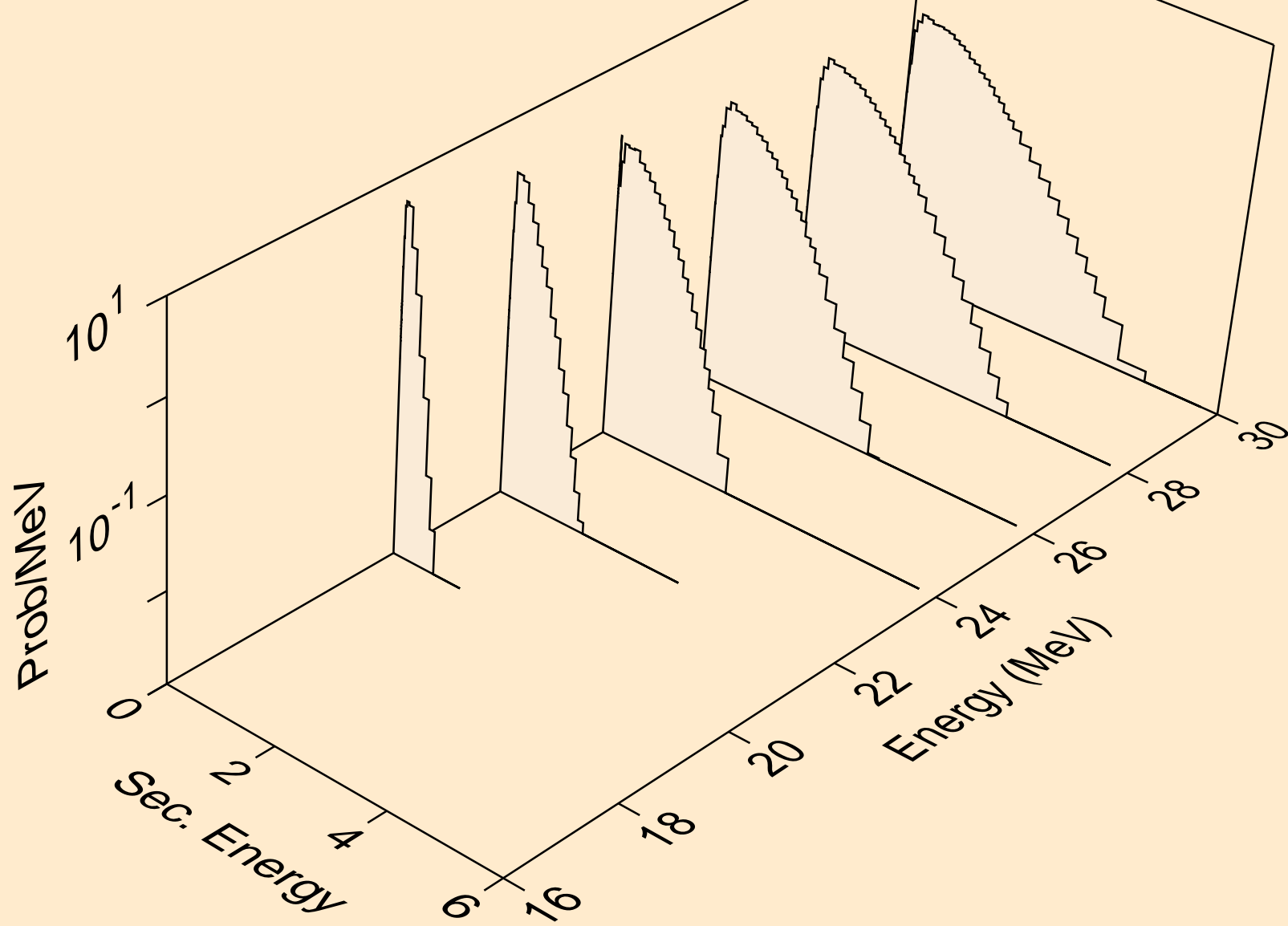

TM153M NEUTRON ACER TENDL-2024 LIBRARY; T=293.6K
Neutron emission for (n,2n)

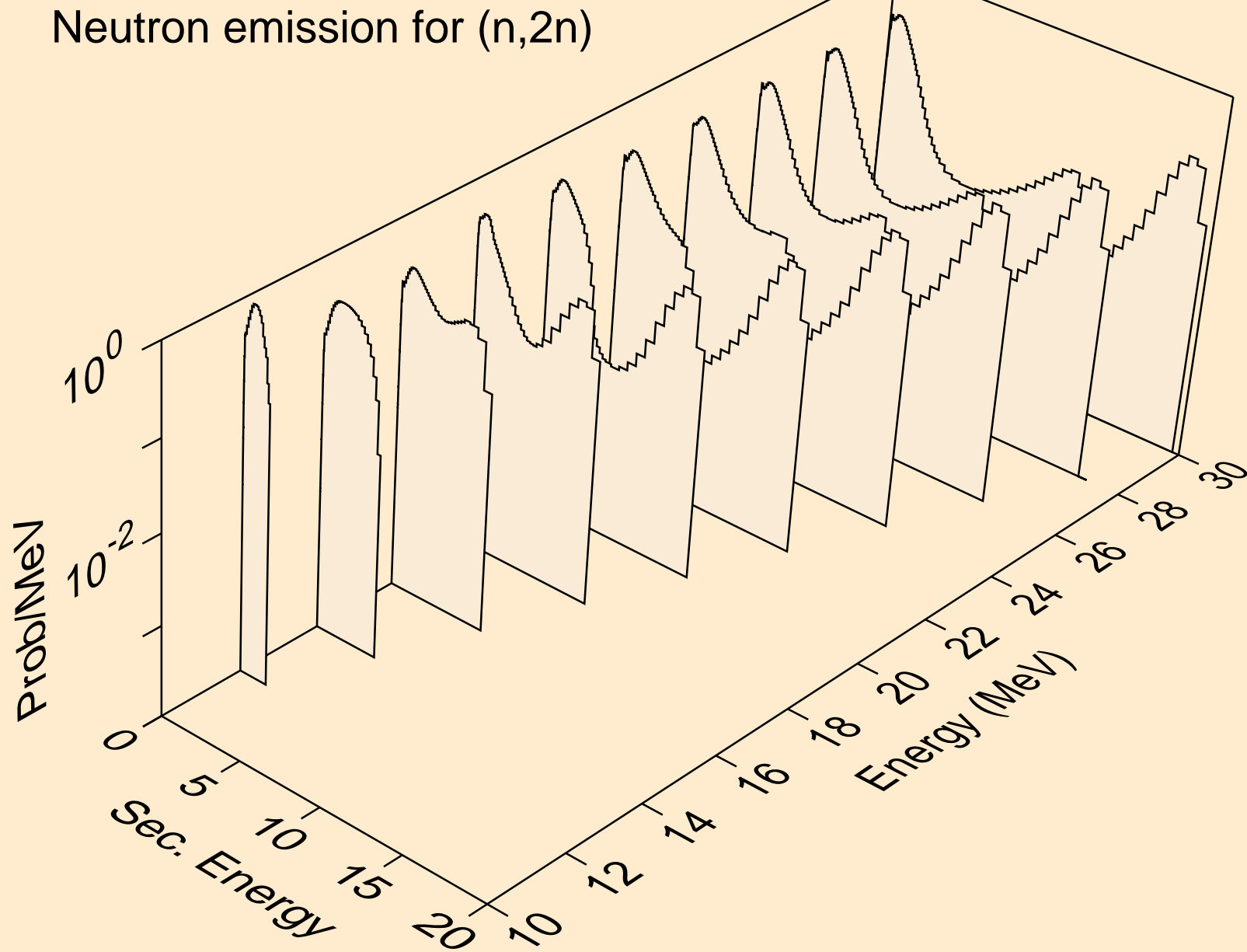

TM153M NEUTRON ACER TENDL-2024 LIBRARY; T=293.6K
Neutron emission for (n,3n)

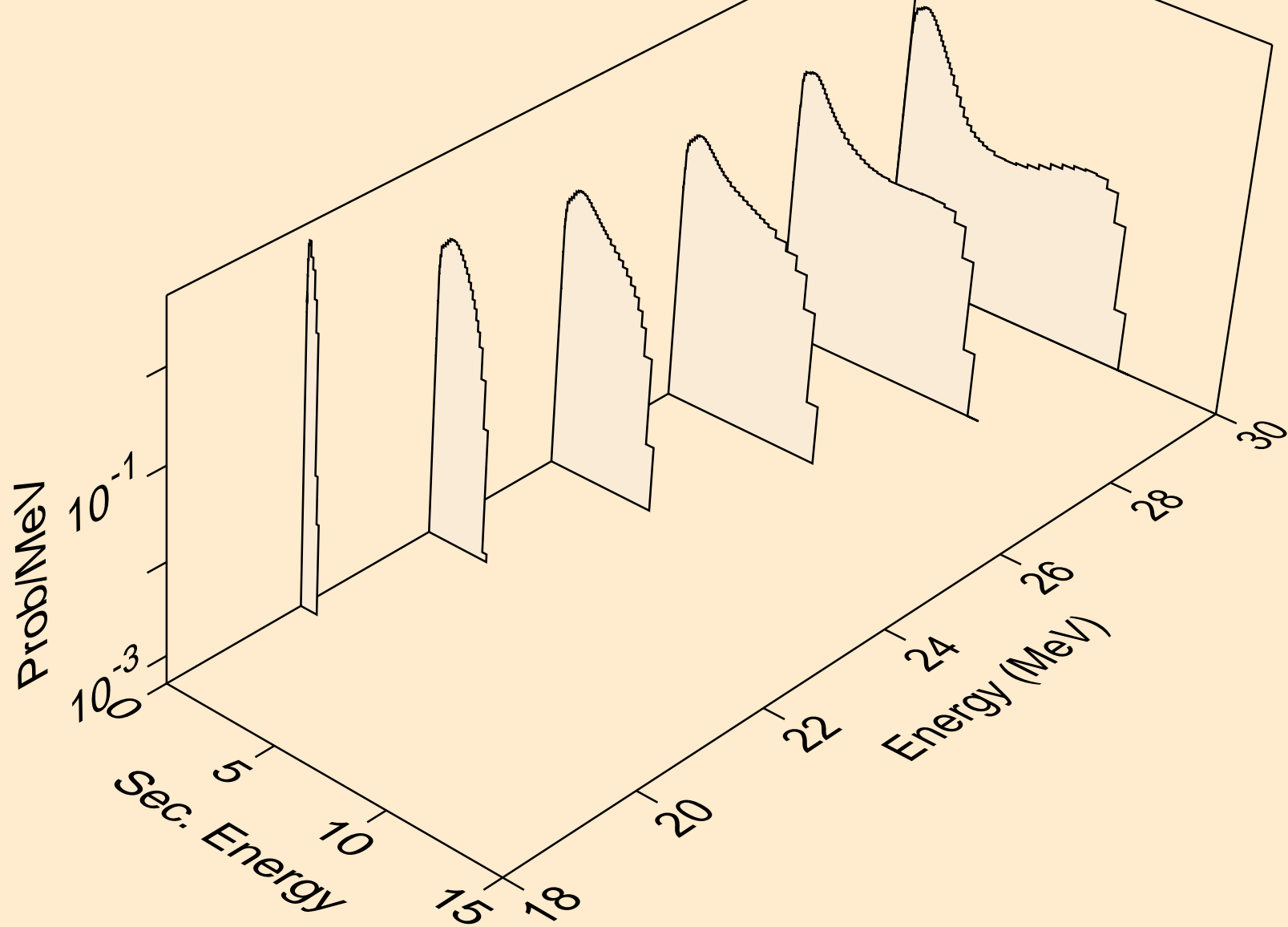

TM153M NEUTRON ACER TENDL-2024 LIBRARY; T=293.6K
Neutron emission for (n,n*)a

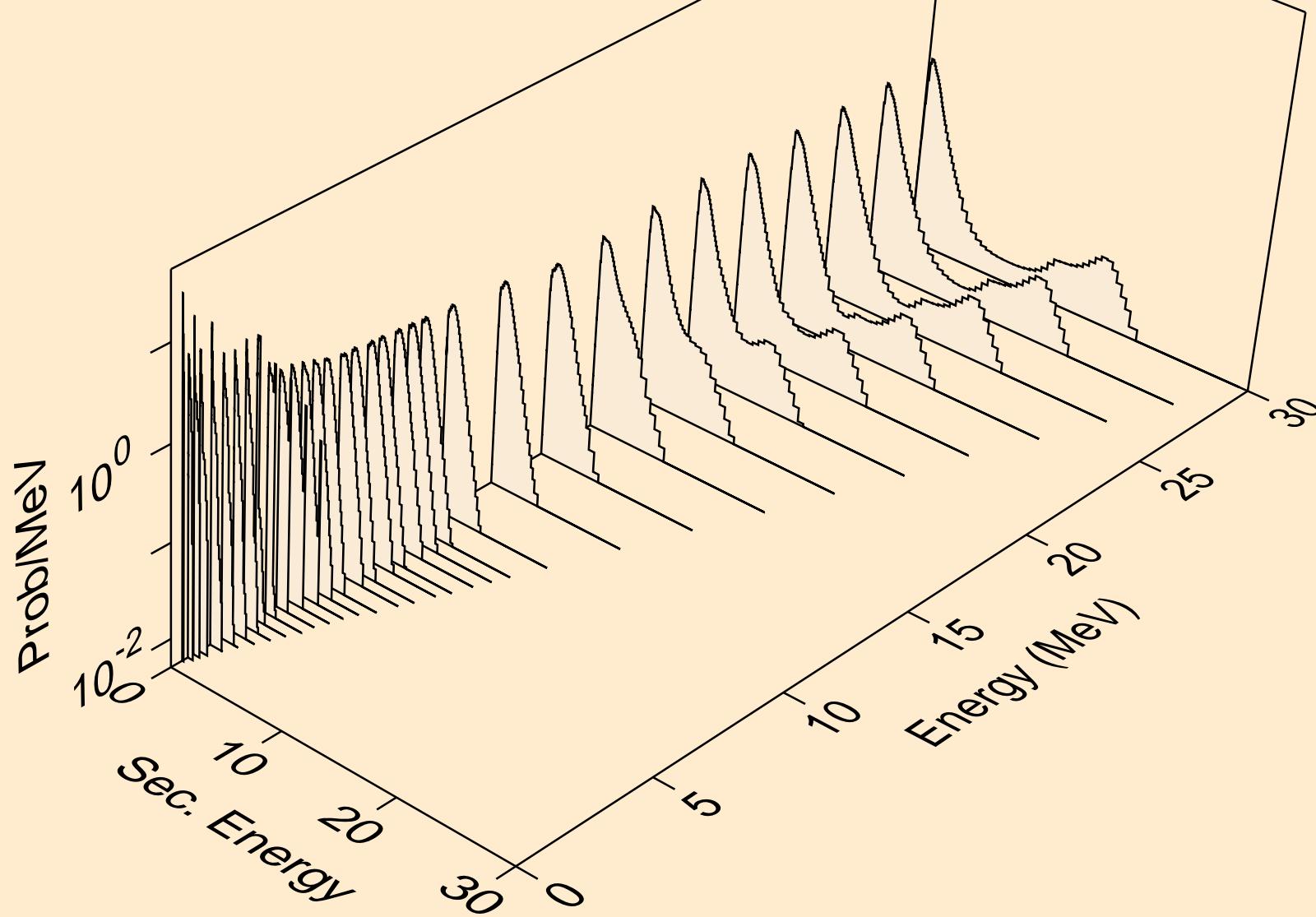

TM153M NEUTRON ACER TENDL-2024 LIBRARY; T=293.6K
Neutron emission for (n,2n)_a

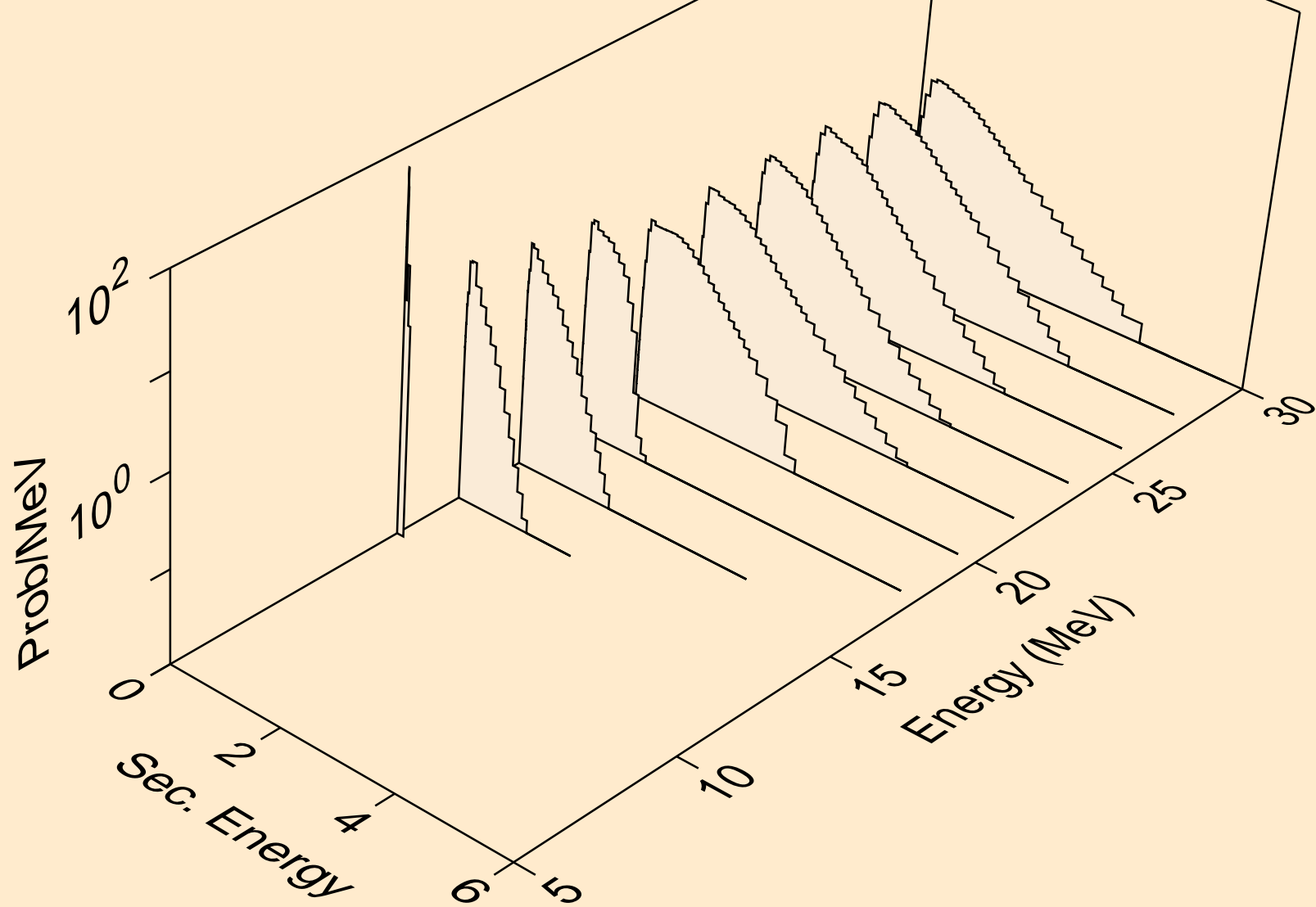

TM153M NEUTRON ACER TENDL-2024 LIBRARY; T=293.6K
Neutron emission for (n,3n)a

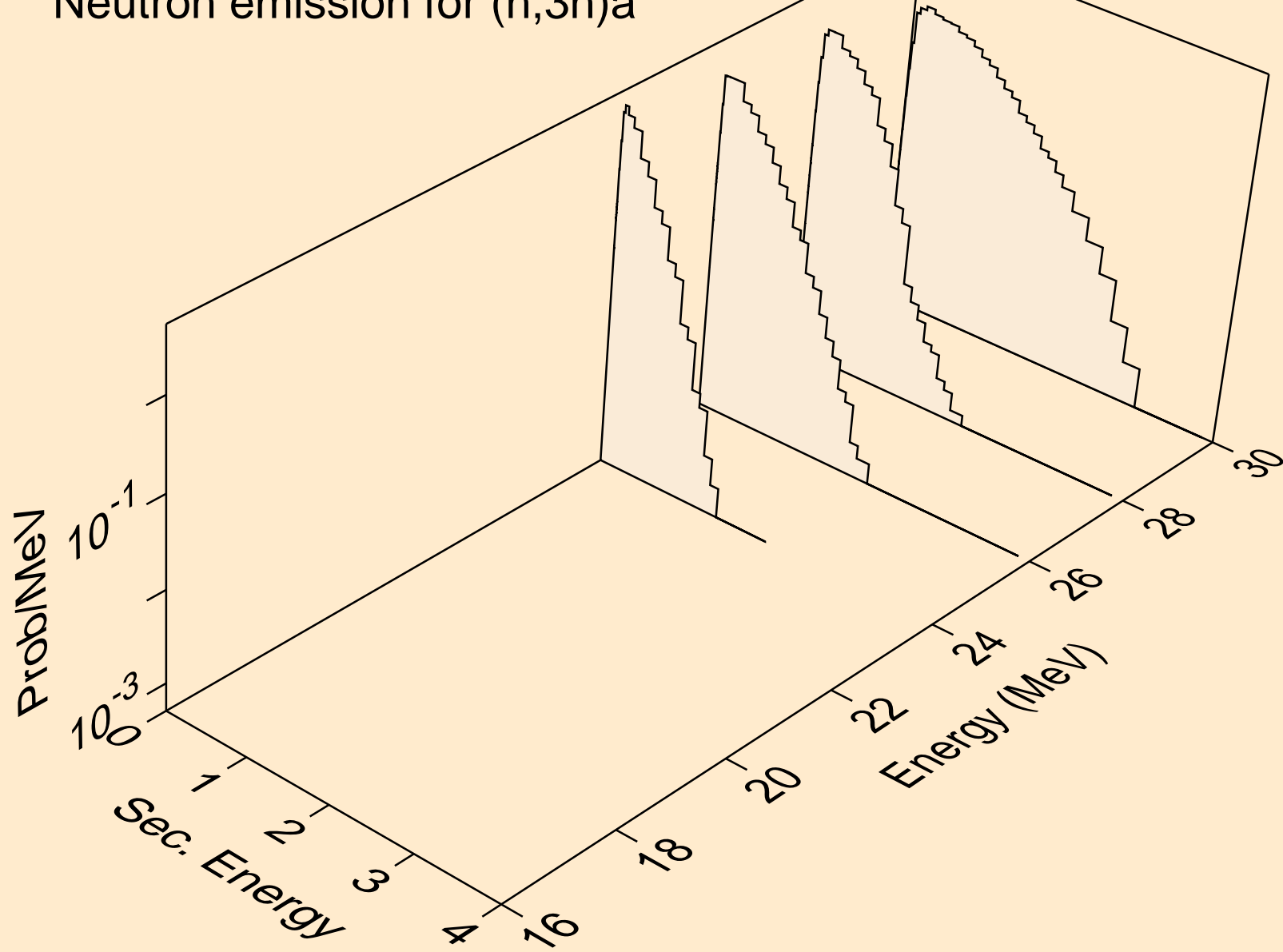

TM153M NEUTRON ACER TENDL-2024 LIBRARY; T=293.6K
Neutron emission for (n,n*)p

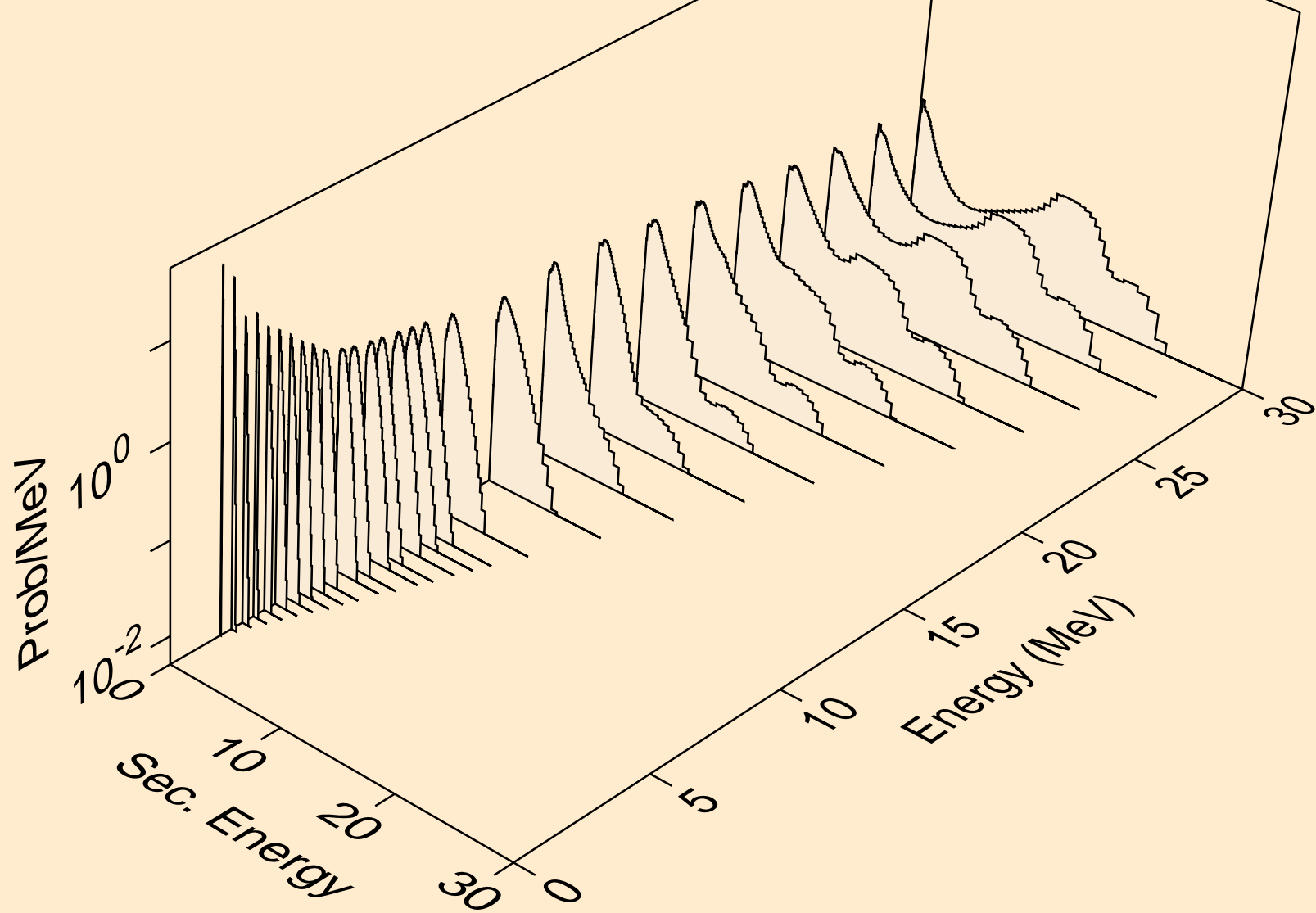

TM153M NEUTRON ACER TENDL-2024 LIBRARY; T=293.6K
Neutron emission for (n,n*)2a

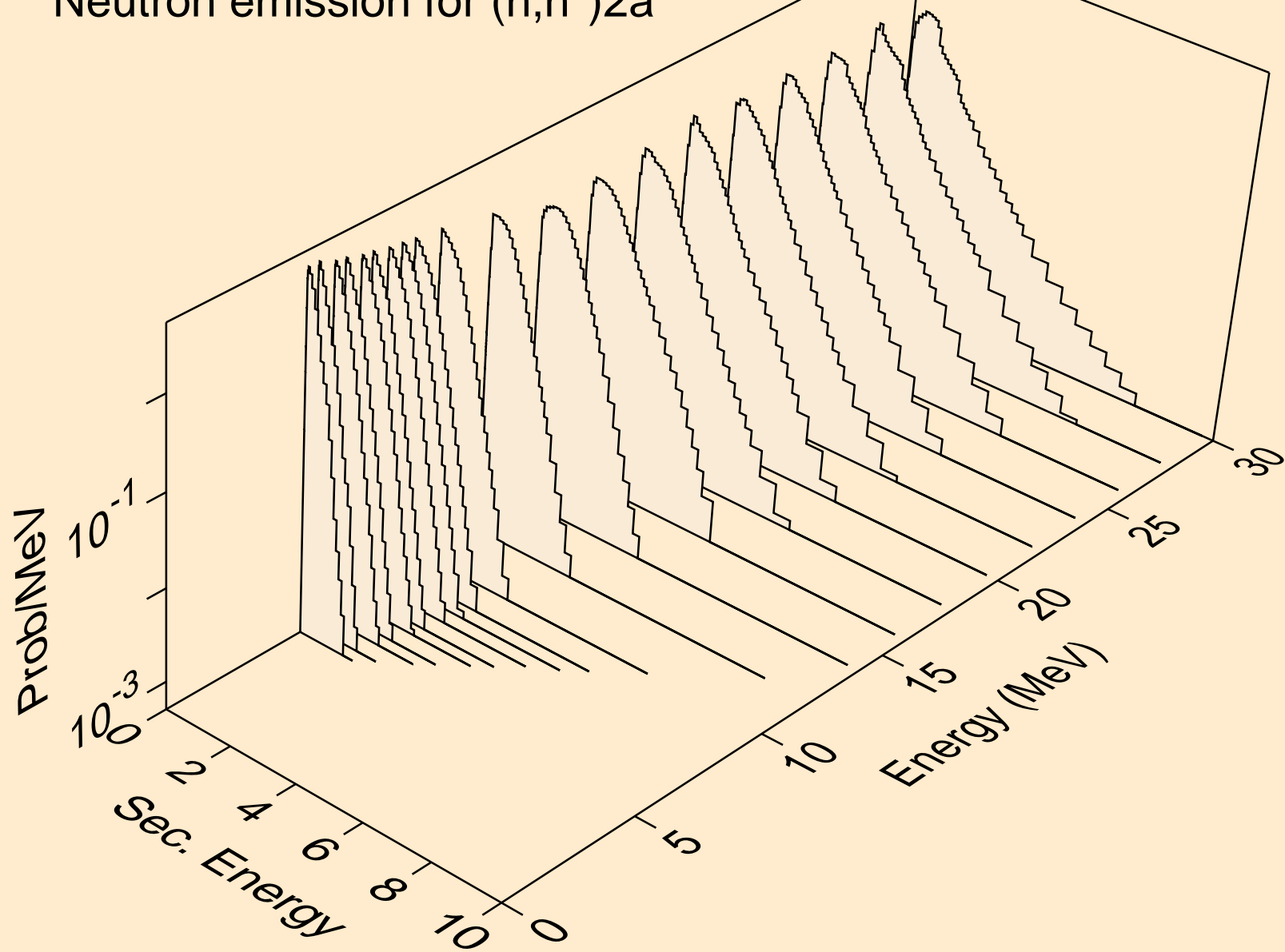

TM153M NEUTRON ACER TENDL-2024 LIBRARY; T=293.6K
Neutron emission for (n,n*)d

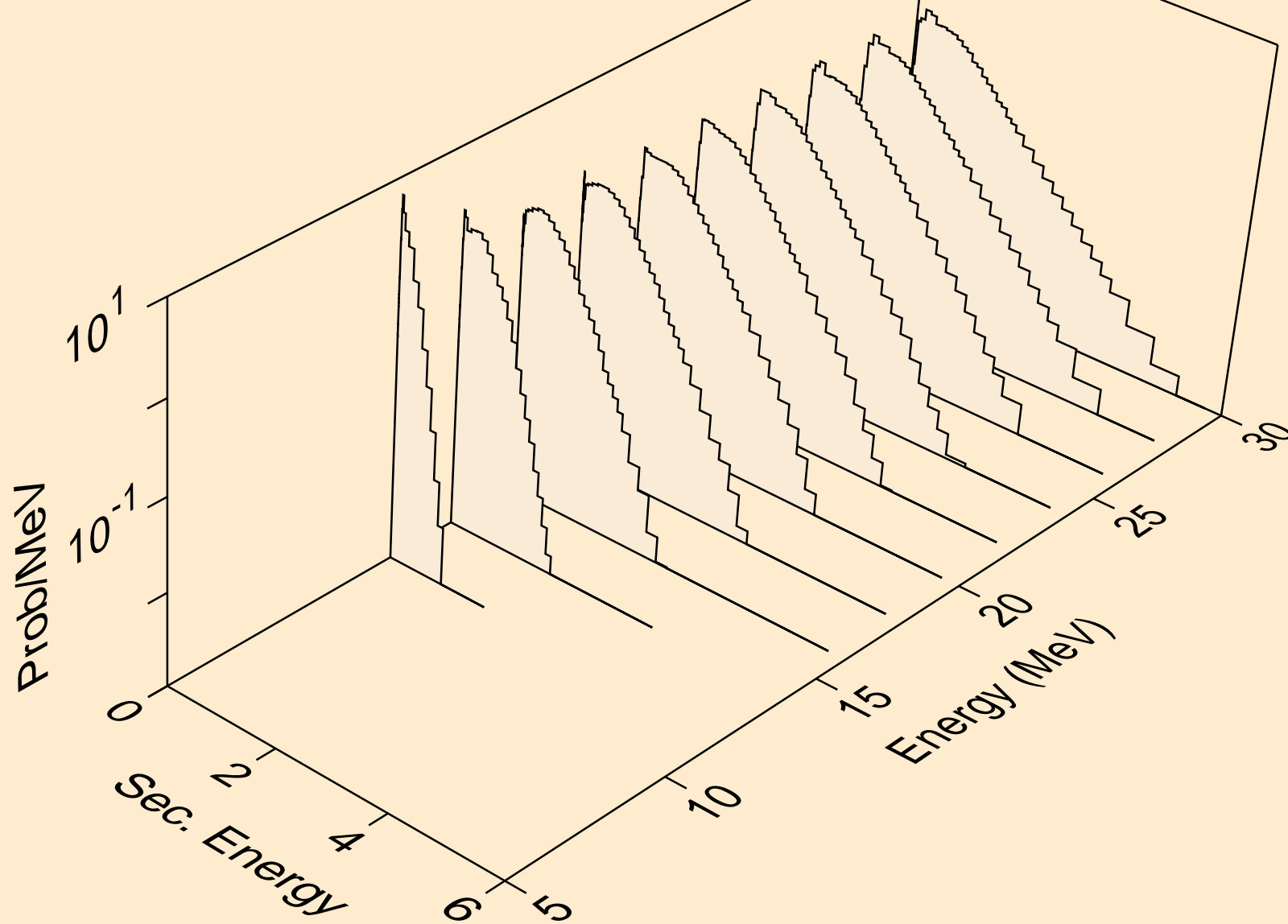

TM153M NEUTRON ACER TENDL-2024 LIBRARY; T=293.6K
Neutron emission for (n,n*)t

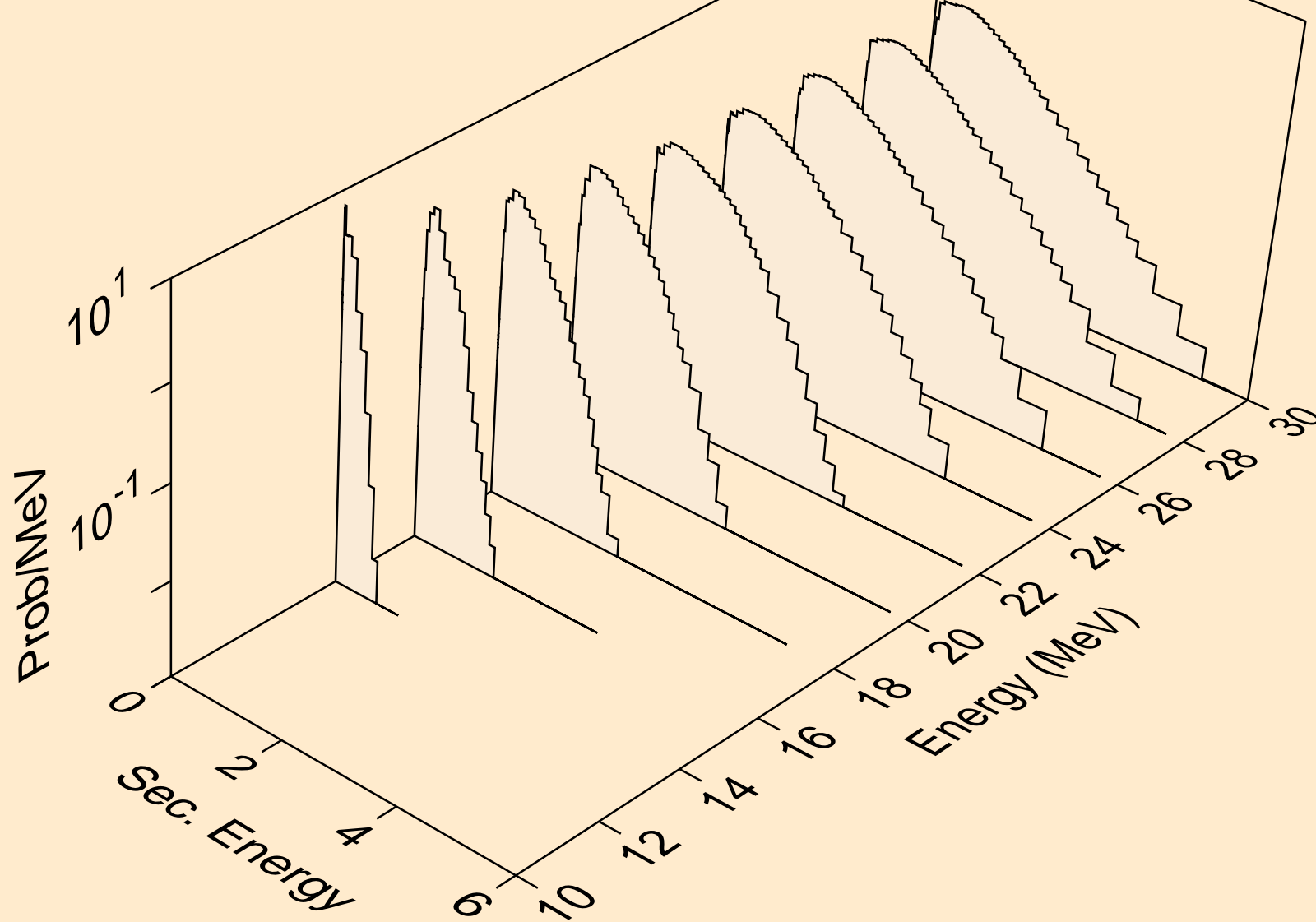

TM153M NEUTRON ACER TENDL-2024 LIBRARY; T=293.6K
Neutron emission for (n,n*)he3

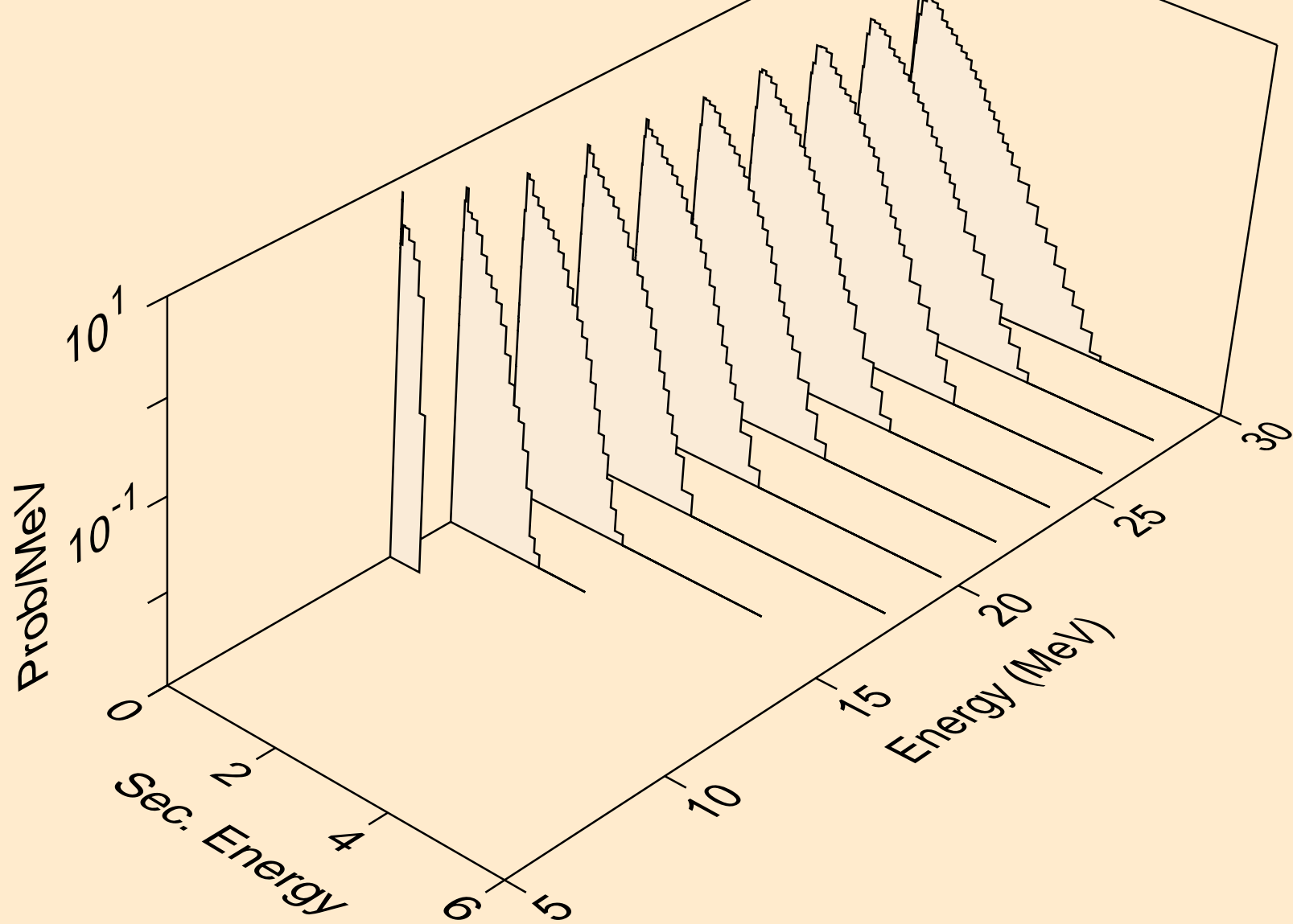

TM153M NEUTRON ACER TENDL-2024 LIBRARY; T=293.6K
Neutron emission for (n,2np)

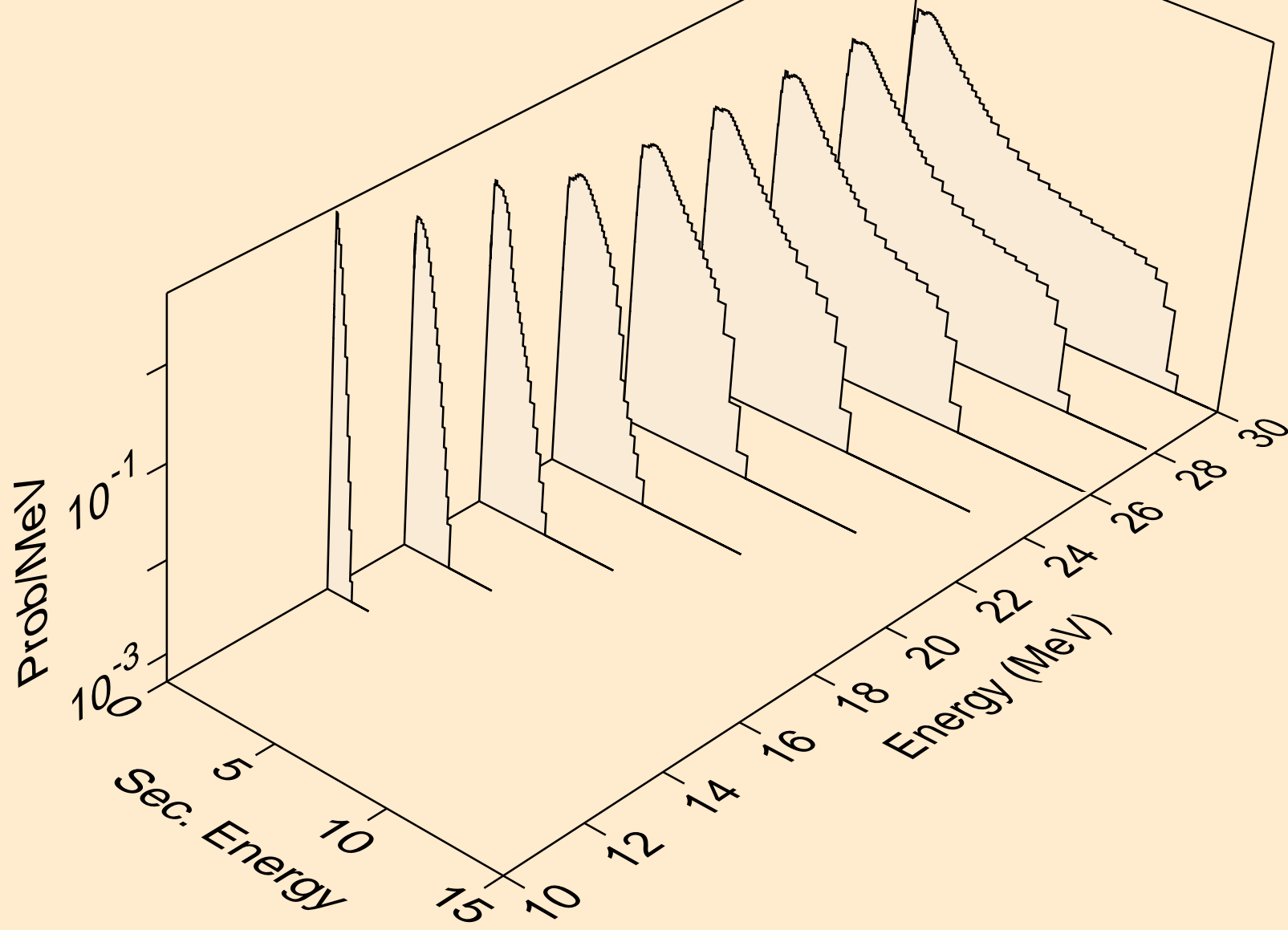

TM153M NEUTRON ACER TENDL-2024 LIBRARY; T=293.6K
Neutron emission for (n,3np)

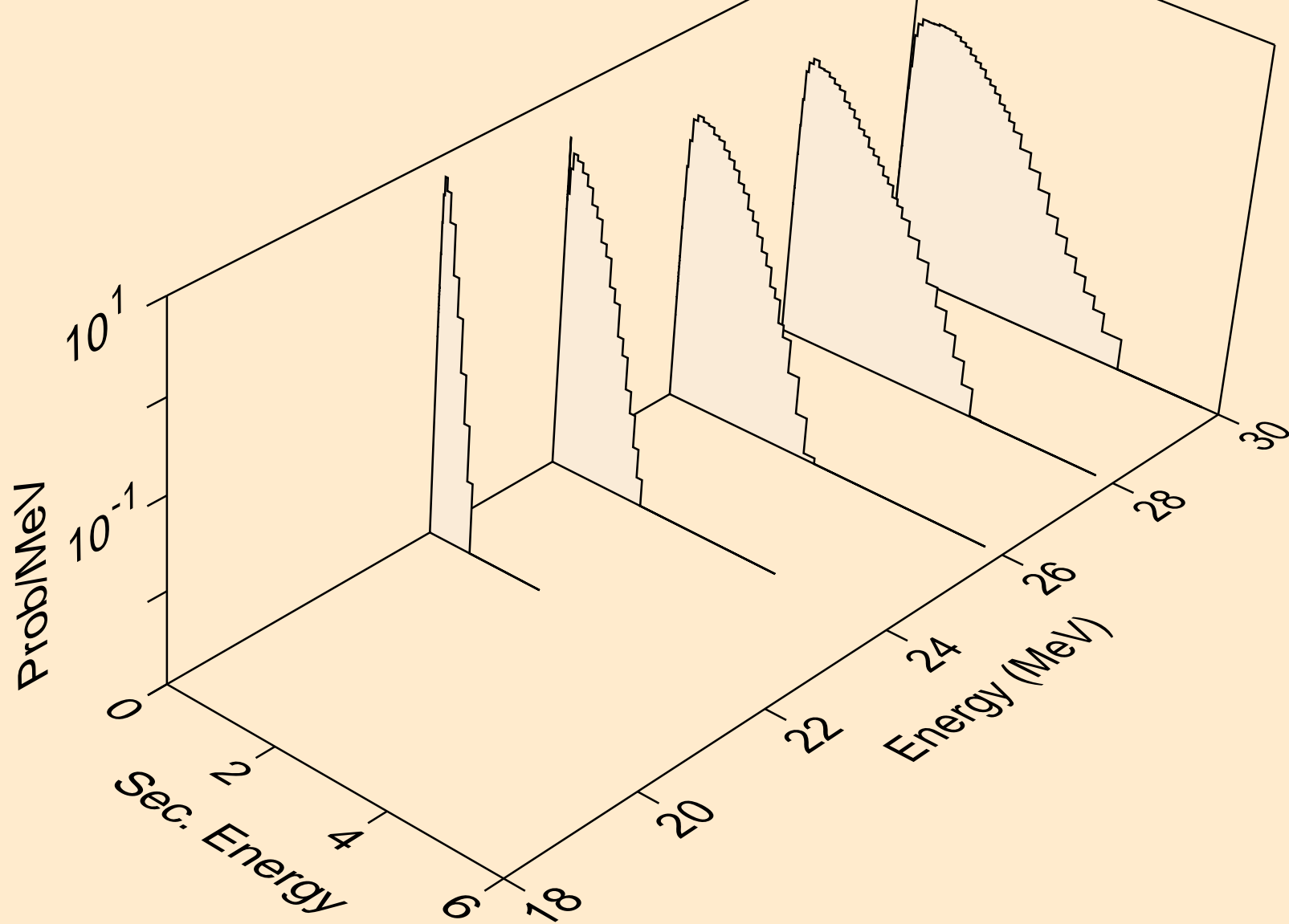

TM153M NEUTRON ACER TENDL-2024 LIBRARY; T=293.6K
Neutron emission for (n,n2p)

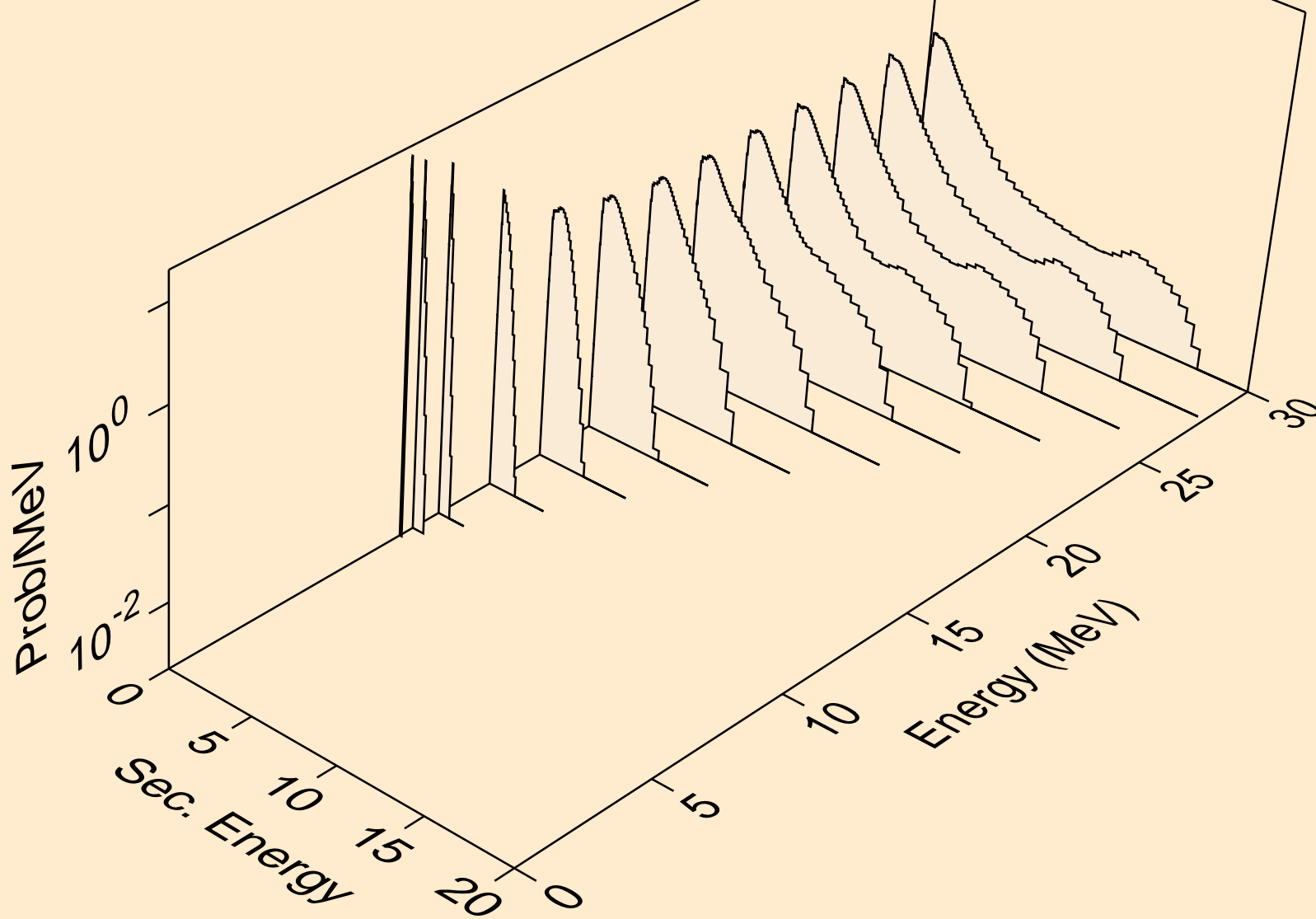

TM153M NEUTRON ACER TENDL-2024 LIBRARY; T=293.6K
Neutron emission for (n,npa)

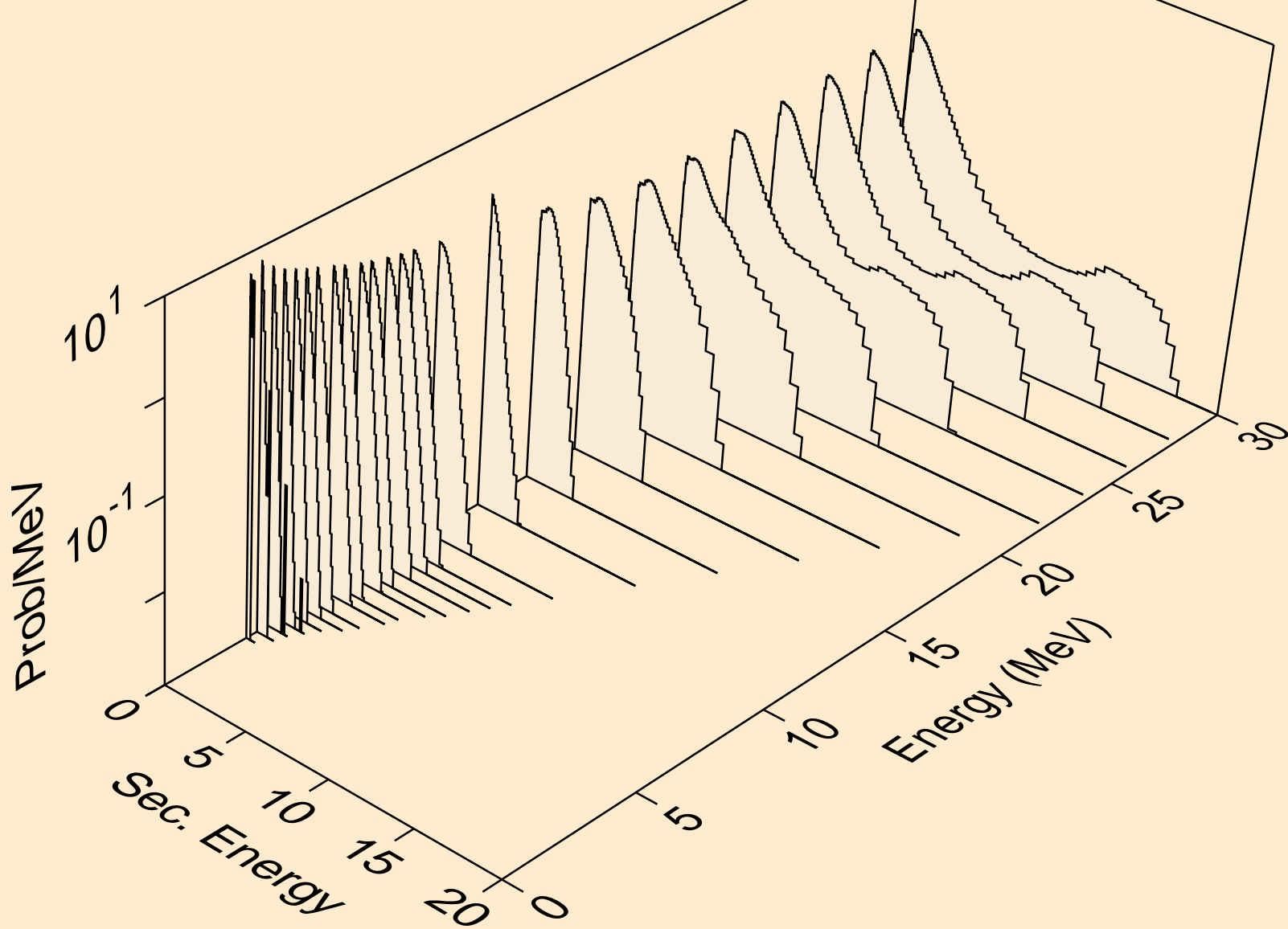

TM153M NEUTRON ACER TENDL-2024 LIBRARY; T=293.6K
Neutron emission for (n,n*c)

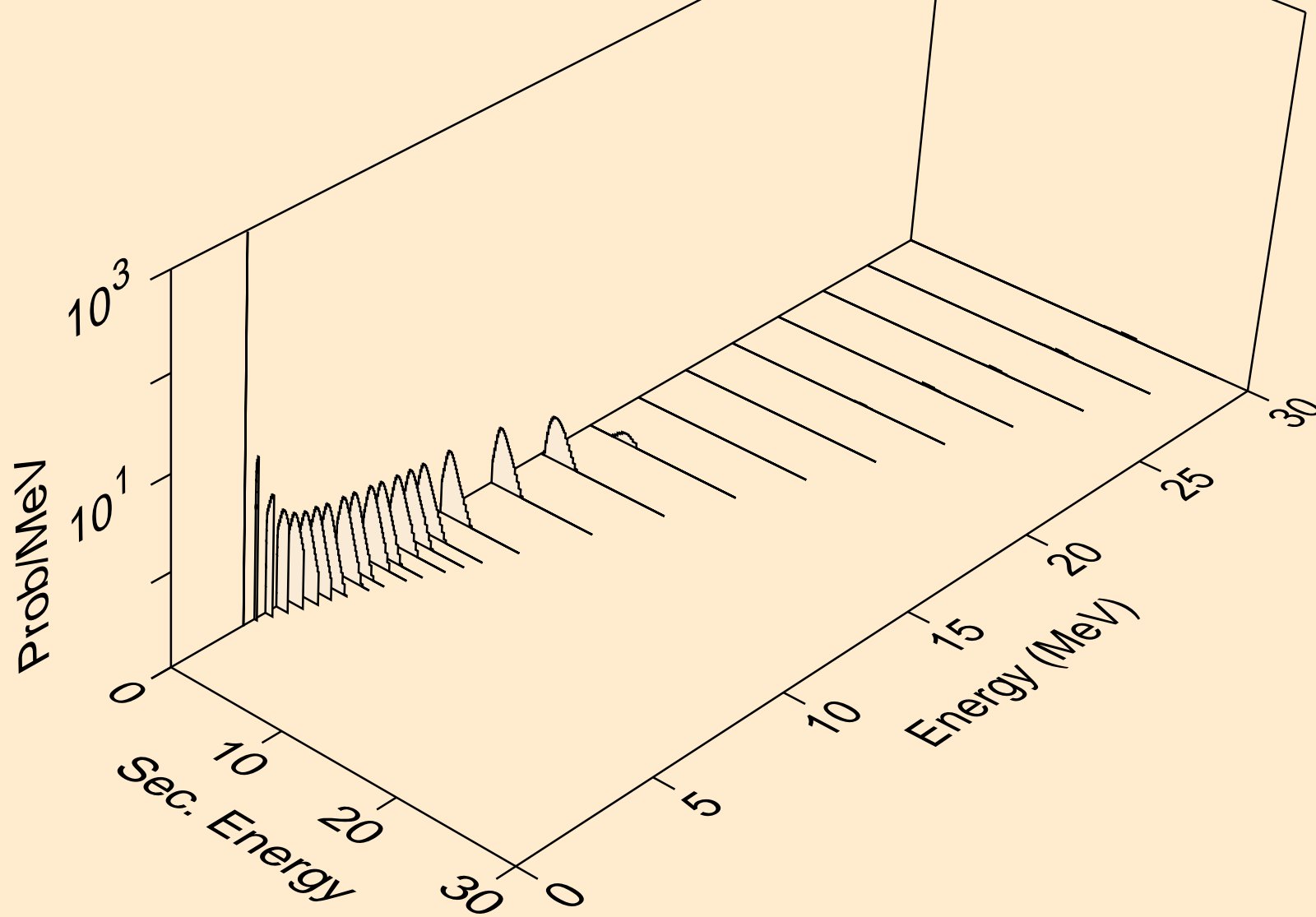

TM153M NEUTRON ACER TENDL-2024 LIBRARY; T=293.6K
Photon emission for (n,x)

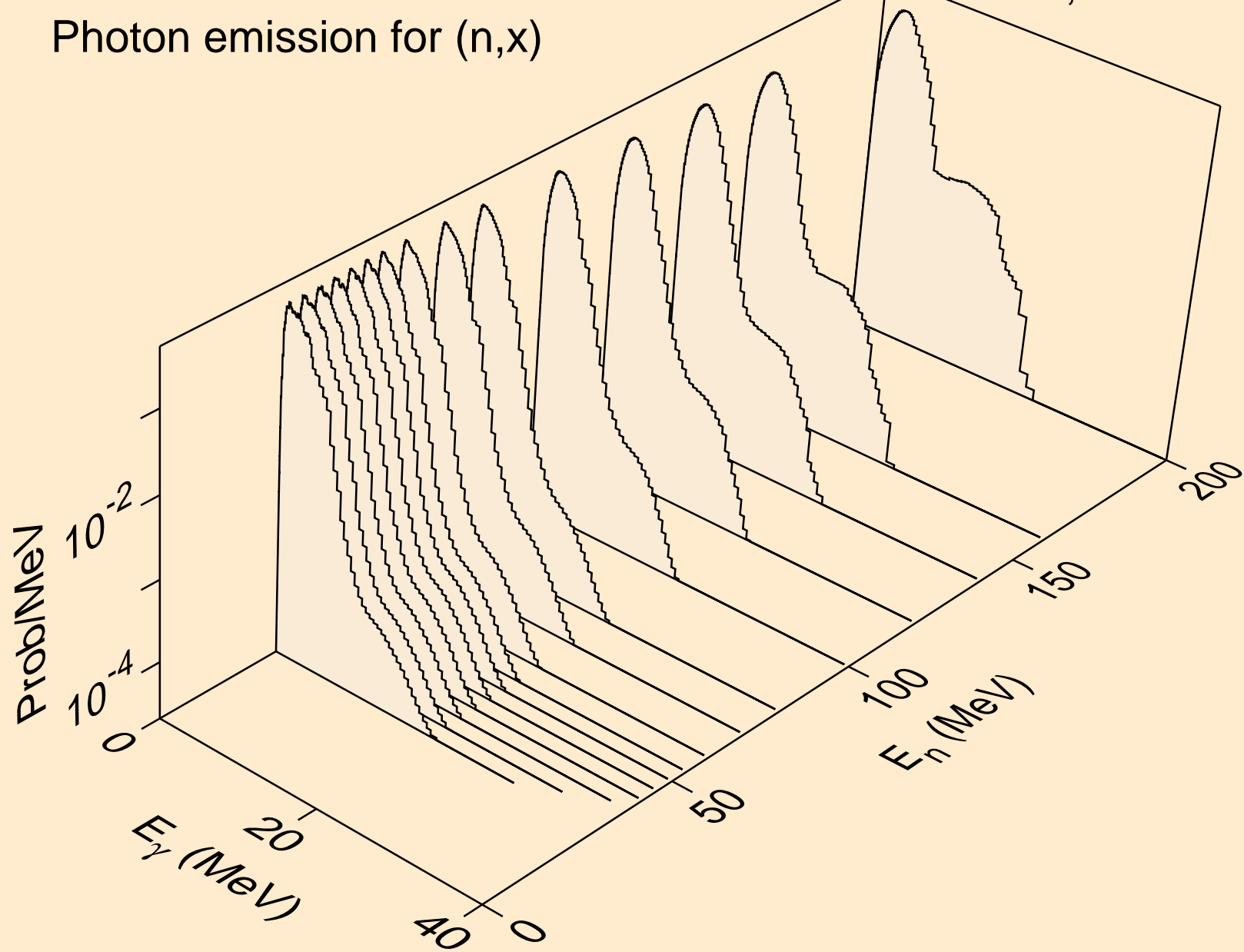

TM153M NEUTRON ACER TENDL-2024 LIBRARY; T=293.6K
Photon emission for (n,2nd)

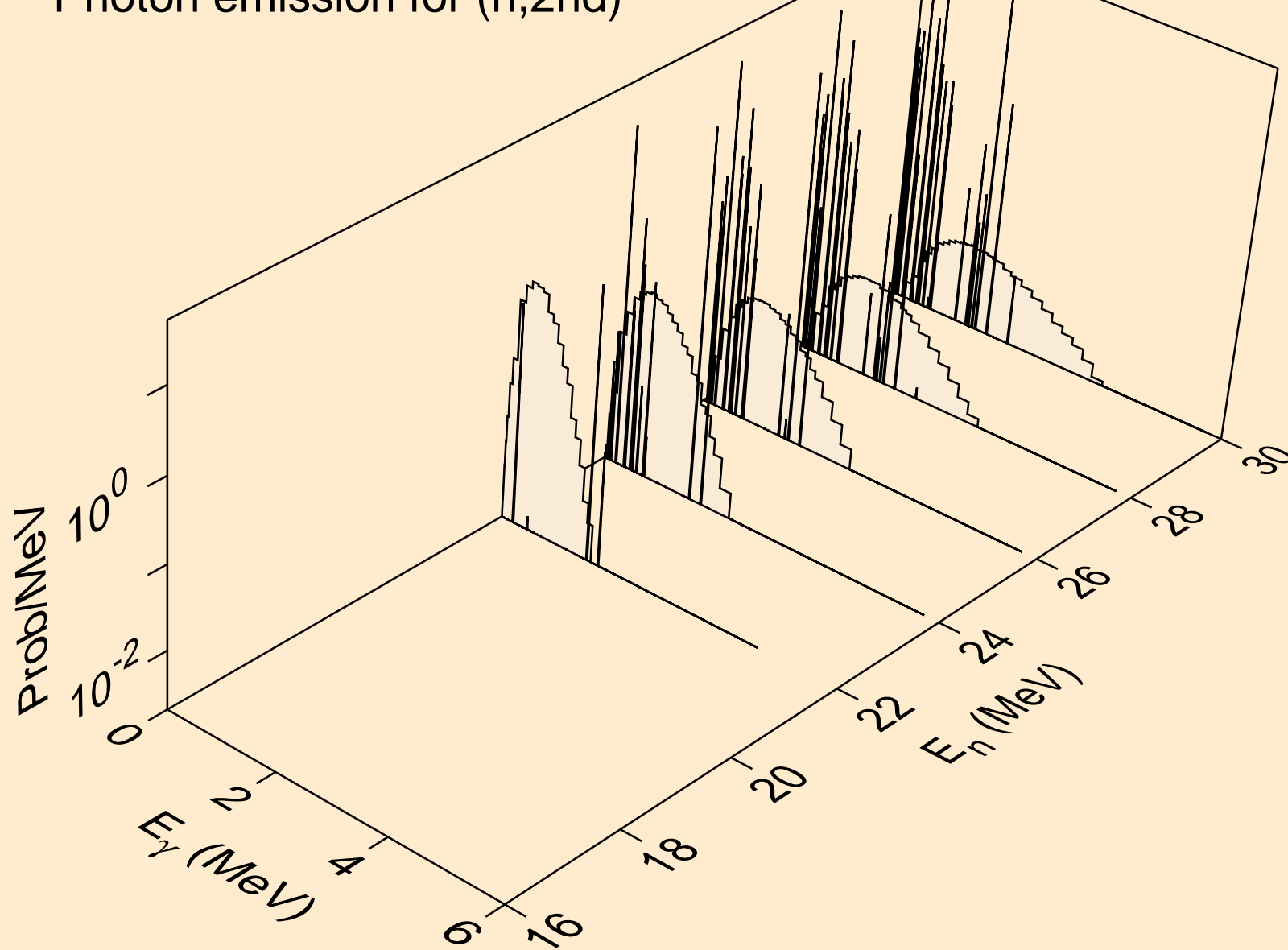

TM153M NEUTRON ACER TENDL-2024 LIBRARY; T=293.6K
Photon emission for (n,2n)

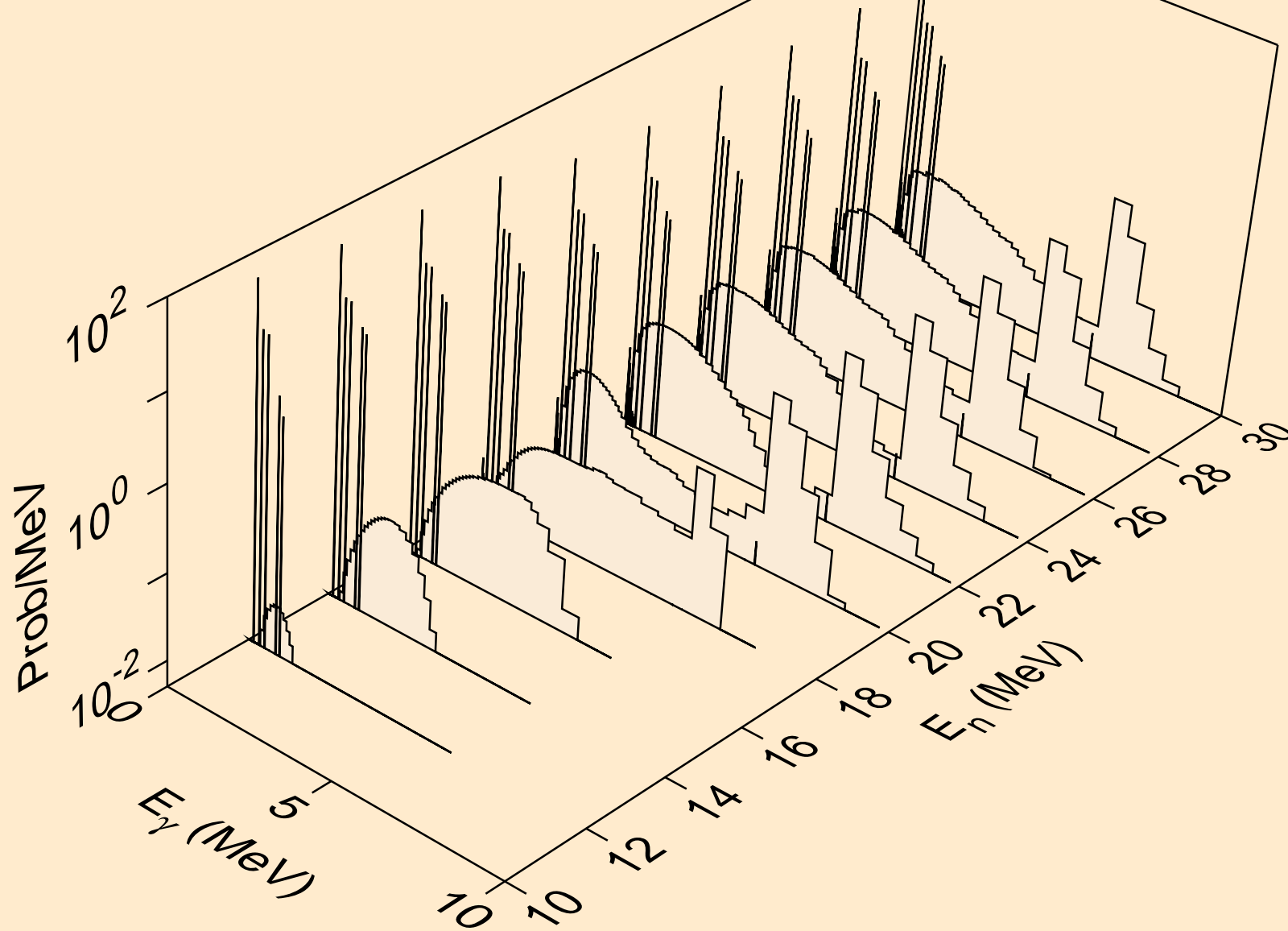

TM153M NEUTRON ACER TENDL-2024 LIBRARY; T=293.6K
Photon emission for (n,3n)

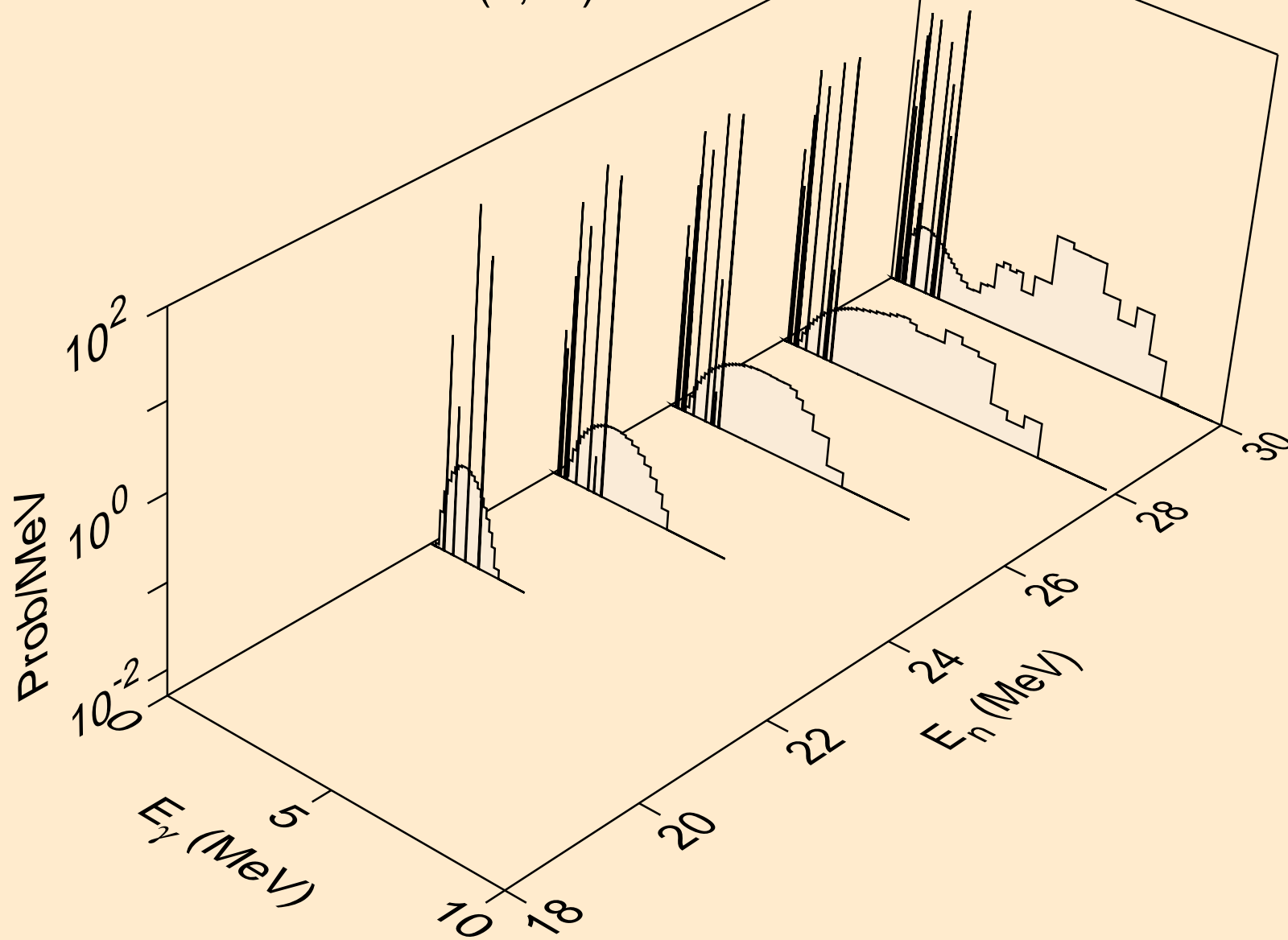

TM153M NEUTRON ACER TENDL-2024 LIBRARY; T=293.6K
Photon emission for (n,n*)a

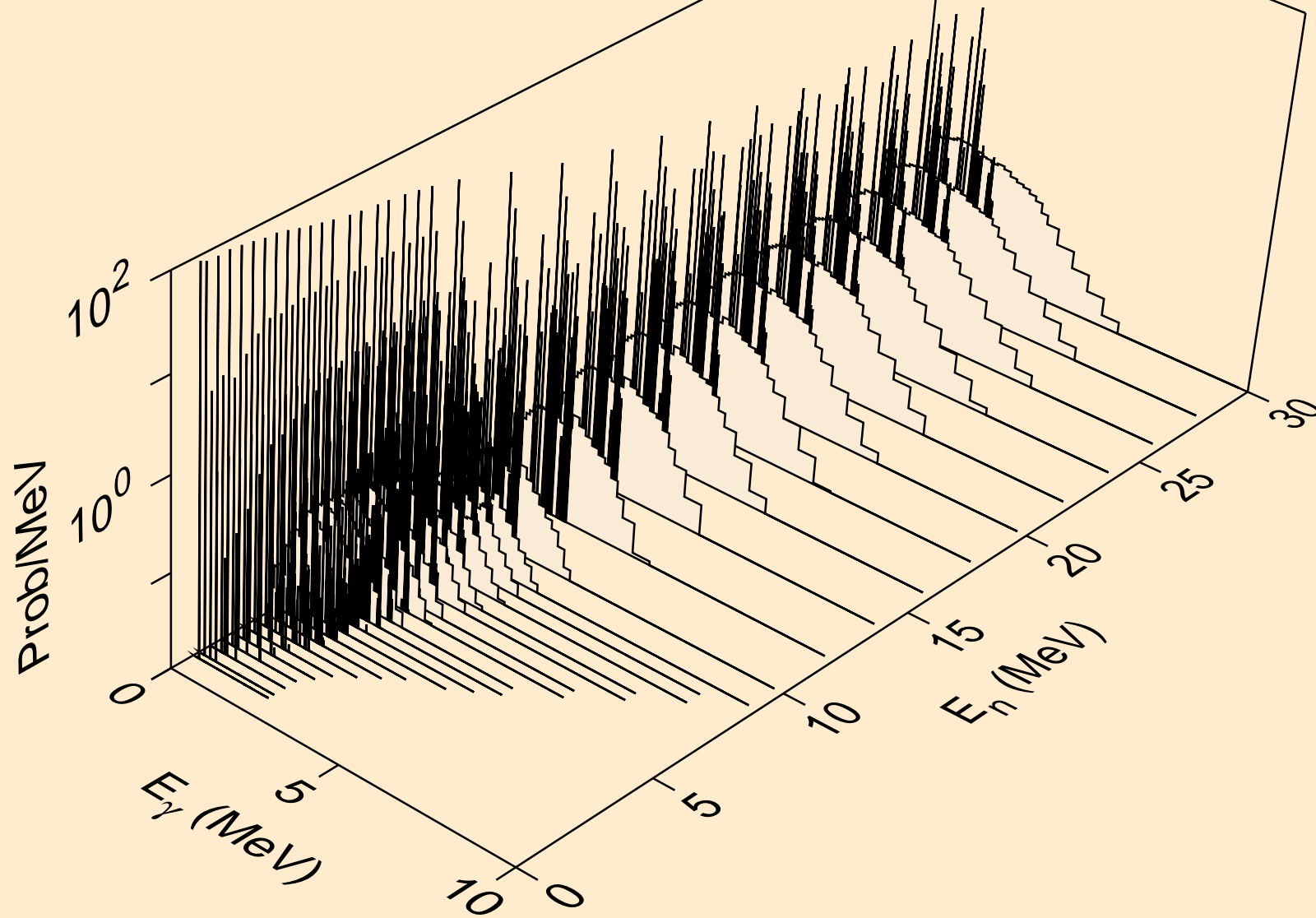

TM153M NEUTRON ACER TENDL-2024 LIBRARY; T=293.6K
Photon emission for (n,2n)a

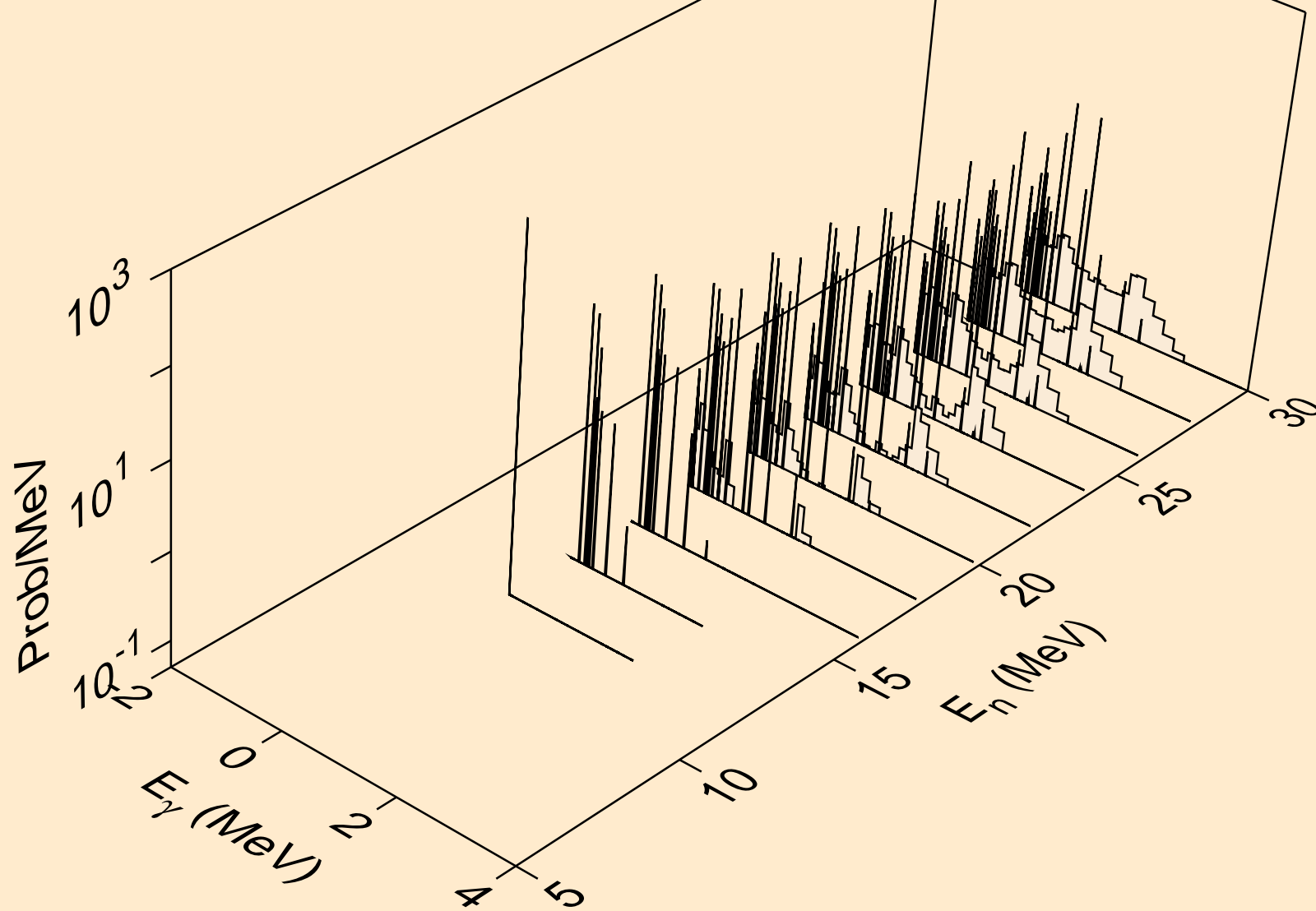

TM153M NEUTRON ACER TENDL-2024 LIBRARY; T=293.6K
Photon emission for (n,3n)a

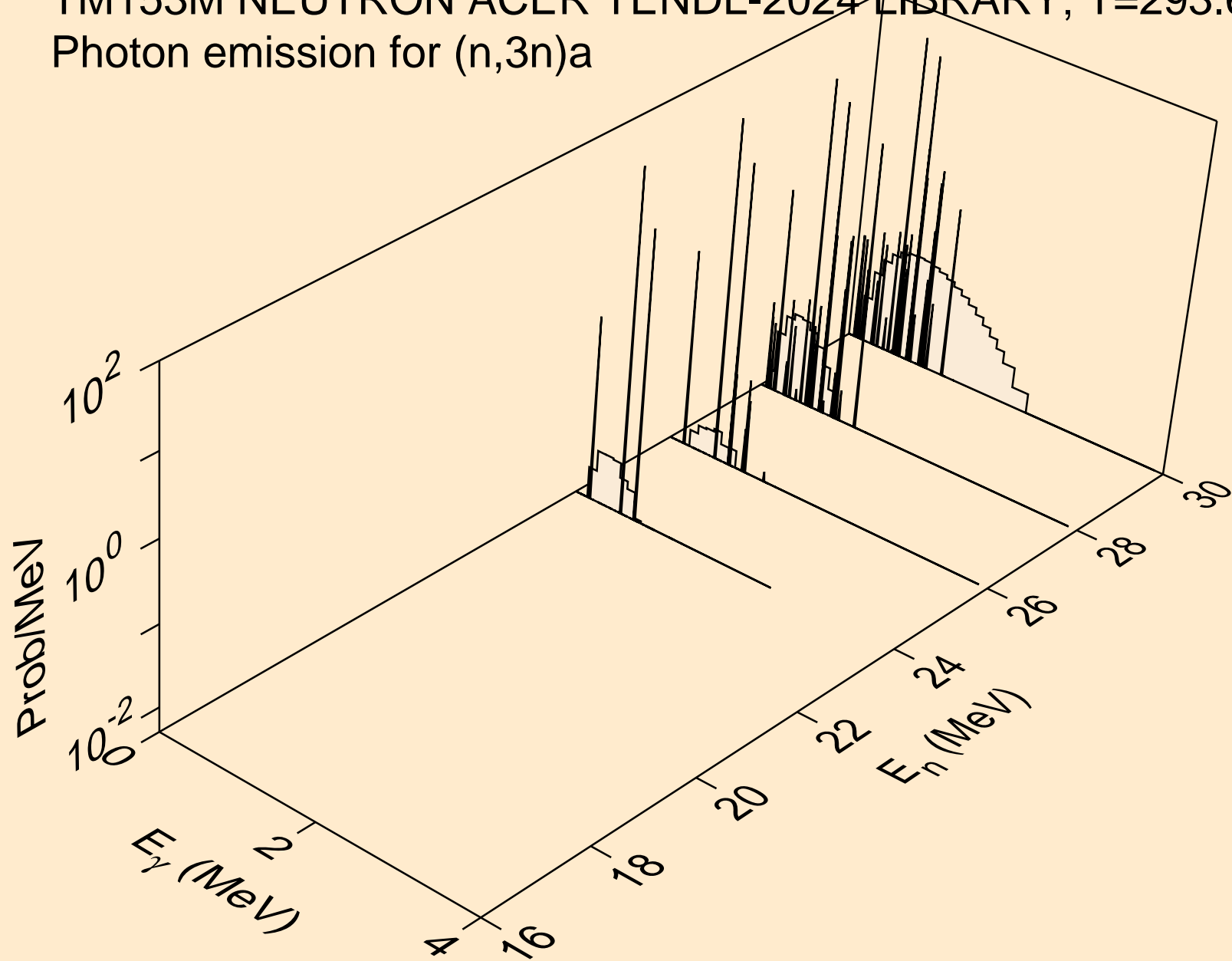

TM153M NEUTRON ACER TENDL-2024 LIBRARY; T=293.6K
Photon emission for (n,n*)p

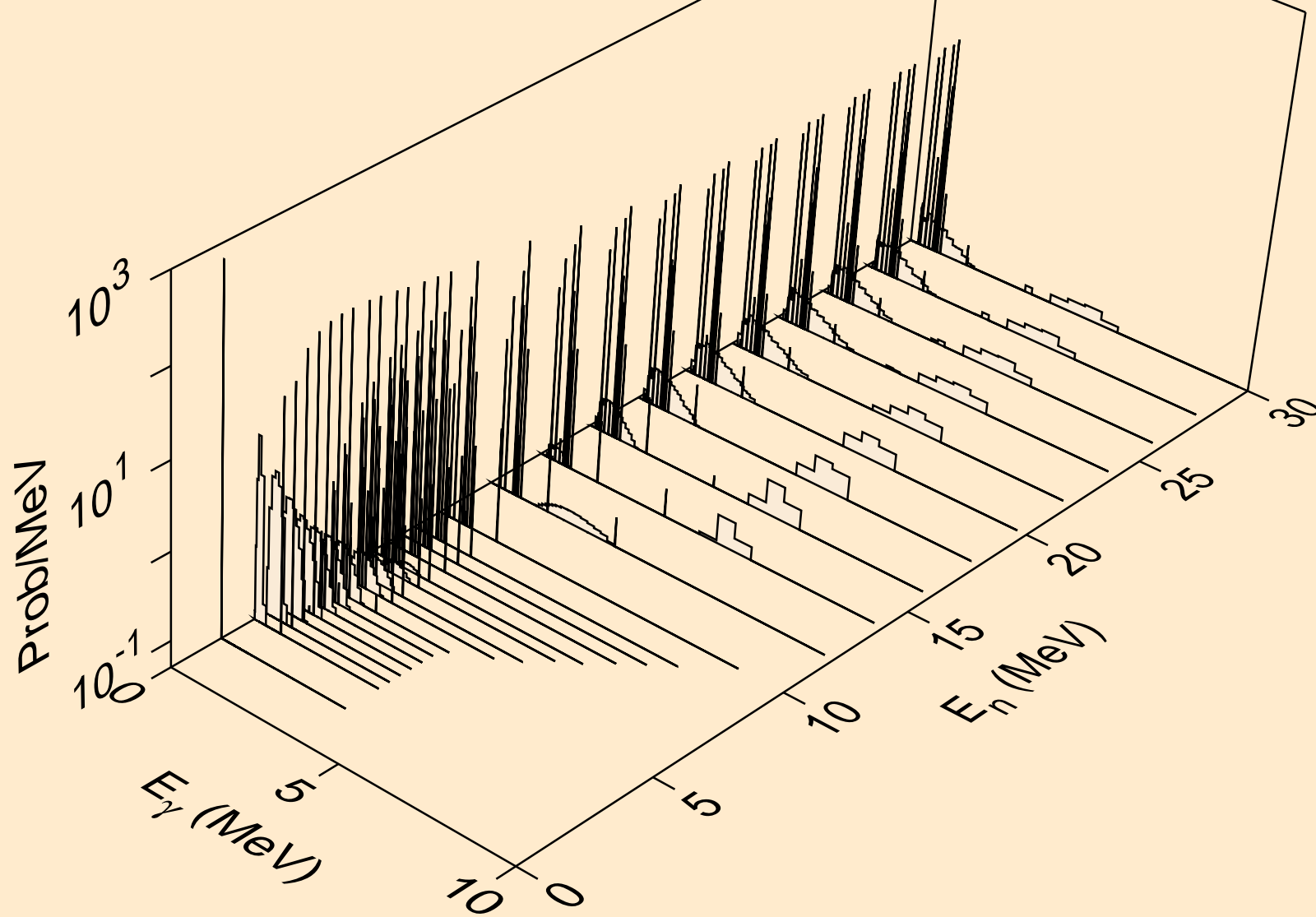

TM153M NEUTRON ACER TENDL-2024 LIBRARY; T=293.6K
Photon emission for (n,n*)2a

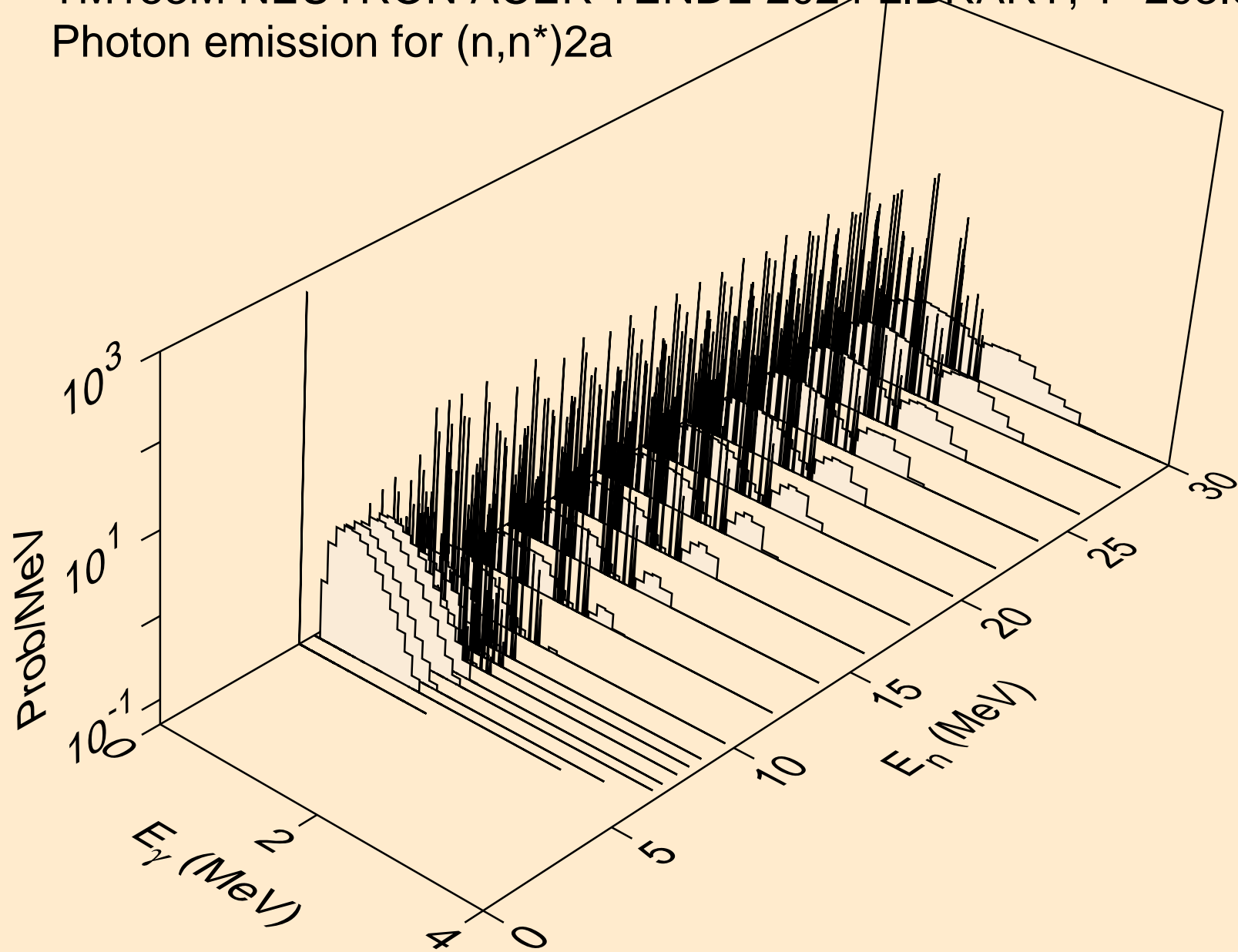

TM153M NEUTRON ACER TENDL-2024 LIBRARY; T=293.6K
Photon emission for (n,n*)d

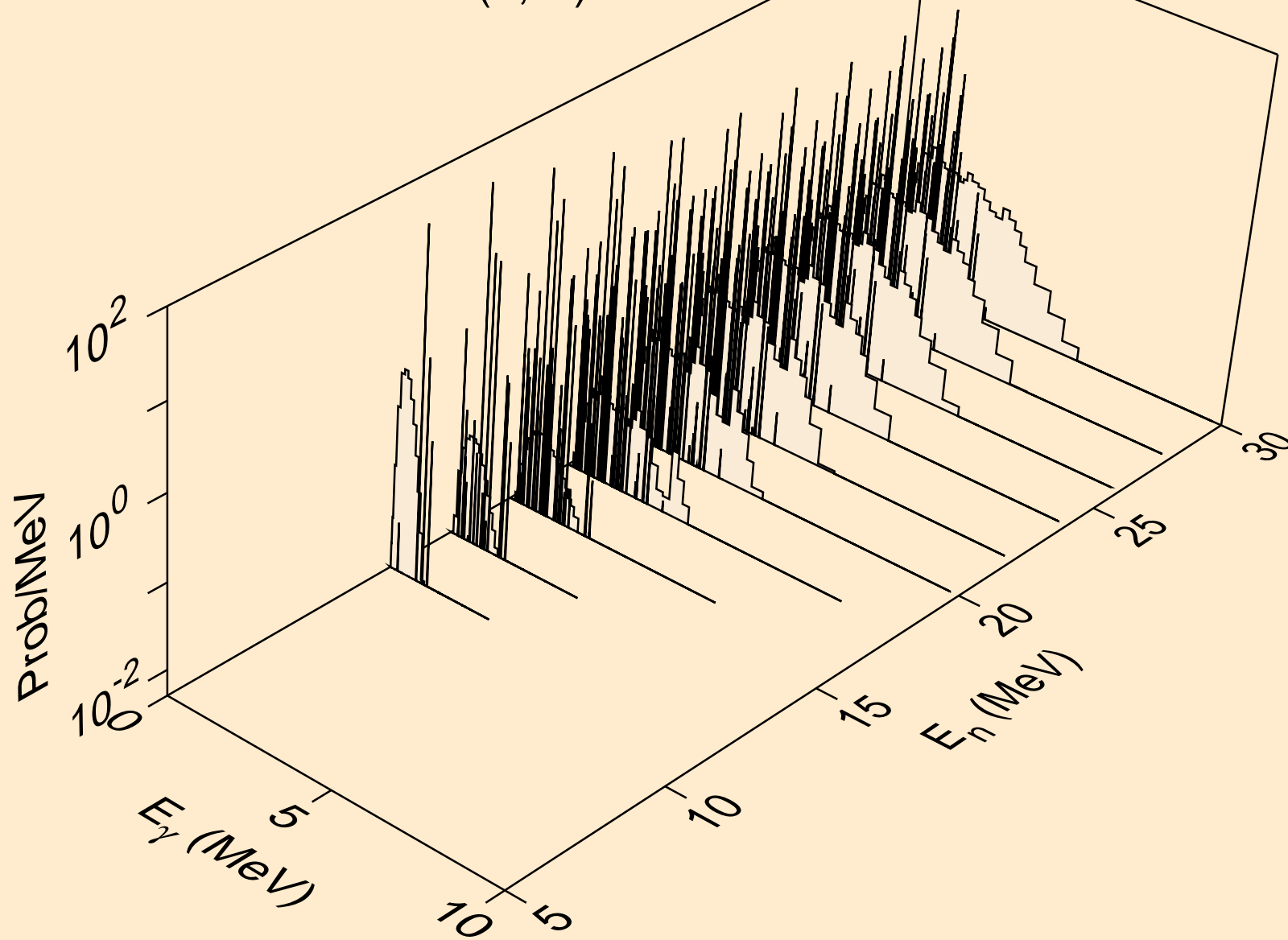

TM153M NEUTRON ACER TENDL-2024 LIBRARY; T=293.6K
Photon emission for (n,n*)t

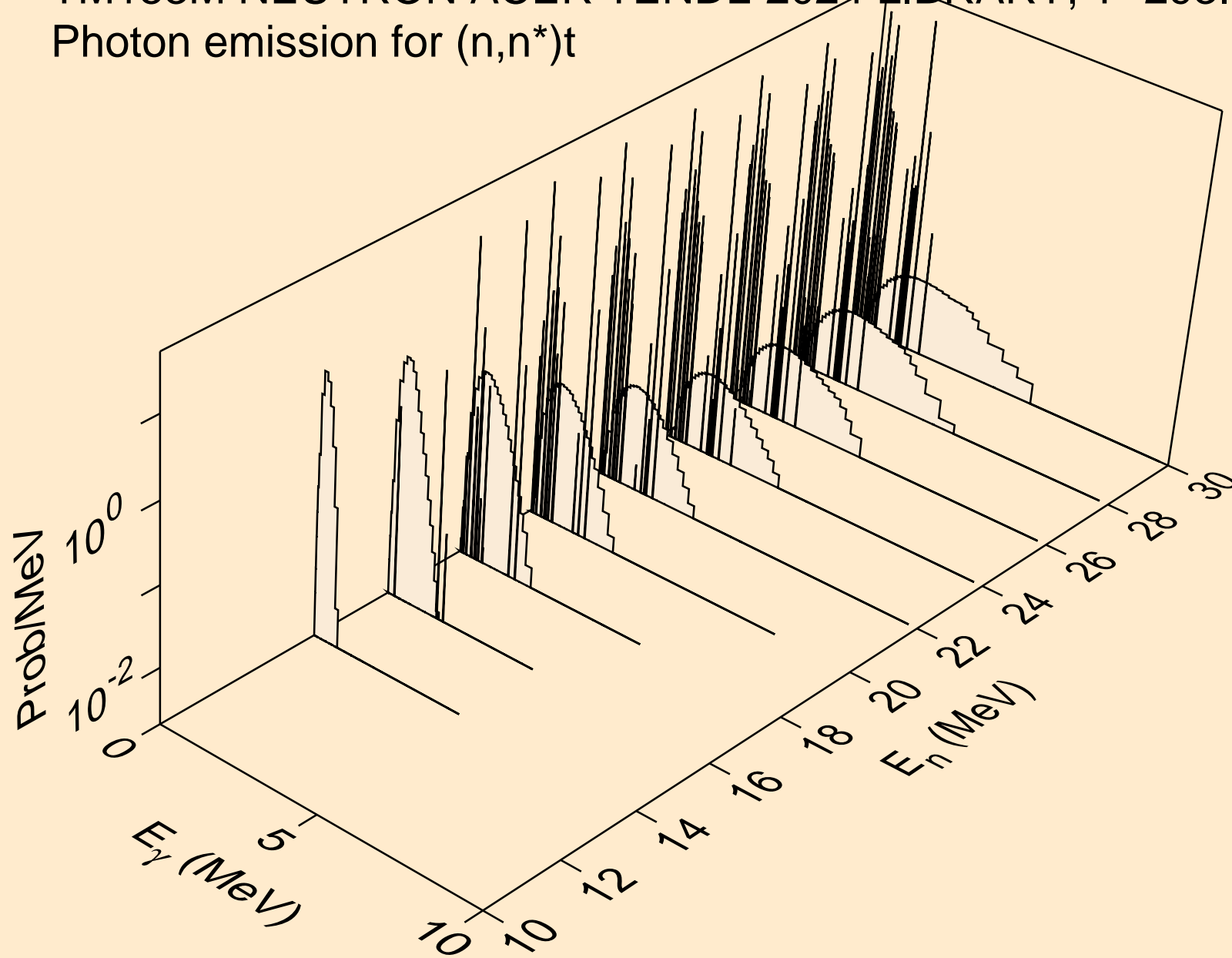

TM153M NEUTRON ACER TENDL-2024 LIBRARY; T=293.6K
Photon emission for (n,n*)he3

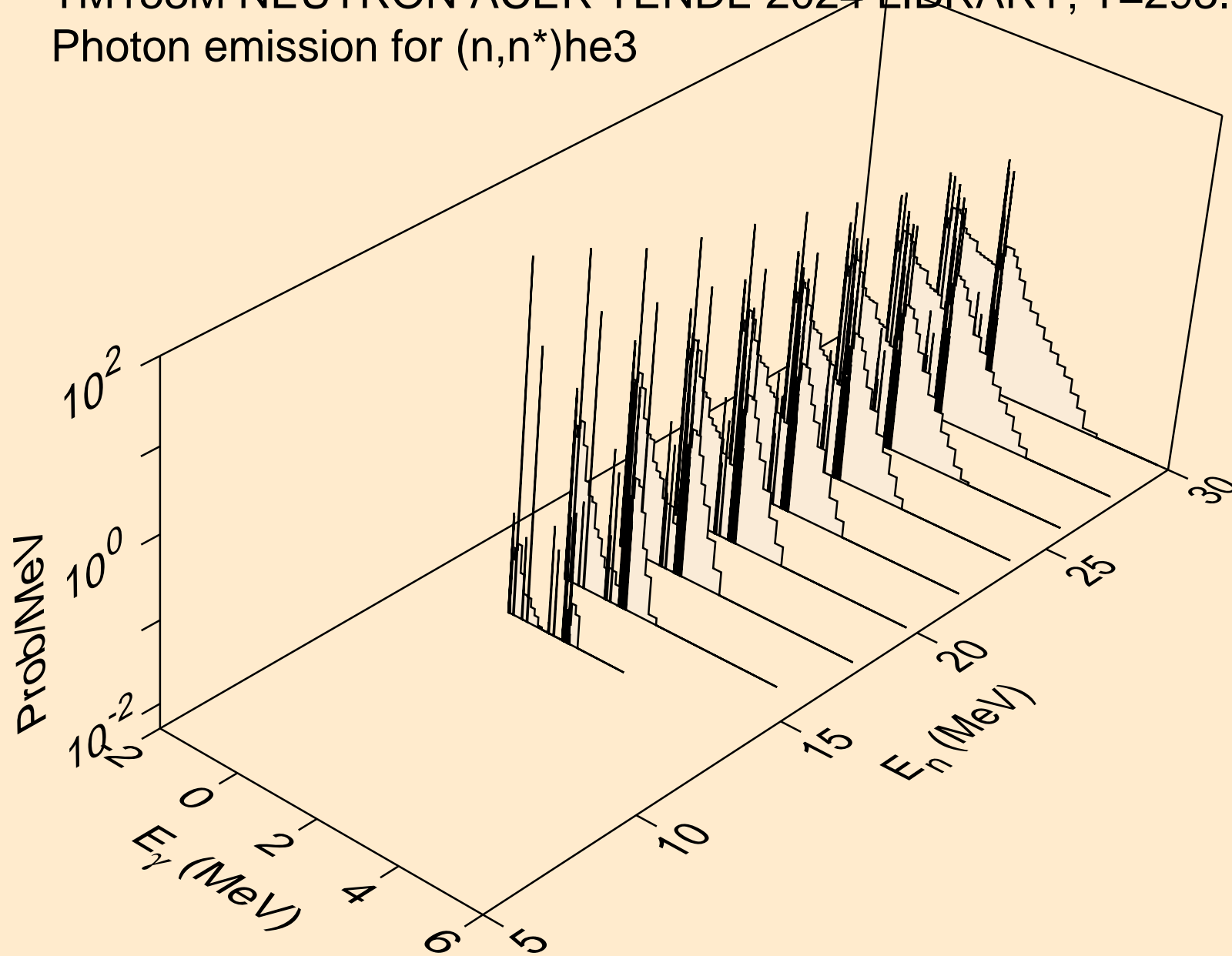

TM153M NEUTRON ACER TENDL-2024 LIBRARY; T=293.6K
Photon emission for (n,2np)

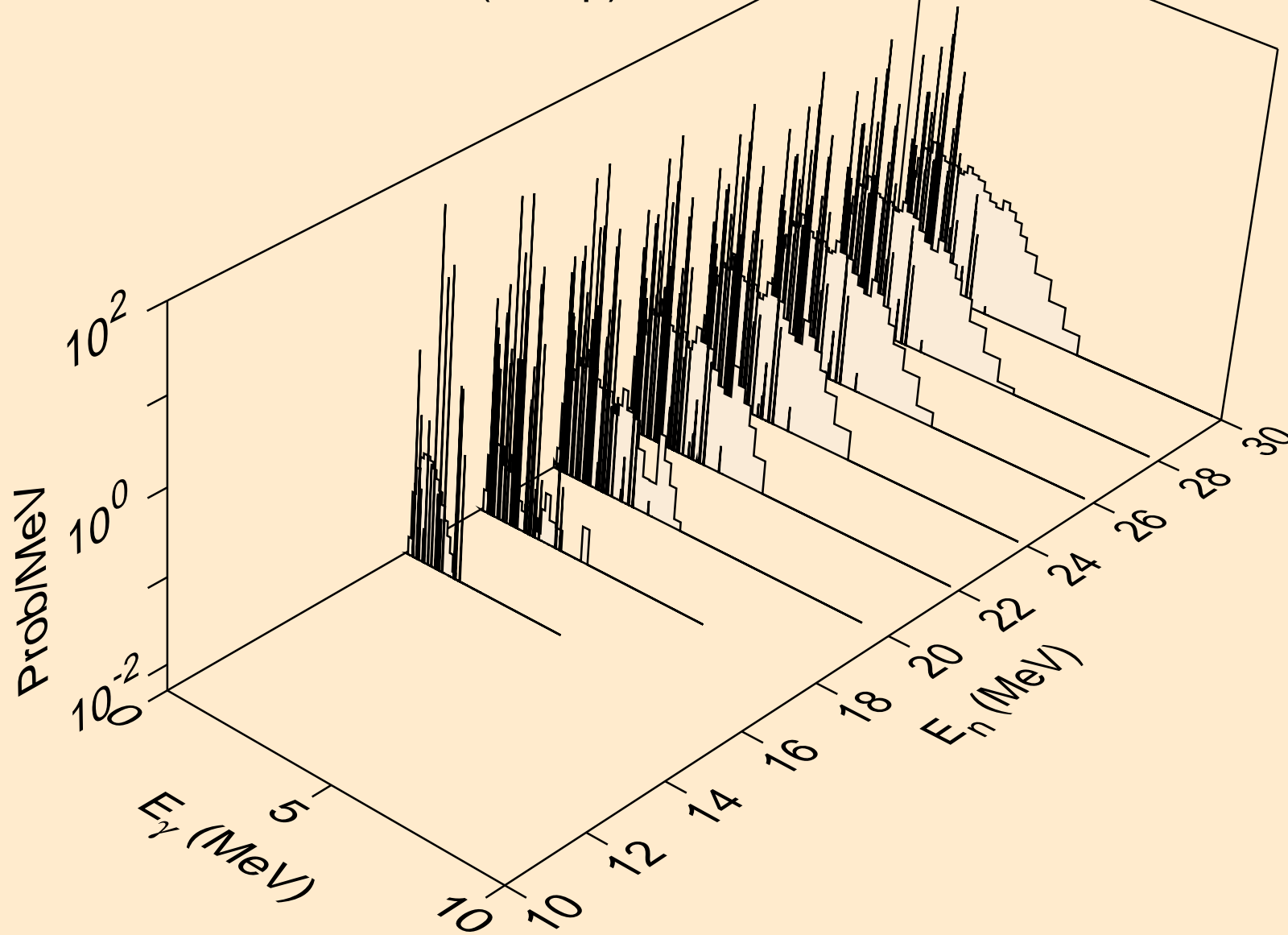

TM153M NEUTRON ACER TENDL-2024 LIBRARY; T=293.6K
Photon emission for (n,3np)

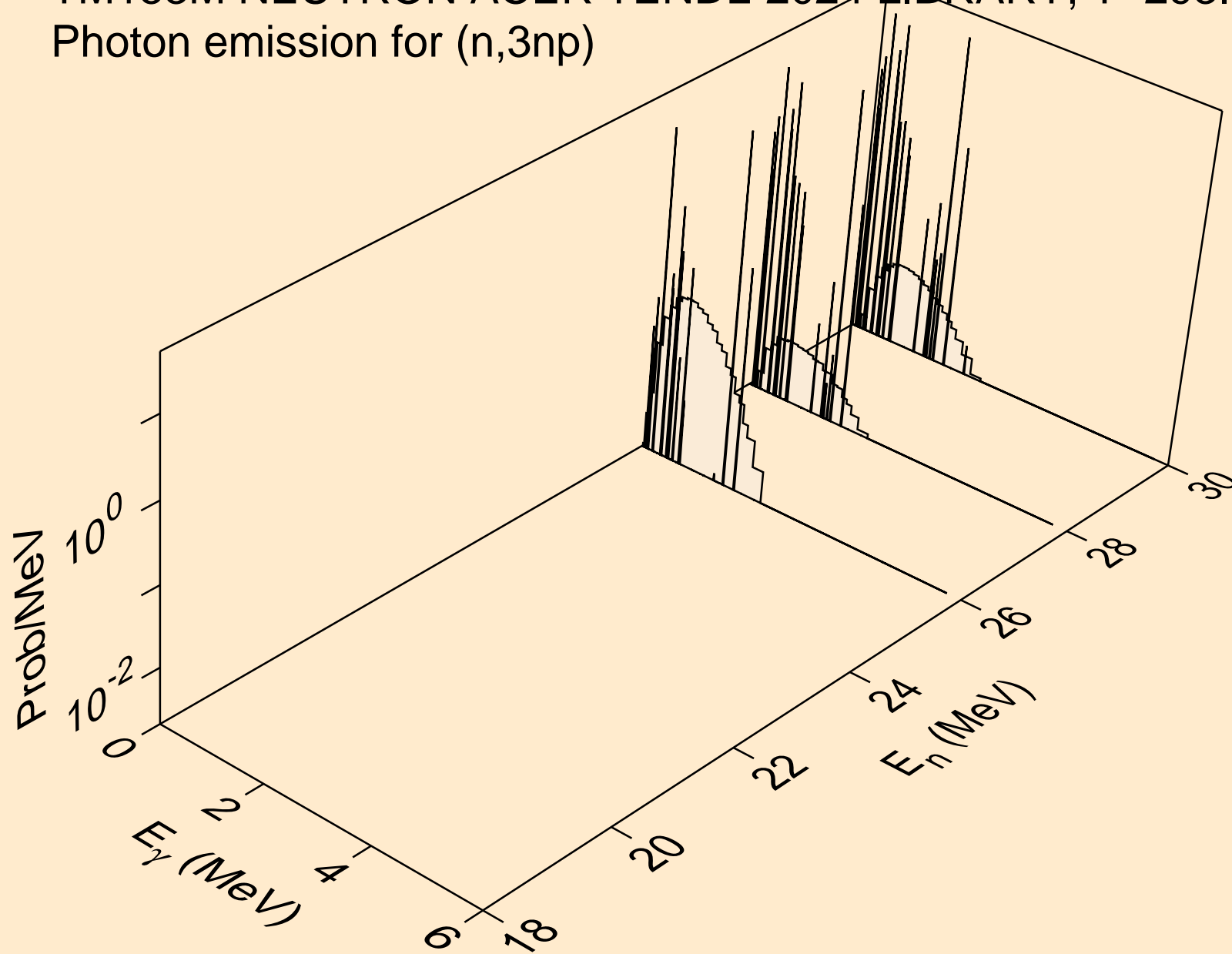

TM153M NEUTRON ACER TENDL-2024 LIBRARY; T=293.6K
Photon emission for (n,n2p)

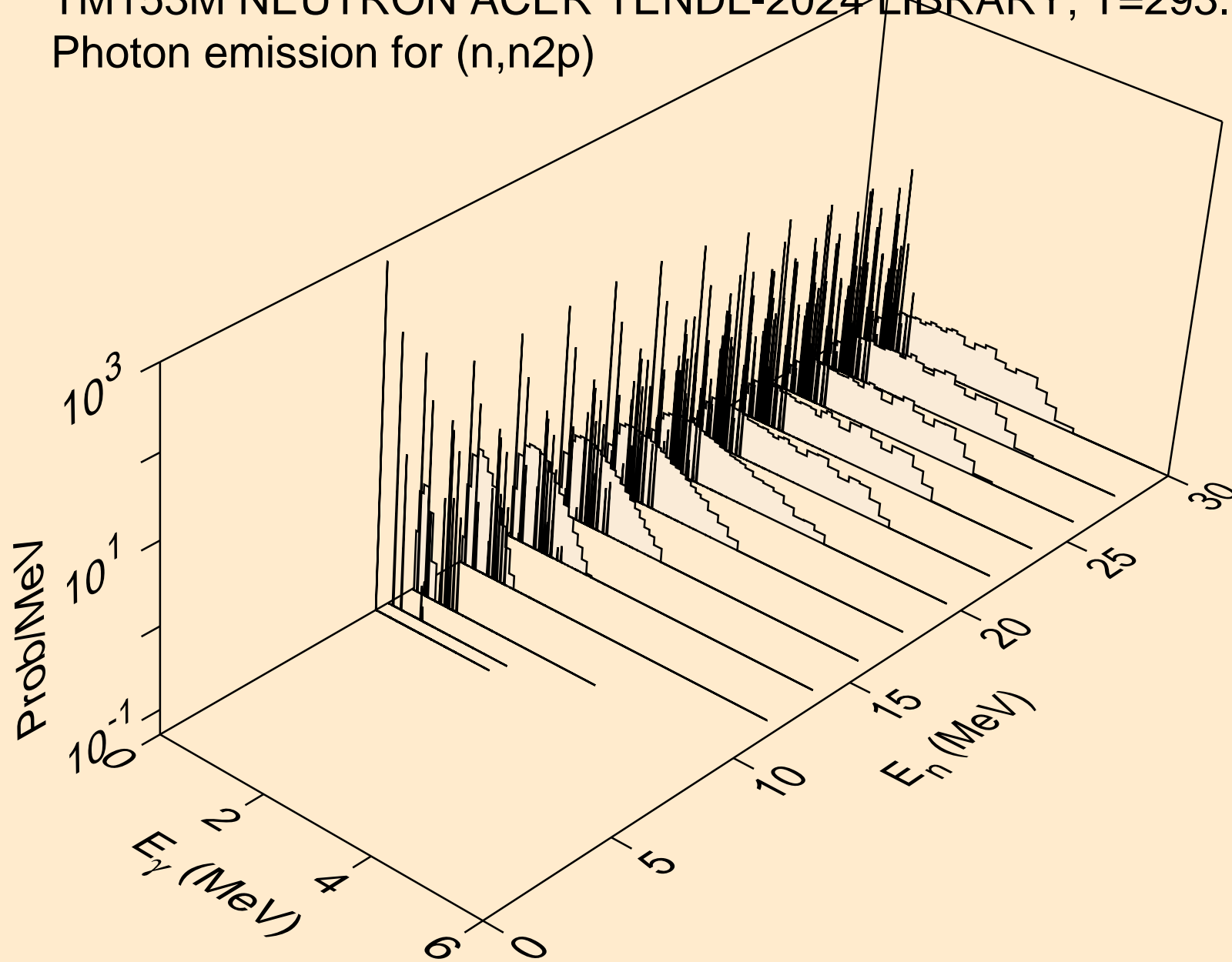

TM153M NEUTRON ACER TENDL-2024 LIBRARY; T=293.6K
Photon emission for (n,npa)

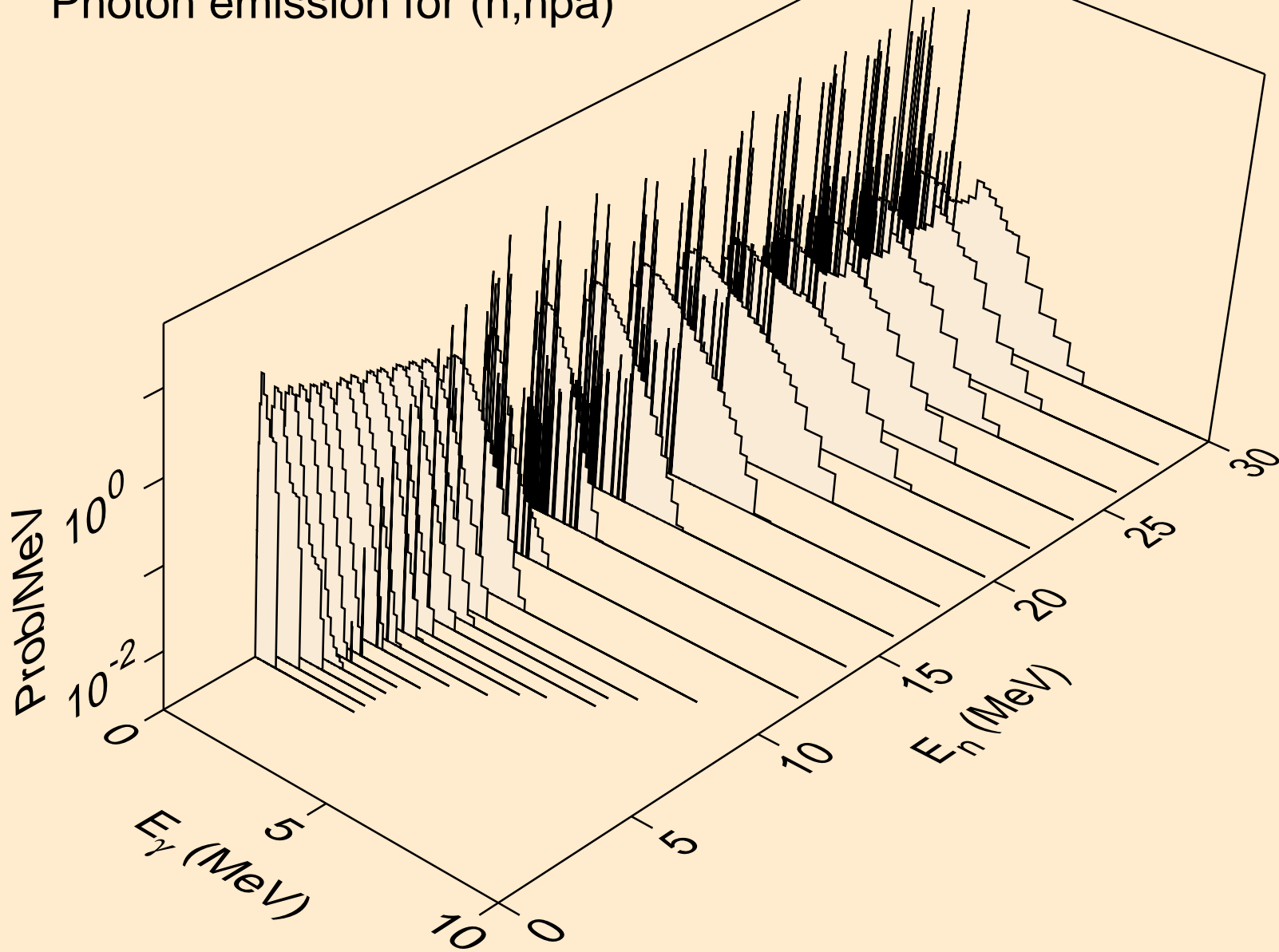

TM153M NEUTRON ACER TENDL-2024 LIBRARY; T=293.6K
Photon emission for (n,n*2)

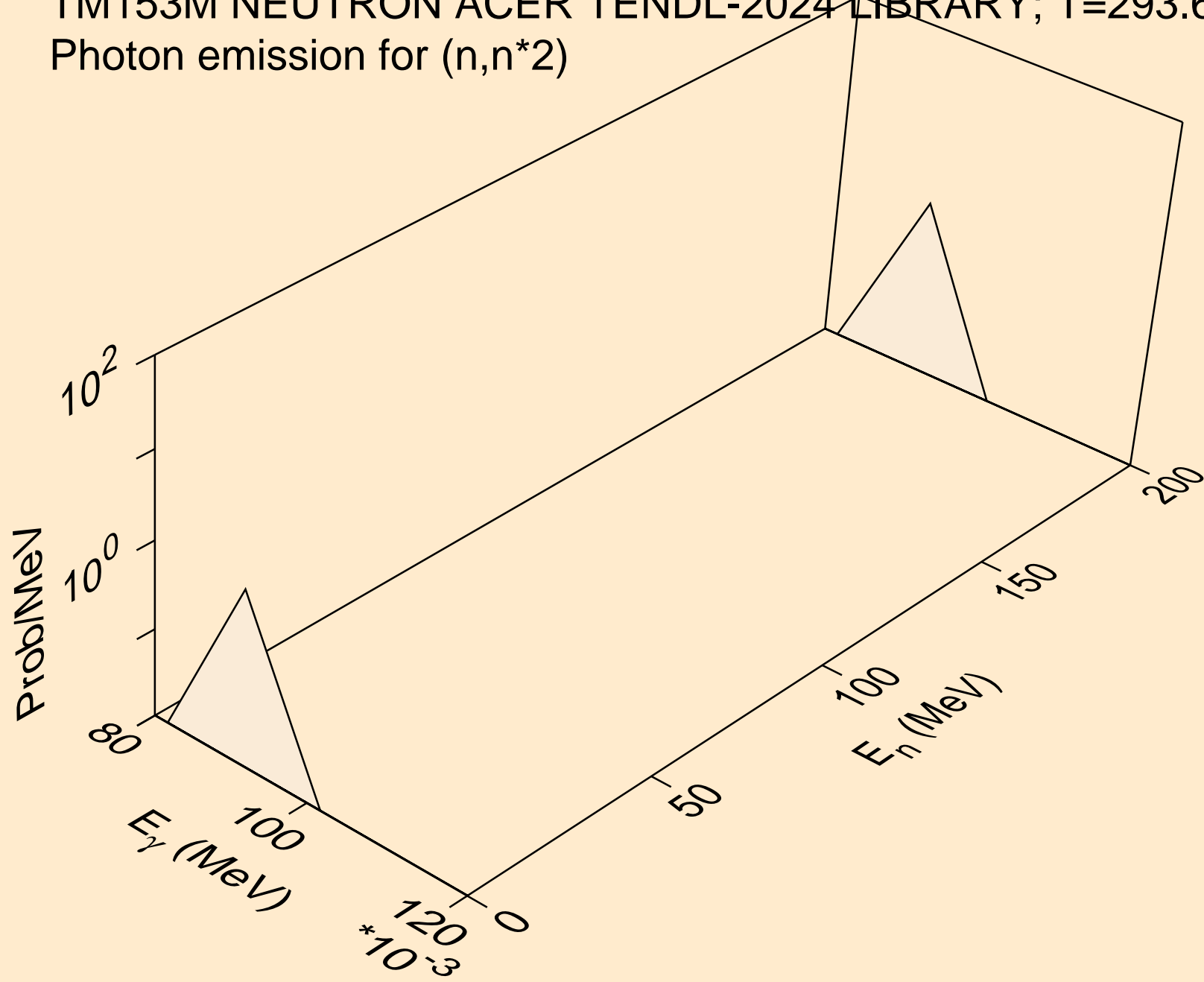

TM153M NEUTRON ACER TENDL-2024 LIBRARY; T=293.6K
Photon emission for (n,n*3)

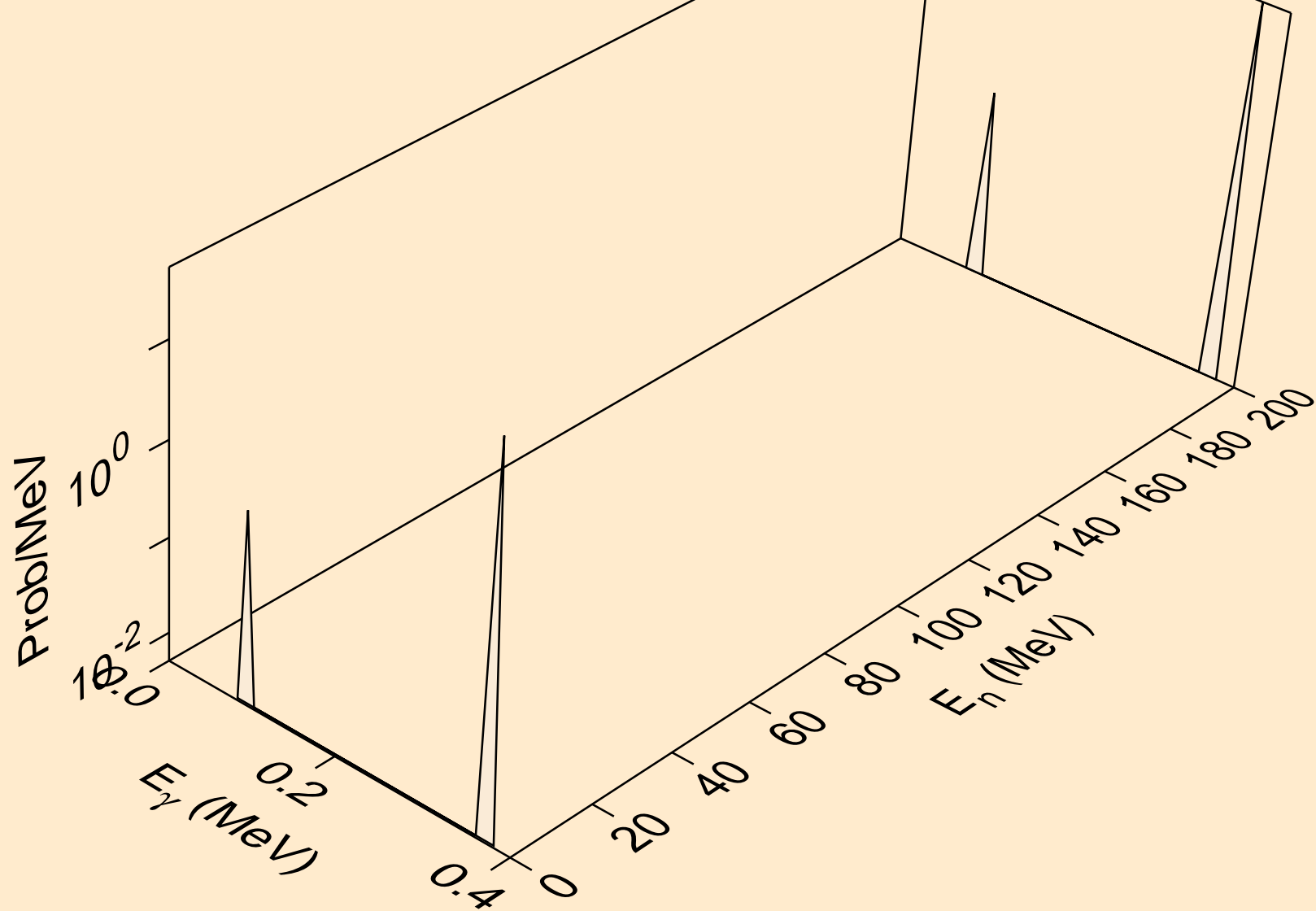

TM153M NEUTRON ACER TENDL-2024 LIBRARY; T=293.6K
Photon emission for (n,n*4)

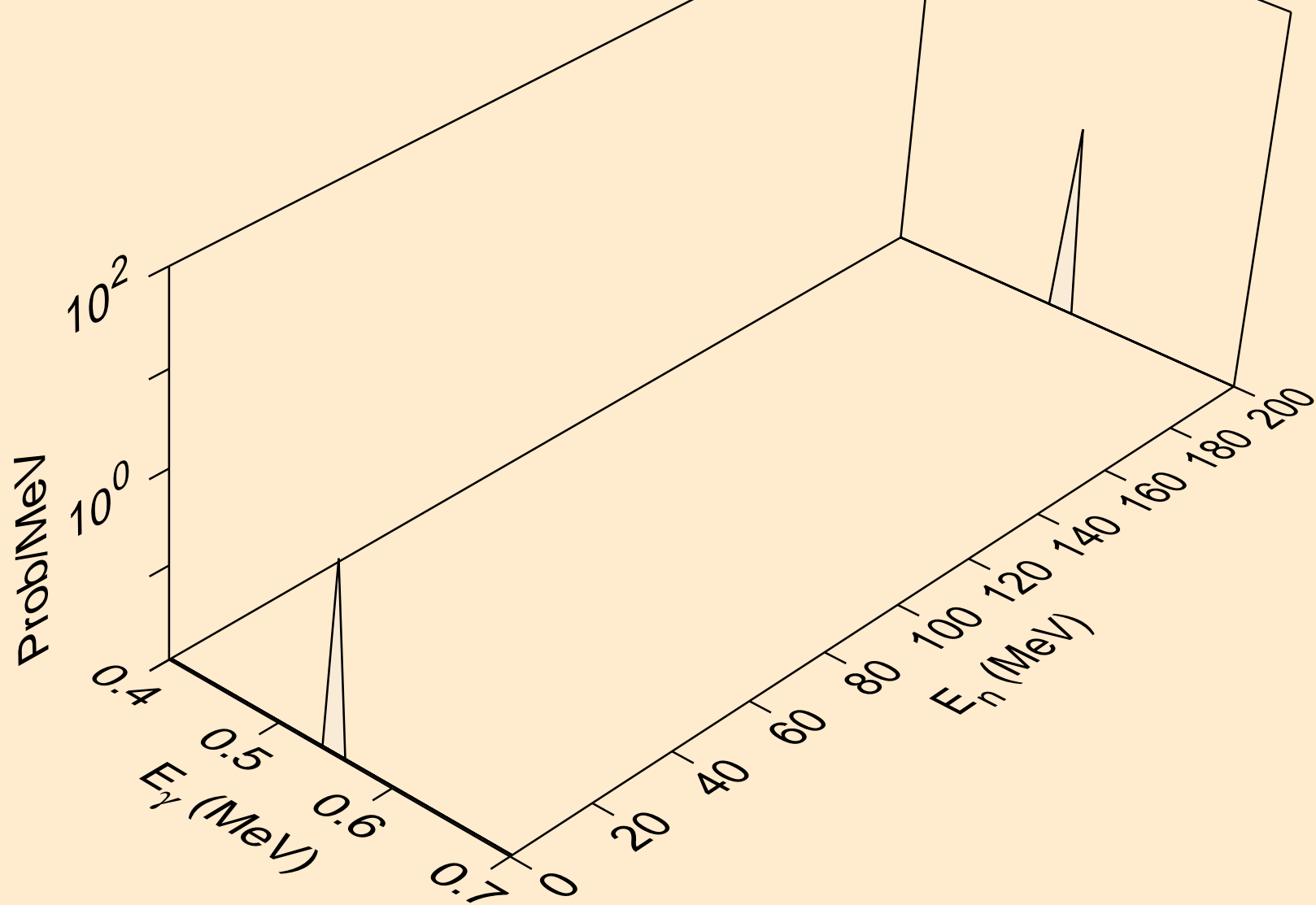

TM153M NEUTRON ACER TENDL-2024 LIBRARY; T=293.6K
Photon emission for (n,n*5)

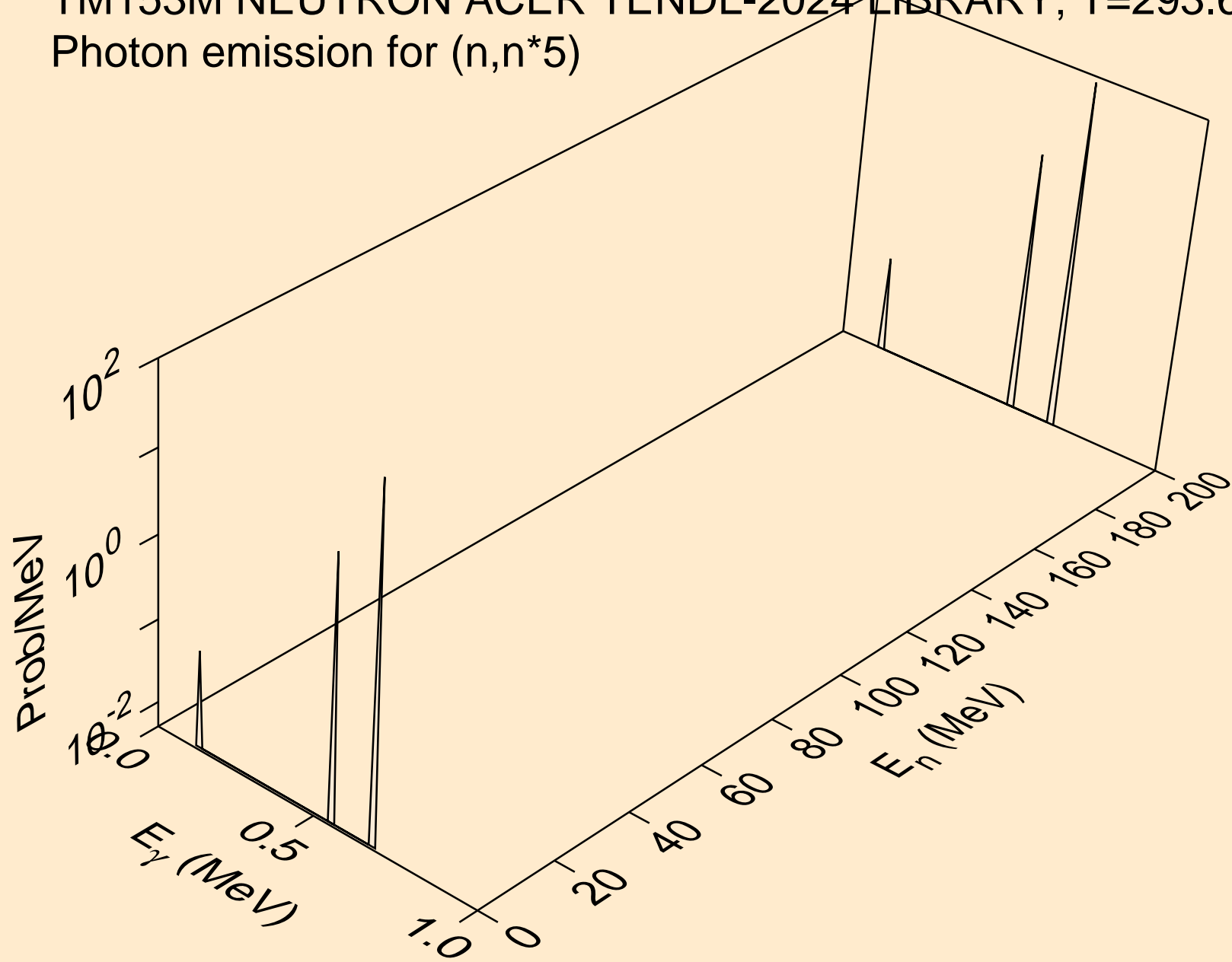

TM153M NEUTRON ACER TENDL-2024 LIBRARY; T=293.6K
Photon emission for (n,n*6)

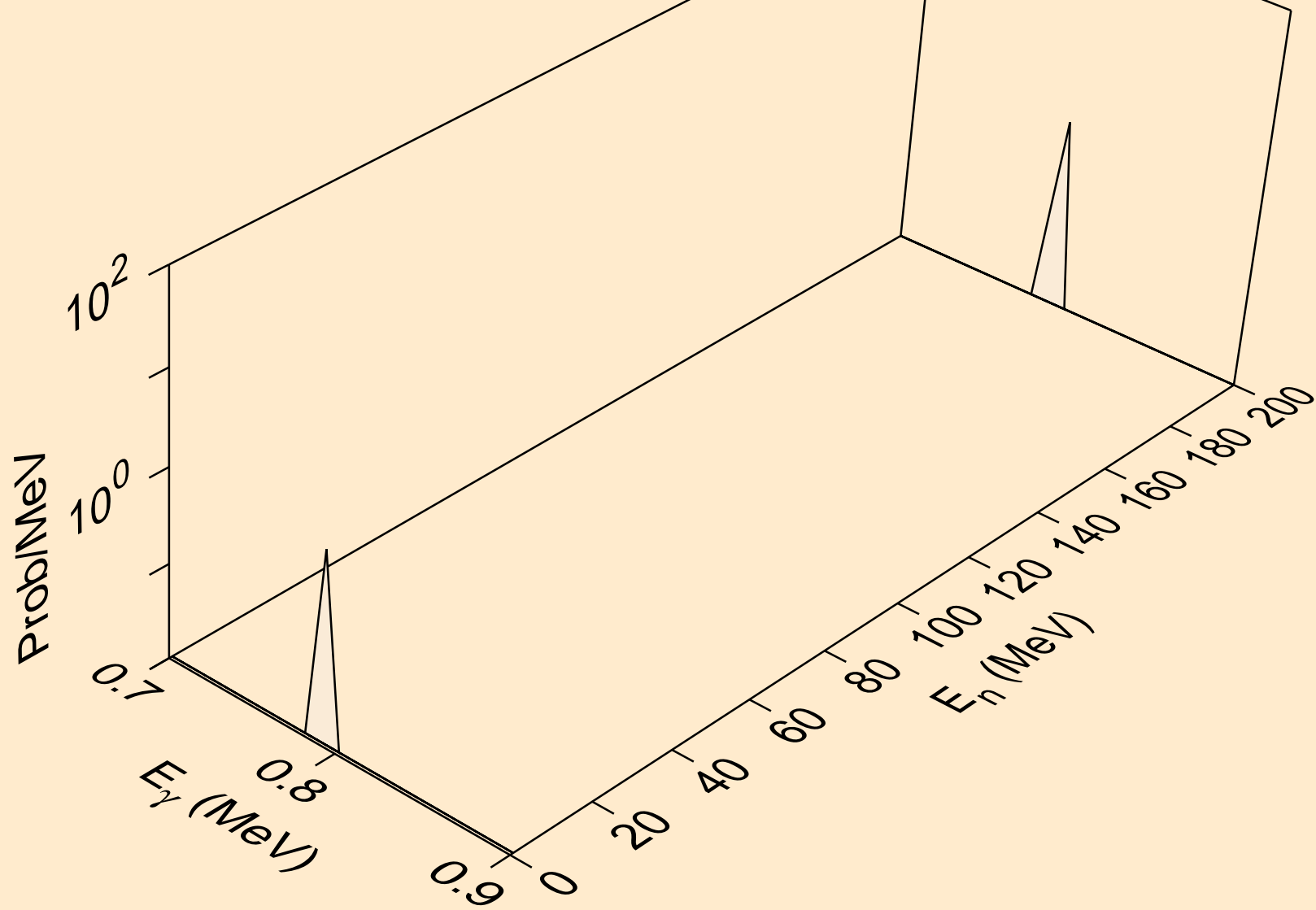

TM153M NEUTRON ACER TENDL-2024 LIBRARY; T=293.6K
Photon emission for (n,n*7)

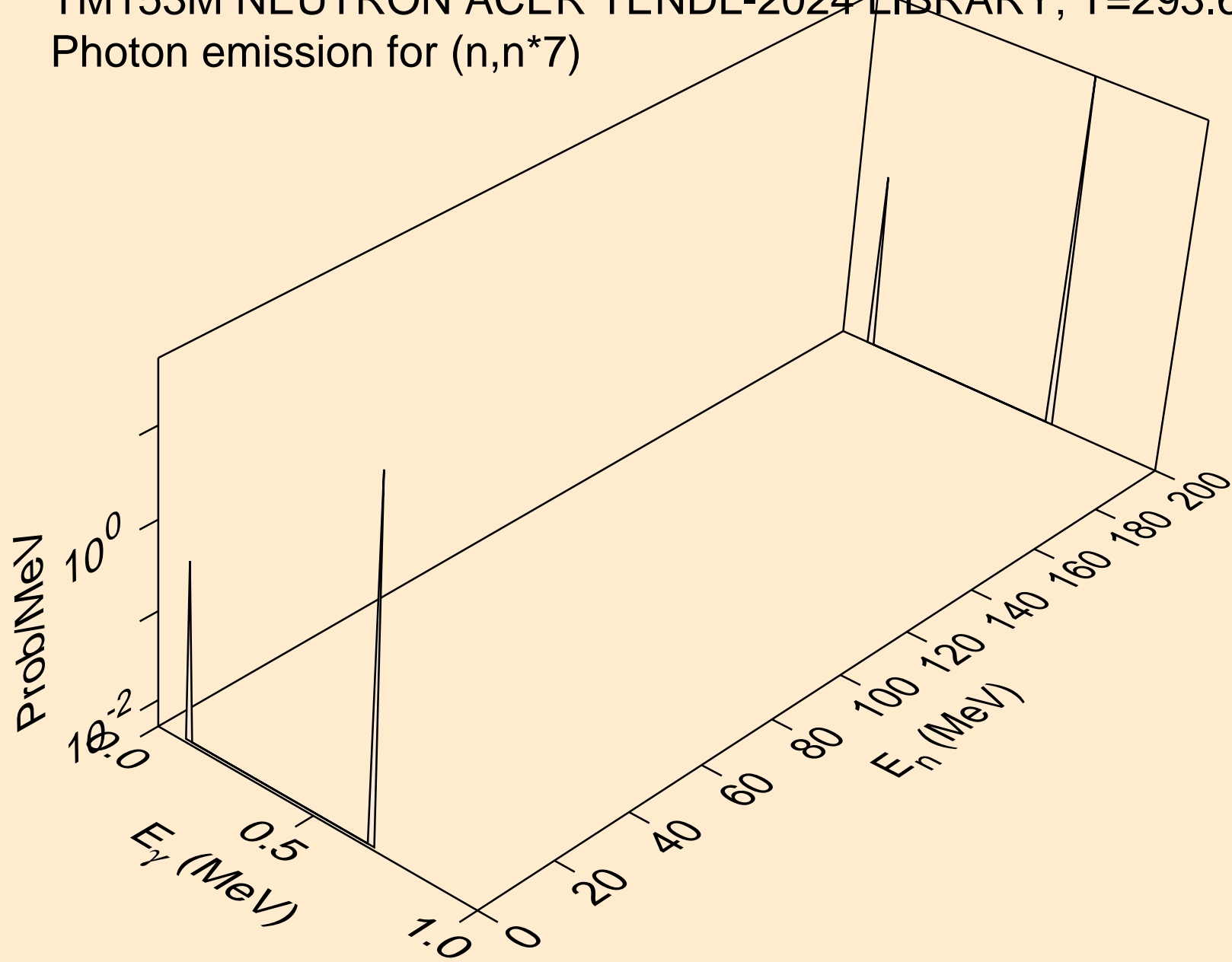

TM153M NEUTRON ACER TENDL-2024 LIBRARY; T=293.6K
Photon emission for (n,n*8)

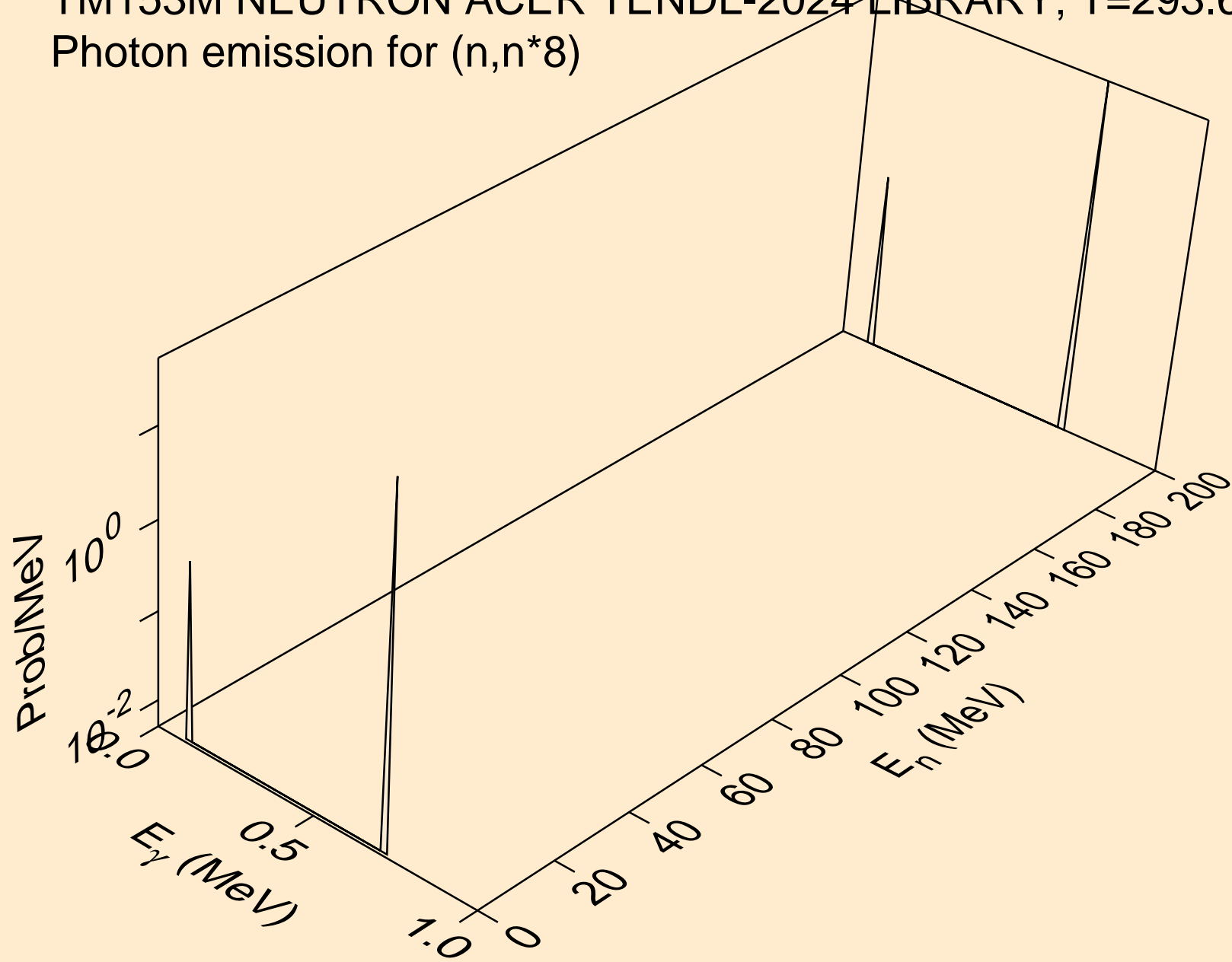

TM153M NEUTRON ACER TENDL-2024 LIBRARY; T=293.6K
Photon emission for (n,n*9)

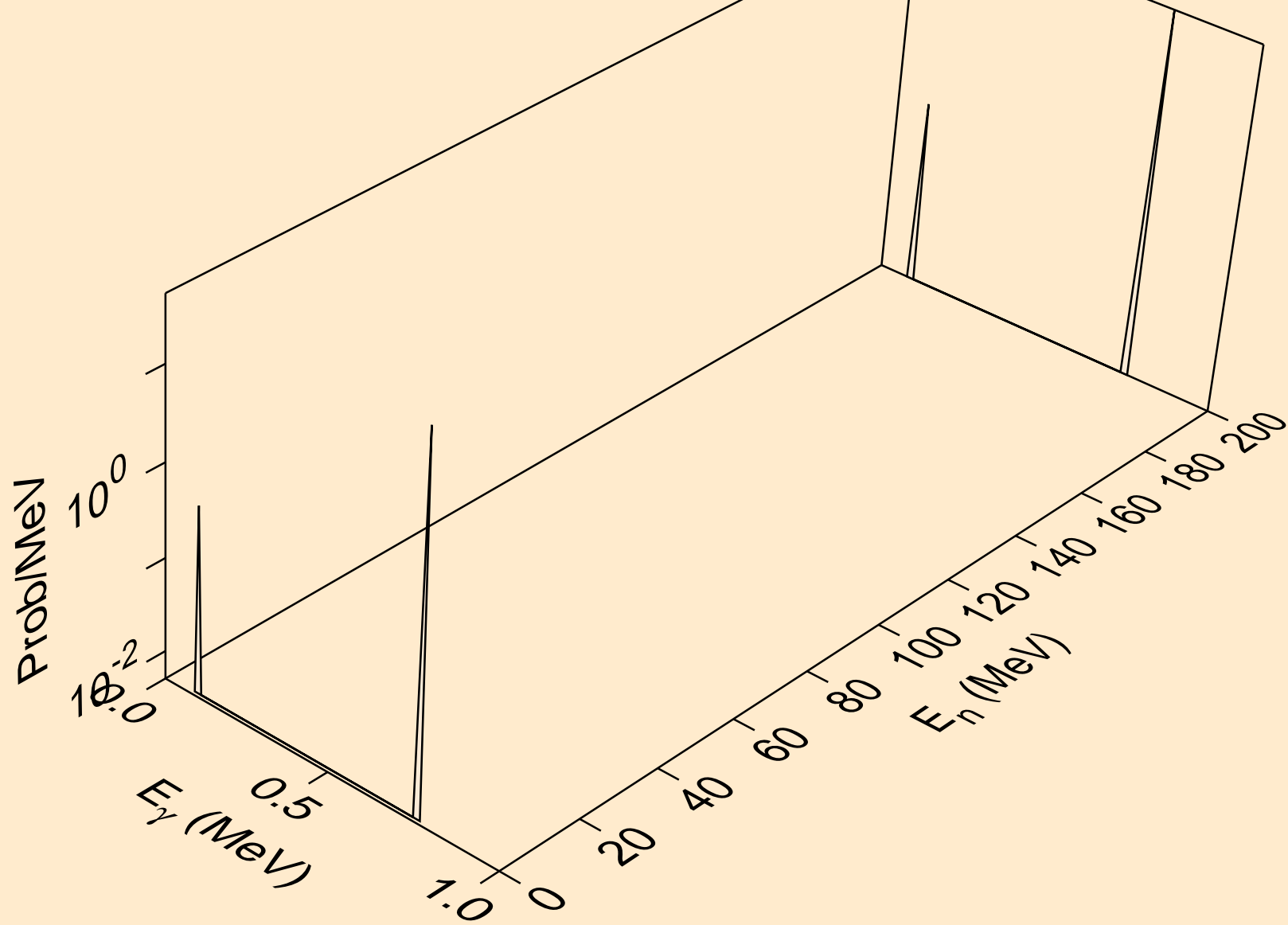

TM153M NEUTRON ACER TENDL-2024 LIBRARY; T=293.6K
Photon emission for (n,n*10)

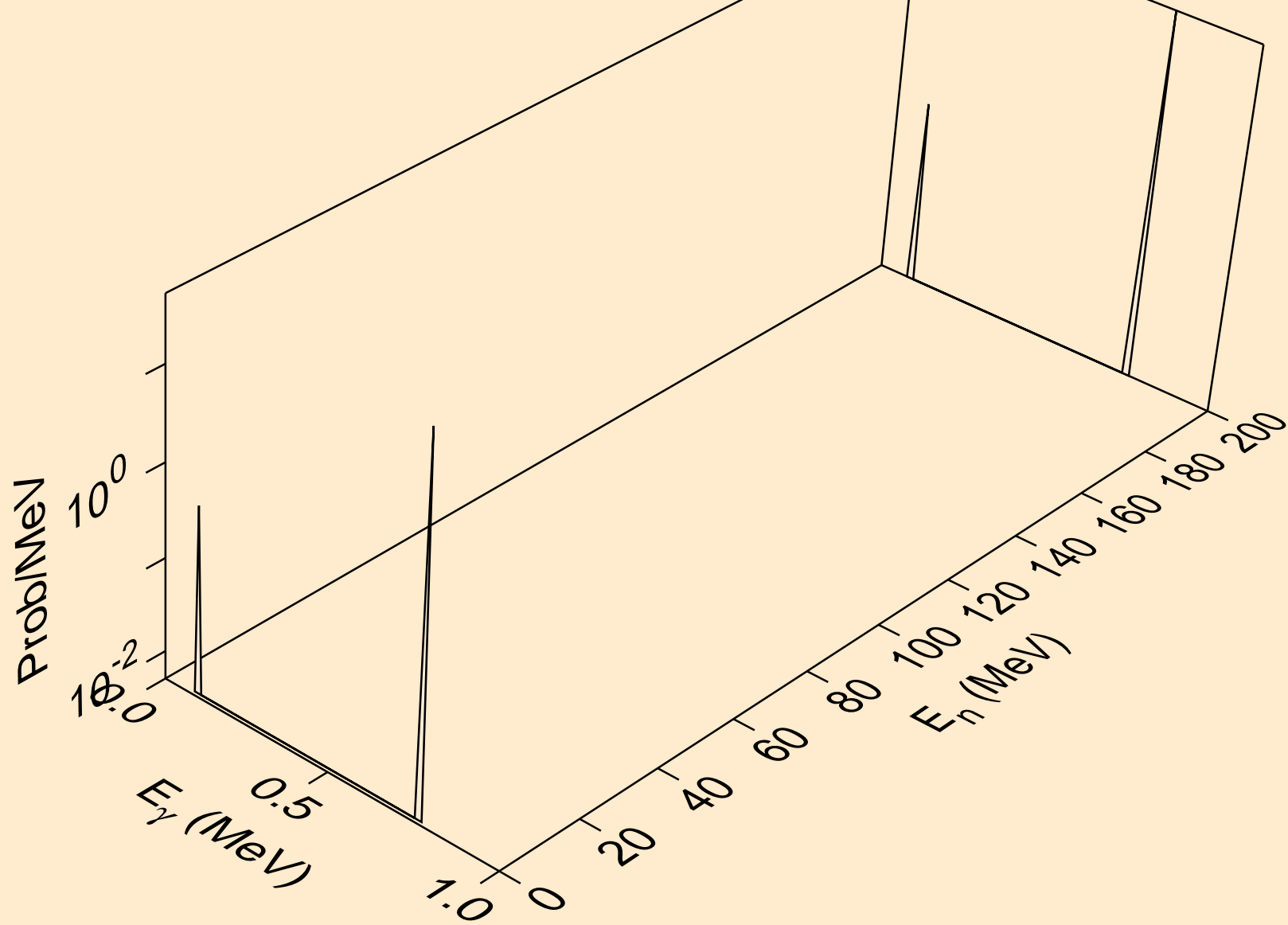

TM153M NEUTRON ACER TENDL-2024 LIBRARY; T=293.6K
Photon emission for (n,n*11)

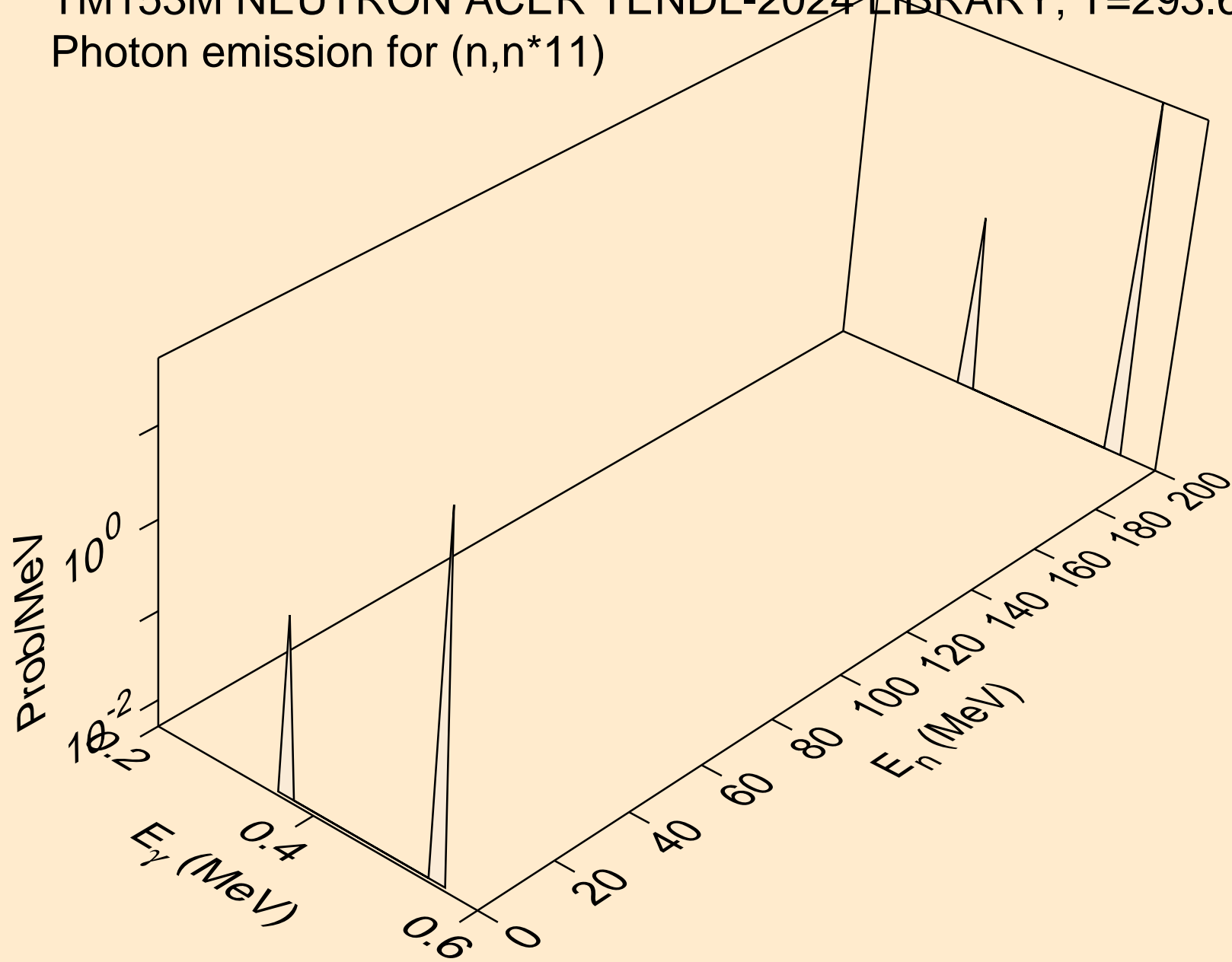

TM153M NEUTRON ACER TENDL-2024 LIBRARY; T=293.6K
Photon emission for (n,n*12)

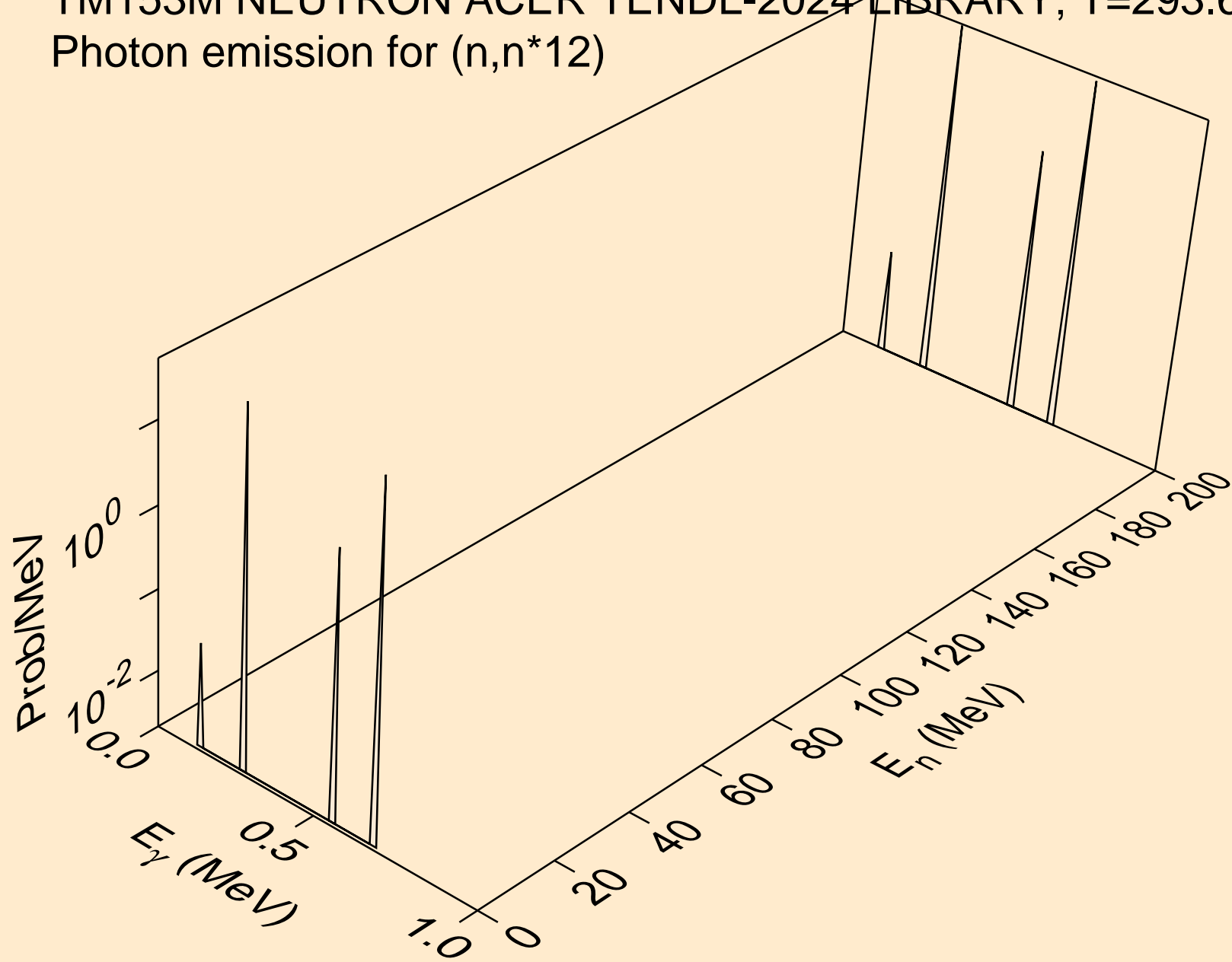

TM153M NEUTRON ACER TENDL-2024 LIBRARY; T=293.6K
Photon emission for (n,n*13)

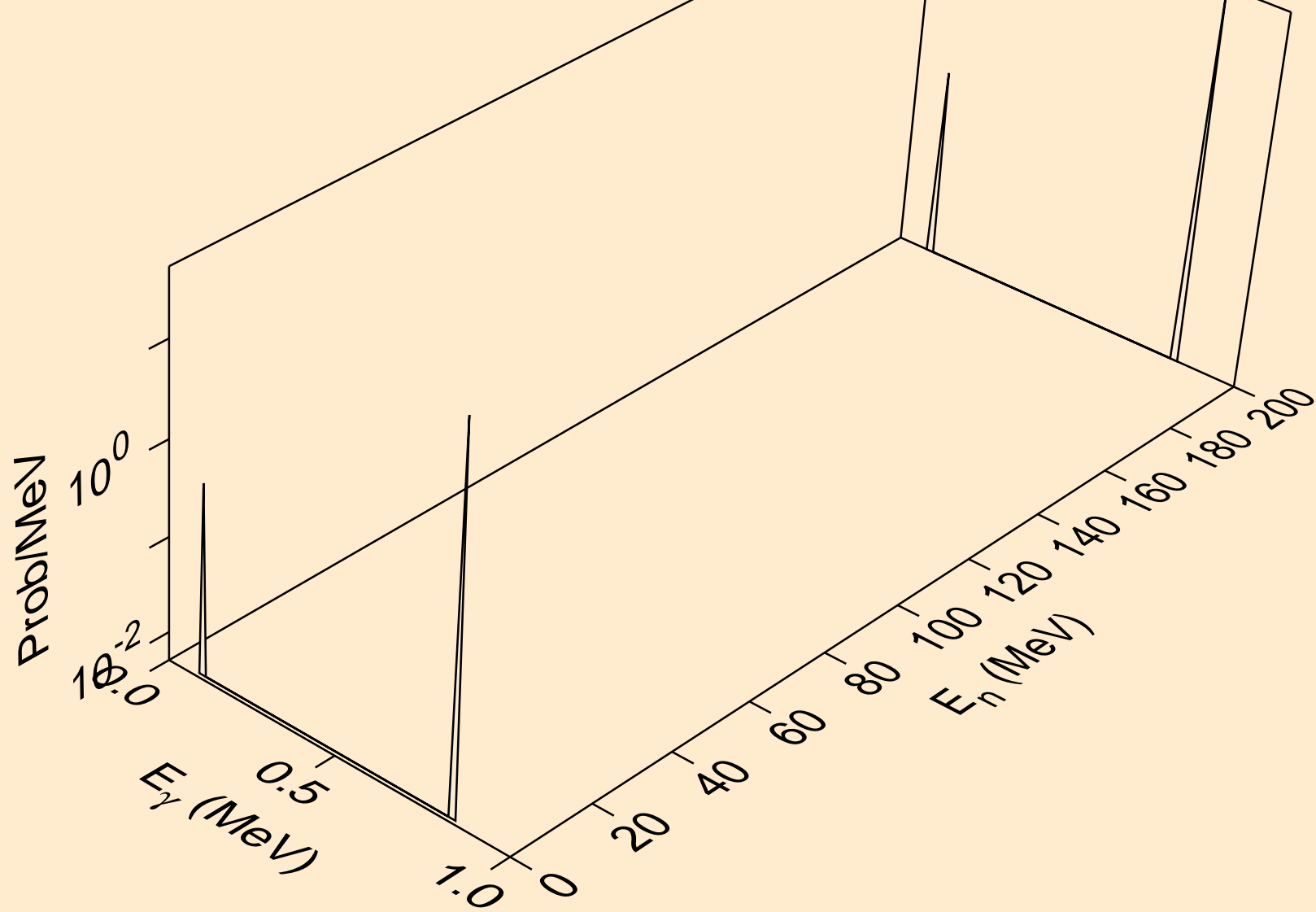

TM153M NEUTRON ACER TENDL-2024 LIBRARY; T=293.6K
Photon emission for (n,n*14)

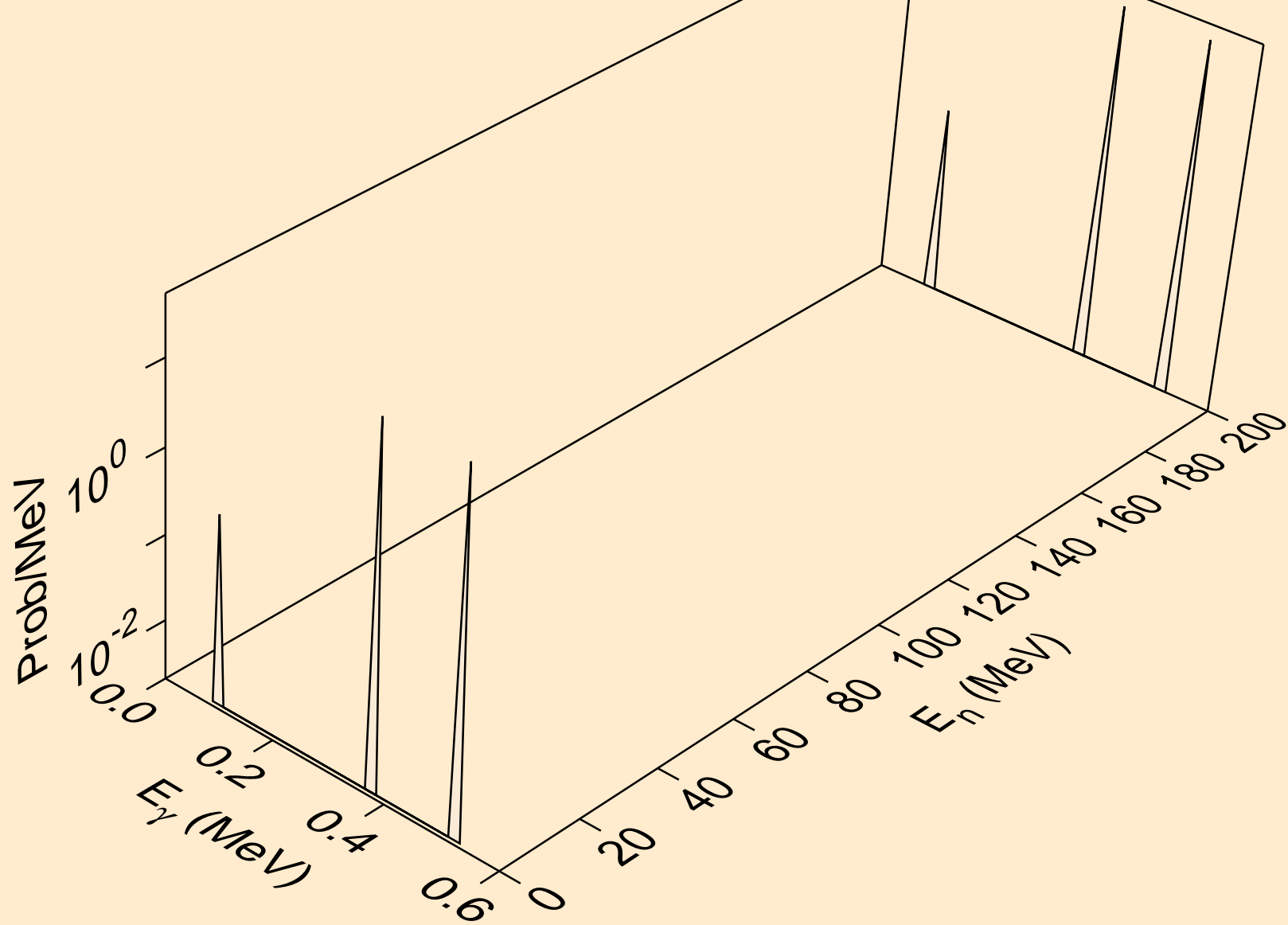

TM153M NEUTRON ACER TENDL-2024 LIBRARY; T=293.6K
Photon emission for (n,n*15)

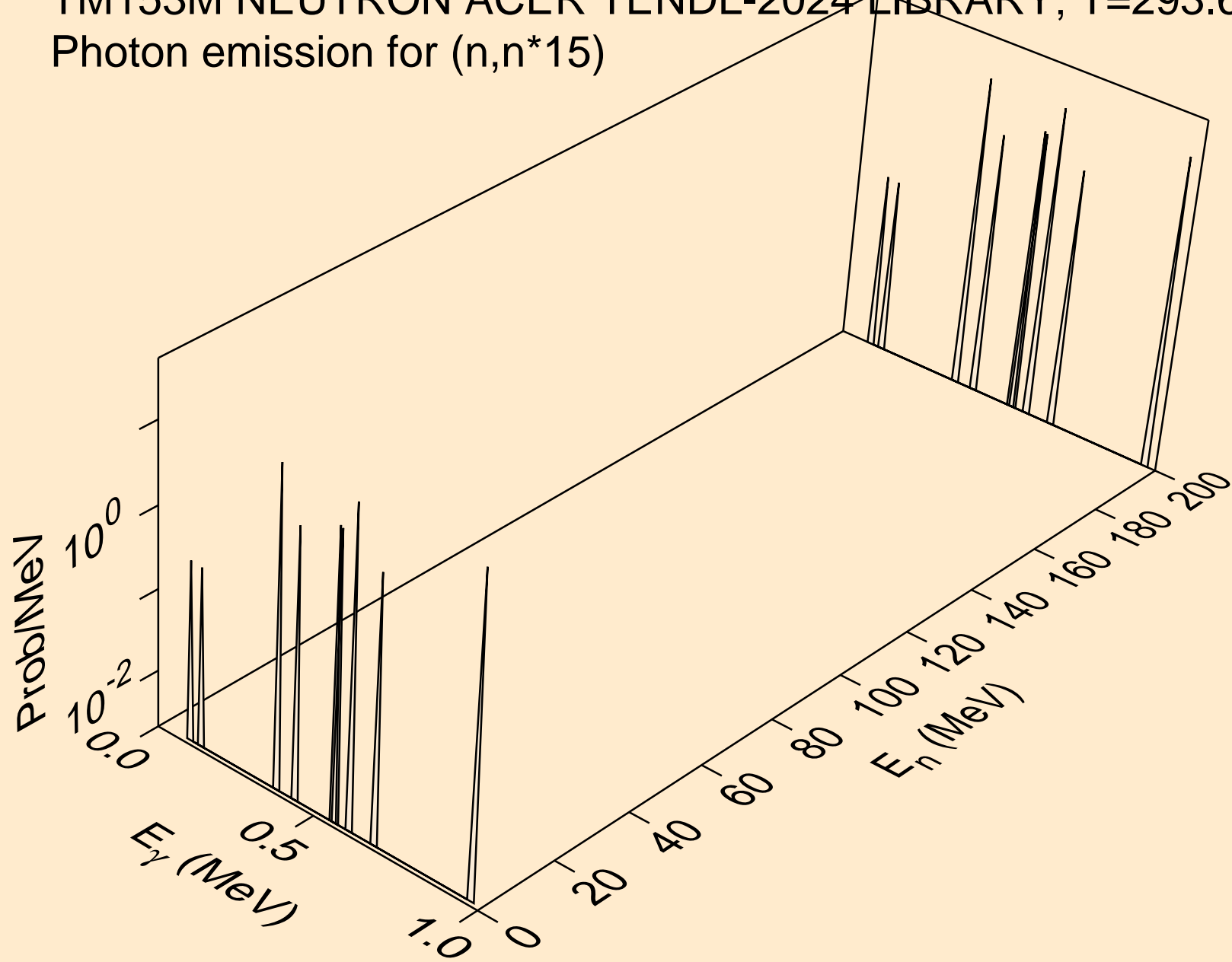

TM153M NEUTRON ACER TENDL-2024 LIBRARY; T=293.6K
Photon emission for (n,n*16)

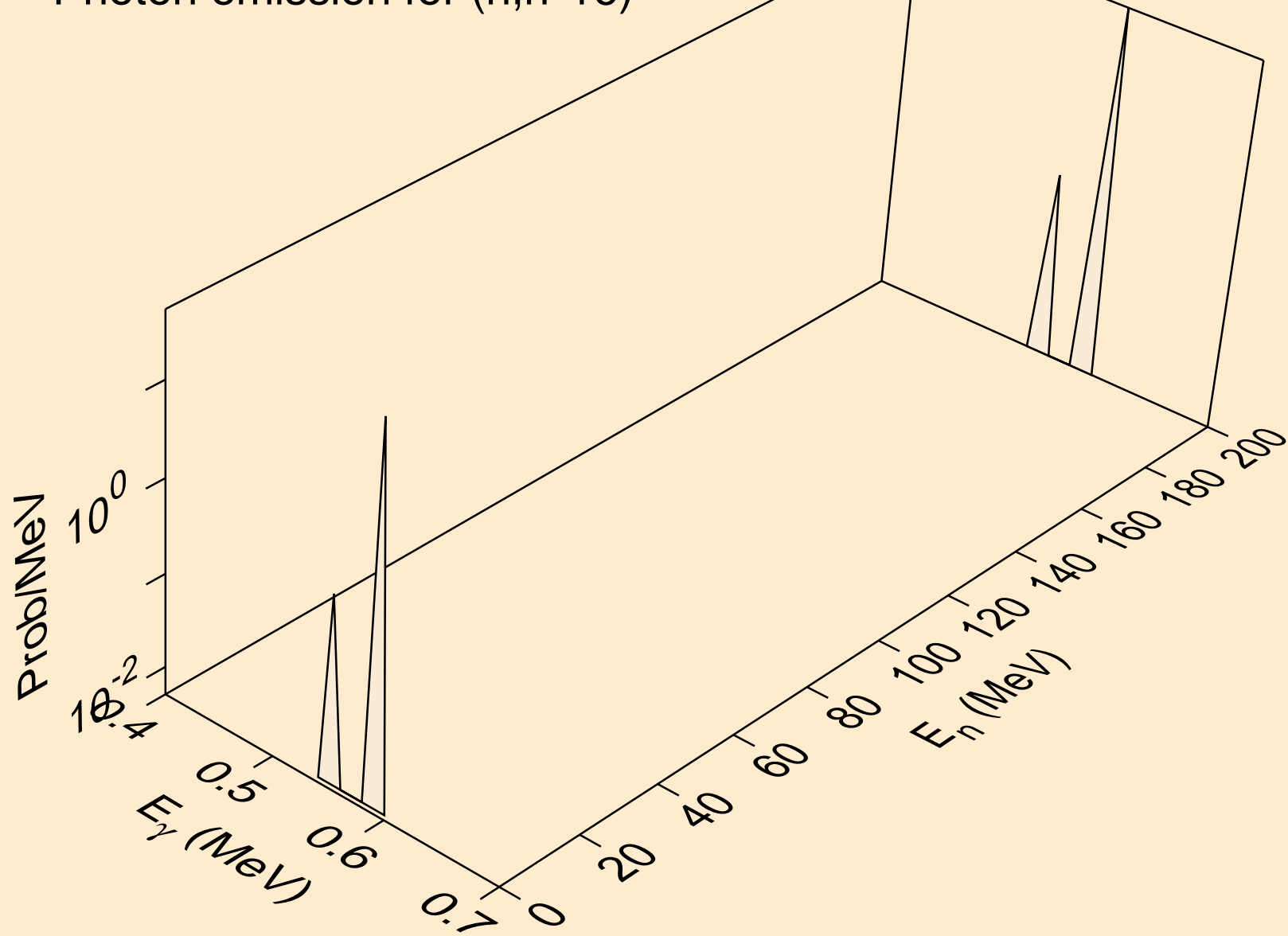

TM153M NEUTRON ACER TENDL-2024 LIBRARY; T=293.6K
Photon emission for (n,n*17)

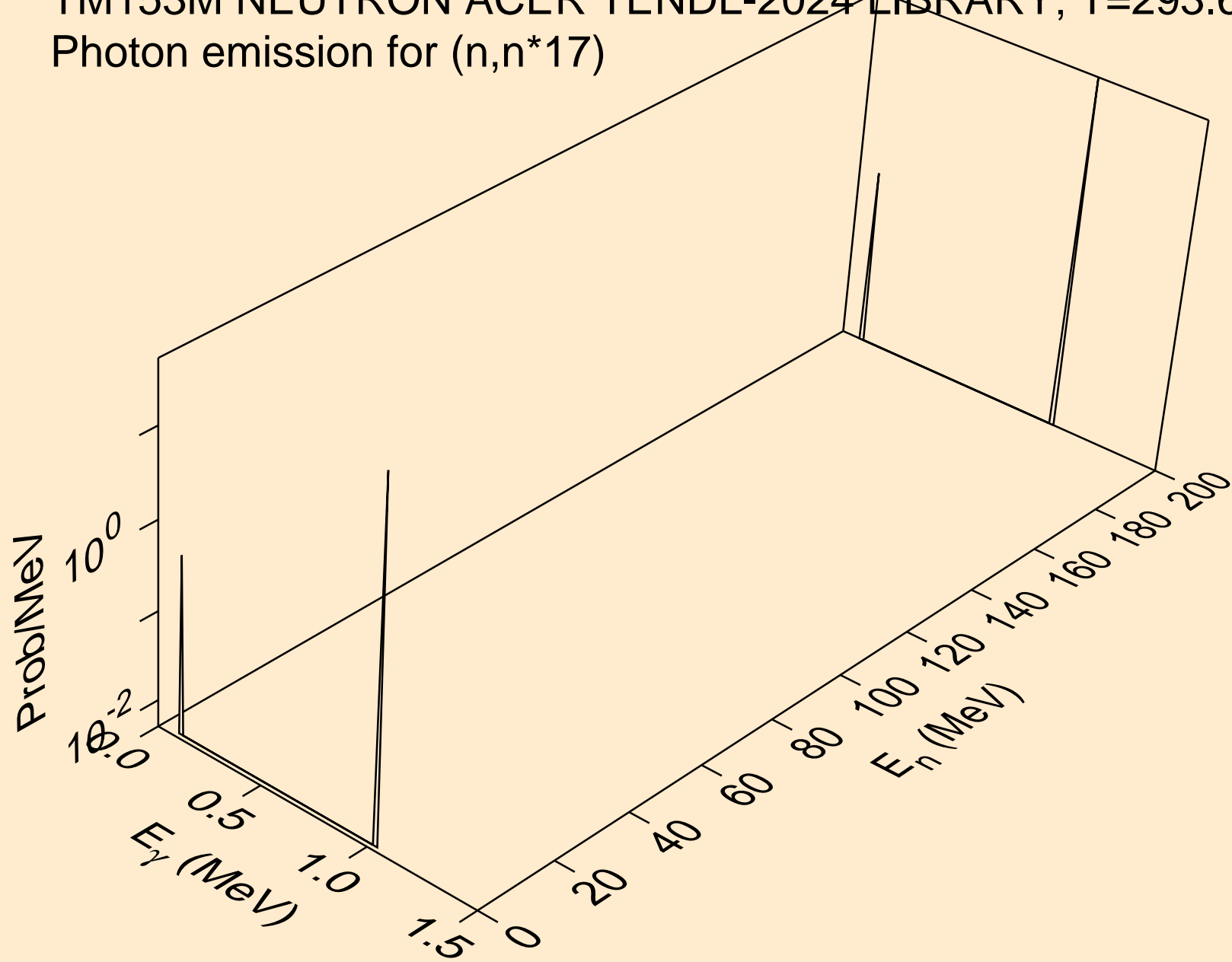

TM153M NEUTRON ACER TENDL-2024 LIBRARY; T=293.6K
Photon emission for (n,n*18)

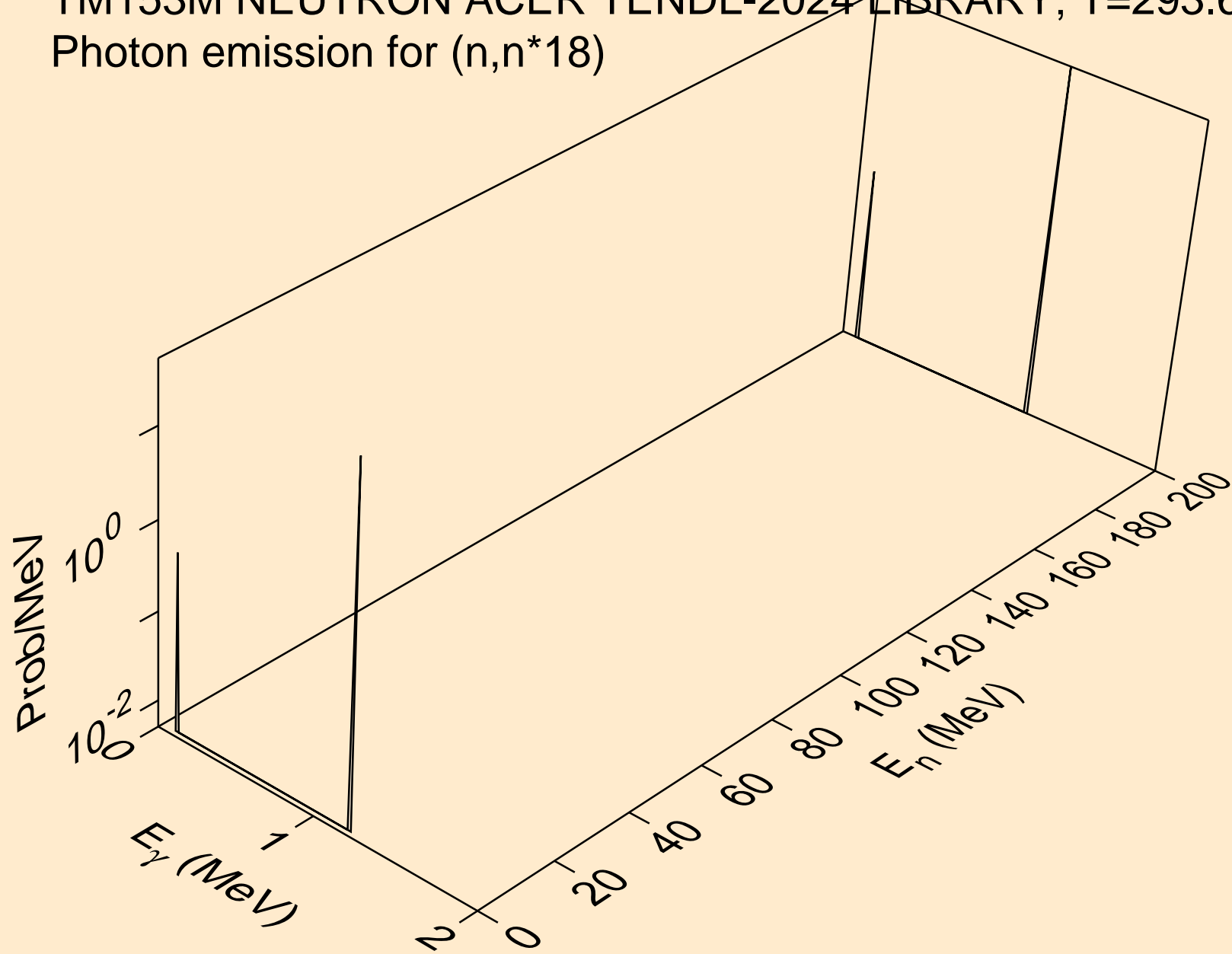

TM153M NEUTRON ACER TENDL-2024 LIBRARY; T=293.6K
Photon emission for (n,n*19)

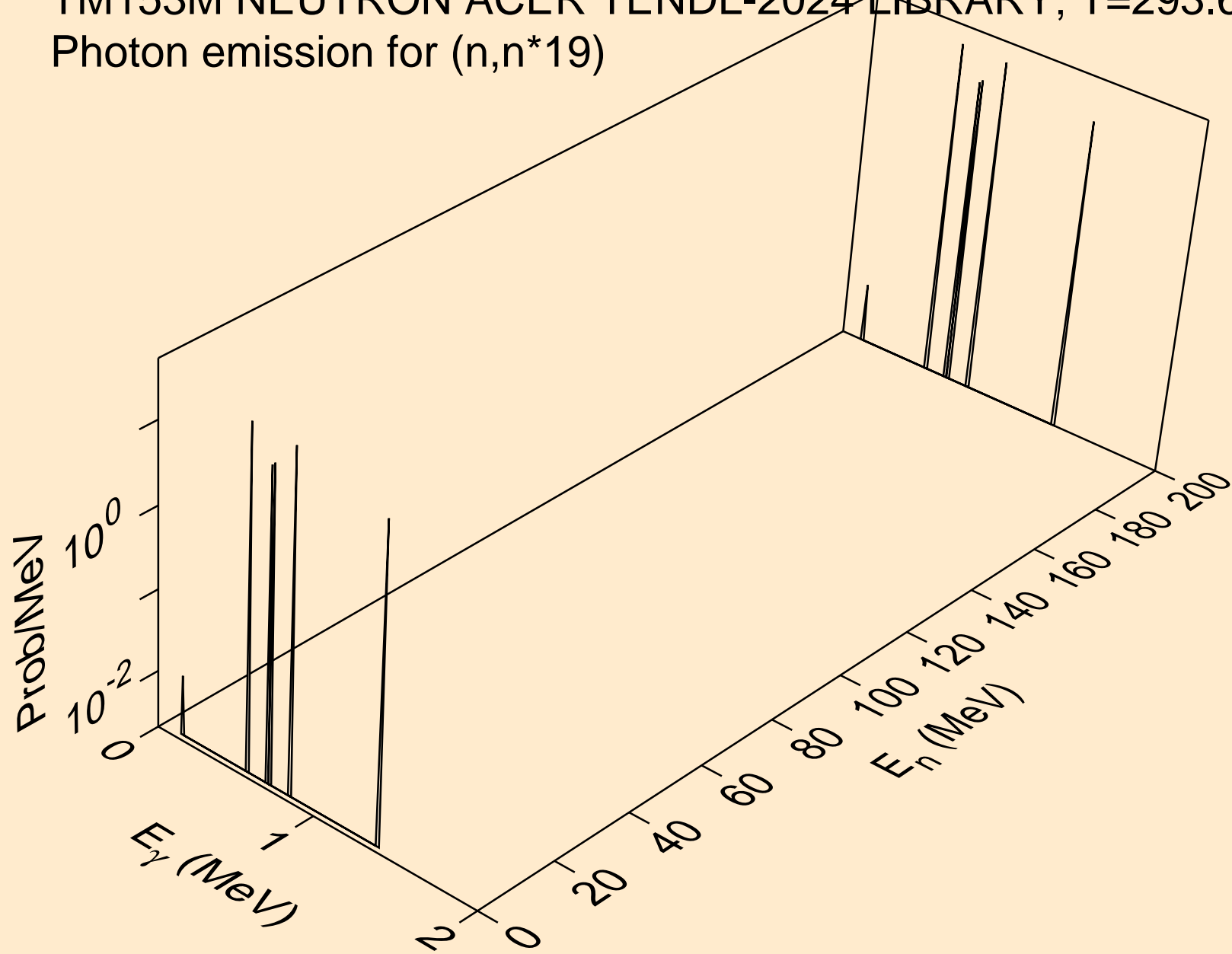

TM153M NEUTRON ACER TENDL-2024 LIBRARY; T=293.6K
Photon emission for (n,n*20)

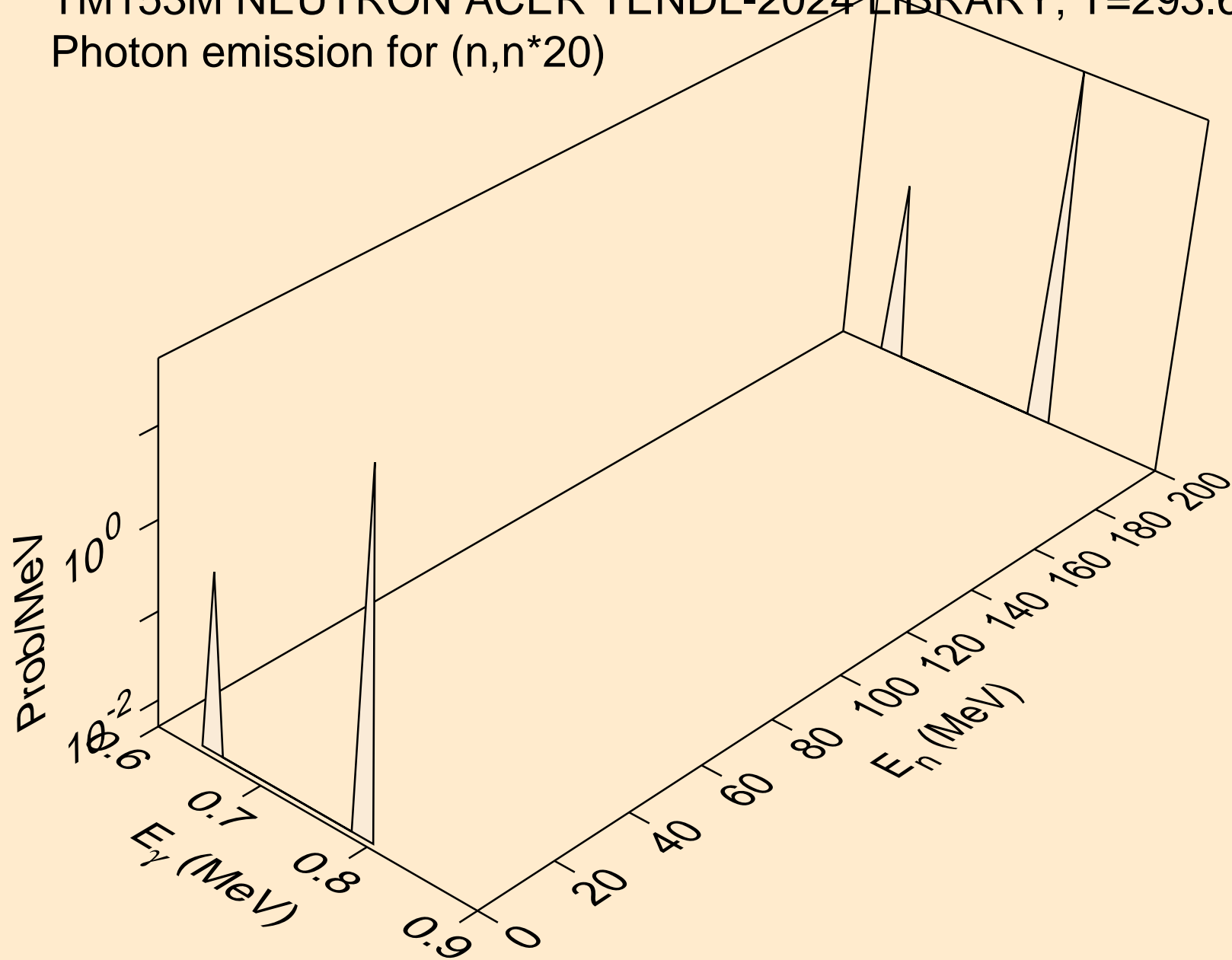

TM153M NEUTRON ACER TENDL-2024 LIBRARY; T=293.6K
Photon emission for (n,n*21)

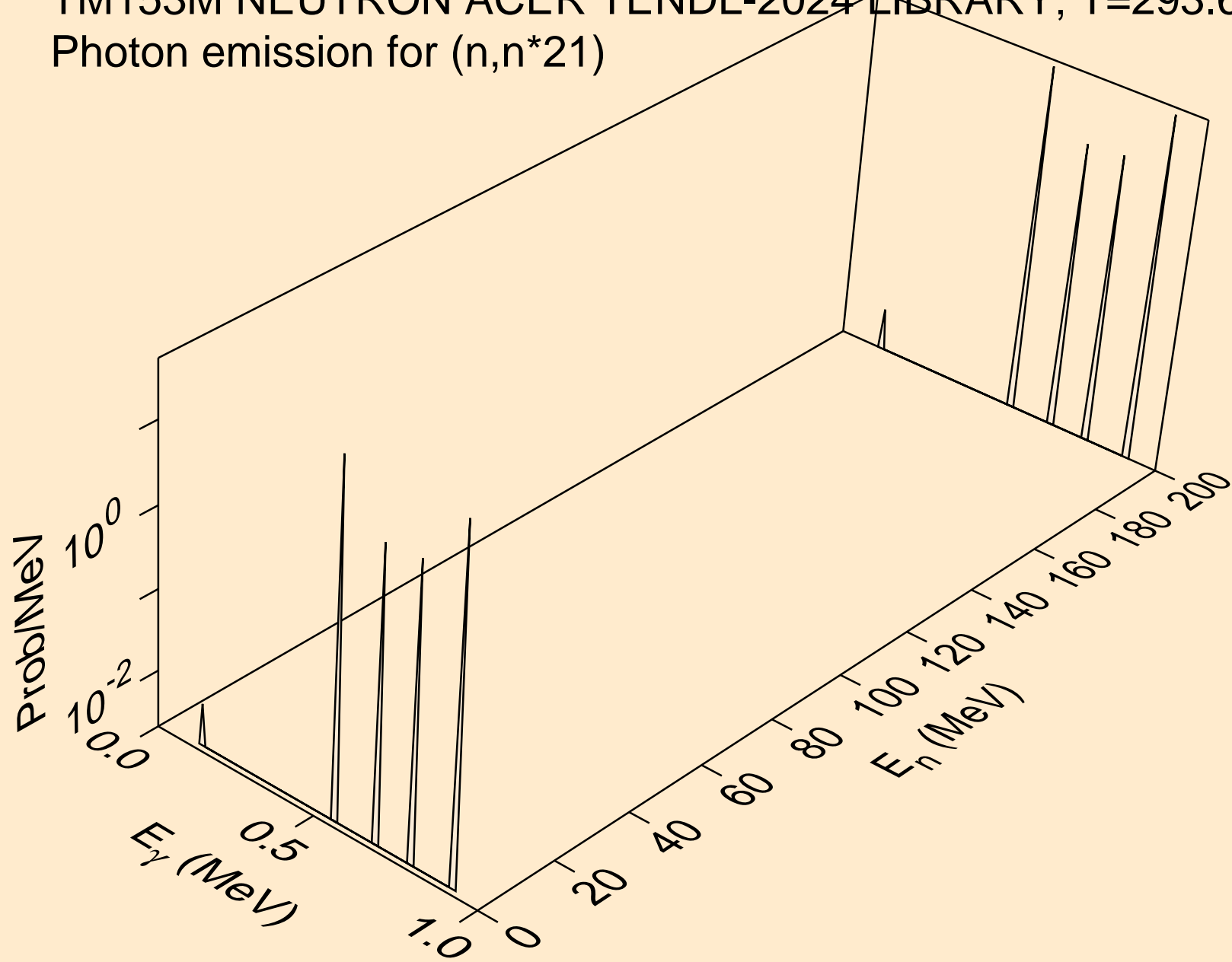

TM153M NEUTRON ACER TENDL-2024 LIBRARY; T=293.6K
Photon emission for (n,n*22)

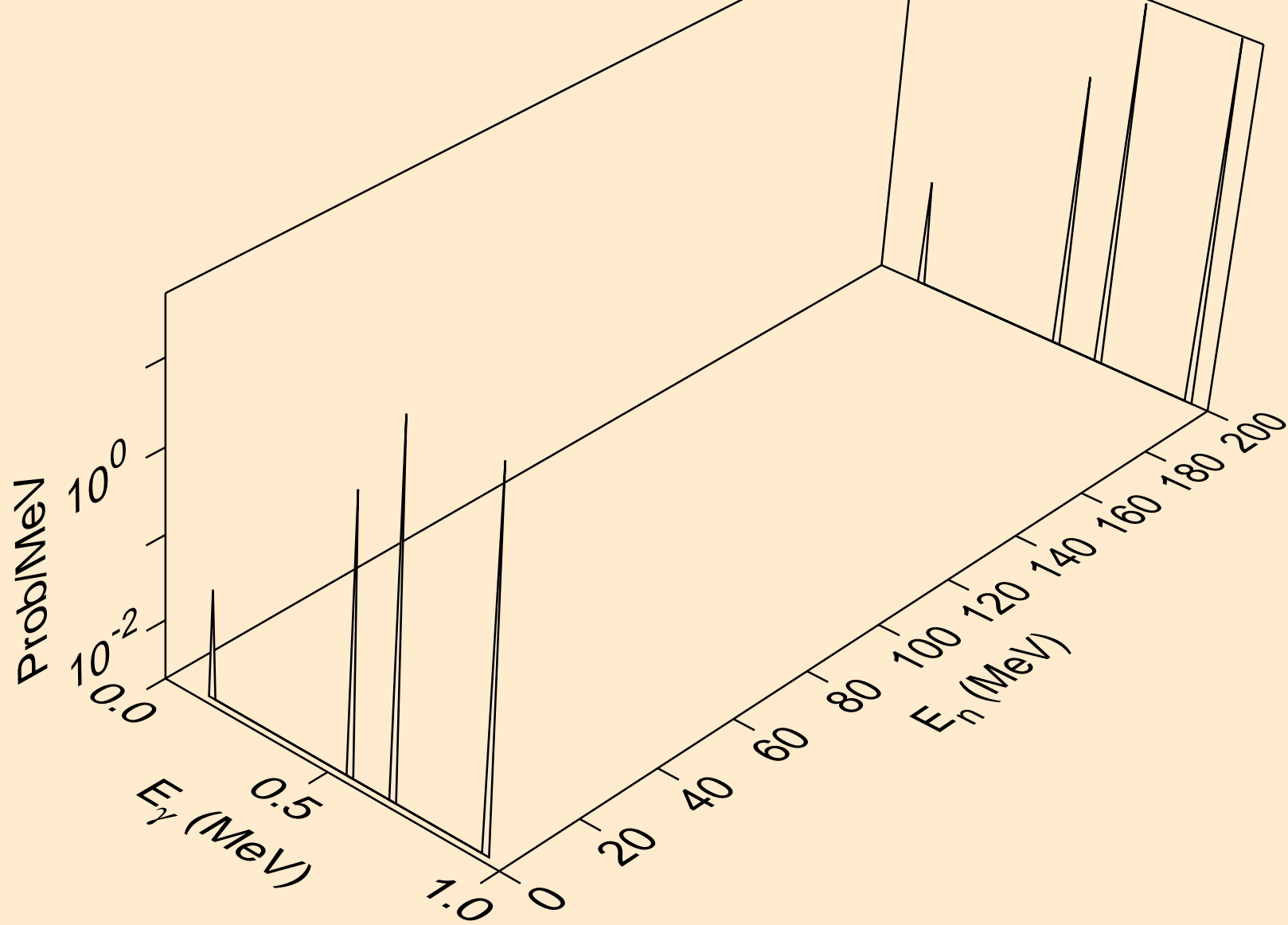

TM153M NEUTRON ACER TENDL-2024 LIBRARY; T=293.6K
Photon emission for (n,n*23)

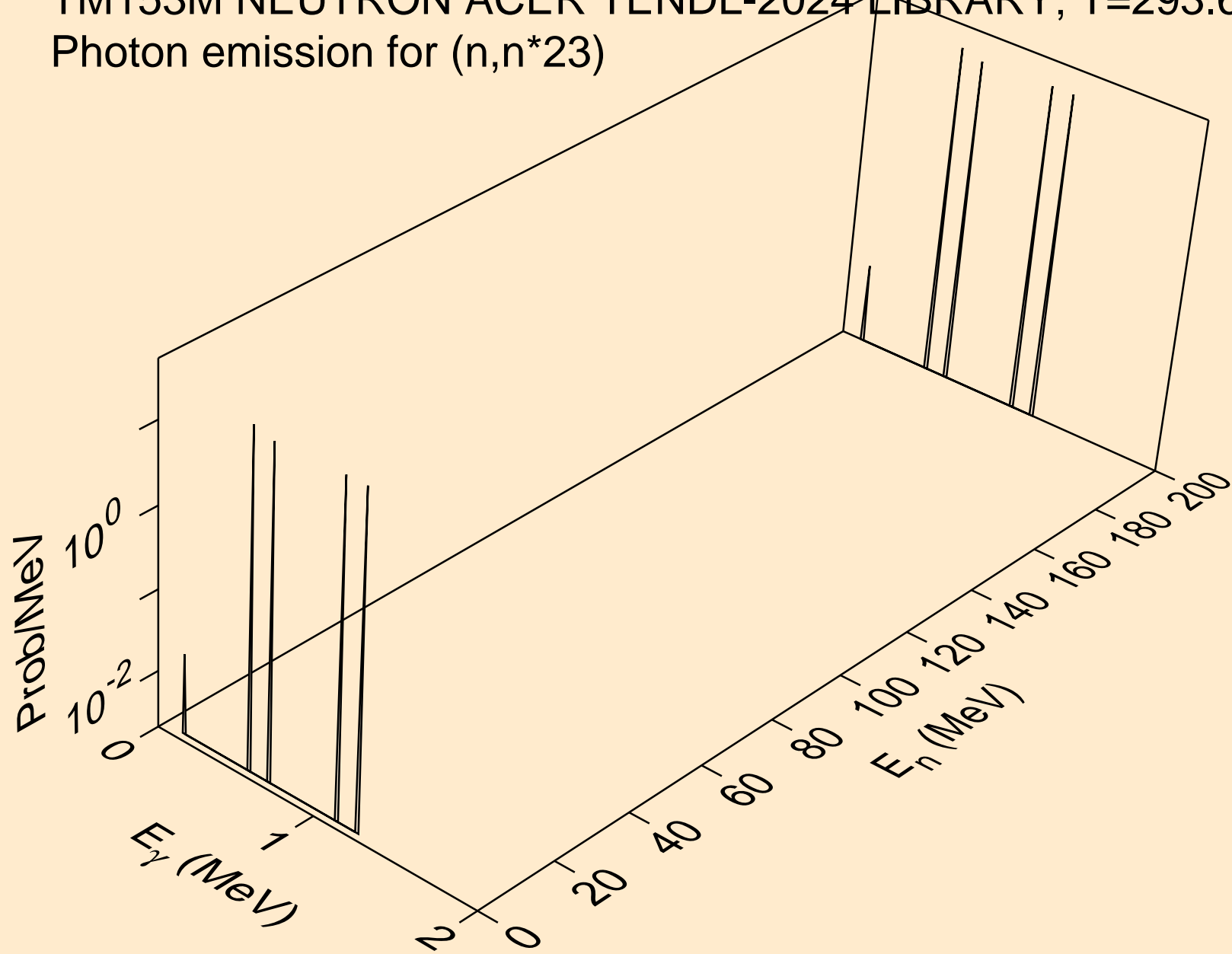

TM153M NEUTRON ACER TENDL-2024 LIBRARY; T=293.6K
Photon emission for (n,n*24)

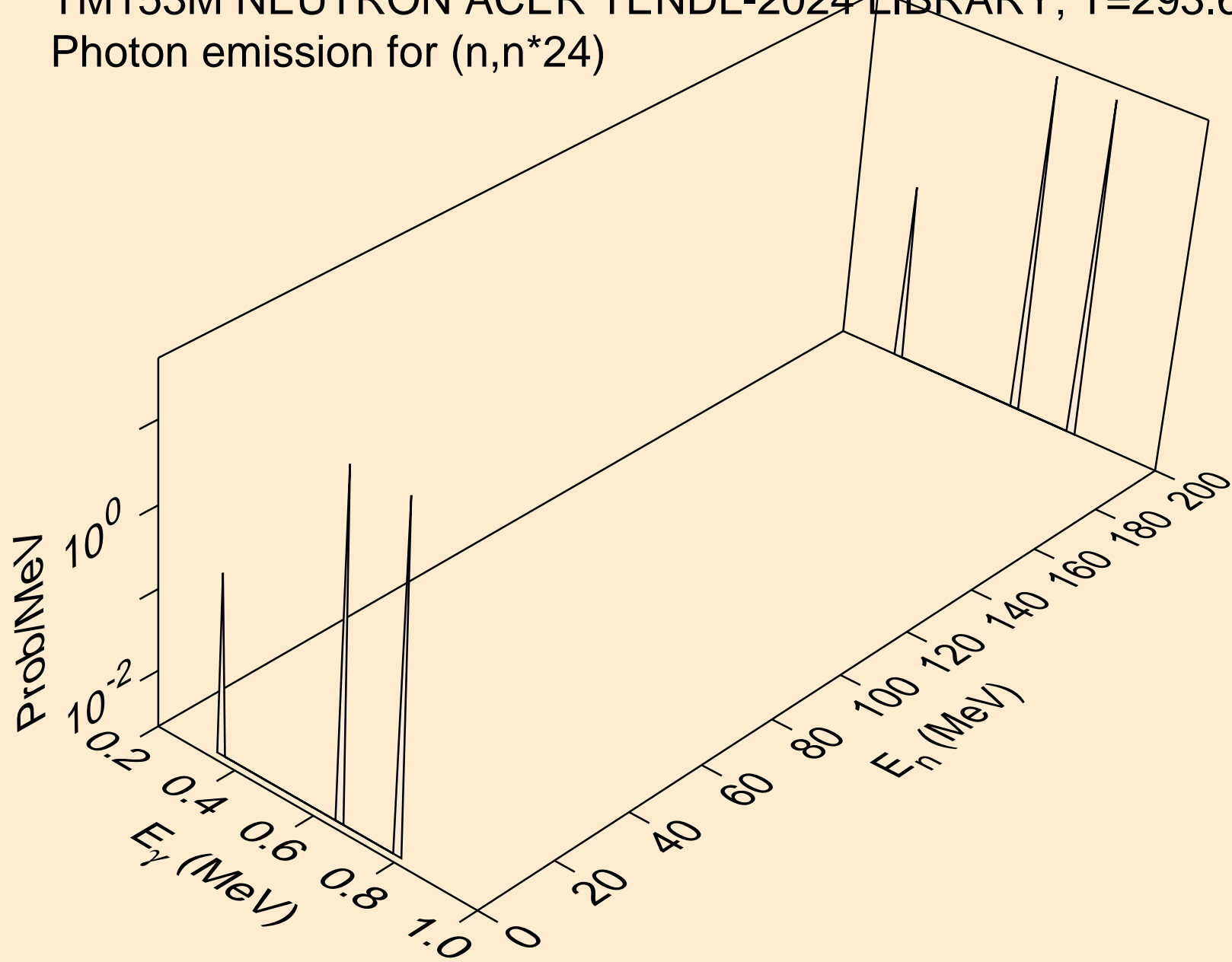

TM153M NEUTRON ACER TENDL-2024 LIBRARY; T=293.6K
Photon emission for (n,n*25)

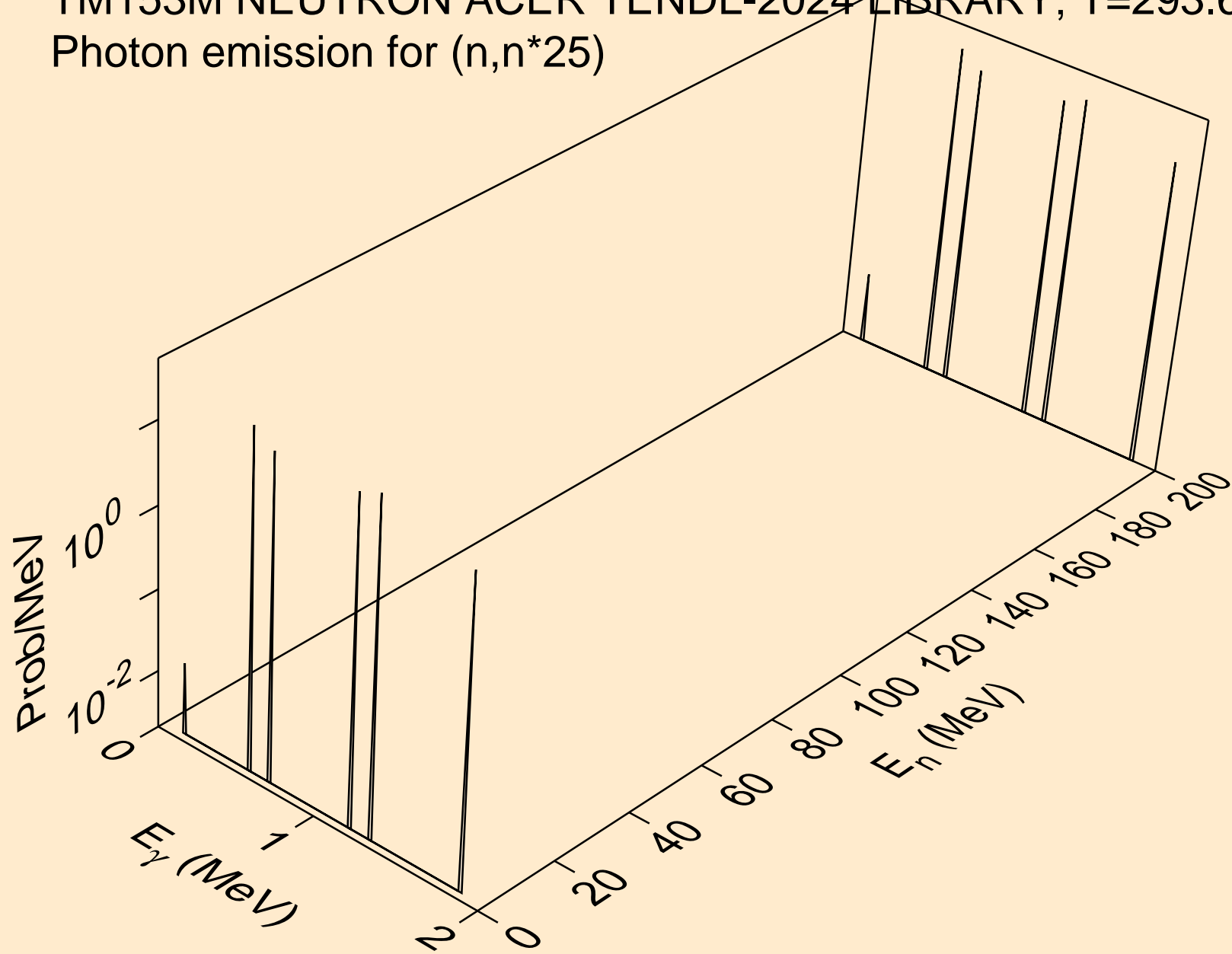

TM153M NEUTRON ACER TENDL-2024 LIBRARY; T=293.6K
Photon emission for (n,n*26)

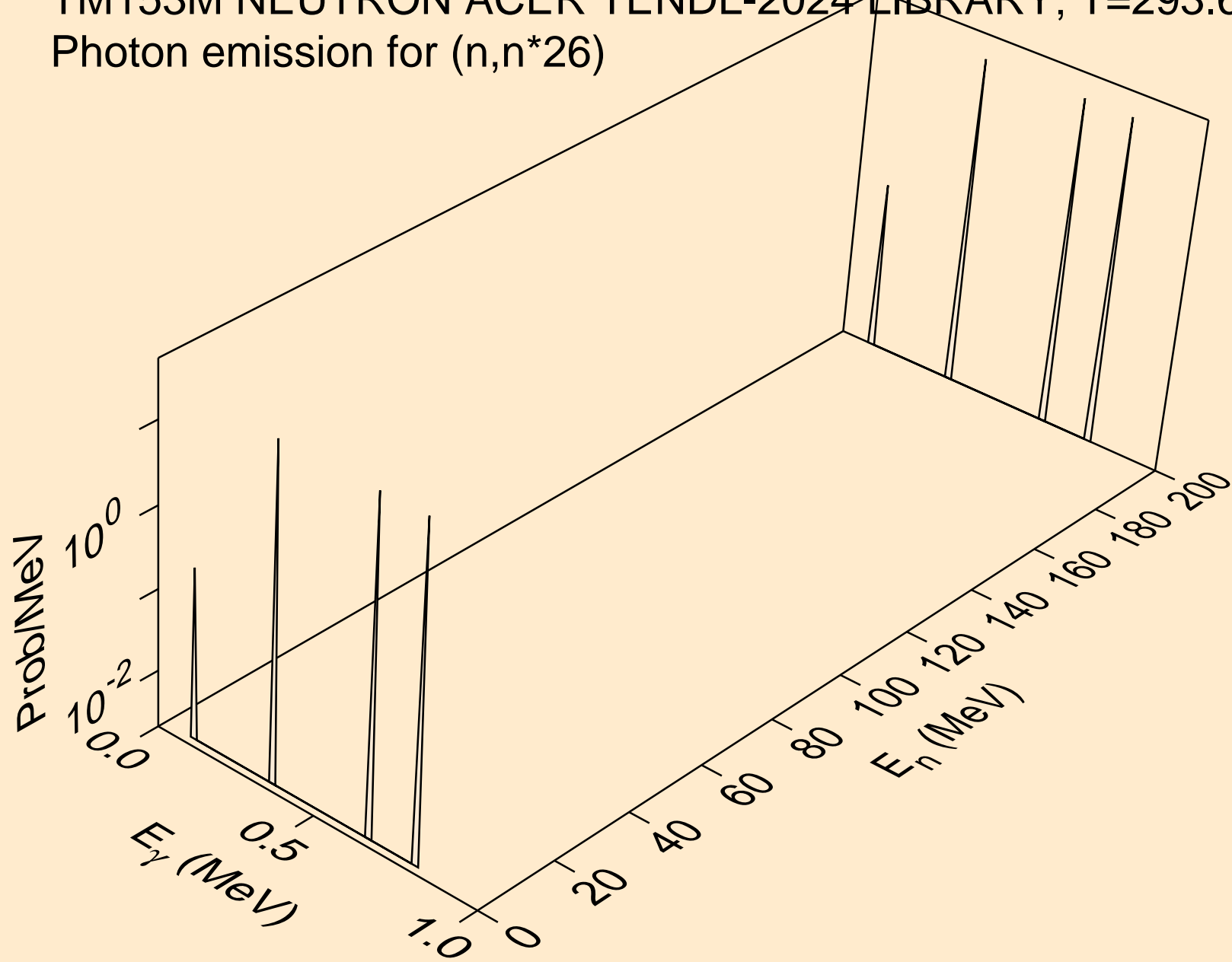

TM153M NEUTRON ACER TENDL-2024 LIBRARY; T=293.6K
Photon emission for (n,n*27)

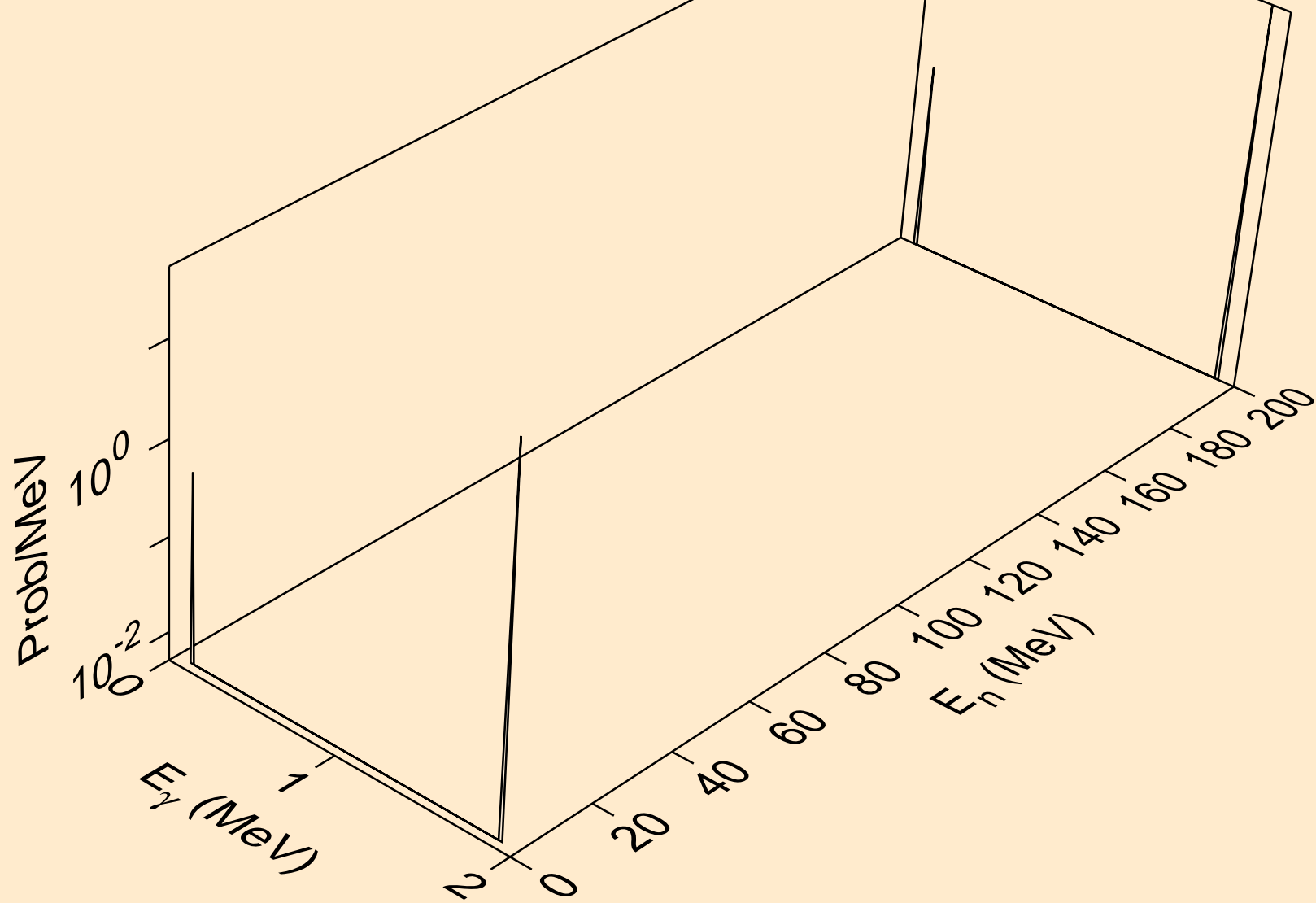

TM153M NEUTRON ACER TENDL-2024 LIBRARY; T=293.6K
Photon emission for (n,n*28)

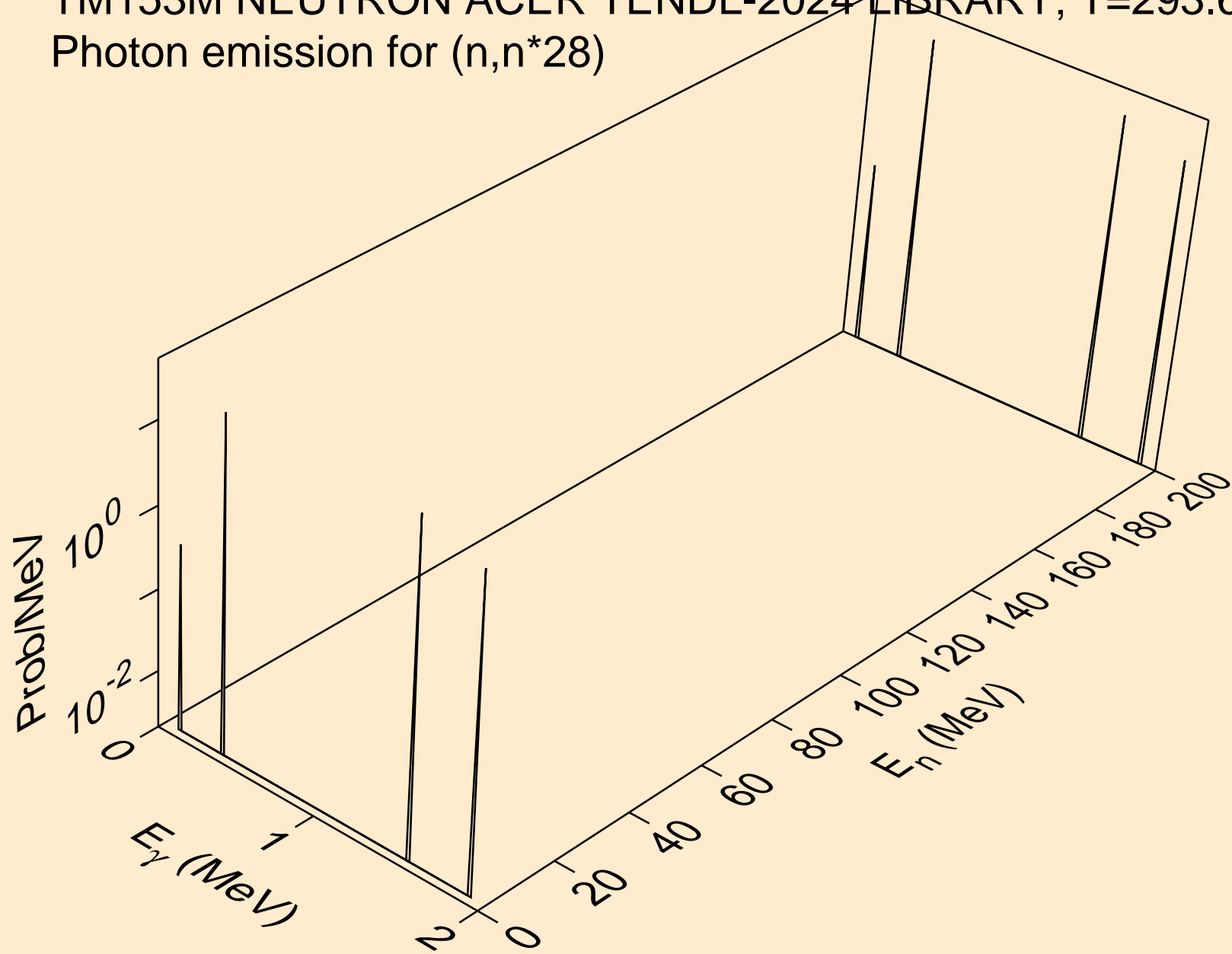

TM153M NEUTRON ACER TENDL-2024 LIBRARY; T=293.6K
Photon emission for (n,n*c)

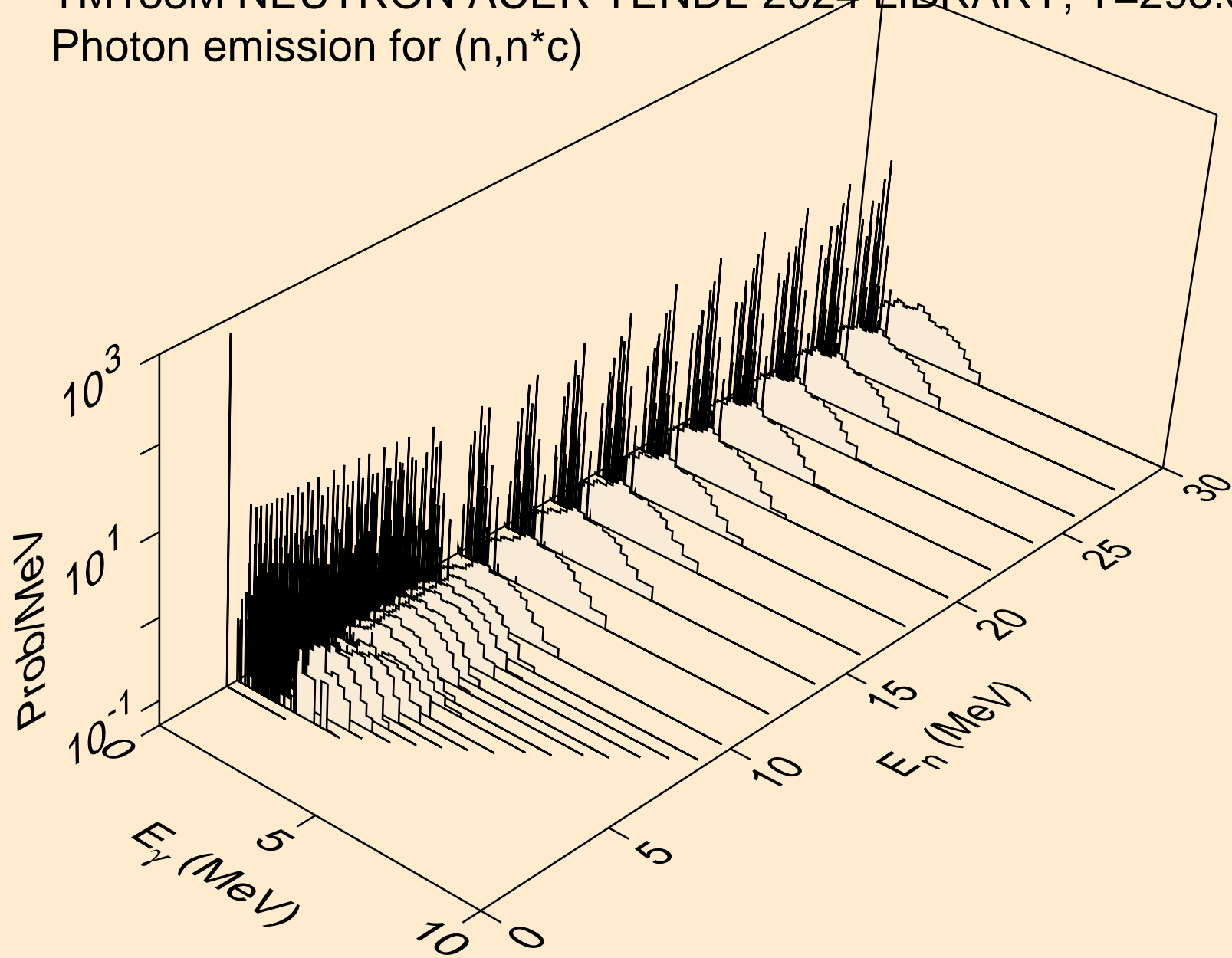

TM153M NEUTRON ACER TENDL-2024 LIBRARY; T=293.6K
Photon emission for (n,gma)

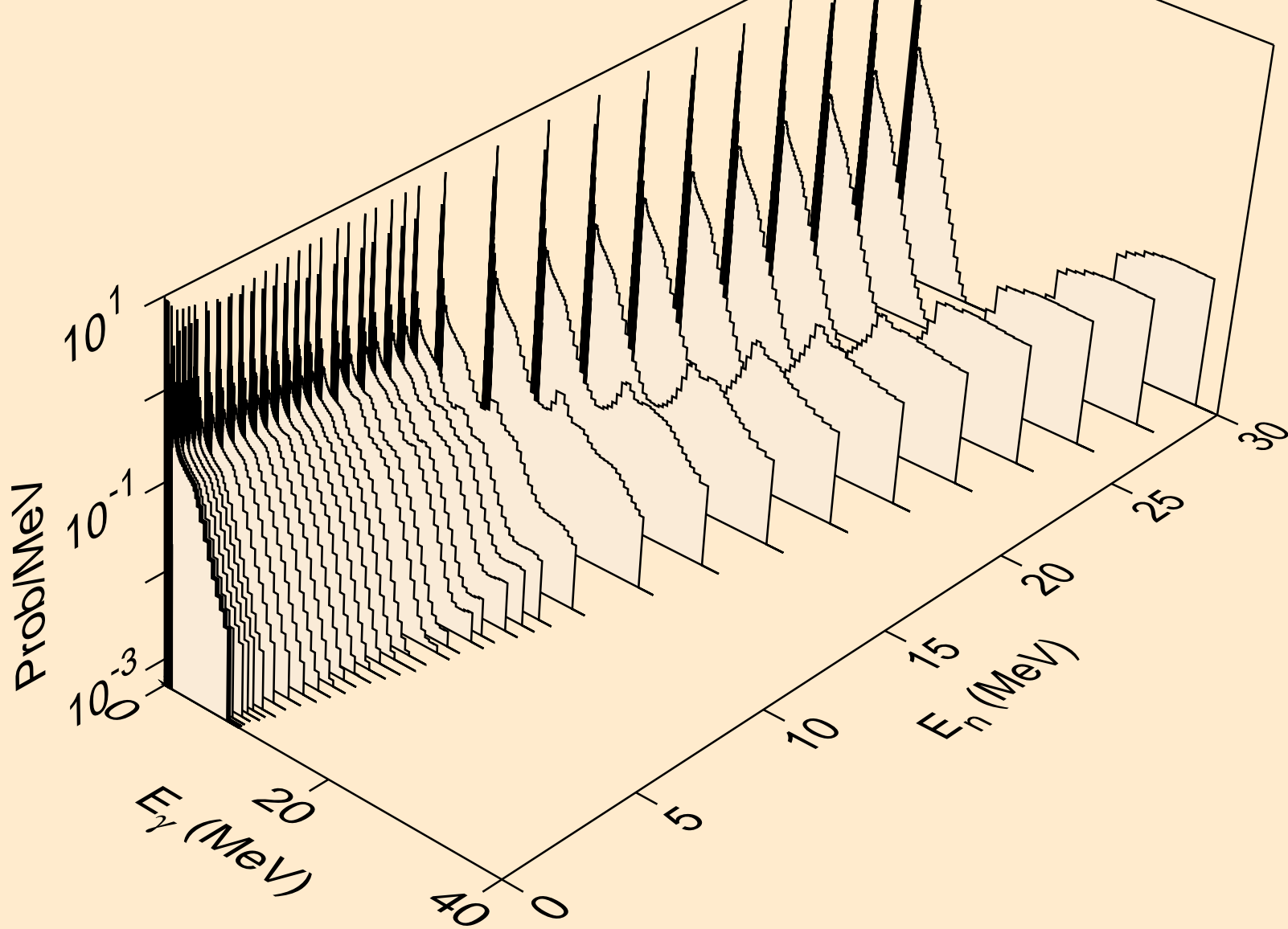

TM153M NEUTRON ACER TENDL-2024 LIBRARY; T=293.6K
Photon emission for (n,p)

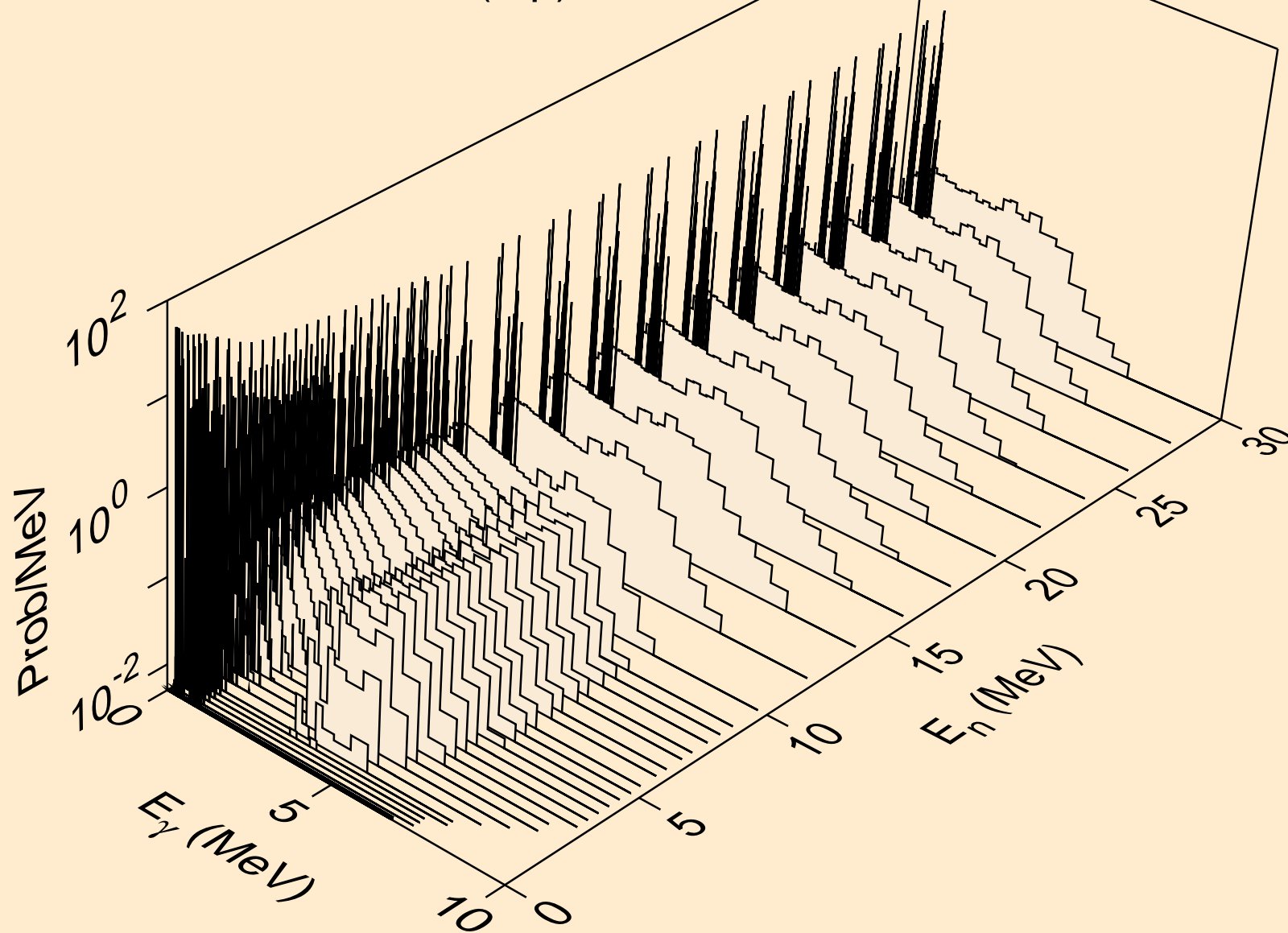

TM153M NEUTRON ACER TENDL-2024 LIBRARY; T=293.6K
Photon emission for (n,d)

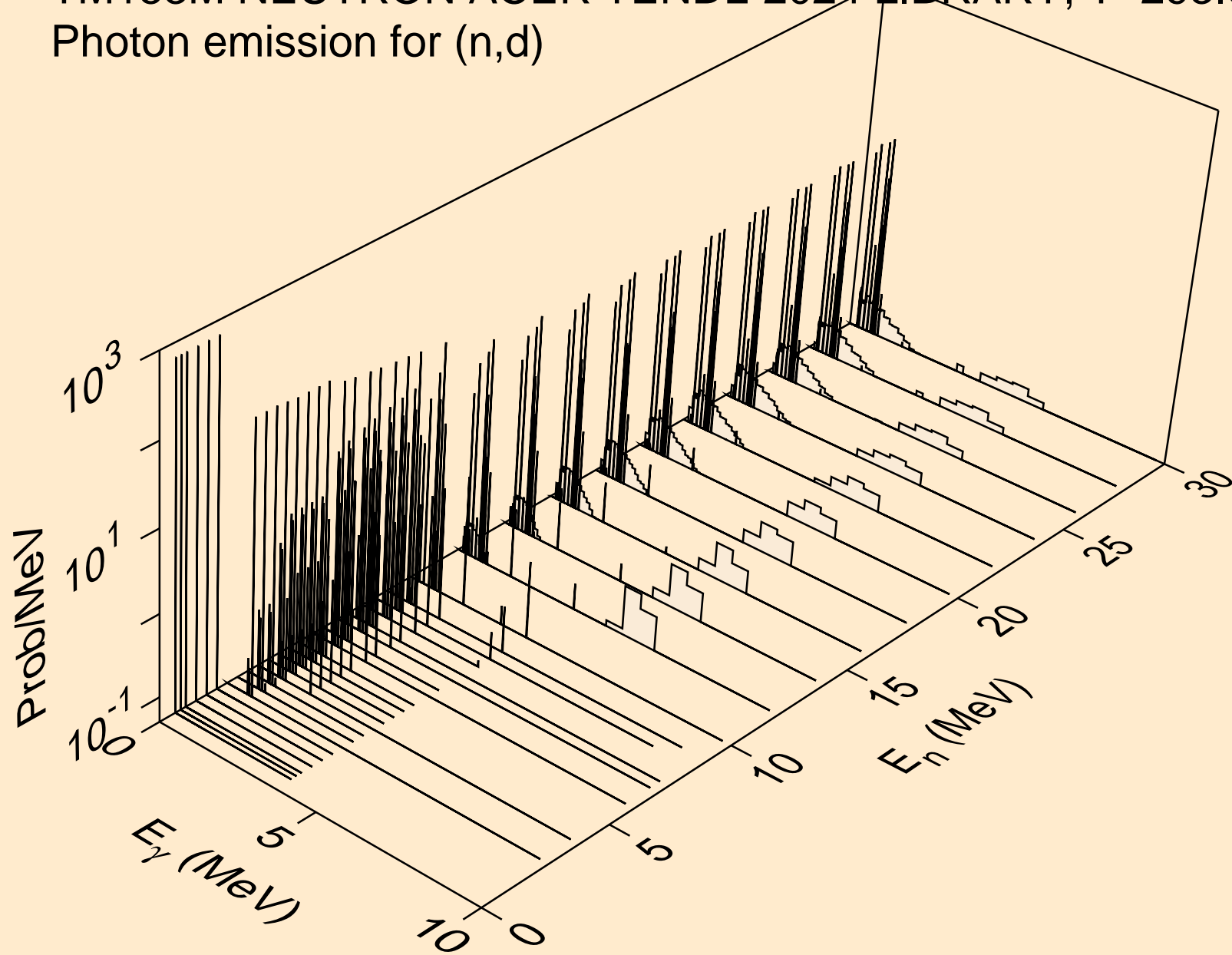

TM153M NEUTRON ACER TENDL-2024 LIBRARY; T=293.6K
Photon emission for (n,t)

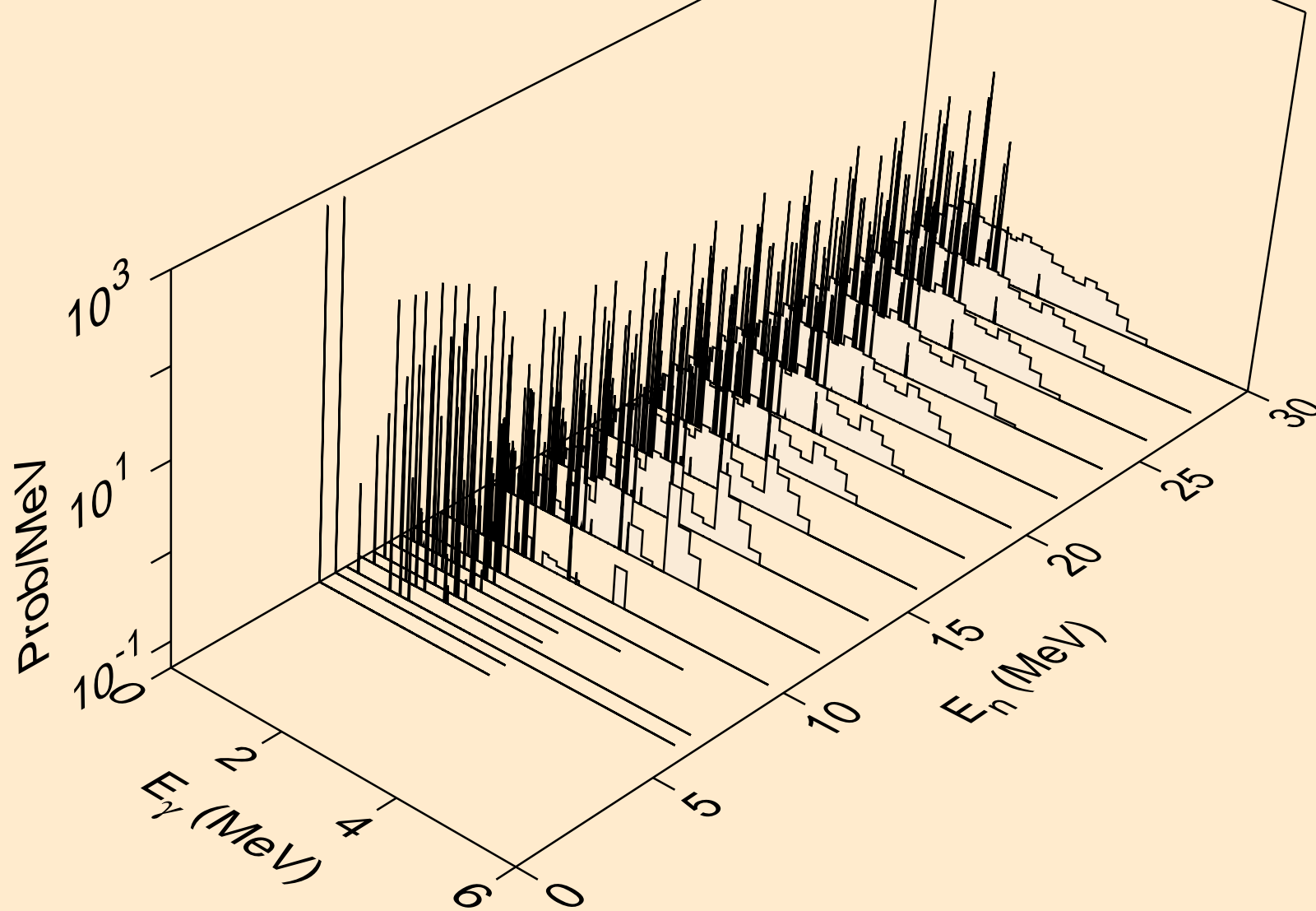

TM153M NEUTRON ACER TENDL-2024 LIBRARY; T=293.6K
Photon emission for (n,he3)

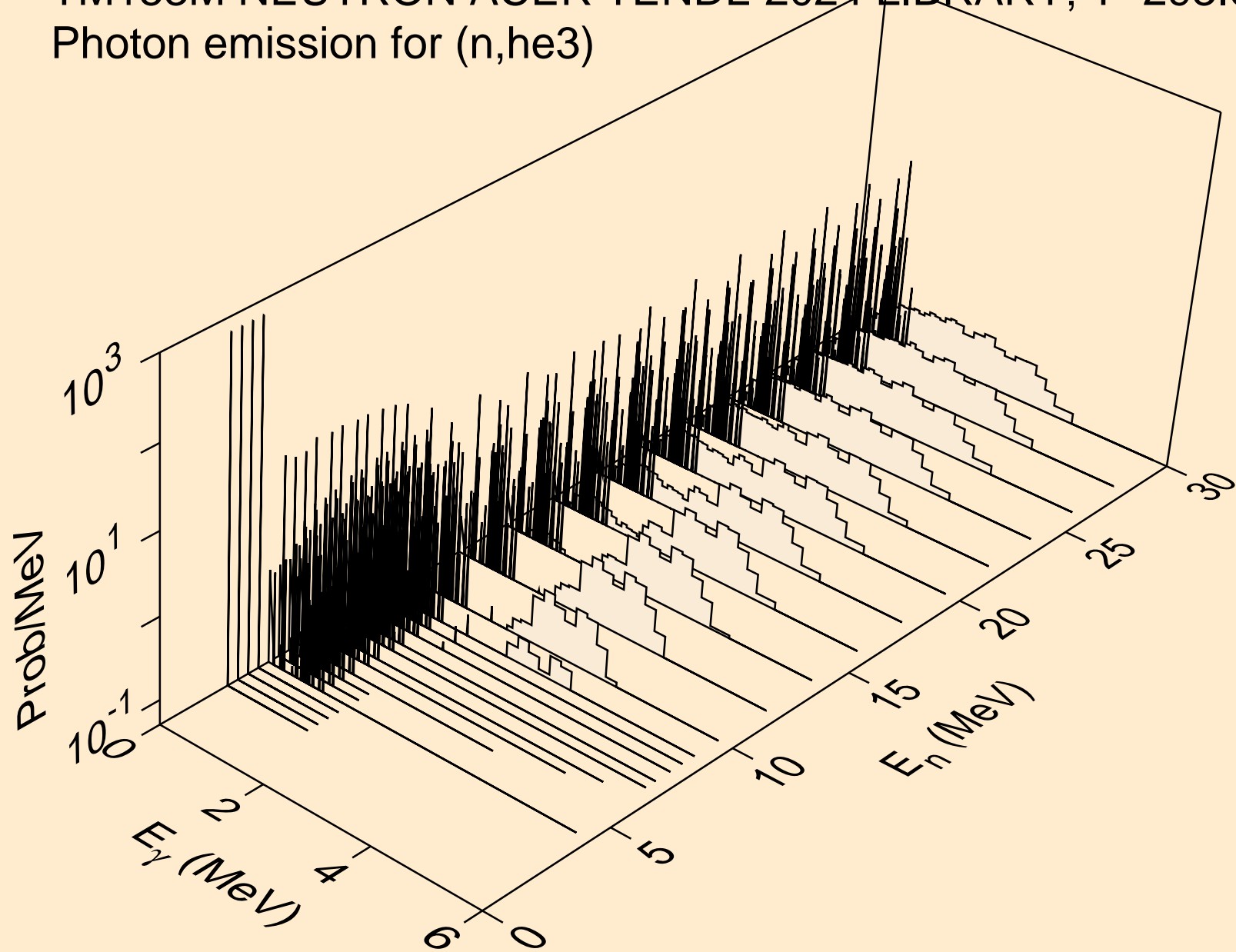

TM153M NEUTRON ACER TENDL-2024 LIBRARY; T=293.6K
Photon emission for (n,a)

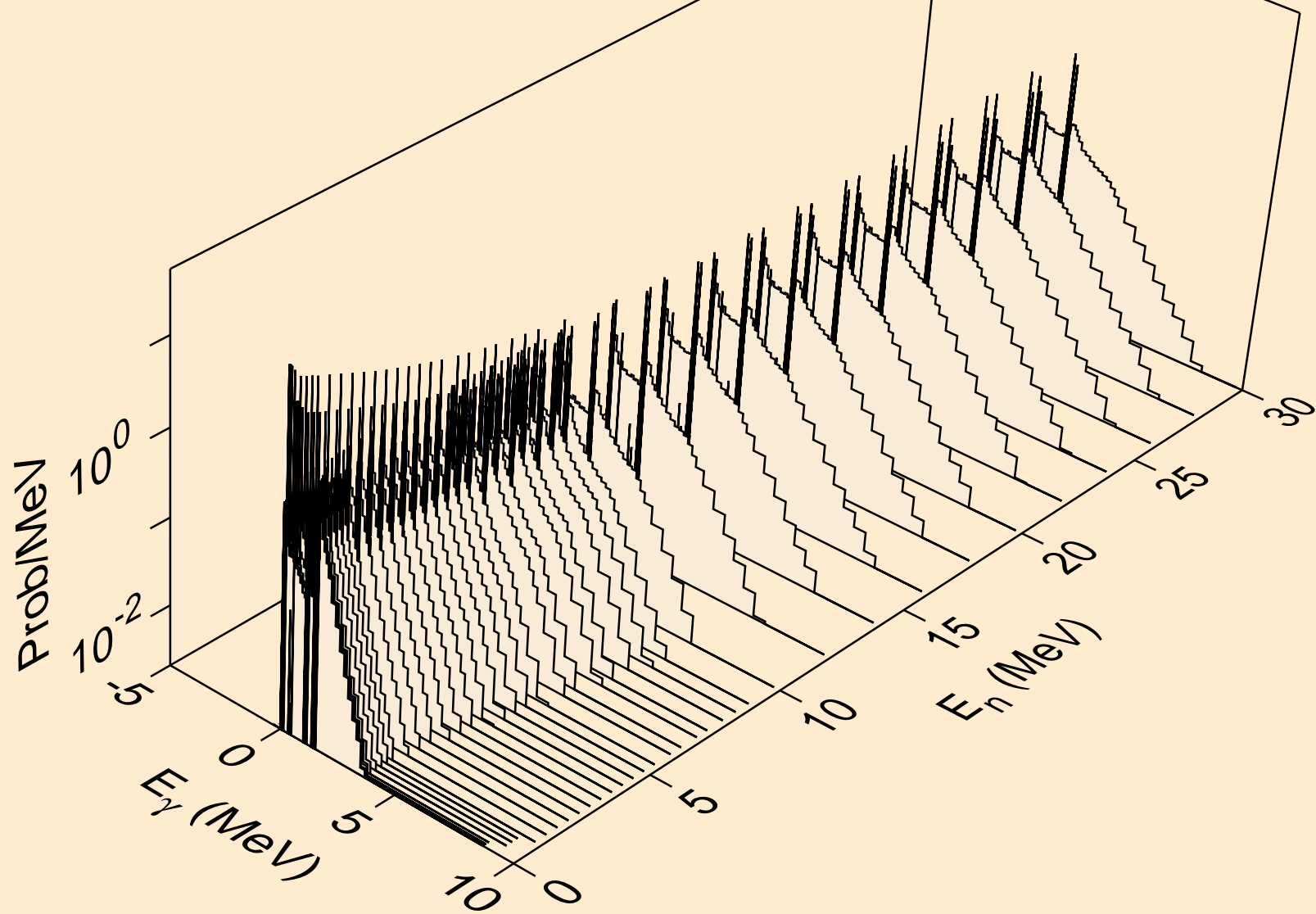

TM153M NEUTRON ACER TENDL-2024 LIBRARY; T=293.6K
Photon emission for (n,2a)

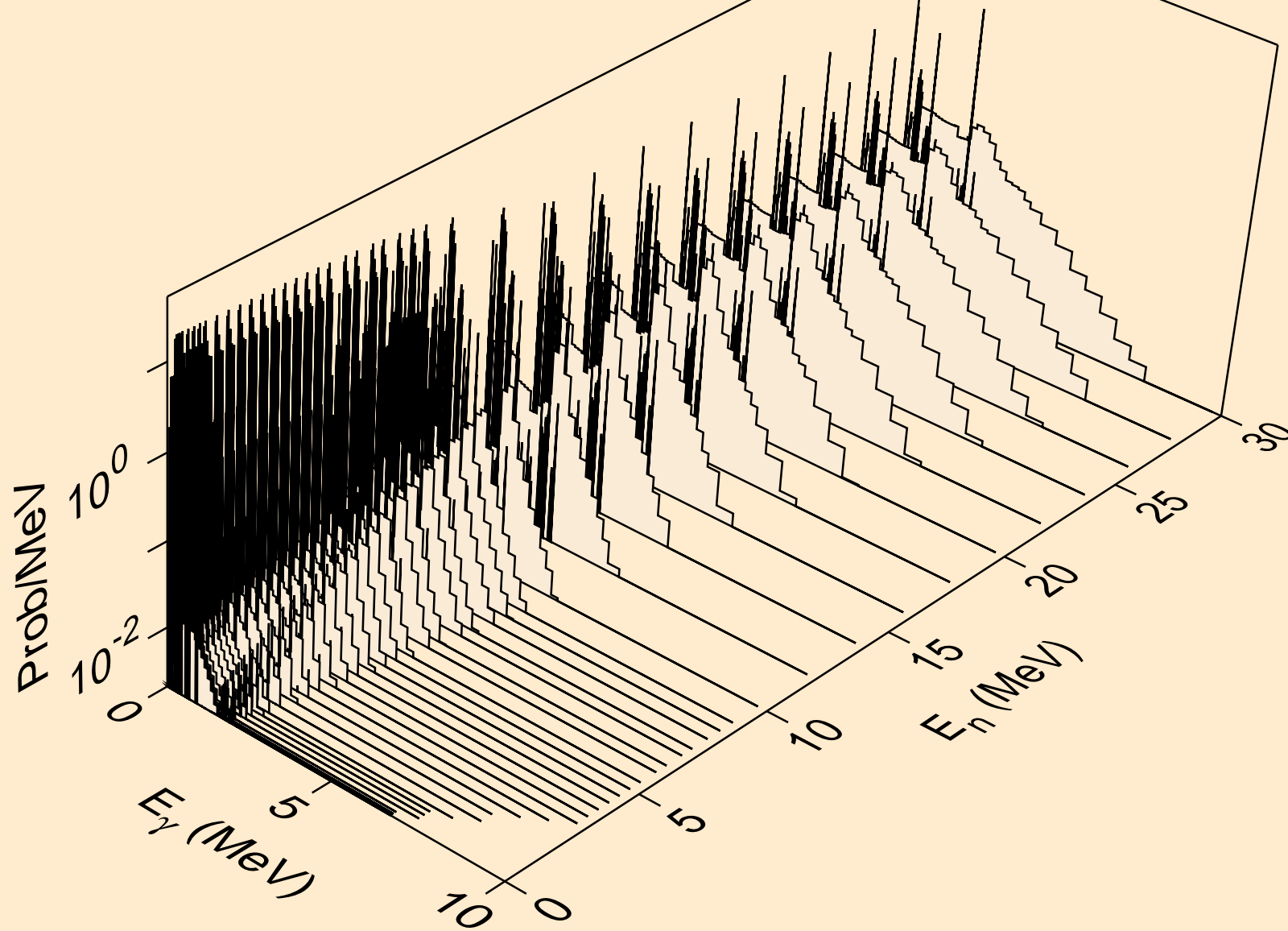

TM153M NEUTRON ACER TENDL-2024 LIBRARY; T=293.6K
Photon emission for (n,3a)

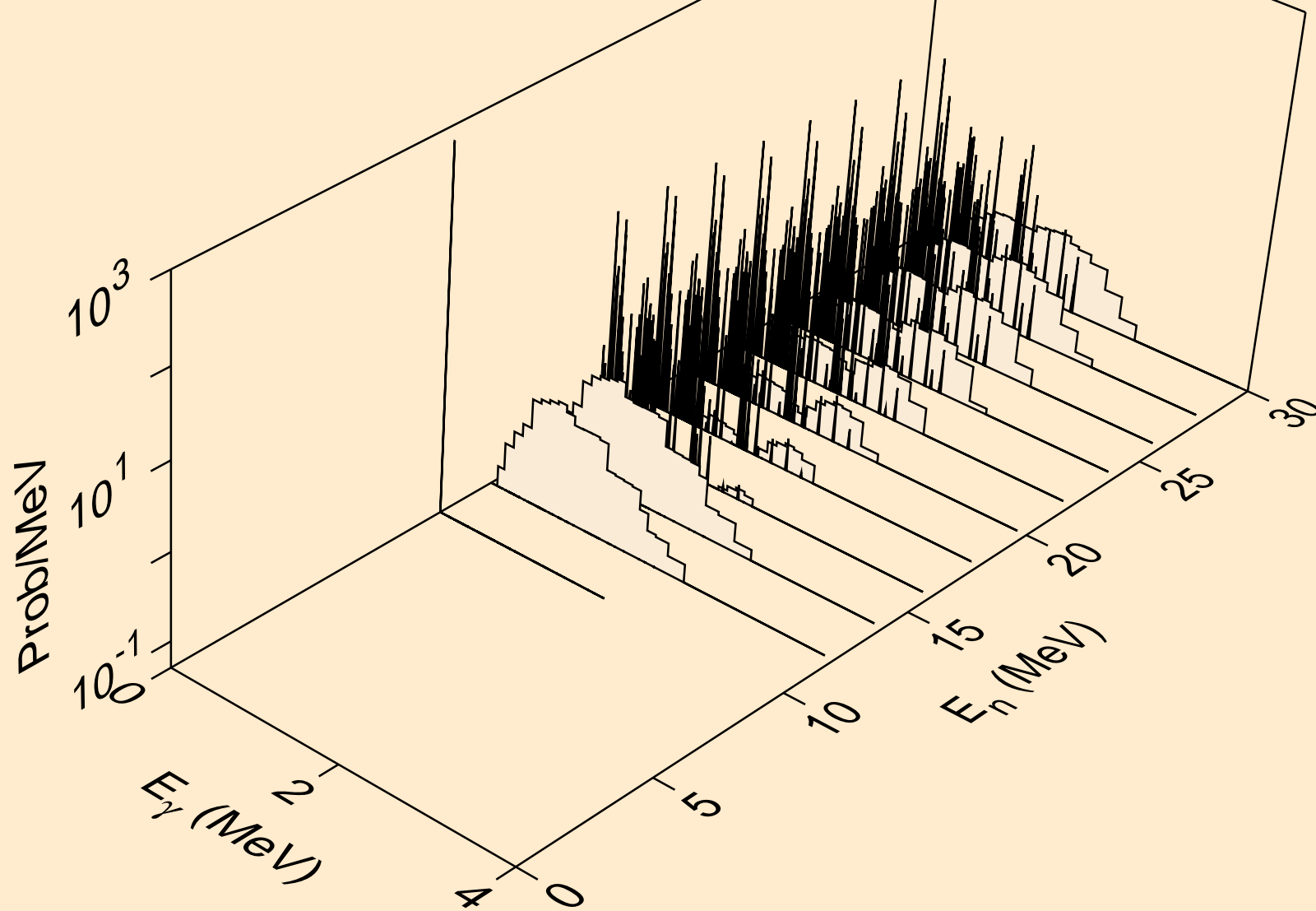

TM153M NEUTRON ACER TENDL-2024 LIBRARY; T=293.6K
Photon emission for (n,2p)

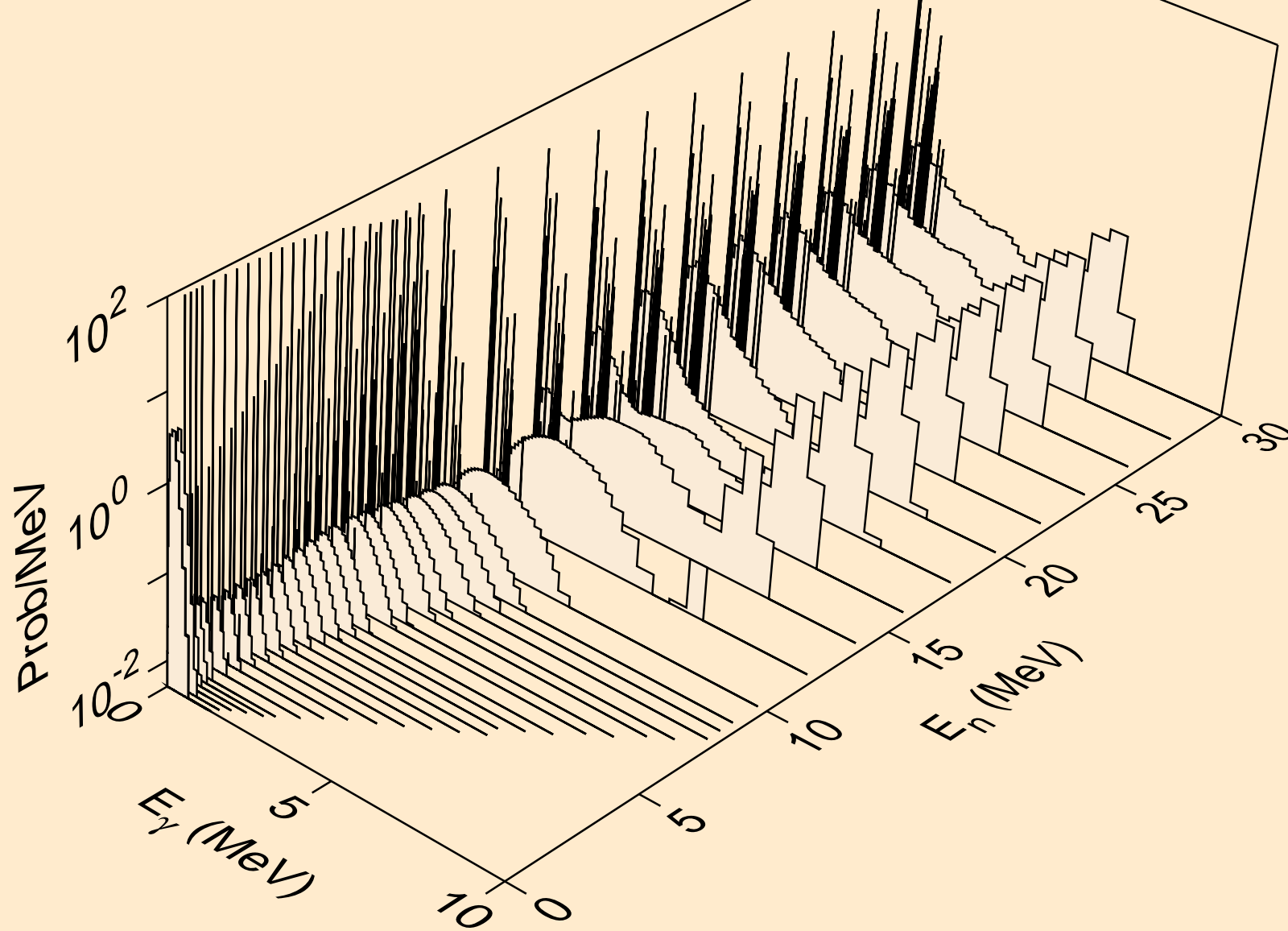

TM153M NEUTRON ACER TENDL-2024 LIBRARY; T=293.6K
Photon emission for (n,p α)

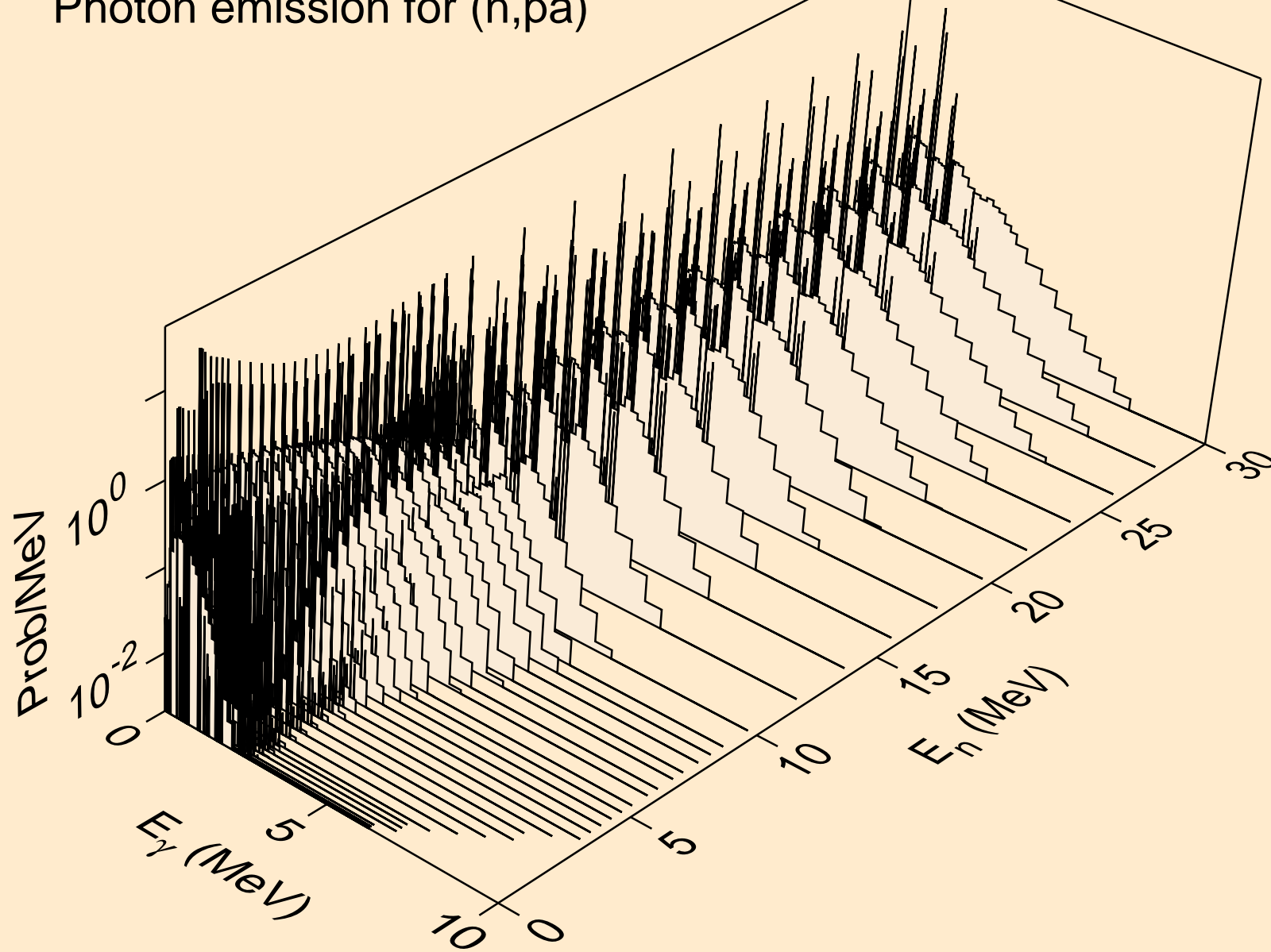

TM153M NEUTRON ACER TENDL-2024 LIBRARY; T=293.6K
Photon emission for (n,d2a)

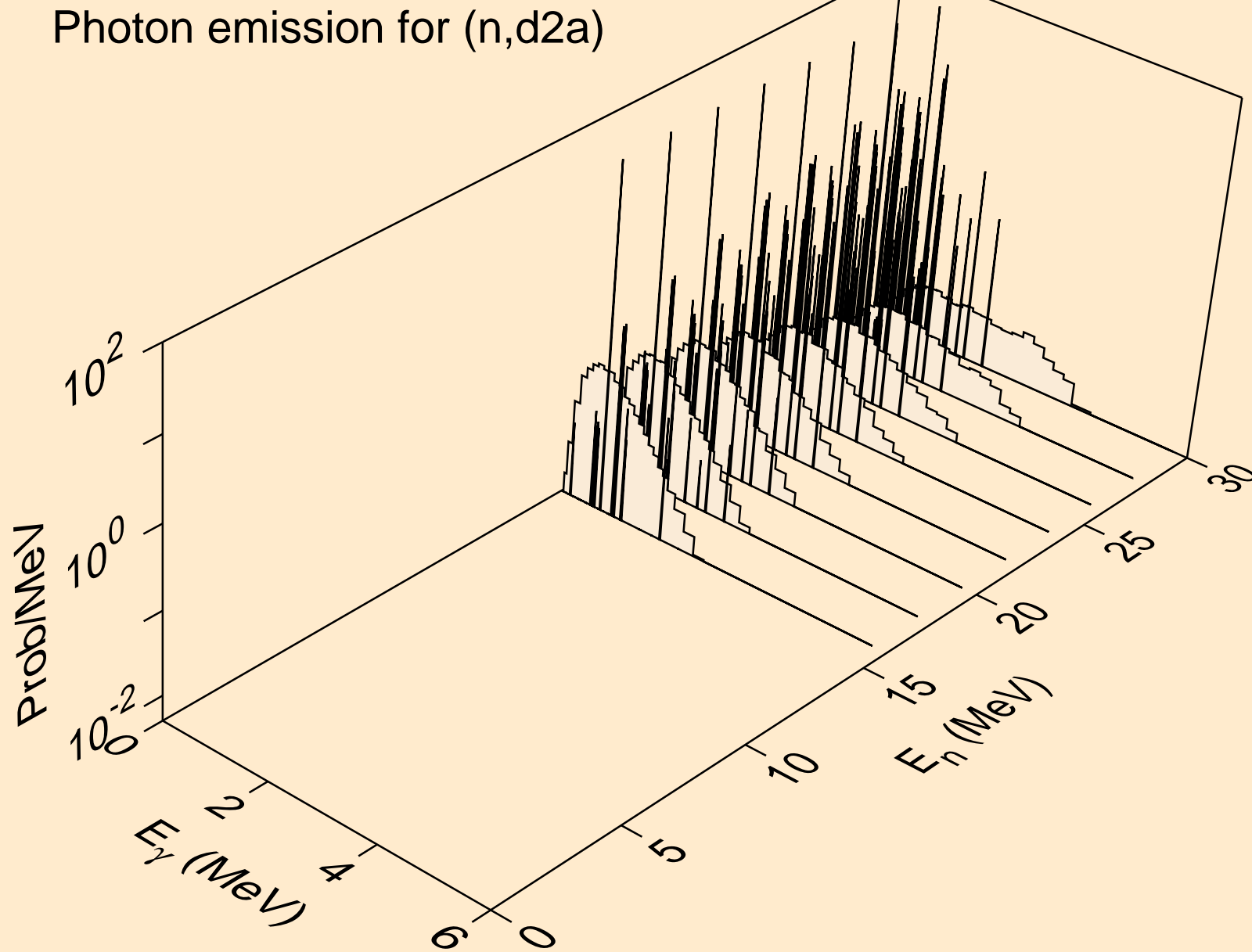

TM153M NEUTRON ACER TENDL-2024 LIBRARY; T=293.6K
Photon emission for (n,pd)

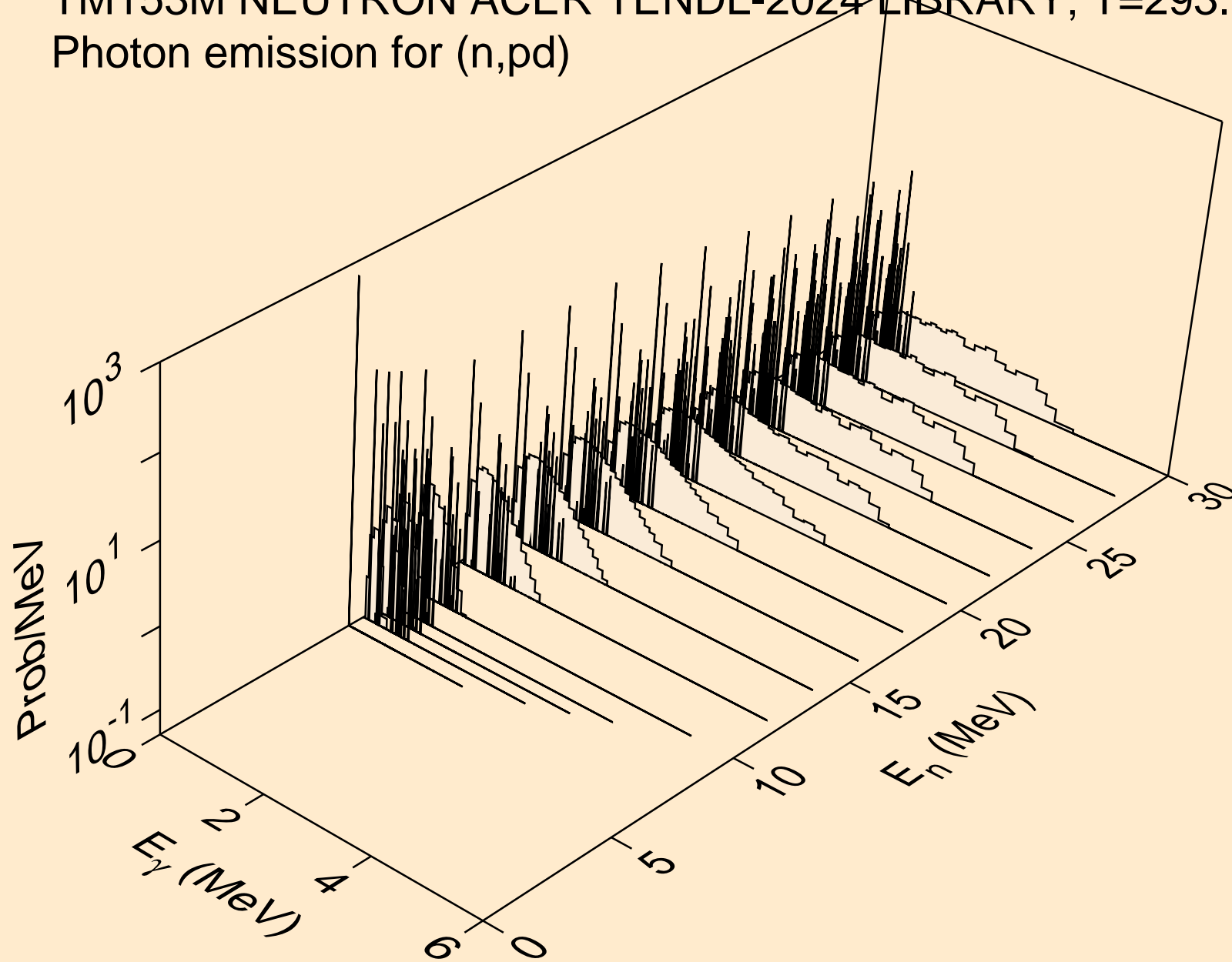

TM153M NEUTRON ACER TENDL-2024 LIBRARY; T=293.6K
Photon emission for (n,pt)

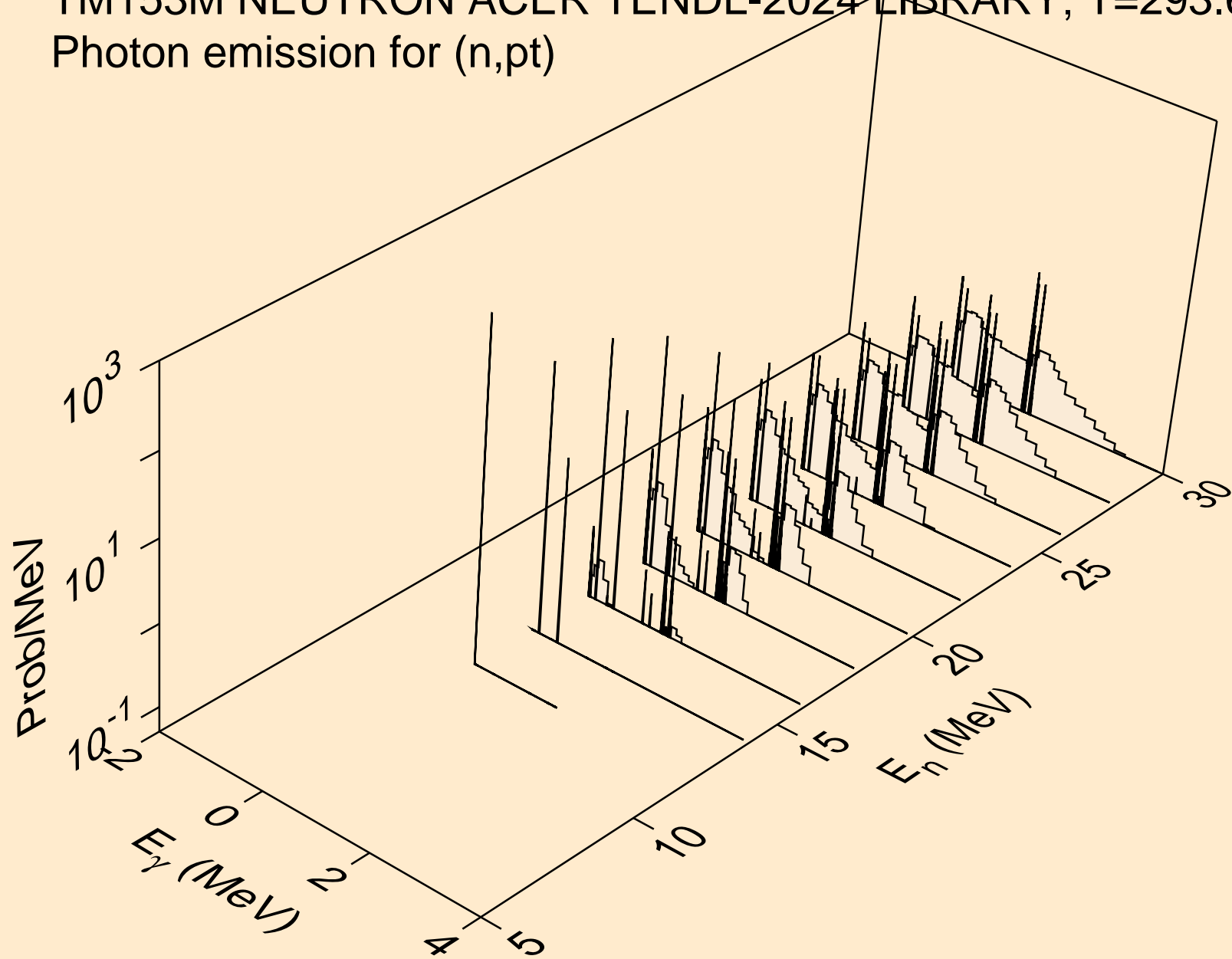

TM153M NEUTRON ACER TENDL-2024 LIBRARY; T=293.6K
Photon emission for (n,da)

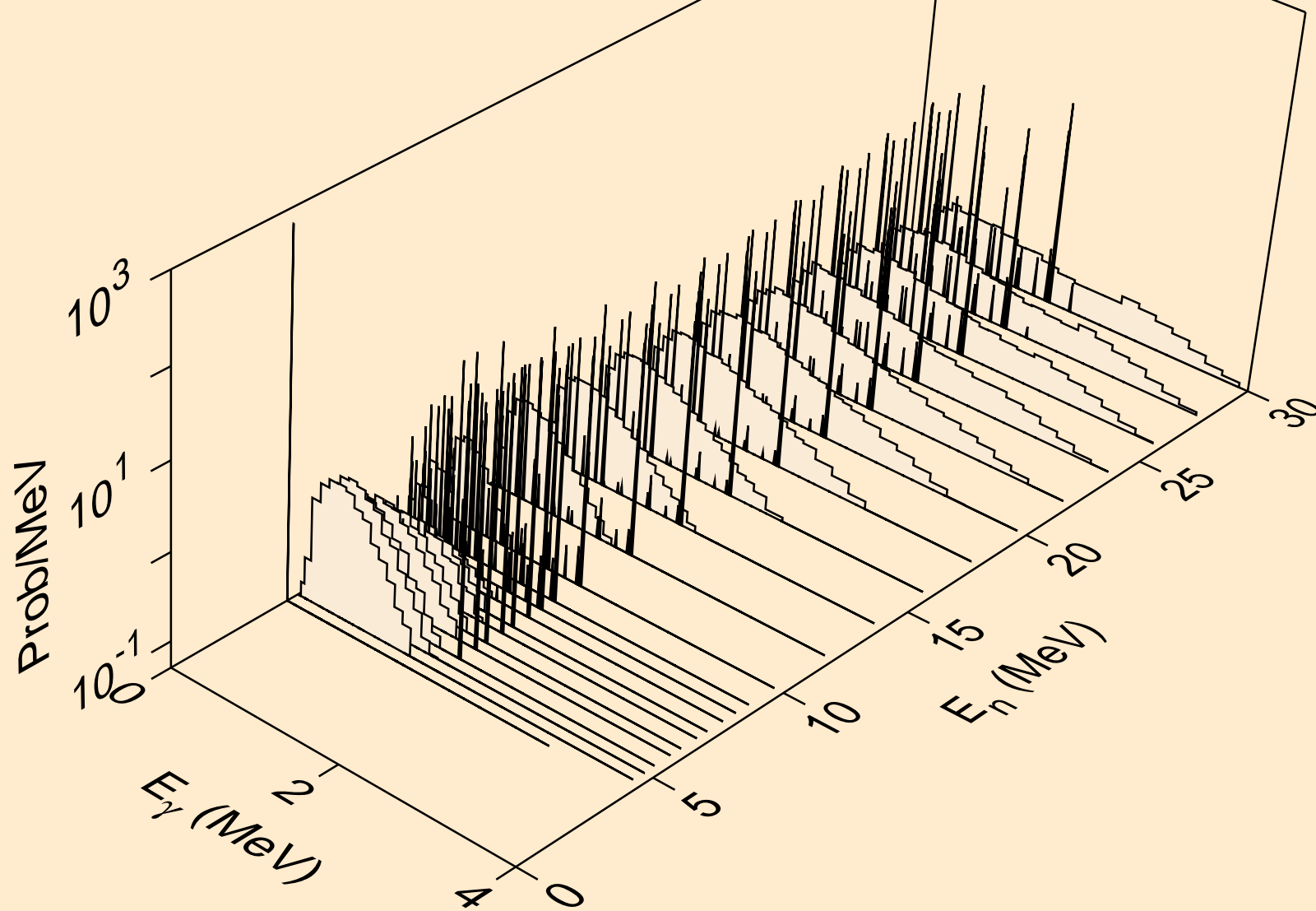

TM153M NEUTRON ACER TENDL-2024 LIBRARY; T=293.6K
thermal capture photon spectrum

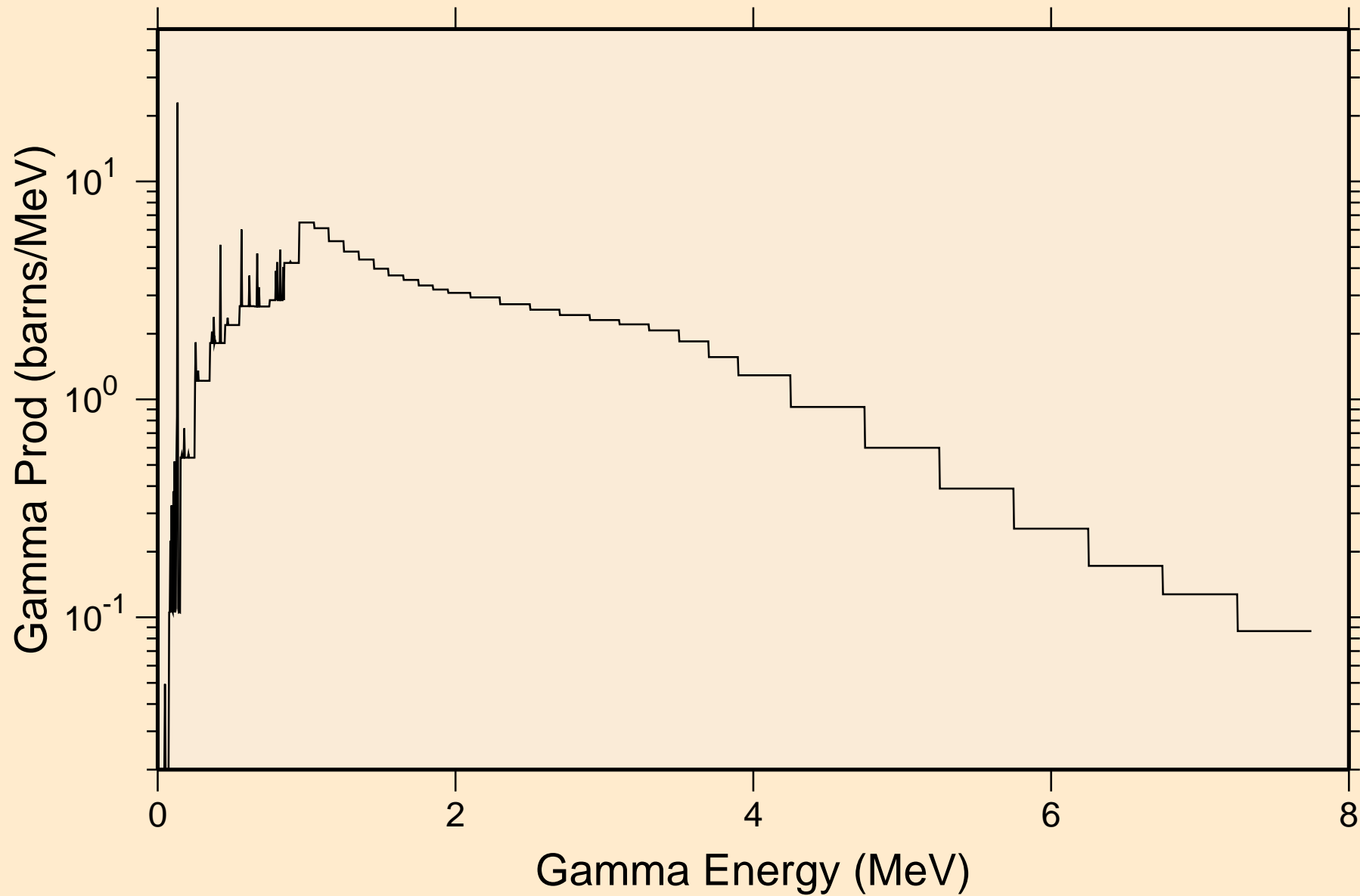

TM153M NEUTRON ACER TENDL-2024 LIBRARY; T=293.6K
14 MeV photon spectrum

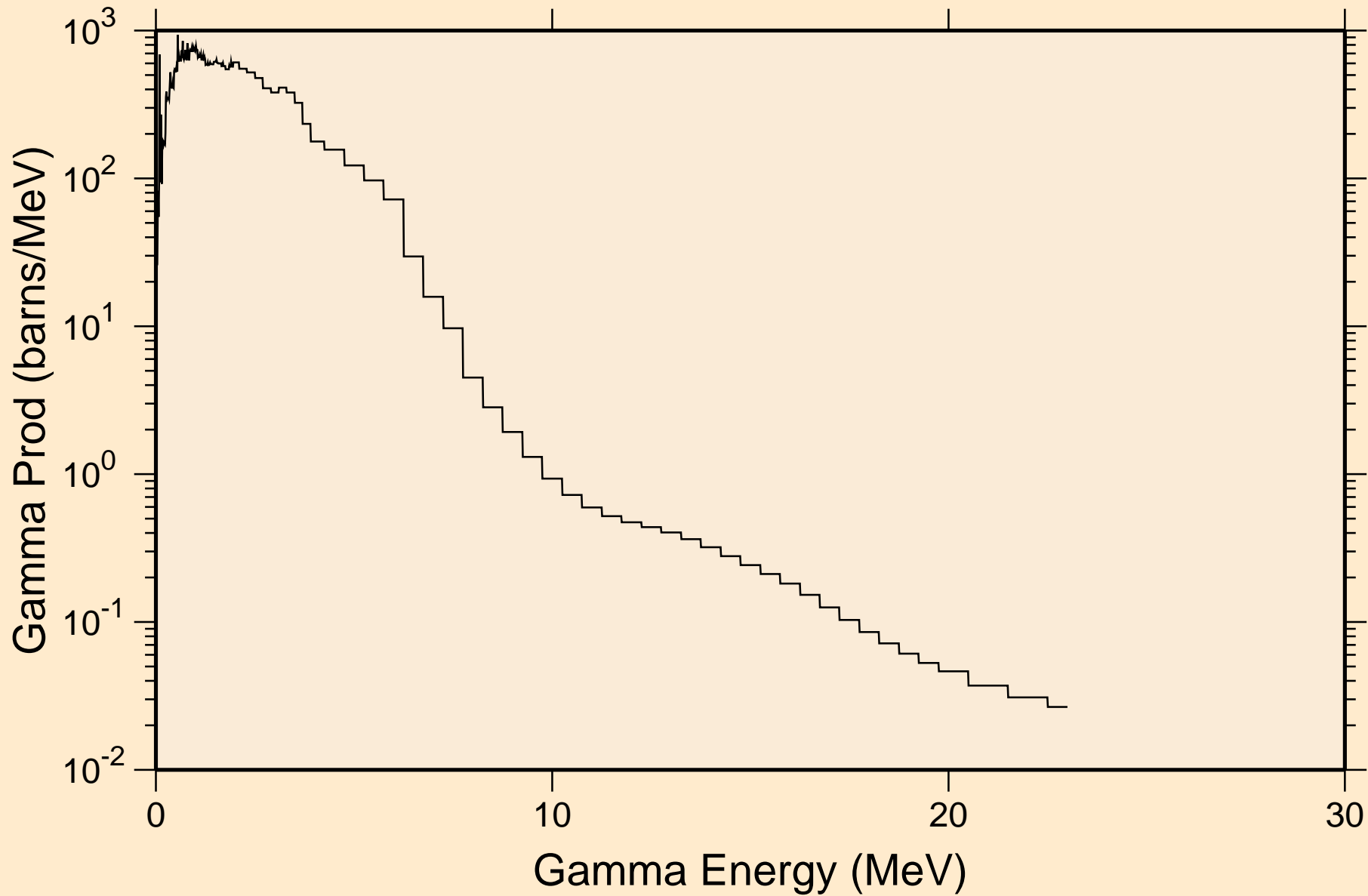

TM153M NEUTRON ACER TENDL-2024 LIBRARY; T=293.6K
Particle heating contributions

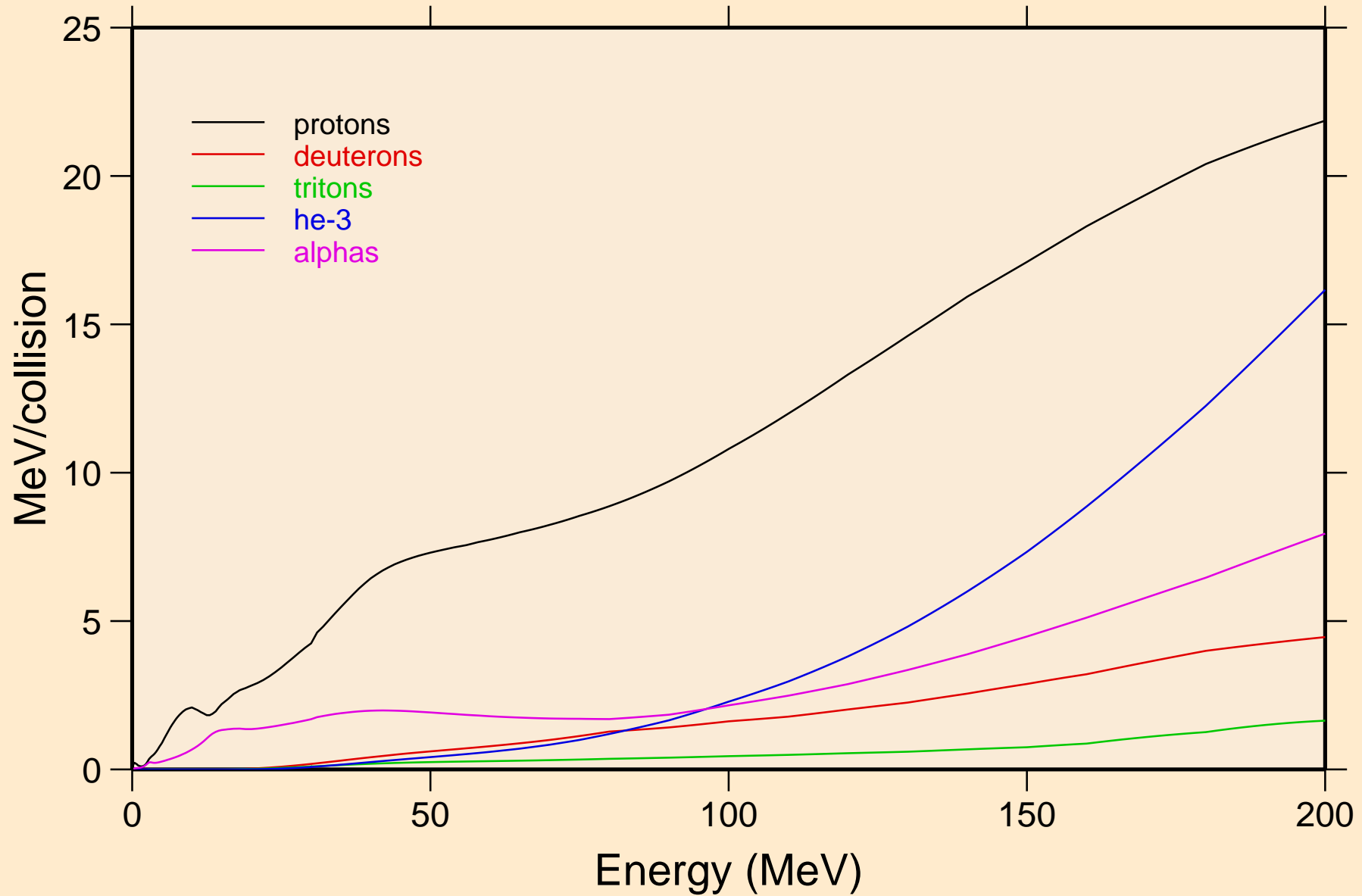

TM153M NEUTRON ACER TENDL-2024 LIBRARY; T=293.6K
Recoil Heating

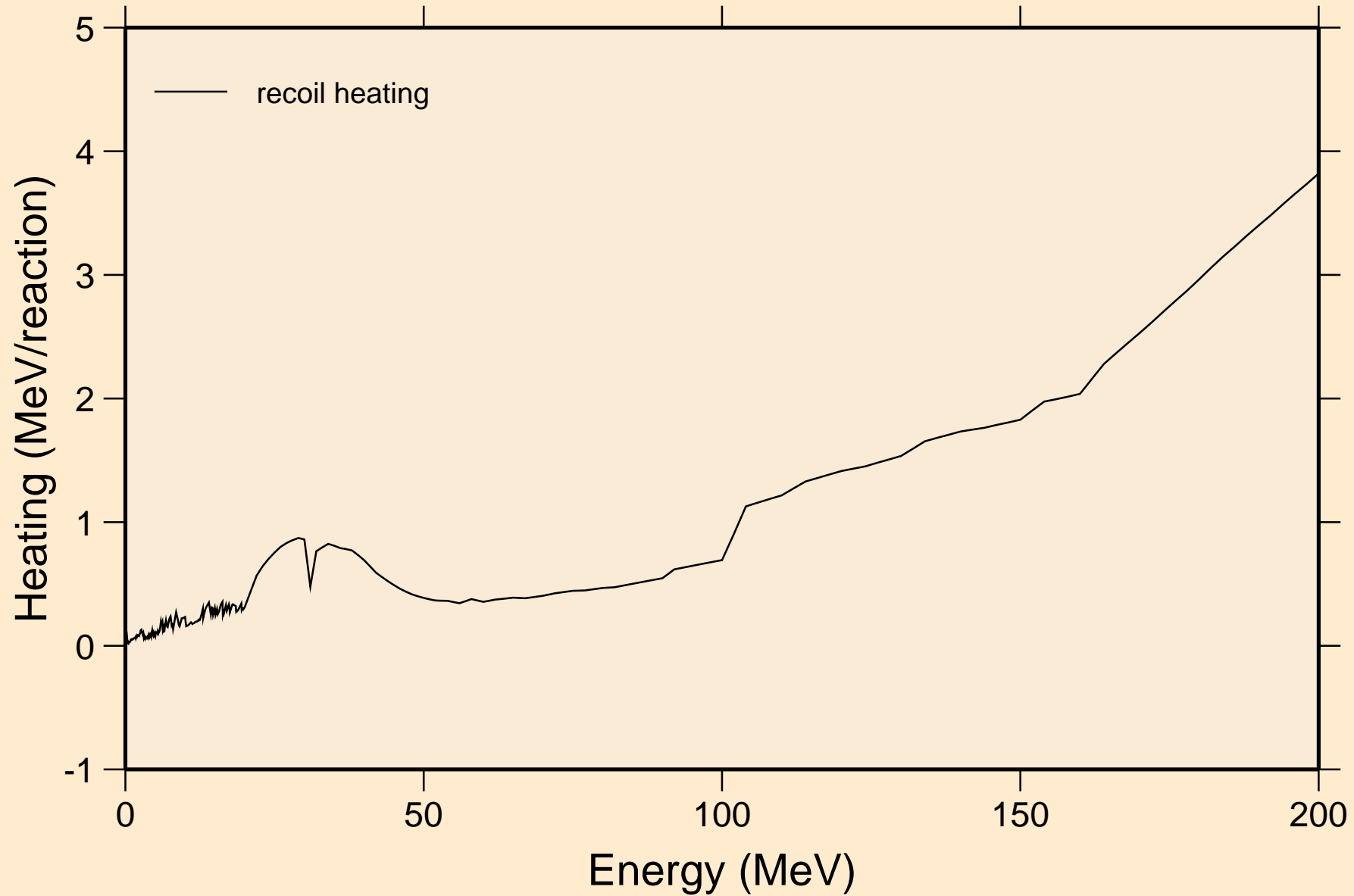

TM153M NEUTRON ACER TENDL-2024 LIBRARY; T=293.6K
Particle production cross sections

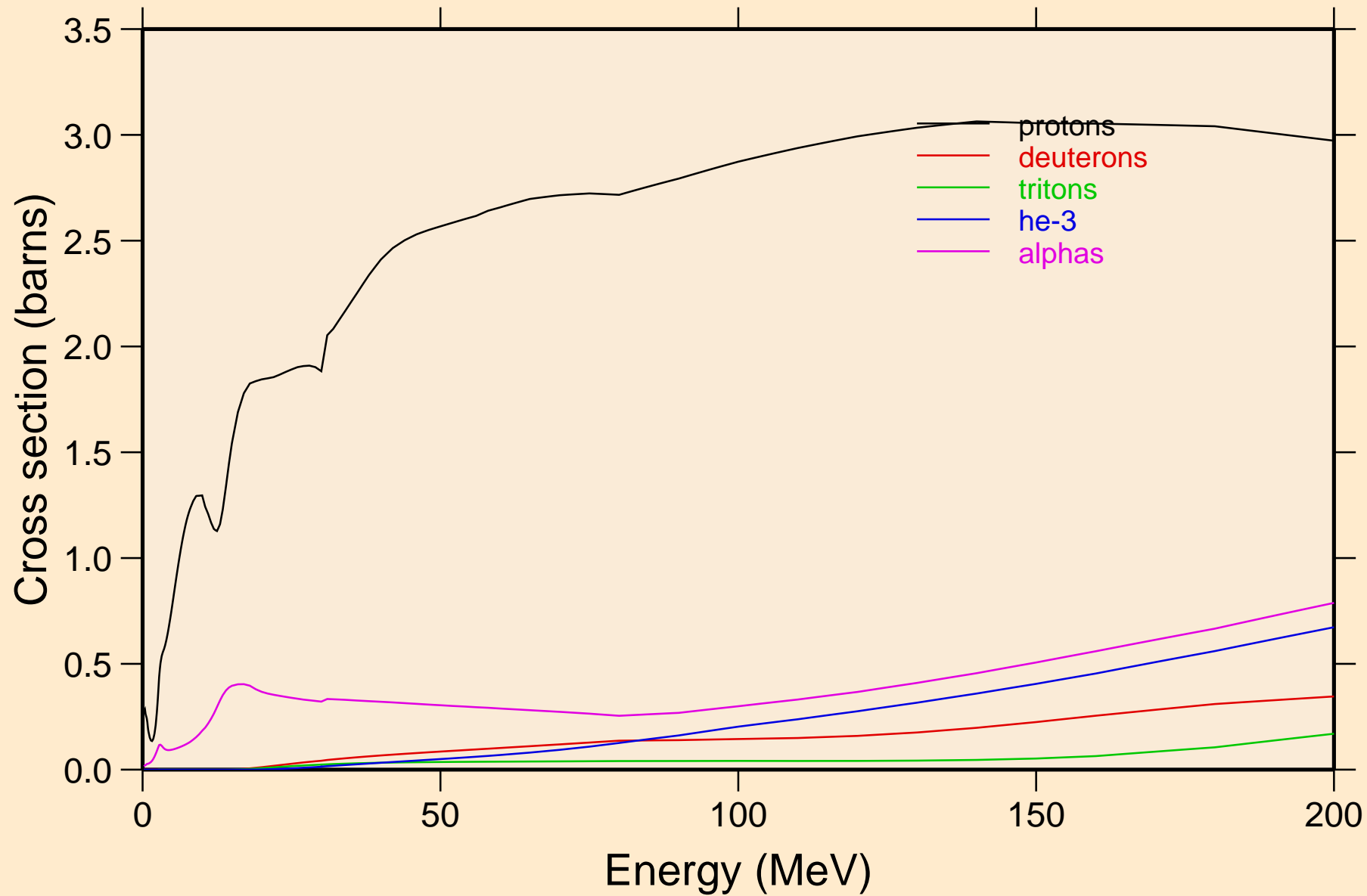

TM153M NEUTRON ACER TENDL-2024 LIBRARY; T=293.6K
protons from (n,x)

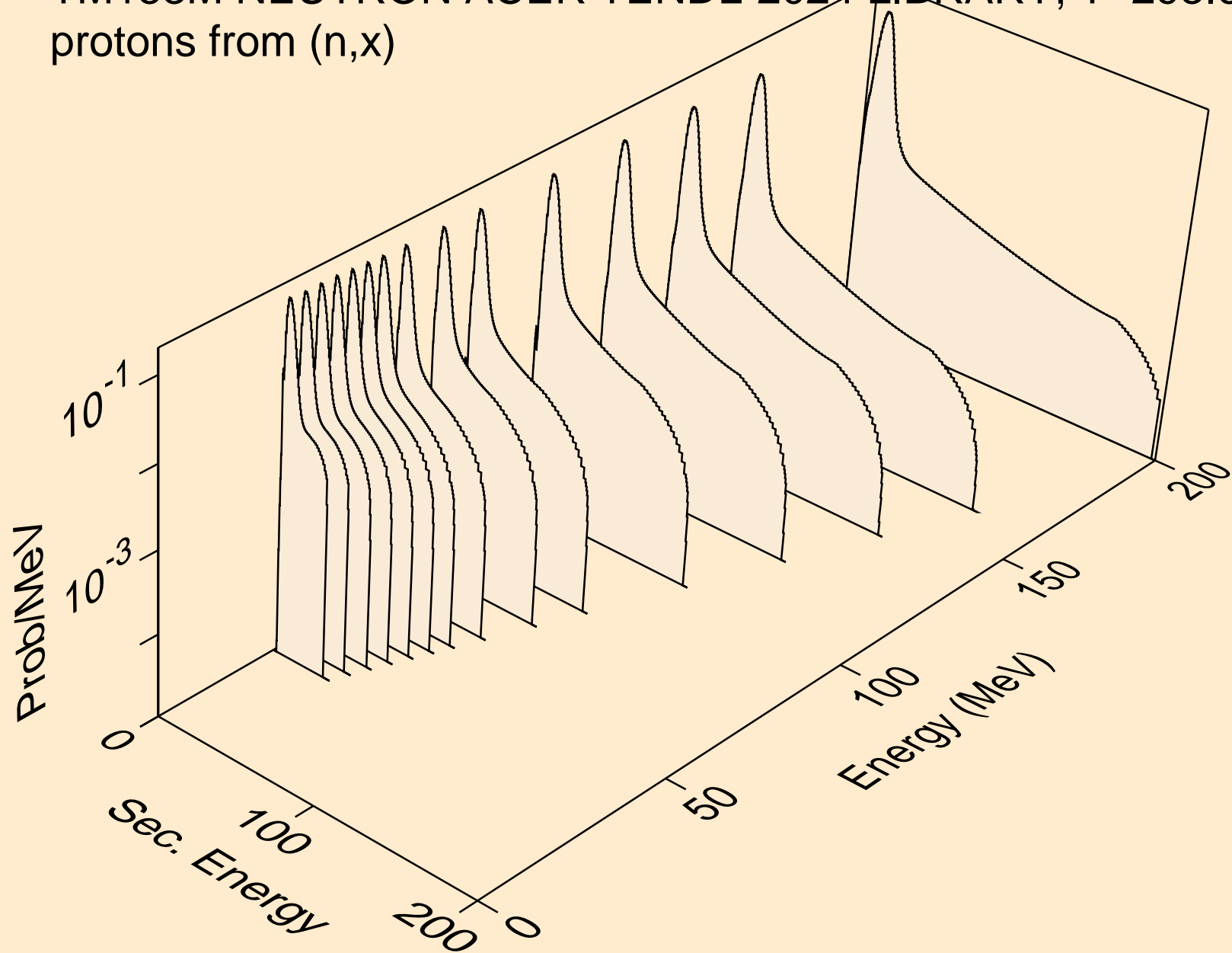

TM153M NEUTRON ACER TENDL-2024 LIBRARY; T=293.6K
protons from (n,n*)p

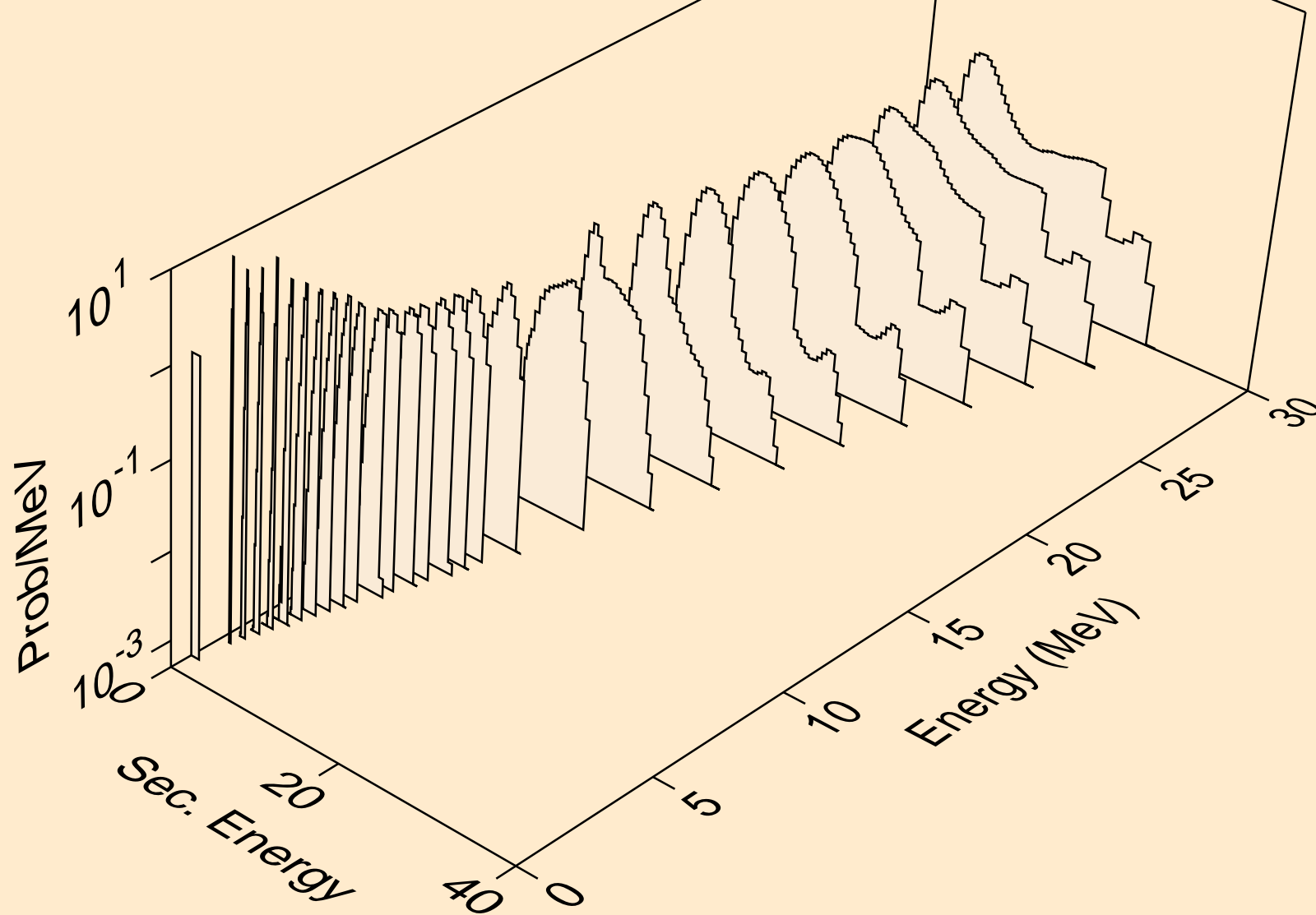

TM153M NEUTRON ACER TENDL-2024 LIBRARY; T=293.6K
protons from (n,2np)

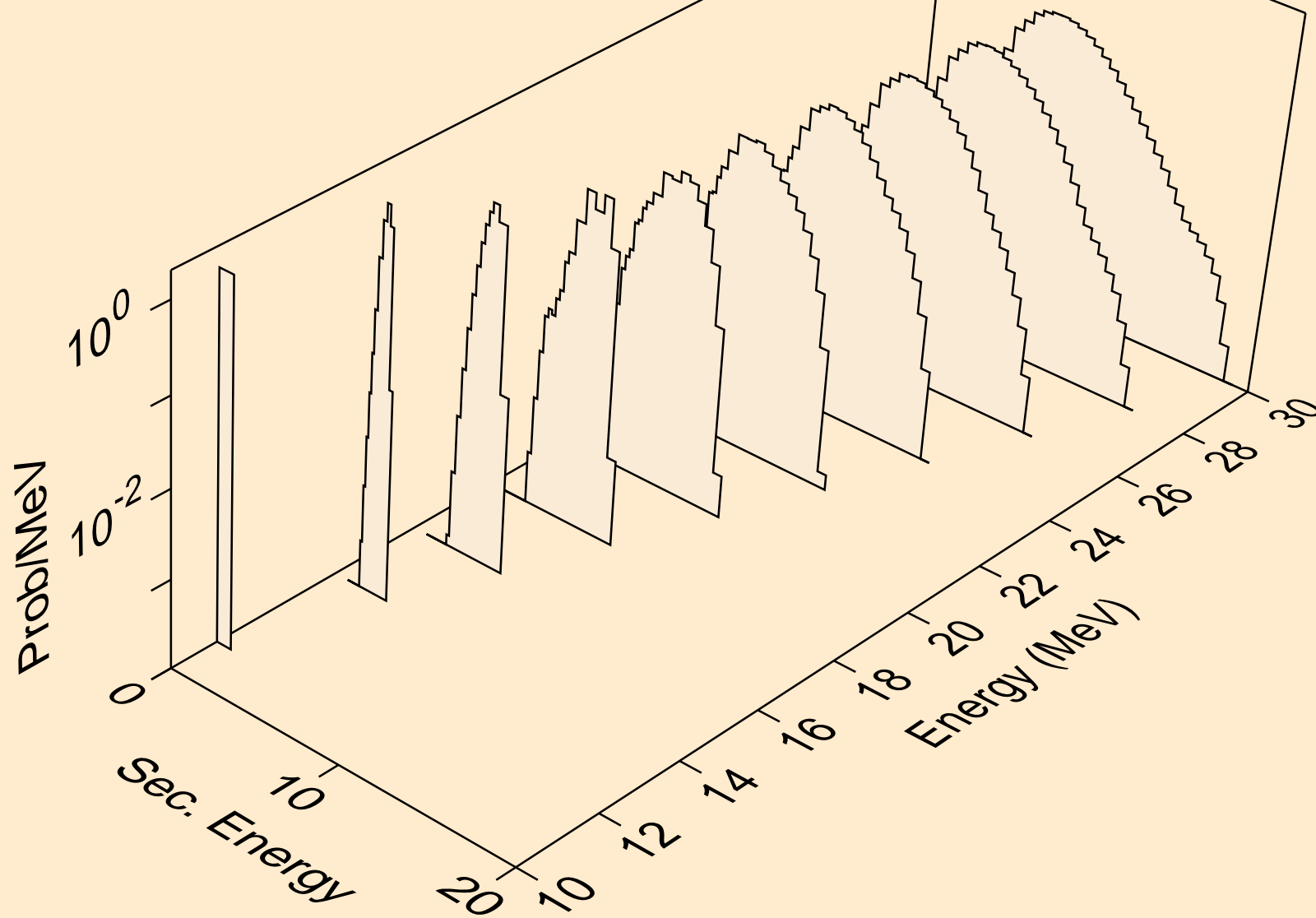

TM153M NEUTRON ACER TENDL-2024 LIBRARY; T=293.6K
protons from (n,3np)

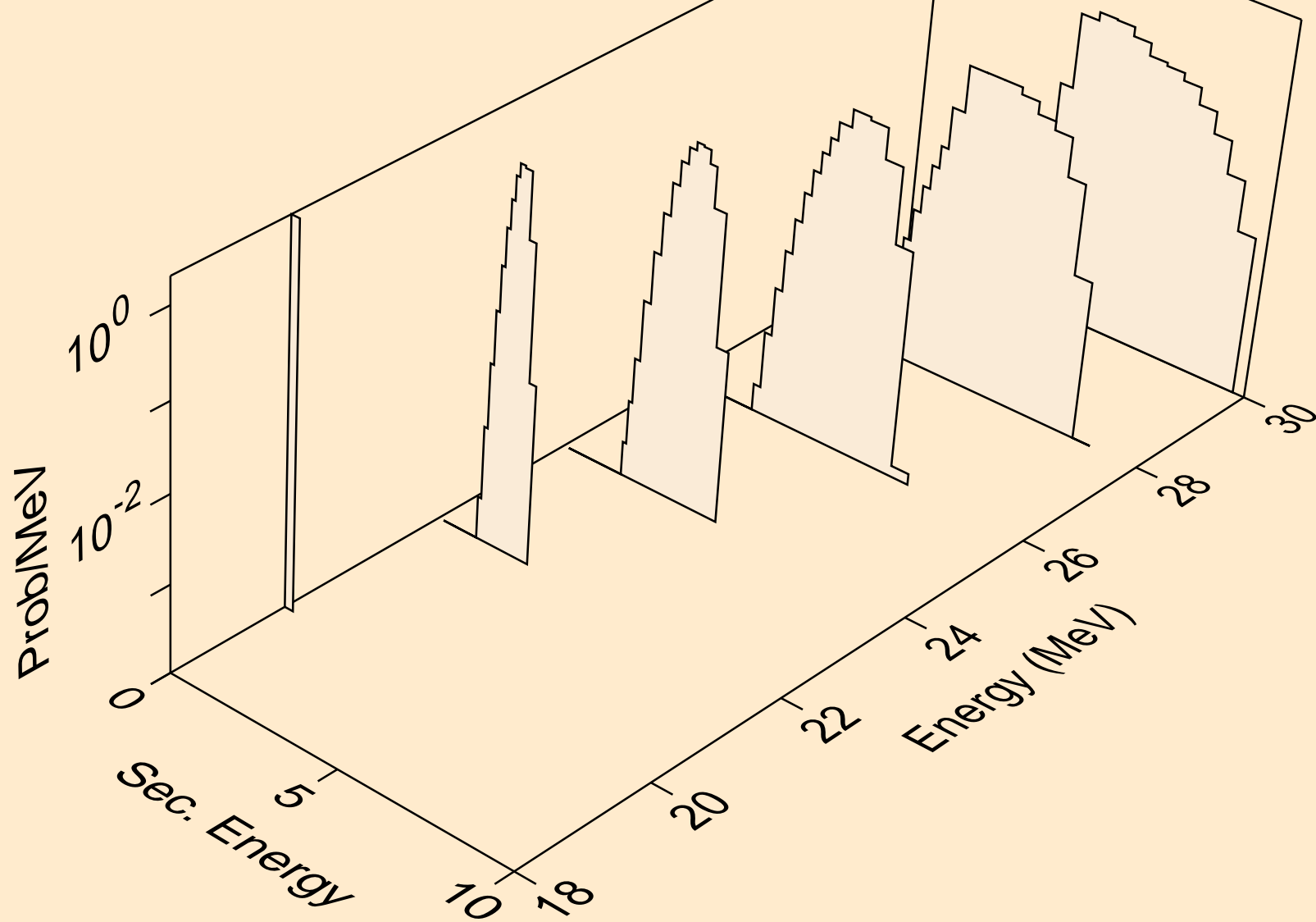

TM153M NEUTRON ACER TENDL-2024 LIBRARY; T=293.6K
protons from (n,n2p)

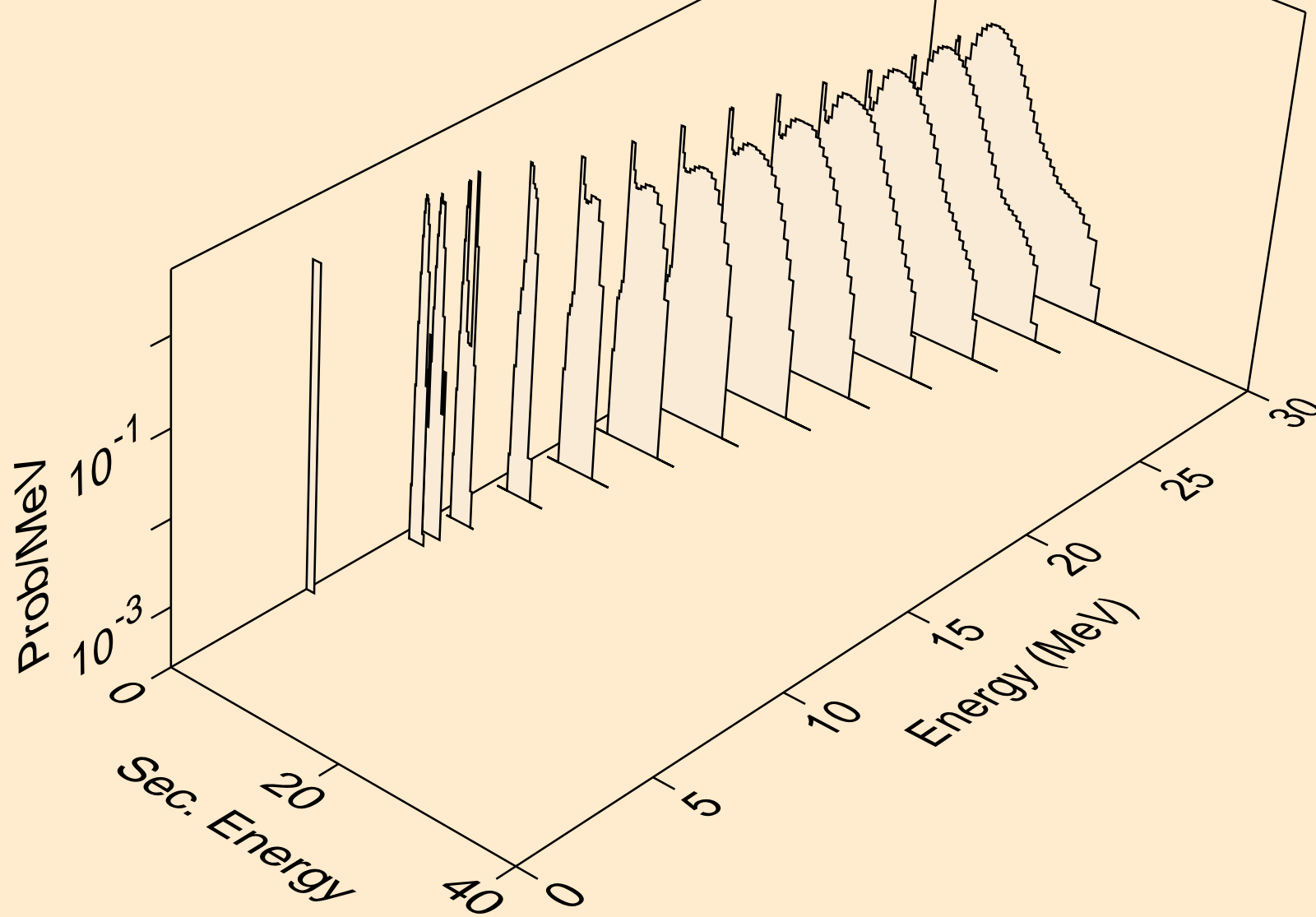

TM153M NEUTRON ACER TENDL-2024 LIBRARY; T=293.6K
protons from (n,npa)

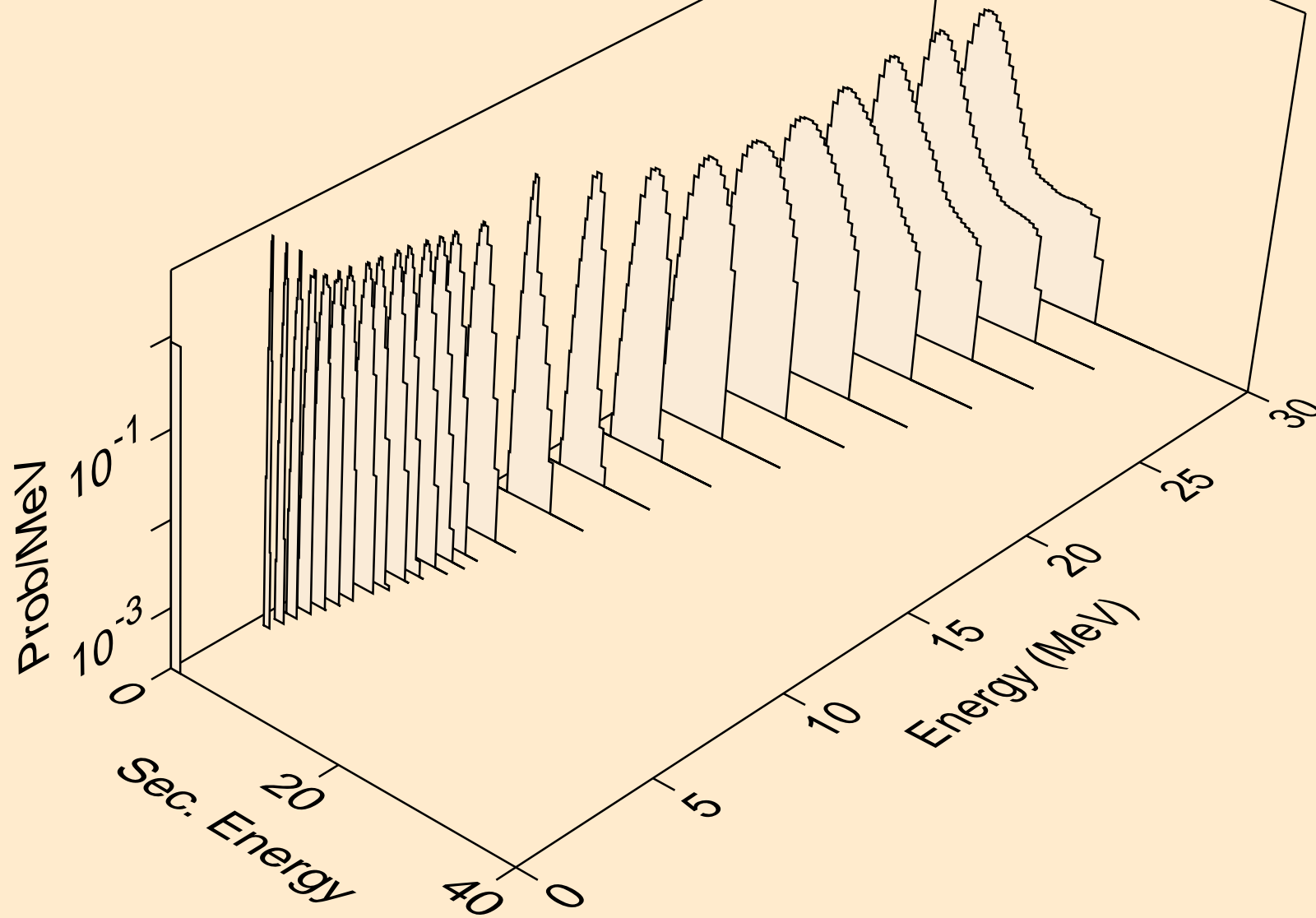

TM153M NEUTRON ACER TENDL-2024 LIBRARY; T=293.6K
protons from (n,p)

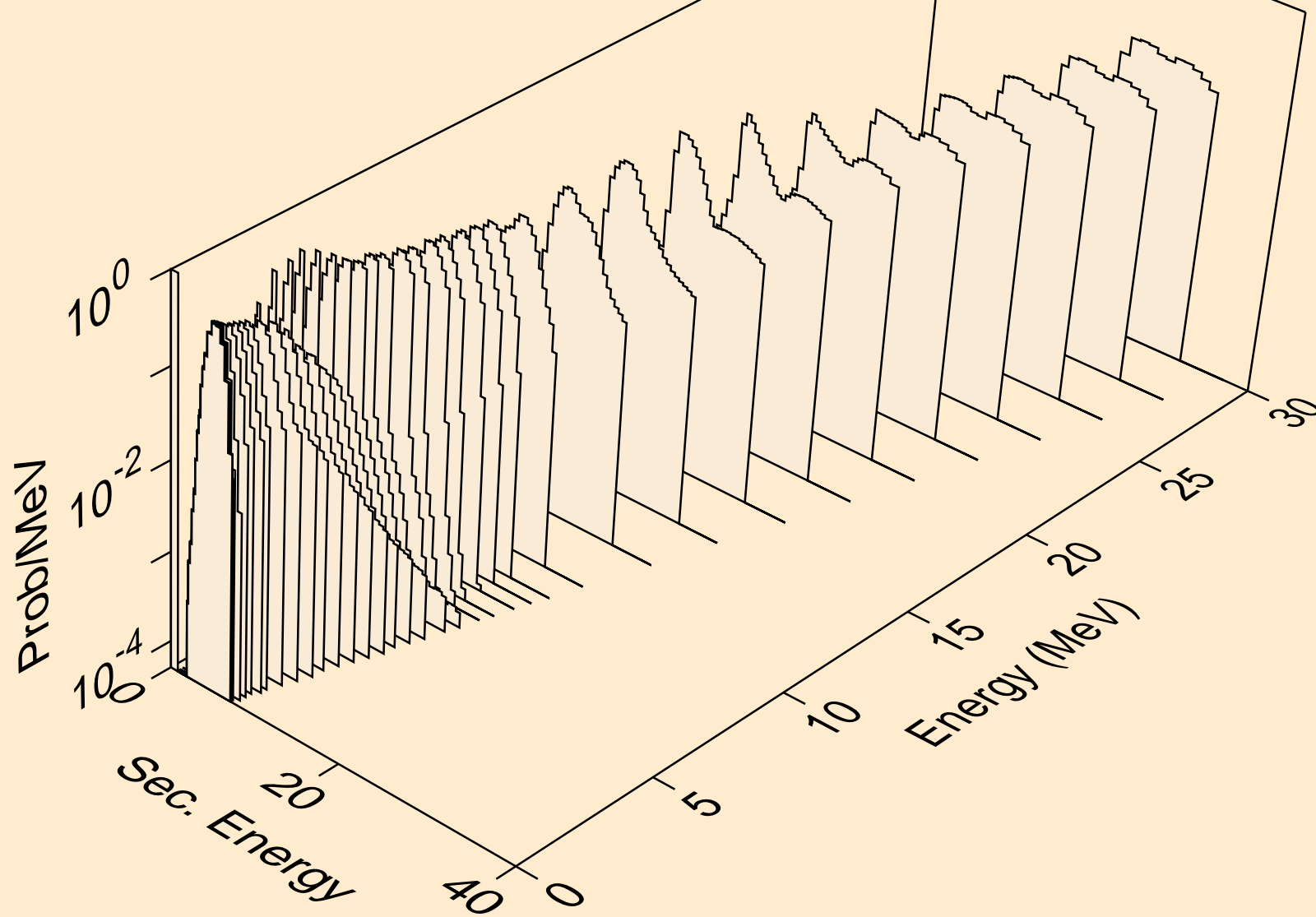

TM153M NEUTRON ACER TENDL-2024 LIBRARY; T=293.6K
protons from (n,2p)

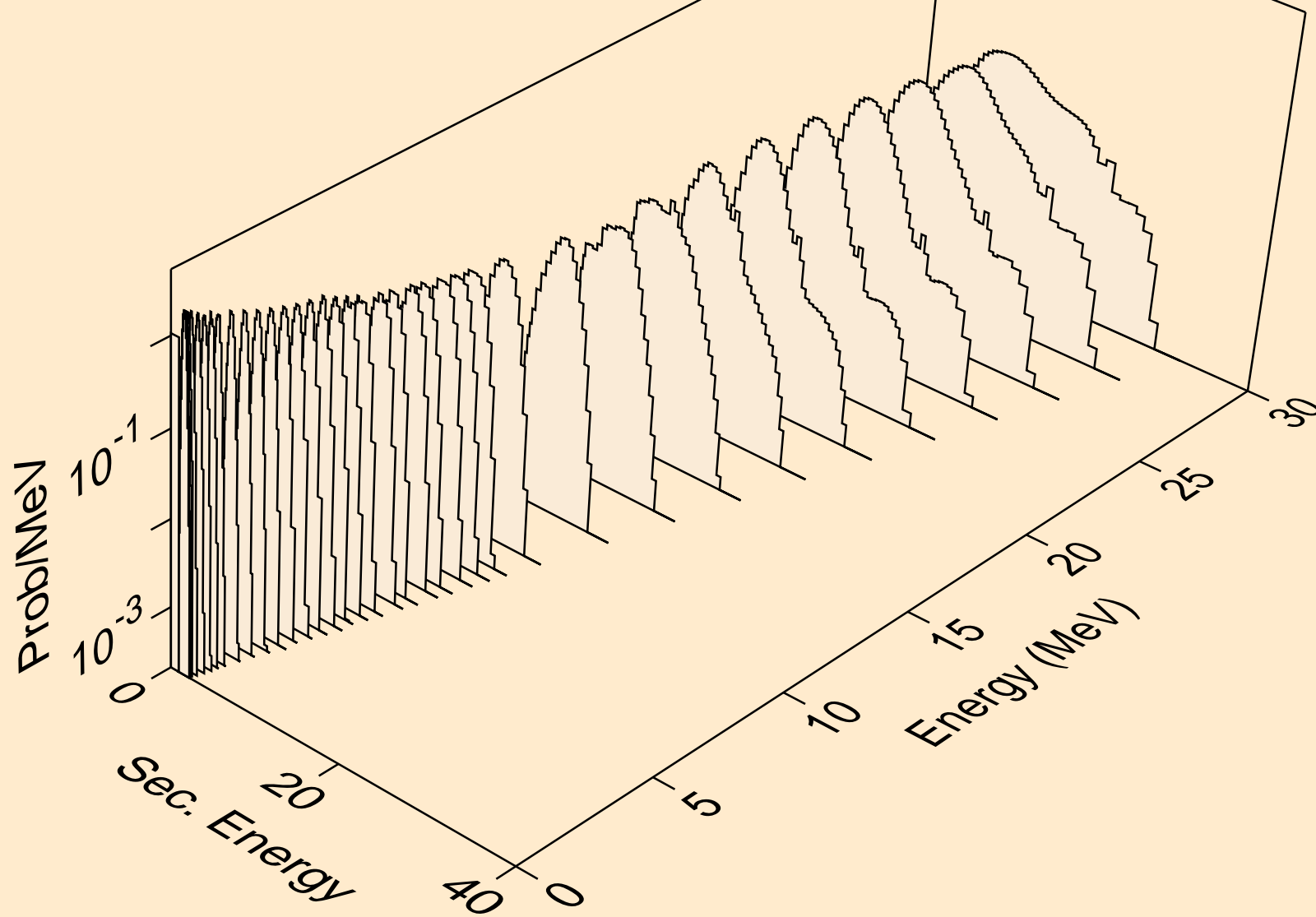

TM153M NEUTRON ACER TENDL-2024 LIBRARY; T=293.6K
protons from (n,p)

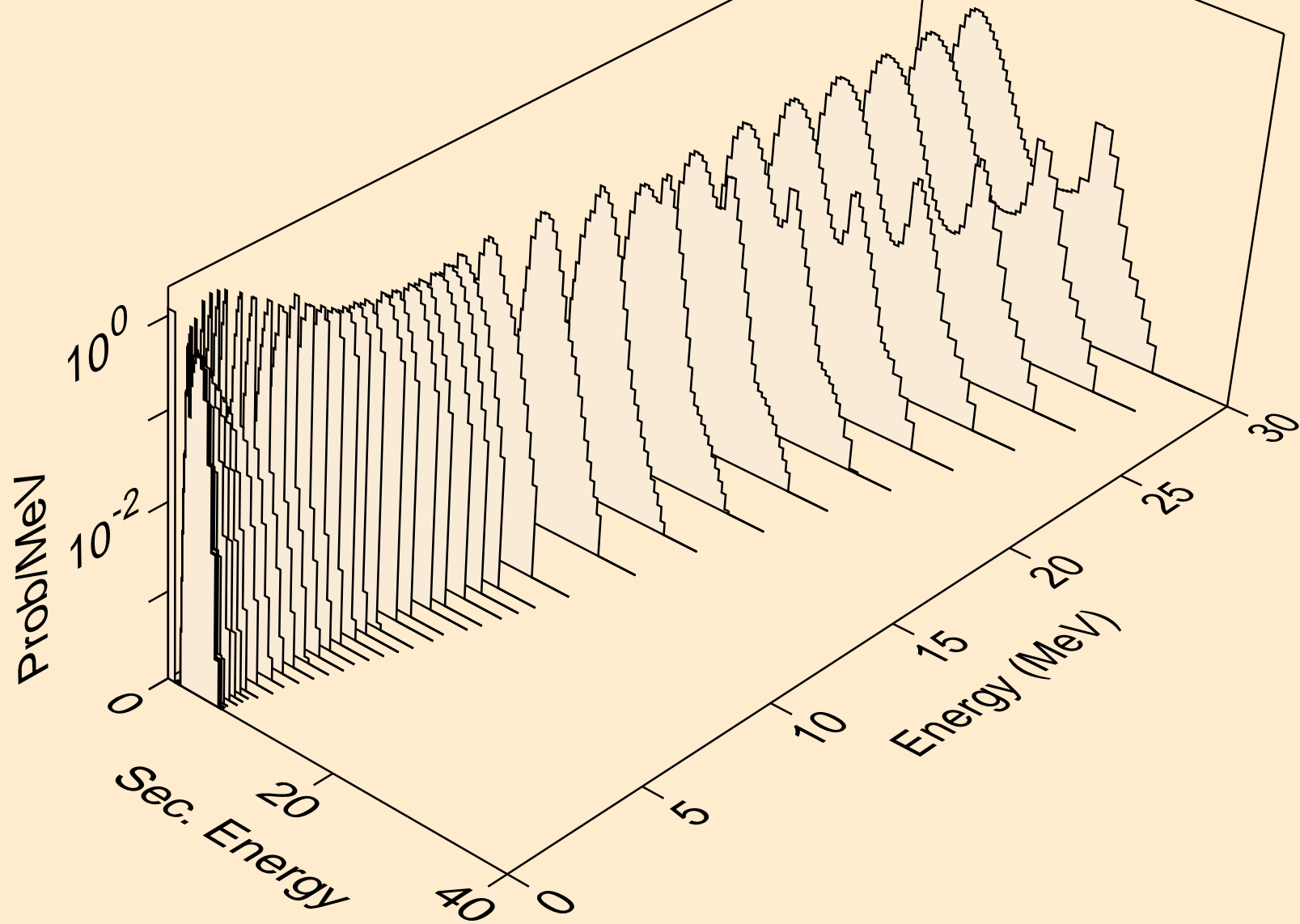

TM153M NEUTRON ACER TENDL-2024 LIBRARY; T=293.6K
protons from (n,pd)

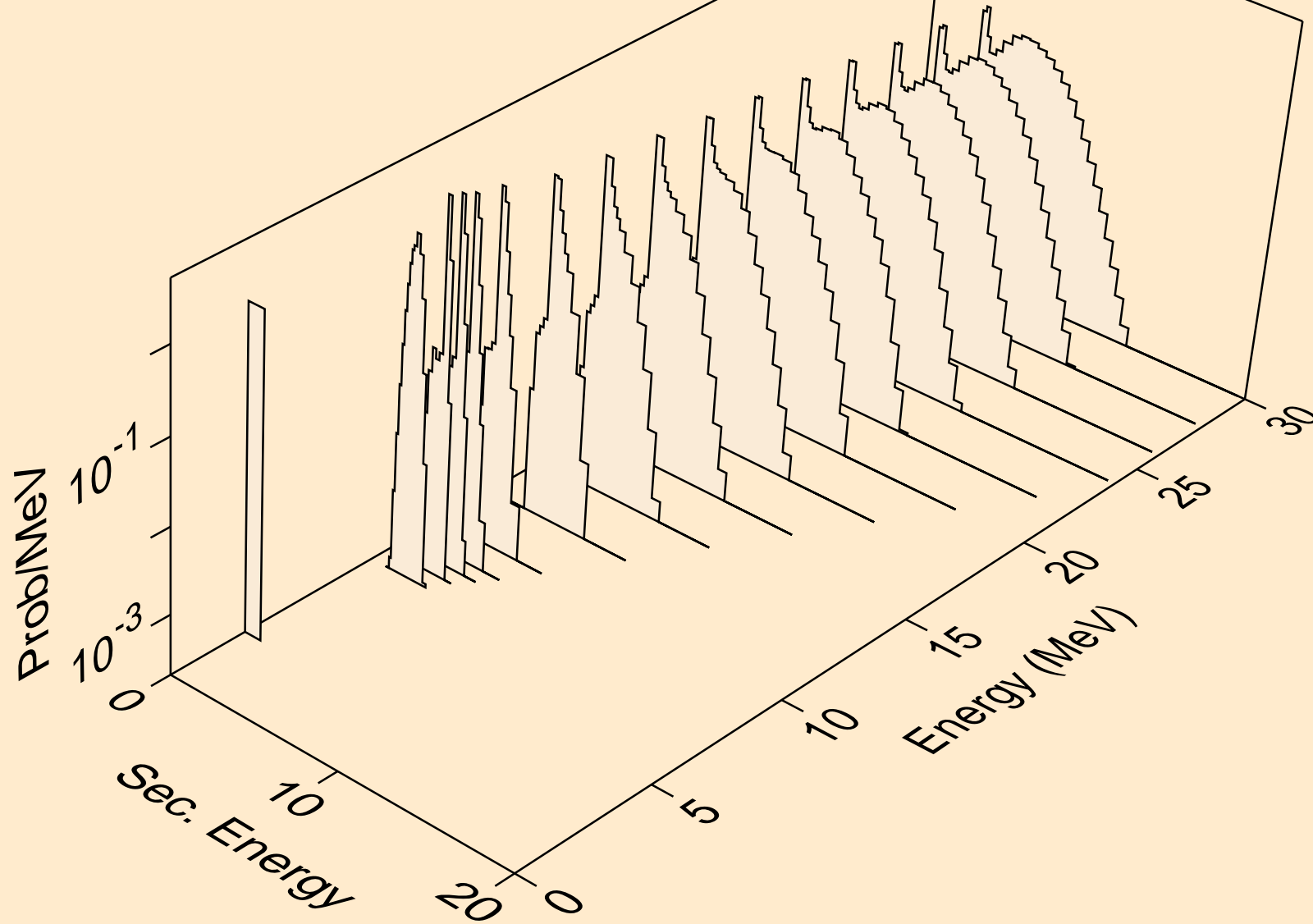

TM153M NEUTRON ACER TENDL-2024 LIBRARY; T=293.6K
protons from (n,pt)

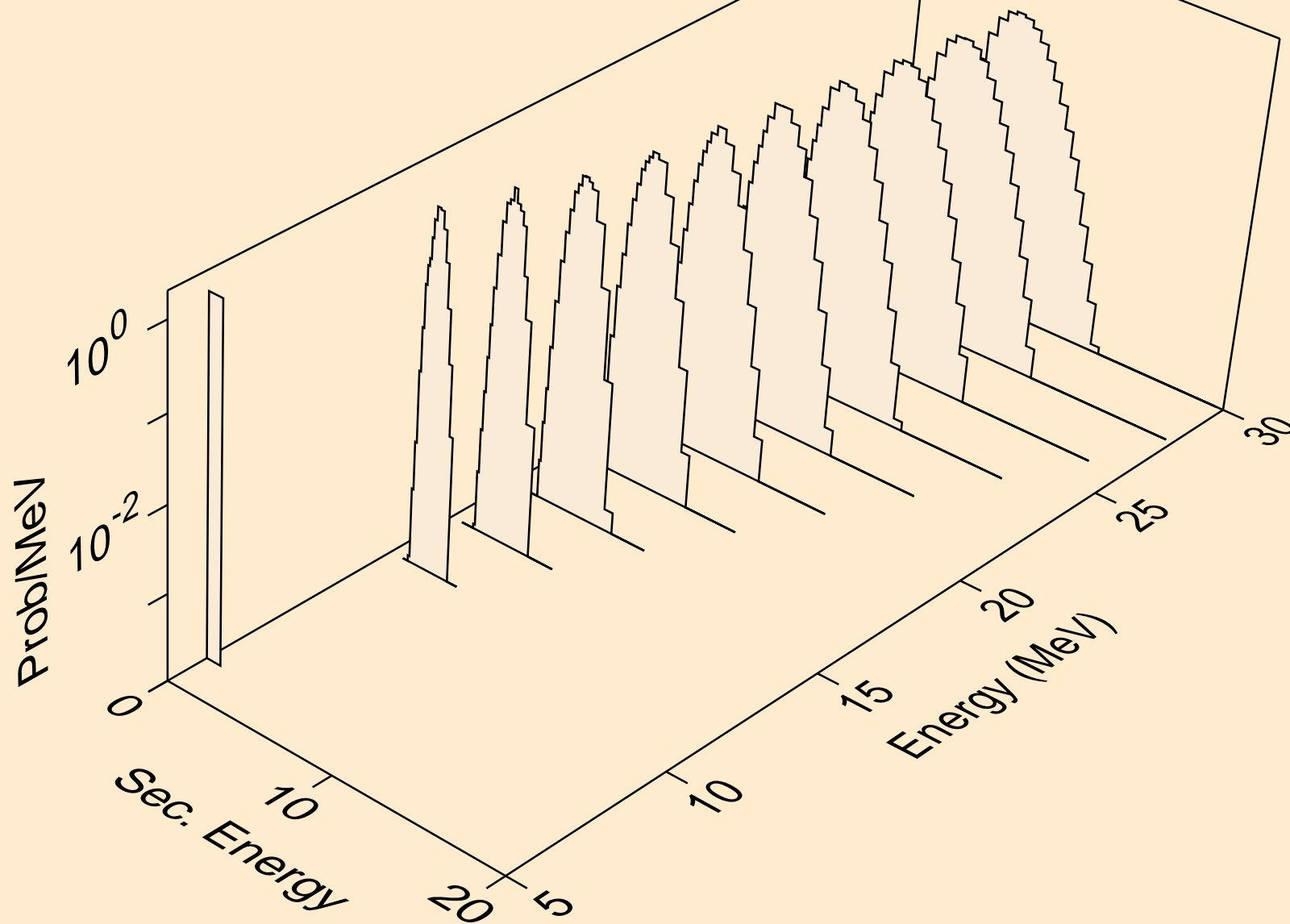

TM153M NEUTRON ACER TENDL-2024 LIBRARY; T=293.6K
deuterons from (n,x)

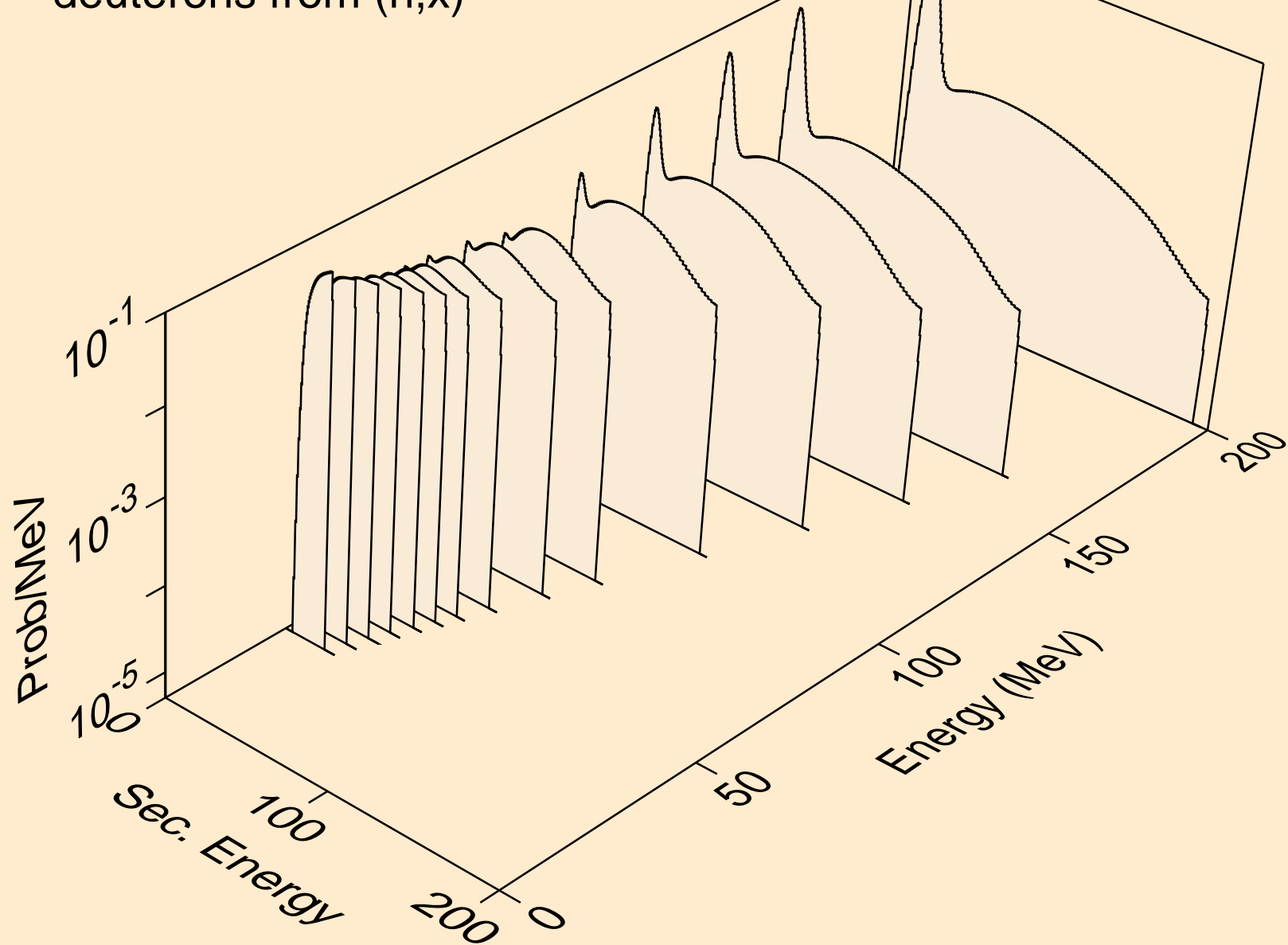

TM153M NEUTRON ACER TENDL-2024 LIBRARY; T=293.6K
deuterons from (n,2nd)

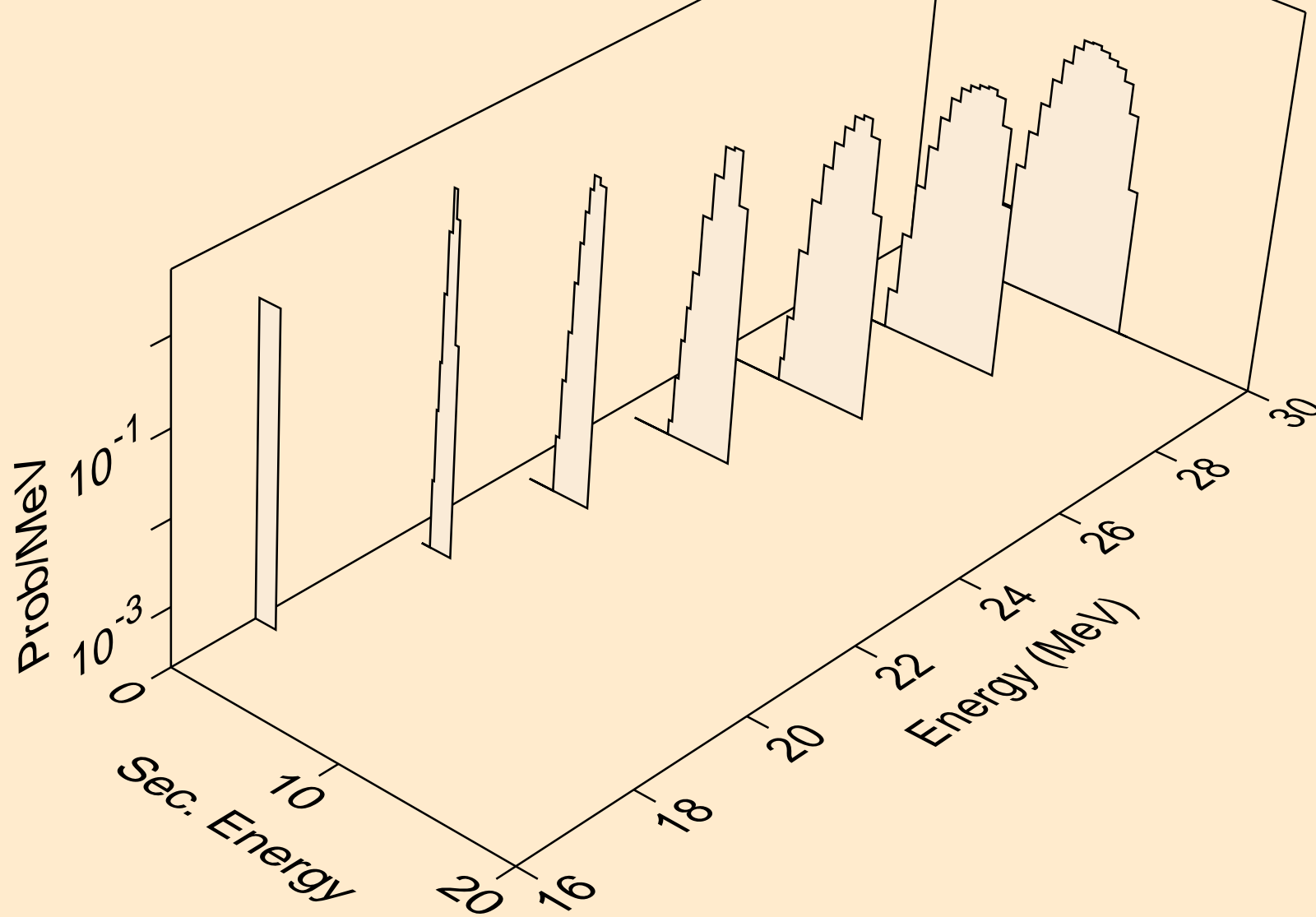

TM153M NEUTRON ACER TENDL-2024 LIBRARY; T=293.6K
deuterons from (n,n*)d

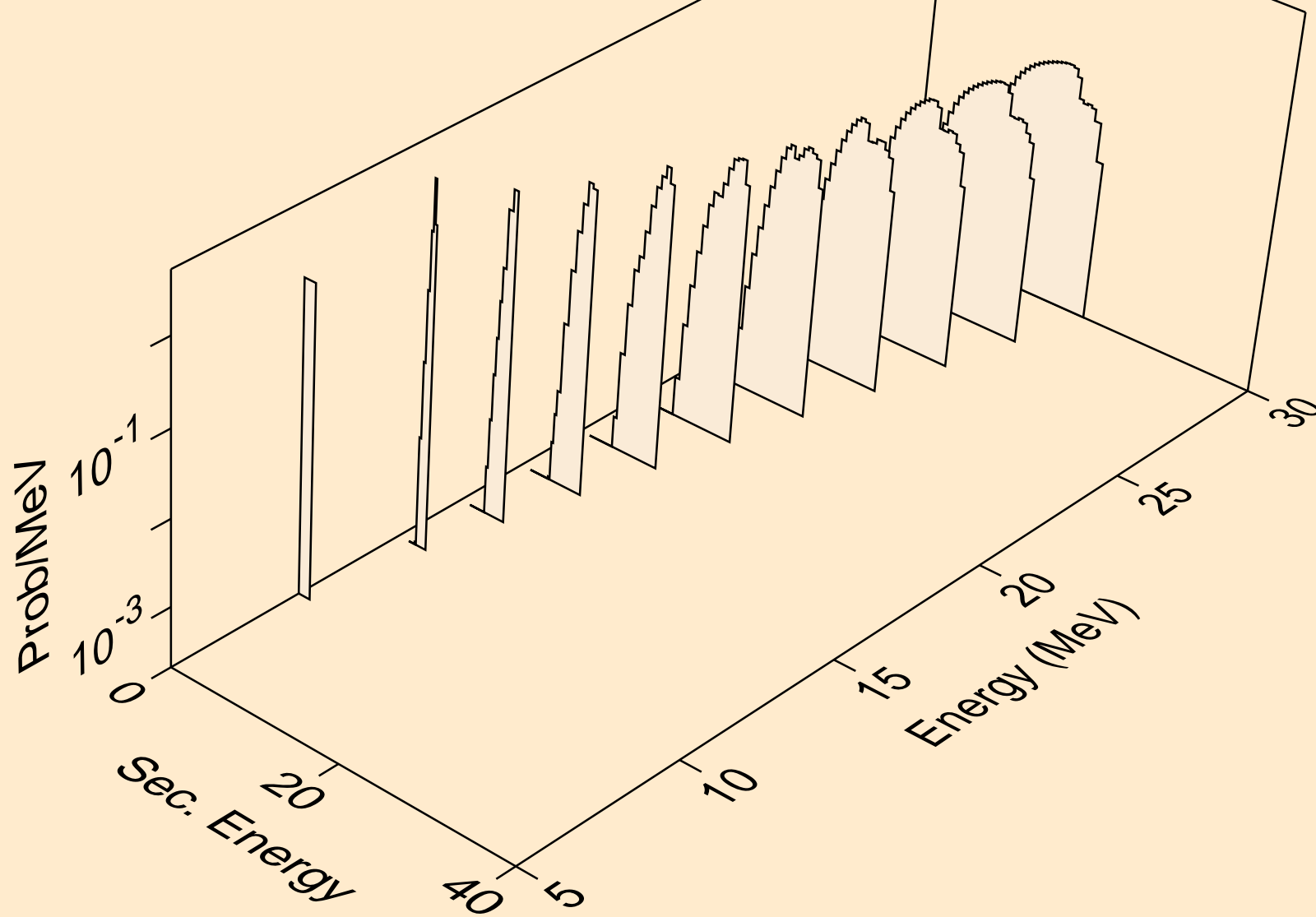

TM153M NEUTRON ACER TENDL-2024 LIBRARY; T=293.6K
deuterons from (n,d)

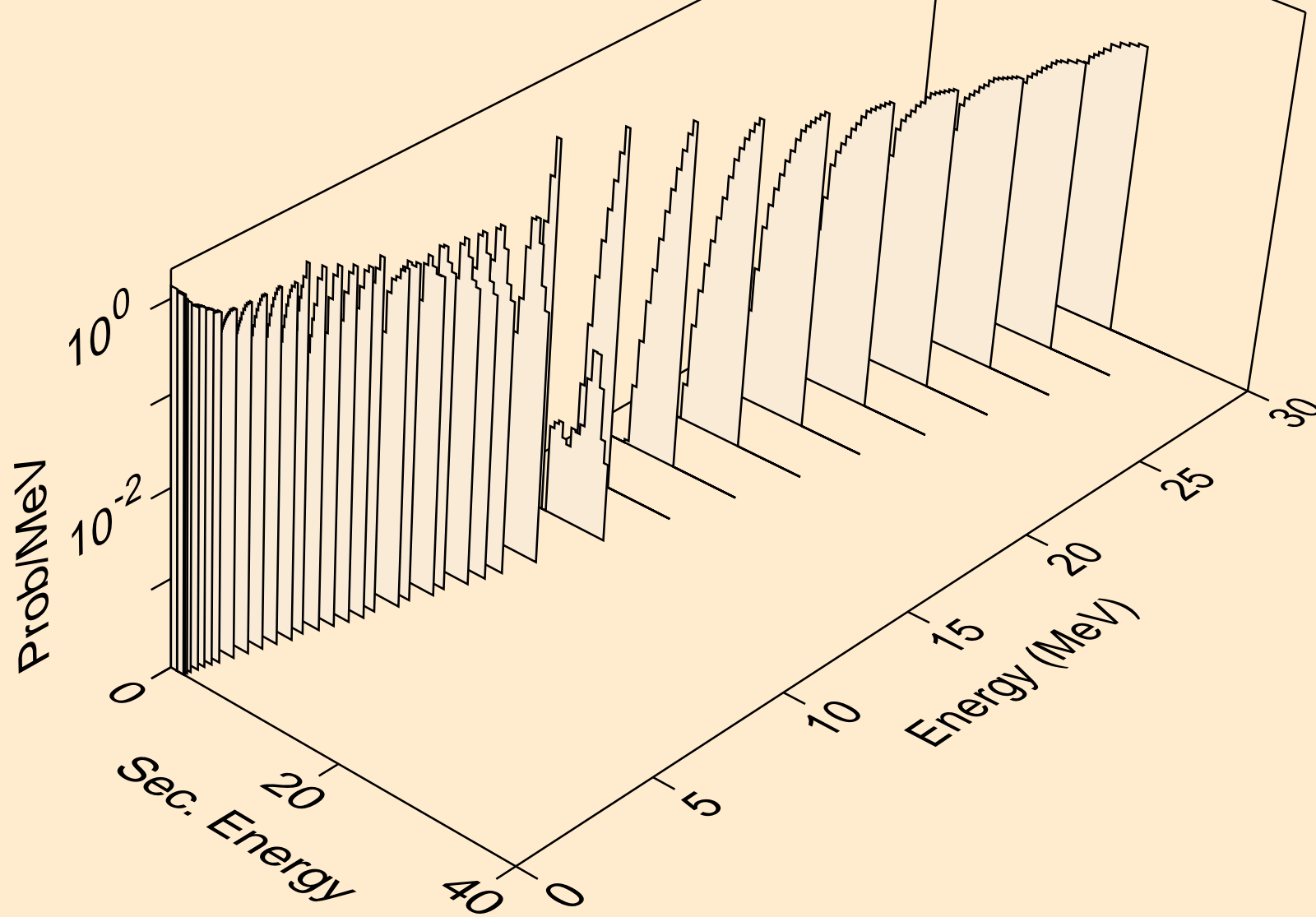

TM153M NEUTRON ACER TENDL-2024 LIBRARY; T=293.6K
deuterons from (n,d2a)

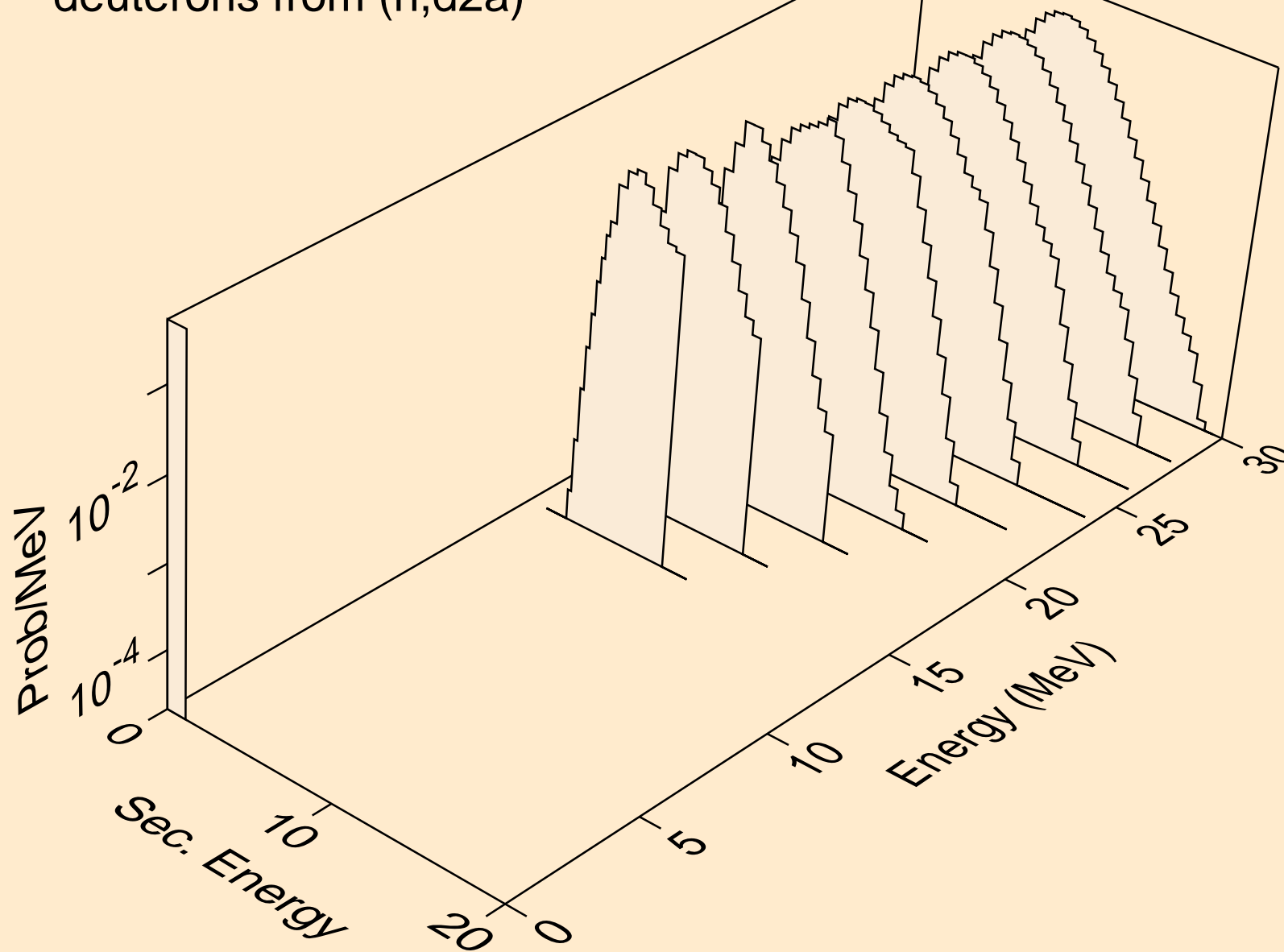

TM153M NEUTRON ACER TENDL-2024 LIBRARY; T=293.6K
deuterons from (n,pd)

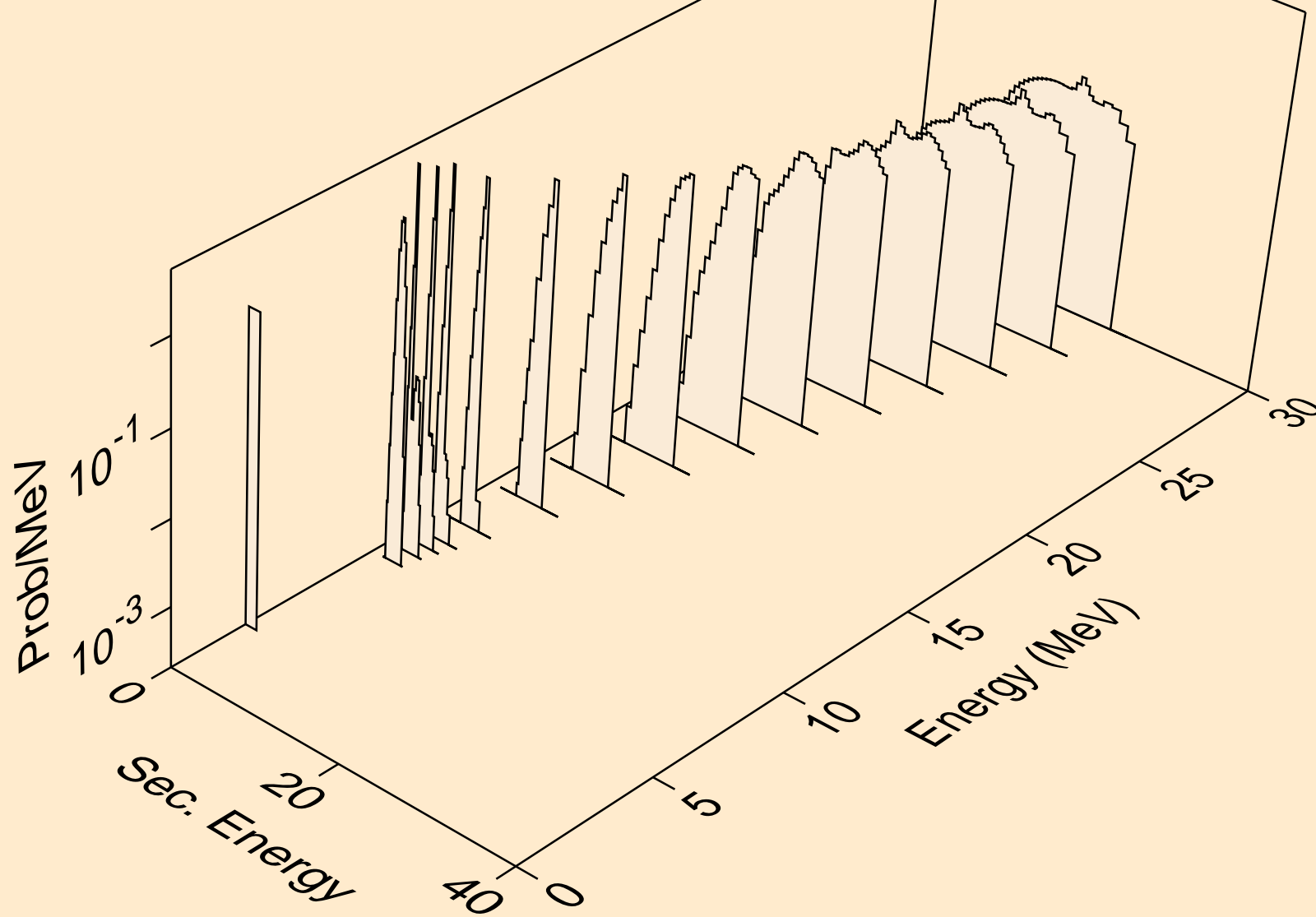

TM153M NEUTRON ACER TENDL-2024 LIBRARY; T=293.6K
deuterons from (n,da)

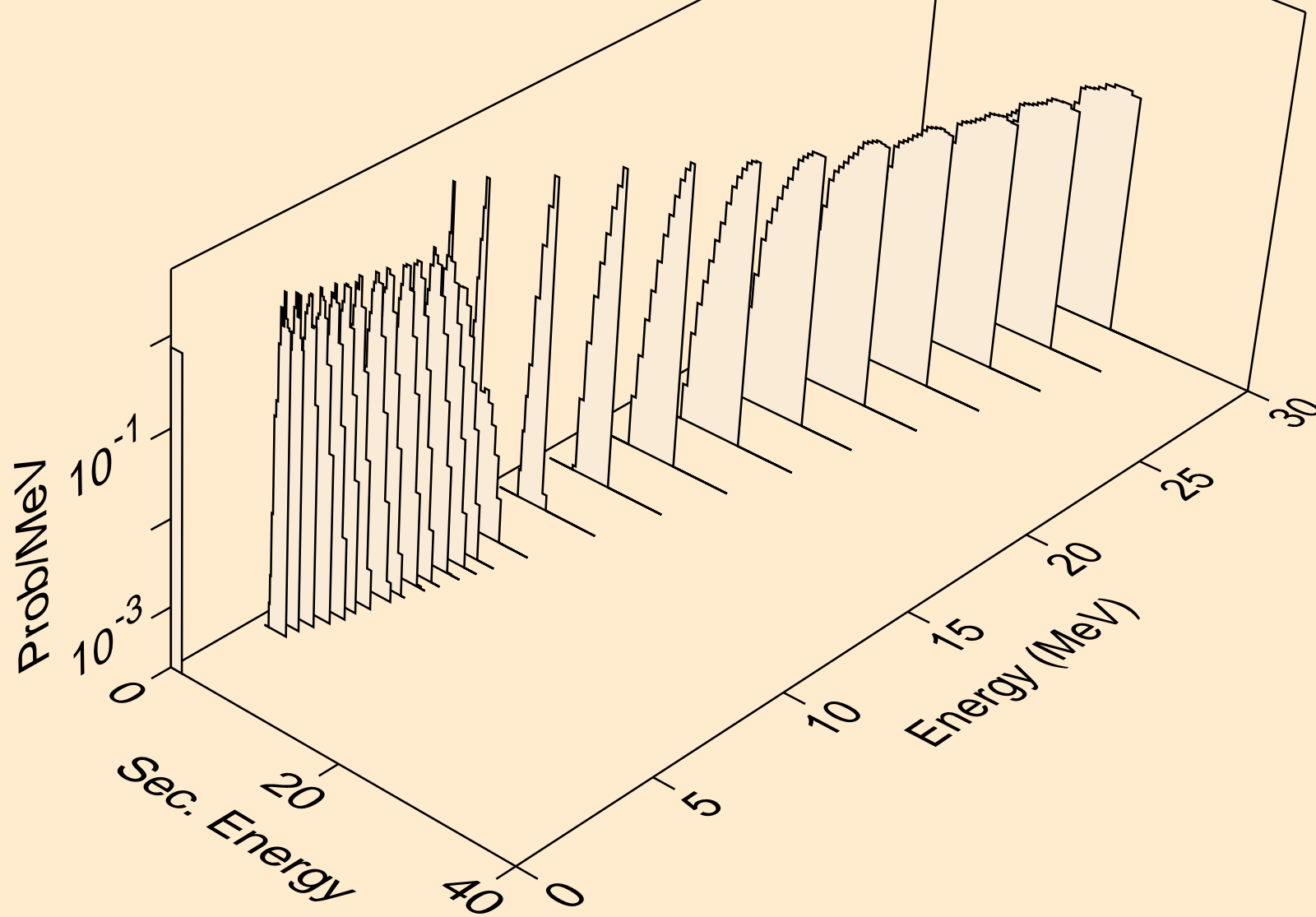

TM153M NEUTRON ACER TENDL-2024 LIBRARY; T=293.6K
tritons from (n,x)

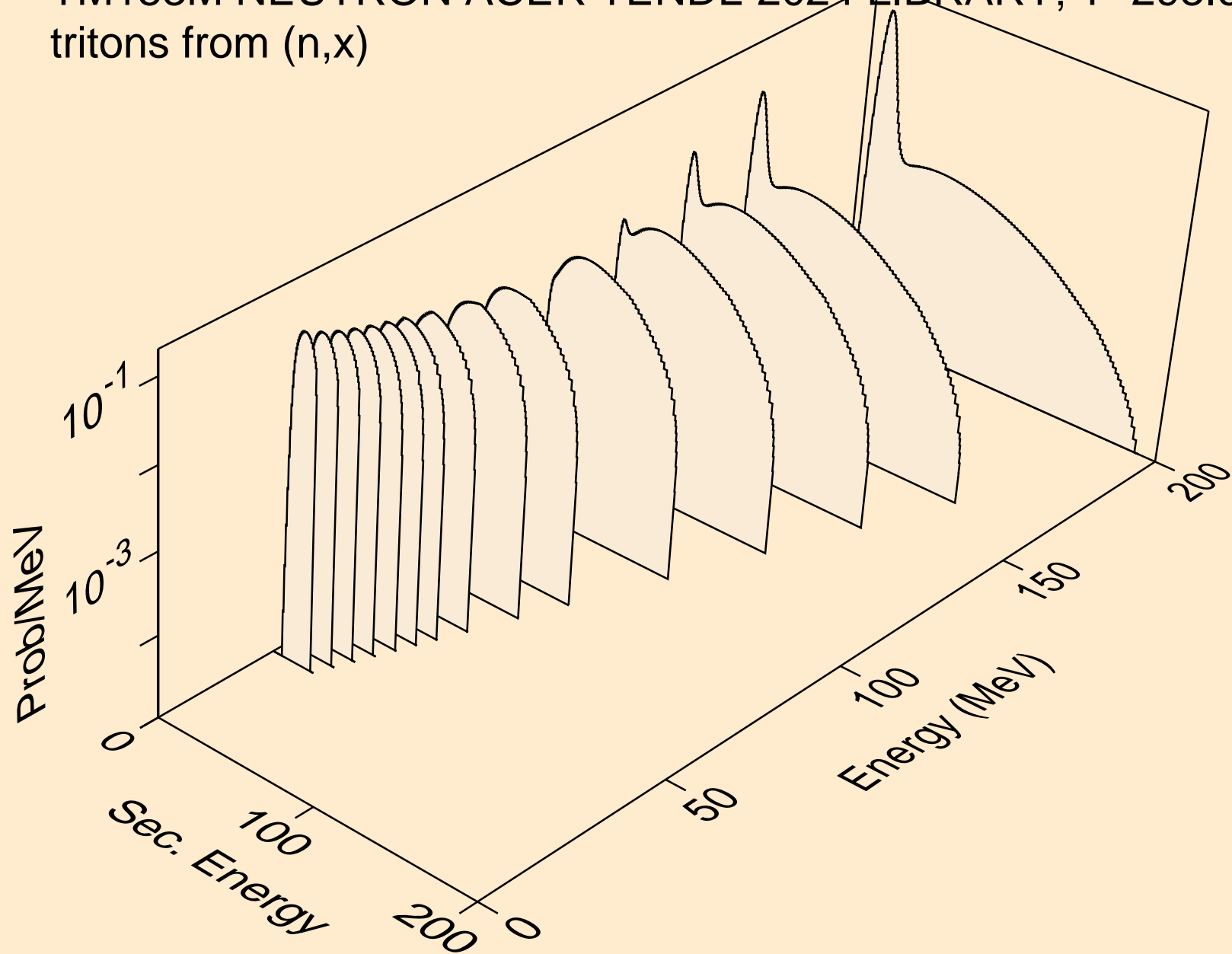

TM153M NEUTRON ACER TENDL-2024 LIBRARY; T=293.6K
tritons from (n,n*)t

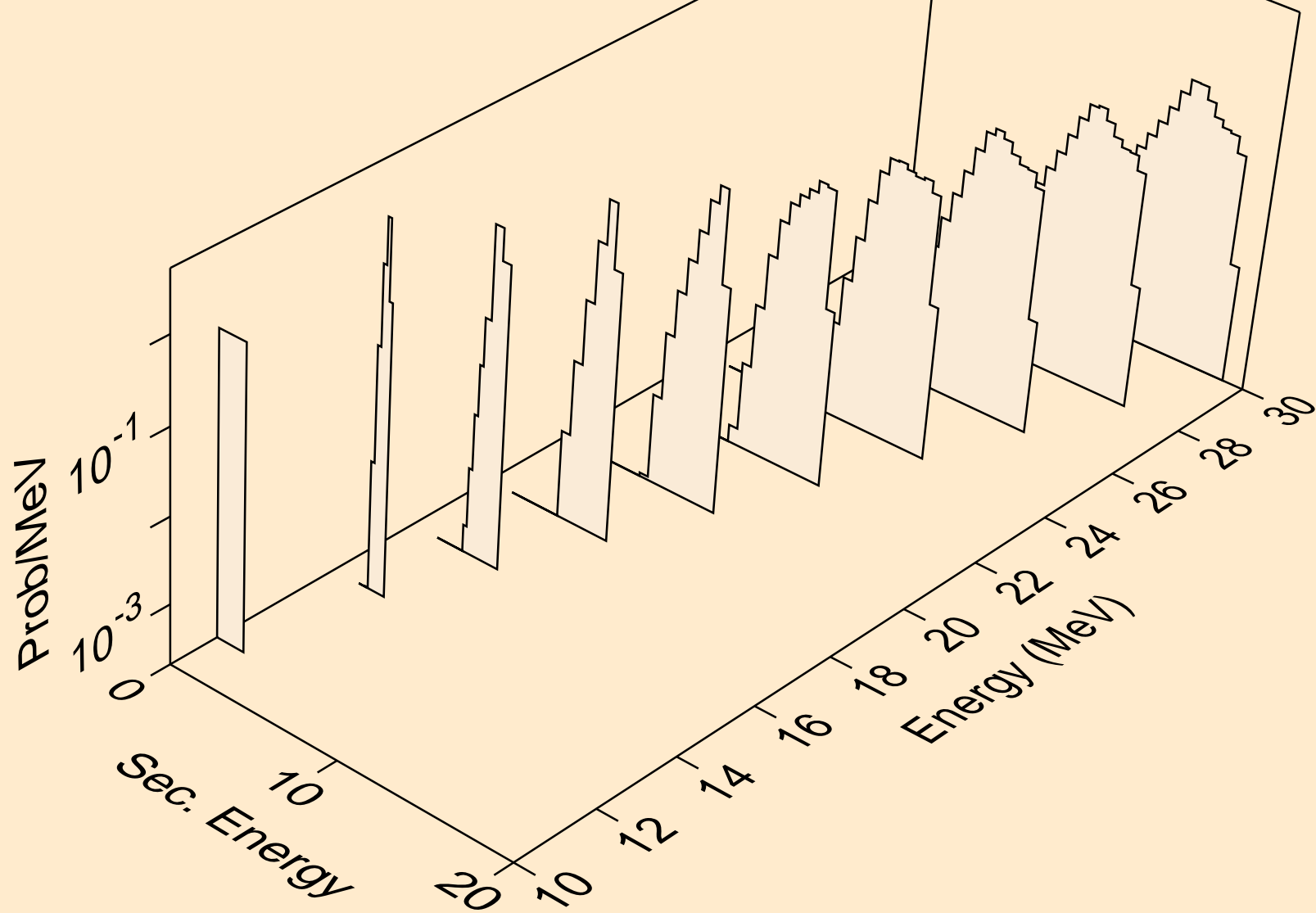

TM153M NEUTRON ACER TENDL-2024 LIBRARY; T=293.6K
tritons from (n,t)

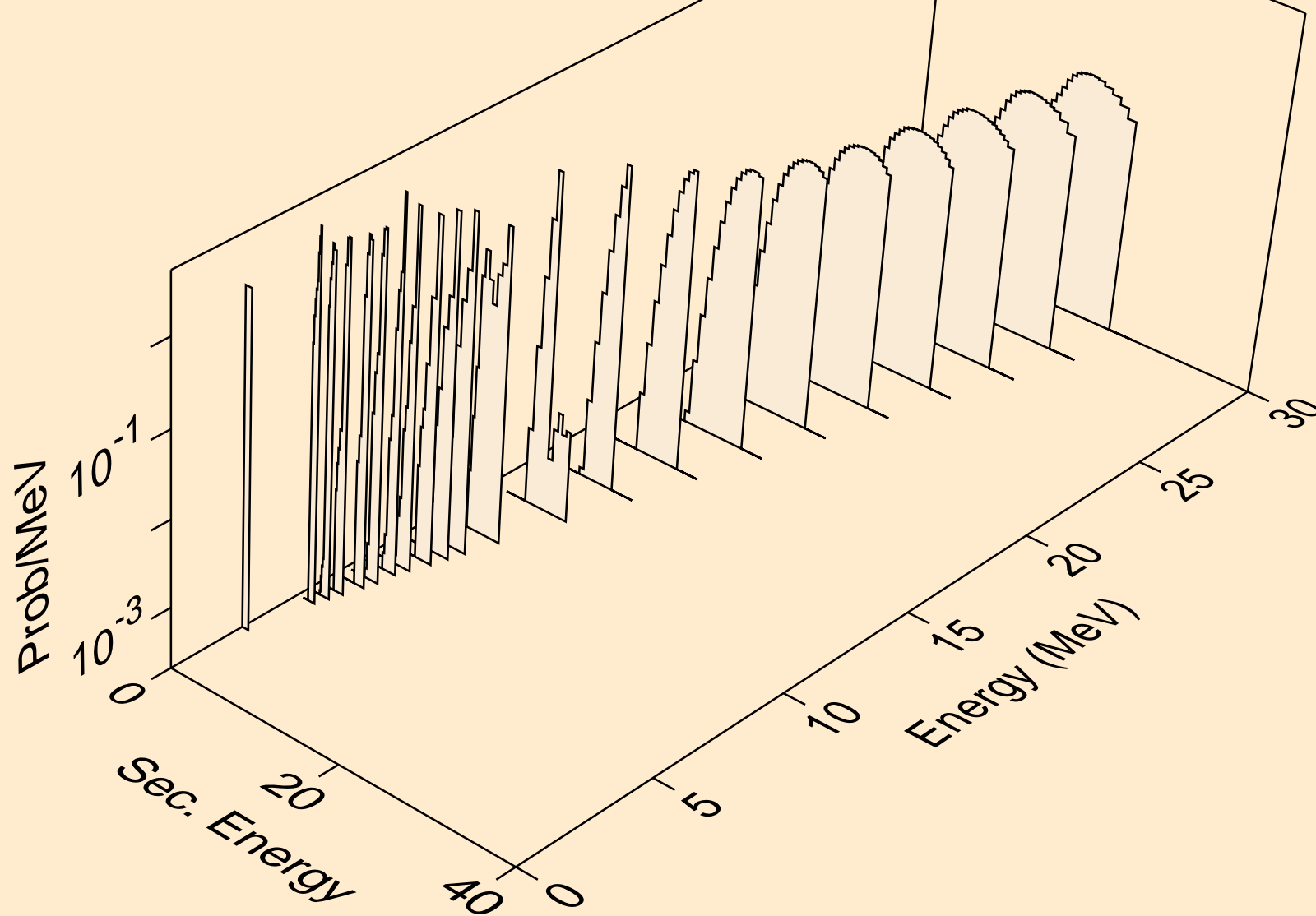

TM153M NEUTRON ACER TENDL-2024 LIBRARY; T=293.6K
tritons from (n,pt)

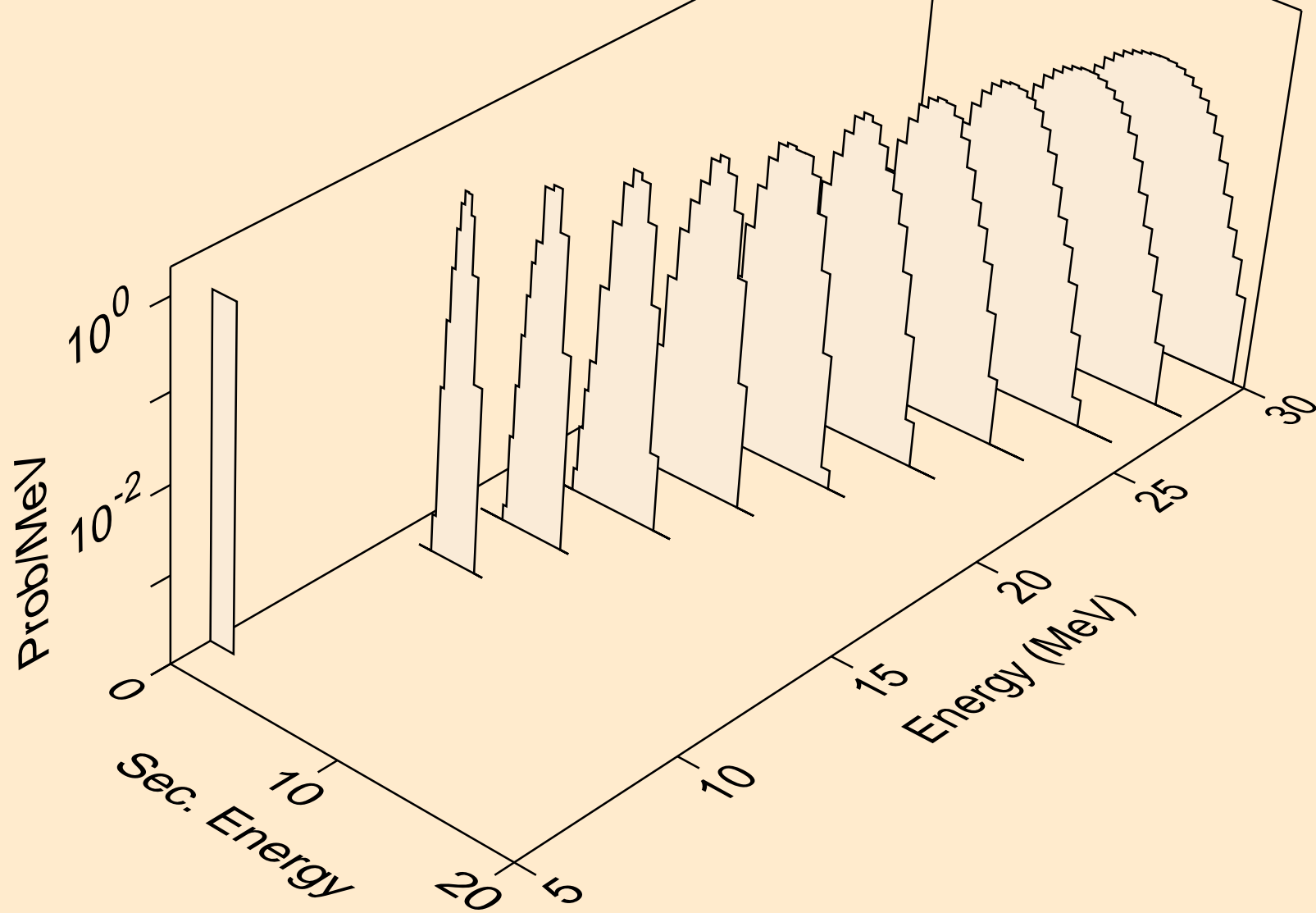

TM153M NEUTRON ACER TENDL-2024 LIBRARY; T=293.6K
he3s from (n,x)

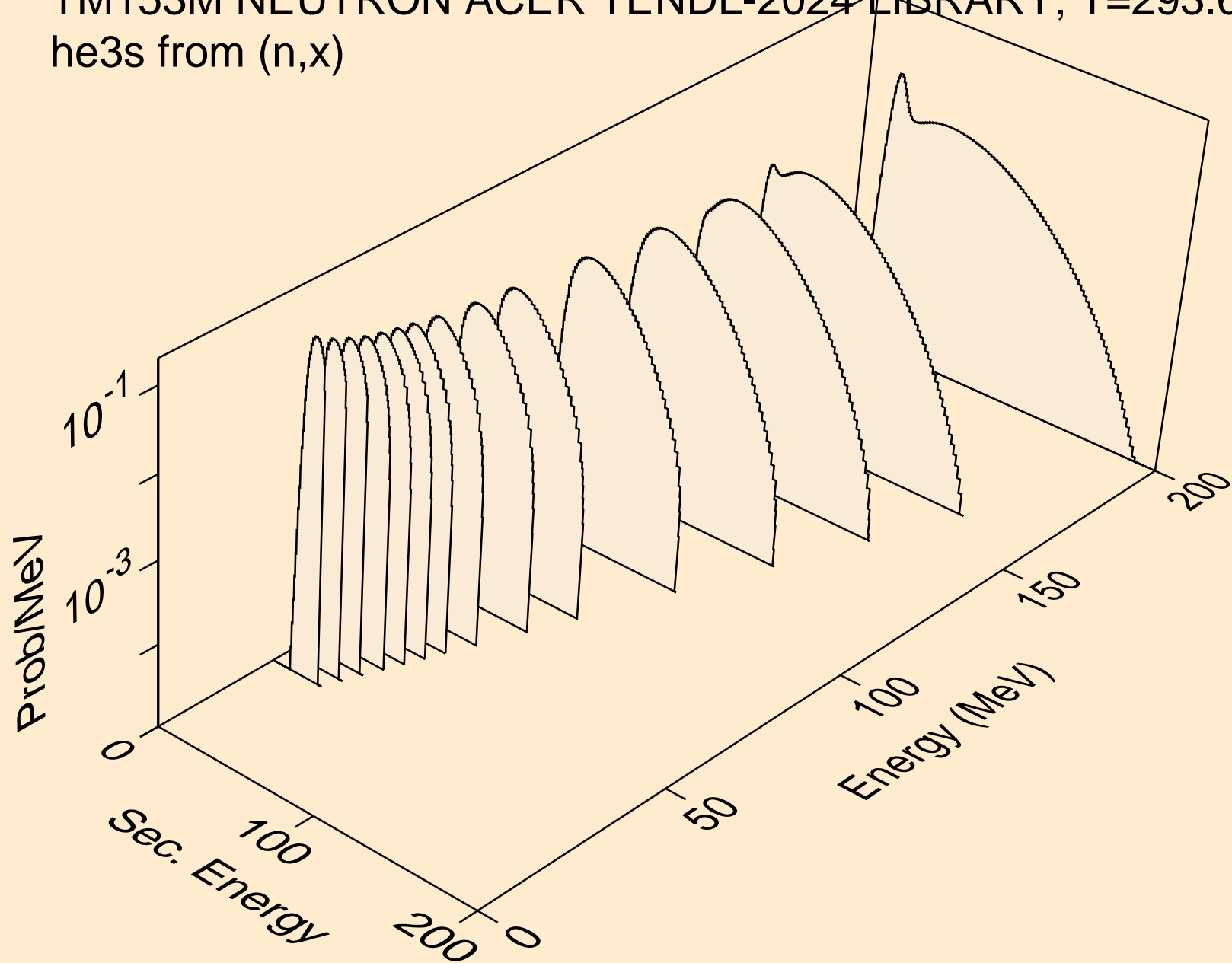

TM153M NEUTRON ACER TENDL-2024 LIBRARY; T=293.6K
he3s from (n,n*)he3

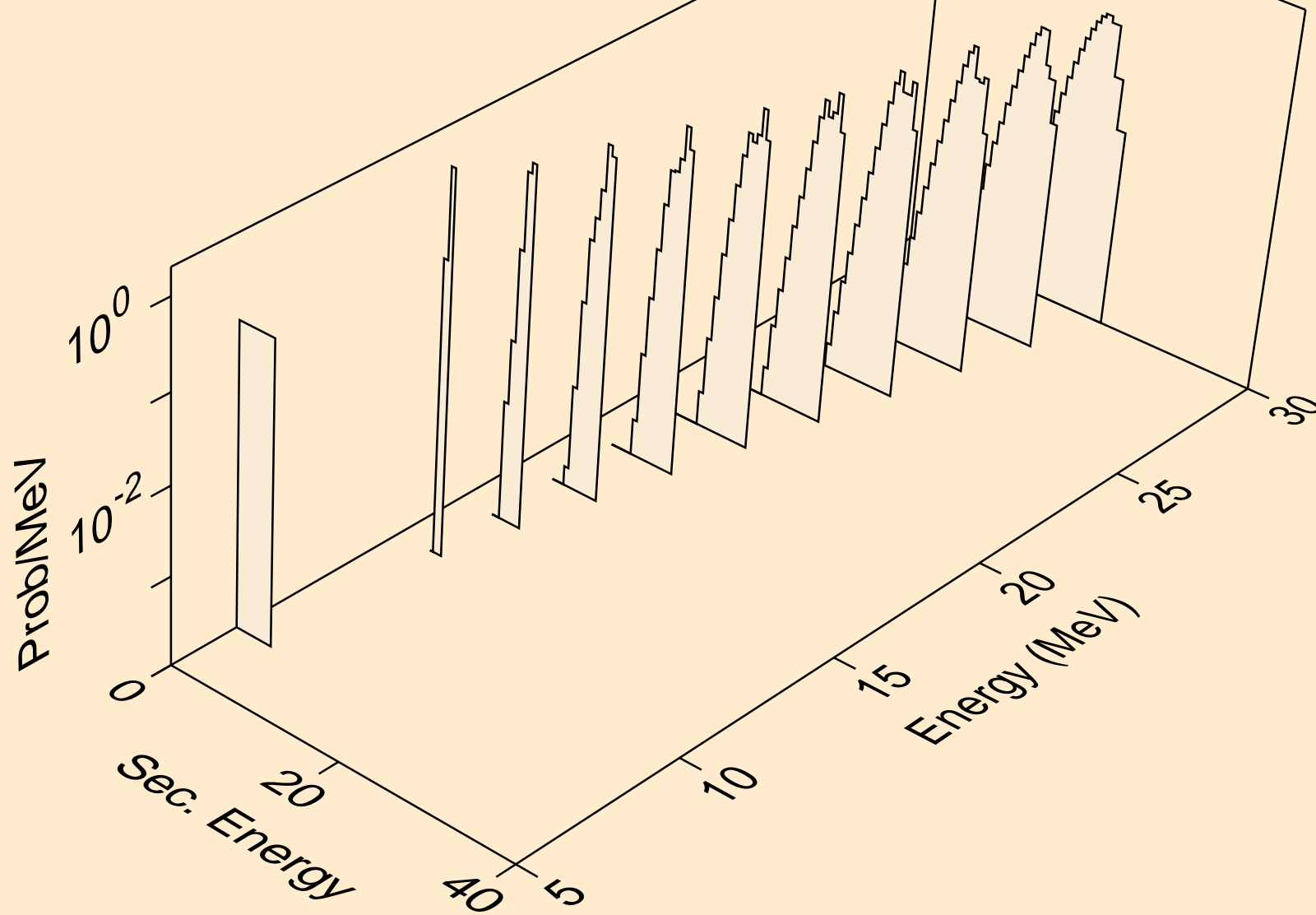

TM153M NEUTRON ACER TENDL-2024 LIBRARY; T=293.6K
he3s from (n,he3)

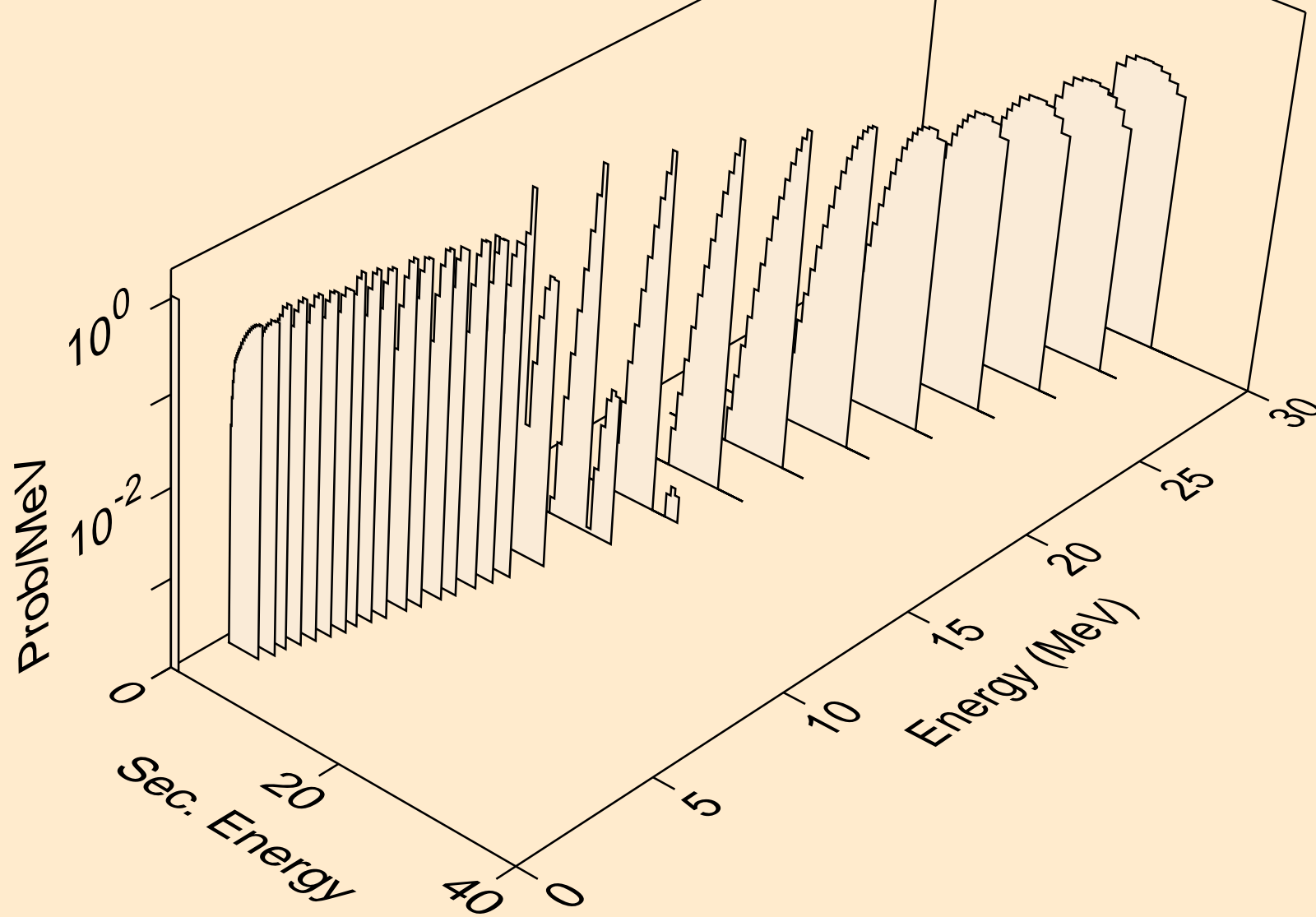

TM153M NEUTRON ACER TENDL-2024 LIBRARY; T=293.6K
alphas from (n,x)

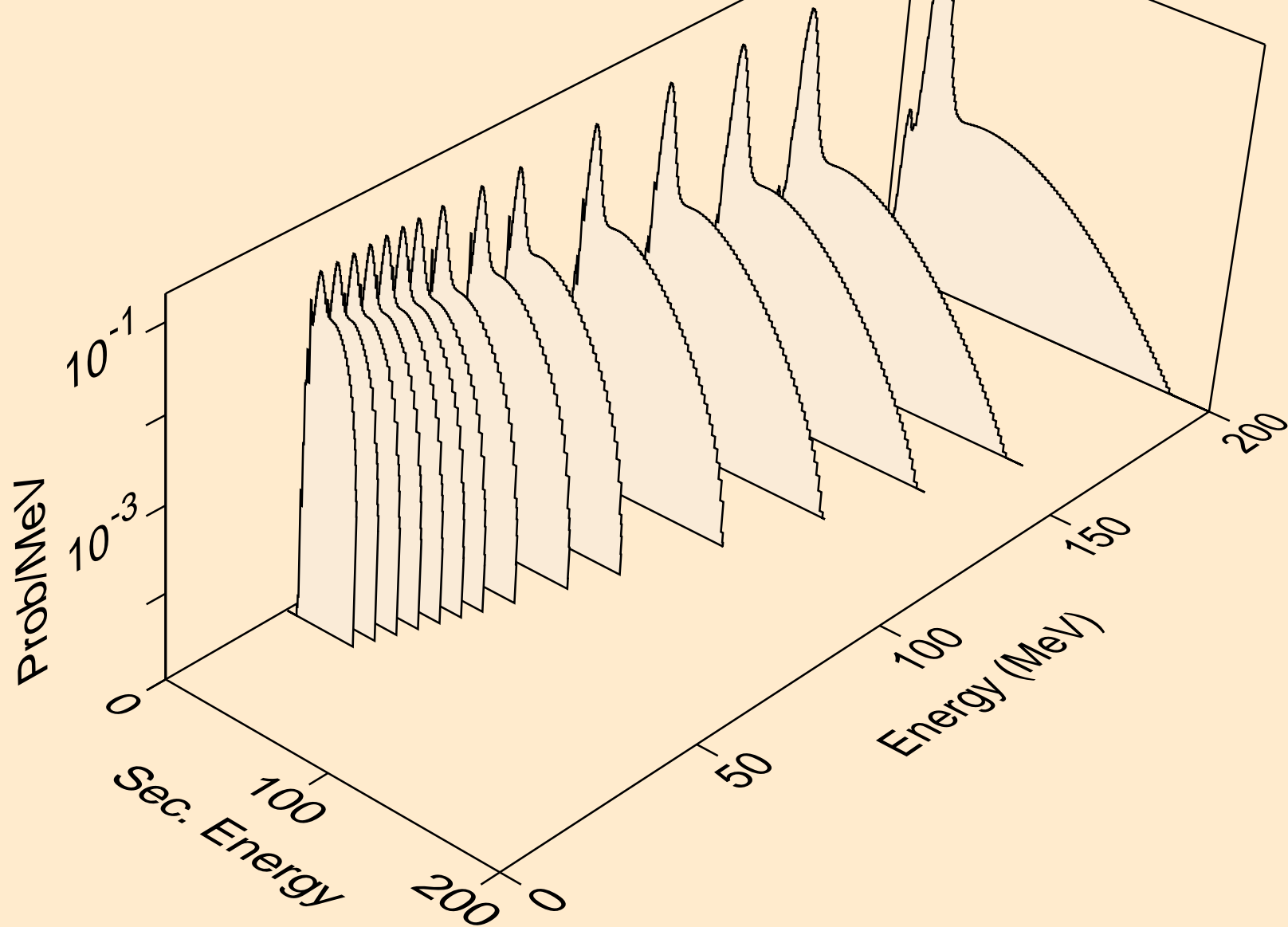

TM153M NEUTRON ACER TENDL-2024 LIBRARY; T=293.6K
alphas from (n,n*)a

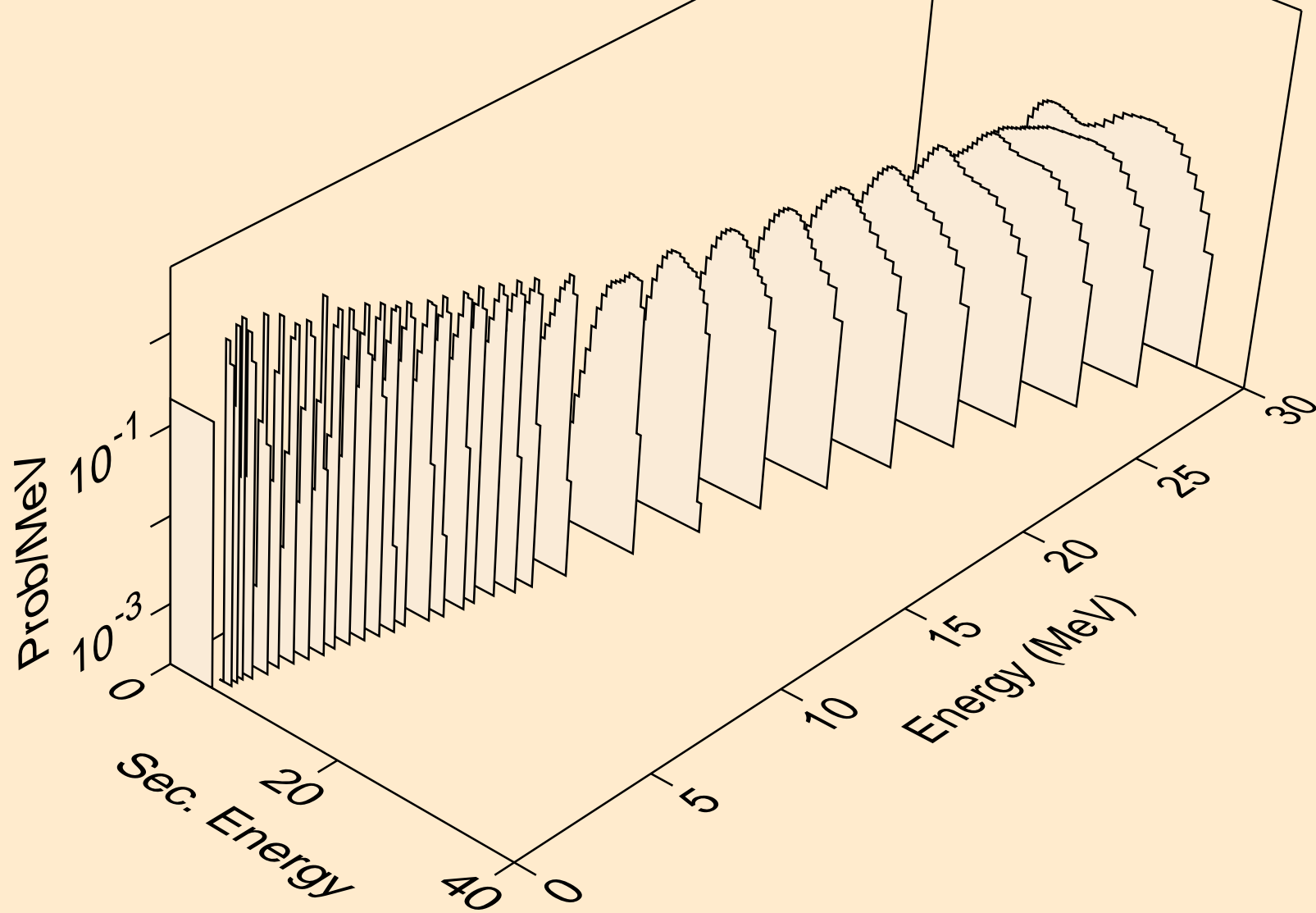

TM153M NEUTRON ACER TENDL-2024 LIBRARY; T=293.6K
alphas from (n,2n)a

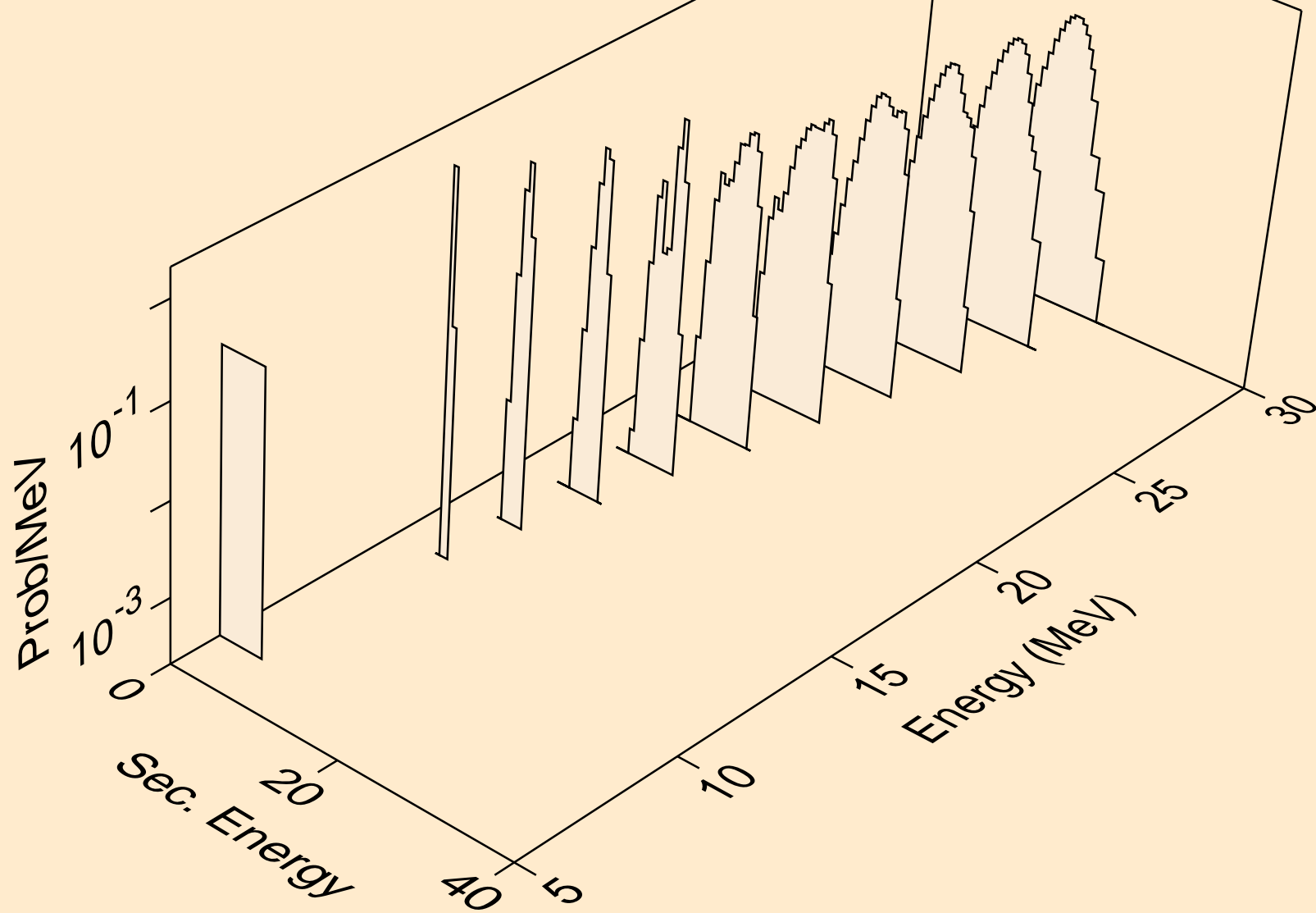

TM153M NEUTRON ACER TENDL-2024 LIBRARY; T=293.6K
alphas from (n,3n)a

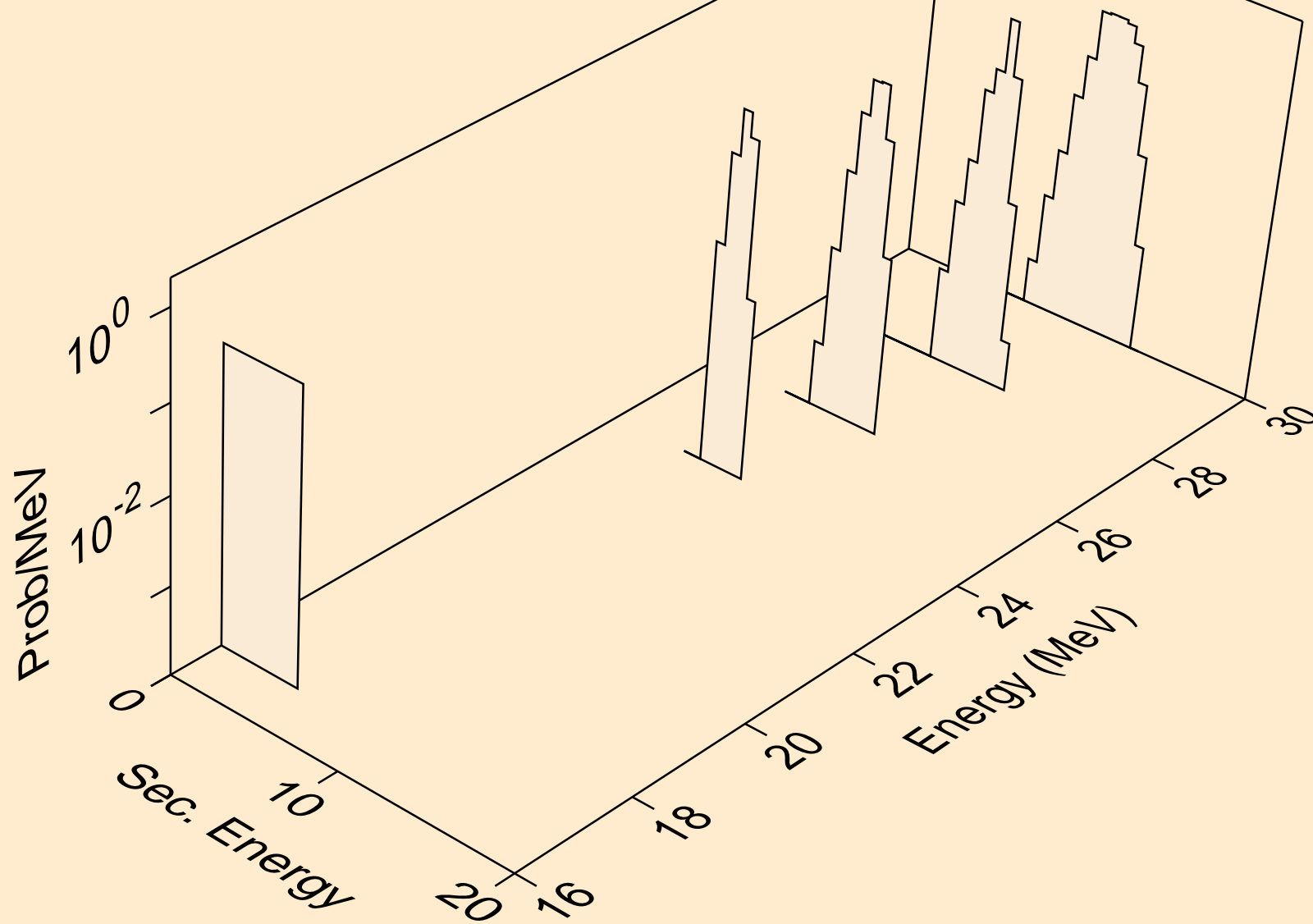

TM153M NEUTRON ACER TENDL-2024 LIBRARY; T=293.6K
alphas from (n,n*)2a

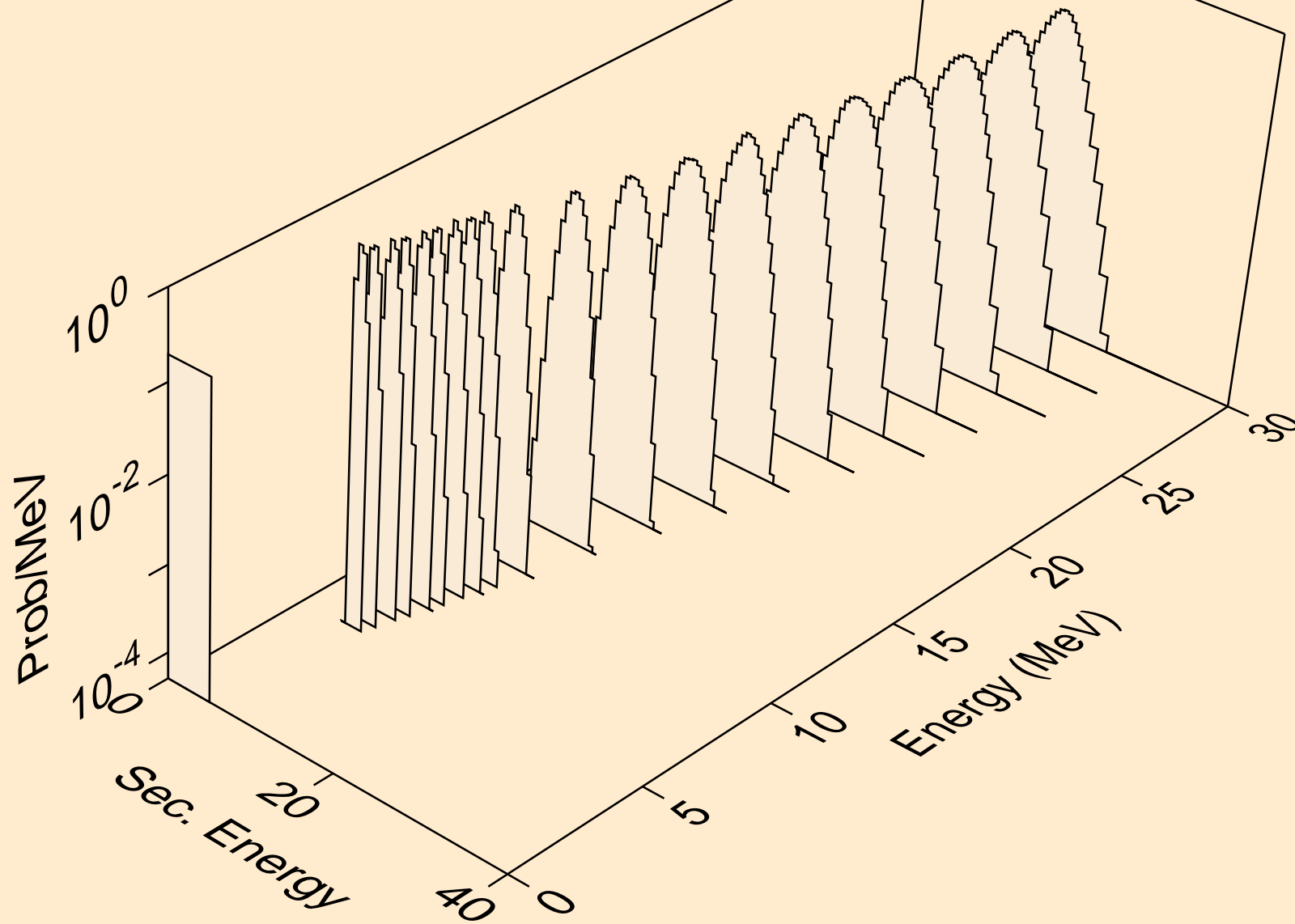

TM153M NEUTRON ACER TENDL-2024 LIBRARY; T=293.6K
alphas from (n,npa)

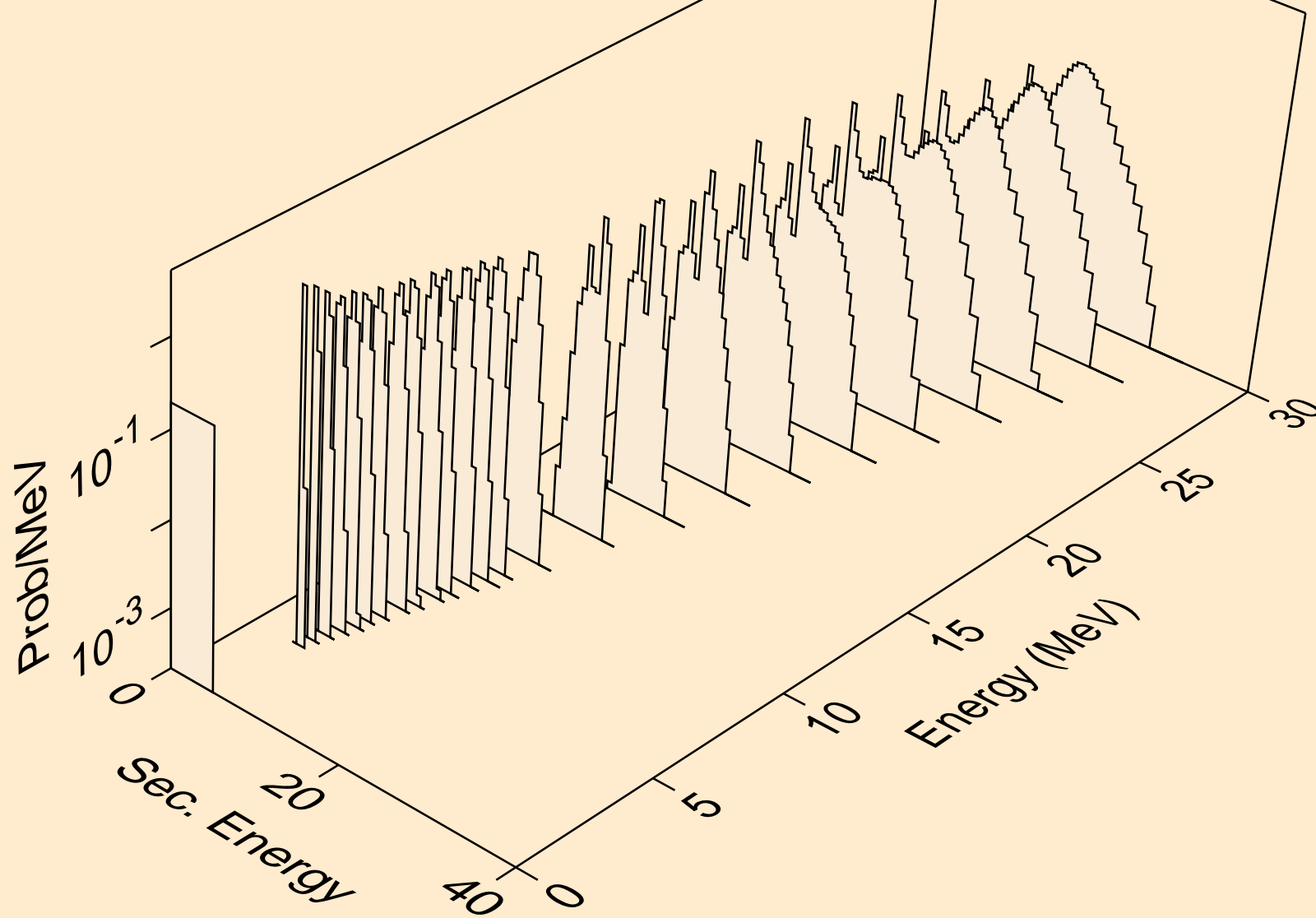

TM153M NEUTRON ACER TENDL-2024 LIBRARY; T=293.6K
alphas from (n,a)

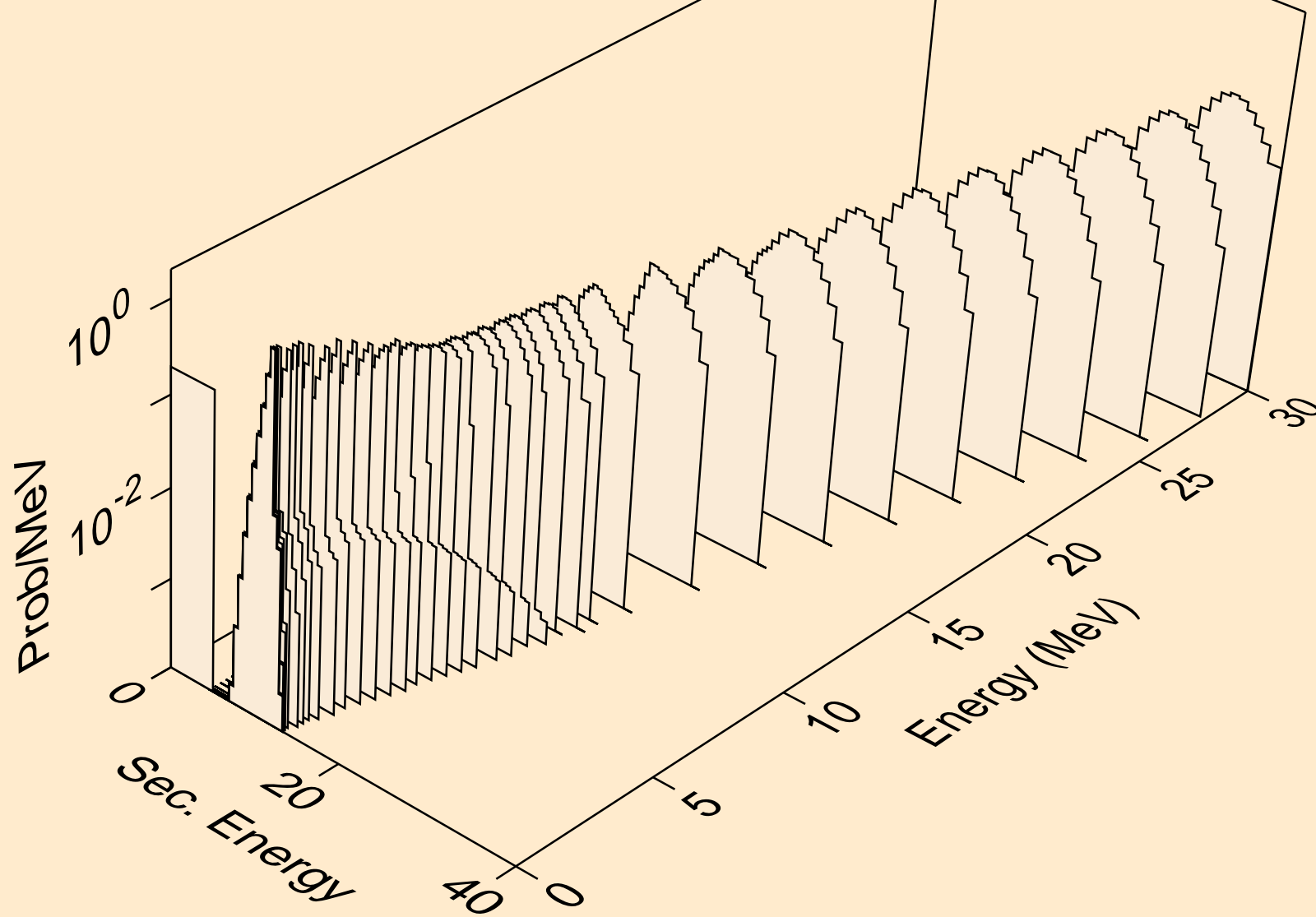

TM153M NEUTRON ACER TENDL-2024 LIBRARY; T=293.6K
alphas from (n,2a)

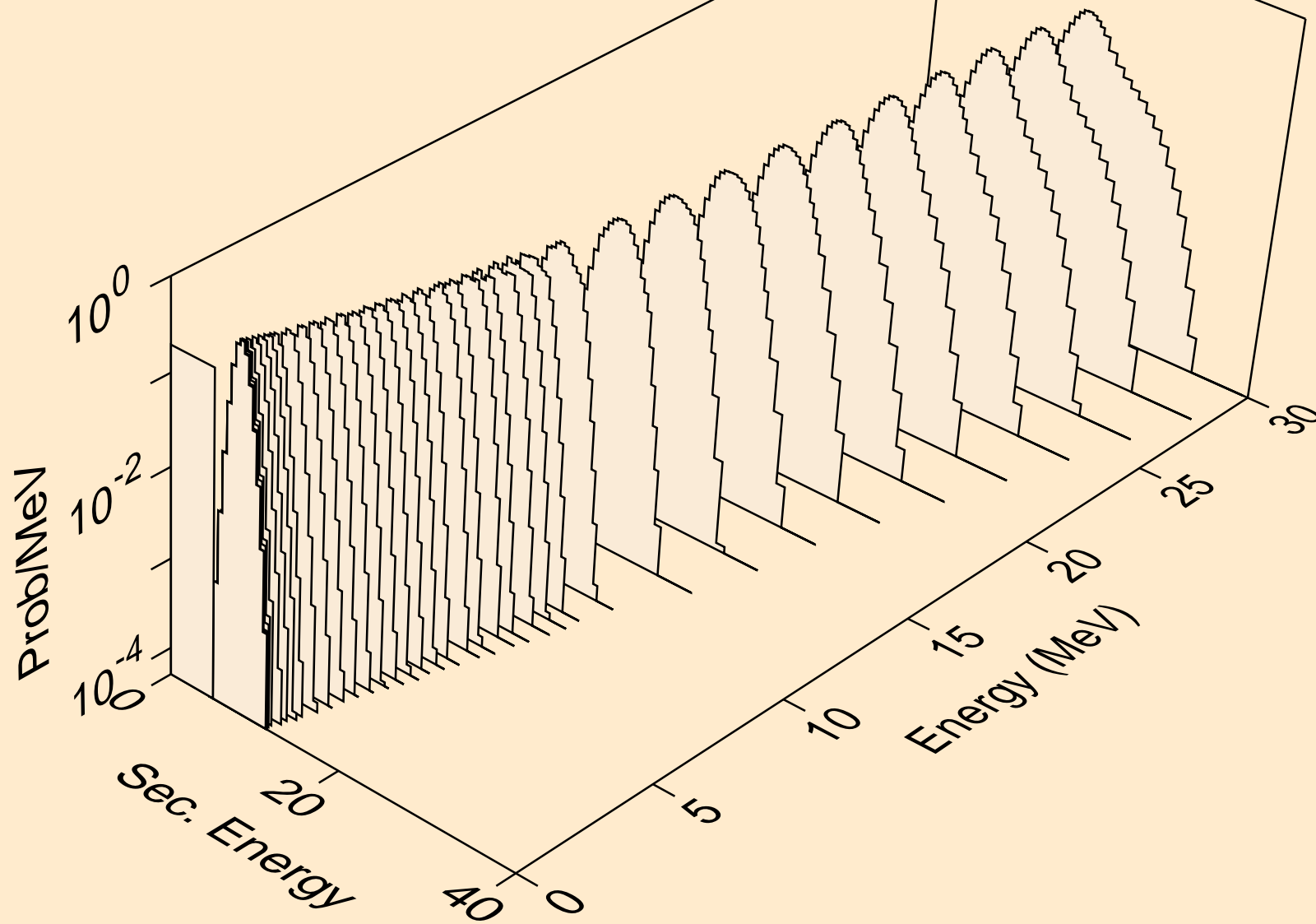

TM153M NEUTRON ACER TENDL-2024 LIBRARY; T=293.6K
alphas from (n,3a)

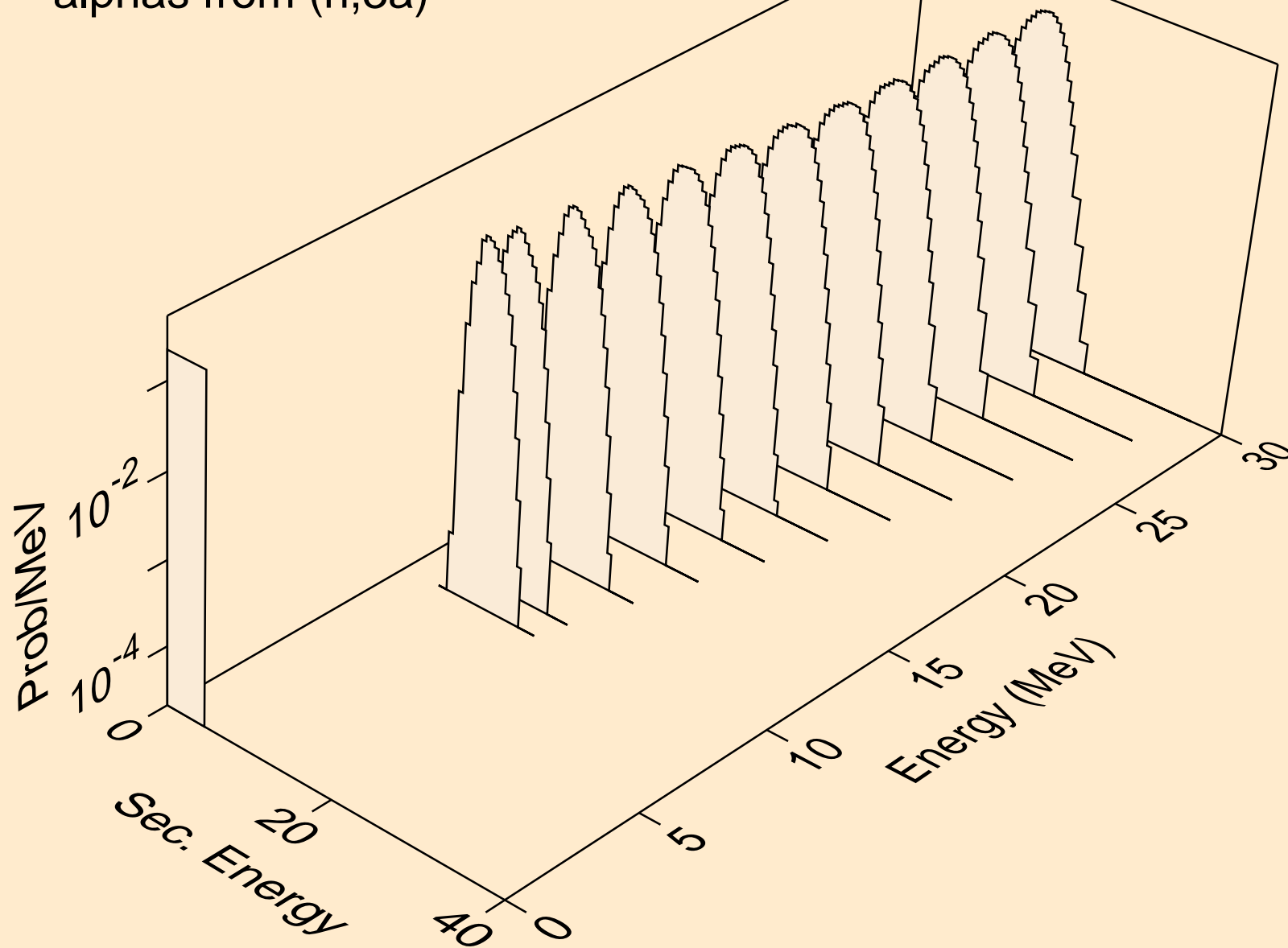

TM153M NEUTRON ACER TENDL-2024 LIBRARY; T=293.6K
alphas from (n,pa)

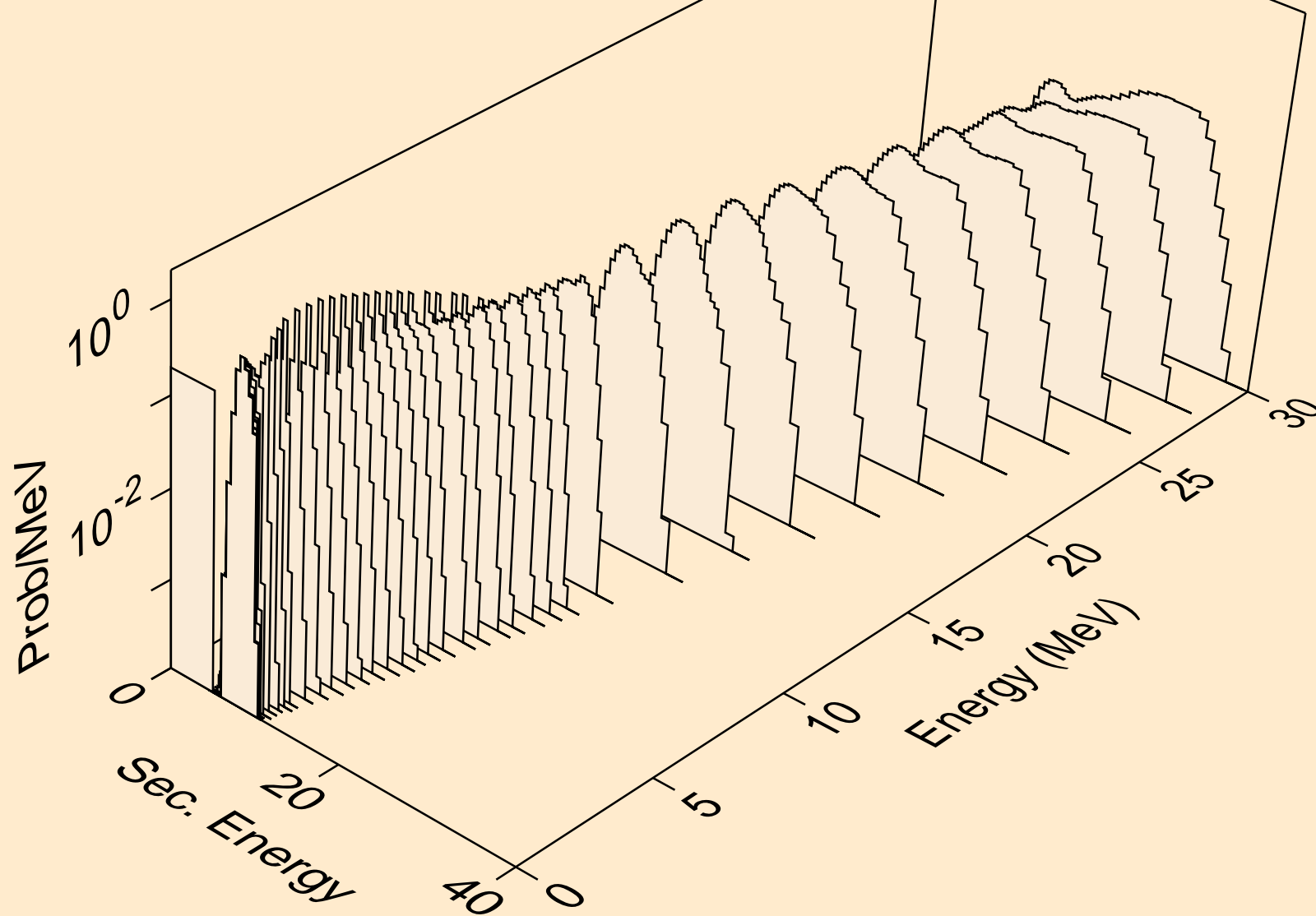

TM153M NEUTRON ACER TENDL-2024 LIBRARY; T=293.6K
alphas from (n,d2a)

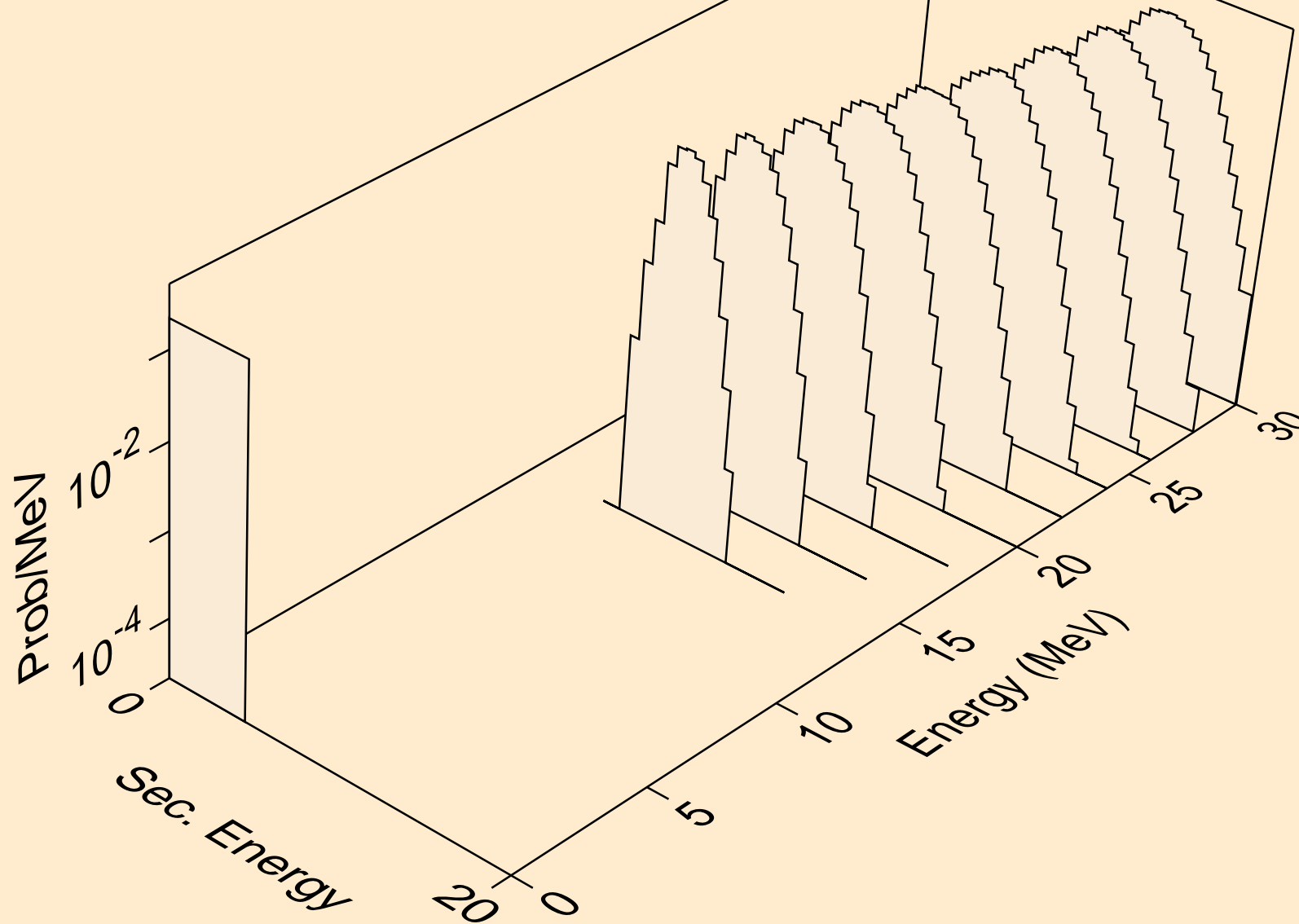

TM153M NEUTRON ACER TENDL-2024 LIBRARY; T=293.6K
alphas from (n,da)

