

XE125M NEUTRON ACER TENDL-2024 LIBRARY; T=293.6K
Principal cross sections

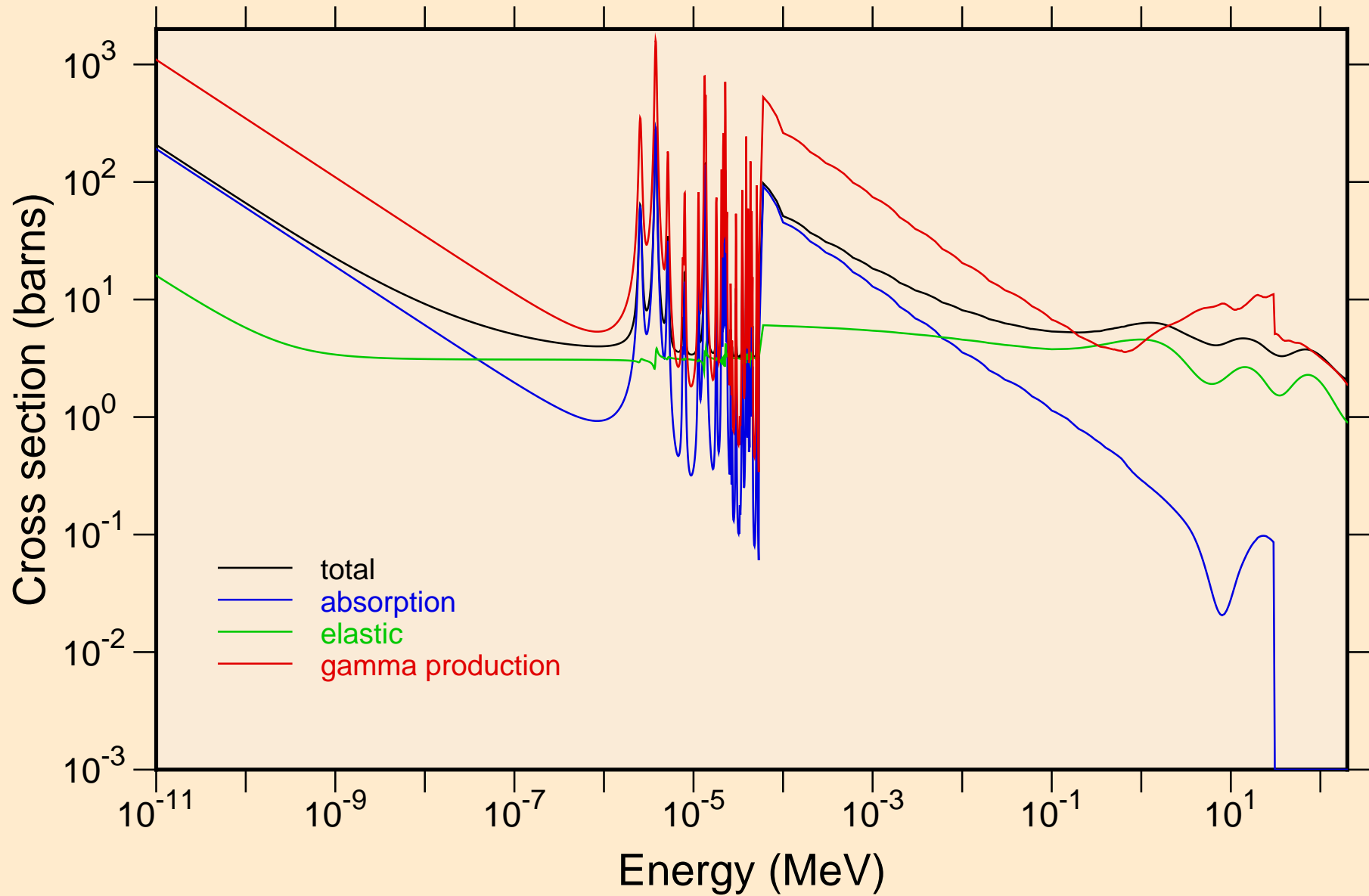

XE125M NEUTRON ACER TENDL-2024 LIBRARY; T=293.6K
resonance total cross section

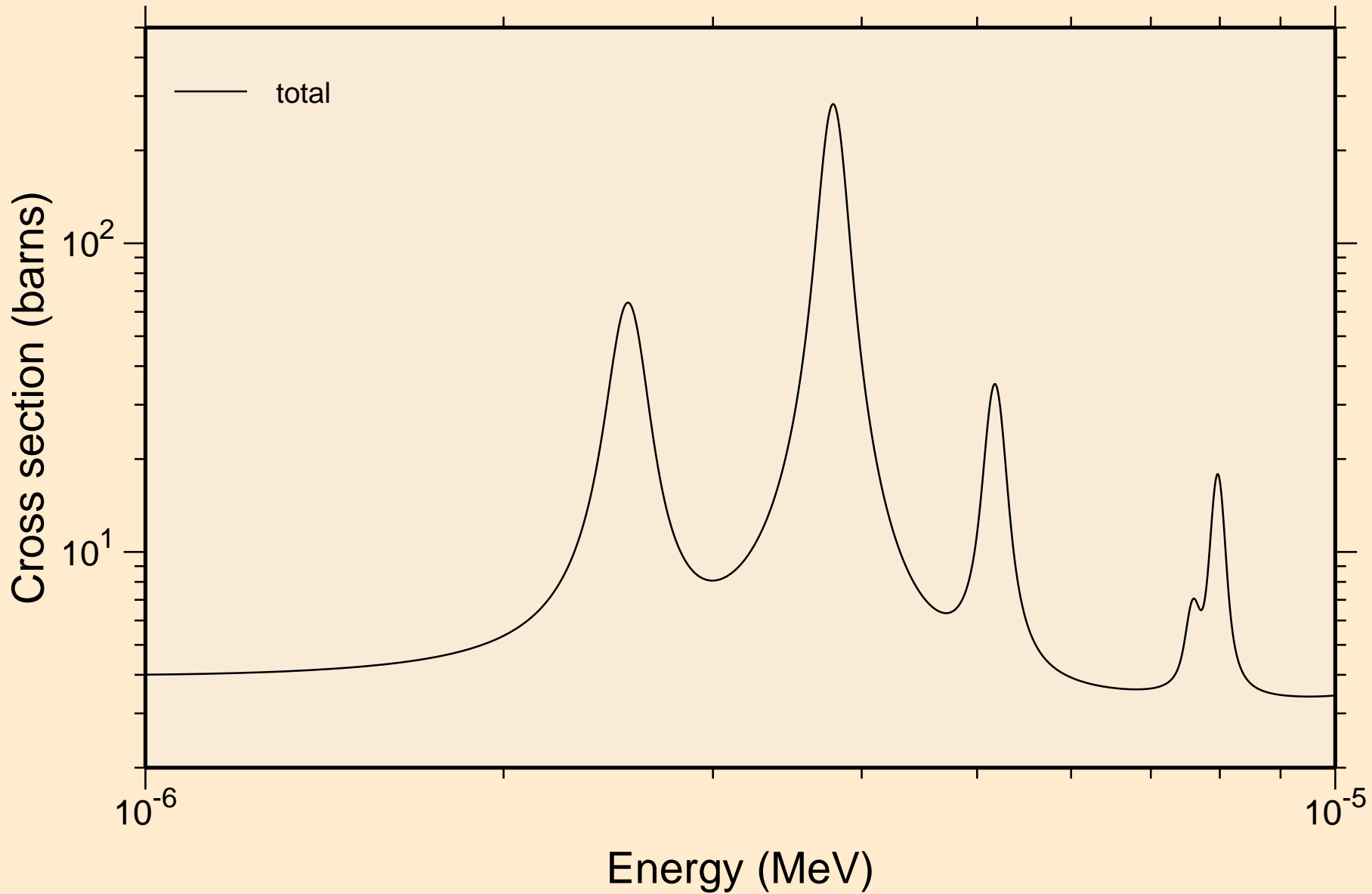

XE125M NEUTRON ACER TENDL-2024 LIBRARY; T=293.6K
resonance total cross section

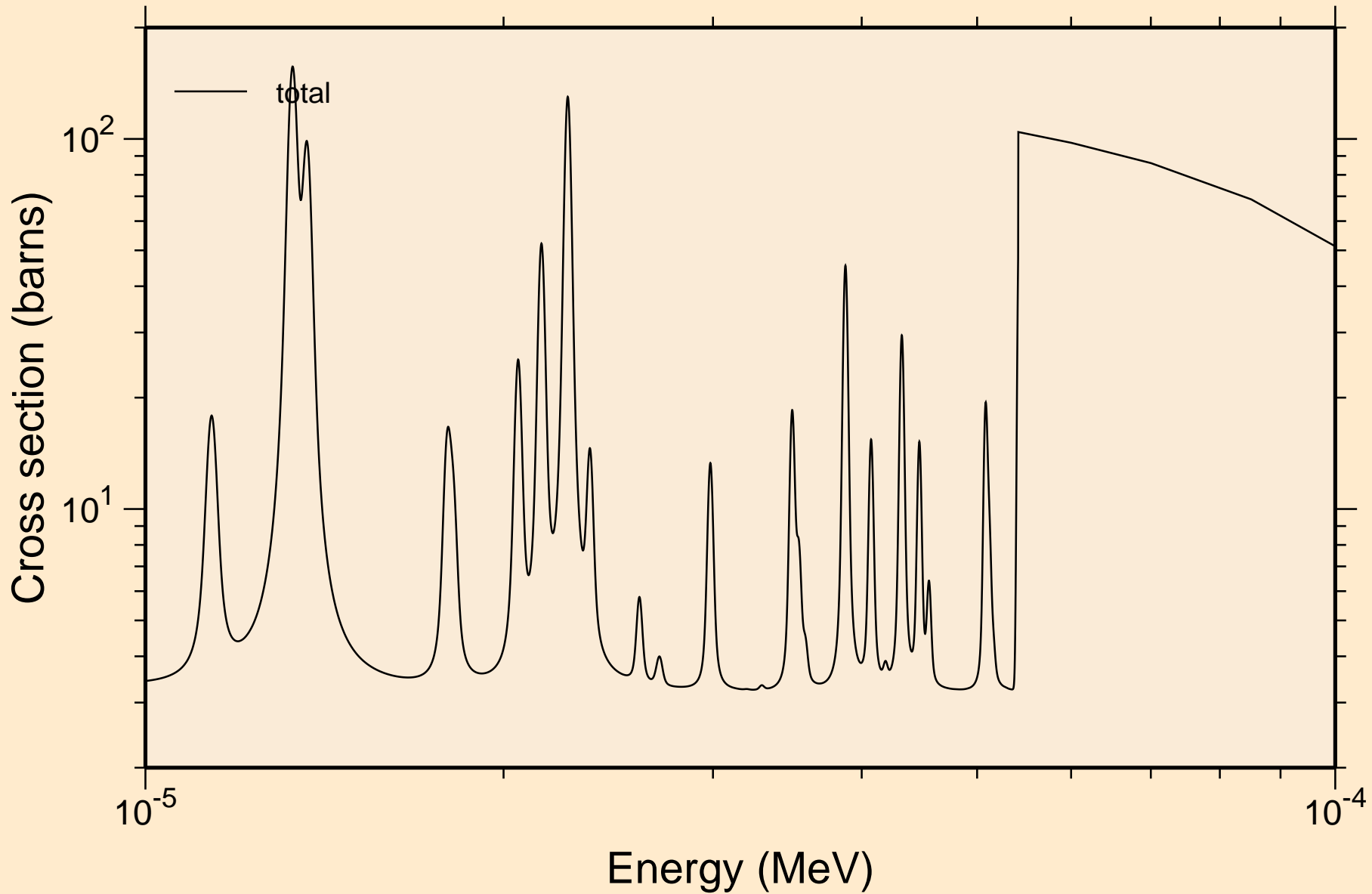

XE125M NEUTRON ACER TENDL-2024 LIBRARY; T=293.6K
resonance total cross section

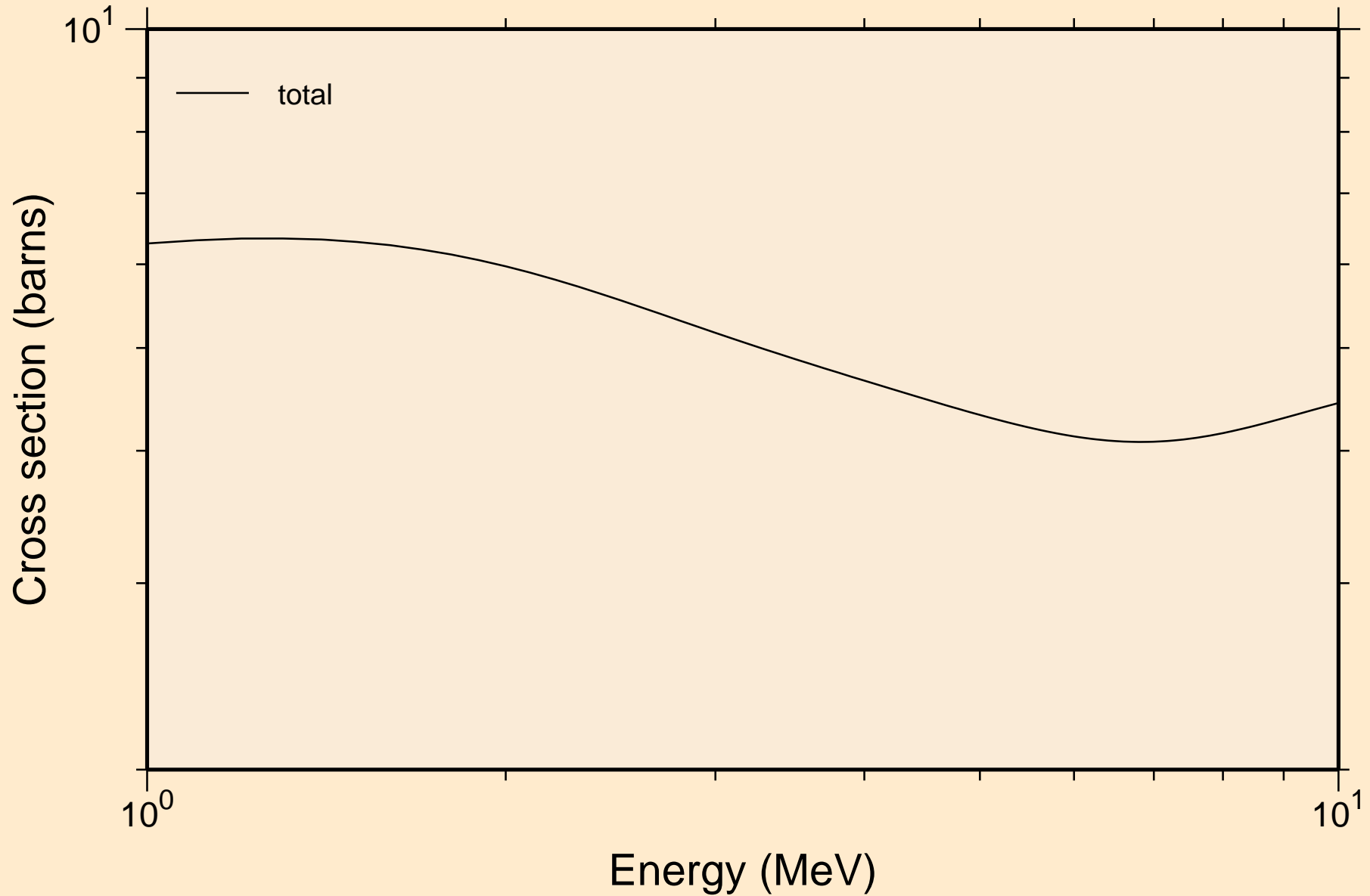

XE125M NEUTRON ACER TENDL-2024 LIBRARY; T=293.6K
resonance absorption cross sections

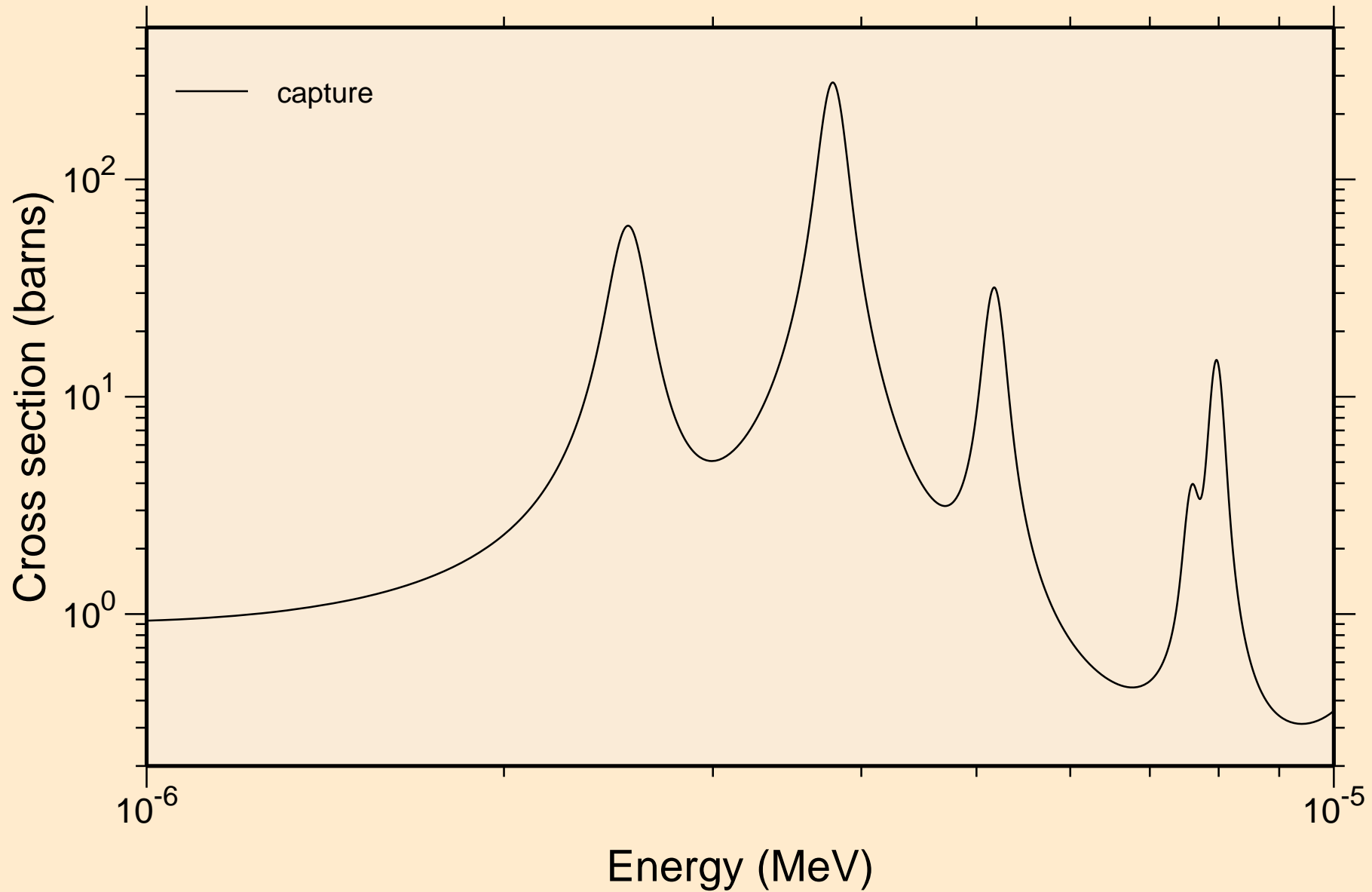

XE125M NEUTRON ACER TENDL-2024 LIBRARY; T=293.6K
resonance absorption cross sections

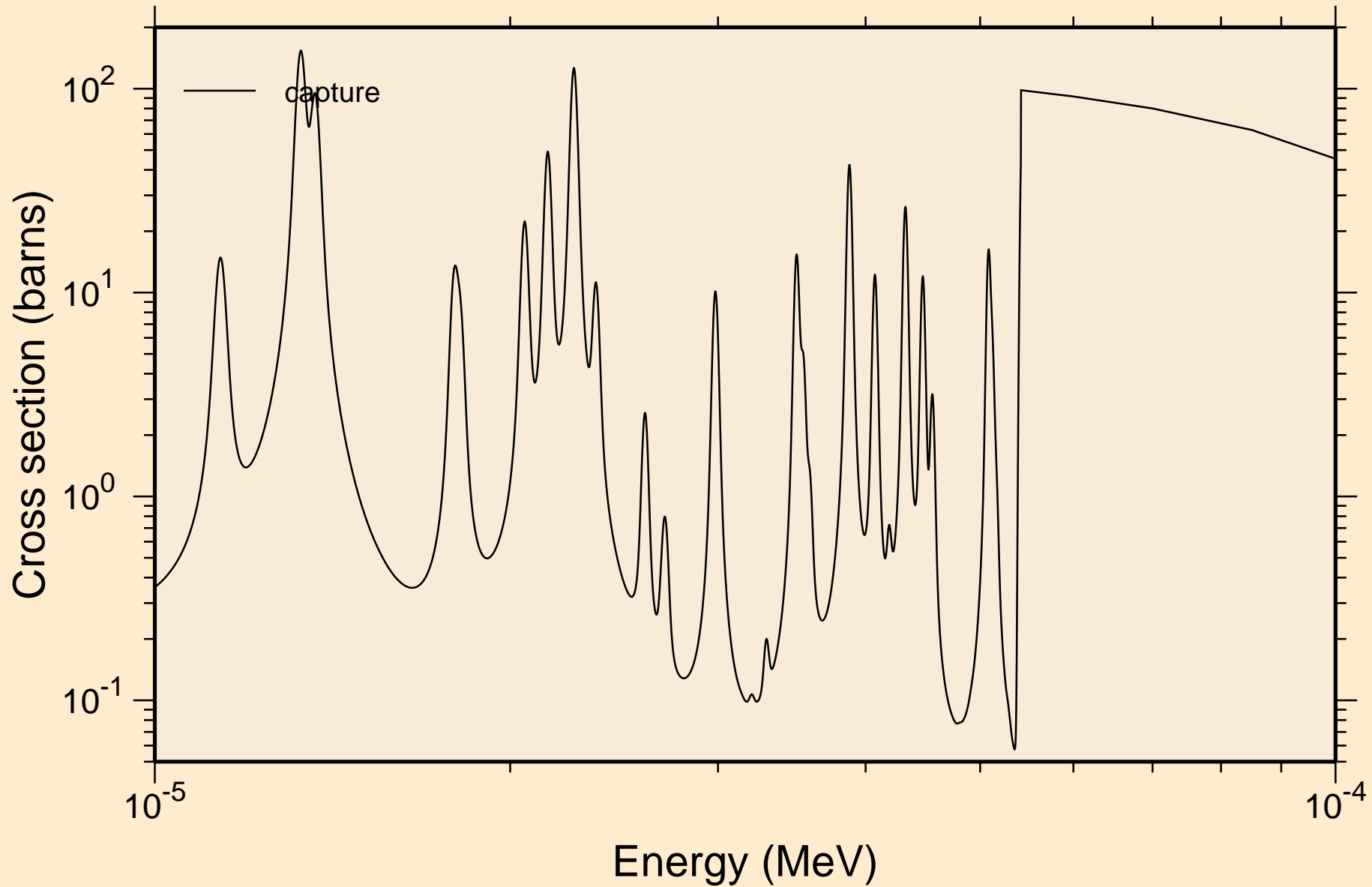

XE125M NEUTRON ACER TENDL-2024 LIBRARY; T=293.6K
resonance absorption cross sections

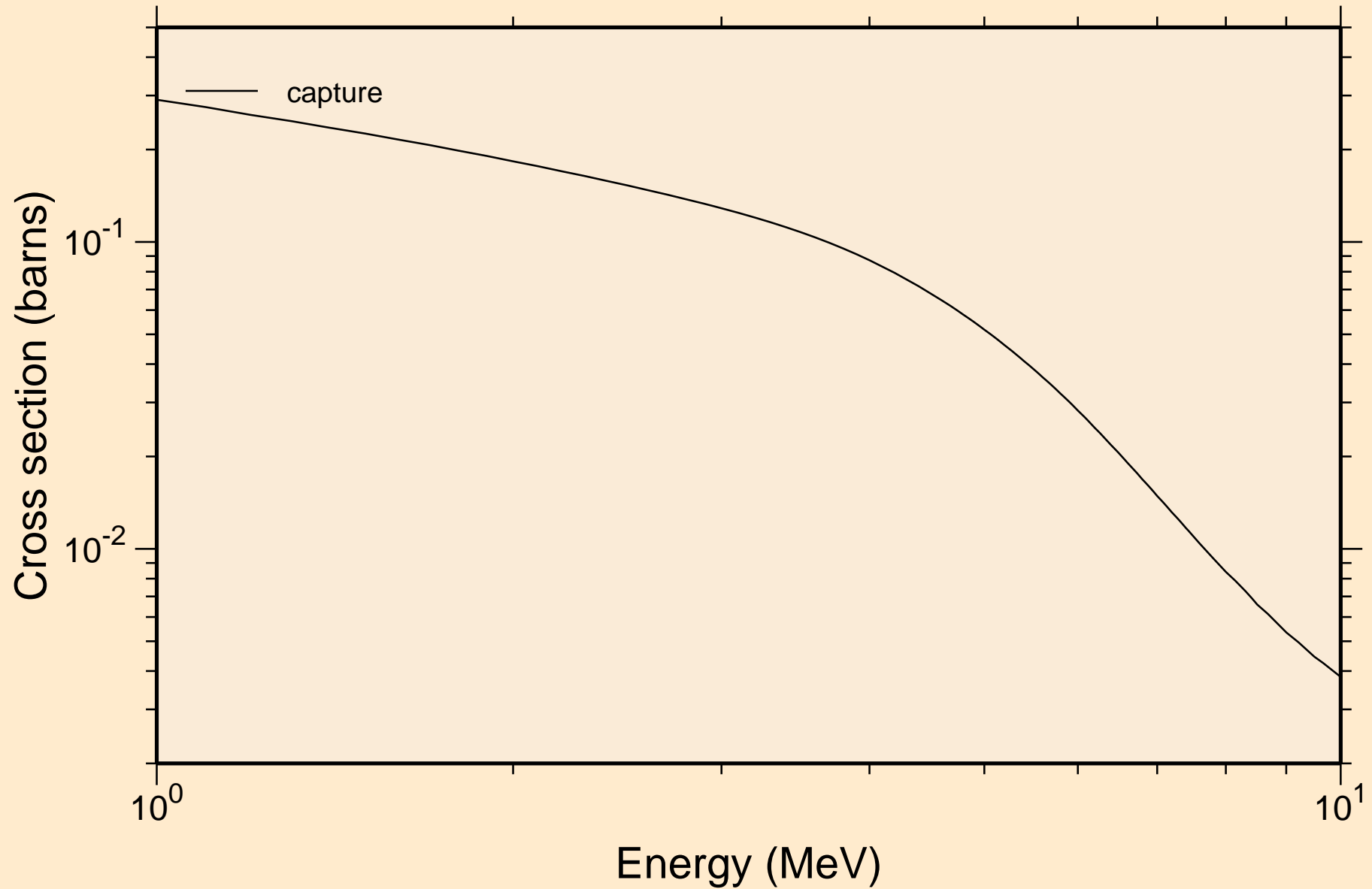

XE125M NEUTRON ACER TENDL-2024 LIBRARY; T=293.6K
Heating

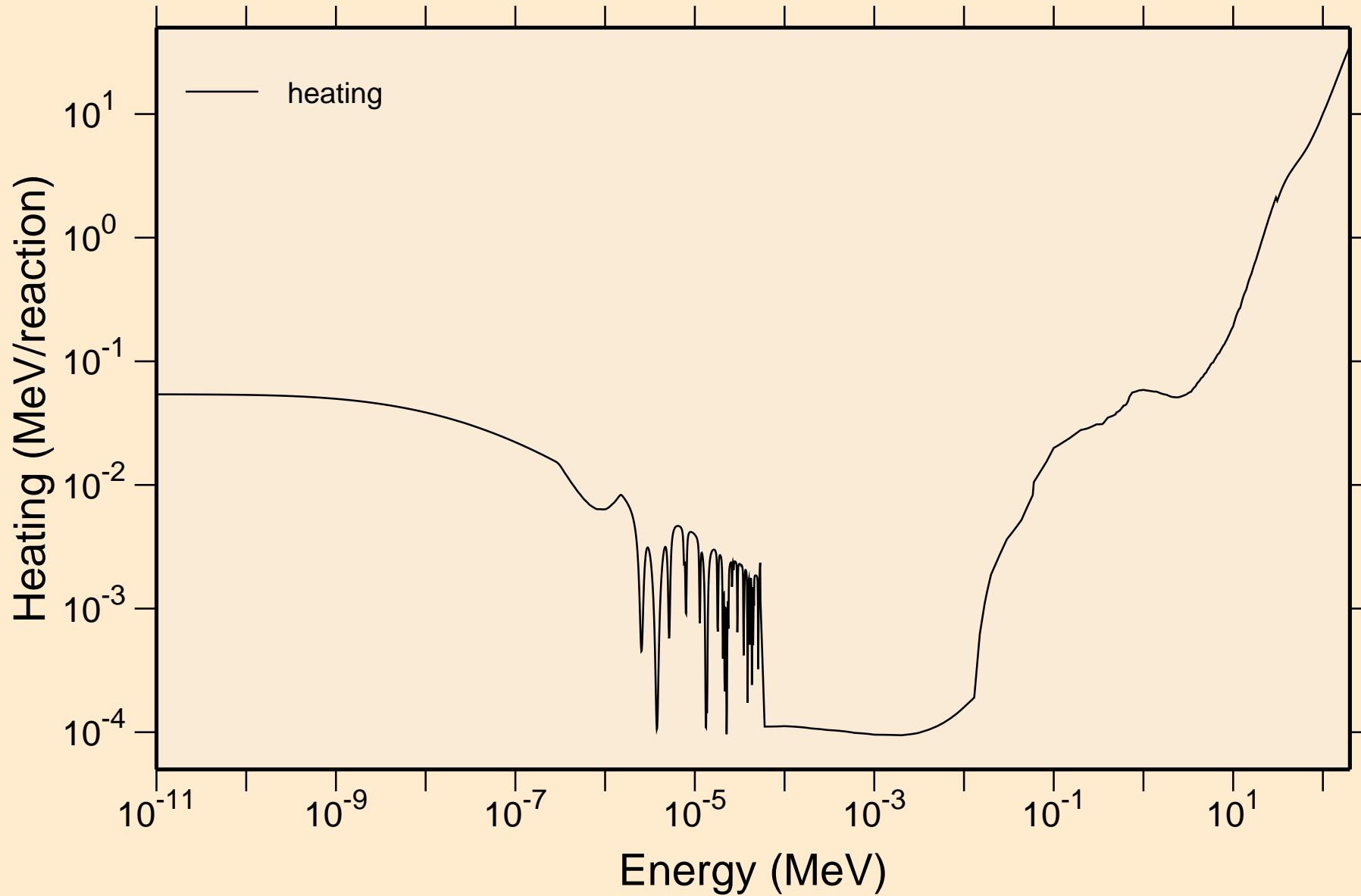

XE125M NEUTRON ACER TENDL-2024 LIBRARY; T=293.6K
Damage

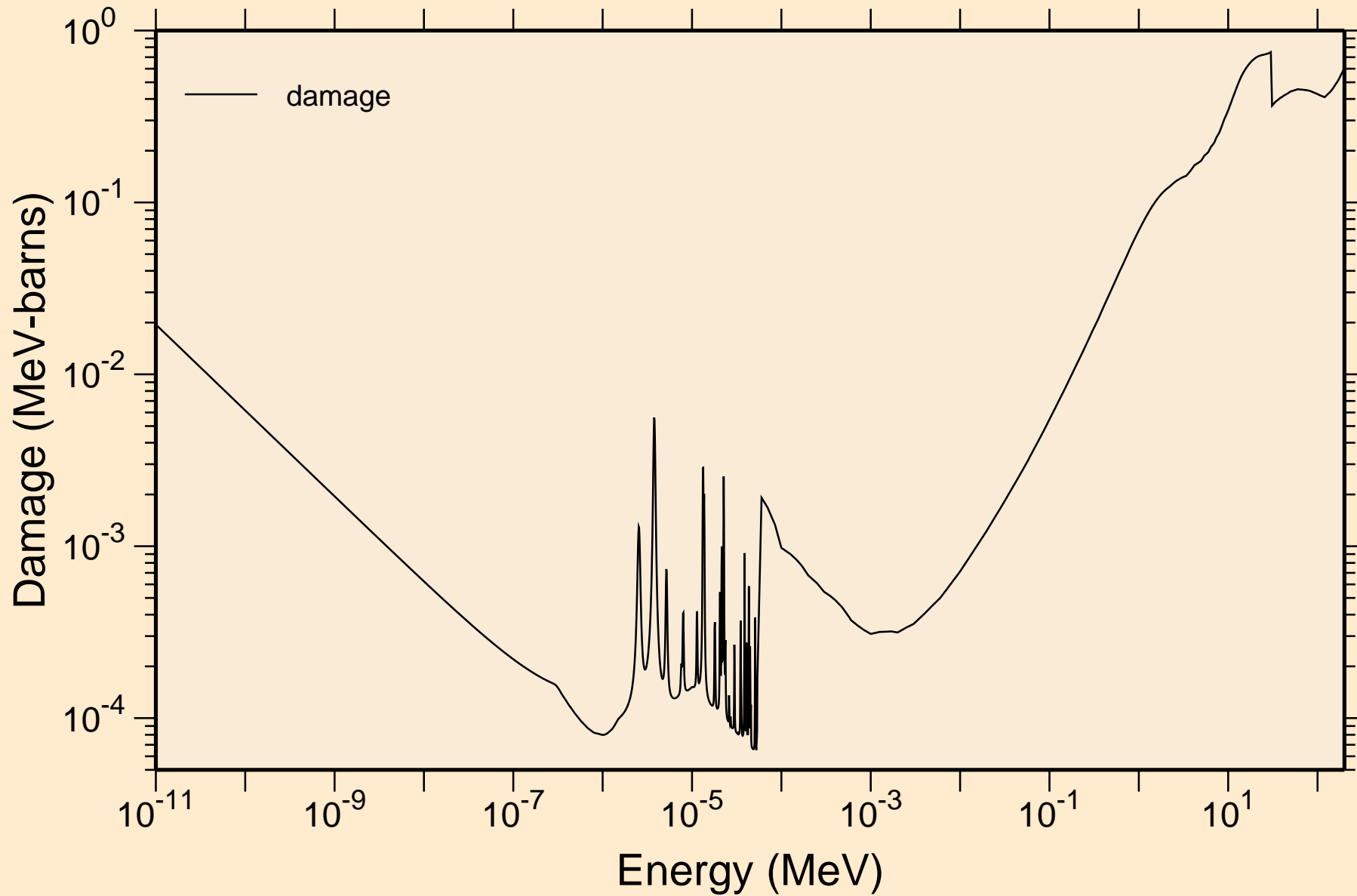

XE125M NEUTRON ACER TENDL-2024 LIBRARY; T=293.6K
Non-threshold reactions

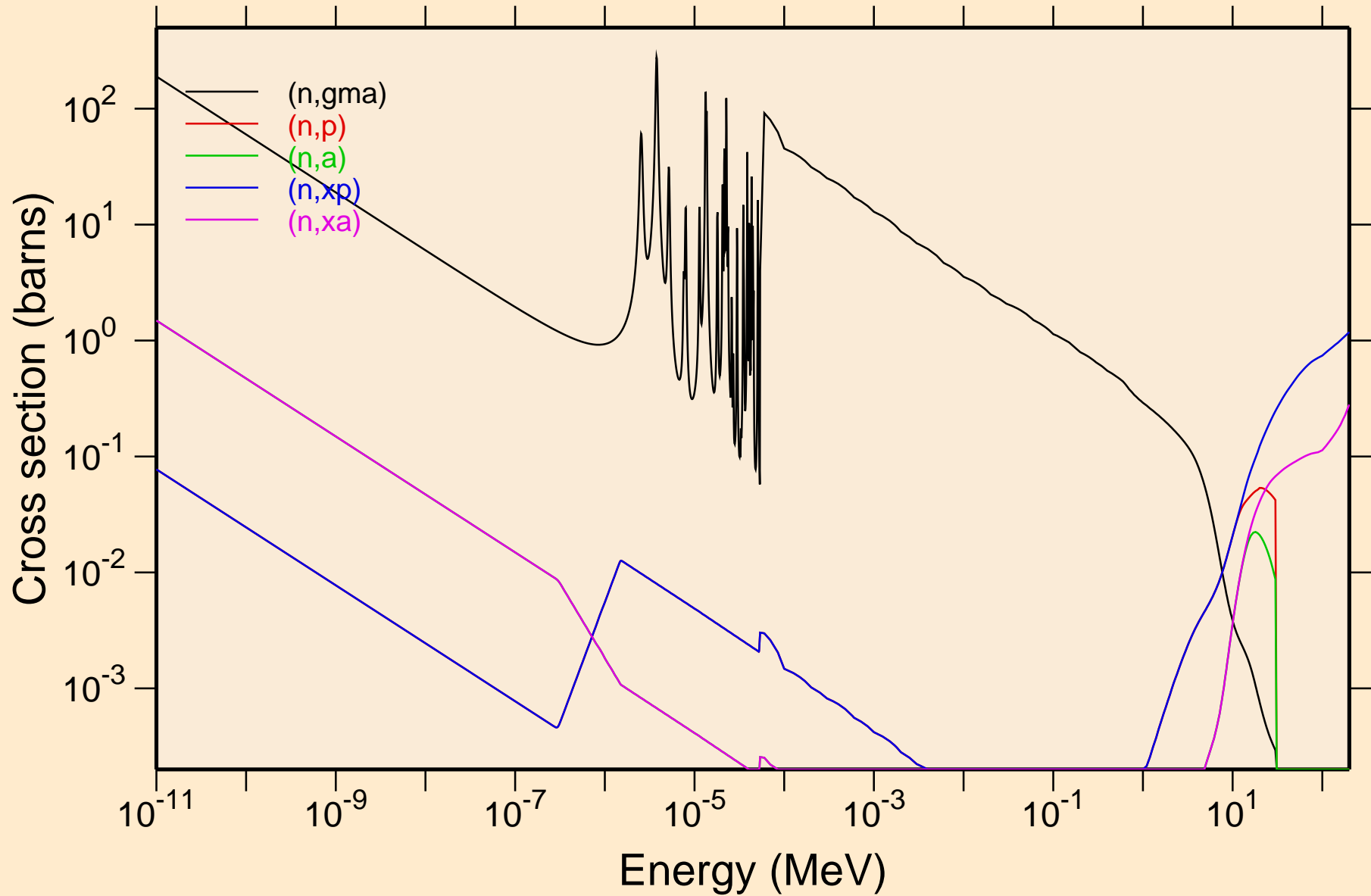

XE125M NEUTRON ACER TENDL-2024 LIBRARY; T=293.6K

Principal cross sections

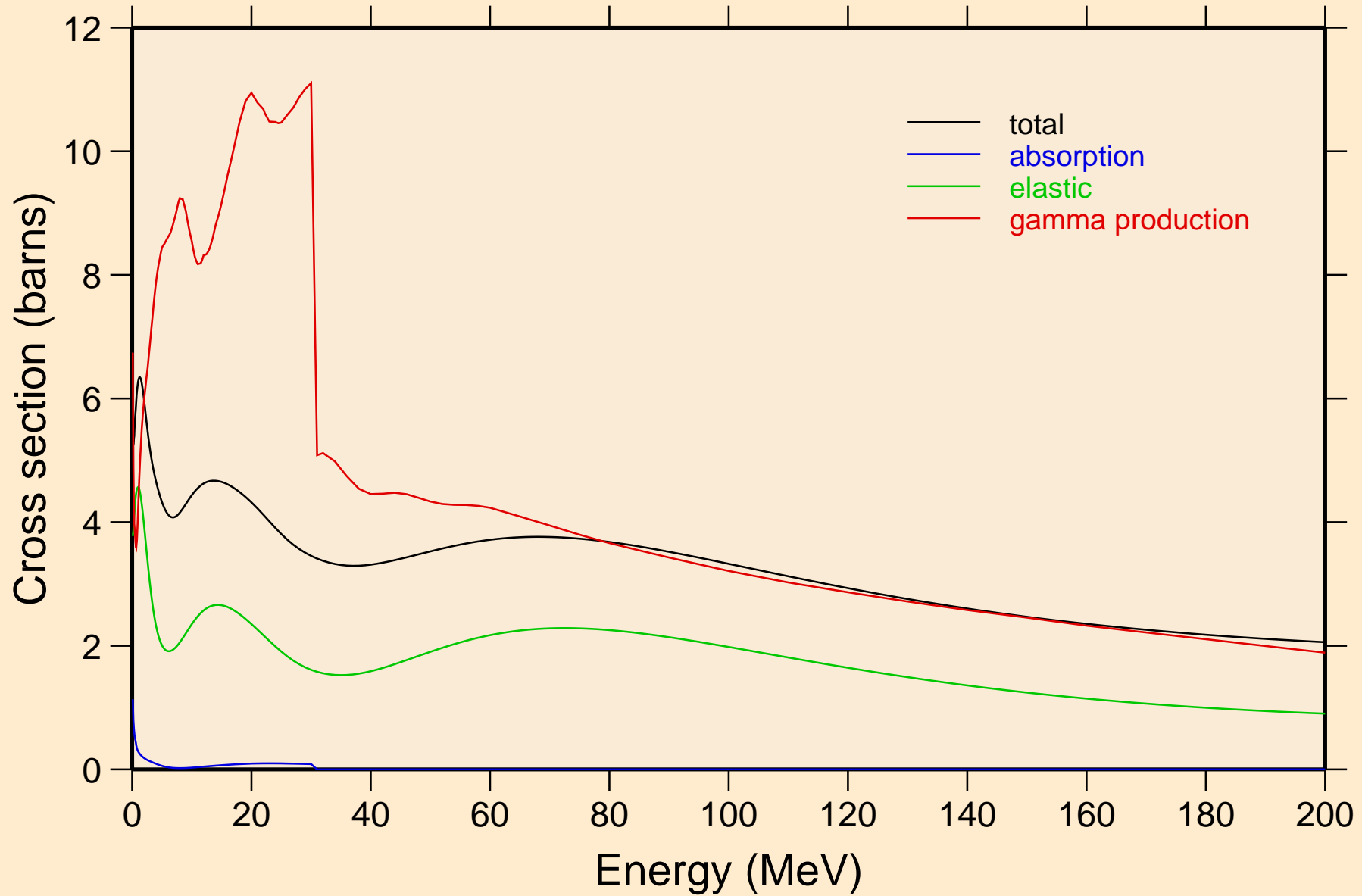

XE125M NEUTRON ACER TENDL-2024 LIBRARY; T=293.6K
Heating

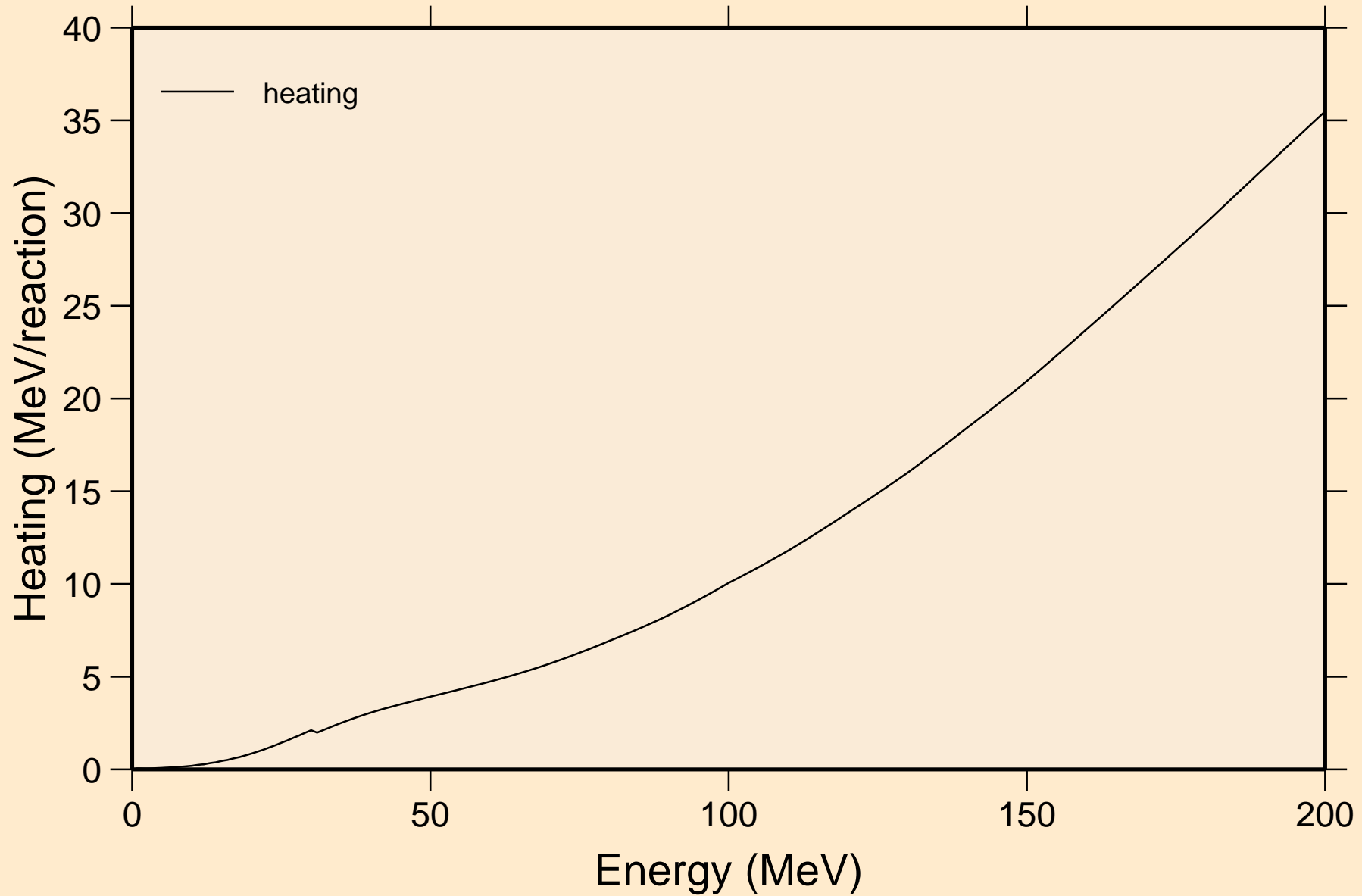

XE125M NEUTRON ACER TENDL-2024 LIBRARY; T=293.6K
Damage

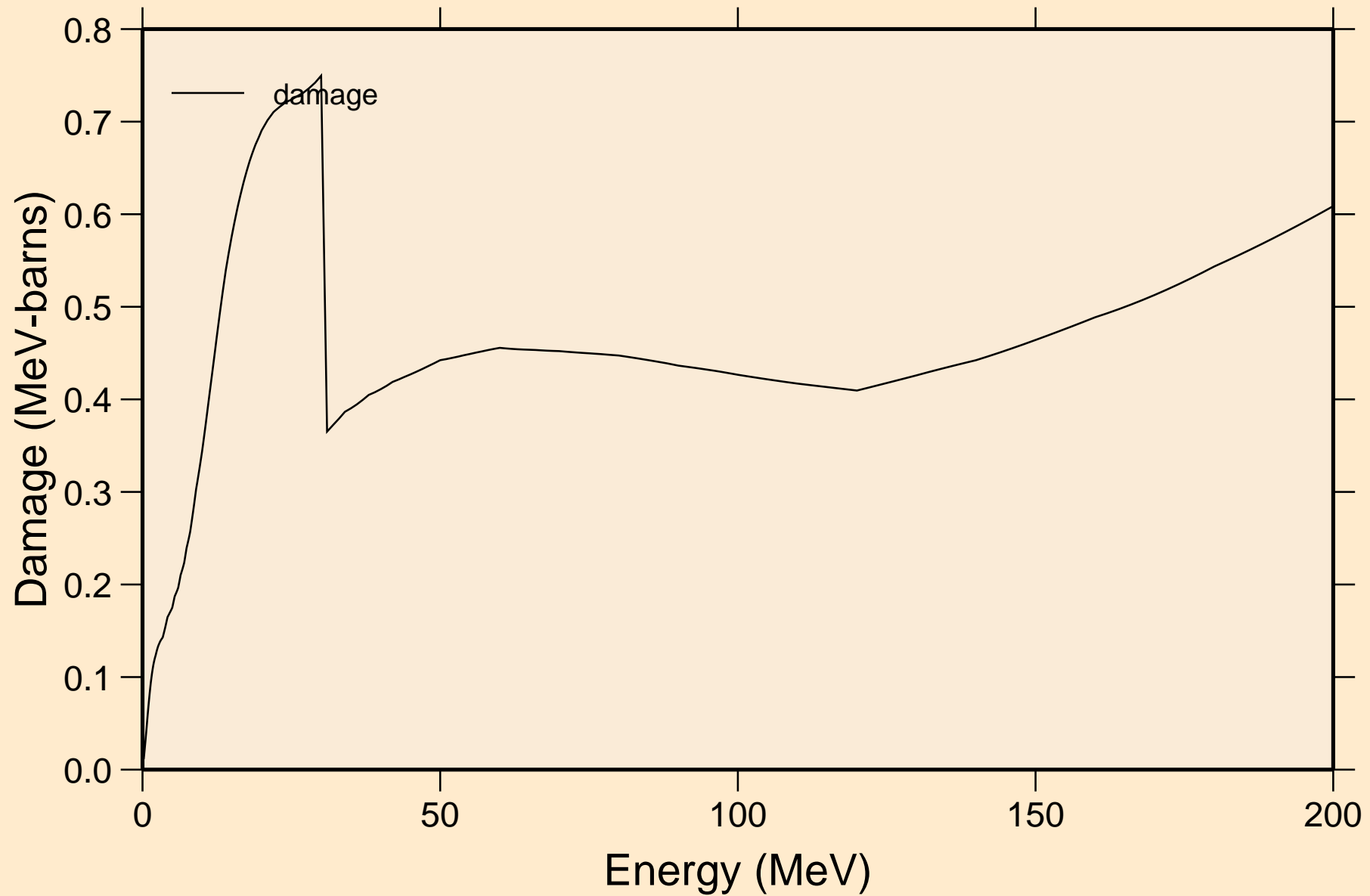

XE125M NEUTRON ACER TENDL-2024 LIBRARY; T=293.6K
Non-threshold reactions

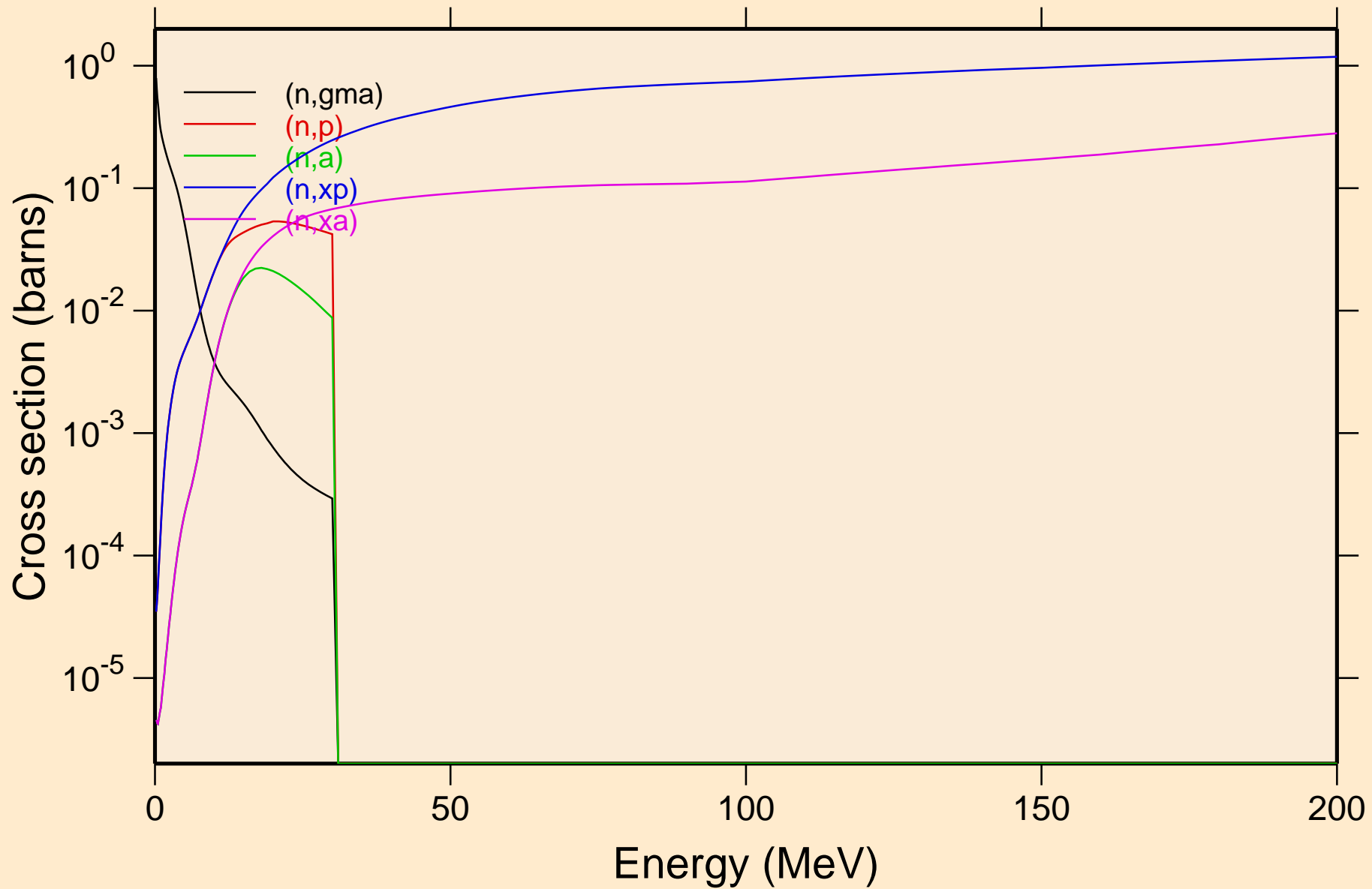

XE125M NEUTRON ACER TENDL-2024 LIBRARY; T=293.6K
Inelastic levels

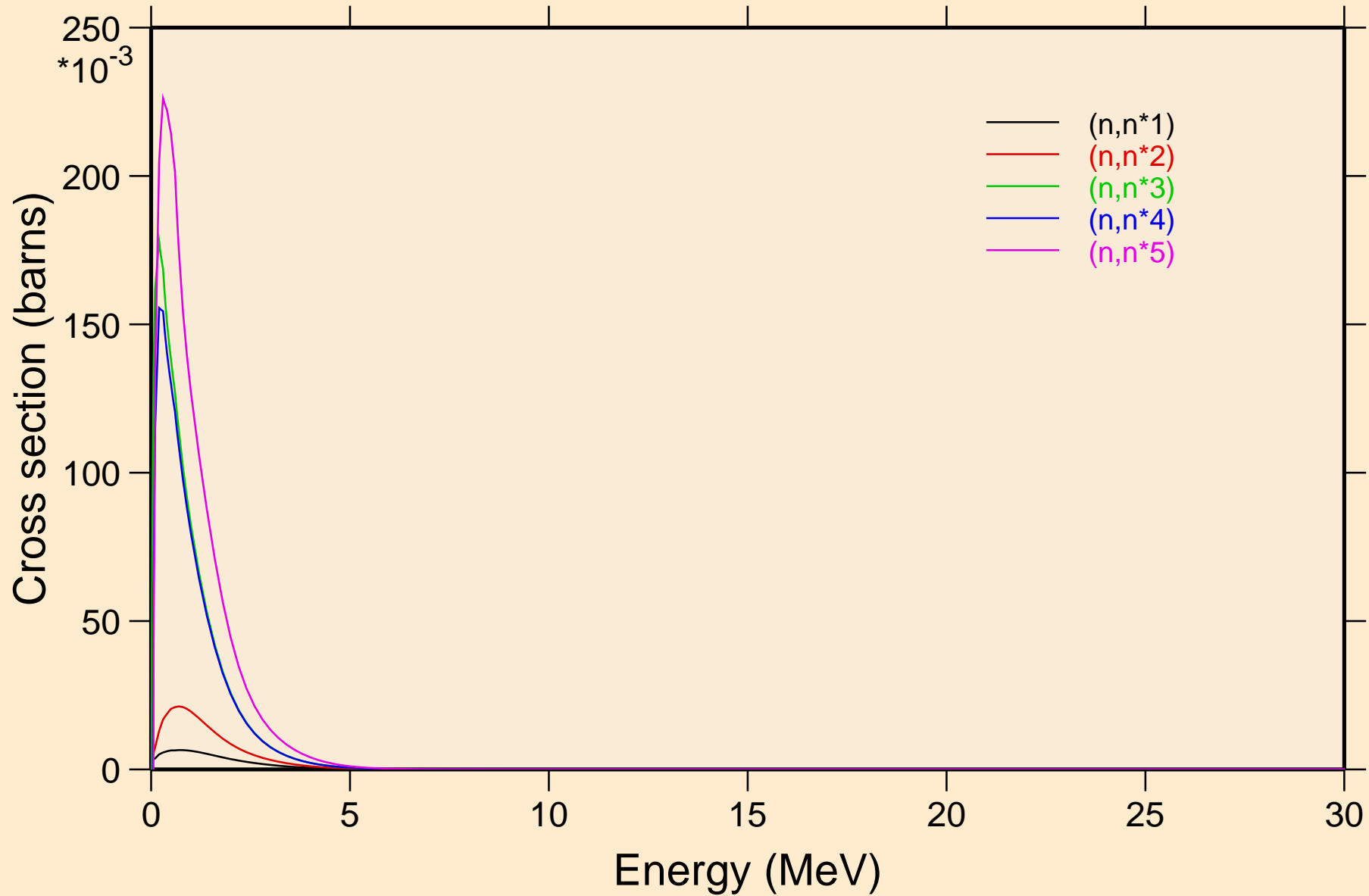

XE125M NEUTRON ACER TENDL-2024 LIBRARY; T=293.6K
Inelastic levels

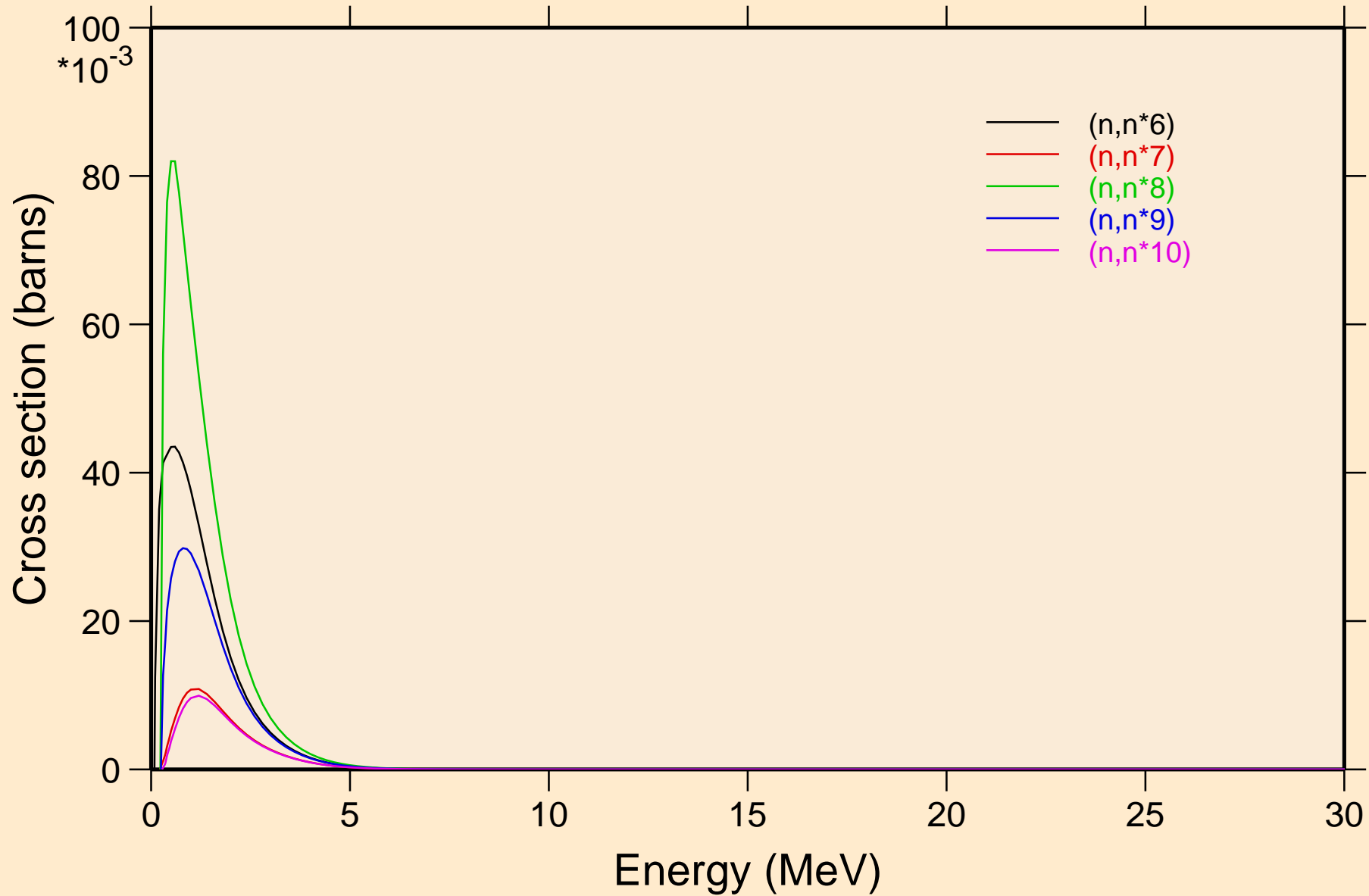

XE125M NEUTRON ACER TENDL-2024 LIBRARY; T=293.6K
Inelastic levels

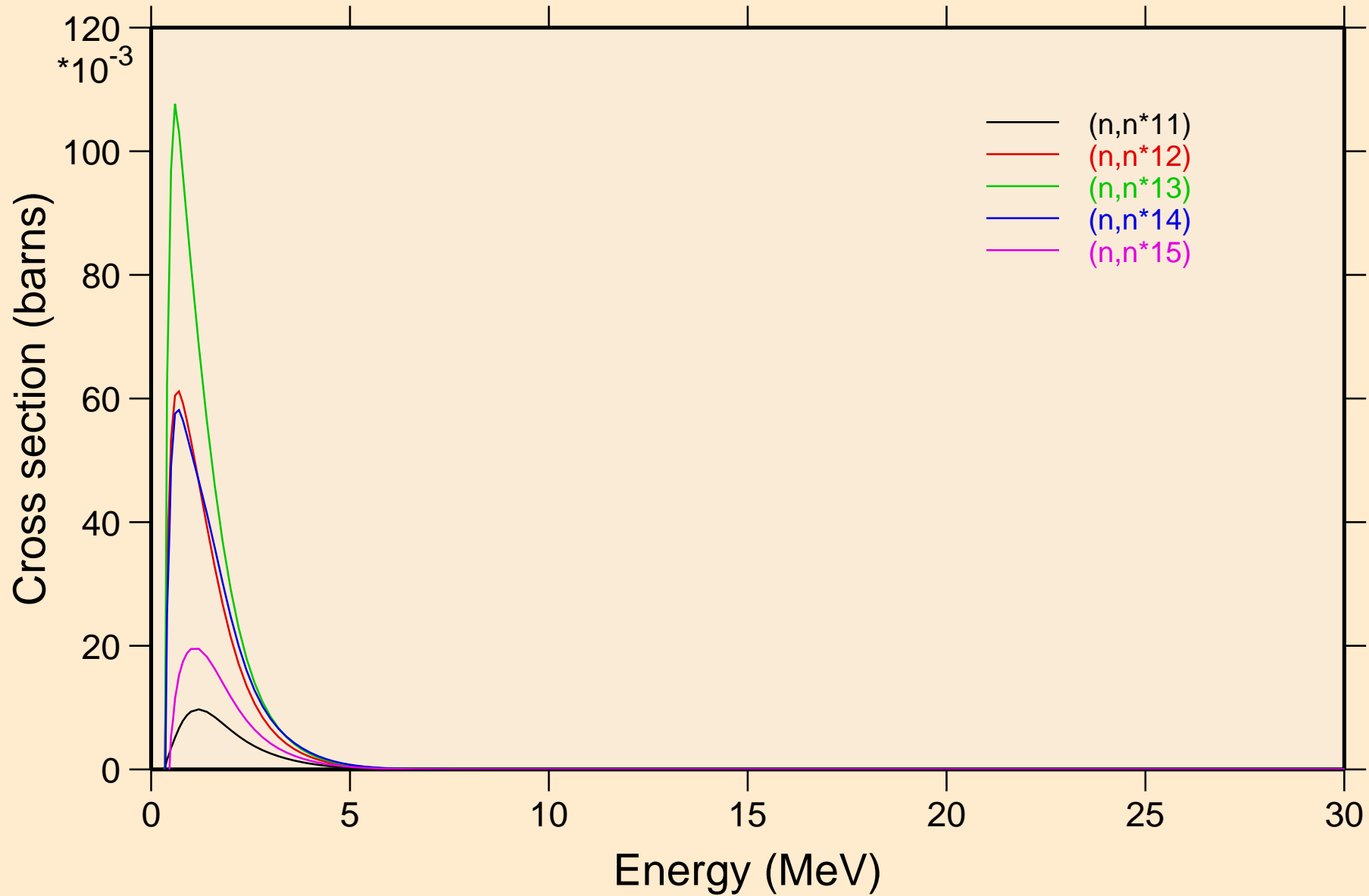

XE125M NEUTRON ACER TENDL-2024 LIBRARY; T=293.6K
Inelastic levels

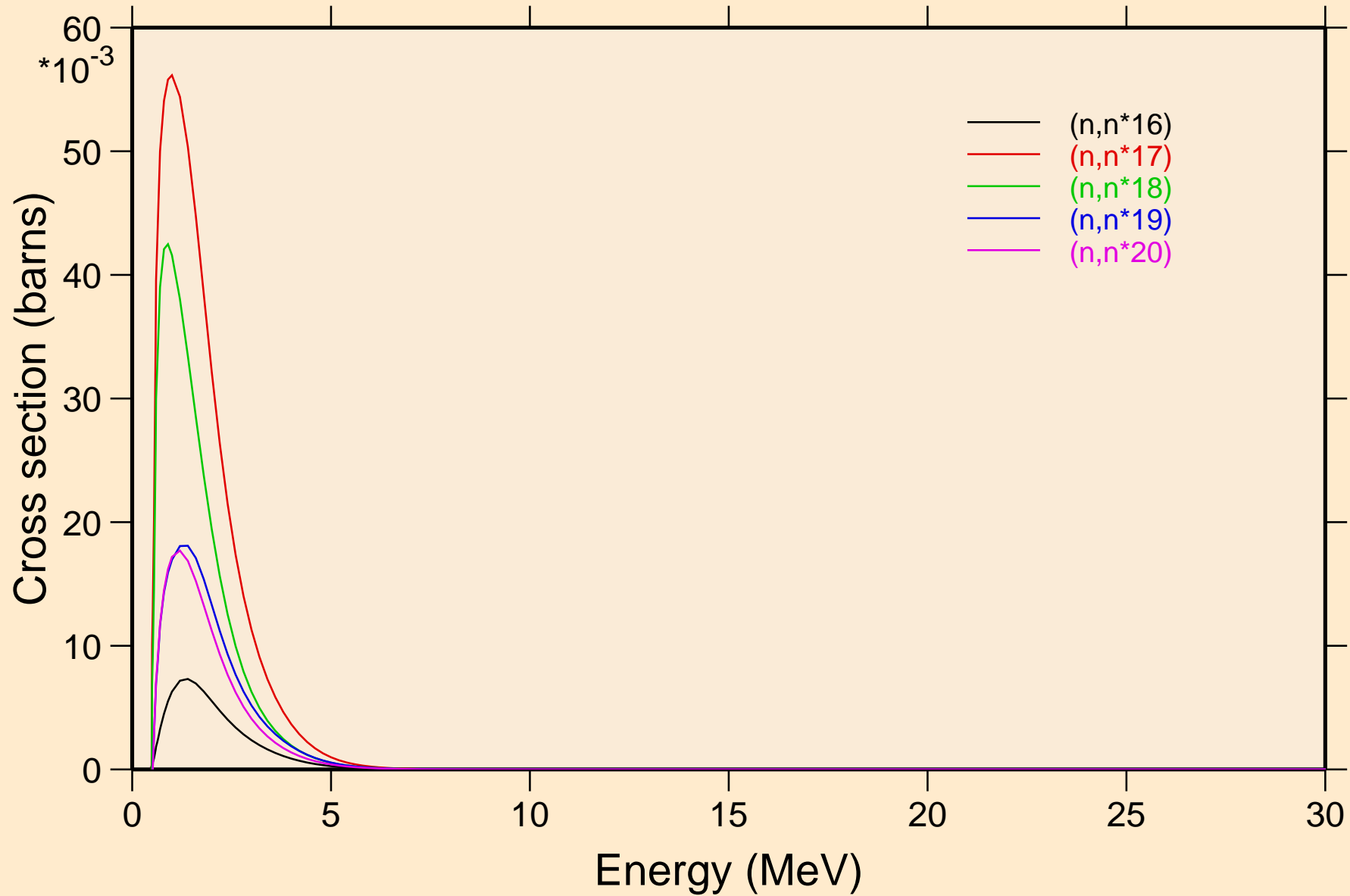

XE125M NEUTRON ACER TENDL-2024 LIBRARY; T=293.6K
Inelastic levels

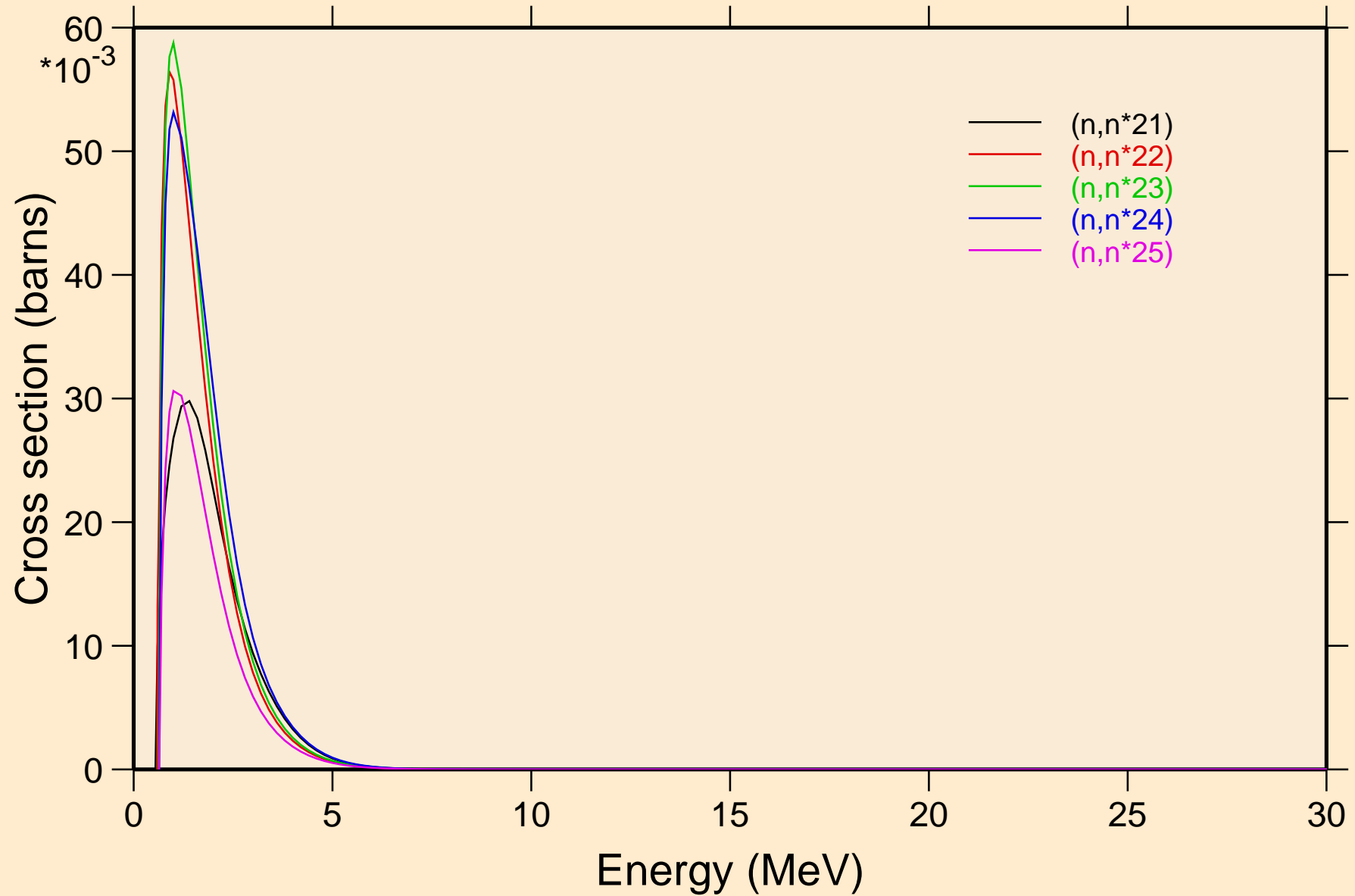

XE125M NEUTRON ACER TENDL-2024 LIBRARY; T=293.6K
Inelastic levels

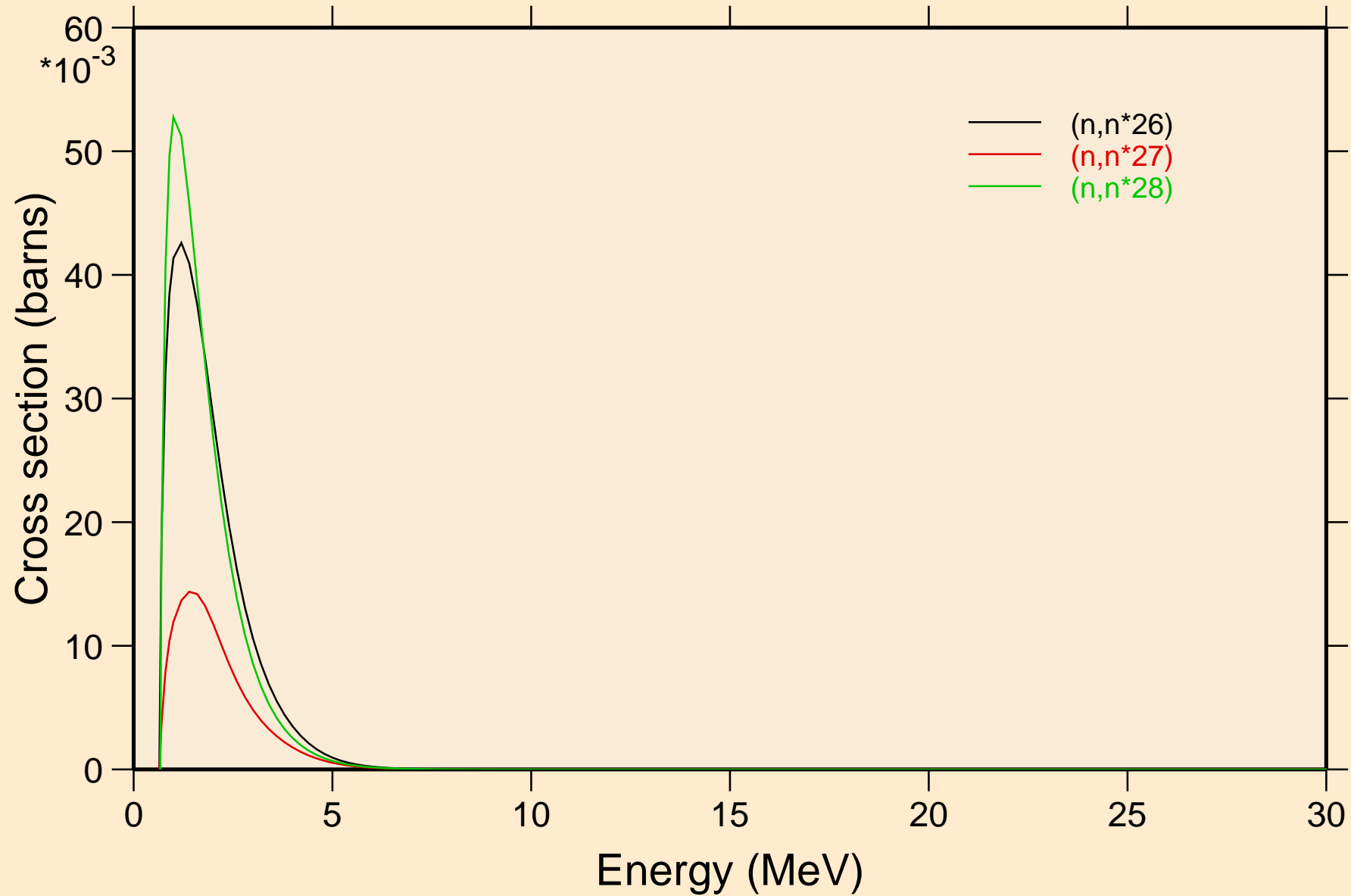

XE125M NEUTRON ACER TENDL-2024 LIBRARY; T=293.6K
Threshold reactions

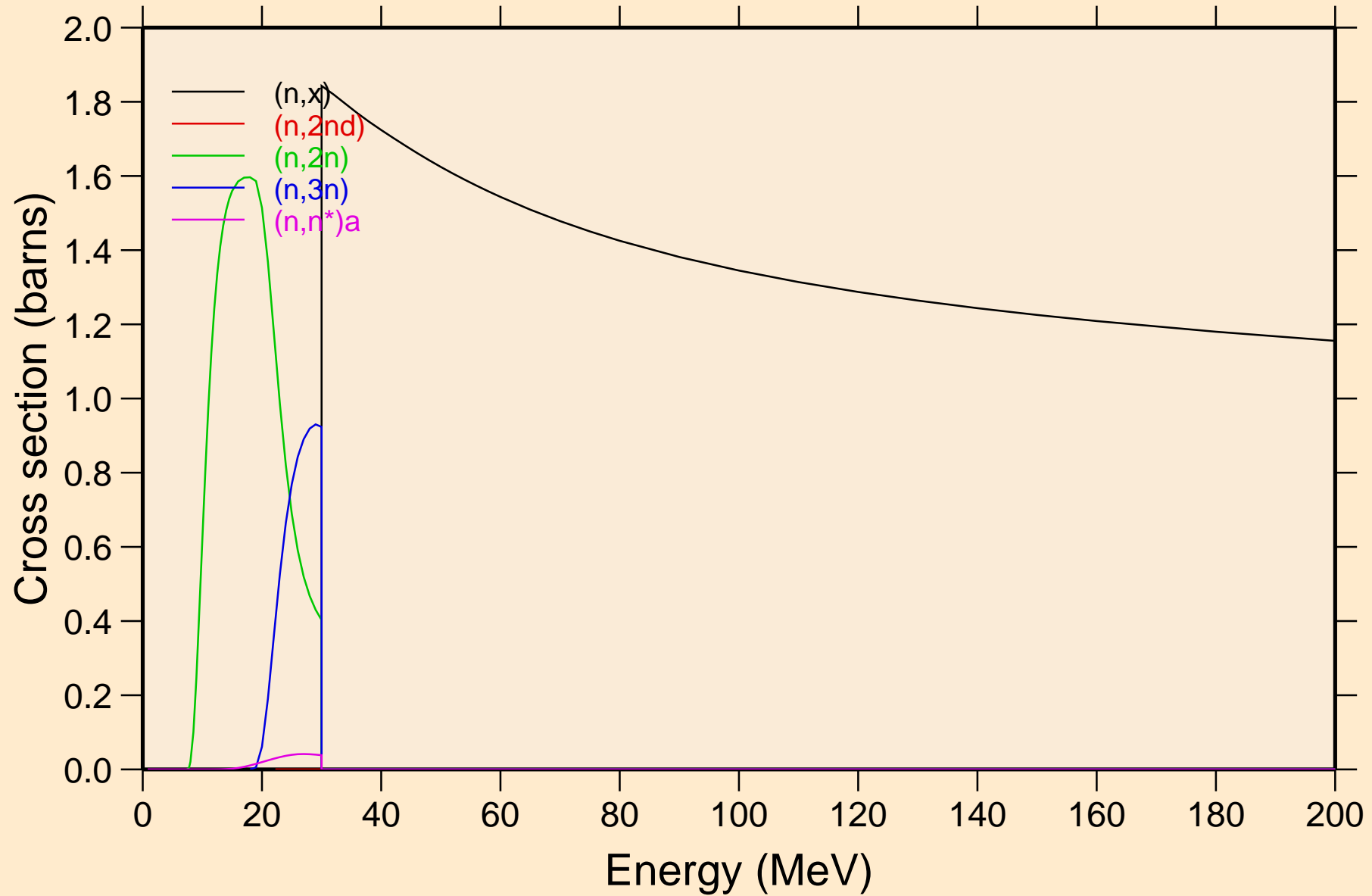

XE125M NEUTRON ACER TENDL-2024 LIBRARY; T=293.6K
Threshold reactions

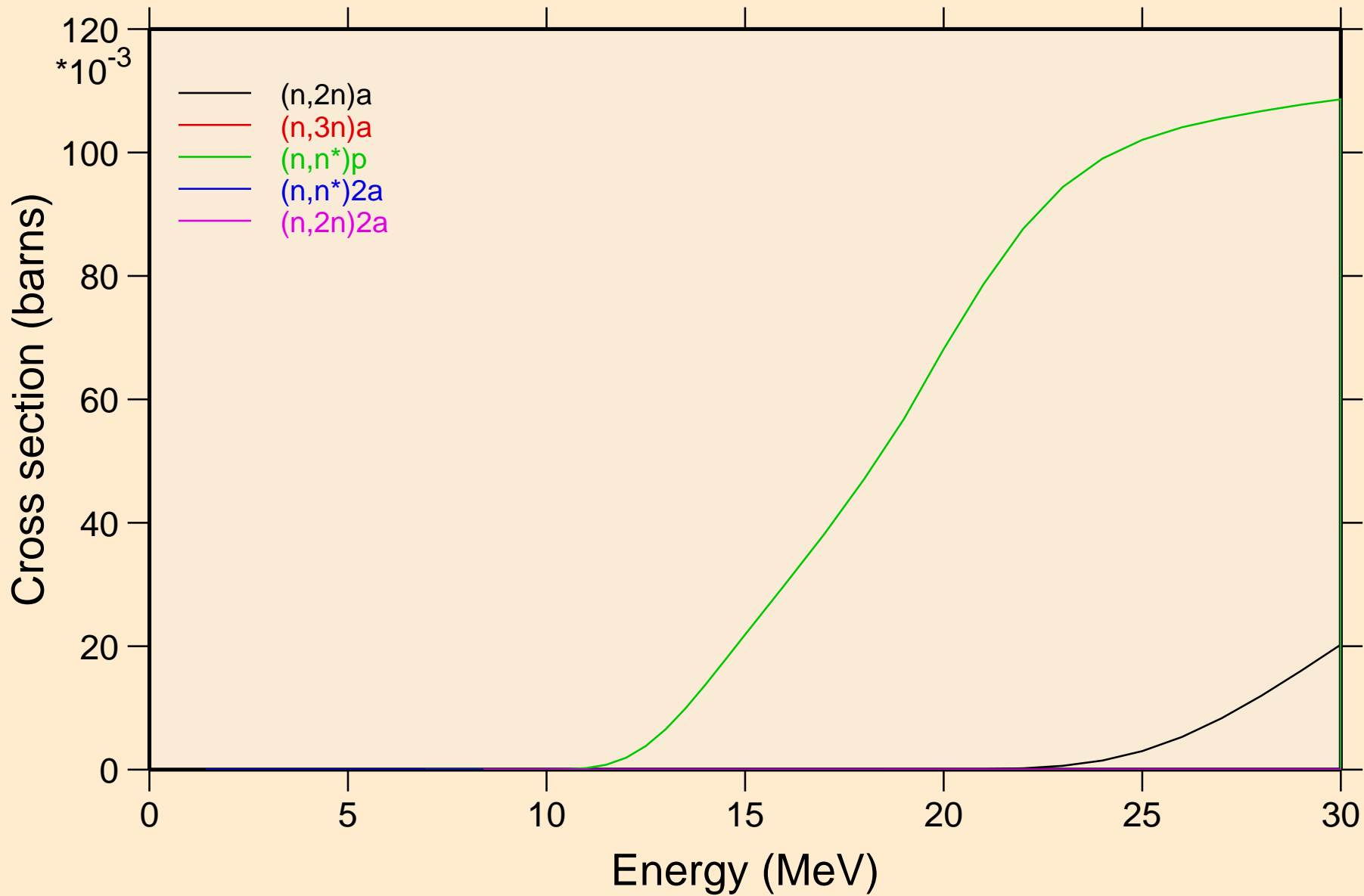

XE125M NEUTRON ACER TENDL-2024 LIBRARY; T=293.6K
Threshold reactions

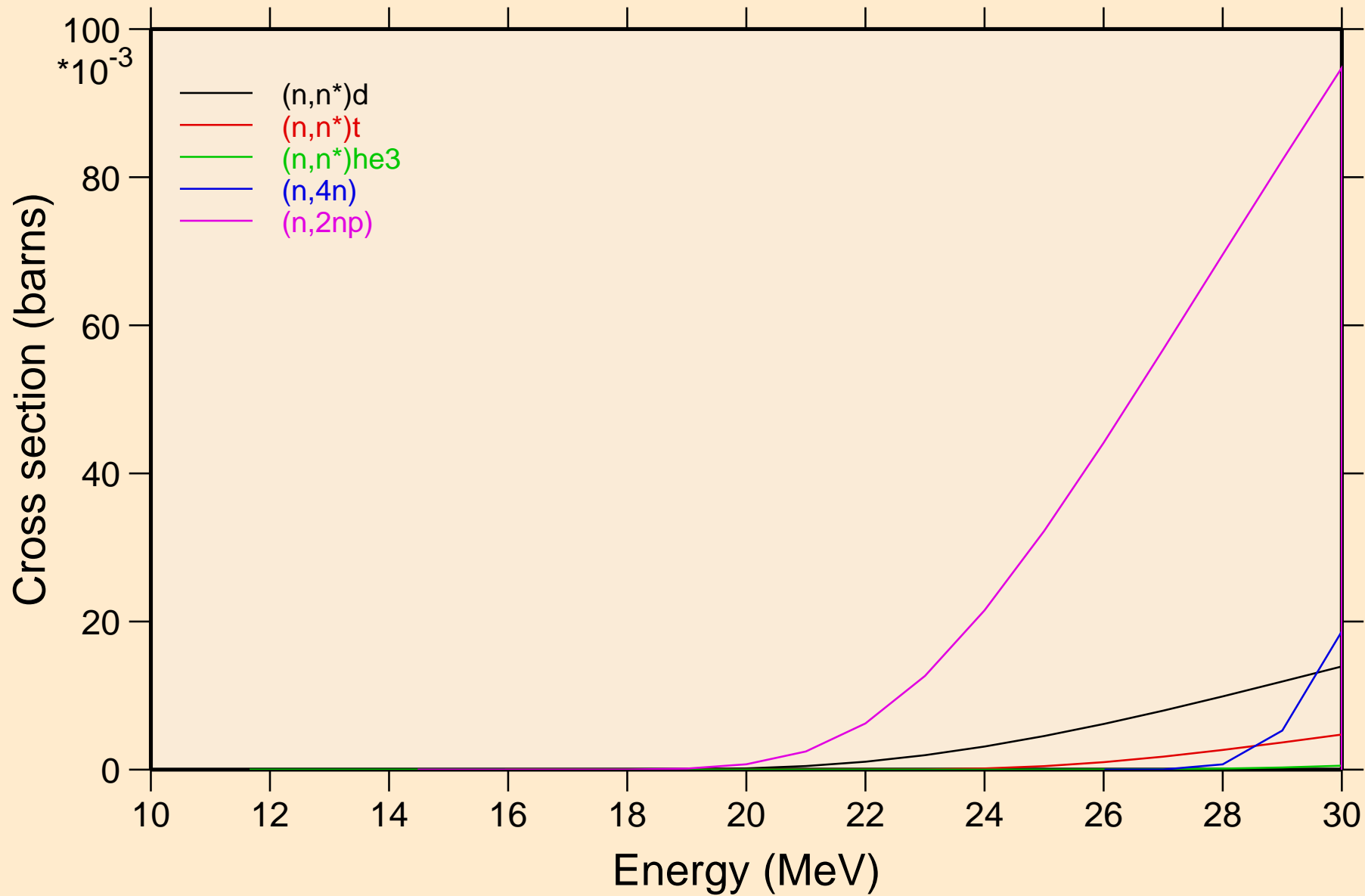

XE125M NEUTRON ACER TENDL-2024 LIBRARY; T=293.6K
Threshold reactions

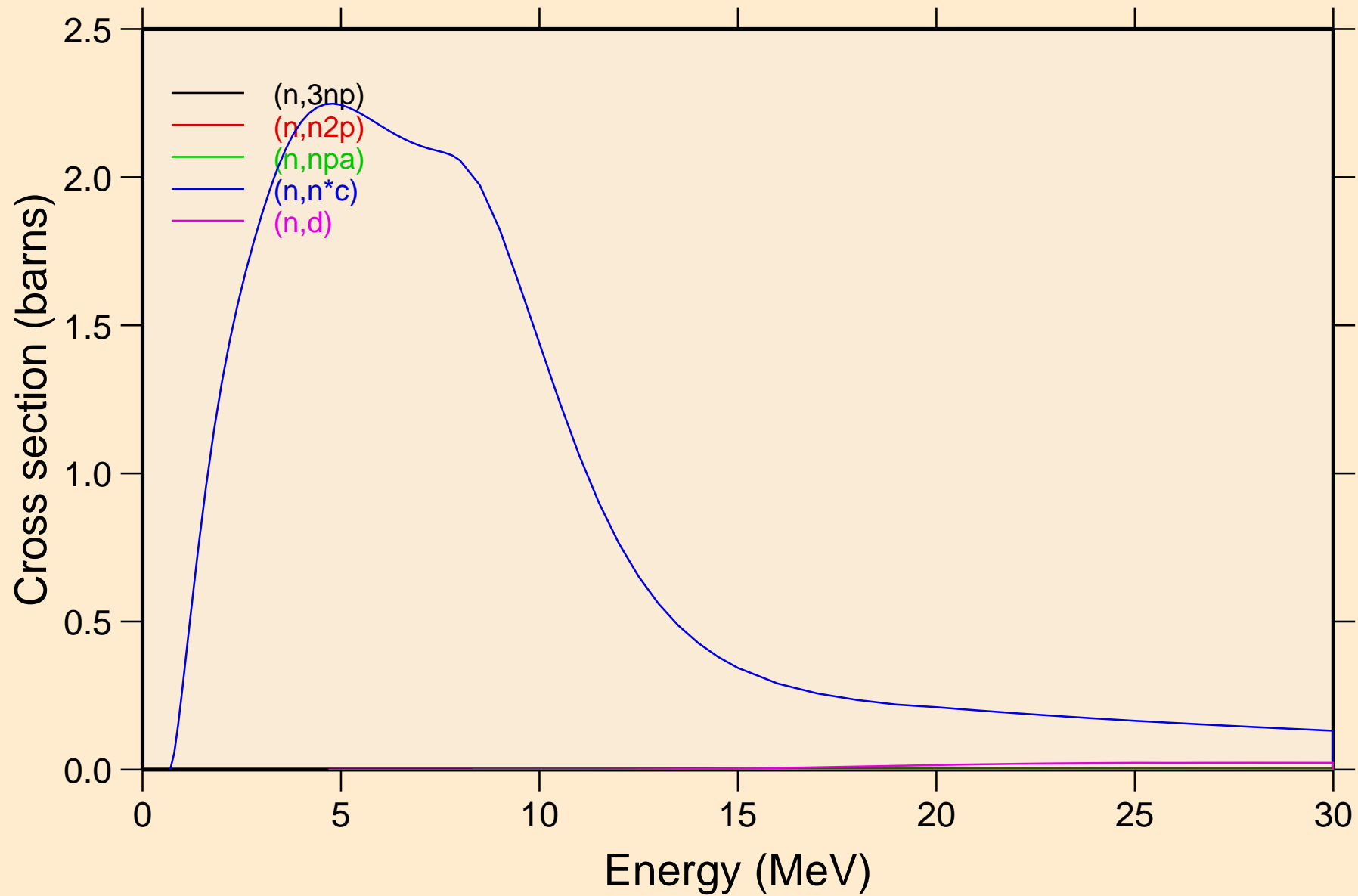

XE125M NEUTRON ACER TENDL-2024 LIBRARY; T=293.6K
Threshold reactions

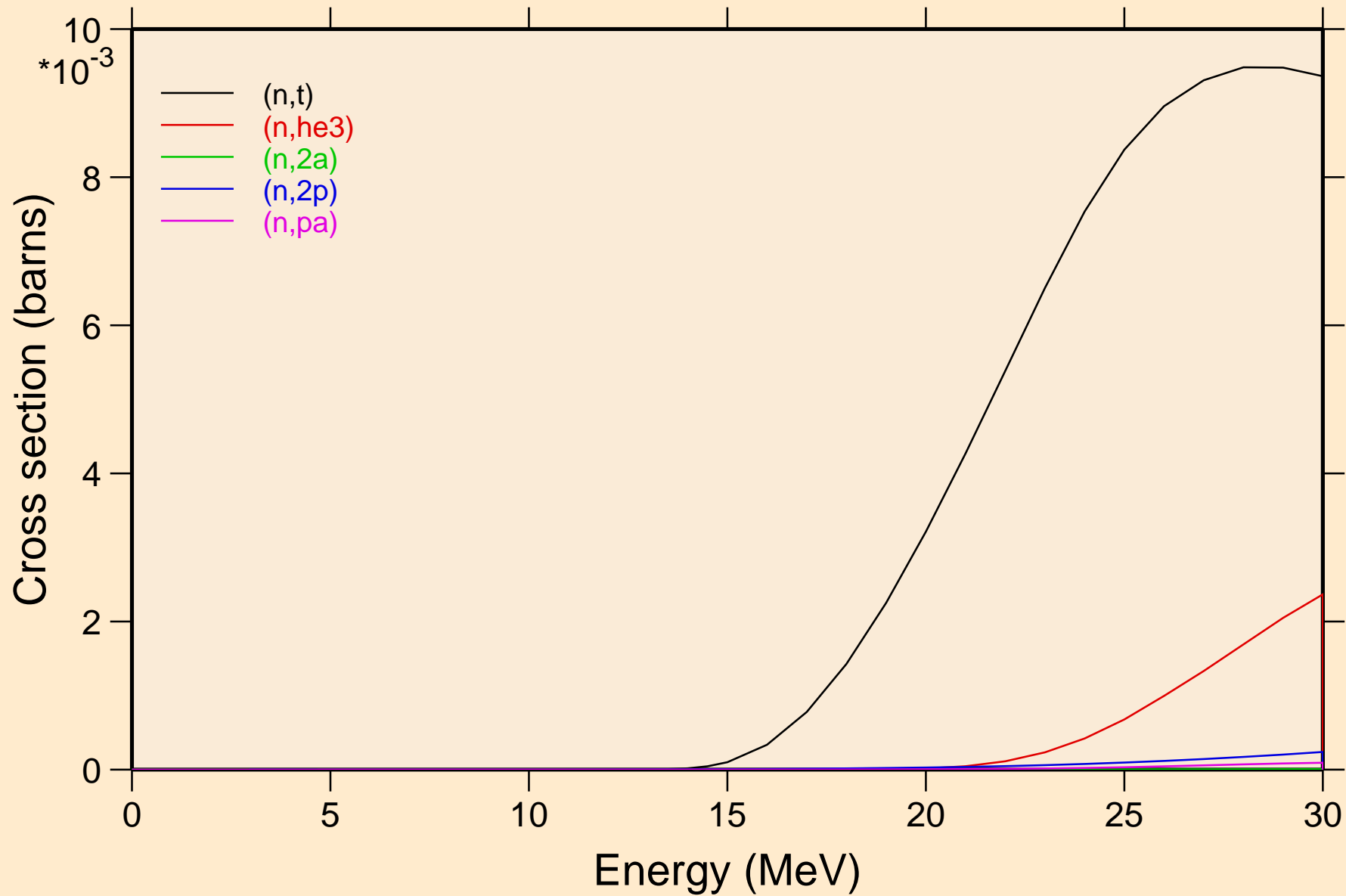

XE125M NEUTRON ACER TENDL-2024 LIBRARY; T=293.6K
Threshold reactions

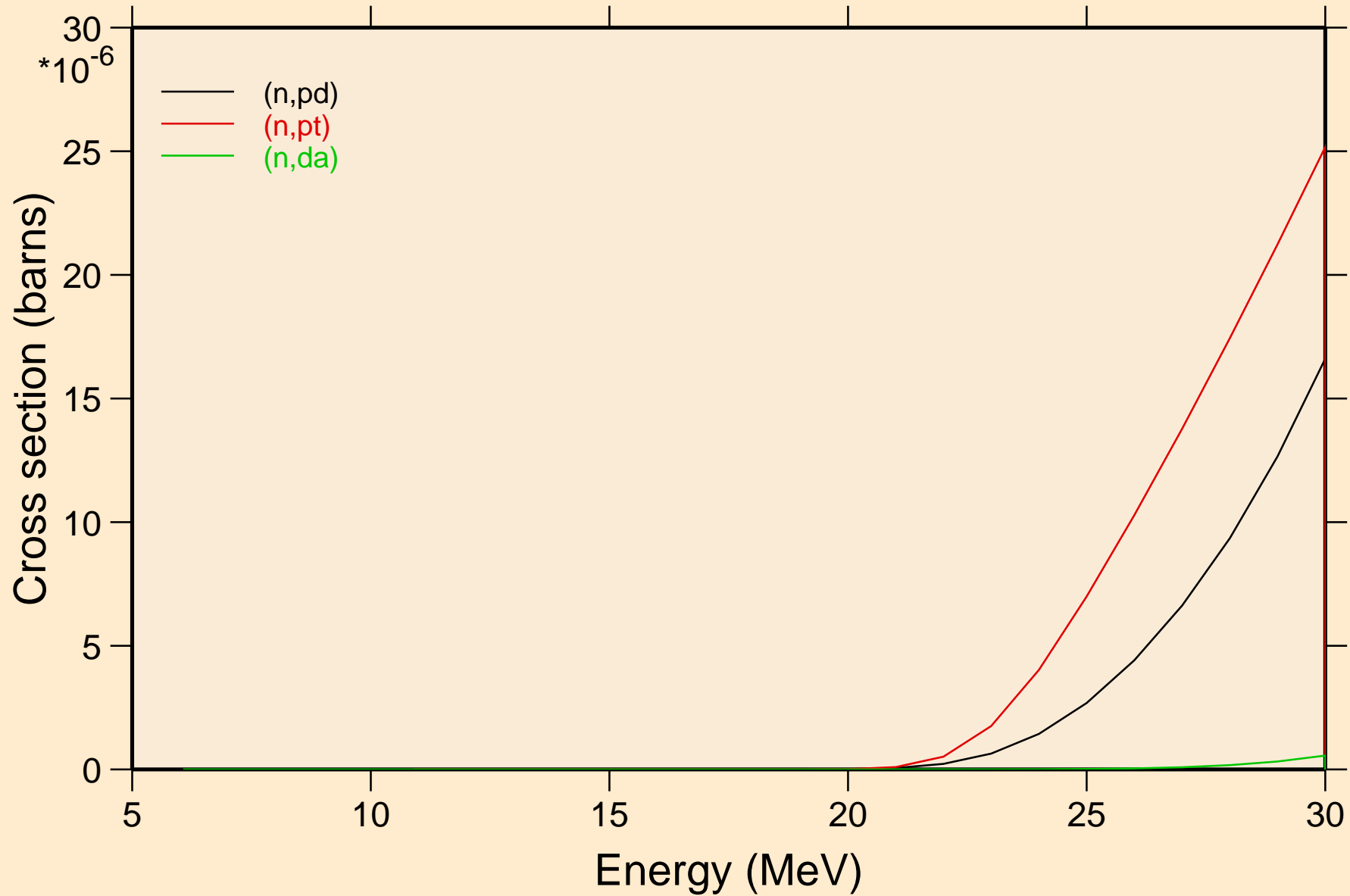

XE125M NEUTRON ACER TENDL-2024 LIBRARY; T=293.6K

Threshold reactions

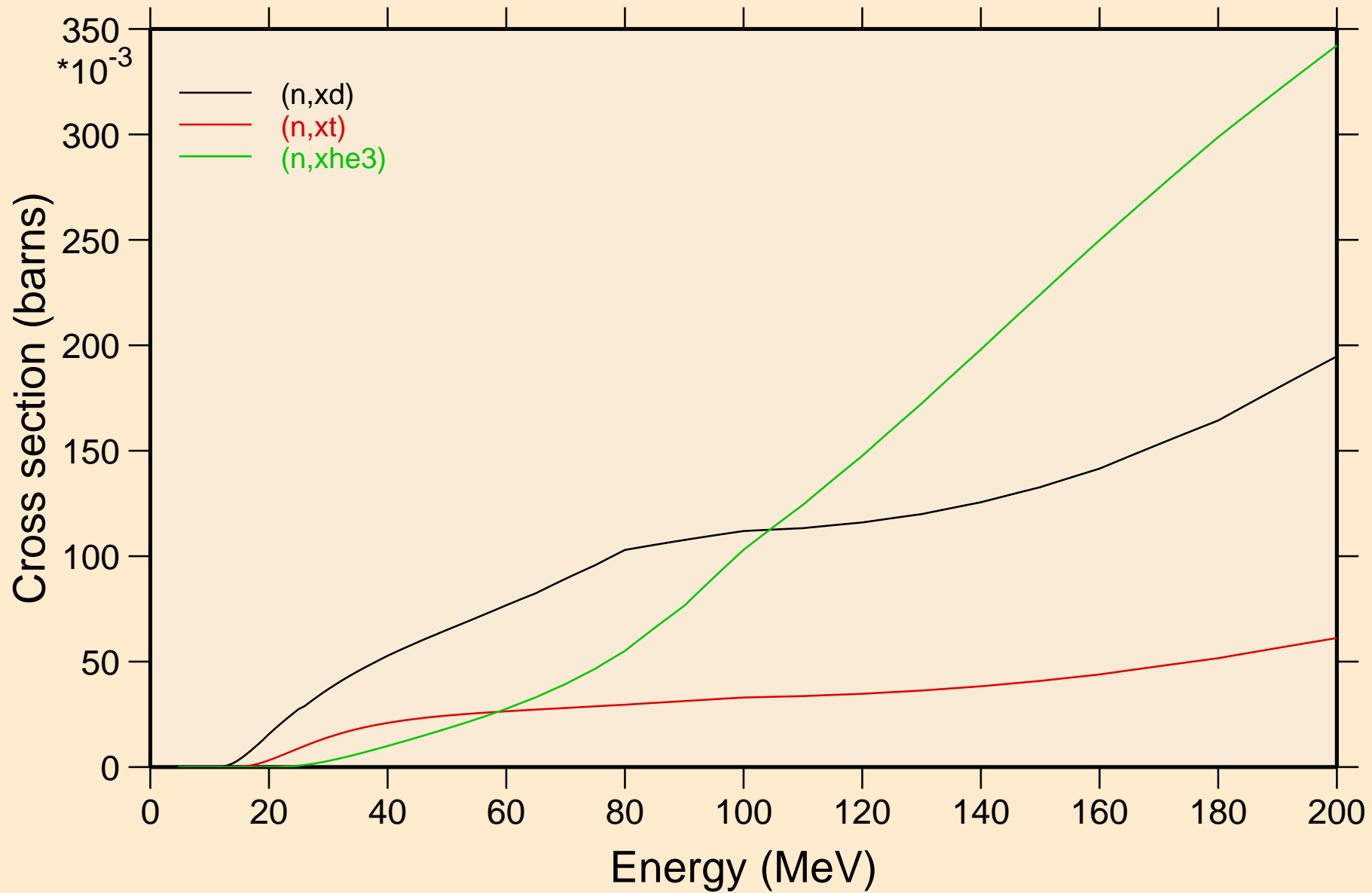

XE125M NEUTRON ACER TENDL-2024 LIBRARY; T=293.6K
angular distribution for elastic

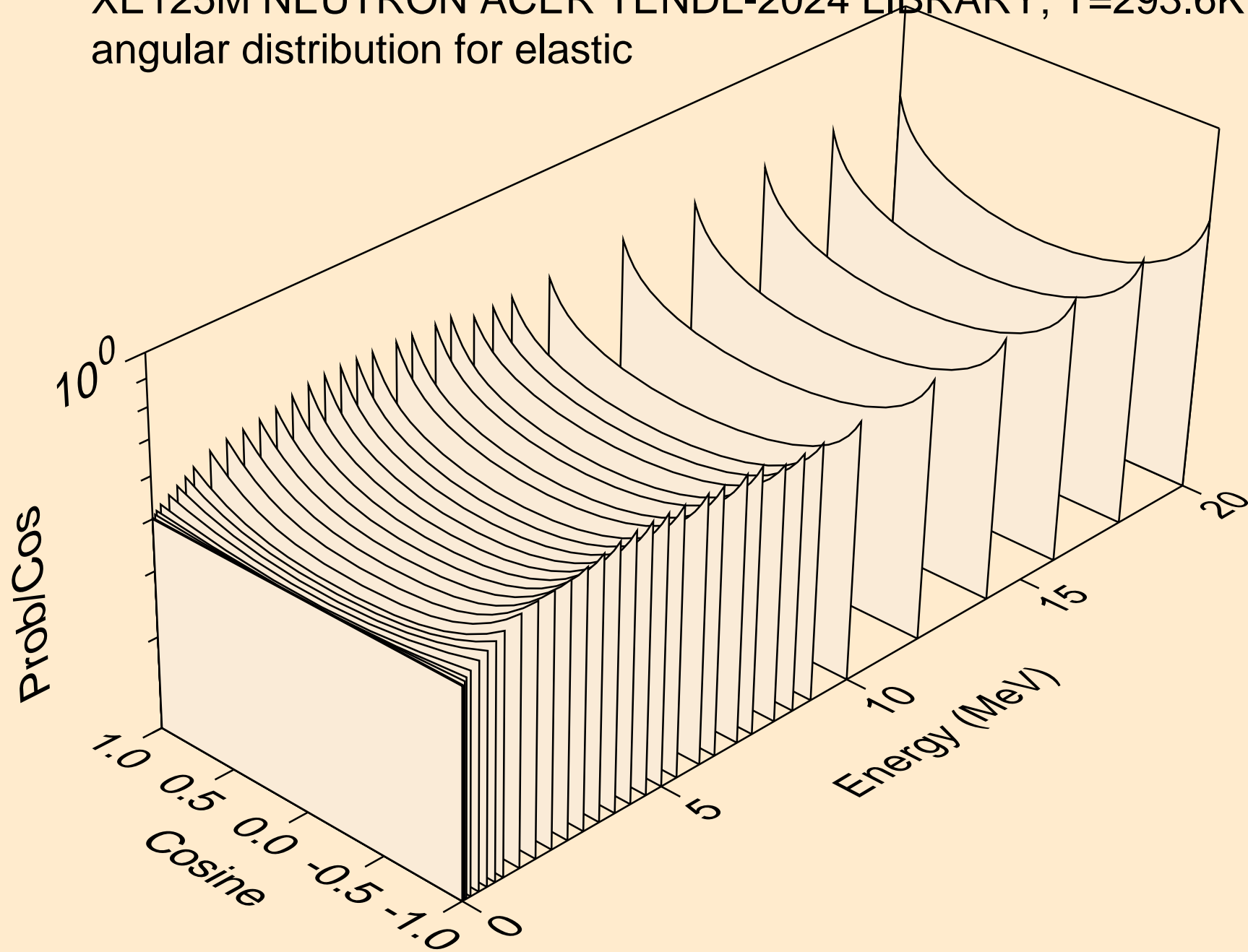

XE125M NEUTRON ACER TENDL-2024 LIBRARY; T=293.6K
angular distribution for elastic

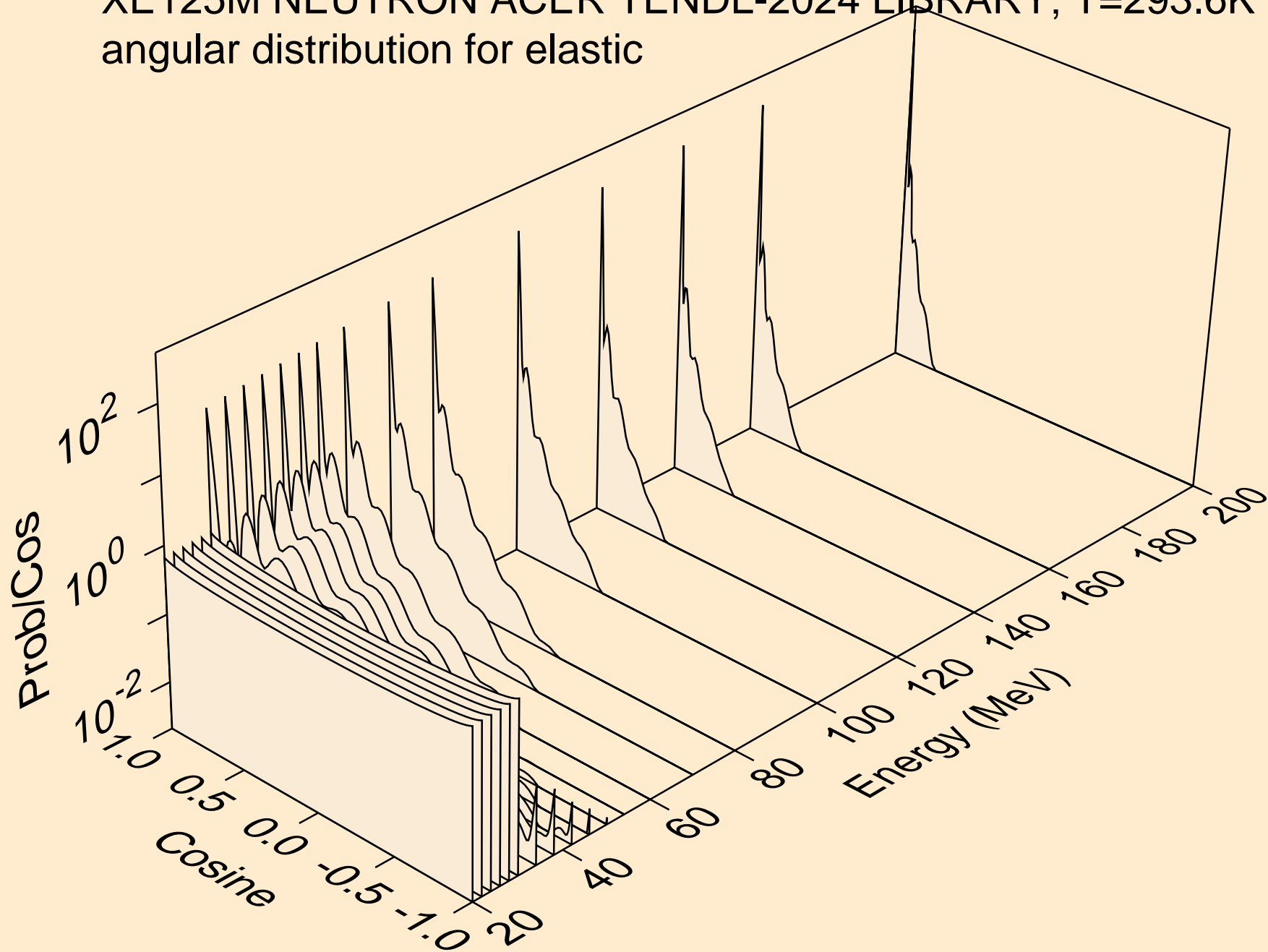

XE125M NEUTRON ACER TENDL-2024 LIBRARY; T=293.6K
angular distribution for (n,n*1)

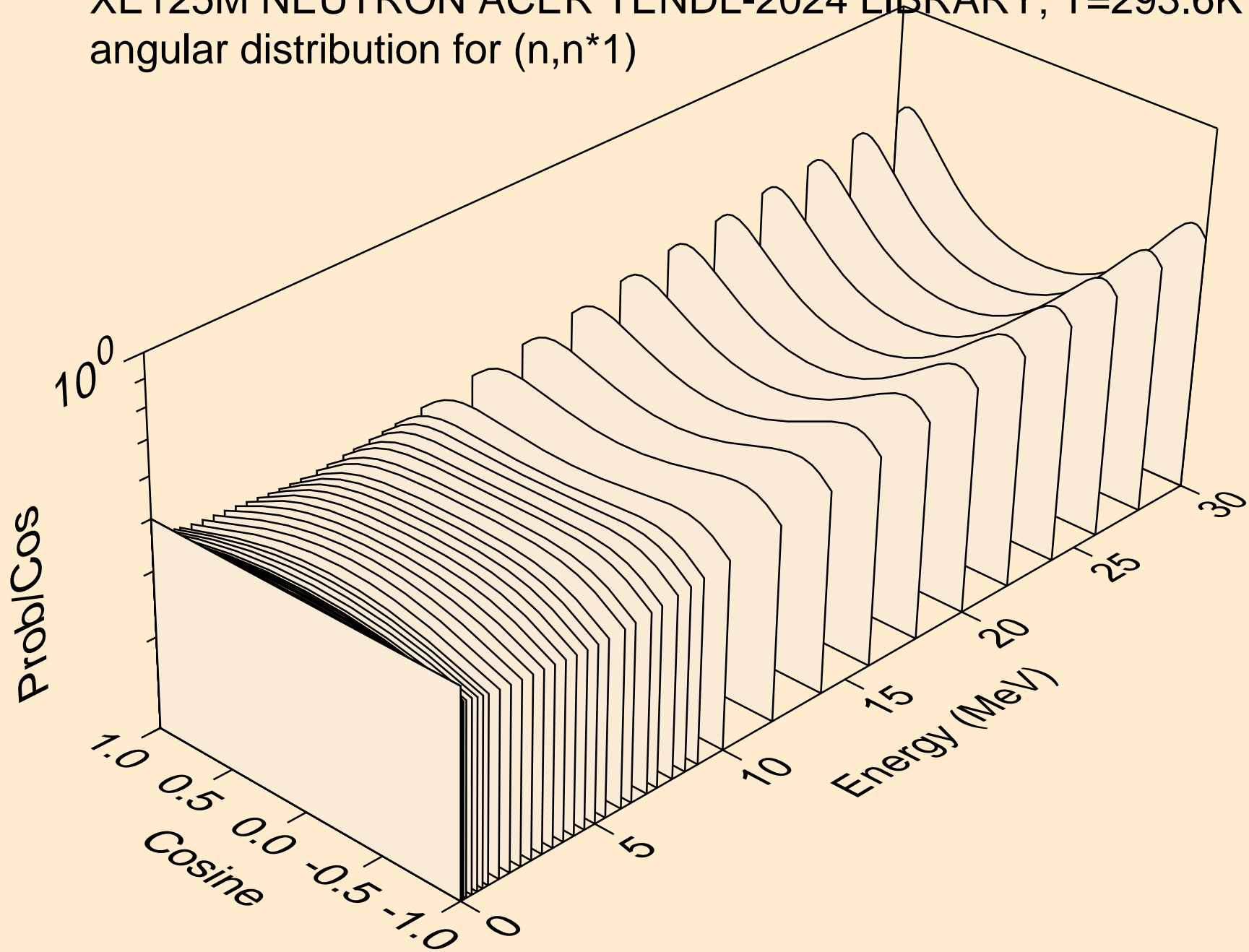

XE125M NEUTRON ACER TENDL-2024 LIBRARY; T=293.6K
angular distribution for (n,n*2)

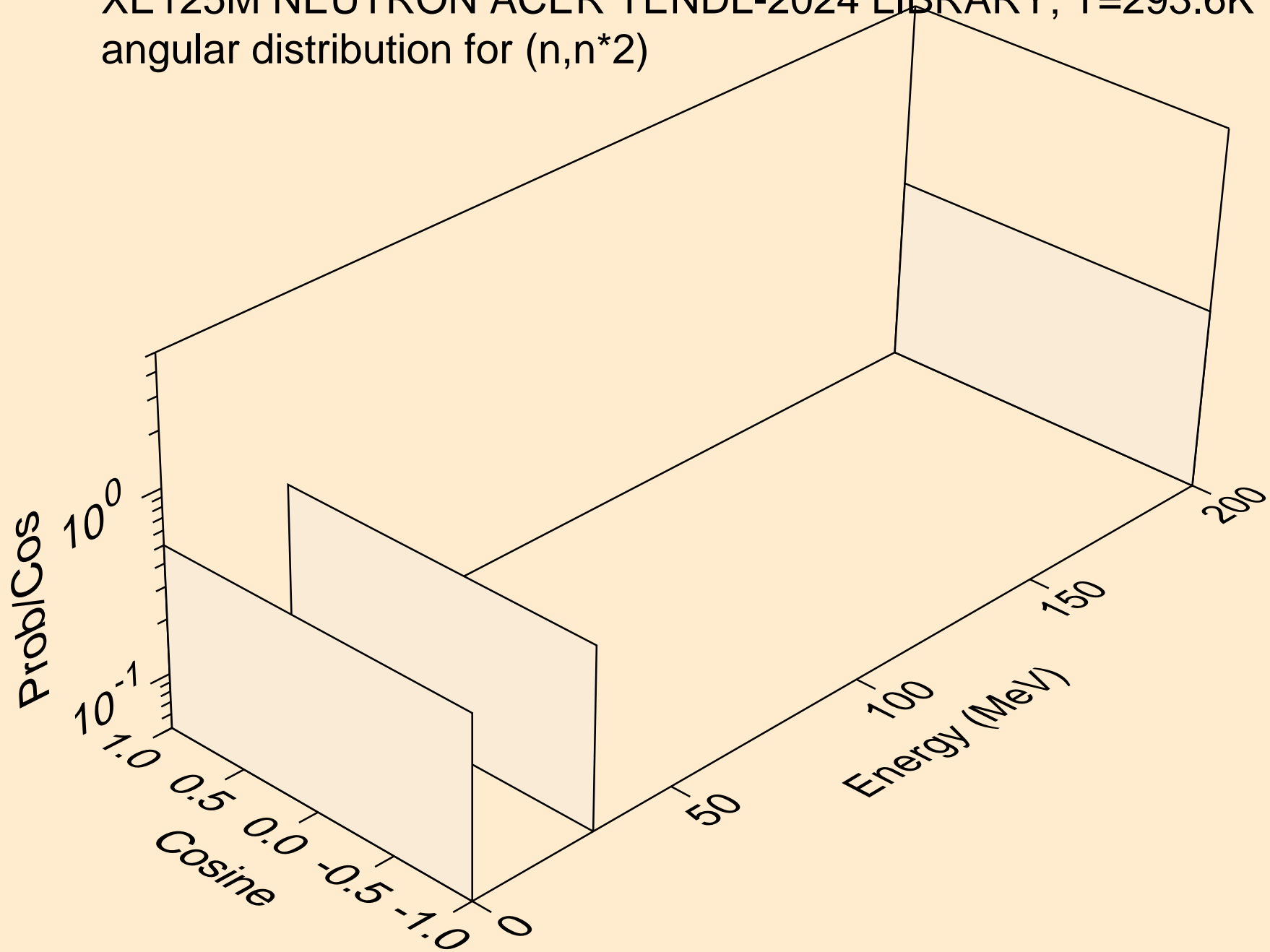

XE125M NEUTRON ACER TENDL-2024 LIBRARY; T=293.6K
angular distribution for (n,n*3)

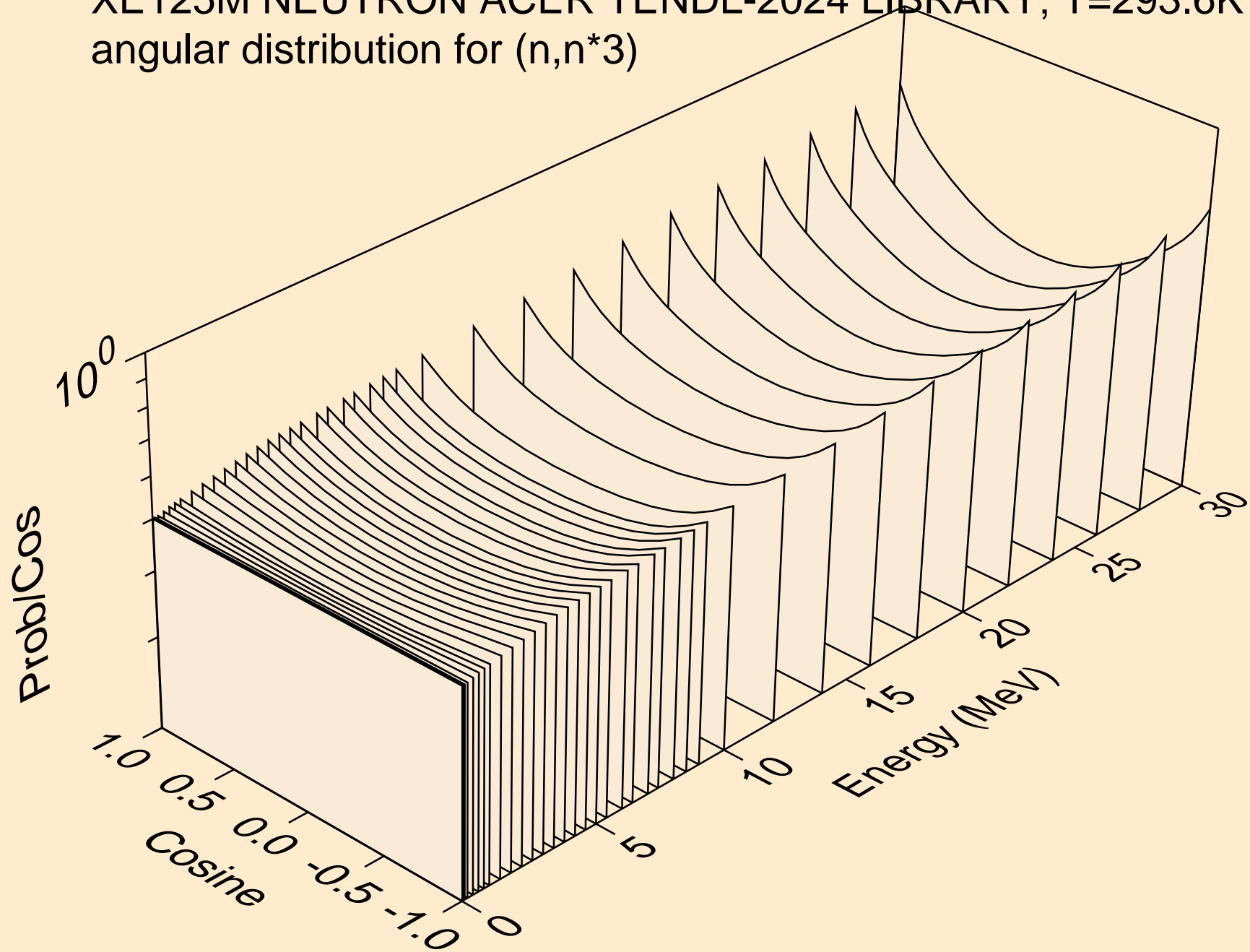

XE125M NEUTRON ACER TENDL-2024 LIBRARY; T=293.6K
angular distribution for (n,n*4)

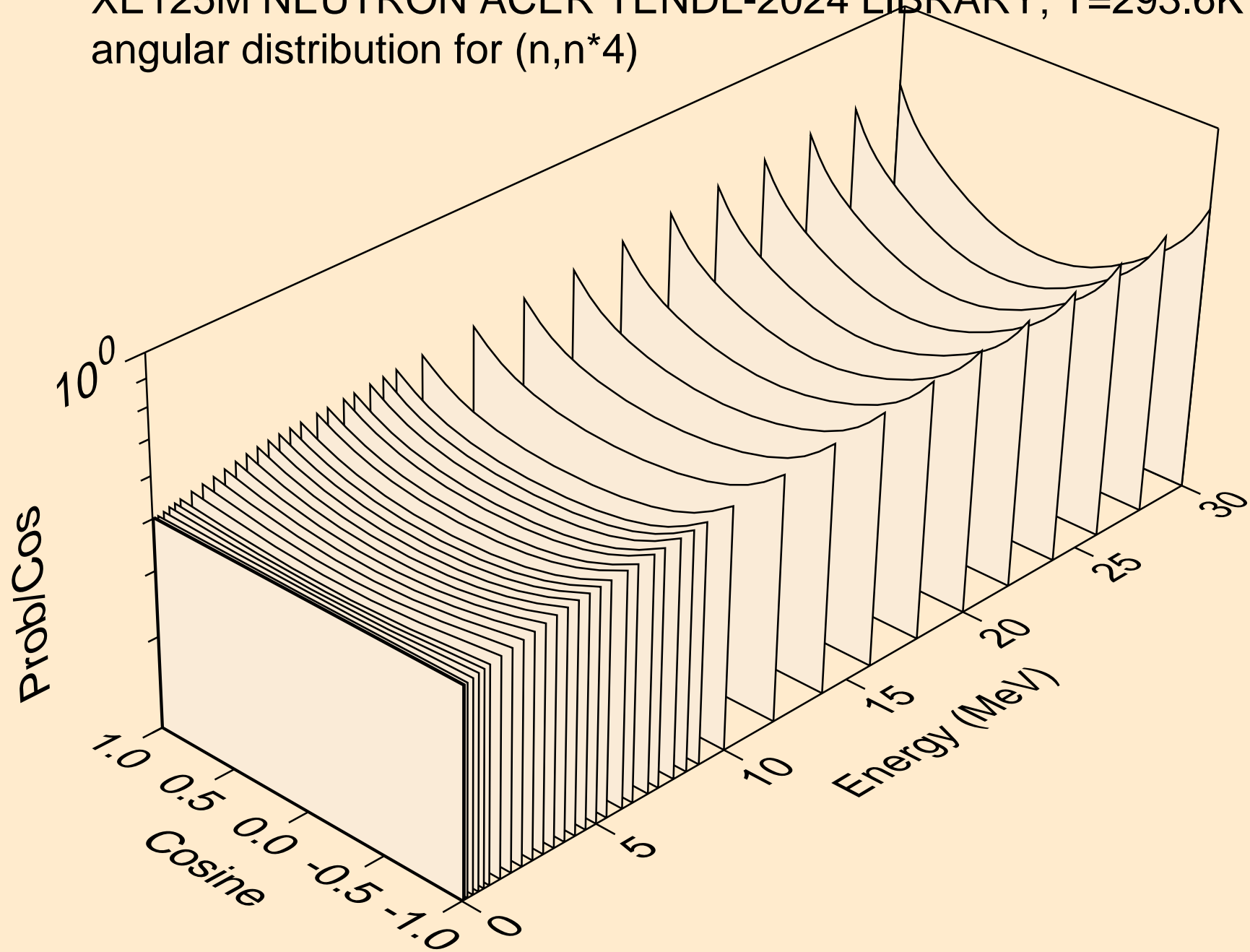

XE125M NEUTRON ACER TENDL-2024 LIBRARY; T=293.6K
angular distribution for (n,n*5)

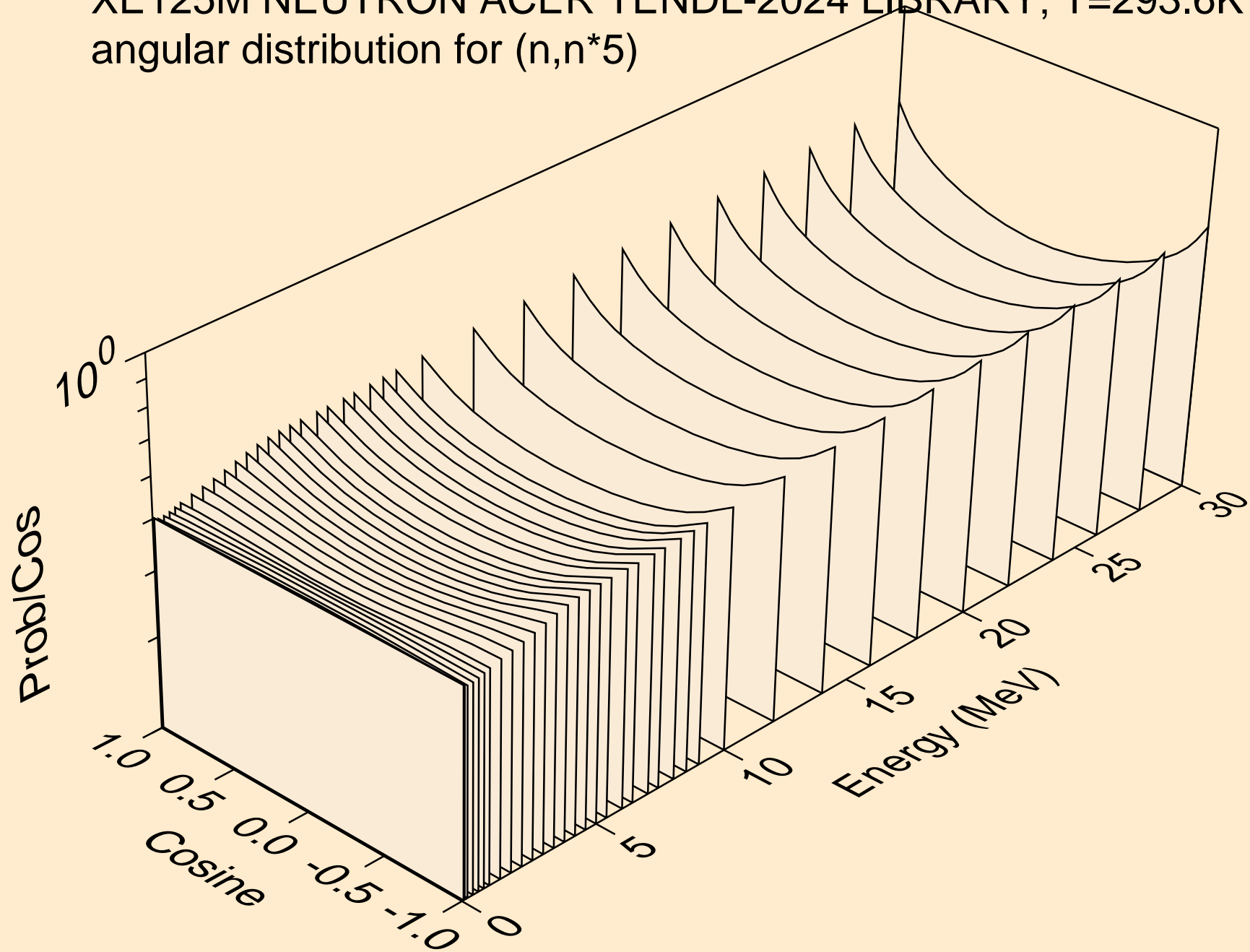

XE125M NEUTRON ACER TENDL-2024 LIBRARY; T=293.6K
angular distribution for (n,n*6)

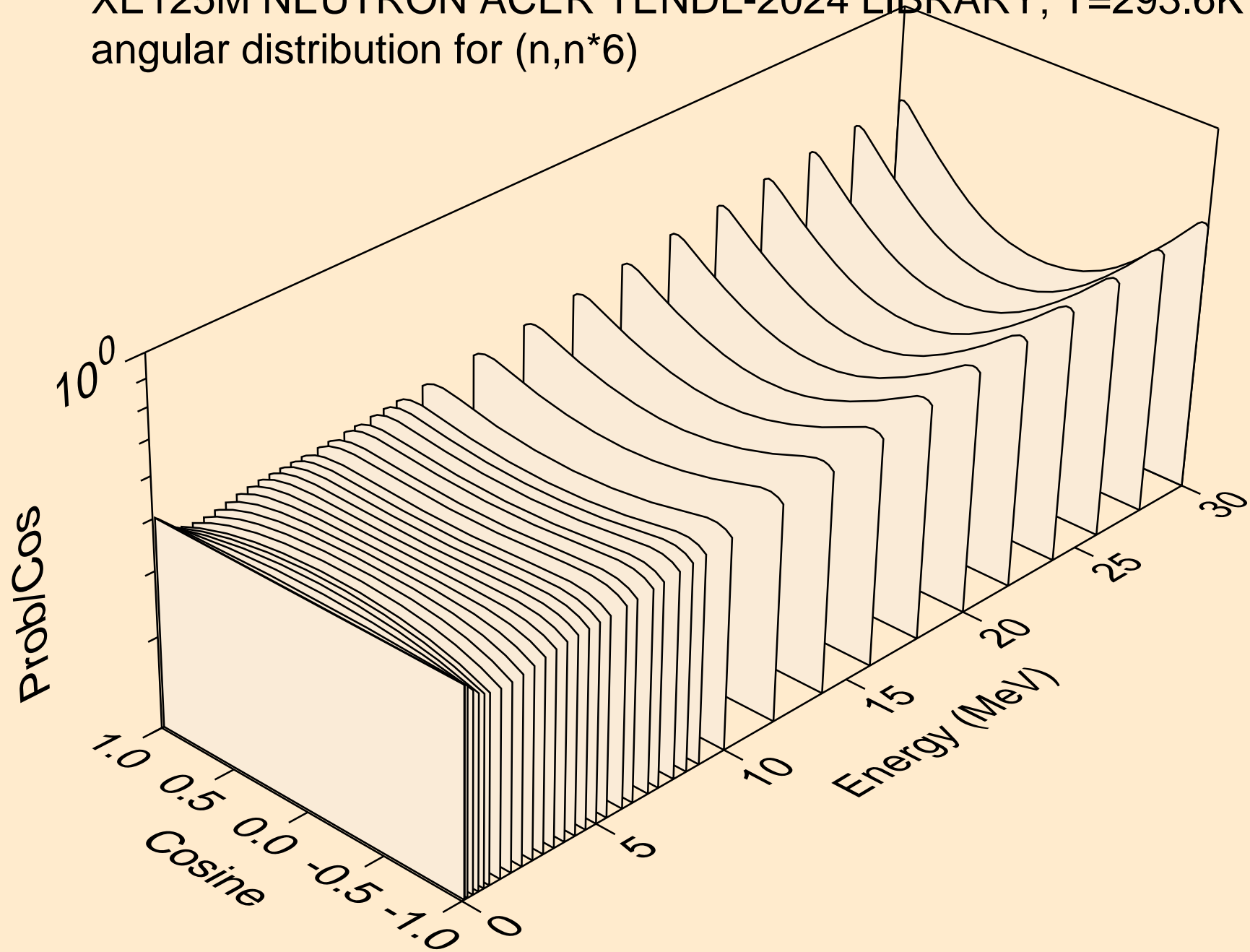

XE125M NEUTRON ACER TENDL-2024 LIBRARY; T=293.6K
angular distribution for (n,n*7)

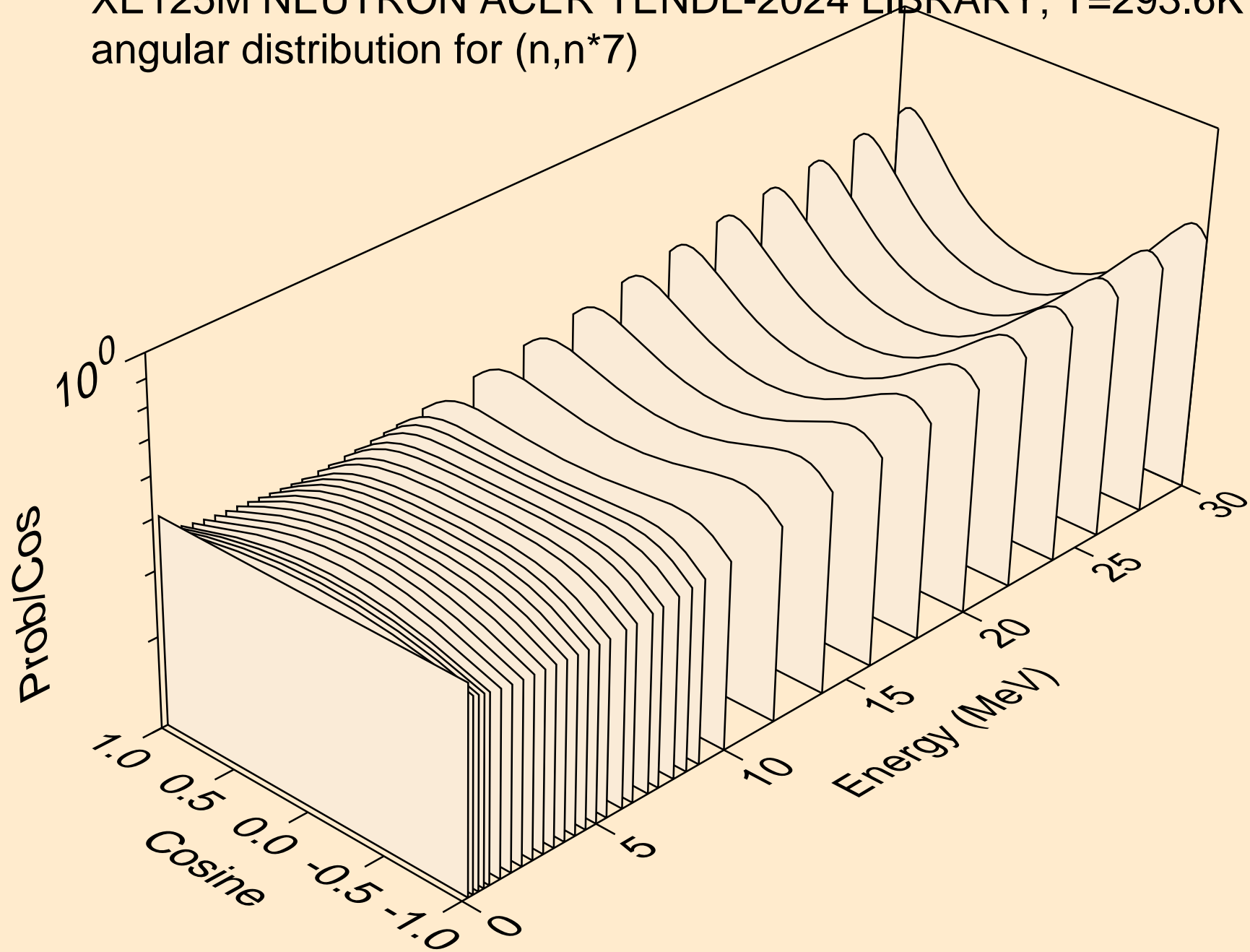

XE125M NEUTRON ACER TENDL-2024 LIBRARY; T=293.6K
angular distribution for (n,n*8)

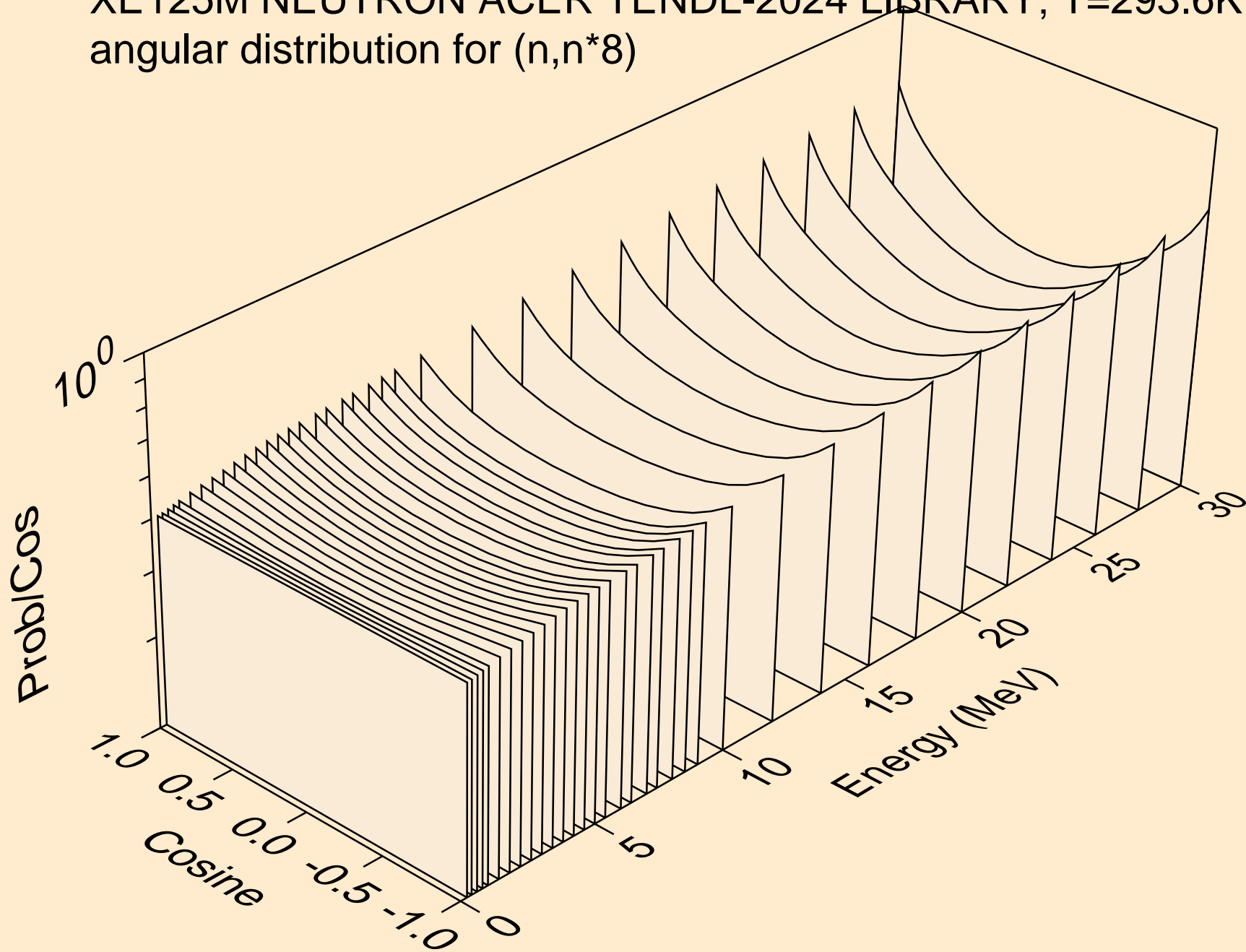

XE125M NEUTRON ACER TENDL-2024 LIBRARY; T=293.6K
angular distribution for (n,n*9)

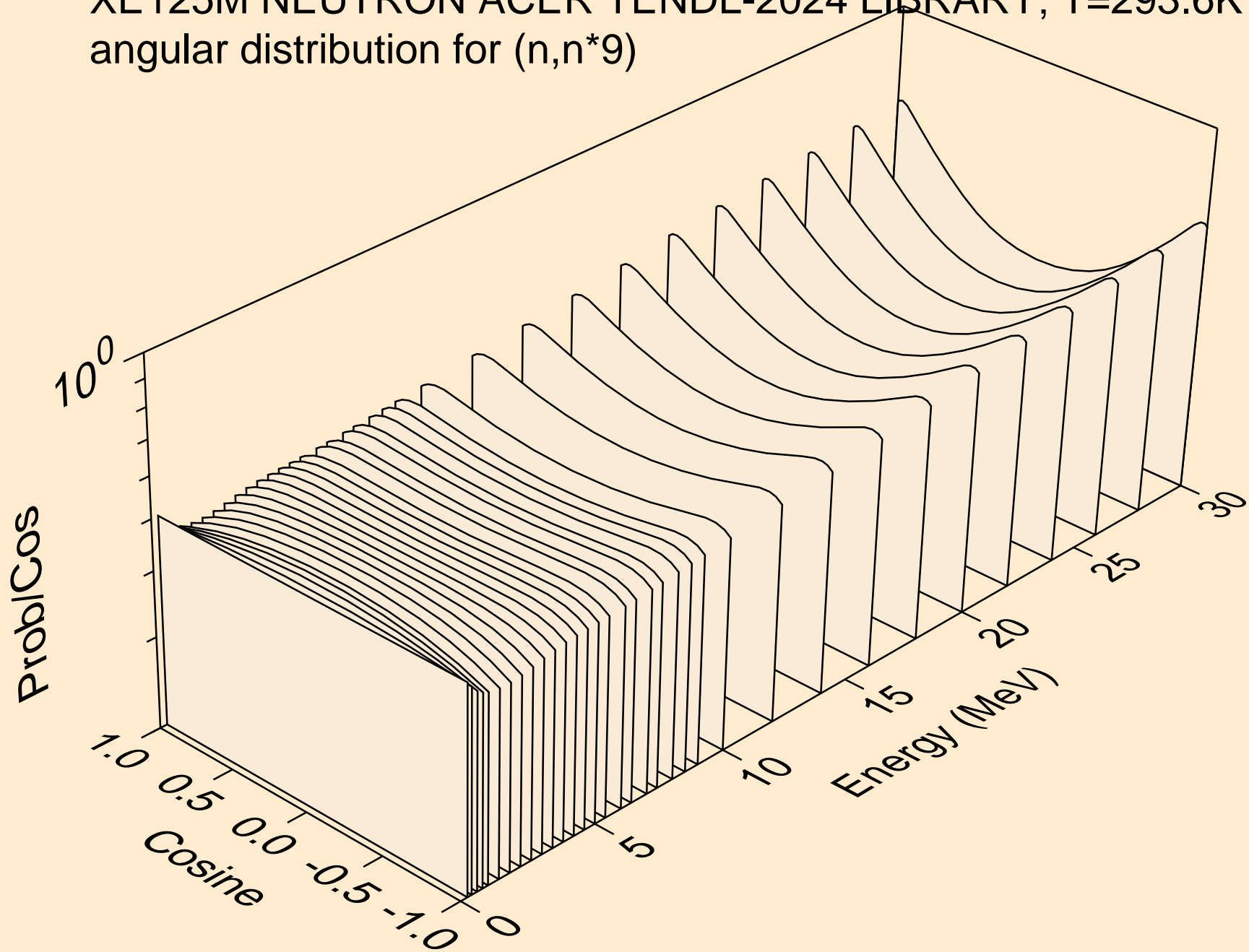

XE125M NEUTRON ACER TENDL-2024 LIBRARY; T=293.6K
angular distribution for (n,n*10)

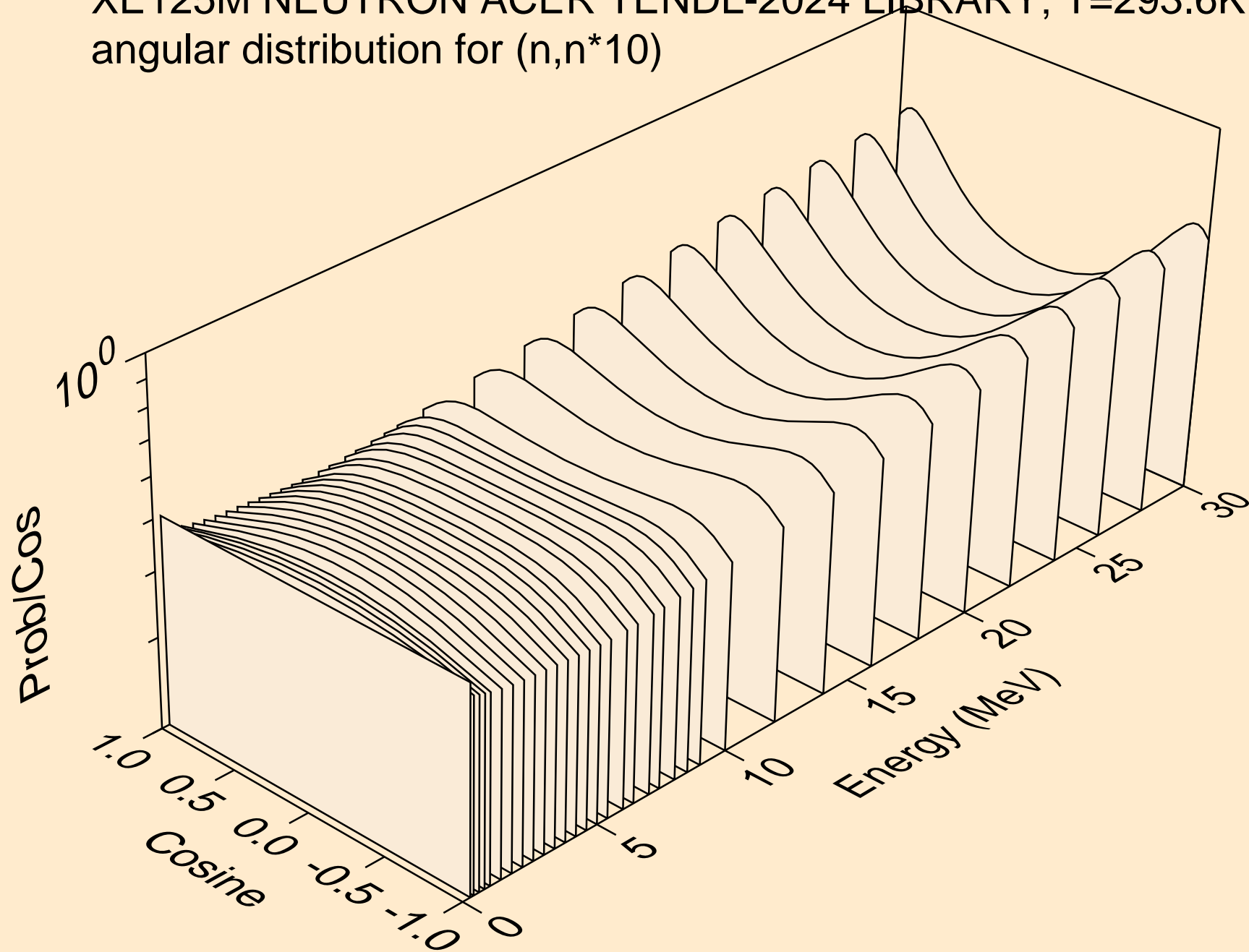

XE125M NEUTRON ACER TENDL-2024 LIBRARY; T=293.6K
angular distribution for (n,n*11)

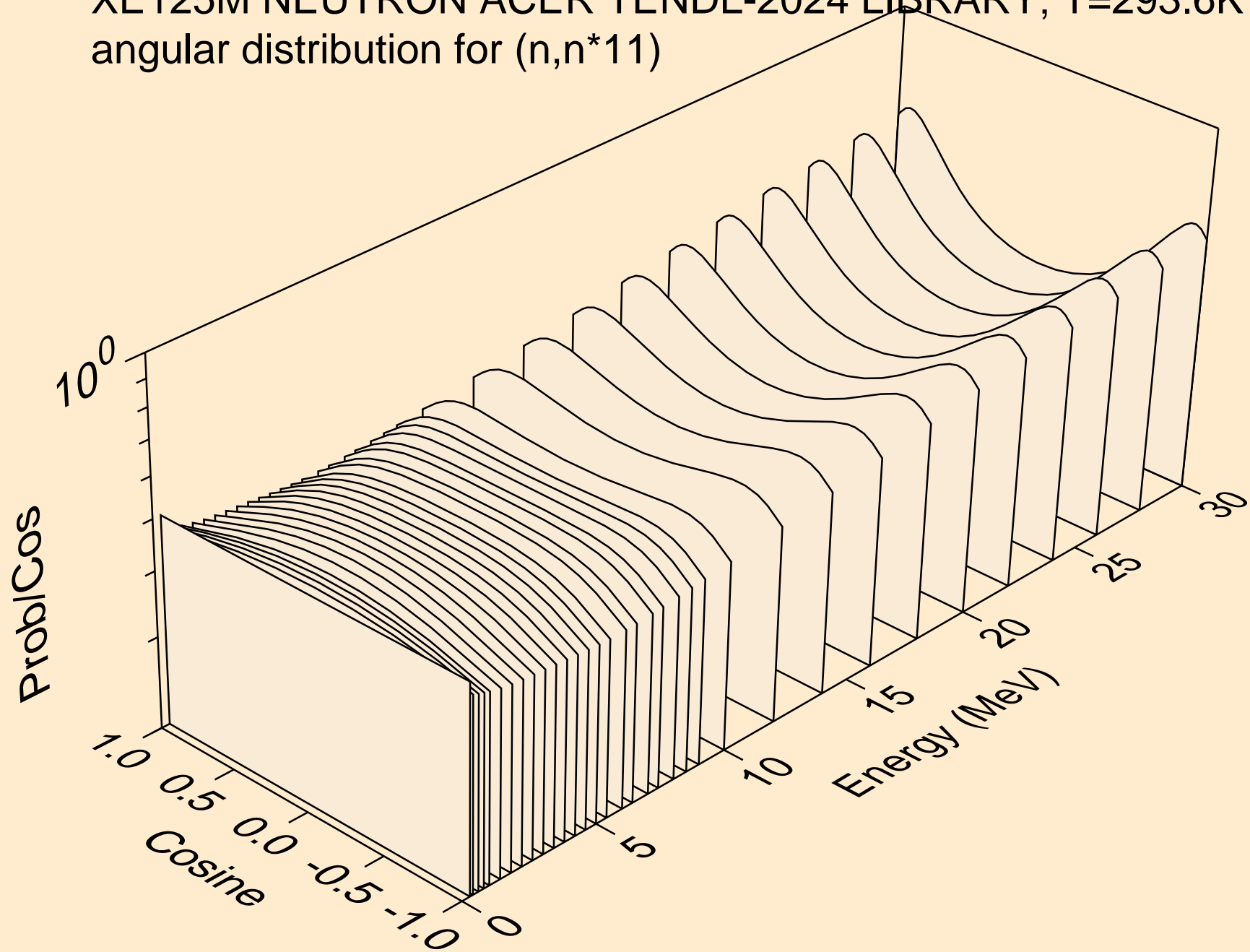

XE125M NEUTRON ACER TENDL-2024 LIBRARY; T=293.6K
angular distribution for (n,n*12)

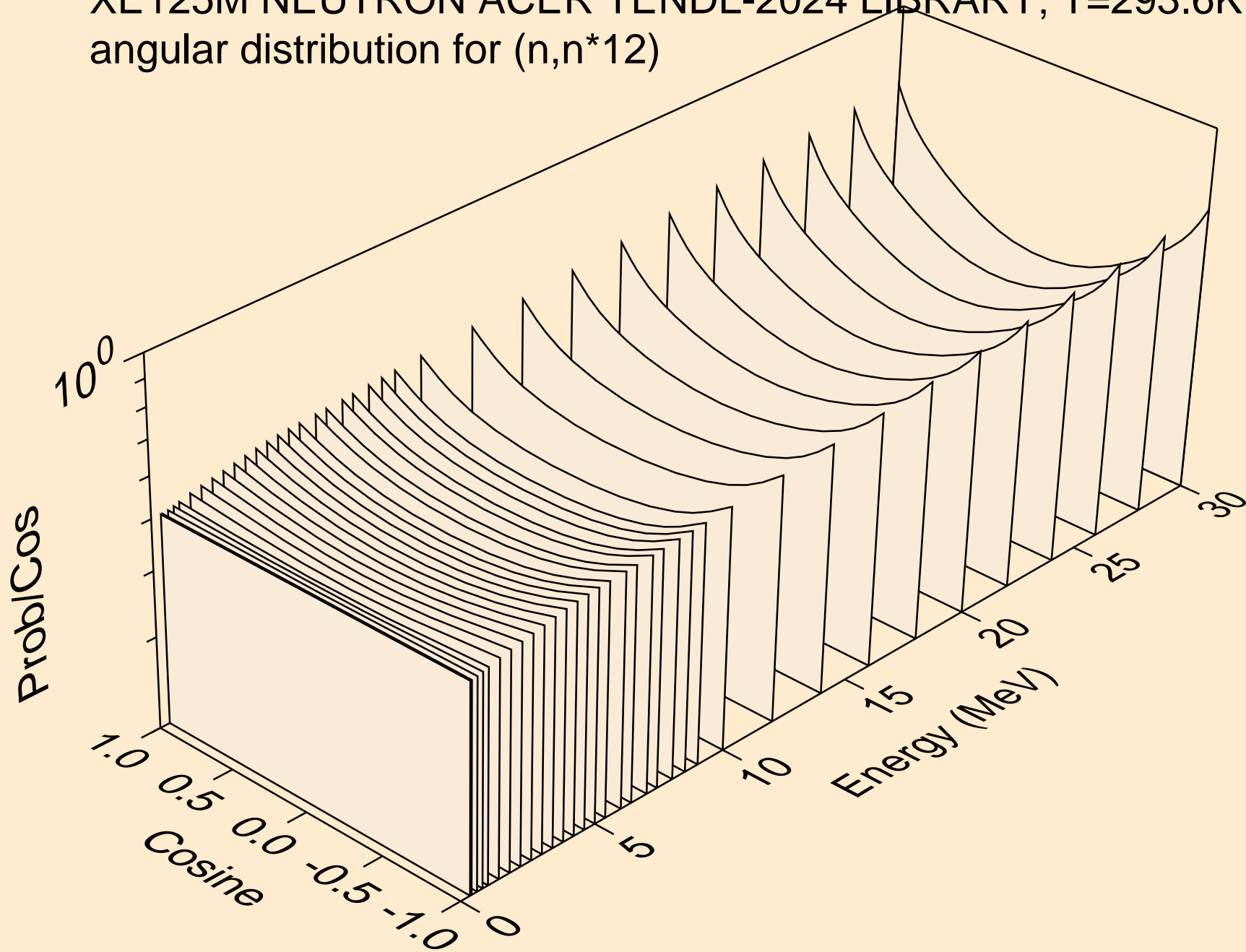

XE125M NEUTRON ACER TENDL-2024 LIBRARY; T=293.6K
angular distribution for (n,n*13)

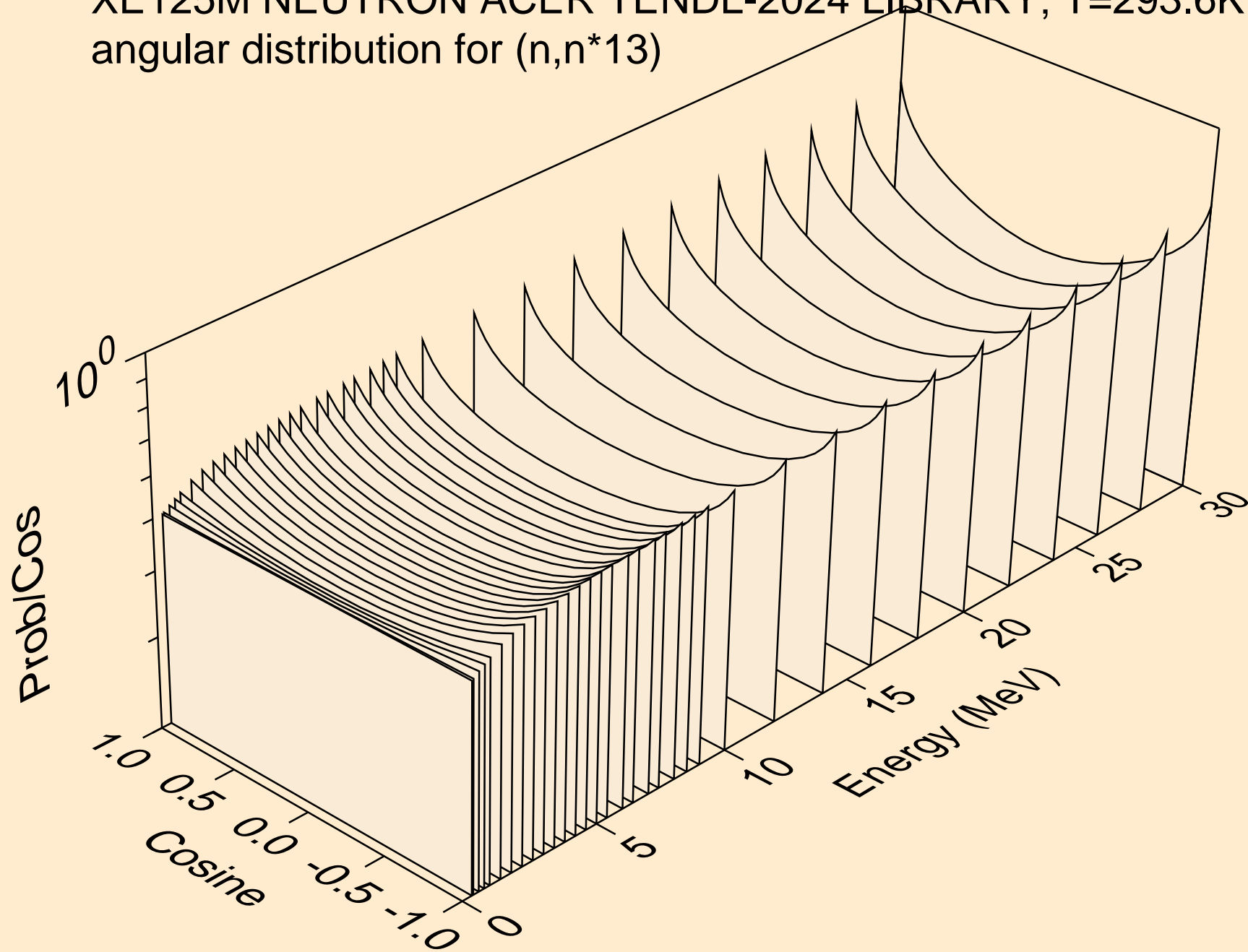

XE125M NEUTRON ACER TENDL-2024 LIBRARY; T=293.6K
angular distribution for (n,n*14)

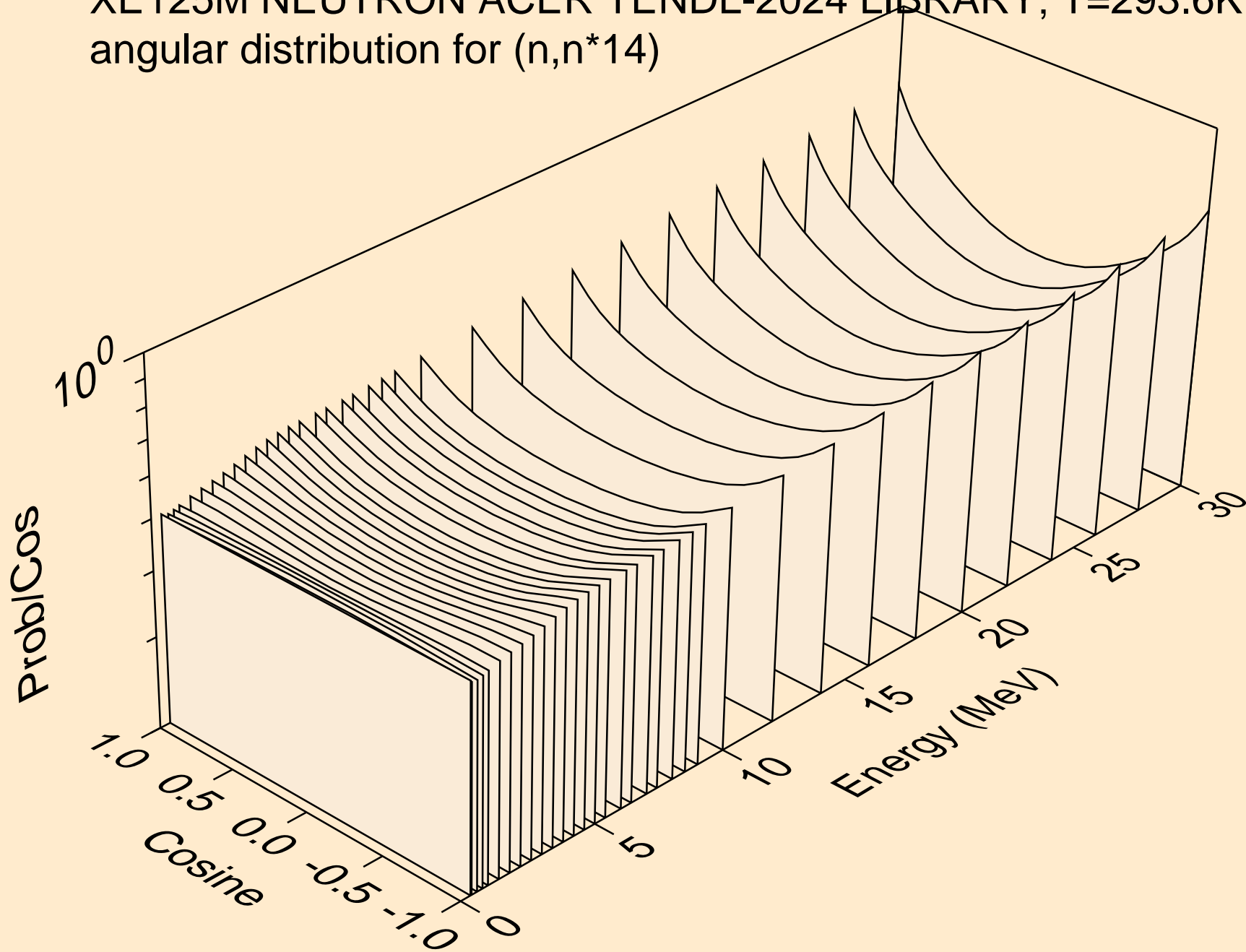

XE125M NEUTRON ACER TENDL-2024 LIBRARY; T=293.6K
angular distribution for (n,n*15)

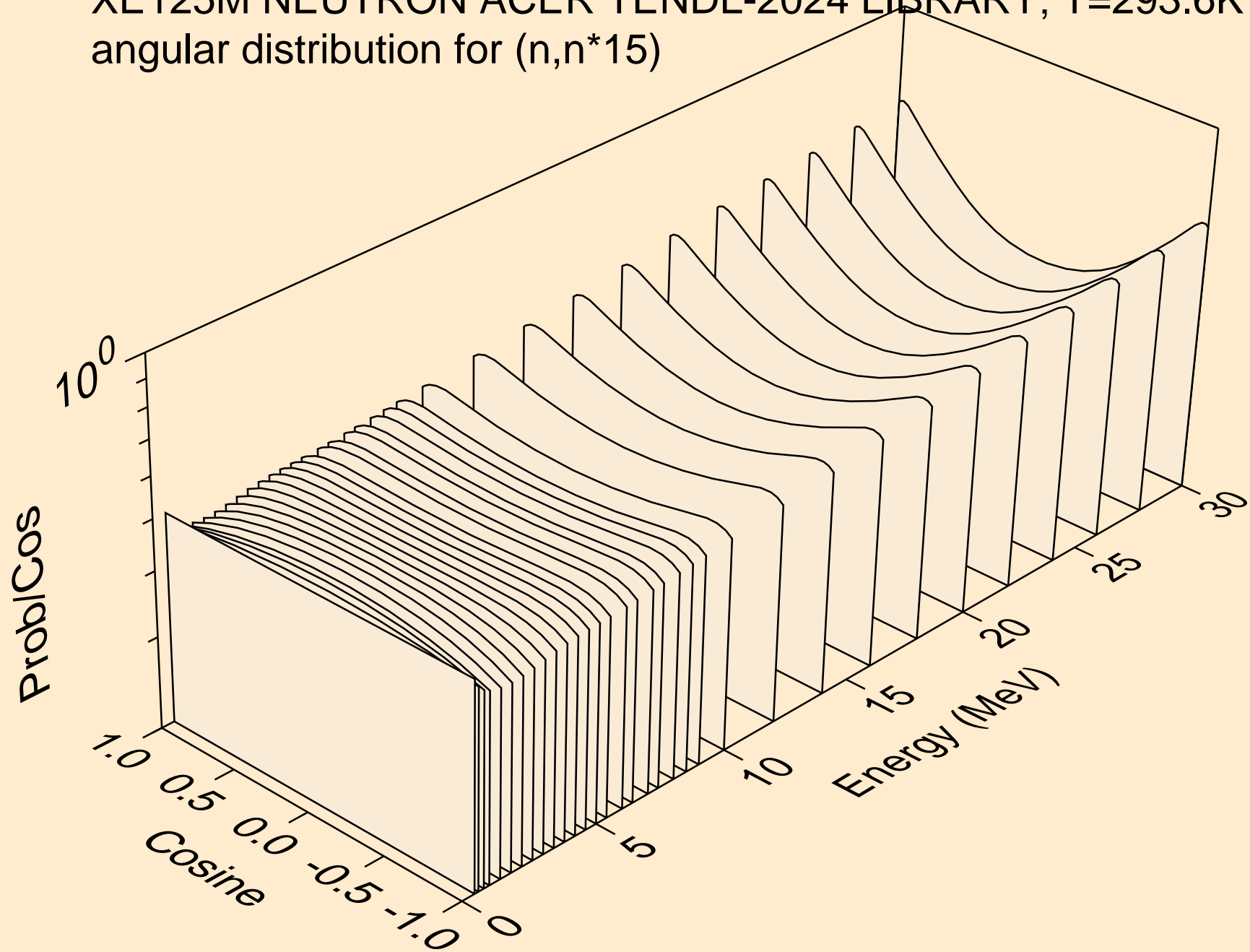

XE125M NEUTRON ACER TENDL-2024 LIBRARY; T=293.6K
angular distribution for (n,n*16)

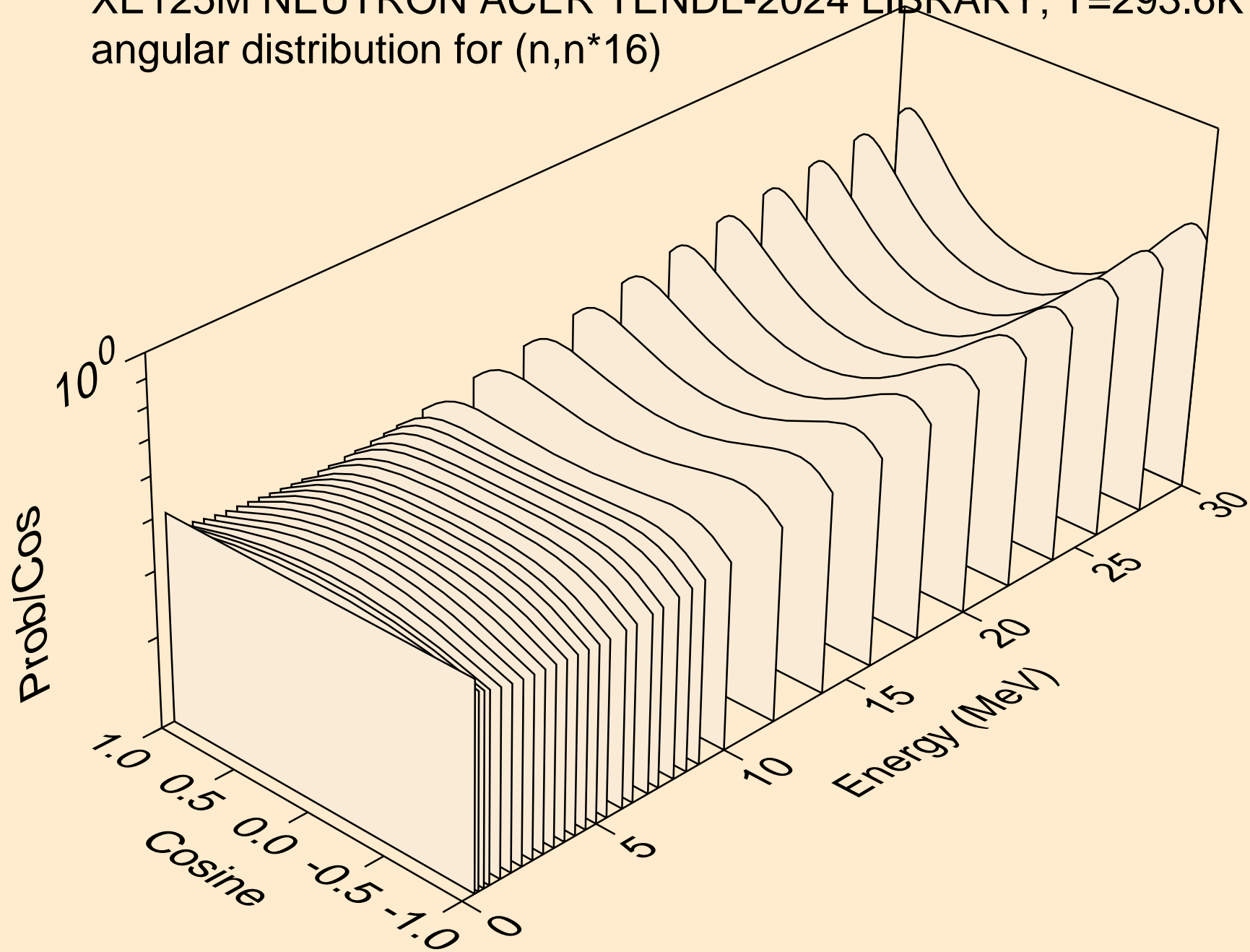

XE125M NEUTRON ACER TENDL-2024 LIBRARY; T=293.6K
angular distribution for (n,n*17)

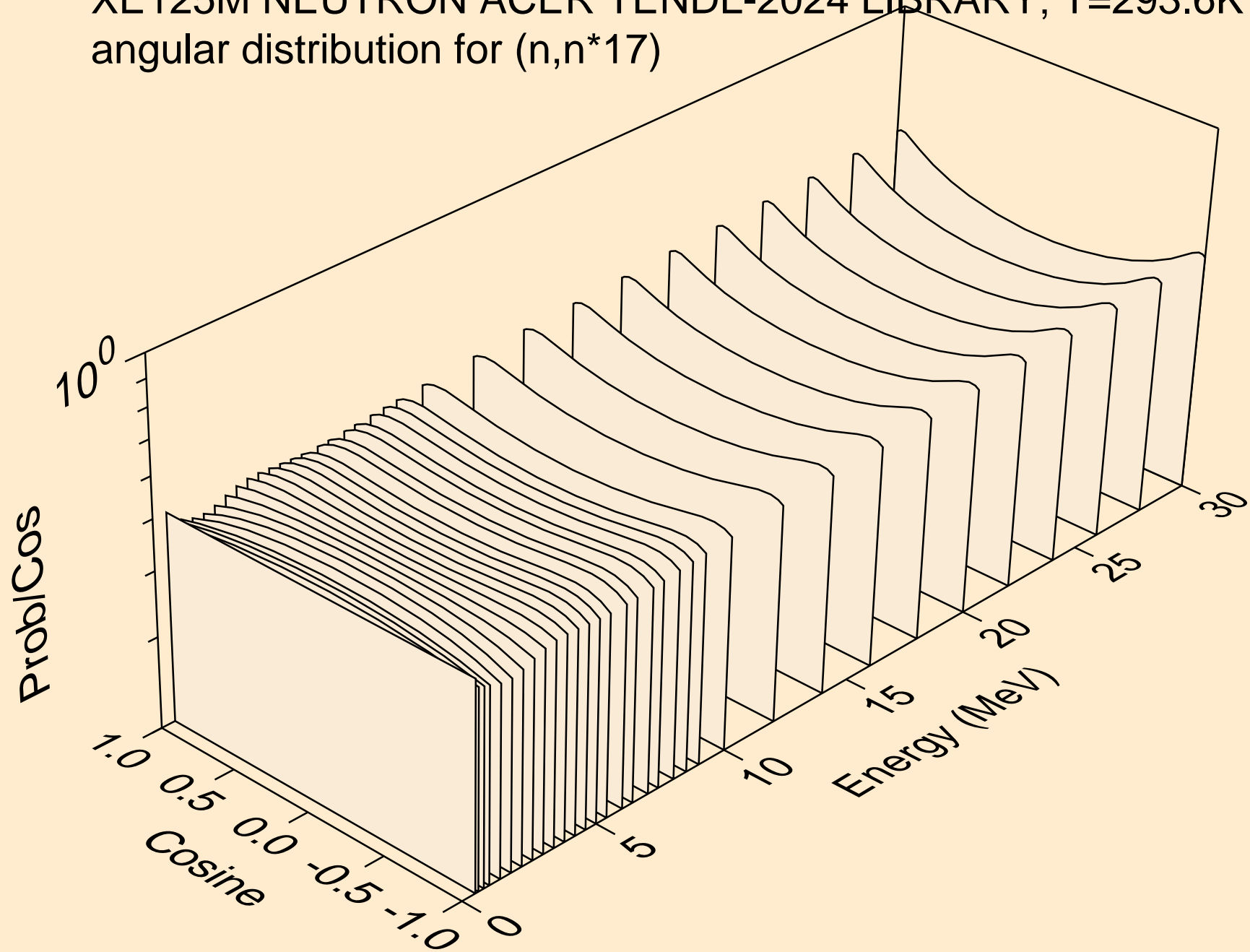

XE125M NEUTRON ACER TENDL-2024 LIBRARY; T=293.6K
angular distribution for (n,n*18)

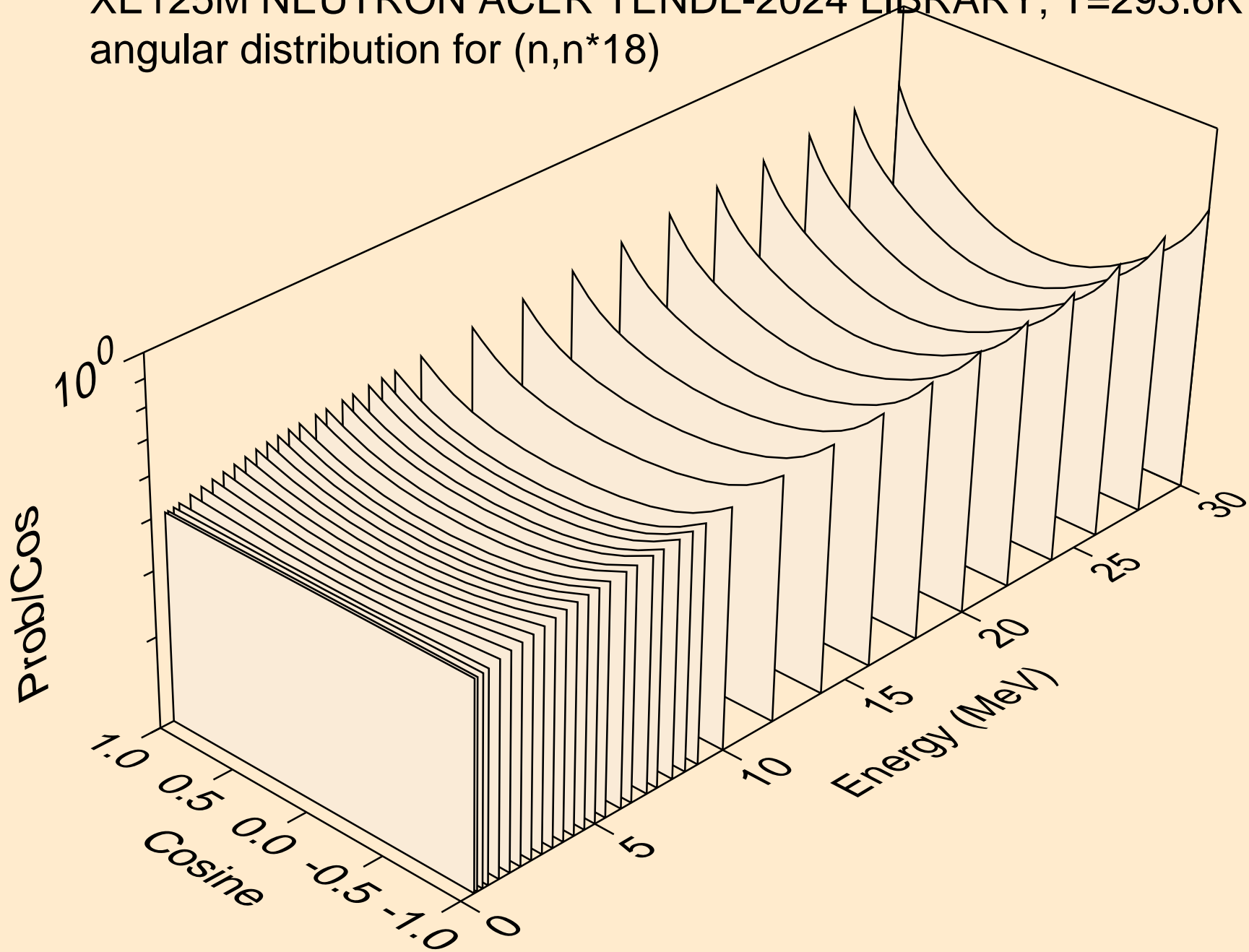

XE125M NEUTRON ACER TENDL-2024 LIBRARY; T=293.6K
angular distribution for (n,n*19)

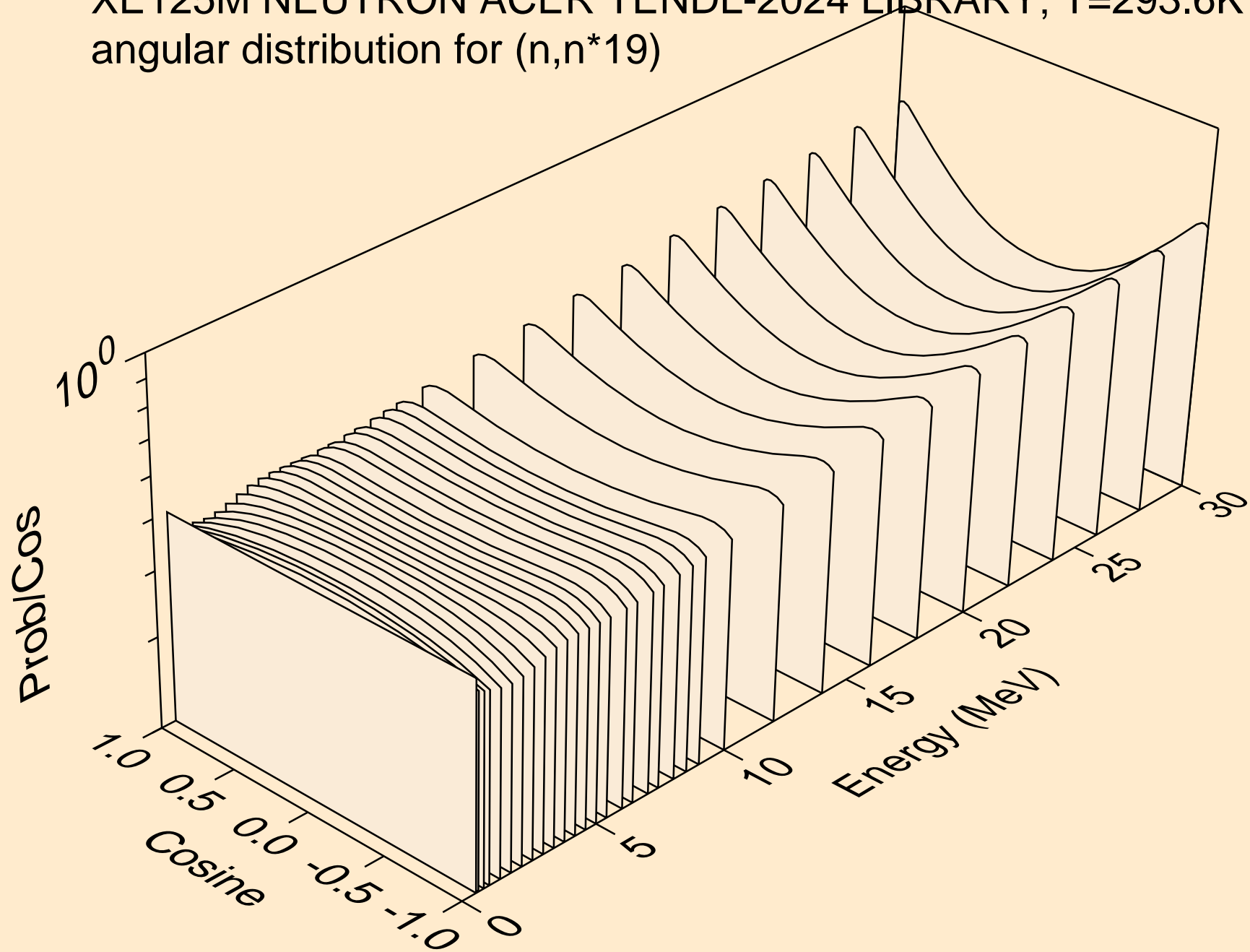

XE125M NEUTRON ACER TENDL-2024 LIBRARY; T=293.6K
angular distribution for (n,n*20)

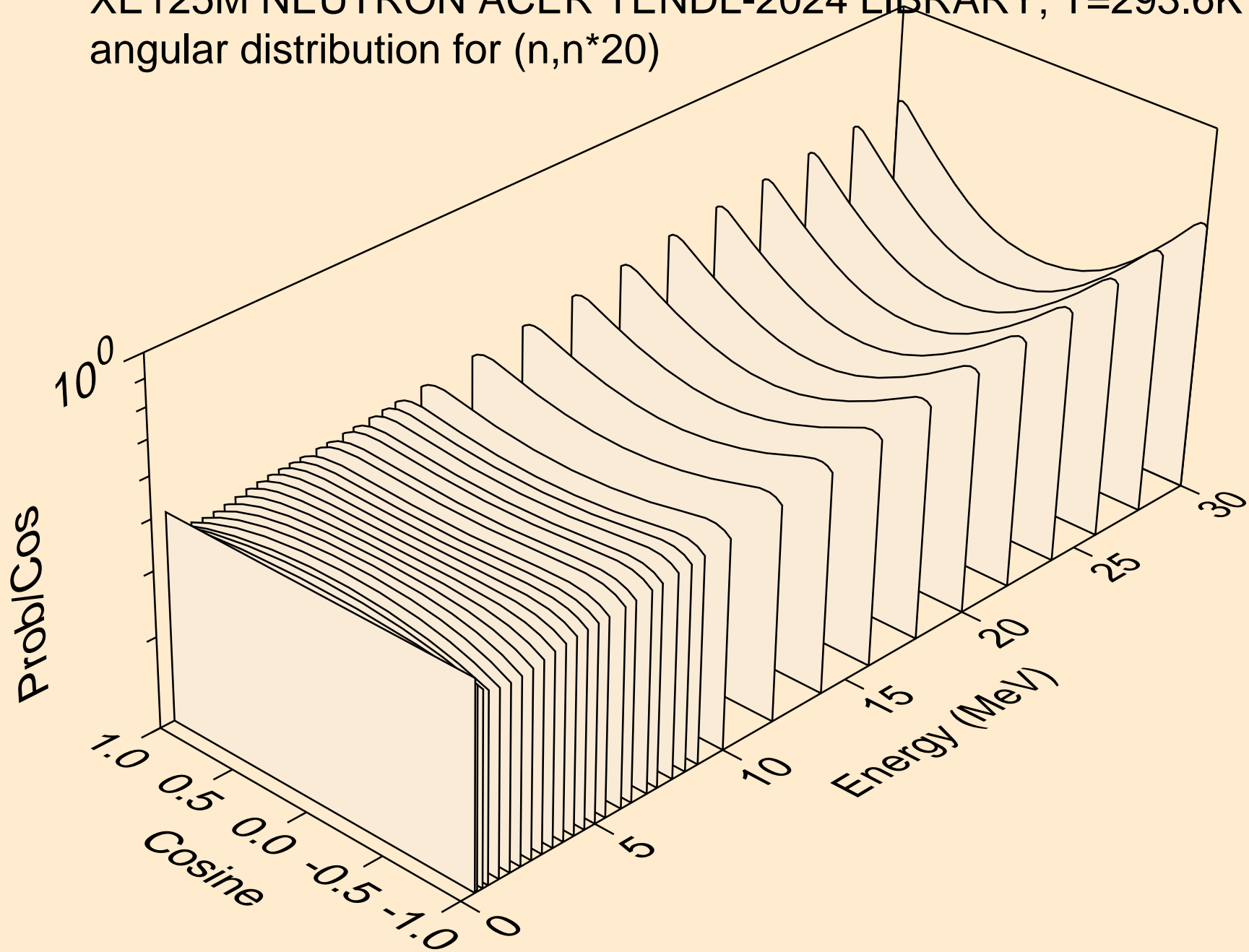

XE125M NEUTRON ACER TENDL-2024 LIBRARY; T=293.6K
angular distribution for (n,n*21)

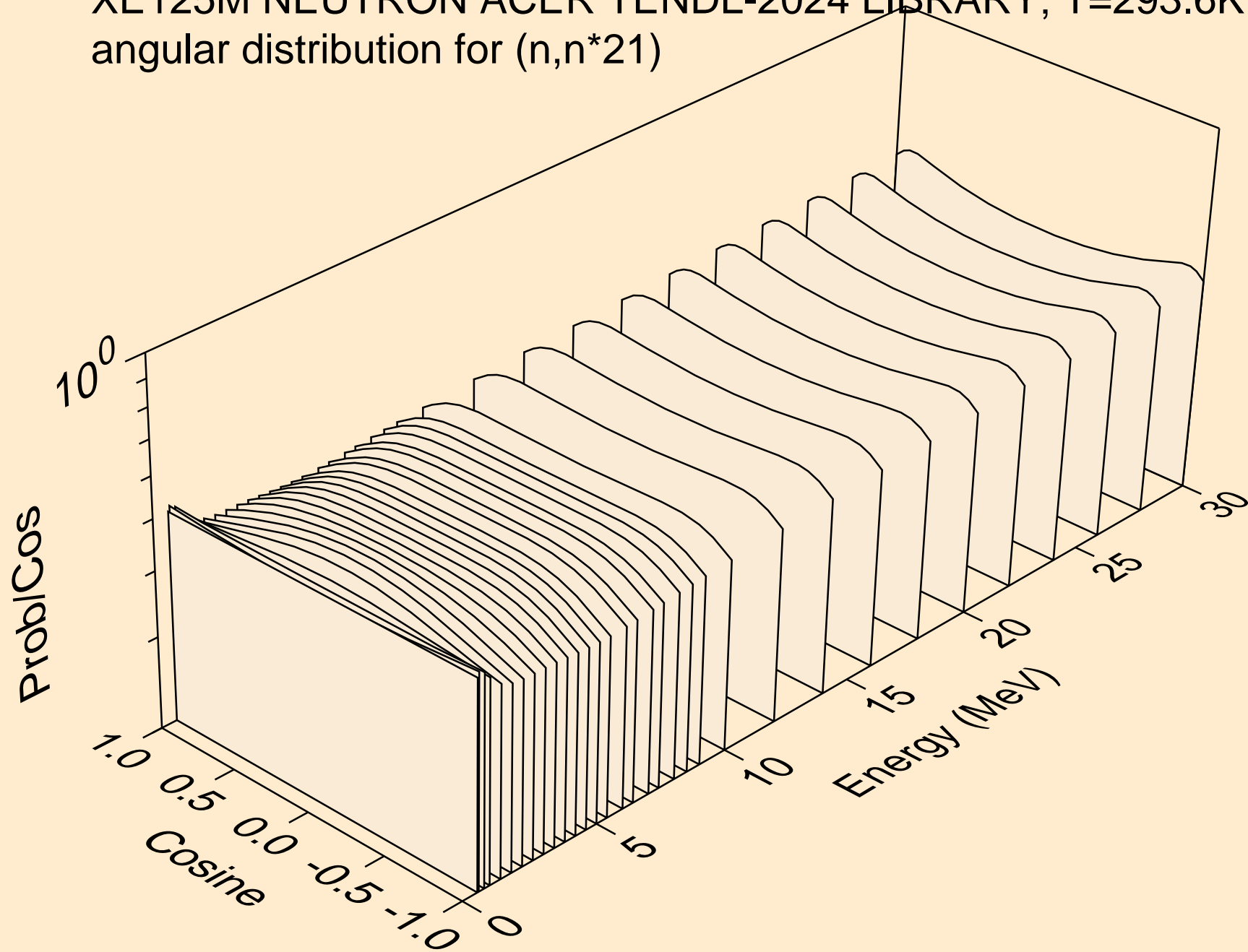

XE125M NEUTRON ACER TENDL-2024 LIBRARY; T=293.6K
angular distribution for (n,n*22)

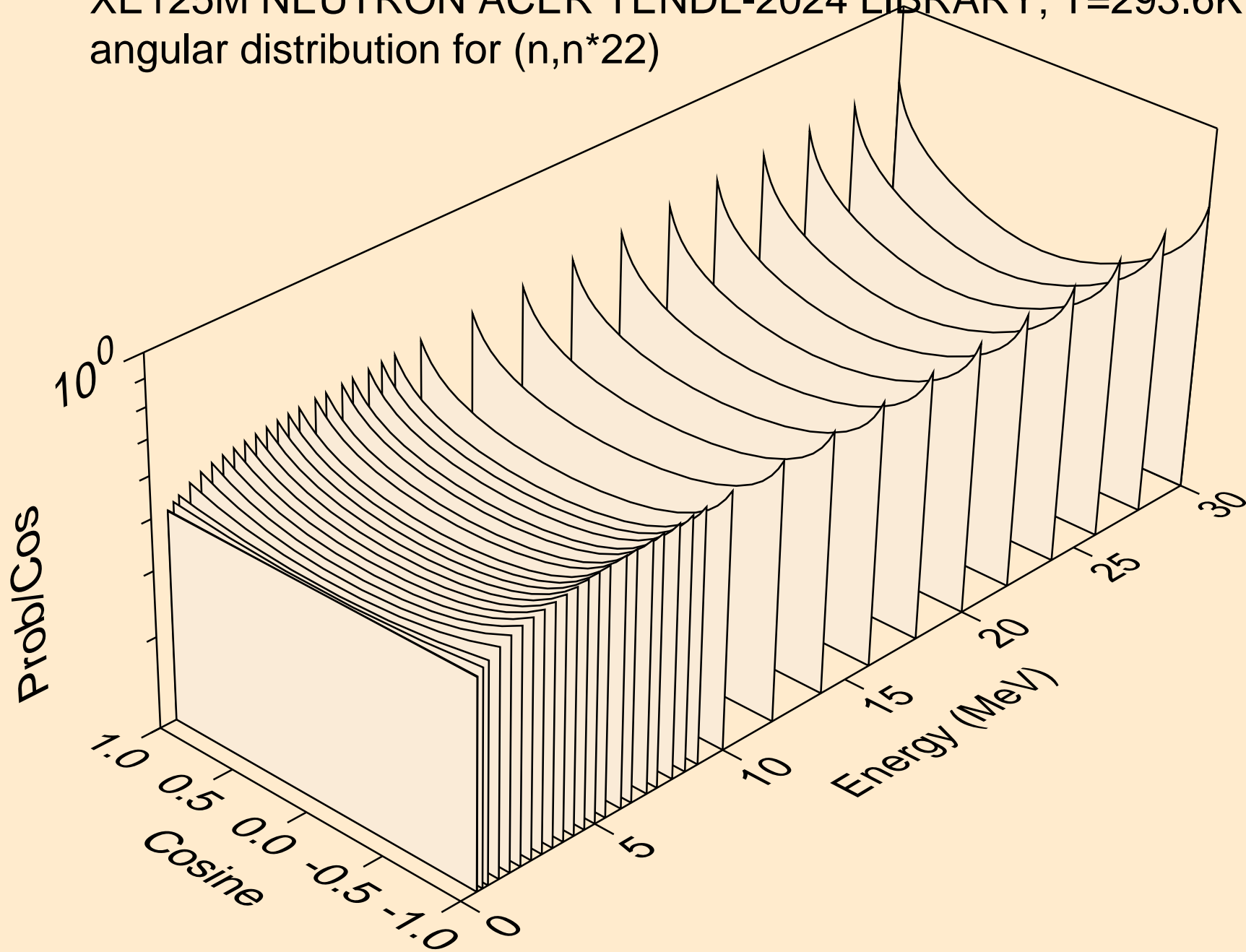

XE125M NEUTRON ACER TENDL-2024 LIBRARY; T=293.6K
angular distribution for (n,n*23)

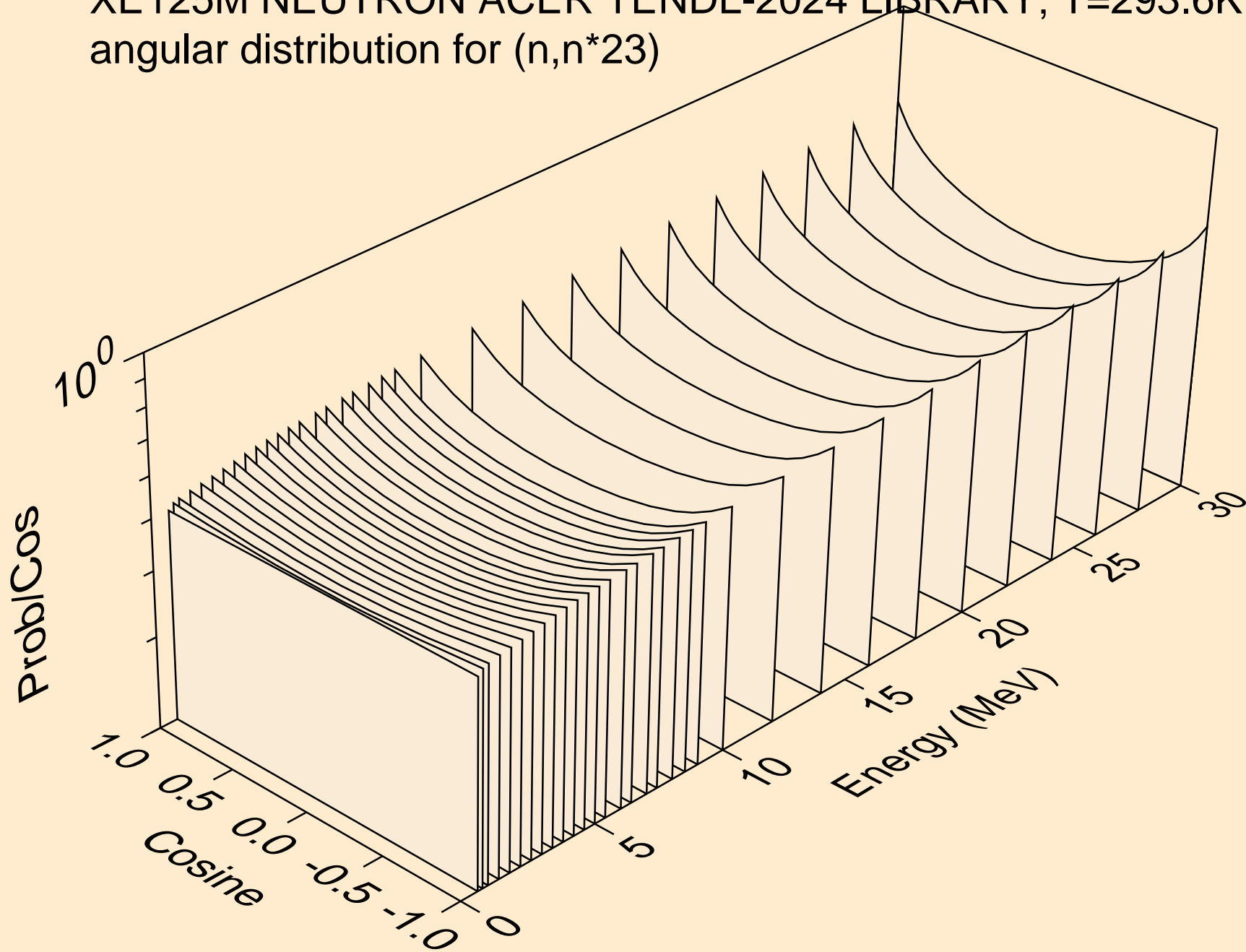

XE125M NEUTRON ACER TENDL-2024 LIBRARY; T=293.6K
angular distribution for (n,n*24)

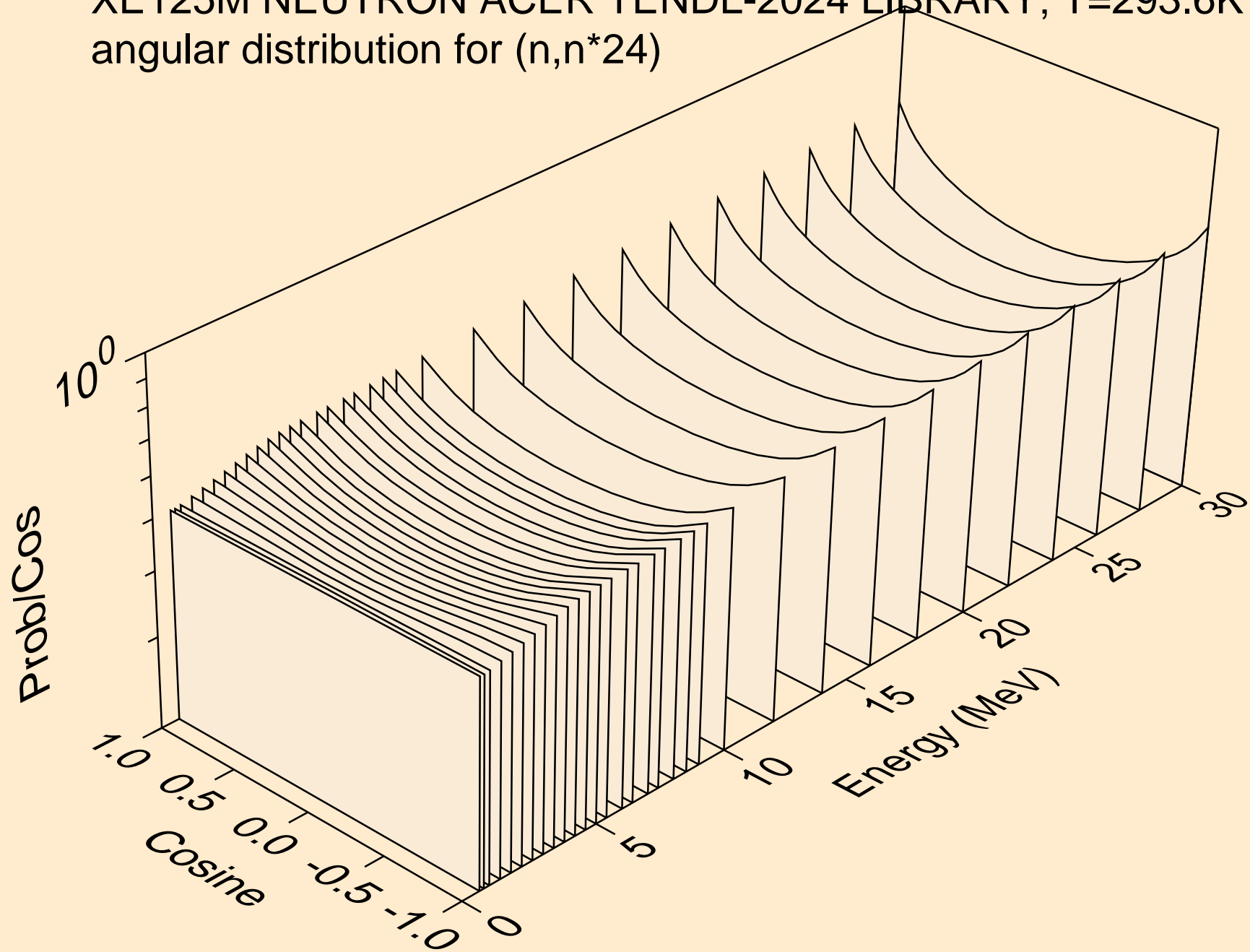

XE125M NEUTRON ACER TENDL-2024 LIBRARY; T=293.6K
angular distribution for (n,n*25)

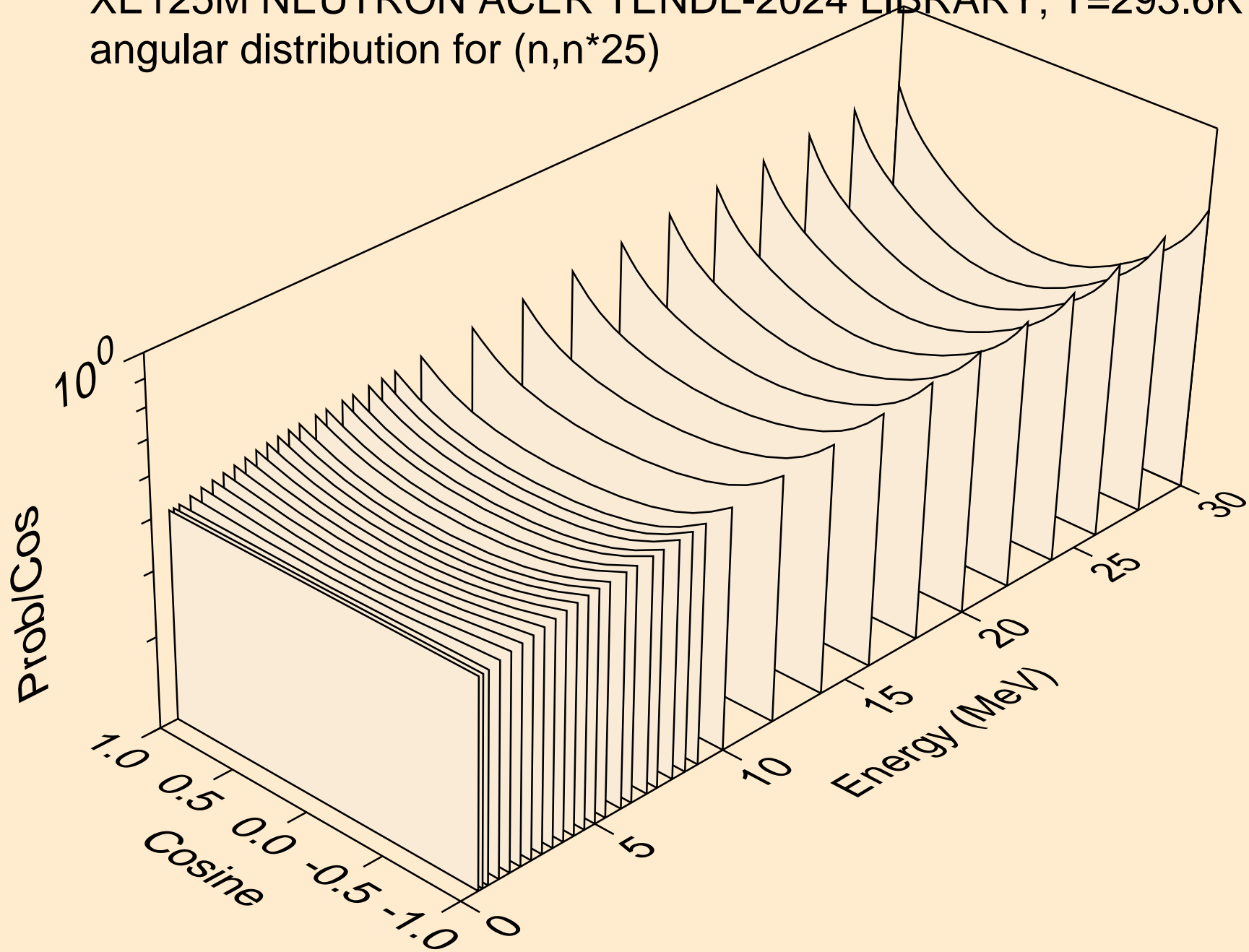

XE125M NEUTRON ACER TENDL-2024 LIBRARY; T=293.6K
angular distribution for (n,n*26)

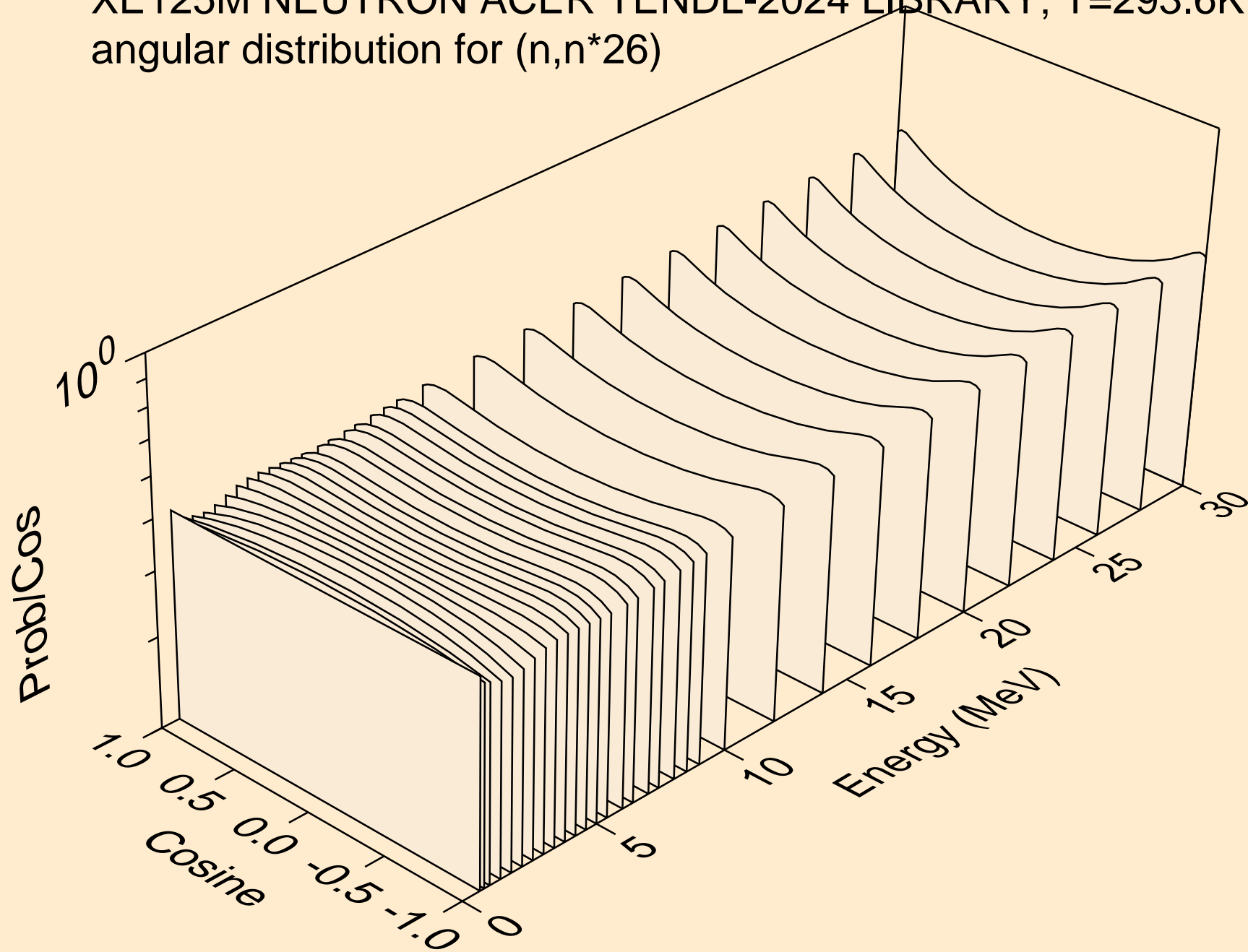

XE125M NEUTRON ACER TENDL-2024 LIBRARY; T=293.6K
angular distribution for (n,n*27)

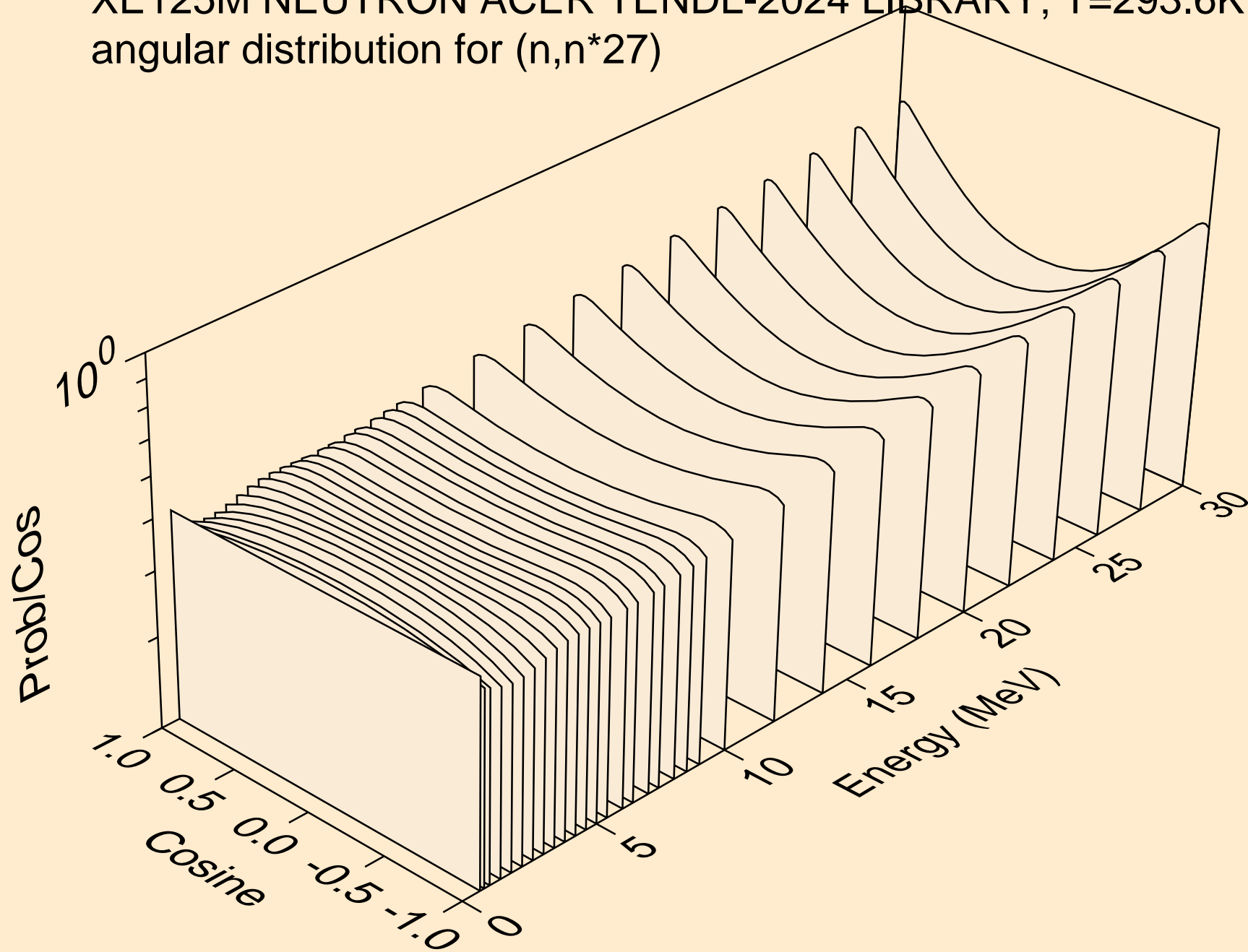

XE125M NEUTRON ACER TENDL-2024 LIBRARY; T=293.6K
angular distribution for (n,n*28)

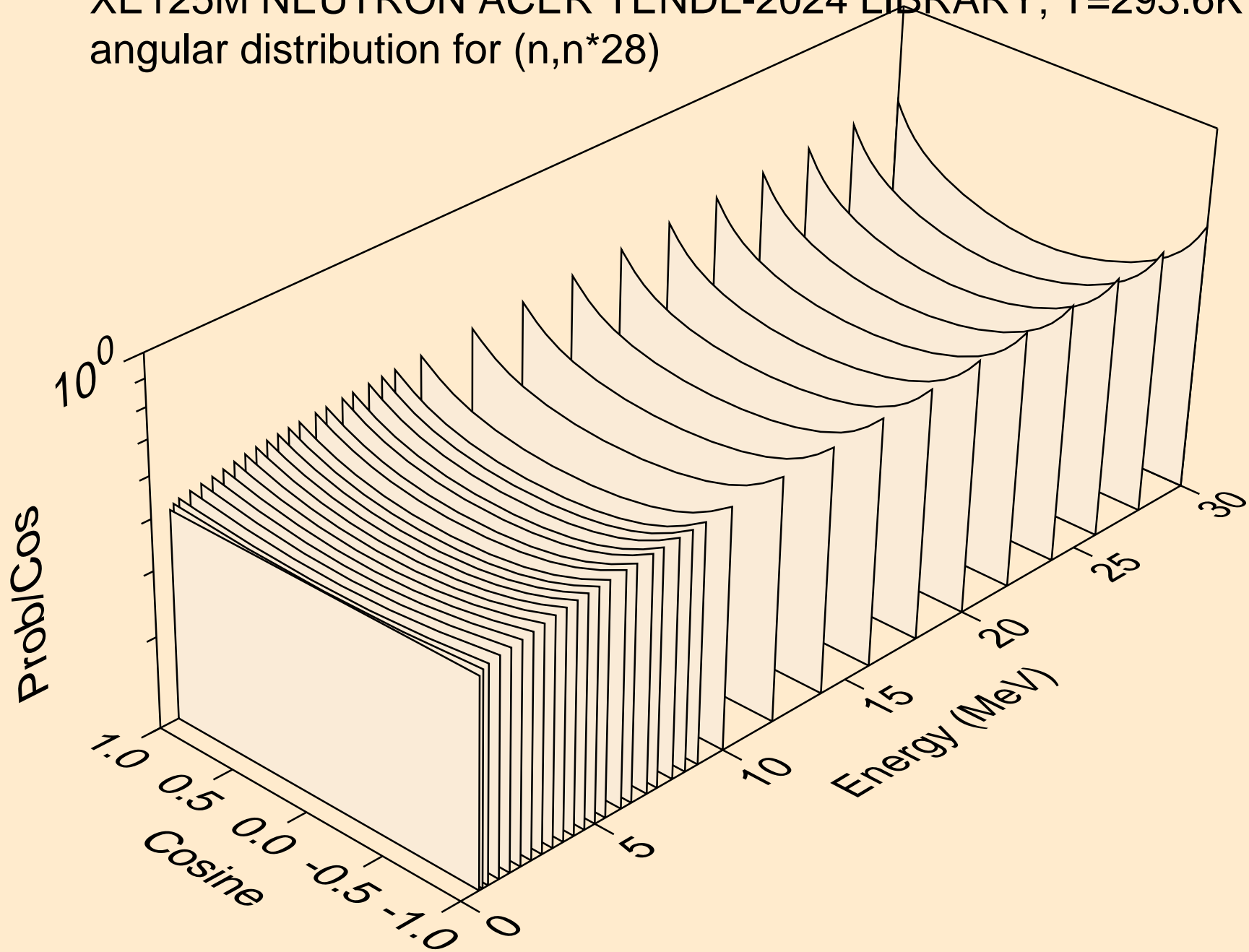

XE125M NEUTRON ACER TENDL-2024 LIBRARY; T=293.6K
Neutron emission for (n,x)

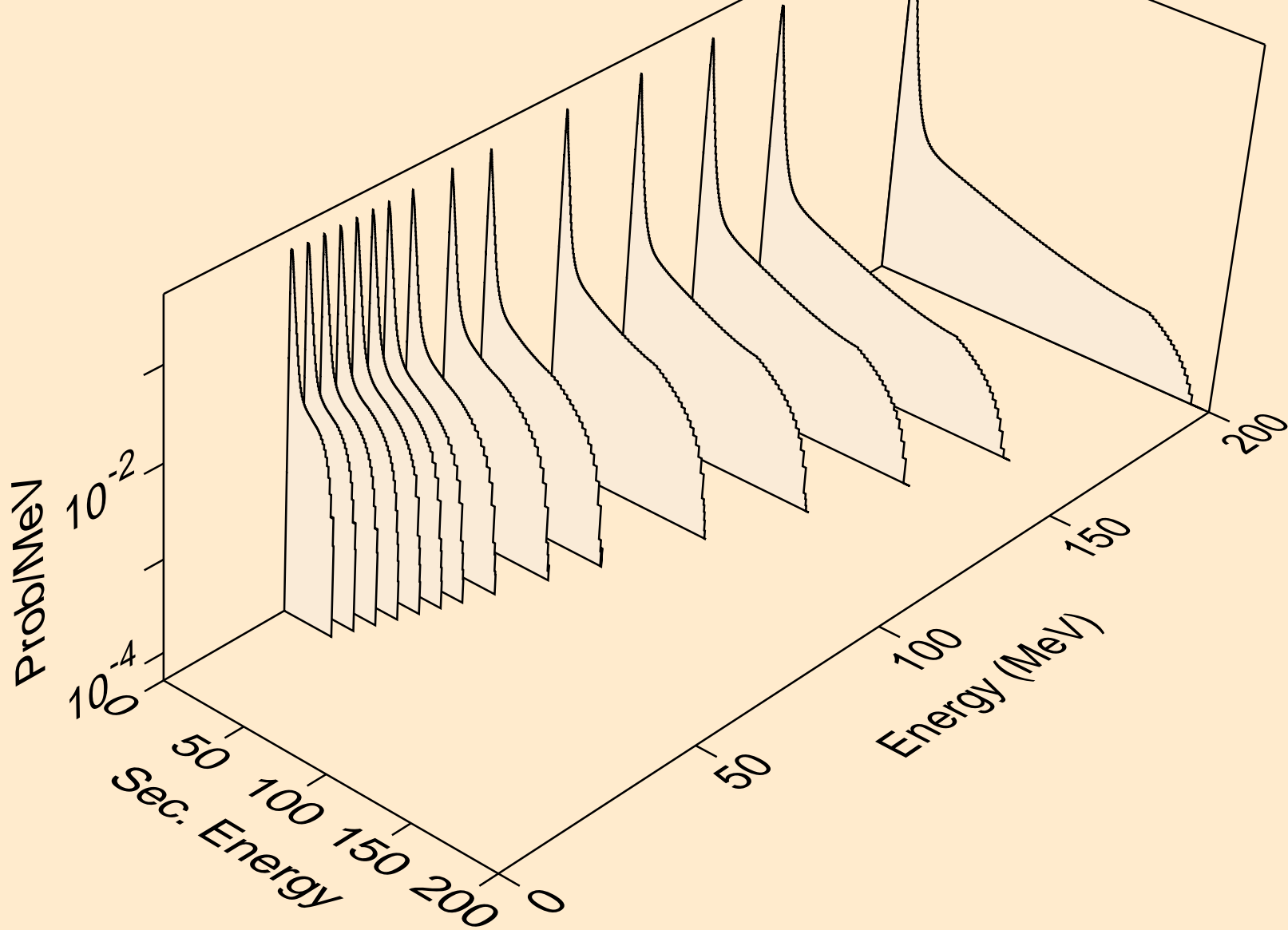

XE125M NEUTRON ACER TENDL-2024 LIBRARY; T=293.6K
Neutron emission for (n,2nd)

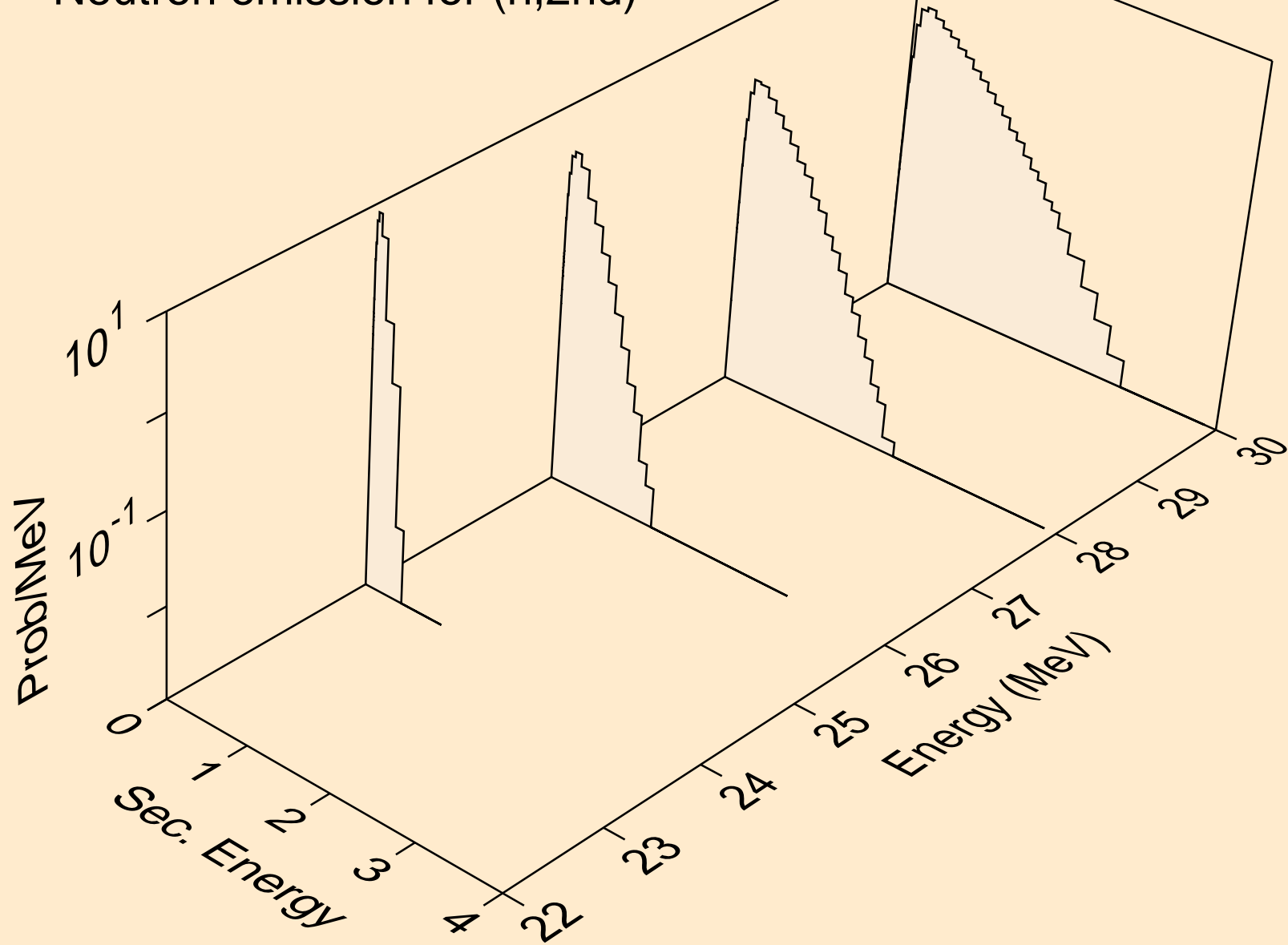

XE125M NEUTRON ACER TENDL-2024 LIBRARY; T=293.6K
Neutron emission for (n,2n)

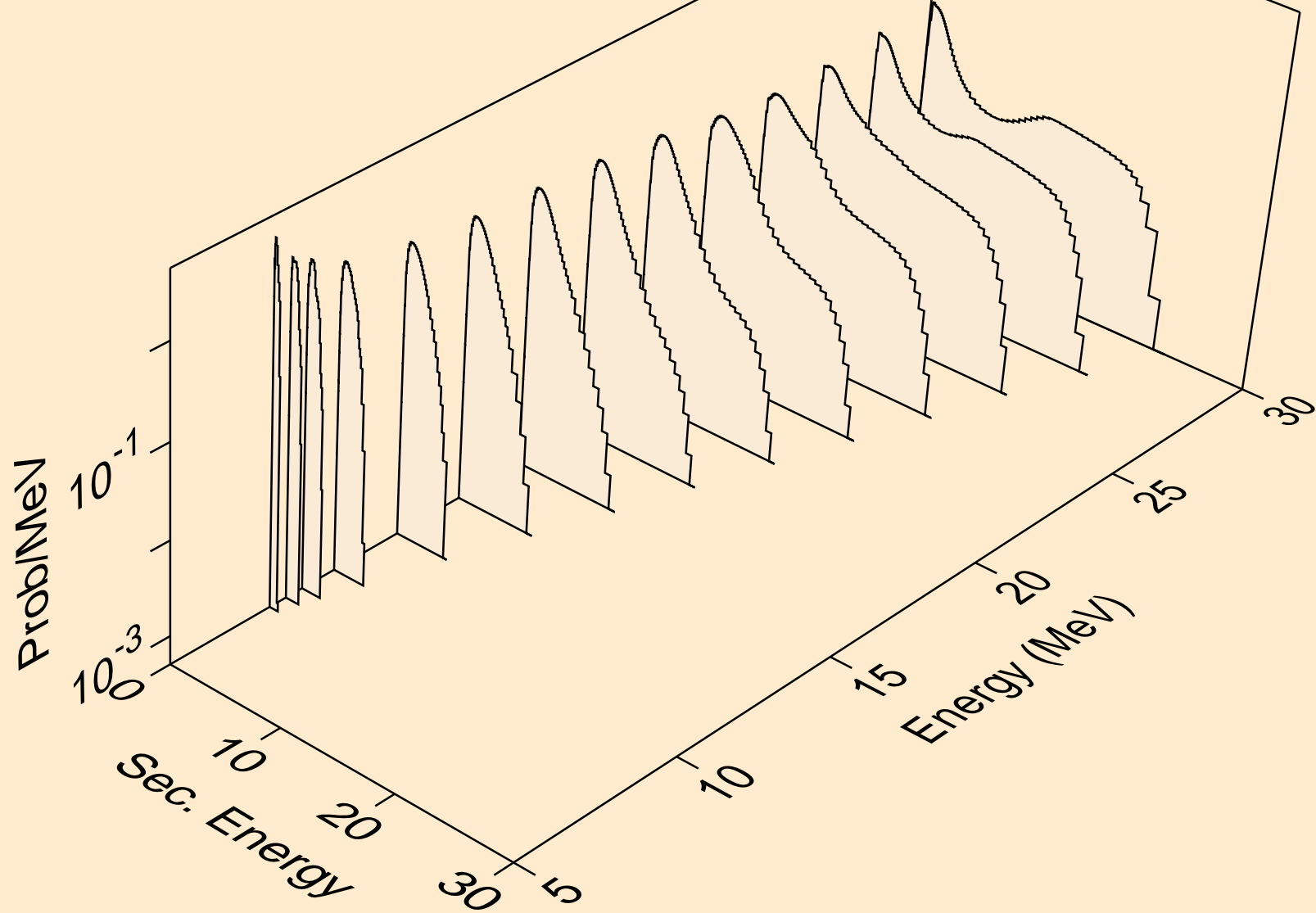

XE125M NEUTRON ACER TENDL-2024 LIBRARY; T=293.6K
Neutron emission for (n,3n)

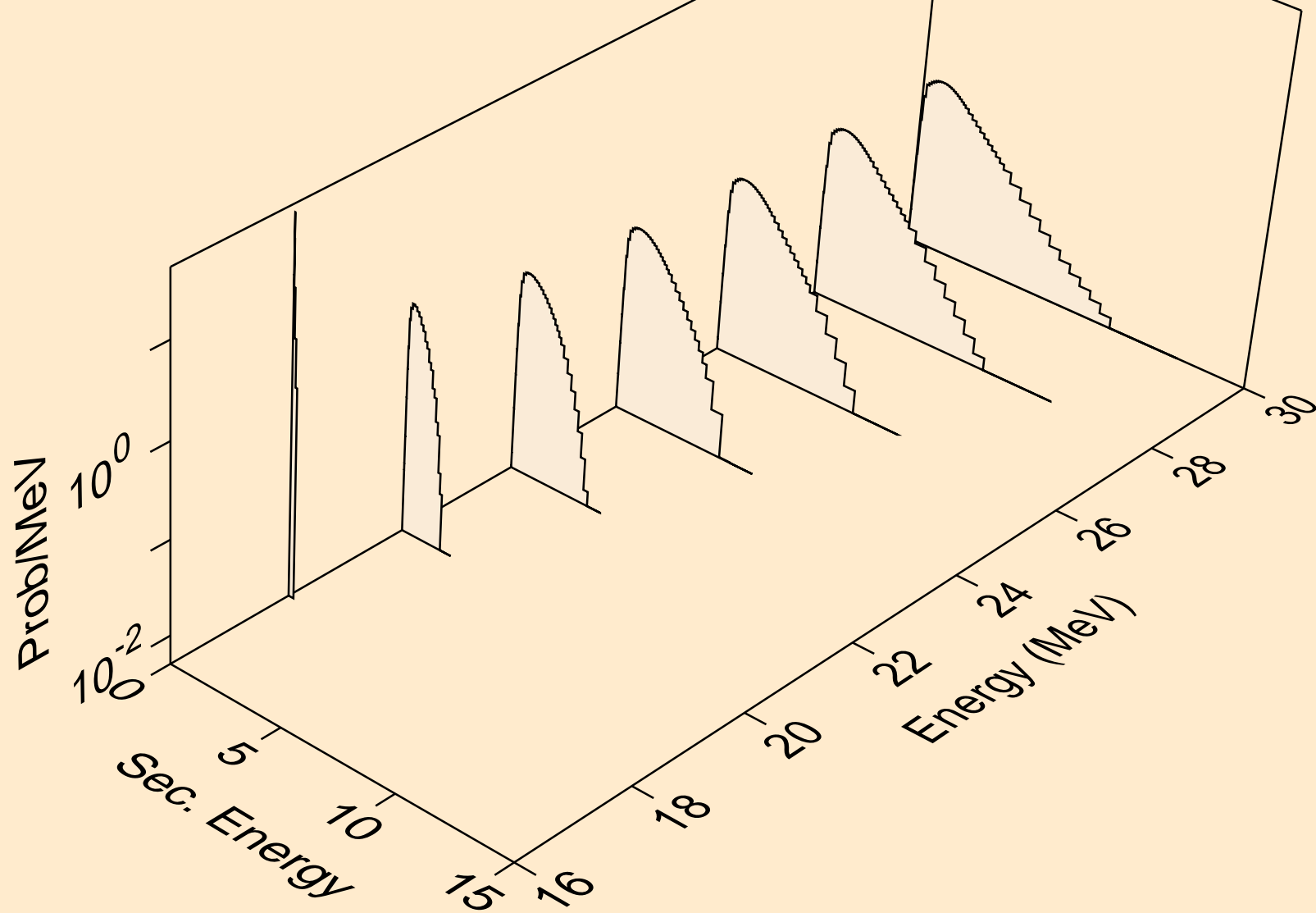

XE125M NEUTRON ACER TENDL-2024 LIBRARY; T=293.6K
Neutron emission for (n,n*)a

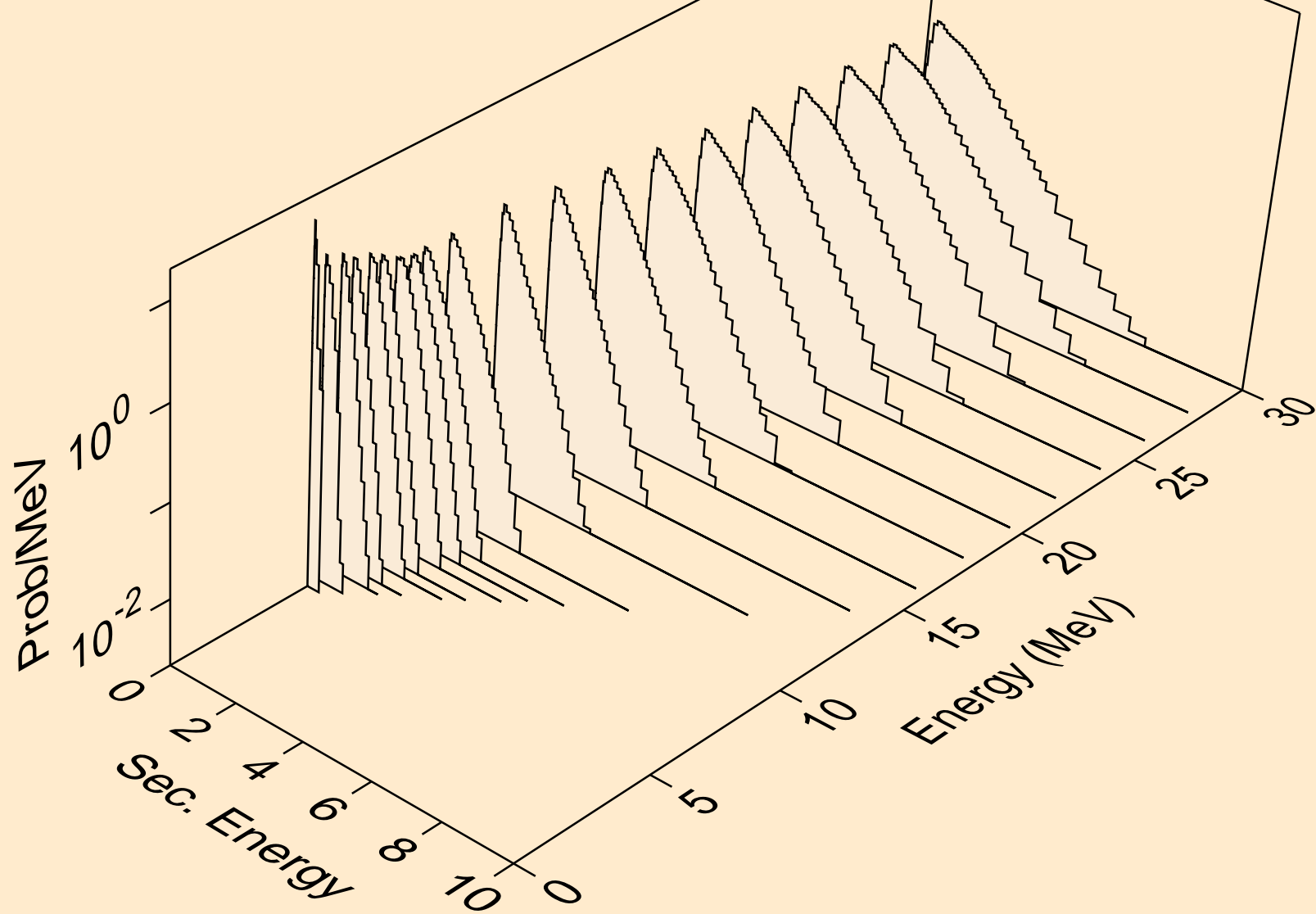

XE125M NEUTRON ACER TENDL-2024 LIBRARY; T=293.6K
Neutron emission for (n,2n)_a

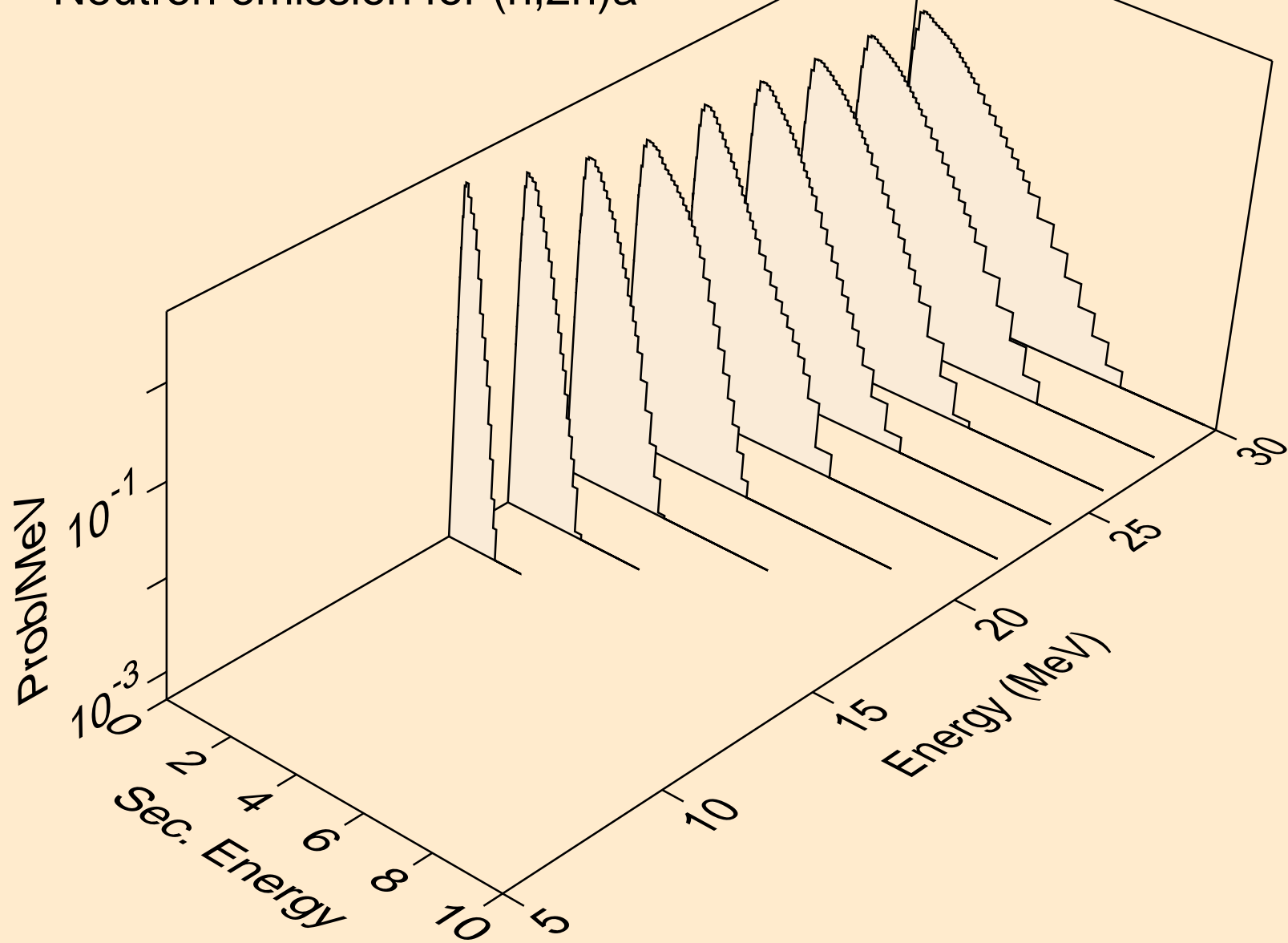

XE125M NEUTRON ACER TENDL-2024 LIBRARY; T=293.6K
Neutron emission for (n,3n)a

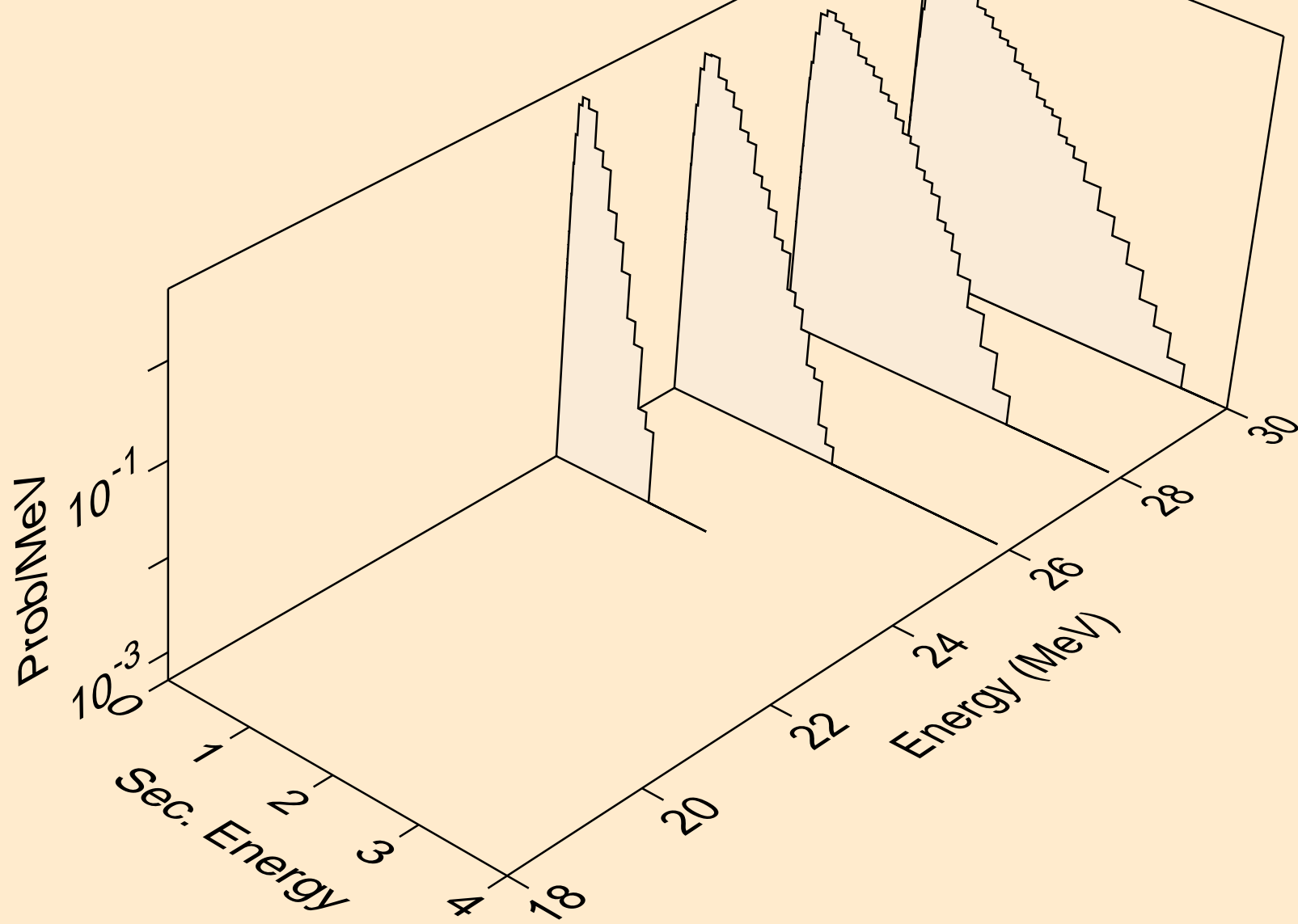

XE125M NEUTRON ACER TENDL-2024 LIBRARY; T=293.6K
Neutron emission for (n,n*)p

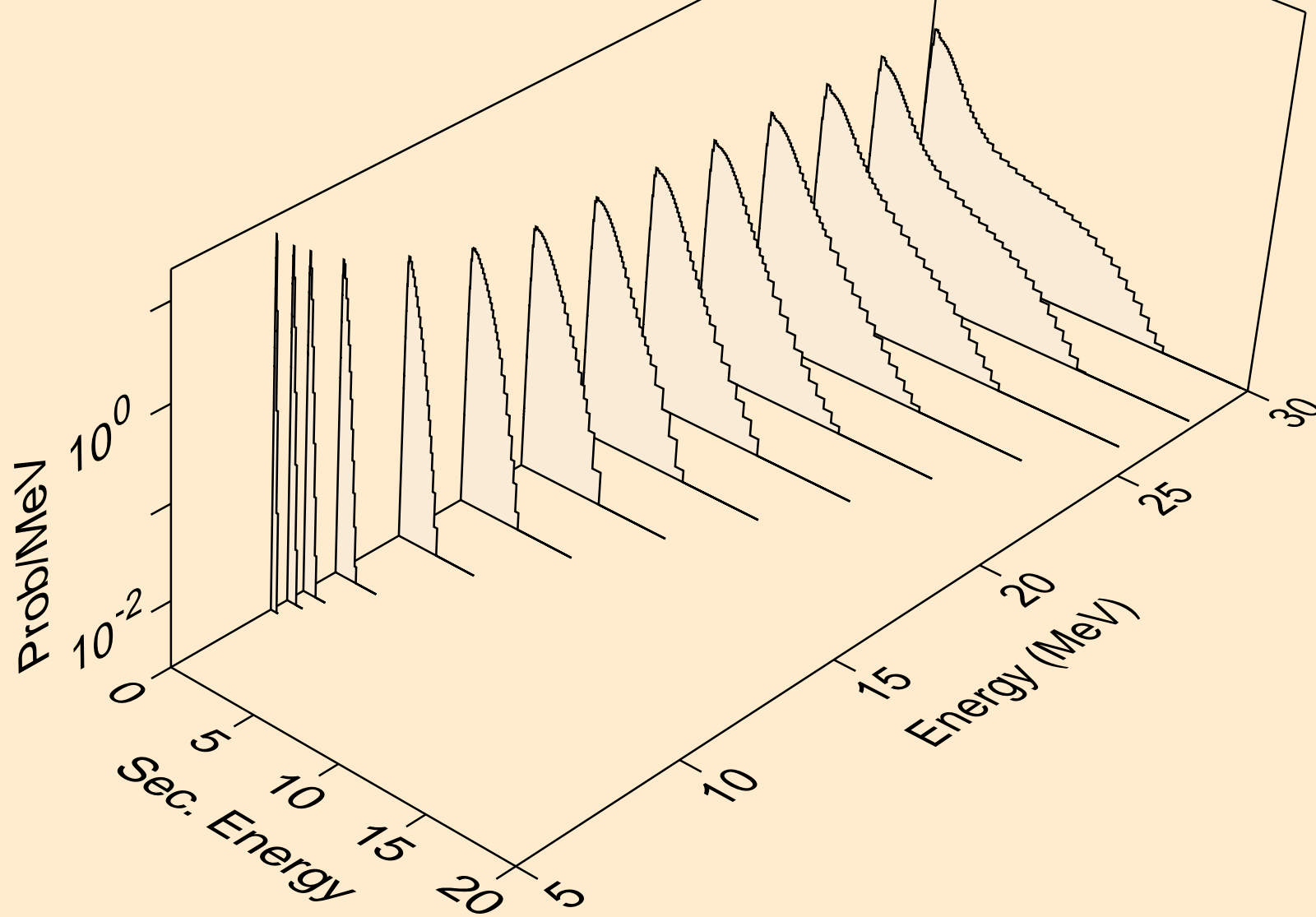

XE125M NEUTRON ACER TENDL-2024 LIBRARY; T=293.6K
Neutron emission for (n,n*)2a

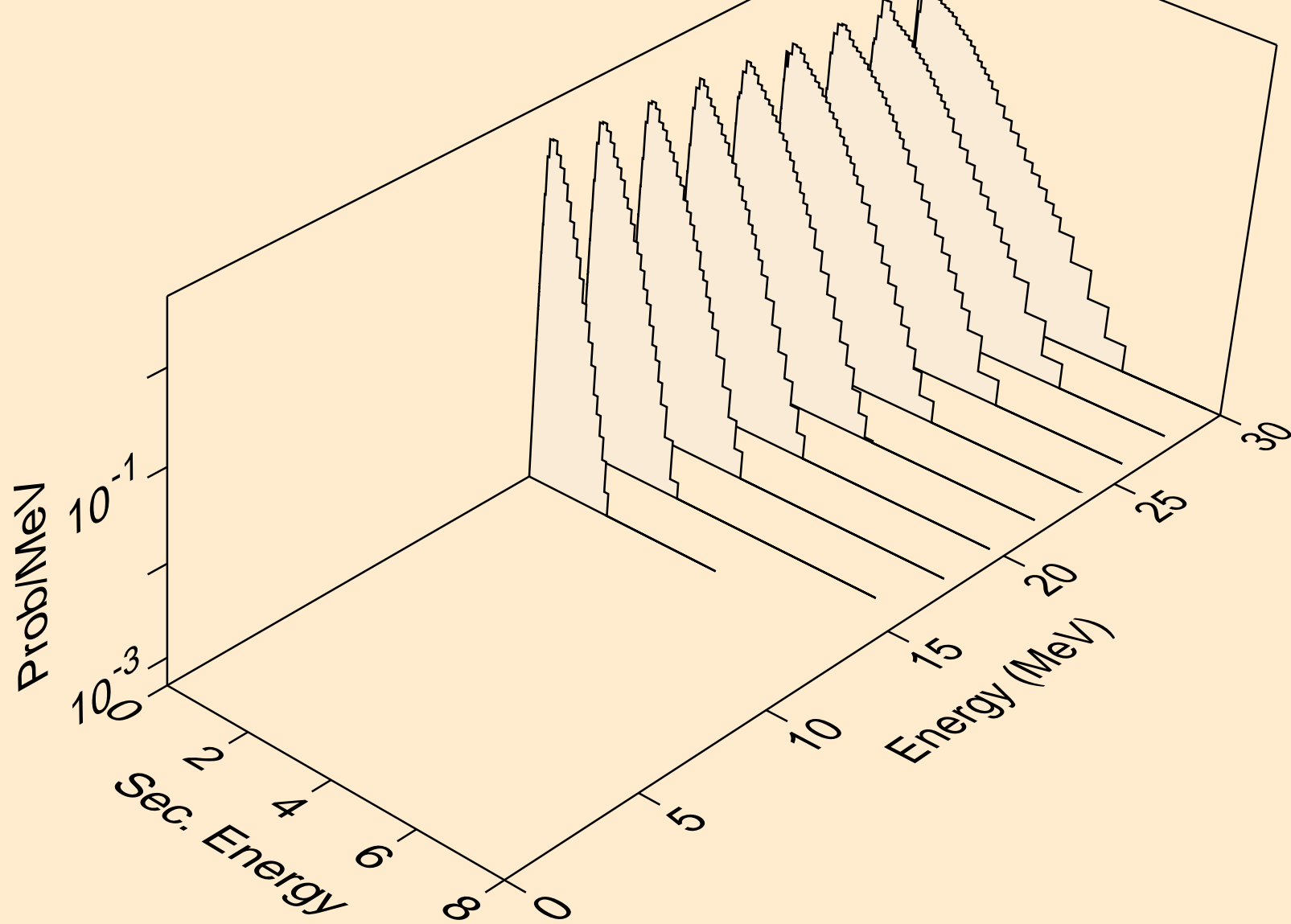

XE125M NEUTRON ACER TENDL-2024 LIBRARY; T=293.6K
Neutron emission for (n,2n)2a

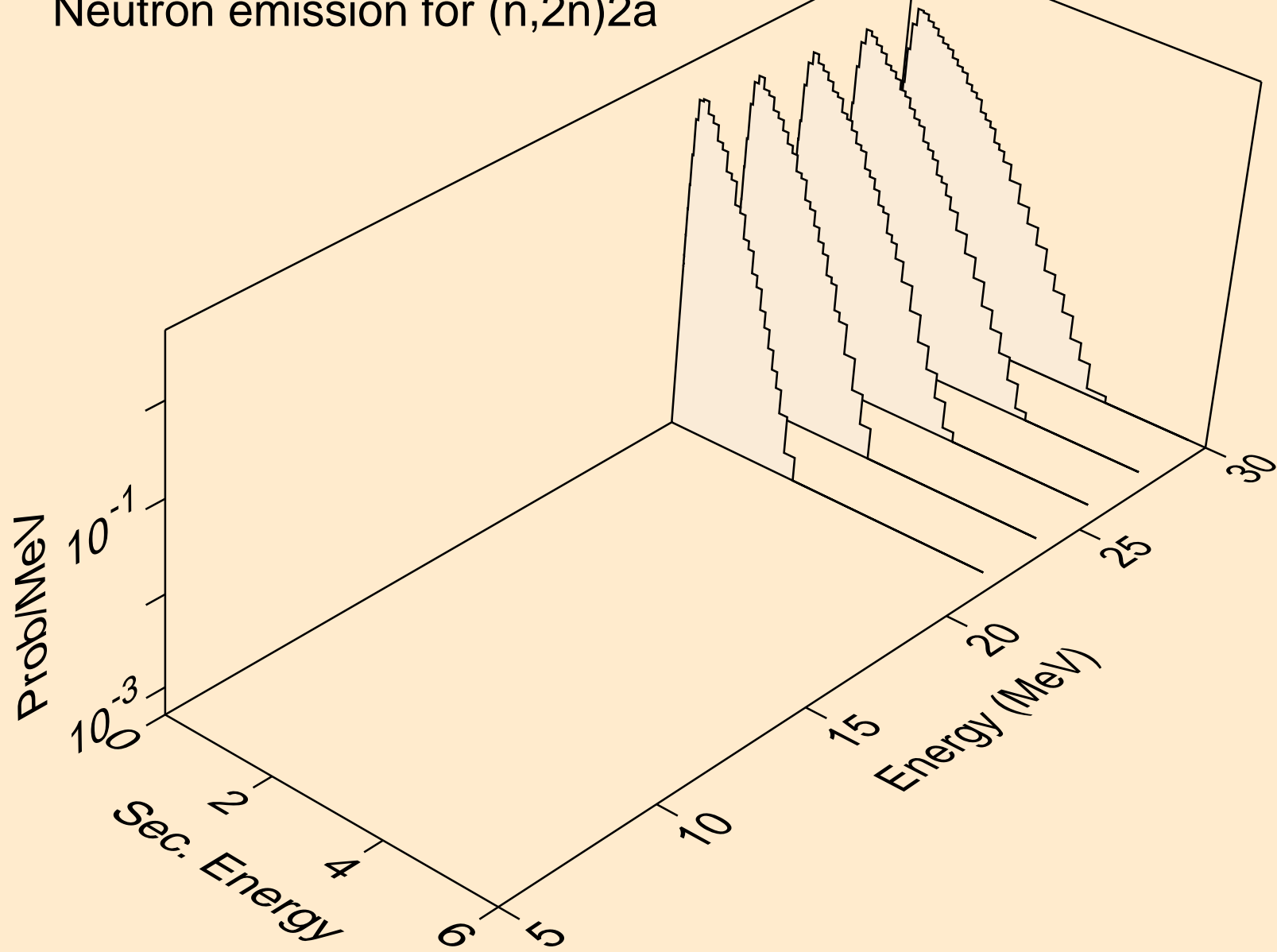

XE125M NEUTRON ACER TENDL-2024 LIBRARY; T=293.6K
Neutron emission for (n,n*)d

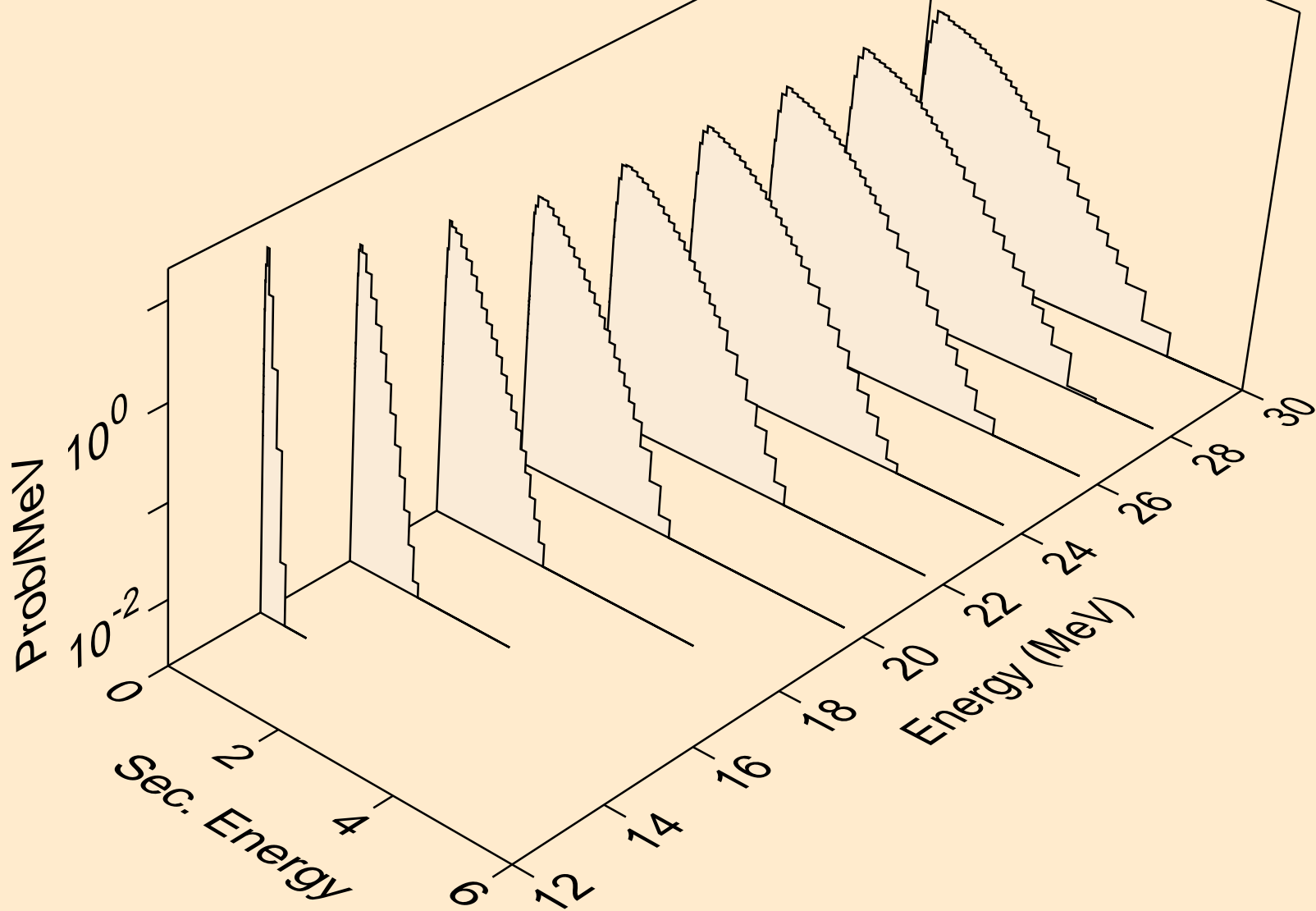

XE125M NEUTRON ACER TENDL-2024 LIBRARY; T=293.6K
Neutron emission for (n,n*)t

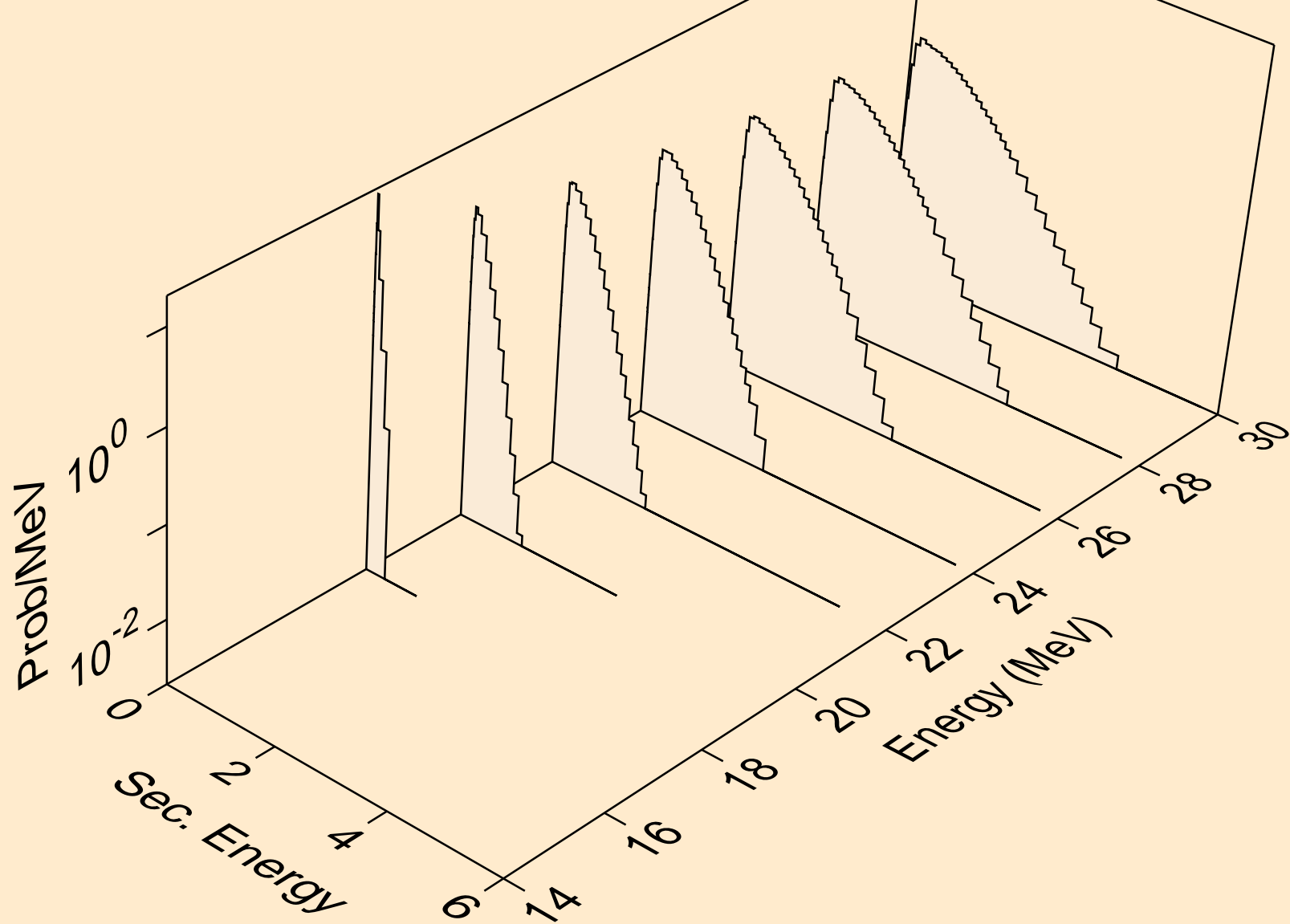

XE125M NEUTRON ACER TENDL-2024 LIBRARY; T=293.6K
Neutron emission for (n,n*)he3

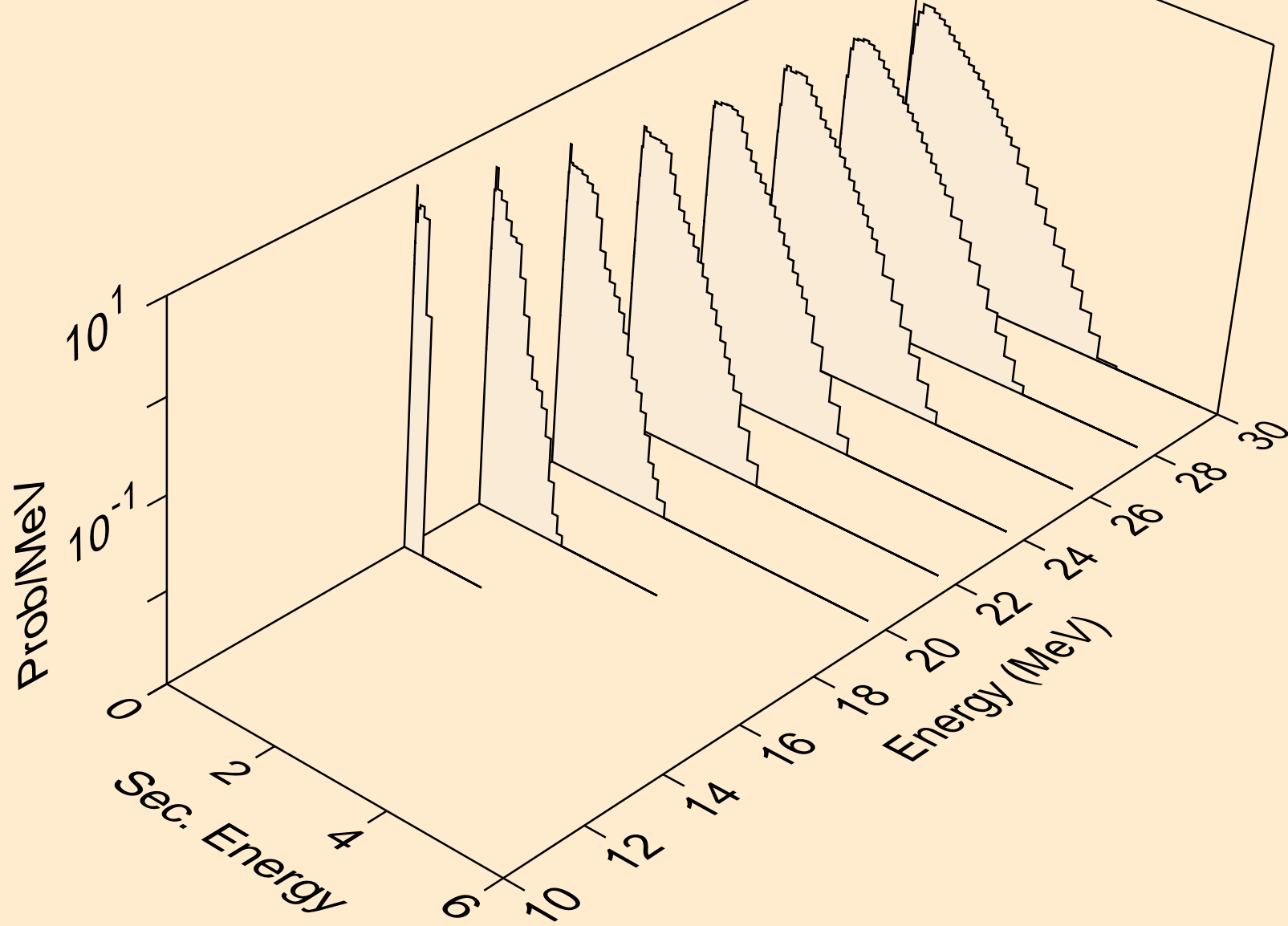

XE125M NEUTRON ACER TENDL-2024 LIBRARY; T=293.6K
Neutron emission for (n,4n)

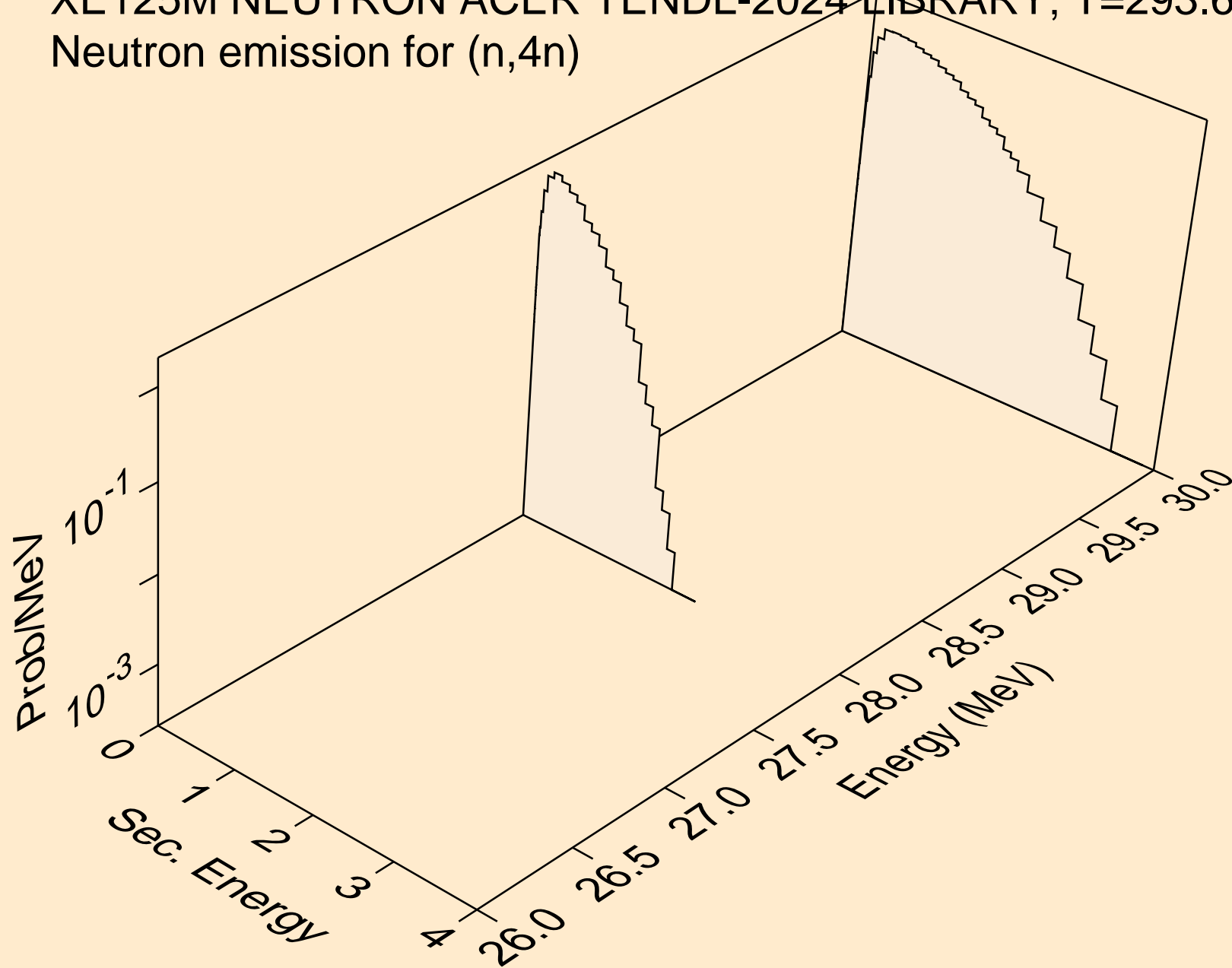

XE125M NEUTRON ACER TENDL-2024 LIBRARY; T=293.6K
Neutron emission for (n,2np)

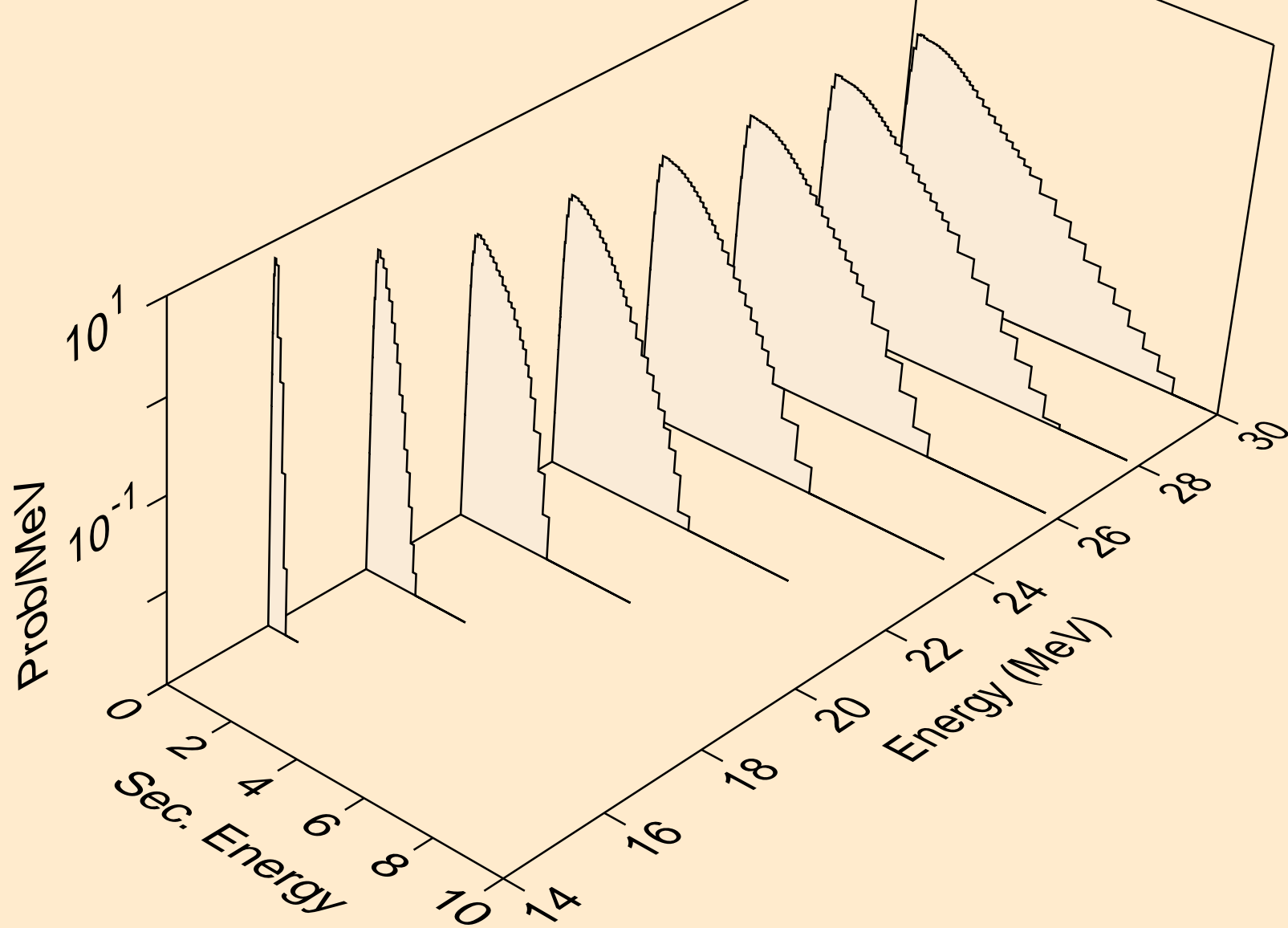

XE125M NEUTRON ACER TENDL-2024 LIBRARY; T=293.6K
Neutron emission for (n,3np)

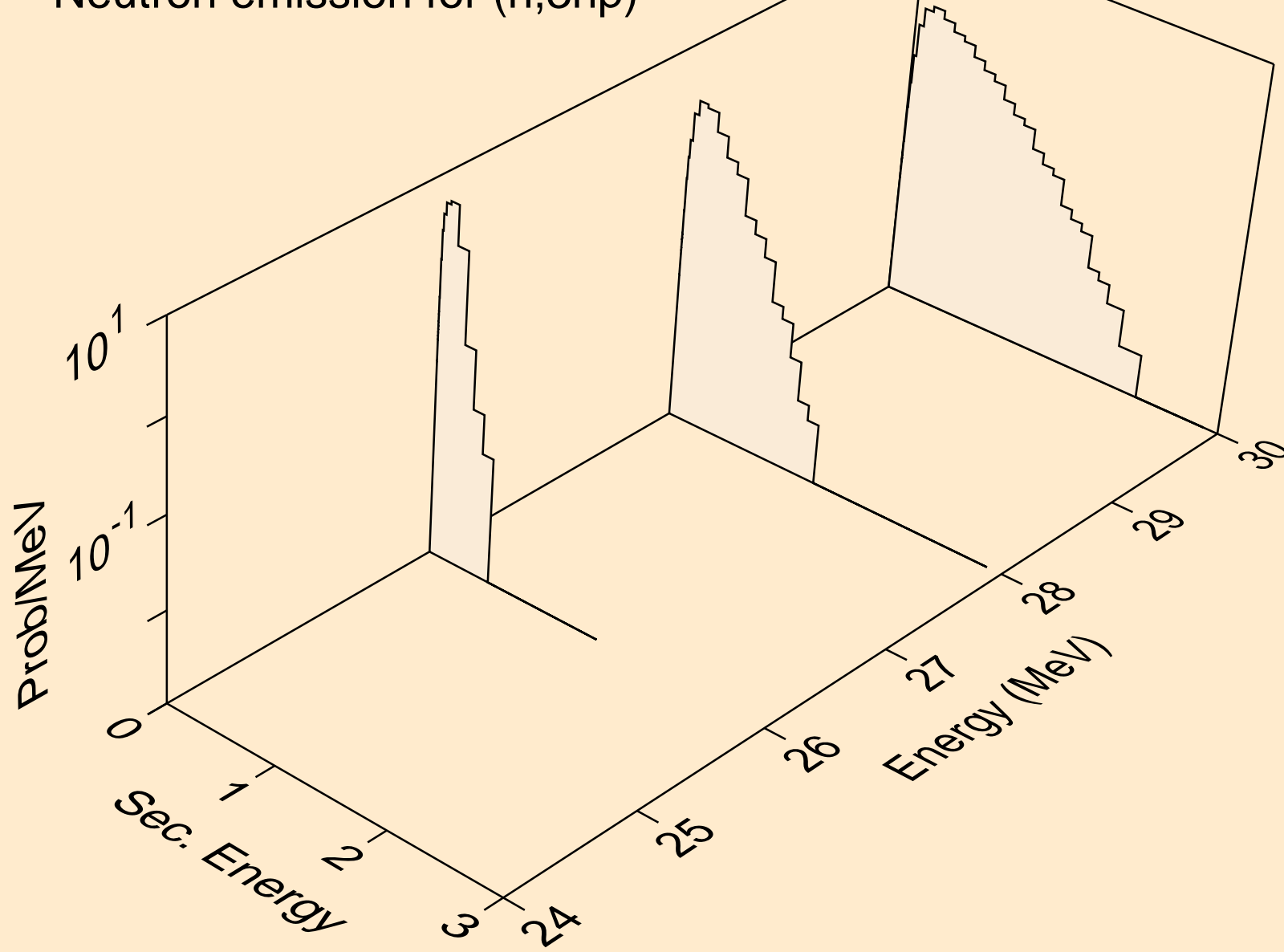

XE125M NEUTRON ACER TENDL-2024 LIBRARY; T=293.6K
Neutron emission for (n,n2p)

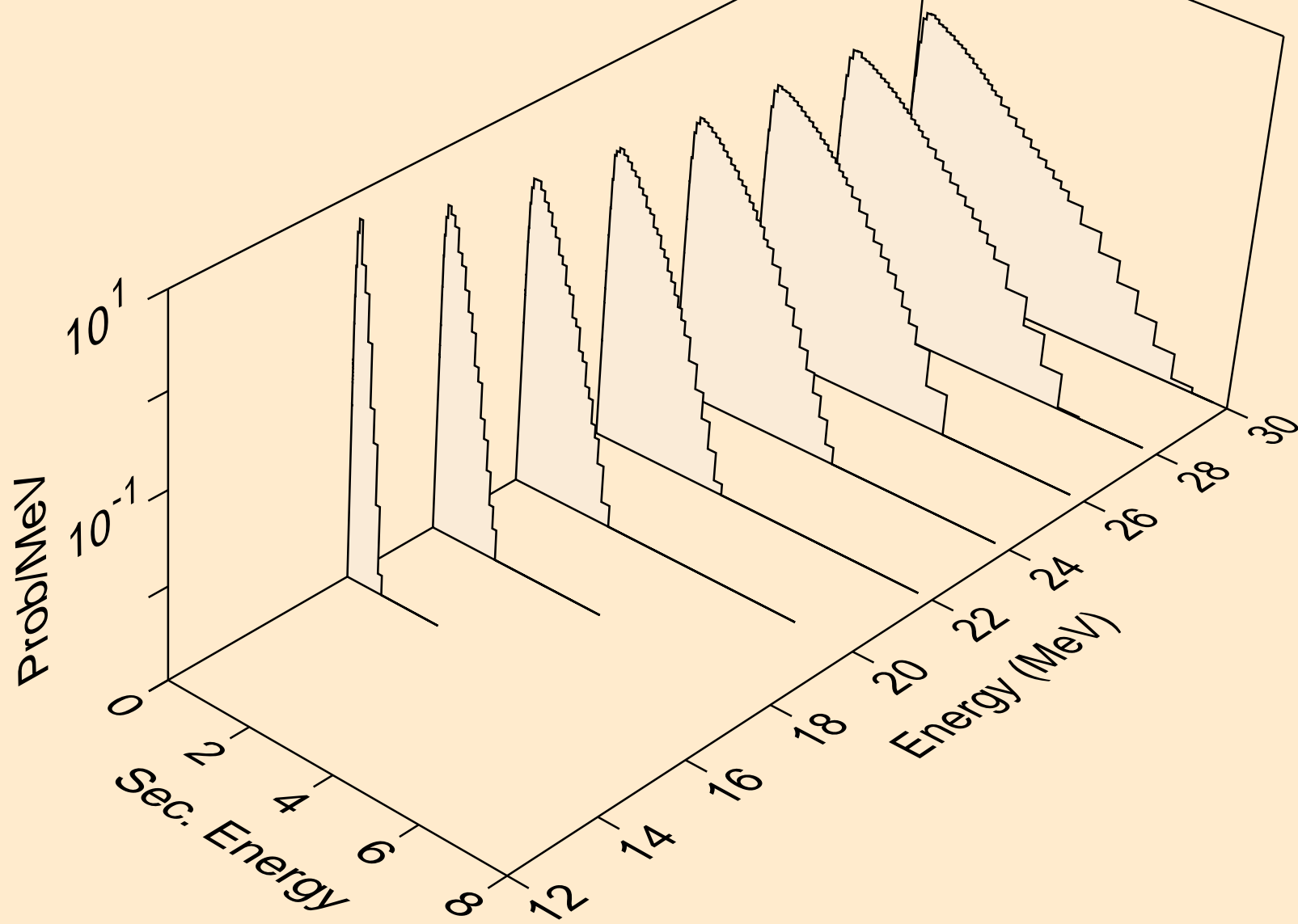

XE125M NEUTRON ACER TENDL-2024 LIBRARY; T=293.6K
Neutron emission for (n,npa)

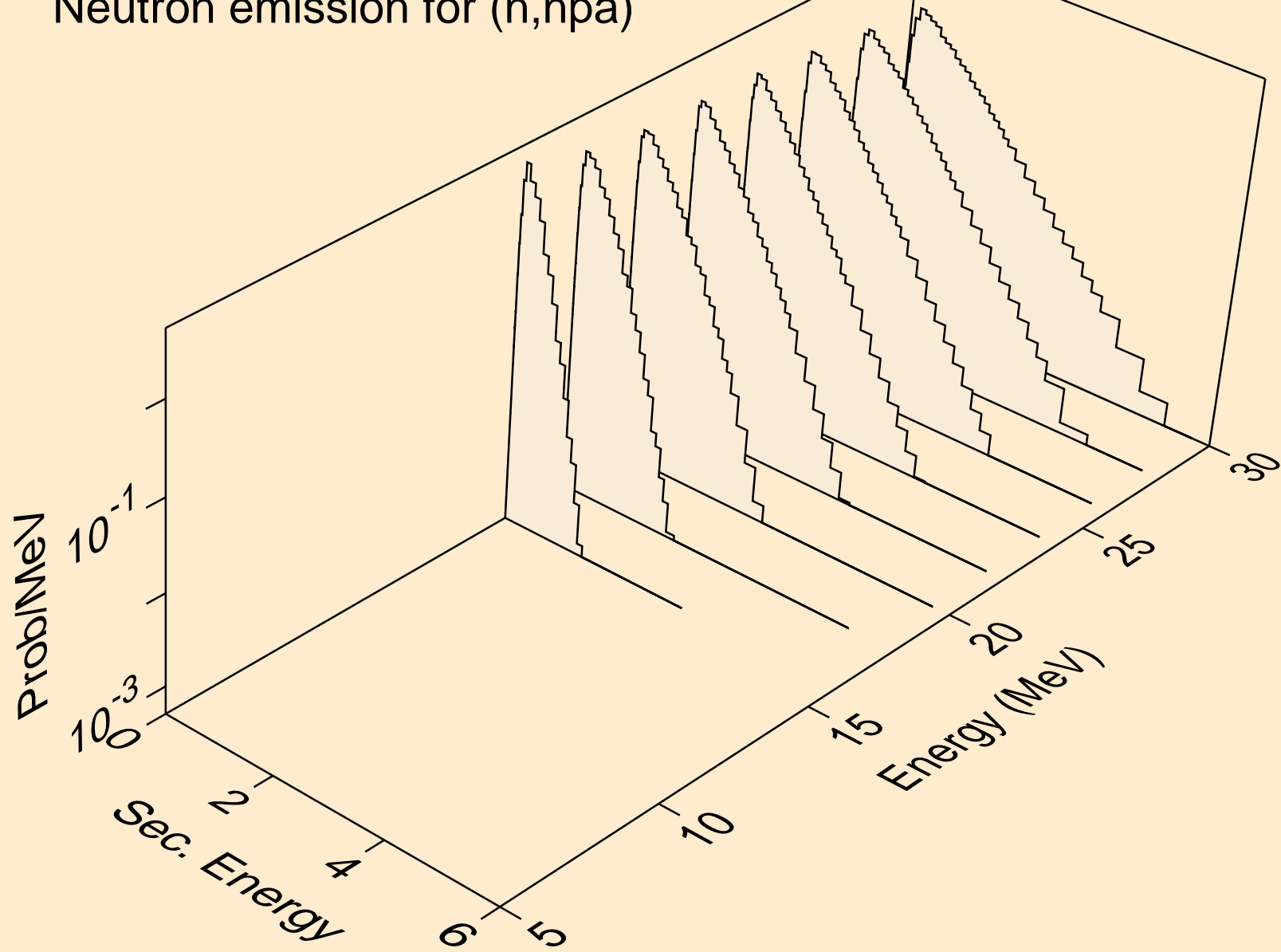

XE125M NEUTRON ACER TENDL-2024 LIBRARY; T=293.6K
Neutron emission for (n,n*c)

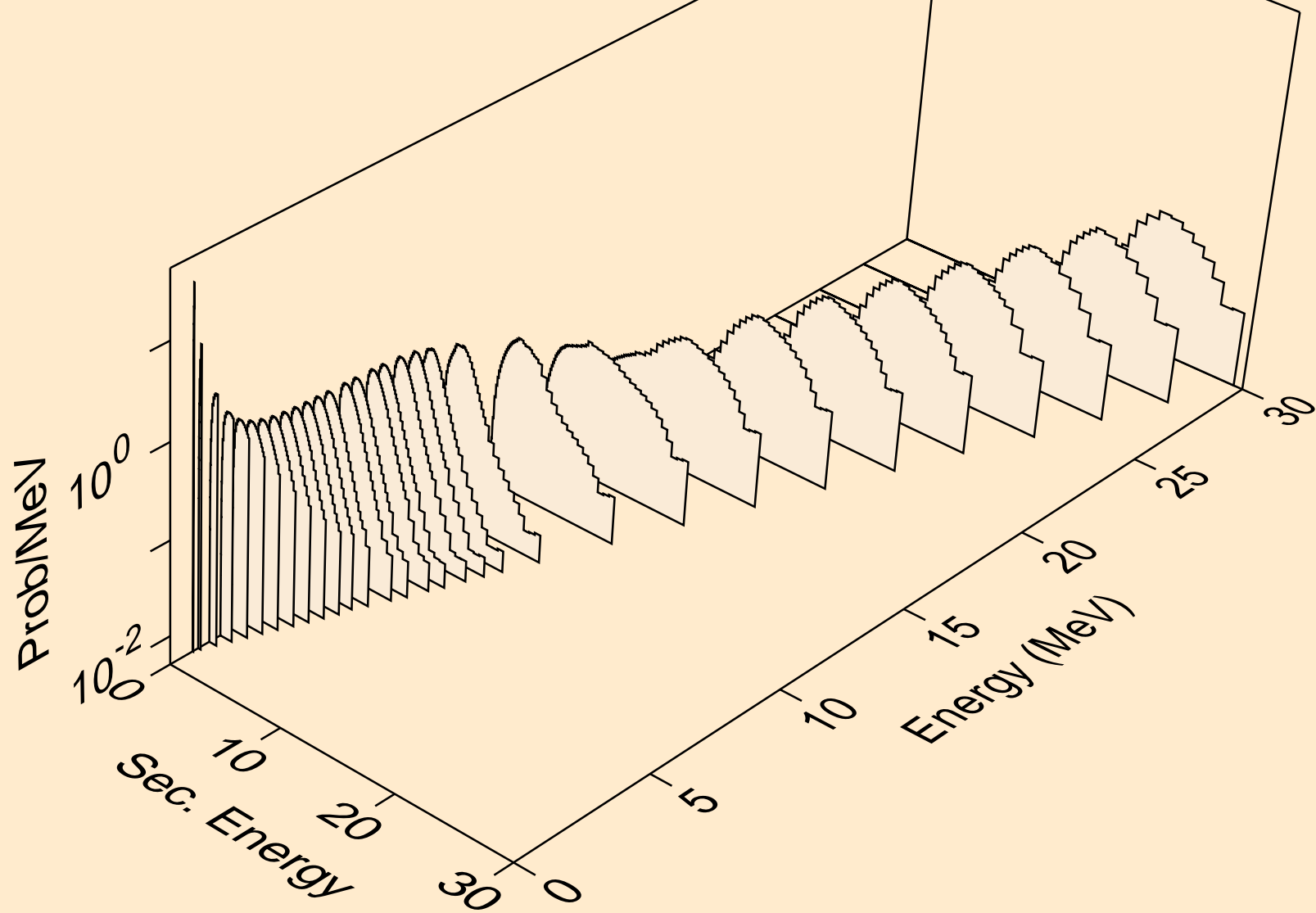

XE125M NEUTRON ACER TENDL-2024 LIBRARY; T=293.6K
Photon emission for (n,x)

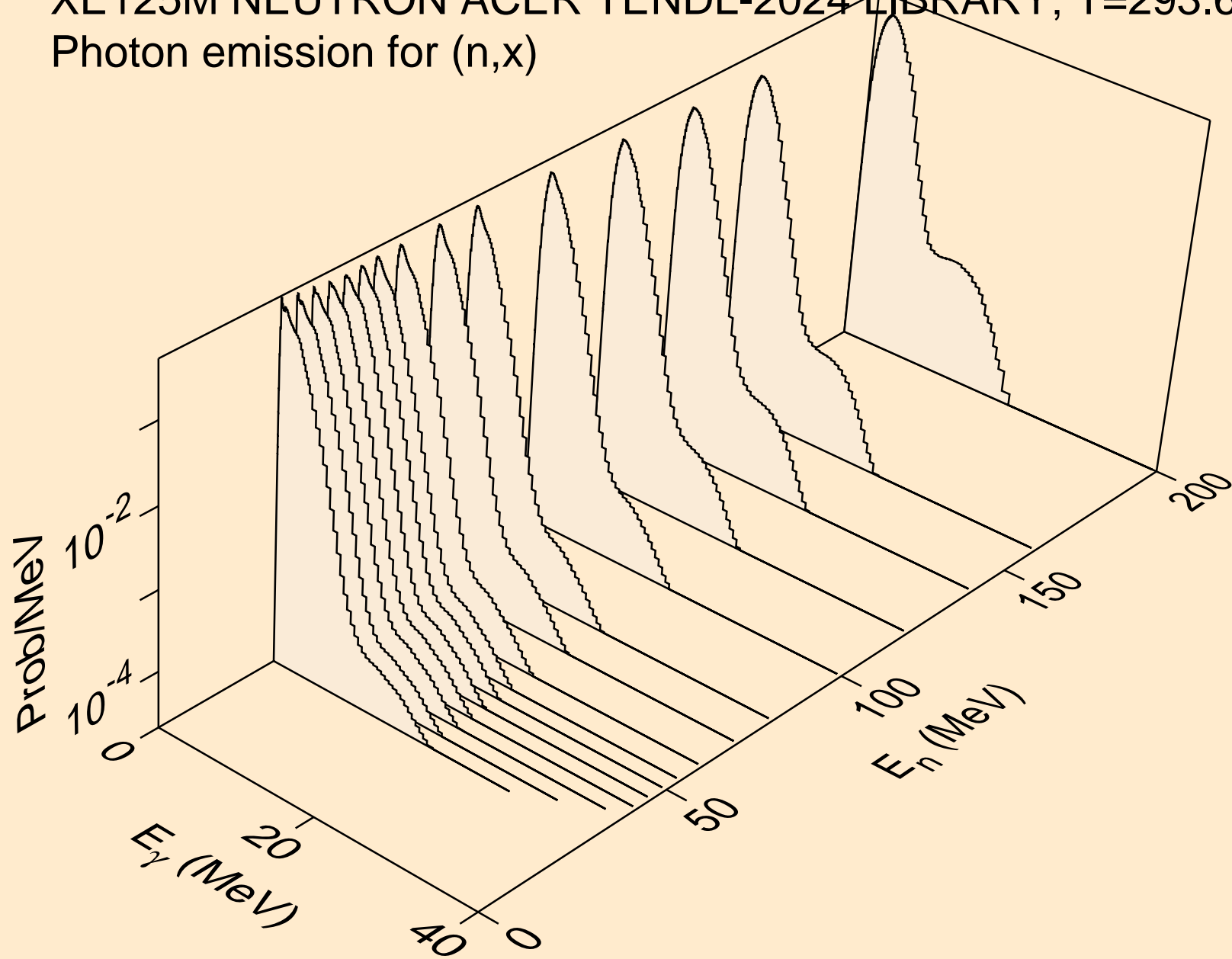

XE125M NEUTRON ACER TENDL-2024 LIBRARY; T=293.6K
Photon emission for (n,2nd)

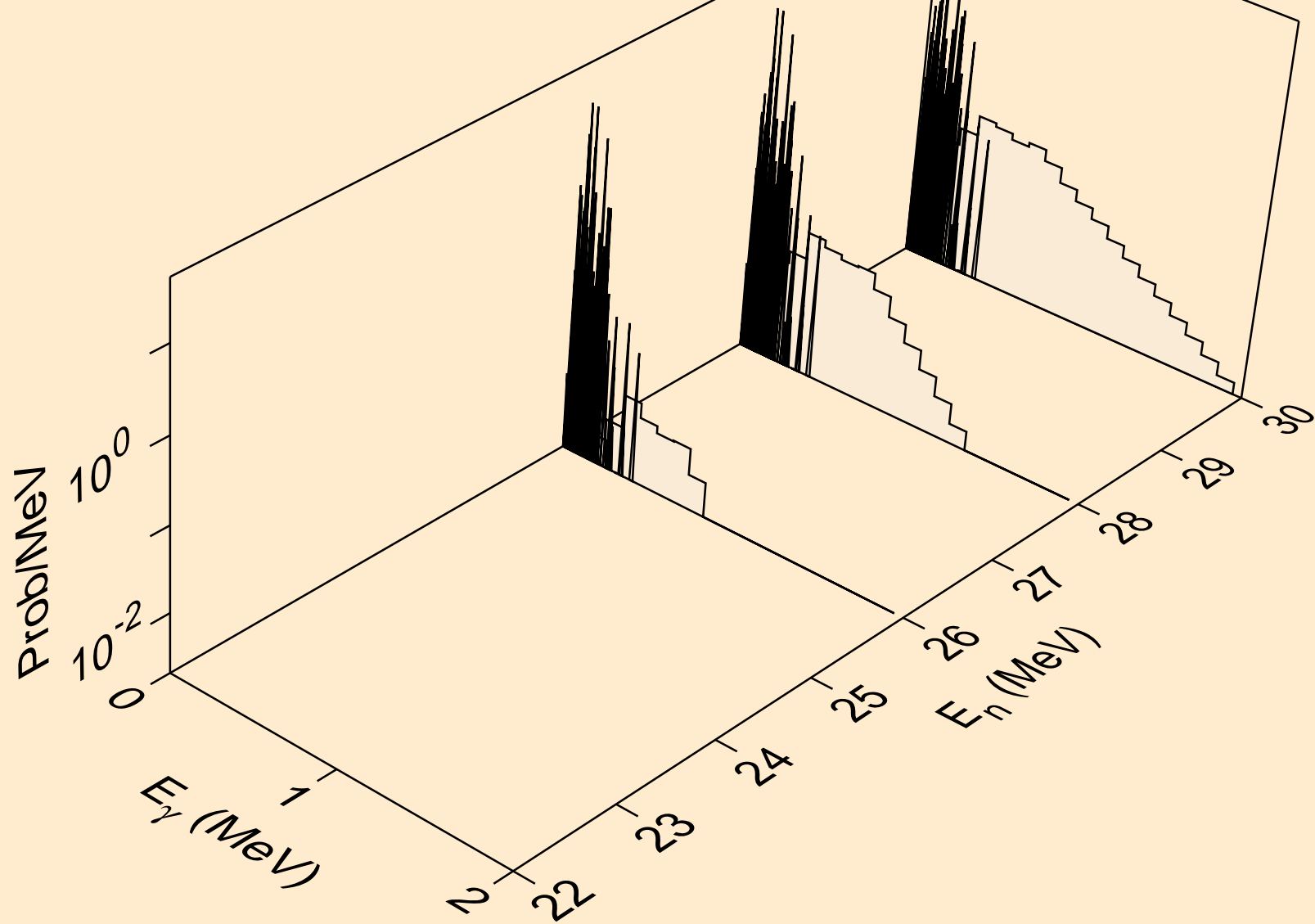

XE125M NEUTRON ACER TENDL-2024 LIBRARY; T=293.6K
Photon emission for (n,2n)

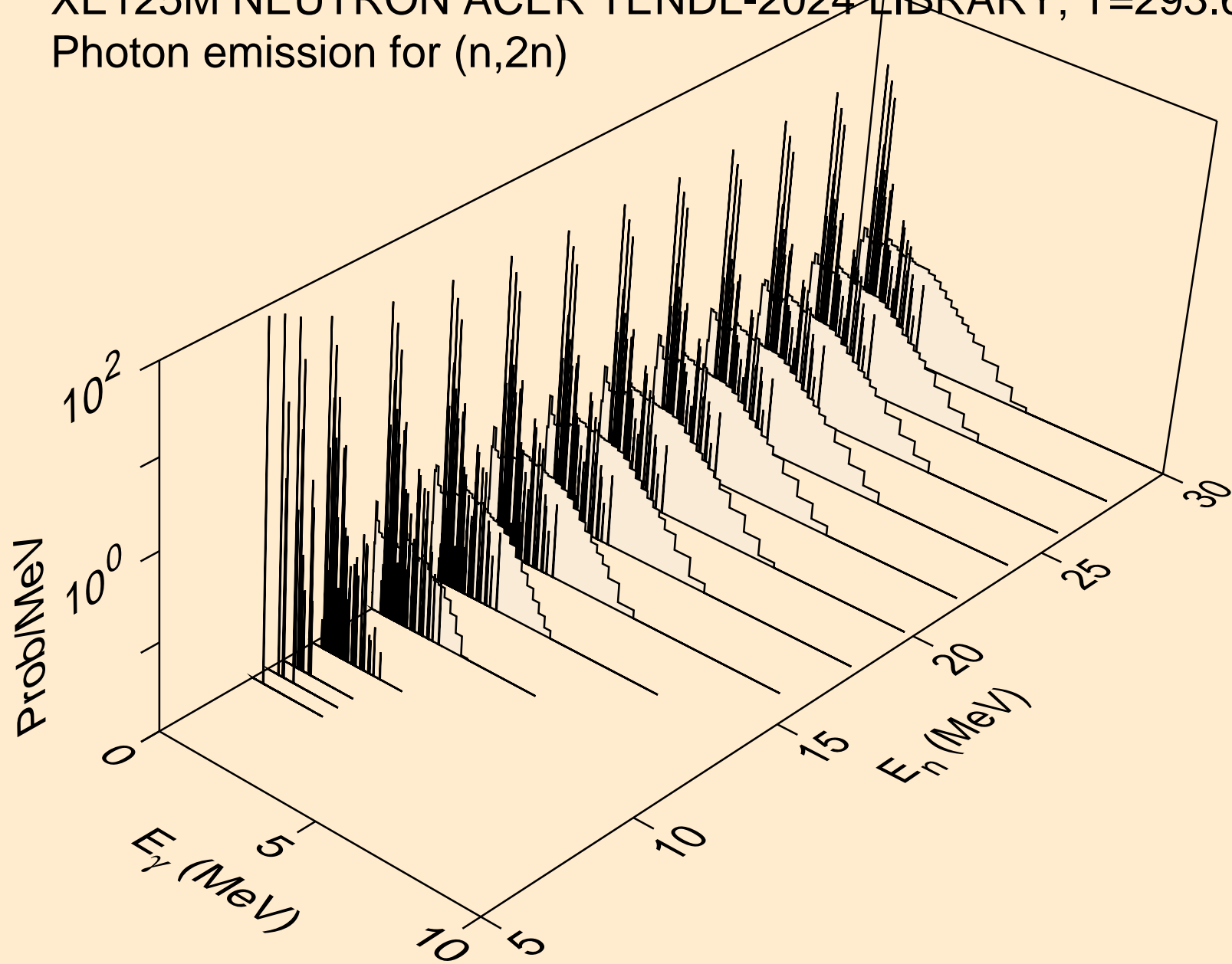

XE125M NEUTRON ACER TENDL-2024 LIBRARY; T=293.6K
Photon emission for (n,3n)

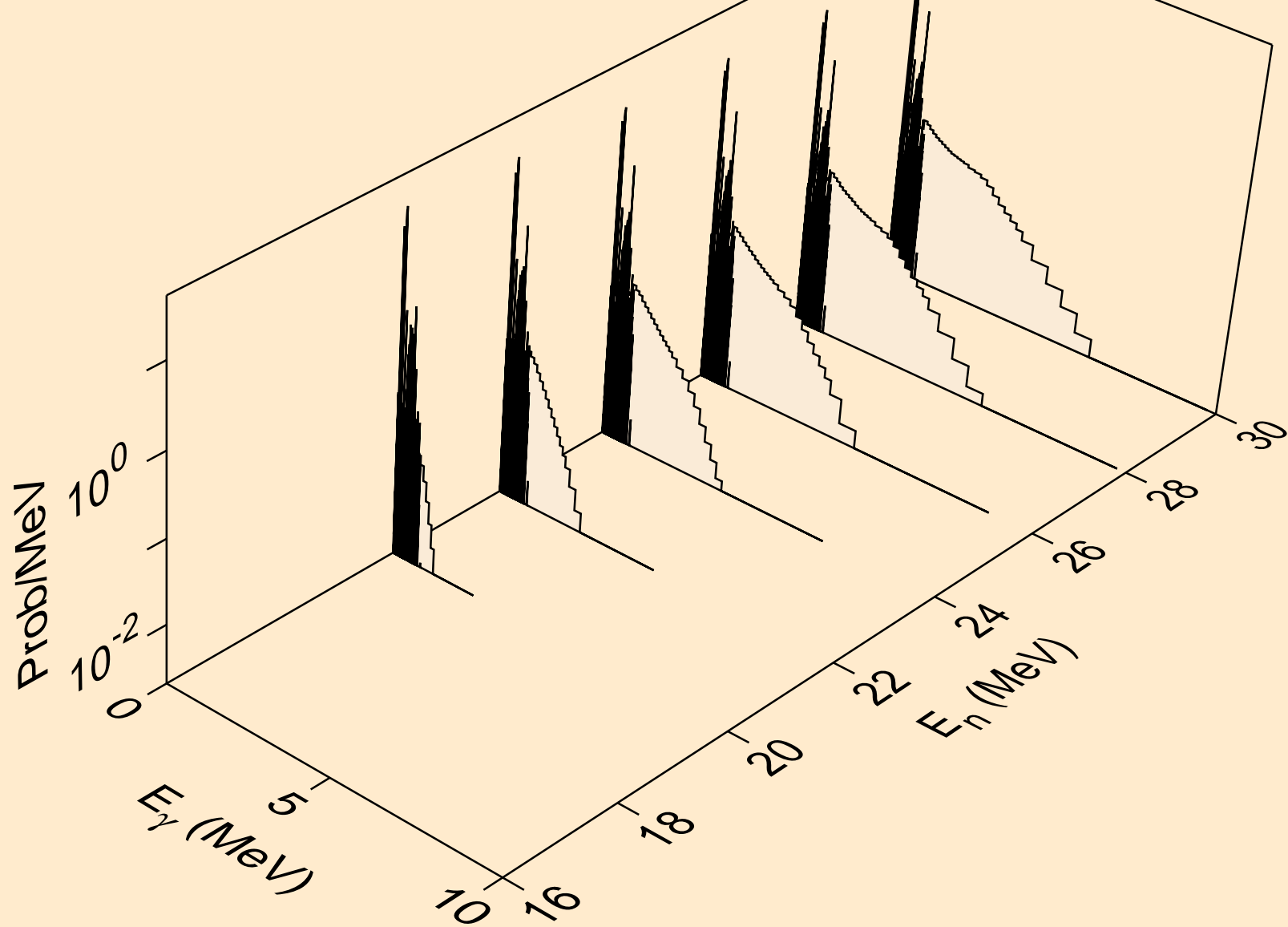

XE125M NEUTRON ACER TENDL-2024 LIBRARY; T=293.6K
Photon emission for (n,n*)a

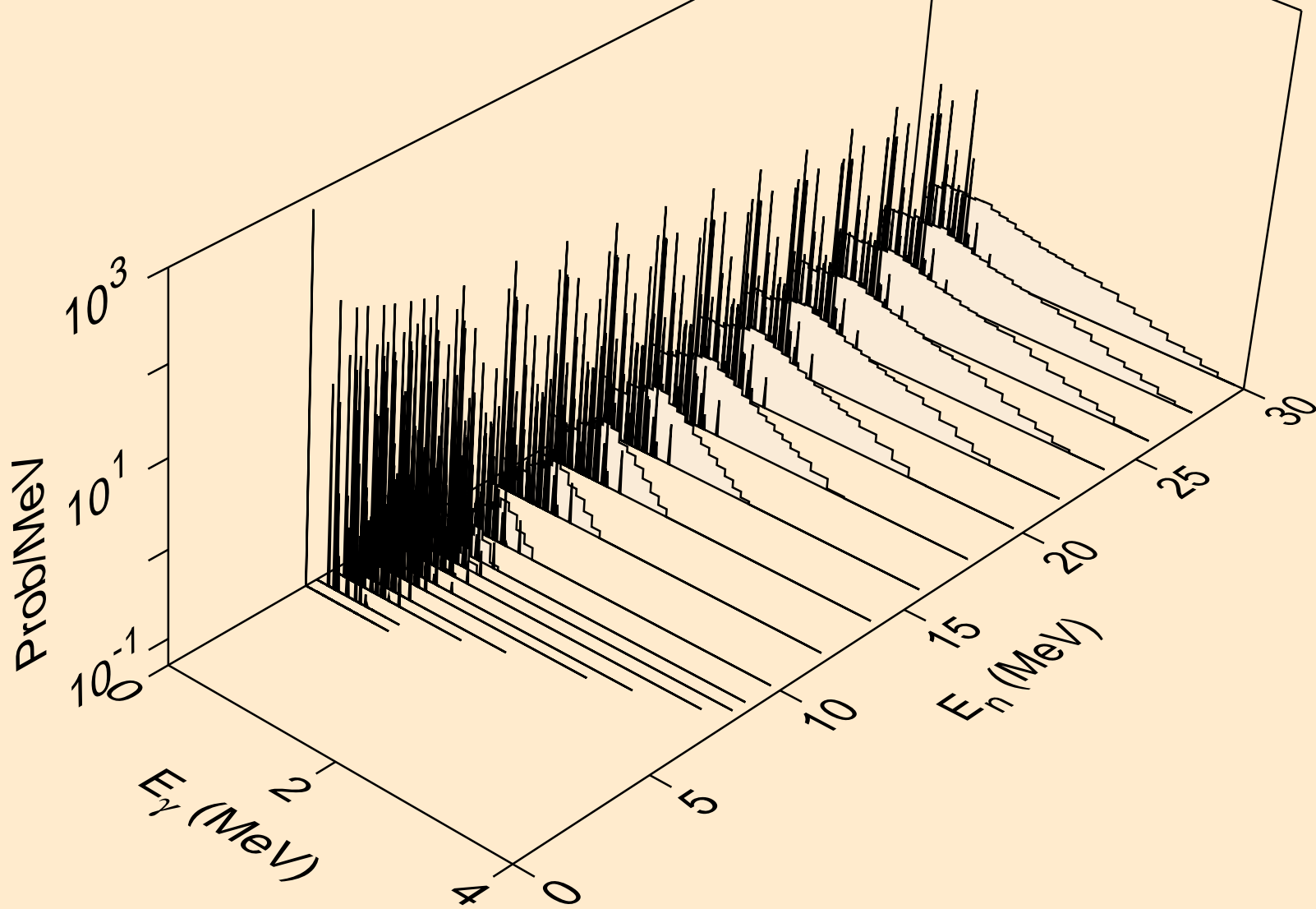

XE125M NEUTRON ACER TENDL-2024 LIBRARY; T=293.6K
Photon emission for (n,2n)a

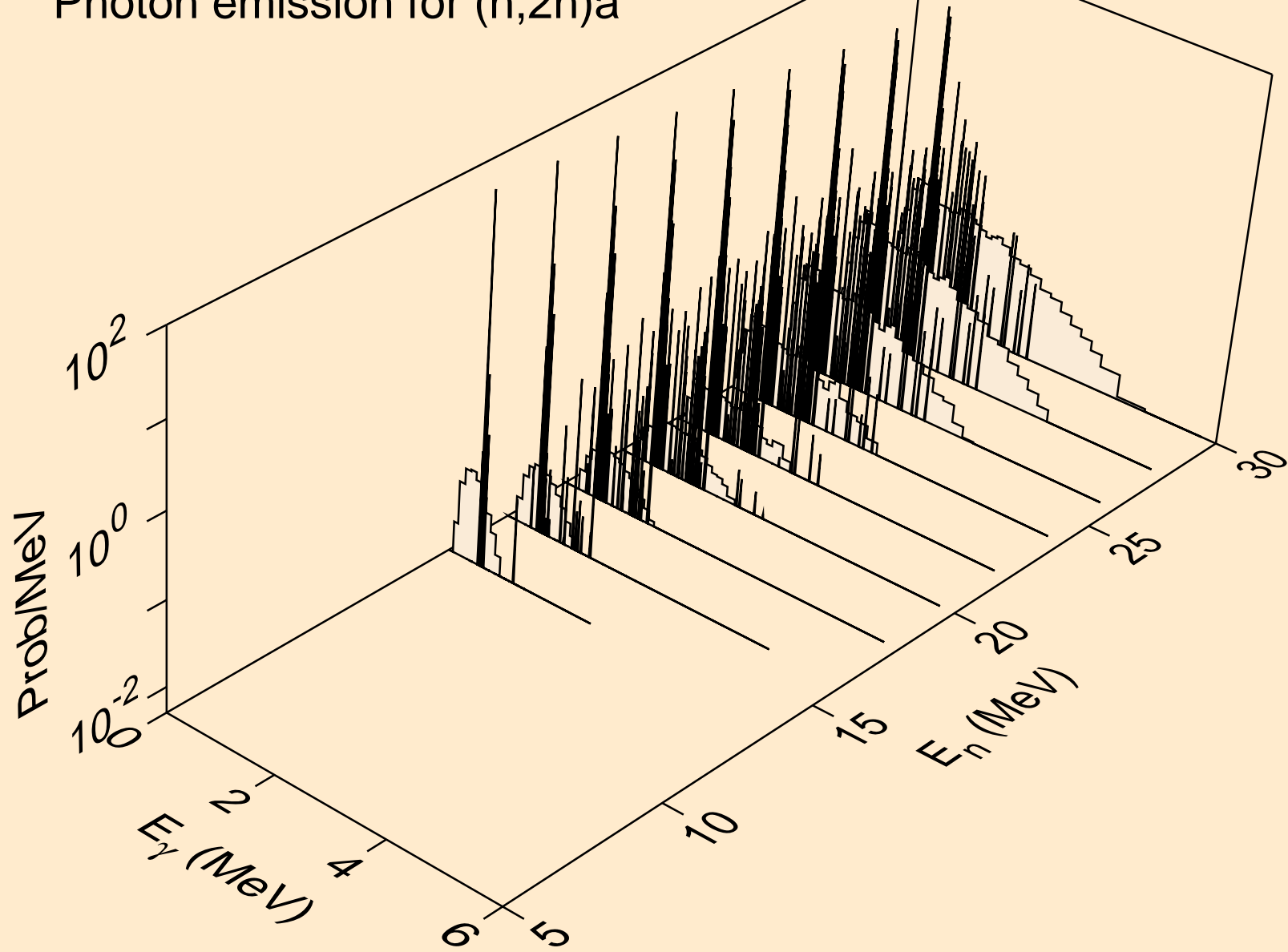

XE125M NEUTRON ACER TENDL-2024 LIBRARY; T=293.6K
Photon emission for (n,3n)a

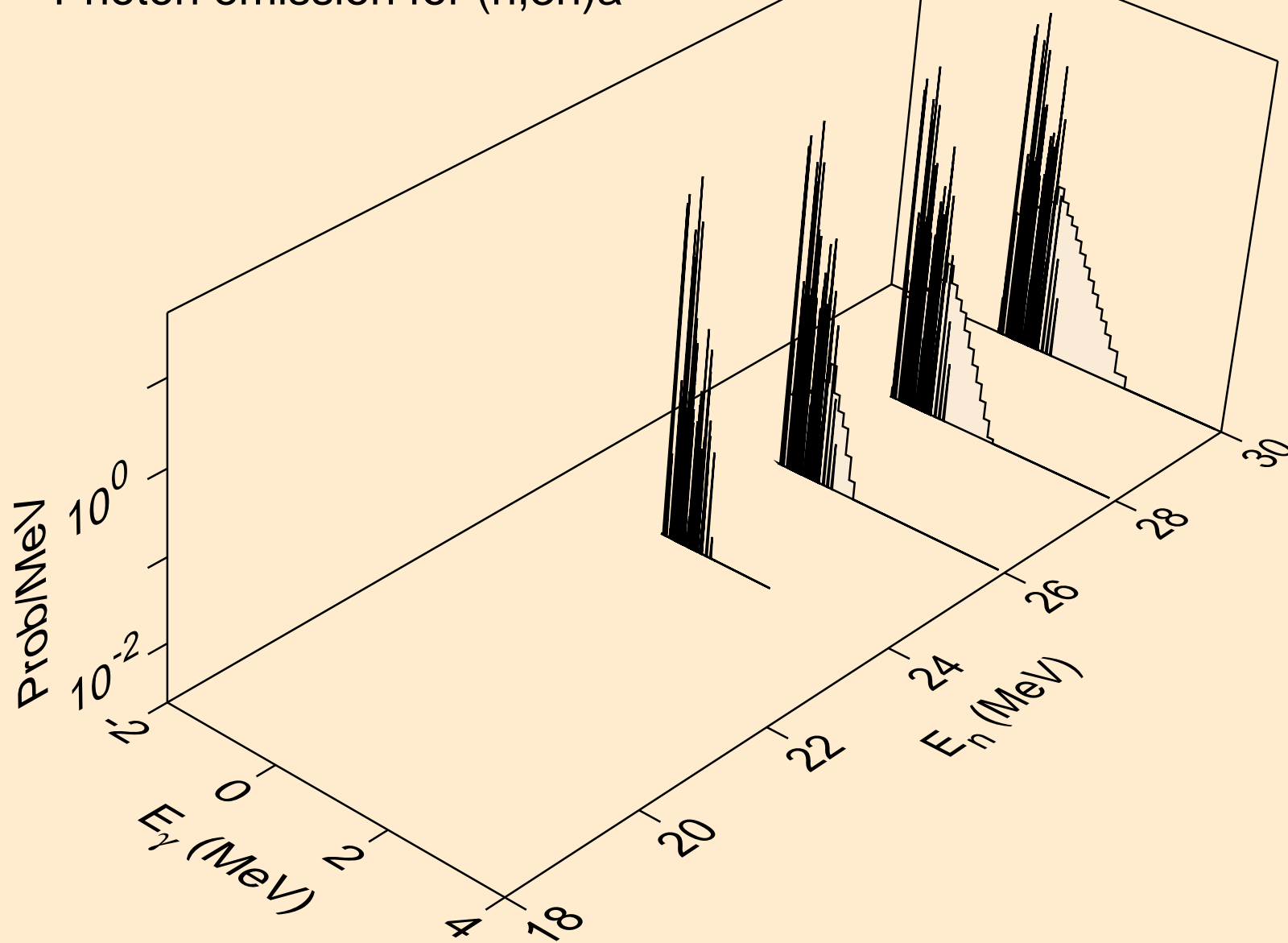

XE125M NEUTRON ACER TENDL-2024 LIBRARY; T=293.6K
Photon emission for (n,n*)p

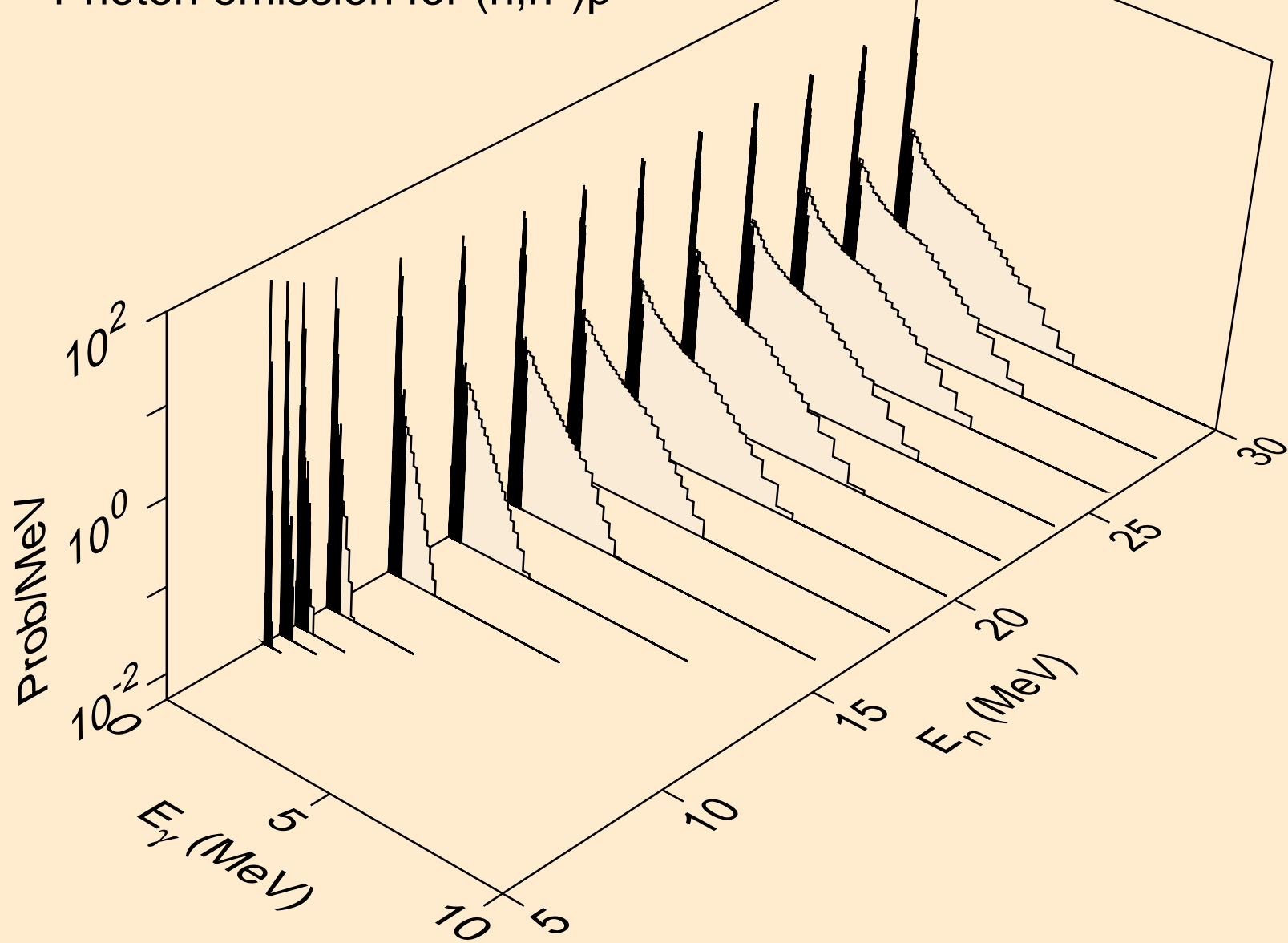

XE125M NEUTRON ACER TENDL-2024 LIBRARY; T=293.6K
Photon emission for (n,n*)2a

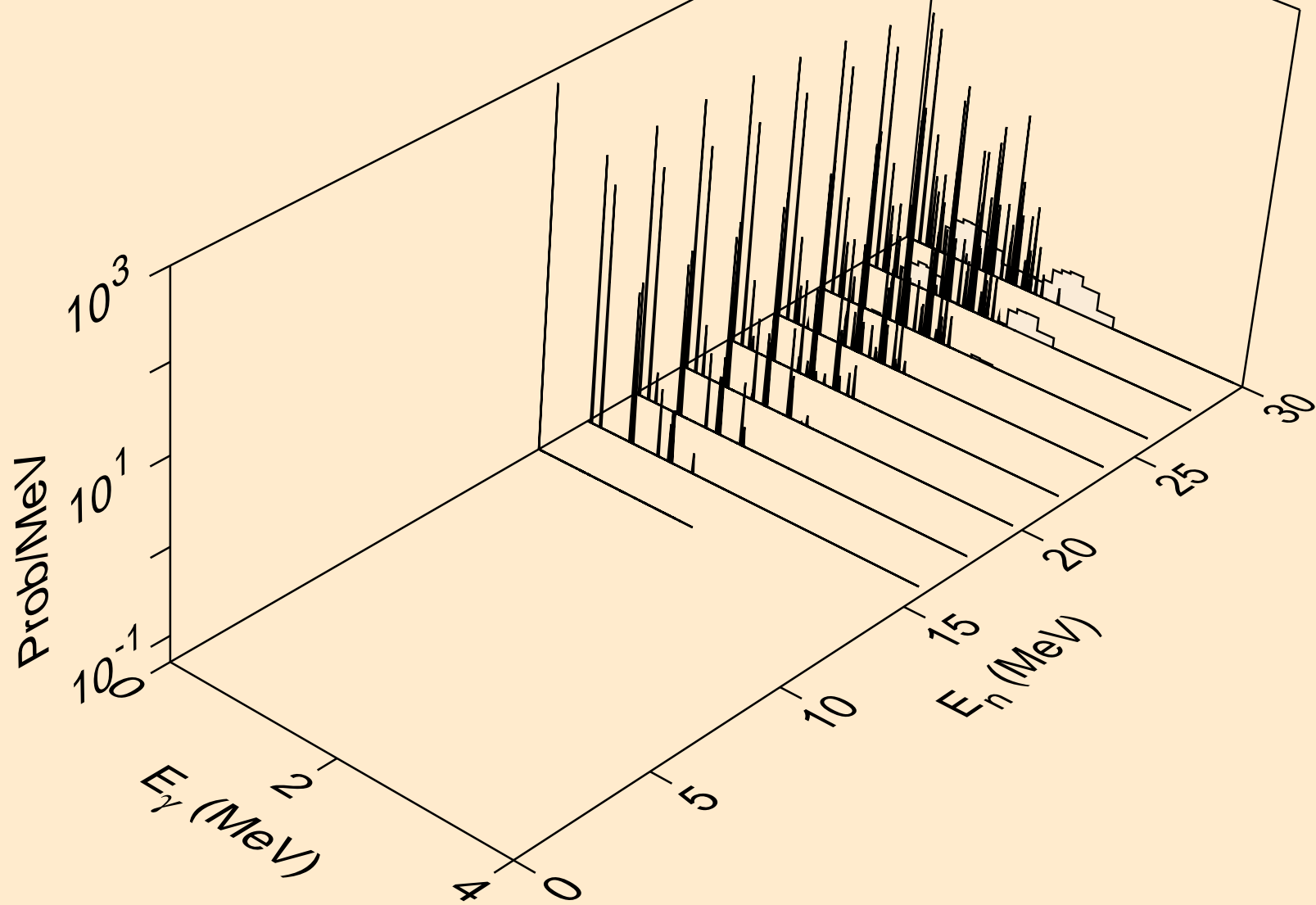

XE125M NEUTRON ACER TENDL-2024 LIBRARY; T=293.6K
Photon emission for (n,2n)2a

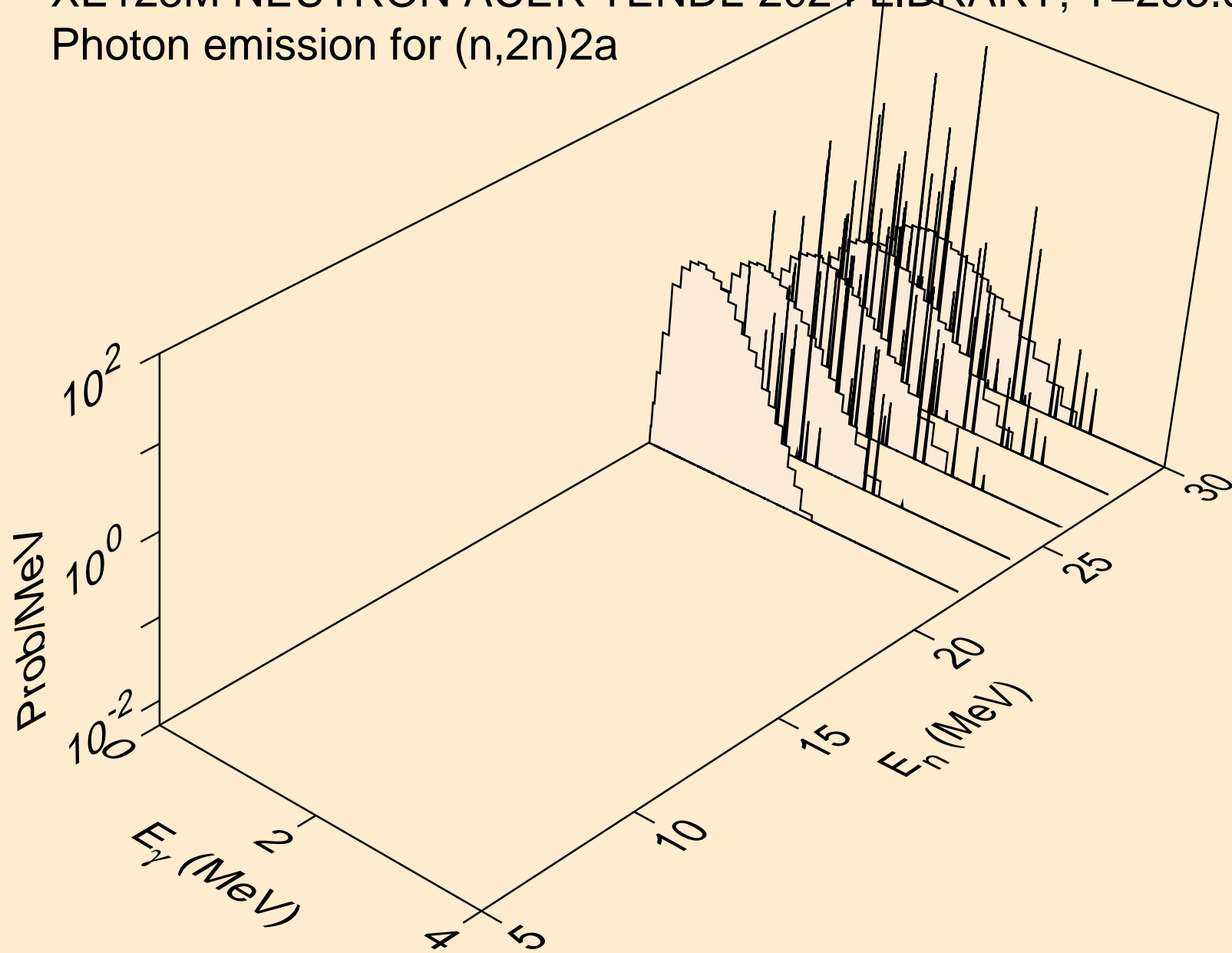

XE125M NEUTRON ACER TENDL-2024 LIBRARY; T=293.6K
Photon emission for (n,n*)d

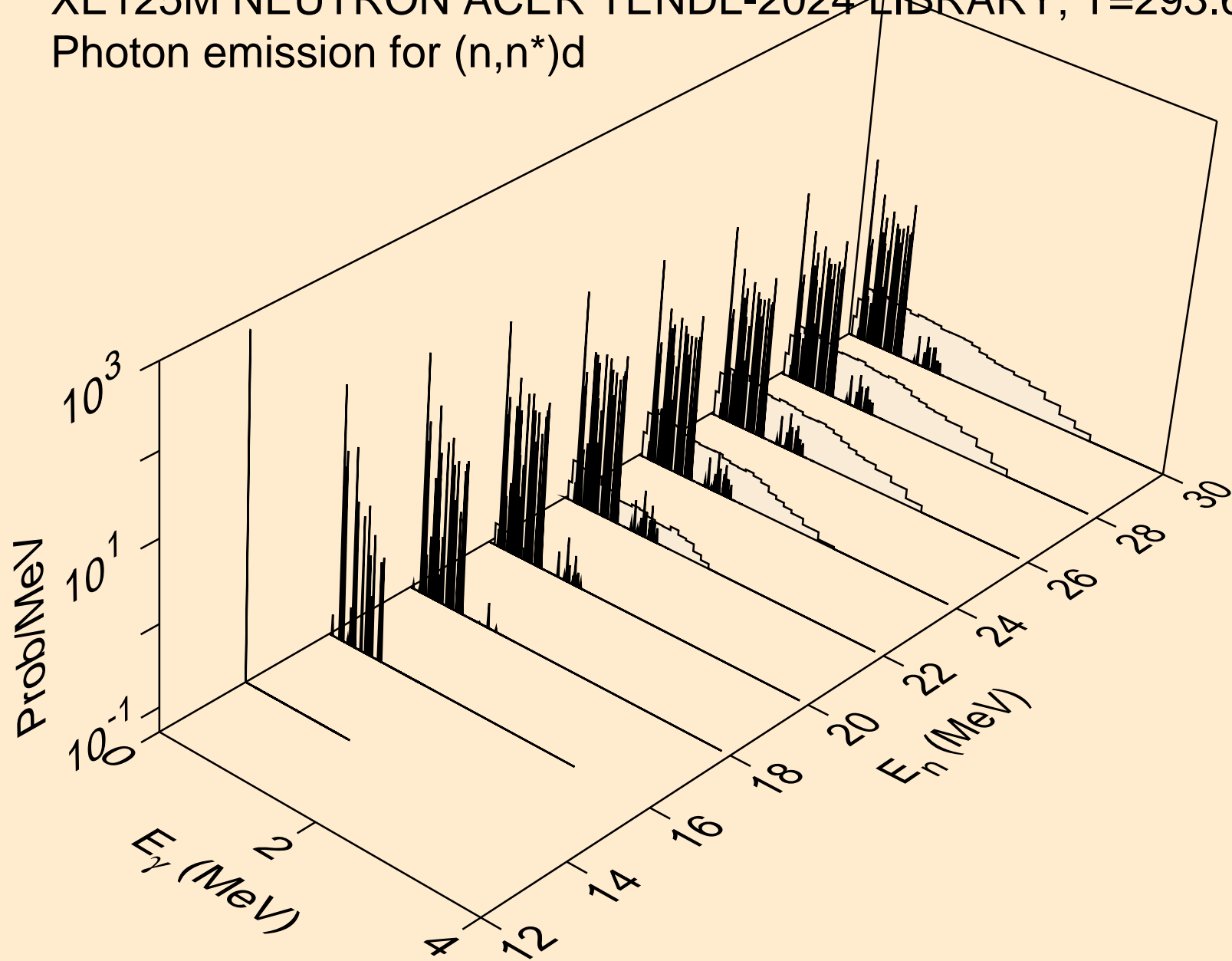

XE125M NEUTRON ACER TENDL-2024 LIBRARY; T=293.6K
Photon emission for (n,n*)t

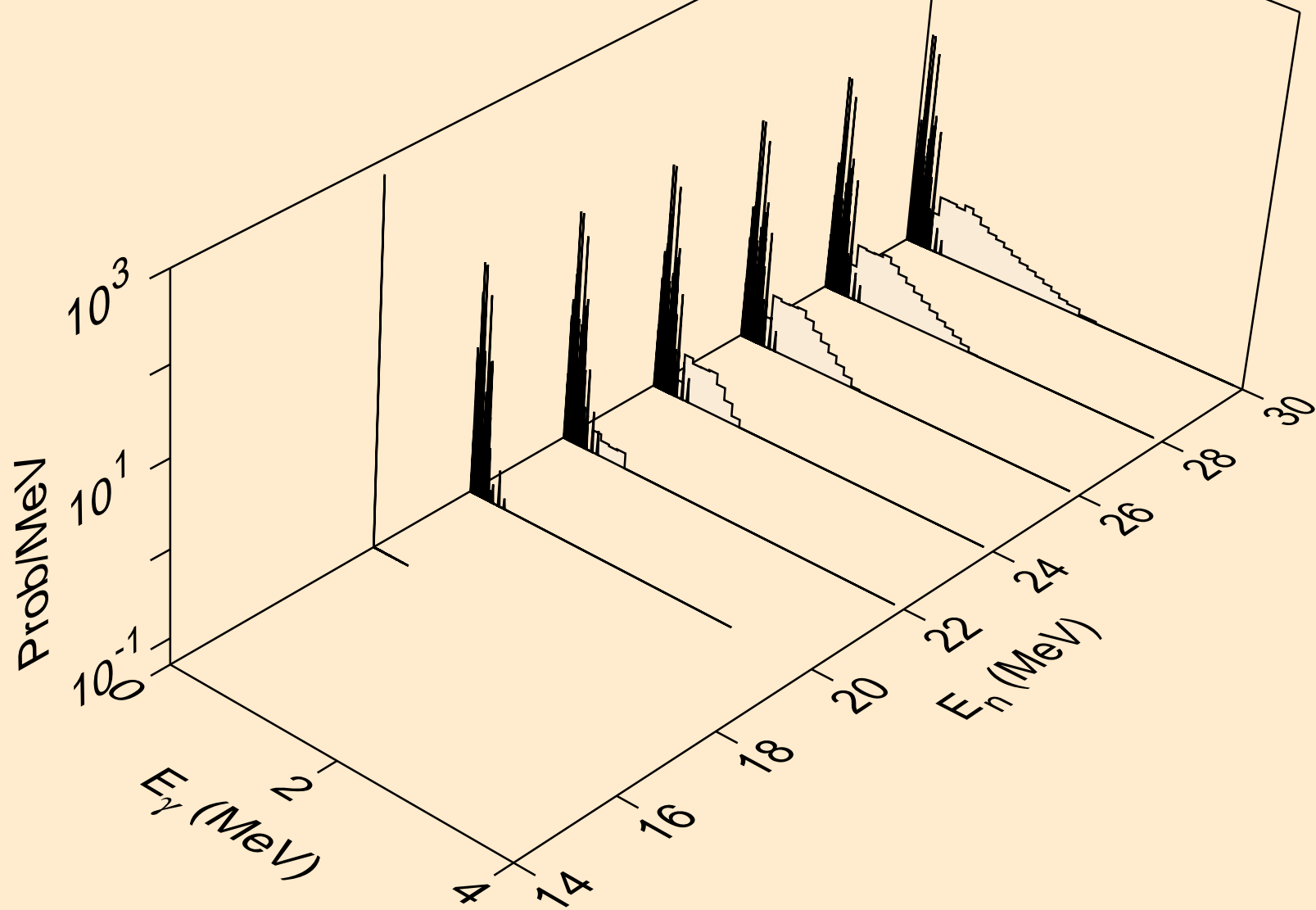

XE125M NEUTRON ACER TENDL-2024 LIBRARY; T=293.6K
Photon emission for (n,n*)he3

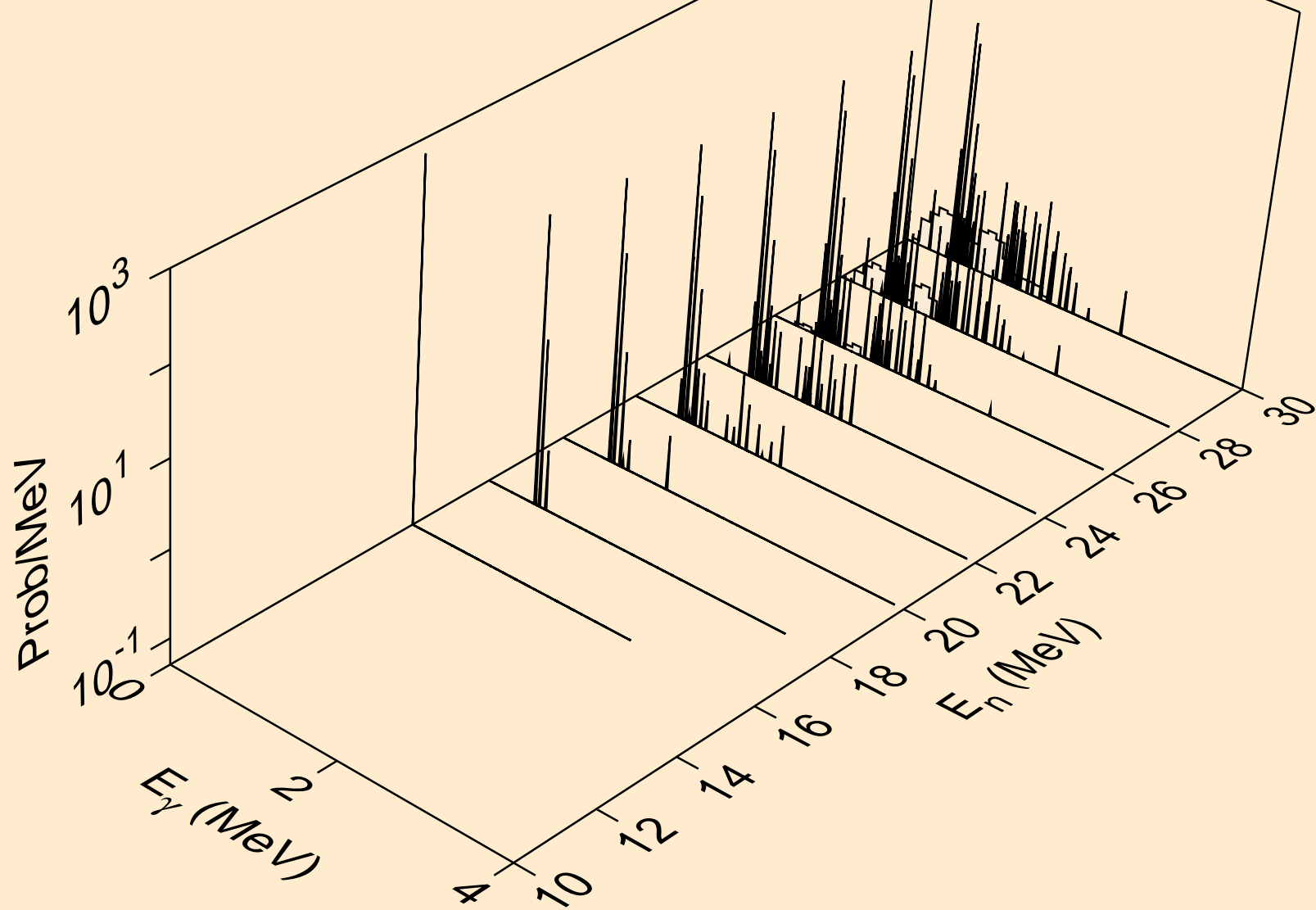

XE125M NEUTRON ACER TENDL-2024 LIBRARY; T=293.6K
Photon emission for (n,4n)

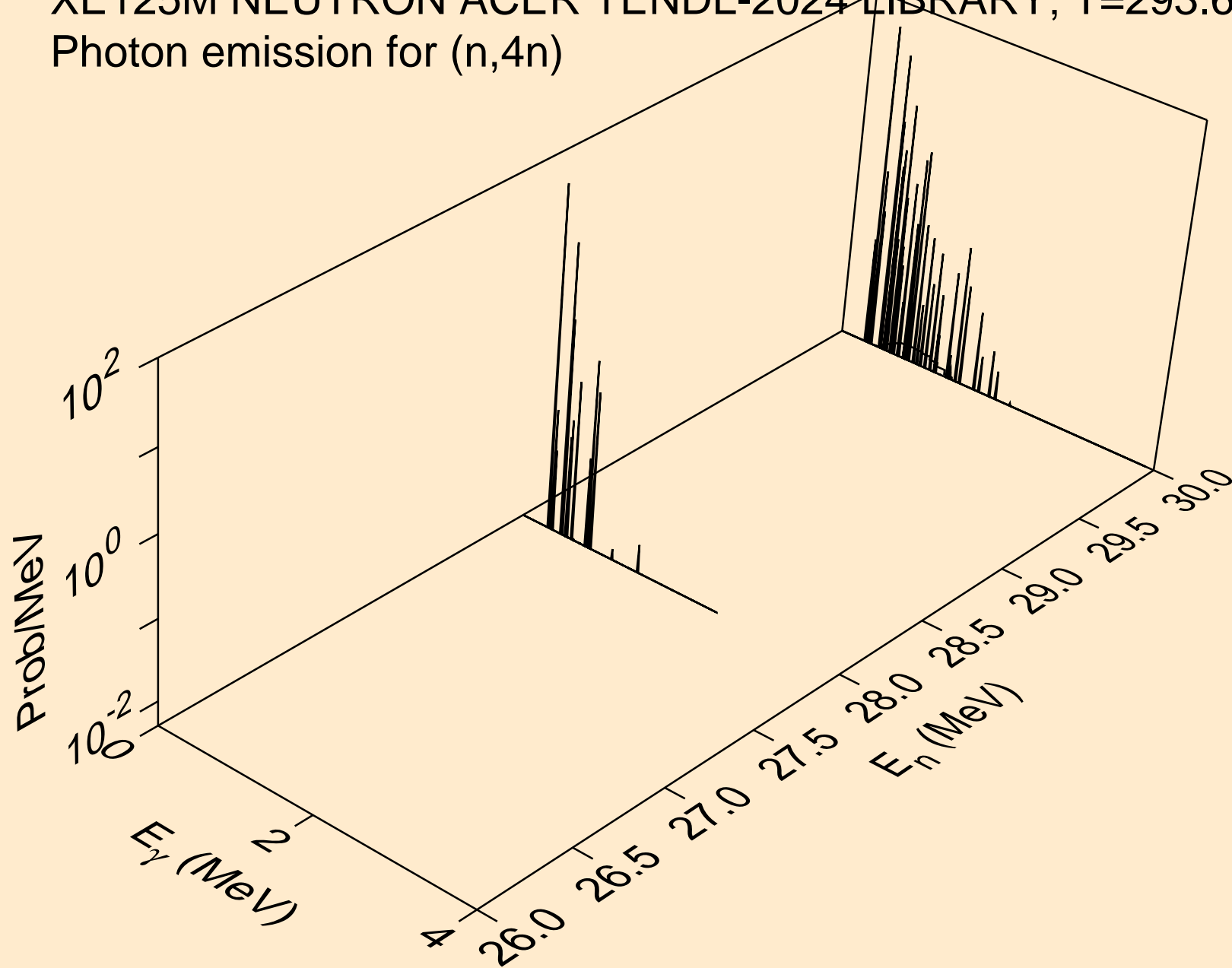

XE125M NEUTRON ACER TENDL-2024 LIBRARY; T=293.6K
Photon emission for (n,2np)

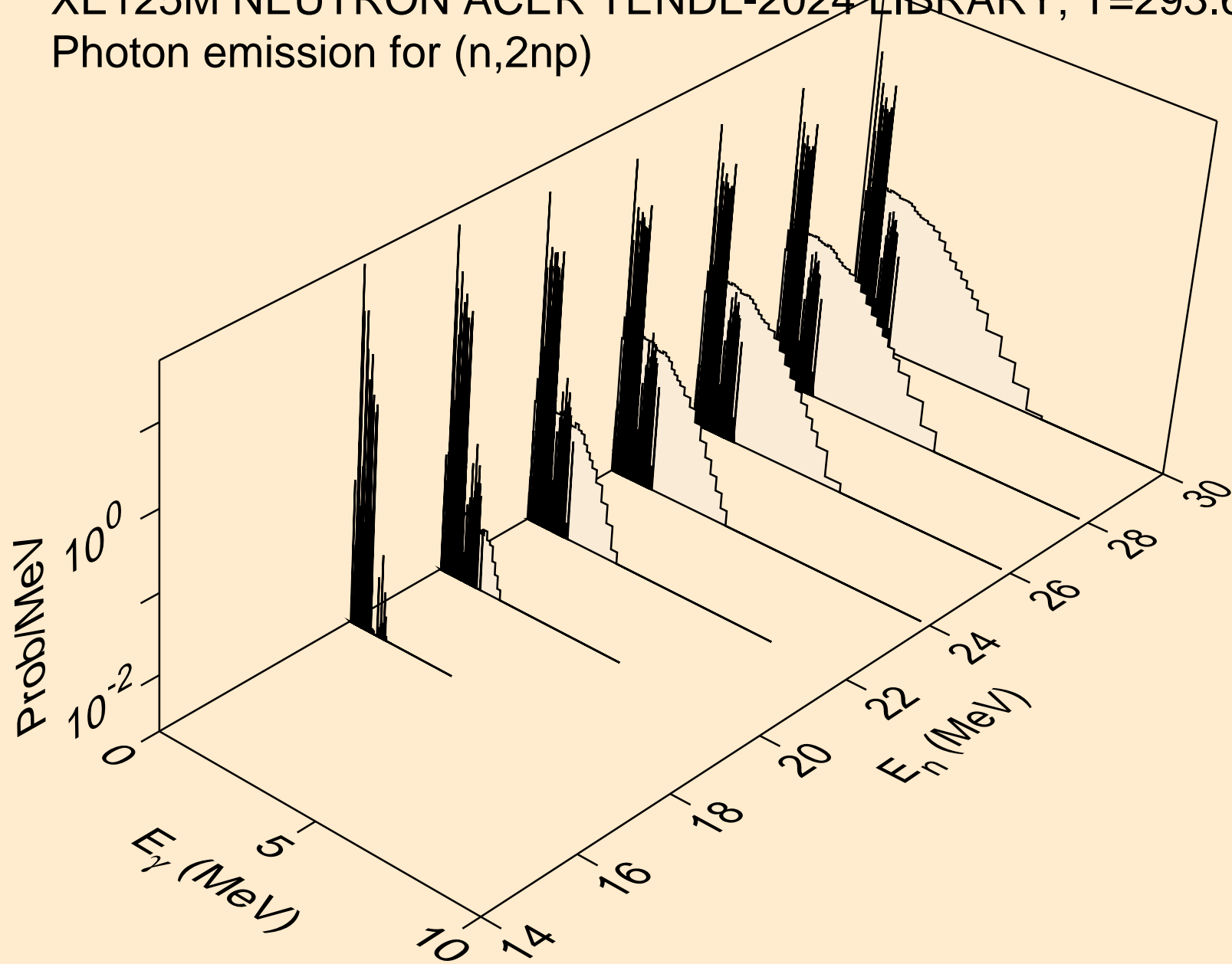

XE125M NEUTRON ACER TENDL-2024 LIBRARY; T=293.6K
Photon emission for (n,3np)

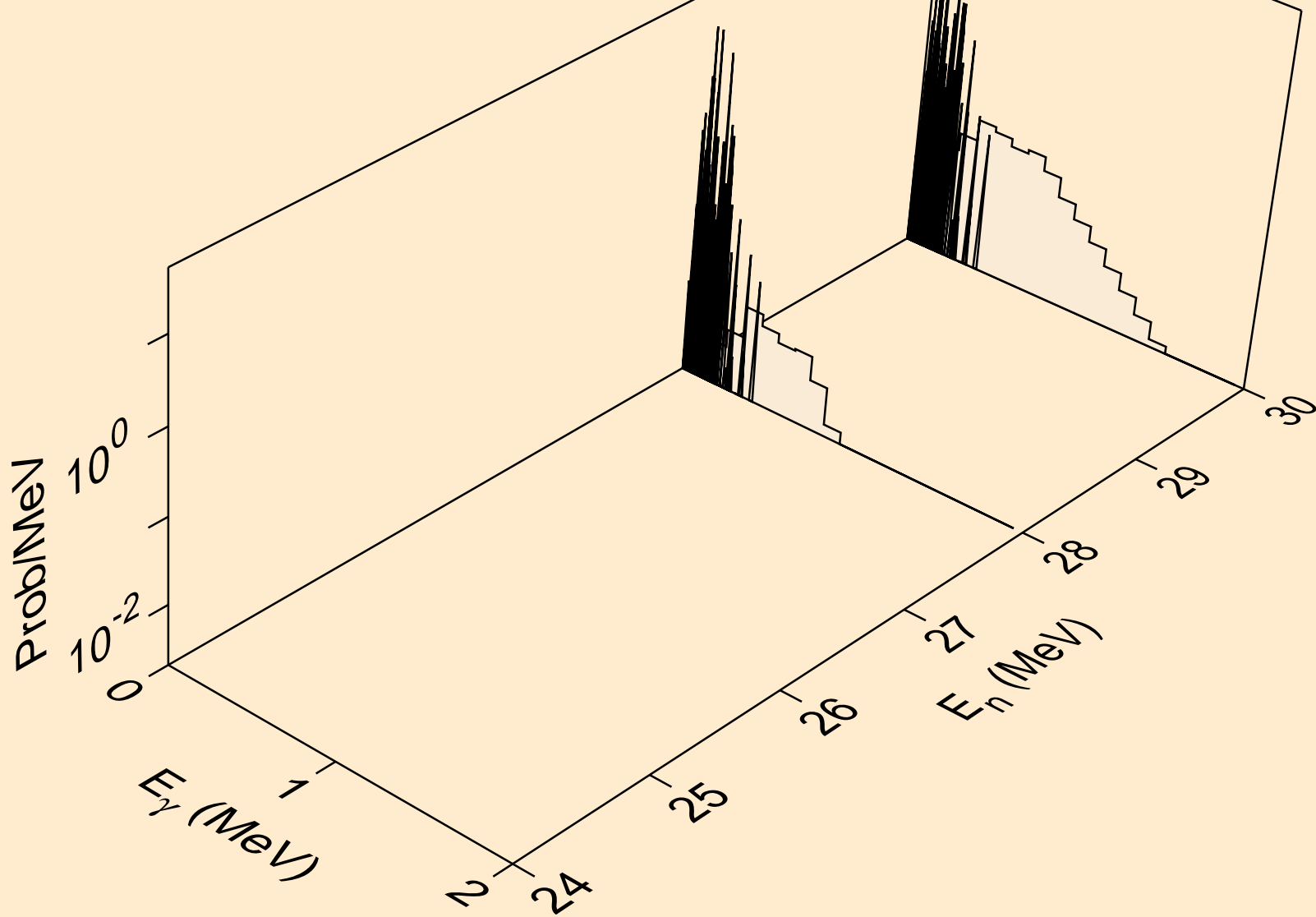

XE125M NEUTRON ACER TENDL-2024 LIBRARY; T=293.6K
Photon emission for (n,n2p)

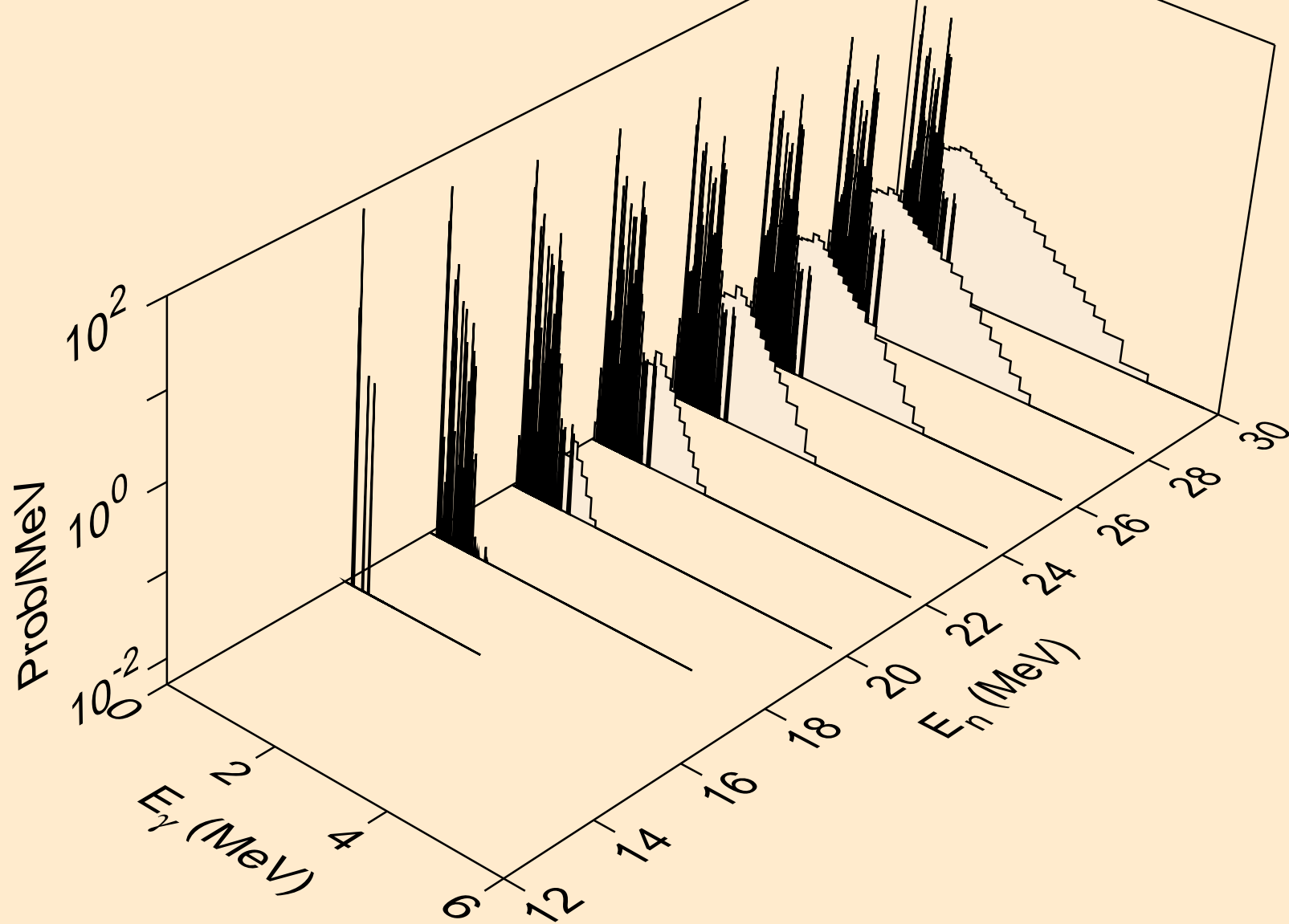

XE125M NEUTRON ACER TENDL-2024 LIBRARY; T=293.6K
Photon emission for (n,npa)

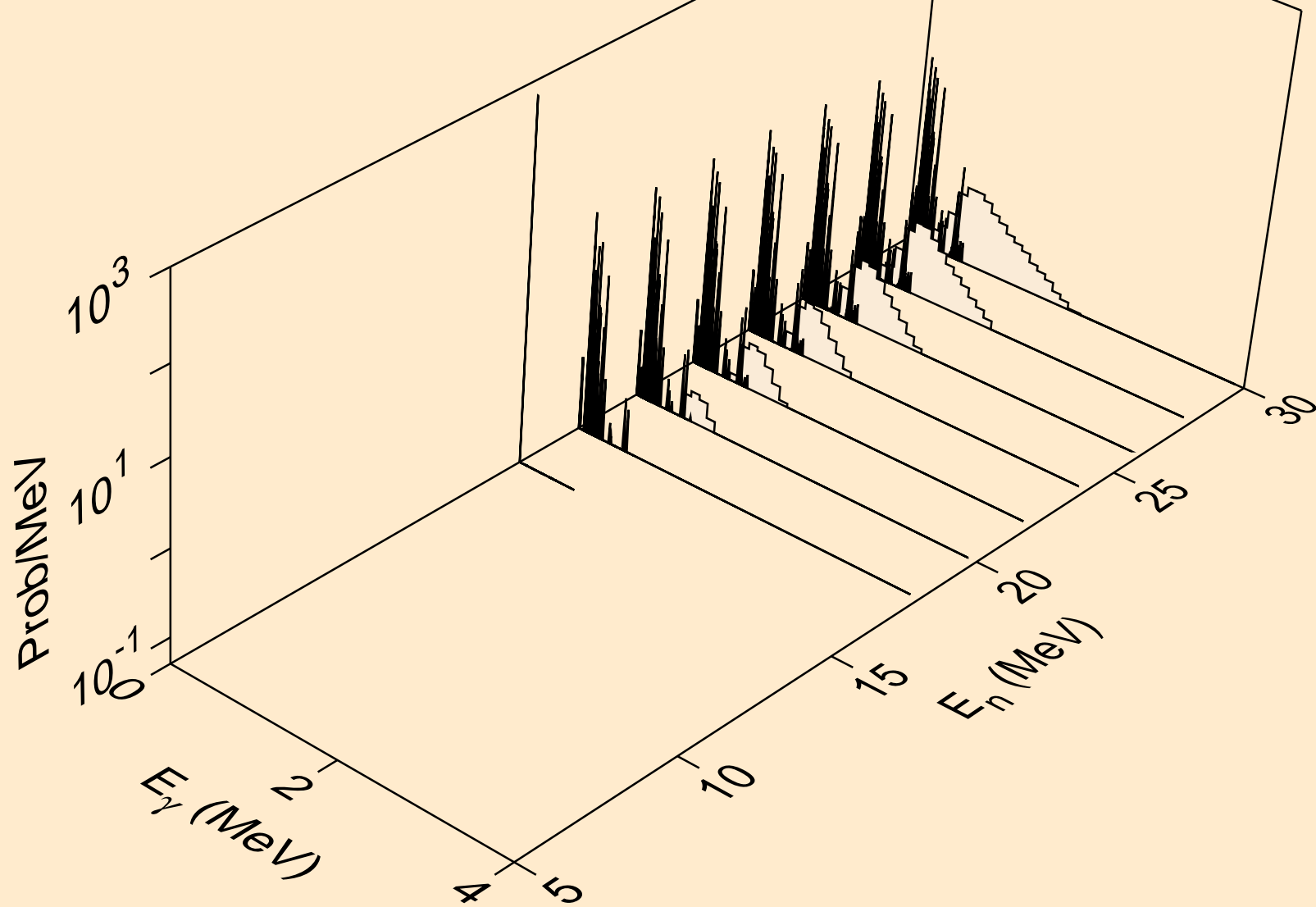

XE125M NEUTRON ACER TENDL-2024 LIBRARY; T=293.6K
Photon emission for (n,n*1)

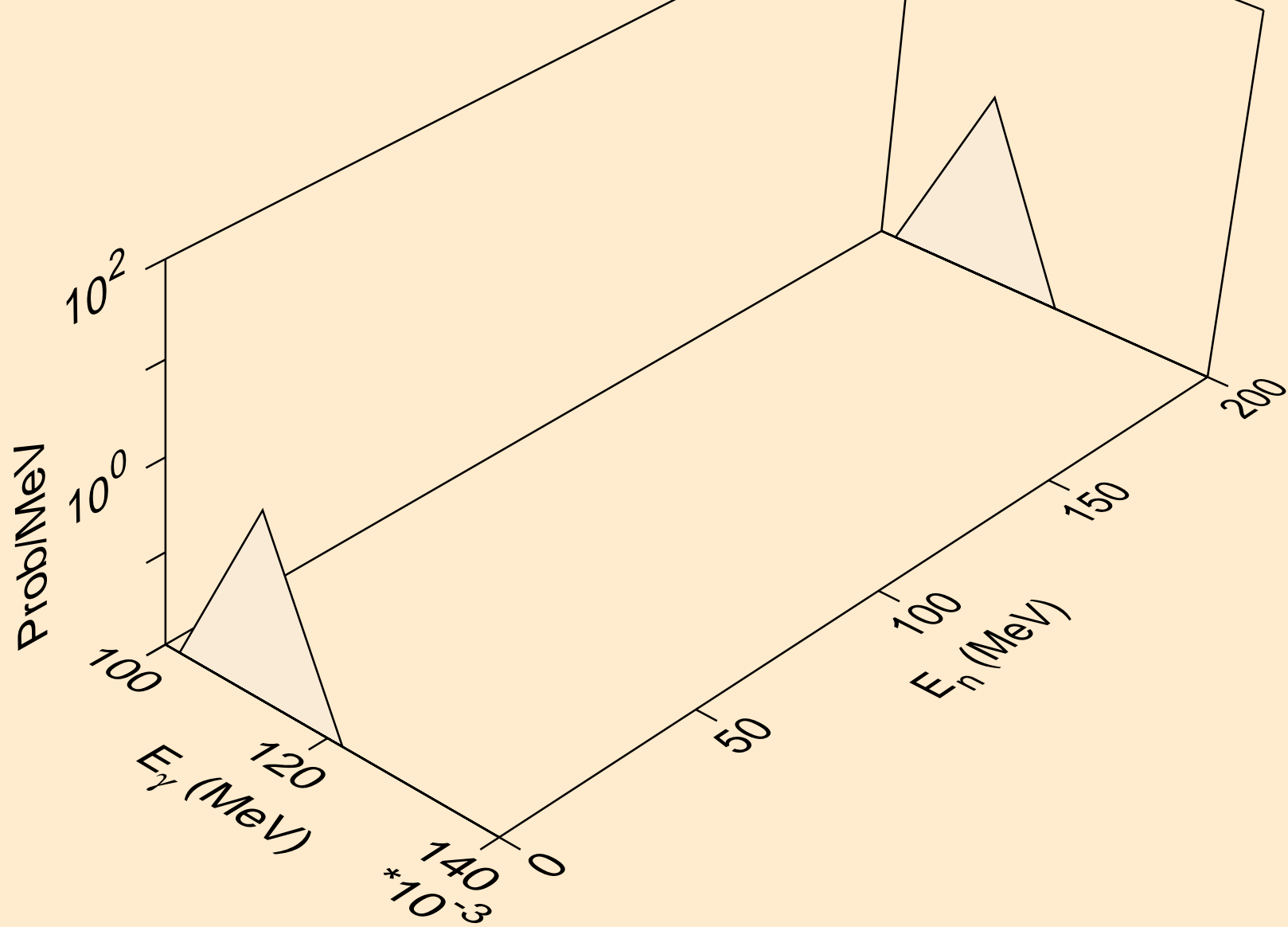

XE125M NEUTRON ACER TENDL-2024 LIBRARY; T=293.6K
Photon emission for (n,n*3)

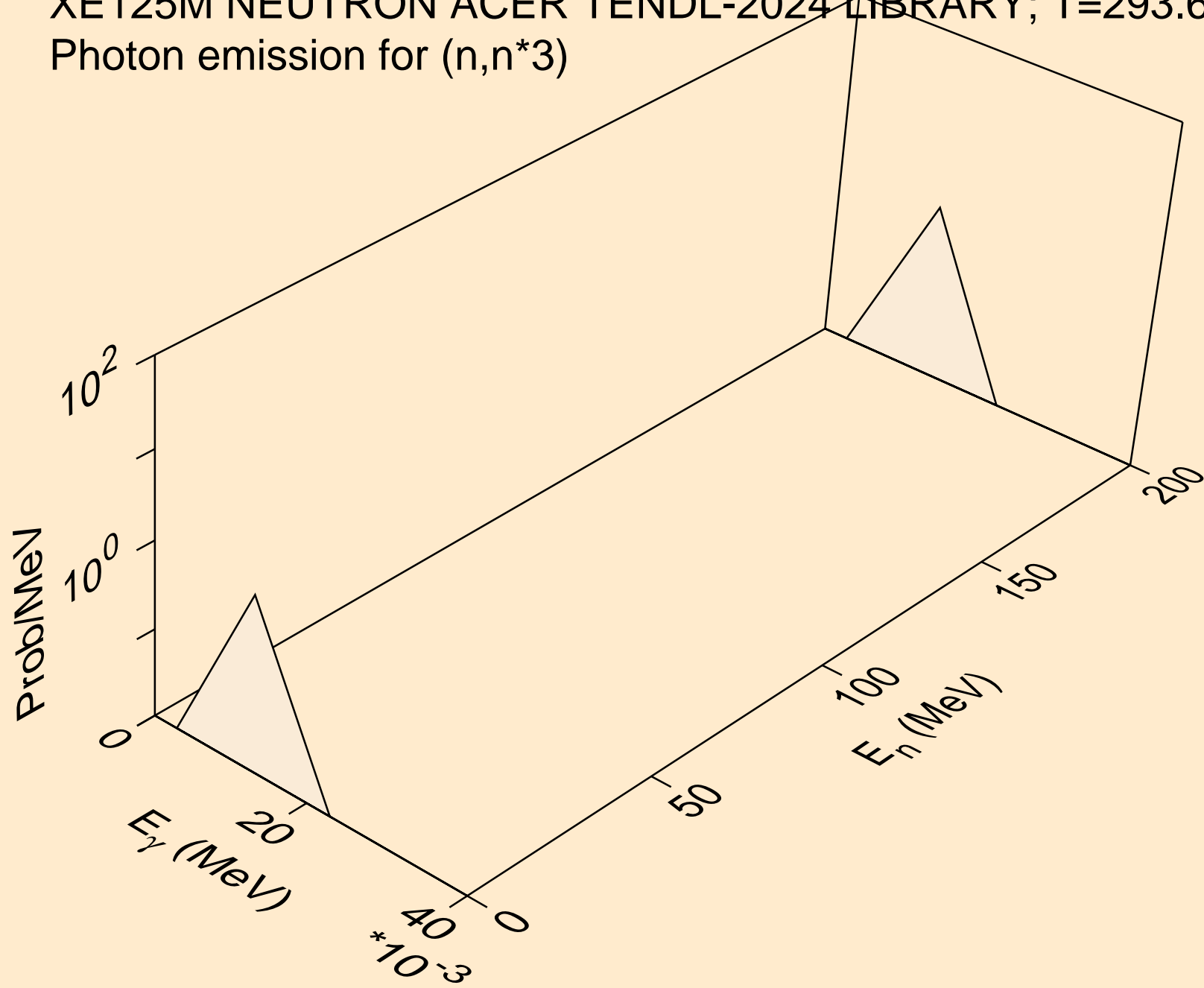

XE125M NEUTRON ACER TENDL-2024 LIBRARY; T=293.6K
Photon emission for (n,n*4)

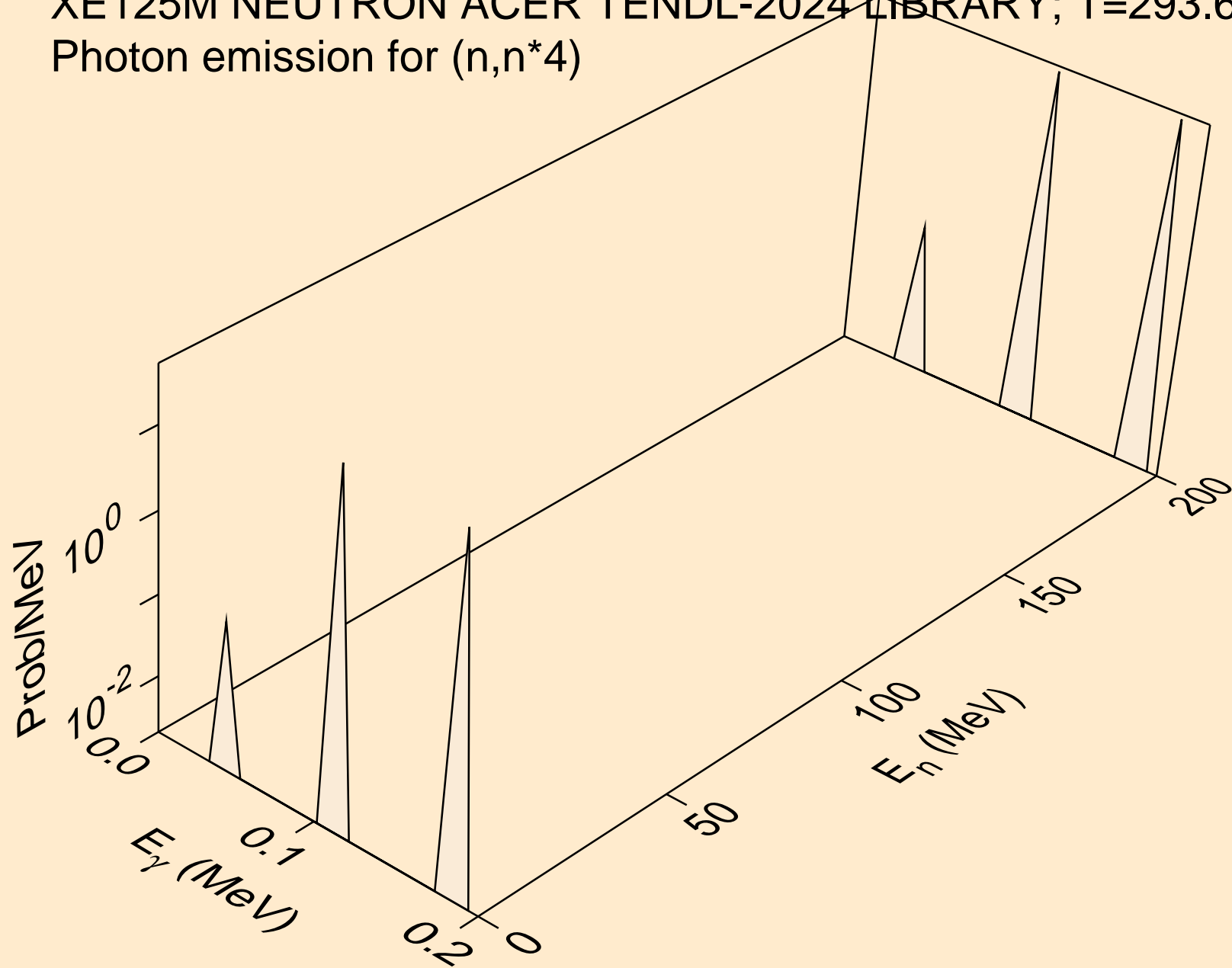

XE125M NEUTRON ACER TENDL-2024 LIBRARY; T=293.6K
Photon emission for (n,n*5)

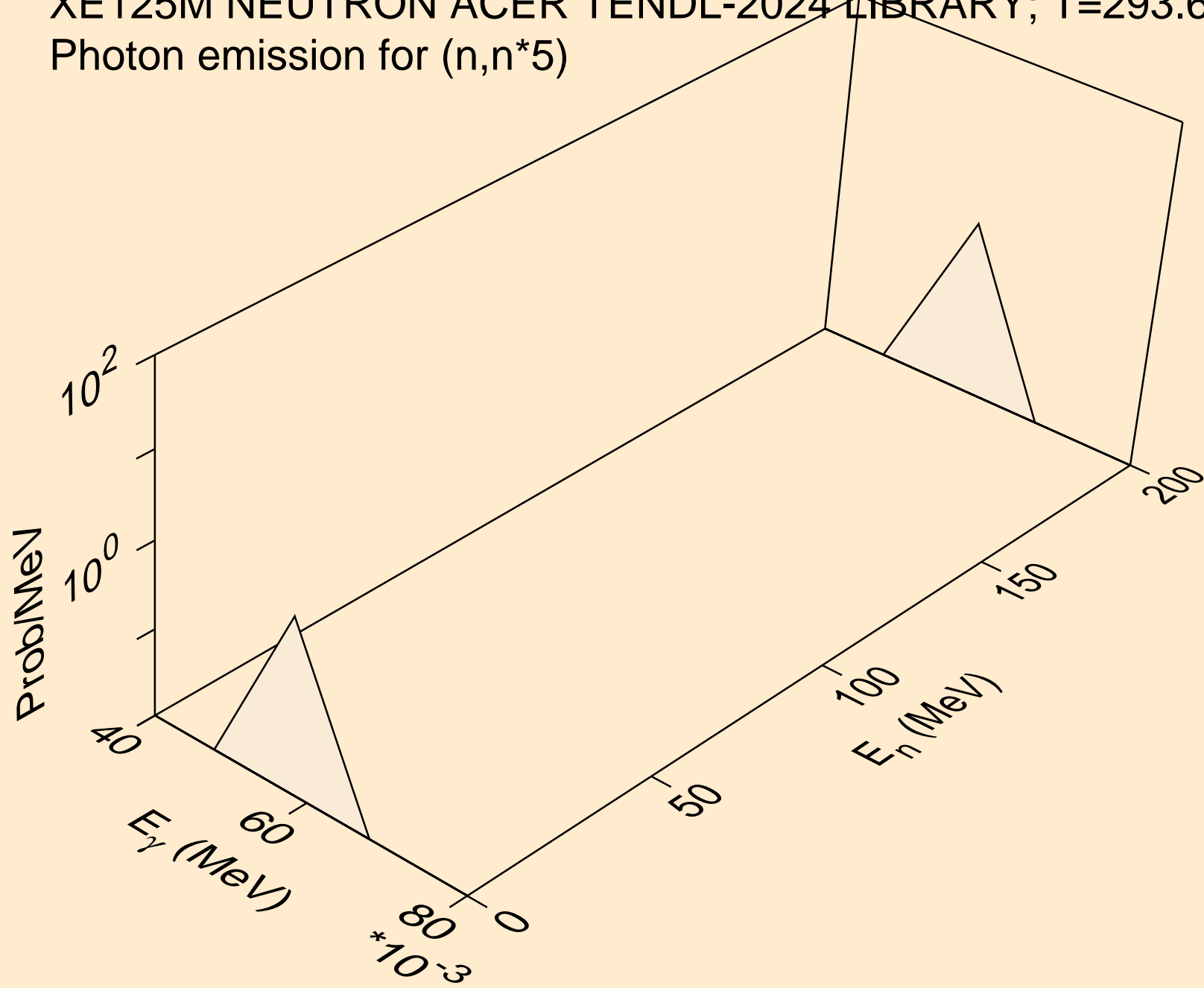

XE125M NEUTRON ACER TENDL-2024 LIBRARY; T=293.6K
Photon emission for (n,n*6)

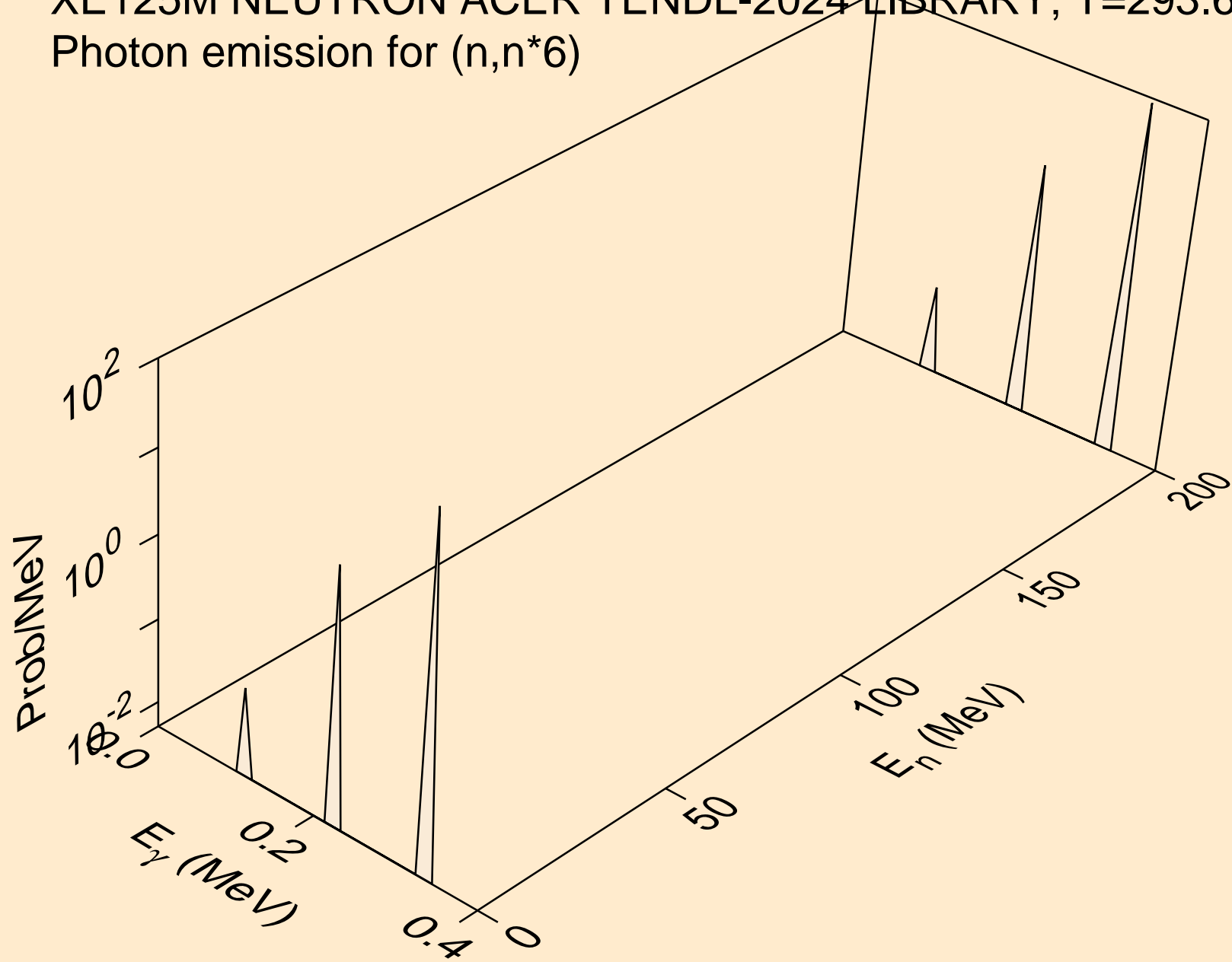

XE125M NEUTRON ACER TENDL-2024 LIBRARY; T=293.6K
Photon emission for (n,n*7)

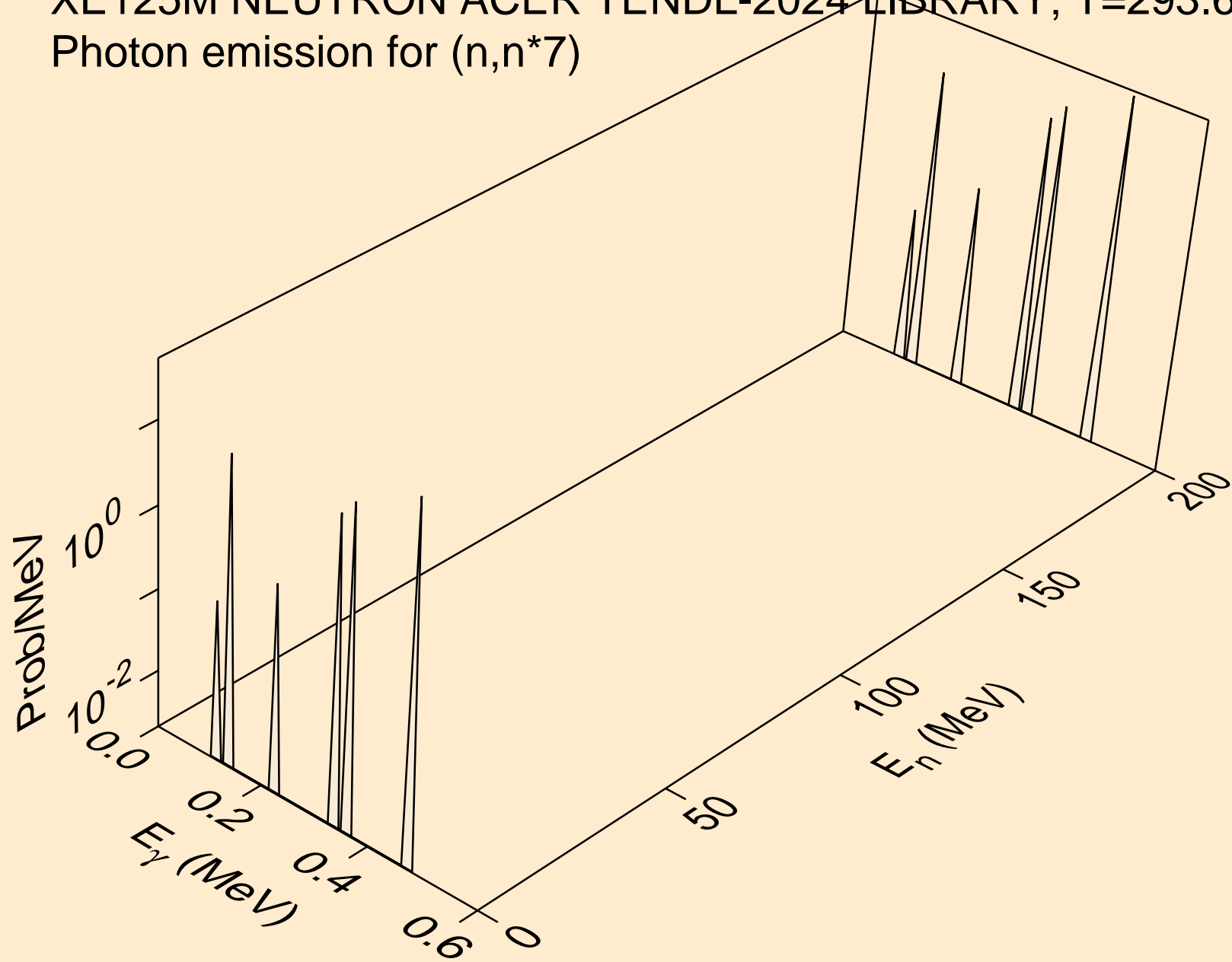

XE125M NEUTRON ACER TENDL-2024 LIBRARY; T=293.6K
Photon emission for (n,n*8)

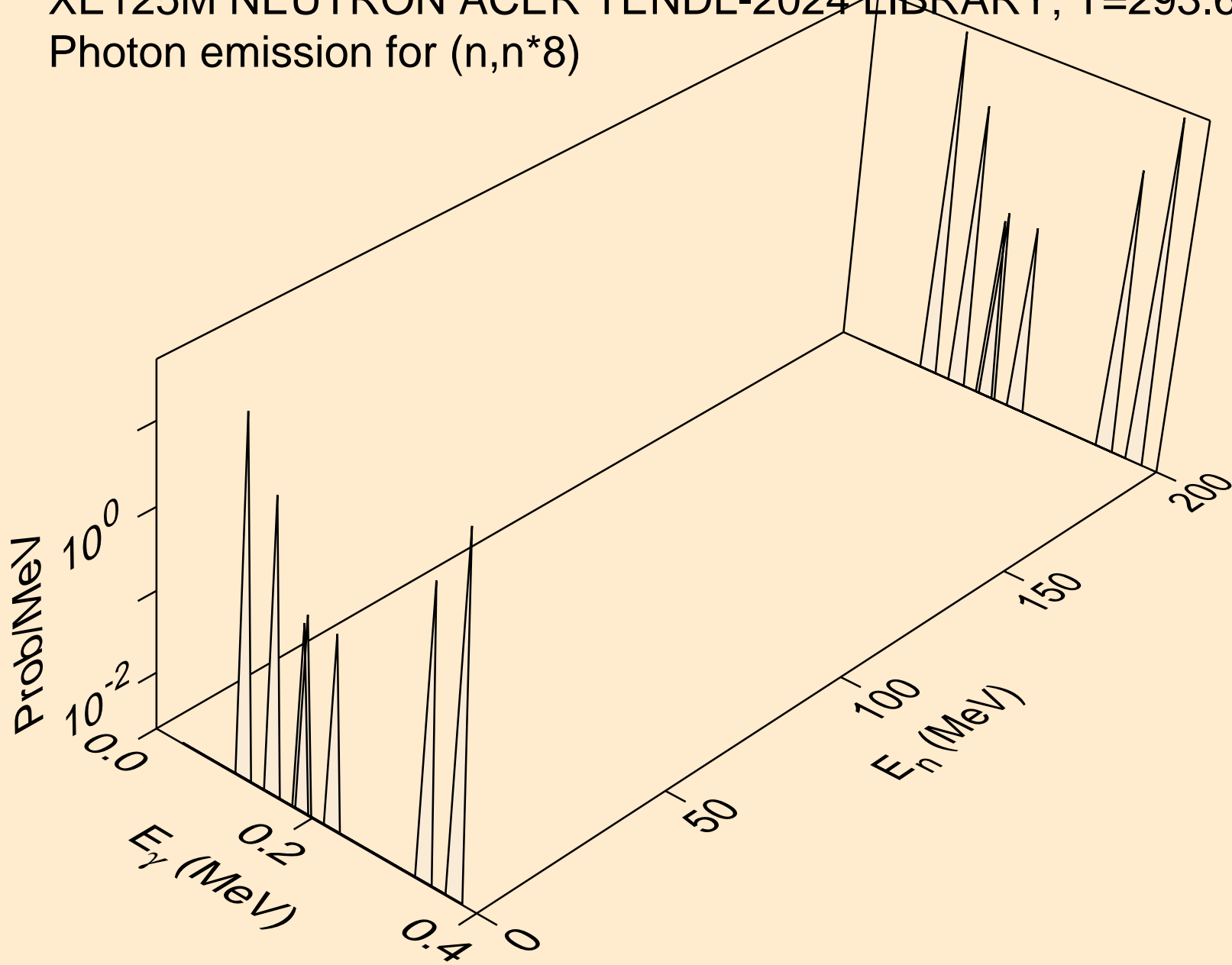

XE125M NEUTRON ACER TENDL-2024 LIBRARY; T=293.6K
Photon emission for (n,n*9)

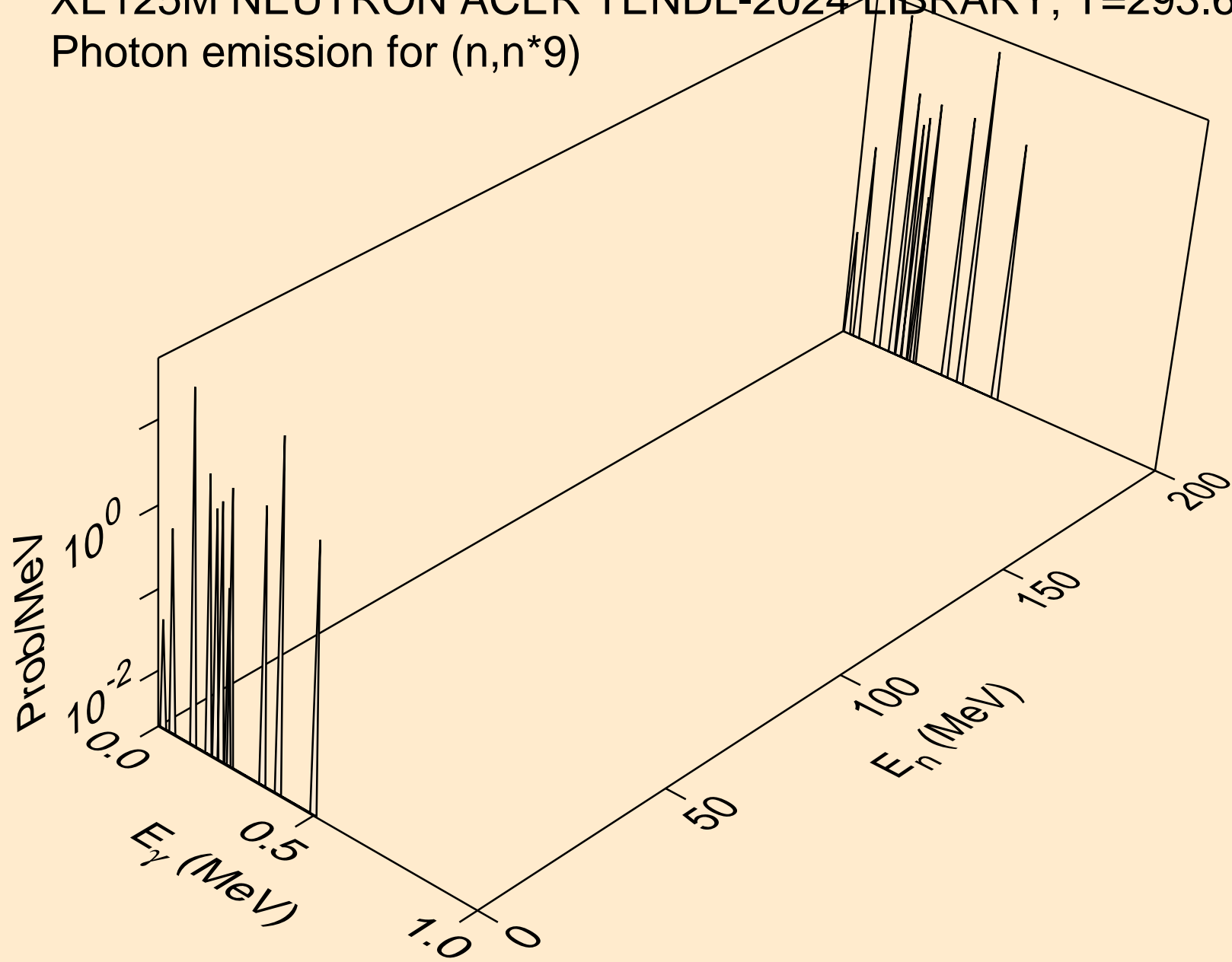

XE125M NEUTRON ACER TENDL-2024 LIBRARY; T=293.6K
Photon emission for (n,n*10)

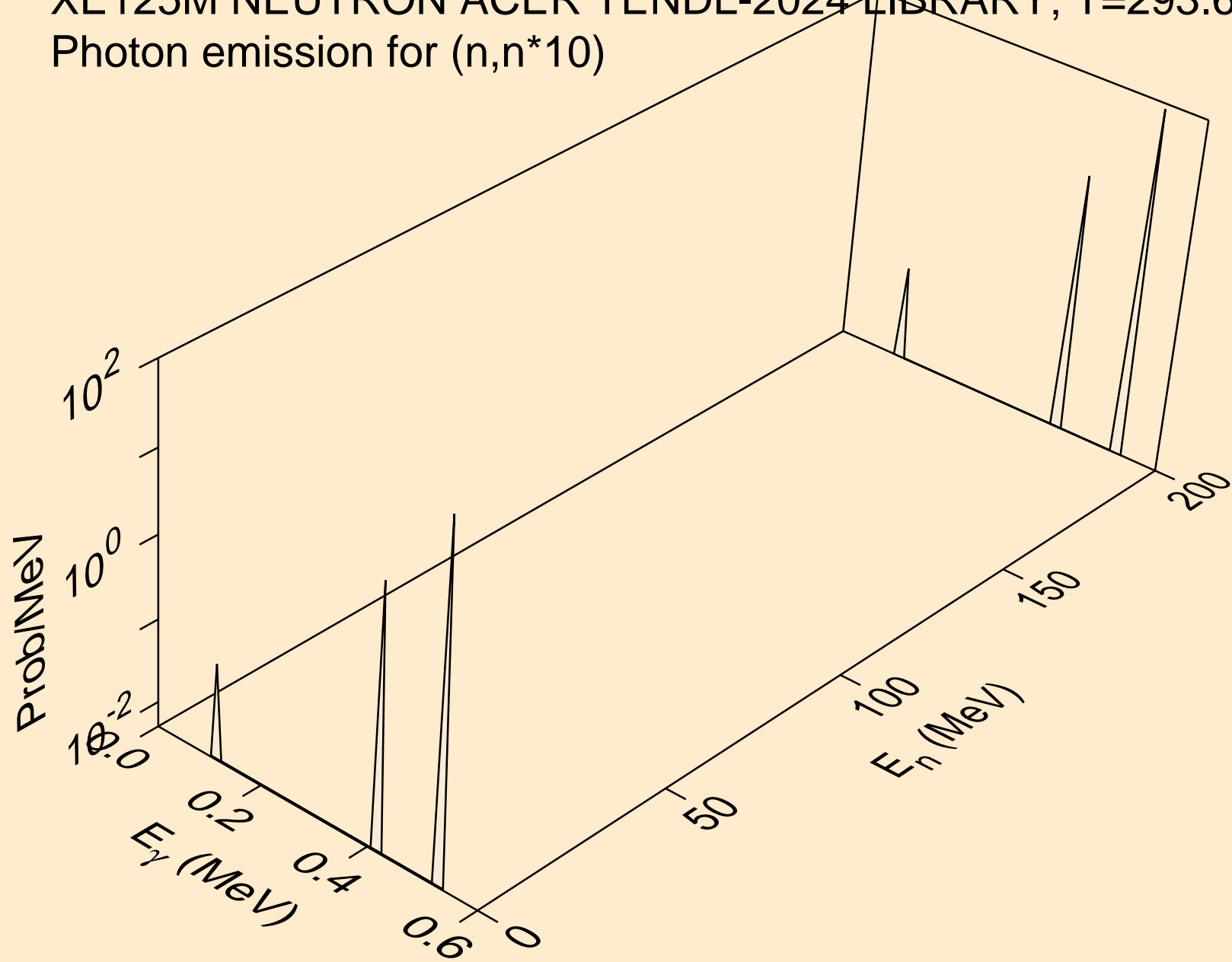

XE125M NEUTRON ACER TENDL-2024 LIBRARY; T=293.6K
Photon emission for (n,n*11)

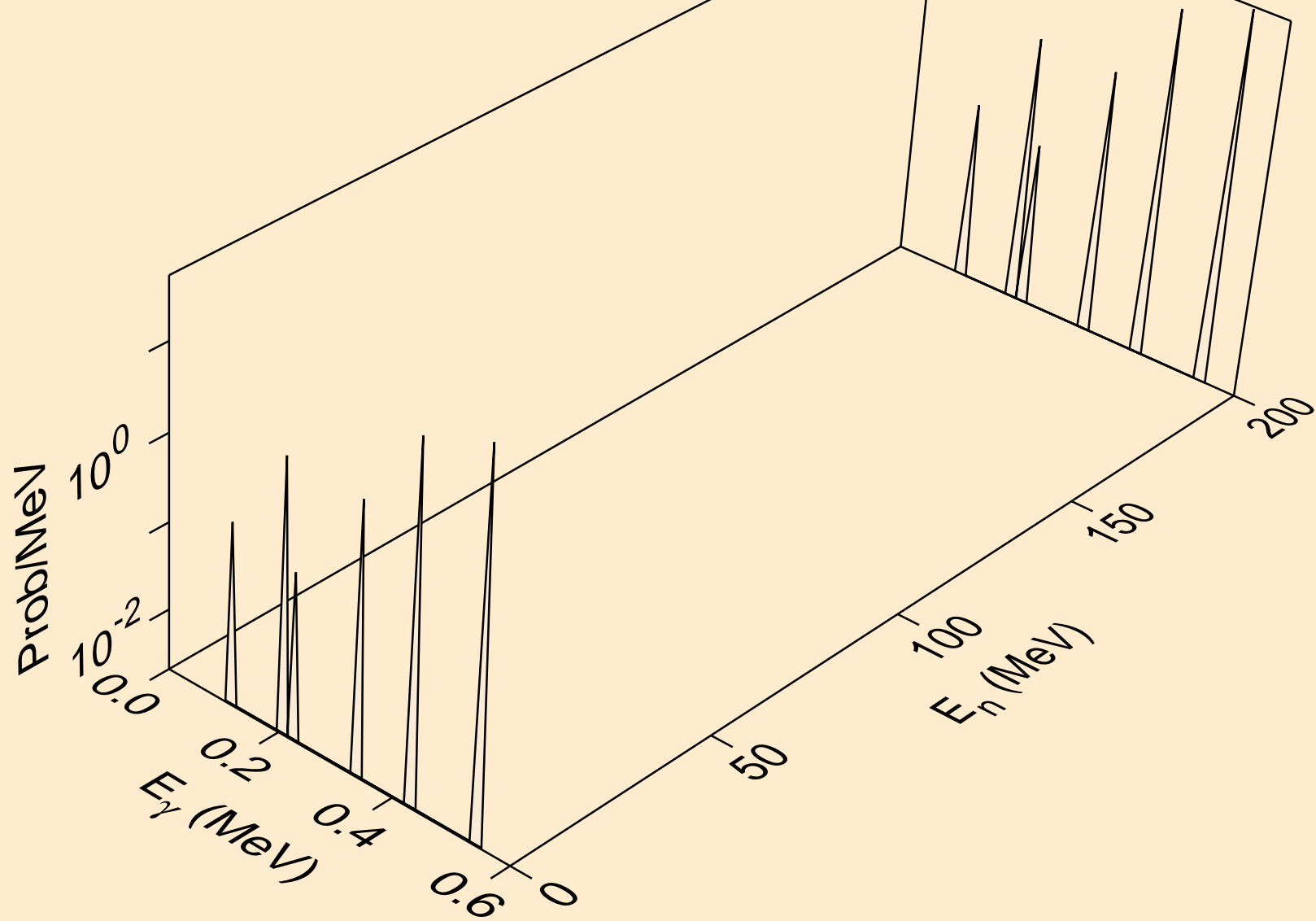

XE125M NEUTRON ACER TENDL-2024 LIBRARY; T=293.6K
Photon emission for (n,n*12)

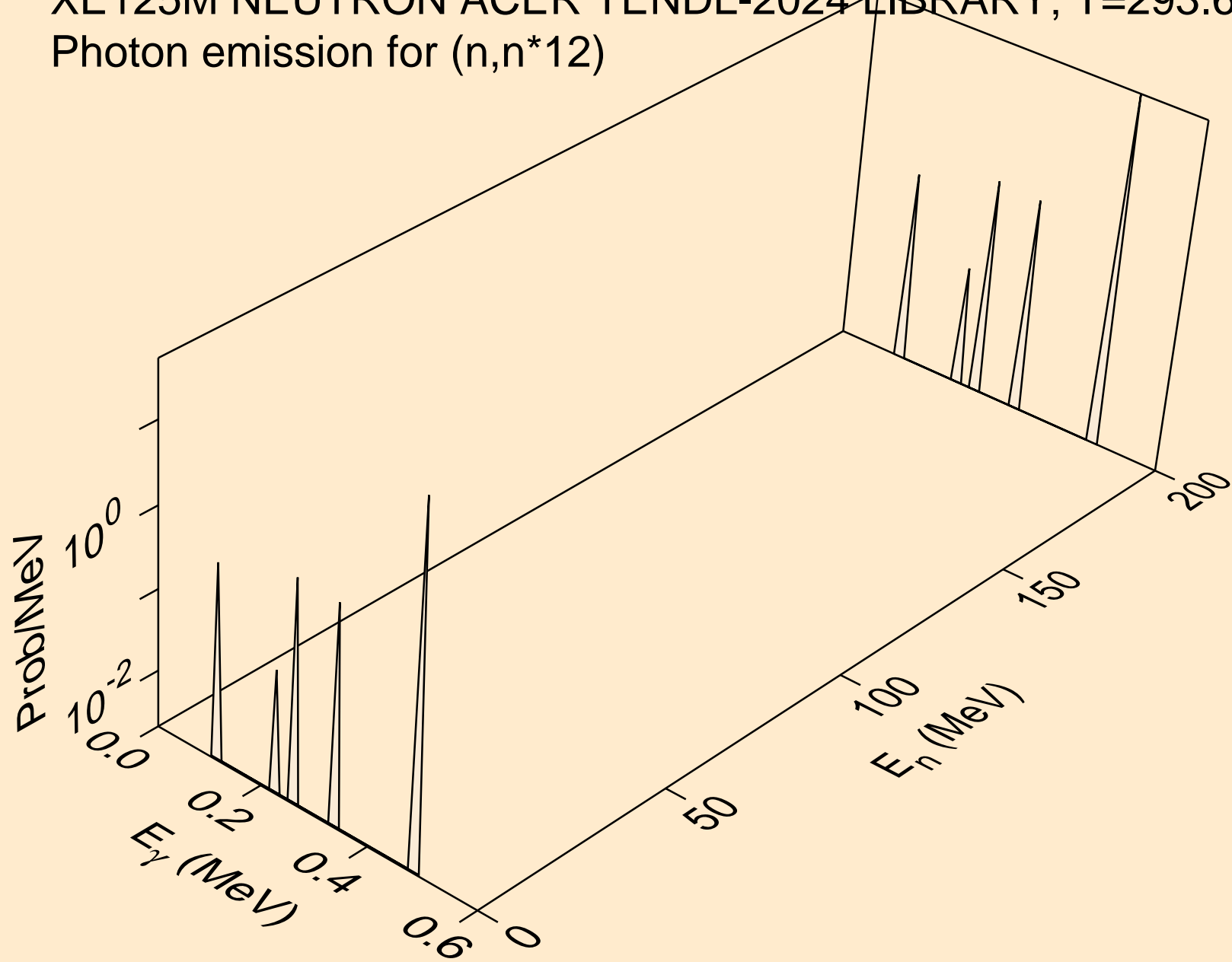

XE125M NEUTRON ACER TENDL-2024 LIBRARY; T=293.6K
Photon emission for (n,n*13)

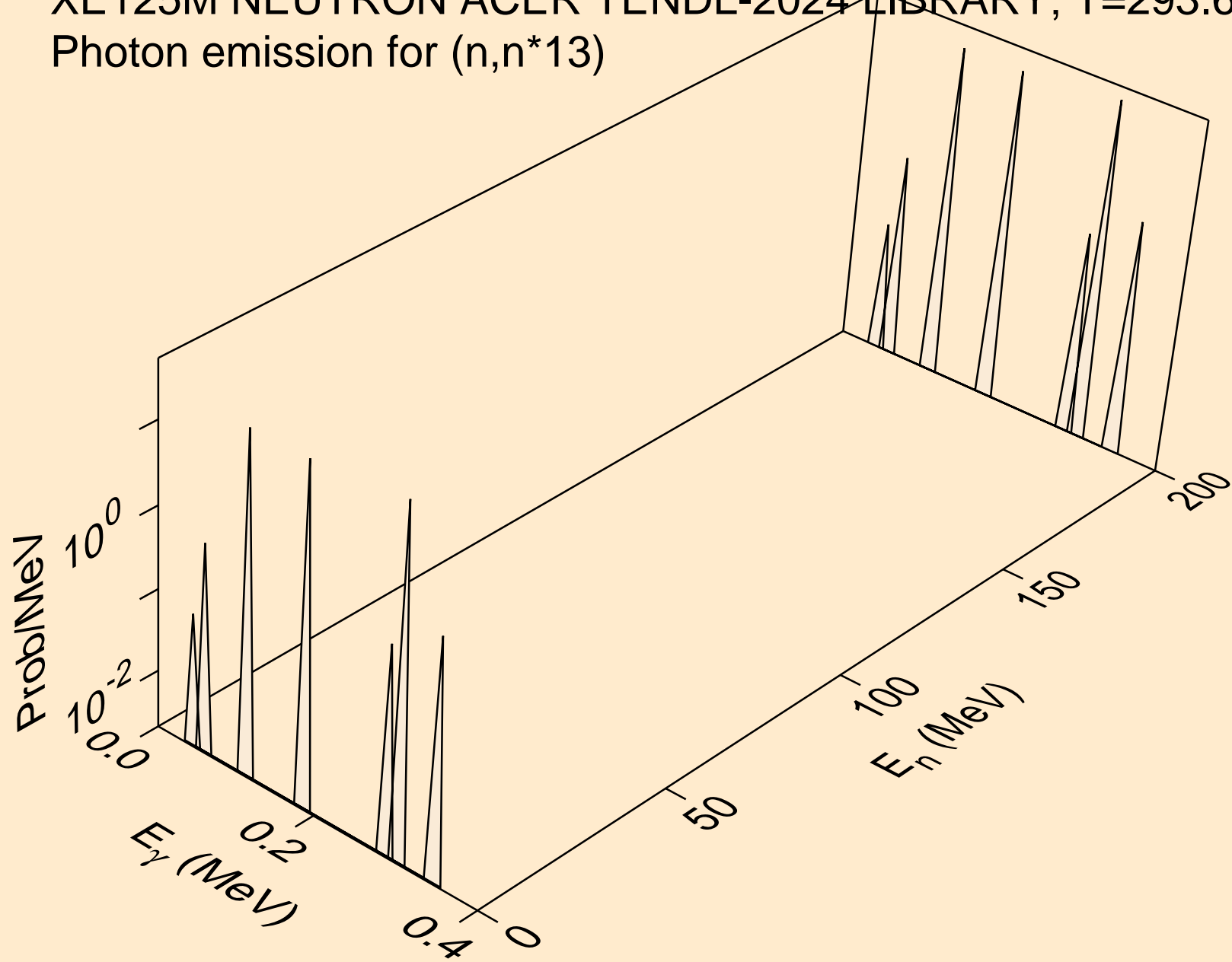

XE125M NEUTRON ACER TENDL-2024 LIBRARY; T=293.6K
Photon emission for (n,n*14)

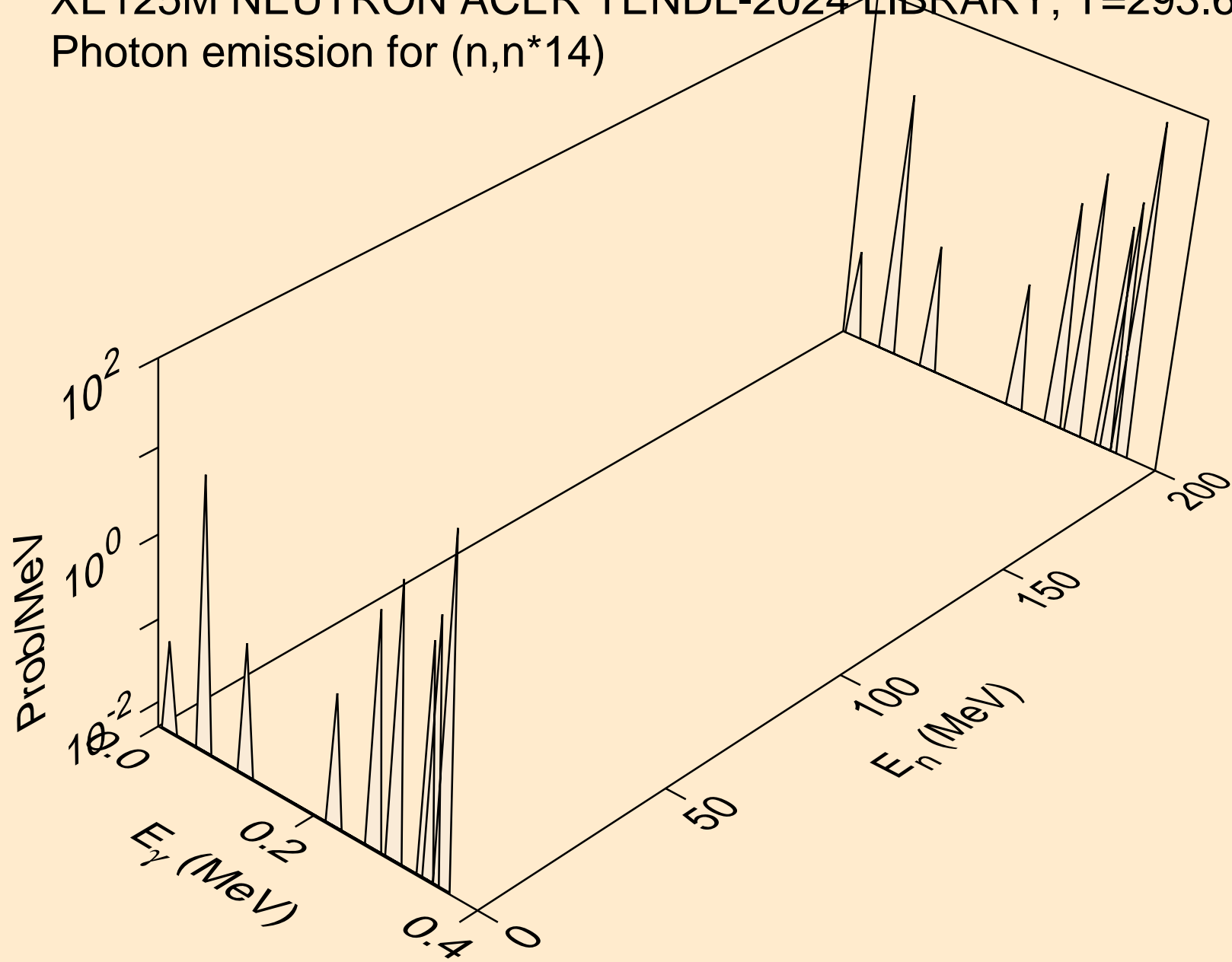

XE125M NEUTRON ACER TENDL-2024 LIBRARY; T=293.6K
Photon emission for (n,n*15)

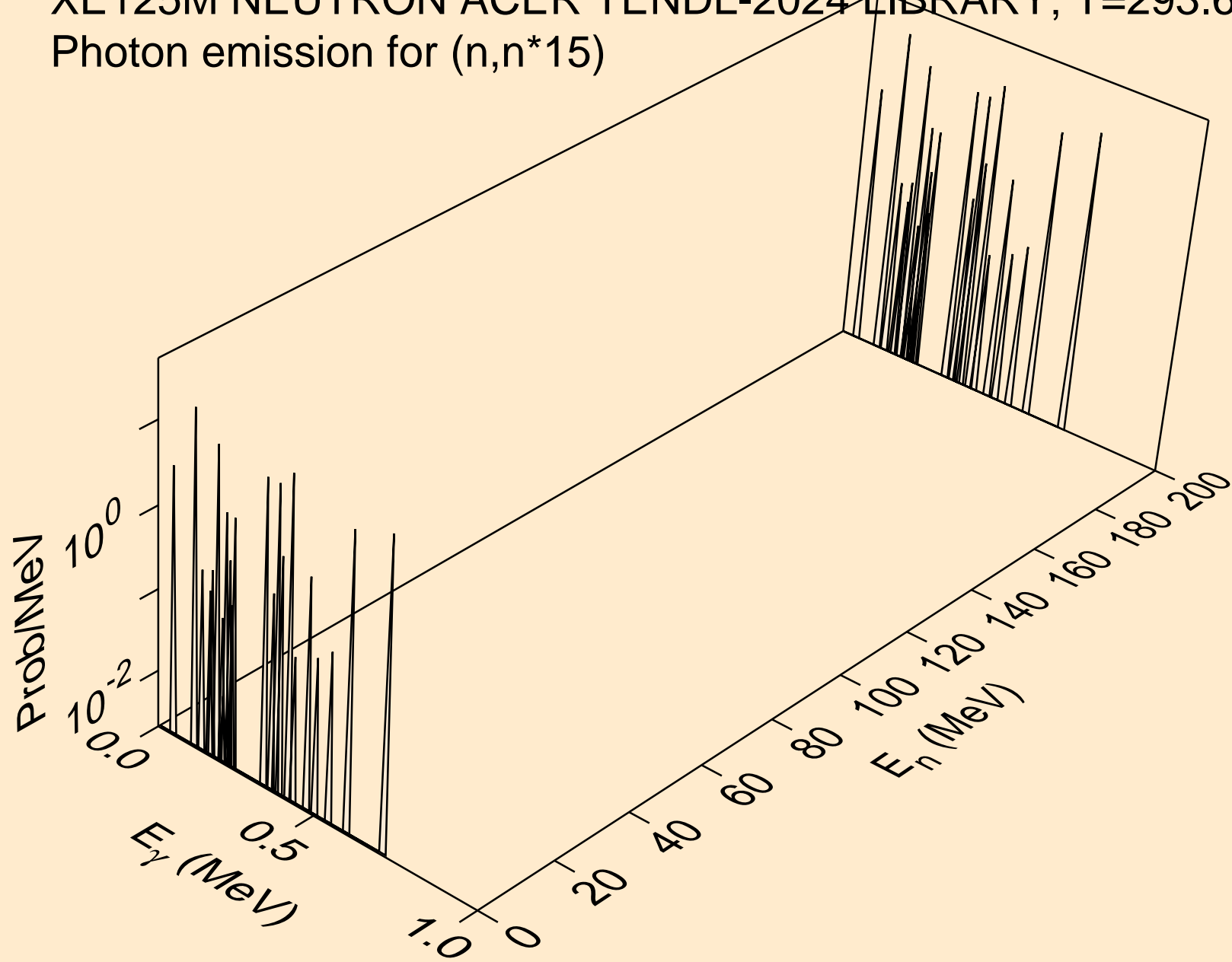

XE125M NEUTRON ACER TENDL-2024 LIBRARY; T=293.6K
Photon emission for (n,n*16)

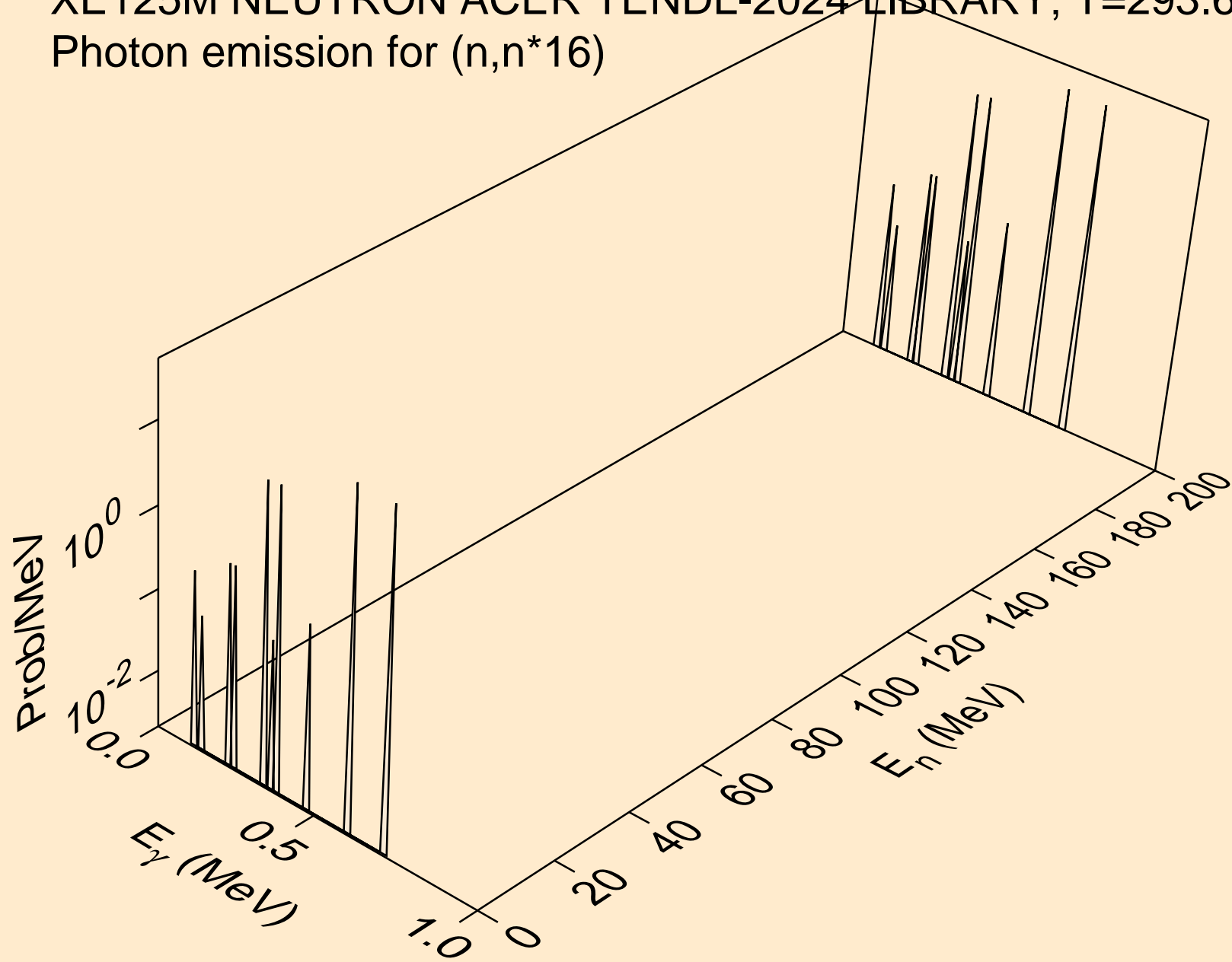

XE125M NEUTRON ACER TENDL-2024 LIBRARY; T=293.6K
Photon emission for (n,n*17)

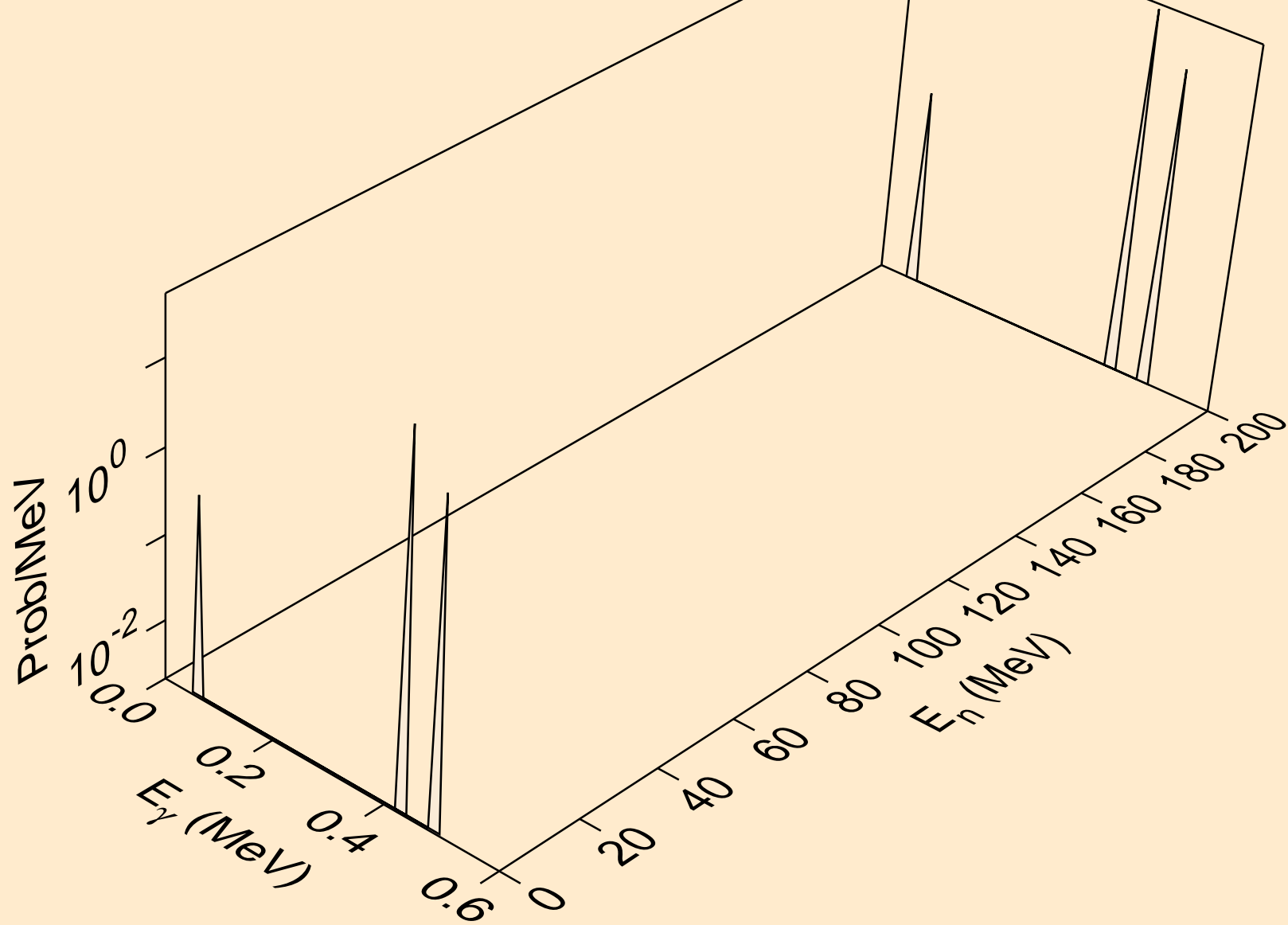

XE125M NEUTRON ACER TENDL-2024 LIBRARY; T=293.6K
Photon emission for (n,n*18)

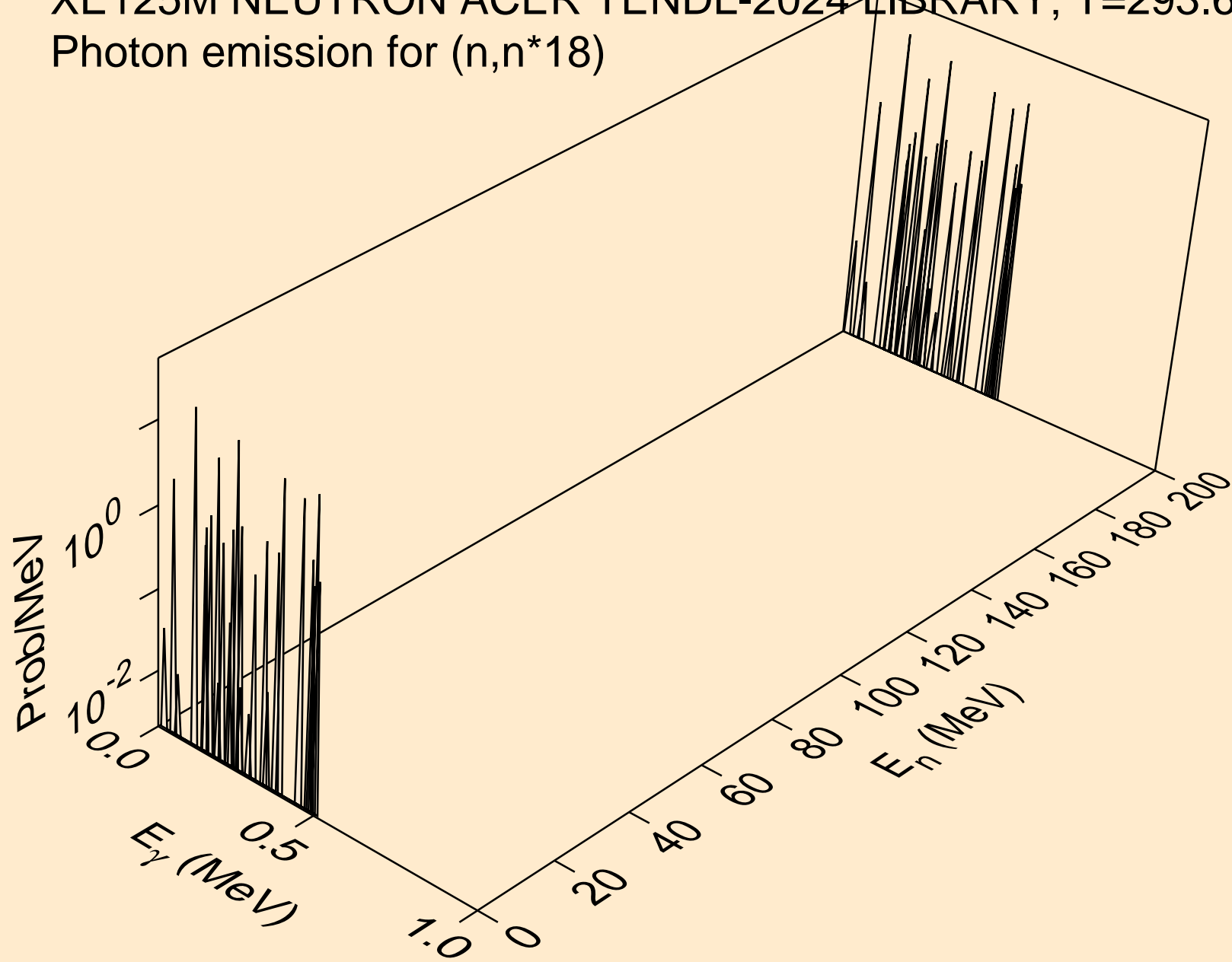

XE125M NEUTRON ACER TENDL-2024 LIBRARY; T=293.6K
Photon emission for (n,n*19)

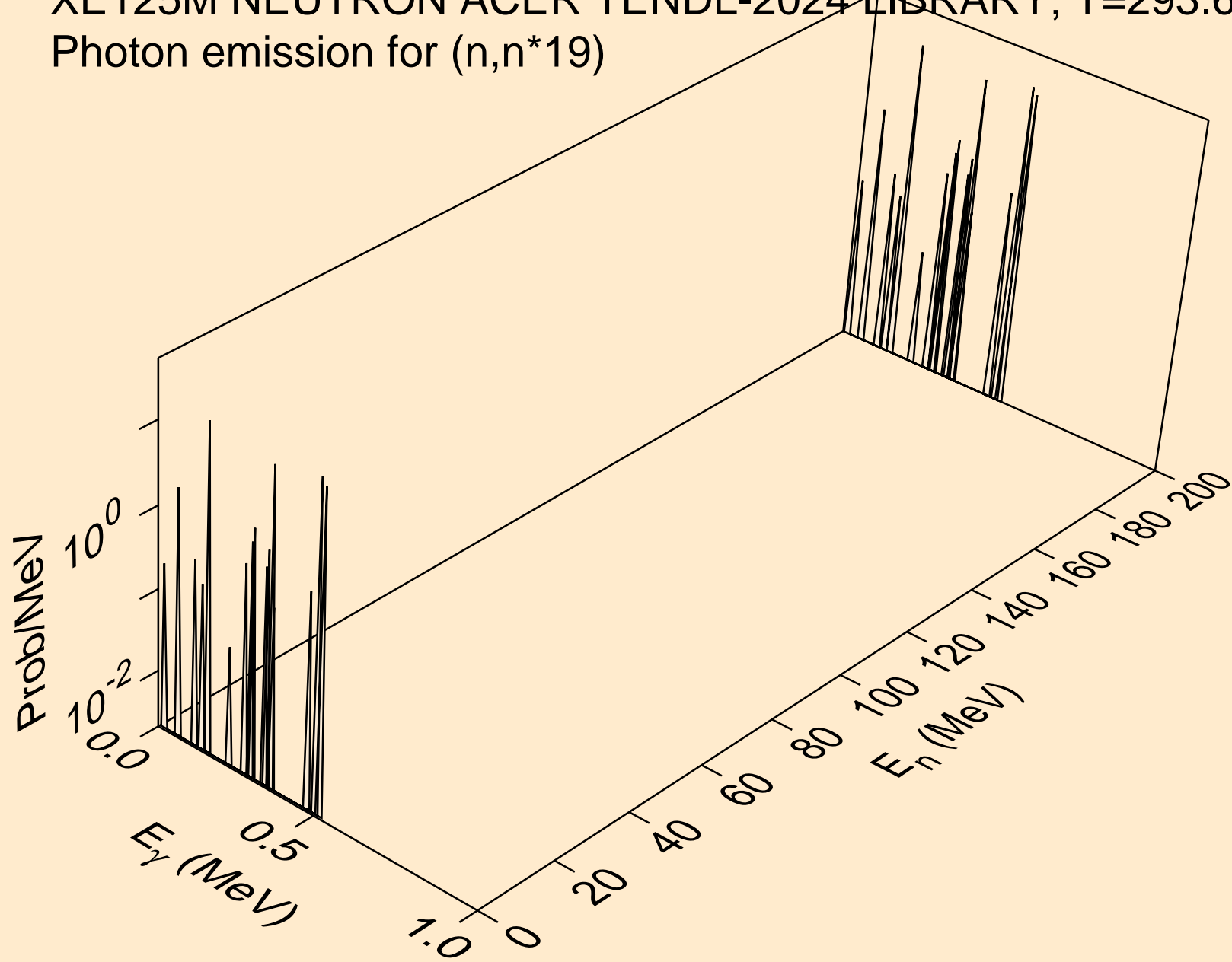

XE125M NEUTRON ACER TENDL-2024 LIBRARY; T=293.6K
Photon emission for (n,n*20)

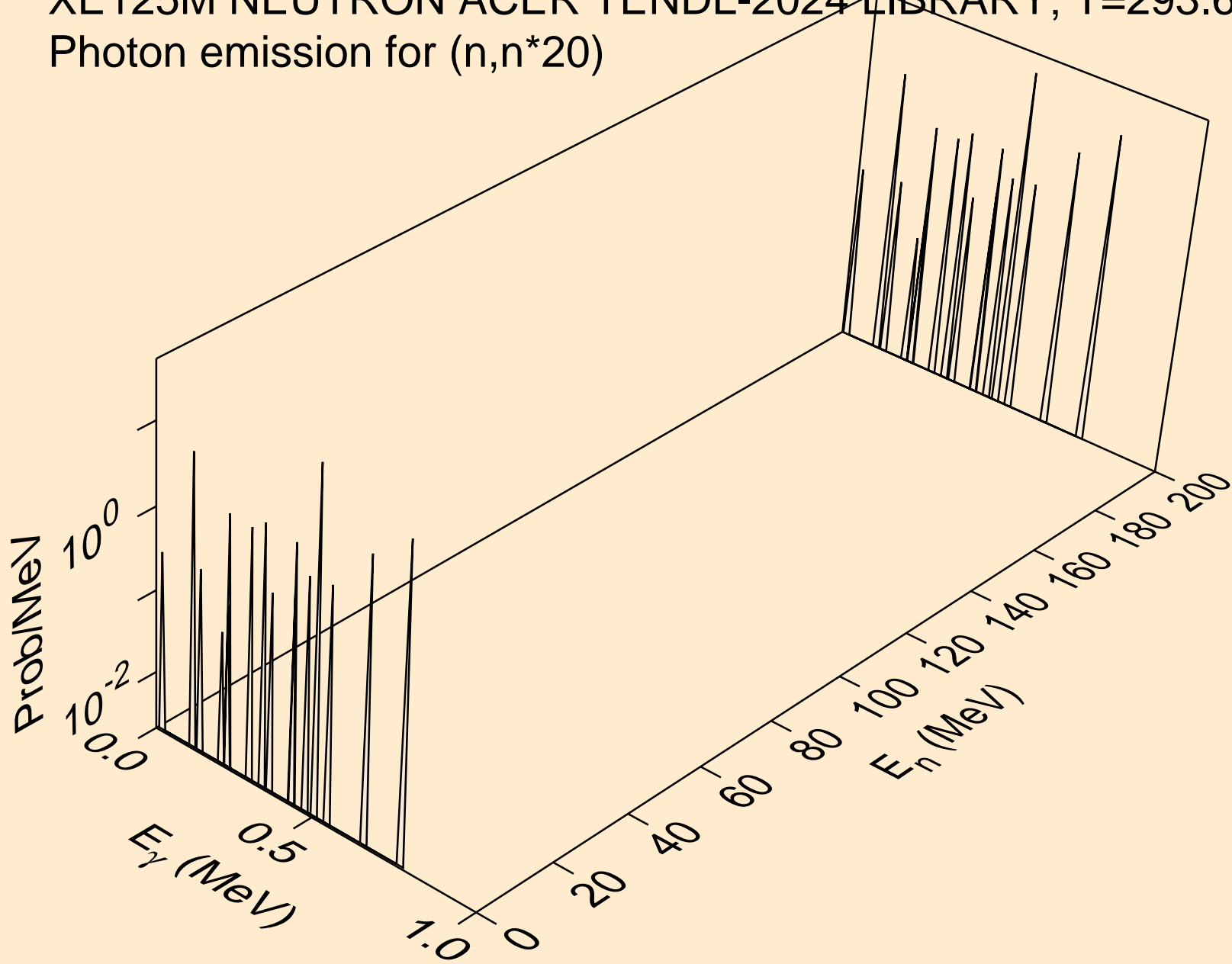

XE125M NEUTRON ACER TENDL-2024 LIBRARY; T=293.6K
Photon emission for (n,n*21)

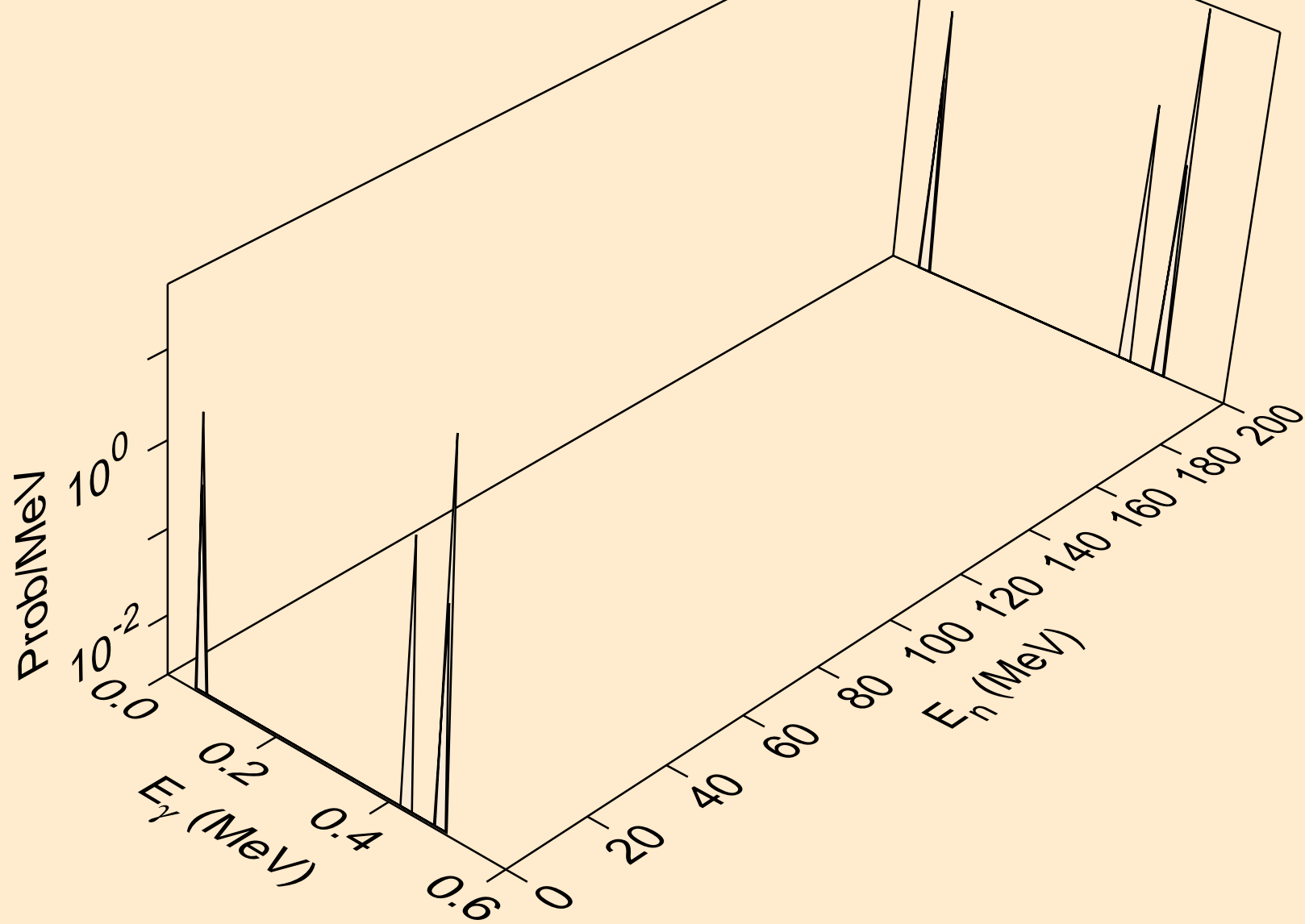

XE125M NEUTRON ACER TENDL-2024 LIBRARY; T=293.6K
Photon emission for (n,n*22)

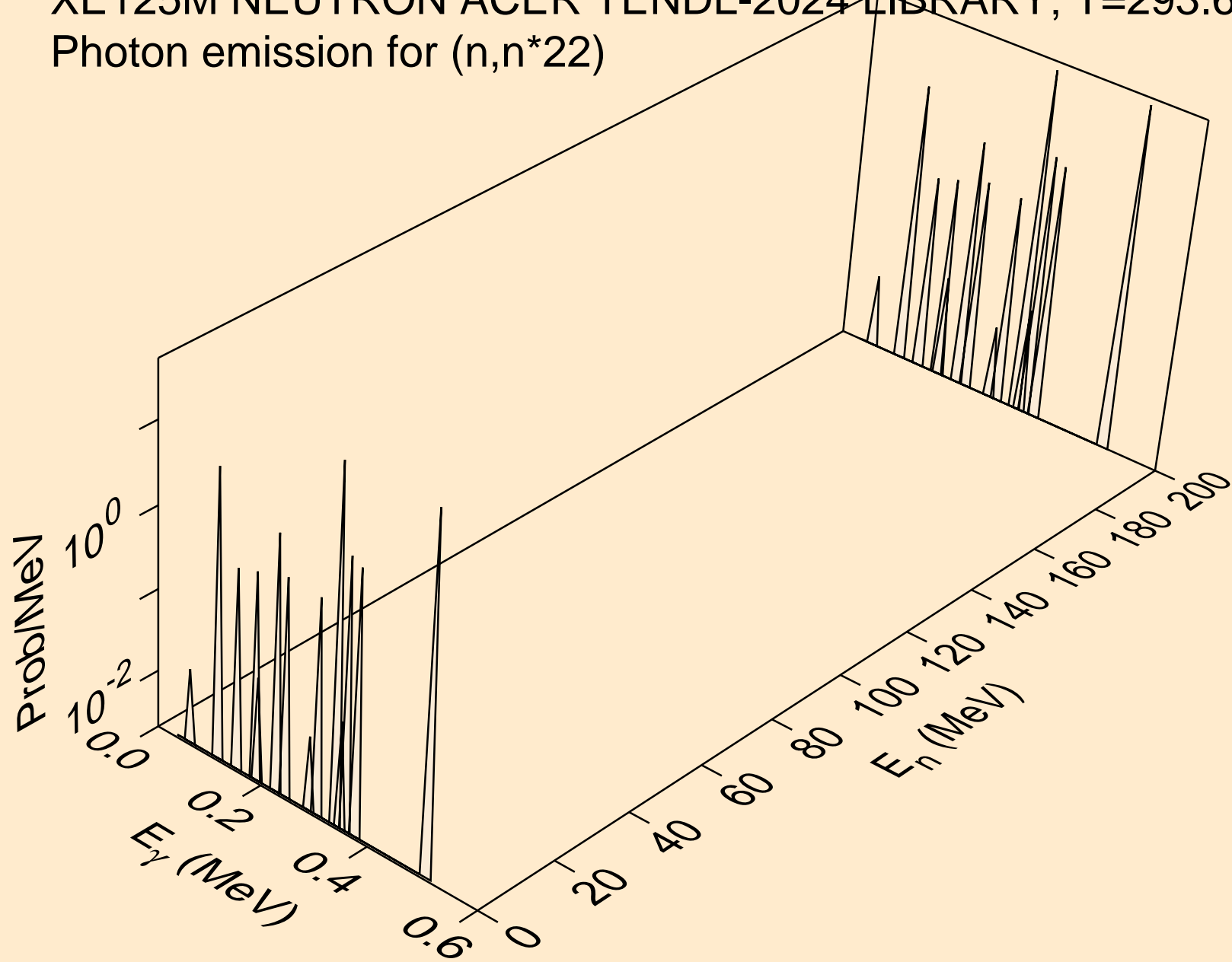

XE125M NEUTRON ACER TENDL-2024 LIBRARY; T=293.6K
Photon emission for (n,n*23)

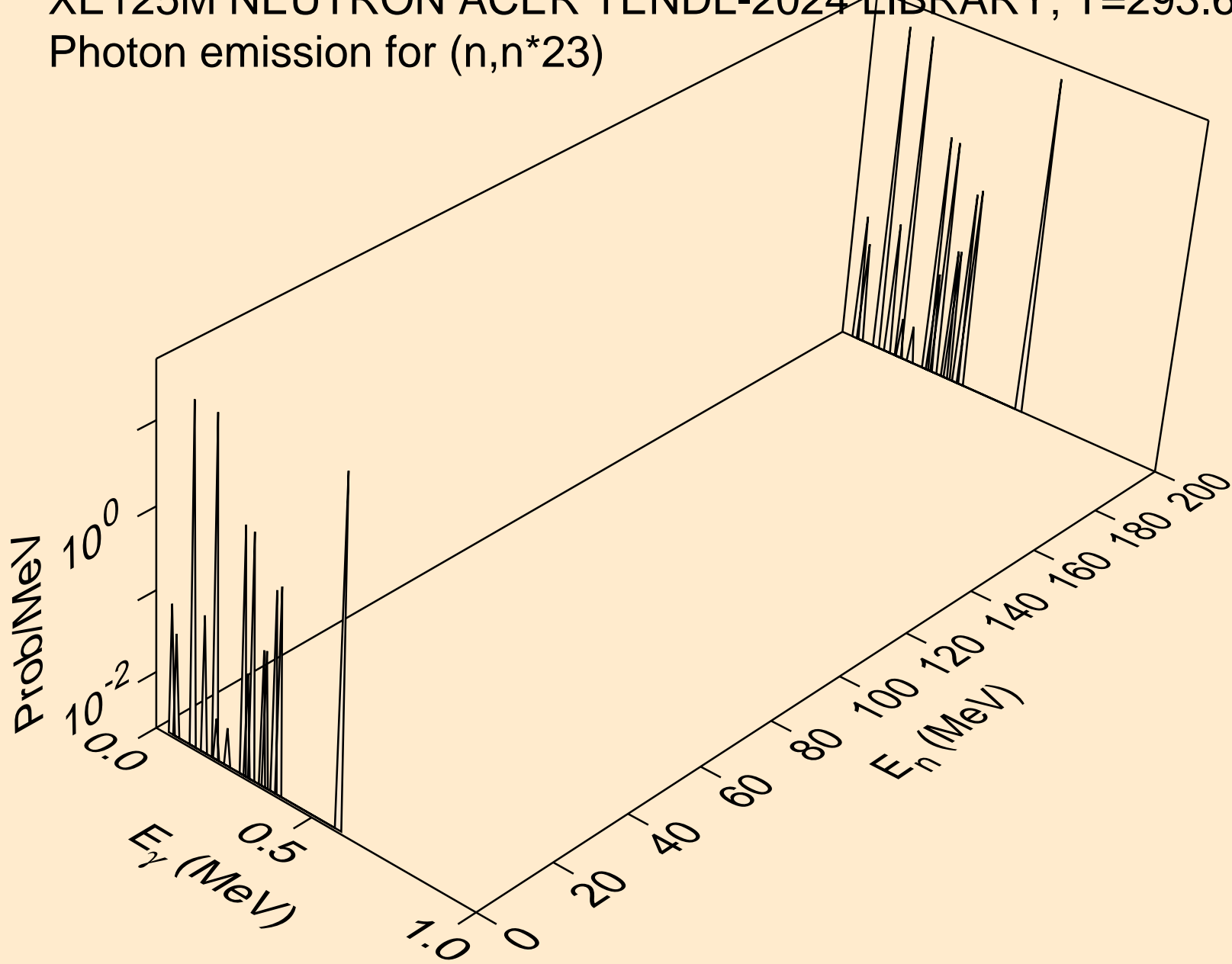

XE125M NEUTRON ACER TENDL-2024 LIBRARY; T=293.6K
Photon emission for (n,n*24)

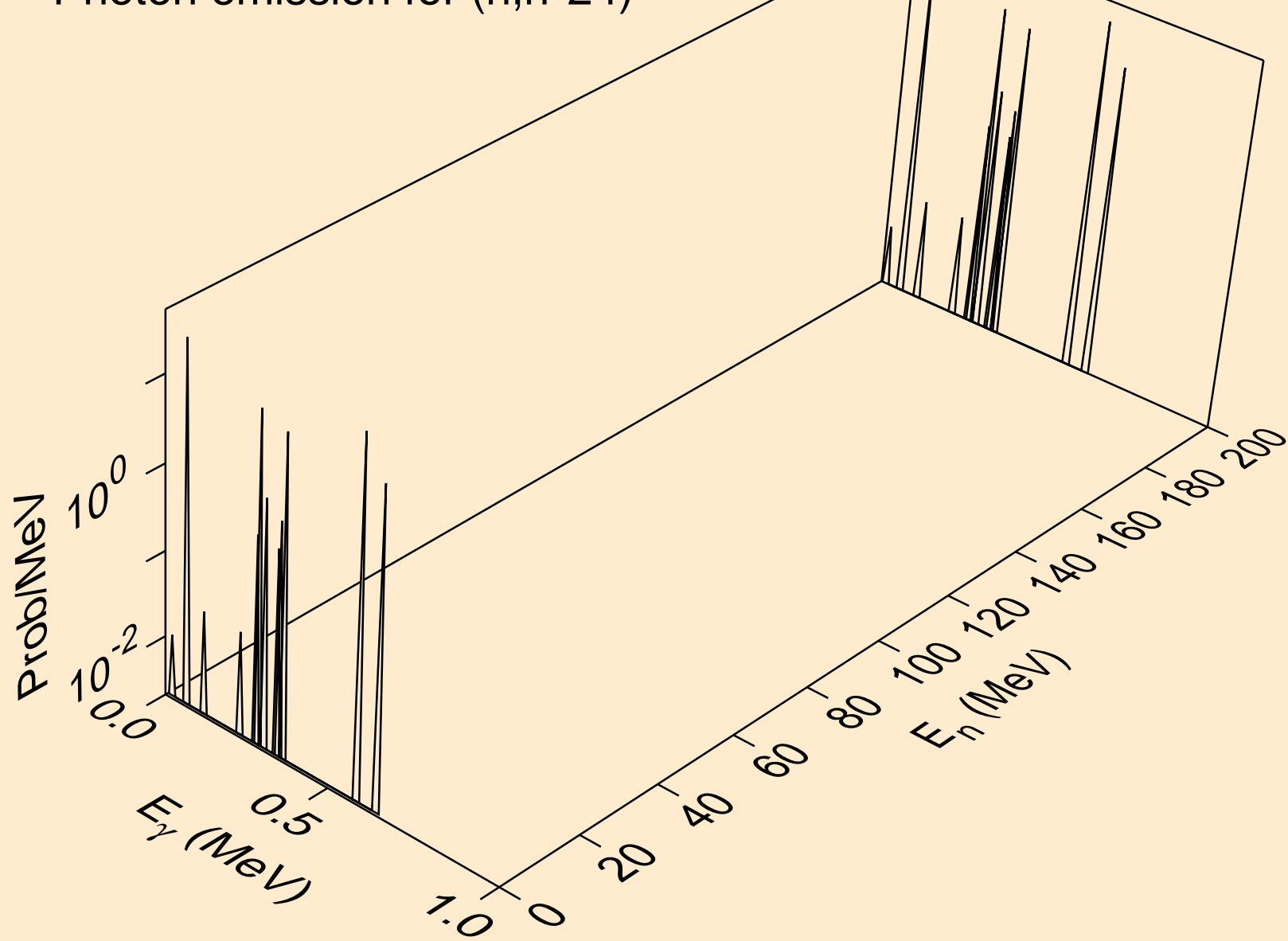

XE125M NEUTRON ACER TENDL-2024 LIBRARY; T=293.6K
Photon emission for (n,n*25)

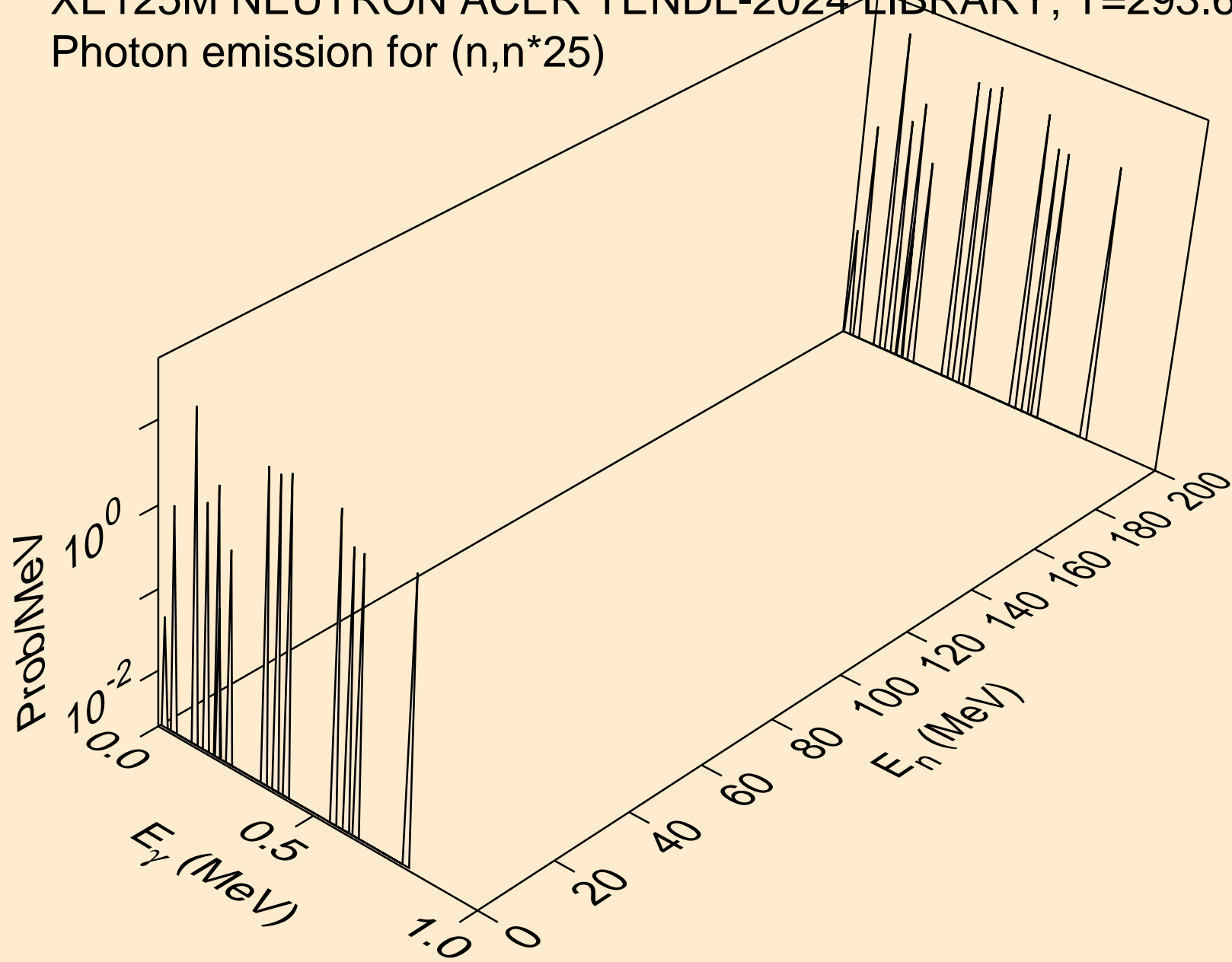

XE125M NEUTRON ACER TENDL-2024 LIBRARY; T=293.6K
Photon emission for (n,n*26)

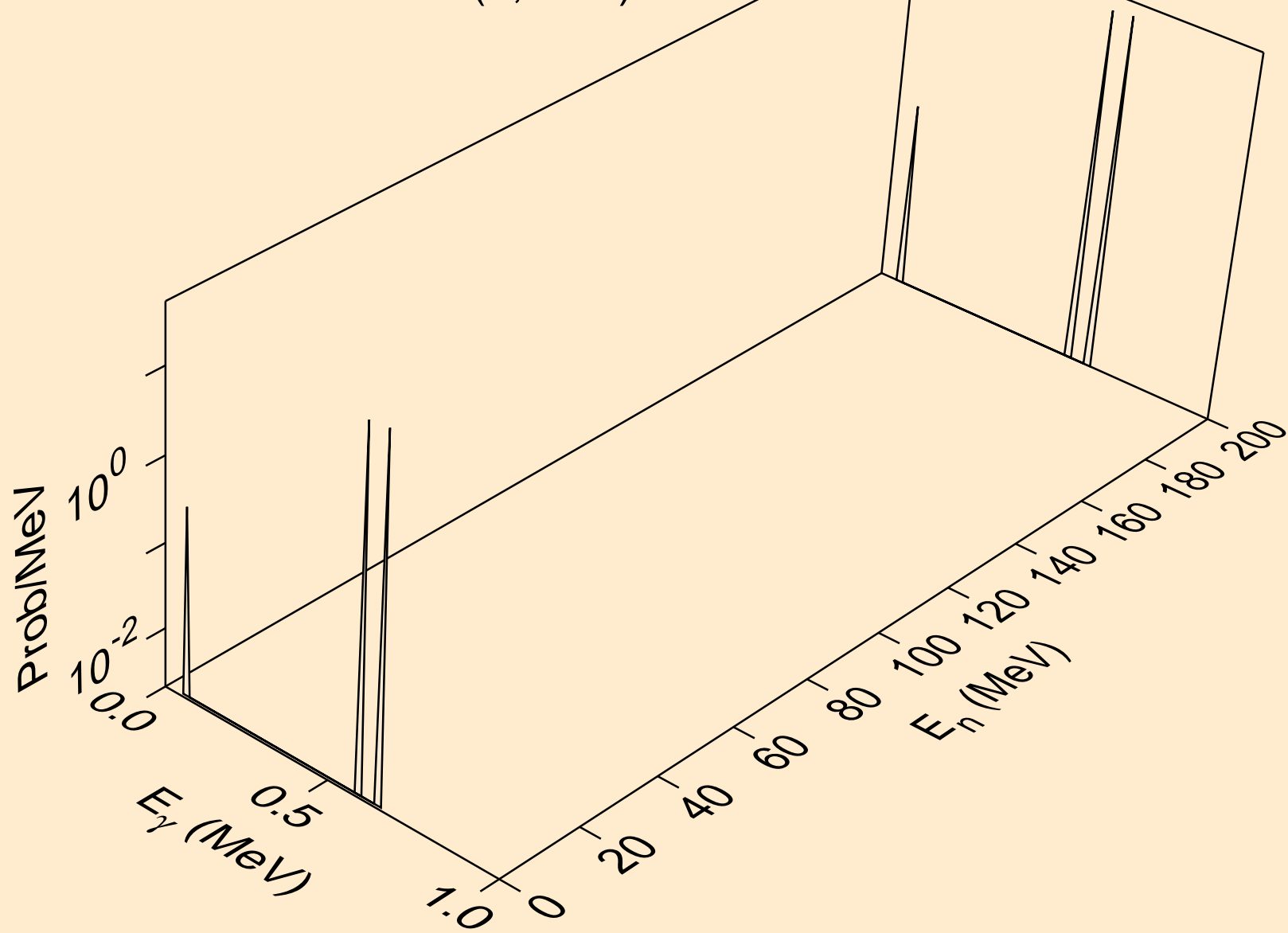

XE125M NEUTRON ACER TENDL-2024 LIBRARY; T=293.6K
Photon emission for (n,n*27)

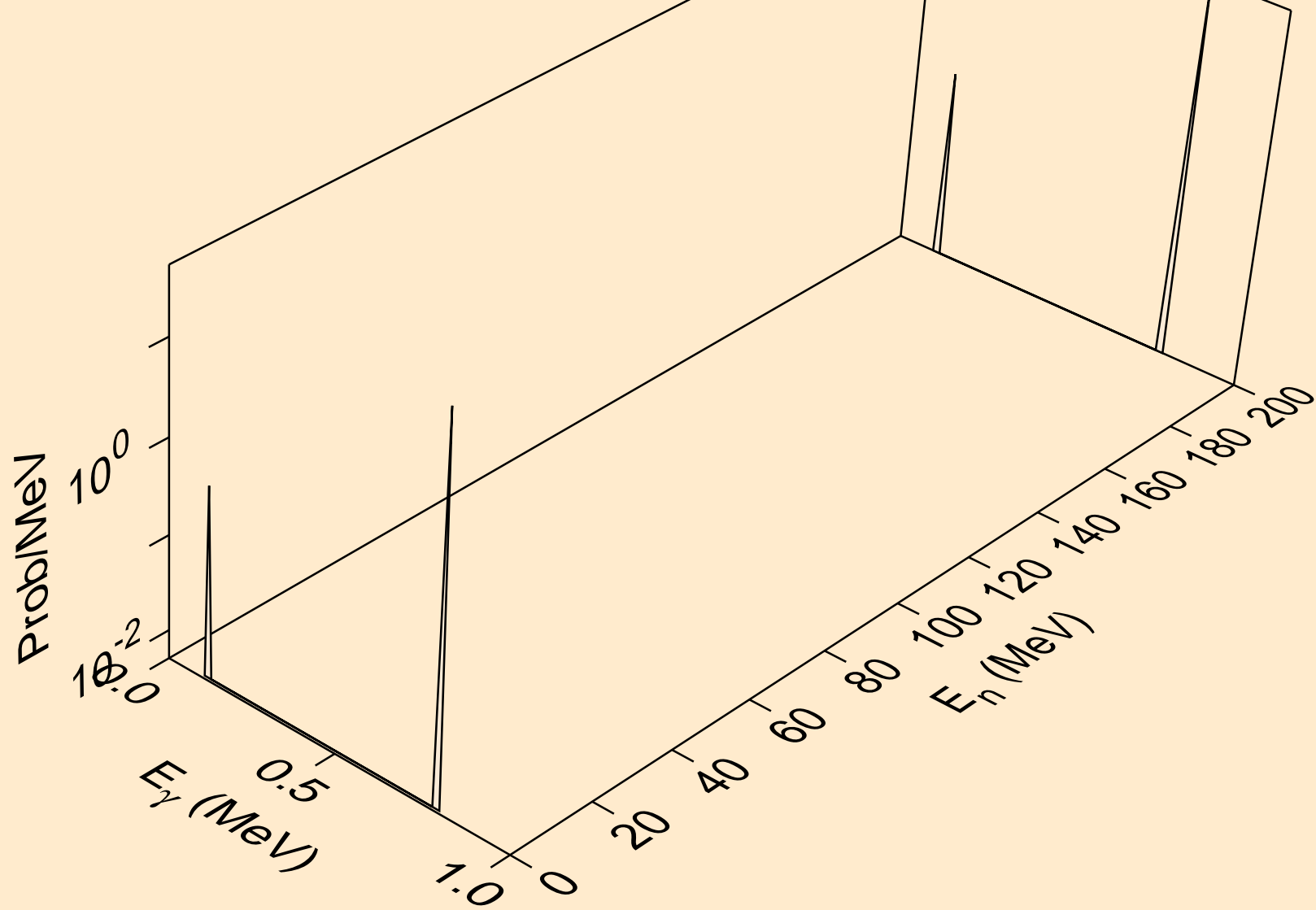

XE125M NEUTRON ACER TENDL-2024 LIBRARY; T=293.6K
Photon emission for (n,n*28)

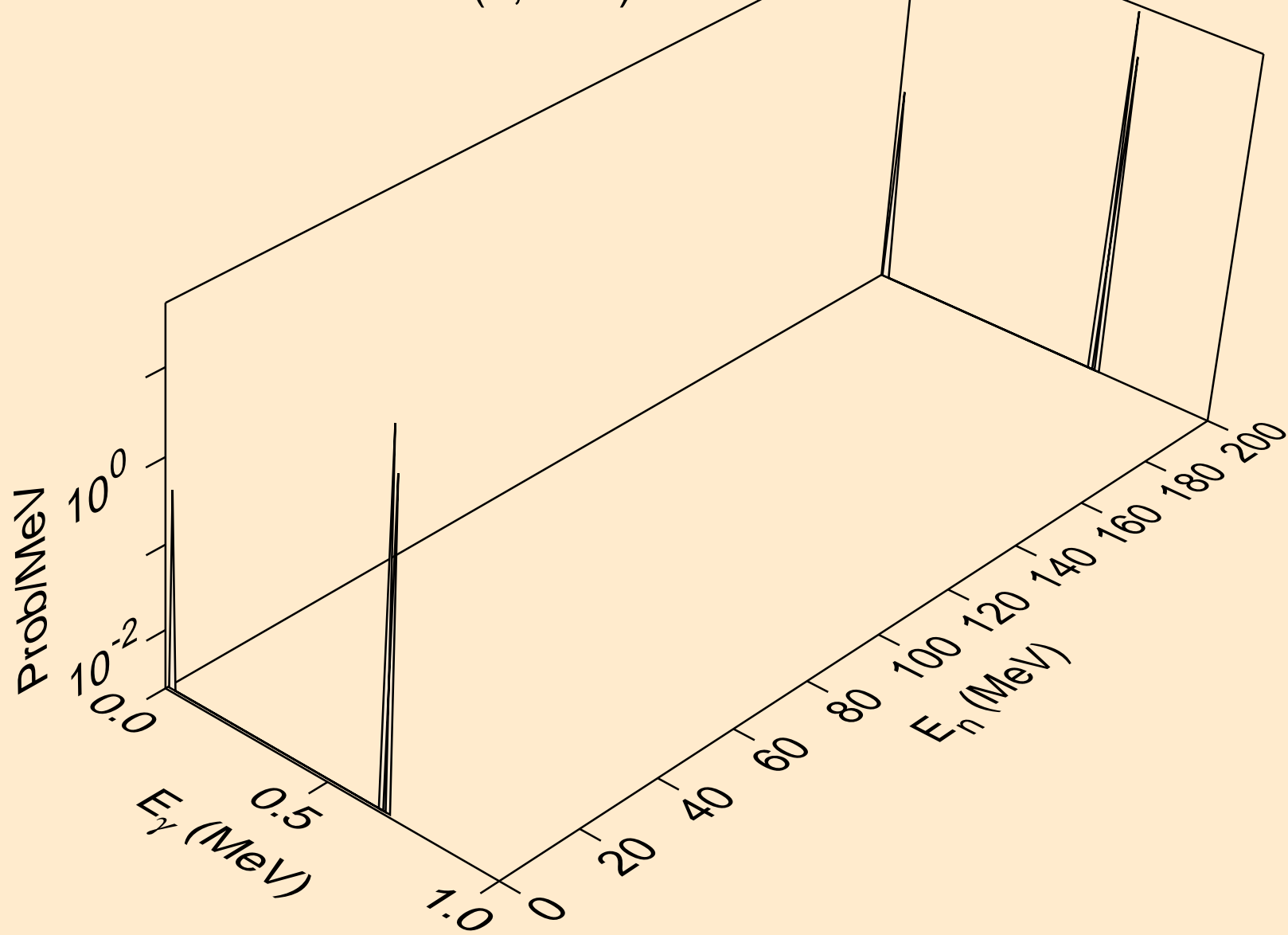

XE125M NEUTRON ACER TENDL-2024 LIBRARY; T=293.6K
Photon emission for (n,n*c)

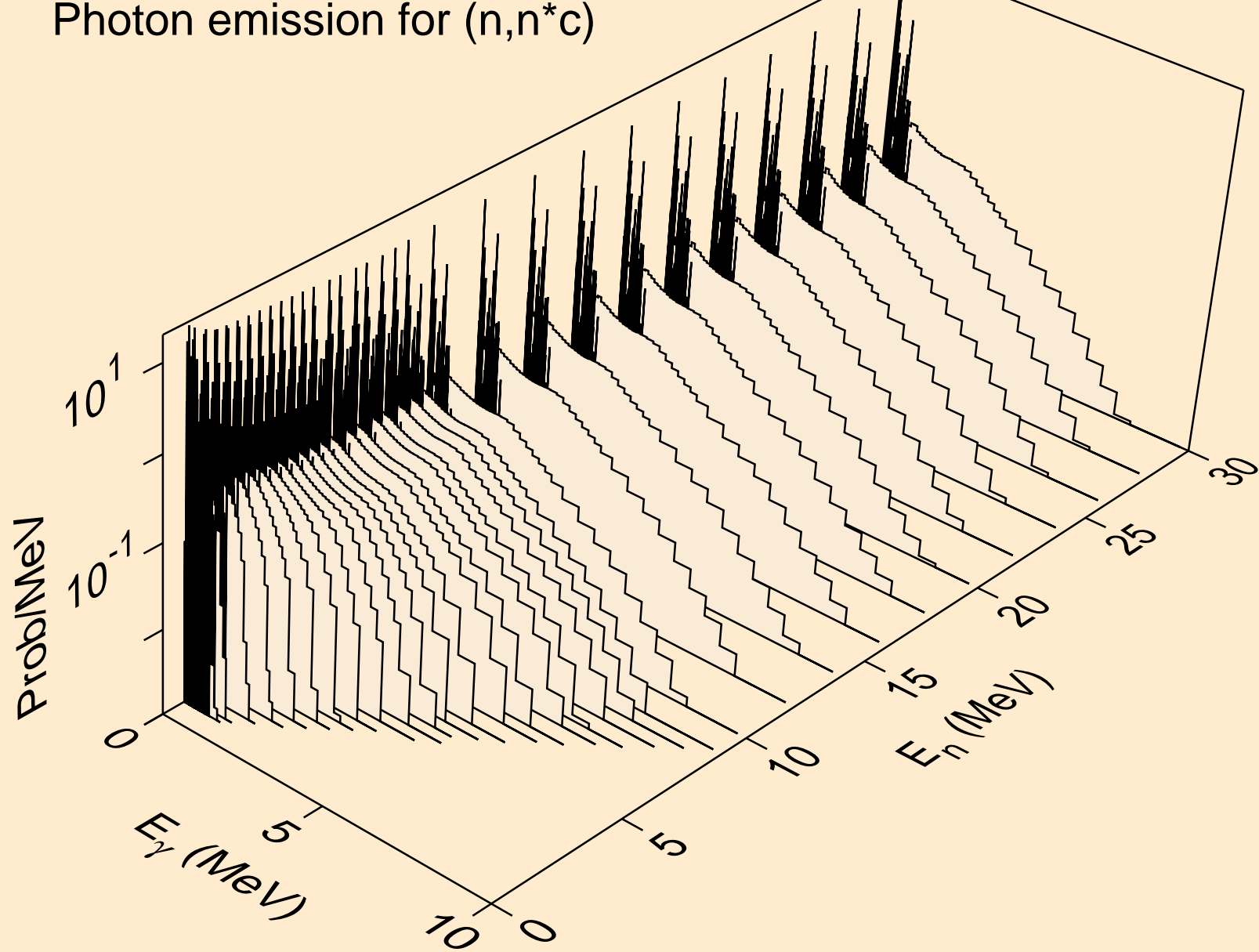

XE125M NEUTRON ACER TENDL-2024 LIBRARY; T=293.6K
Photon emission for (n,gma)

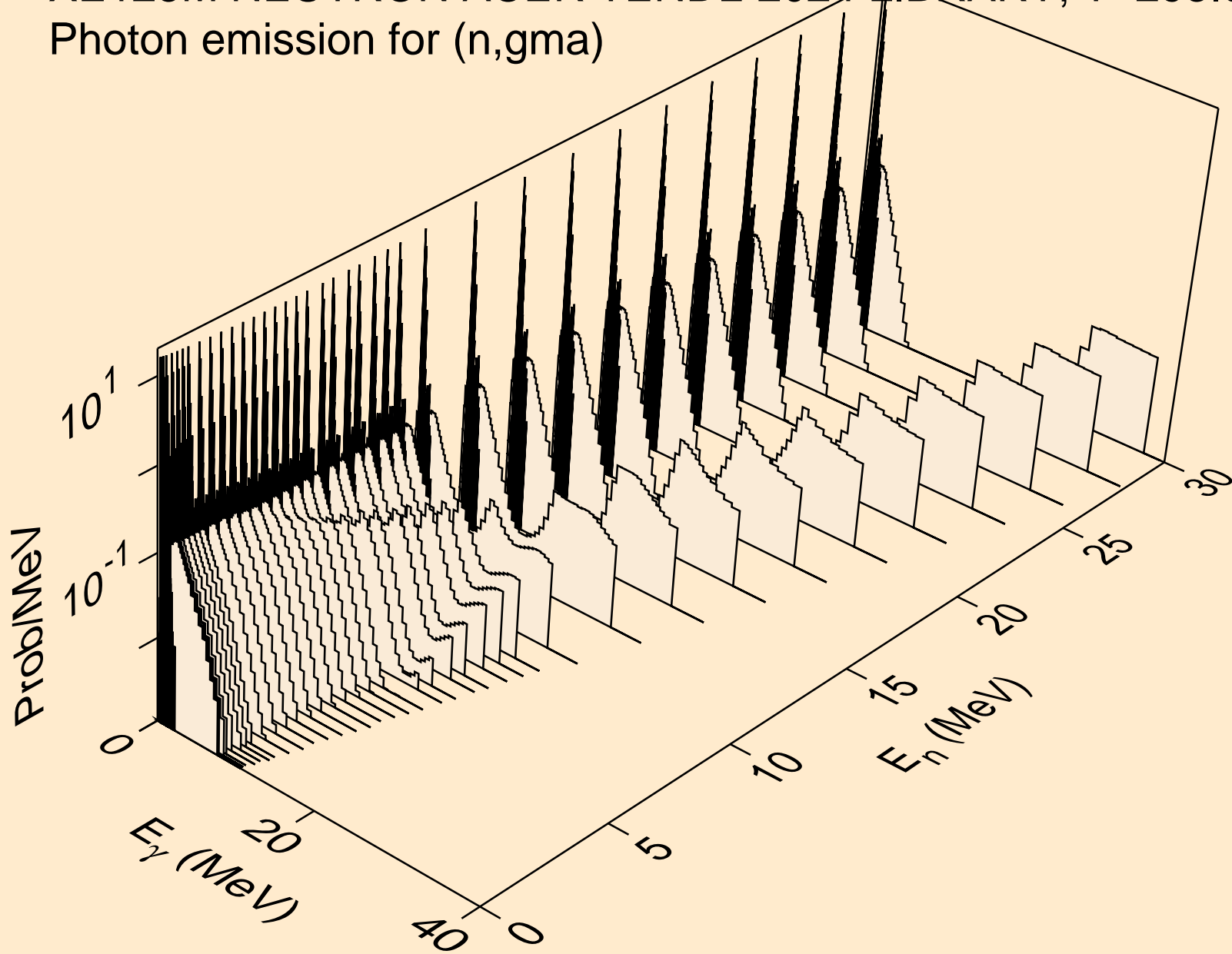

XE125M NEUTRON ACER TENDL-2024 LIBRARY; T=293.6K
Photon emission for (n,p)

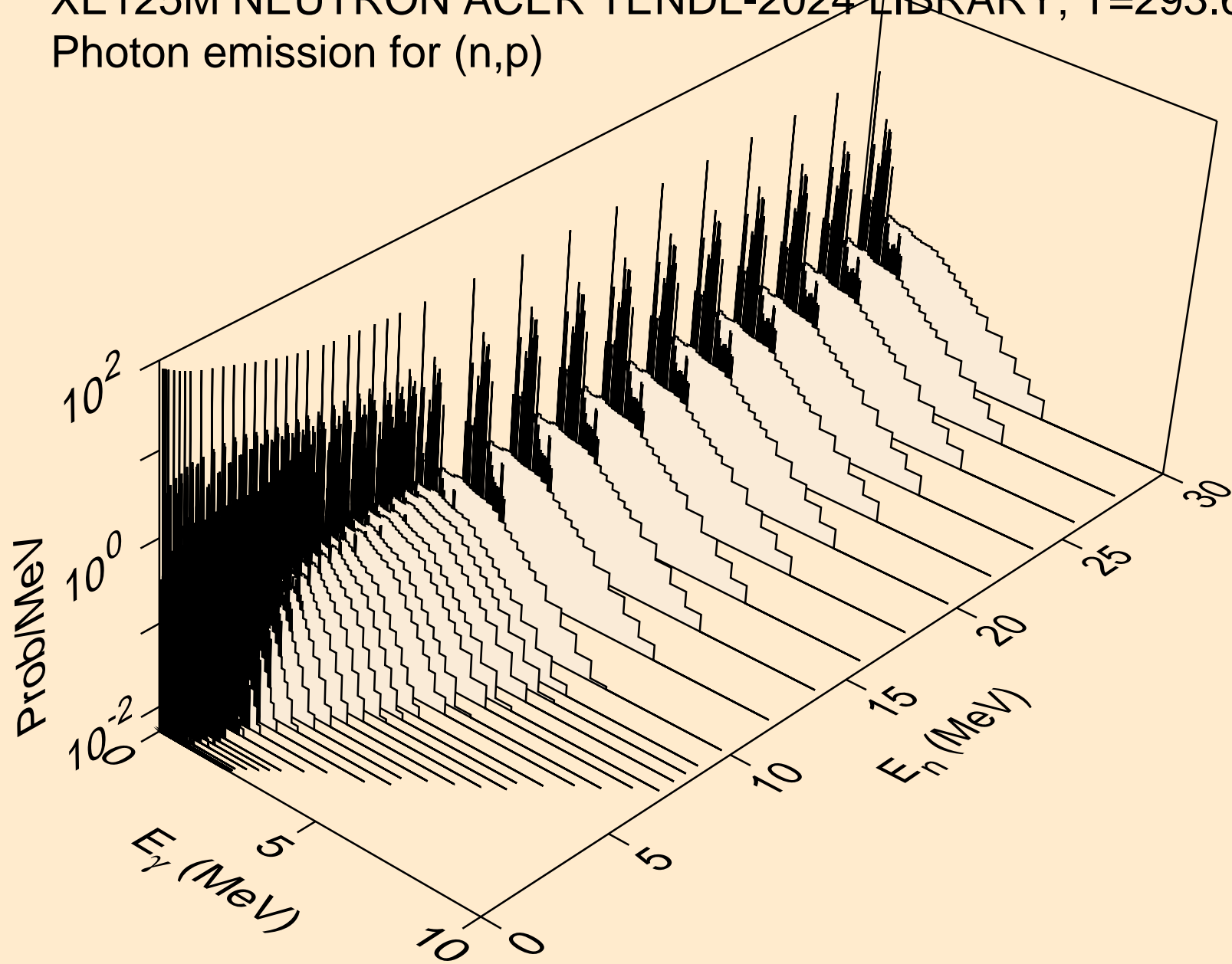

XE125M NEUTRON ACER TENDL-2024 LIBRARY; T=293.6K
Photon emission for (n,d)

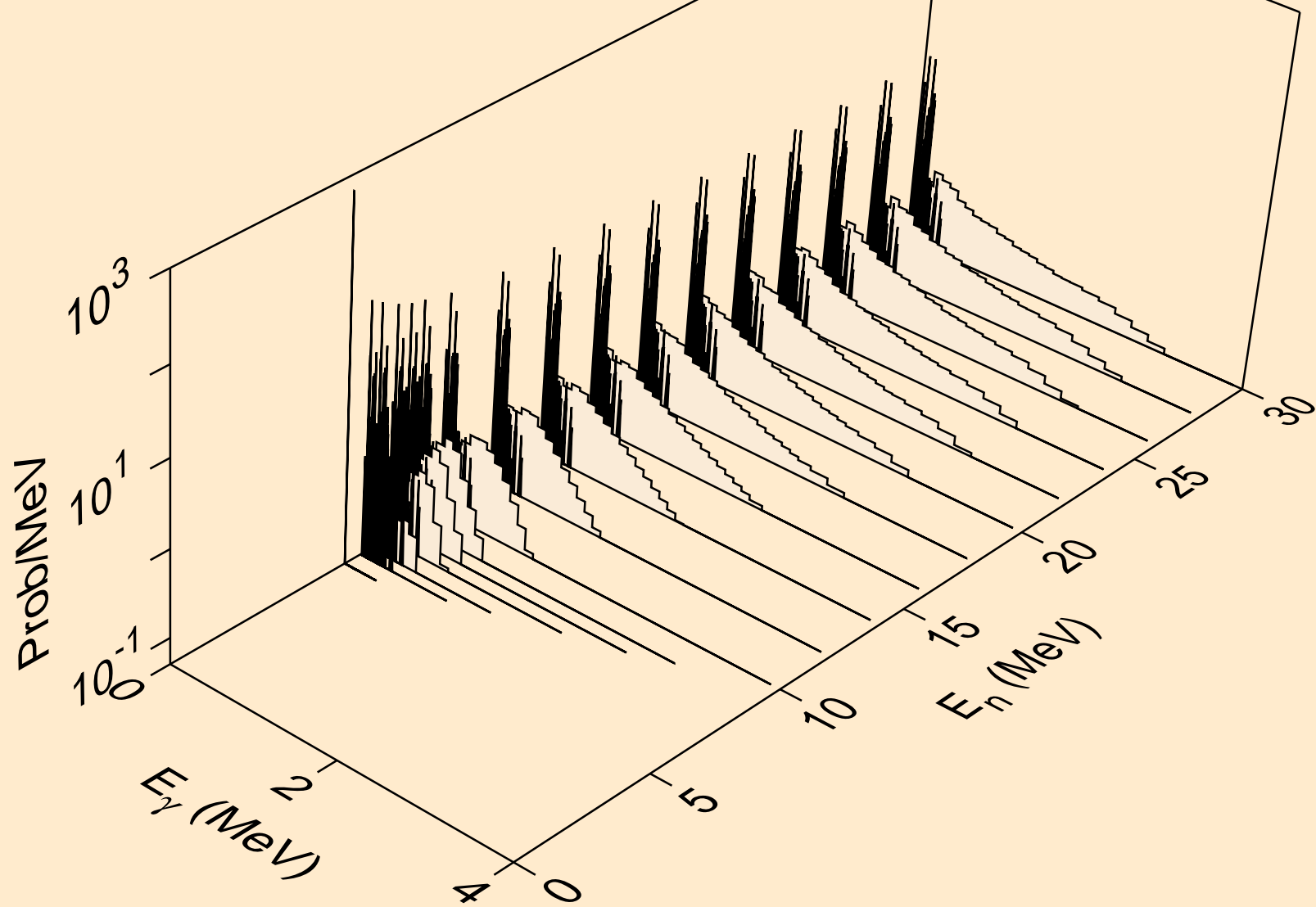

XE125M NEUTRON ACER TENDL-2024 LIBRARY; T=293.6K
Photon emission for (n,t)

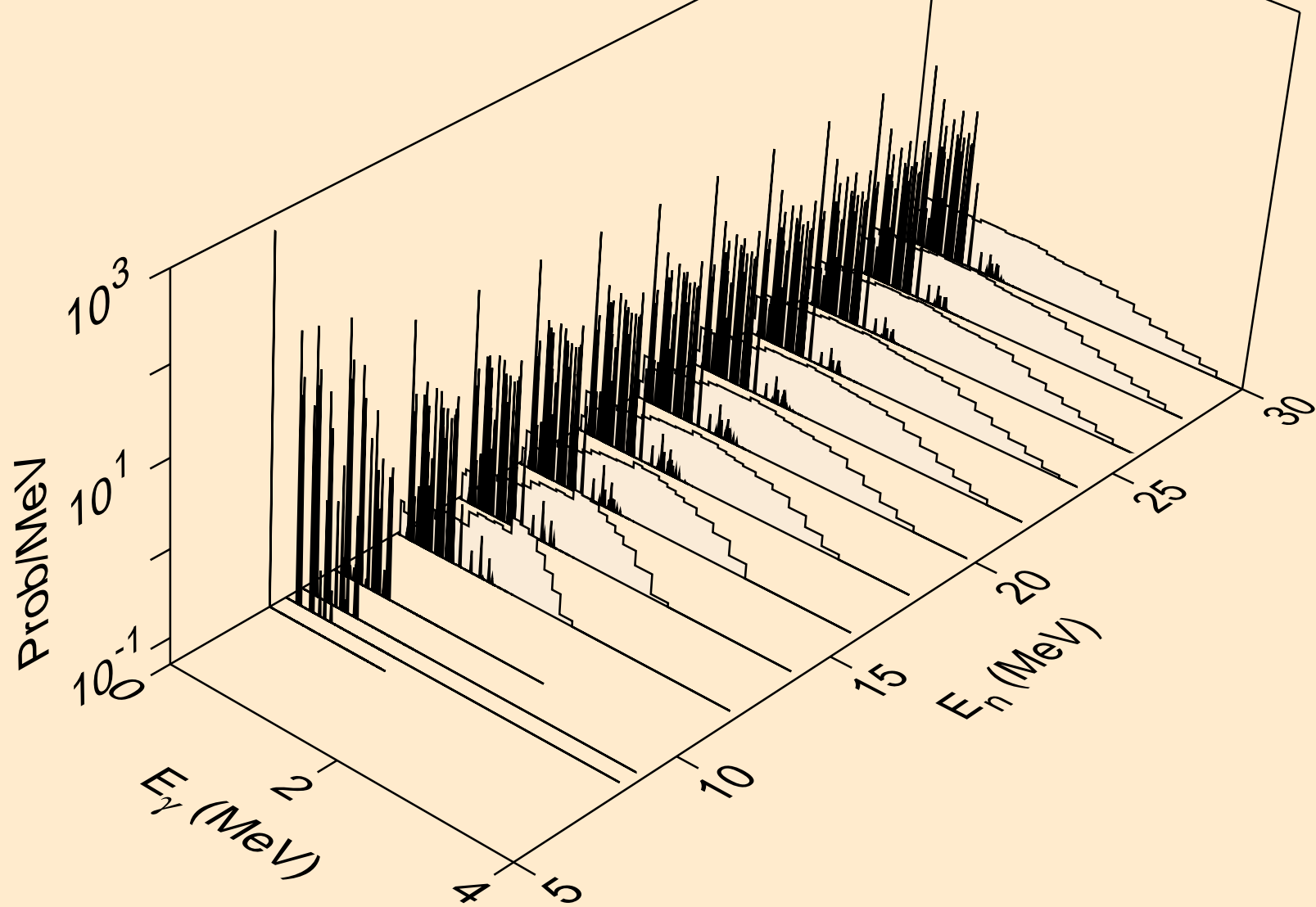

XE125M NEUTRON ACER TENDL-2024 LIBRARY; T=293.6K
Photon emission for (n,he3)

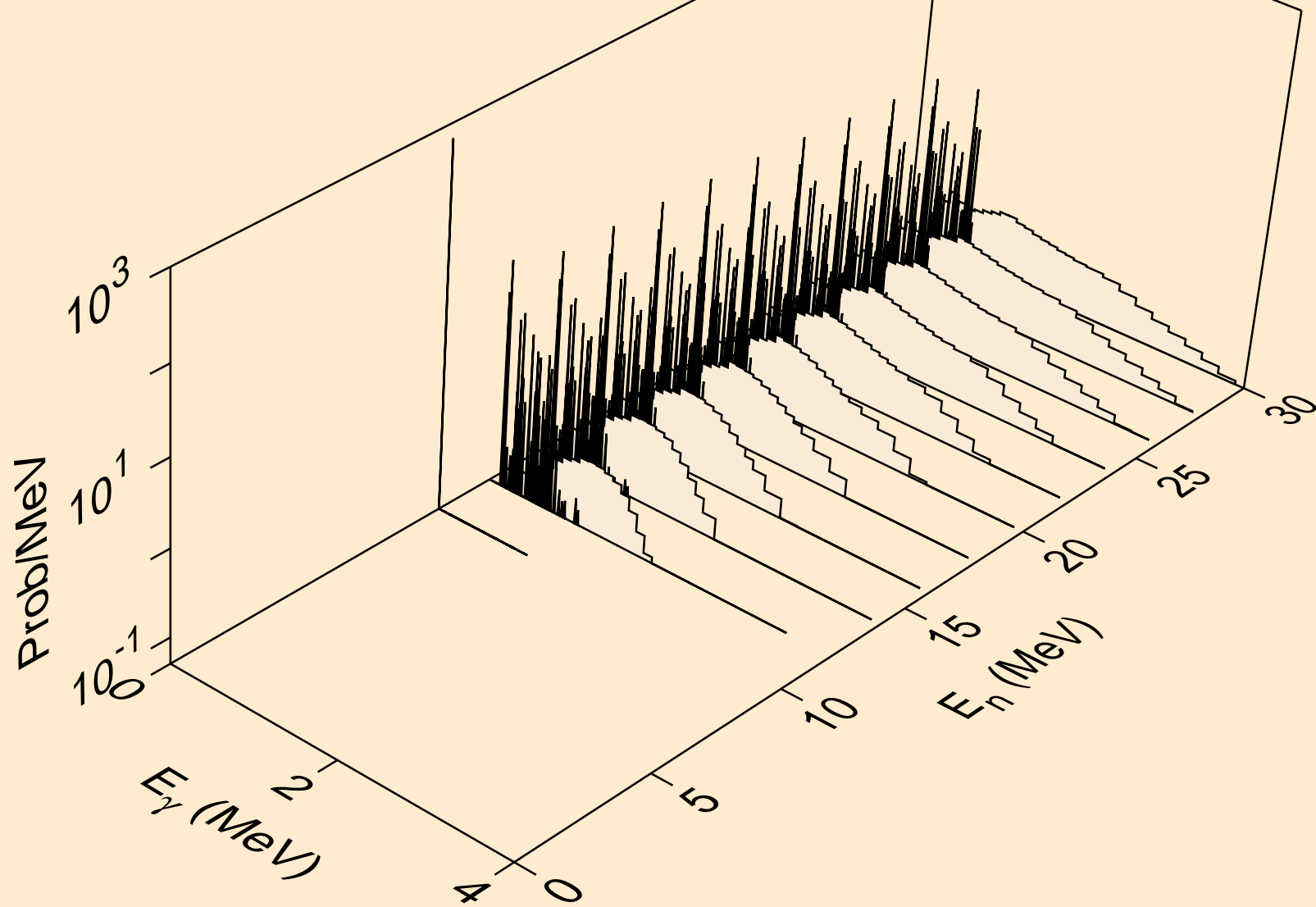

XE125M NEUTRON ACER TENDL-2024 LIBRARY; T=293.6K
Photon emission for (n,a)

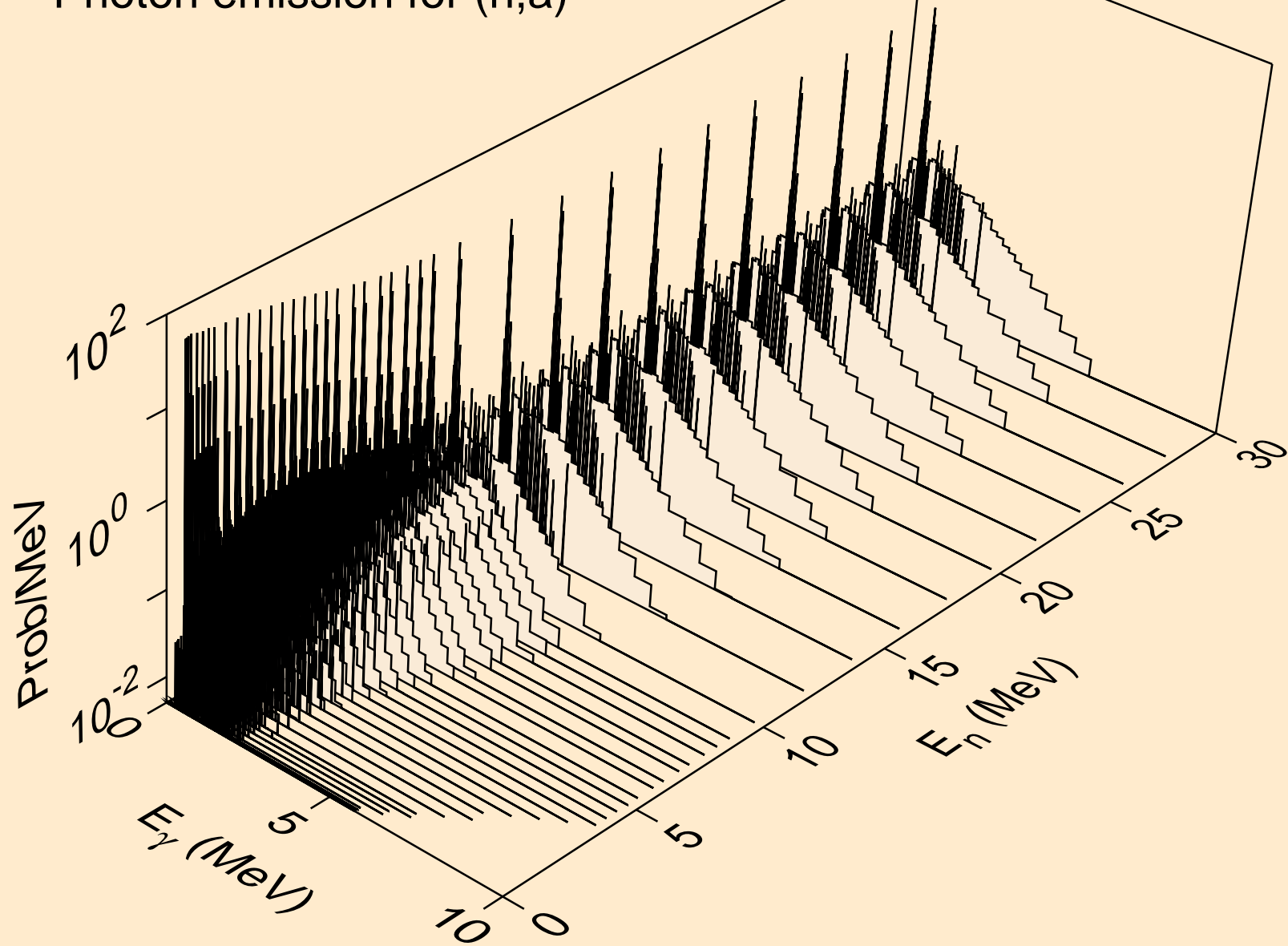

XE125M NEUTRON ACER TENDL-2024 LIBRARY; T=293.6K
Photon emission for (n,2a)

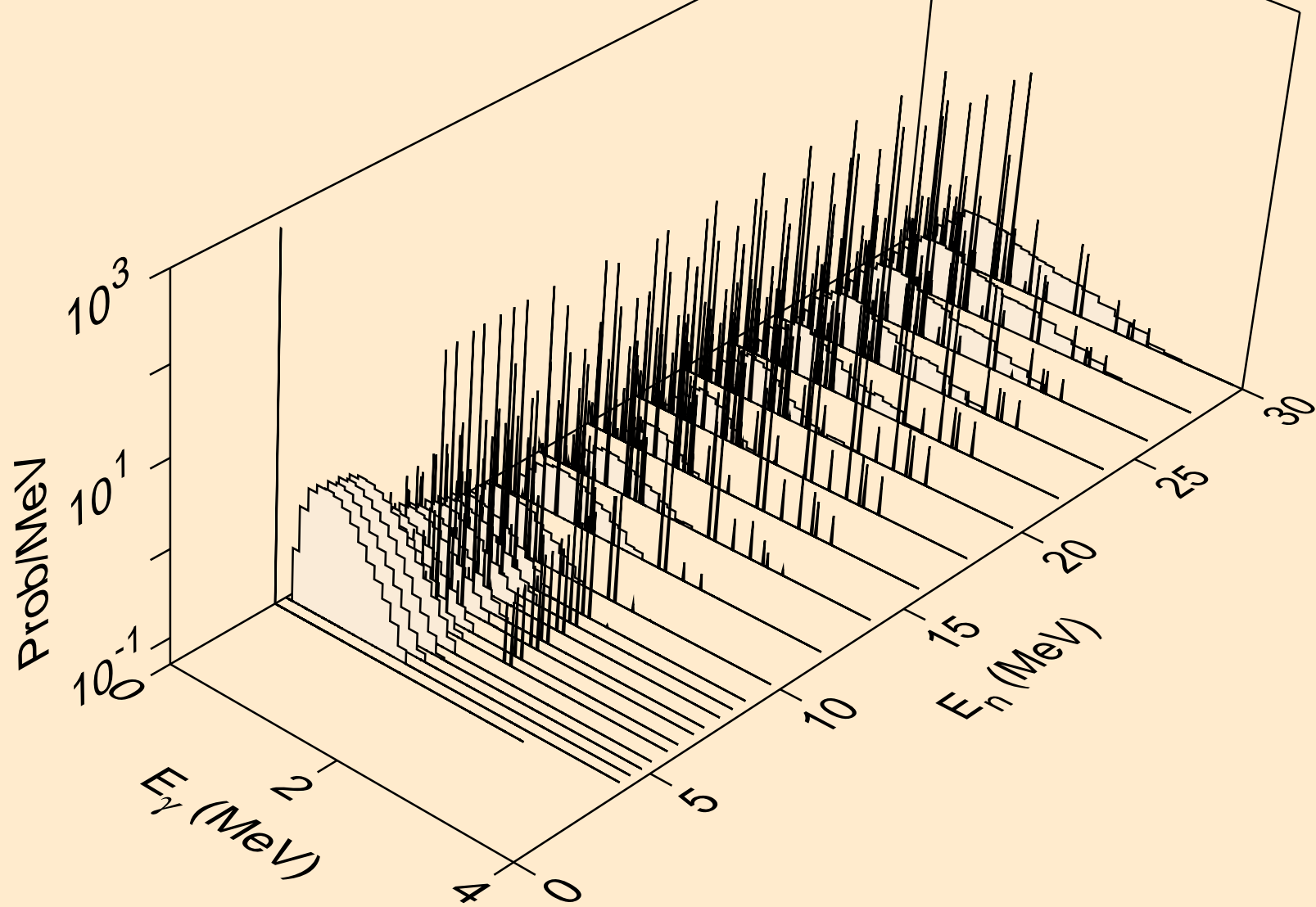

XE125M NEUTRON ACER TENDL-2024 LIBRARY; T=293.6K
Photon emission for (n,2p)

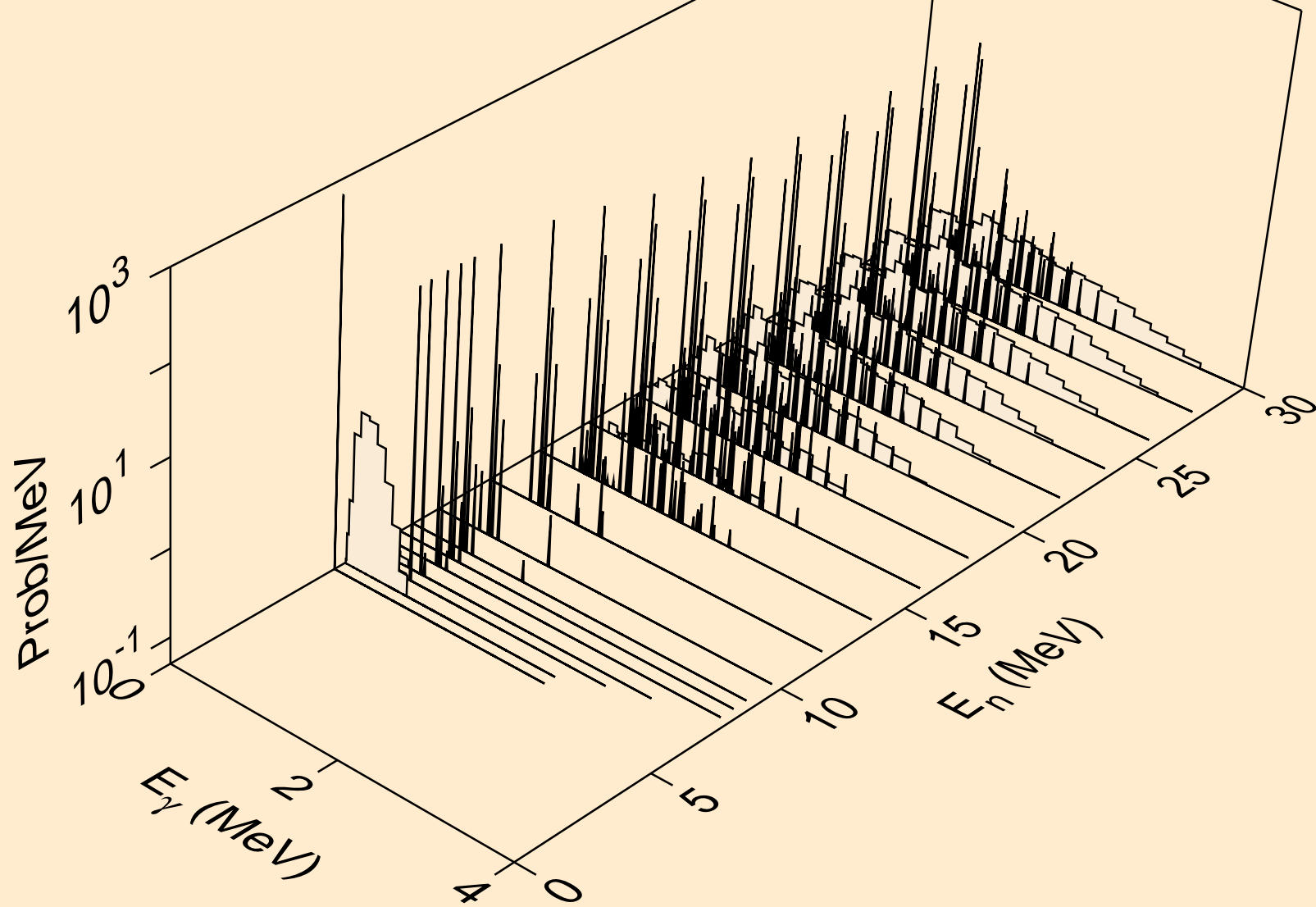

XE125M NEUTRON ACER TENDL-2024 LIBRARY; T=293.6K
Photon emission for (n,p α)

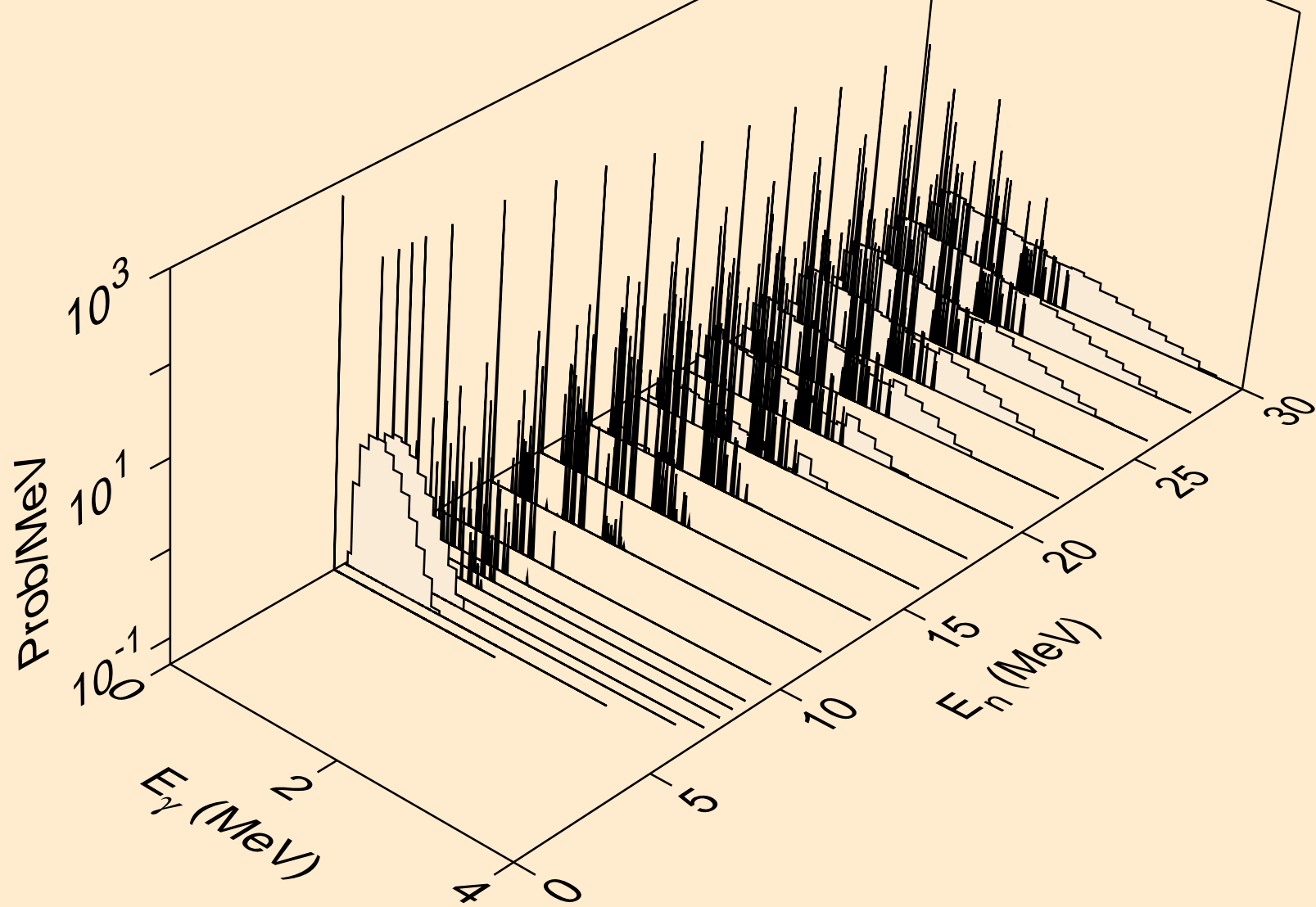

XE125M NEUTRON ACER TENDL-2024 LIBRARY; T=293.6K
Photon emission for (n,pd)

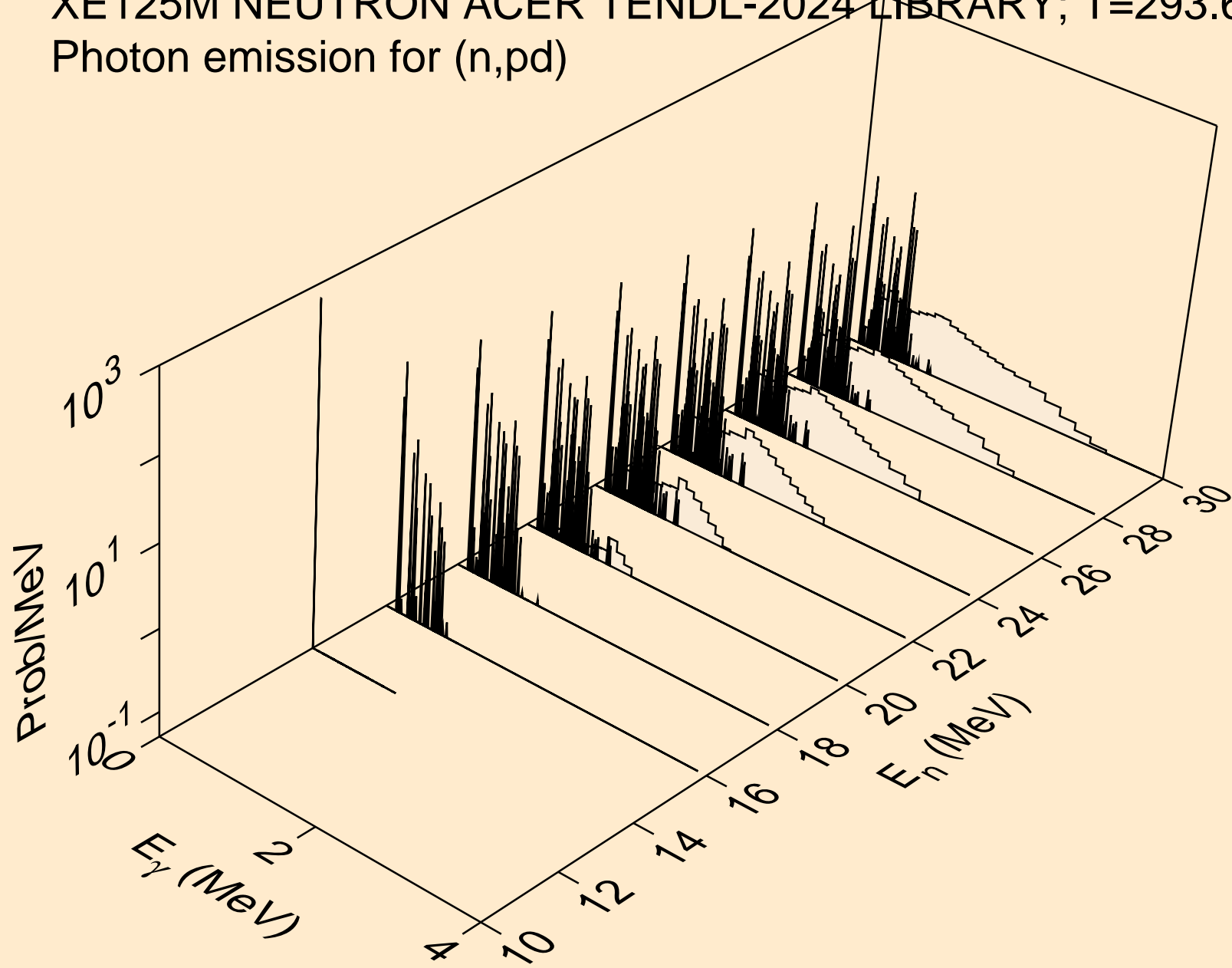

XE125M NEUTRON ACER TENDL-2024 LIBRARY; T=293.6K
Photon emission for (n,pt)

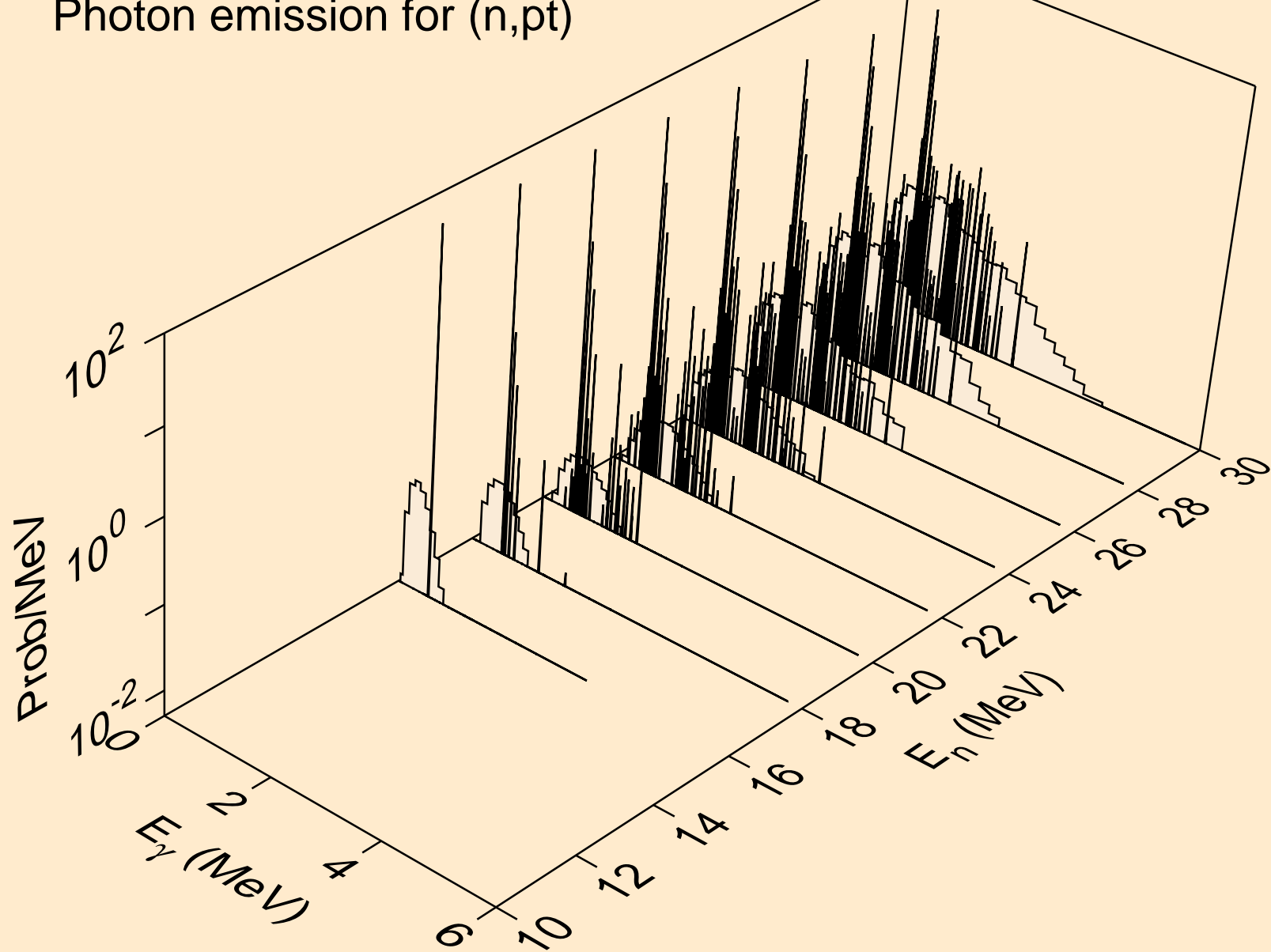

XE125M NEUTRON ACER TENDL-2024 LIBRARY; T=293.6K
Photon emission for (n,da)

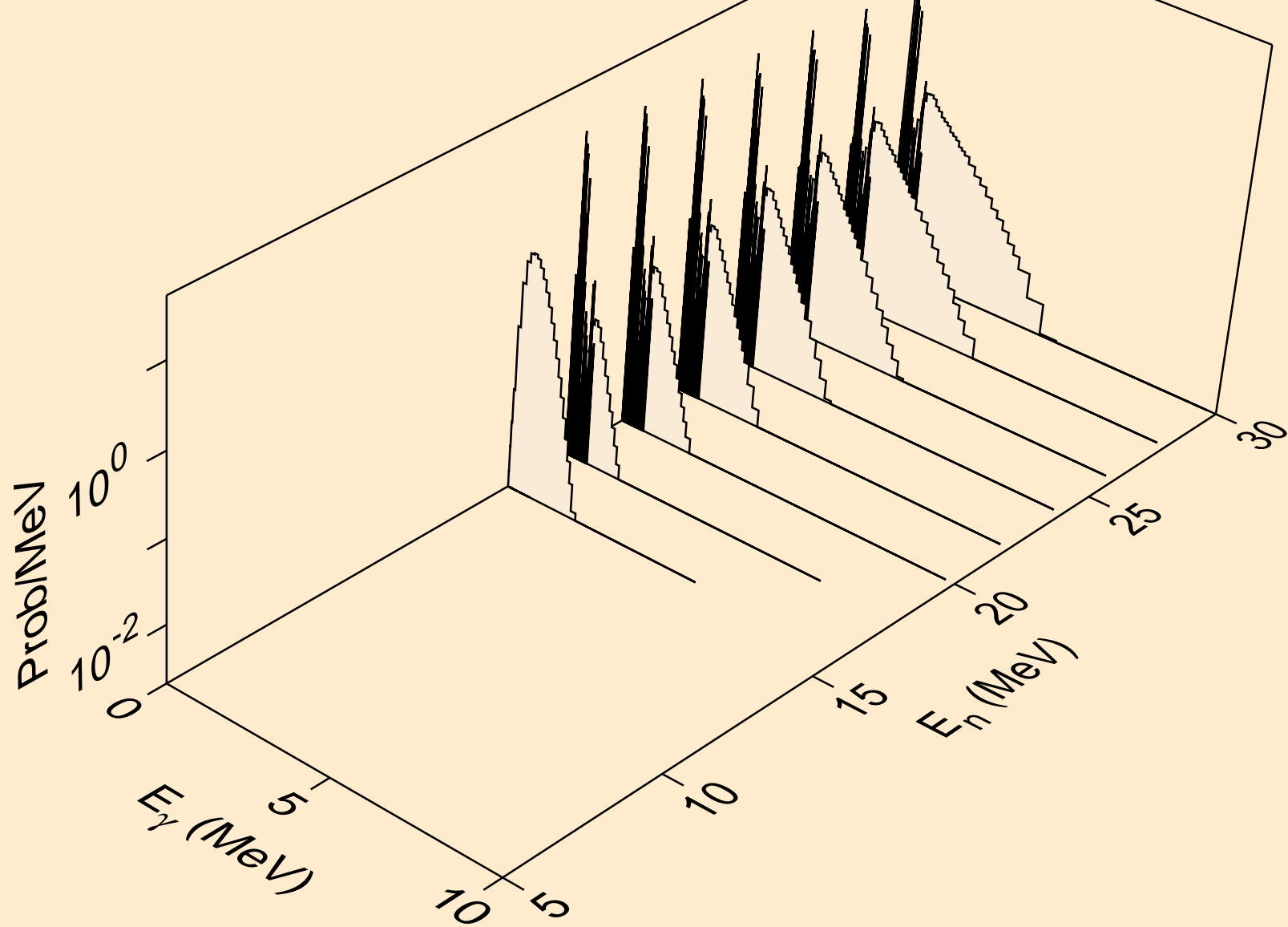

XE125M NEUTRON ACER TENDL-2024 LIBRARY; T=293.6K
thermal capture photon spectrum

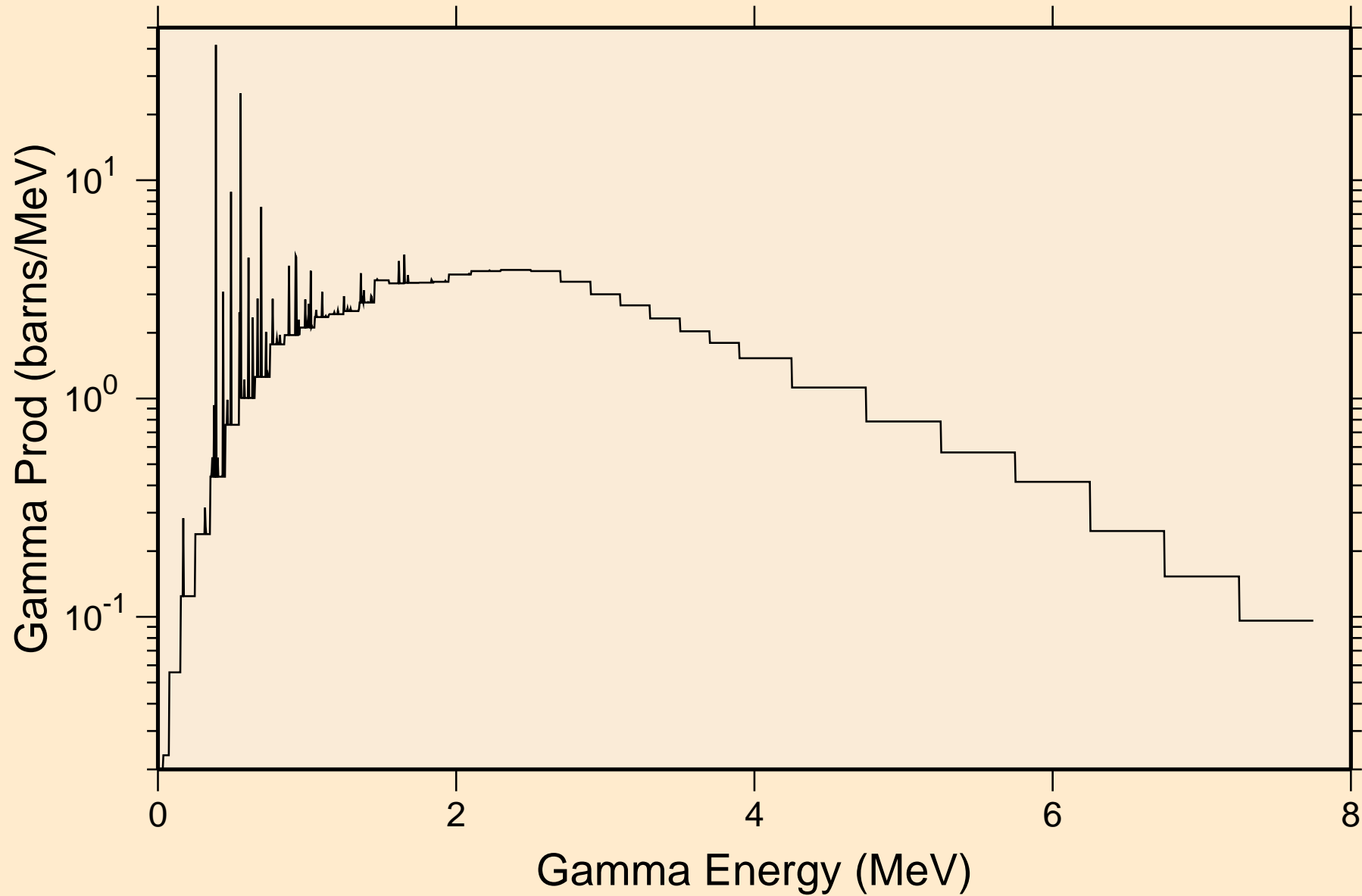

XE125M NEUTRON ACER TENDL-2024 LIBRARY; T=293.6K
14 MeV photon spectrum

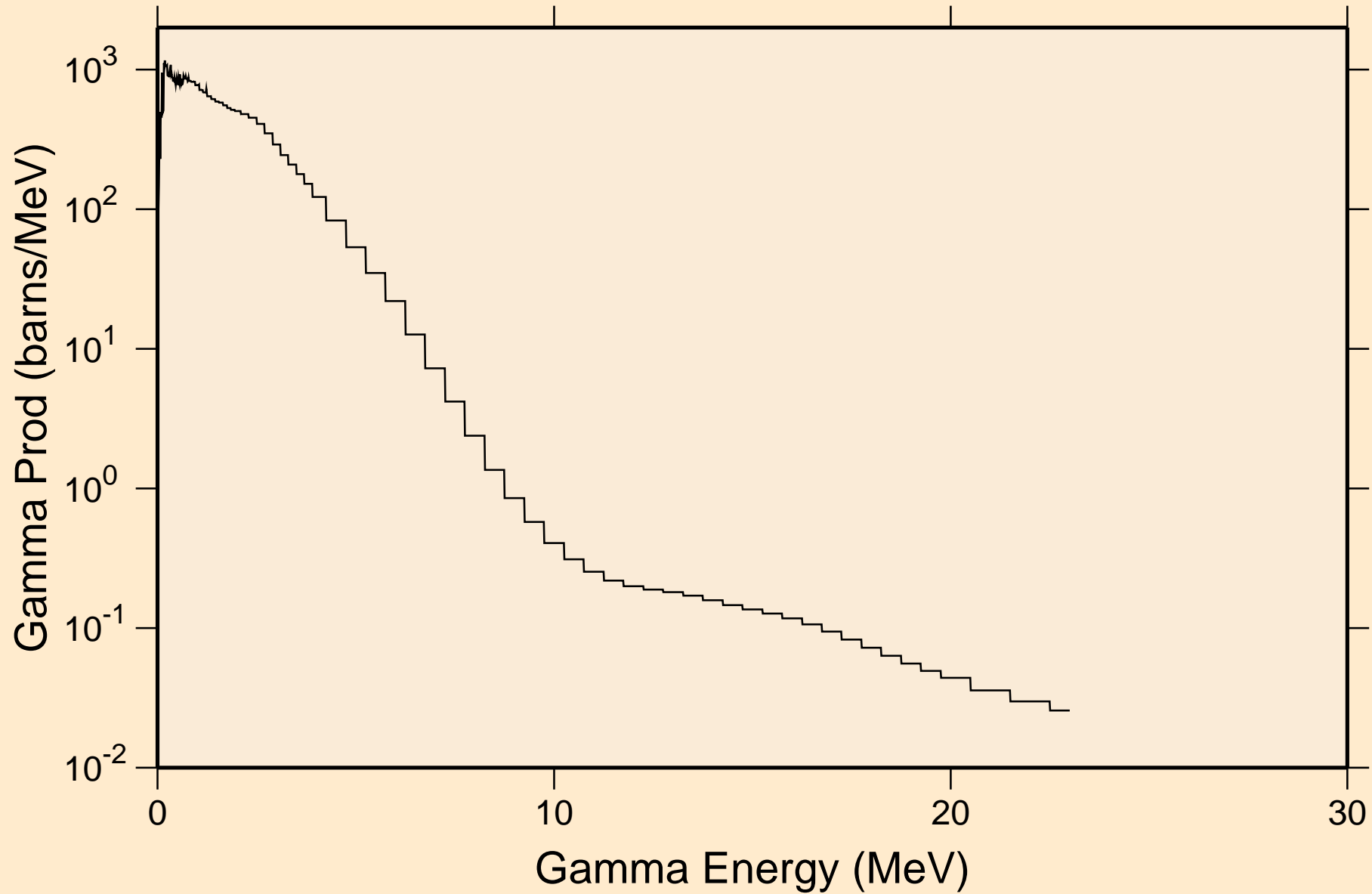

XE125M NEUTRON ACER TENDL-2024 LIBRARY; T=293.6K
Particle heating contributions

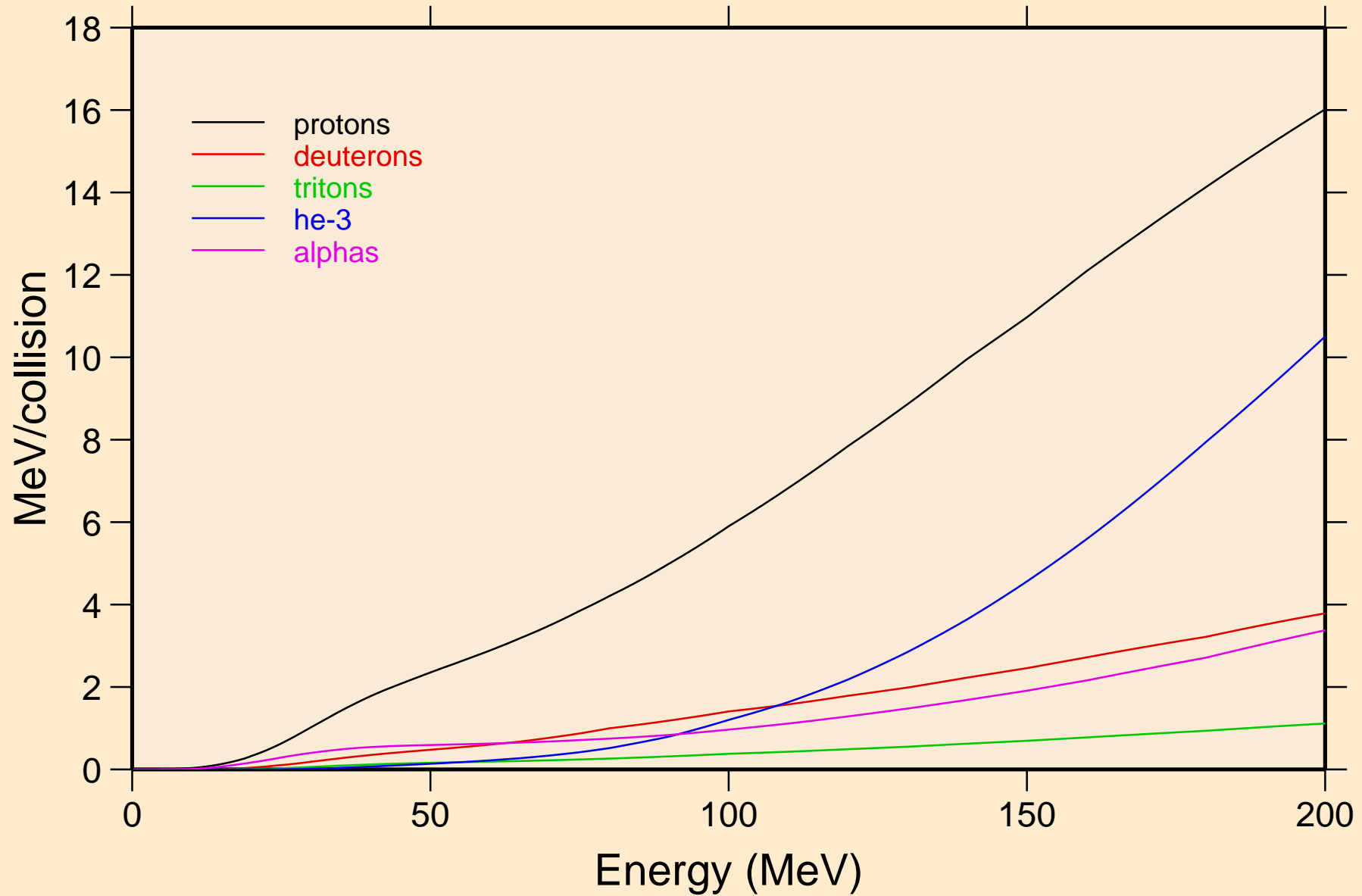

XE125M NEUTRON ACER TENDL-2024 LIBRARY; T=293.6K
Recoil Heating

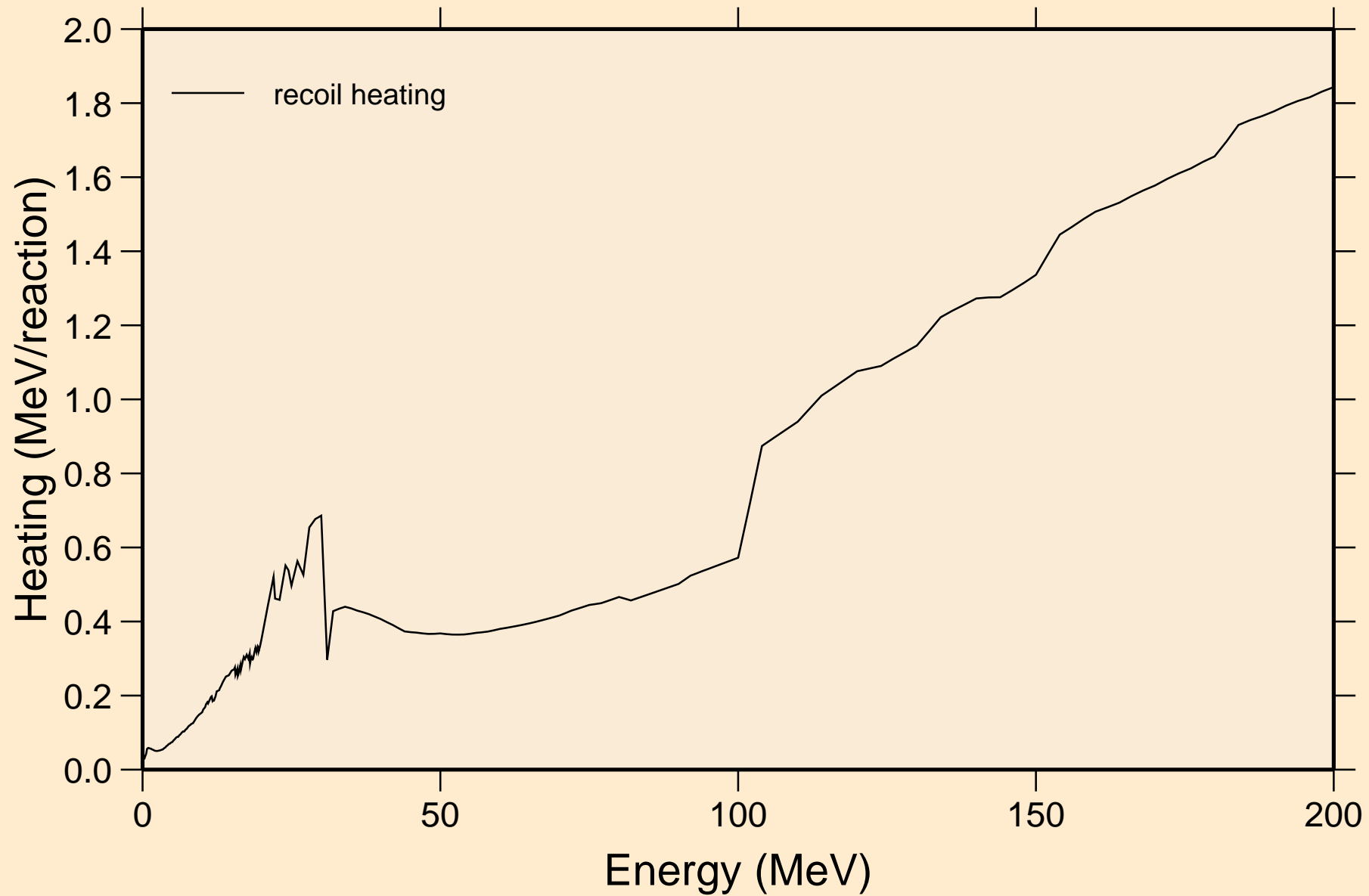

XE125M NEUTRON ACER TENDL-2024 LIBRARY; T=293.6K
Particle production cross sections

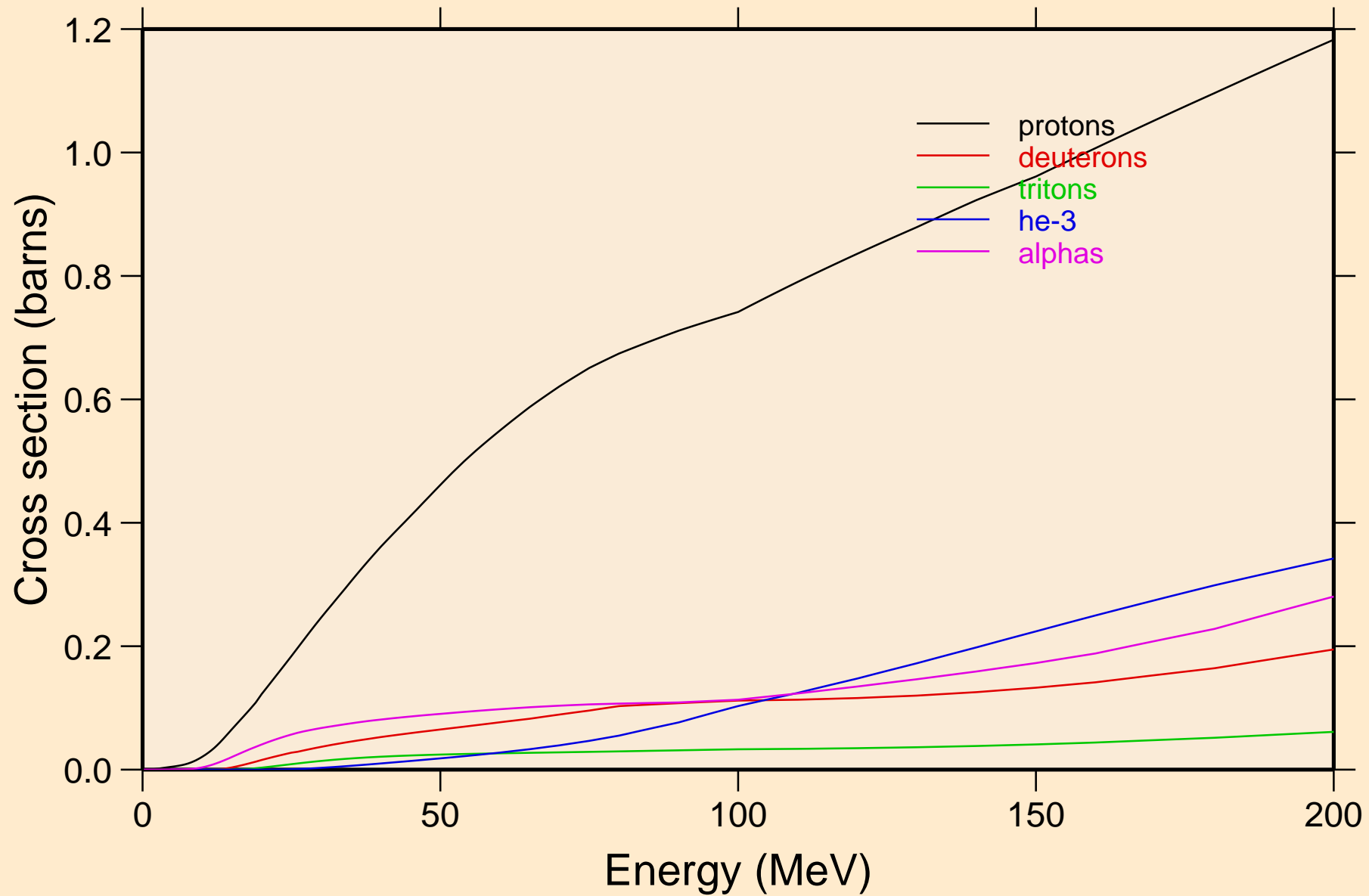

XE125M NEUTRON ACER TENDL-2024 LIBRARY; T=293.6K
protons from (n,x)

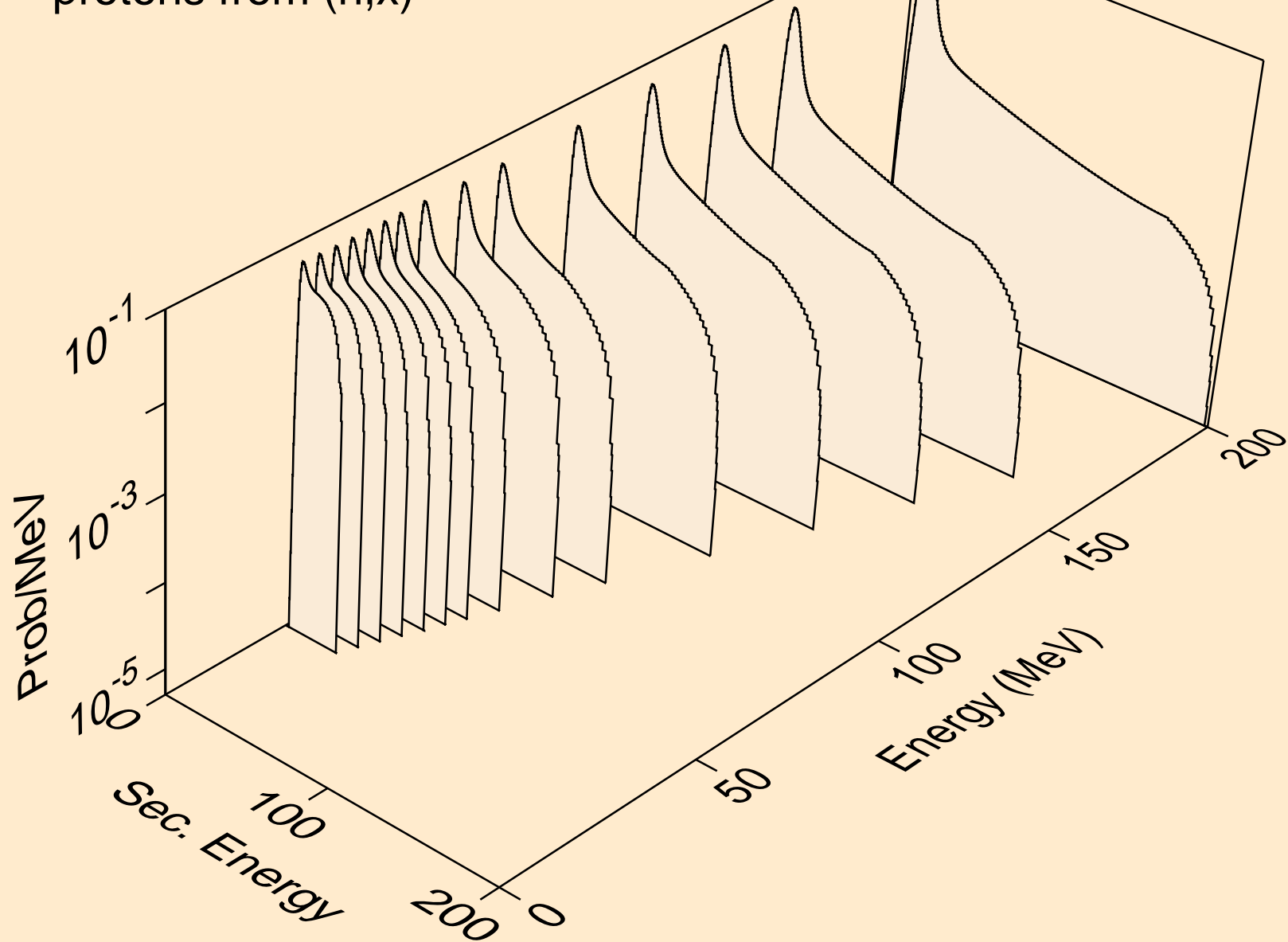

XE125M NEUTRON ACER TENDL-2024 LIBRARY; T=293.6K
protons from (n,n*)p

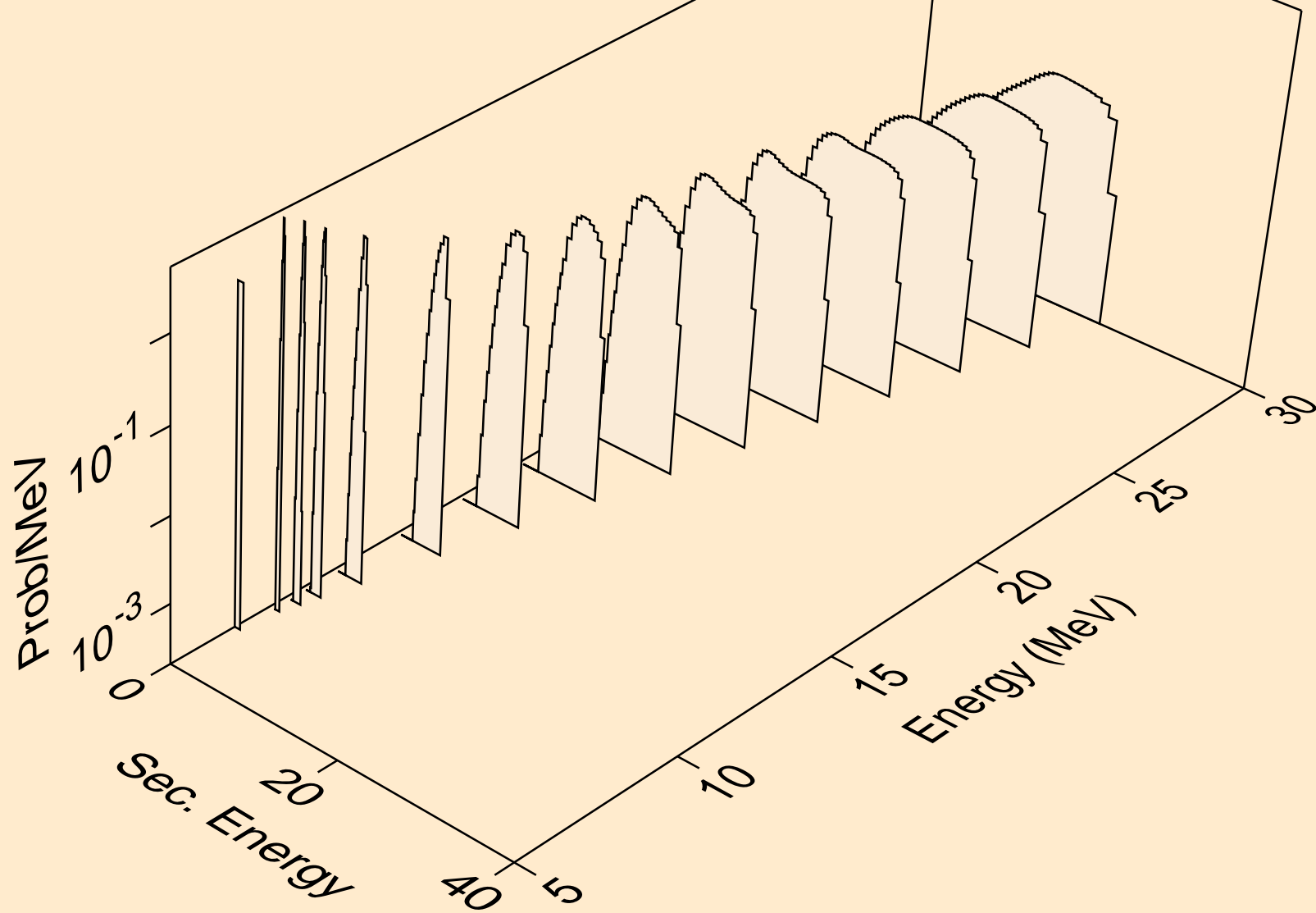

XE125M NEUTRON ACER TENDL-2024 LIBRARY; T=293.6K
protons from (n,2np)

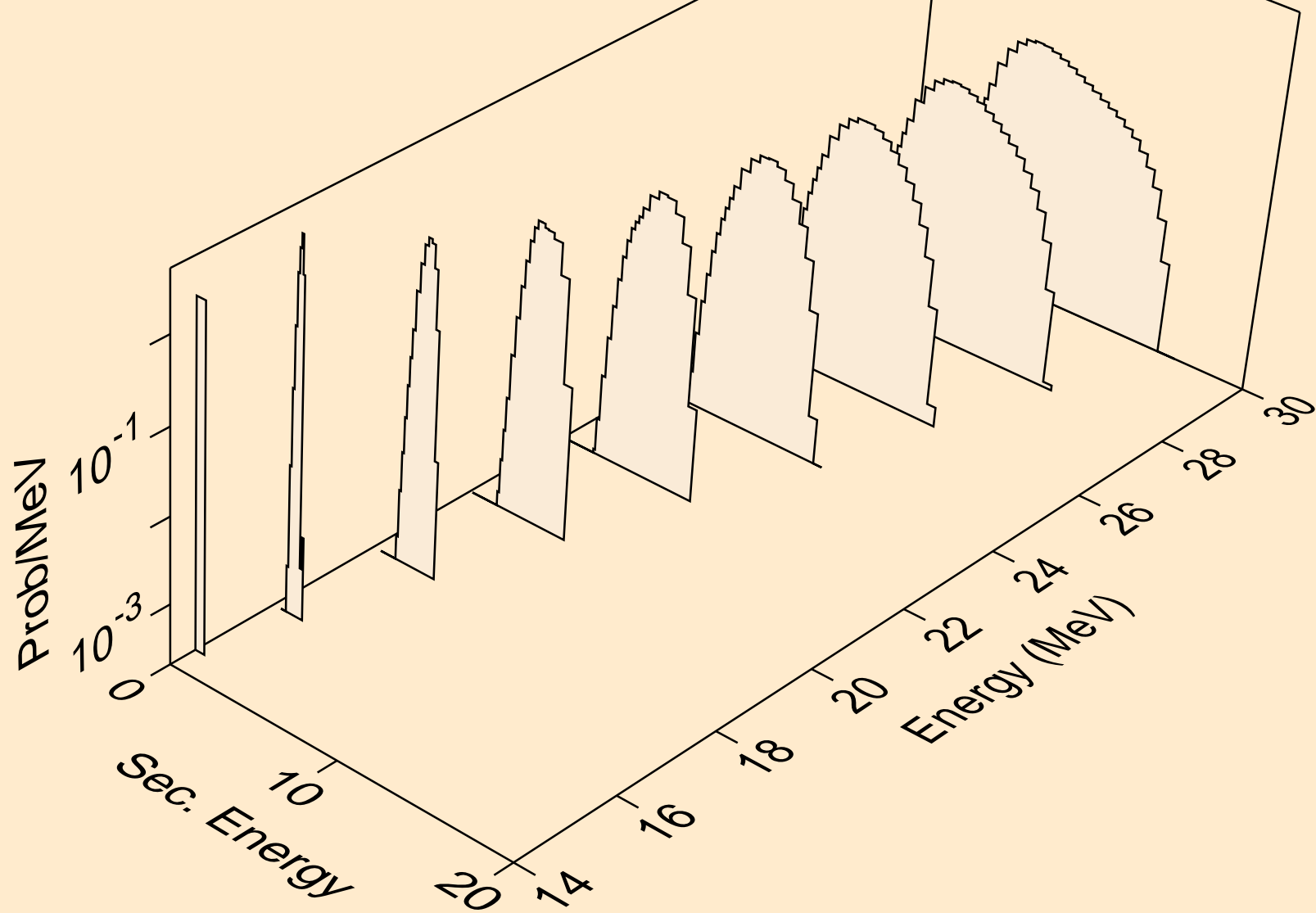

XE125M NEUTRON ACER TENDL-2024 LIBRARY; T=293.6K
protons from (n,3np)

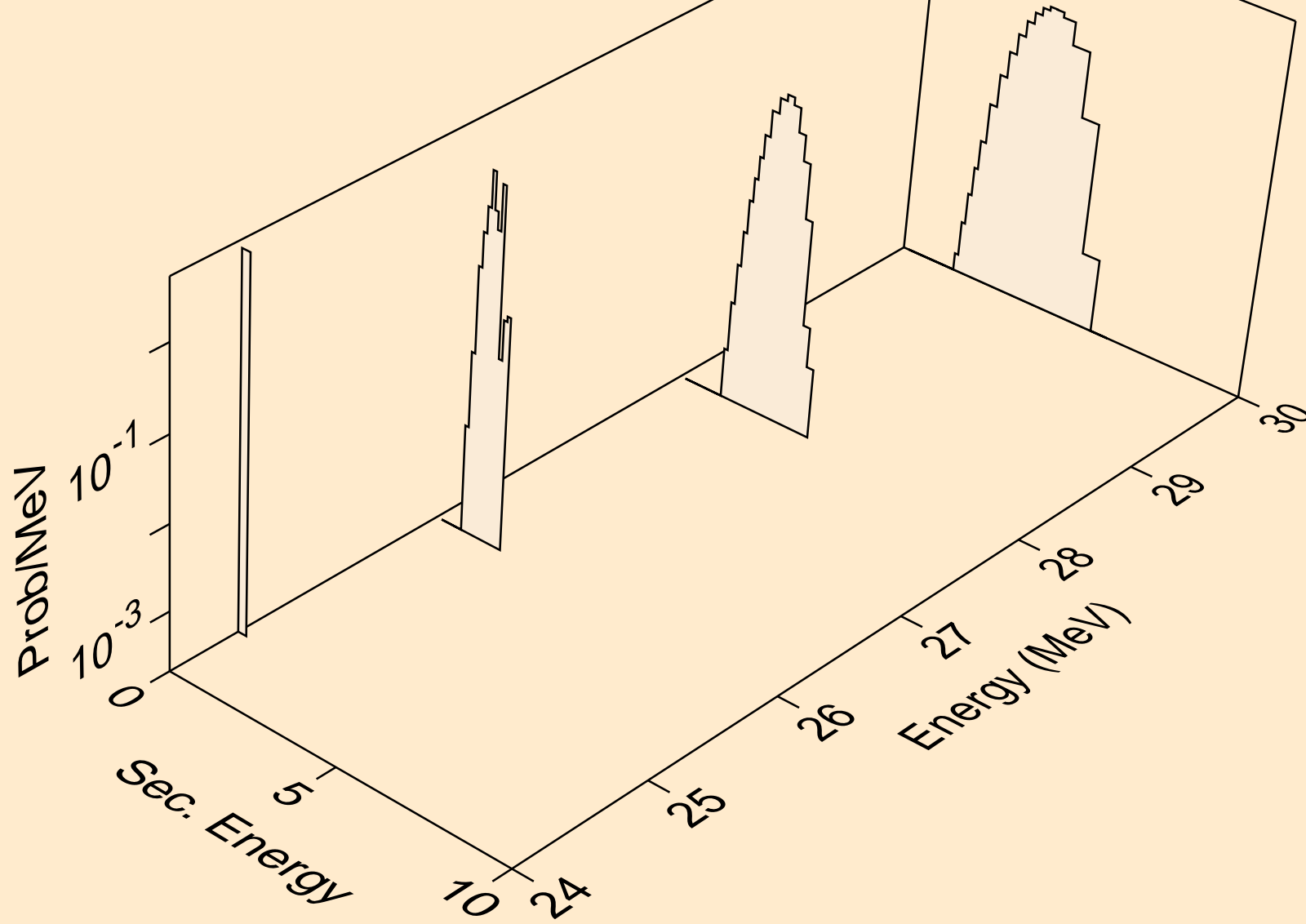

XE125M NEUTRON ACER TENDL-2024 LIBRARY; T=293.6K
protons from (n,n2p)

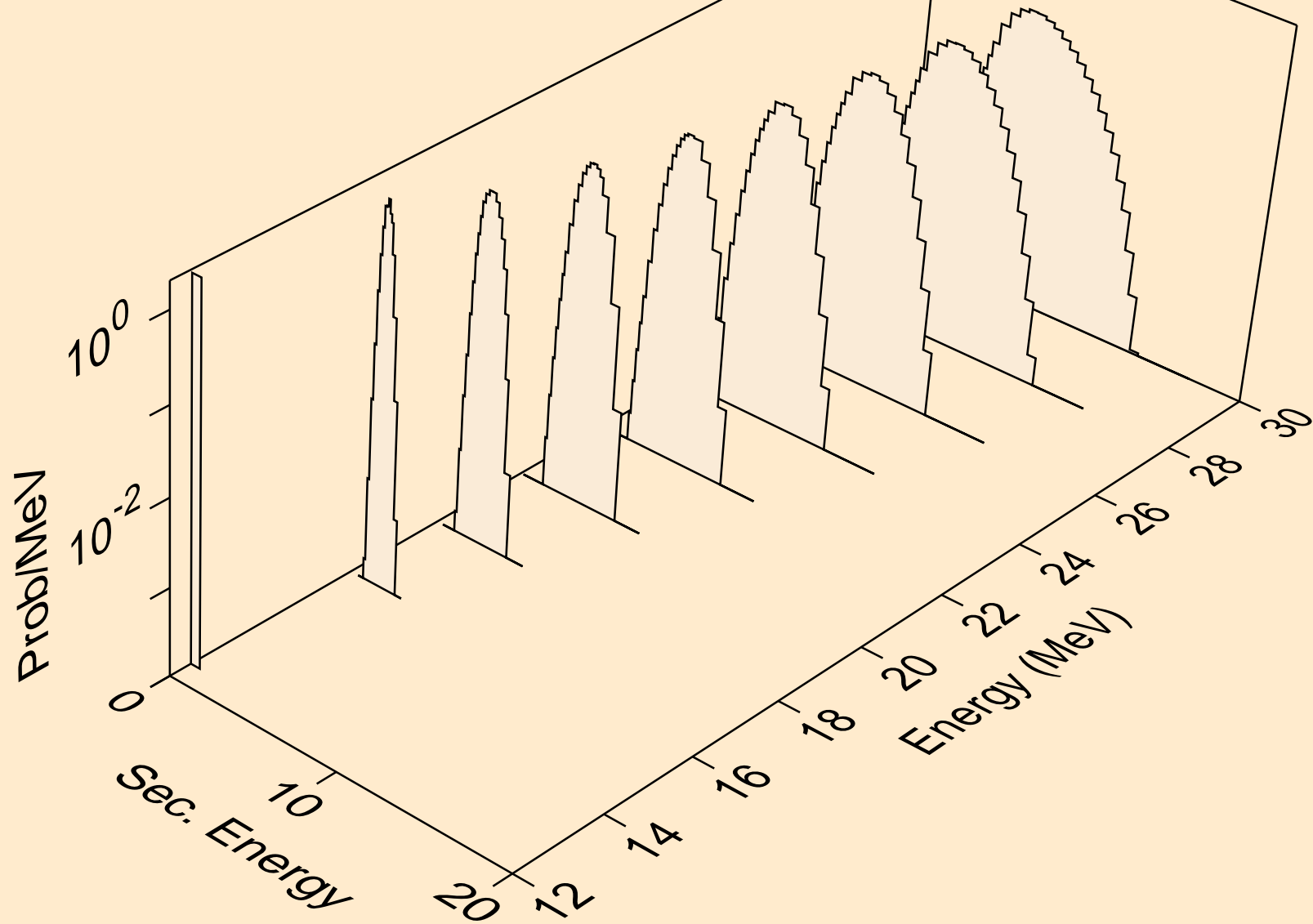

XE125M NEUTRON ACER TENDL-2024 LIBRARY; T=293.6K
protons from (n,npa)

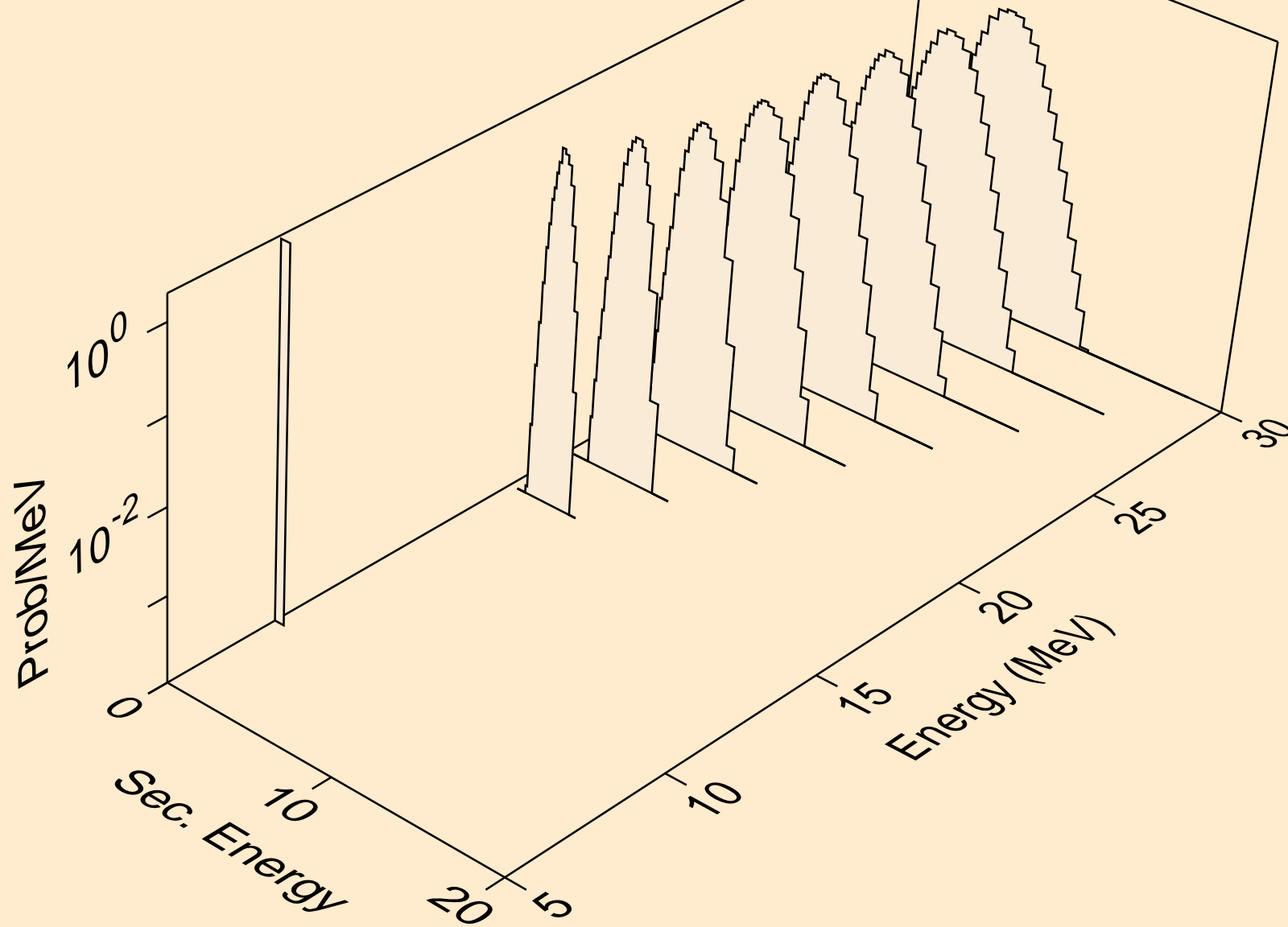

XE125M NEUTRON ACER TENDL-2024 LIBRARY; T=293.6K
protons from (n,p)

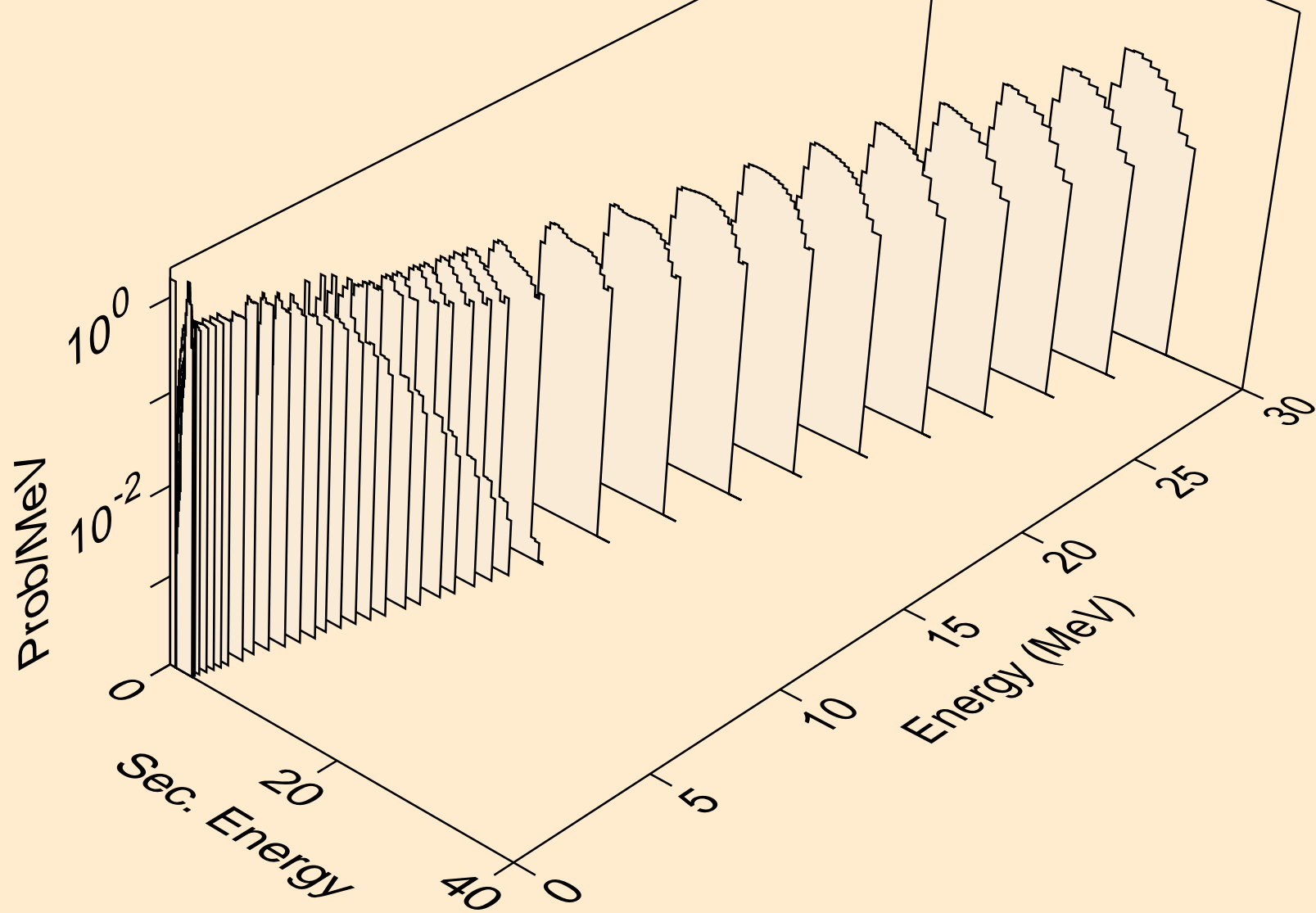

XE125M NEUTRON ACER TENDL-2024 LIBRARY; T=293.6K
protons from (n,2p)

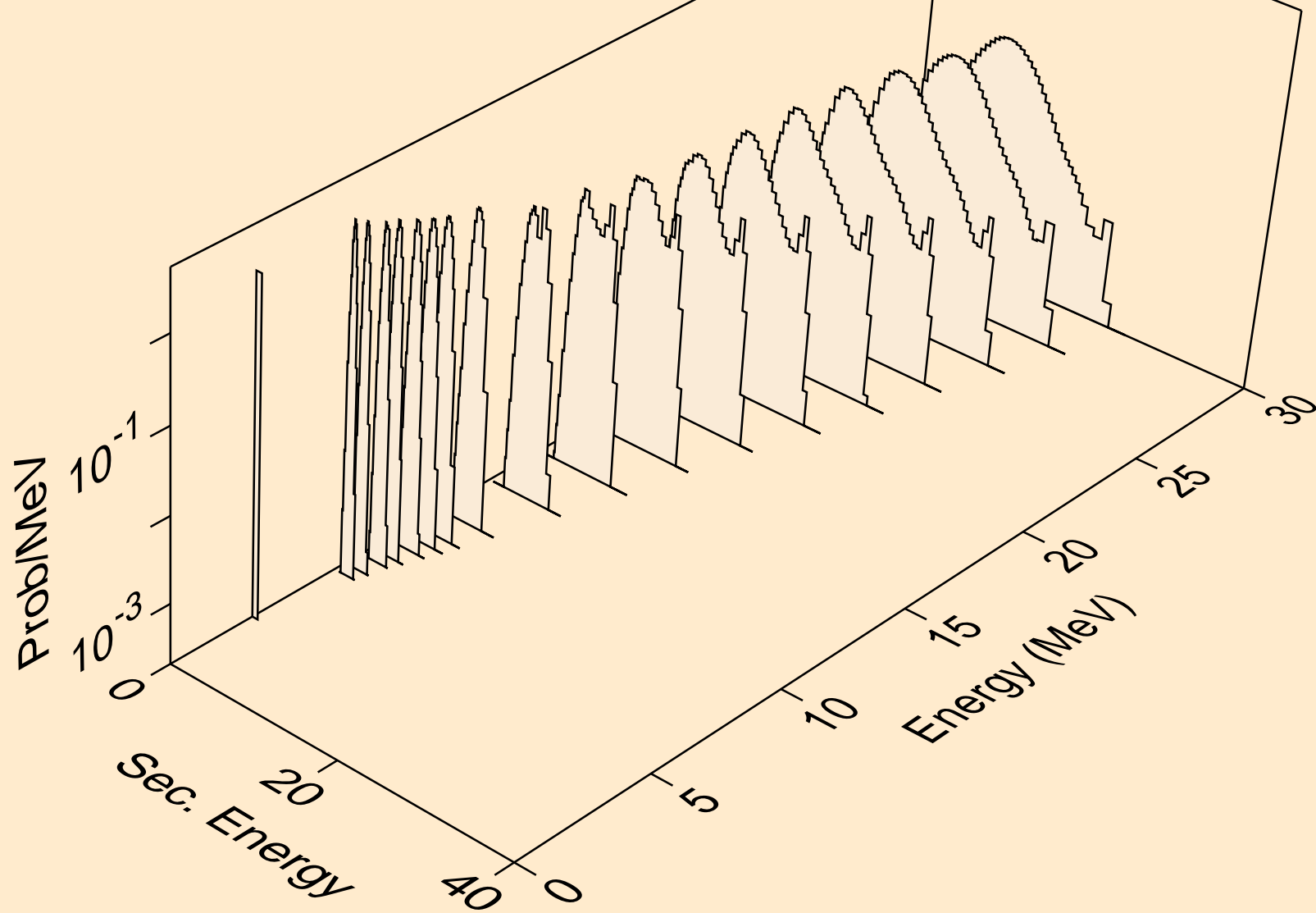

XE125M NEUTRON ACER TENDL-2024 LIBRARY; T=293.6K
protons from (n,p)

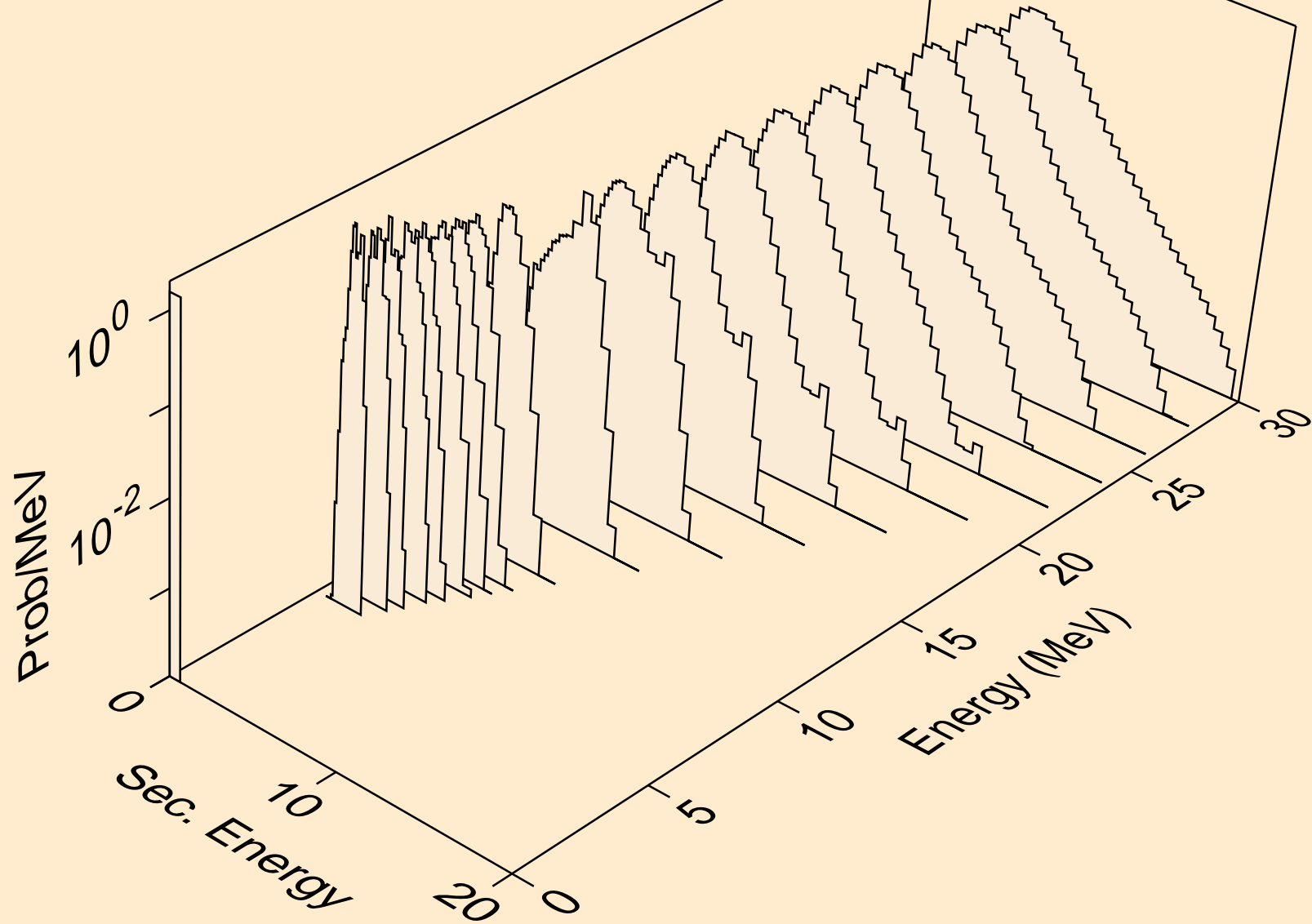

XE125M NEUTRON ACER TENDL-2024 LIBRARY; T=293.6K
protons from (n,pd)

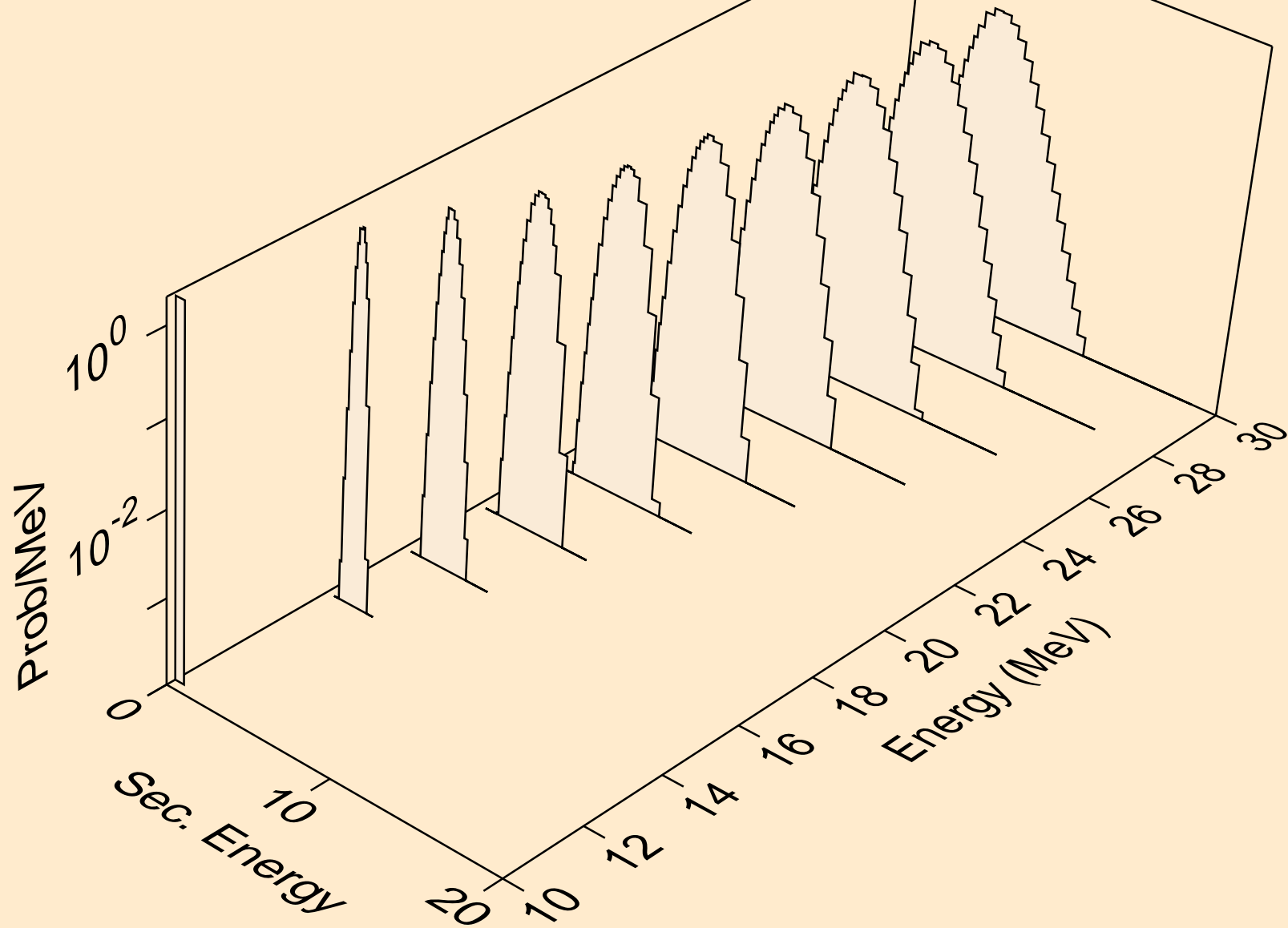

XE125M NEUTRON ACER TENDL-2024 LIBRARY; T=293.6K
protons from (n,pt)

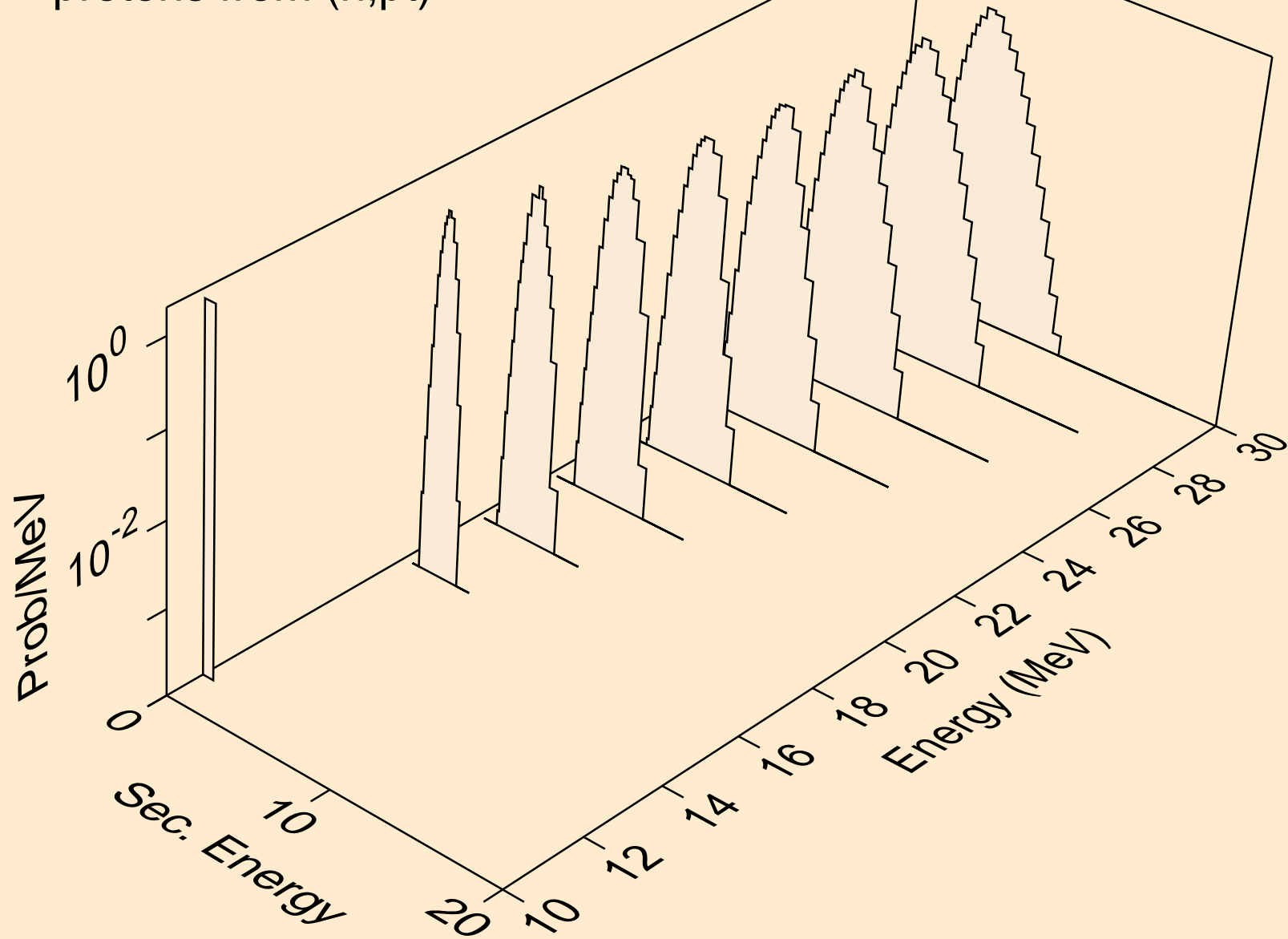

XE125M NEUTRON ACER TENDL-2024 LIBRARY; T=293.6K
deuterons from (n,x)

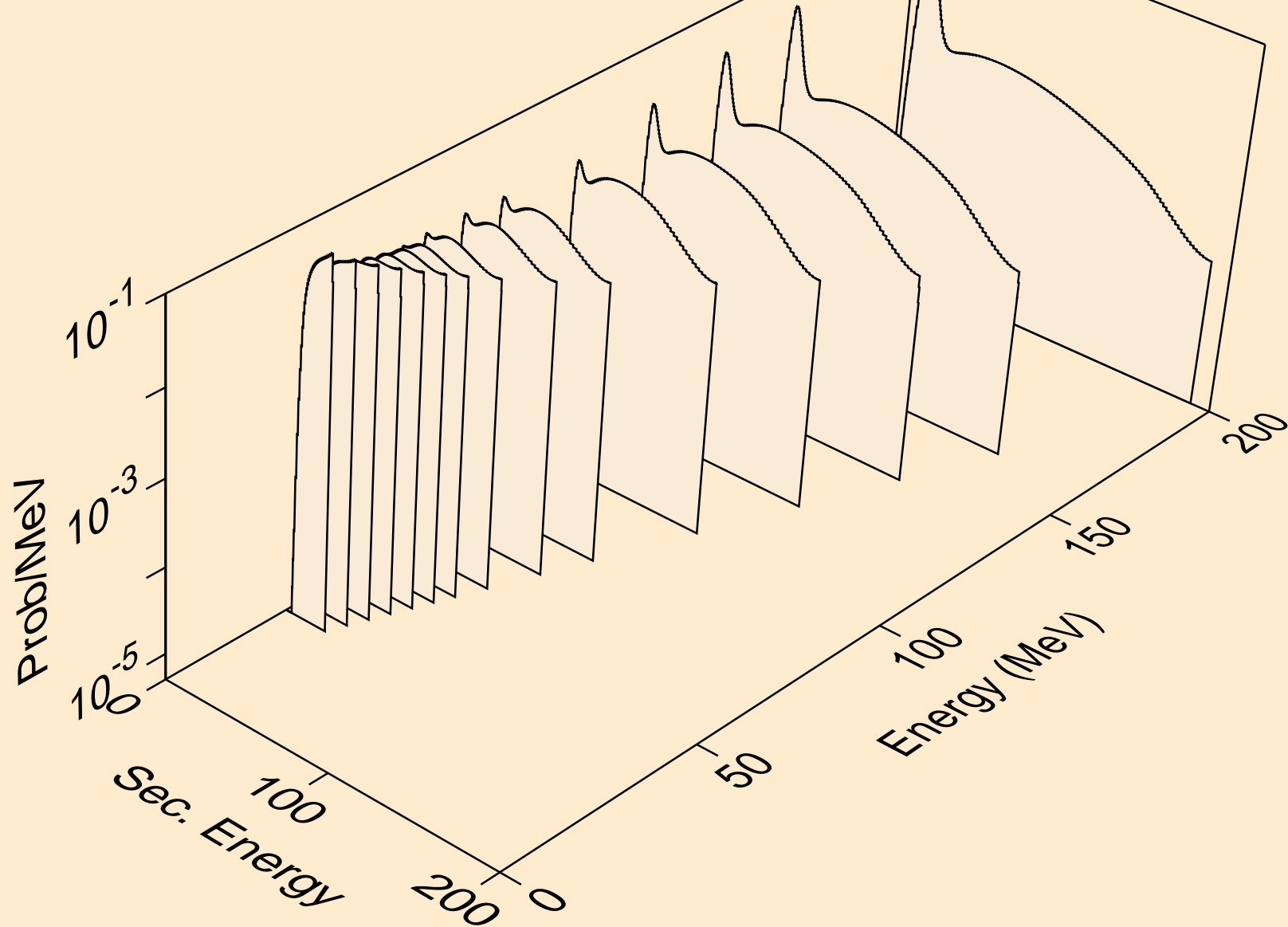

XE125M NEUTRON ACER TENDL-2024 LIBRARY; T=293.6K
deuterons from (n,2nd)

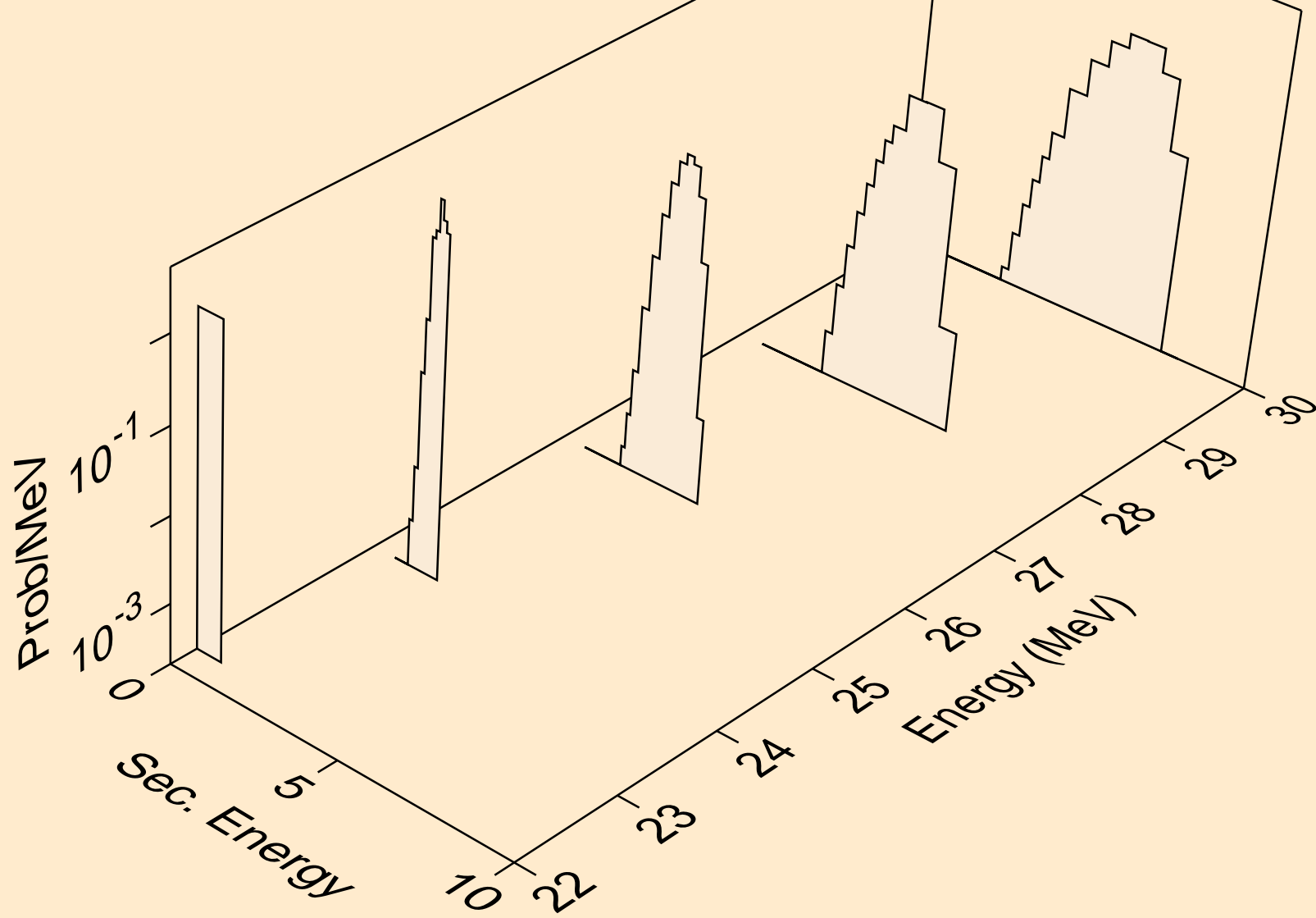

XE125M NEUTRON ACER TENDL-2024 LIBRARY; T=293.6K
deuterons from (n,n*)d

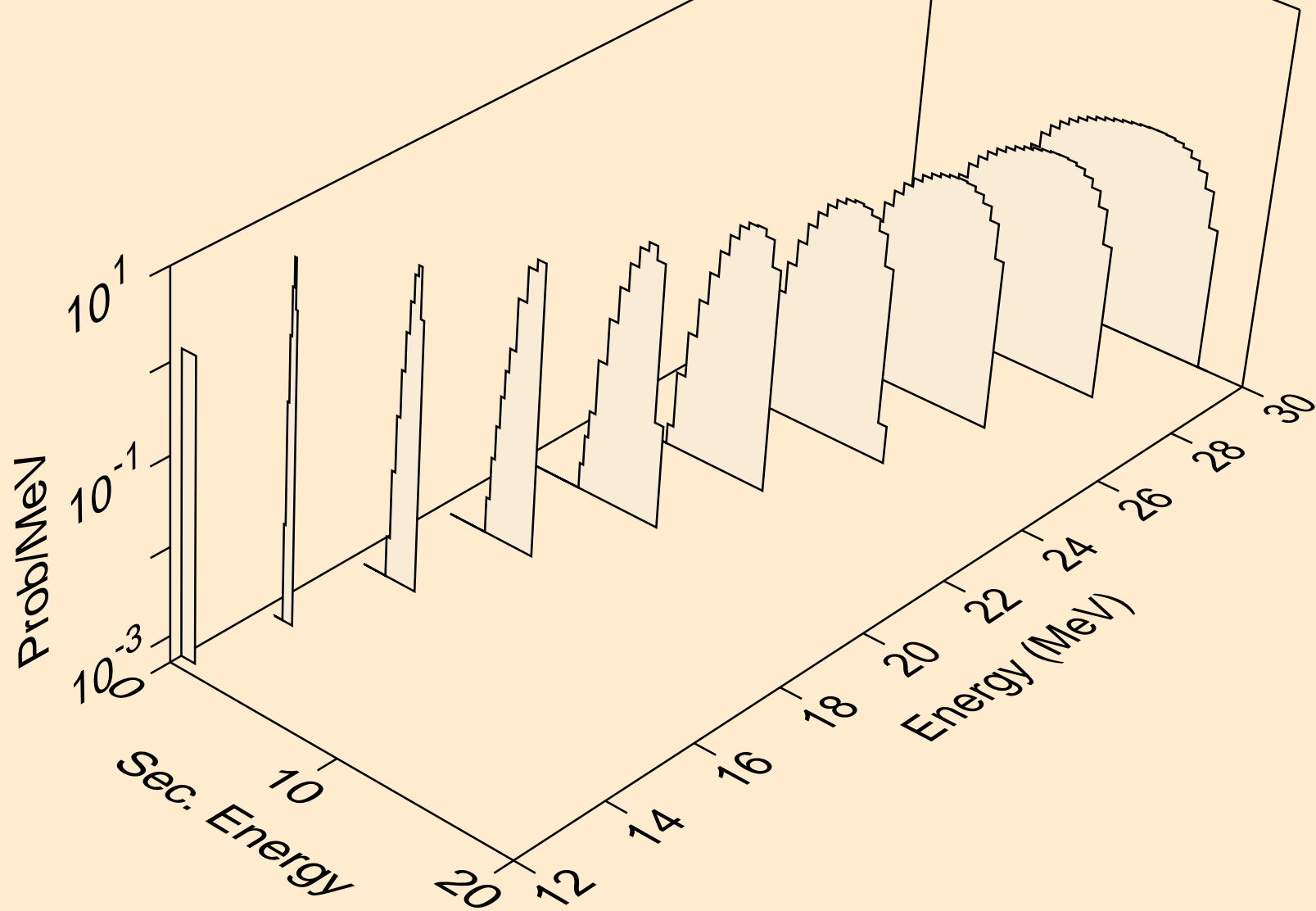

XE125M NEUTRON ACER TENDL-2024 LIBRARY; T=293.6K
deuterons from (n,d)

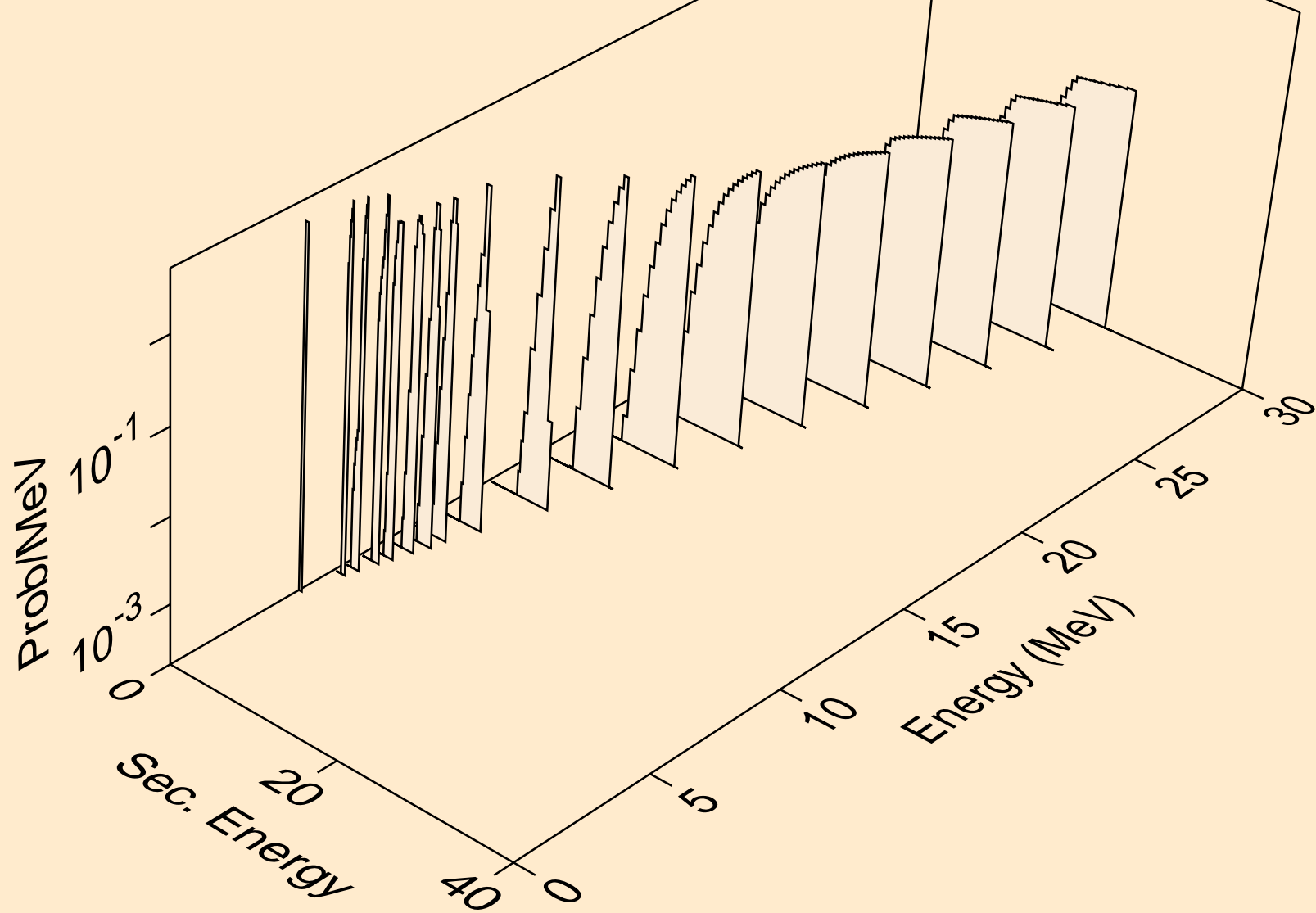

XE125M NEUTRON ACER TENDL-2024 LIBRARY; T=293.6K
deuterons from (n,pd)

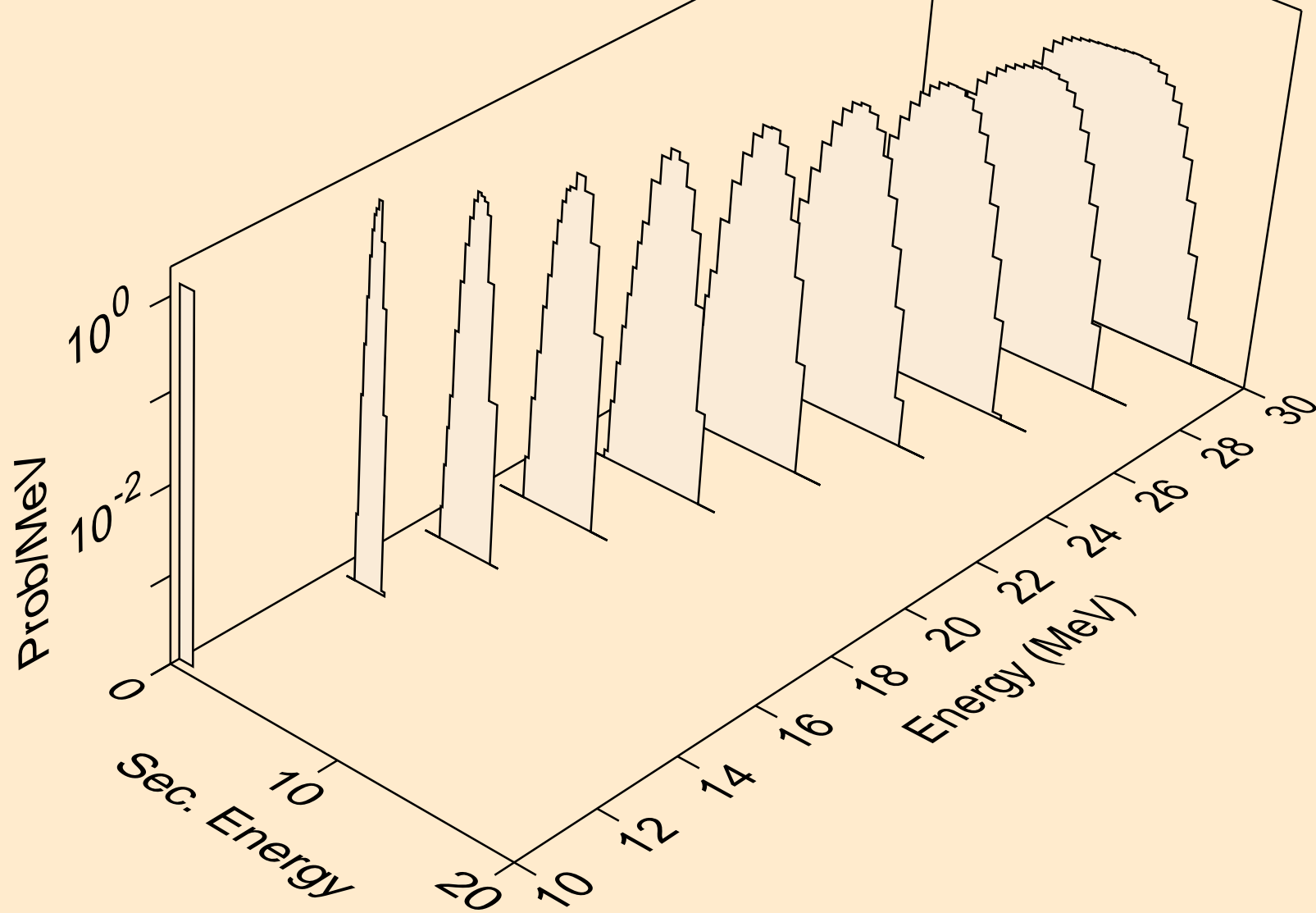

XE125M NEUTRON ACER TENDL-2024 LIBRARY; T=293.6K
deuterons from (n,da)

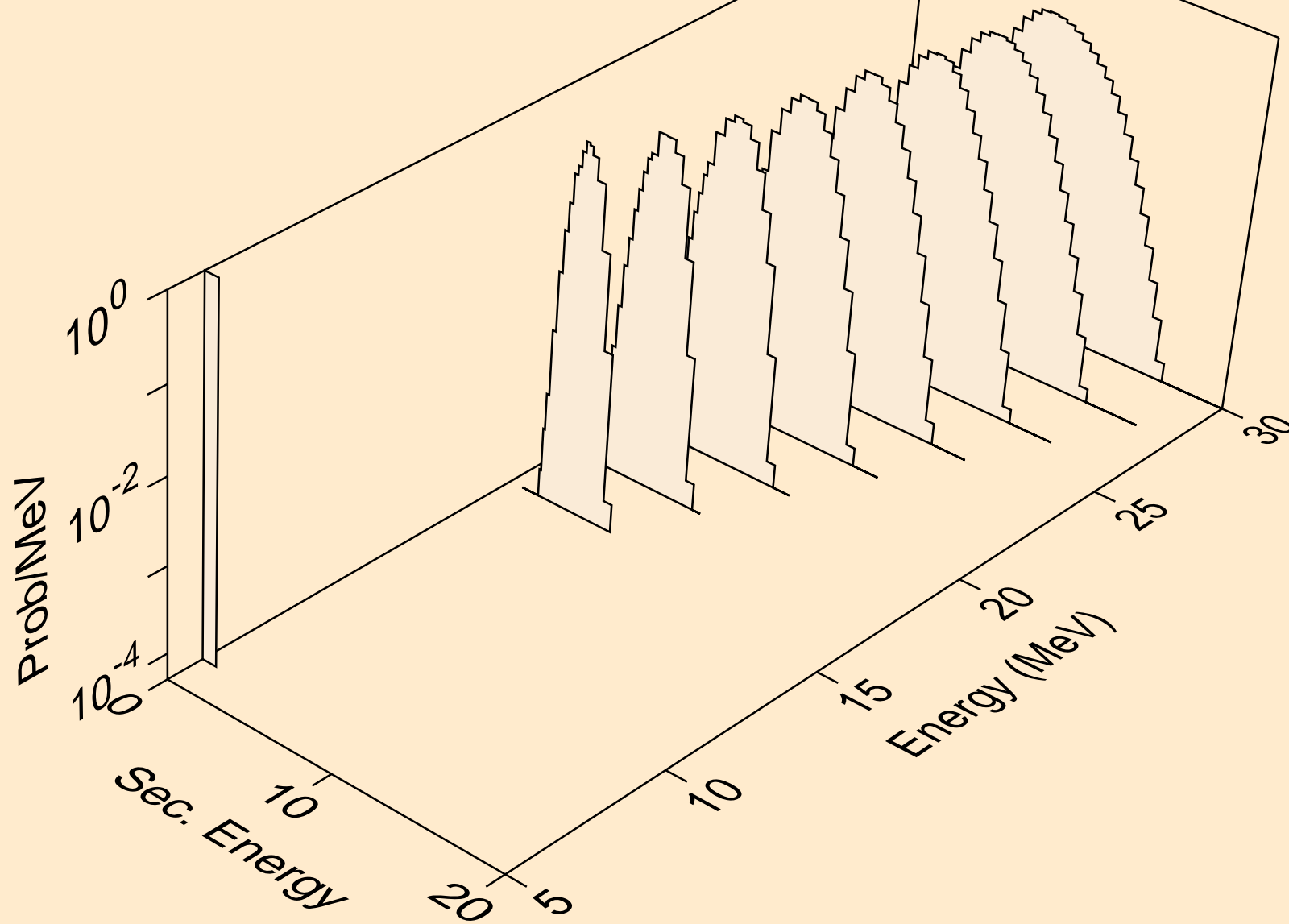

XE125M NEUTRON ACER TENDL-2024 LIBRARY; T=293.6K
tritons from (n,x)

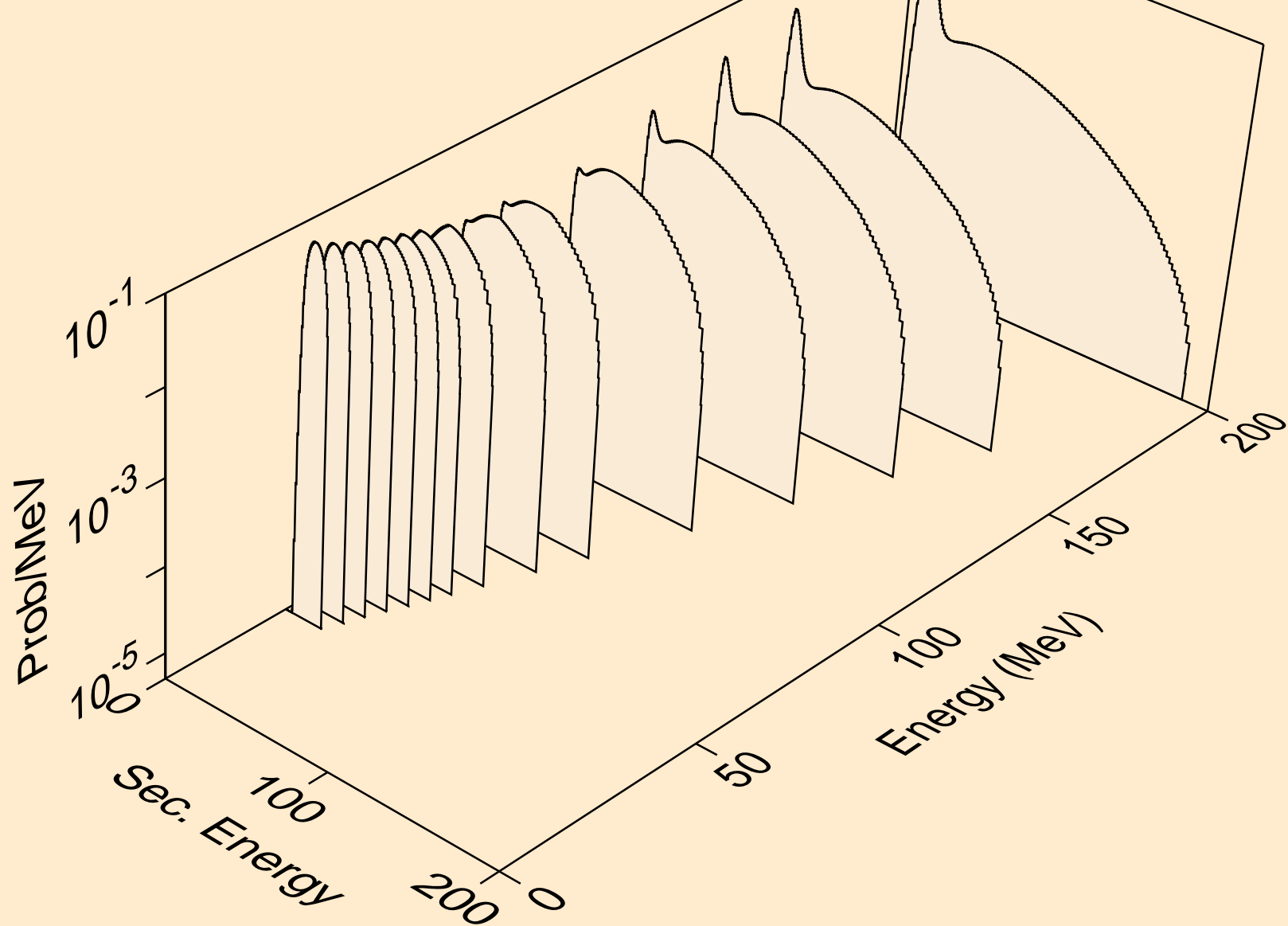

XE125M NEUTRON ACER TENDL-2024 LIBRARY; T=293.6K
tritons from (n,n*)t

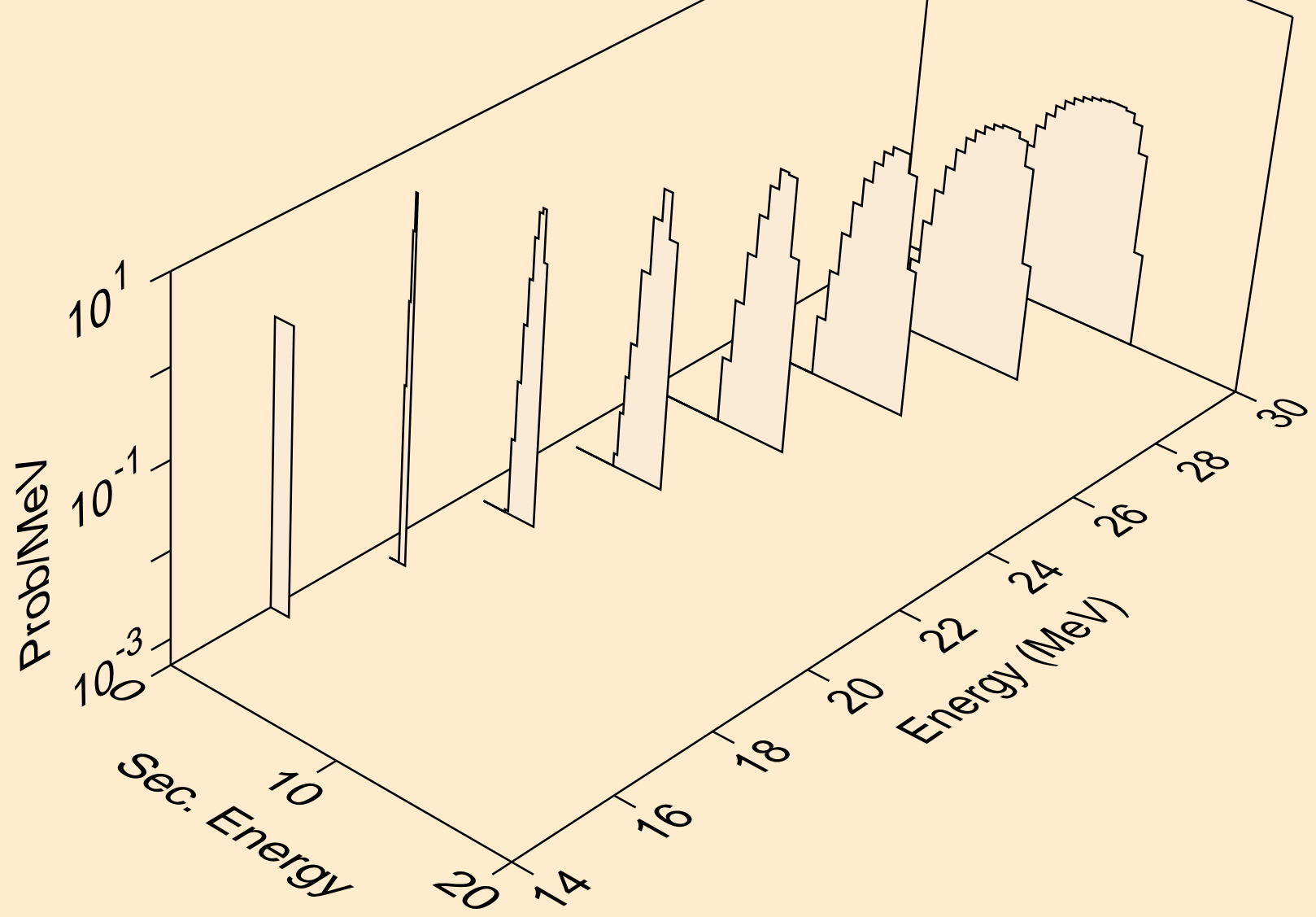

XE125M NEUTRON ACER TENDL-2024 LIBRARY; T=293.6K
tritons from (n,t)

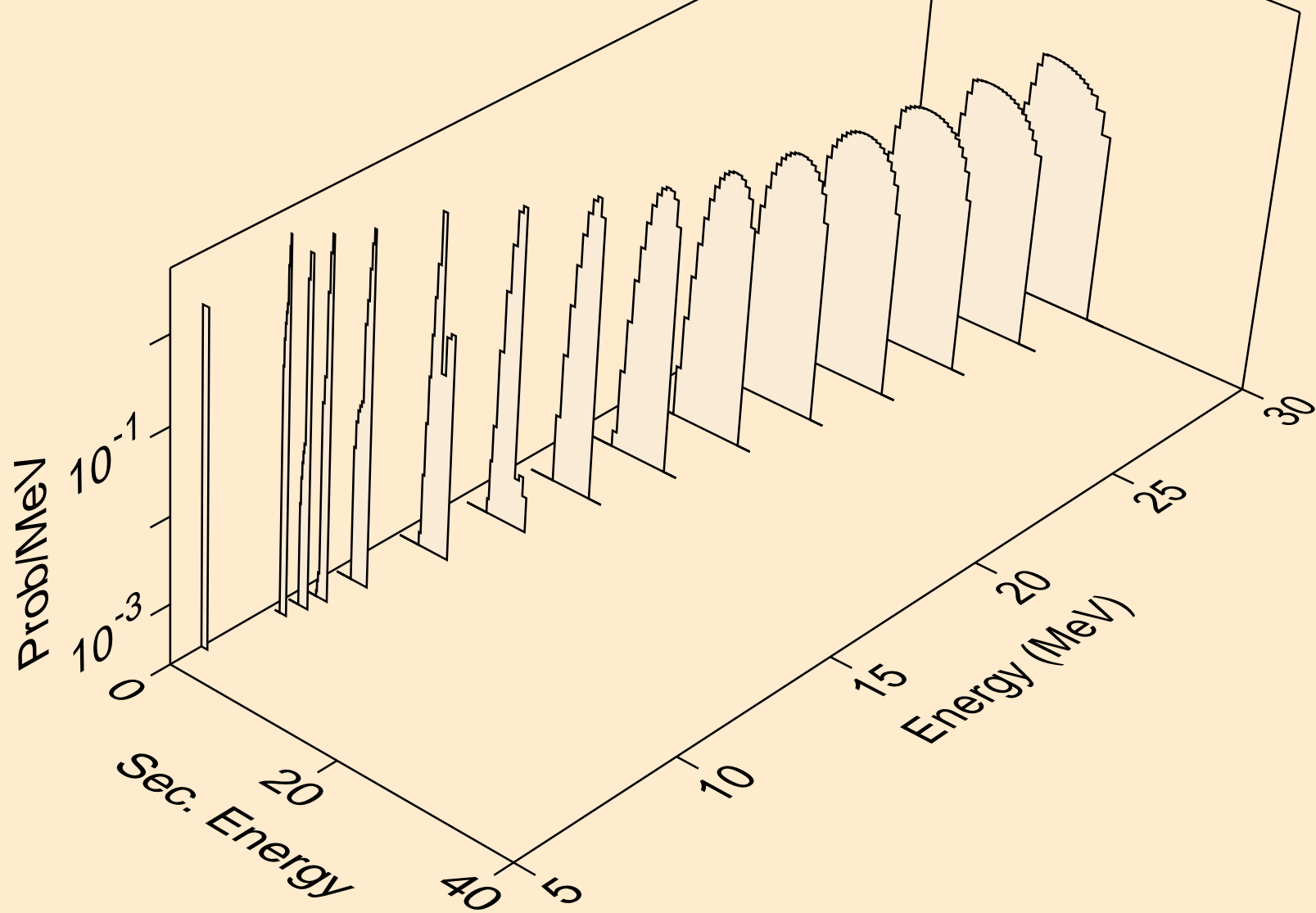

XE125M NEUTRON ACER TENDL-2024 LIBRARY; T=293.6K
tritons from (n,pt)

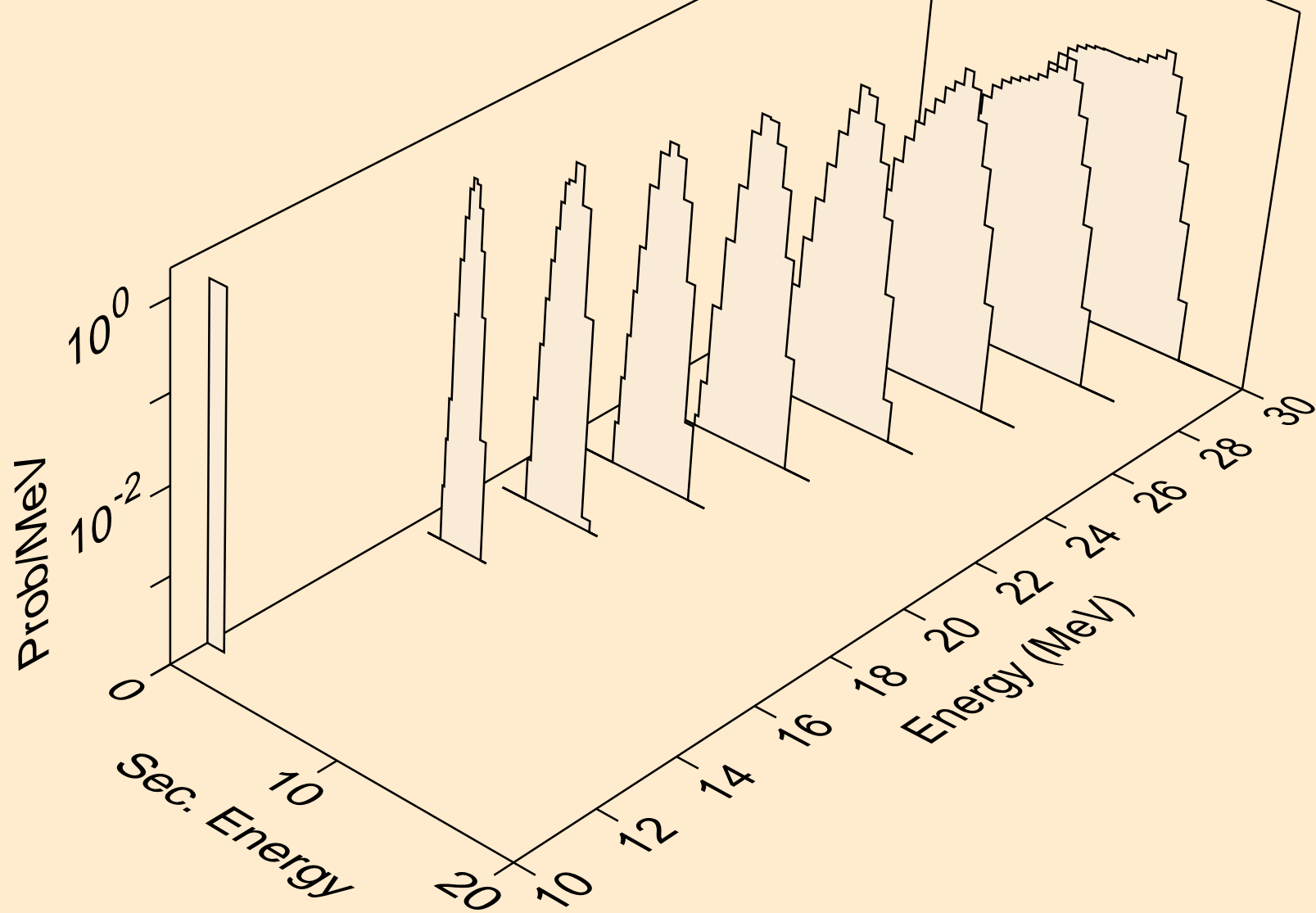

XE125M NEUTRON ACER TENDL-2024 LIBRARY; T=293.6K
he3s from (n,x)

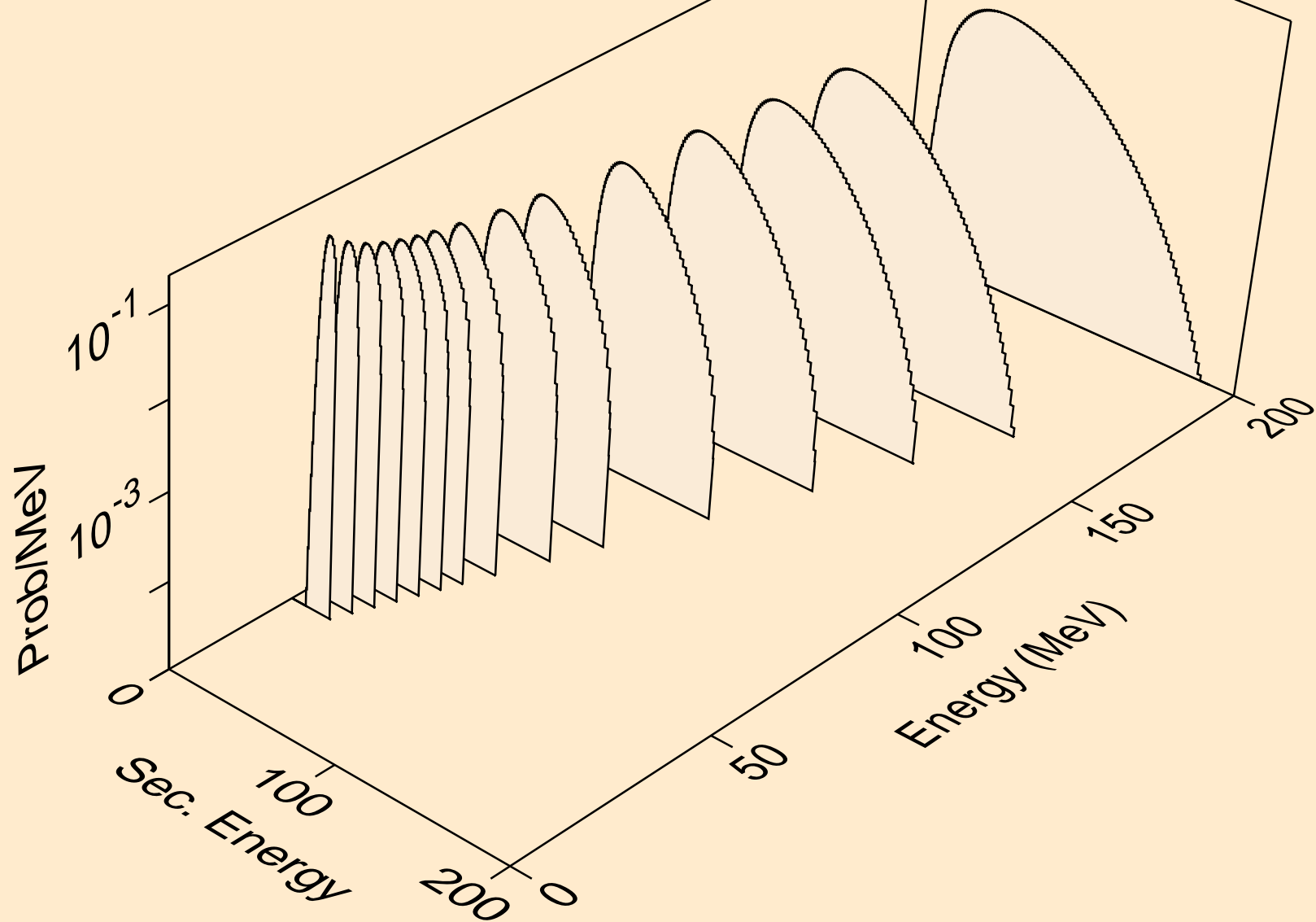

XE125M NEUTRON ACER TENDL-2024 LIBRARY; T=293.6K
he3s from (n,n*)he3

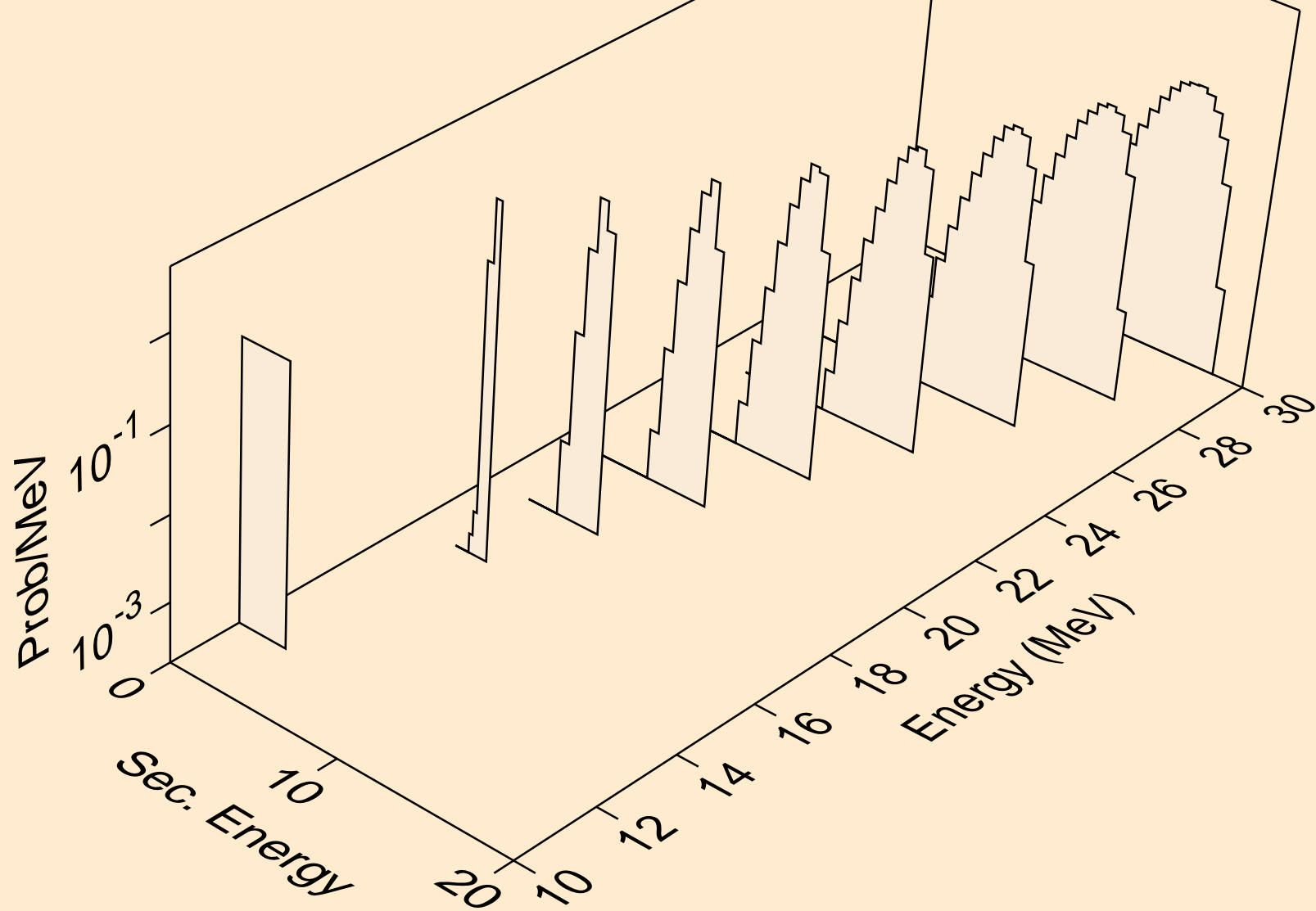

XE125M NEUTRON ACER TENDL-2024 LIBRARY; T=293.6K
he3s from (n,he3)

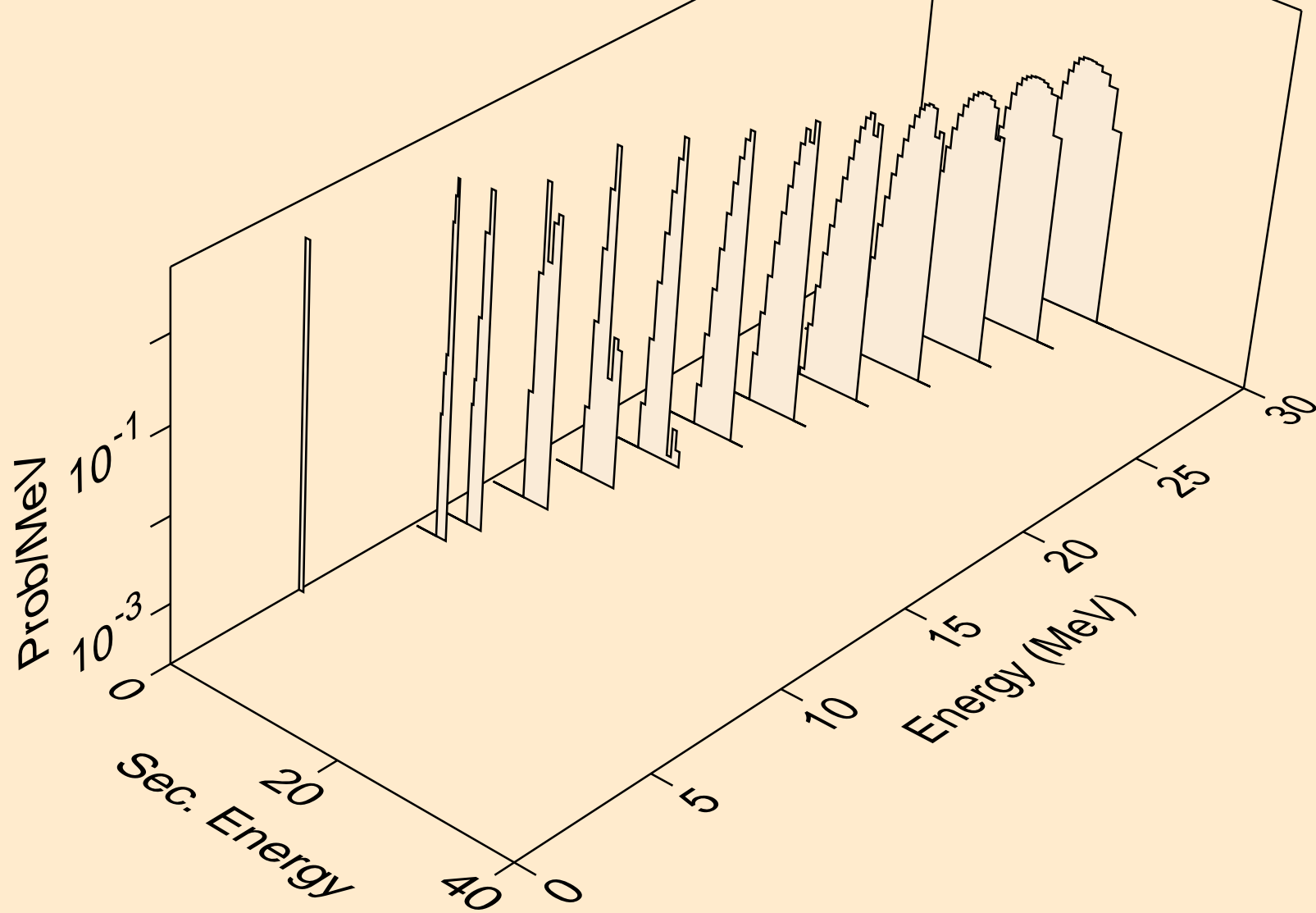

XE125M NEUTRON ACER TENDL-2024 LIBRARY; T=293.6K
alphas from (n,x)

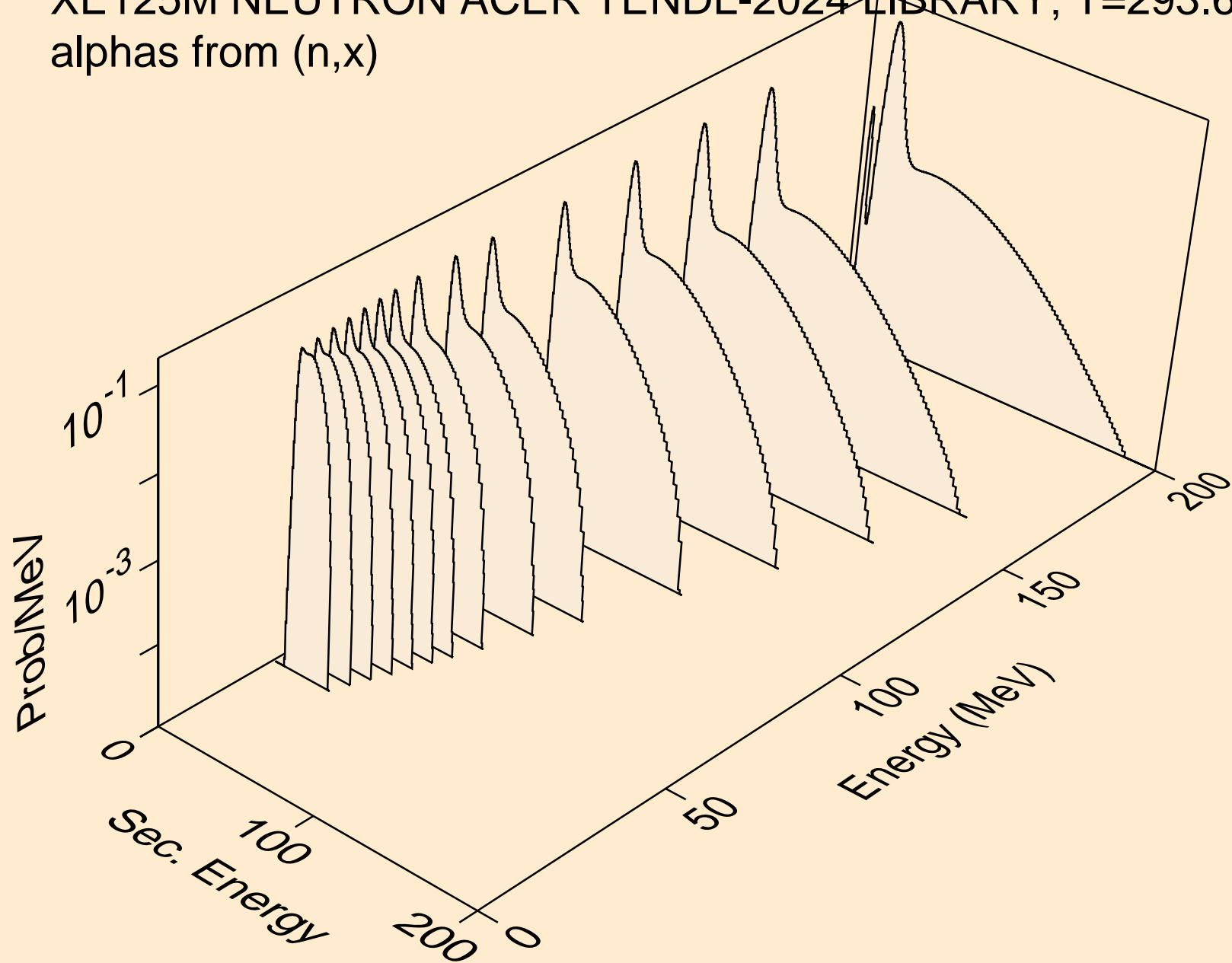

XE125M NEUTRON ACER TENDL-2024 LIBRARY; T=293.6K
alphas from (n,n*)a

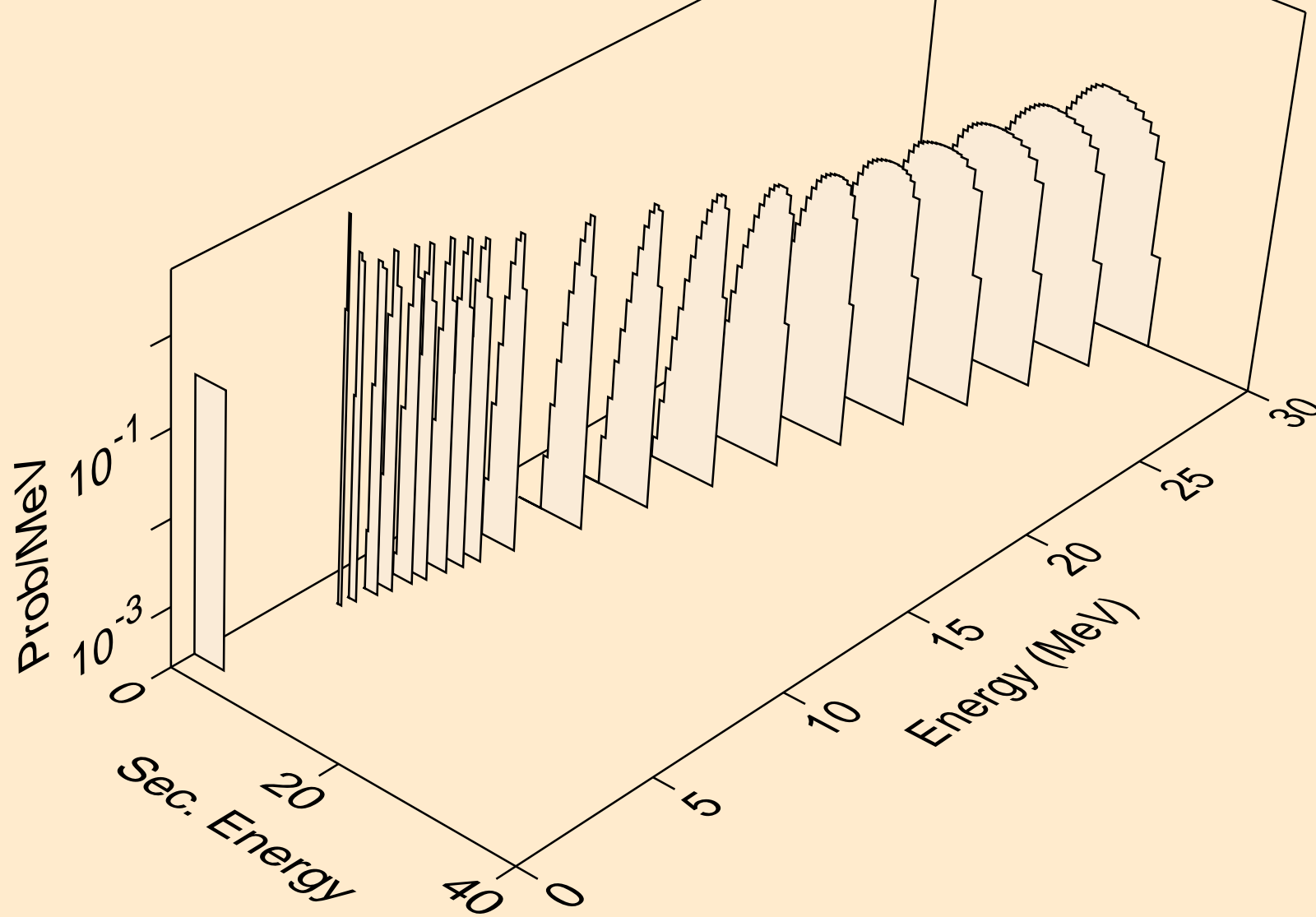

XE125M NEUTRON ACER TENDL-2024 LIBRARY; T=293.6K
alphas from (n,2n)a

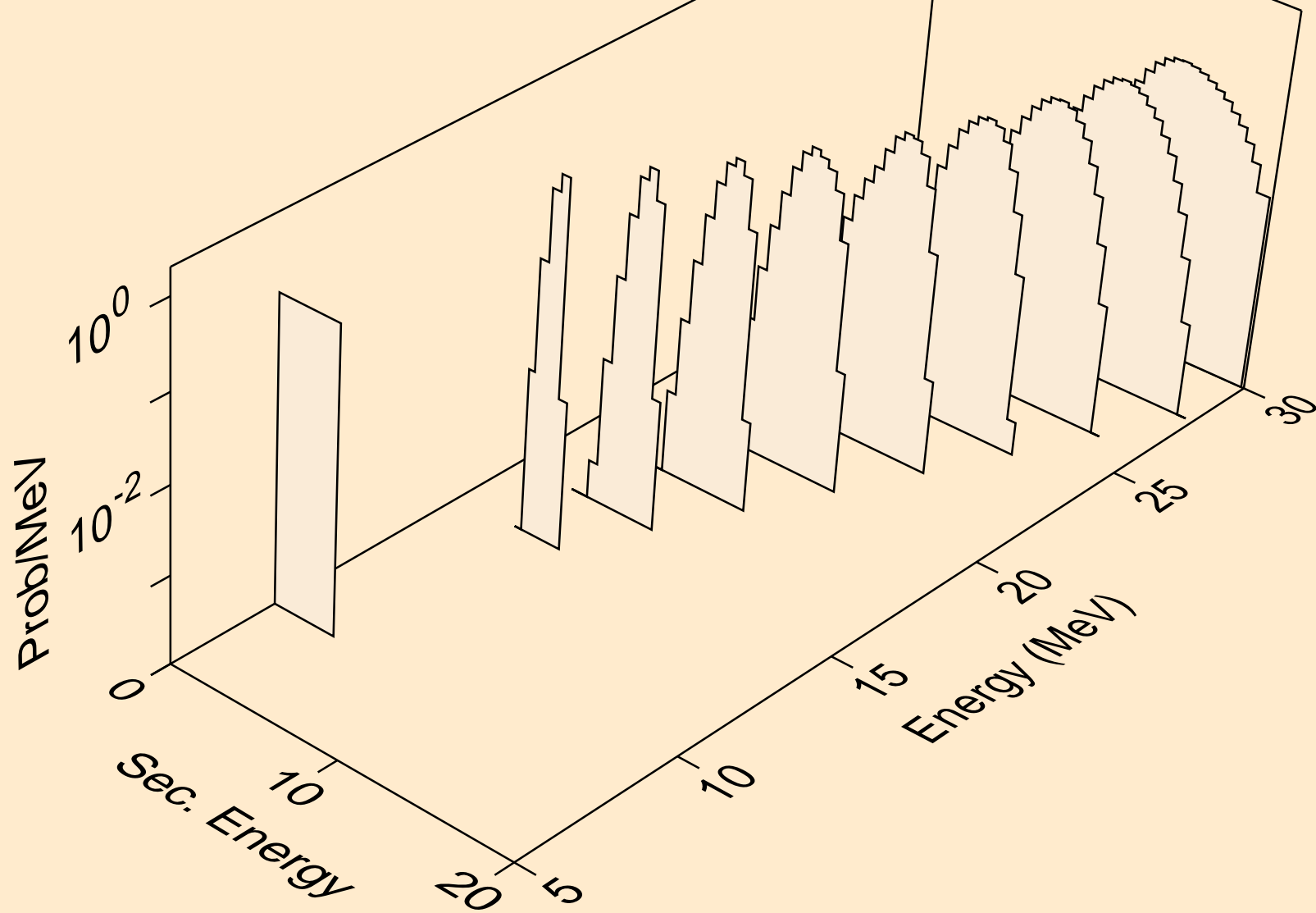

XE125M NEUTRON ACER TENDL-2024 LIBRARY; T=293.6K
alphas from (n,3n)a

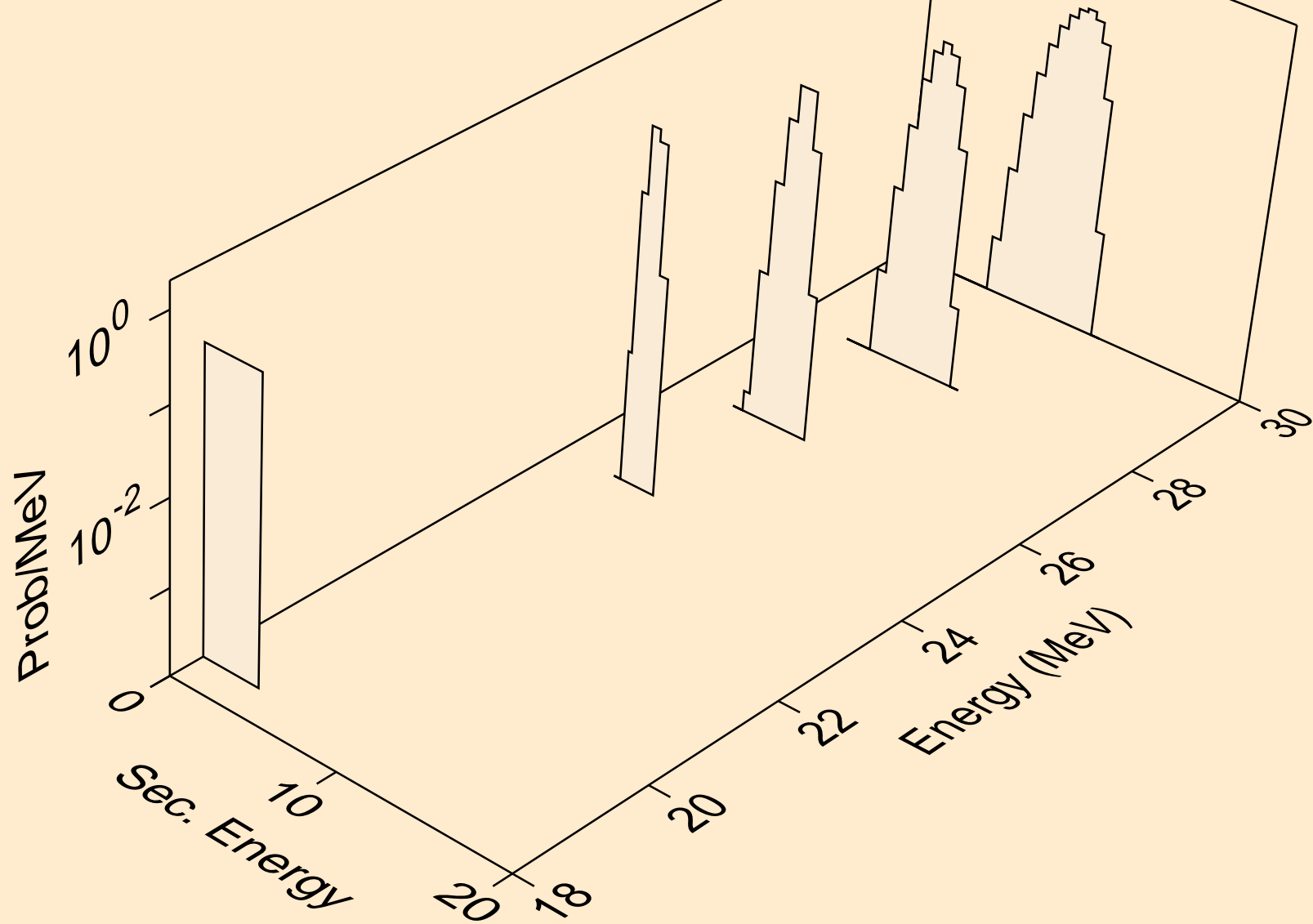

XE125M NEUTRON ACER TENDL-2024 LIBRARY; T=293.6K
alphas from (n,n*)2a

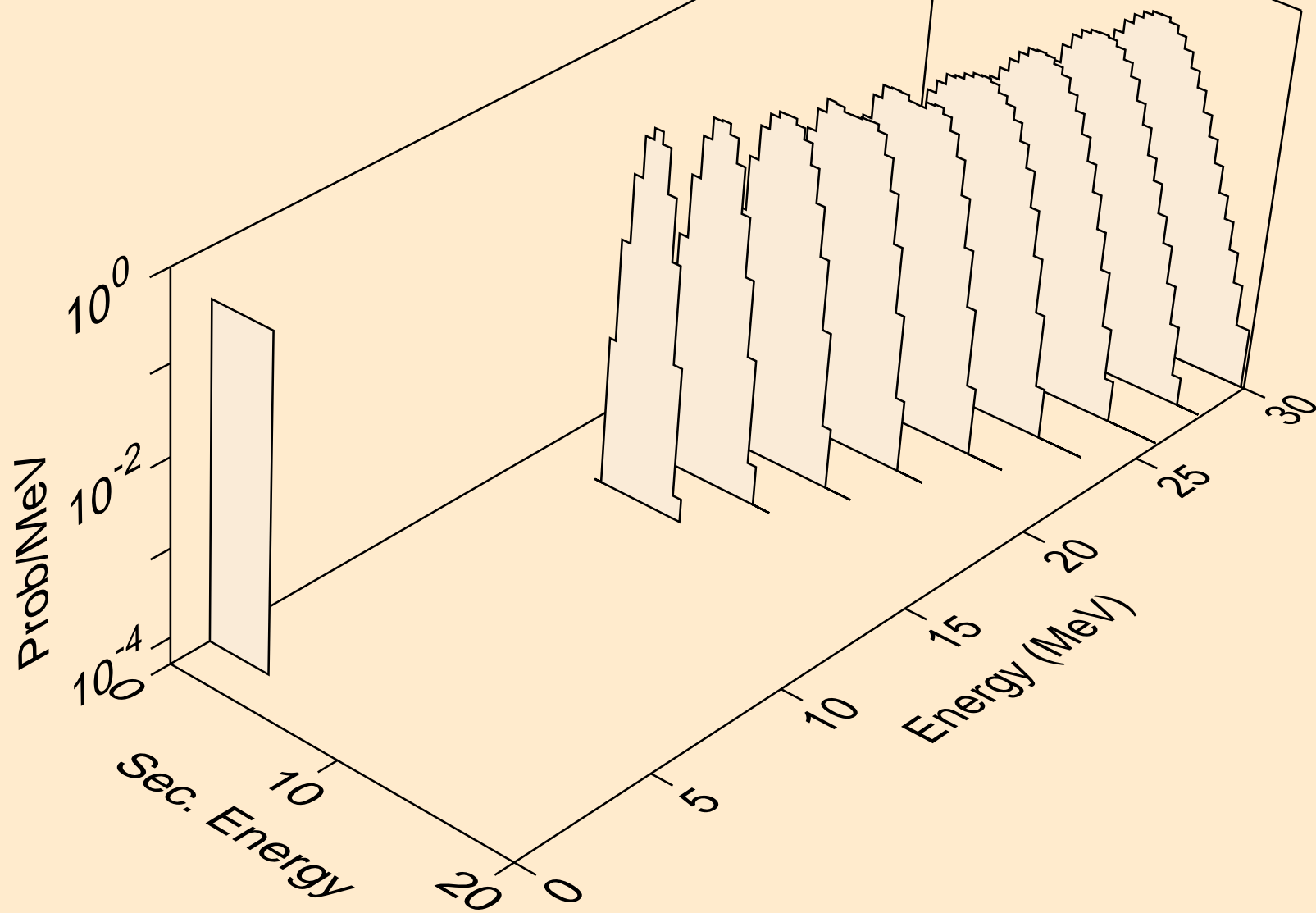

XE125M NEUTRON ACER TENDL-2024 LIBRARY; T=293.6K
alphas from (n,2n)2a

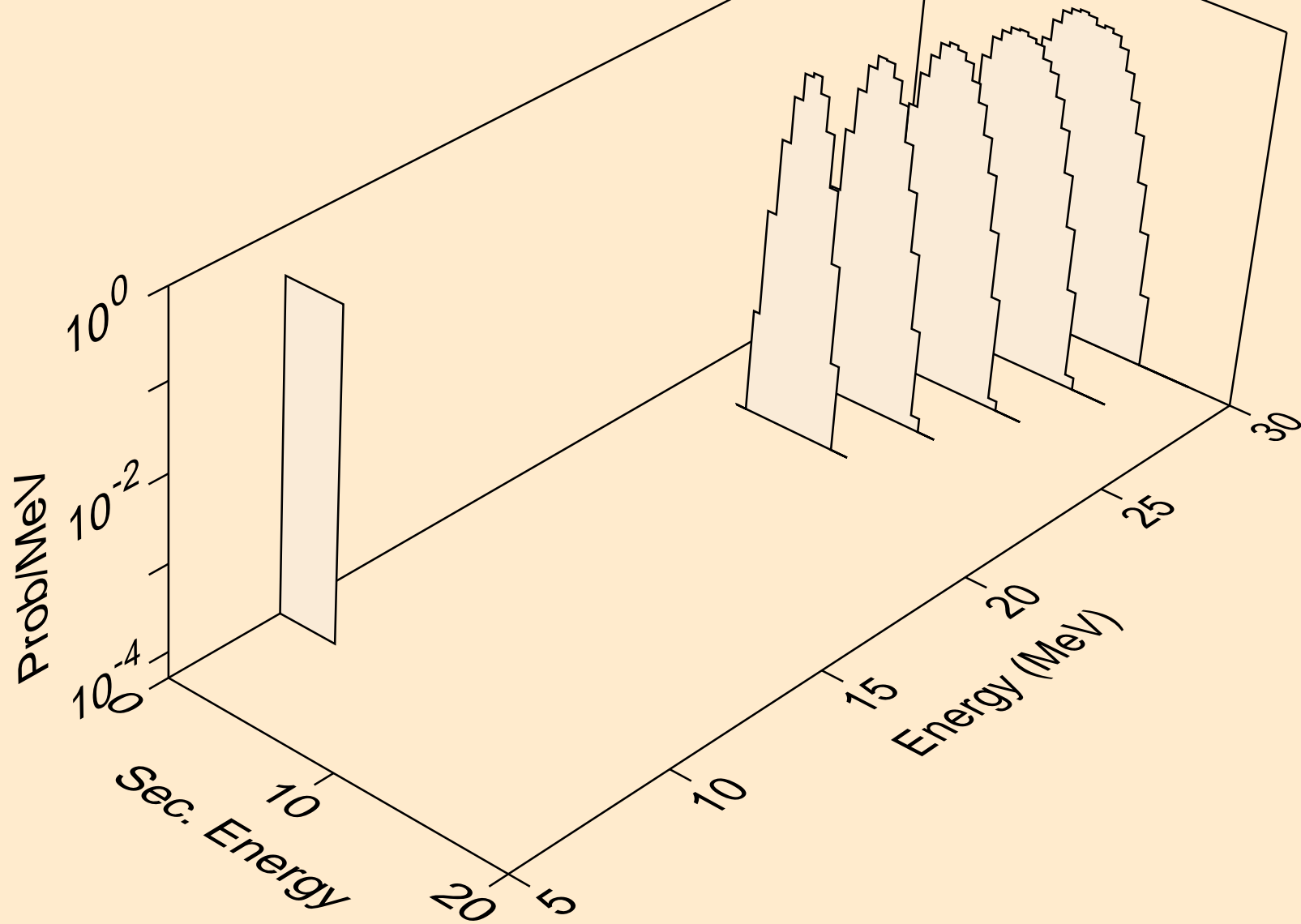

XE125M NEUTRON ACER TENDL-2024 LIBRARY; T=293.6K
alphas from (n,npa)

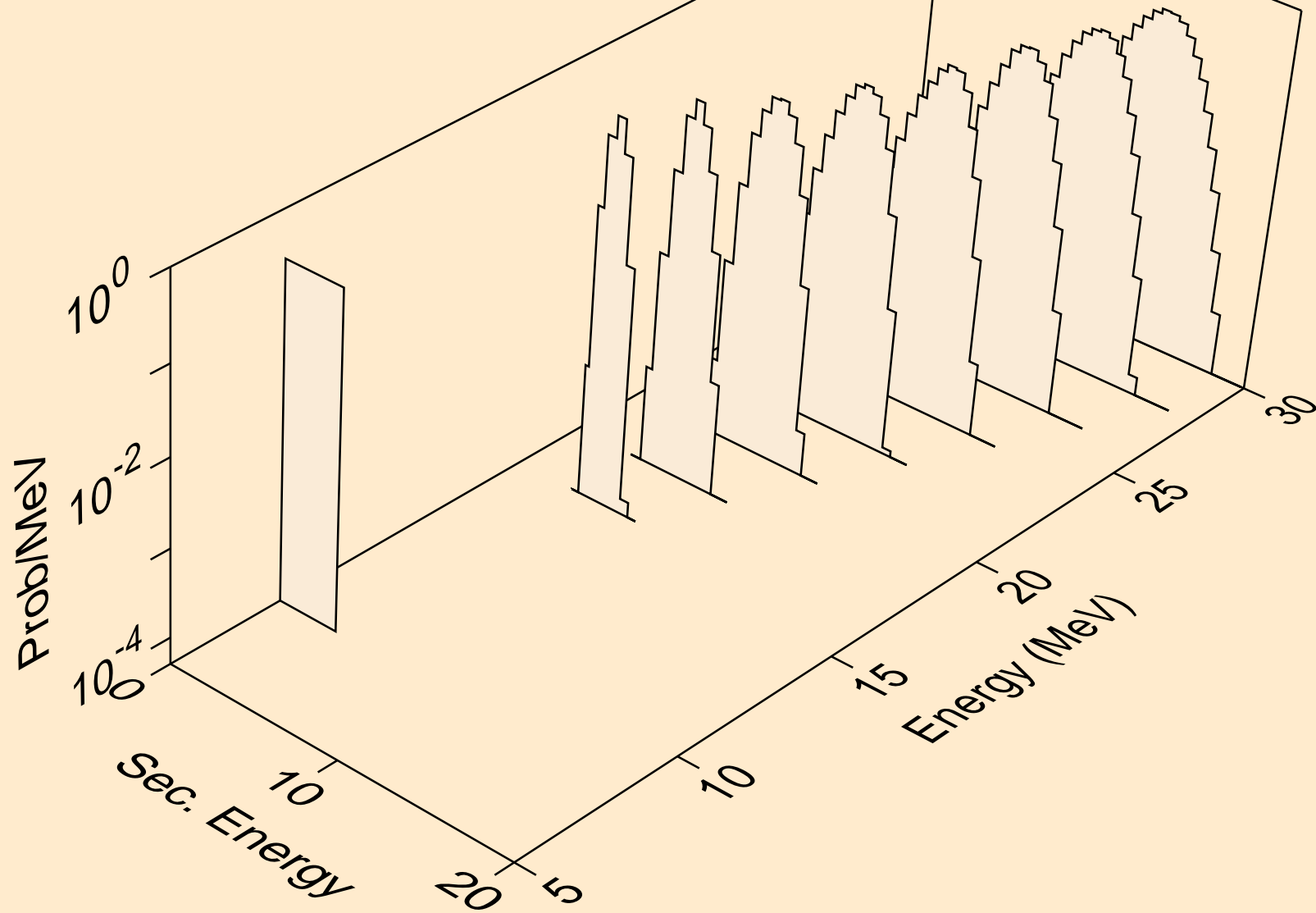

XE125M NEUTRON ACER TENDL-2024 LIBRARY; T=293.6K
alphas from (n,a)

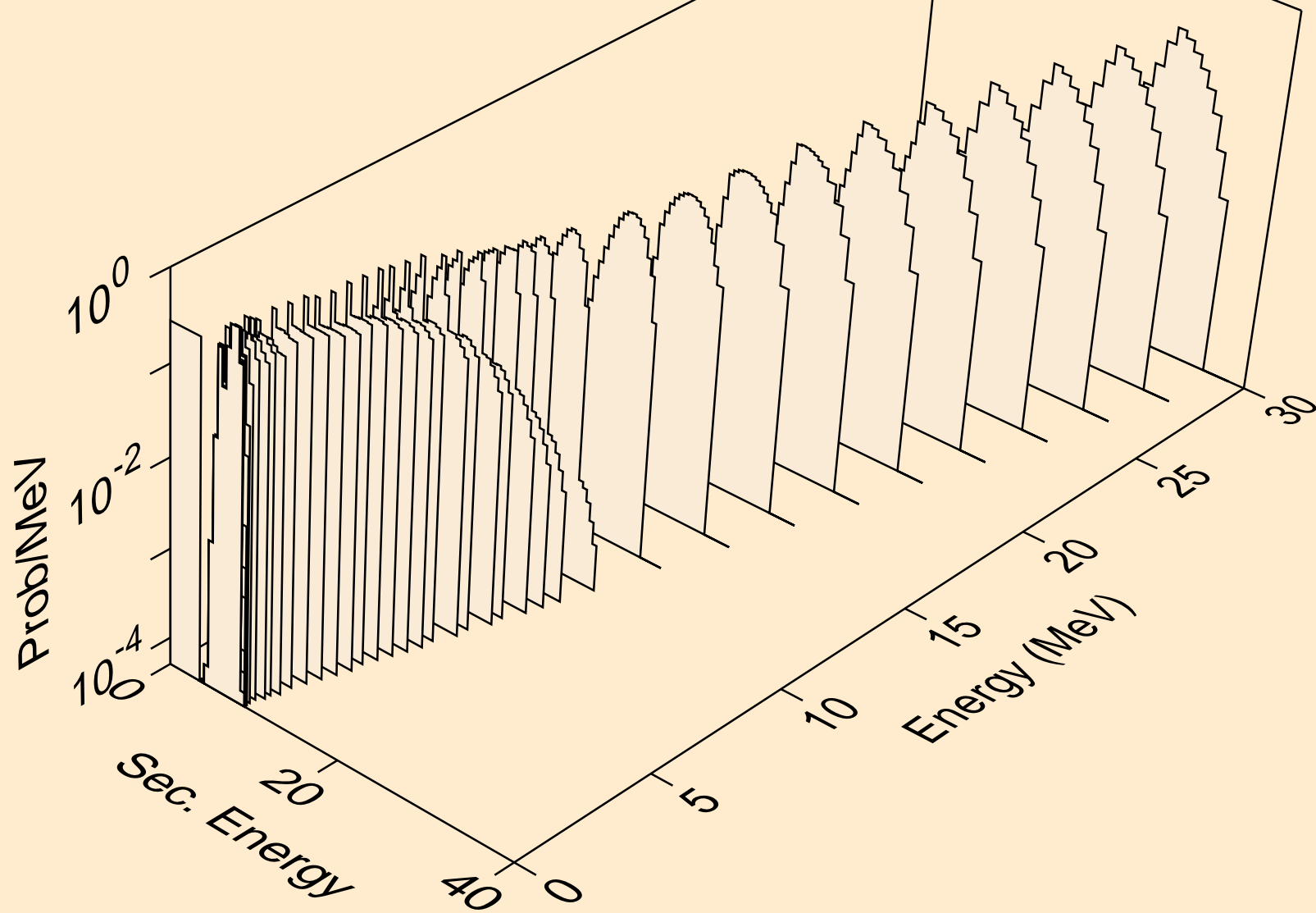

XE125M NEUTRON ACER TENDL-2024 LIBRARY; T=293.6K
alphas from (n,2a)

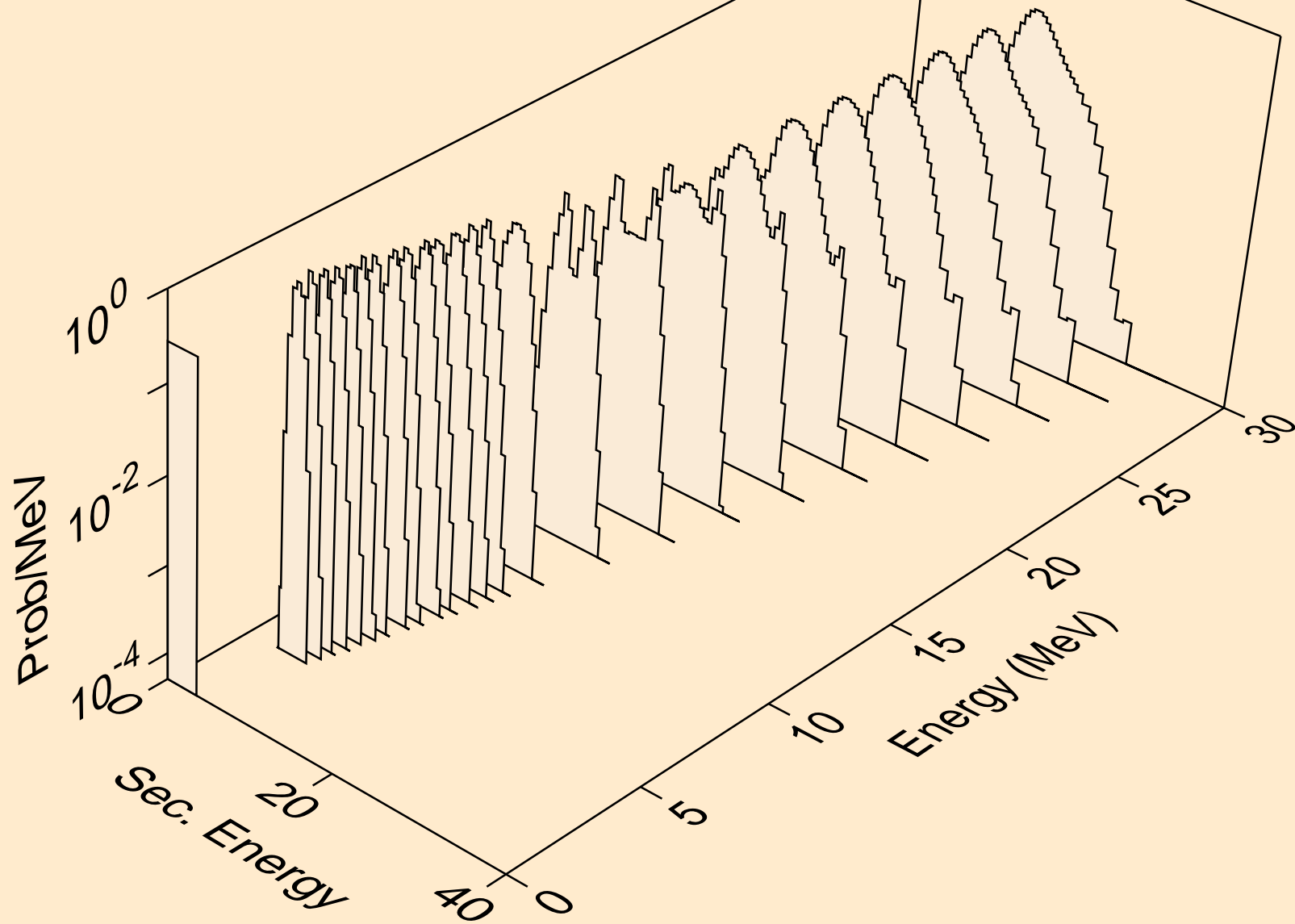

XE125M NEUTRON ACER TENDL-2024 LIBRARY; T=293.6K
alphas from (n,pa)

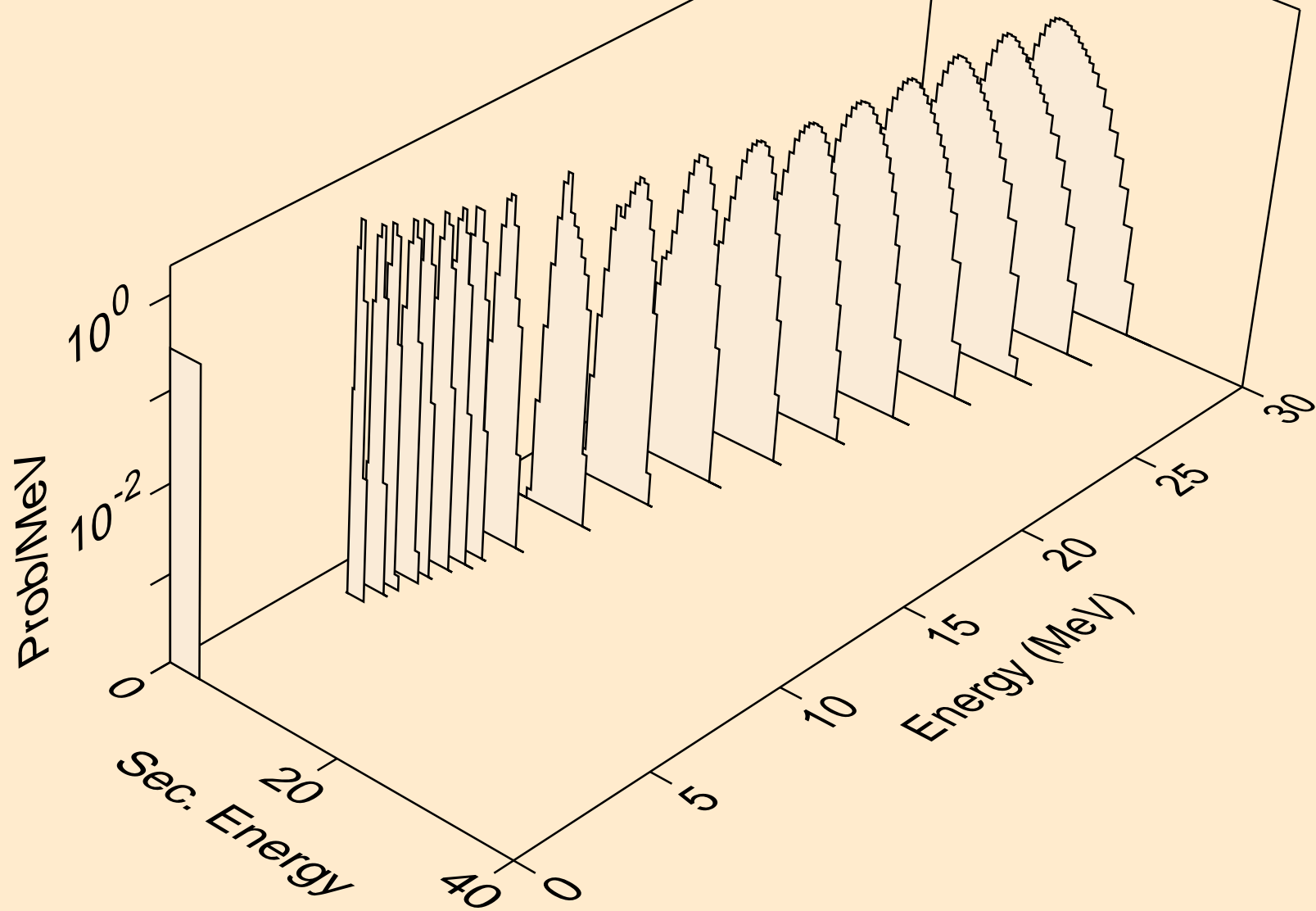

XE125M NEUTRON ACER TENDL-2024 LIBRARY; T=293.6K
alphas from (n,da)

