

Y078M NEUTRON ACER TENDL-2024 LIBRARY; T=293.6K
Principal cross sections

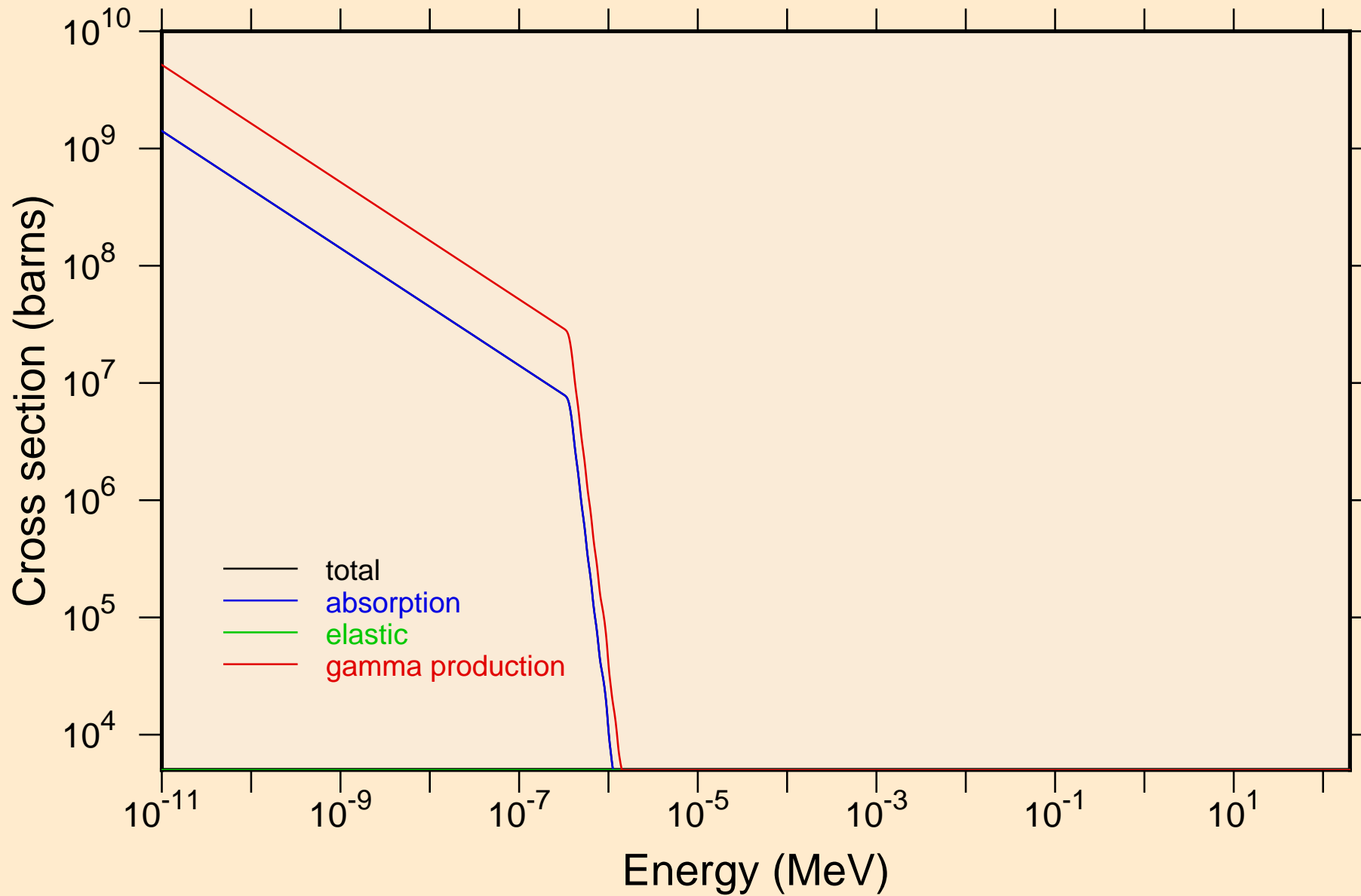

Y078M NEUTRON ACER TENDL-2024 LIBRARY; T=293.6K
resonance total cross section

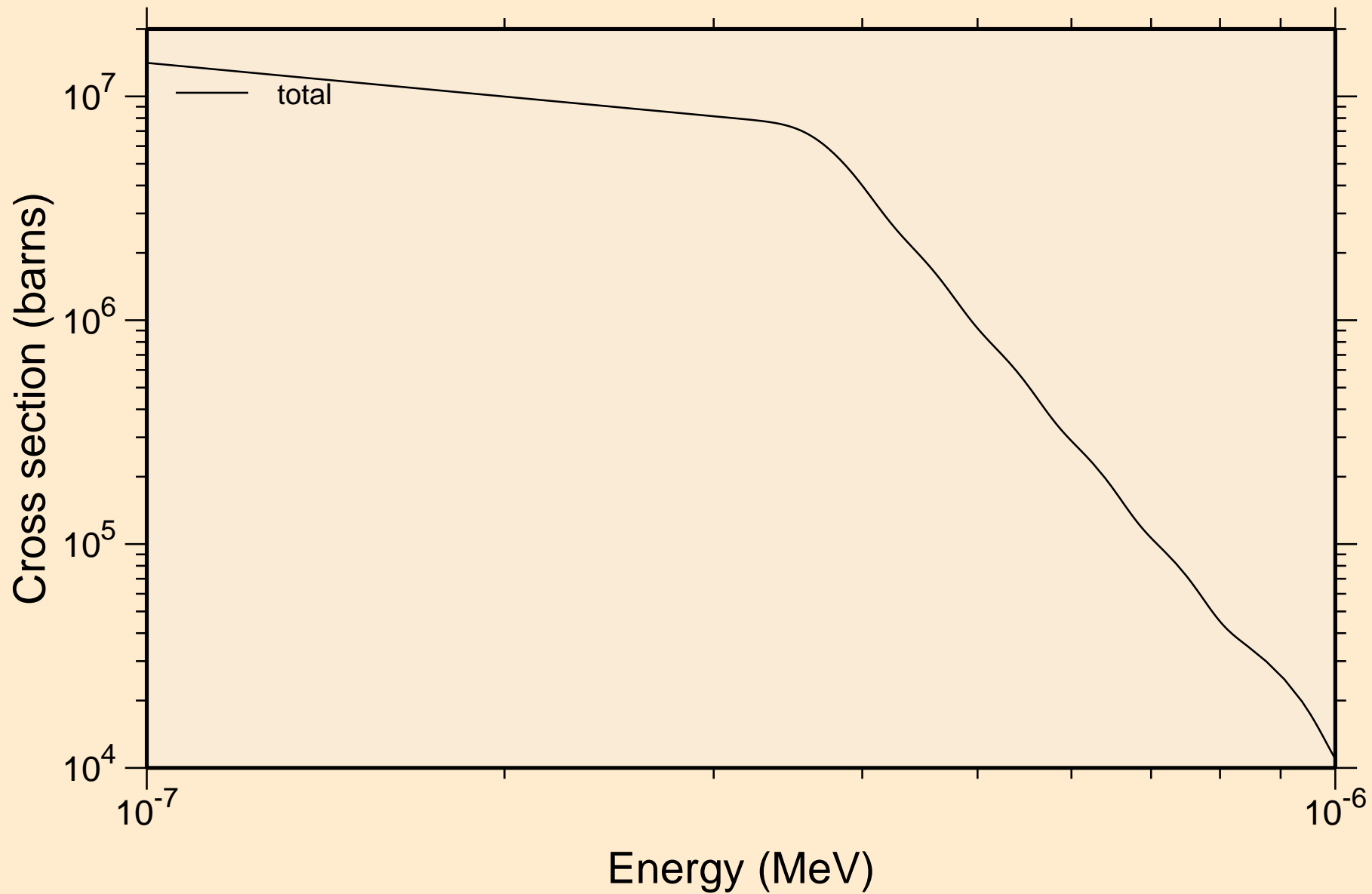

Y078M NEUTRON ACER TENDL-2024 LIBRARY; T=293.6K
resonance total cross section

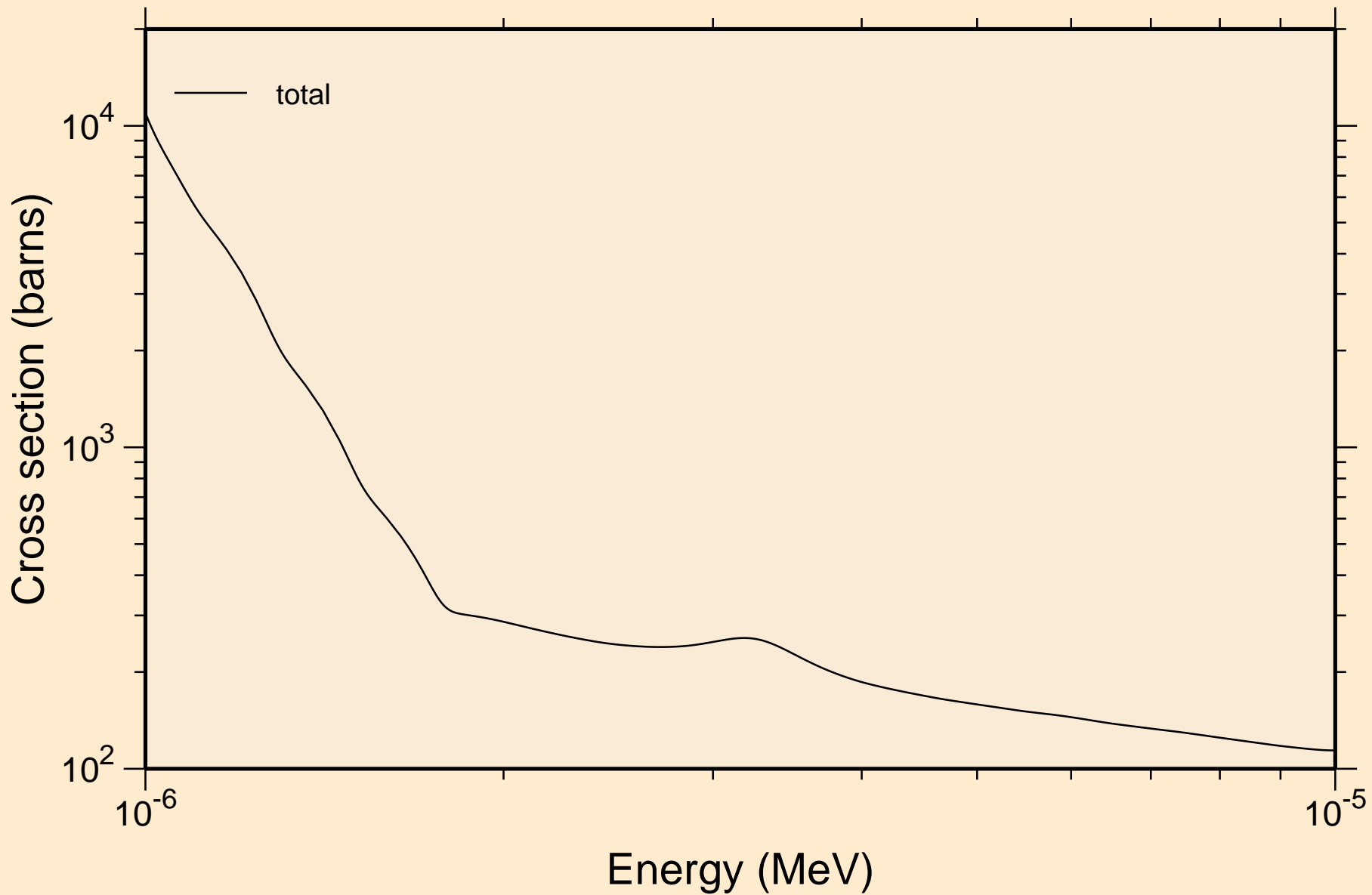

Y078M NEUTRON ACER TENDL-2024 LIBRARY; T=293.6K
resonance total cross section

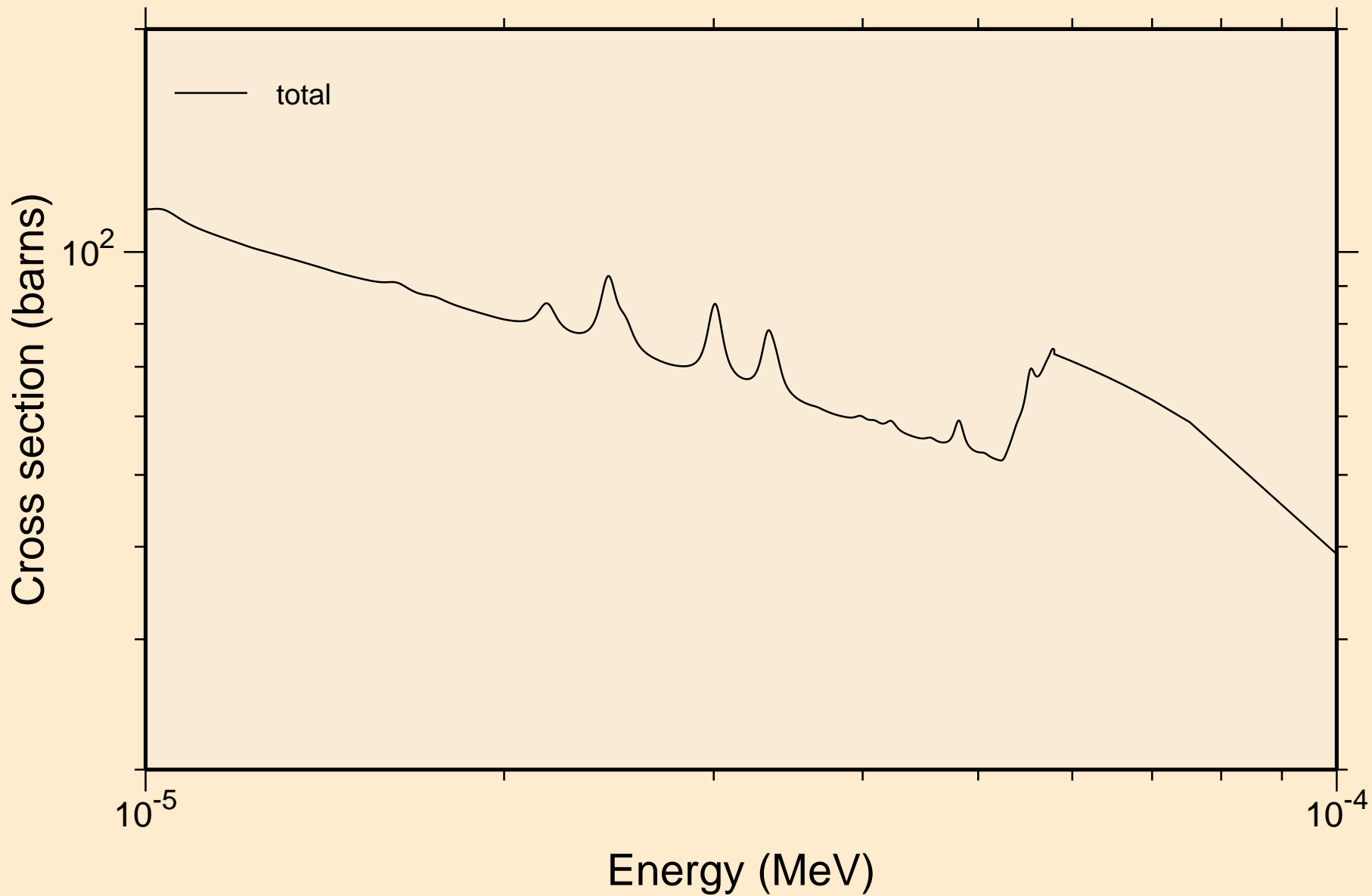

Y078M NEUTRON ACER TENDL-2024 LIBRARY; T=293.6K
resonance total cross section

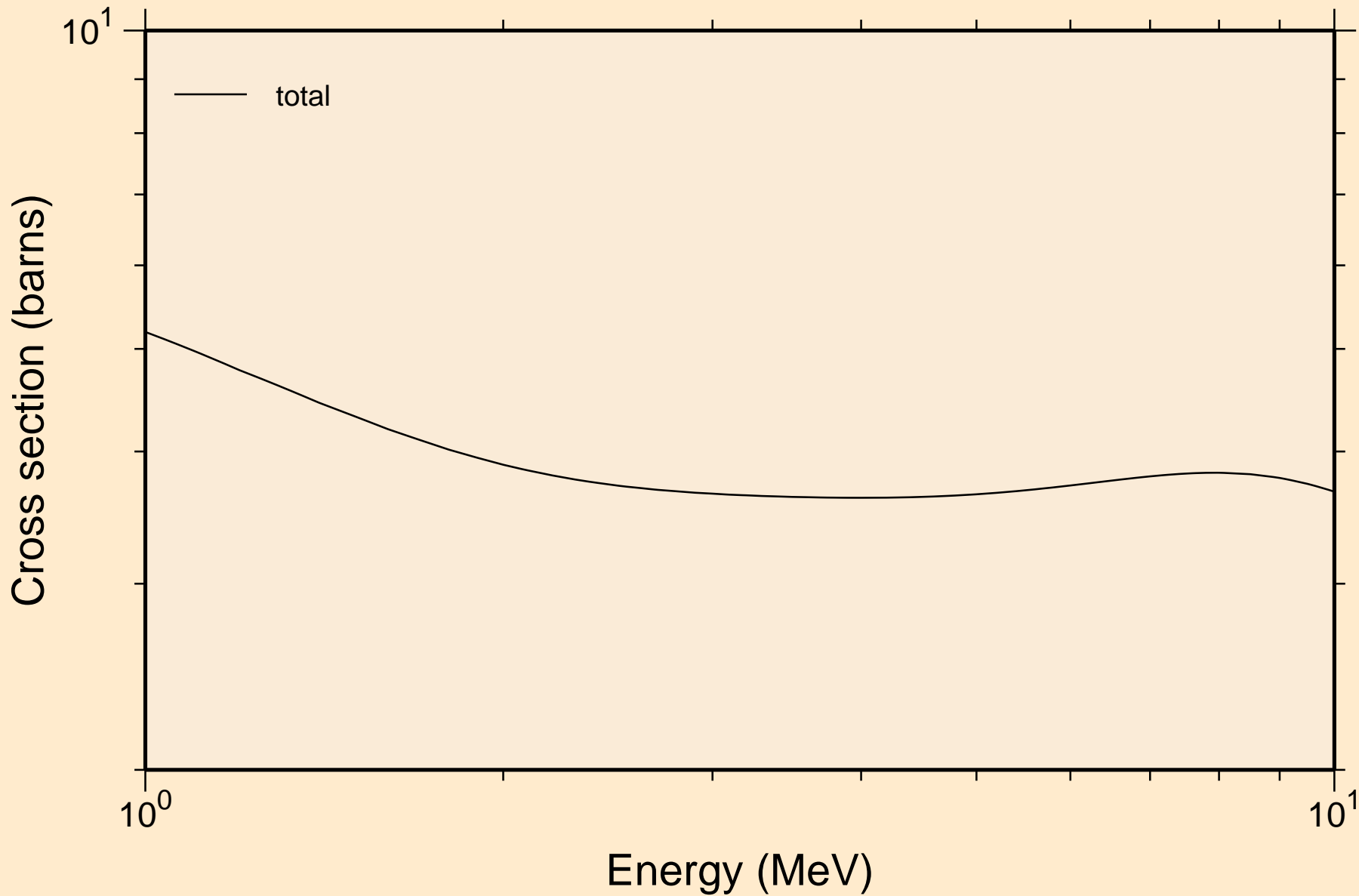

Y078M NEUTRON ACER TENDL-2024 LIBRARY; T=293.6K
resonance absorption cross sections

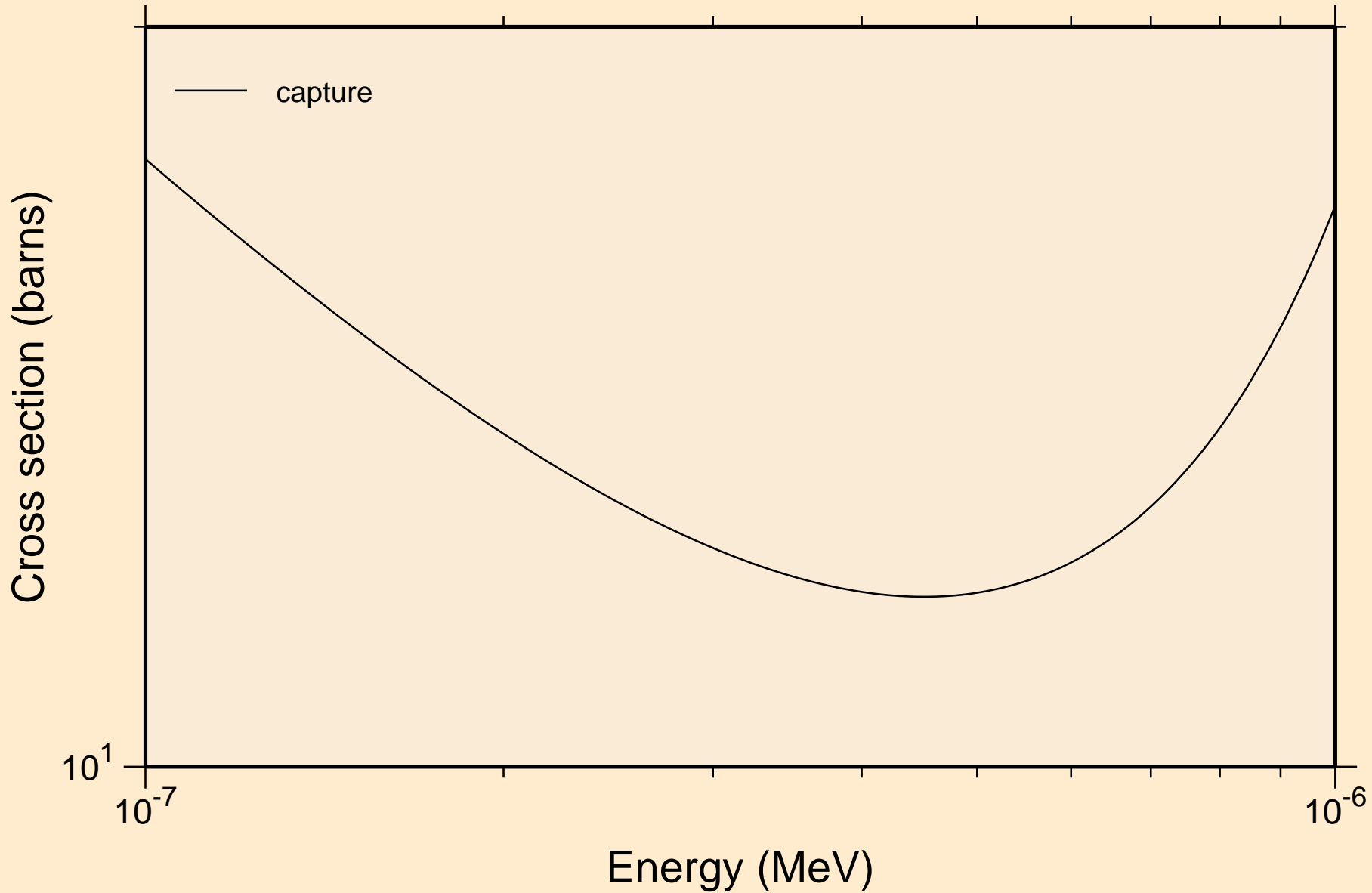

Y078M NEUTRON ACER TENDL-2024 LIBRARY; T=293.6K
resonance absorption cross sections

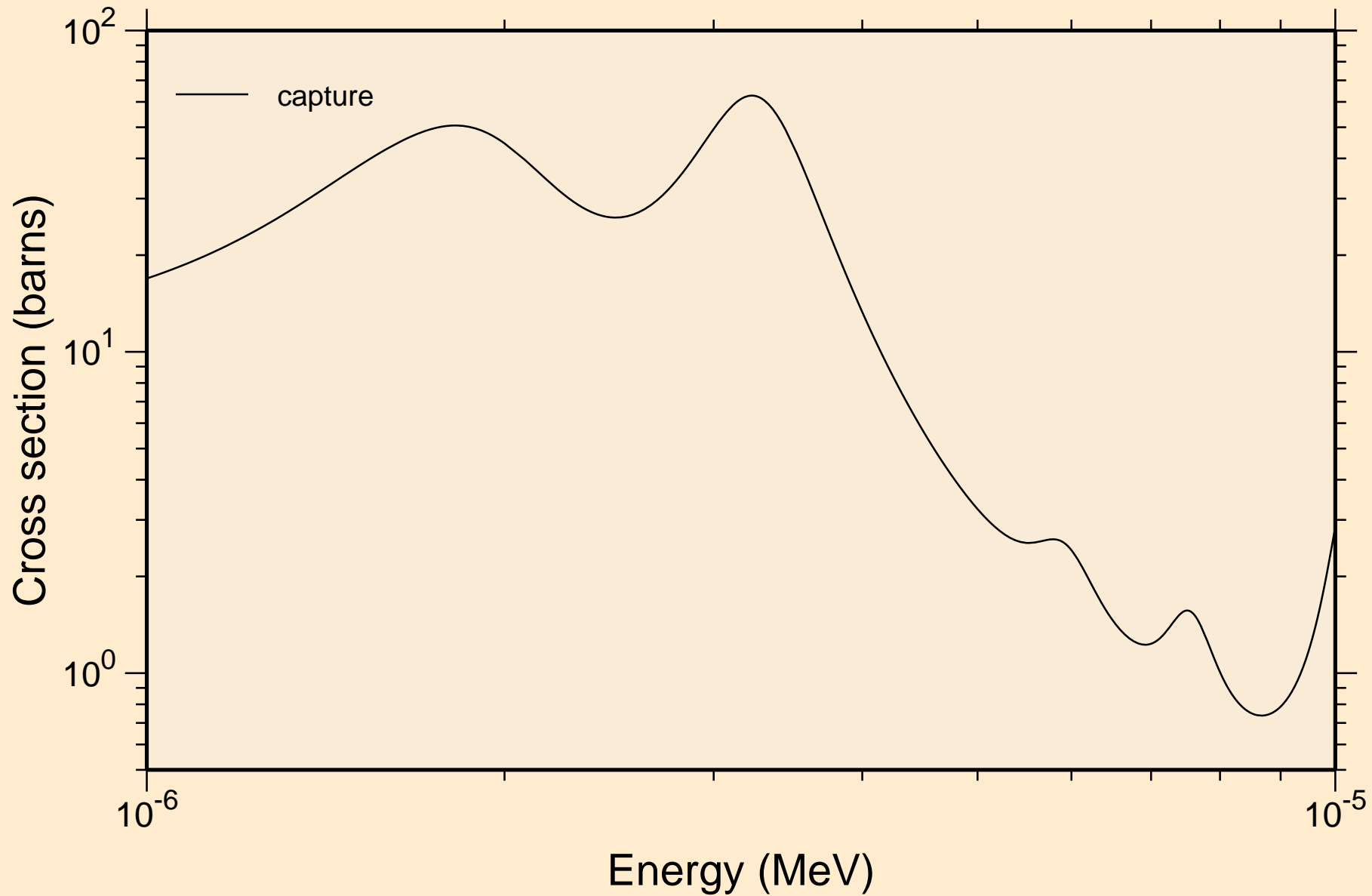

Y078M NEUTRON ACER TENDL-2024 LIBRARY; T=293.6K
resonance absorption cross sections

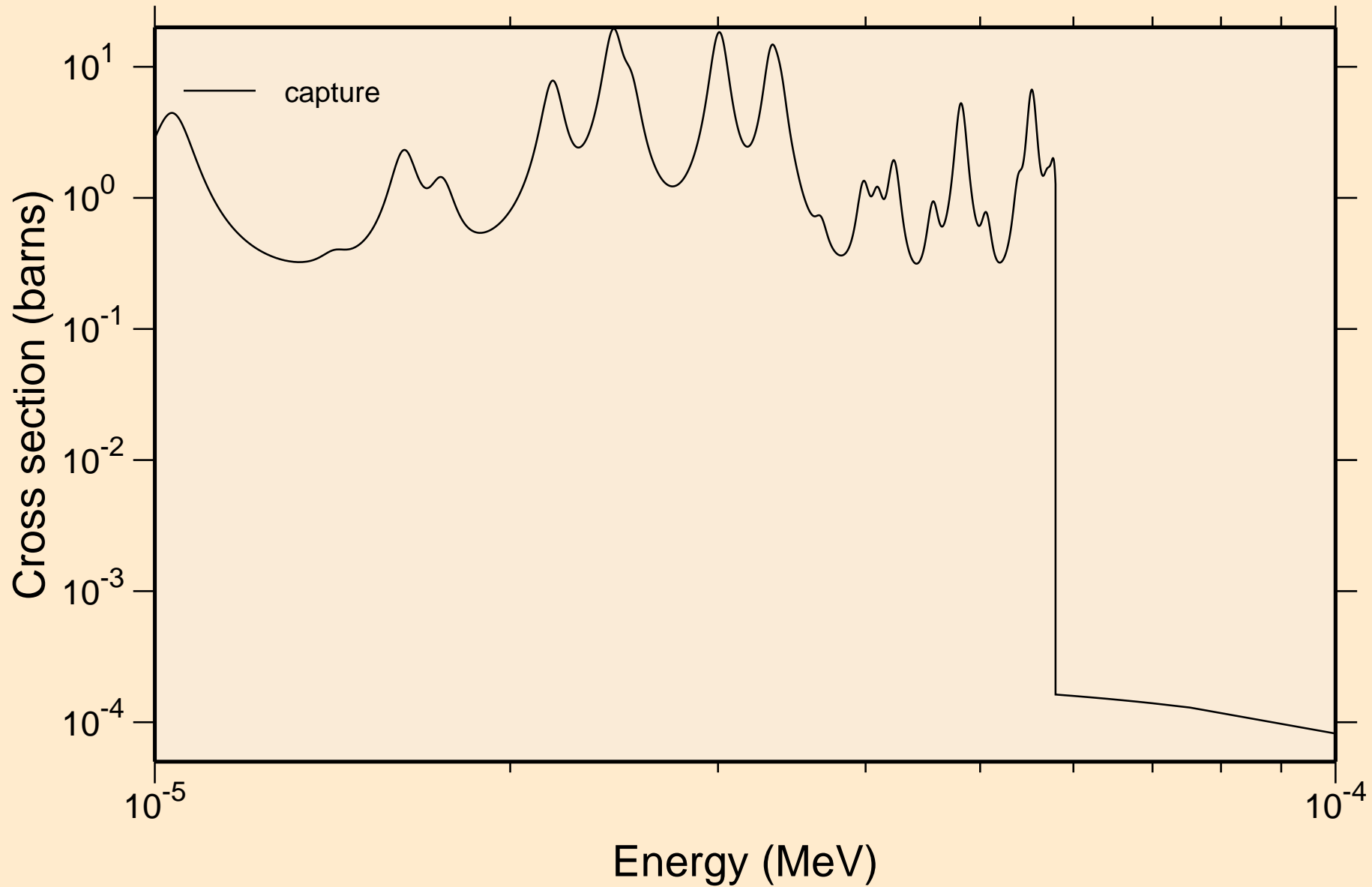

Y078M NEUTRON ACER TENDL-2024 LIBRARY; T=293.6K
resonance absorption cross sections

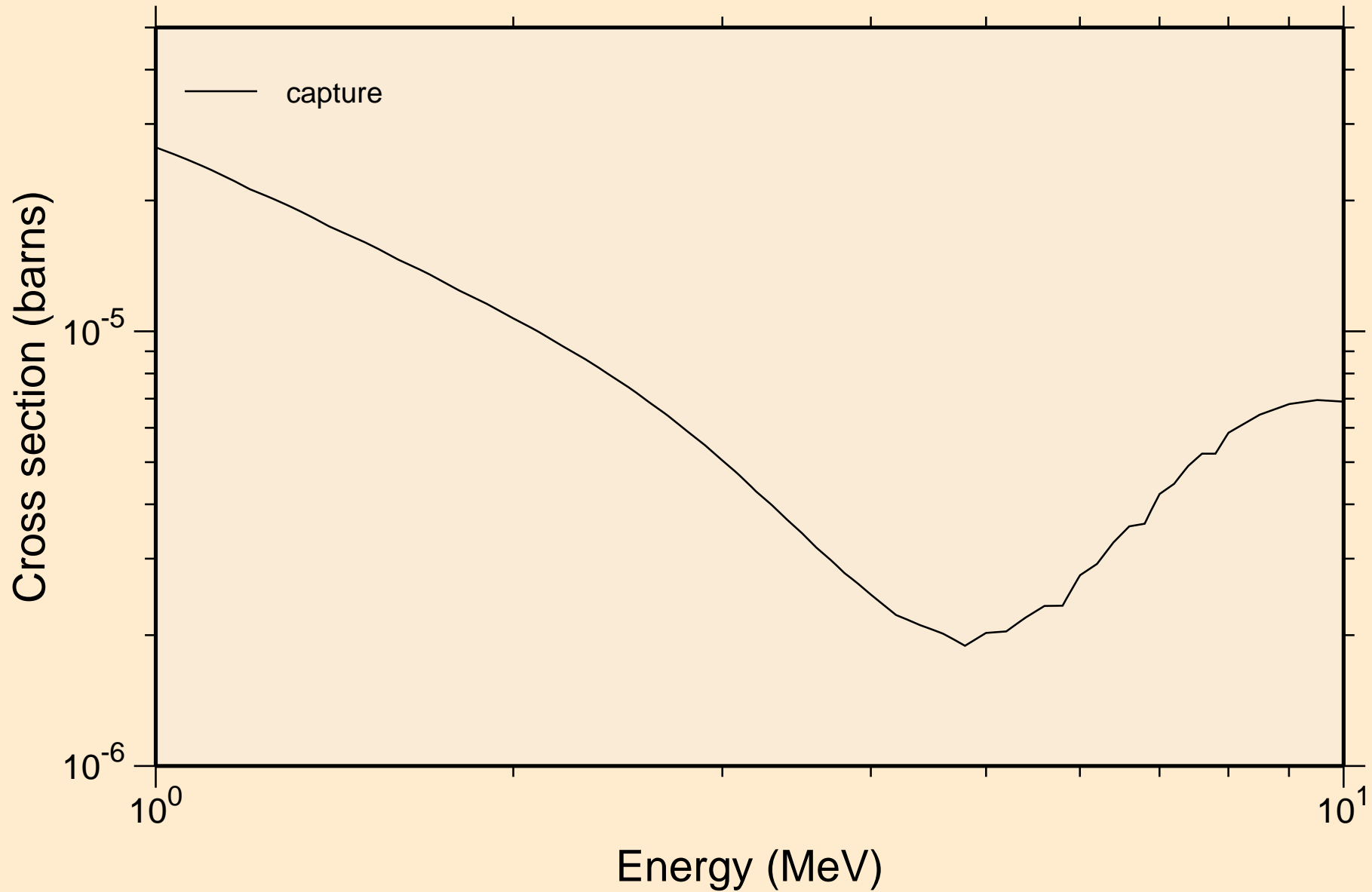

Y078M NEUTRON ACER TENDL-2024 LIBRARY; T=293.6K

Heating

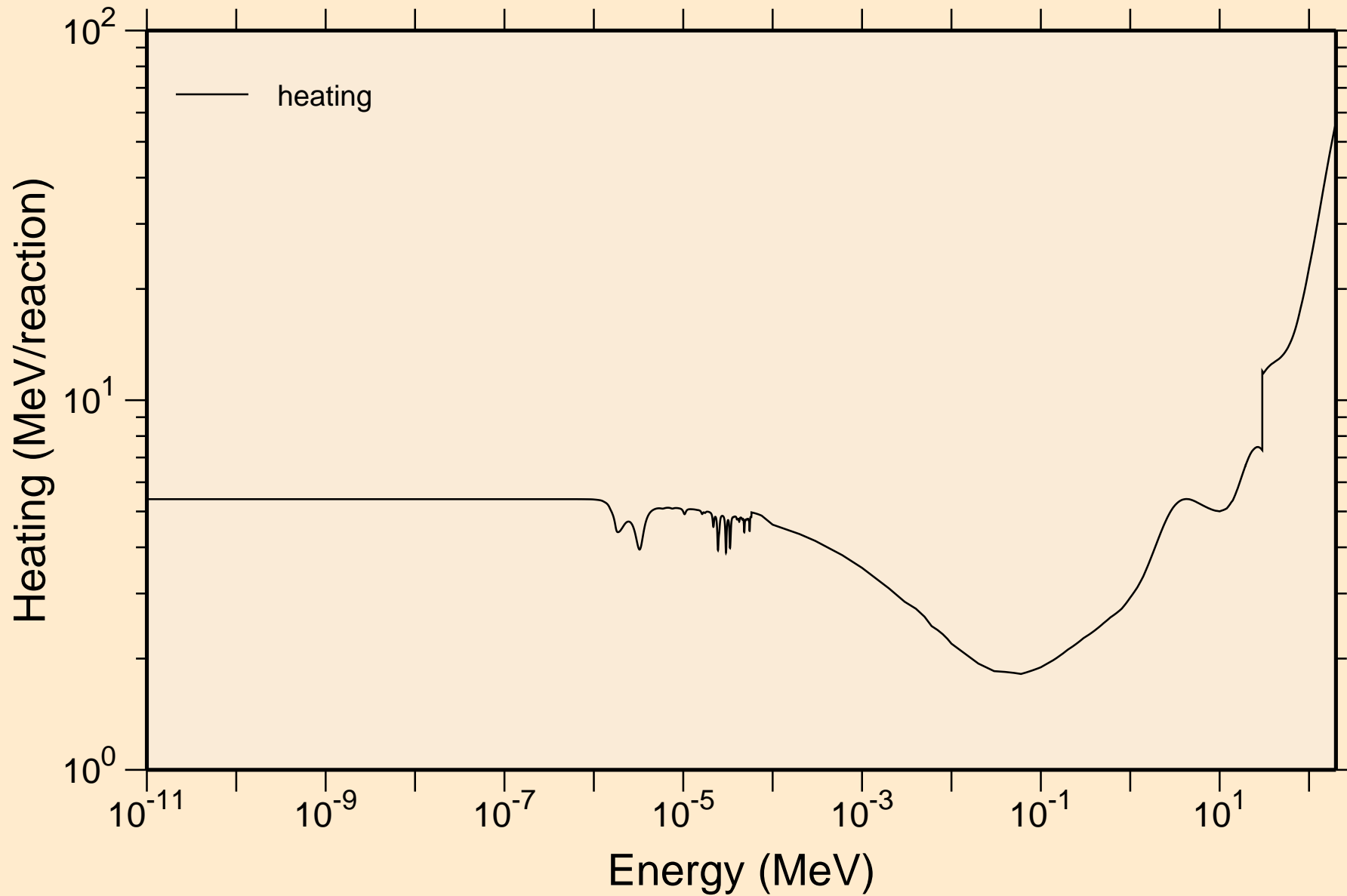

Y078M NEUTRON ACER TENDL-2024 LIBRARY; T=293.6K
Damage

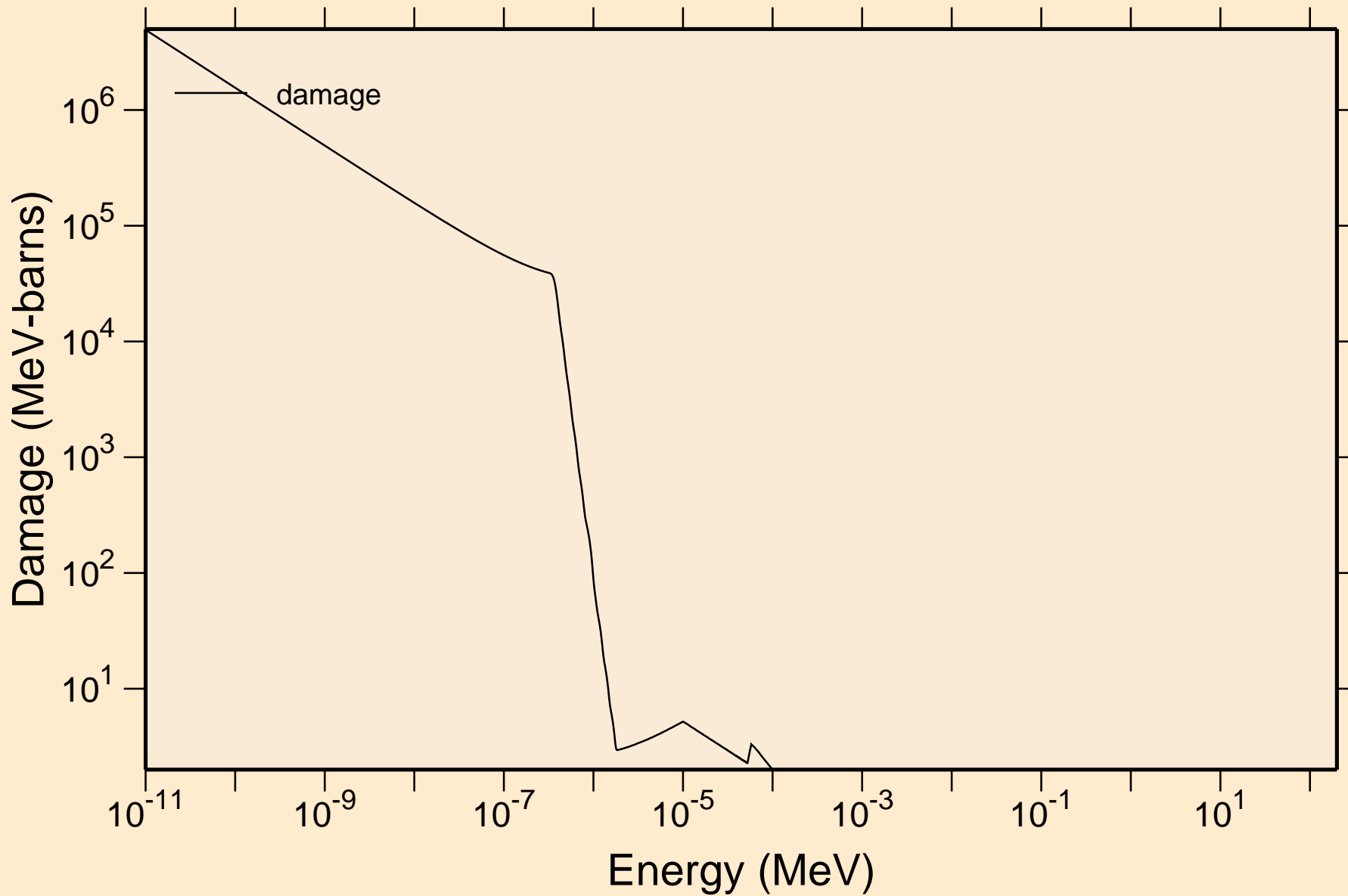

Y078M NEUTRON ACER TENDL-2024 LIBRARY; T=293.6K
Non-threshold reactions

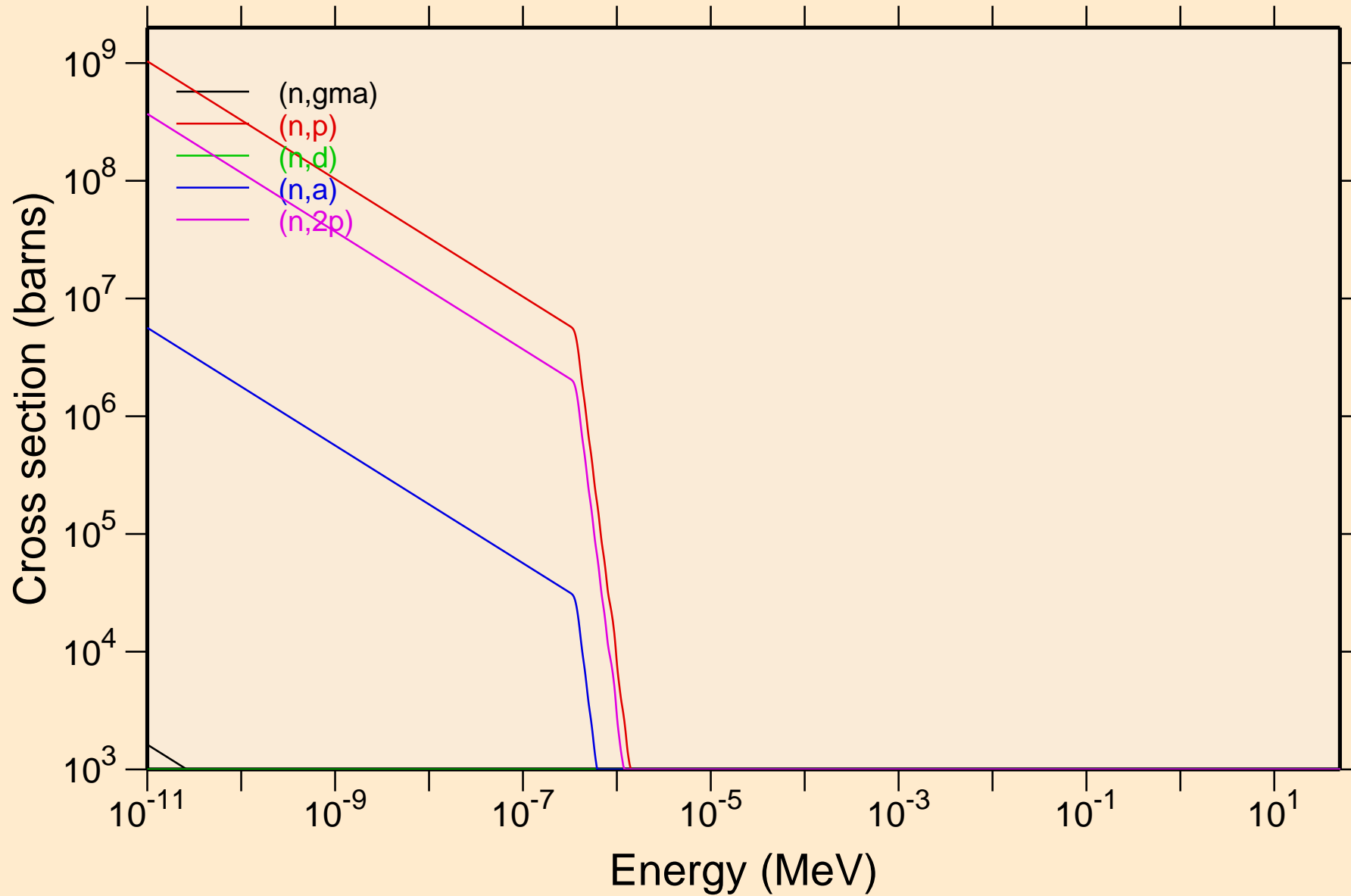

Y078M NEUTRON ACER TENDL-2024 LIBRARY; T=293.6K
Non-threshold reactions

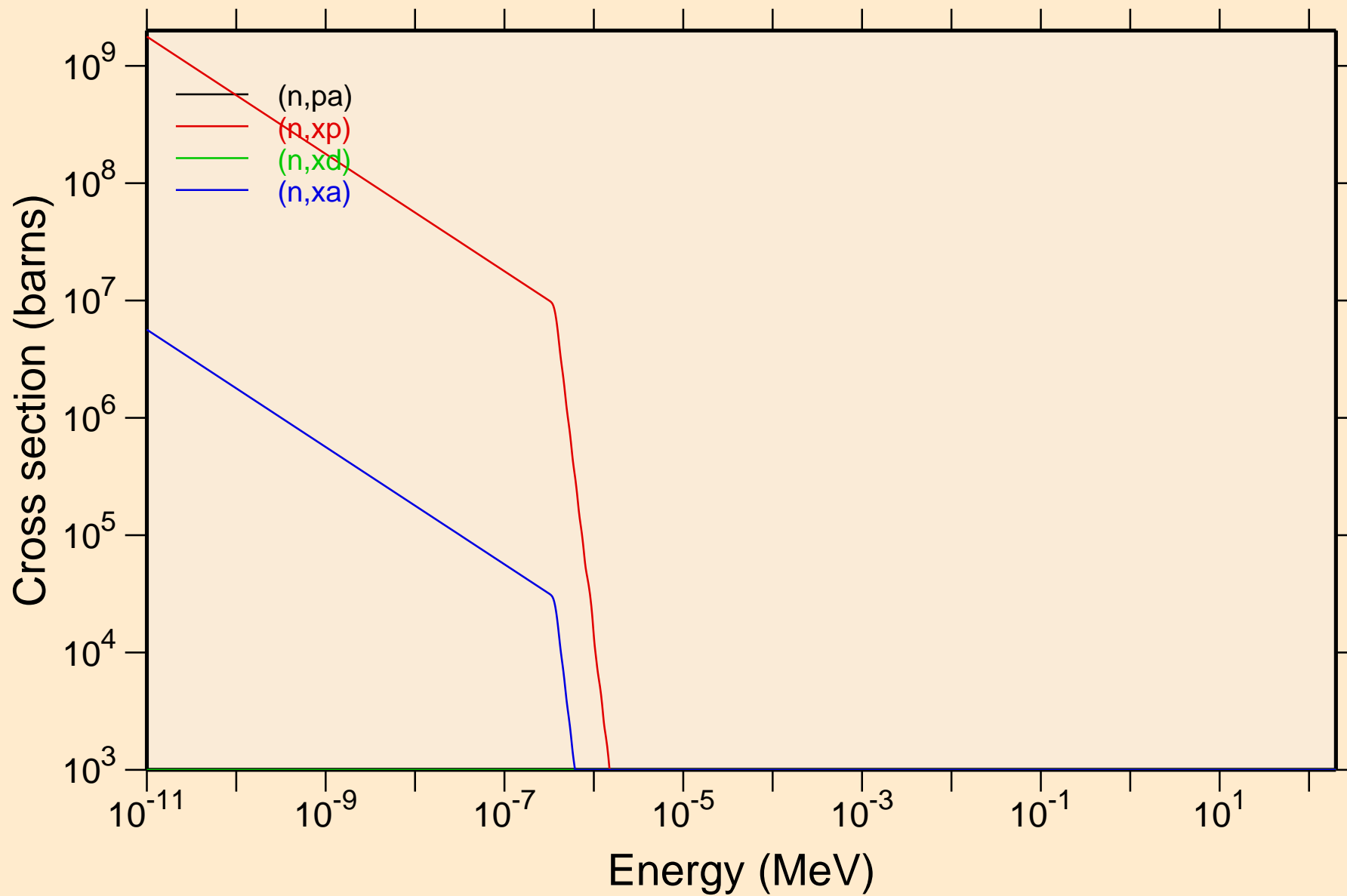

Y078M NEUTRON ACER TENDL-2024 LIBRARY; T=293.6K
Principal cross sections

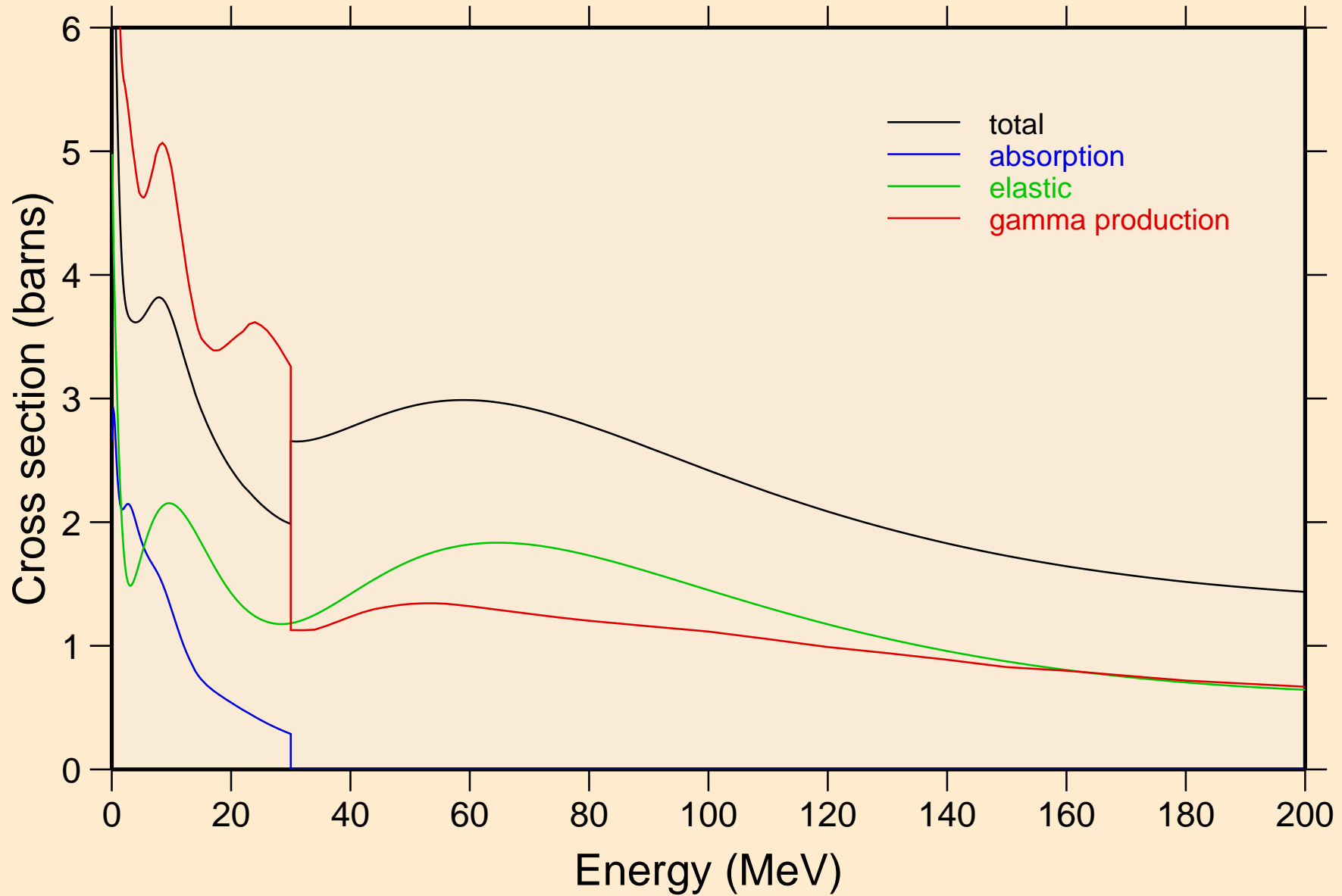

Y078M NEUTRON ACER TENDL-2024 LIBRARY; T=293.6K

Heating

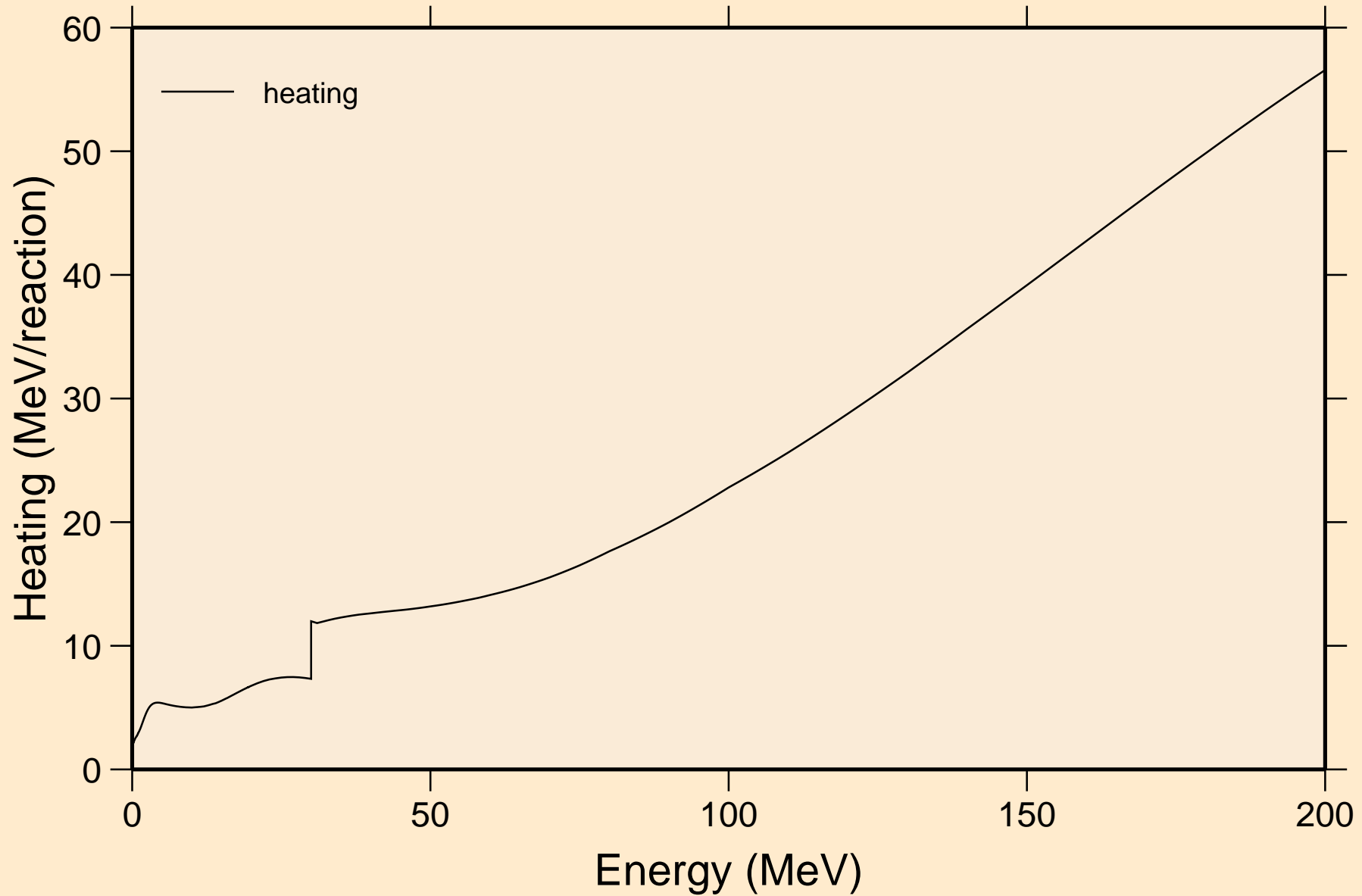

Y078M NEUTRON ACER TENDL-2024 LIBRARY; T=293.6K
Damage

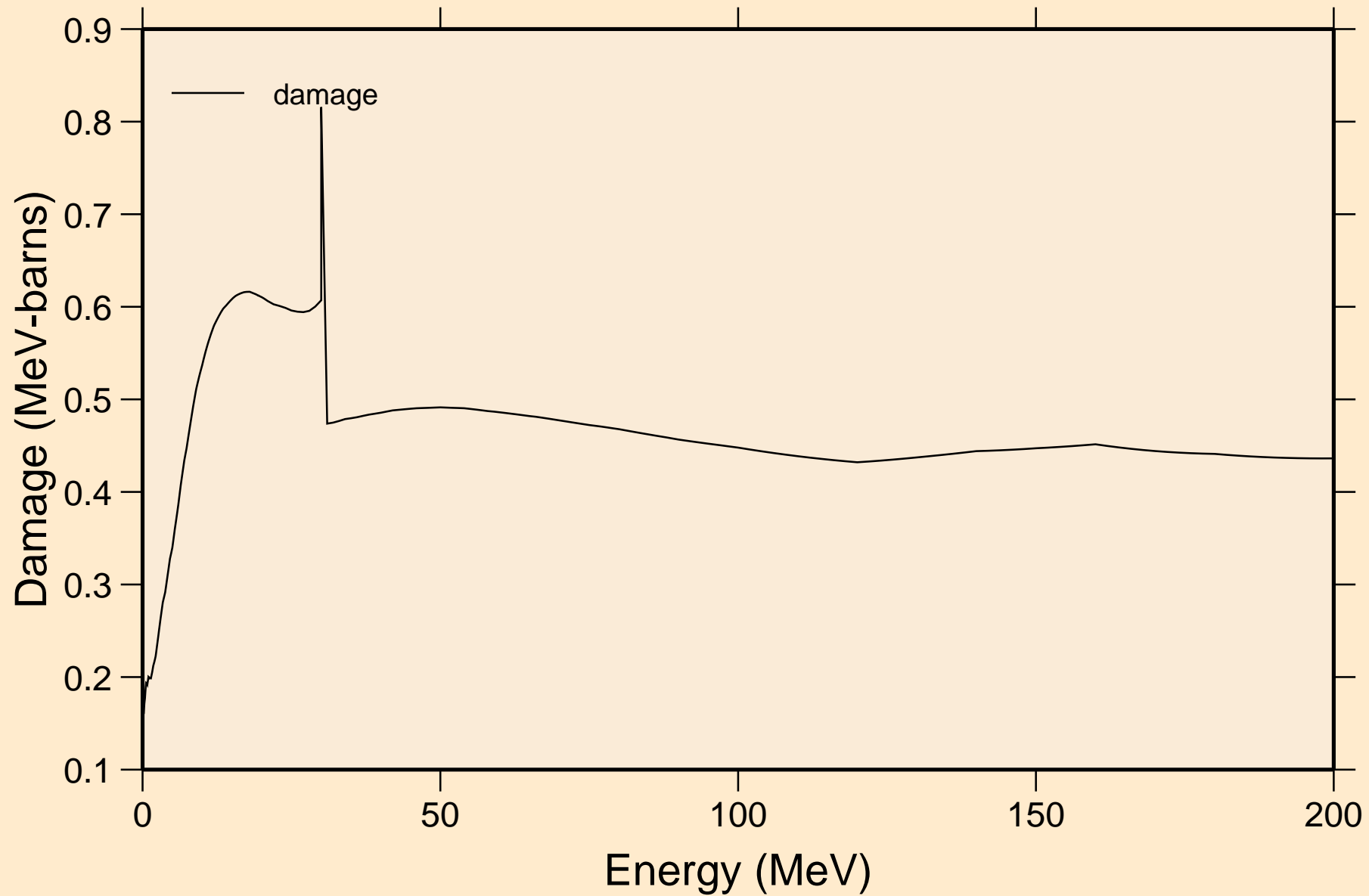

Y078M NEUTRON ACER TENDL-2024 LIBRARY; T=293.6K
Non-threshold reactions

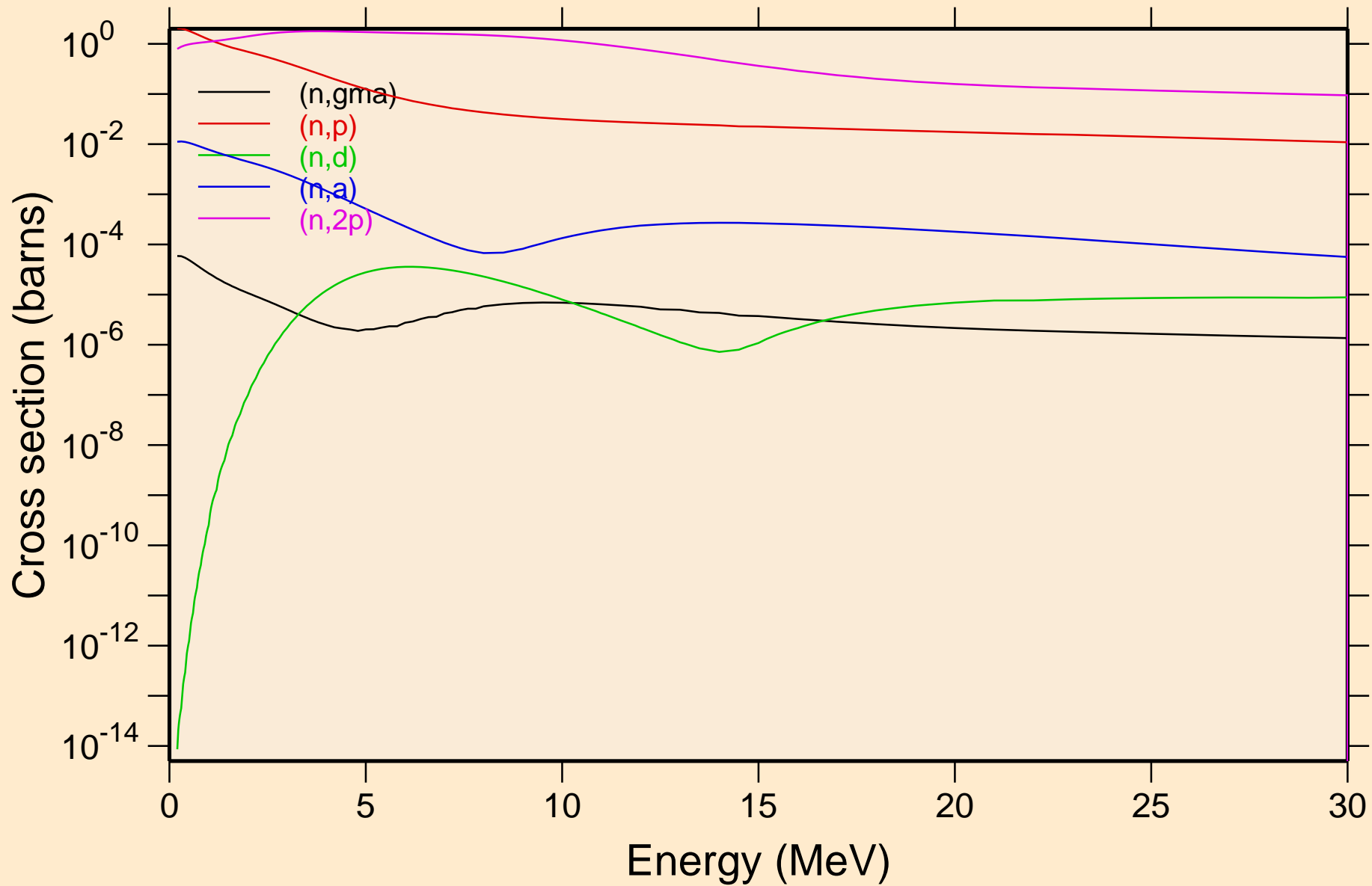

Y078M NEUTRON ACER TENDL-2024 LIBRARY; T=293.6K
Non-threshold reactions

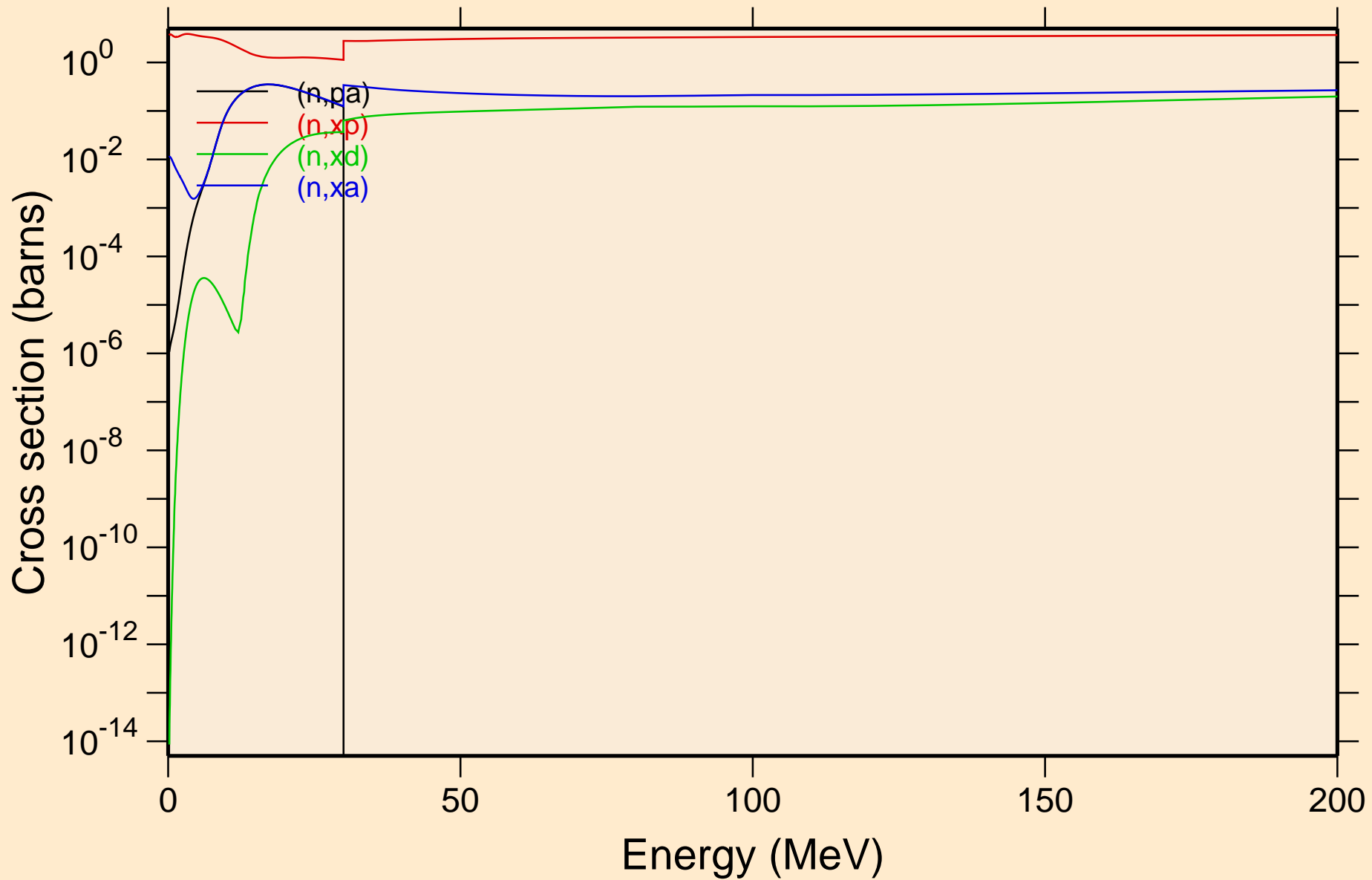

Y078M NEUTRON ACER TENDL-2024 LIBRARY; T=293.6K
Inelastic levels

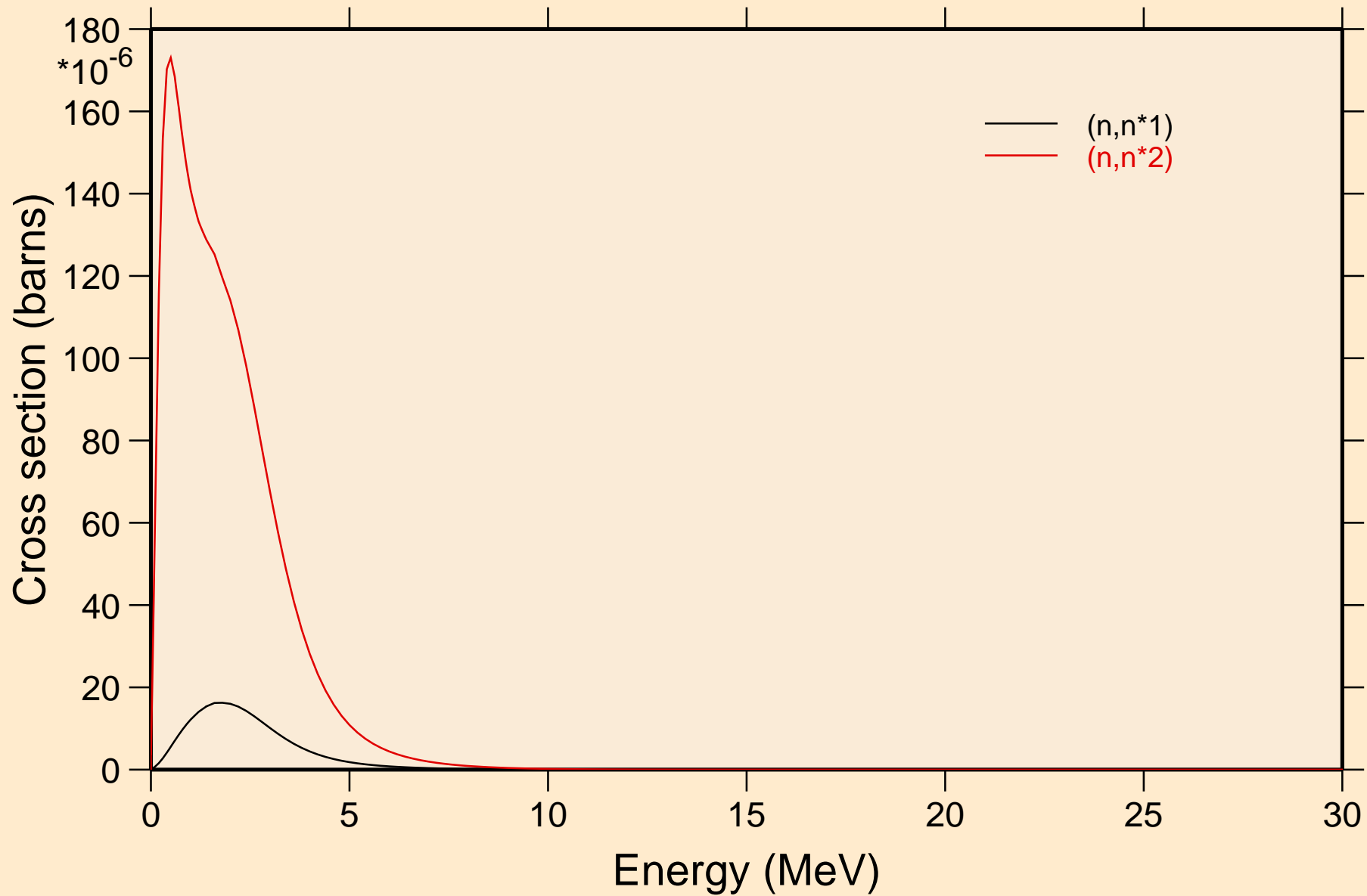

Y078M NEUTRON ACER TENDL-2024 LIBRARY; T=293.6K
Threshold reactions

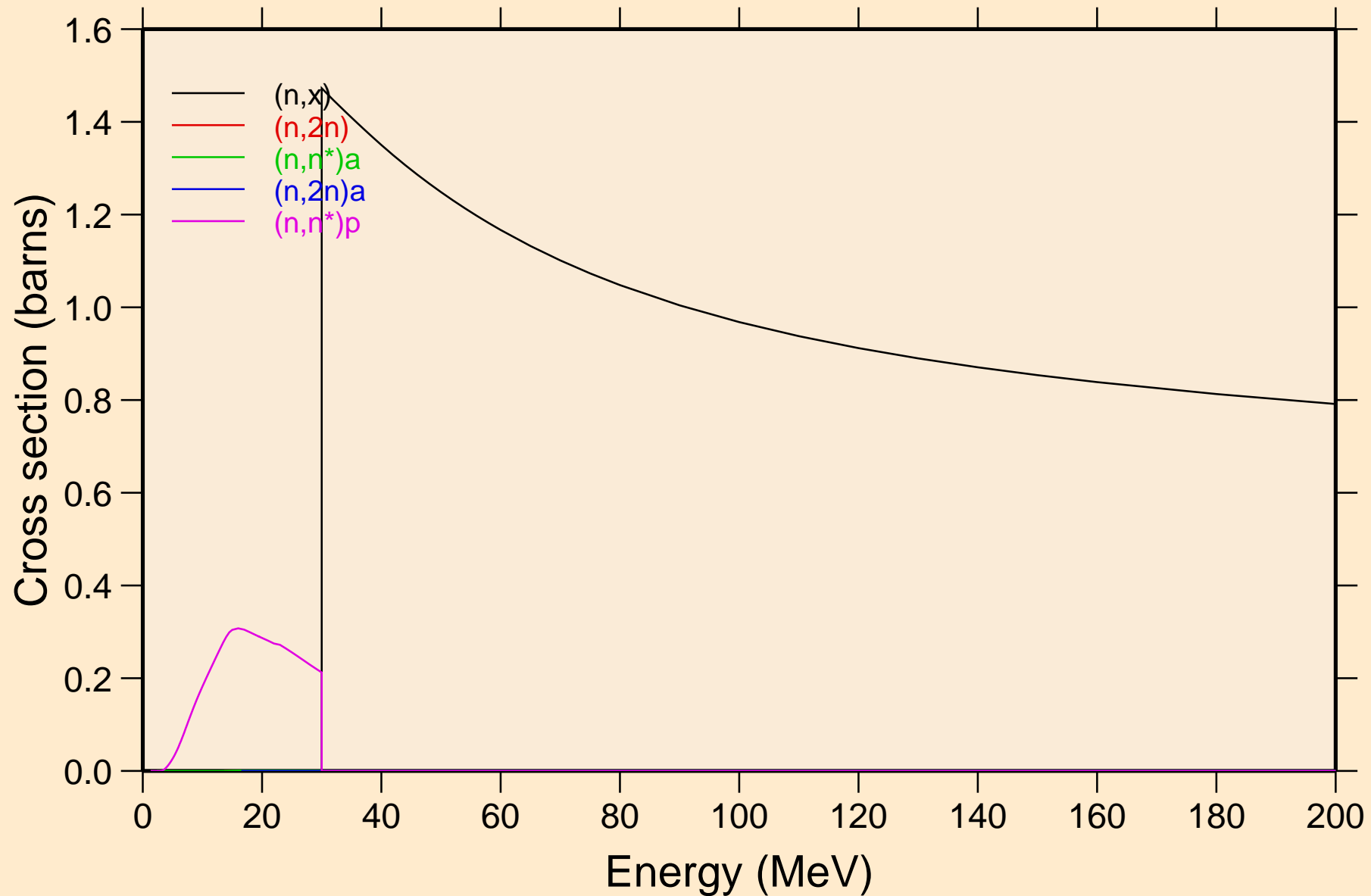

Y078M NEUTRON ACER TENDL-2024 LIBRARY; T=293.6K
Threshold reactions

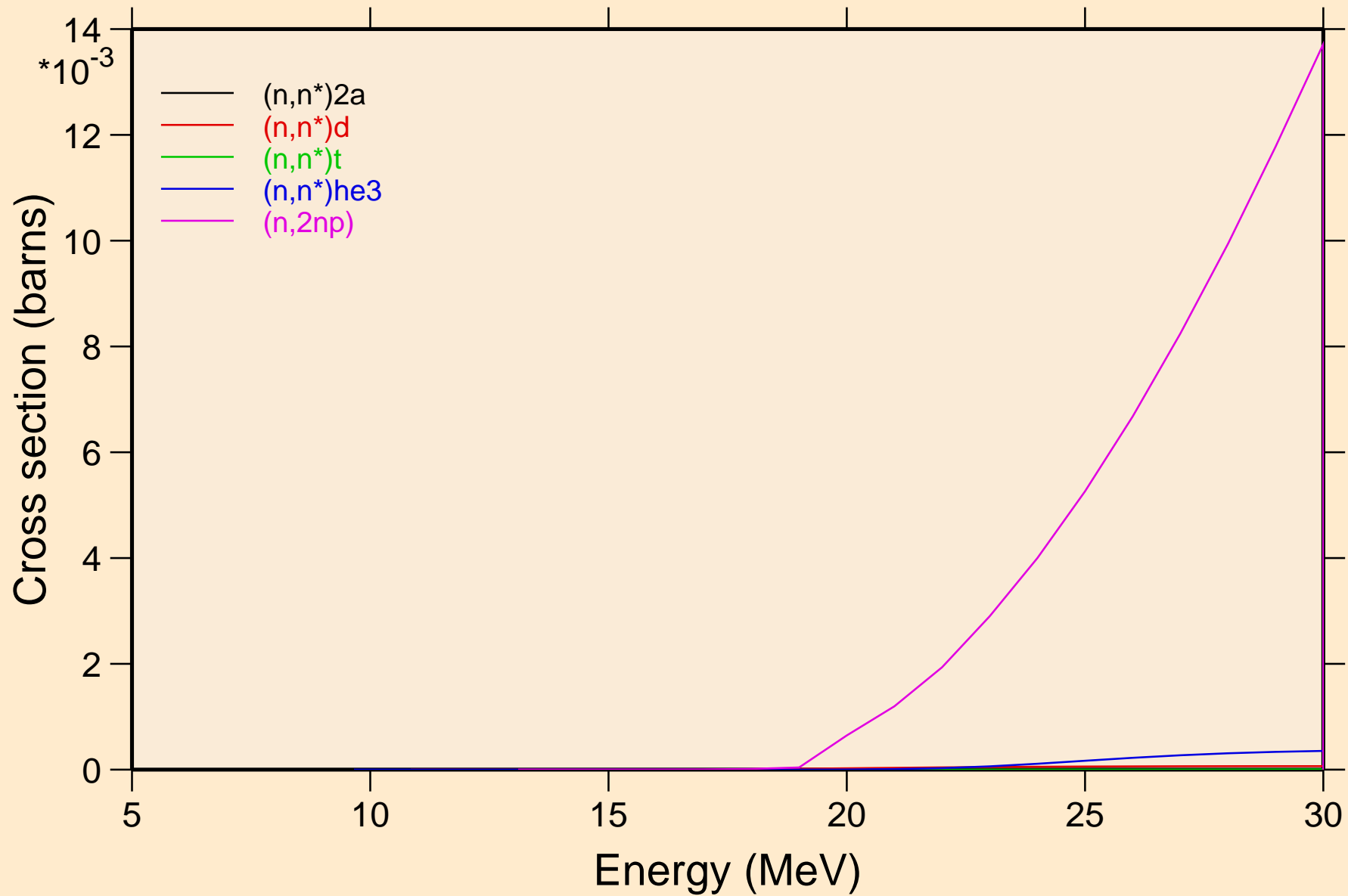

Y078M NEUTRON ACER TENDL-2024 LIBRARY; T=293.6K
Threshold reactions

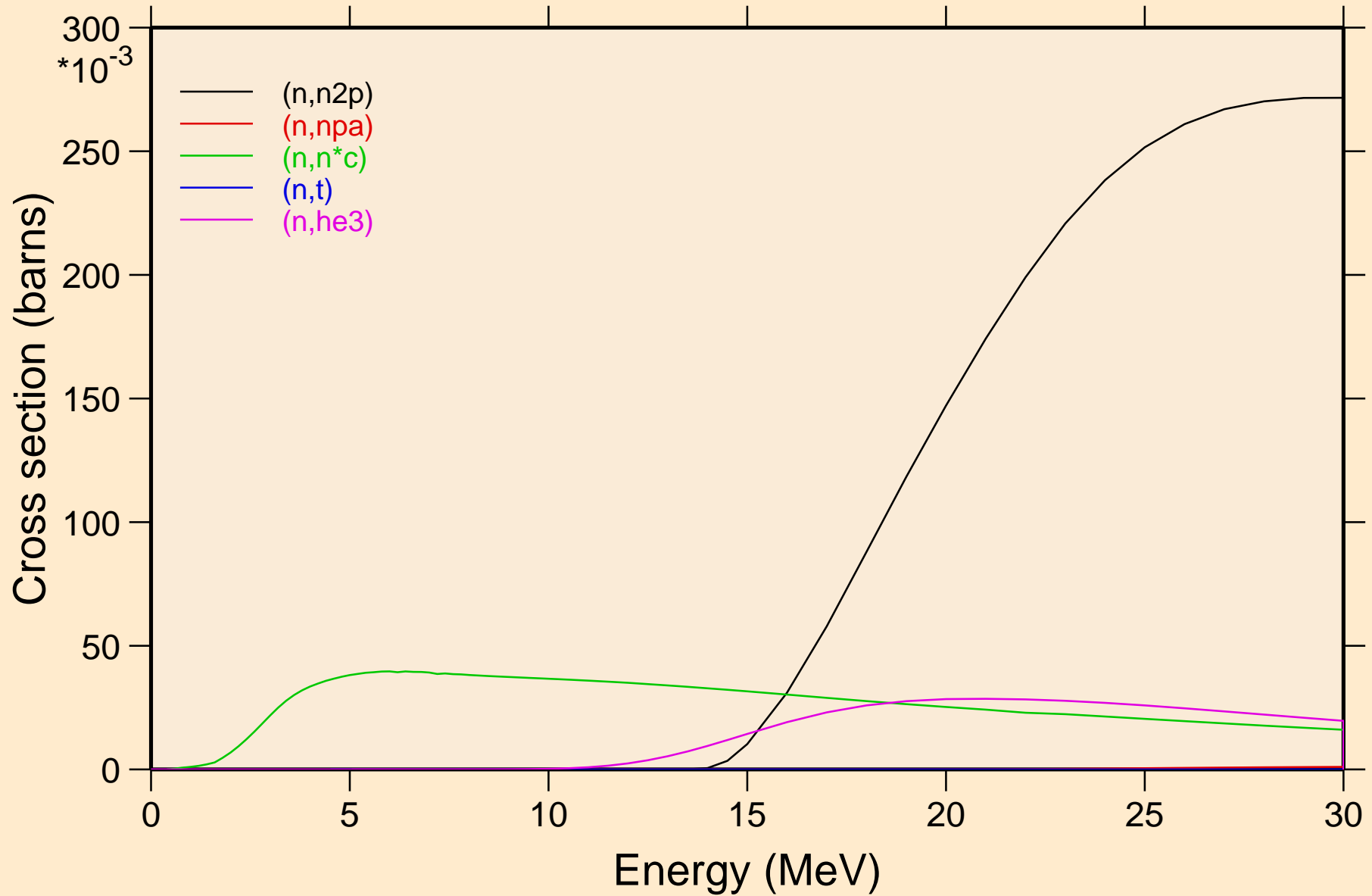

Y078M NEUTRON ACER TENDL-2024 LIBRARY; T=293.6K
Threshold reactions

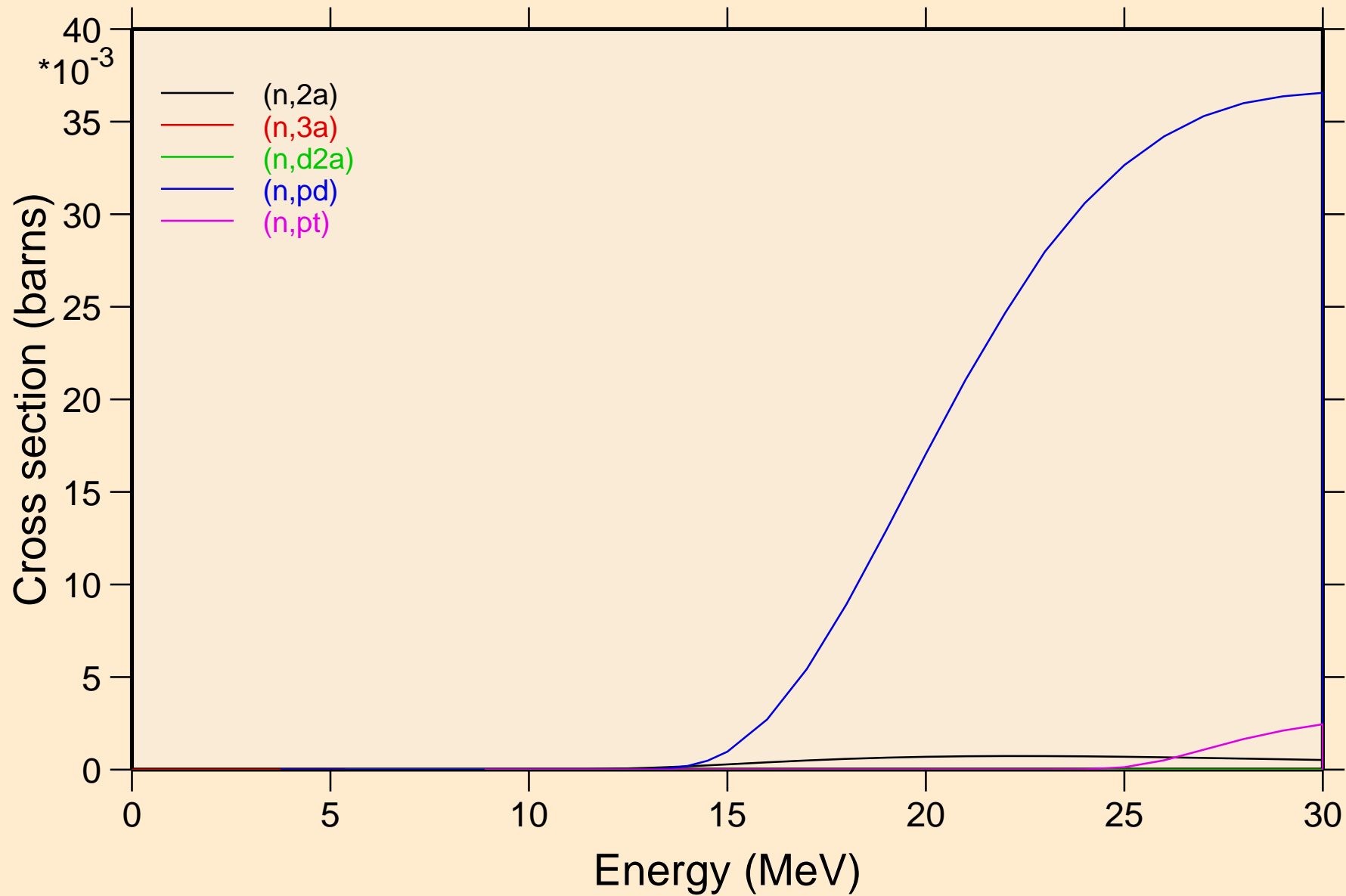

Y078M NEUTRON ACER TENDL-2024 LIBRARY; T=293.6K
Threshold reactions

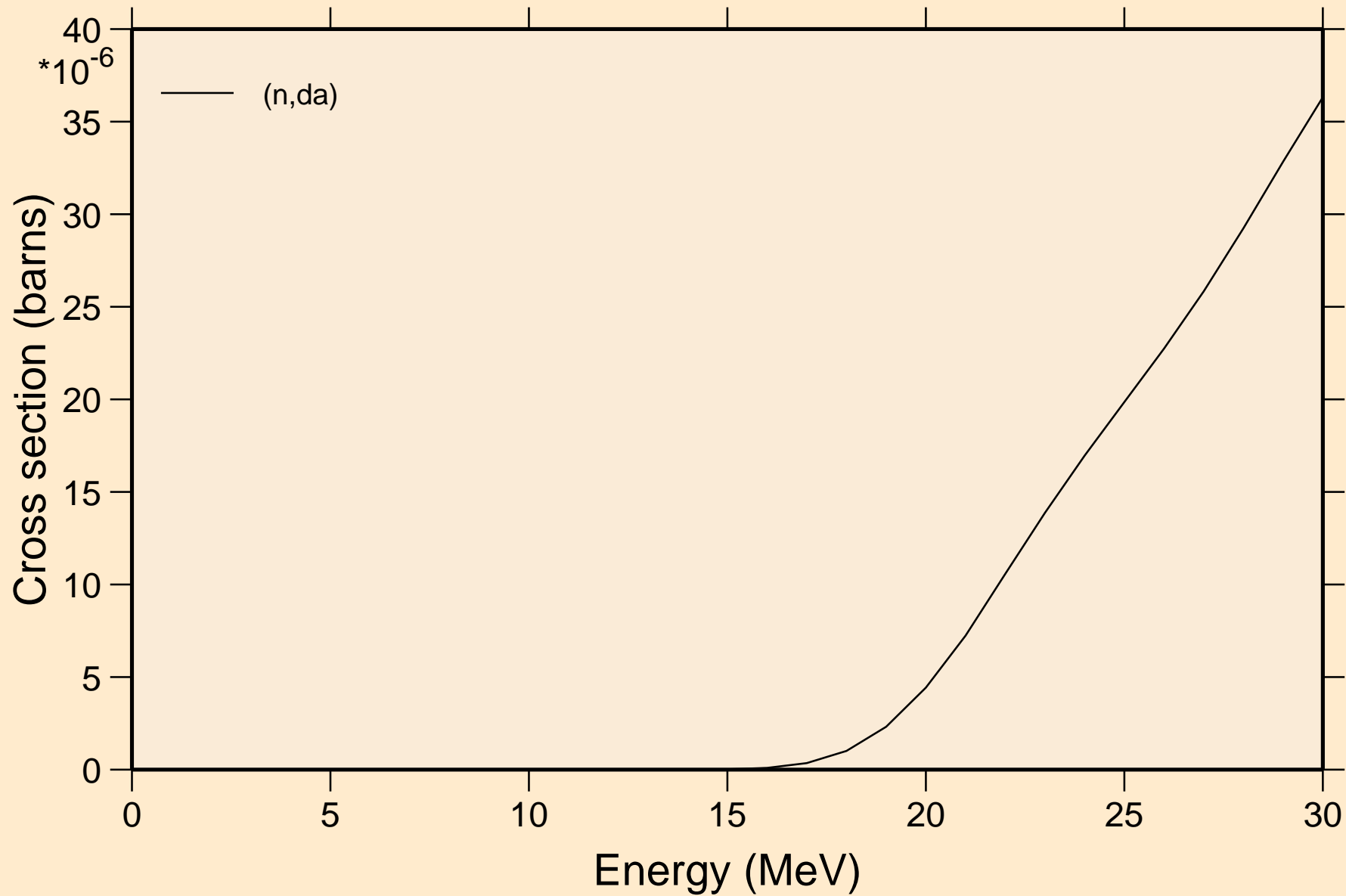

Y078M NEUTRON ACER TENDL-2024 LIBRARY; T=293.6K
Threshold reactions

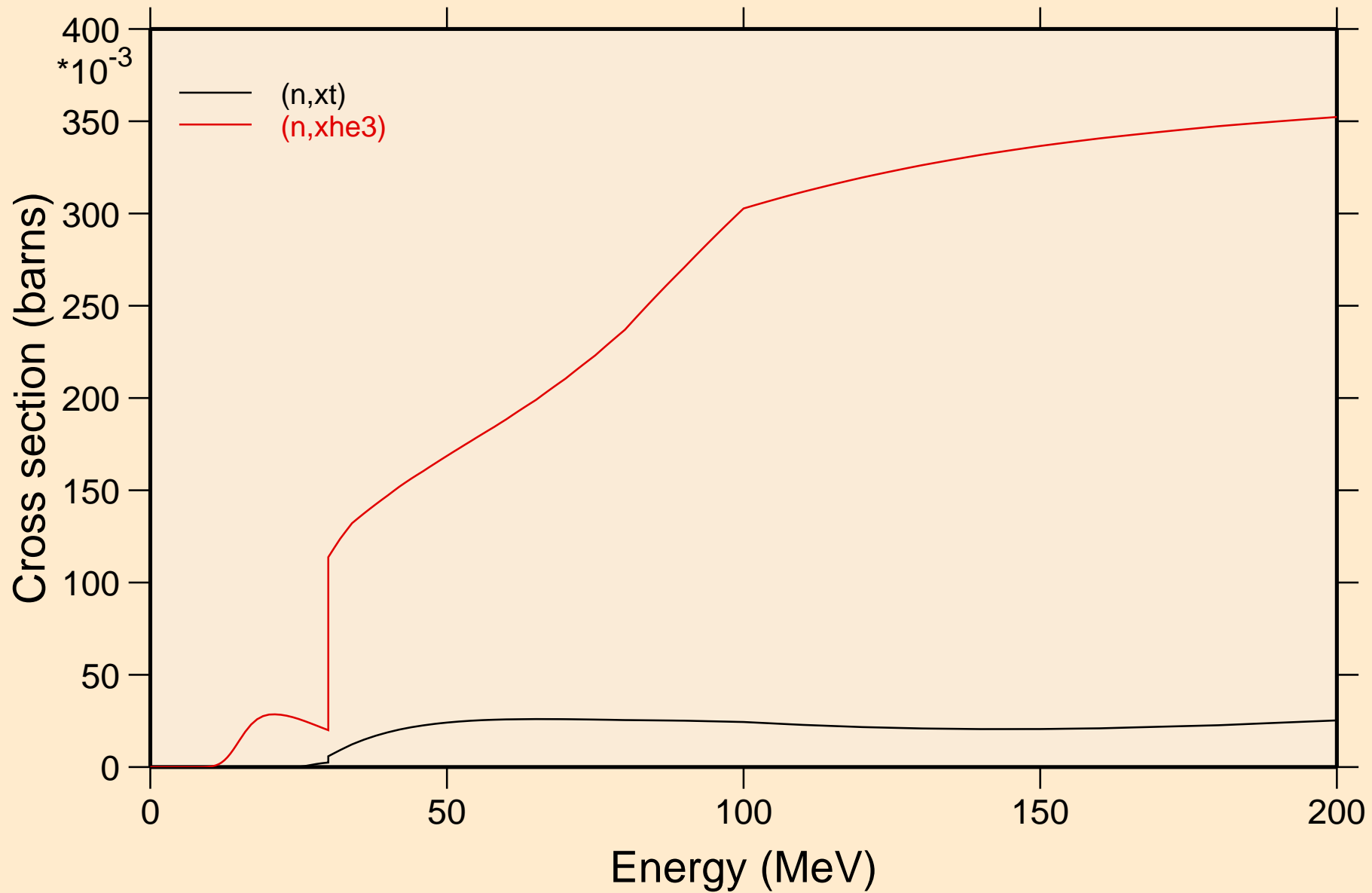

Y078M NEUTRON ACER TENDL-2024 LIBRARY; T=293.6K
angular distribution for elastic

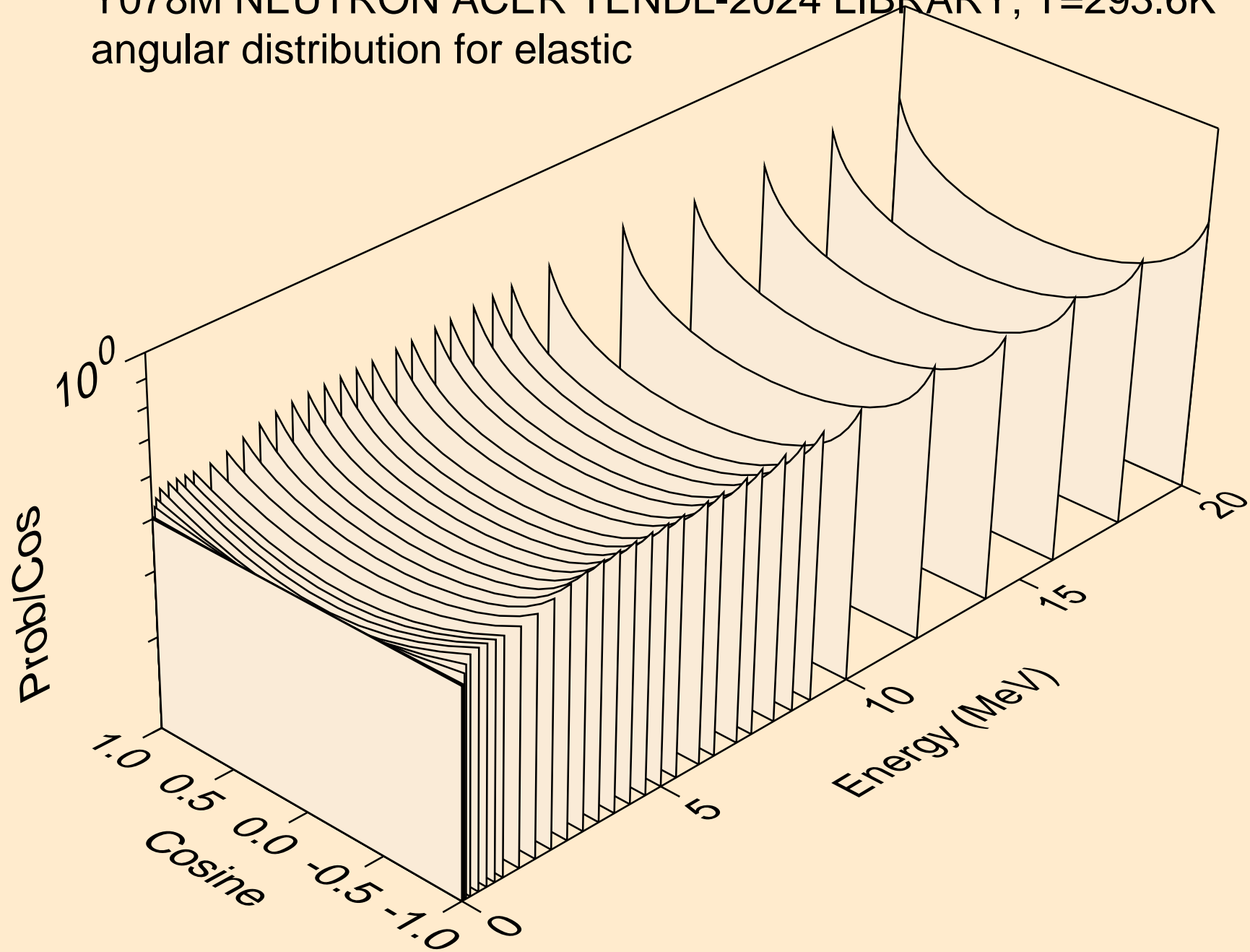

Y078M NEUTRON ACER TENDL-2024 LIBRARY; T=293.6K
angular distribution for elastic

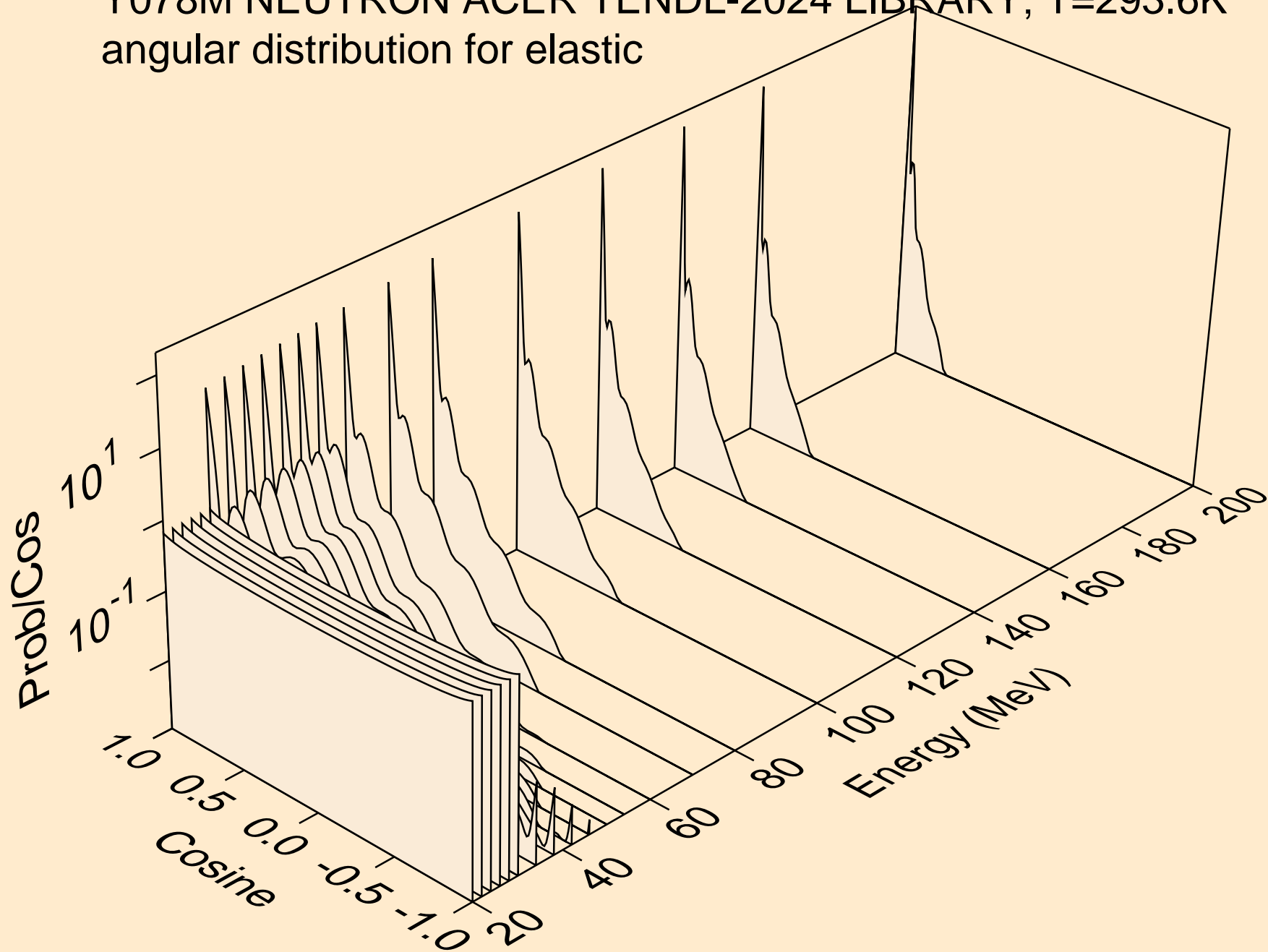

Y078M NEUTRON ACER TENDL-2024 LIBRARY; T=293.6K
angular distribution for (n,n*1)

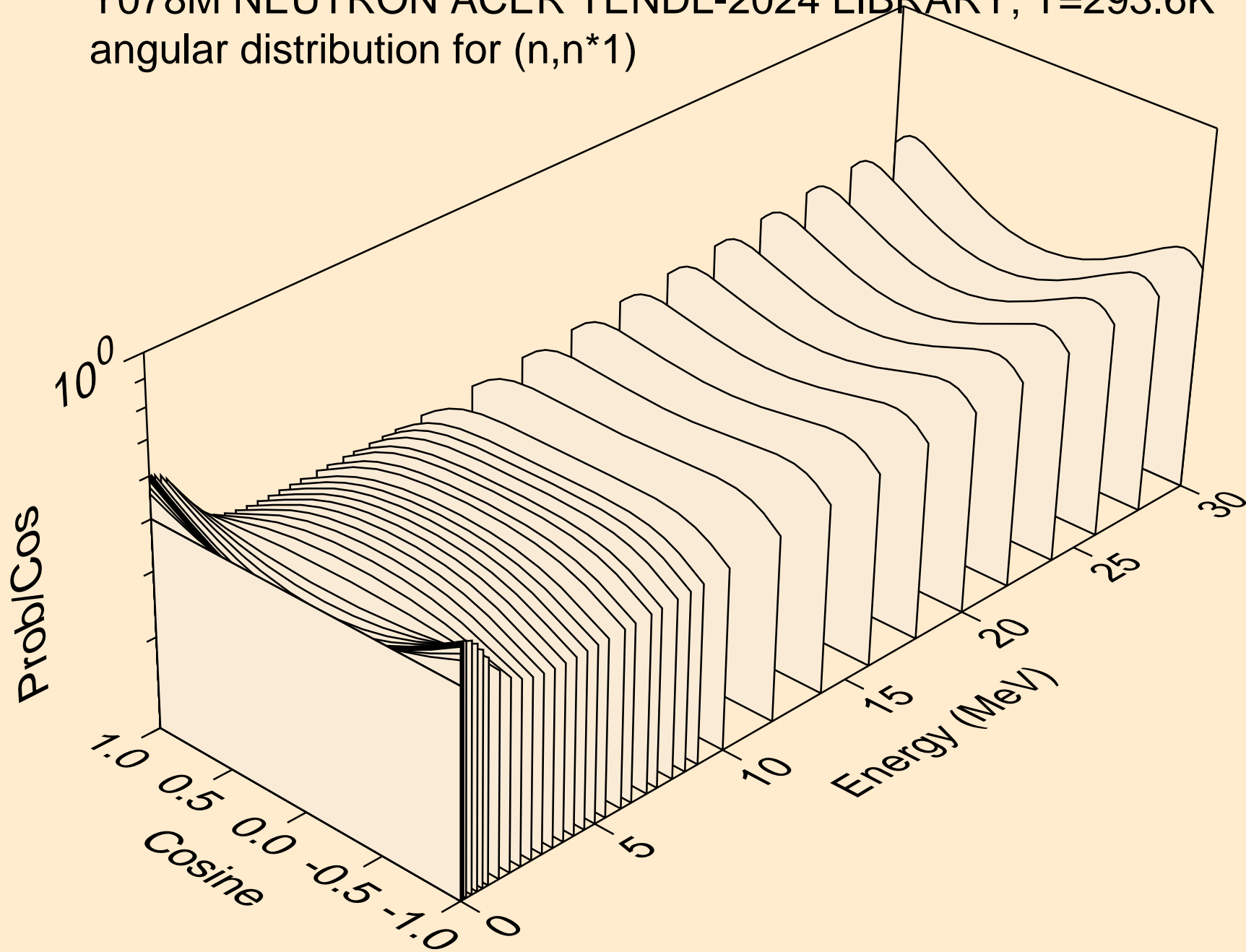

Y078M NEUTRON ACER TENDL-2024 LIBRARY; T=293.6K
angular distribution for (n,n*2)

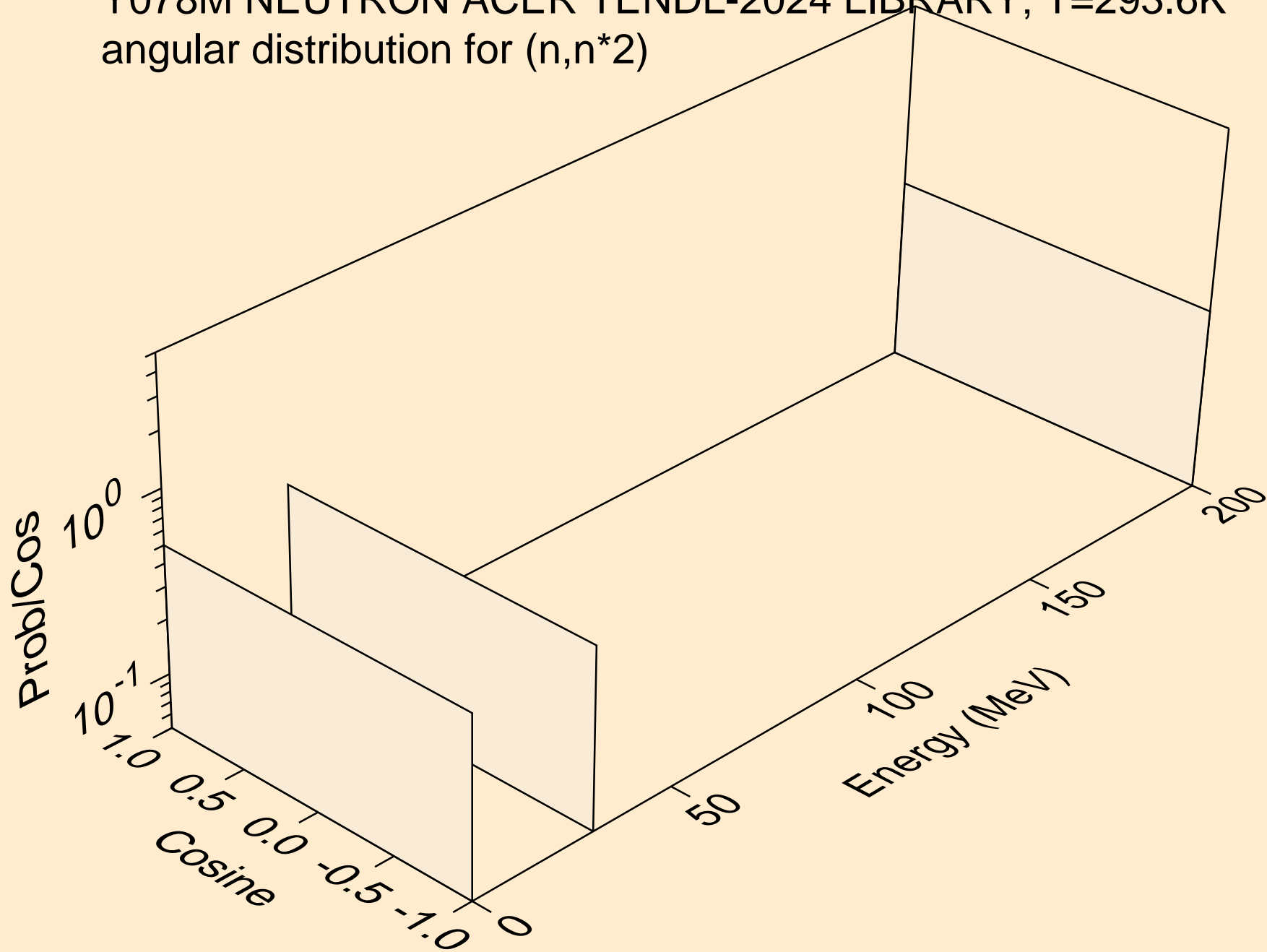

Y078M NEUTRON ACER TENDL-2024 LIBRARY; T=293.6K
Neutron emission for (n,x)

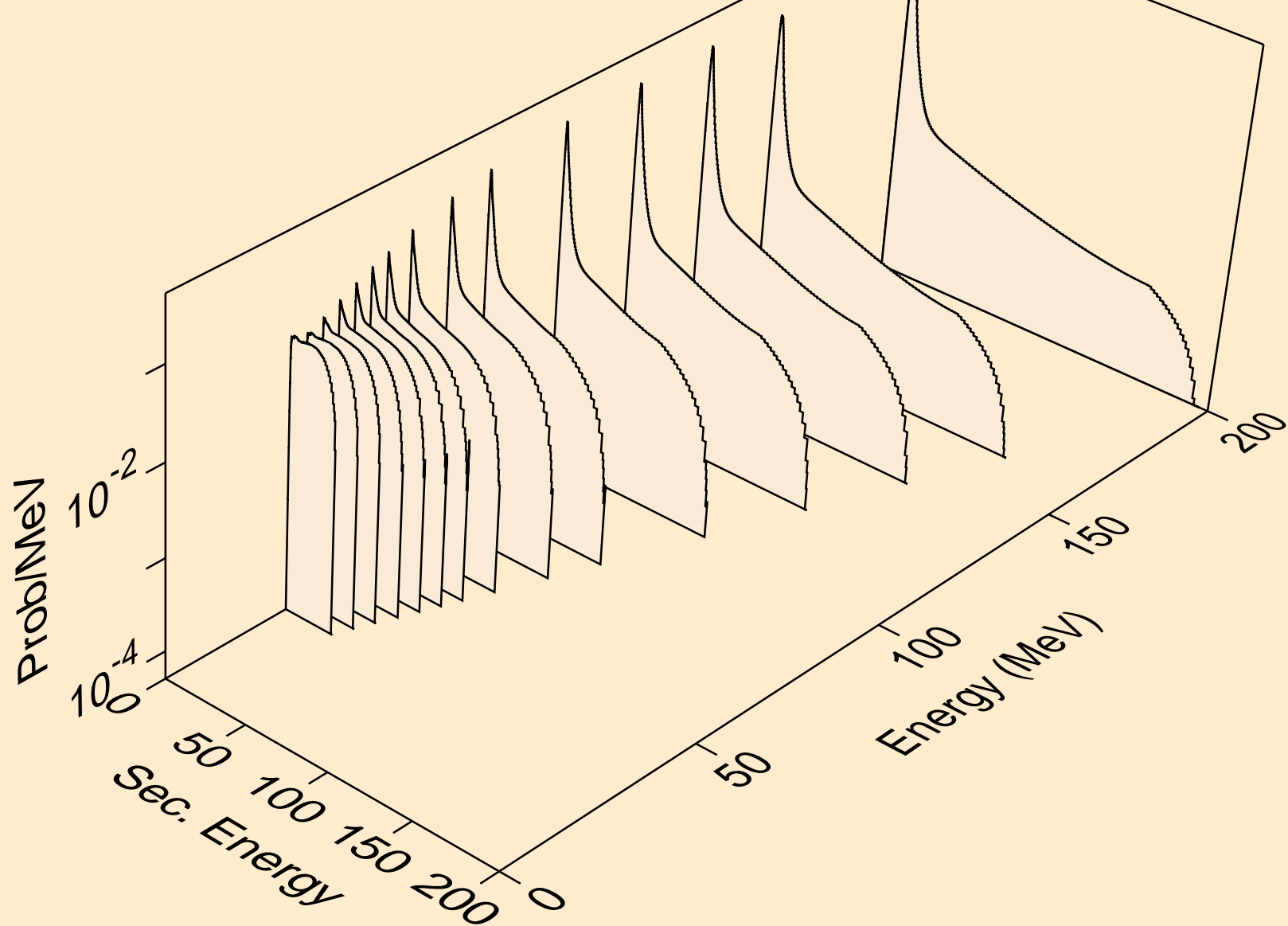

Y078M NEUTRON ACER TENDL-2024 LIBRARY; T=293.6K
Neutron emission for (n,2n)

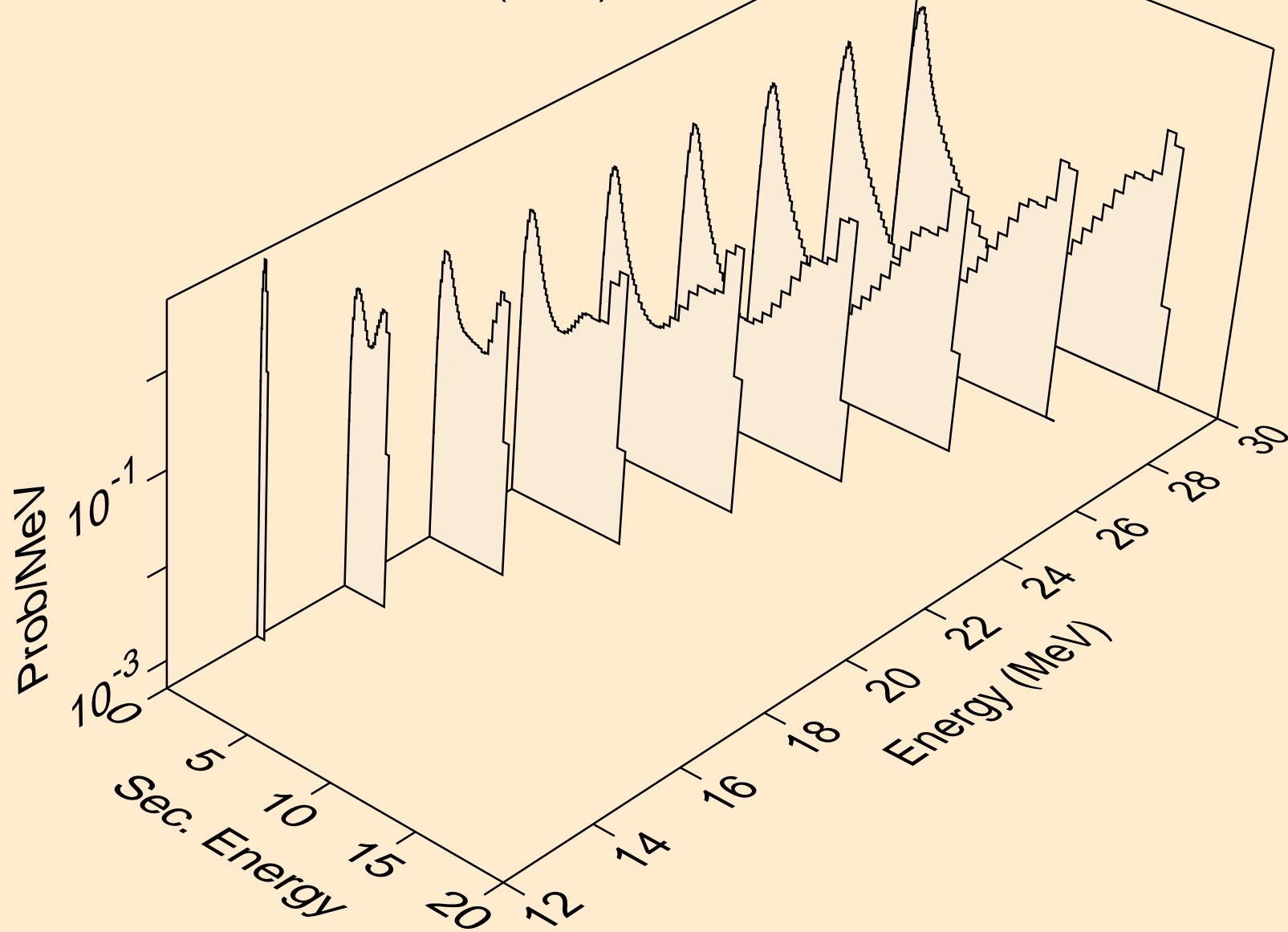

Y078M NEUTRON ACER TENDL-2024 LIBRARY; T=293.6K
Neutron emission for (n,n*)a

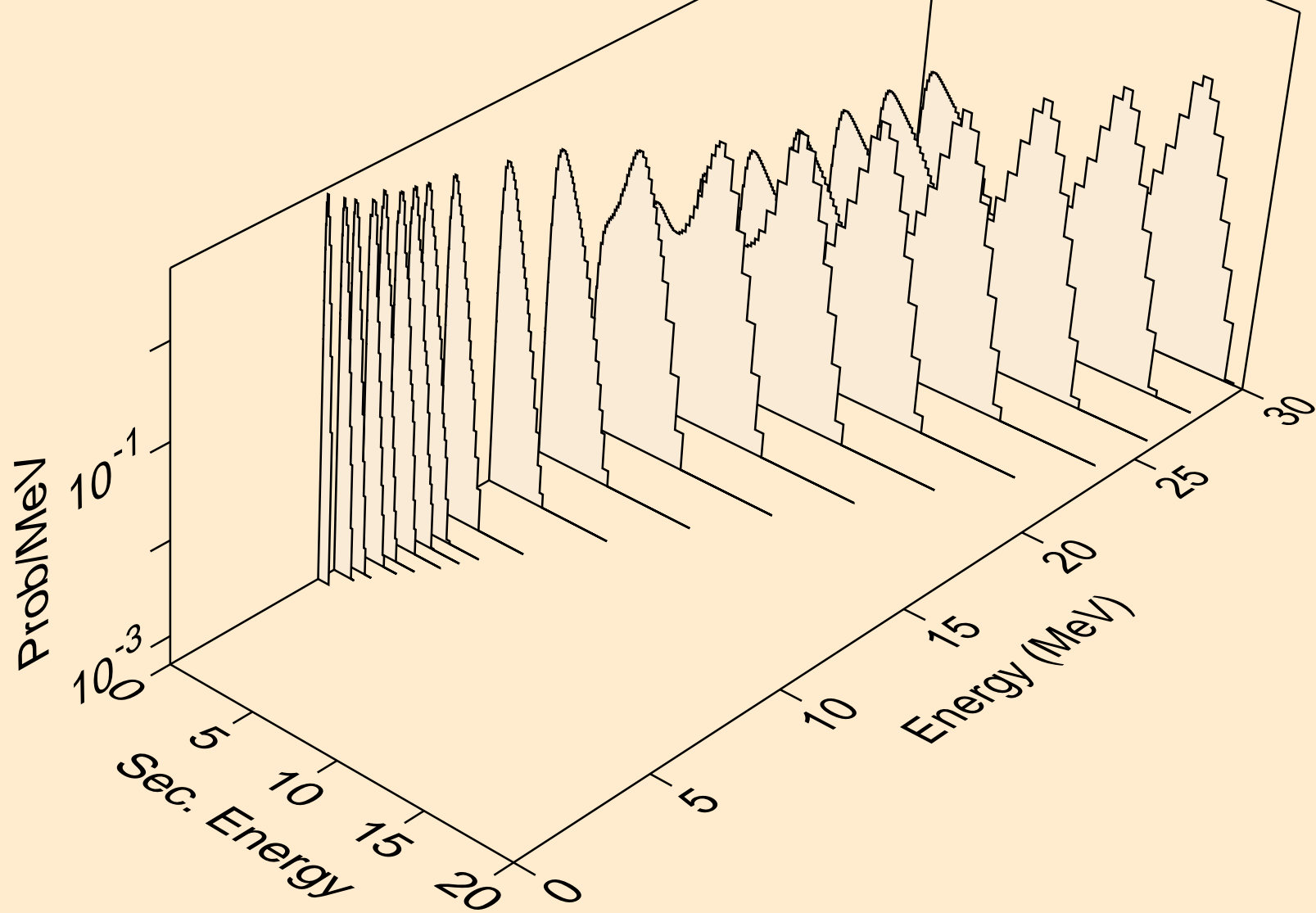

Y078M NEUTRON ACER TENDL-2024 LIBRARY; T=293.6K
Neutron emission for (n,2n)a

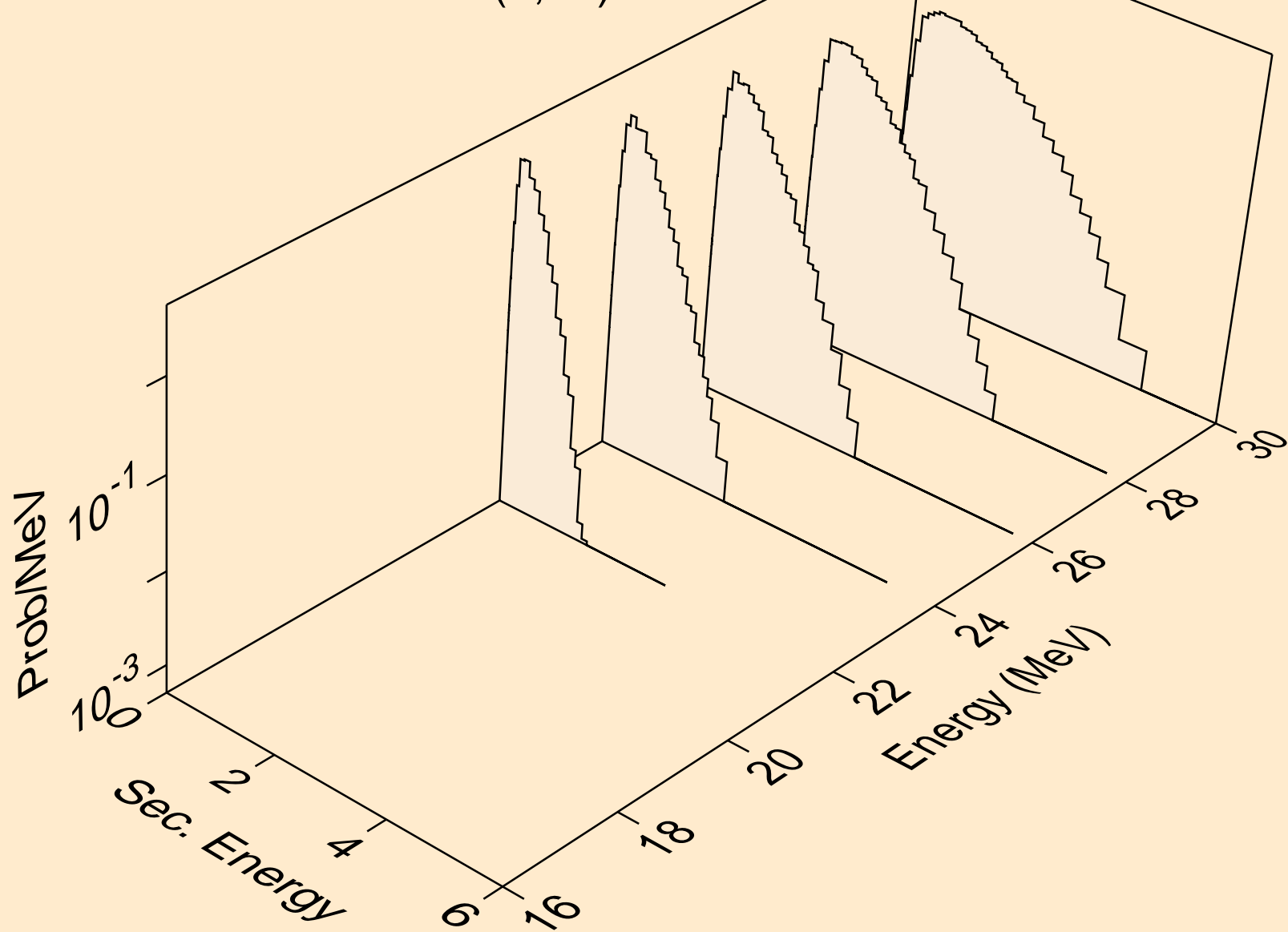

Y078M NEUTRON ACER TENDL-2024 LIBRARY; T=293.6K
Neutron emission for (n,n*)p

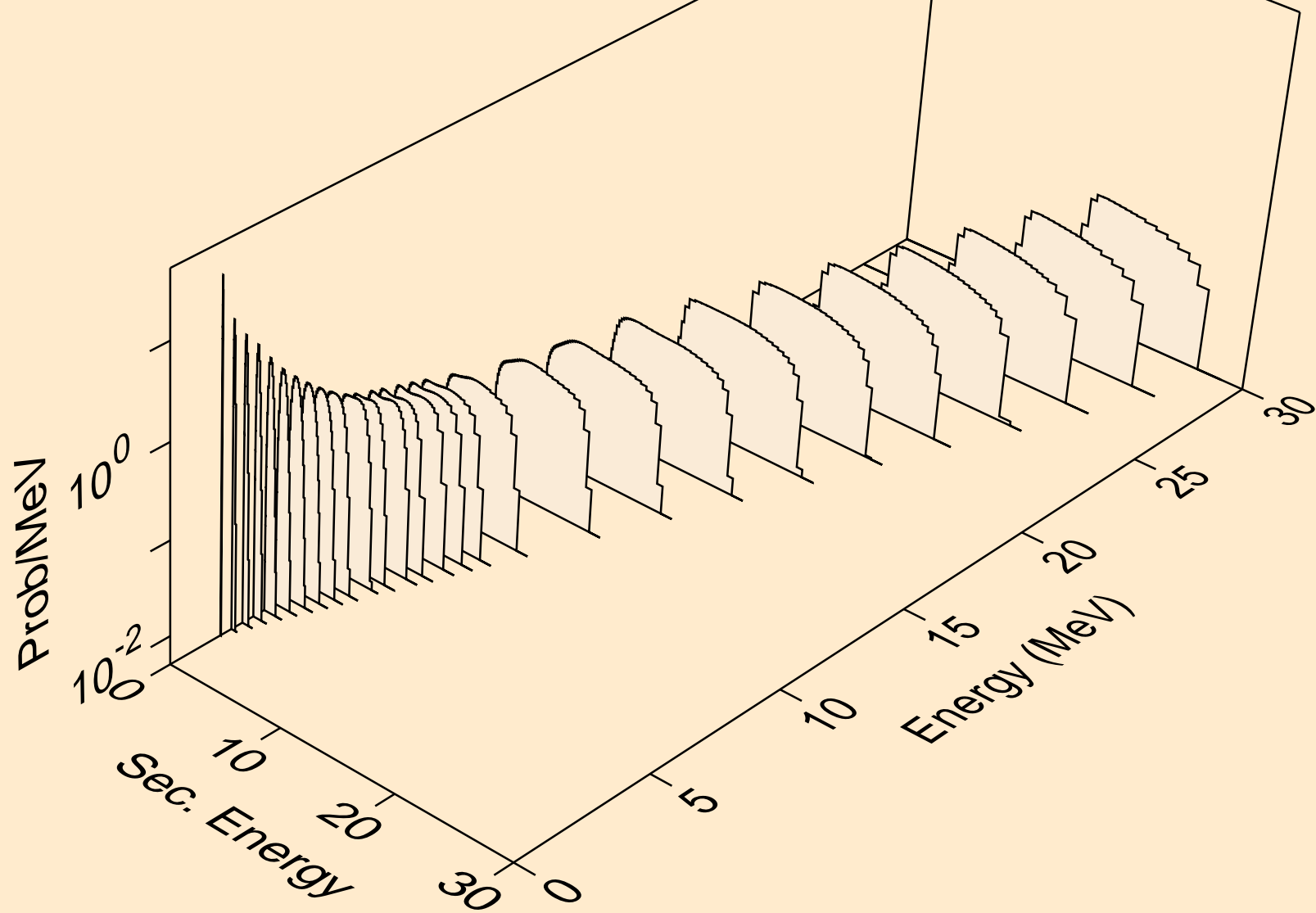

Y078M NEUTRON ACER TENDL-2024 LIBRARY; T=293.6K
Neutron emission for (n,n*)2a

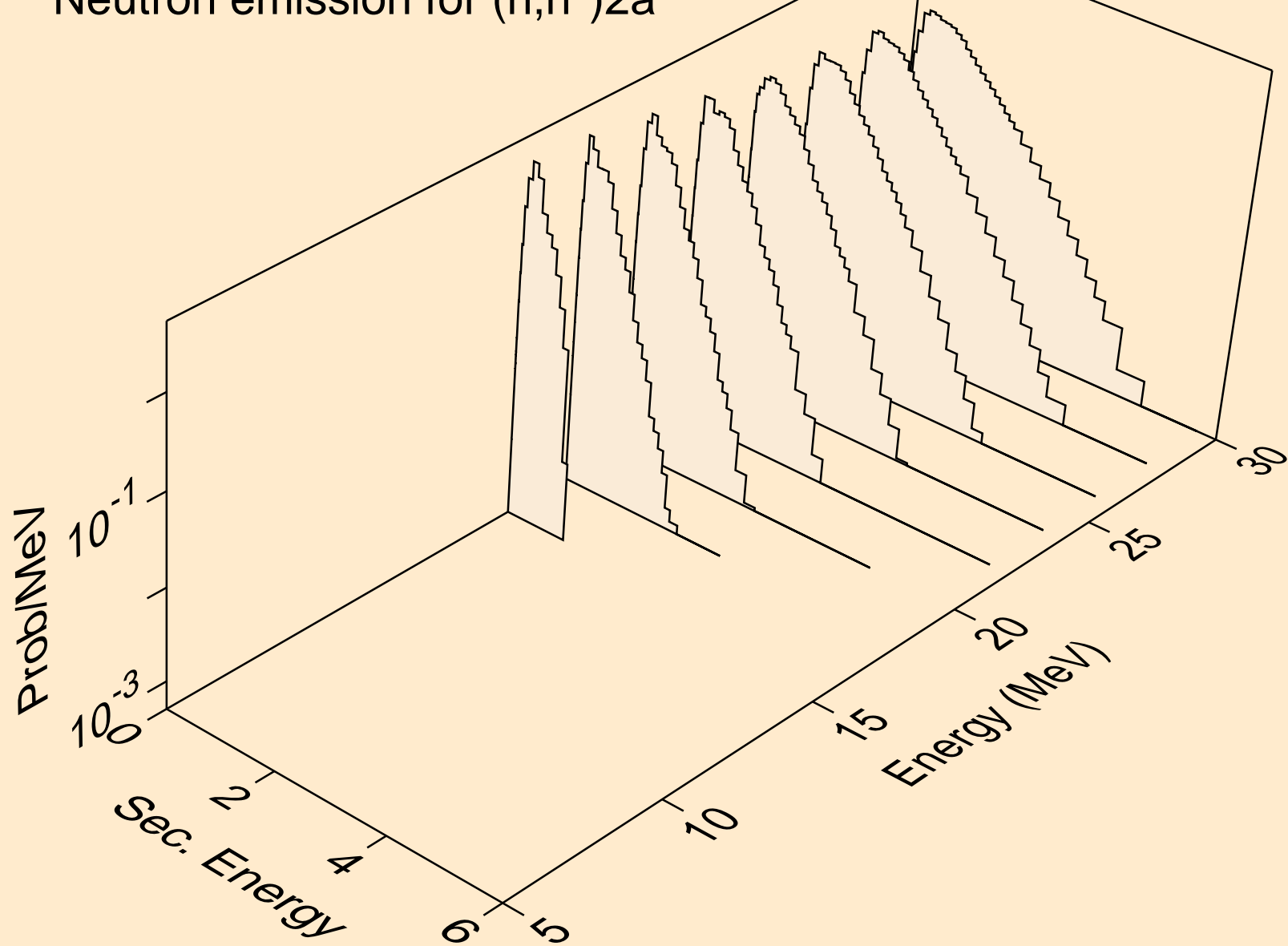

Y078M NEUTRON ACER TENDL-2024 LIBRARY; T=293.6K
Neutron emission for (n,n*)d

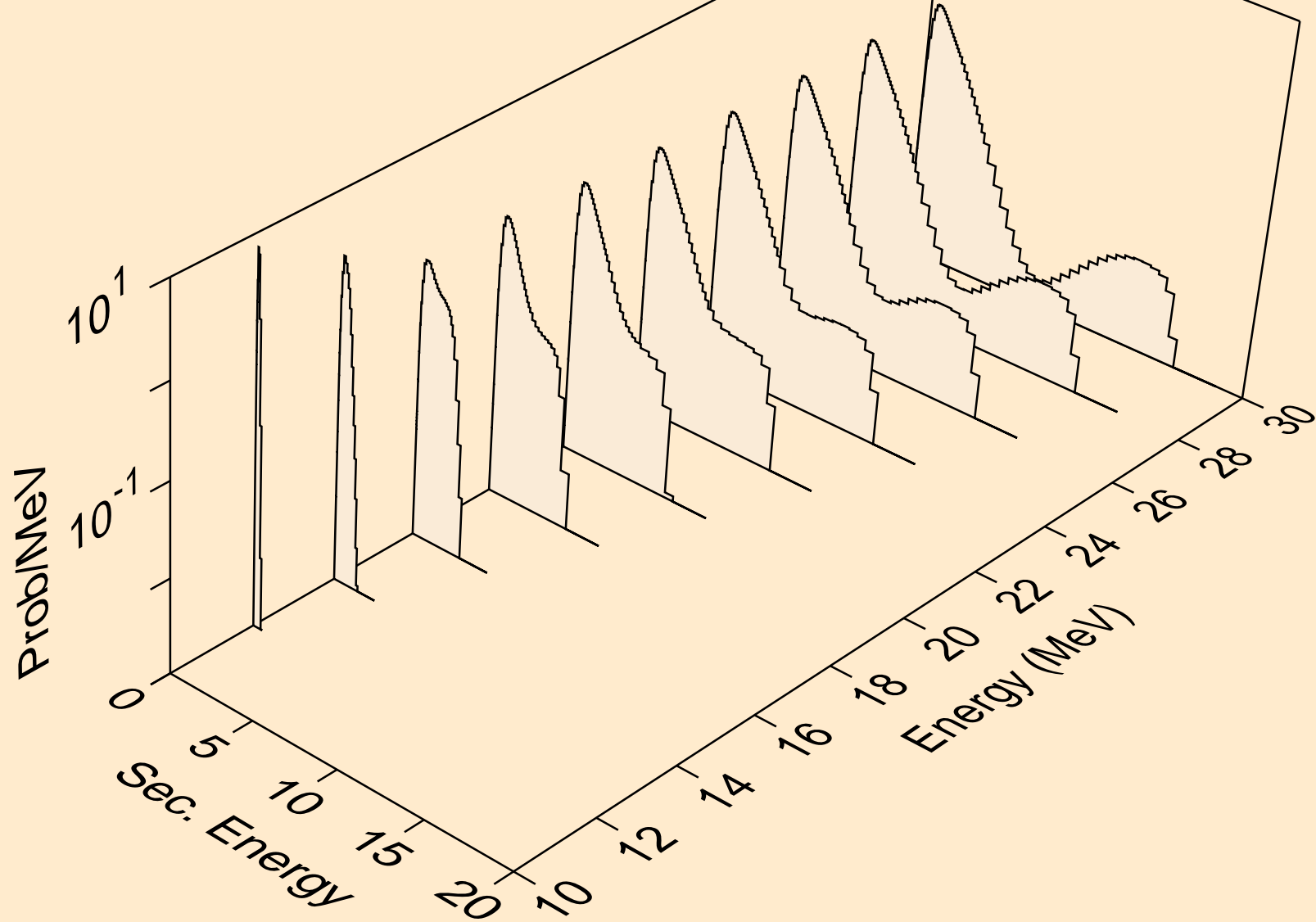

Y078M NEUTRON ACER TENDL-2024 LIBRARY; T=293.6K
Neutron emission for (n,n*)t

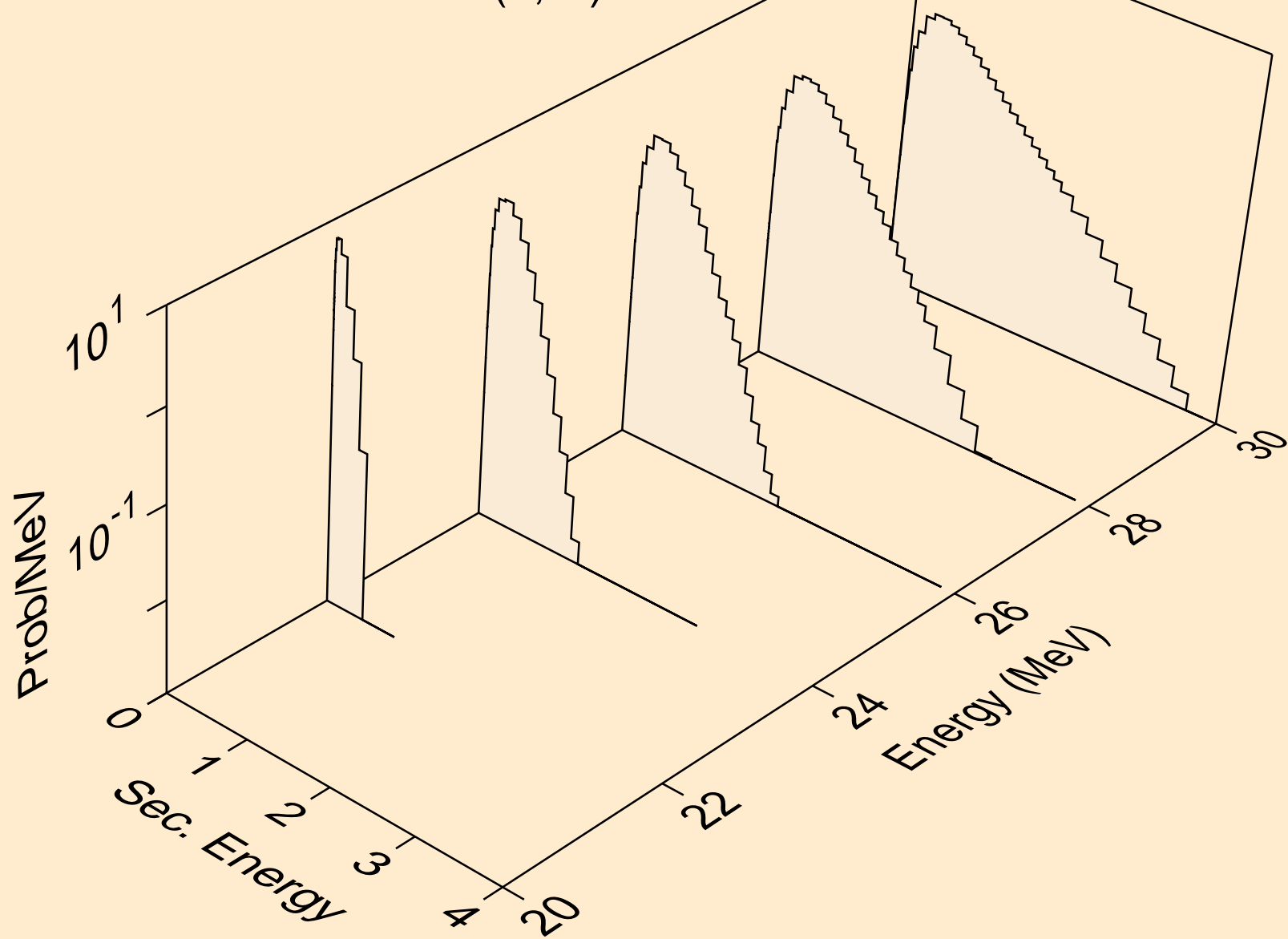

Y078M NEUTRON ACER TENDL-2024 LIBRARY; T=293.6K
Neutron emission for (n,n*)he3

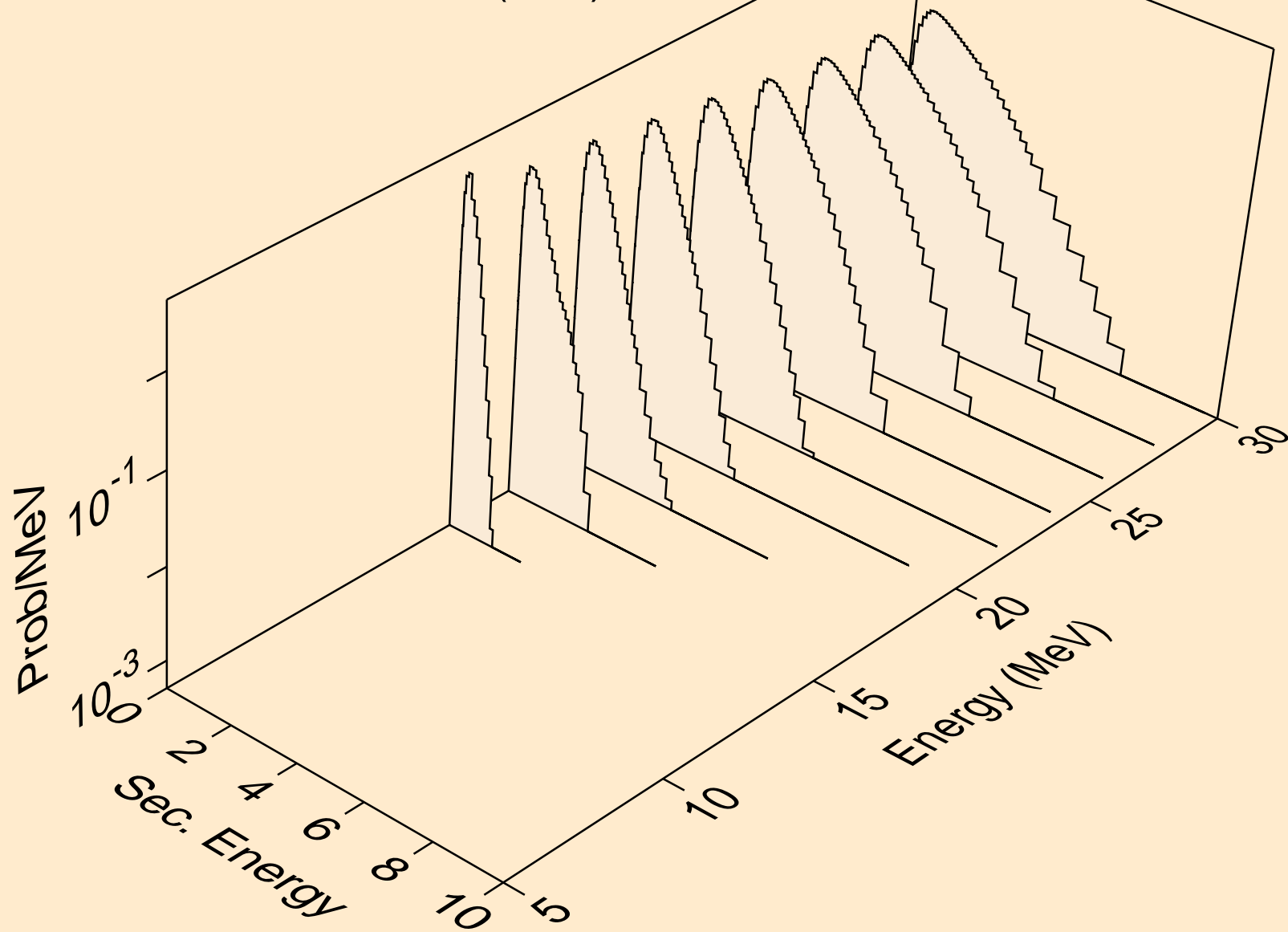

Y078M NEUTRON ACER TENDL-2024 LIBRARY; T=293.6K
Neutron emission for (n,2np)

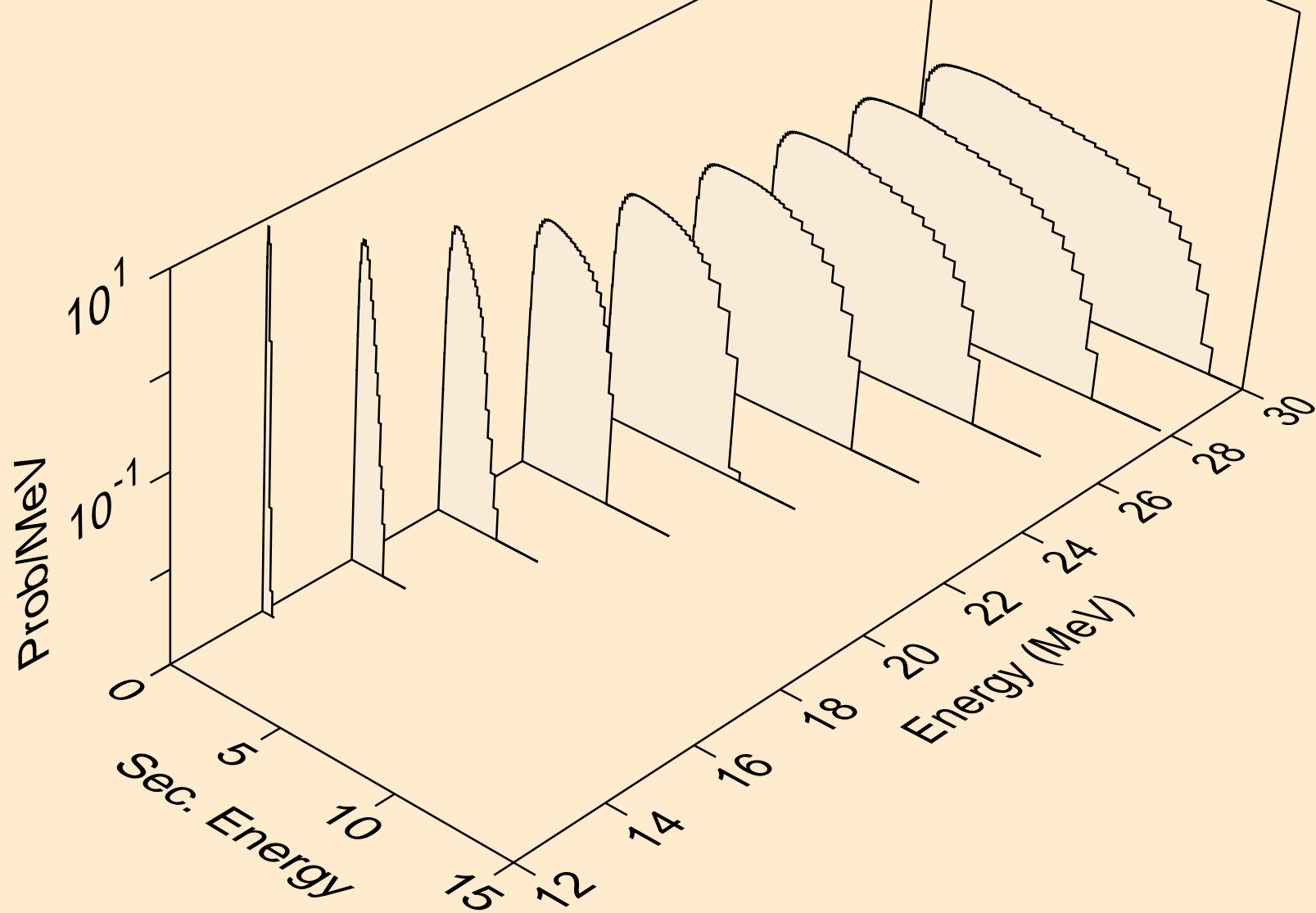

Y078M NEUTRON ACER TENDL-2024 LIBRARY; T=293.6K
Neutron emission for (n,n2p)

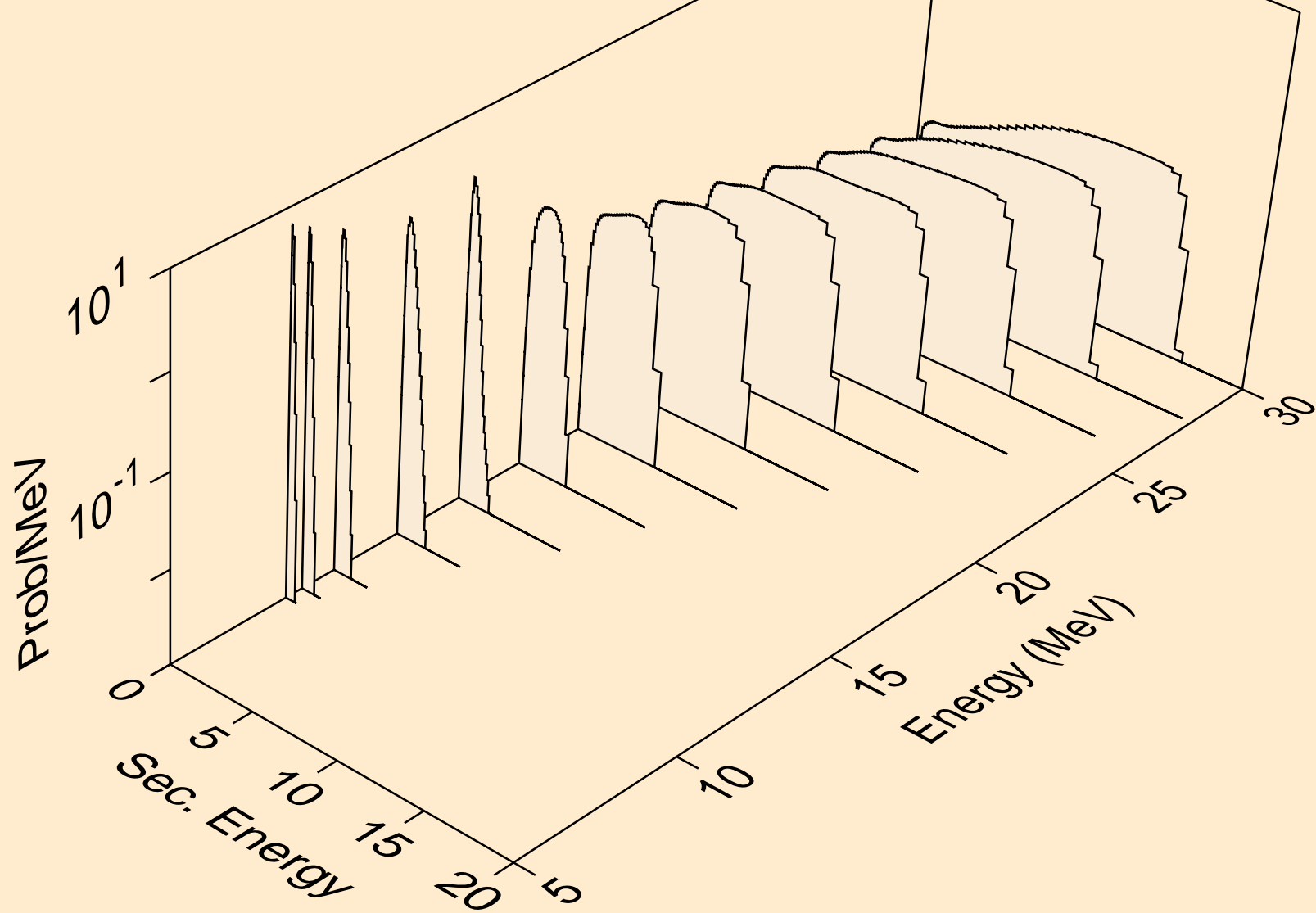

Y078M NEUTRON ACER TENDL-2024 LIBRARY; T=293.6K
Neutron emission for (n,npa)

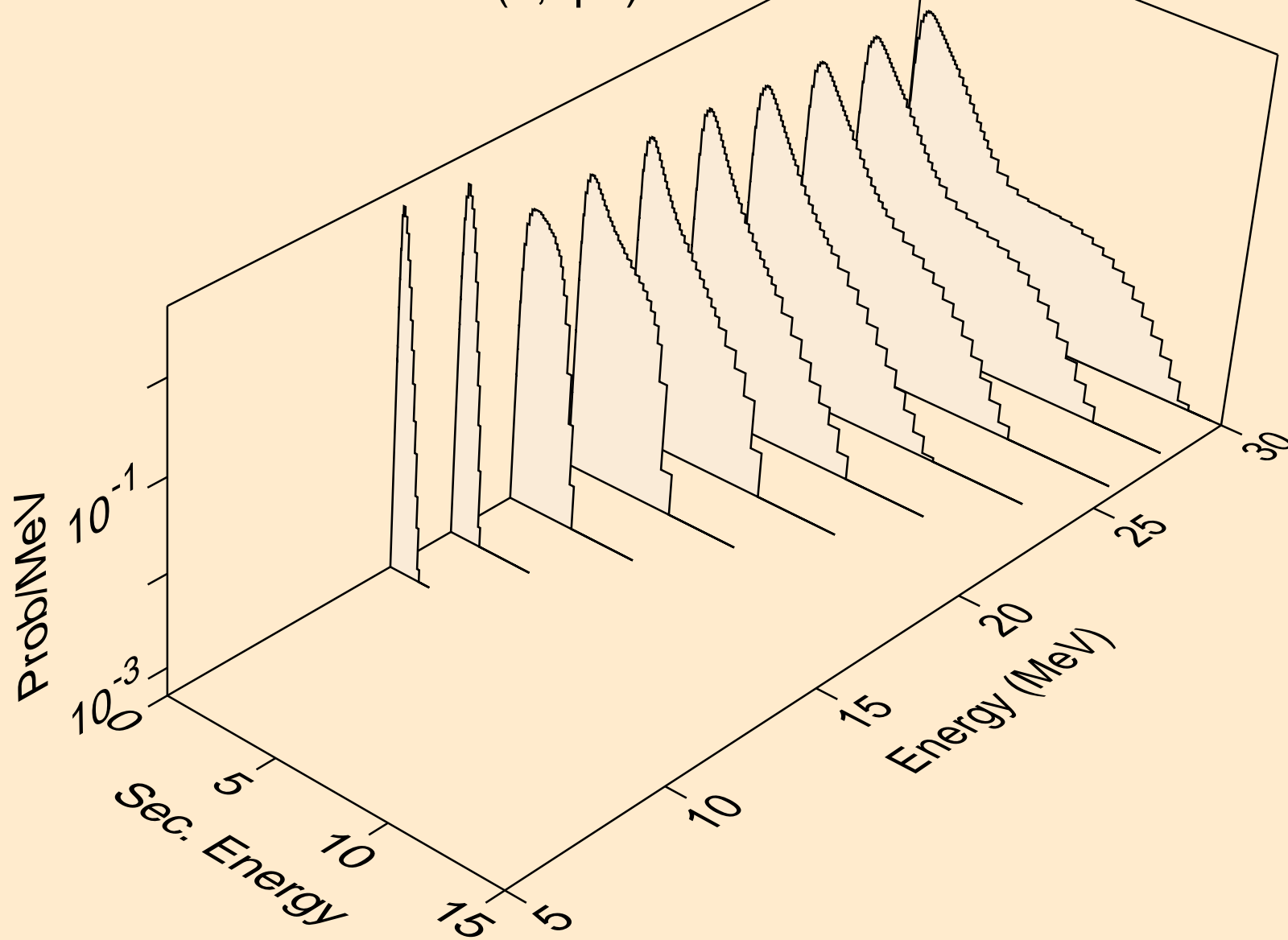

Y078M NEUTRON ACER TENDL-2024 LIBRARY; T=293.6K
Neutron emission for (n,n*c)

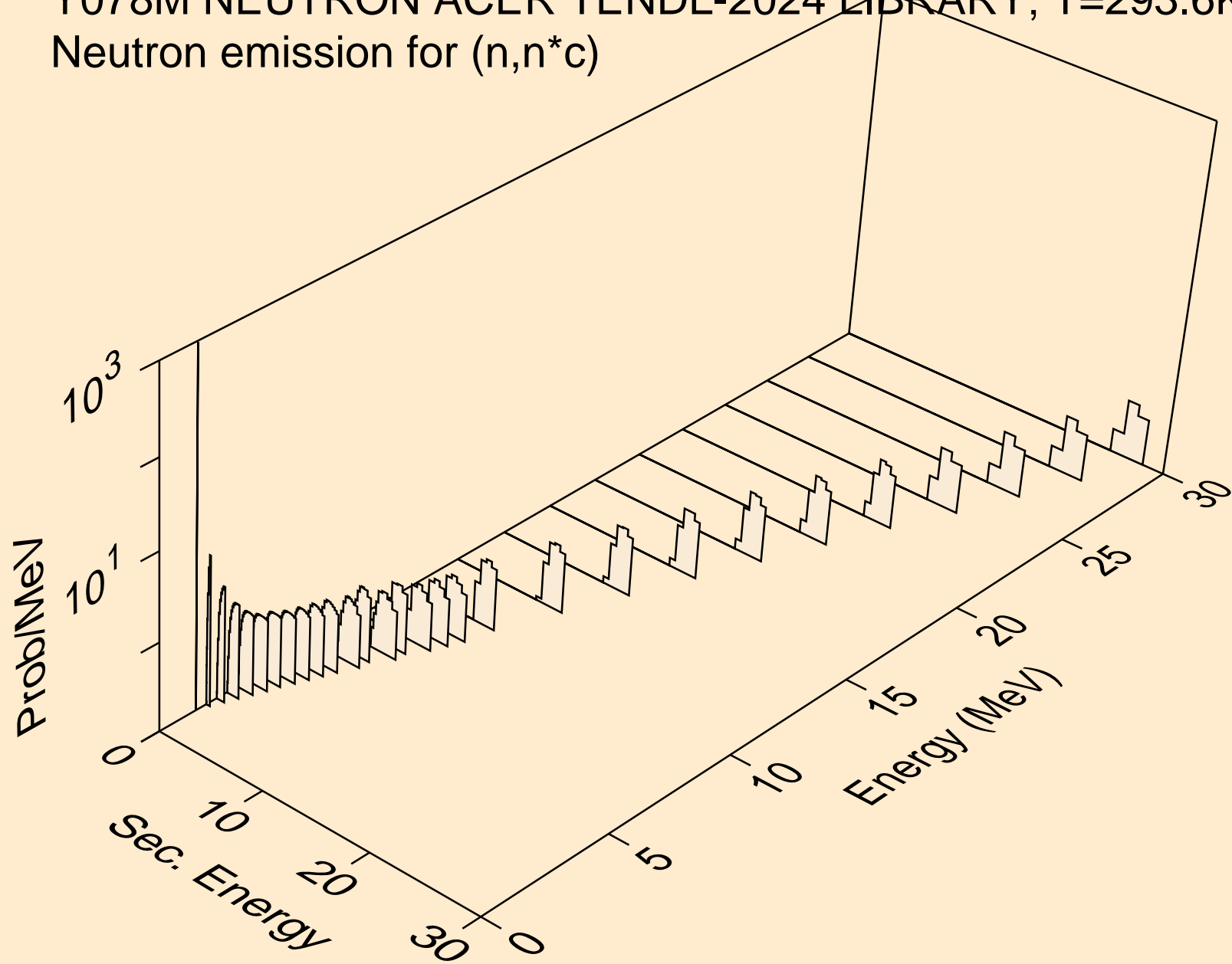

Y078M NEUTRON ACER TENDL-2024 LIBRARY; T=293.6K
Photon emission for (n,x)

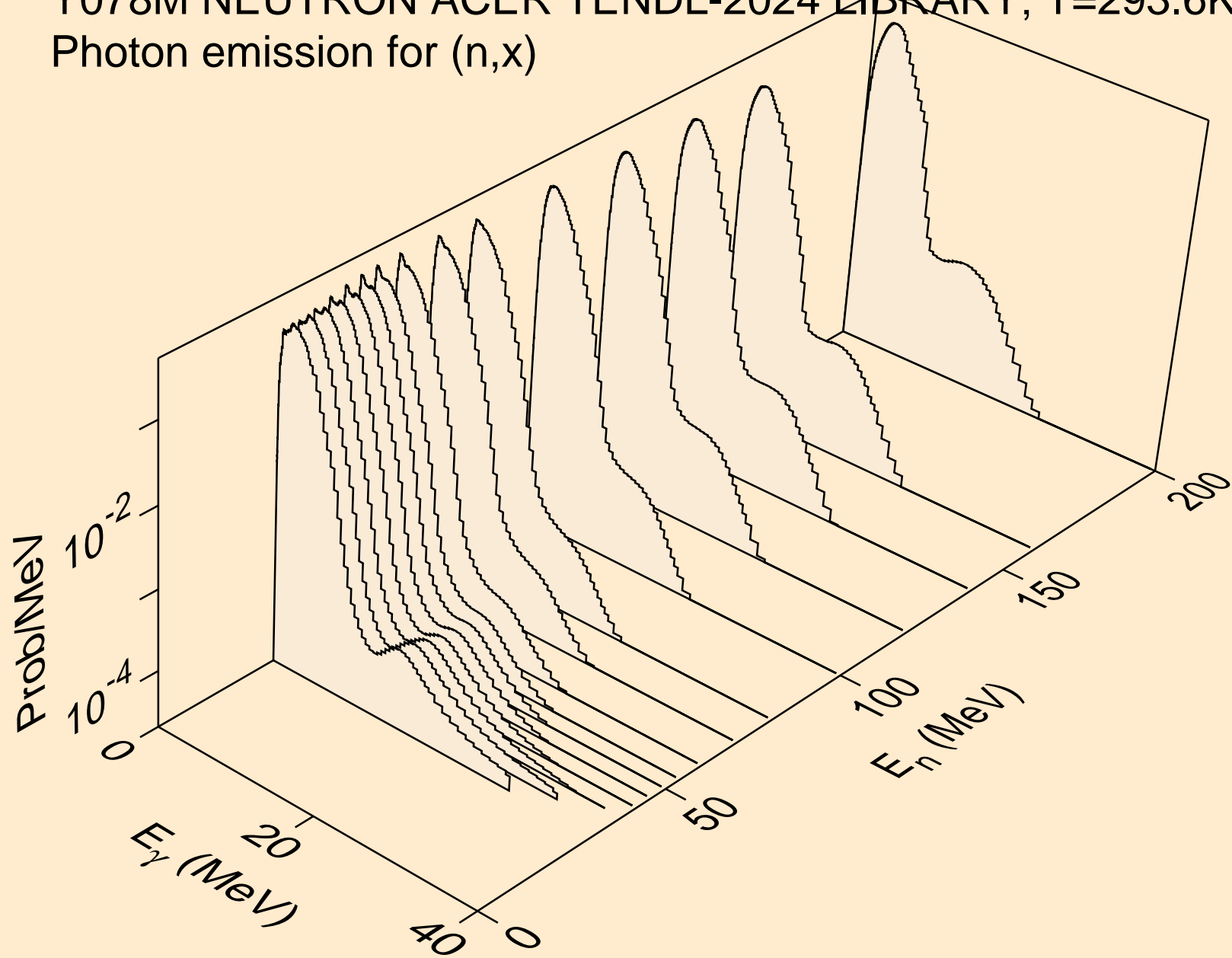

Y078M NEUTRON ACER TENDL-2024 LIBRARY; T=293.6K
Photon emission for (n,2n)

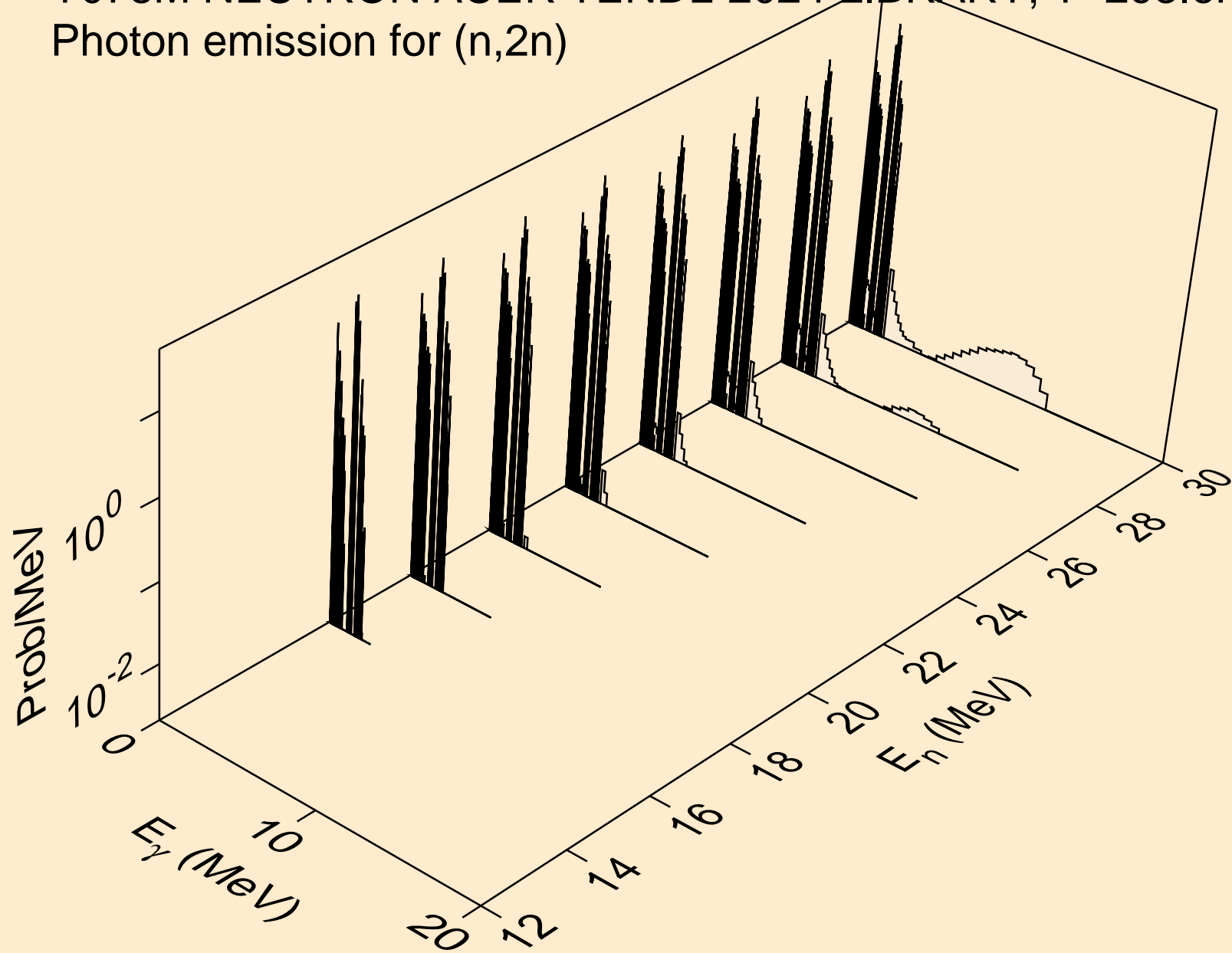

Y078M NEUTRON ACER TENDL-2024 LIBRARY; T=293.6K
Photon emission for (n,n*)a

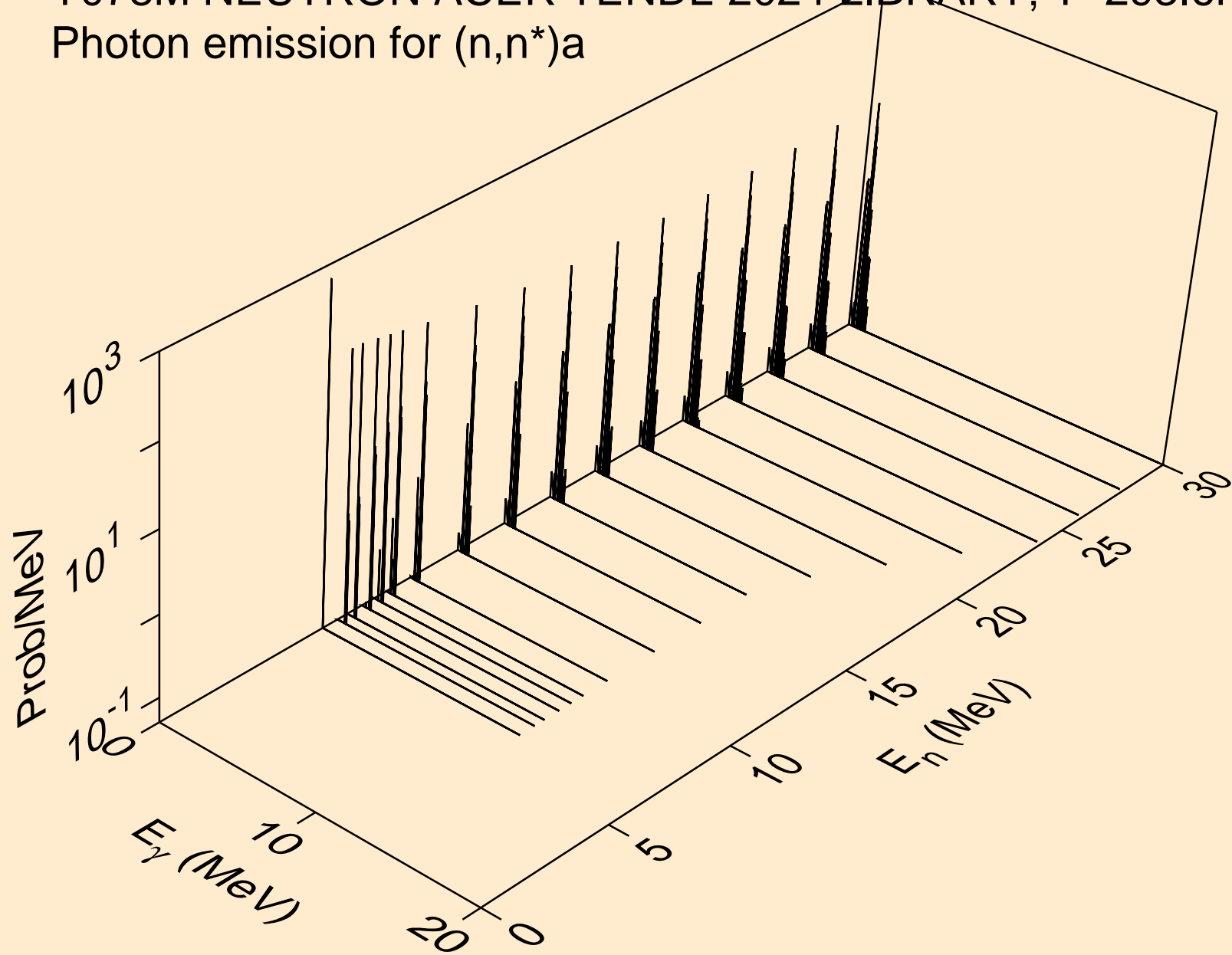

Y078M NEUTRON ACER TENDL-2024 LIBRARY; T=293.6K
Photon emission for (n,2n)a

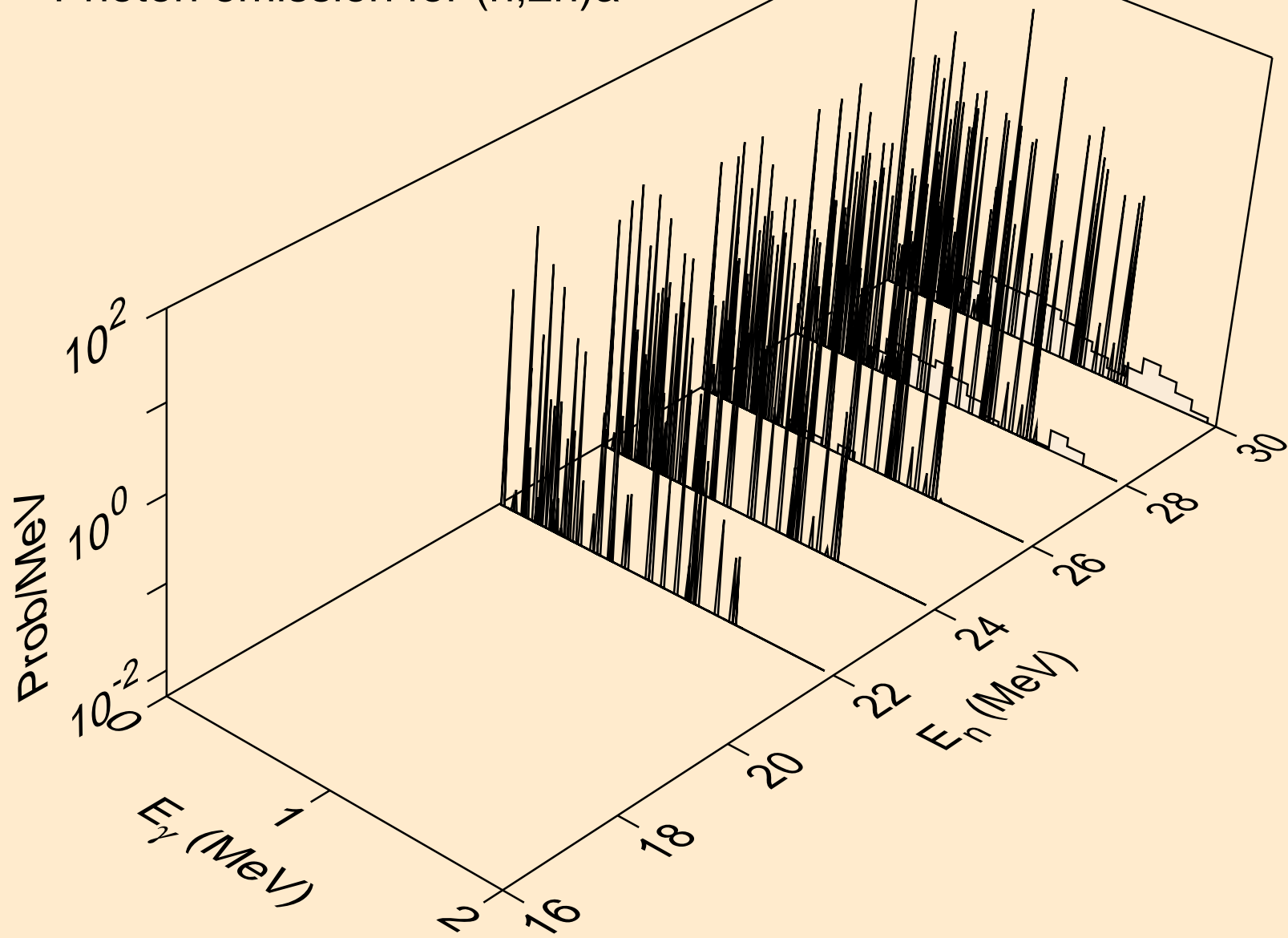

Y078M NEUTRON ACER TENDL-2024 LIBRARY; T=293.6K
Photon emission for (n,n*)p

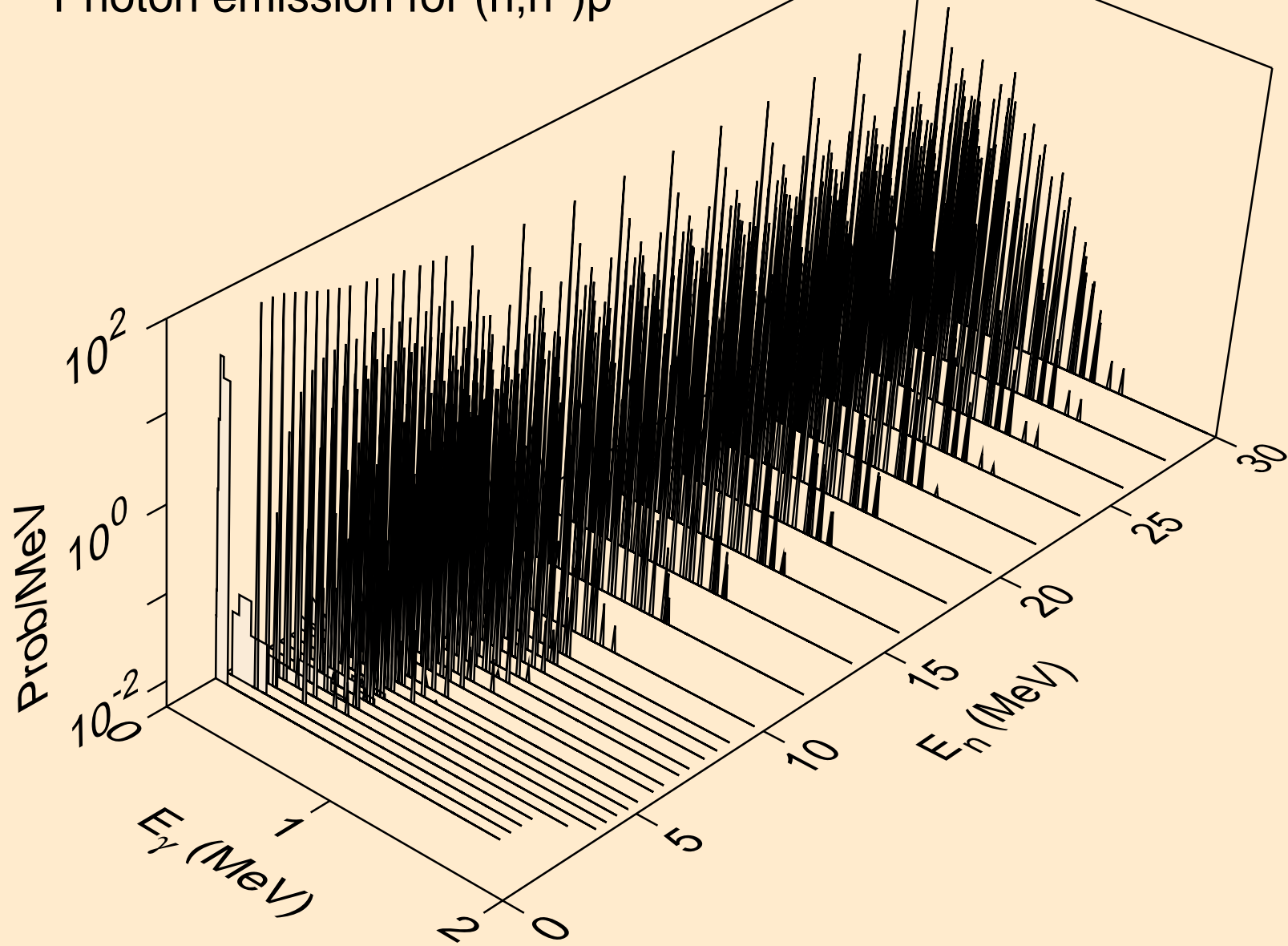

Y078M NEUTRON ACER TENDL-2024 LIBRARY; T=293.6K
Photon emission for (n,n*)2a

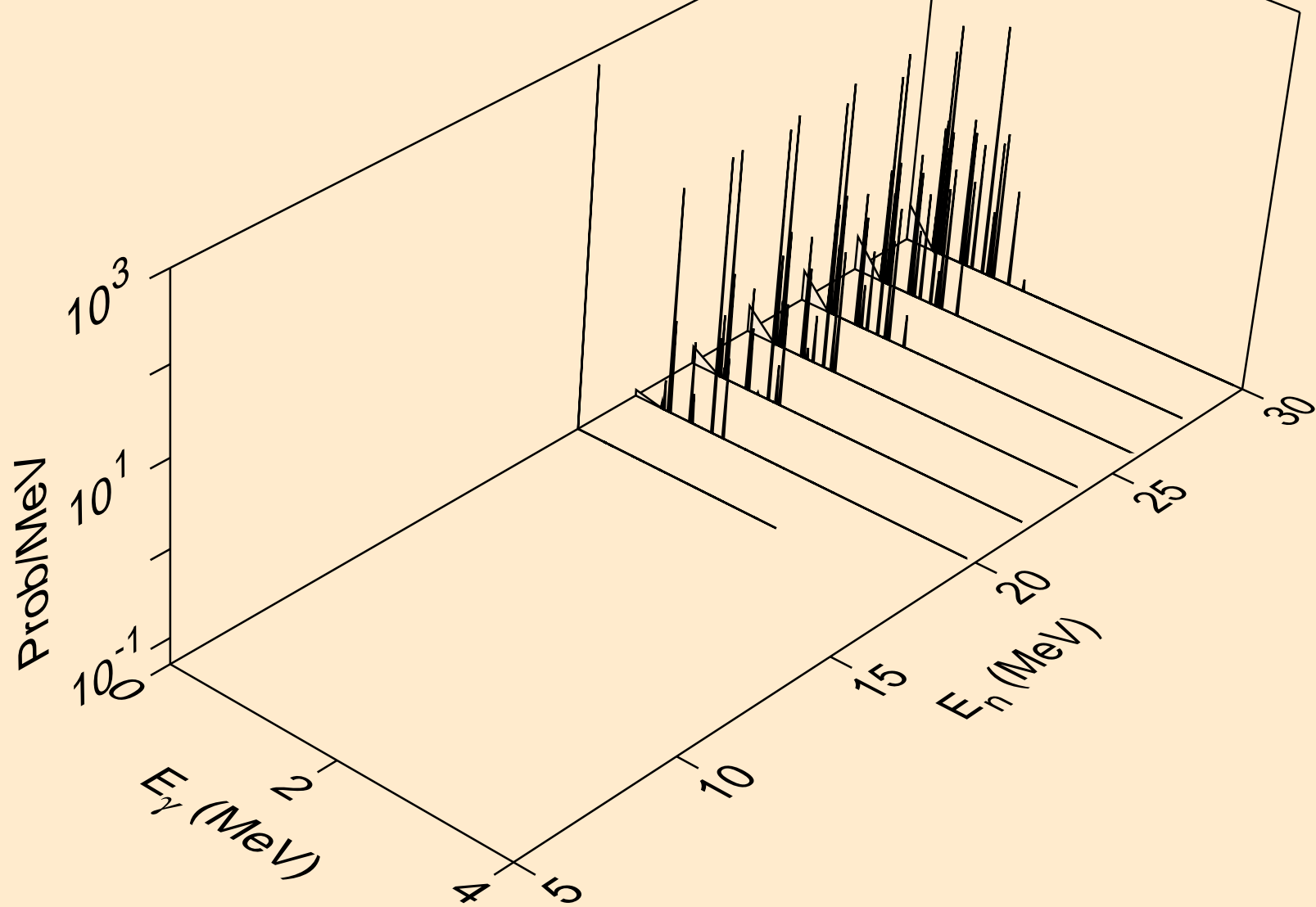

Y078M NEUTRON ACER TENDL-2024 LIBRARY; T=293.6K
Photon emission for (n,n*)d

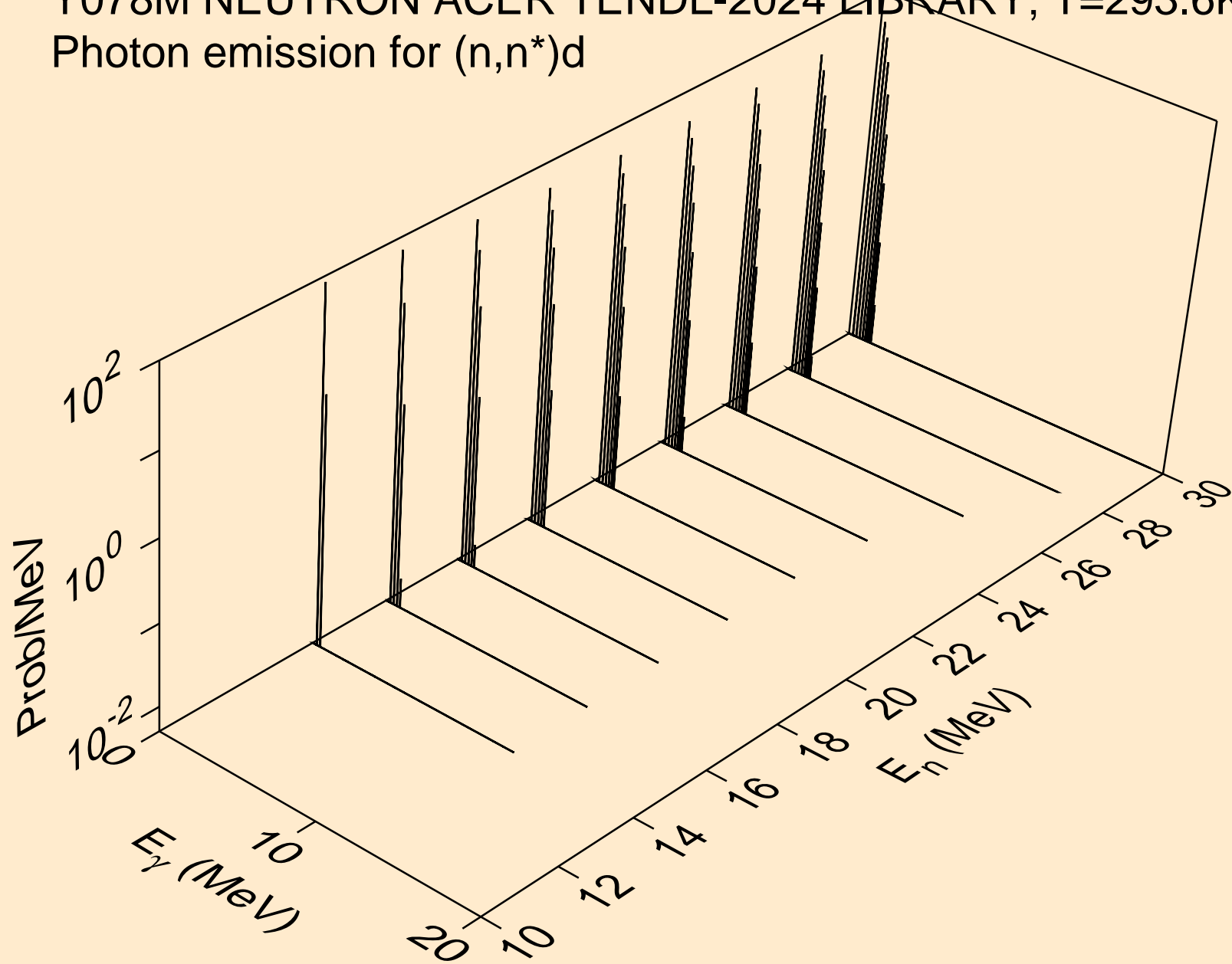

Y078M NEUTRON ACER TENDL-2024 LIBRARY; T=293.6K
Photon emission for (n,n*)t

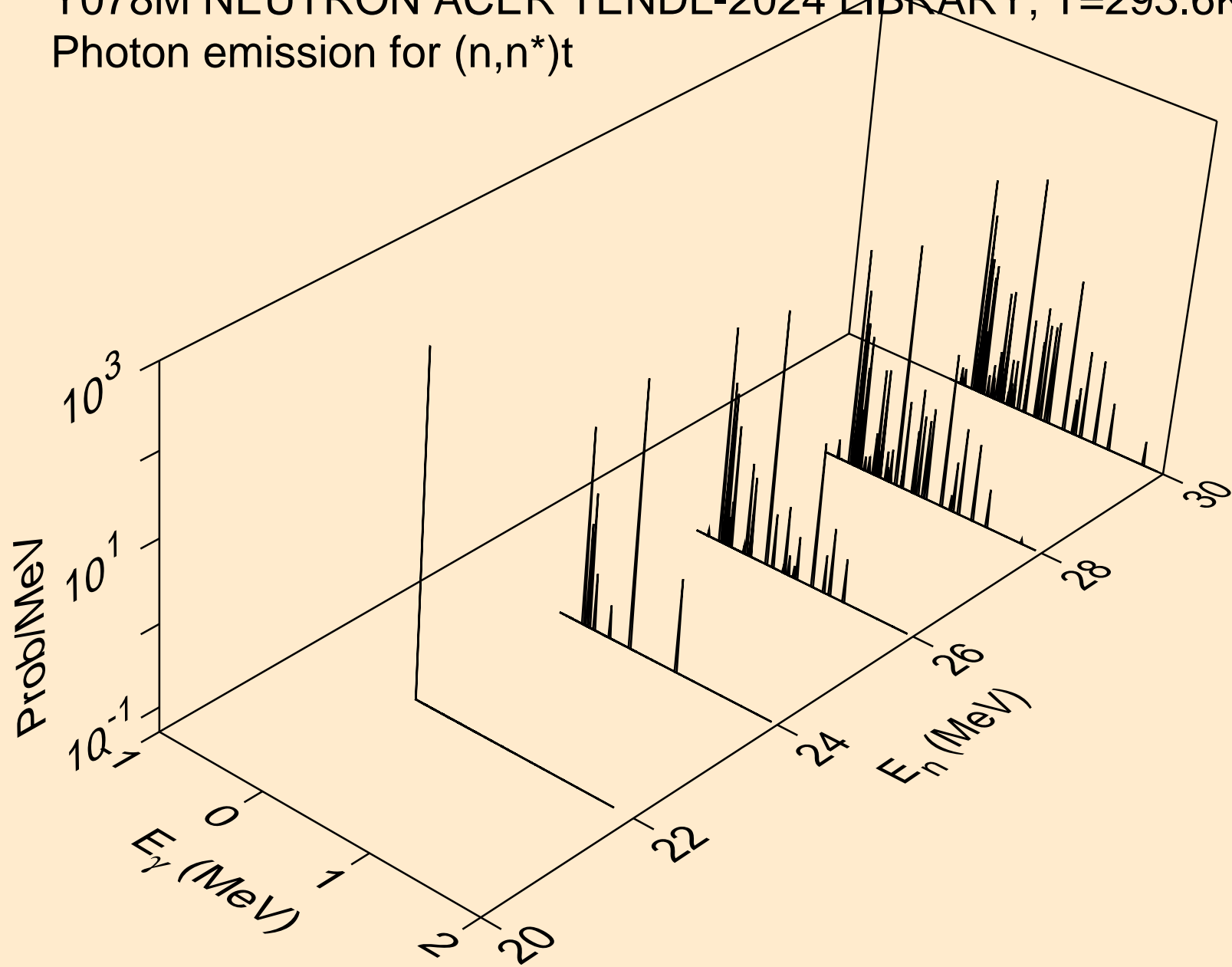

Y078M NEUTRON ACER TENDL-2024 LIBRARY; T=293.6K
Photon emission for (n,n*)he3

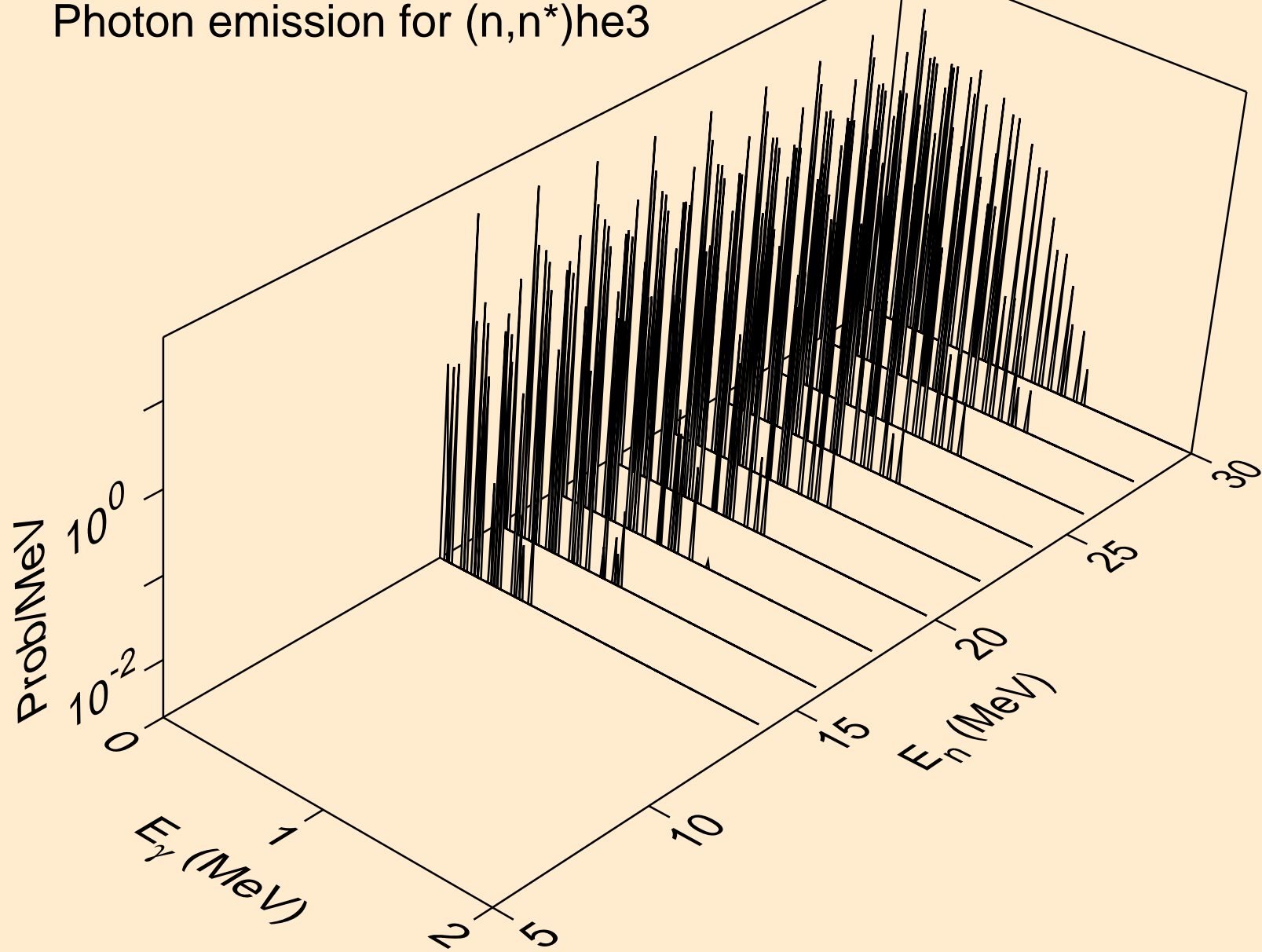

Y078M NEUTRON ACER TENDL-2024 LIBRARY; T=293.6K
Photon emission for (n,2np)

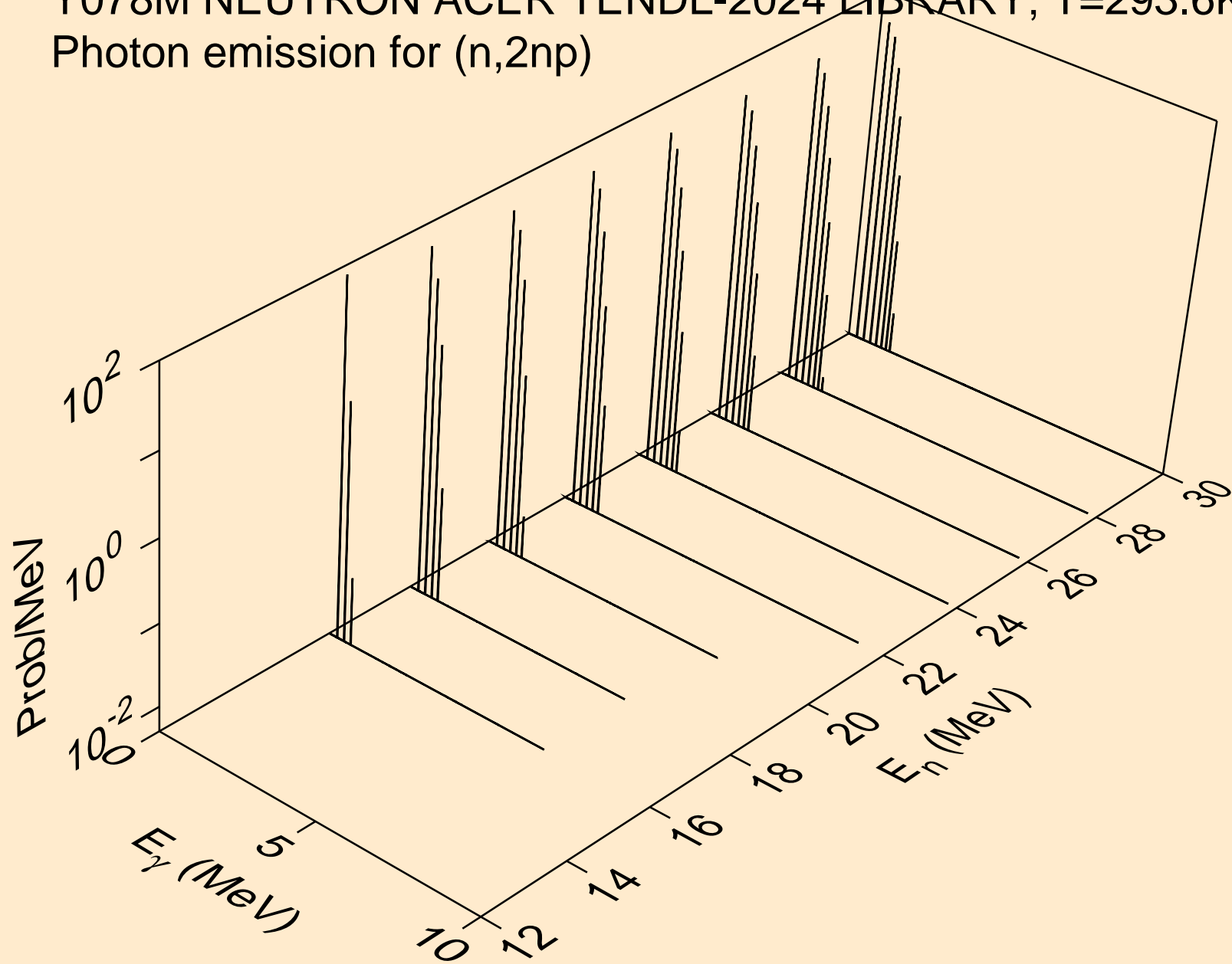

Y078M NEUTRON ACER TENDL-2024 LIBRARY; T=293.6K
Photon emission for (n,n2p)

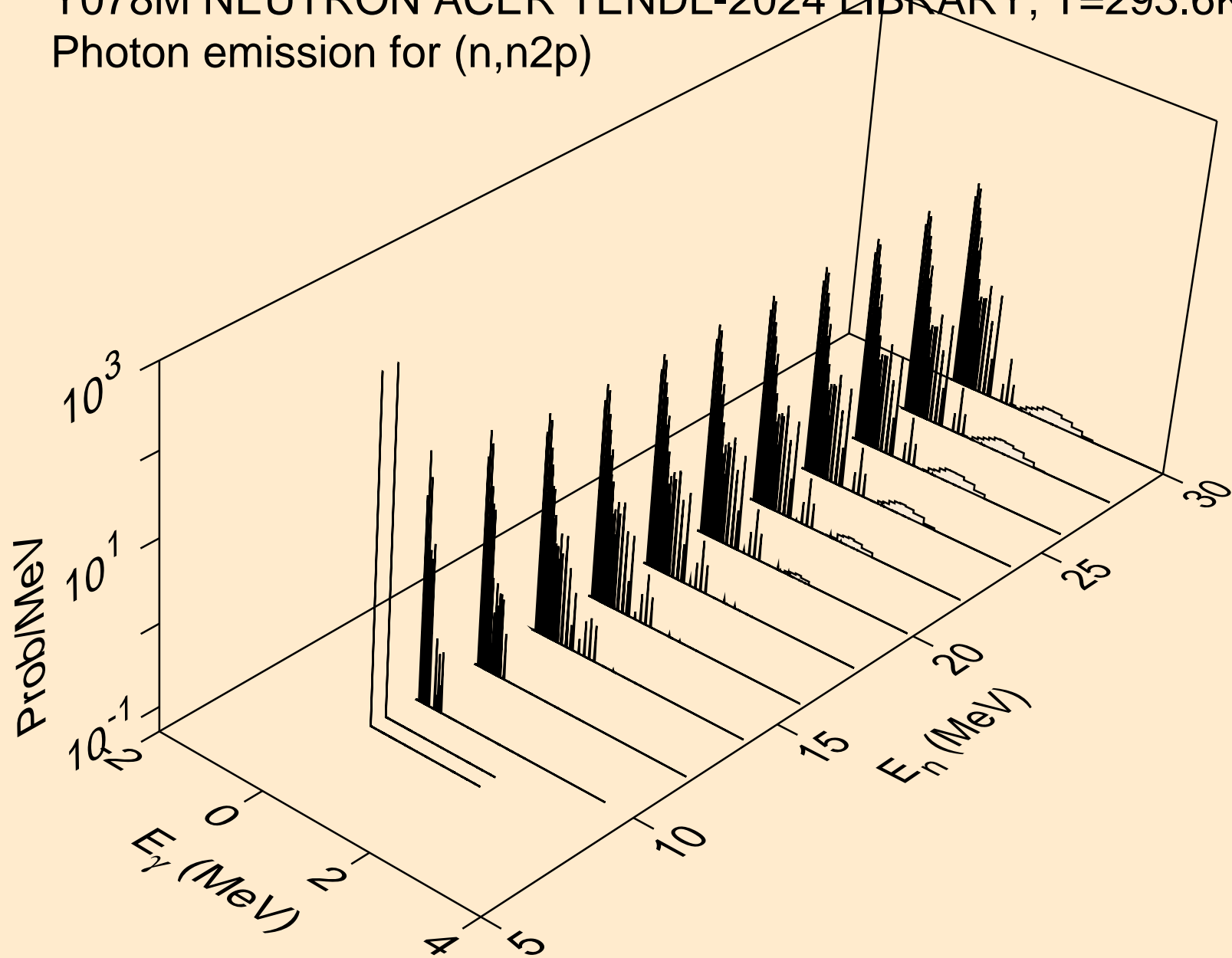

Y078M NEUTRON ACER TENDL-2024 LIBRARY; T=293.6K
Photon emission for (n,npa)

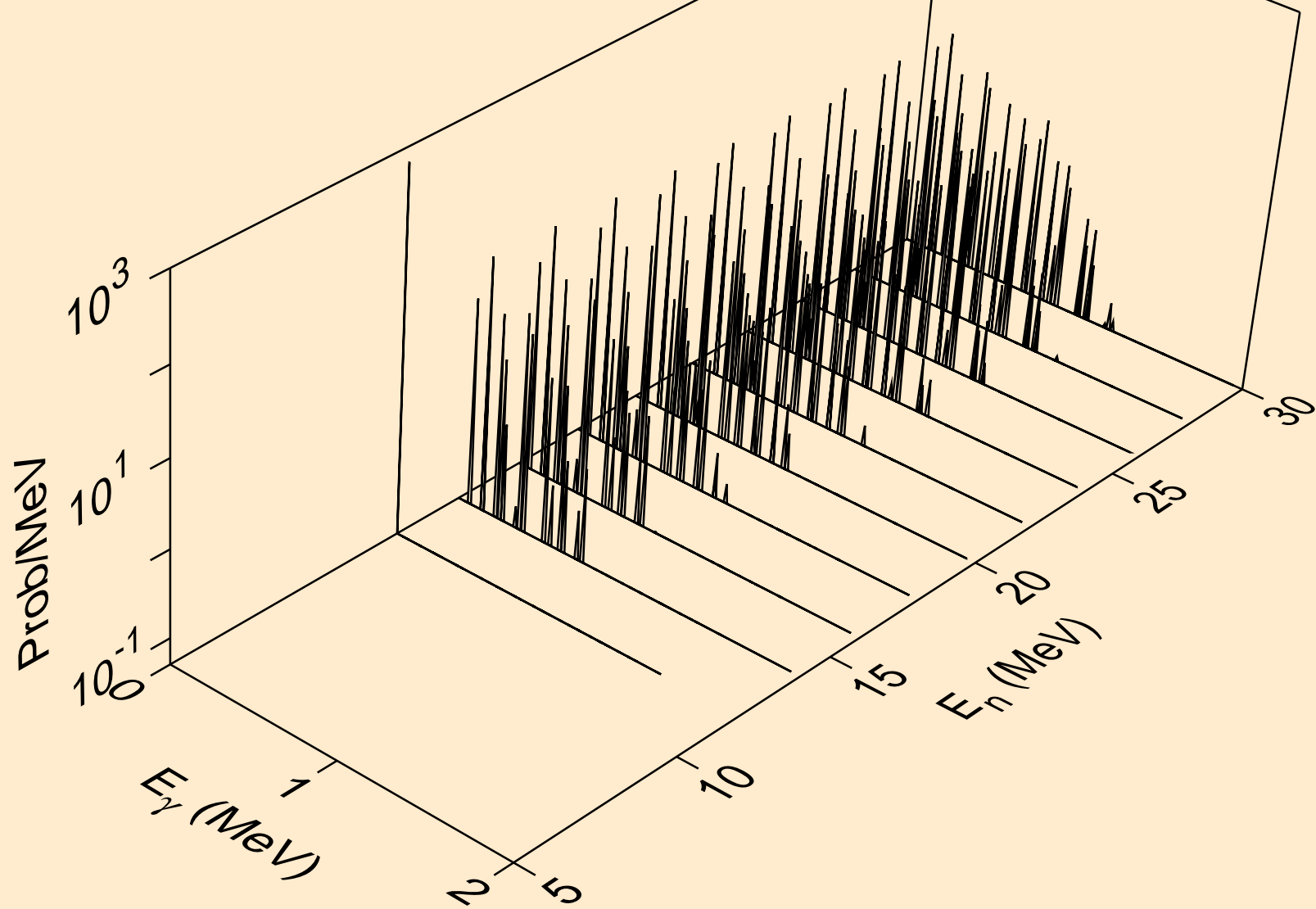

Y078M NEUTRON ACER TENDL-2024 LIBRARY; T=293.6K
Photon emission for (n,n*1)

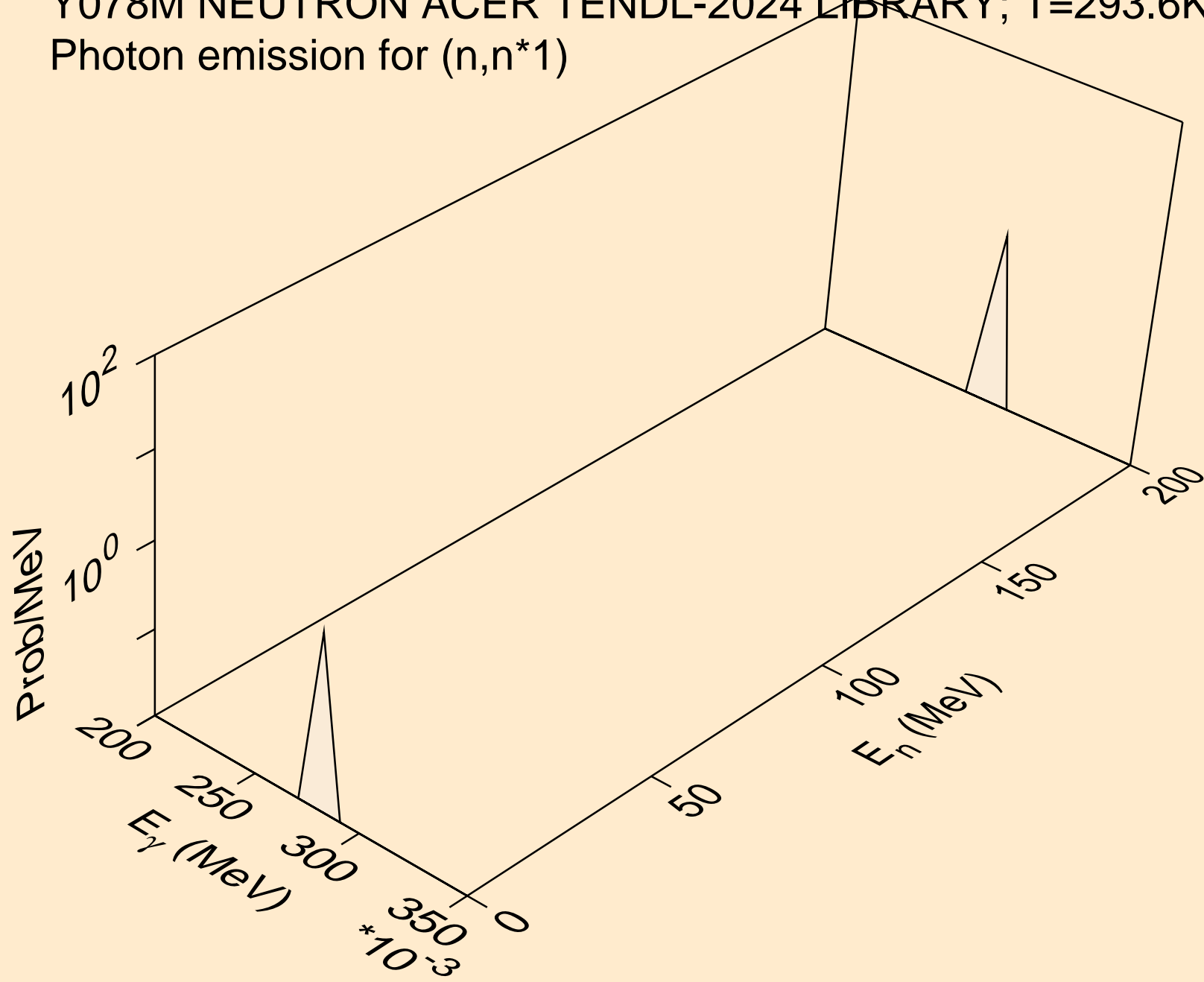

Y078M NEUTRON ACER TENDL-2024 LIBRARY; T=293.6K
Photon emission for (n,n*c)

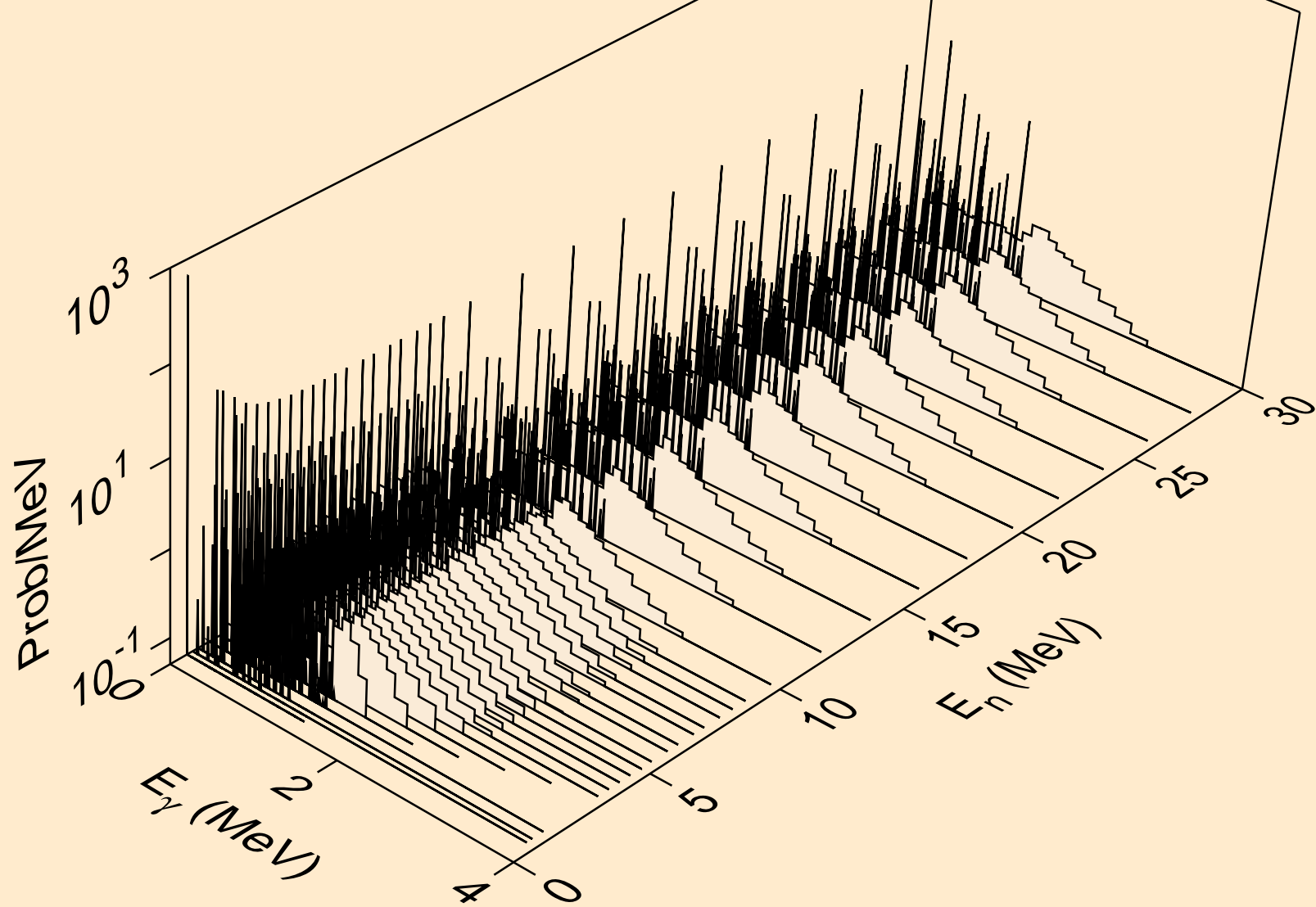

Y078M NEUTRON ACER TENDL-2024 LIBRARY; T=293.6K
Photon emission for (n,gma)

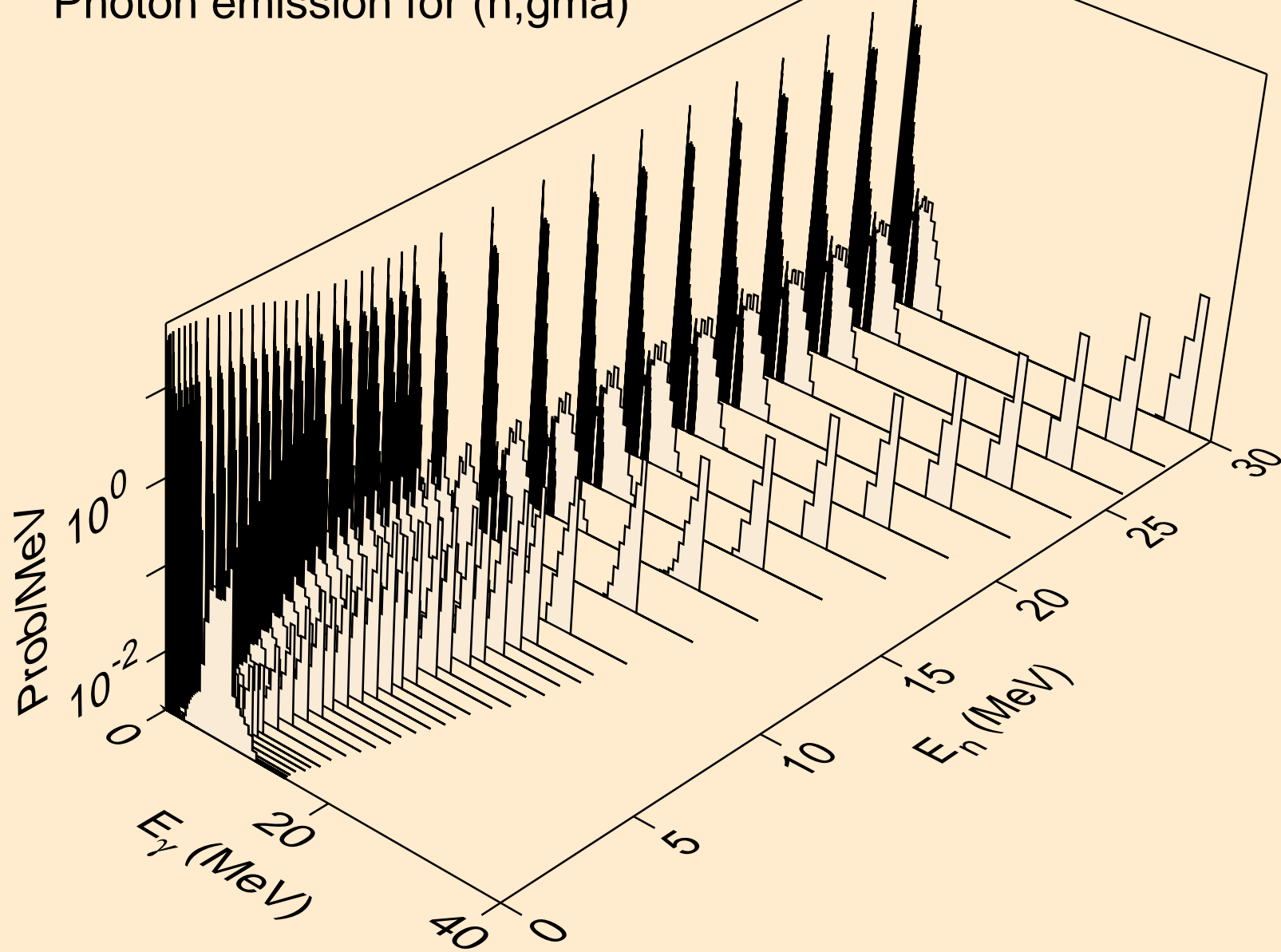

Y078M NEUTRON ACER TENDL-2024 LIBRARY; T=293.6K
Photon emission for (n,p)

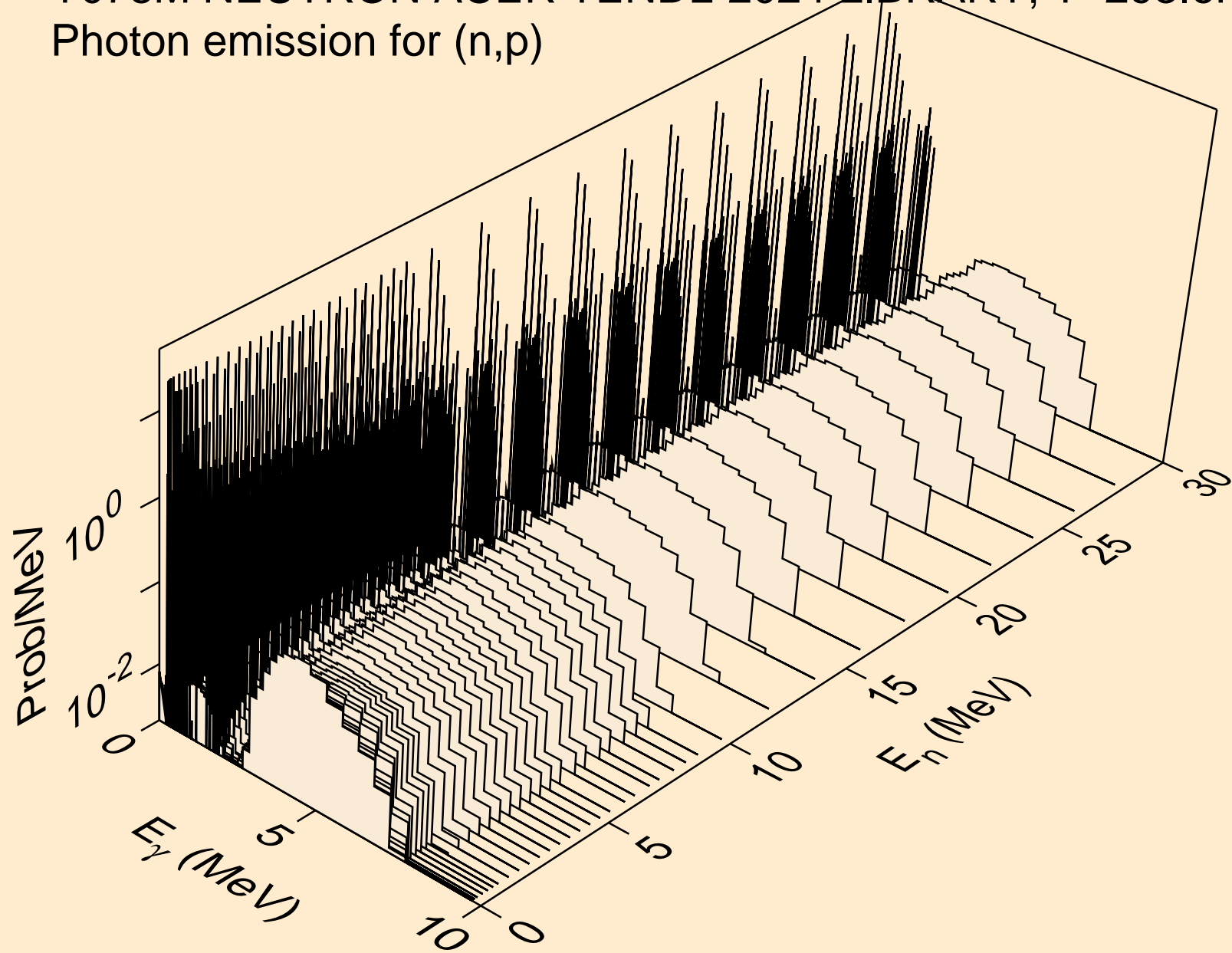

Y078M NEUTRON ACER TENDL-2024 LIBRARY; T=293.6K
Photon emission for (n,d)

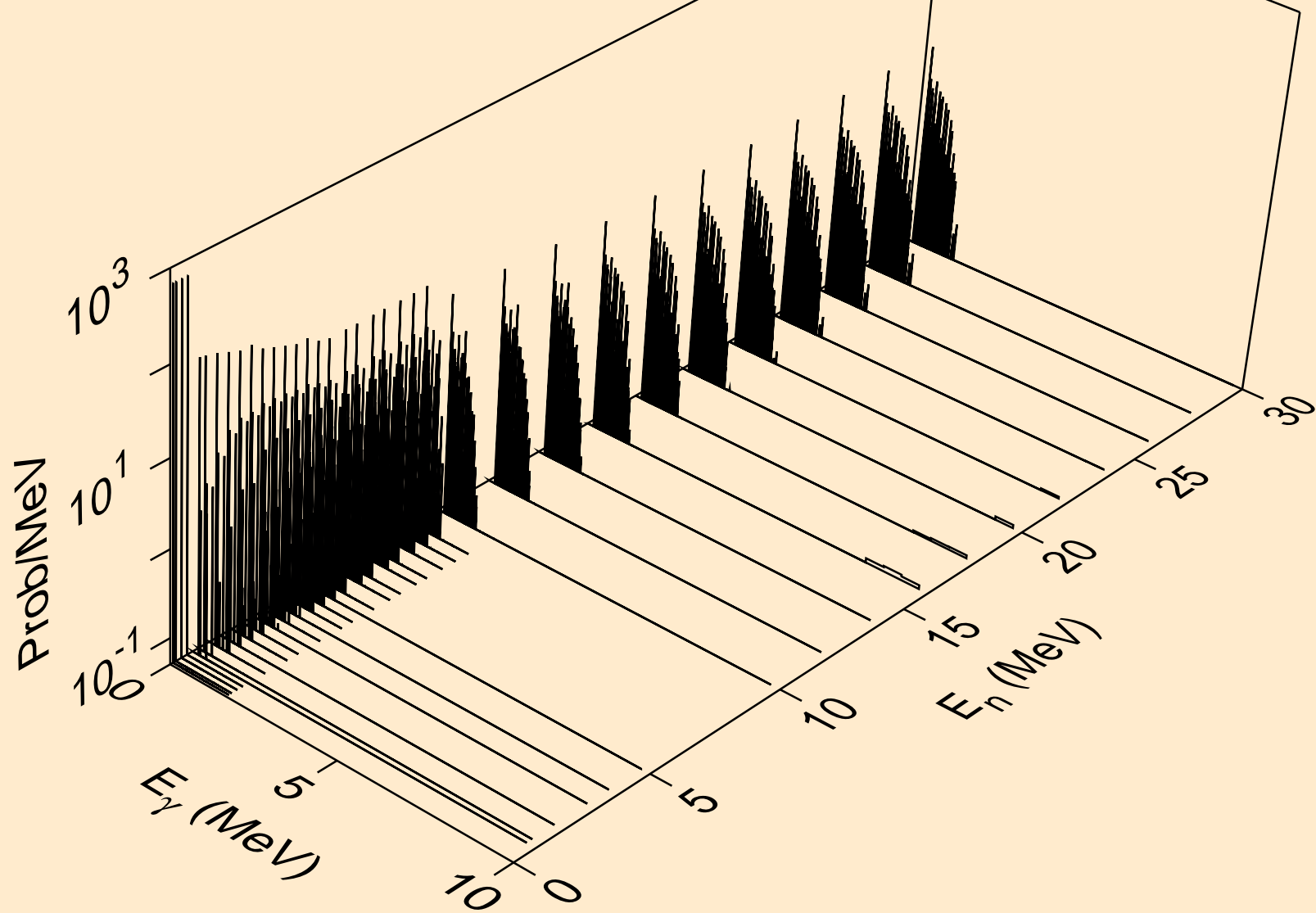

Y078M NEUTRON ACER TENDL-2024 LIBRARY; T=293.6K
Photon emission for (n,t)

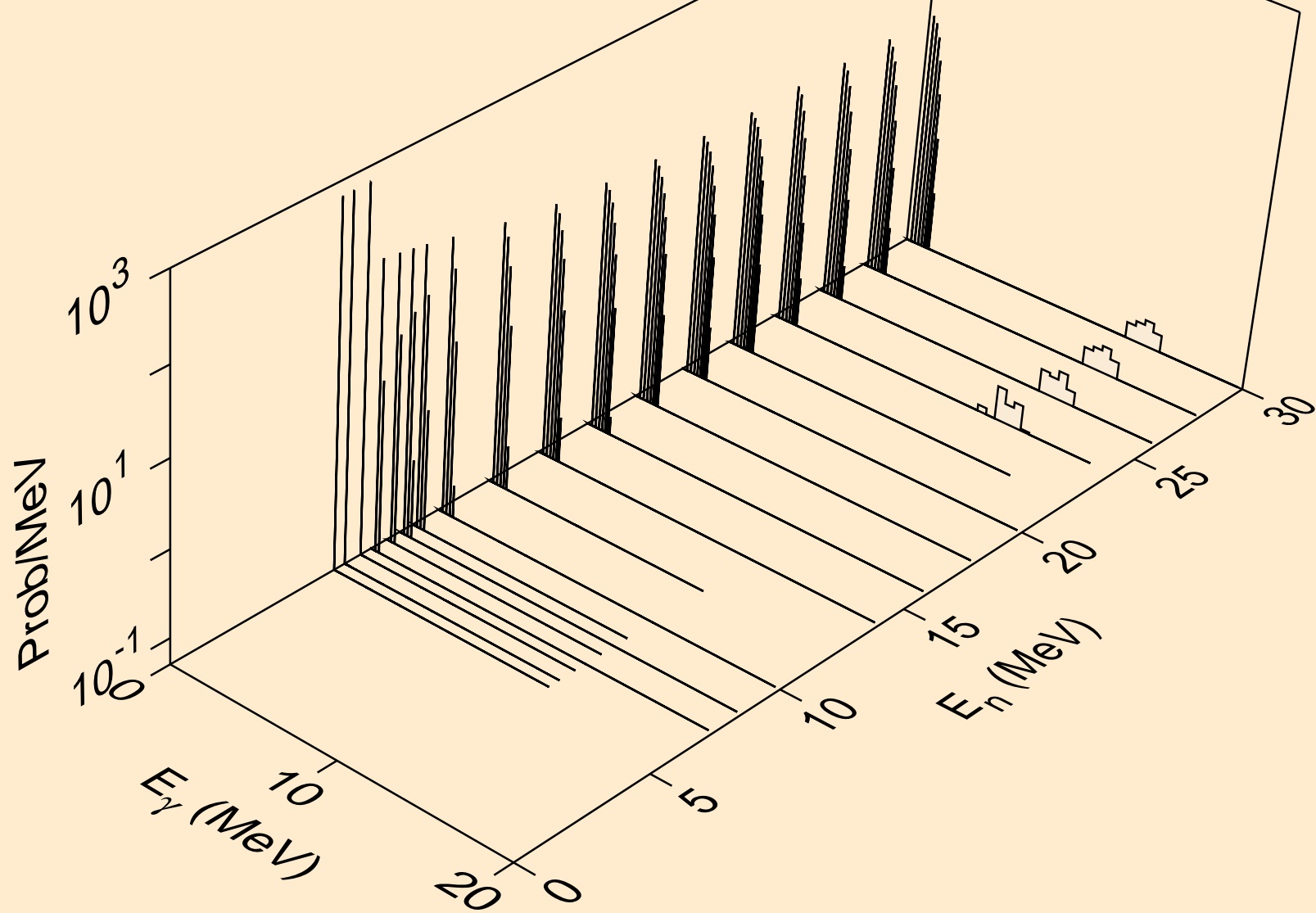

Y078M NEUTRON ACER TENDL-2024 LIBRARY; T=293.6K
Photon emission for (n,he3)

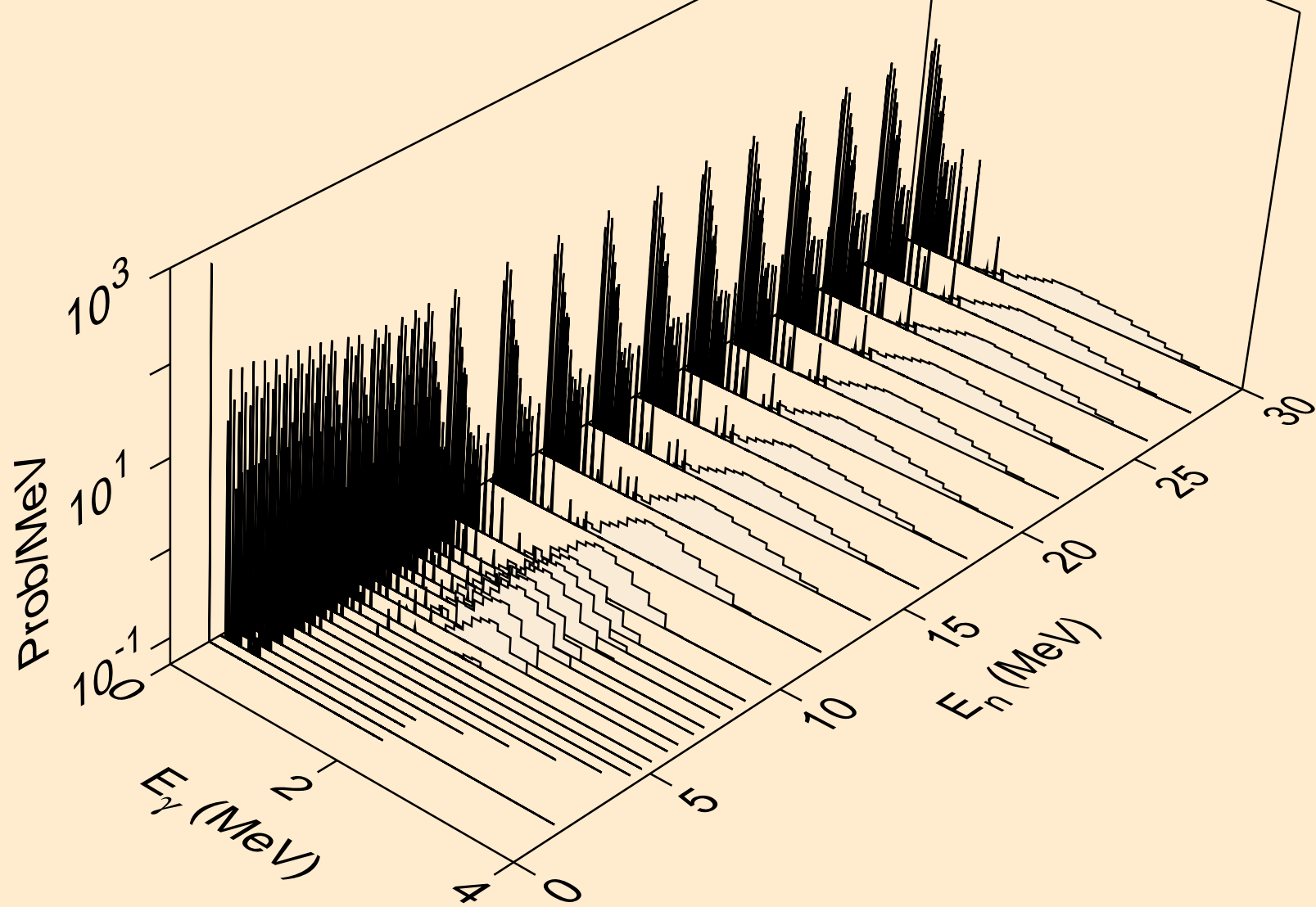

Y078M NEUTRON ACER TENDL-2024 LIBRARY; T=293.6K
Photon emission for (n,a)

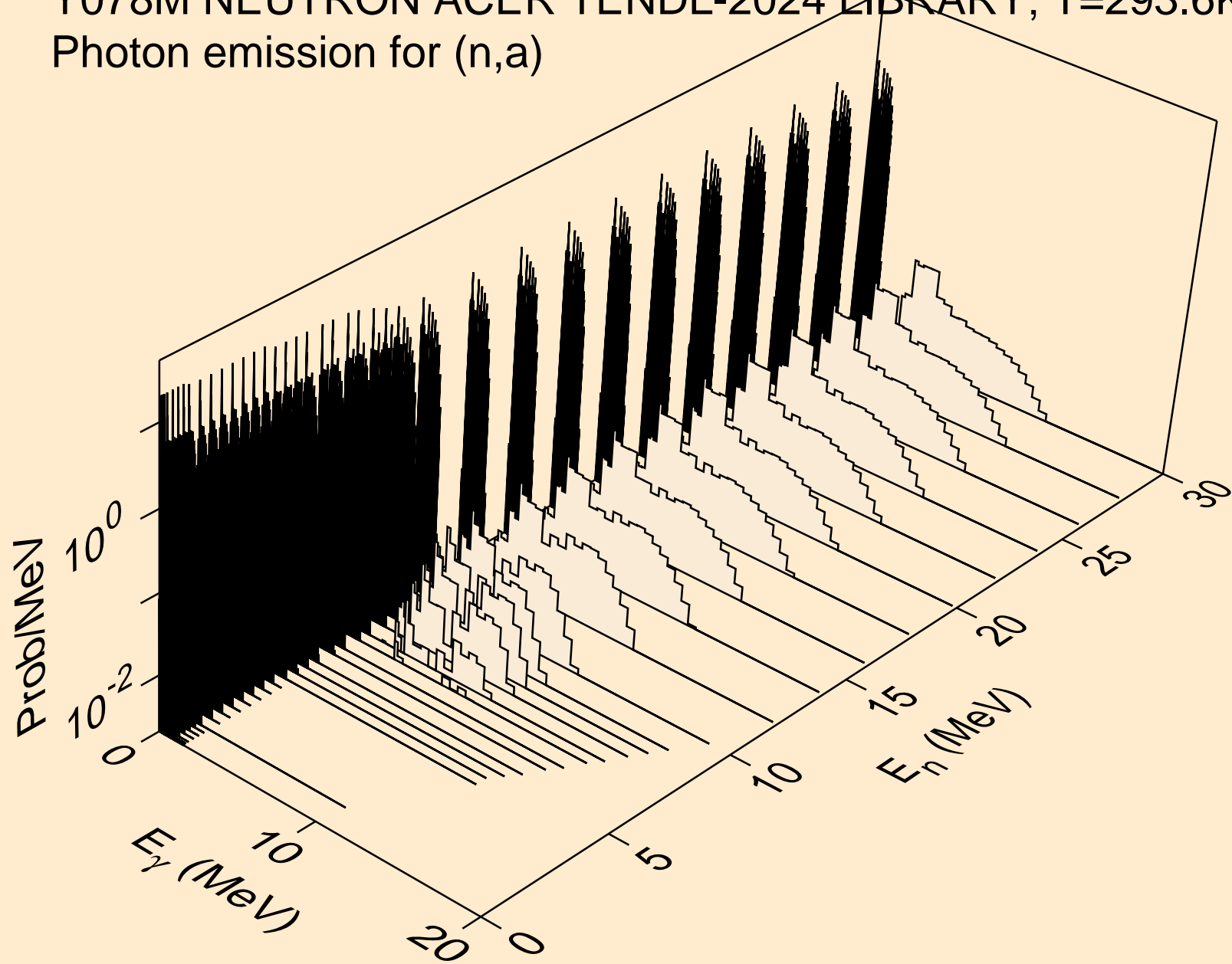

Y078M NEUTRON ACER TENDL-2024 LIBRARY; T=293.6K
Photon emission for (n,2a)

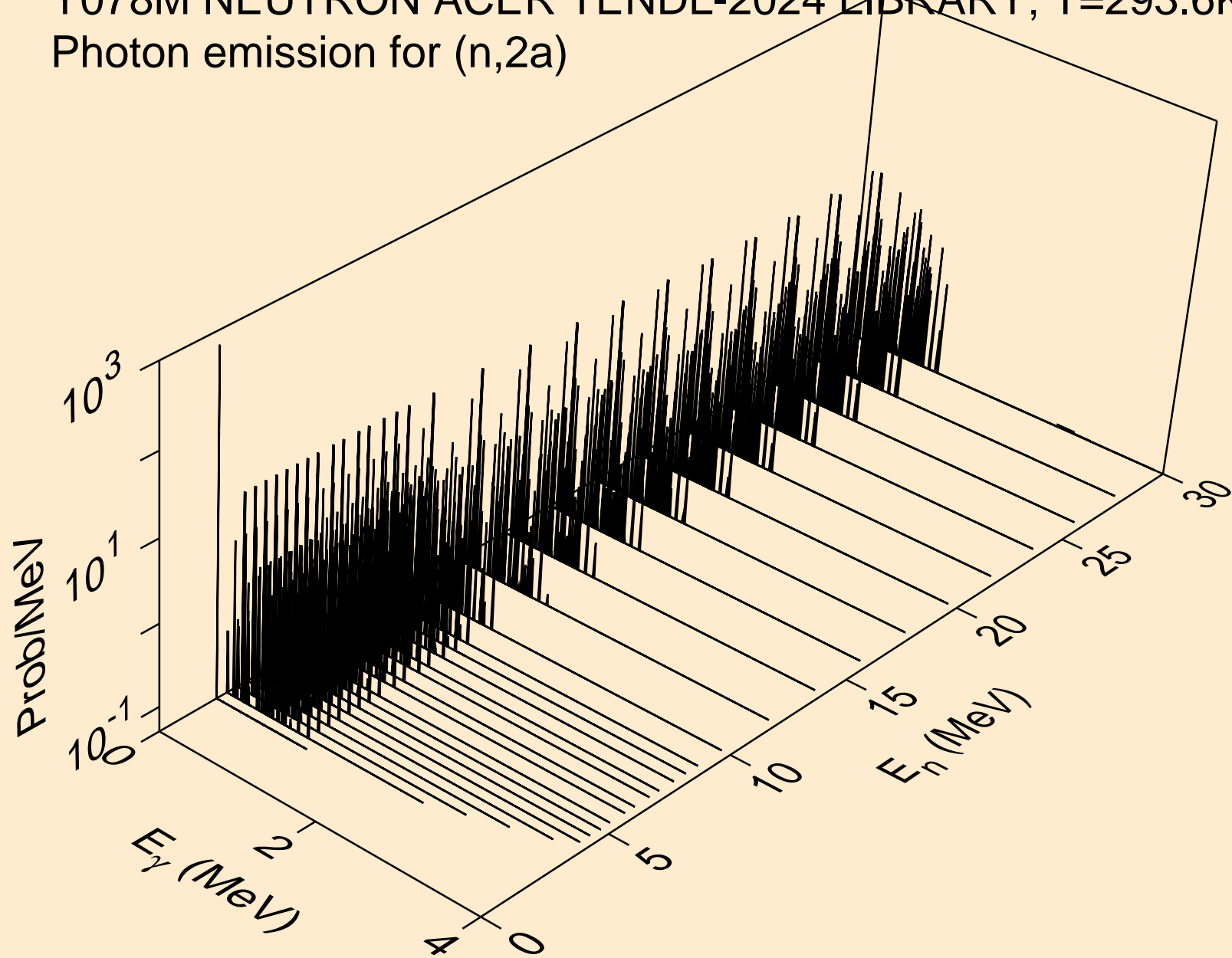

Y078M NEUTRON ACER TENDL-2024 LIBRARY; T=293.6K
Photon emission for (n,3a)

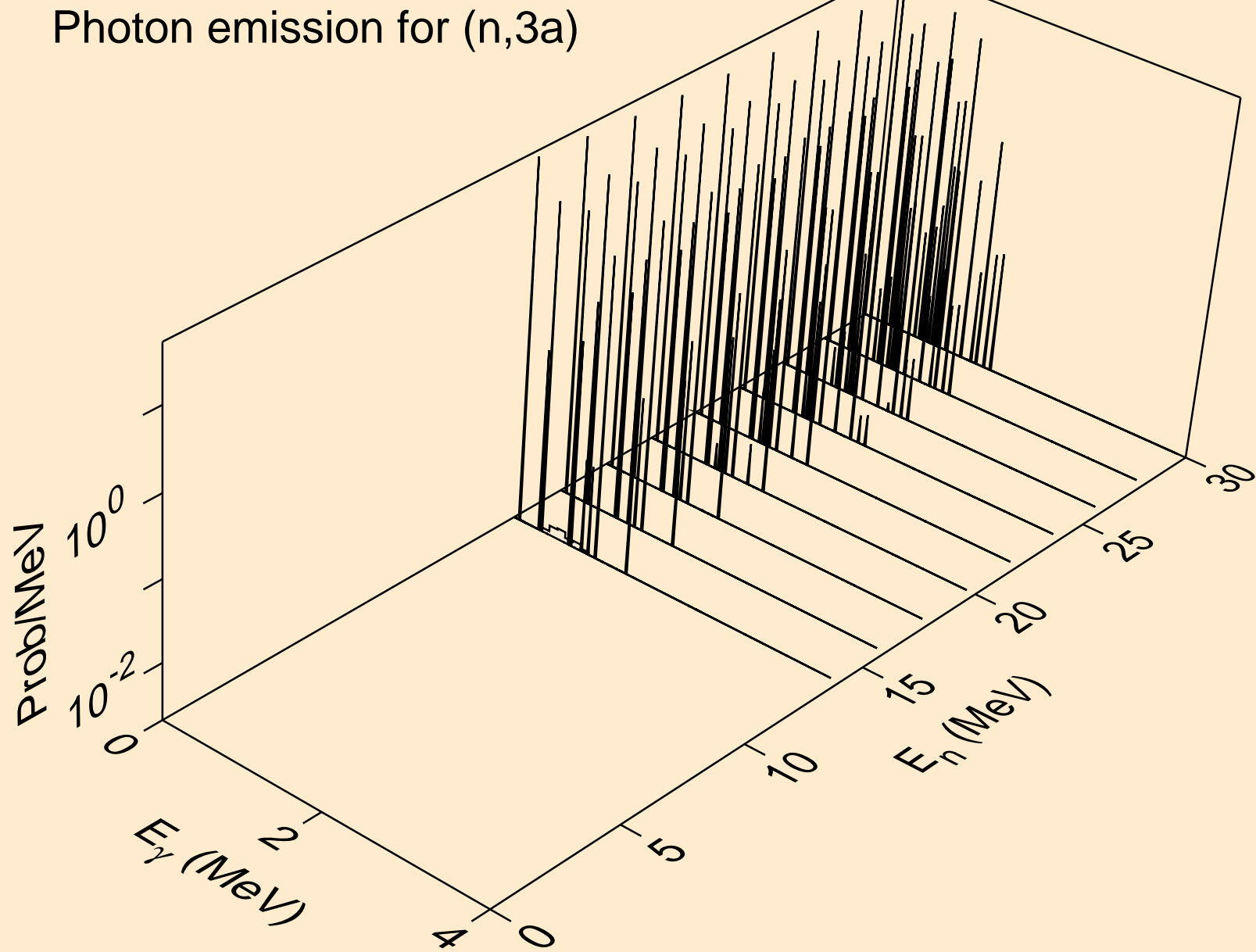

Y078M NEUTRON ACER TENDL-2024 LIBRARY; T=293.6K
Photon emission for (n,2p)

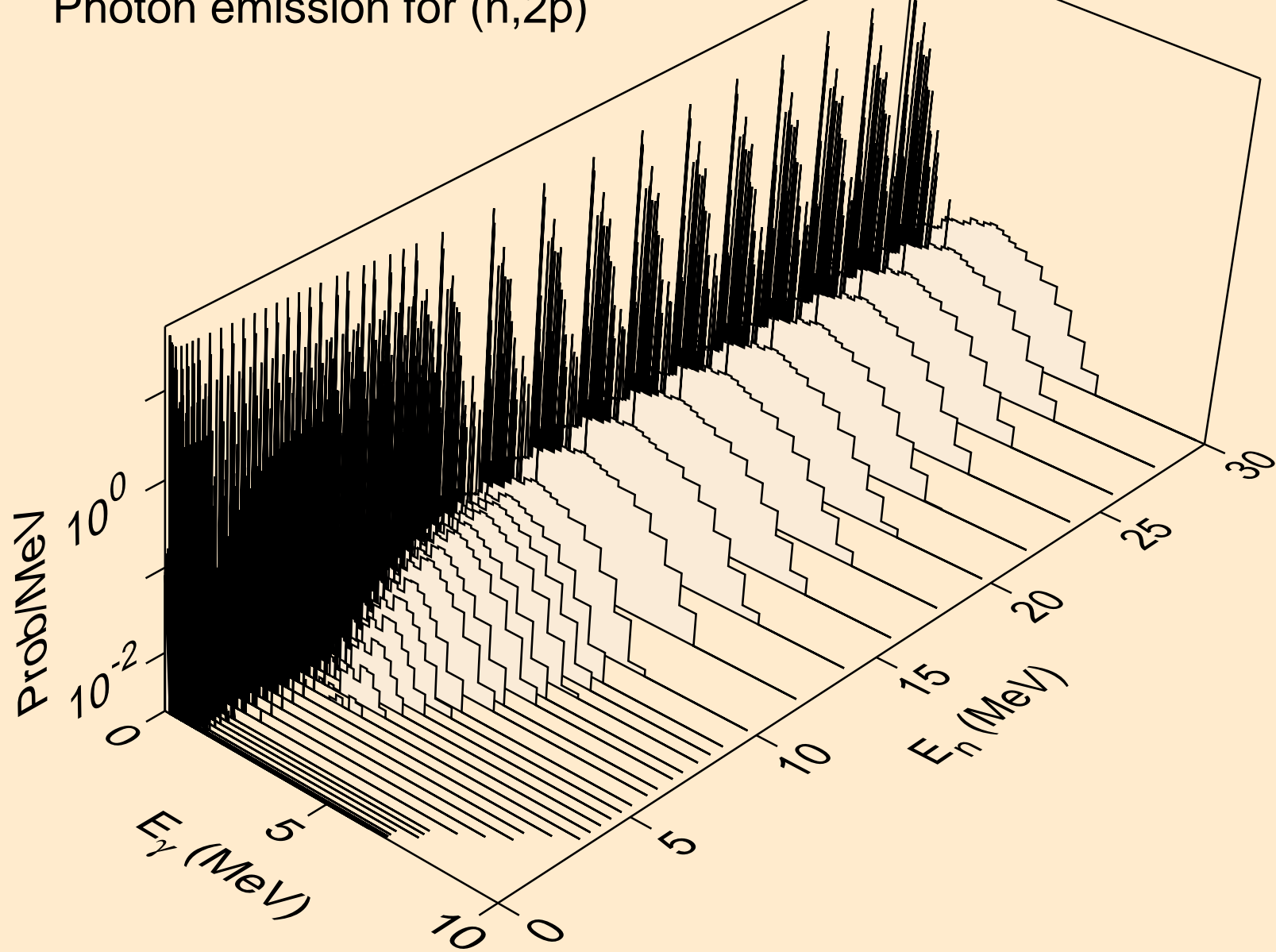

Y078M NEUTRON ACER TENDL-2024 LIBRARY; T=293.6K
Photon emission for (n,p α)

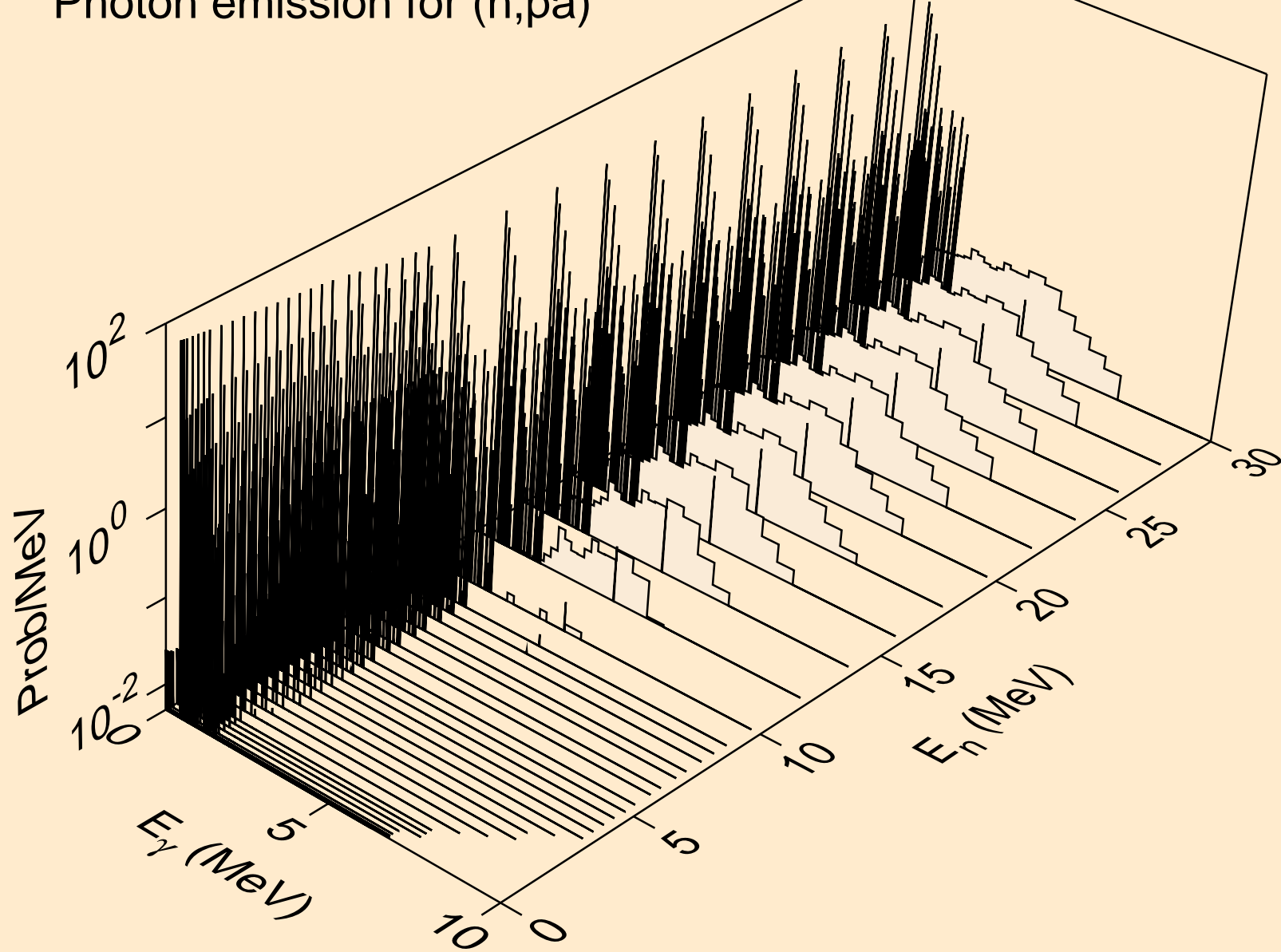

Y078M NEUTRON ACER TENDL-2024 LIBRARY; T=293.6K
Photon emission for (n,d2a)

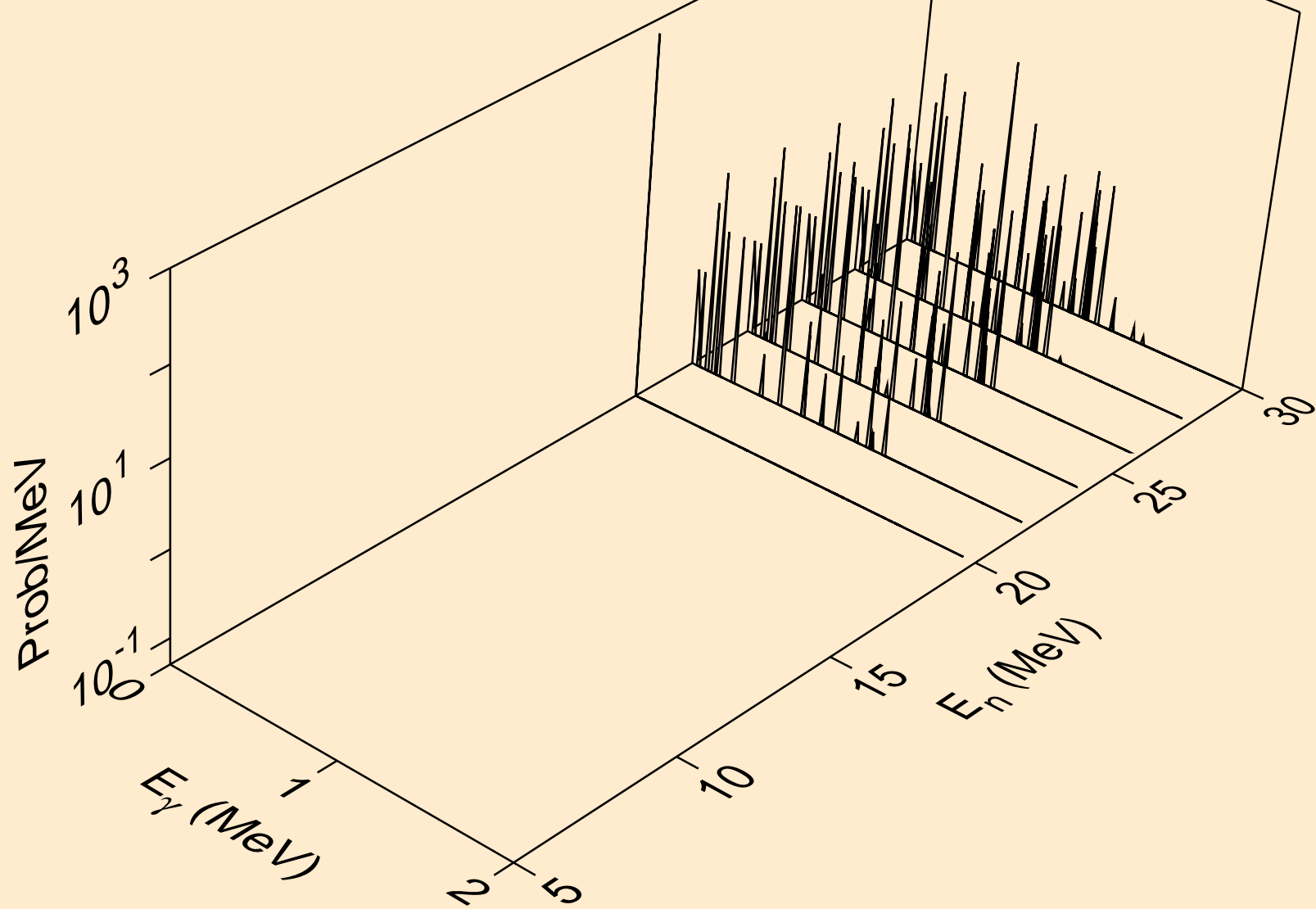

Y078M NEUTRON ACER TENDL-2024 LIBRARY; T=293.6K
Photon emission for (n,pd)

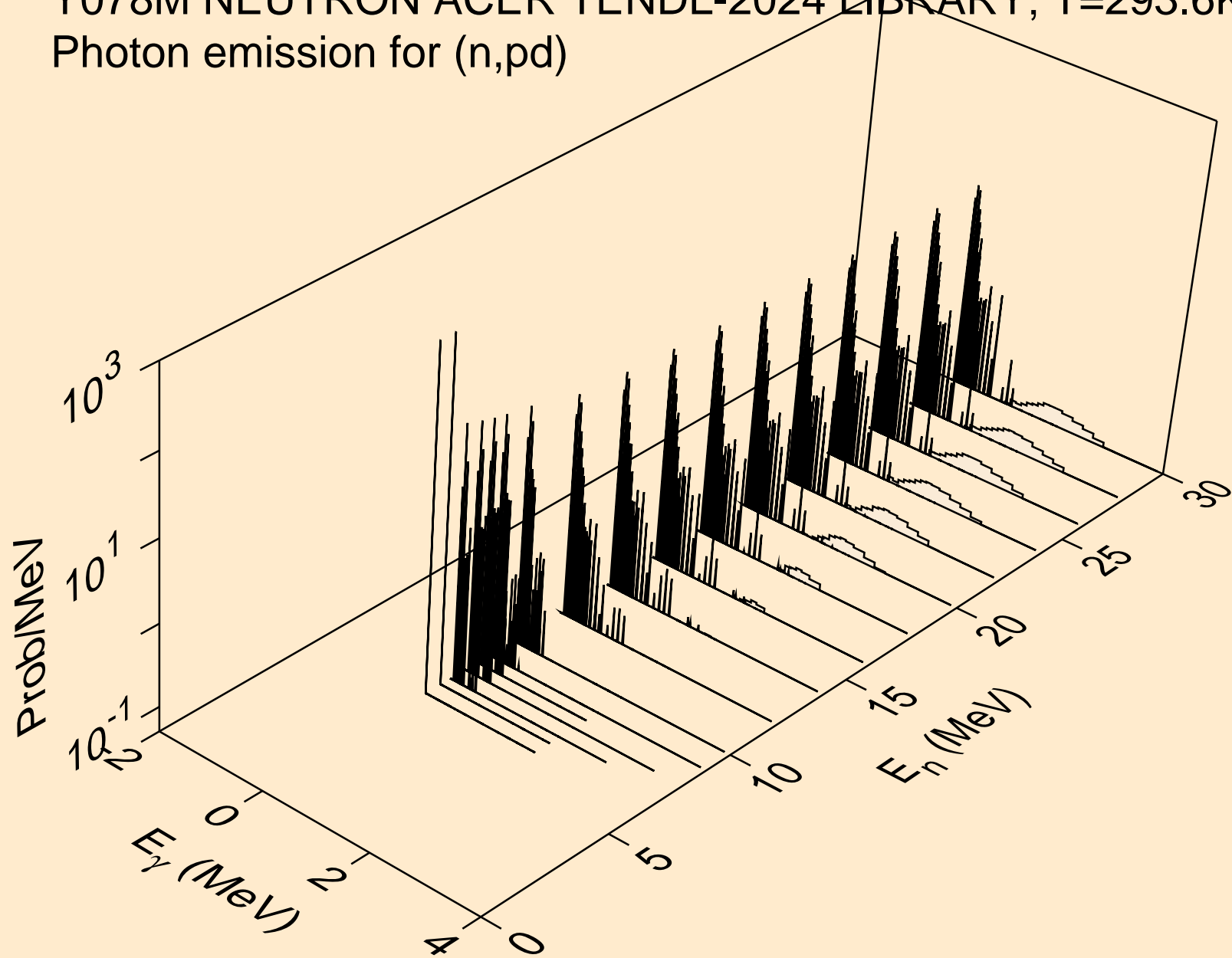

Y078M NEUTRON ACER TENDL-2024 LIBRARY; T=293.6K
Photon emission for (n,pt)

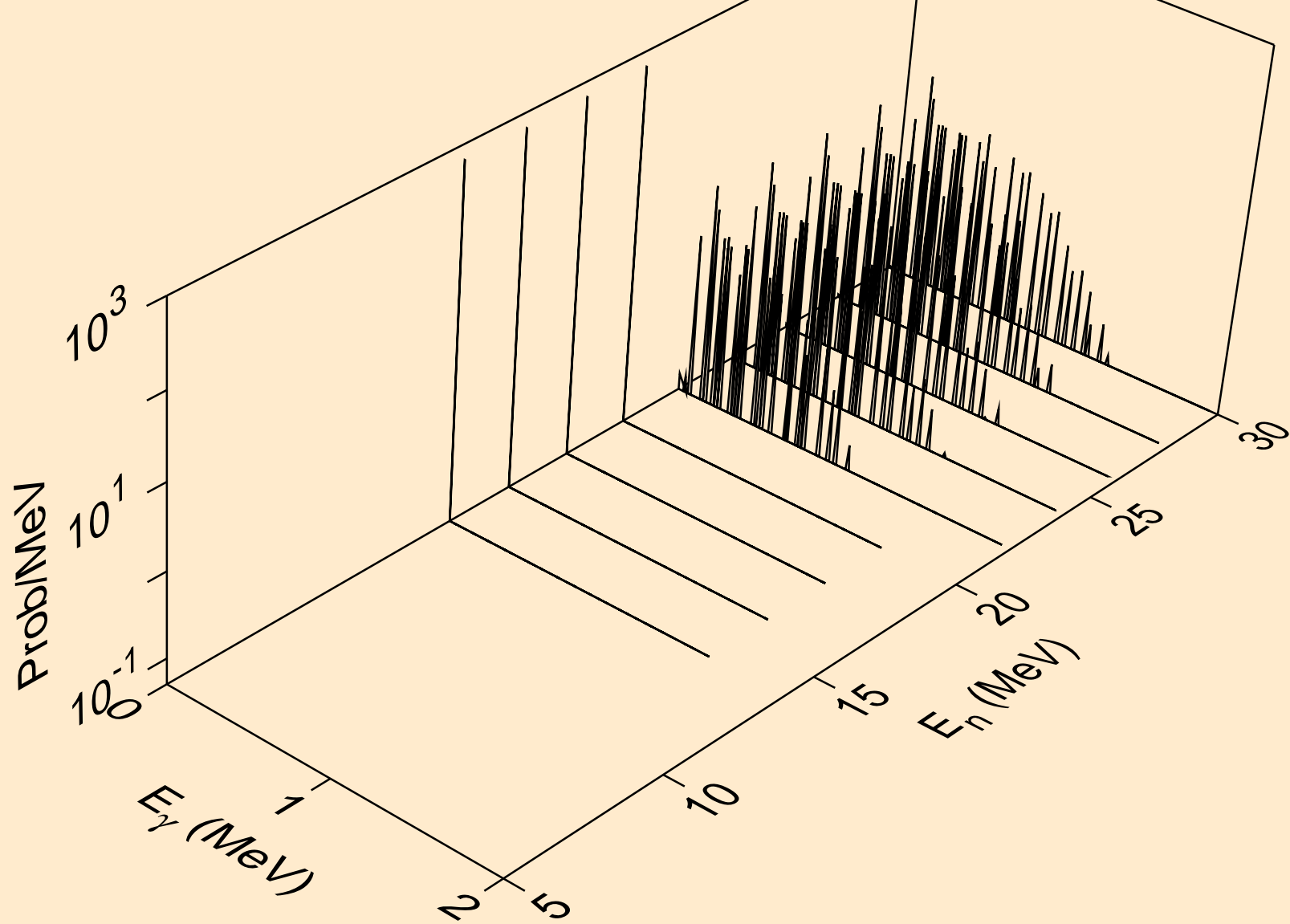

Y078M NEUTRON ACER TENDL-2024 LIBRARY; T=293.6K
Photon emission for (n,da)

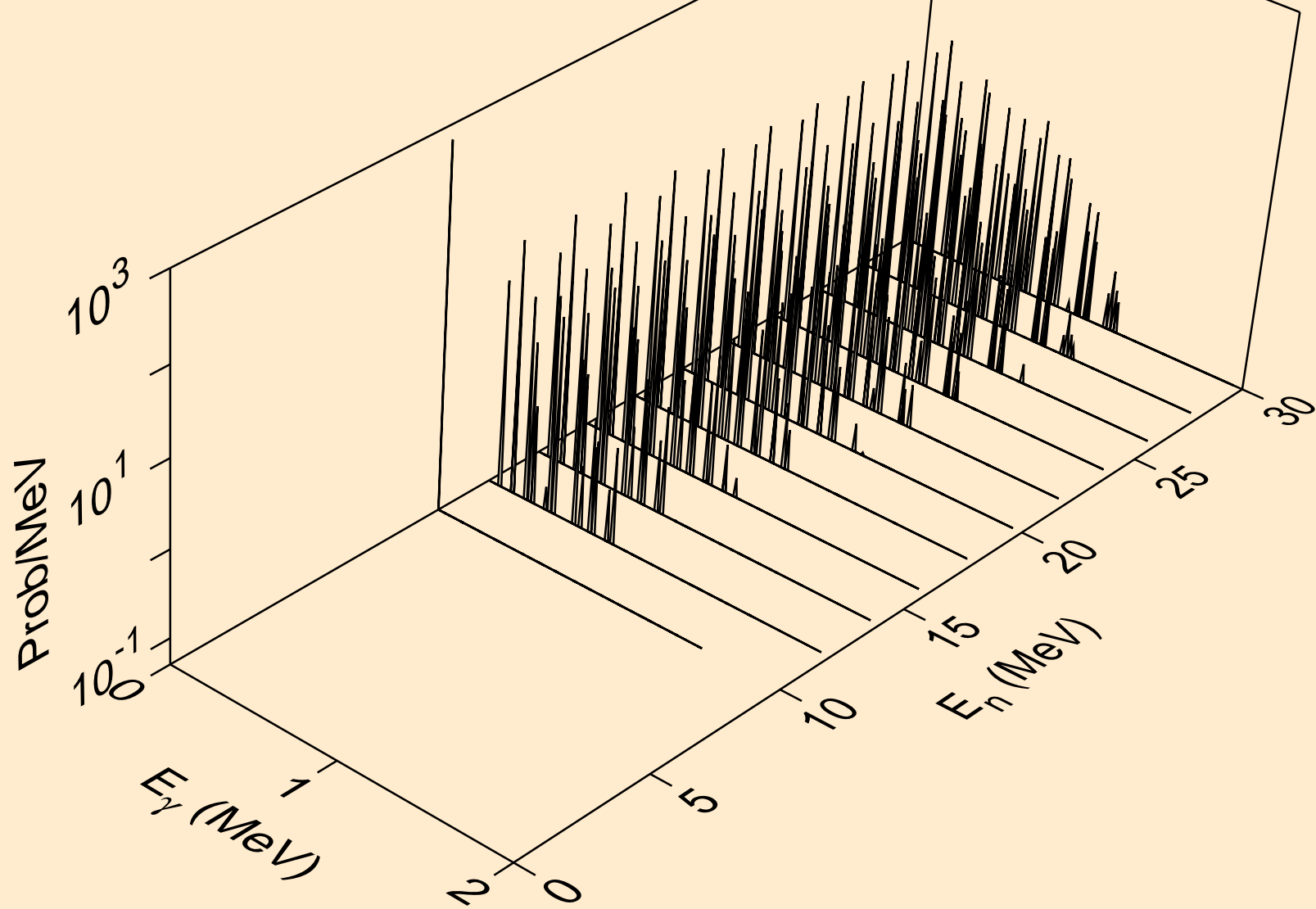

Y078M NEUTRON ACER TENDL-2024 LIBRARY; T=293.6K
14 MeV photon spectrum

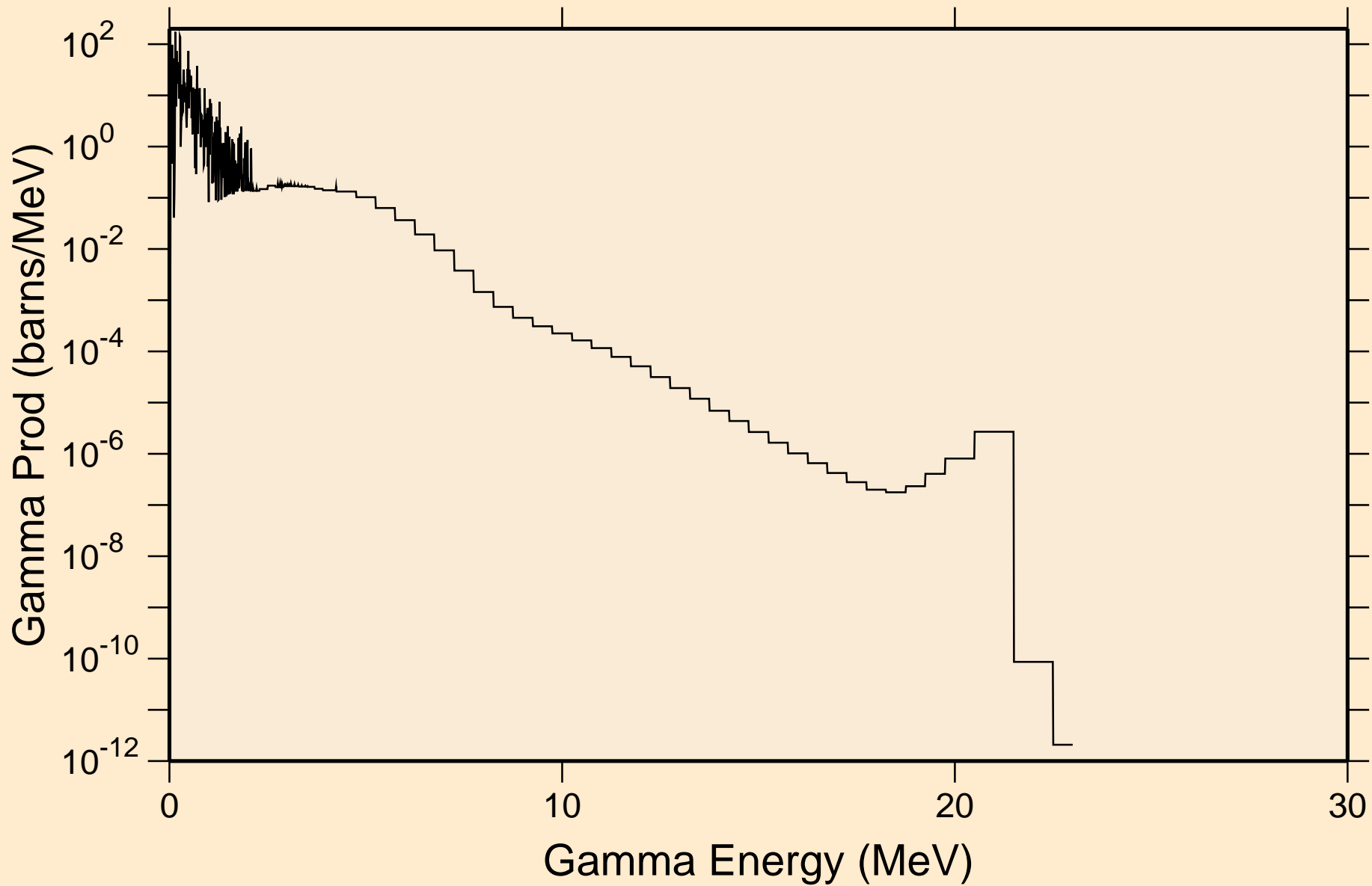

Y078M NEUTRON ACER TENDL-2024 LIBRARY; T=293.6K
Particle heating contributions

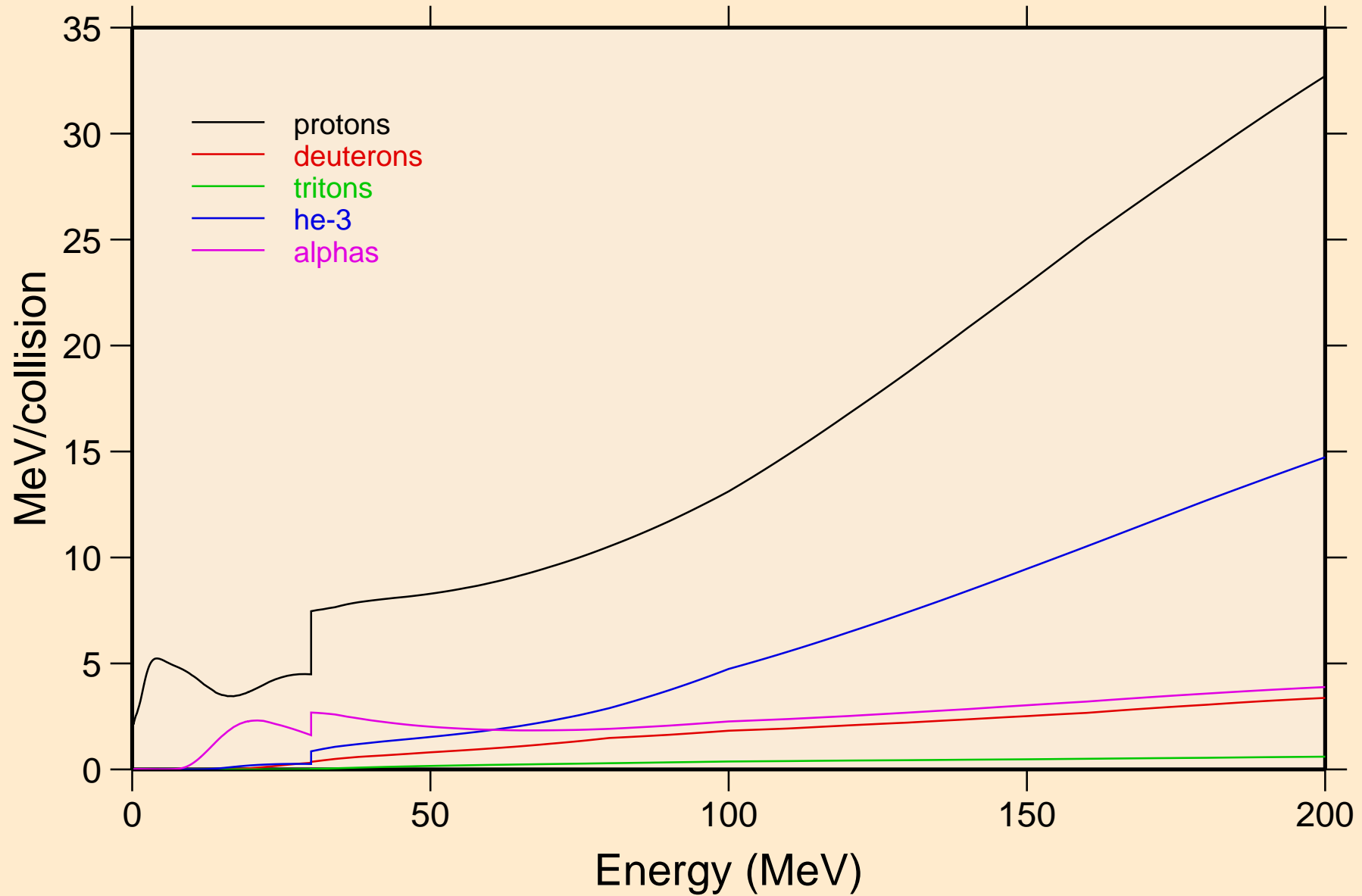

Y078M NEUTRON ACER TENDL-2024 LIBRARY; T=293.6K
Recoil Heating

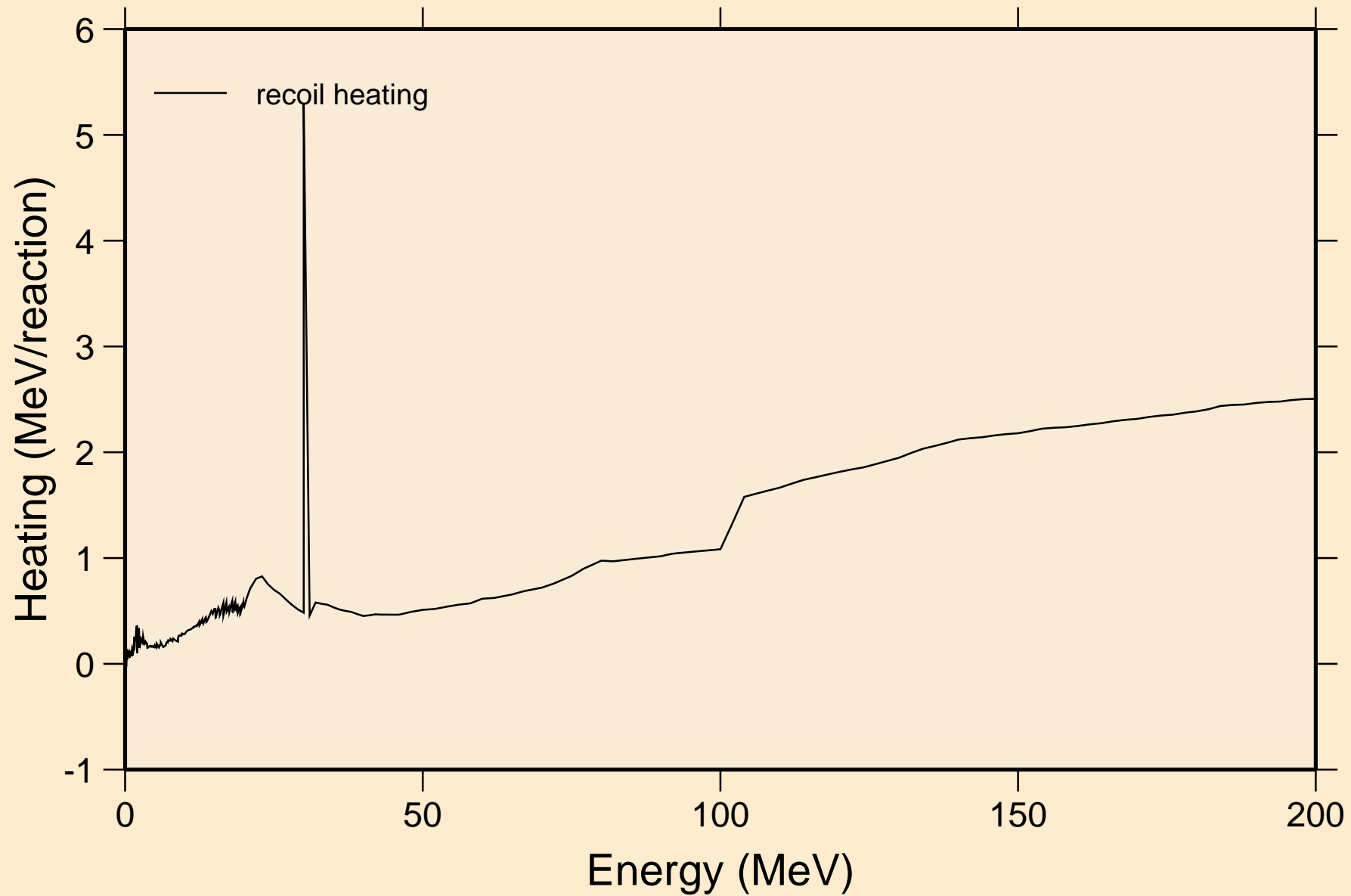

Y078M NEUTRON ACER TENDL-2024 LIBRARY; T=293.6K
Particle production cross sections

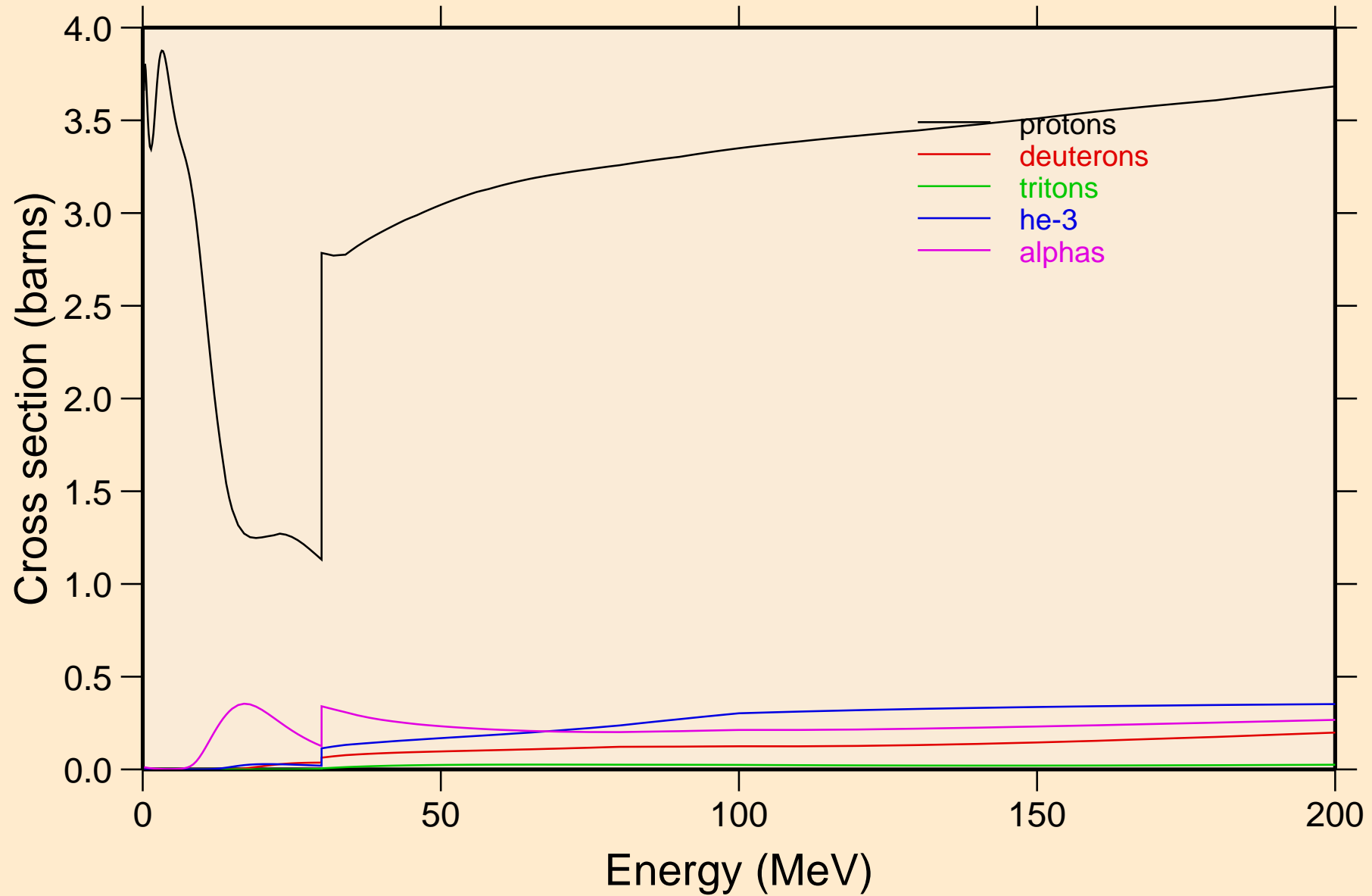

Y078M NEUTRON ACER TENDL-2024 LIBRARY; T=293.6K
protons from (n,x)

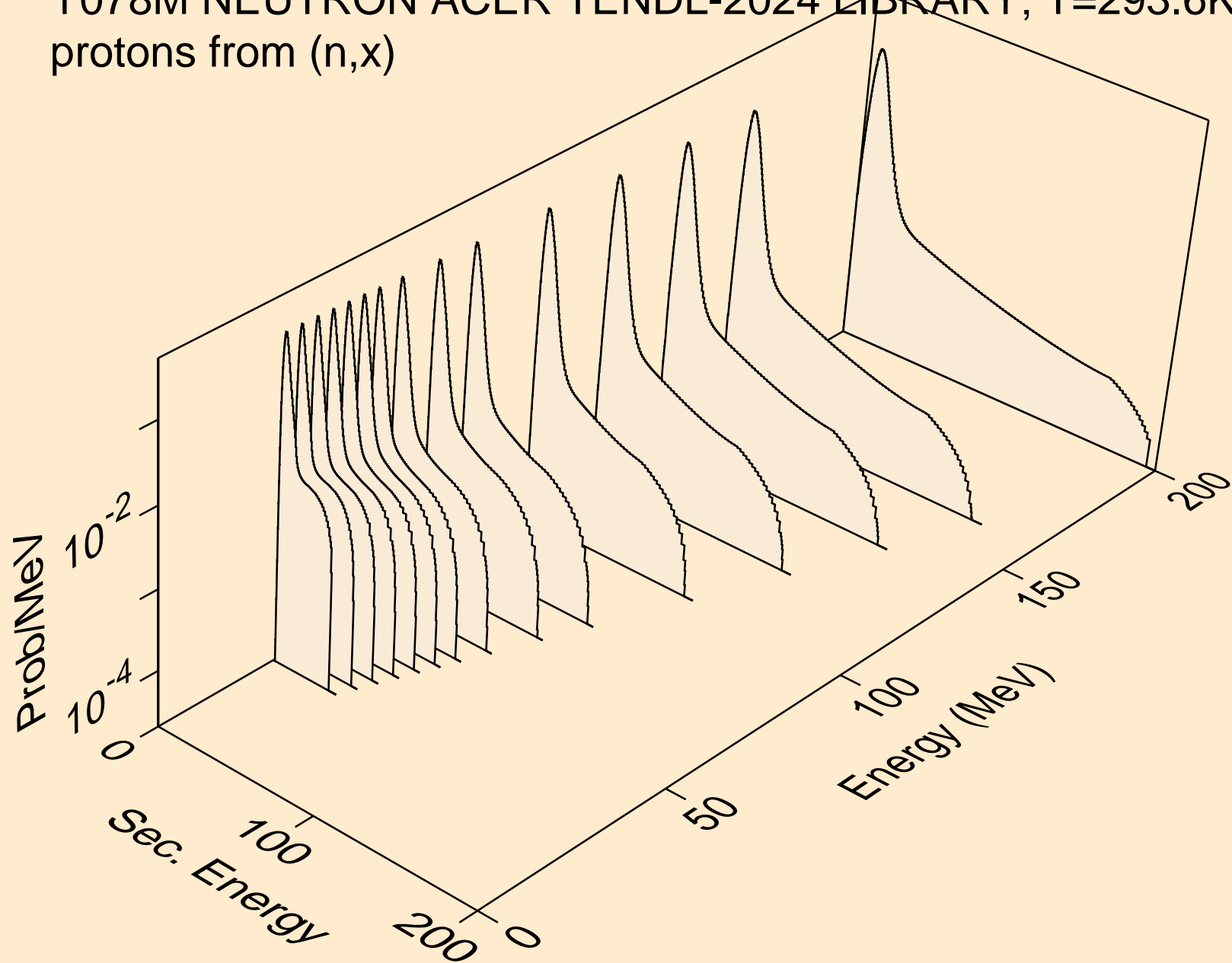

Y078M NEUTRON ACER TENDL-2024 LIBRARY; T=293.6K
protons from (n,n*)p

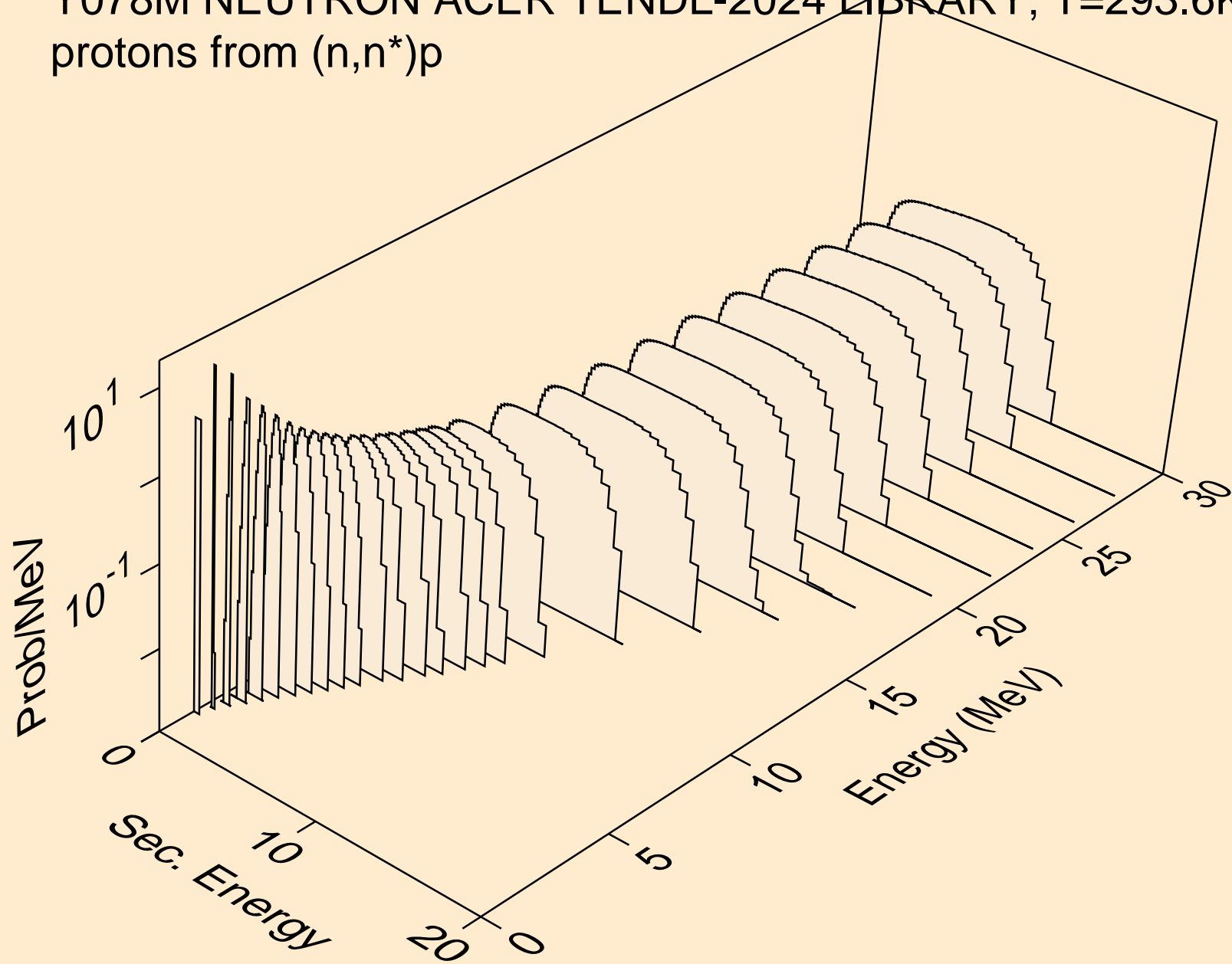

Y078M NEUTRON ACER TENDL-2024 LIBRARY; T=293.6K
protons from (n,2np)

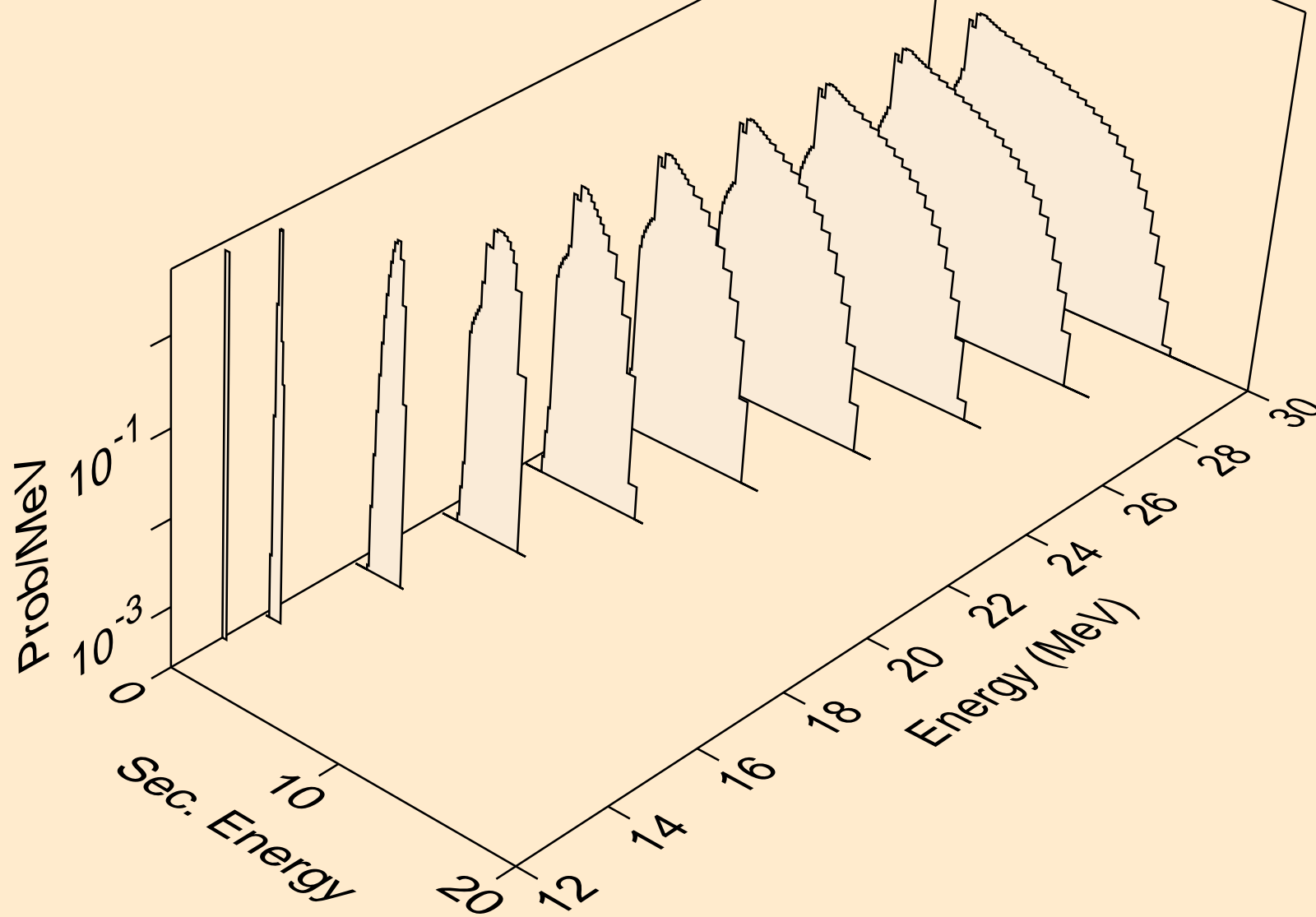

Y078M NEUTRON ACER TENDL-2024 LIBRARY; T=293.6K
protons from (n,n2p)

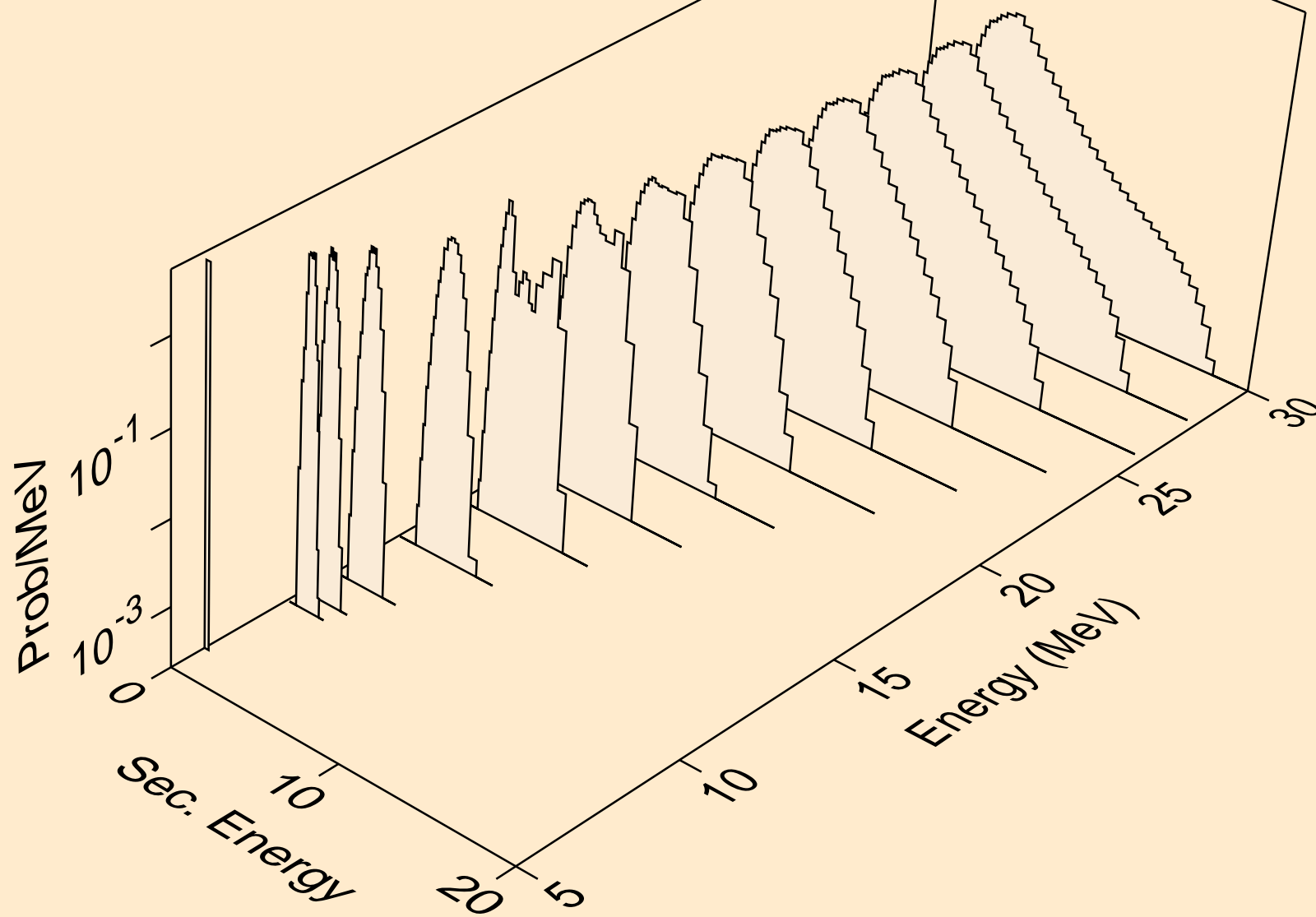

Y078M NEUTRON ACER TENDL-2024 LIBRARY; T=293.6K
protons from (n,npa)

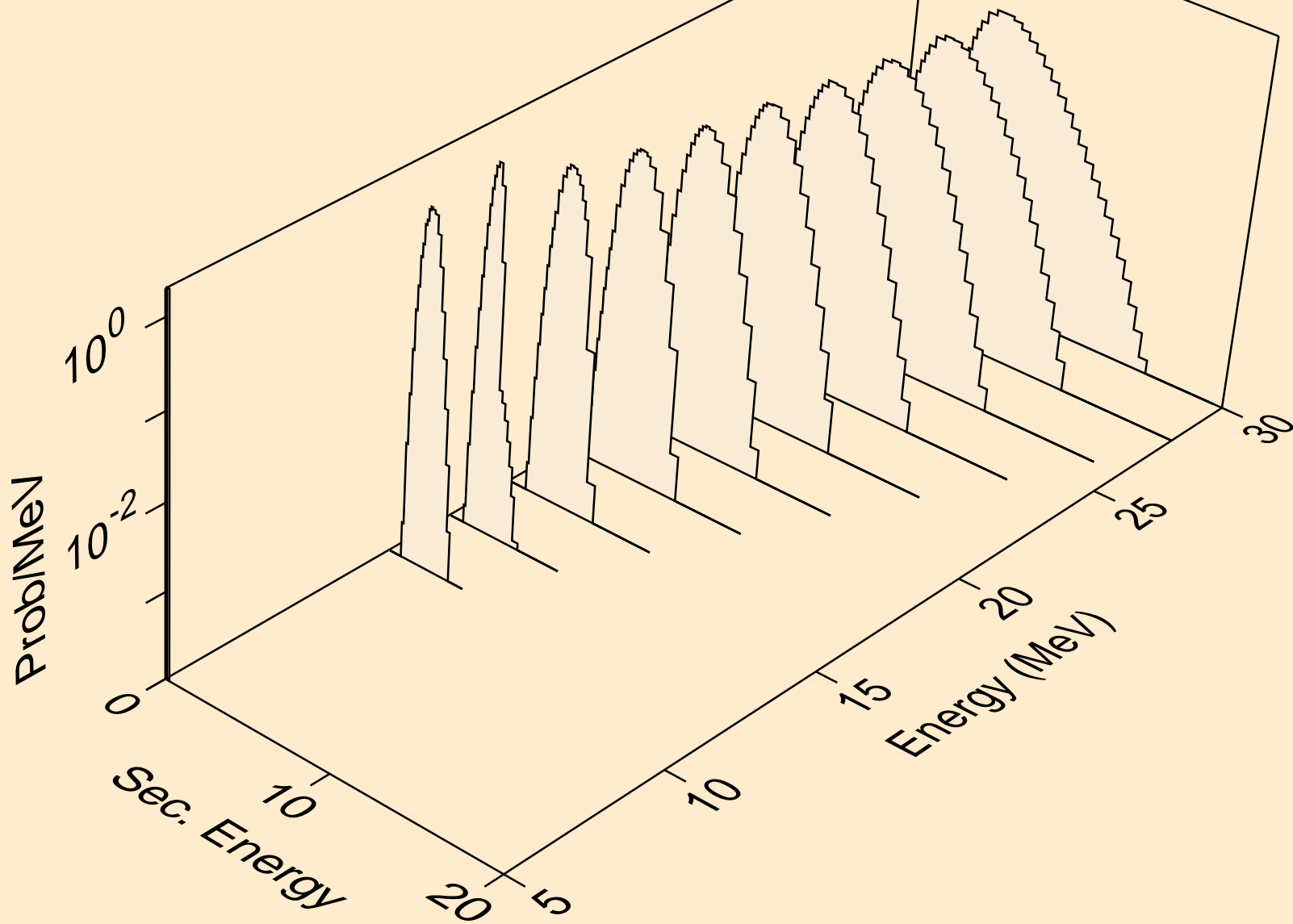

Y078M NEUTRON ACER TENDL-2024 LIBRARY; T=293.6K
protons from (n,p)

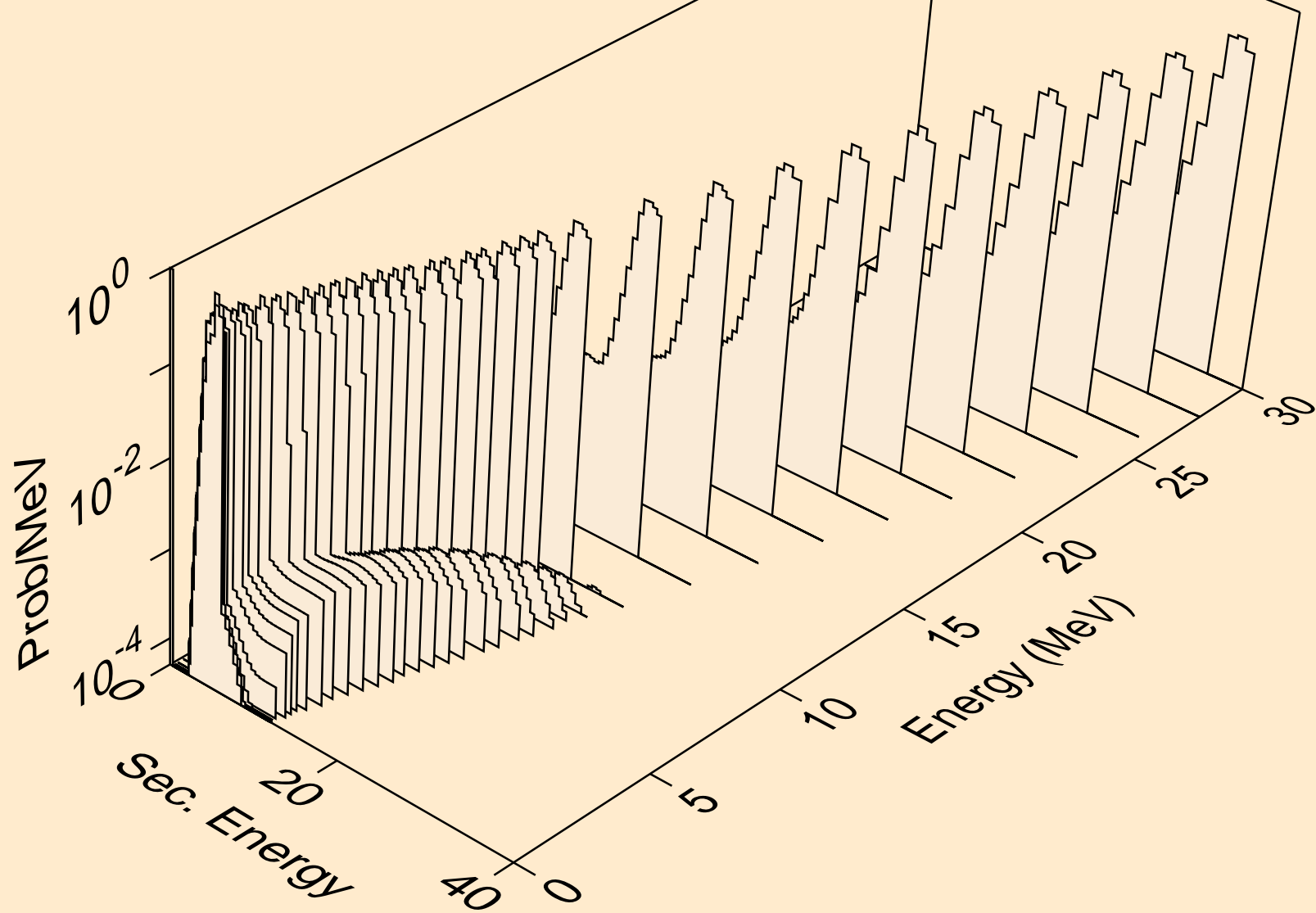

Y078M NEUTRON ACER TENDL-2024 LIBRARY; T=293.6K
protons from (n,2p)

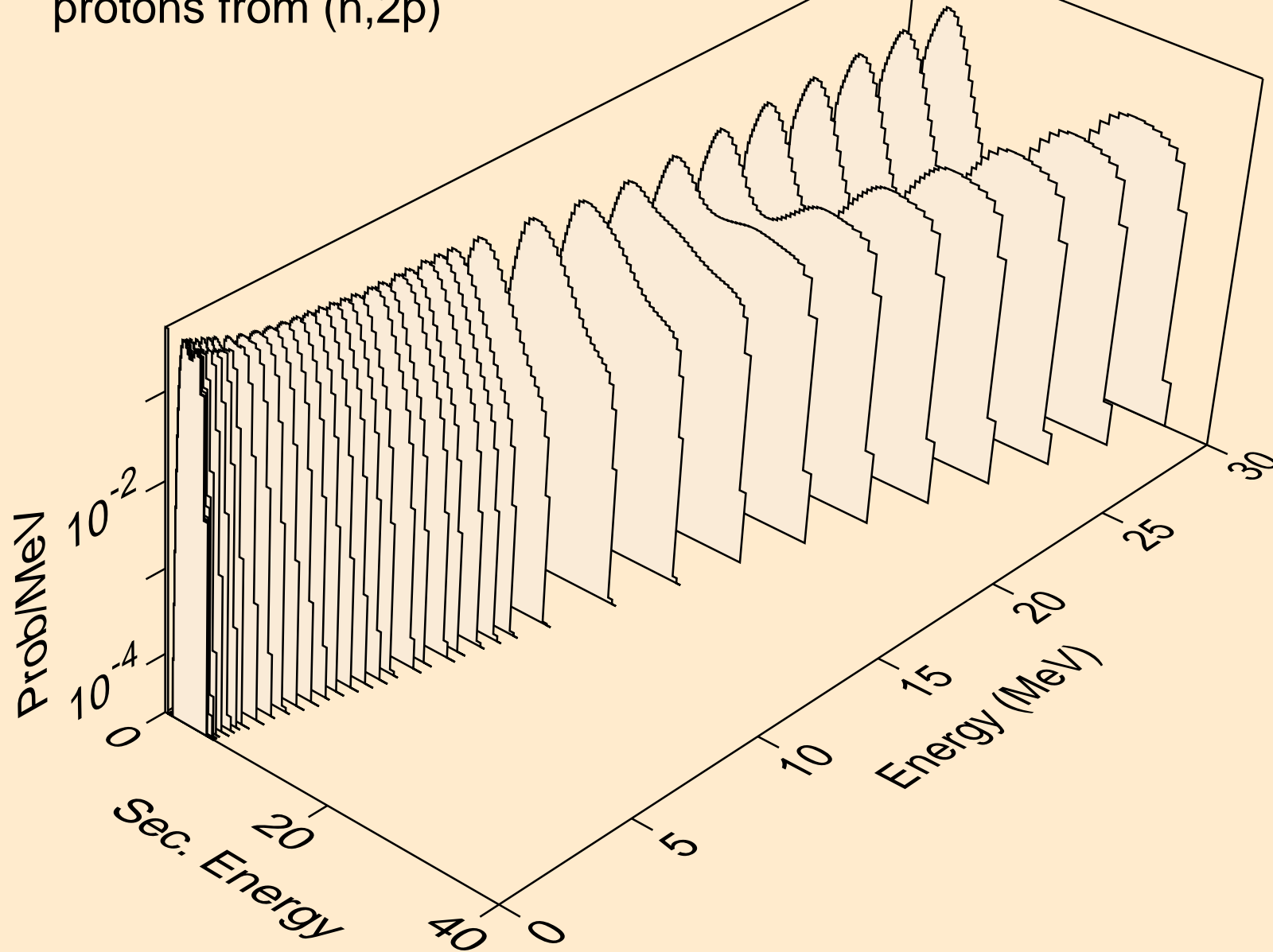

Y078M NEUTRON ACER TENDL-2024 LIBRARY; T=293.6K
protons from (n,p)

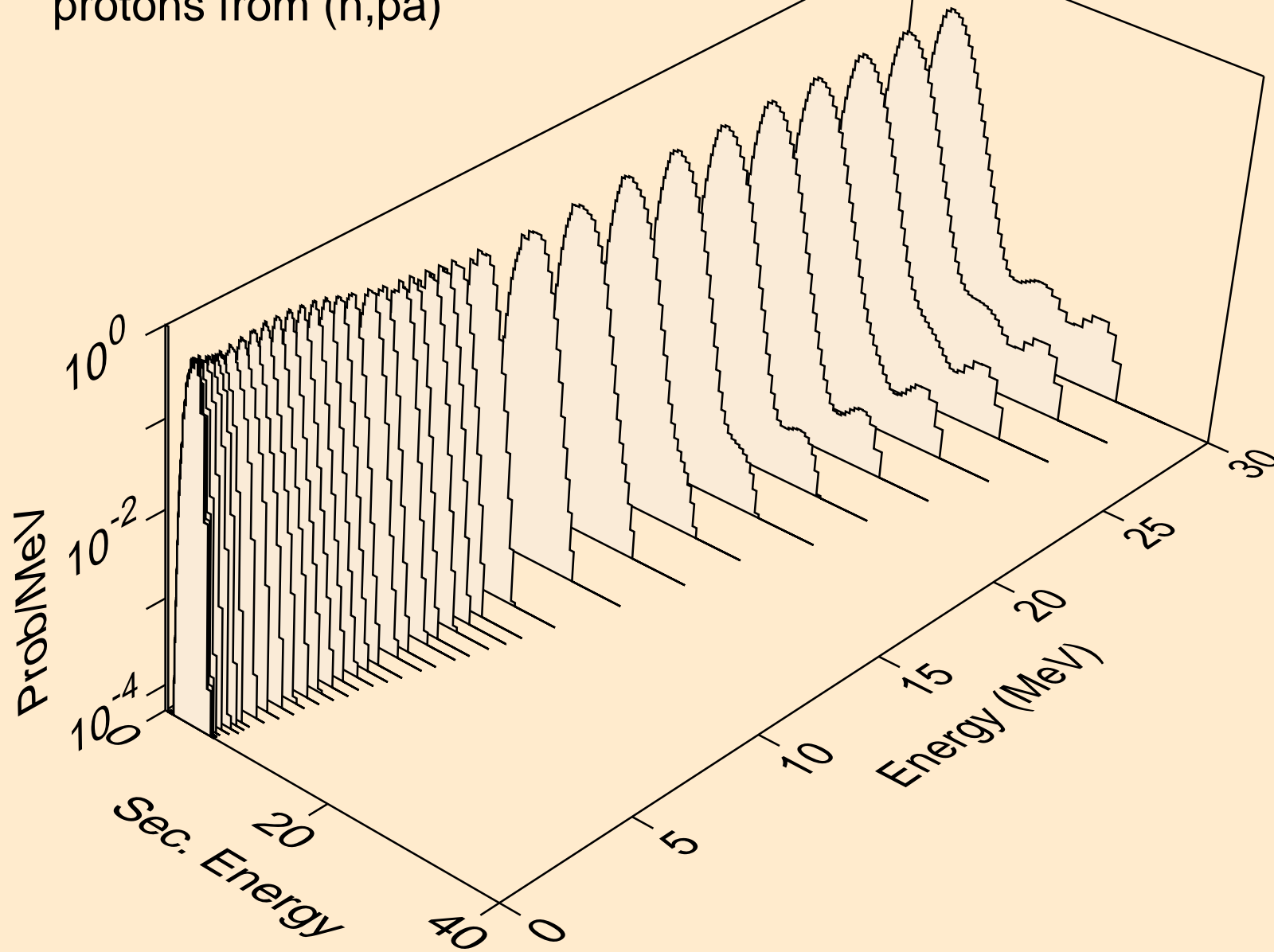

Y078M NEUTRON ACER TENDL-2024 LIBRARY; T=293.6K
protons from (n,pd)

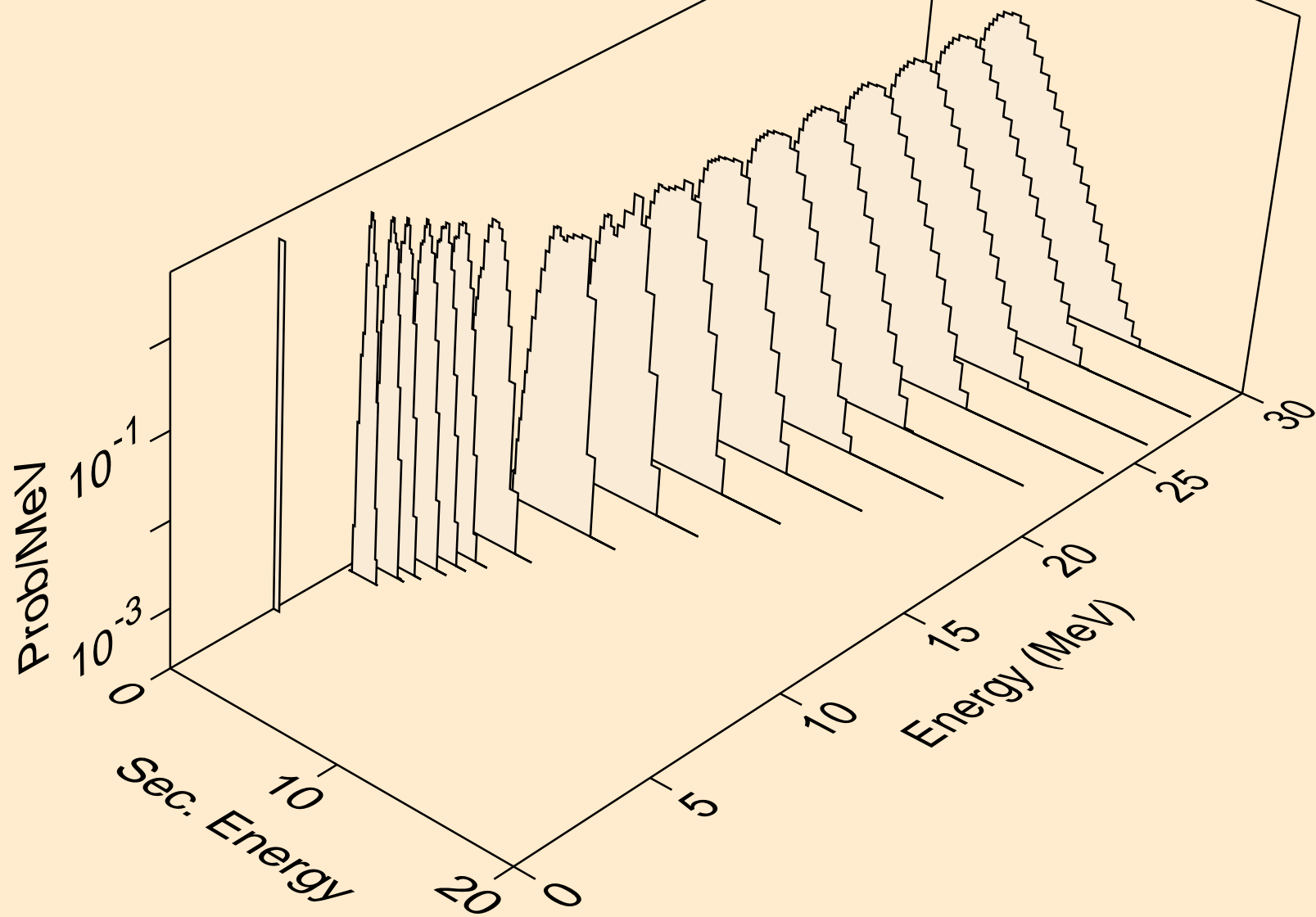

Y078M NEUTRON ACER TENDL-2024 LIBRARY; T=293.6K
protons from (n,pt)

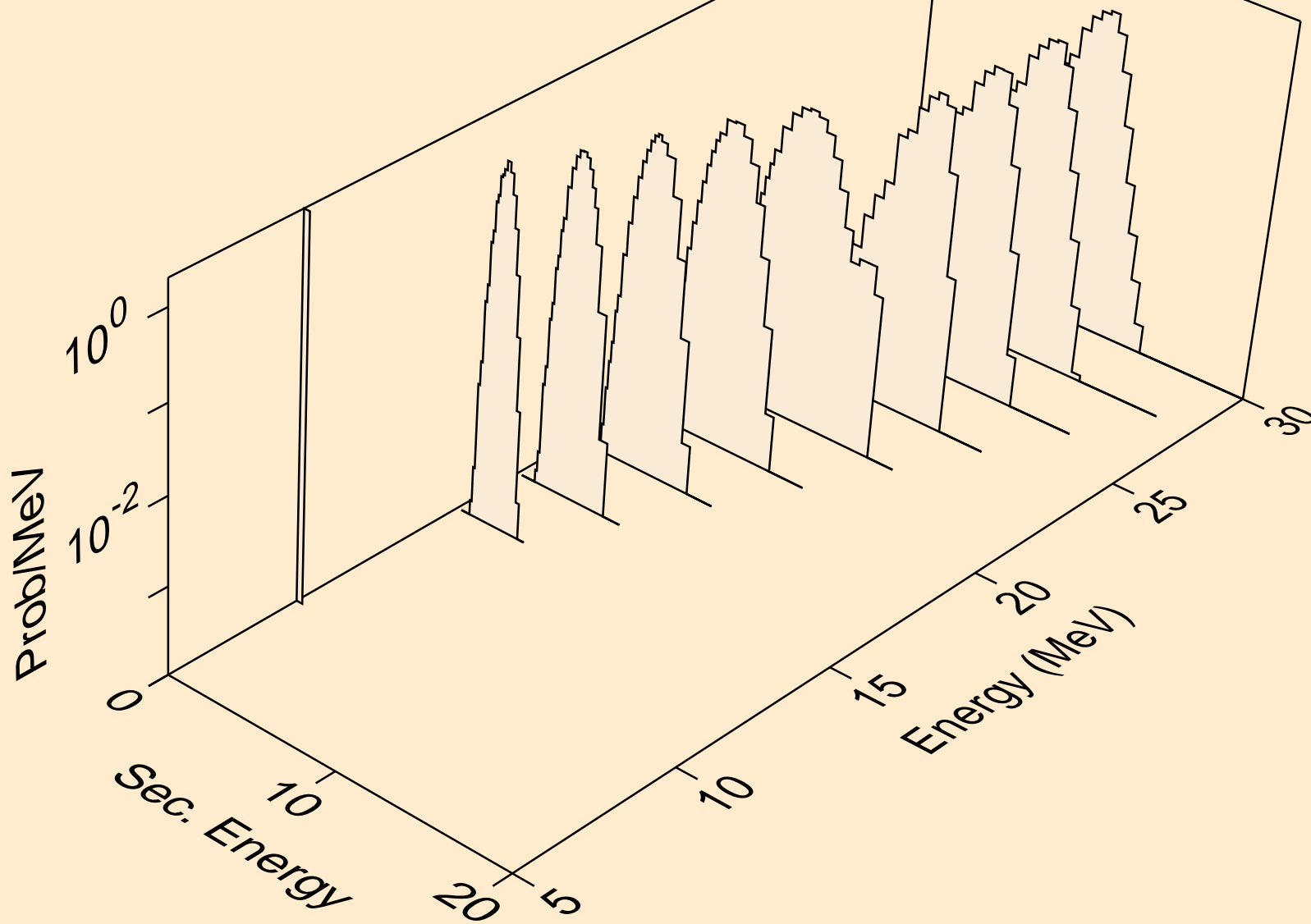

Y078M NEUTRON ACER TENDL-2024 LIBRARY; T=293.6K
deuterons from (n,x)

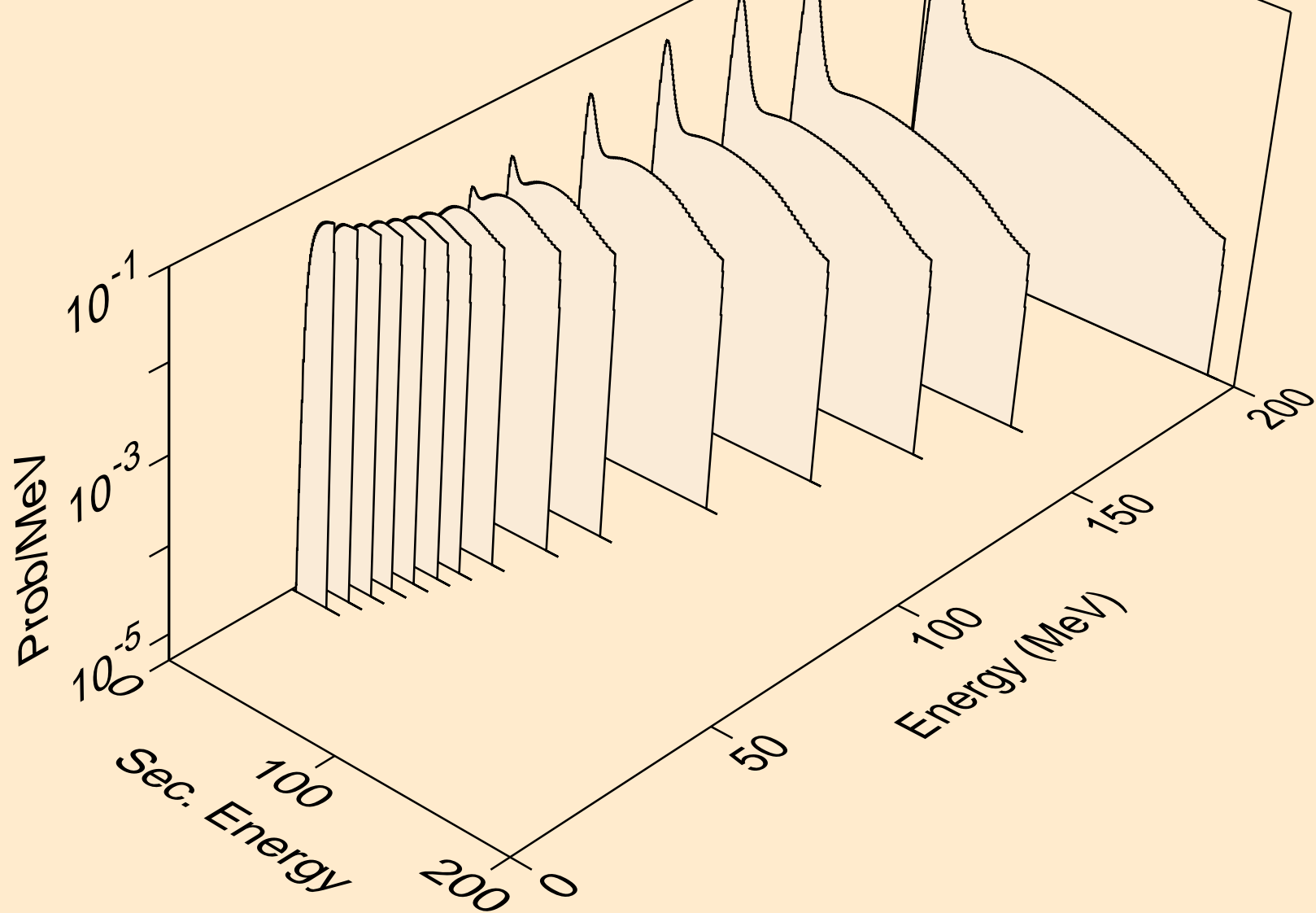

Y078M NEUTRON ACER TENDL-2024 LIBRARY; T=293.6K
deuterons from (n,n*)d

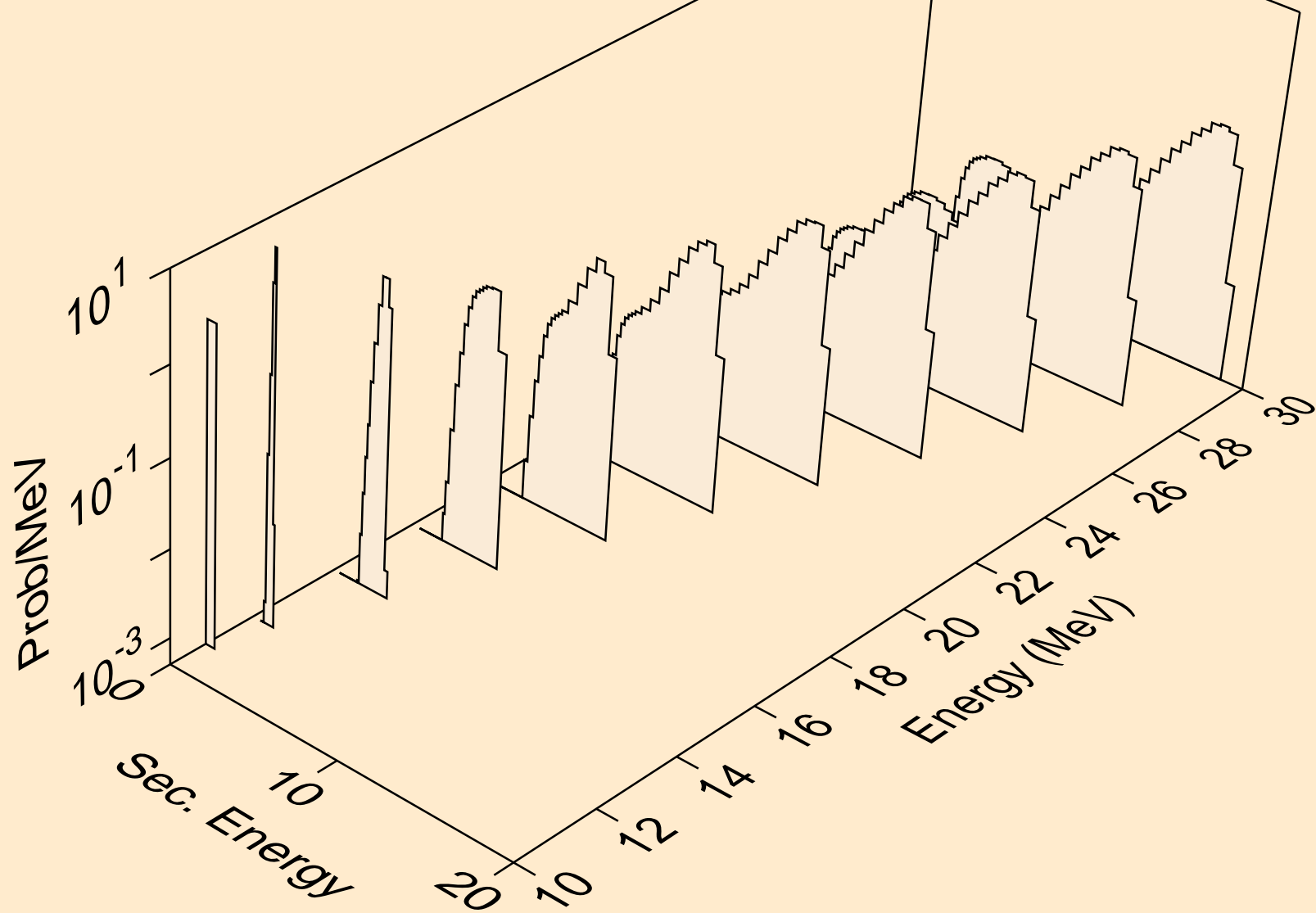

Y078M NEUTRON ACER TENDL-2024 LIBRARY; T=293.6K
deuterons from (n,d)

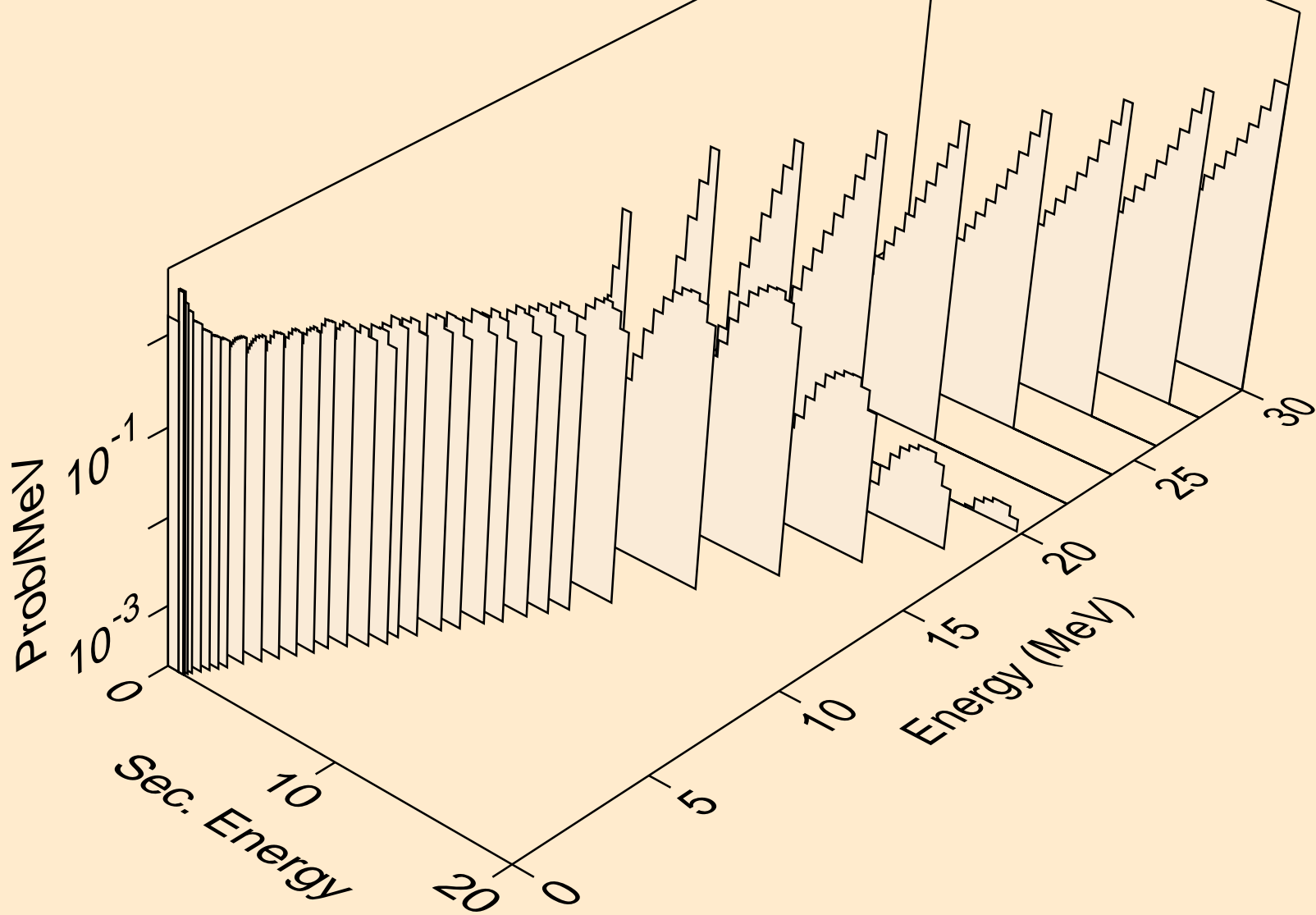

Y078M NEUTRON ACER TENDL-2024 LIBRARY; T=293.6K
deuterons from (n,d2a)

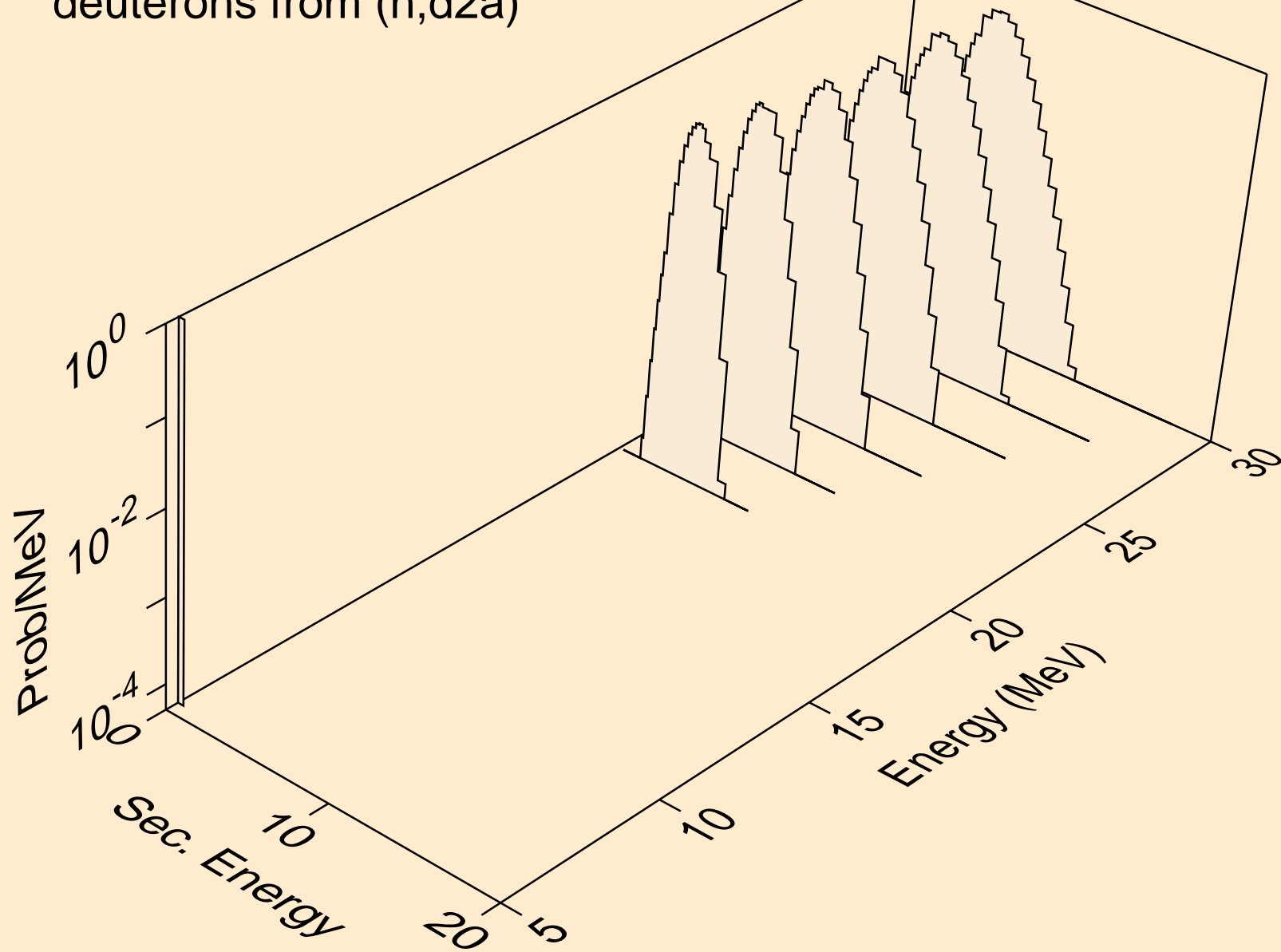

Y078M NEUTRON ACER TENDL-2024 LIBRARY; T=293.6K
deuterons from (n,pd)

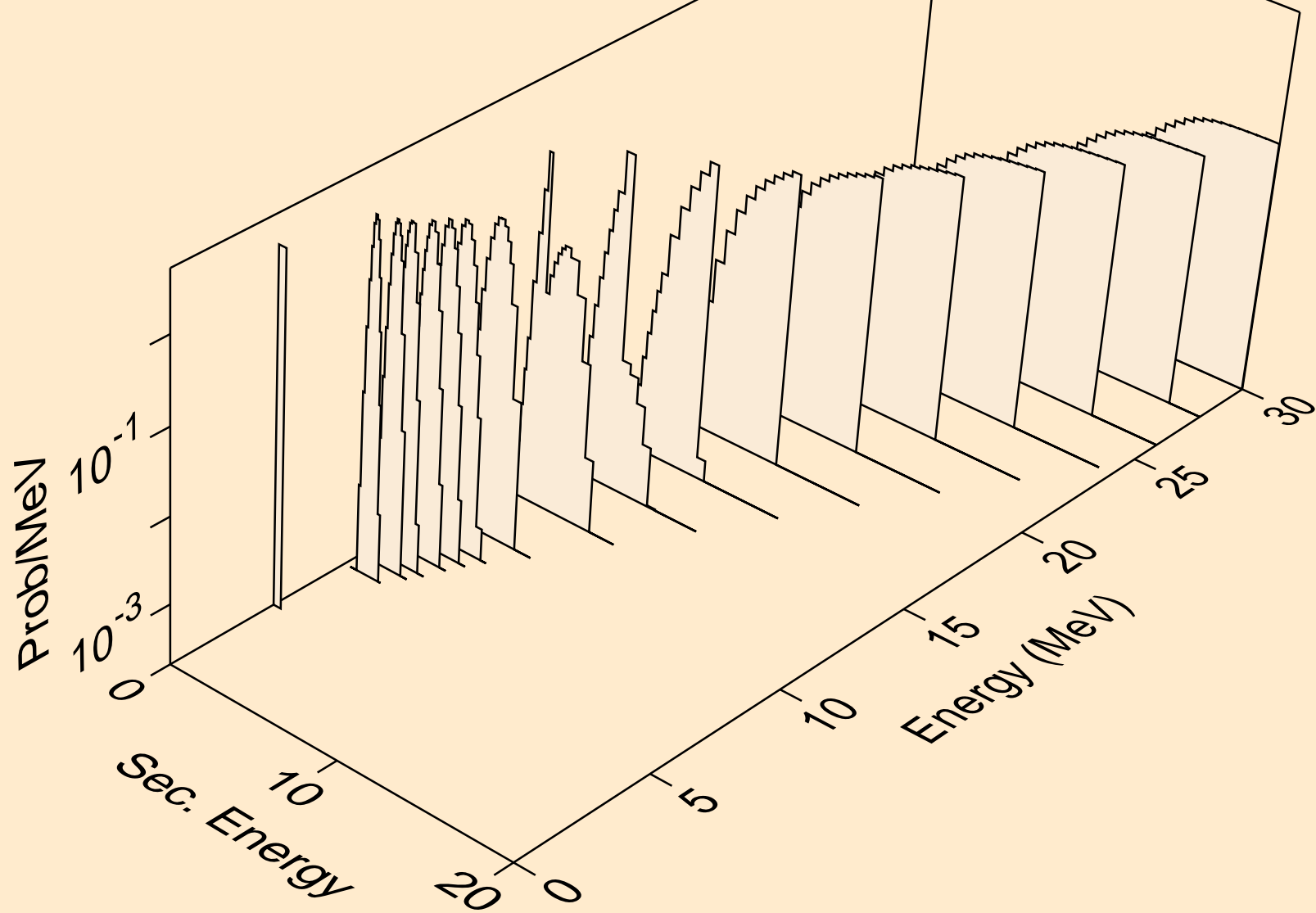

Y078M NEUTRON ACER TENDL-2024 LIBRARY; T=293.6K
deuterons from (n,da)

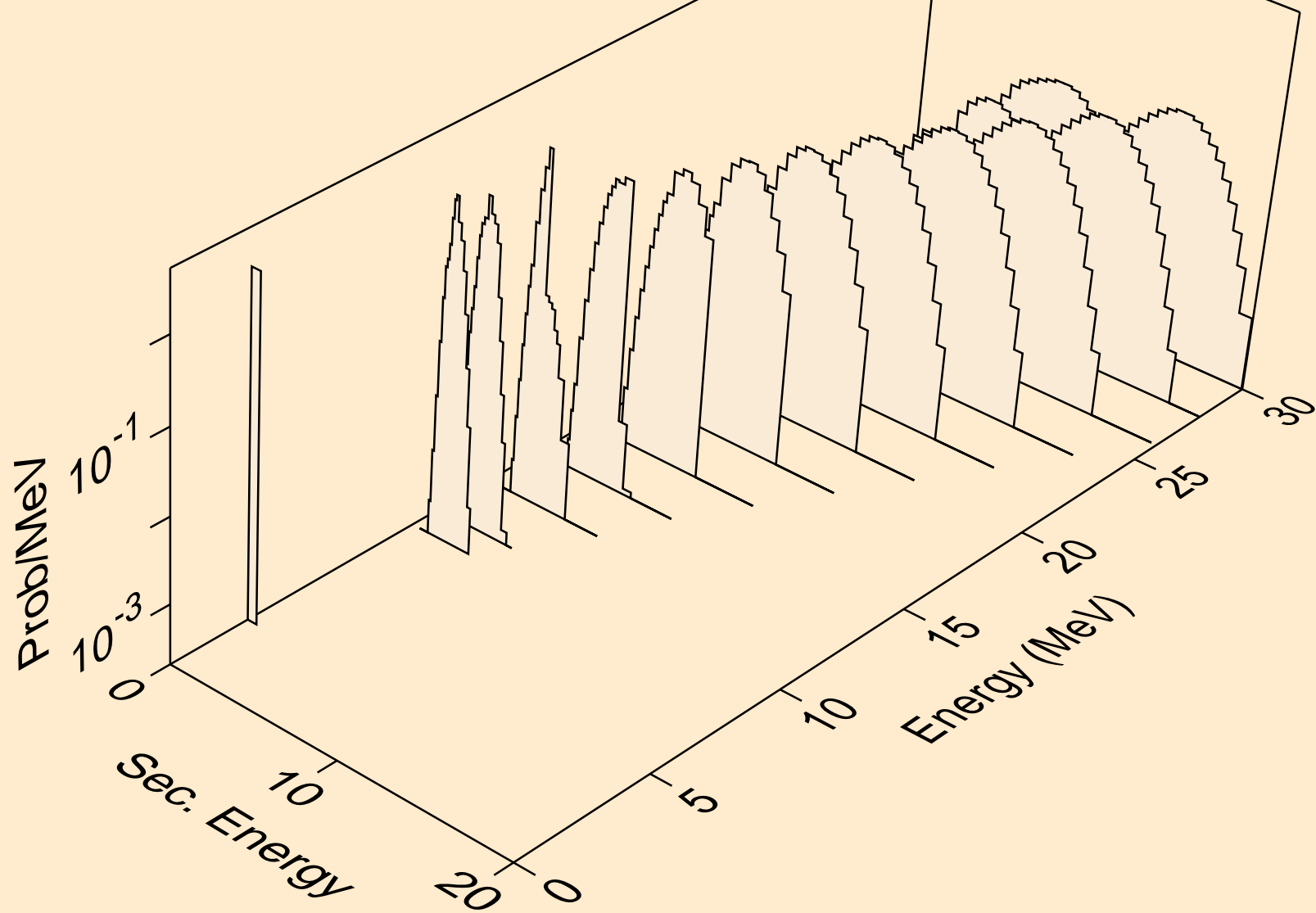

Y078M NEUTRON ACER TENDL-2024 LIBRARY; T=293.6K
tritons from (n,x)

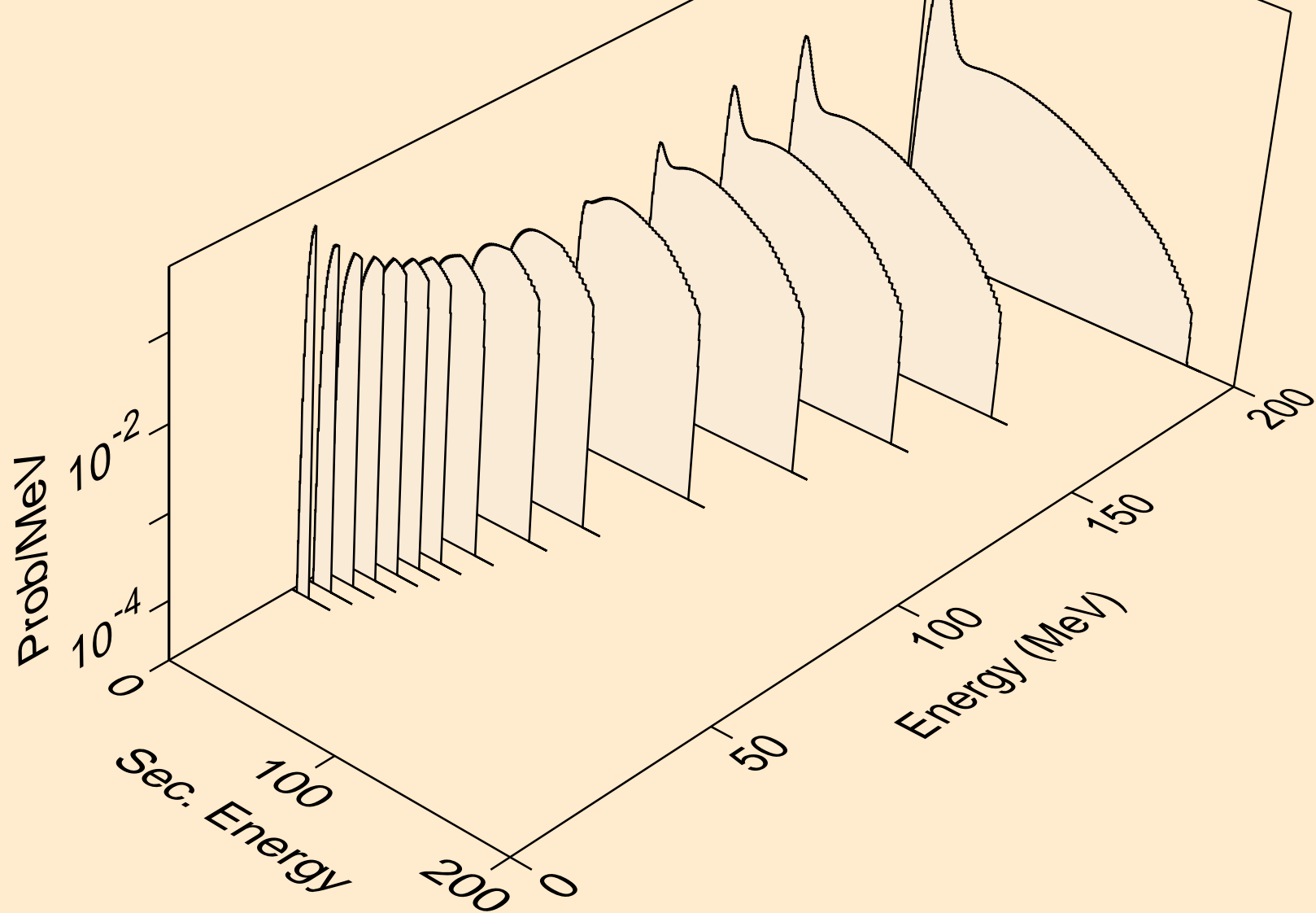

Y078M NEUTRON ACER TENDL-2024 LIBRARY; T=293.6K
tritons from (n,n*)t

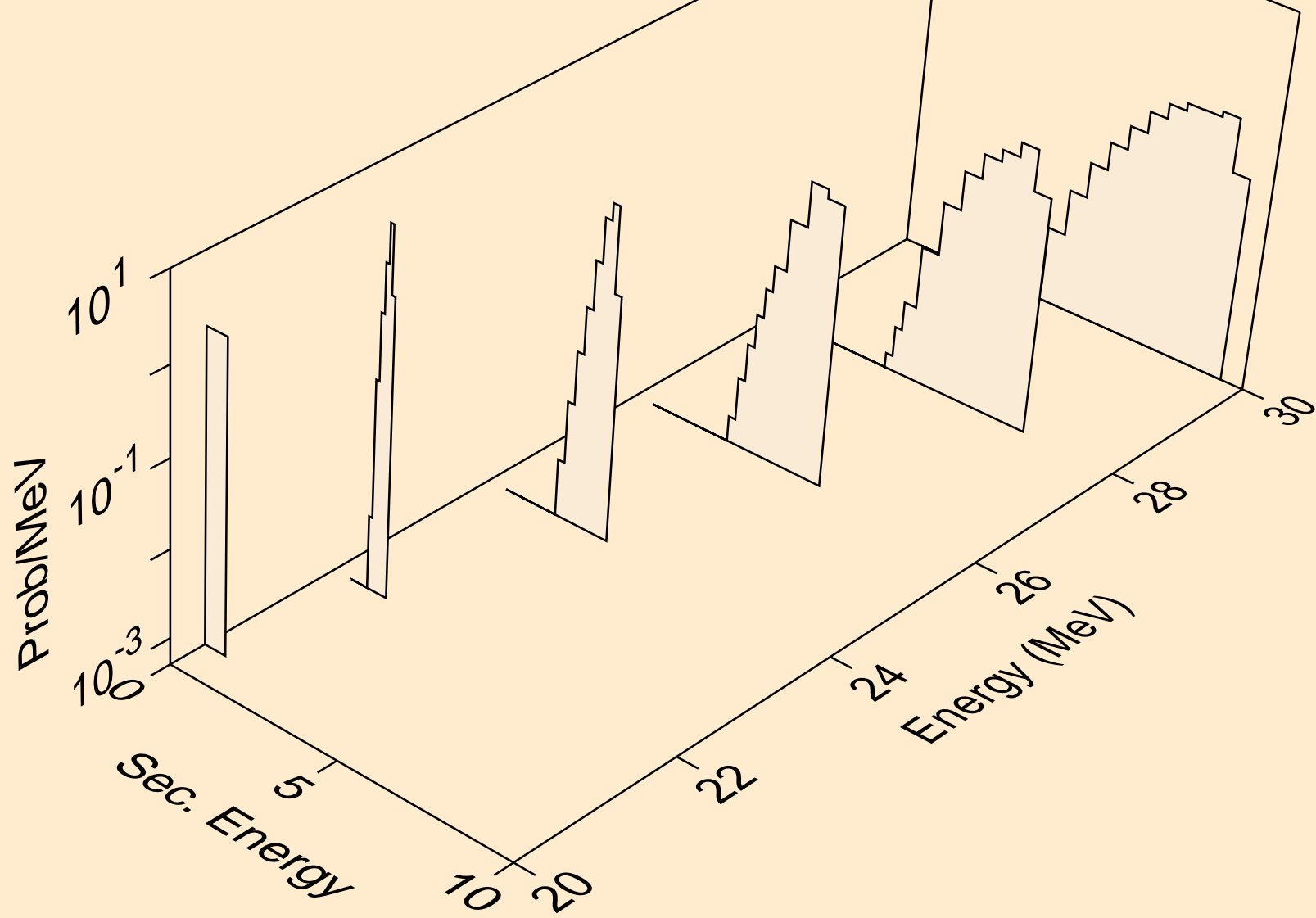

Y078M NEUTRON ACER TENDL-2024 LIBRARY; T=293.6K
tritons from (n,t)

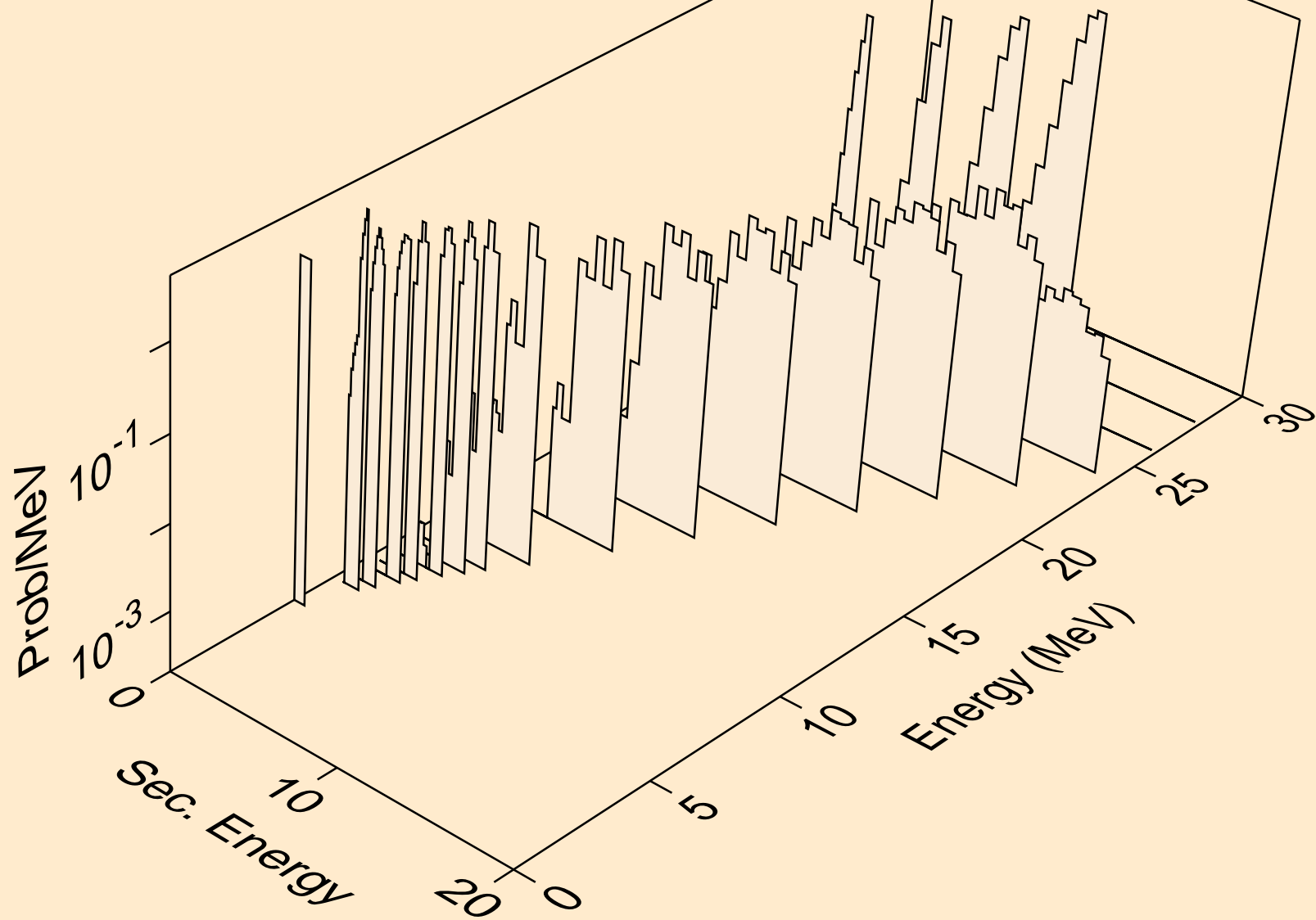

Y078M NEUTRON ACER TENDL-2024 LIBRARY; T=293.6K
tritons from (n,pt)

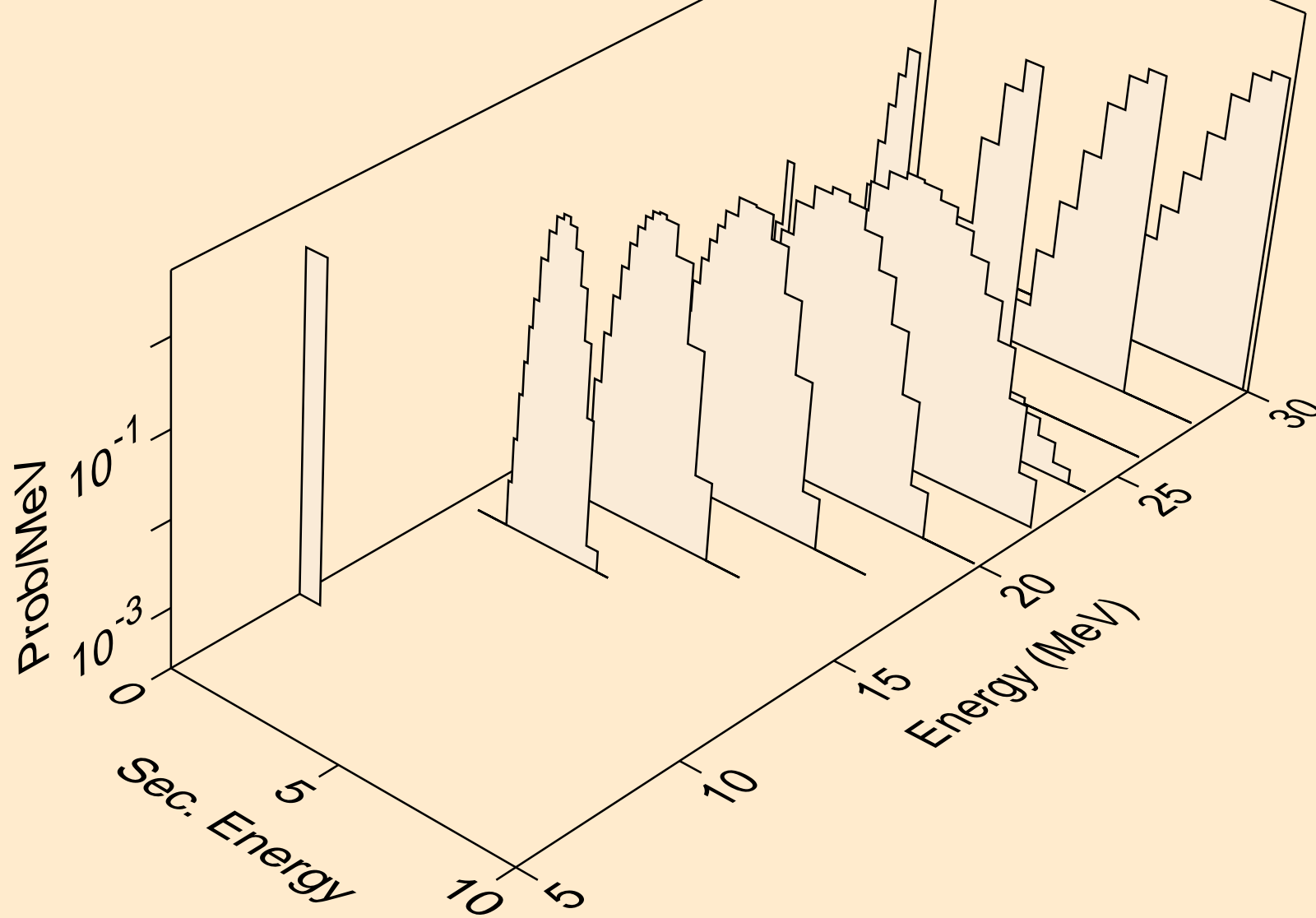

Y078M NEUTRON ACER TENDL-2024 LIBRARY; T=293.6K
he3s from (n,x)

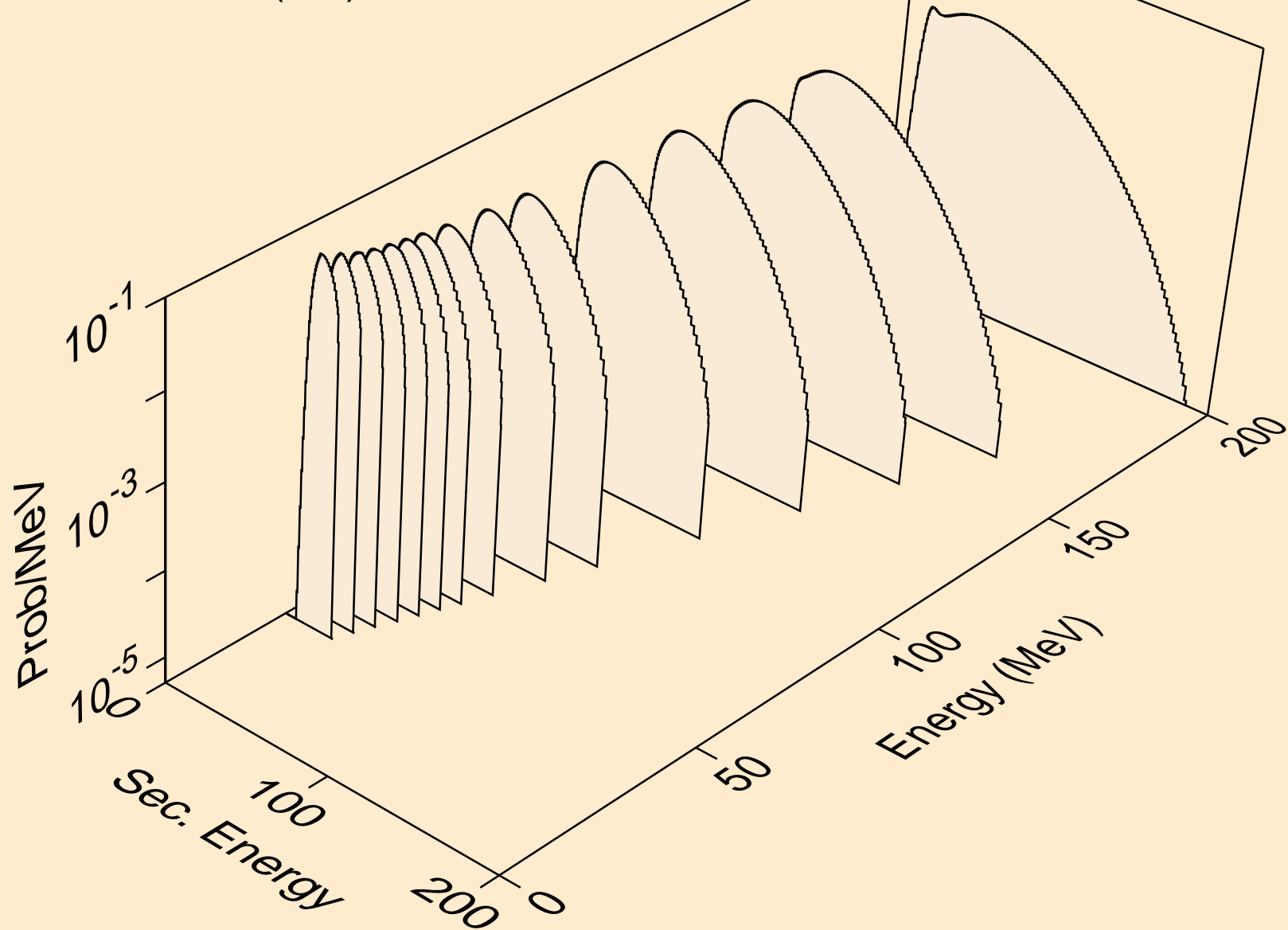

Y078M NEUTRON ACER TENDL-2024 LIBRARY; T=293.6K
he3s from (n,n*)he3

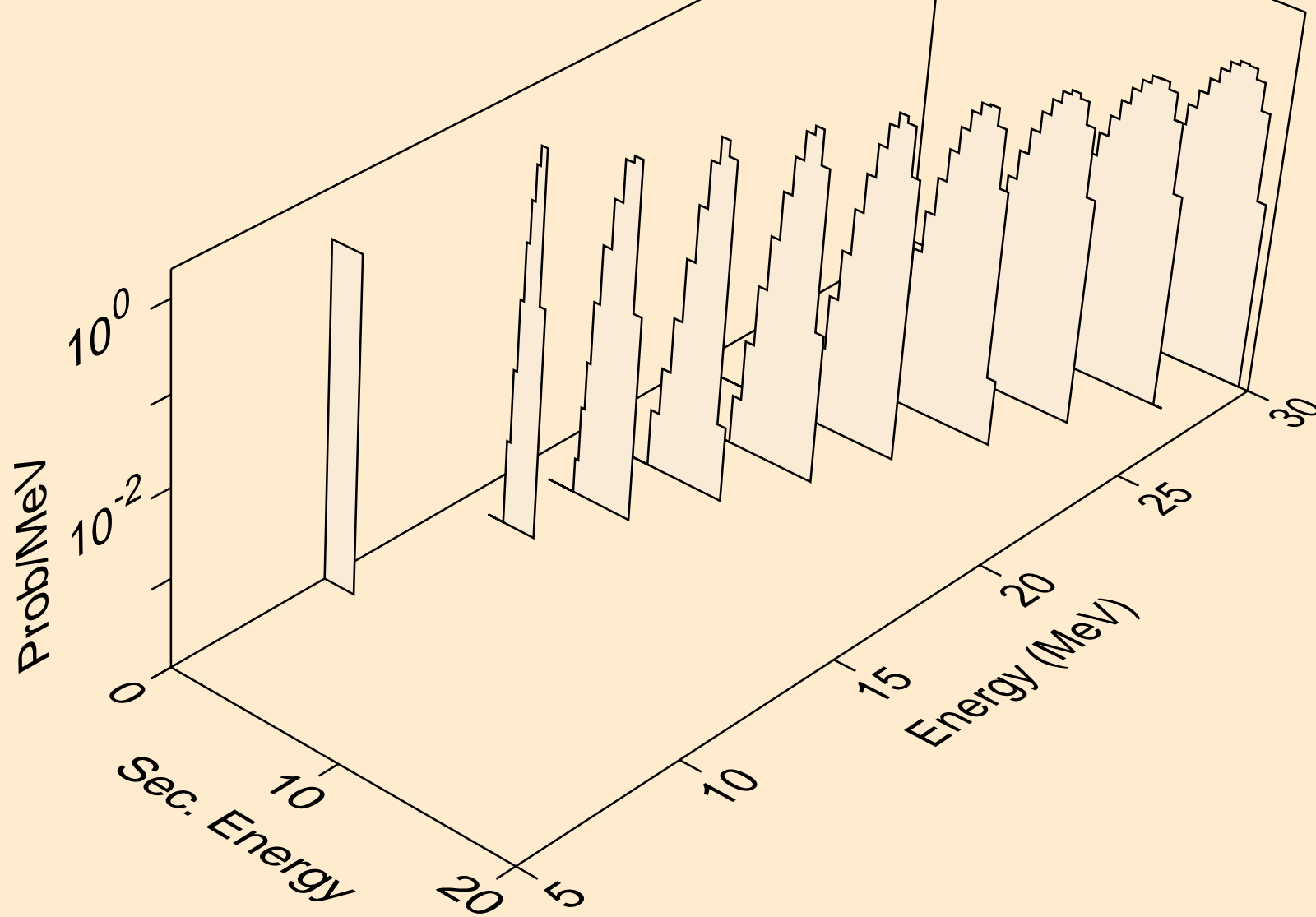

Y078M NEUTRON ACER TENDL-2024 LIBRARY; T=293.6K
he3s from (n,he3)

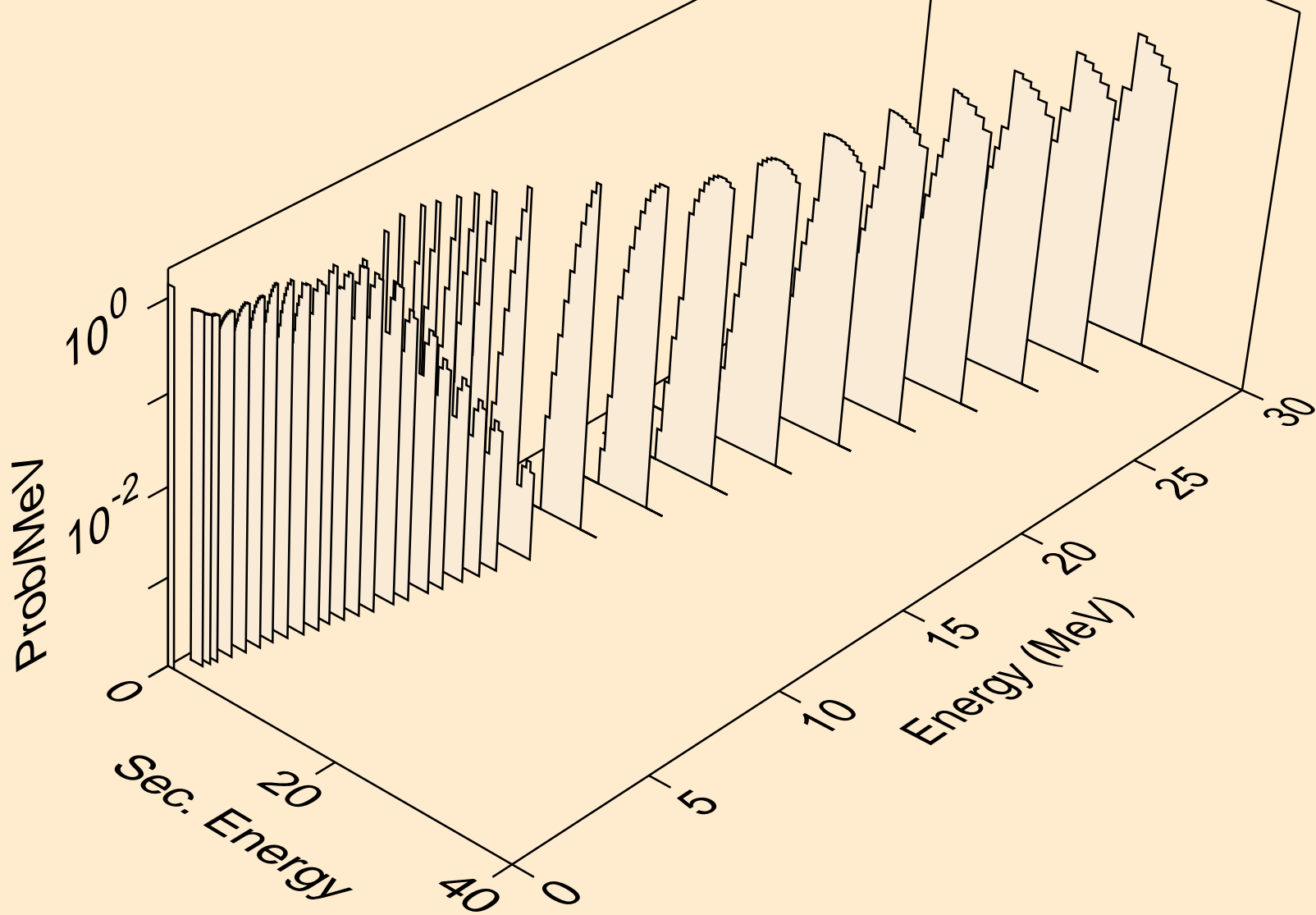

Y078M NEUTRON ACER TENDL-2024 LIBRARY; T=293.6K
alphas from (n,x)

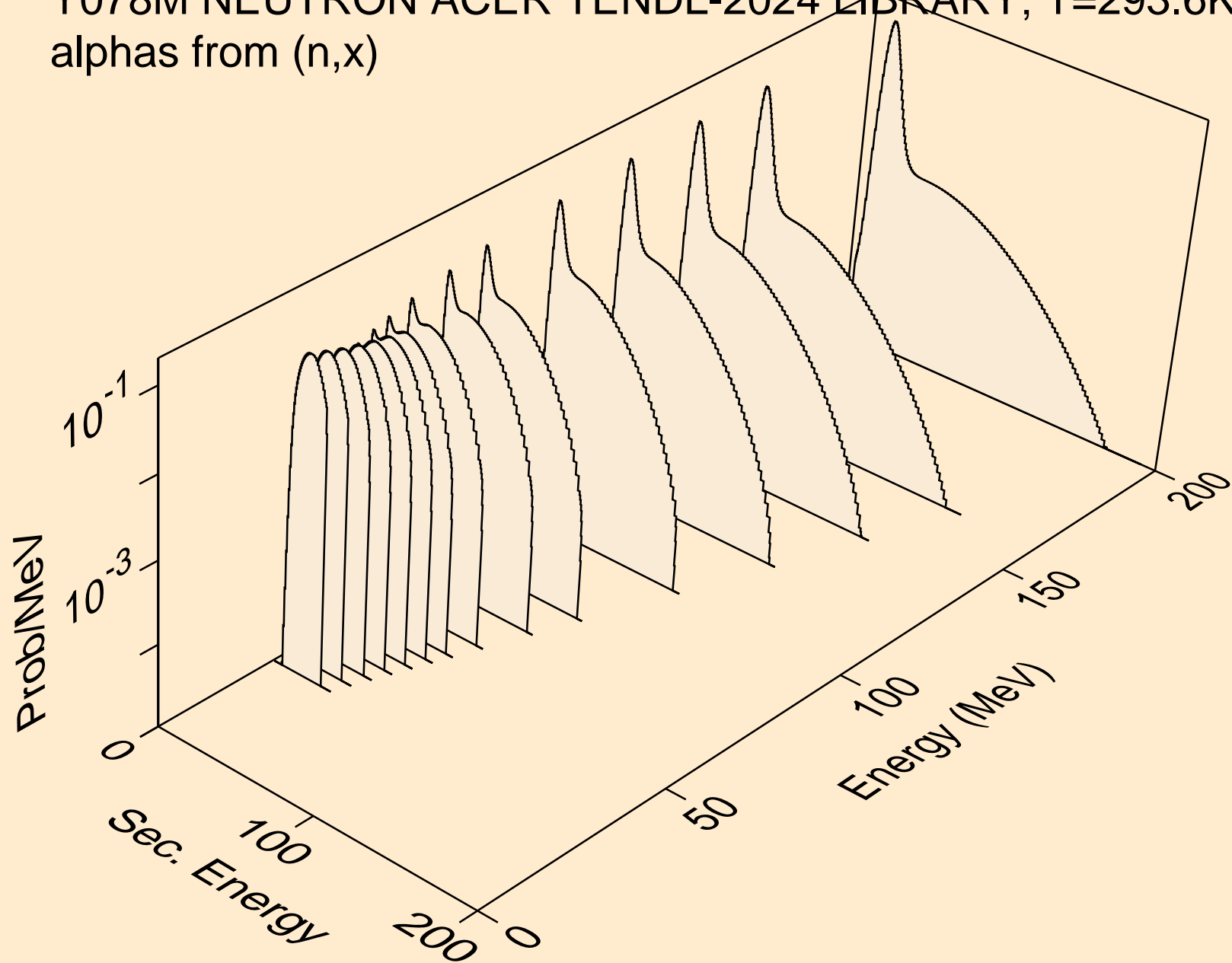

Y078M NEUTRON ACER TENDL-2024 LIBRARY; T=293.6K
alphas from (n,n*)a

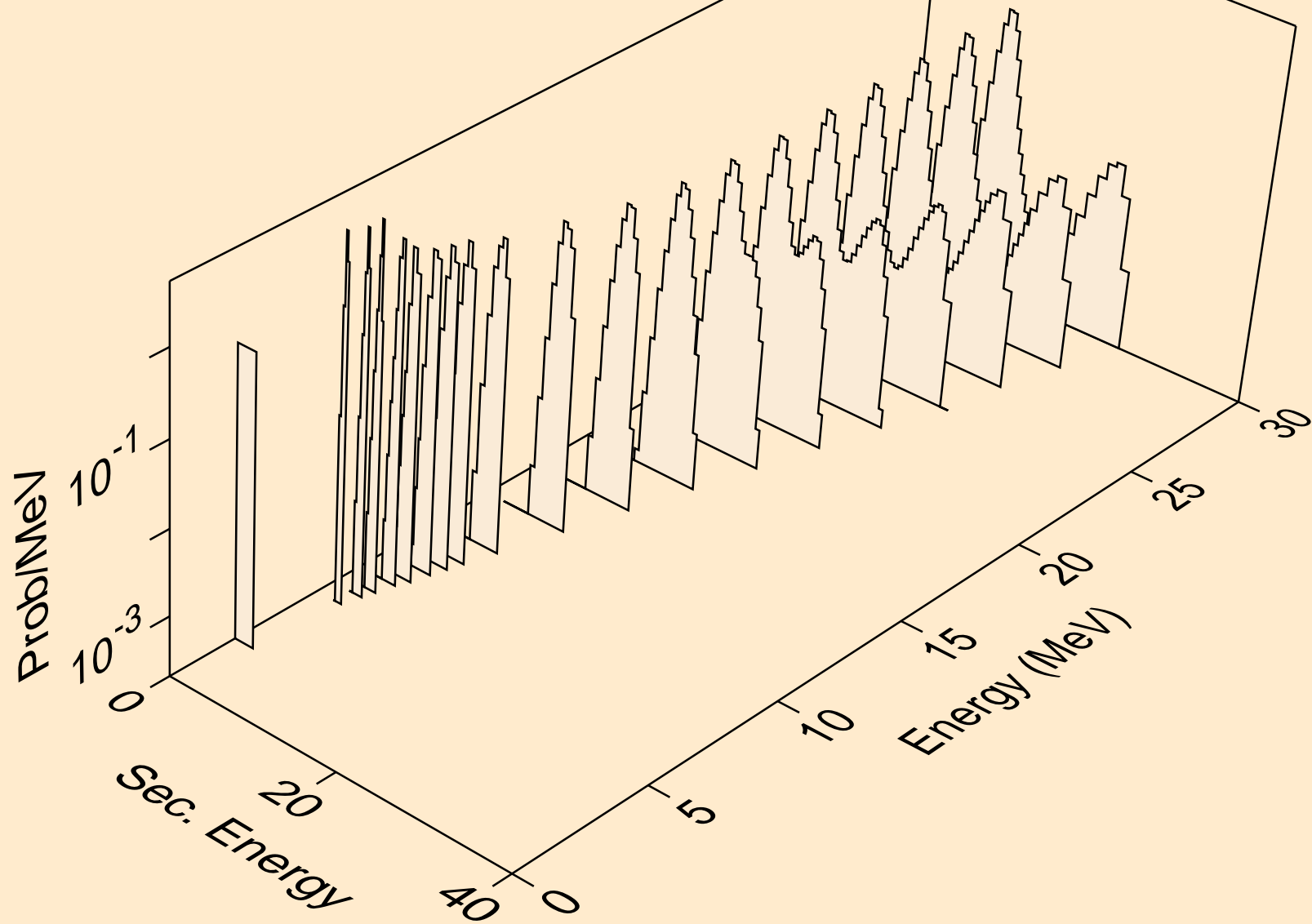

Y078M NEUTRON ACER TENDL-2024 LIBRARY; T=293.6K
alphas from (n,2n)a

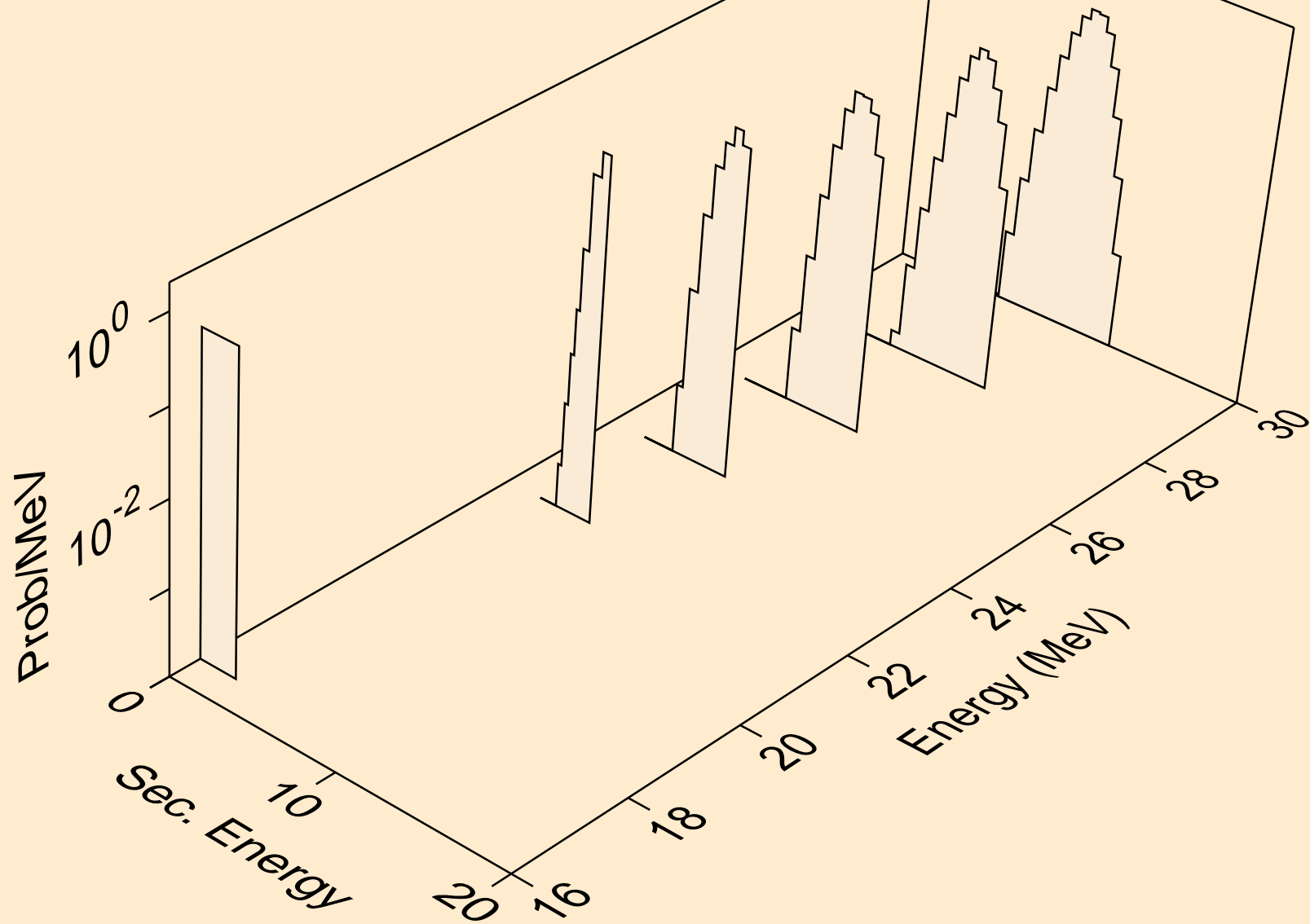

Y078M NEUTRON ACER TENDL-2024 LIBRARY; T=293.6K
alphas from (n,n*)2a

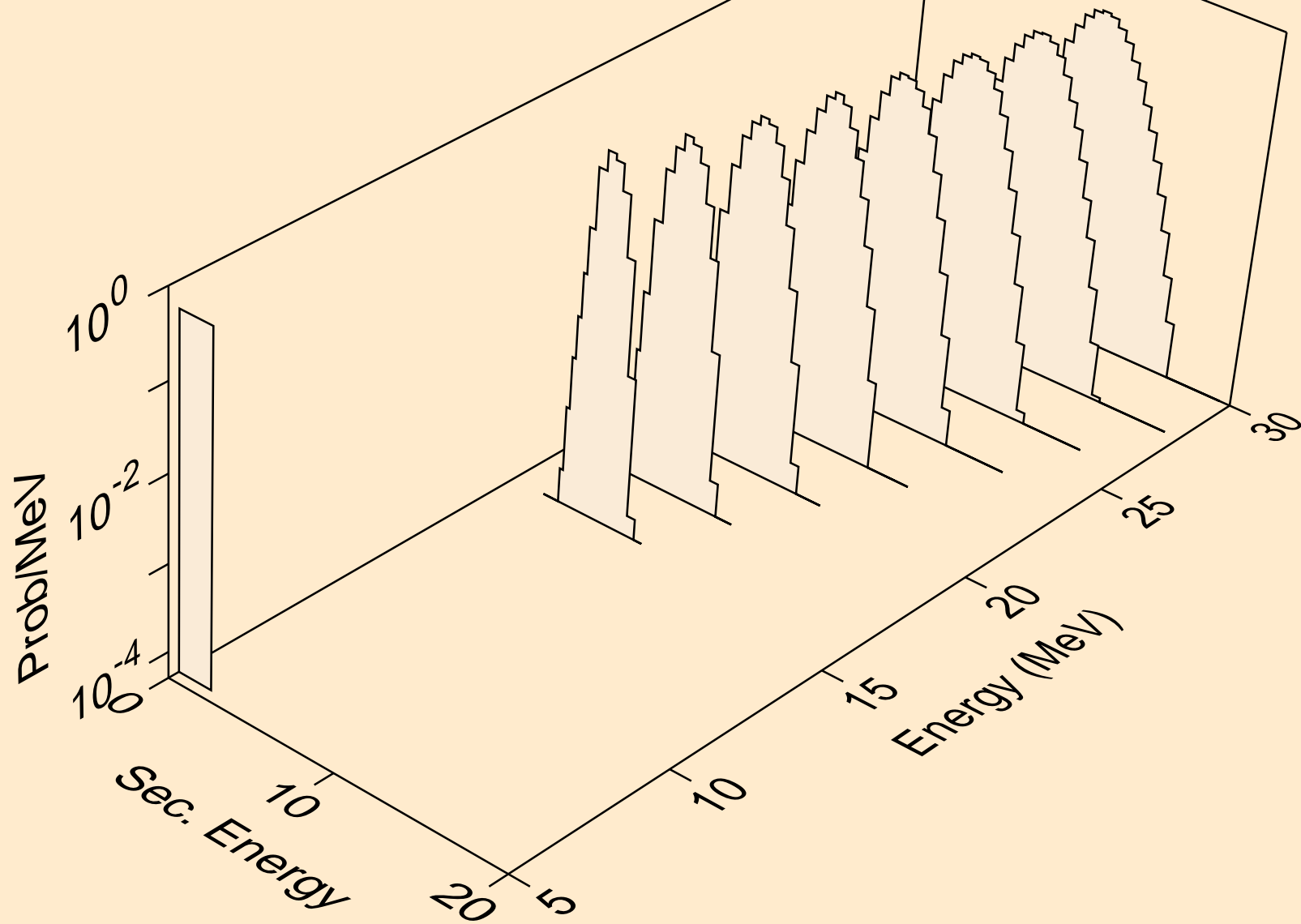

Y078M NEUTRON ACER TENDL-2024 LIBRARY; T=293.6K
alphas from (n,npa)

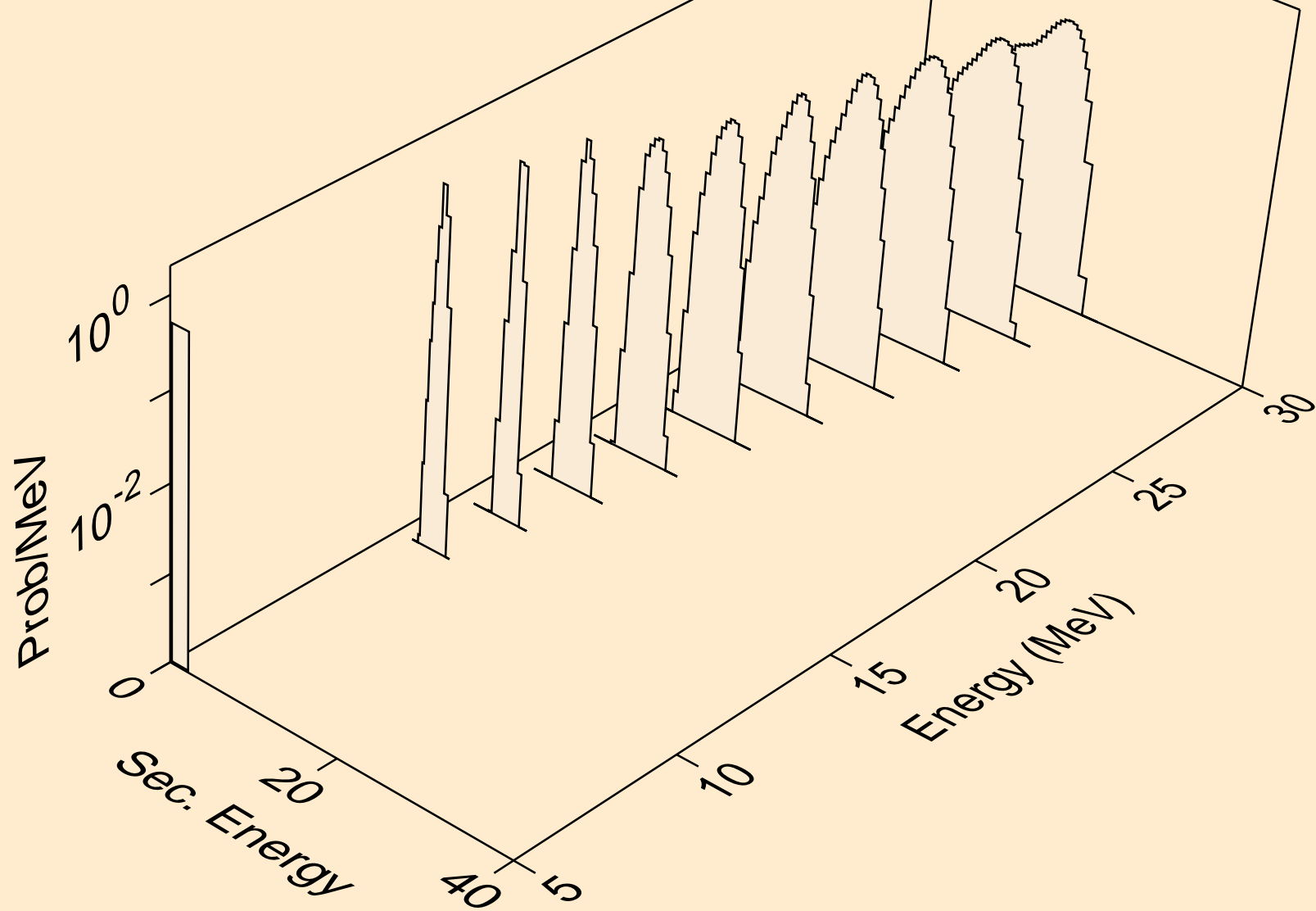

Y078M NEUTRON ACER TENDL-2024 LIBRARY; T=293.6K
alphas from (n,a)

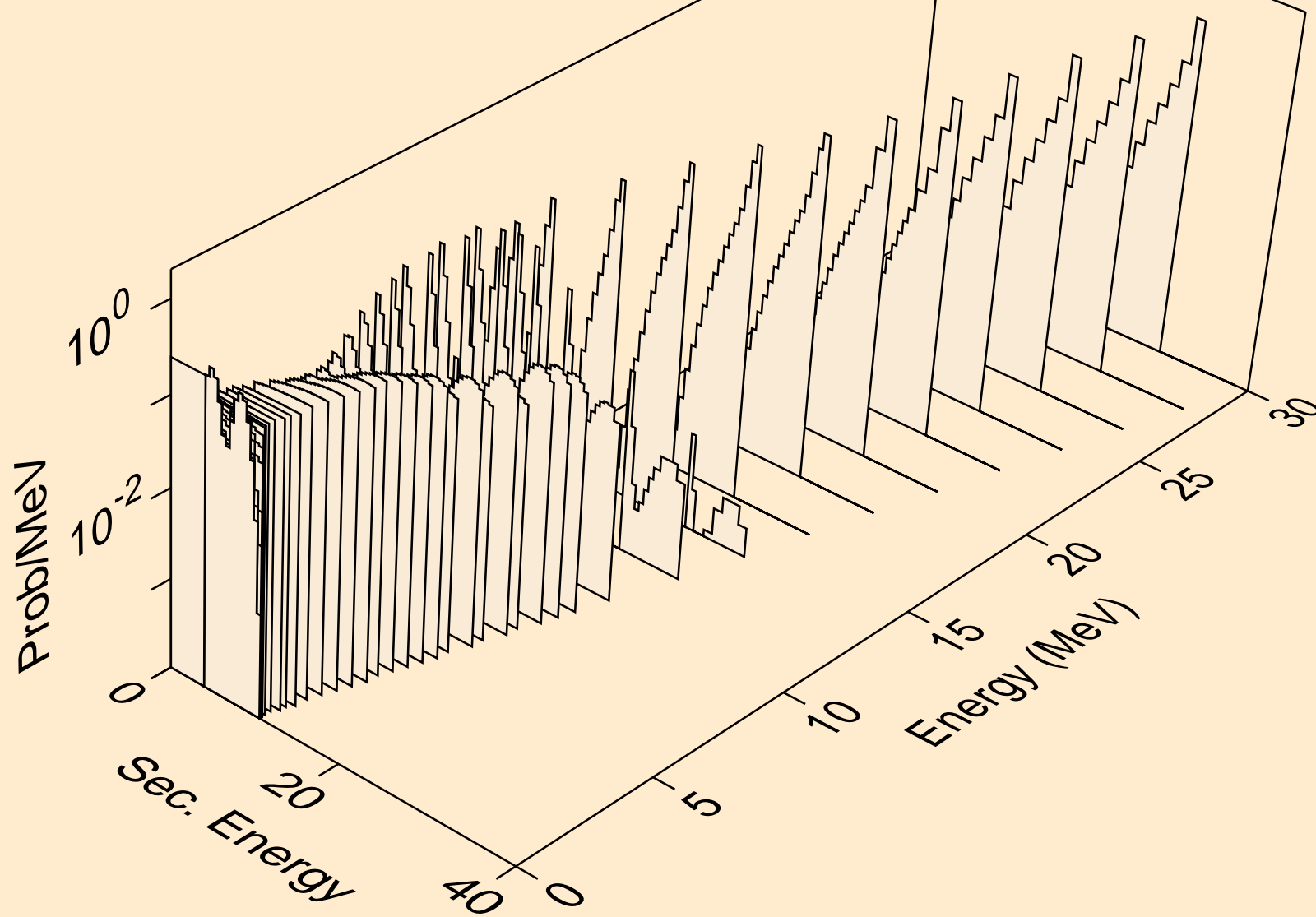

Y078M NEUTRON ACER TENDL-2024 LIBRARY; T=293.6K
alphas from (n,2a)

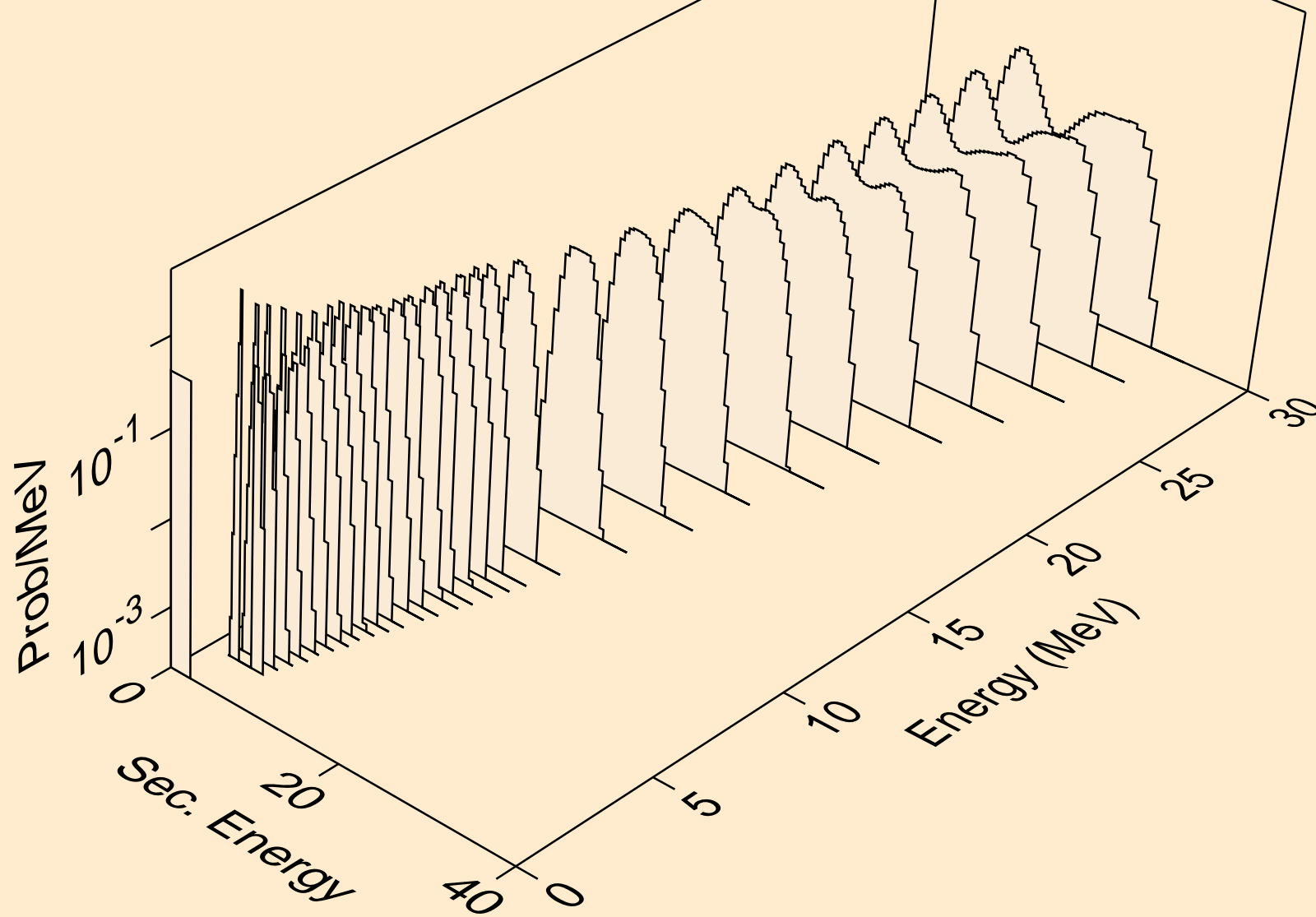

Y078M NEUTRON ACER TENDL-2024 LIBRARY; T=293.6K
alphas from (n,3a)

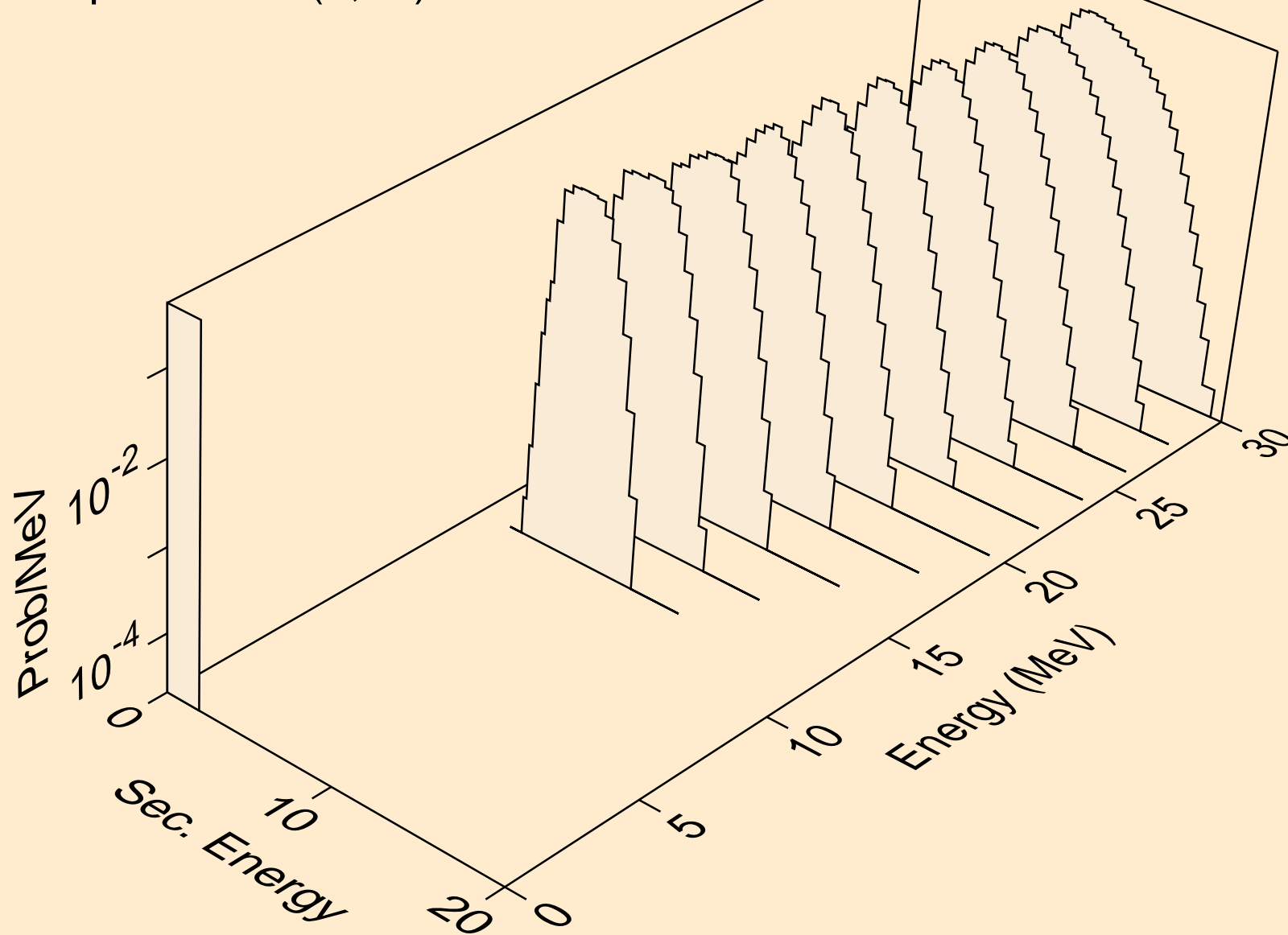

Y078M NEUTRON ACER TENDL-2024 LIBRARY; T=293.6K
alphas from (n,pa)

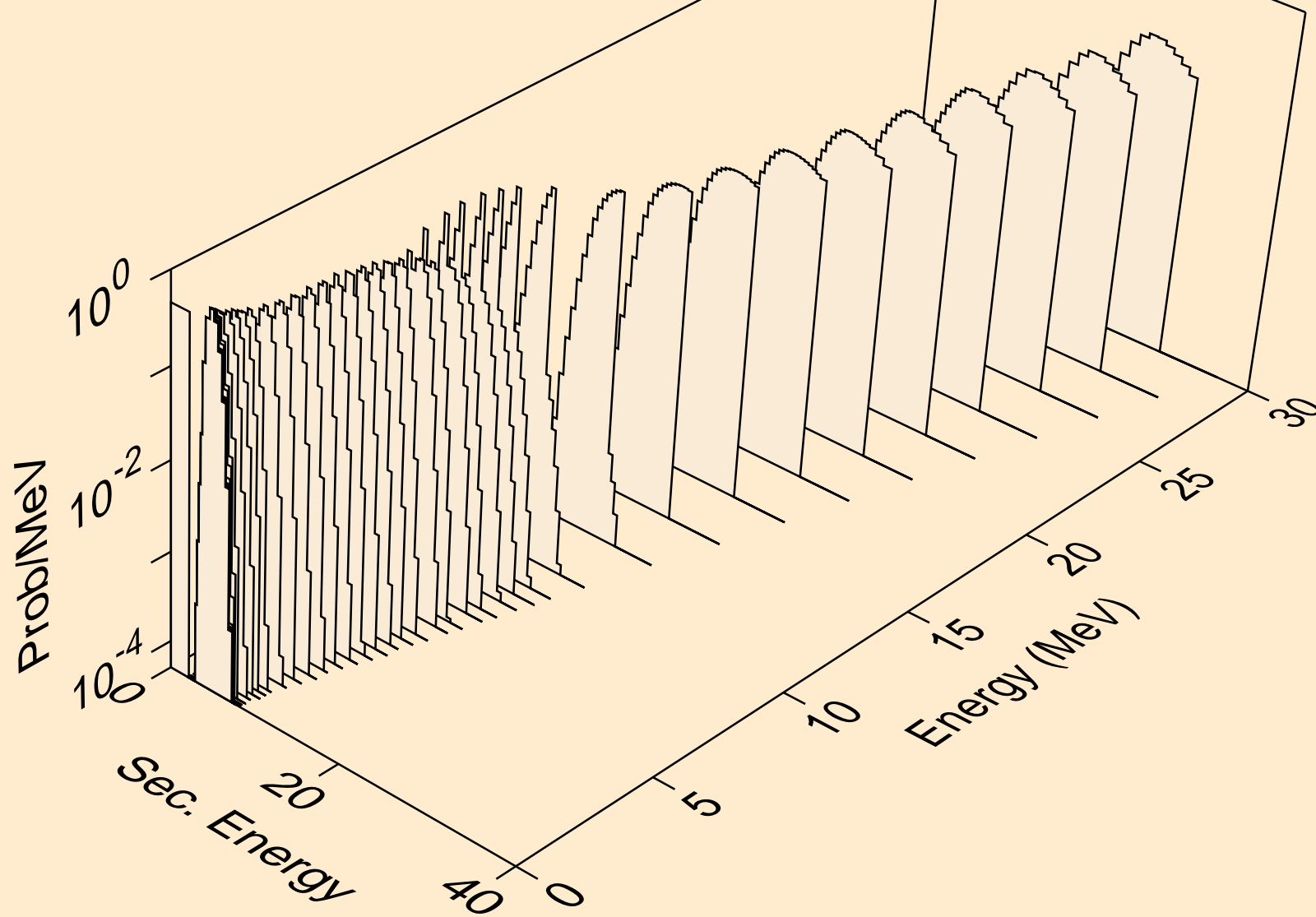

Y078M NEUTRON ACER TENDL-2024 LIBRARY; T=293.6K
alphas from (n,d2a)

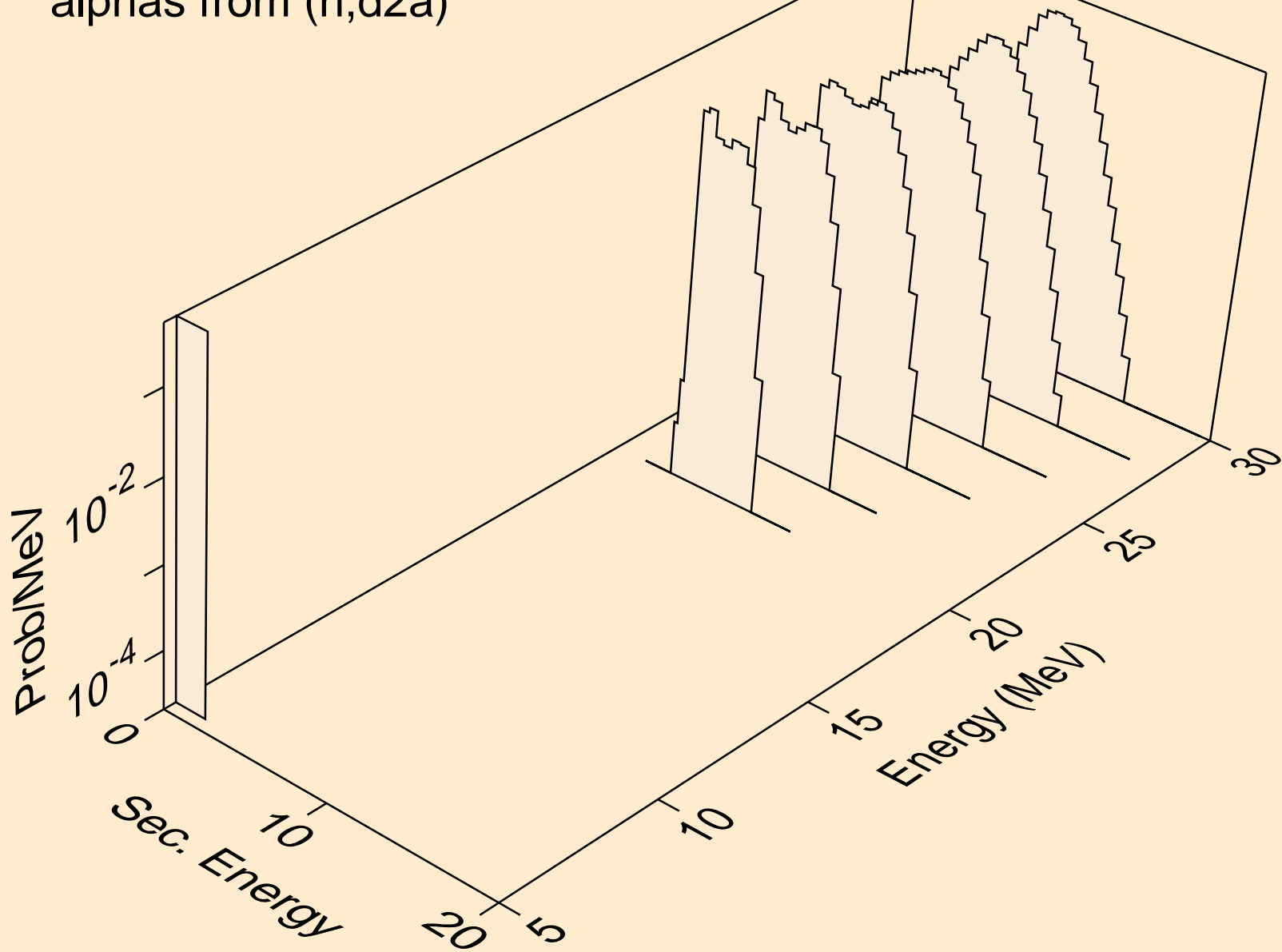

Y078M NEUTRON ACER TENDL-2024 LIBRARY; T=293.6K
alphas from (n,da)

