

Y085 NEUTRON ACER TENDL-2024 LIBRARY; T=293.6K  
Principal cross sections

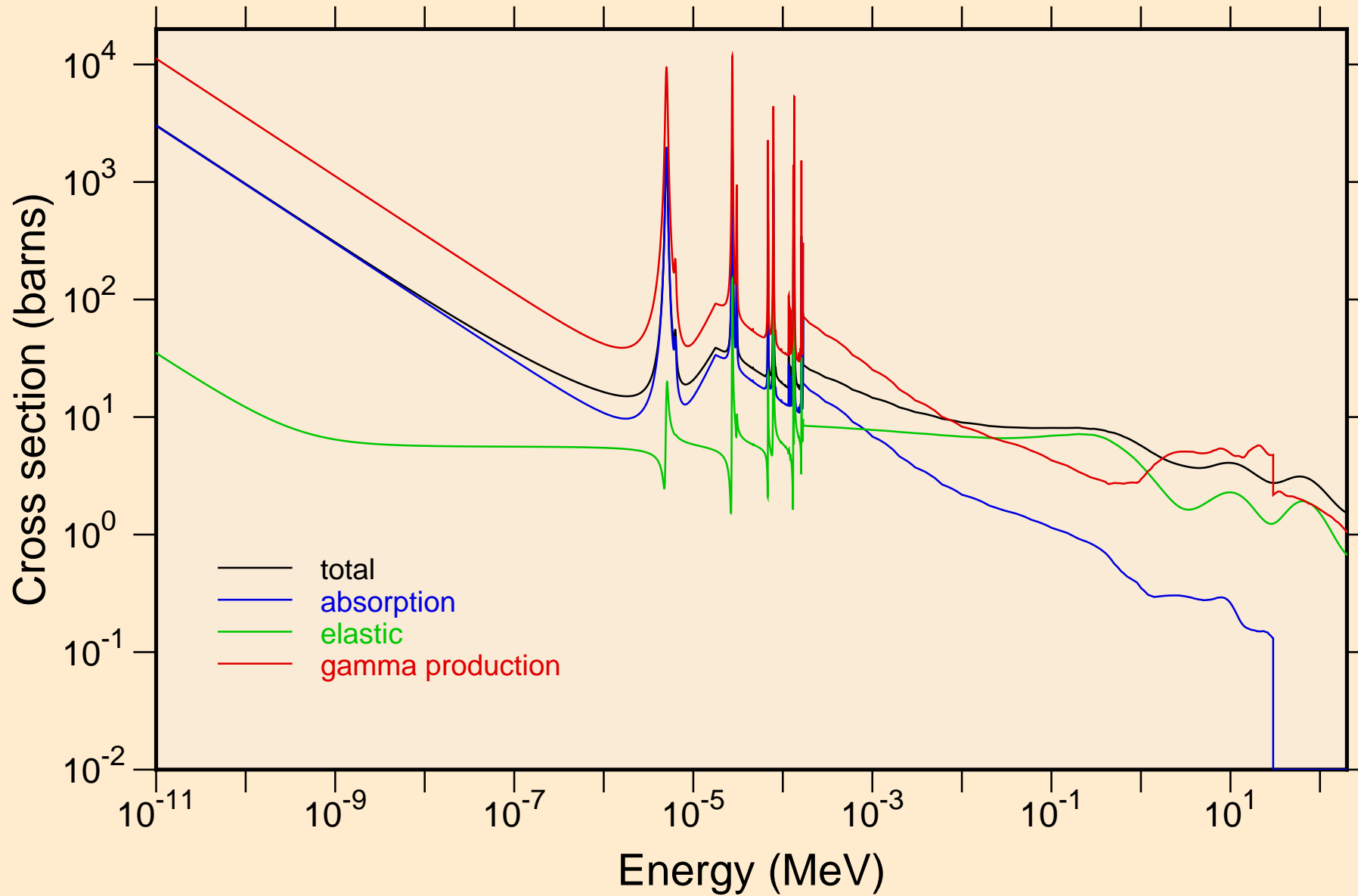

Y085 NEUTRON ACER TENDL-2024 LIBRARY; T=293.6K  
resonance total cross section

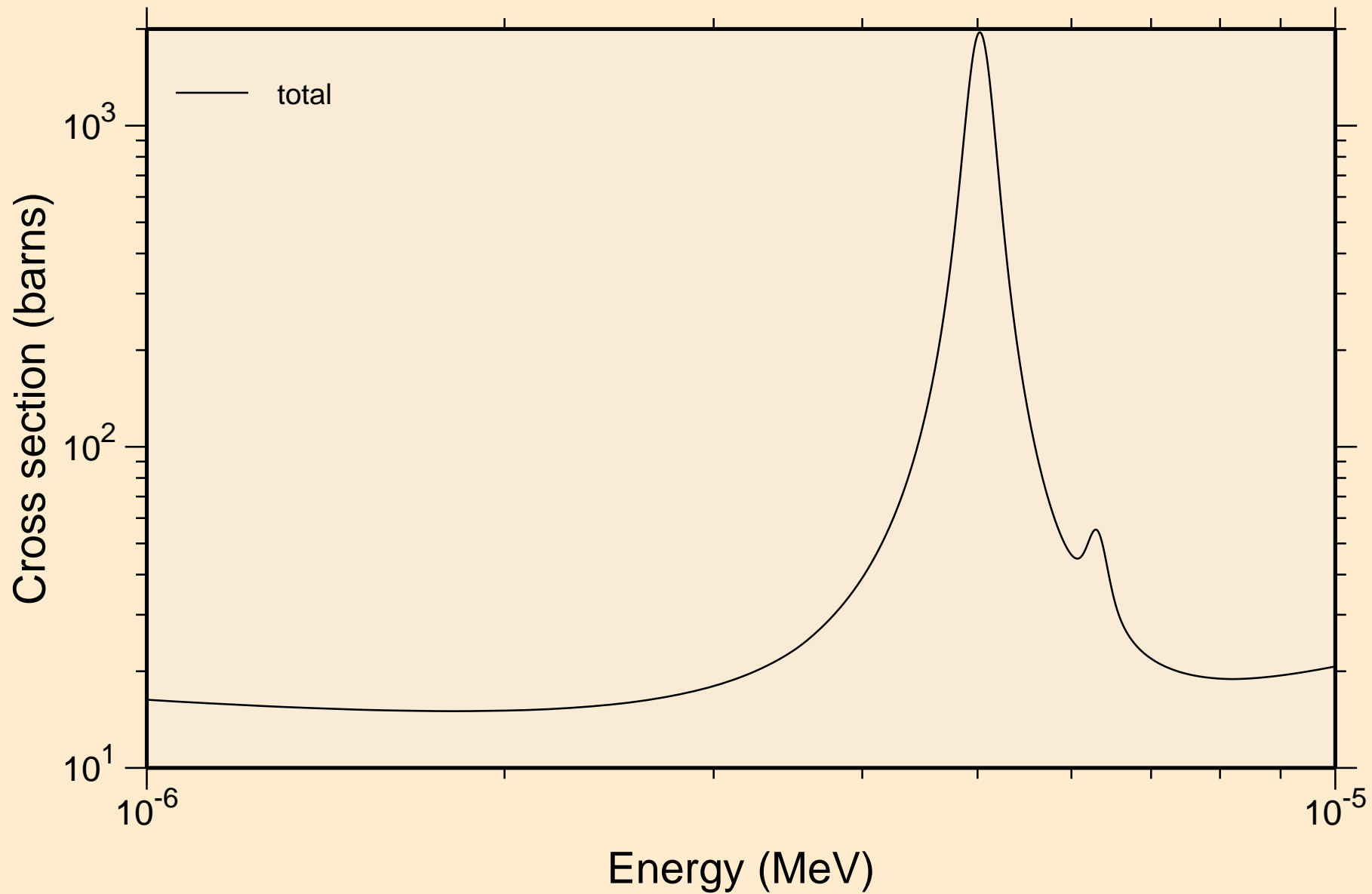

Y085 NEUTRON ACER TENDL-2024 LIBRARY; T=293.6K  
resonance total cross section

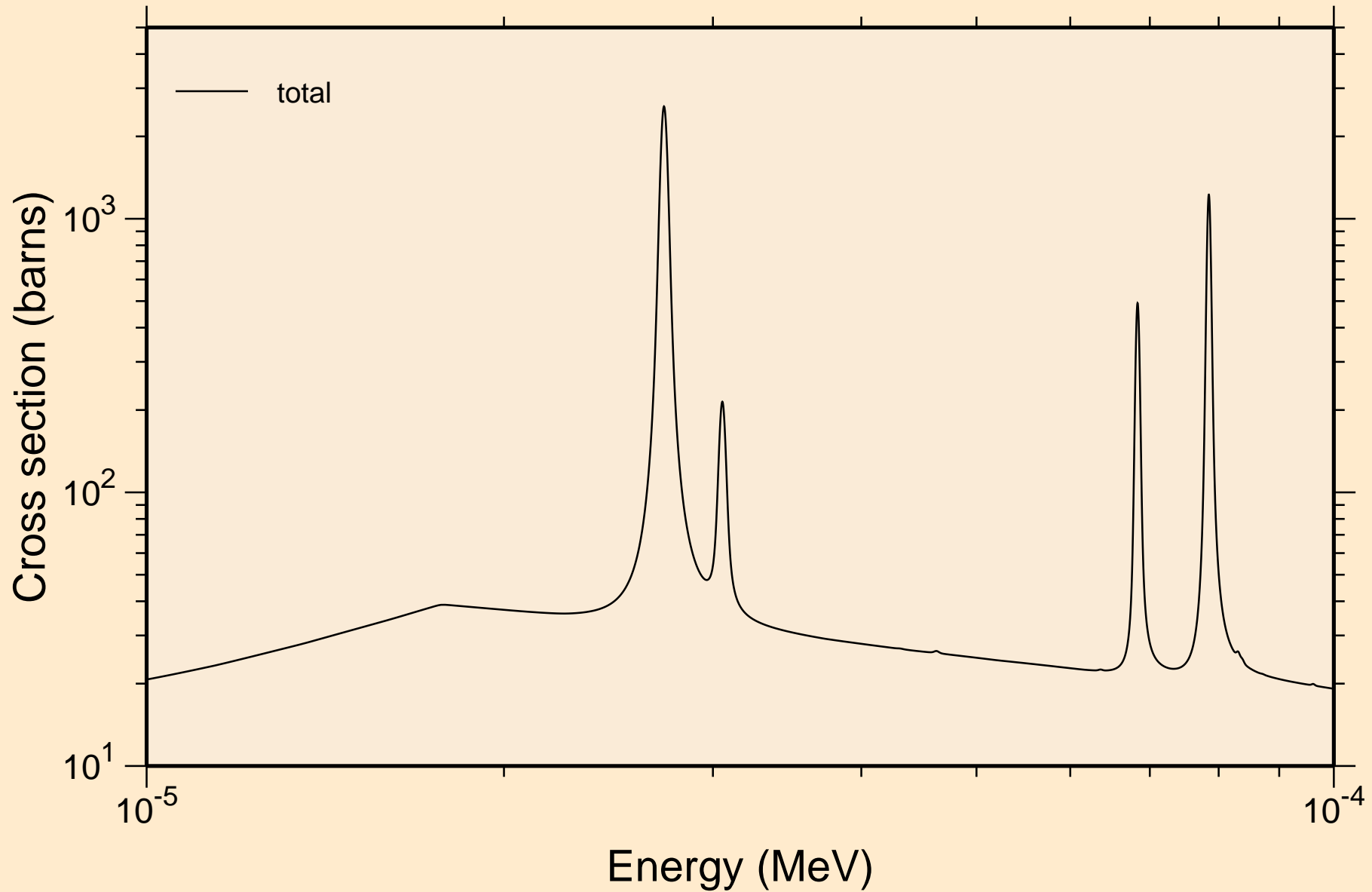

Y085 NEUTRON ACER TENDL-2024 LIBRARY; T=293.6K  
resonance total cross section

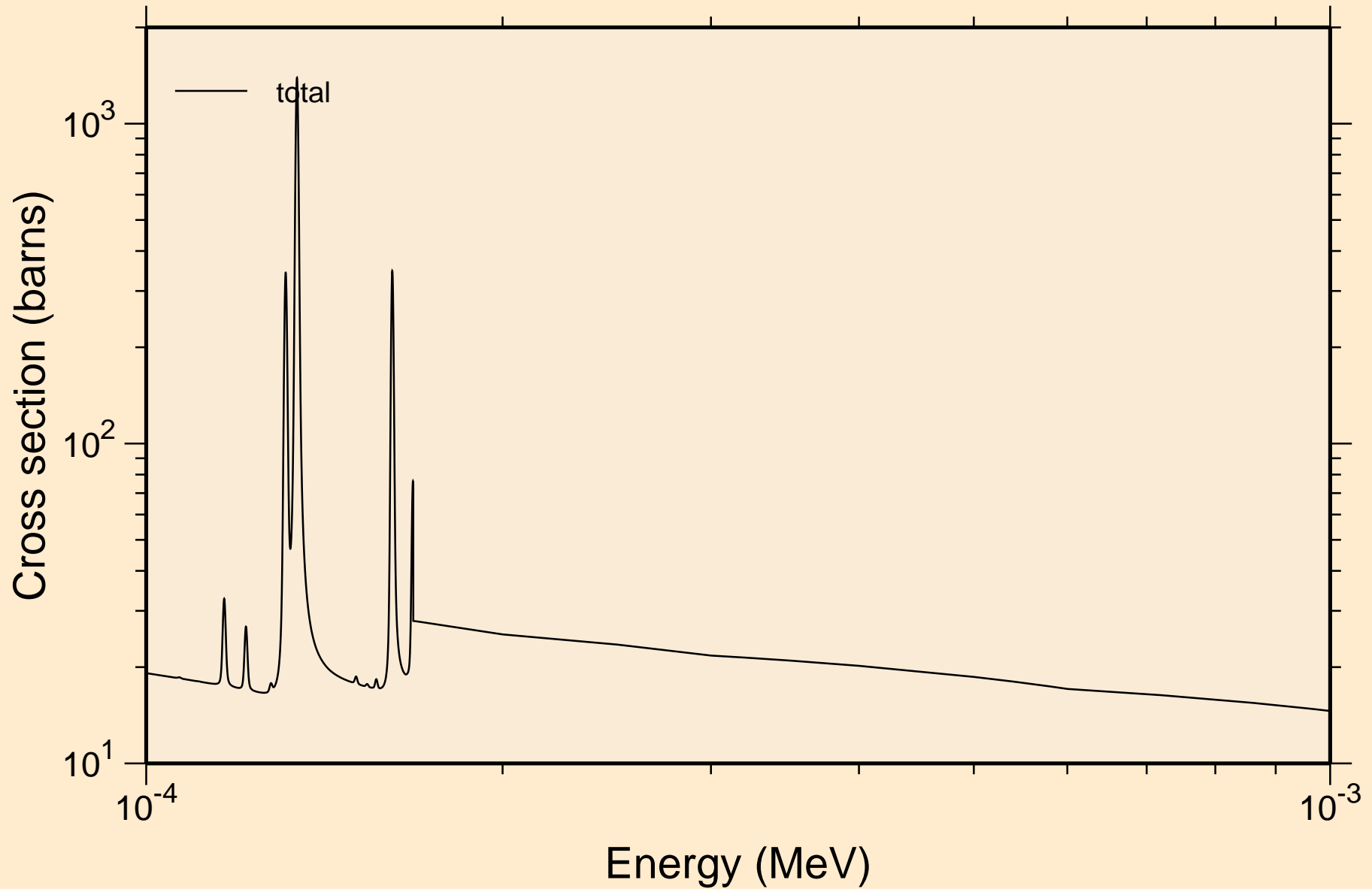

Y085 NEUTRON ACER TENDL-2024 LIBRARY; T=293.6K  
resonance total cross section

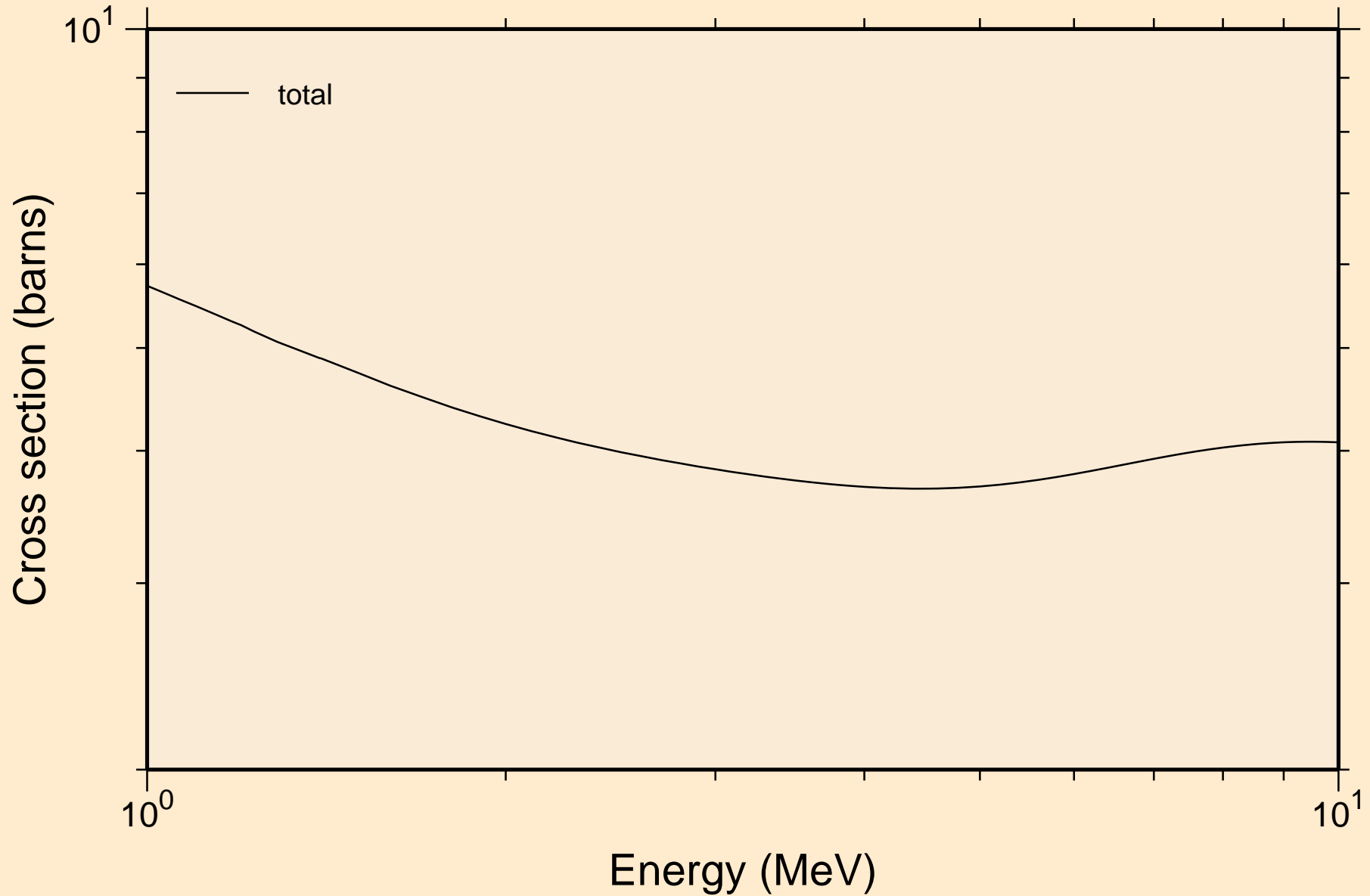

Y085 NEUTRON ACER TENDL-2024 LIBRARY; T=293.6K  
resonance absorption cross sections

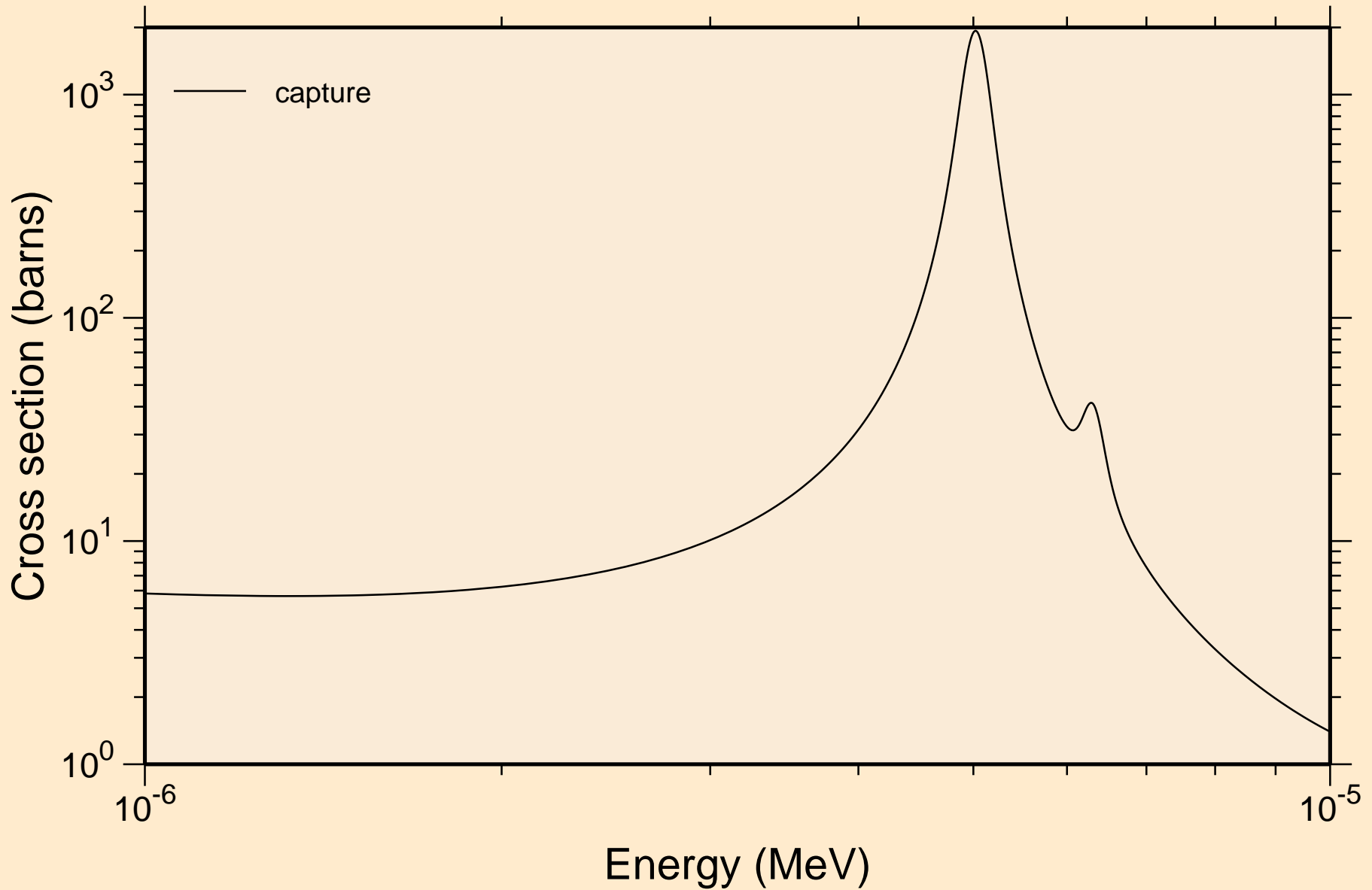

Y085 NEUTRON ACER TENDL-2024 LIBRARY; T=293.6K  
resonance absorption cross sections

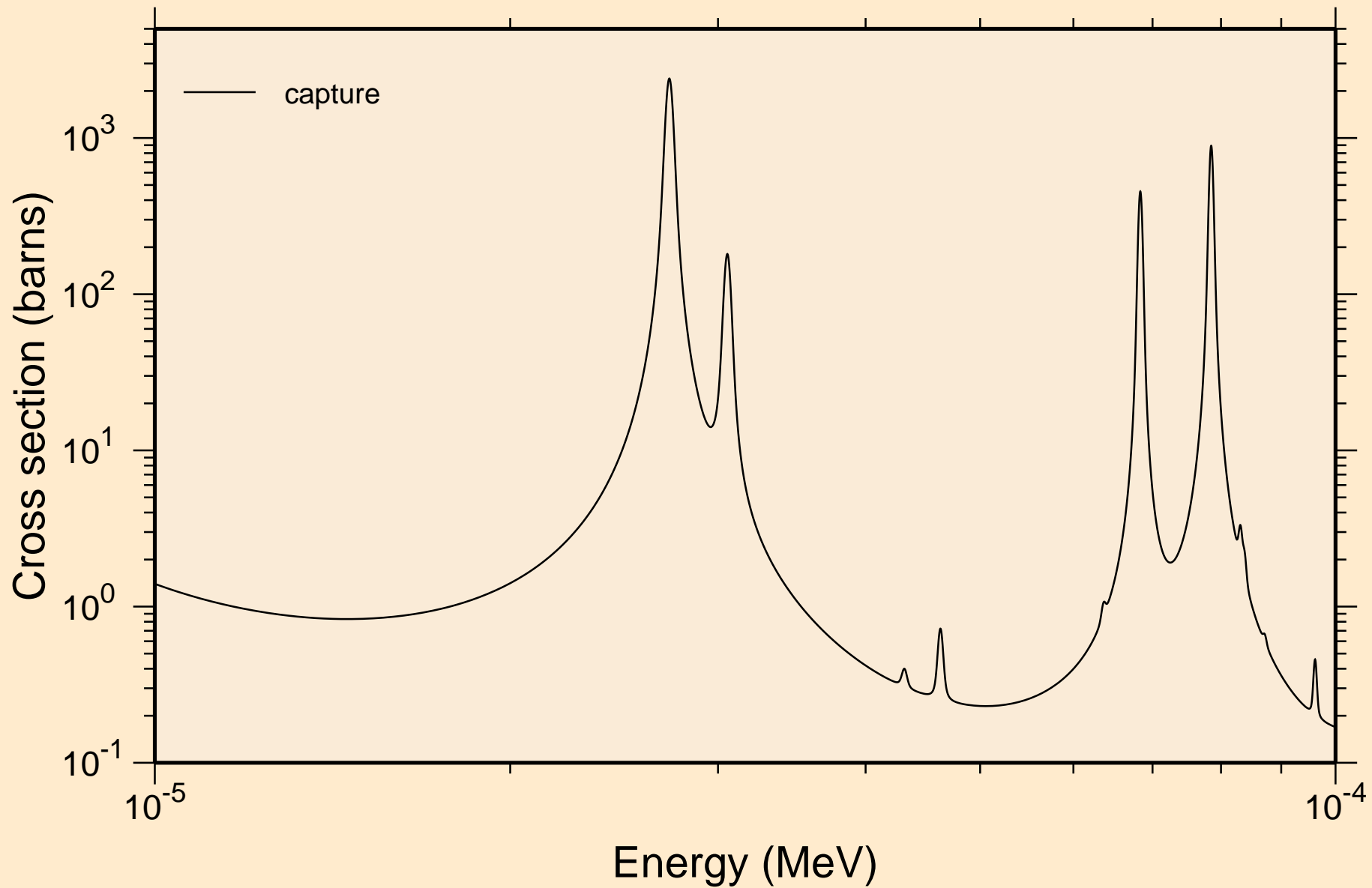

Y085 NEUTRON ACER TENDL-2024 LIBRARY; T=293.6K  
resonance absorption cross sections

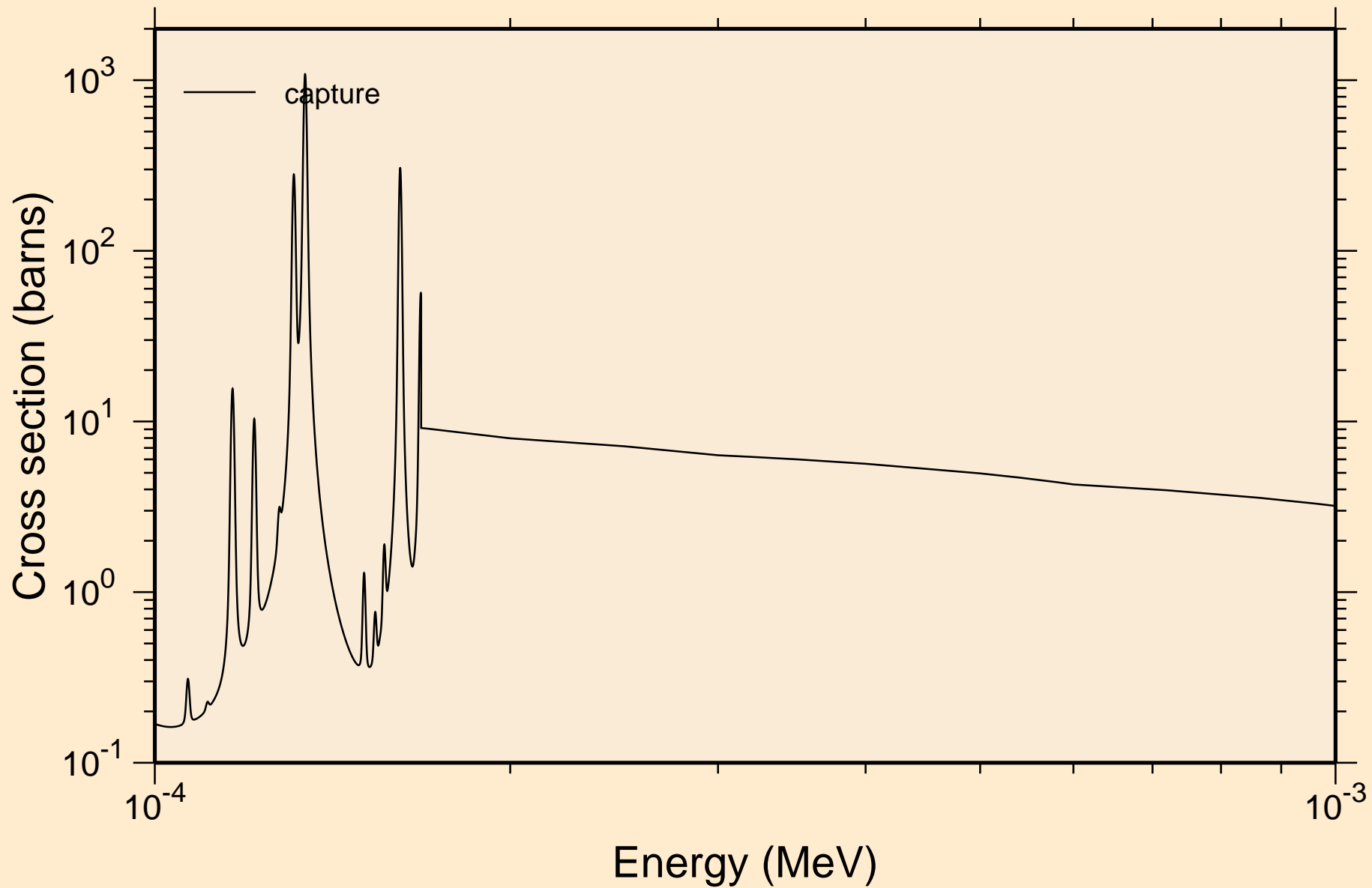

Y085 NEUTRON ACER TENDL-2024 LIBRARY; T=293.6K  
resonance absorption cross sections

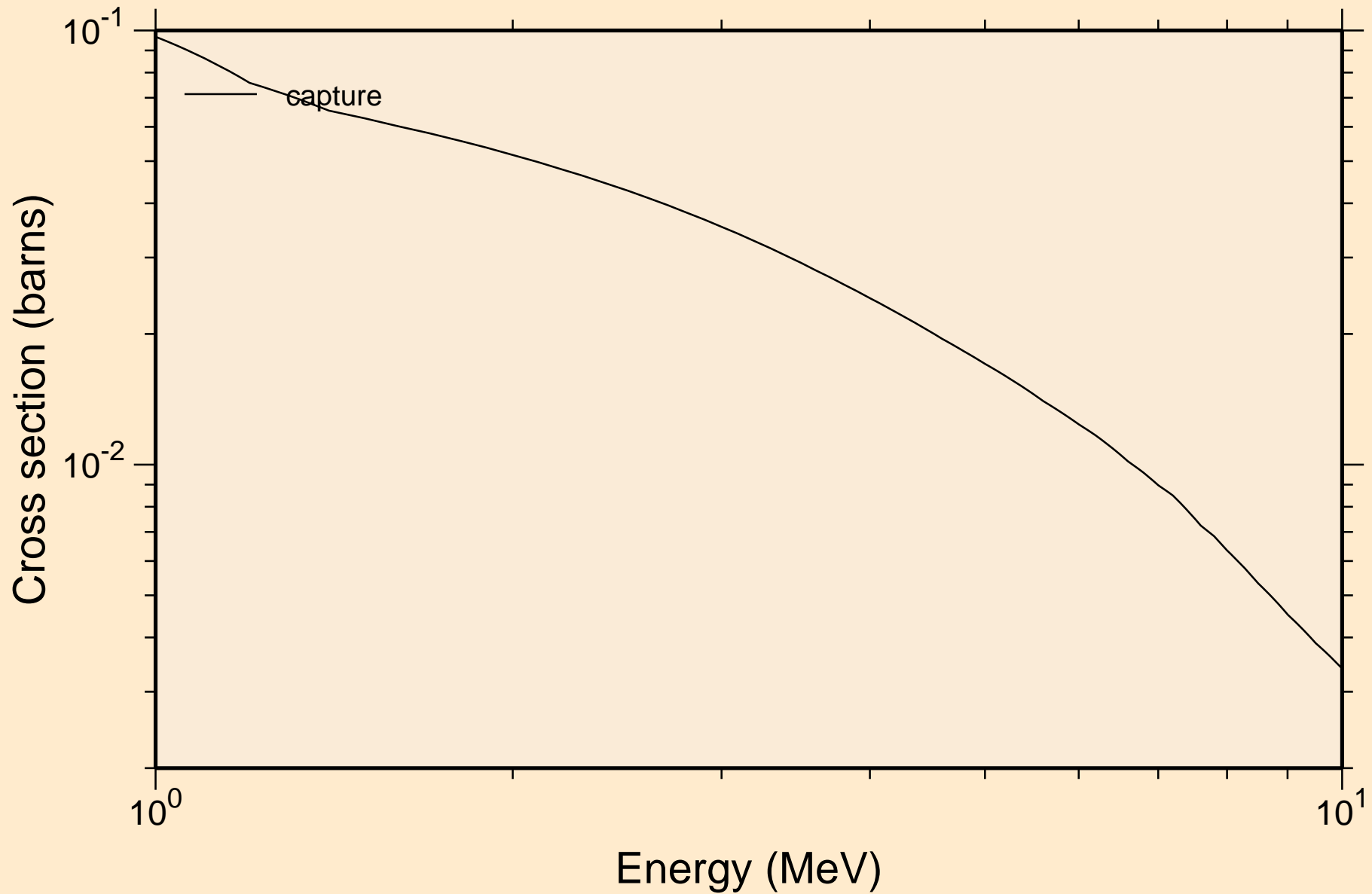

# Y085 NEUTRON ACER TENDL-2024 LIBRARY; T=293.6K

## Heating

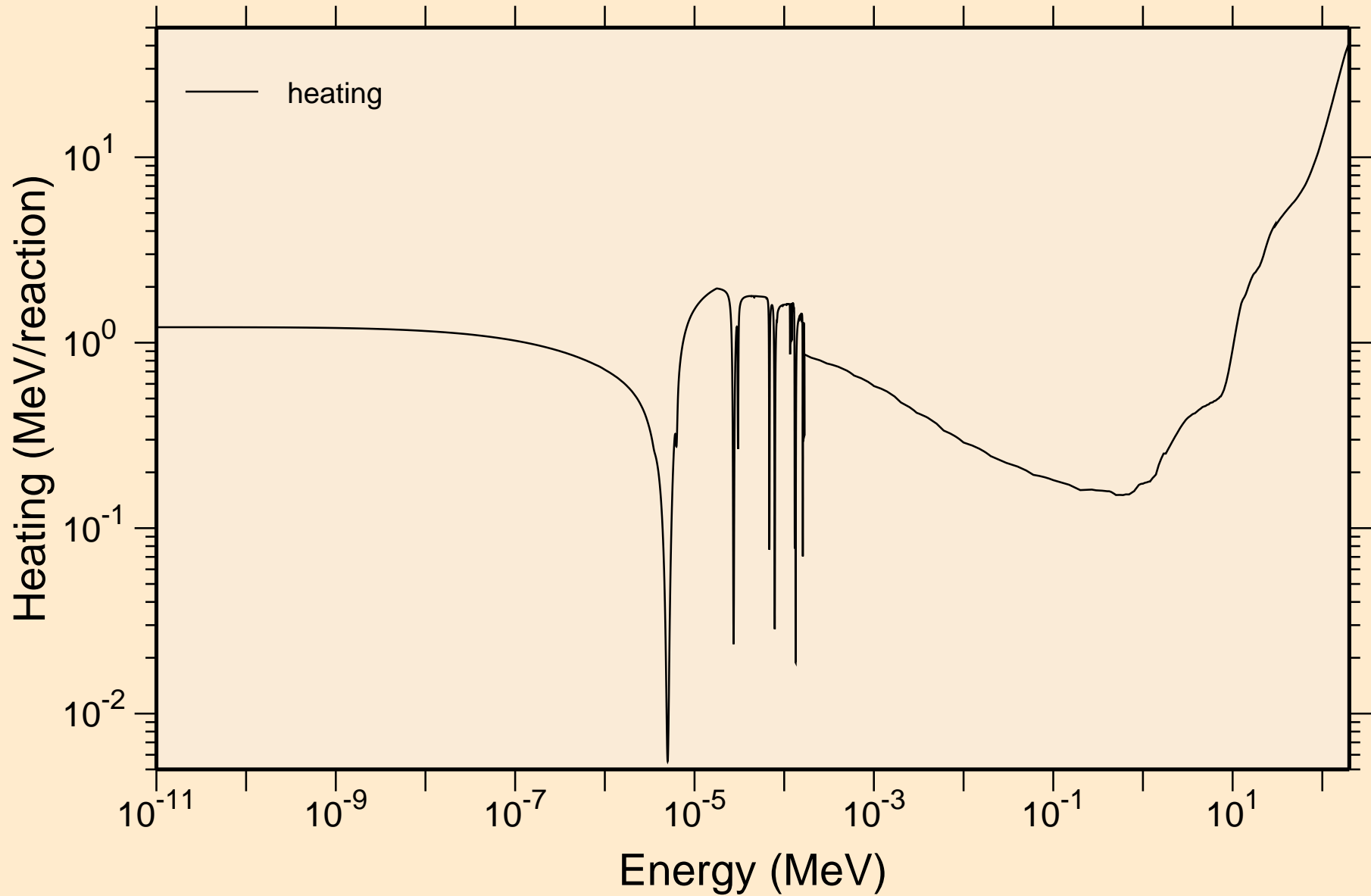

Y085 NEUTRON ACER TENDL-2024 LIBRARY; T=293.6K  
Damage

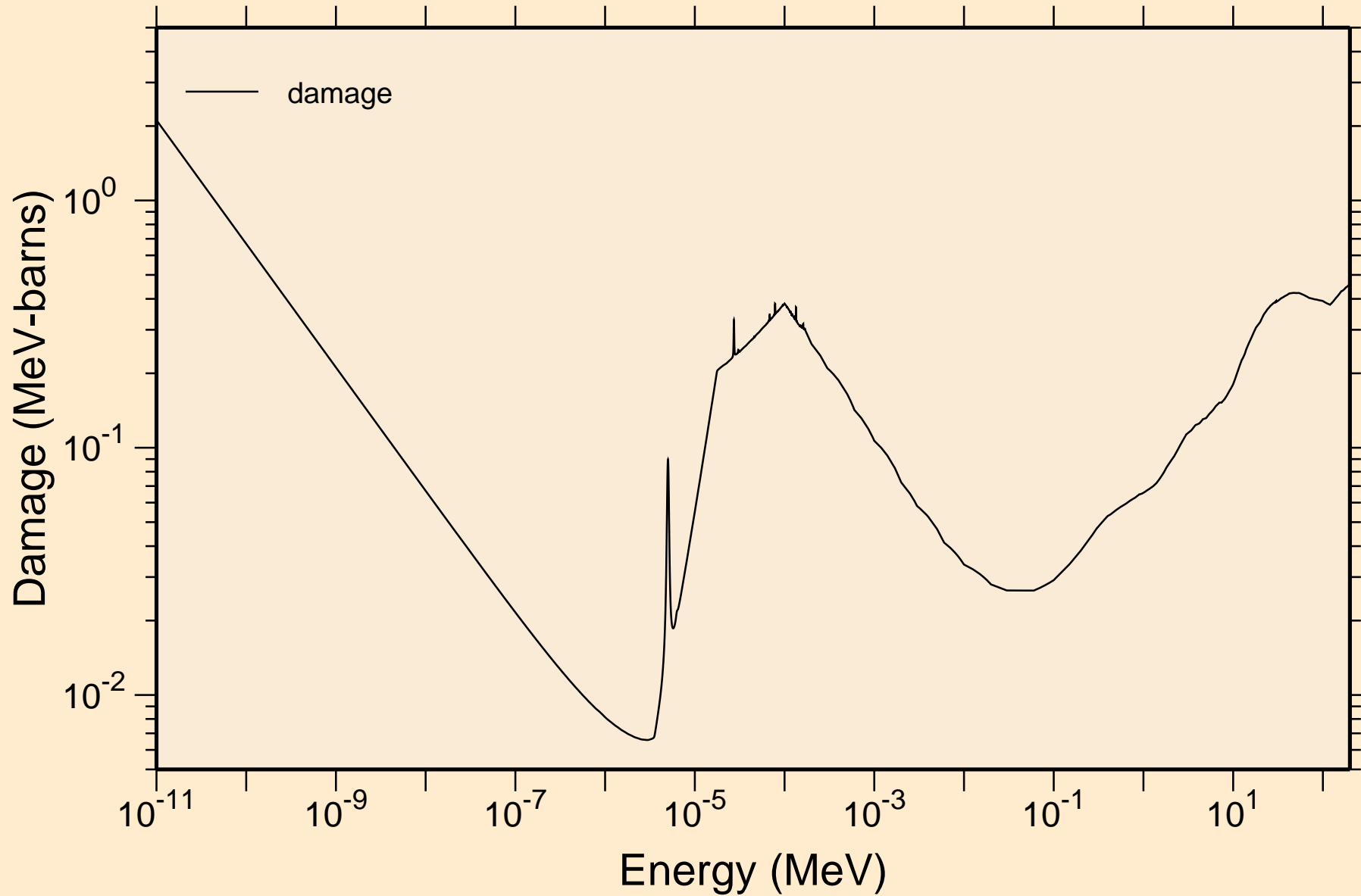

Y085 NEUTRON ACER TENDL-2024 LIBRARY; T=293.6K  
Non-threshold reactions

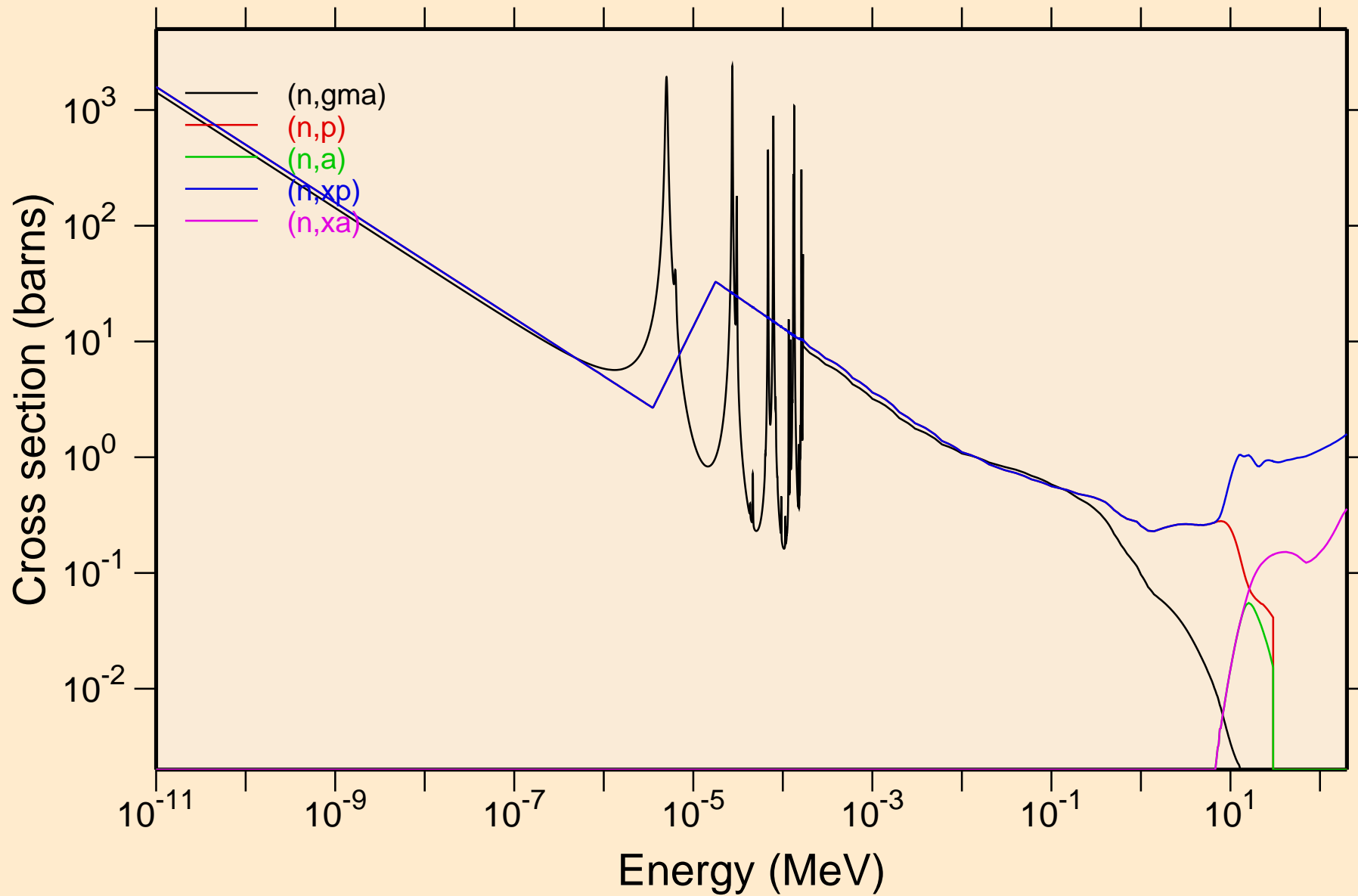

Y085 NEUTRON ACER TENDL-2024 LIBRARY; T=293.6K  
Principal cross sections

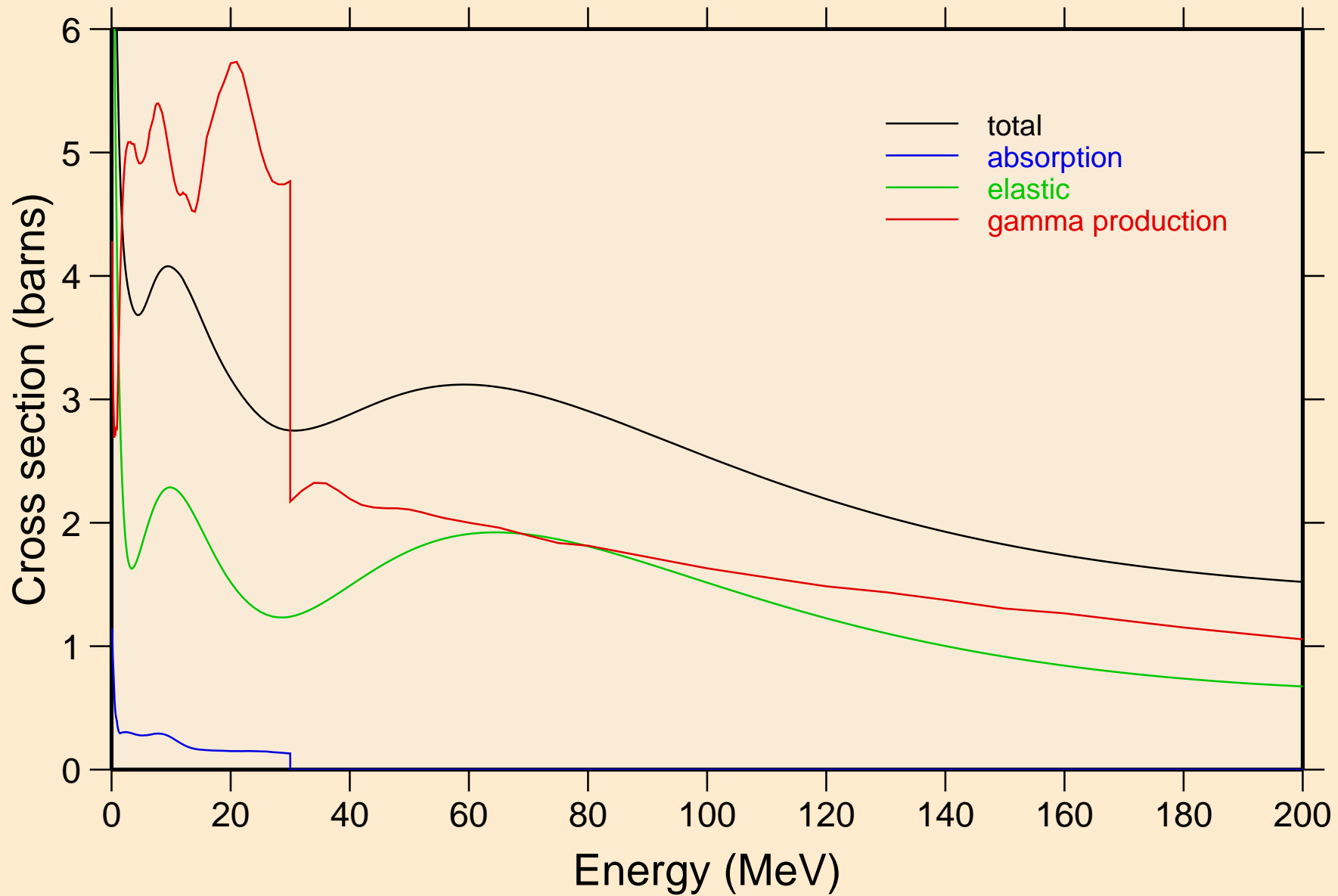

# Y085 NEUTRON ACER TENDL-2024 LIBRARY; T=293.6K

## Heating

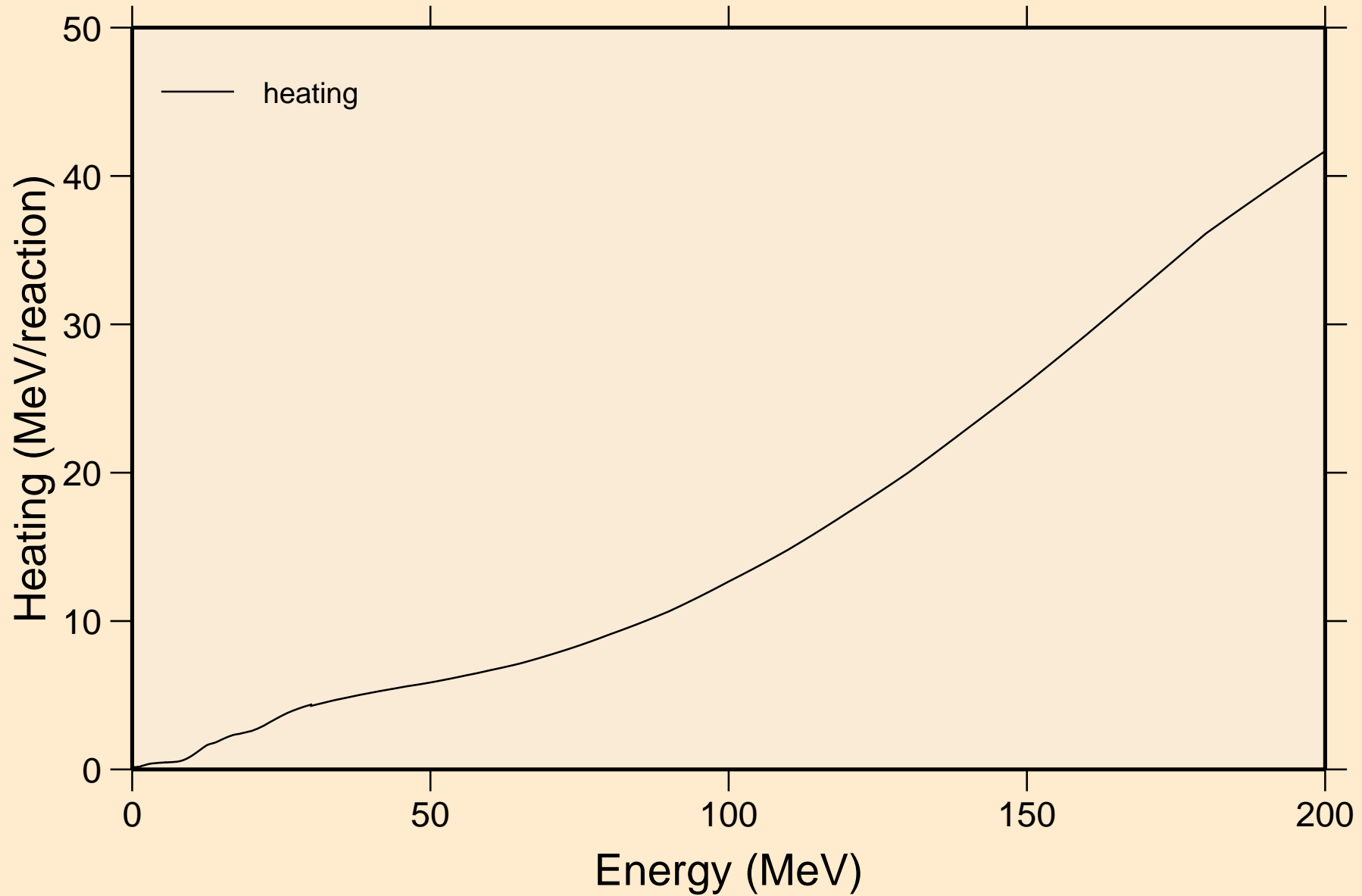

Y085 NEUTRON ACER TENDL-2024 LIBRARY; T=293.6K  
Damage

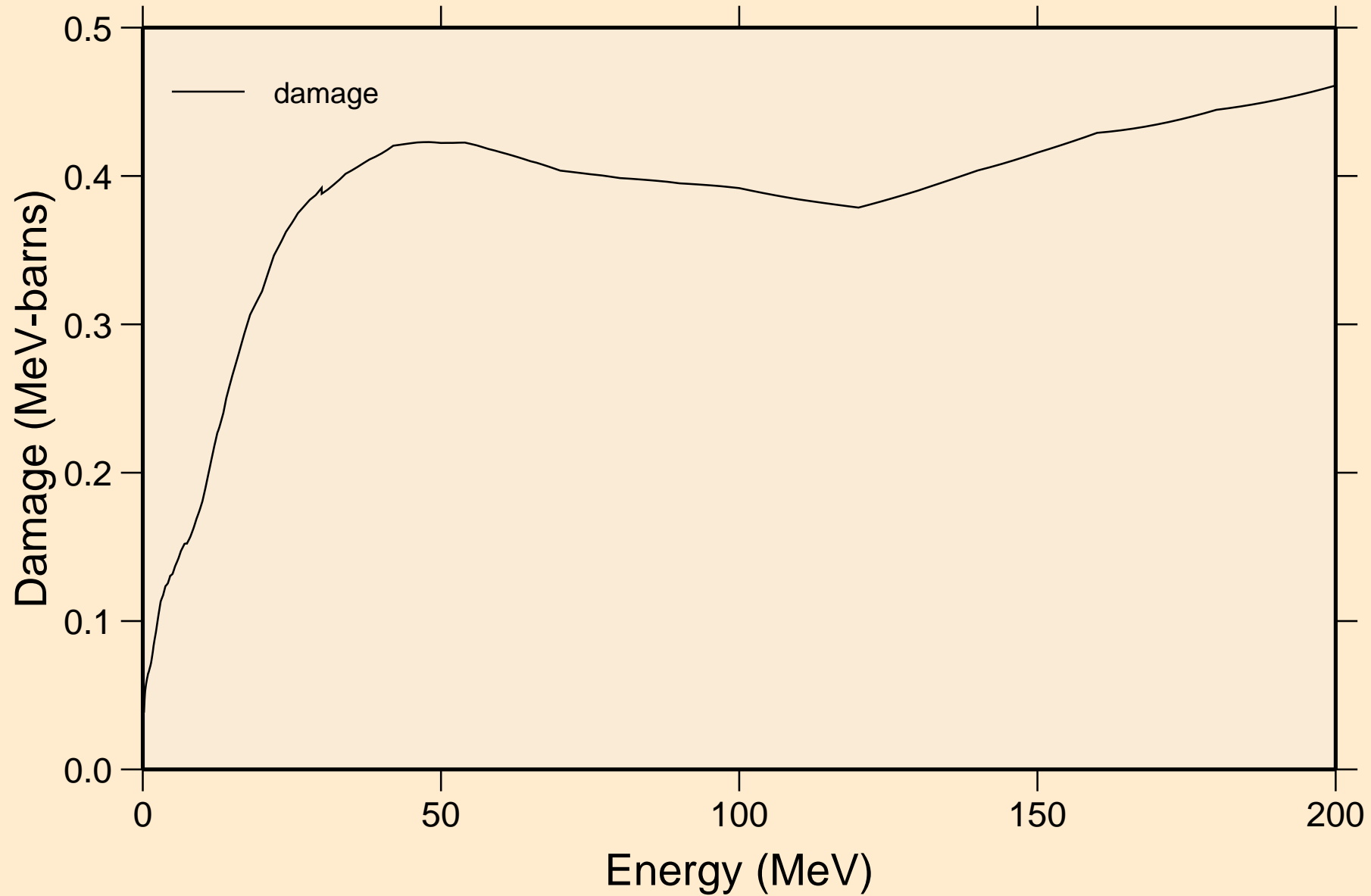

Y085 NEUTRON ACER TENDL-2024 LIBRARY; T=293.6K  
Non-threshold reactions

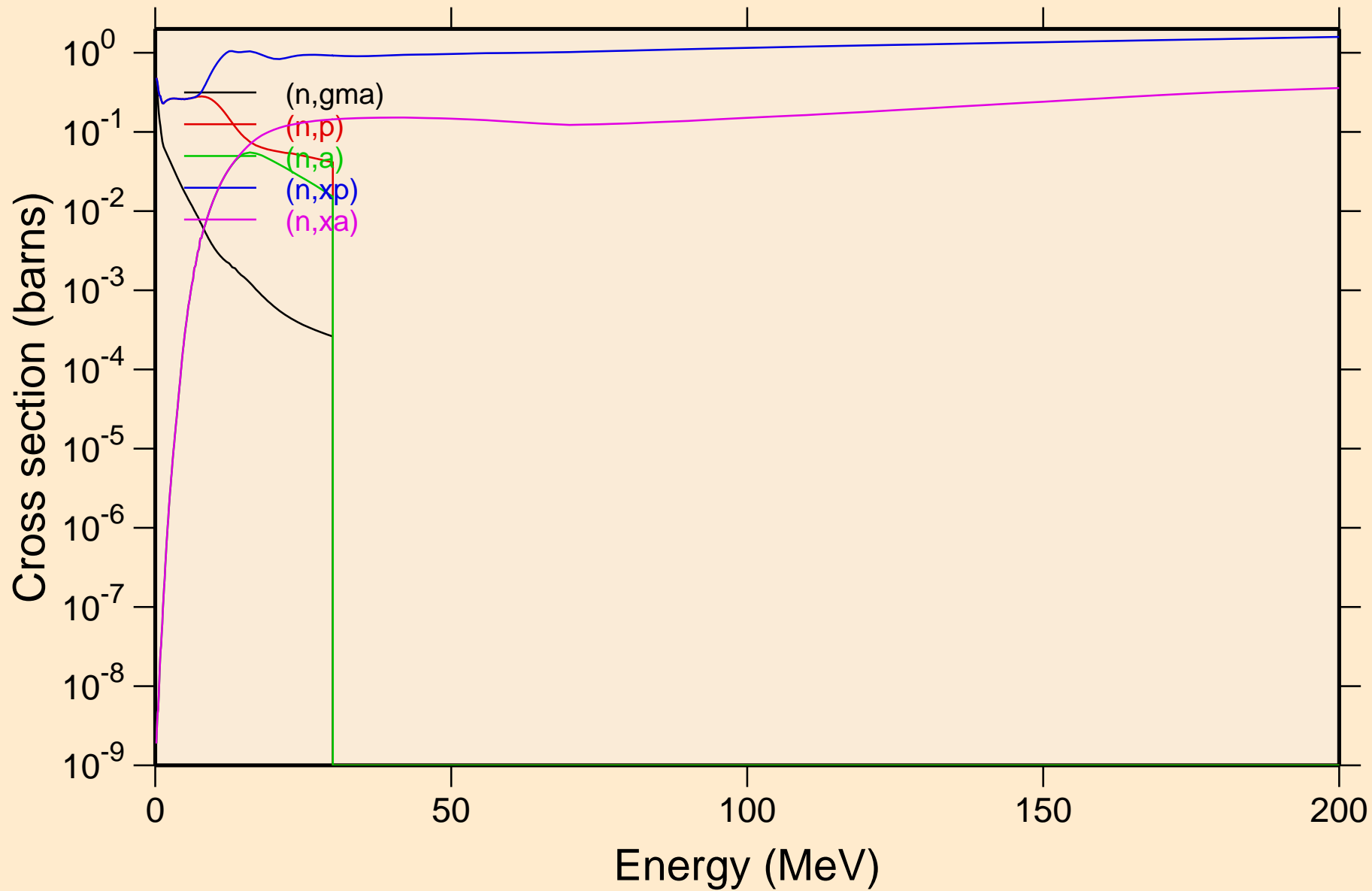

Y085 NEUTRON ACER TENDL-2024 LIBRARY; T=293.6K  
Inelastic levels

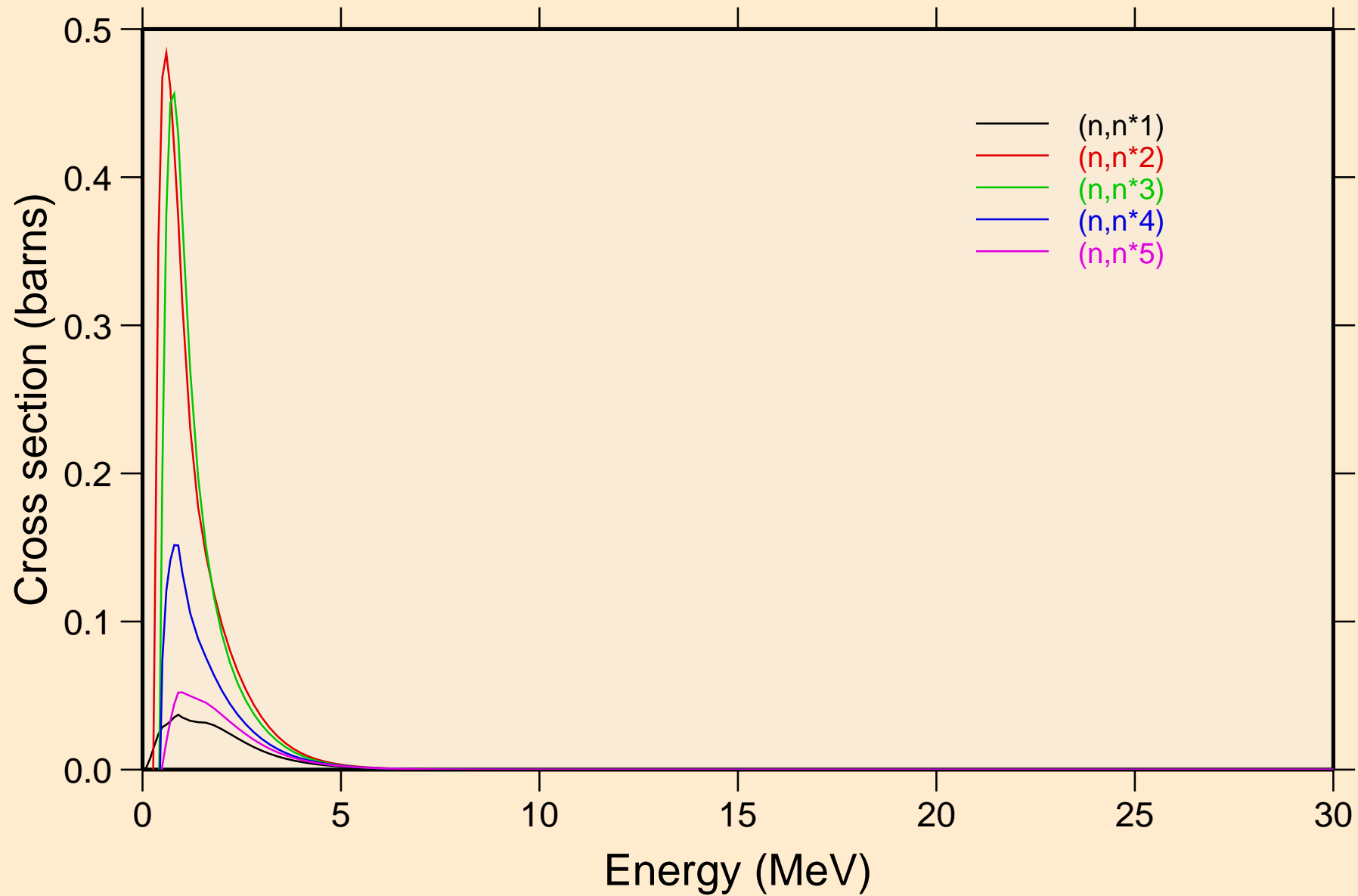

Y085 NEUTRON ACER TENDL-2024 LIBRARY; T=293.6K  
Inelastic levels

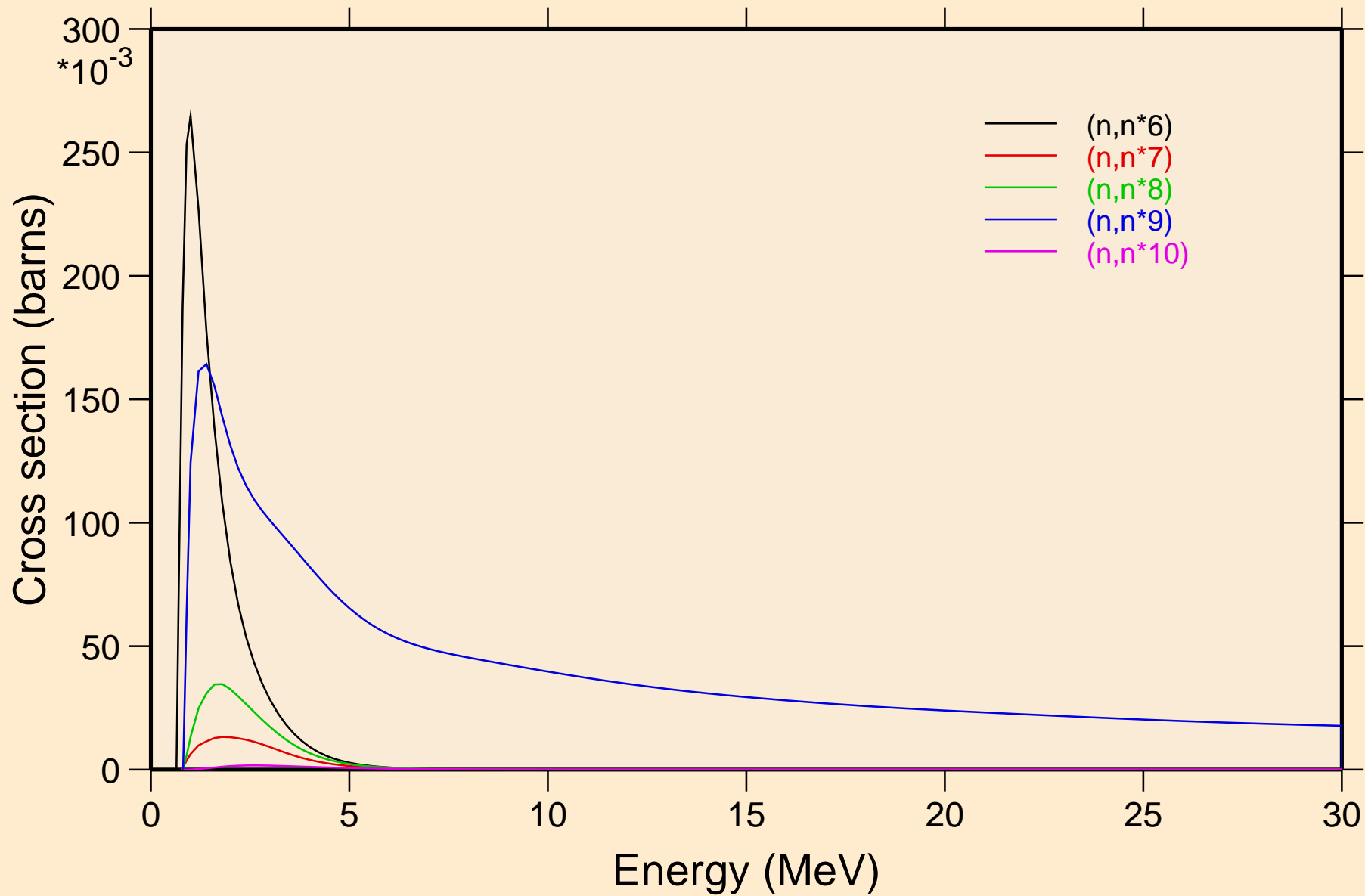

Y085 NEUTRON ACER TENDL-2024 LIBRARY; T=293.6K  
Inelastic levels

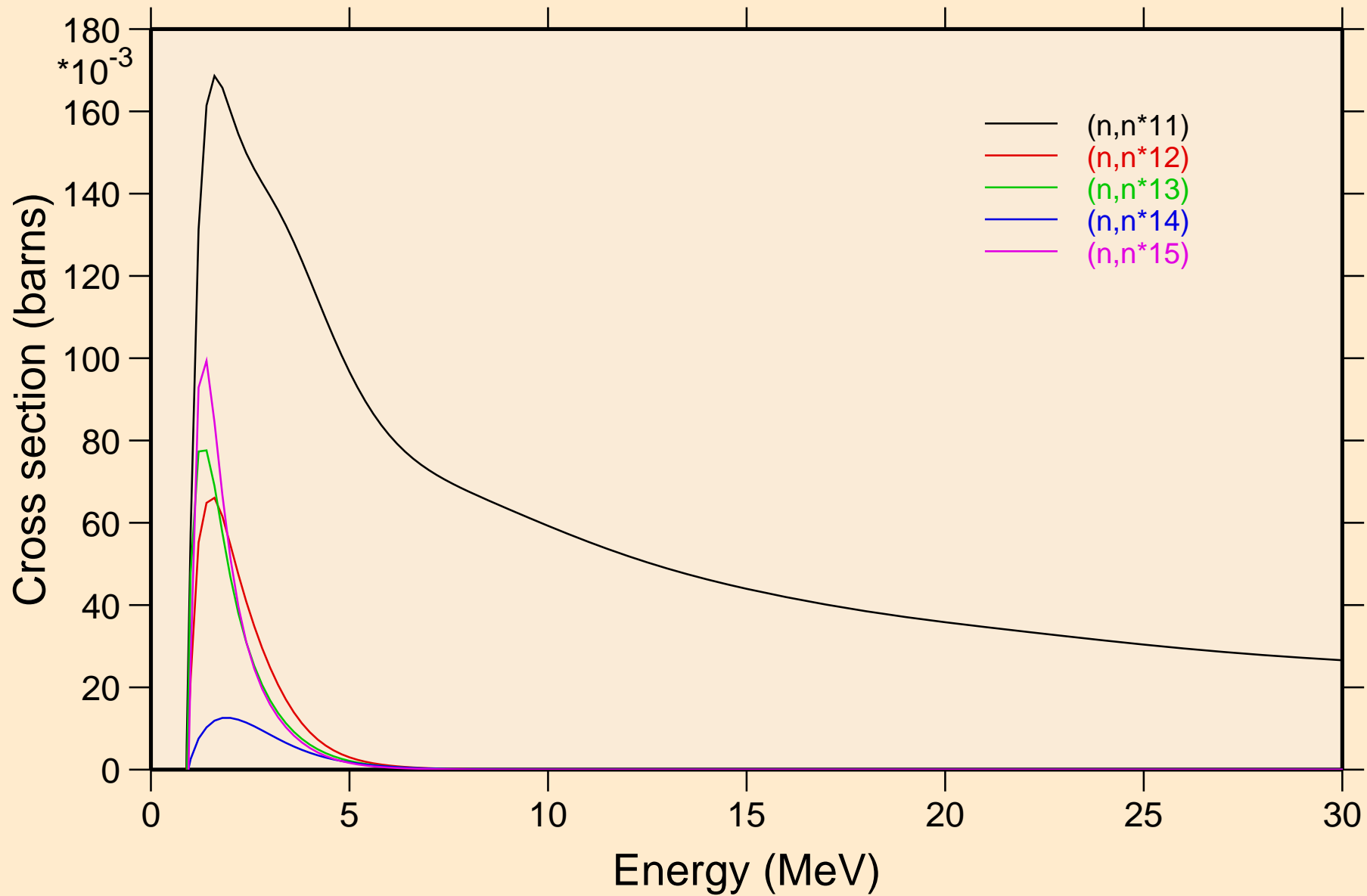

Y085 NEUTRON ACER TENDL-2024 LIBRARY; T=293.6K  
Inelastic levels

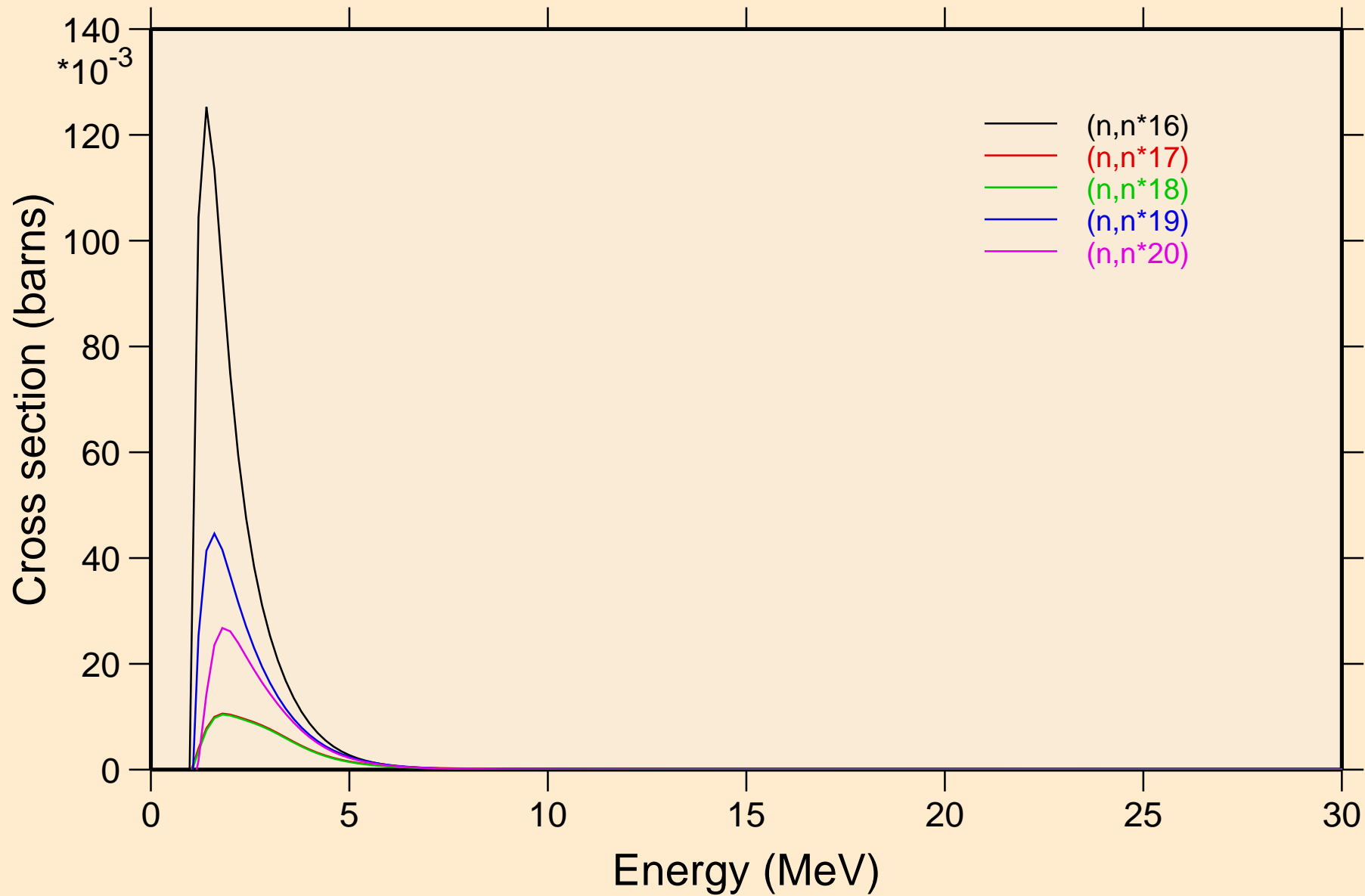

Y085 NEUTRON ACER TENDL-2024 LIBRARY; T=293.6K  
Inelastic levels

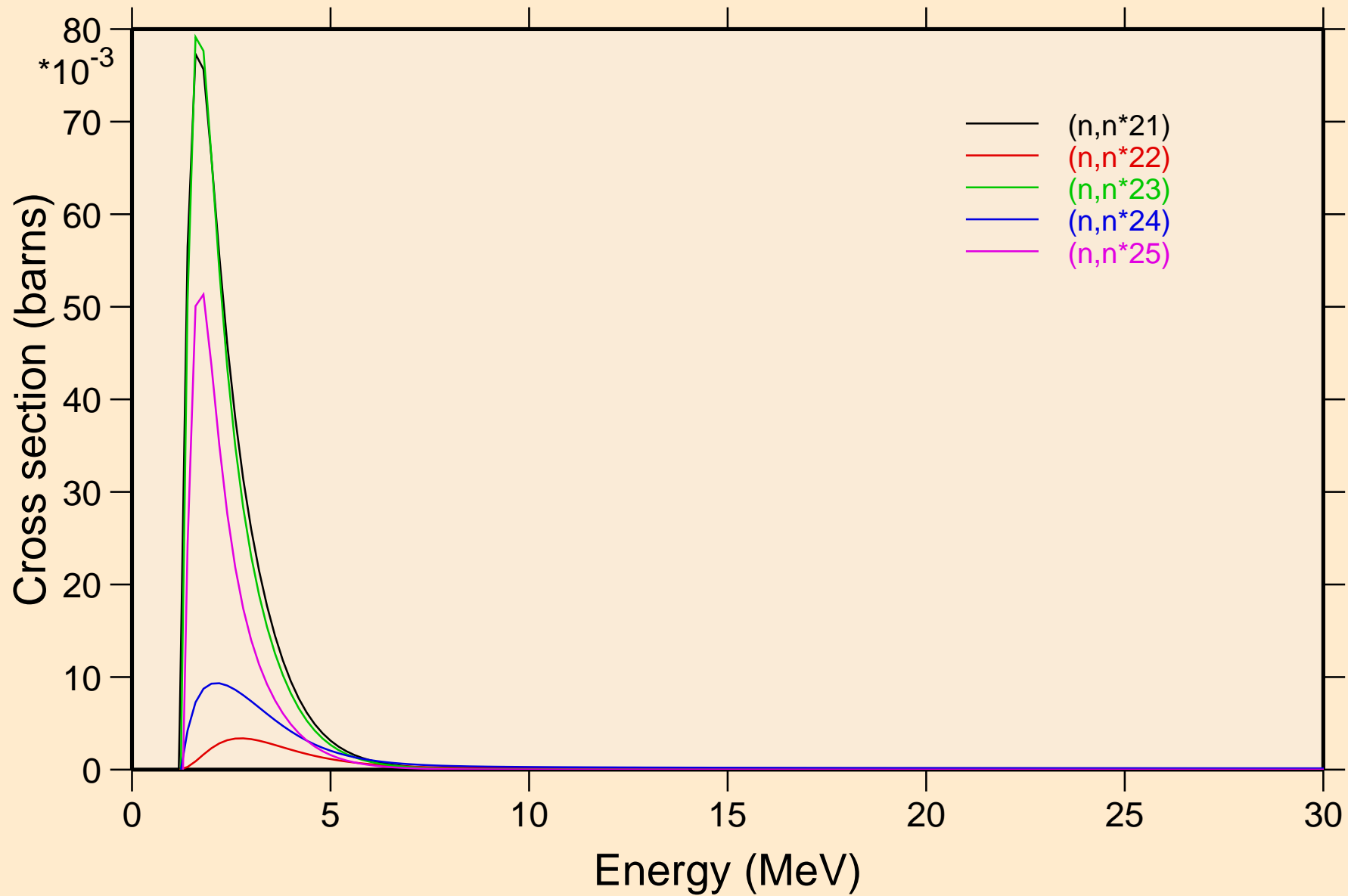

Y085 NEUTRON ACER TENDL-2024 LIBRARY; T=293.6K  
Inelastic levels

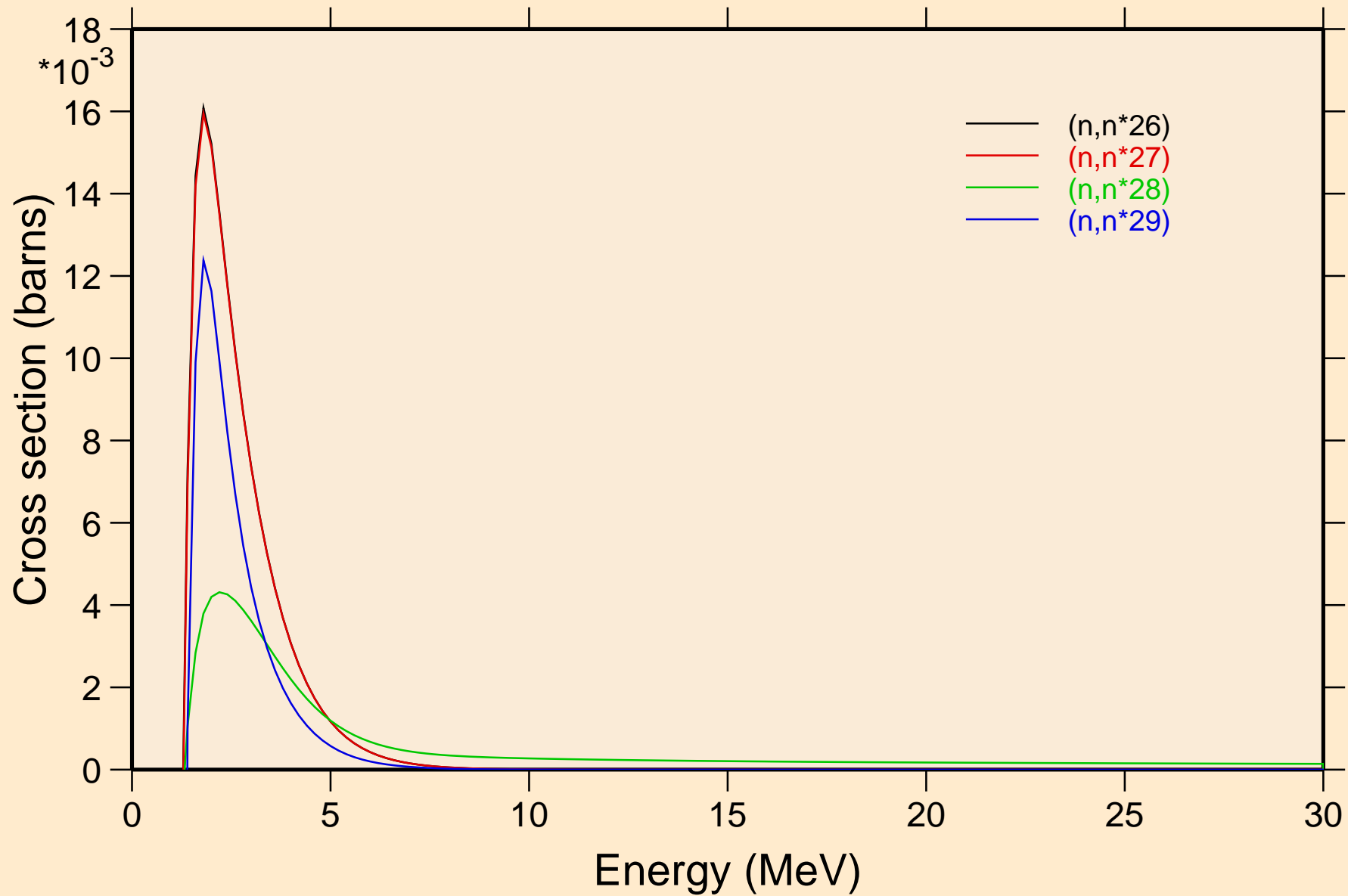

Y085 NEUTRON ACER TENDL-2024 LIBRARY; T=293.6K  
Threshold reactions

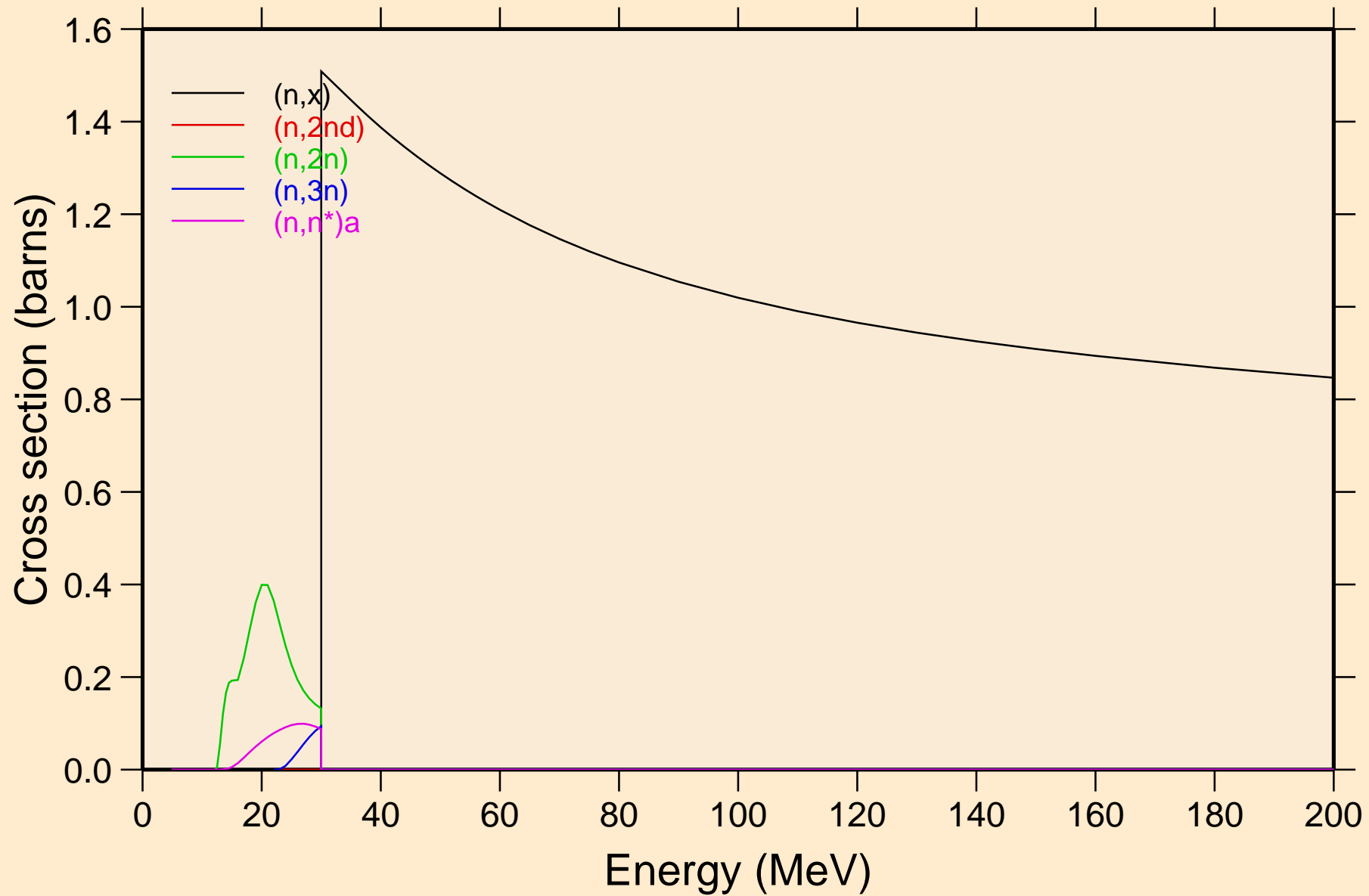

Y085 NEUTRON ACER TENDL-2024 LIBRARY; T=293.6K  
Threshold reactions

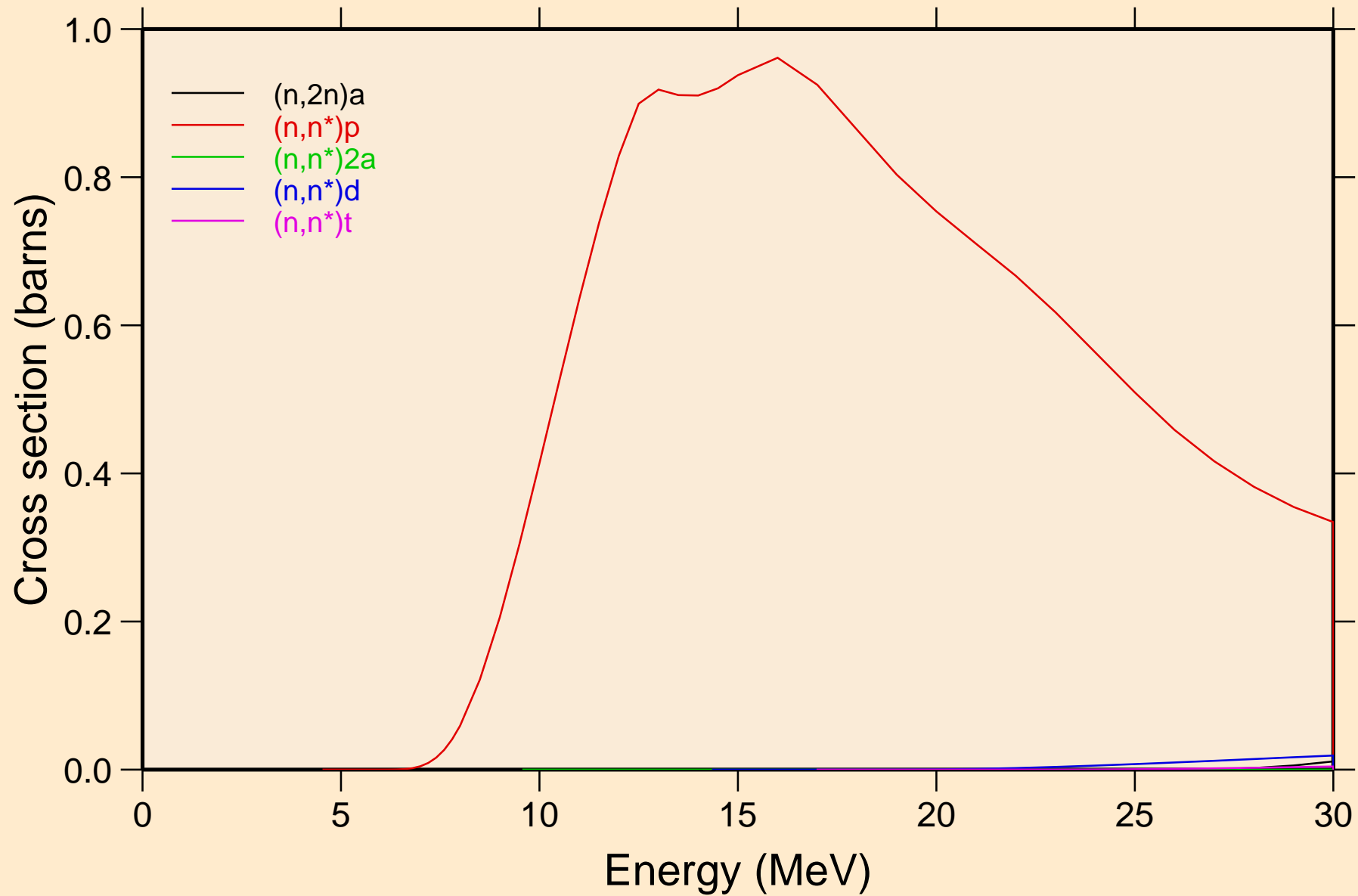

Y085 NEUTRON ACER TENDL-2024 LIBRARY; T=293.6K  
Threshold reactions

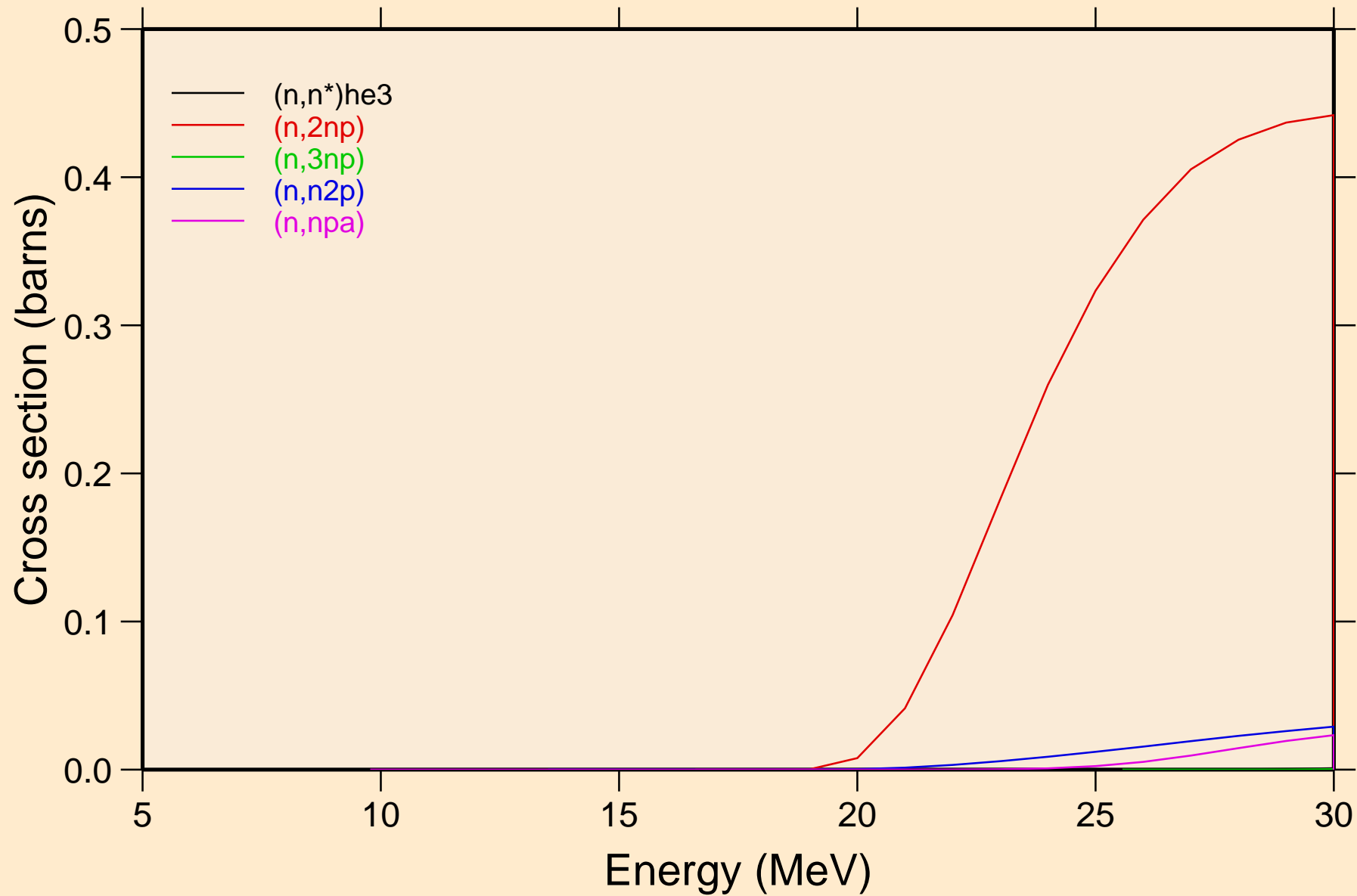

Y085 NEUTRON ACER TENDL-2024 LIBRARY; T=293.6K  
Threshold reactions

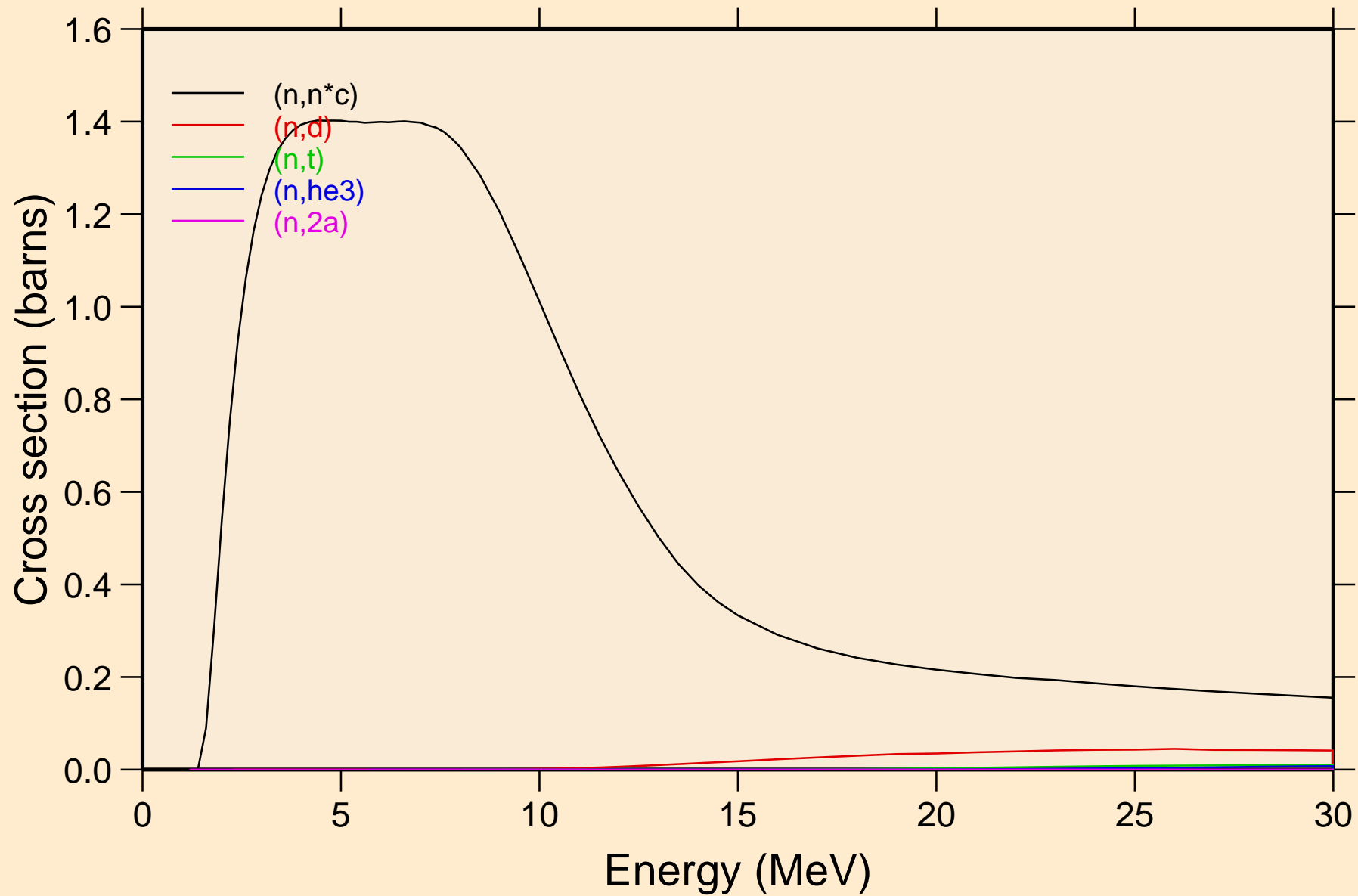

Y085 NEUTRON ACER TENDL-2024 LIBRARY; T=293.6K  
Threshold reactions

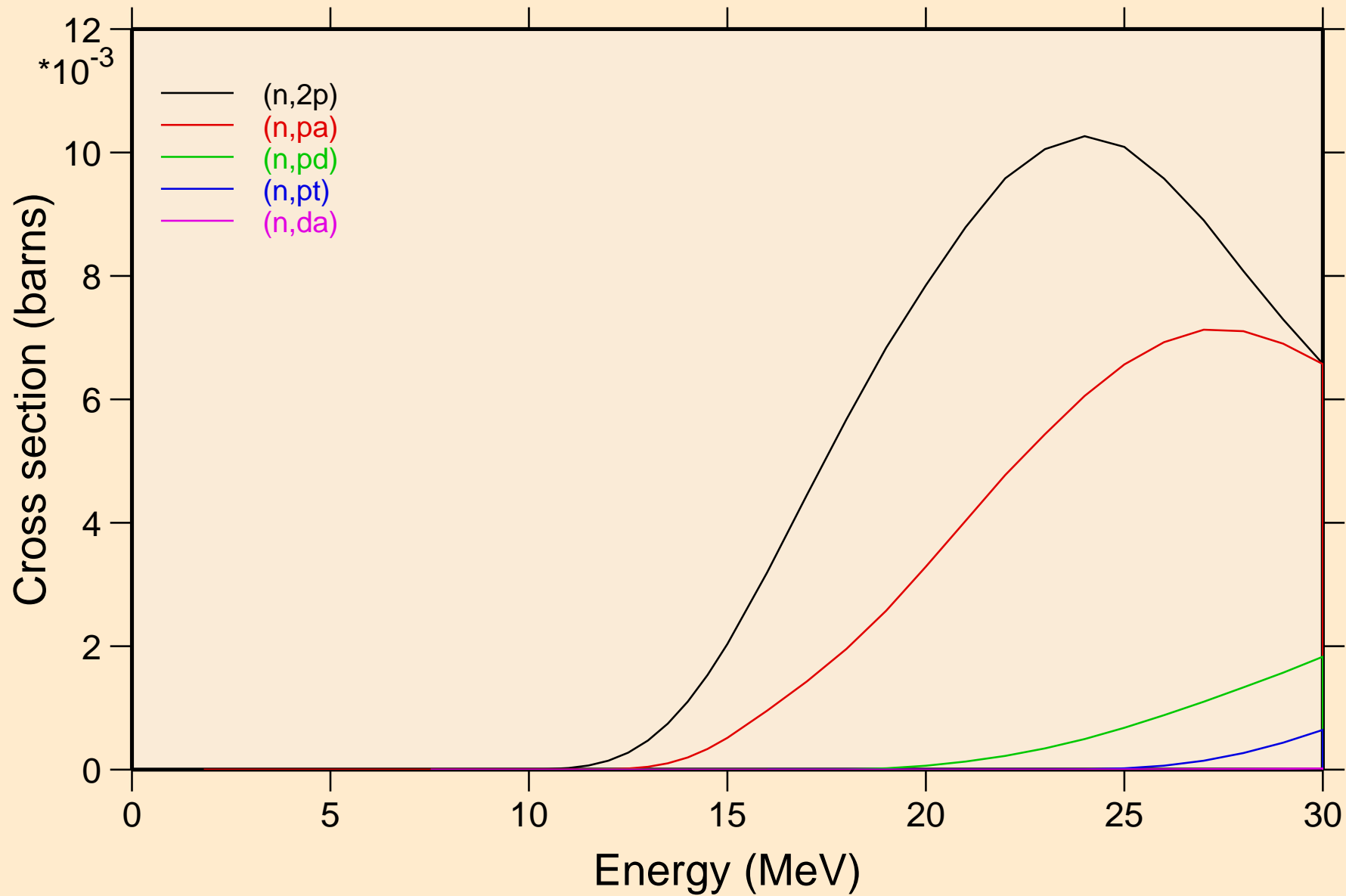

Y085 NEUTRON ACER TENDL-2024 LIBRARY; T=293.6K  
Threshold reactions

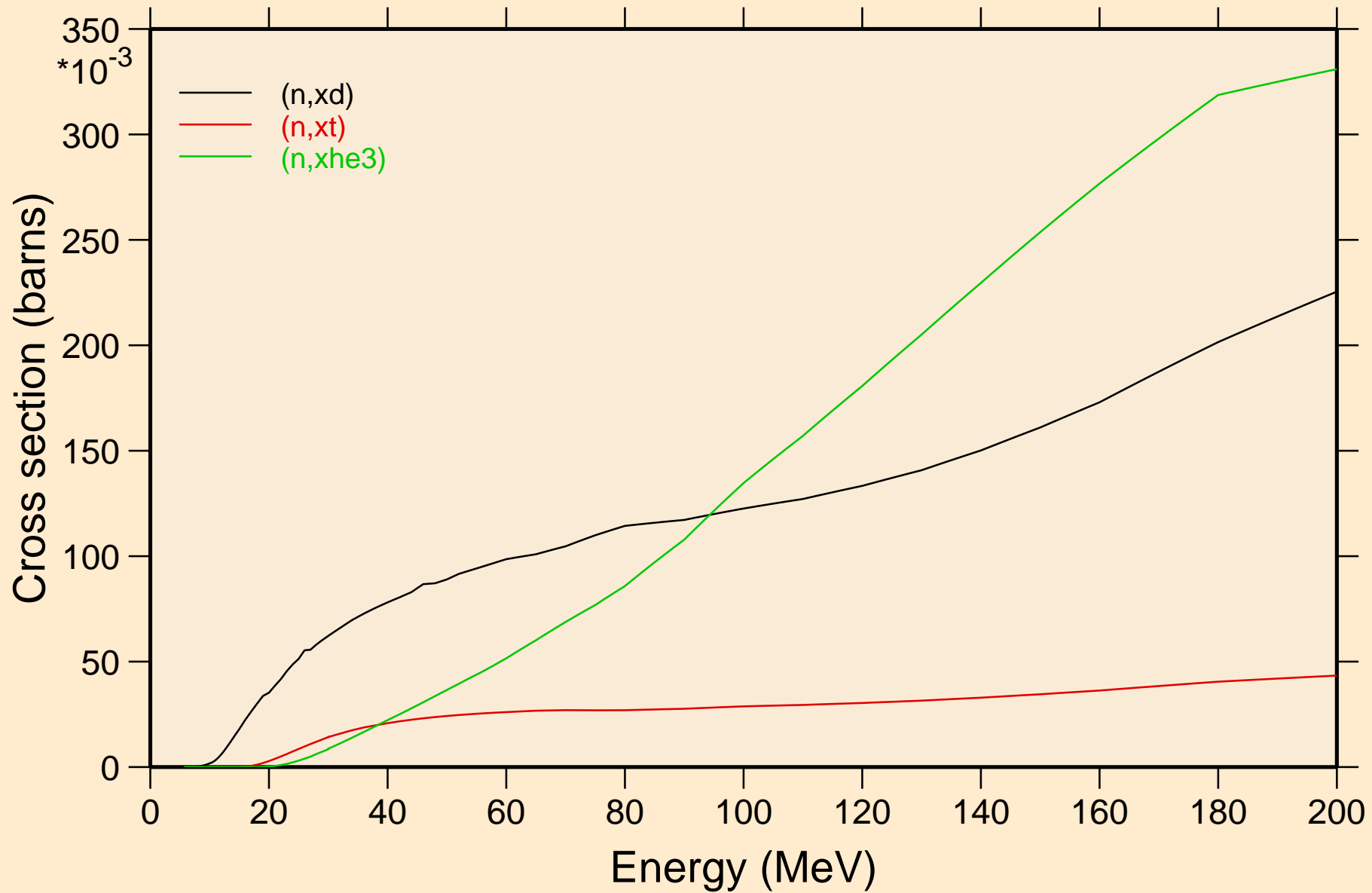

Y085 NEUTRON ACER TENDL-2024 LIBRARY; T=293.6K  
angular distribution for elastic

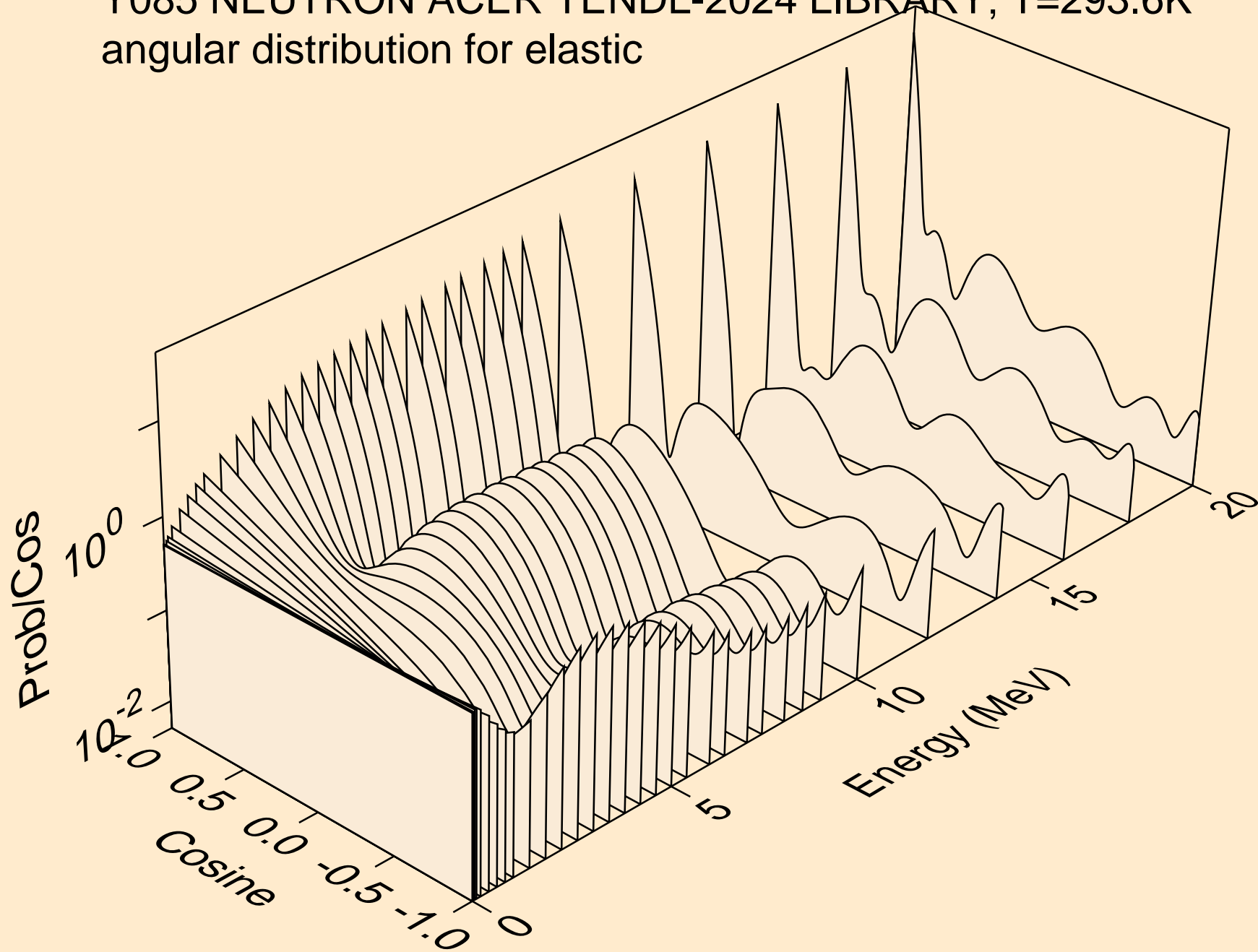

Y085 NEUTRON ACER TENDL-2024 LIBRARY; T=293.6K  
angular distribution for elastic

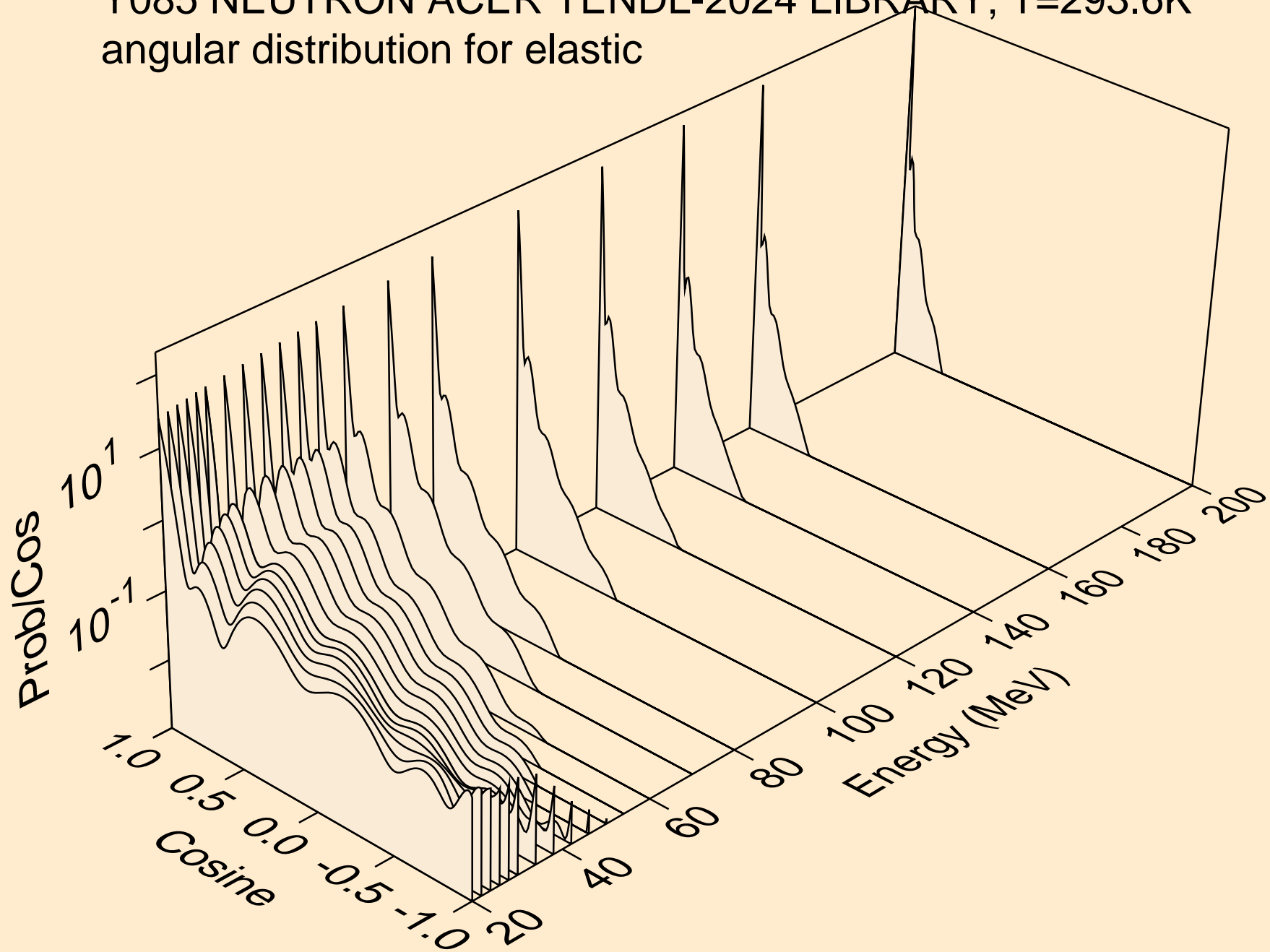

Y085 NEUTRON ACER TENDL-2024 LIBRARY; T=293.6K  
angular distribution for (n,n\*1)

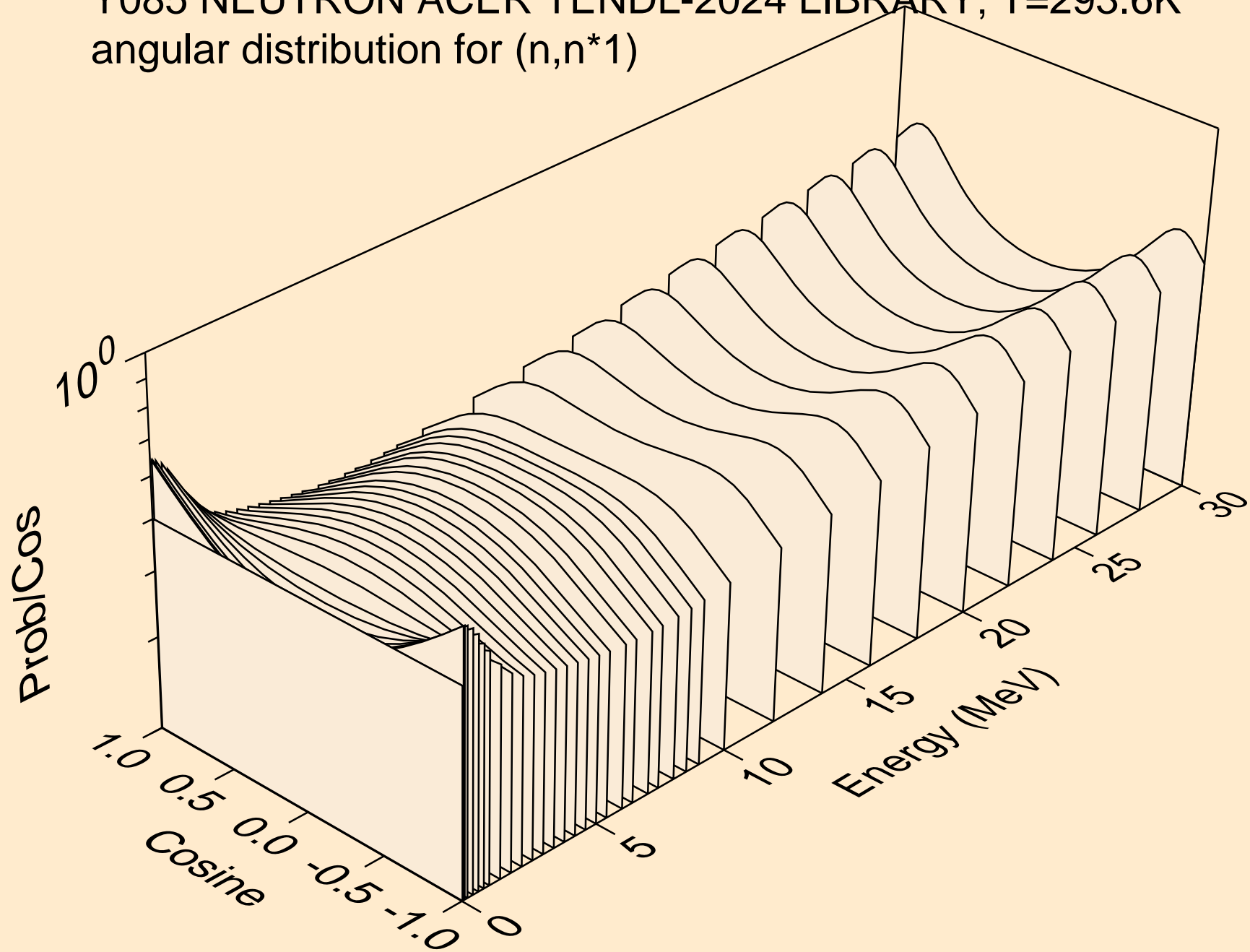

Y085 NEUTRON ACER TENDL-2024 LIBRARY; T=293.6K  
angular distribution for (n,n\*2)

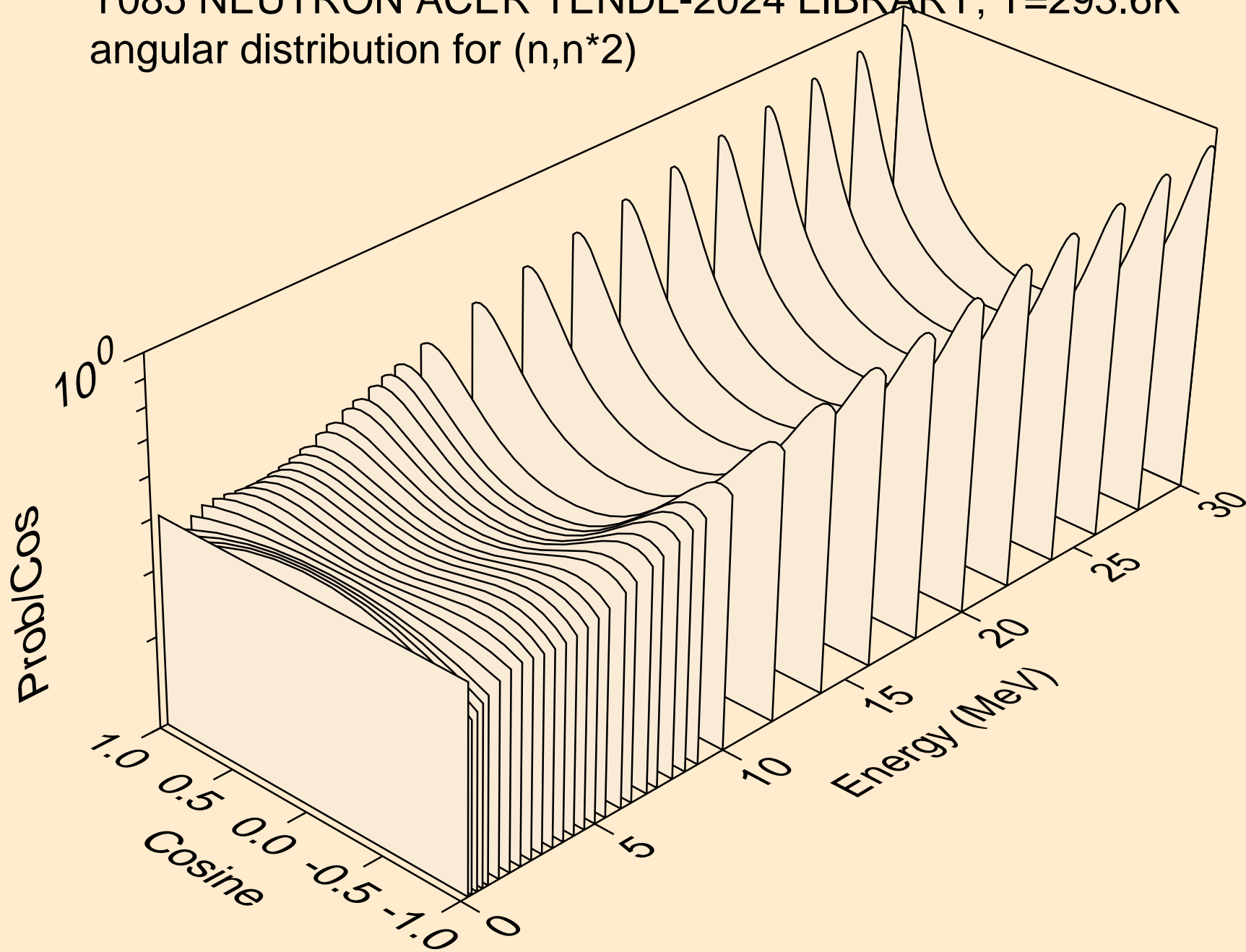

Y085 NEUTRON ACER TENDL-2024 LIBRARY; T=293.6K  
angular distribution for (n,n\*3)

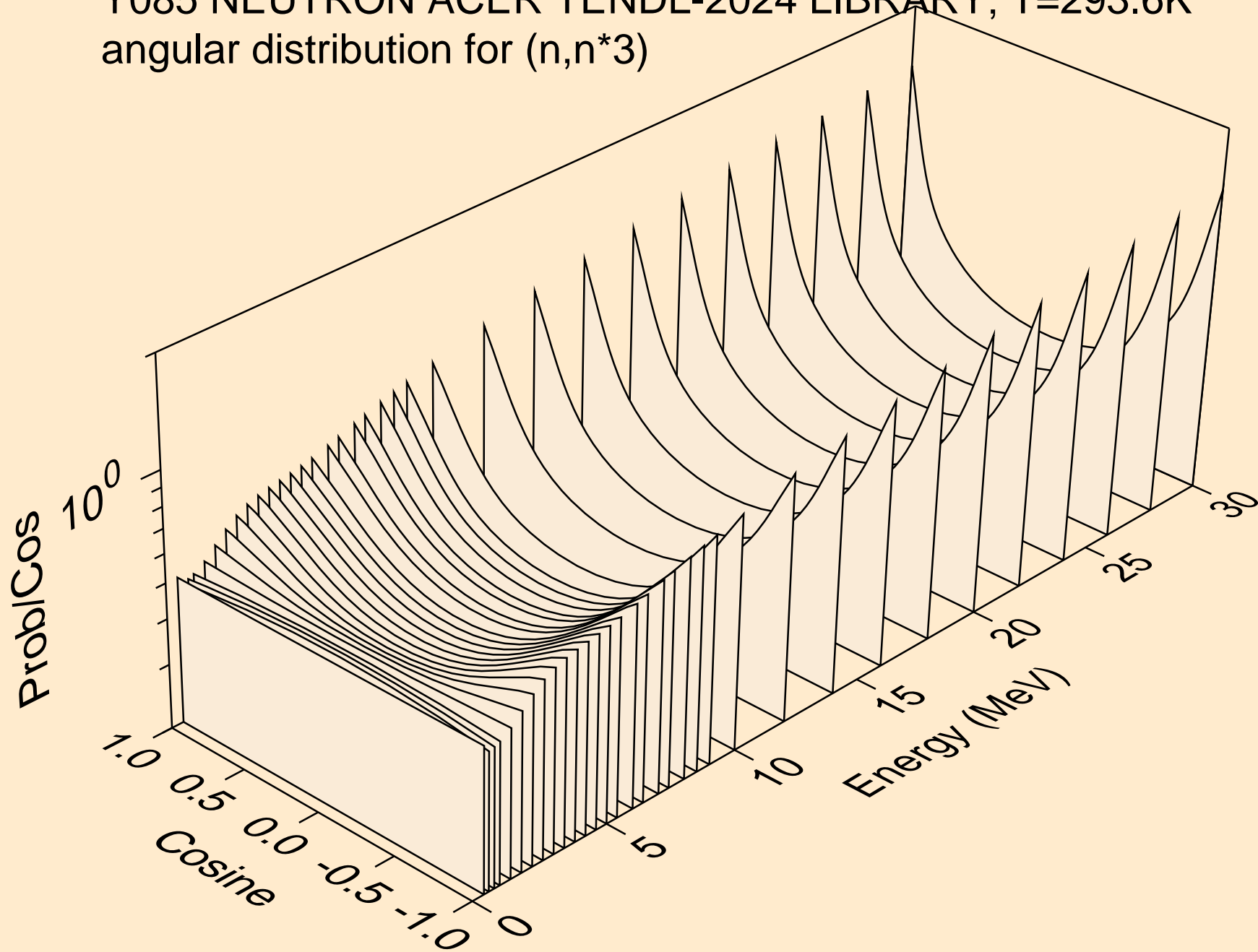

Y085 NEUTRON ACER TENDL-2024 LIBRARY; T=293.6K  
angular distribution for (n,n\*4)

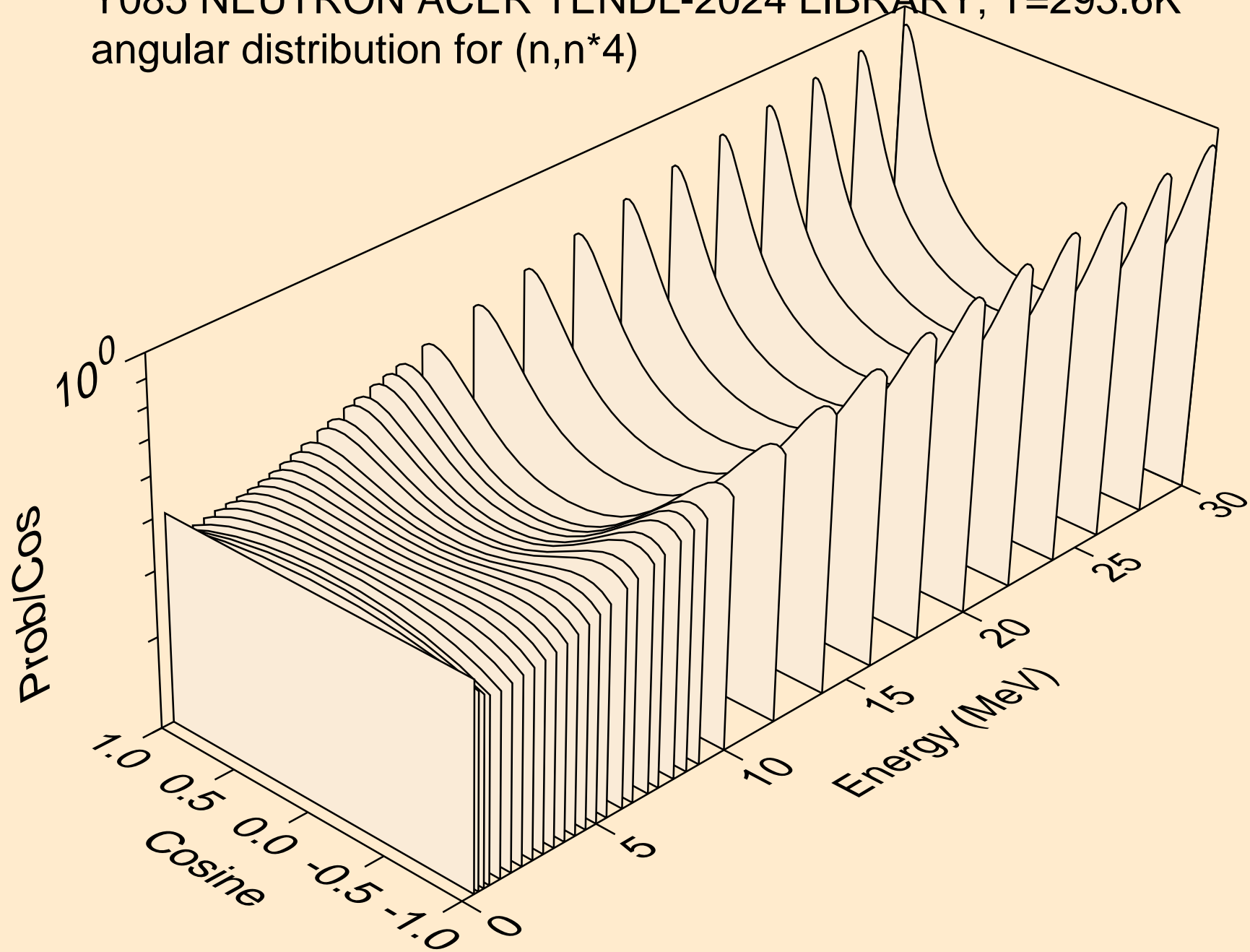

Y085 NEUTRON ACER TENDL-2024 LIBRARY; T=293.6K  
angular distribution for (n,n\*5)

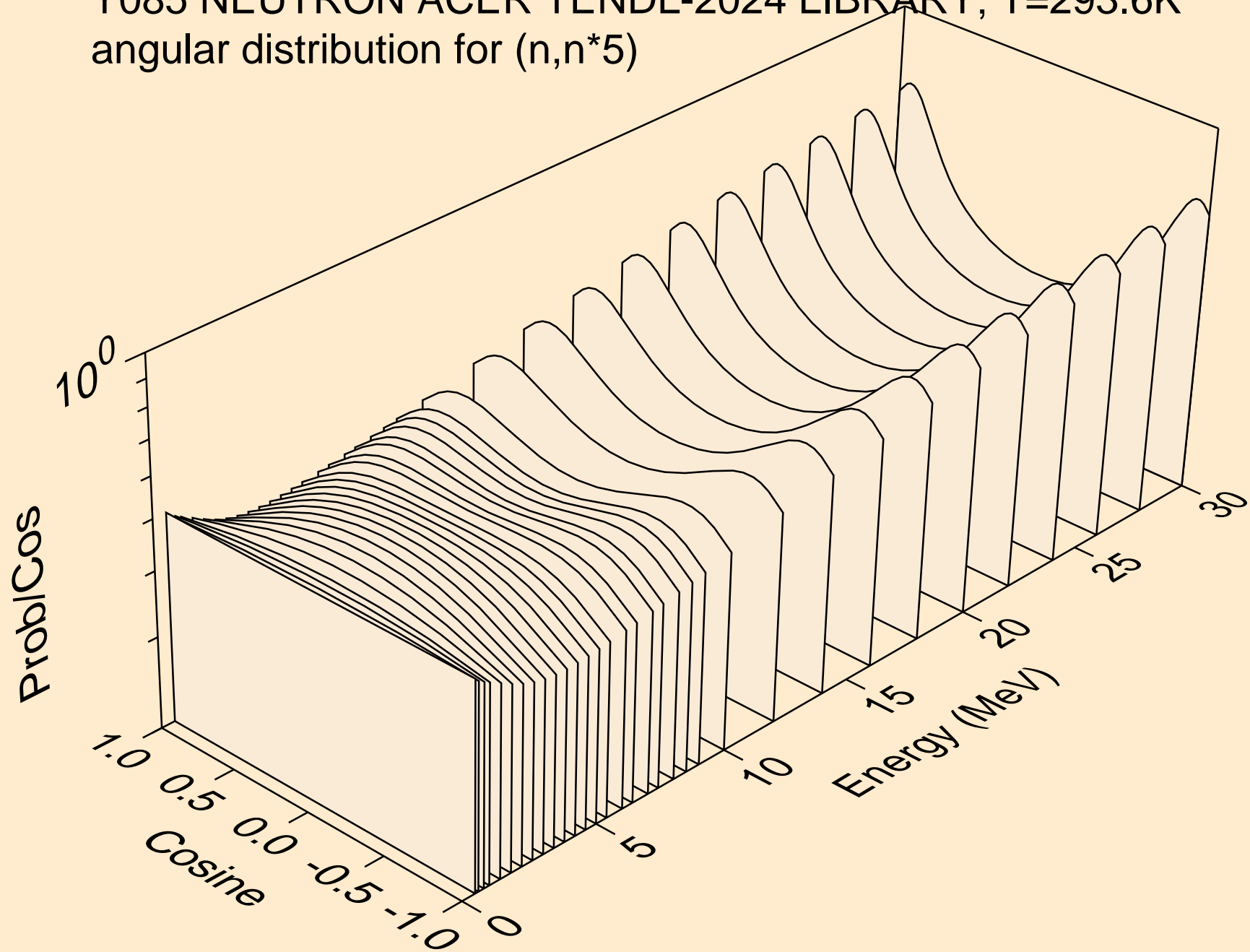

Y085 NEUTRON ACER TENDL-2024 LIBRARY; T=293.6K  
angular distribution for (n,n\*6)

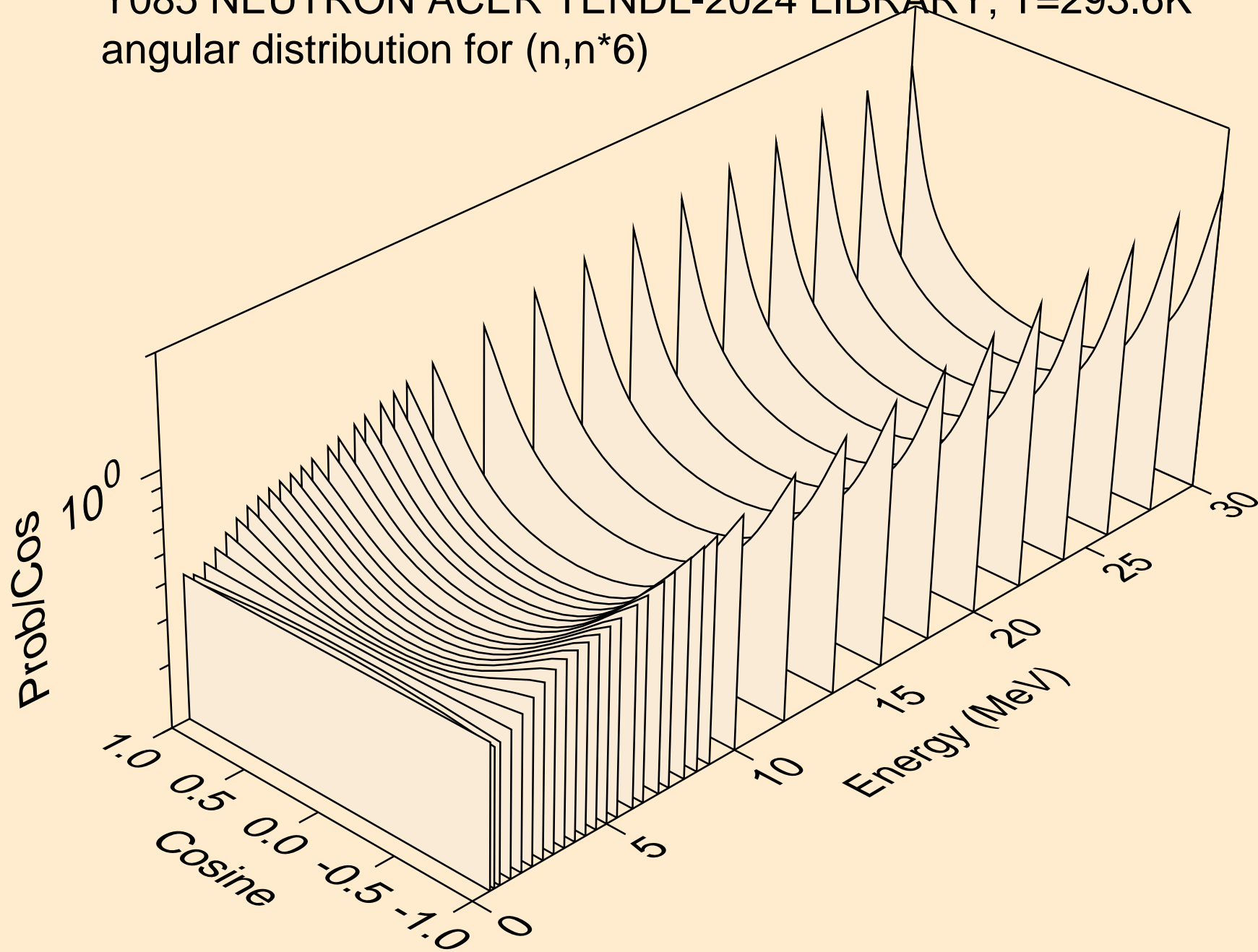

Y085 NEUTRON ACER TENDL-2024 LIBRARY; T=293.6K  
angular distribution for (n,n\*7)

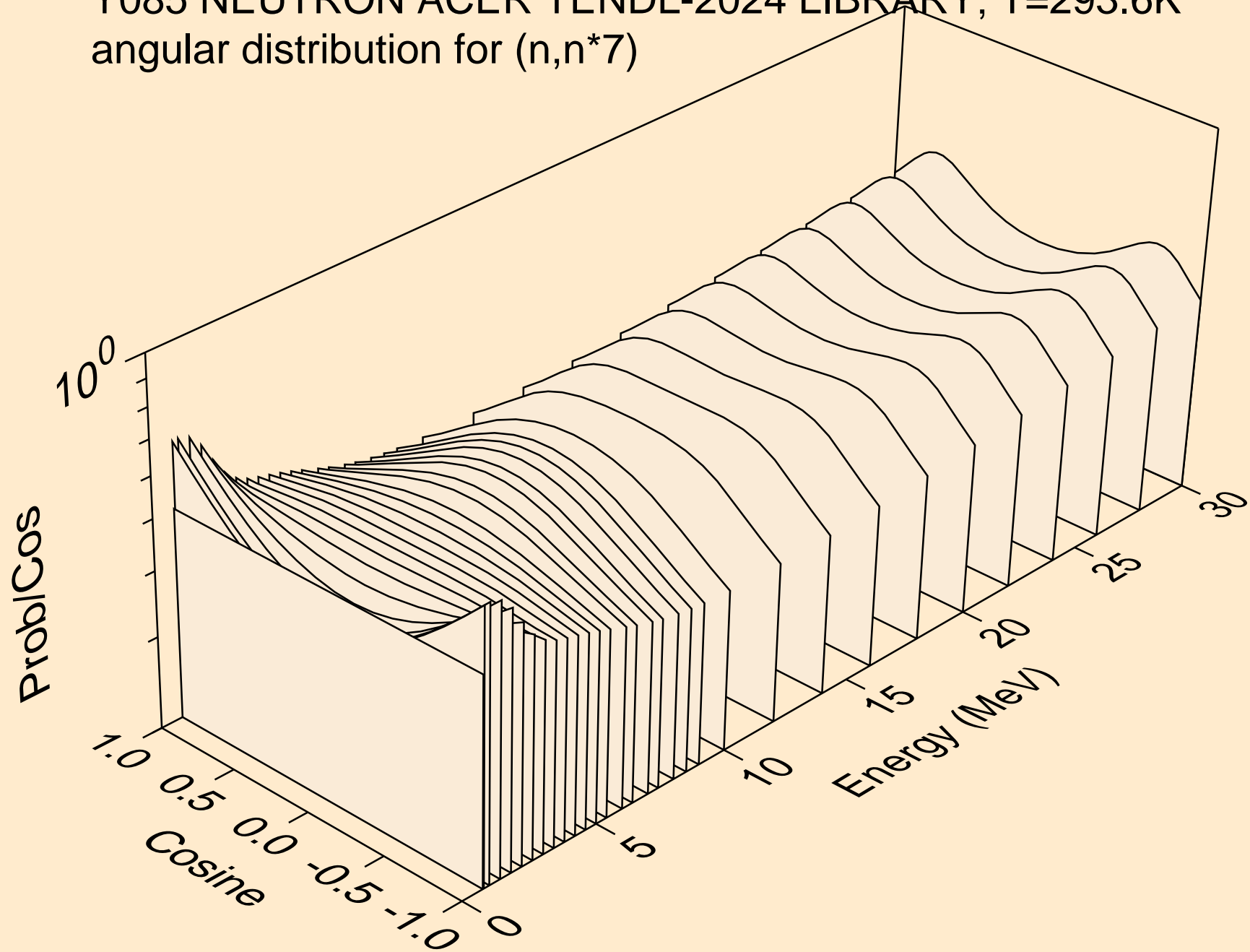

Y085 NEUTRON ACER TENDL-2024 LIBRARY; T=293.6K  
angular distribution for (n,n\*8)

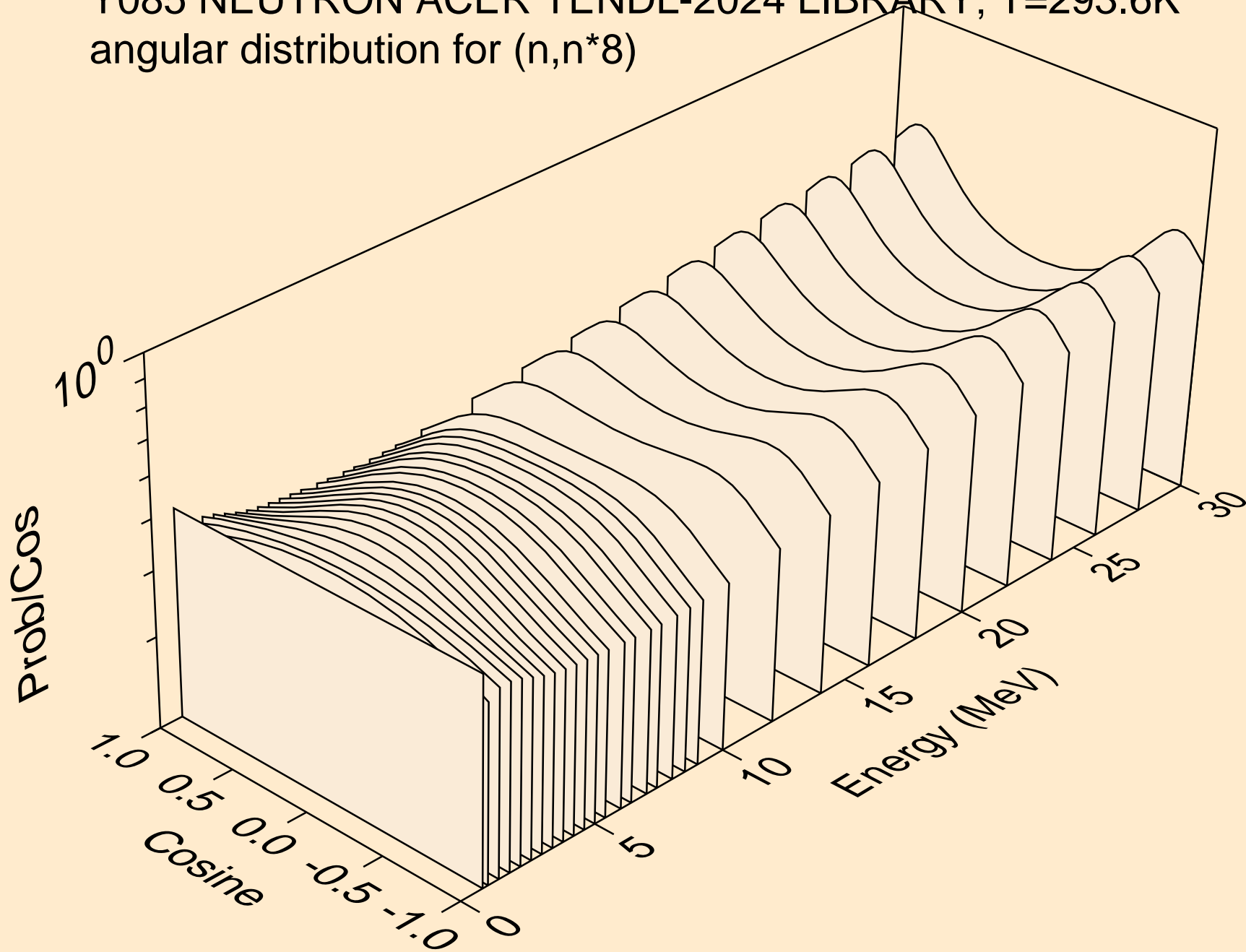

Y085 NEUTRON ACER TENDL-2024 LIBRARY; T=293.6K  
angular distribution for (n,n\*9)

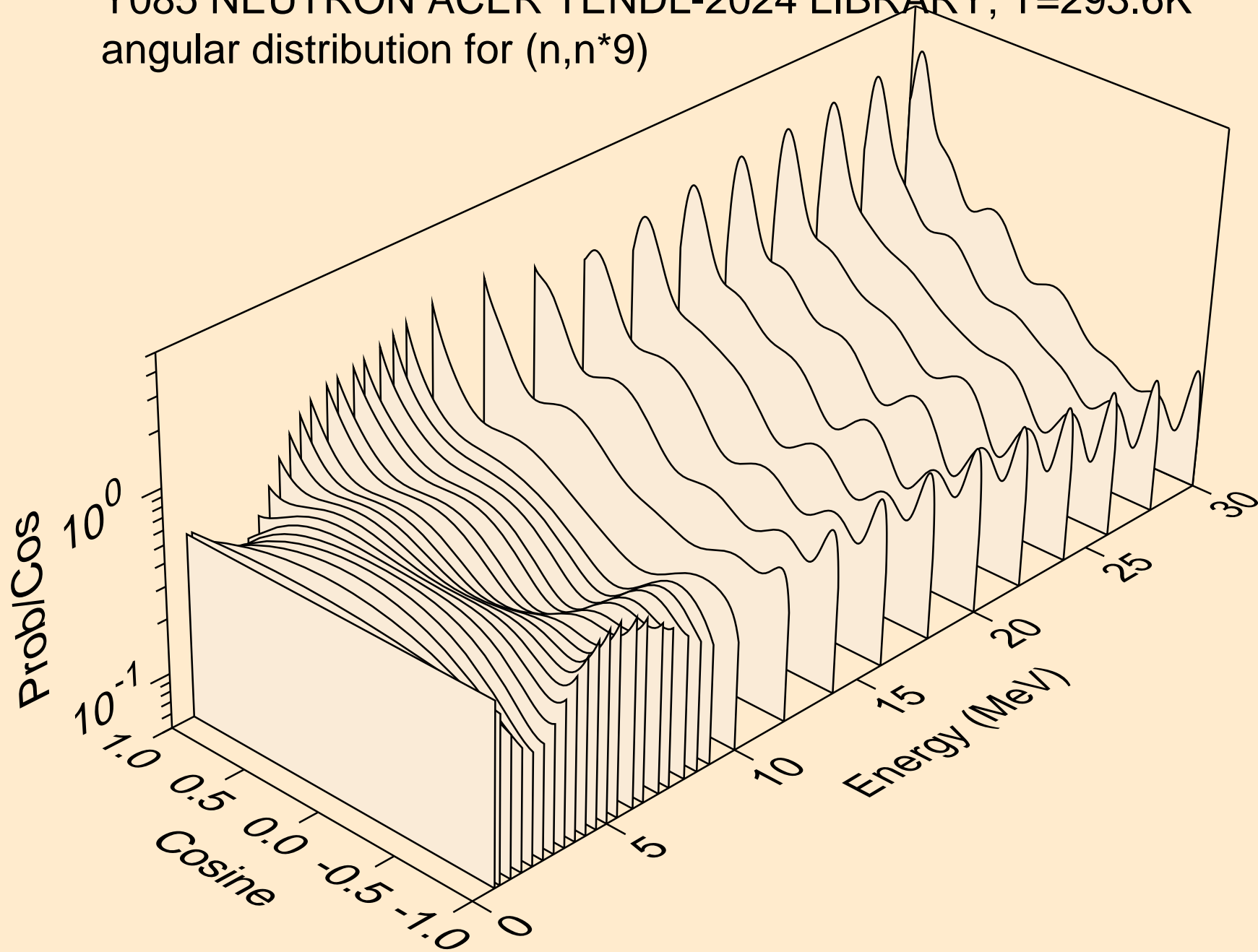

Y085 NEUTRON ACER TENDL-2024 LIBRARY; T=293.6K  
angular distribution for (n,n\*10)

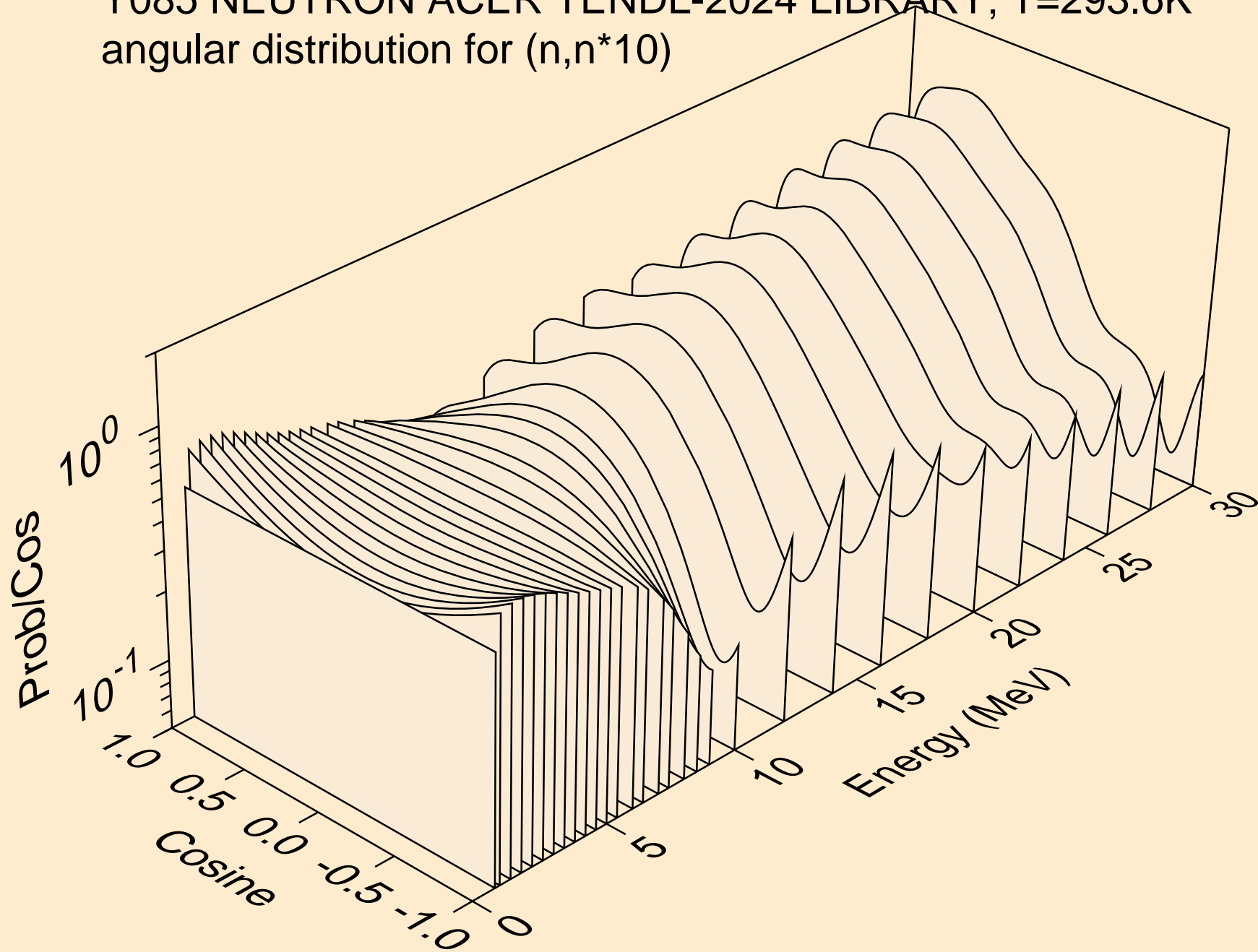

Y085 NEUTRON ACER TENDL-2024 LIBRARY; T=293.6K  
angular distribution for (n,n\*11)

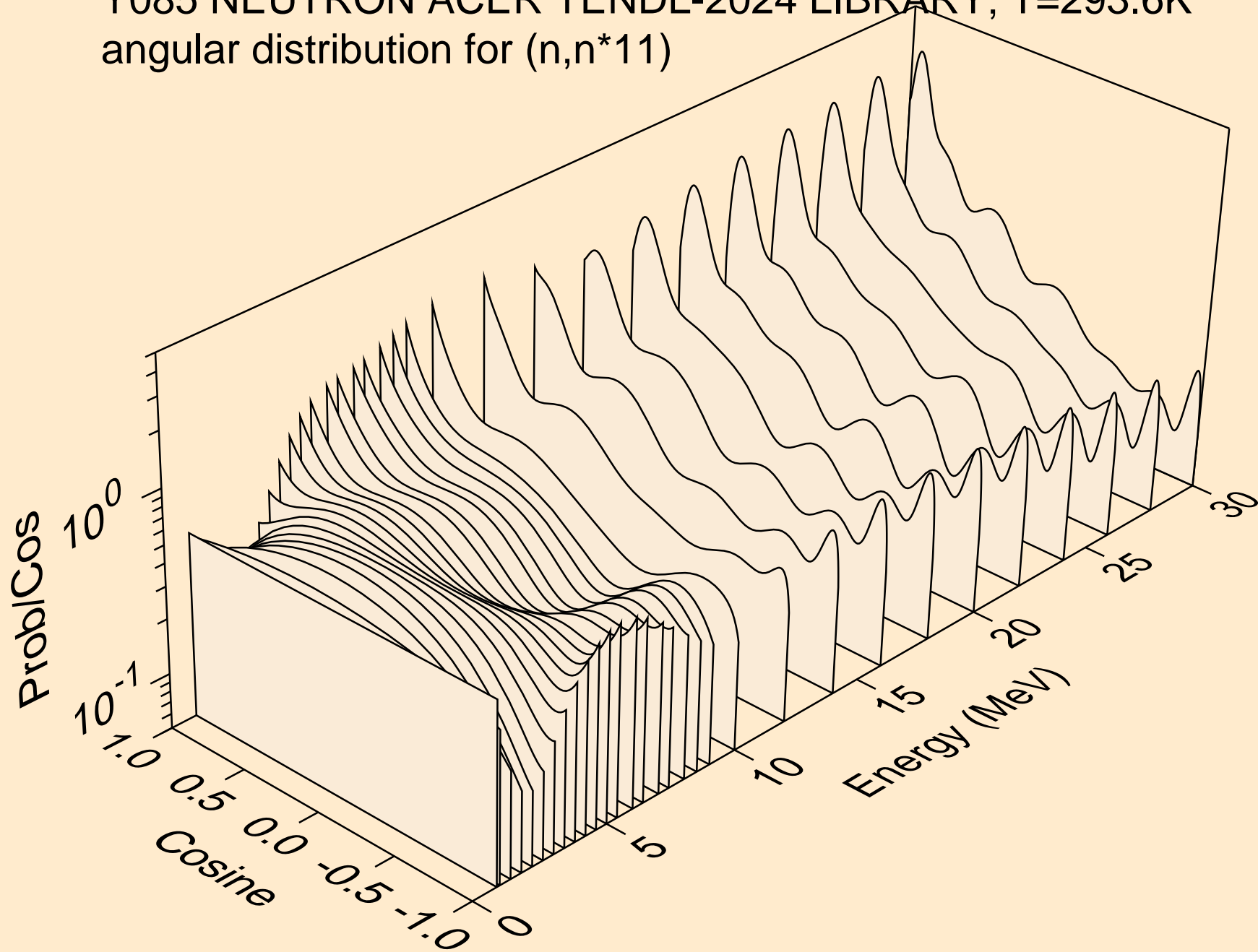

Y085 NEUTRON ACER TENDL-2024 LIBRARY; T=293.6K  
angular distribution for (n,n\*12)

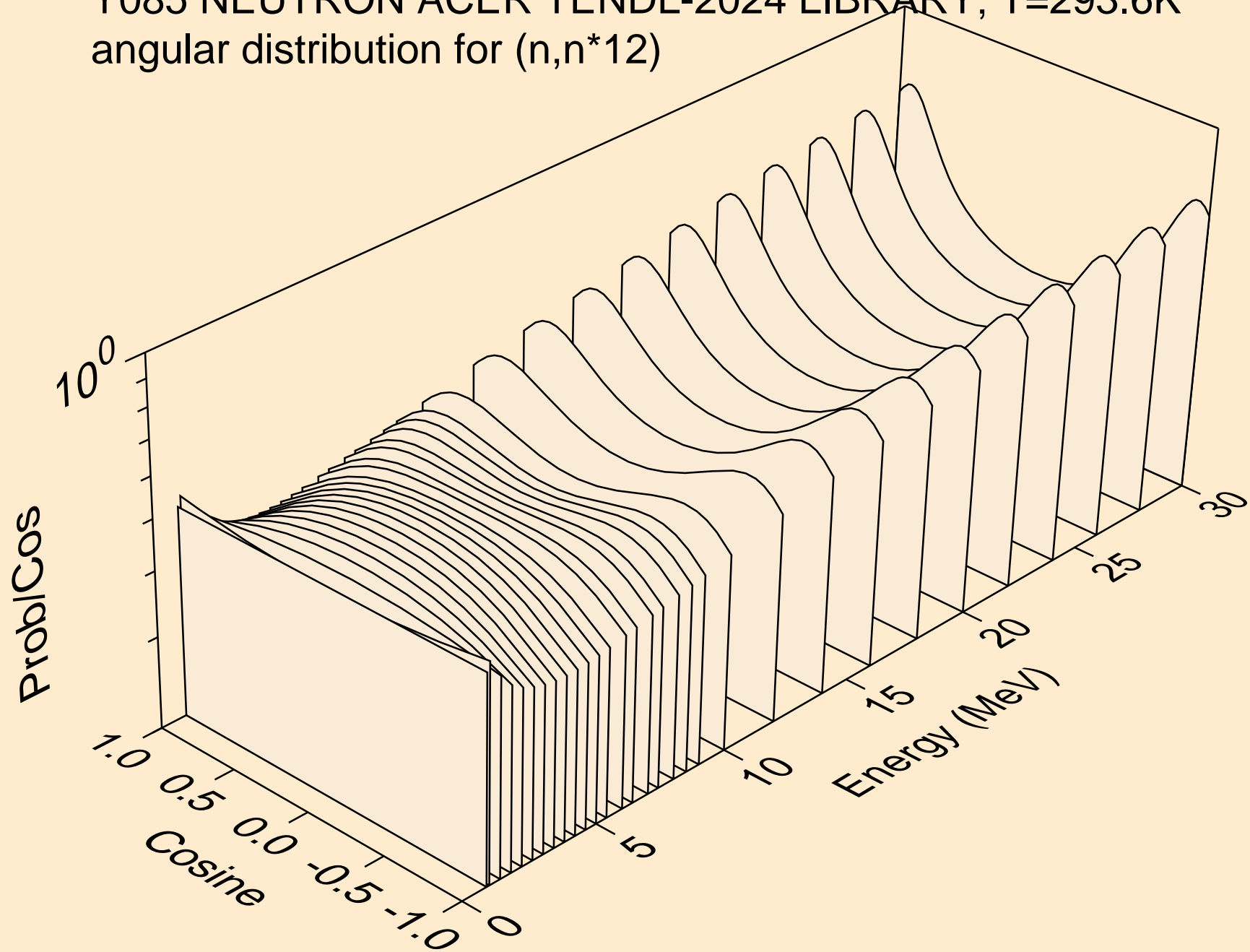

Y085 NEUTRON ACER TENDL-2024 LIBRARY; T=293.6K  
angular distribution for (n,n\*13)

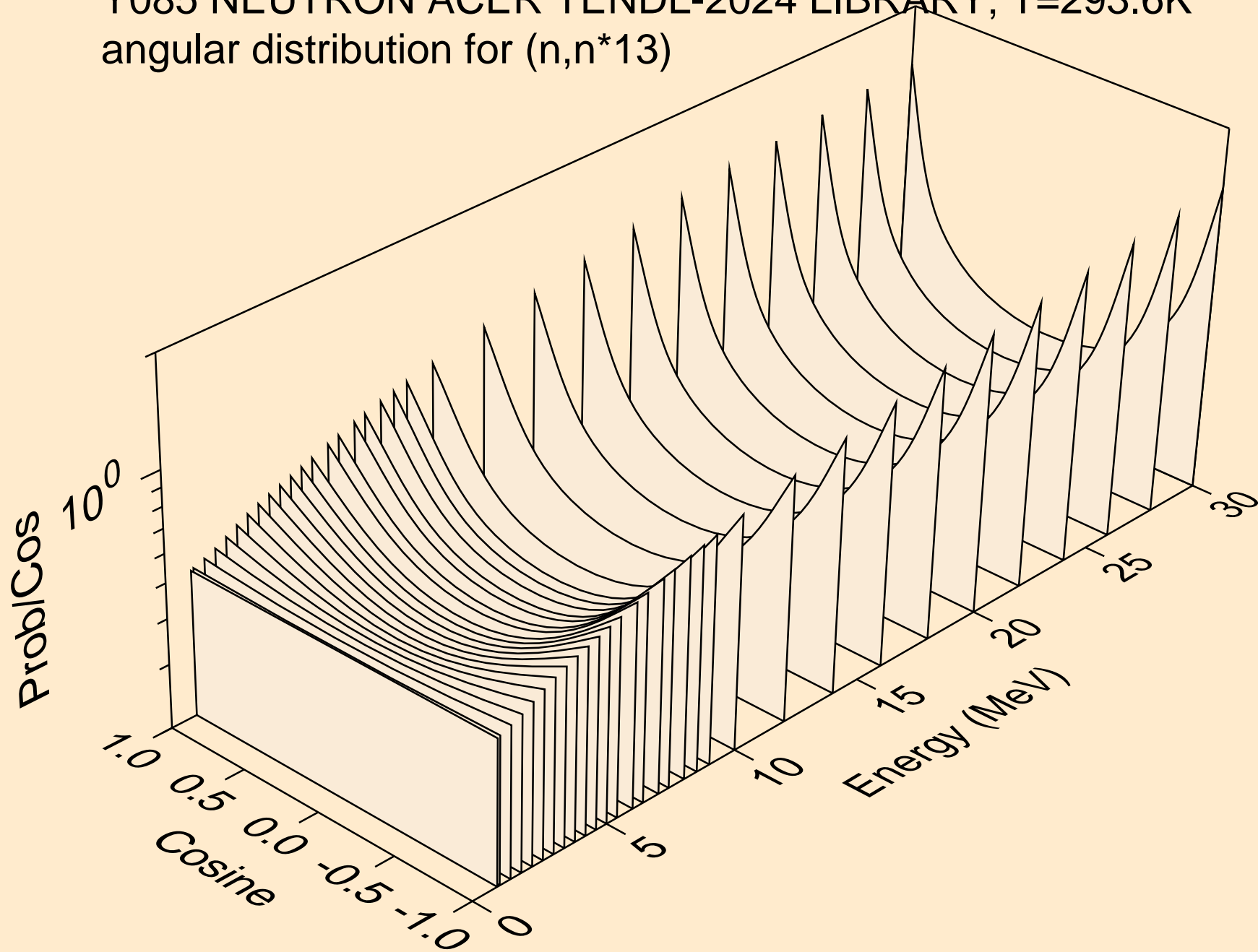

Y085 NEUTRON ACER TENDL-2024 LIBRARY; T=293.6K  
angular distribution for (n,n\*14)

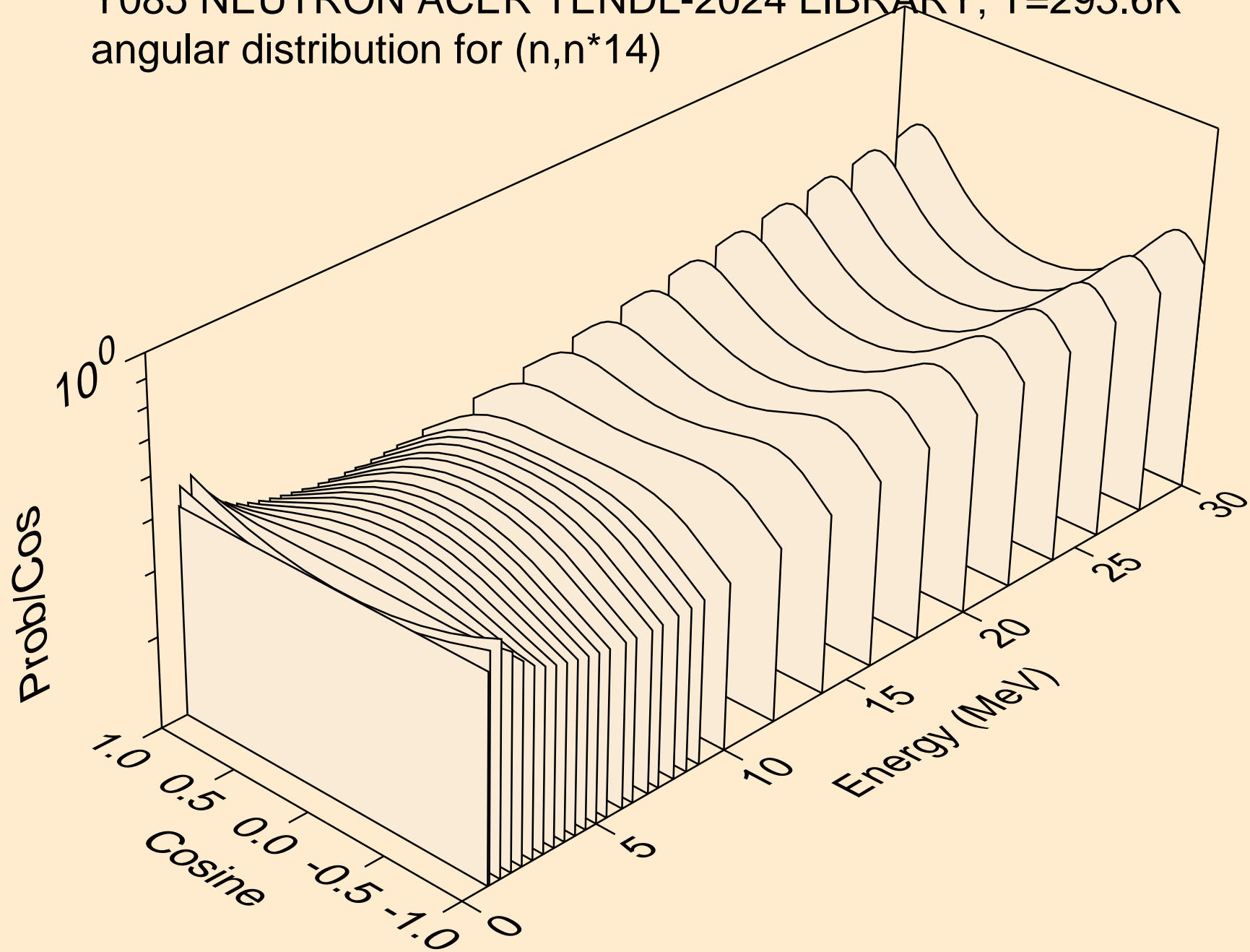

Y085 NEUTRON ACER TENDL-2024 LIBRARY; T=293.6K  
angular distribution for (n,n\*15)

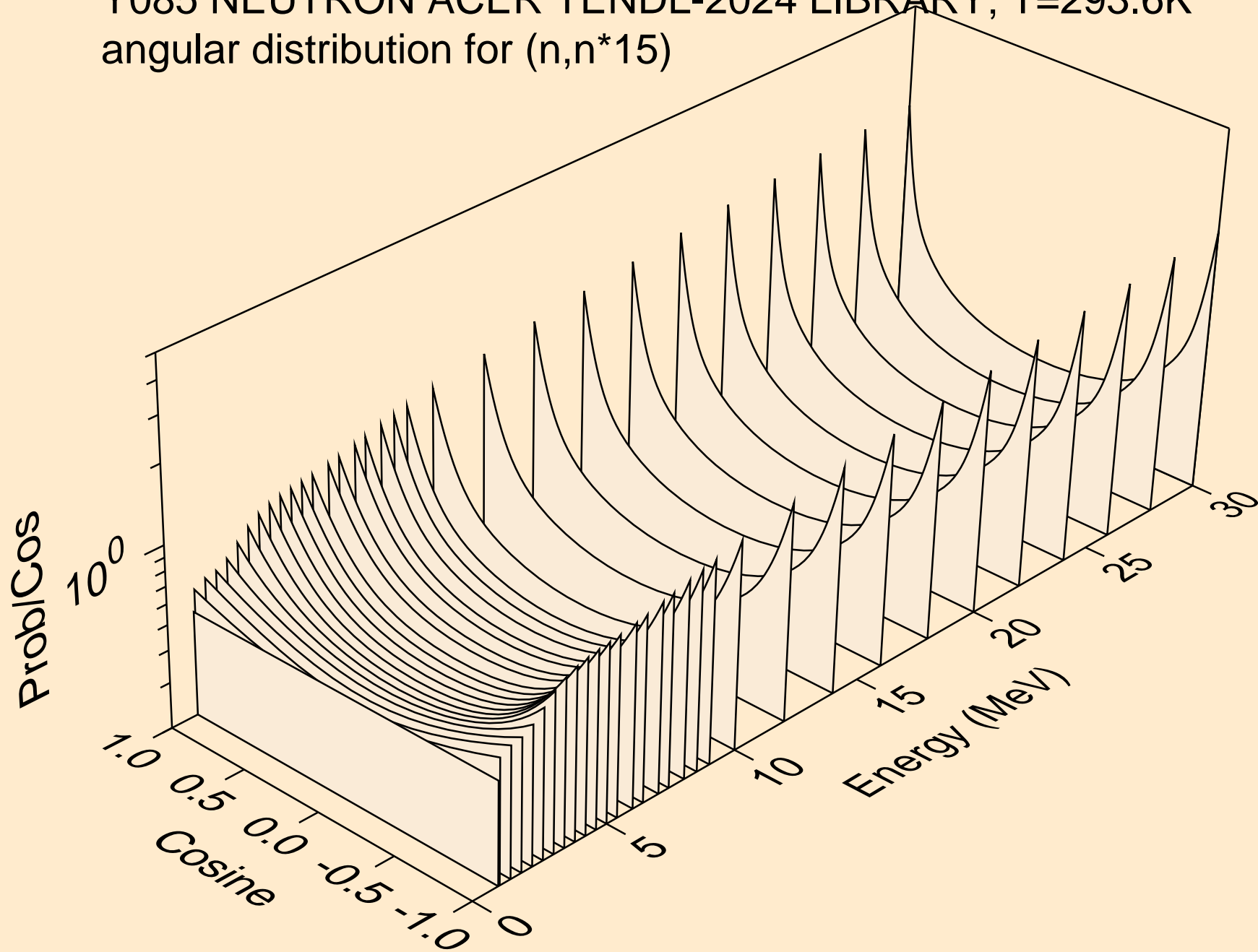

Y085 NEUTRON ACER TENDL-2024 LIBRARY; T=293.6K  
angular distribution for (n,n\*16)

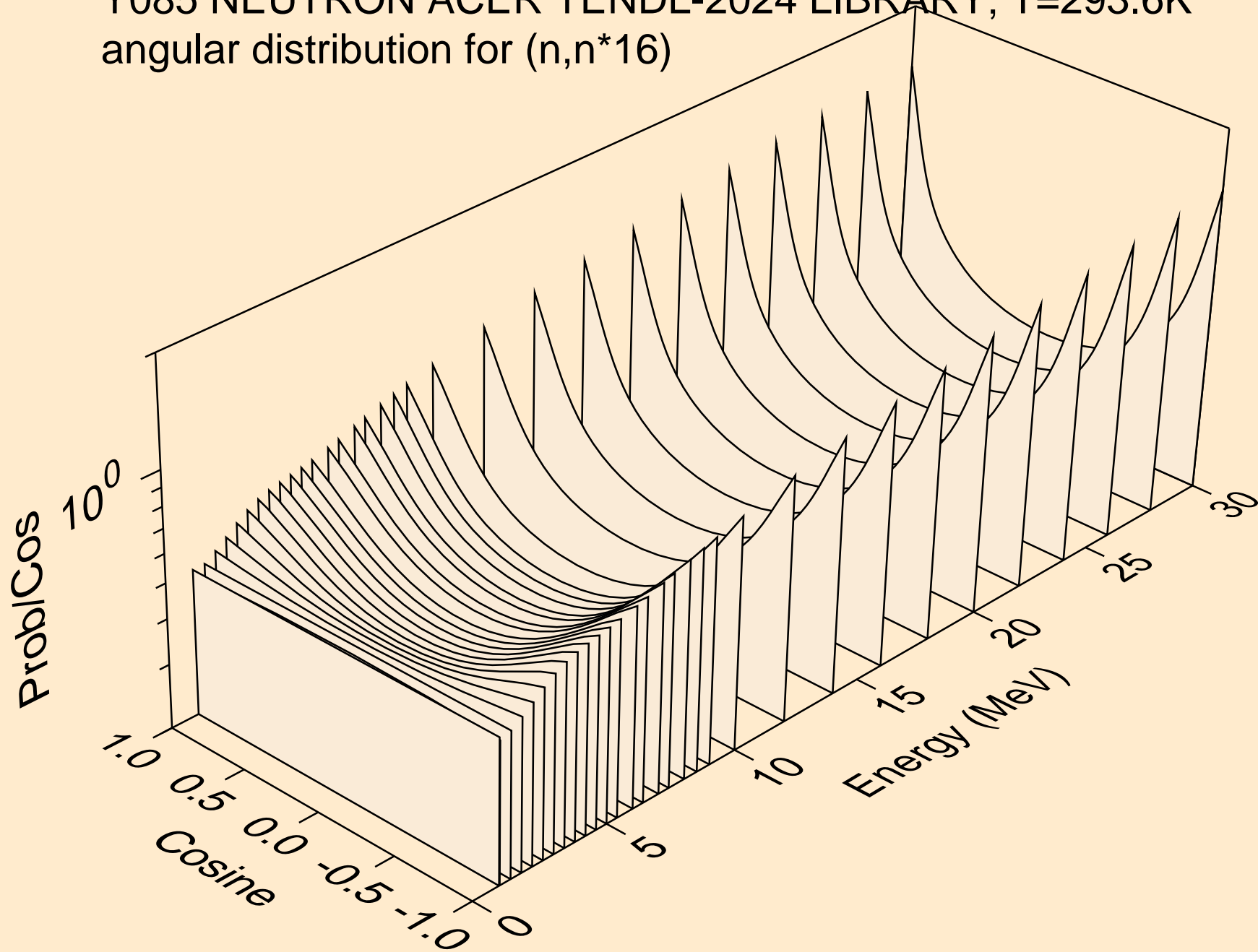

Y085 NEUTRON ACER TENDL-2024 LIBRARY; T=293.6K  
angular distribution for (n,n\*17)

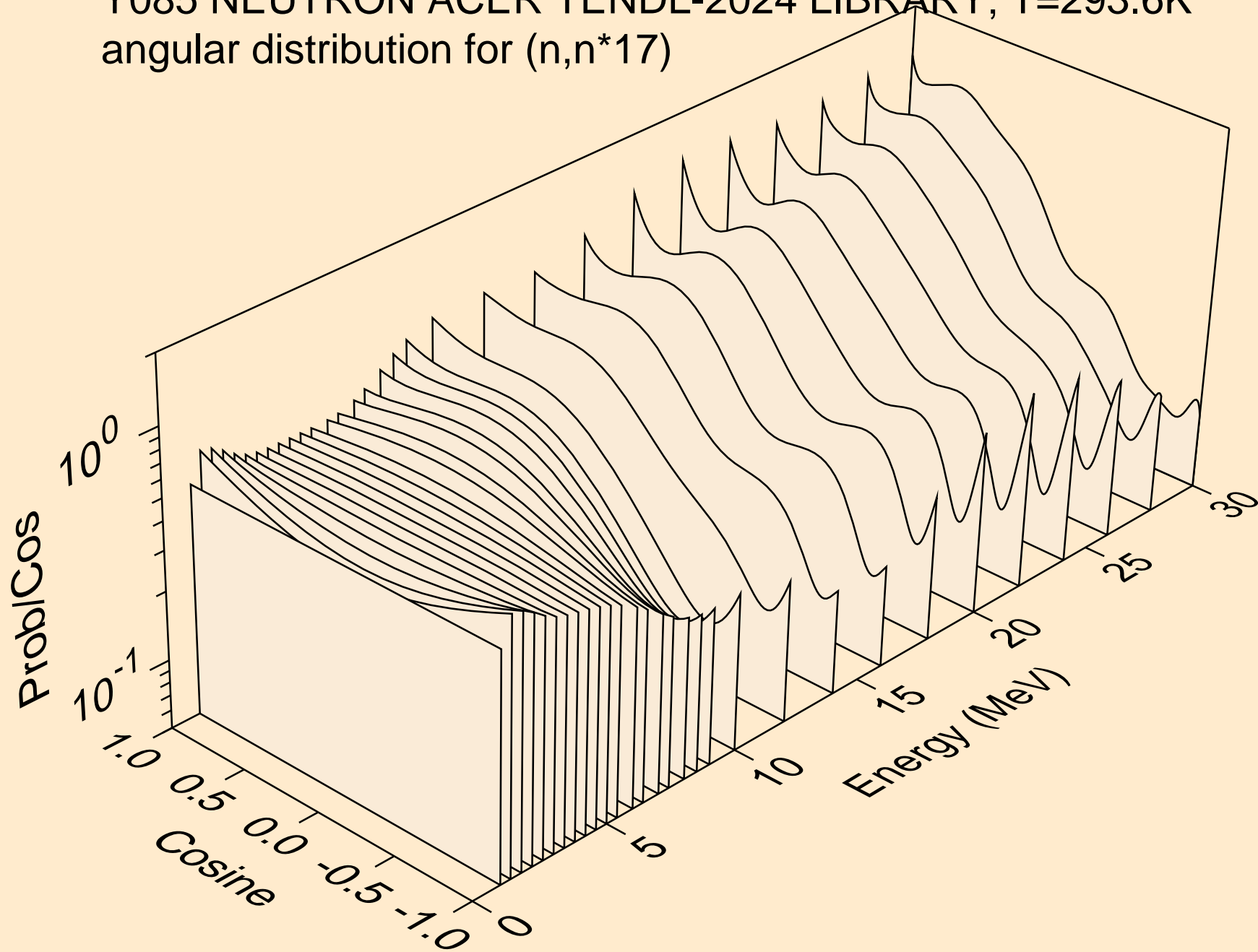

Y085 NEUTRON ACER TENDL-2024 LIBRARY; T=293.6K  
angular distribution for (n,n\*18)

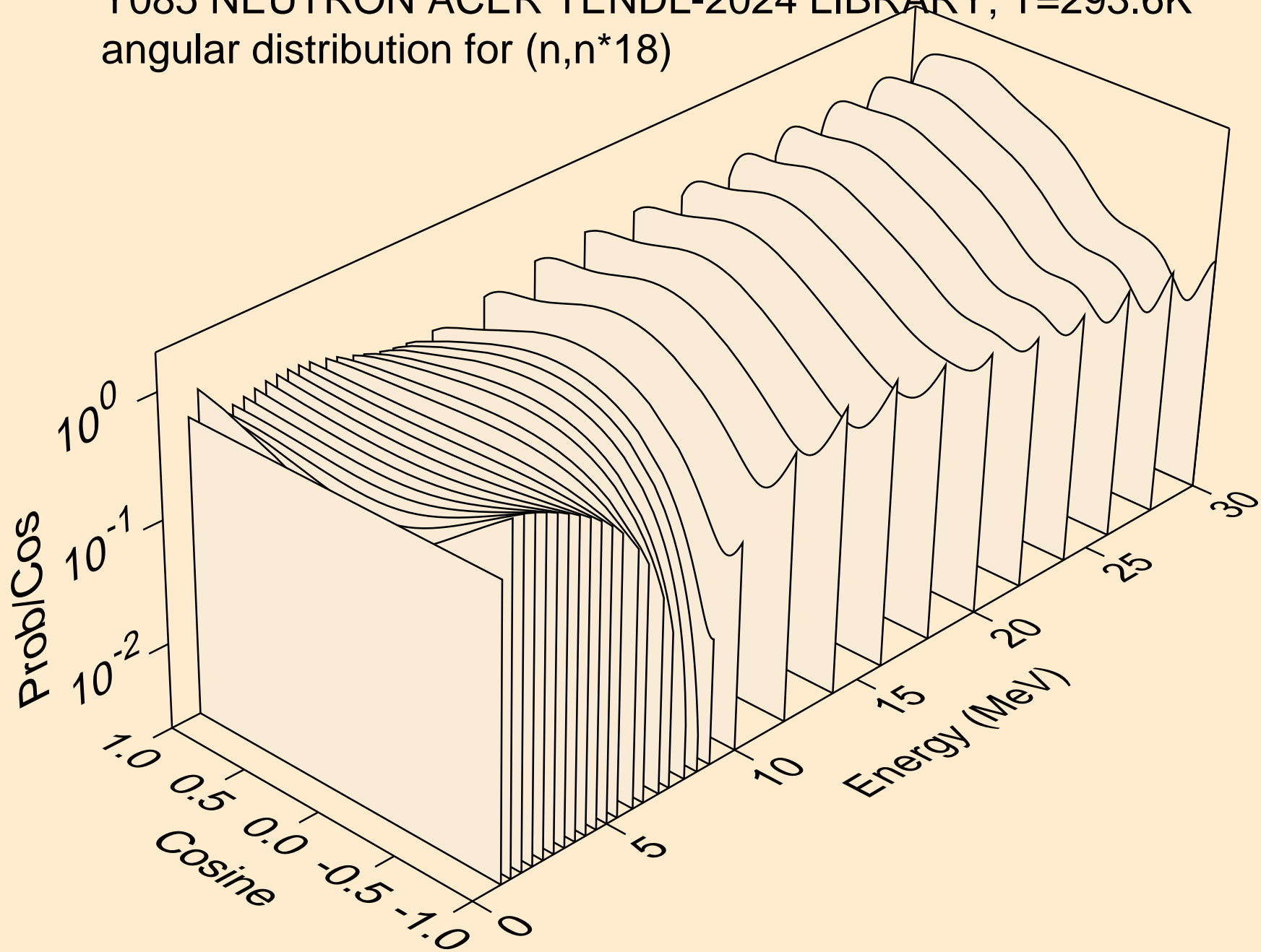

Y085 NEUTRON ACER TENDL-2024 LIBRARY; T=293.6K  
angular distribution for (n,n\*19)

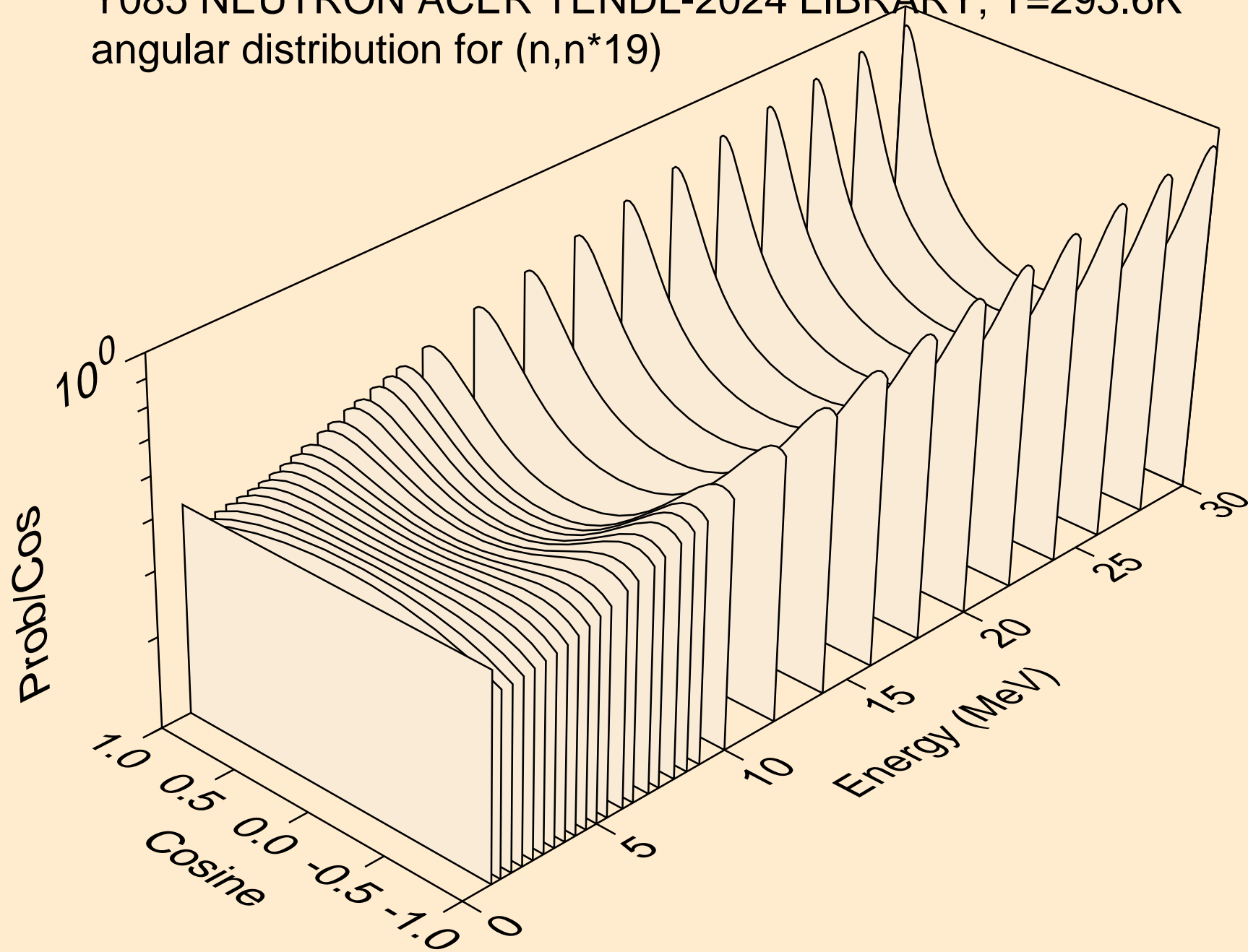

Y085 NEUTRON ACER TENDL-2024 LIBRARY; T=293.6K  
angular distribution for (n,n\*20)

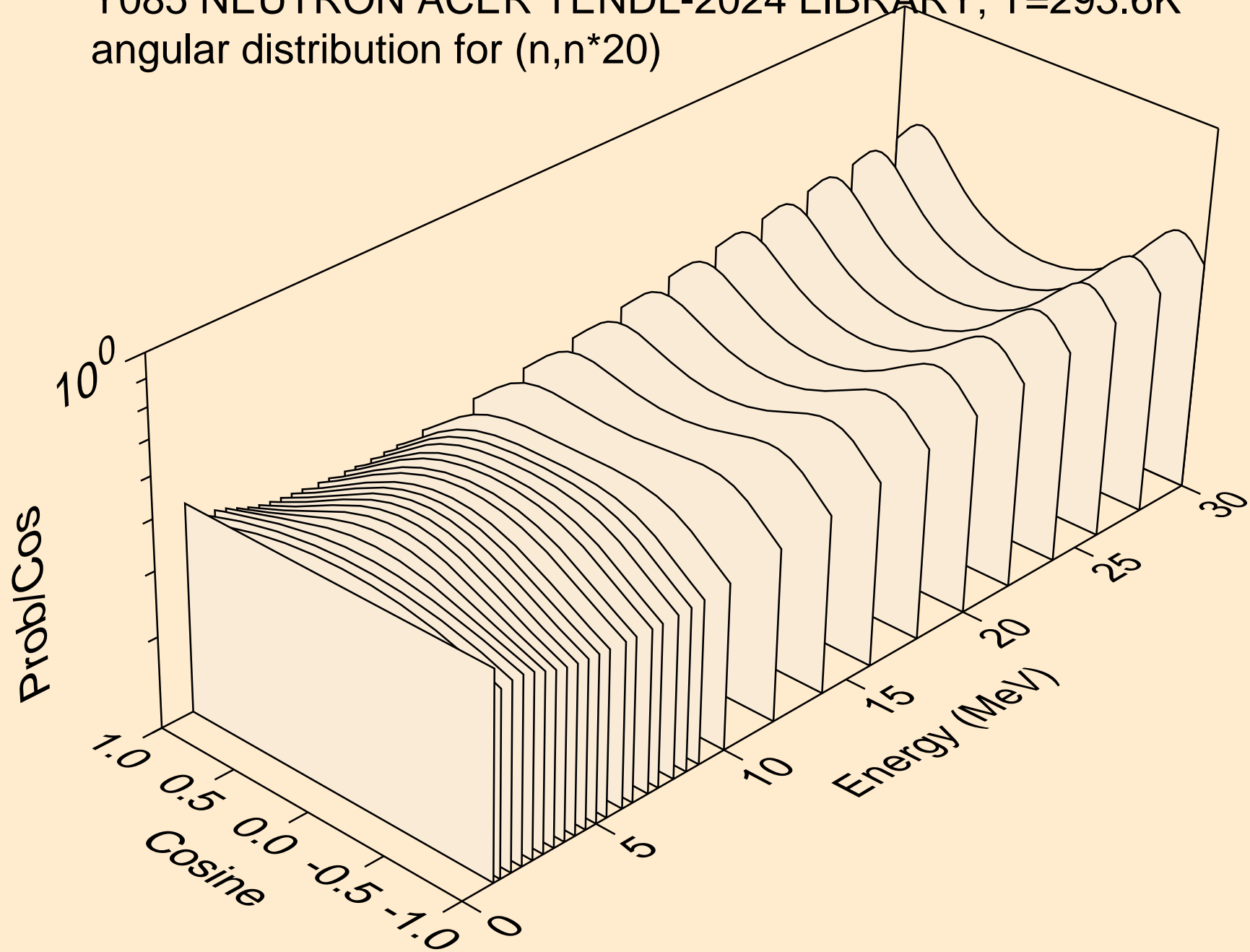

Y085 NEUTRON ACER TENDL-2024 LIBRARY; T=293.6K  
angular distribution for (n,n\*21)

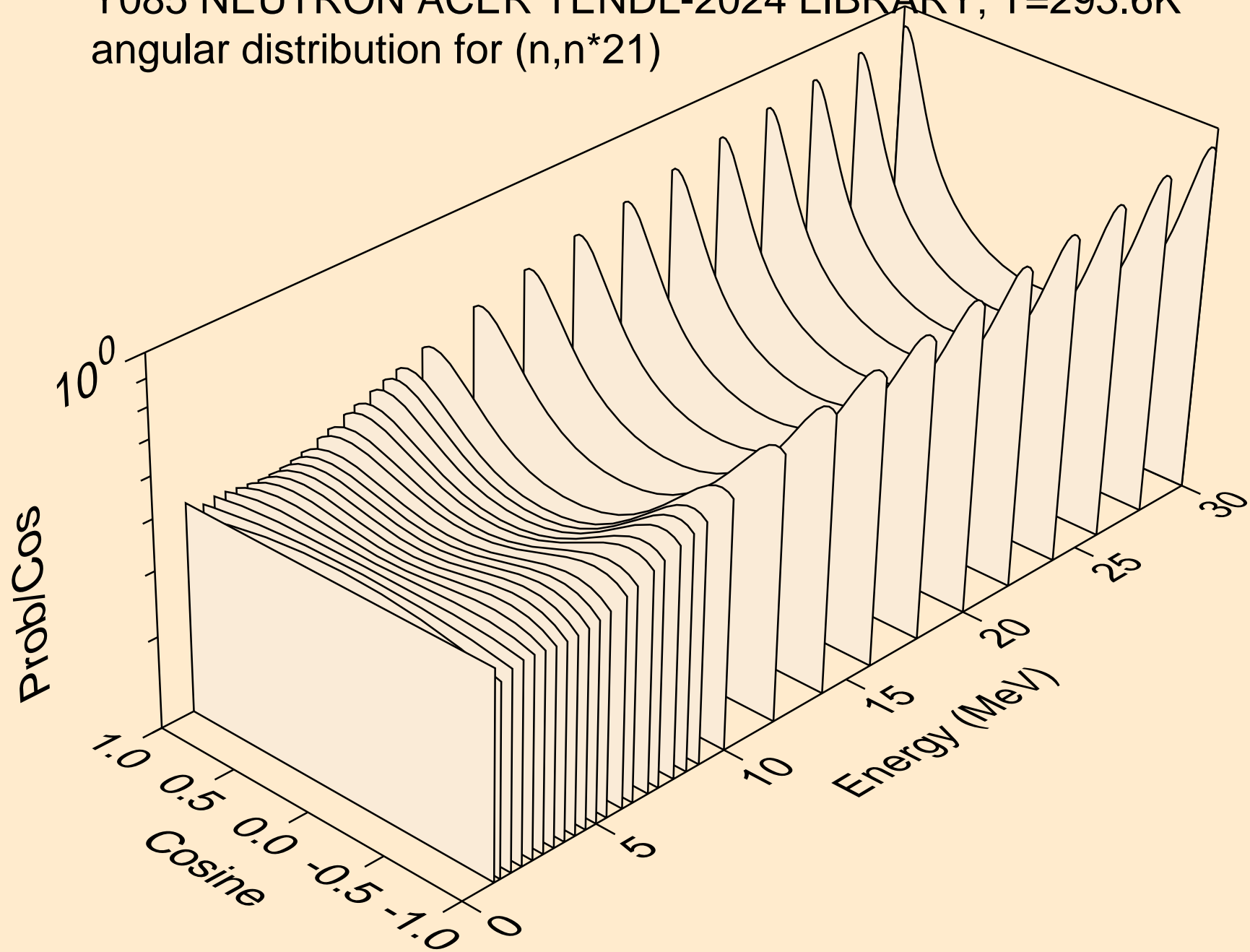

Y085 NEUTRON ACER TENDL-2024 LIBRARY; T=293.6K  
angular distribution for (n,n\*22)

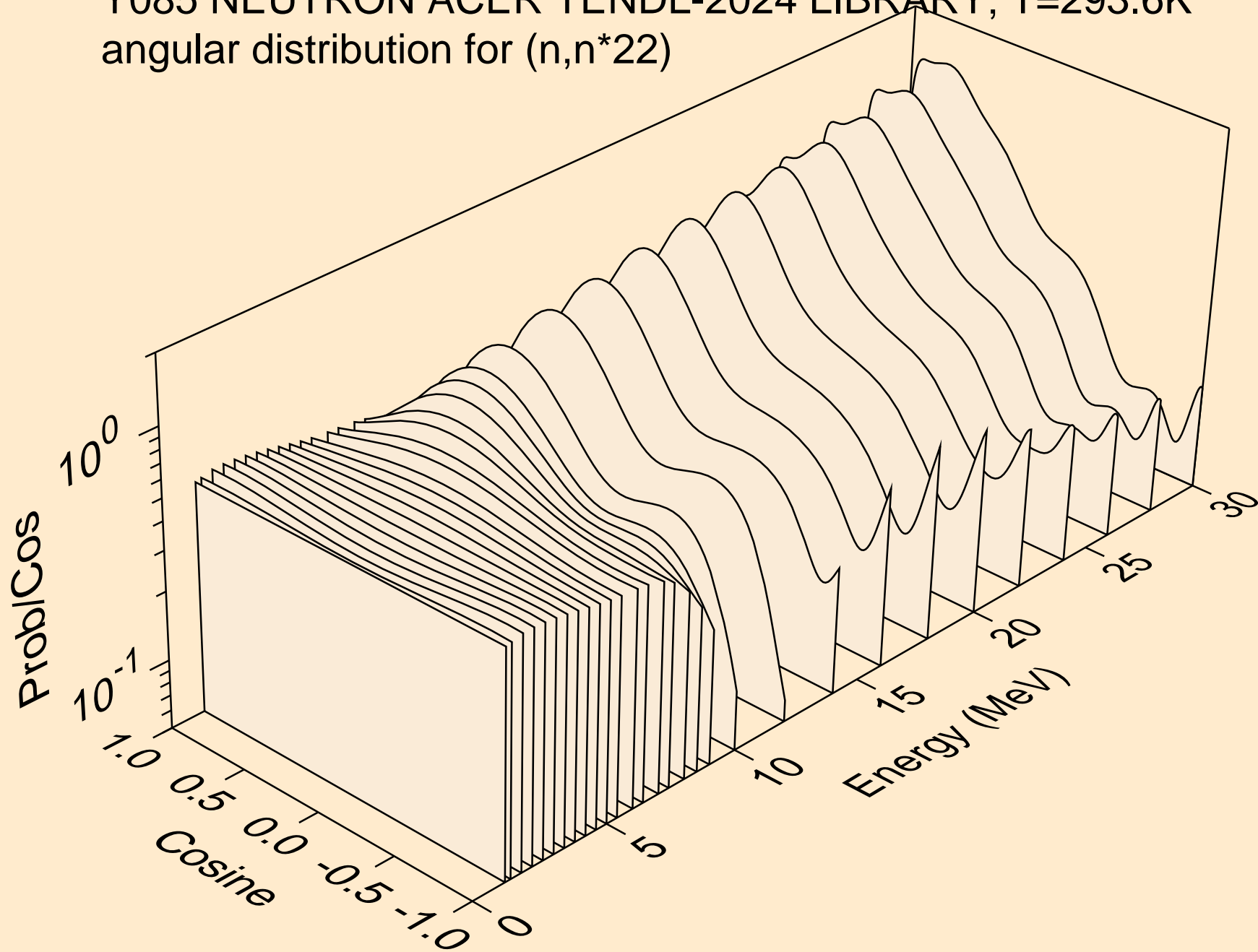

Y085 NEUTRON ACER TENDL-2024 LIBRARY; T=293.6K  
angular distribution for (n,n\*23)

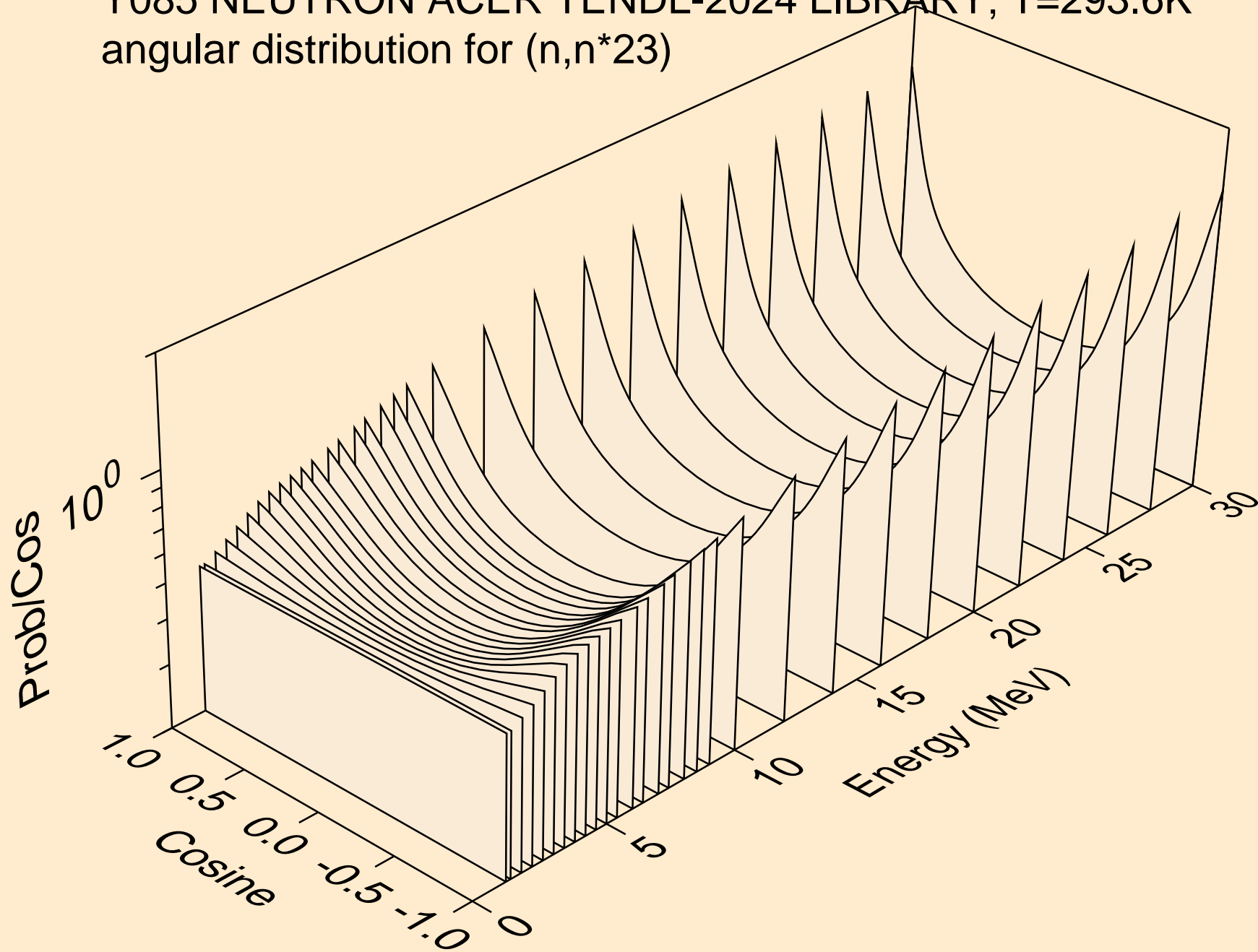

Y085 NEUTRON ACER TENDL-2024 LIBRARY; T=293.6K  
angular distribution for (n,n\*24)

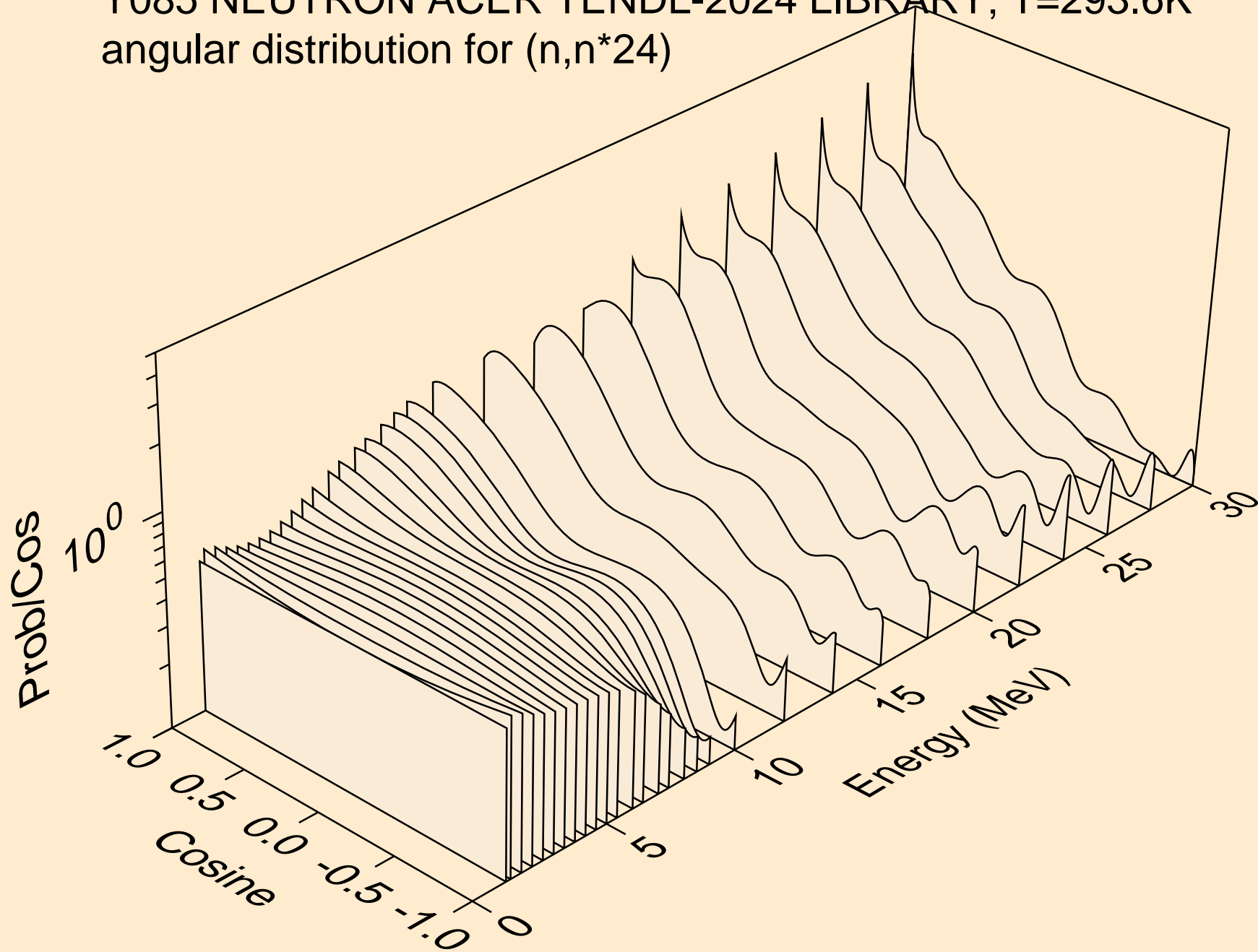

Y085 NEUTRON ACER TENDL-2024 LIBRARY; T=293.6K  
angular distribution for (n,n\*25)

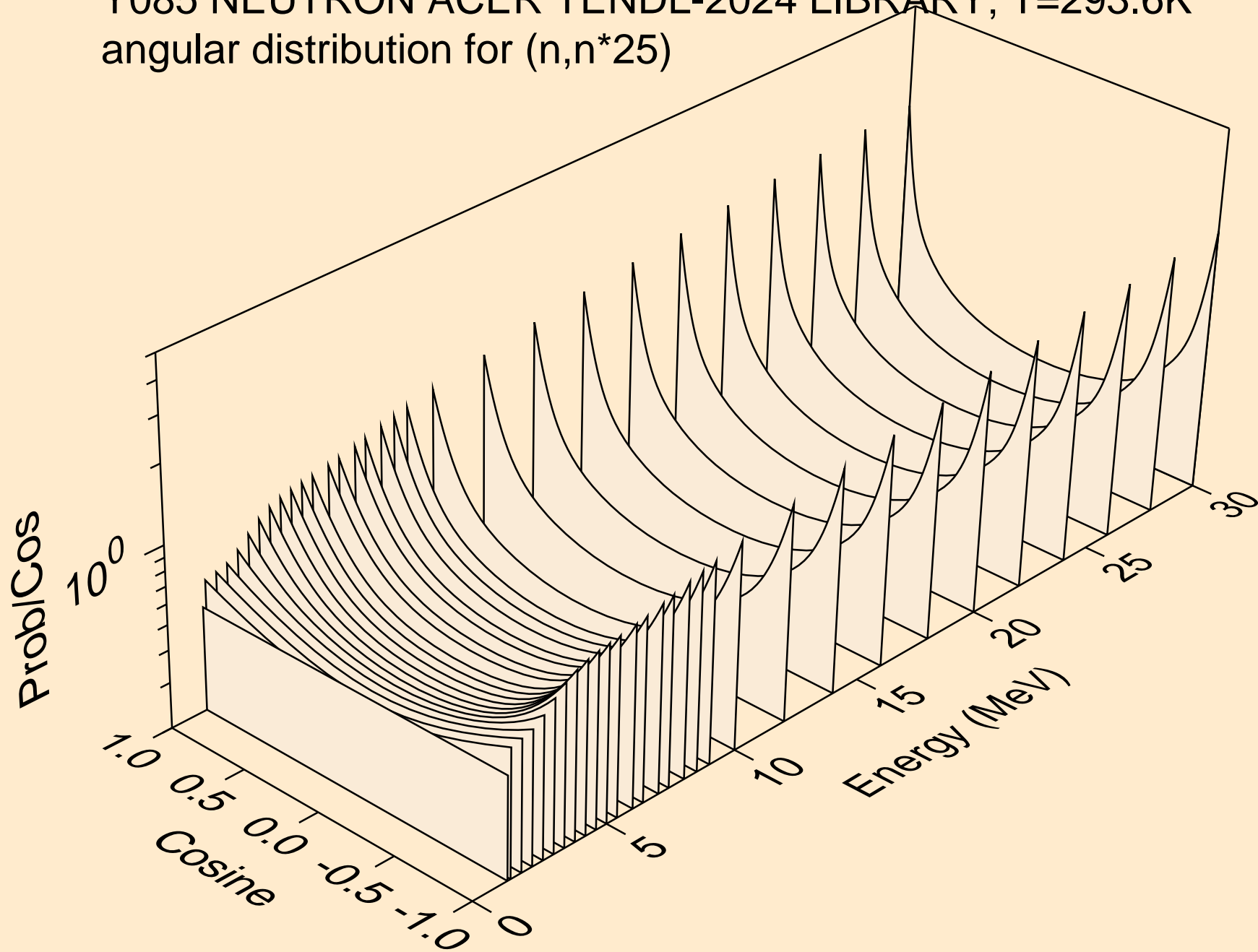

Y085 NEUTRON ACER TENDL-2024 LIBRARY; T=293.6K  
angular distribution for (n,n\*26)

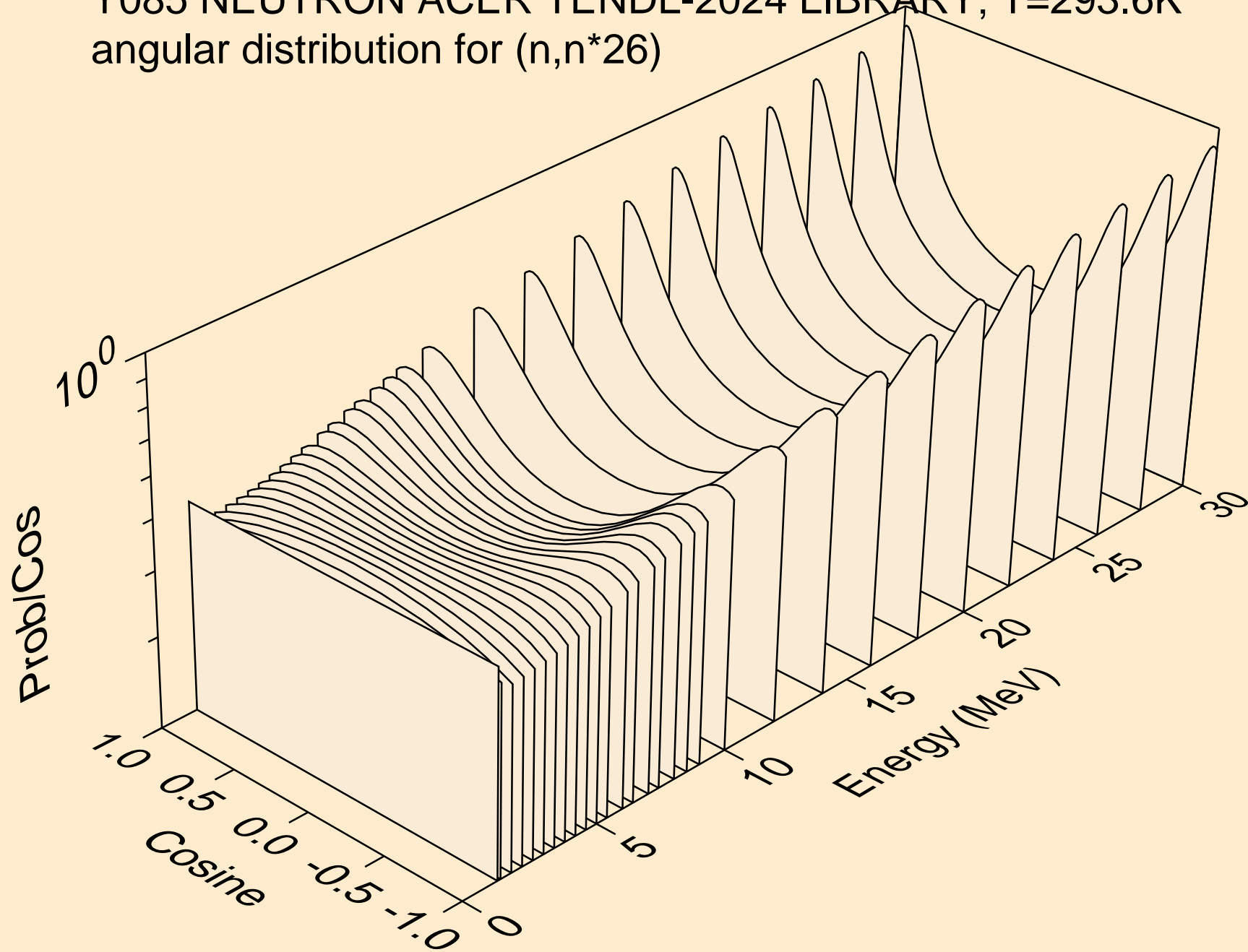

Y085 NEUTRON ACER TENDL-2024 LIBRARY; T=293.6K  
angular distribution for (n,n\*27)

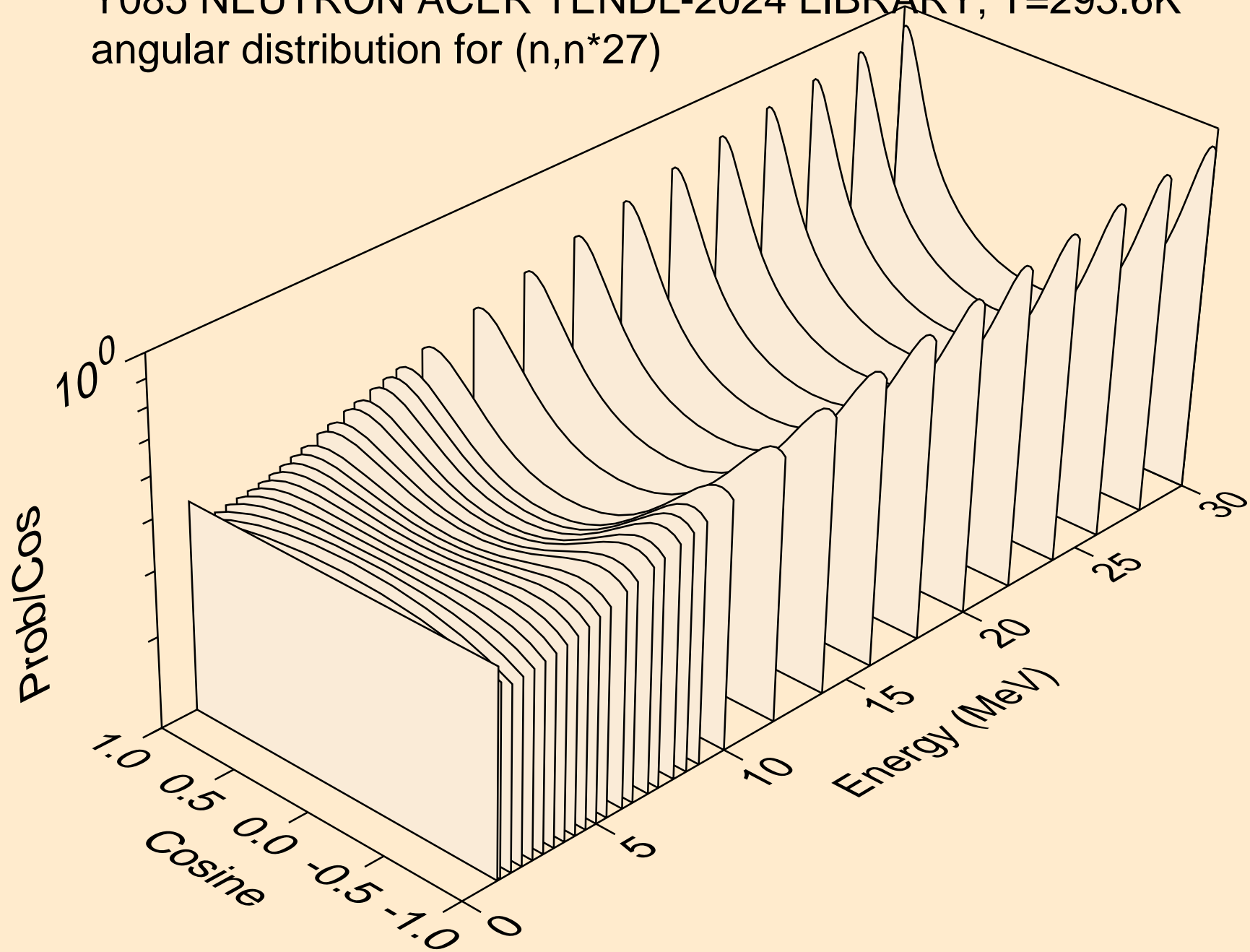

Y085 NEUTRON ACER TENDL-2024 LIBRARY; T=293.6K  
angular distribution for (n,n\*28)

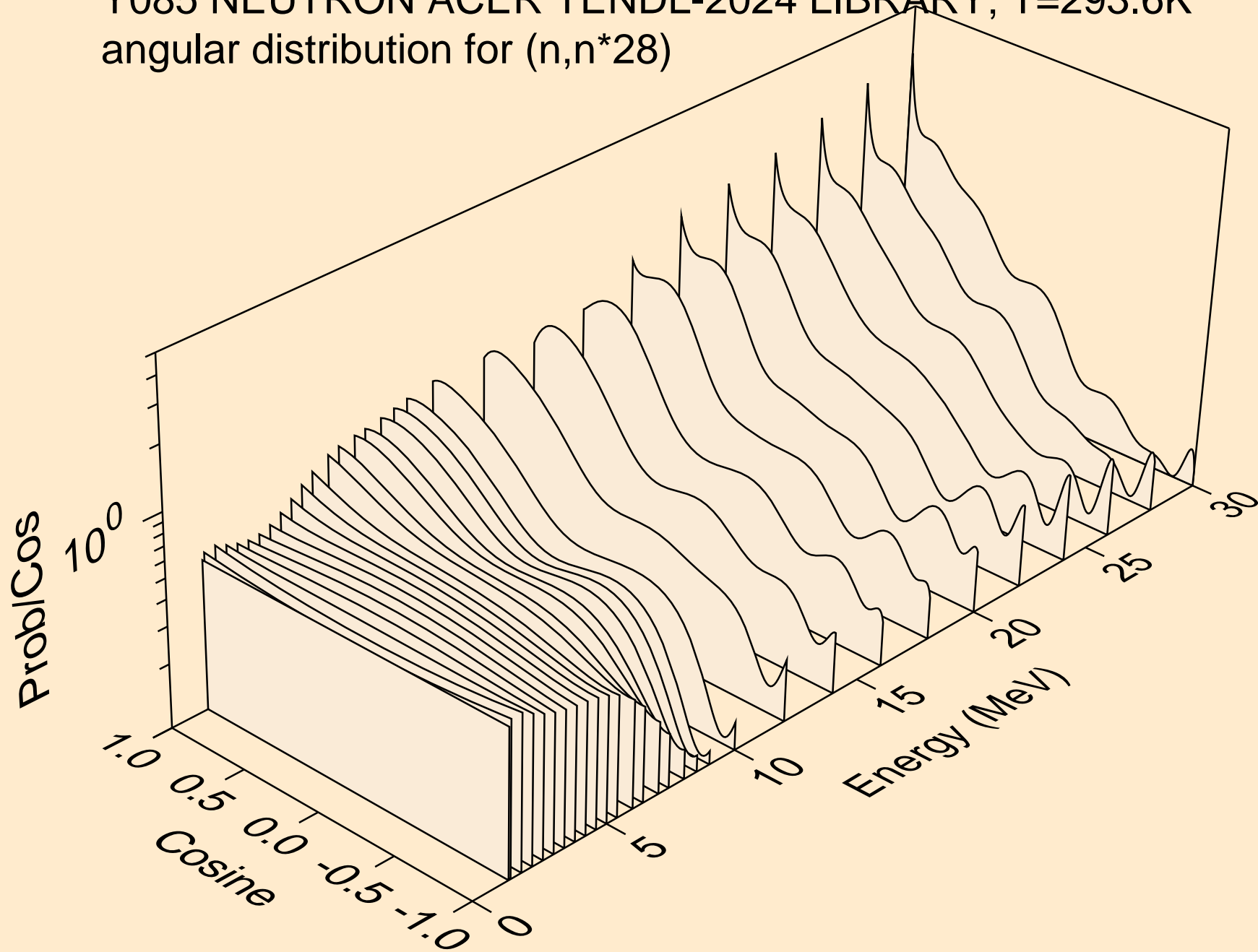

Y085 NEUTRON ACER TENDL-2024 LIBRARY; T=293.6K  
angular distribution for (n,n\*29)

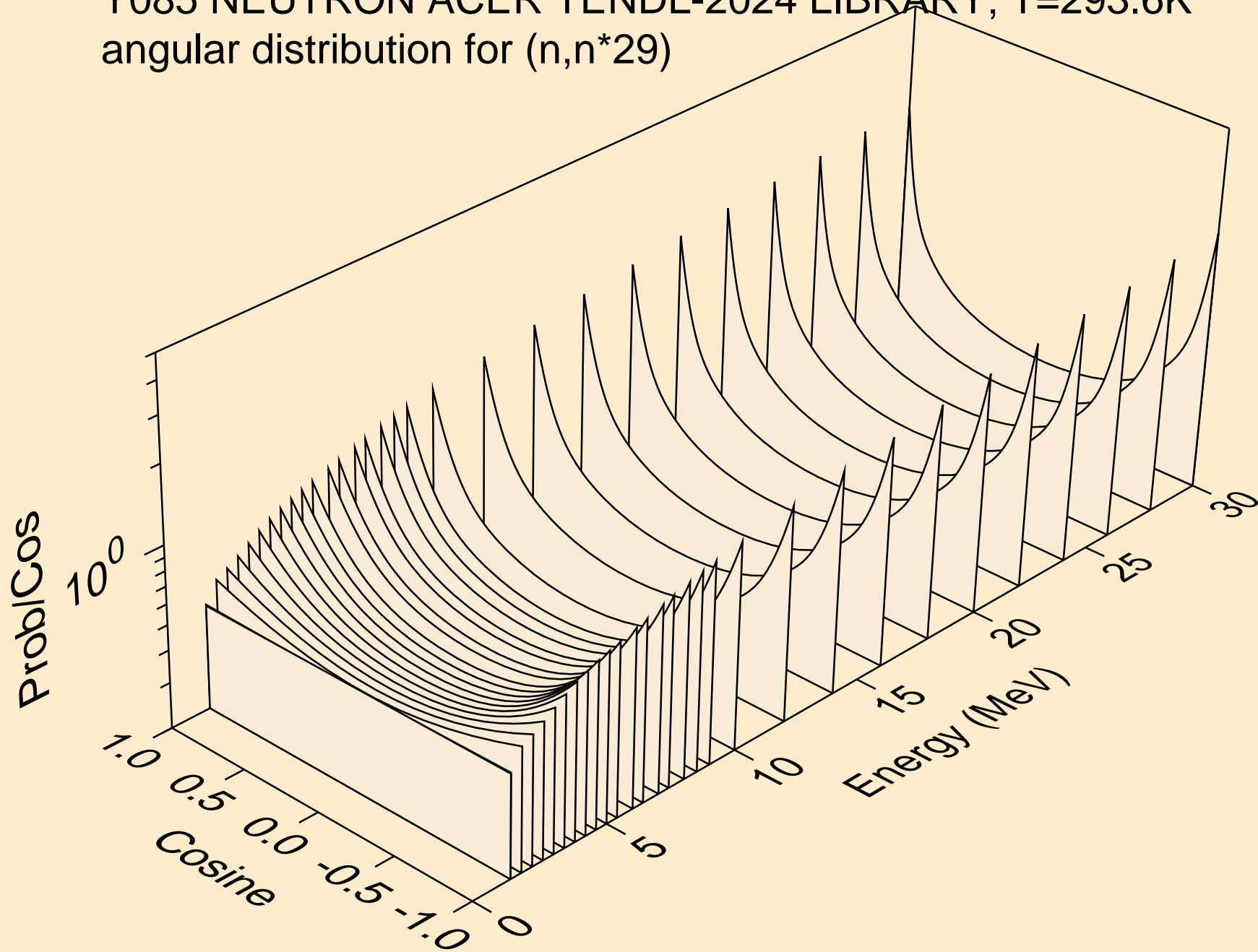

Y085 NEUTRON ACER TENDL-2024 LIBRARY; T=293.6K  
Neutron emission for (n,x)

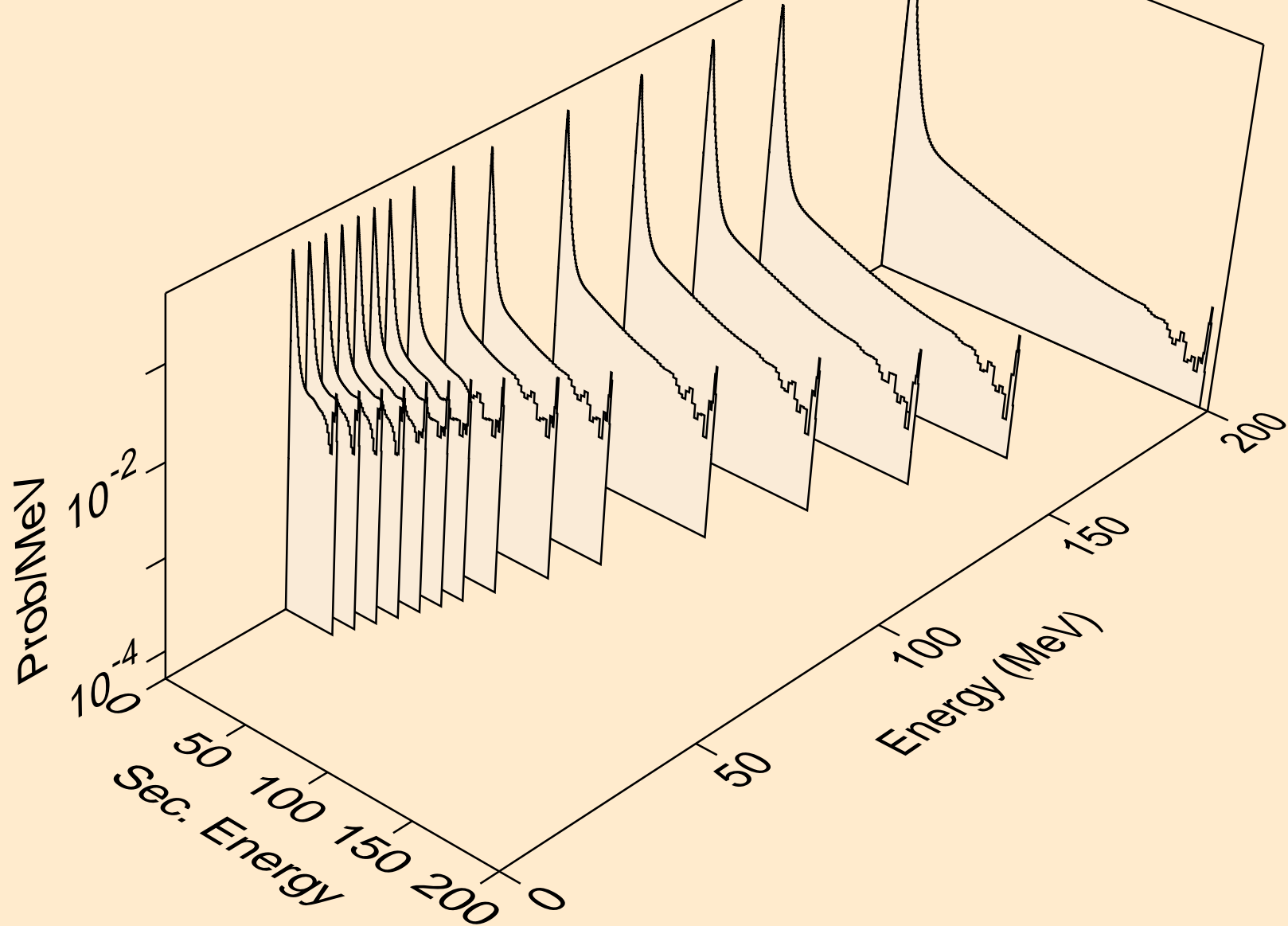

Y085 NEUTRON ACER TENDL-2024 LIBRARY; T=293.6K  
Neutron emission for (n,2nd)

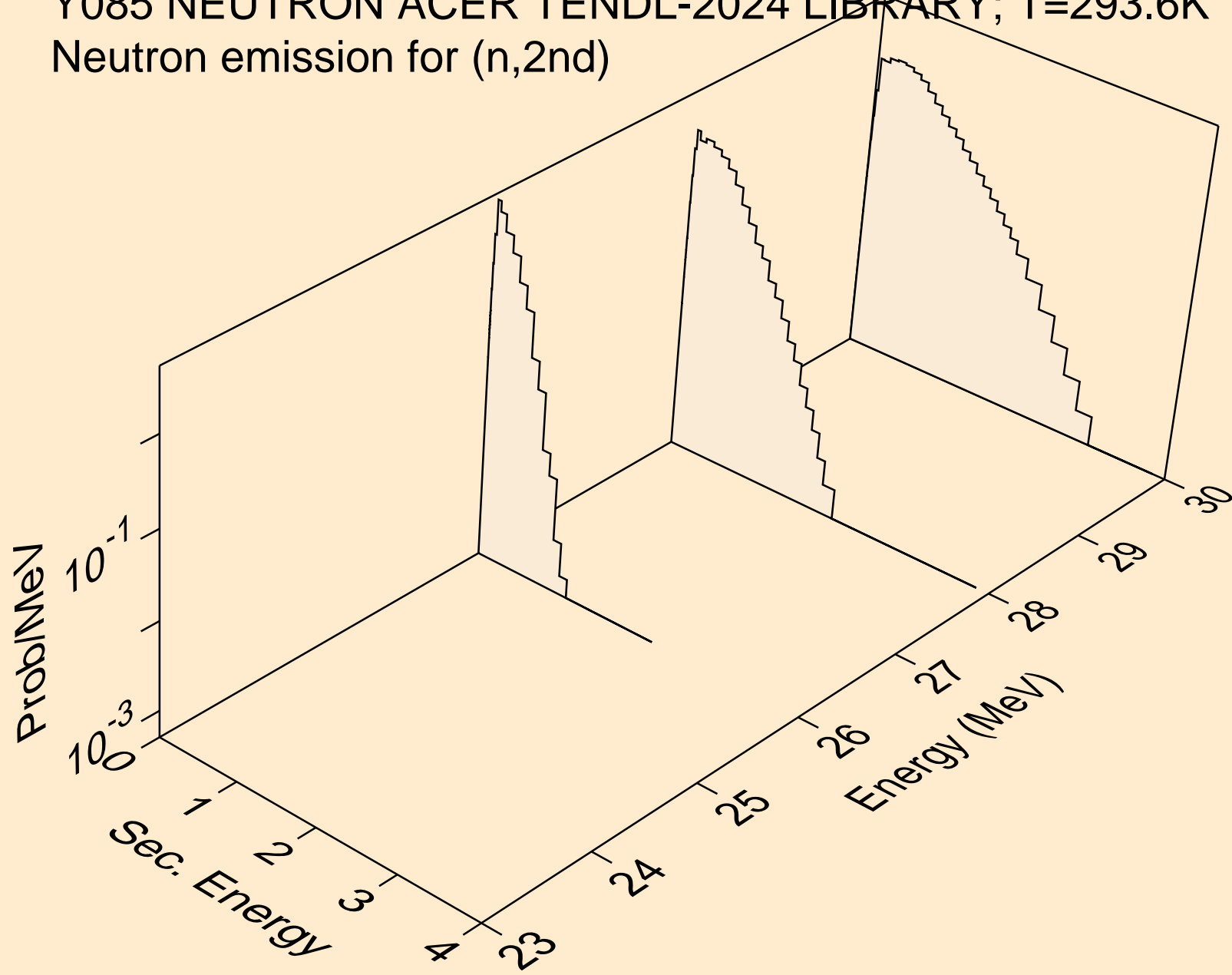

Y085 NEUTRON ACER TENDL-2024 LIBRARY; T=293.6K  
Neutron emission for (n,2n)

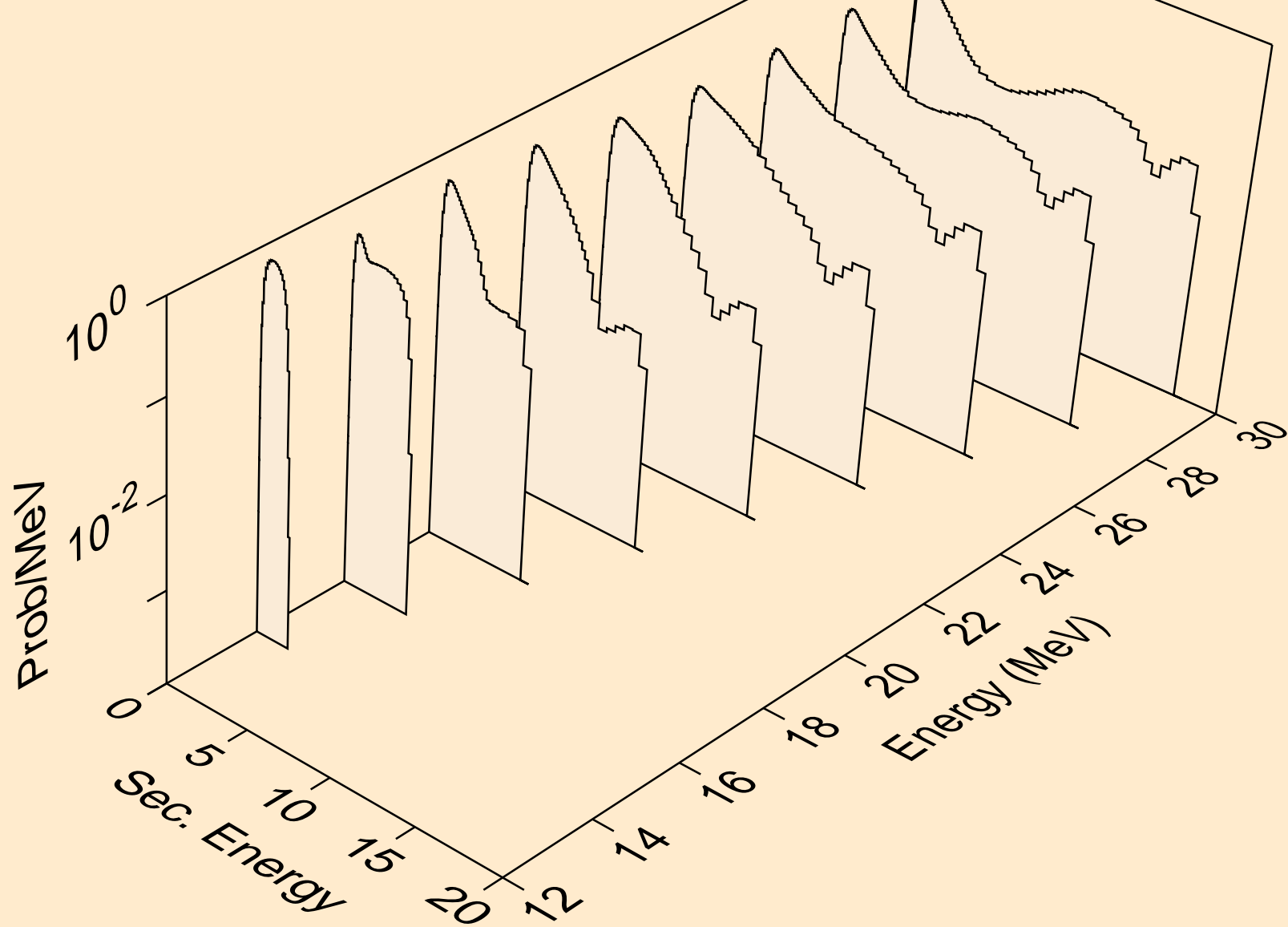

Y085 NEUTRON ACER TENDL-2024 LIBRARY; T=293.6K  
Neutron emission for (n,3n)

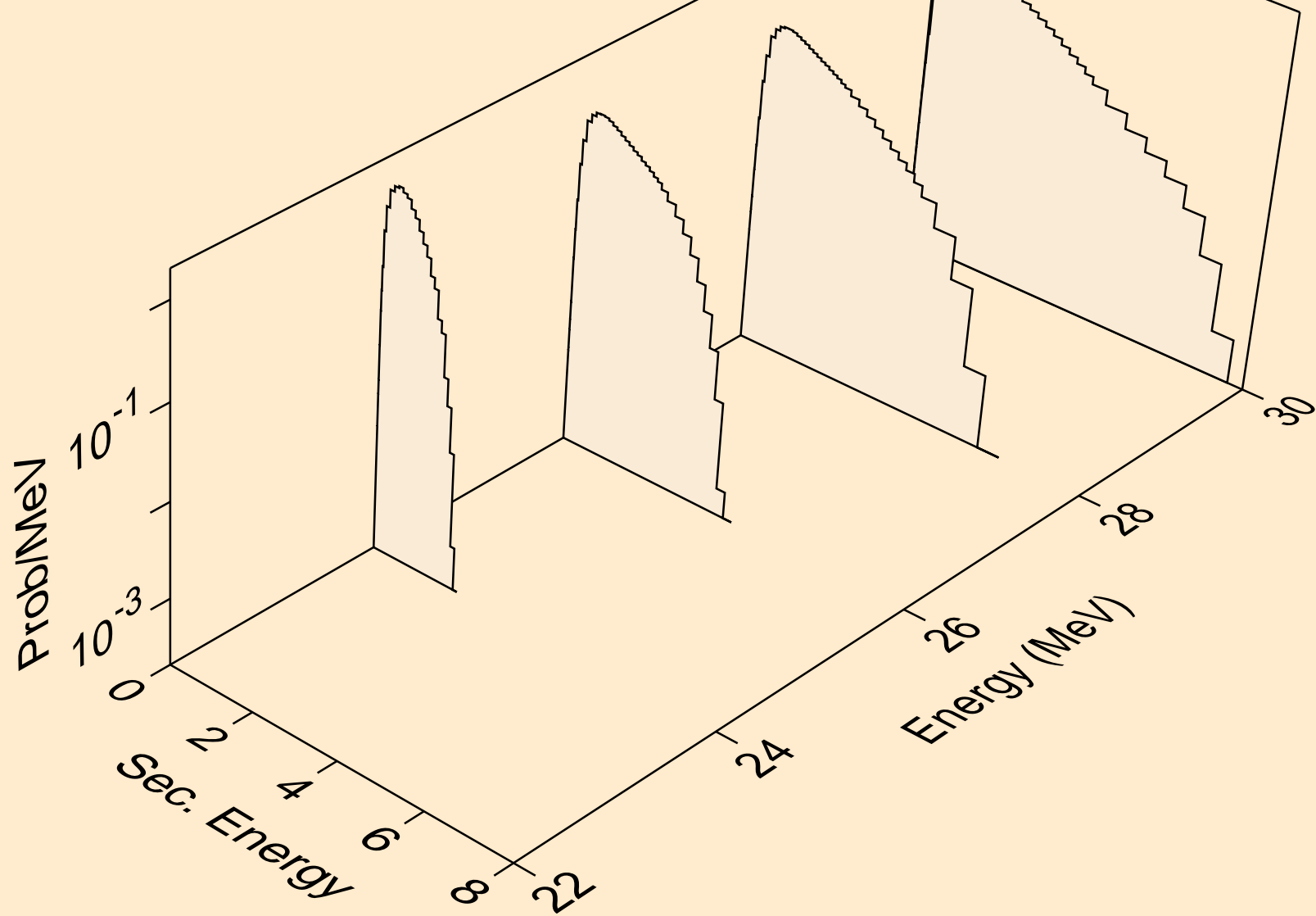

Y085 NEUTRON ACER TENDL-2024 LIBRARY; T=293.6K  
Neutron emission for (n,n\*)a

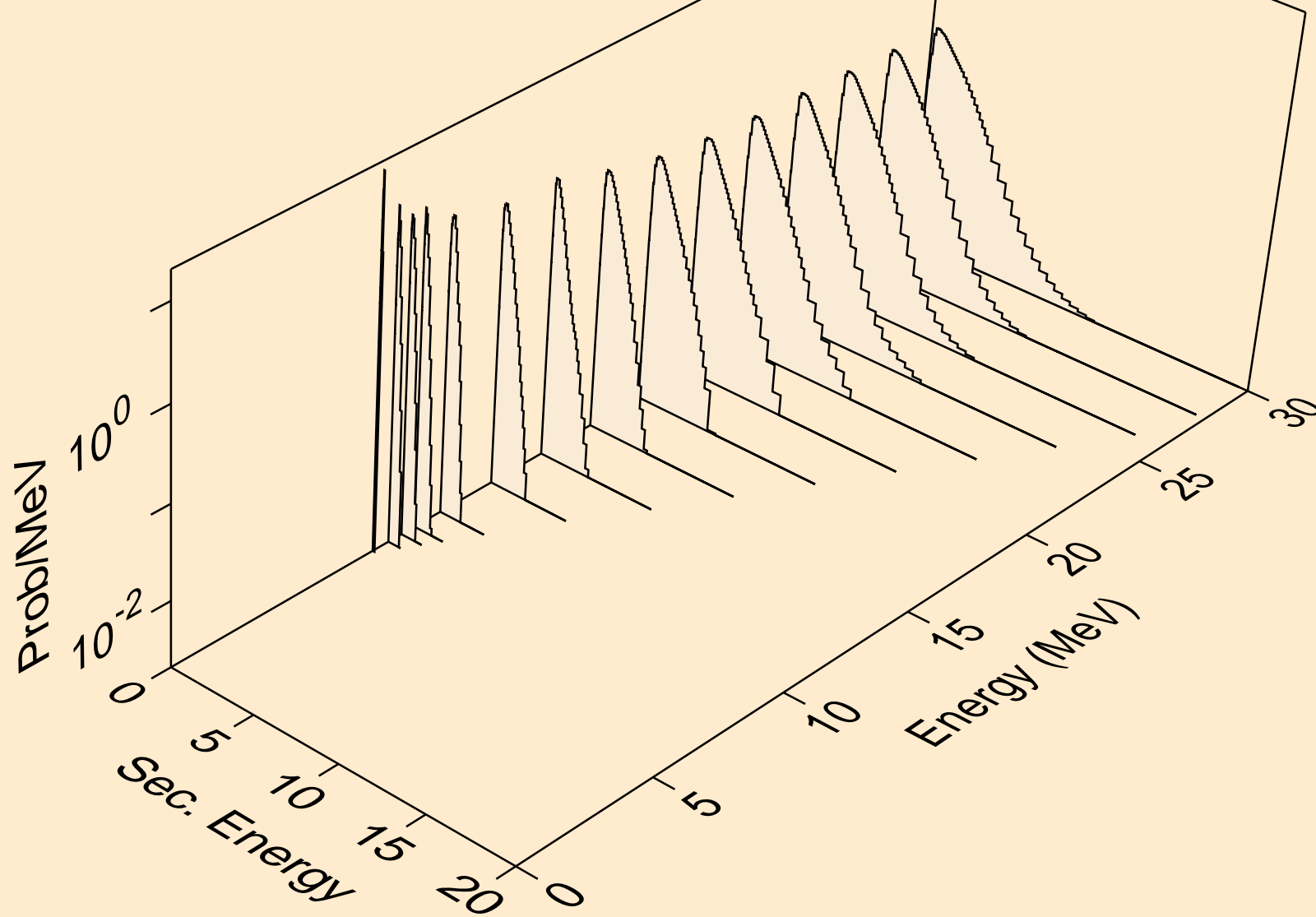

Y085 NEUTRON ACER TENDL-2024 LIBRARY; T=293.6K  
Neutron emission for (n,2n)a

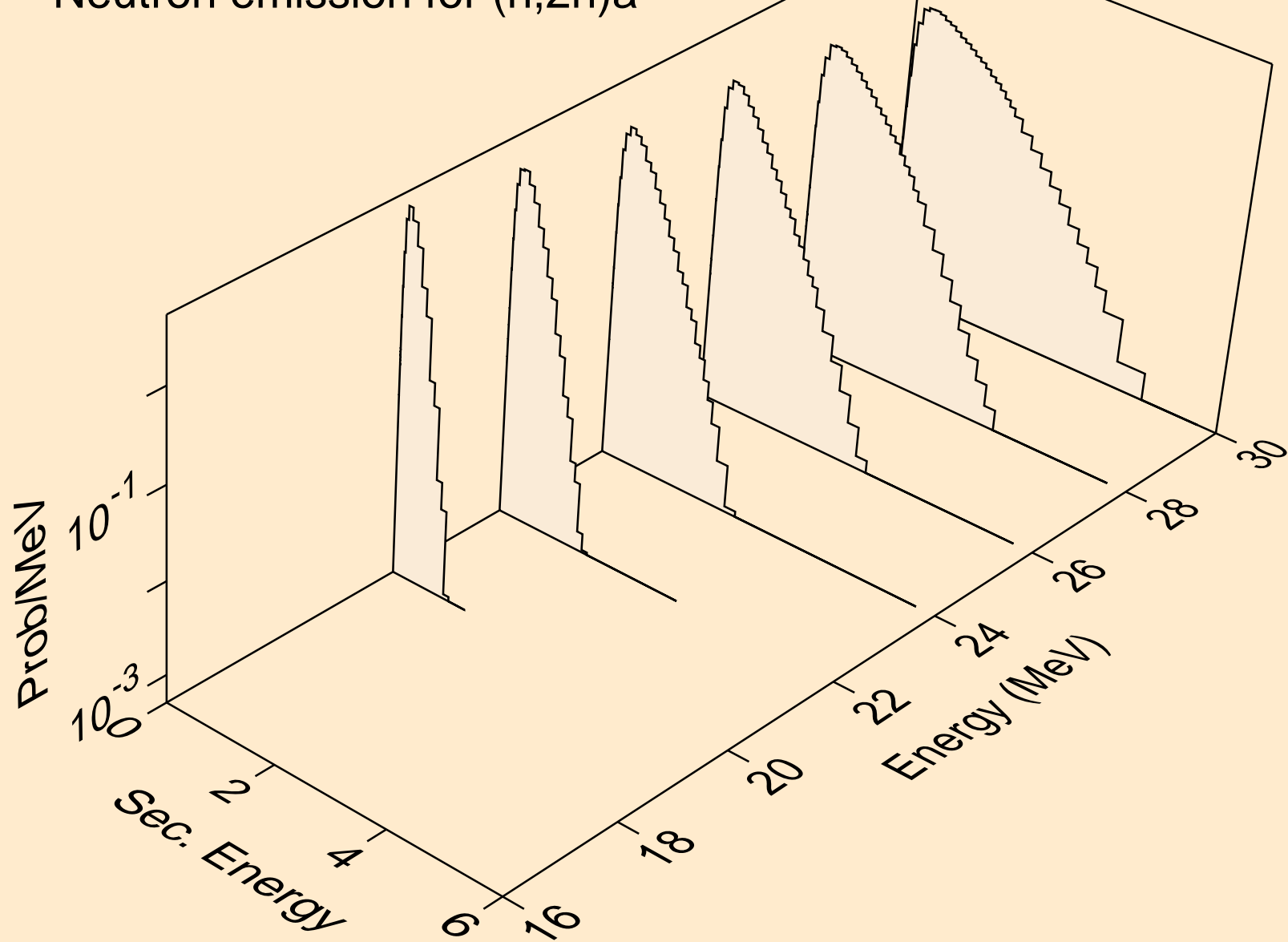

Y085 NEUTRON ACER TENDL-2024 LIBRARY; T=293.6K  
Neutron emission for (n,n\*)p

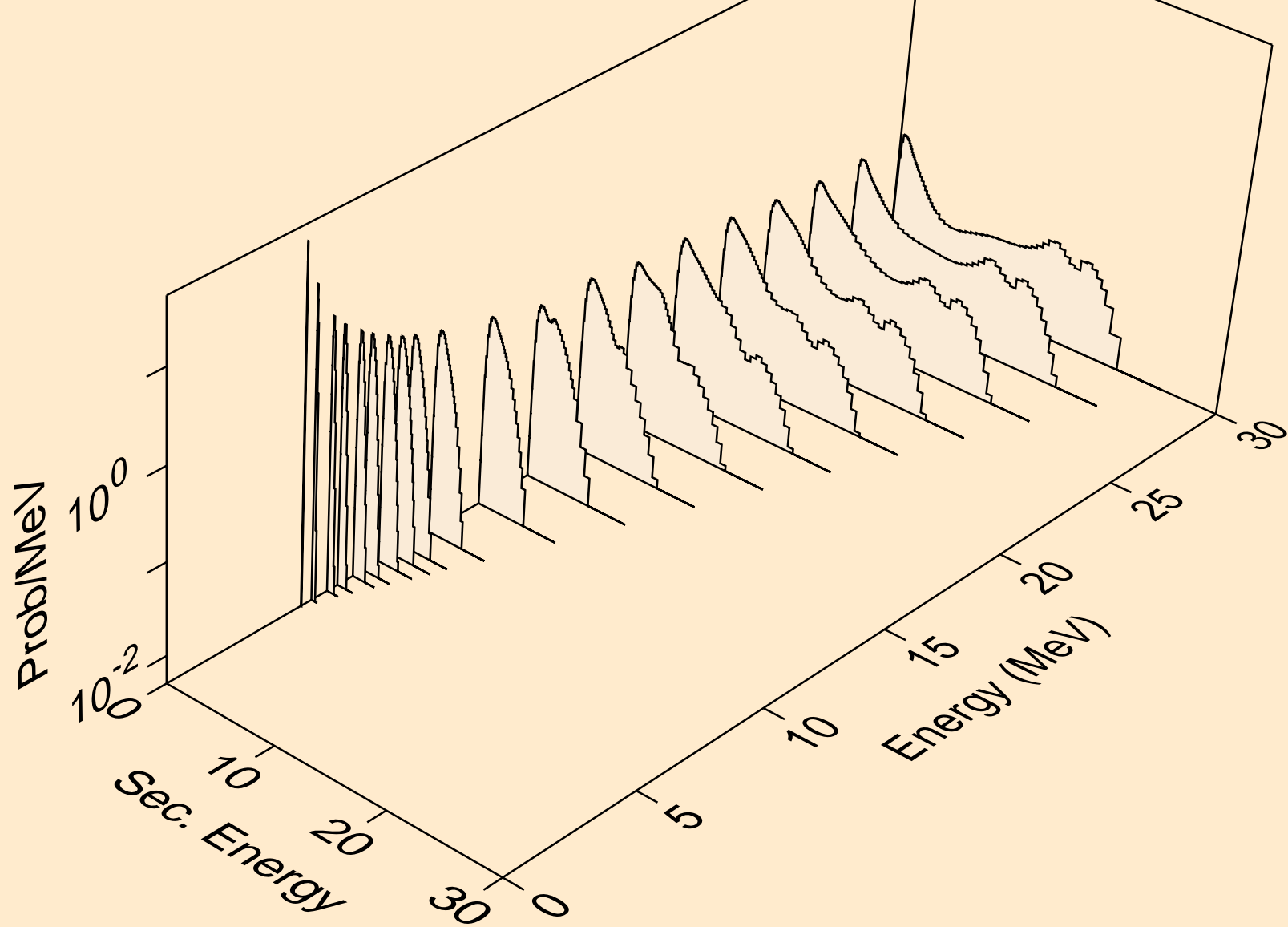

Y085 NEUTRON ACER TENDL-2024 LIBRARY; T=293.6K  
Neutron emission for (n,n\*)2a

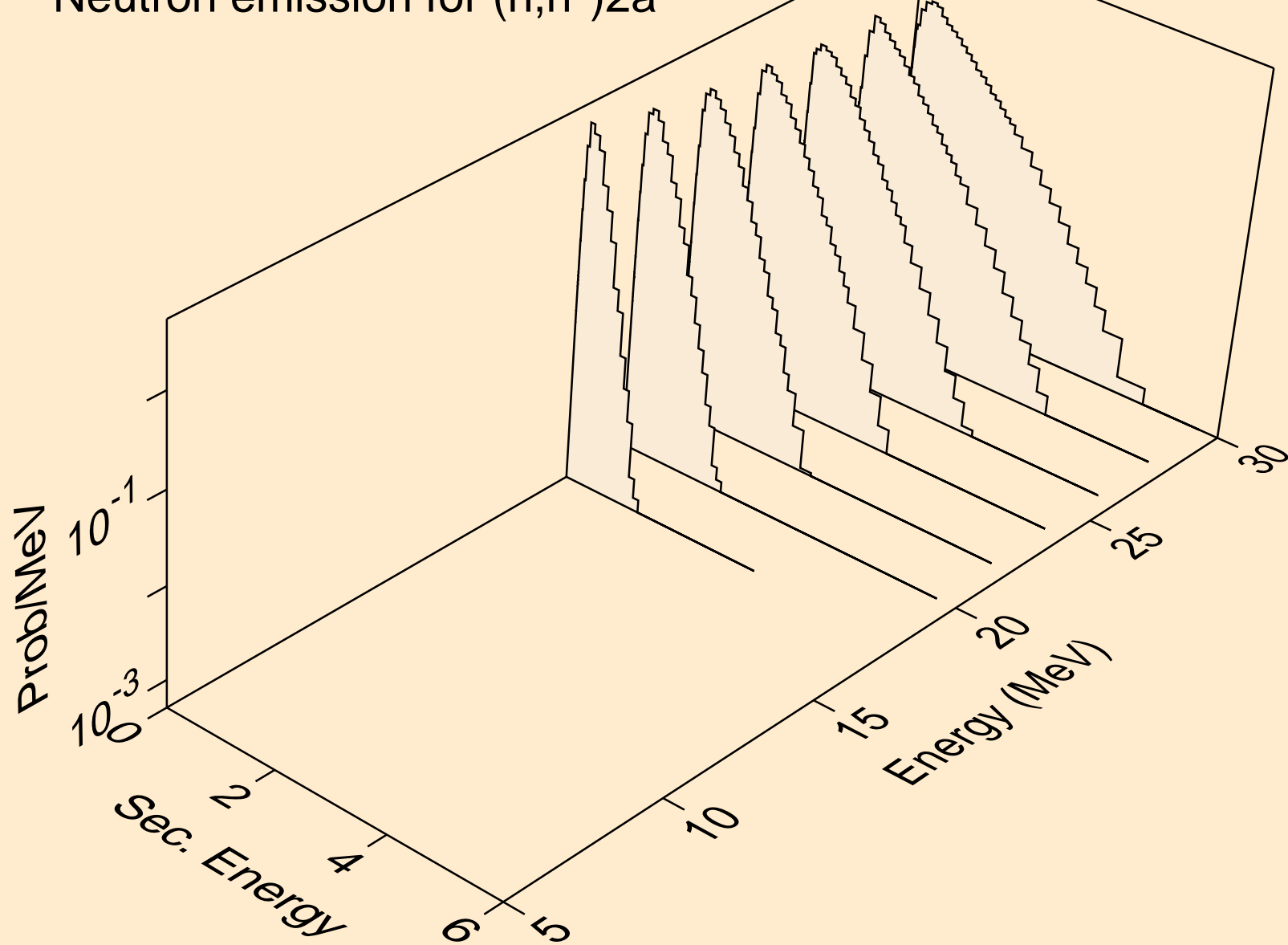

Y085 NEUTRON ACER TENDL-2024 LIBRARY; T=293.6K  
Neutron emission for (n,n\*)d

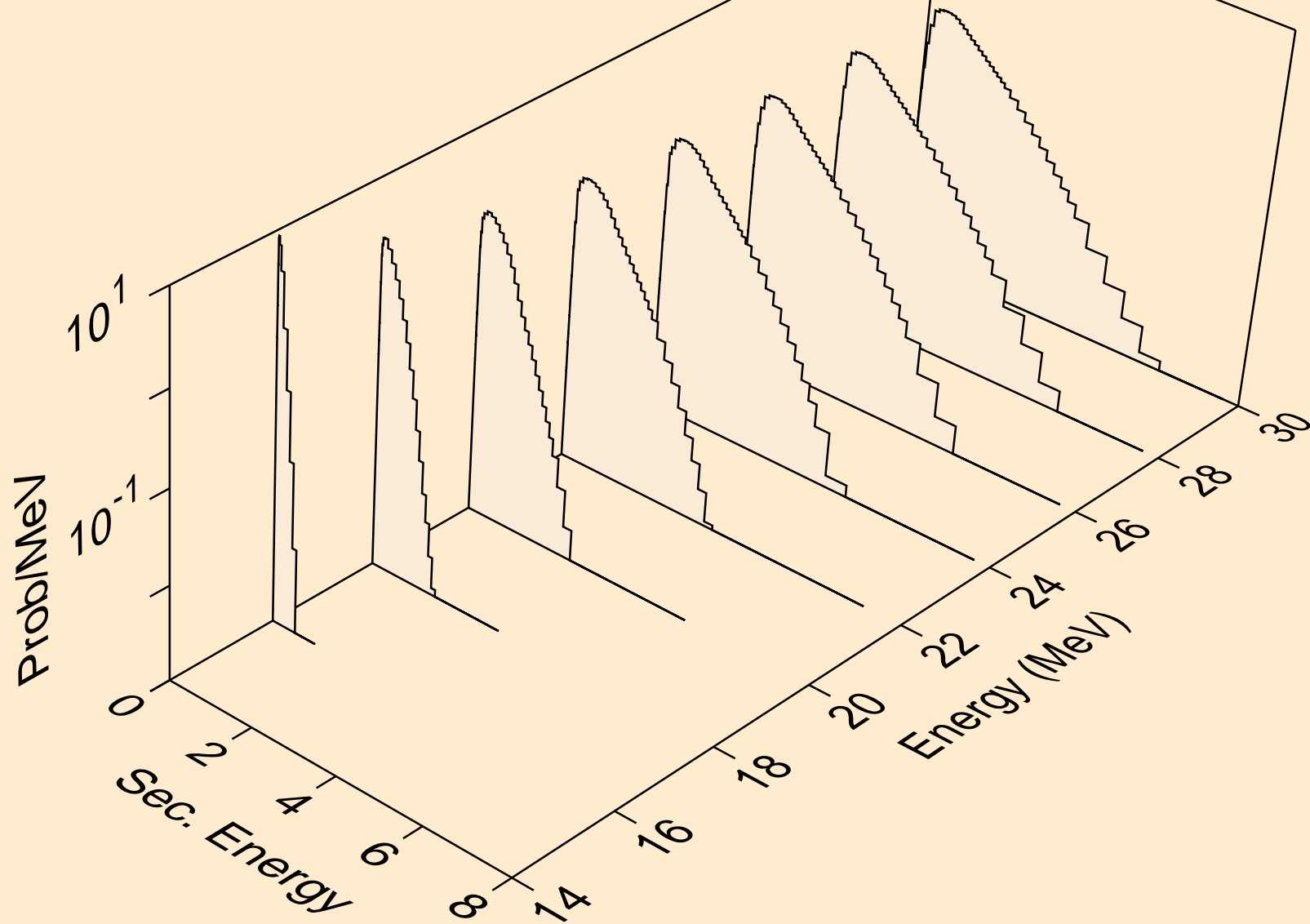

Y085 NEUTRON ACER TENDL-2024 LIBRARY; T=293.6K  
Neutron emission for (n,n\*)t

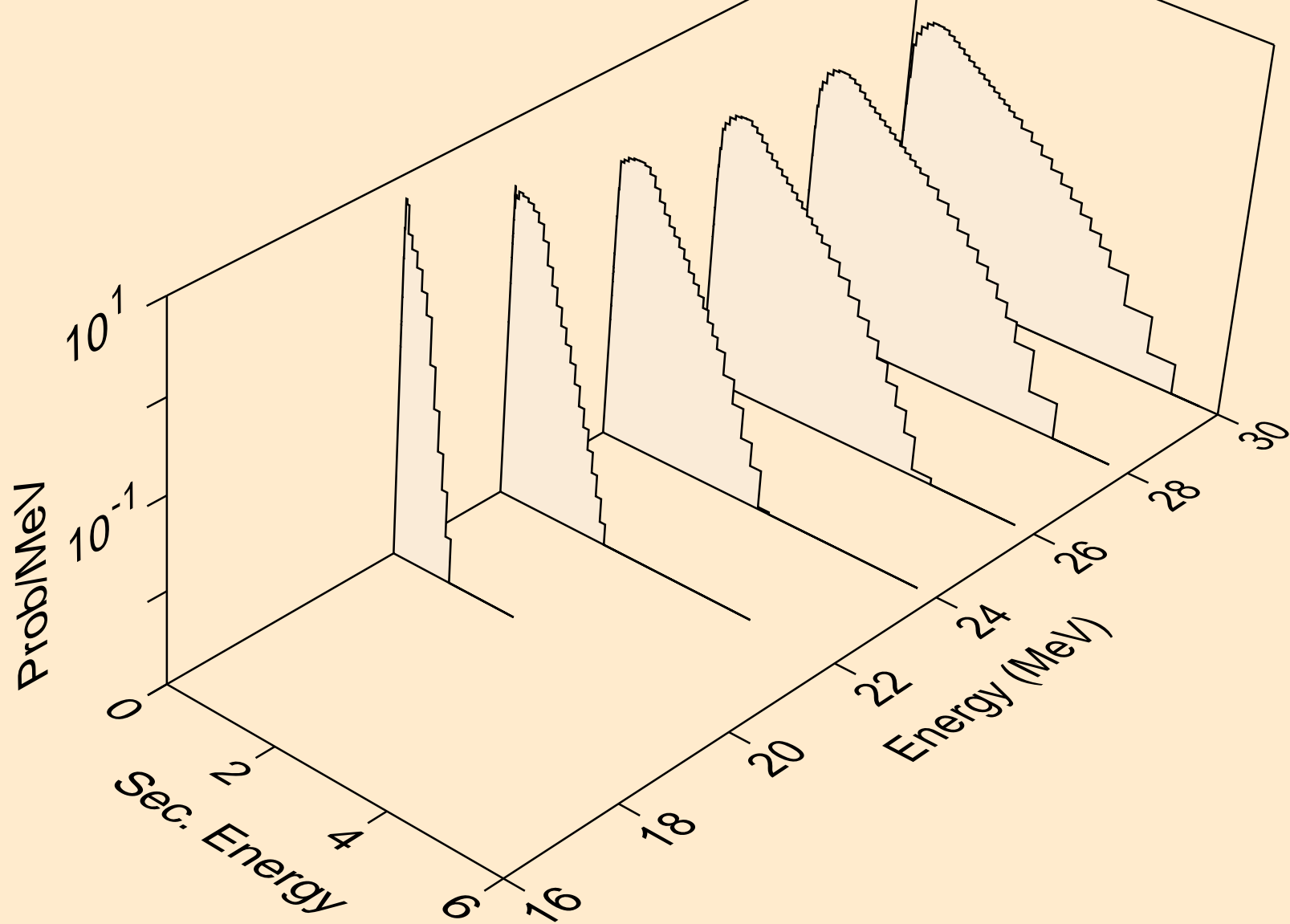

Y085 NEUTRON ACER TENDL-2024 LIBRARY; T=293.6K  
Neutron emission for (n,n\*)he3

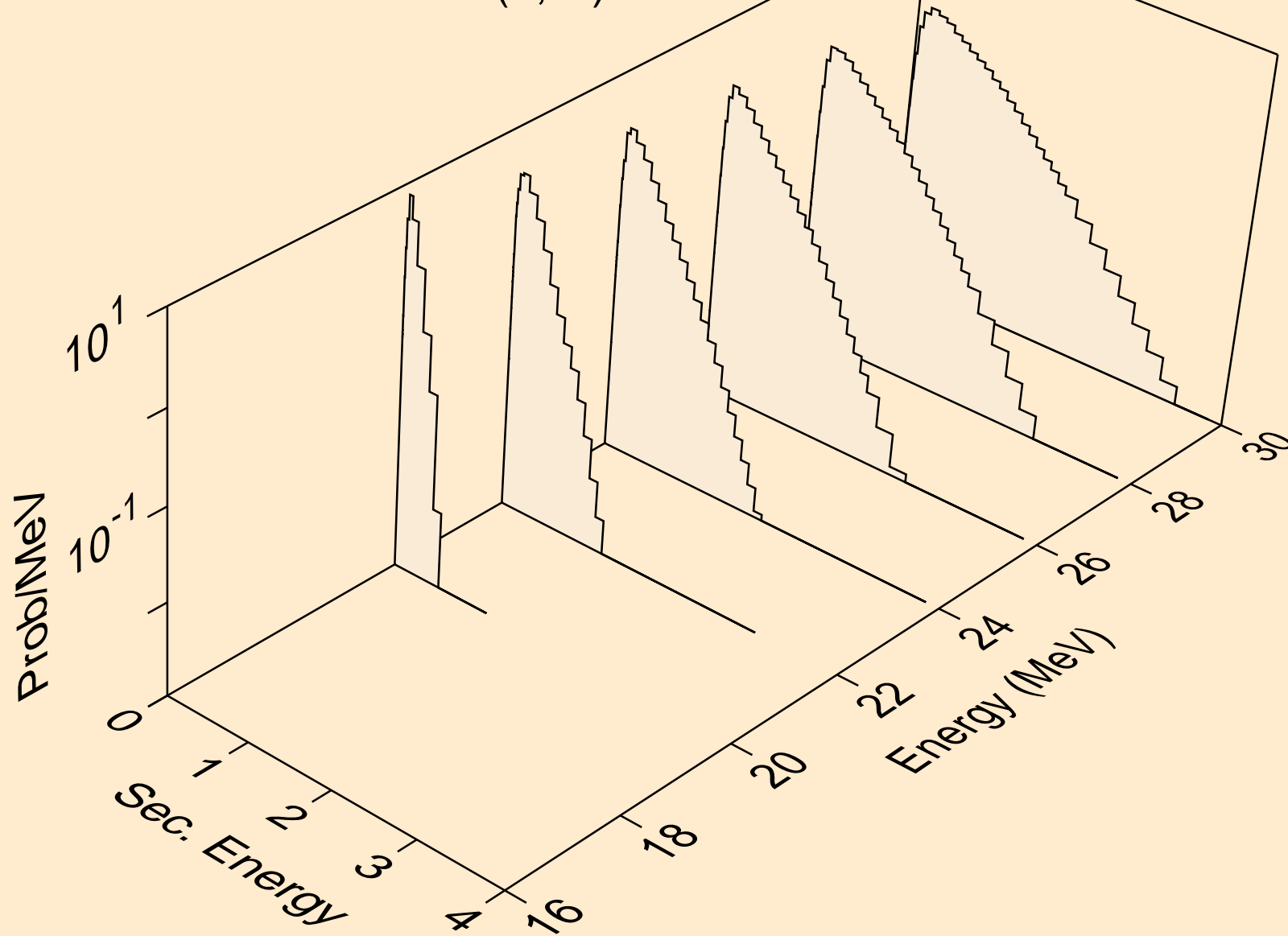

Y085 NEUTRON ACER TENDL-2024 LIBRARY; T=293.6K  
Neutron emission for (n,2np)

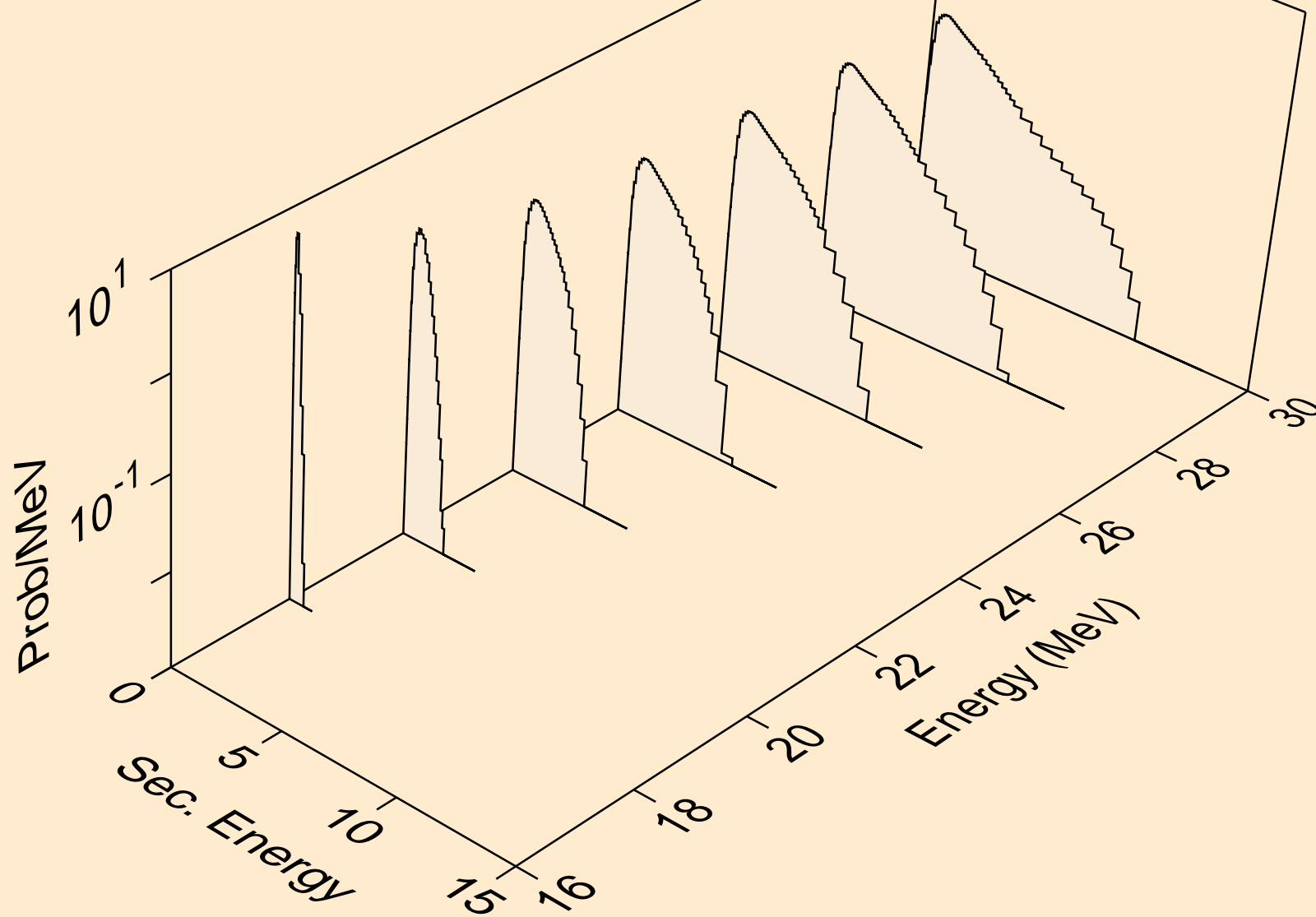

Y085 NEUTRON ACER TENDL-2024 LIBRARY; T=293.6K  
Neutron emission for (n,3np)

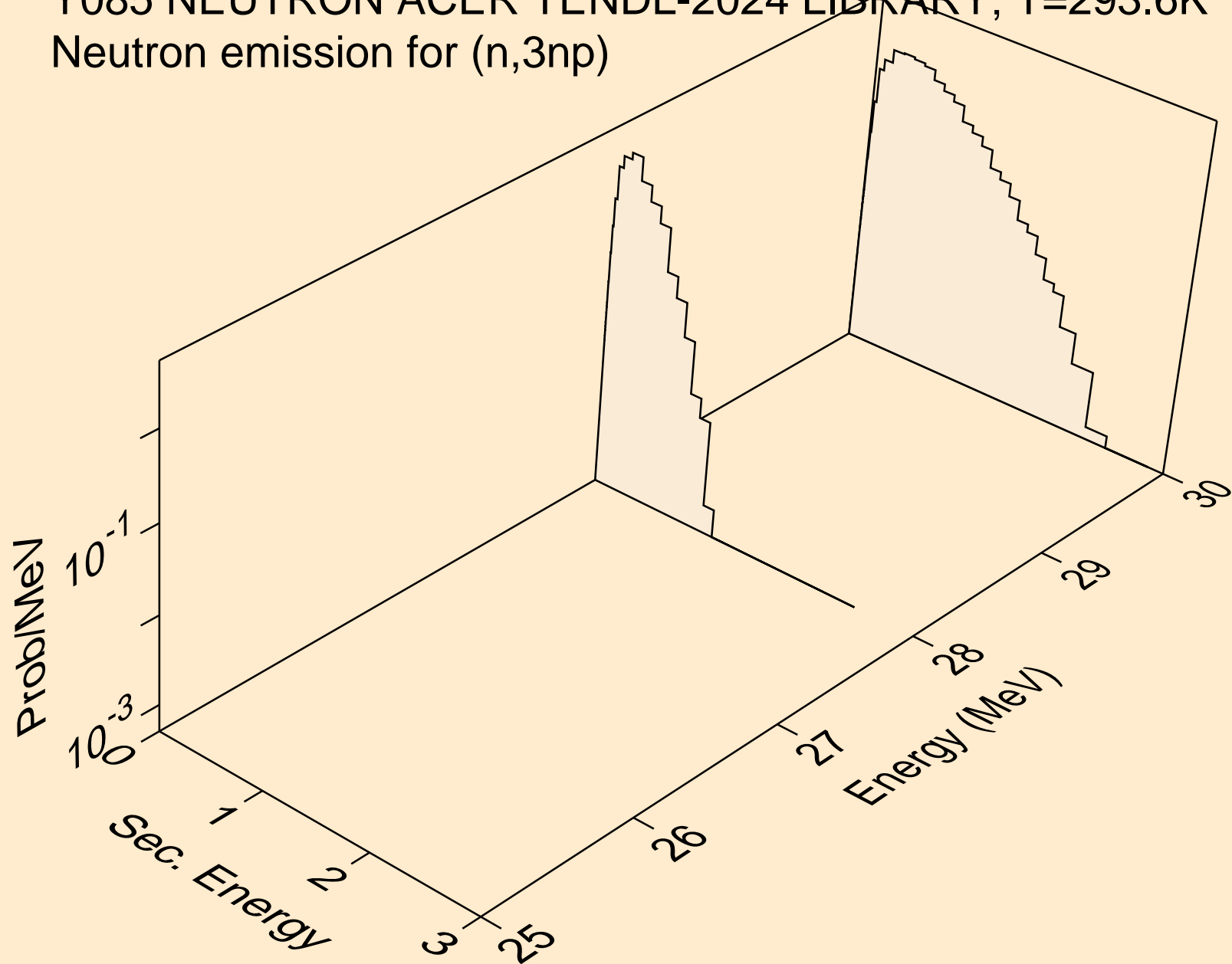

Y085 NEUTRON ACER TENDL-2024 LIBRARY; T=293.6K  
Neutron emission for (n,n2p)

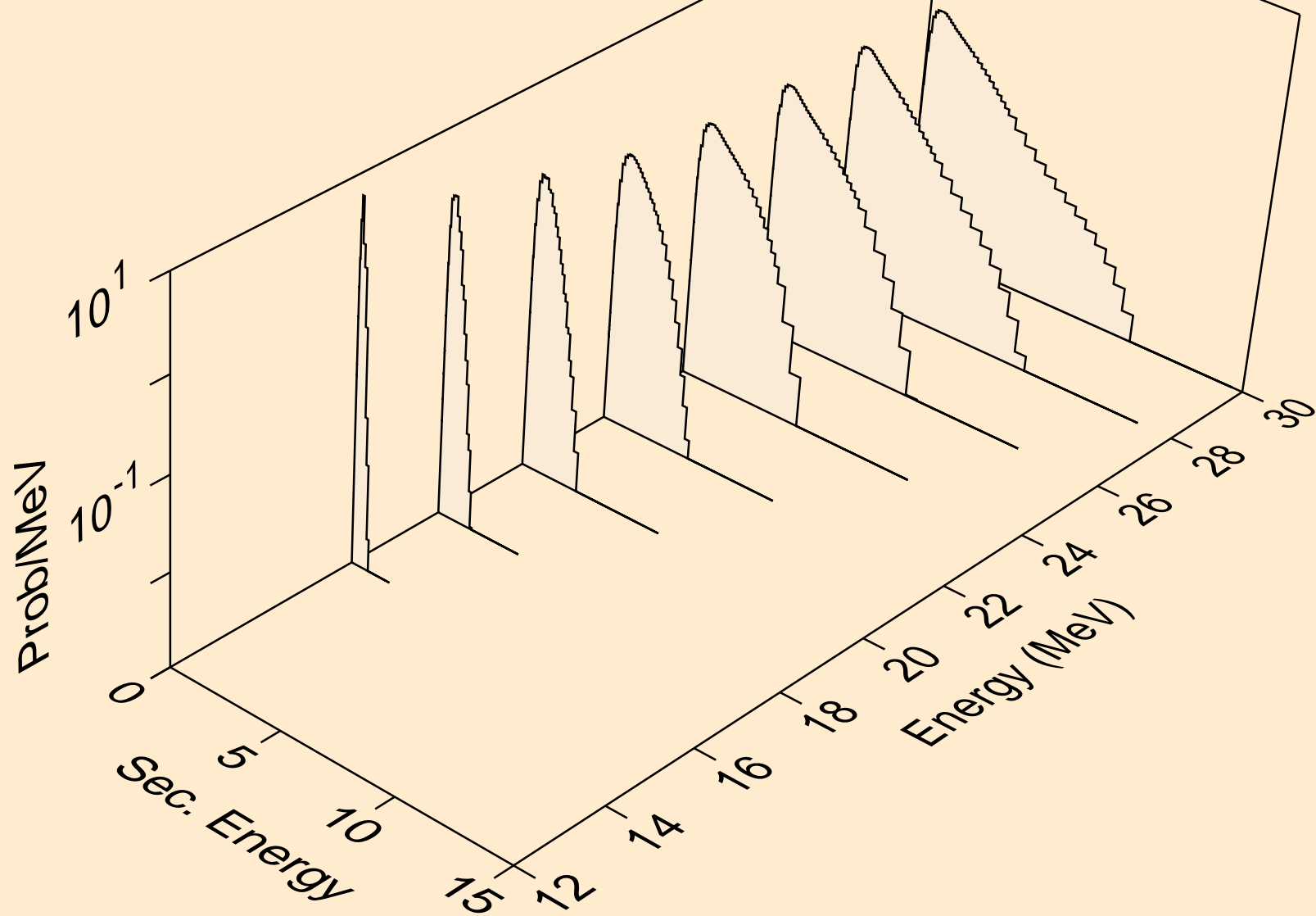

Y085 NEUTRON ACER TENDL-2024 LIBRARY; T=293.6K  
Neutron emission for (n,npa)

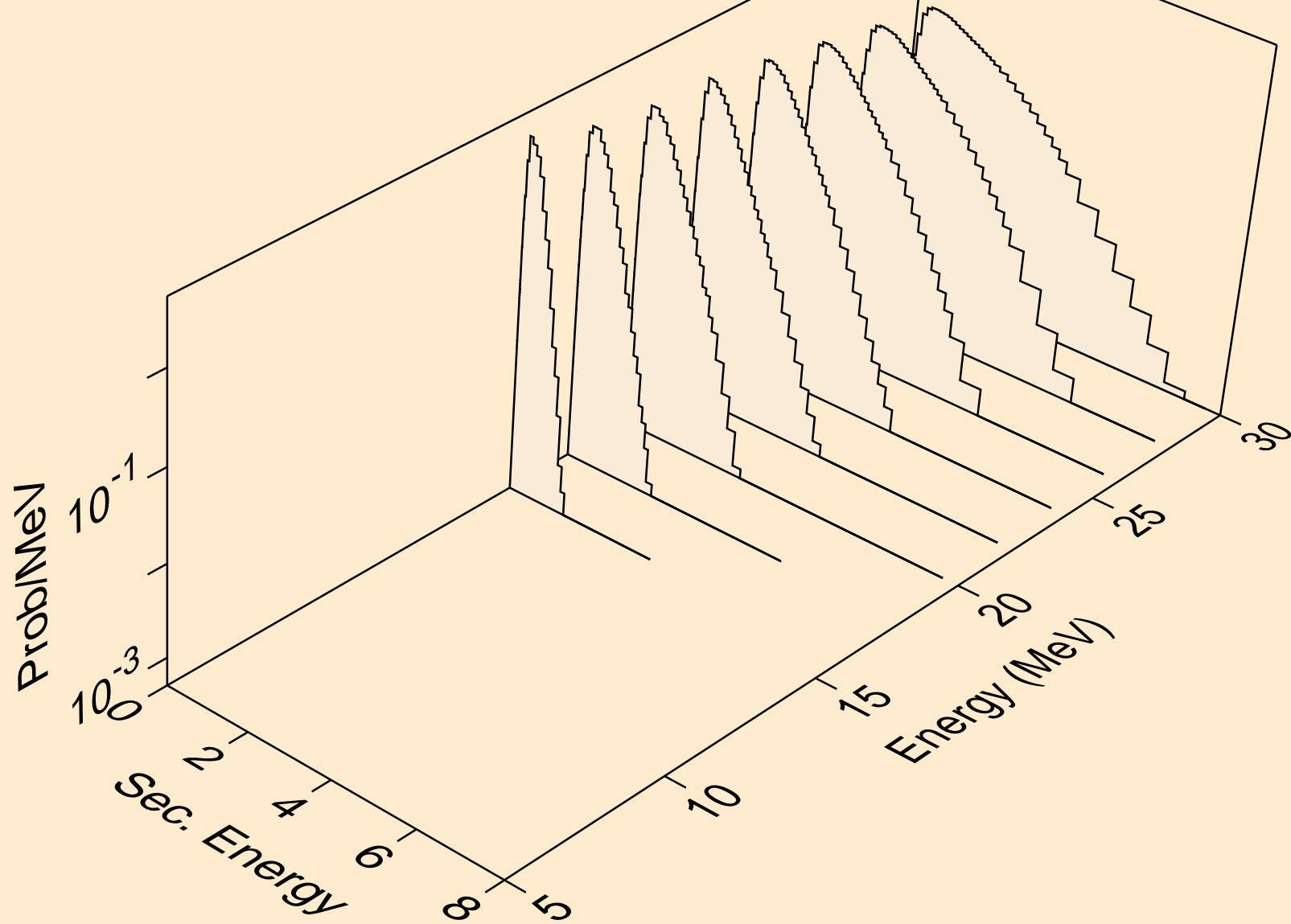

Y085 NEUTRON ACER TENDL-2024 LIBRARY; T=293.6K  
Neutron emission for (n,n\*c)

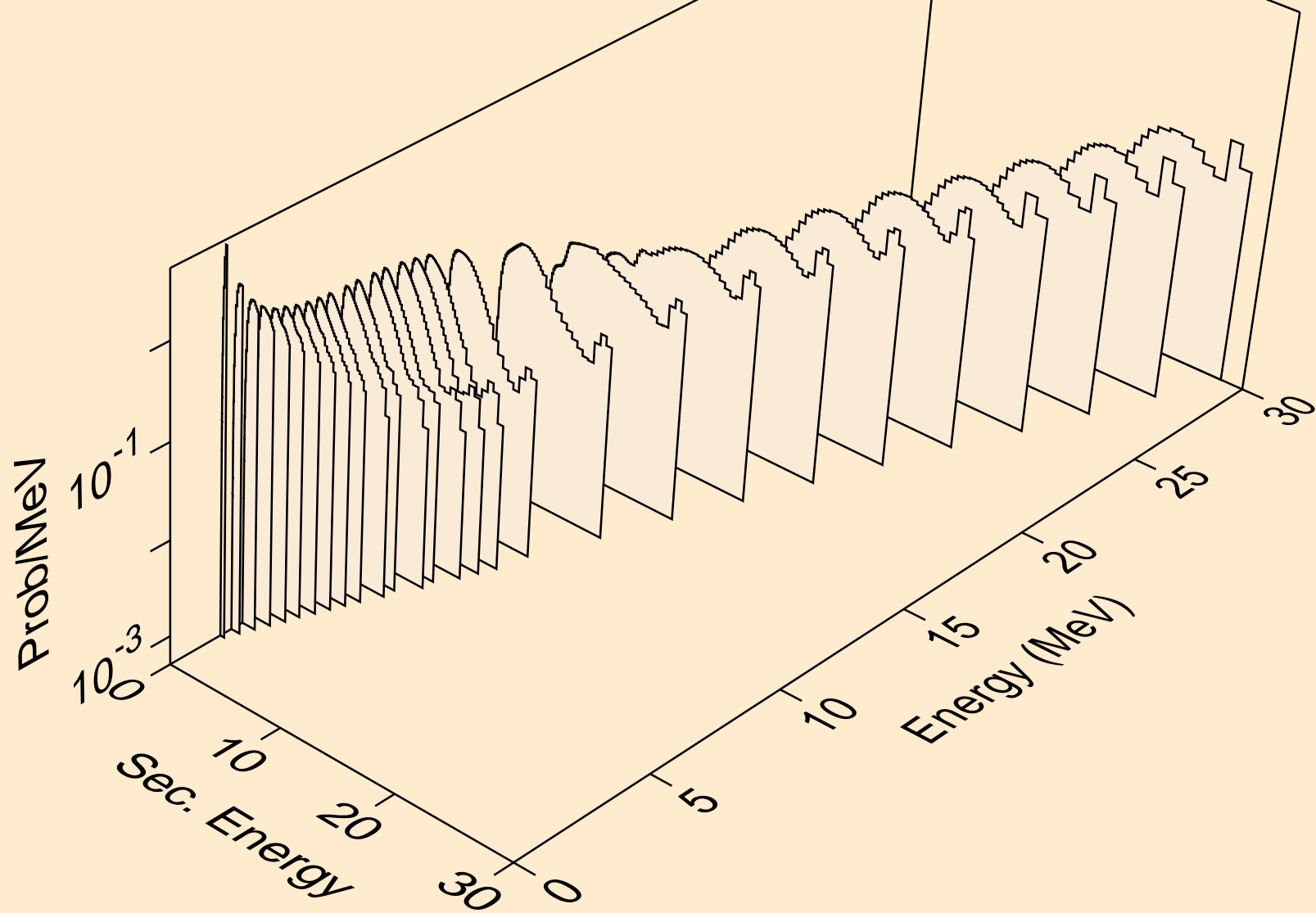

Y085 NEUTRON ACER TENDL-2024 LIBRARY; T=293.6K  
Photon emission for (n,x)

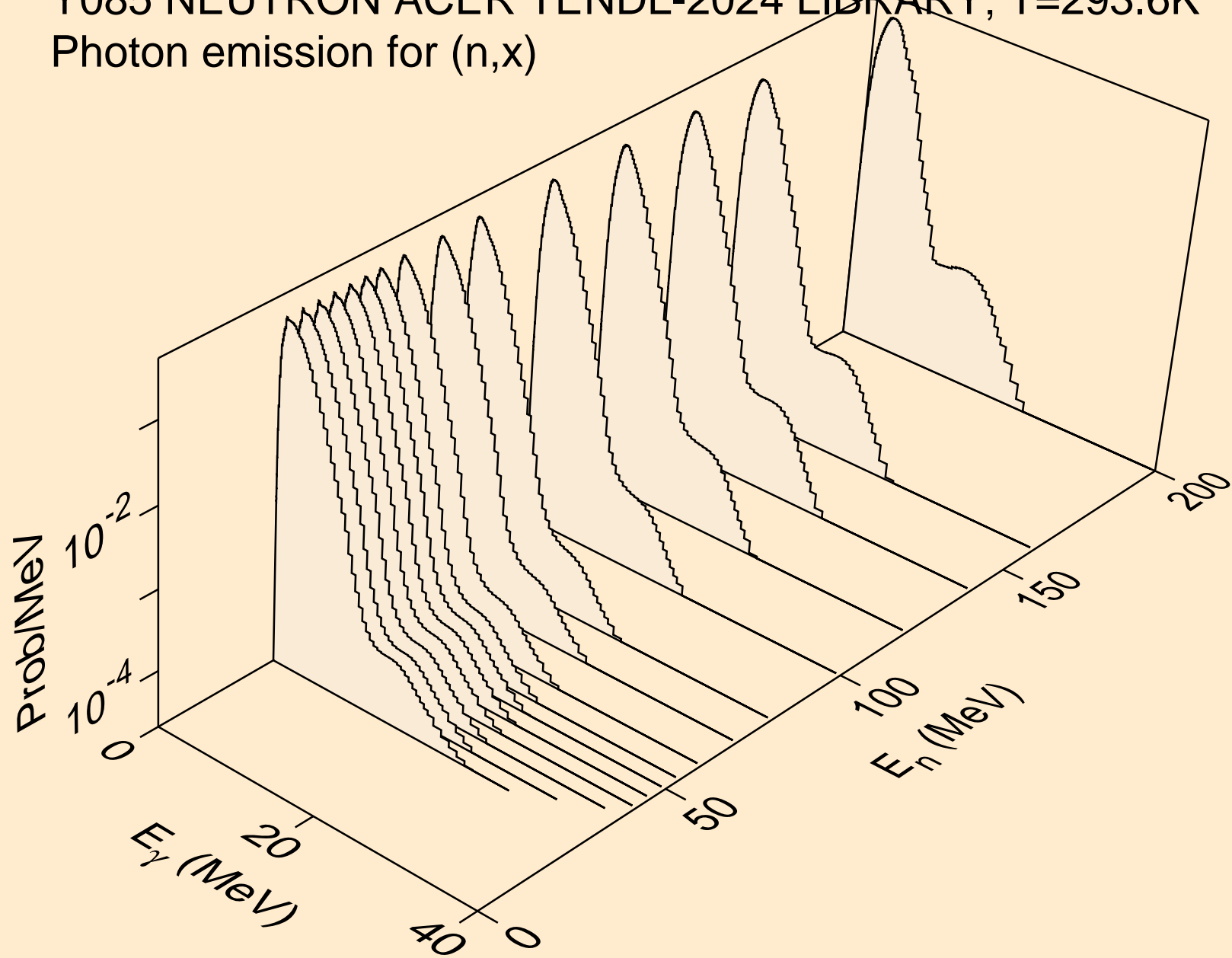

Y085 NEUTRON ACER TENDL-2024 LIBRARY; T=293.6K  
Photon emission for (n,2nd)

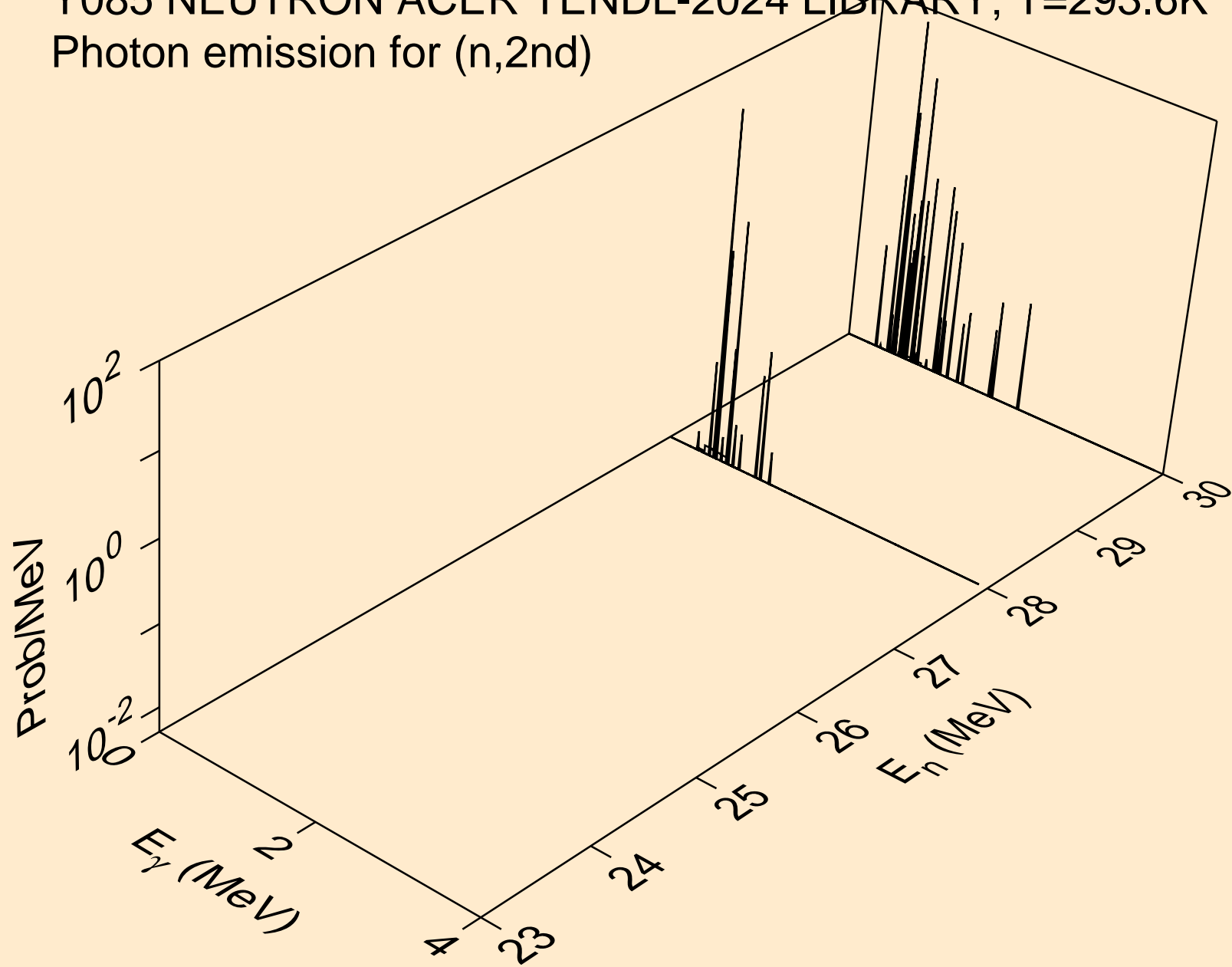

Y085 NEUTRON ACER TENDL-2024 LIBRARY; T=293.6K  
Photon emission for (n,2n)

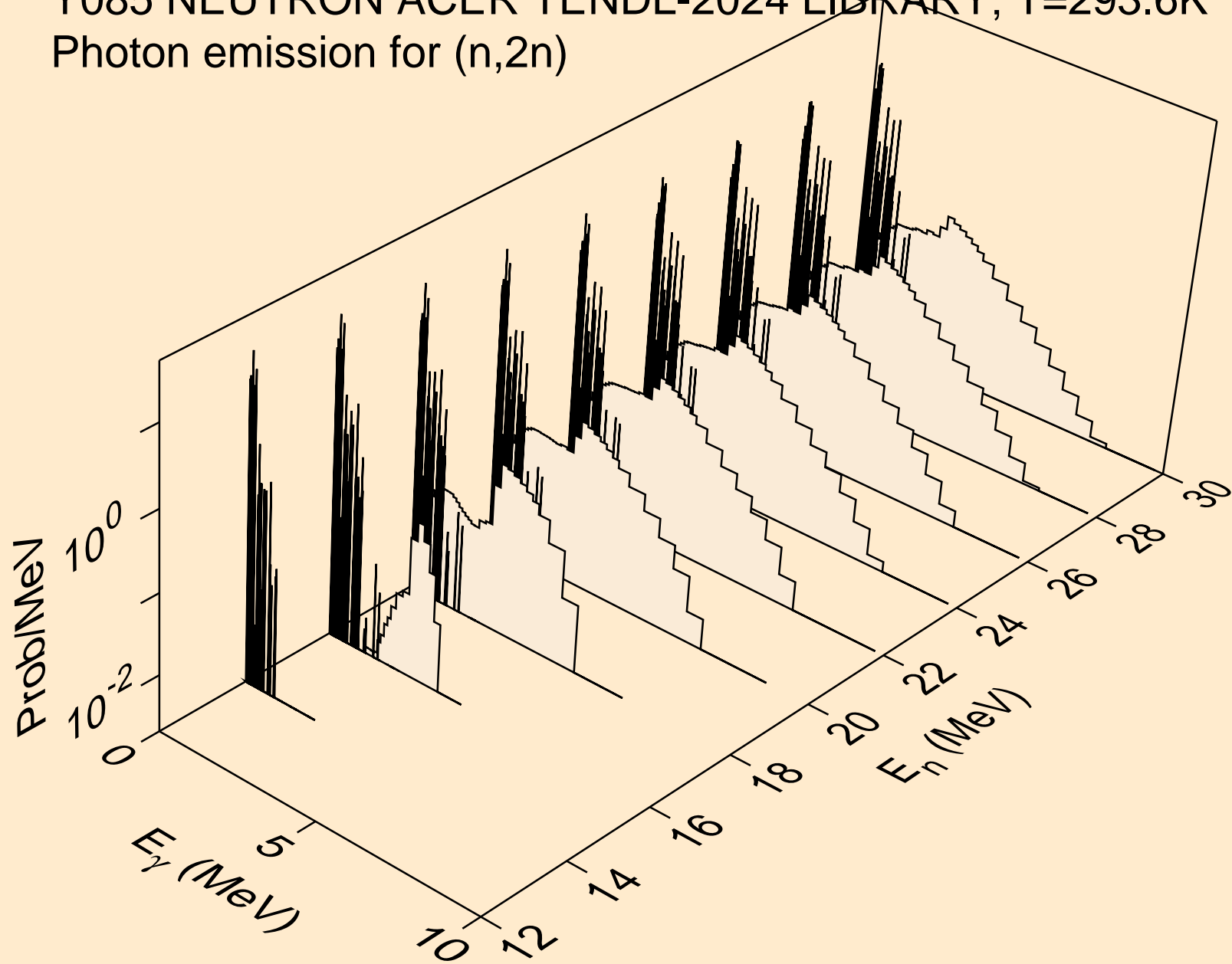

Y085 NEUTRON ACER TENDL-2024 LIBRARY; T=293.6K  
Photon emission for (n,3n)

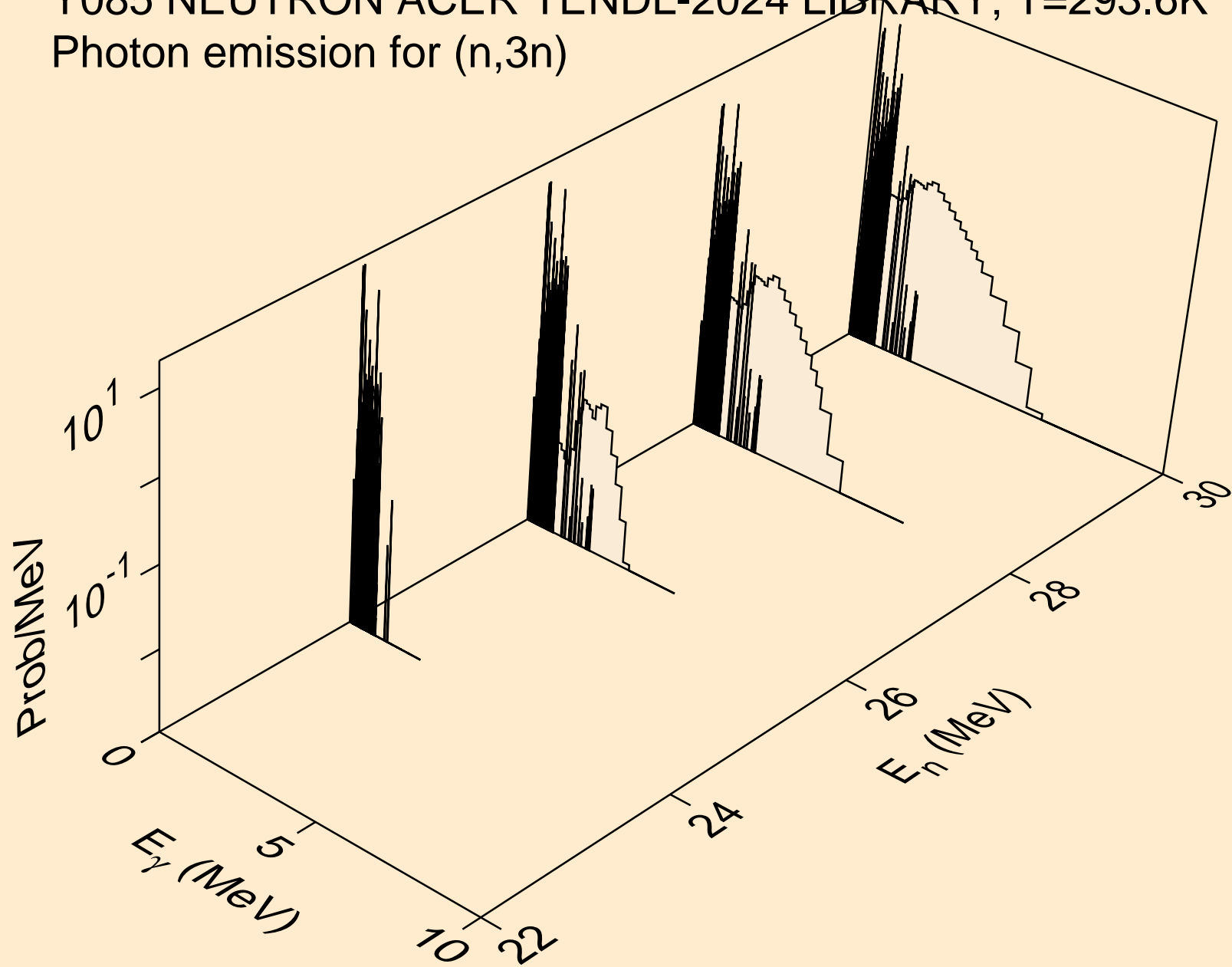

Y085 NEUTRON ACER TENDL-2024 LIBRARY; T=293.6K  
Photon emission for (n,n\*)a

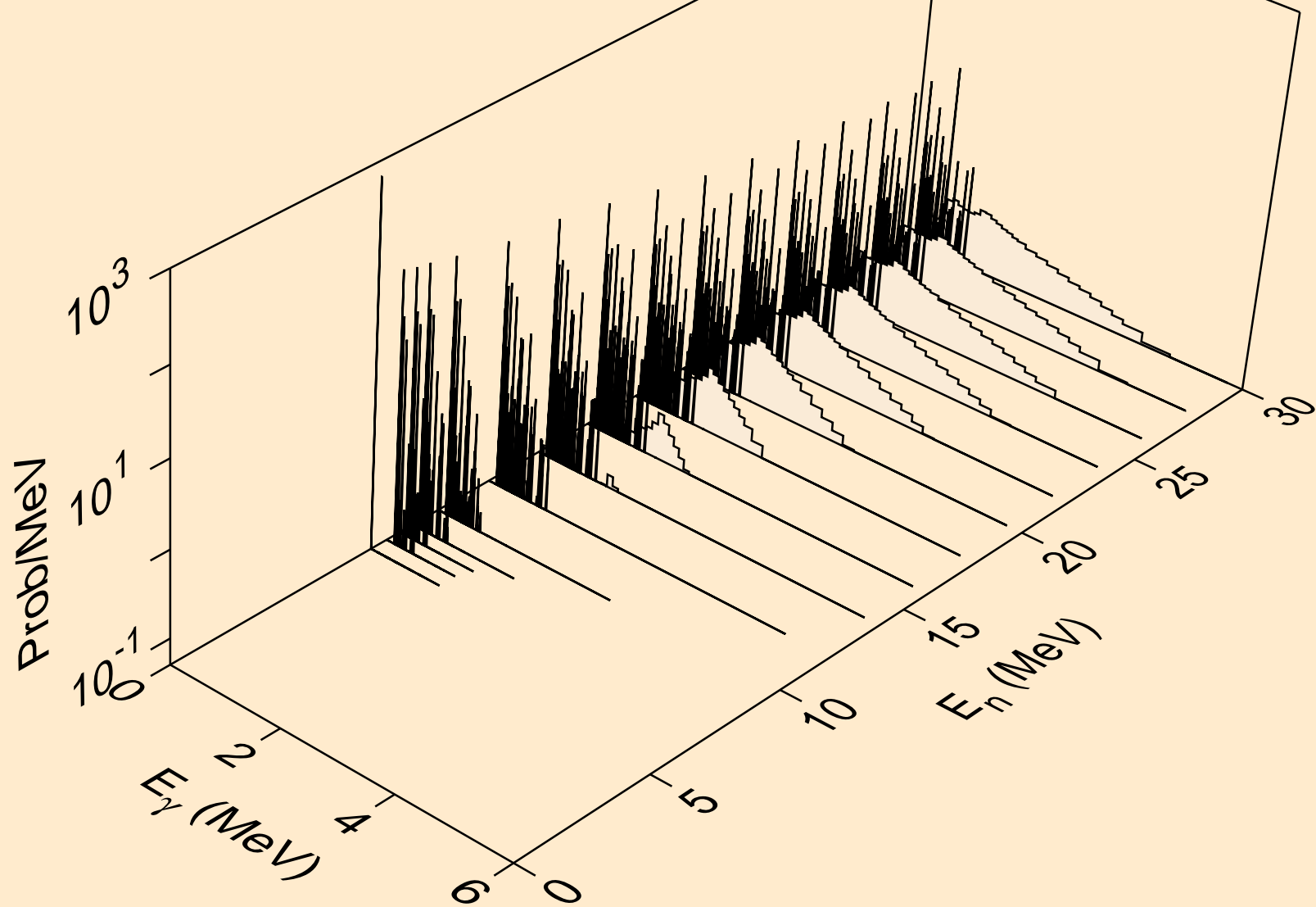

Y085 NEUTRON ACER TENDL-2024 LIBRARY; T=293.6K  
Photon emission for (n,2n)a

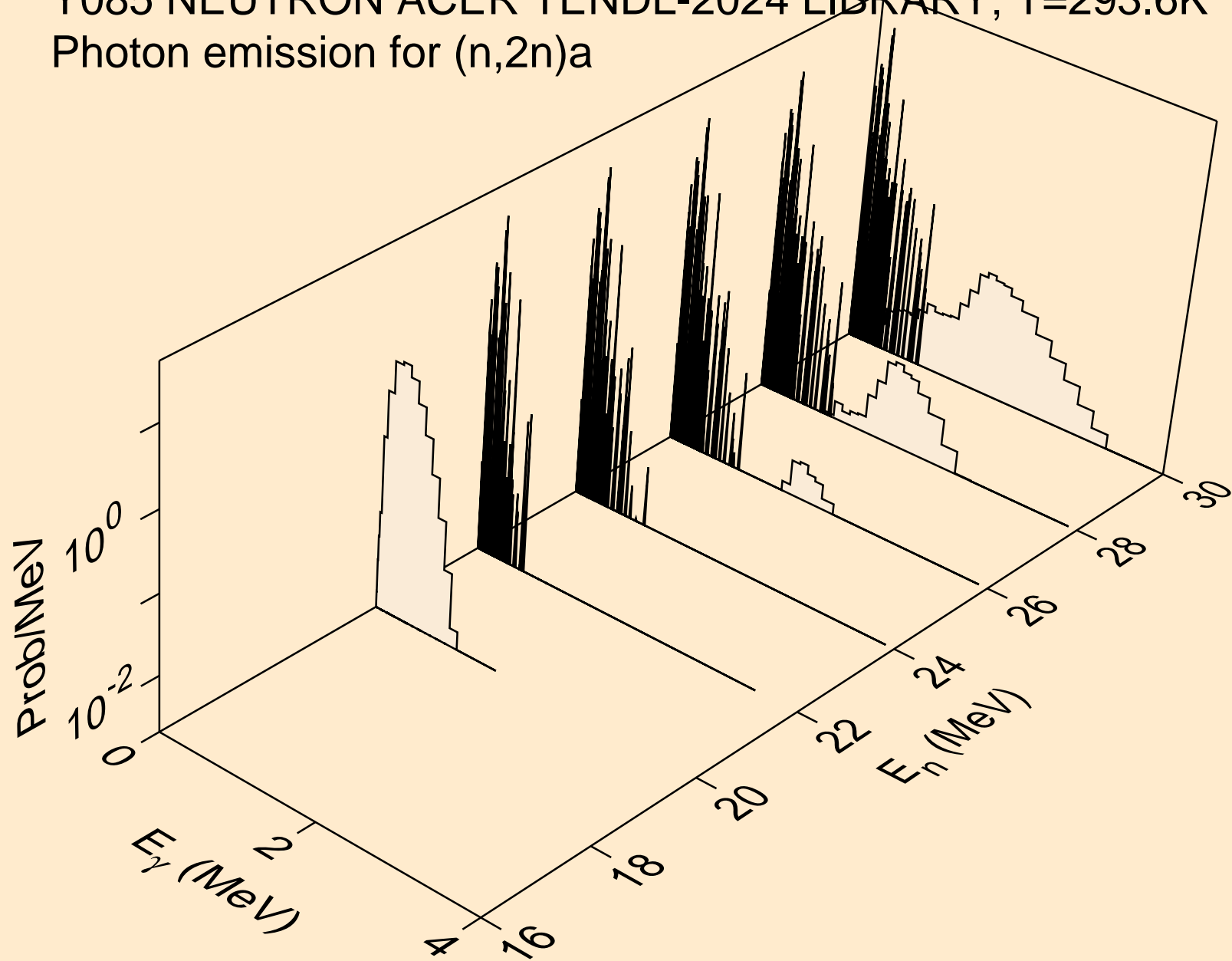

Y085 NEUTRON ACER TENDL-2024 LIBRARY; T=293.6K  
Photon emission for (n,n\*)p

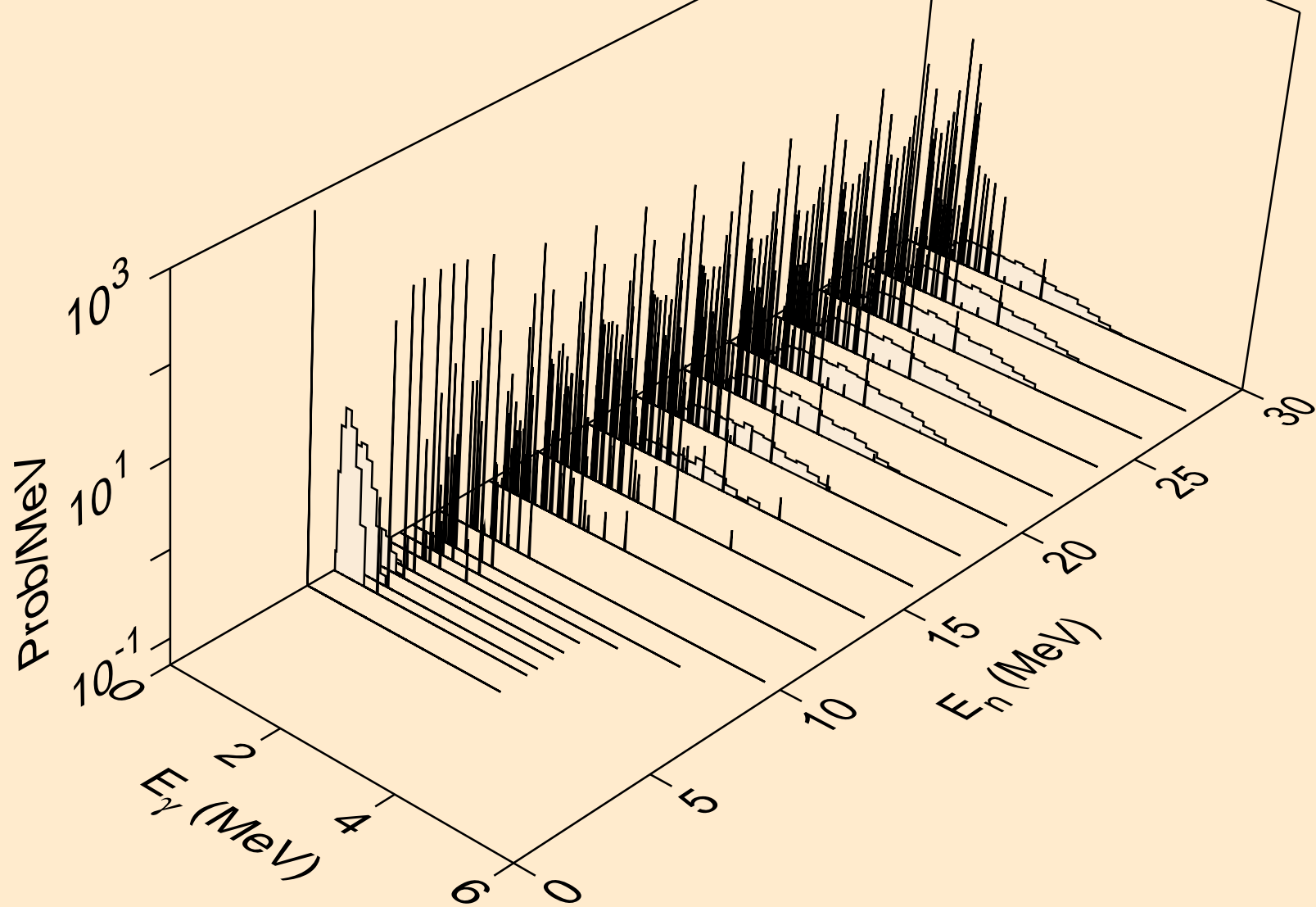

Y085 NEUTRON ACER TENDL-2024 LIBRARY; T=293.6K  
Photon emission for (n,n\*)2a

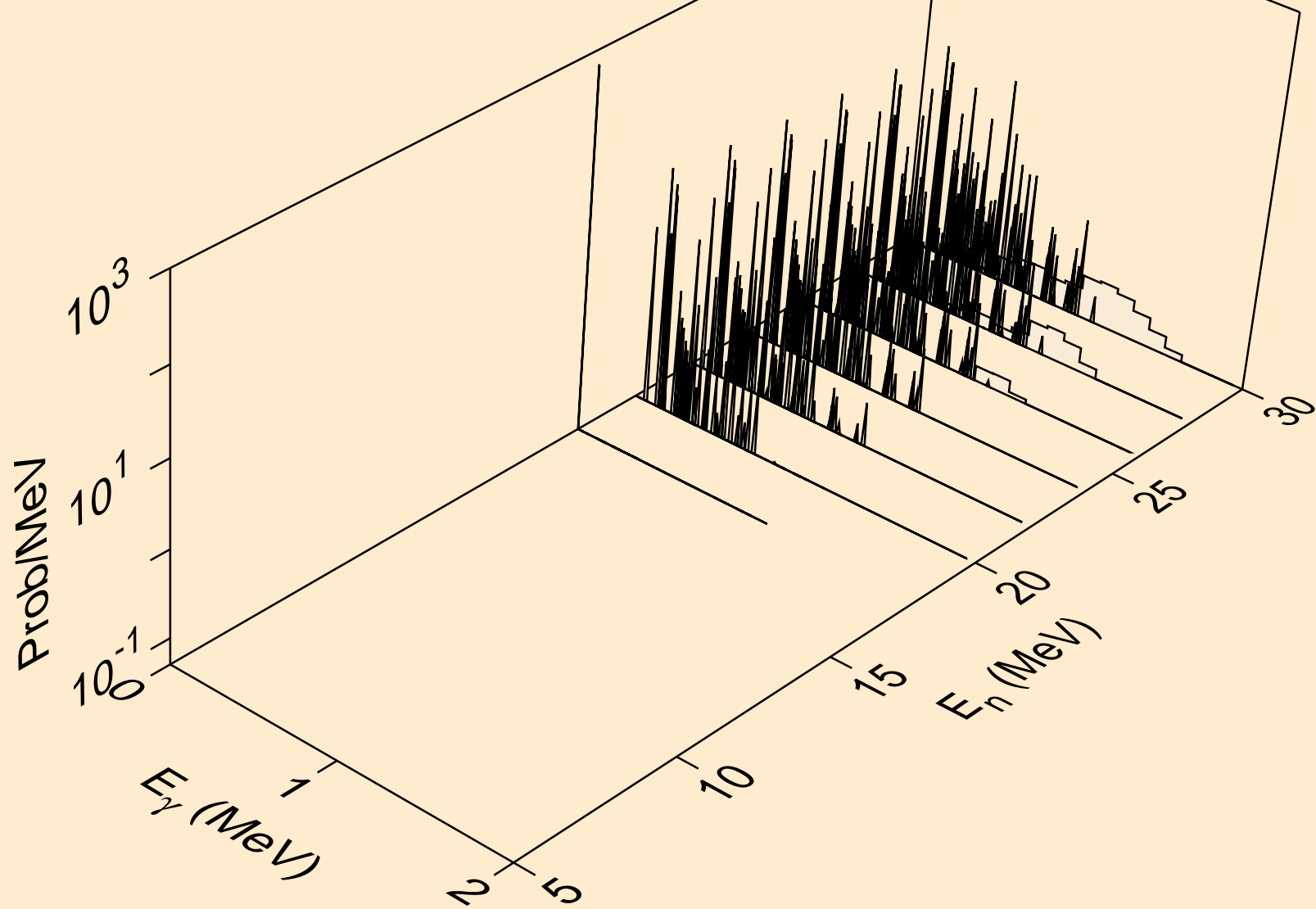

Y085 NEUTRON ACER TENDL-2024 LIBRARY; T=293.6K  
Photon emission for (n,n\*)d

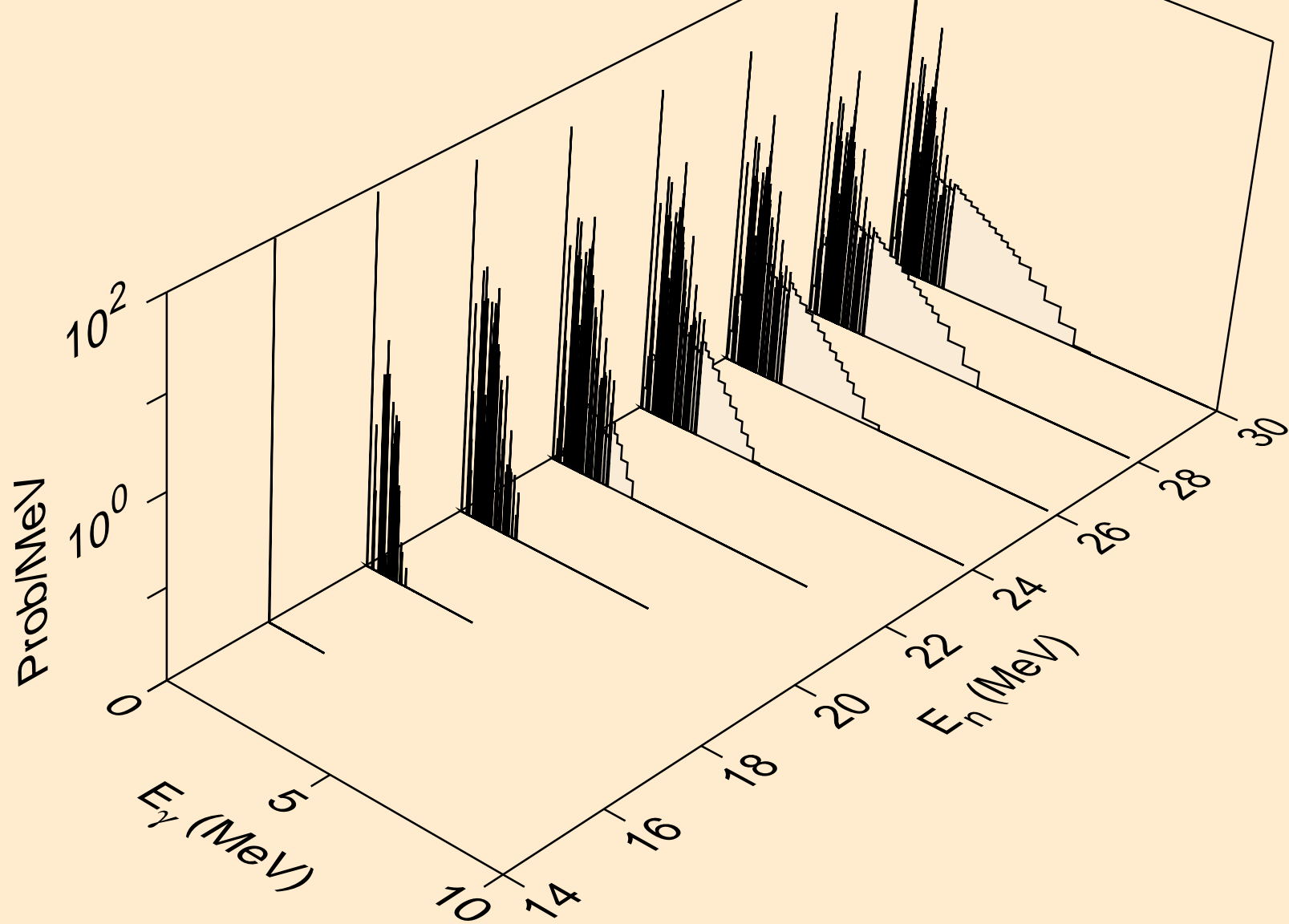

Y085 NEUTRON ACER TENDL-2024 LIBRARY; T=293.6K  
Photon emission for (n,n\*)t

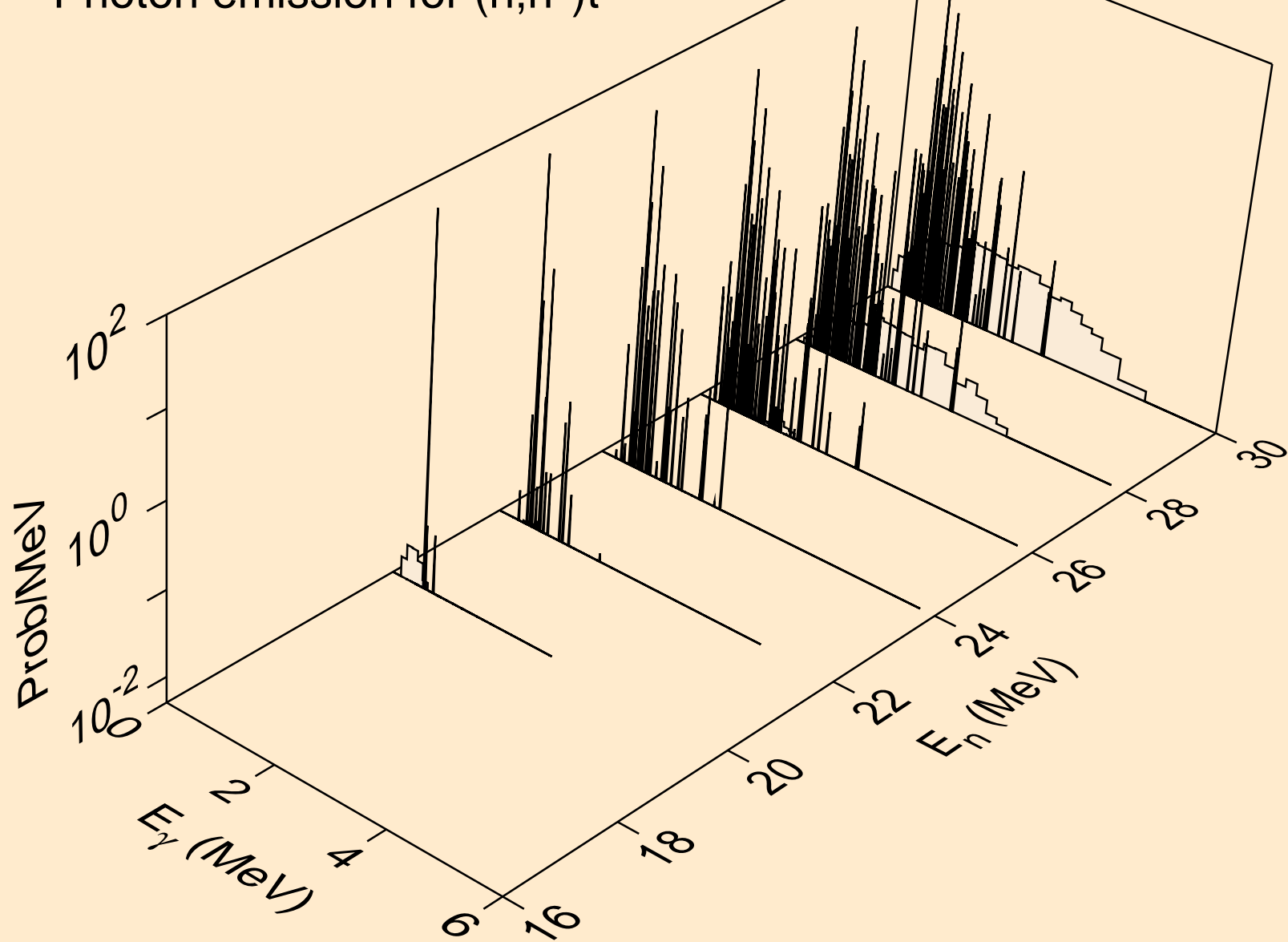

Y085 NEUTRON ACER TENDL-2024 LIBRARY; T=293.6K  
Photon emission for (n,n\*)he3

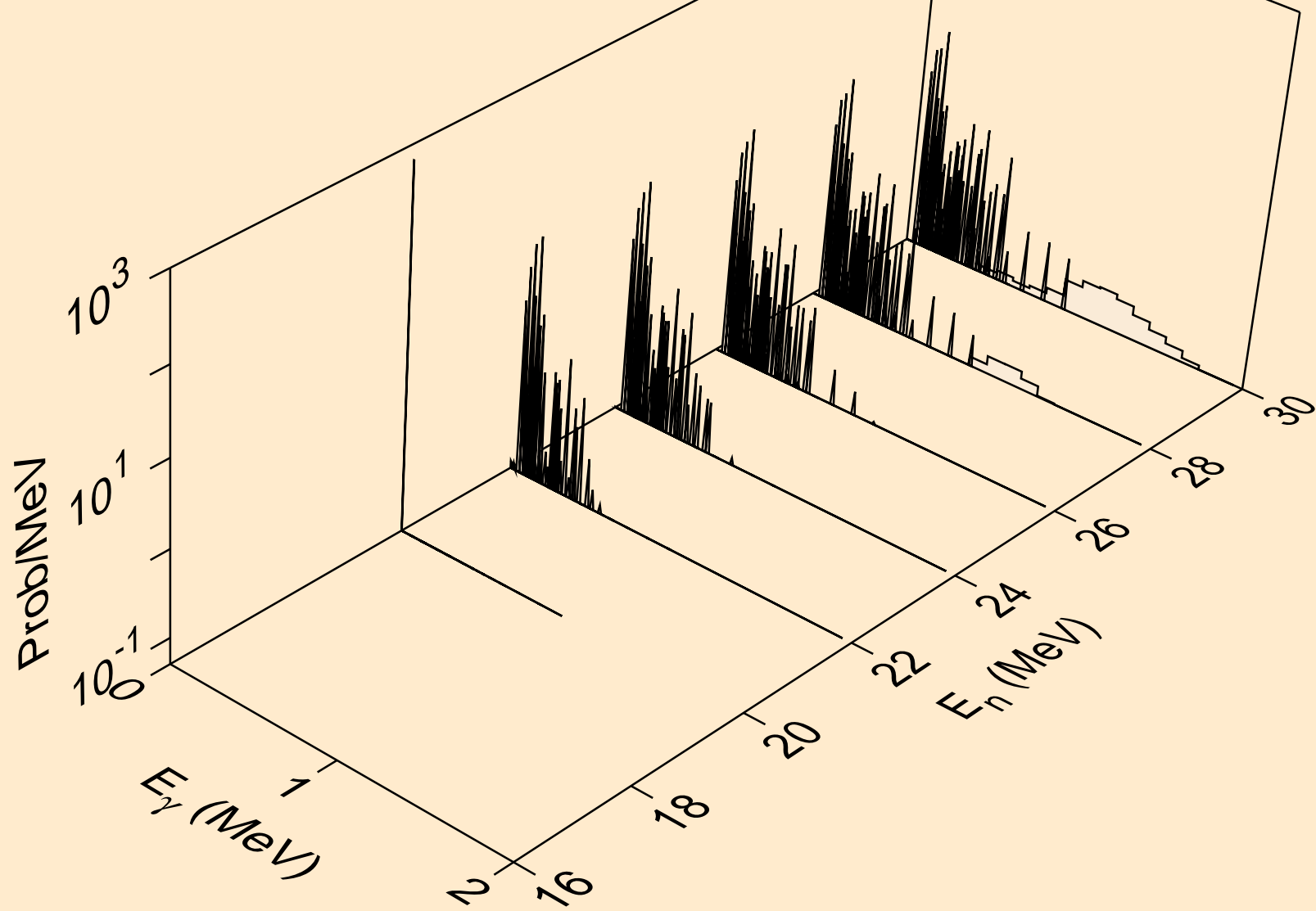

Y085 NEUTRON ACER TENDL-2024 LIBRARY; T=293.6K  
Photon emission for (n,2np)

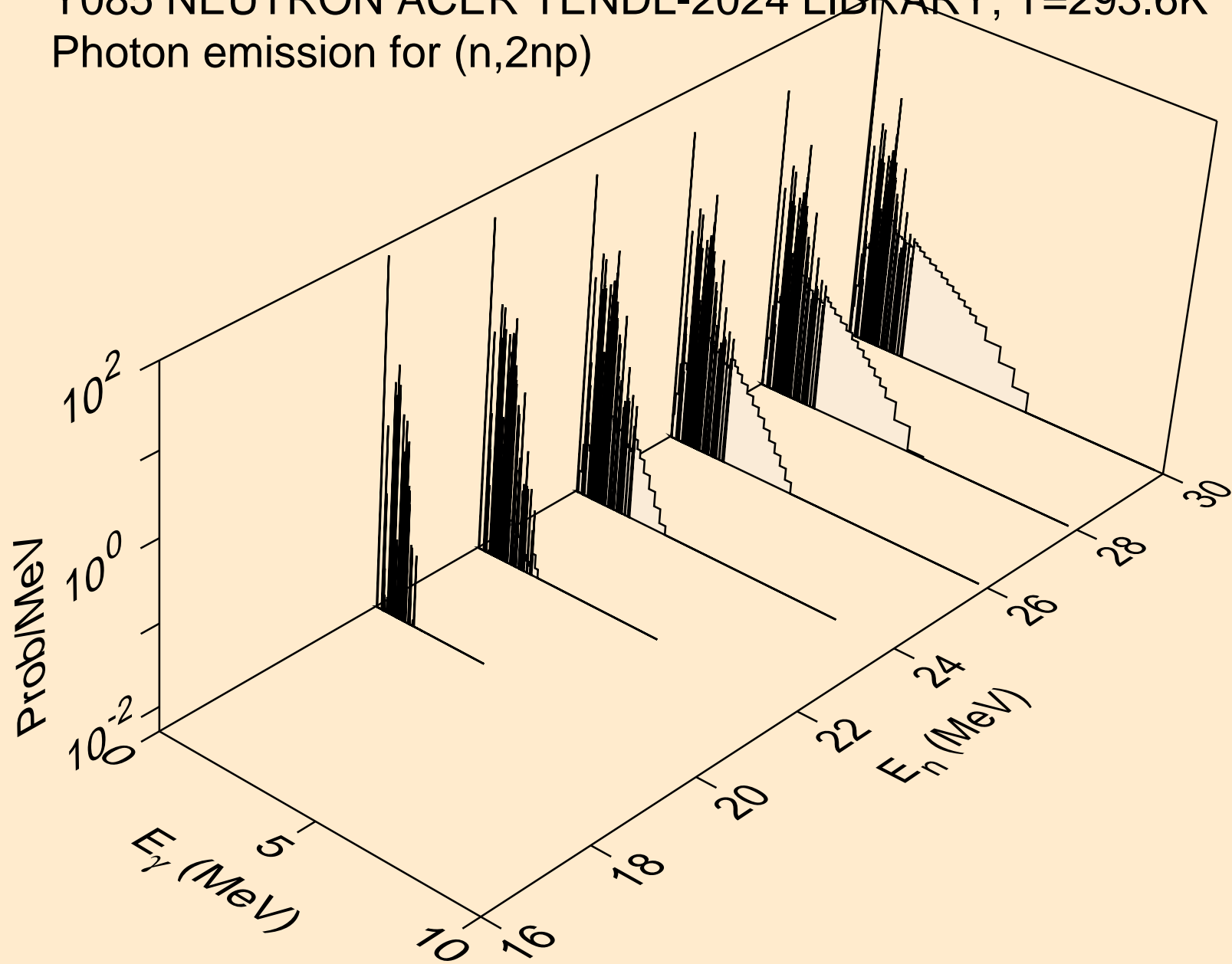

Y085 NEUTRON ACER TENDL-2024 LIBRARY; T=293.6K  
Photon emission for (n,3np)

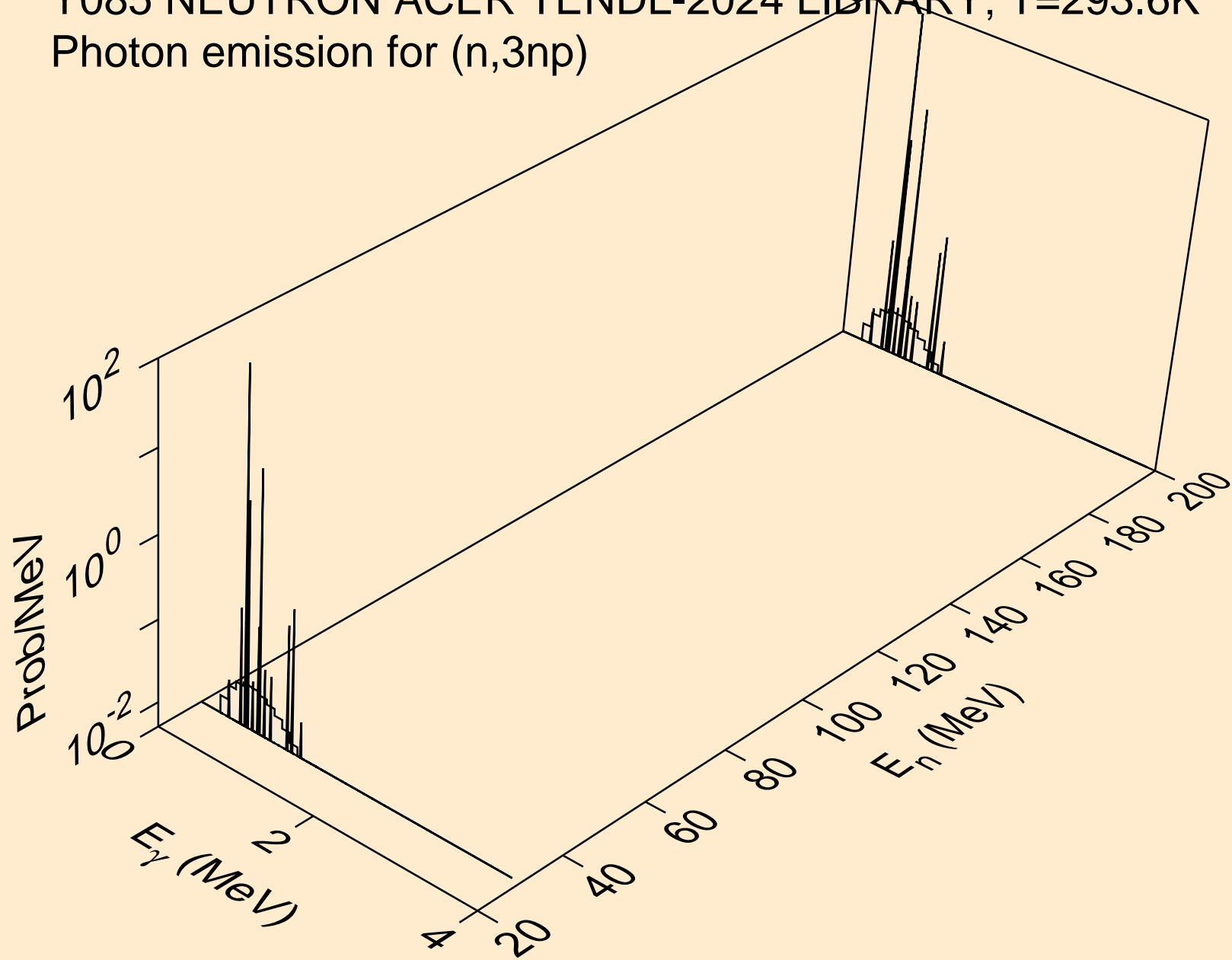

Y085 NEUTRON ACER TENDL-2024 LIBRARY; T=293.6K  
Photon emission for (n,n2p)

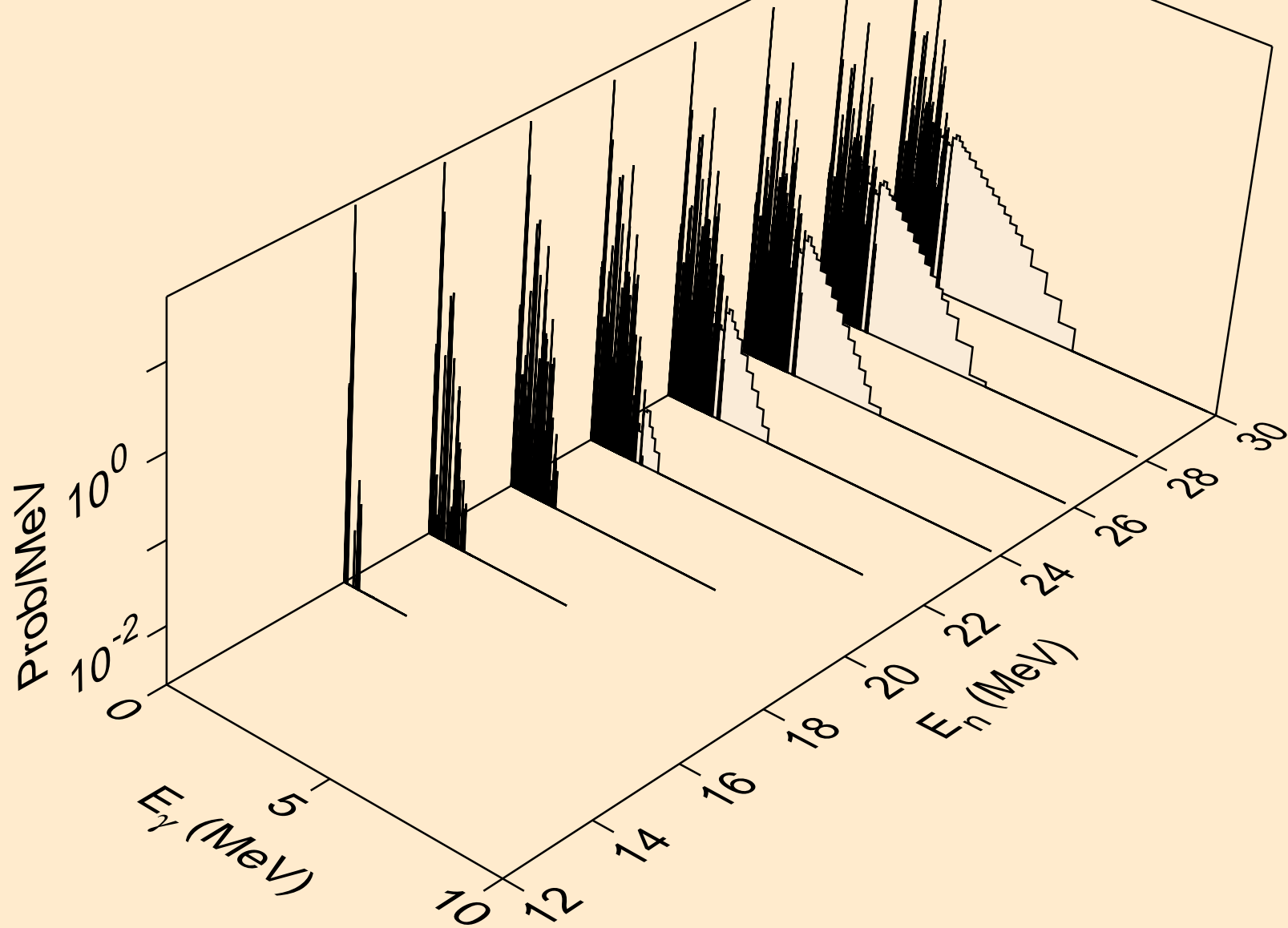

Y085 NEUTRON ACER TENDL-2024 LIBRARY; T=293.6K  
Photon emission for (n,npa)

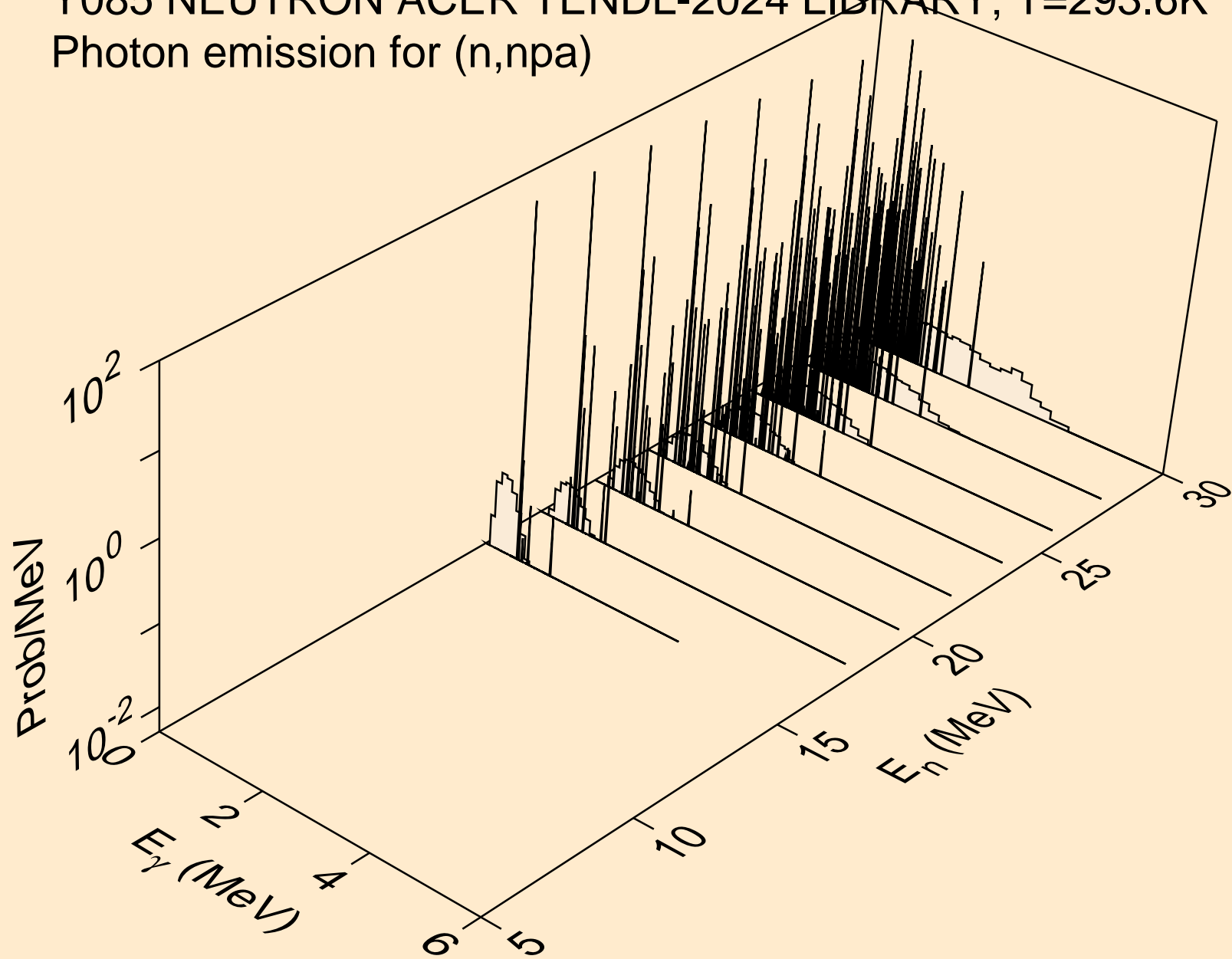

Y085 NEUTRON ACER TENDL-2024 LIBRARY; T=293.6K  
Photon emission for (n,n\*c)

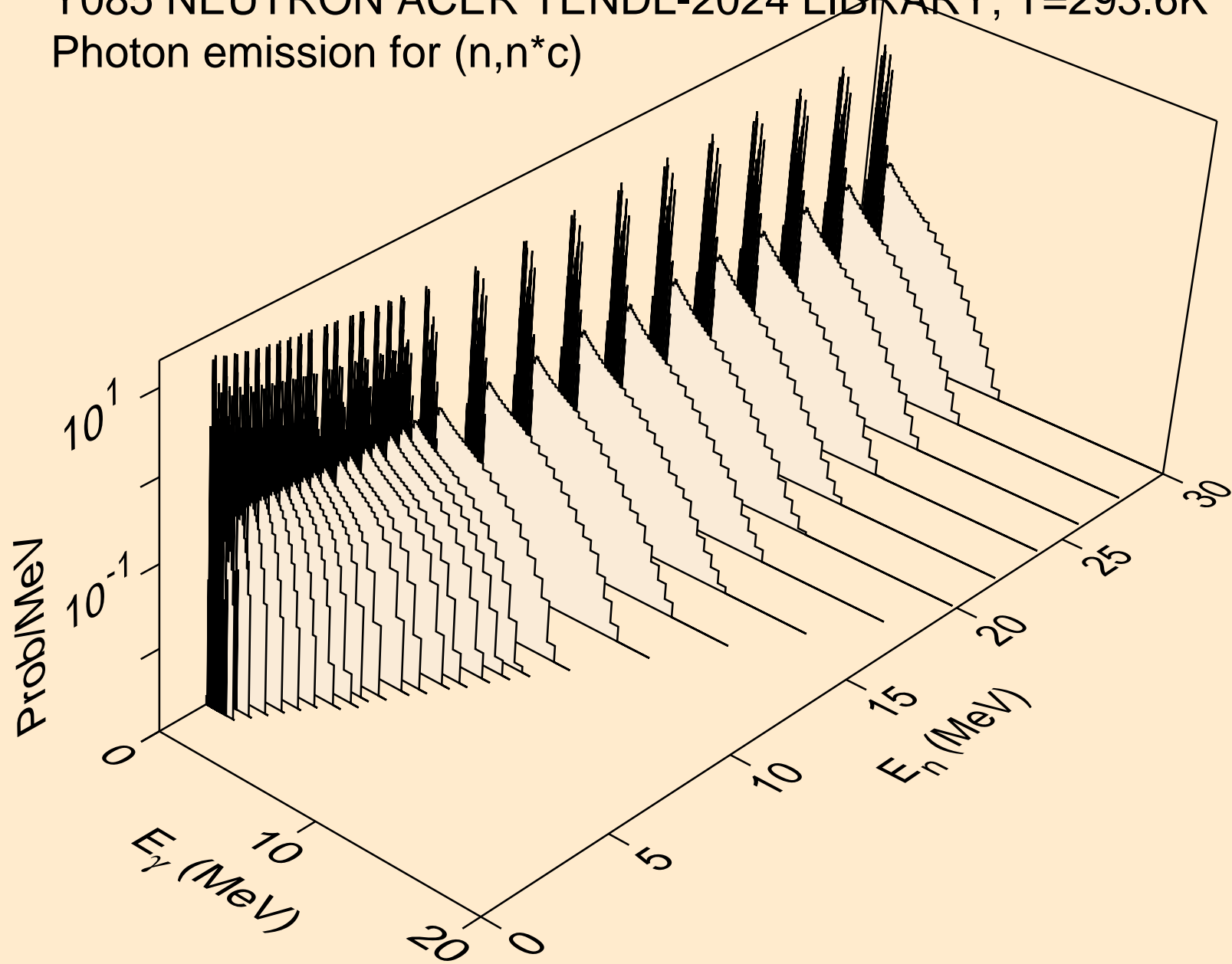

Y085 NEUTRON ACER TENDL-2024 LIBRARY; T=293.6K  
Photon emission for (n,gma)

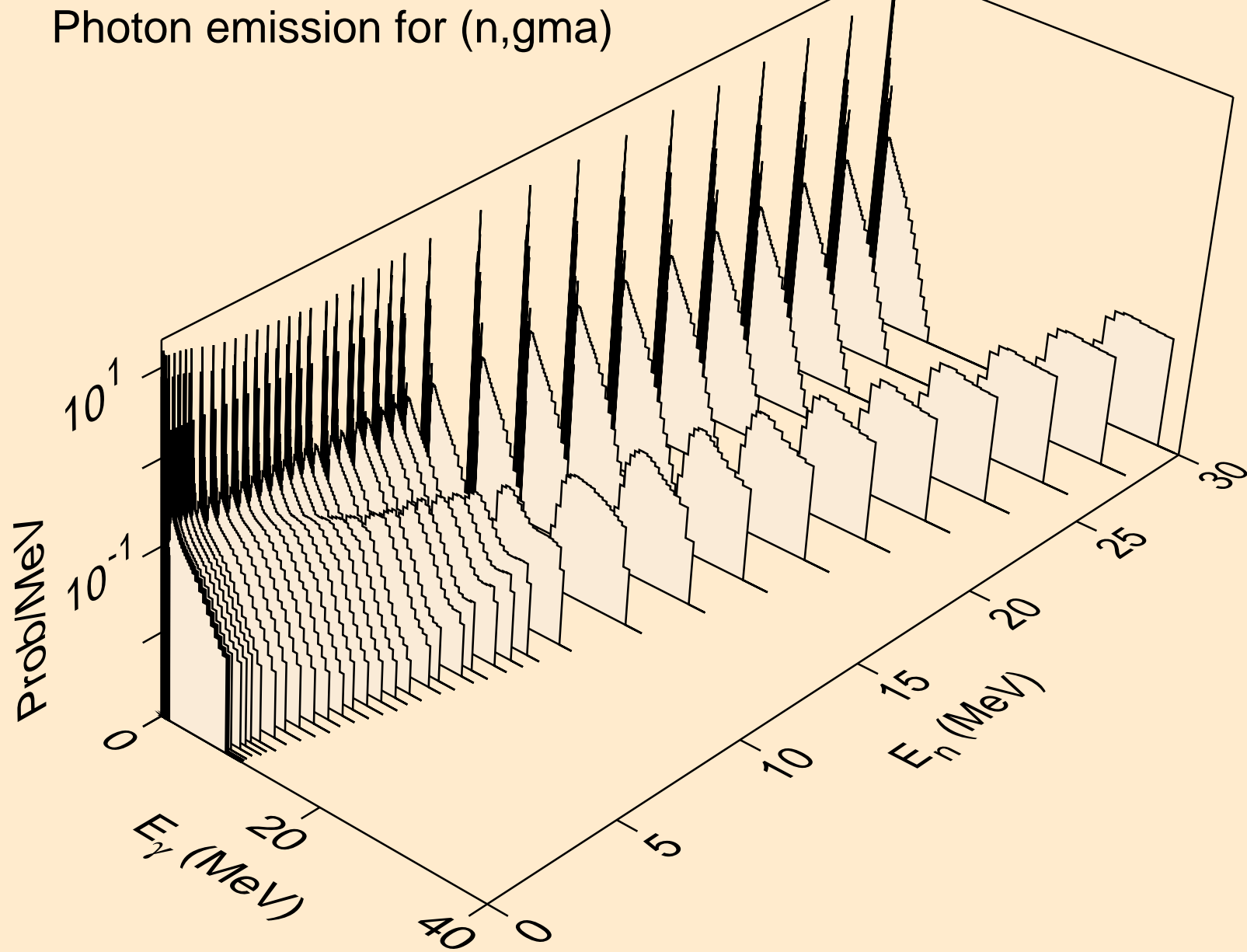

Y085 NEUTRON ACER TENDL-2024 LIBRARY; T=293.6K  
Photon emission for (n,p)

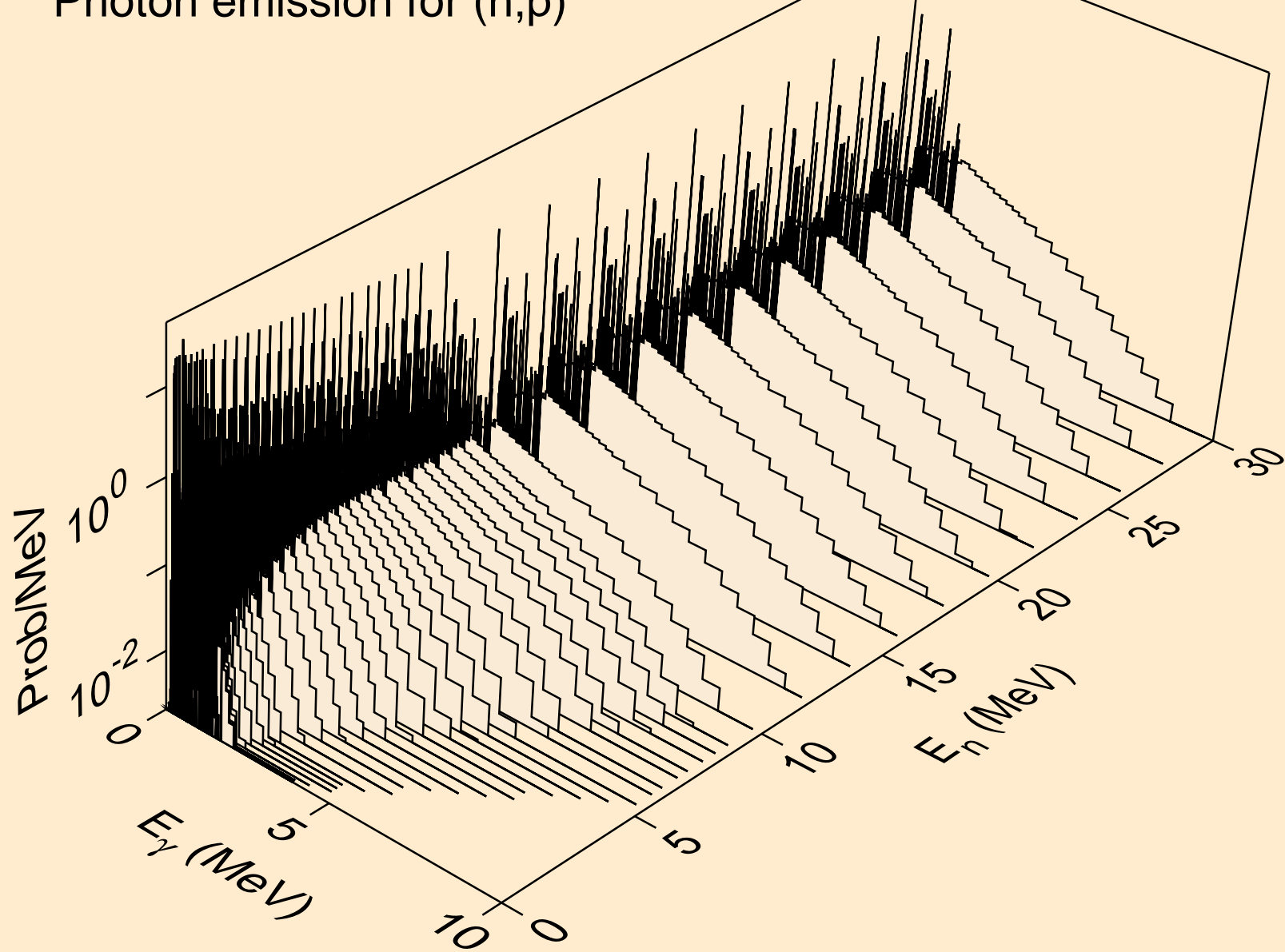

Y085 NEUTRON ACER TENDL-2024 LIBRARY; T=293.6K  
Photon emission for (n,d)

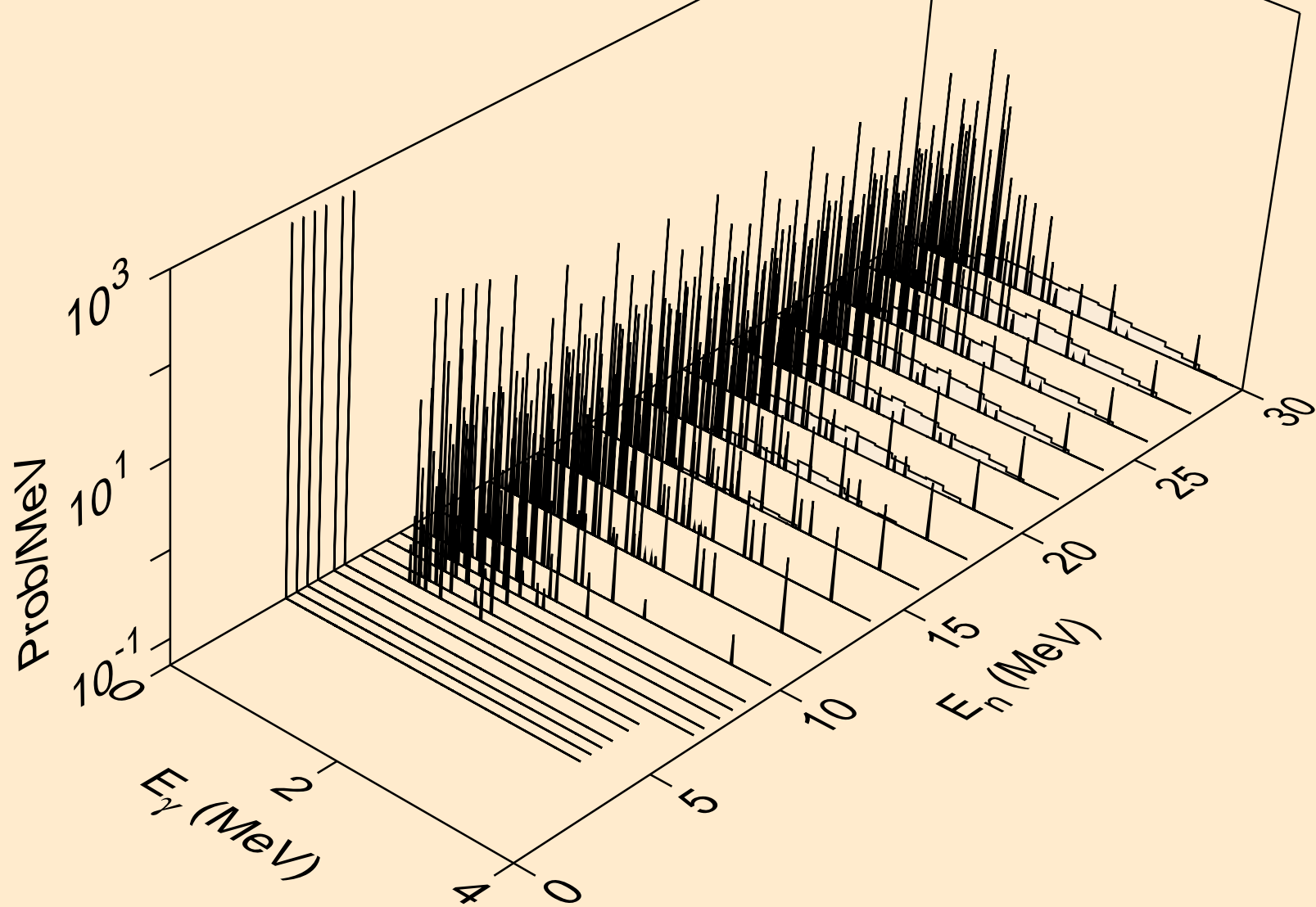

Y085 NEUTRON ACER TENDL-2024 LIBRARY; T=293.6K  
Photon emission for (n,t)

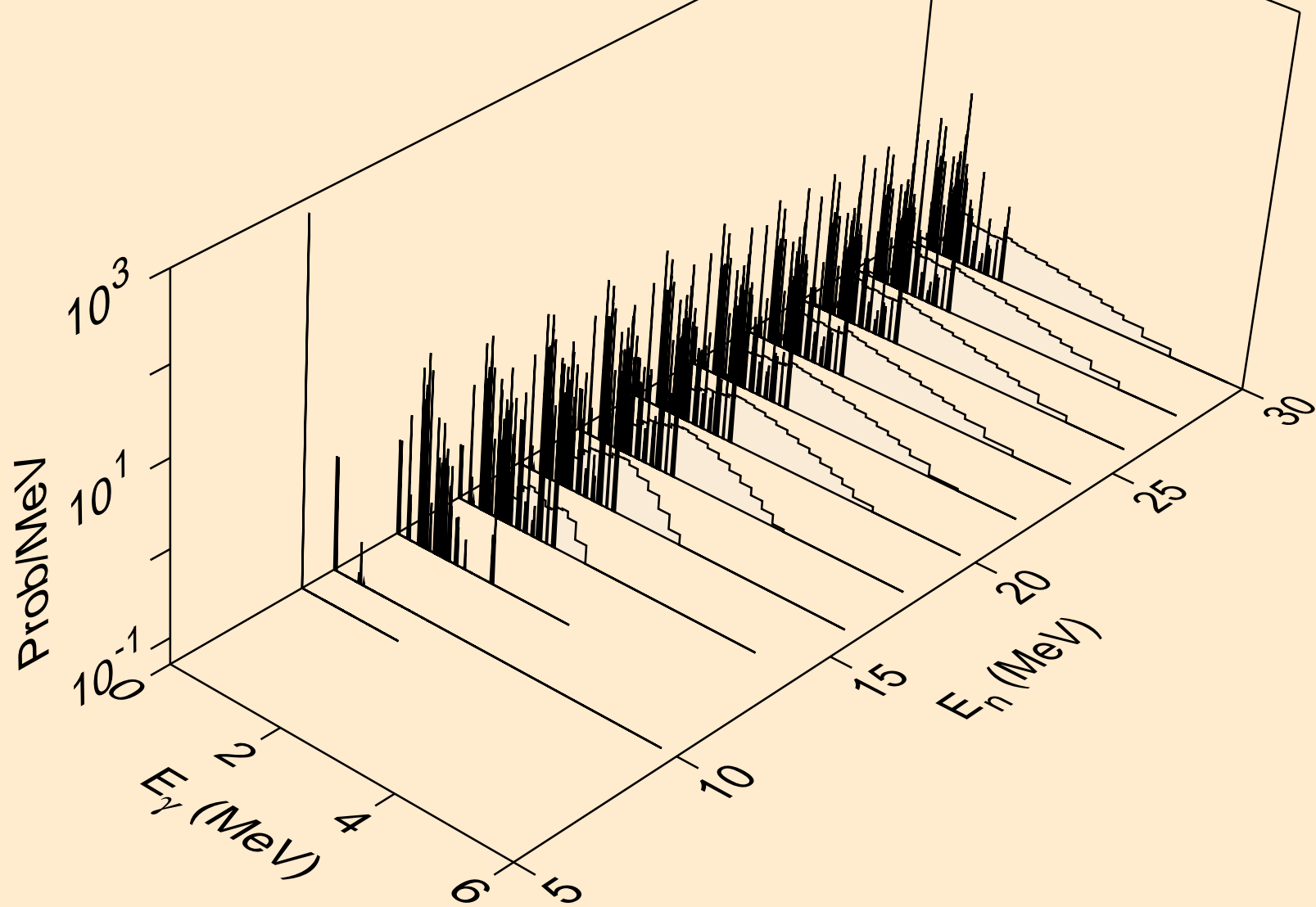

Y085 NEUTRON ACER TENDL-2024 LIBRARY; T=293.6K  
Photon emission for (n,he3)

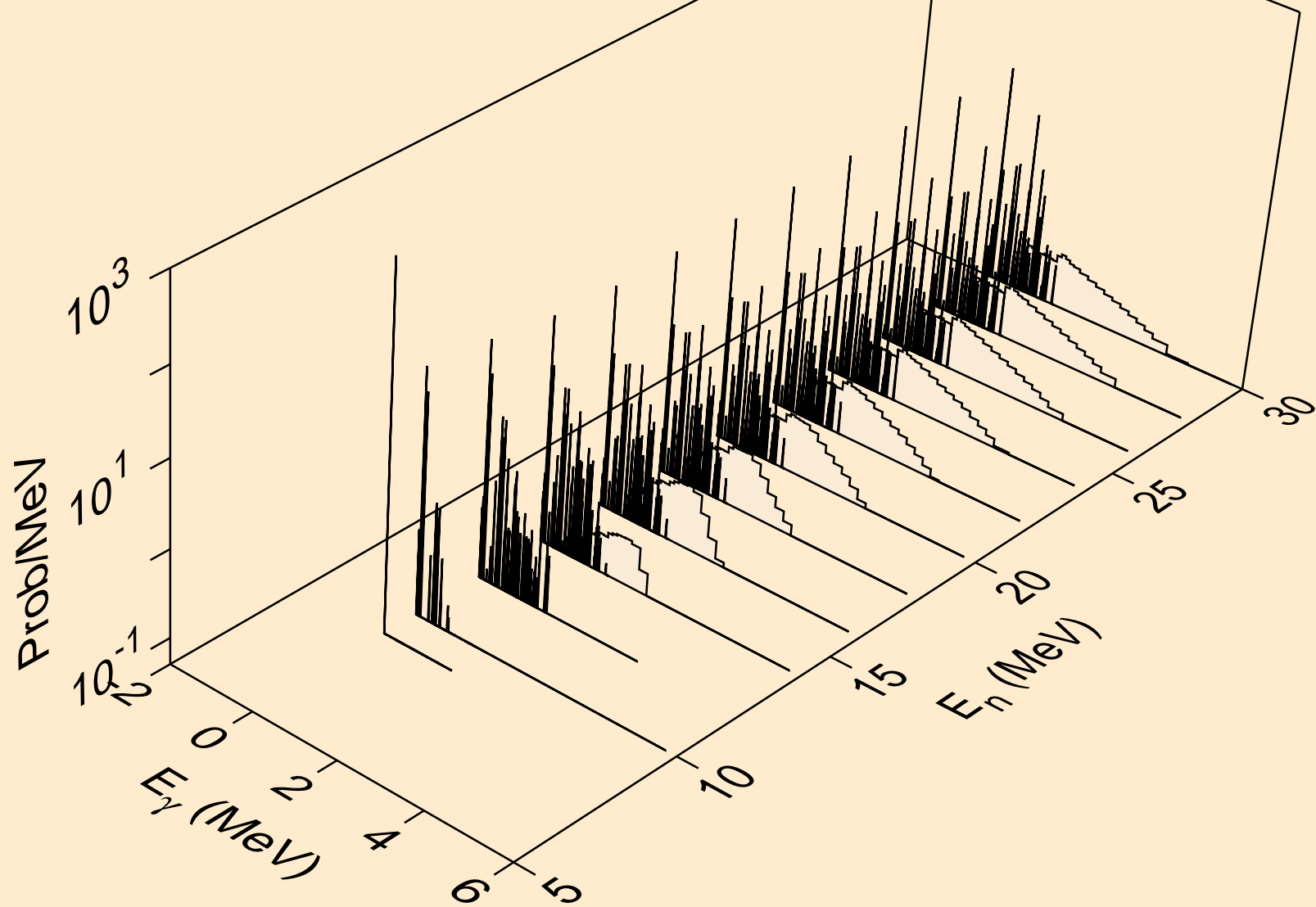

Y085 NEUTRON ACER TENDL-2024 LIBRARY; T=293.6K  
Photon emission for (n,a)

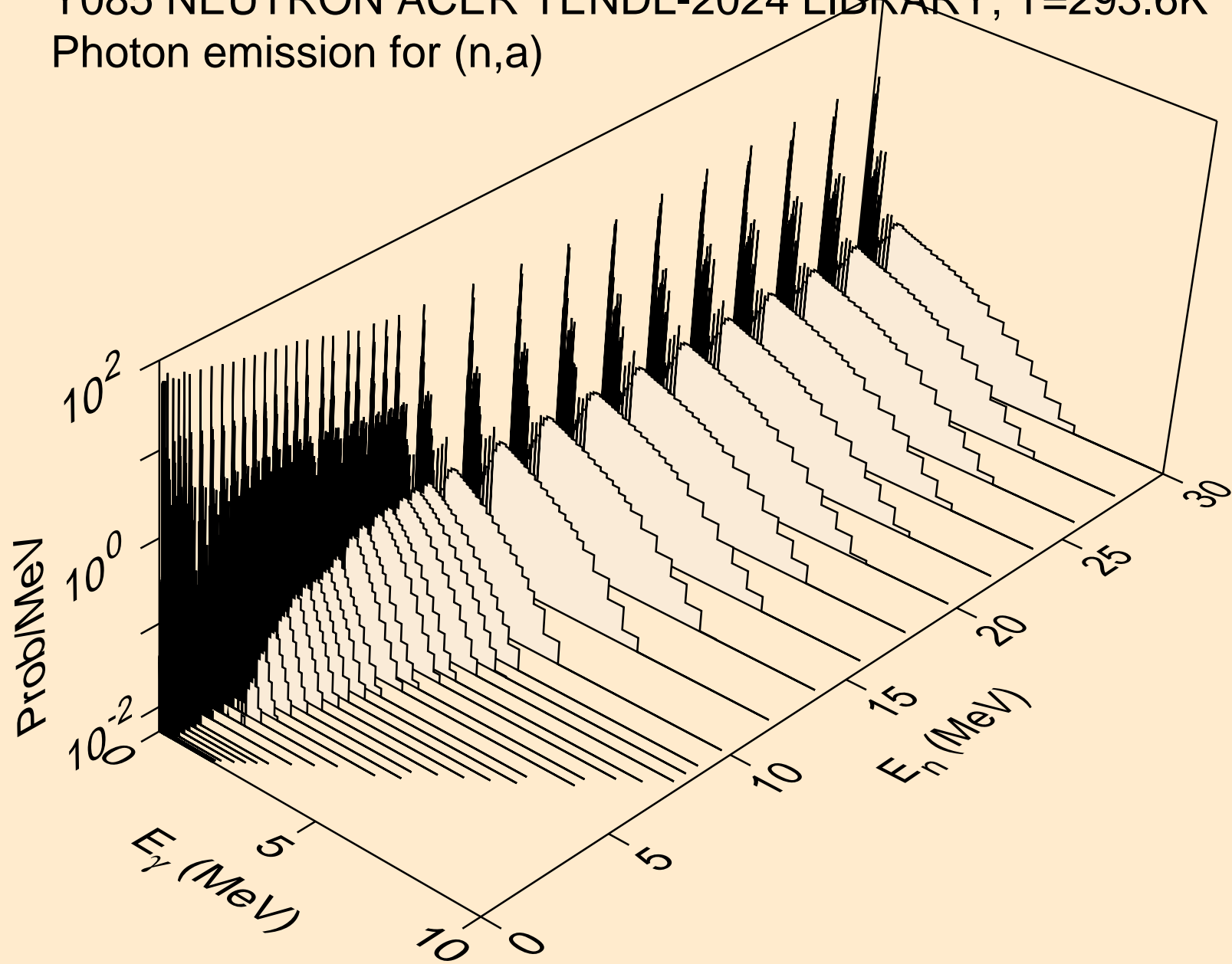

Y085 NEUTRON ACER TENDL-2024 LIBRARY; T=293.6K  
Photon emission for (n,2a)

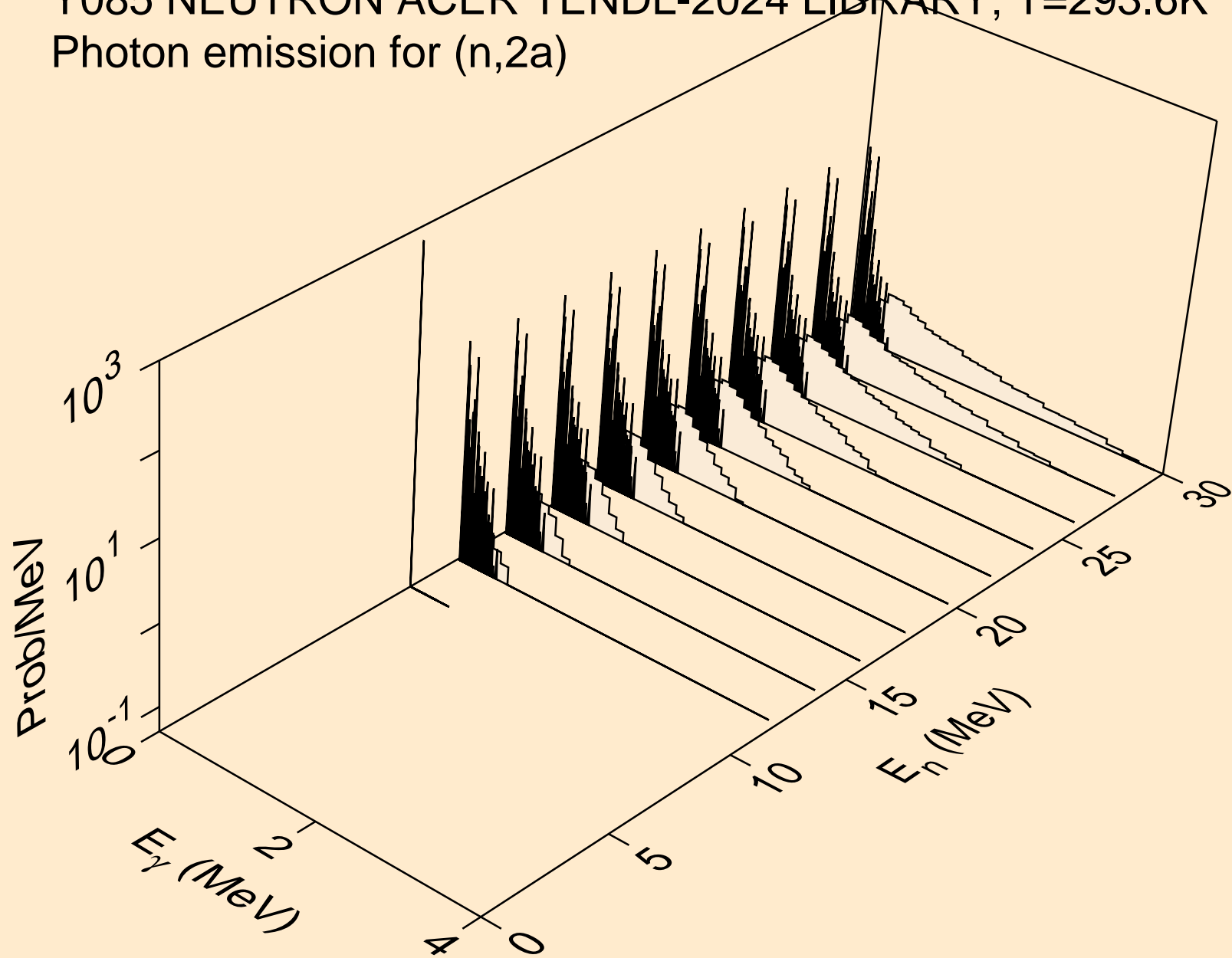

Y085 NEUTRON ACER TENDL-2024 LIBRARY; T=293.6K  
Photon emission for (n,2p)

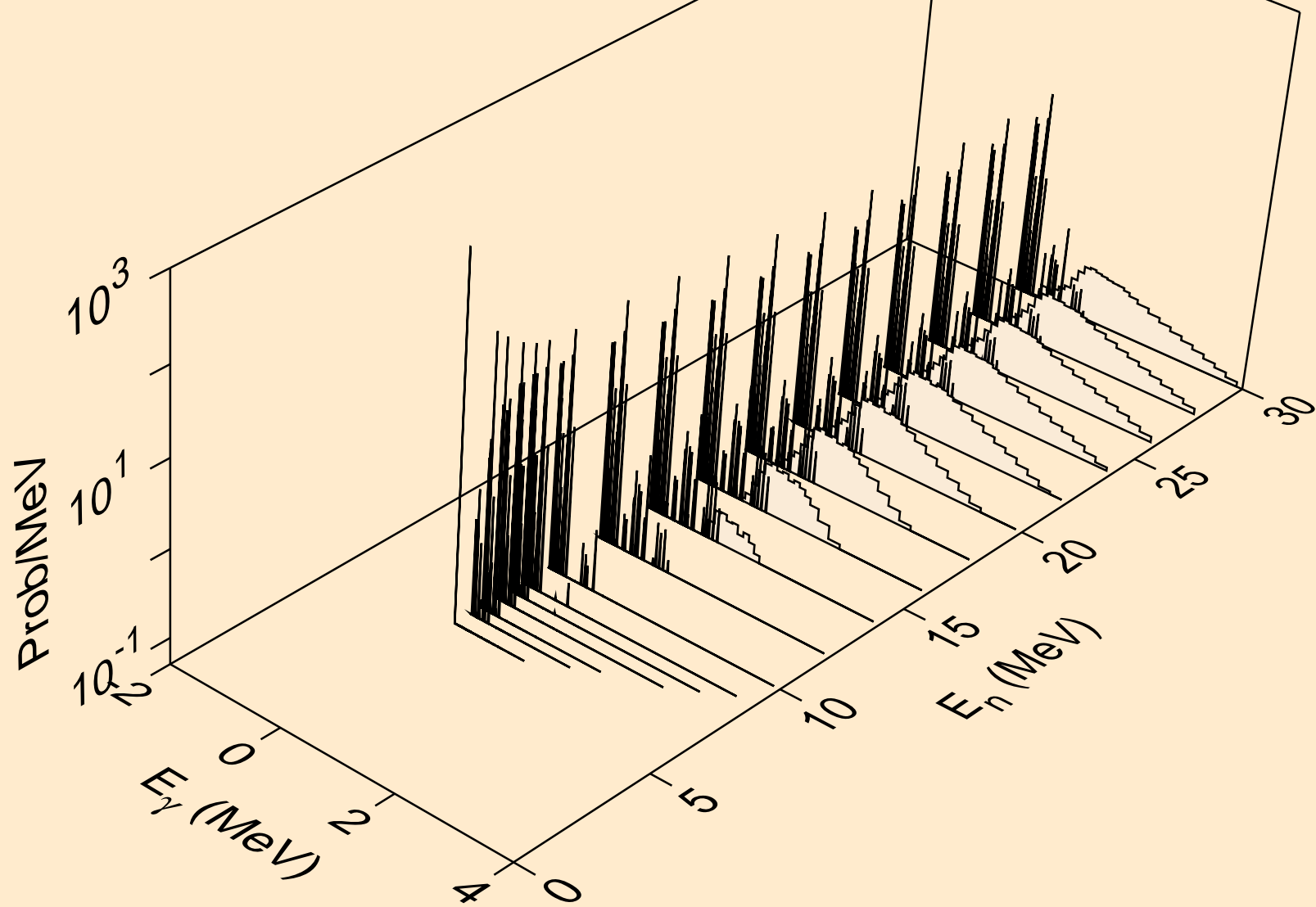

Y085 NEUTRON ACER TENDL-2024 LIBRARY; T=293.6K  
Photon emission for (n,p)

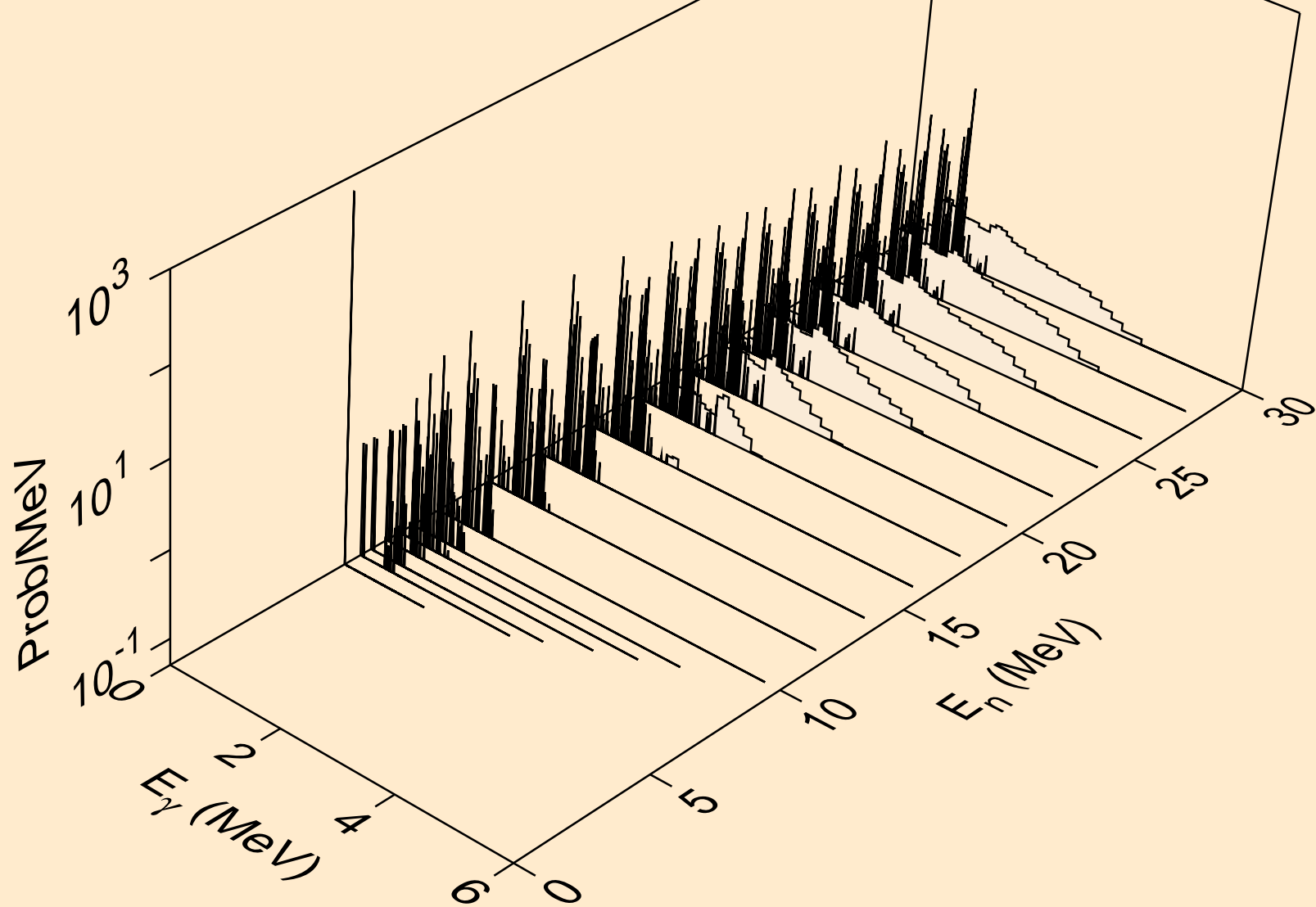

Y085 NEUTRON ACER TENDL-2024 LIBRARY; T=293.6K  
Photon emission for (n,pd)

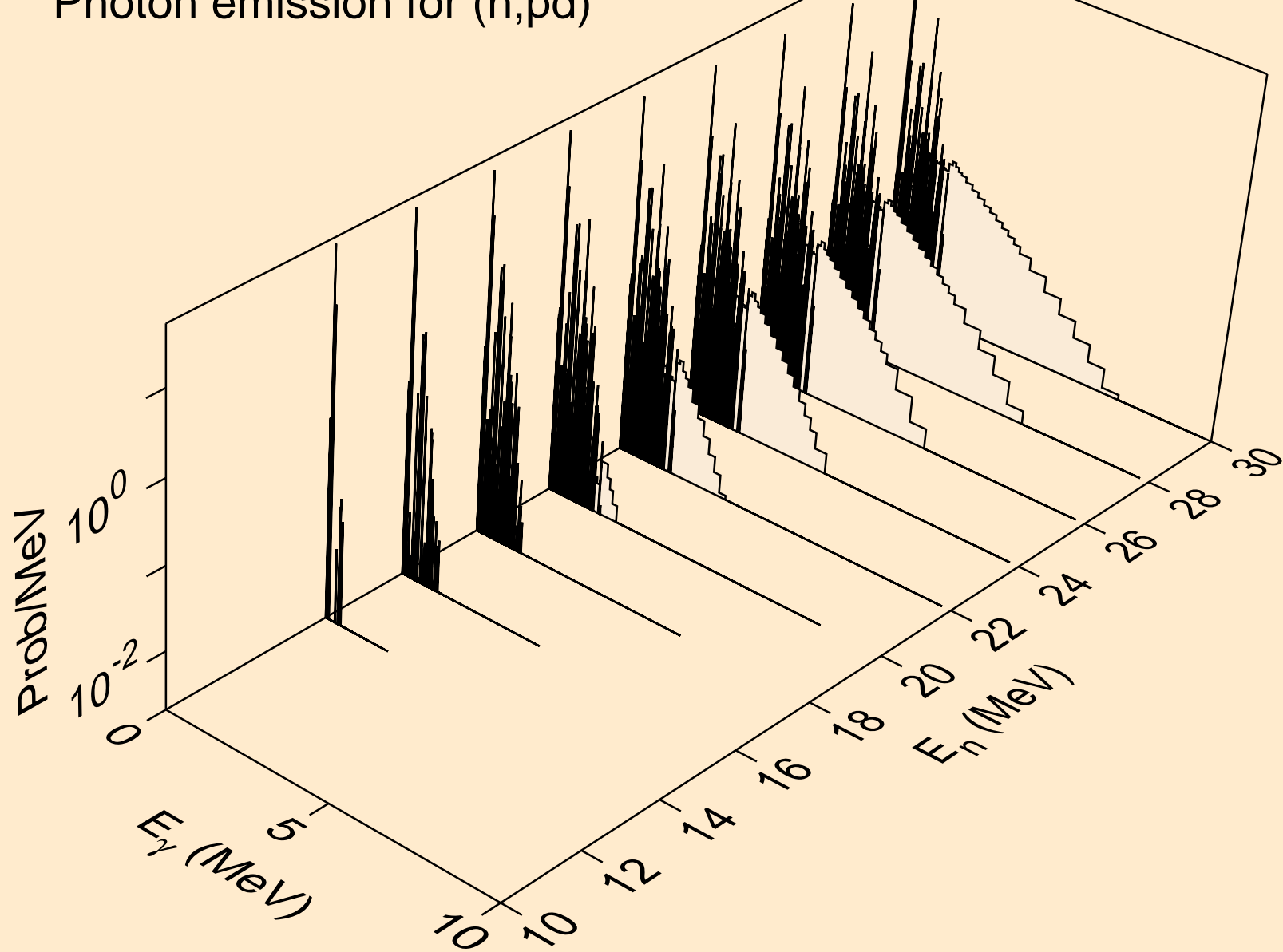

Y085 NEUTRON ACER TENDL-2024 LIBRARY; T=293.6K  
Photon emission for (n,pt)

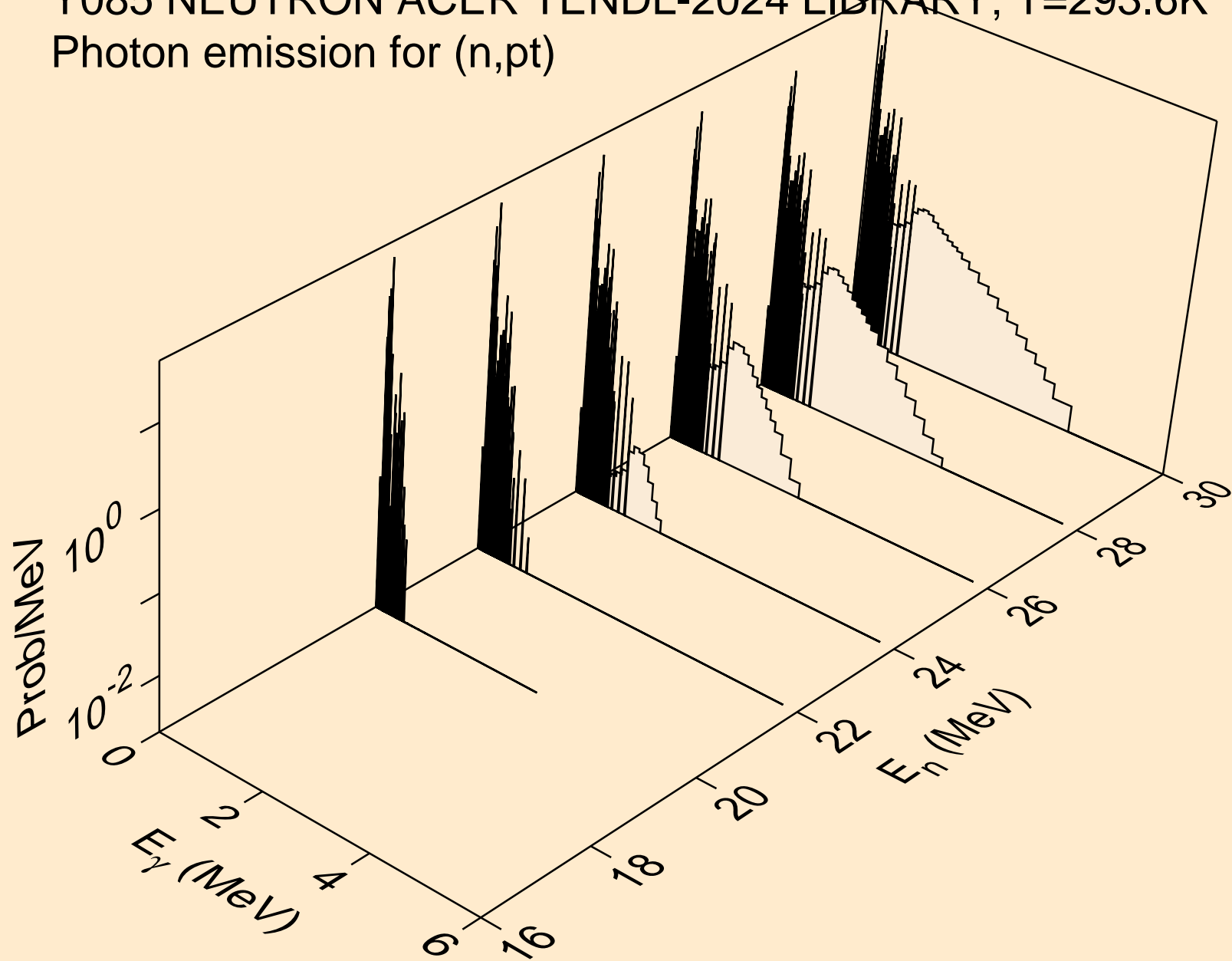

Y085 NEUTRON ACER TENDL-2024 LIBRARY; T=293.6K  
Photon emission for (n,da)

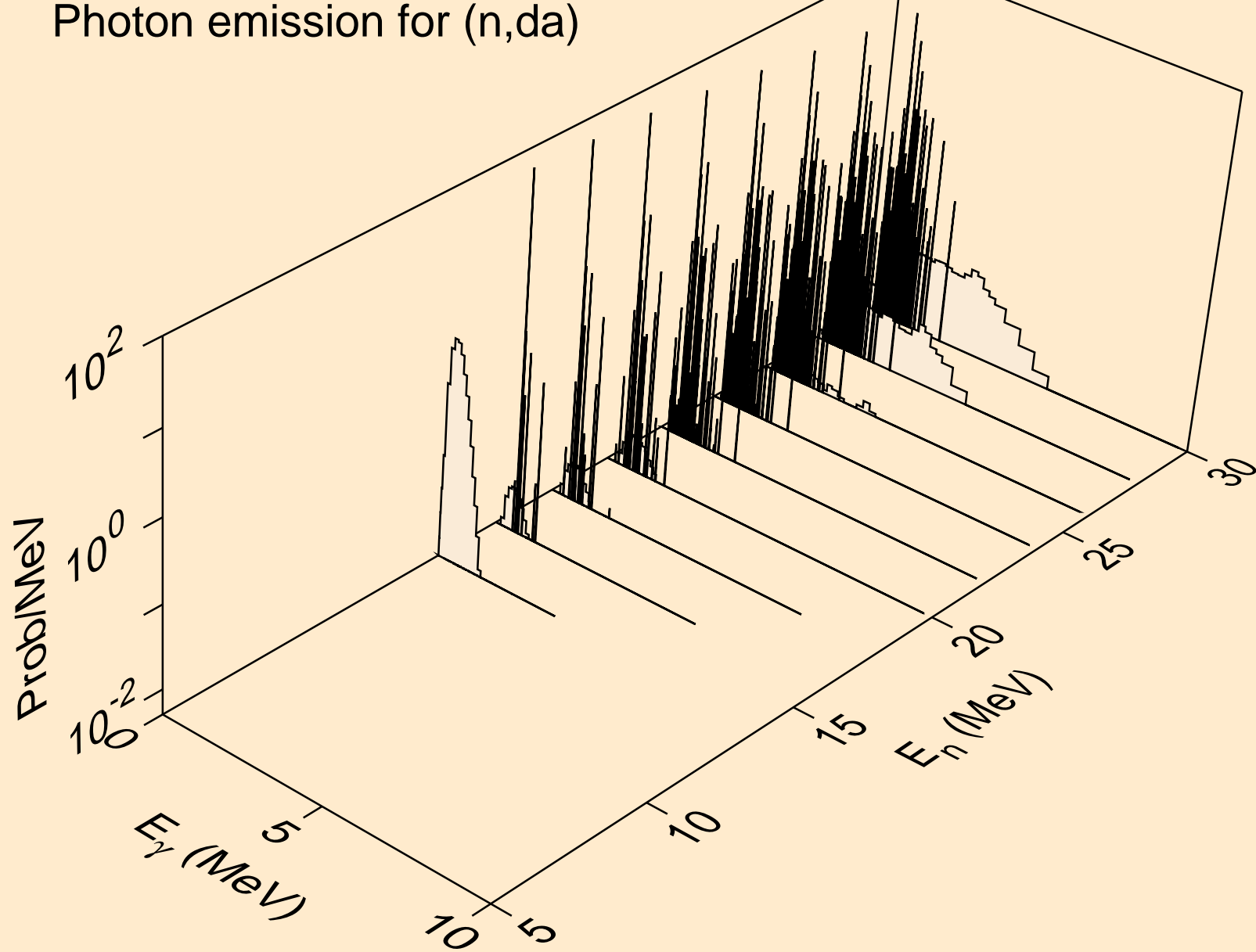

Y085 NEUTRON ACER TENDL-2024 LIBRARY; T=293.6K  
thermal capture photon spectrum

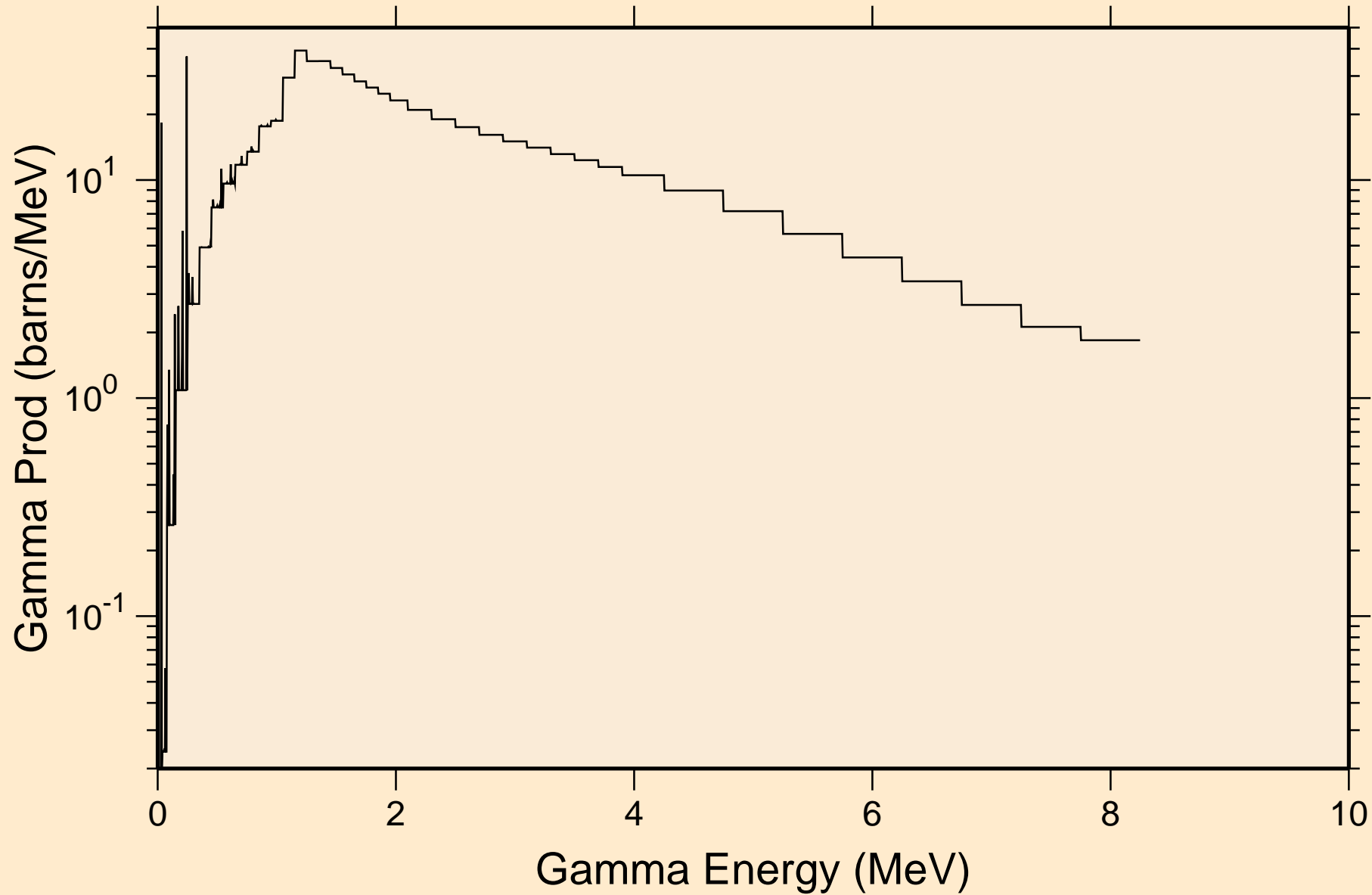

Y085 NEUTRON ACER TENDL-2024 LIBRARY; T=293.6K  
14 MeV photon spectrum

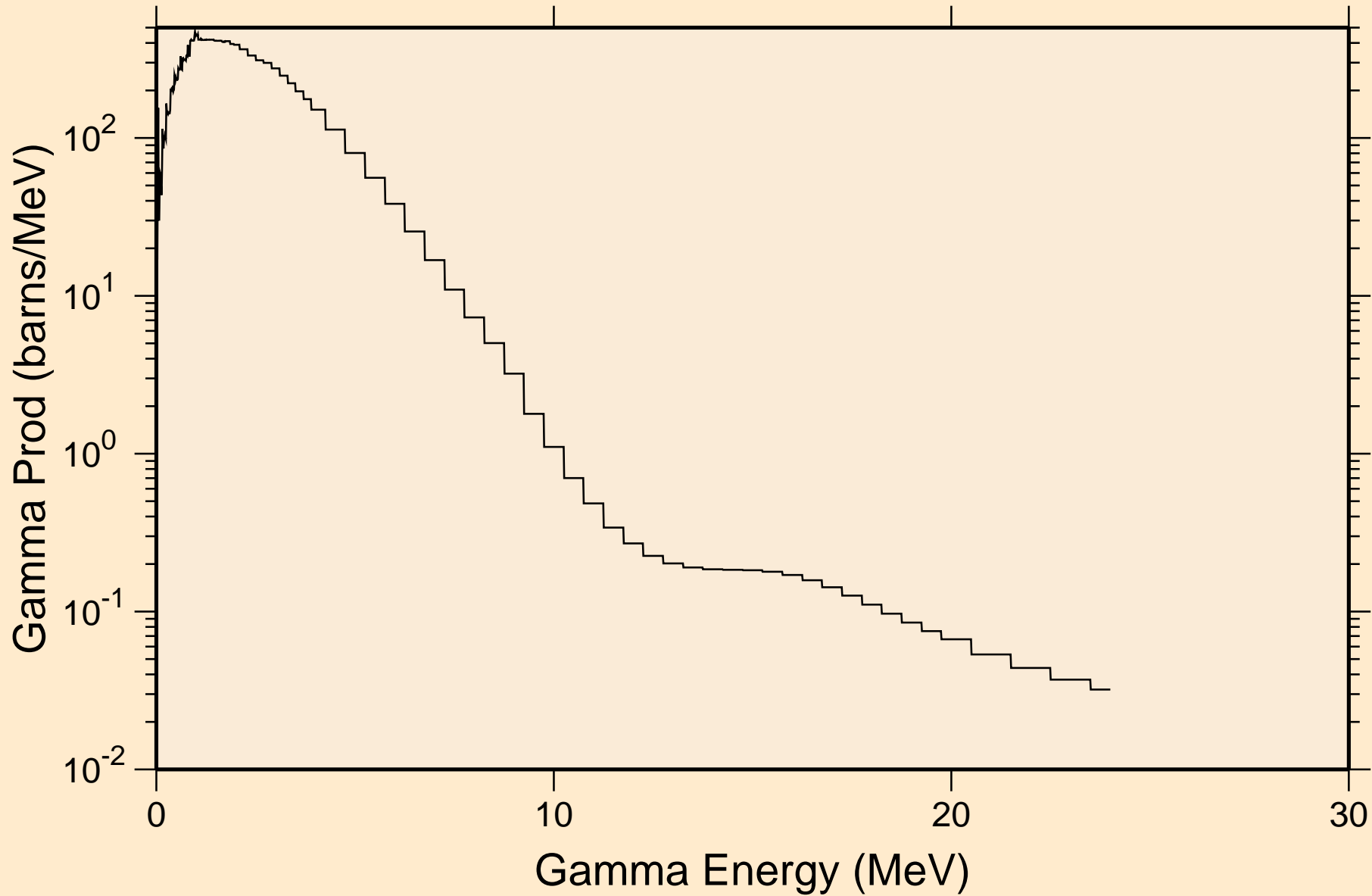

Y085 NEUTRON ACER TENDL-2024 LIBRARY; T=293.6K  
Particle heating contributions

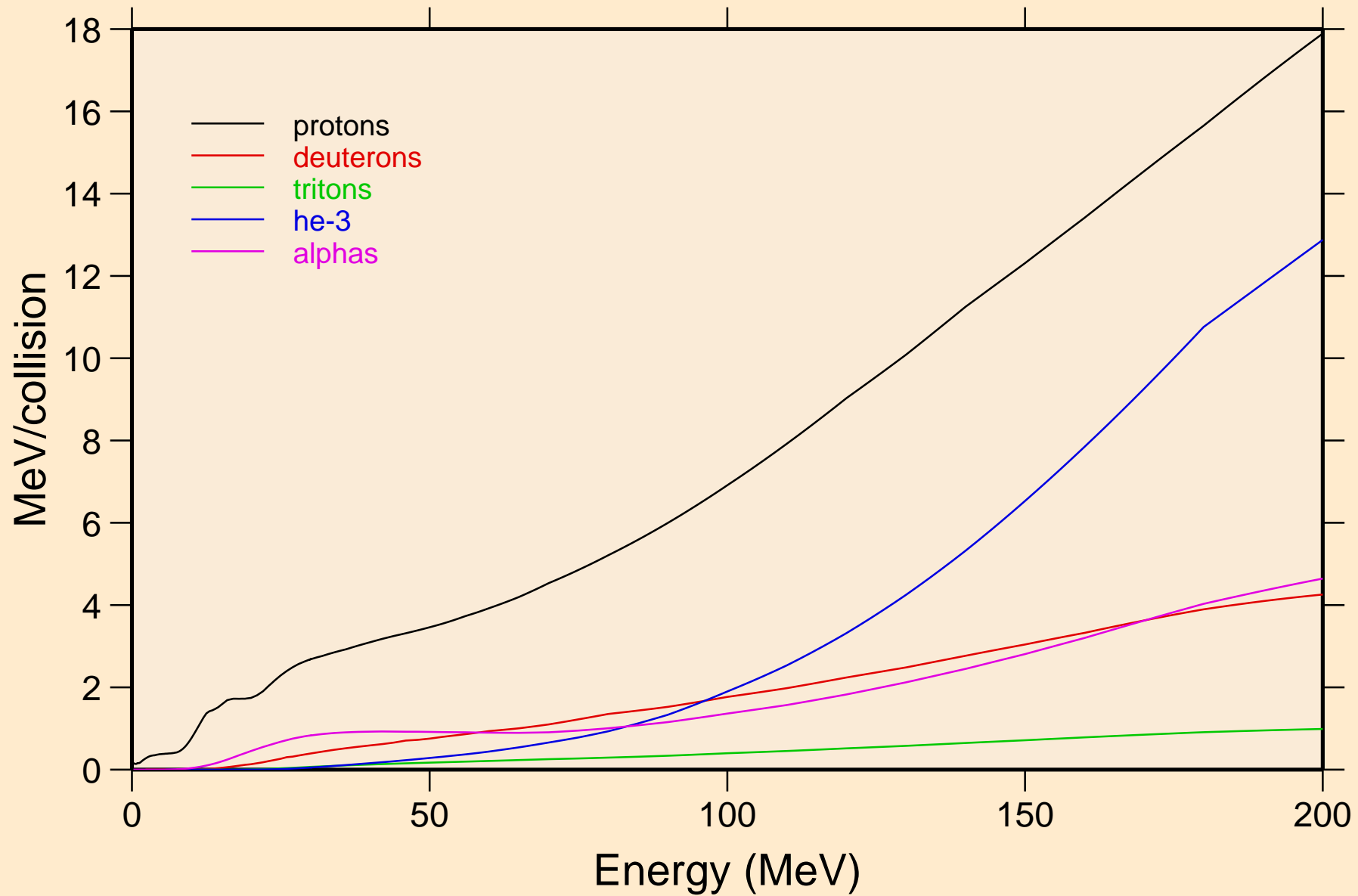

Y085 NEUTRON ACER TENDL-2024 LIBRARY; T=293.6K  
Recoil Heating

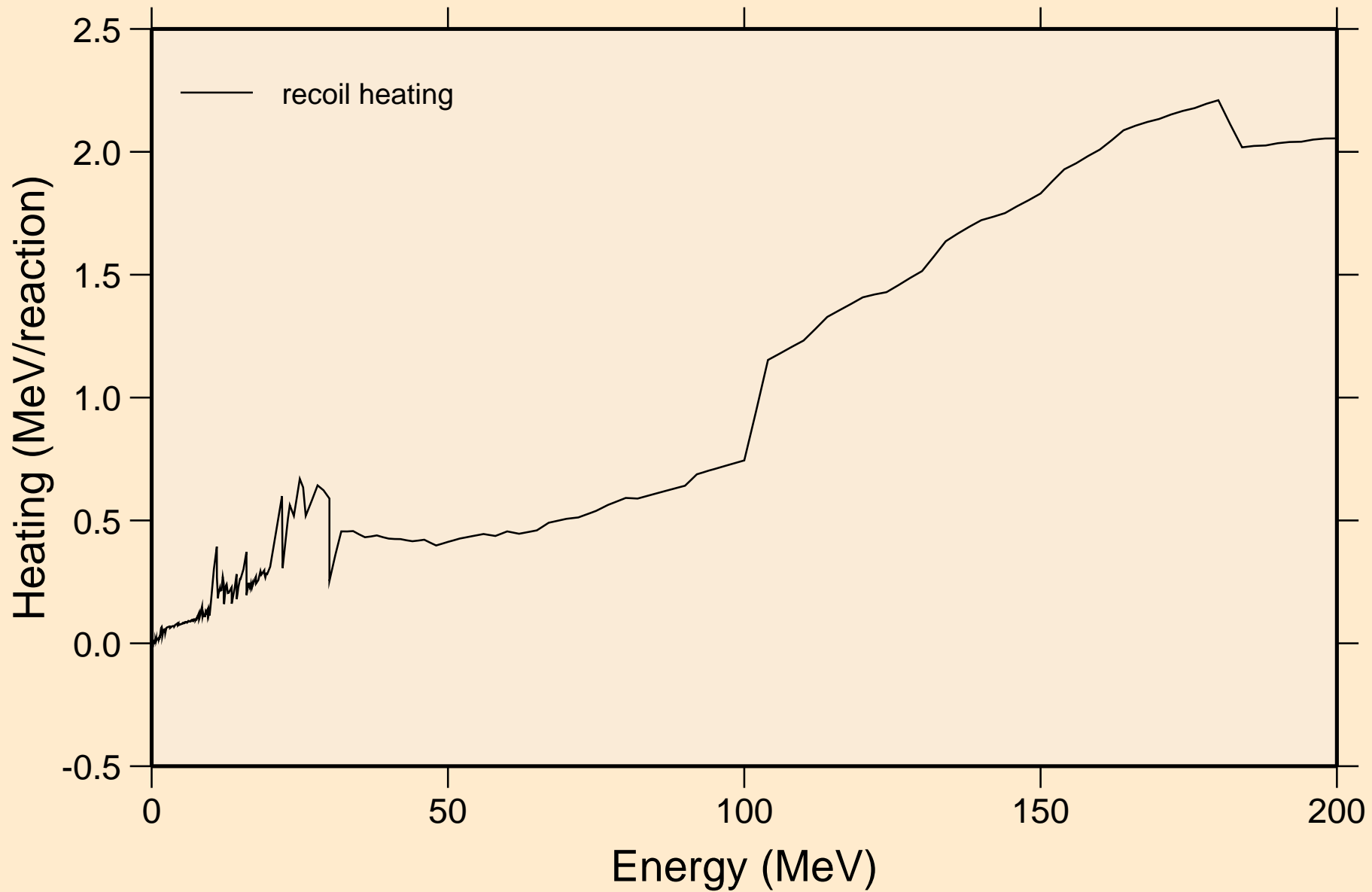

Y085 NEUTRON ACER TENDL-2024 LIBRARY; T=293.6K  
Particle production cross sections

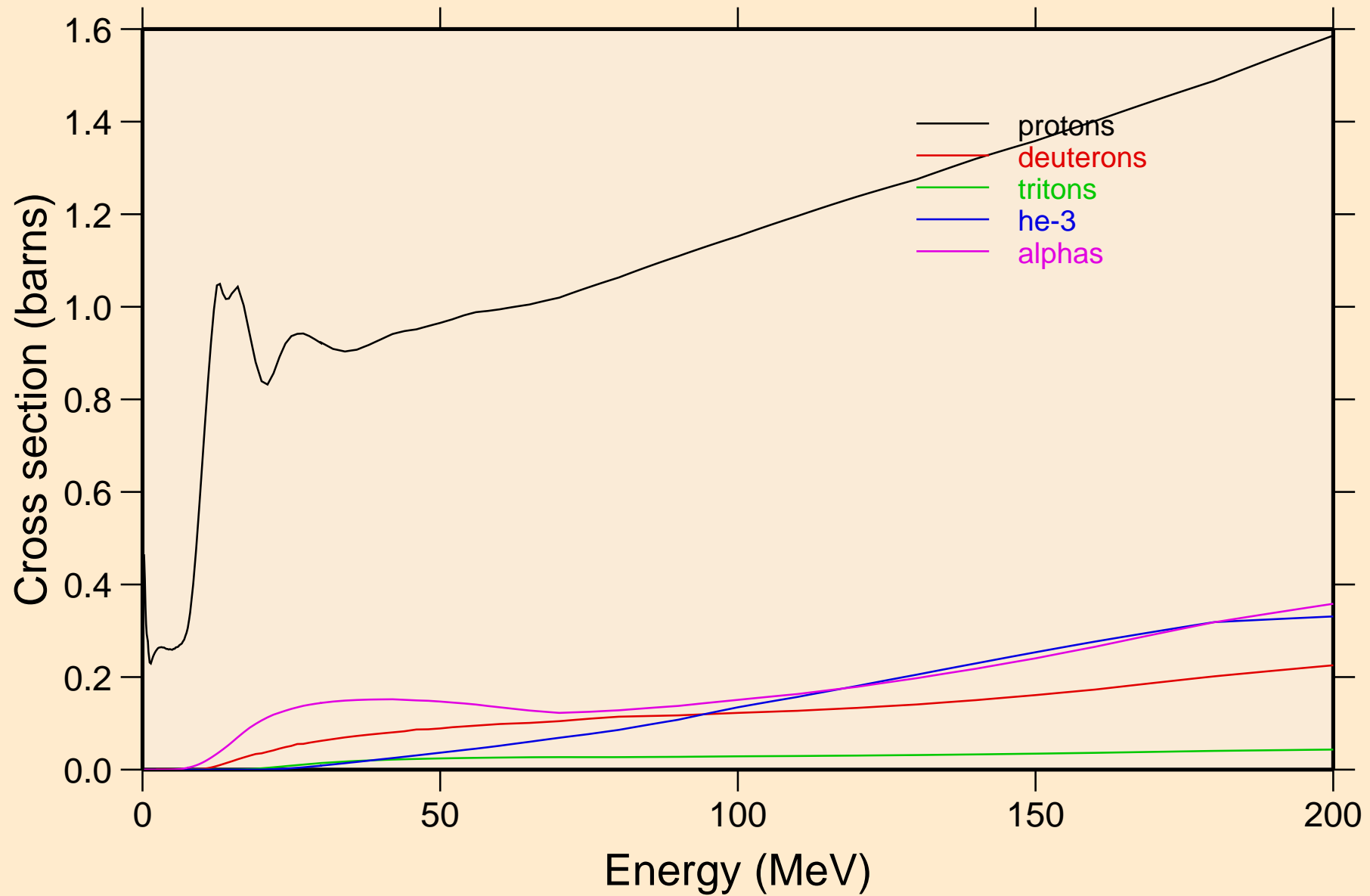

Y085 NEUTRON ACER TENDL-2024 LIBRARY; T=293.6K  
protons from (n,x)

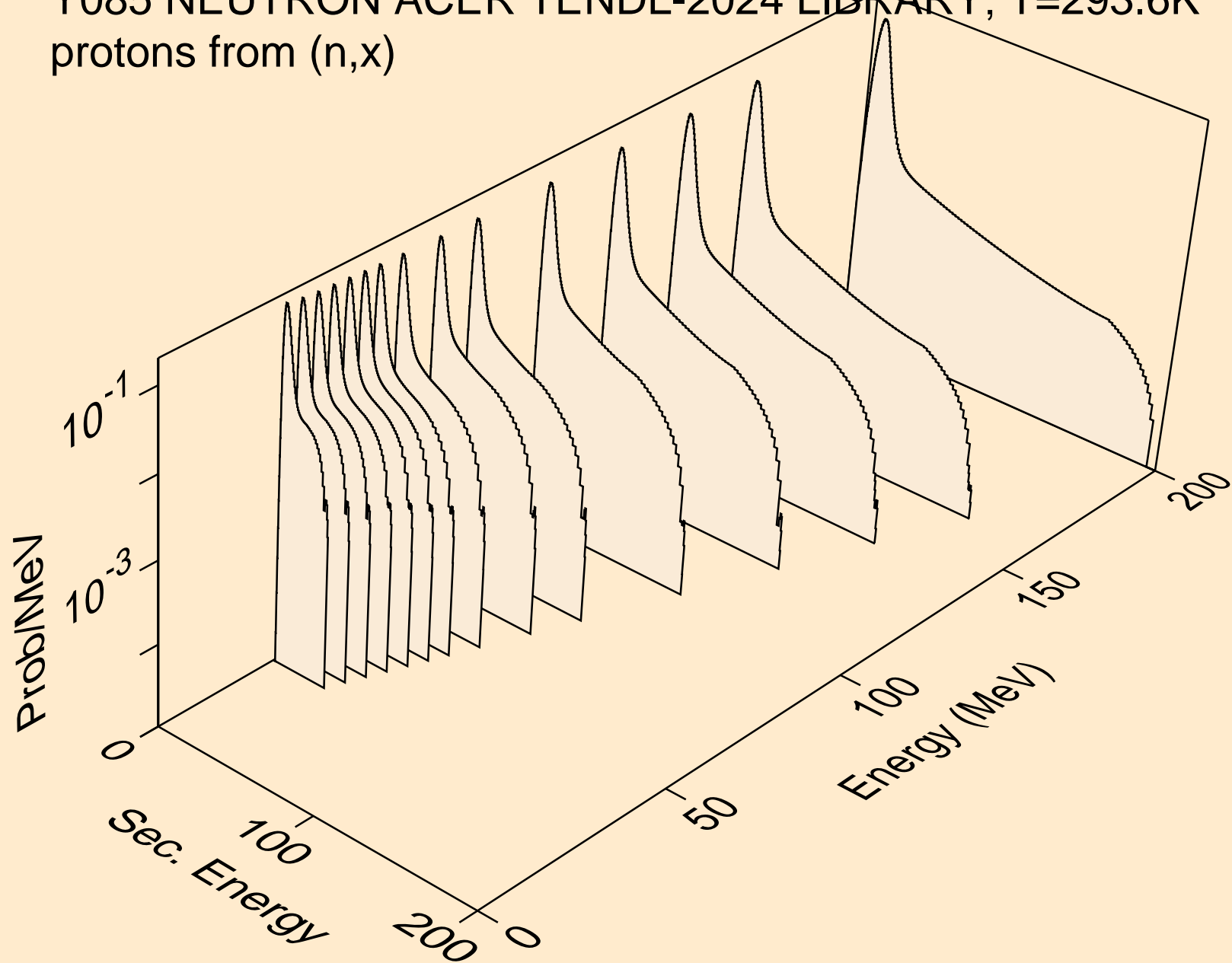

Y085 NEUTRON ACER TENDL-2024 LIBRARY; T=293.6K  
protons from (n,n\*)p

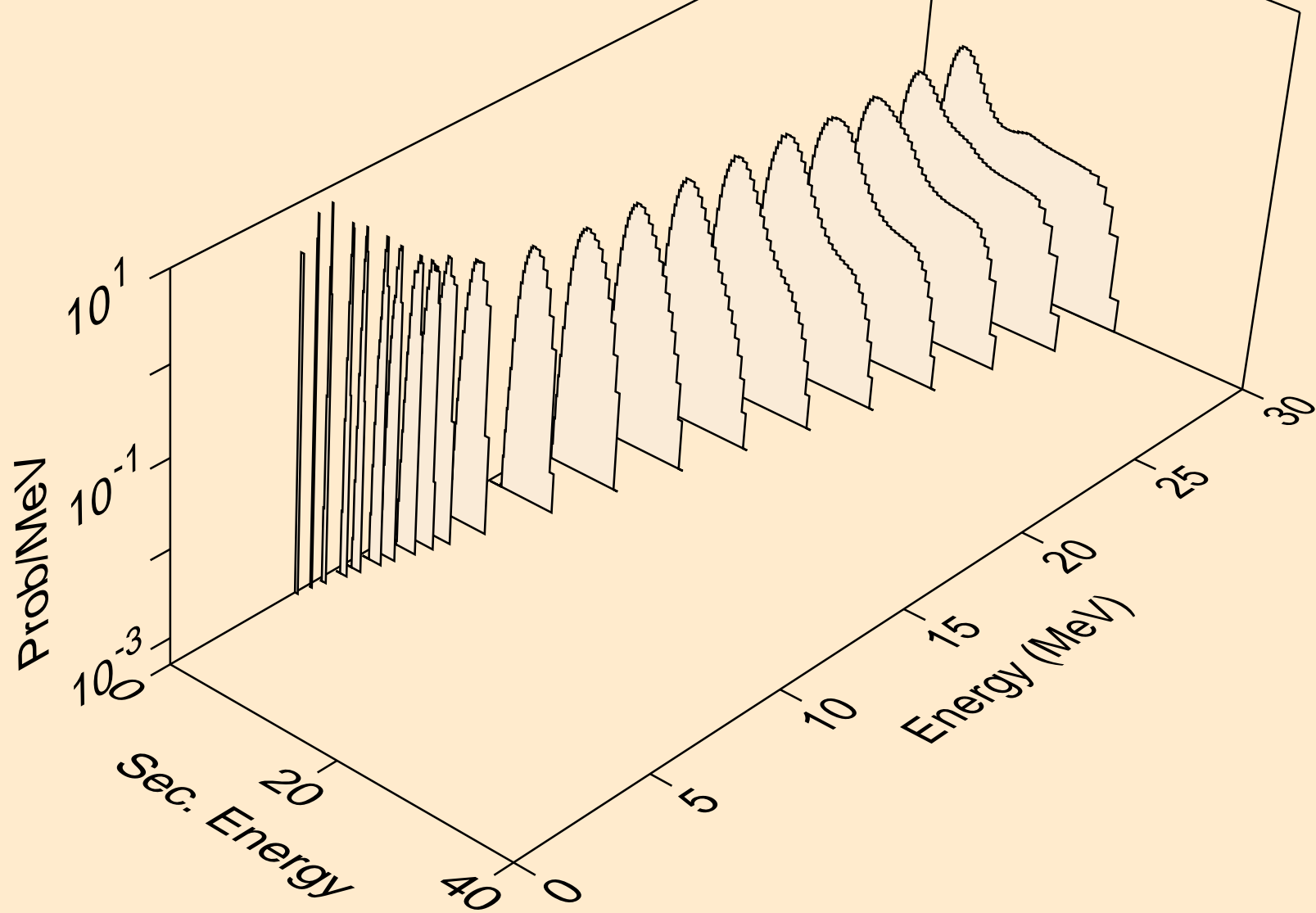

Y085 NEUTRON ACER TENDL-2024 LIBRARY; T=293.6K  
protons from (n,2np)

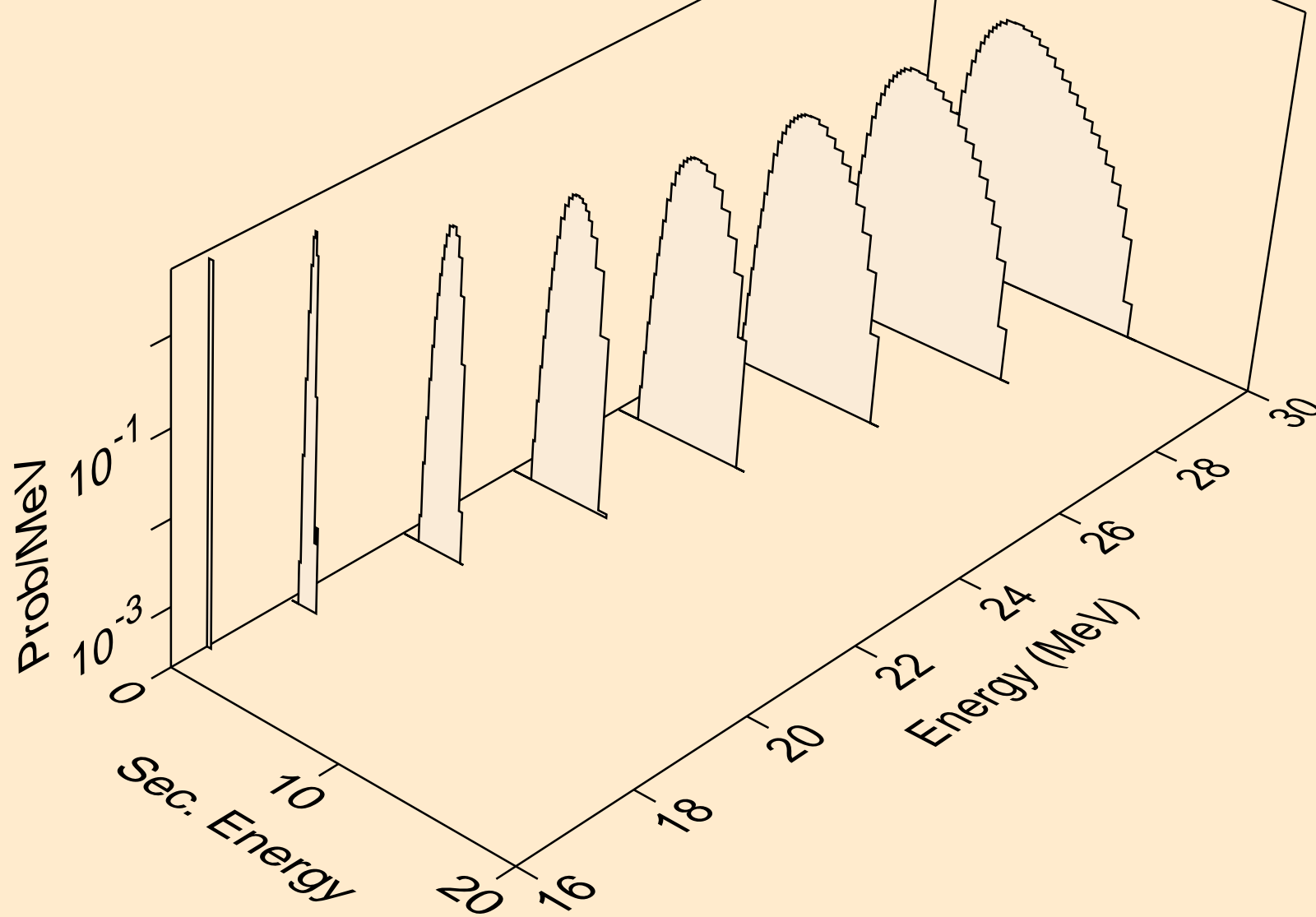

Y085 NEUTRON ACER TENDL-2024 LIBRARY; T=293.6K  
protons from (n,3np)

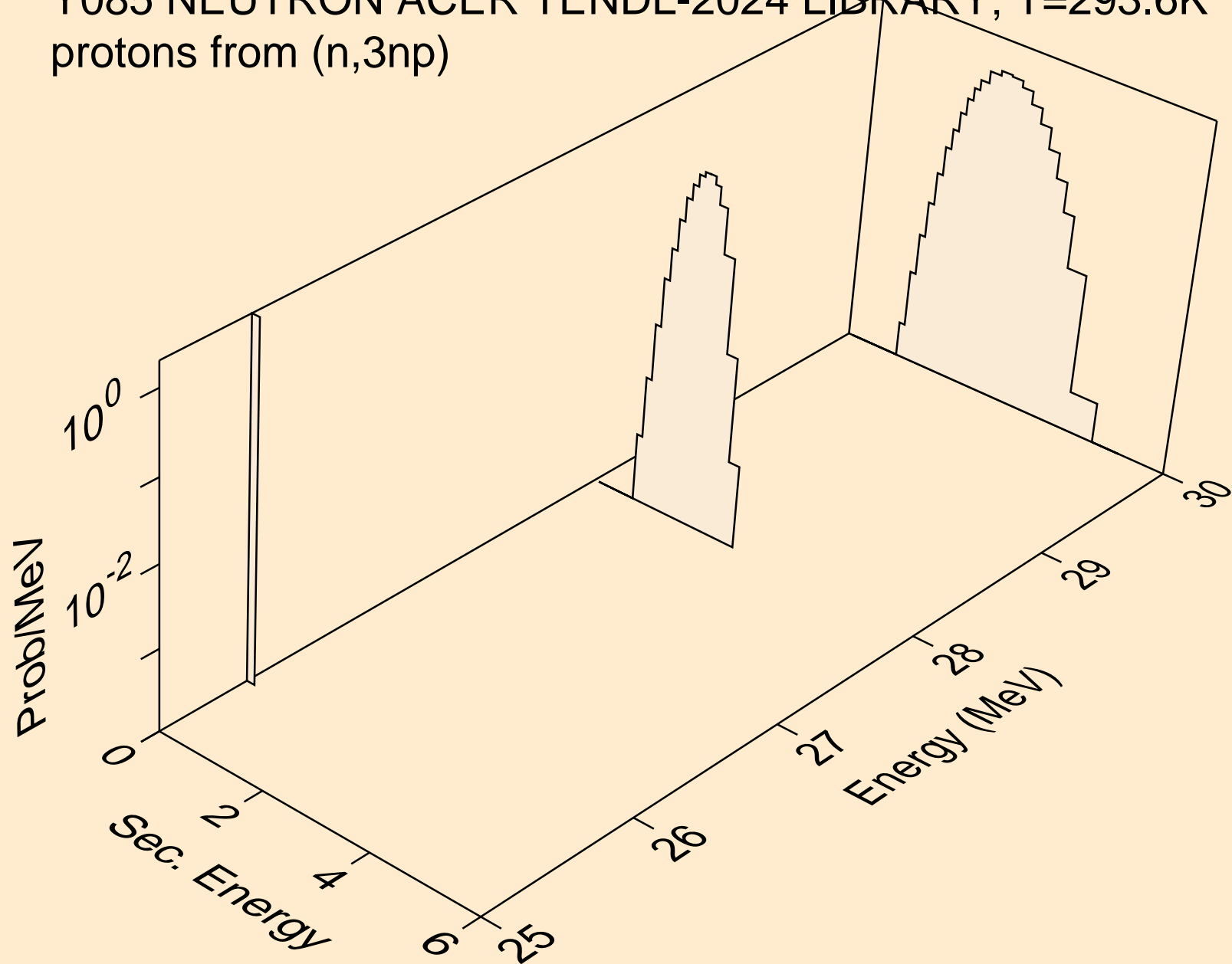

Y085 NEUTRON ACER TENDL-2024 LIBRARY; T=293.6K  
protons from (n,n2p)

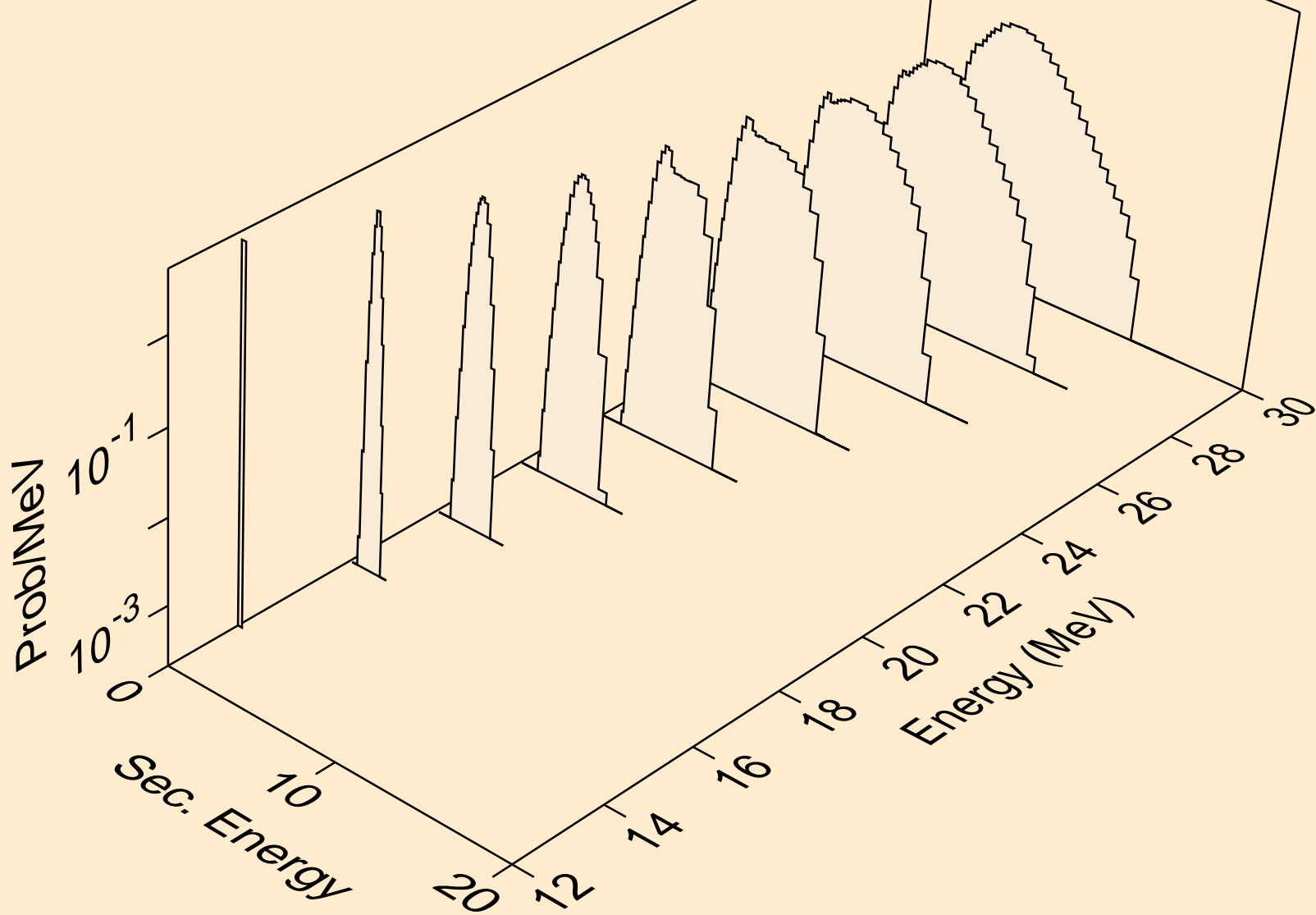

Y085 NEUTRON ACER TENDL-2024 LIBRARY; T=293.6K  
protons from (n,npa)

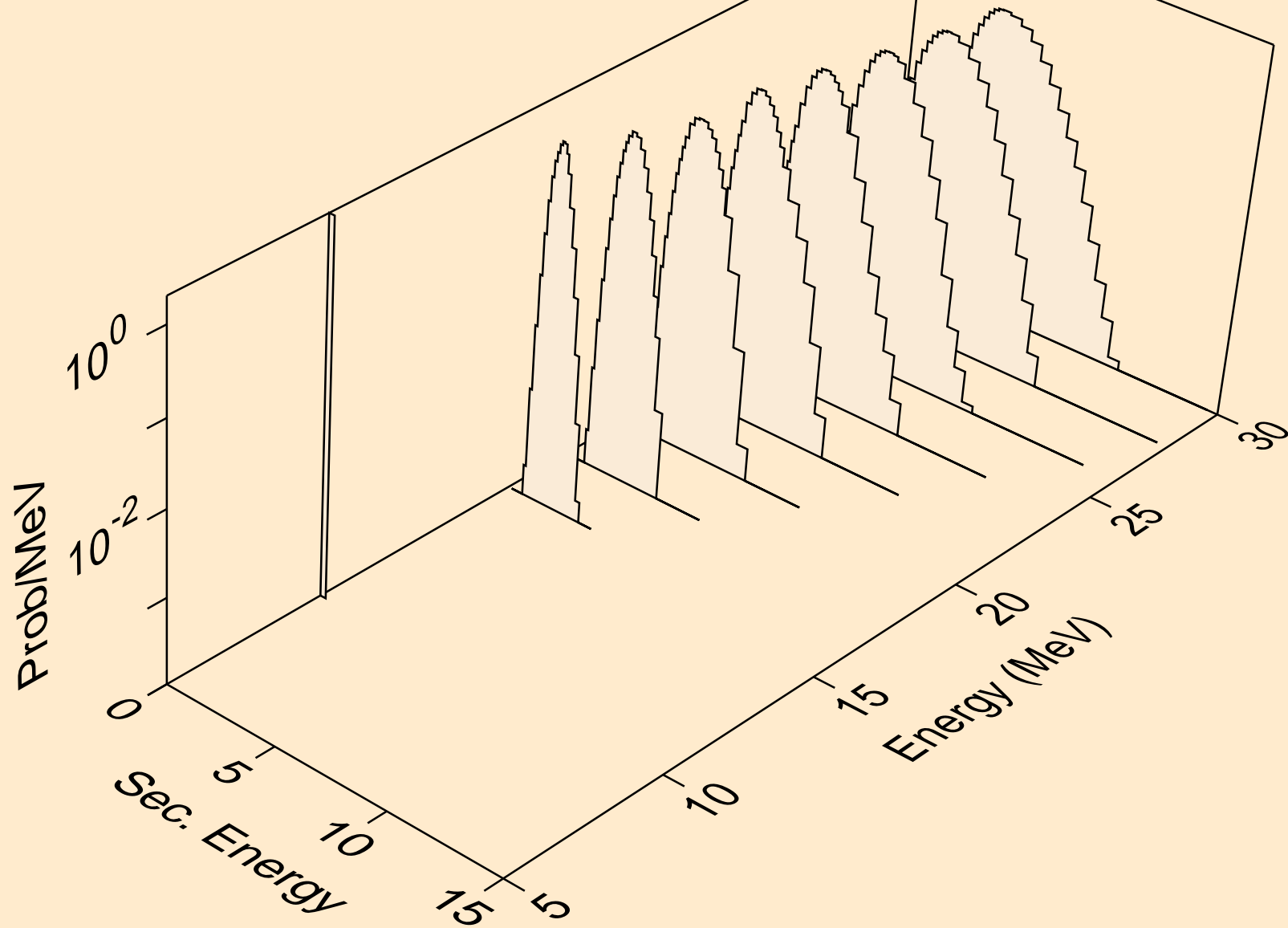

Y085 NEUTRON ACER TENDL-2024 LIBRARY; T=293.6K  
protons from (n,p)

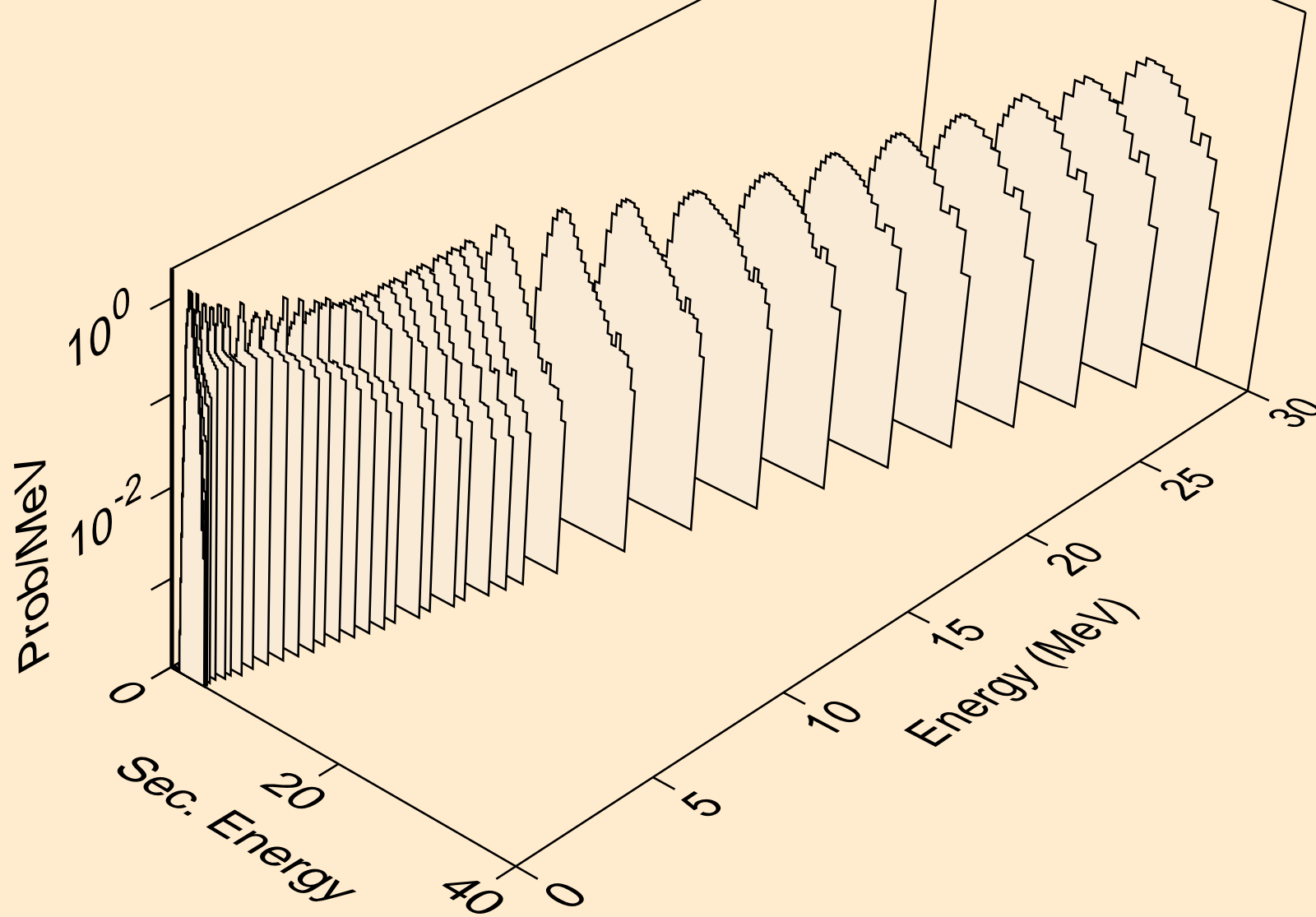

Y085 NEUTRON ACER TENDL-2024 LIBRARY; T=293.6K  
protons from (n,2p)

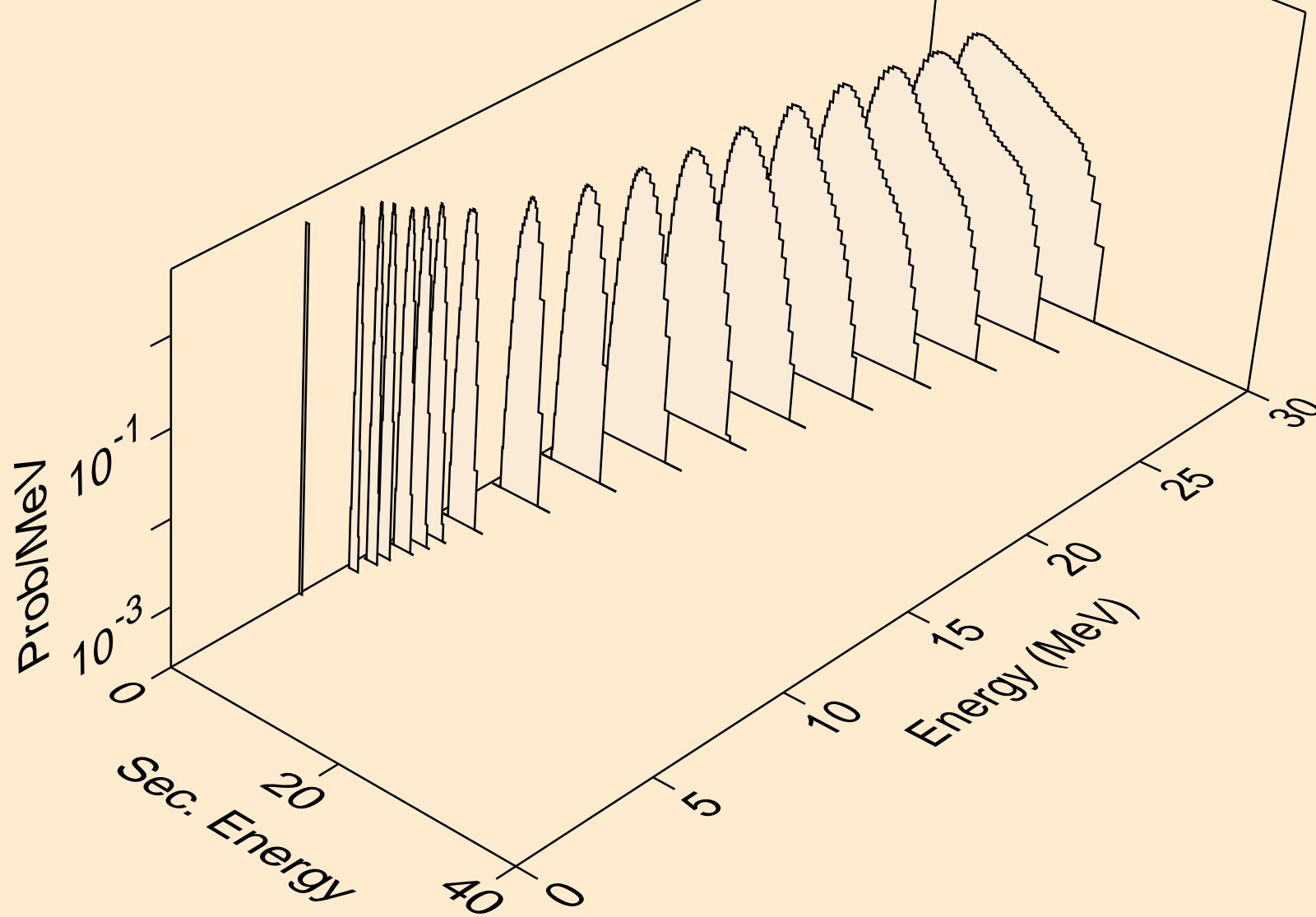

Y085 NEUTRON ACER TENDL-2024 LIBRARY; T=293.6K  
protons from (n,p)

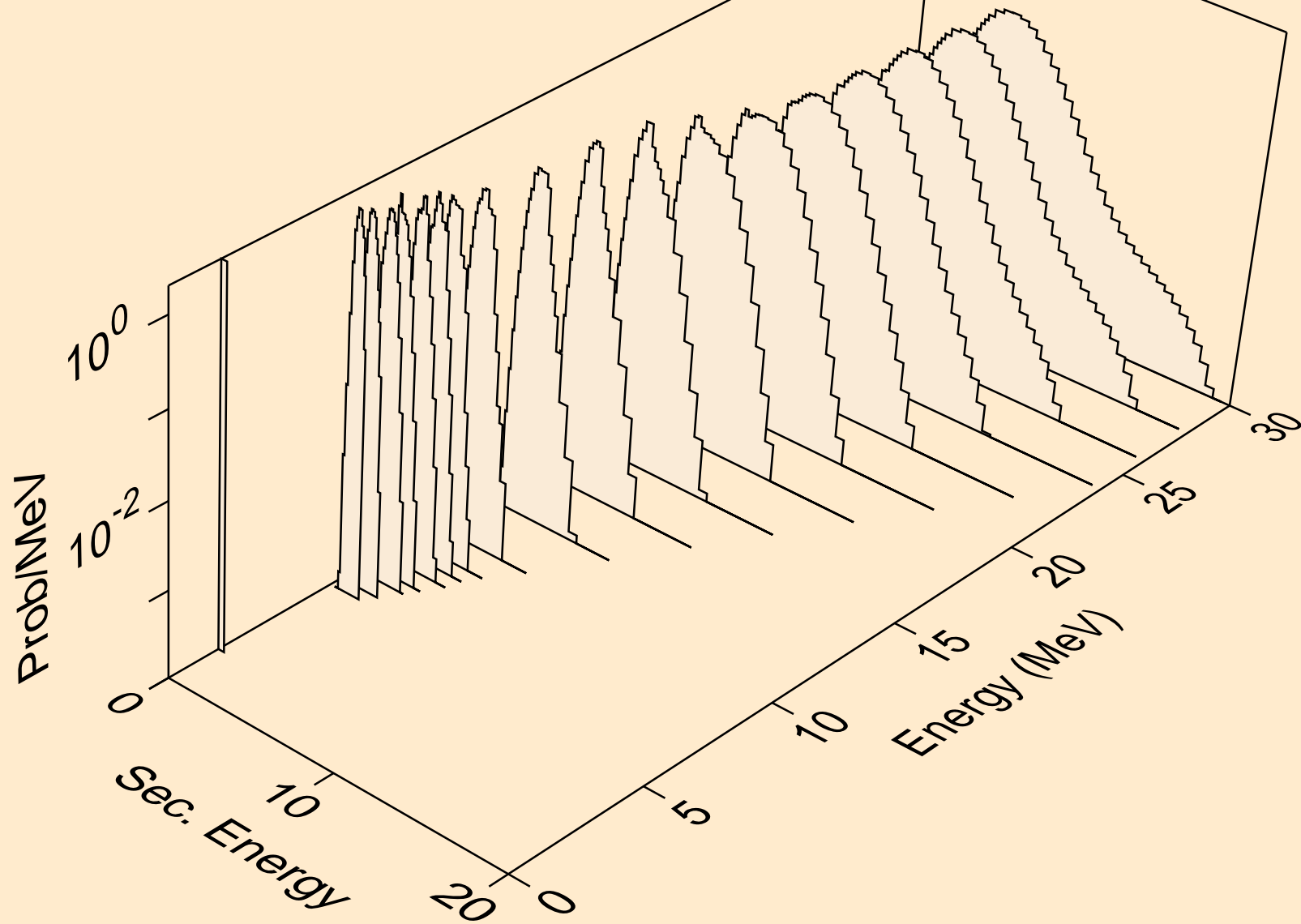

Y085 NEUTRON ACER TENDL-2024 LIBRARY; T=293.6K  
protons from (n,pd)

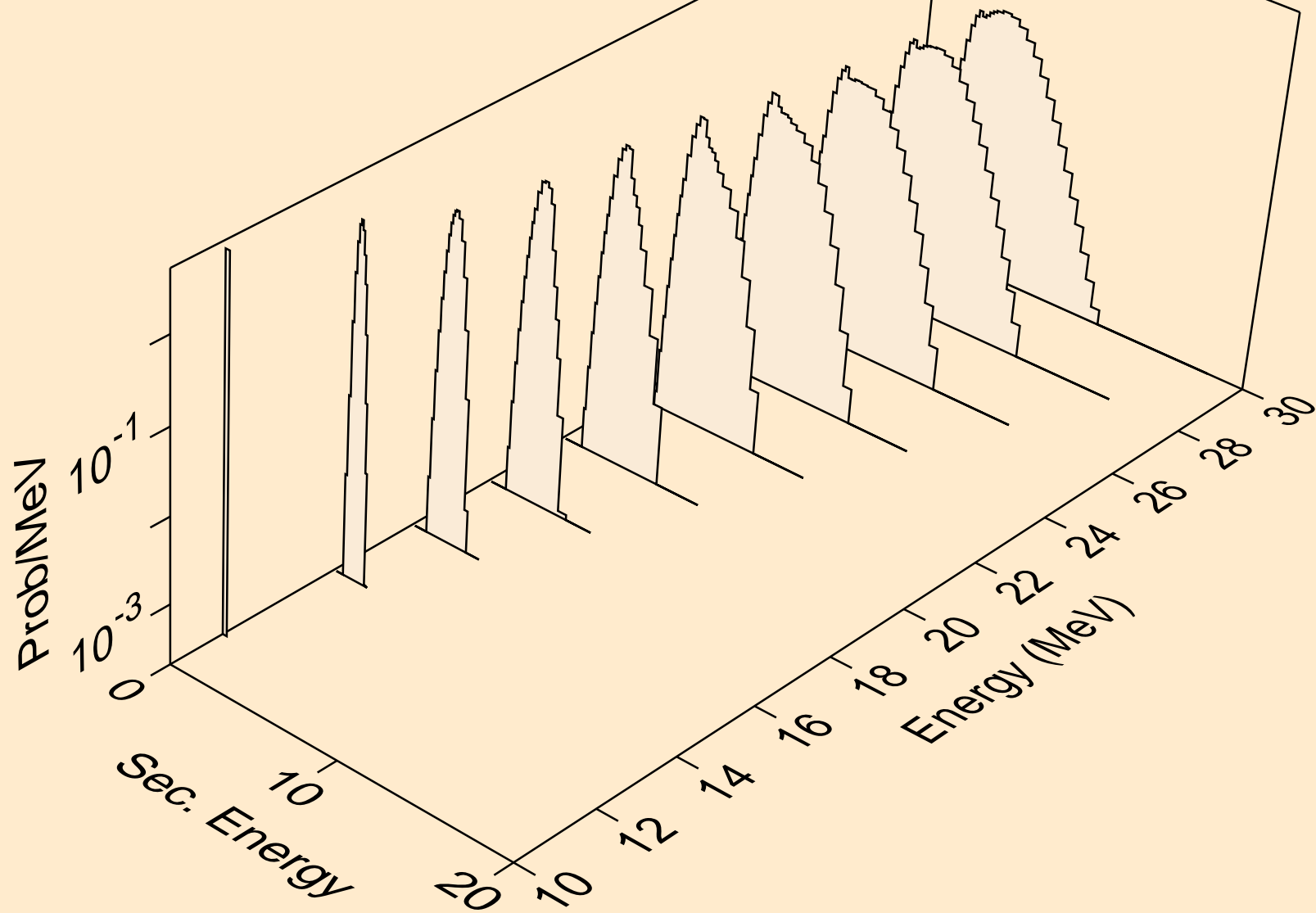

Y085 NEUTRON ACER TENDL-2024 LIBRARY; T=293.6K  
protons from (n,pt)

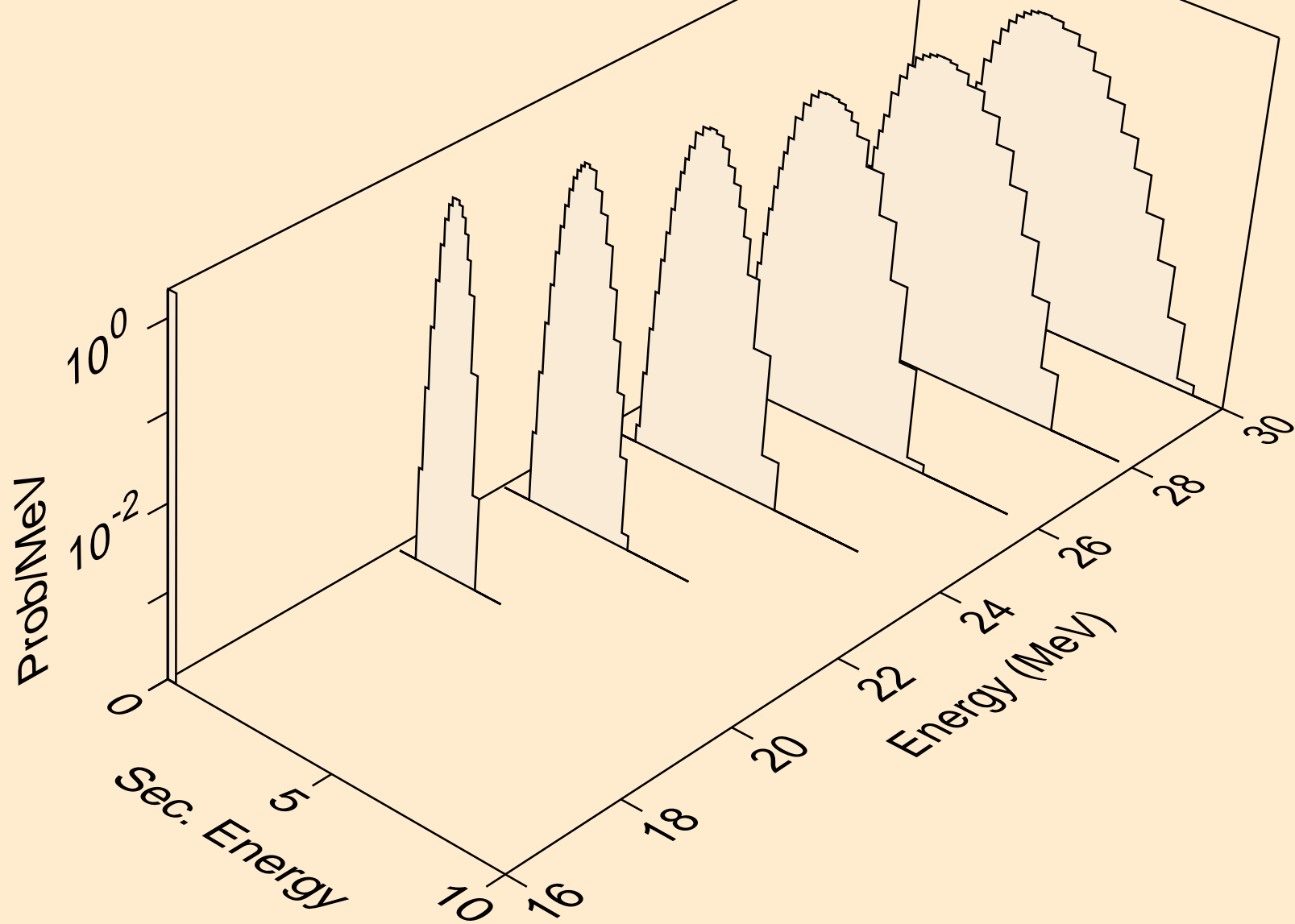

Y085 NEUTRON ACER TENDL-2024 LIBRARY; T=293.6K  
deuterons from (n,x)

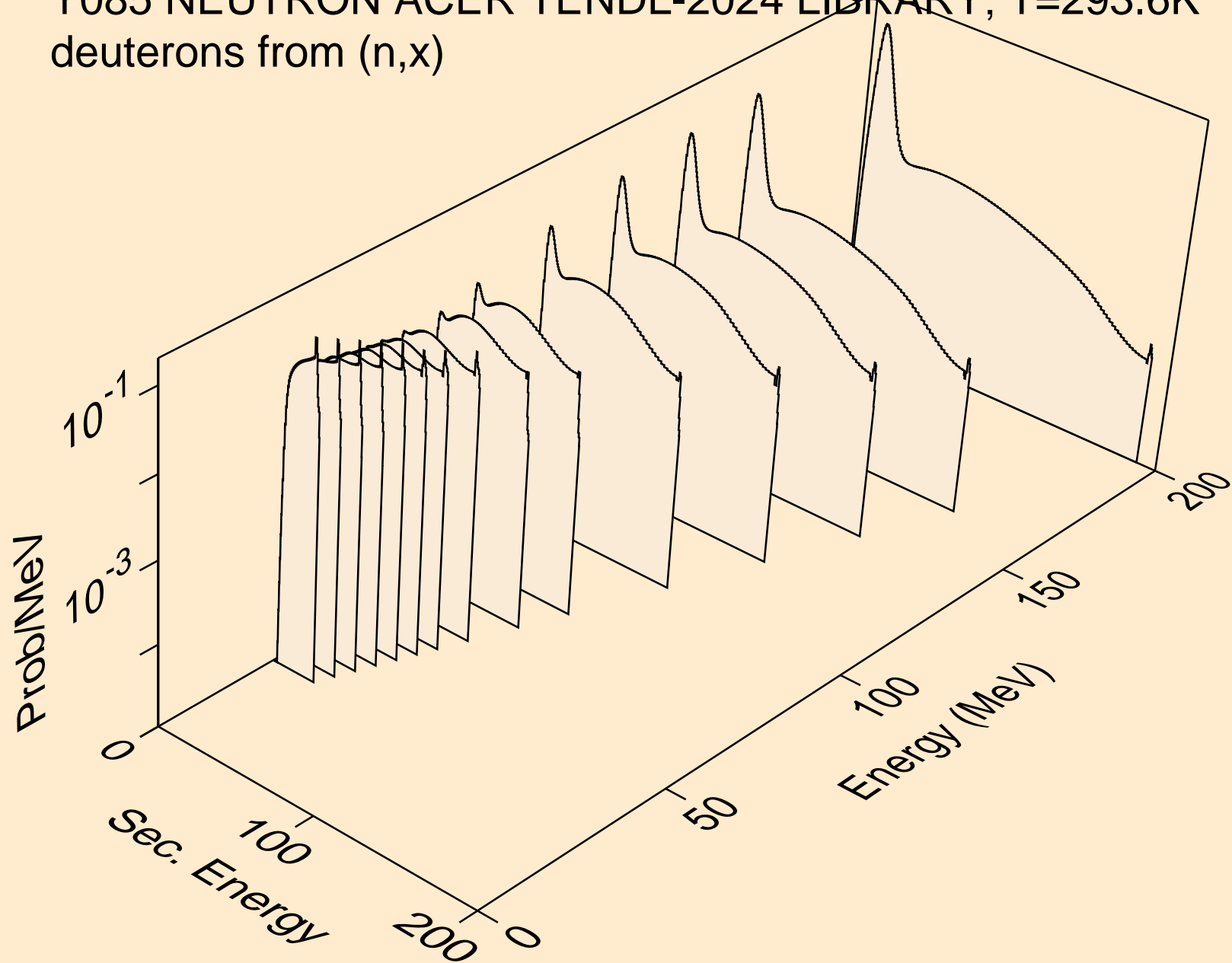

Y085 NEUTRON ACER TENDL-2024 LIBRARY; T=293.6K  
deuterons from (n,2nd)

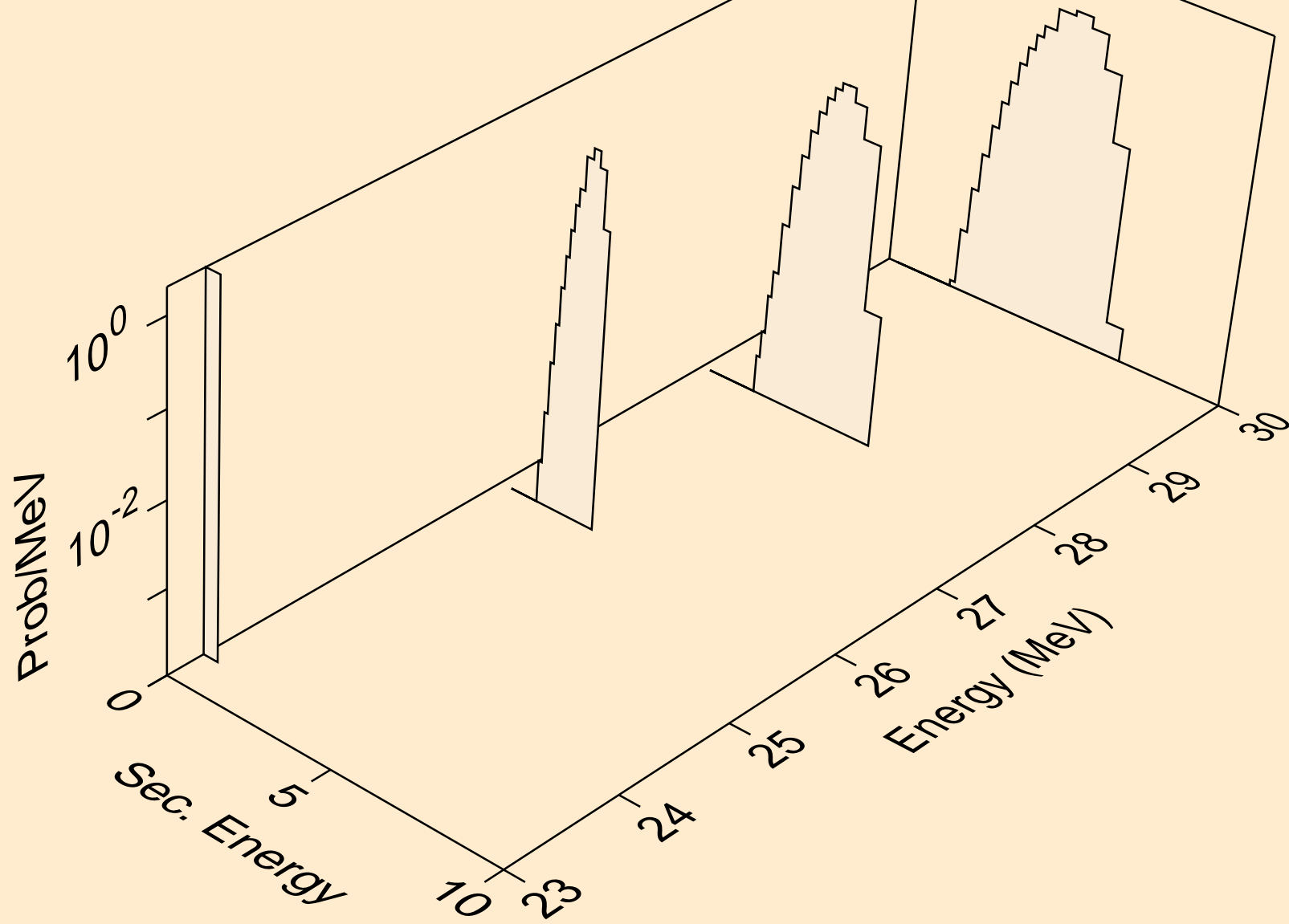

Y085 NEUTRON ACER TENDL-2024 LIBRARY; T=293.6K  
deuterons from (n,n\*)d

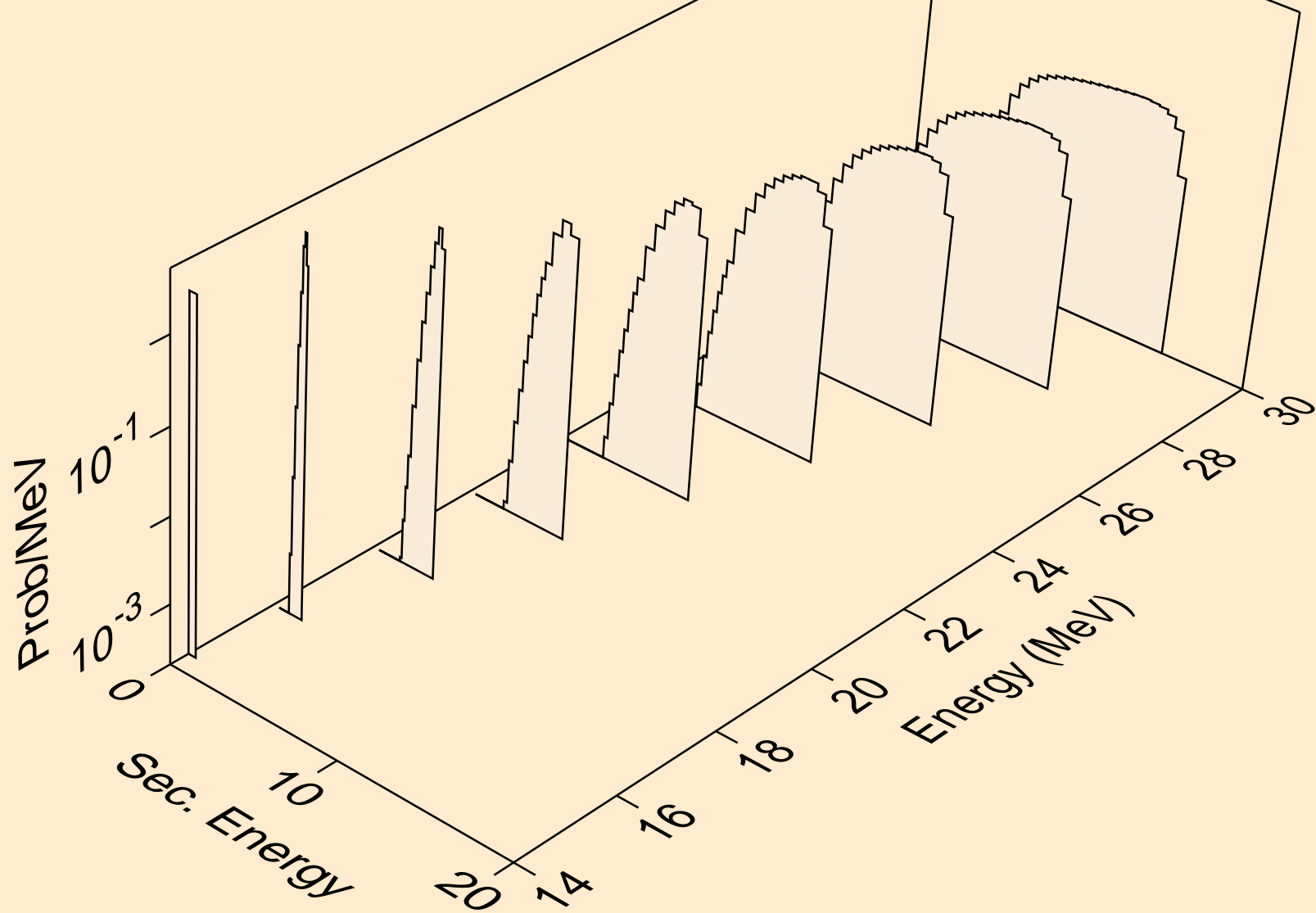

Y085 NEUTRON ACER TENDL-2024 LIBRARY; T=293.6K  
deuterons from (n,d)

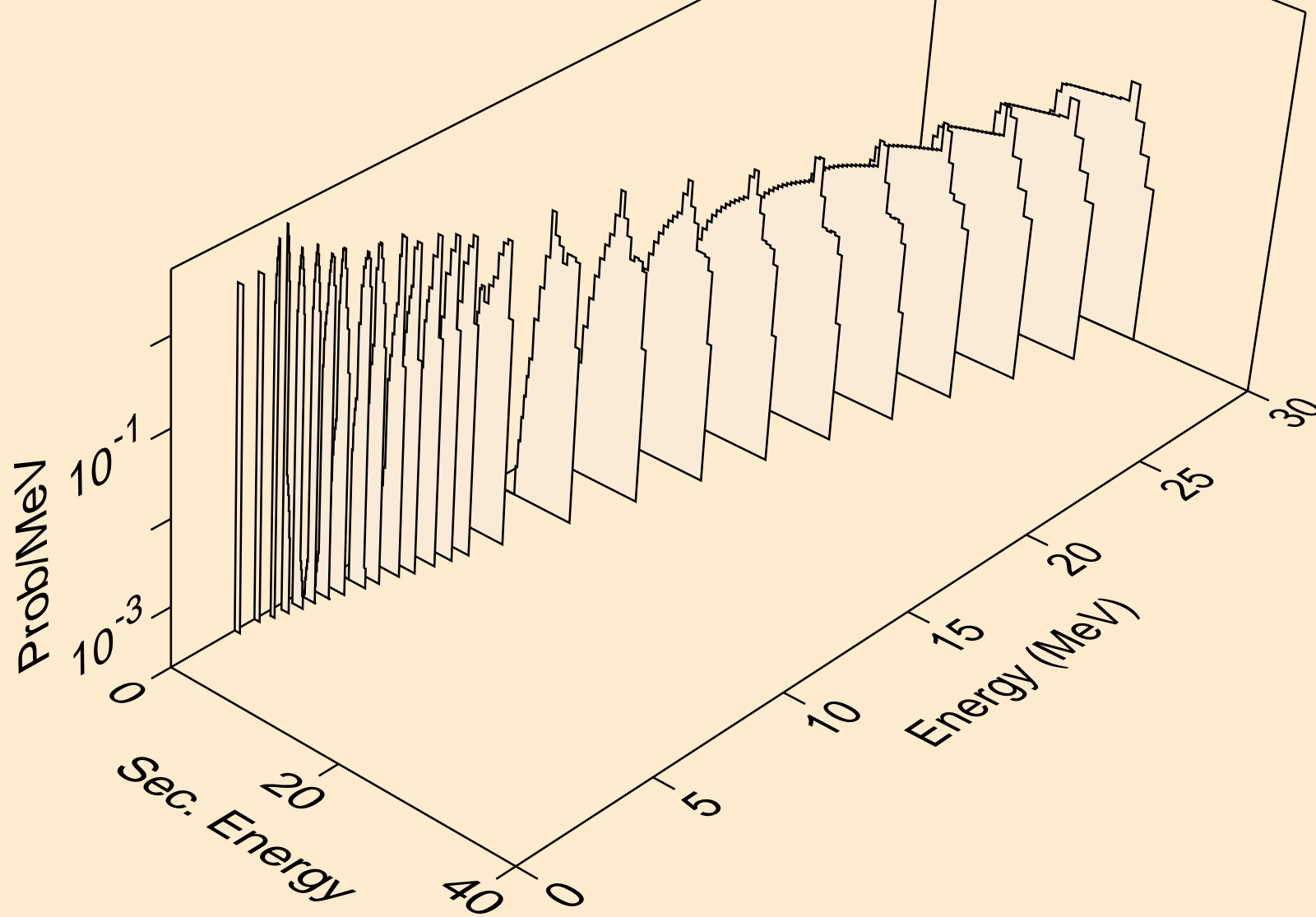

Y085 NEUTRON ACER TENDL-2024 LIBRARY; T=293.6K  
deuterons from (n,pd)

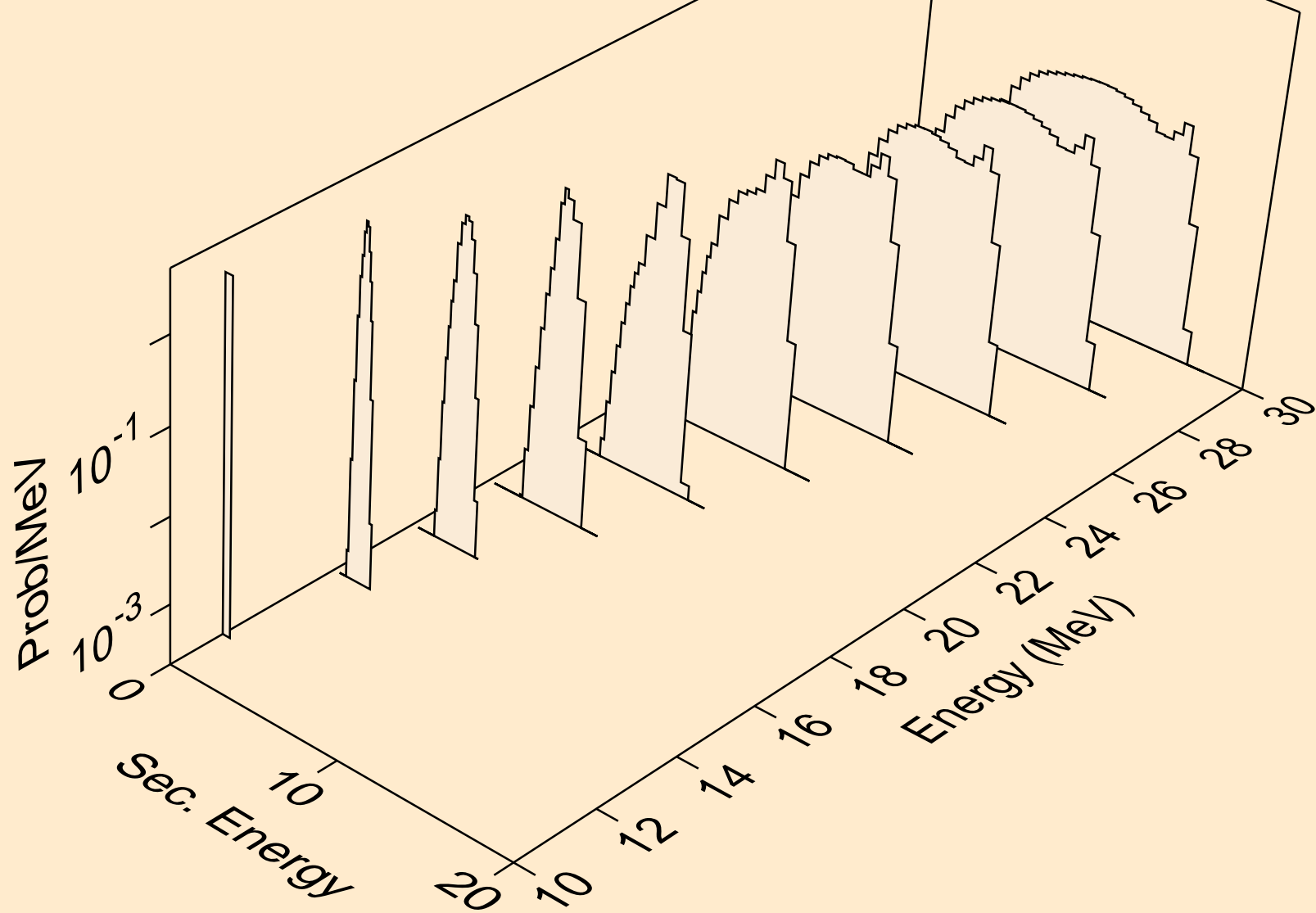

Y085 NEUTRON ACER TENDL-2024 LIBRARY; T=293.6K  
deuterons from (n,da)

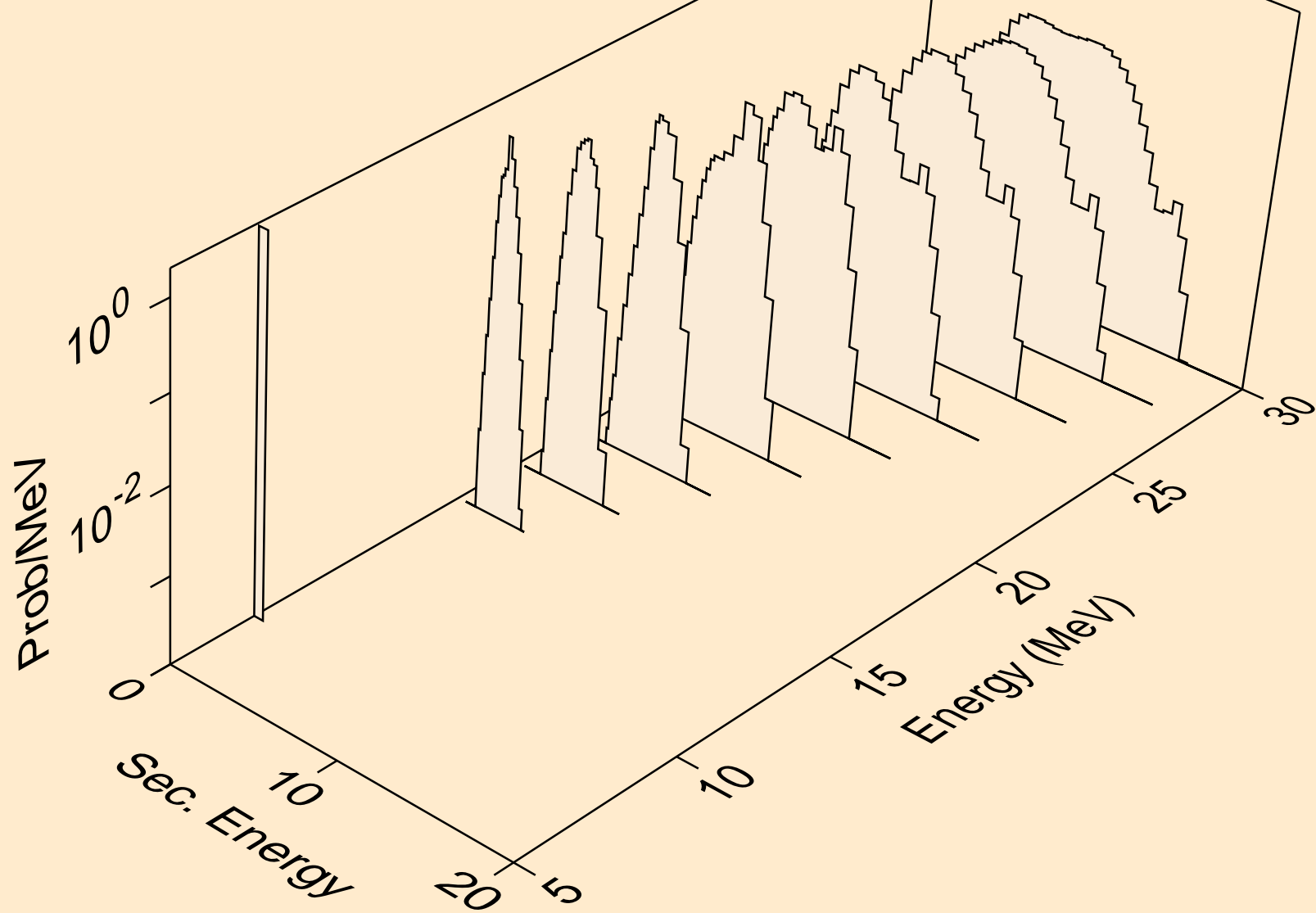

Y085 NEUTRON ACER TENDL-2024 LIBRARY; T=293.6K  
tritons from (n,x)

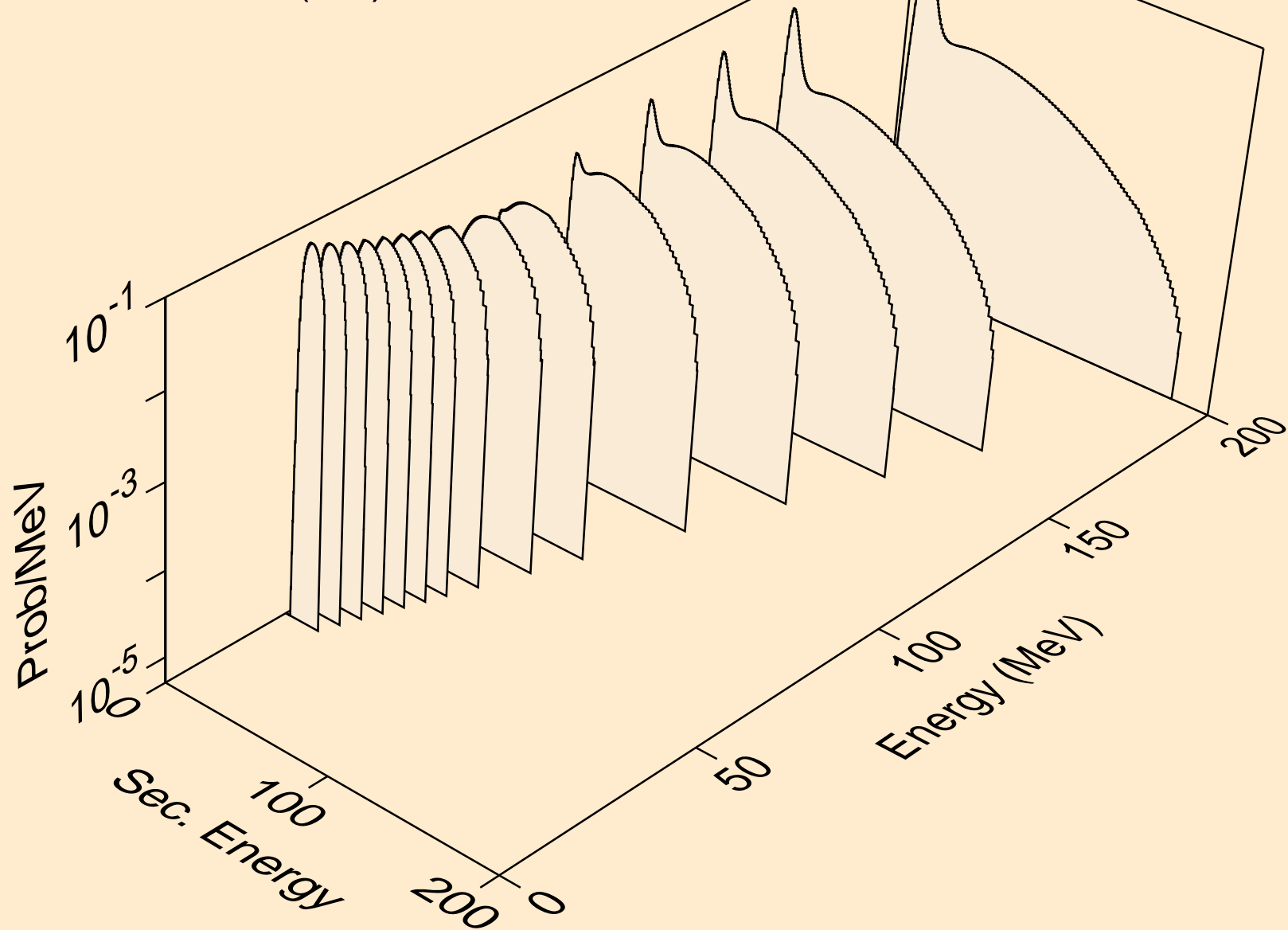

Y085 NEUTRON ACER TENDL-2024 LIBRARY; T=293.6K  
tritons from (n,n\*)t

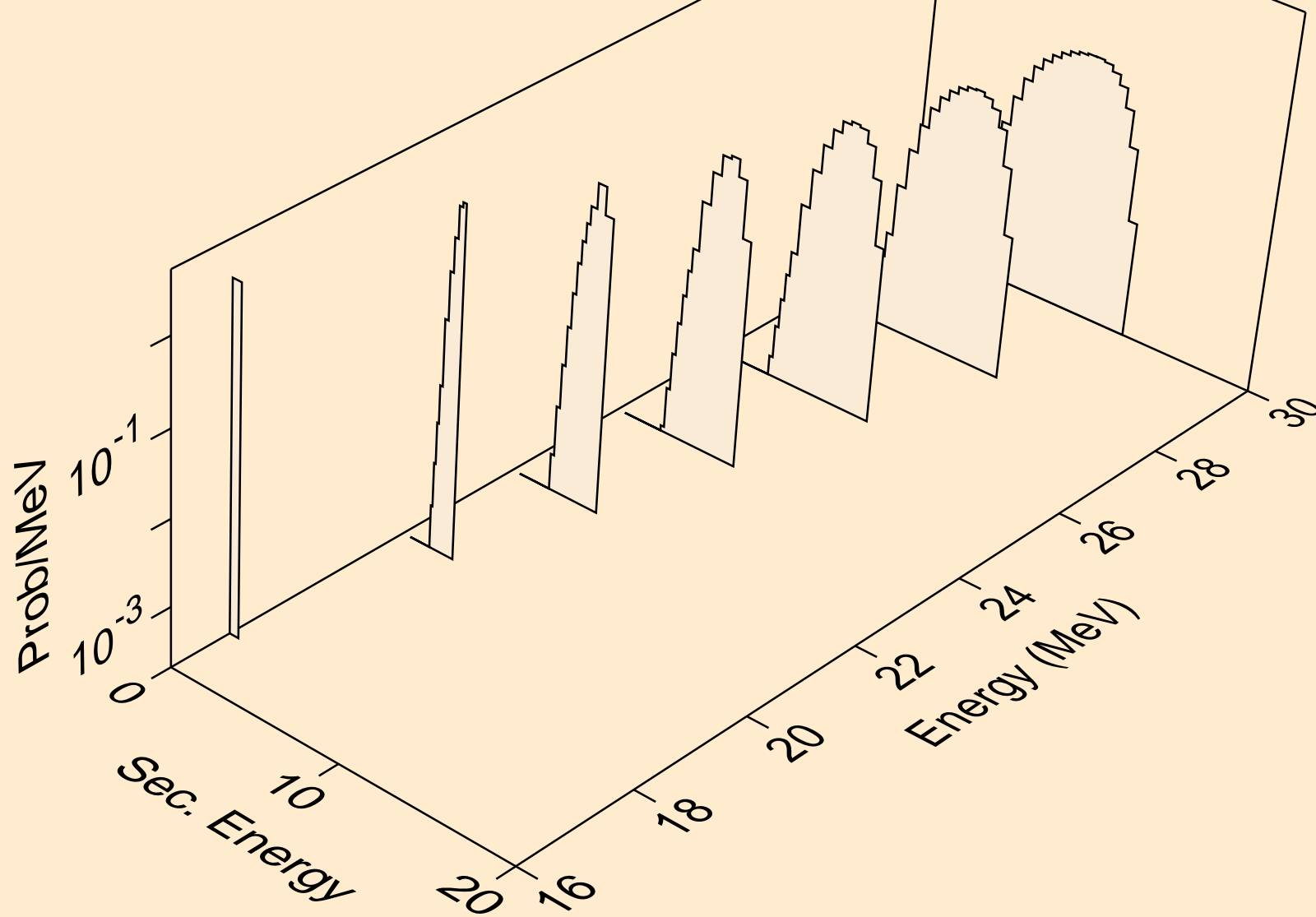

Y085 NEUTRON ACER TENDL-2024 LIBRARY; T=293.6K  
tritons from (n,t)

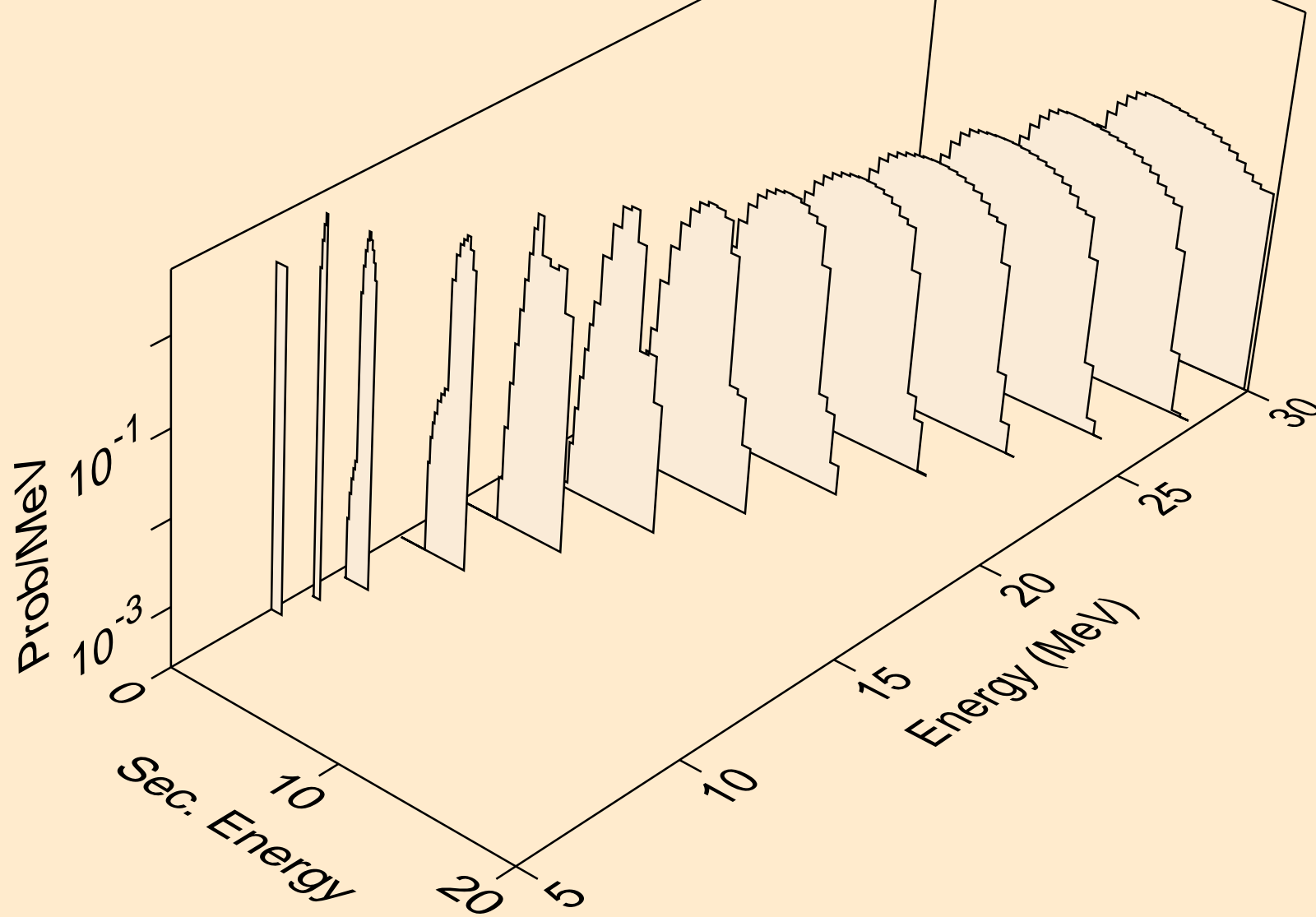

Y085 NEUTRON ACER TENDL-2024 LIBRARY; T=293.6K  
tritons from (n,pt)

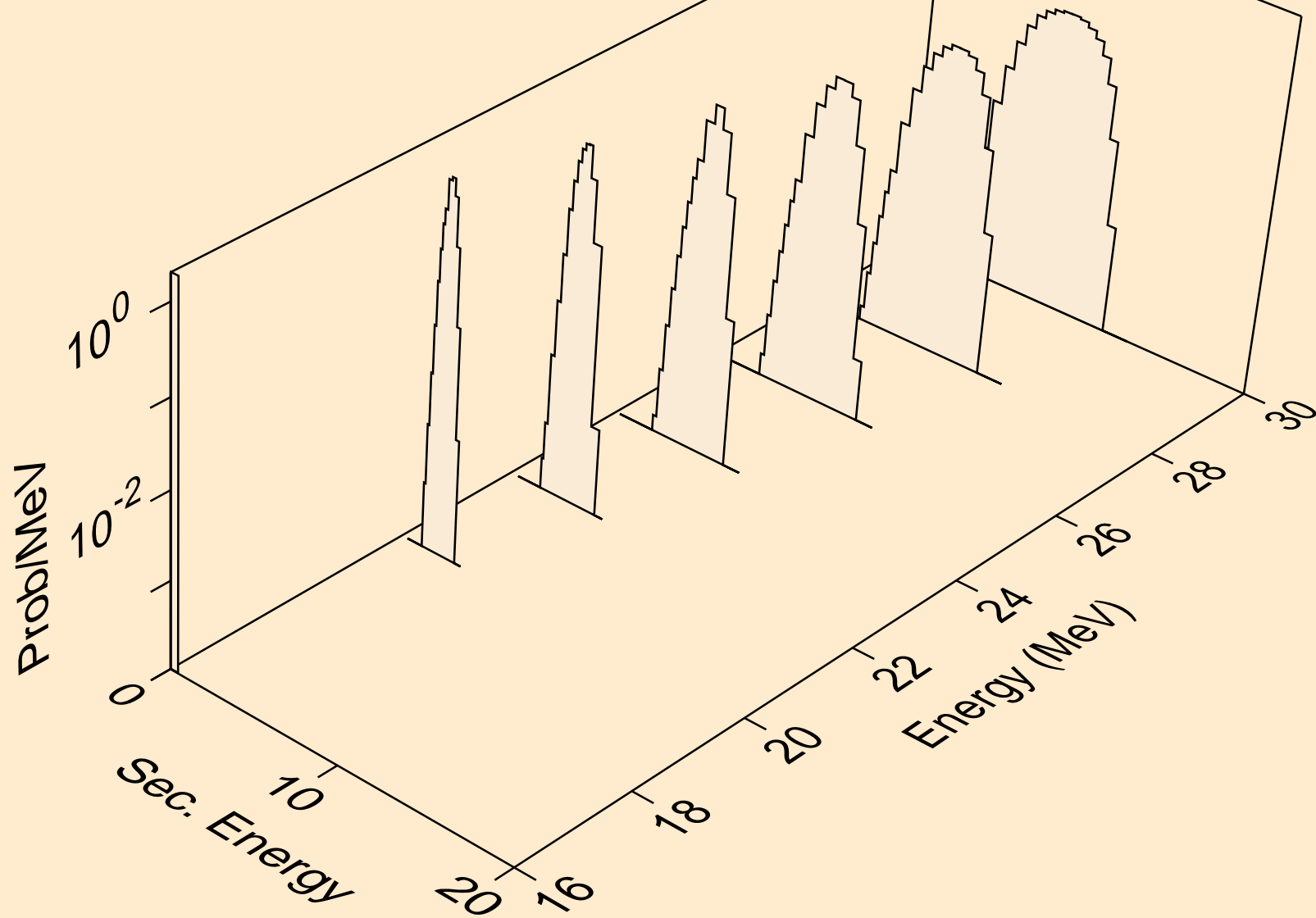

Y085 NEUTRON ACER TENDL-2024 LIBRARY; T=293.6K  
he3s from (n,x)

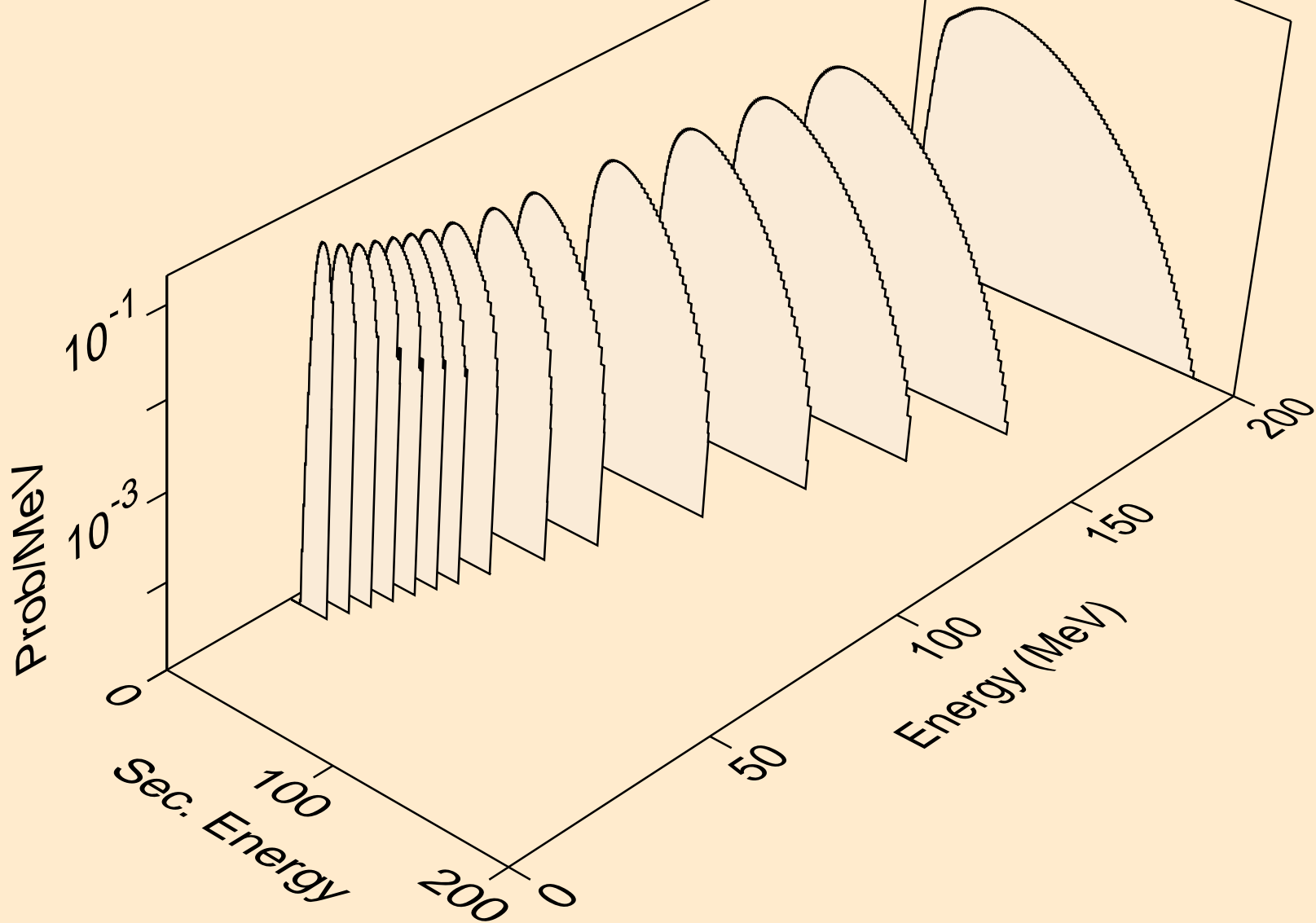

Y085 NEUTRON ACER TENDL-2024 LIBRARY; T=293.6K  
he3s from (n,n\*)he3

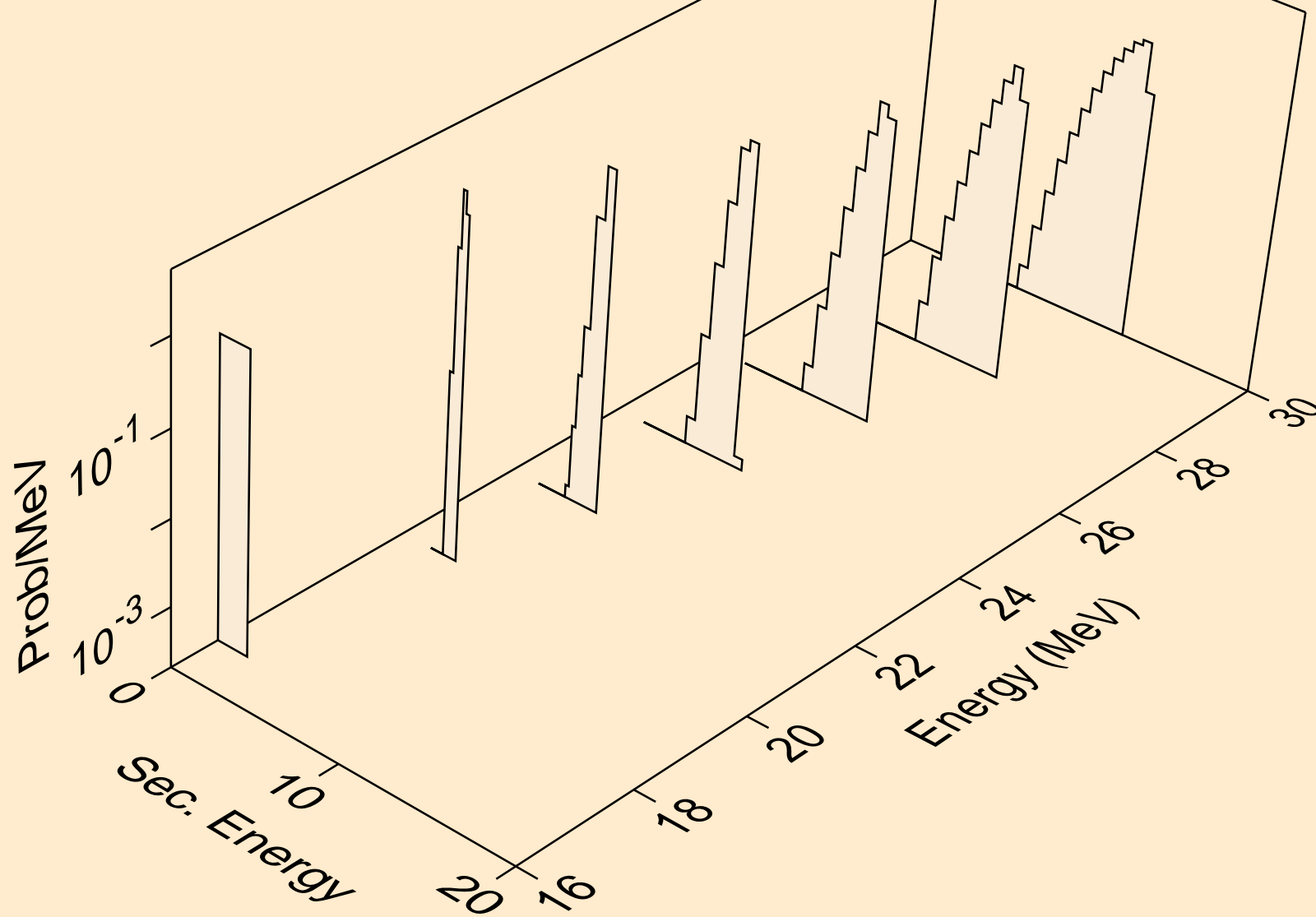

Y085 NEUTRON ACER TENDL-2024 LIBRARY; T=293.6K  
he3s from (n,he3)

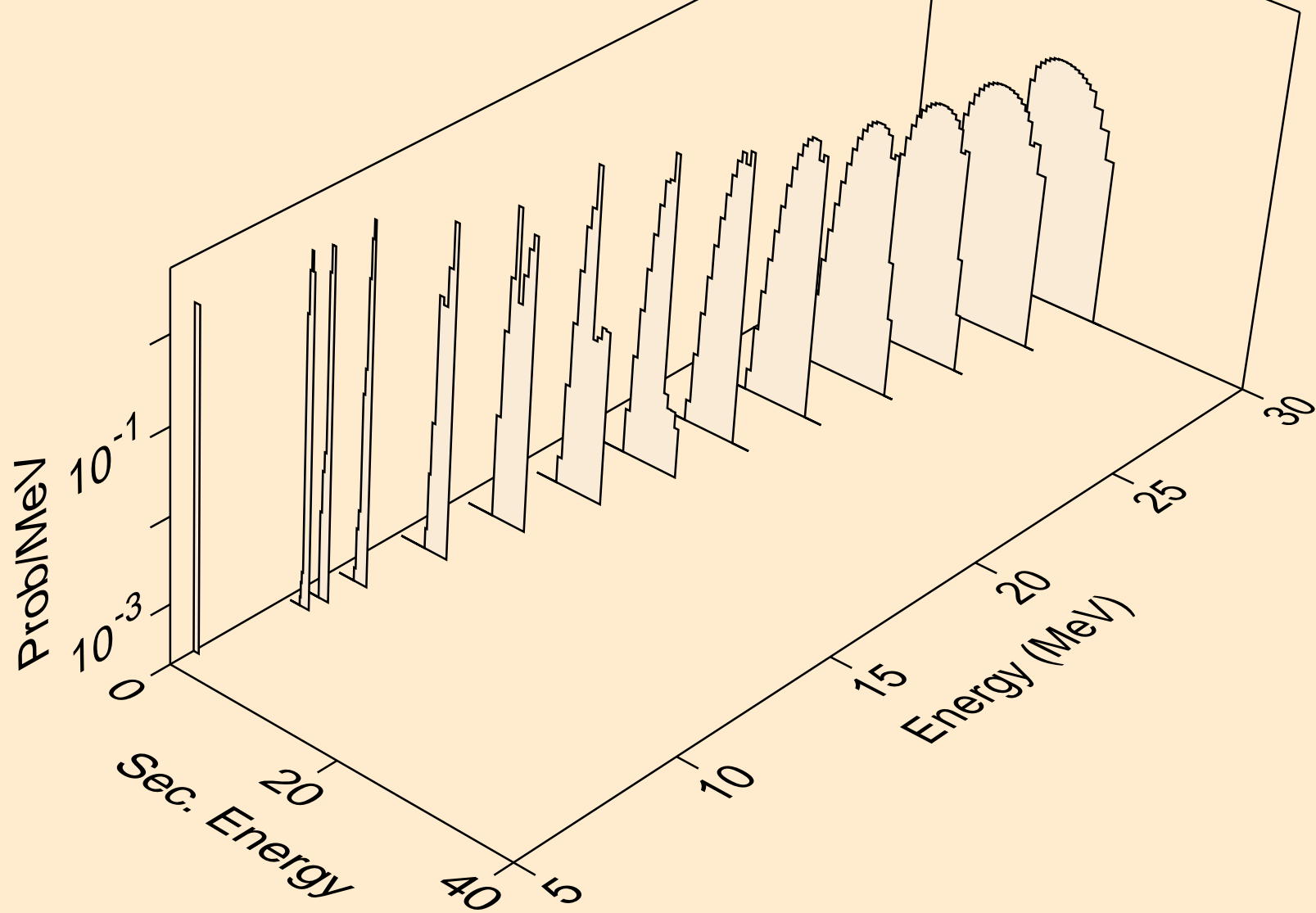

Y085 NEUTRON ACER TENDL-2024 LIBRARY; T=293.6K  
alphas from (n,x)

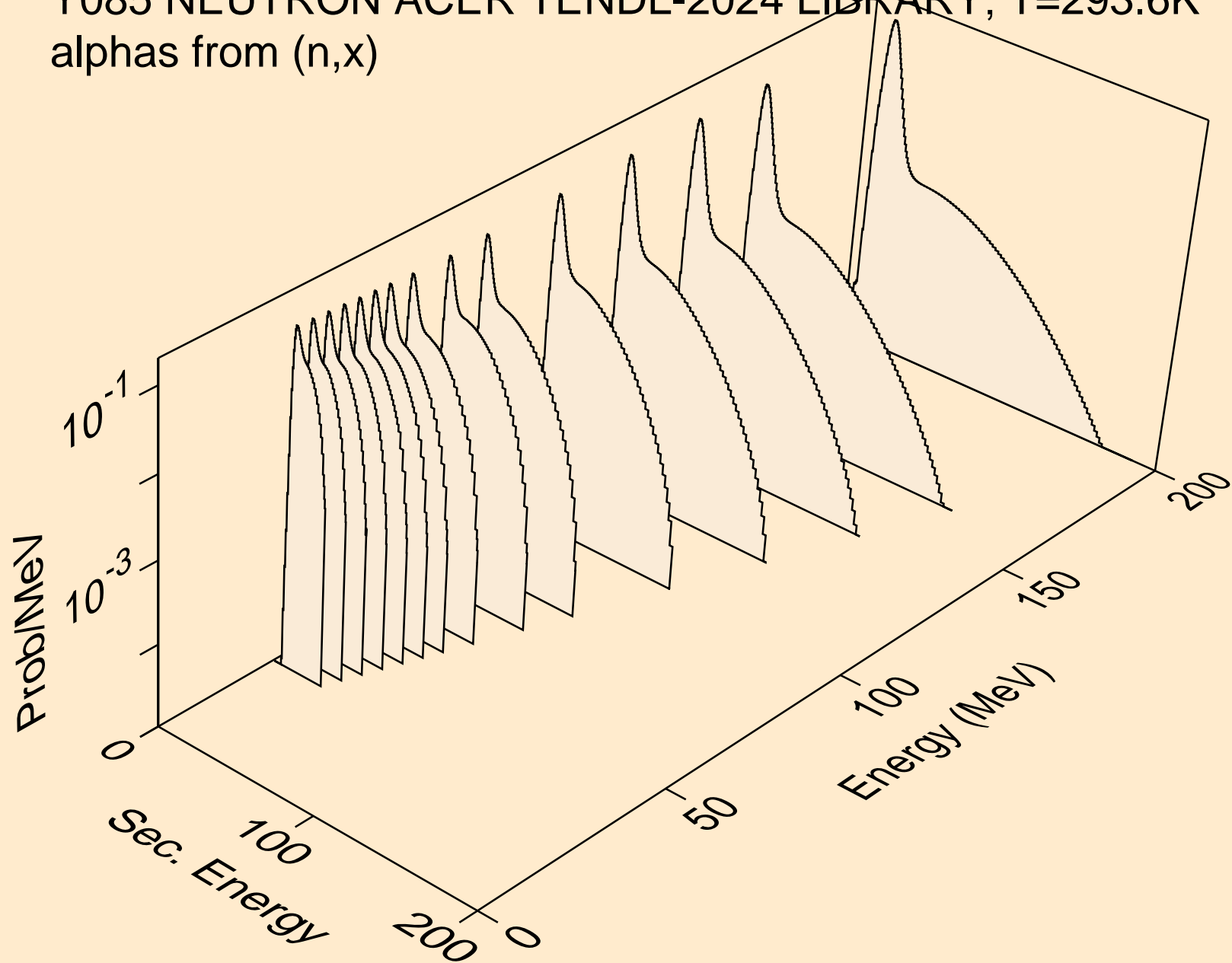

Y085 NEUTRON ACER TENDL-2024 LIBRARY; T=293.6K  
alphas from (n,n\*)a

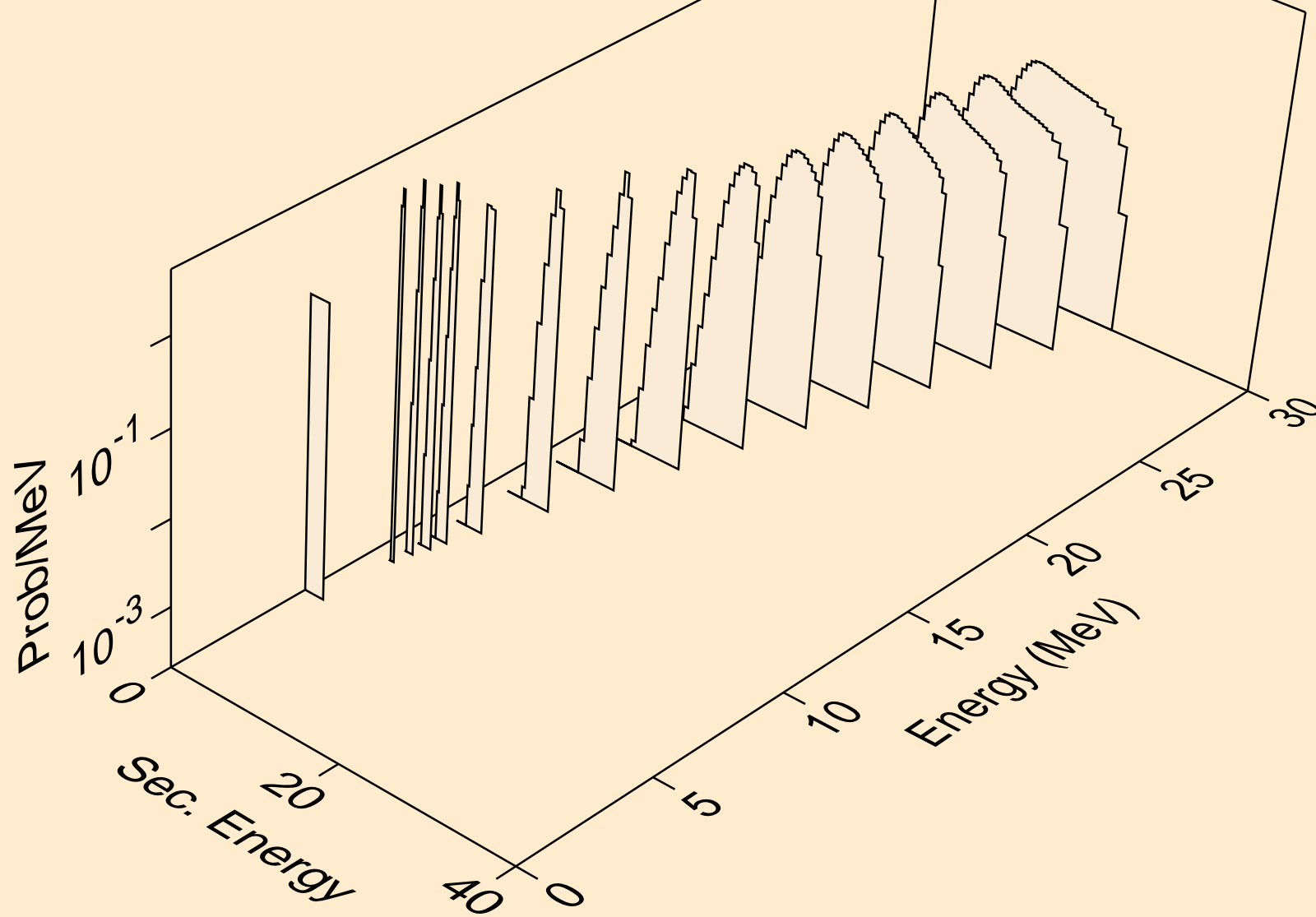

Y085 NEUTRON ACER TENDL-2024 LIBRARY; T=293.6K  
alphas from (n,2n)a

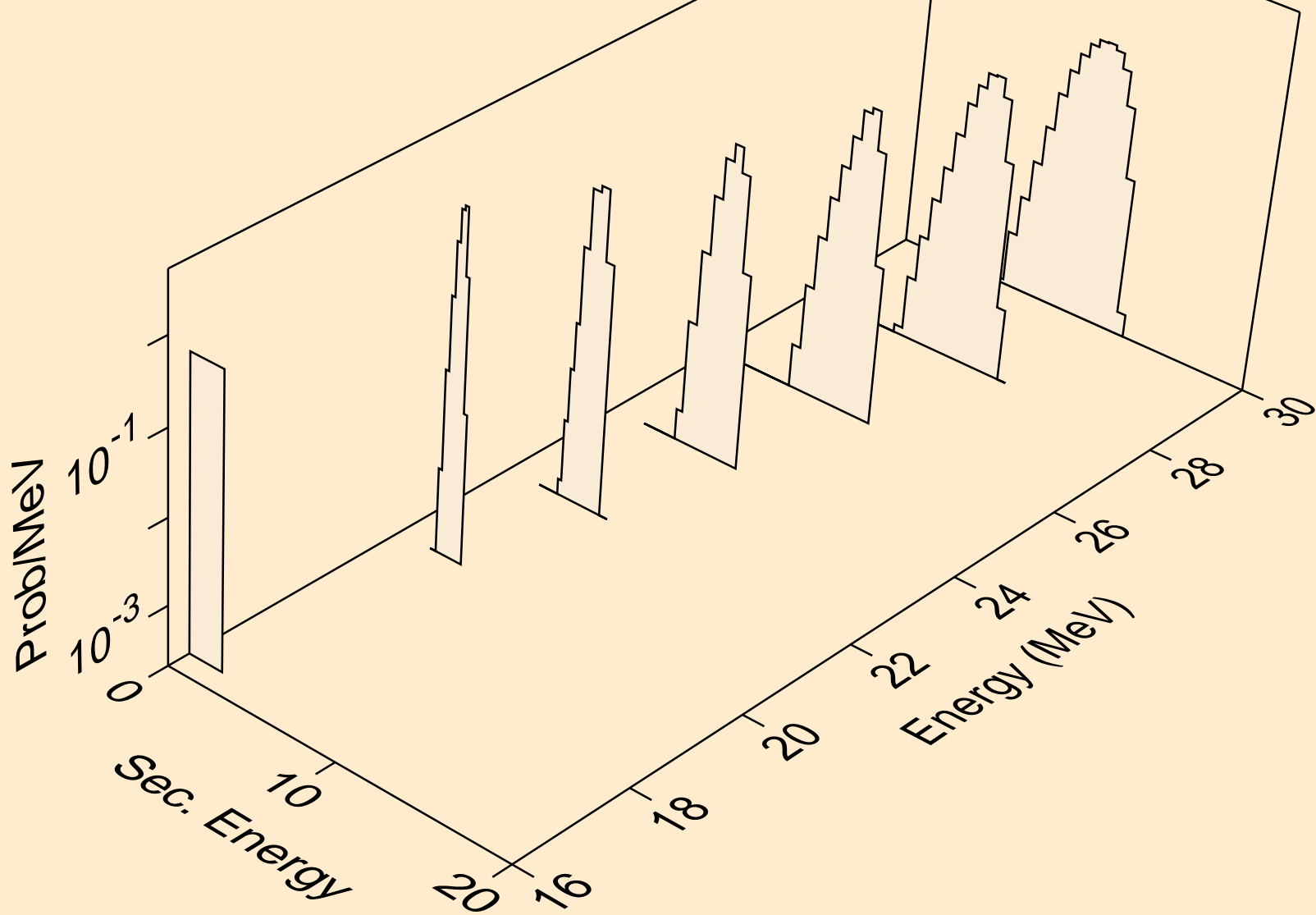

Y085 NEUTRON ACER TENDL-2024 LIBRARY; T=293.6K  
alphas from (n,n\*)2a

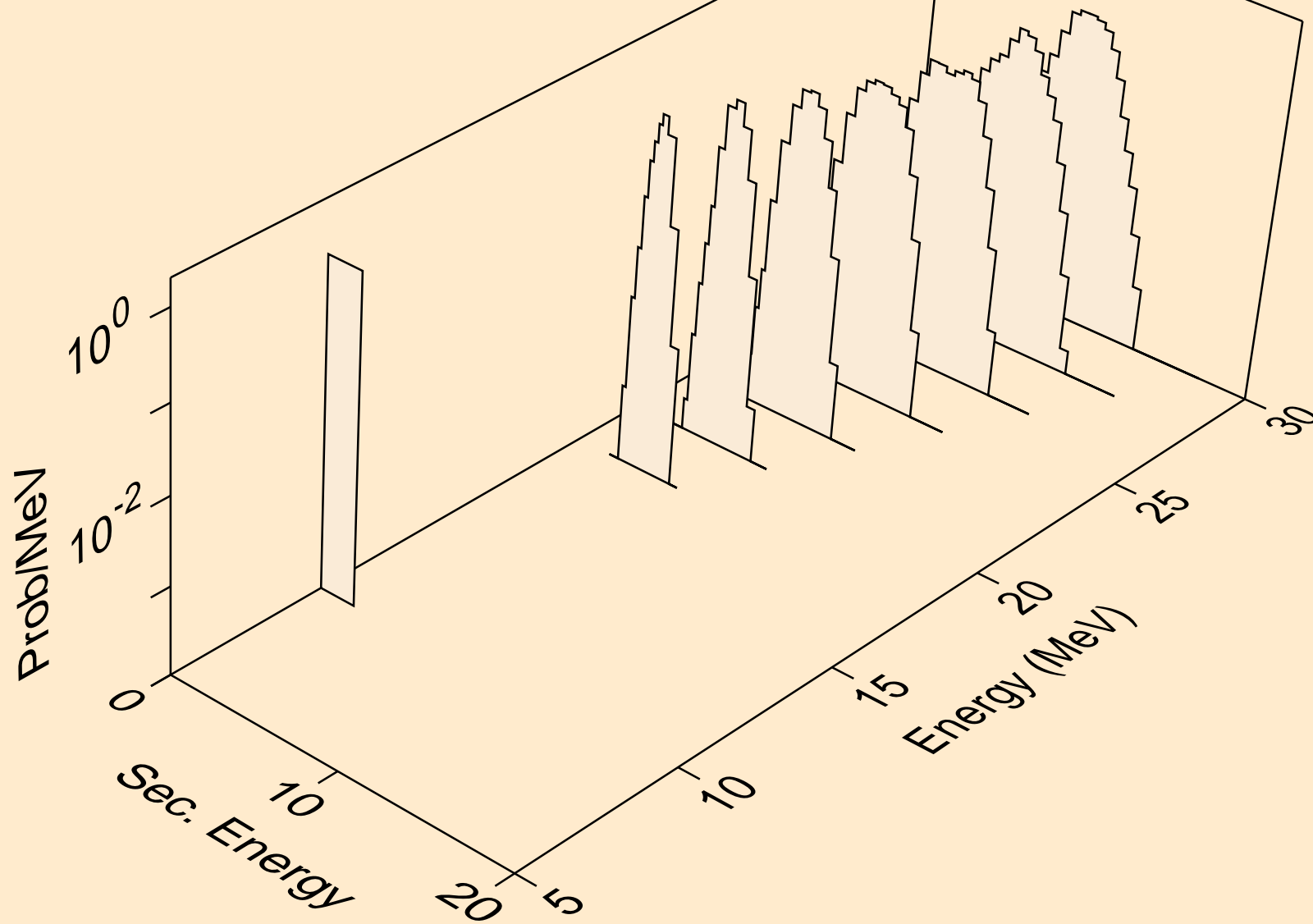

Y085 NEUTRON ACER TENDL-2024 LIBRARY; T=293.6K  
alphas from (n,npa)

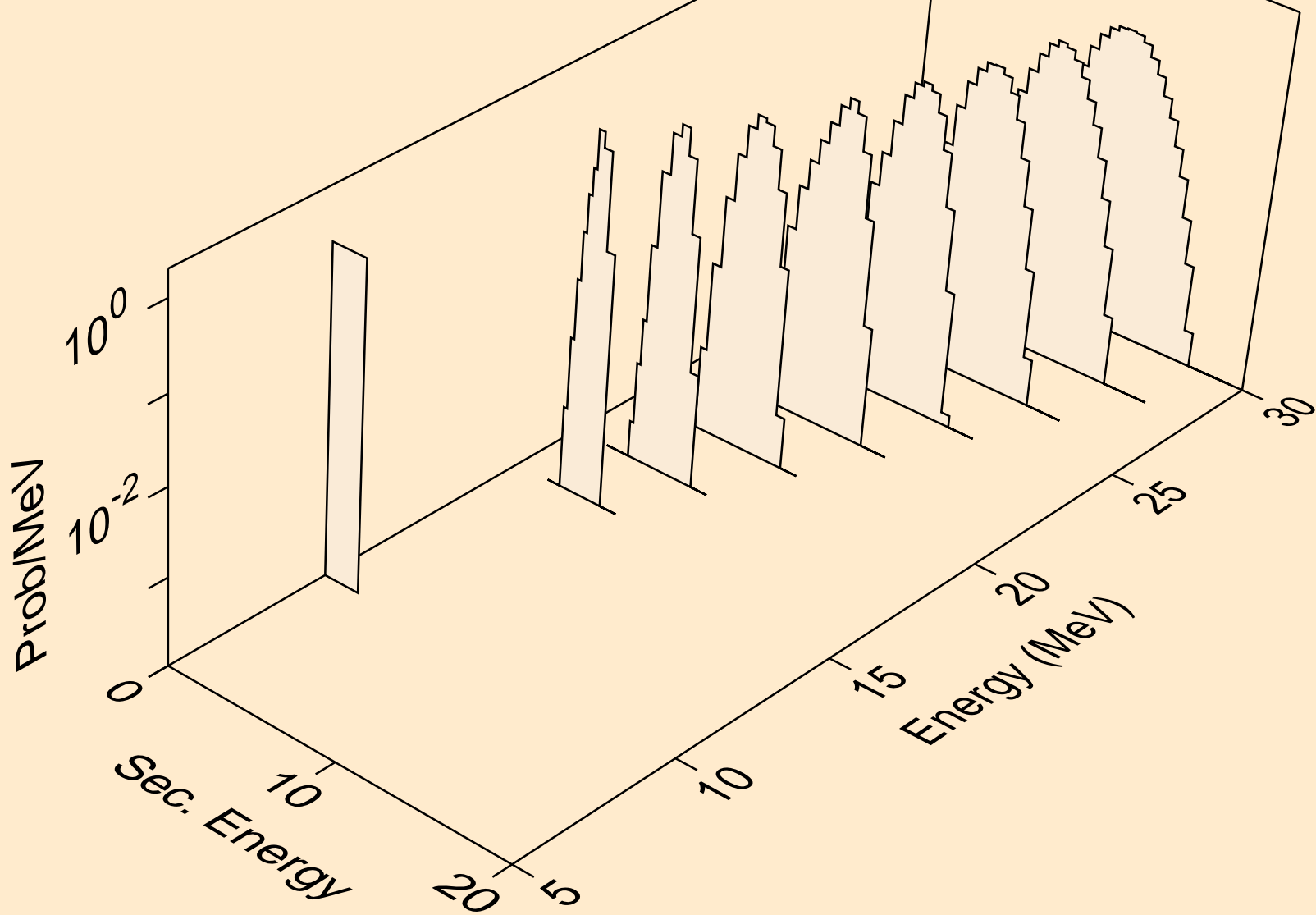

Y085 NEUTRON ACER TENDL-2024 LIBRARY; T=293.6K  
alphas from (n,a)

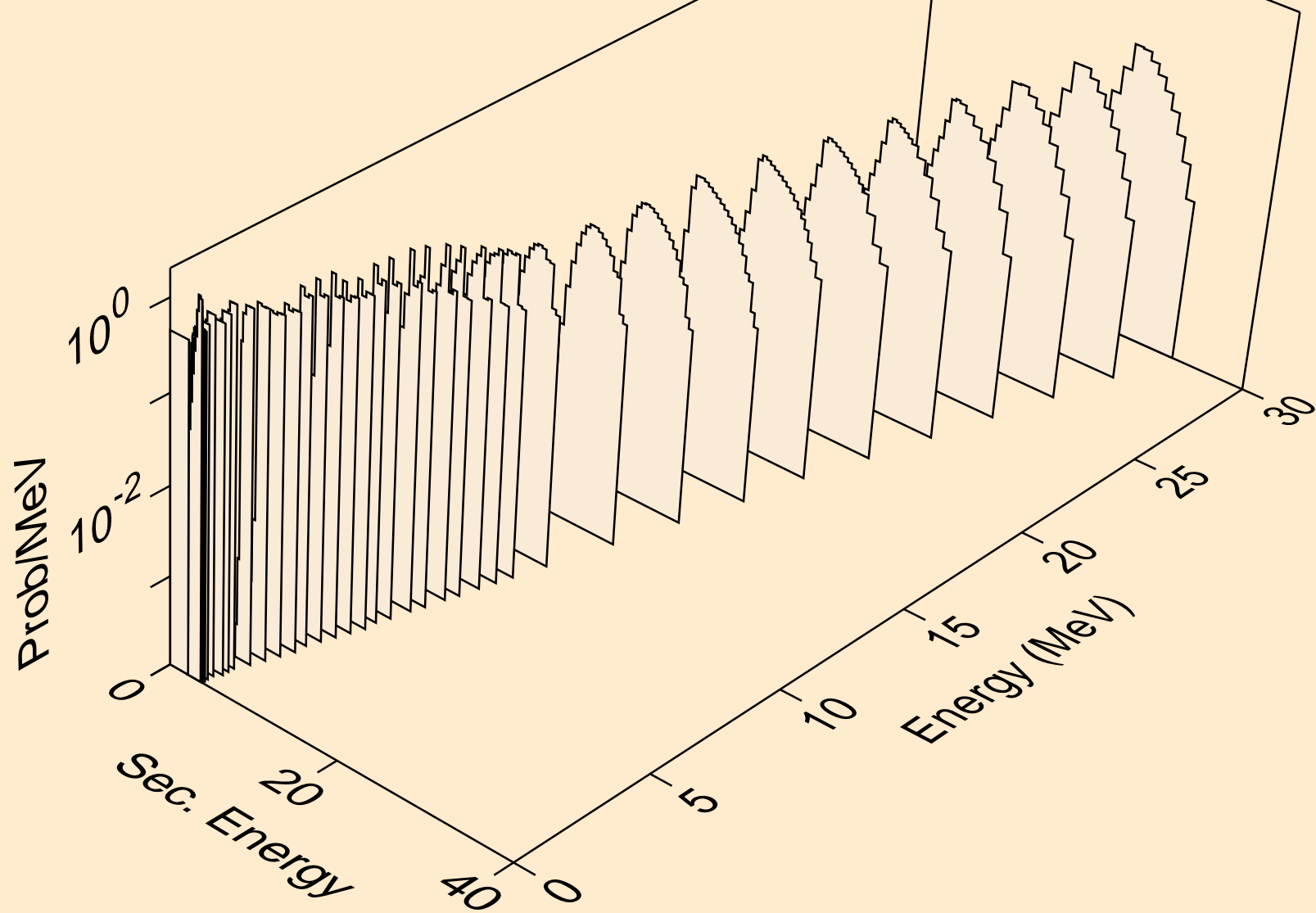

Y085 NEUTRON ACER TENDL-2024 LIBRARY; T=293.6K  
alphas from (n,2a)

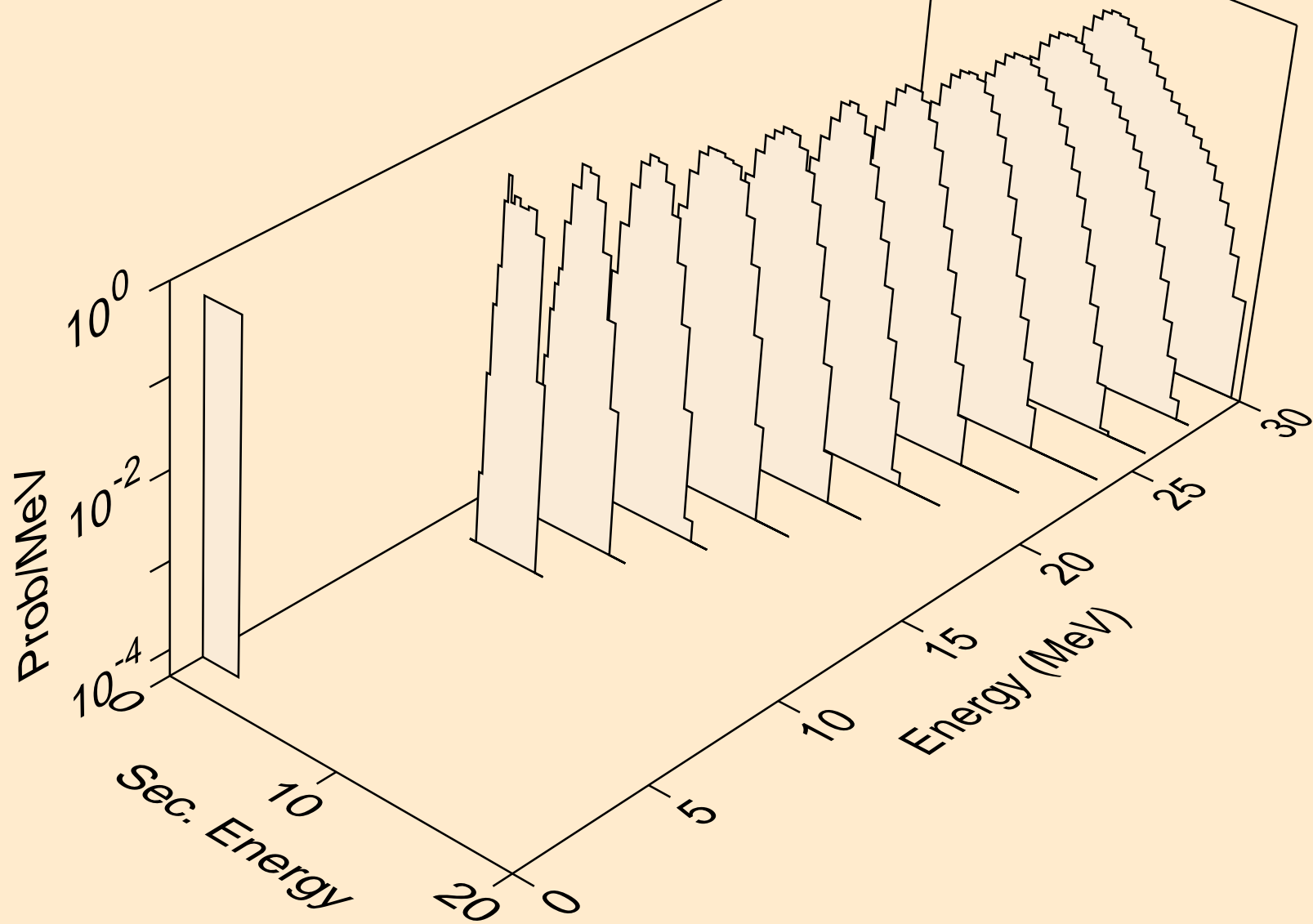

Y085 NEUTRON ACER TENDL-2024 LIBRARY; T=293.6K  
alphas from (n,pa)

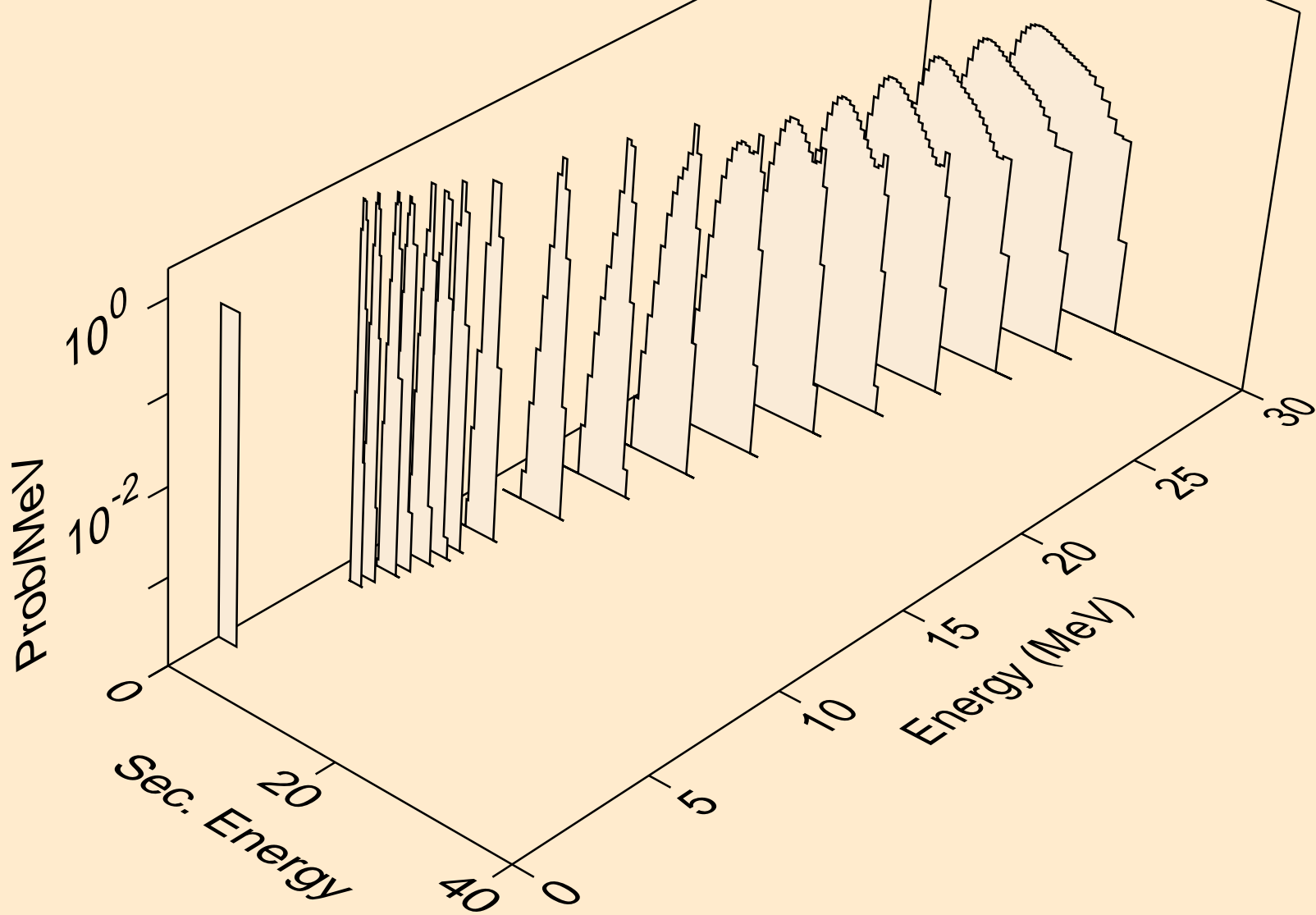

Y085 NEUTRON ACER TENDL-2024 LIBRARY; T=293.6K  
alphas from (n,da)

