

YB155 NEUTRON ACER TENDL-2024 LIBRARY; T=293.6K
Principal cross sections

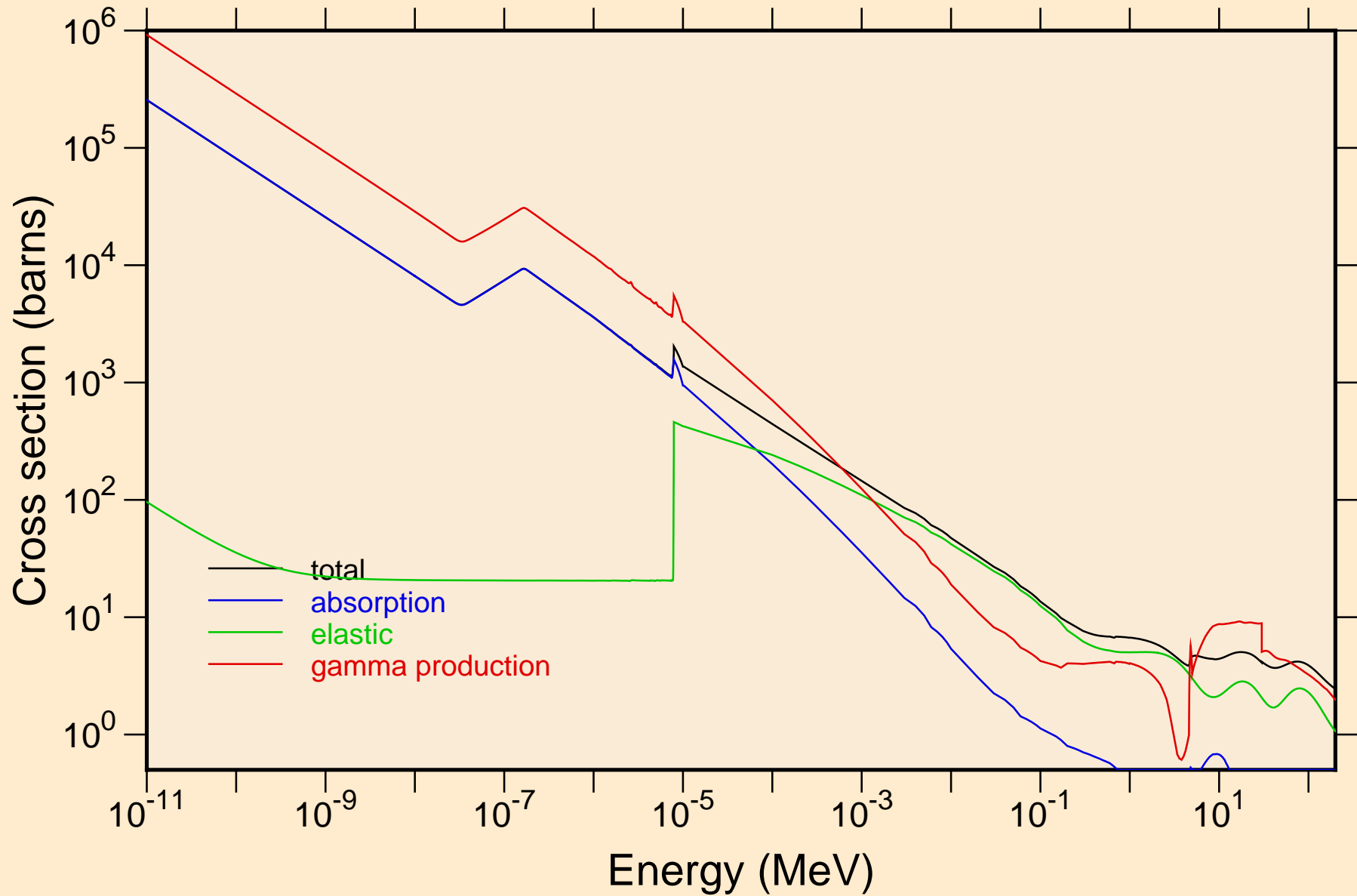

YB155 NEUTRON ACER TENDL-2024 LIBRARY; T=293.6K
resonance total cross section

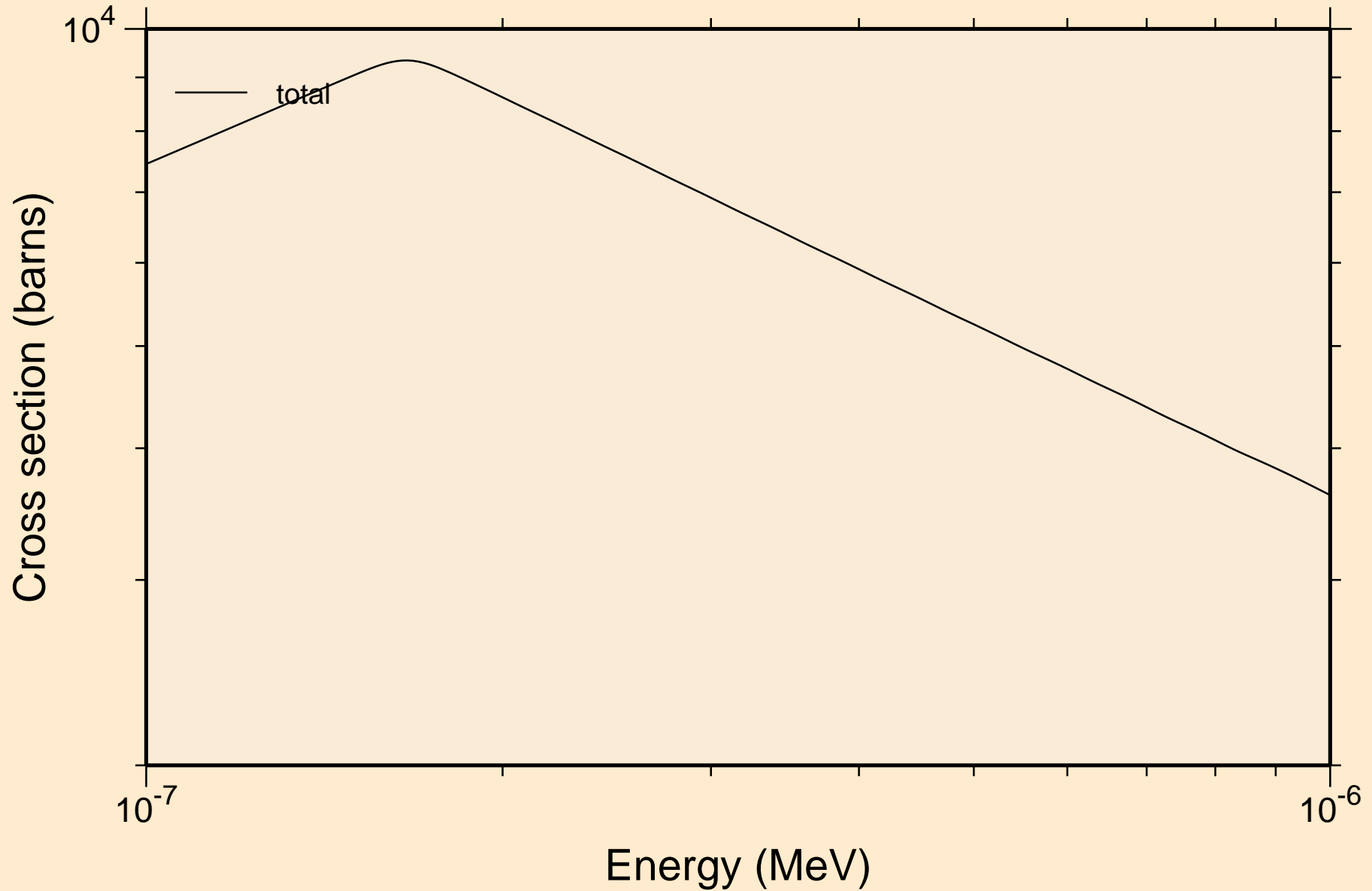

YB155 NEUTRON ACER TENDL-2024 LIBRARY; T=293.6K
resonance total cross section

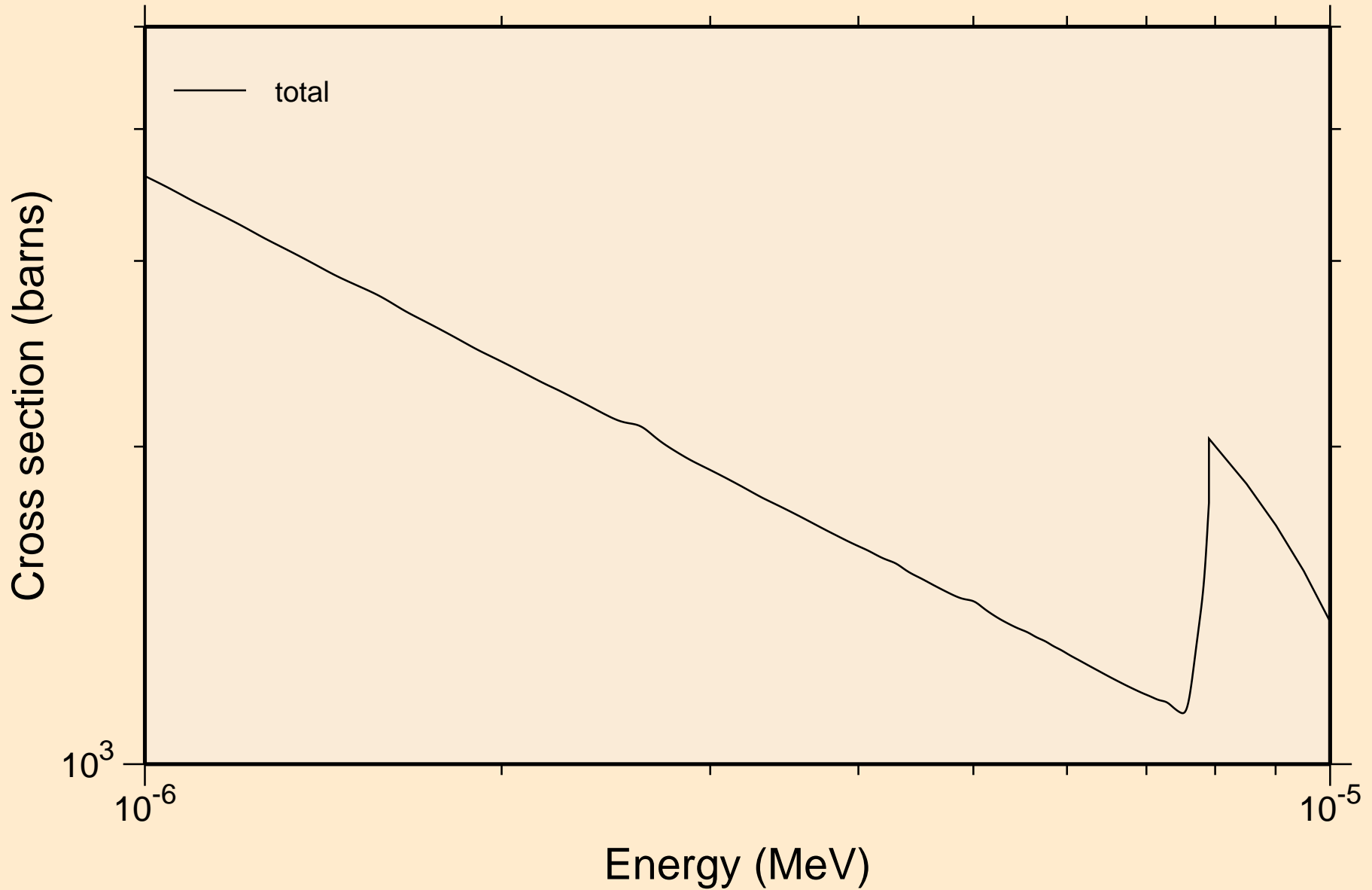

YB155 NEUTRON ACER TENDL-2024 LIBRARY; T=293.6K
resonance total cross section

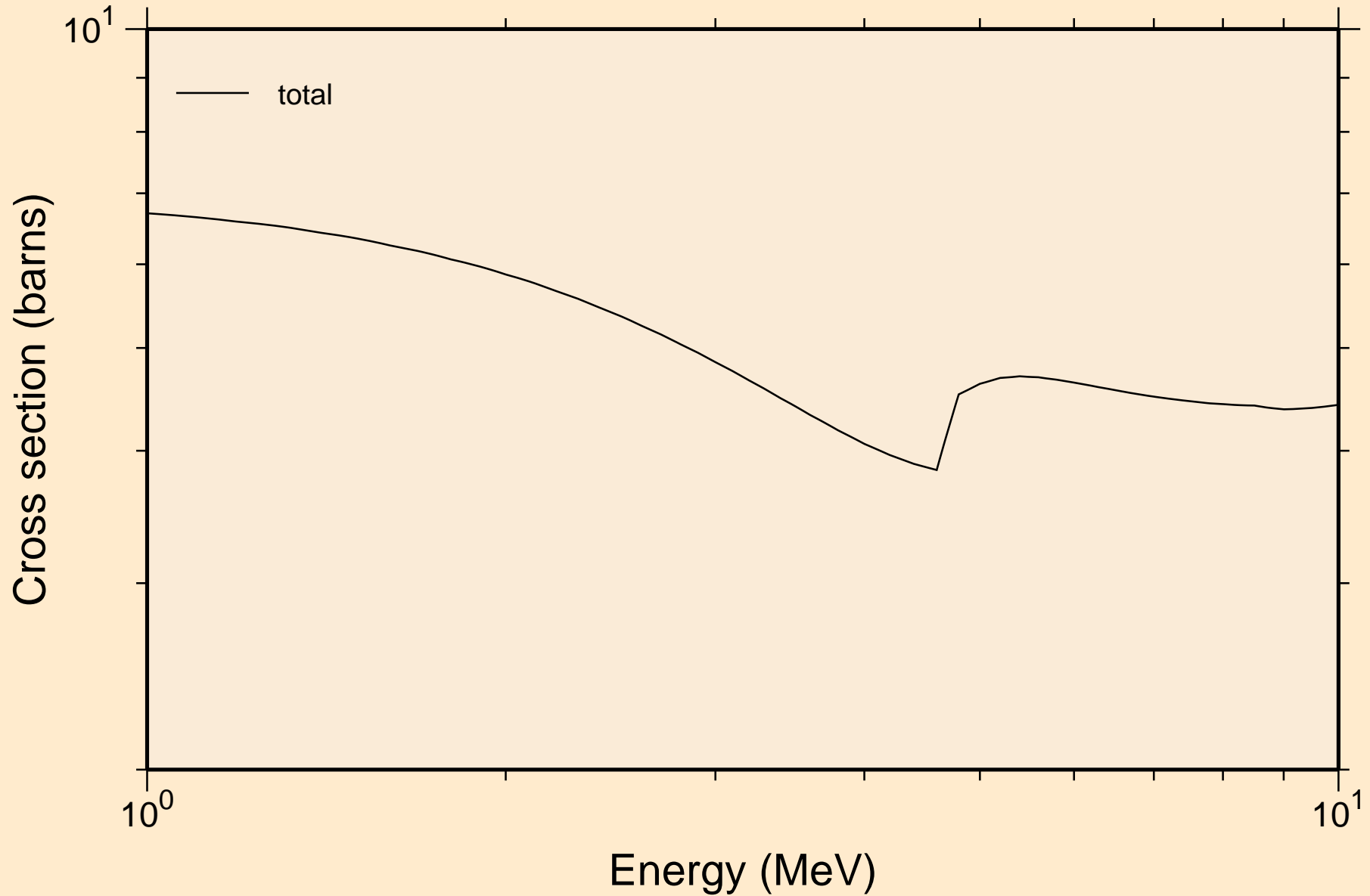

YB155 NEUTRON ACER TENDL-2024 LIBRARY; T=293.6K
resonance absorption cross sections

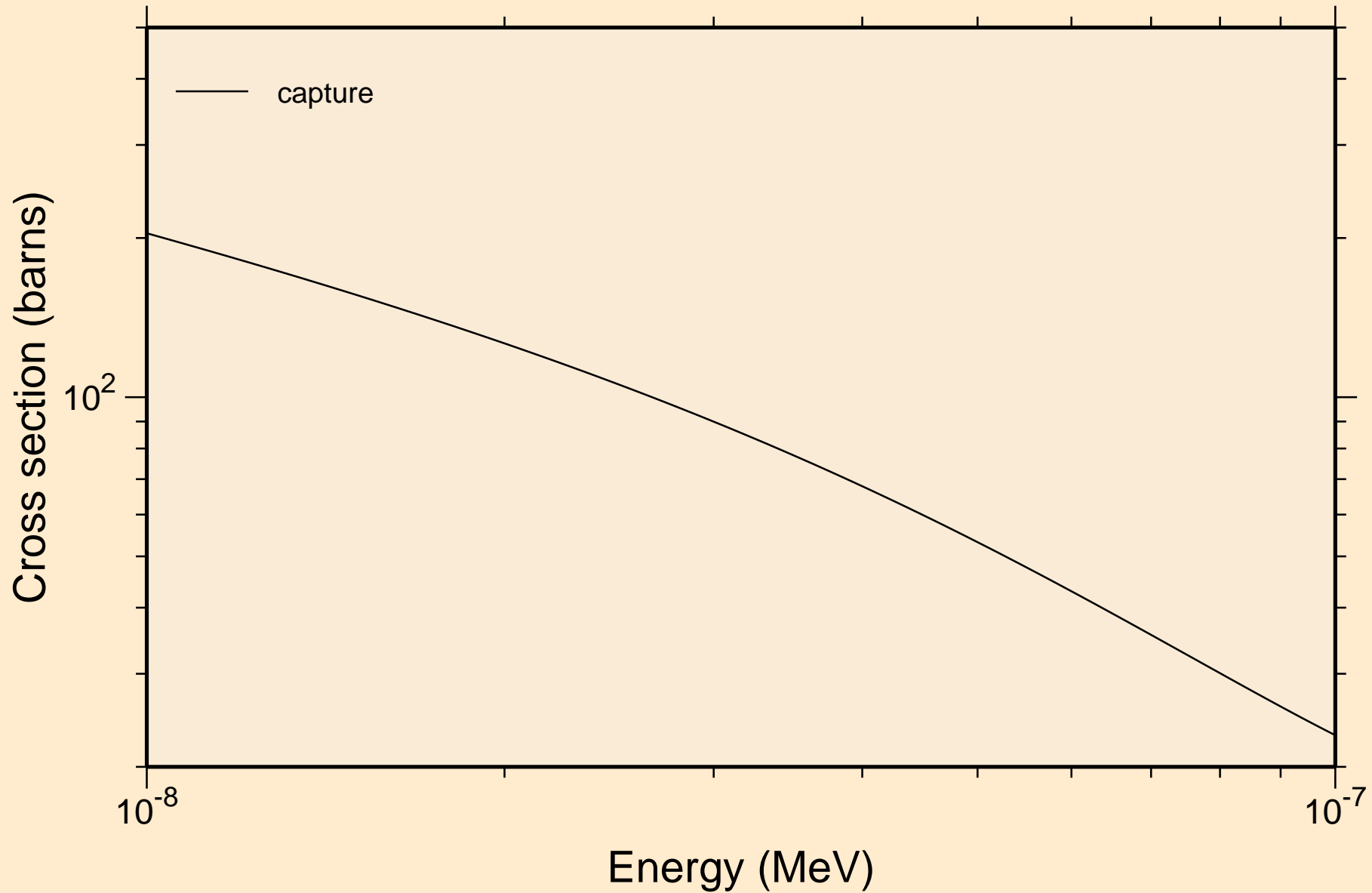

YB155 NEUTRON ACER TENDL-2024 LIBRARY; T=293.6K
resonance absorption cross sections

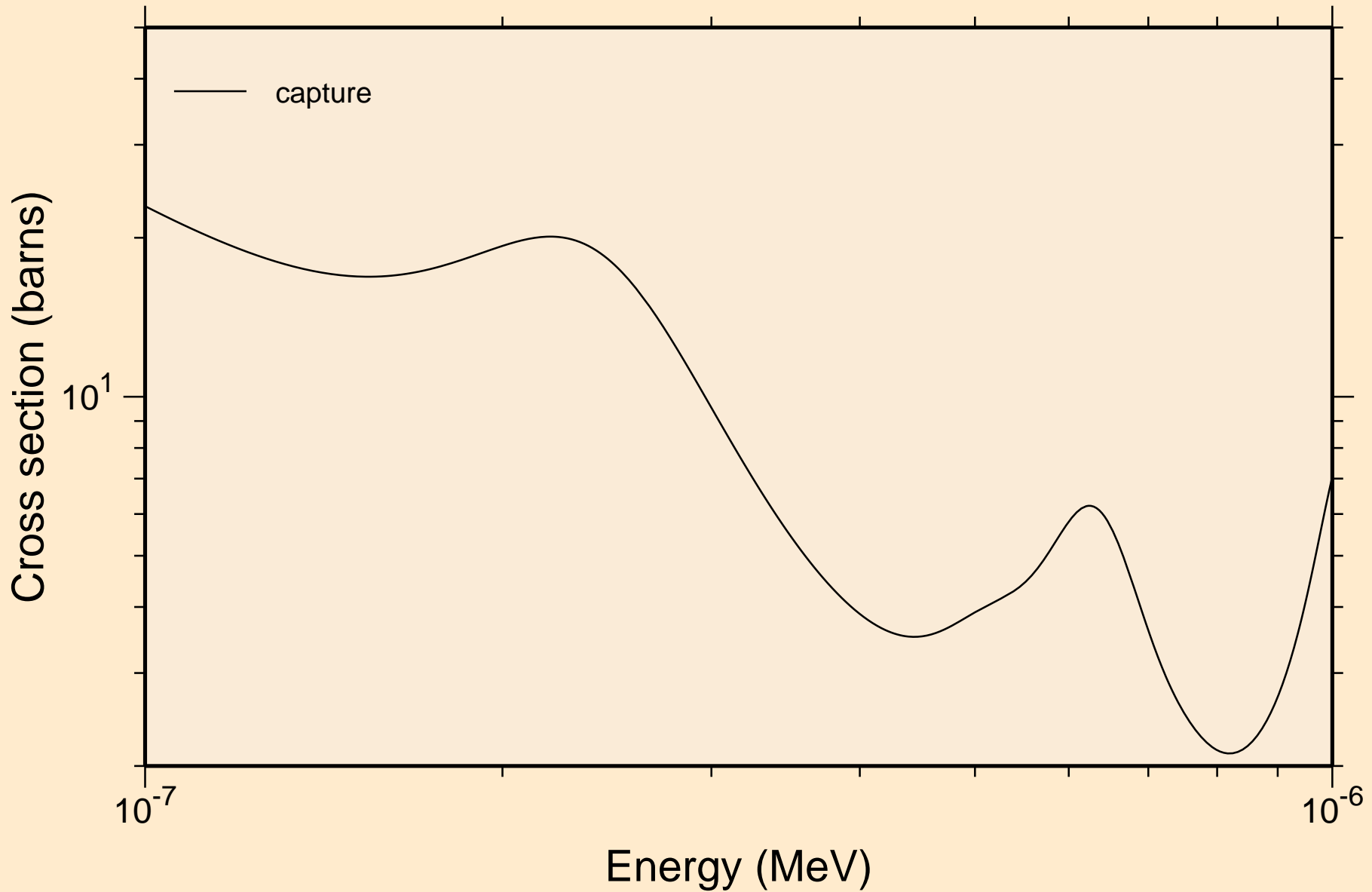

YB155 NEUTRON ACER TENDL-2024 LIBRARY; T=293.6K
resonance absorption cross sections

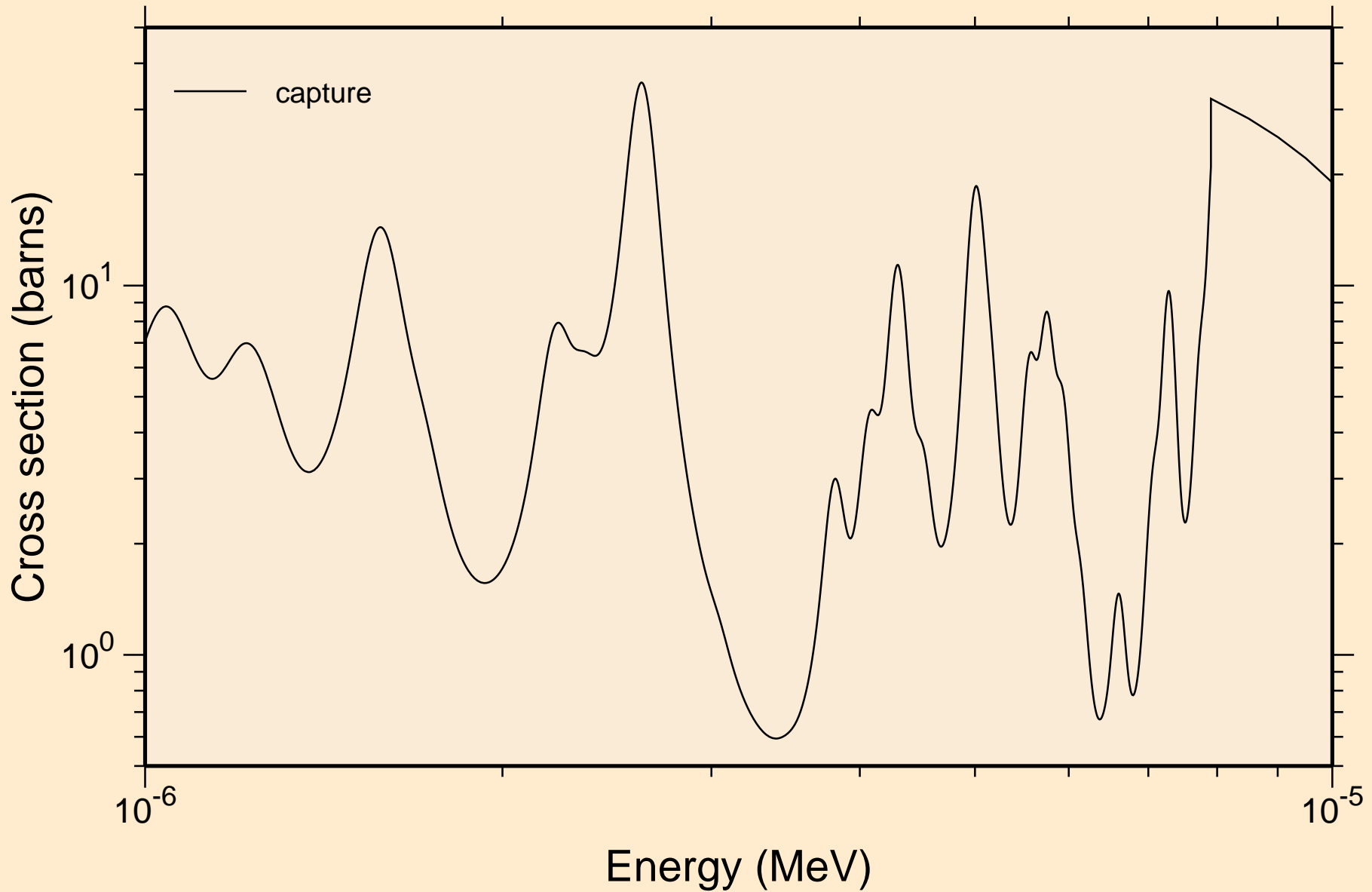

YB155 NEUTRON ACER TENDL-2024 LIBRARY; T=293.6K
resonance absorption cross sections

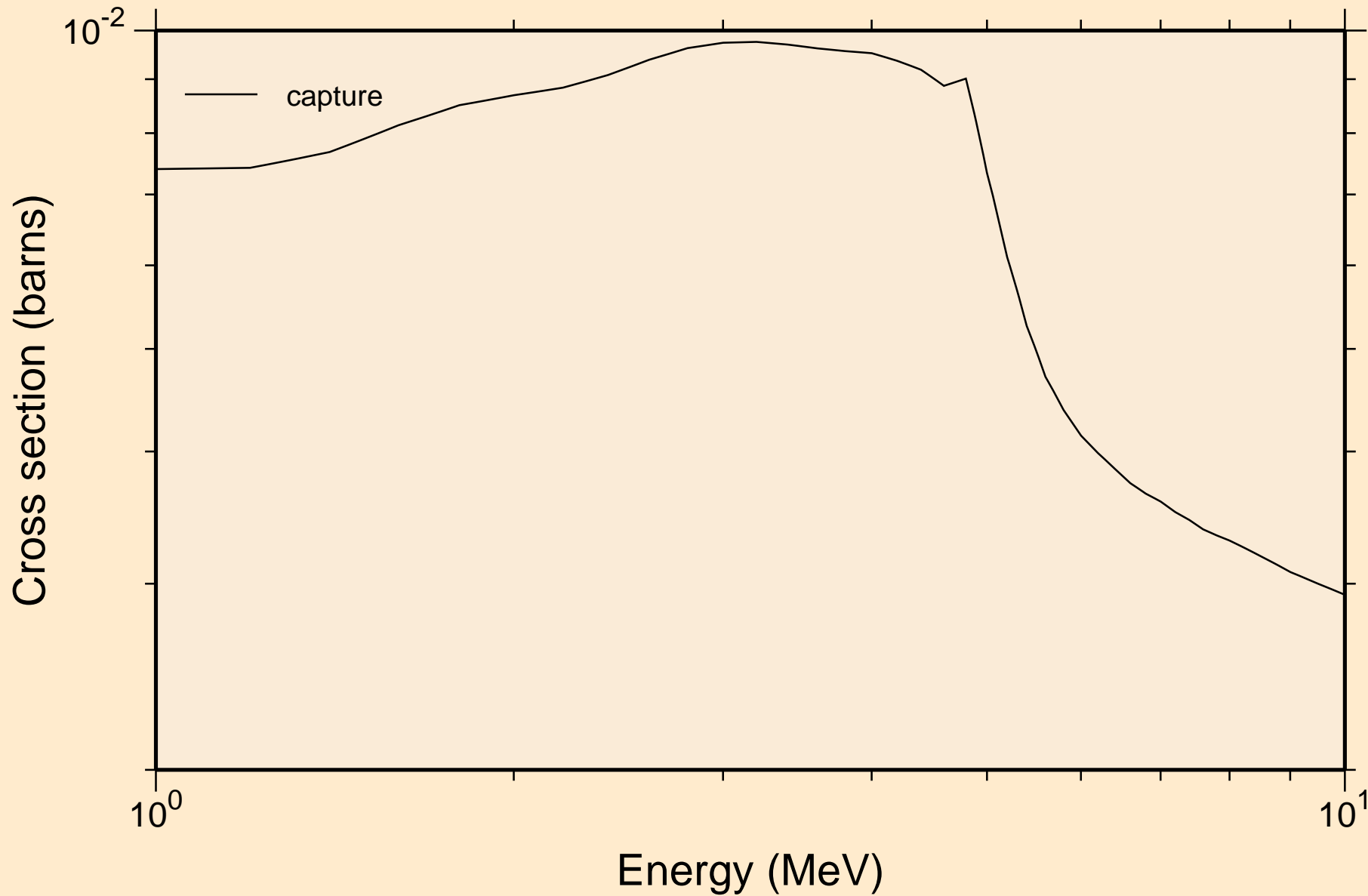

YB155 NEUTRON ACER TENDL-2024 LIBRARY; T=293.6K

Heating

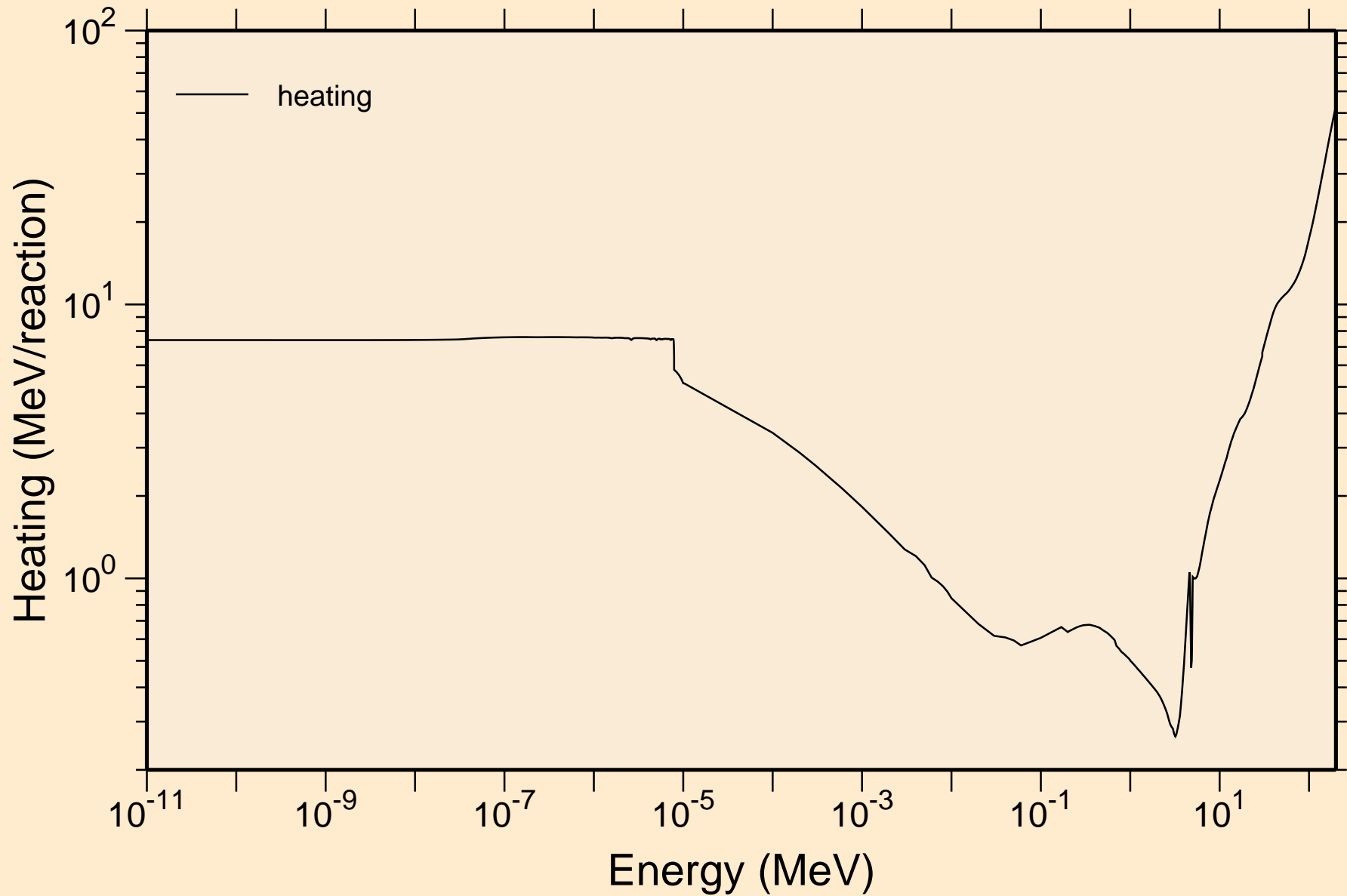

YB155 NEUTRON ACER TENDL-2024 LIBRARY; T=293.6K

Damage

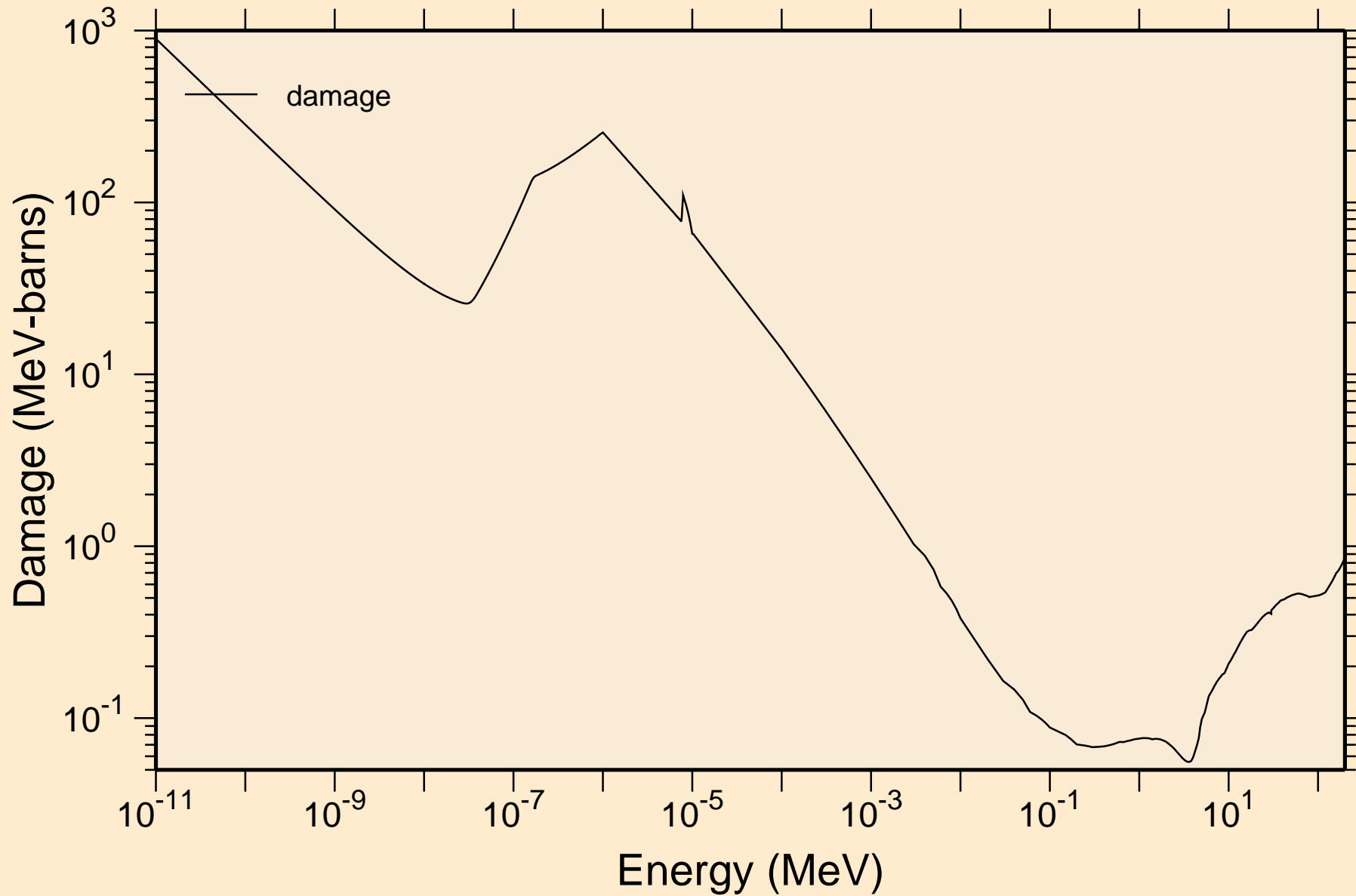

YB155 NEUTRON ACER TENDL-2024 LIBRARY; T=293.6K
Non-threshold reactions

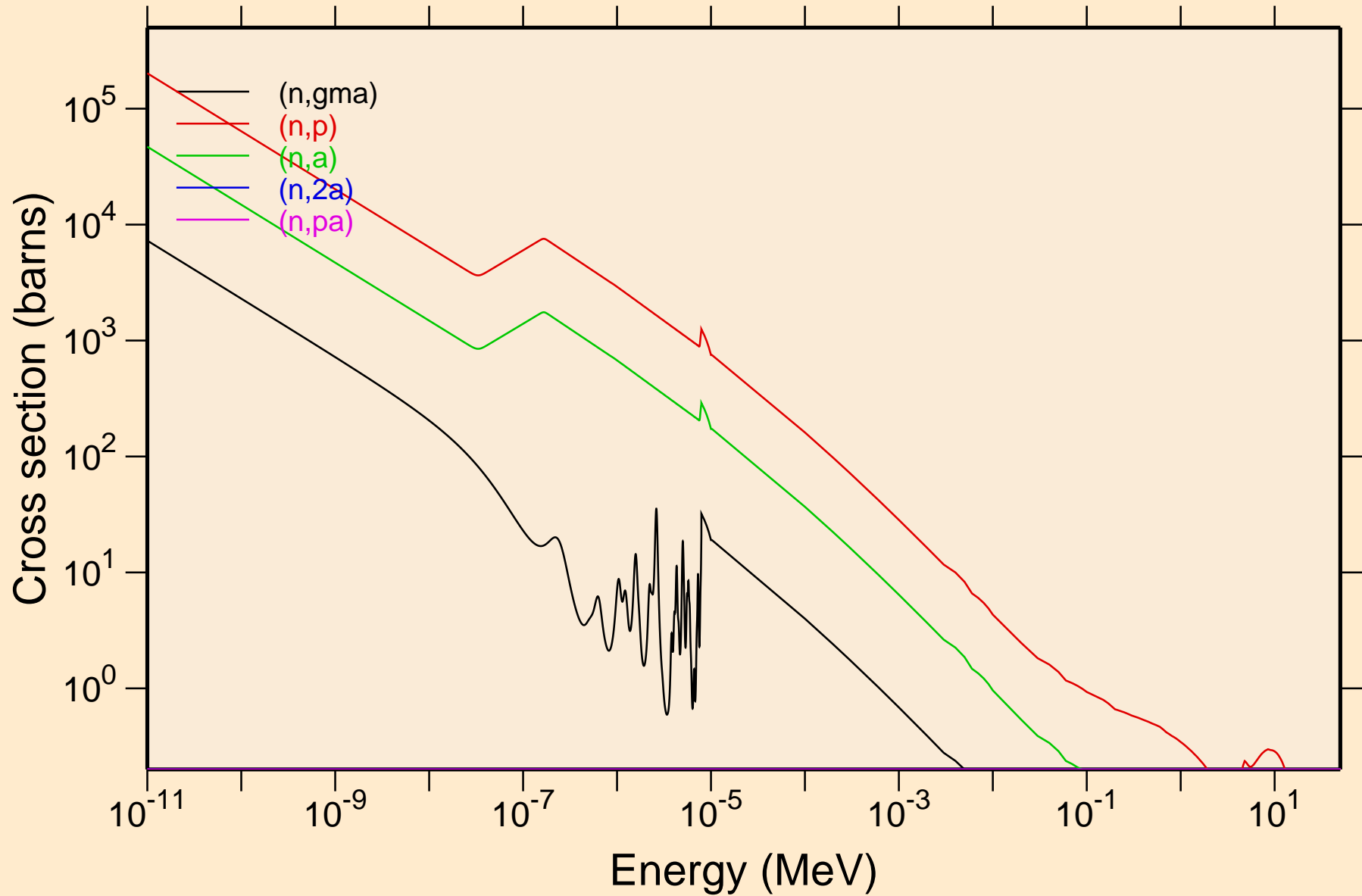

YB155 NEUTRON ACER TENDL-2024 LIBRARY; T=293.6K
Non-threshold reactions

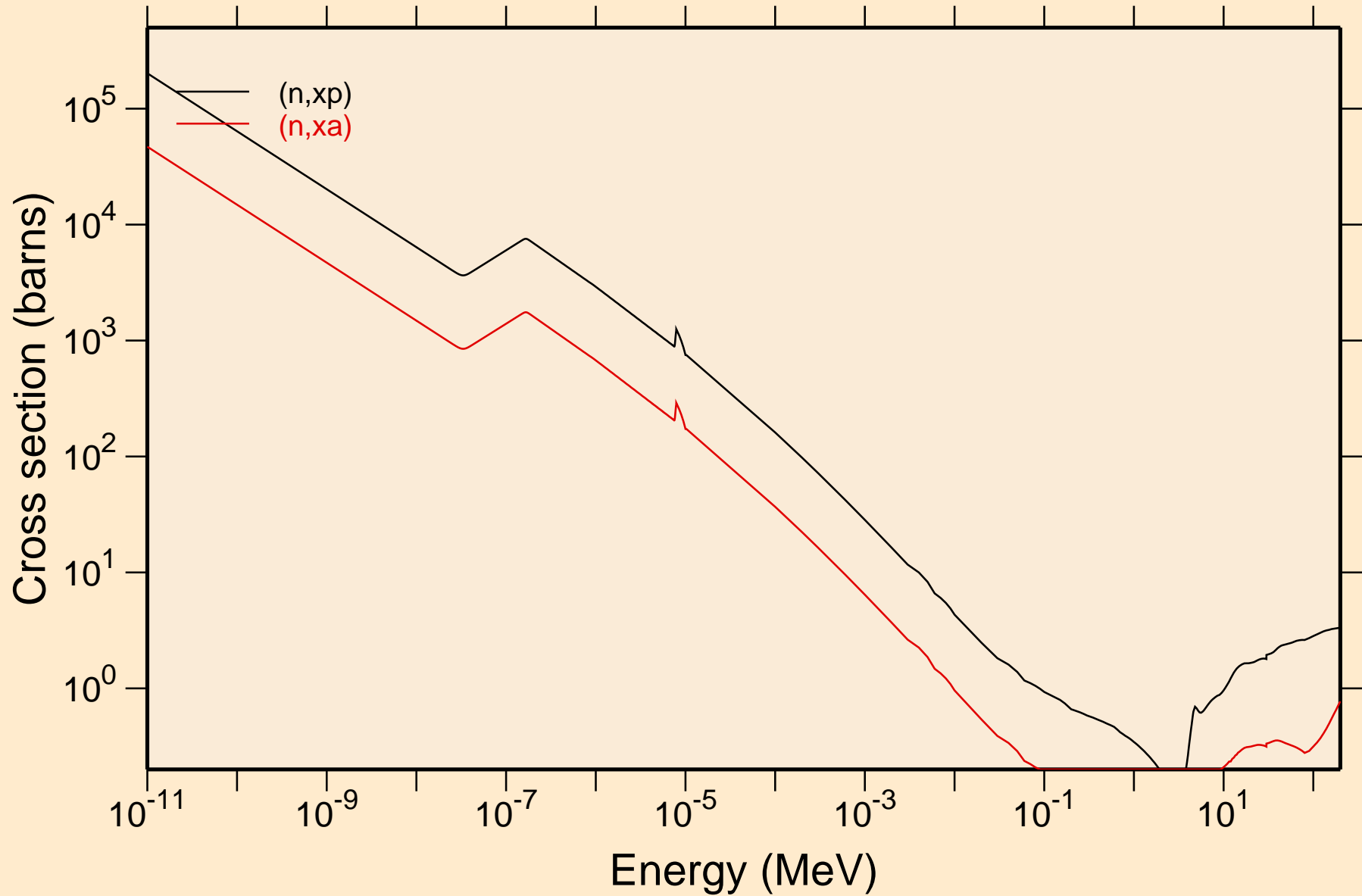

YB155 NEUTRON ACER TENDL-2024 LIBRARY; T=293.6K

Principal cross sections

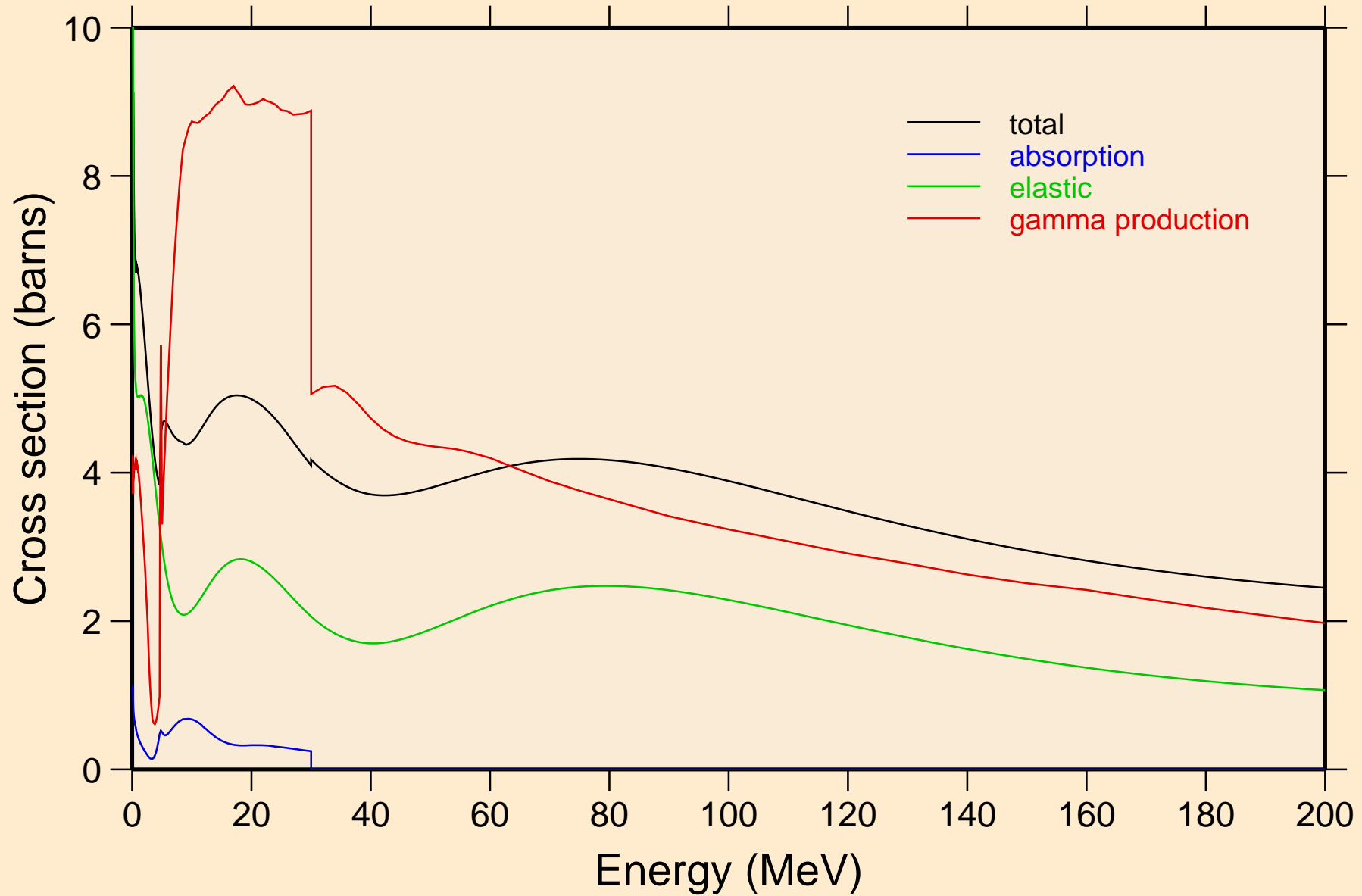

YB155 NEUTRON ACER TENDL-2024 LIBRARY; T=293.6K

Heating

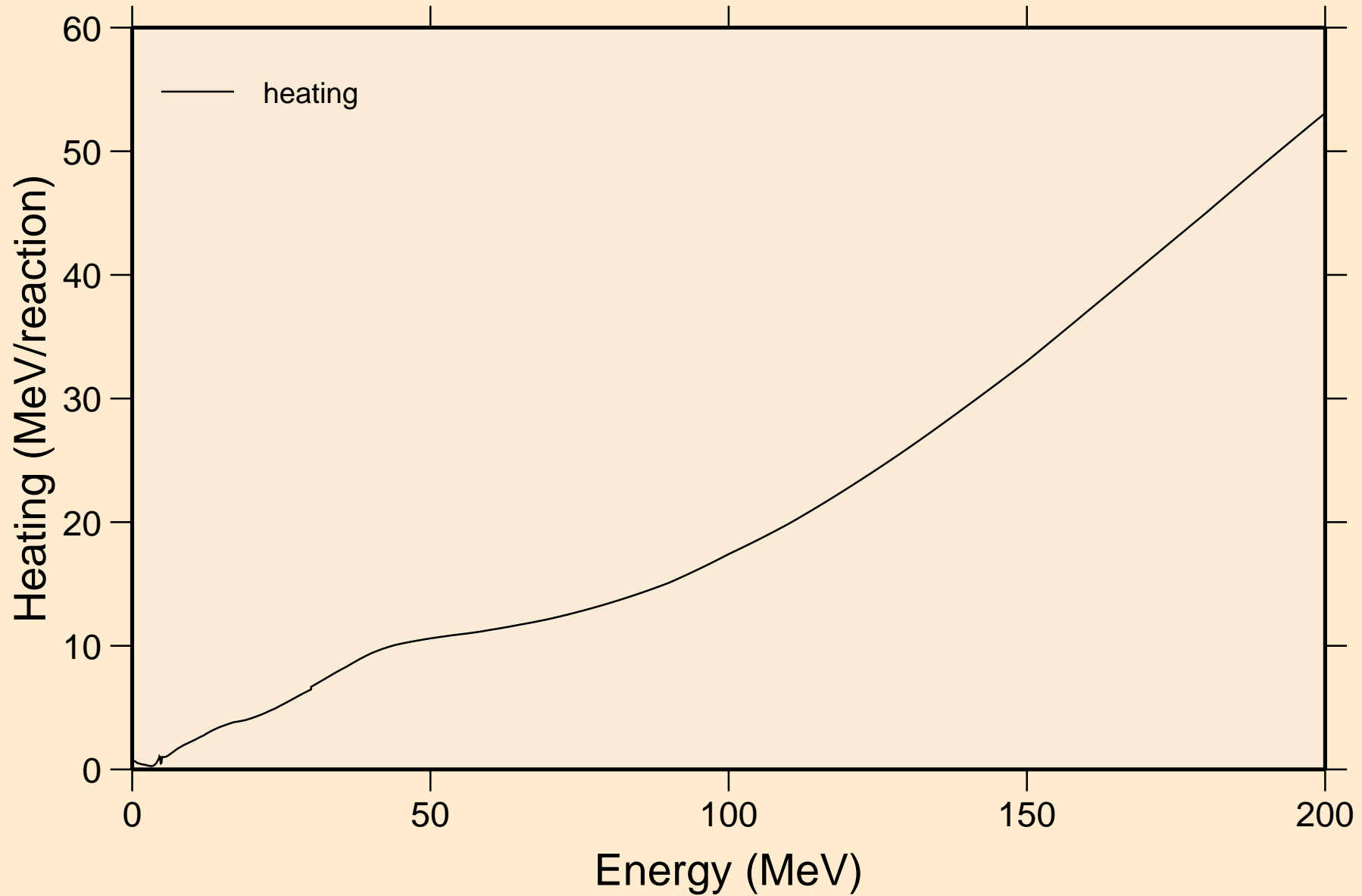

YB155 NEUTRON ACER TENDL-2024 LIBRARY; T=293.6K
Damage

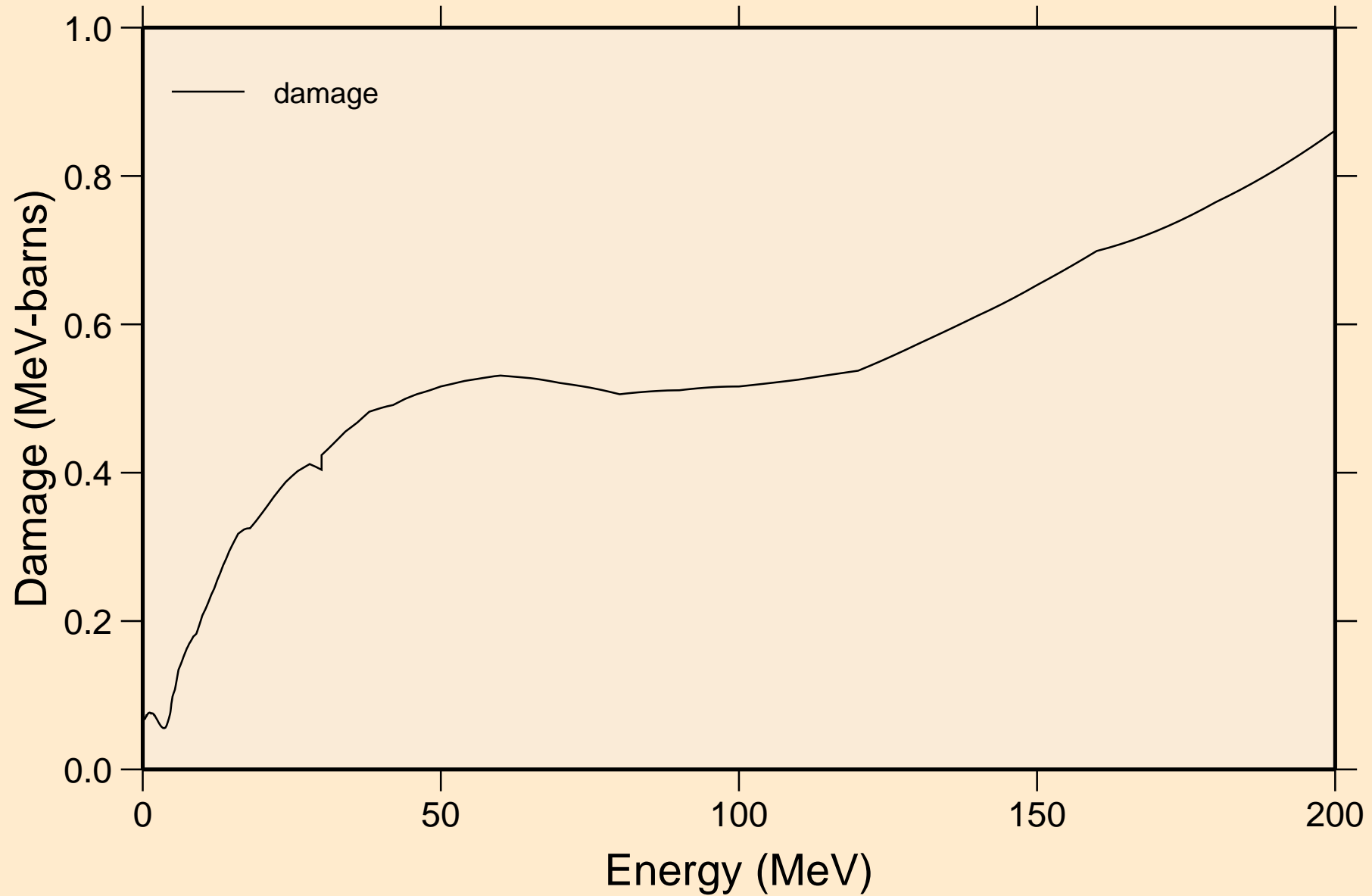

YB155 NEUTRON ACER TENDL-2024 LIBRARY; T=293.6K
Non-threshold reactions

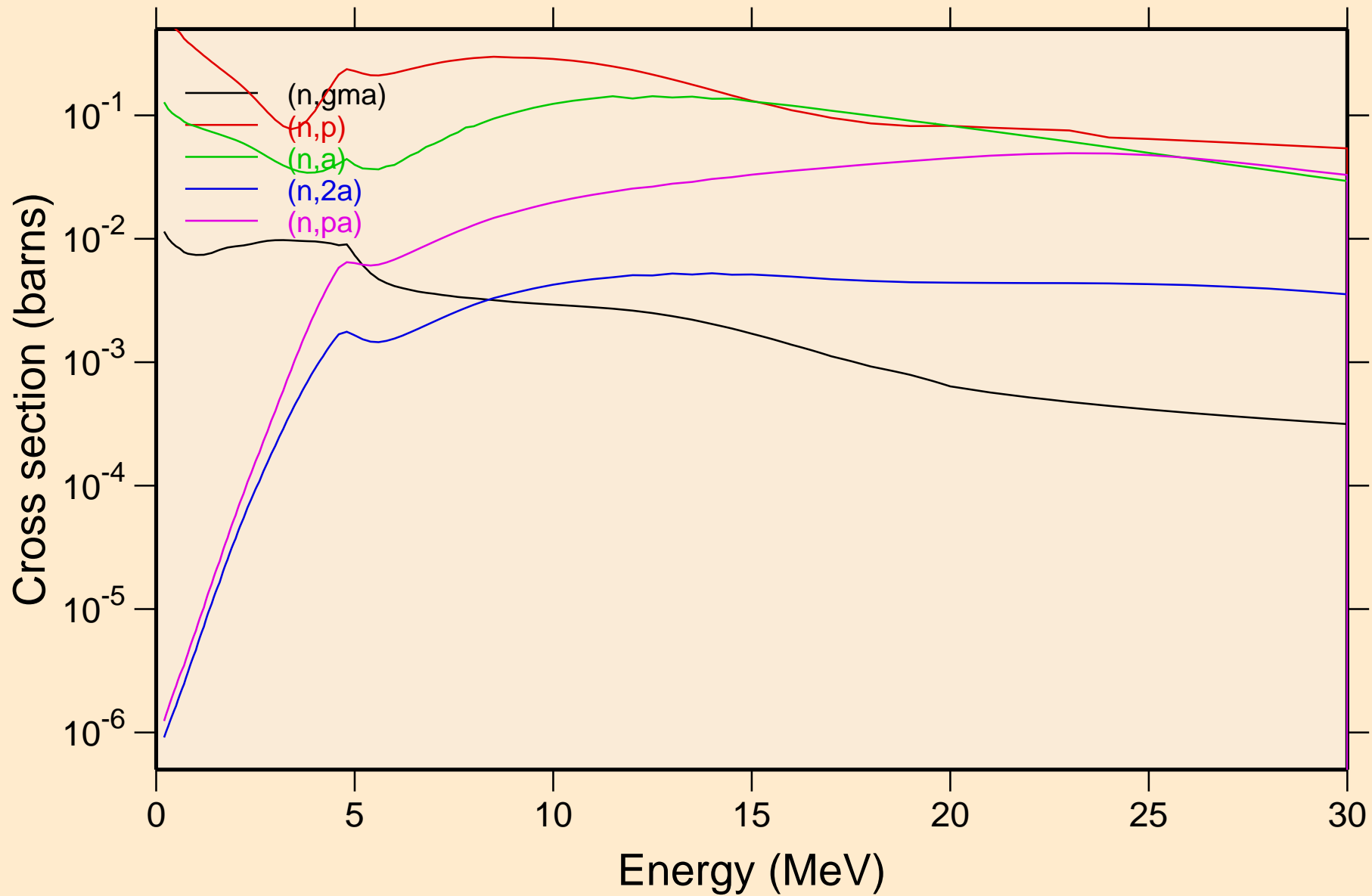

YB155 NEUTRON ACER TENDL-2024 LIBRARY; T=293.6K
Non-threshold reactions

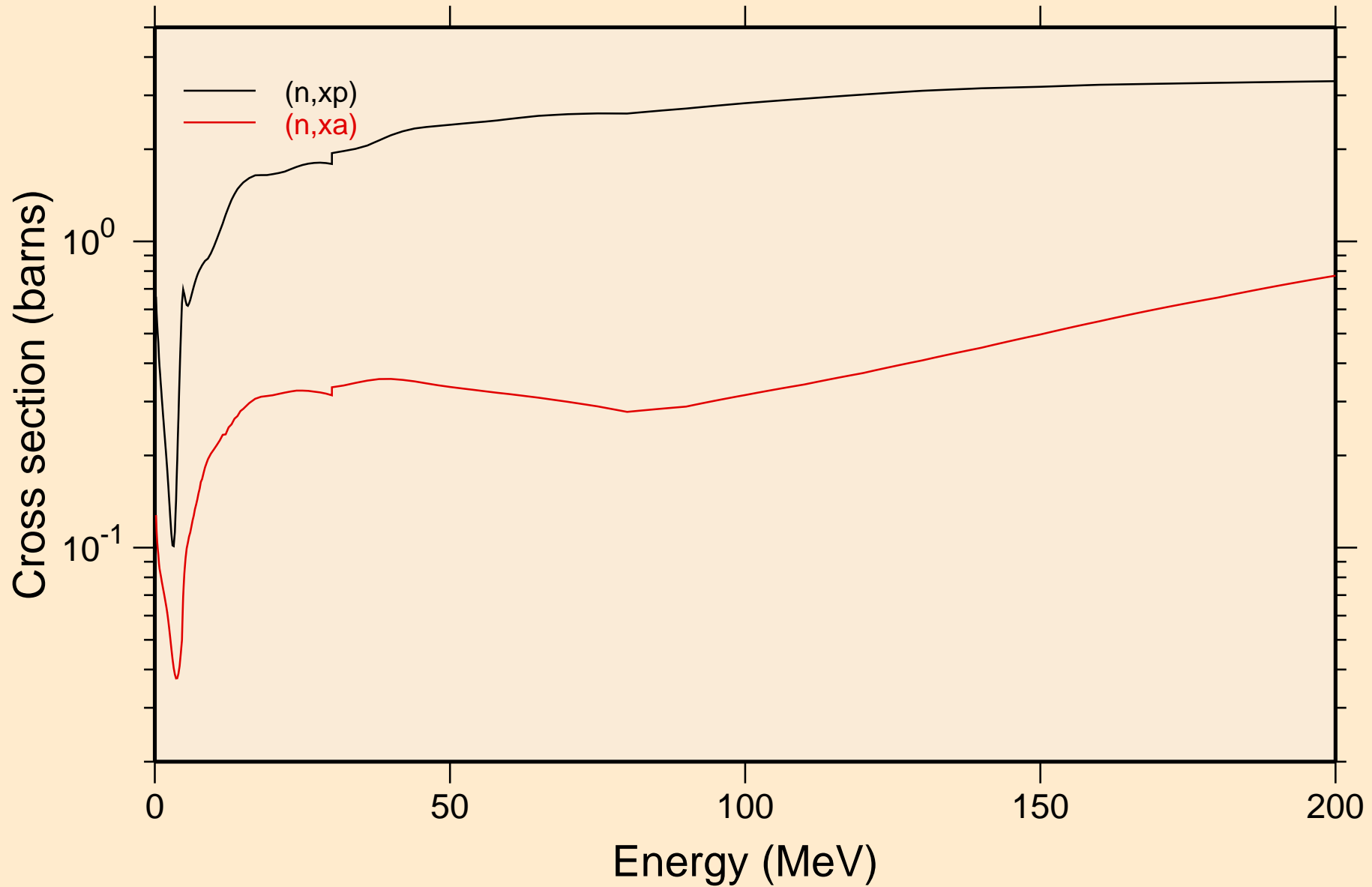

YB155 NEUTRON ACER TENDL-2024 LIBRARY; T=293.6K
Inelastic levels

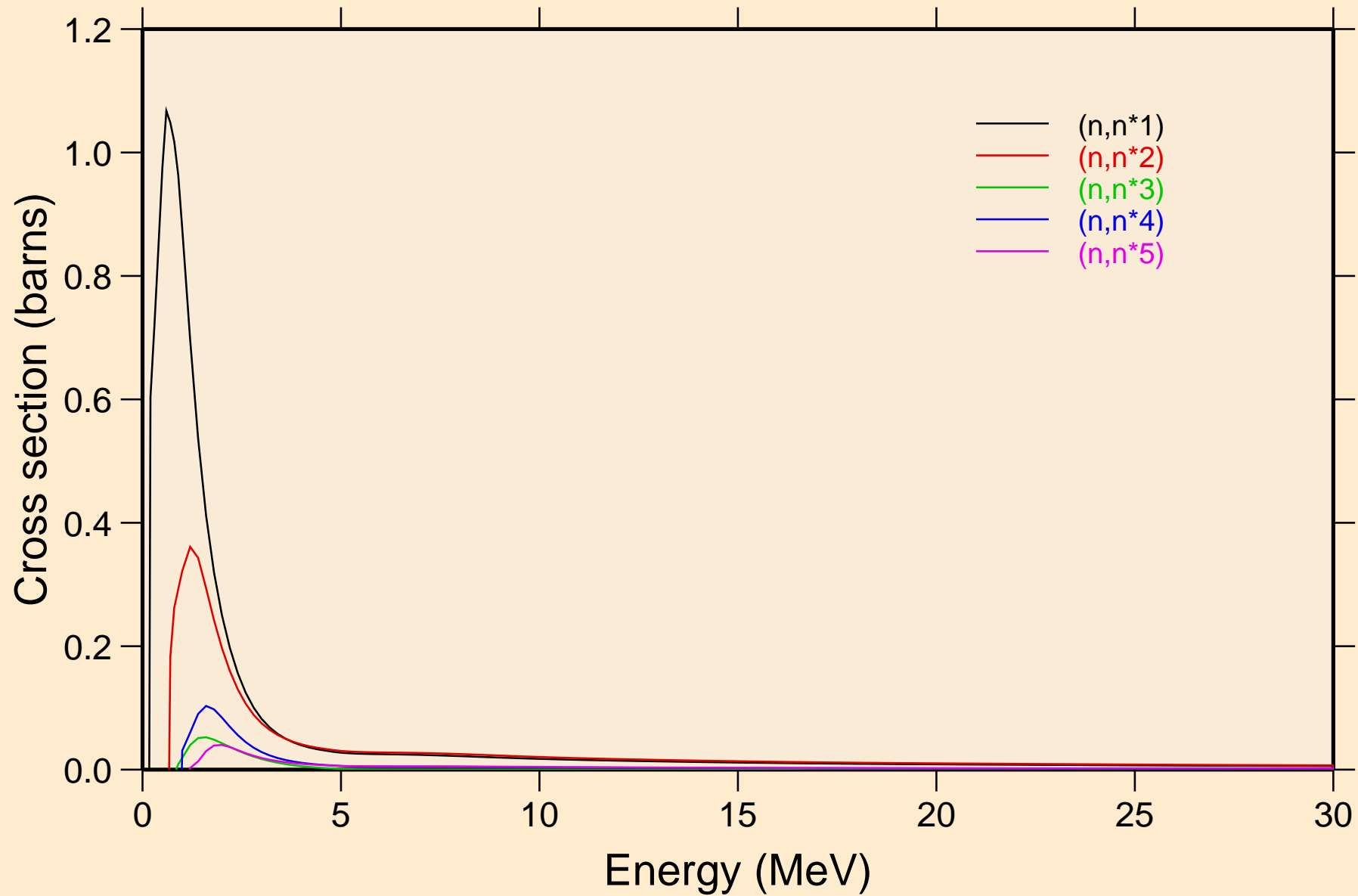

YB155 NEUTRON ACER TENDL-2024 LIBRARY; T=293.6K

Threshold reactions

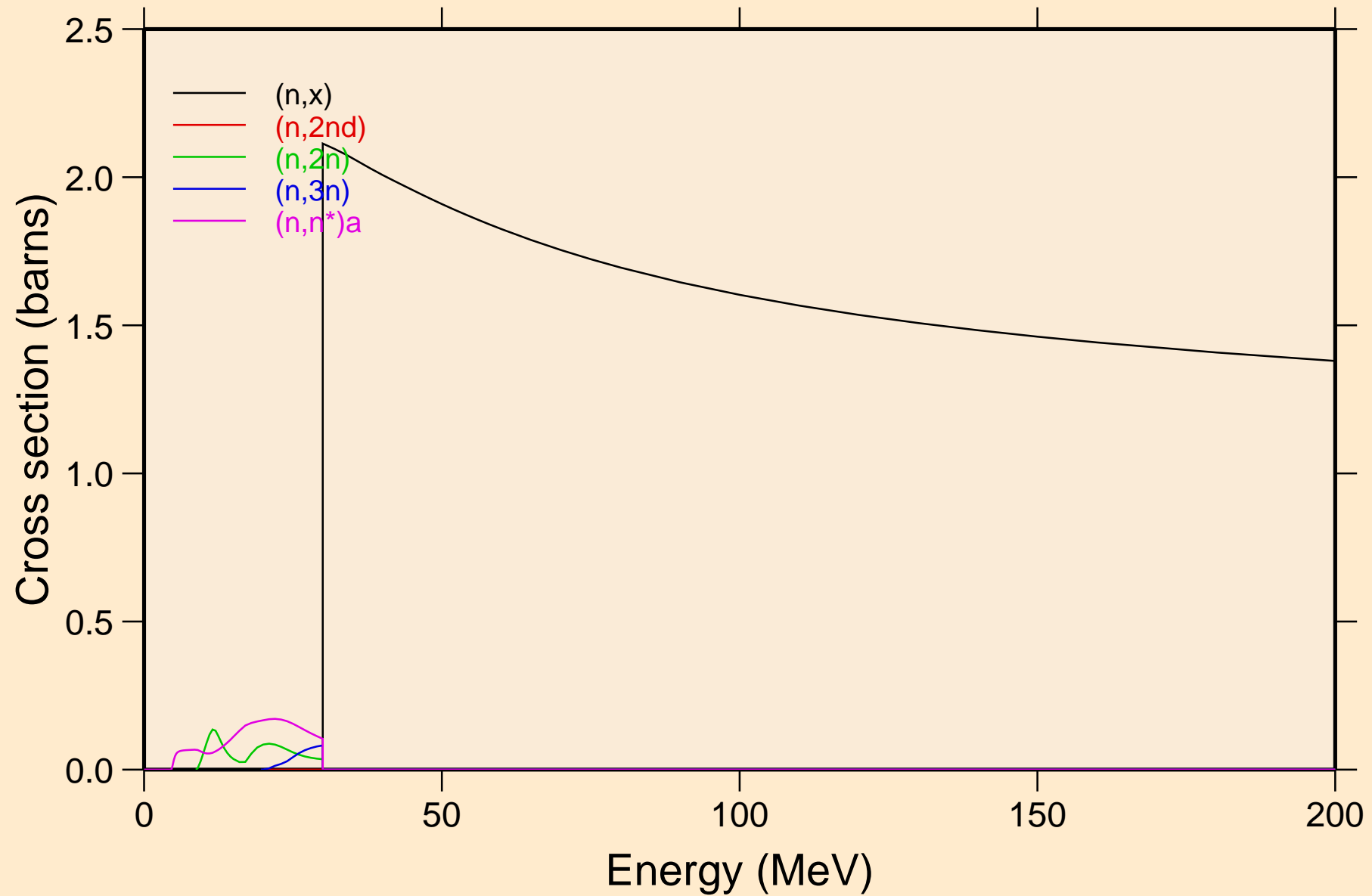

YB155 NEUTRON ACER TENDL-2024 LIBRARY; T=293.6K
Threshold reactions

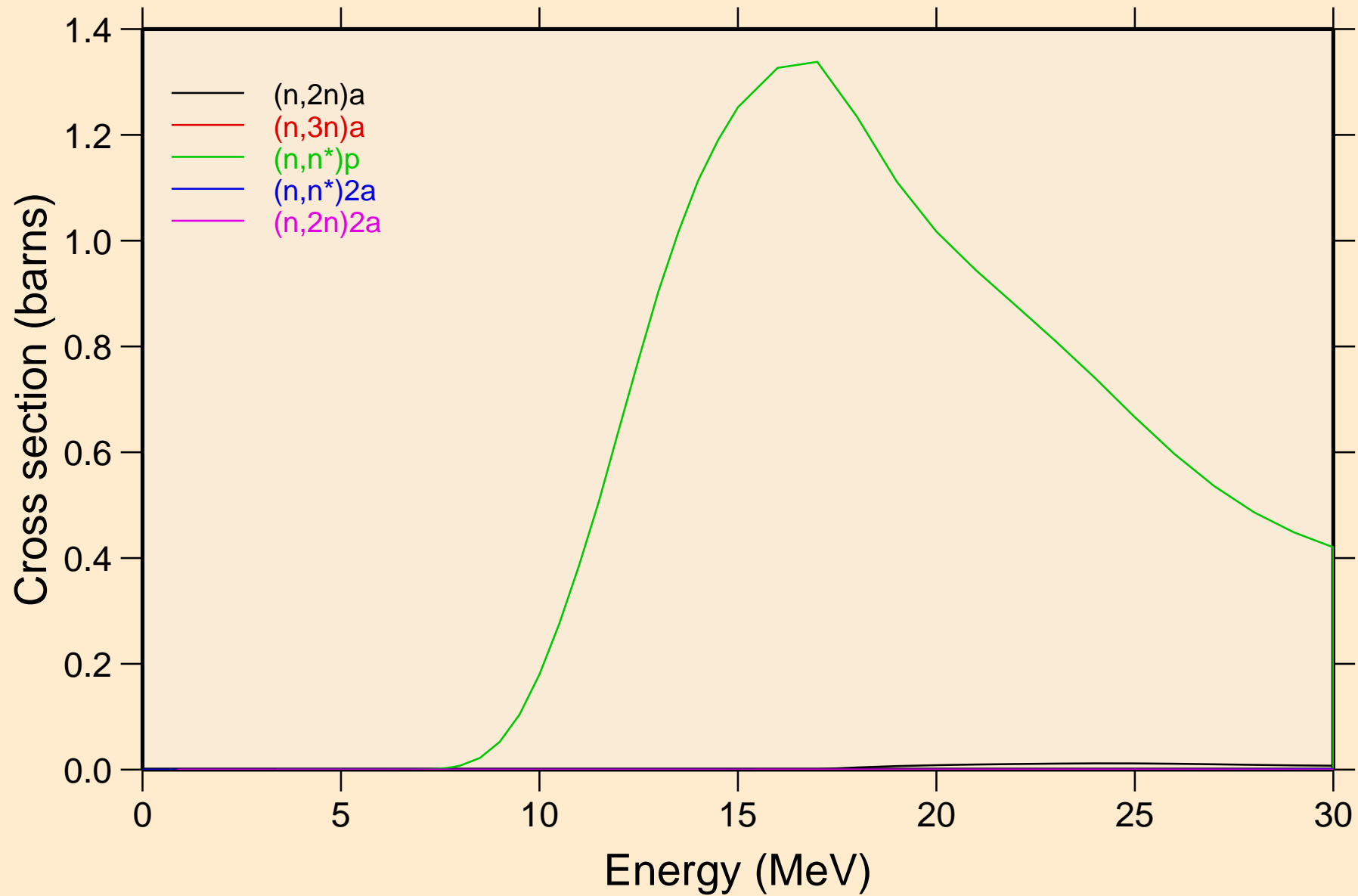

YB155 NEUTRON ACER TENDL-2024 LIBRARY; T=293.6K
Threshold reactions

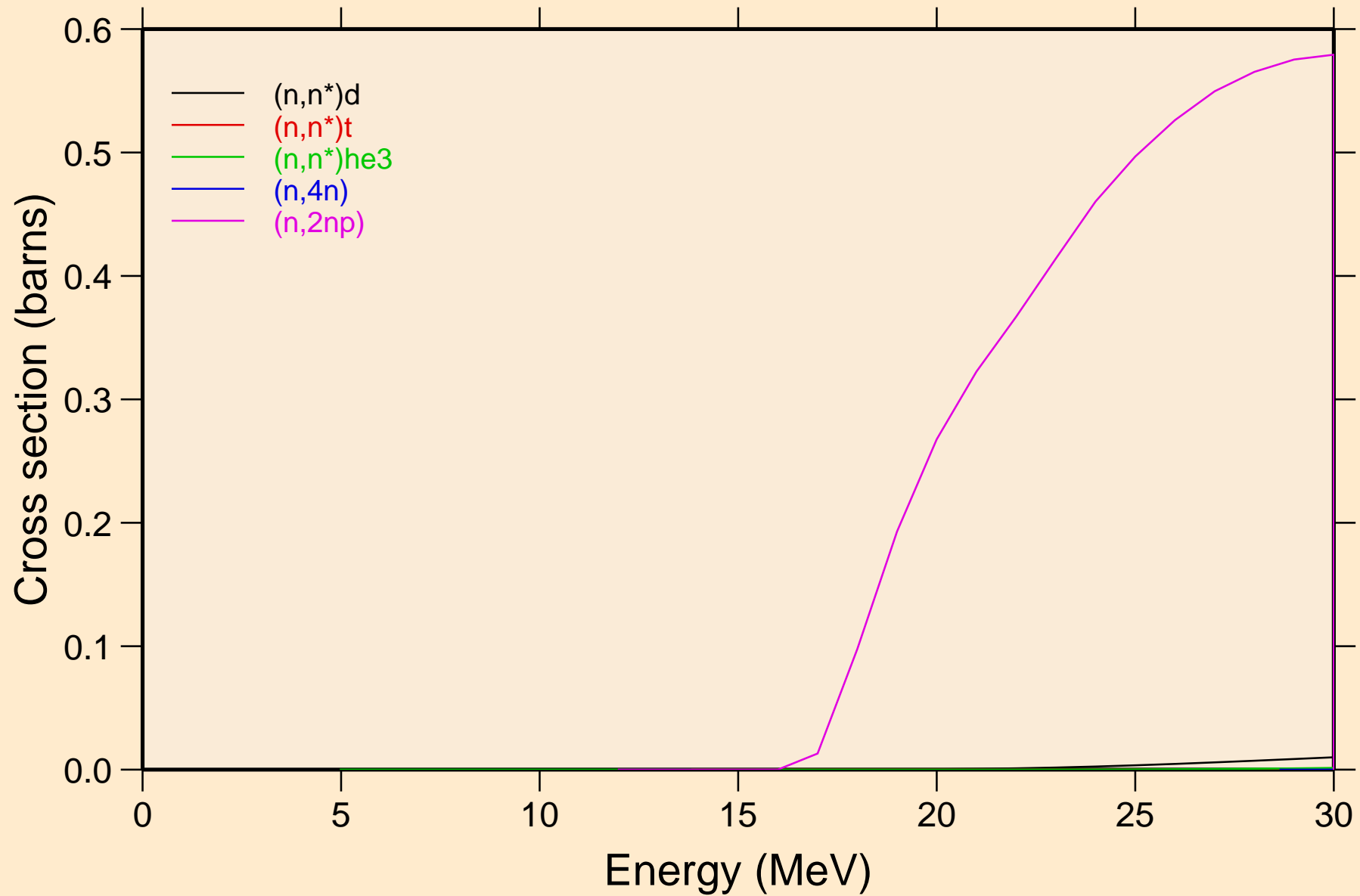

YB155 NEUTRON ACER TENDL-2024 LIBRARY; T=293.6K

Threshold reactions

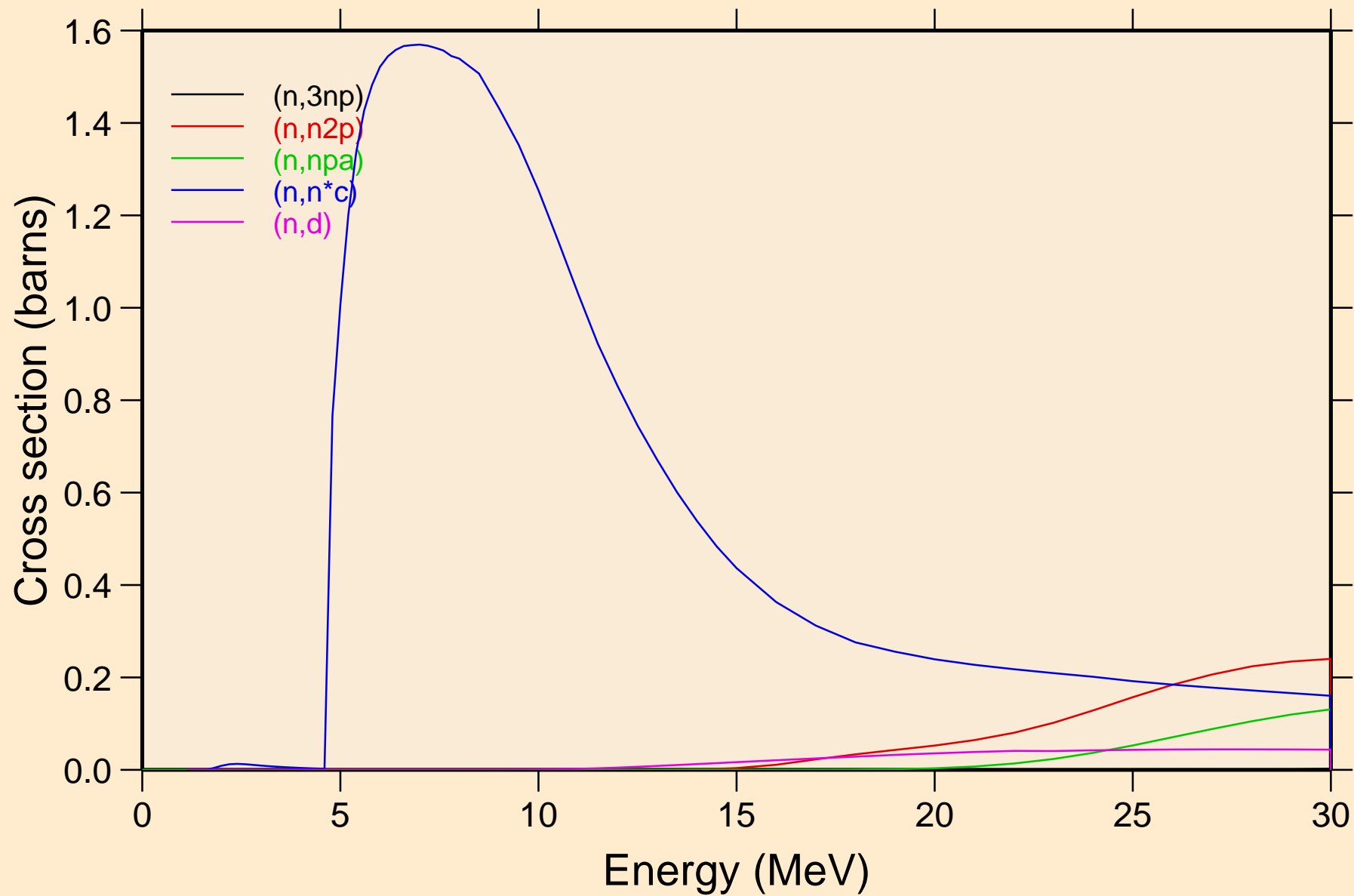

YB155 NEUTRON ACER TENDL-2024 LIBRARY; T=293.6K

Threshold reactions

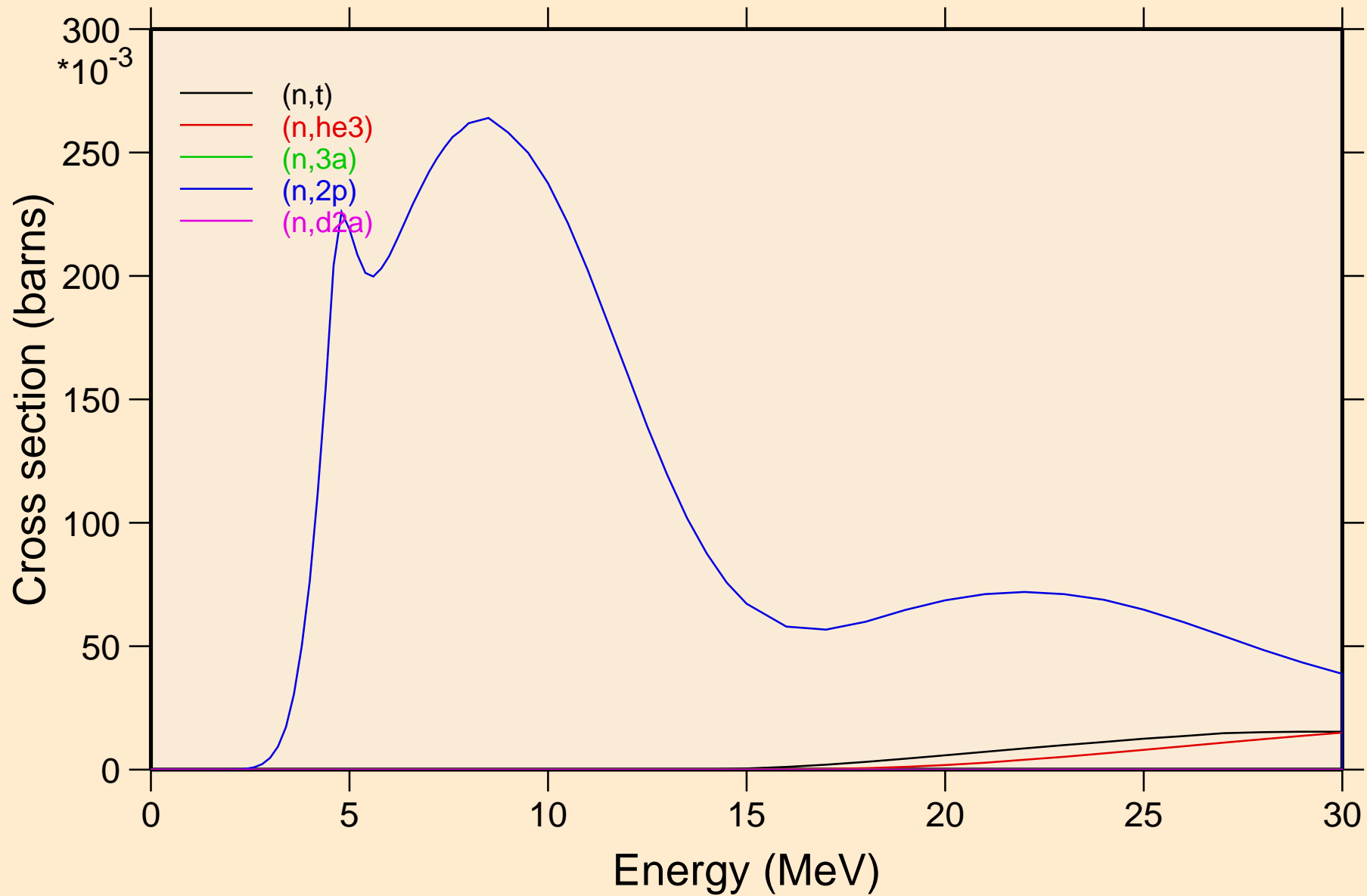

YB155 NEUTRON ACER TENDL-2024 LIBRARY; T=293.6K
Threshold reactions

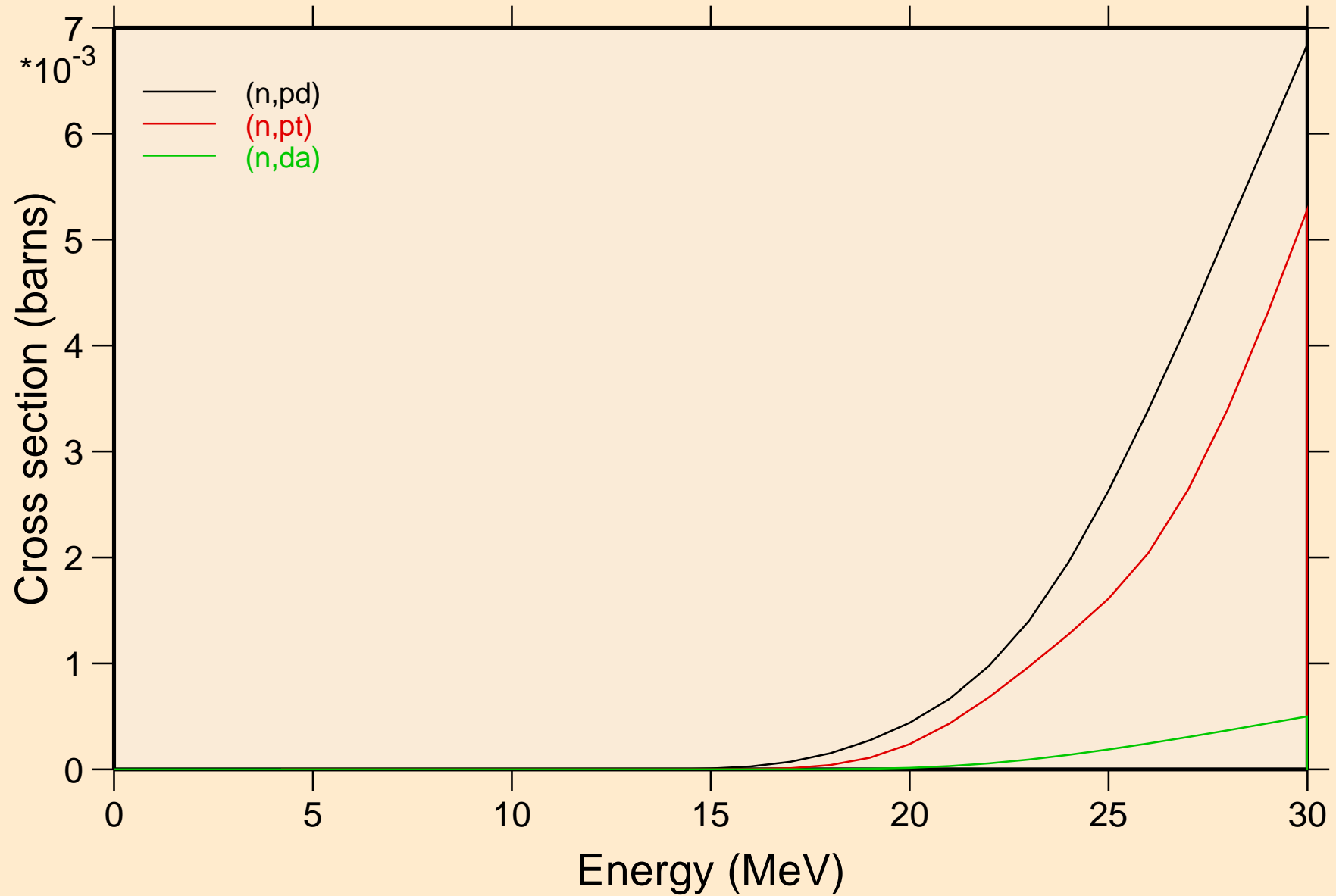

YB155 NEUTRON ACER TENDL-2024 LIBRARY; T=293.6K
Threshold reactions

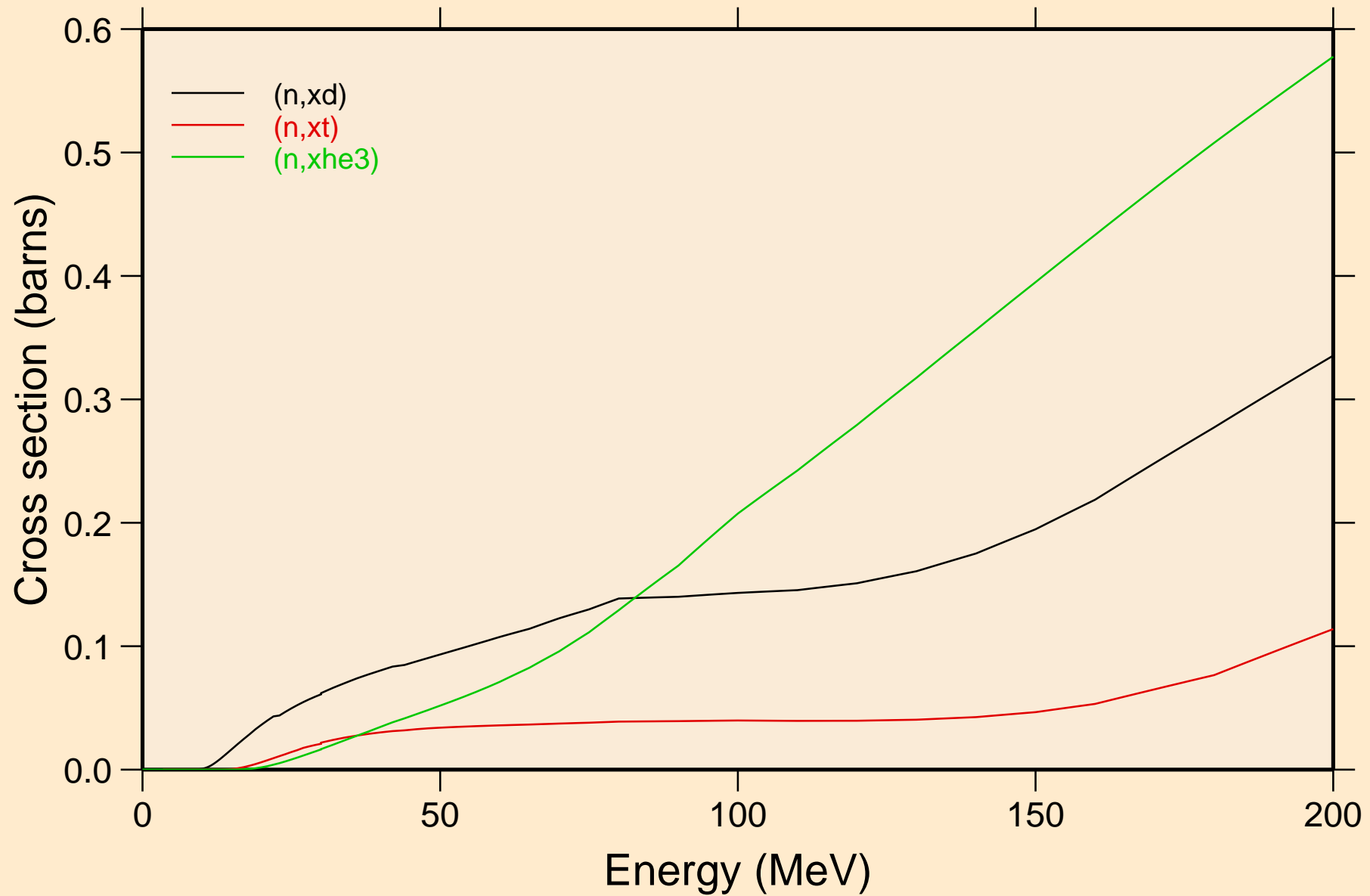

YB155 NEUTRON ACER TENDL-2024 LIBRARY; T=293.6K
angular distribution for elastic

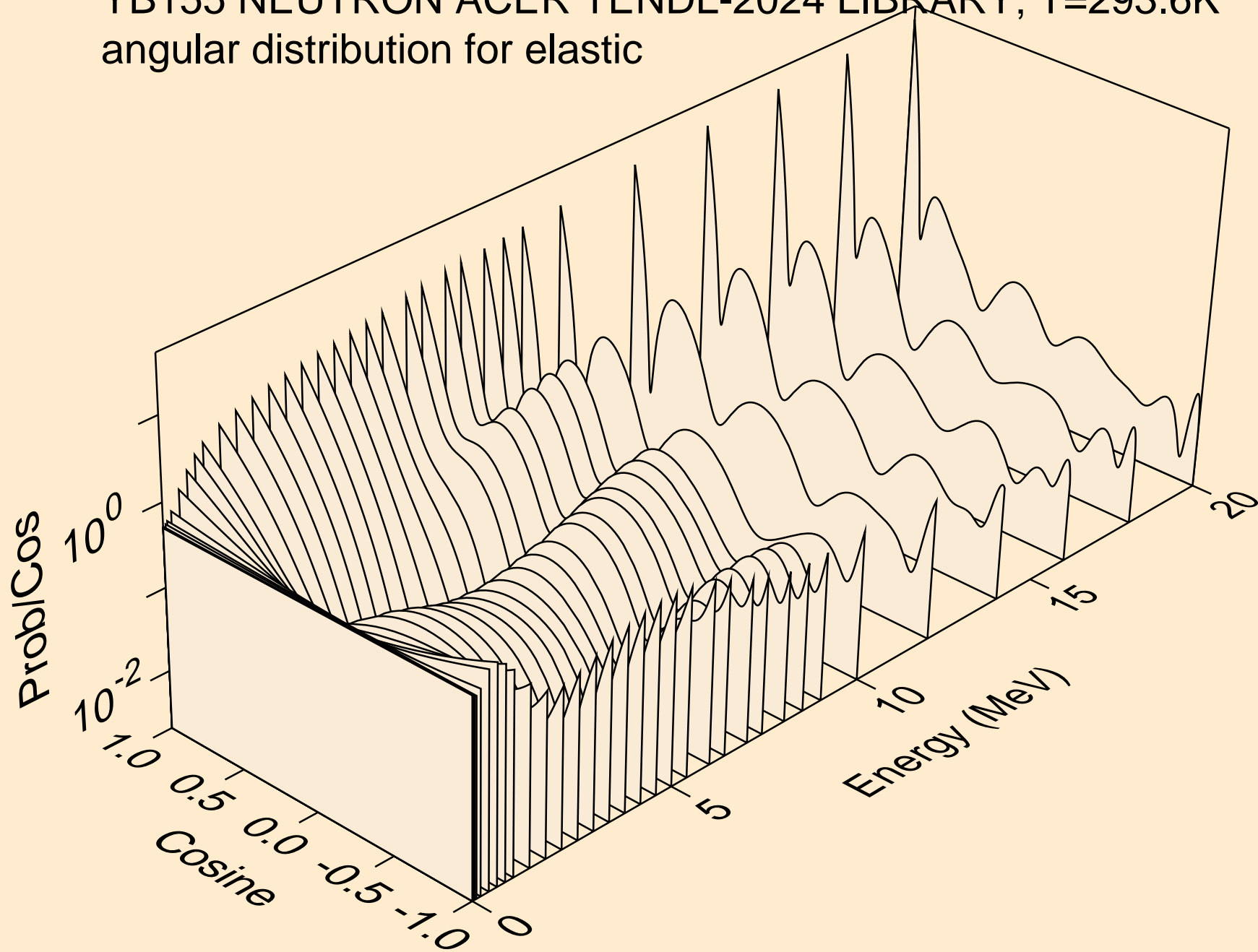

YB155 NEUTRON ACER TENDL-2024 LIBRARY; T=293.6K
angular distribution for elastic

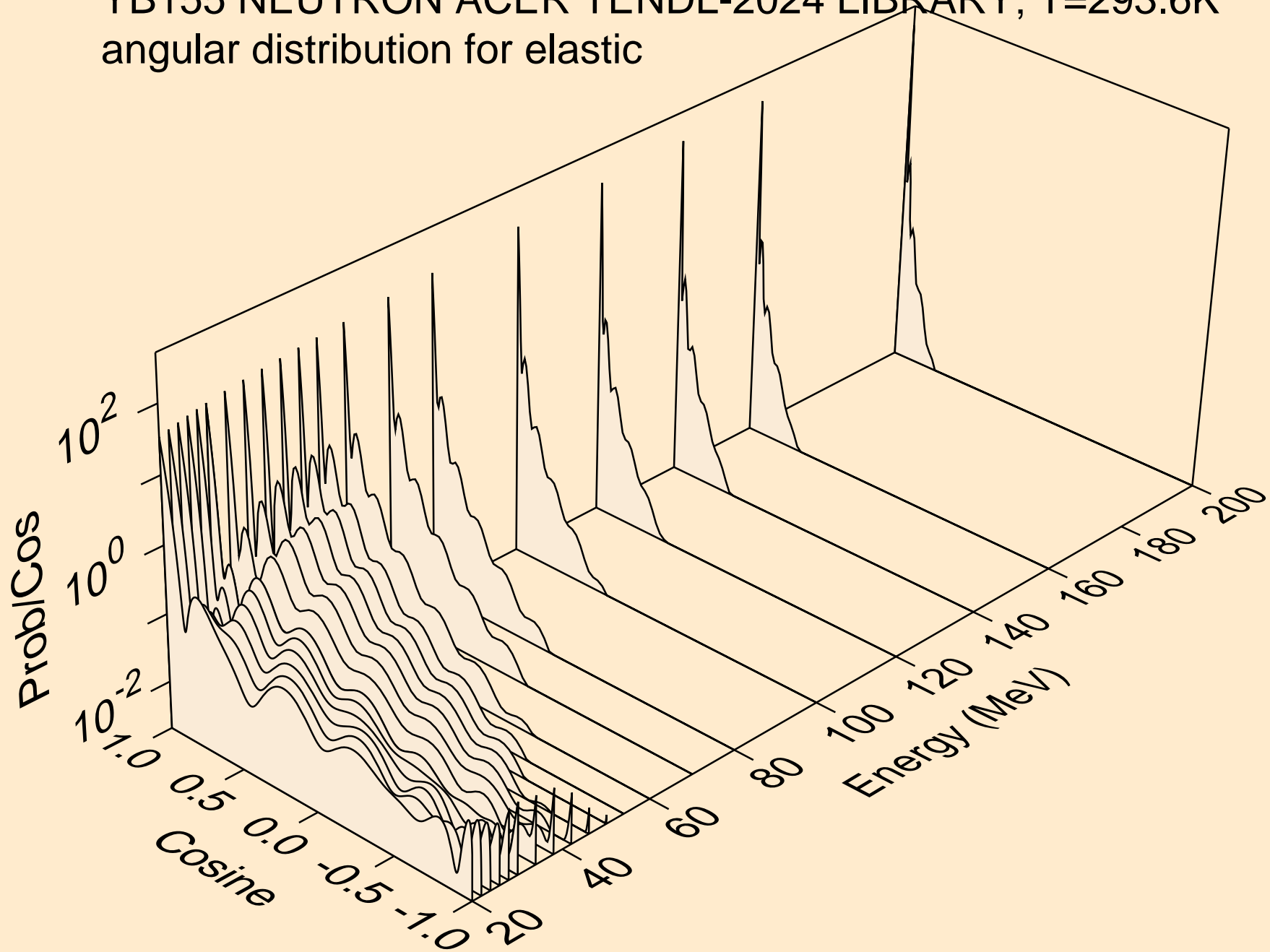

YB155 NEUTRON ACER TENDL-2024 LIBRARY; T=293.6K
angular distribution for (n,n*1)

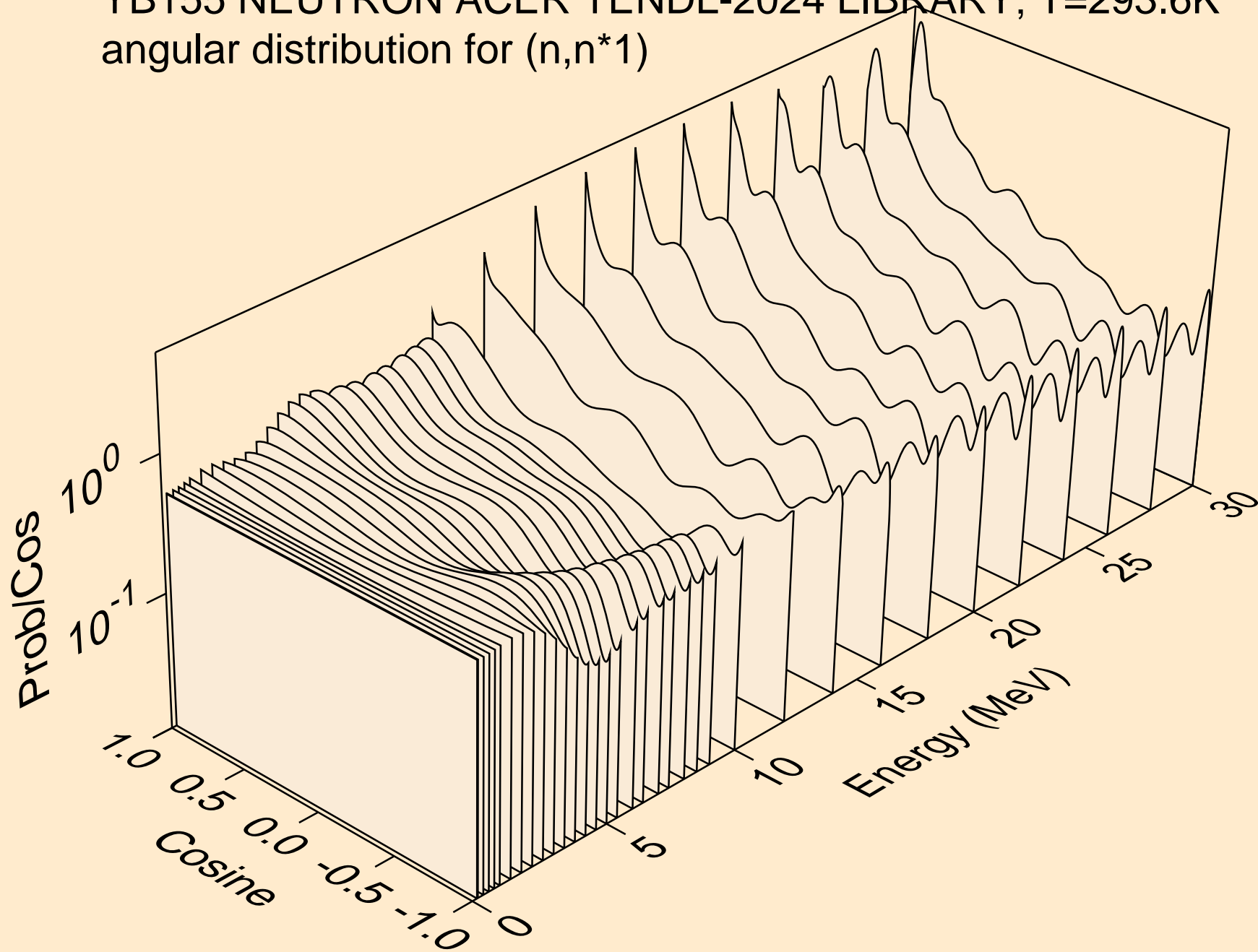

YB155 NEUTRON ACER TENDL-2024 LIBRARY; T=293.6K
angular distribution for (n,n*2)

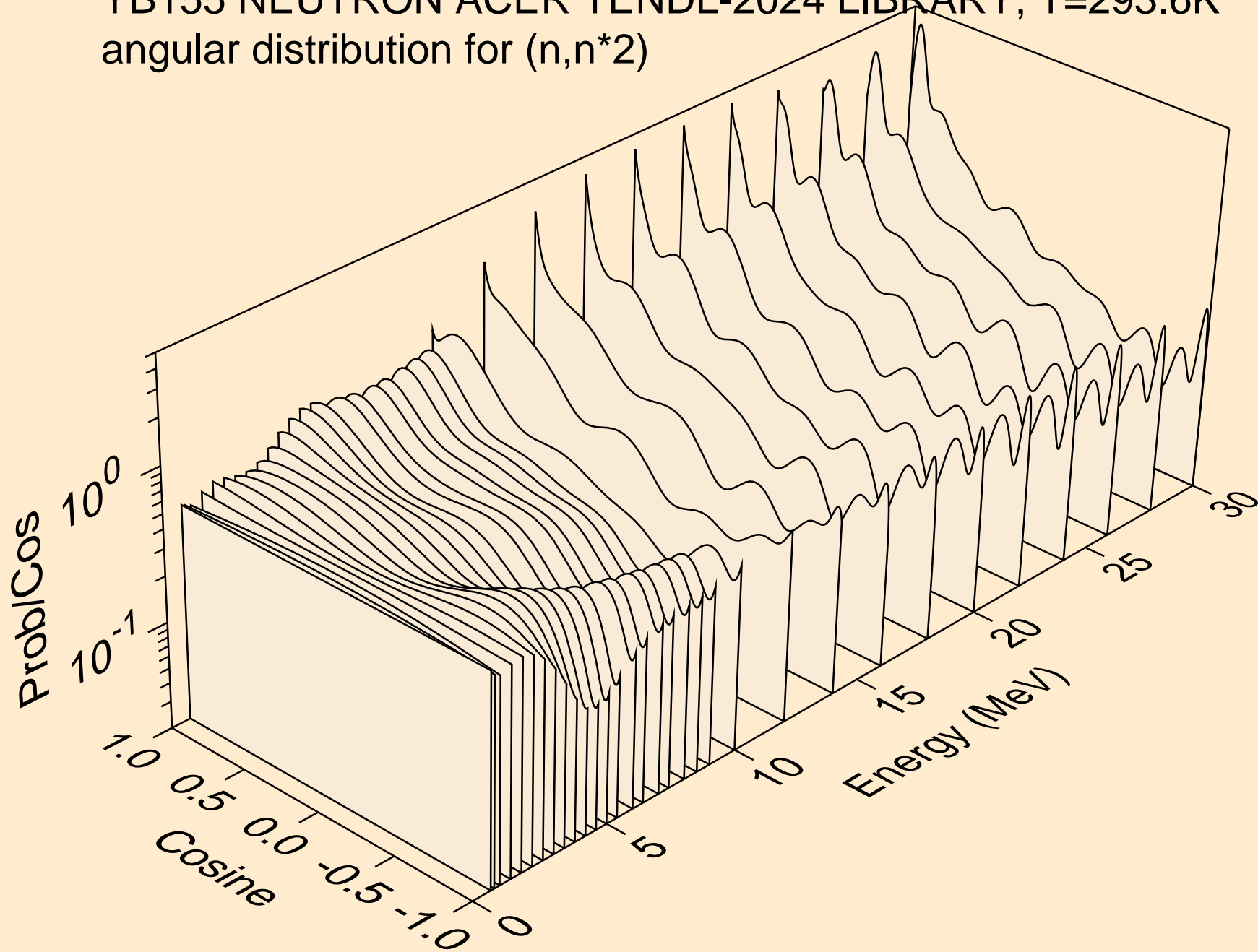

YB155 NEUTRON ACER TENDL-2024 LIBRARY; T=293.6K
angular distribution for (n,n*3)

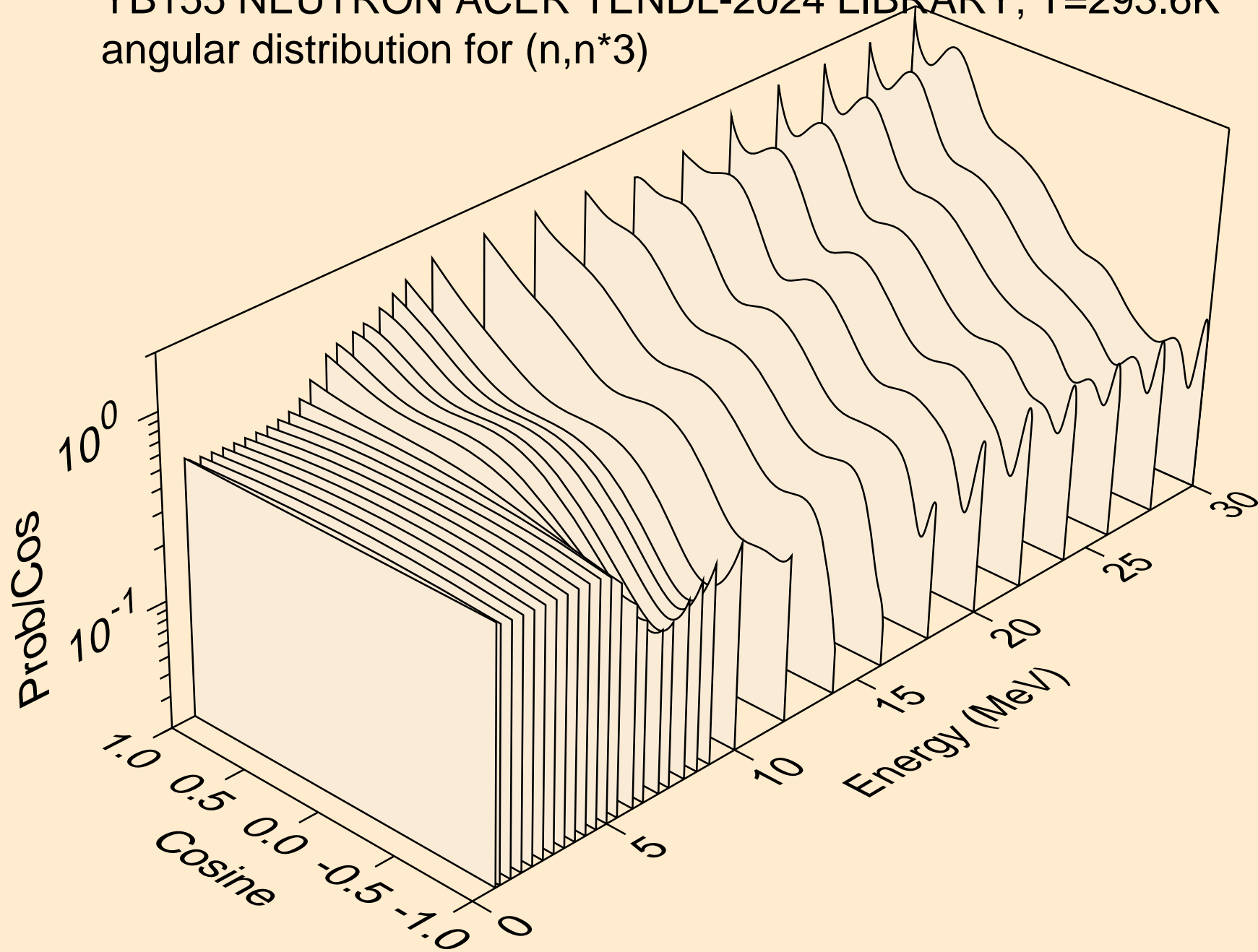

YB155 NEUTRON ACER TENDL-2024 LIBRARY; T=293.6K
angular distribution for (n,n*4)

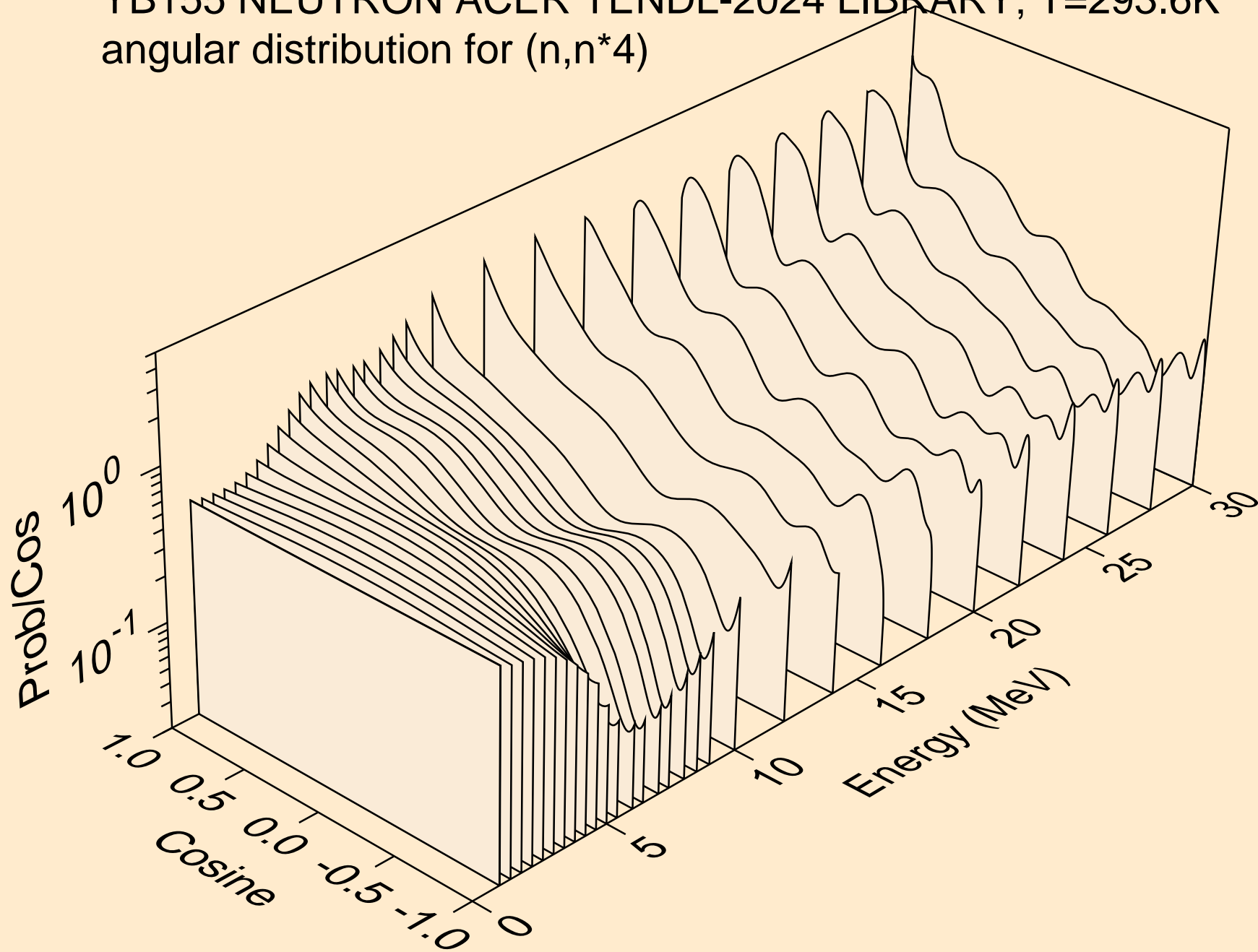

YB155 NEUTRON ACER TENDL-2024 LIBRARY; T=293.6K
angular distribution for (n,n*5)

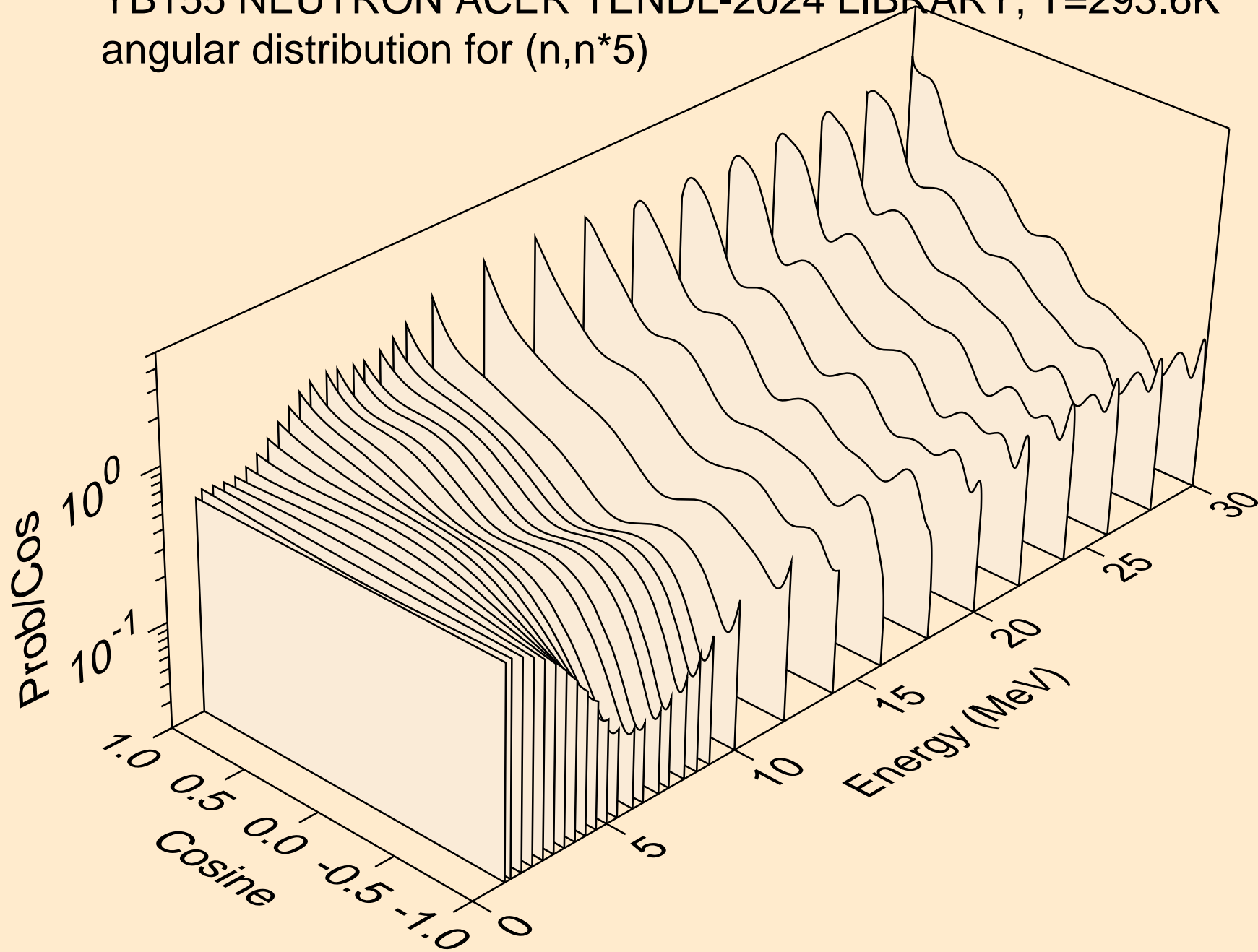

YB155 NEUTRON ACER TENDL-2024 LIBRARY; T=293.6K
Neutron emission for (n,x)

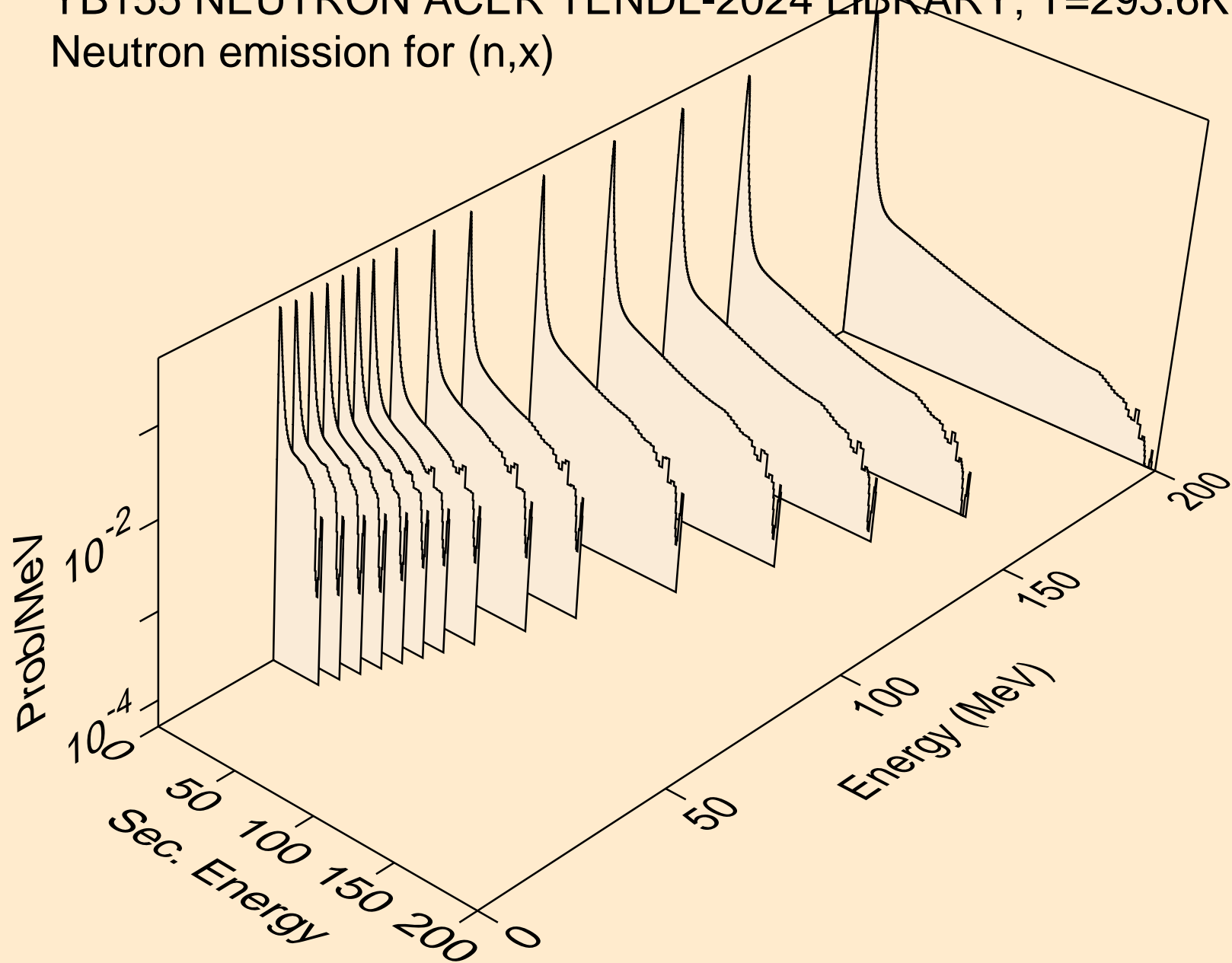

YB155 NEUTRON ACER TENDL-2024 LIBRARY; T=293.6K
Neutron emission for (n,2nd)

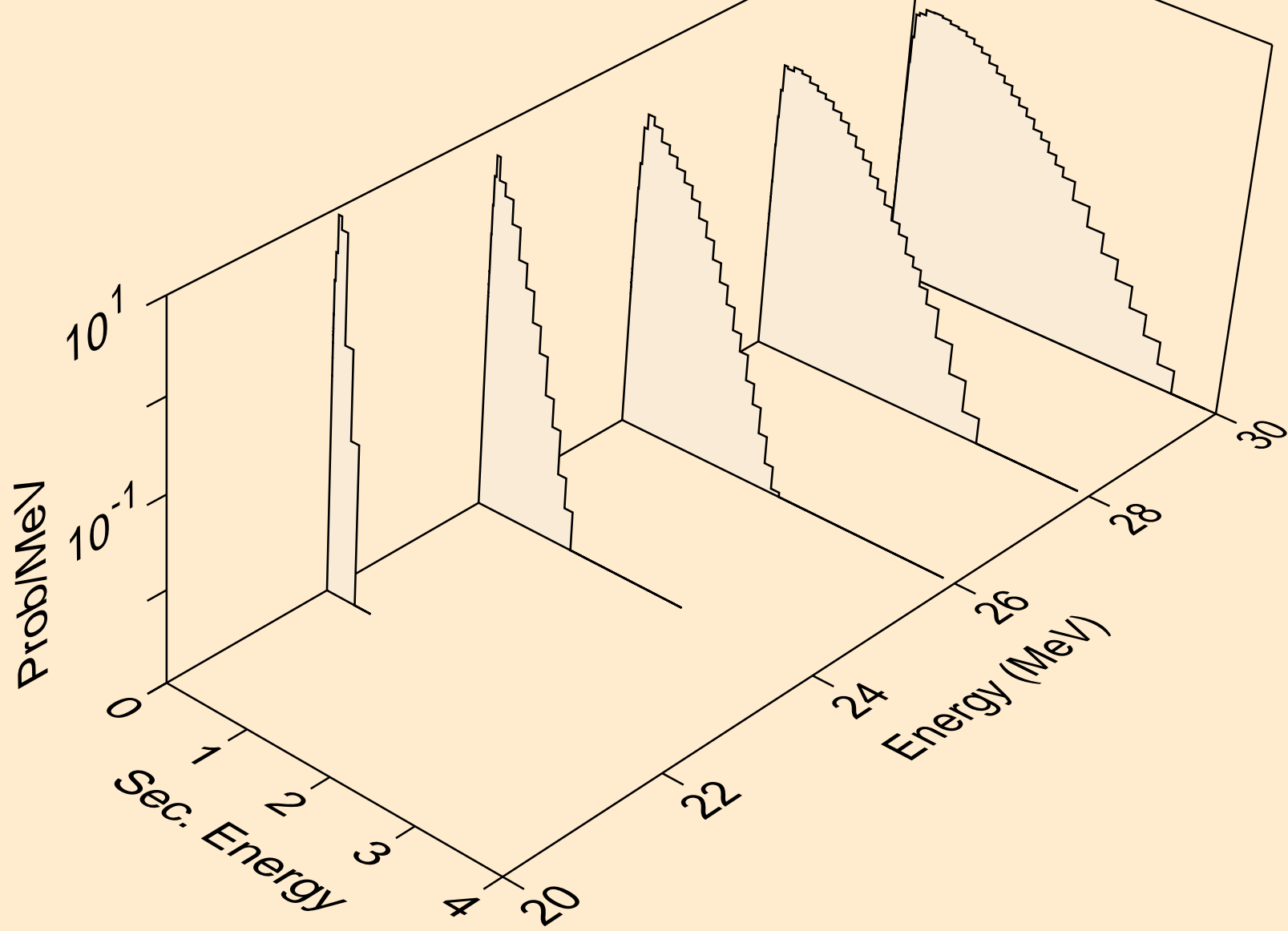

YB155 NEUTRON ACER TENDL-2024 LIBRARY; T=293.6K
Neutron emission for (n,2n)

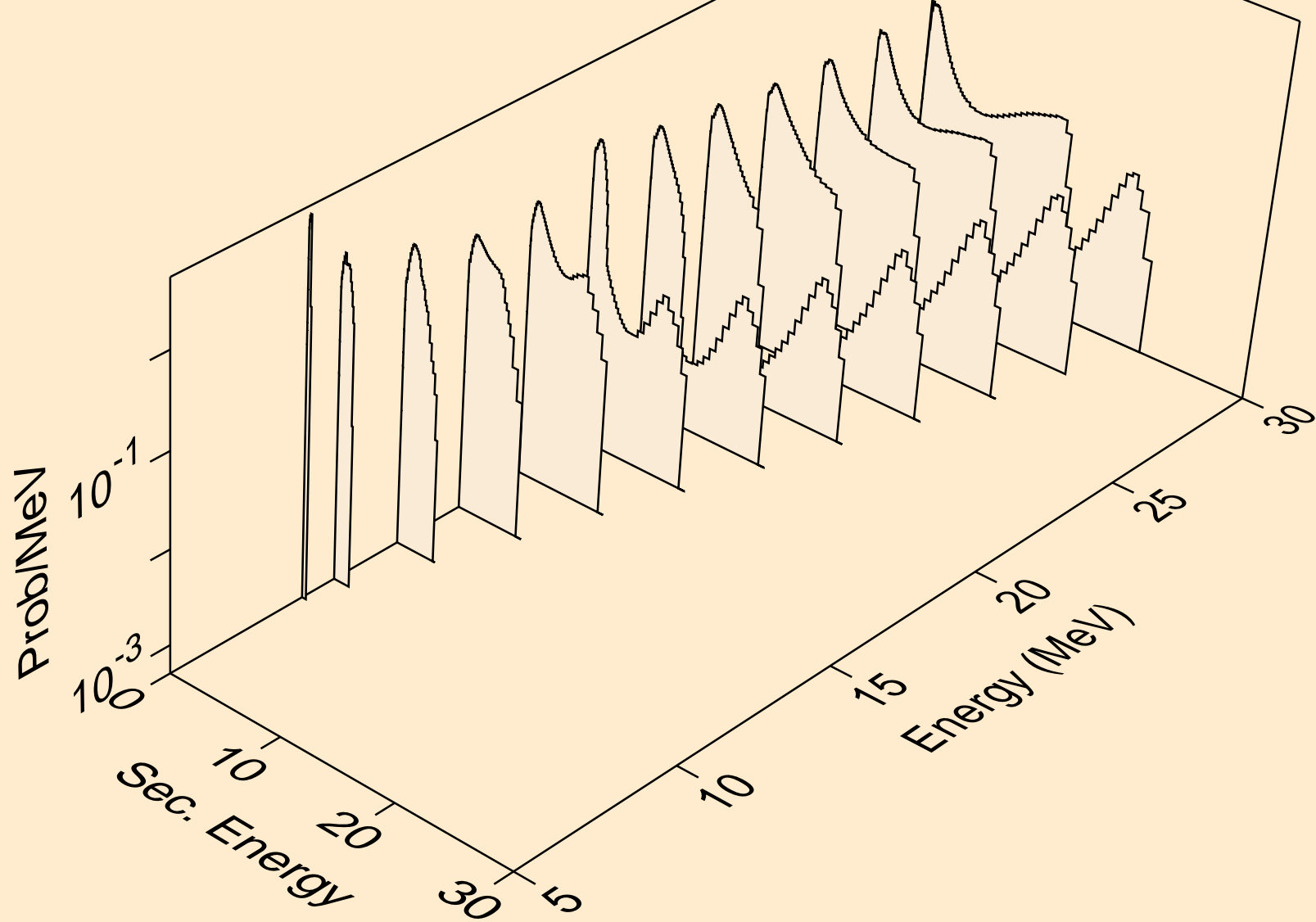

YB155 NEUTRON ACER TENDL-2024 LIBRARY; T=293.6K
Neutron emission for (n,3n)

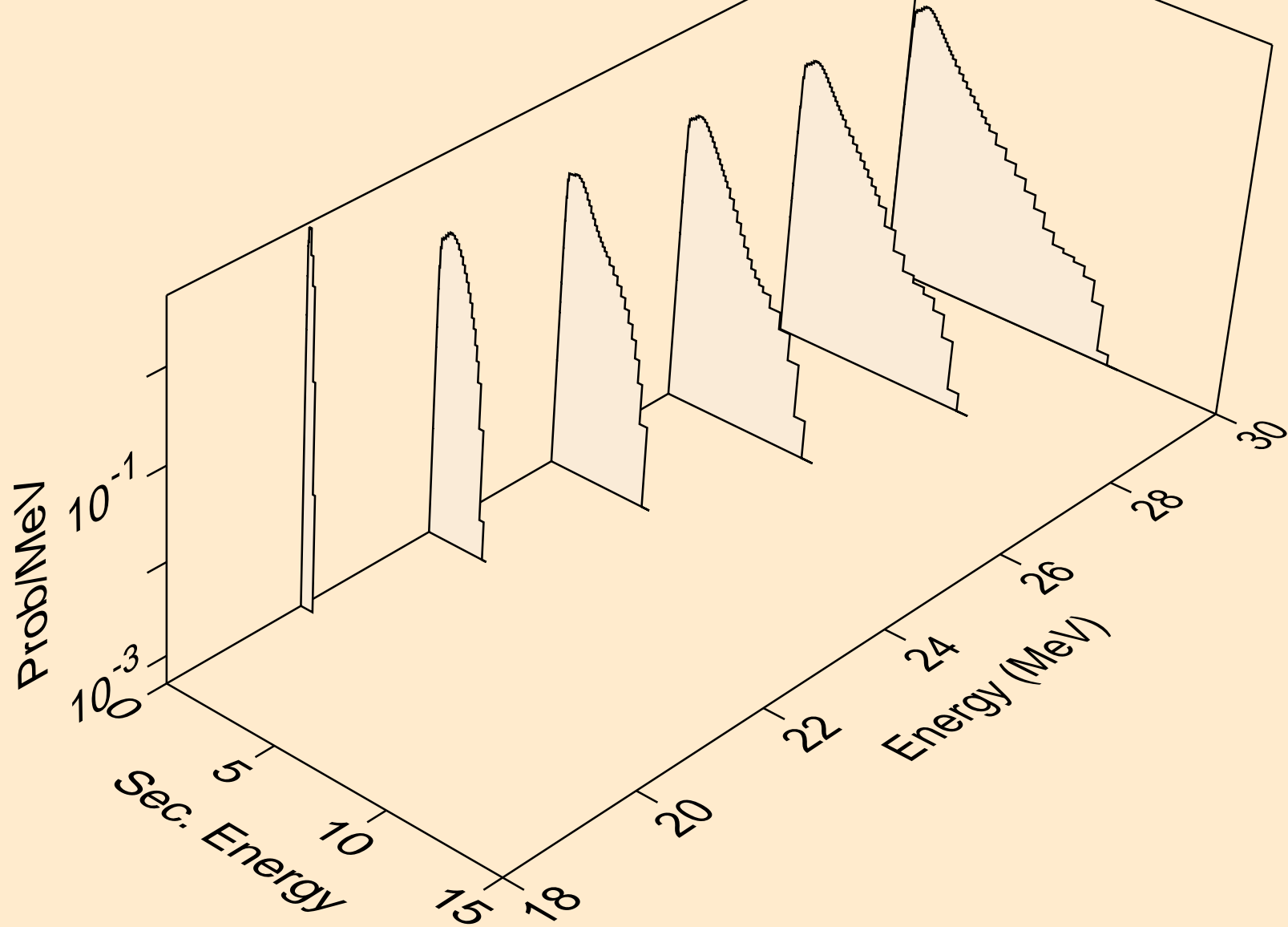

YB155 NEUTRON ACER TENDL-2024 LIBRARY; T=293.6K
Neutron emission for (n,n*)a

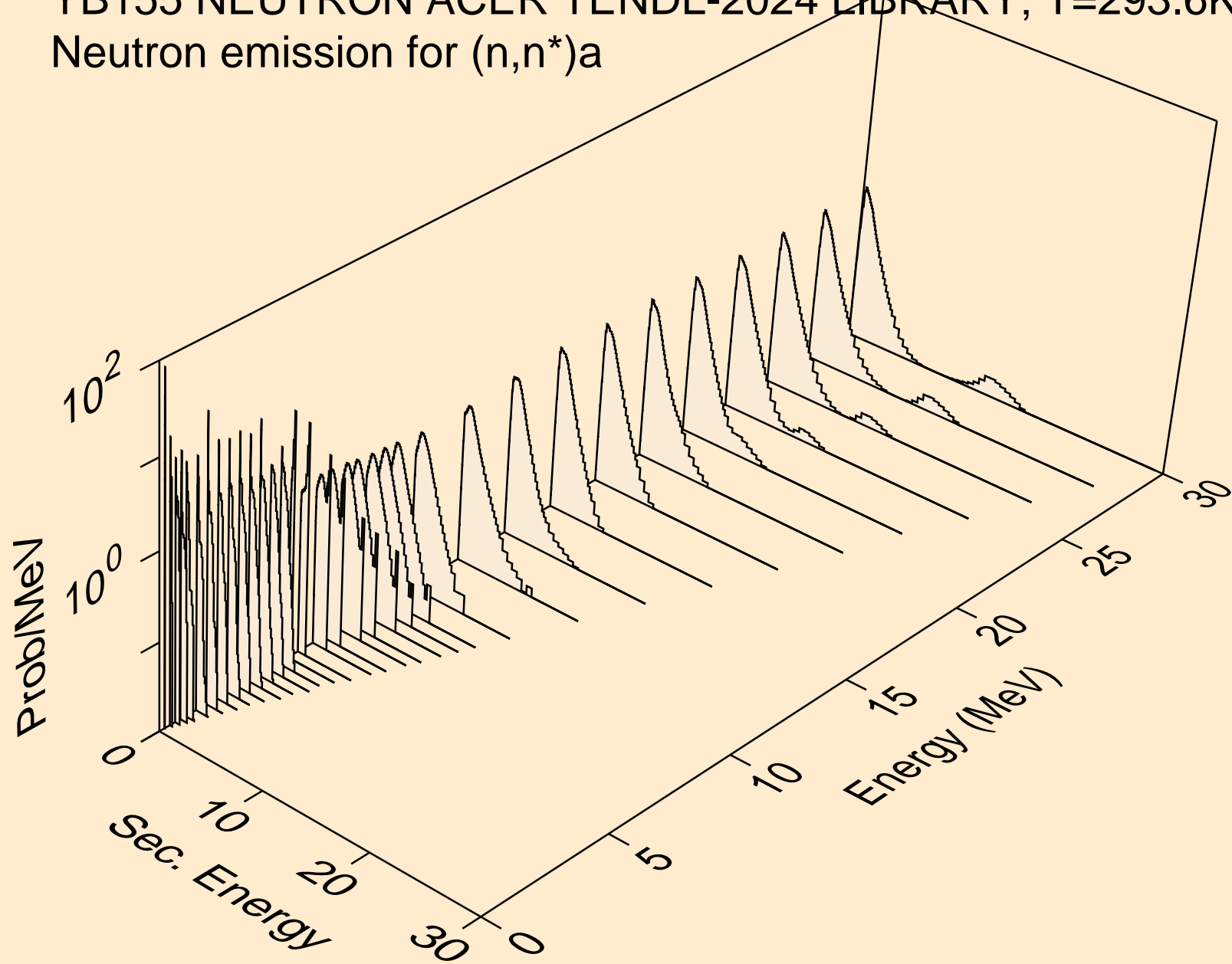

YB155 NEUTRON ACER TENDL-2024 LIBRARY; T=293.6K
Neutron emission for (n,2n)_a

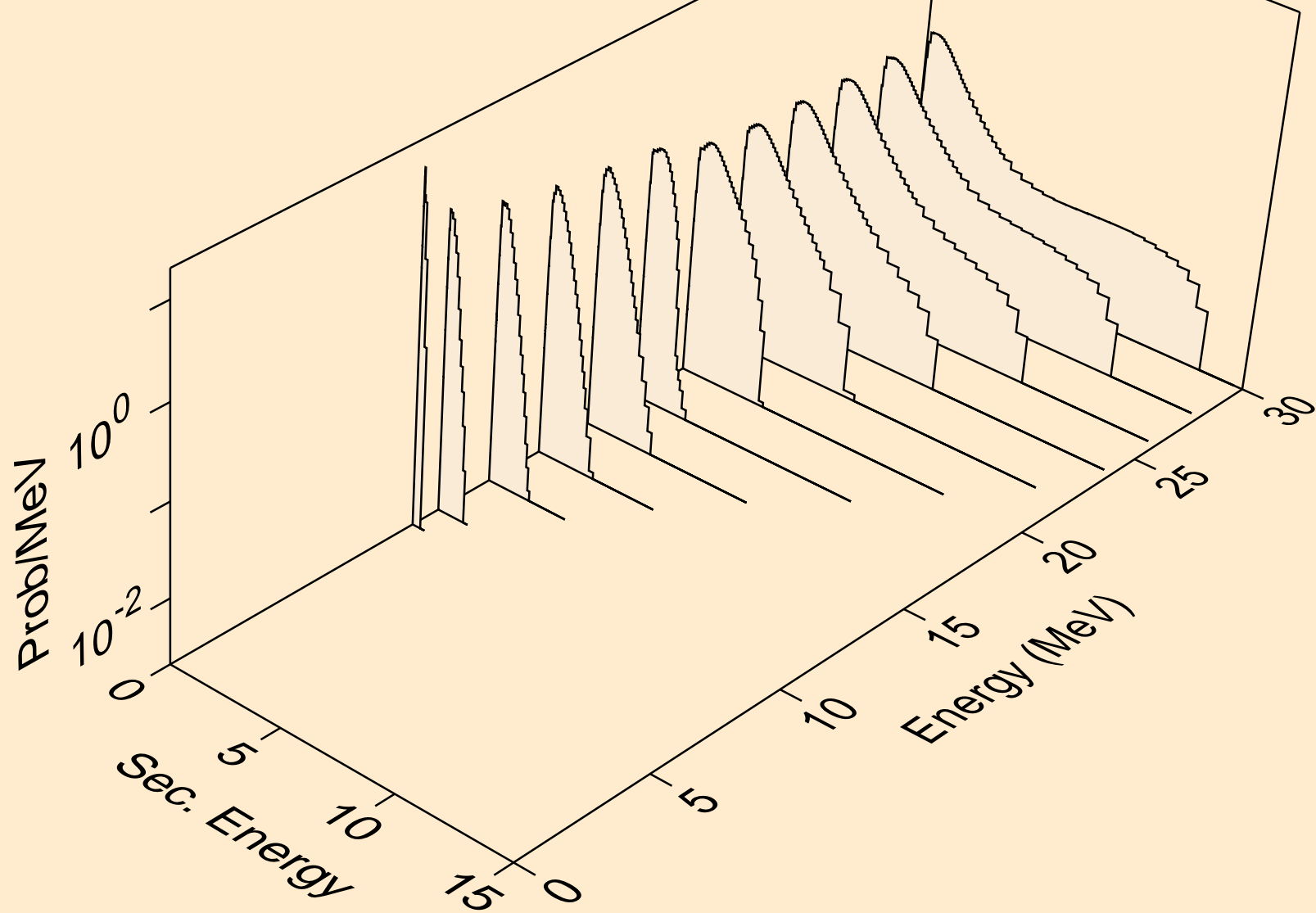

YB155 NEUTRON ACER TENDL-2024 LIBRARY; T=293.6K
Neutron emission for (n,3n)a

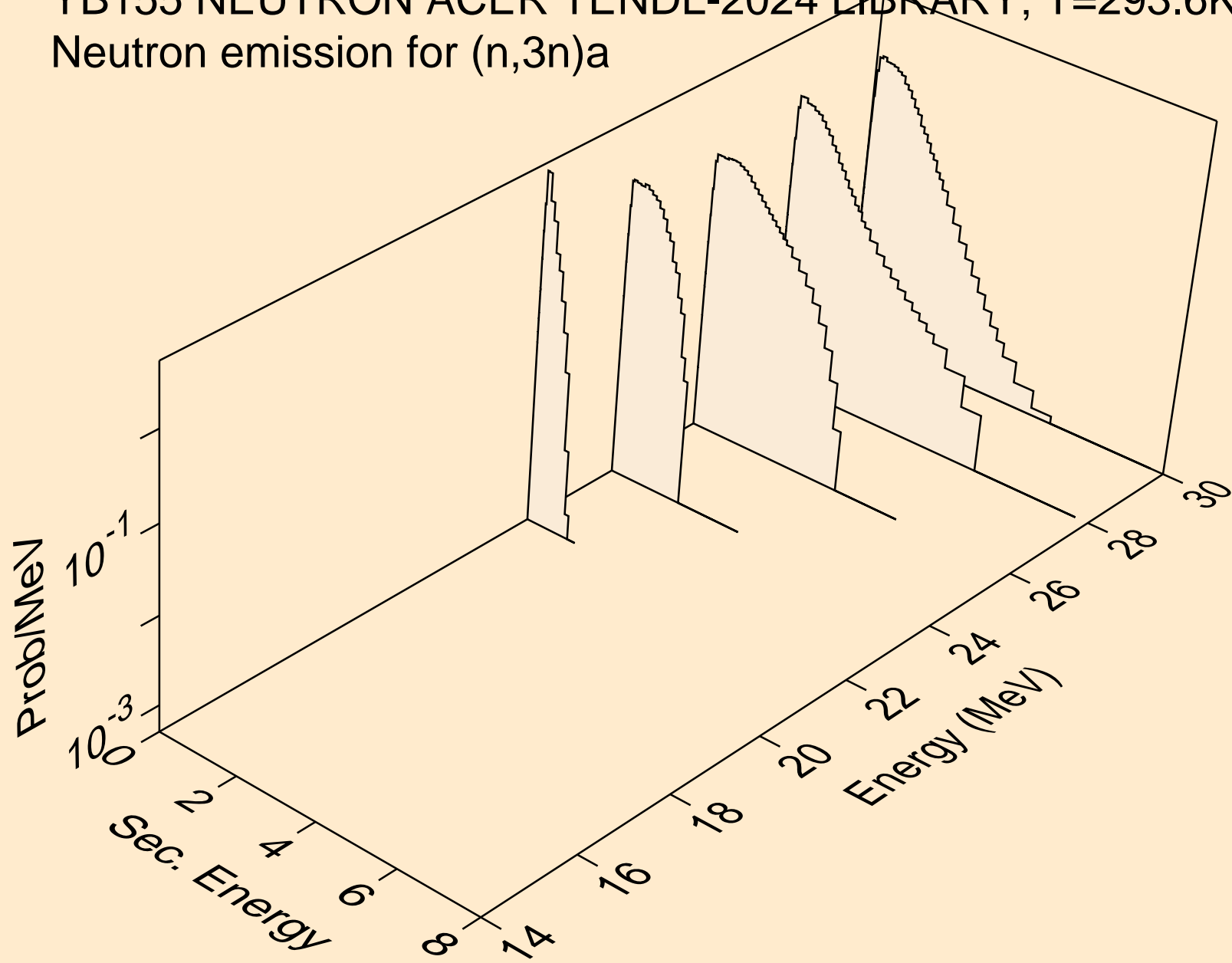

YB155 NEUTRON ACER TENDL-2024 LIBRARY; T=293.6K
Neutron emission for (n,n*)p

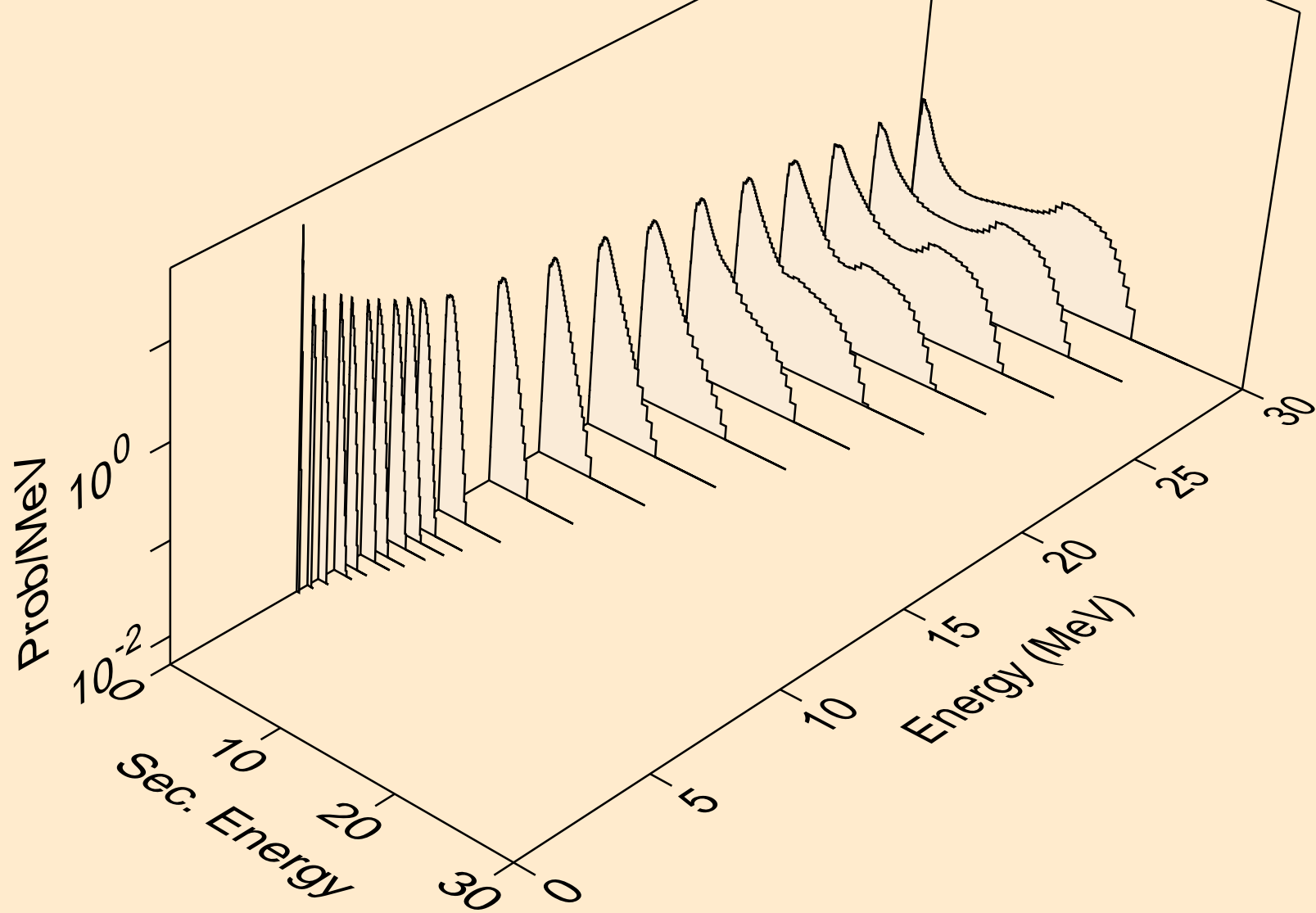

YB155 NEUTRON ACER TENDL-2024 LIBRARY; T=293.6K
Neutron emission for (n,n*)2a

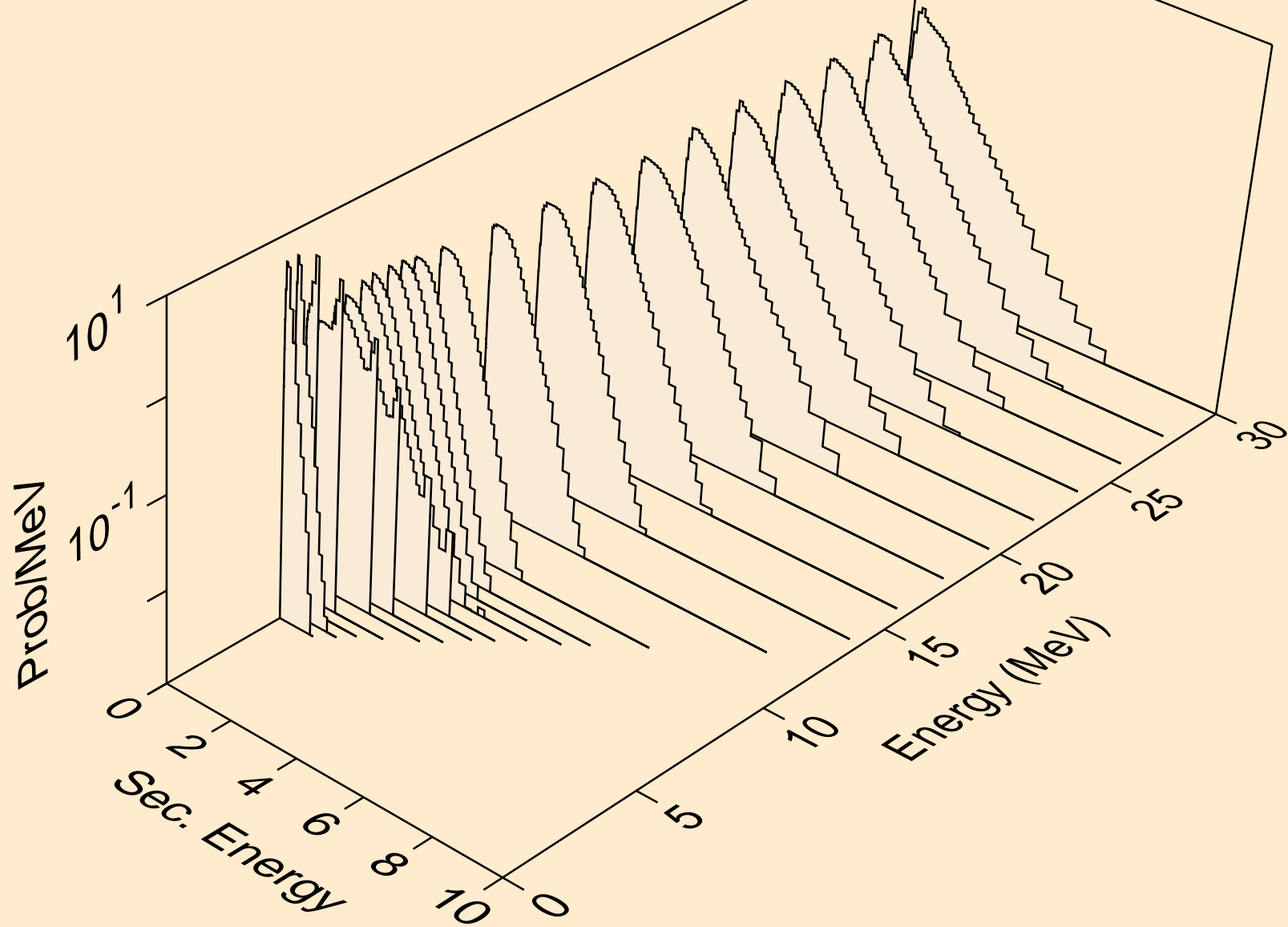

YB155 NEUTRON ACER TENDL-2024 LIBRARY; T=293.6K
Neutron emission for (n,2n)2a

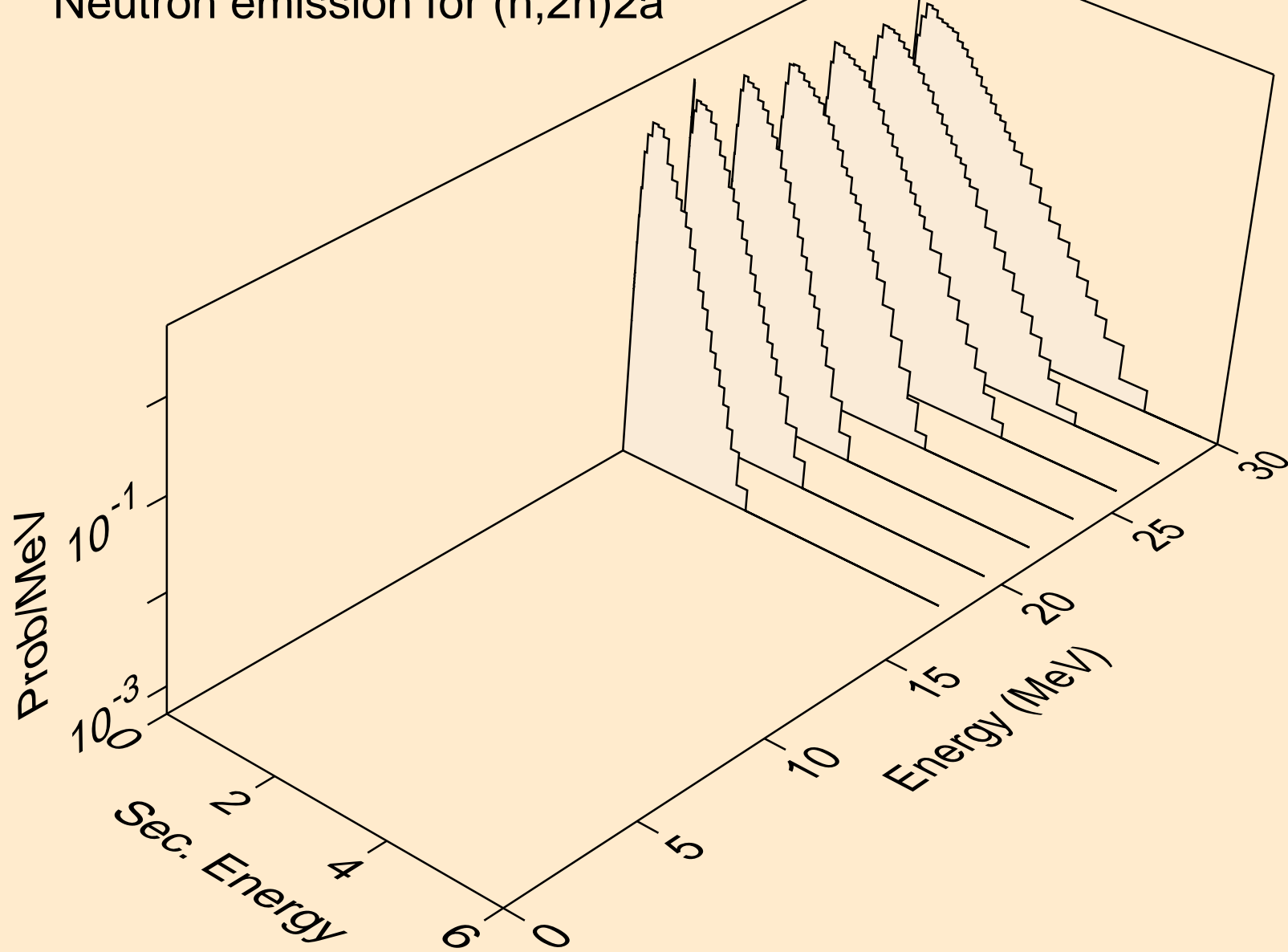

YB155 NEUTRON ACER TENDL-2024 LIBRARY; T=293.6K
Neutron emission for (n,n*)d

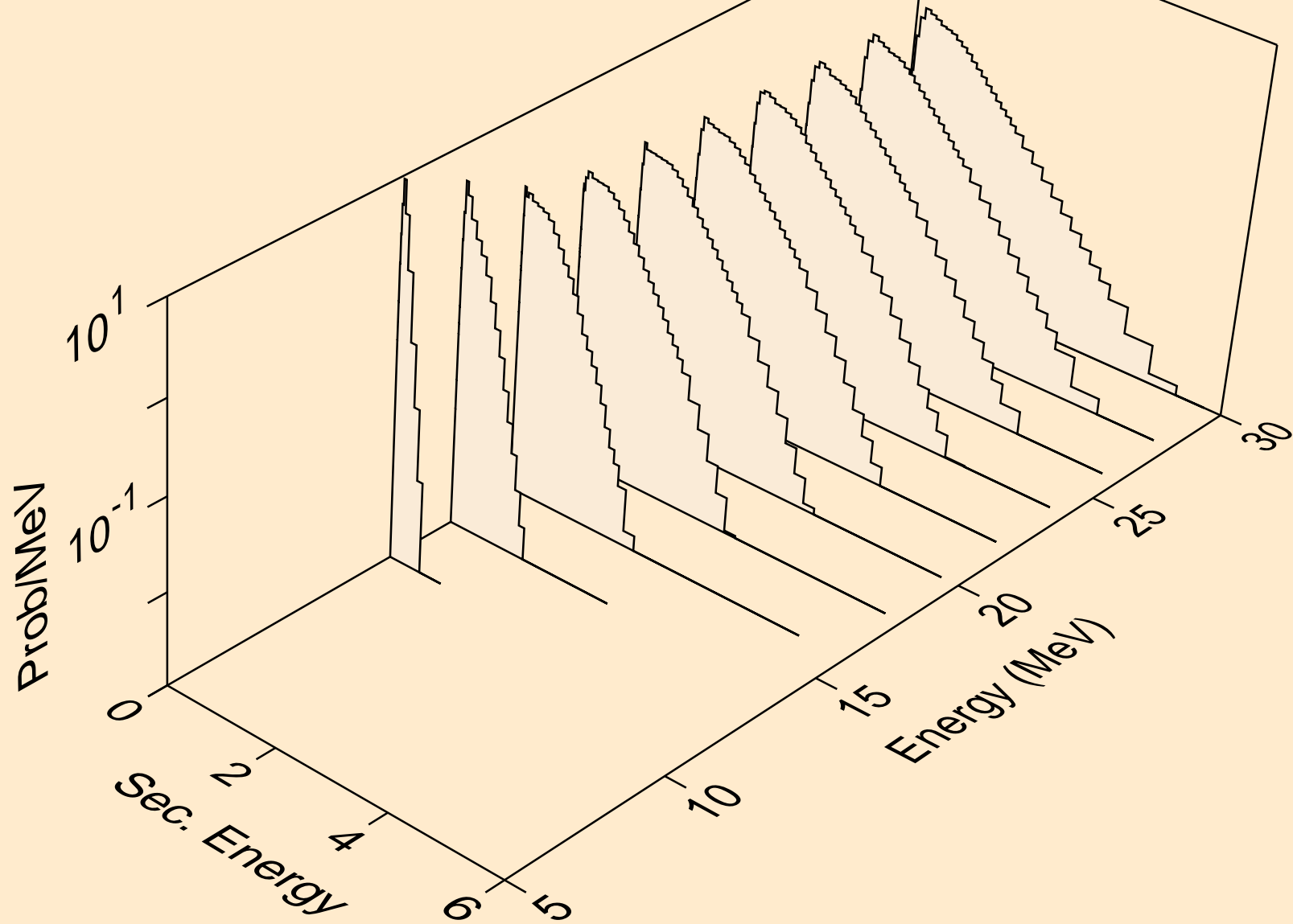

YB155 NEUTRON ACER TENDL-2024 LIBRARY; T=293.6K
Neutron emission for (n,n*)t

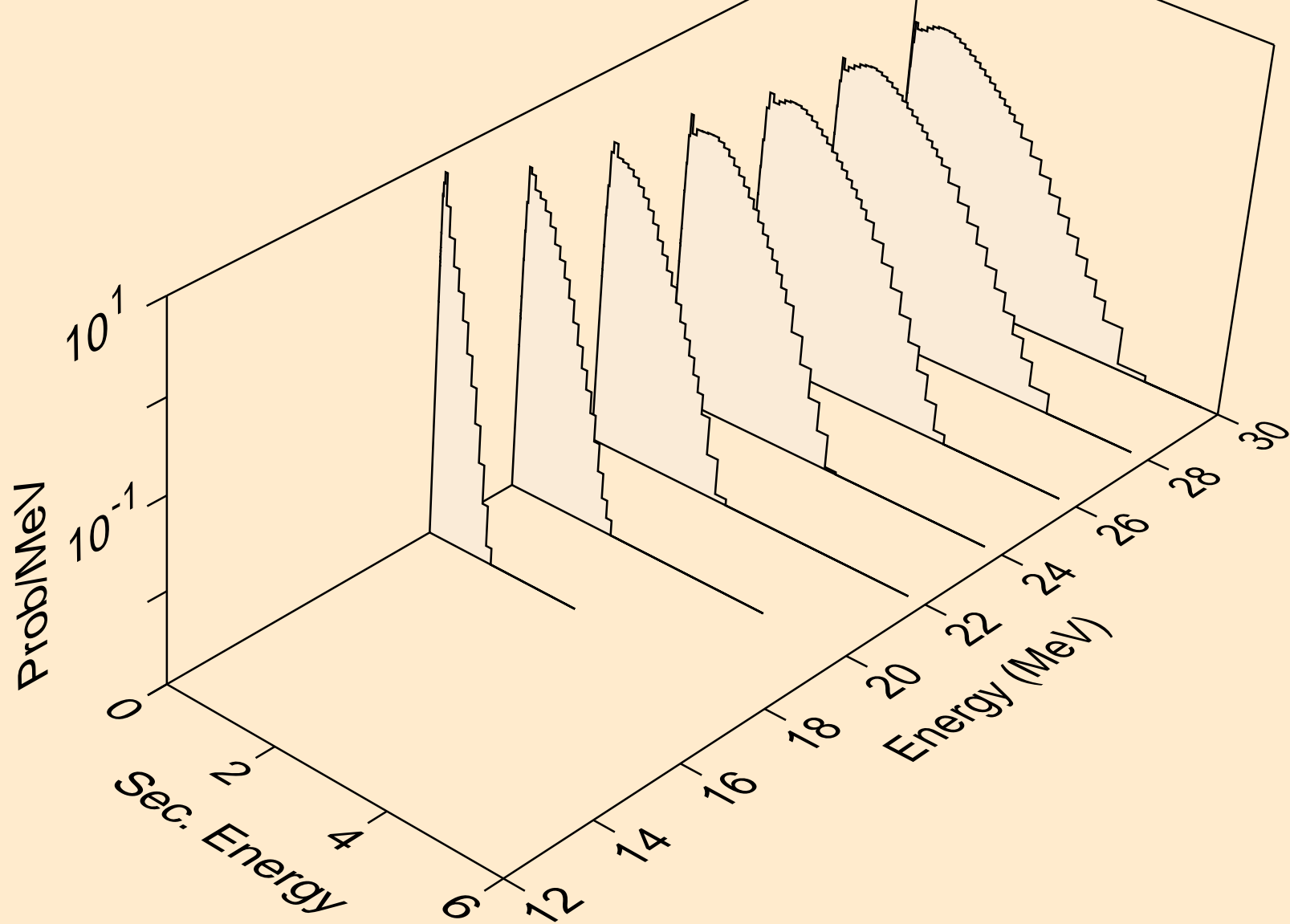

YB155 NEUTRON ACER TENDL-2024 LIBRARY; T=293.6K
Neutron emission for (n,n*)he3

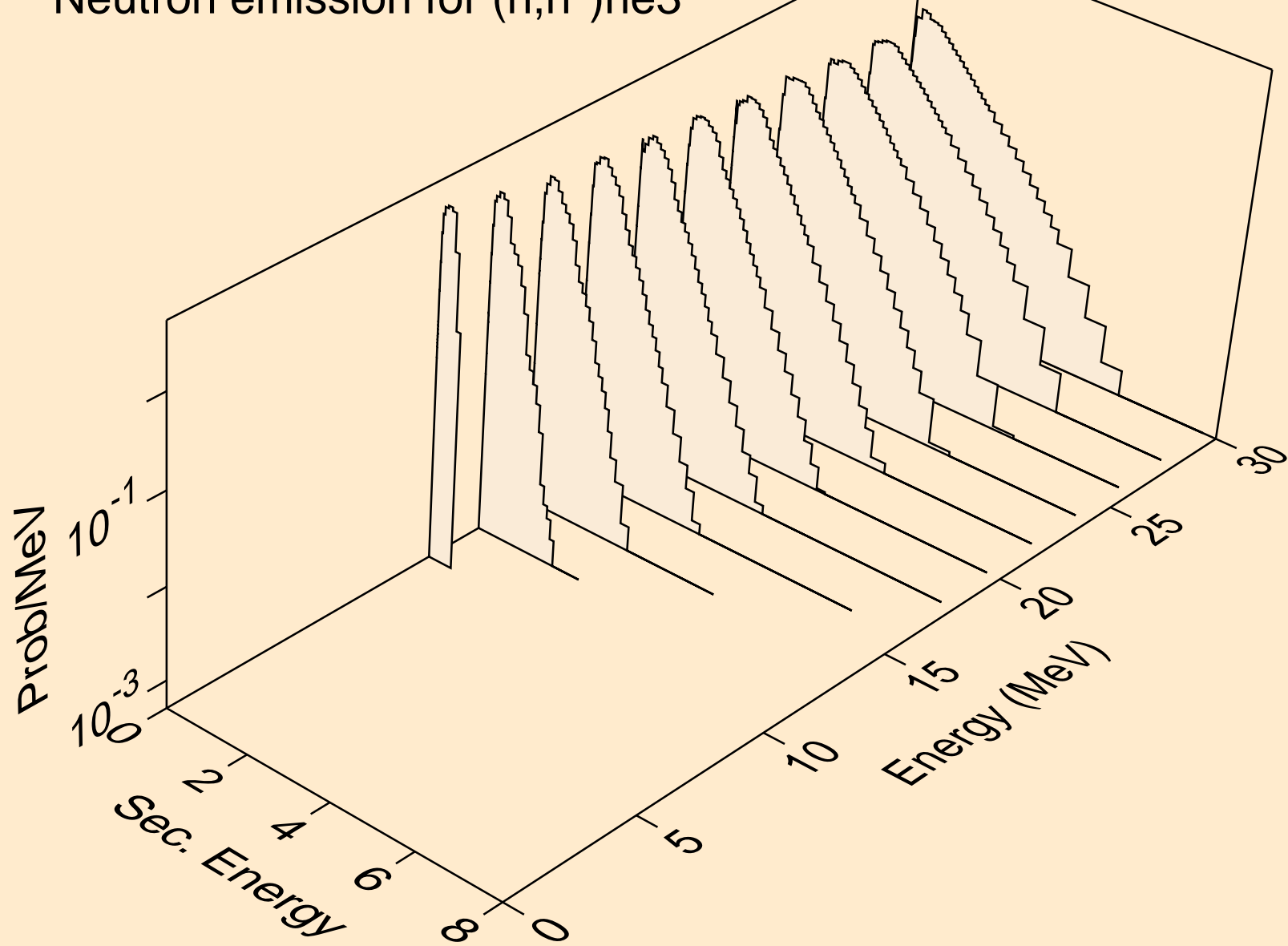

YB155 NEUTRON ACER TENDL-2024 LIBRARY; T=293.6K
Neutron emission for (n,4n)

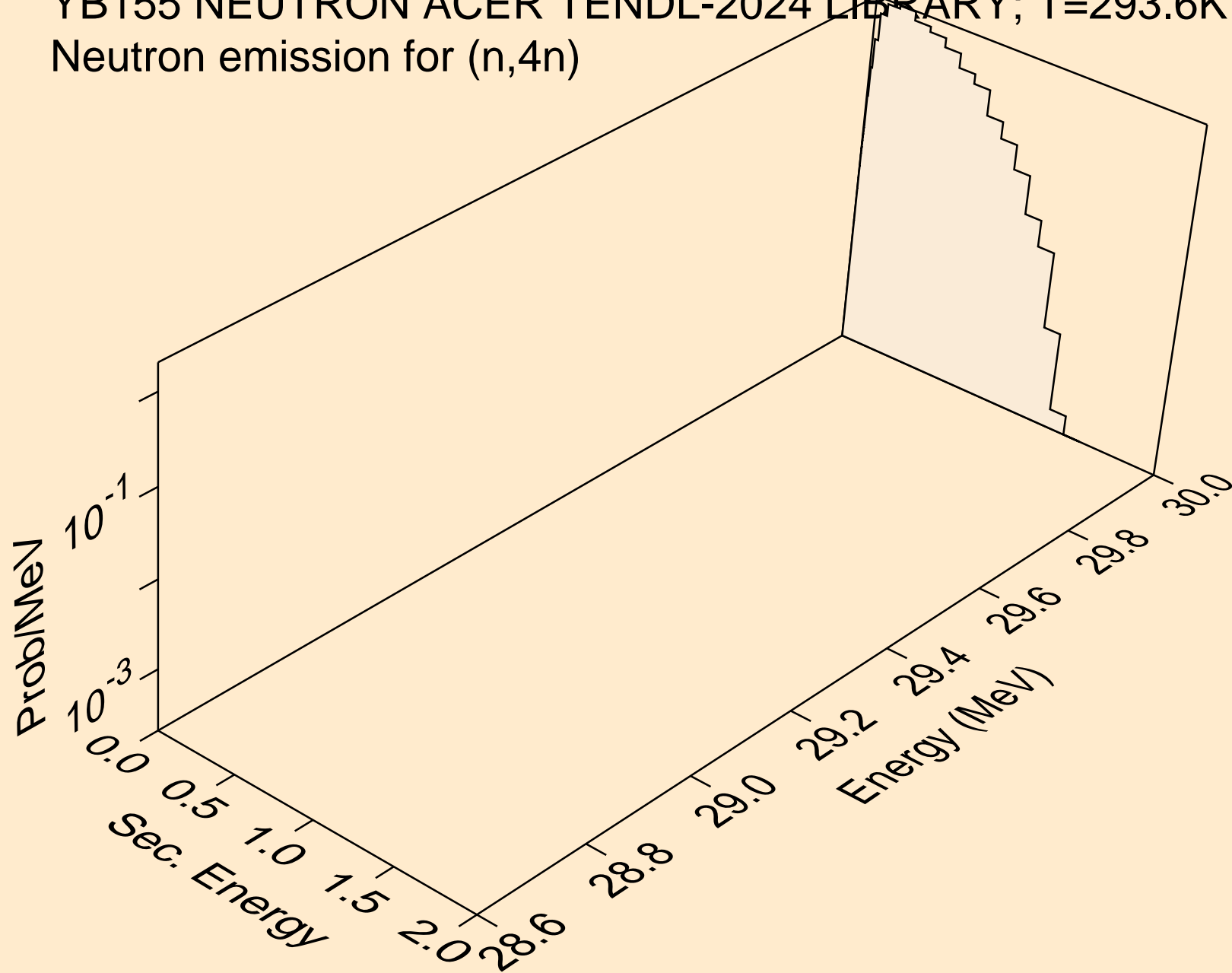

YB155 NEUTRON ACER TENDL-2024 LIBRARY; T=293.6K
Neutron emission for (n,2np)

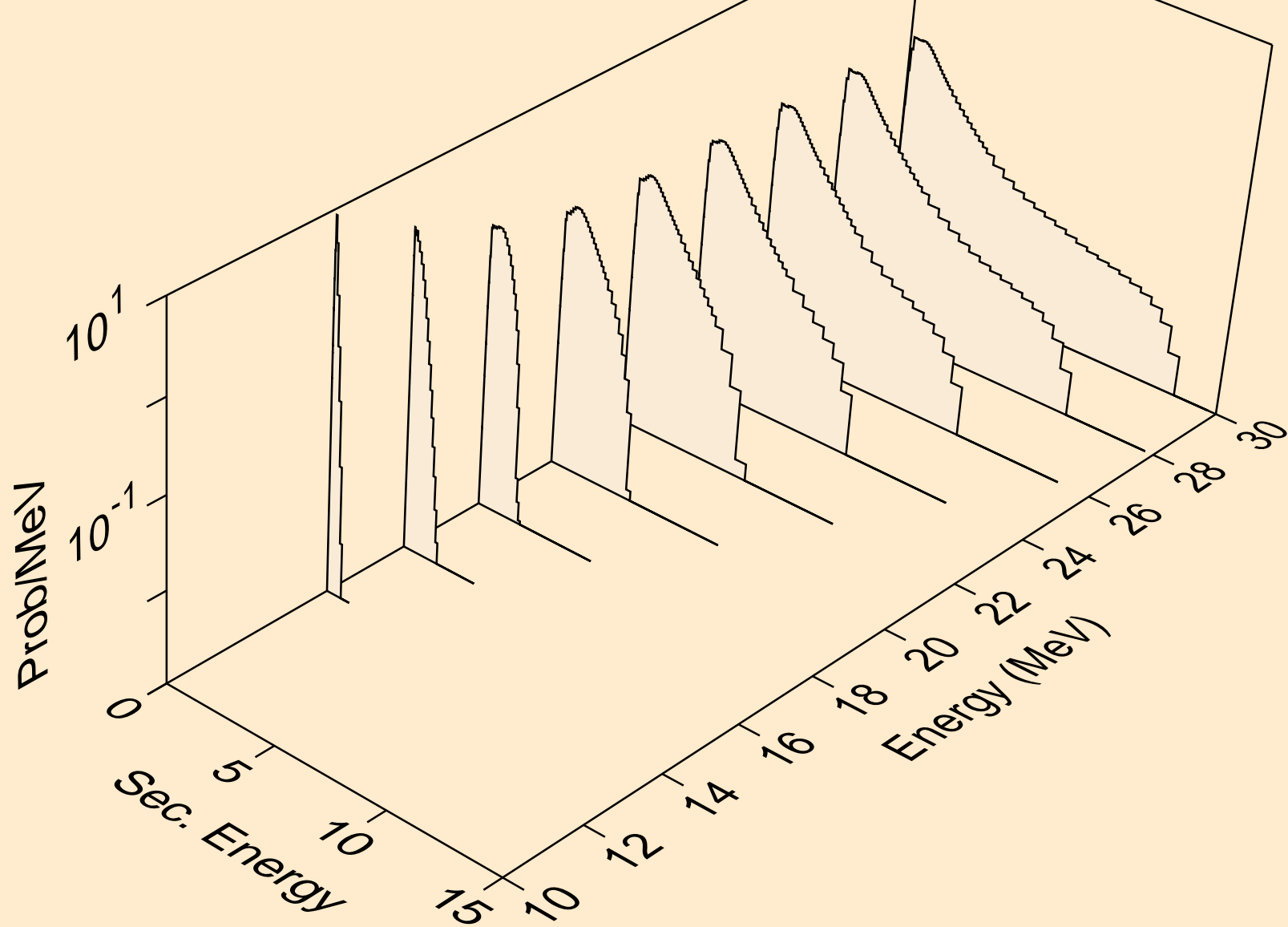

YB155 NEUTRON ACER TENDL-2024 LIBRARY; T=293.6K
Neutron emission for (n,3np)

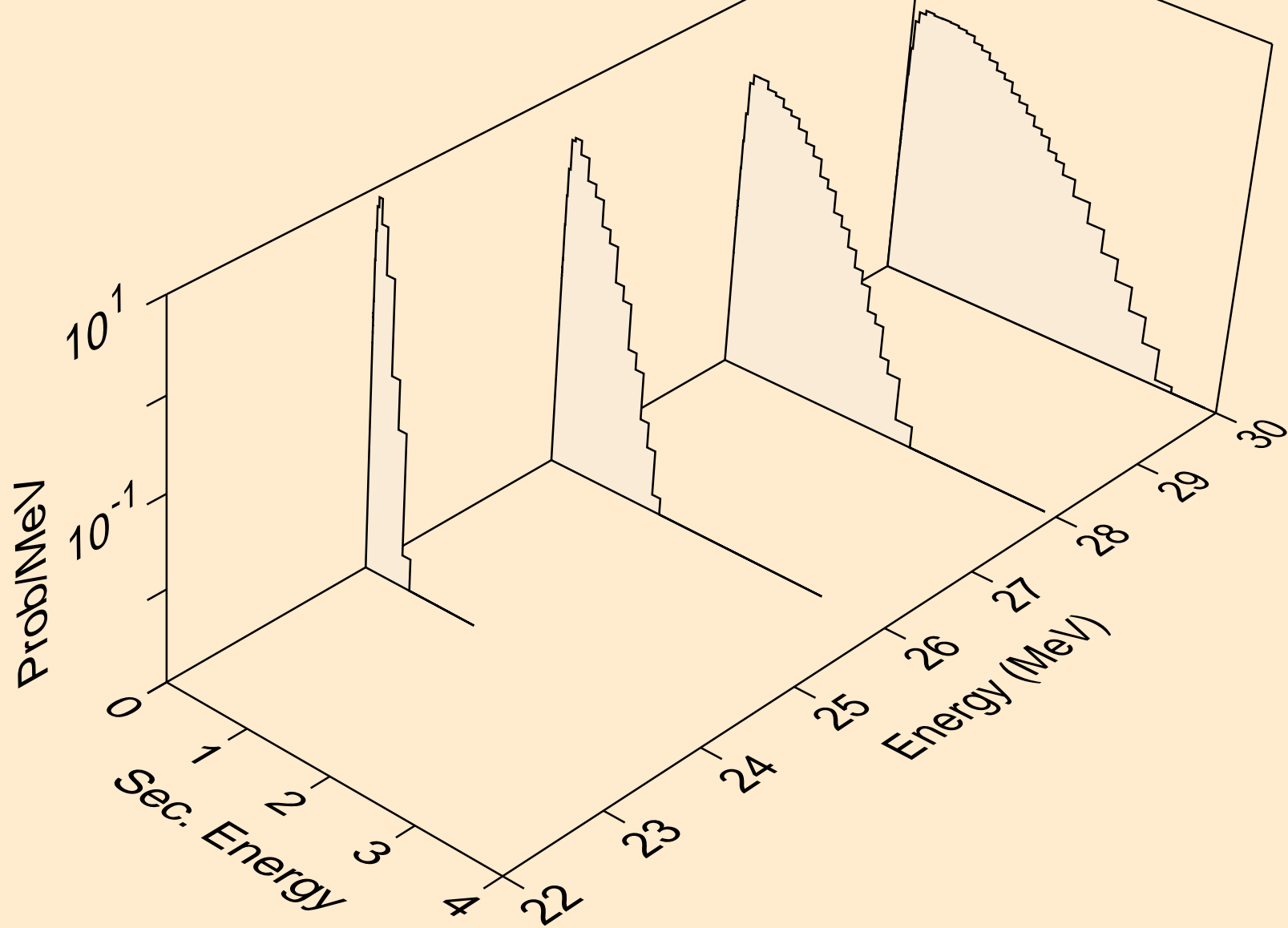

YB155 NEUTRON ACER TENDL-2024 LIBRARY; T=293.6K
Neutron emission for (n,n2p)

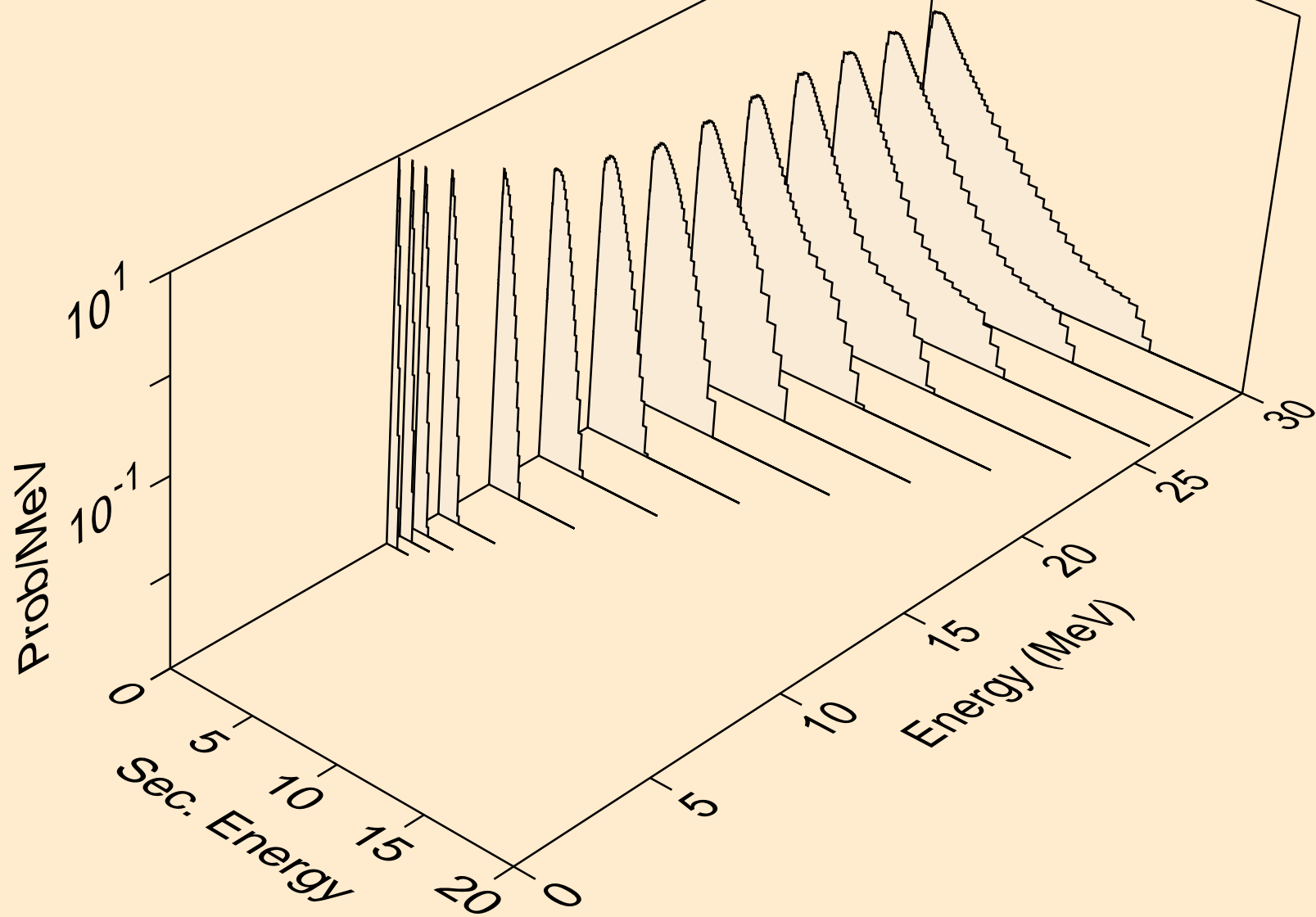

YB155 NEUTRON ACER TENDL-2024 LIBRARY; T=293.6K
Neutron emission for (n,npa)

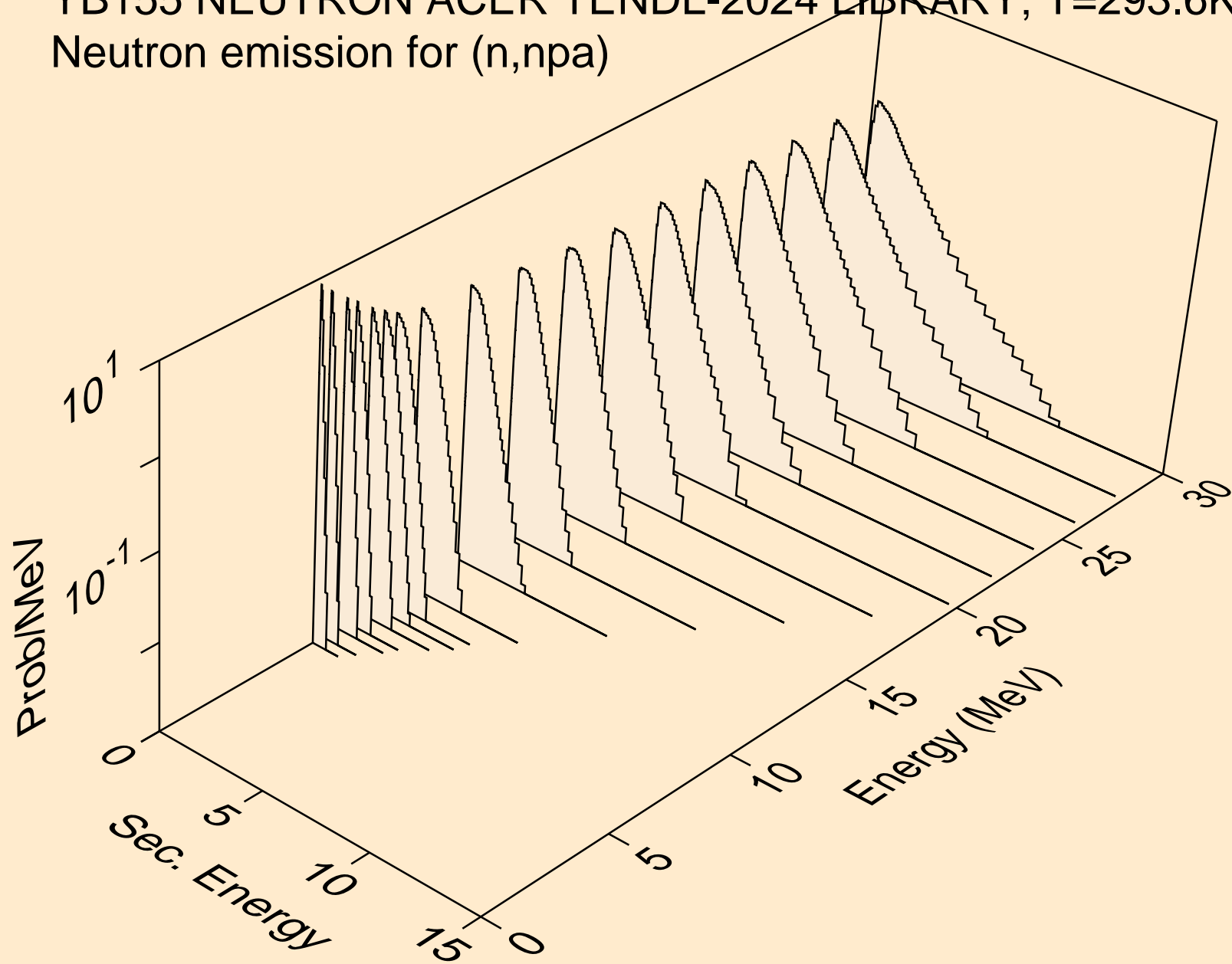

YB155 NEUTRON ACER TENDL-2024 LIBRARY; T=293.6K
Neutron emission for (n,n*c)

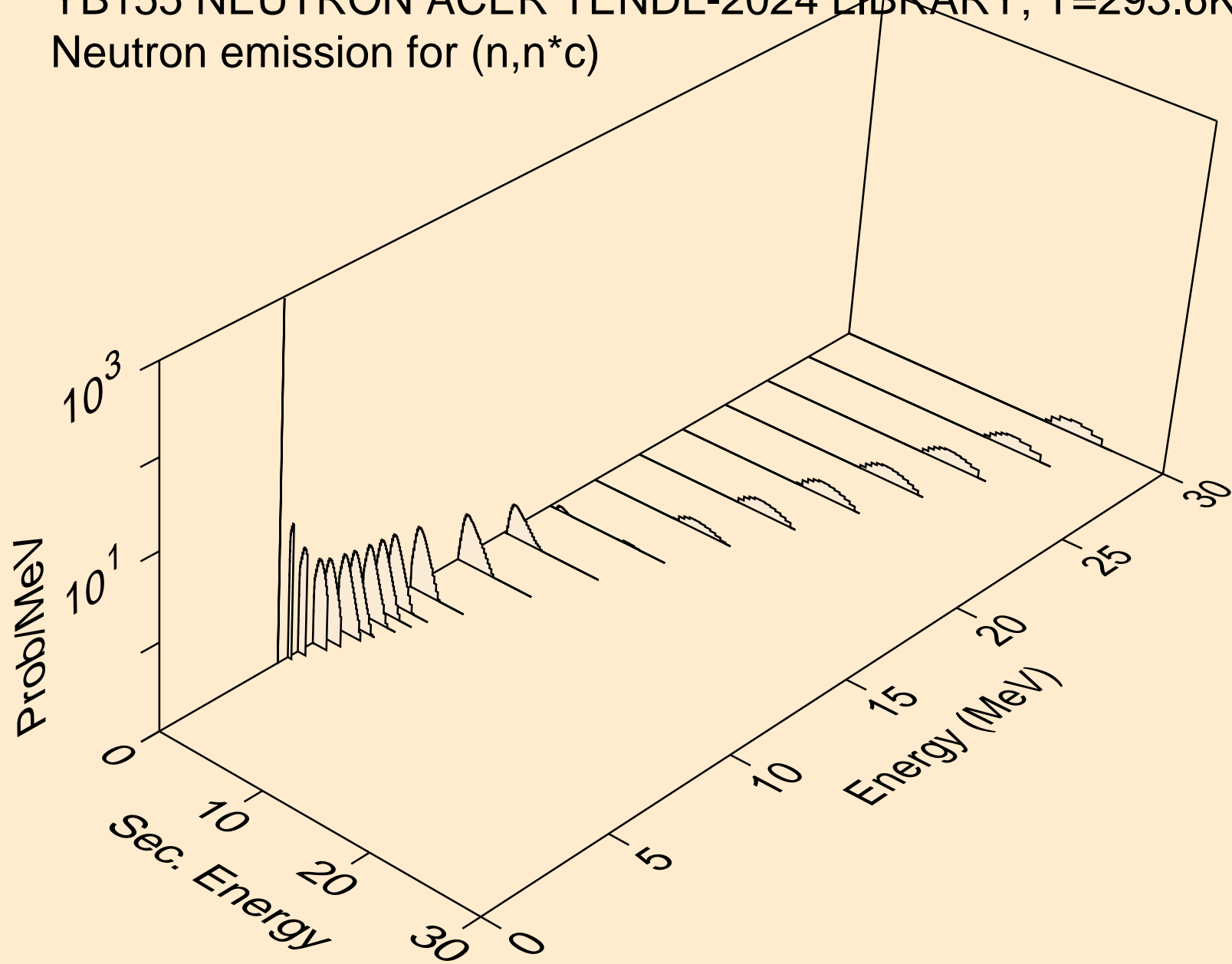

YB155 NEUTRON ACER TENDL-2024 LIBRARY; T=293.6K
Photon emission for (n,x)

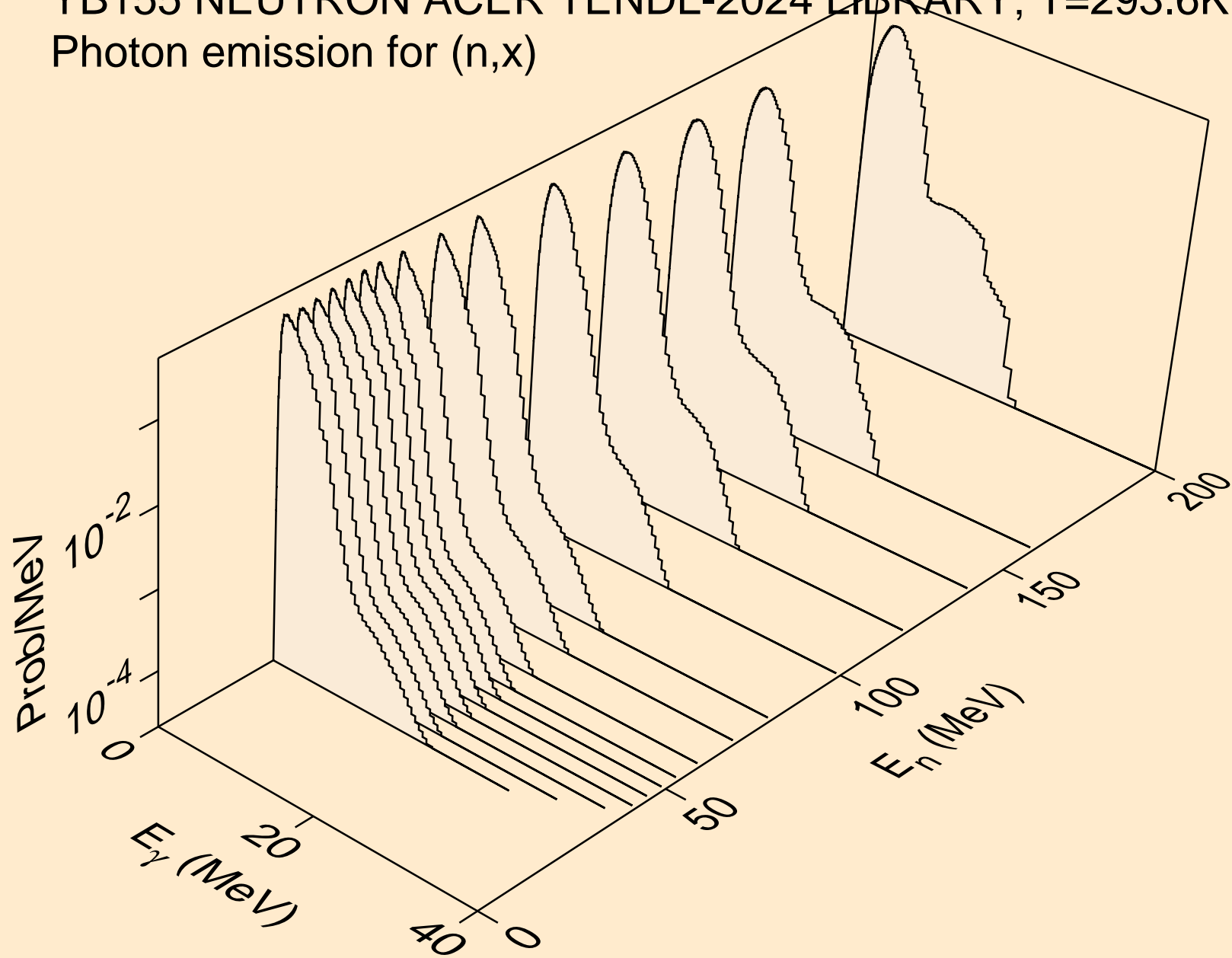

YB155 NEUTRON ACER TENDL-2024 LIBRARY; T=293.6K
Photon emission for (n,2nd)

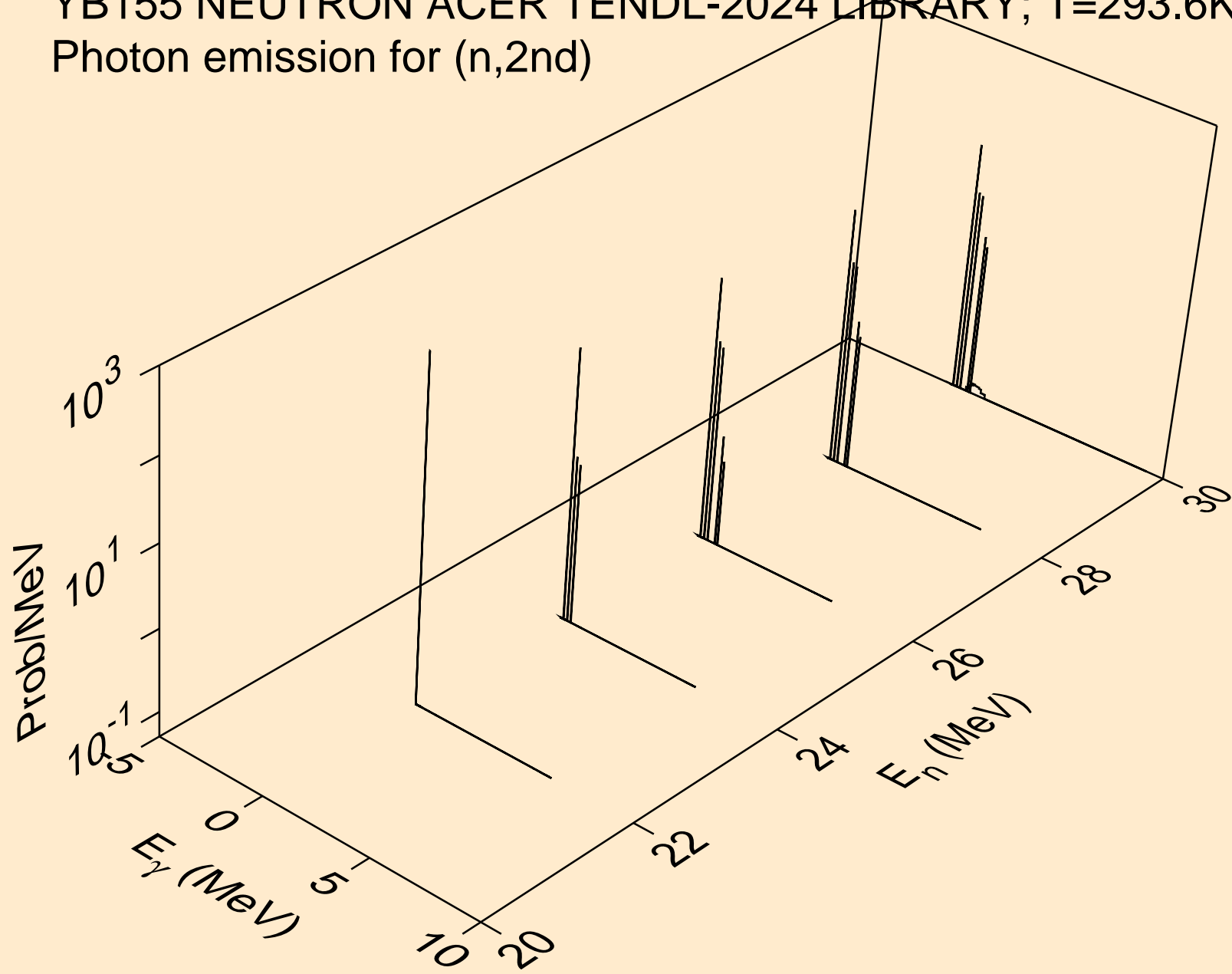

YB155 NEUTRON ACER TENDL-2024 LIBRARY; T=293.6K
Photon emission for (n,2n)

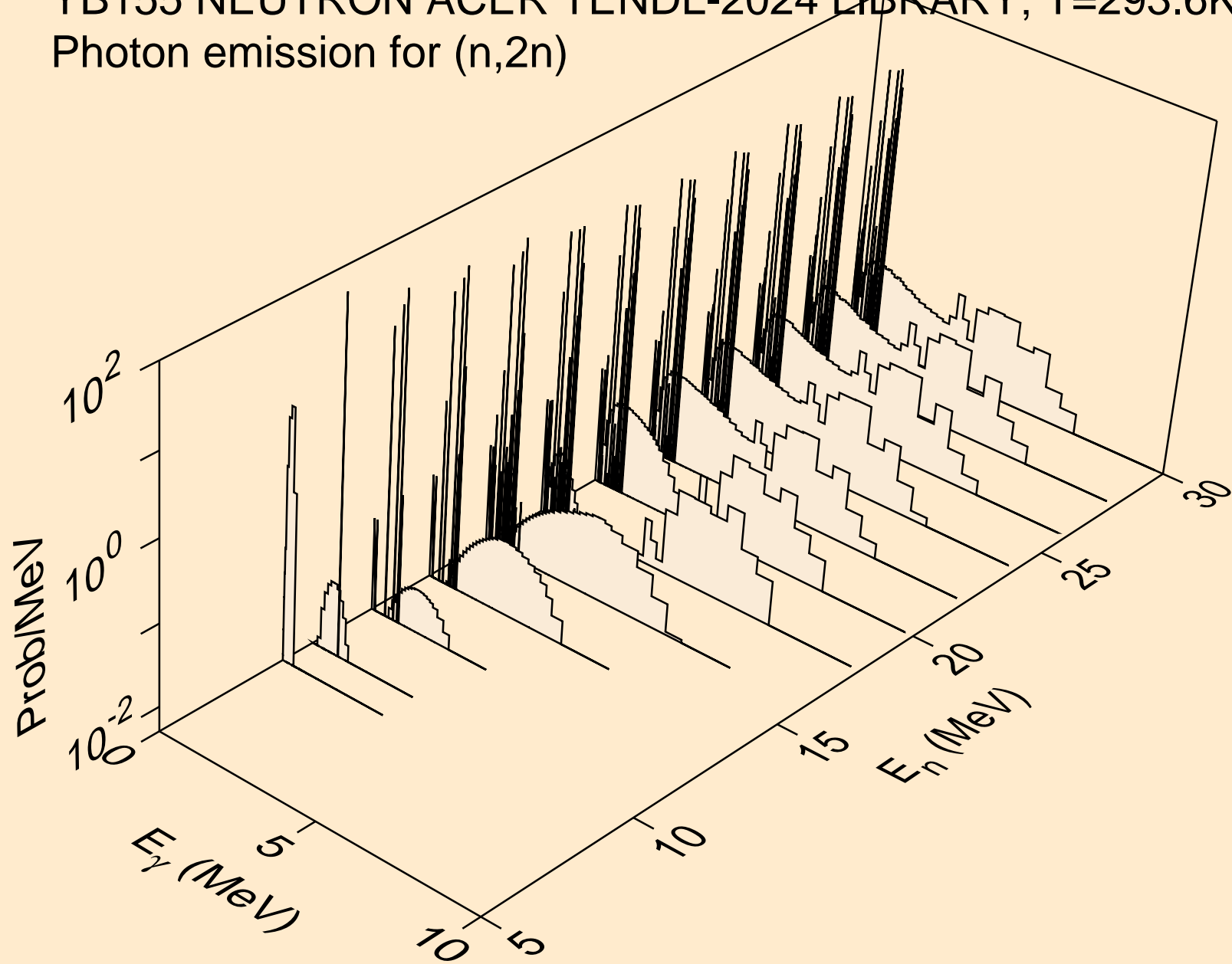

YB155 NEUTRON ACER TENDL-2024 LIBRARY; T=293.6K
Photon emission for (n,3n)

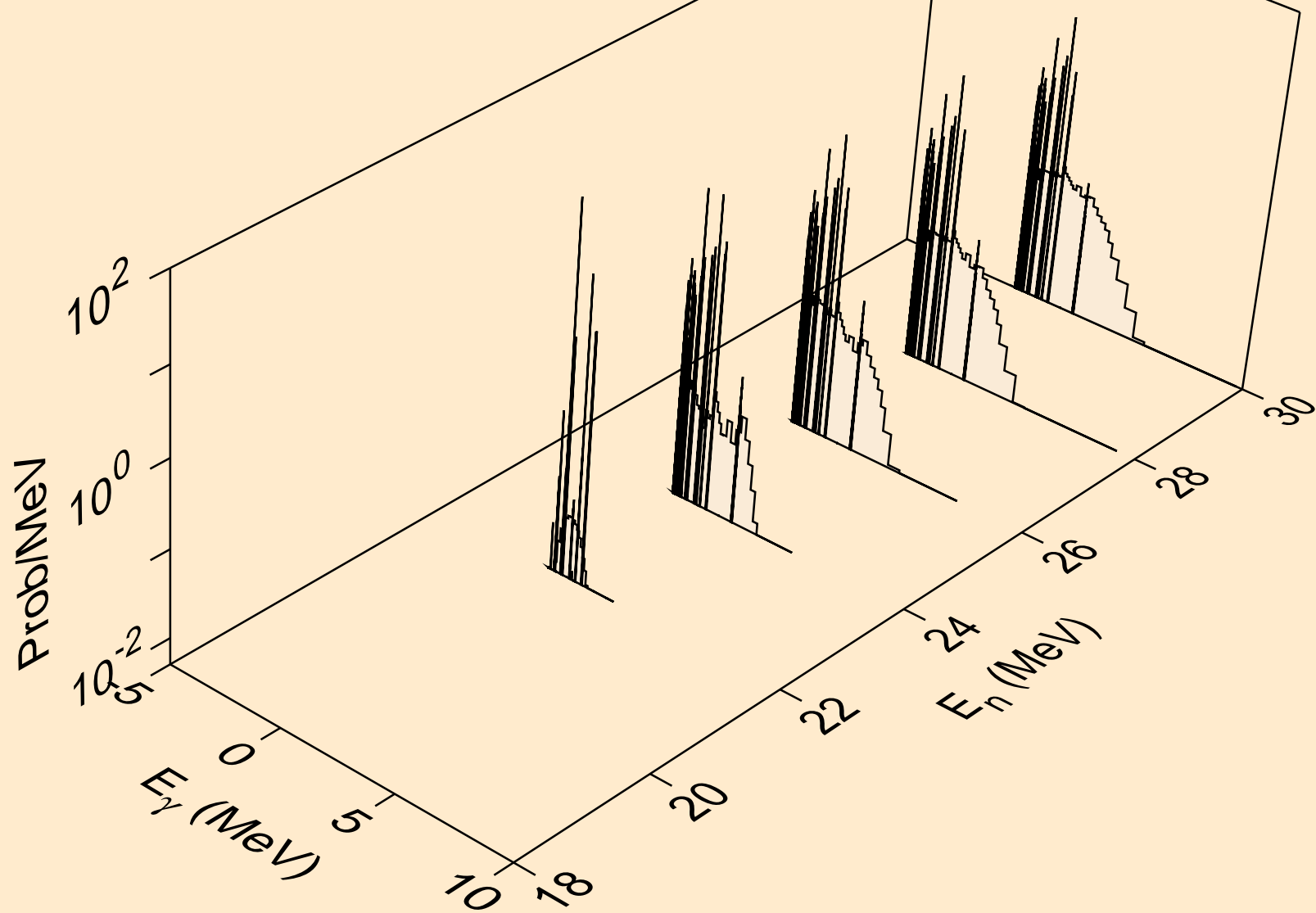

YB155 NEUTRON ACER TENDL-2024 LIBRARY; T=293.6K
Photon emission for (n,n*)a

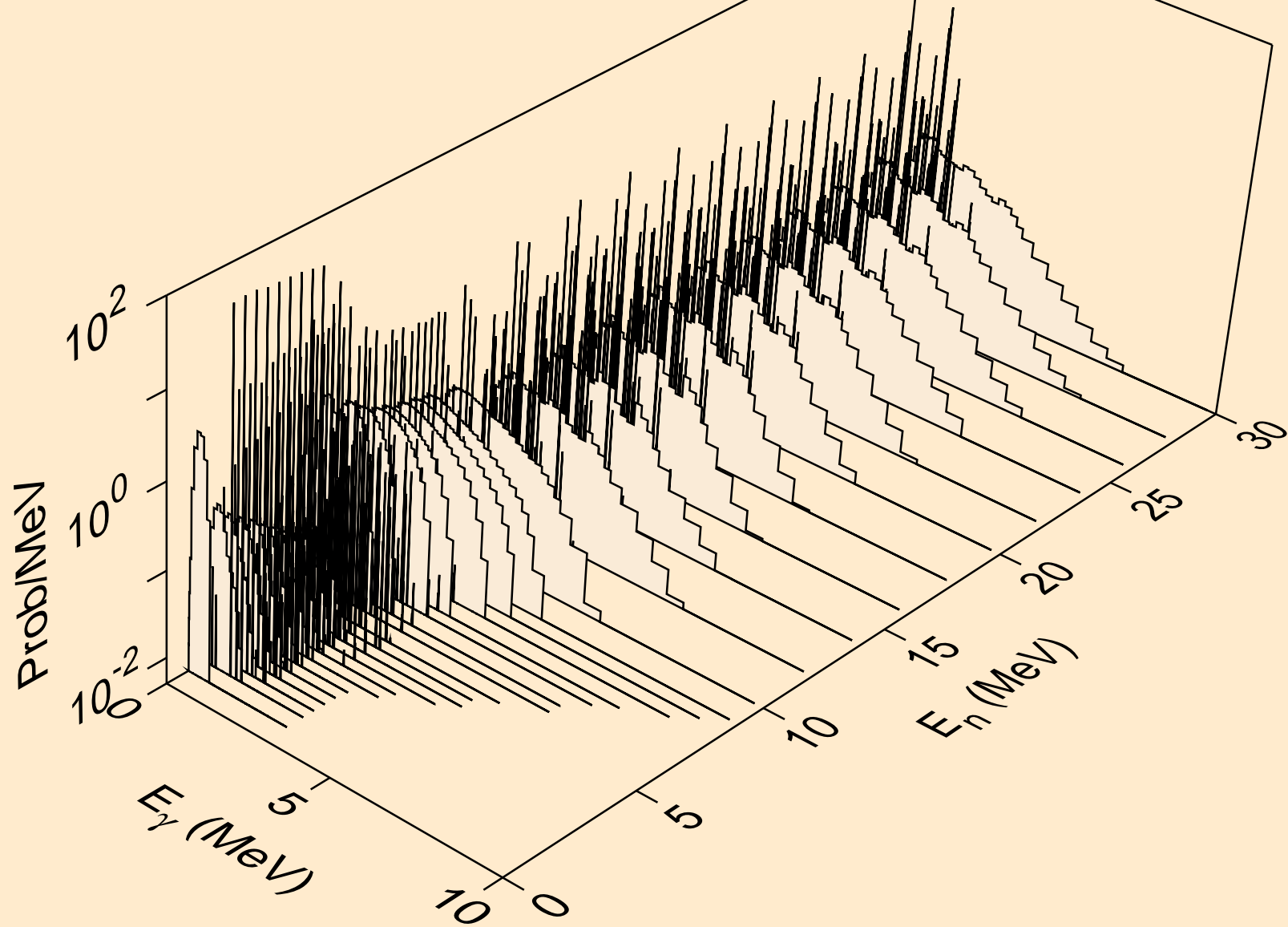

YB155 NEUTRON ACER TENDL-2024 LIBRARY; T=293.6K
Photon emission for (n,2n)a

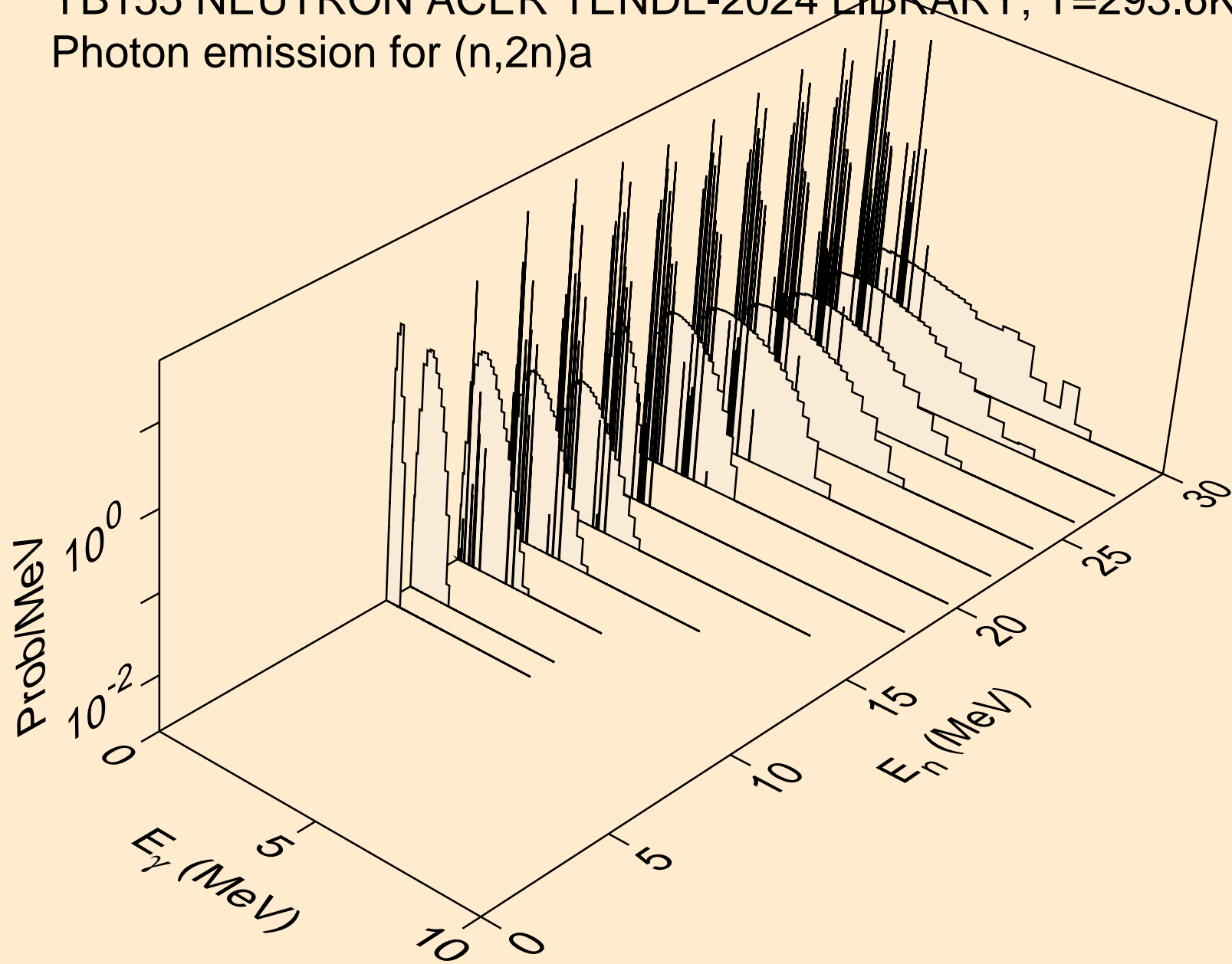

YB155 NEUTRON ACER TENDL-2024 LIBRARY; T=293.6K
Photon emission for (n,3n)a

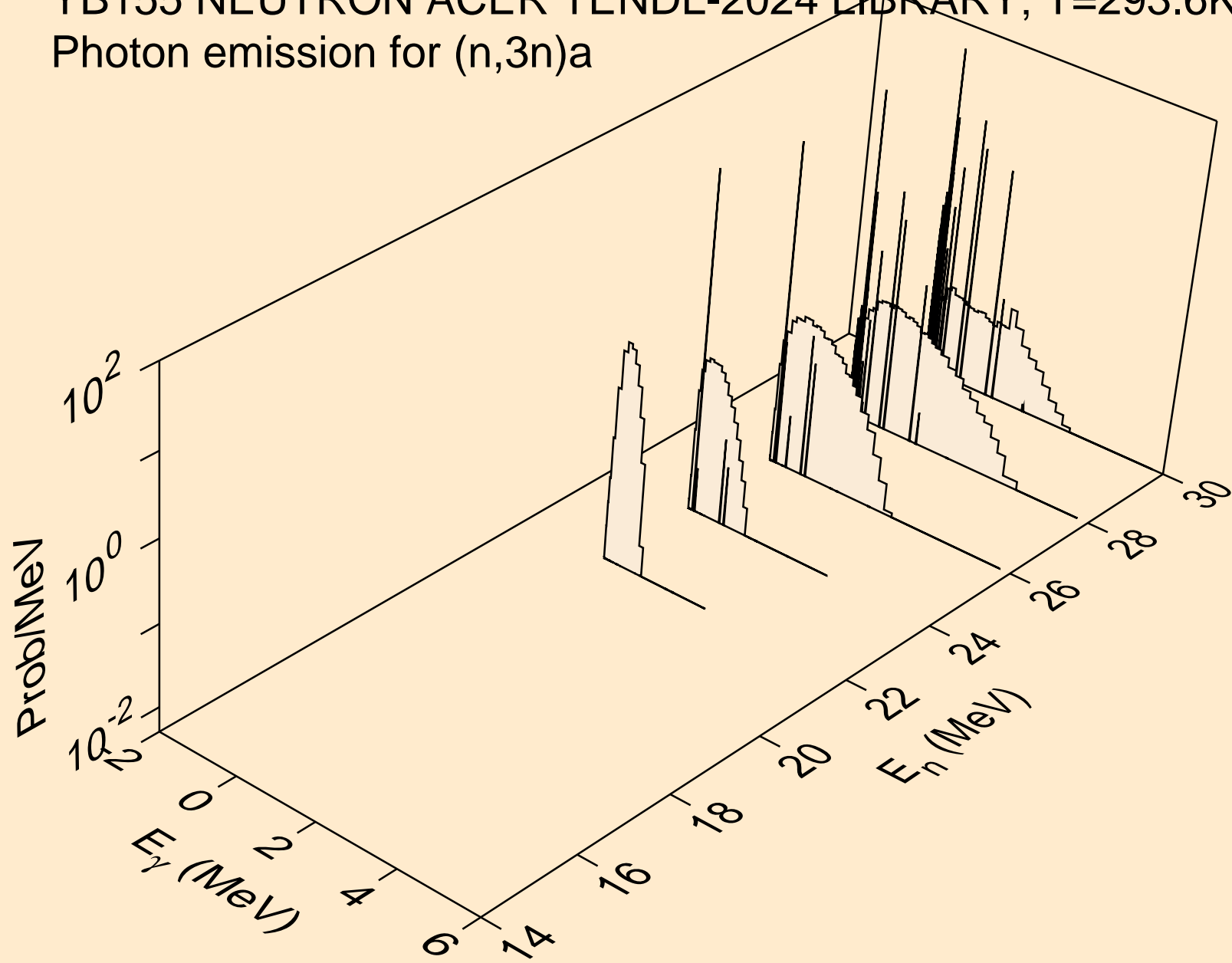

YB155 NEUTRON ACER TENDL-2024 LIBRARY; T=293.6K
Photon emission for (n,n*)p

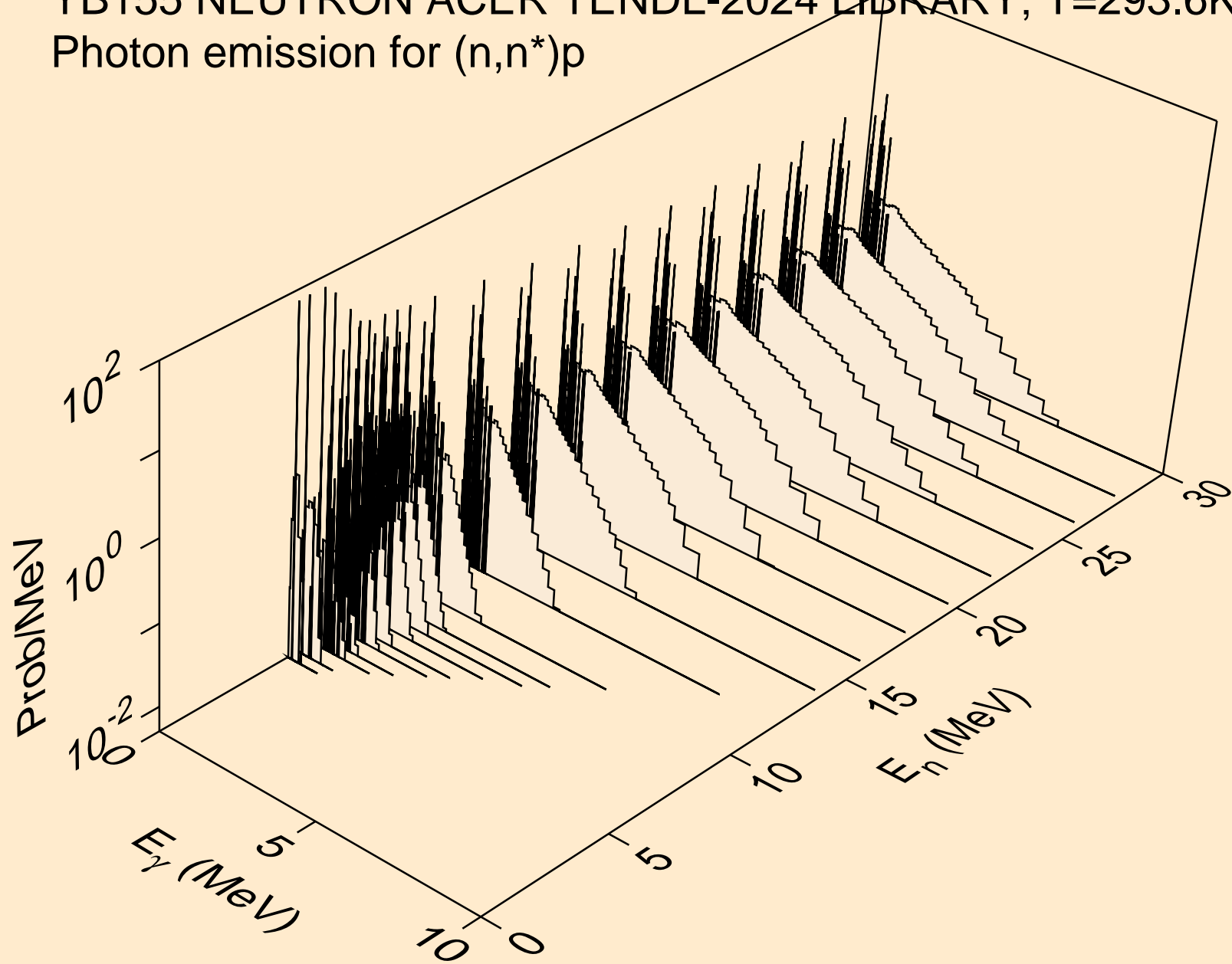

YB155 NEUTRON ACER TENDL-2024 LIBRARY; T=293.6K
Photon emission for (n,n*)2a

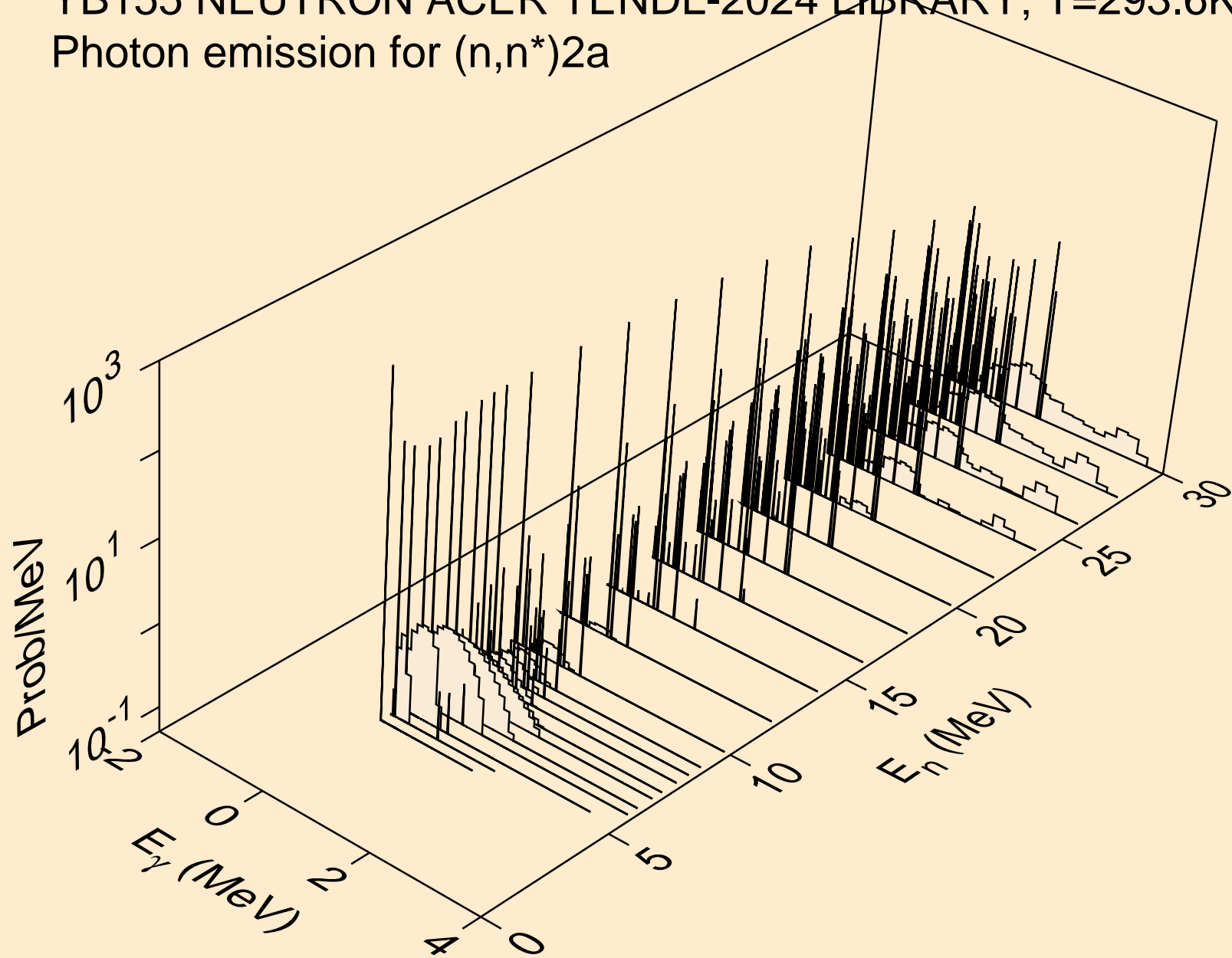

YB155 NEUTRON ACER TENDL-2024 LIBRARY; T=293.6K
Photon emission for (n,2n)2a

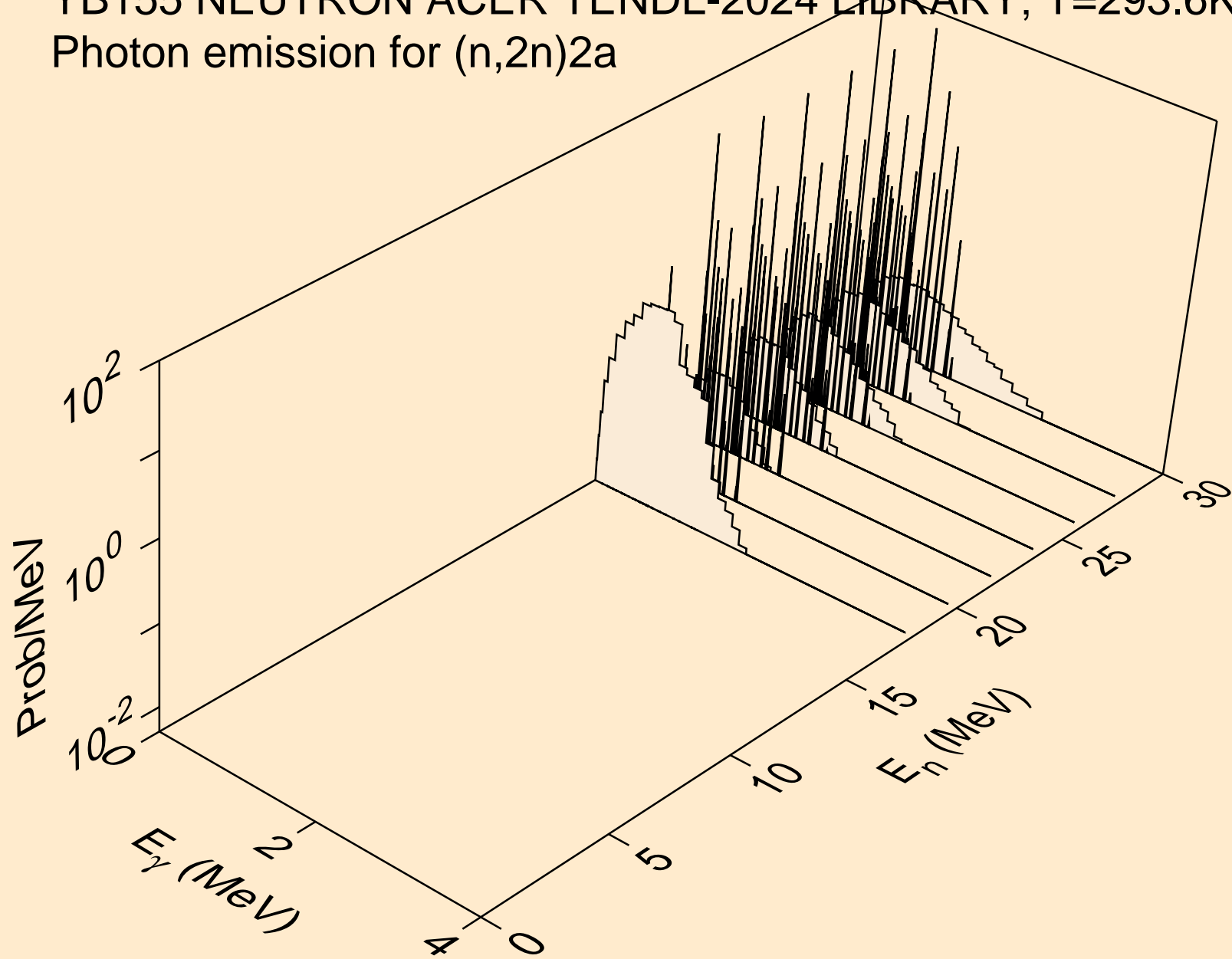

YB155 NEUTRON ACER TENDL-2024 LIBRARY; T=293.6K
Photon emission for (n,n*)d

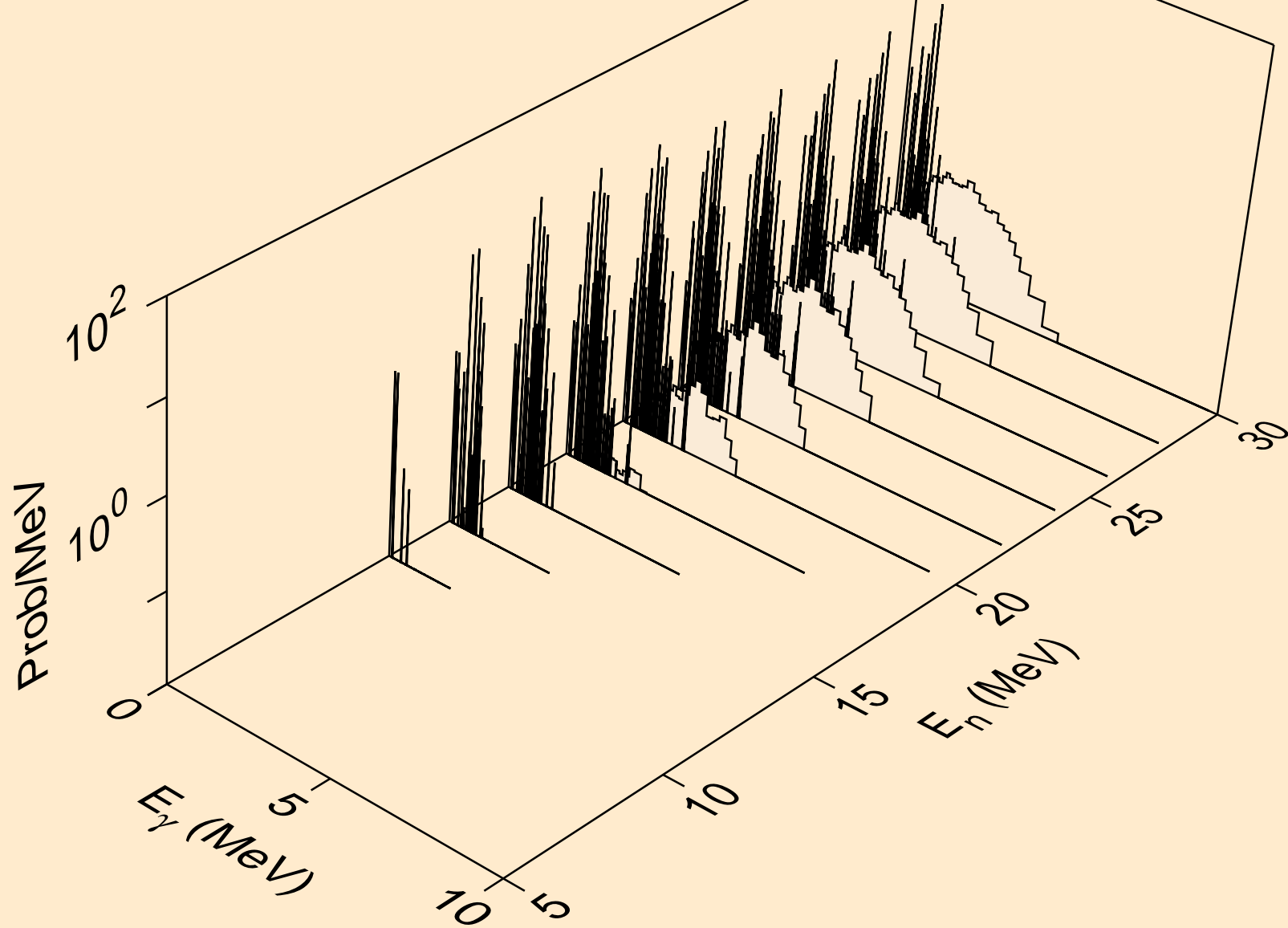

YB155 NEUTRON ACER TENDL-2024 LIBRARY; T=293.6K
Photon emission for (n,n*)t

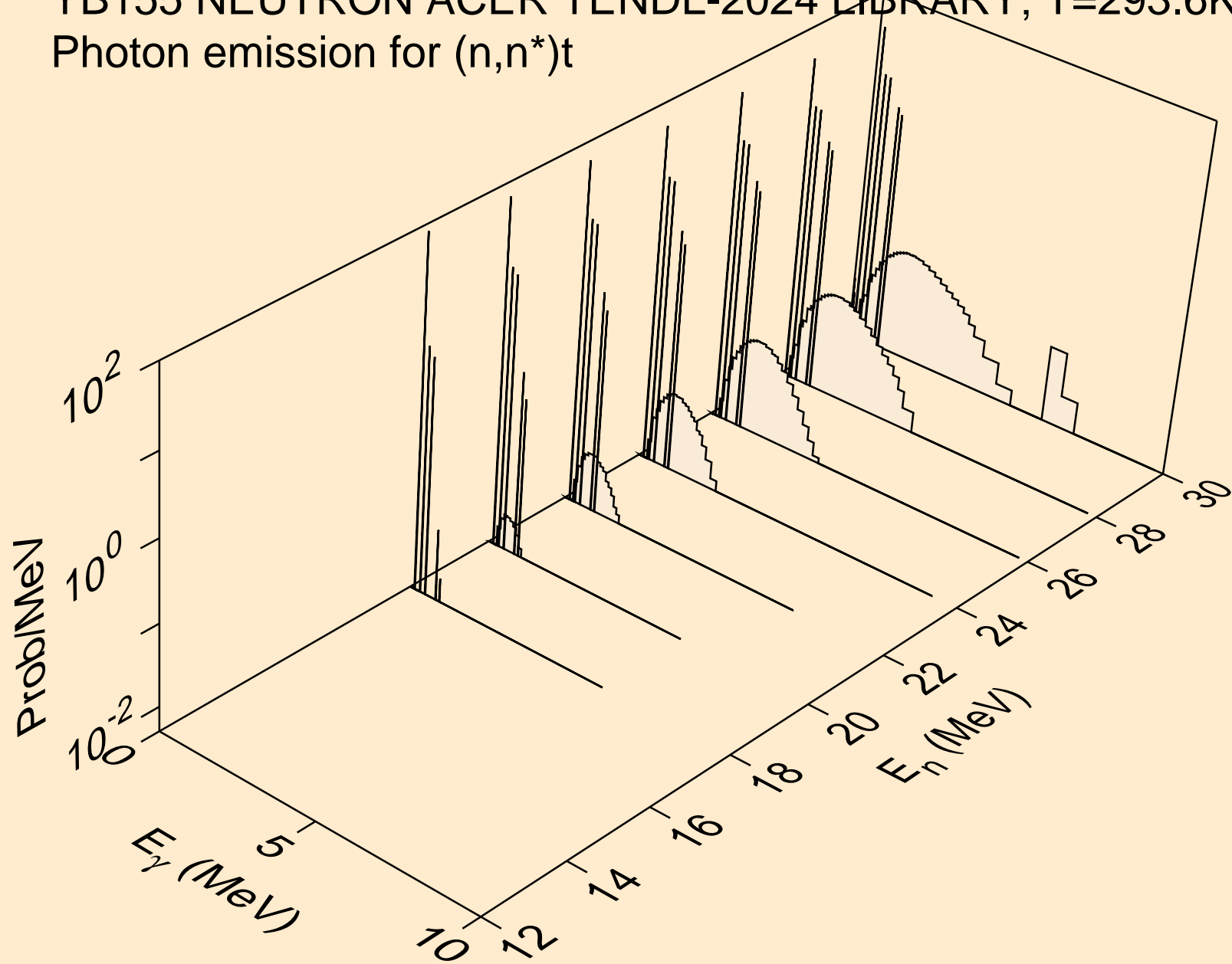

YB155 NEUTRON ACER TENDL-2024 LIBRARY; T=293.6K
Photon emission for (n,n*)he3

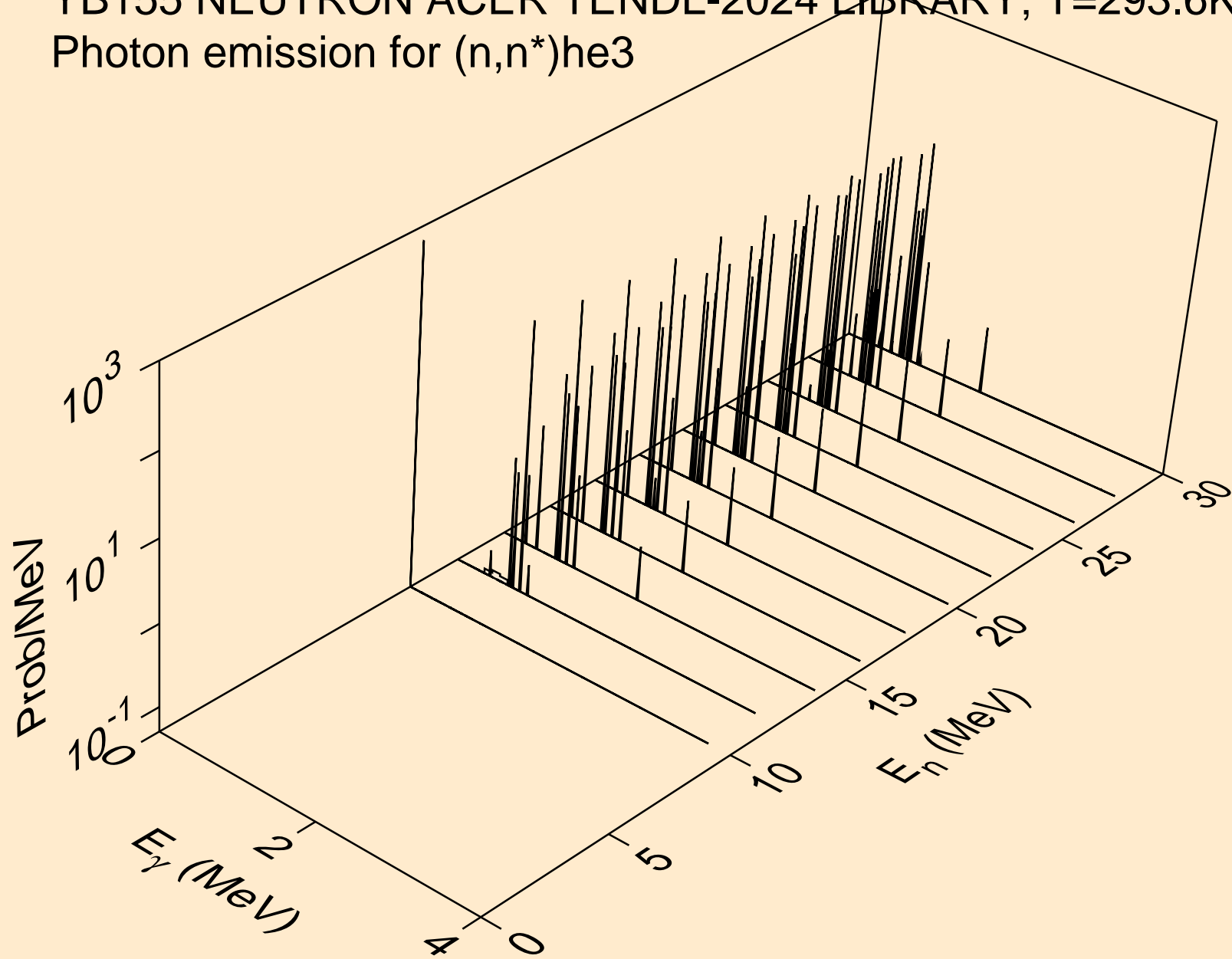

YB155 NEUTRON ACER TENDL-2024 LIBRARY; T=293.6K
Photon emission for (n,4n)

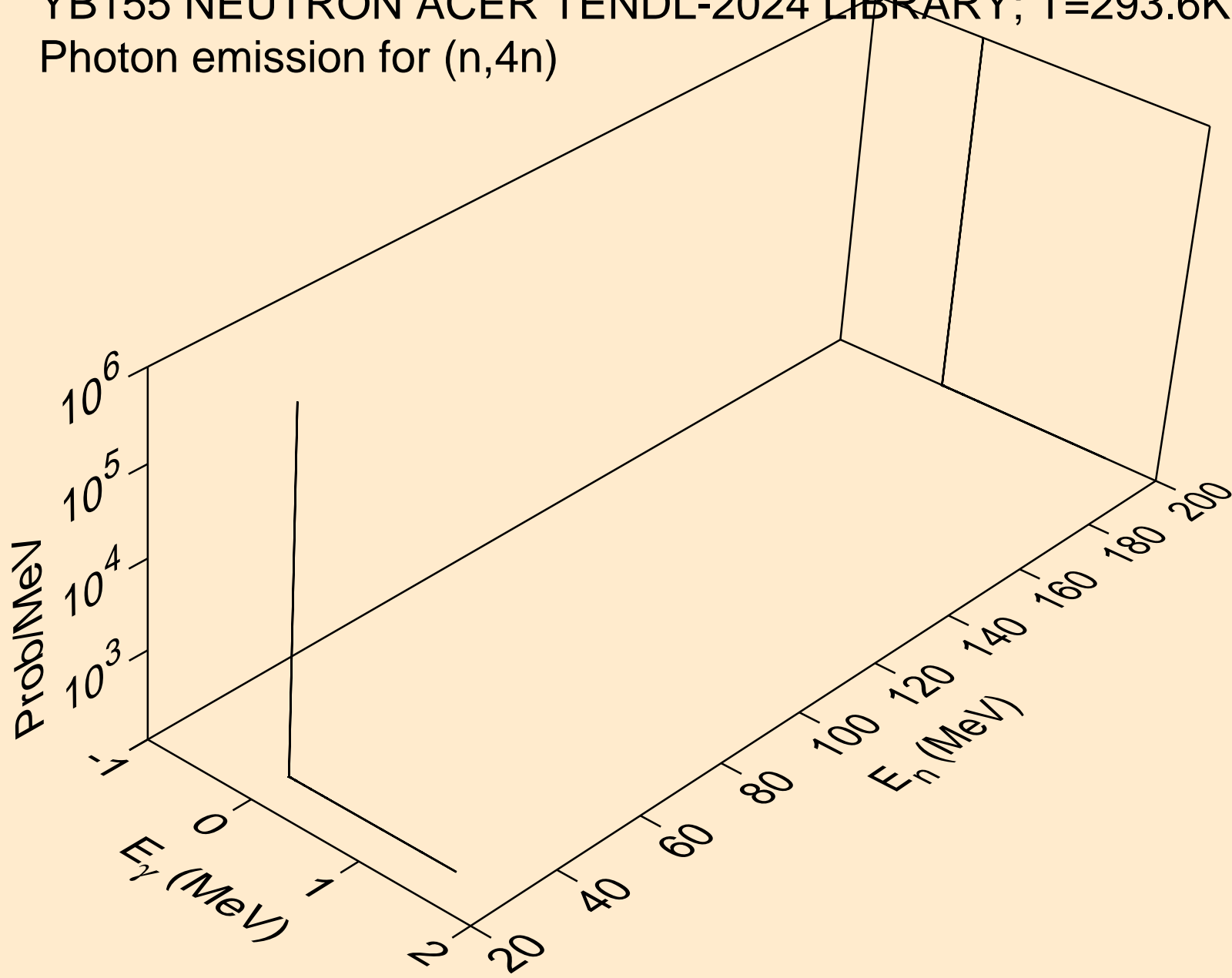

YB155 NEUTRON ACER TENDL-2024 LIBRARY; T=293.6K
Photon emission for (n,2np)

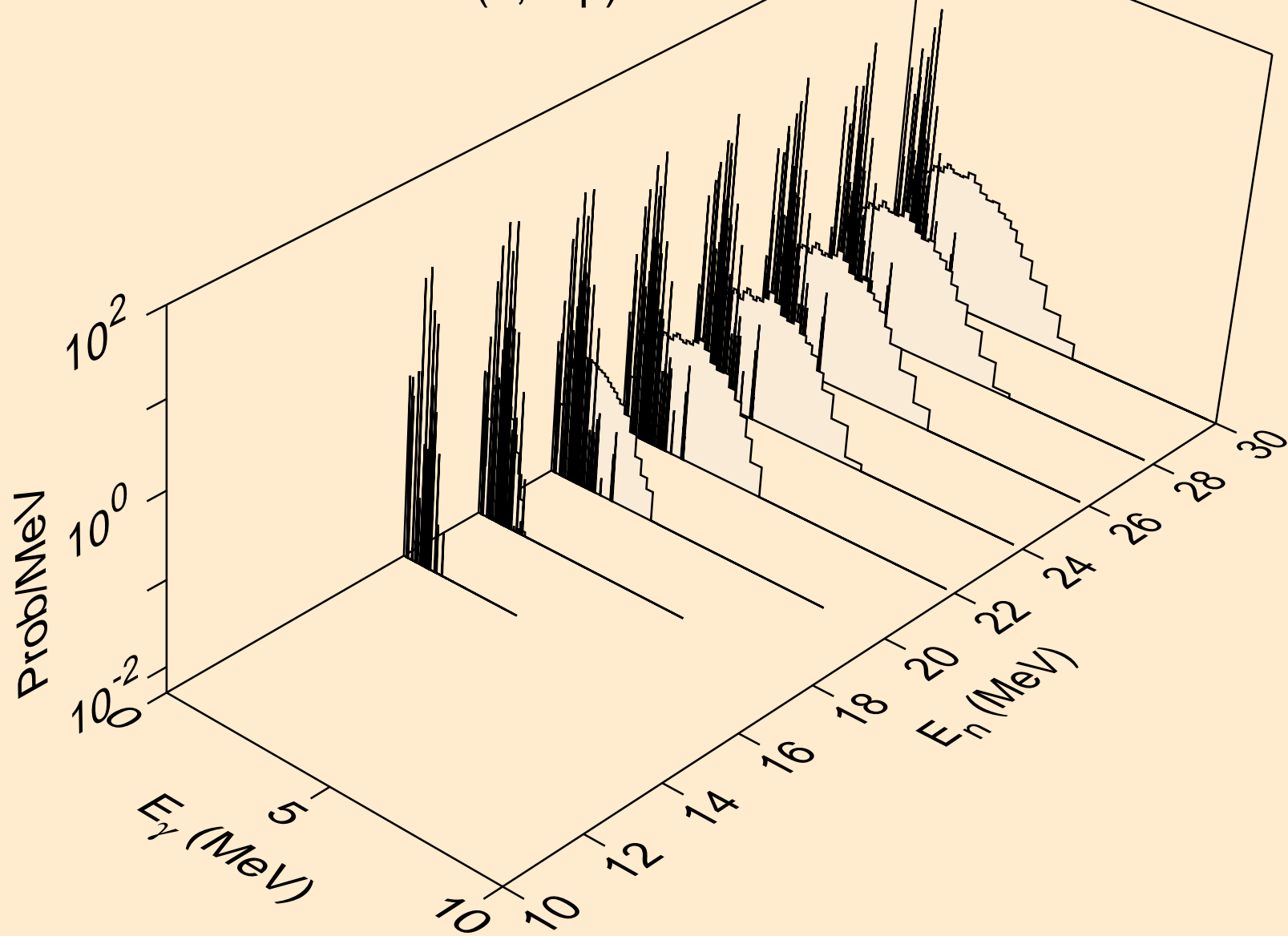

YB155 NEUTRON ACER TENDL-2024 LIBRARY; T=293.6K
Photon emission for (n,3np)

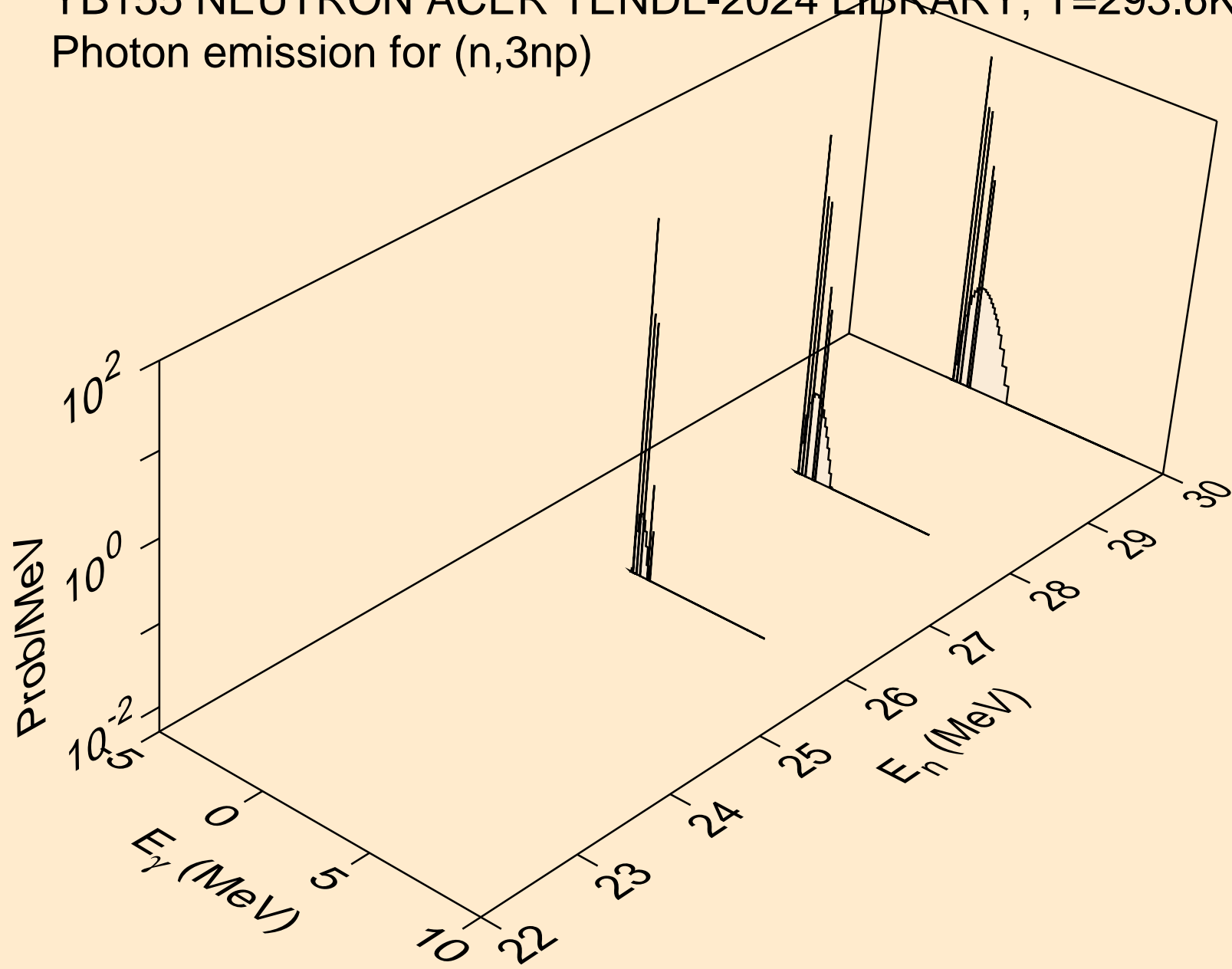

YB155 NEUTRON ACER TENDL-2024 LIBRARY; T=293.6K
Photon emission for (n,n2p)

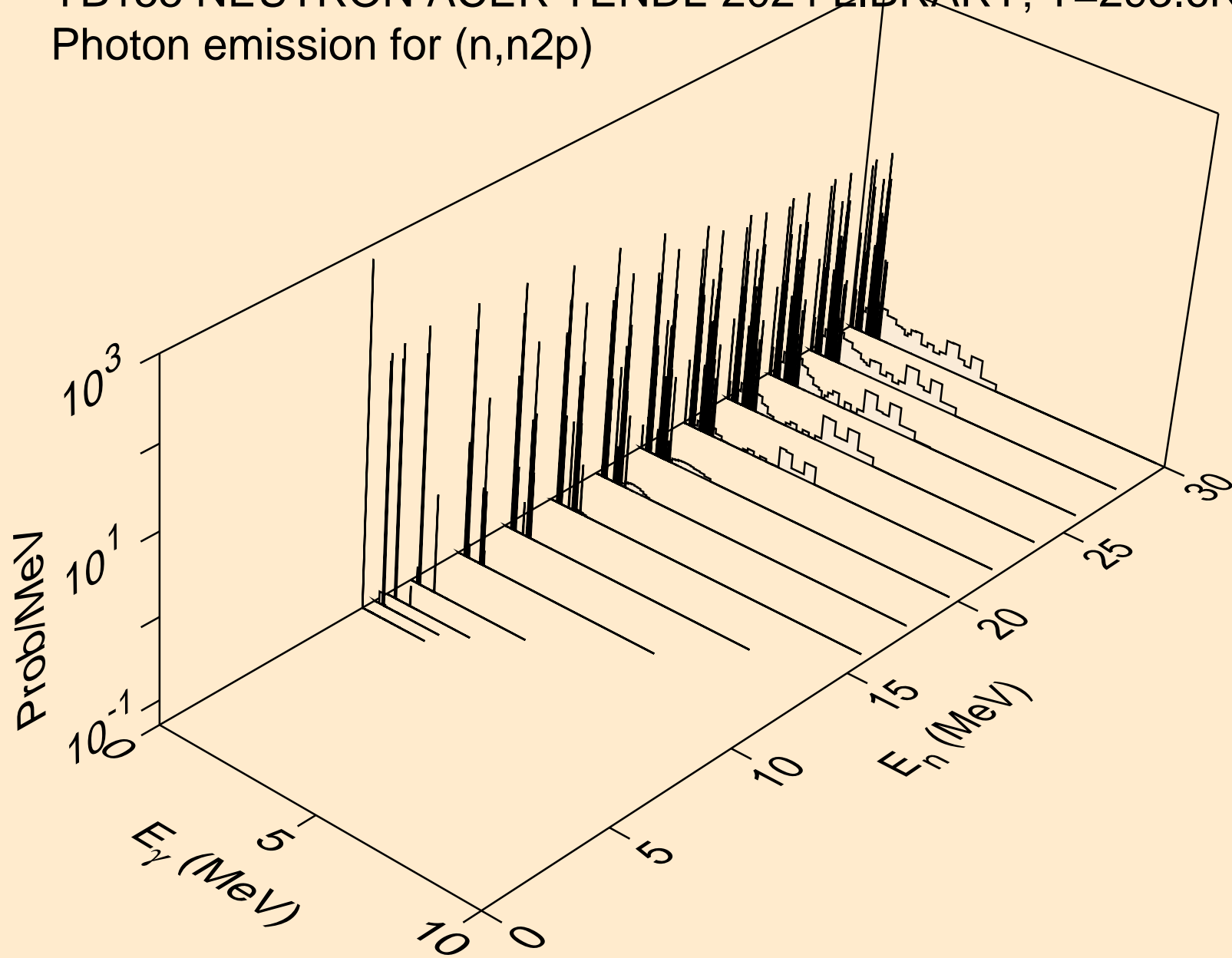

YB155 NEUTRON ACER TENDL-2024 LIBRARY; T=293.6K
Photon emission for (n,npa)

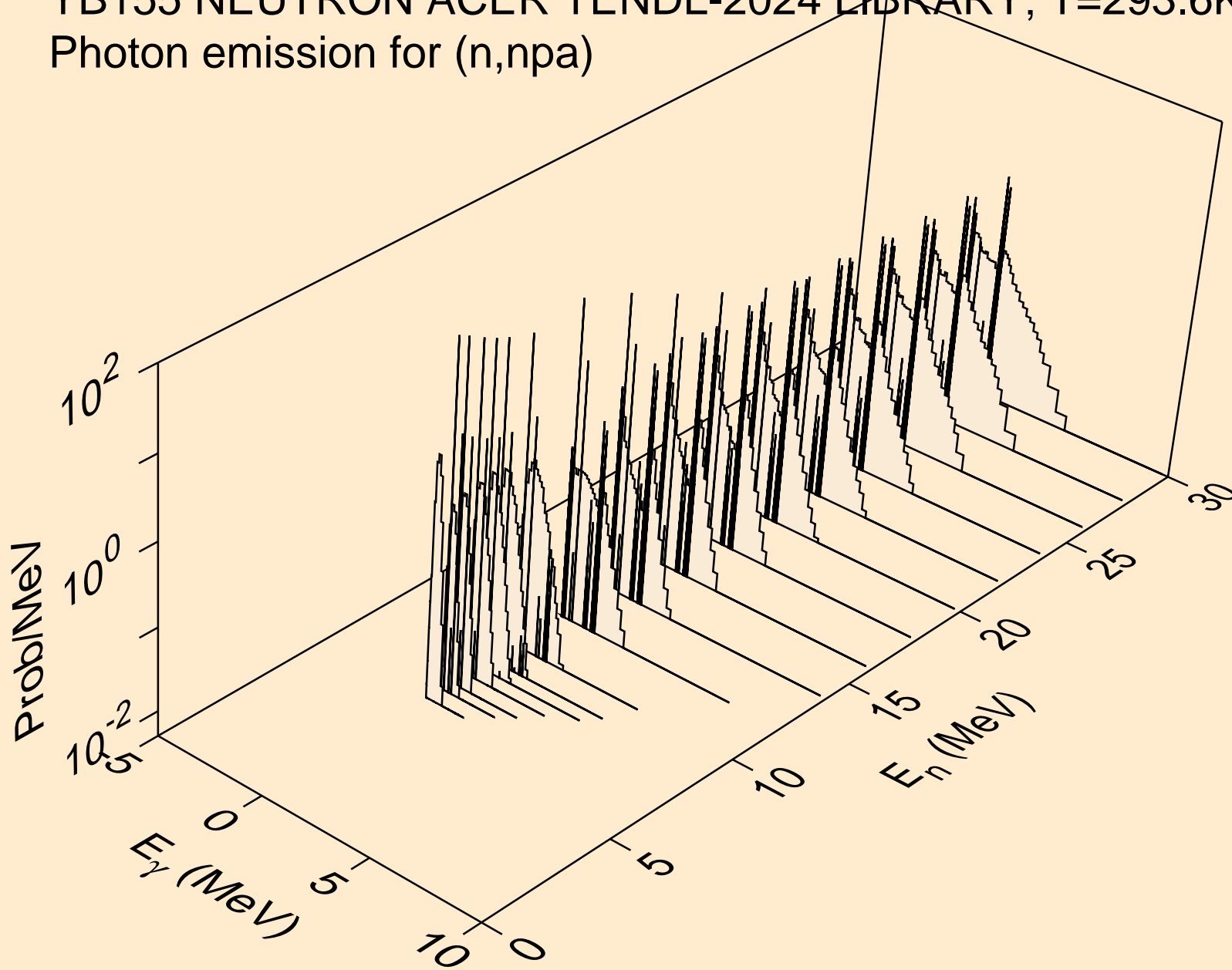

YB155 NEUTRON ACER TENDL-2024 LIBRARY; T=293.6K
Photon emission for (n,n*c)

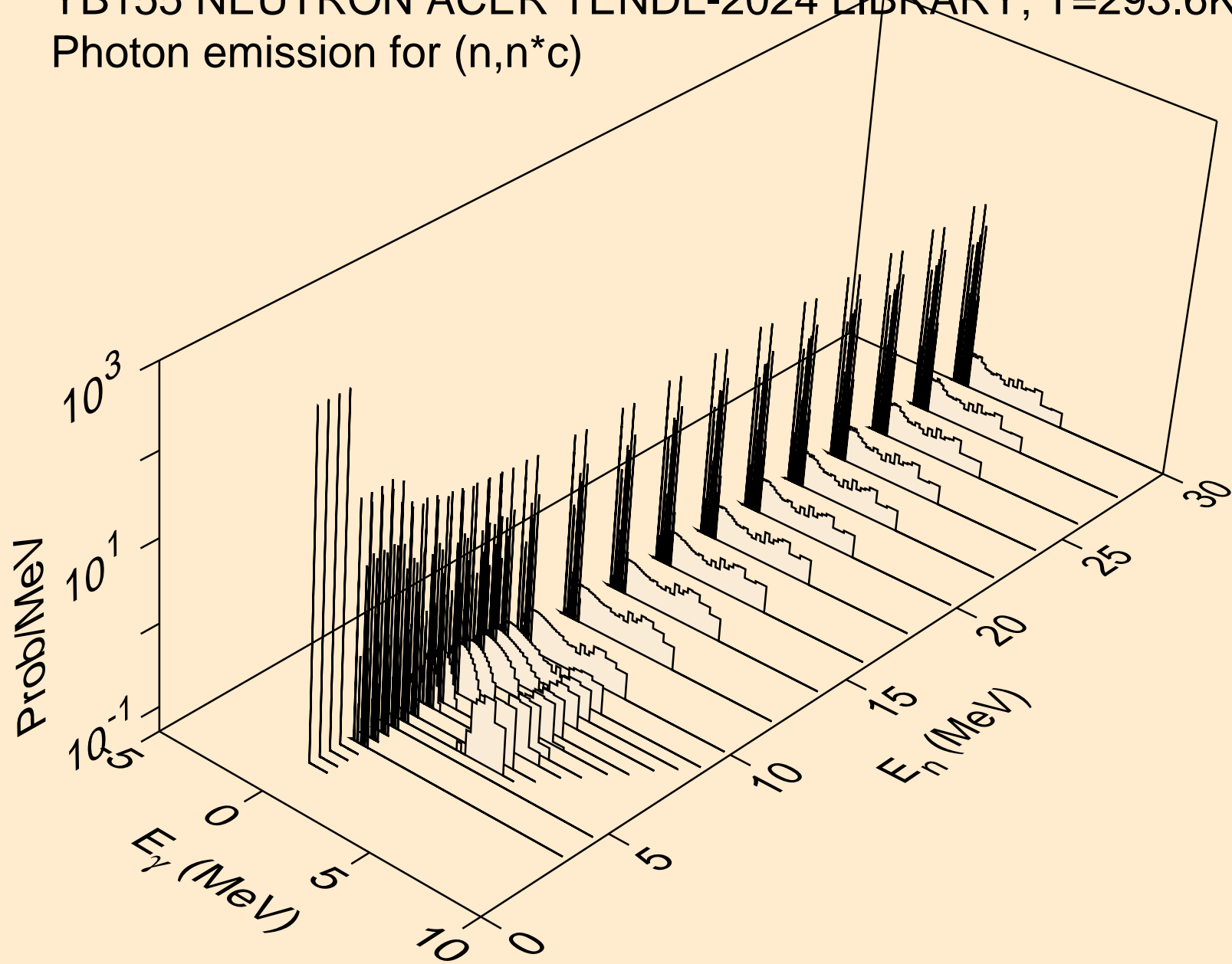

YB155 NEUTRON ACER TENDL-2024 LIBRARY; T=293.6K
Photon emission for (n,gma)

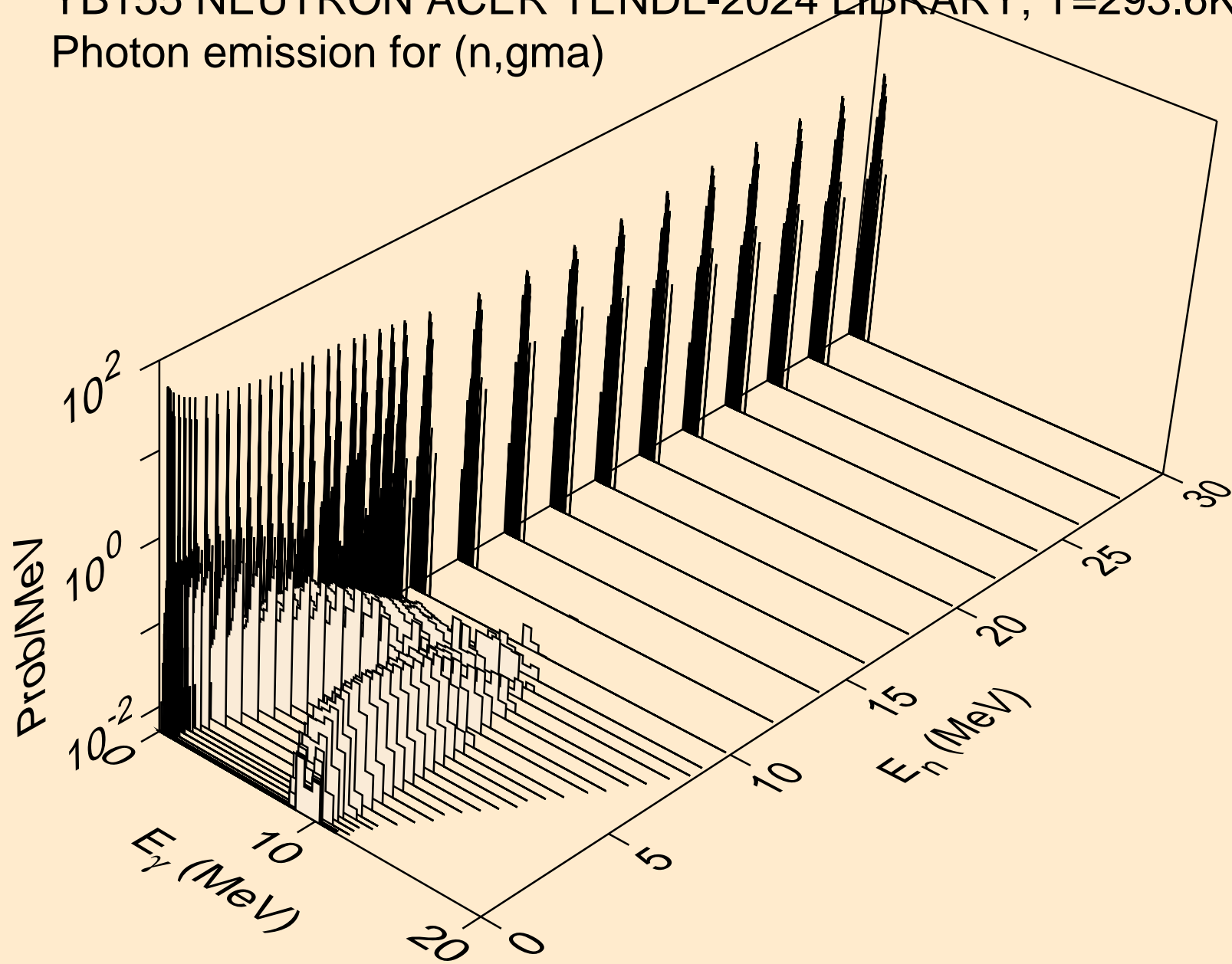

YB155 NEUTRON ACER TENDL-2024 LIBRARY; T=293.6K
Photon emission for (n,p)

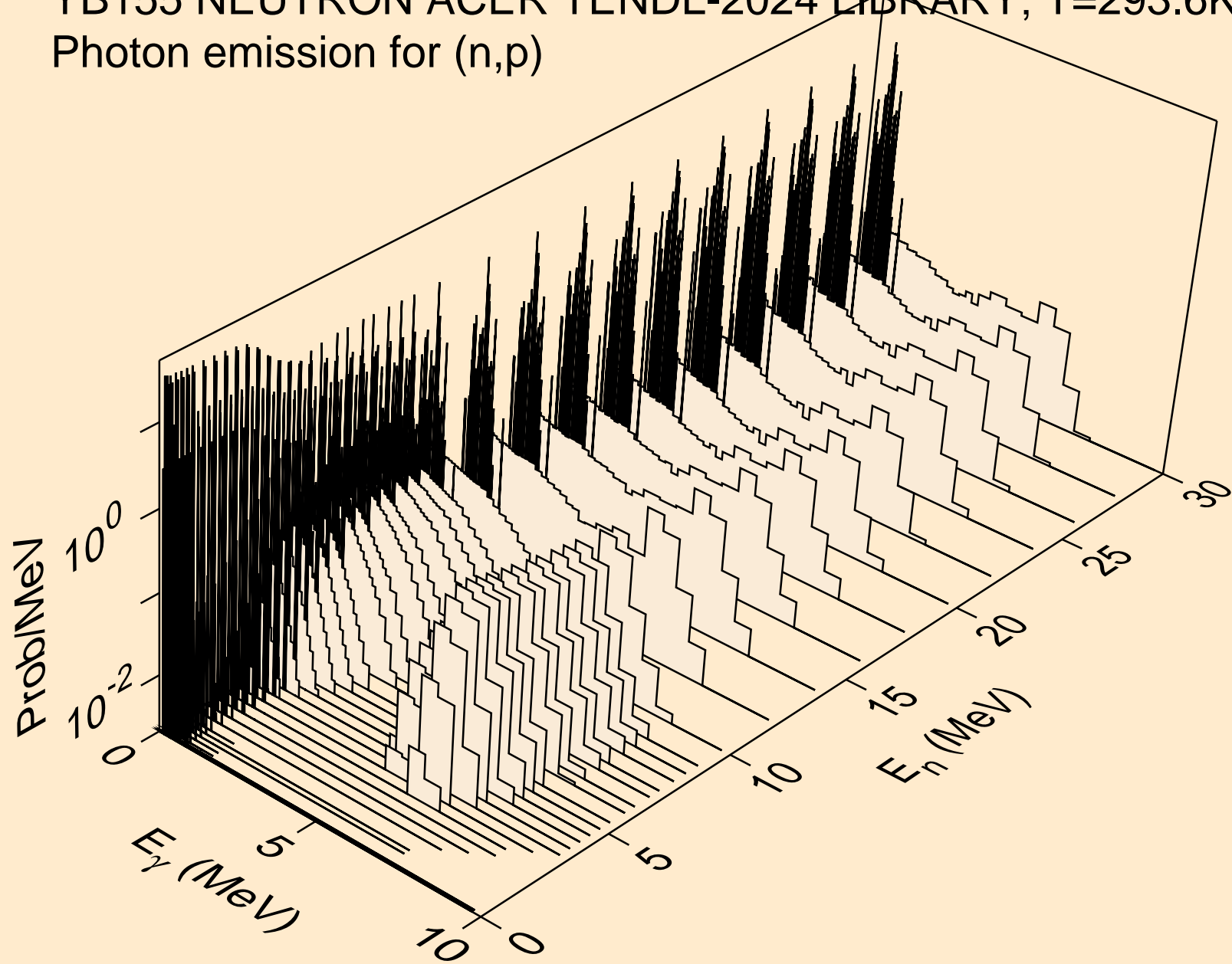

YB155 NEUTRON ACER TENDL-2024 LIBRARY; T=293.6K
Photon emission for (n,d)

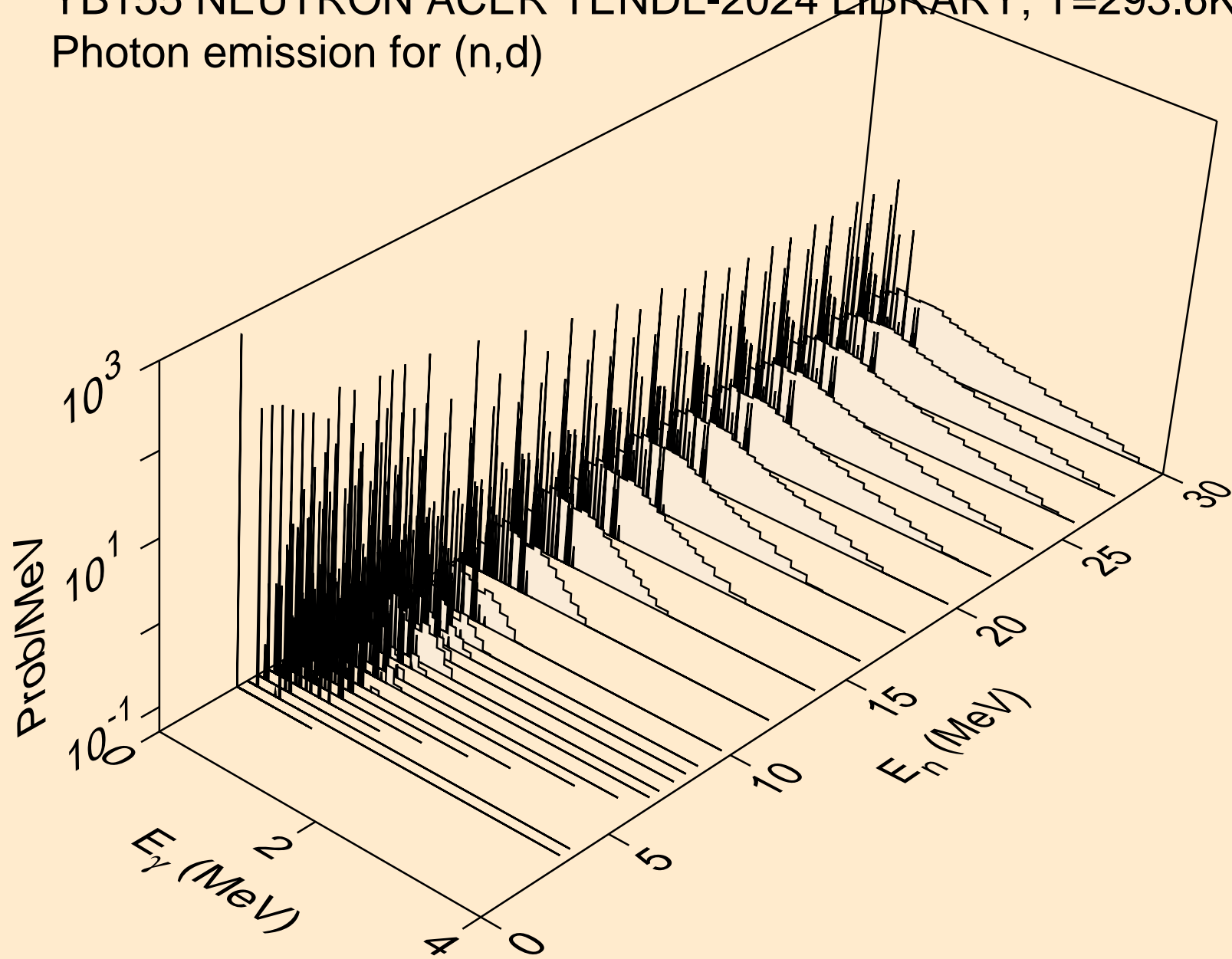

YB155 NEUTRON ACER TENDL-2024 LIBRARY; T=293.6K
Photon emission for (n,t)

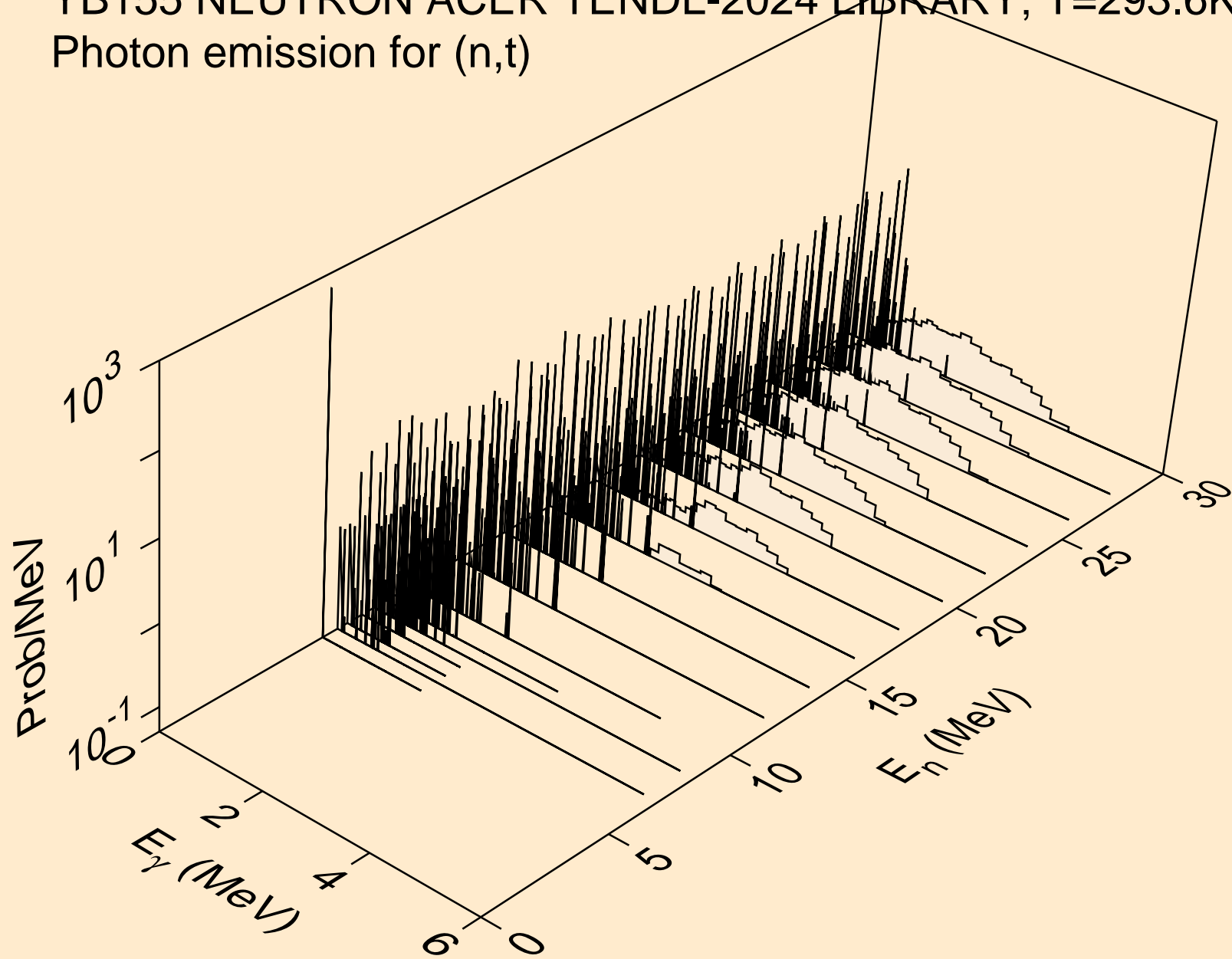

YB155 NEUTRON ACER TENDL-2024 LIBRARY; T=293.6K
Photon emission for (n,he3)

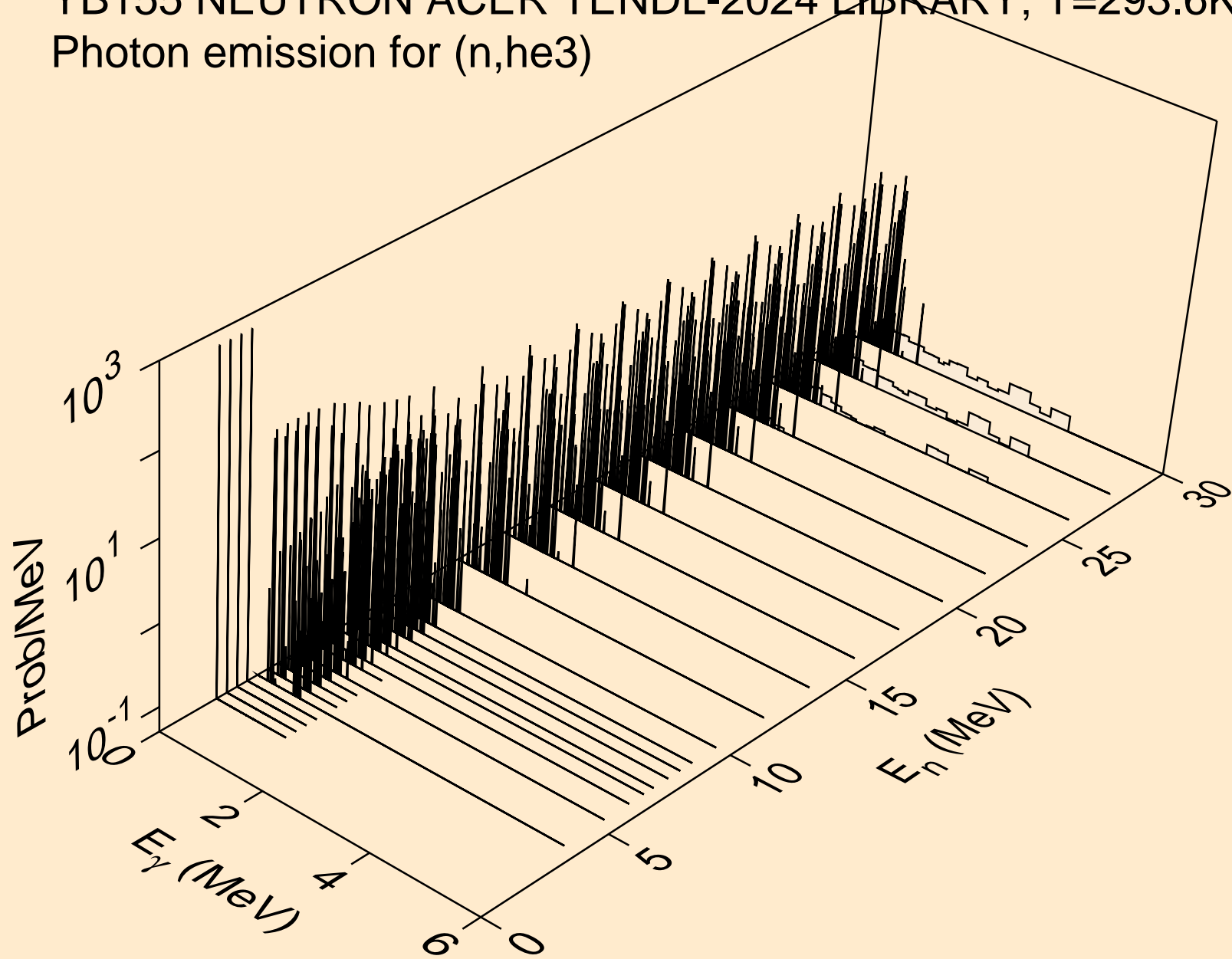

YB155 NEUTRON ACER TENDL-2024 LIBRARY; T=293.6K
Photon emission for (n,a)

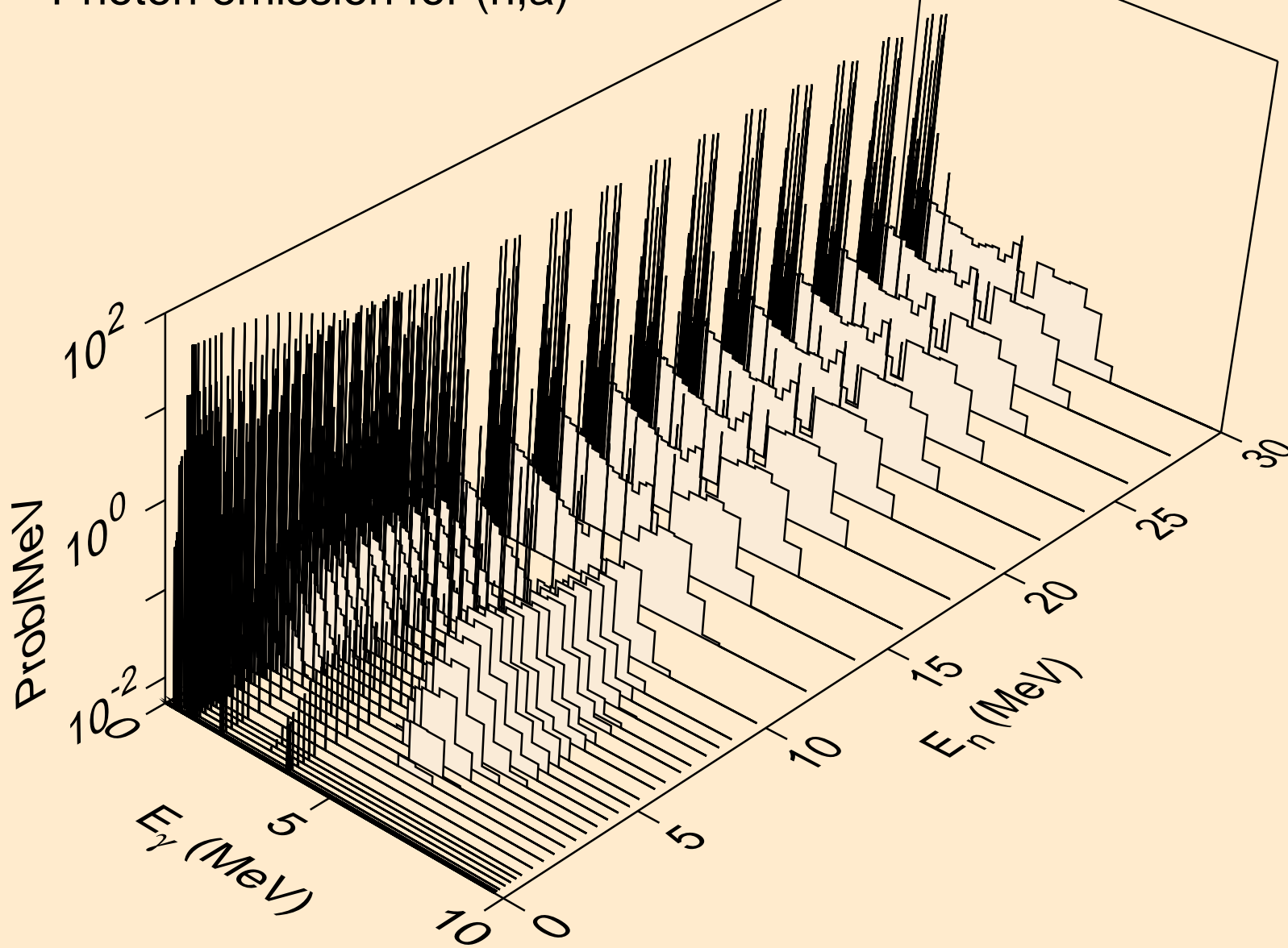

YB155 NEUTRON ACER TENDL-2024 LIBRARY; T=293.6K
Photon emission for (n,2a)

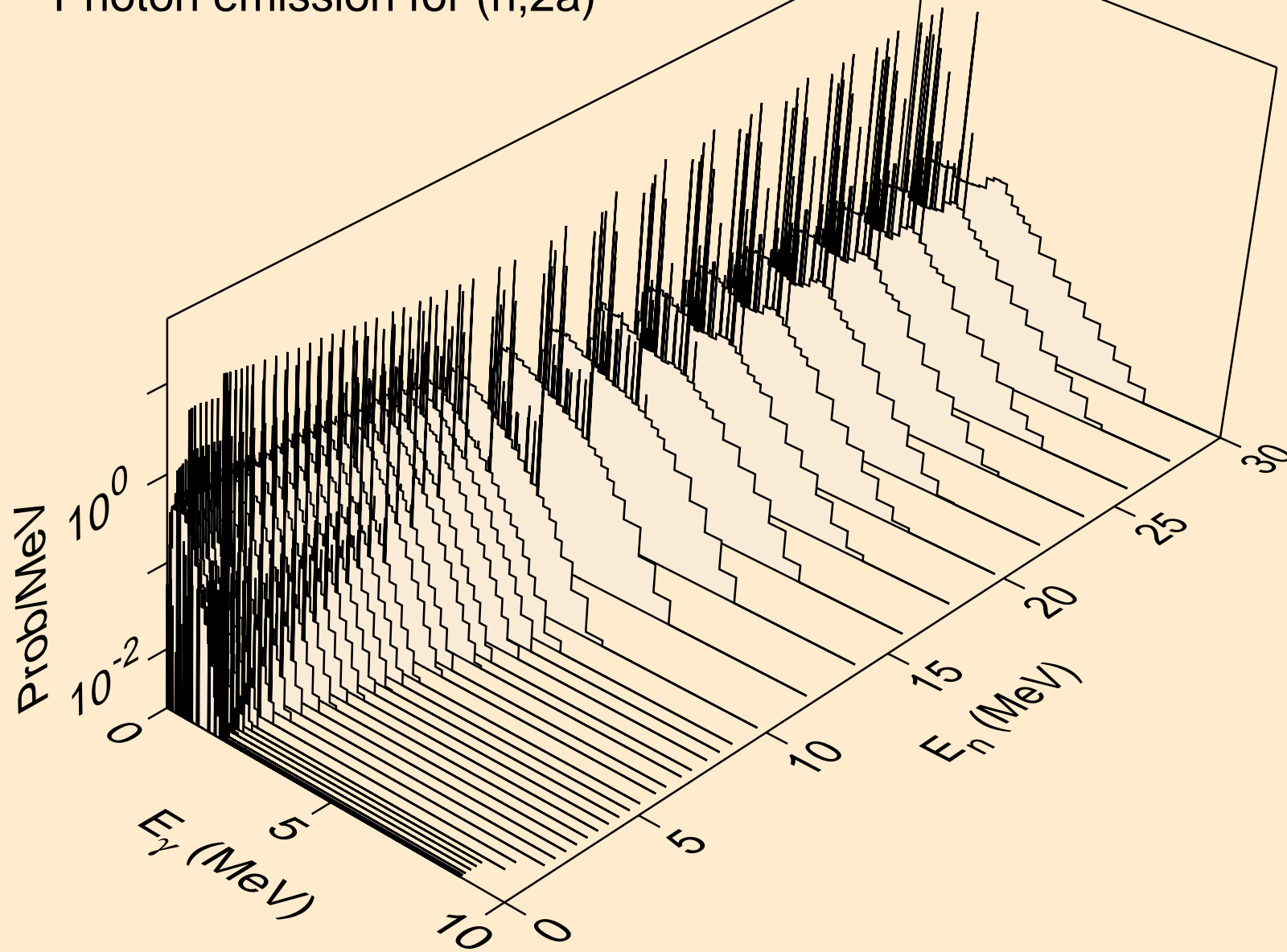

YB155 NEUTRON ACER TENDL-2024 LIBRARY; T=293.6K
Photon emission for (n,3a)

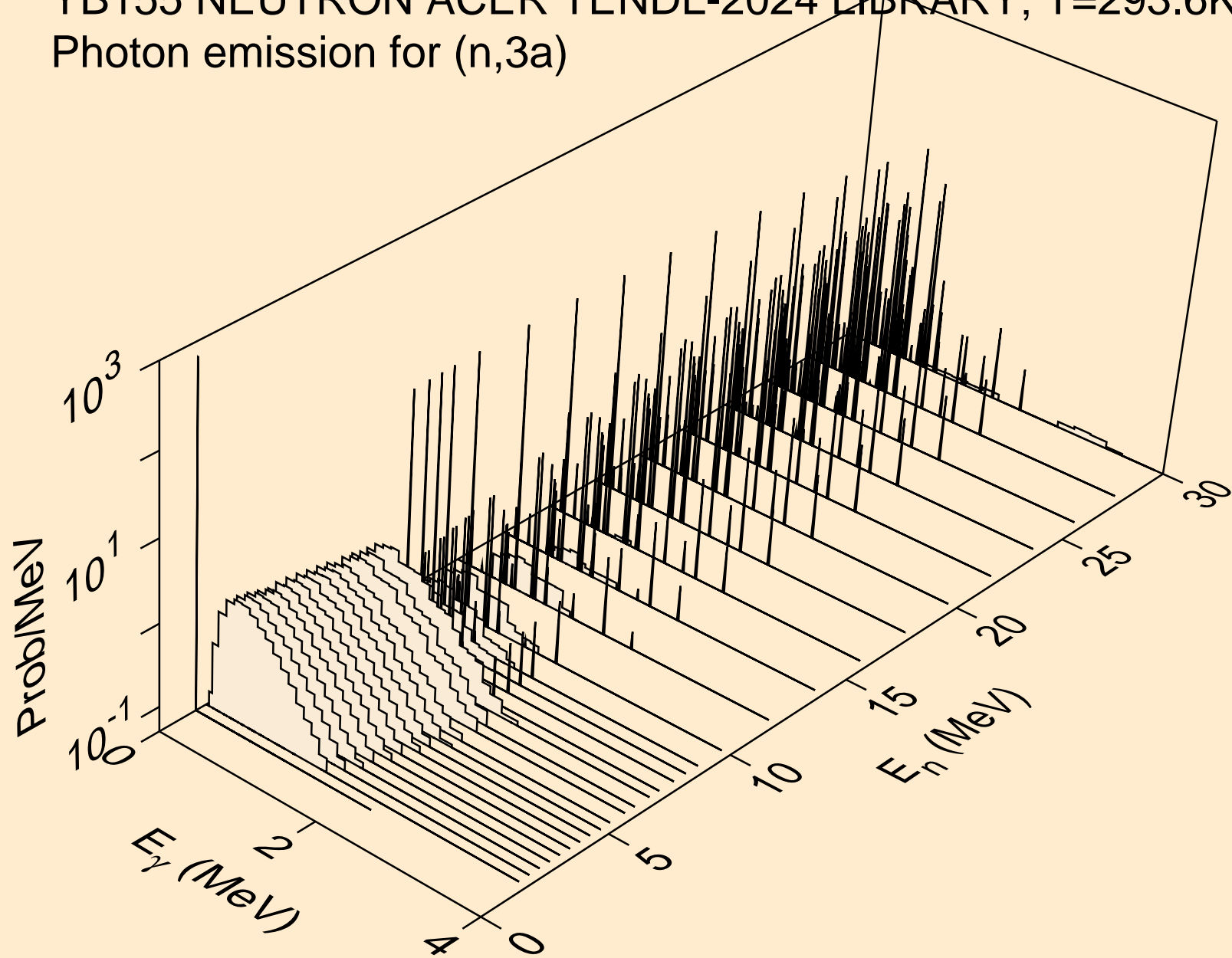

YB155 NEUTRON ACER TENDL-2024 LIBRARY; T=293.6K
Photon emission for (n,2p)

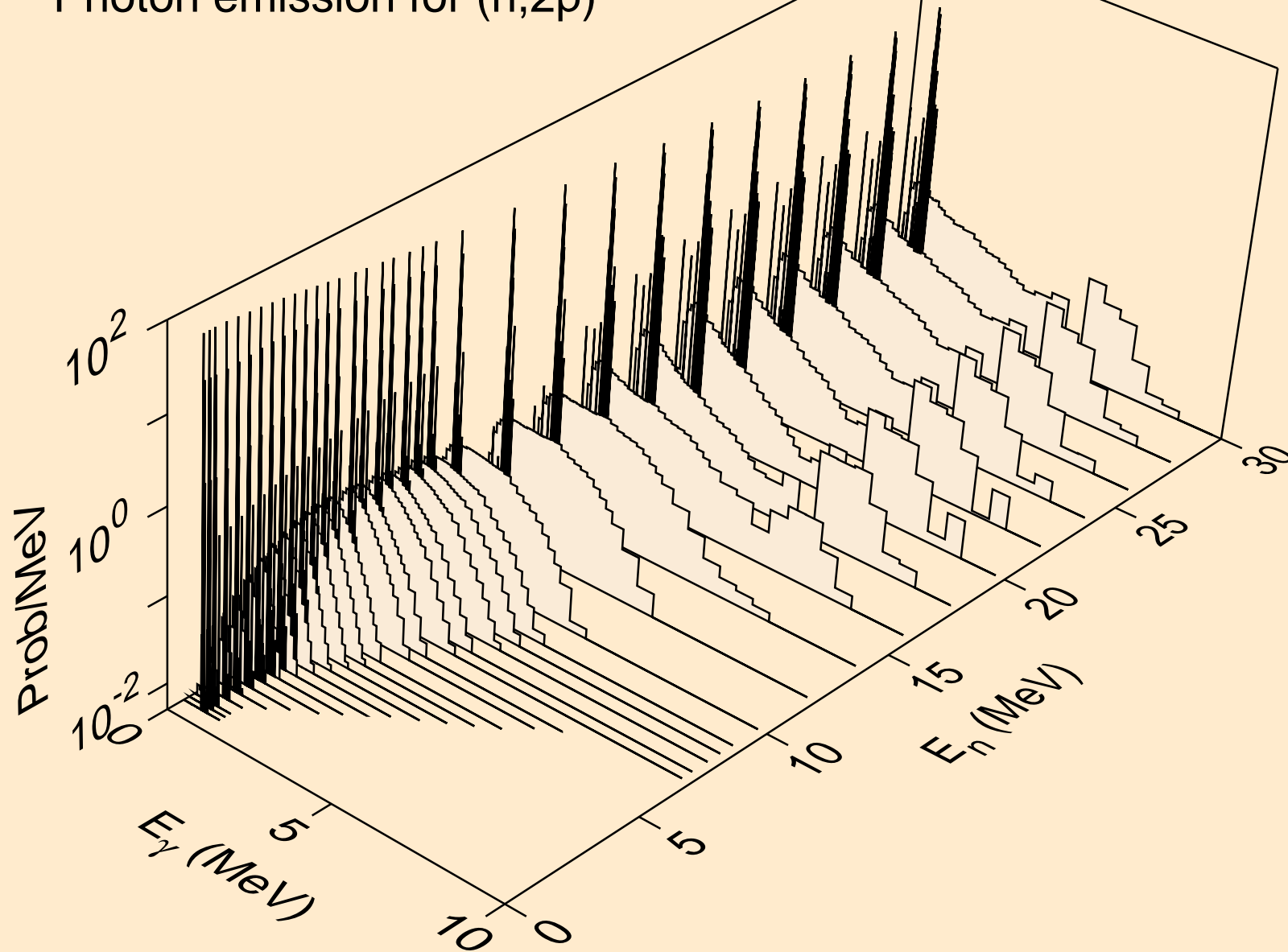

YB155 NEUTRON ACER TENDL-2024 LIBRARY; T=293.6K
Photon emission for (n,p α)

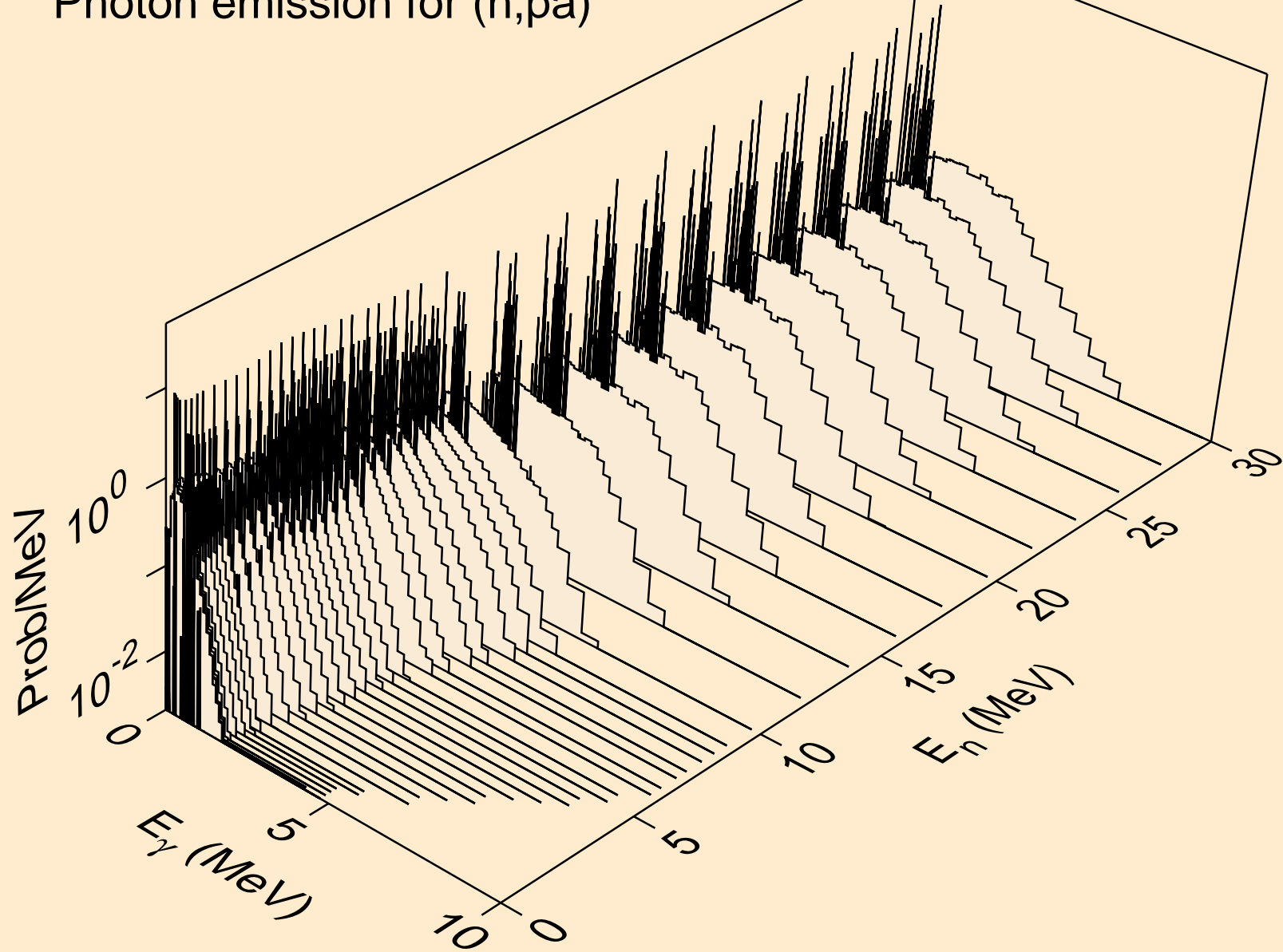

YB155 NEUTRON ACER TENDL-2024 LIBRARY; T=293.6K
Photon emission for (n,d2a)

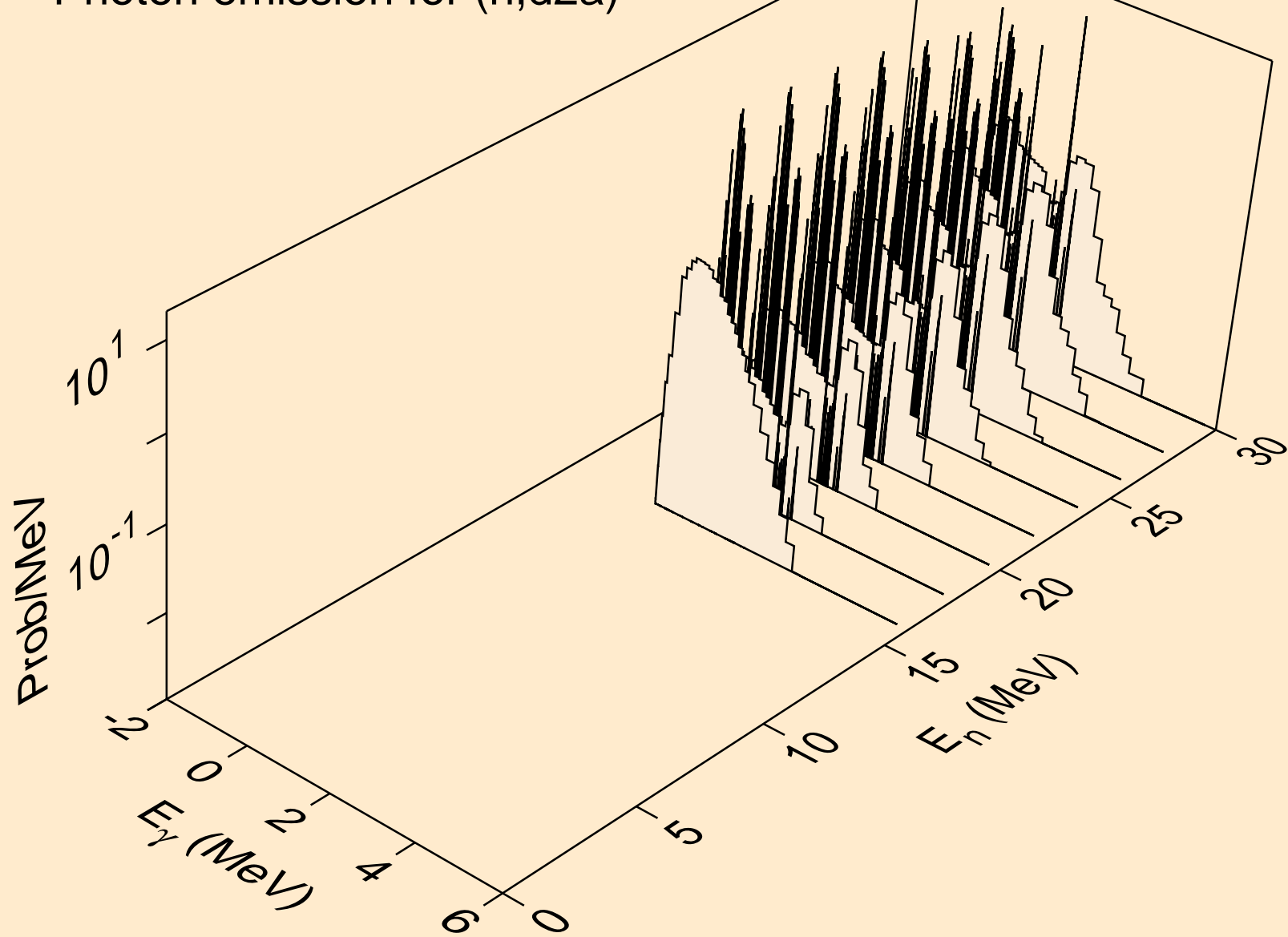

YB155 NEUTRON ACER TENDL-2024 LIBRARY; T=293.6K
Photon emission for (n,pd)

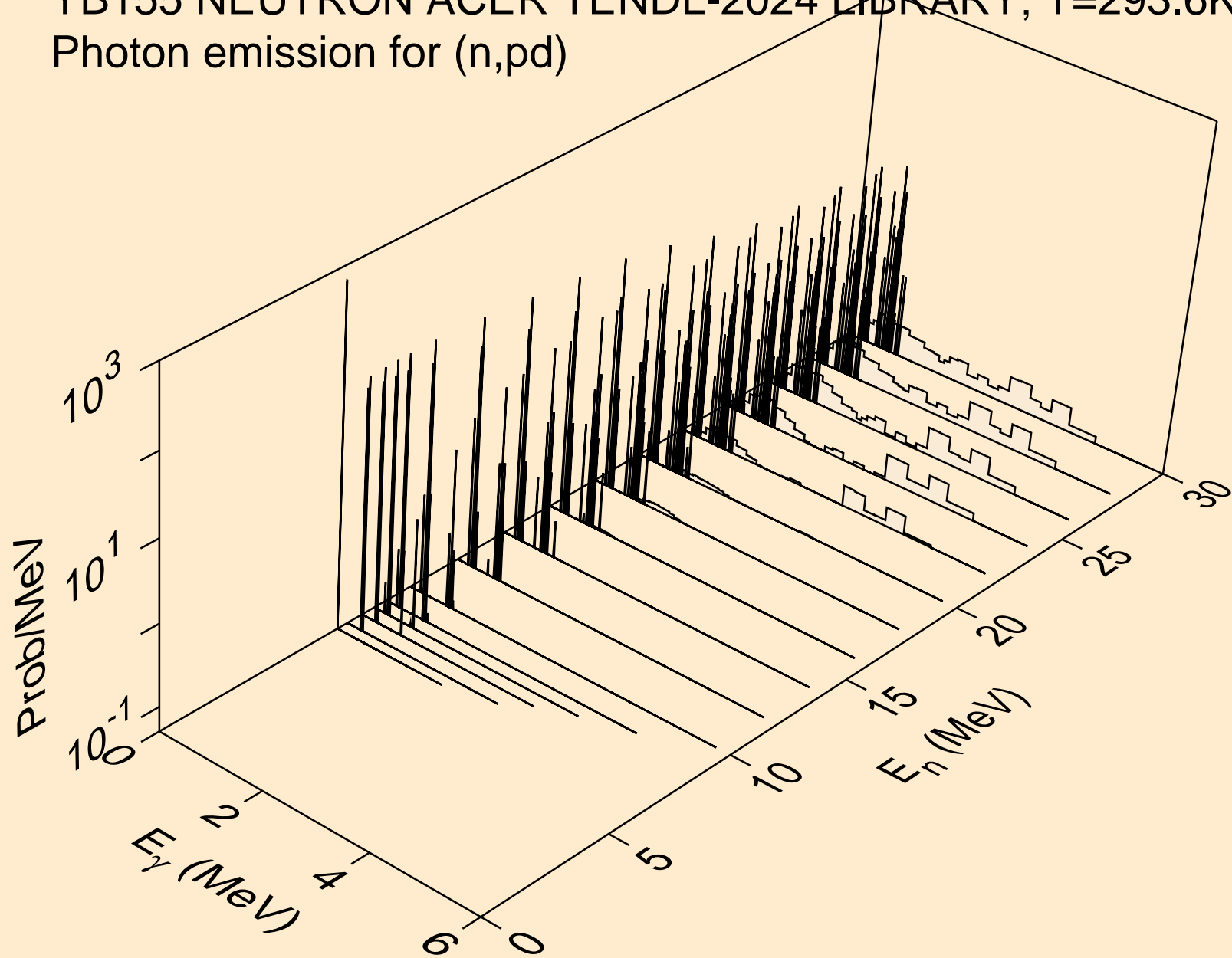

YB155 NEUTRON ACER TENDL-2024 LIBRARY; T=293.6K
Photon emission for (n,pt)

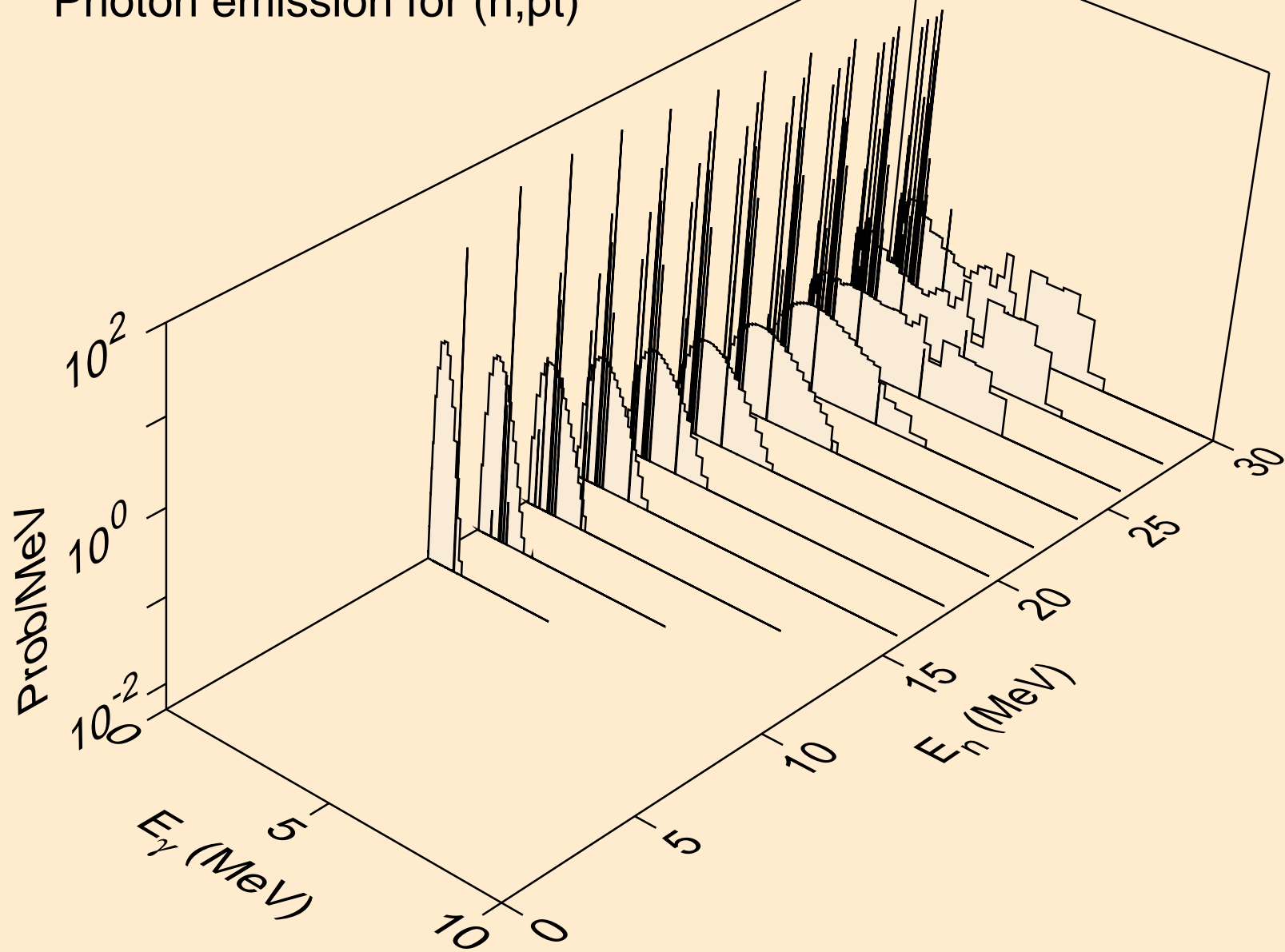

YB155 NEUTRON ACER TENDL-2024 LIBRARY; T=293.6K
Photon emission for (n,da)

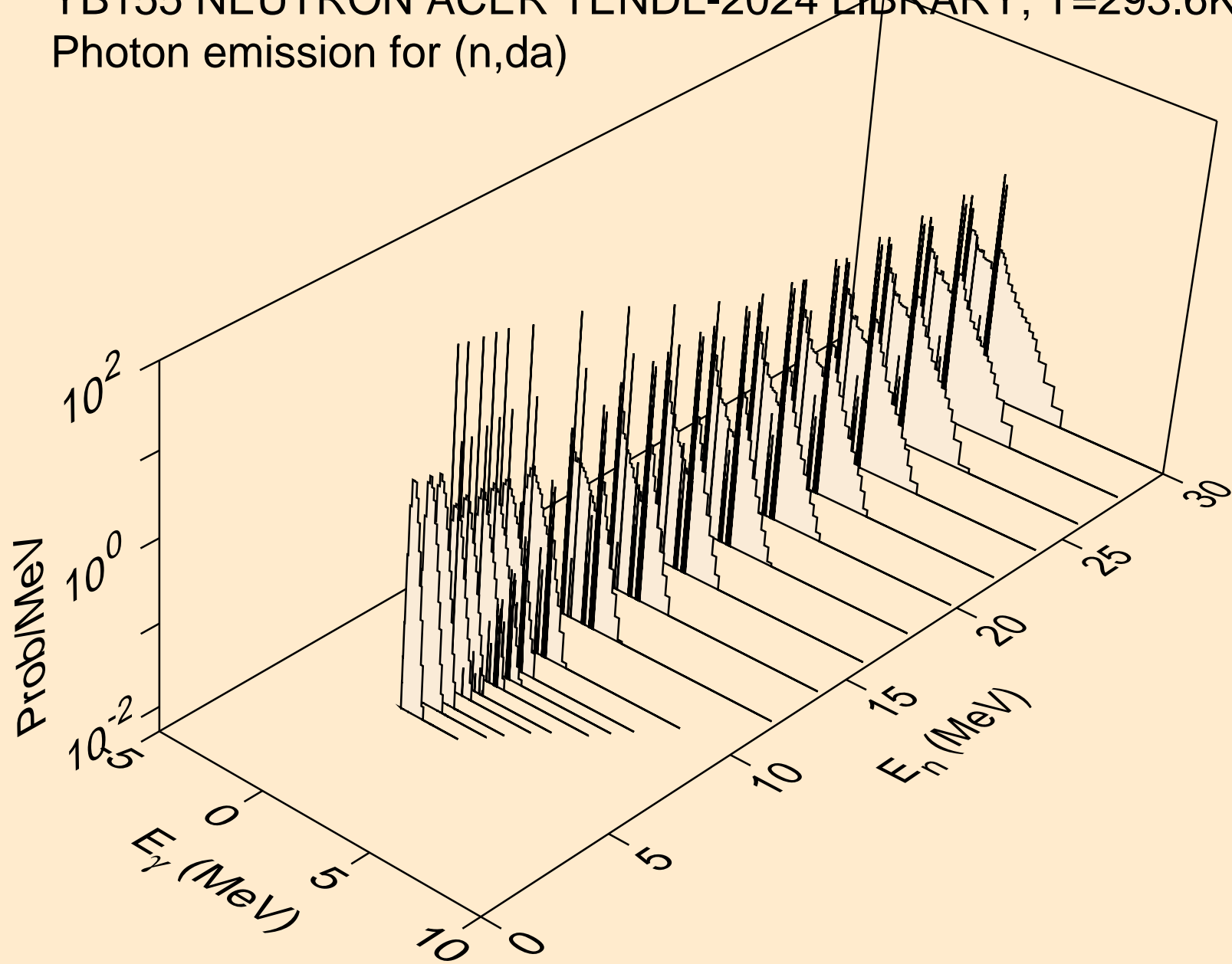

YB155 NEUTRON ACER TENDL-2024 LIBRARY; T=293.6K
14 MeV photon spectrum

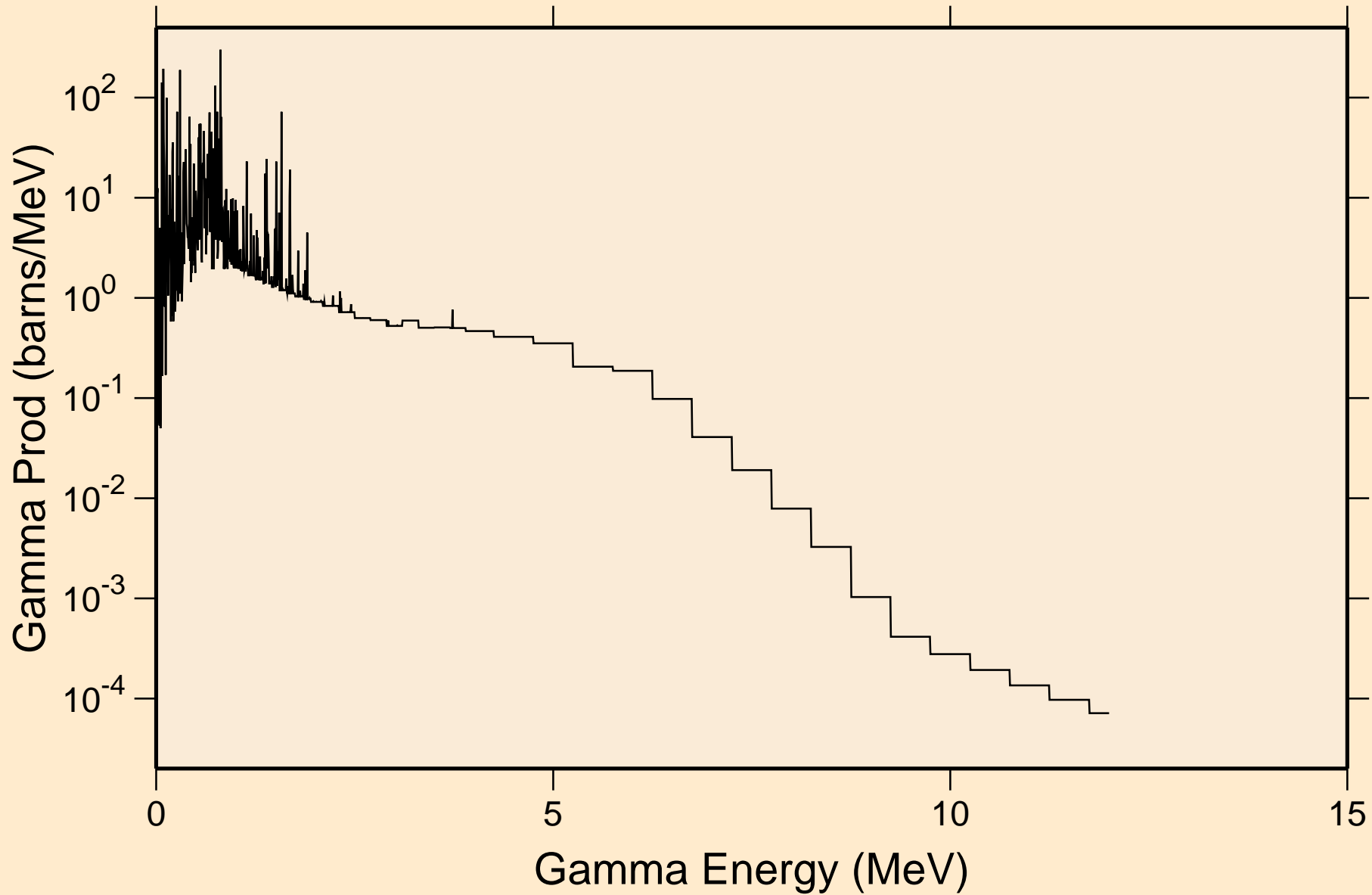

YB155 NEUTRON ACER TENDL-2024 LIBRARY; T=293.6K

Particle heating contributions

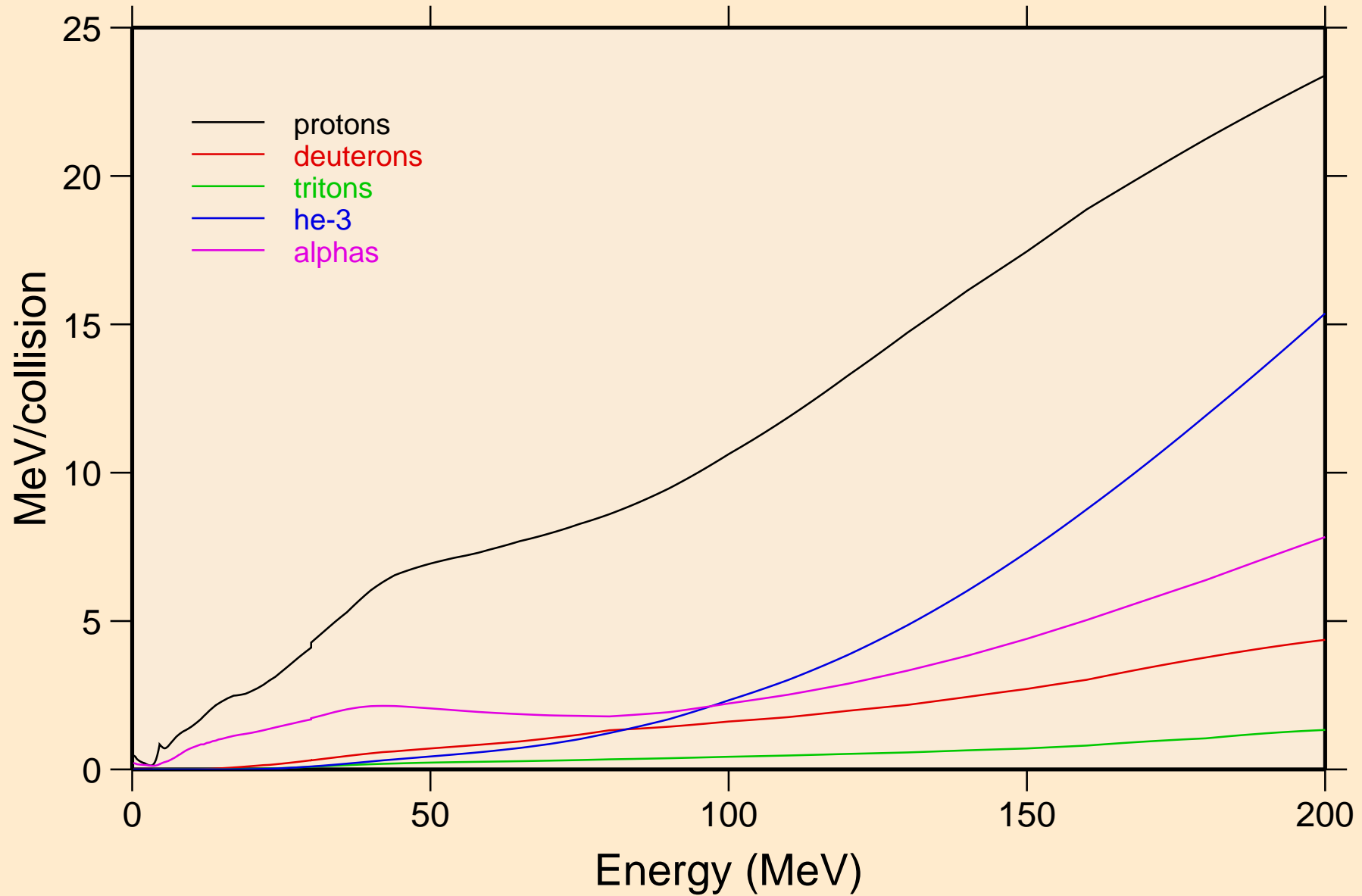

YB155 NEUTRON ACER TENDL-2024 LIBRARY; T=293.6K
Recoil Heating

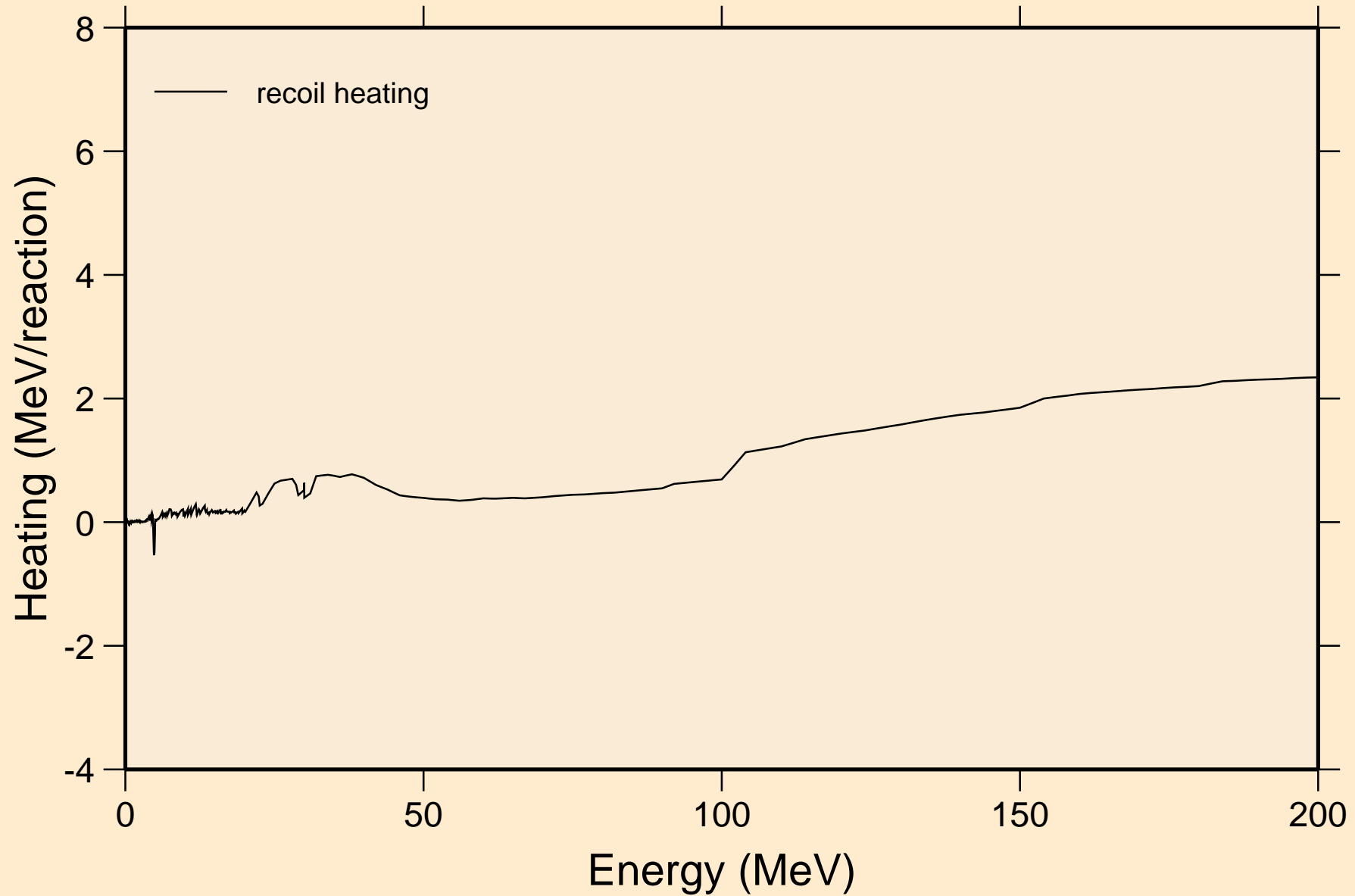

YB155 NEUTRON ACER TENDL-2024 LIBRARY; T=293.6K
Particle production cross sections

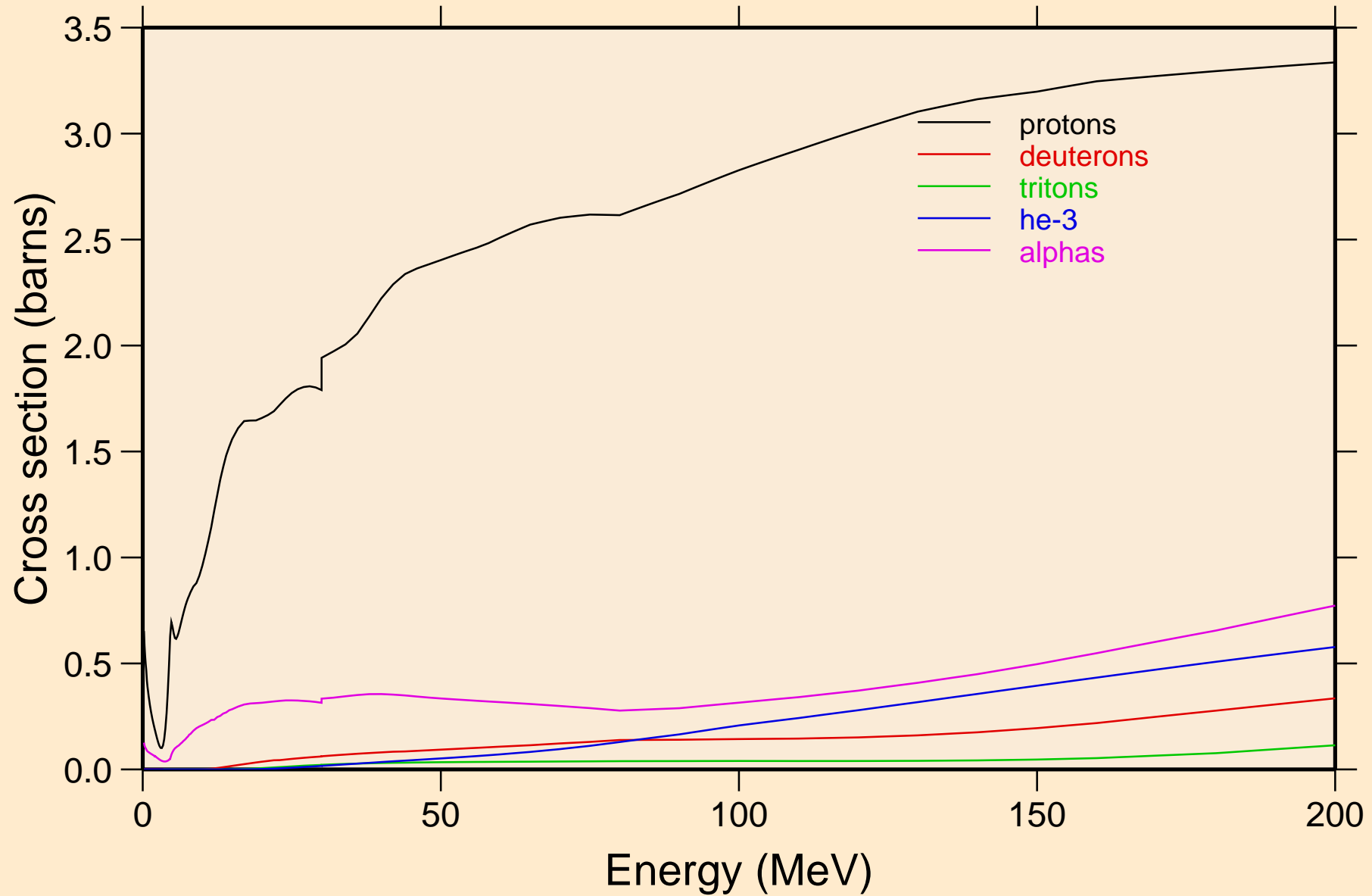

YB155 NEUTRON ACER TENDL-2024 LIBRARY; T=293.6K
protons from (n,x)

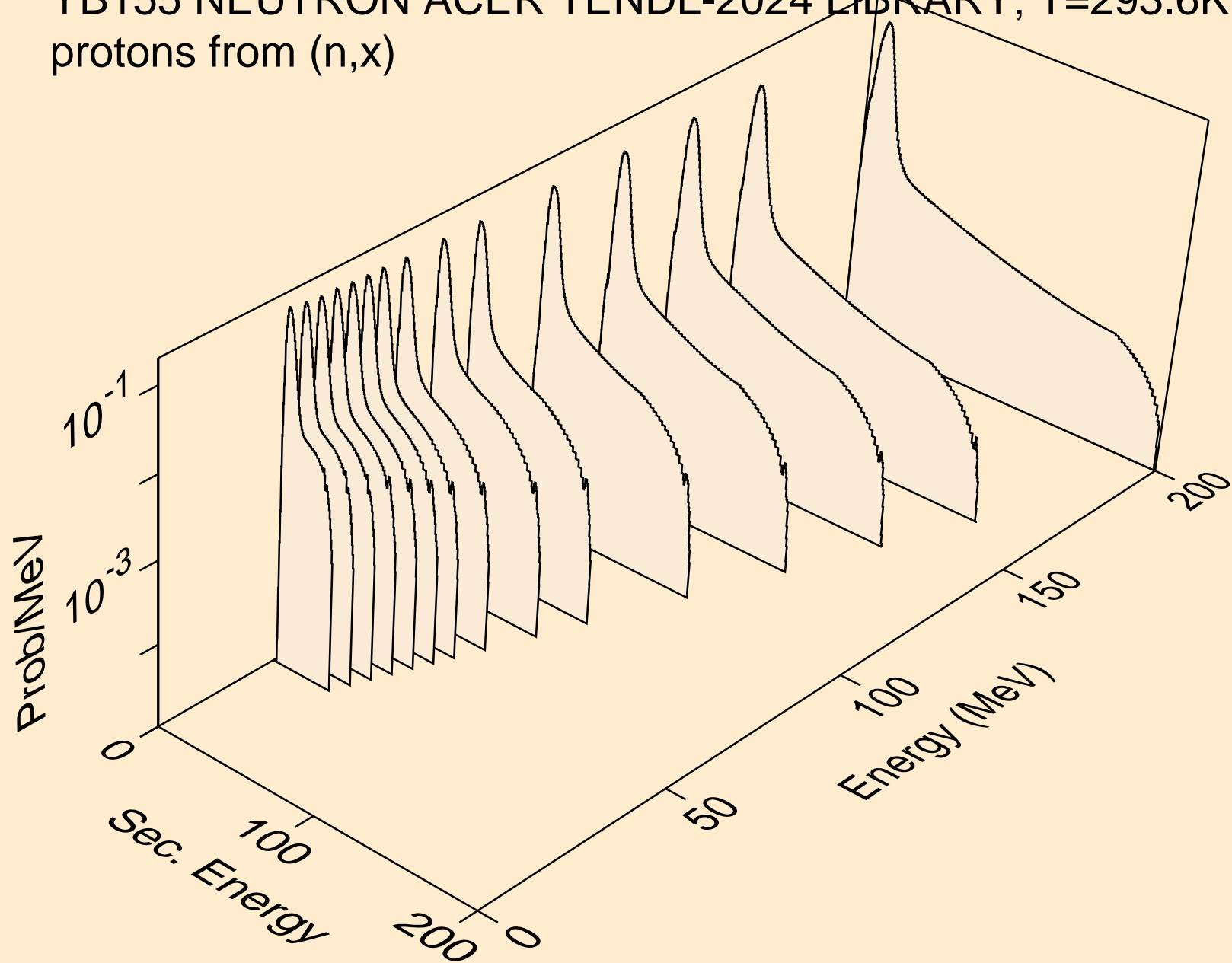

YB155 NEUTRON ACER TENDL-2024 LIBRARY; T=293.6K
protons from (n,n*)p

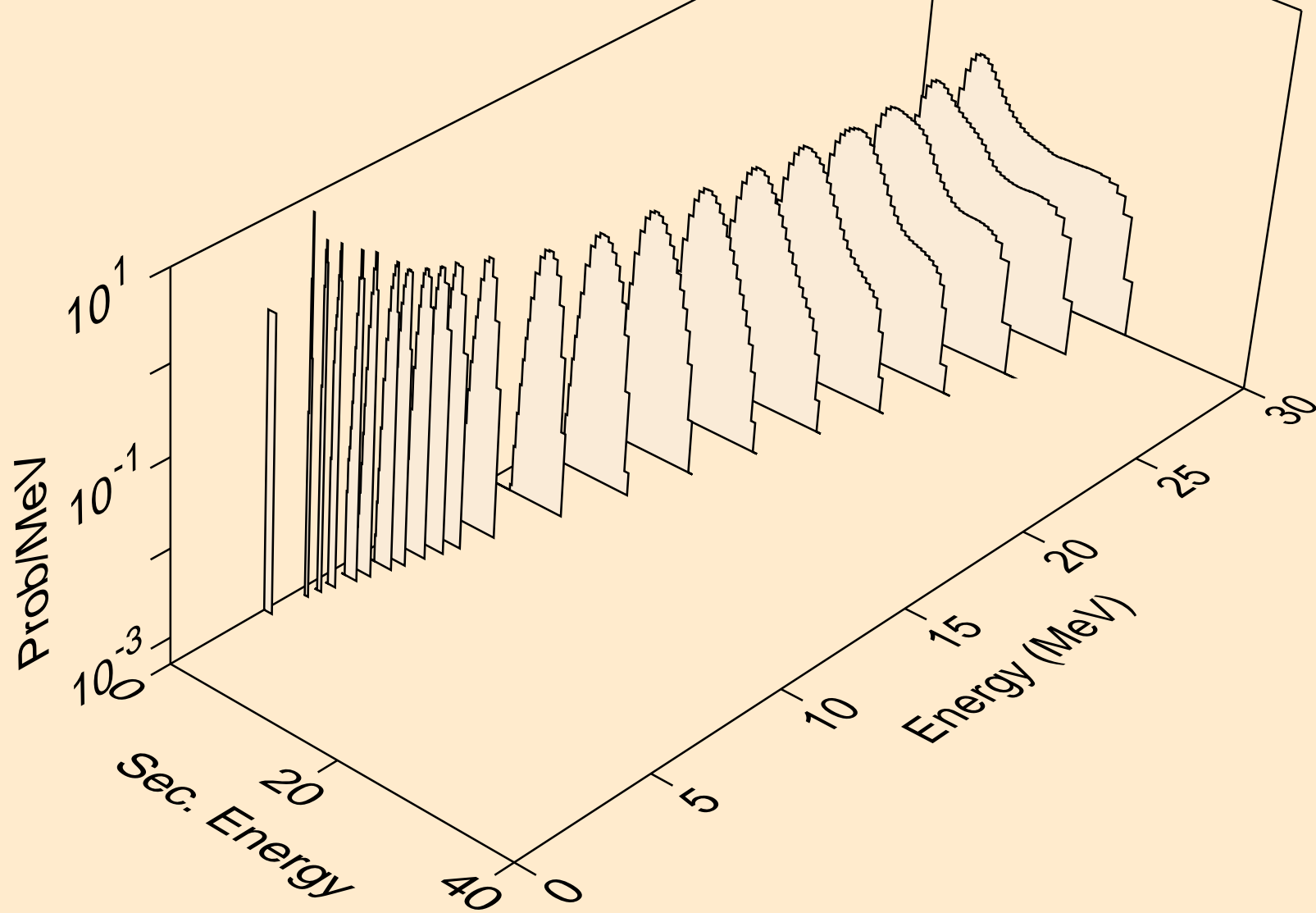

YB155 NEUTRON ACER TENDL-2024 LIBRARY; T=293.6K
protons from (n,2np)

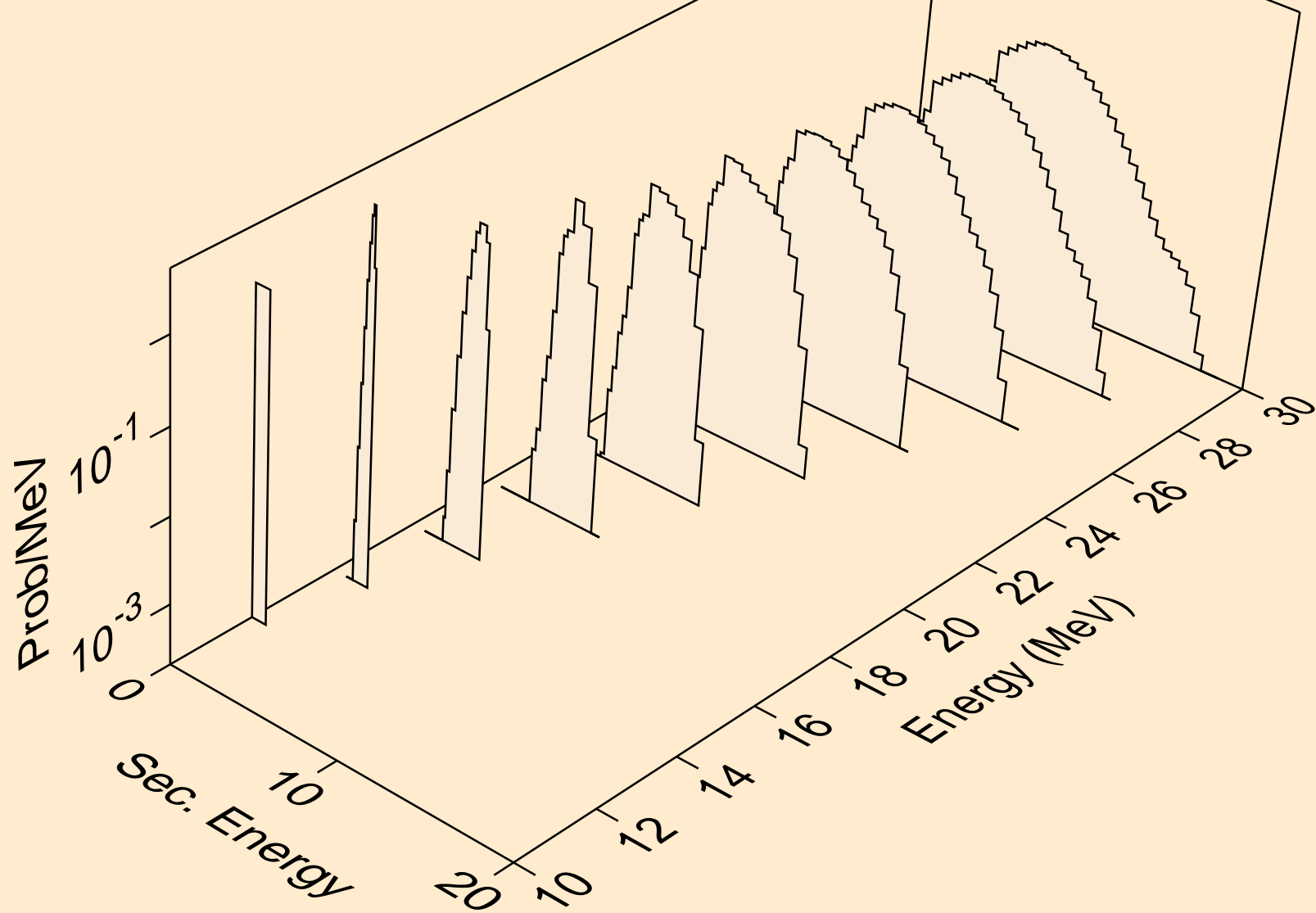

YB155 NEUTRON ACER TENDL-2024 LIBRARY; T=293.6K
protons from (n,3np)

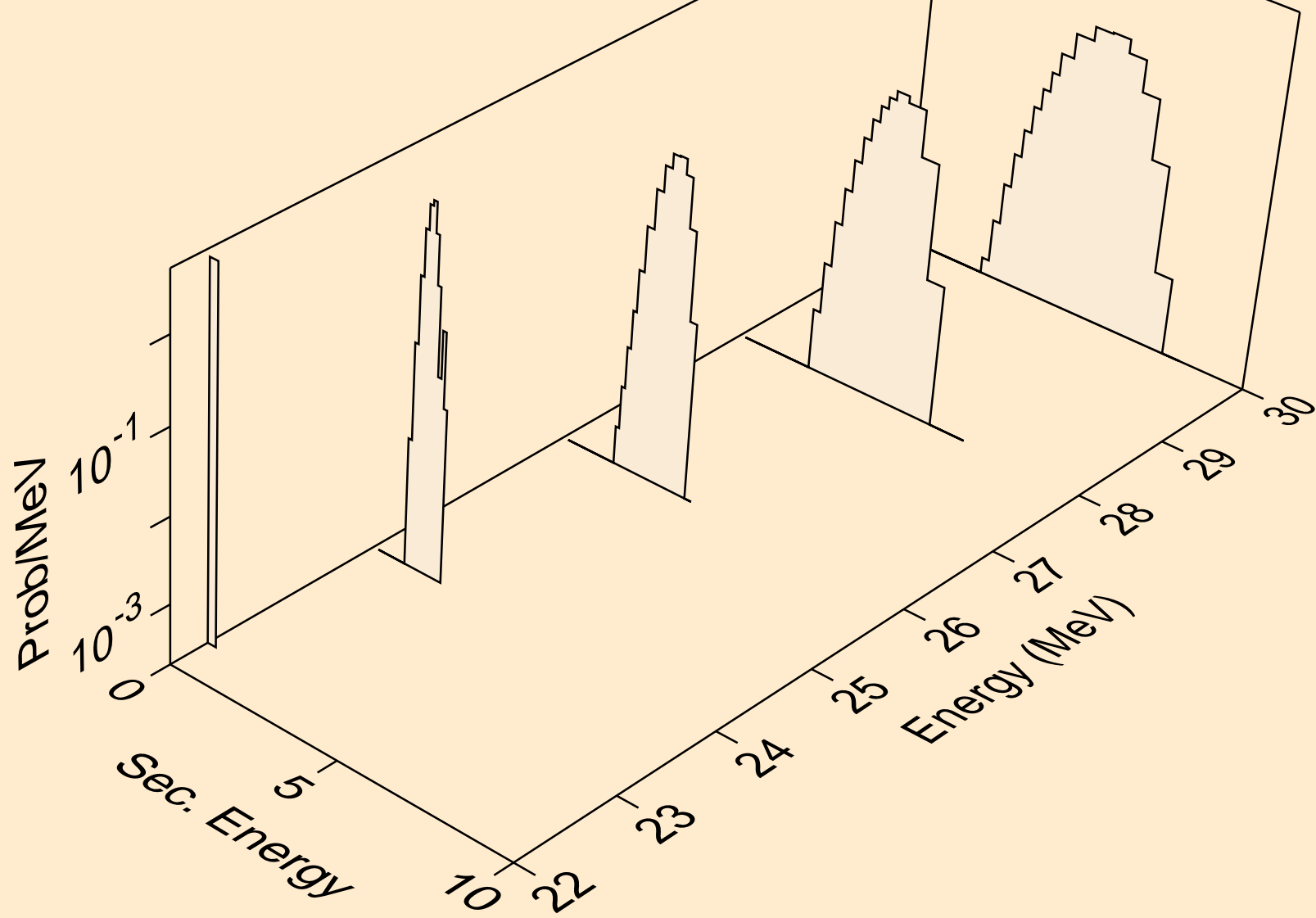

YB155 NEUTRON ACER TENDL-2024 LIBRARY; T=293.6K
protons from (n,n2p)

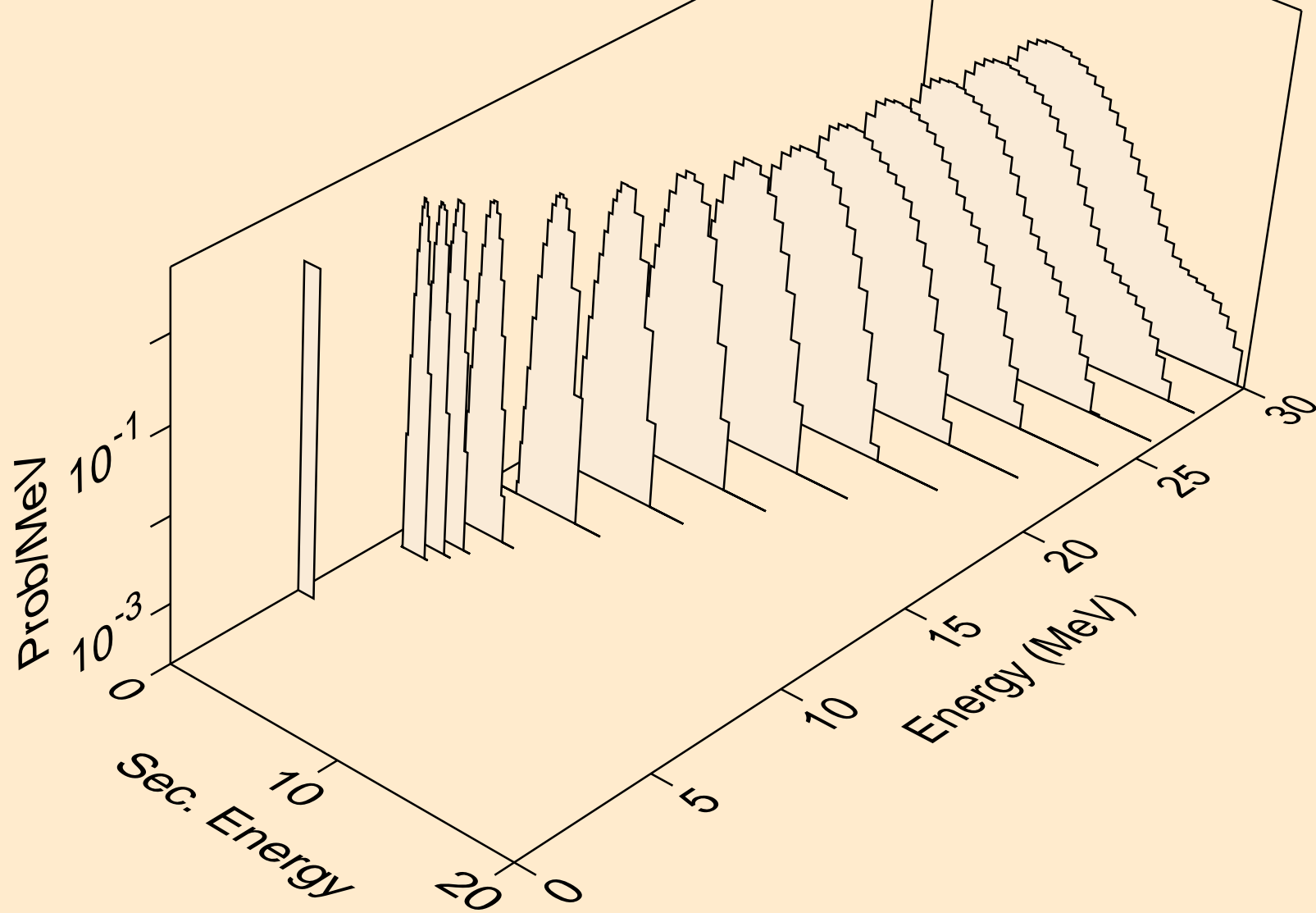

YB155 NEUTRON ACER TENDL-2024 LIBRARY; T=293.6K
protons from (n,npa)

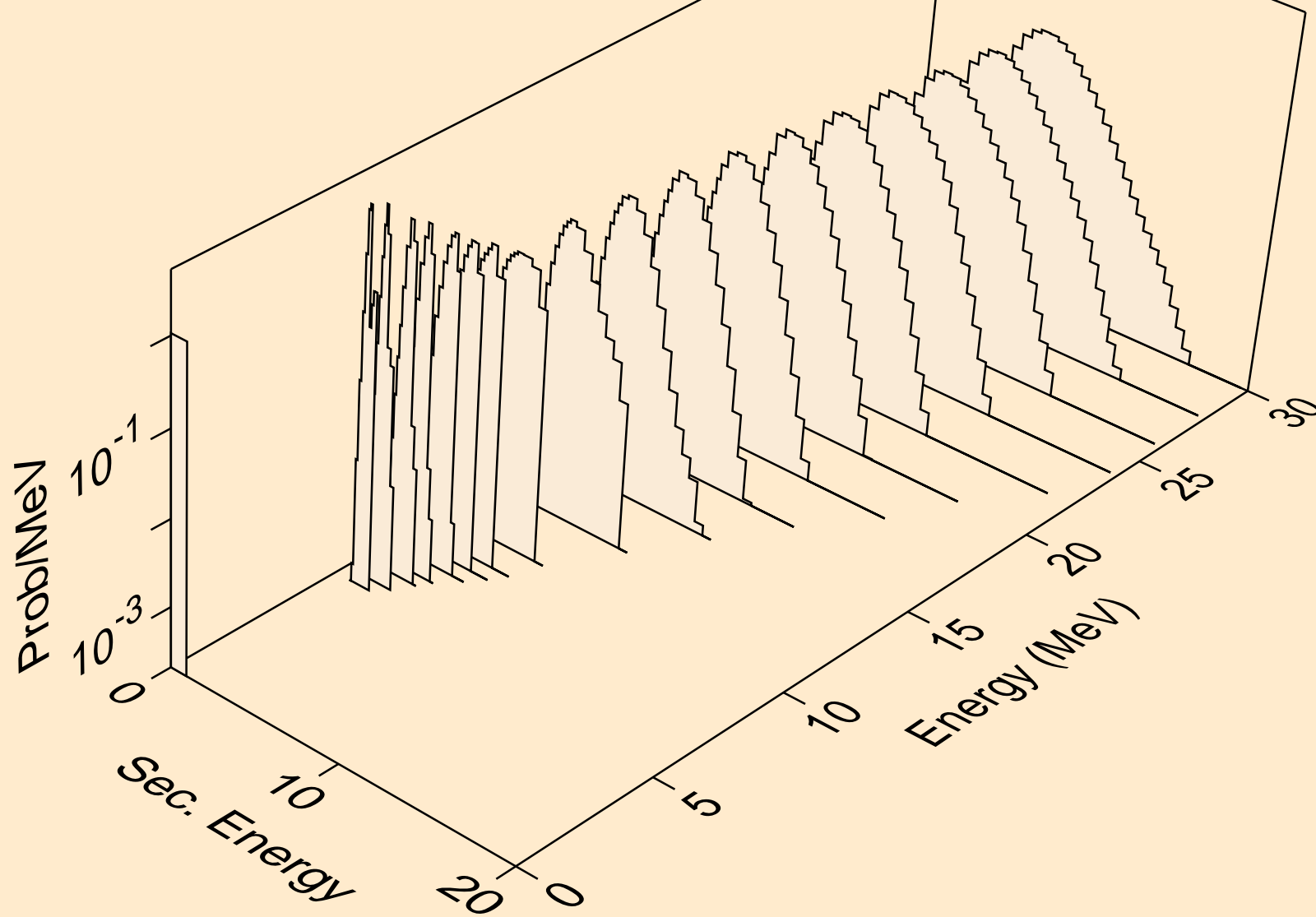

YB155 NEUTRON ACER TENDL-2024 LIBRARY; T=293.6K
protons from (n,p)

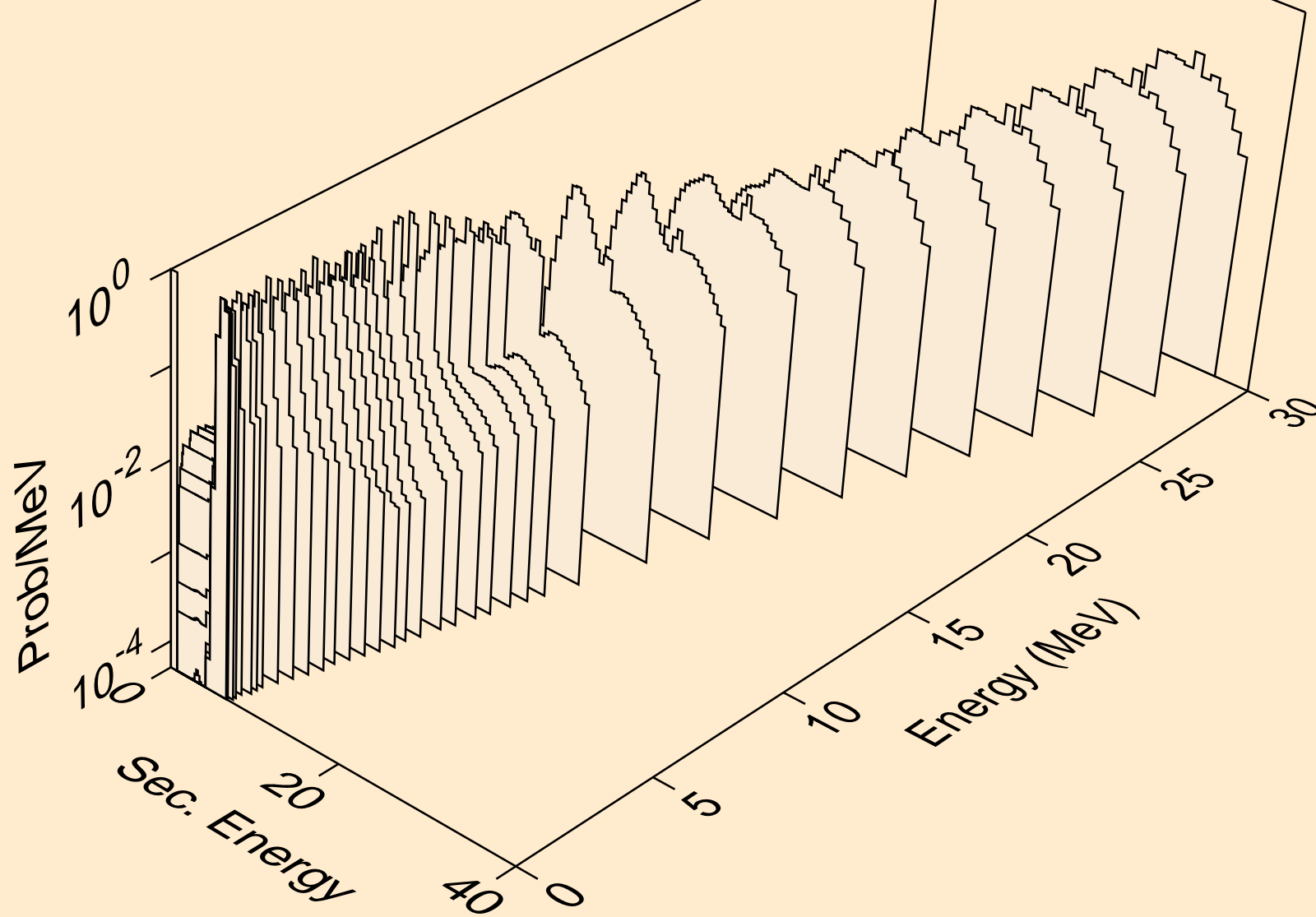

YB155 NEUTRON ACER TENDL-2024 LIBRARY; T=293.6K
protons from (n,2p)

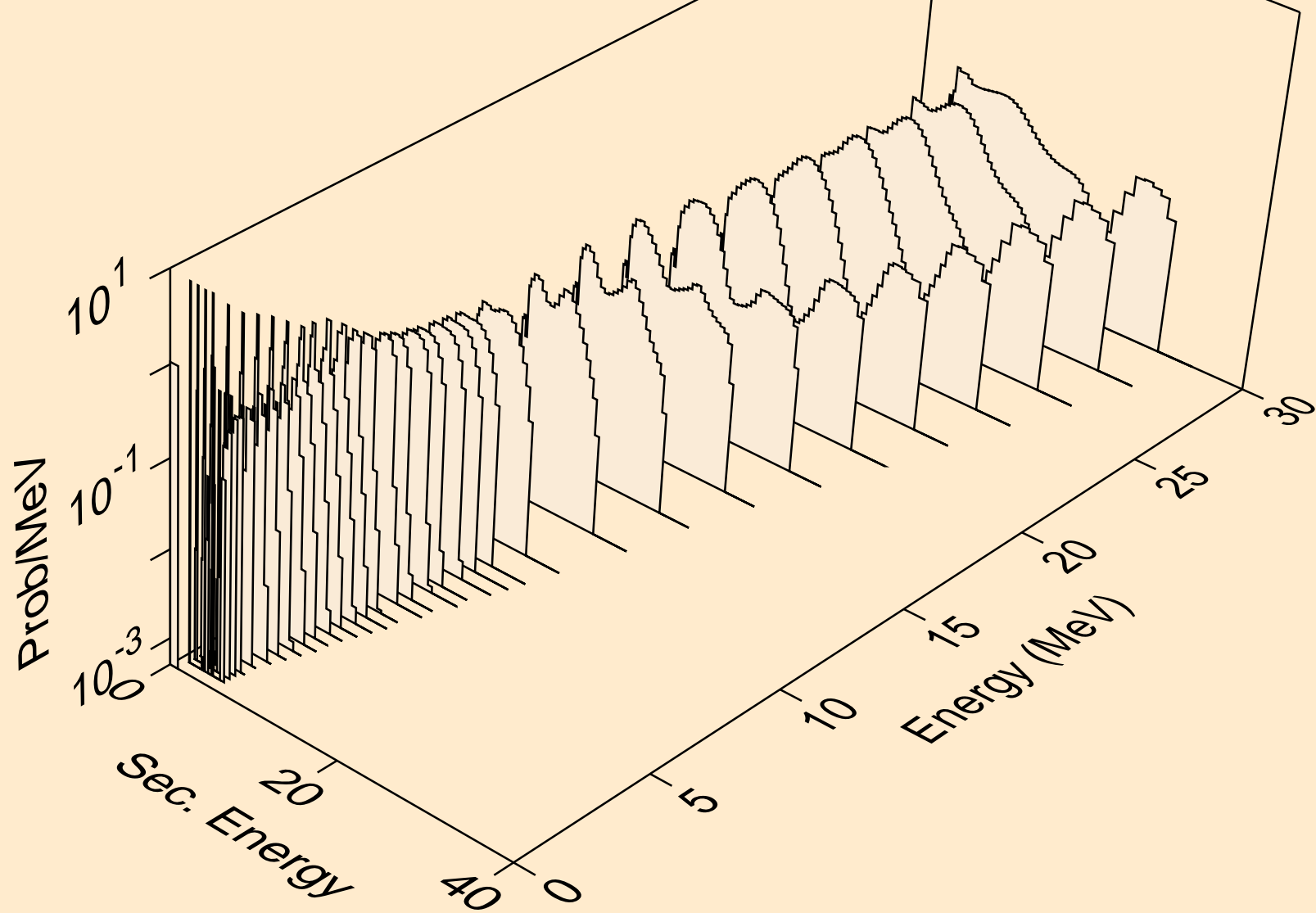

YB155 NEUTRON ACER TENDL-2024 LIBRARY; T=293.6K
protons from (n,p)

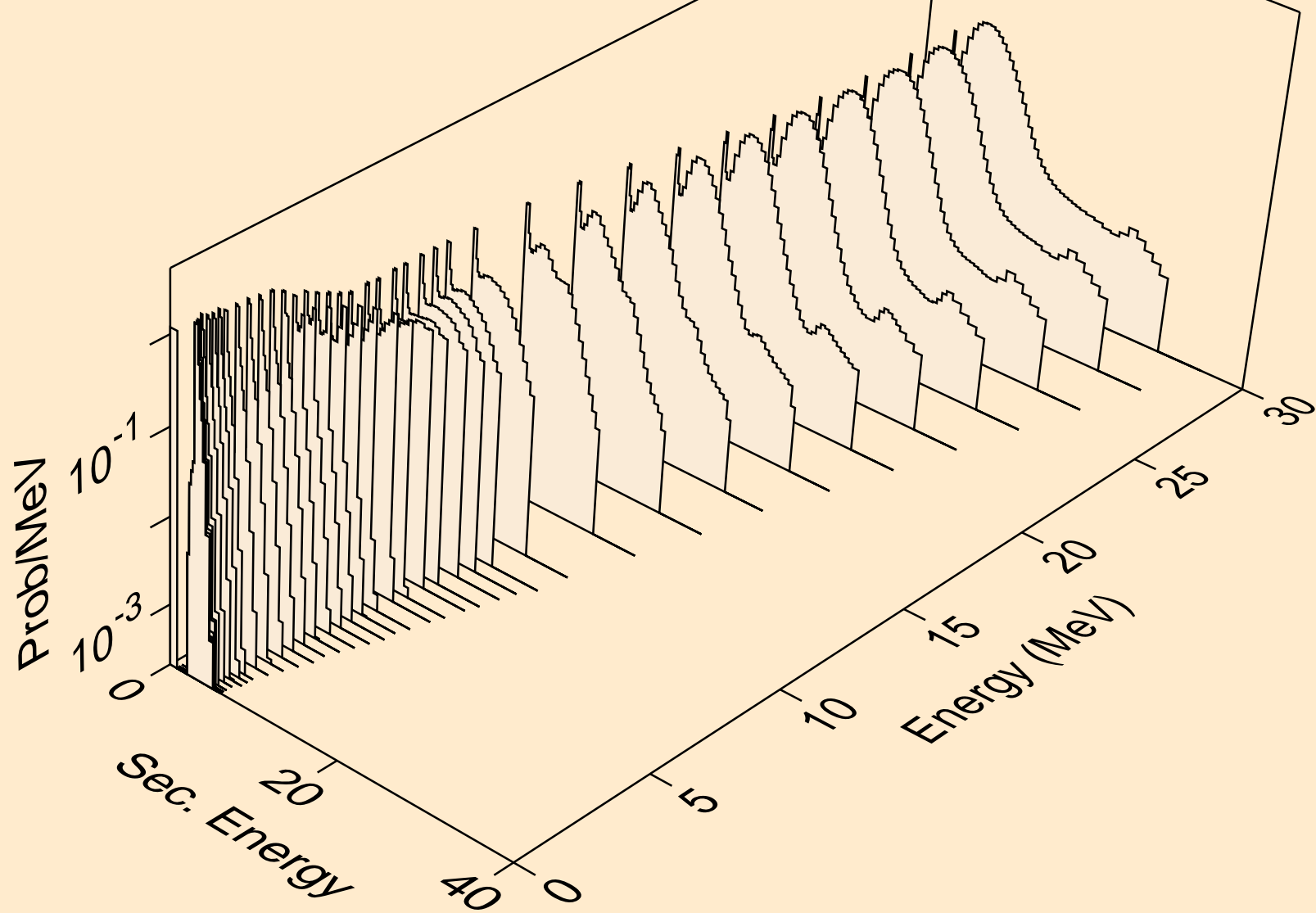

YB155 NEUTRON ACER TENDL-2024 LIBRARY; T=293.6K
protons from (n,pd)

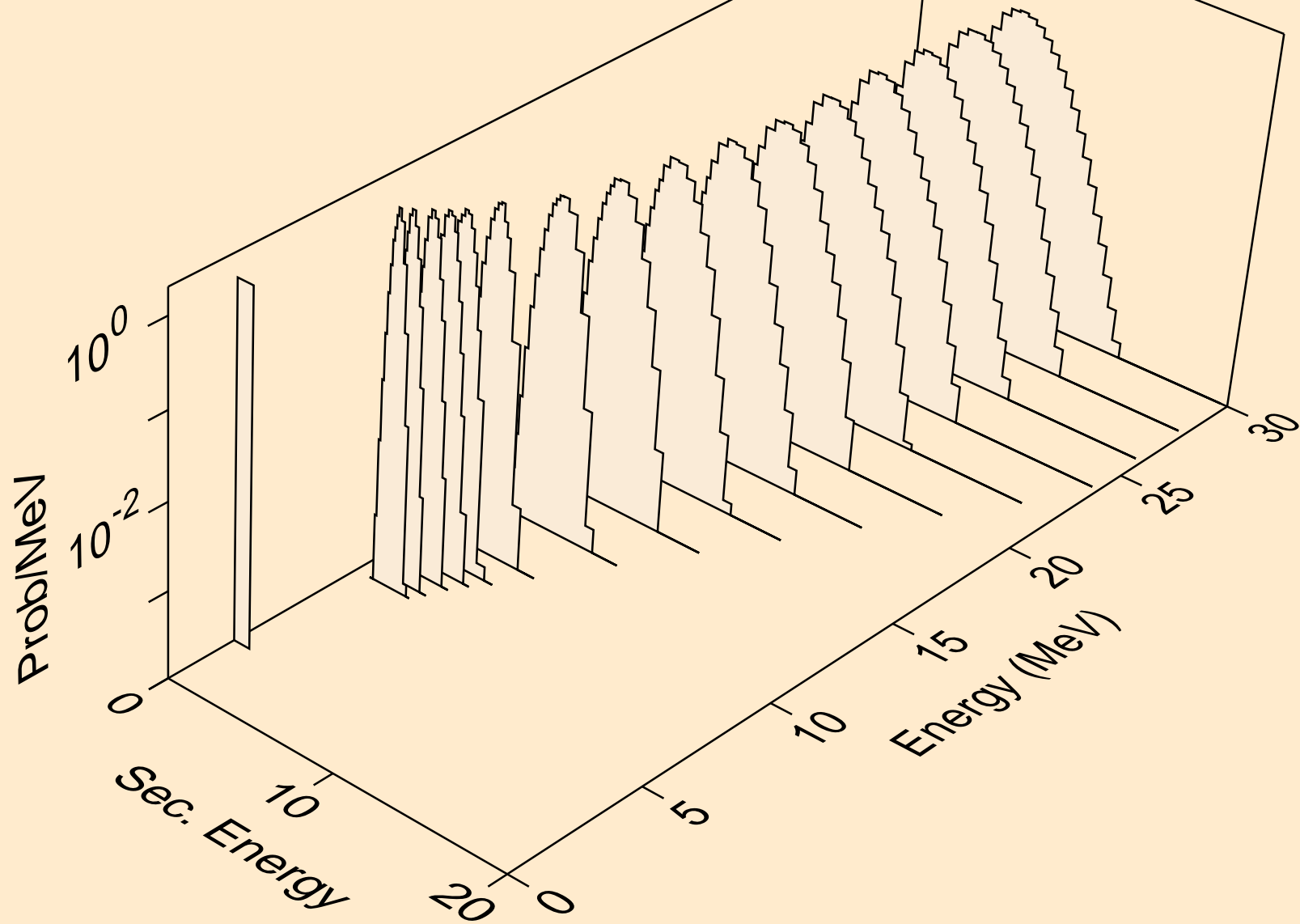

YB155 NEUTRON ACER TENDL-2024 LIBRARY; T=293.6K
protons from (n,pt)

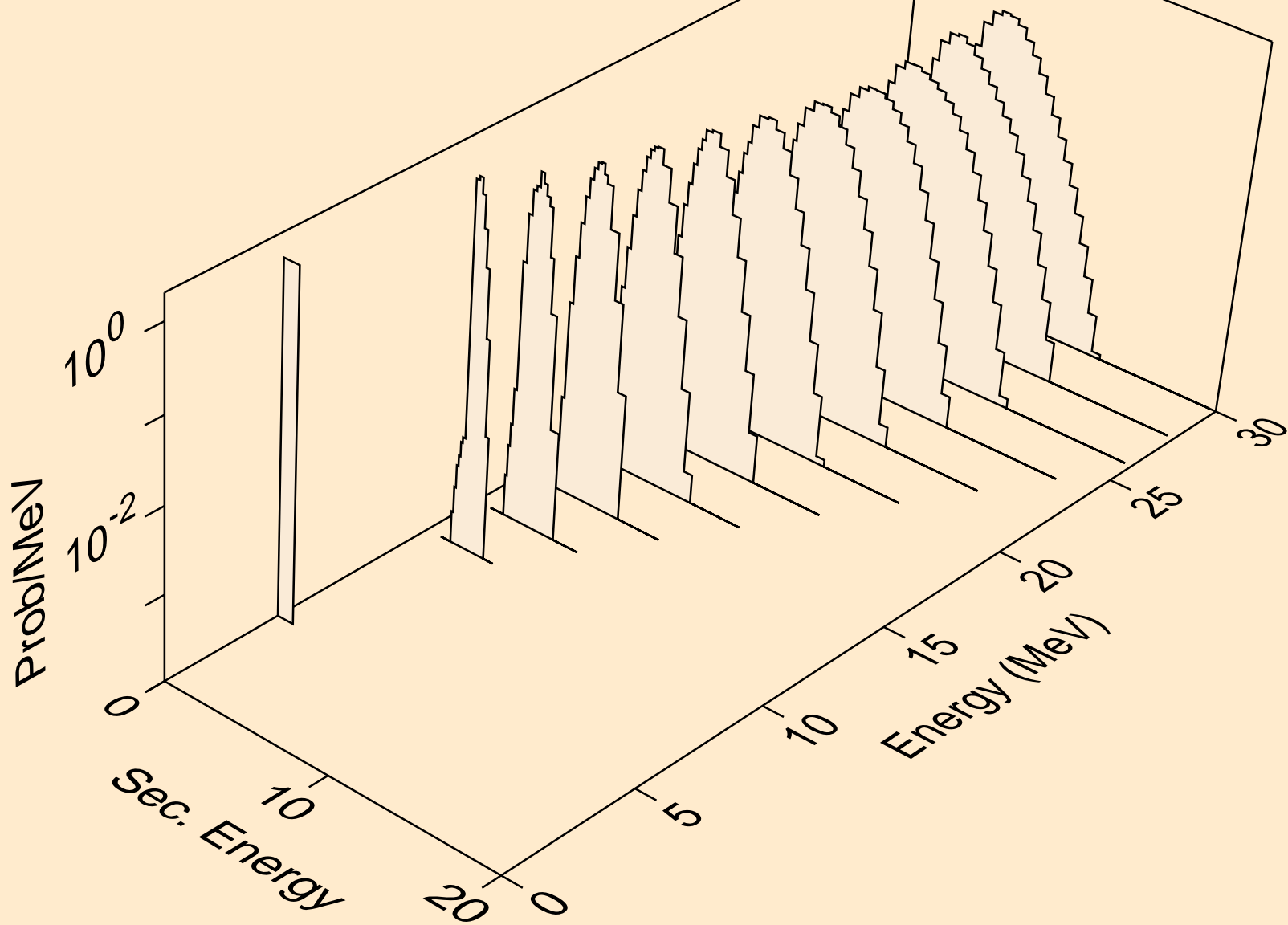

YB155 NEUTRON ACER TENDL-2024 LIBRARY; T=293.6K
deuterons from (n,x)

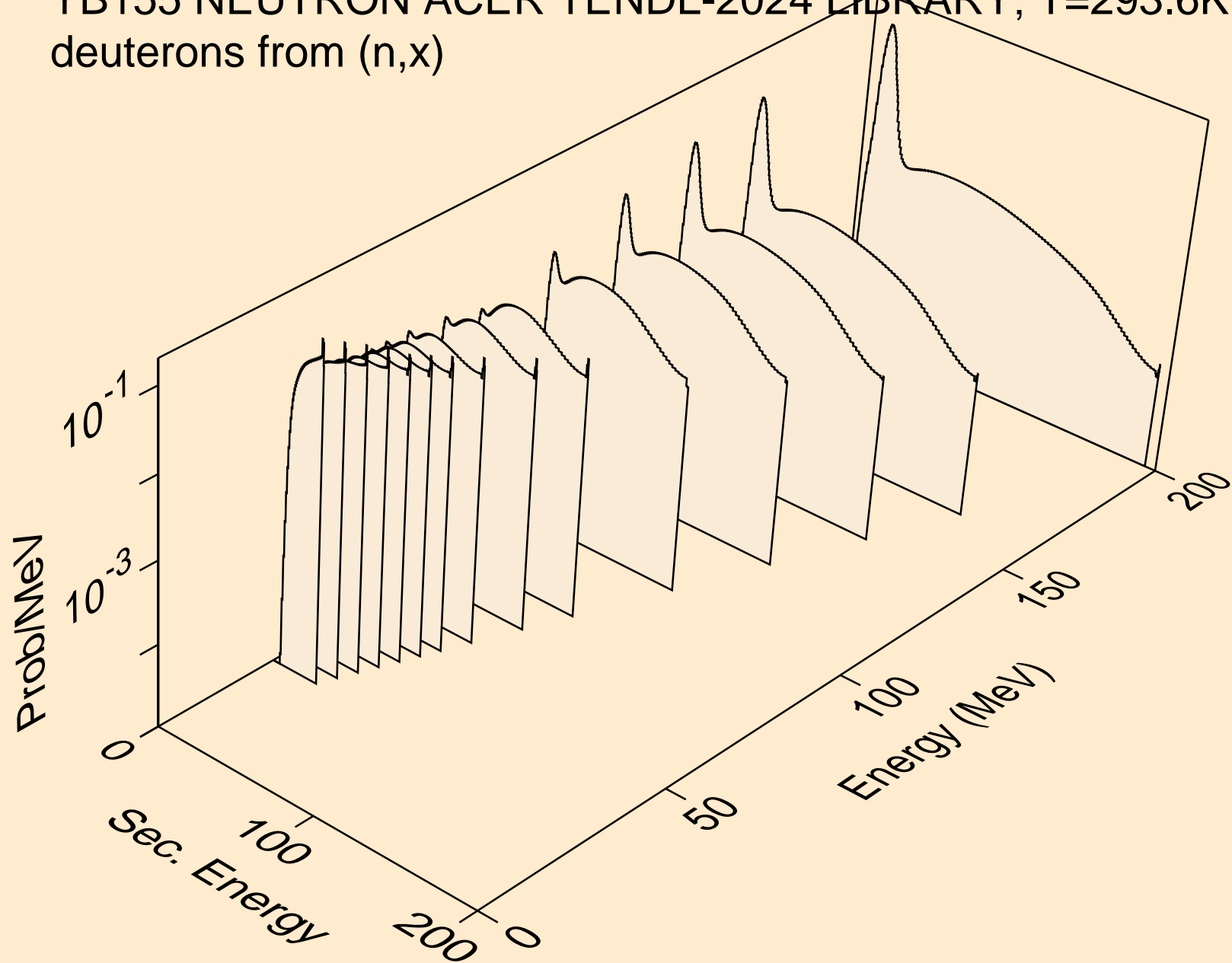

YB155 NEUTRON ACER TENDL-2024 LIBRARY; T=293.6K
deuterons from (n,2nd)

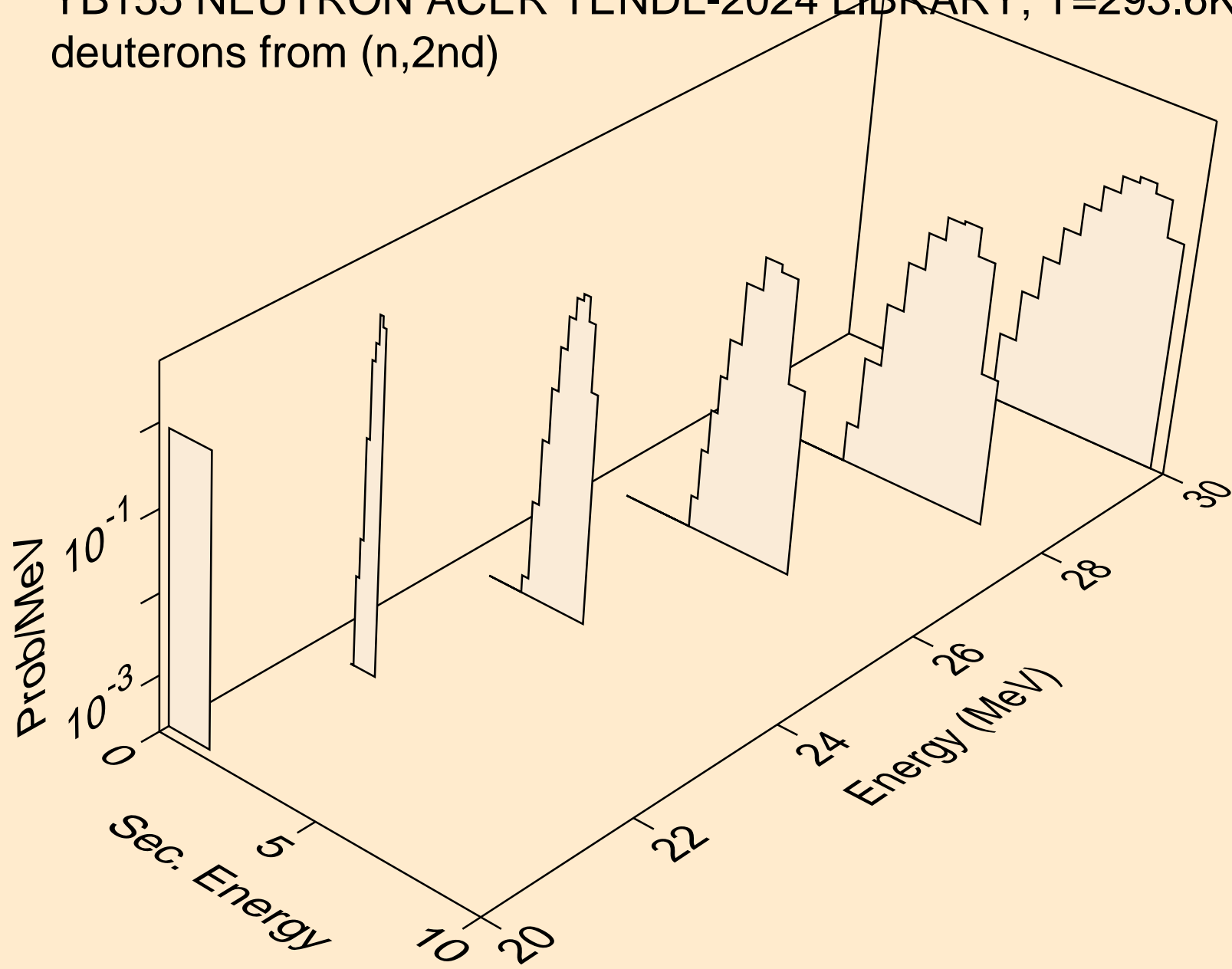

YB155 NEUTRON ACER TENDL-2024 LIBRARY; T=293.6K
deuterons from (n,n*)d

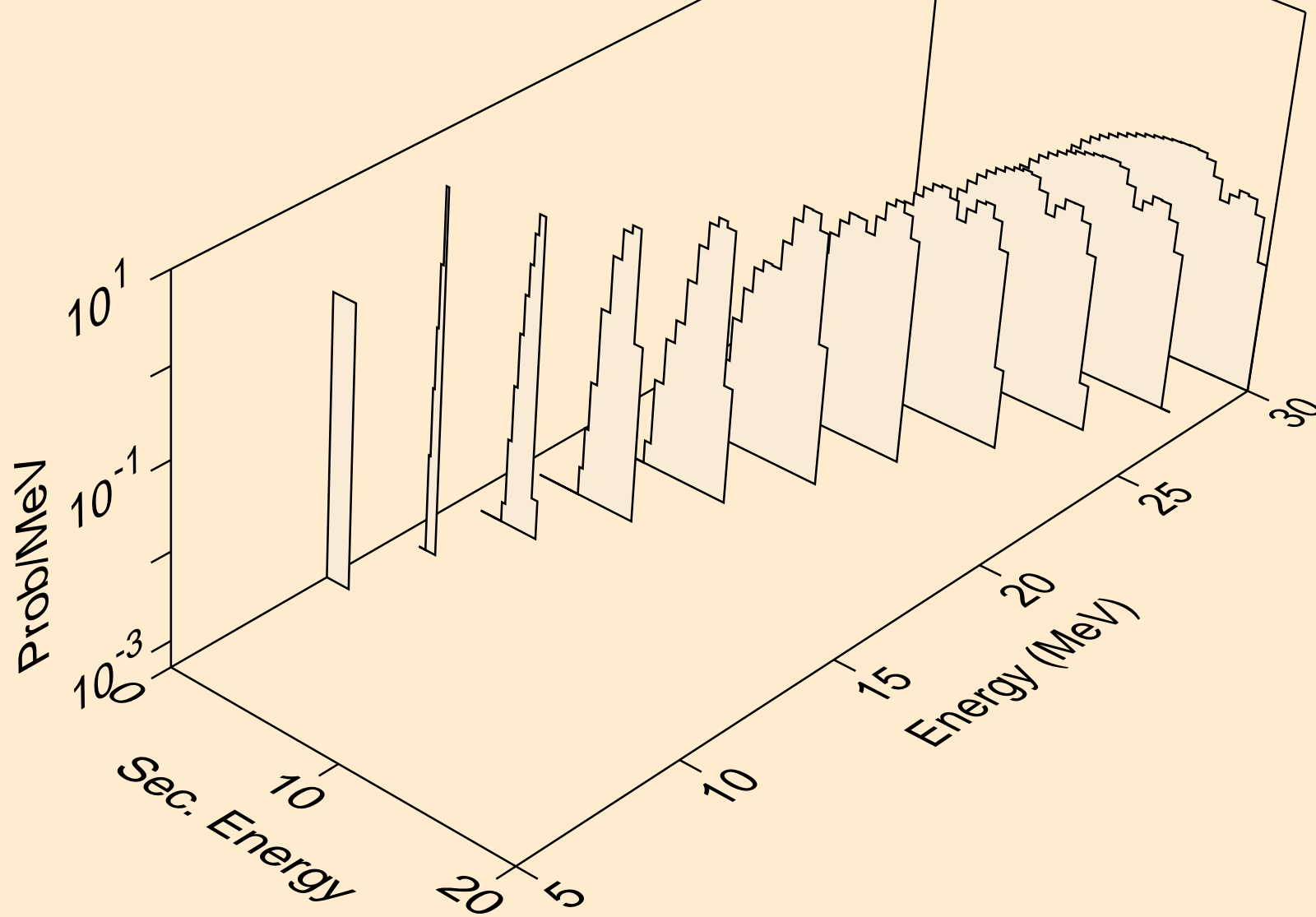

YB155 NEUTRON ACER TENDL-2024 LIBRARY; T=293.6K
deuterons from (n,d)

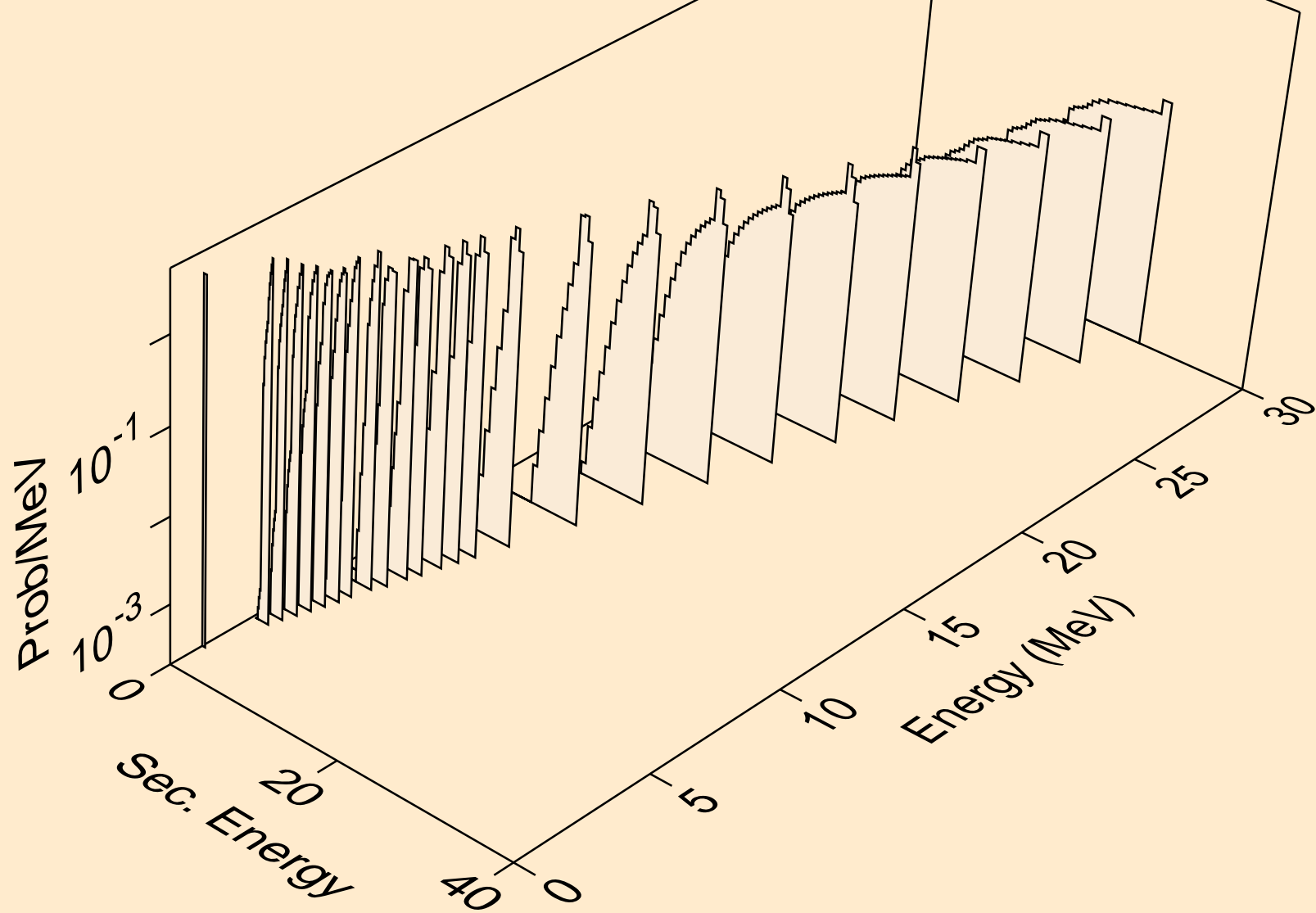

YB155 NEUTRON ACER TENDL-2024 LIBRARY; T=293.6K
deuterons from (n,d2a)

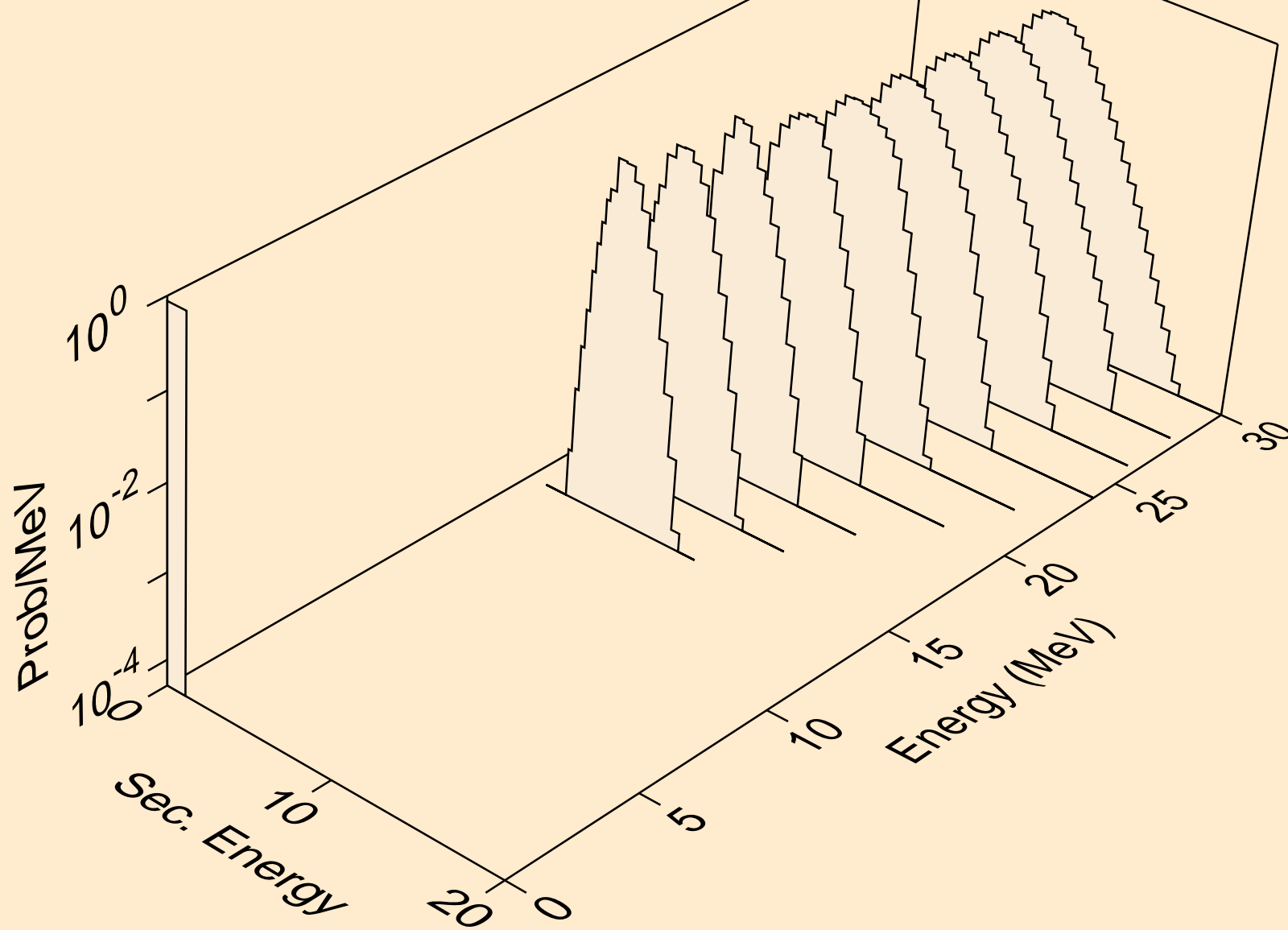

YB155 NEUTRON ACER TENDL-2024 LIBRARY; T=293.6K
deuterons from (n,pd)

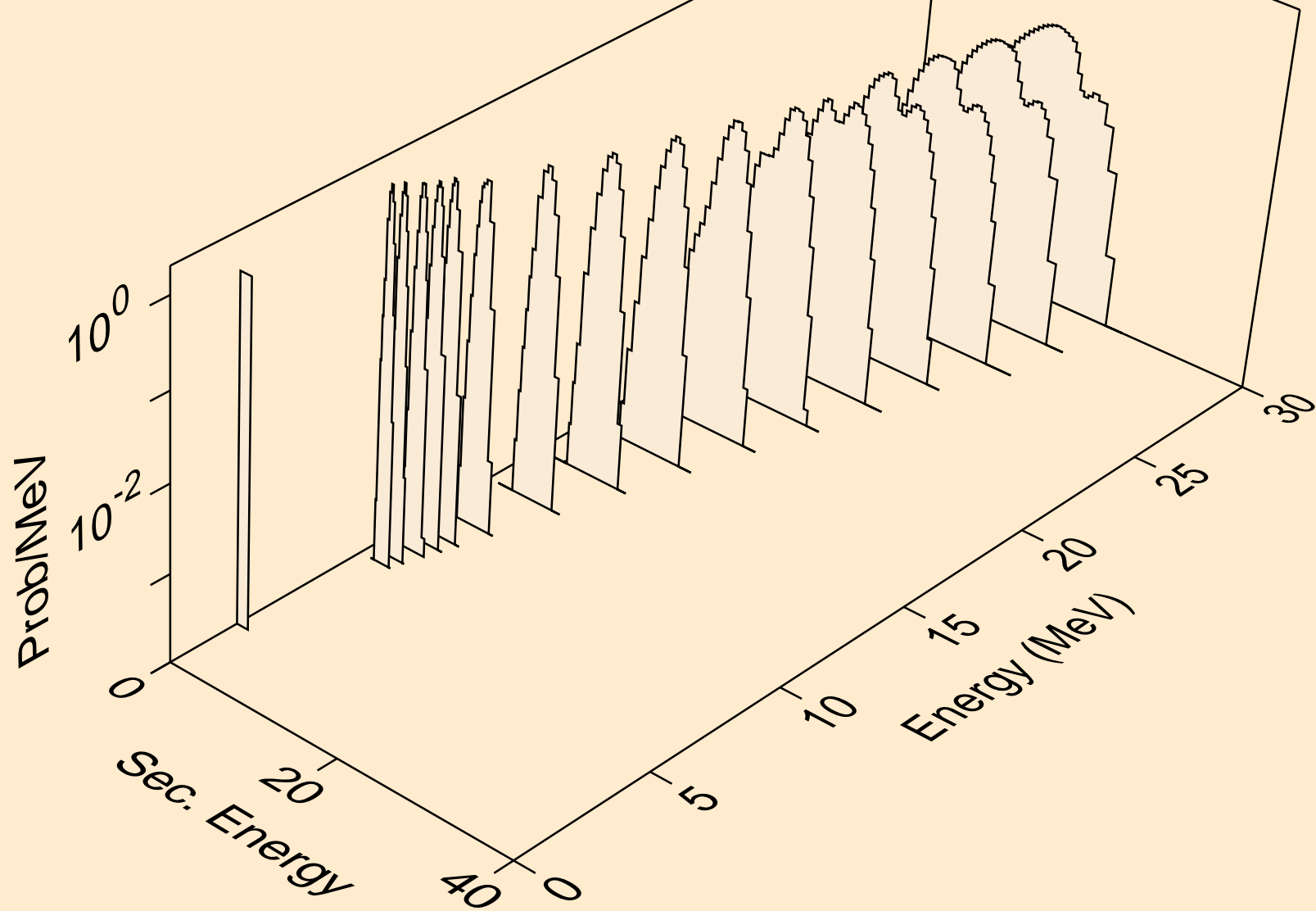

YB155 NEUTRON ACER TENDL-2024 LIBRARY; T=293.6K
deuterons from (n,da)

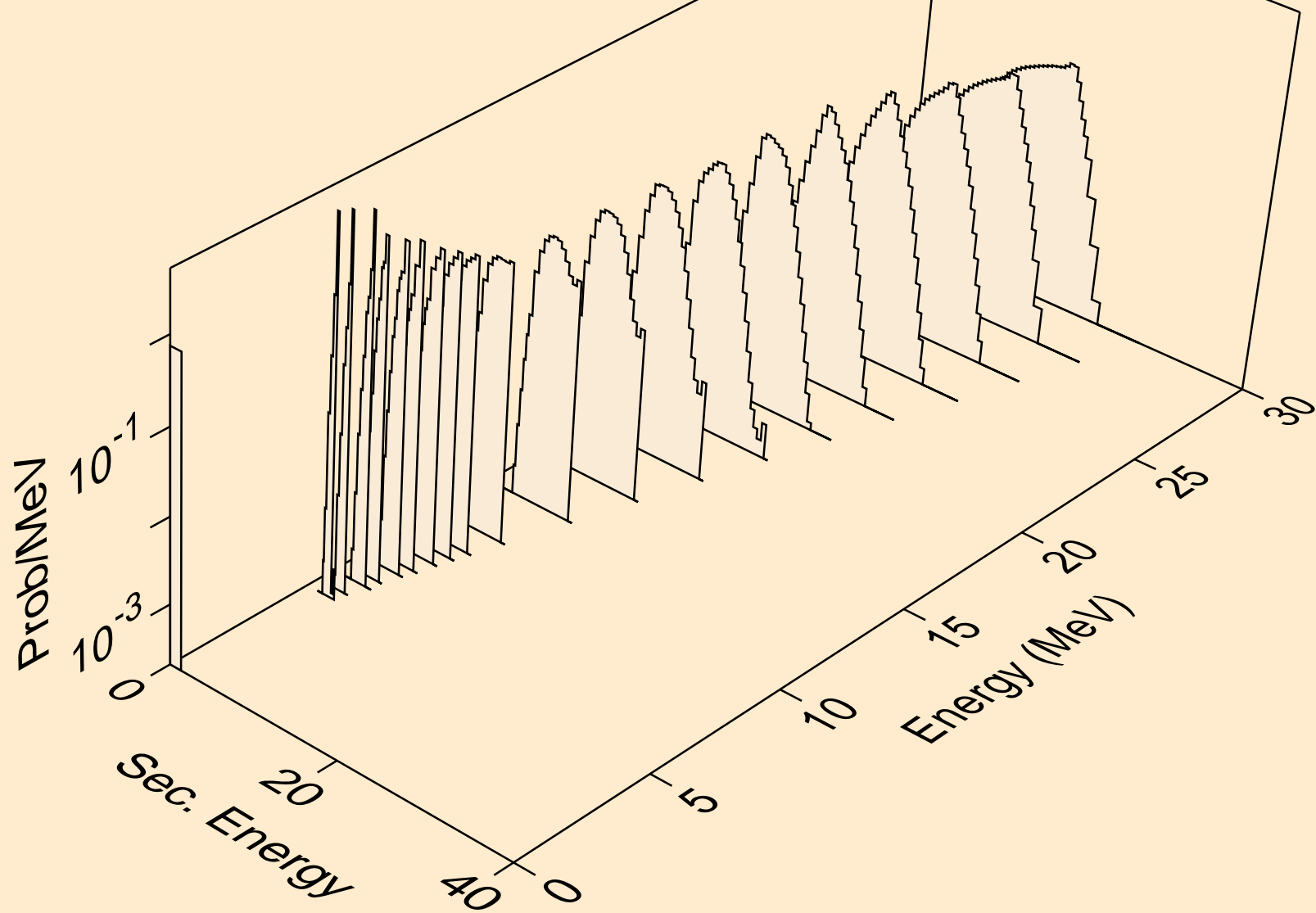

YB155 NEUTRON ACER TENDL-2024 LIBRARY; T=293.6K
tritons from (n,x)

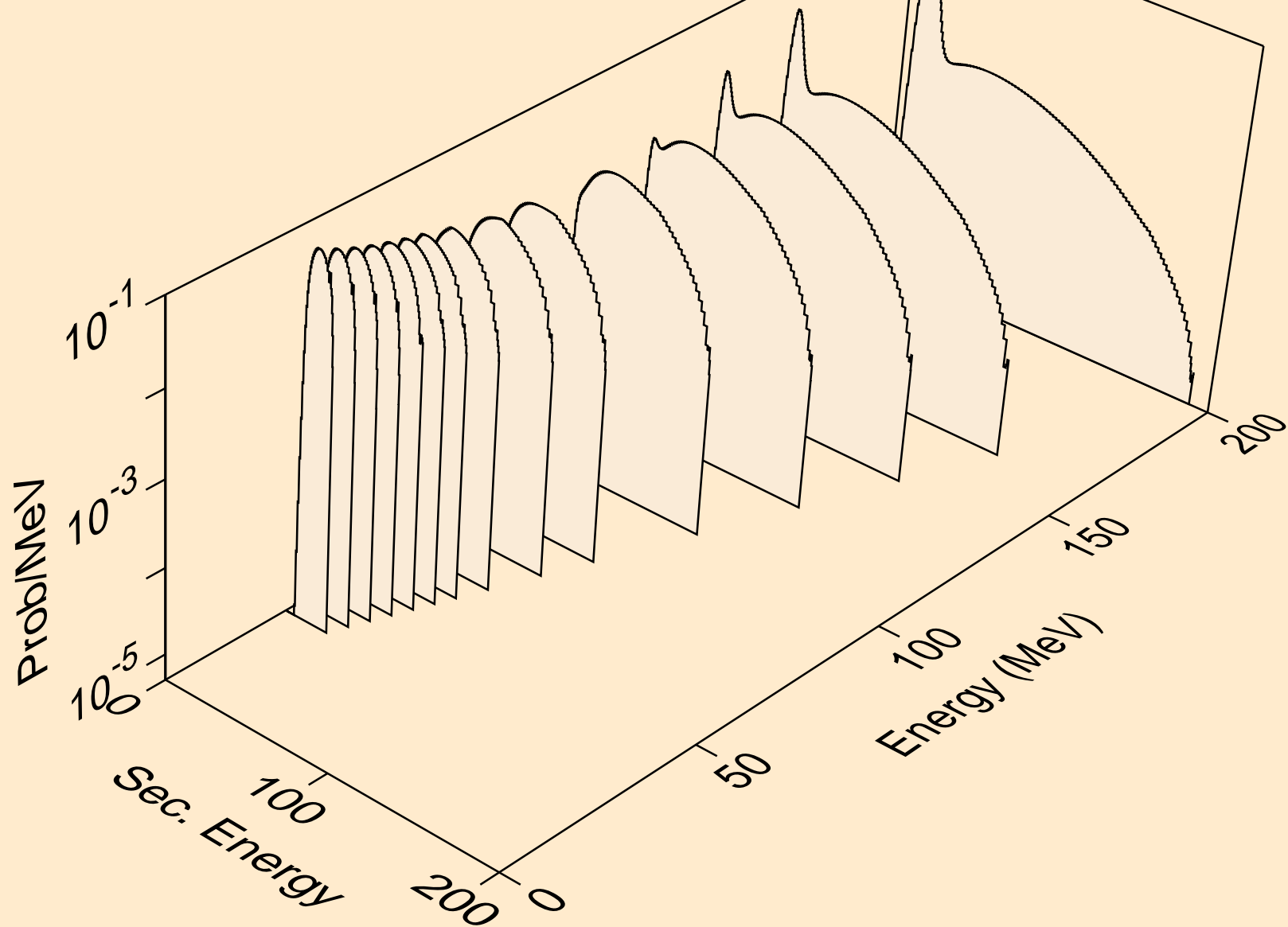

YB155 NEUTRON ACER TENDL-2024 LIBRARY; T=293.6K
tritons from (n,n*)t

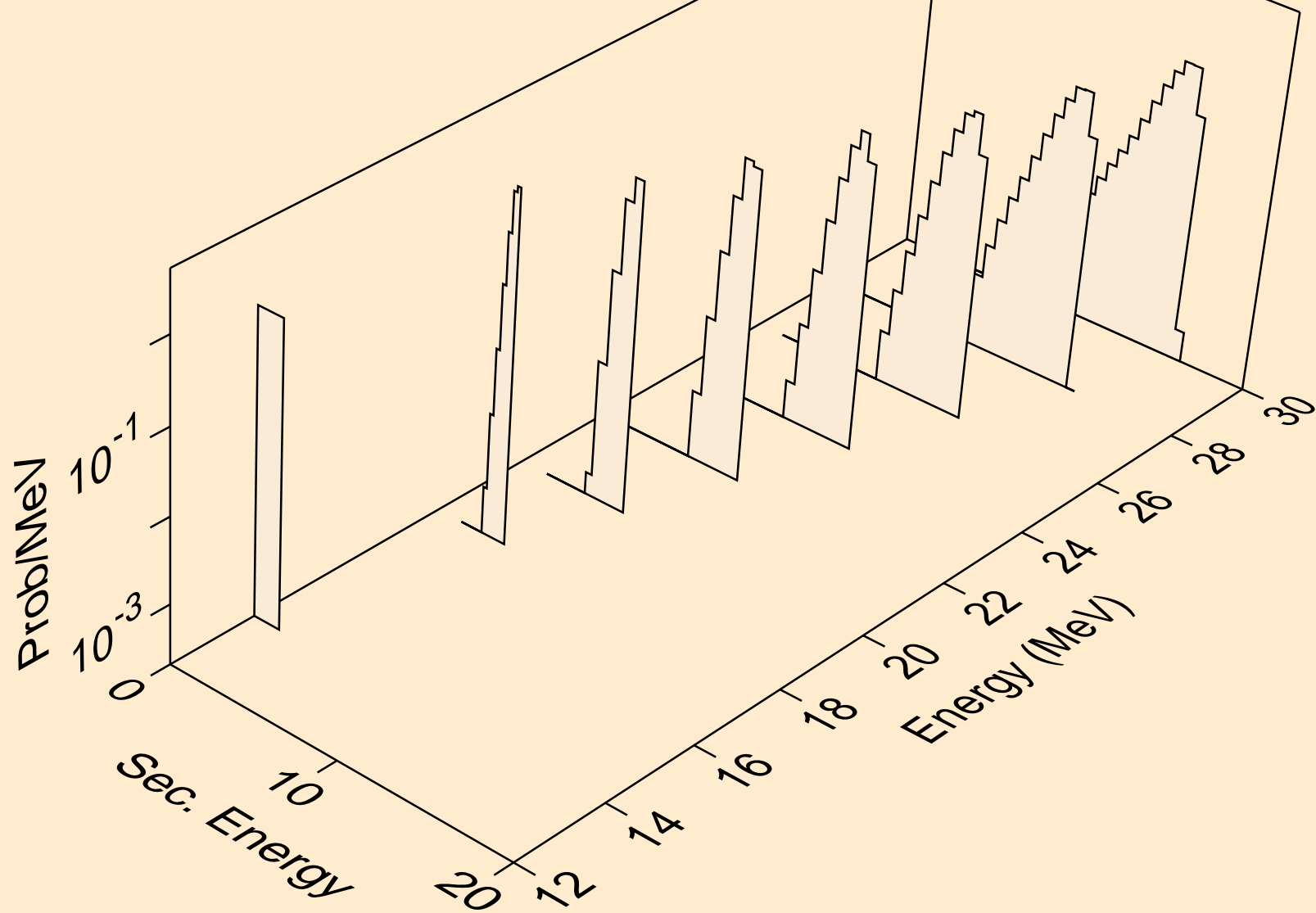

YB155 NEUTRON ACER TENDL-2024 LIBRARY; T=293.6K
tritons from (n,t)

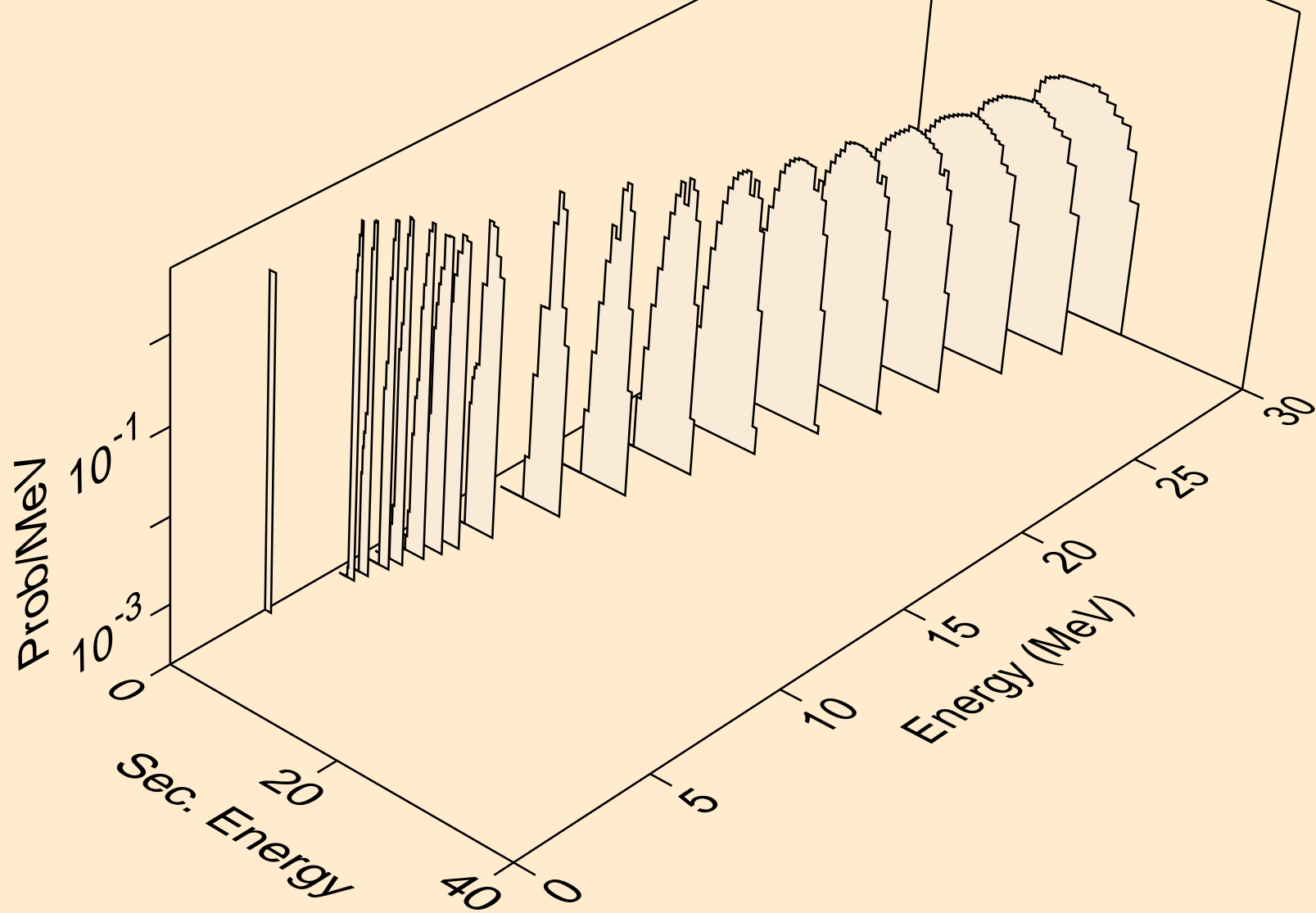

YB155 NEUTRON ACER TENDL-2024 LIBRARY; T=293.6K
tritons from (n,pt)

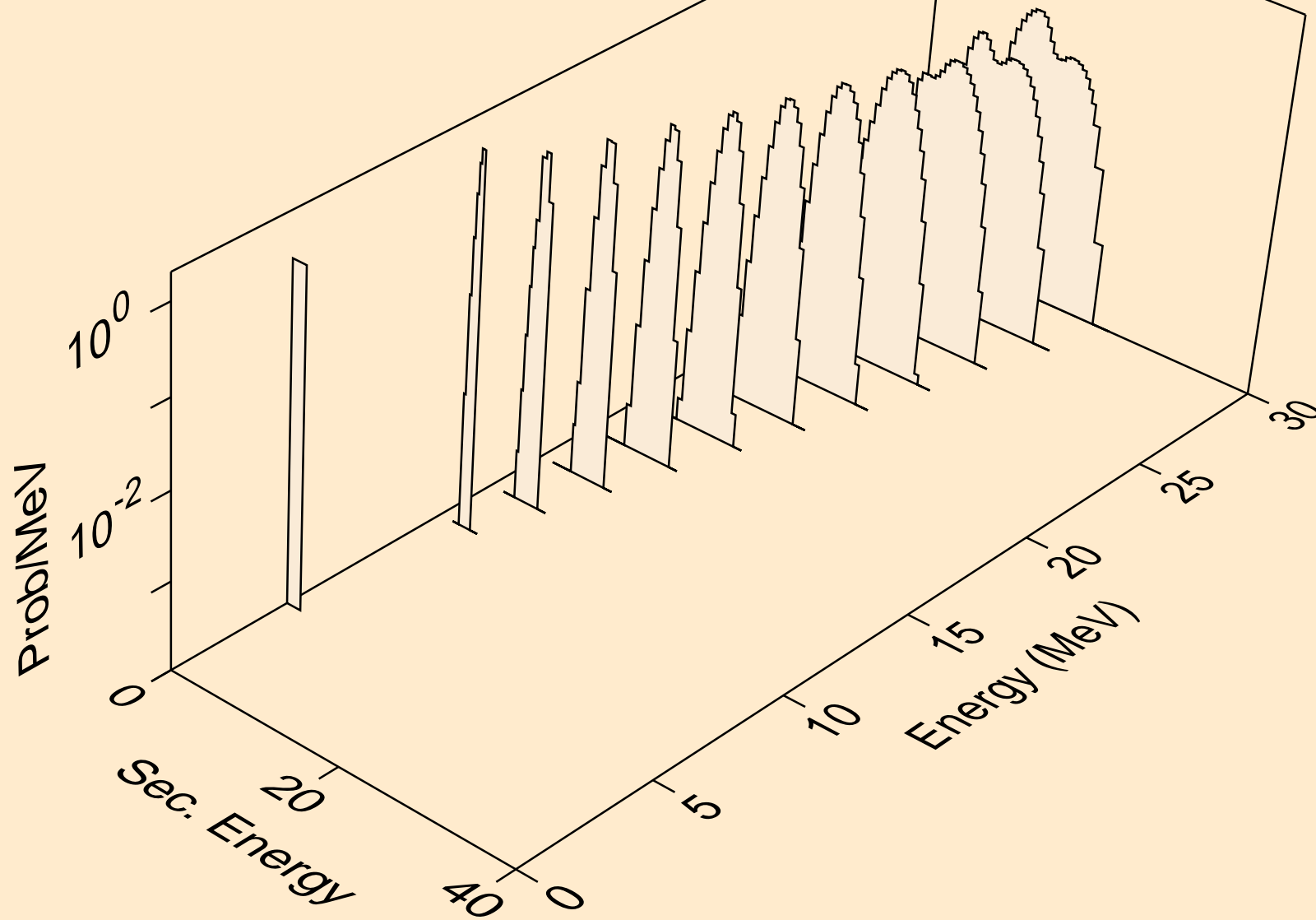

YB155 NEUTRON ACER TENDL-2024 LIBRARY; T=293.6K
he3s from (n,x)

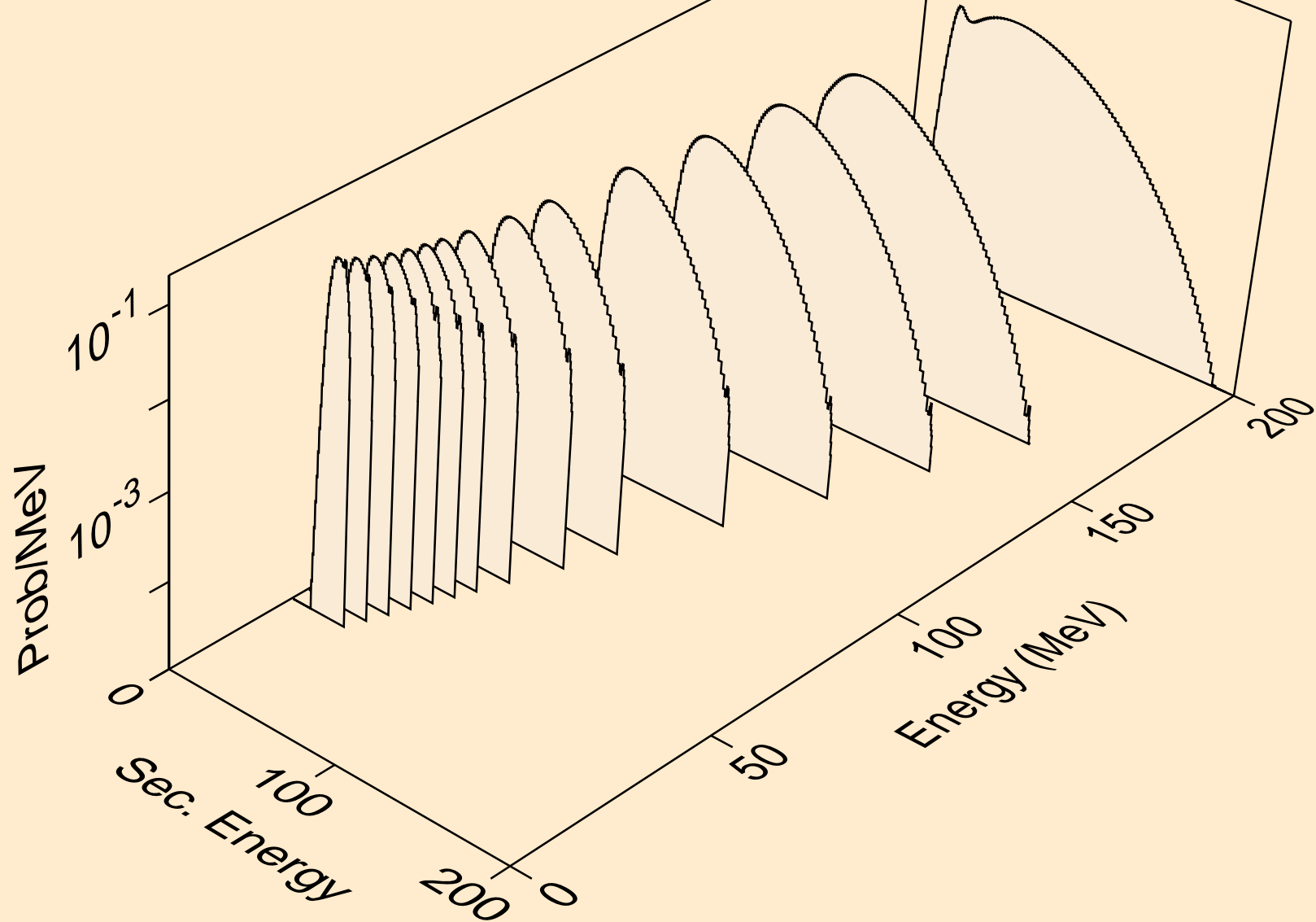

YB155 NEUTRON ACER TENDL-2024 LIBRARY; T=293.6K
he3s from (n,n*)he3

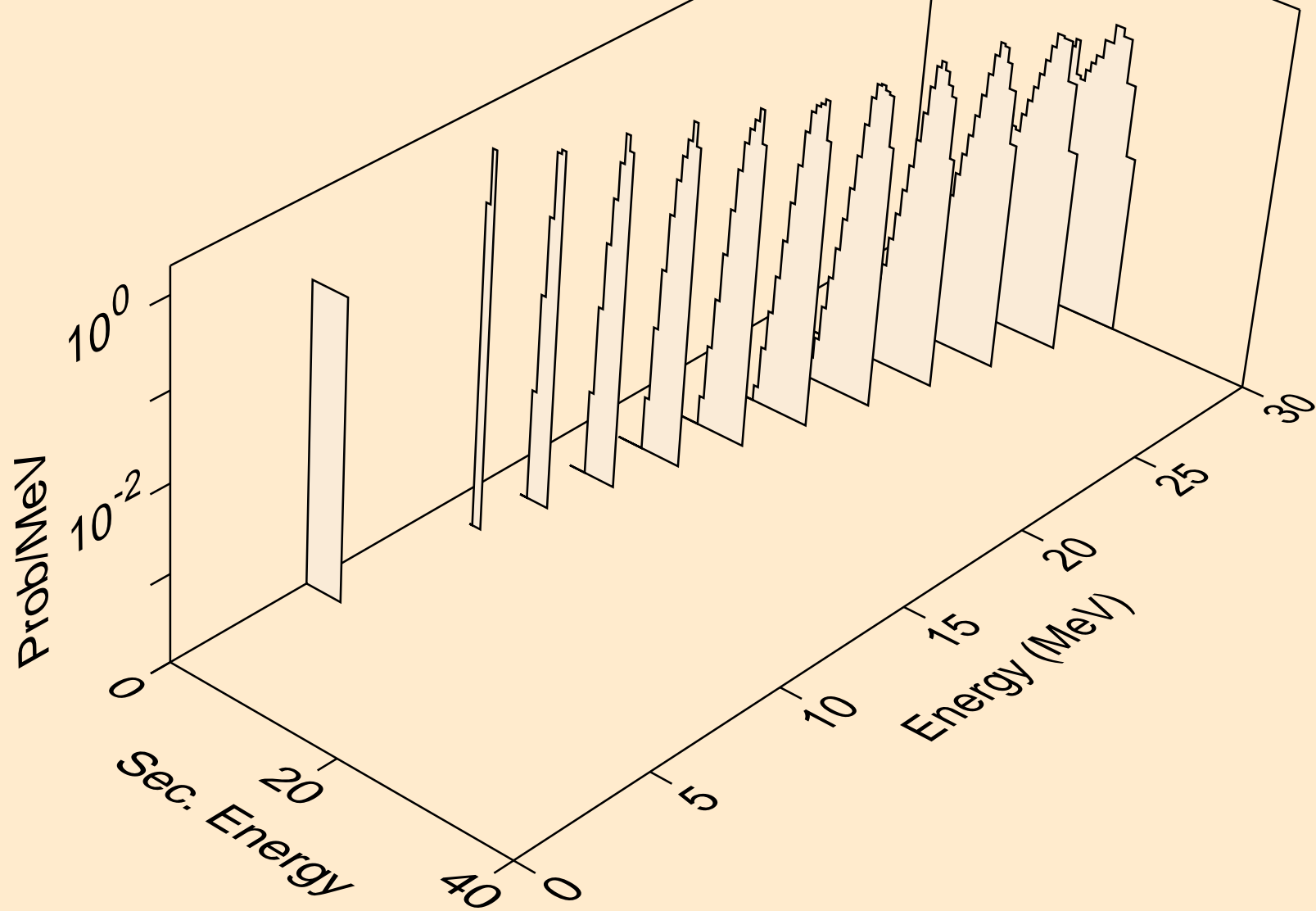

YB155 NEUTRON ACER TENDL-2024 LIBRARY; T=293.6K
he3s from (n,he3)

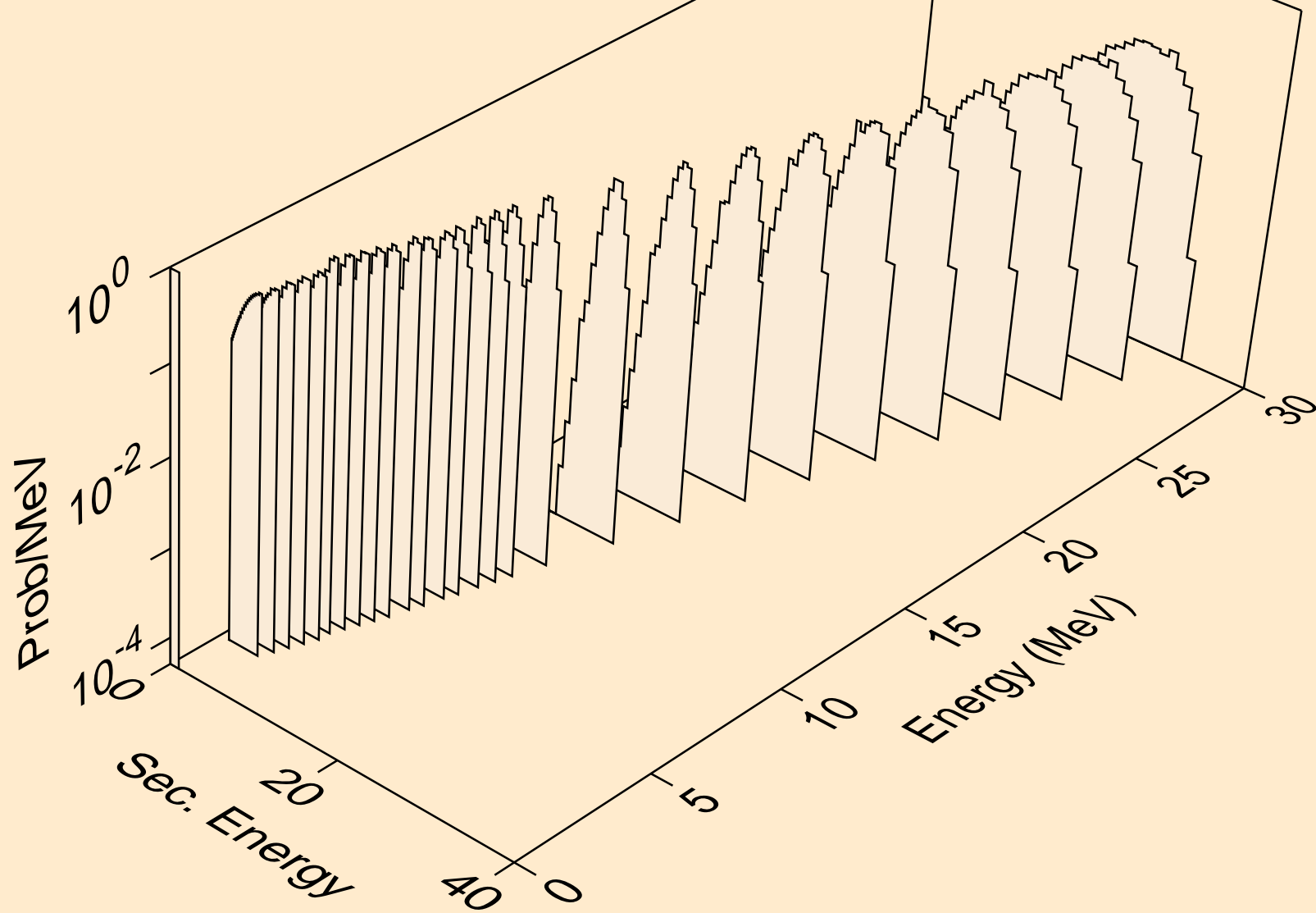

YB155 NEUTRON ACER TENDL-2024 LIBRARY; T=293.6K
alphas from (n,x)

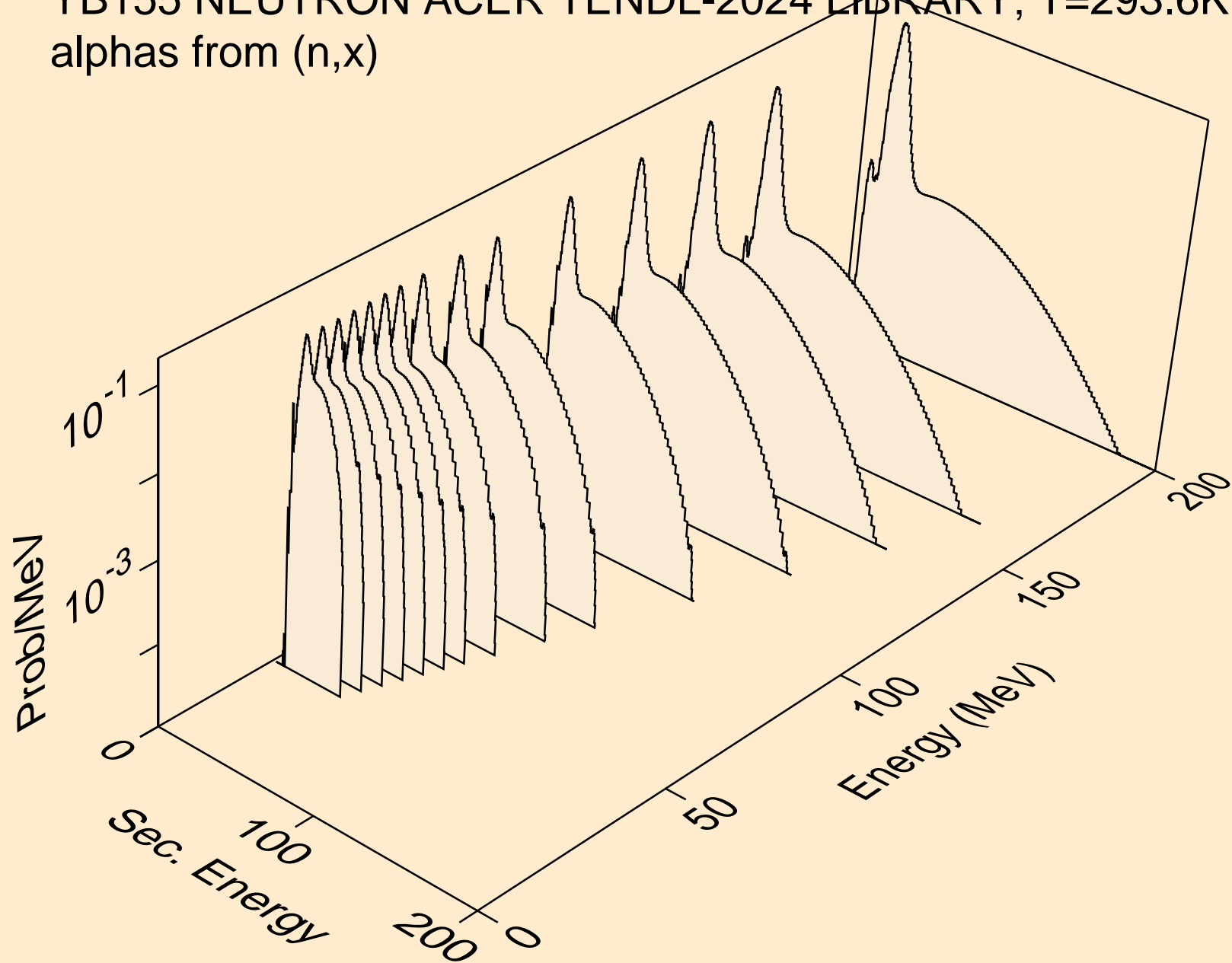

YB155 NEUTRON ACER TENDL-2024 LIBRARY; T=293.6K
alphas from (n,n*)a

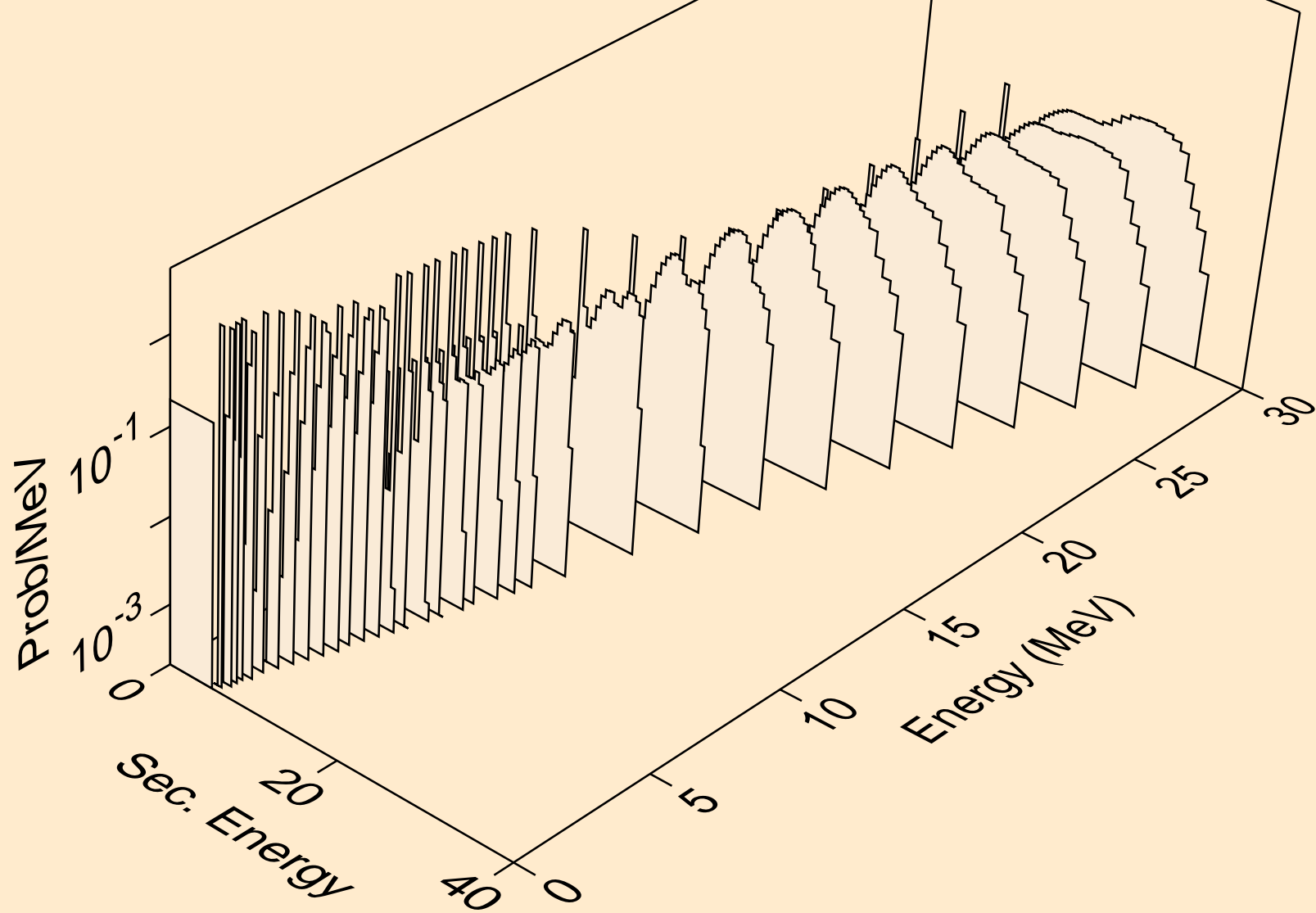

YB155 NEUTRON ACER TENDL-2024 LIBRARY; T=293.6K
alphas from (n,2n)a

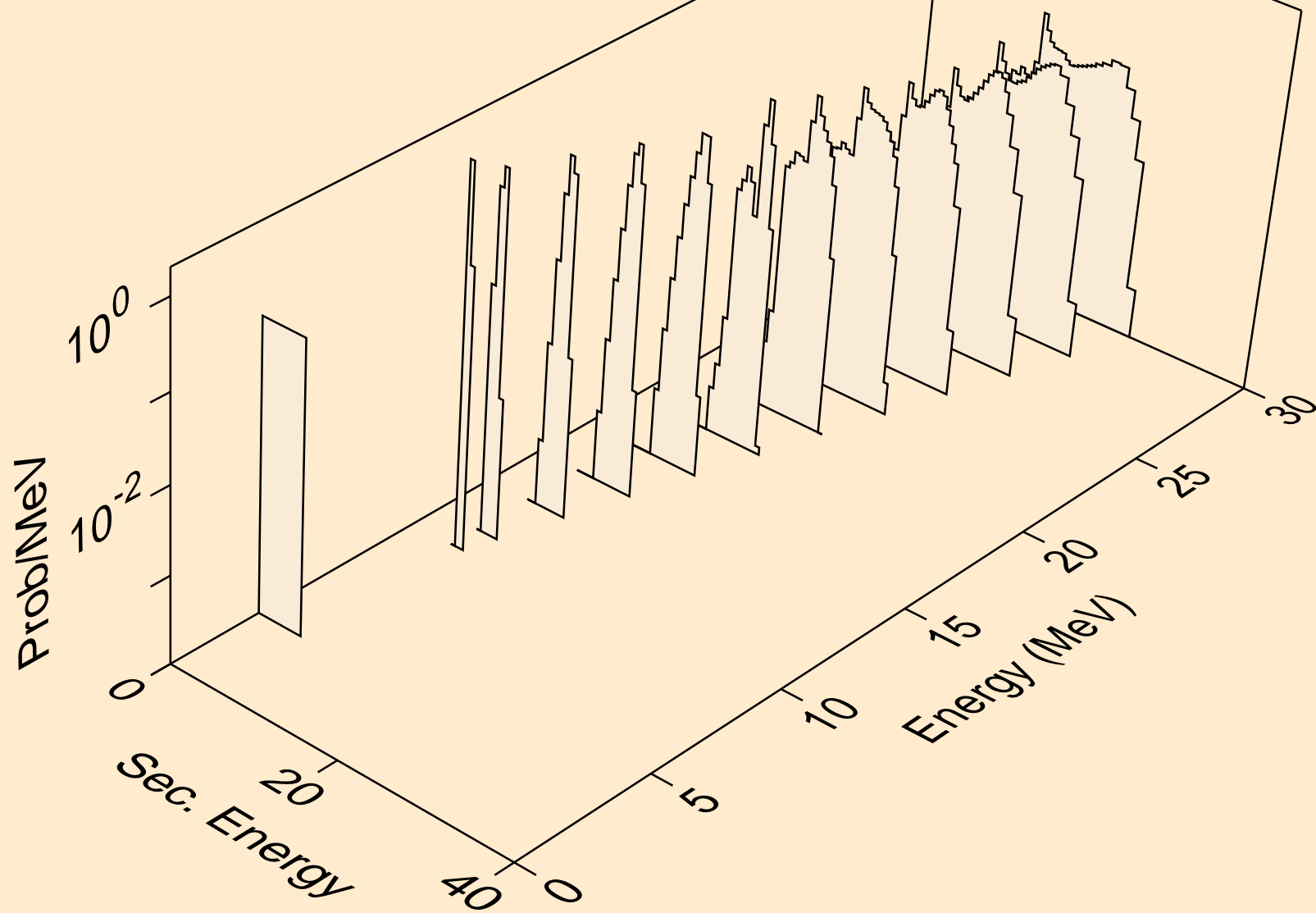

YB155 NEUTRON ACER TENDL-2024 LIBRARY; T=293.6K
alphas from (n,3n)a

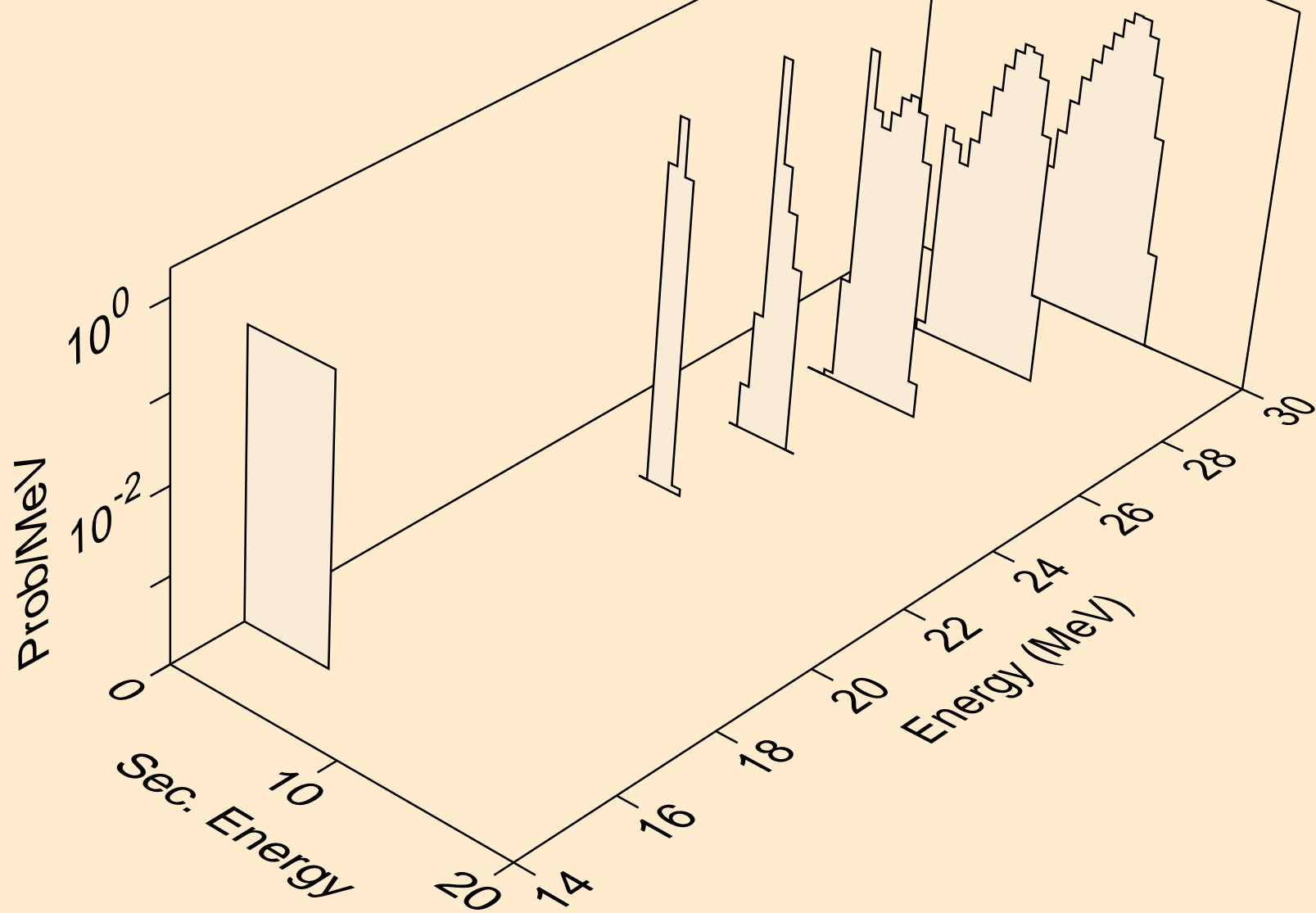

YB155 NEUTRON ACER TENDL-2024 LIBRARY; T=293.6K
alphas from (n,n*)2a

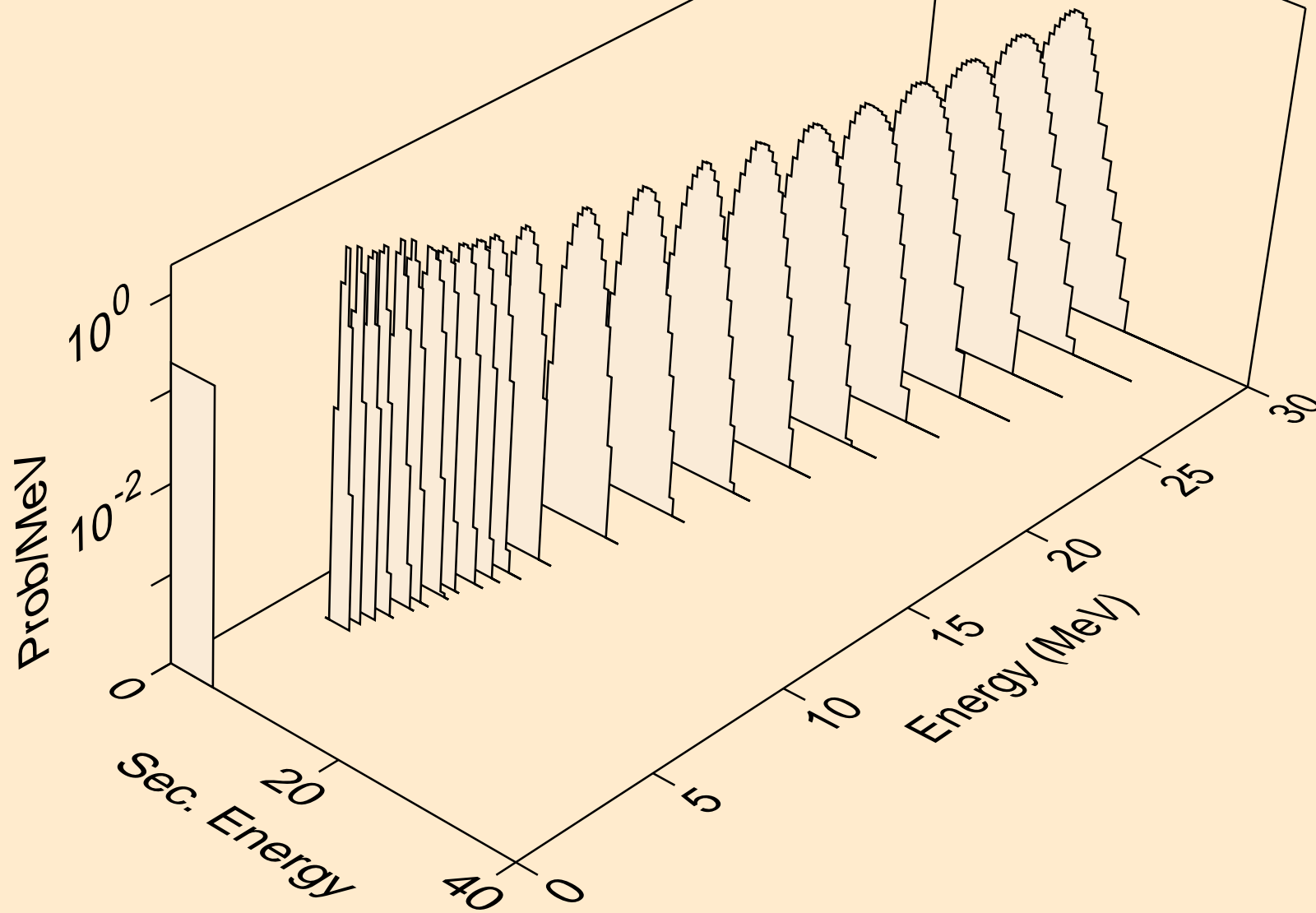

YB155 NEUTRON ACER TENDL-2024 LIBRARY; T=293.6K
alphas from (n,2n)2a

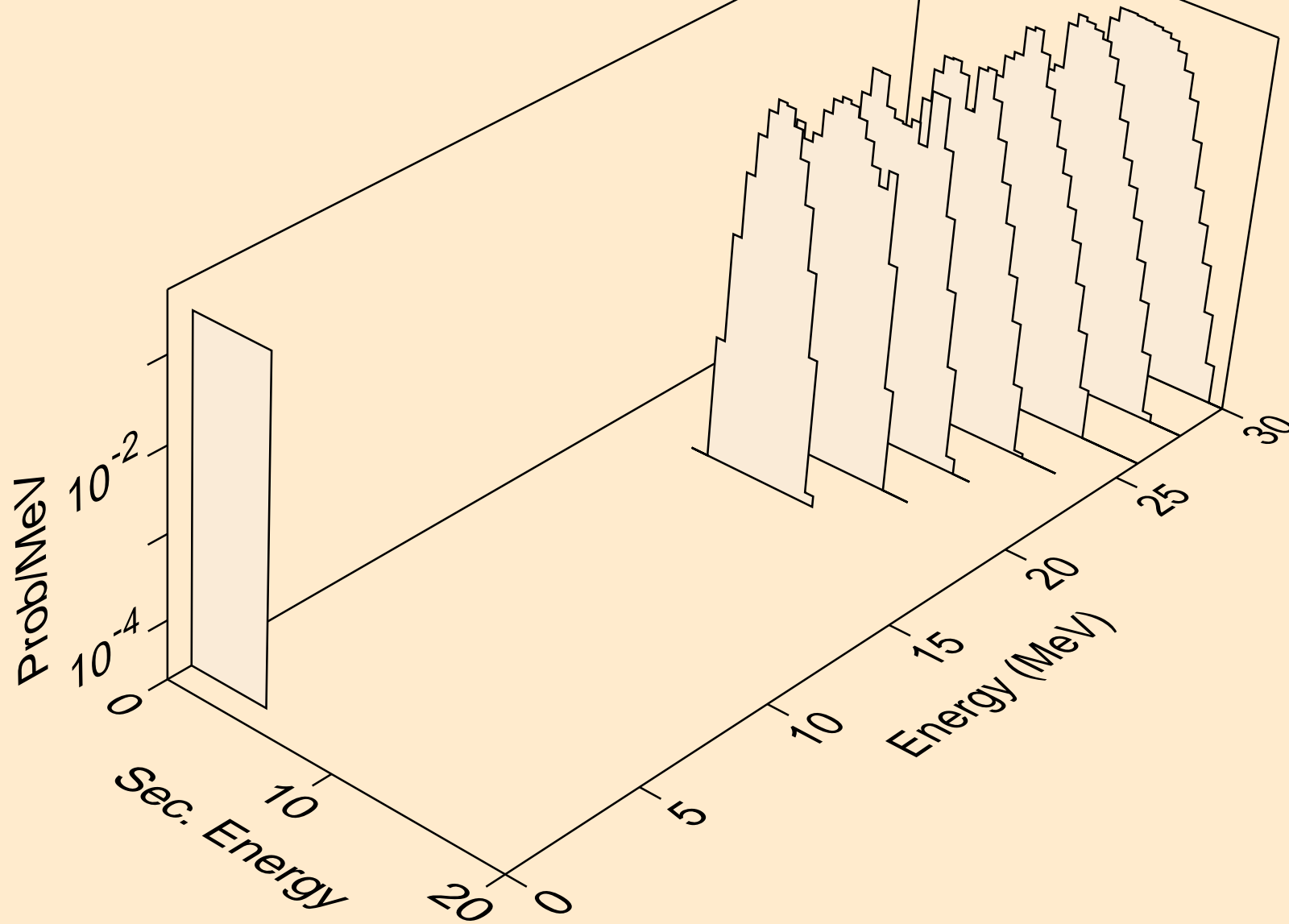

YB155 NEUTRON ACER TENDL-2024 LIBRARY; T=293.6K
alphas from (n,npa)

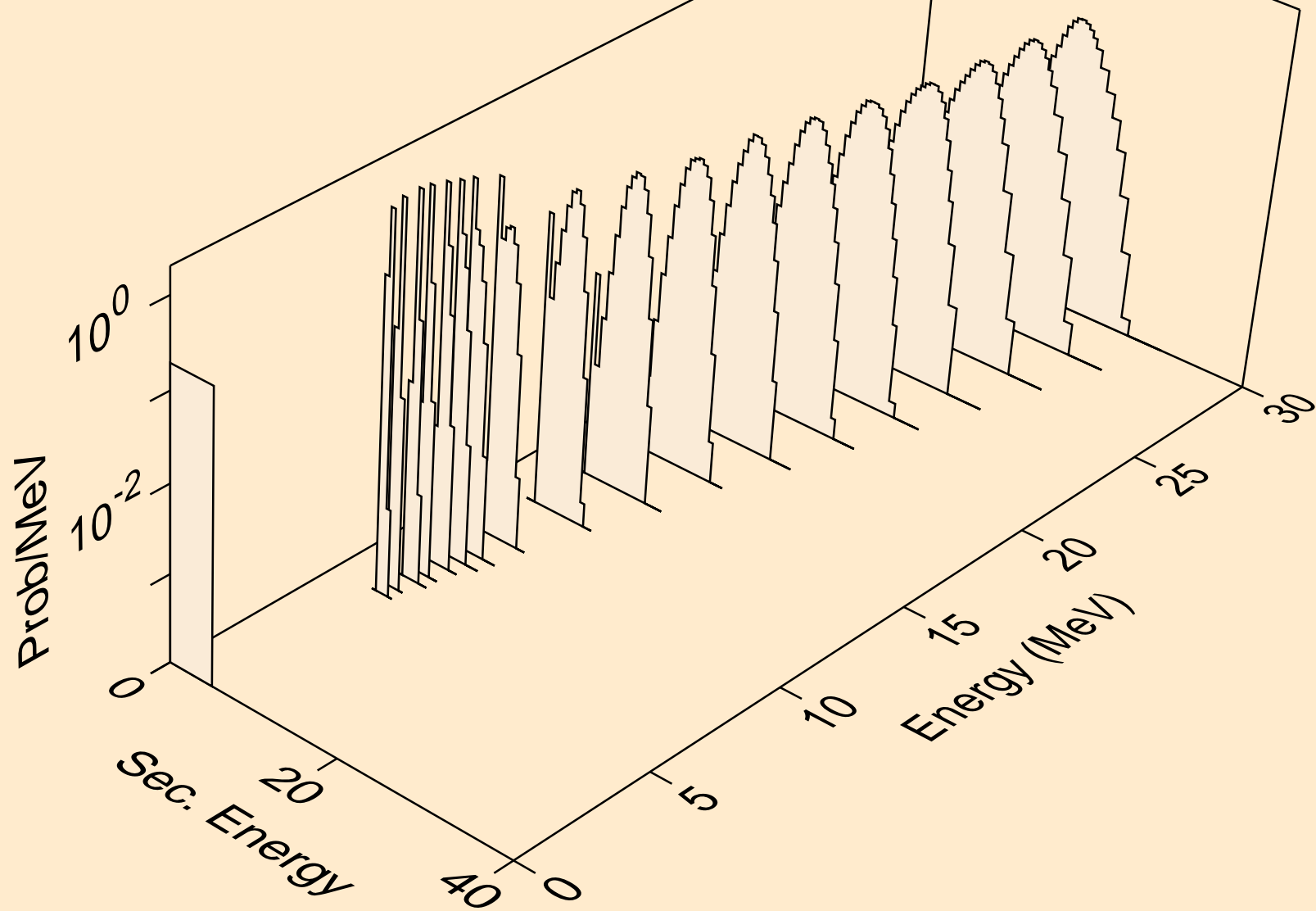

YB155 NEUTRON ACER TENDL-2024 LIBRARY; T=293.6K
alphas from (n,a)

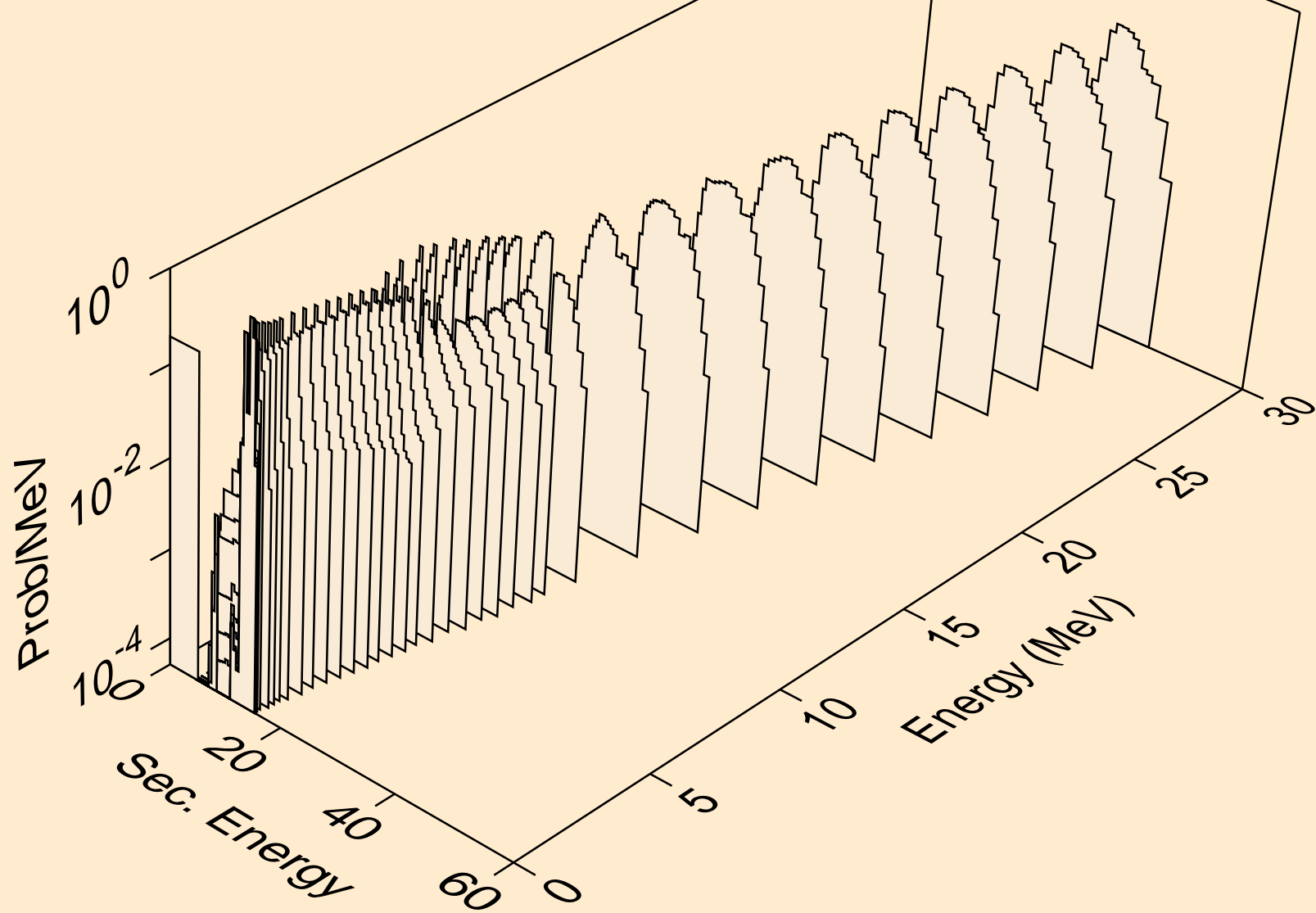

YB155 NEUTRON ACER TENDL-2024 LIBRARY; T=293.6K
alphas from (n,2a)

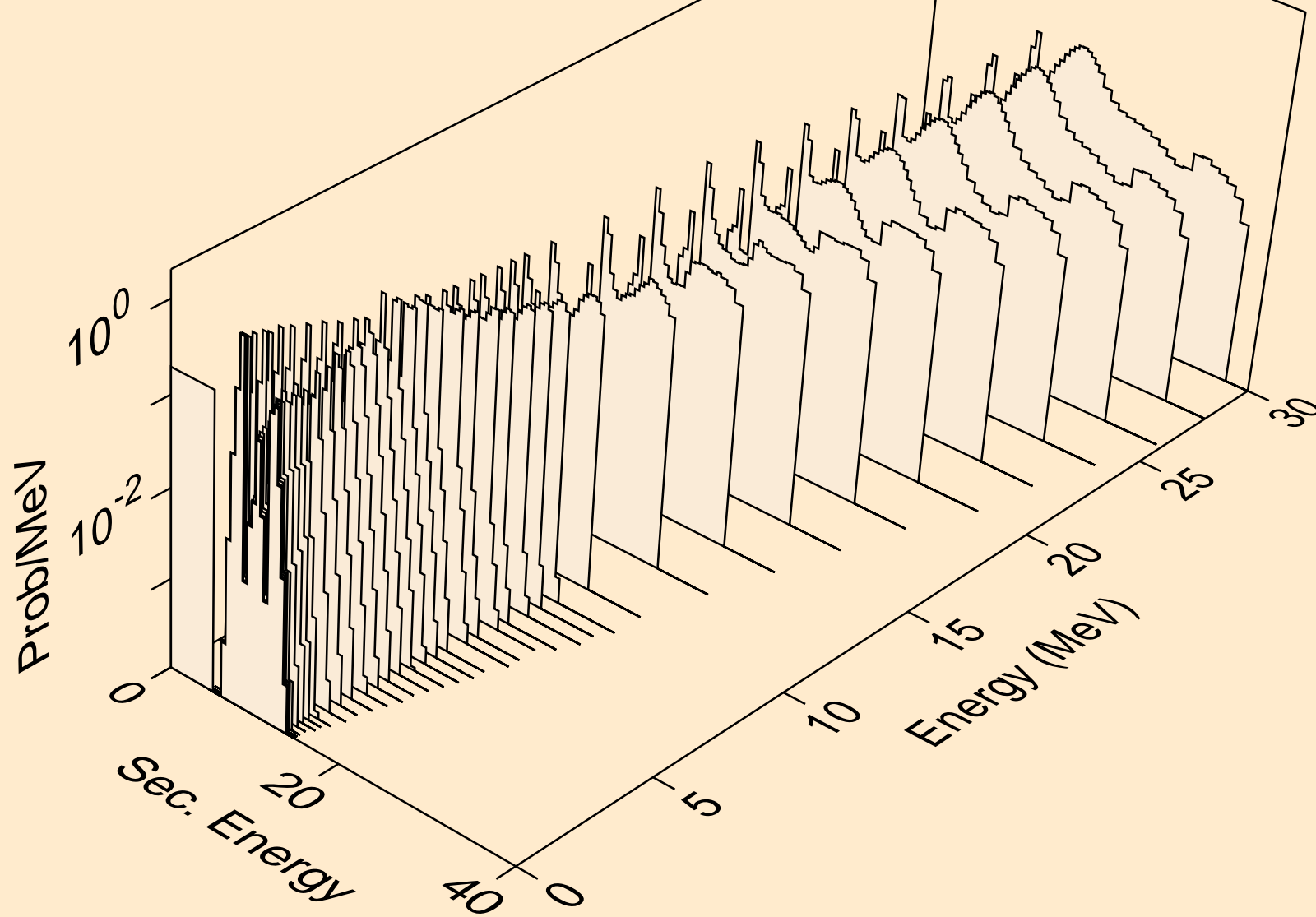

YB155 NEUTRON ACER TENDL-2024 LIBRARY; T=293.6K
alphas from (n,3a)

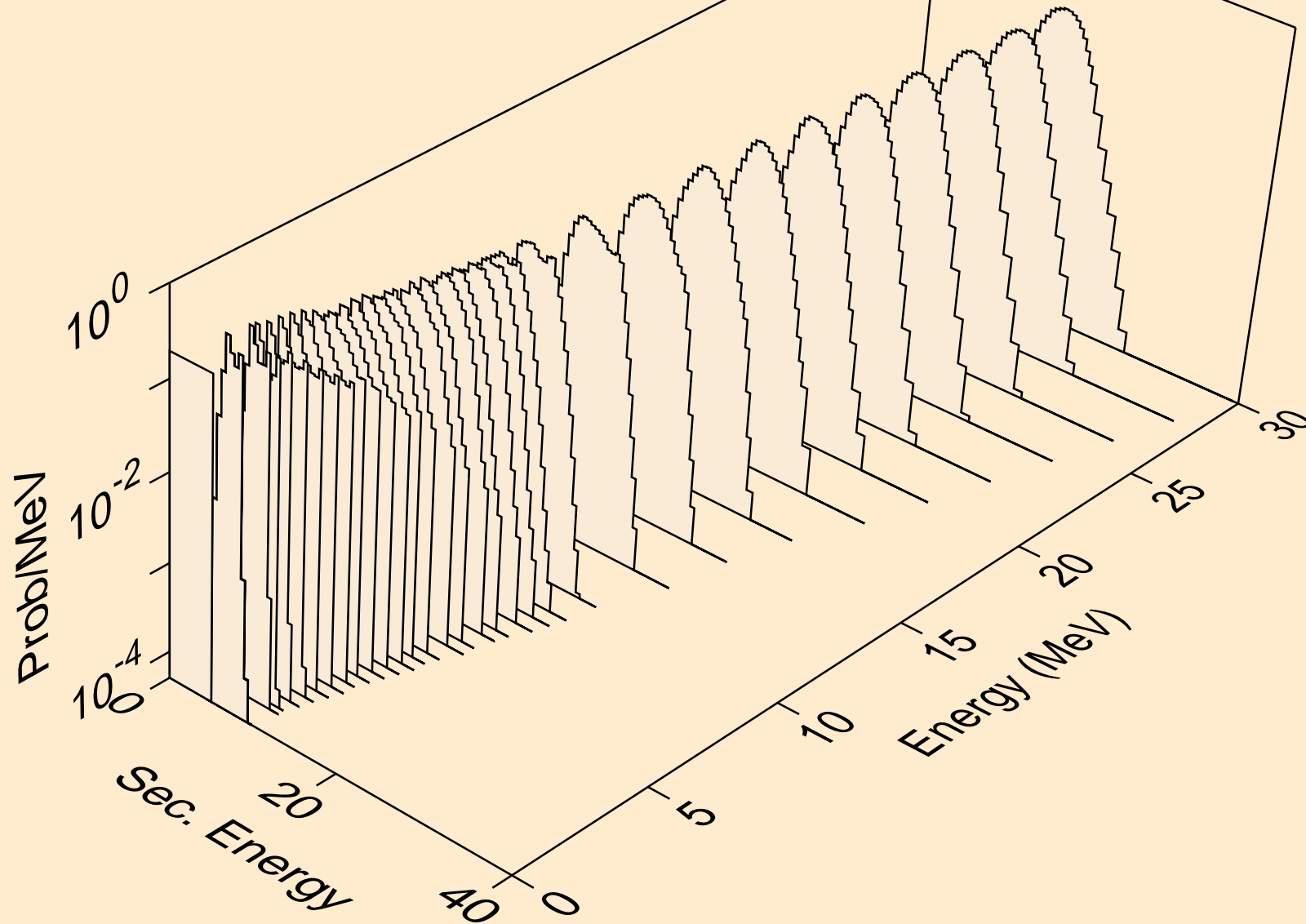

YB155 NEUTRON ACER TENDL-2024 LIBRARY; T=293.6K
alphas from (n,pa)

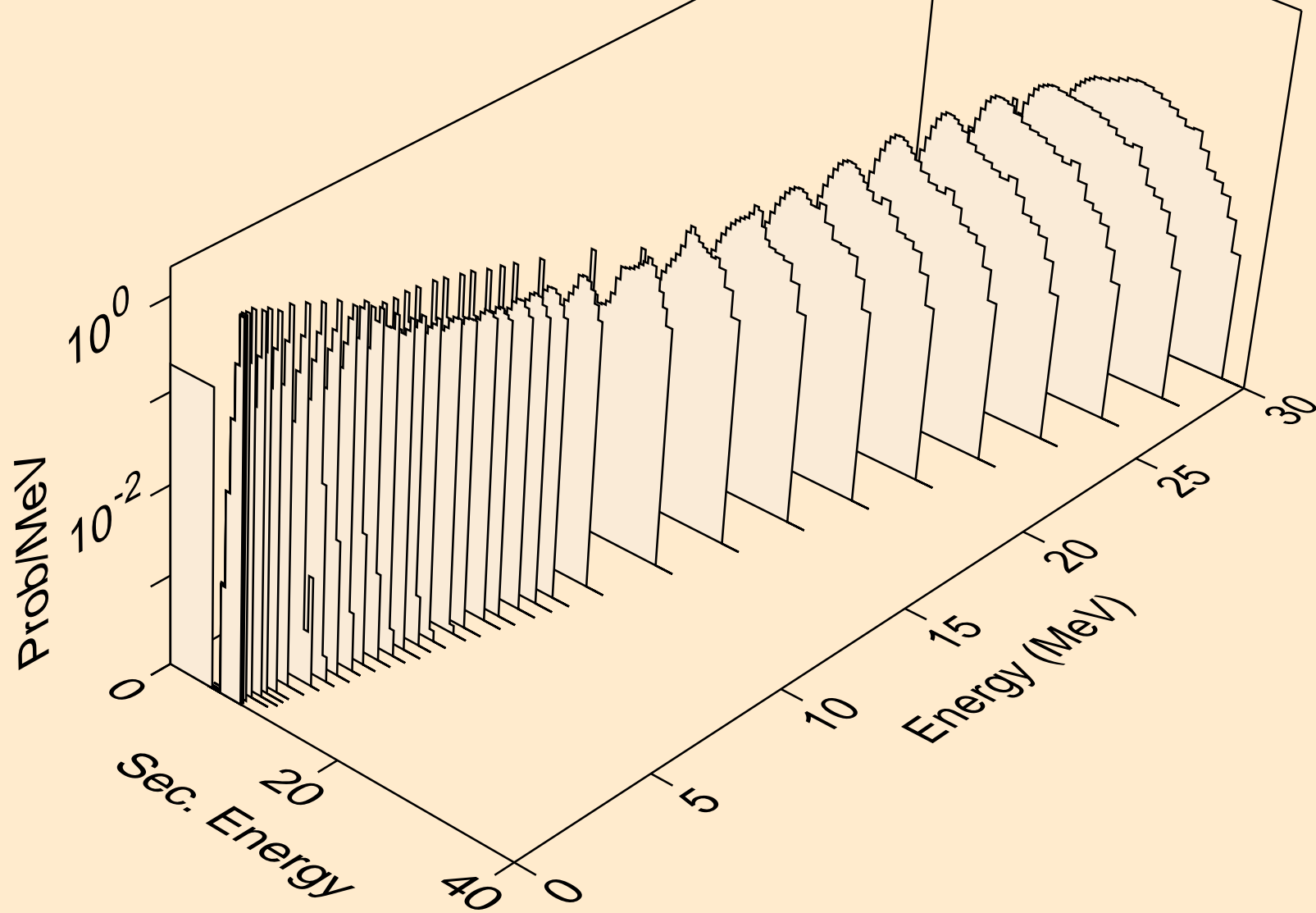

YB155 NEUTRON ACER TENDL-2024 LIBRARY; T=293.6K
alphas from (n,d2a)

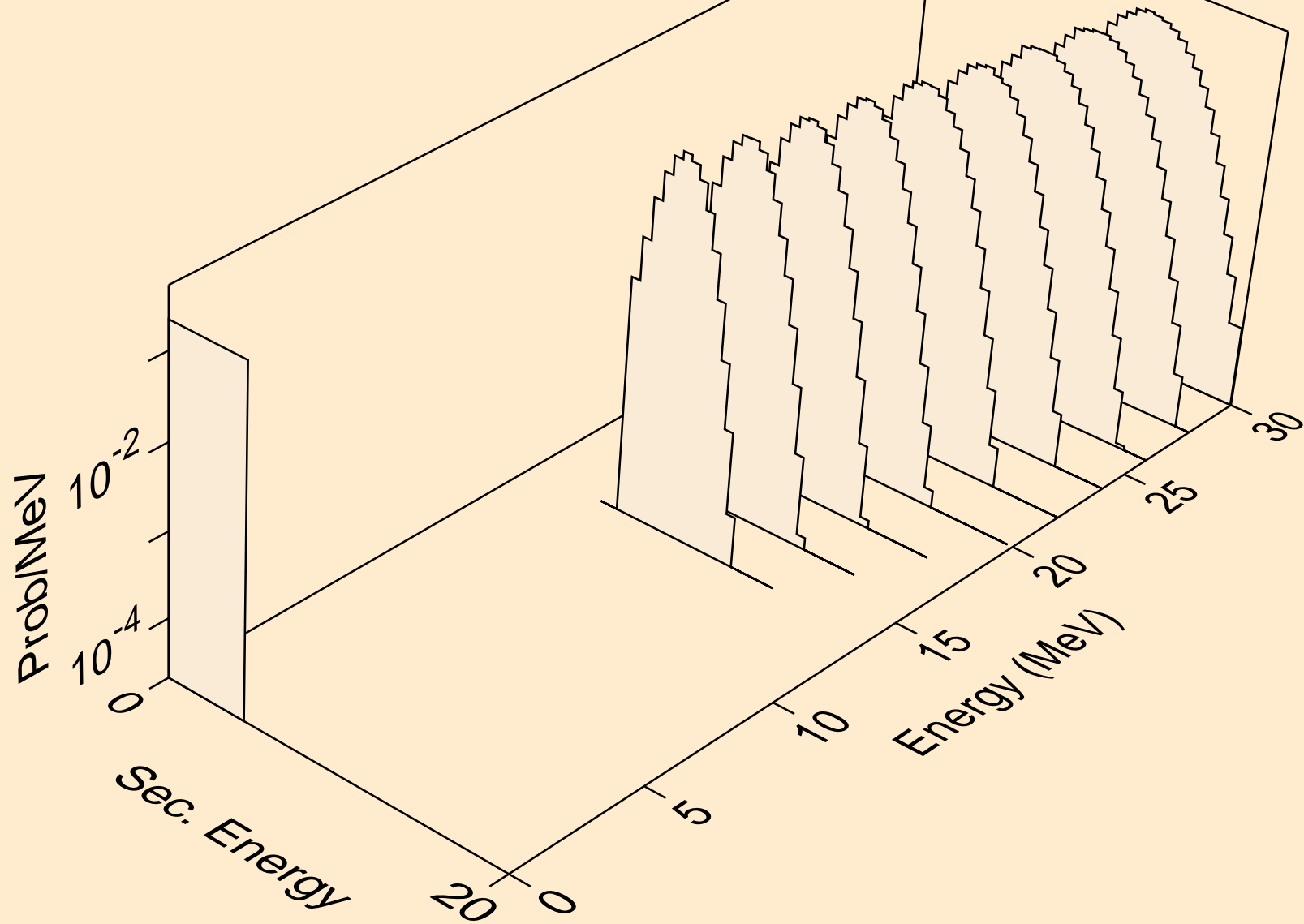

YB155 NEUTRON ACER TENDL-2024 LIBRARY; T=293.6K
alphas from (n,da)

