

YB184 NEUTRON ACER TENDL-2024 LIBRARY; T=293.6K

Principal cross sections

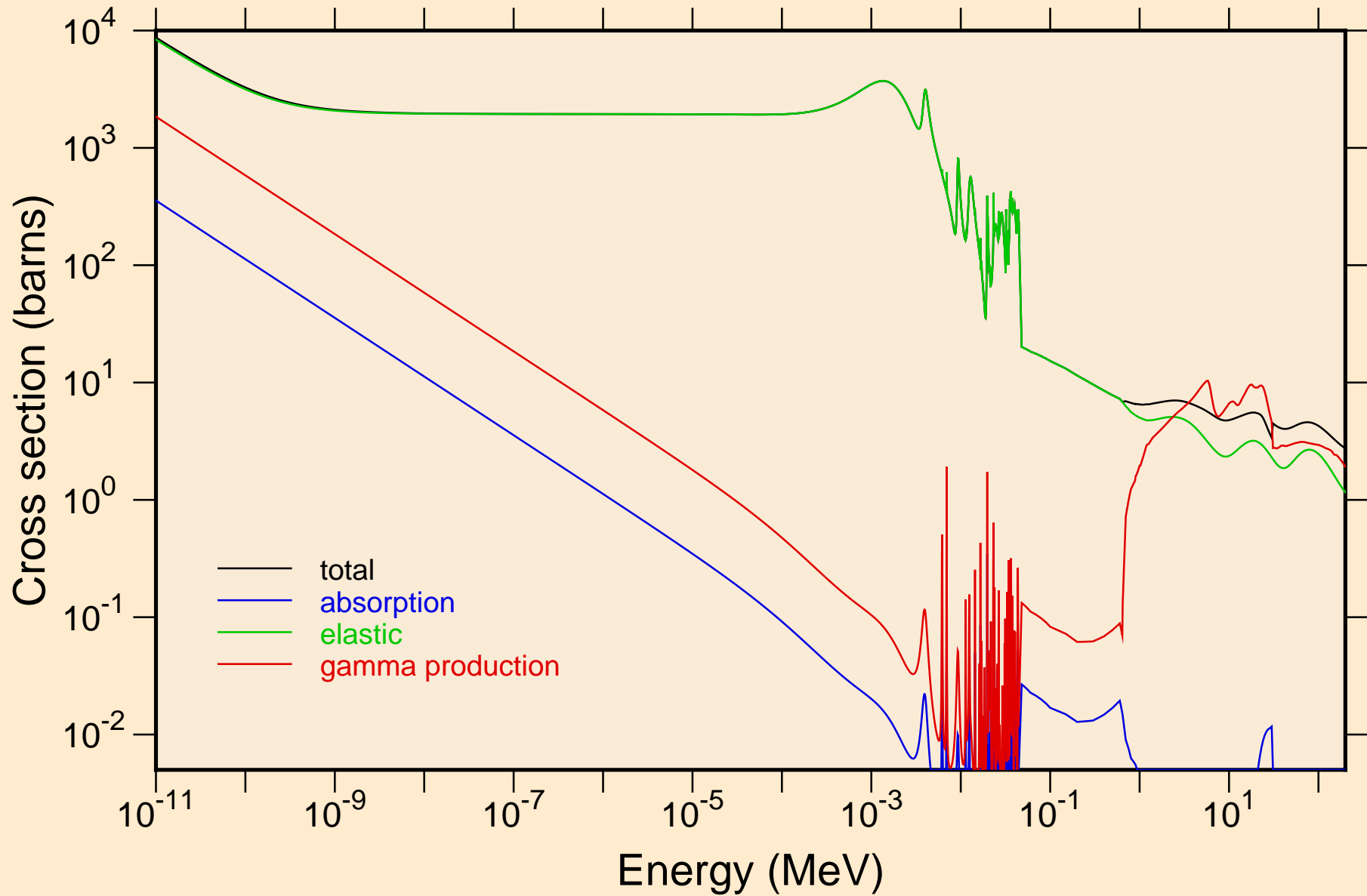

YB184 NEUTRON ACER TENDL-2024 LIBRARY; T=293.6K
resonance total cross section

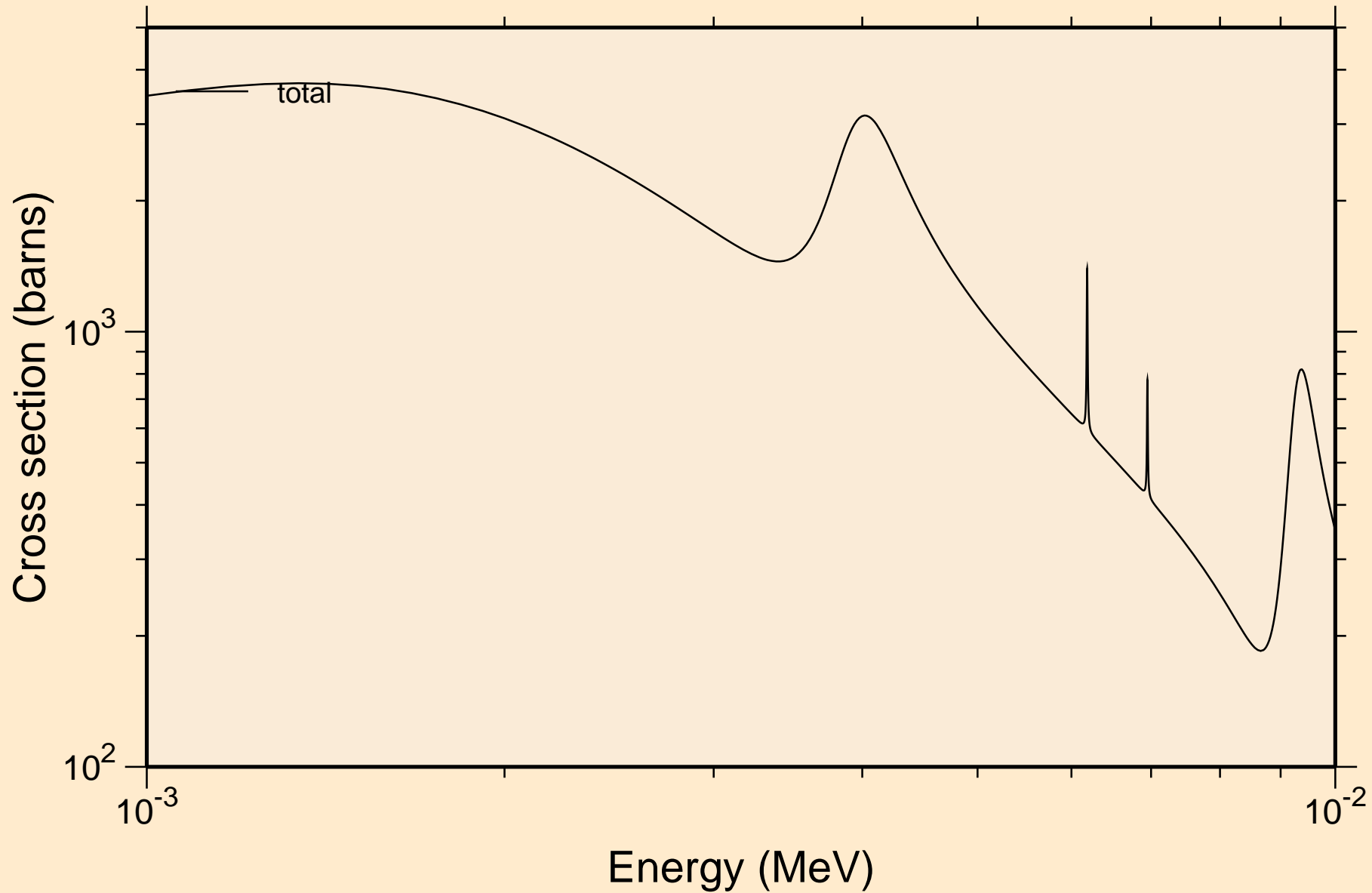

YB184 NEUTRON ACER TENDL-2024 LIBRARY; T=293.6K
resonance total cross section

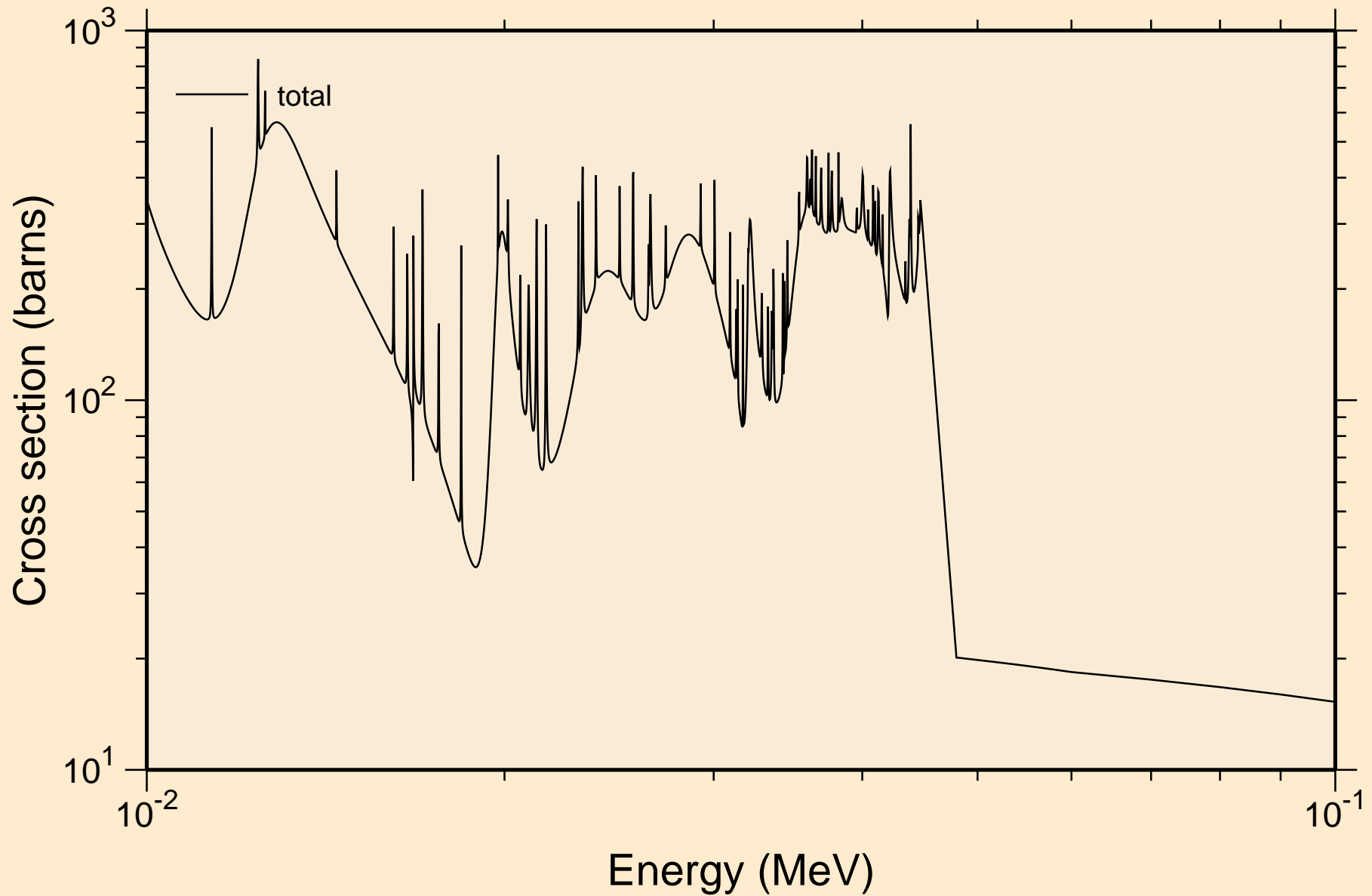

YB184 NEUTRON ACER TENDL-2024 LIBRARY; T=293.6K
resonance total cross section

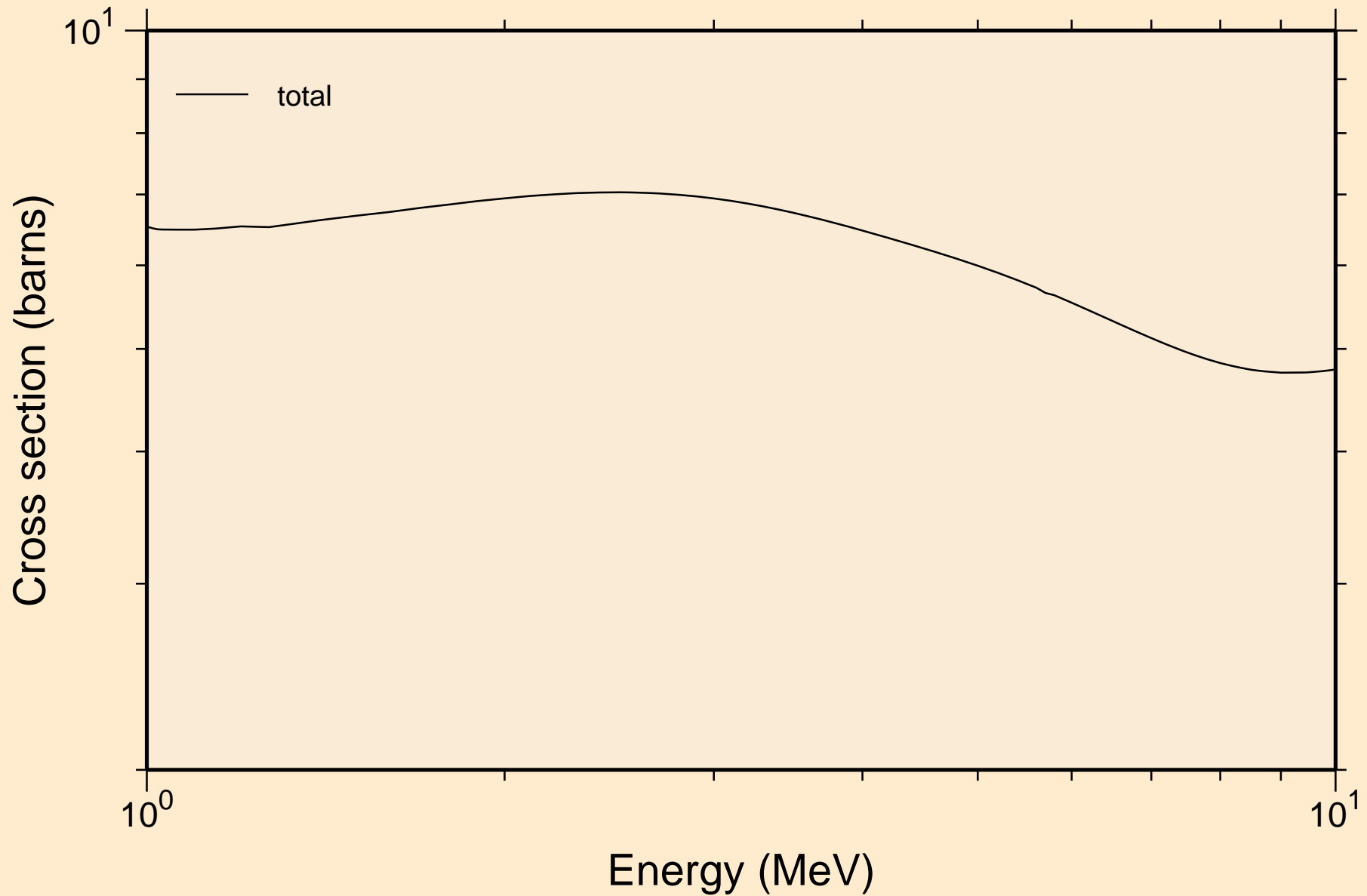

YB184 NEUTRON ACER TENDL-2024 LIBRARY; T=293.6K
resonance absorption cross sections

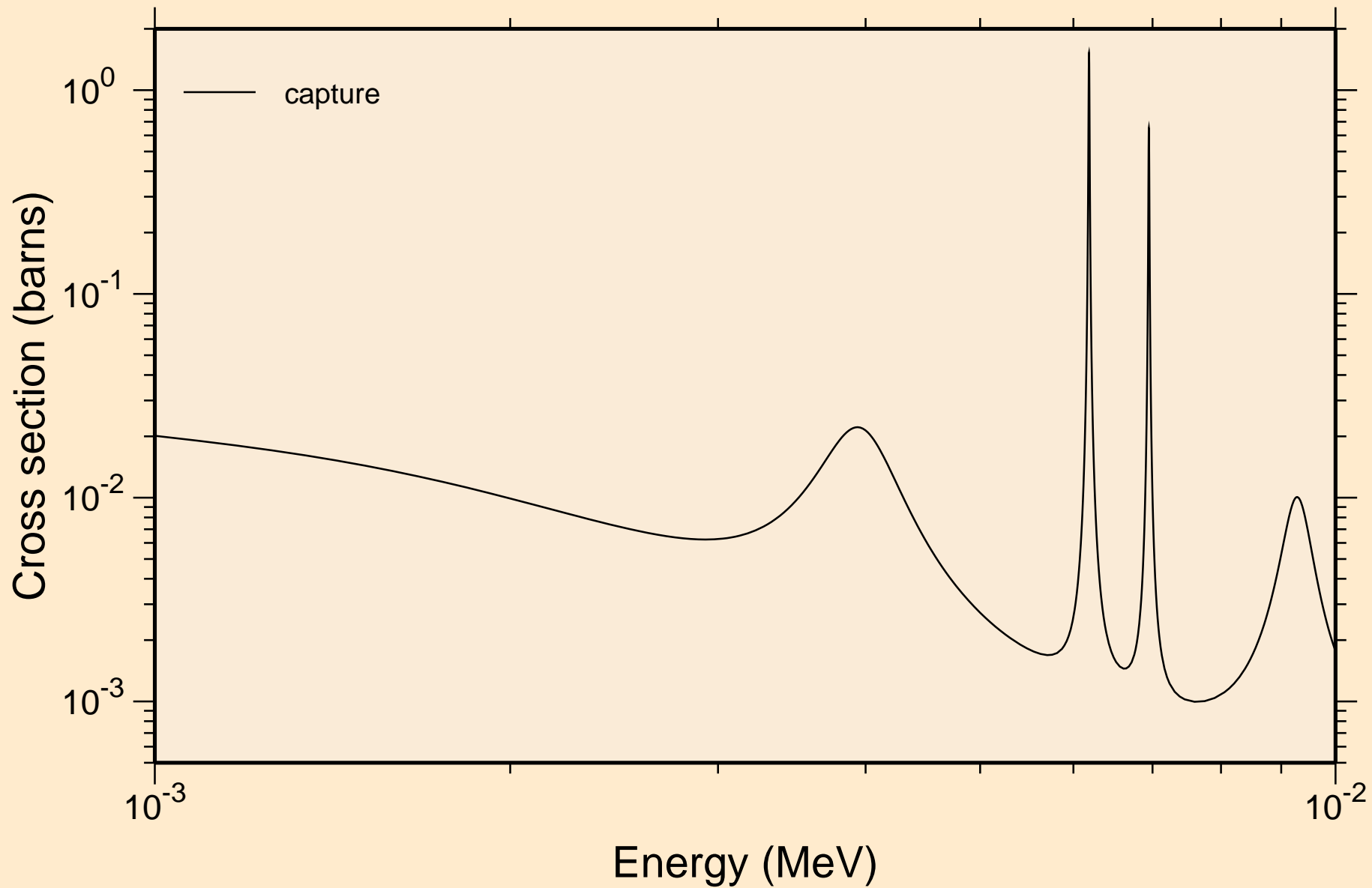

YB184 NEUTRON ACER TENDL-2024 LIBRARY; T=293.6K
resonance absorption cross sections

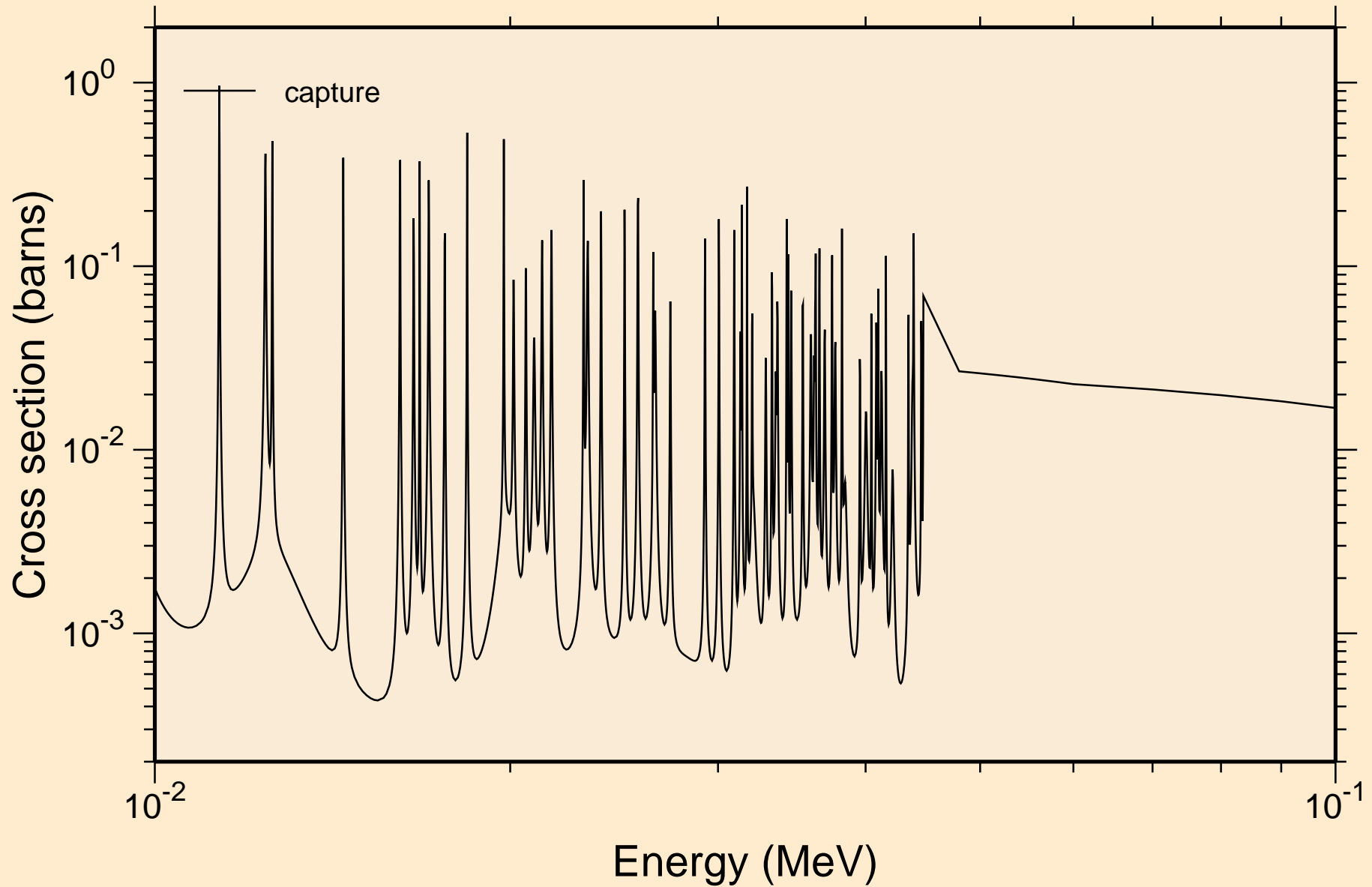

YB184 NEUTRON ACER TENDL-2024 LIBRARY; T=293.6K
resonance absorption cross sections

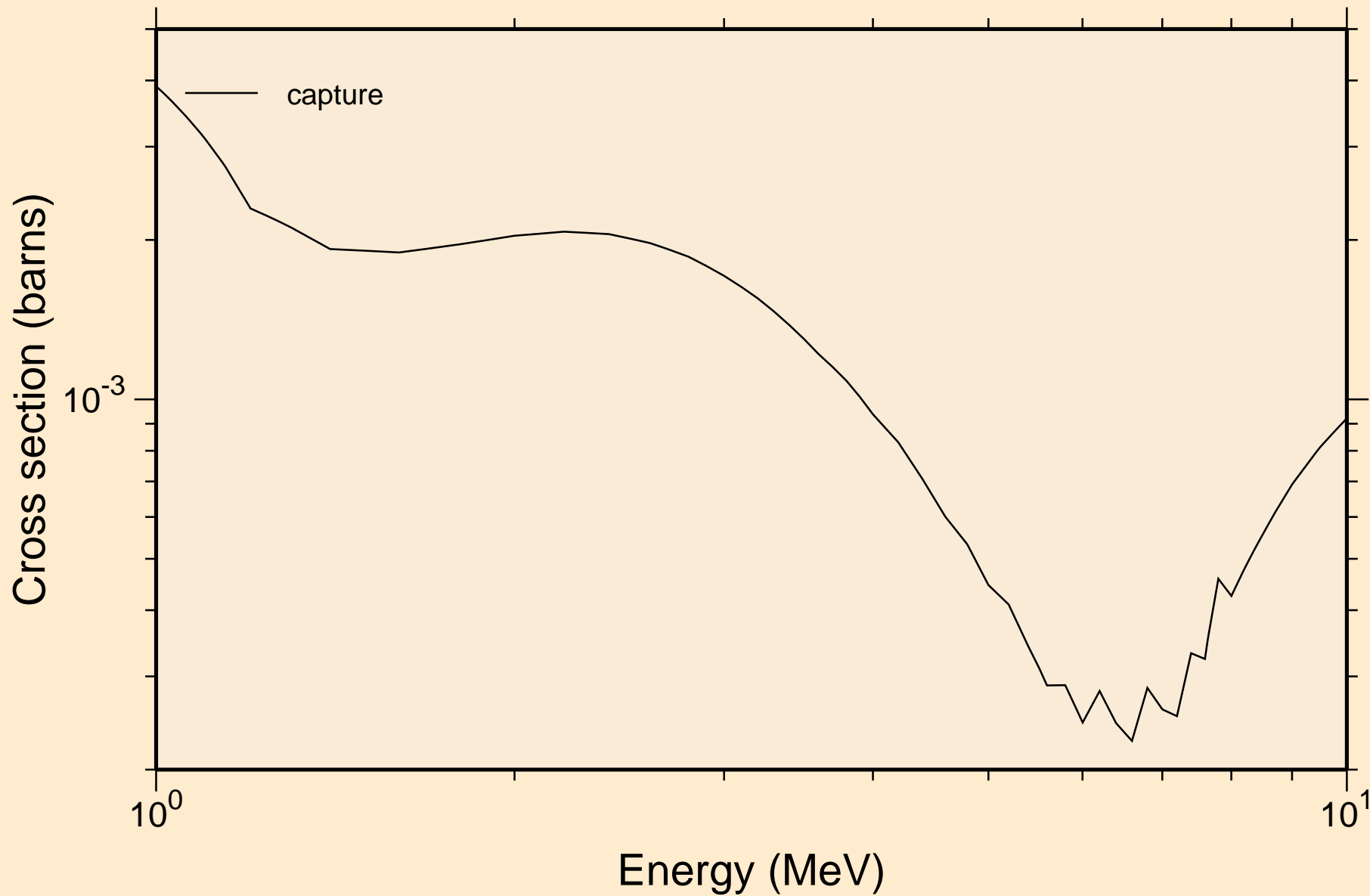

YB184 NEUTRON ACER TENDL-2024 LIBRARY; T=293.6K
Heating

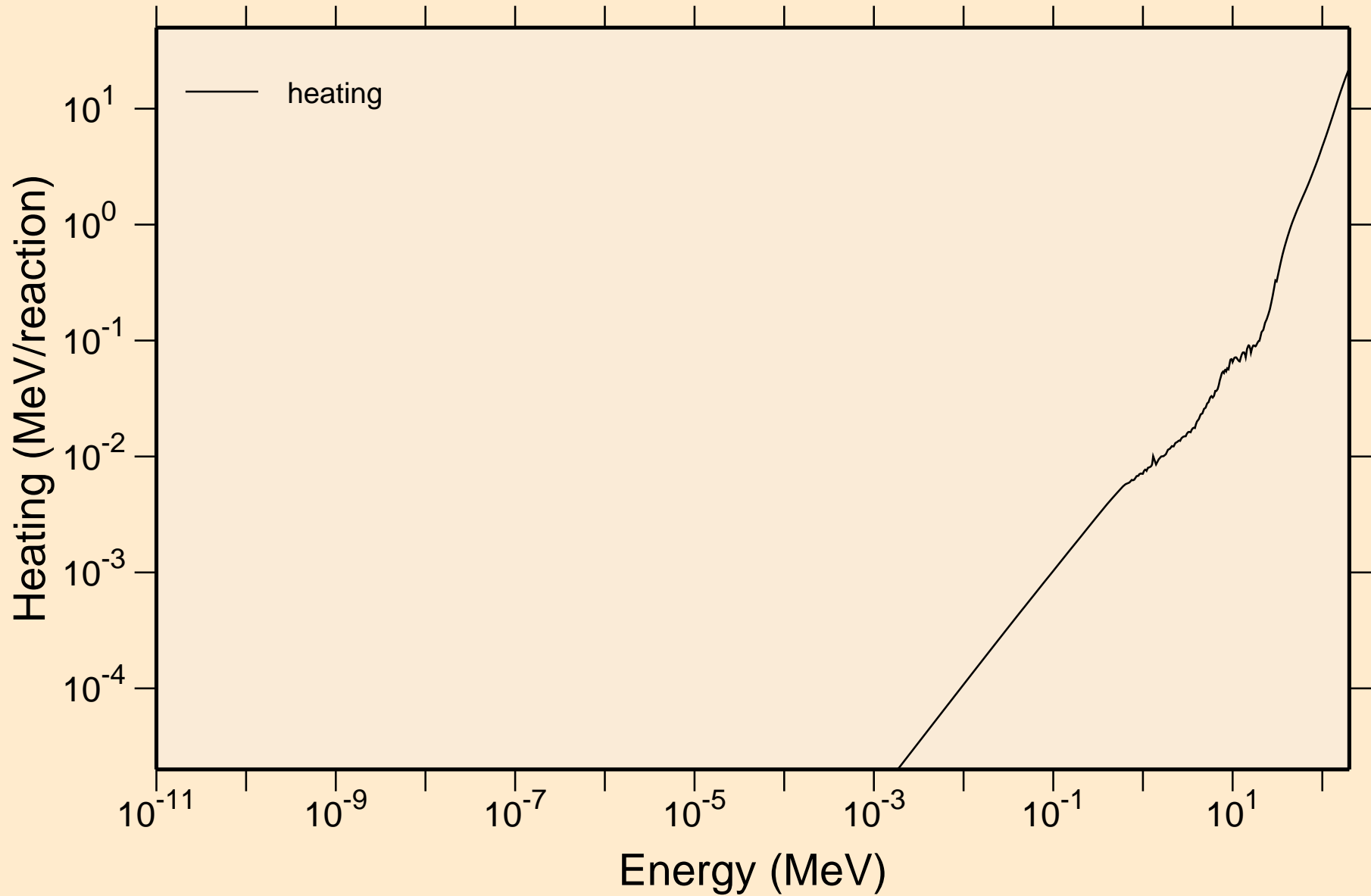

YB184 NEUTRON ACER TENDL-2024 LIBRARY; T=293.6K
Damage

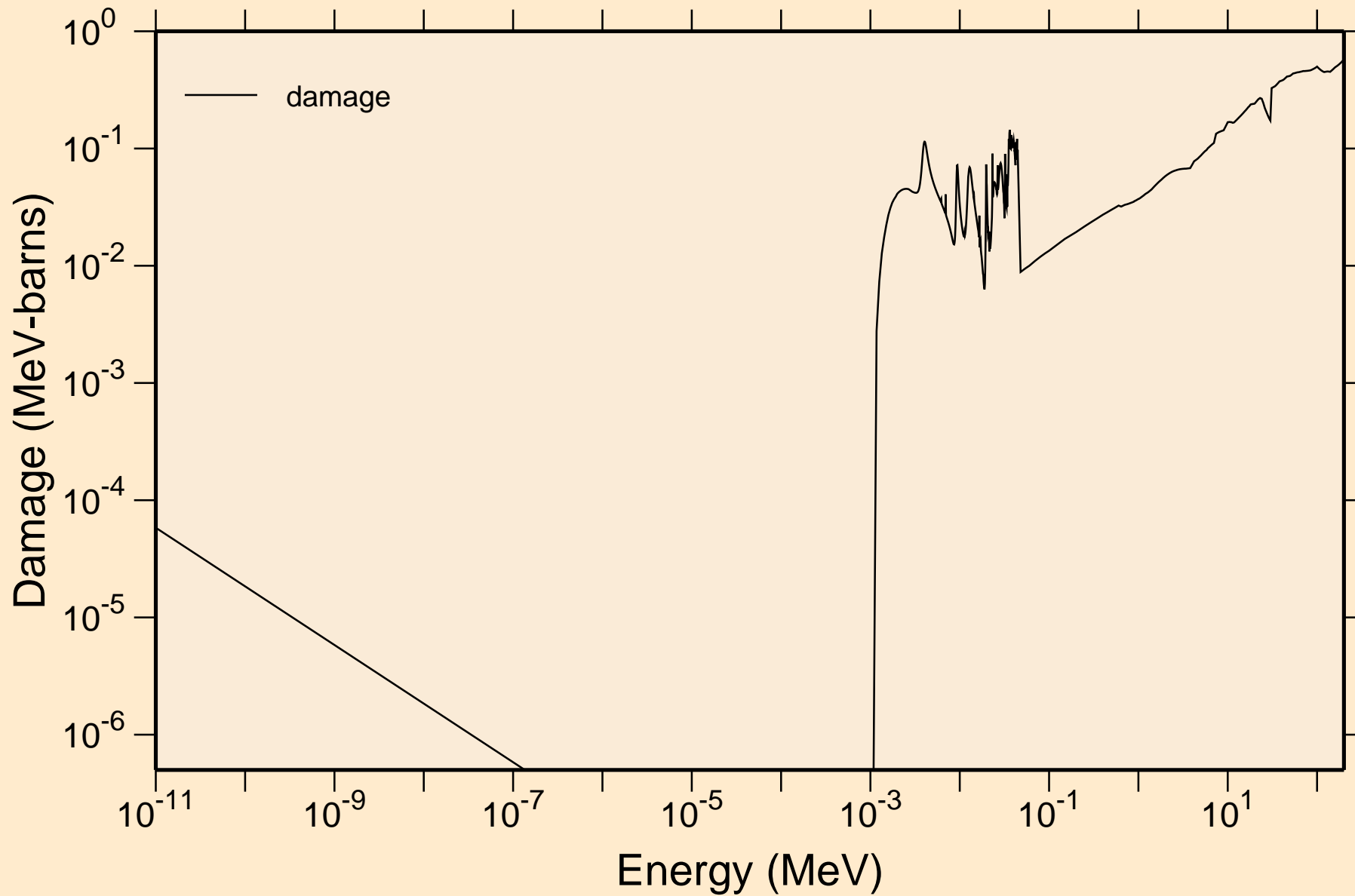

YB184 NEUTRON ACER TENDL-2024 LIBRARY; T=293.6K
Non-threshold reactions

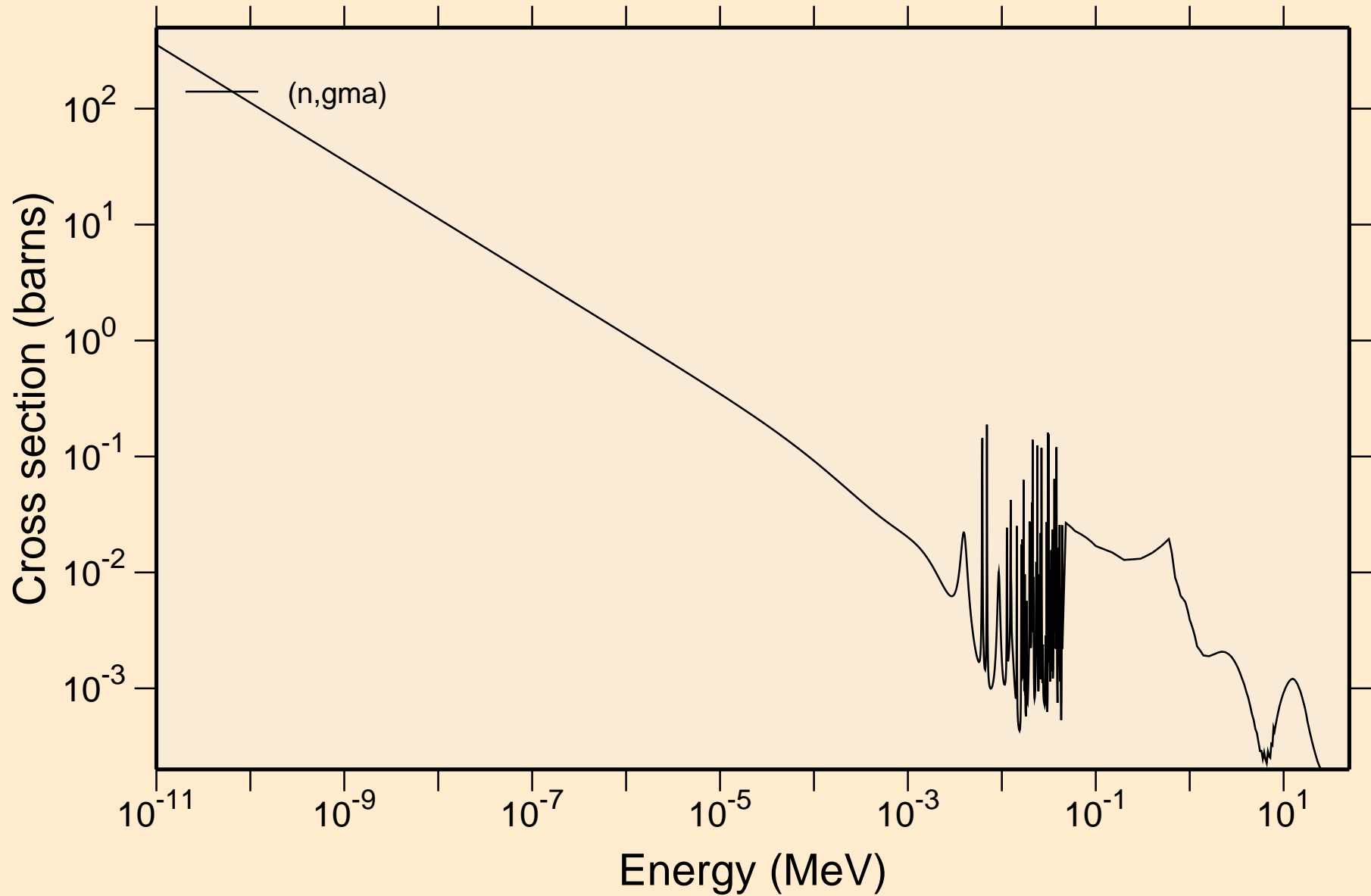

YB184 NEUTRON ACER TENDL-2024 LIBRARY; T=293.6K
Principal cross sections

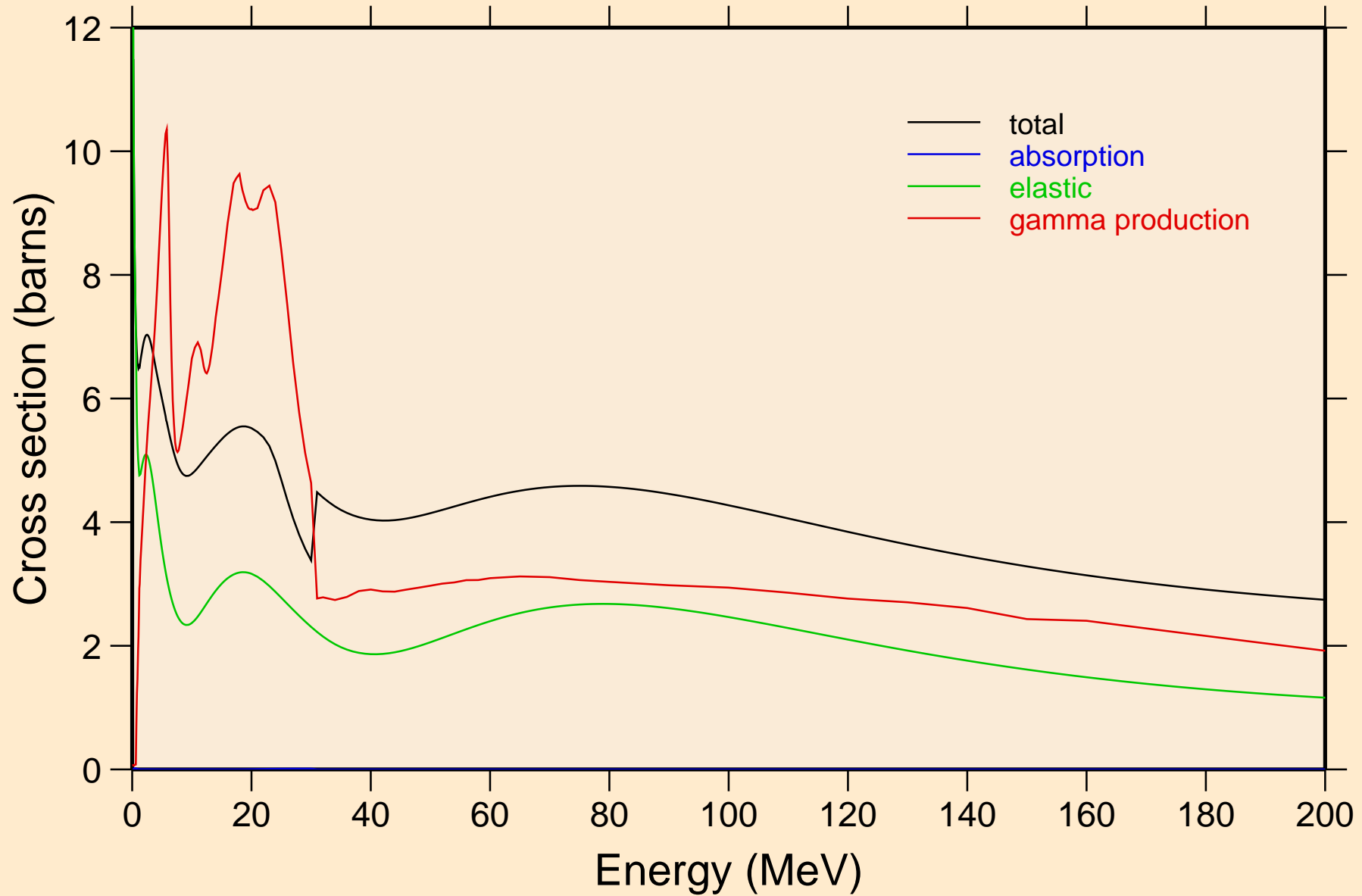

YB184 NEUTRON ACER TENDL-2024 LIBRARY; T=293.6K
Heating

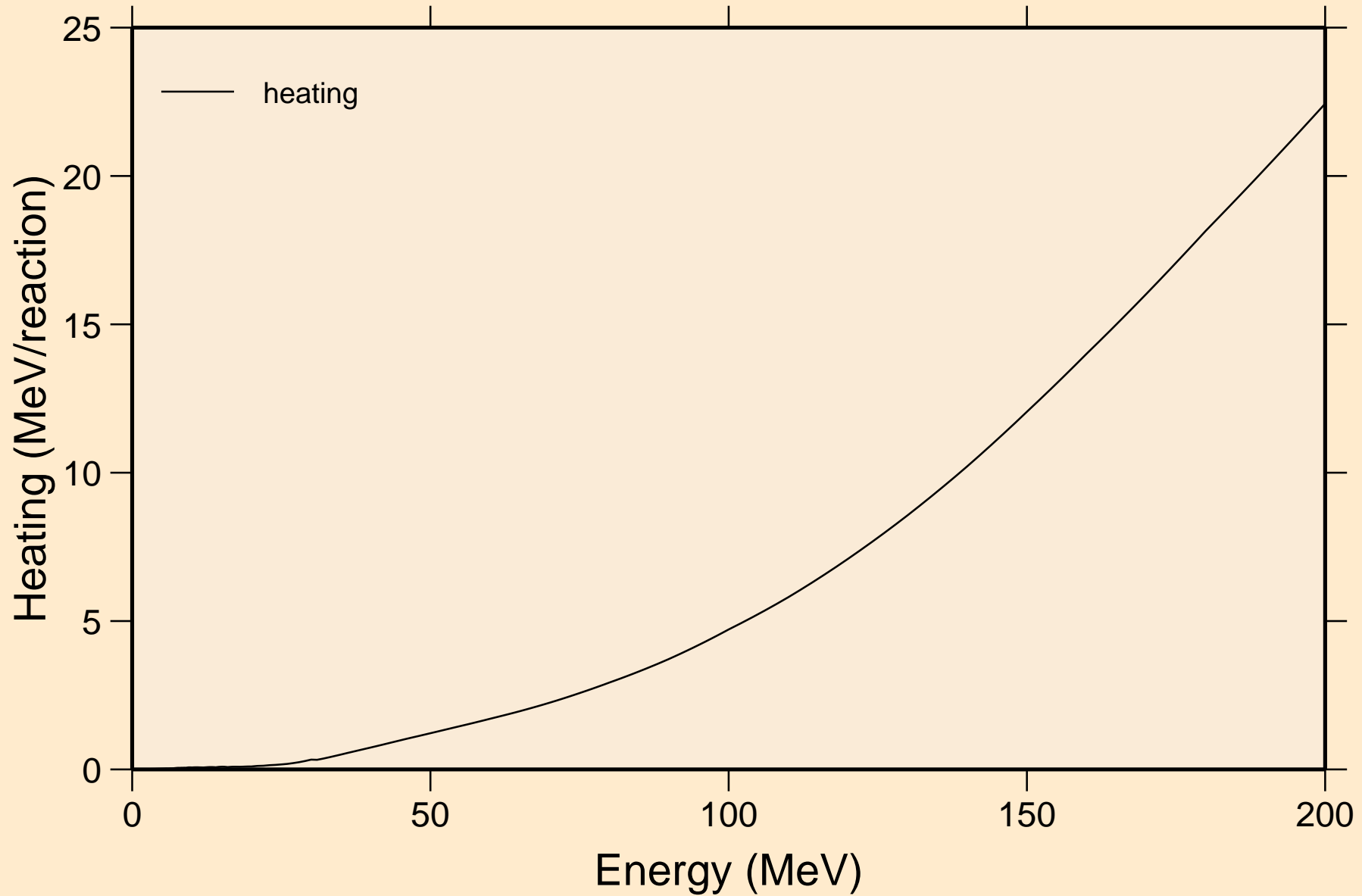

YB184 NEUTRON ACER TENDL-2024 LIBRARY; T=293.6K

Damage

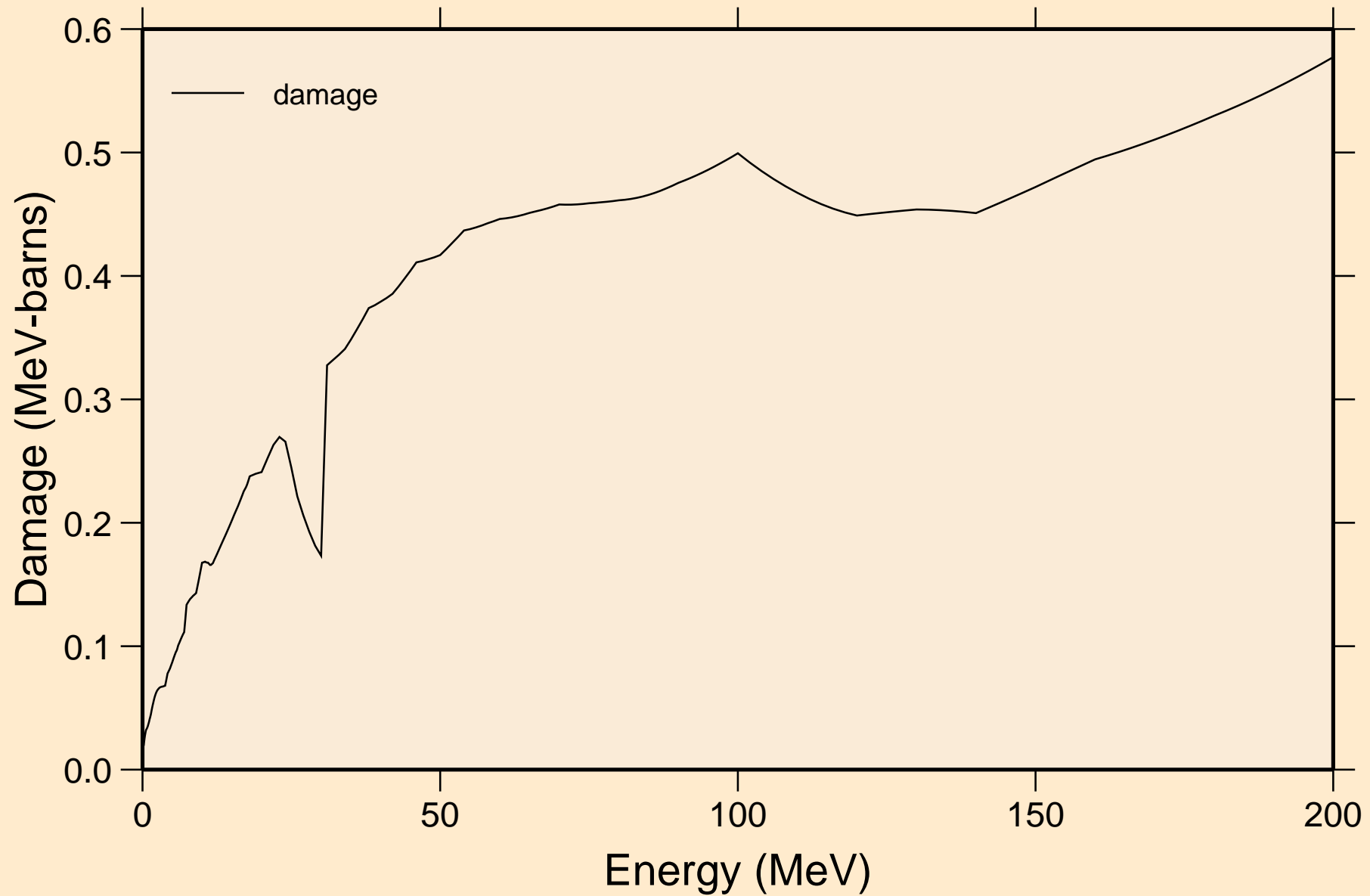

YB184 NEUTRON ACER TENDL-2024 LIBRARY; T=293.6K
Non-threshold reactions

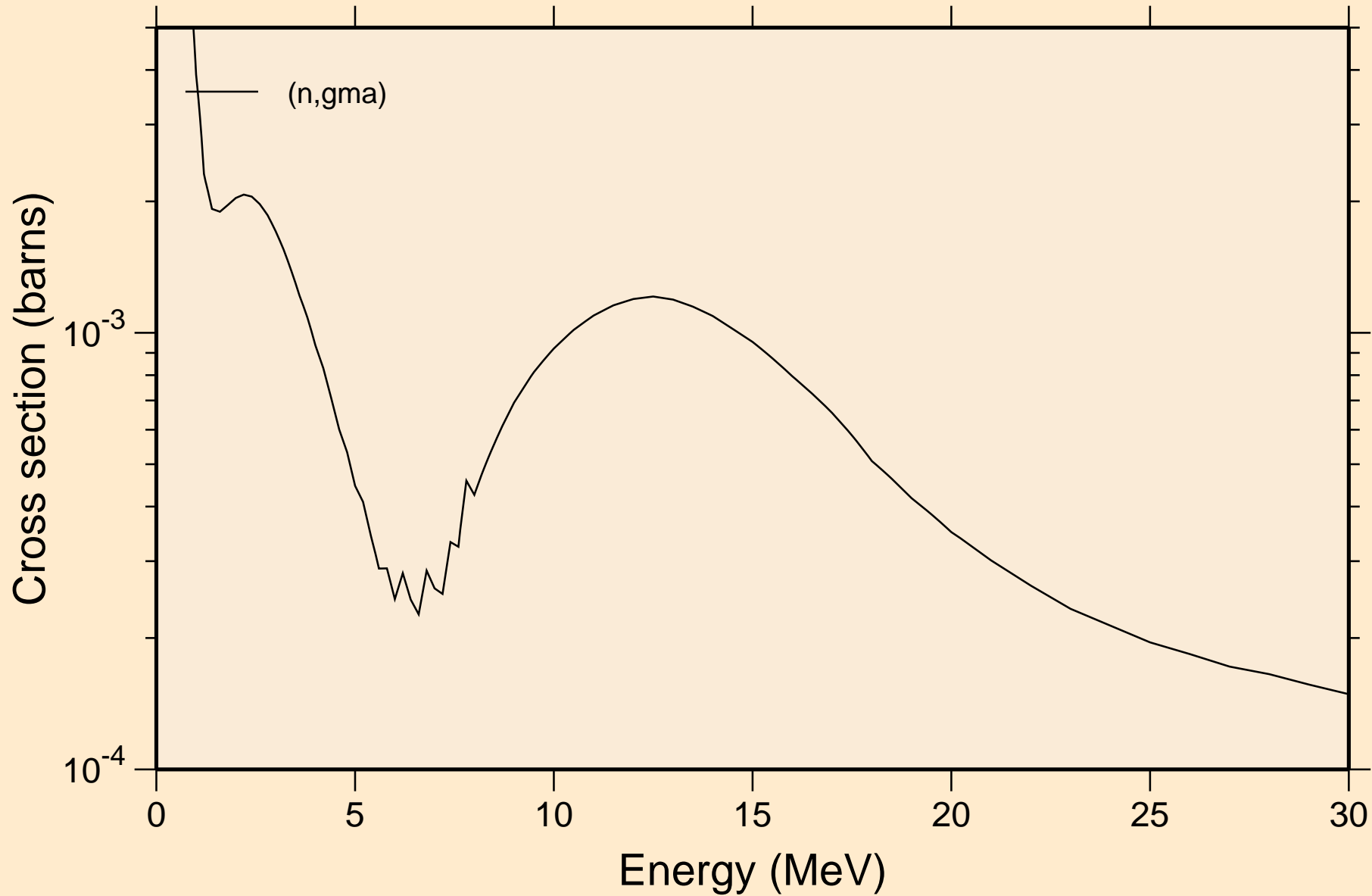

YB184 NEUTRON ACER TENDL-2024 LIBRARY; T=293.6K
Inelastic levels

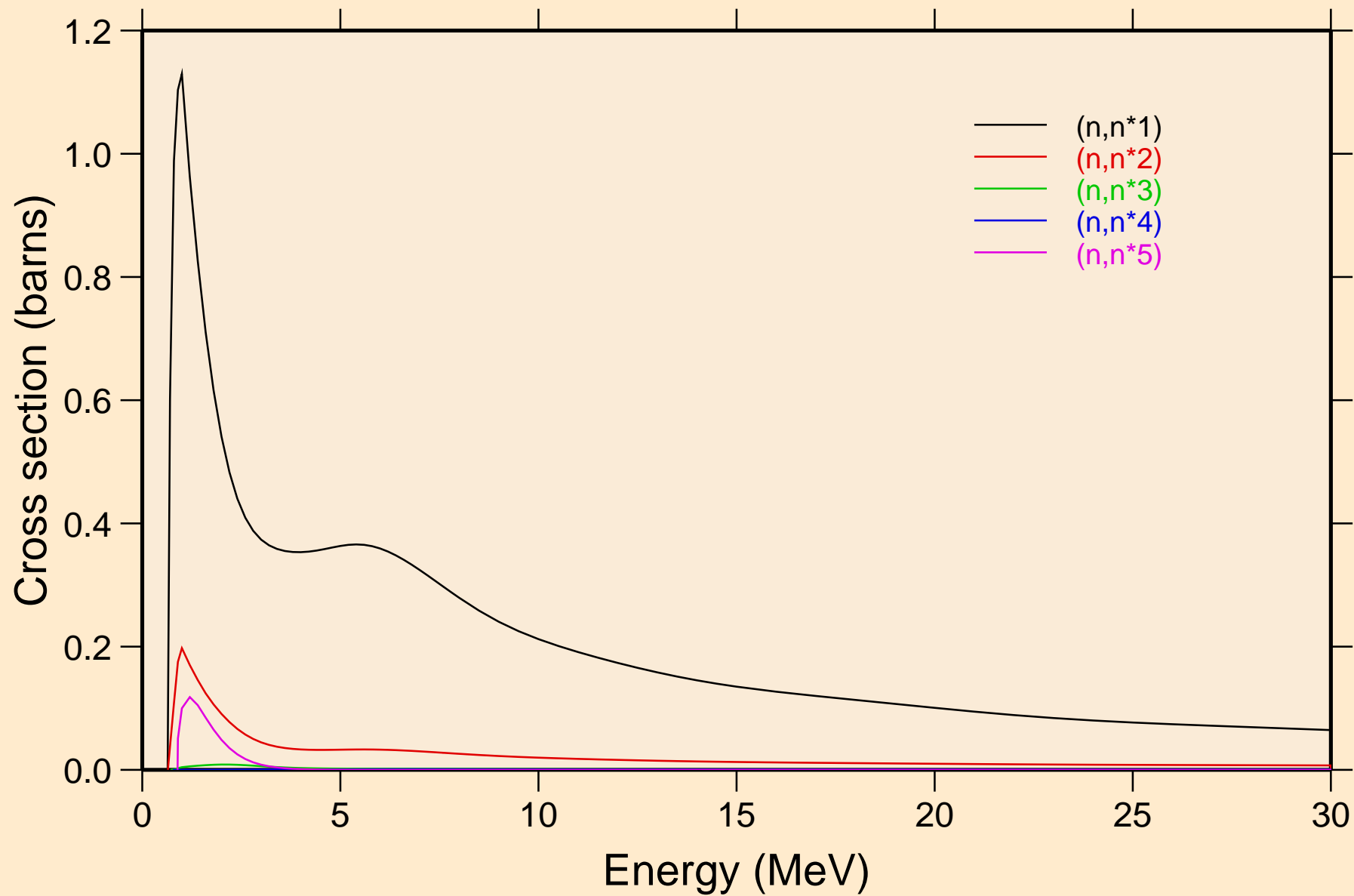

YB184 NEUTRON ACER TENDL-2024 LIBRARY; T=293.6K
Inelastic levels

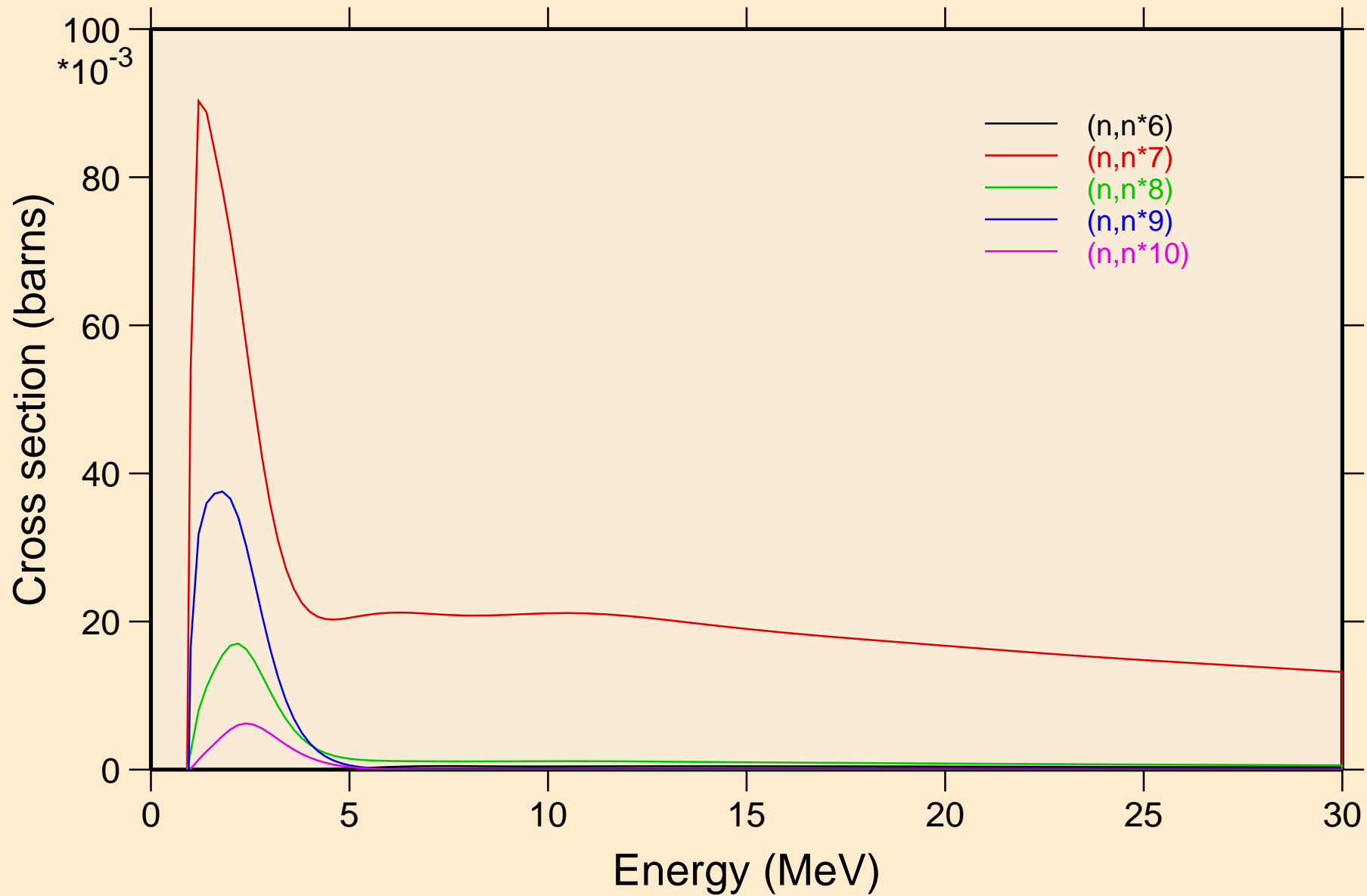

YB184 NEUTRON ACER TENDL-2024 LIBRARY; T=293.6K
Inelastic levels

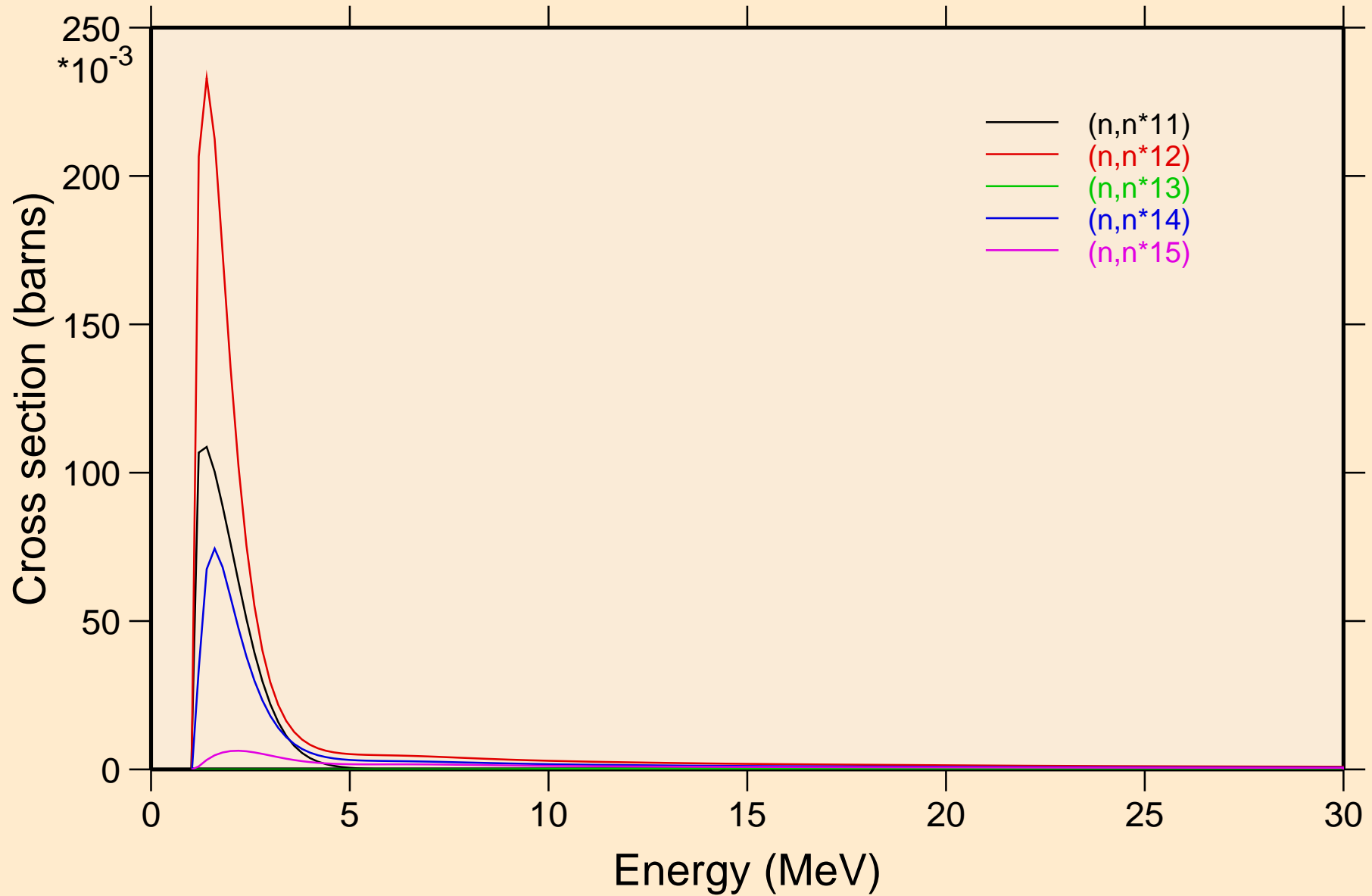

YB184 NEUTRON ACER TENDL-2024 LIBRARY; T=293.6K
Inelastic levels

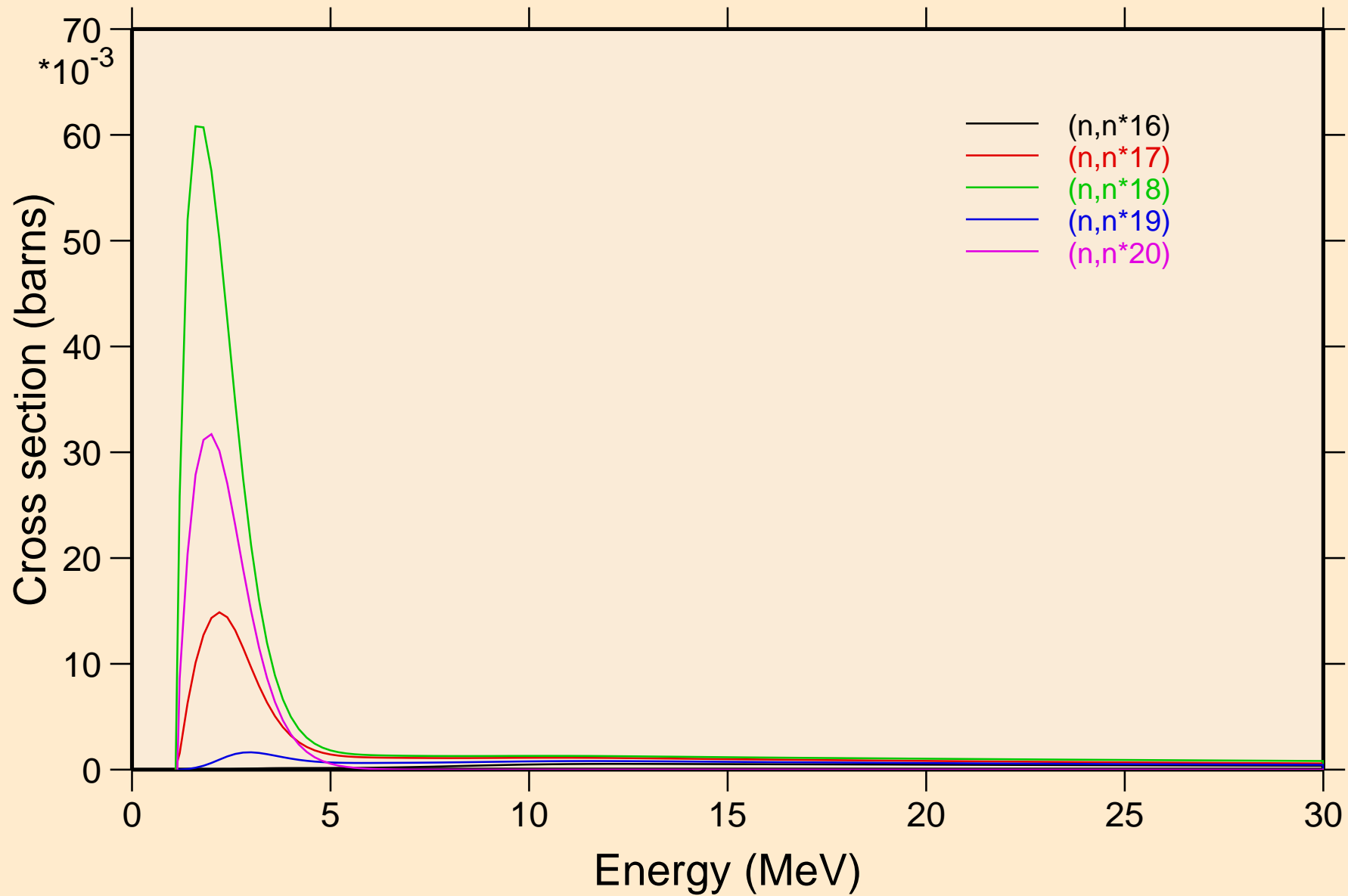

YB184 NEUTRON ACER TENDL-2024 LIBRARY; T=293.6K
Inelastic levels

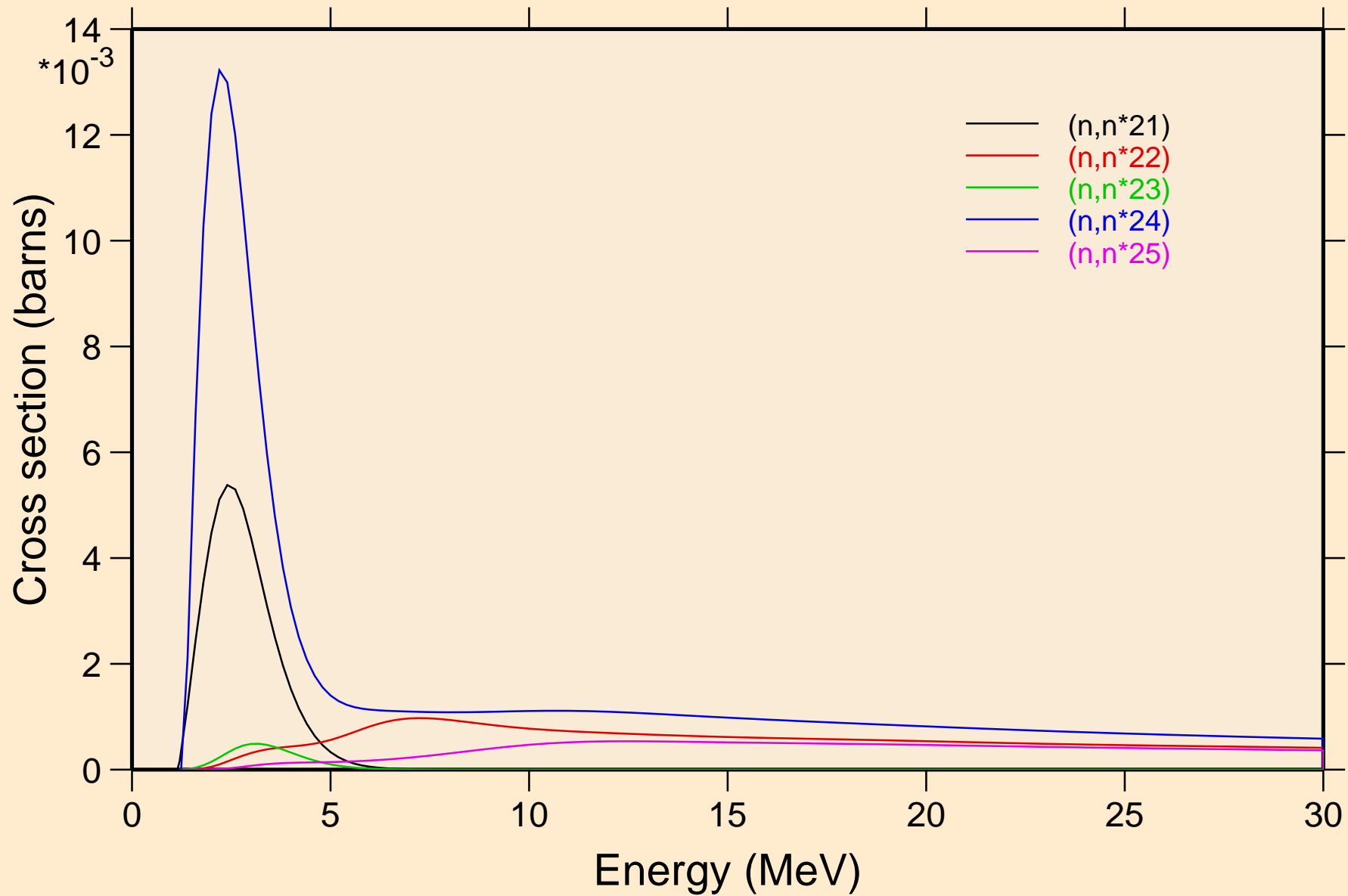

YB184 NEUTRON ACER TENDL-2024 LIBRARY; T=293.6K
Inelastic levels

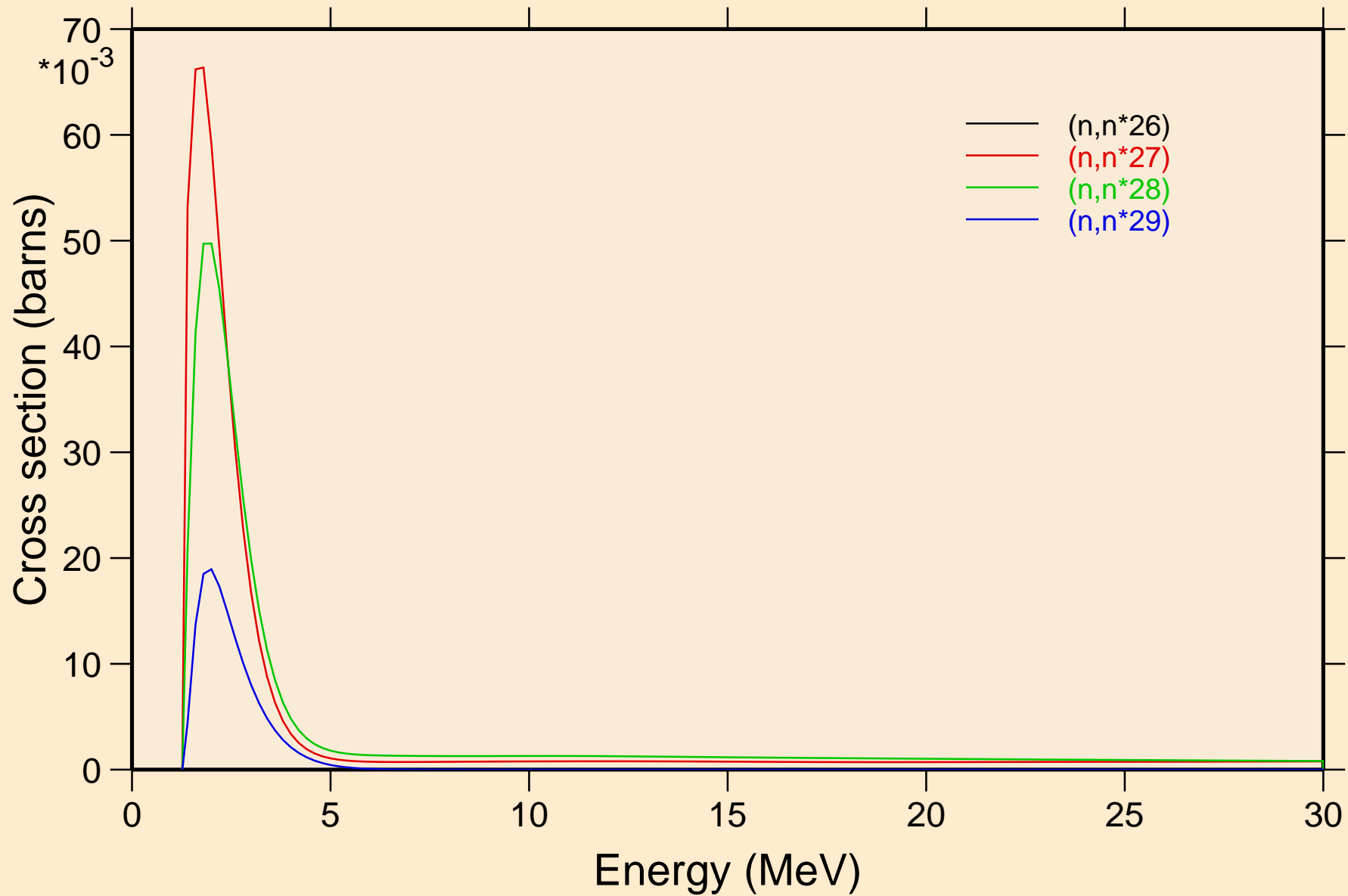

YB184 NEUTRON ACER TENDL-2024 LIBRARY; T=293.6K
Threshold reactions

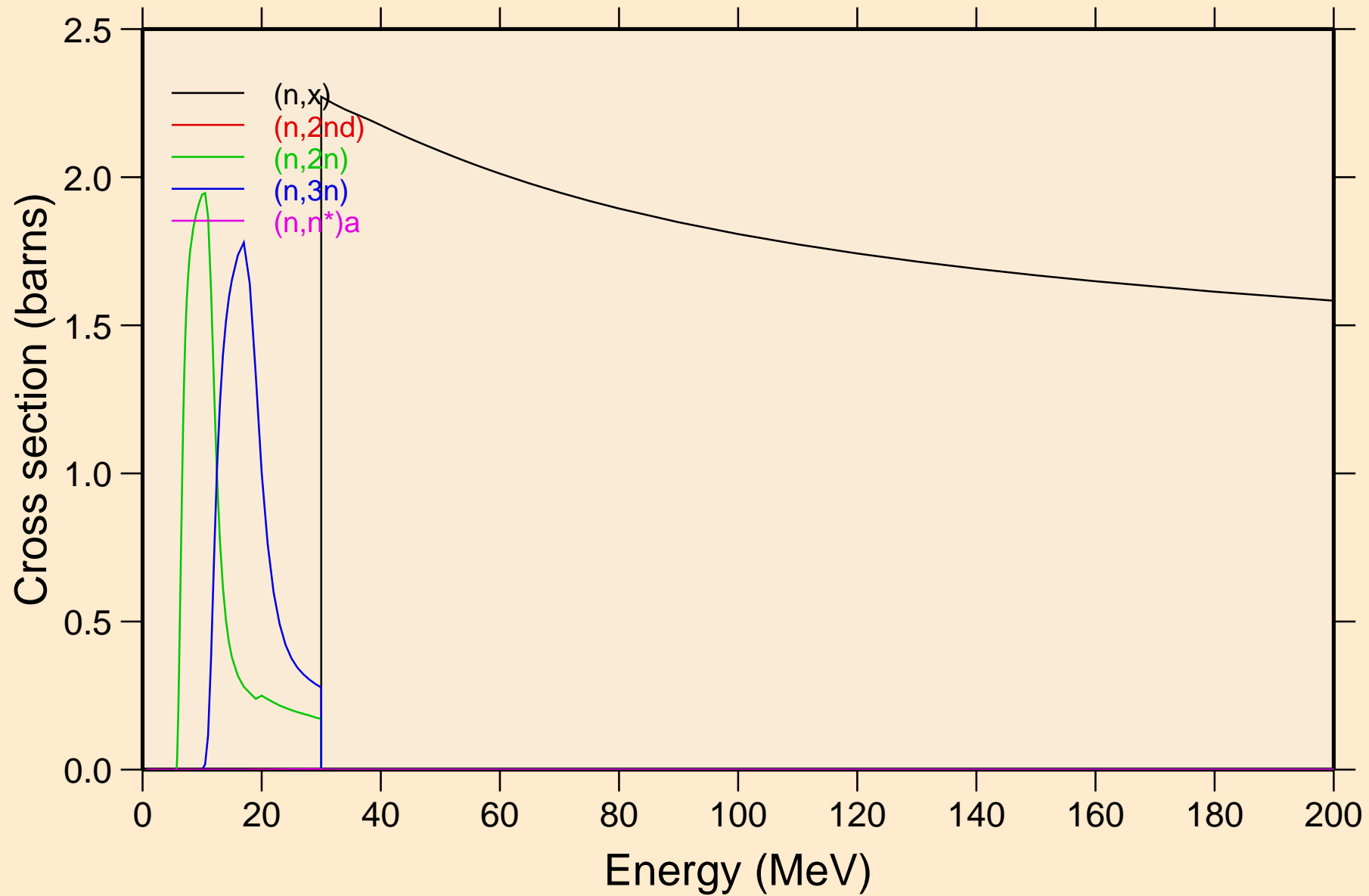

YB184 NEUTRON ACER TENDL-2024 LIBRARY; T=293.6K

Threshold reactions

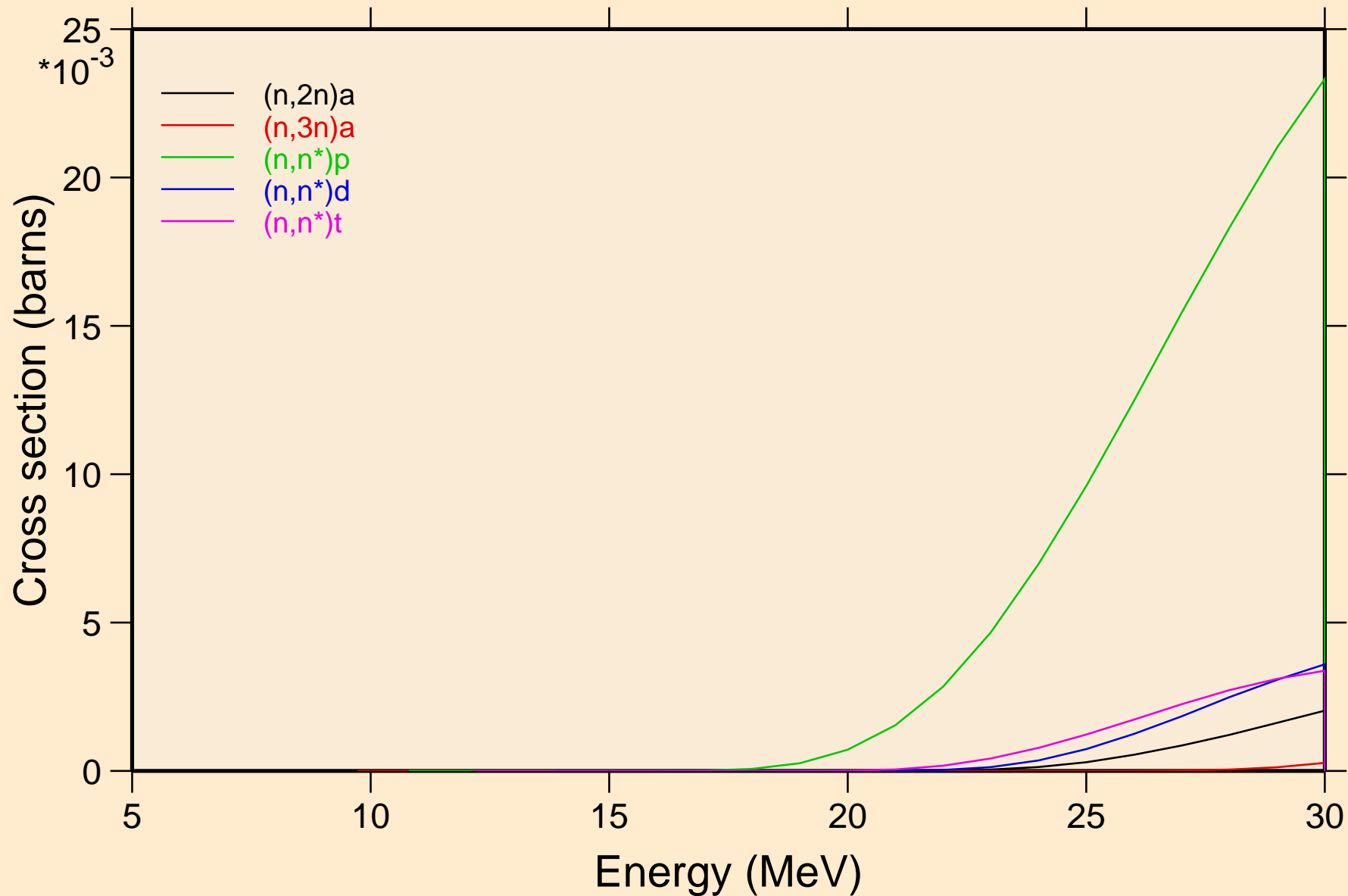

YB184 NEUTRON ACER TENDL-2024 LIBRARY; T=293.6K

Threshold reactions

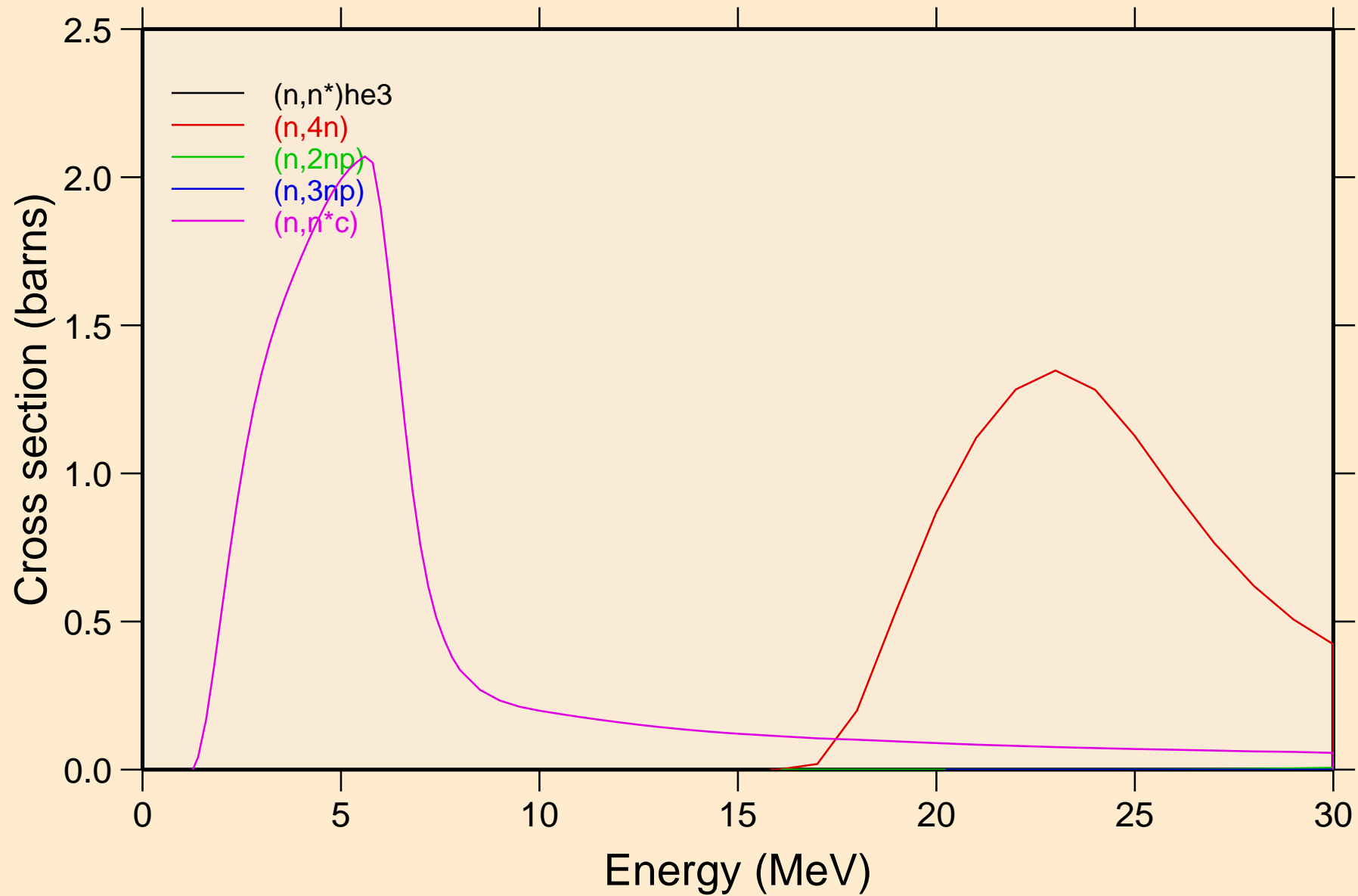

YB184 NEUTRON ACER TENDL-2024 LIBRARY; T=293.6K
Threshold reactions

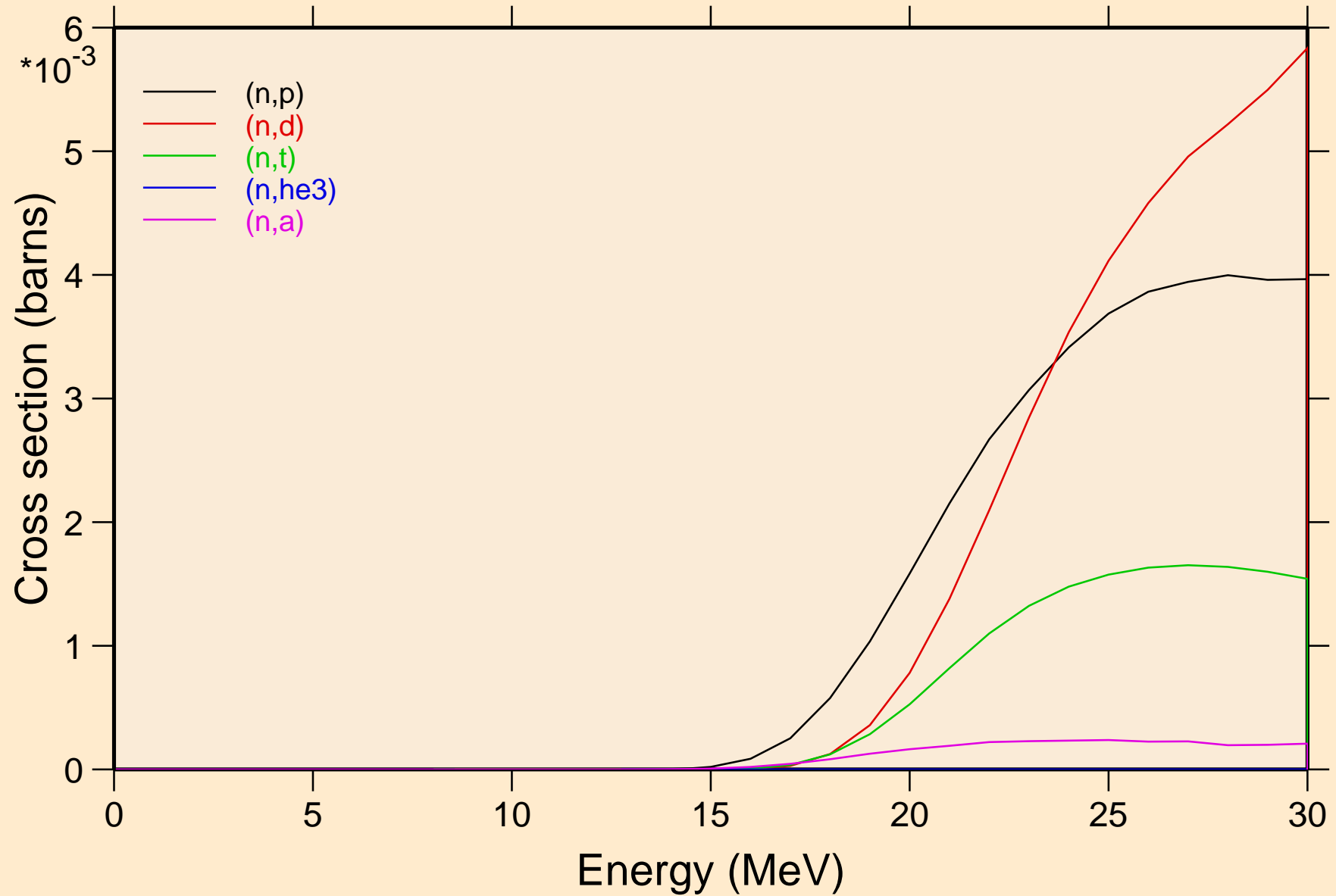

YB184 NEUTRON ACER TENDL-2024 LIBRARY; T=293.6K
Threshold reactions

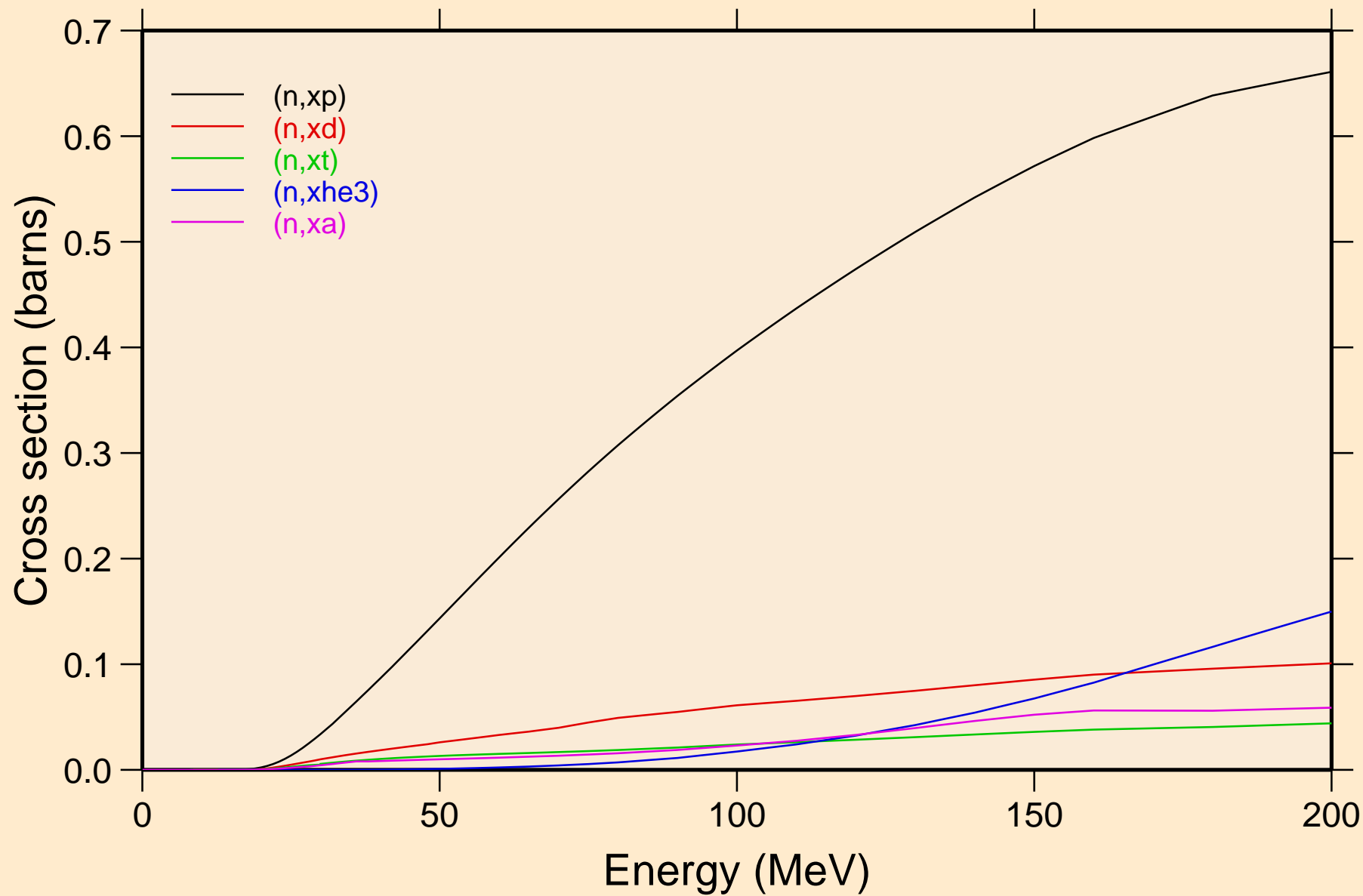

YB184 NEUTRON ACER TENDL-2024 LIBRARY; T=293.6K
angular distribution for elastic

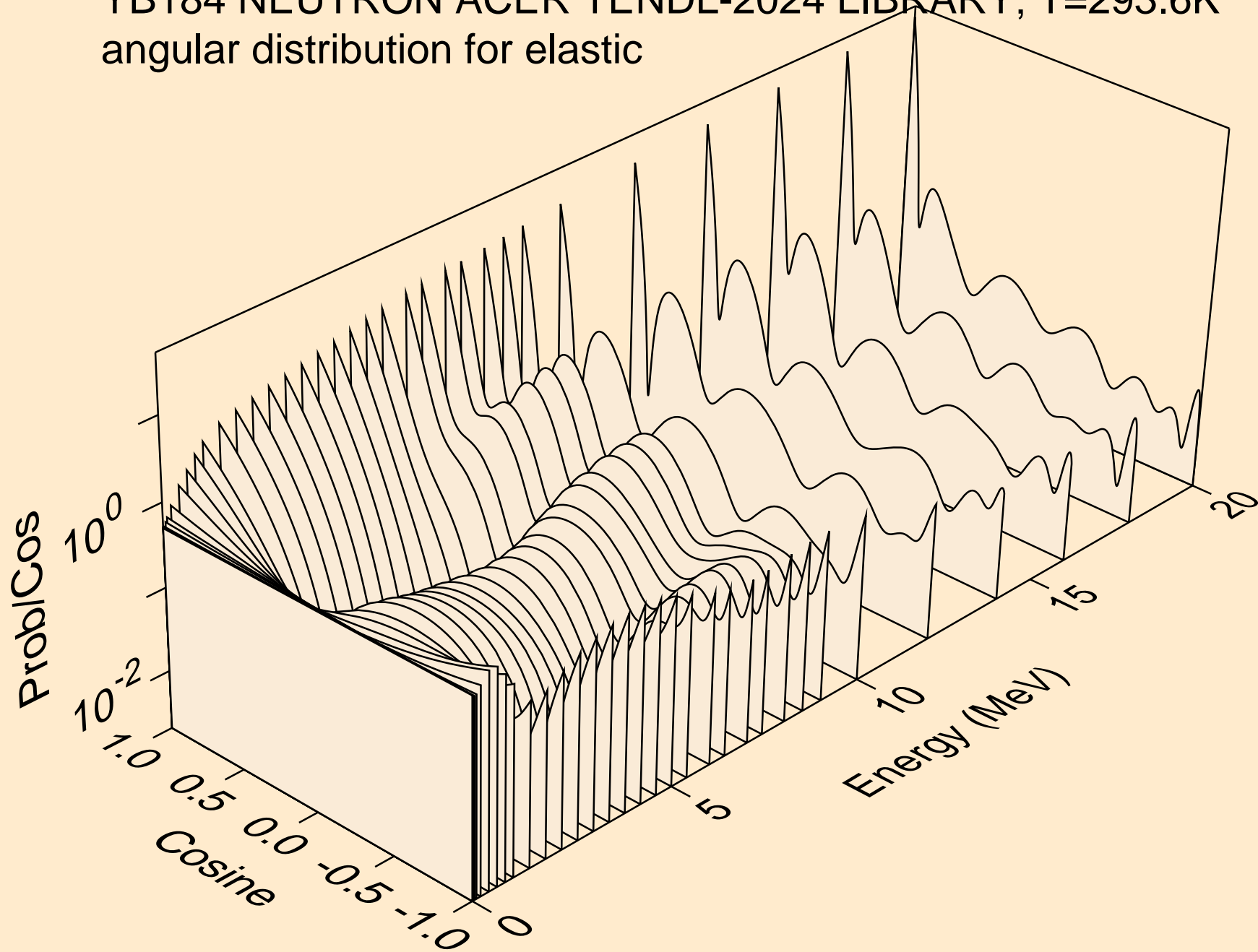

YB184 NEUTRON ACER TENDL-2024 LIBRARY; T=293.6K
angular distribution for elastic

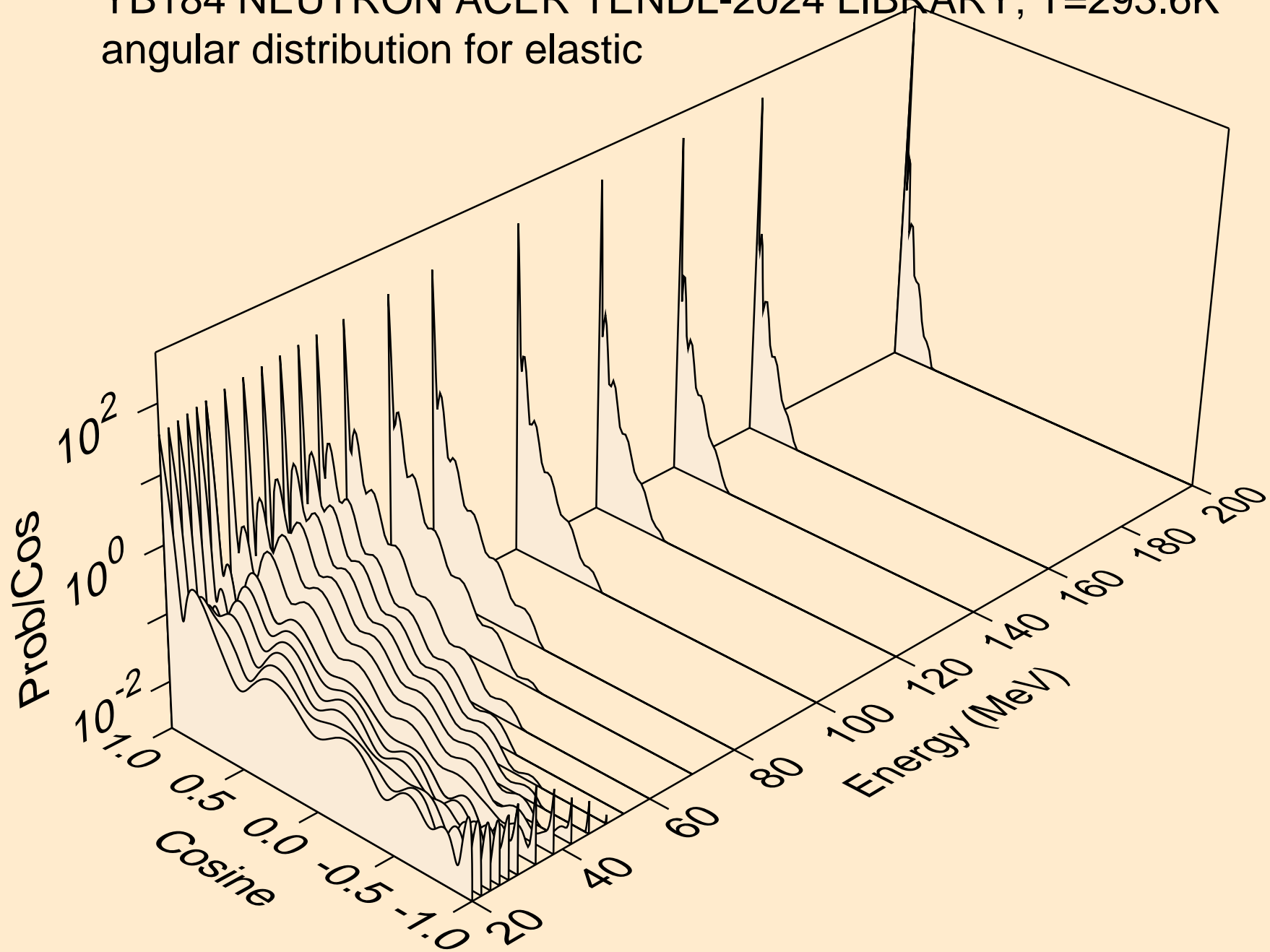

YB184 NEUTRON ACER TENDL-2024 LIBRARY; T=293.6K
angular distribution for (n,n*1)

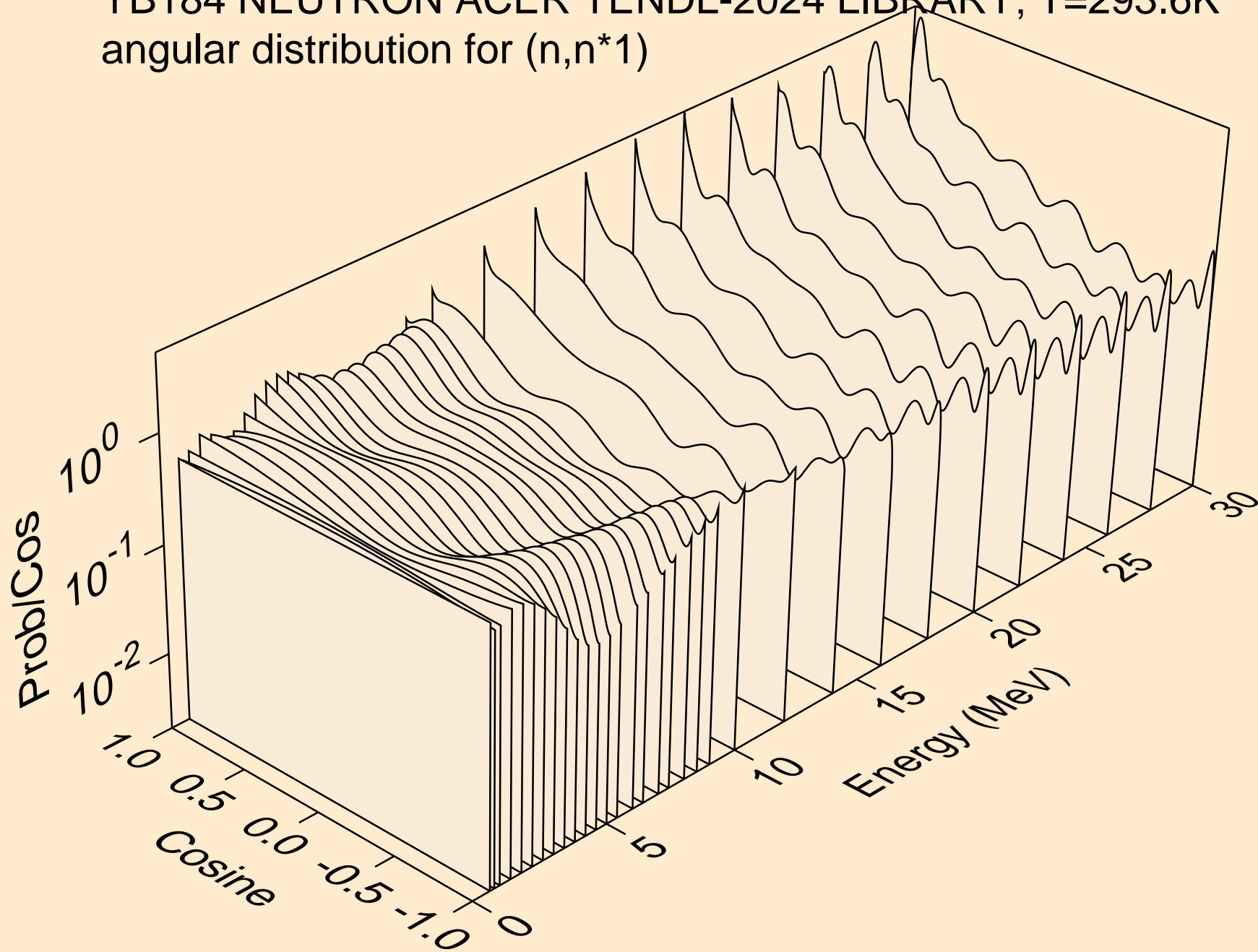

YB184 NEUTRON ACER TENDL-2024 LIBRARY; T=293.6K
angular distribution for (n,n*2)

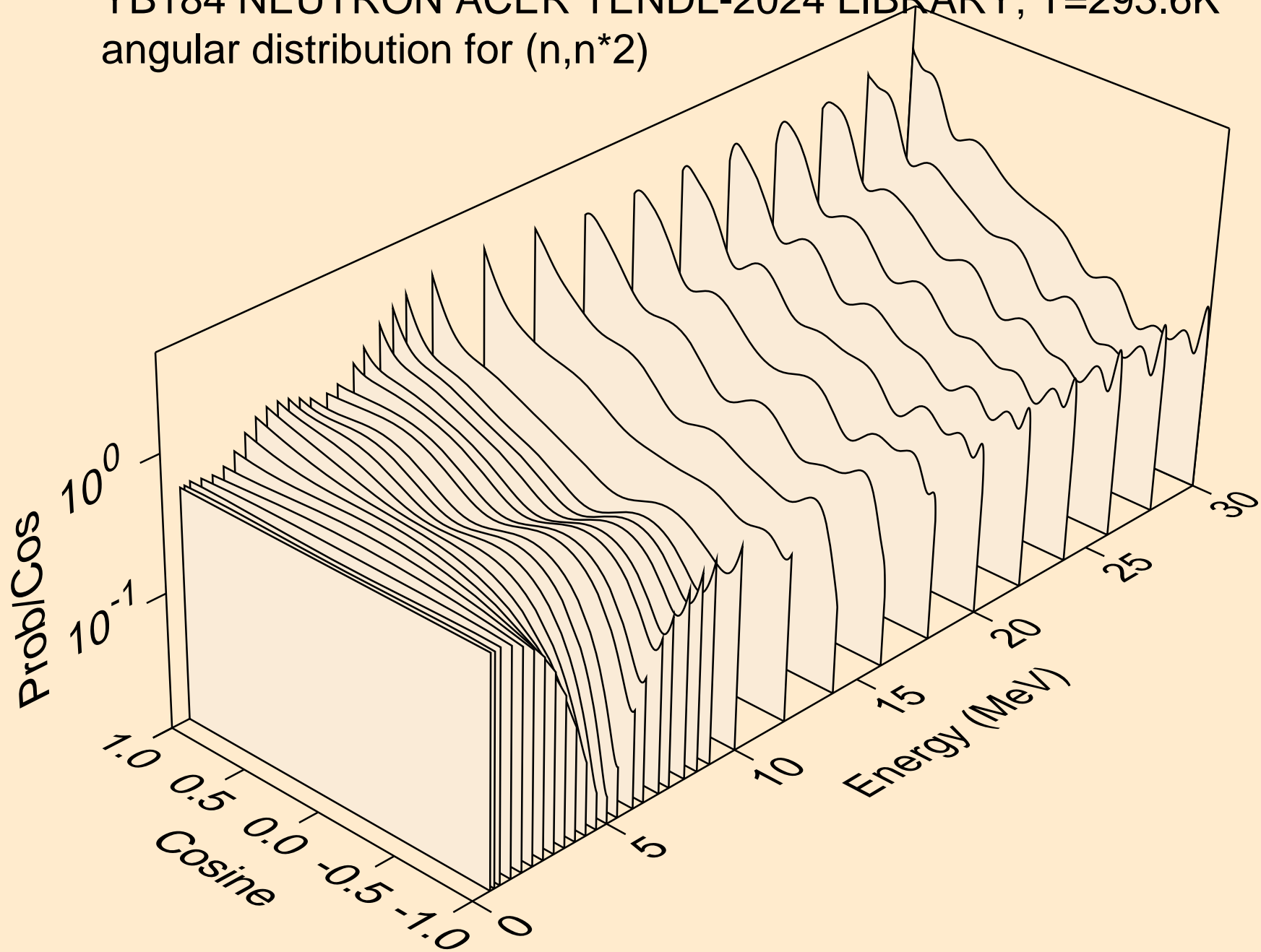

YB184 NEUTRON ACER TENDL-2024 LIBRARY; T=293.6K
angular distribution for (n,n*3)

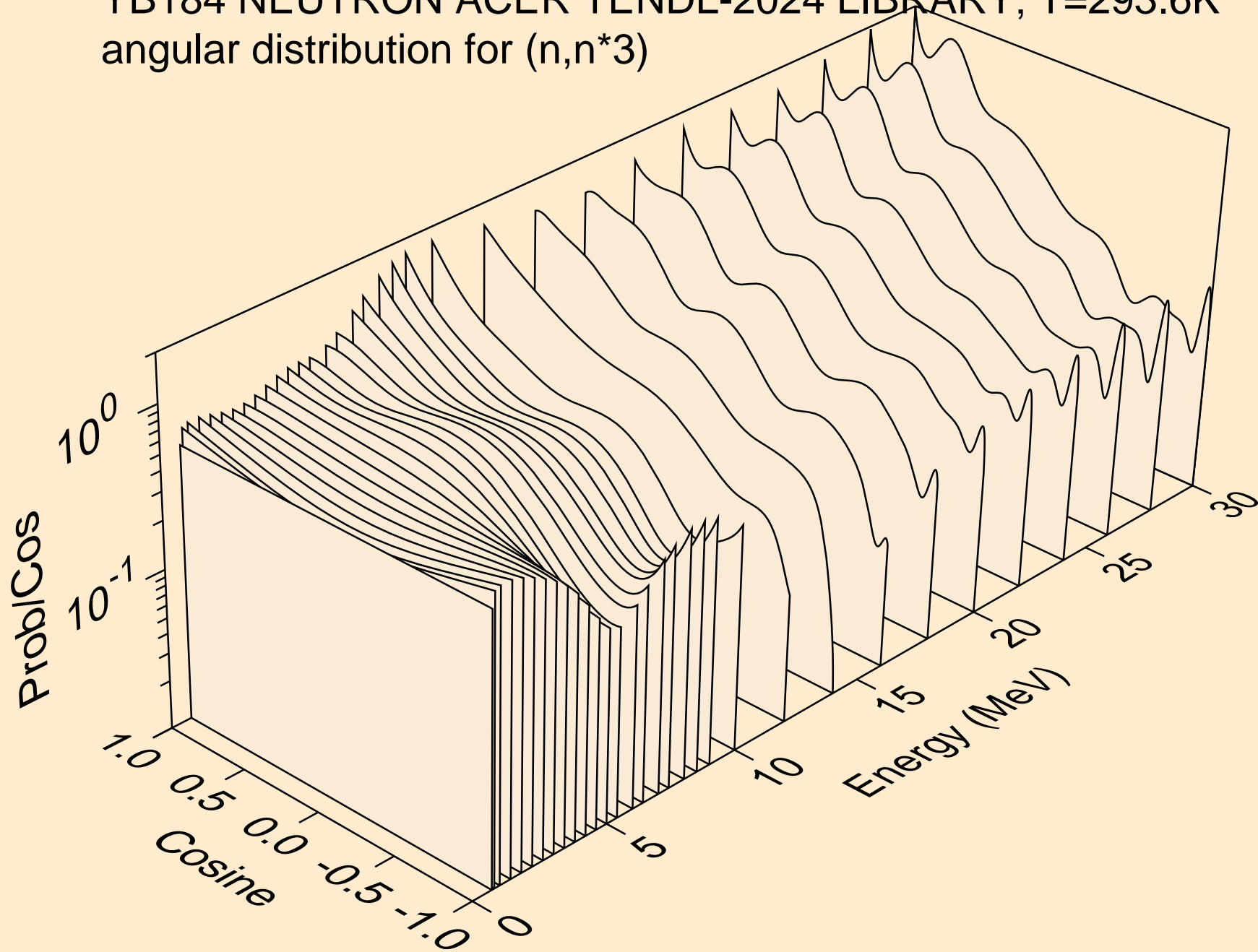

YB184 NEUTRON ACER TENDL-2024 LIBRARY; T=293.6K
angular distribution for (n,n*4)

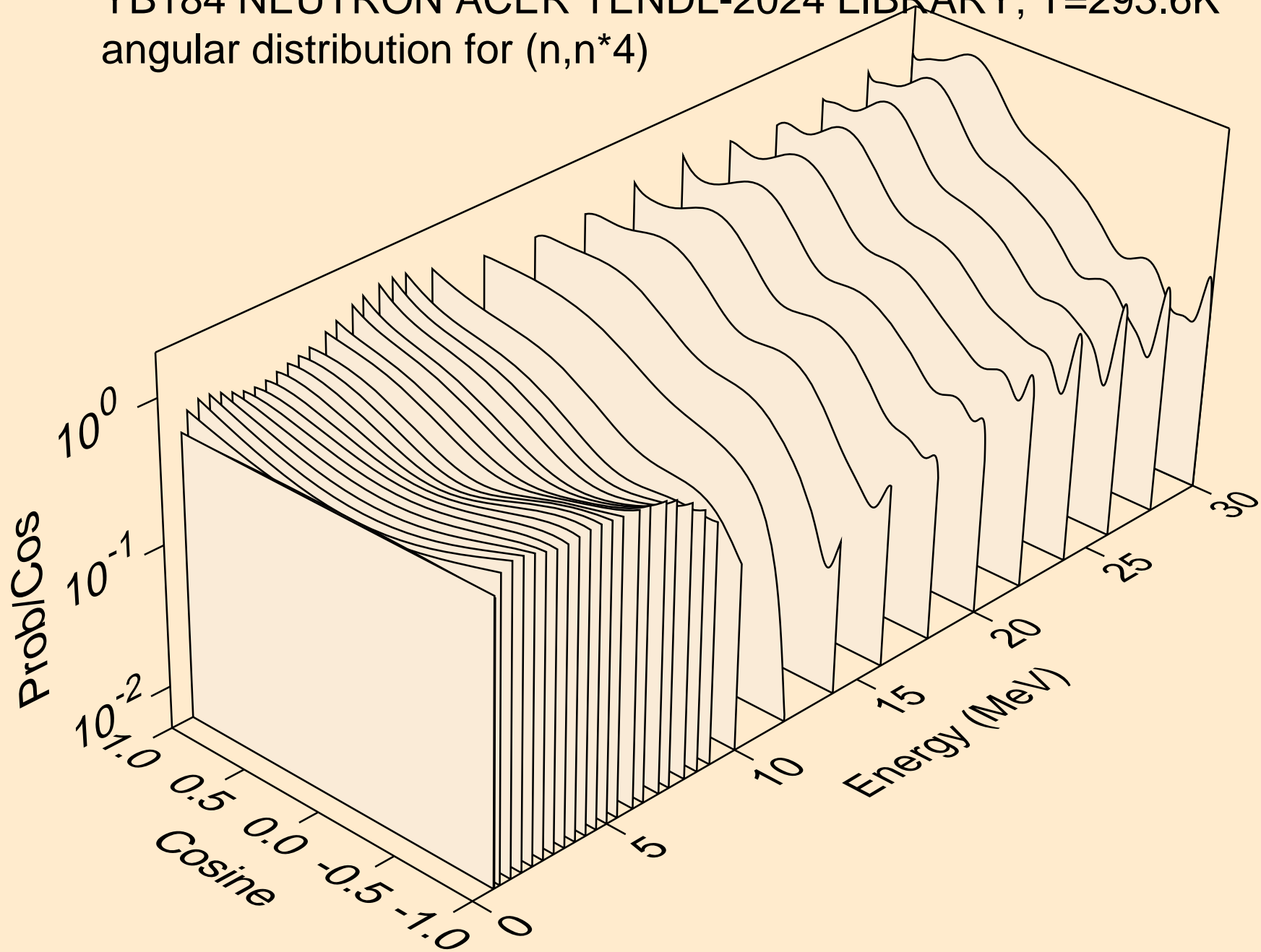

YB184 NEUTRON ACER TENDL-2024 LIBRARY; T=293.6K
angular distribution for (n,n*5)

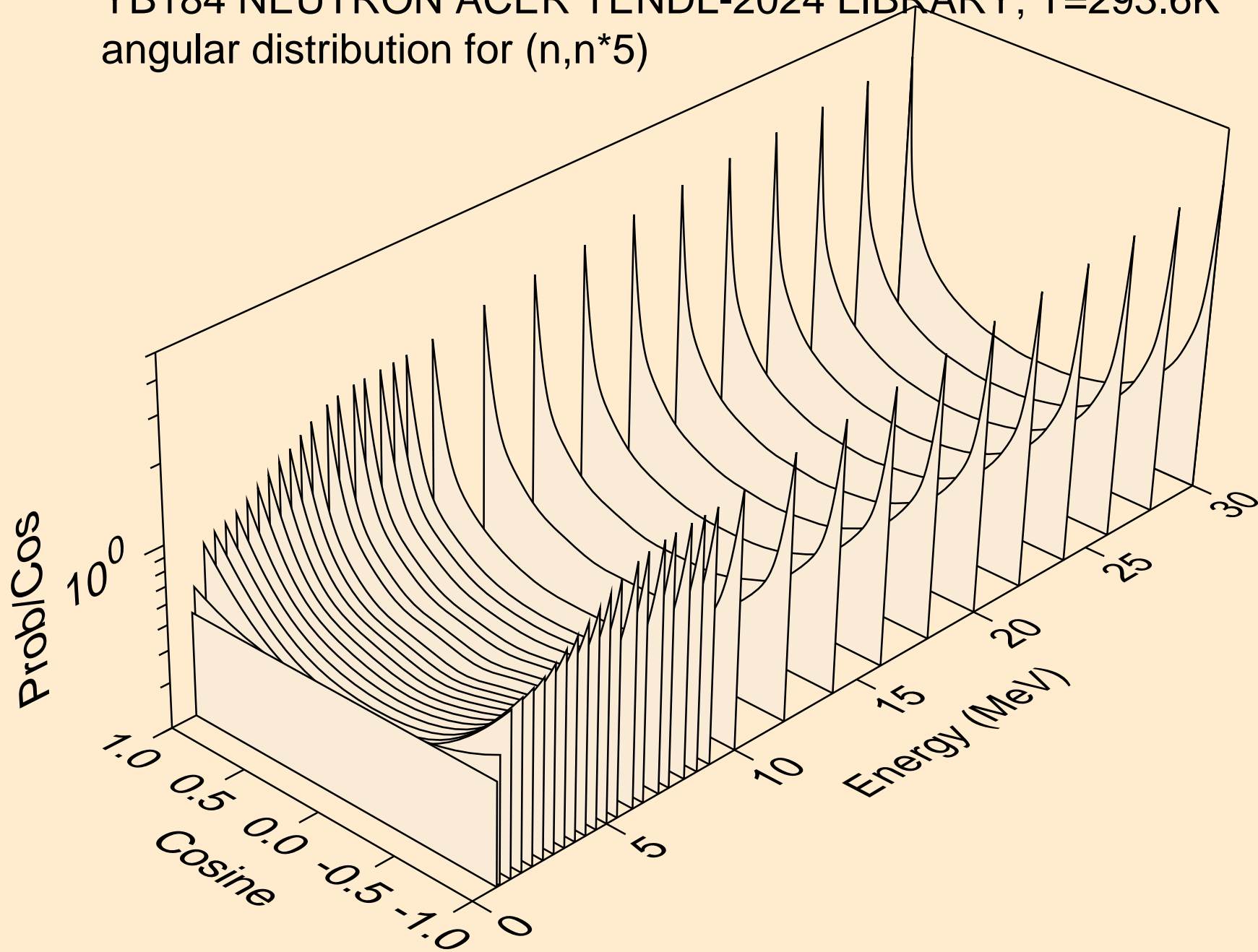

YB184 NEUTRON ACER TENDL-2024 LIBRARY; T=293.6K
angular distribution for (n,n*6)

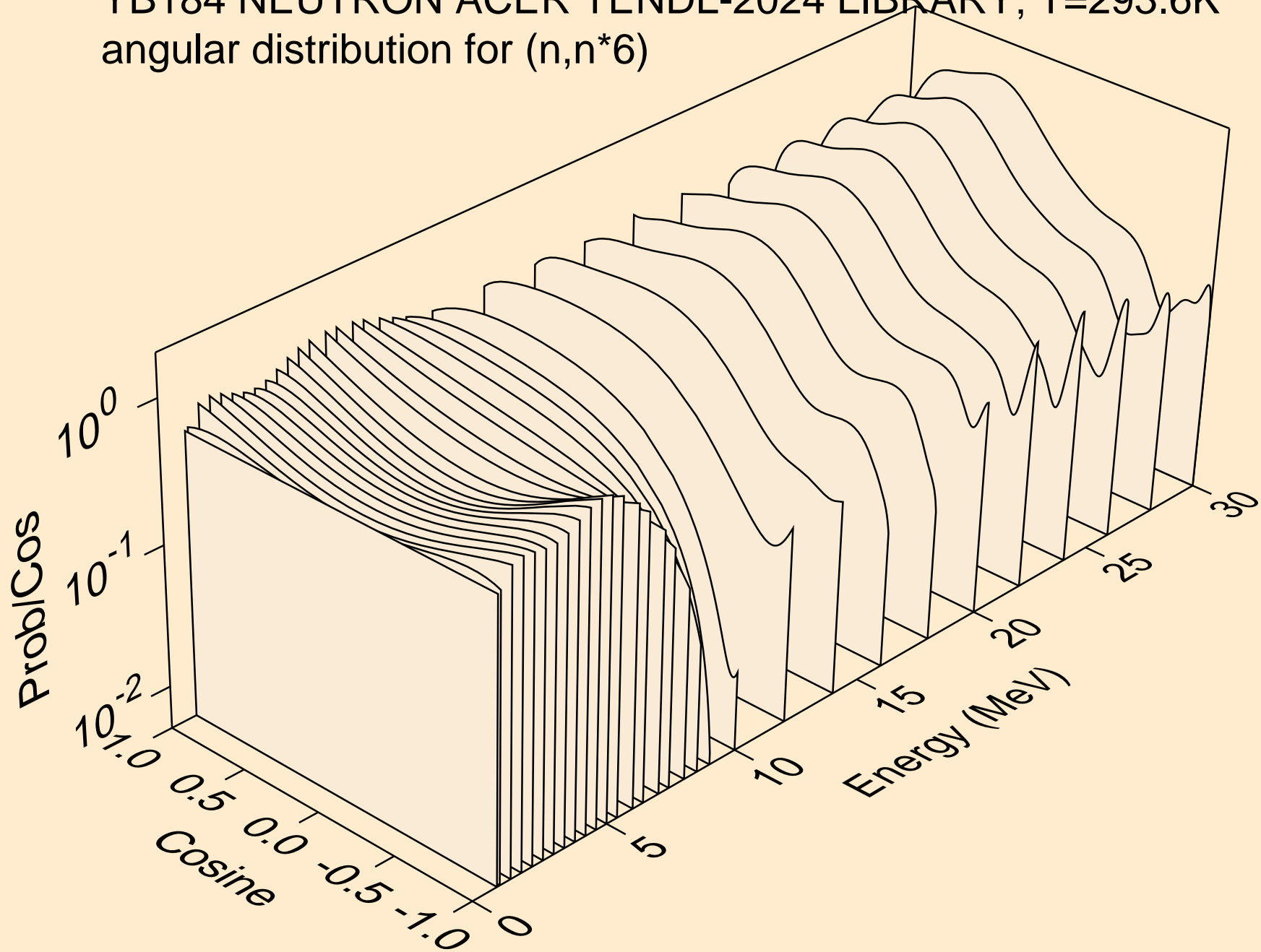

YB184 NEUTRON ACER TENDL-2024 LIBRARY; T=293.6K
angular distribution for (n,n*7)

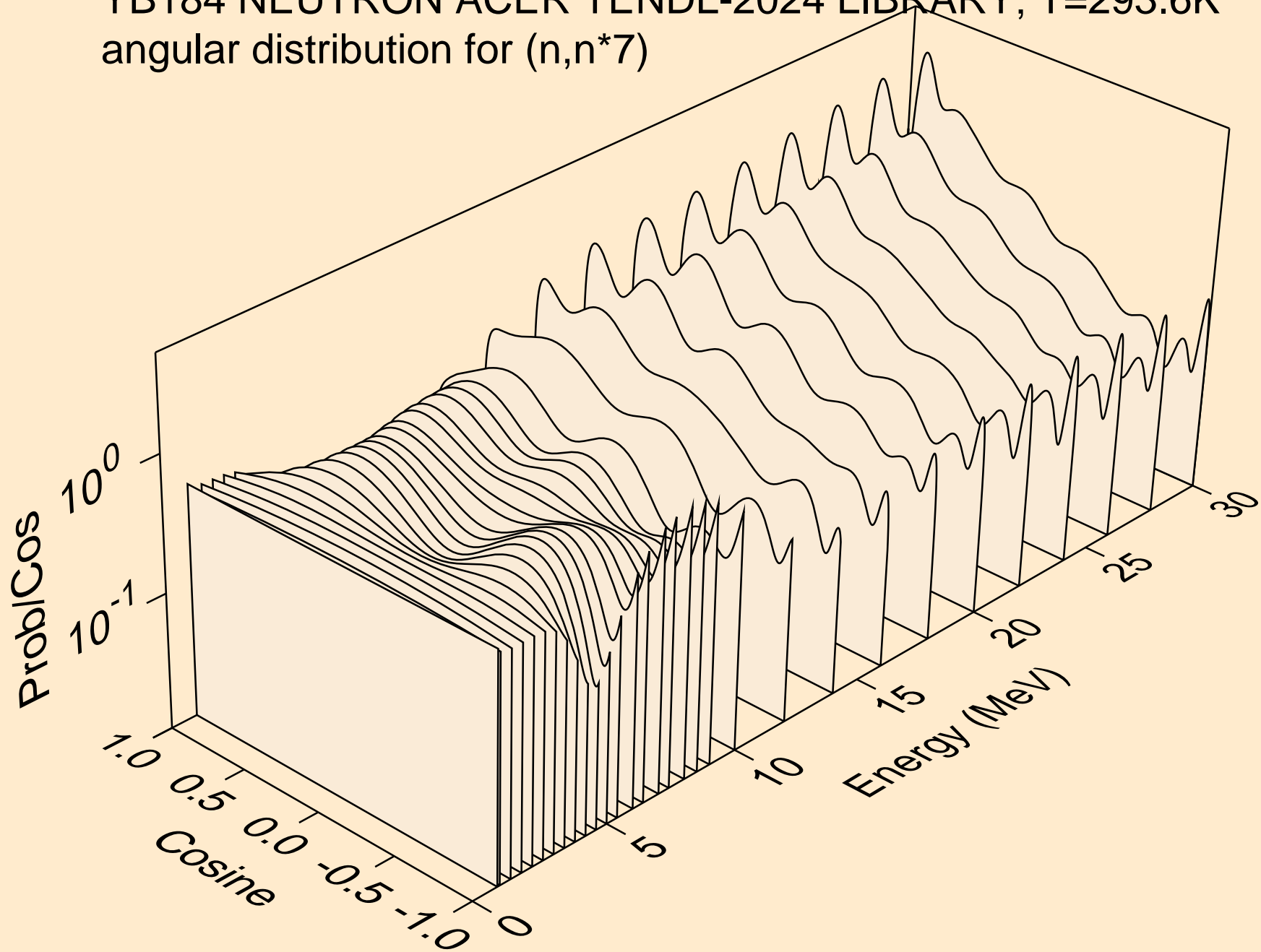

YB184 NEUTRON ACER TENDL-2024 LIBRARY; T=293.6K
angular distribution for (n,n*8)

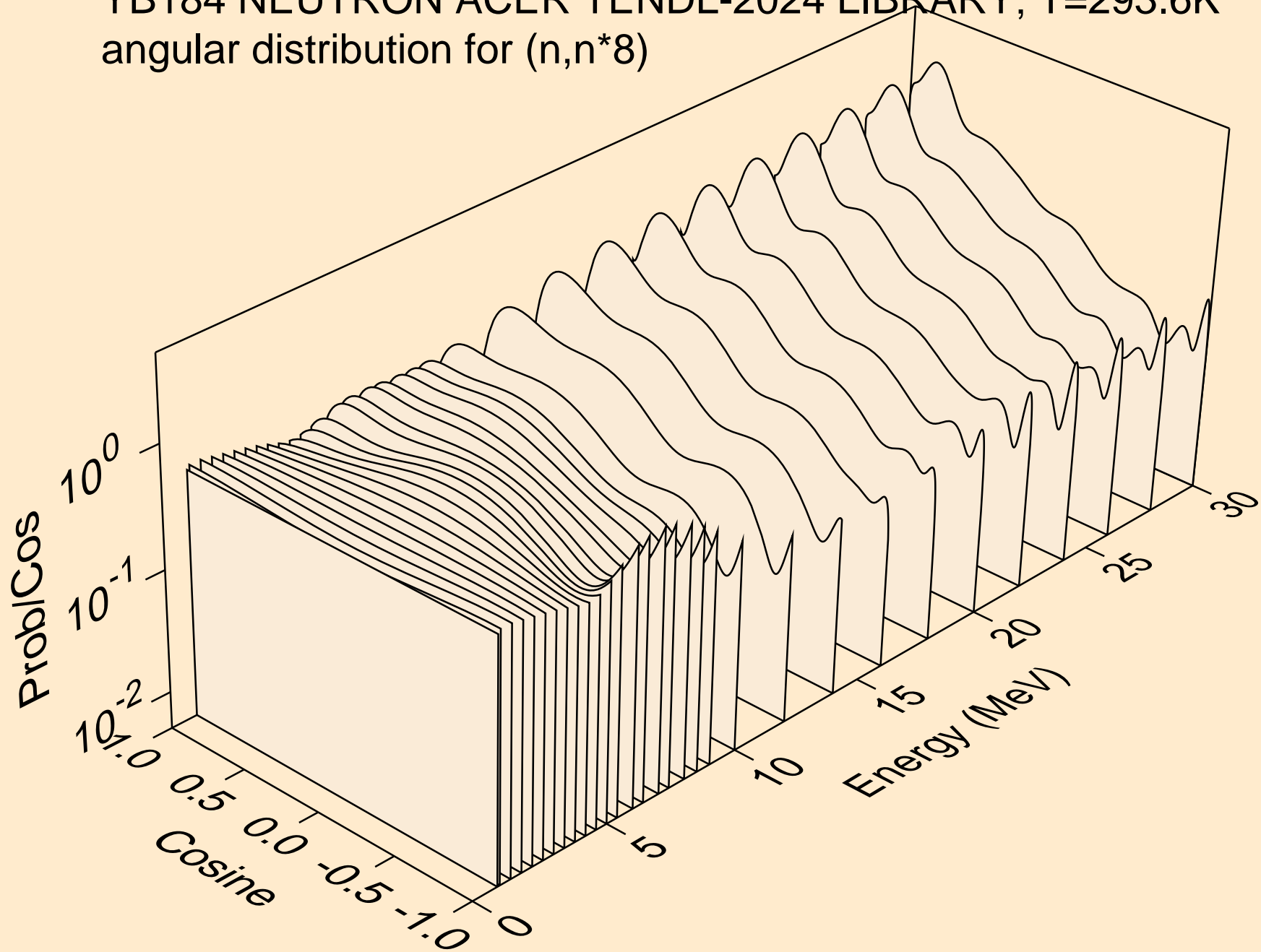

YB184 NEUTRON ACER TENDL-2024 LIBRARY; T=293.6K
angular distribution for (n,n*9)

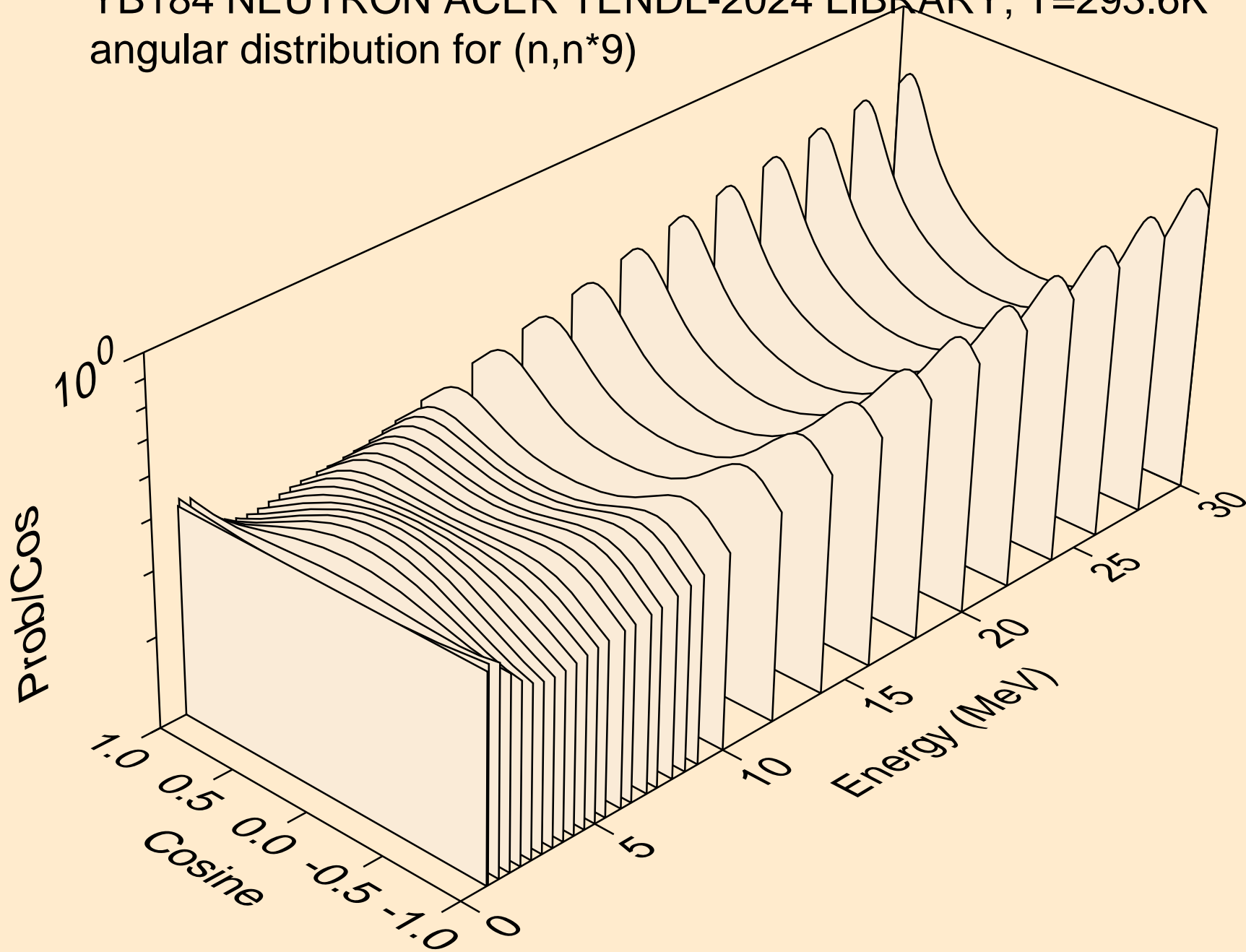

YB184 NEUTRON ACER TENDL-2024 LIBRARY; T=293.6K
angular distribution for (n,n*10)

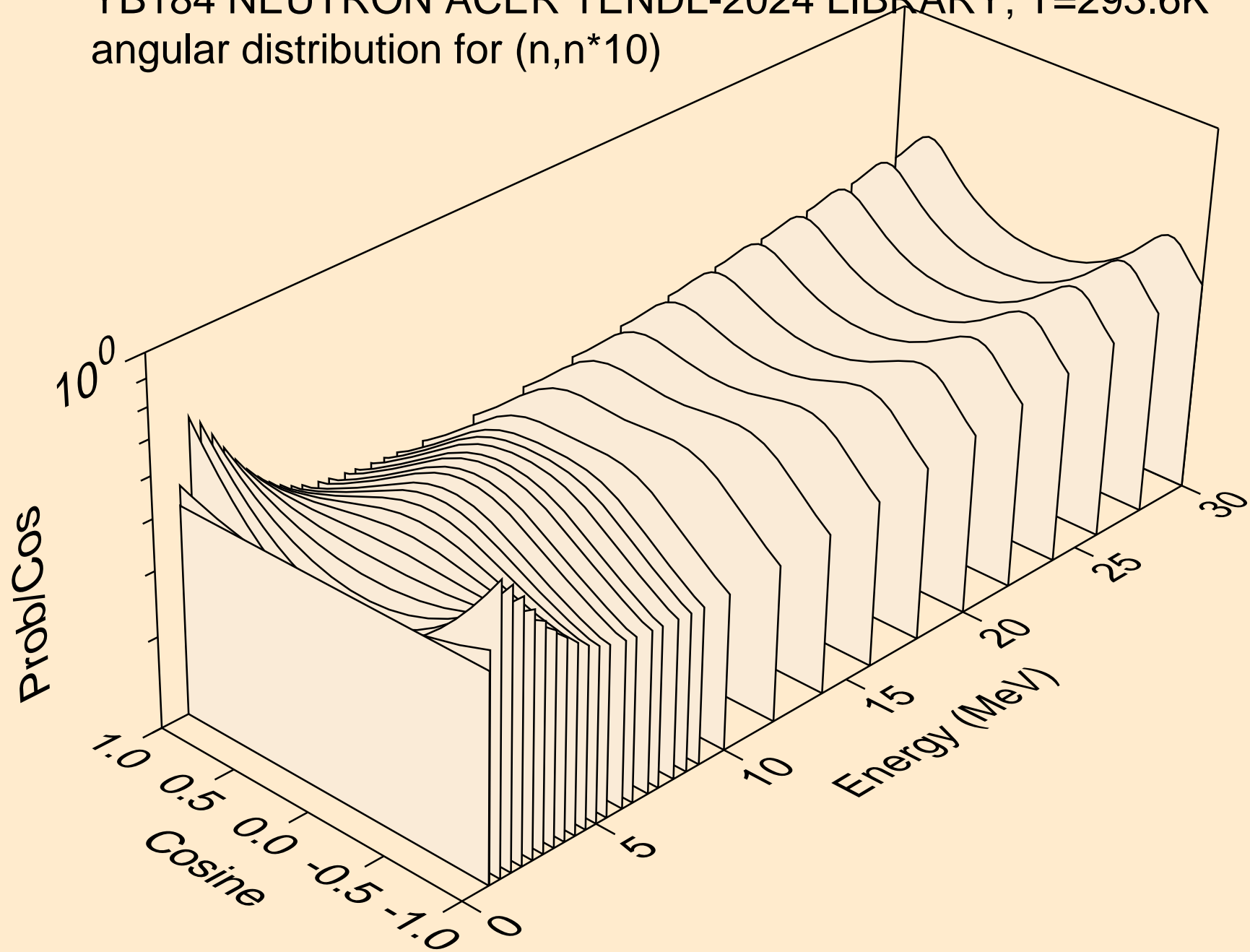

YB184 NEUTRON ACER TENDL-2024 LIBRARY; T=293.6K
angular distribution for (n,n*11)

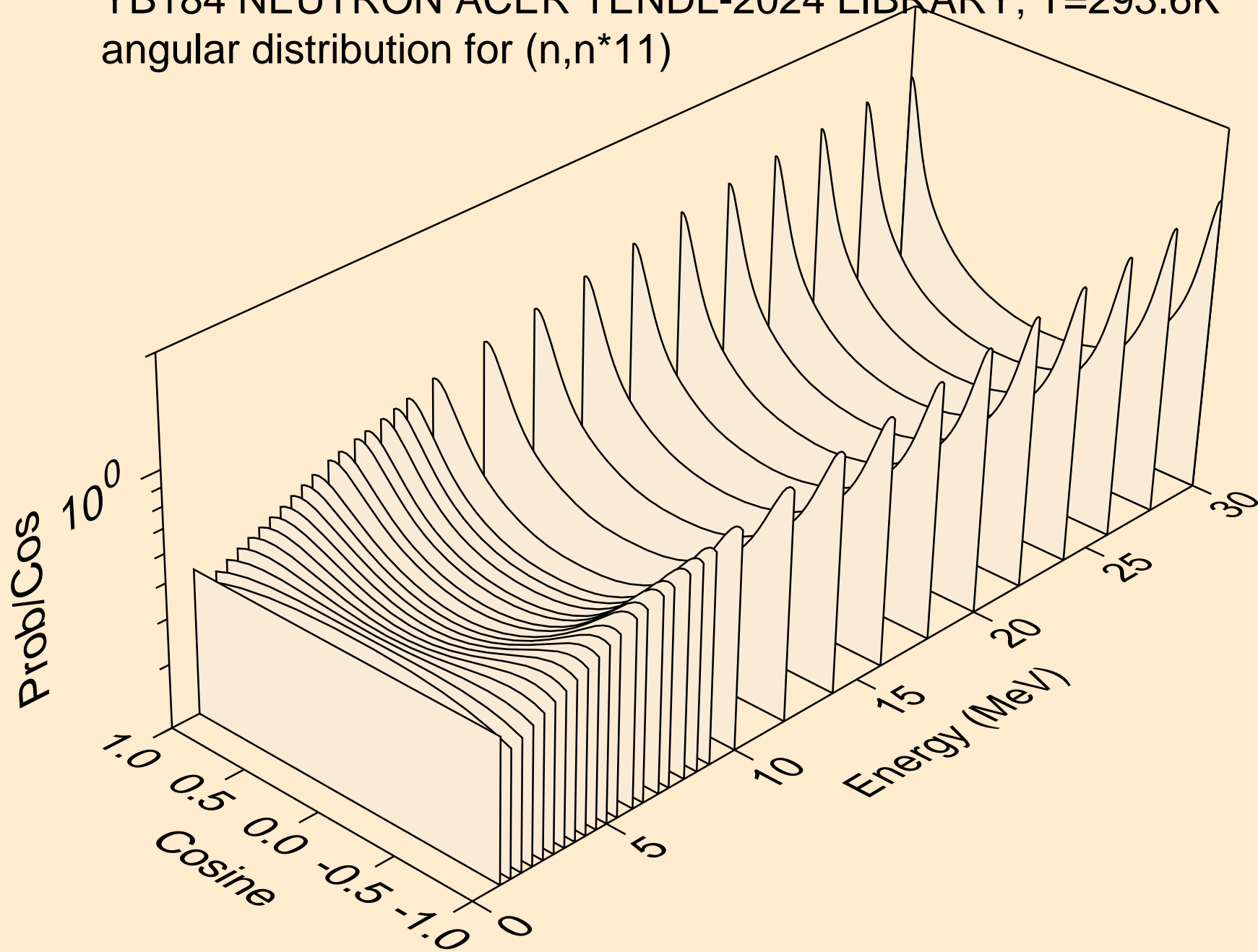

YB184 NEUTRON ACER TENDL-2024 LIBRARY; T=293.6K
angular distribution for (n,n*12)

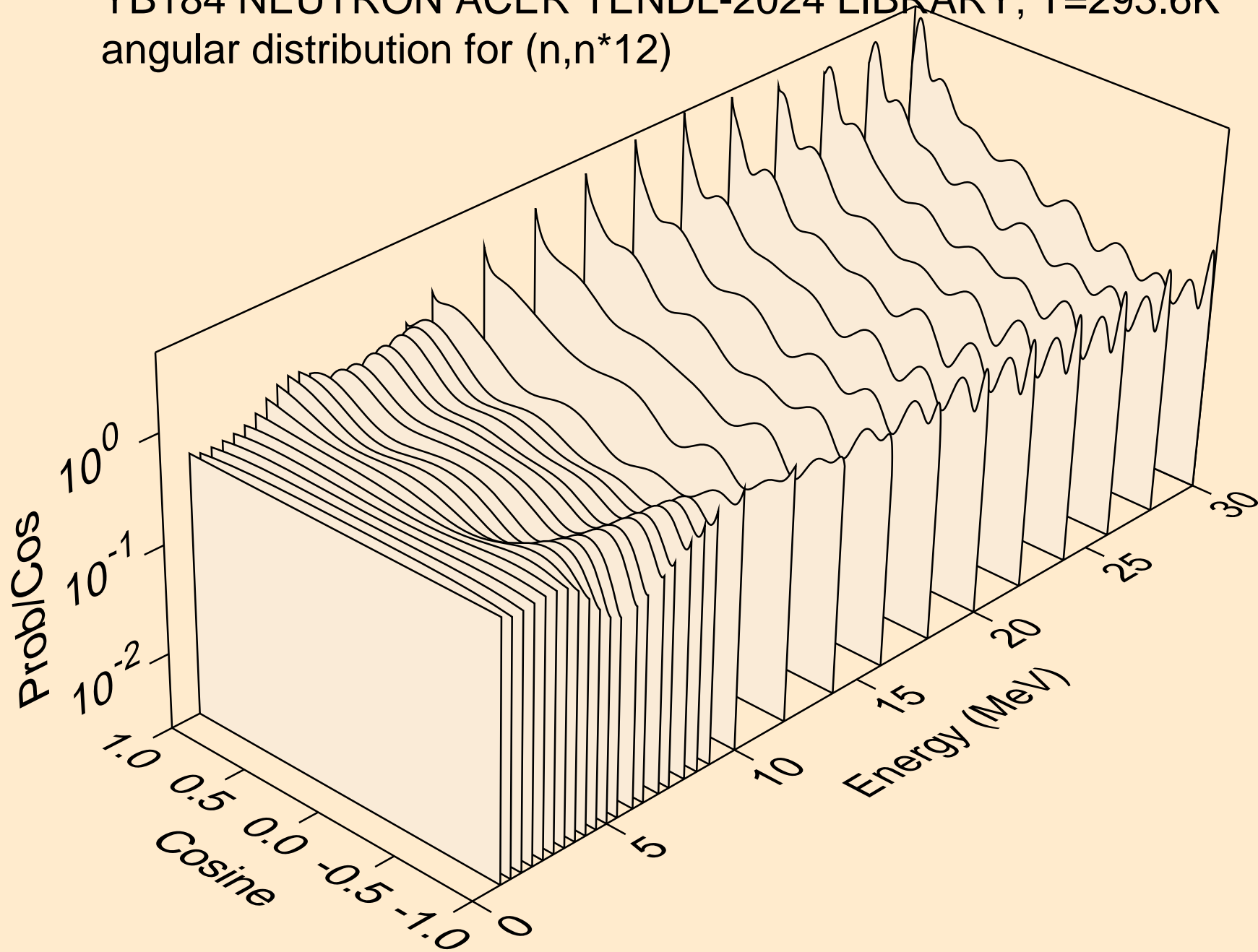

YB184 NEUTRON ACER TENDL-2024 LIBRARY; T=293.6K
angular distribution for (n,n*13)

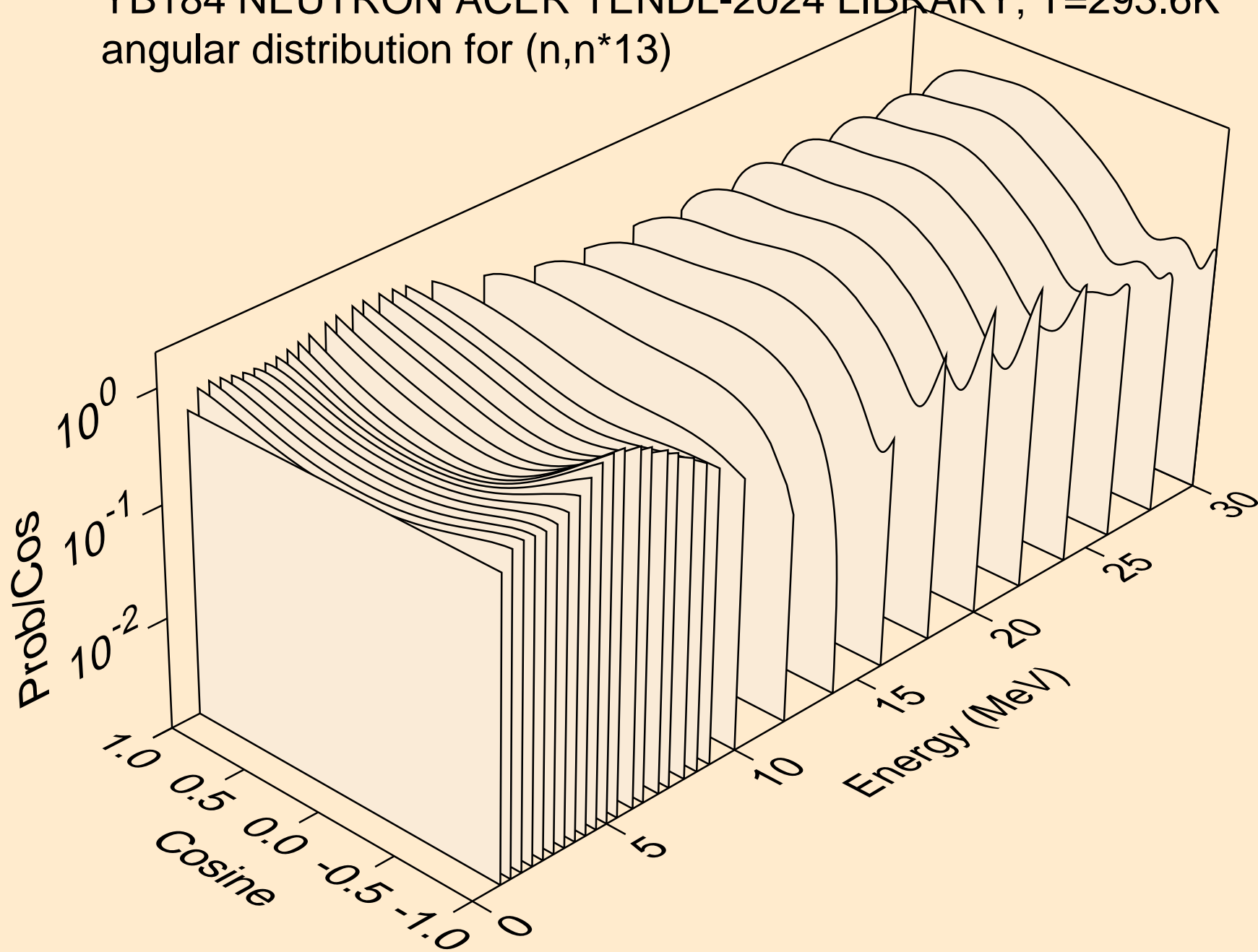

YB184 NEUTRON ACER TENDL-2024 LIBRARY; T=293.6K
angular distribution for (n,n*14)

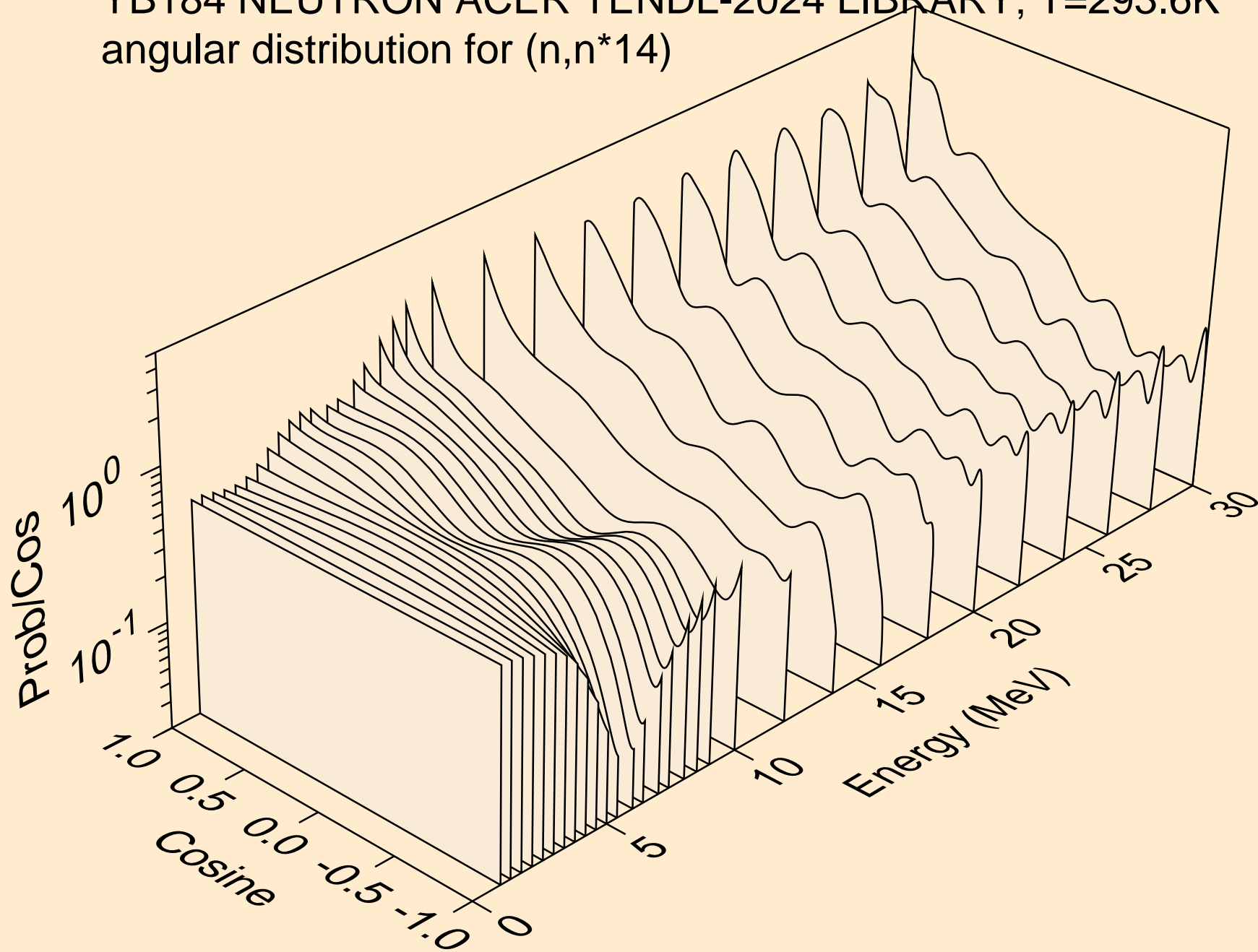

YB184 NEUTRON ACER TENDL-2024 LIBRARY; T=293.6K
angular distribution for (n,n*15)

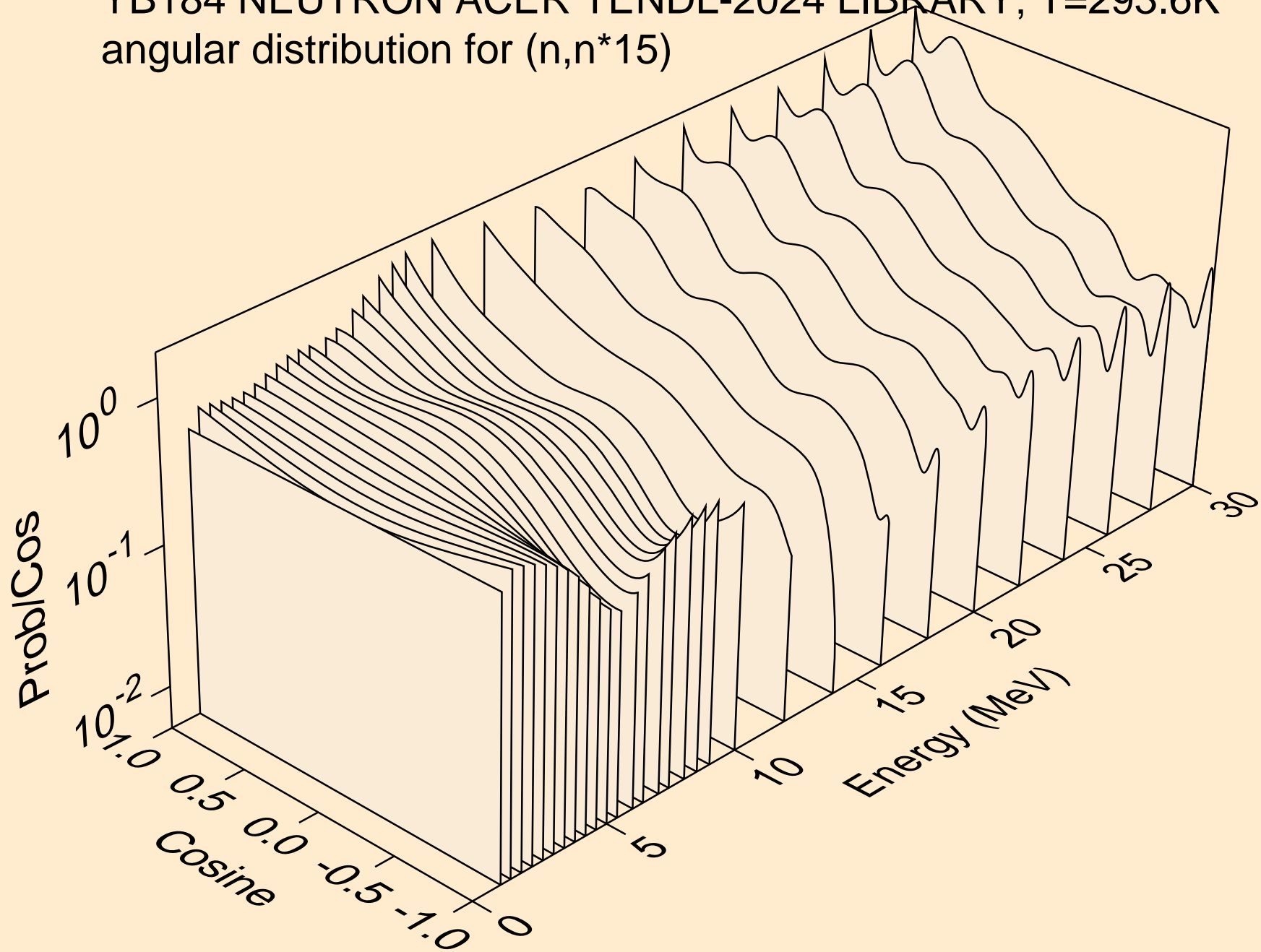

YB184 NEUTRON ACER TENDL-2024 LIBRARY; T=293.6K
angular distribution for (n,n*16)

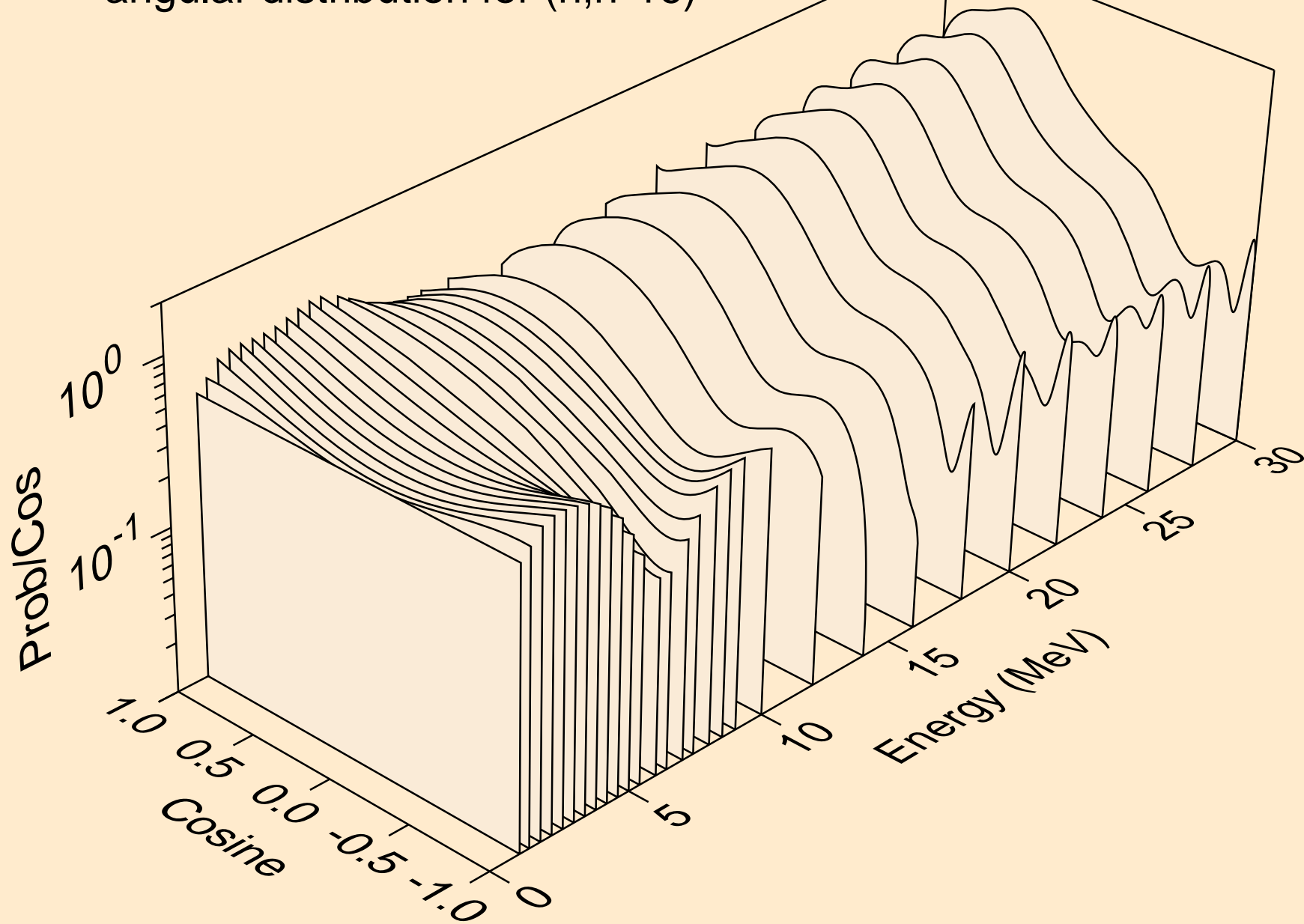

YB184 NEUTRON ACER TENDL-2024 LIBRARY; T=293.6K
angular distribution for (n,n*17)

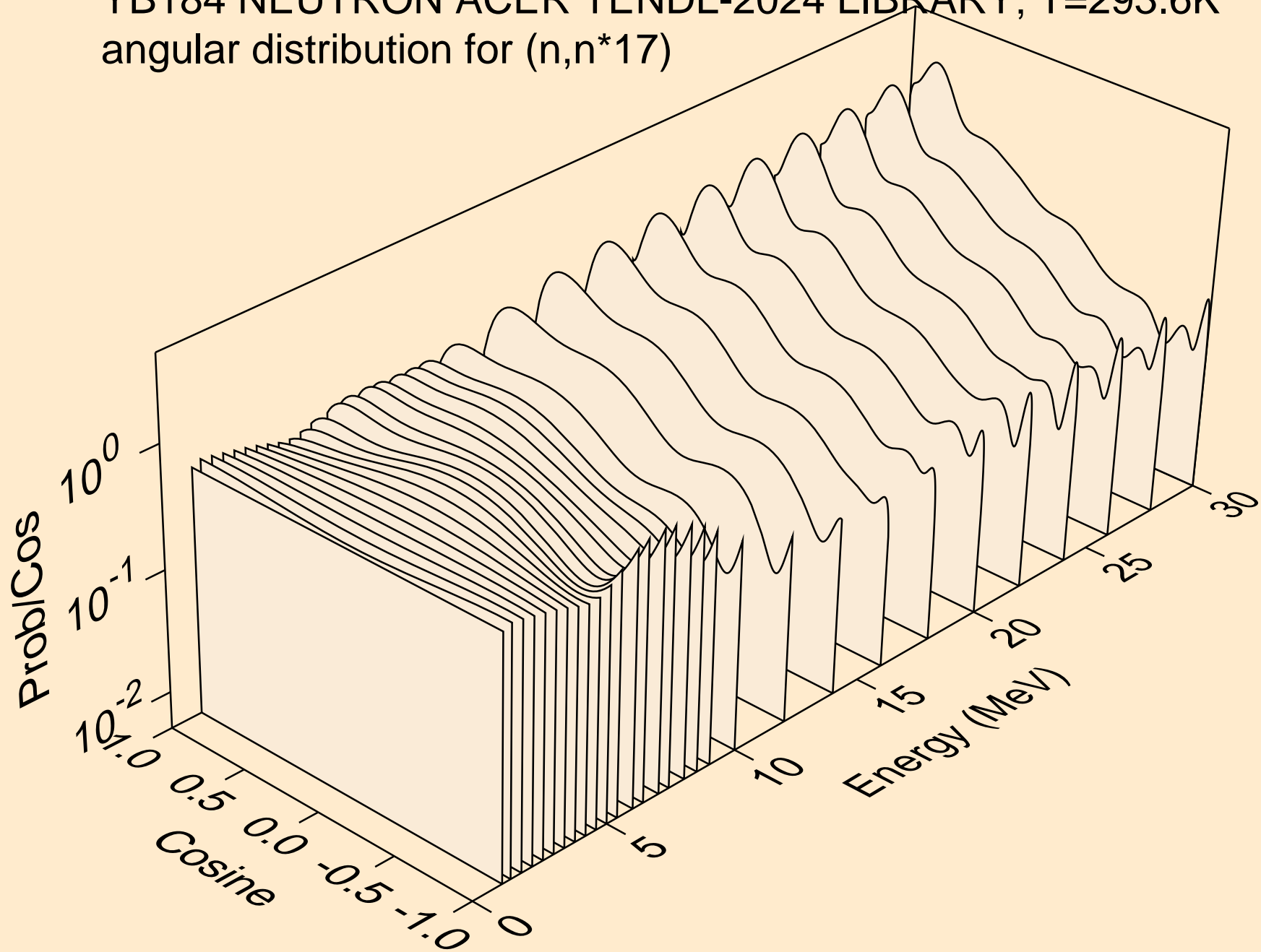

YB184 NEUTRON ACER TENDL-2024 LIBRARY; T=293.6K
angular distribution for (n,n*18)

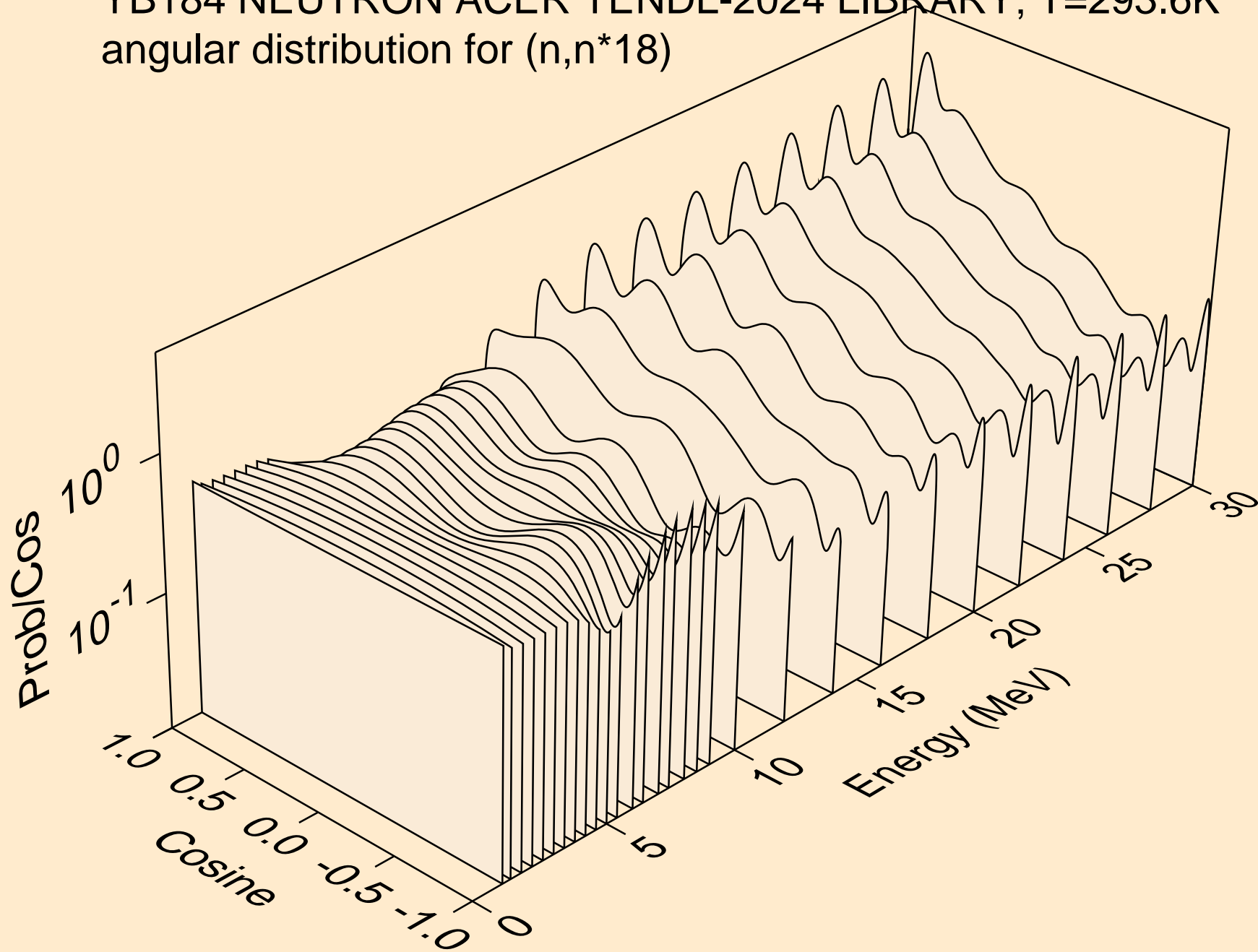

YB184 NEUTRON ACER TENDL-2024 LIBRARY; T=293.6K
angular distribution for (n,n*19)

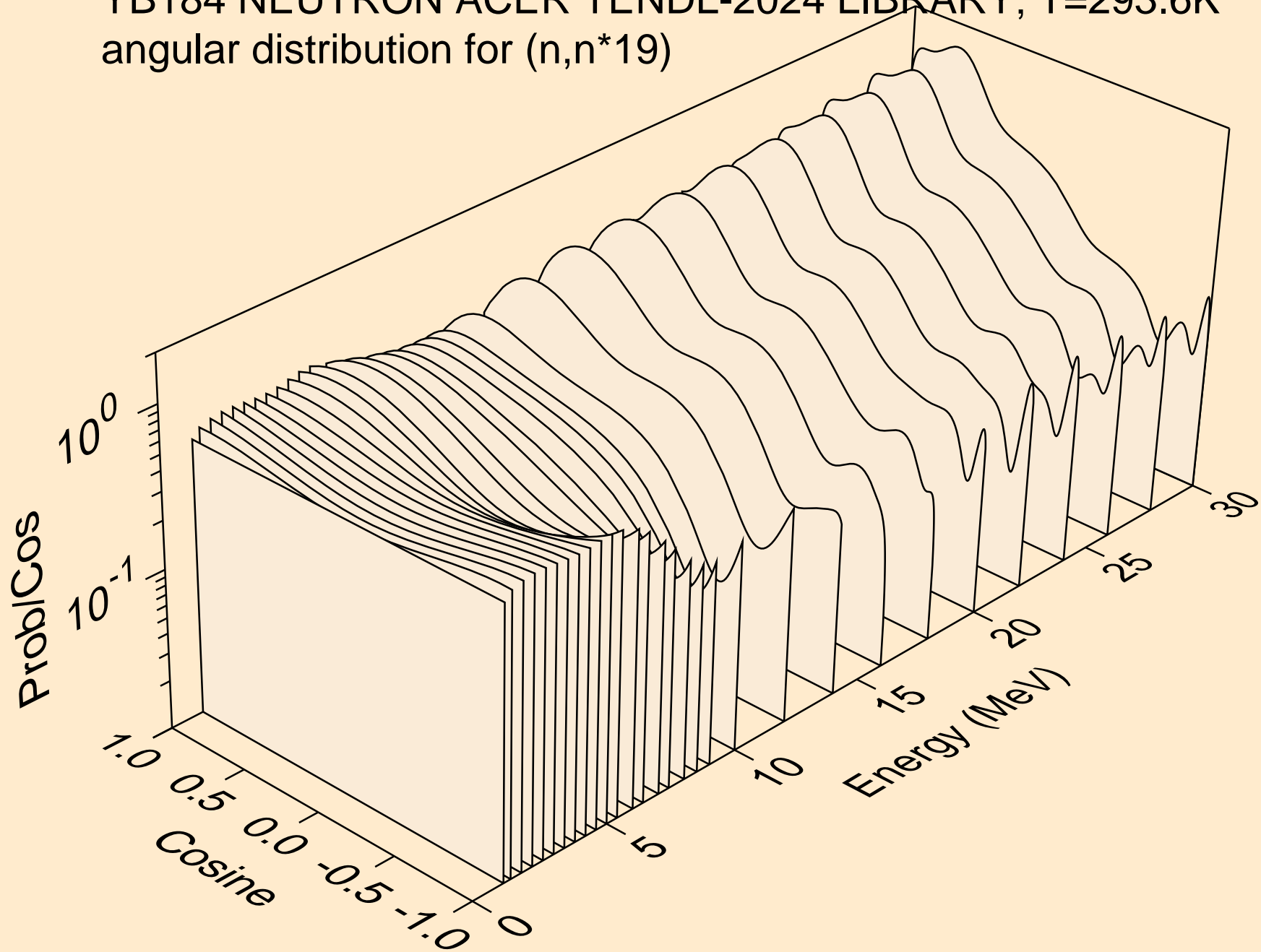

YB184 NEUTRON ACER TENDL-2024 LIBRARY; T=293.6K
angular distribution for (n,n*20)

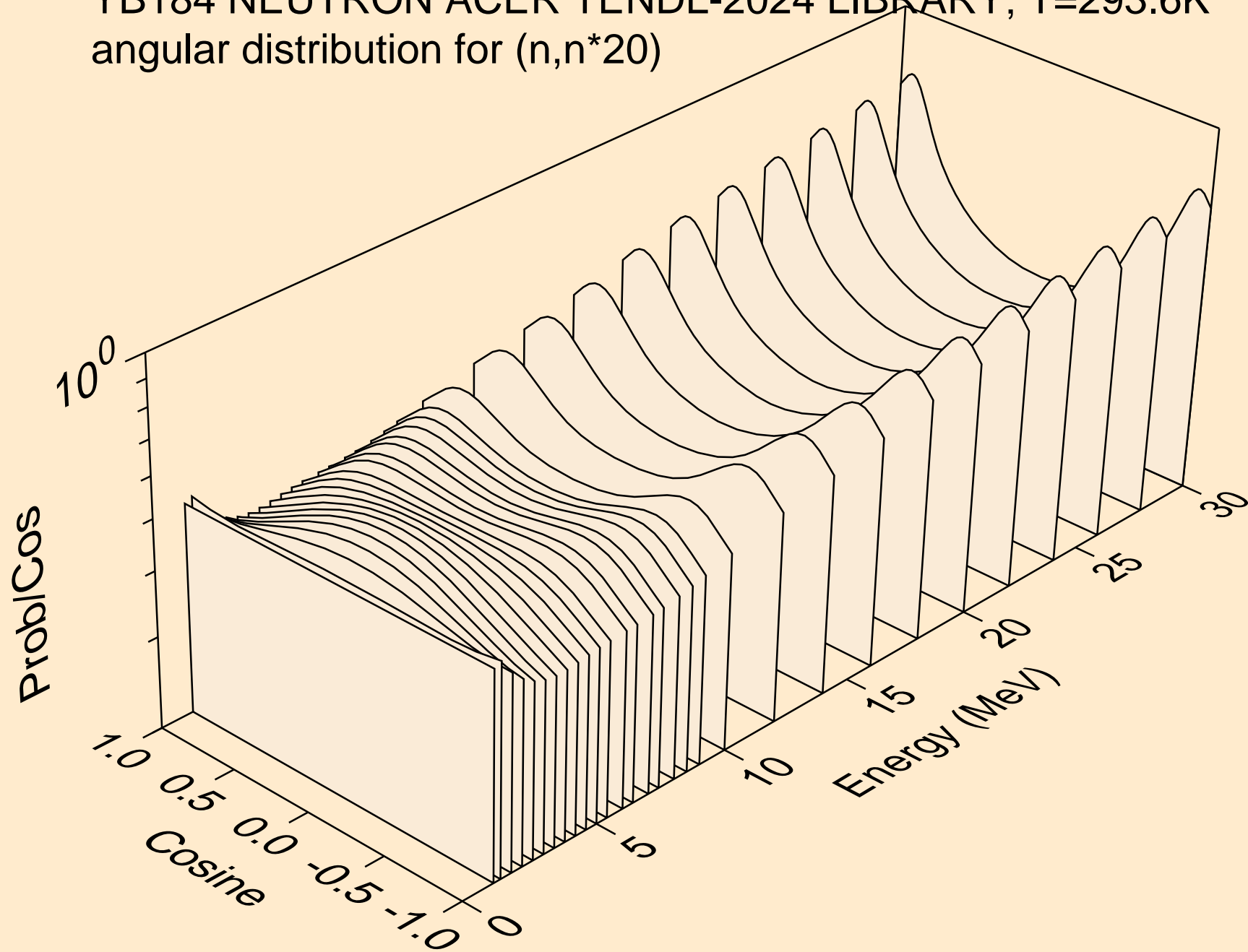

YB184 NEUTRON ACER TENDL-2024 LIBRARY; T=293.6K
angular distribution for (n,n*21)

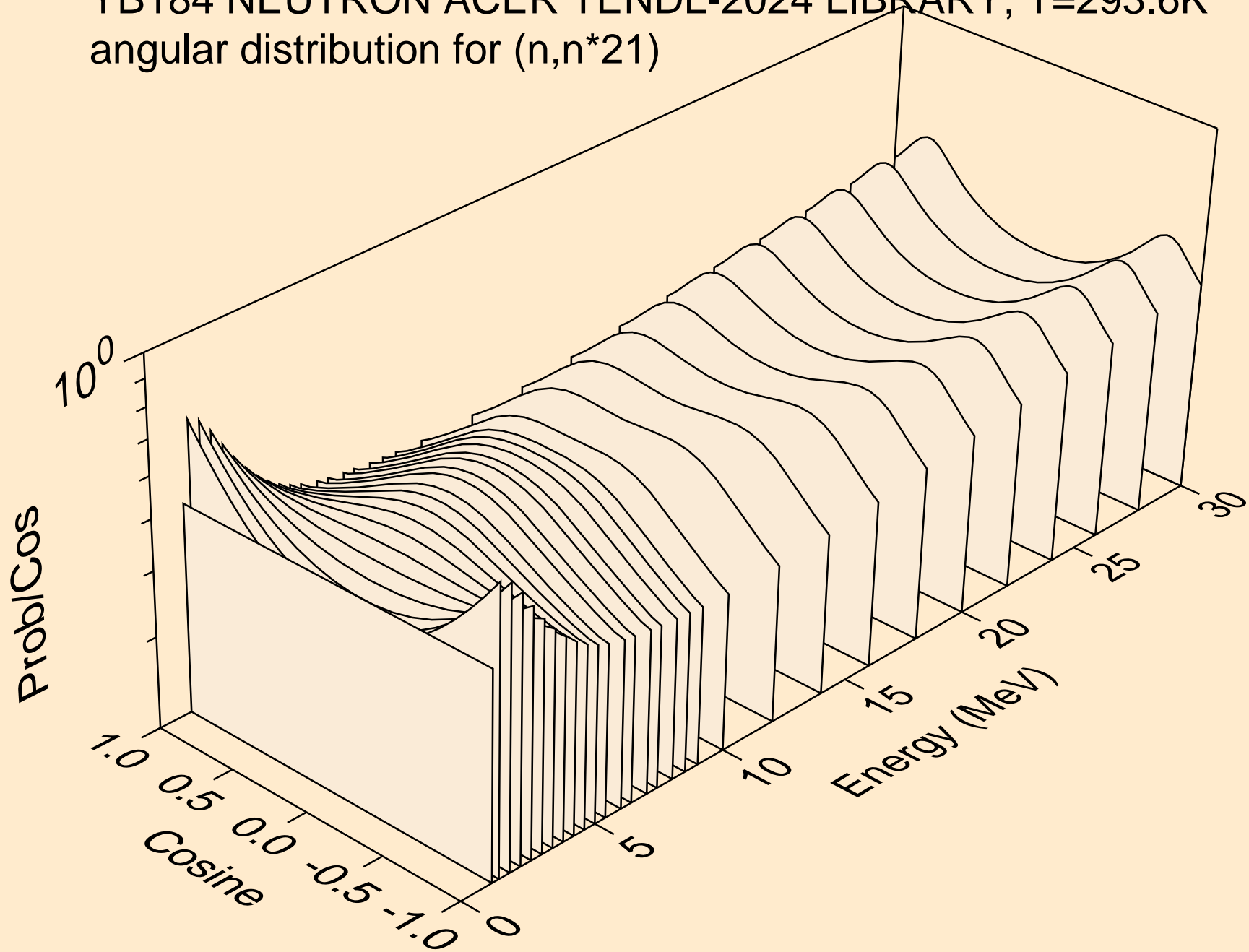

YB184 NEUTRON ACER TENDL-2024 LIBRARY; T=293.6K
angular distribution for (n,n*22)

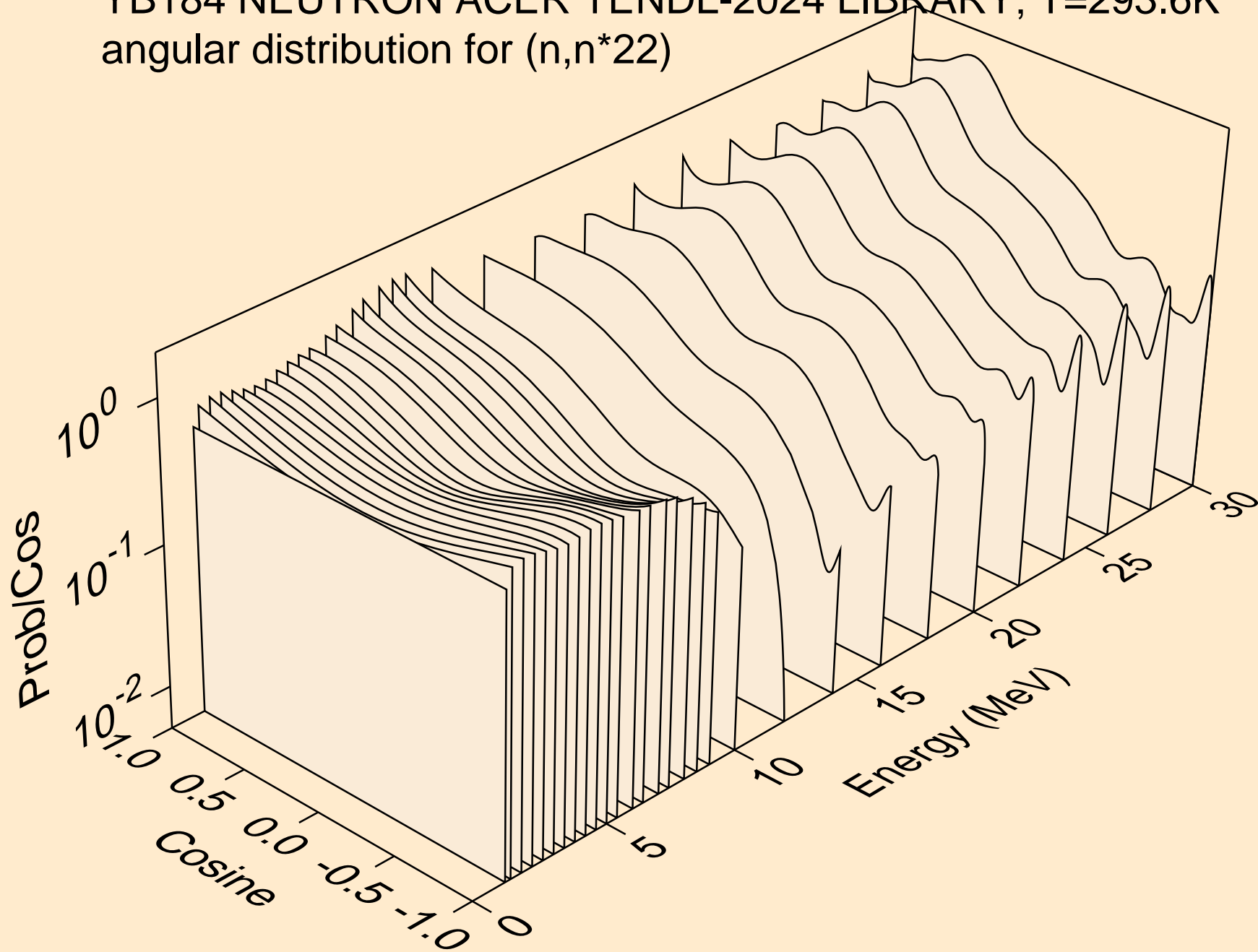

YB184 NEUTRON ACER TENDL-2024 LIBRARY; T=293.6K
angular distribution for (n,n*23)

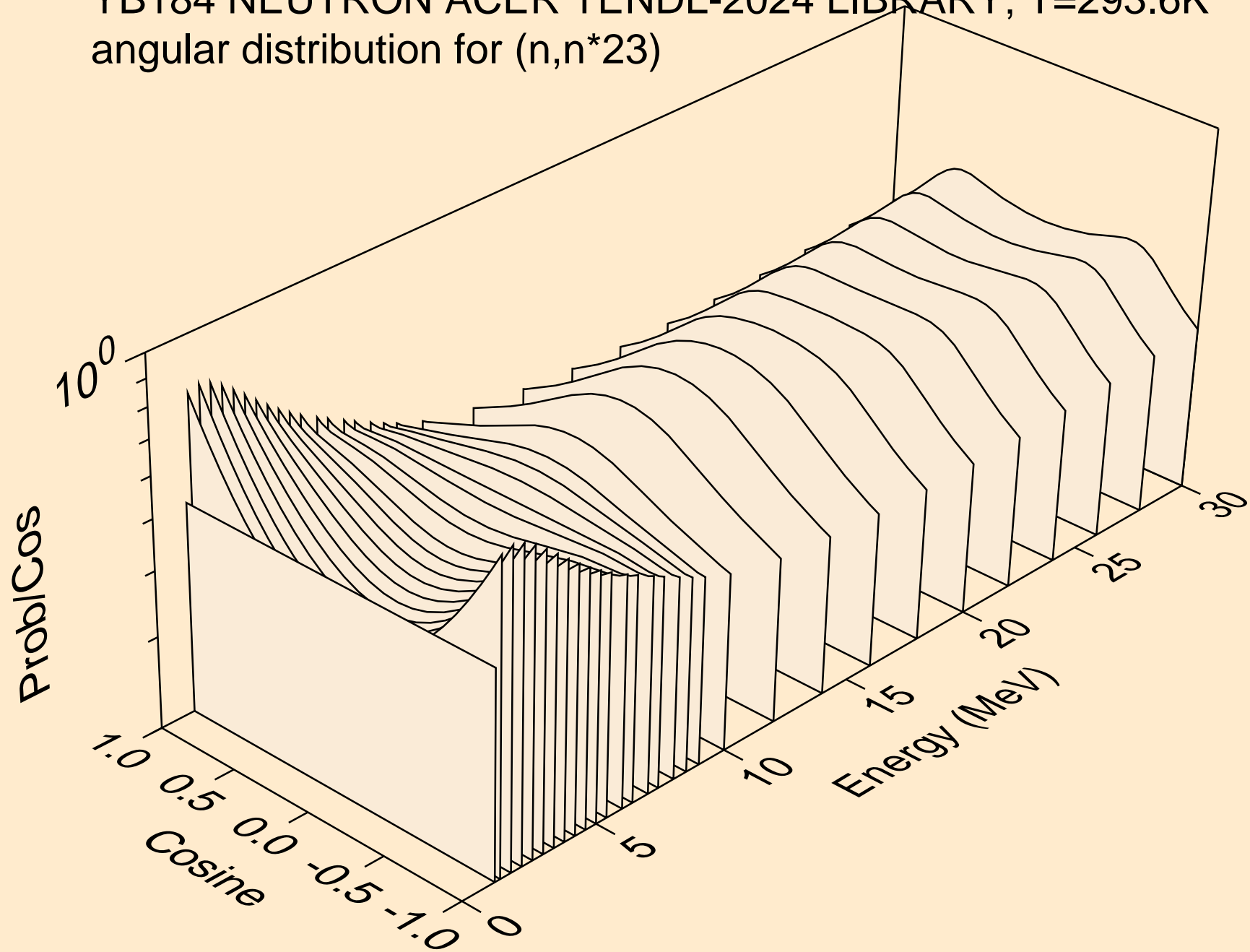

YB184 NEUTRON ACER TENDL-2024 LIBRARY; T=293.6K
angular distribution for (n,n*24)

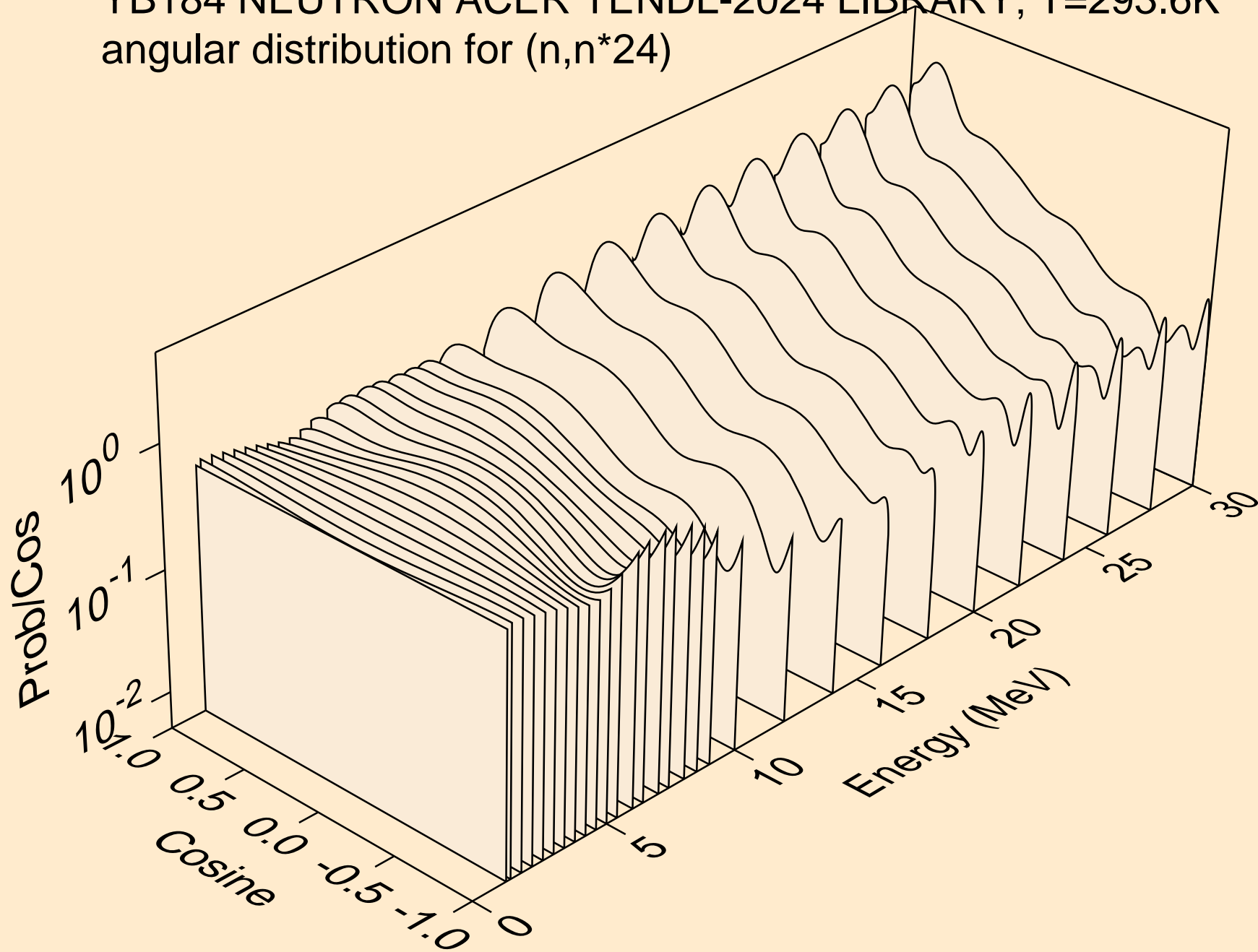

YB184 NEUTRON ACER TENDL-2024 LIBRARY; T=293.6K
angular distribution for (n,n*25)

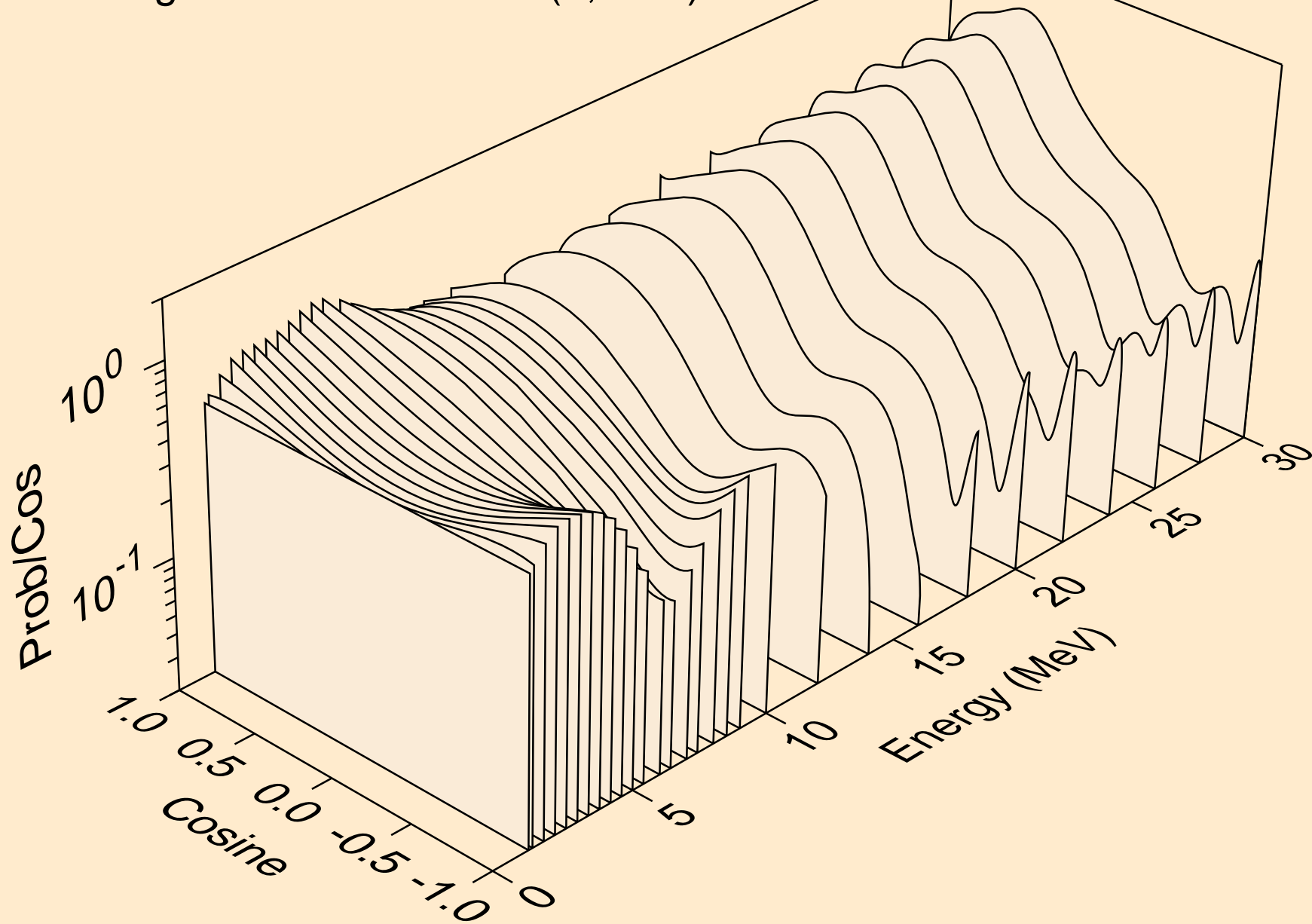

YB184 NEUTRON ACER TENDL-2024 LIBRARY; T=293.6K
angular distribution for (n,n*26)

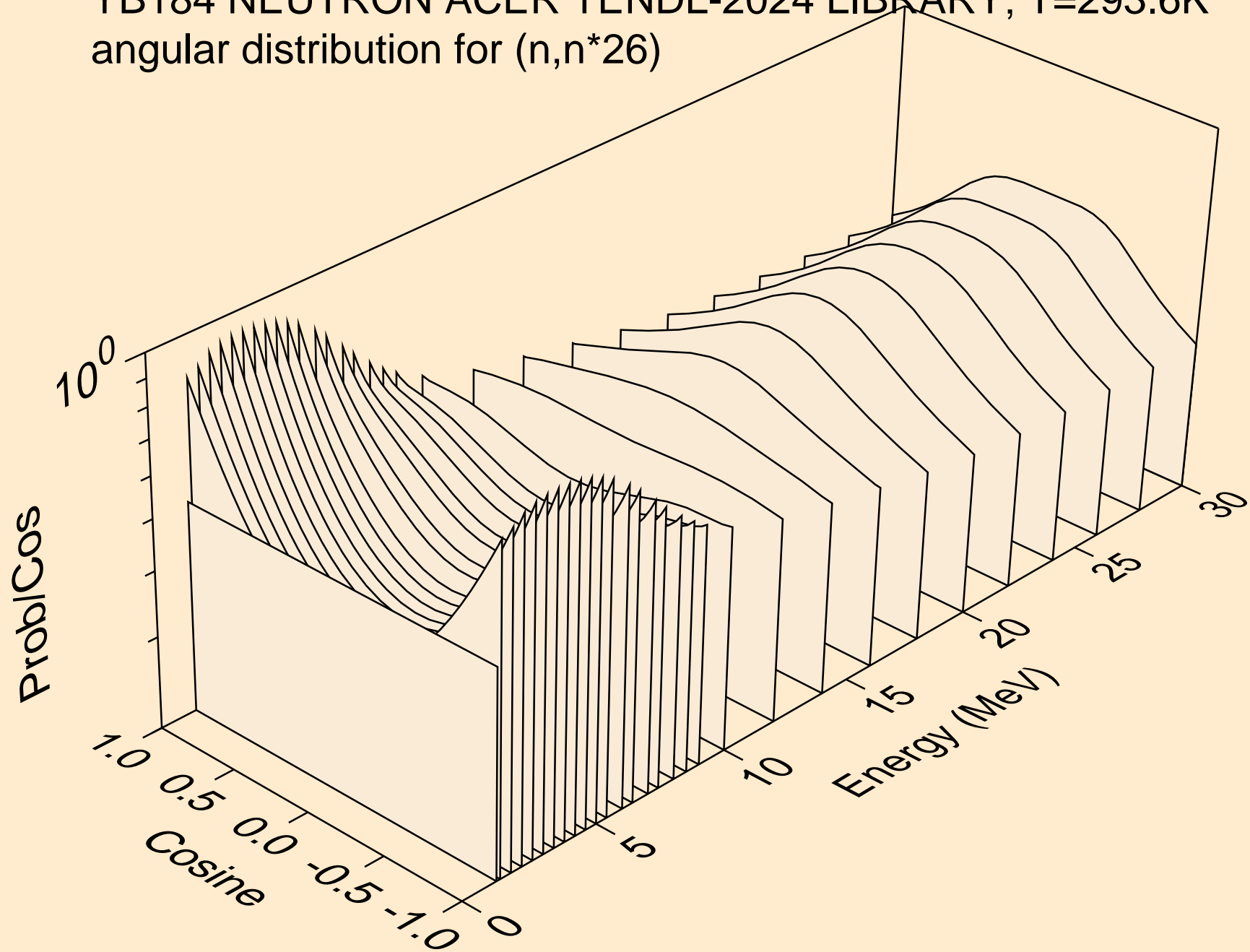

YB184 NEUTRON ACER TENDL-2024 LIBRARY; T=293.6K
angular distribution for (n,n*27)

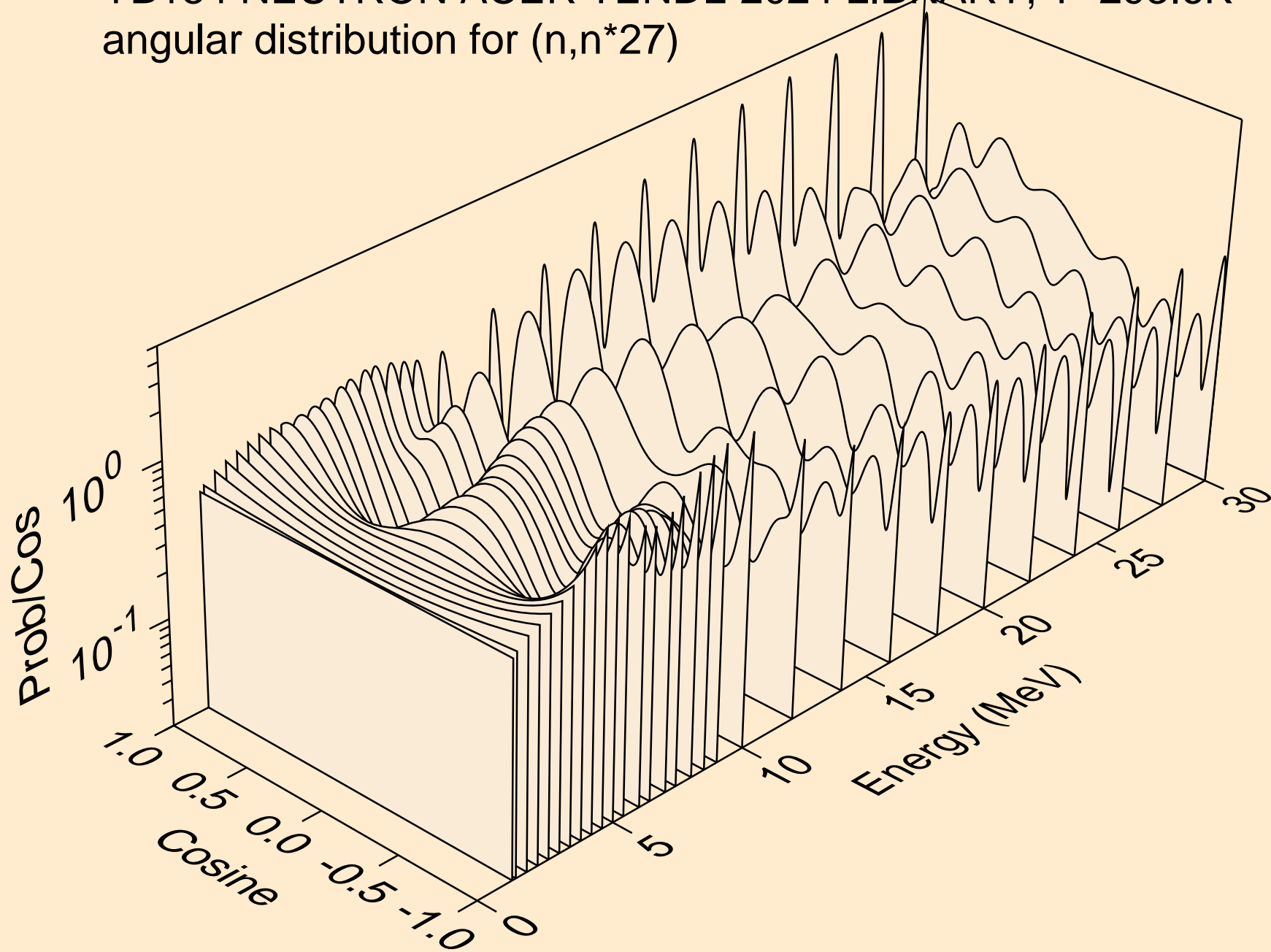

YB184 NEUTRON ACER TENDL-2024 LIBRARY; T=293.6K
angular distribution for (n,n*28)

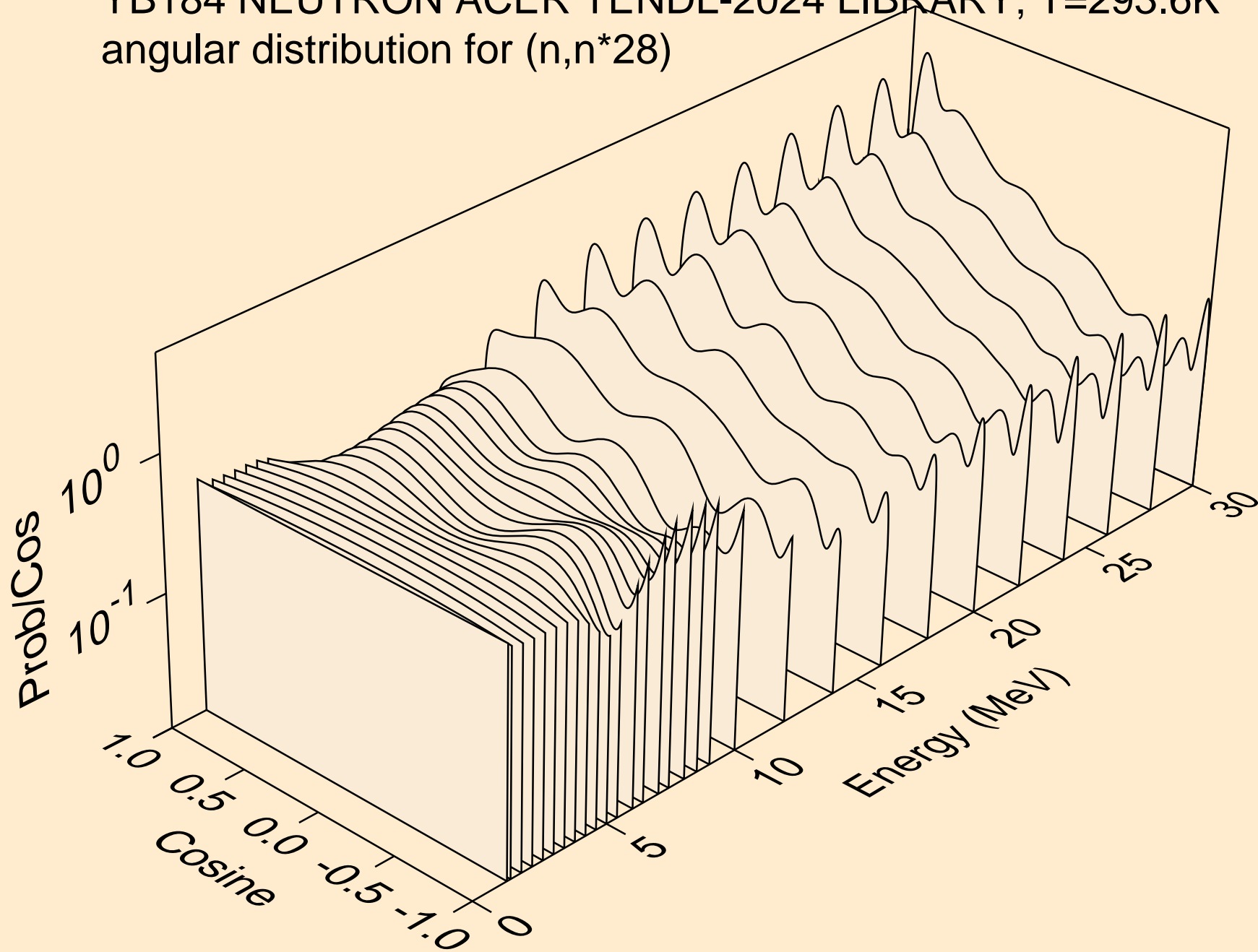

YB184 NEUTRON ACER TENDL-2024 LIBRARY; T=293.6K
angular distribution for (n,n*29)

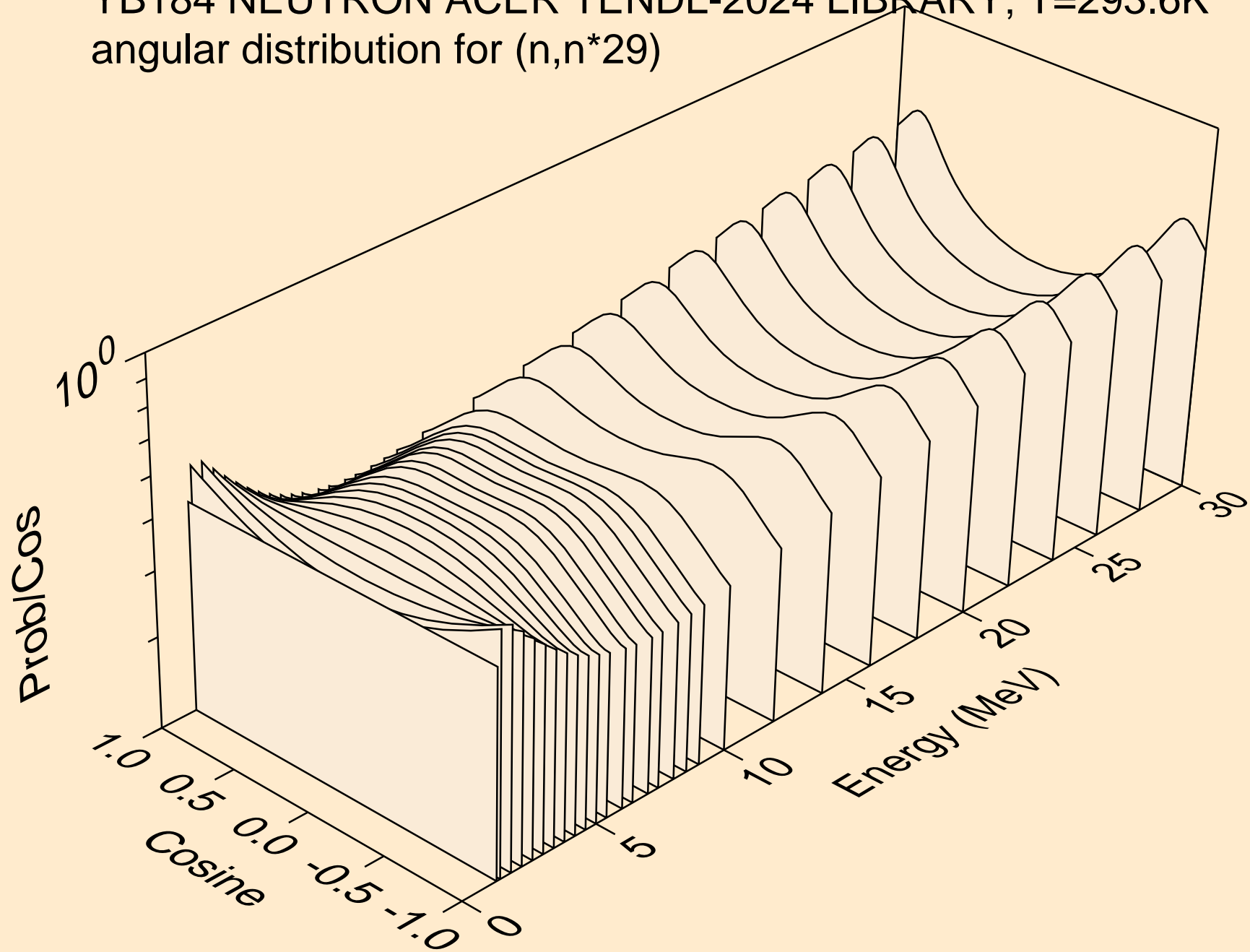

YB184 NEUTRON ACER TENDL-2024 LIBRARY; T=293.6K
Neutron emission for (n,x)

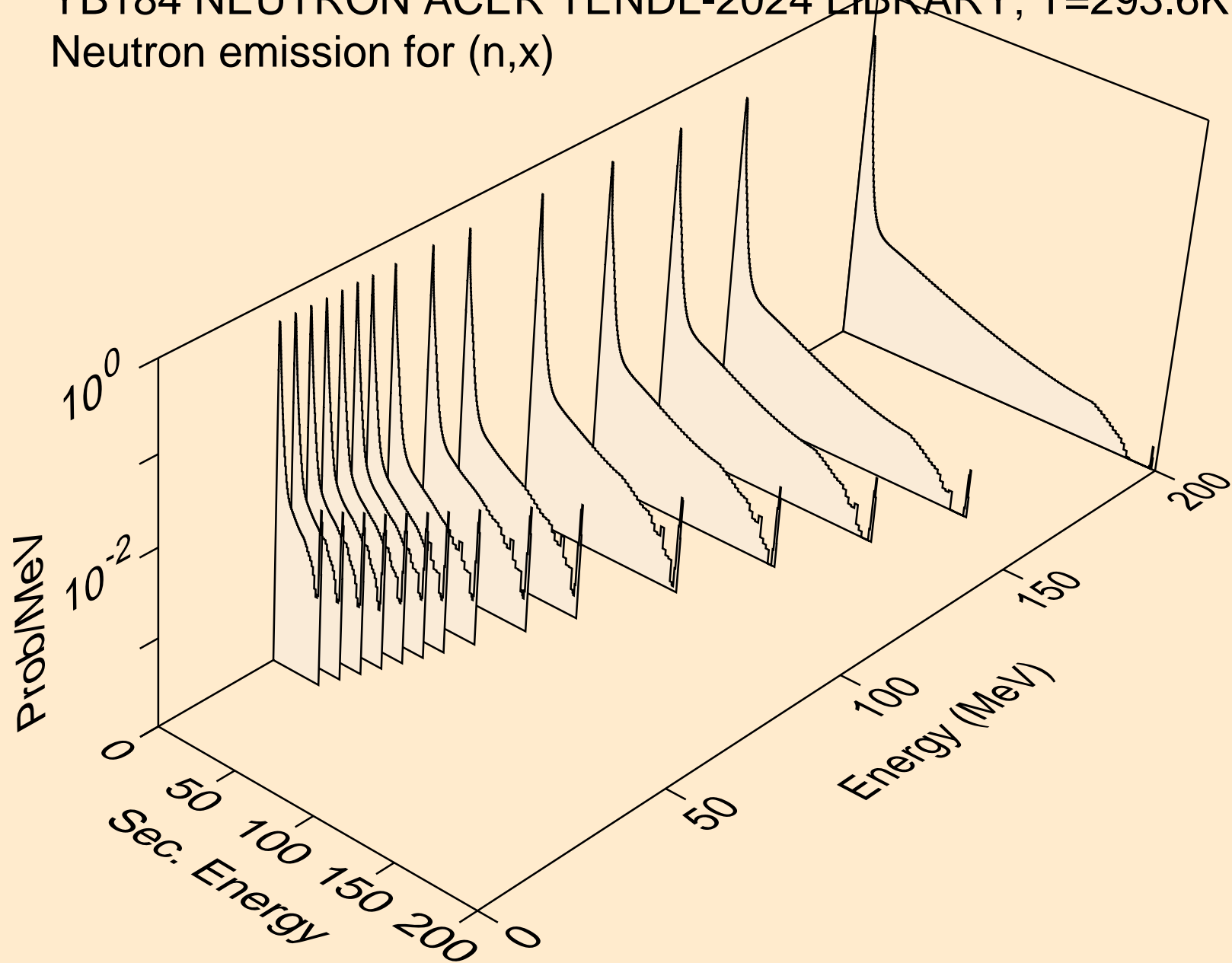

YB184 NEUTRON ACER TENDL-2024 LIBRARY; T=293.6K
Neutron emission for (n,2nd)

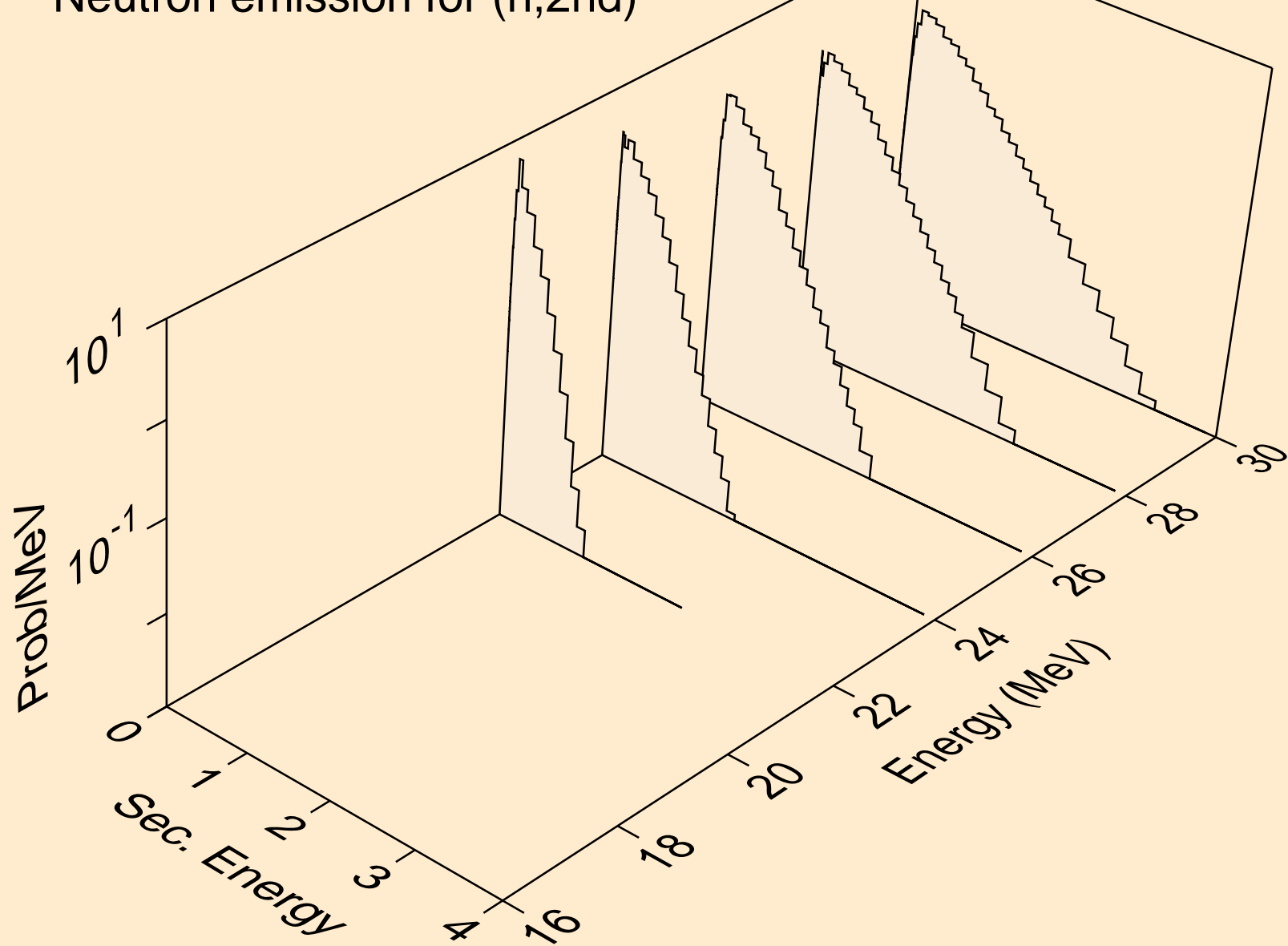

YB184 NEUTRON ACER TENDL-2024 LIBRARY; T=293.6K
Neutron emission for (n,2n)

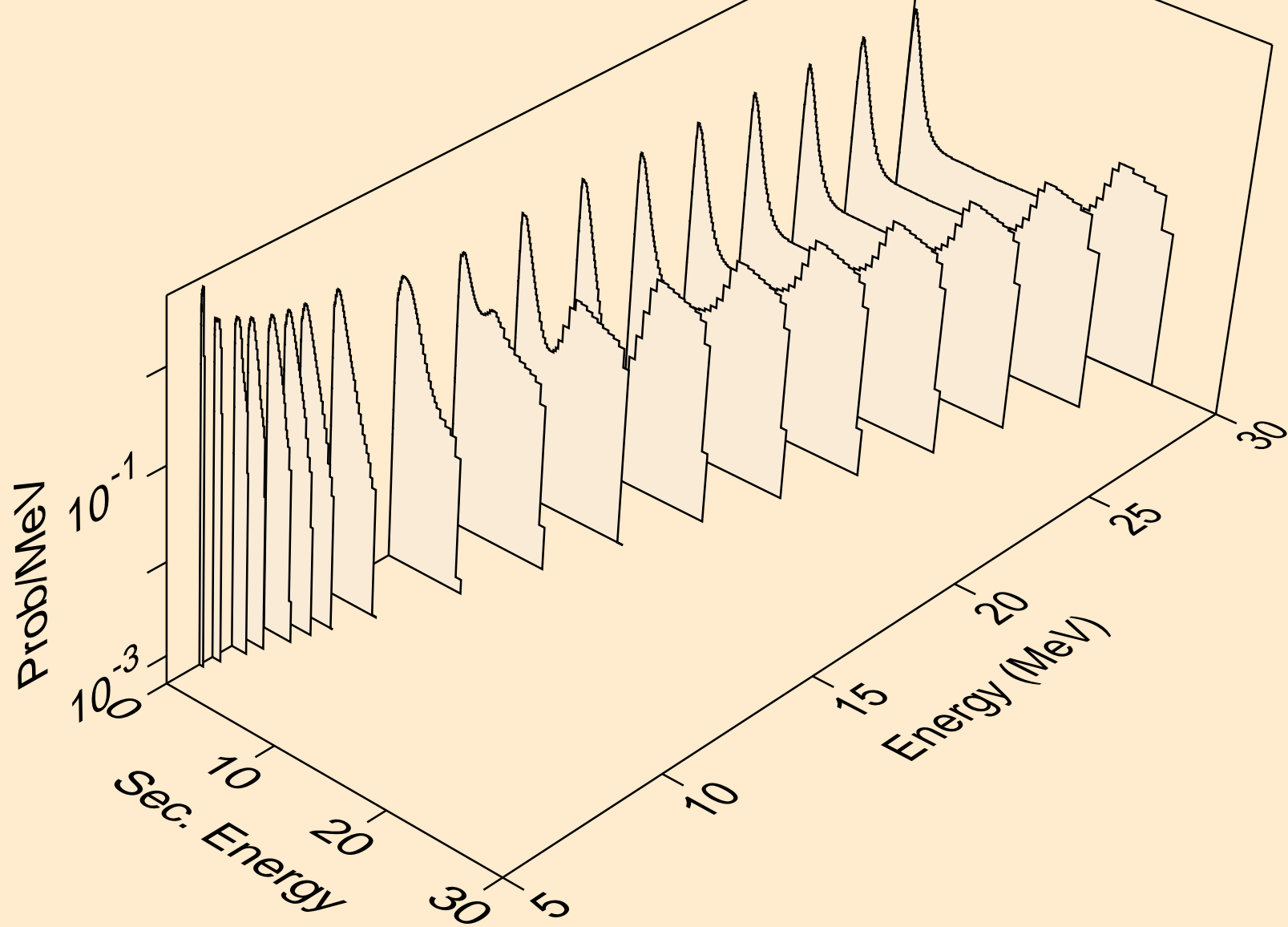

YB184 NEUTRON ACER TENDL-2024 LIBRARY; T=293.6K
Neutron emission for (n,3n)

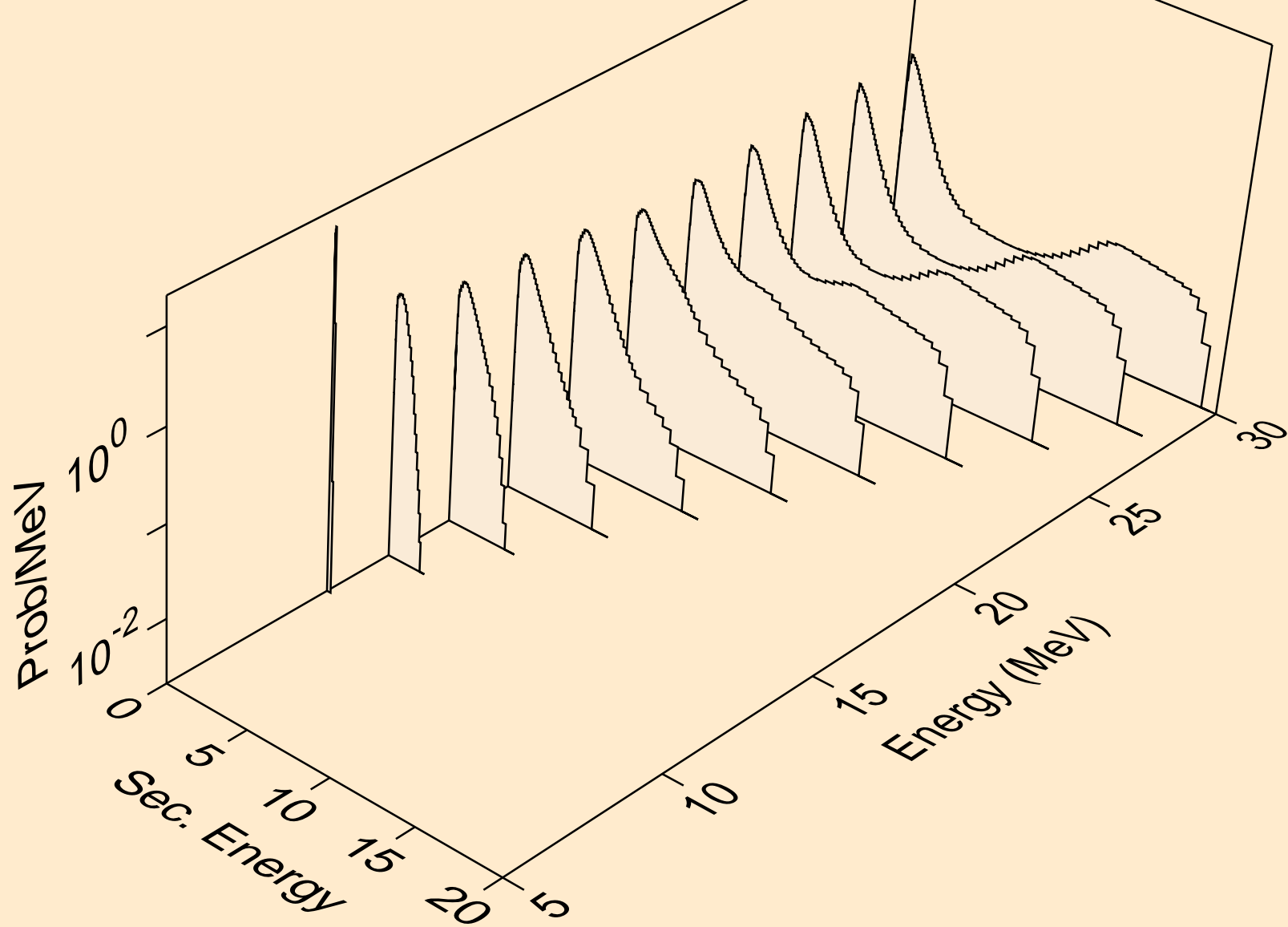

YB184 NEUTRON ACER TENDL-2024 LIBRARY; T=293.6K
Neutron emission for (n,n*)a

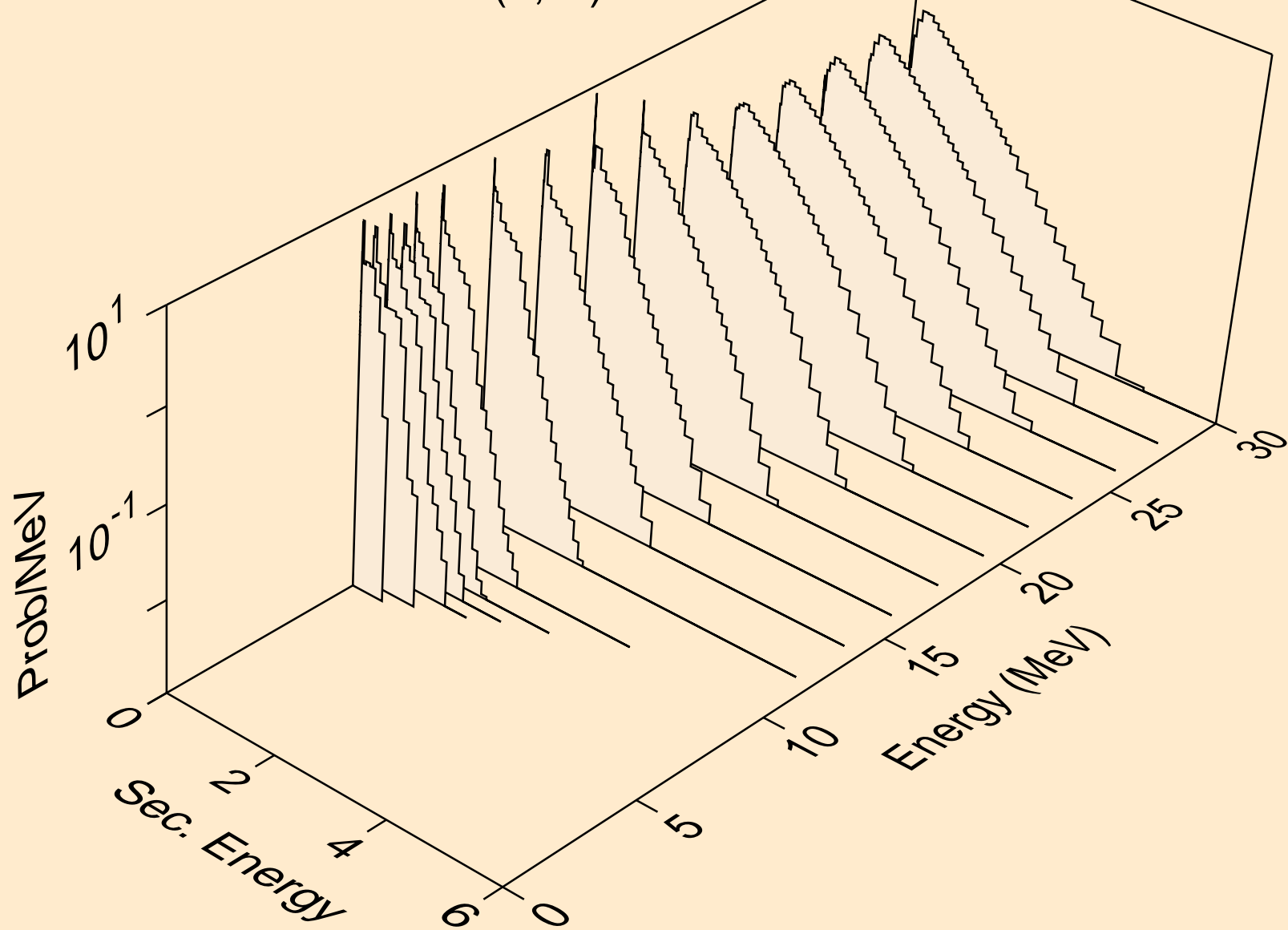

YB184 NEUTRON ACER TENDL-2024 LIBRARY; T=293.6K
Neutron emission for (n,2n)_a

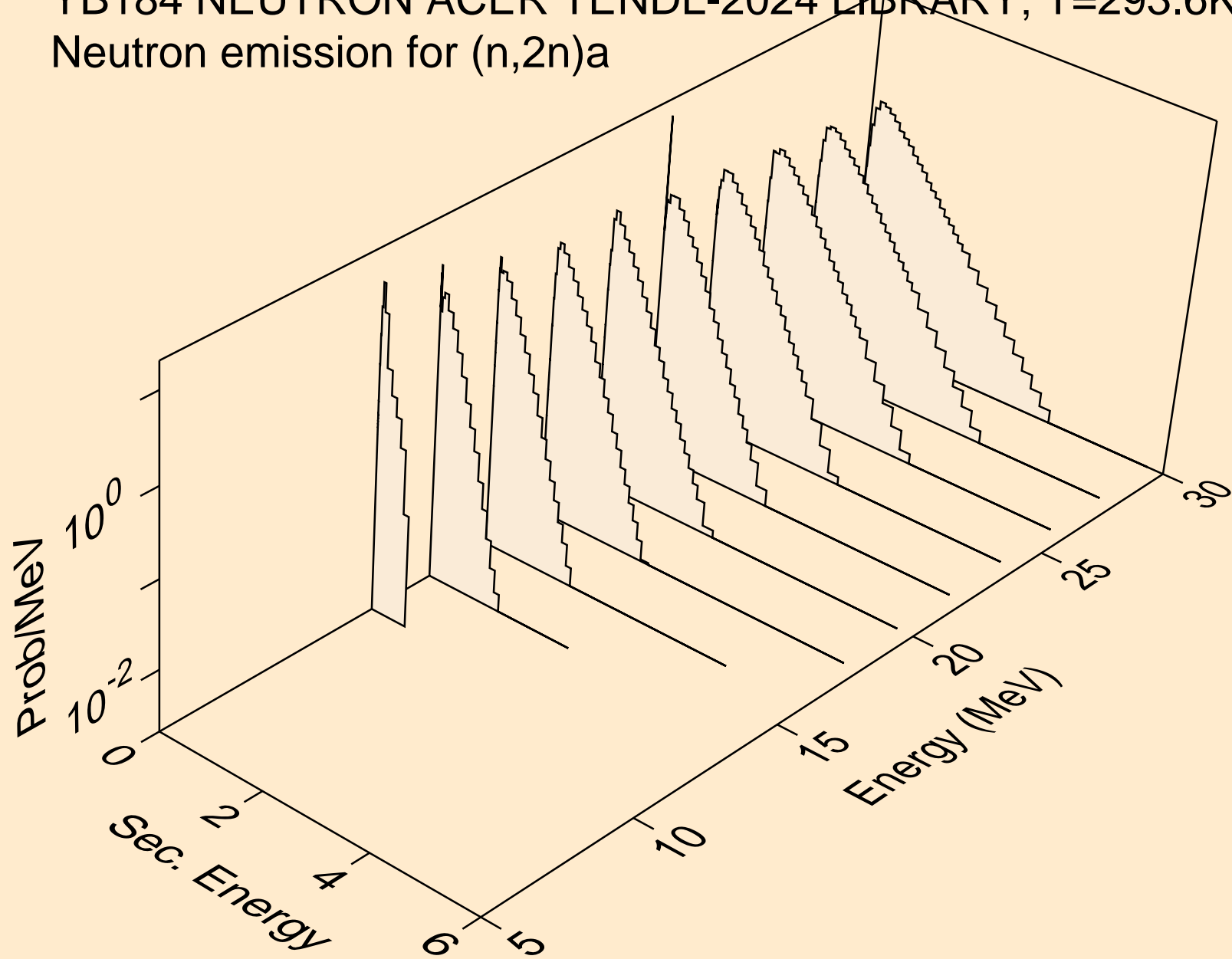

YB184 NEUTRON ACER TENDL-2024 LIBRARY; T=293.6K
Neutron emission for (n,3n)_a

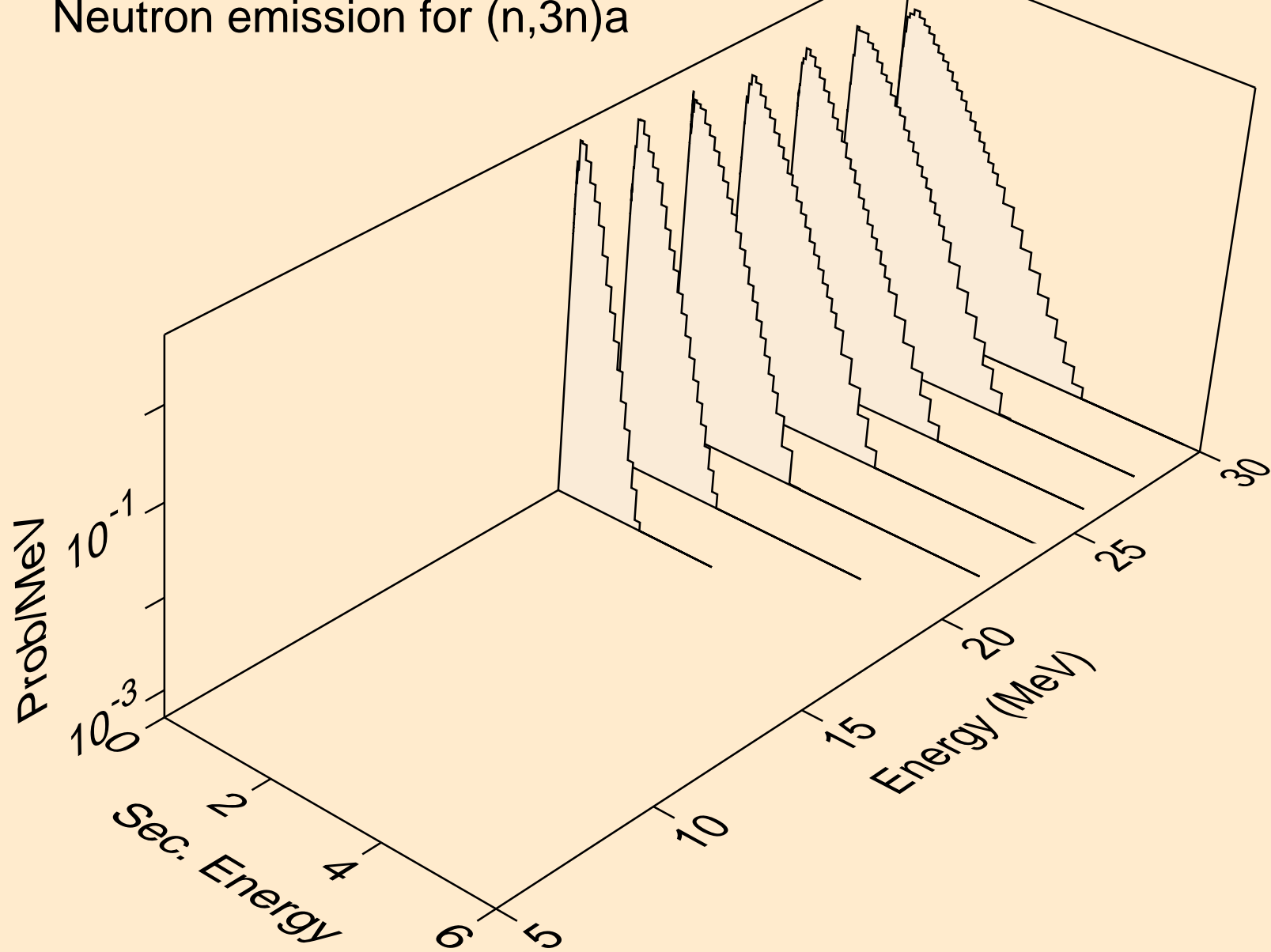

YB184 NEUTRON ACER TENDL-2024 LIBRARY; T=293.6K
Neutron emission for (n,n*)p

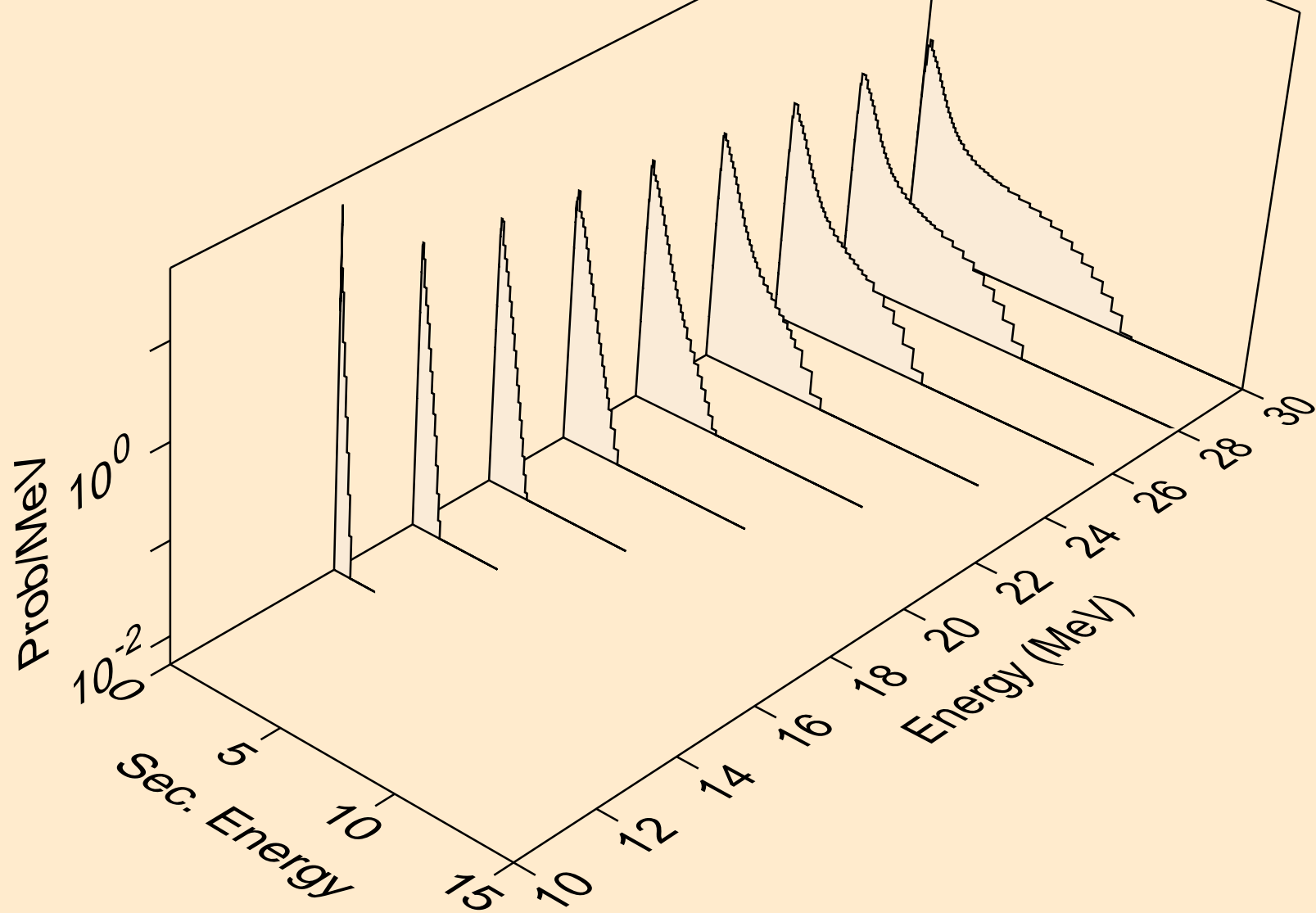

YB184 NEUTRON ACER TENDL-2024 LIBRARY; T=293.6K
Neutron emission for (n,n*)d

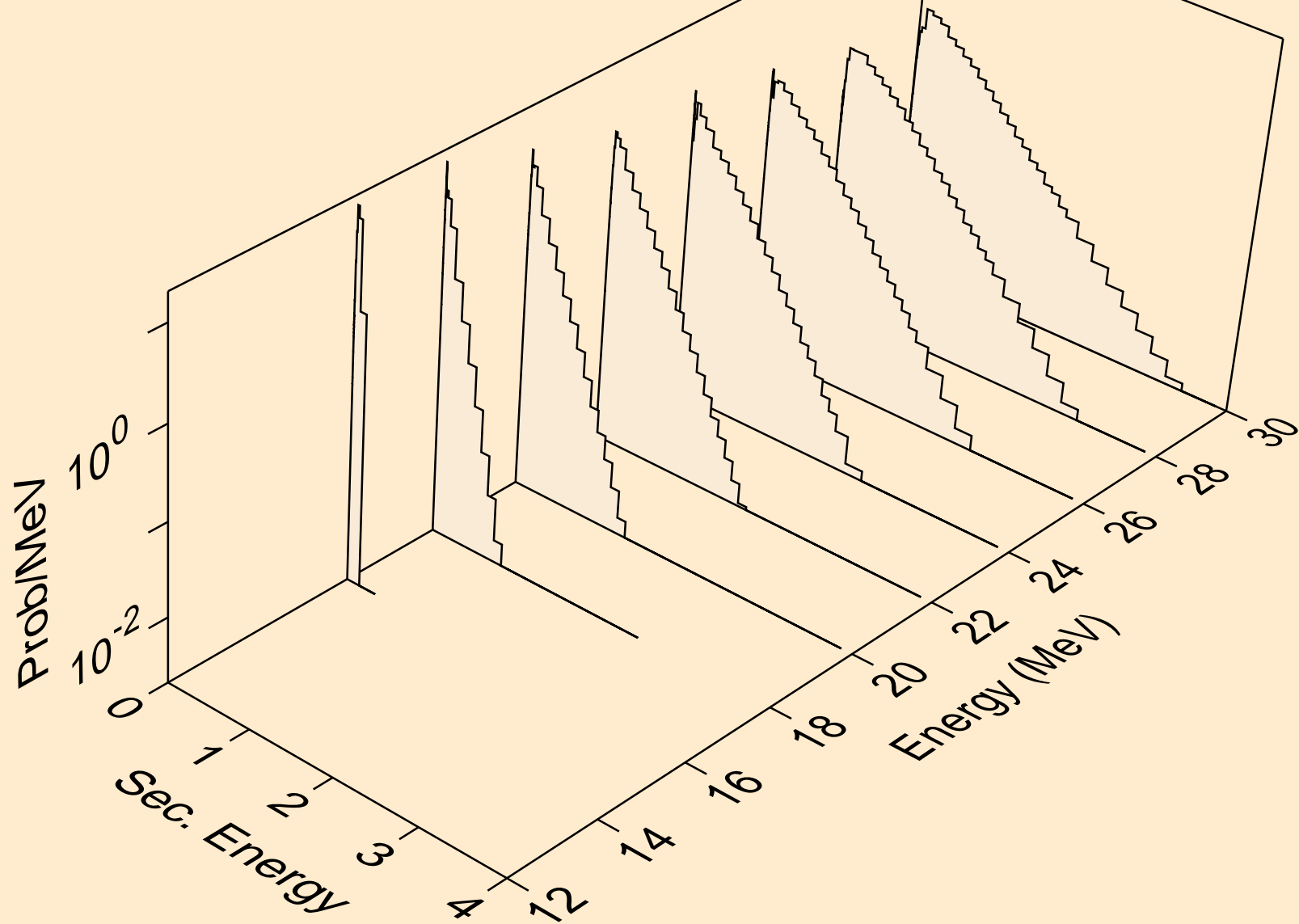

YB184 NEUTRON ACER TENDL-2024 LIBRARY; T=293.6K
Neutron emission for (n,n*)t

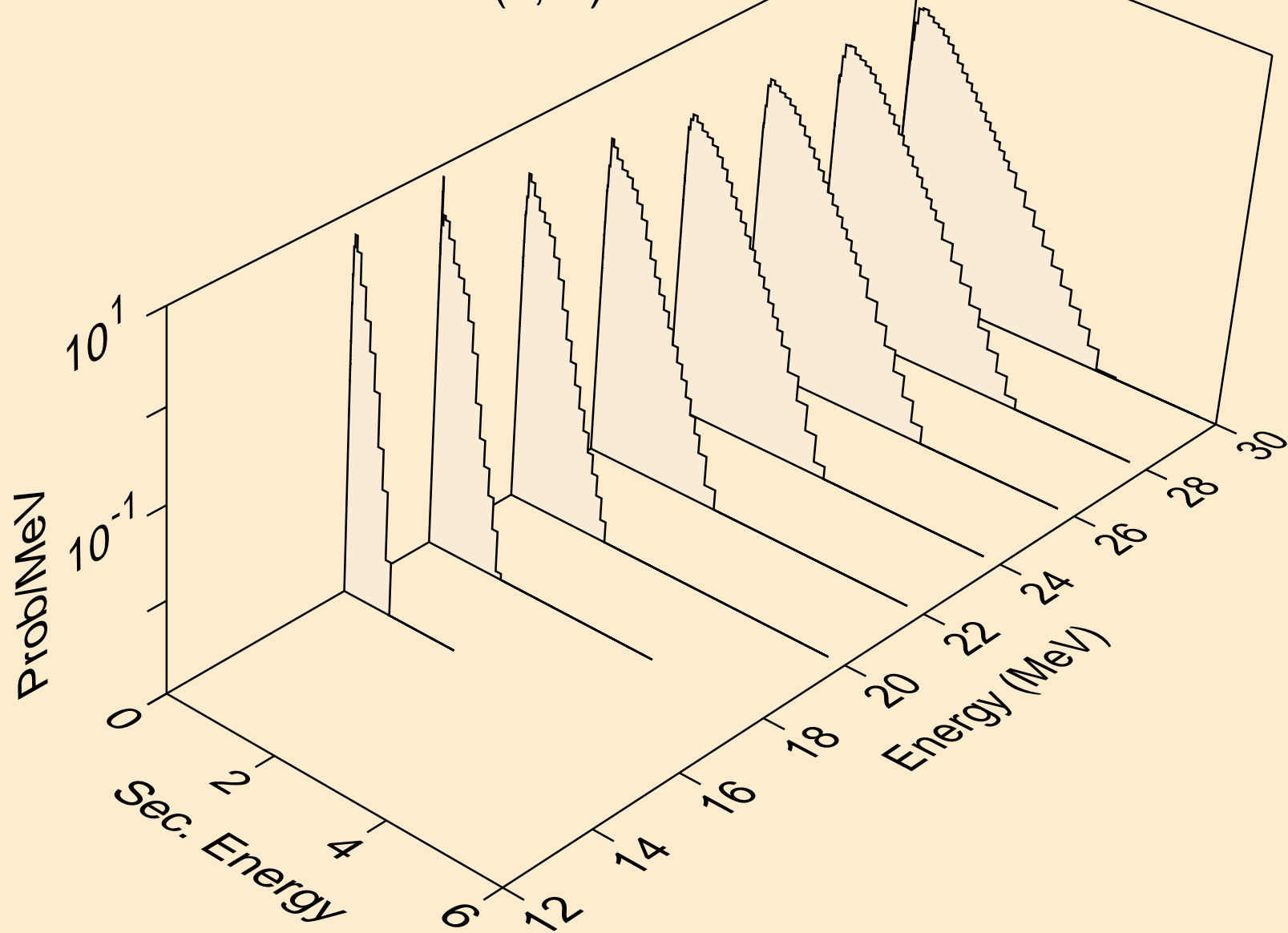

YB184 NEUTRON ACER TENDL-2024 LIBRARY; T=293.6K
Neutron emission for (n,n*)he3

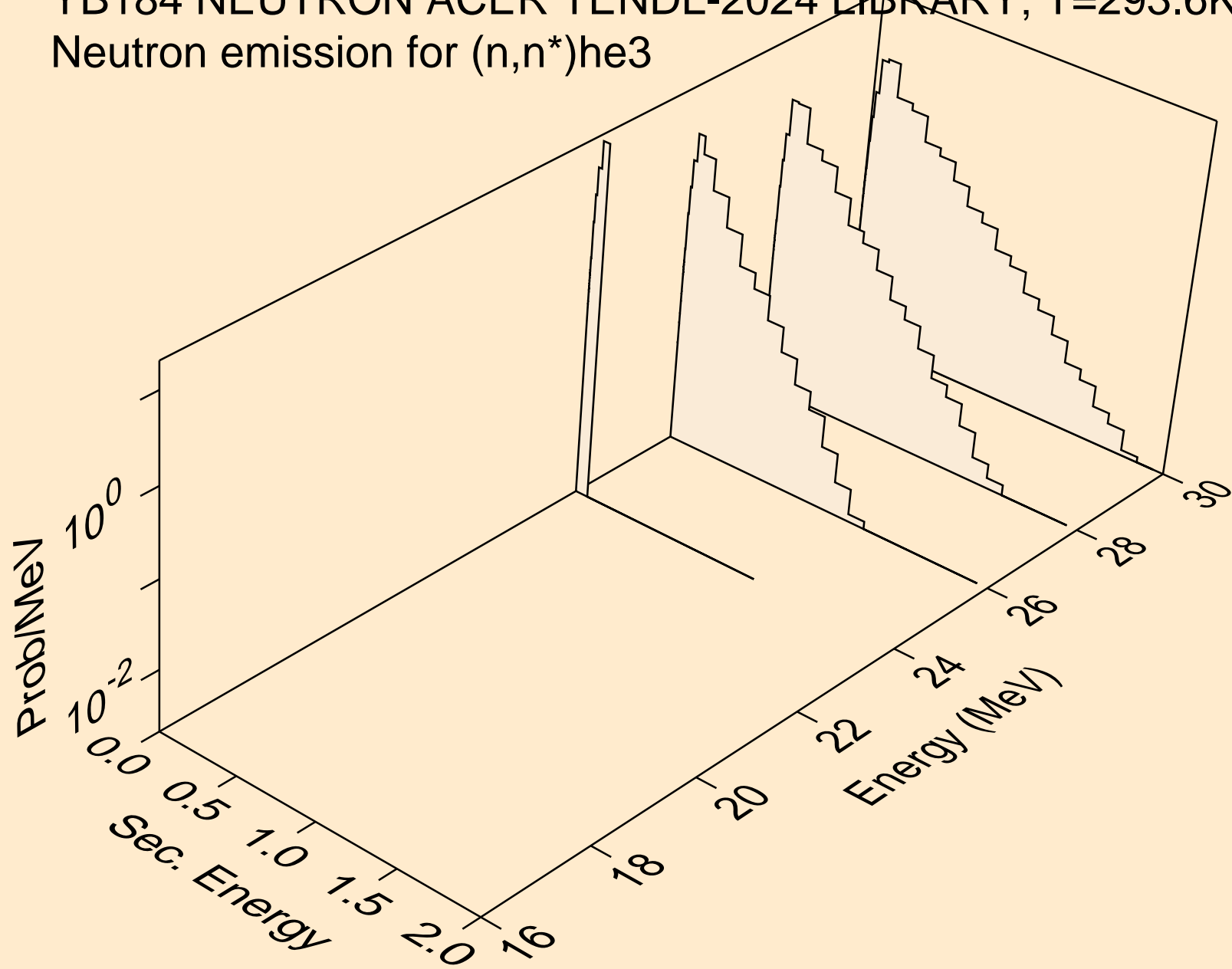

YB184 NEUTRON ACER TENDL-2024 LIBRARY; T=293.6K
Neutron emission for (n,4n)

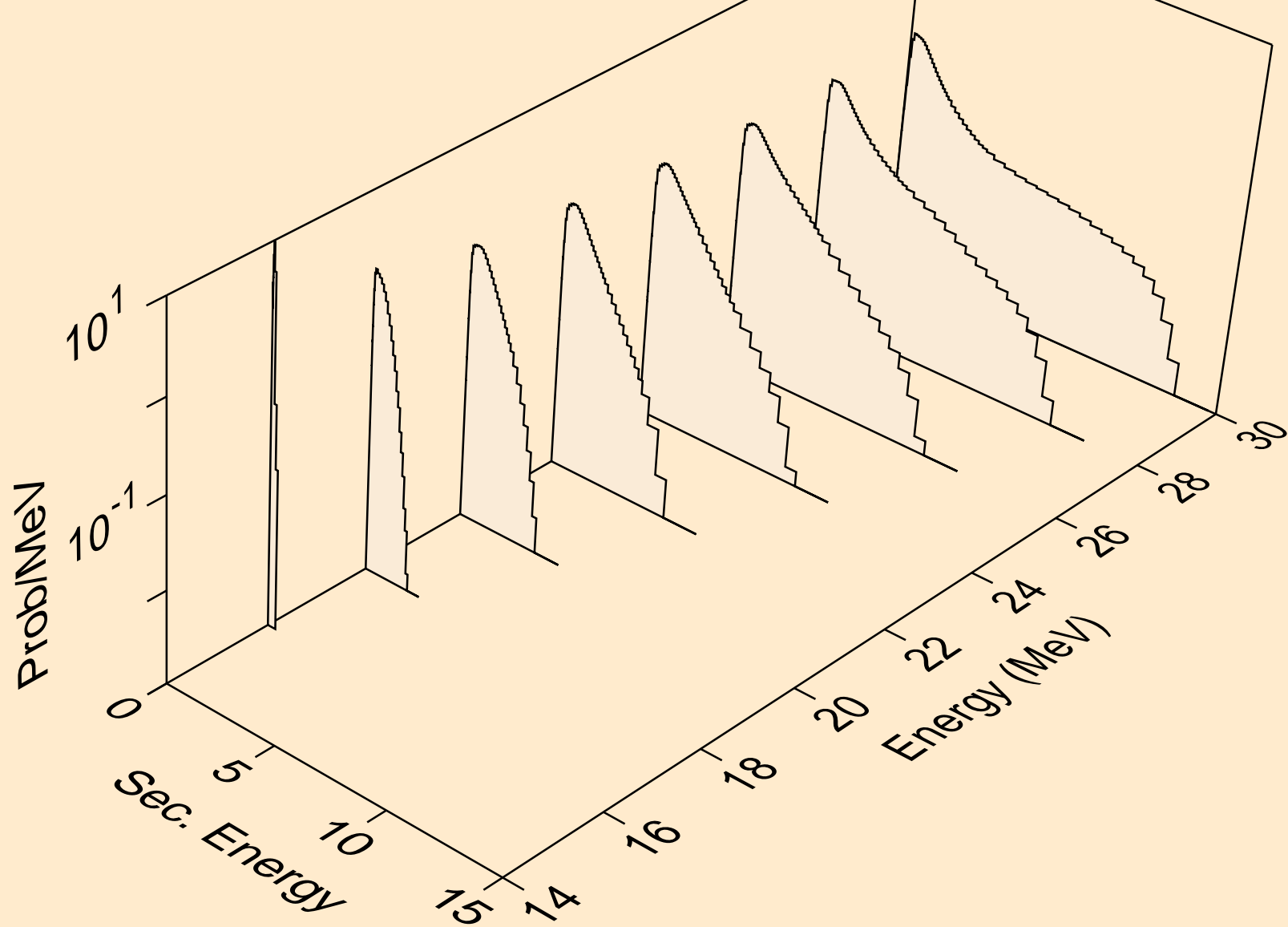

YB184 NEUTRON ACER TENDL-2024 LIBRARY; T=293.6K
Neutron emission for (n,2np)

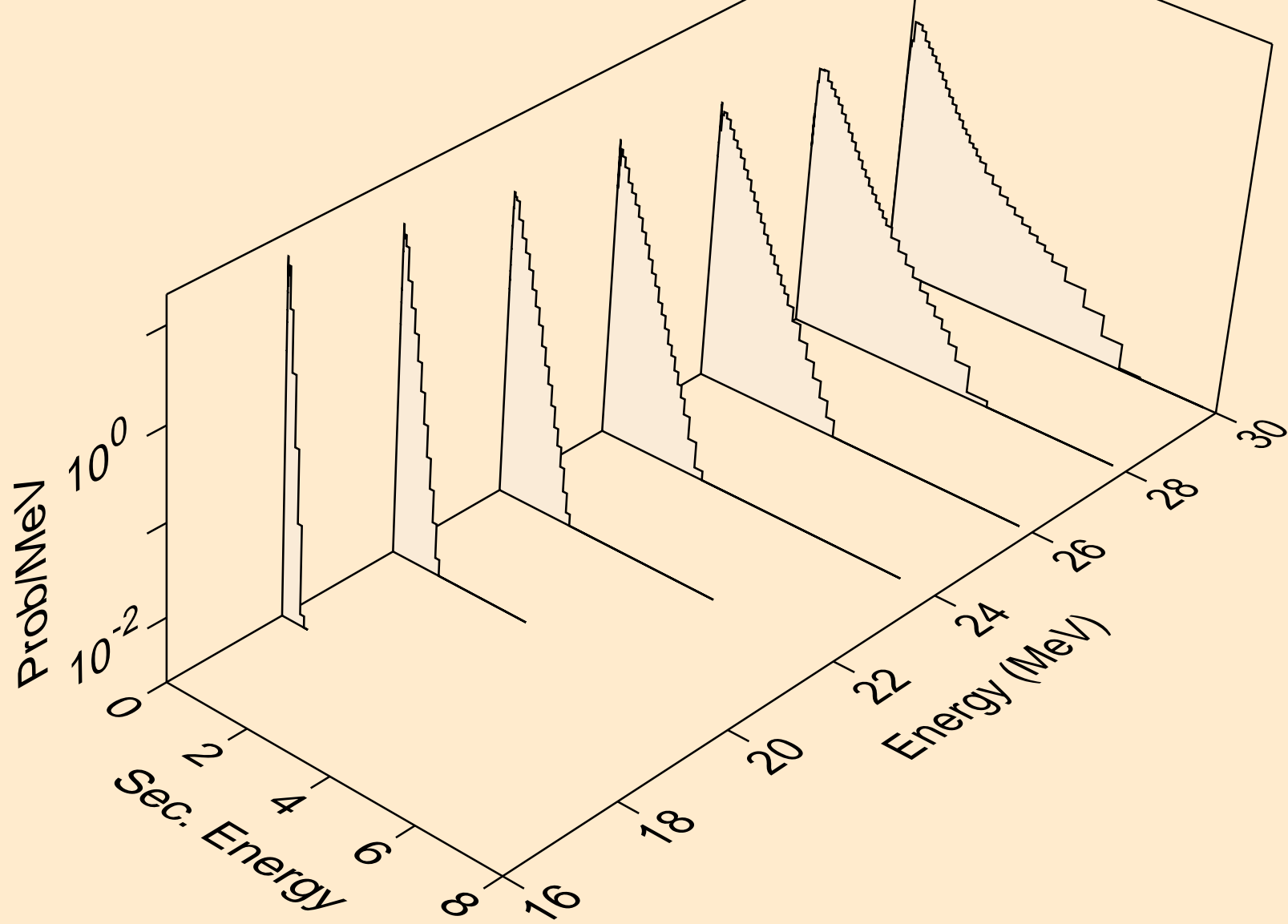

YB184 NEUTRON ACER TENDL-2024 LIBRARY; T=293.6K
Neutron emission for (n,3np)

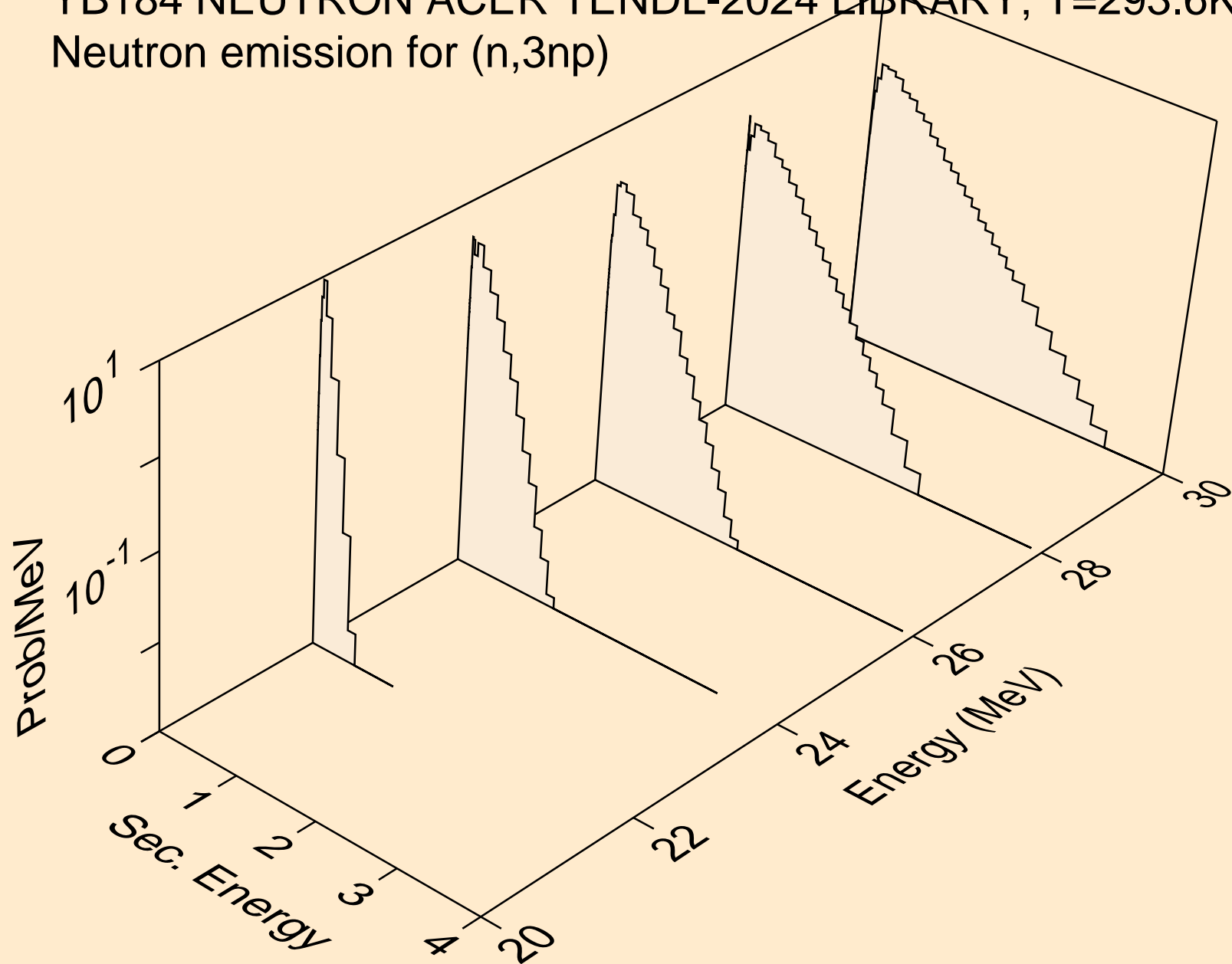

YB184 NEUTRON ACER TENDL-2024 LIBRARY; T=293.6K
Neutron emission for (n,n*c)

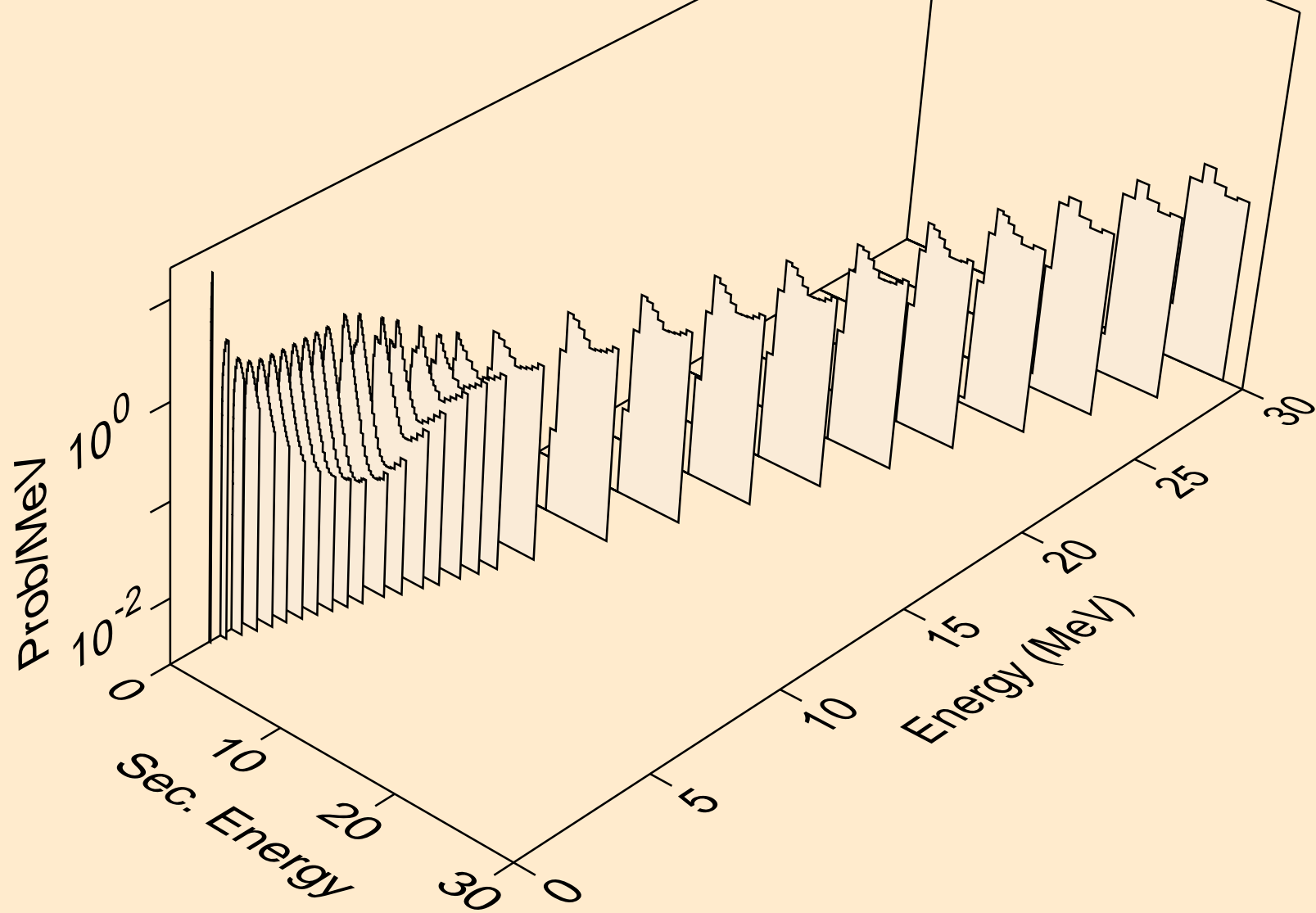

YB184 NEUTRON ACER TENDL-2024 LIBRARY; T=293.6K
Photon emission for (n,x)

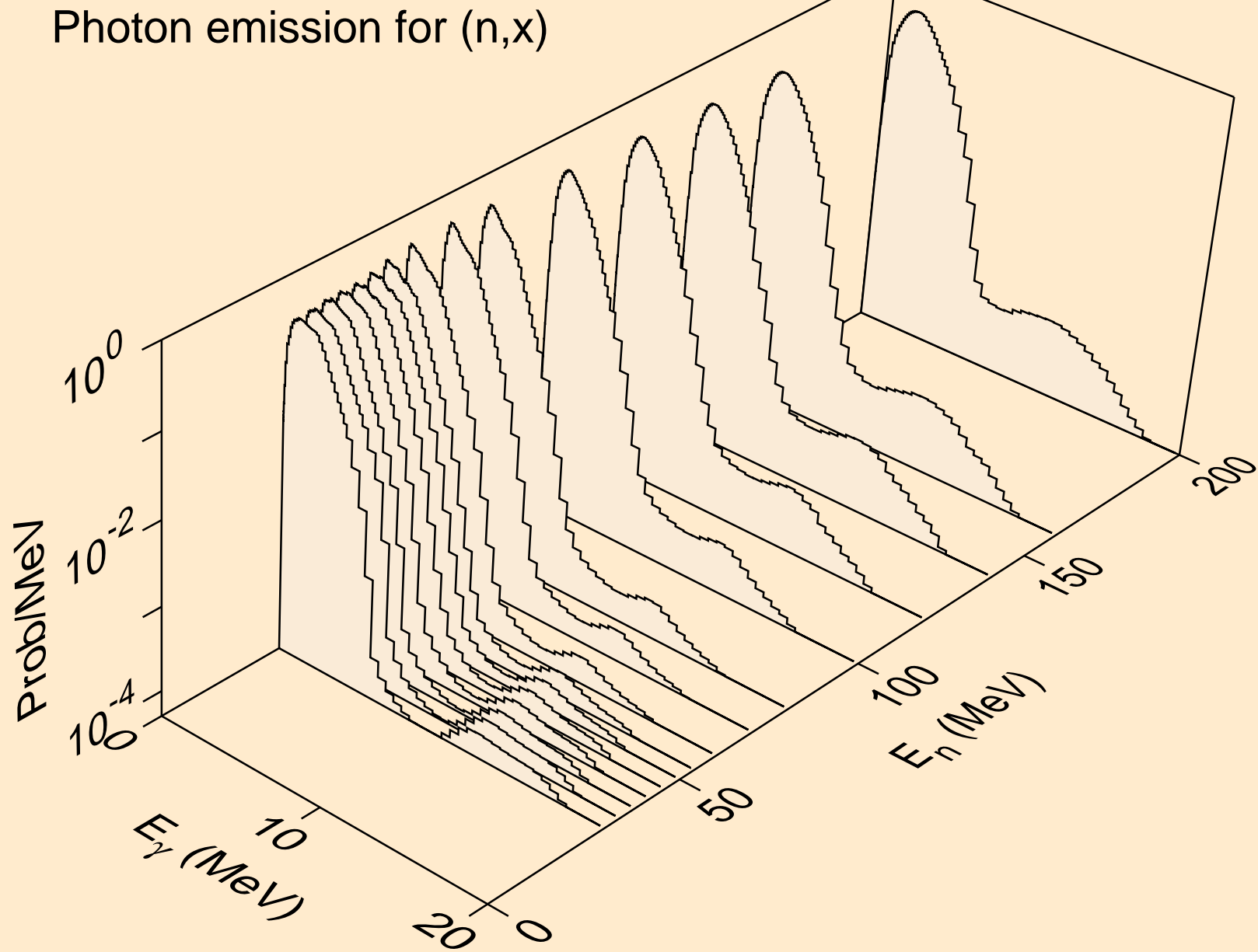

YB184 NEUTRON ACER TENDL-2024 LIBRARY; T=293.6K
Photon emission for (n,2nd)

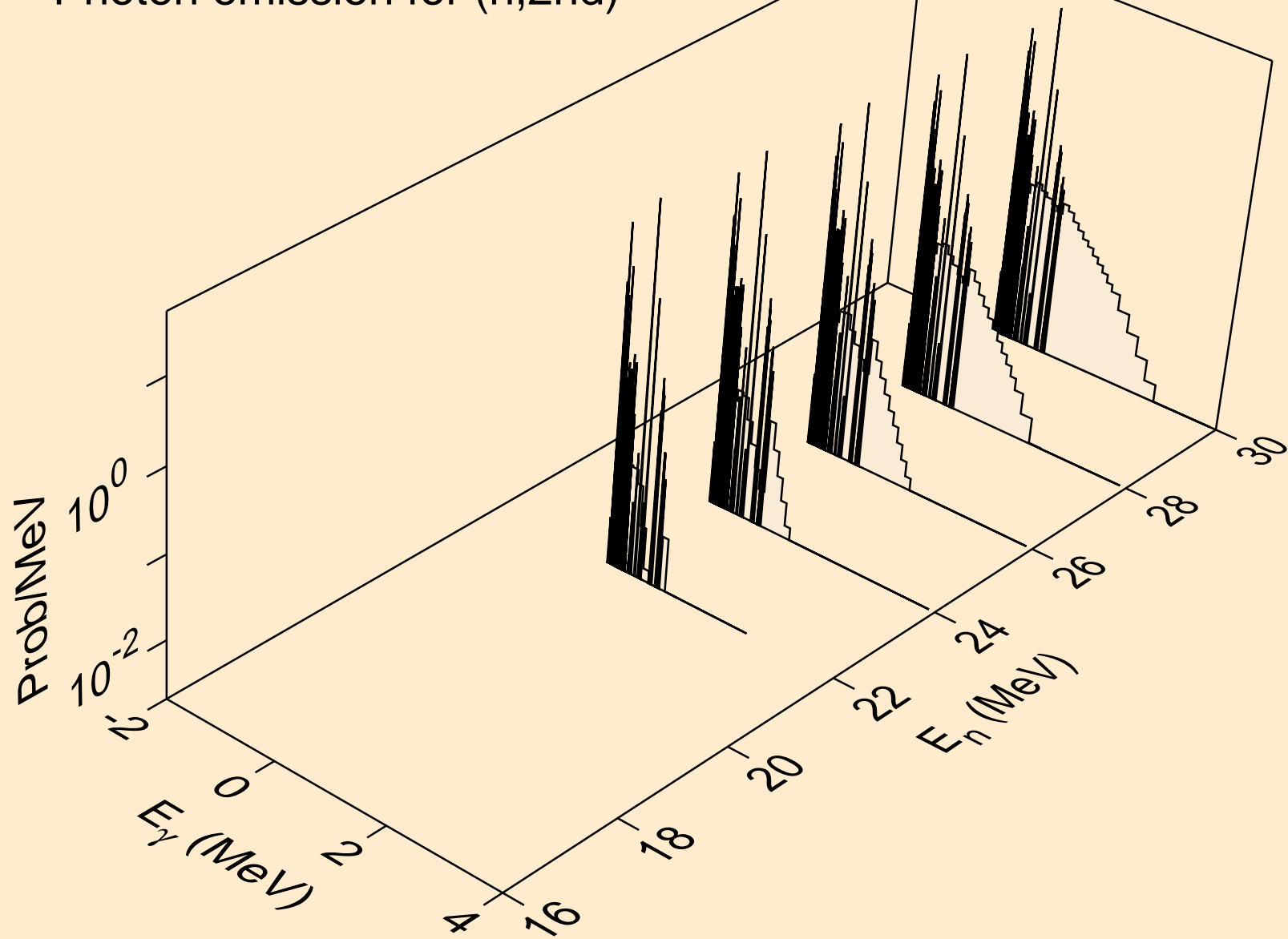

YB184 NEUTRON ACER TENDL-2024 LIBRARY; T=293.6K
Photon emission for (n,2n)

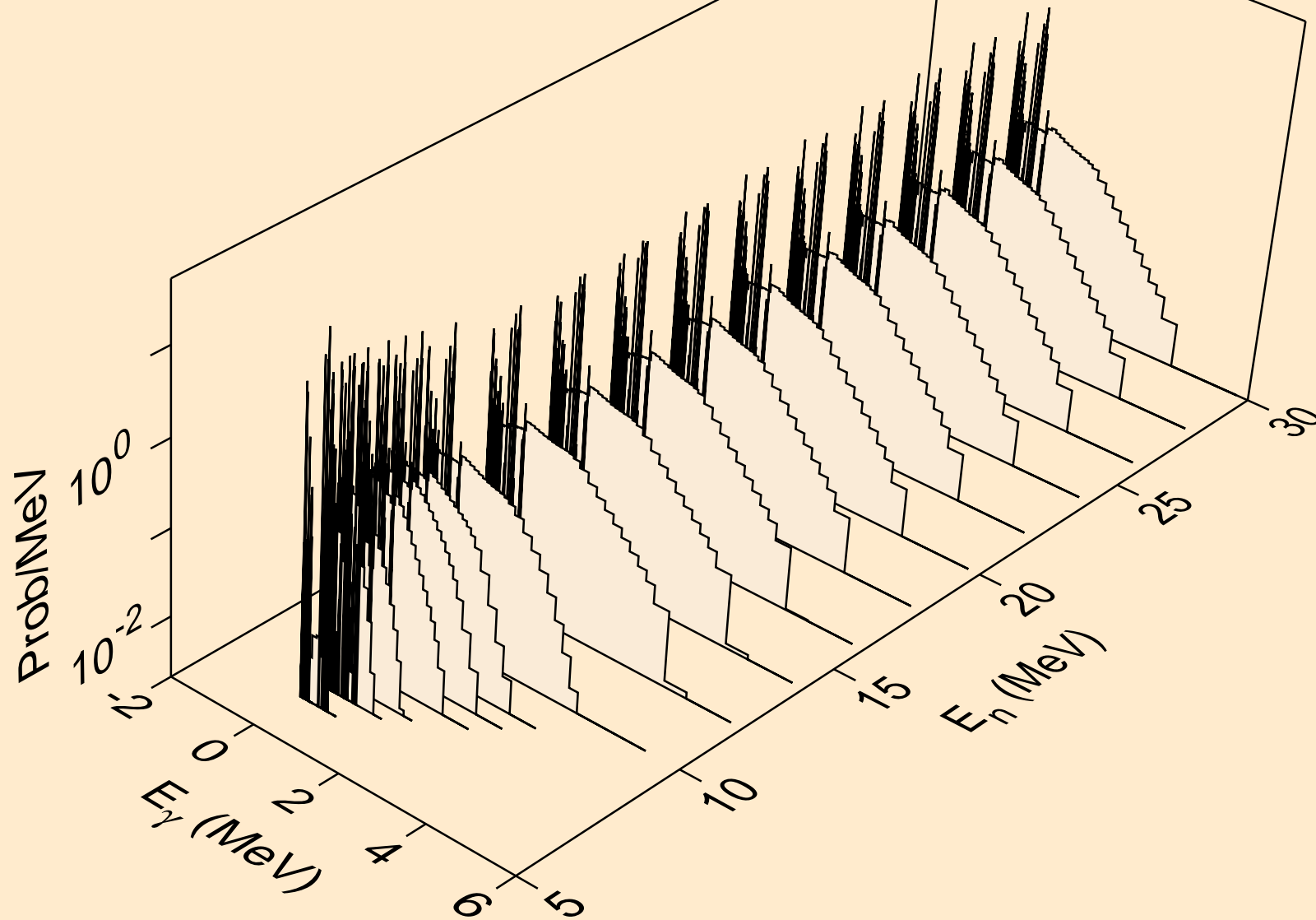

YB184 NEUTRON ACER TENDL-2024 LIBRARY; T=293.6K
Photon emission for (n,3n)

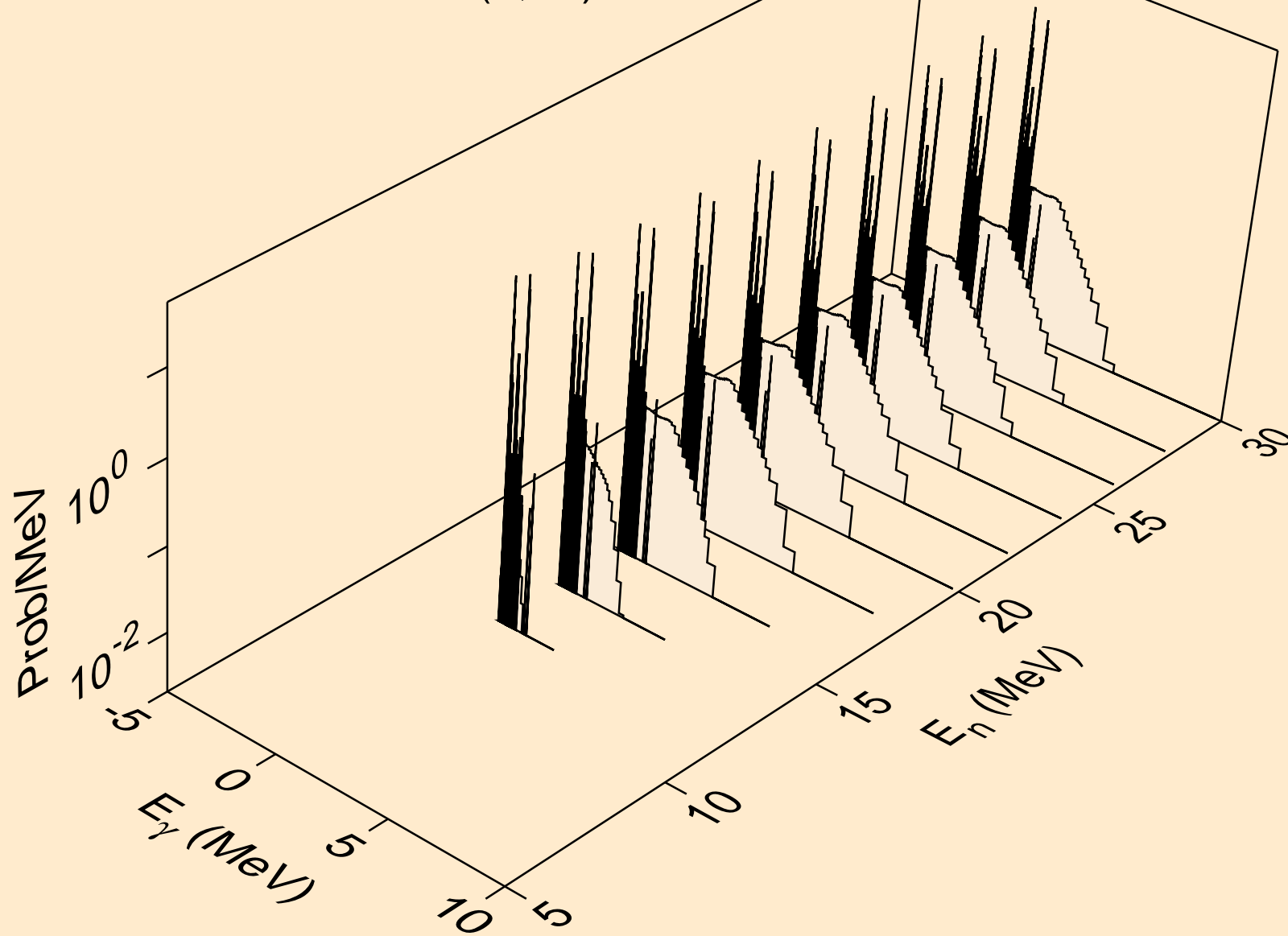

YB184 NEUTRON ACER TENDL-2024 LIBRARY; T=293.6K
Photon emission for (n,n*)a

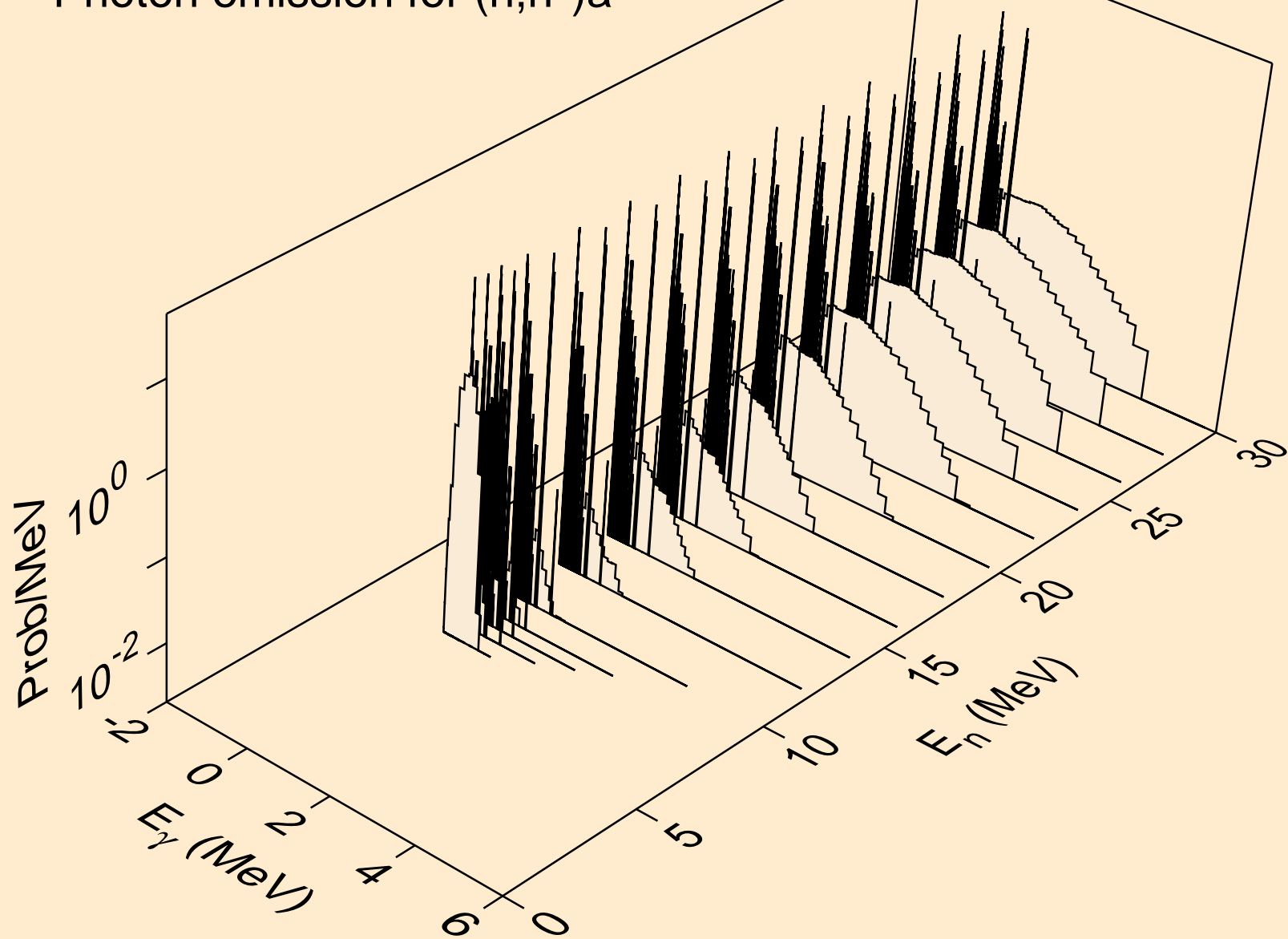

YB184 NEUTRON ACER TENDL-2024 LIBRARY; T=293.6K
Photon emission for (n,2n)a

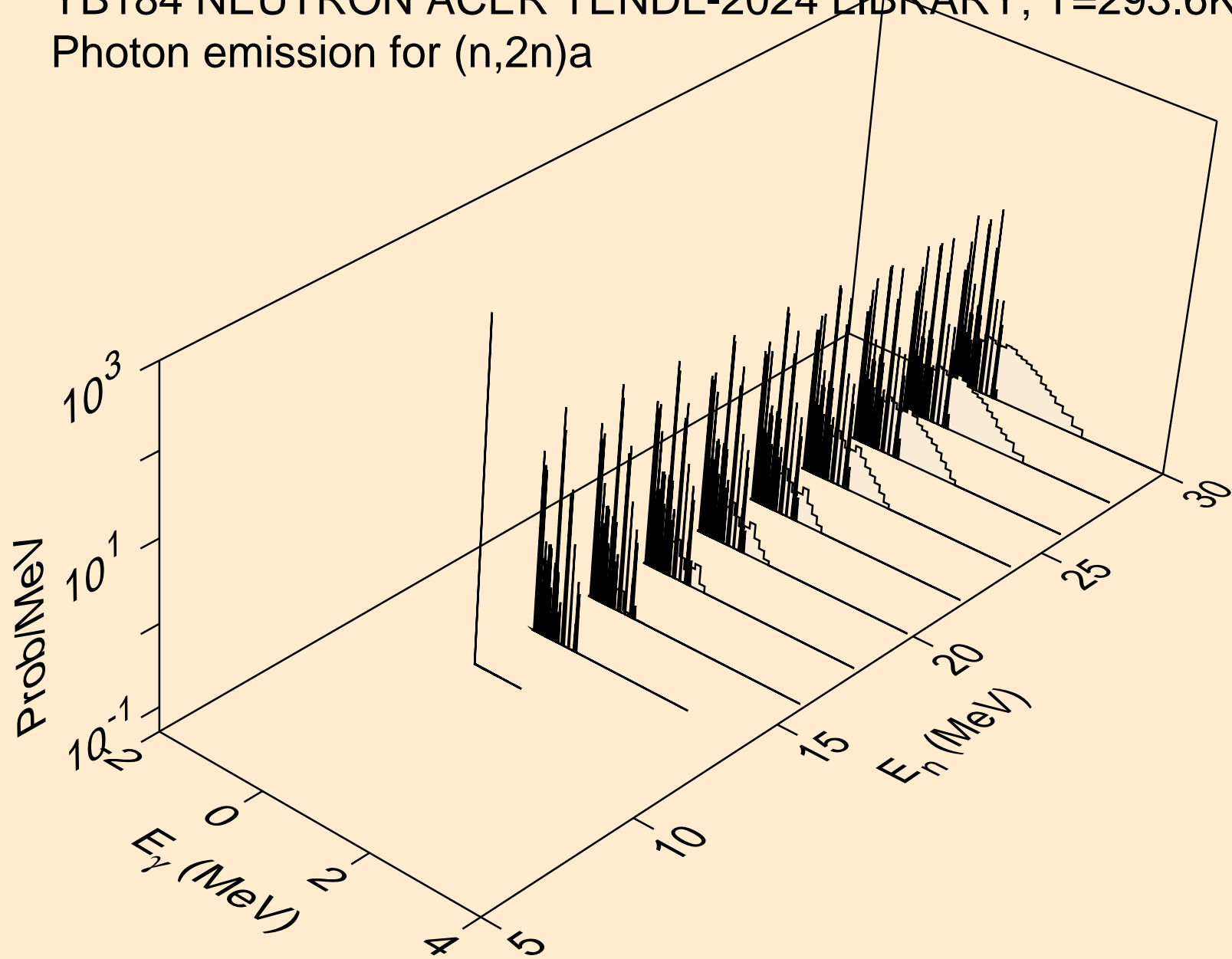

YB184 NEUTRON ACER TENDL-2024 LIBRARY; T=293.6K
Photon emission for (n,3n)a

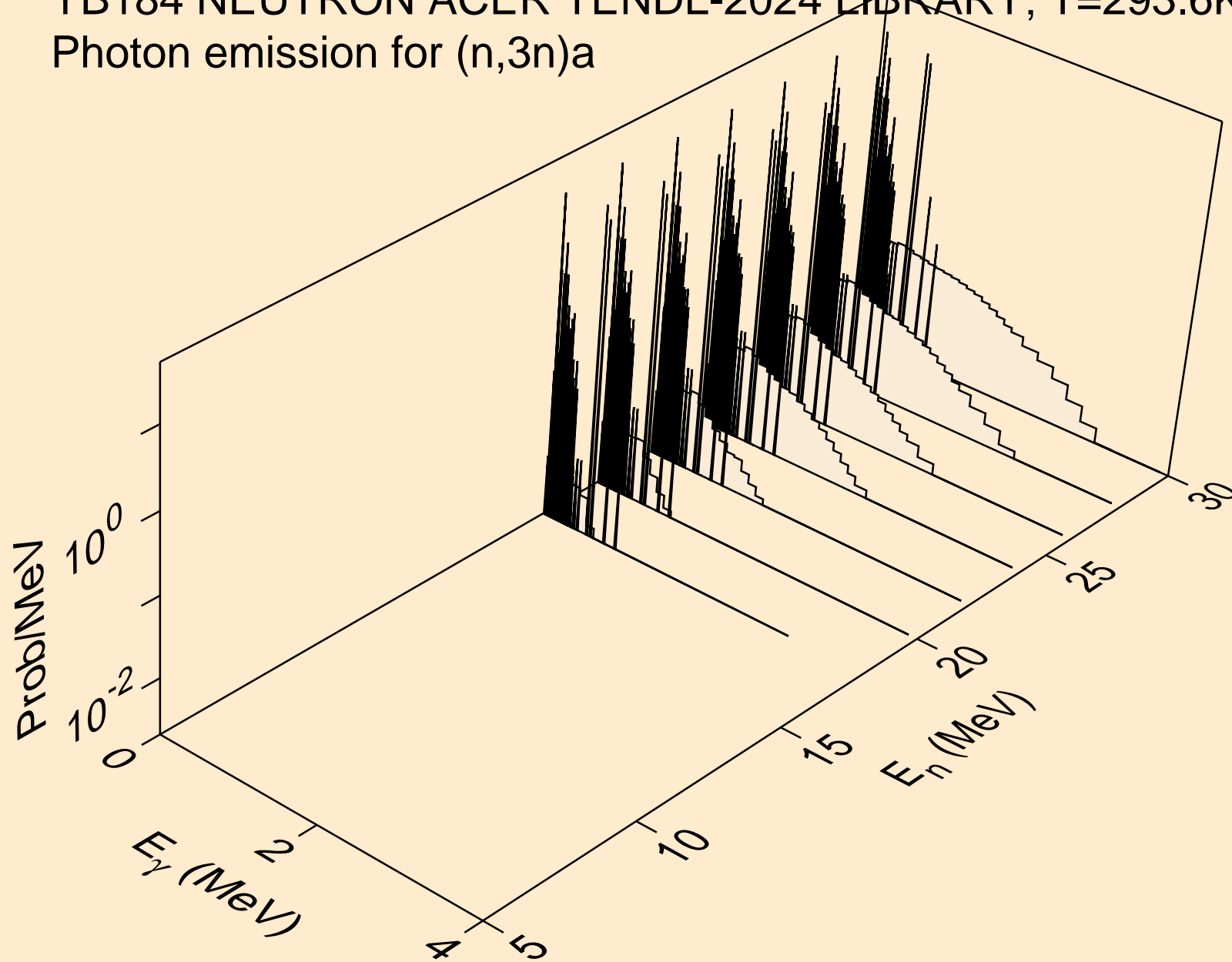

YB184 NEUTRON ACER TENDL-2024 LIBRARY; T=293.6K
Photon emission for (n,n*)p

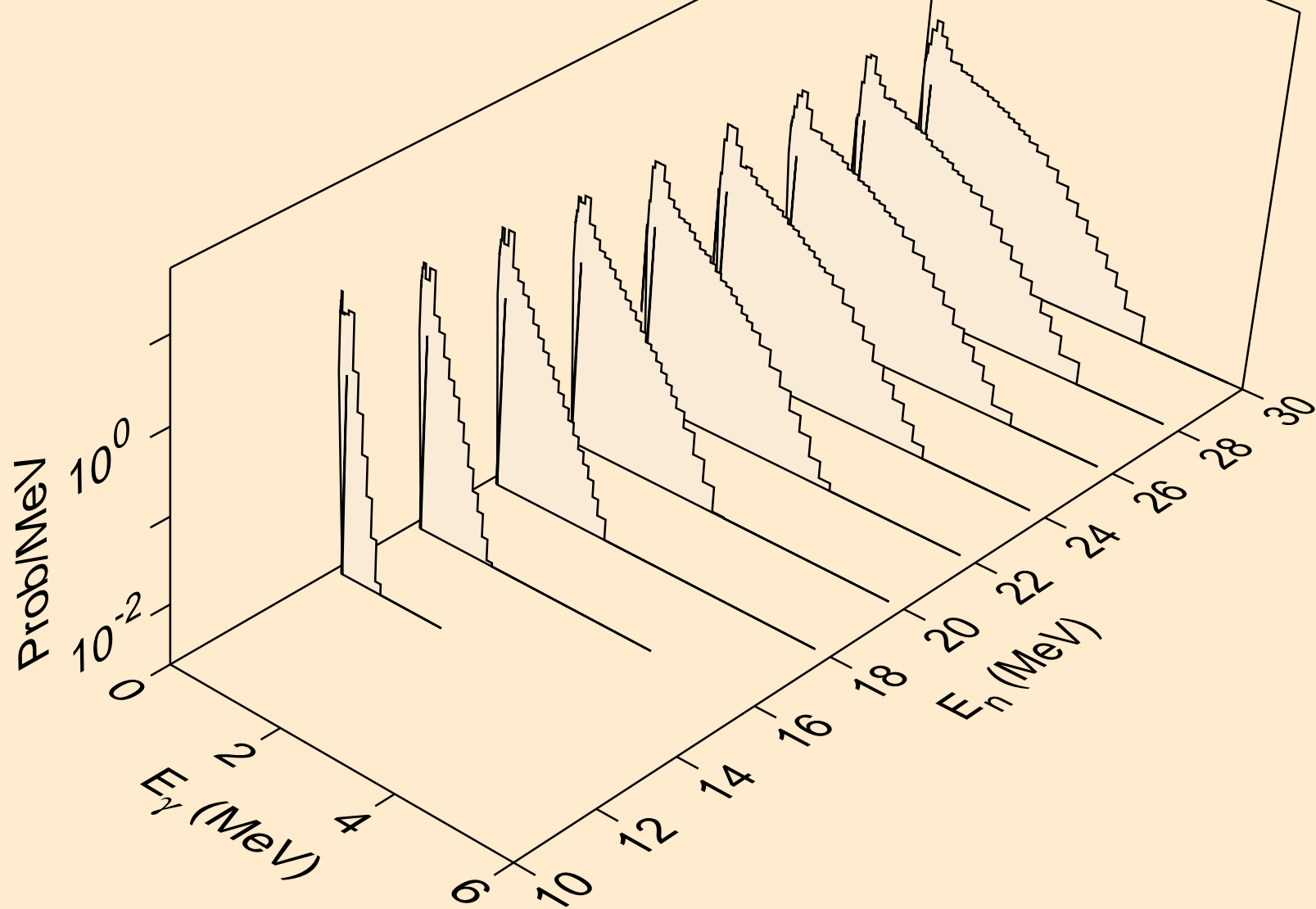

YB184 NEUTRON ACER TENDL-2024 LIBRARY; T=293.6K
Photon emission for (n,n*)d

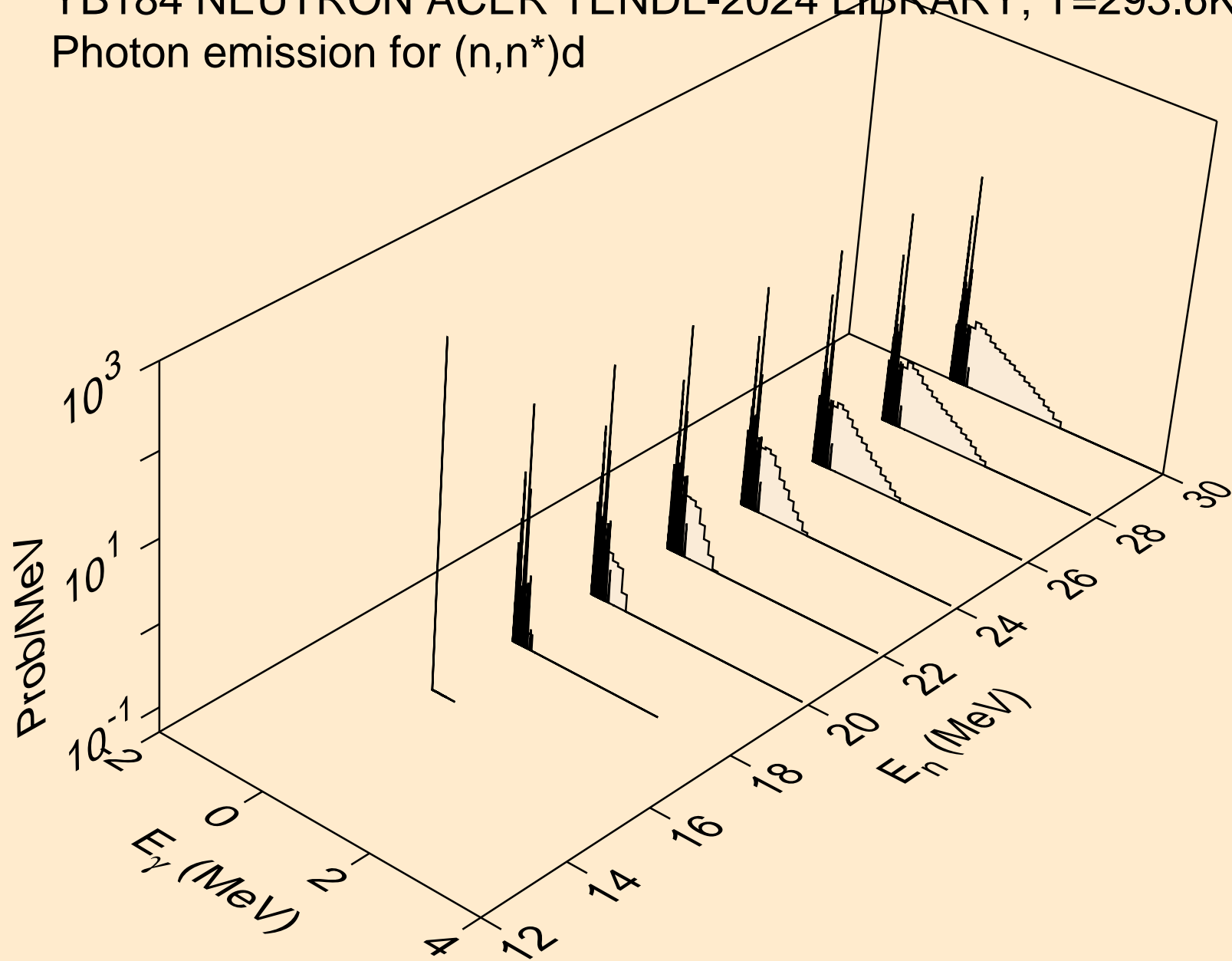

YB184 NEUTRON ACER TENDL-2024 LIBRARY; T=293.6K
Photon emission for (n,n*)t

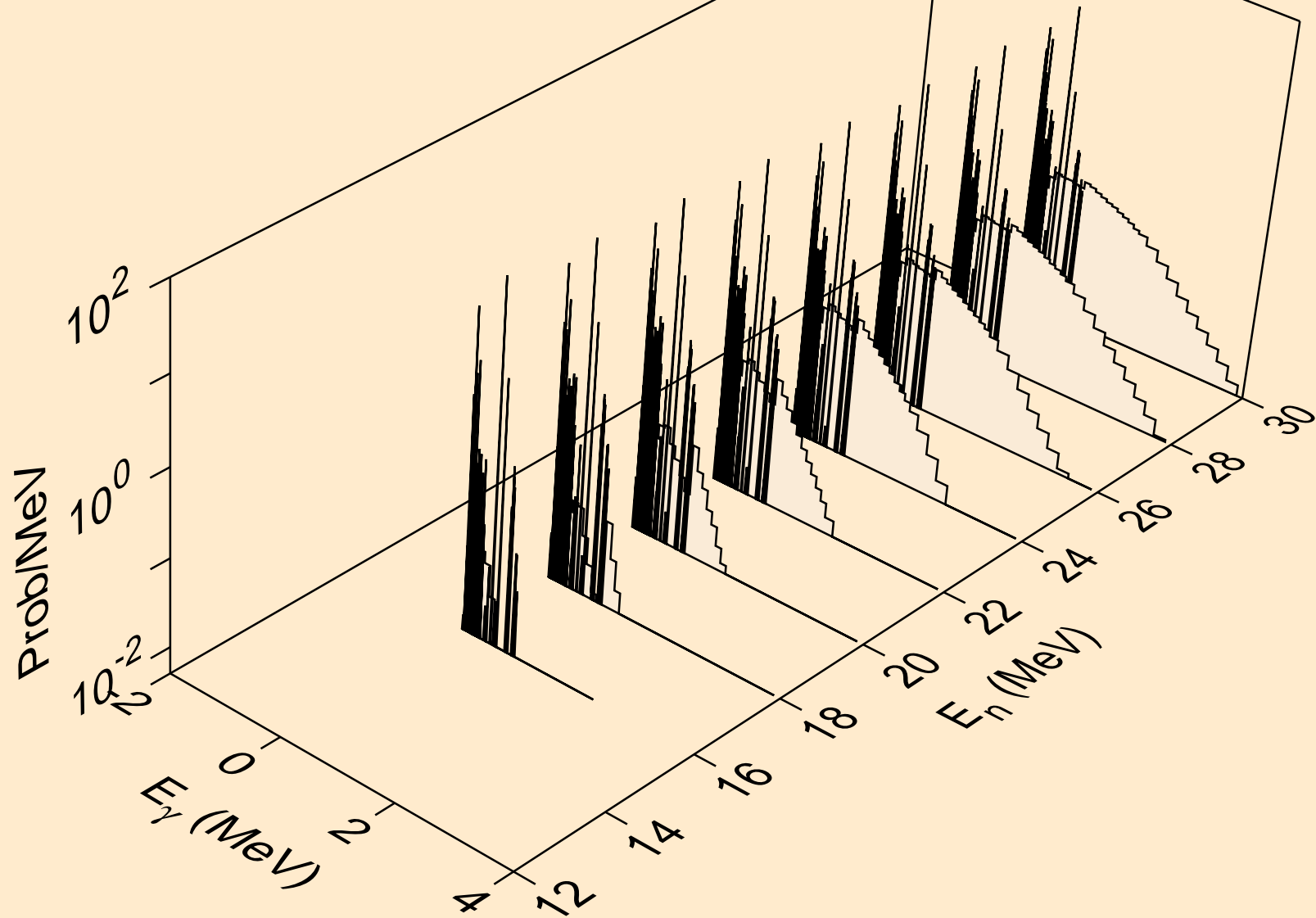

YB184 NEUTRON ACER TENDL-2024 LIBRARY; T=293.6K
Photon emission for (n,n*)he3

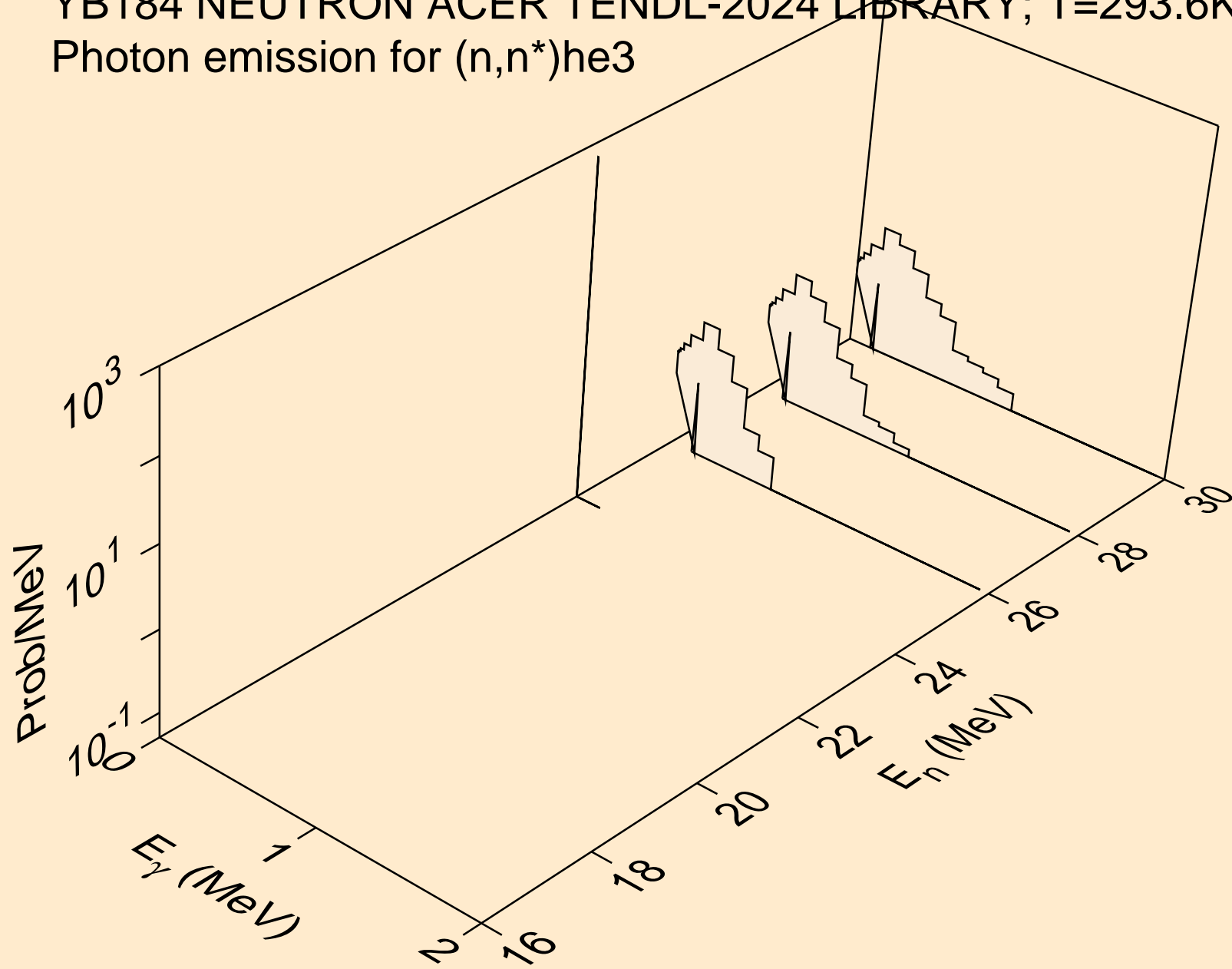

YB184 NEUTRON ACER TENDL-2024 LIBRARY; T=293.6K
Photon emission for (n,4n)

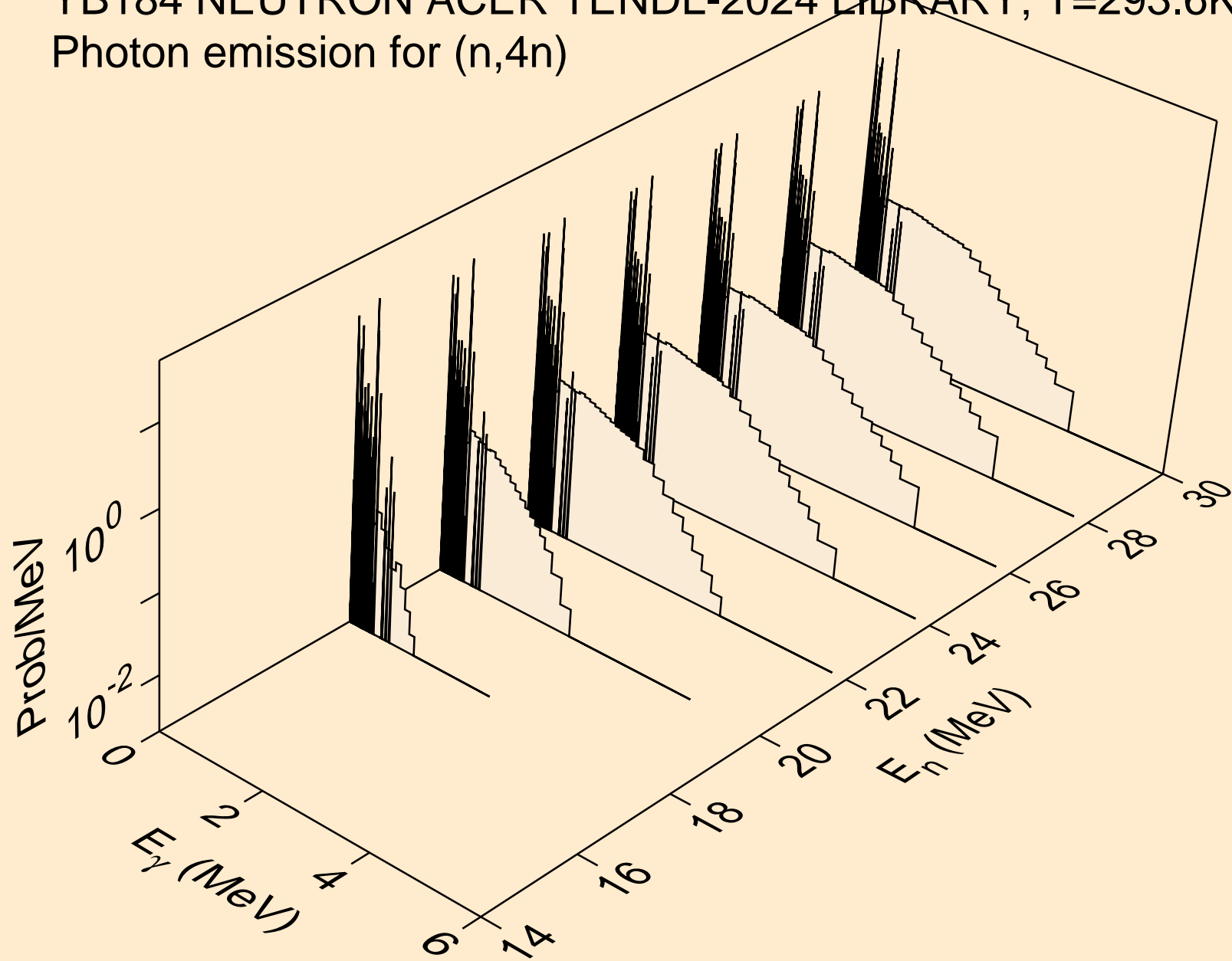

YB184 NEUTRON ACER TENDL-2024 LIBRARY; T=293.6K
Photon emission for (n,2np)

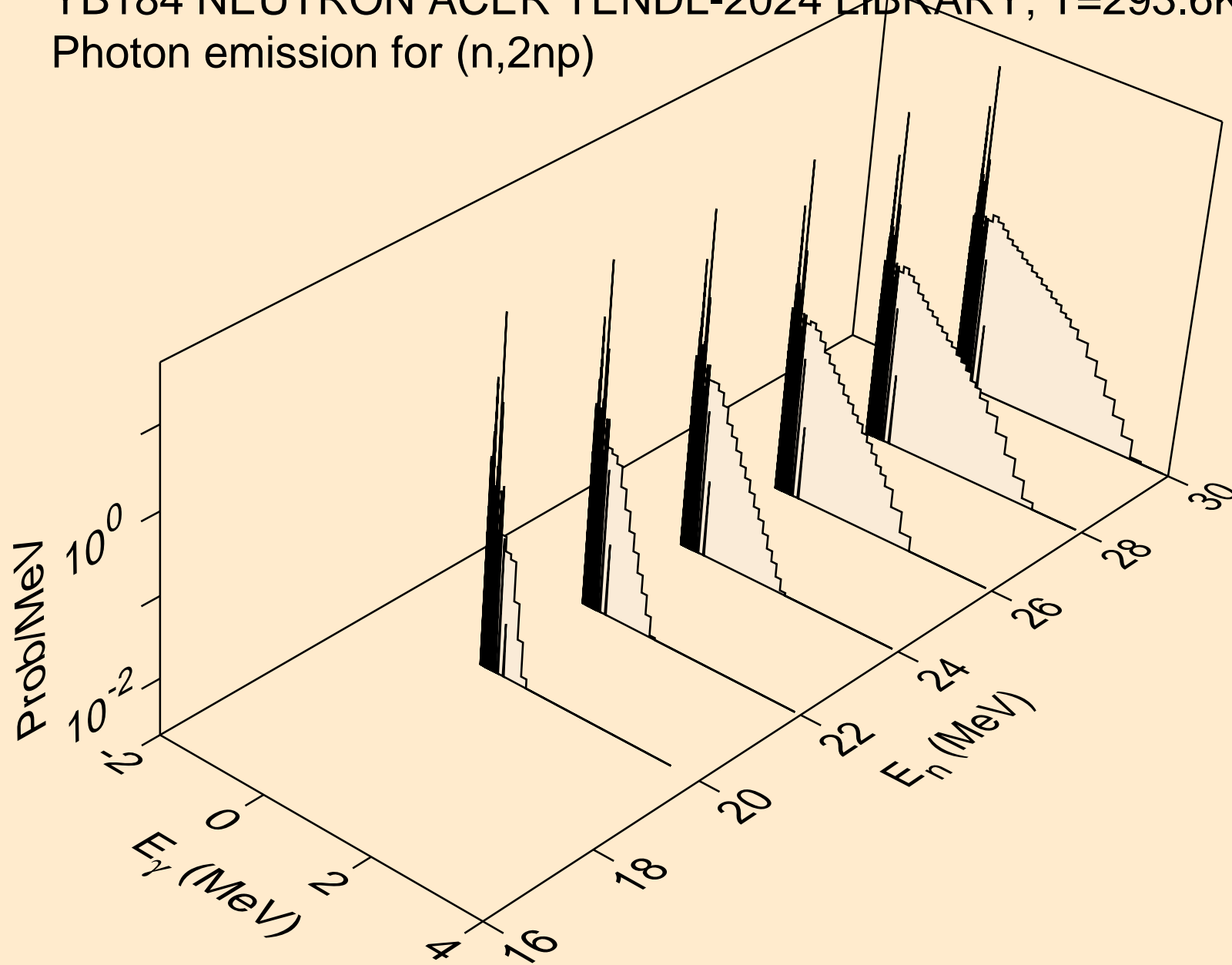

YB184 NEUTRON ACER TENDL-2024 LIBRARY; T=293.6K
Photon emission for (n,3np)

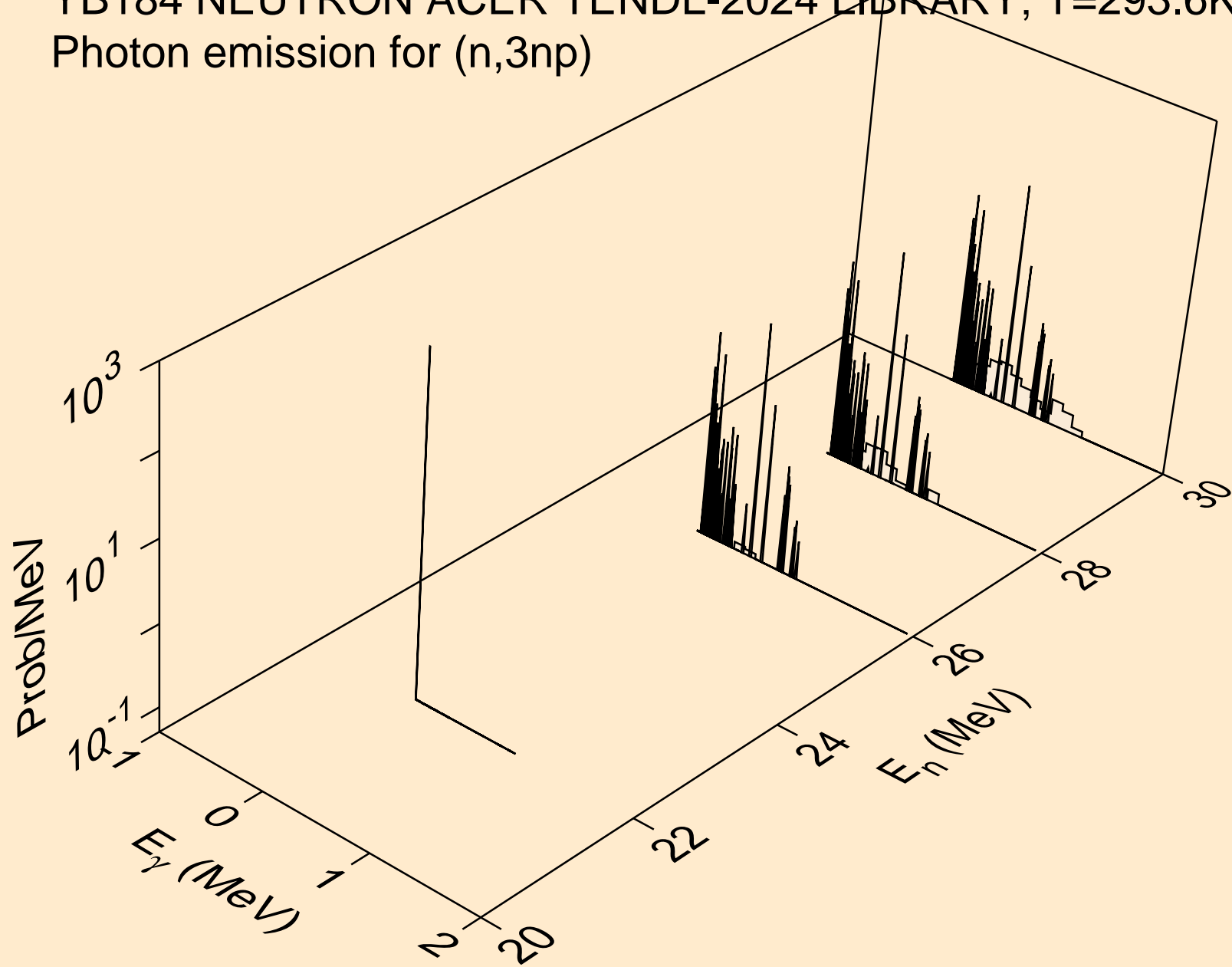

YB184 NEUTRON ACER TENDL-2024 LIBRARY; T=293.6K
Photon emission for (n,n*c)

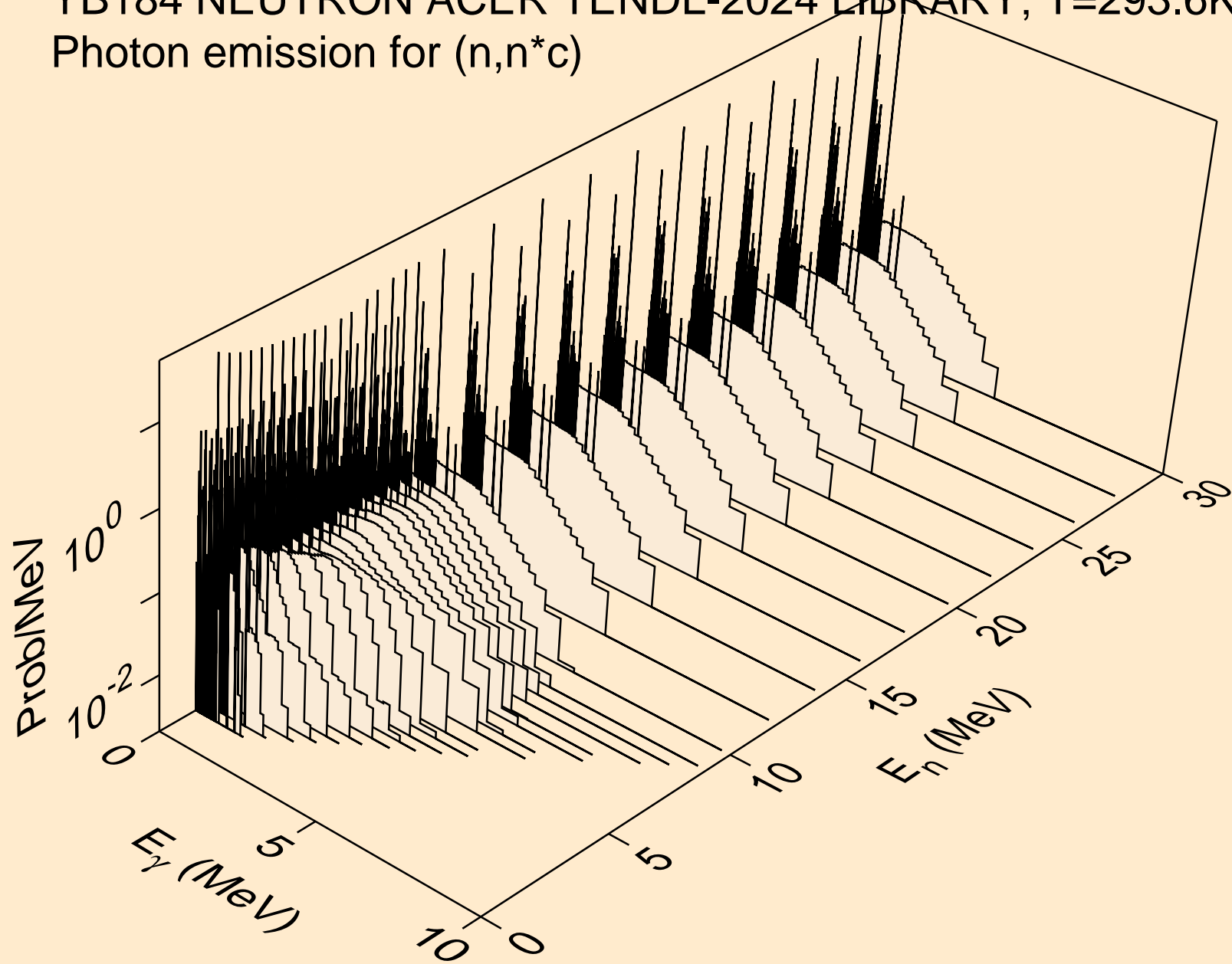

YB184 NEUTRON ACER TENDL-2024 LIBRARY; T=293.6K
Photon emission for (n,gma)

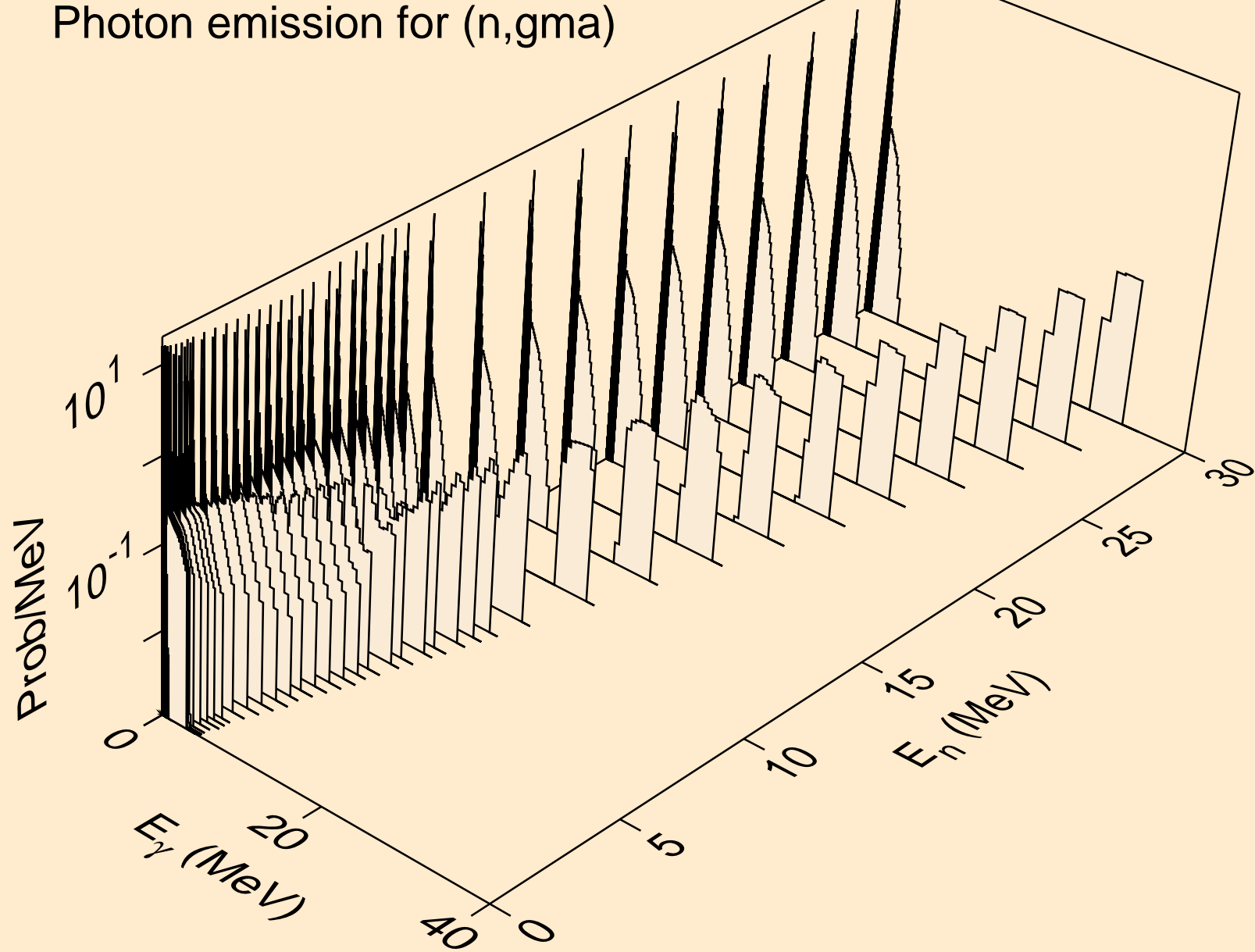

YB184 NEUTRON ACER TENDL-2024 LIBRARY; T=293.6K
Photon emission for (n,p)

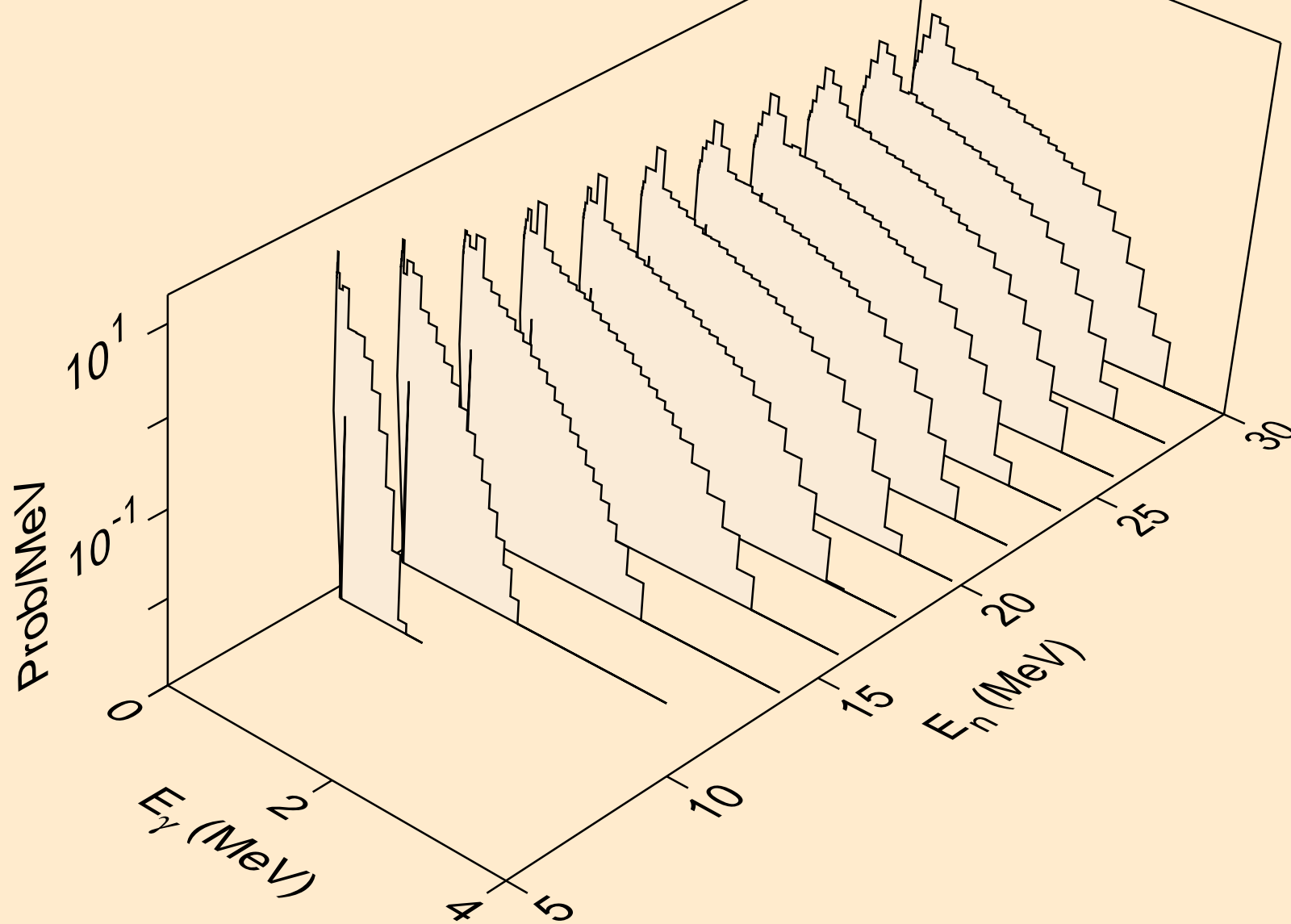

YB184 NEUTRON ACER TENDL-2024 LIBRARY; T=293.6K
Photon emission for (n,d)

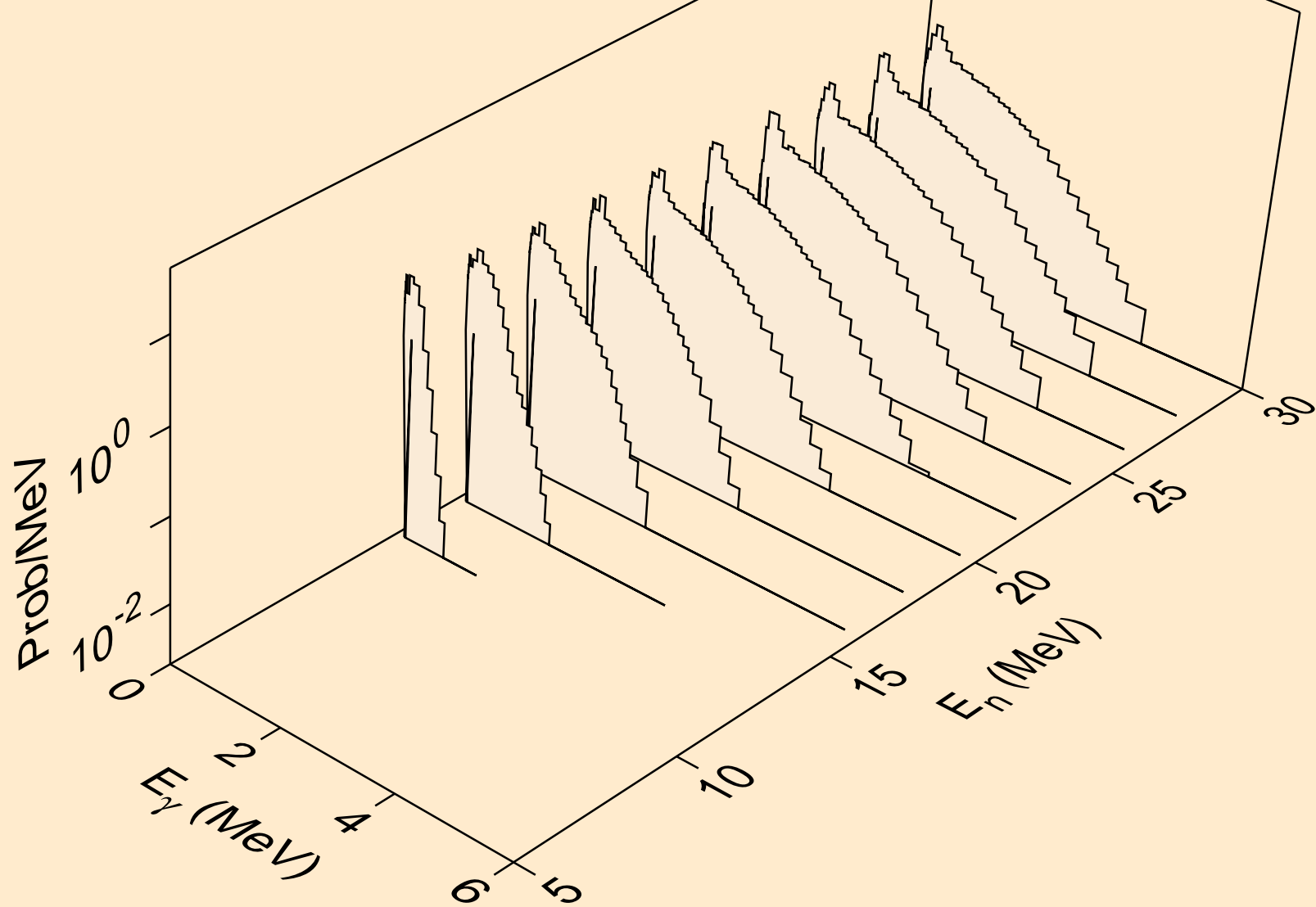

YB184 NEUTRON ACER TENDL-2024 LIBRARY; T=293.6K
Photon emission for (n,t)

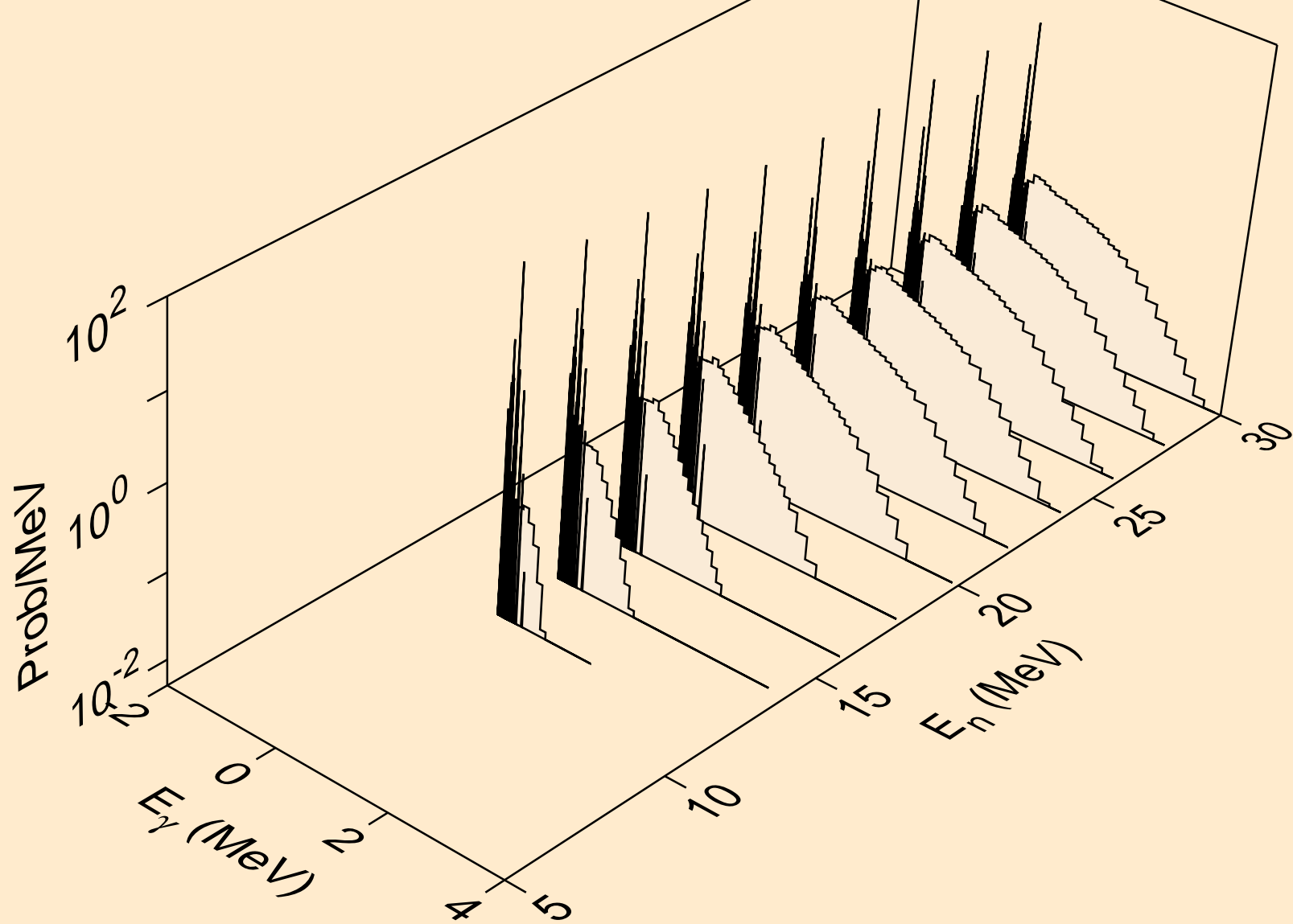

YB184 NEUTRON ACER TENDL-2024 LIBRARY; T=293.6K
Photon emission for (n,he3)

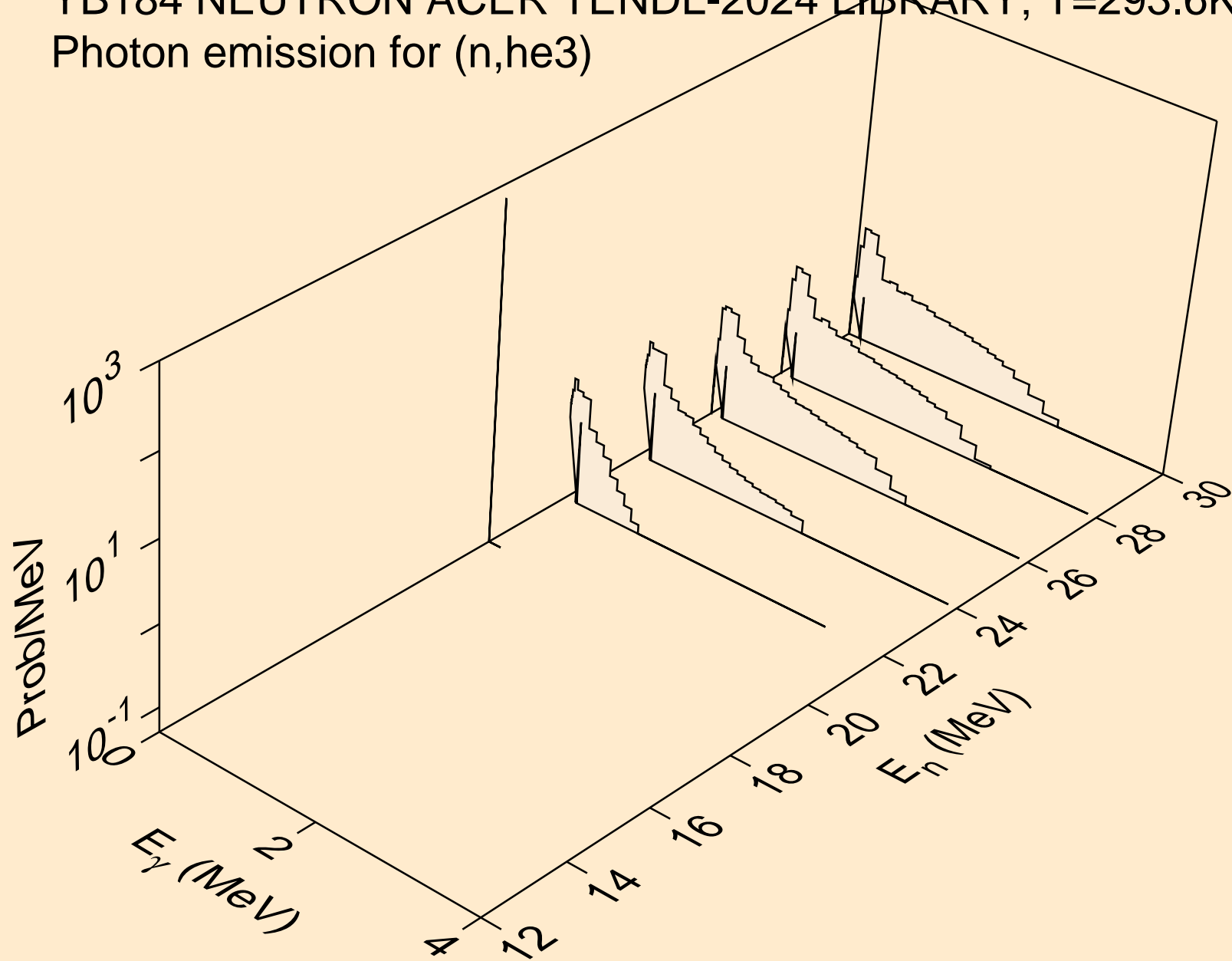

YB184 NEUTRON ACER TENDL-2024 LIBRARY; T=293.6K
Photon emission for (n,a)

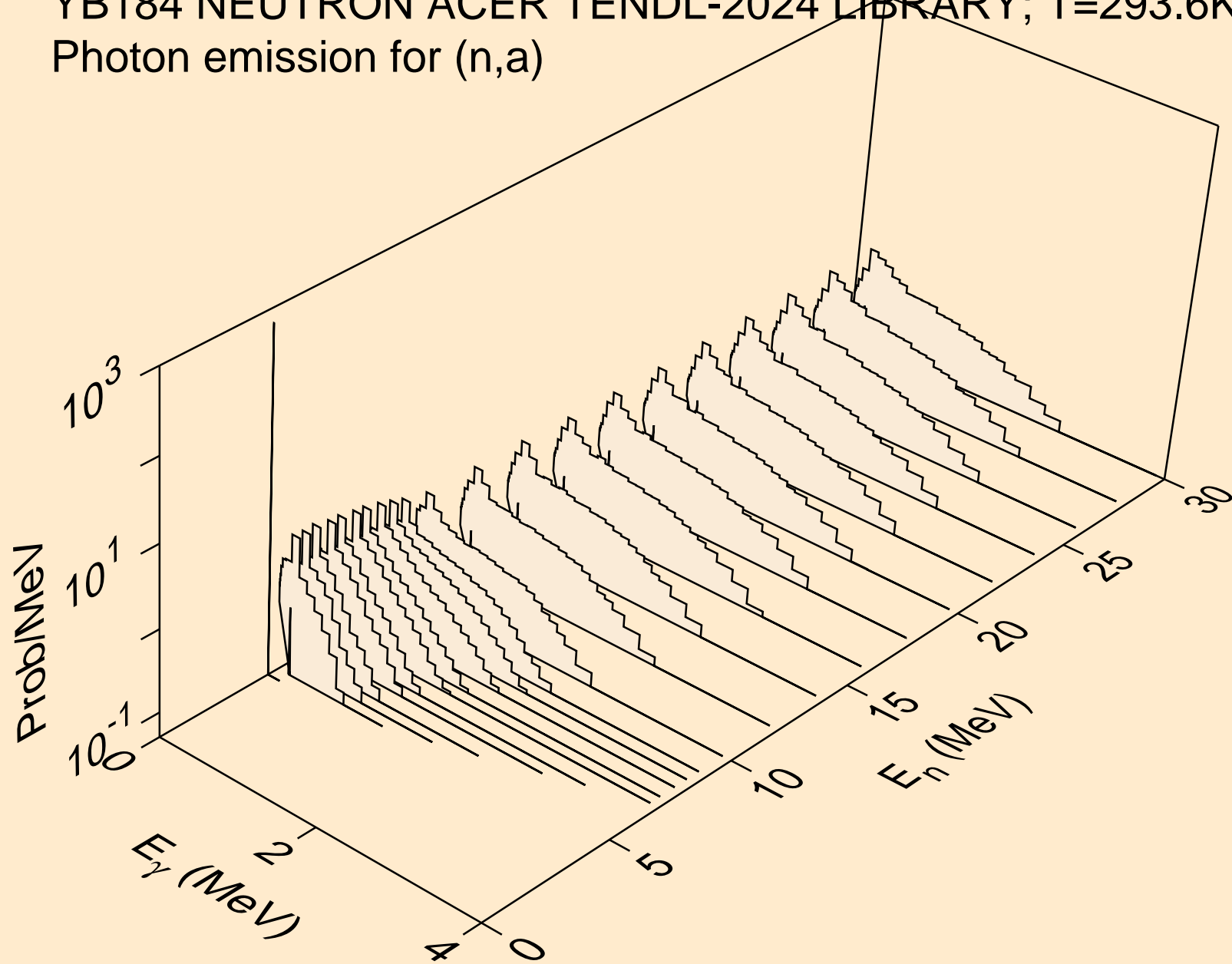

YB184 NEUTRON ACER TENDL-2024 LIBRARY; T=293.6K
thermal capture photon spectrum

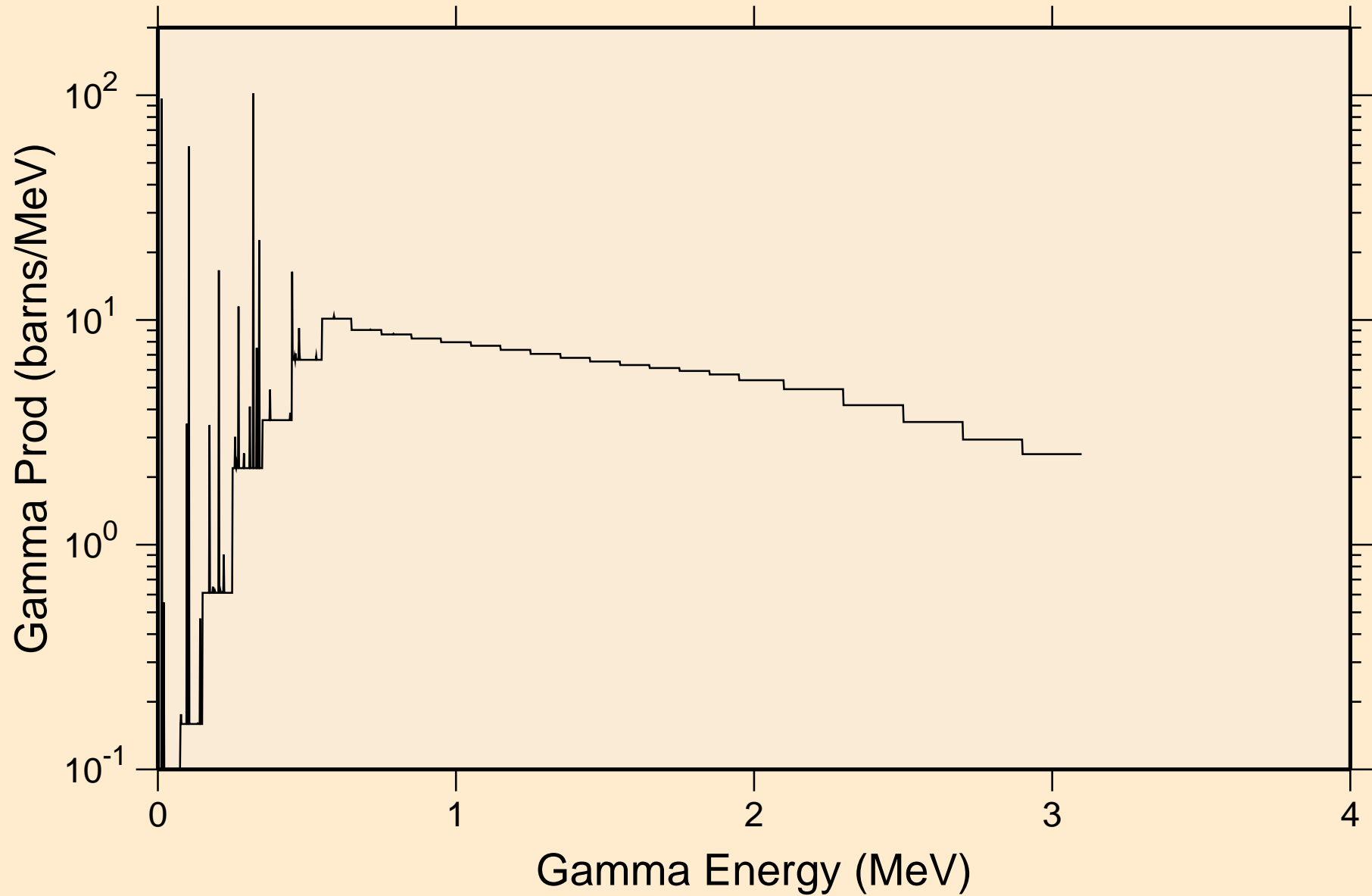

YB184 NEUTRON ACER TENDL-2024 LIBRARY; T=293.6K
14 MeV photon spectrum

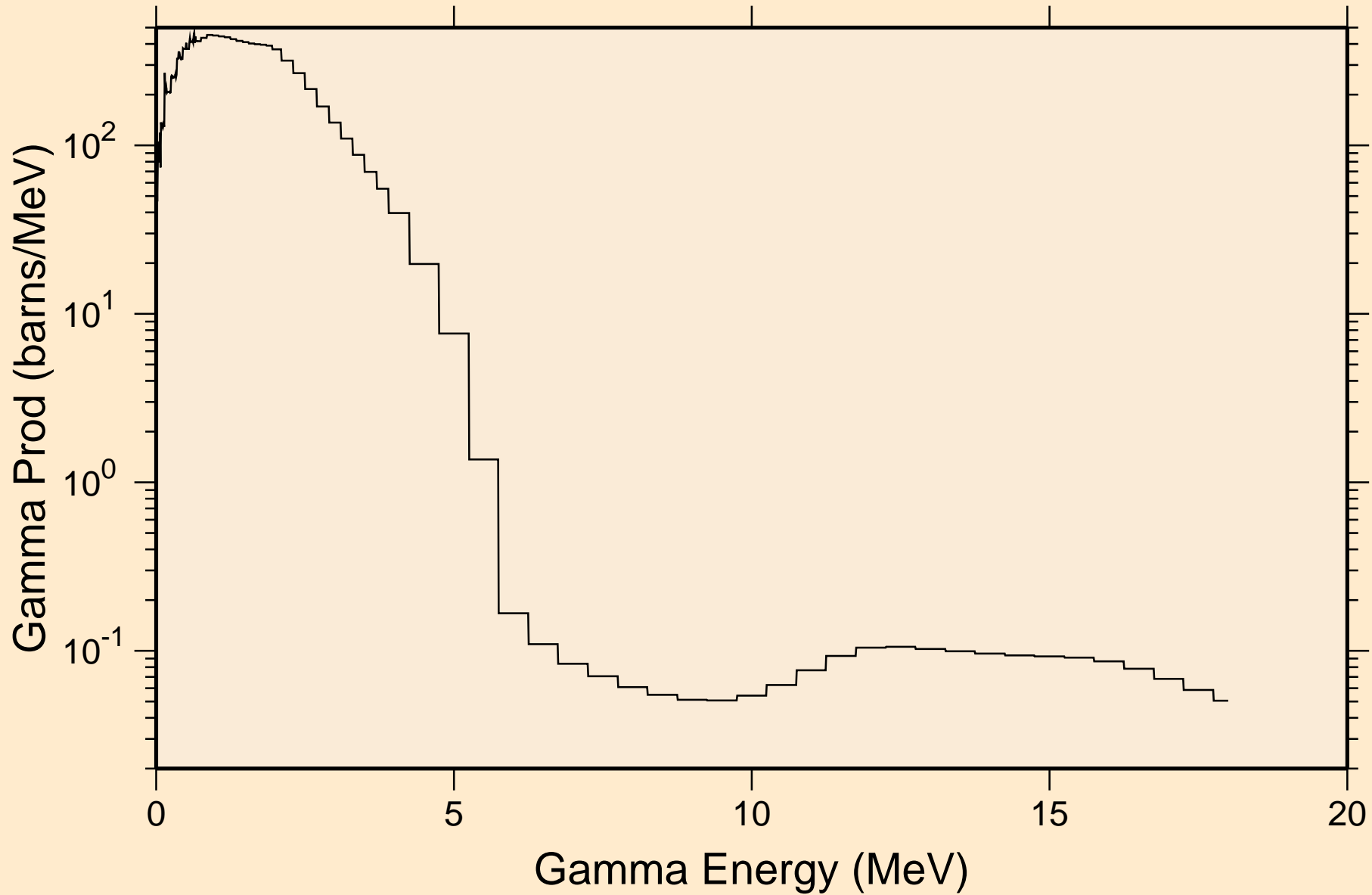

YB184 NEUTRON ACER TENDL-2024 LIBRARY; T=293.6K
Particle heating contributions

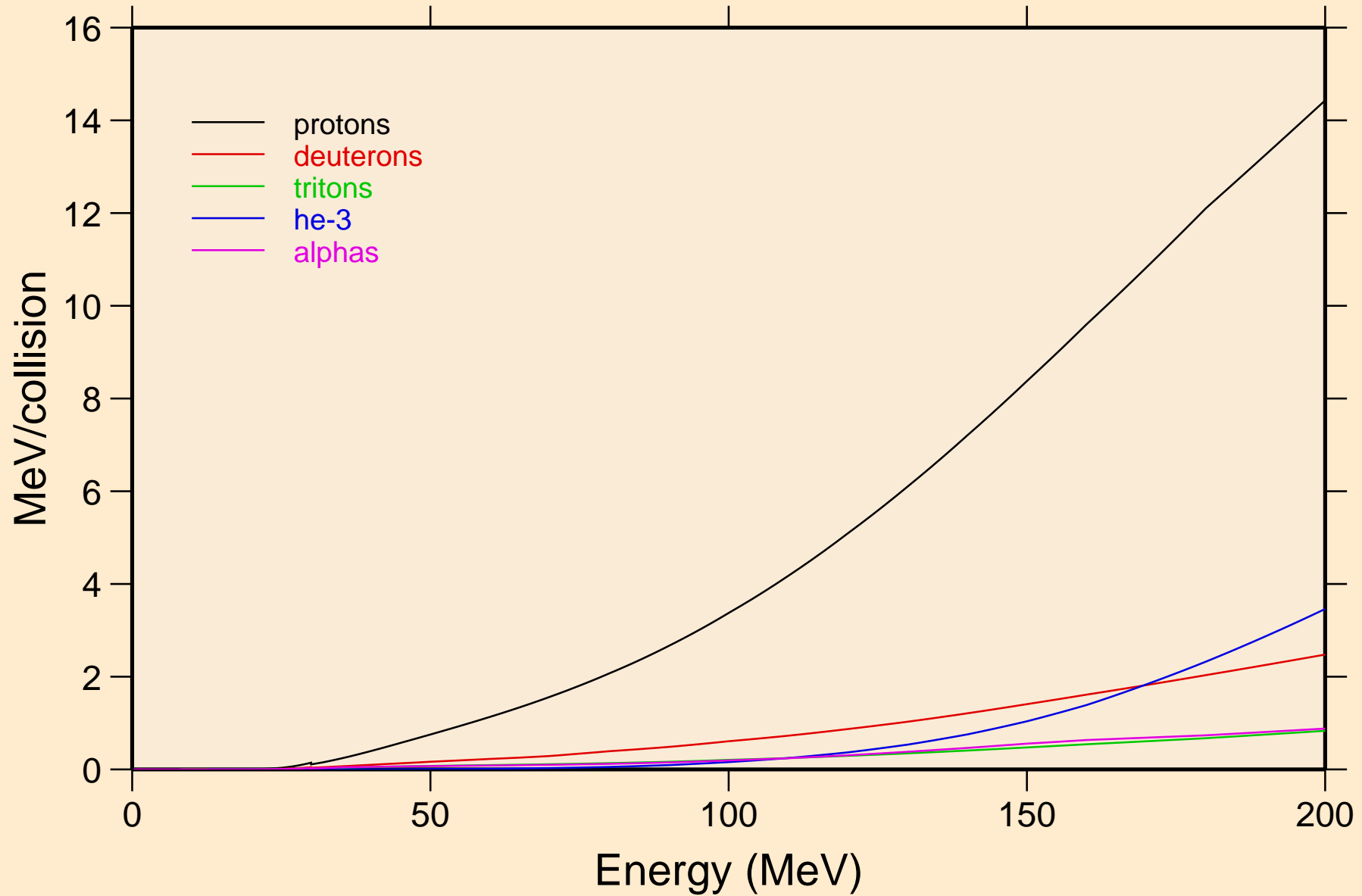

YB184 NEUTRON ACER TENDL-2024 LIBRARY; T=293.6K
Recoil Heating

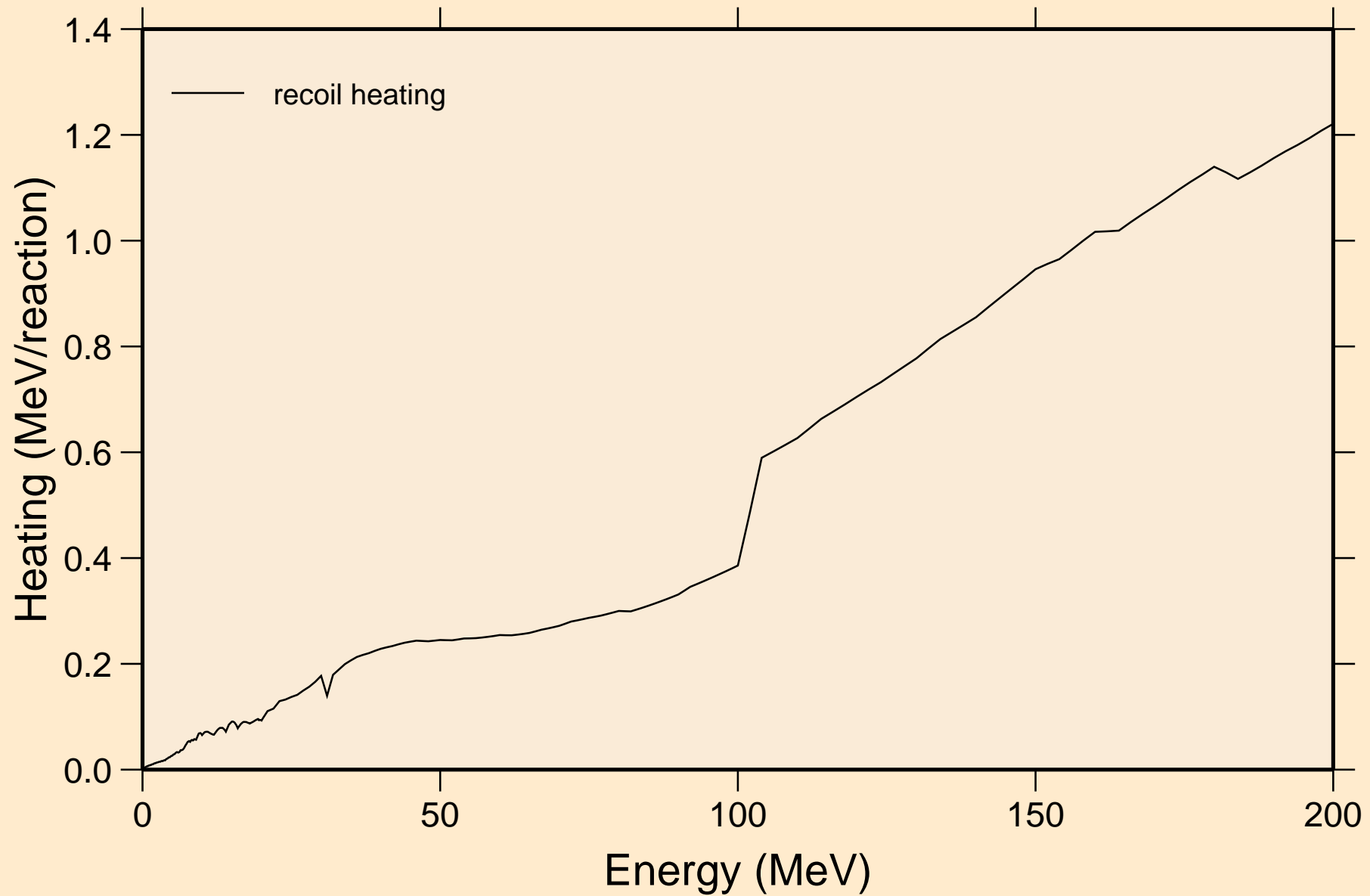

YB184 NEUTRON ACER TENDL-2024 LIBRARY; T=293.6K
Particle production cross sections

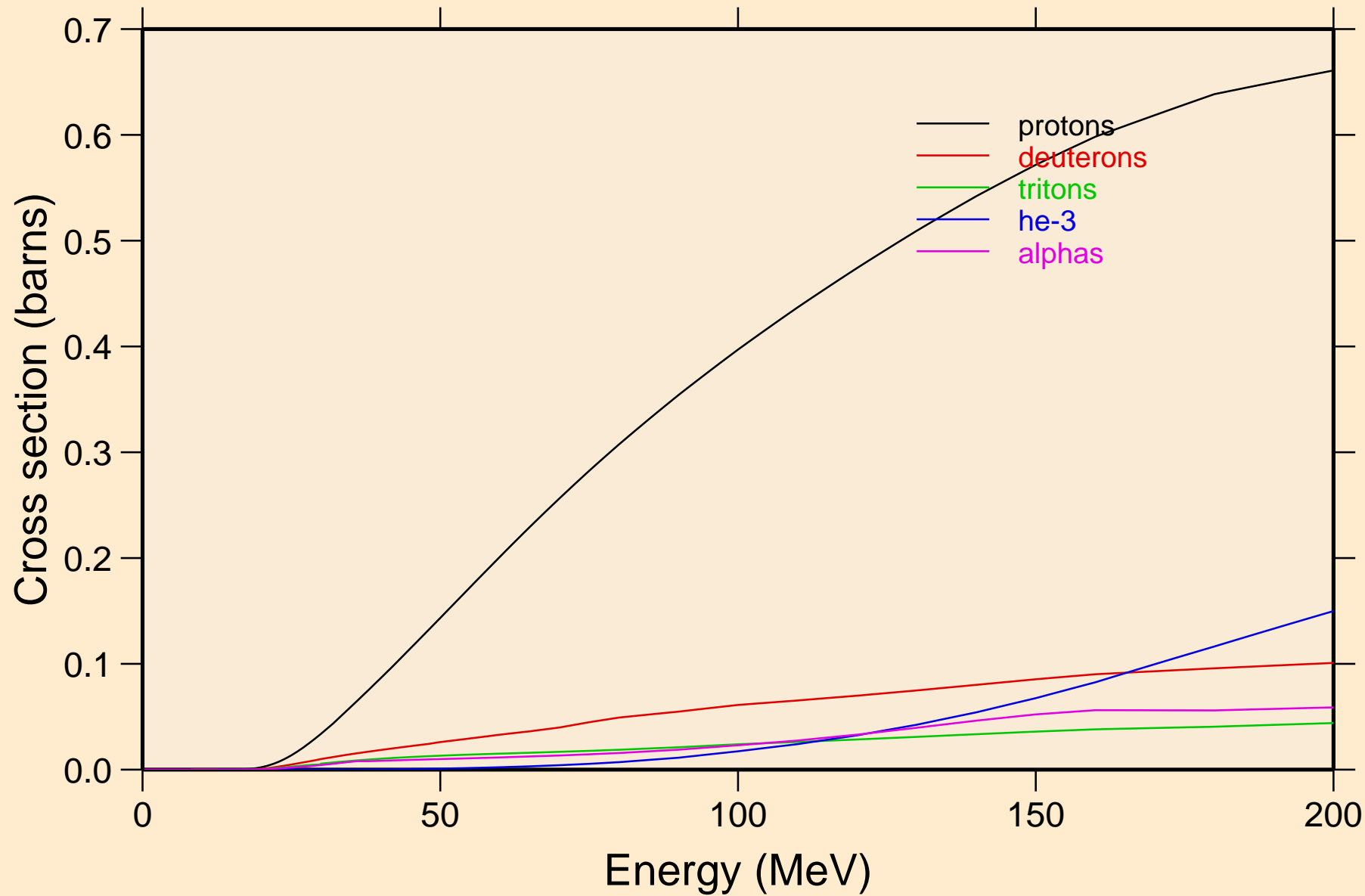

YB184 NEUTRON ACER TENDL-2024 LIBRARY; T=293.6K
protons from (n,x)

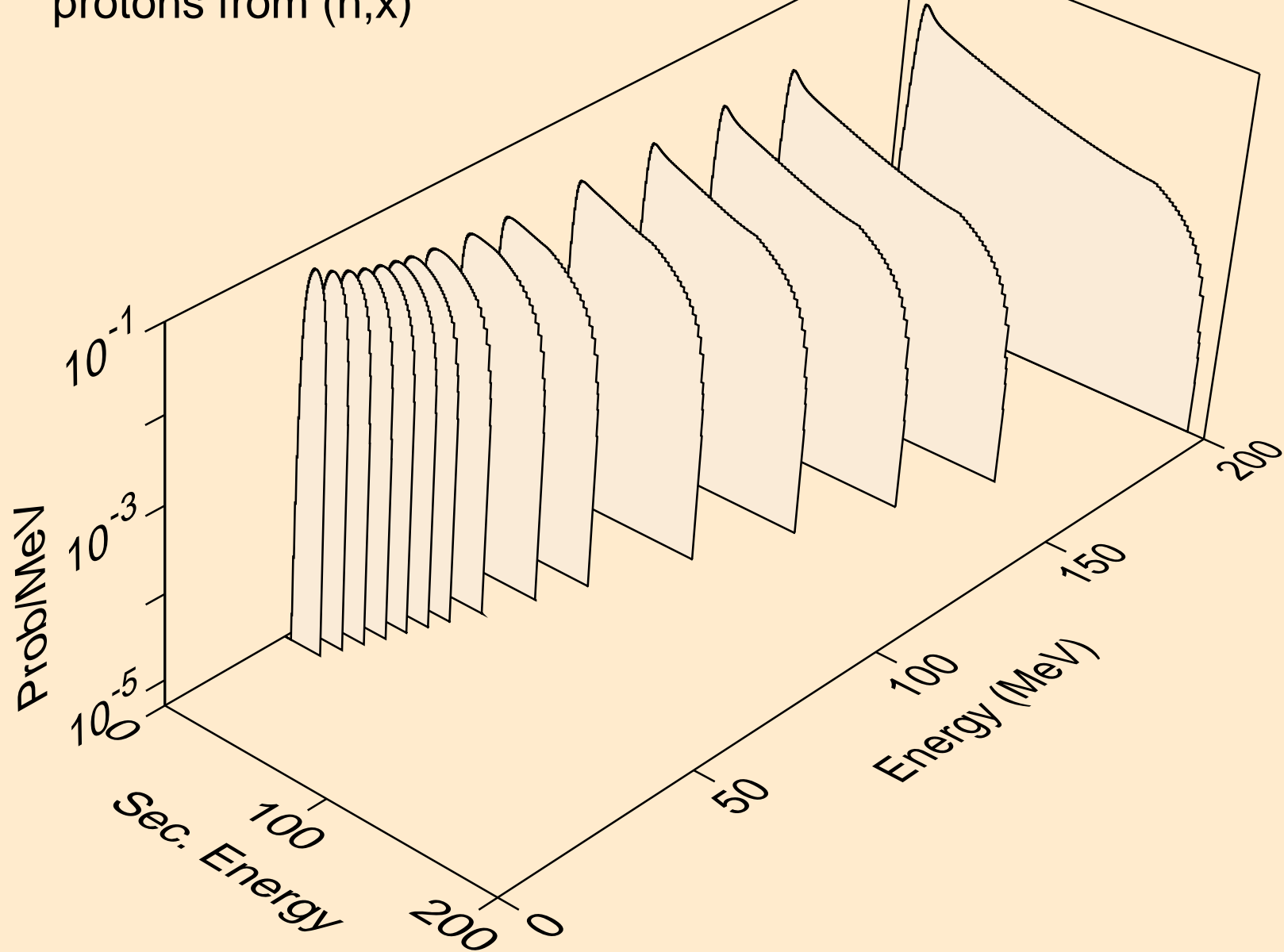

YB184 NEUTRON ACER TENDL-2024 LIBRARY; T=293.6K
protons from (n,n*)p

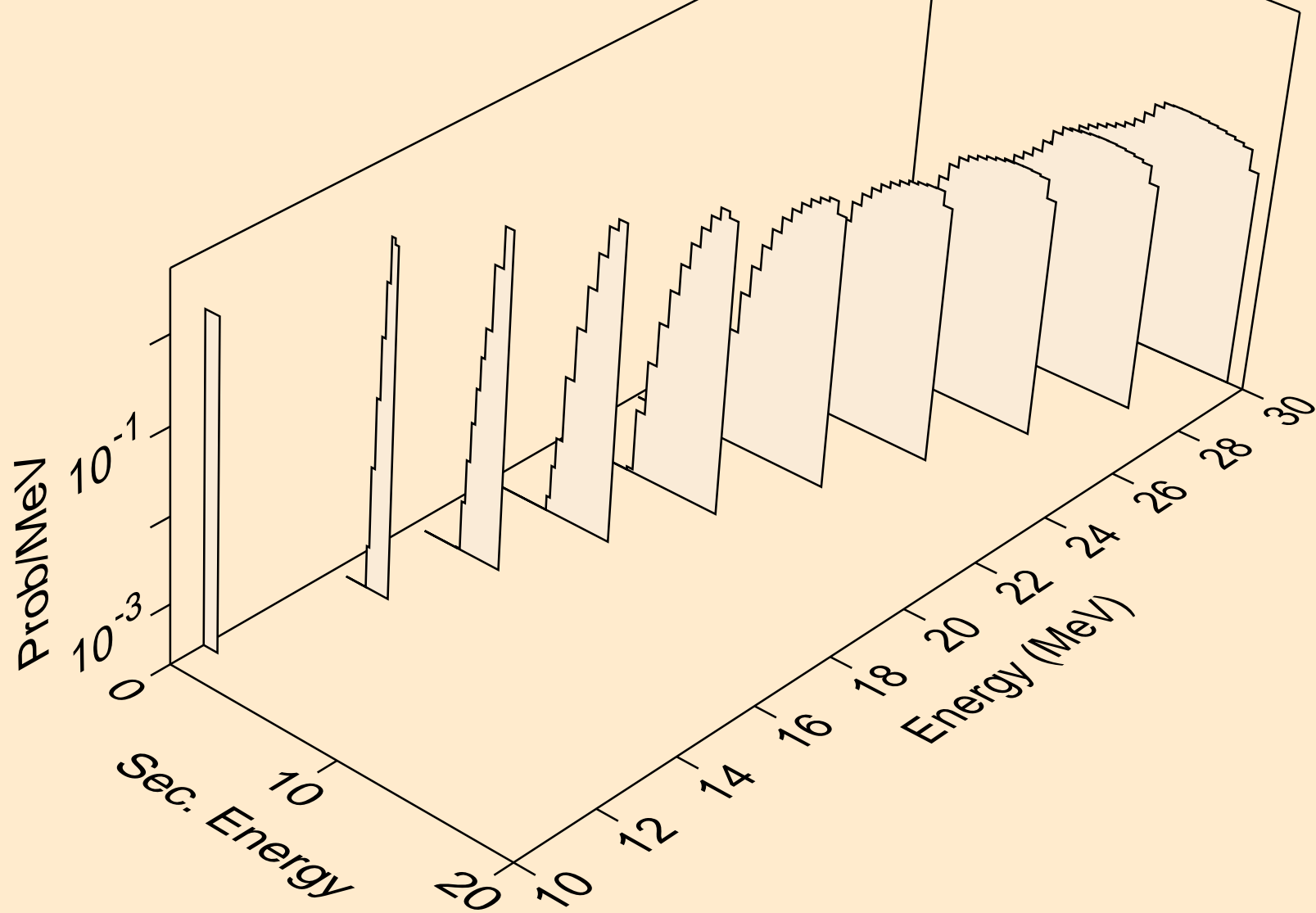

YB184 NEUTRON ACER TENDL-2024 LIBRARY; T=293.6K
protons from (n,2np)

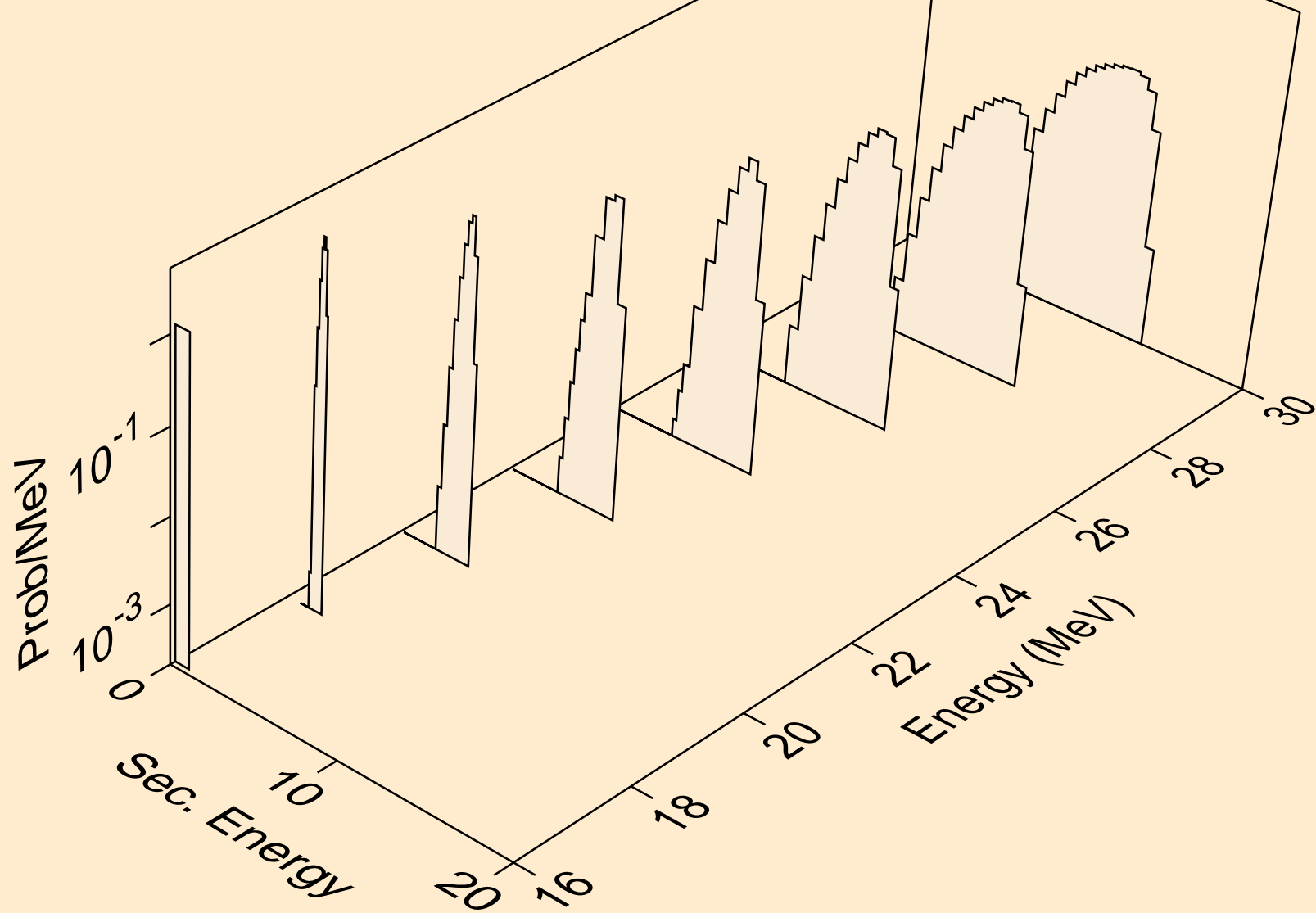

YB184 NEUTRON ACER TENDL-2024 LIBRARY; T=293.6K
protons from (n,3np)

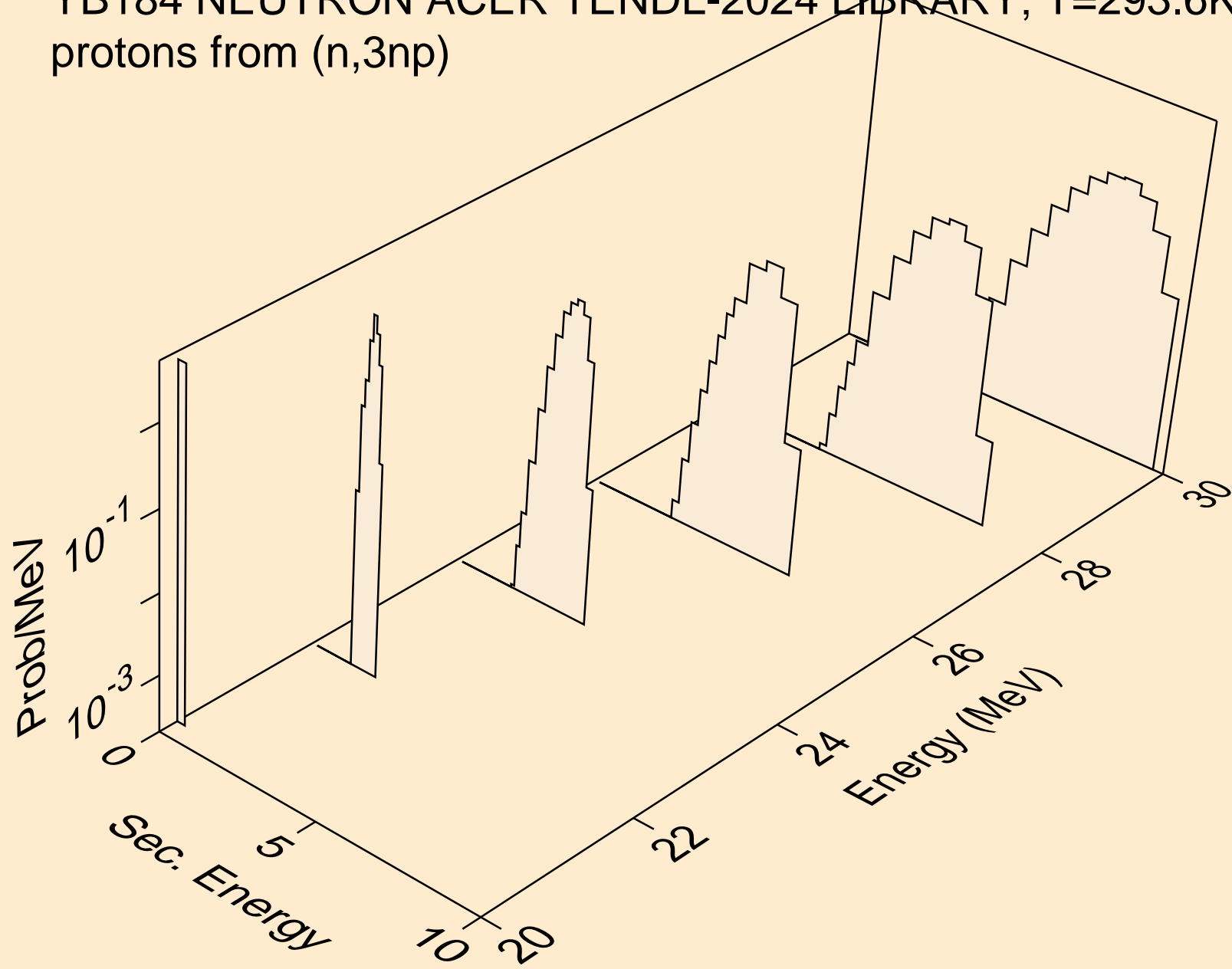

YB184 NEUTRON ACER TENDL-2024 LIBRARY; T=293.6K
protons from (n,p)

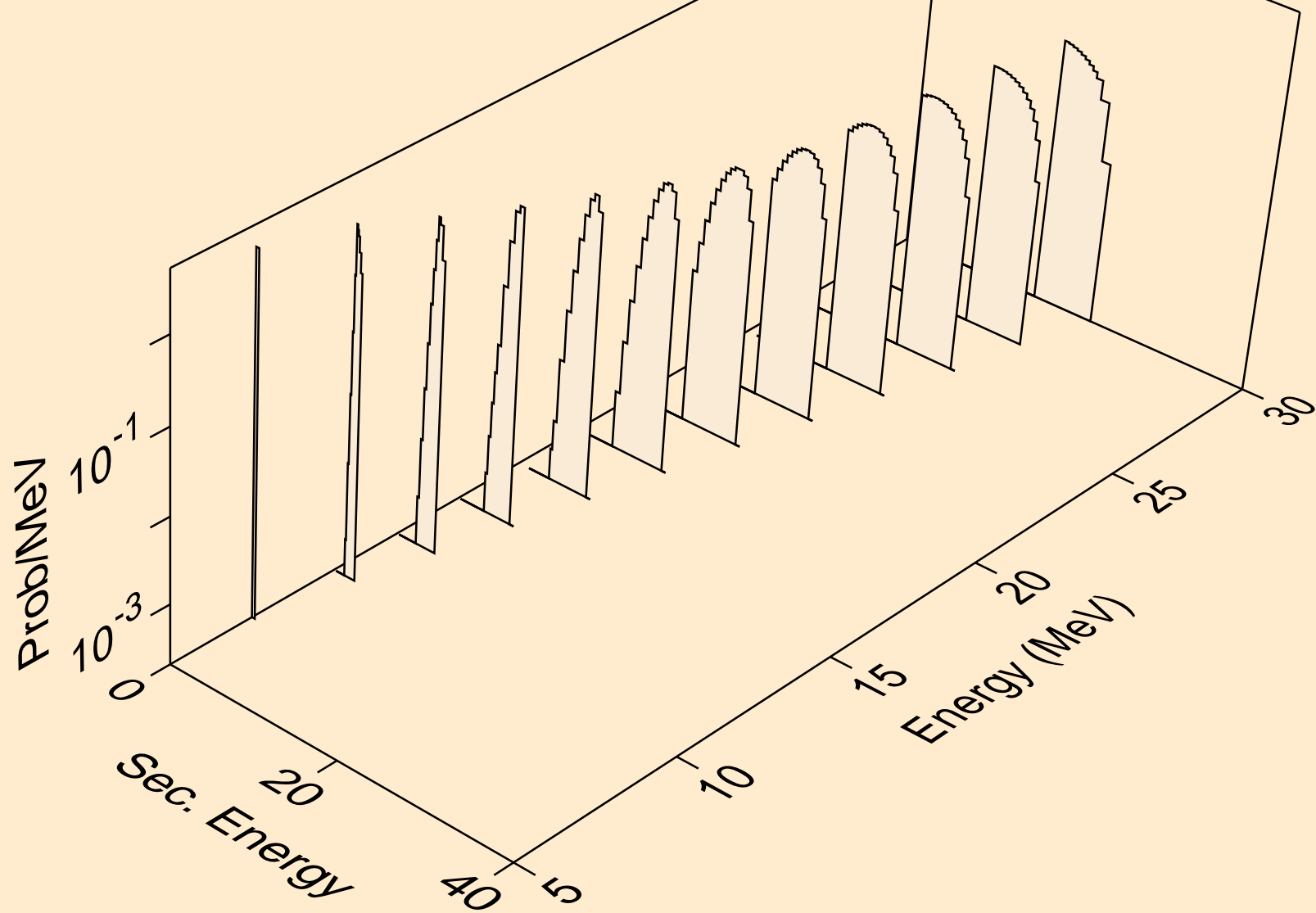

YB184 NEUTRON ACER TENDL-2024 LIBRARY; T=293.6K
deuterons from (n,x)

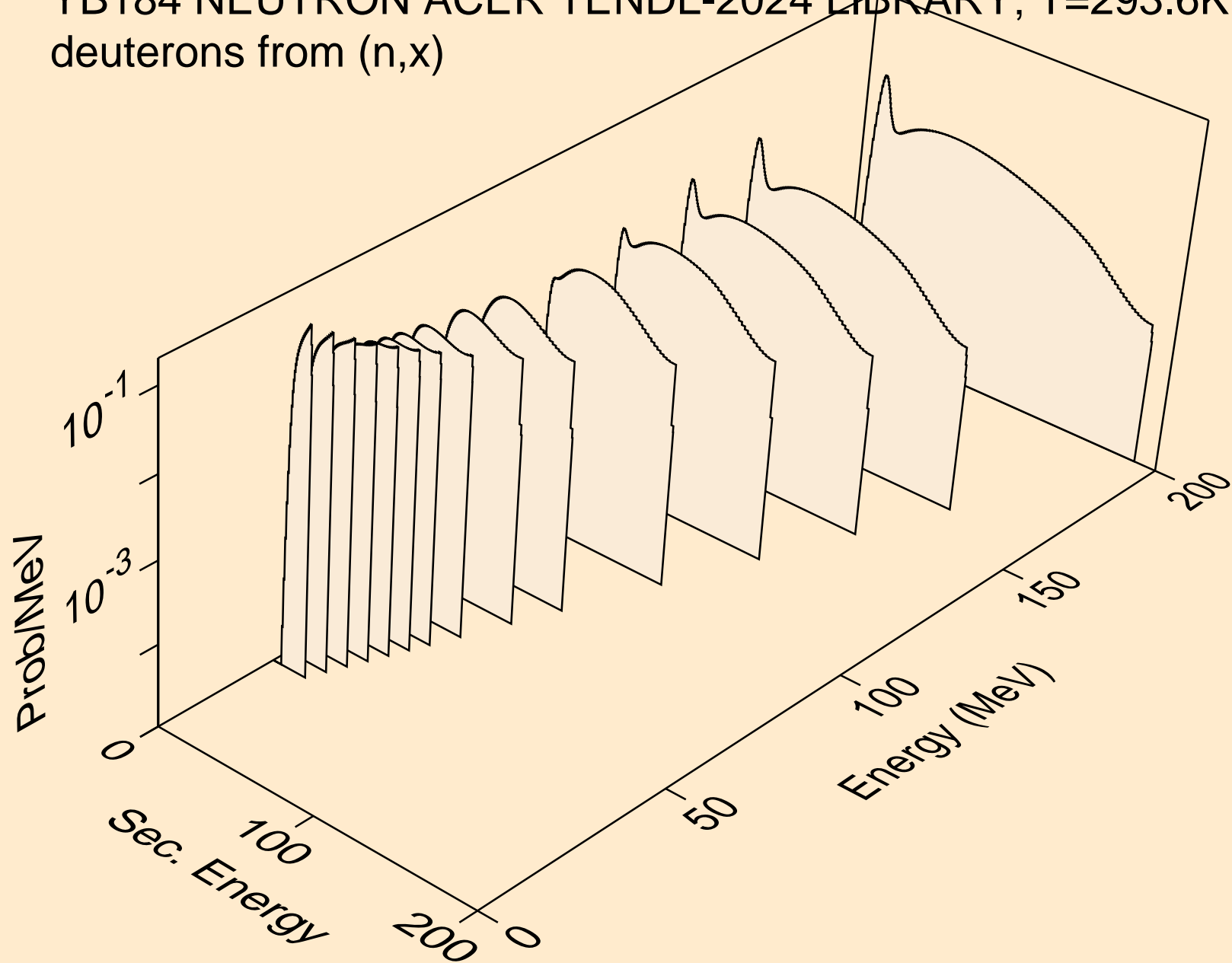

YB184 NEUTRON ACER TENDL-2024 LIBRARY; T=293.6K
deuterons from (n,2nd)

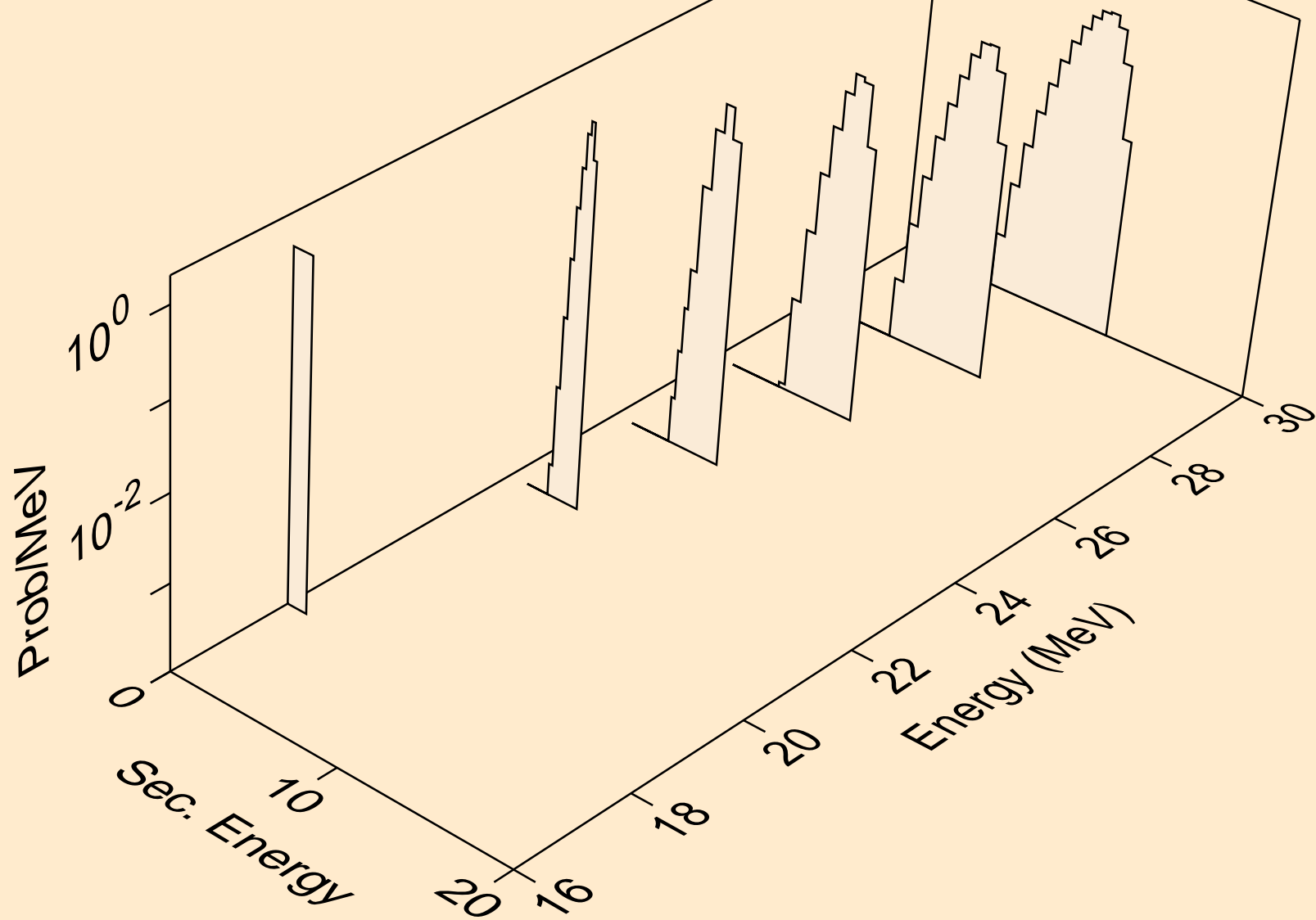

YB184 NEUTRON ACER TENDL-2024 LIBRARY; T=293.6K
deuterons from (n,n*)d

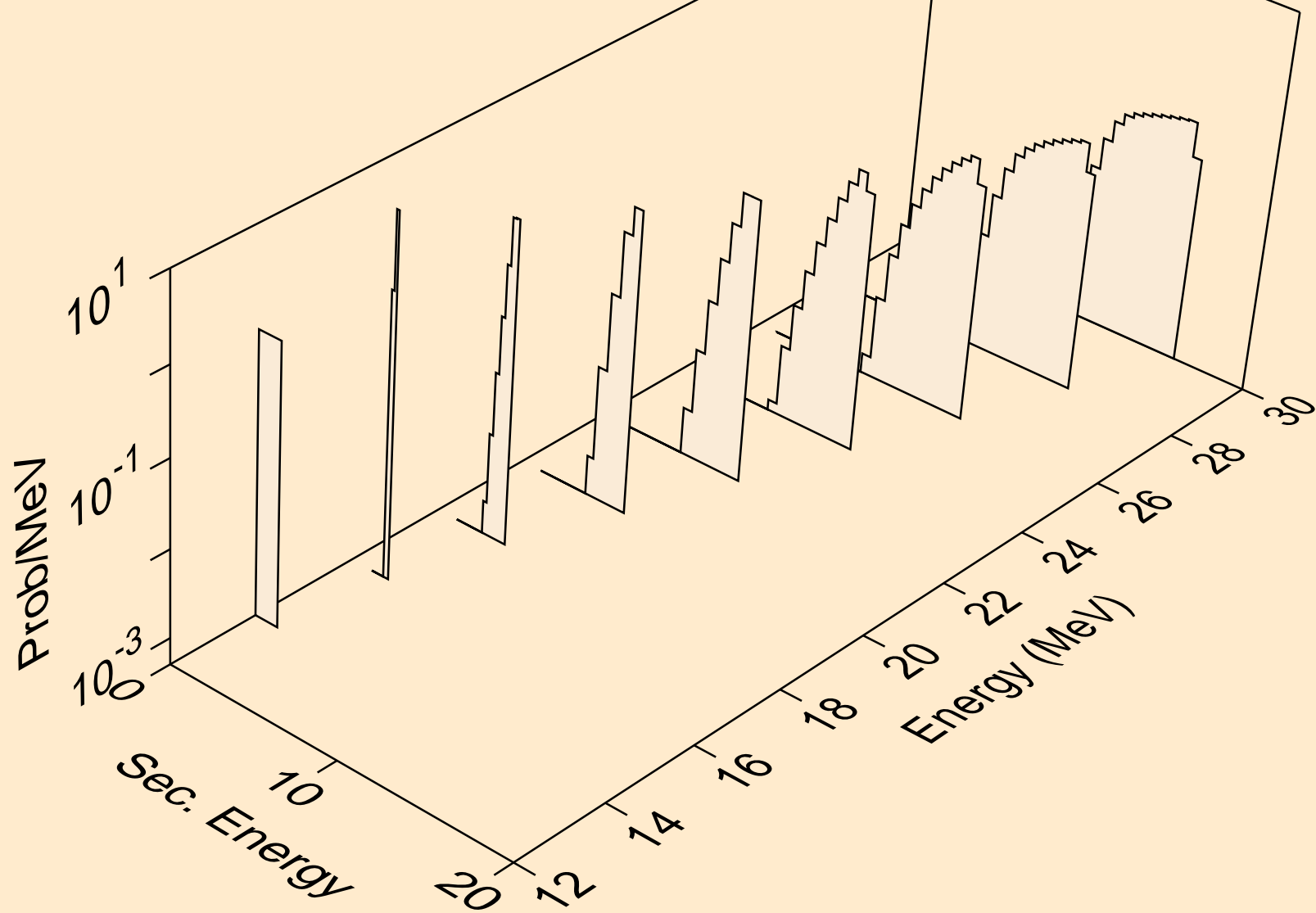

YB184 NEUTRON ACER TENDL-2024 LIBRARY; T=293.6K
deuterons from (n,d)

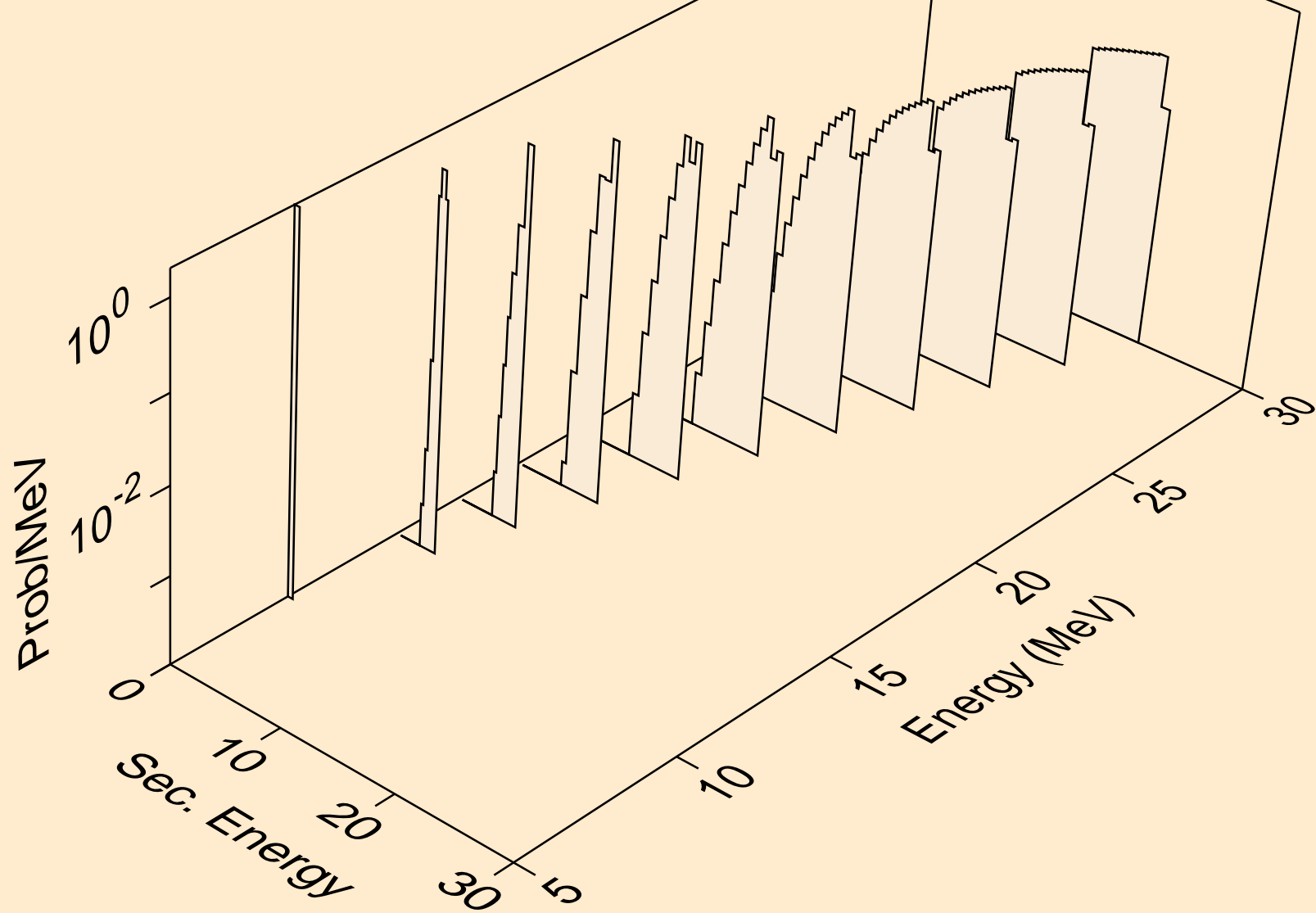

YB184 NEUTRON ACER TENDL-2024 LIBRARY; T=293.6K
tritons from (n,x)

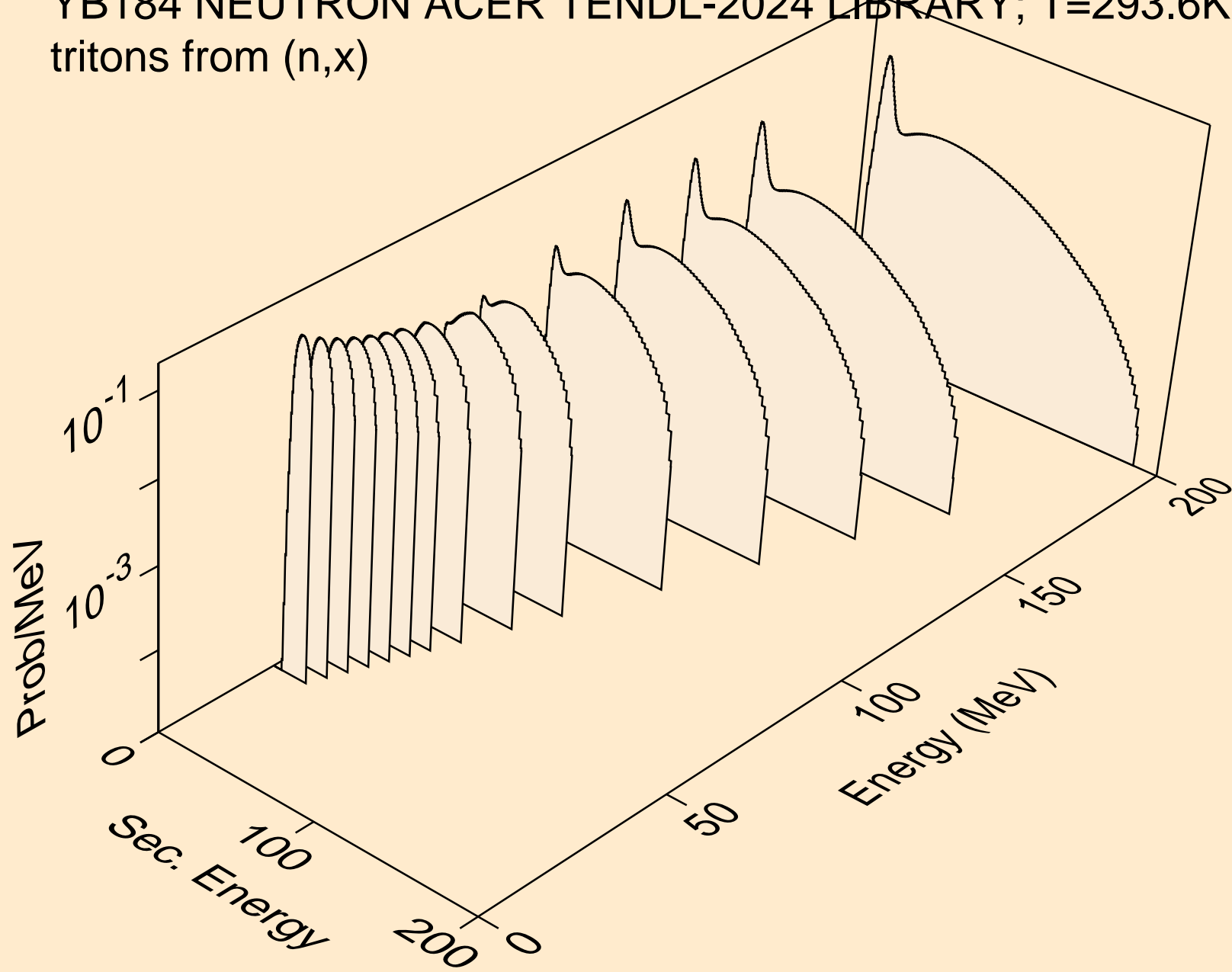

YB184 NEUTRON ACER TENDL-2024 LIBRARY; T=293.6K
tritons from (n,n*)t

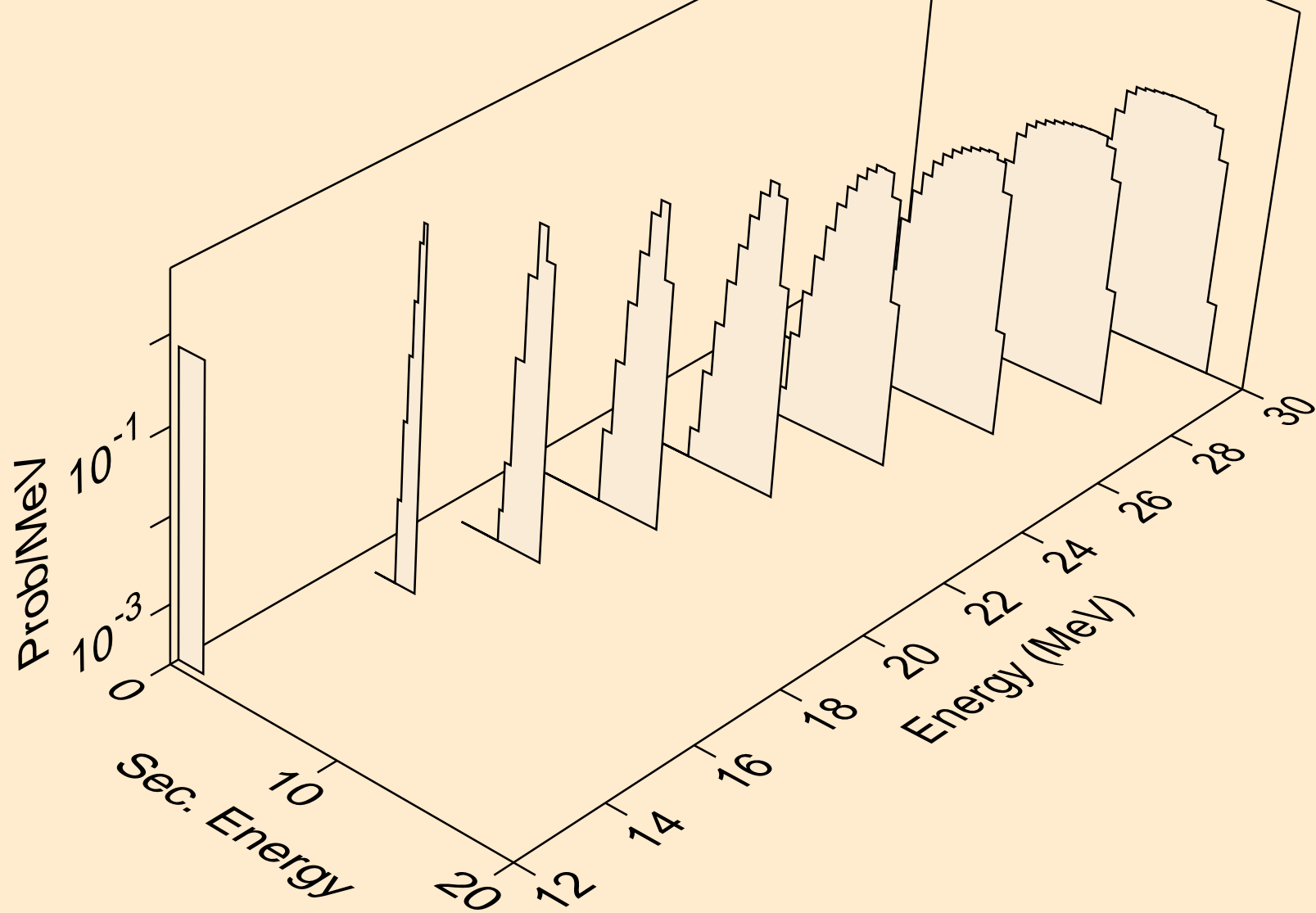

YB184 NEUTRON ACER TENDL-2024 LIBRARY; T=293.6K
tritons from (n,t)

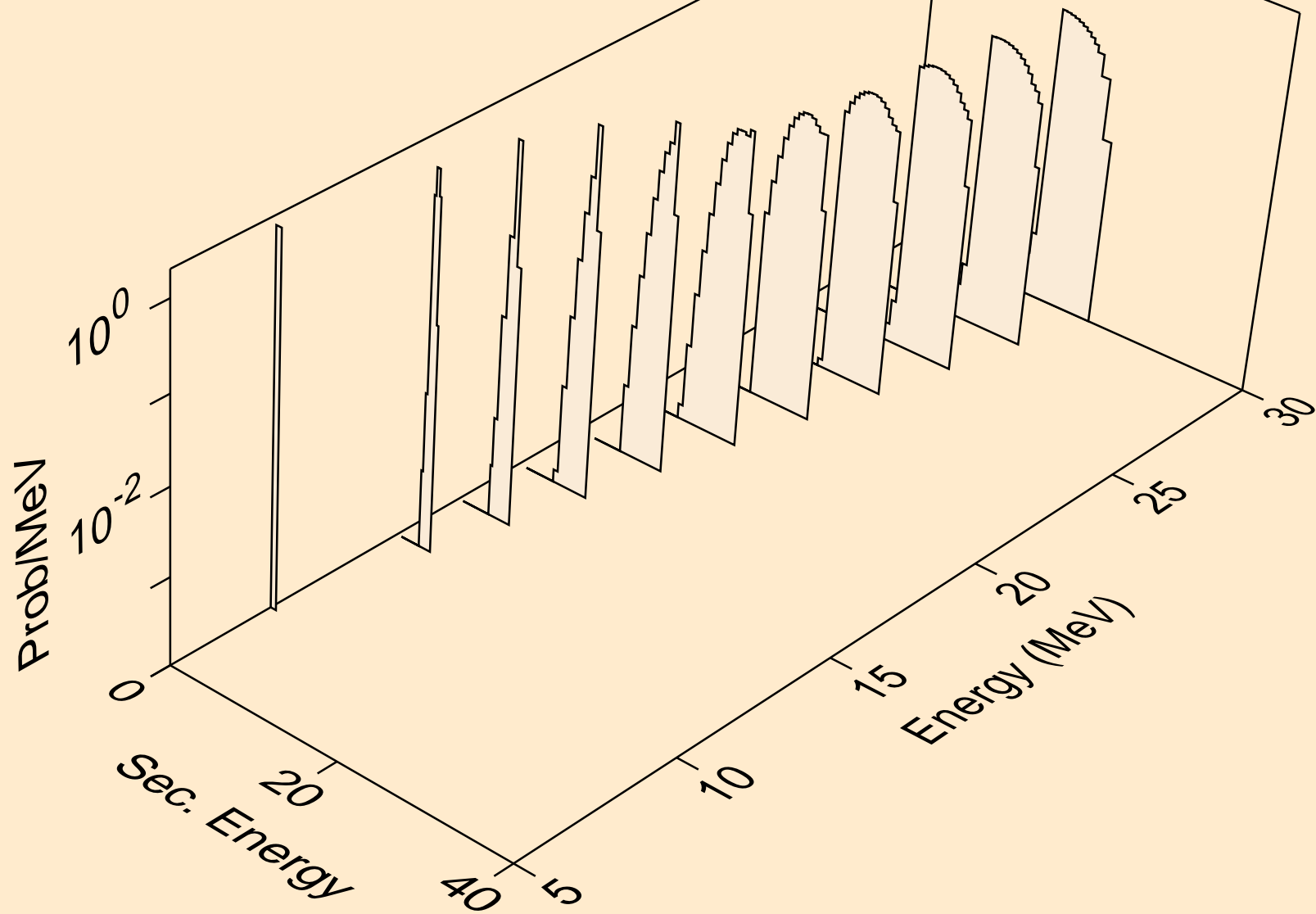

YB184 NEUTRON ACER TENDL-2024 LIBRARY; T=293.6K
he3s from (n,x)

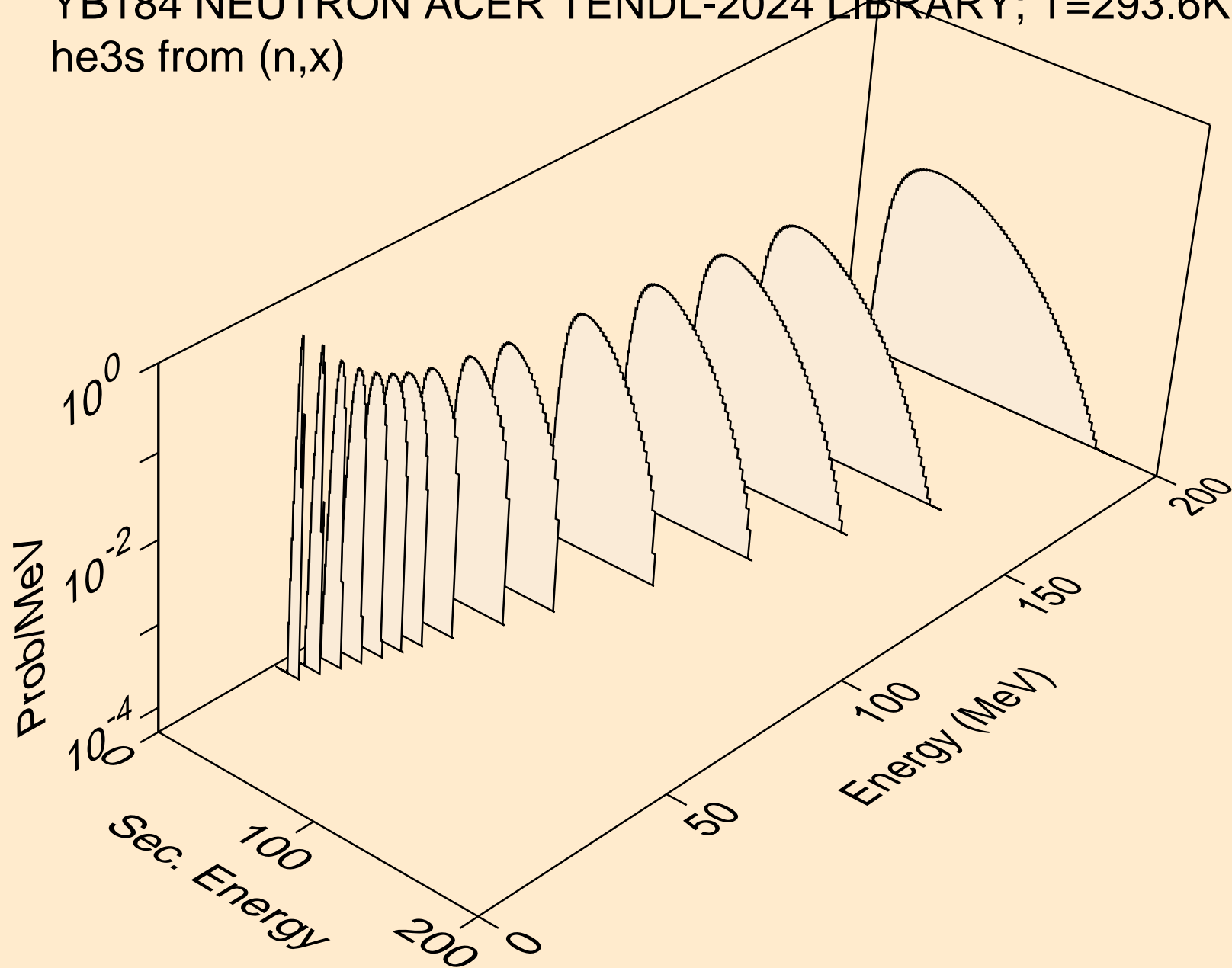

YB184 NEUTRON ACER TENDL-2024 LIBRARY; T=293.6K
he3s from (n,n*)he3

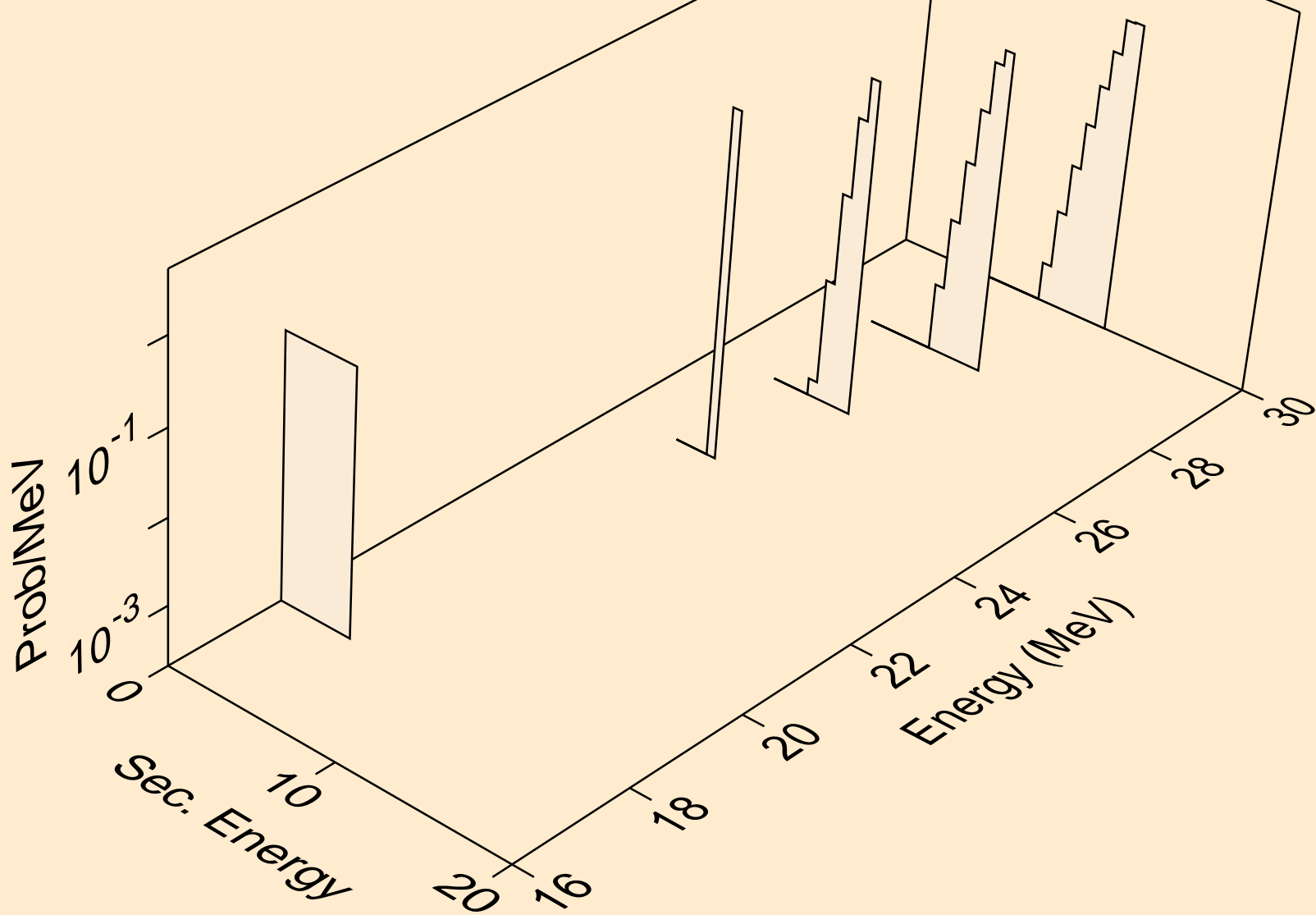

YB184 NEUTRON ACER TENDL-2024 LIBRARY; T=293.6K
he3s from (n,he3)

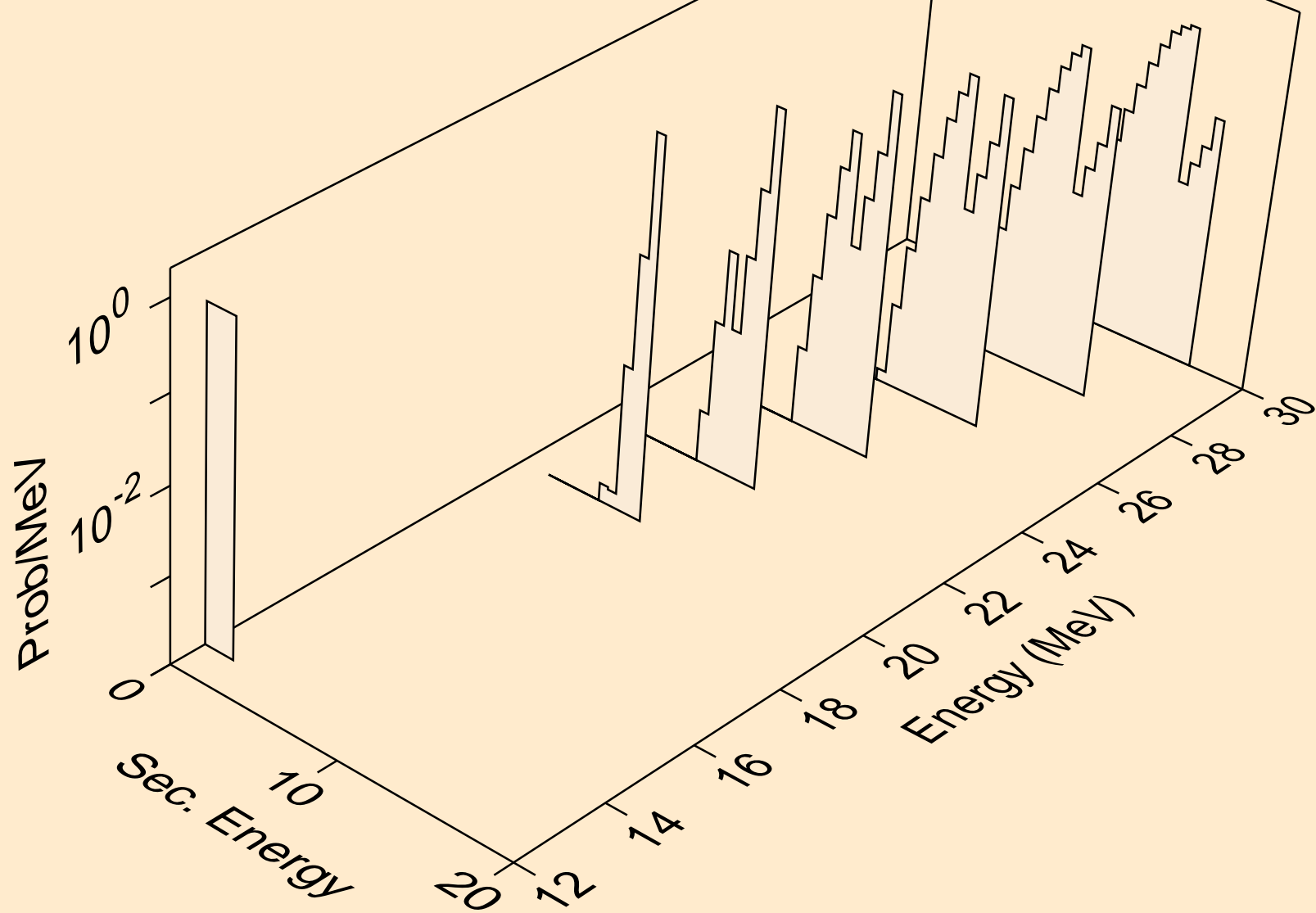

YB184 NEUTRON ACER TENDL-2024 LIBRARY; T=293.6K
alphas from (n,x)

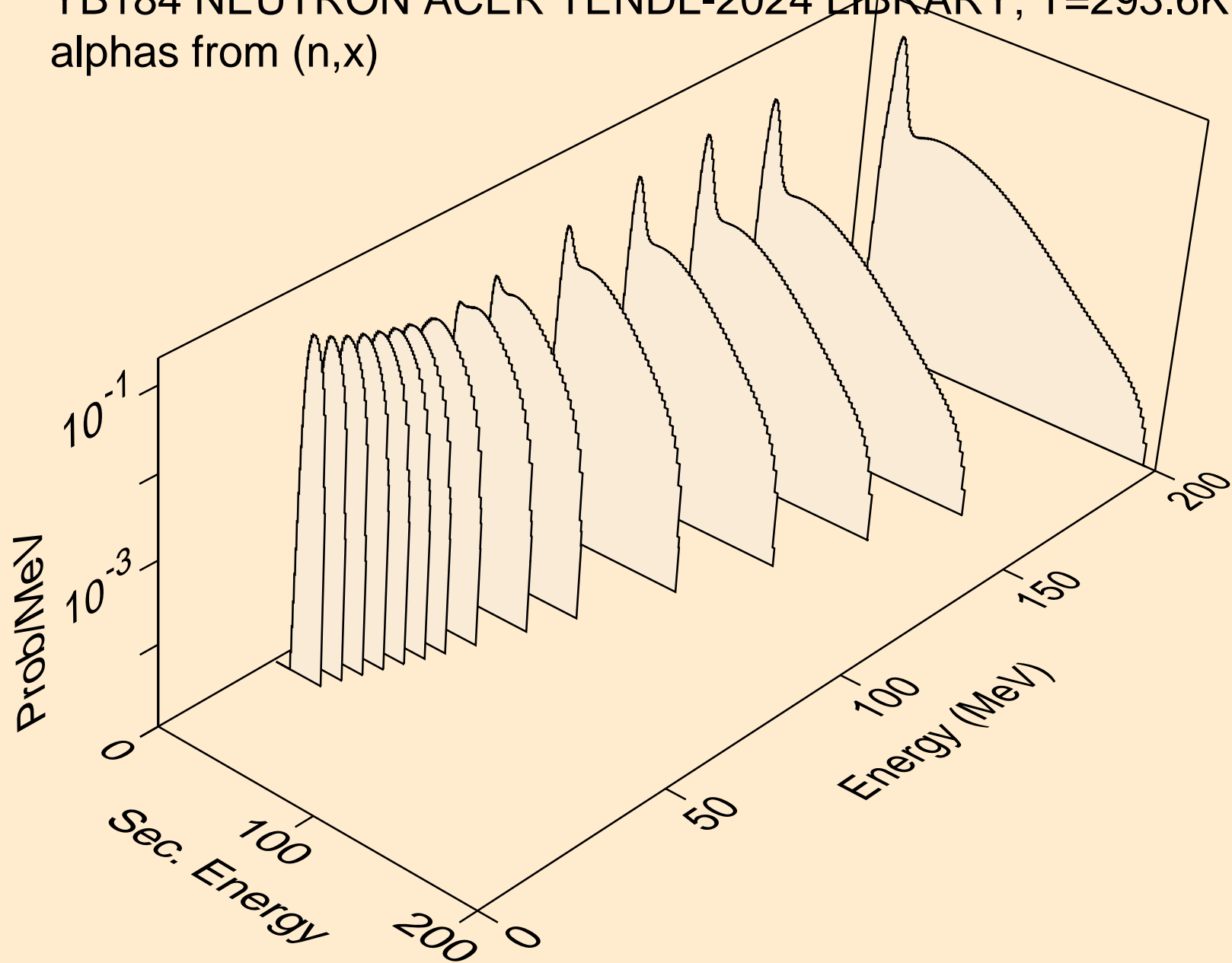

YB184 NEUTRON ACER TENDL-2024 LIBRARY; T=293.6K
alphas from (n,n*)a

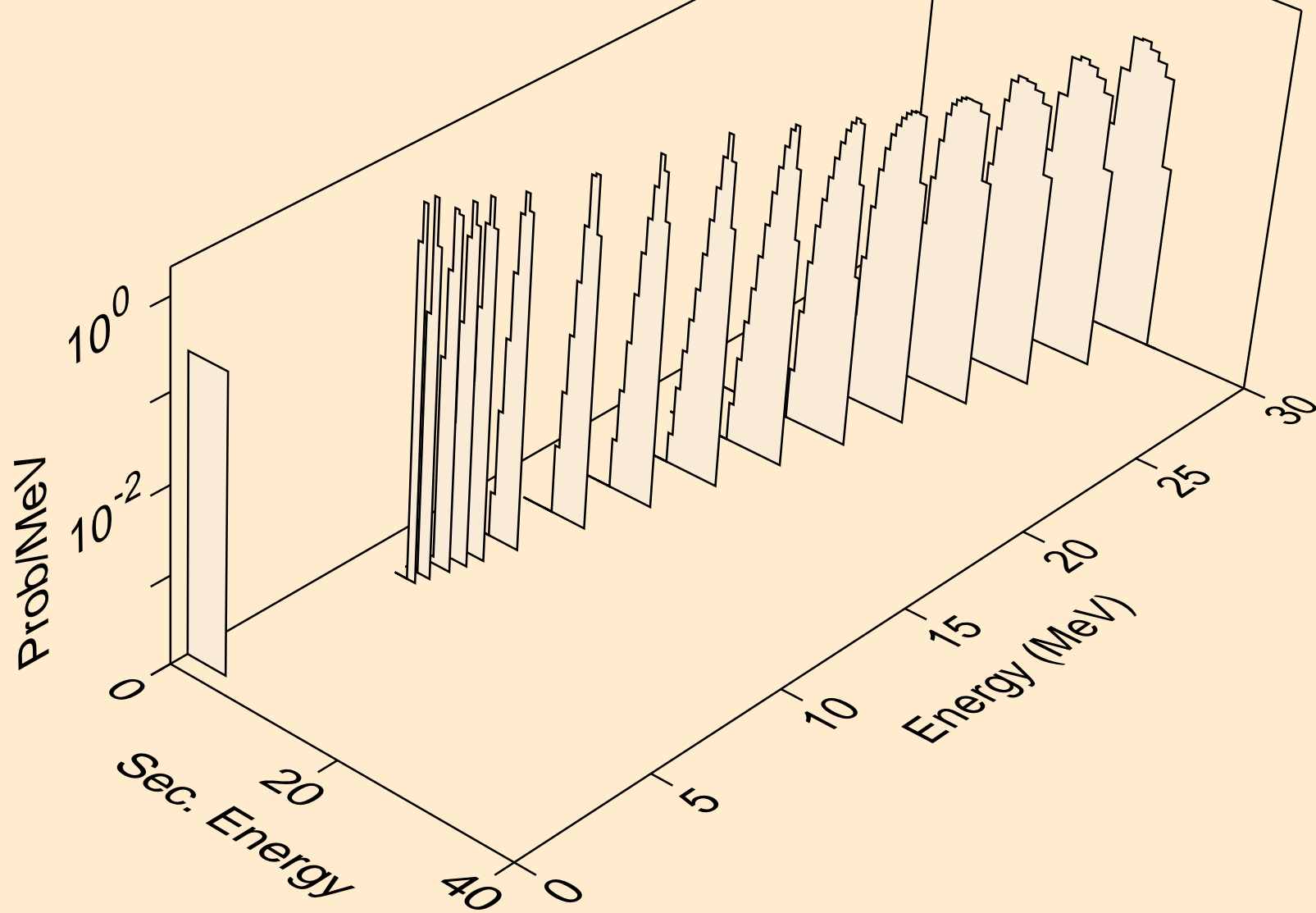

YB184 NEUTRON ACER TENDL-2024 LIBRARY; T=293.6K
alphas from (n,2n)a

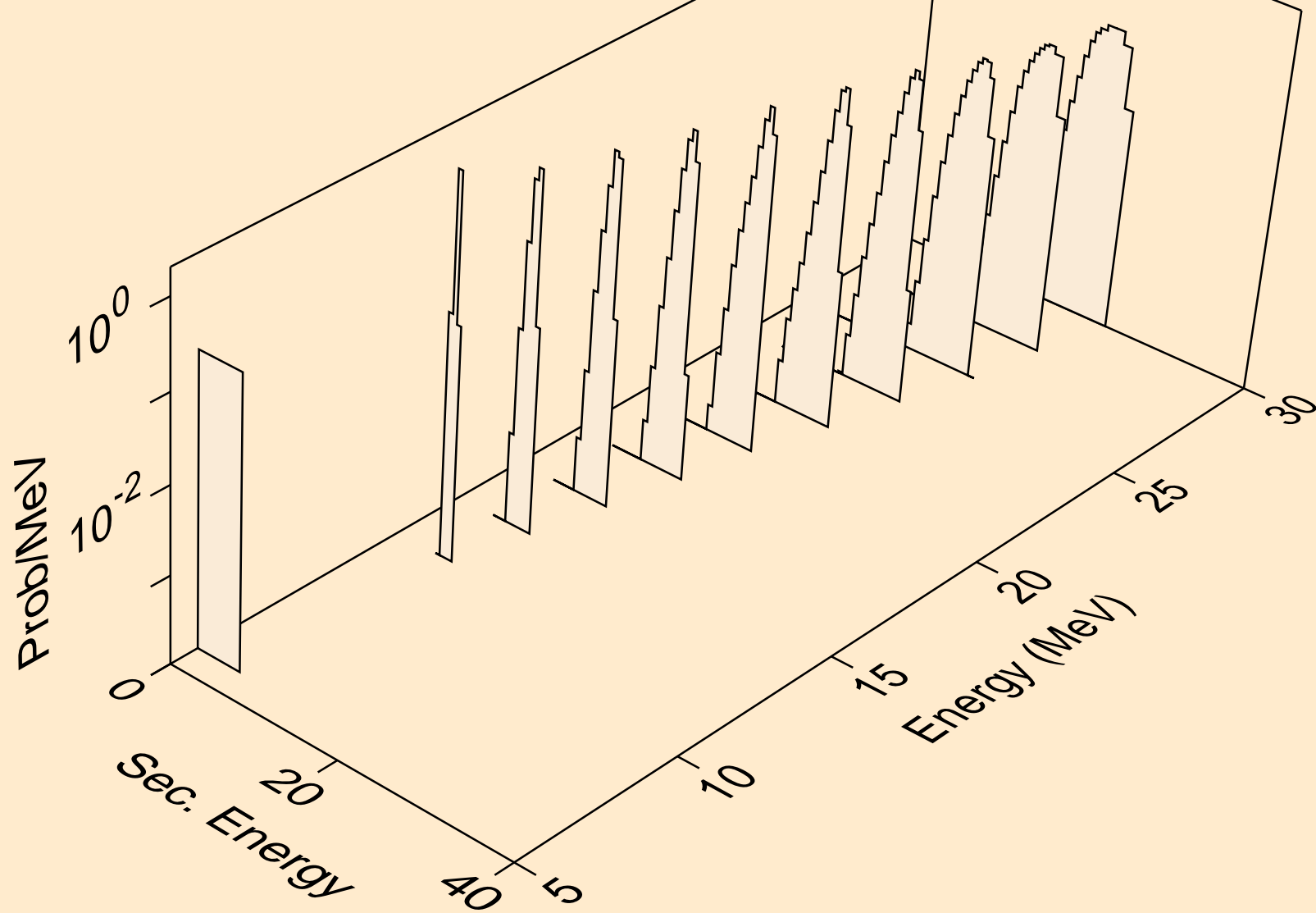

YB184 NEUTRON ACER TENDL-2024 LIBRARY; T=293.6K
alphas from (n,3n)a

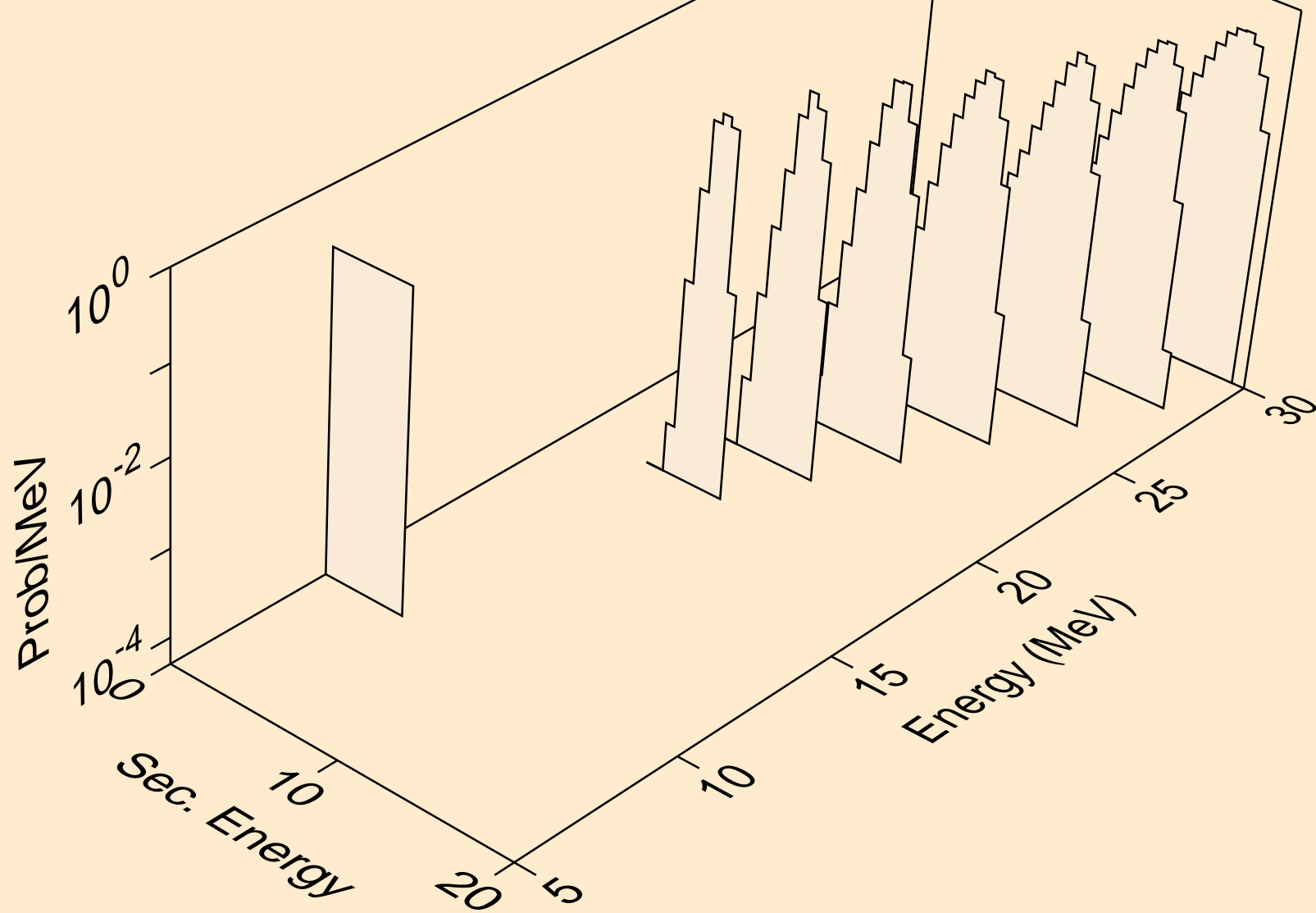

YB184 NEUTRON ACER TENDL-2024 LIBRARY; T=293.6K
alphas from (n,a)

