

ZN072 NEUTRON ACER TENDL-2024 LIBRARY; T=293.6K
Principal cross sections

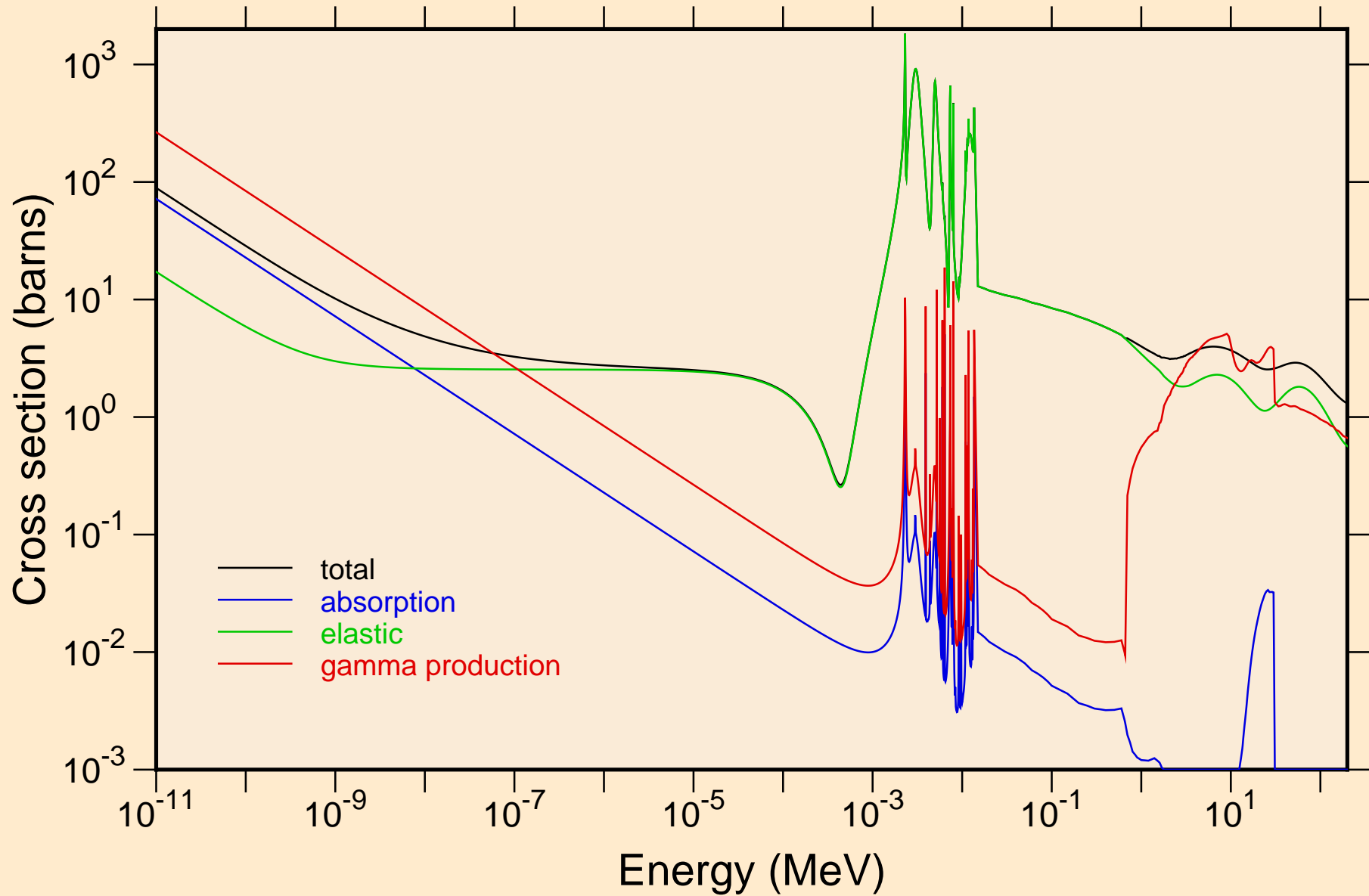

ZN072 NEUTRON ACER TENDL-2024 LIBRARY; T=293.6K
resonance total cross section

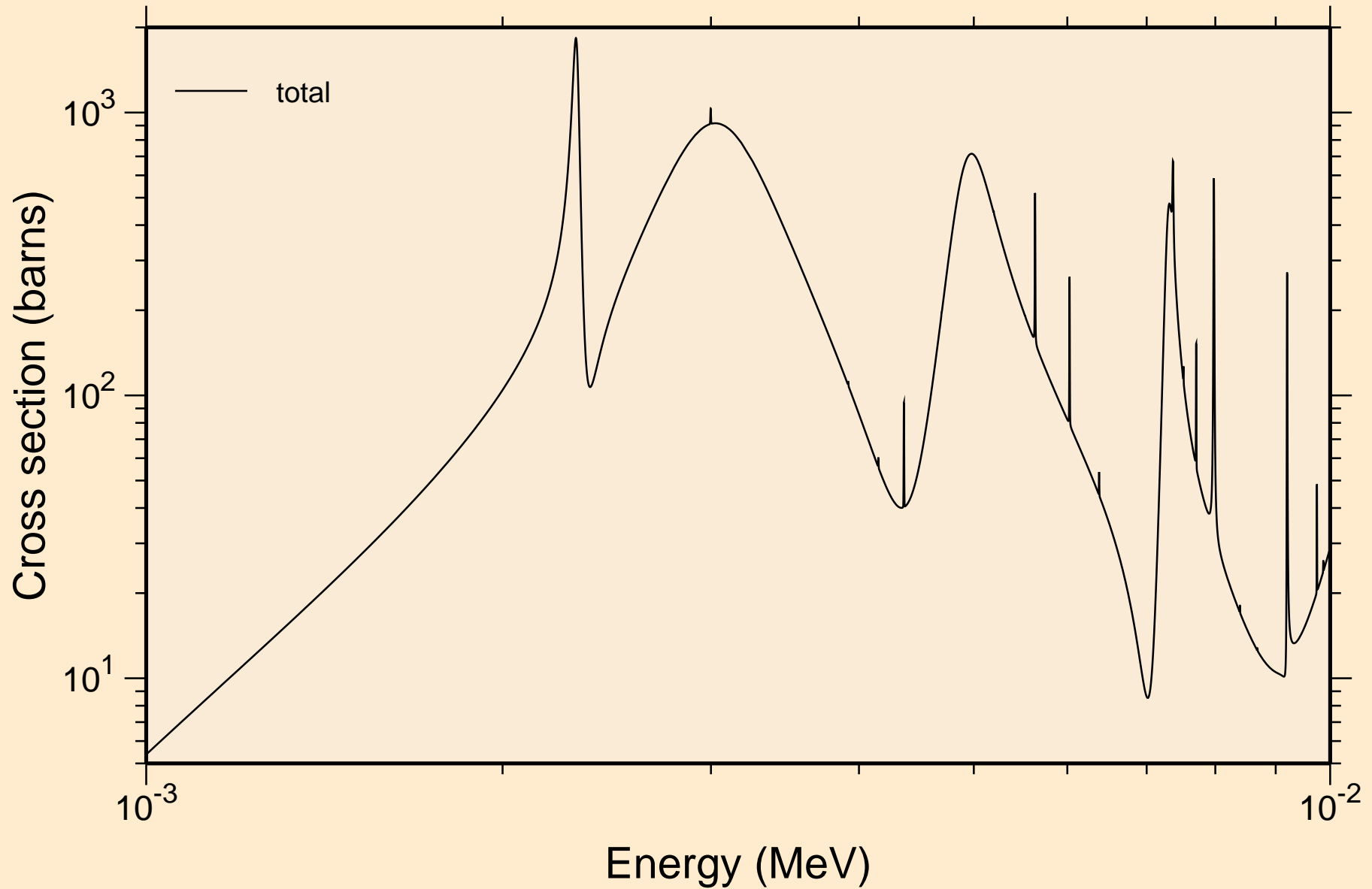

ZN072 NEUTRON ACER TENDL-2024 LIBRARY; T=293.6K
resonance total cross section

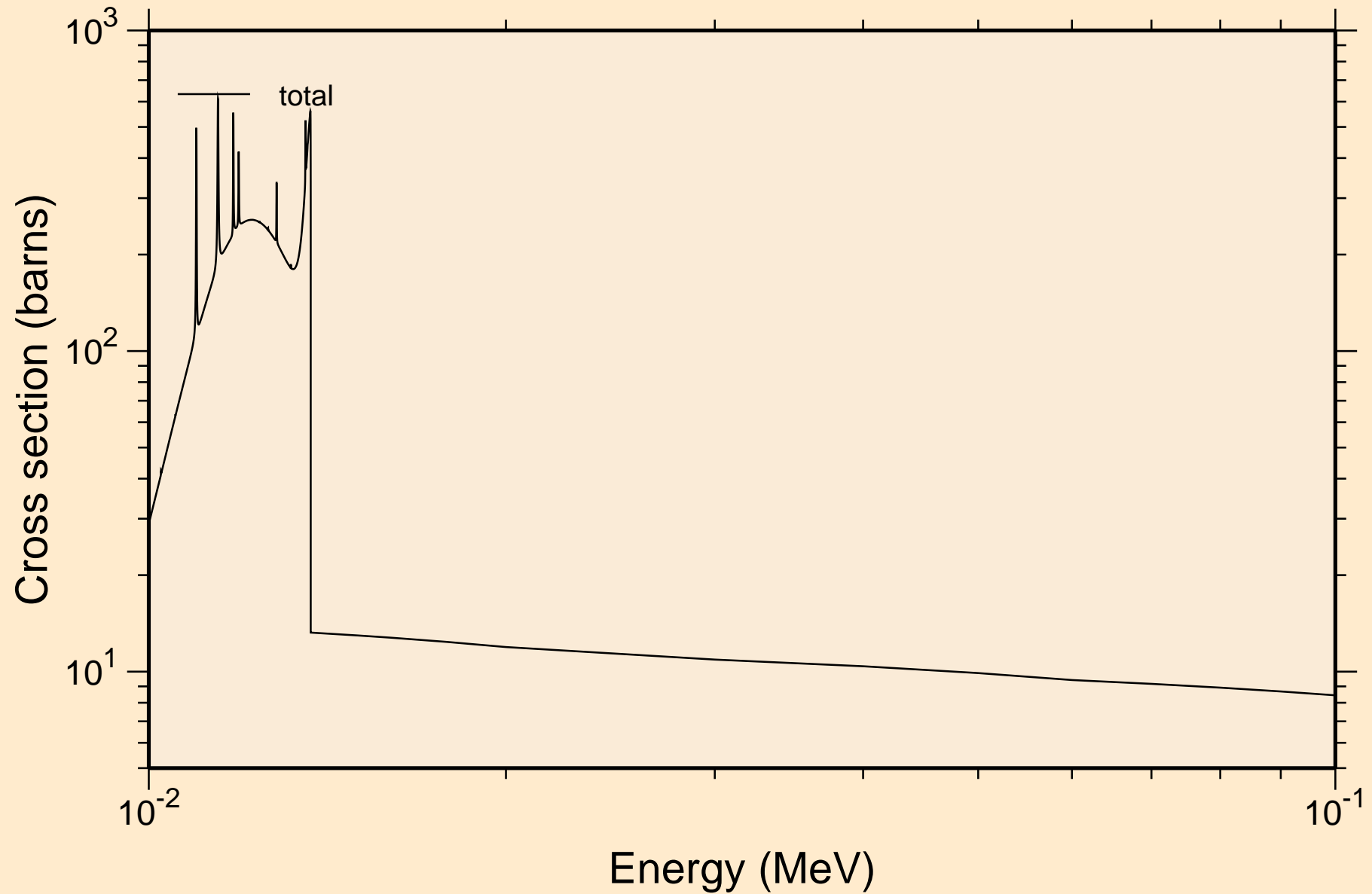

ZN072 NEUTRON ACER TENDL-2024 LIBRARY; T=293.6K
resonance total cross section

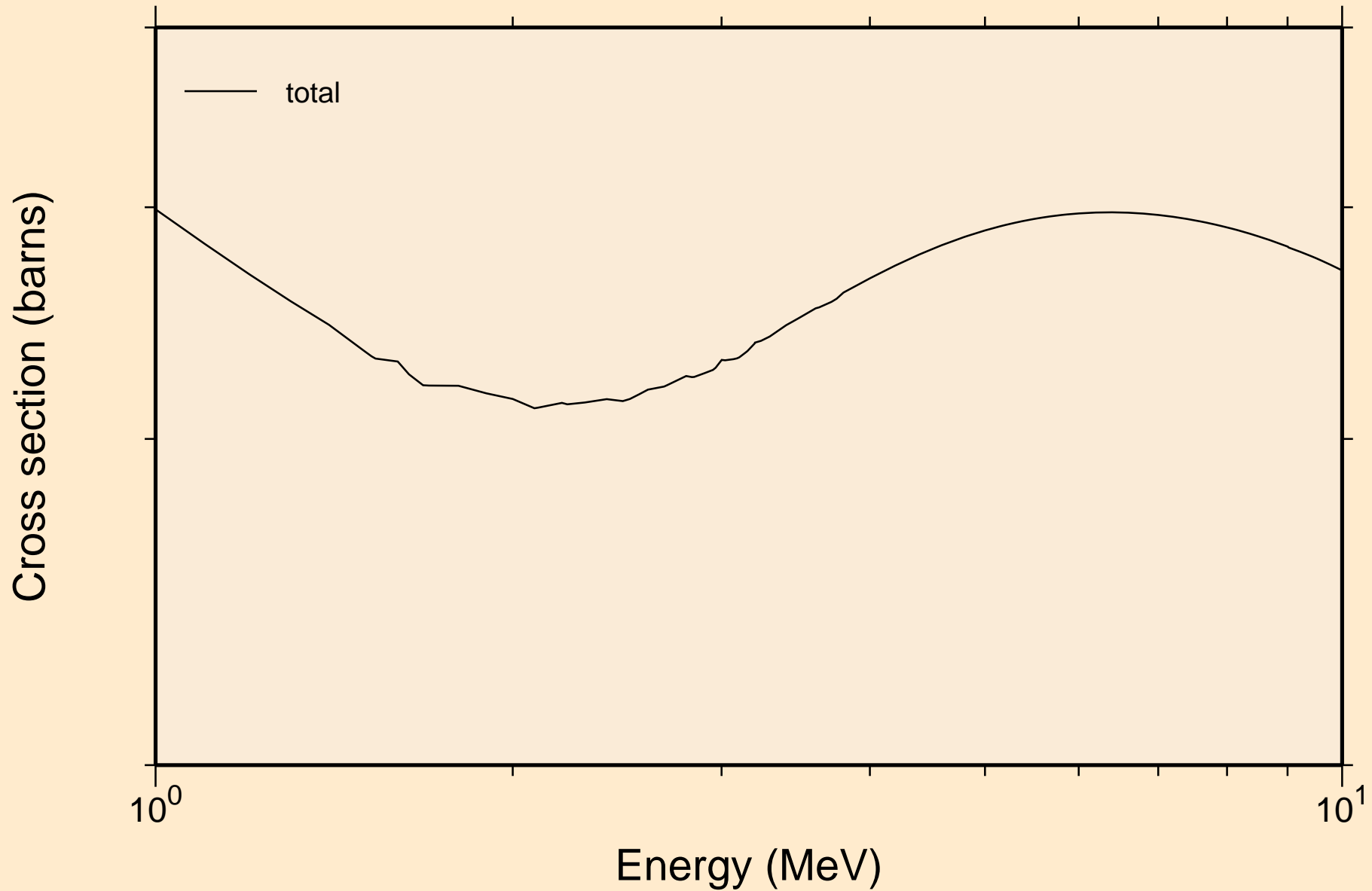

ZN072 NEUTRON ACER TENDL-2024 LIBRARY; T=293.6K
resonance absorption cross sections

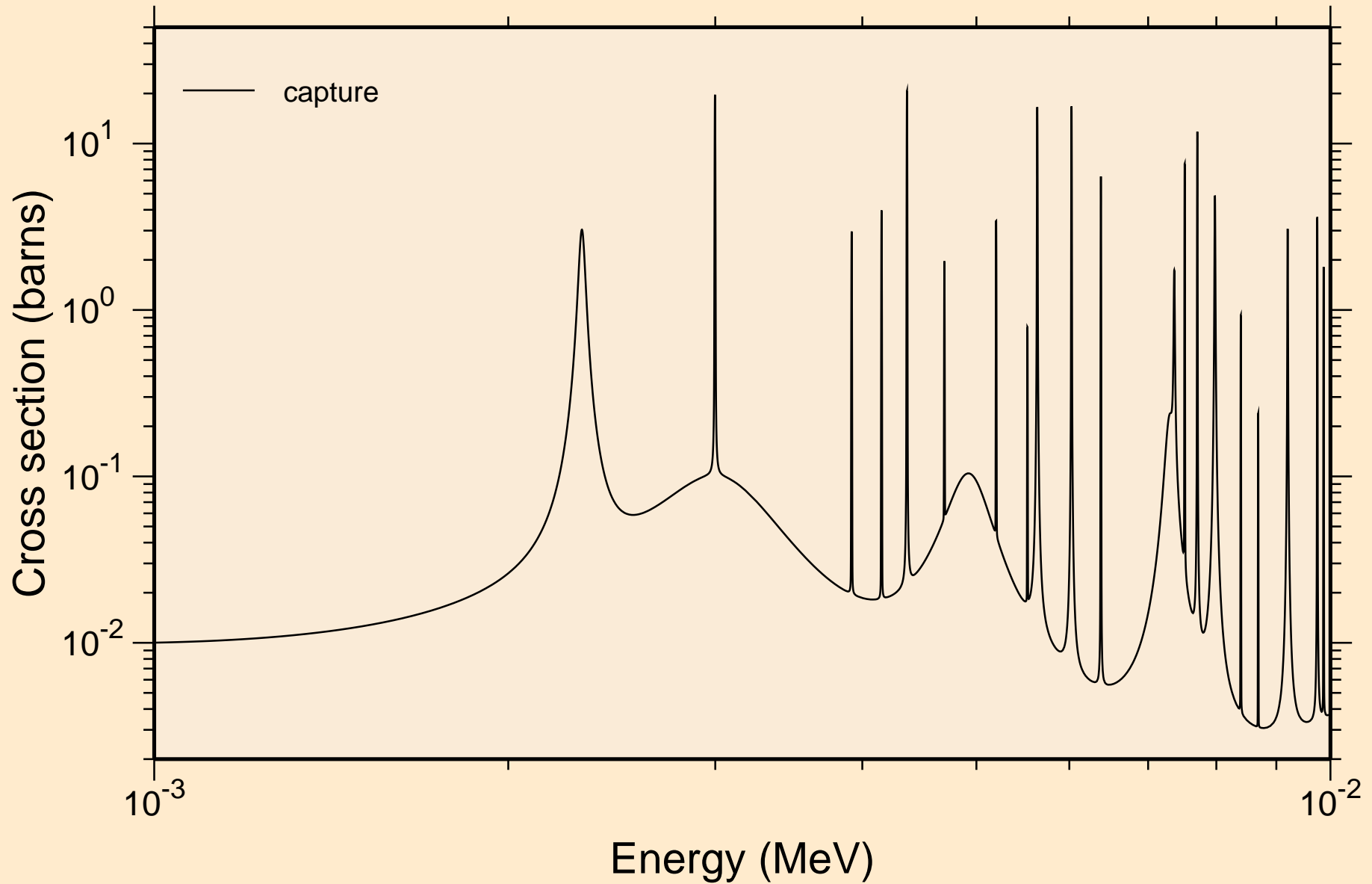

ZN072 NEUTRON ACER TENDL-2024 LIBRARY; T=293.6K
resonance absorption cross sections

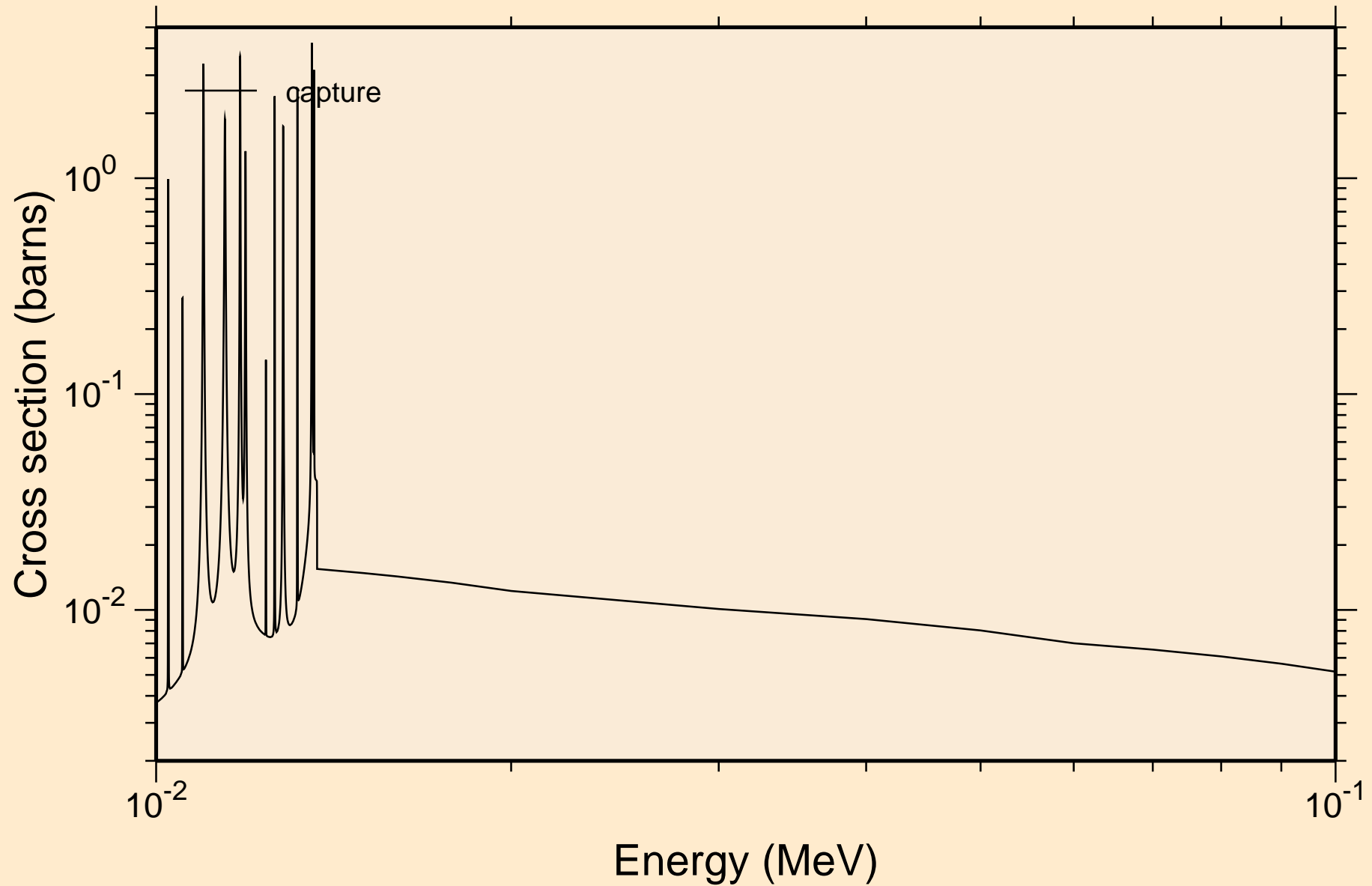

ZN072 NEUTRON ACER TENDL-2024 LIBRARY; T=293.6K
resonance absorption cross sections

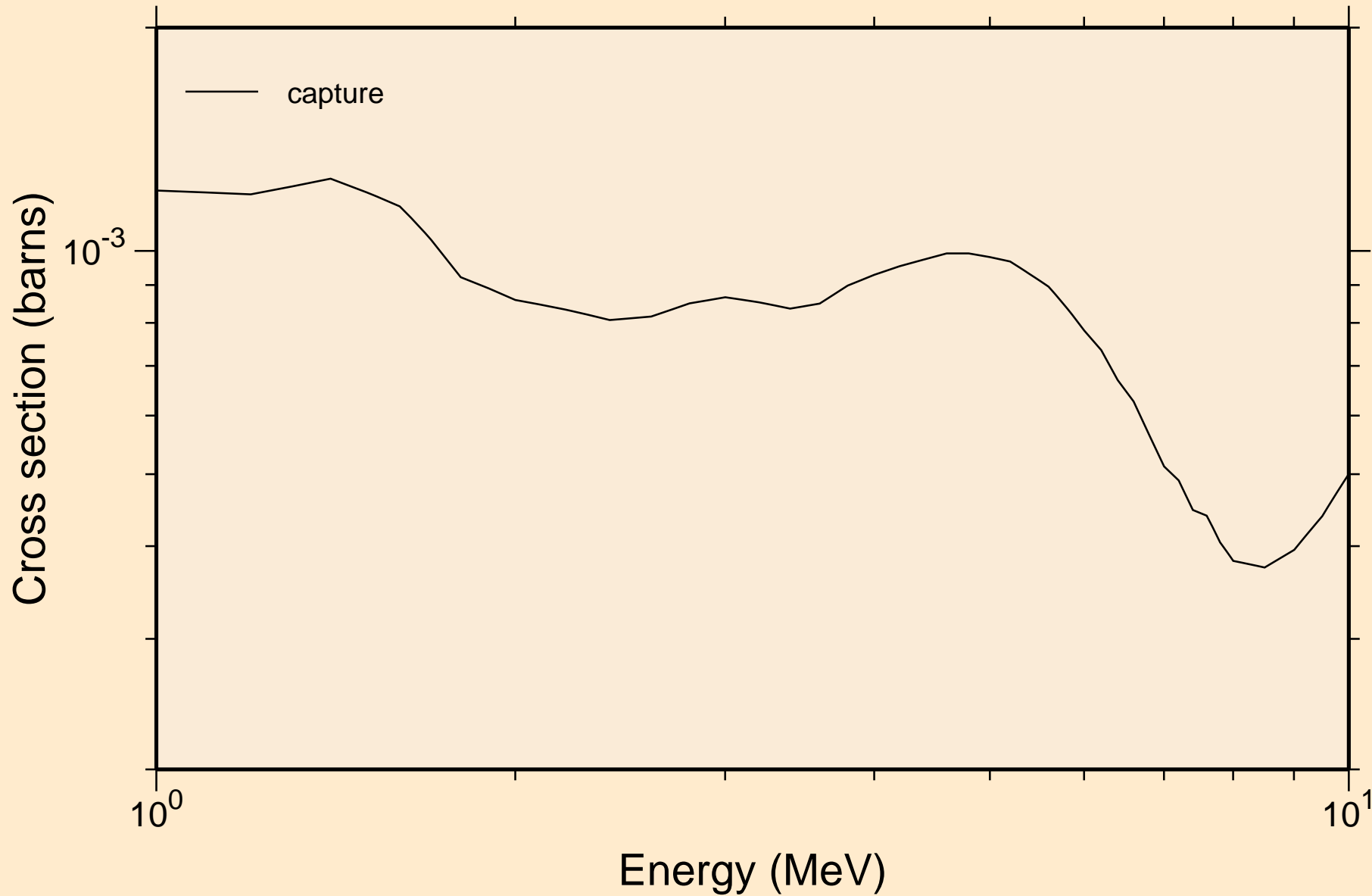

ZN072 NEUTRON ACER TENDL-2024 LIBRARY; T=293.6K
Heating

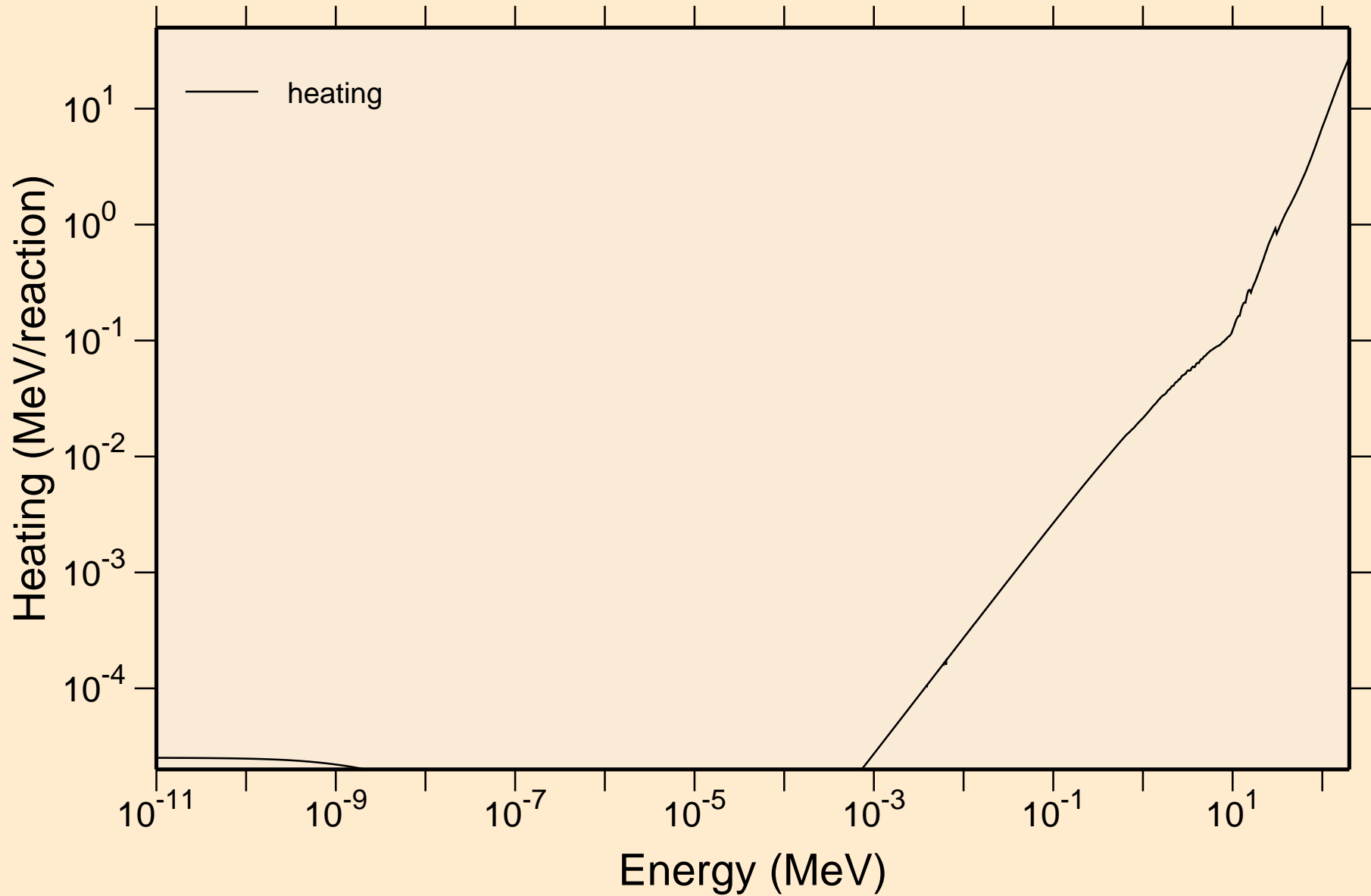

ZN072 NEUTRON ACER TENDL-2024 LIBRARY; T=293.6K
Damage

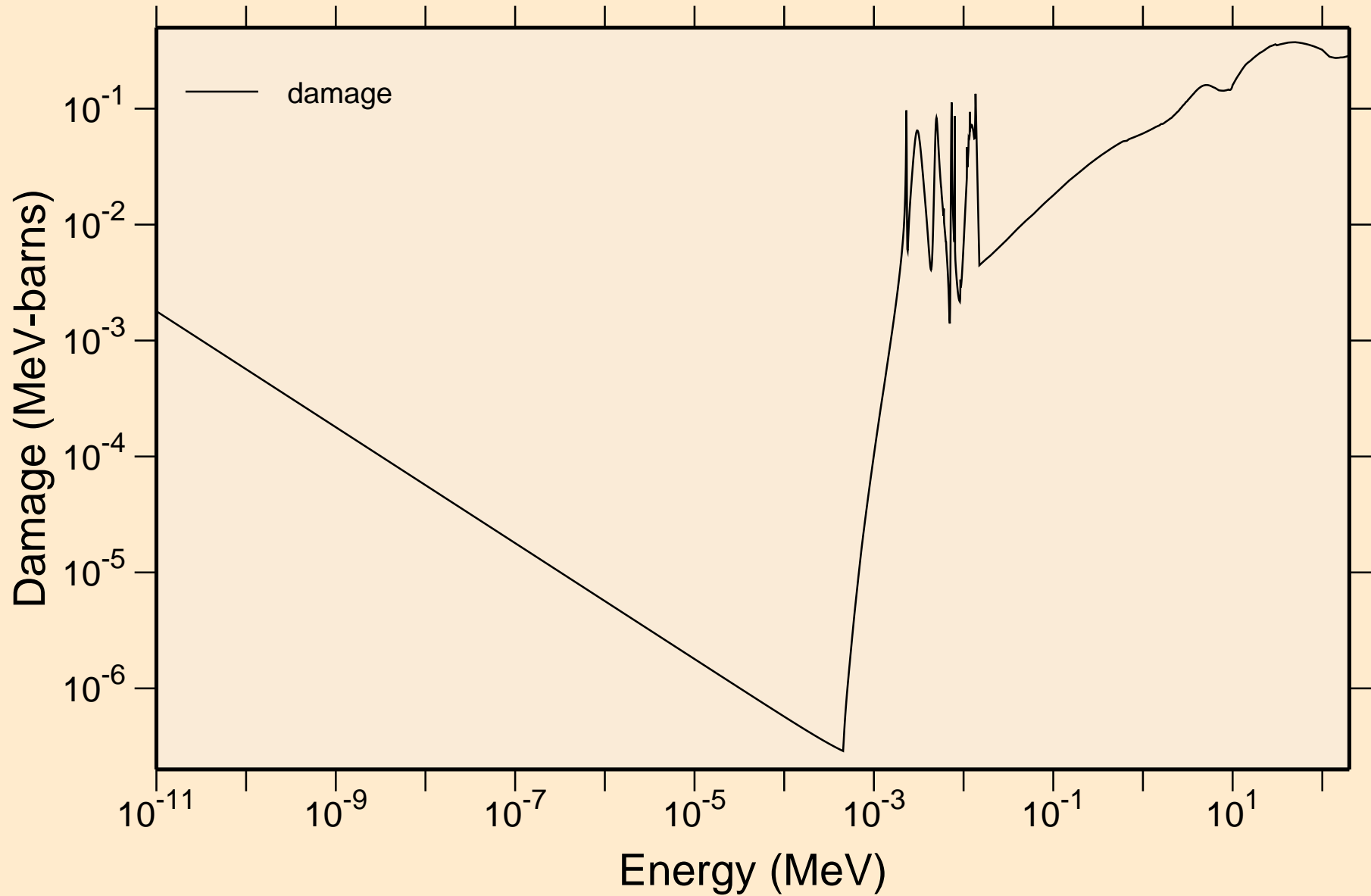

ZN072 NEUTRON ACER TENDL-2024 LIBRARY; T=293.6K
Non-threshold reactions

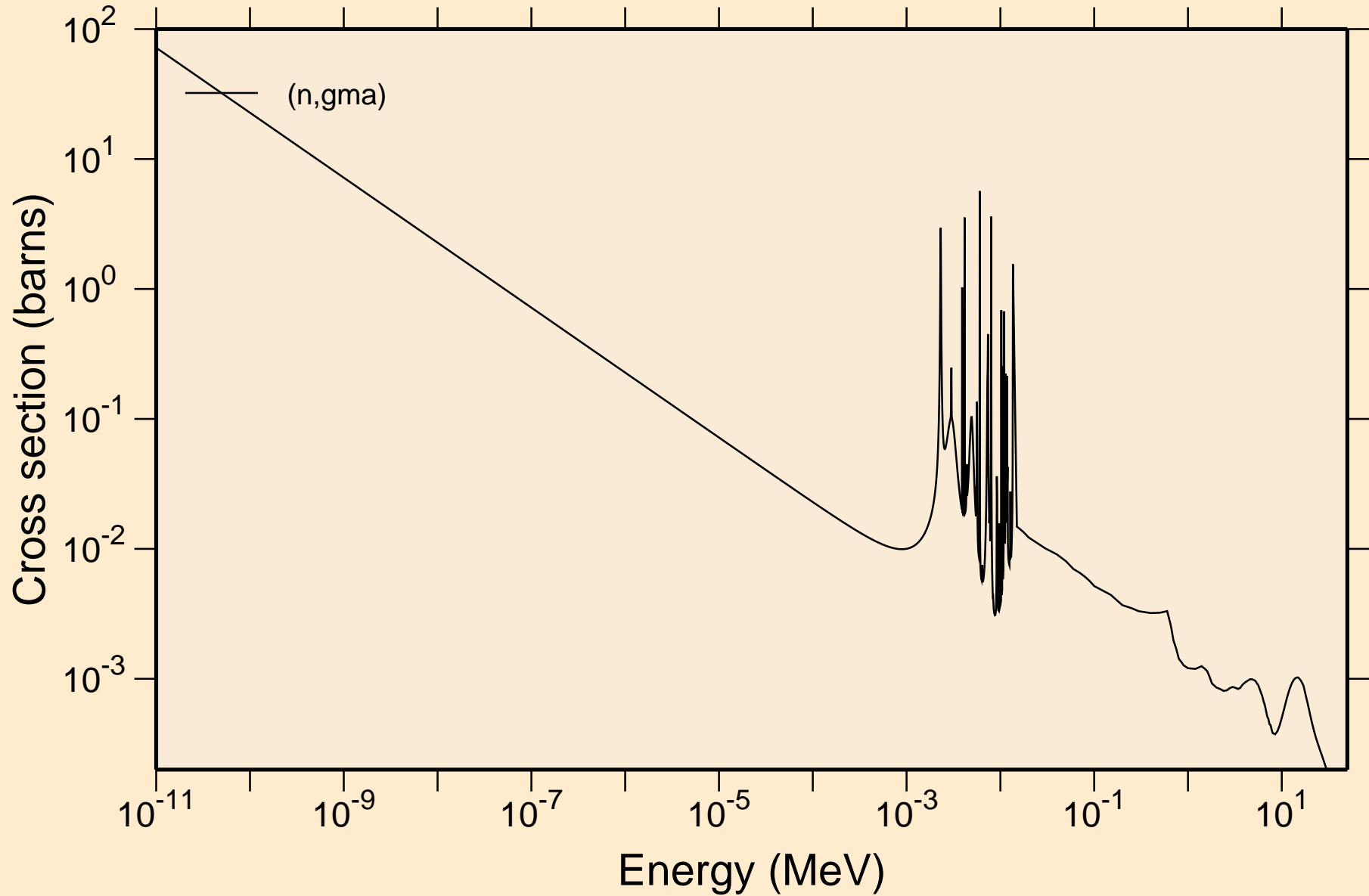

ZN072 NEUTRON ACER TENDL-2024 LIBRARY; T=293.6K
Principal cross sections

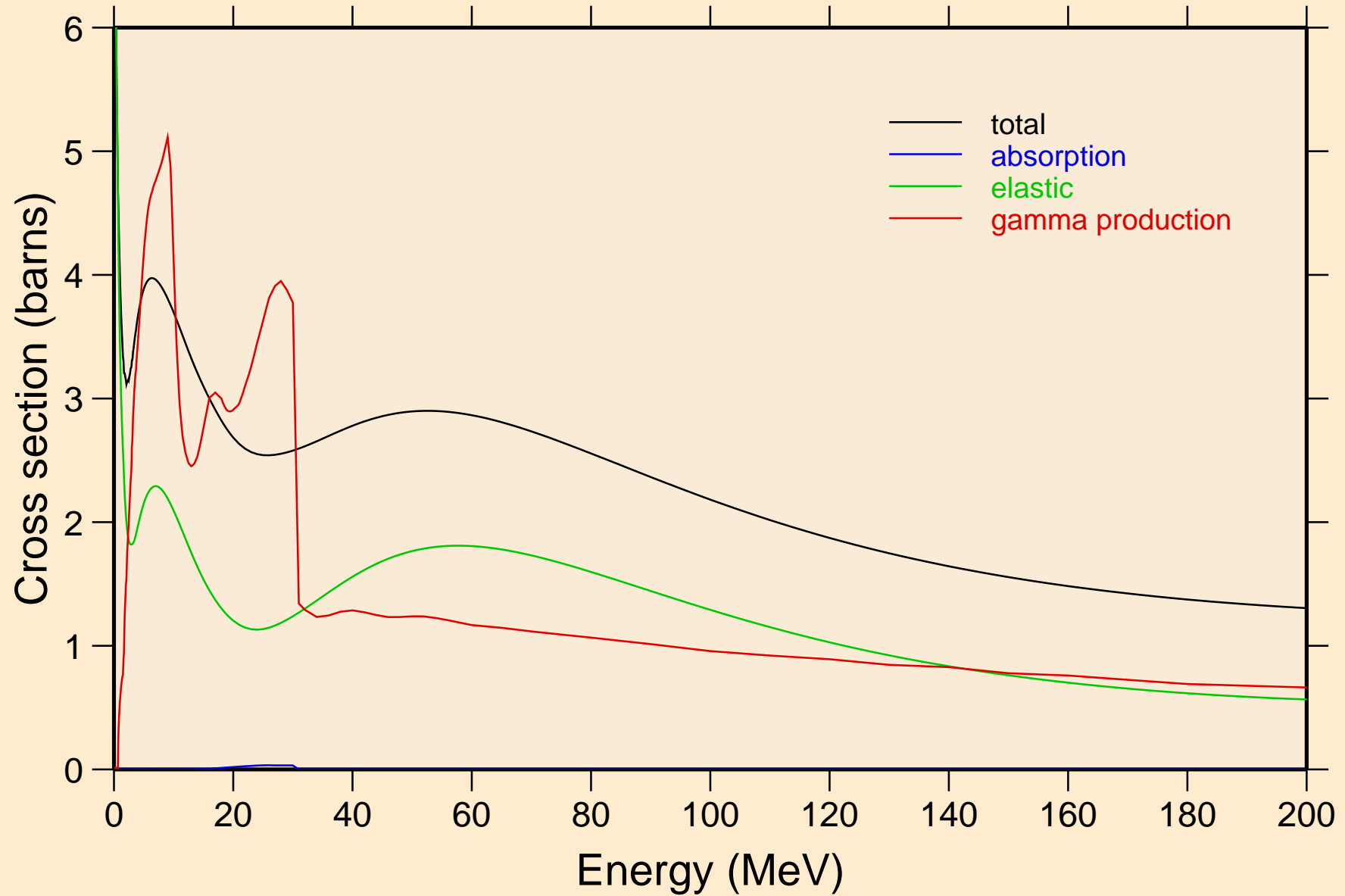

ZN072 NEUTRON ACER TENDL-2024 LIBRARY; T=293.6K

Heating

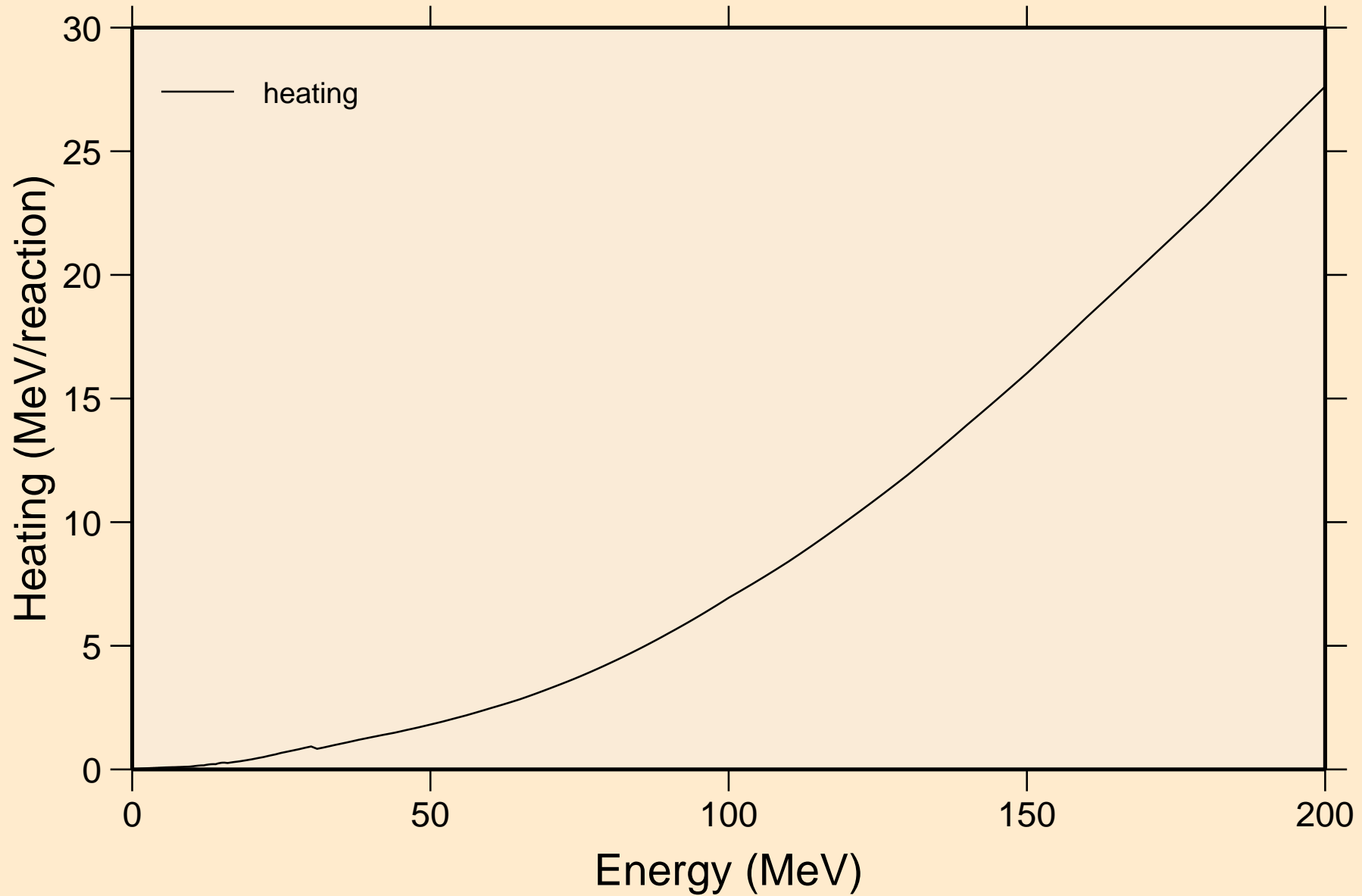

ZN072 NEUTRON ACER TENDL-2024 LIBRARY; T=293.6K
Damage

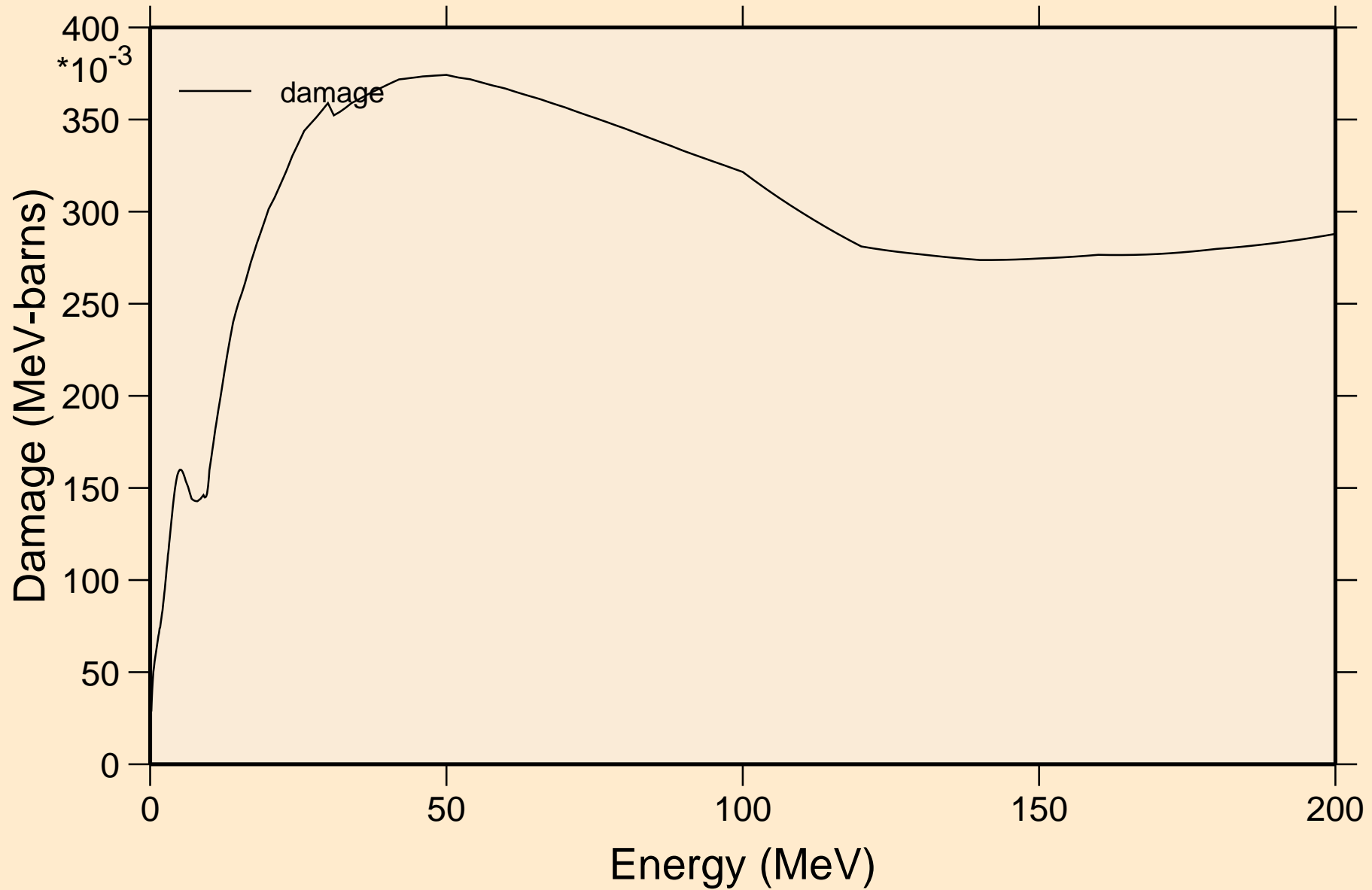

ZN072 NEUTRON ACER TENDL-2024 LIBRARY; T=293.6K
Non-threshold reactions

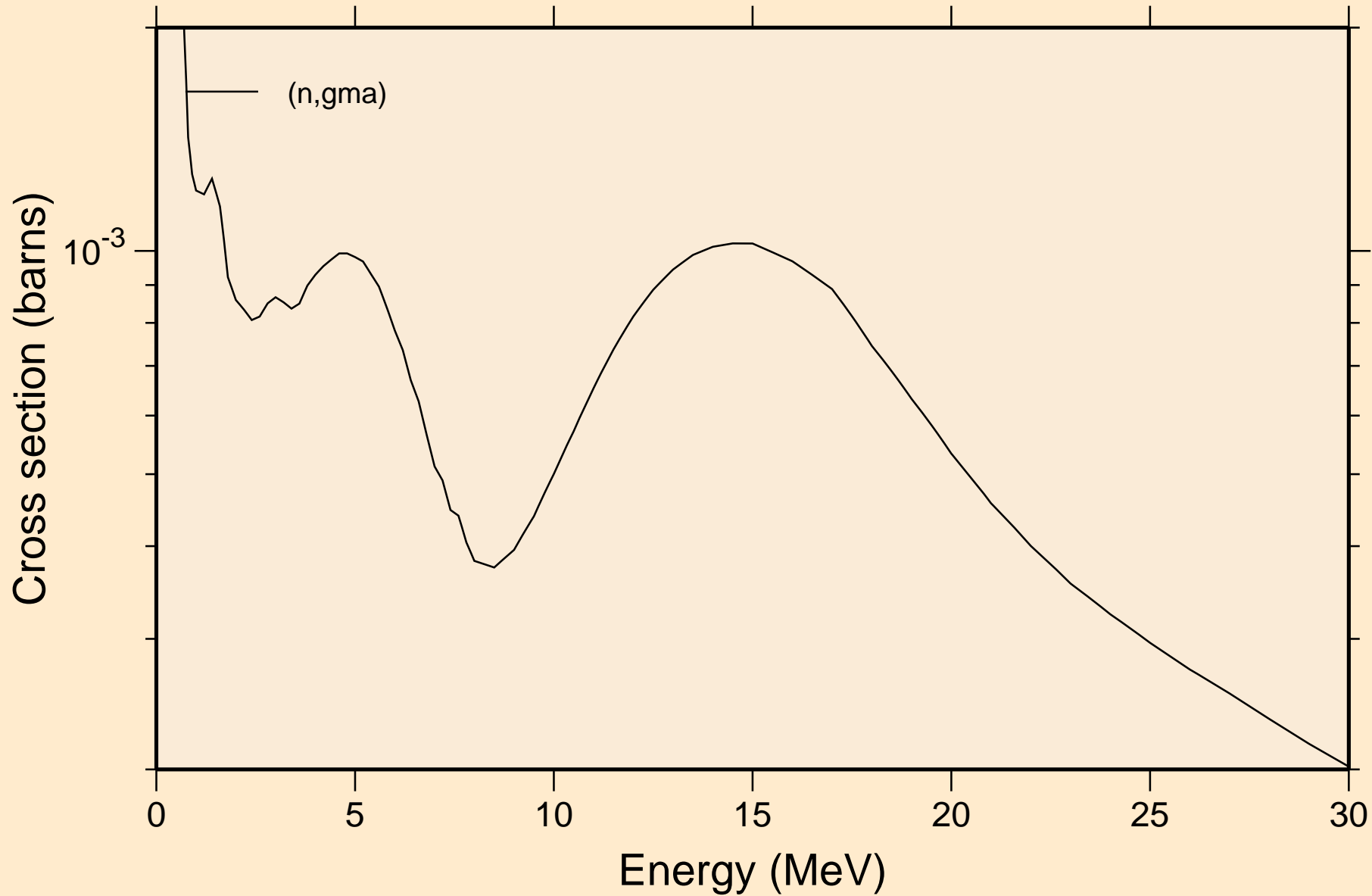

ZN072 NEUTRON ACER TENDL-2024 LIBRARY; T=293.6K
Inelastic levels

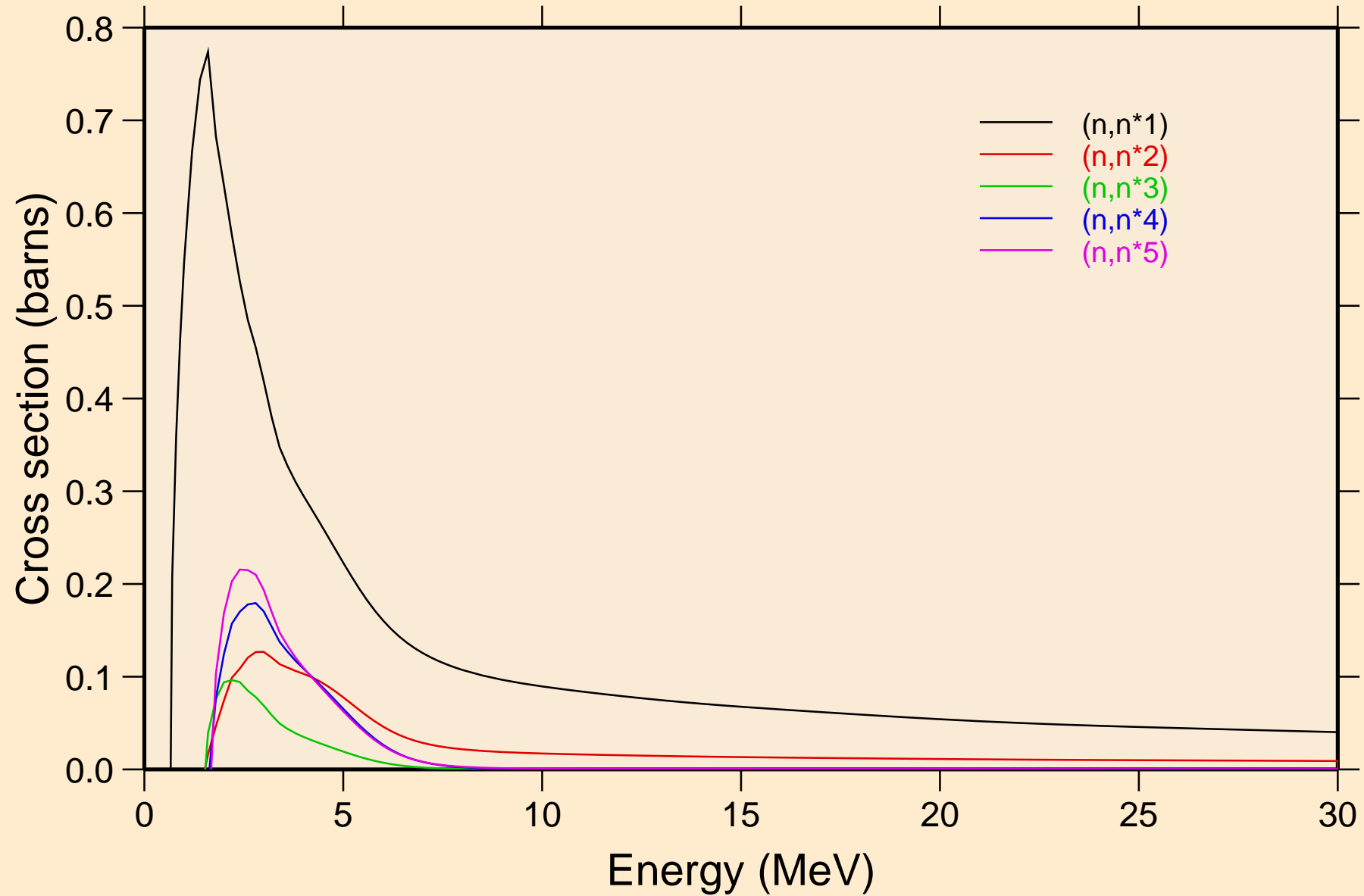

ZN072 NEUTRON ACER TENDL-2024 LIBRARY; T=293.6K
Inelastic levels

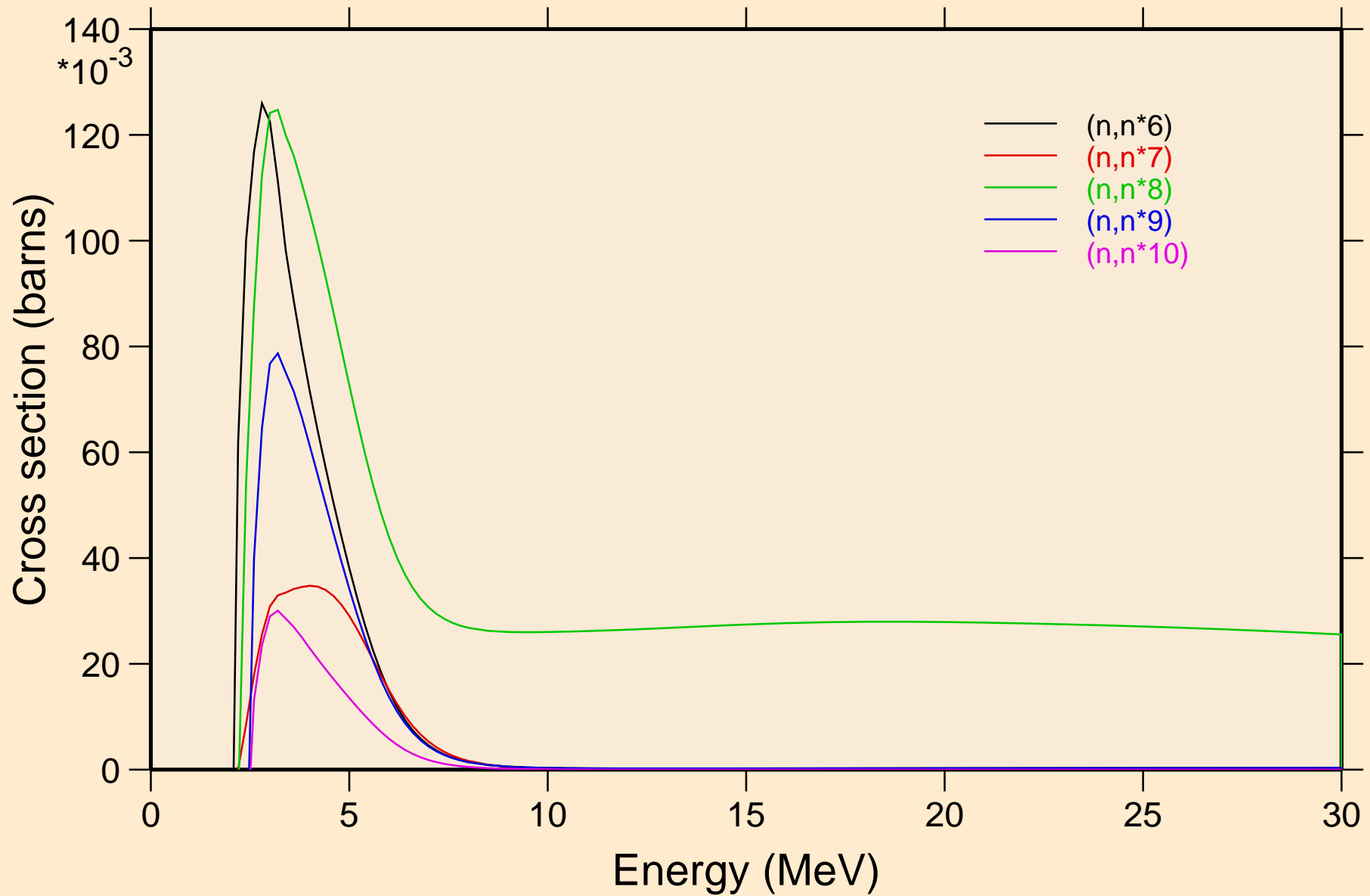

ZN072 NEUTRON ACER TENDL-2024 LIBRARY; T=293.6K
Inelastic levels

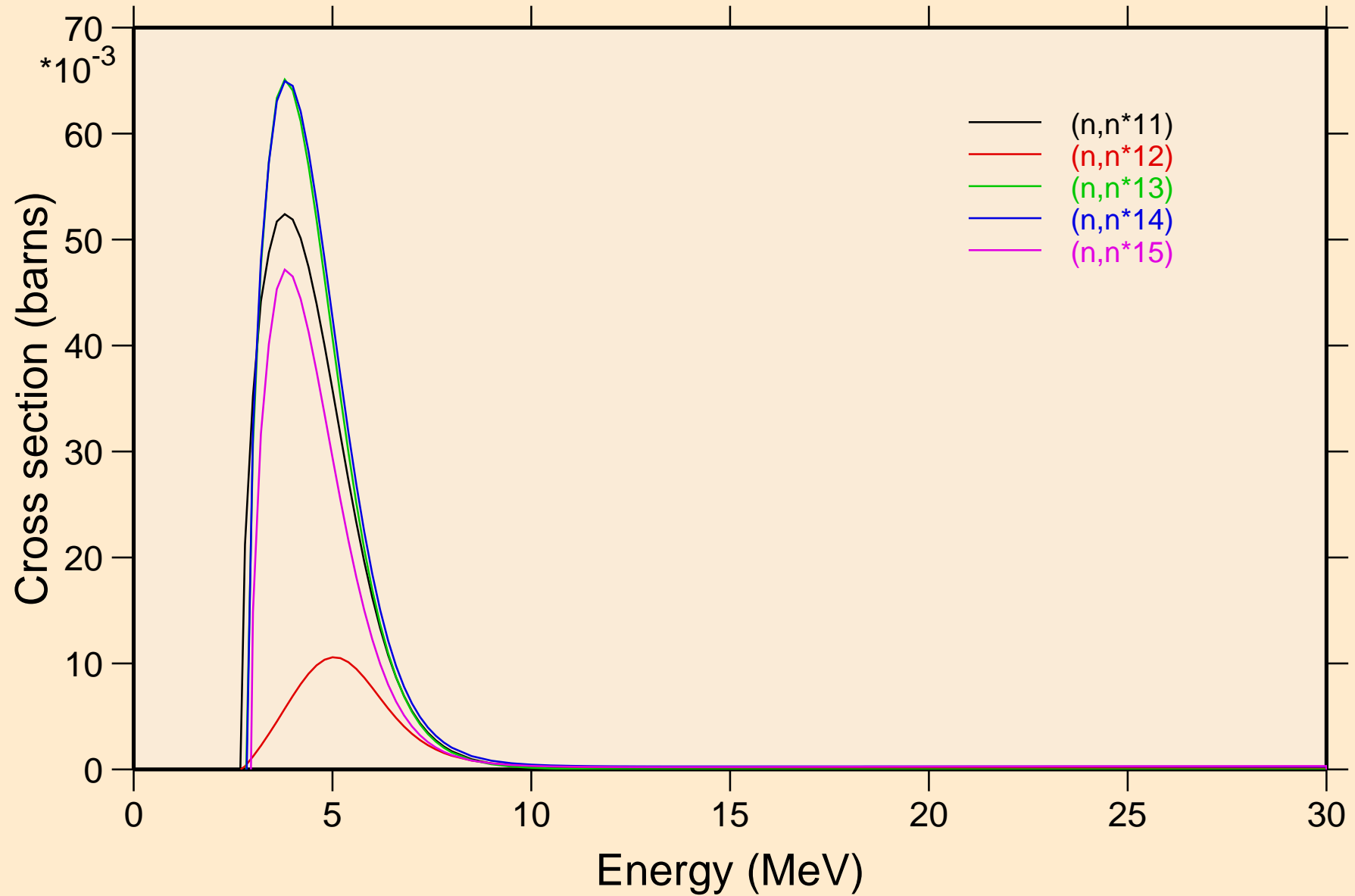

ZN072 NEUTRON ACER TENDL-2024 LIBRARY; T=293.6K
Inelastic levels

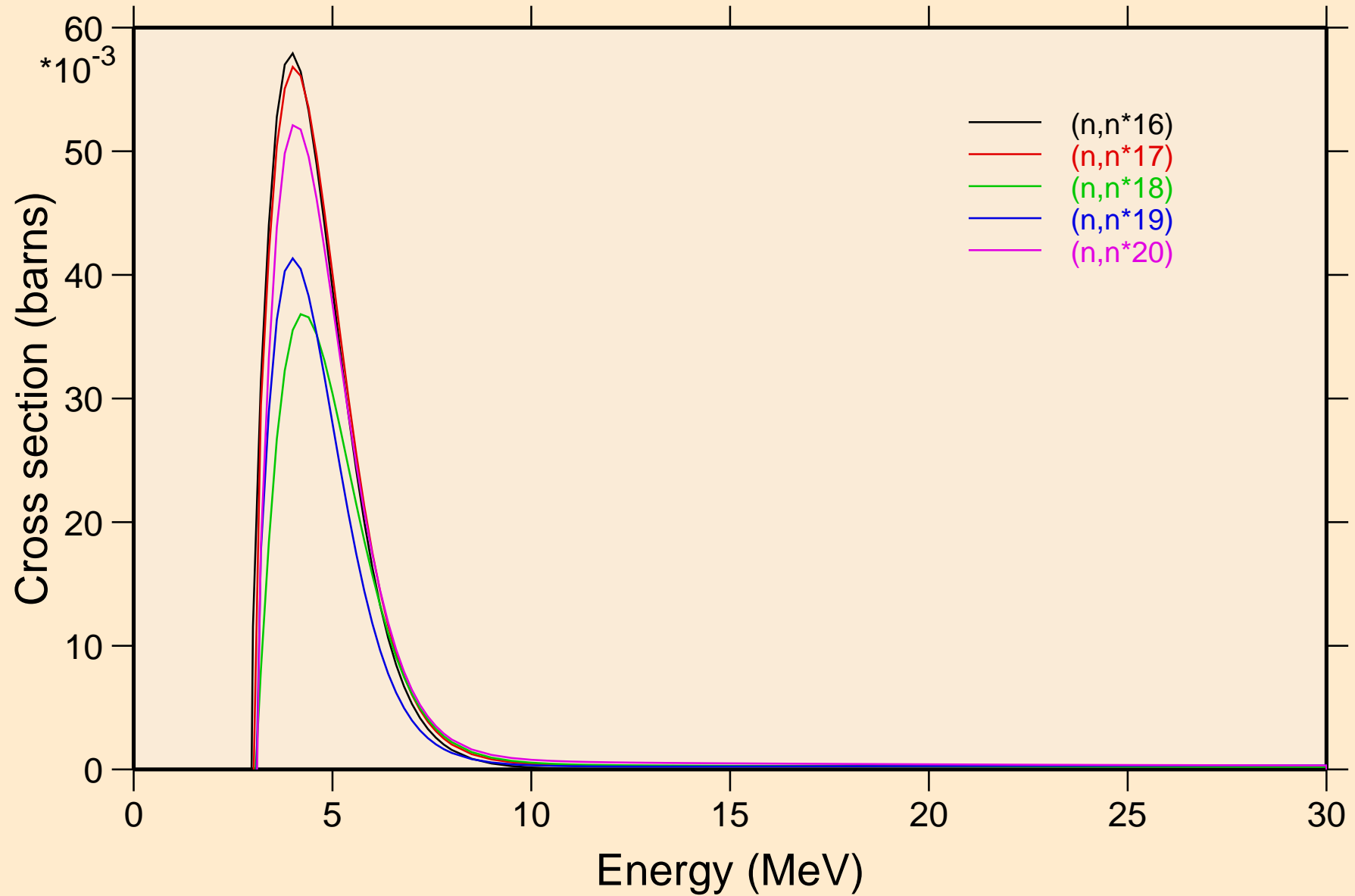

ZN072 NEUTRON ACER TENDL-2024 LIBRARY; T=293.6K
Inelastic levels

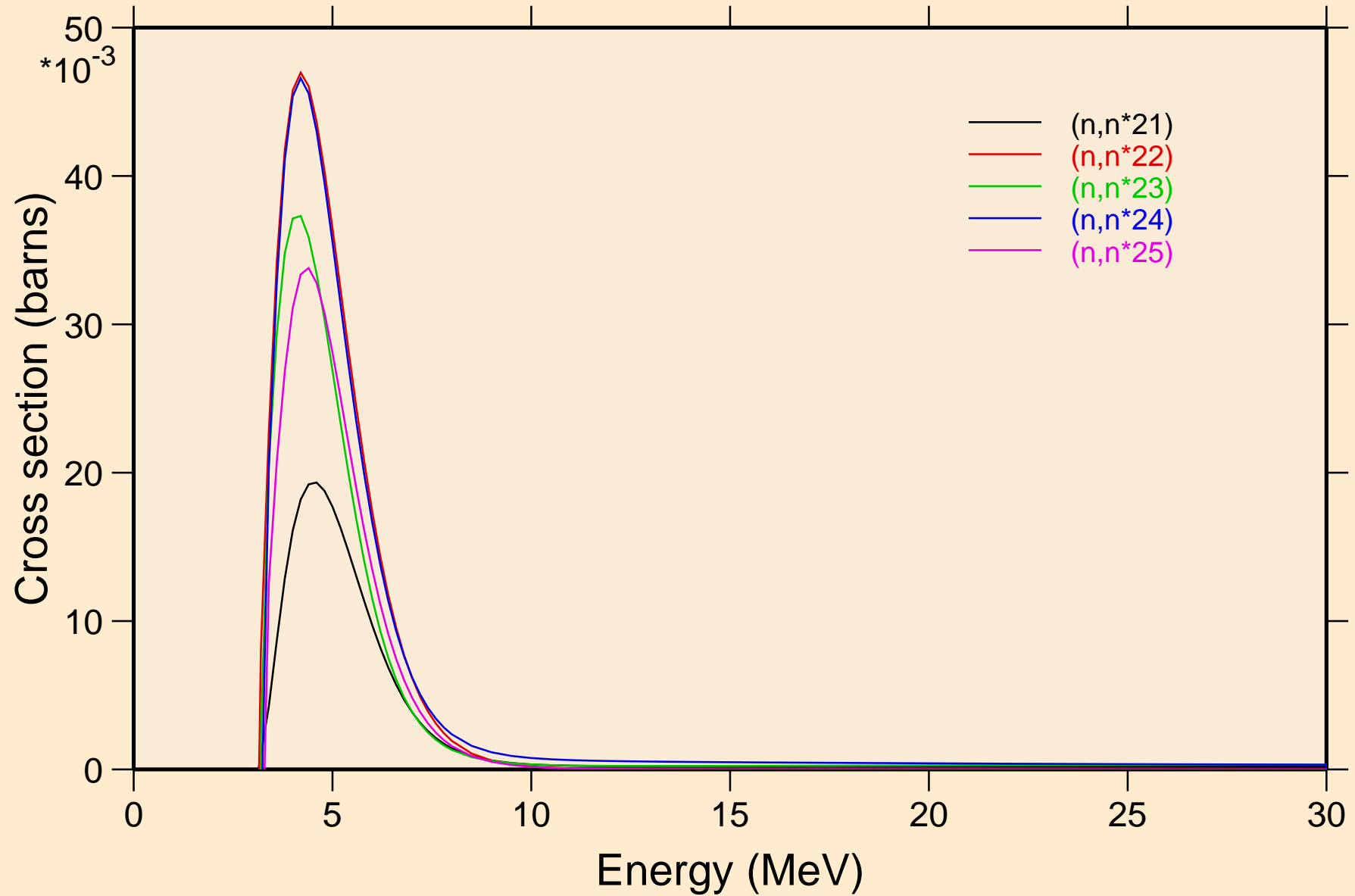

ZN072 NEUTRON ACER TENDL-2024 LIBRARY; T=293.6K
Inelastic levels

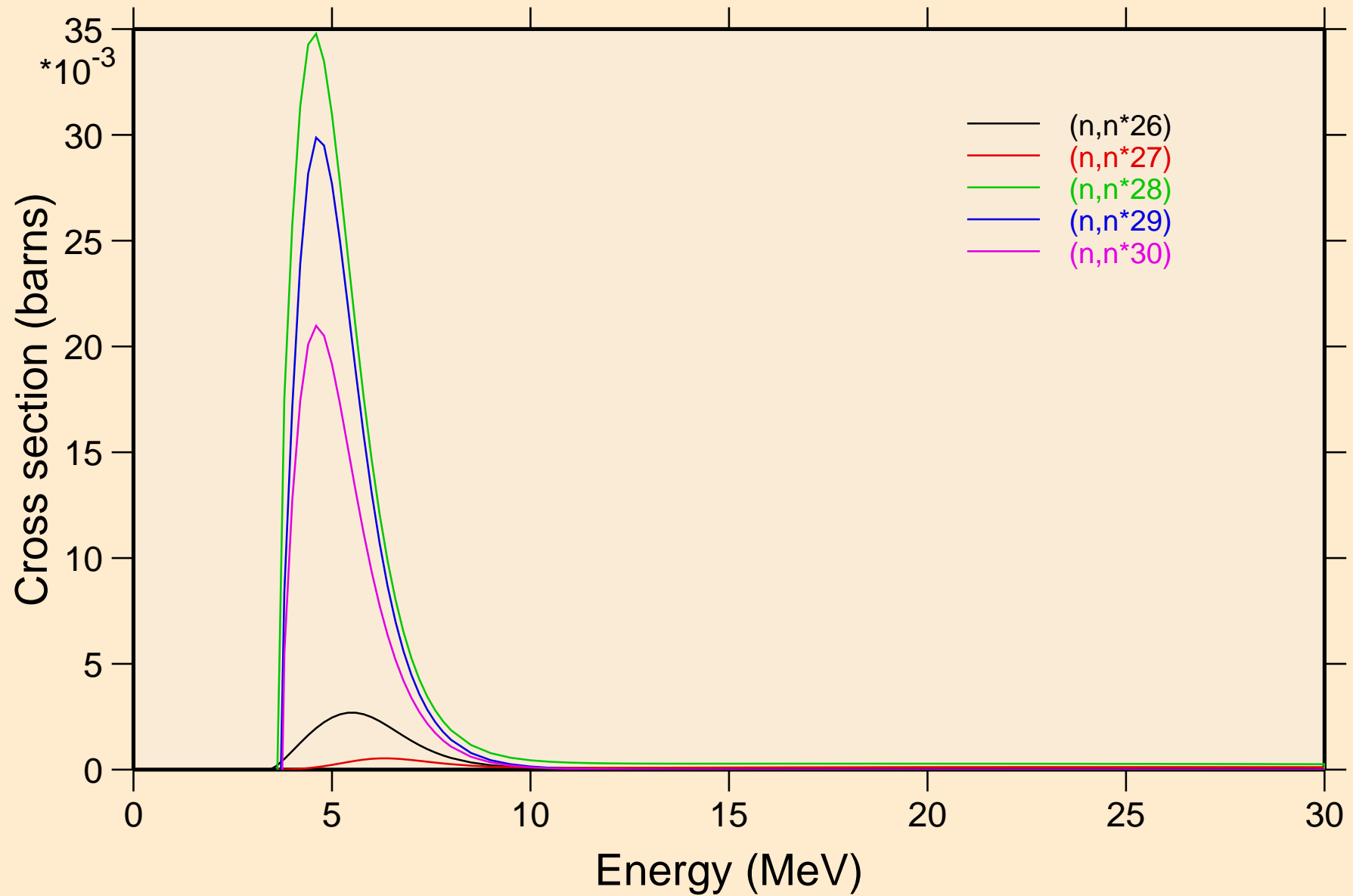

ZN072 NEUTRON ACER TENDL-2024 LIBRARY; T=293.6K
Threshold reactions

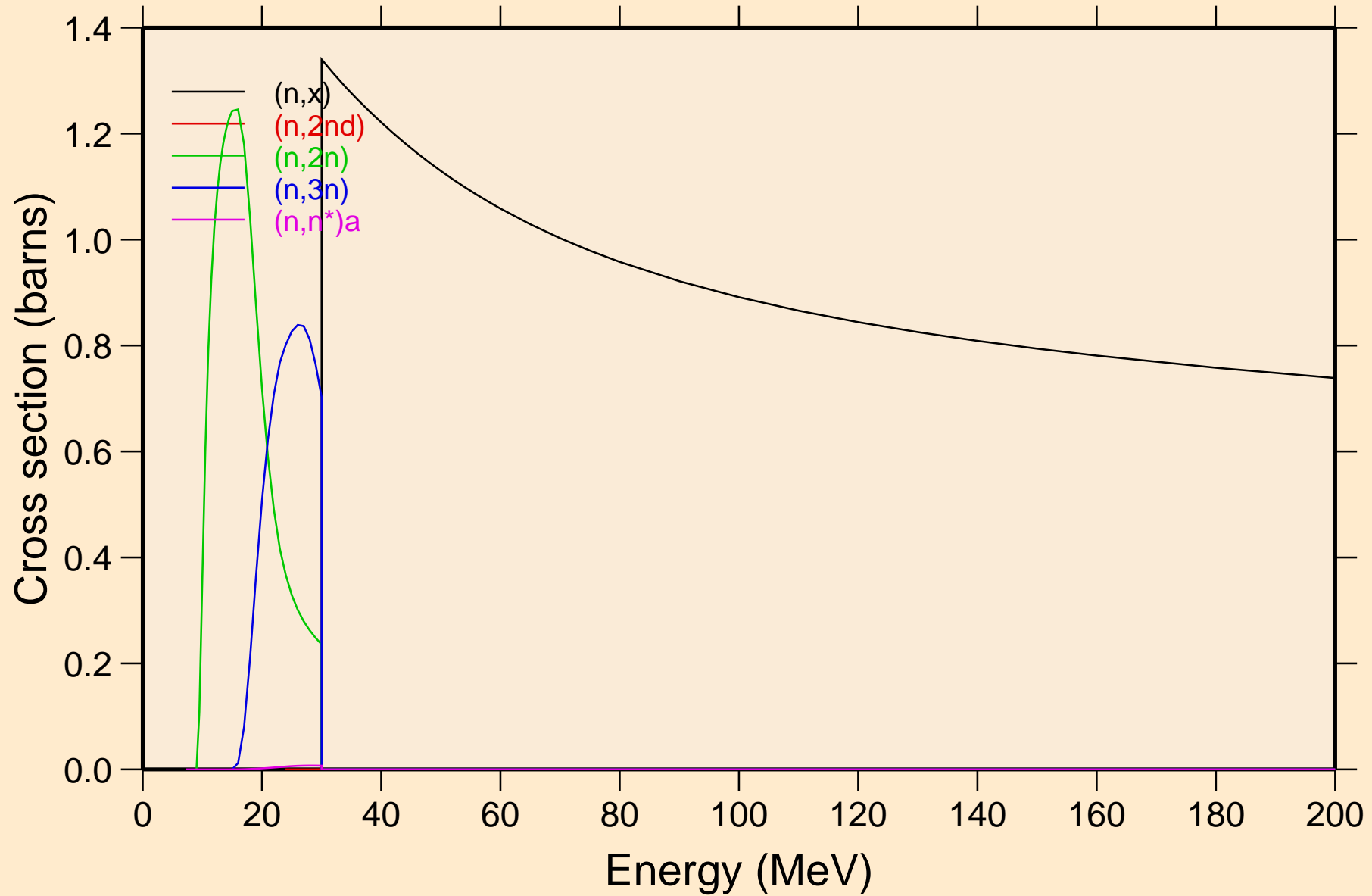

ZN072 NEUTRON ACER TENDL-2024 LIBRARY; T=293.6K
Threshold reactions

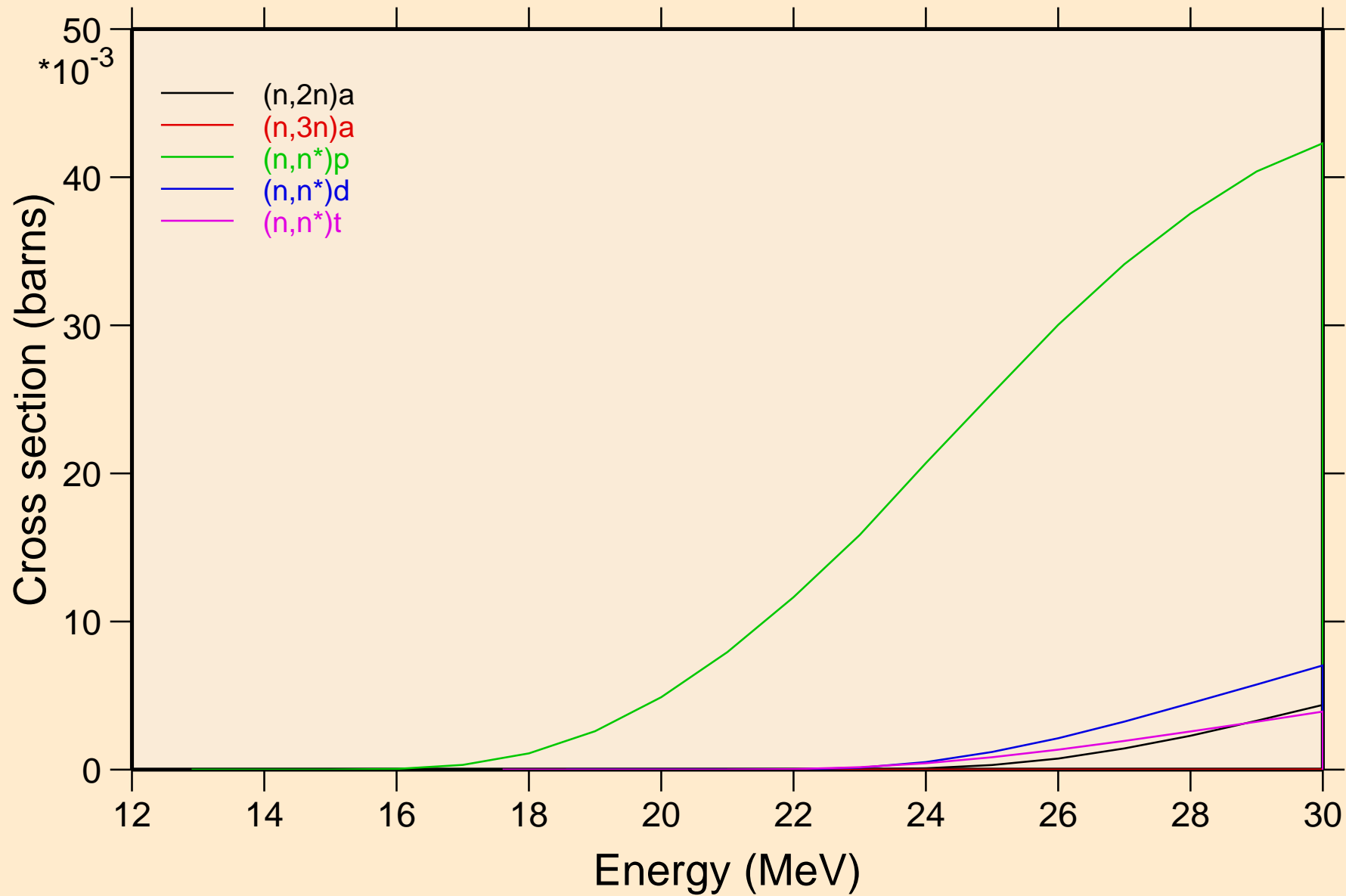

ZN072 NEUTRON ACER TENDL-2024 LIBRARY; T=293.6K
Threshold reactions

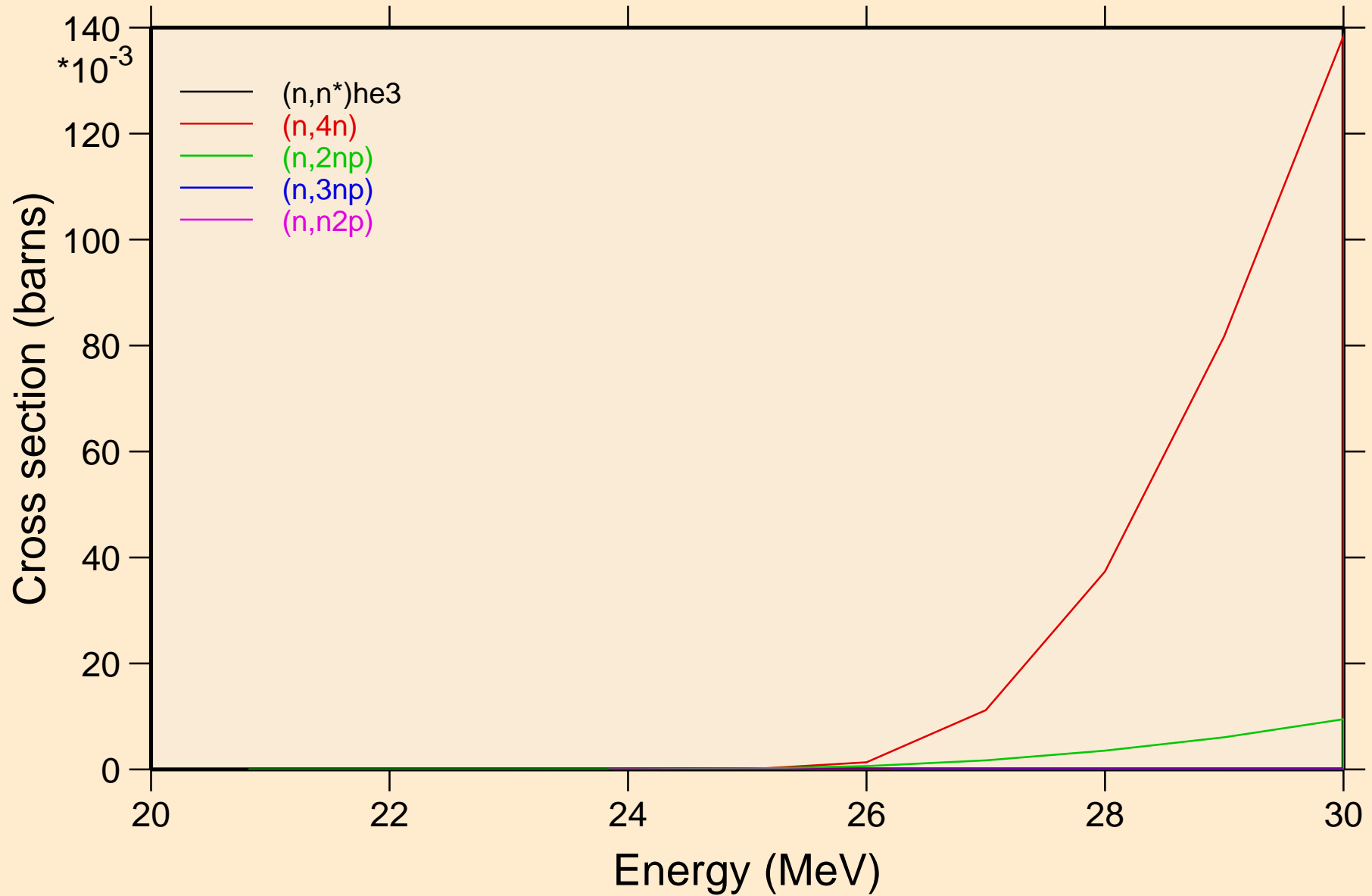

ZN072 NEUTRON ACER TENDL-2024 LIBRARY; T=293.6K
Threshold reactions

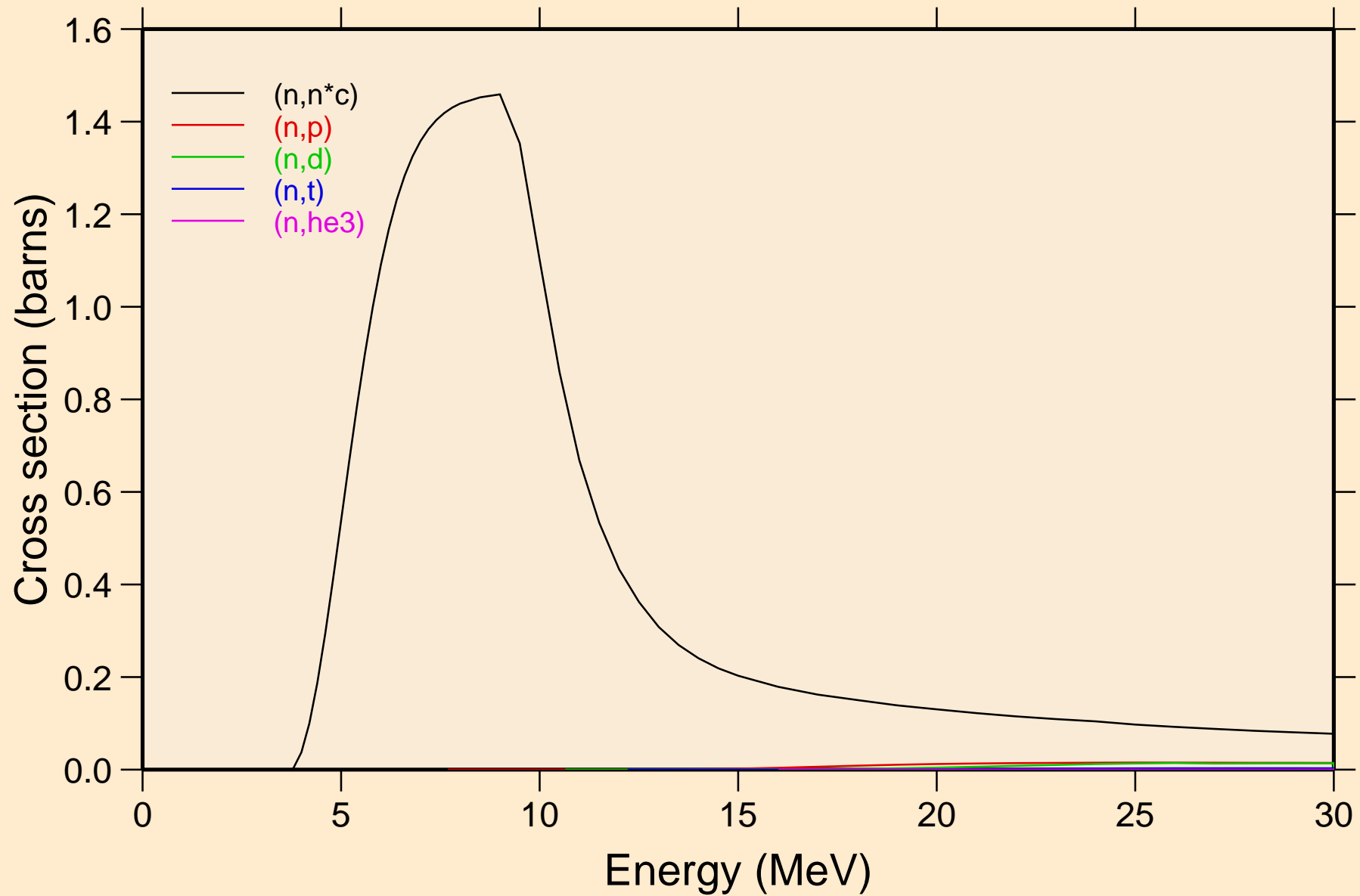

ZN072 NEUTRON ACER TENDL-2024 LIBRARY; T=293.6K
Threshold reactions

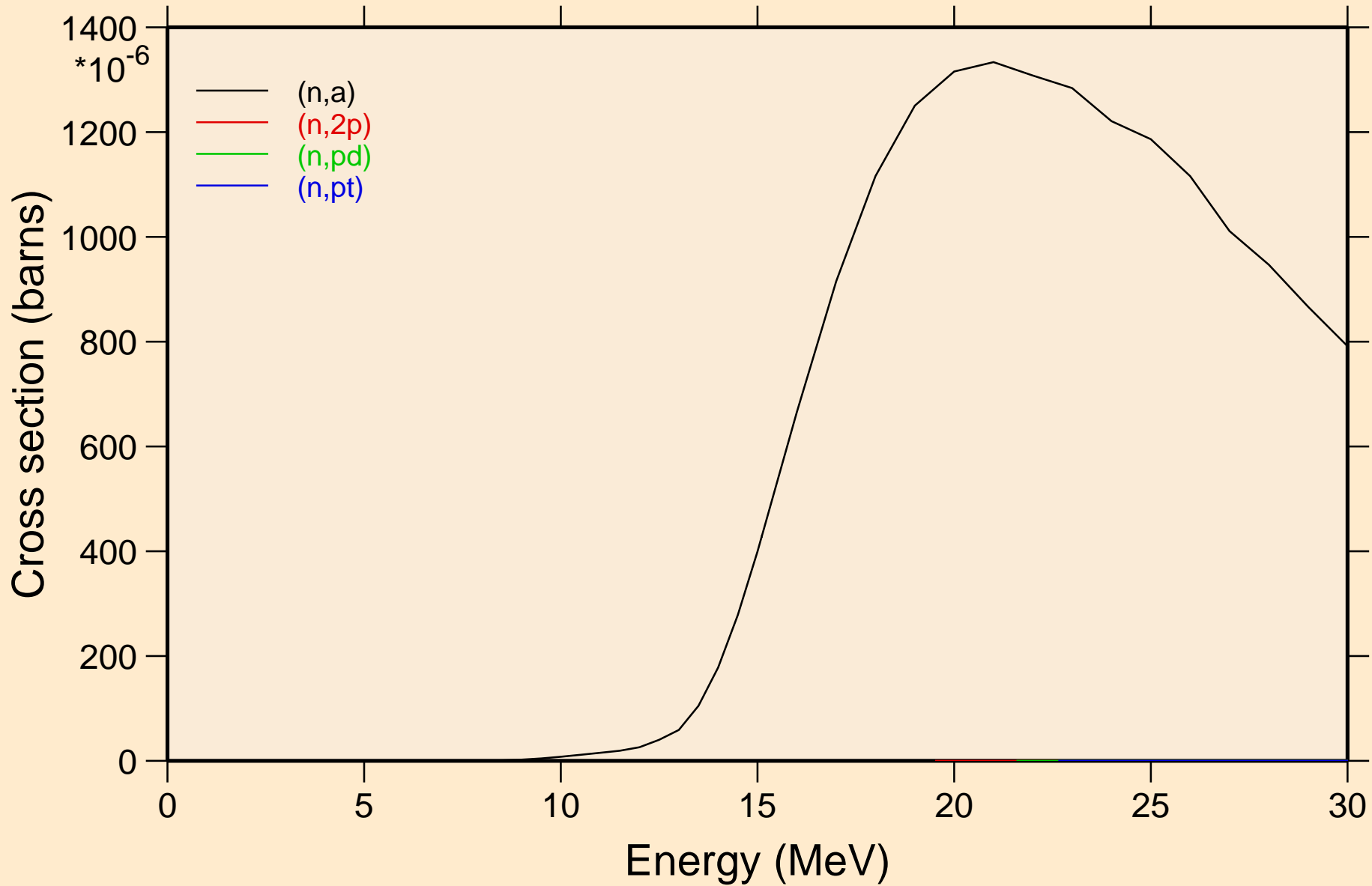

ZN072 NEUTRON ACER TENDL-2024 LIBRARY; T=293.6K
Threshold reactions

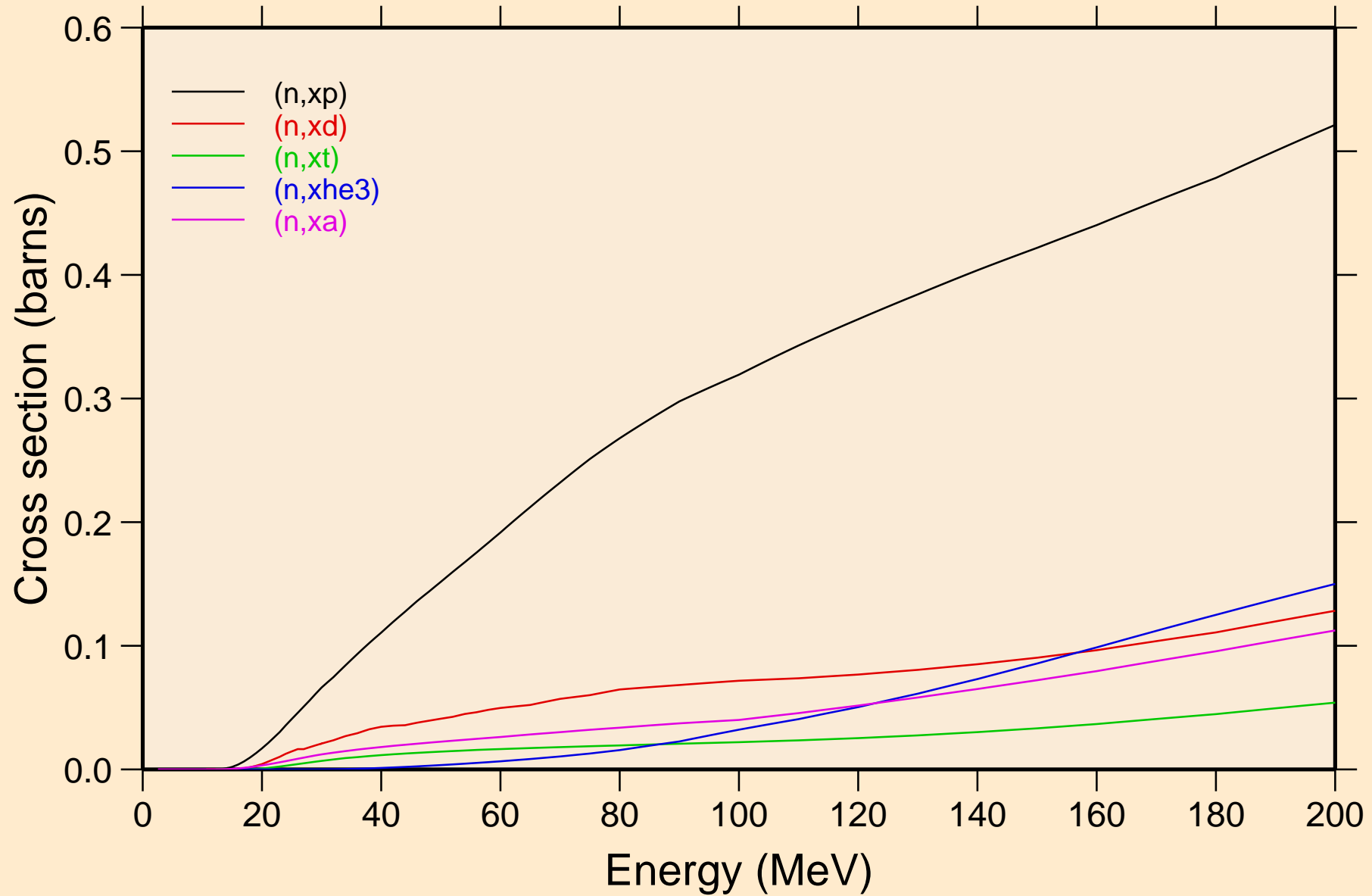

ZN072 NEUTRON ACER TENDL-2024 LIBRARY; T=293.6K
angular distribution for elastic

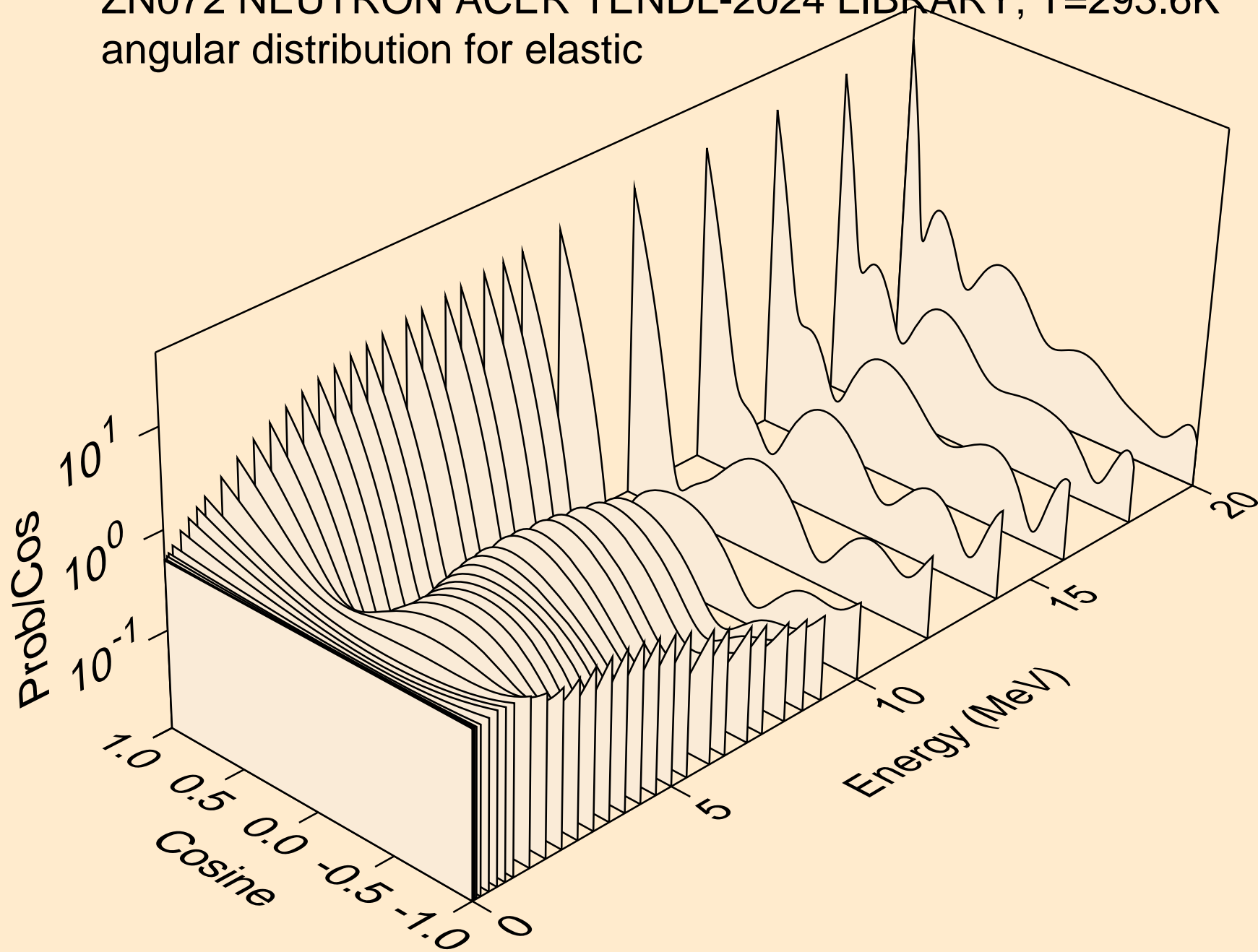

ZN072 NEUTRON ACER TENDL-2024 LIBRARY; T=293.6K
angular distribution for elastic

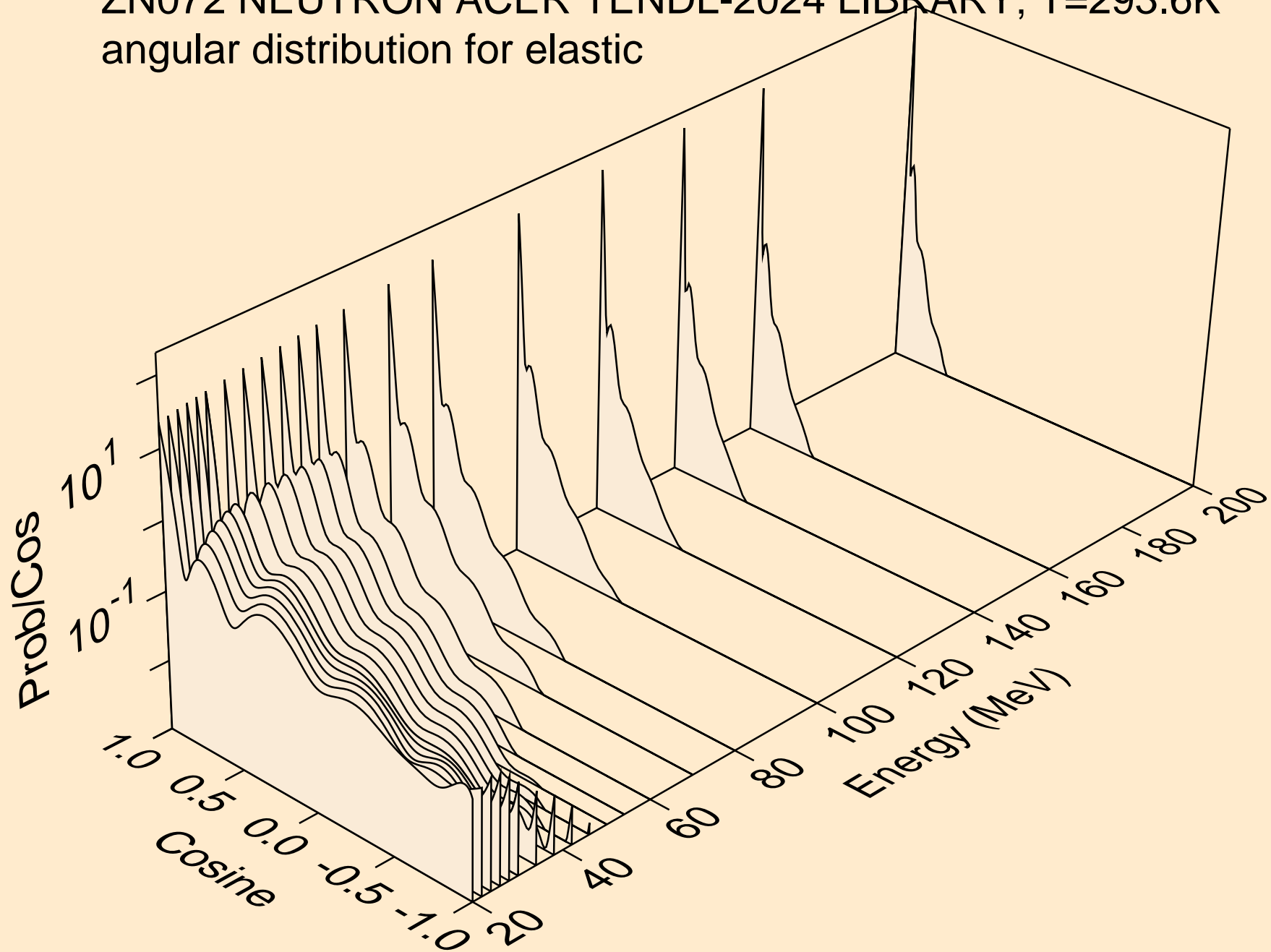

ZN072 NEUTRON ACER TENDL-2024 LIBRARY; T=293.6K
angular distribution for (n,n*1)

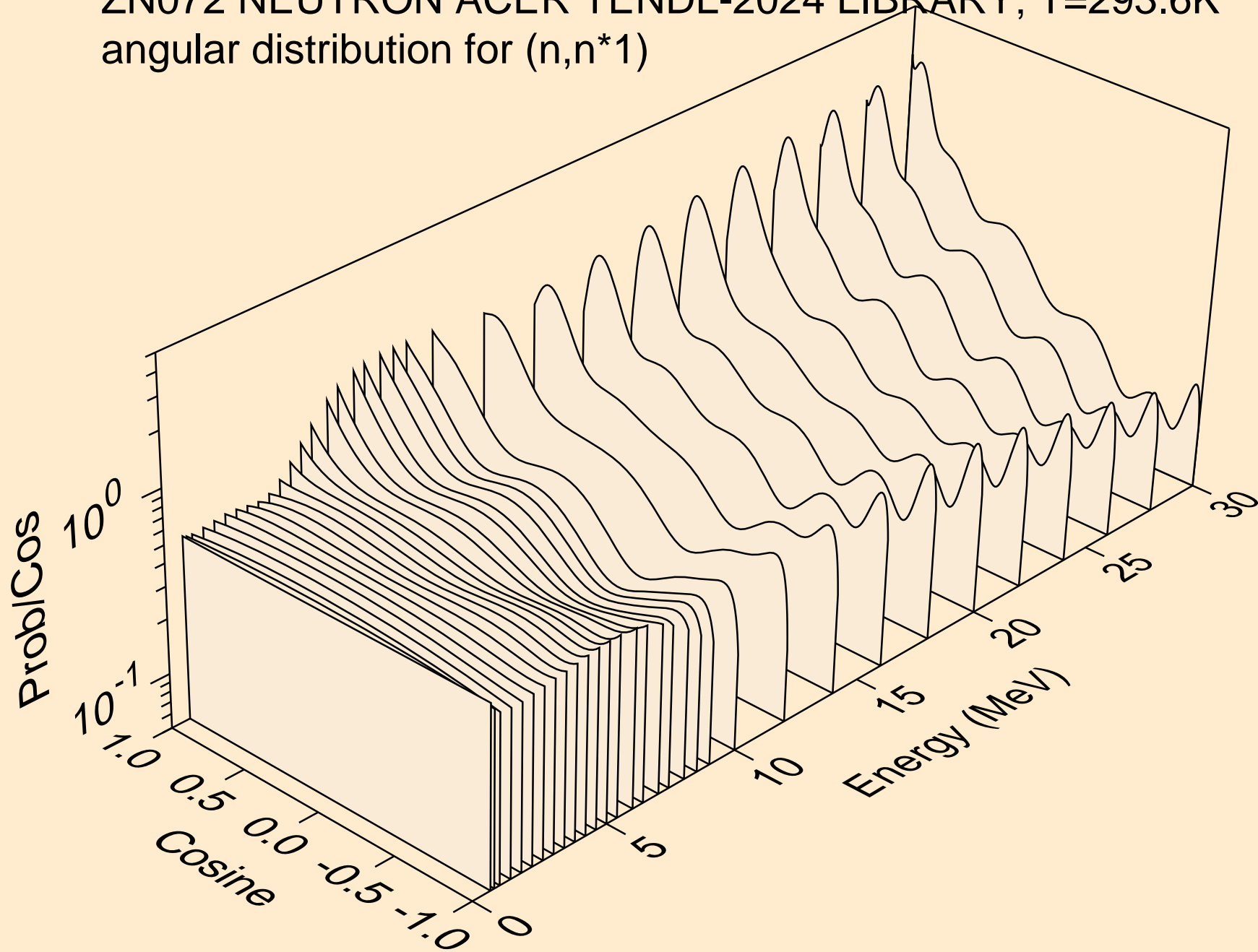

ZN072 NEUTRON ACER TENDL-2024 LIBRARY; T=293.6K
angular distribution for (n,n*2)

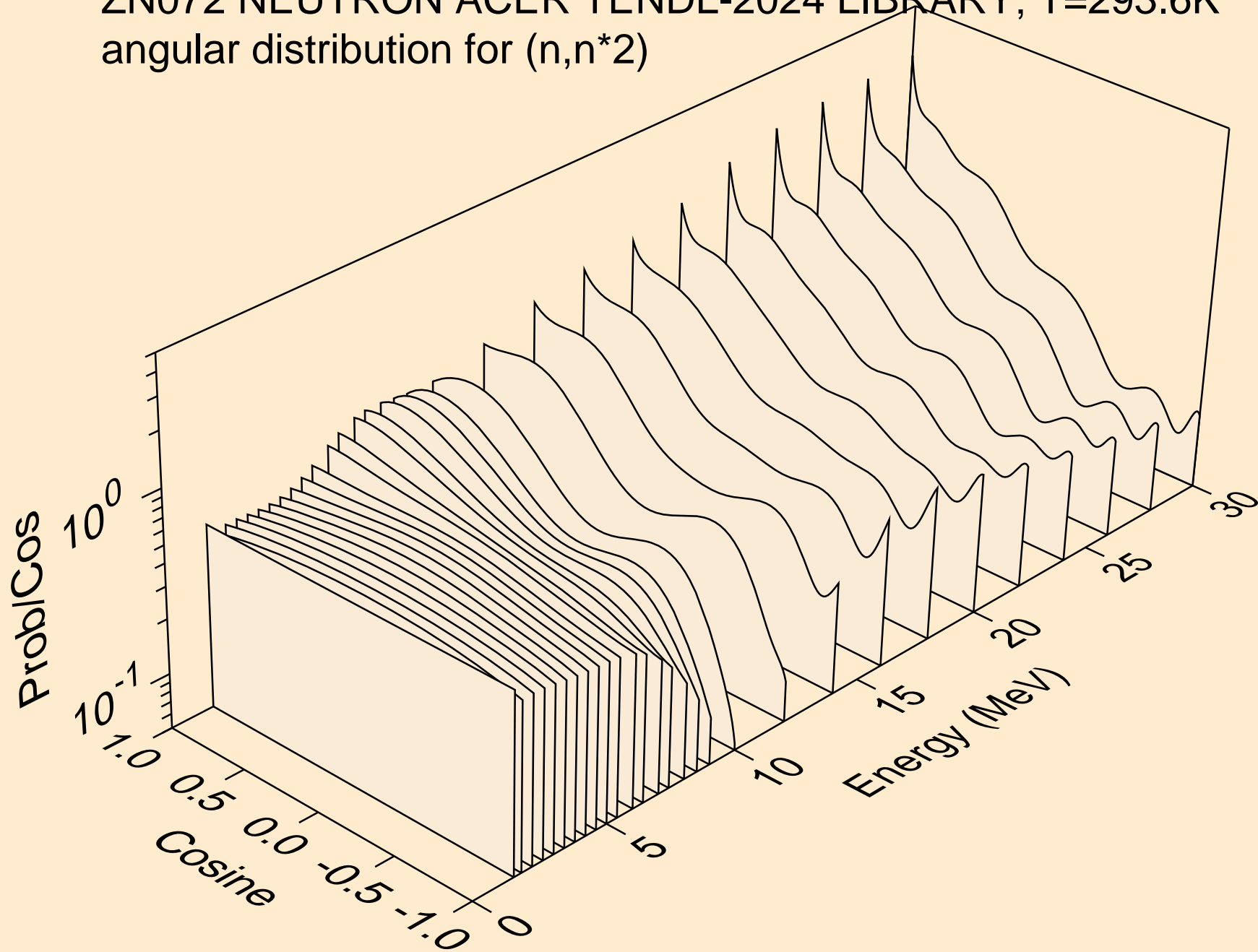

ZN072 NEUTRON ACER TENDL-2024 LIBRARY; T=293.6K
angular distribution for (n,n*3)

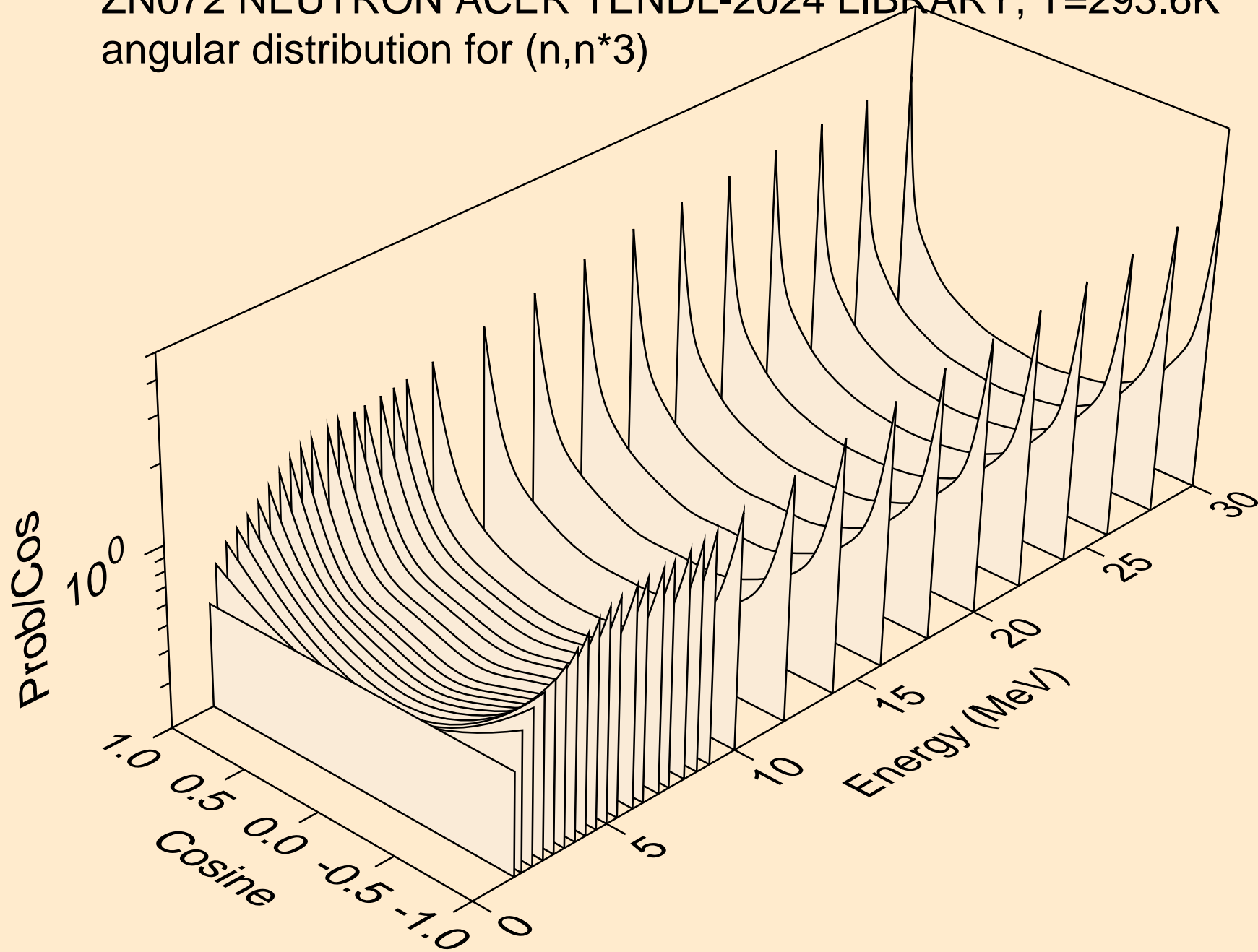

ZN072 NEUTRON ACER TENDL-2024 LIBRARY; T=293.6K
angular distribution for (n,n*4)

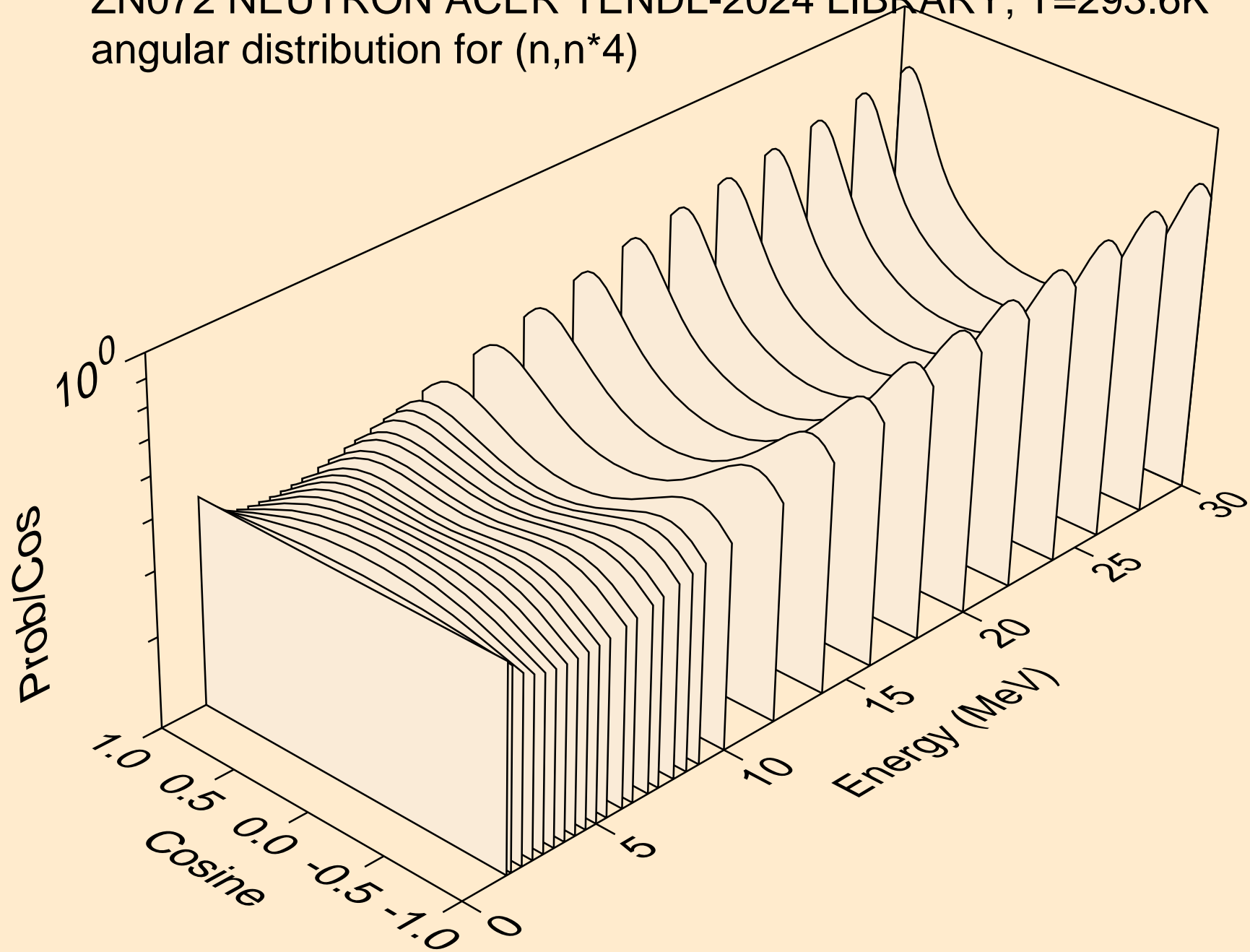

ZN072 NEUTRON ACER TENDL-2024 LIBRARY; T=293.6K
angular distribution for (n,n*5)

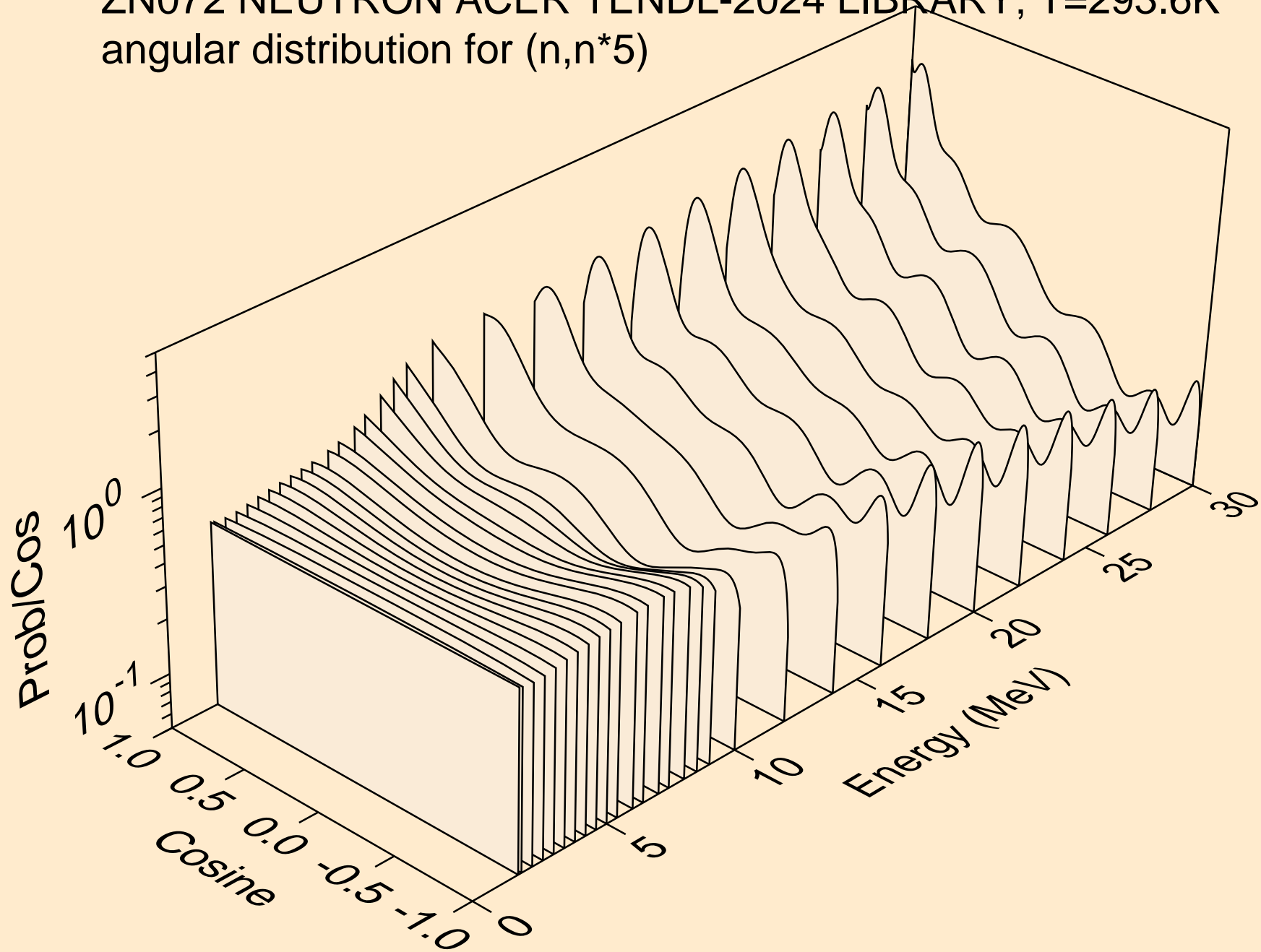

ZN072 NEUTRON ACER TENDL-2024 LIBRARY; T=293.6K
angular distribution for (n,n*6)

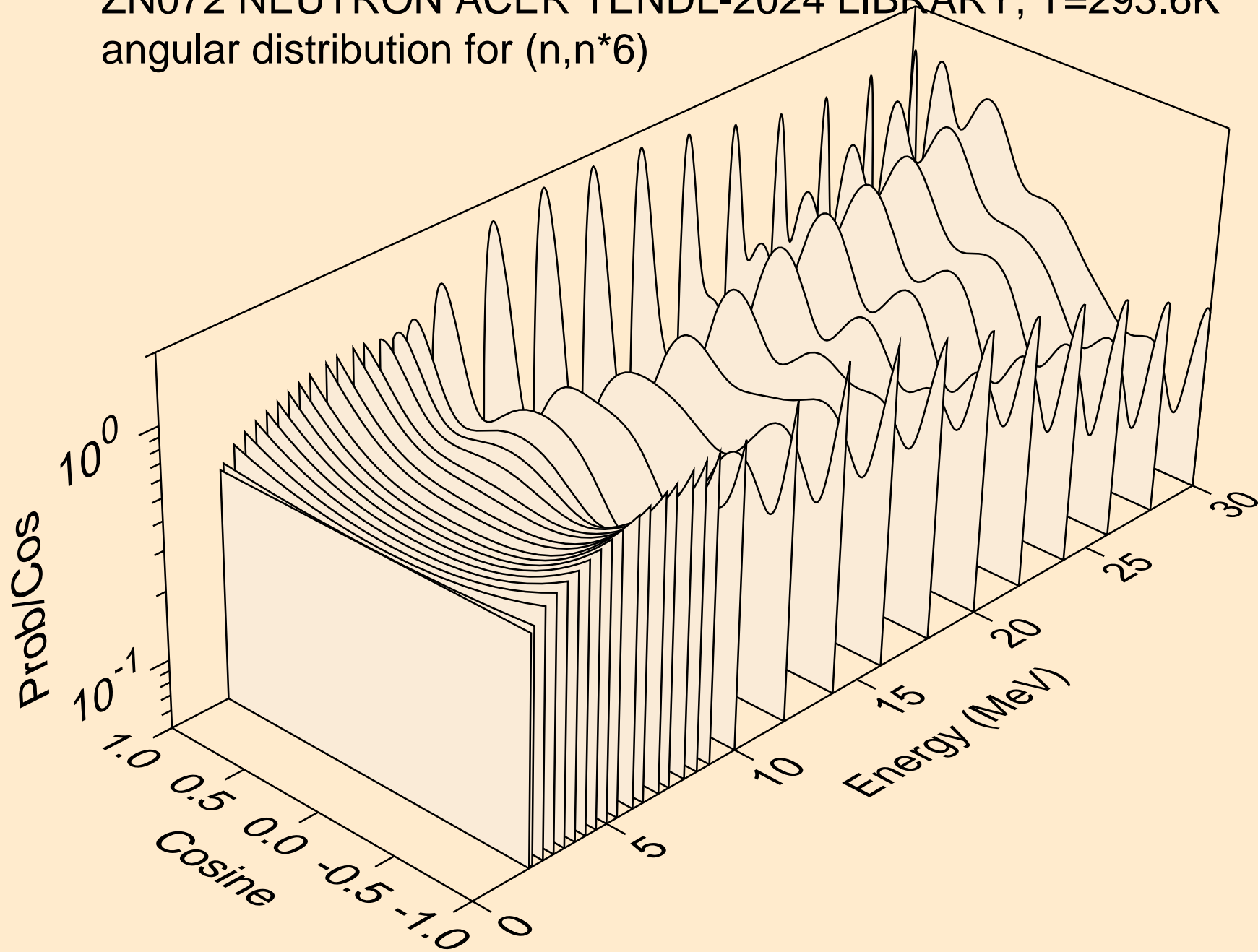

ZN072 NEUTRON ACER TENDL-2024 LIBRARY; T=293.6K
angular distribution for (n,n*7)

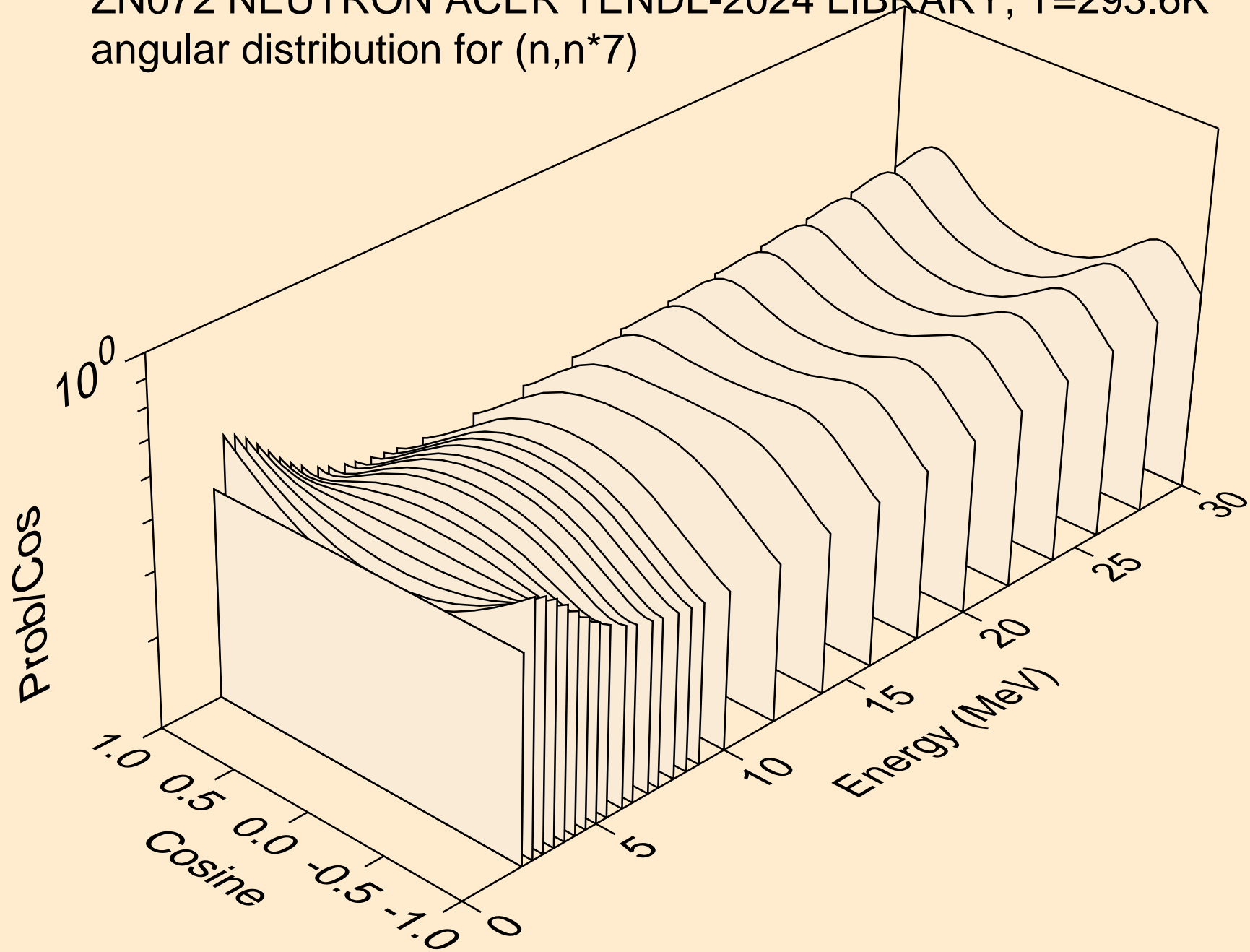

ZN072 NEUTRON ACER TENDL-2024 LIBRARY; T=293.6K
angular distribution for (n,n*8)

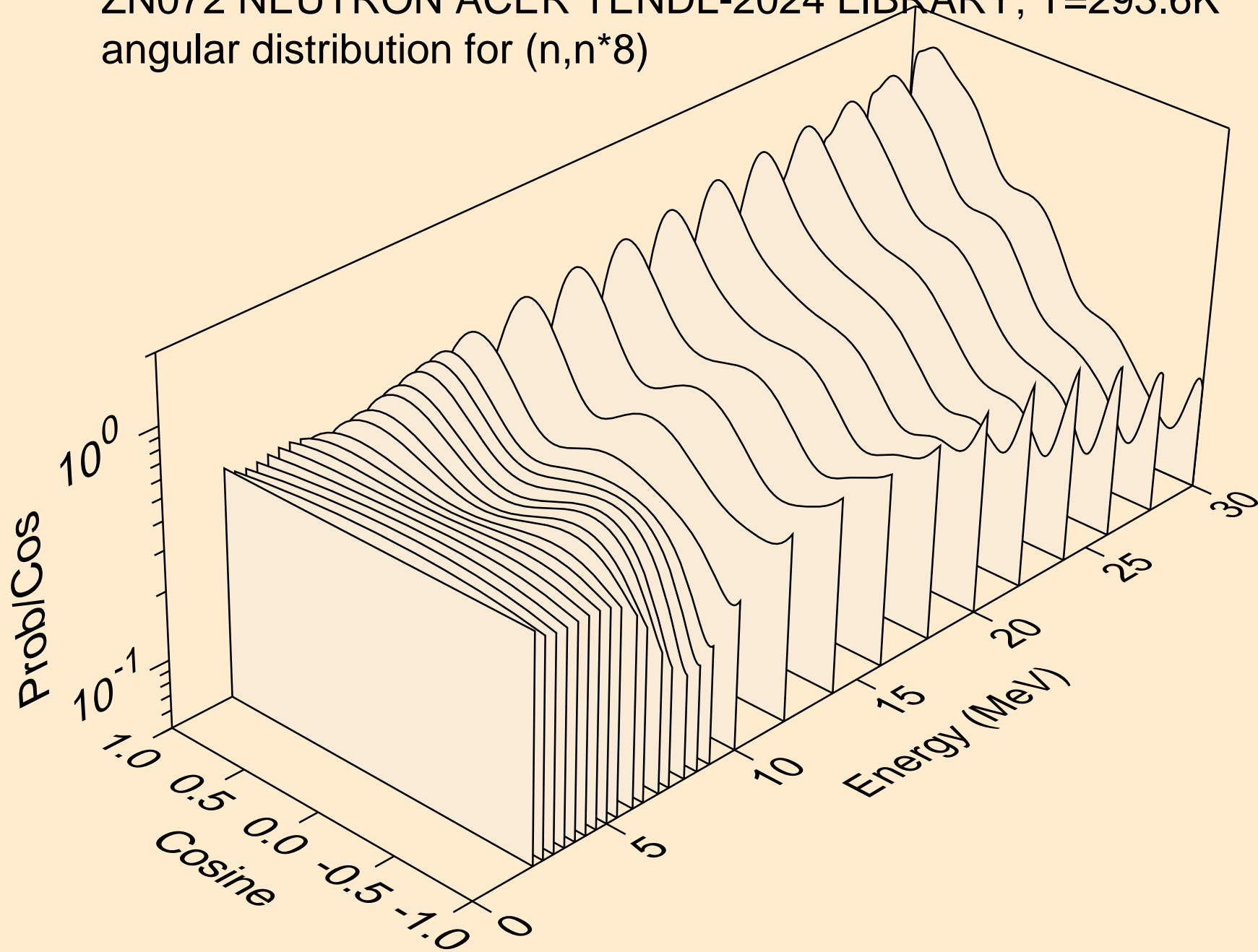

ZN072 NEUTRON ACER TENDL-2024 LIBRARY; T=293.6K
angular distribution for (n,n*9)

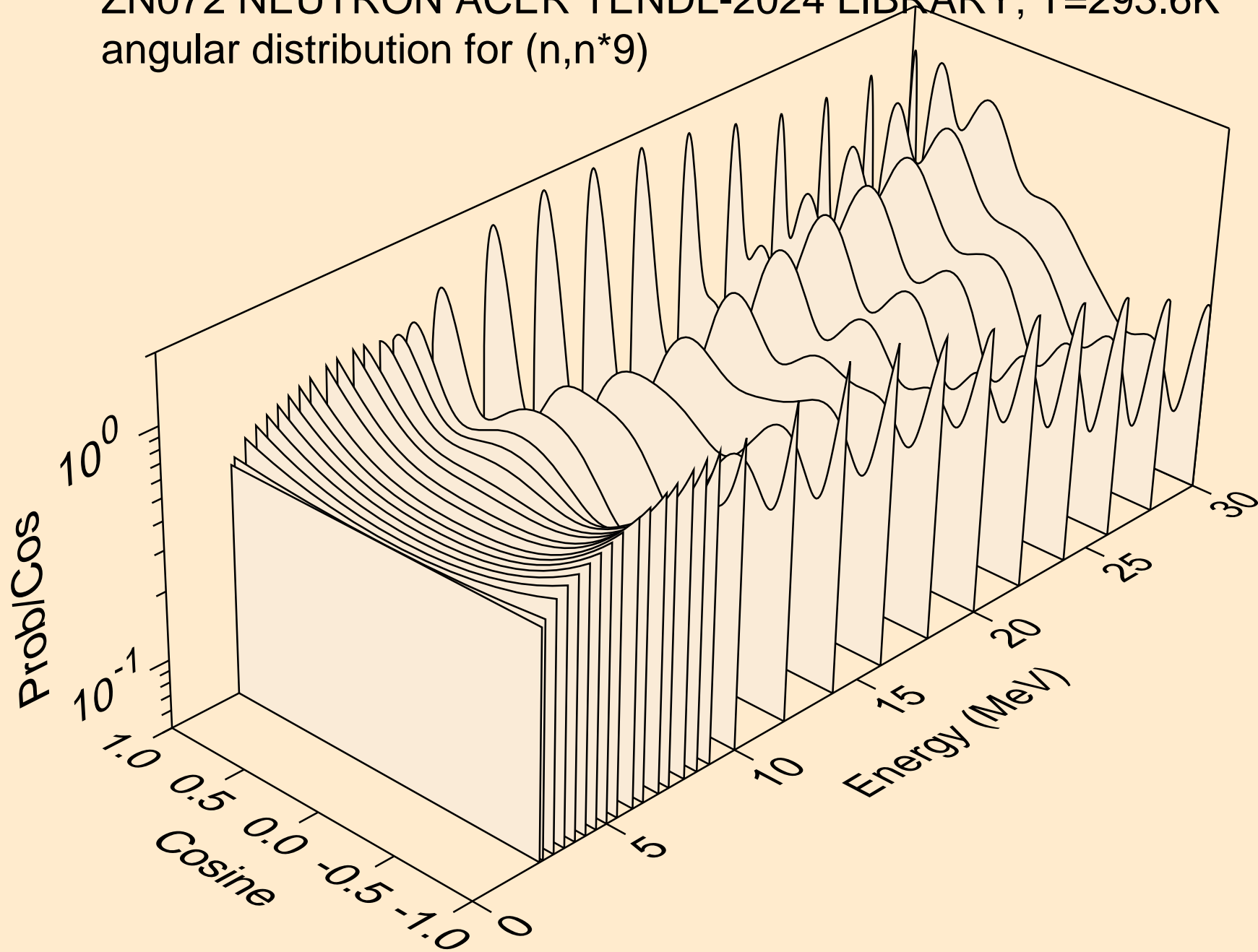

ZN072 NEUTRON ACER TENDL-2024 LIBRARY; T=293.6K
angular distribution for (n,n*10)

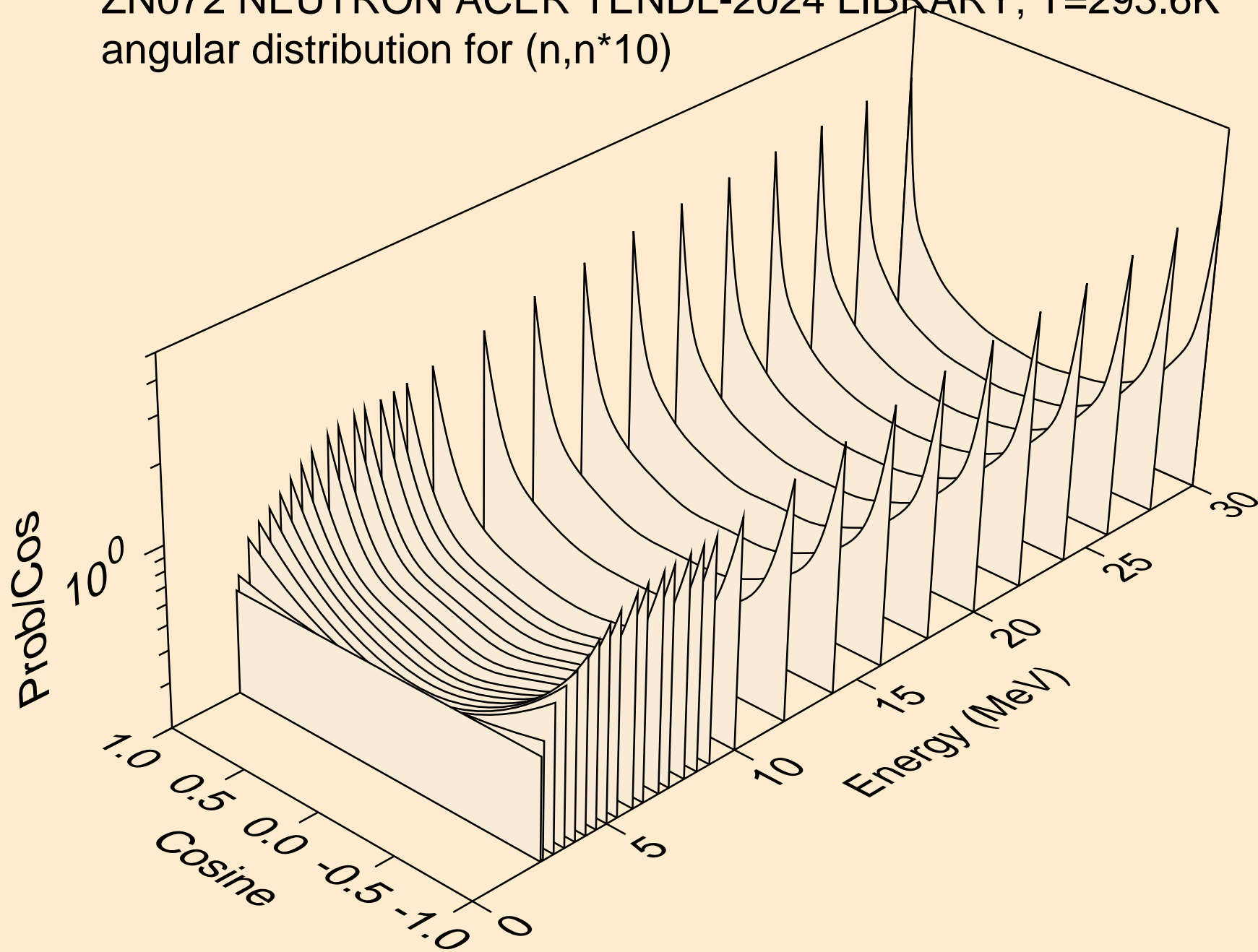

ZN072 NEUTRON ACER TENDL-2024 LIBRARY; T=293.6K
angular distribution for (n,n*11)

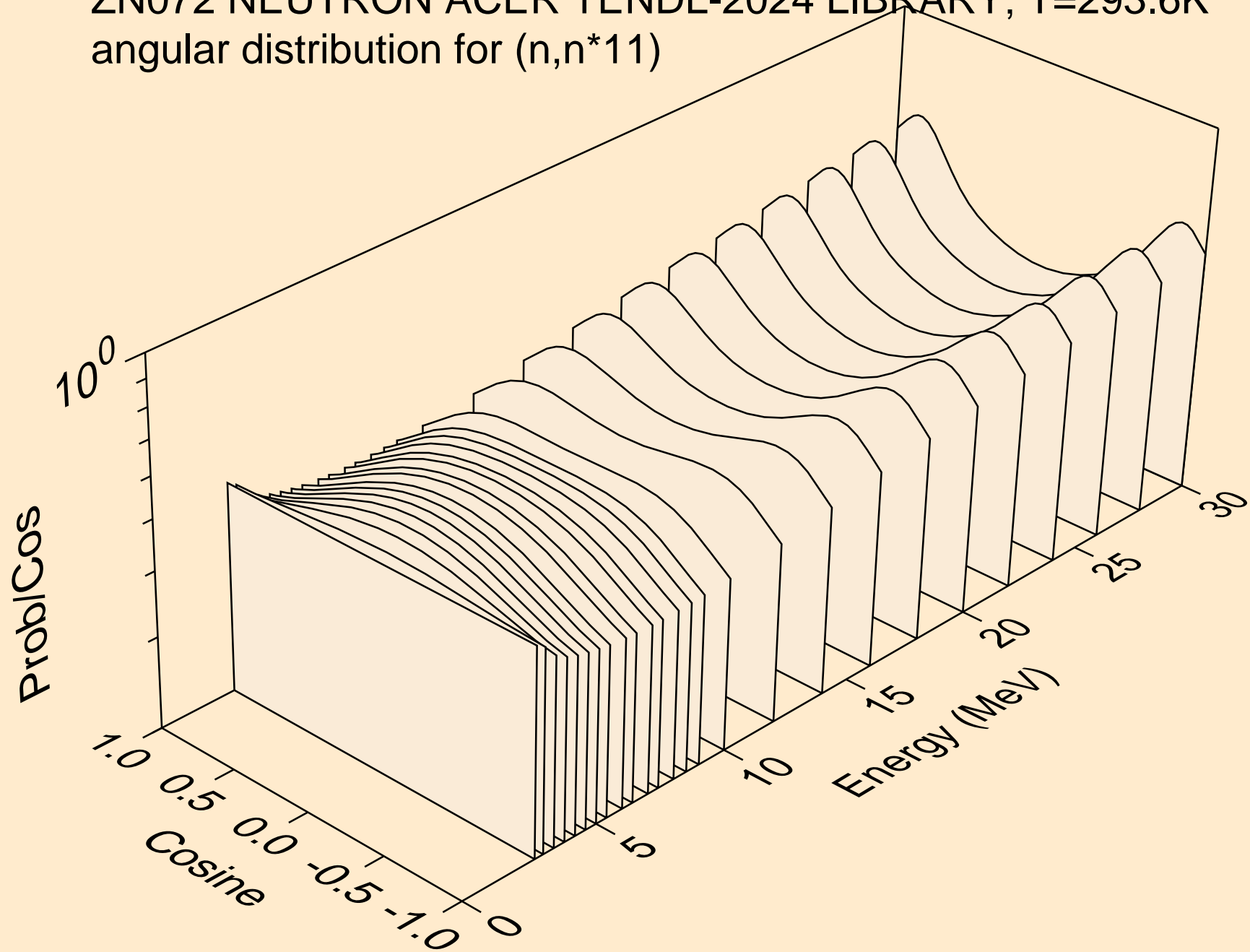

ZN072 NEUTRON ACER TENDL-2024 LIBRARY; T=293.6K
angular distribution for (n,n*12)

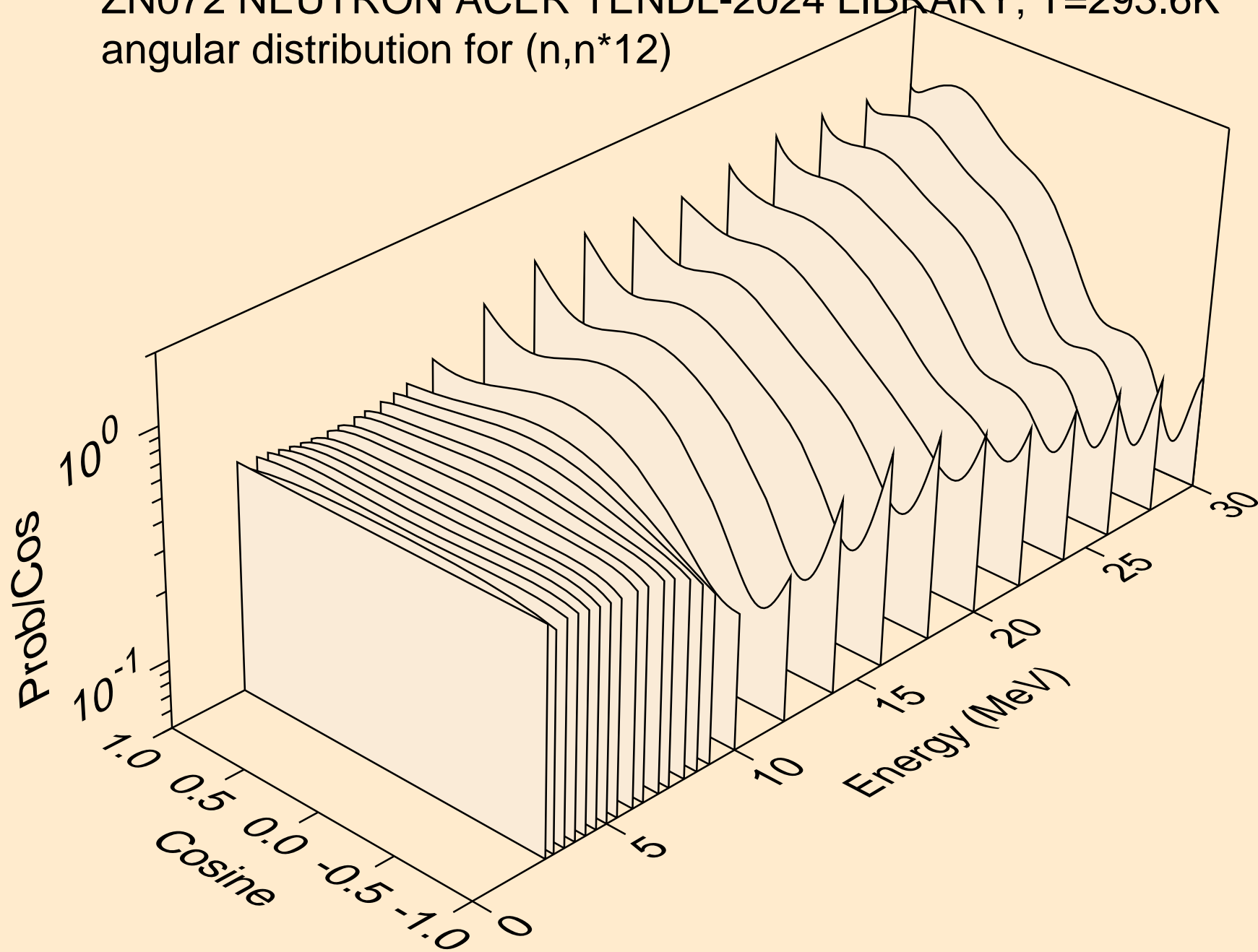

ZN072 NEUTRON ACER TENDL-2024 LIBRARY; T=293.6K
angular distribution for (n,n*13)

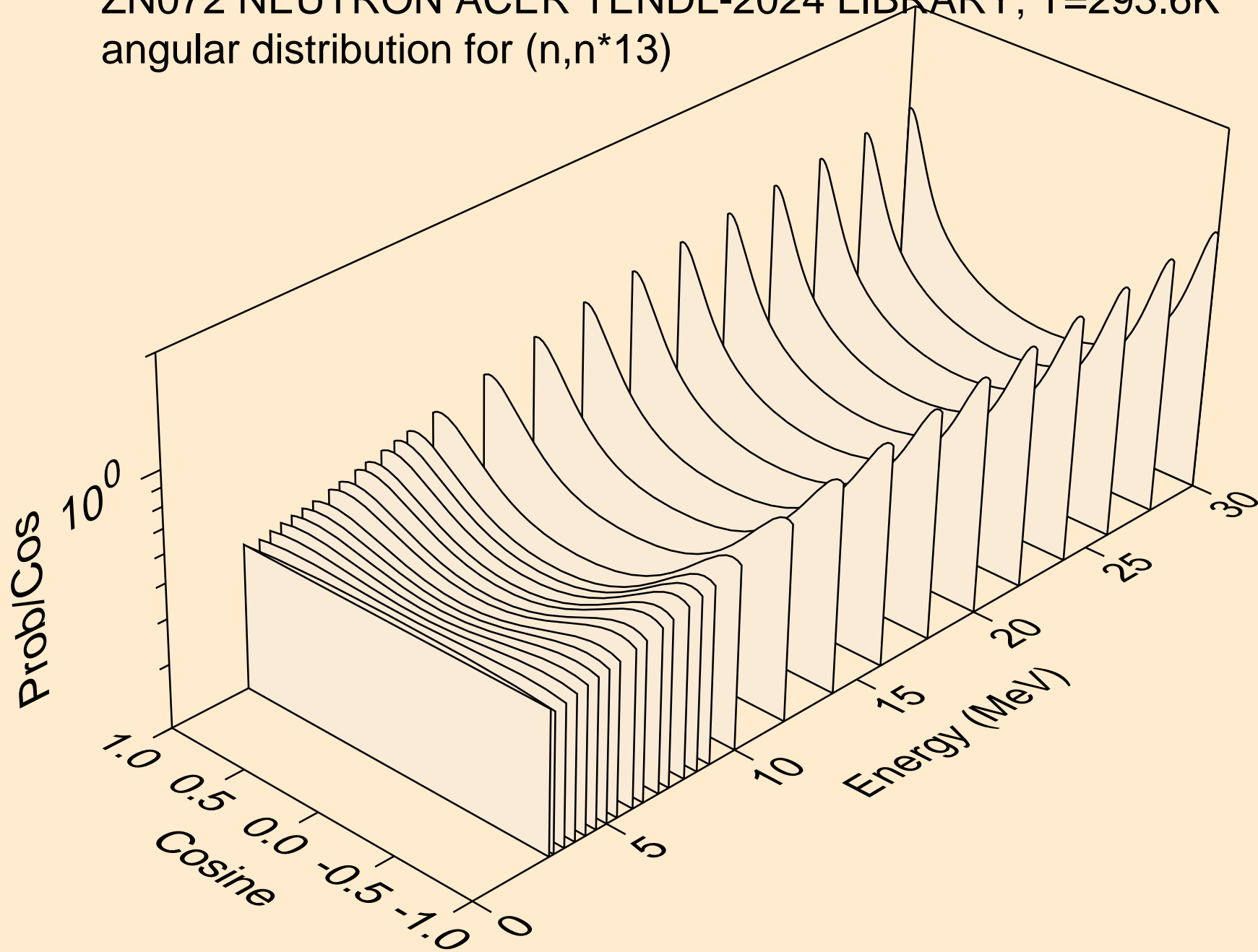

ZN072 NEUTRON ACER TENDL-2024 LIBRARY; T=293.6K
angular distribution for (n,n*14)

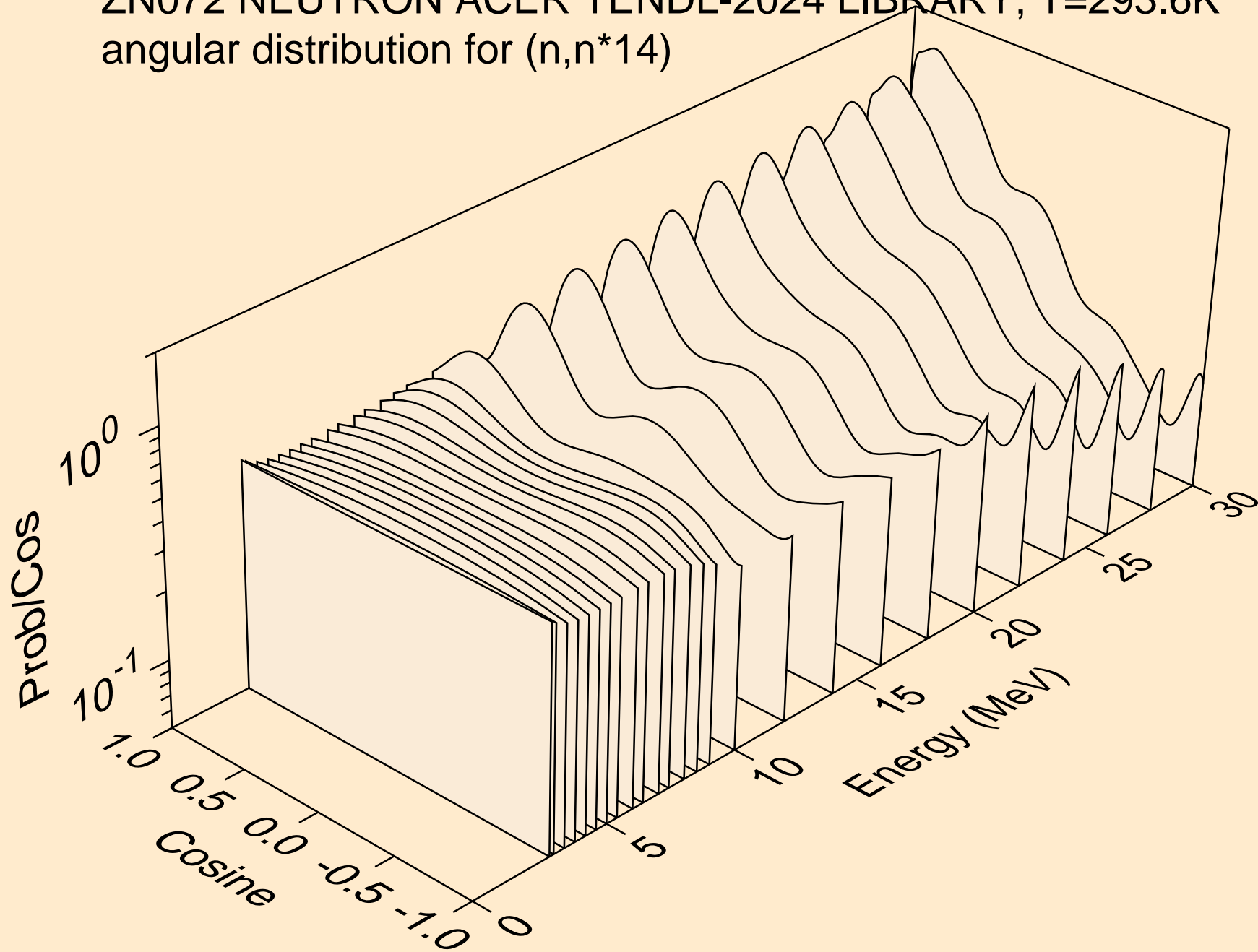

ZN072 NEUTRON ACER TENDL-2024 LIBRARY; T=293.6K
angular distribution for (n,n*15)

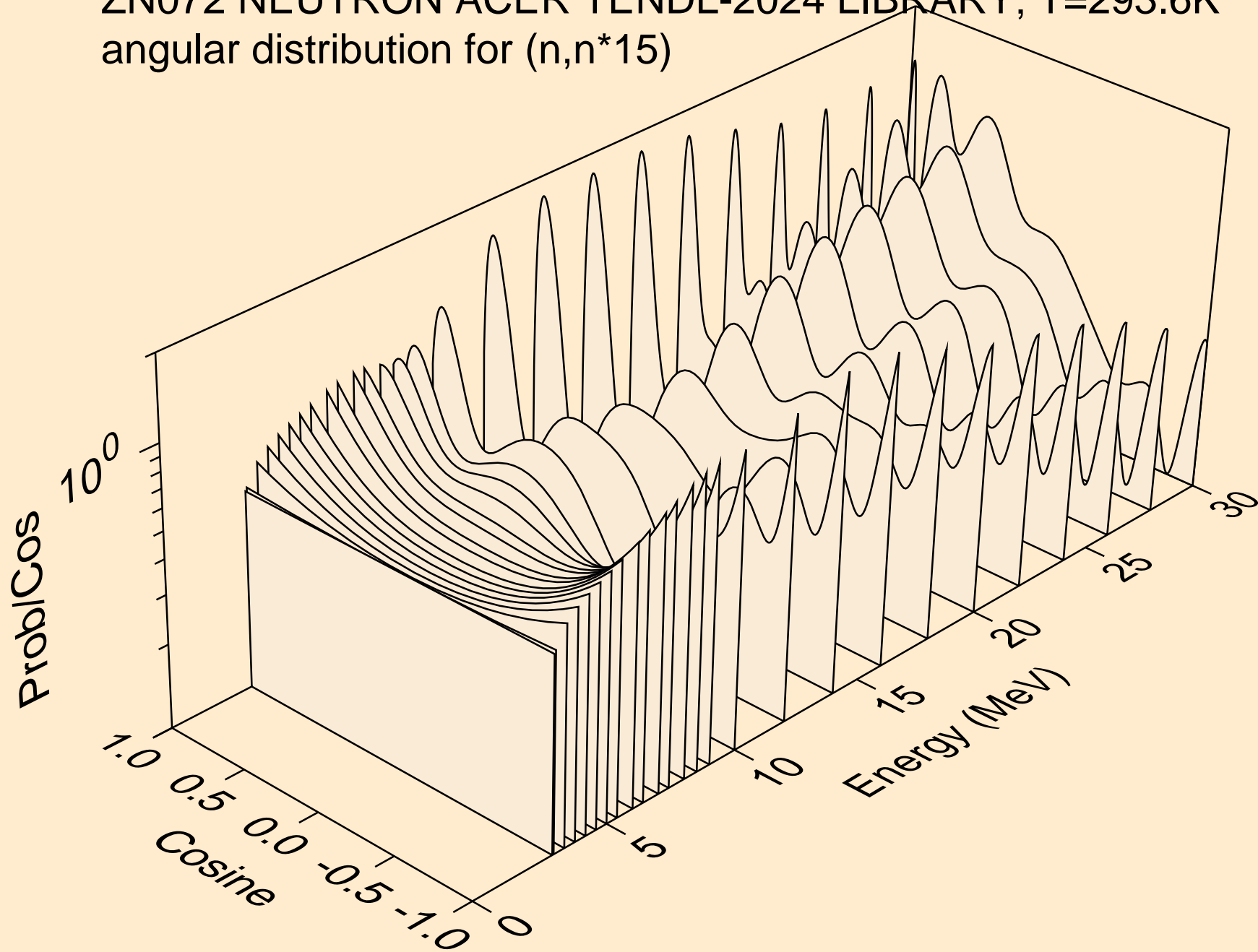

ZN072 NEUTRON ACER TENDL-2024 LIBRARY; T=293.6K
angular distribution for (n,n*16)

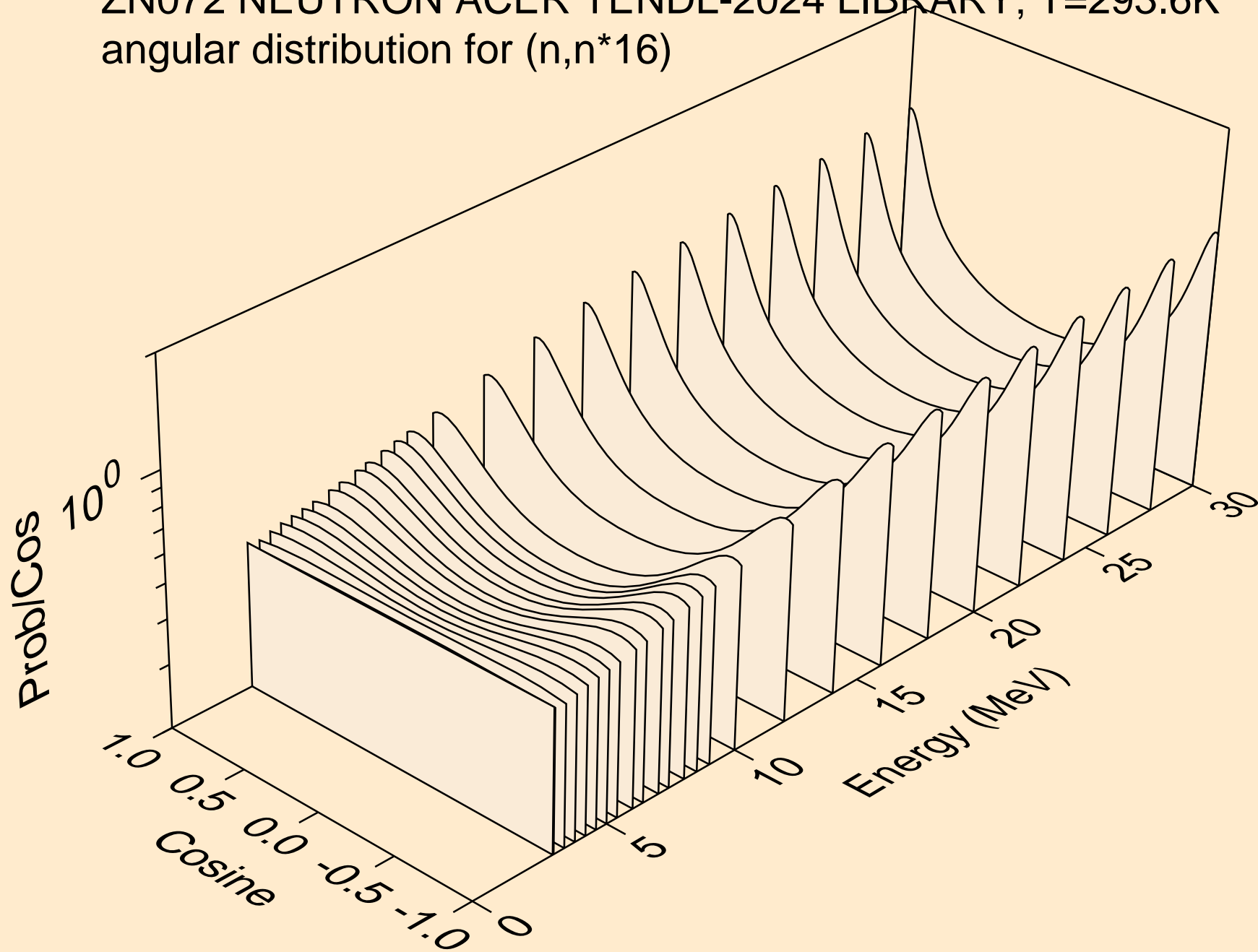

ZN072 NEUTRON ACER TENDL-2024 LIBRARY; T=293.6K
angular distribution for (n,n*17)

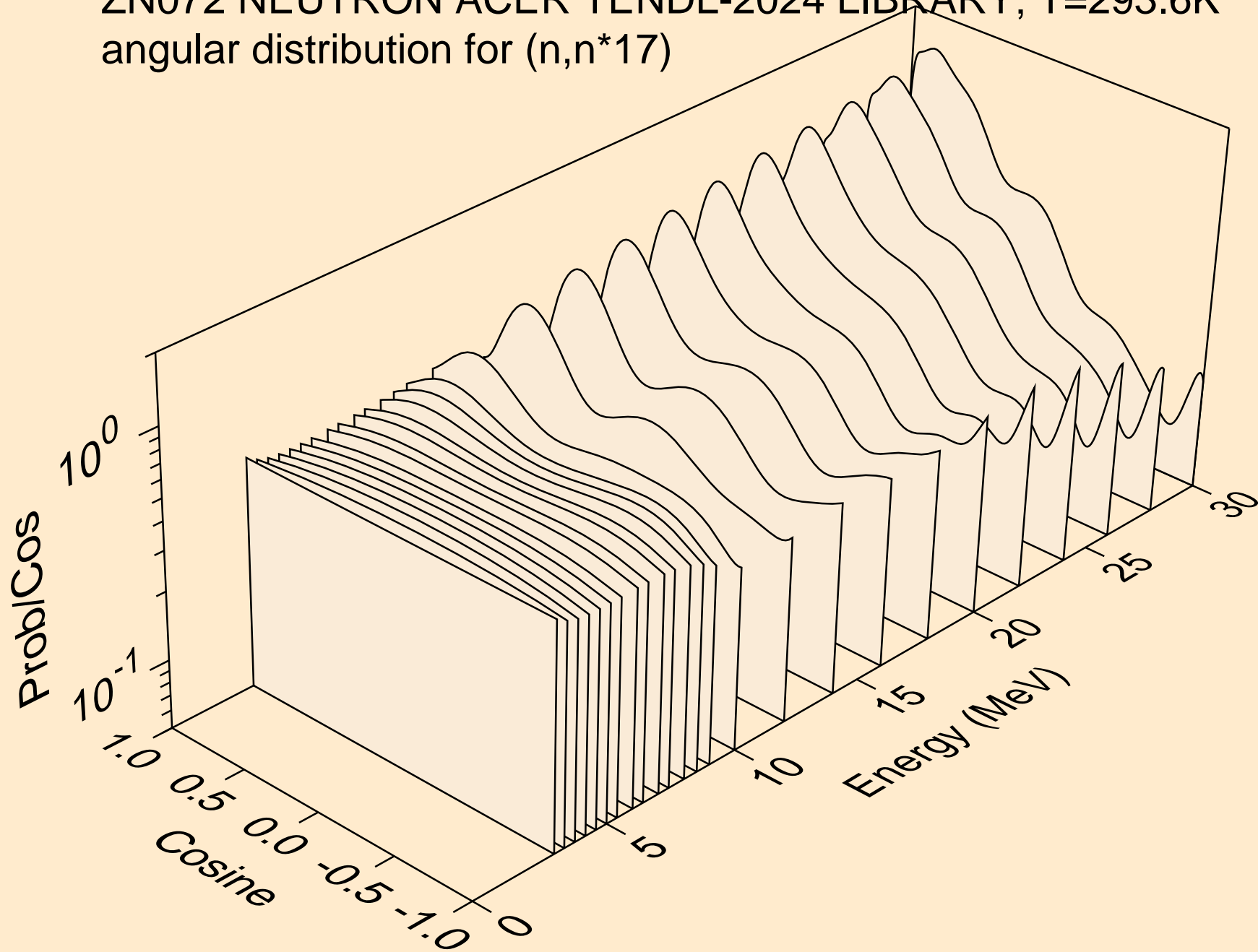

ZN072 NEUTRON ACER TENDL-2024 LIBRARY; T=293.6K
angular distribution for (n,n*18)

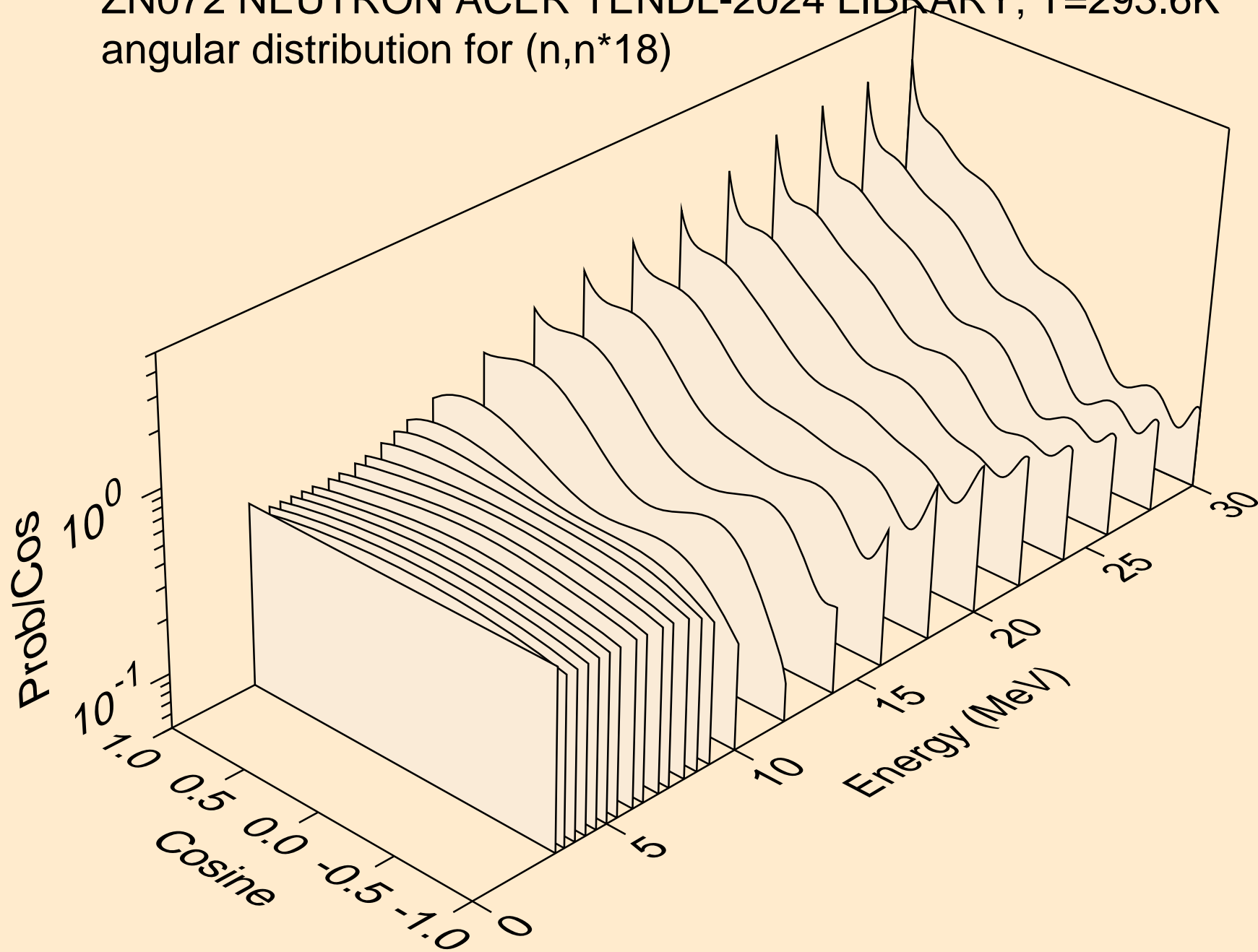

ZN072 NEUTRON ACER TENDL-2024 LIBRARY; T=293.6K
angular distribution for (n,n*19)

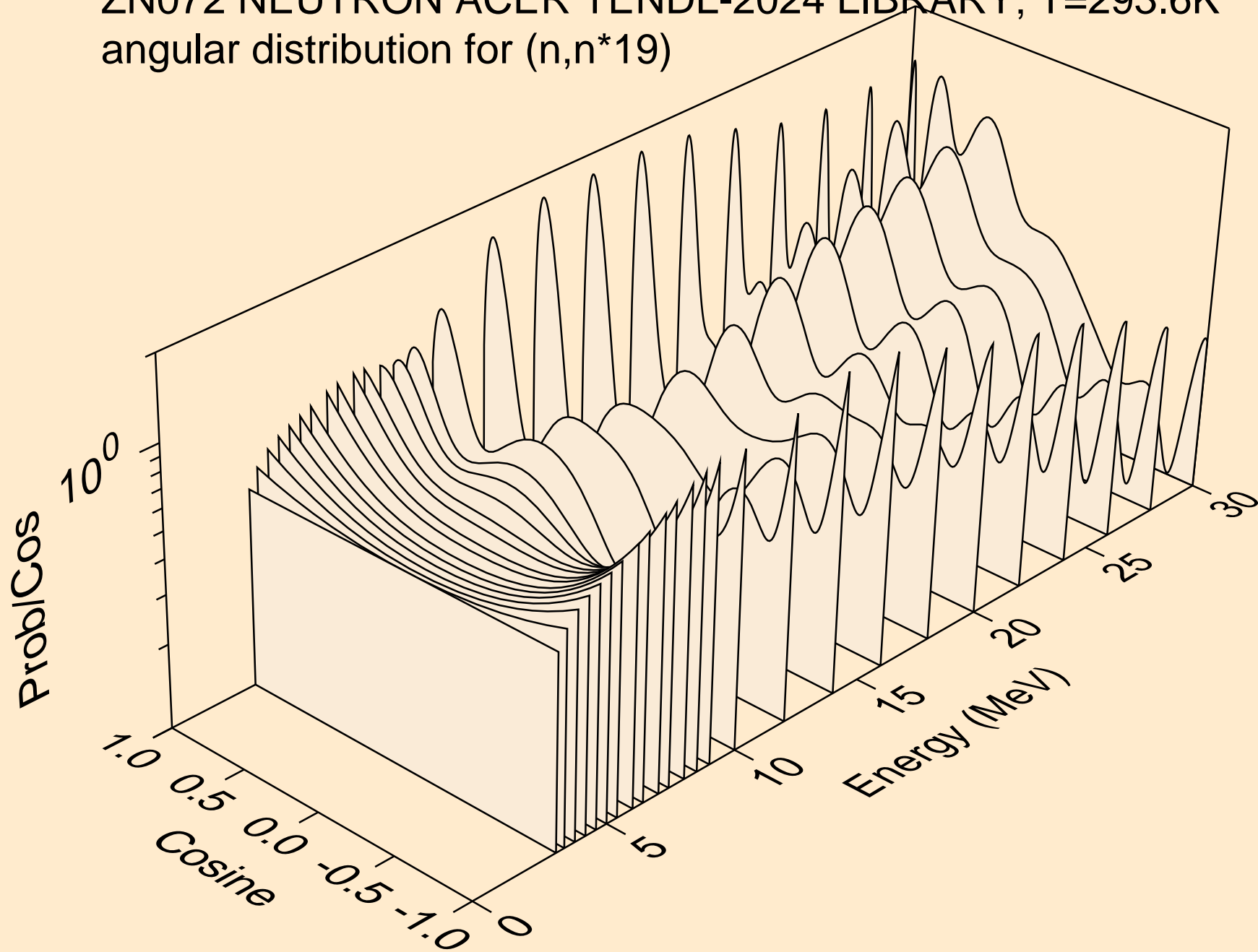

ZN072 NEUTRON ACER TENDL-2024 LIBRARY; T=293.6K
angular distribution for (n,n*20)

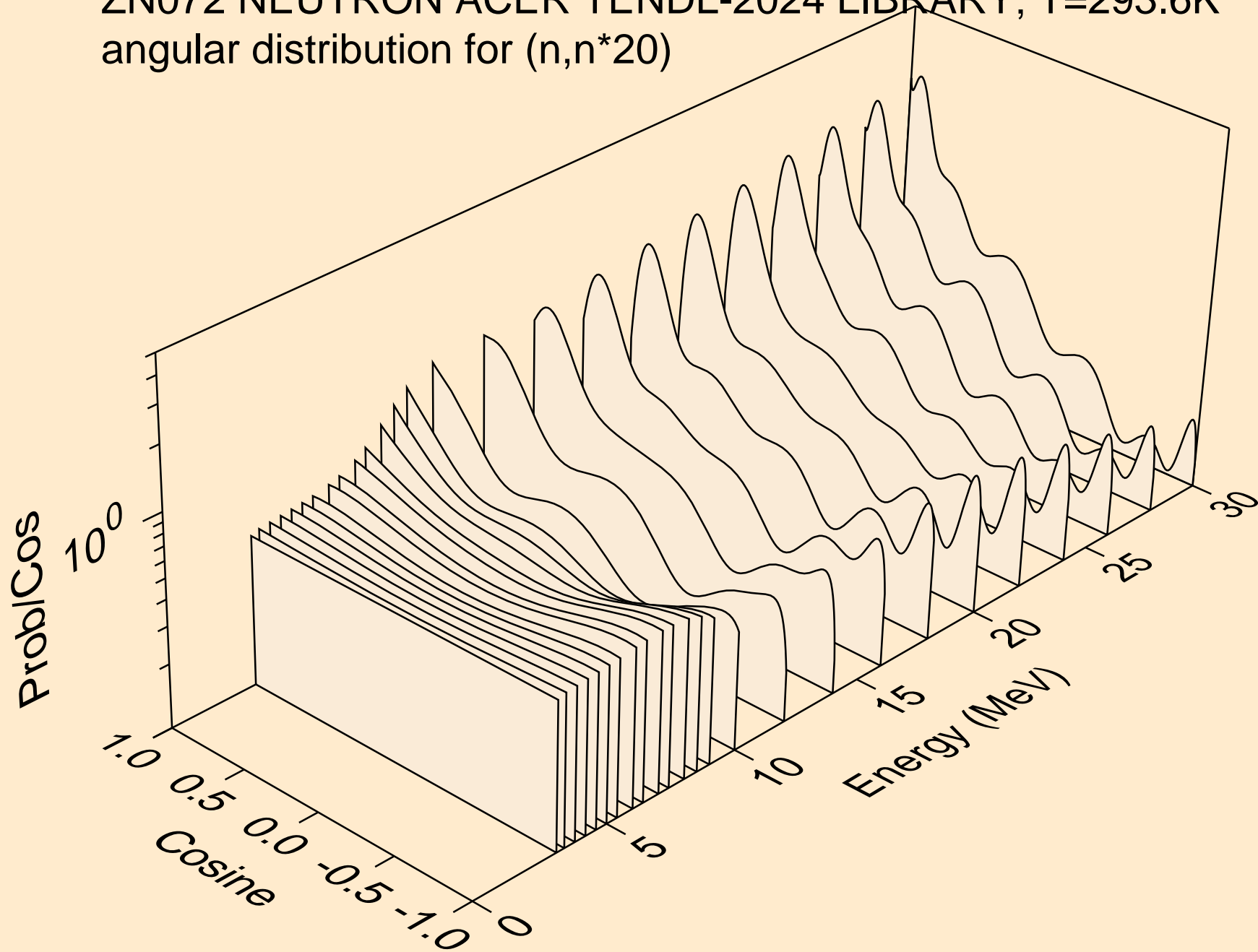

ZN072 NEUTRON ACER TENDL-2024 LIBRARY; T=293.6K
angular distribution for (n,n*21)

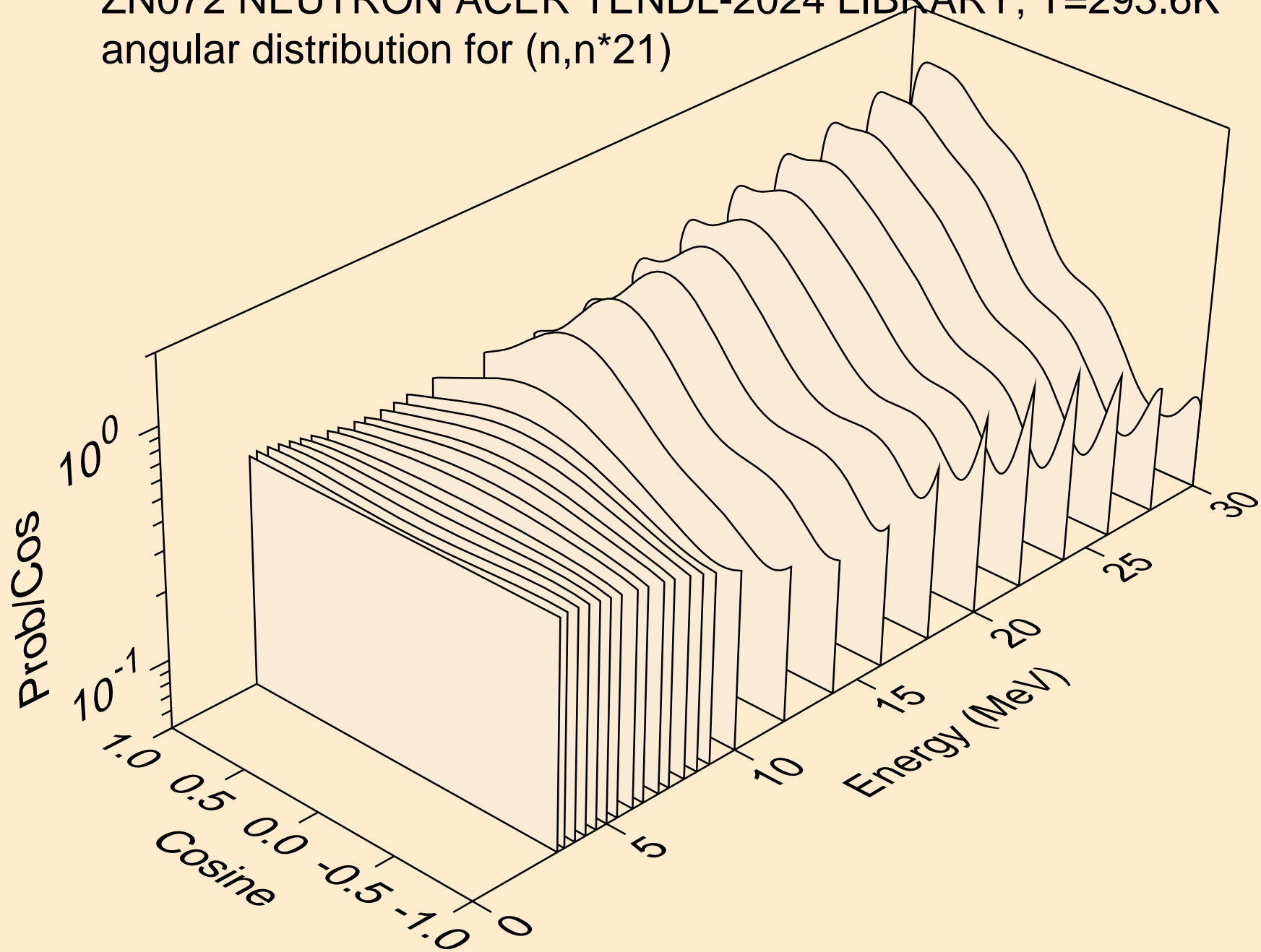

ZN072 NEUTRON ACER TENDL-2024 LIBRARY; T=293.6K
angular distribution for (n,n*22)

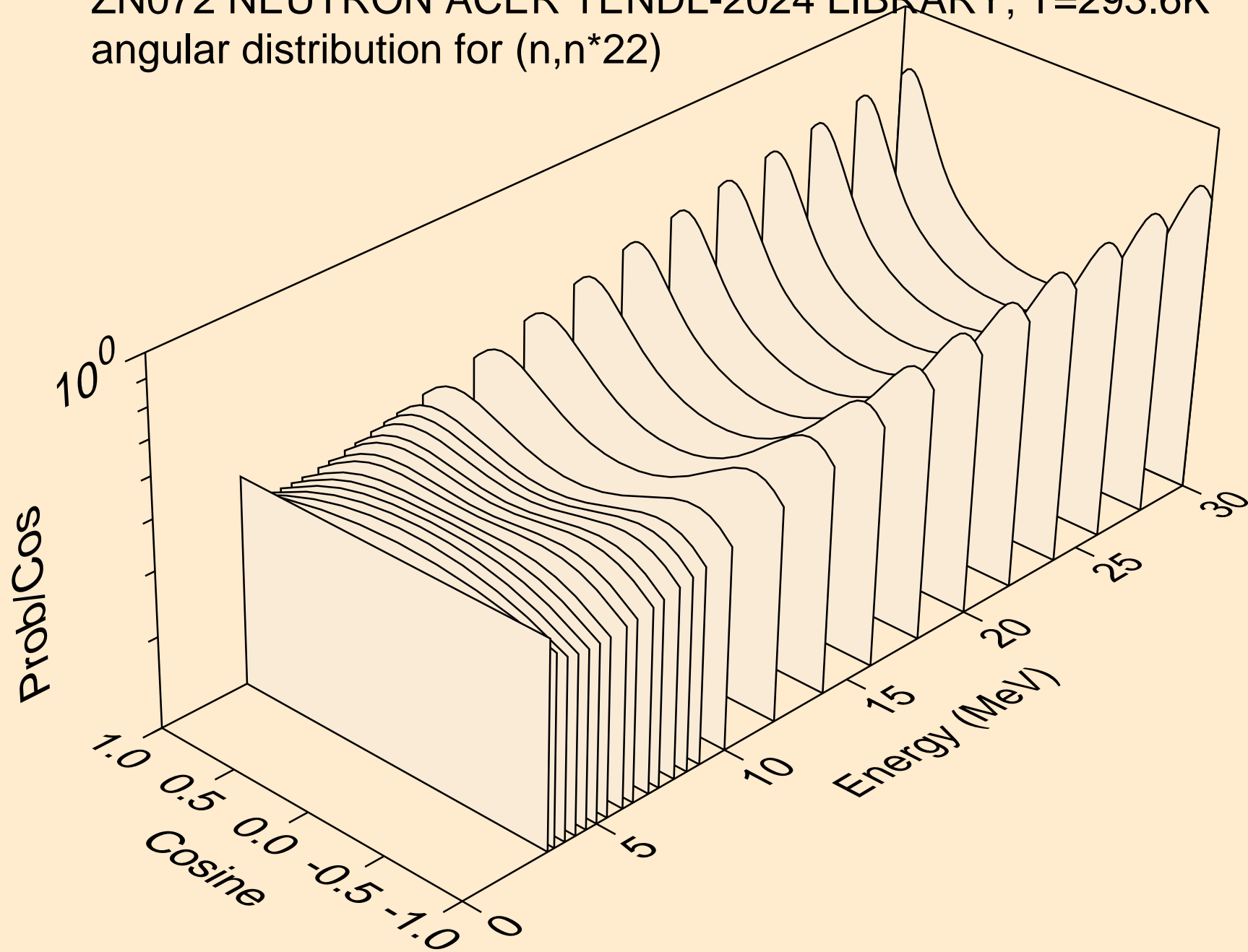

ZN072 NEUTRON ACER TENDL-2024 LIBRARY; T=293.6K
angular distribution for (n,n*23)

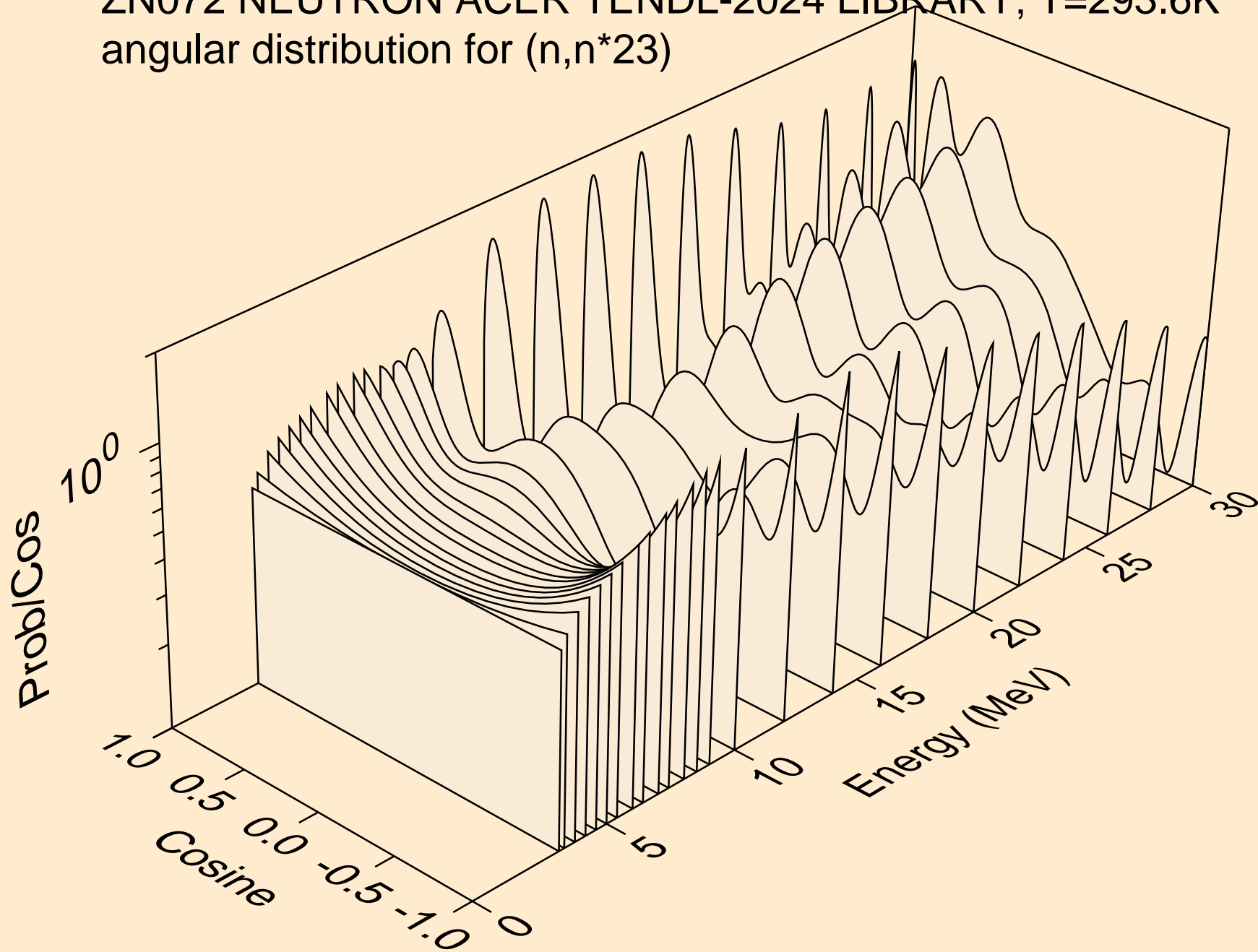

ZN072 NEUTRON ACER TENDL-2024 LIBRARY; T=293.6K
angular distribution for (n,n*24)

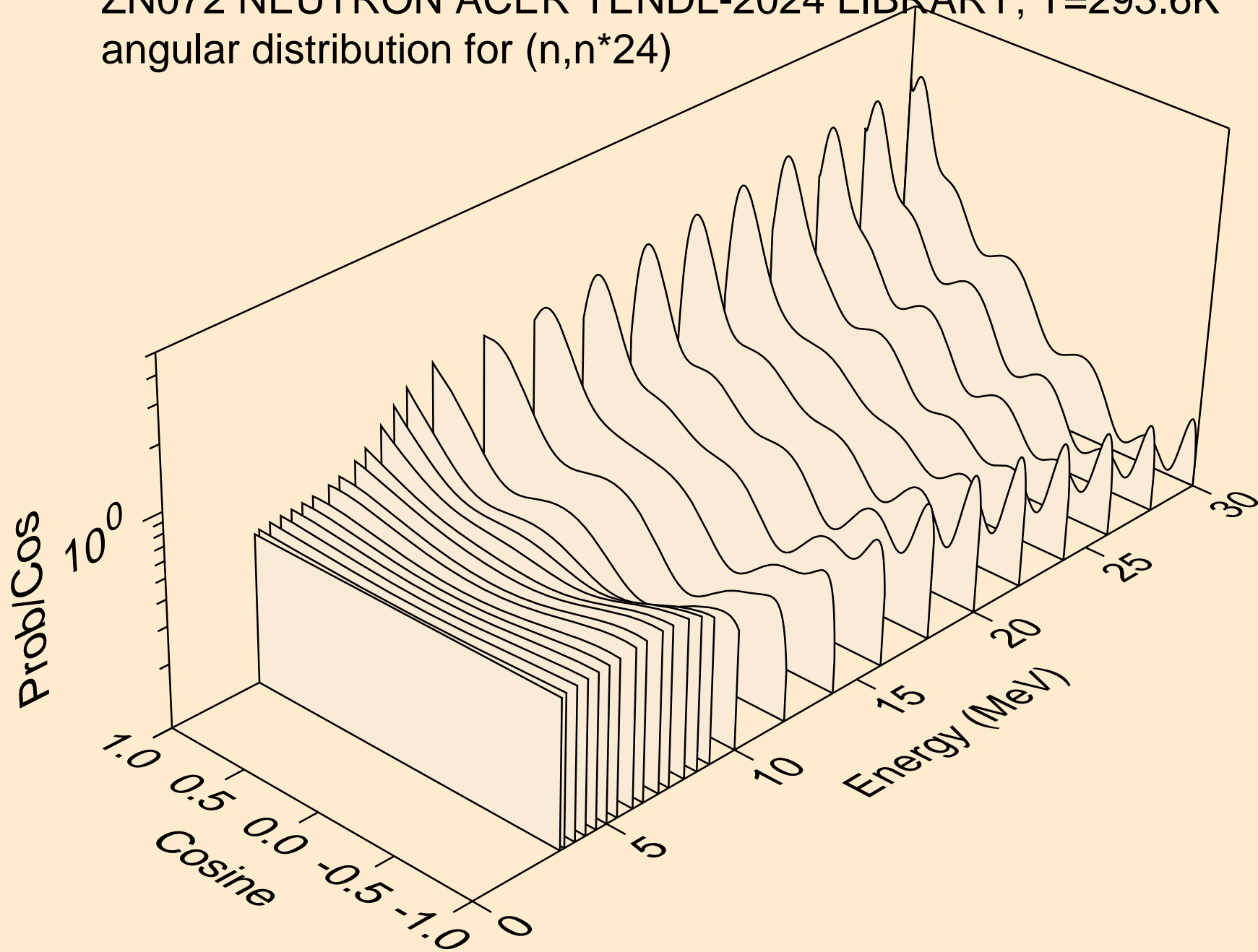

ZN072 NEUTRON ACER TENDL-2024 LIBRARY; T=293.6K
angular distribution for (n,n*25)

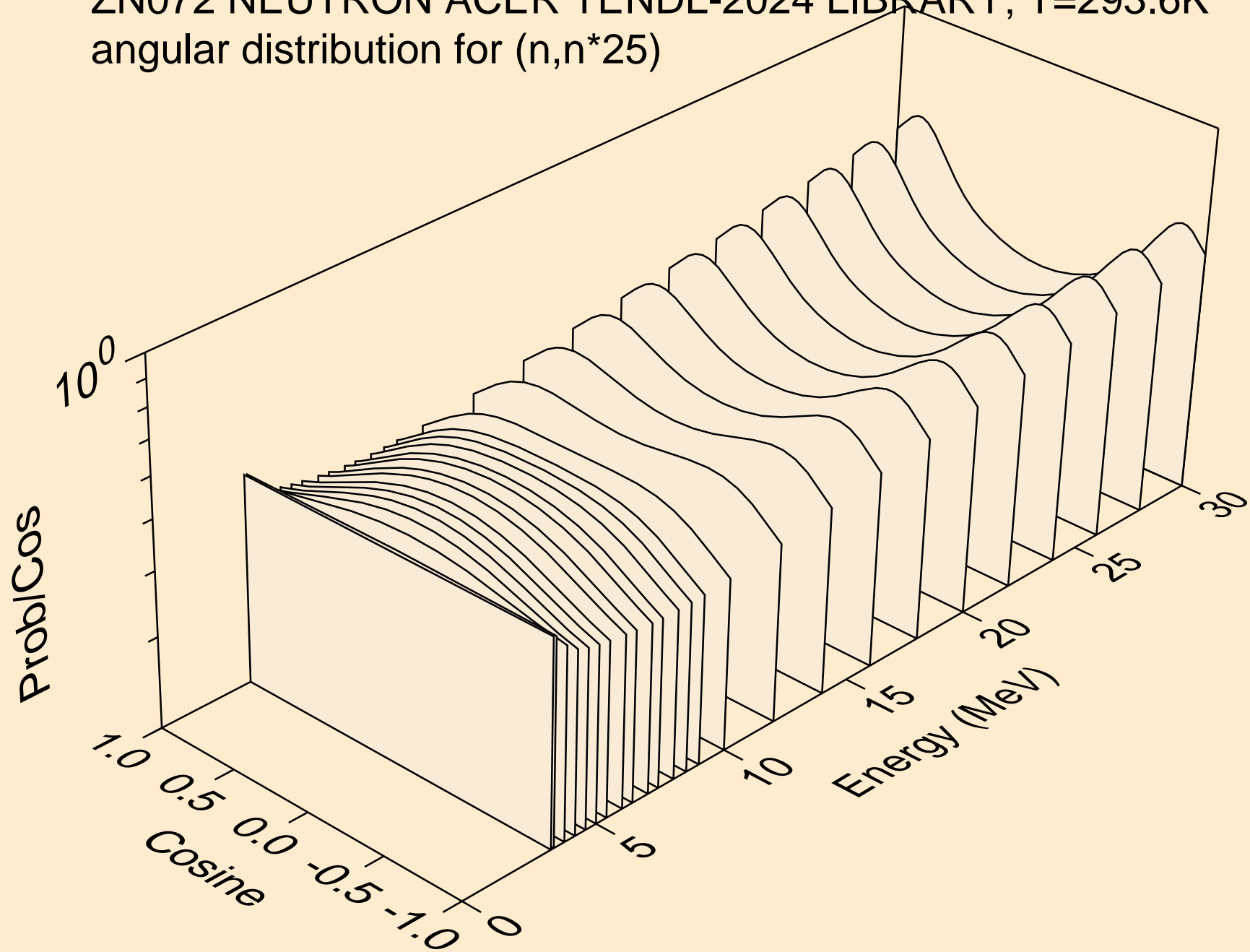

ZN072 NEUTRON ACER TENDL-2024 LIBRARY; T=293.6K
angular distribution for (n,n*26)

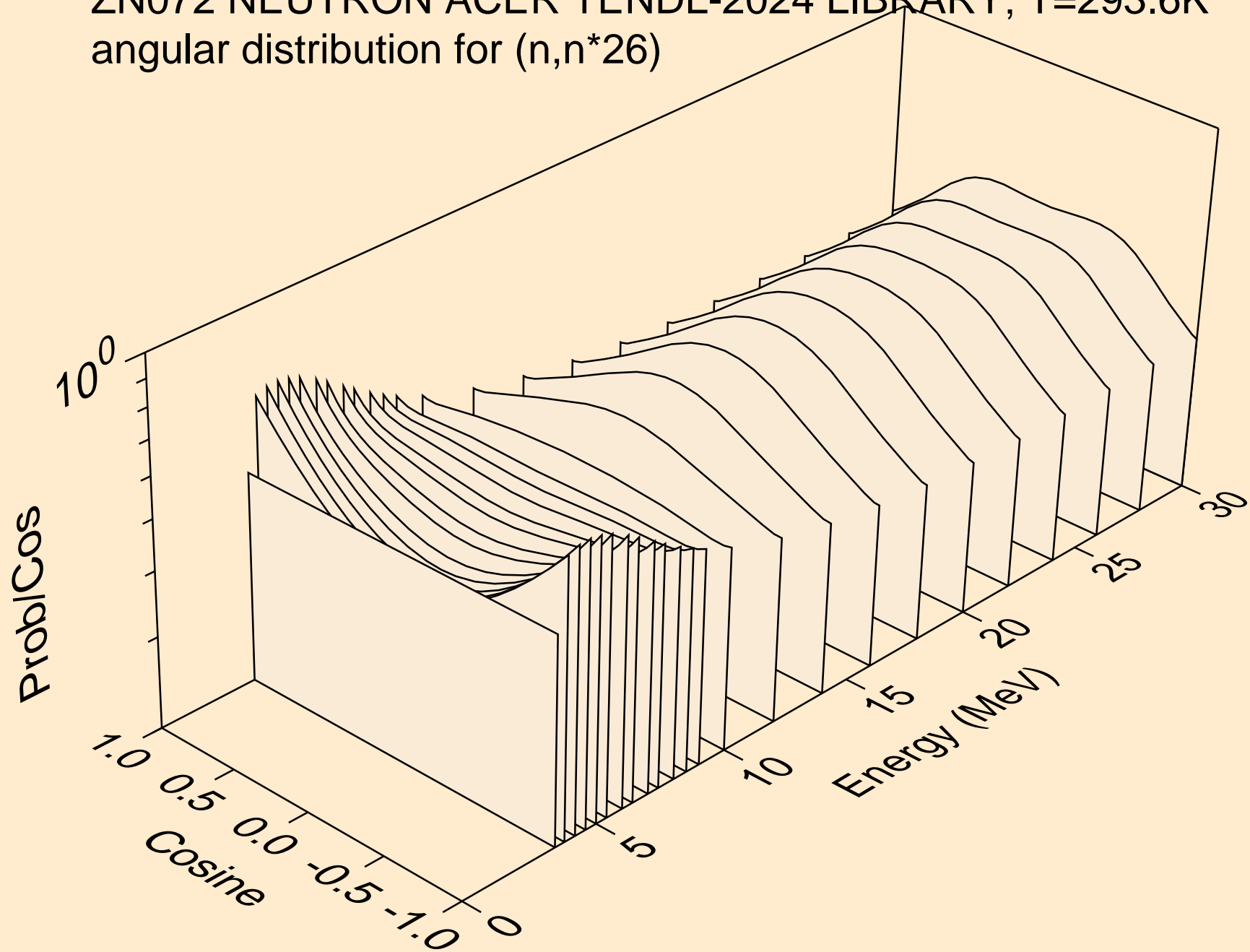

ZN072 NEUTRON ACER TENDL-2024 LIBRARY; T=293.6K
angular distribution for (n,n*27)

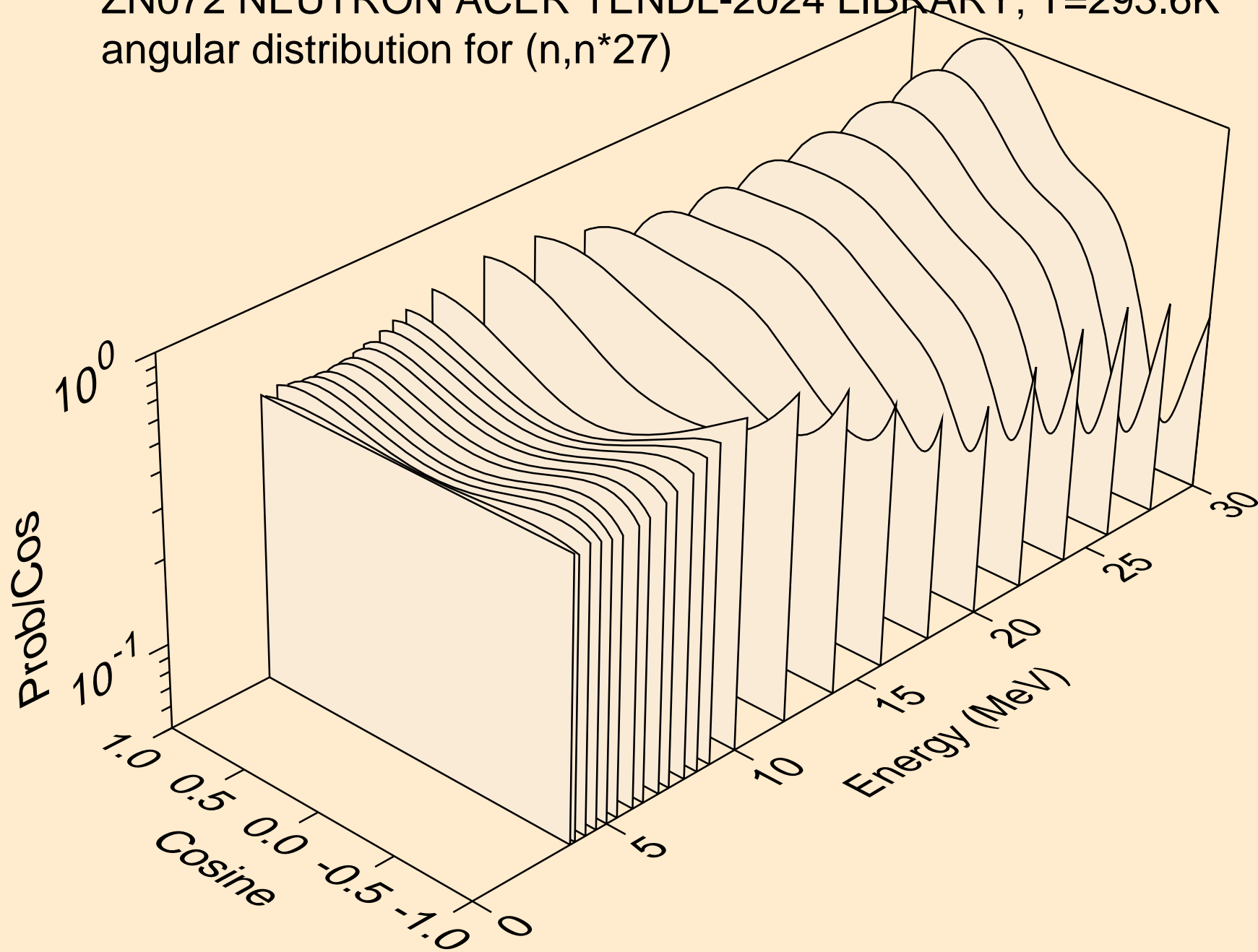

ZN072 NEUTRON ACER TENDL-2024 LIBRARY; T=293.6K
angular distribution for (n,n*28)

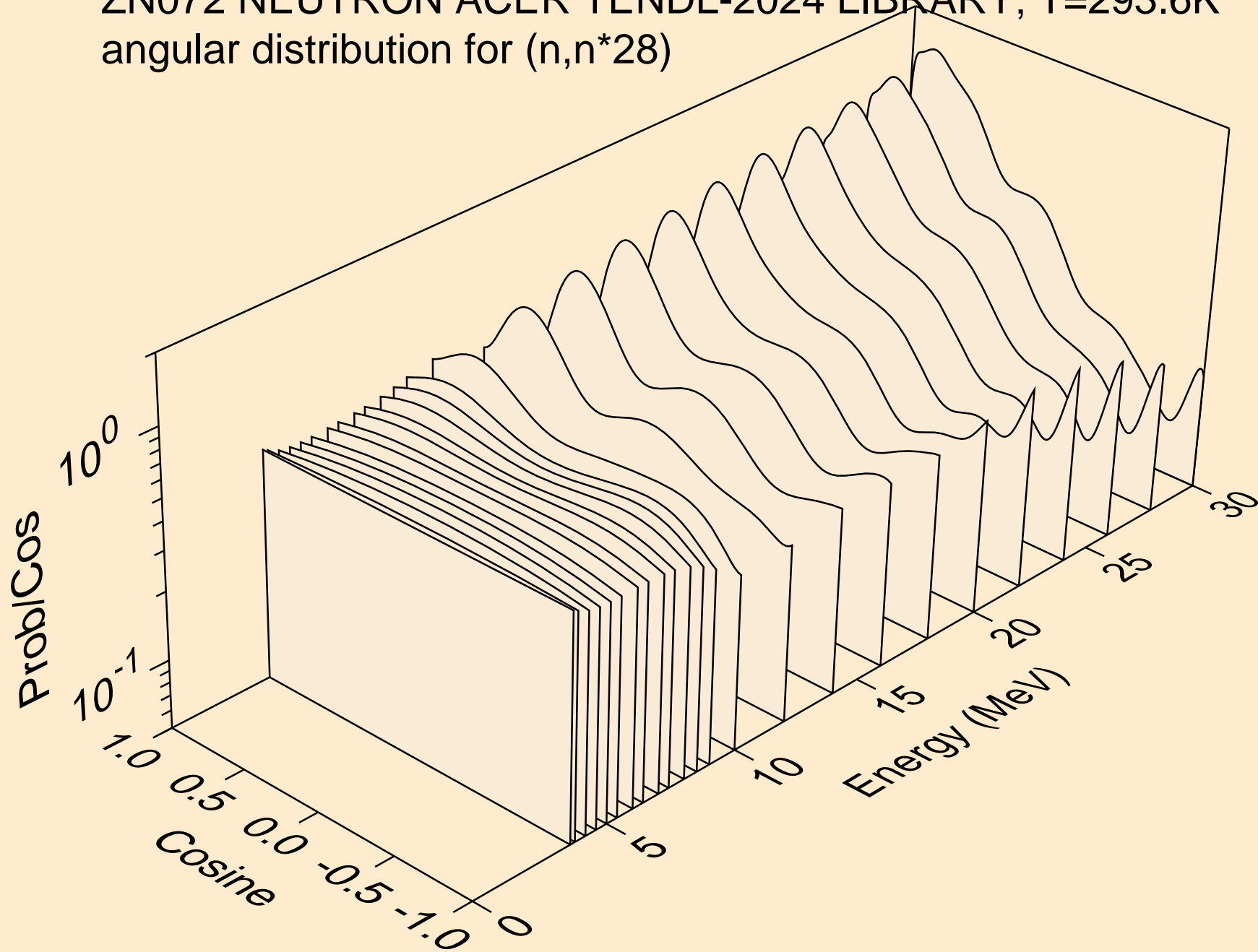

ZN072 NEUTRON ACER TENDL-2024 LIBRARY; T=293.6K
angular distribution for (n,n*29)

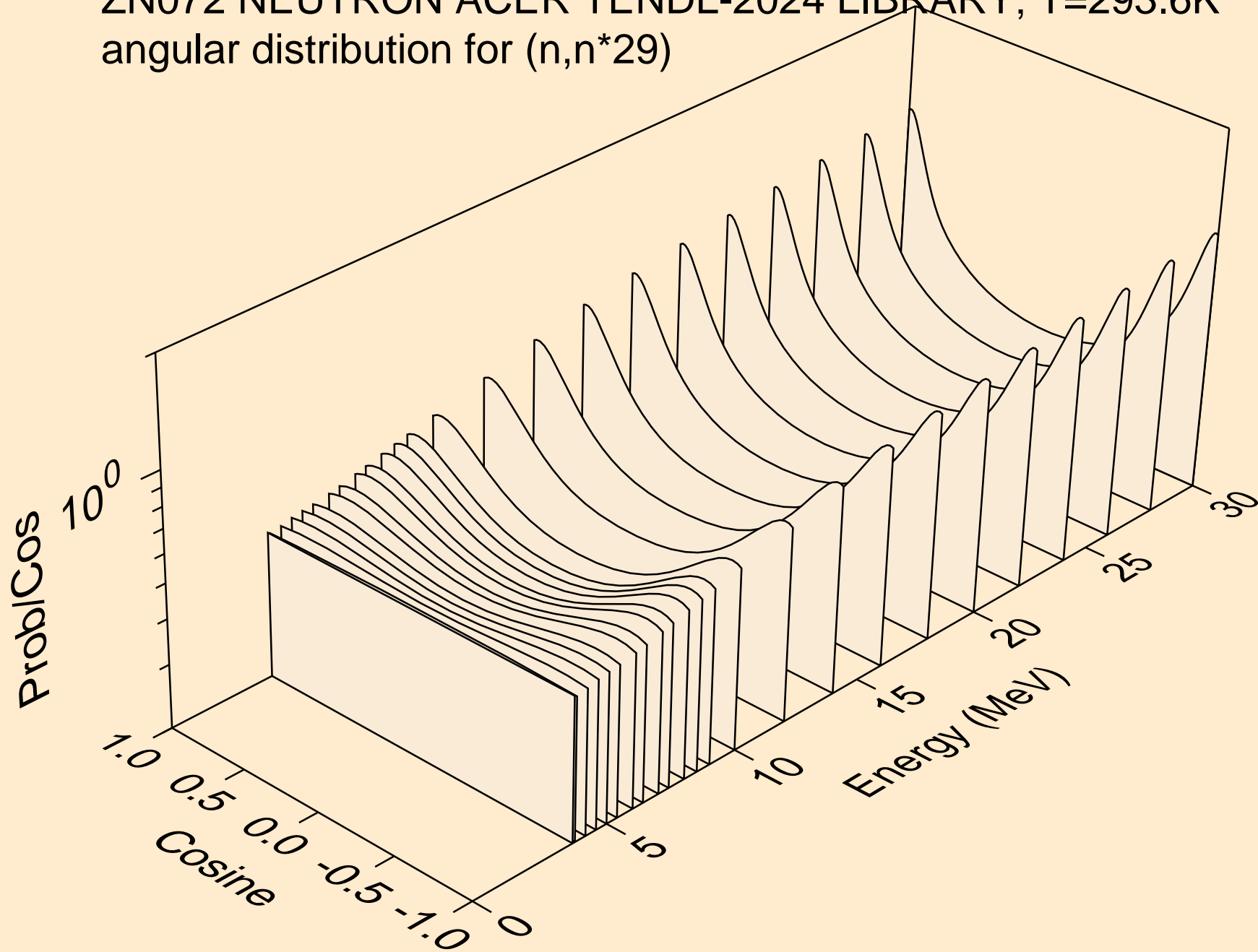

ZN072 NEUTRON ACER TENDL-2024 LIBRARY; T=293.6K
angular distribution for (n,n*30)

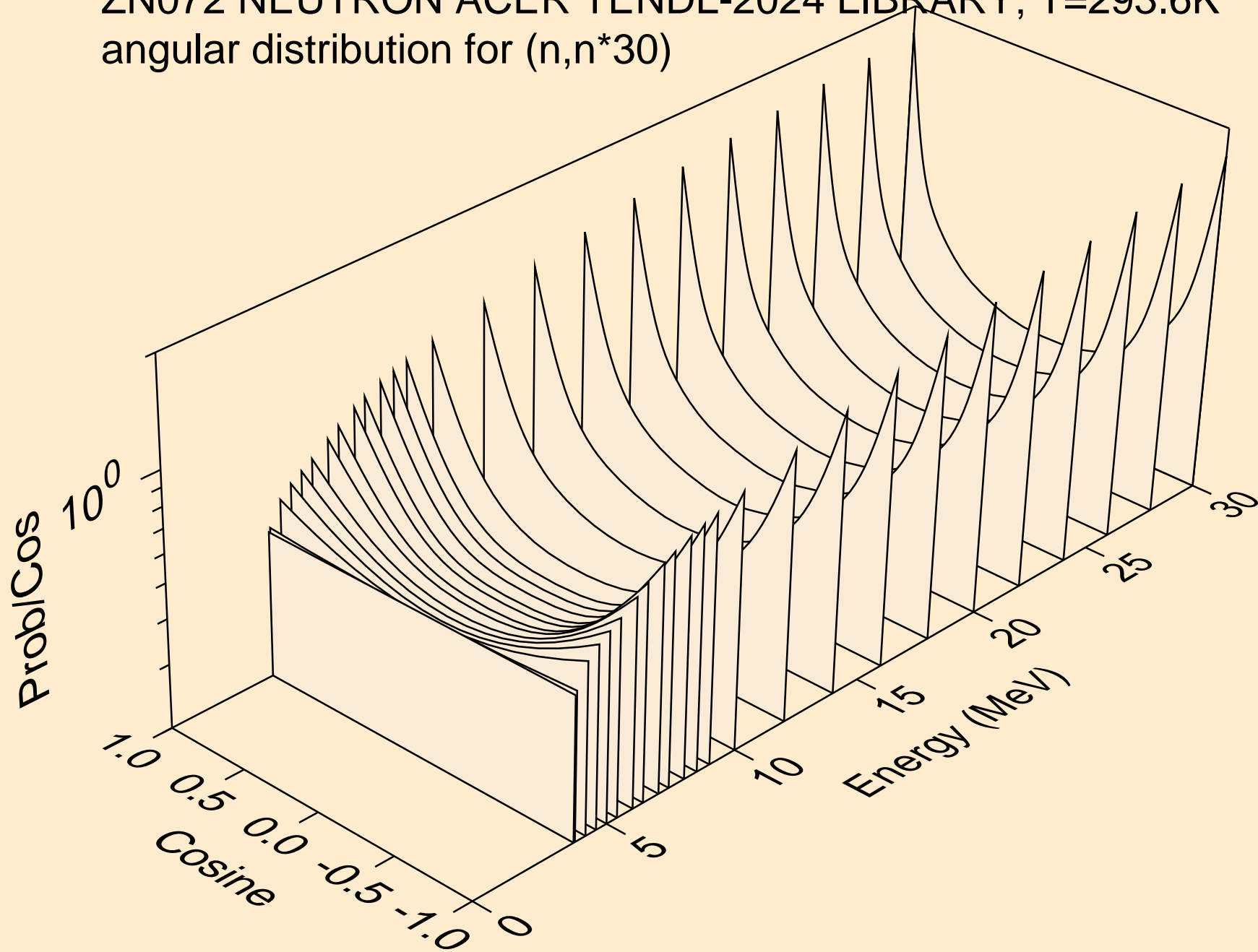

ZN072 NEUTRON ACER TENDL-2024 LIBRARY; T=293.6K
Neutron emission for (n,x)

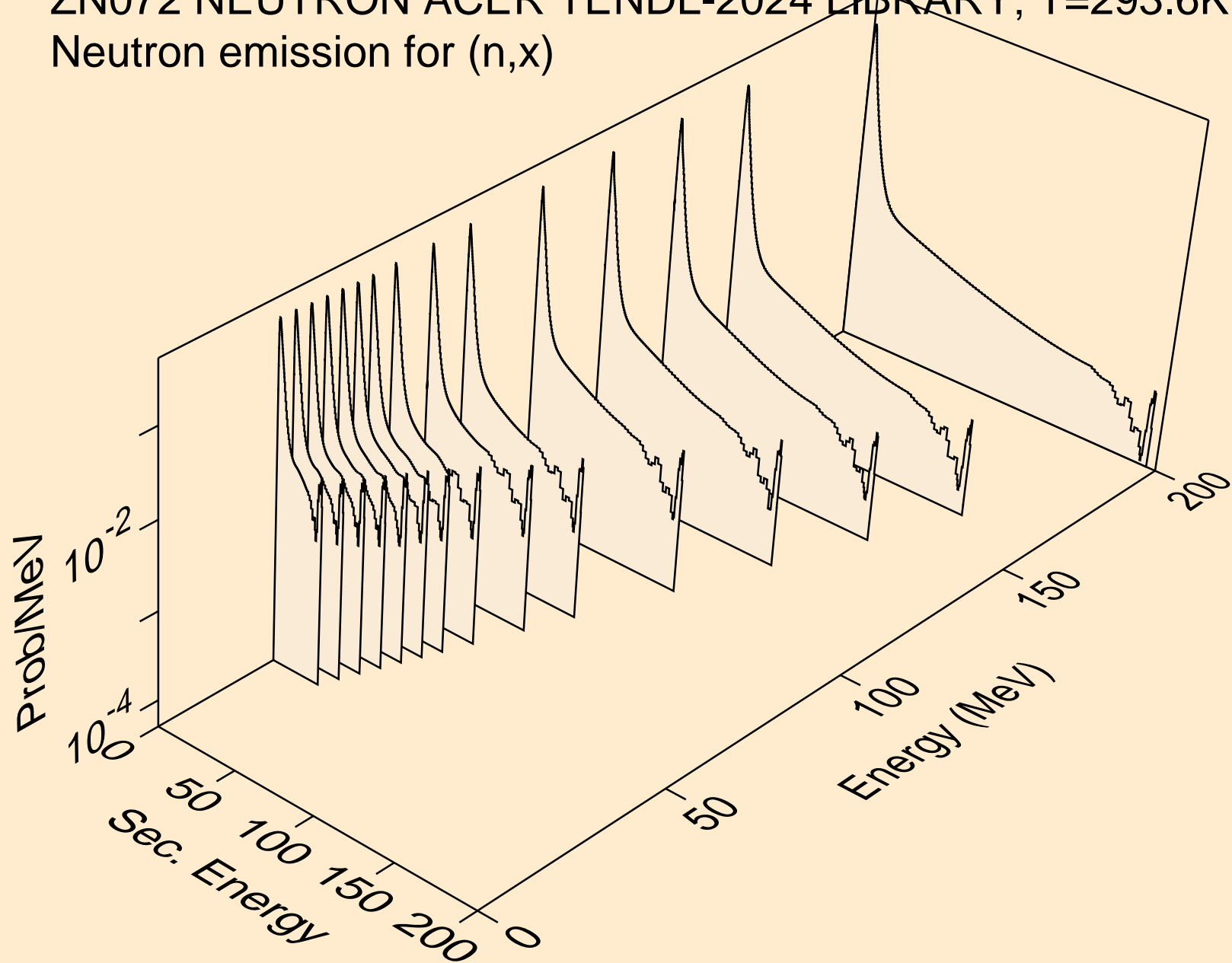

ZN072 NEUTRON ACER TENDL-2024 LIBRARY; T=293.6K
Neutron emission for (n,2nd)

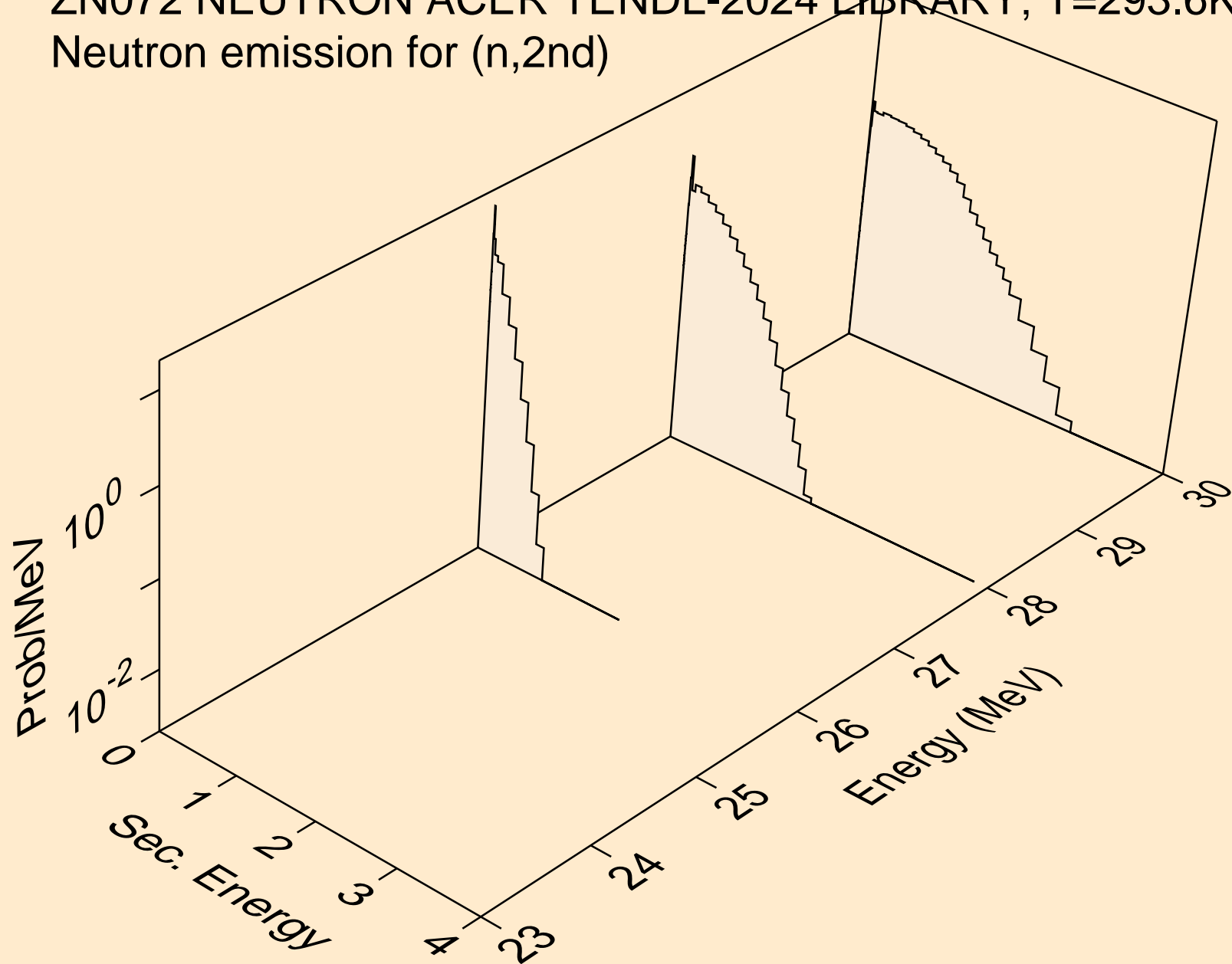

ZN072 NEUTRON ACER TENDL-2024 LIBRARY; T=293.6K
Neutron emission for (n,2n)

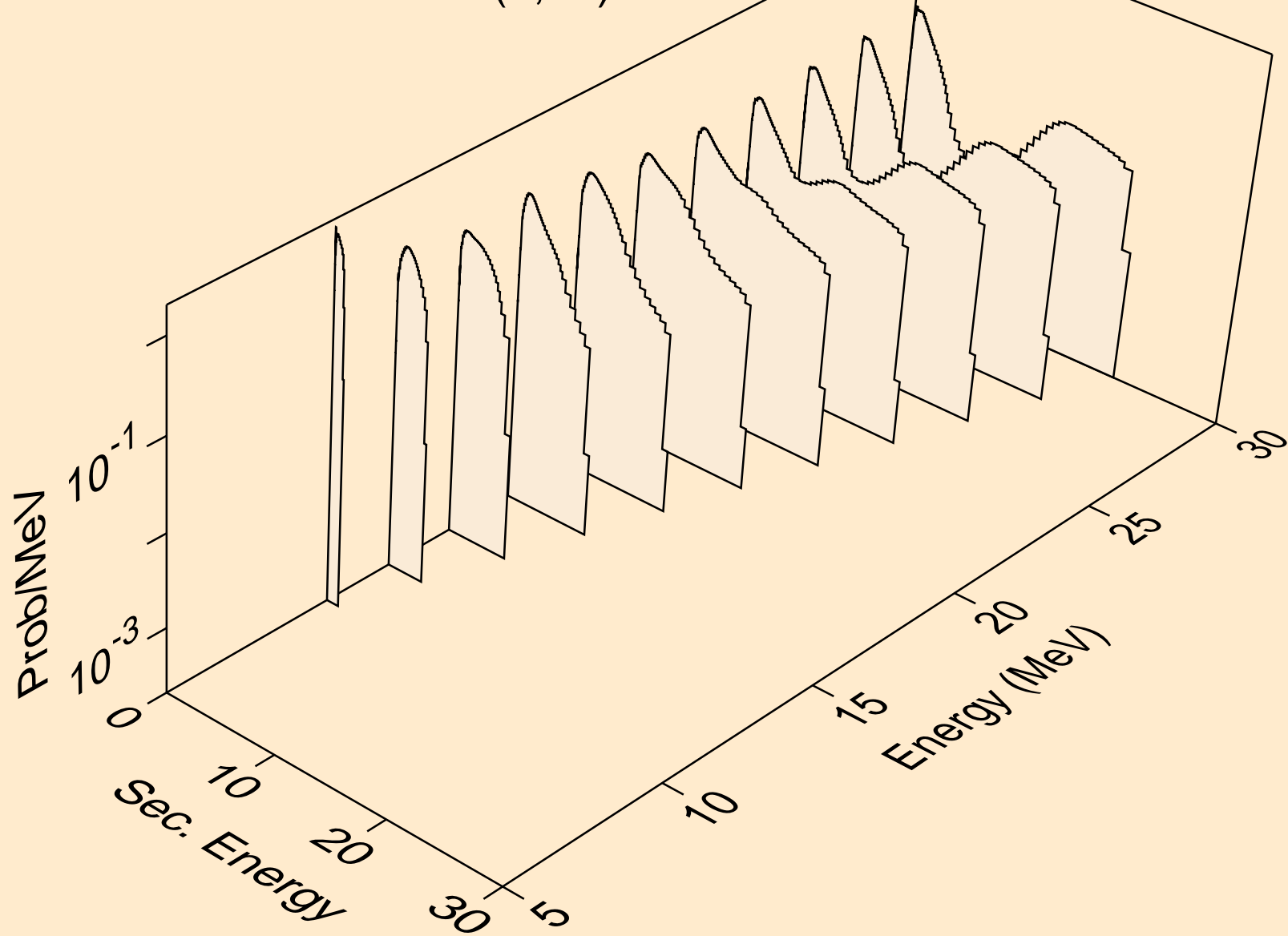

ZN072 NEUTRON ACER TENDL-2024 LIBRARY; T=293.6K
Neutron emission for (n,3n)

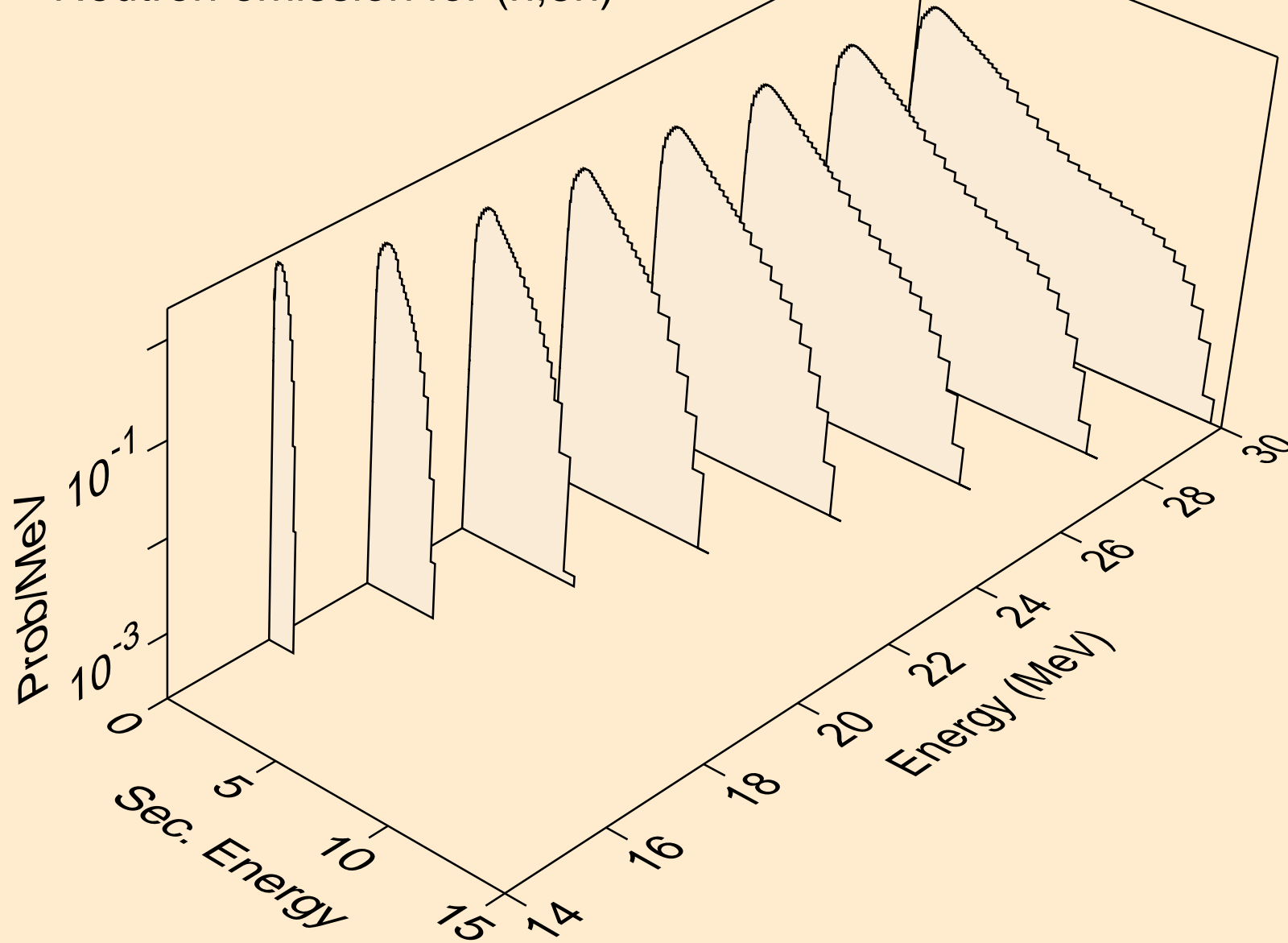

ZN072 NEUTRON ACER TENDL-2024 LIBRARY; T=293.6K
Neutron emission for (n,n*)a

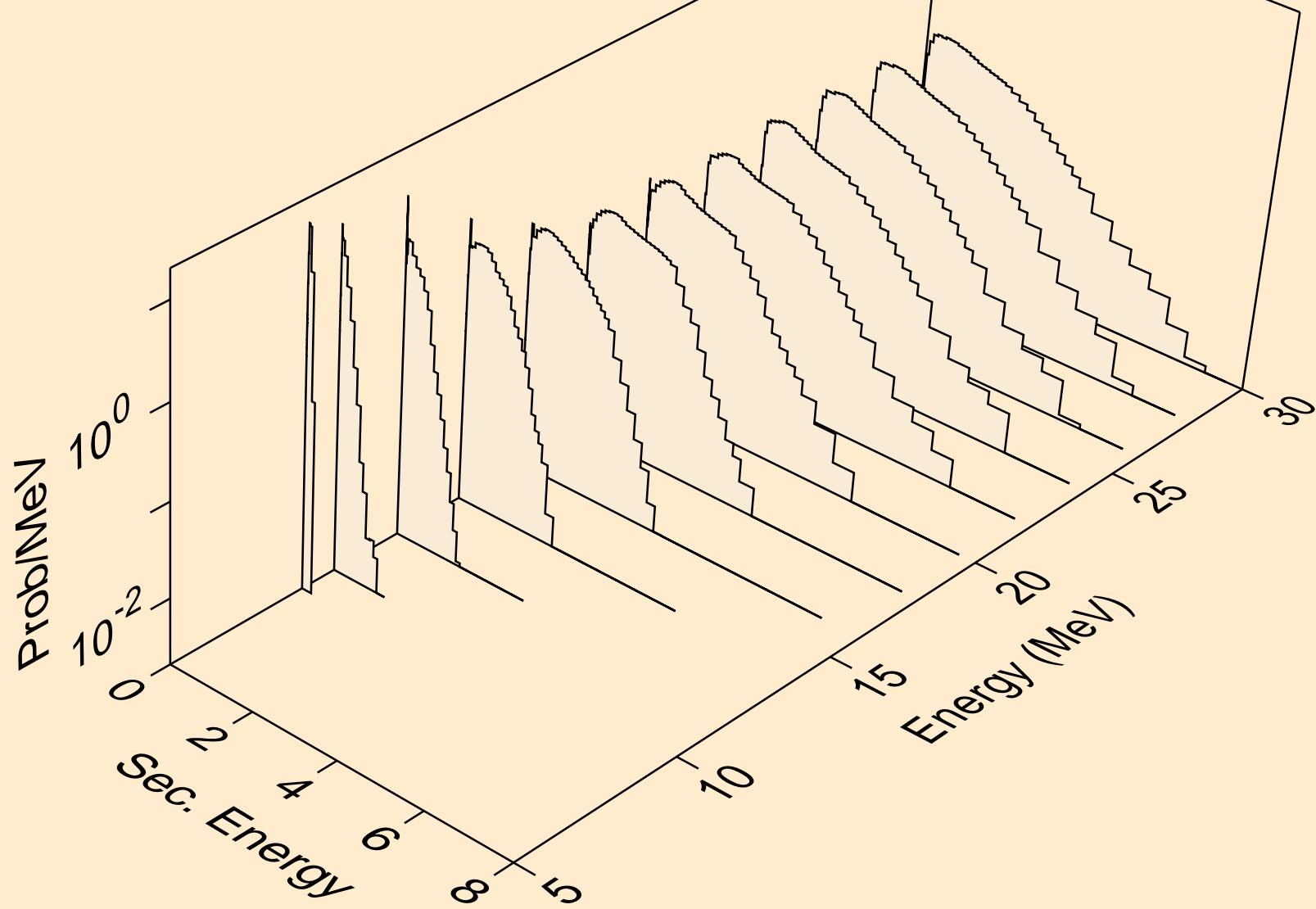

ZN072 NEUTRON ACER TENDL-2024 LIBRARY; T=293.6K
Neutron emission for (n,2n)a

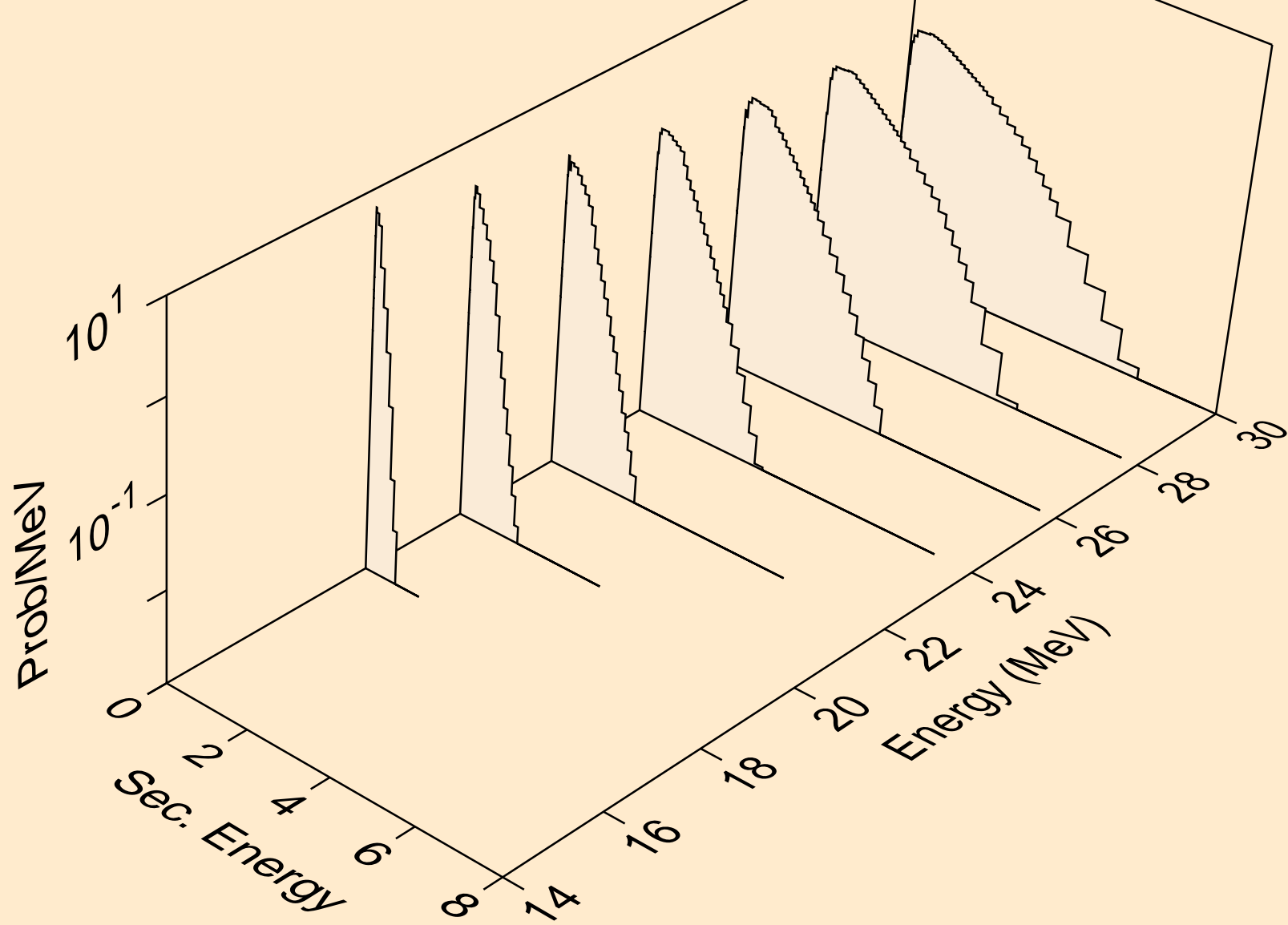

ZN072 NEUTRON ACER TENDL-2024 LIBRARY; T=293.6K
Neutron emission for (n,3n)a

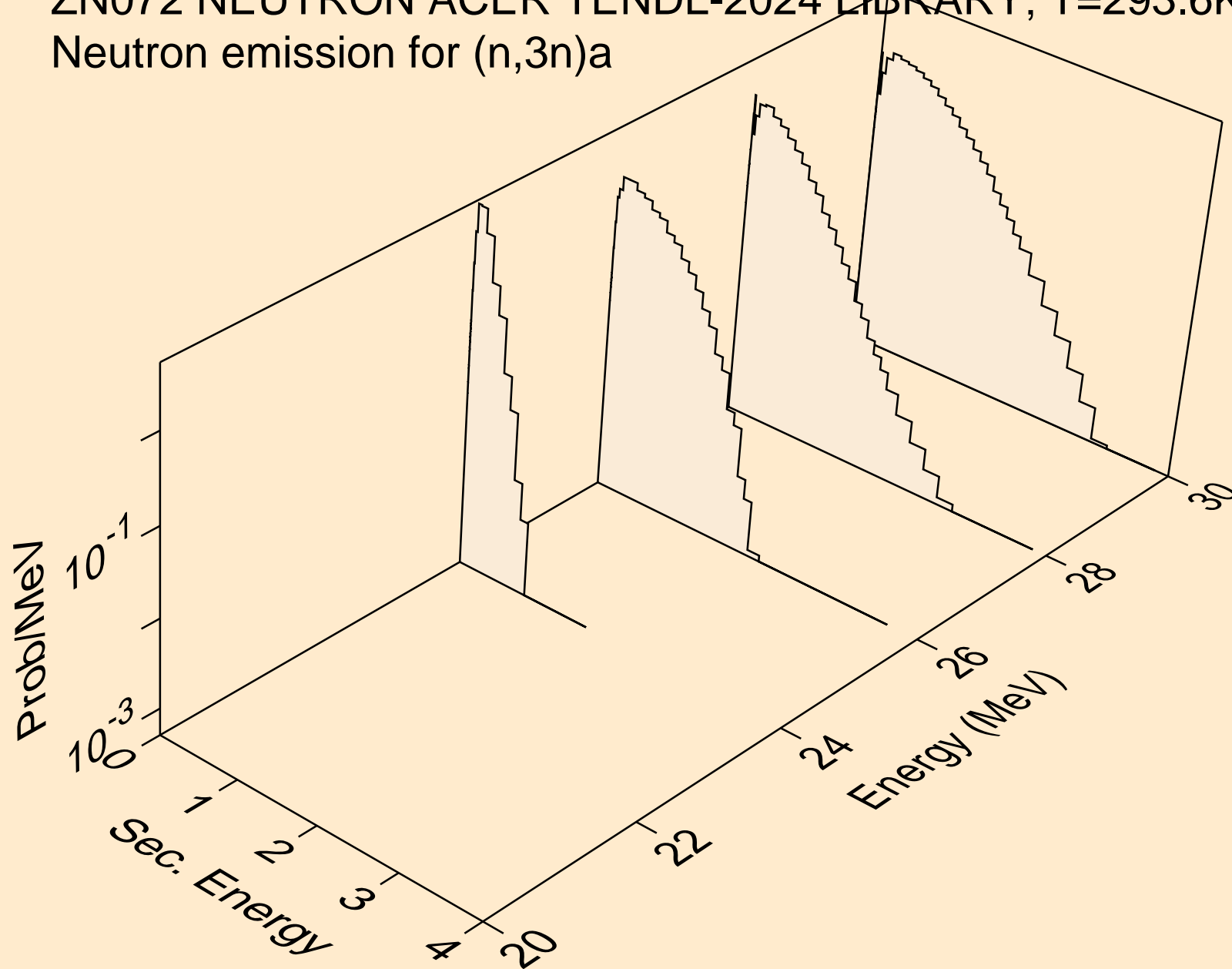

ZN072 NEUTRON ACER TENDL-2024 LIBRARY; T=293.6K
Neutron emission for (n,n*)p

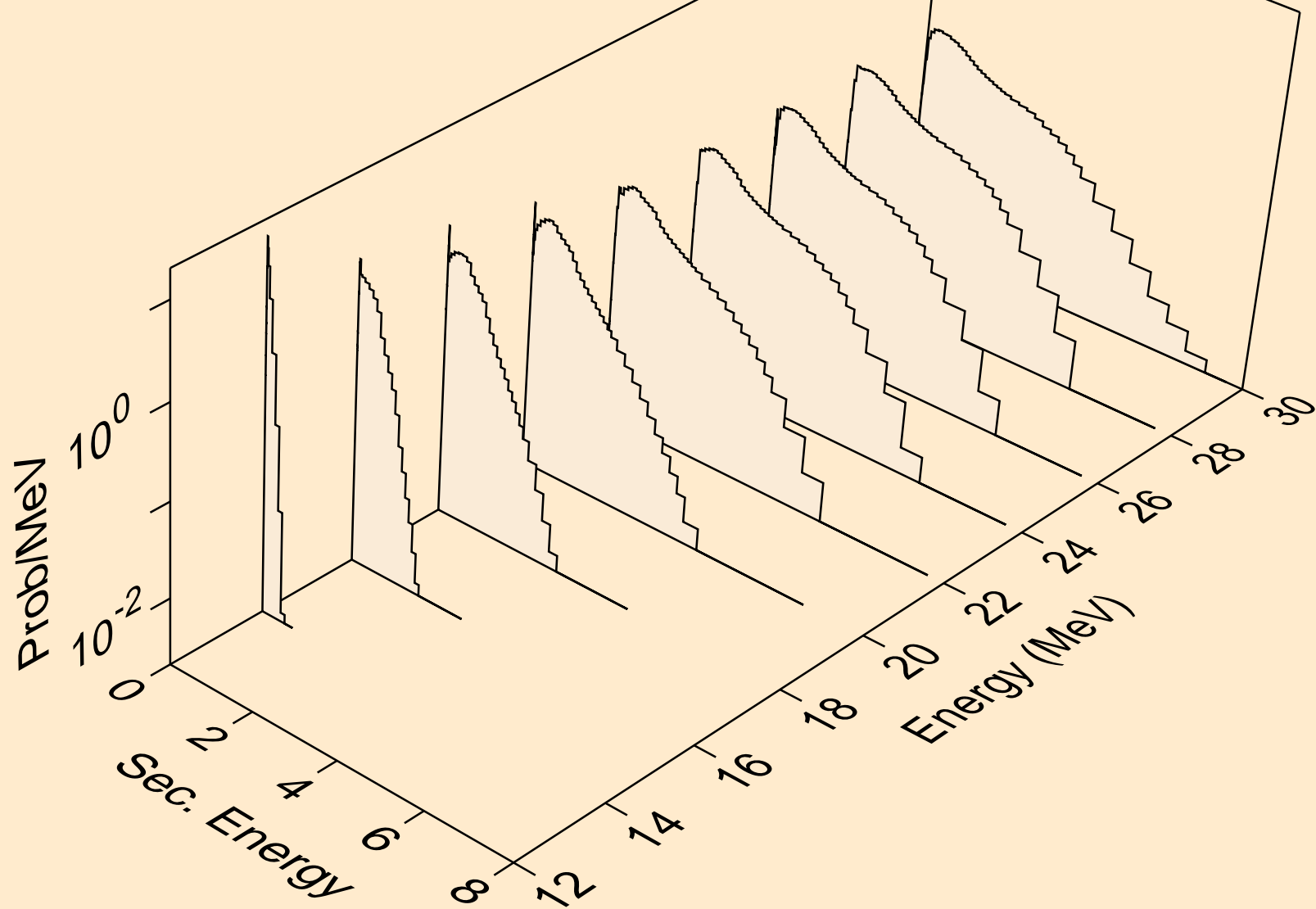

ZN072 NEUTRON ACER TENDL-2024 LIBRARY; T=293.6K
Neutron emission for (n,n*)d

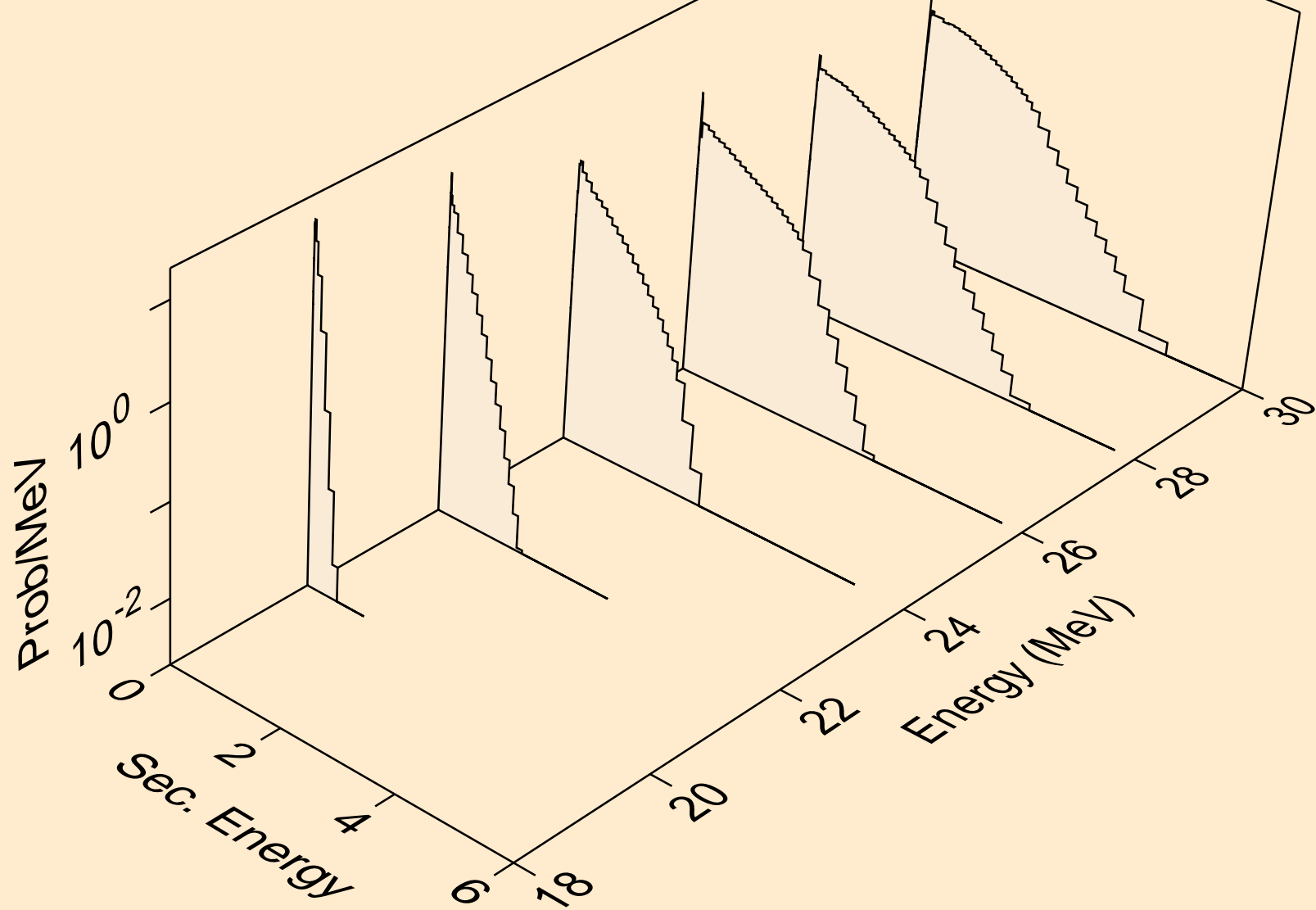

ZN072 NEUTRON ACER TENDL-2024 LIBRARY; T=293.6K
Neutron emission for (n,n*)t

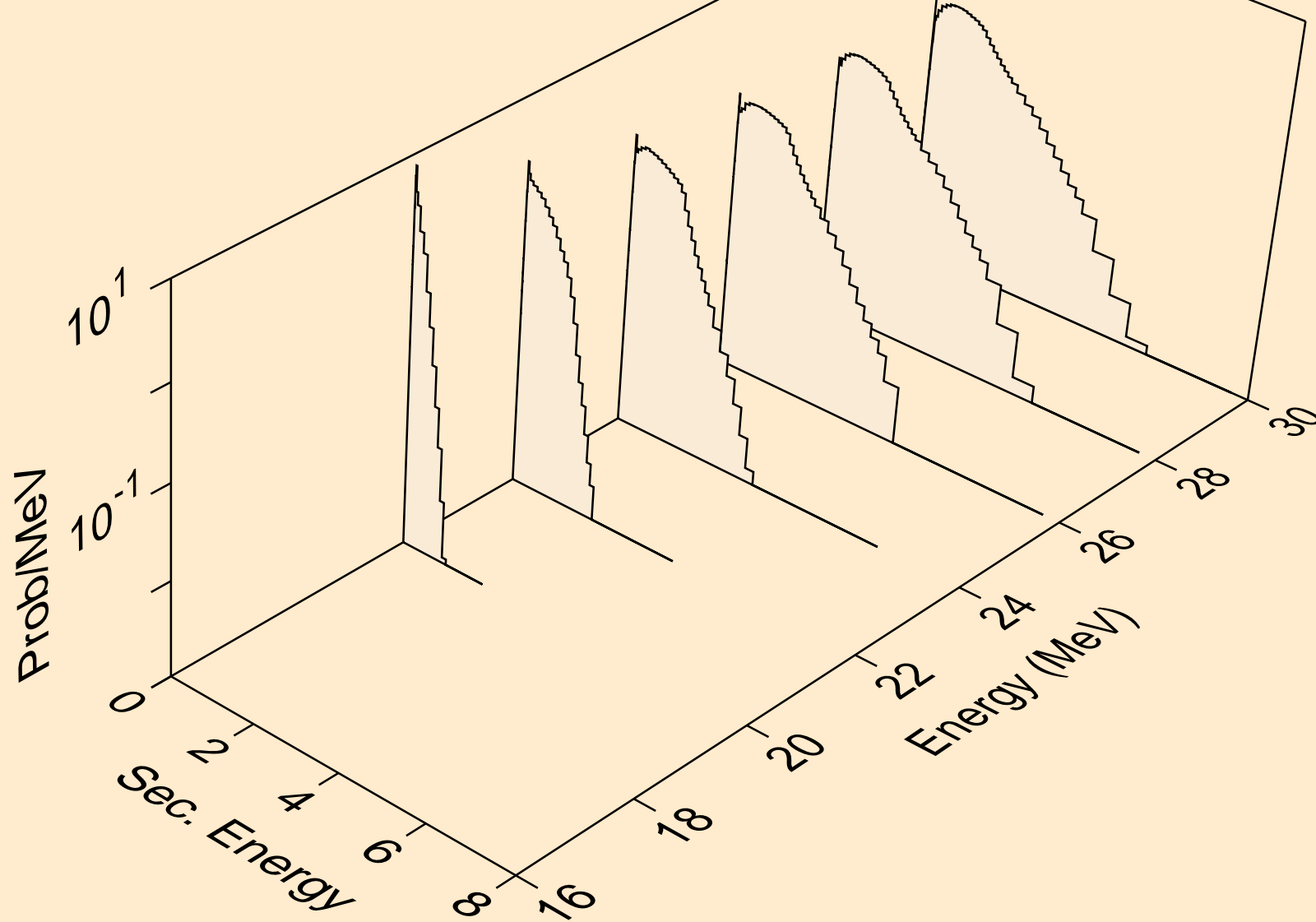

ZN072 NEUTRON ACER TENDL-2024 LIBRARY; T=293.6K
Neutron emission for (n,n*)he3

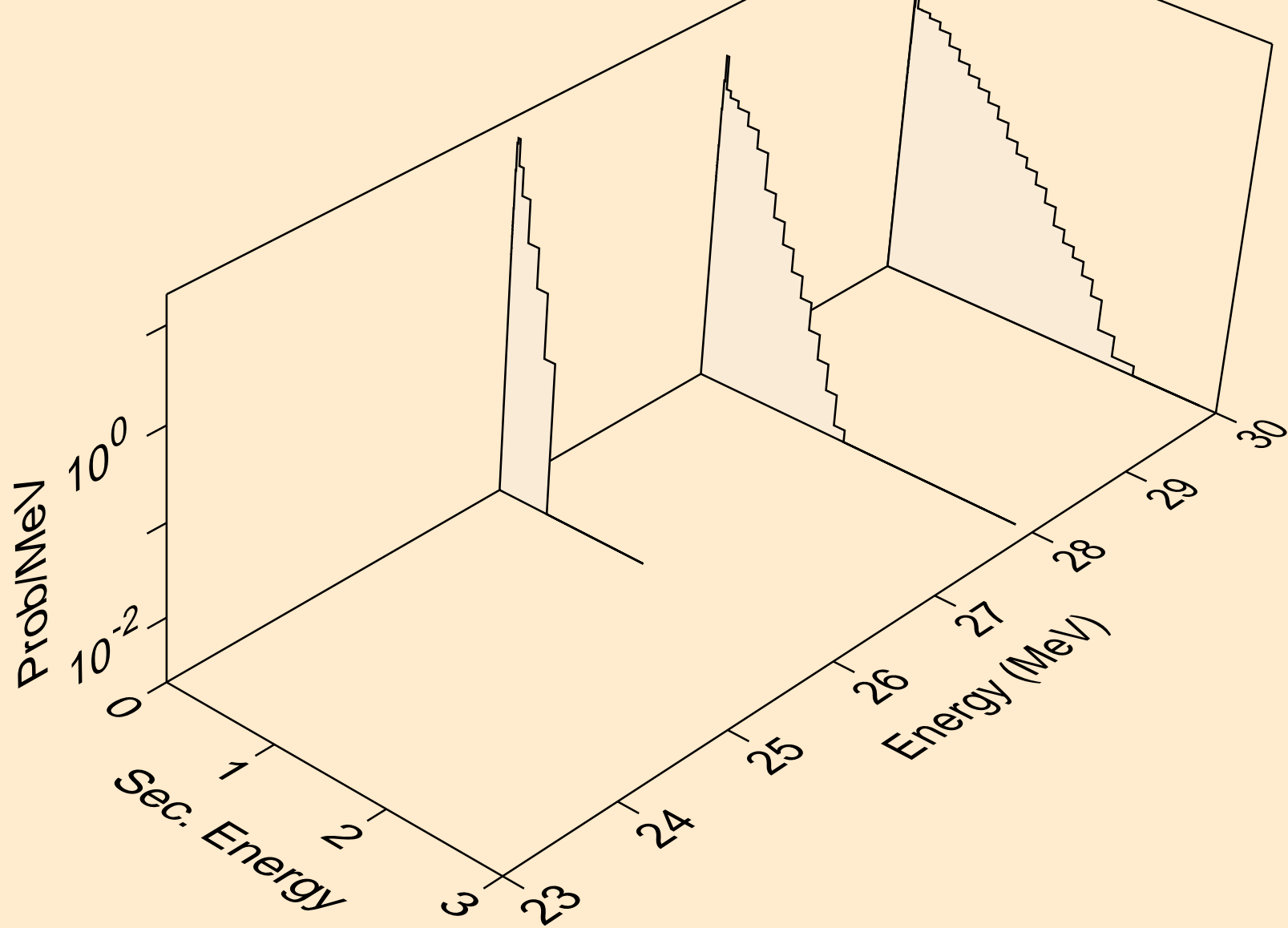

ZN072 NEUTRON ACER TENDL-2024 LIBRARY; T=293.6K
Neutron emission for (n,4n)

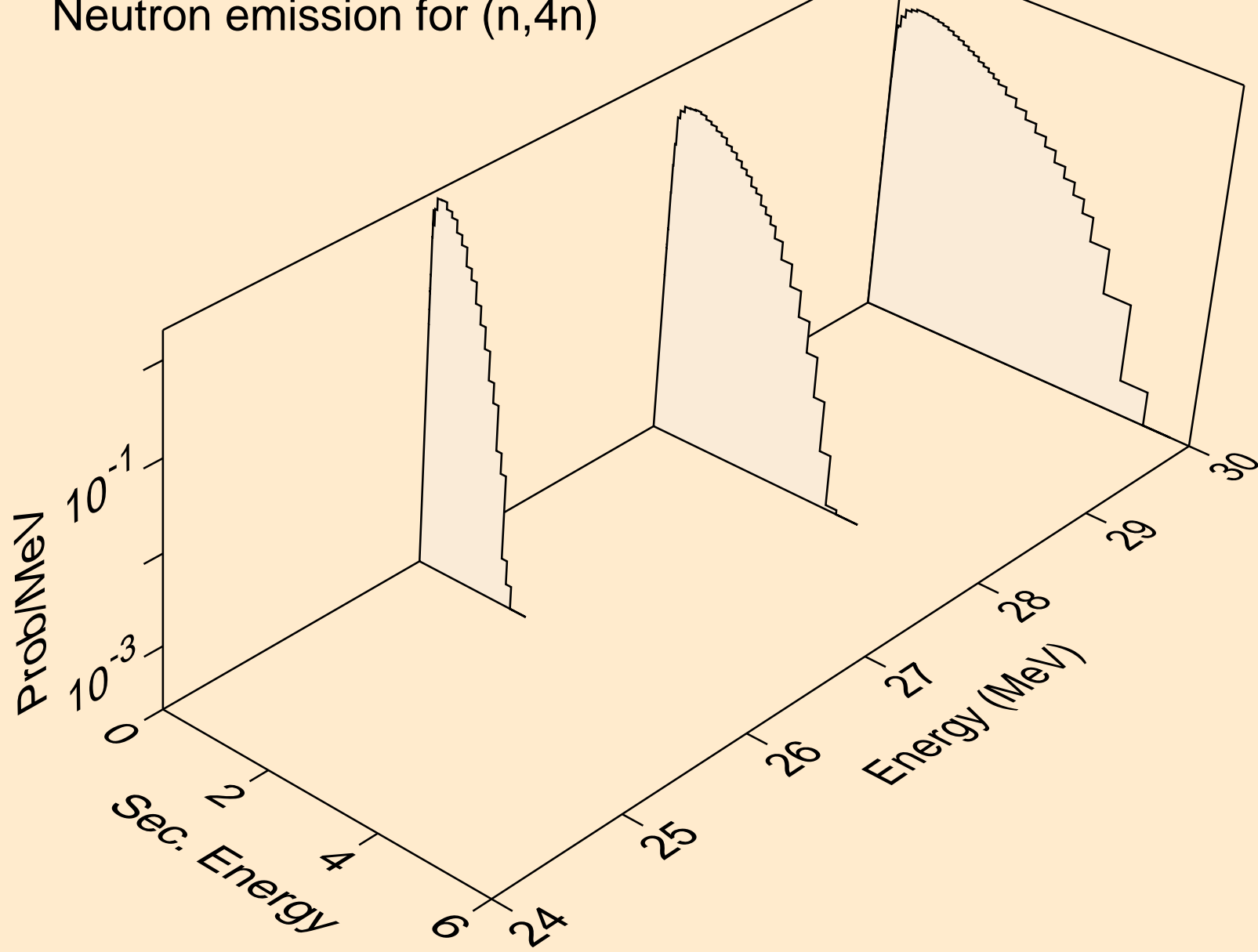

ZN072 NEUTRON ACER TENDL-2024 LIBRARY; T=293.6K
Neutron emission for (n,2np)

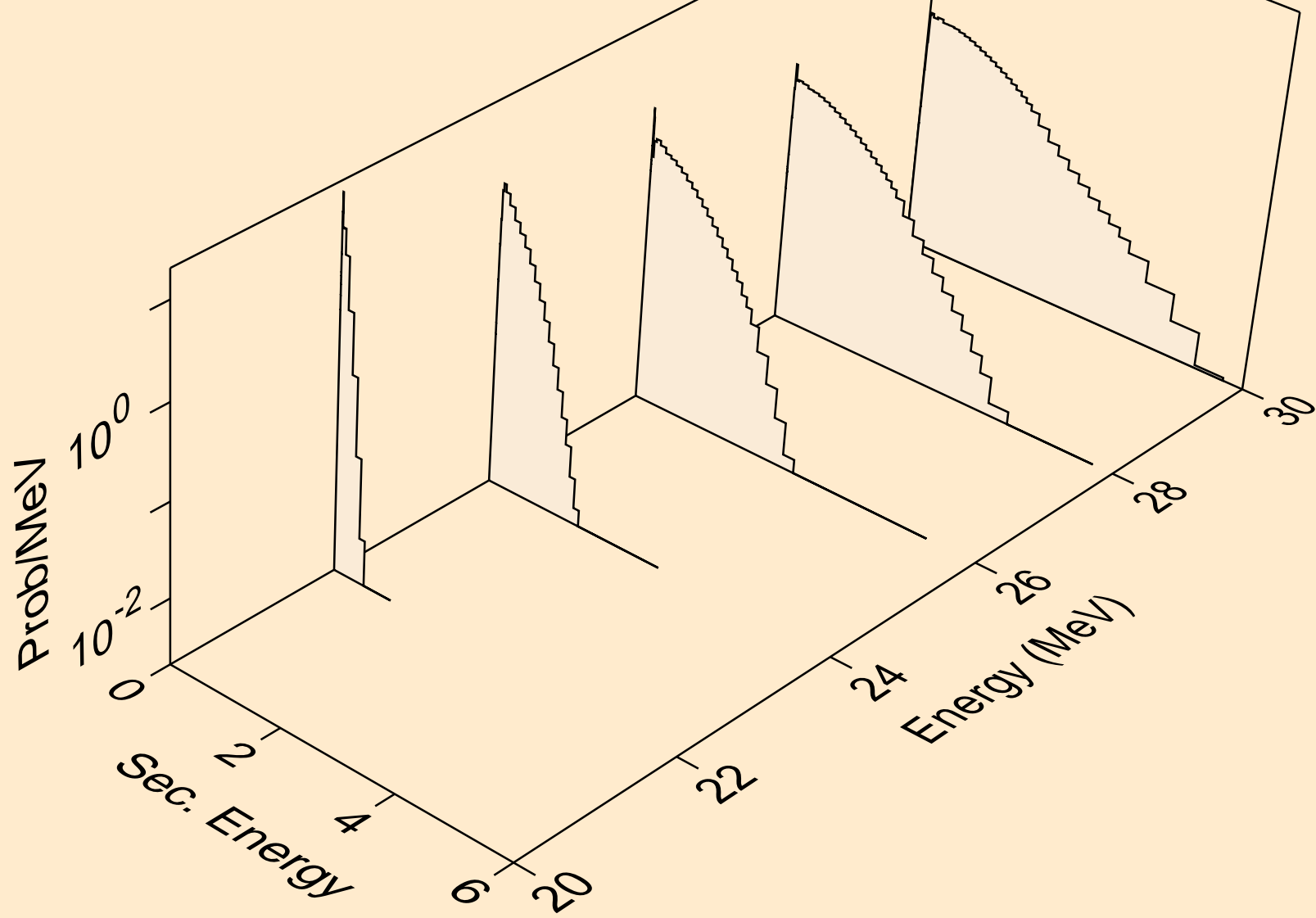

ZN072 NEUTRON ACER TENDL-2024 LIBRARY; T=293.6K
Neutron emission for (n,3np)

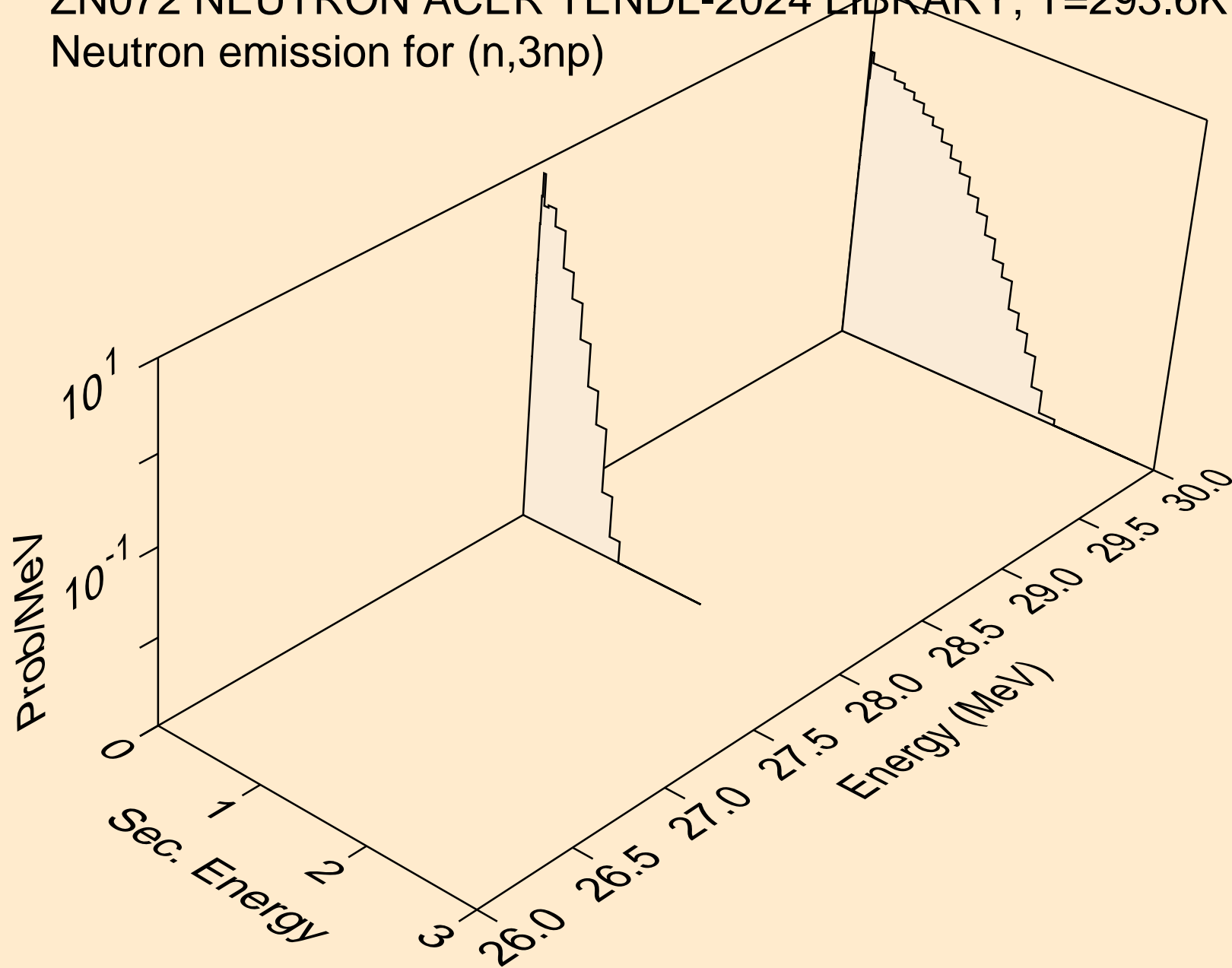

ZN072 NEUTRON ACER TENDL-2024 LIBRARY; T=293.6K
Neutron emission for (n,n2p)

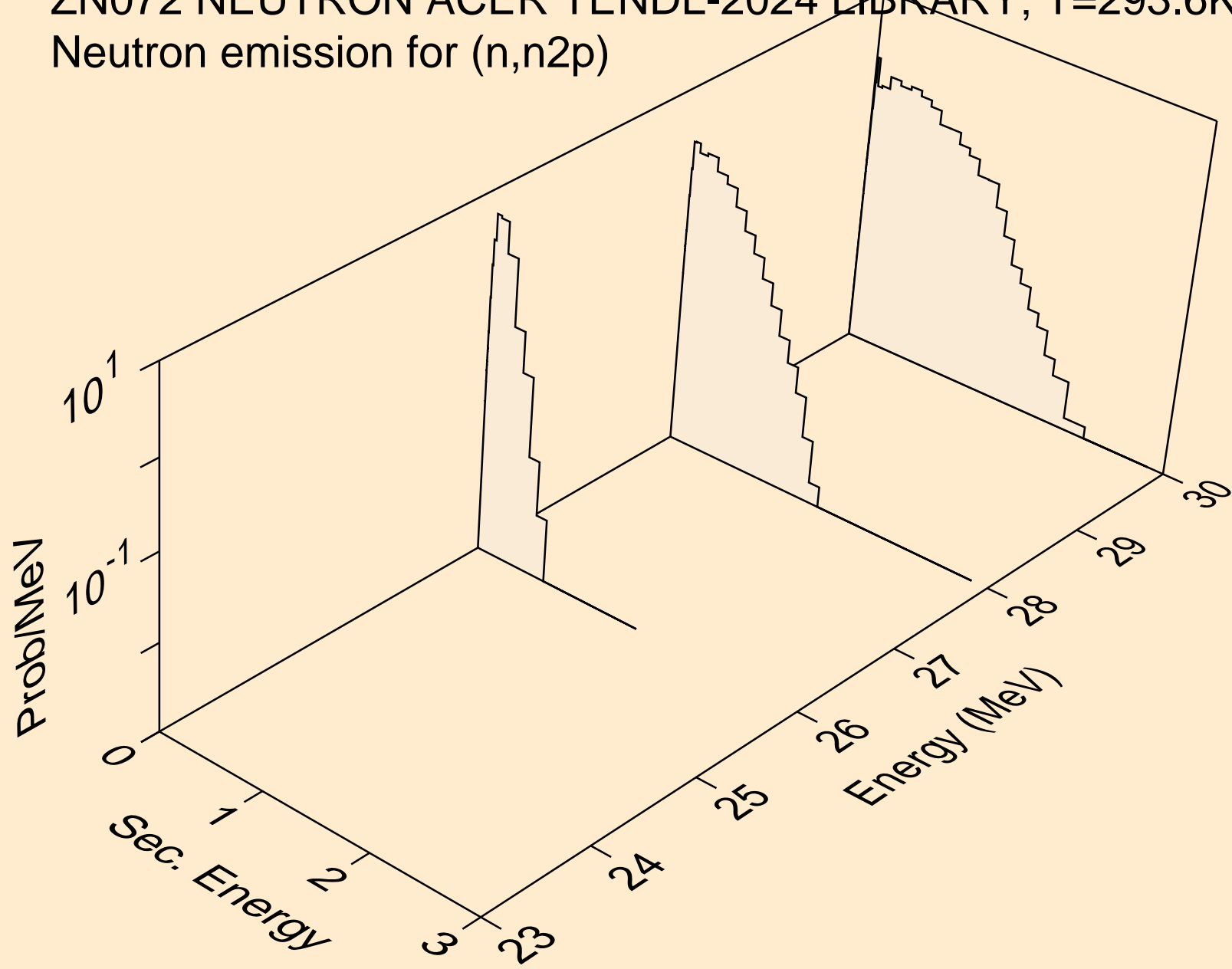

ZN072 NEUTRON ACER TENDL-2024 LIBRARY; T=293.6K
Neutron emission for (n,n*c)

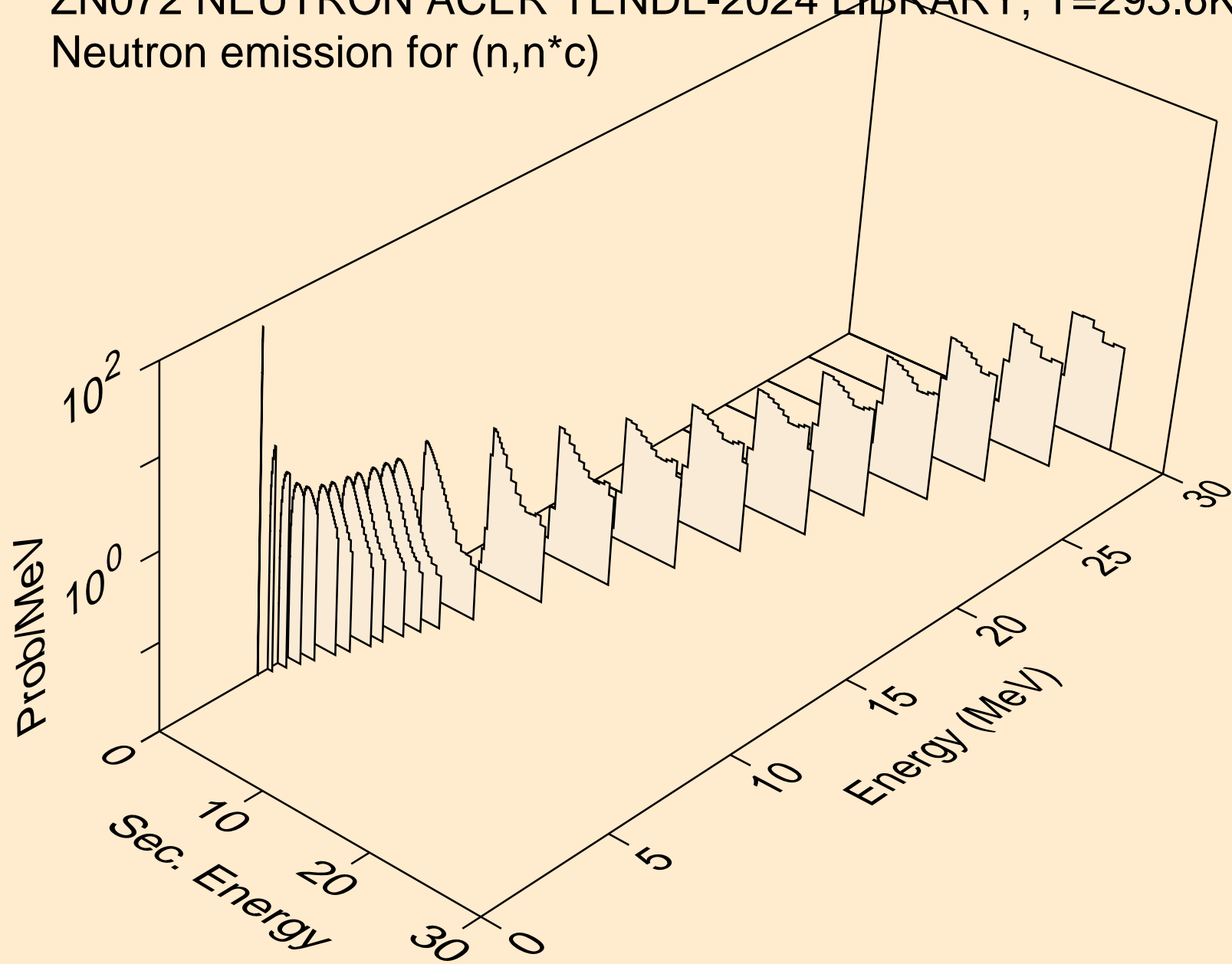

ZN072 NEUTRON ACER TENDL-2024 LIBRARY; T=293.6K
Photon emission for (n,x)

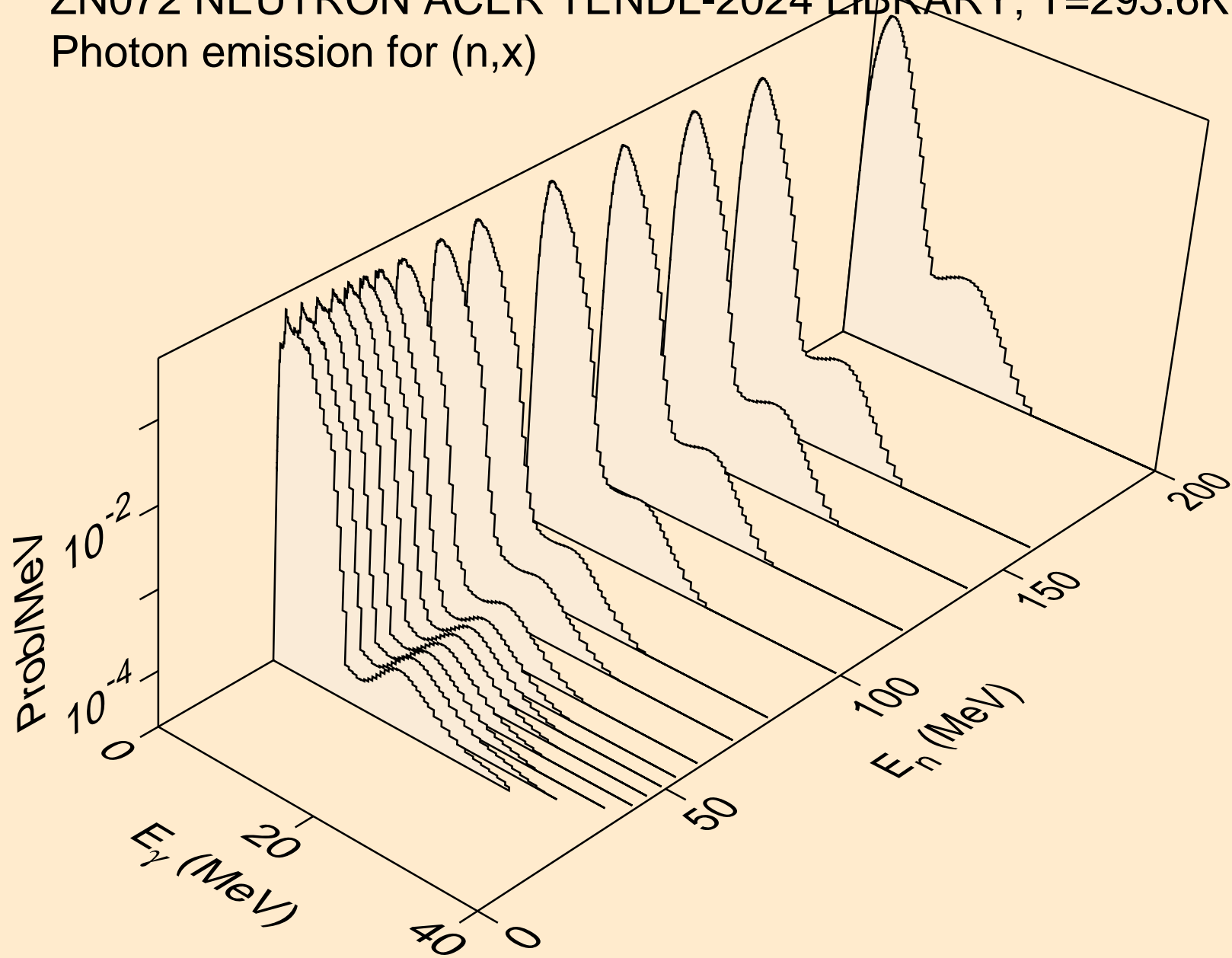

ZN072 NEUTRON ACER TENDL-2024 LIBRARY; T=293.6K
Photon emission for (n,2nd)

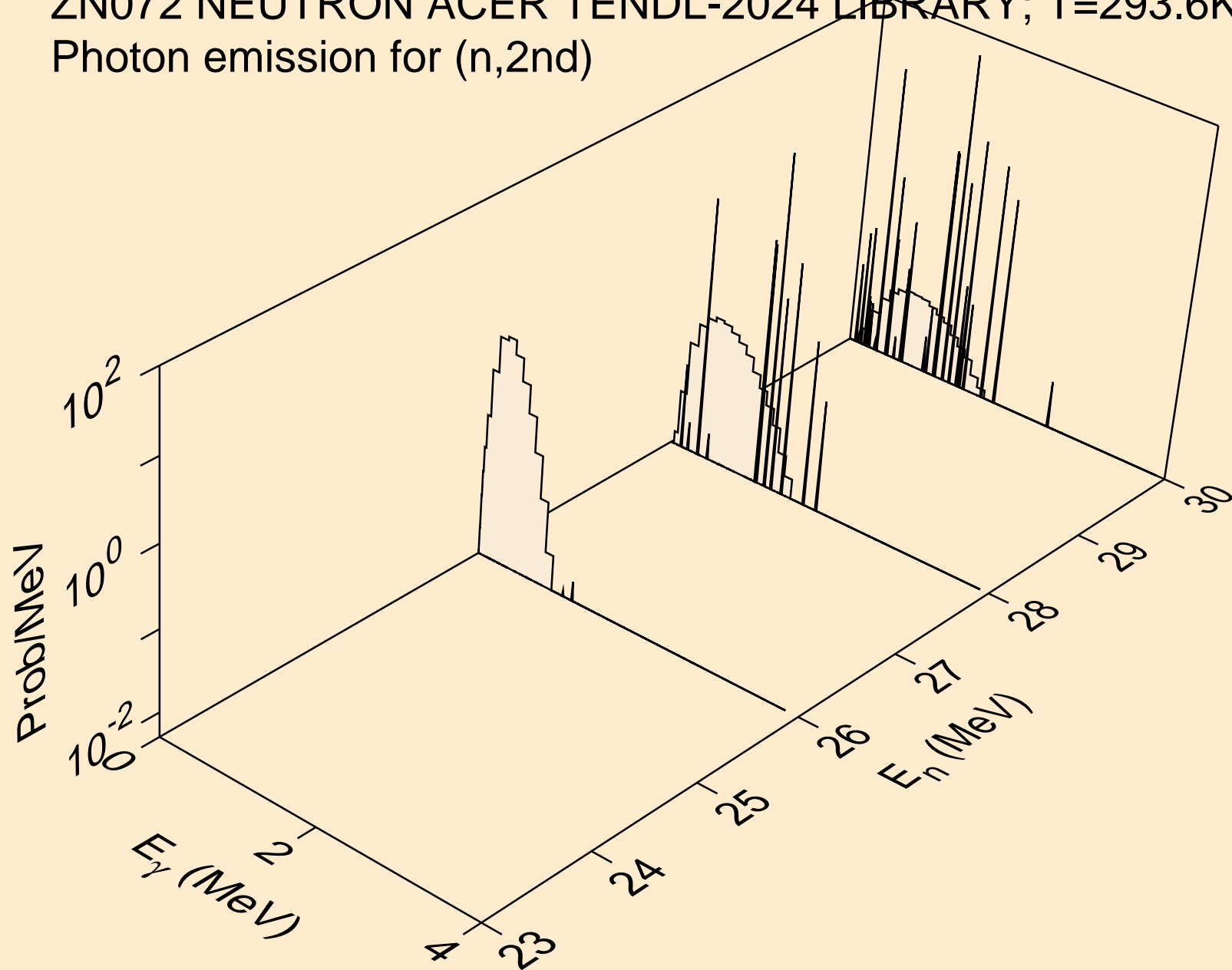

ZN072 NEUTRON ACER TENDL-2024 LIBRARY; T=293.6K
Photon emission for (n,2n)

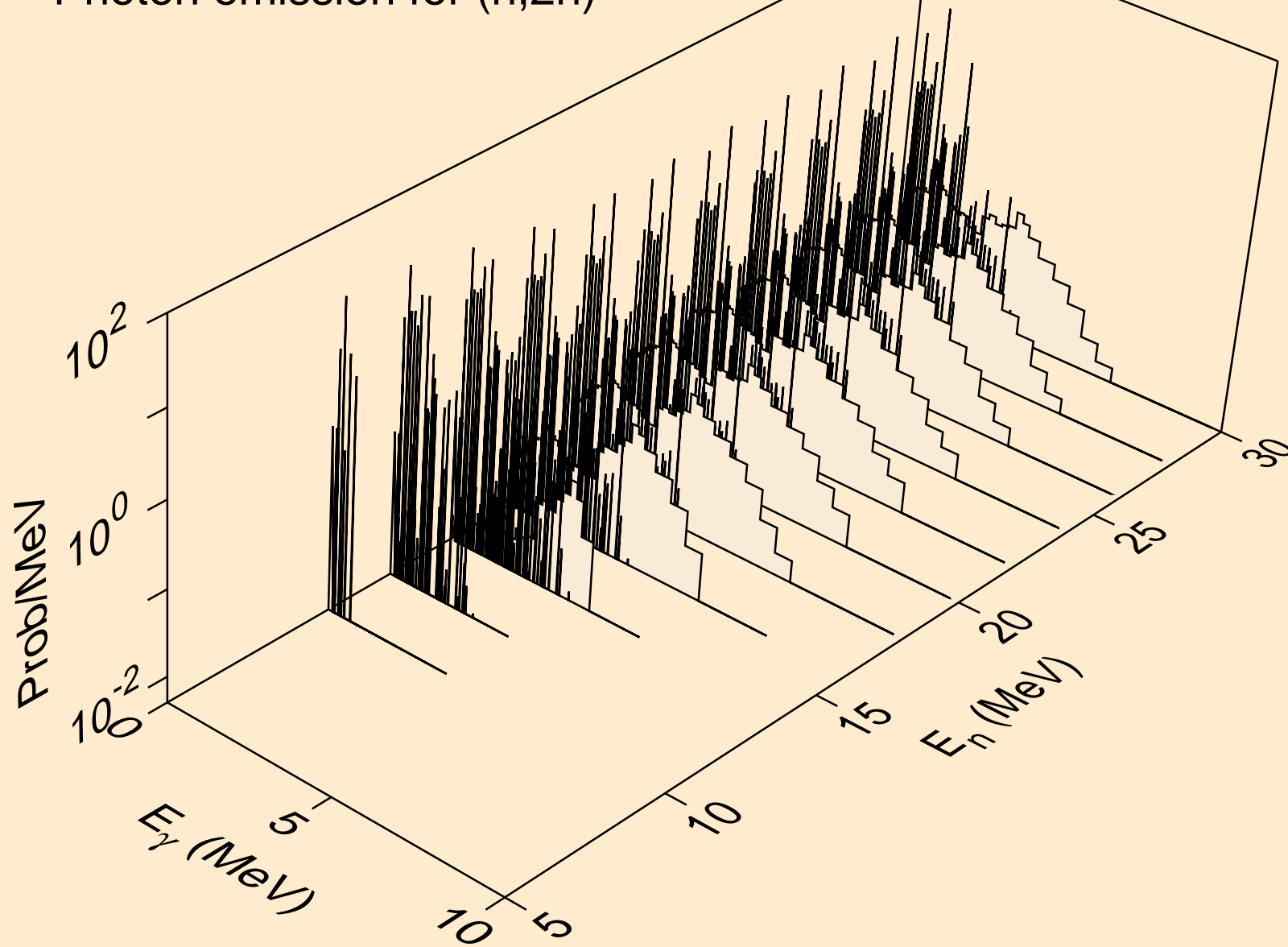

ZN072 NEUTRON ACER TENDL-2024 LIBRARY; T=293.6K
Photon emission for (n,3n)

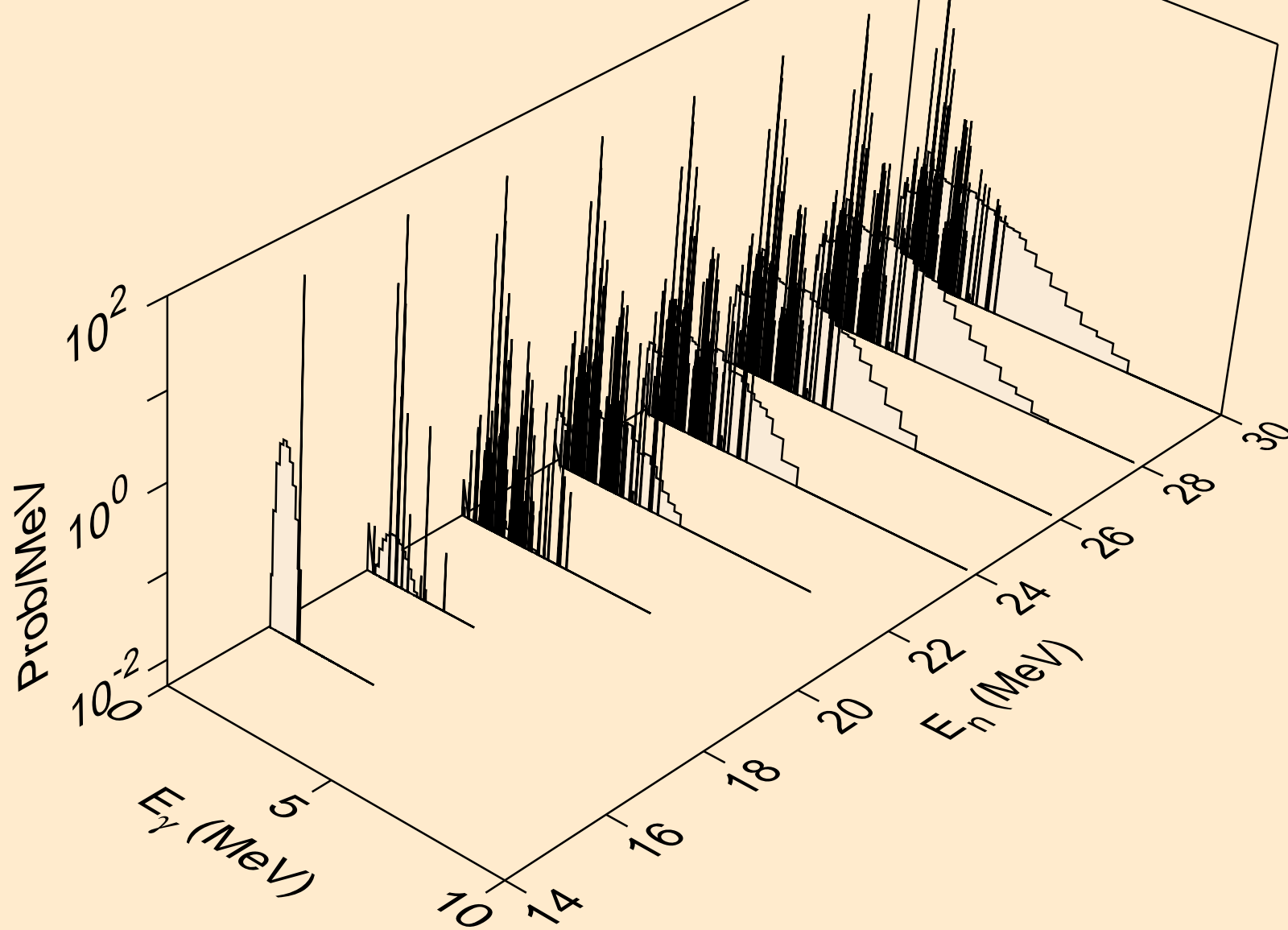

ZN072 NEUTRON ACER TENDL-2024 LIBRARY; T=293.6K
Photon emission for (n,n*)a

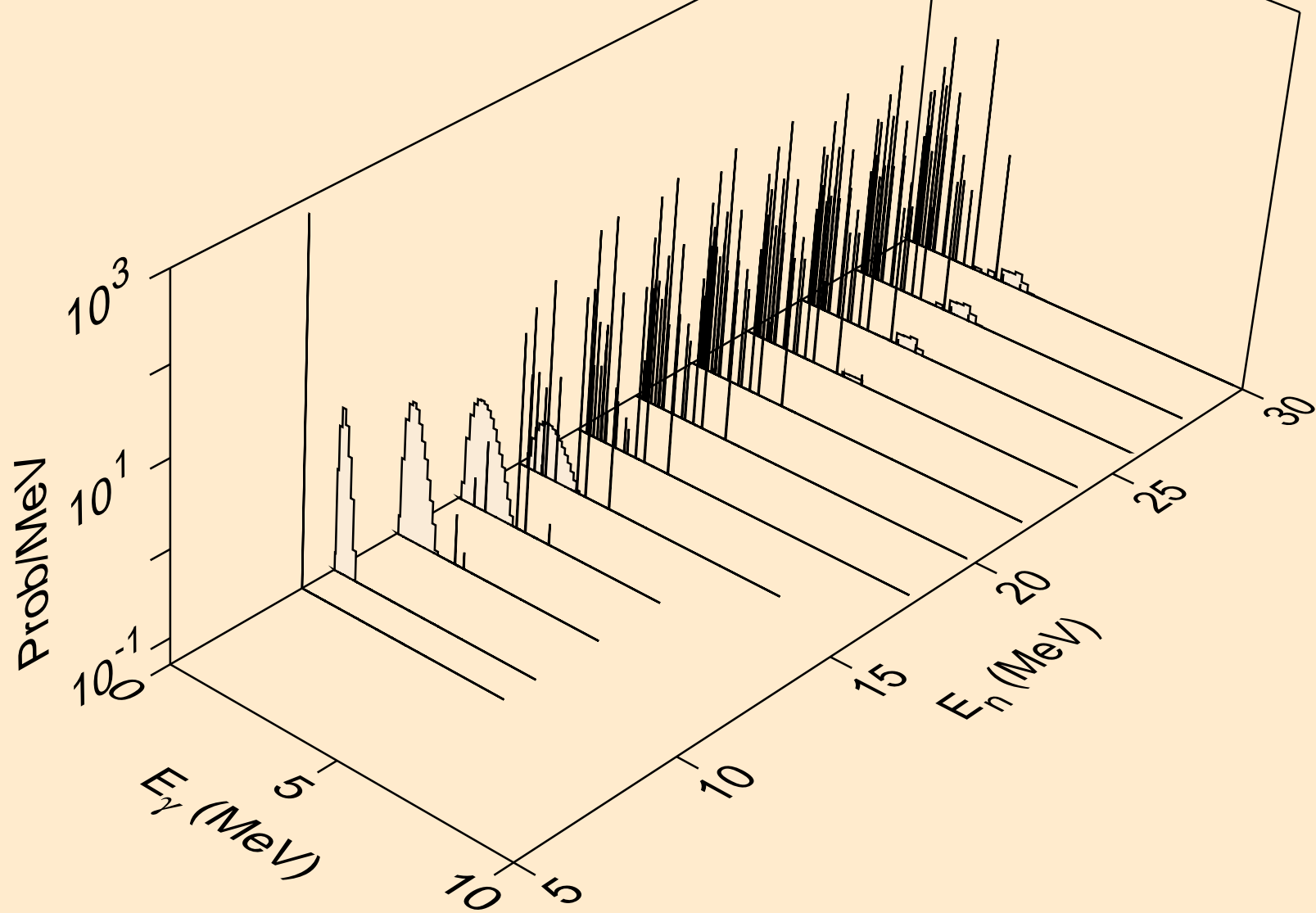

ZN072 NEUTRON ACER TENDL-2024 LIBRARY; T=293.6K
Photon emission for (n,2n)a

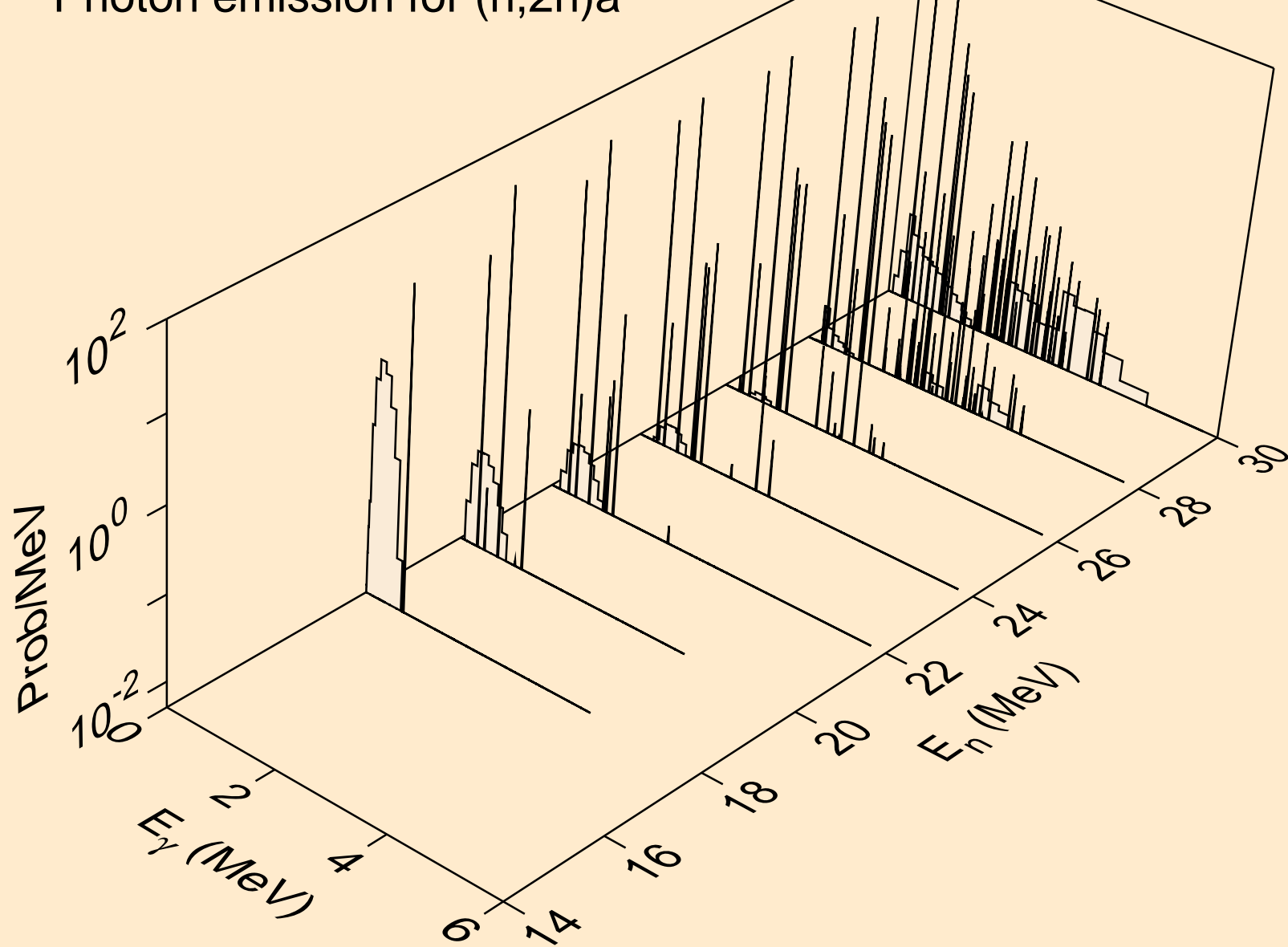

ZN072 NEUTRON ACER TENDL-2024 LIBRARY; T=293.6K
Photon emission for (n,3n)a

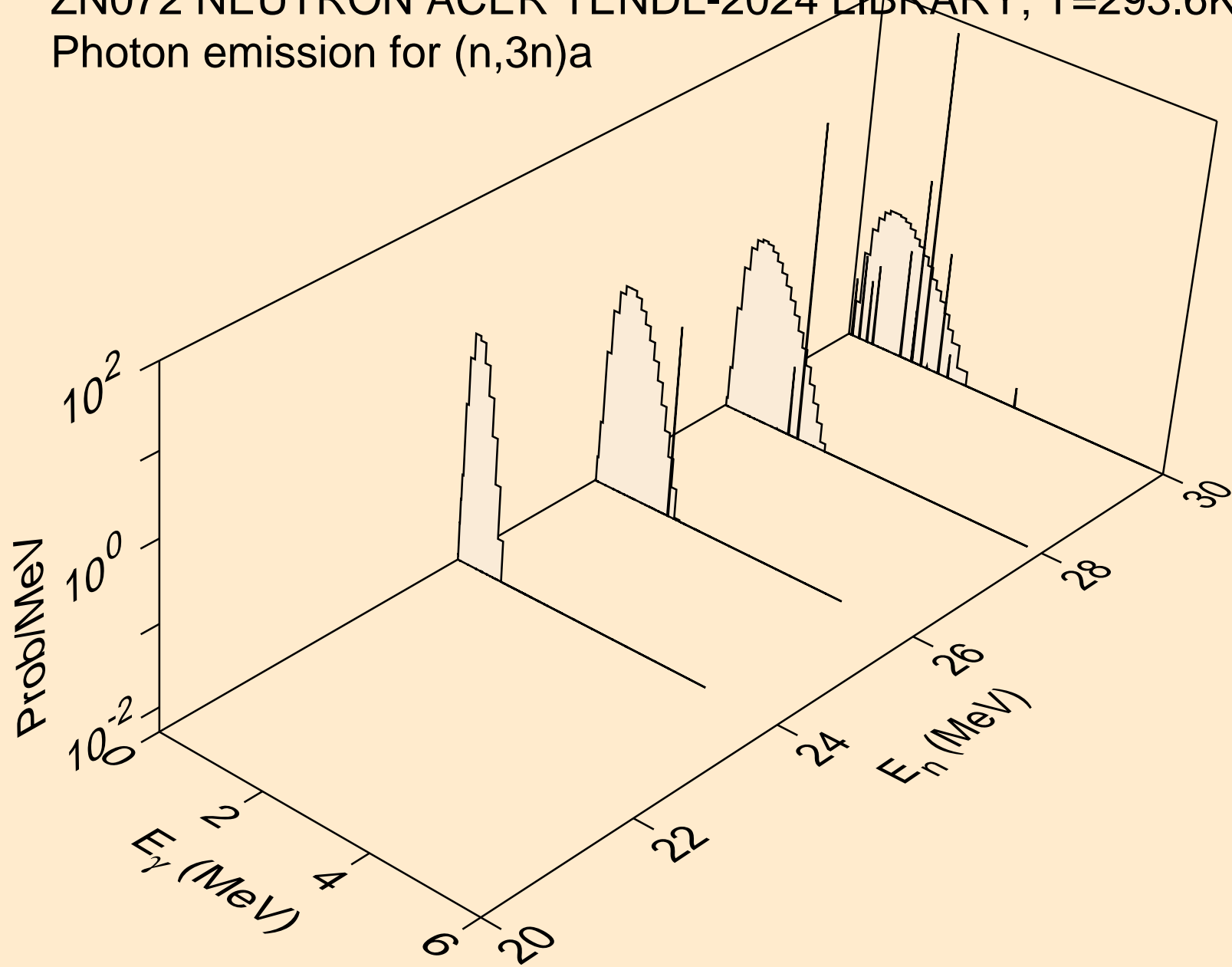

ZN072 NEUTRON ACER TENDL-2024 LIBRARY; T=293.6K
Photon emission for (n,n*)p

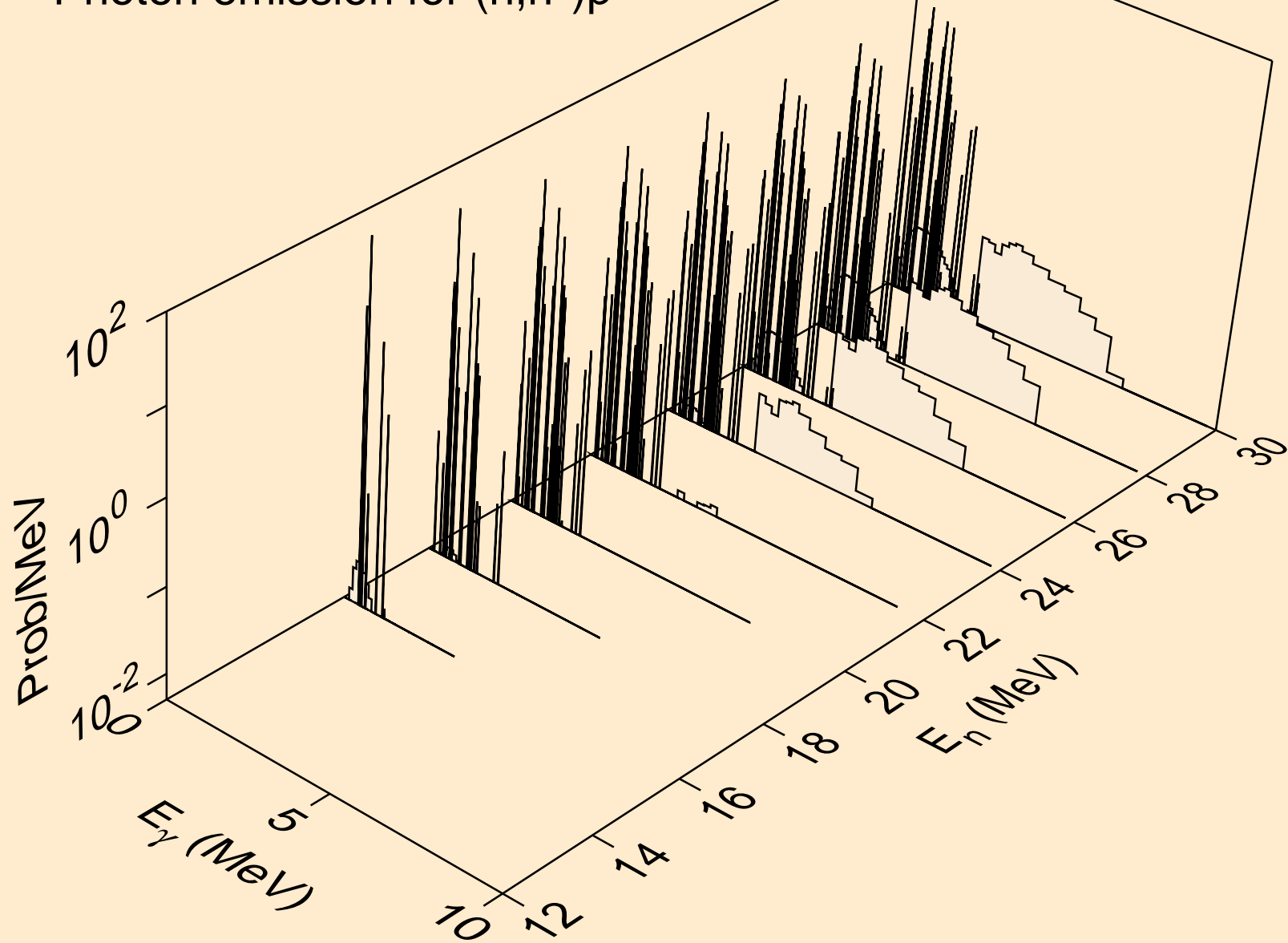

ZN072 NEUTRON ACER TENDL-2024 LIBRARY; T=293.6K
Photon emission for (n,n*)d

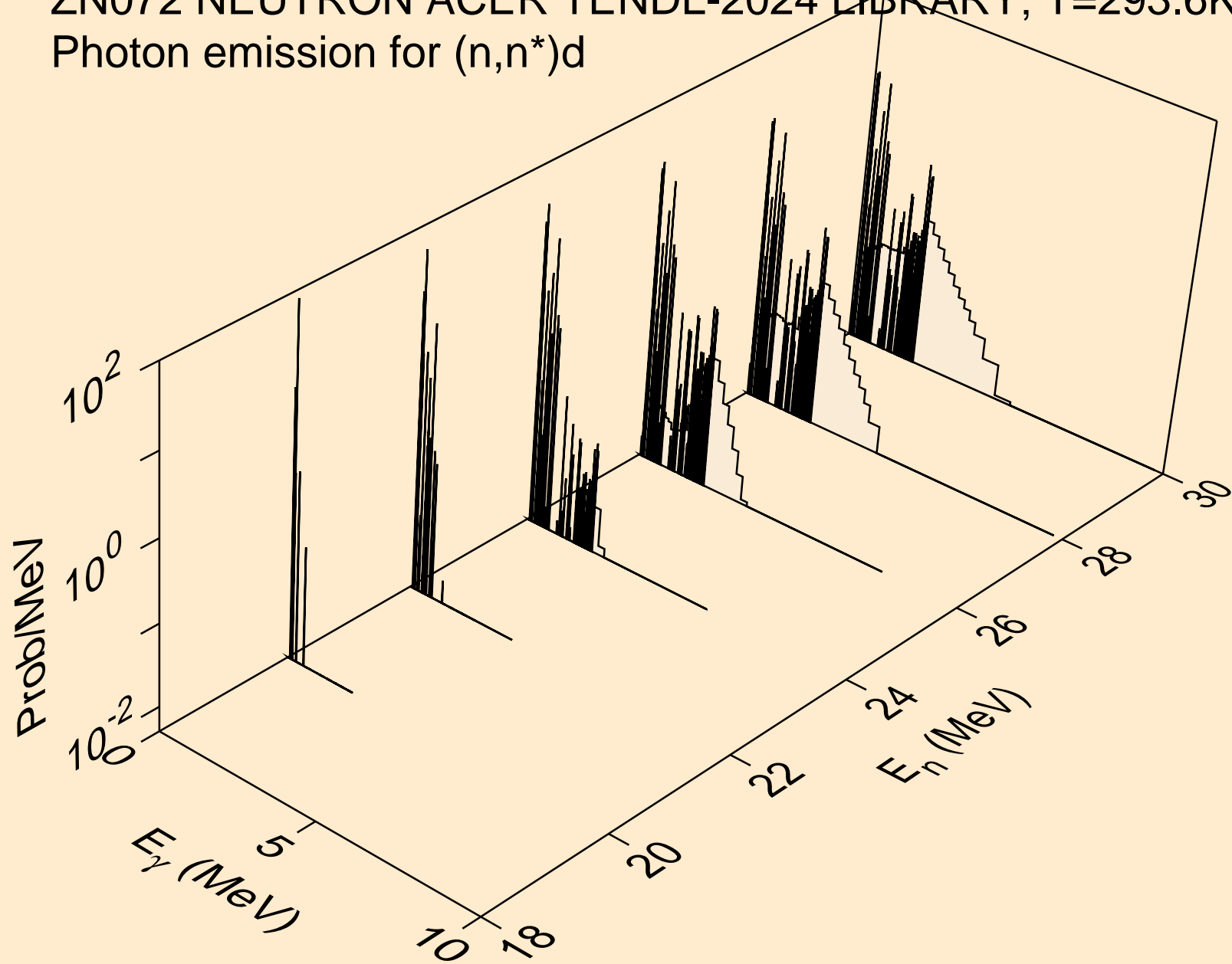

ZN072 NEUTRON ACER TENDL-2024 LIBRARY; T=293.6K
Photon emission for (n,n*)t

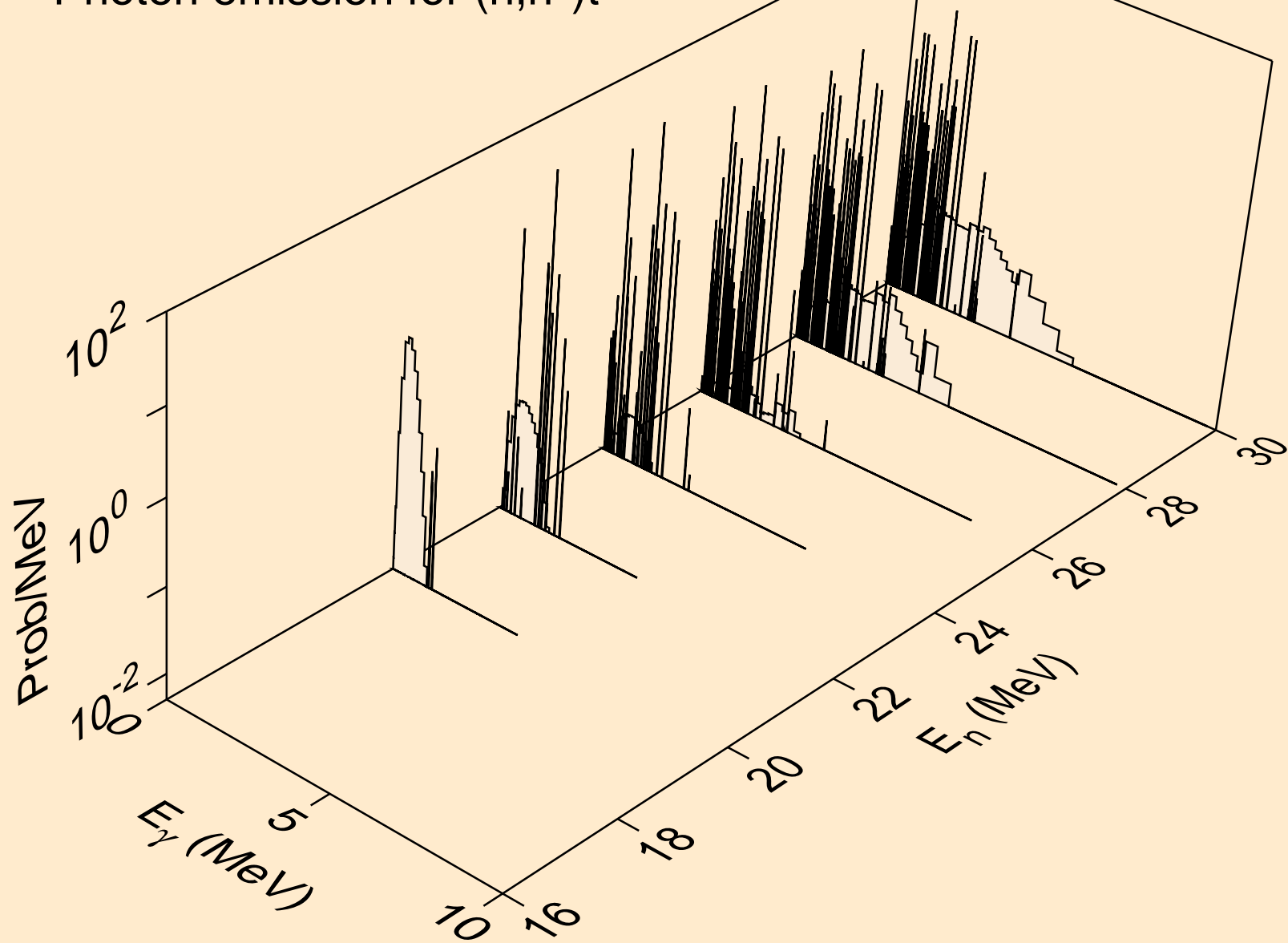

ZN072 NEUTRON ACER TENDL-2024 LIBRARY; T=293.6K
Photon emission for (n,n*)he3

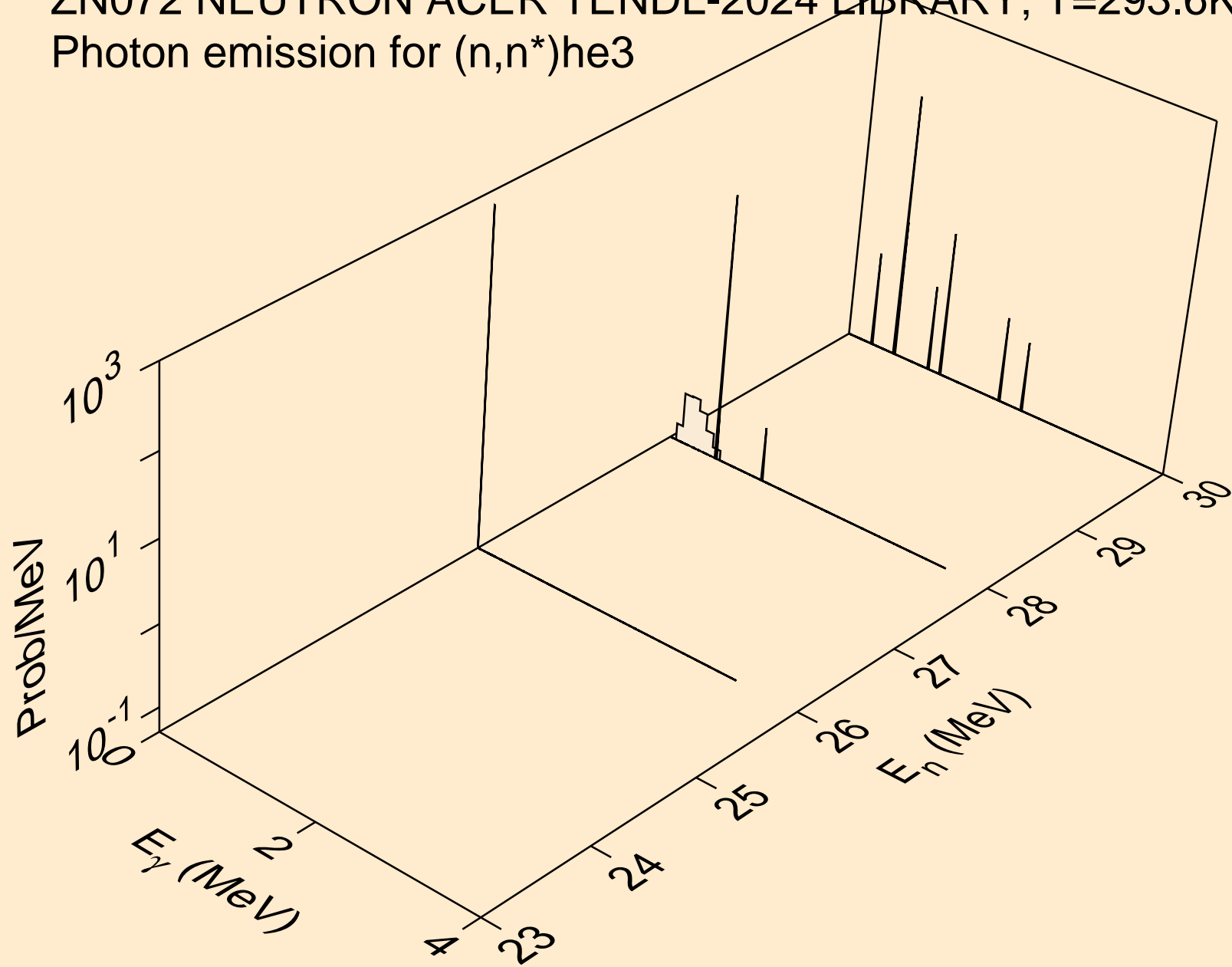

ZN072 NEUTRON ACER TENDL-2024 LIBRARY; T=293.6K
Photon emission for (n,4n)

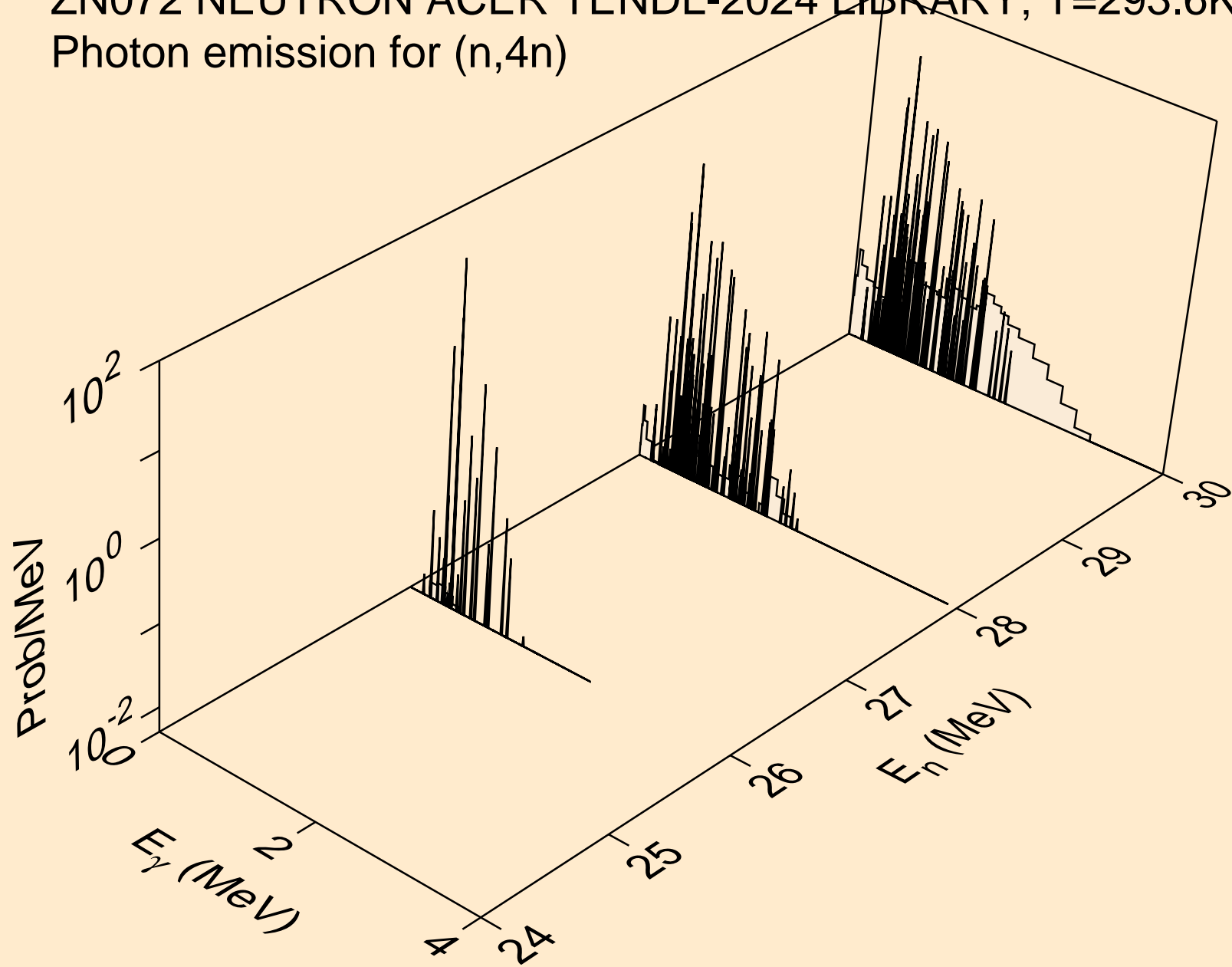

ZN072 NEUTRON ACER TENDL-2024 LIBRARY; T=293.6K
Photon emission for (n,2np)

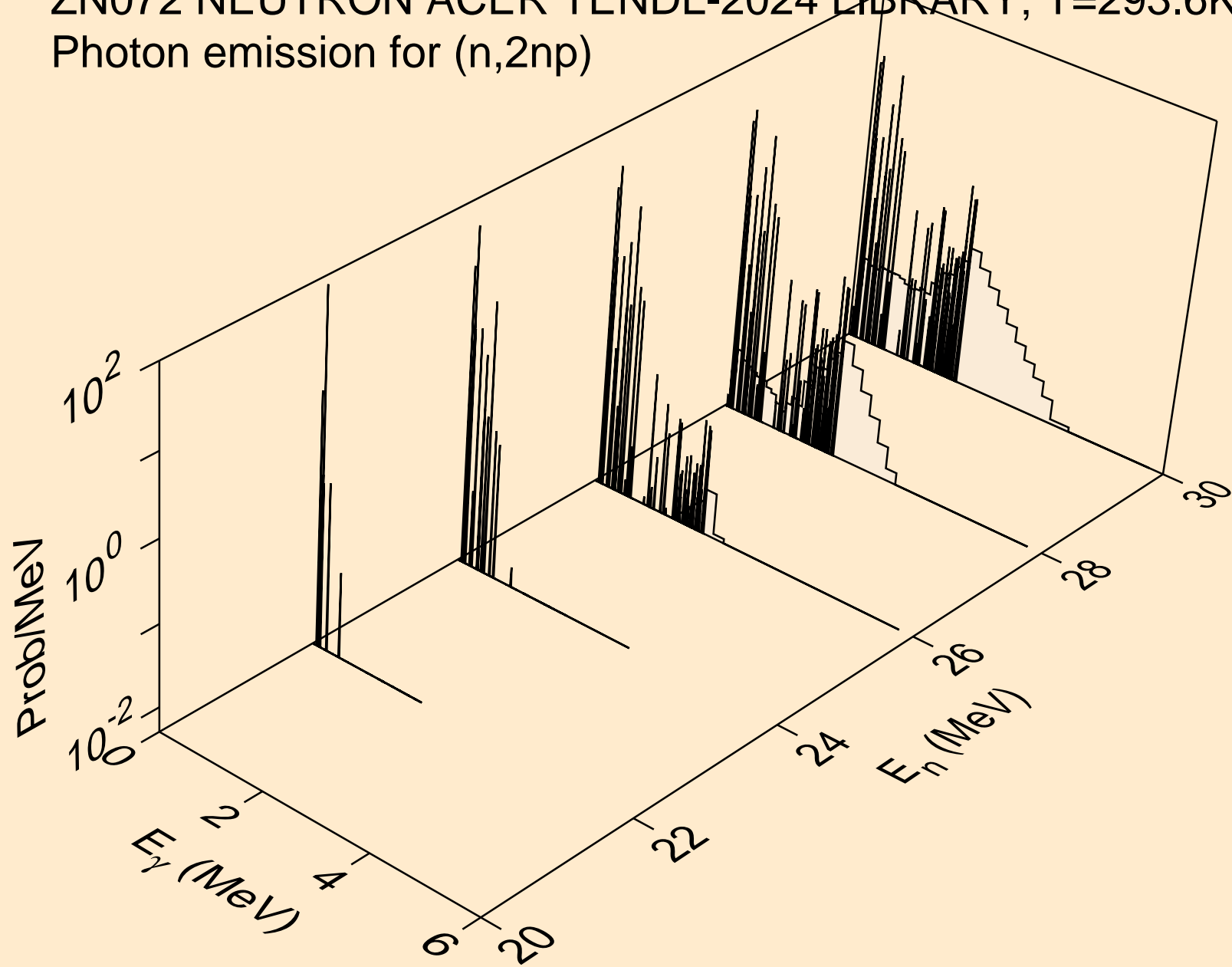

ZN072 NEUTRON ACER TENDL-2024 LIBRARY; T=293.6K
Photon emission for (n,3np)

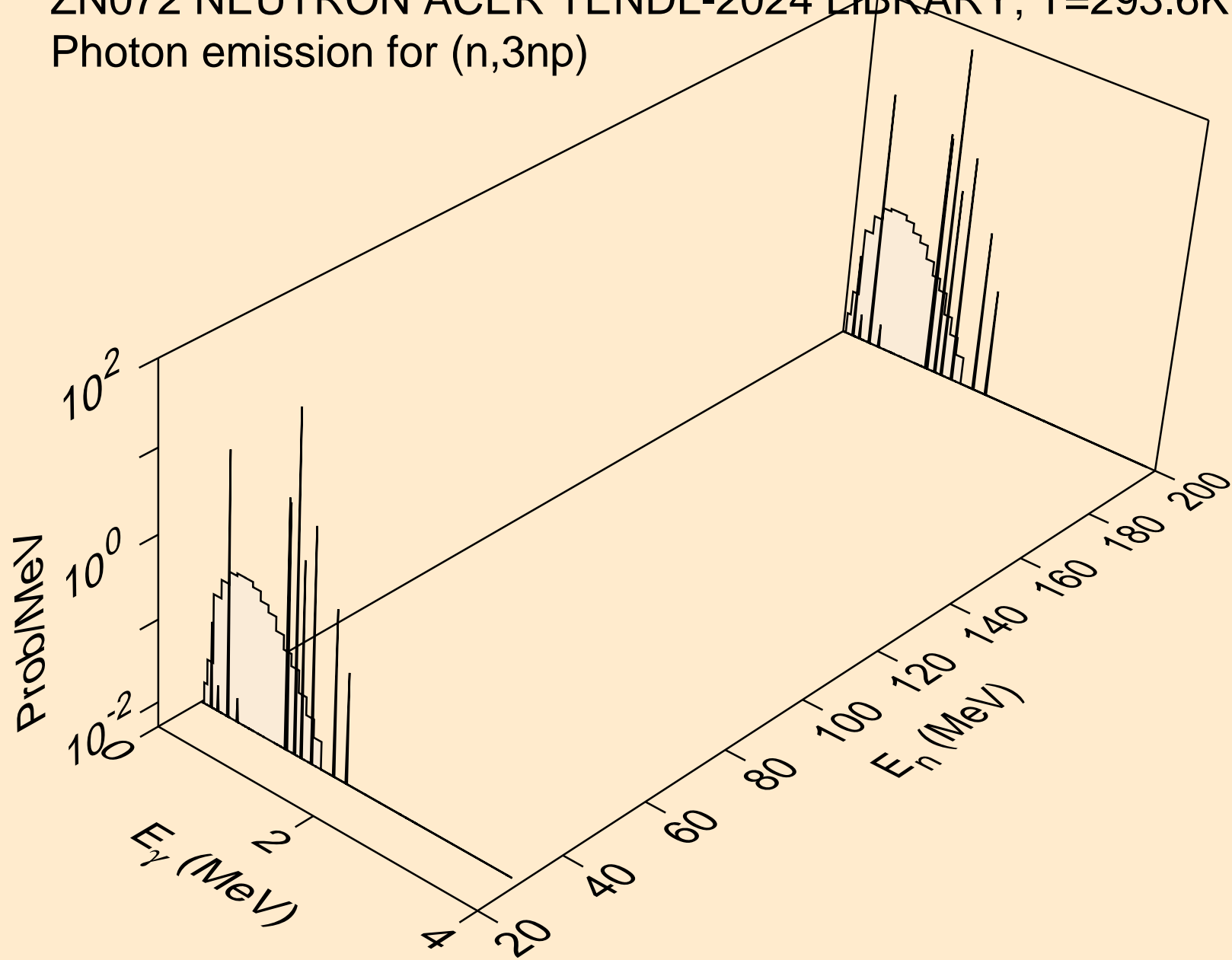

ZN072 NEUTRON ACER TENDL-2024 LIBRARY; T=293.6K
Photon emission for (n,n2p)

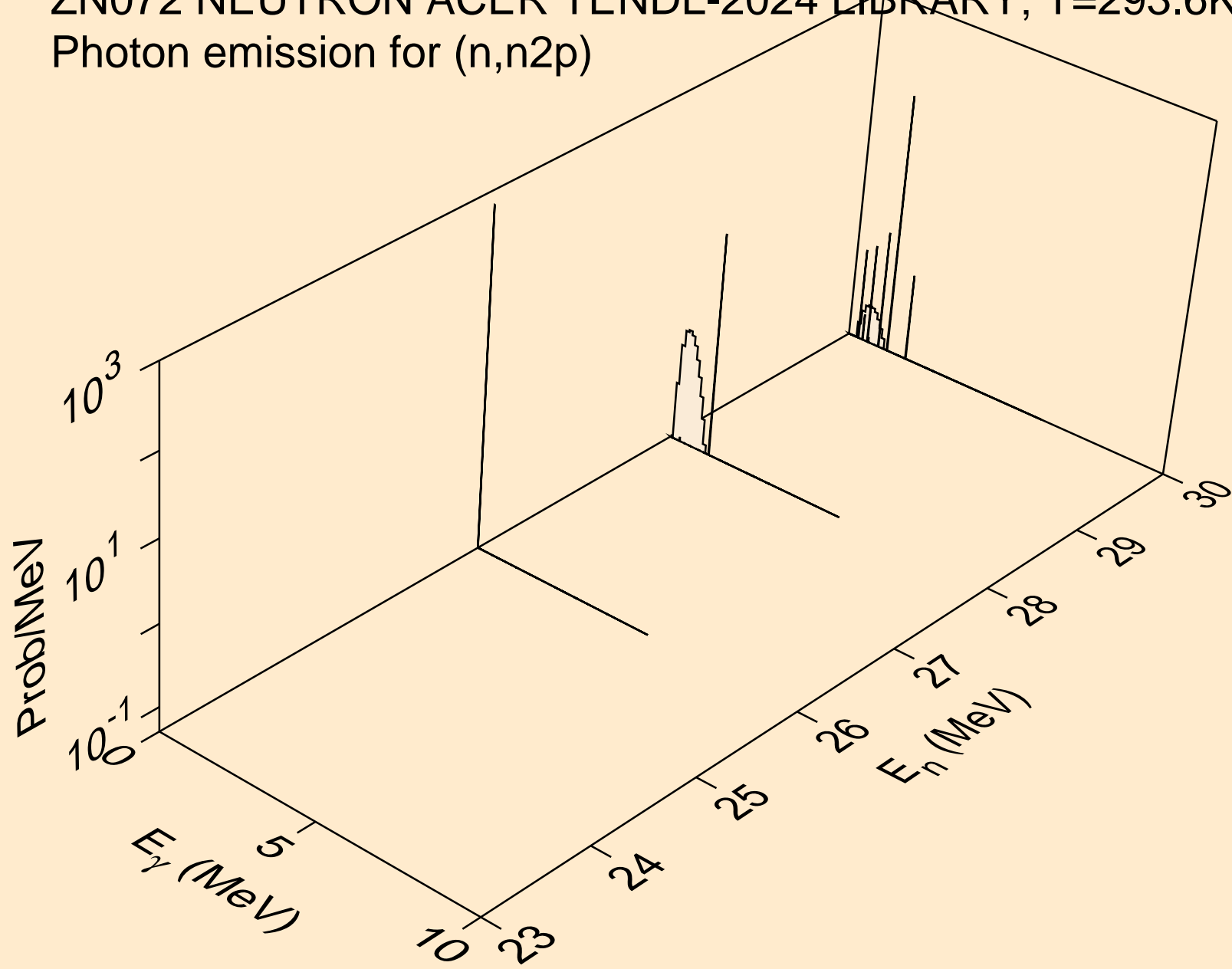

ZN072 NEUTRON ACER TENDL-2024 LIBRARY; T=293.6K
Photon emission for (n,n*c)

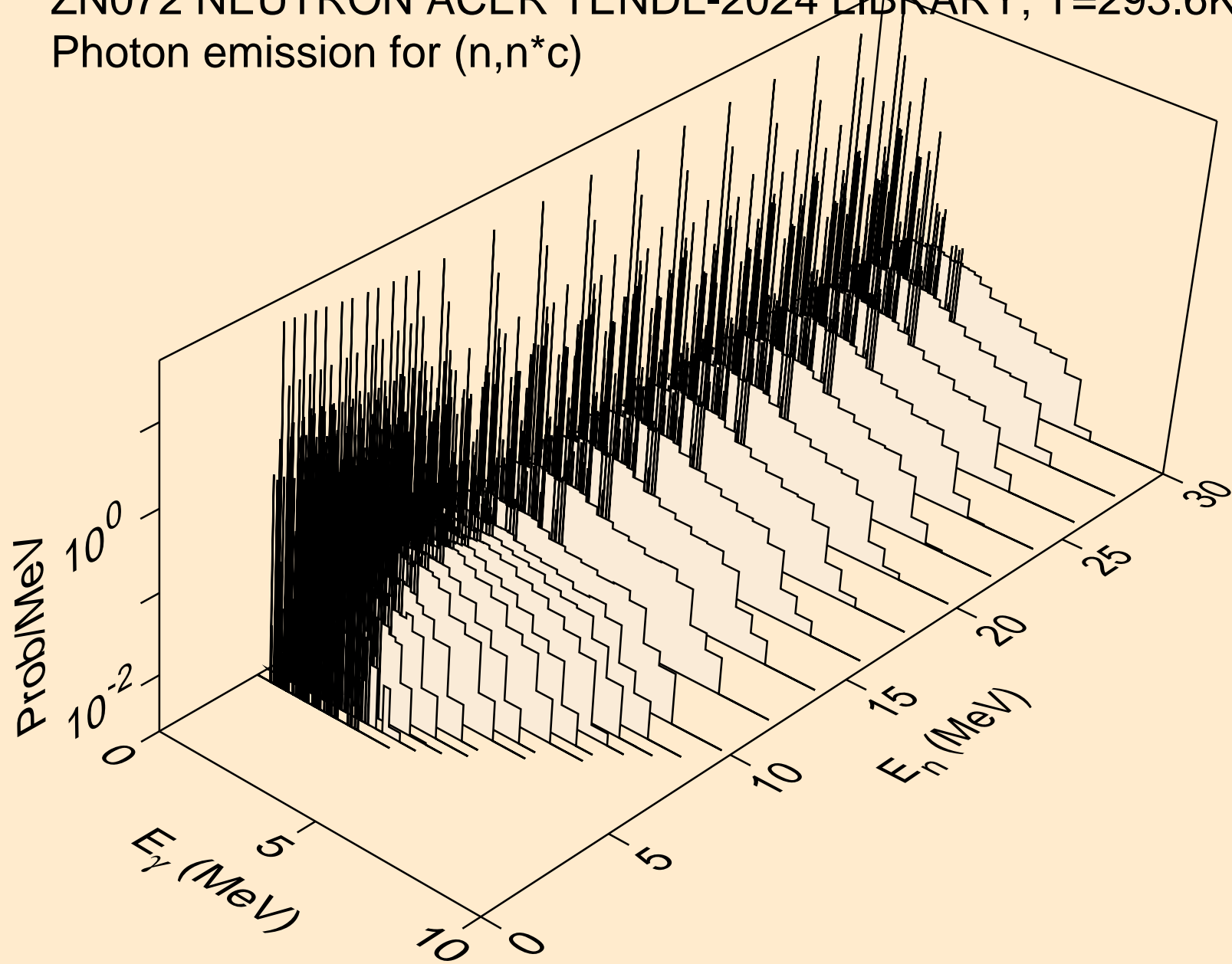

ZN072 NEUTRON ACER TENDL-2024 LIBRARY; T=293.6K
Photon emission for (n,gma)

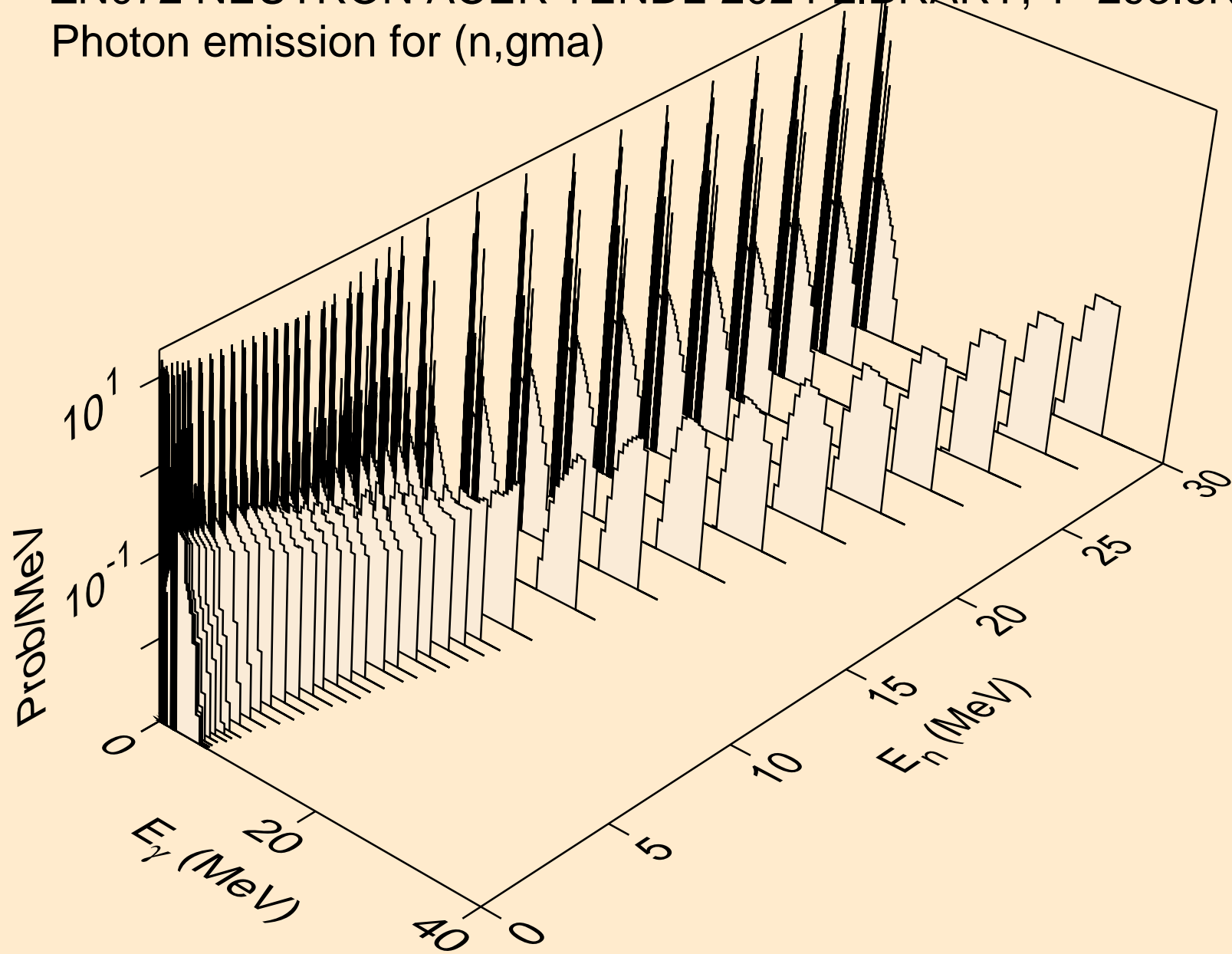

ZN072 NEUTRON ACER TENDL-2024 LIBRARY; T=293.6K
Photon emission for (n,p)

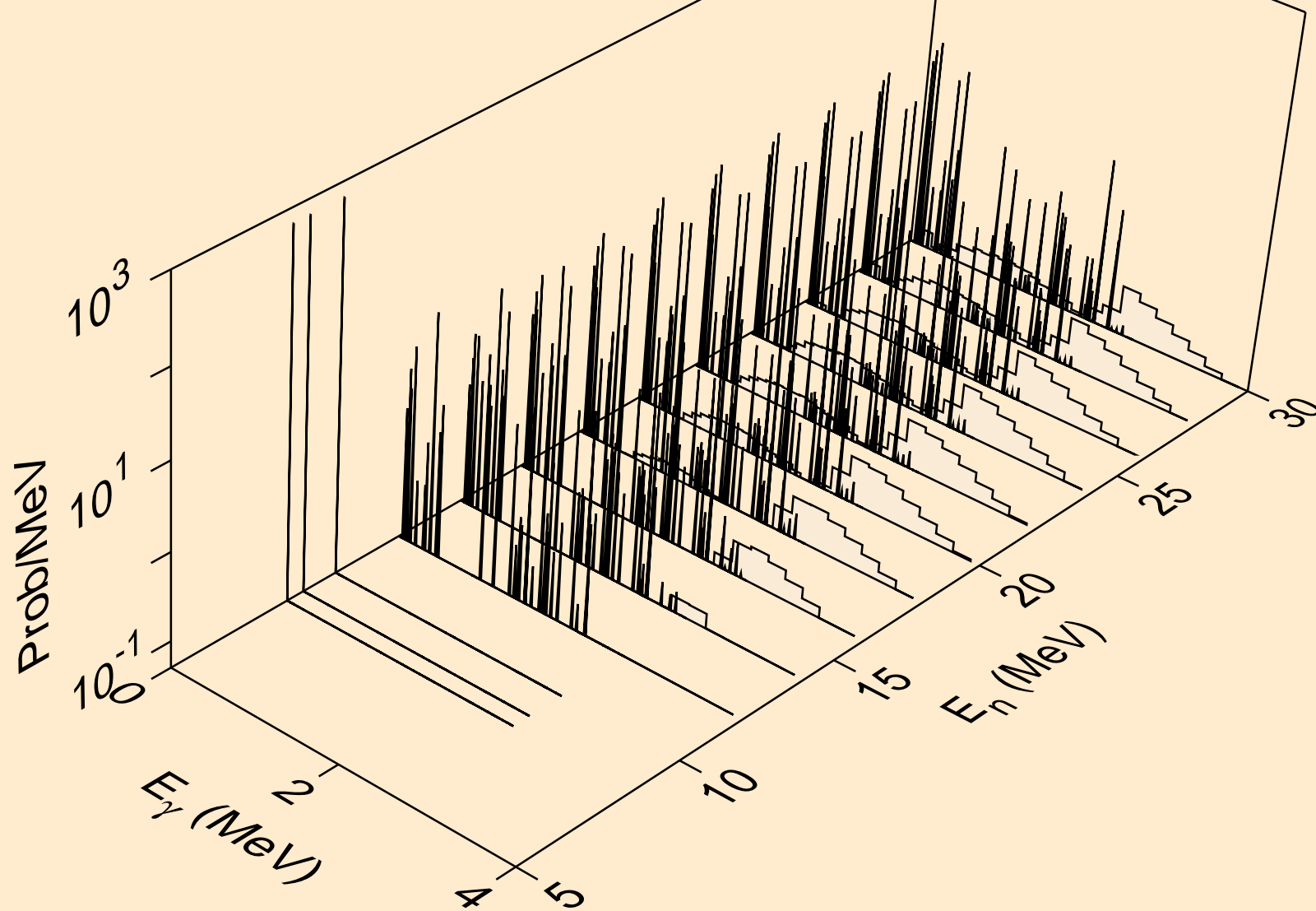

ZN072 NEUTRON ACER TENDL-2024 LIBRARY; T=293.6K
Photon emission for (n,d)

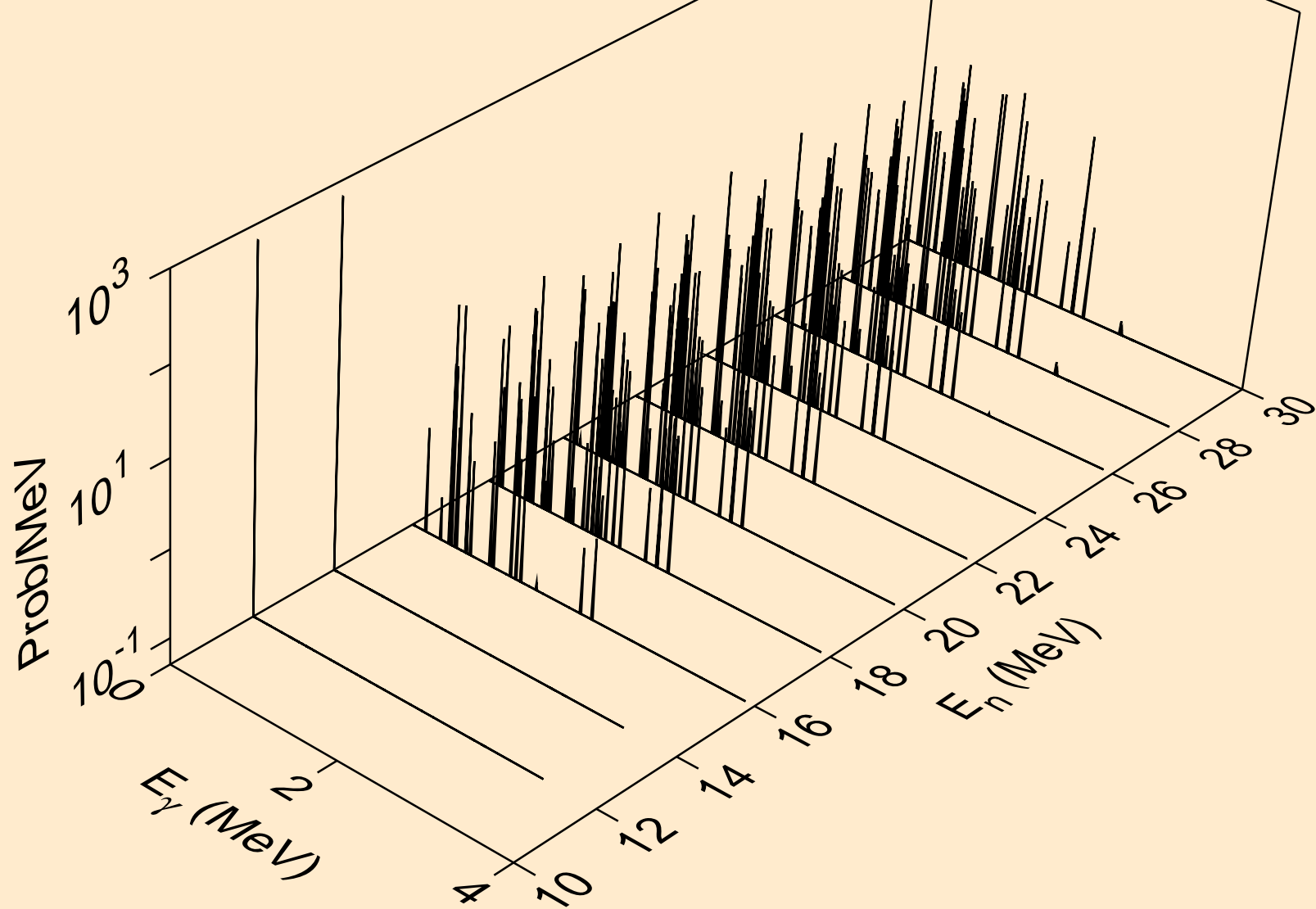

ZN072 NEUTRON ACER TENDL-2024 LIBRARY; T=293.6K
Photon emission for (n,t)

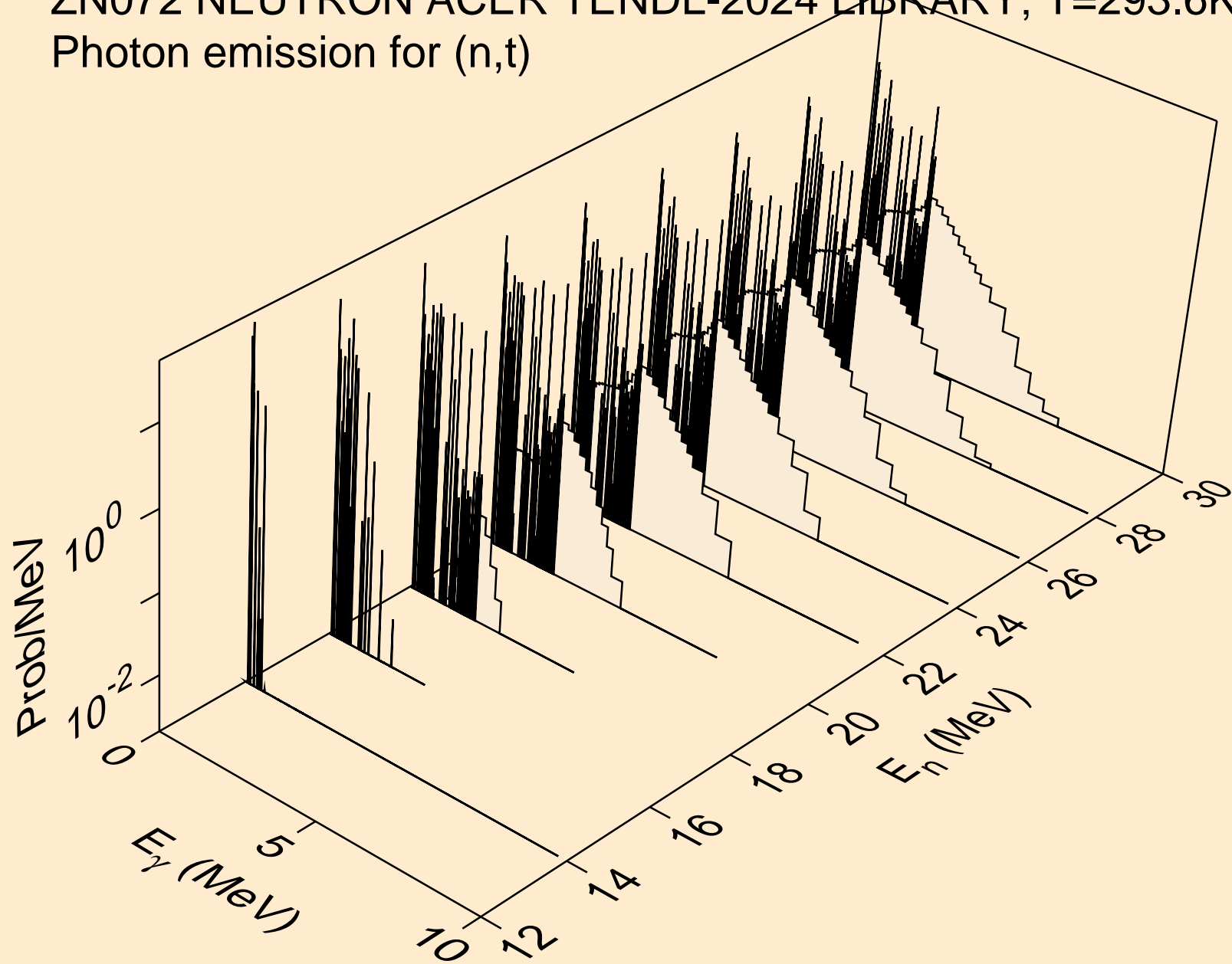

ZN072 NEUTRON ACER TENDL-2024 LIBRARY; T=293.6K
Photon emission for (n,he3)

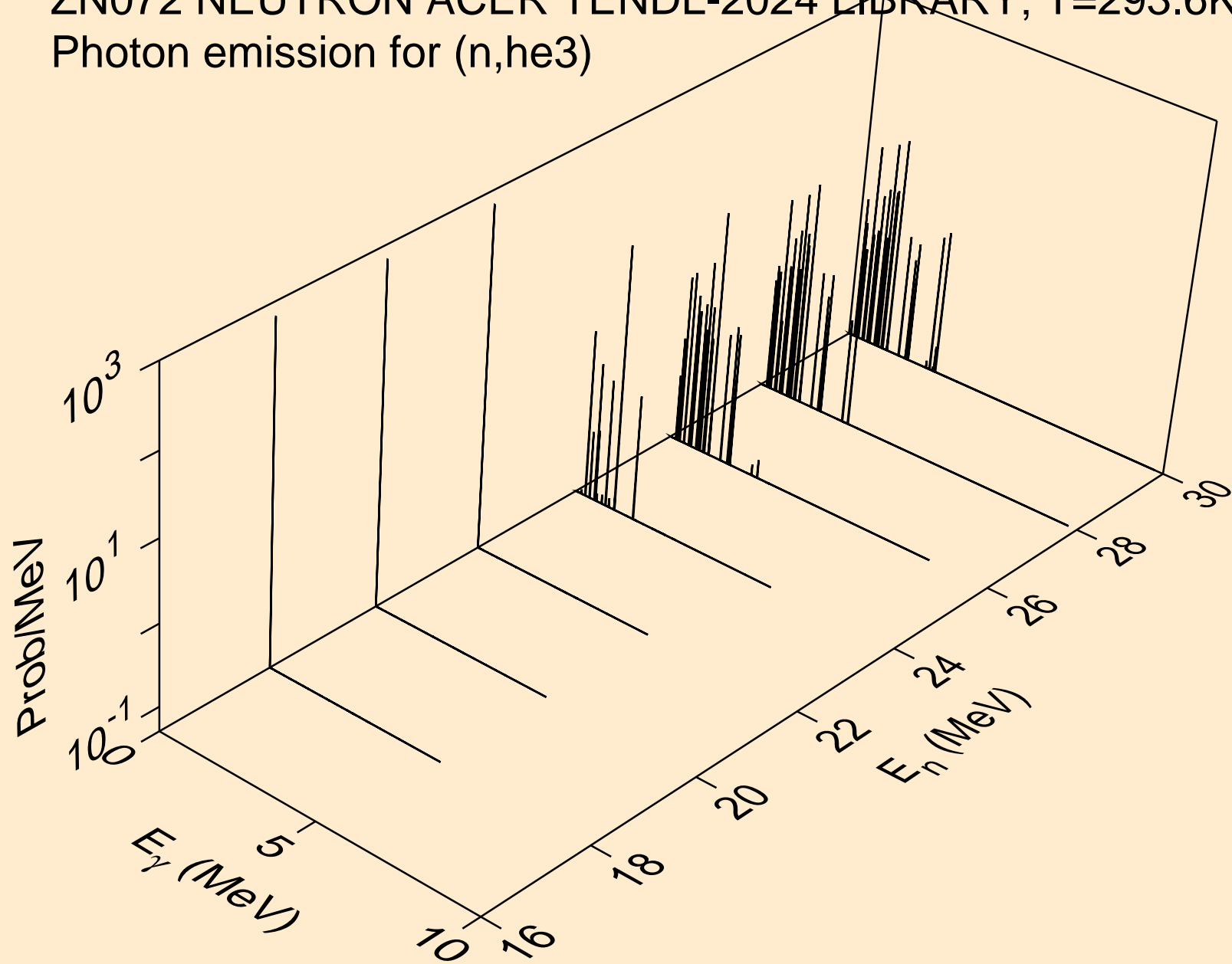

ZN072 NEUTRON ACER TENDL-2024 LIBRARY; T=293.6K
Photon emission for (n,a)

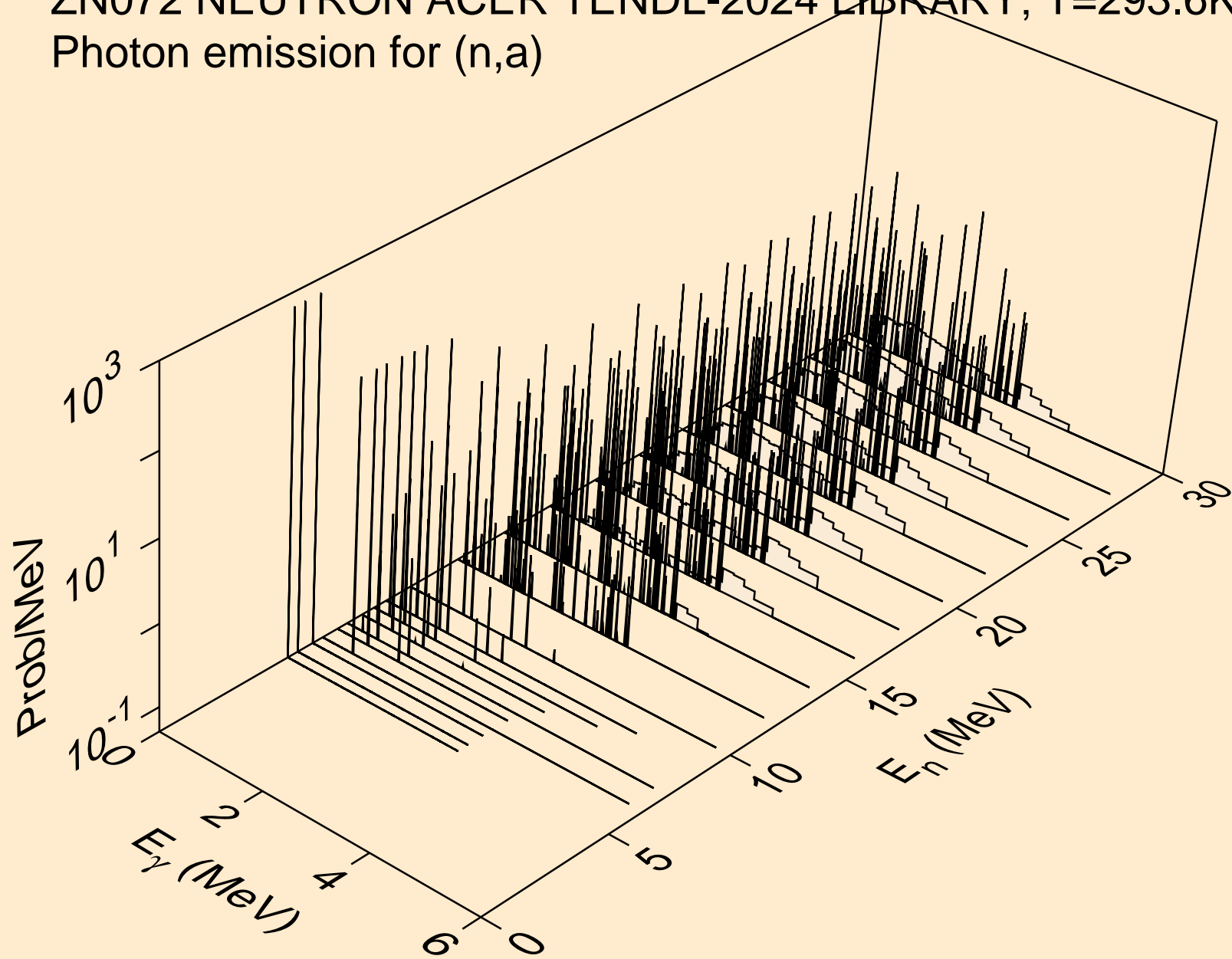

ZN072 NEUTRON ACER TENDL-2024 LIBRARY; T=293.6K
Photon emission for (n,2p)

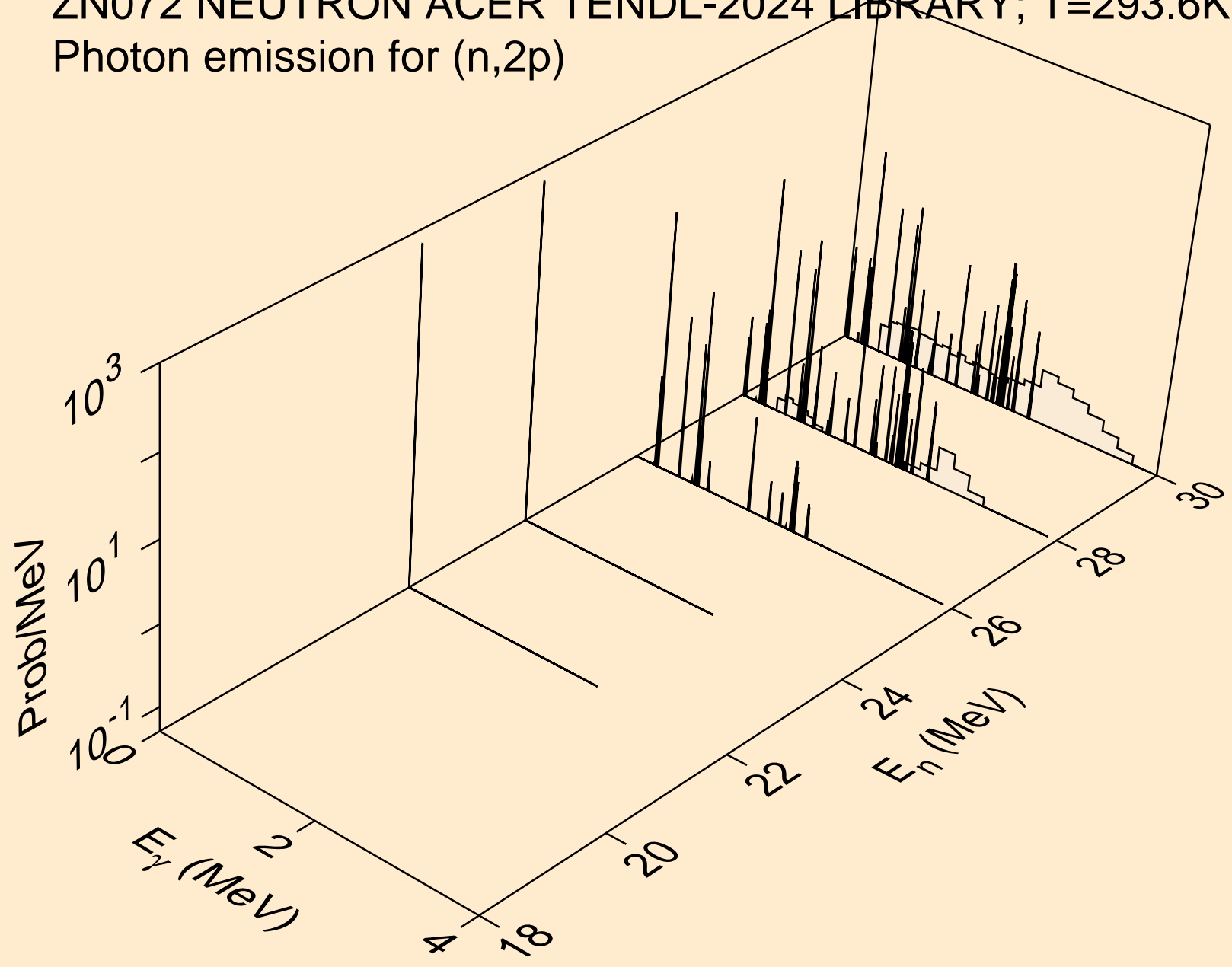

ZN072 NEUTRON ACER TENDL-2024 LIBRARY; T=293.6K
Photon emission for (n,pd)

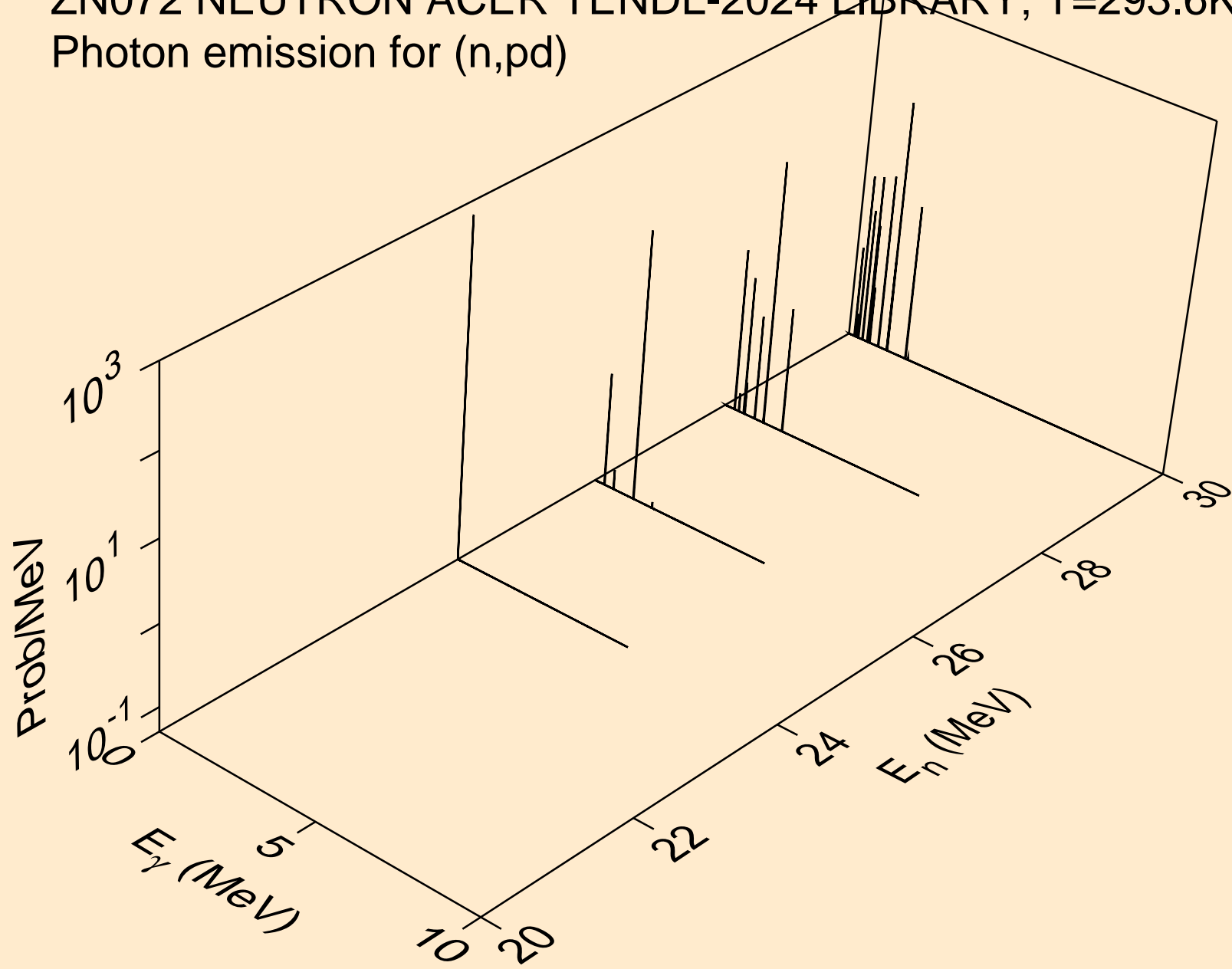

ZN072 NEUTRON ACER TENDL-2024 LIBRARY; T=293.6K
Photon emission for (n,pt)

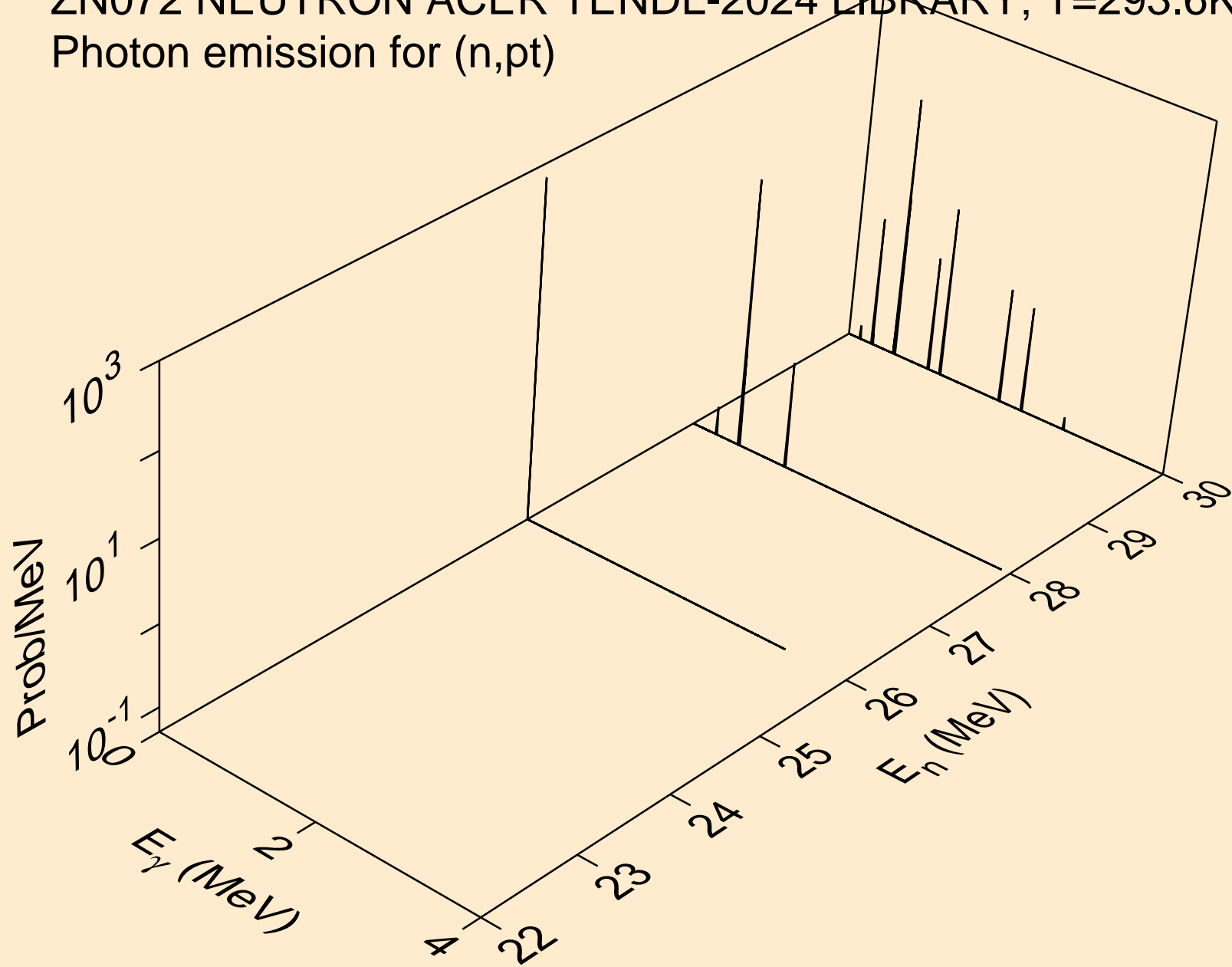

ZN072 NEUTRON ACER TENDL-2024 LIBRARY; T=293.6K
thermal capture photon spectrum

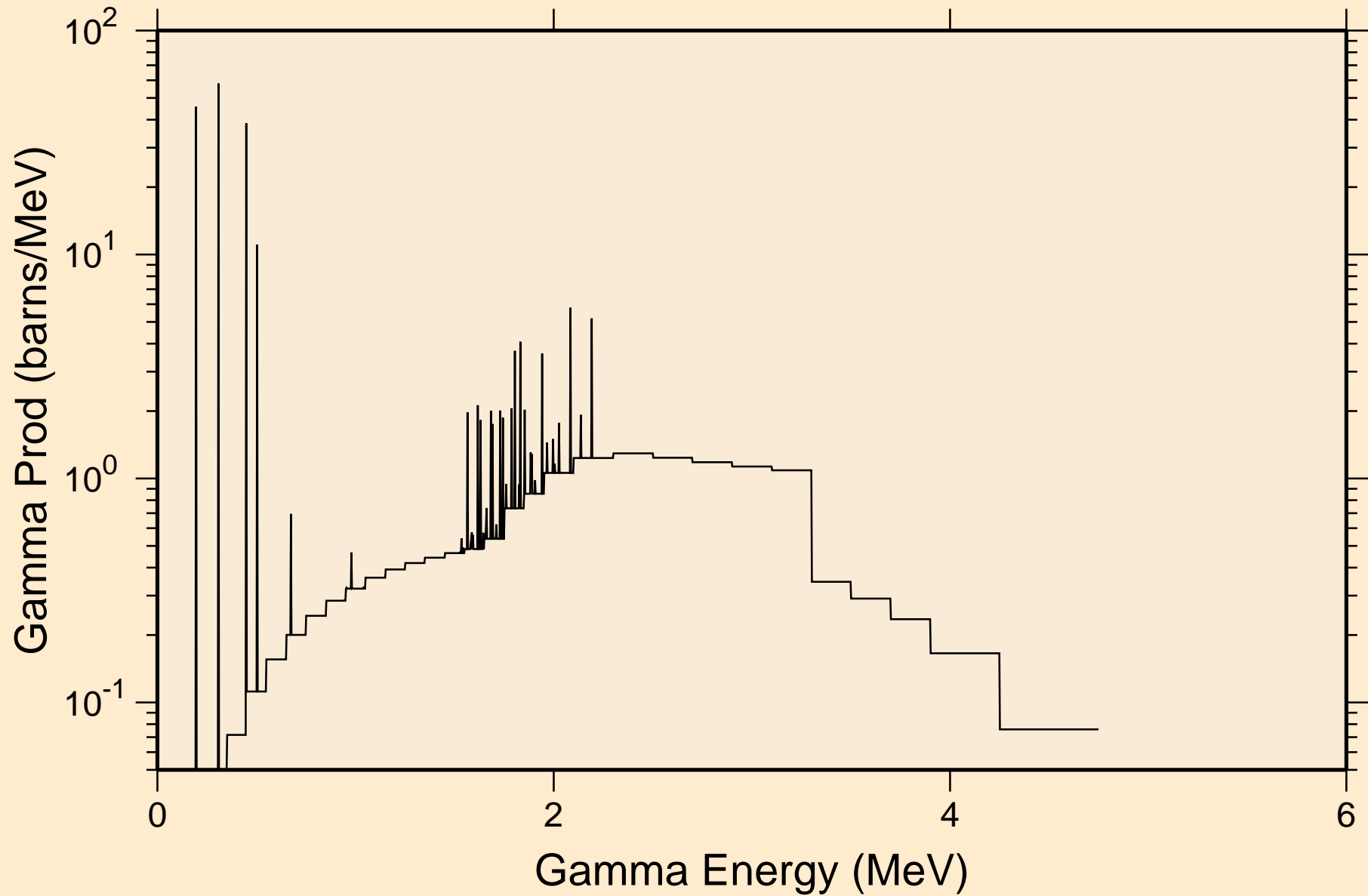

ZN072 NEUTRON ACER TENDL-2024 LIBRARY; T=293.6K
14 MeV photon spectrum

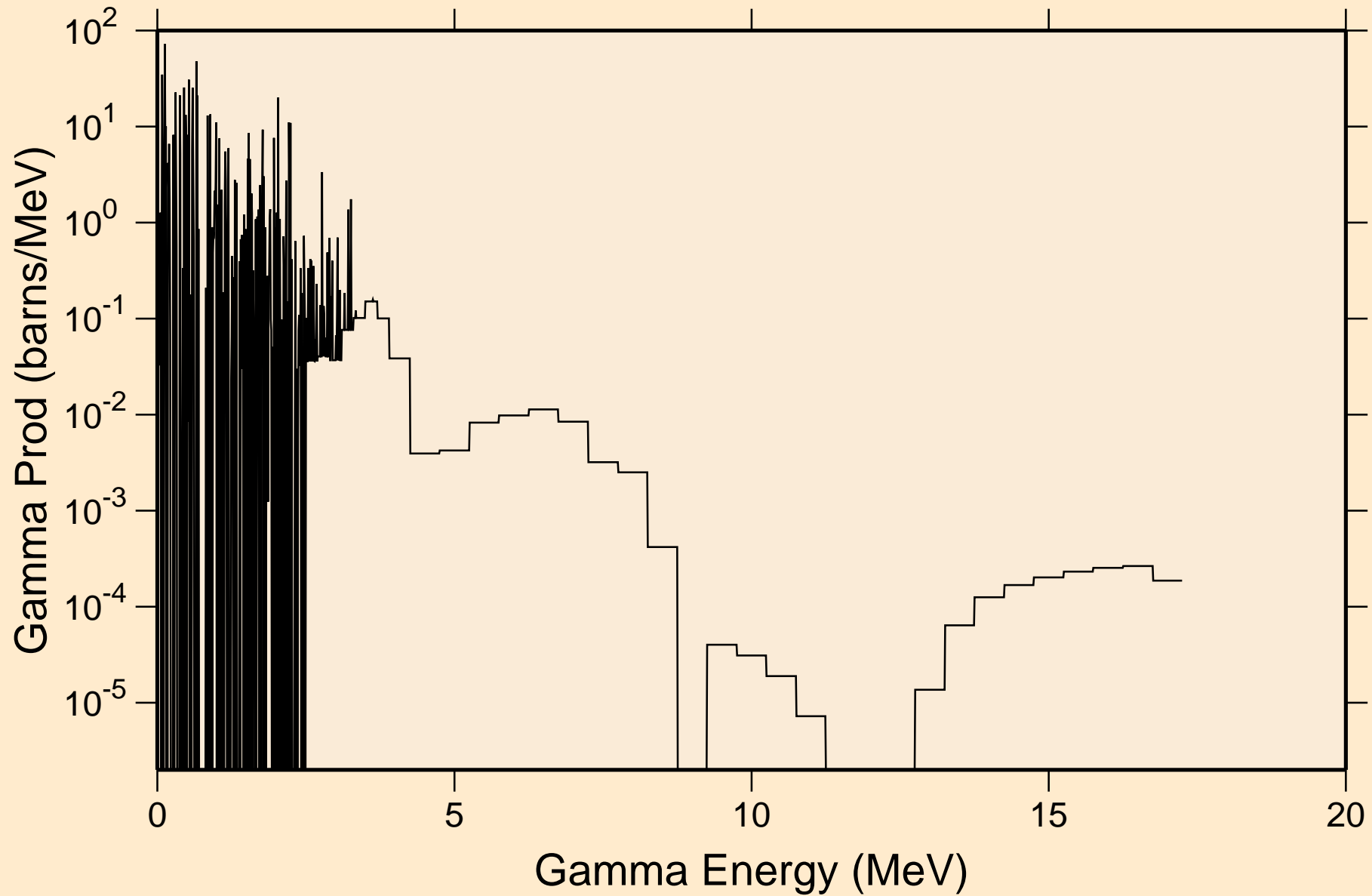

ZN072 NEUTRON ACER TENDL-2024 LIBRARY; T=293.6K

Particle heating contributions

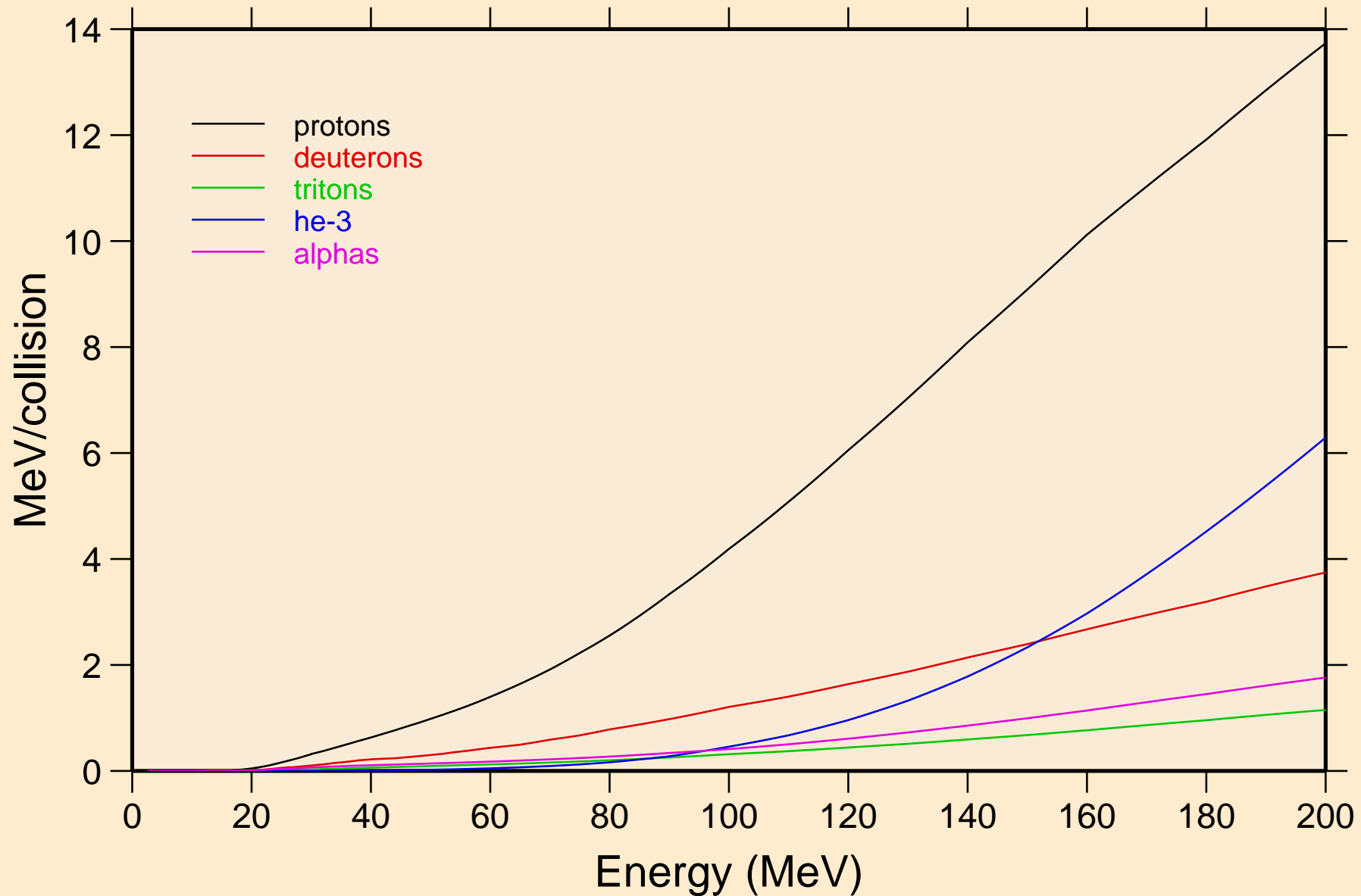

ZN072 NEUTRON ACER TENDL-2024 LIBRARY; T=293.6K
Recoil Heating

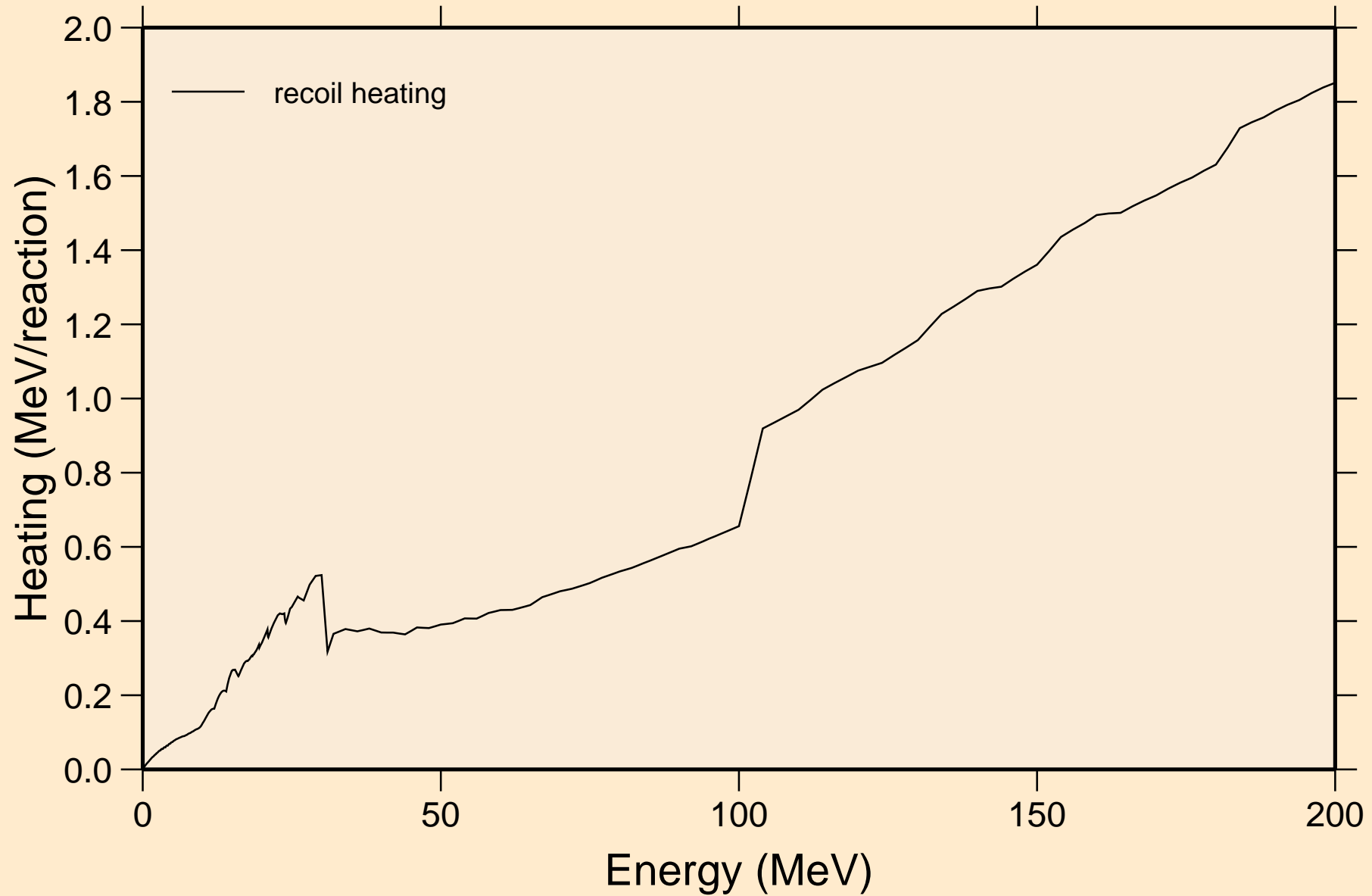

ZN072 NEUTRON ACER TENDL-2024 LIBRARY; T=293.6K
Particle production cross sections

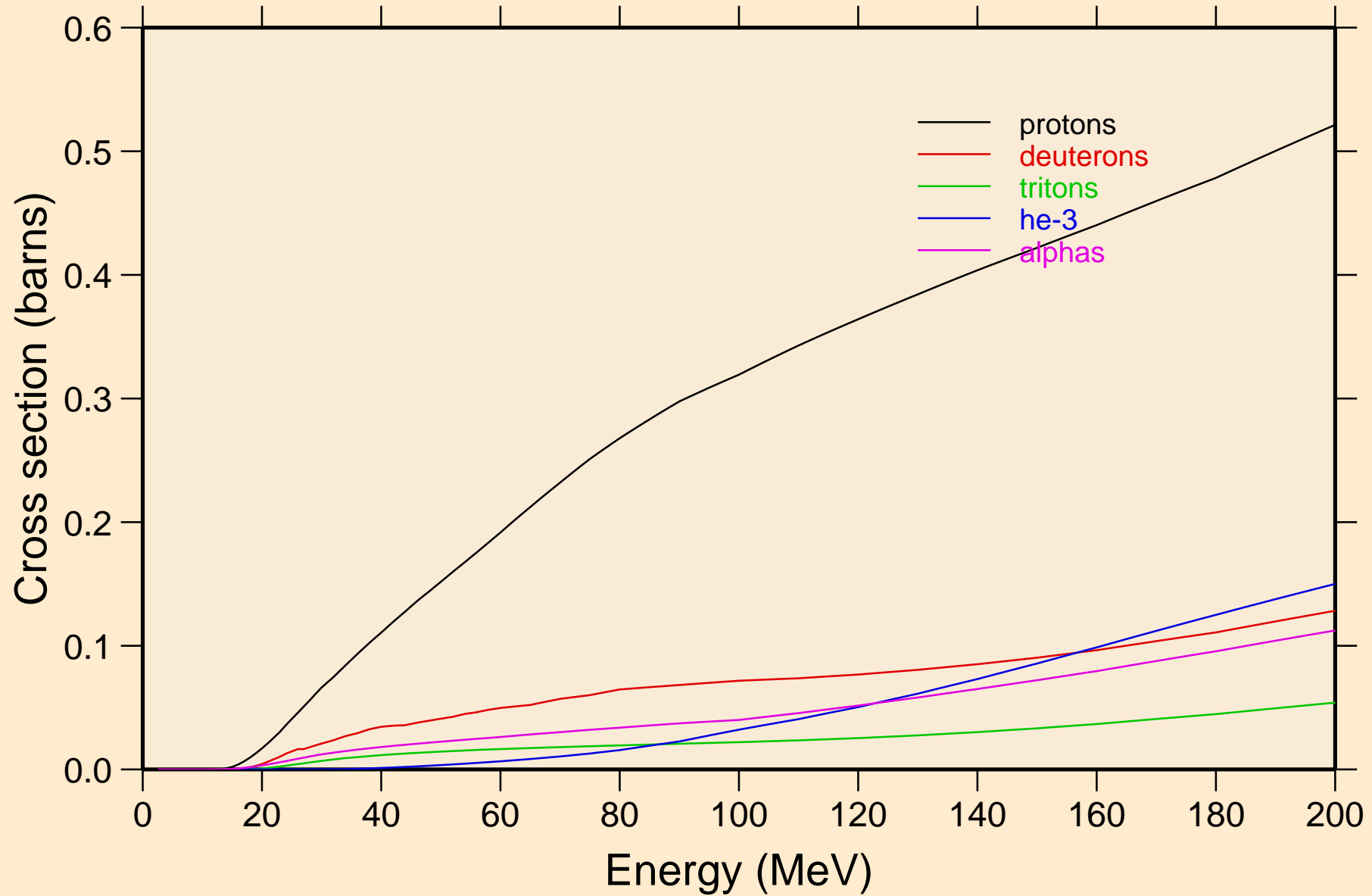

ZN072 NEUTRON ACER TENDL-2024 LIBRARY; T=293.6K
protons from (n,x)

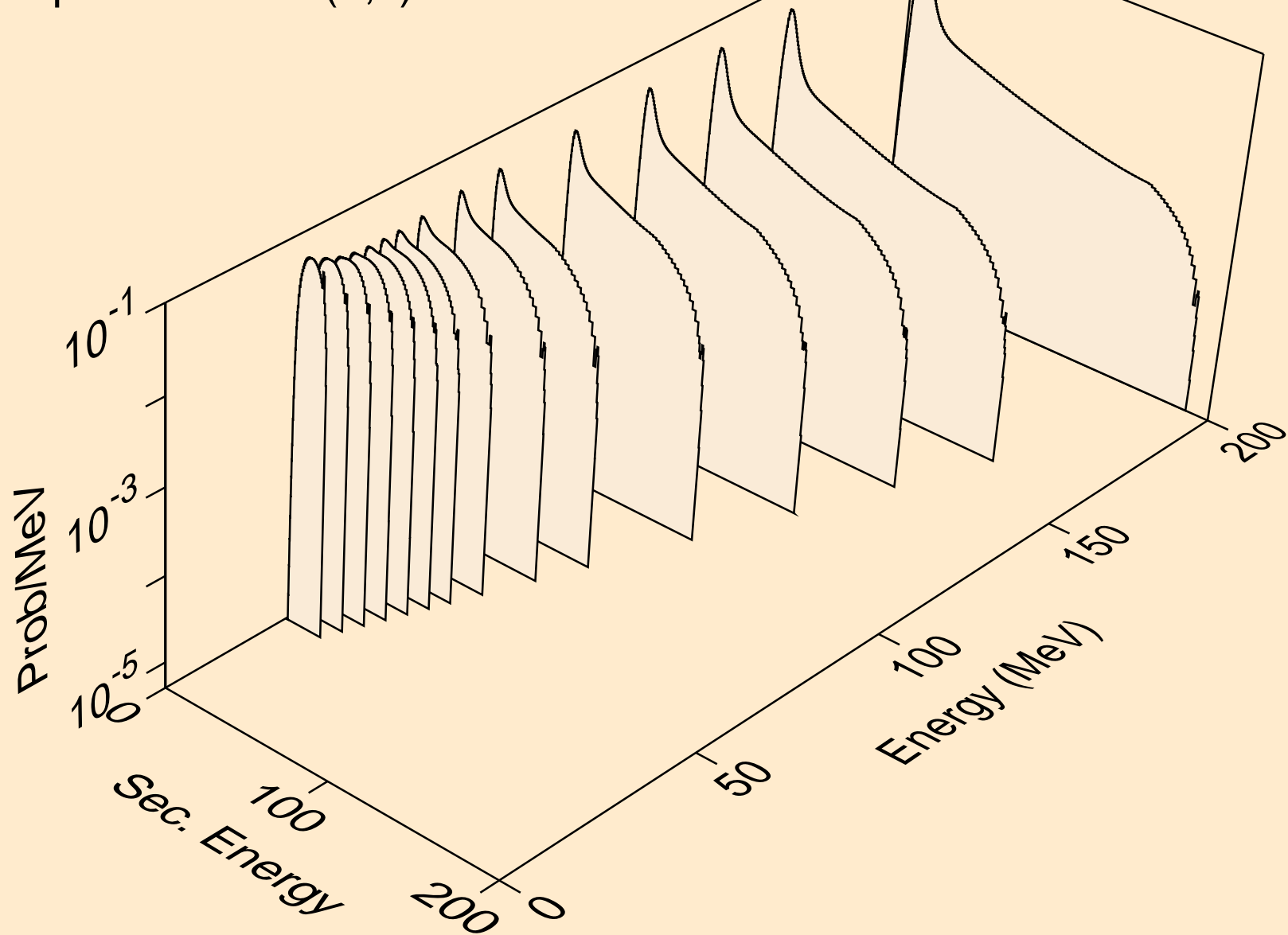

ZN072 NEUTRON ACER TENDL-2024 LIBRARY; T=293.6K
protons from (n,n*)p

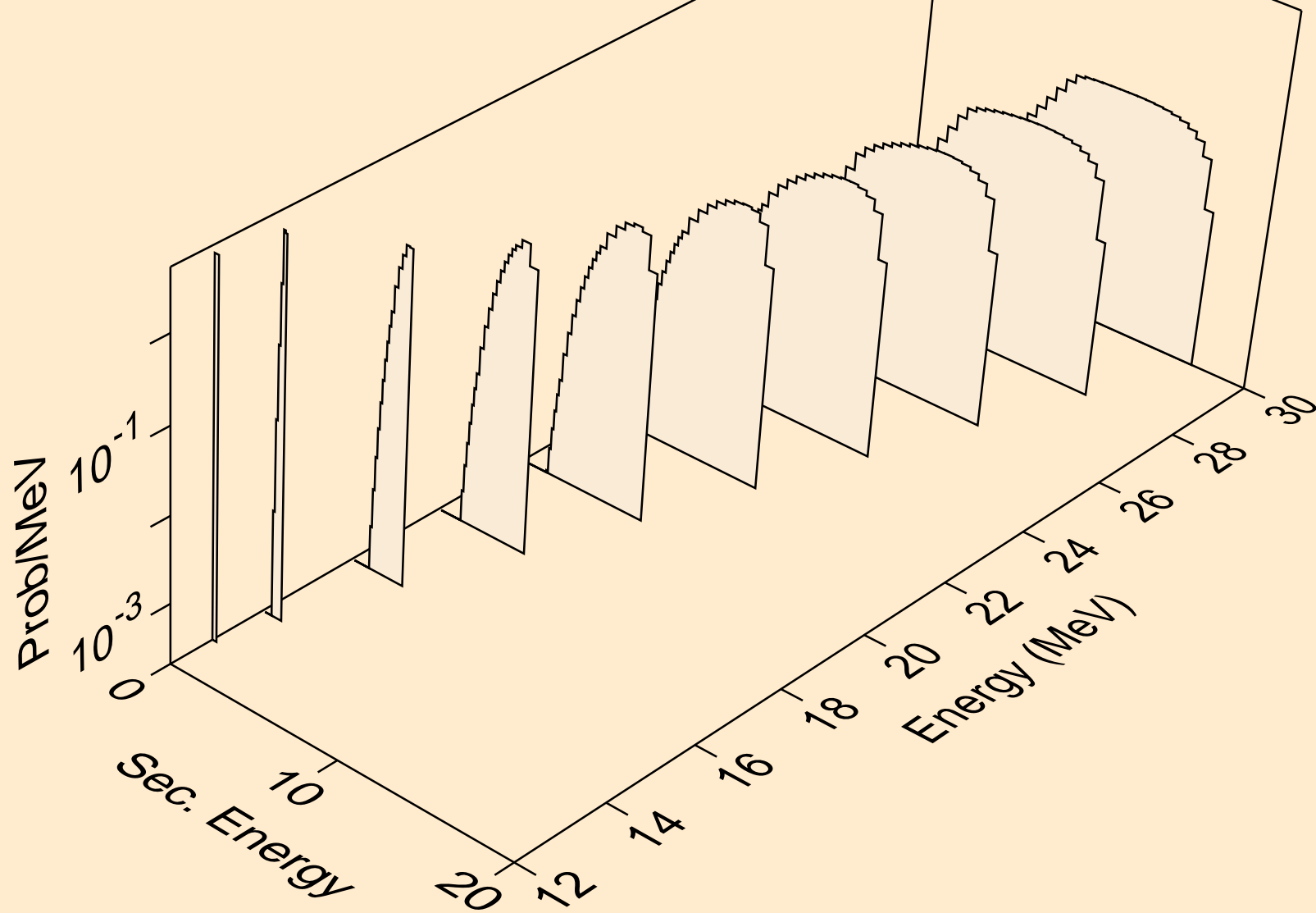

ZN072 NEUTRON ACER TENDL-2024 LIBRARY; T=293.6K
protons from (n,2np)

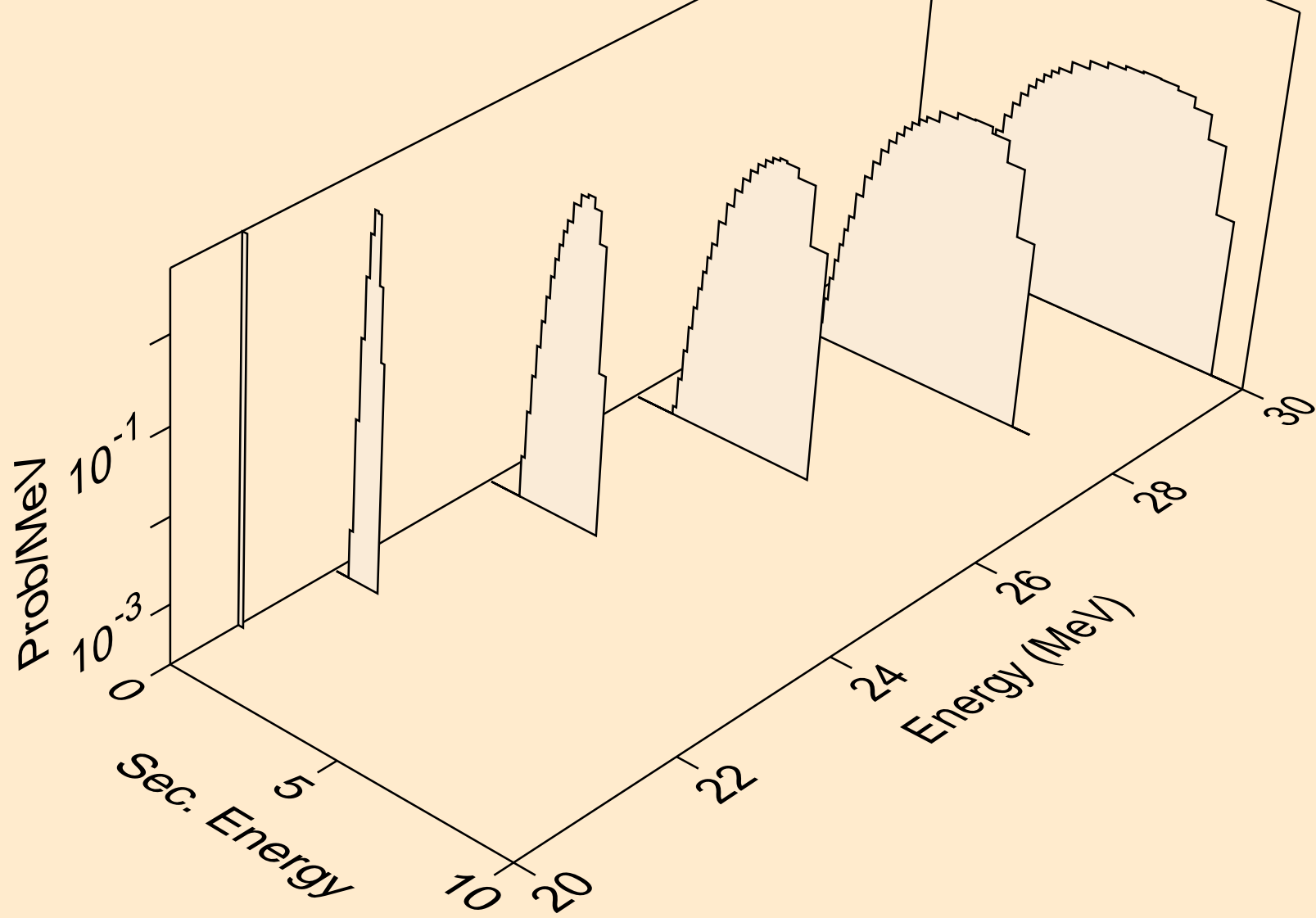

ZN072 NEUTRON ACER TENDL-2024 LIBRARY; T=293.6K
protons from (n,3np)

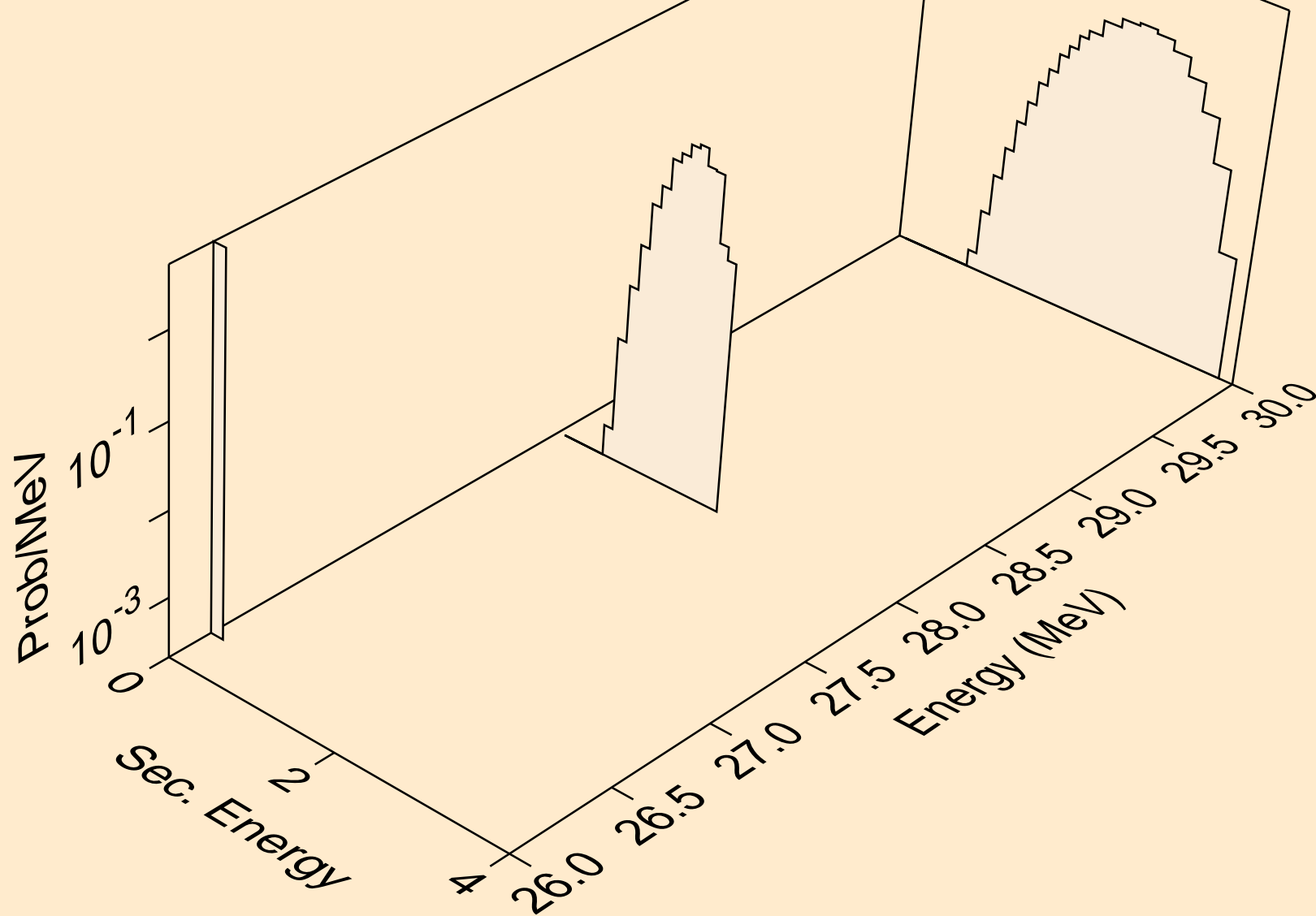

ZN072 NEUTRON ACER TENDL-2024 LIBRARY; T=293.6K
protons from (n,n2p)

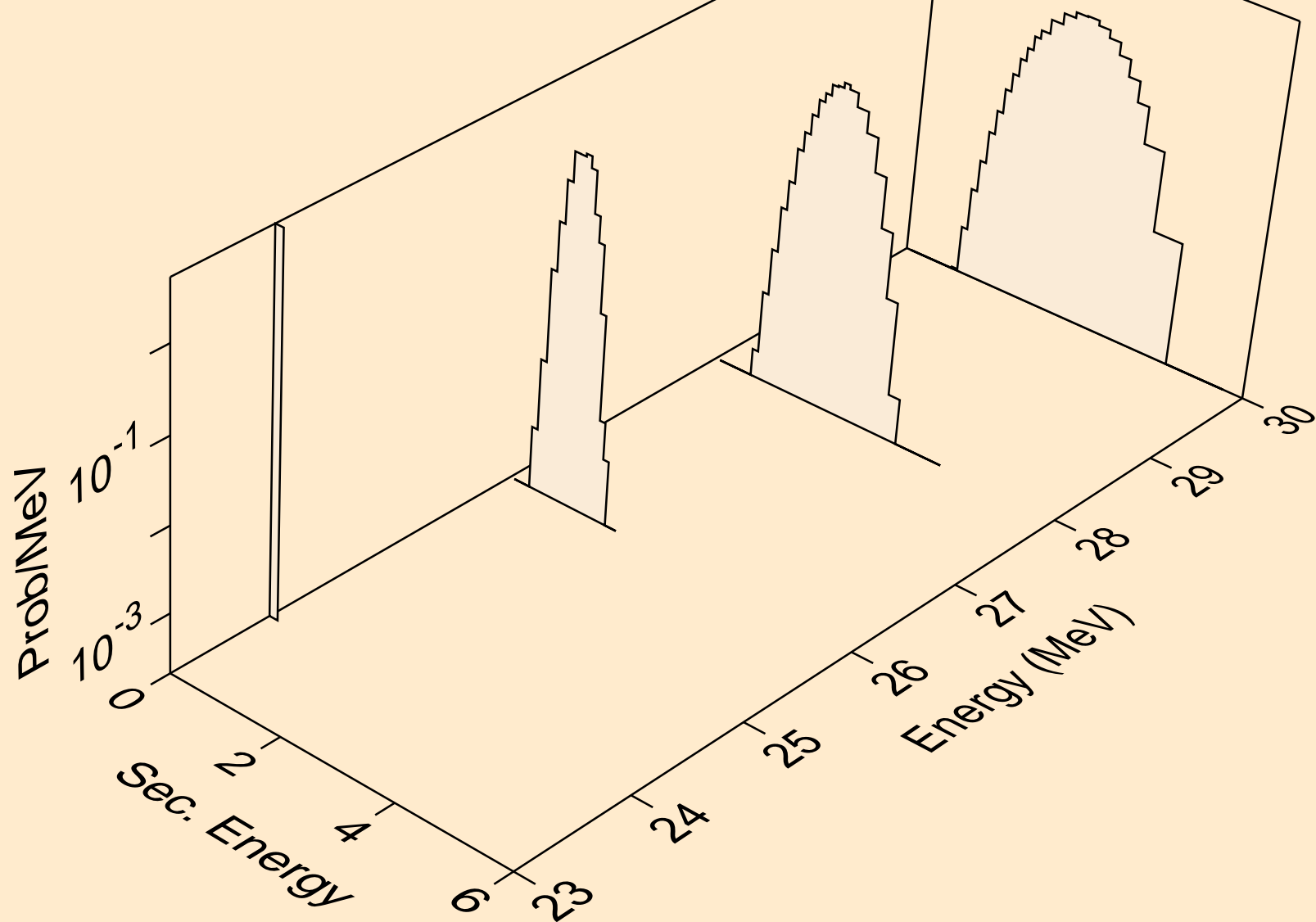

ZN072 NEUTRON ACER TENDL-2024 LIBRARY; T=293.6K
protons from (n,p)

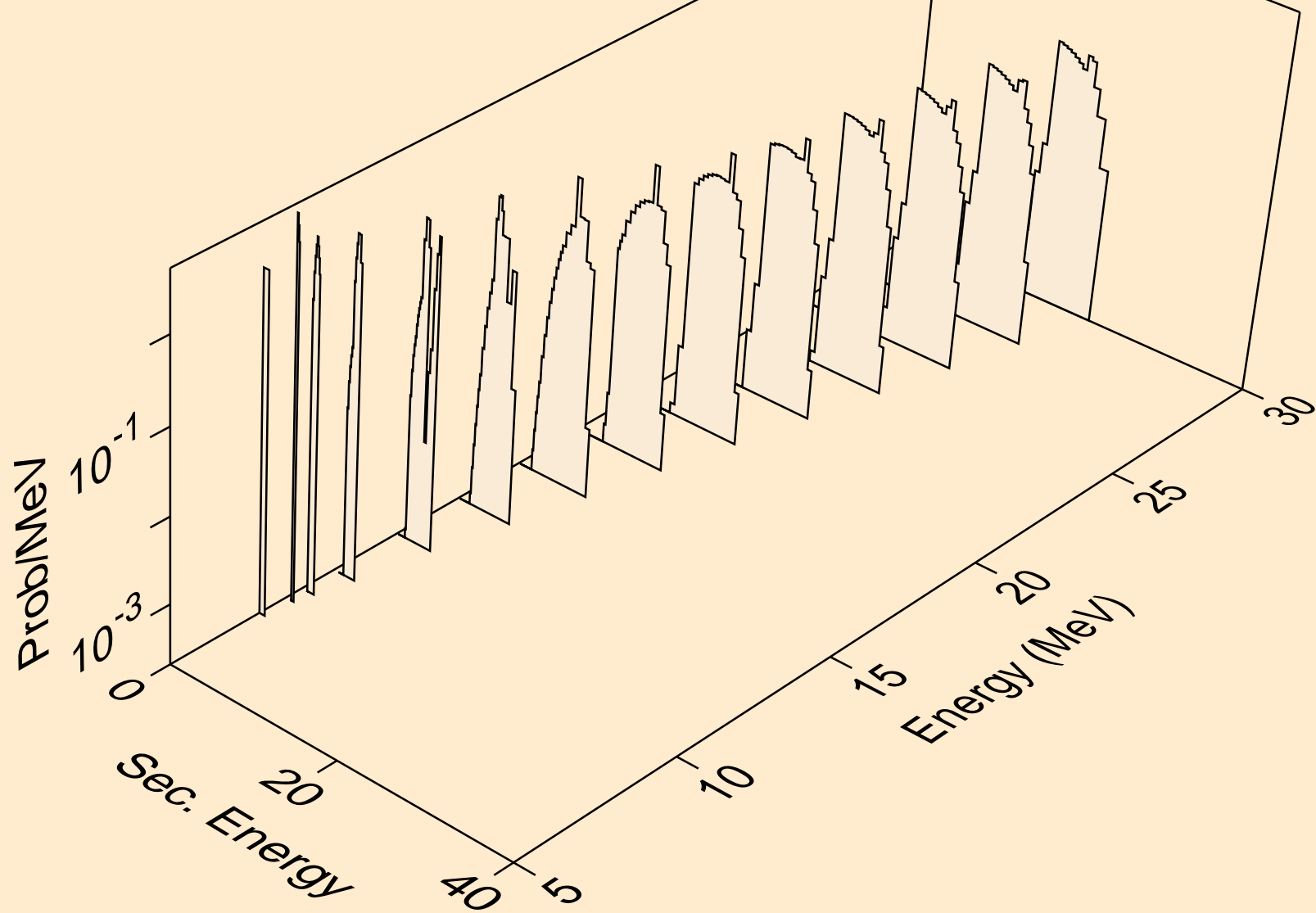

ZN072 NEUTRON ACER TENDL-2024 LIBRARY; T=293.6K
protons from (n,2p)

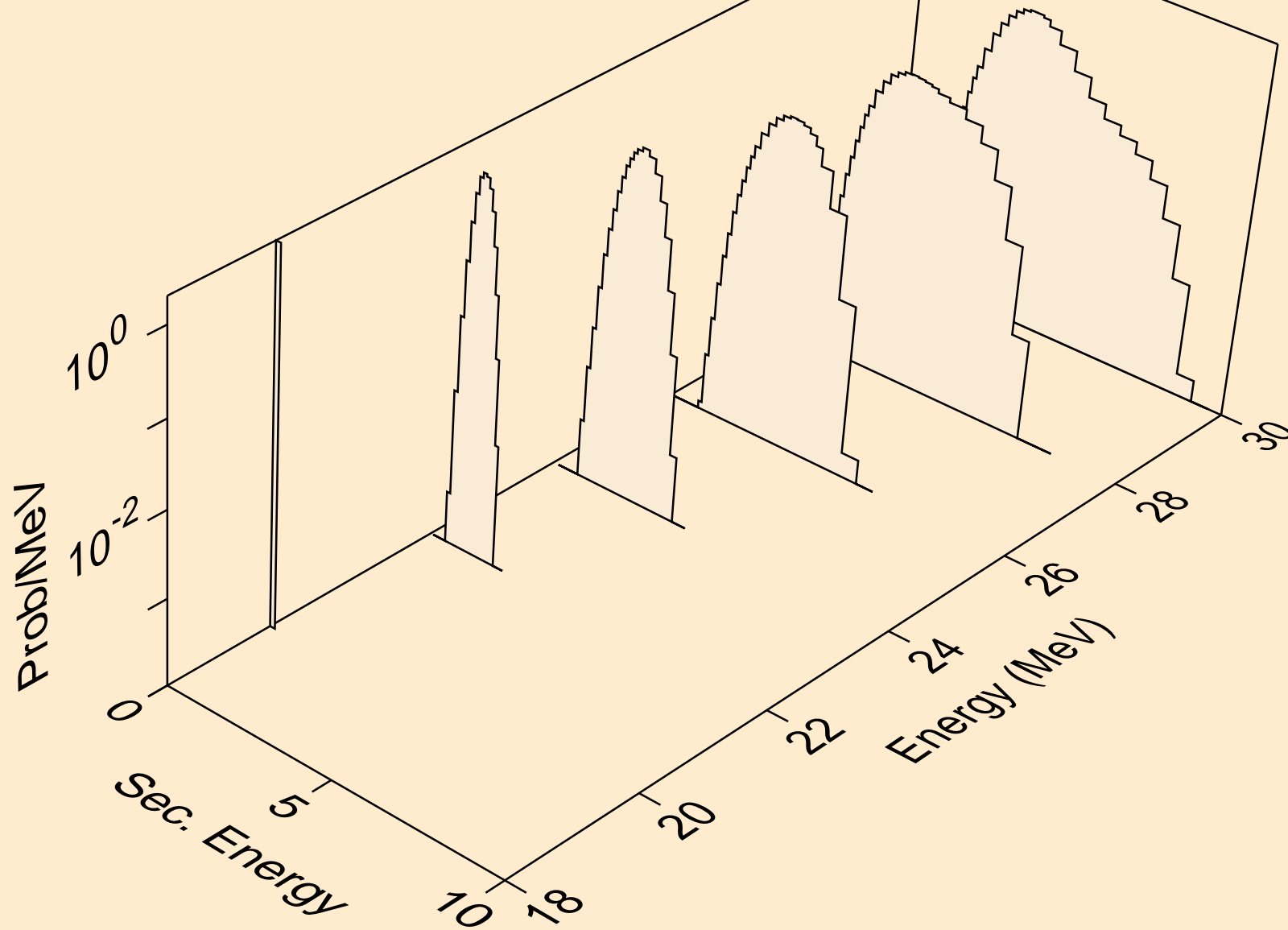

ZN072 NEUTRON ACER TENDL-2024 LIBRARY; T=293.6K
protons from (n,pd)

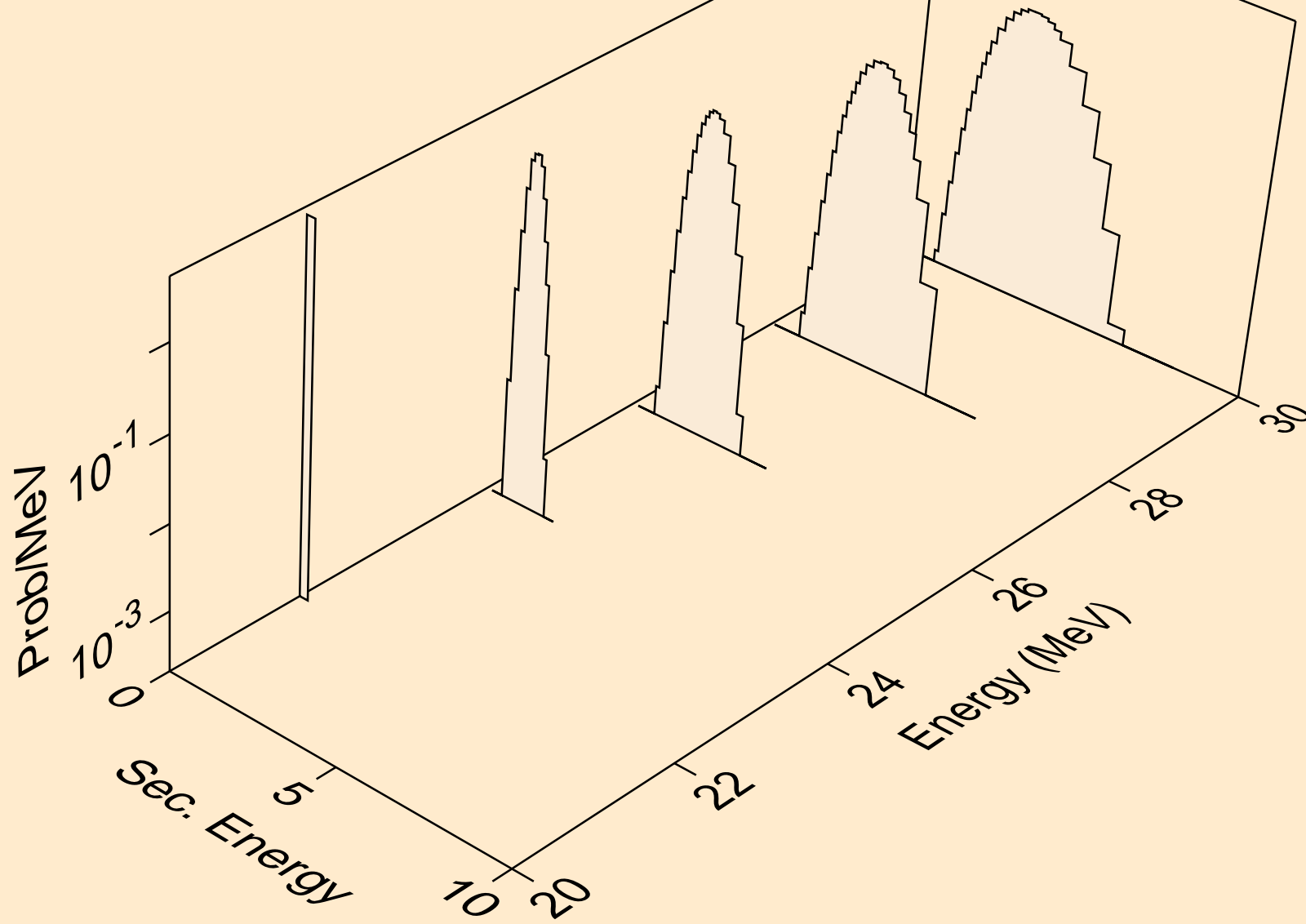

ZN072 NEUTRON ACER TENDL-2024 LIBRARY; T=293.6K
protons from (n,pt)

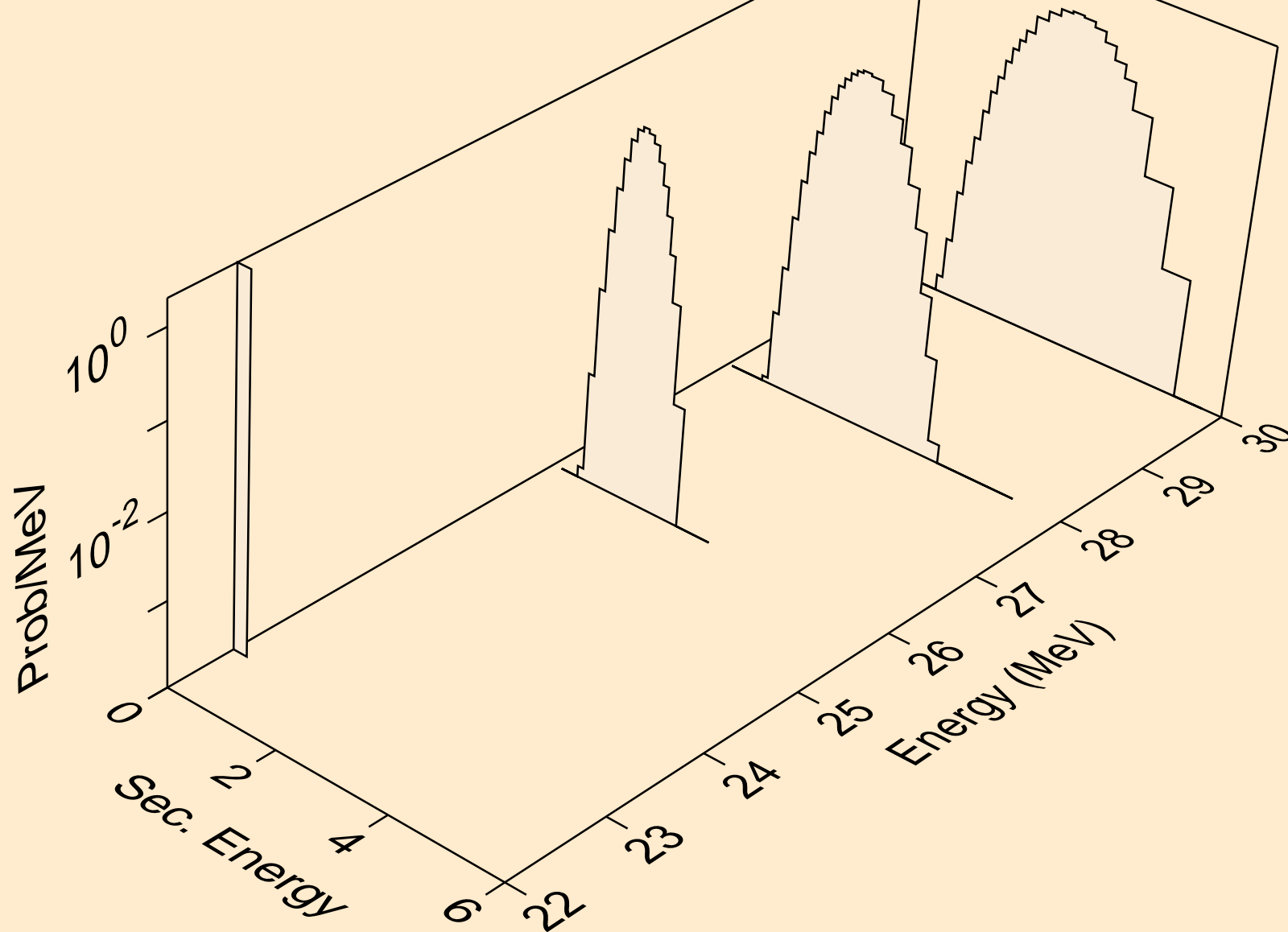

ZN072 NEUTRON ACER TENDL-2024 LIBRARY; T=293.6K
deuterons from (n,x)

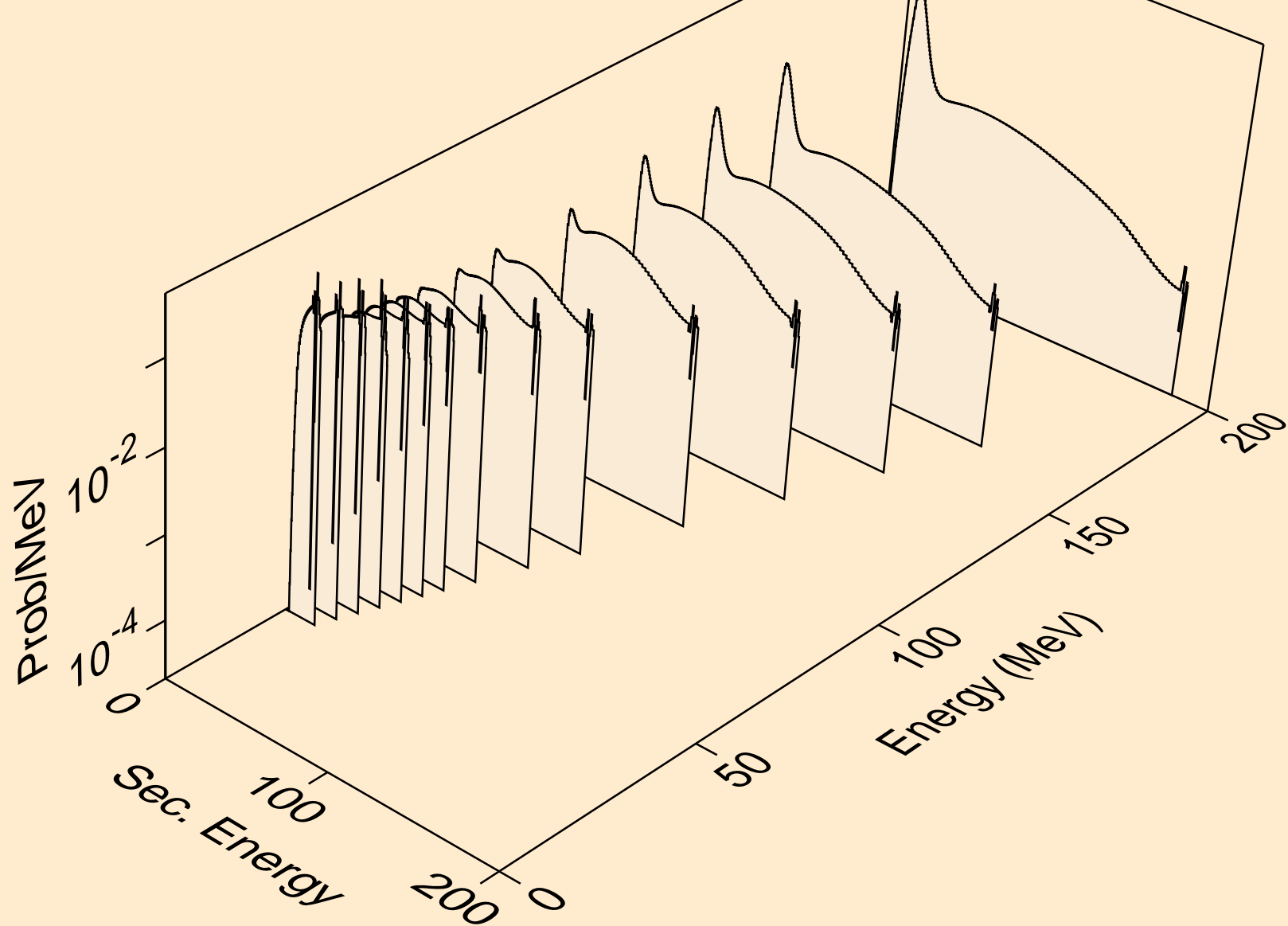

ZN072 NEUTRON ACER TENDL-2024 LIBRARY; T=293.6K
deuterons from (n,2nd)

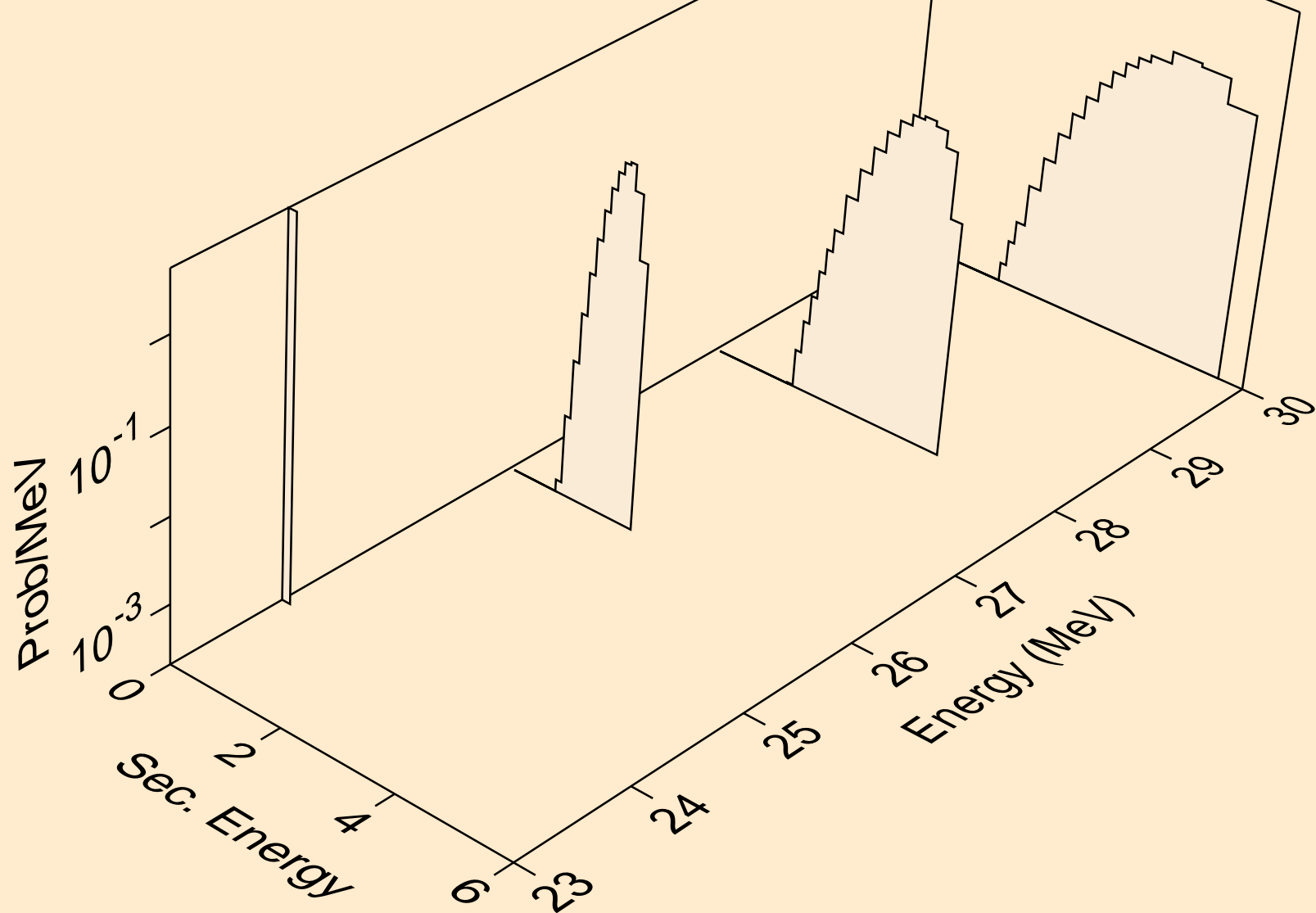

ZN072 NEUTRON ACER TENDL-2024 LIBRARY; T=293.6K
deuterons from (n,n*)d

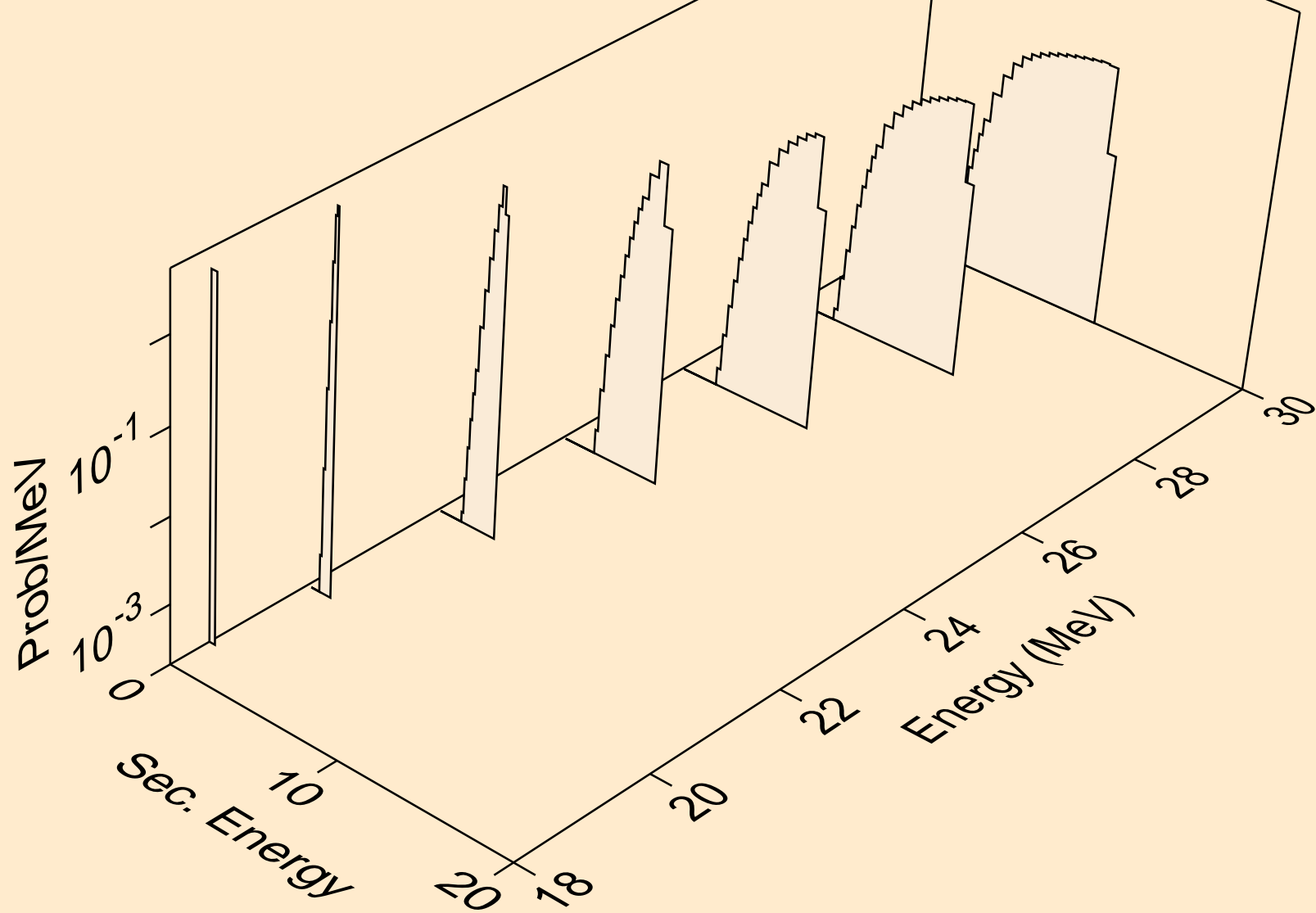

ZN072 NEUTRON ACER TENDL-2024 LIBRARY; T=293.6K
deuterons from (n,d)

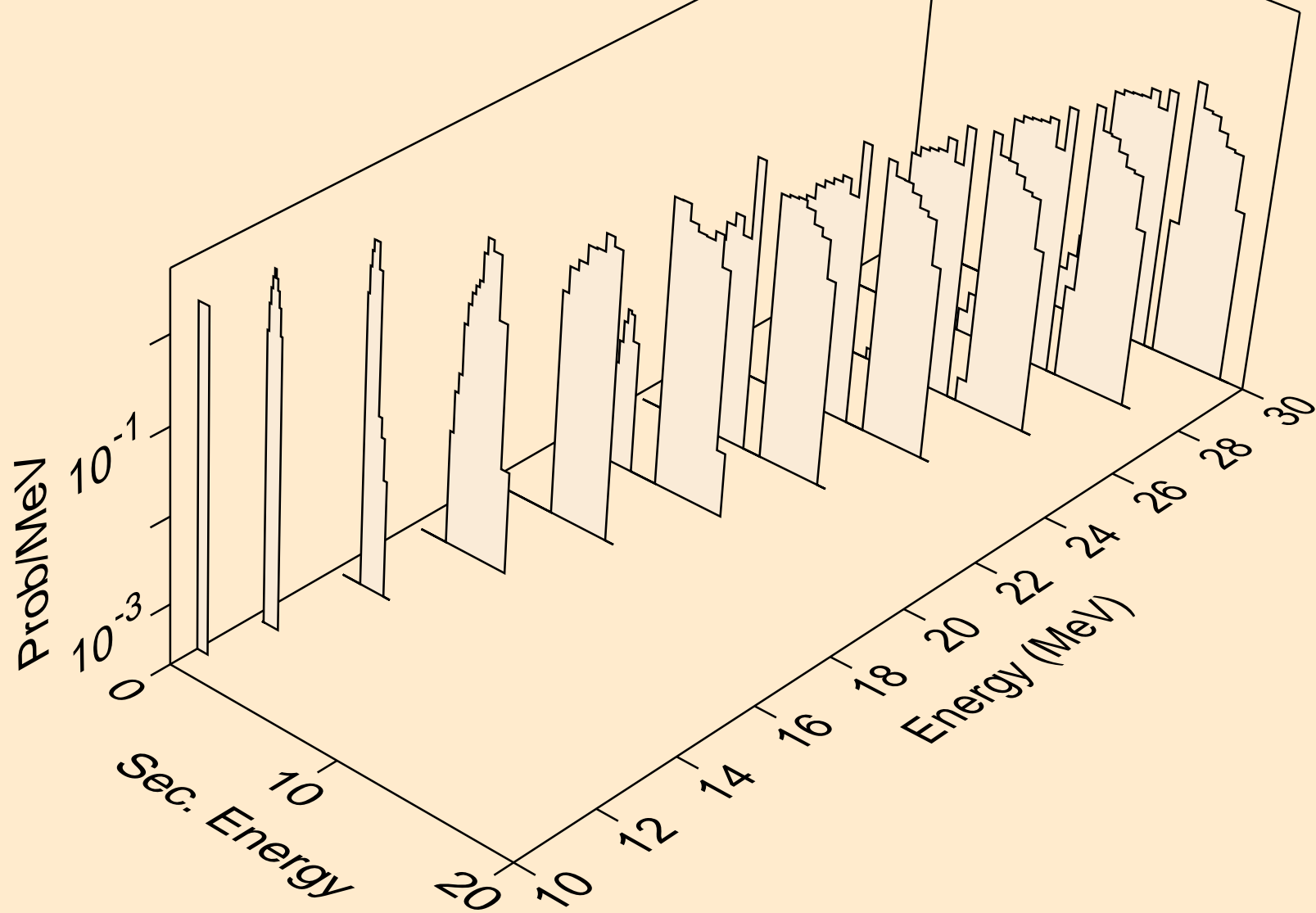

ZN072 NEUTRON ACER TENDL-2024 LIBRARY; T=293.6K
deuterons from (n,pd)

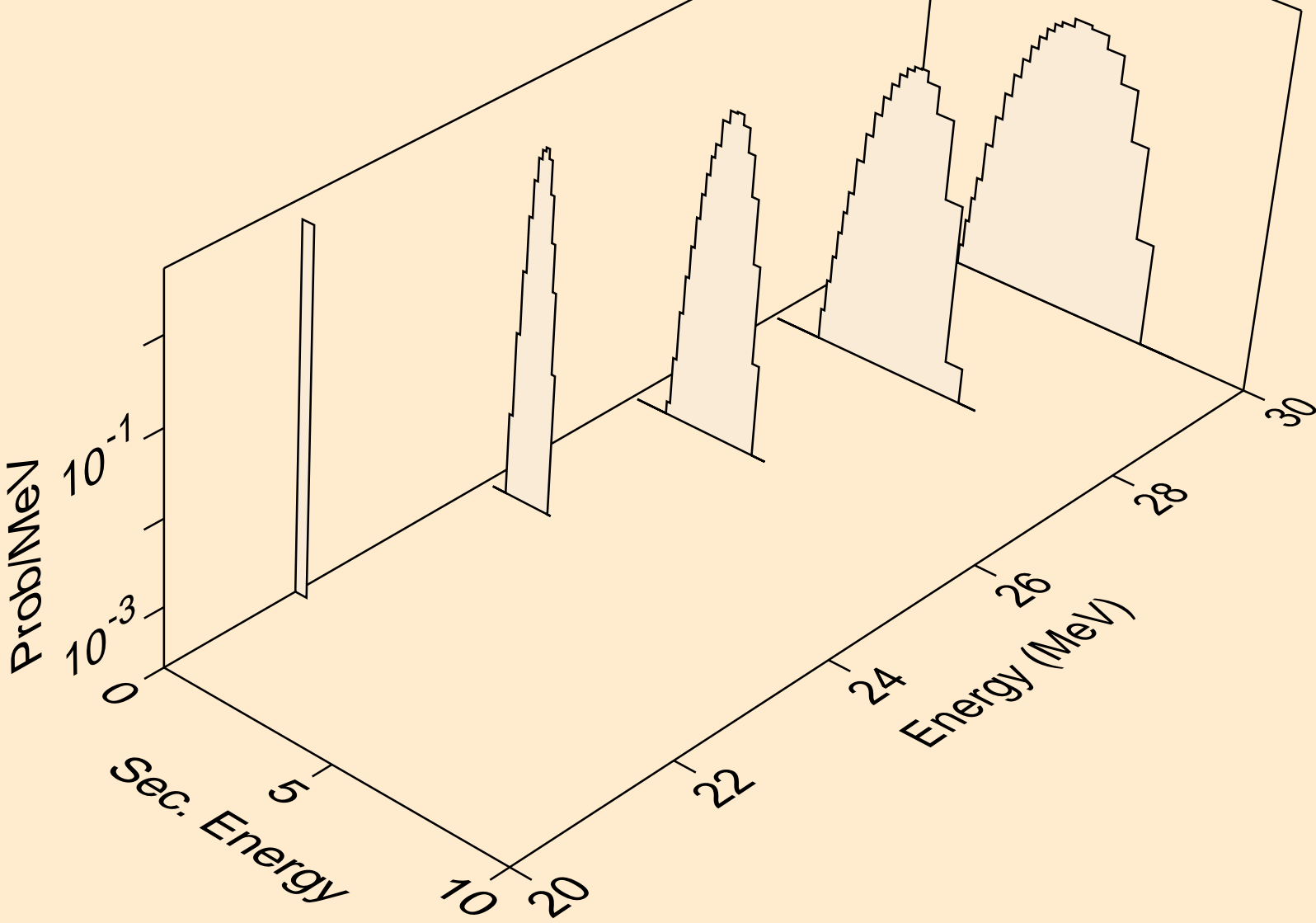

ZN072 NEUTRON ACER TENDL-2024 LIBRARY; T=293.6K
tritons from (n,x)

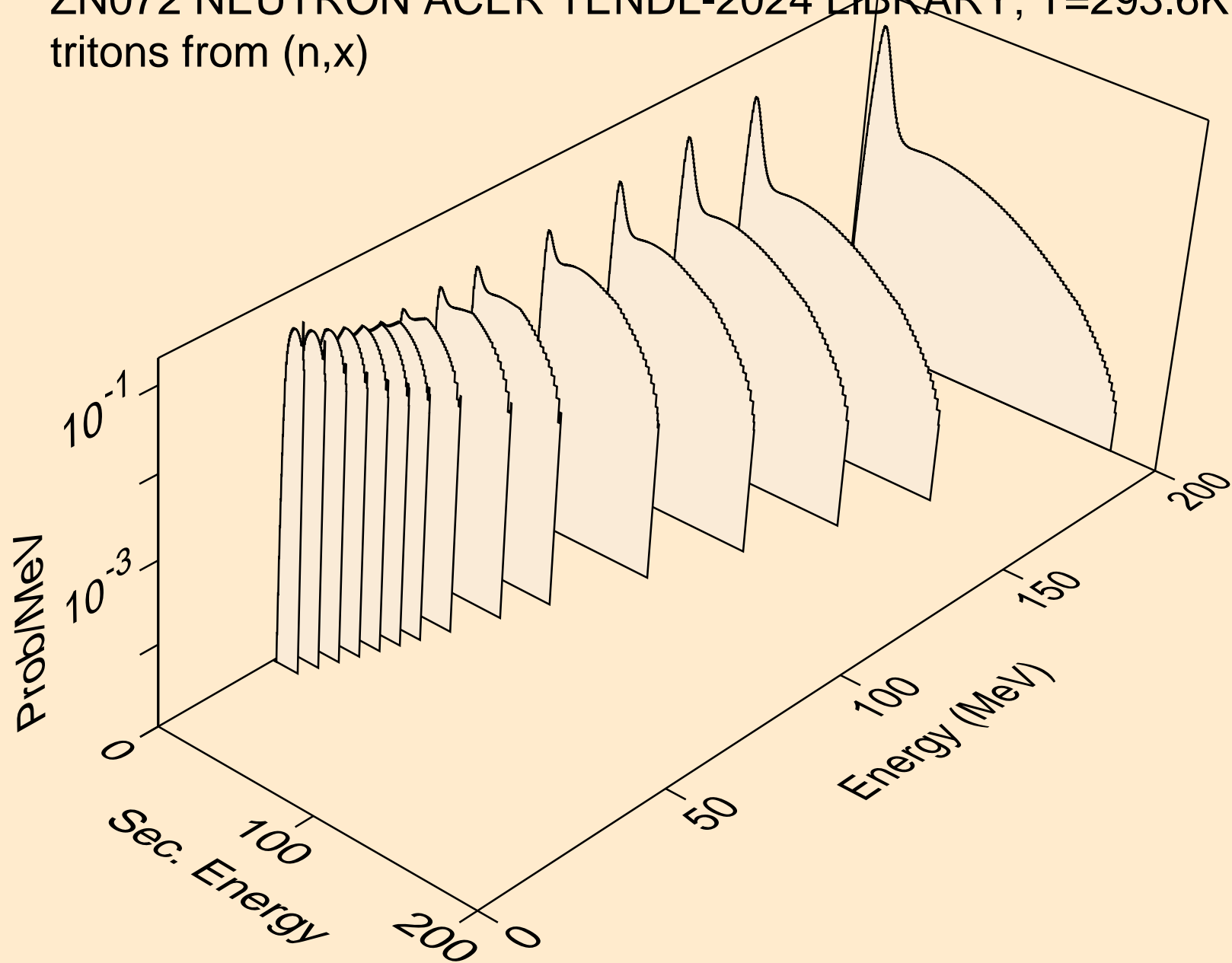

ZN072 NEUTRON ACER TENDL-2024 LIBRARY; T=293.6K
tritons from (n,n*)t

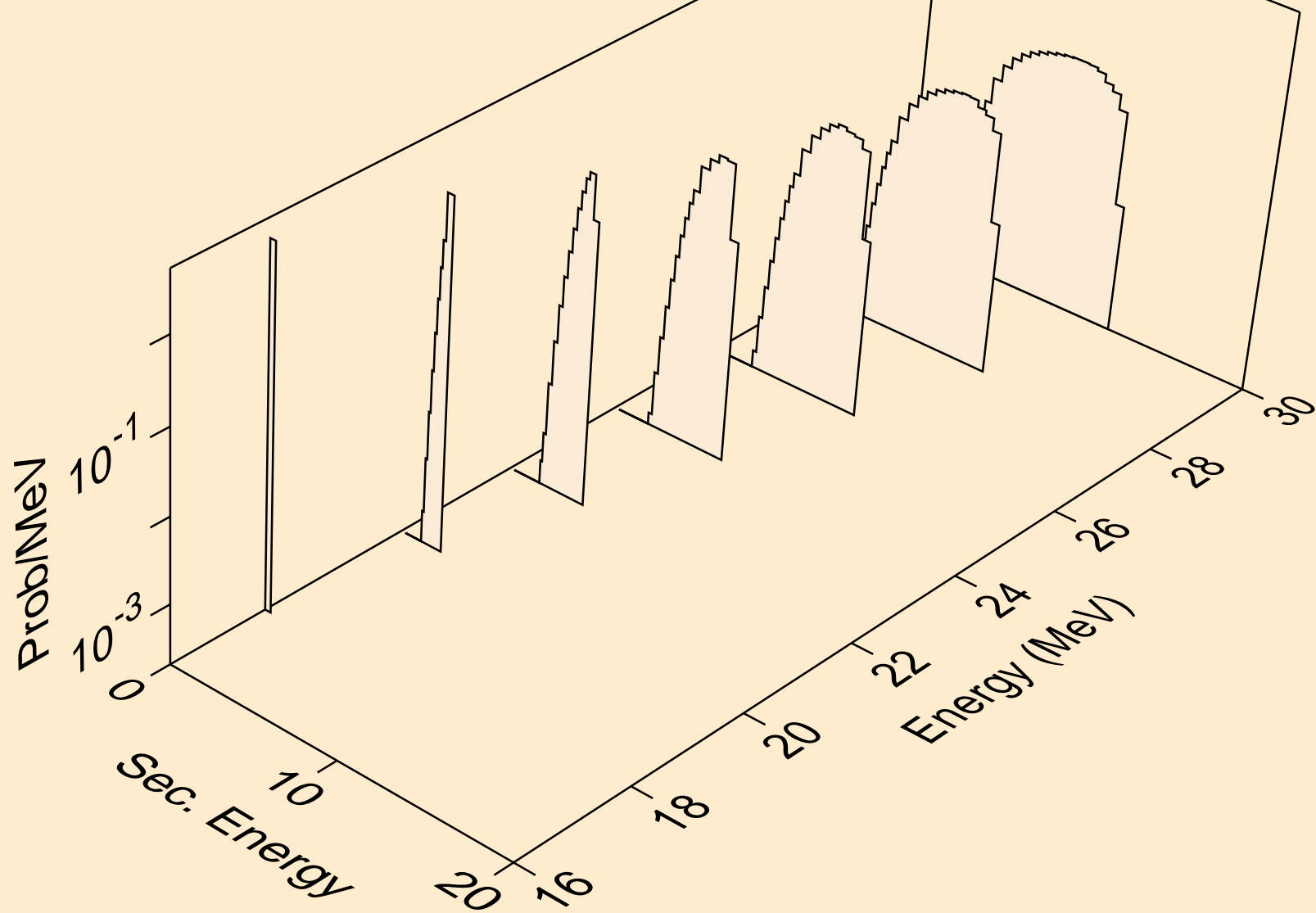

ZN072 NEUTRON ACER TENDL-2024 LIBRARY; T=293.6K
tritons from (n,t)

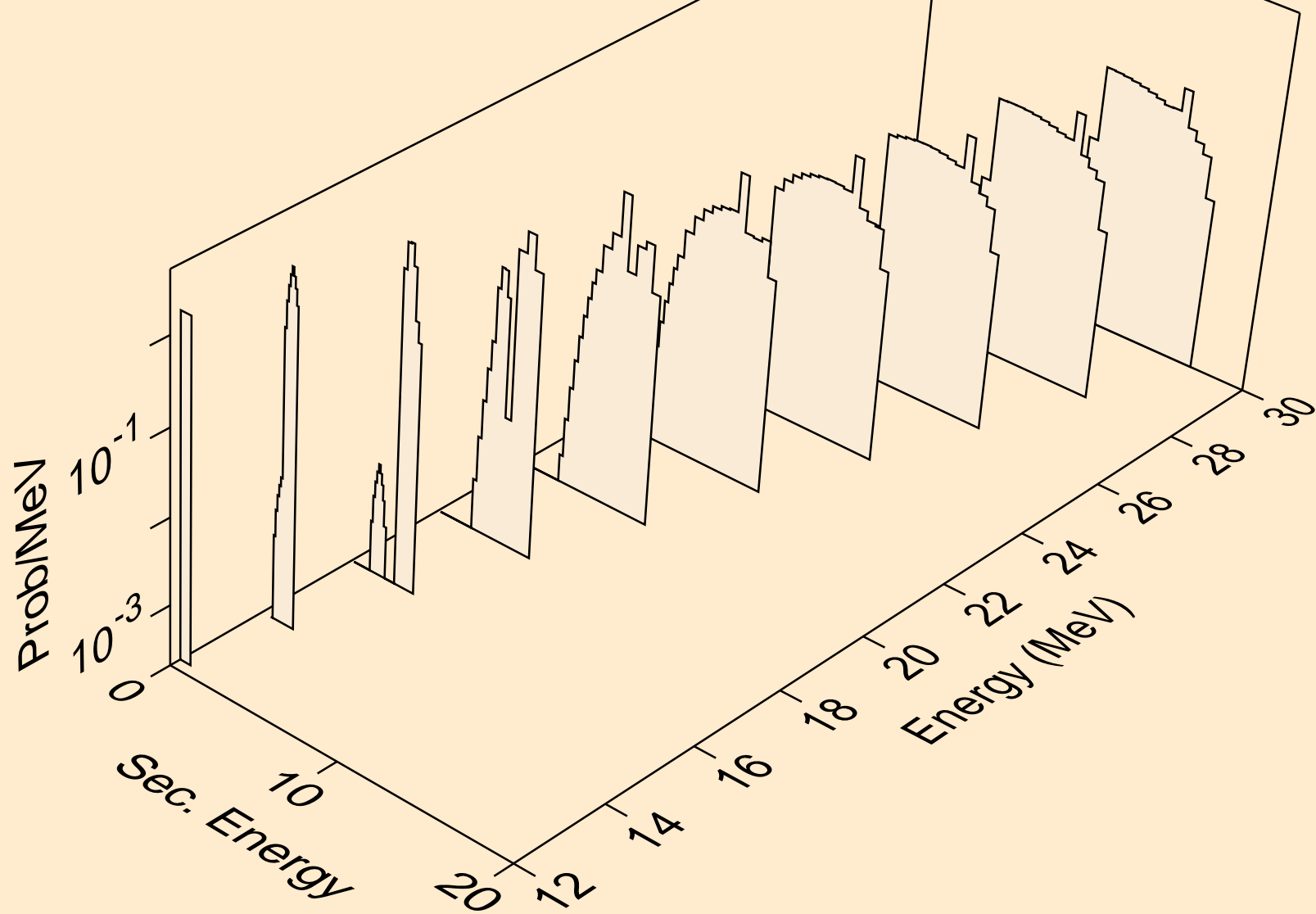

ZN072 NEUTRON ACER TENDL-2024 LIBRARY; T=293.6K
tritons from (n,pt)

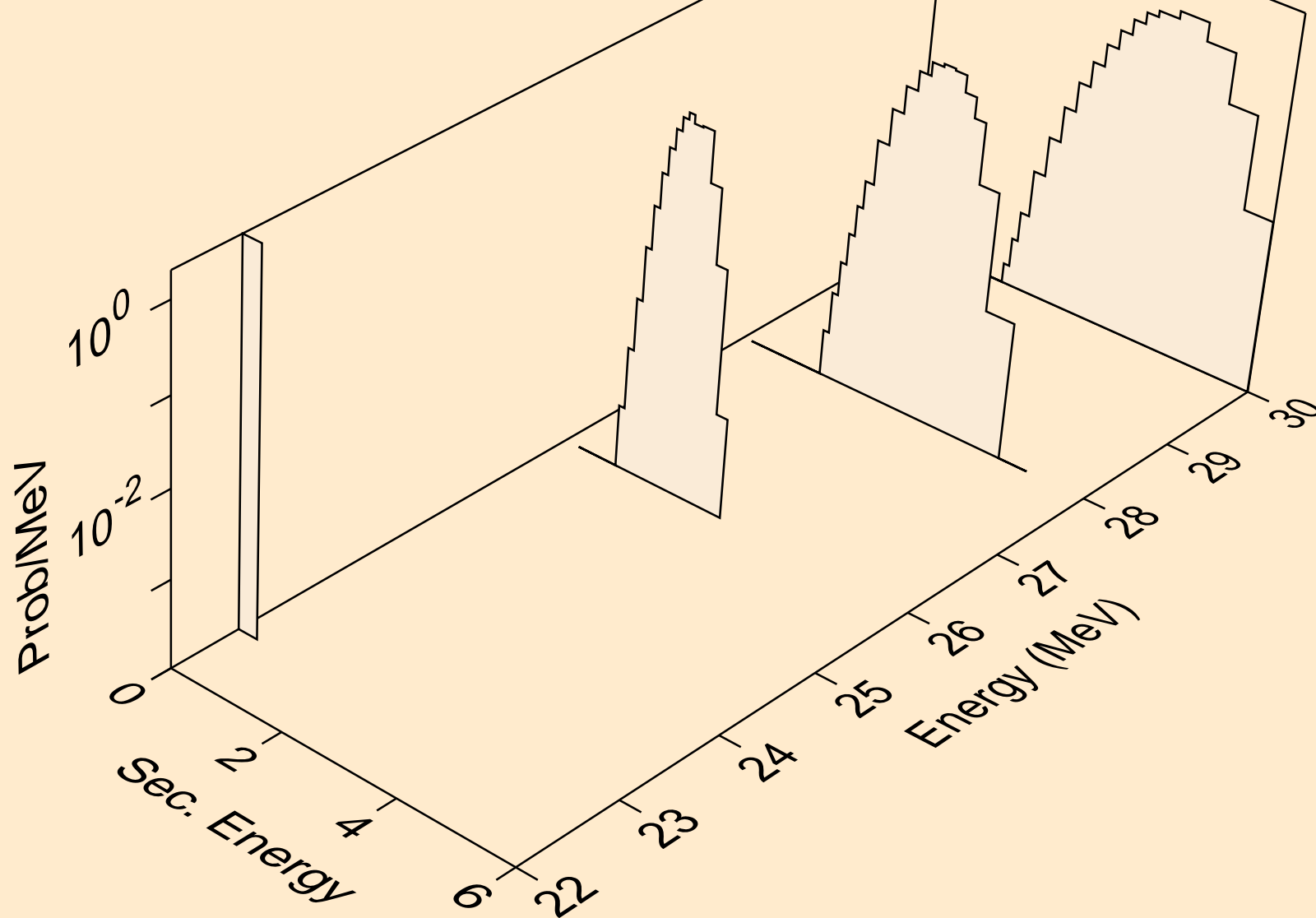

ZN072 NEUTRON ACER TENDL-2024 LIBRARY; T=293.6K
he3s from (n,x)

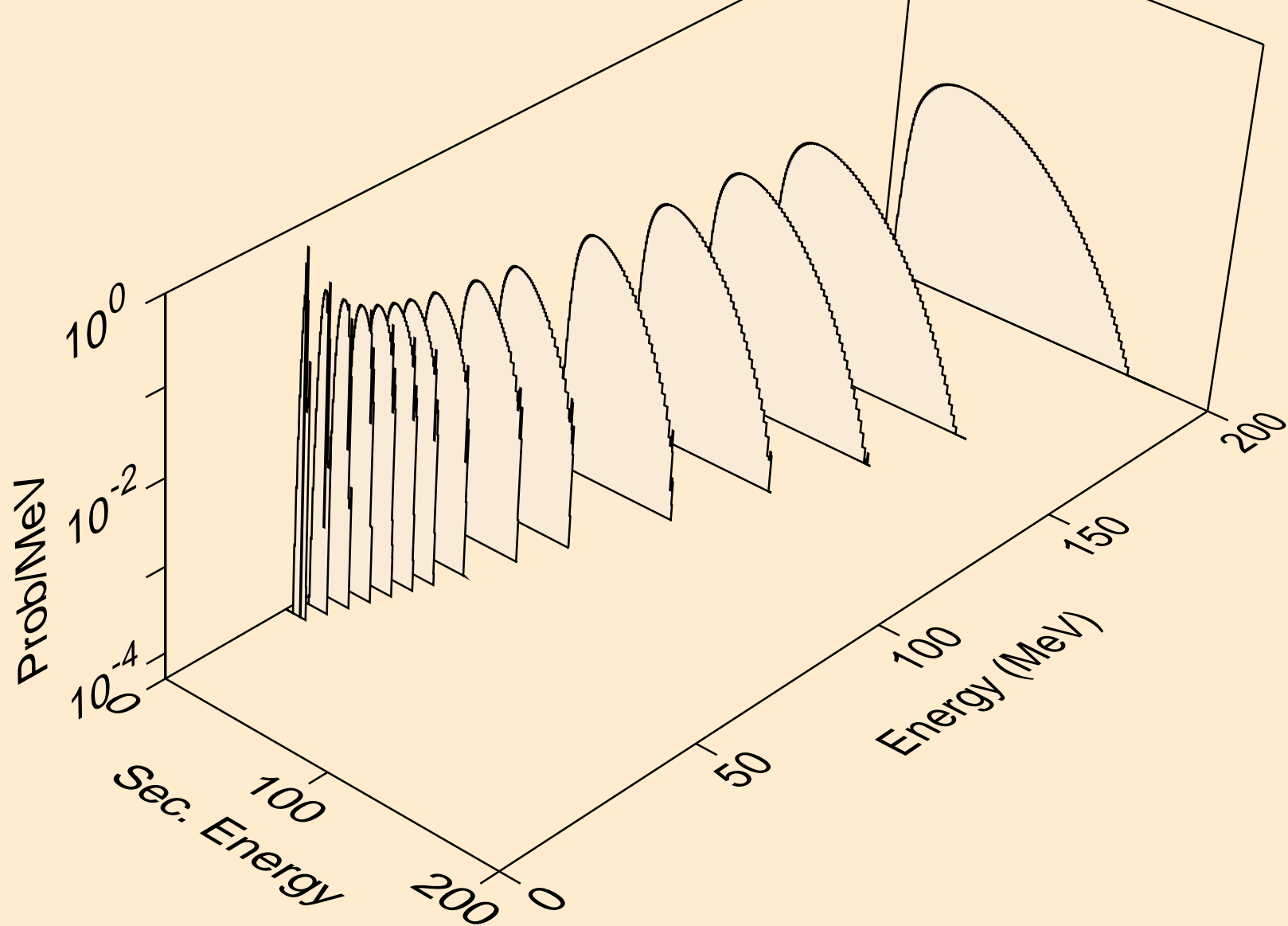

ZN072 NEUTRON ACER TENDL-2024 LIBRARY; T=293.6K
he3s from (n,n*)he3

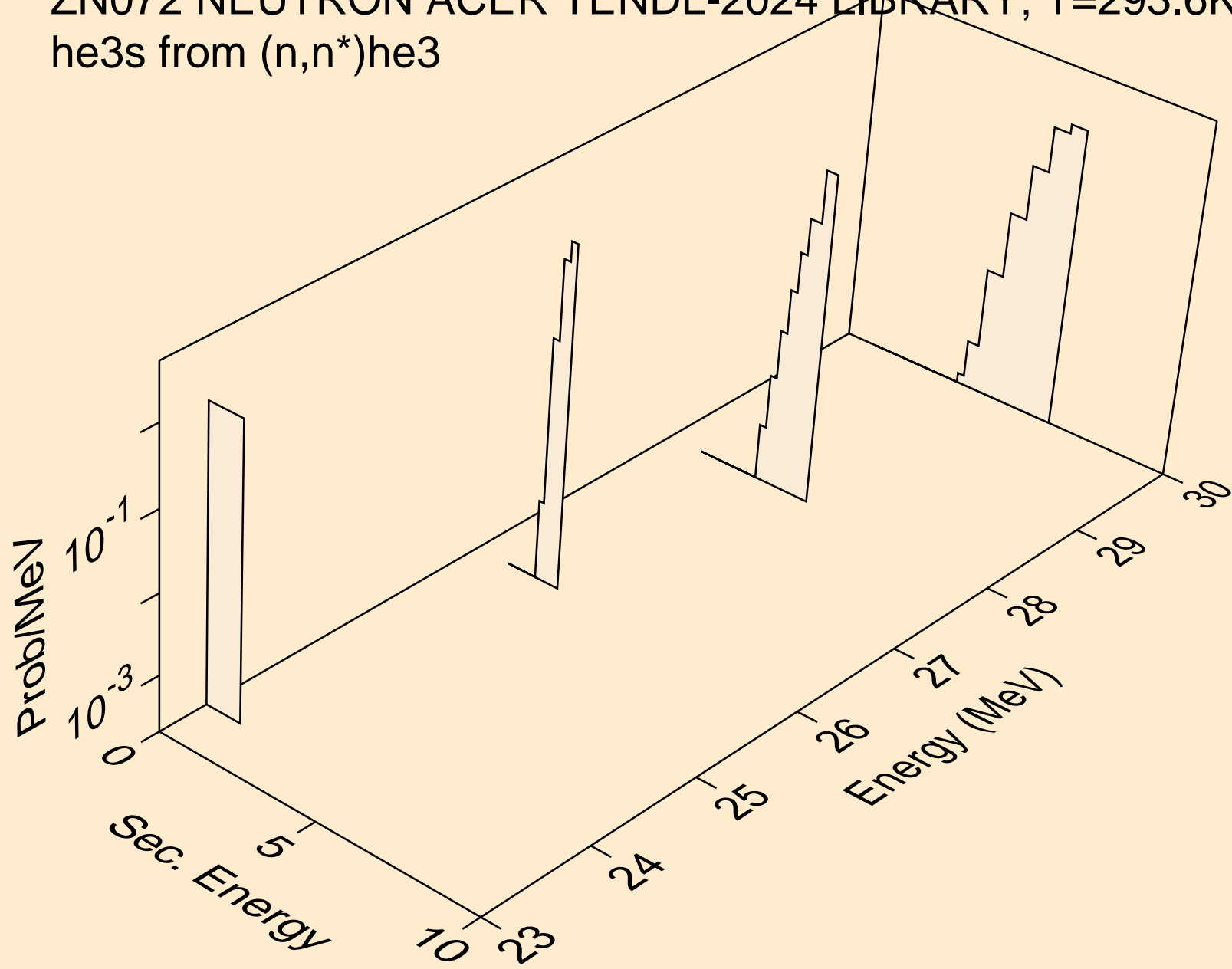

ZN072 NEUTRON ACER TENDL-2024 LIBRARY; T=293.6K
he3s from (n,he3)

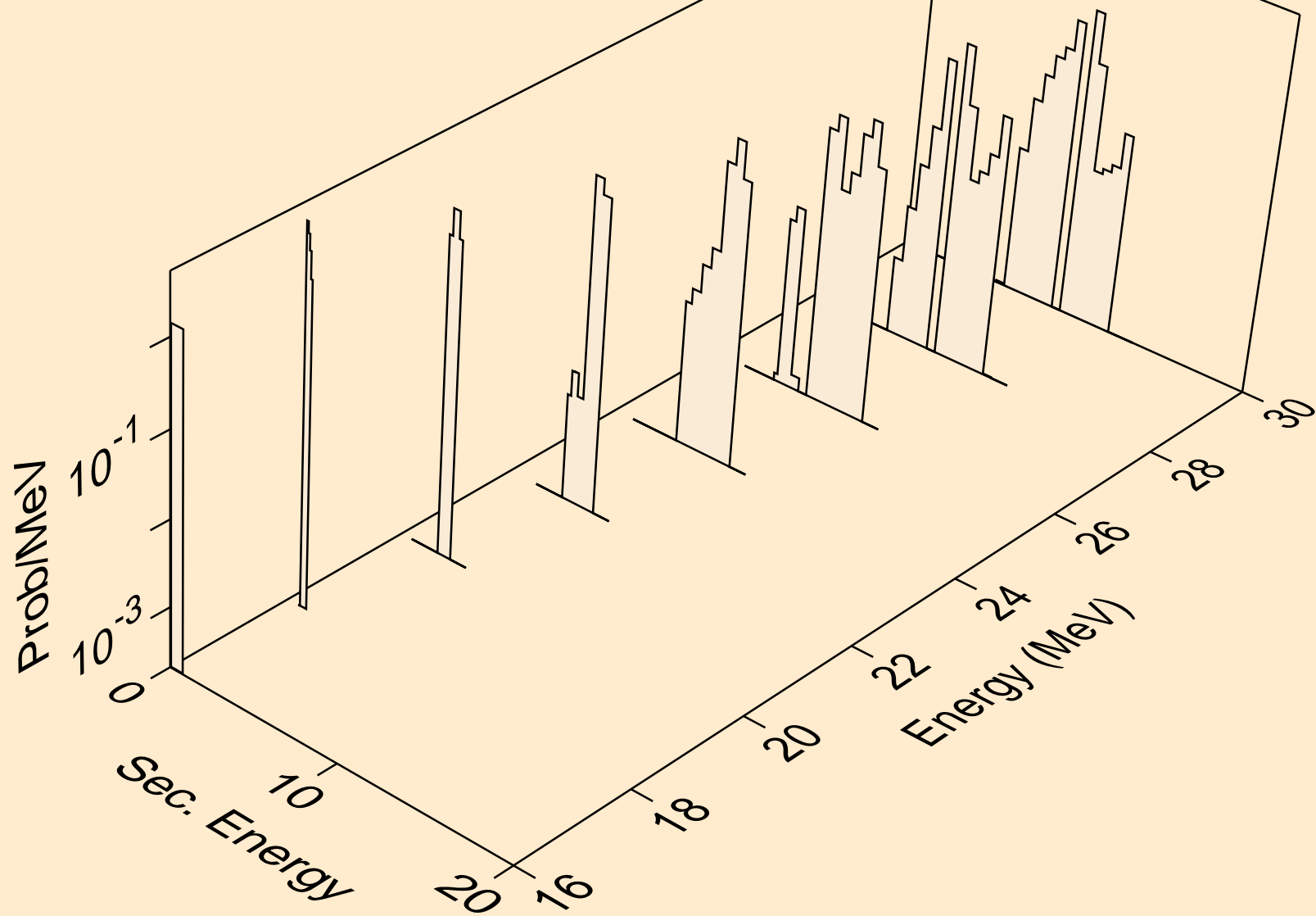

ZN072 NEUTRON ACER TENDL-2024 LIBRARY; T=293.6K
alphas from (n,x)

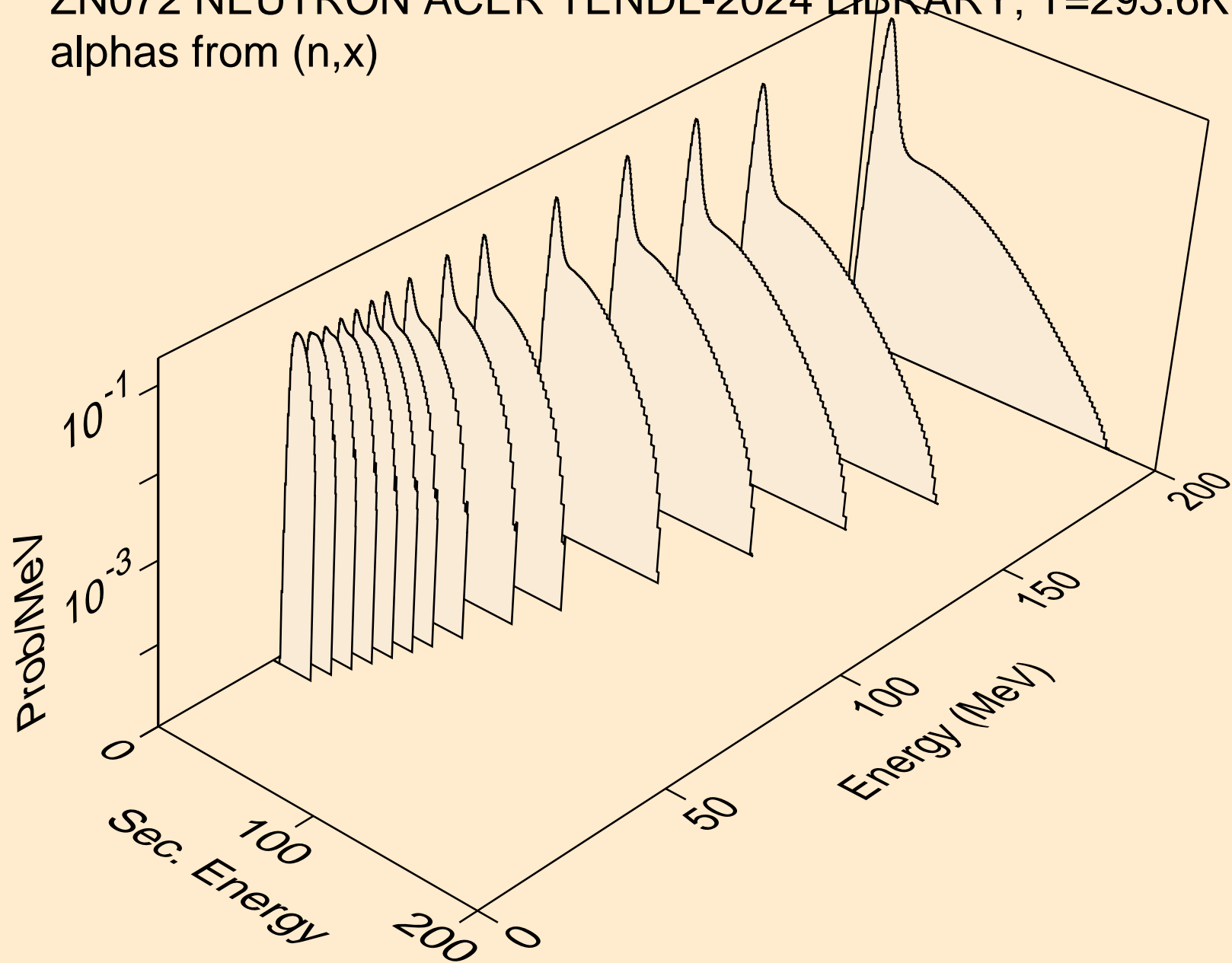

ZN072 NEUTRON ACER TENDL-2024 LIBRARY; T=293.6K
alphas from (n,n*)a

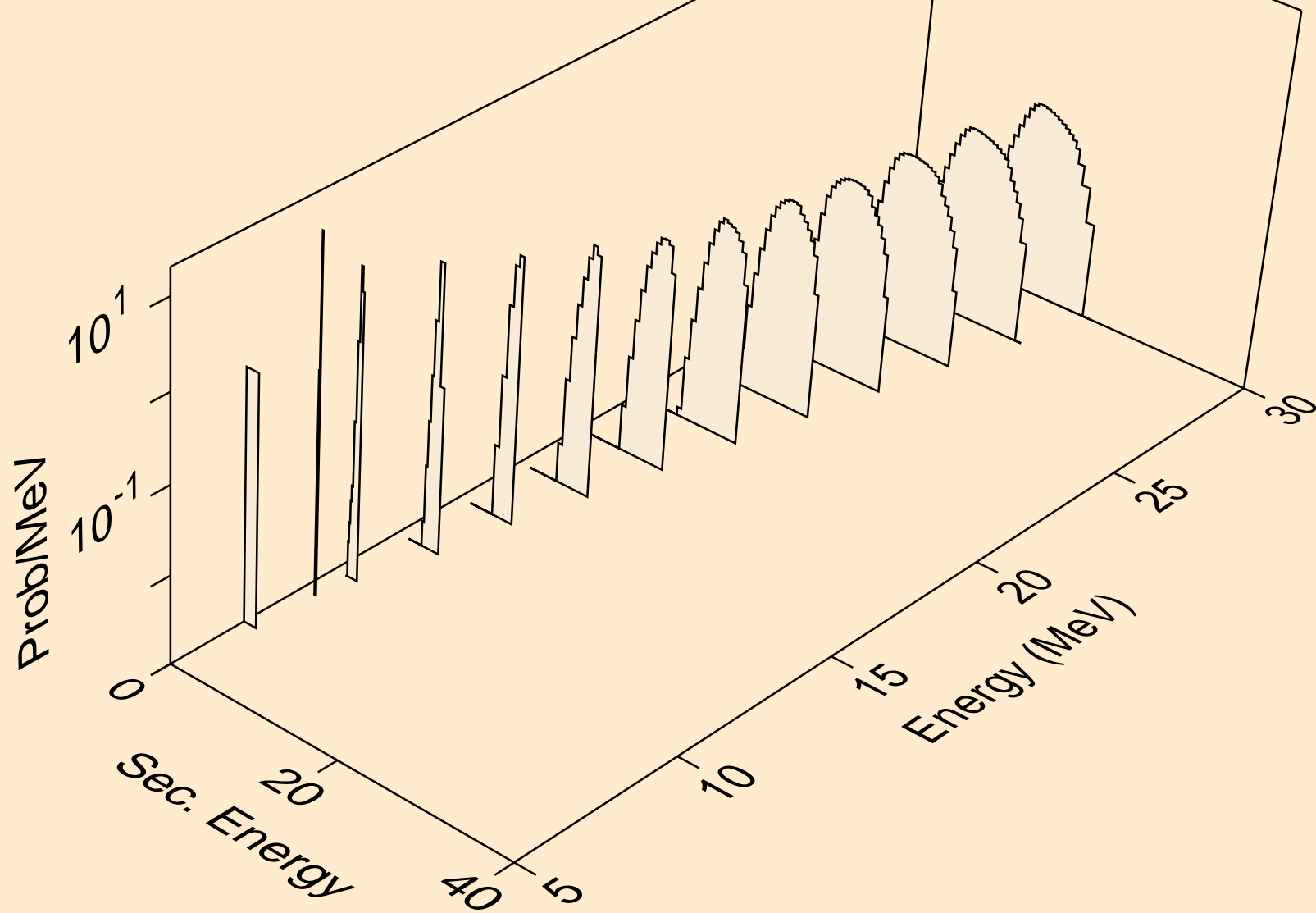

ZN072 NEUTRON ACER TENDL-2024 LIBRARY; T=293.6K
alphas from (n,2n)a

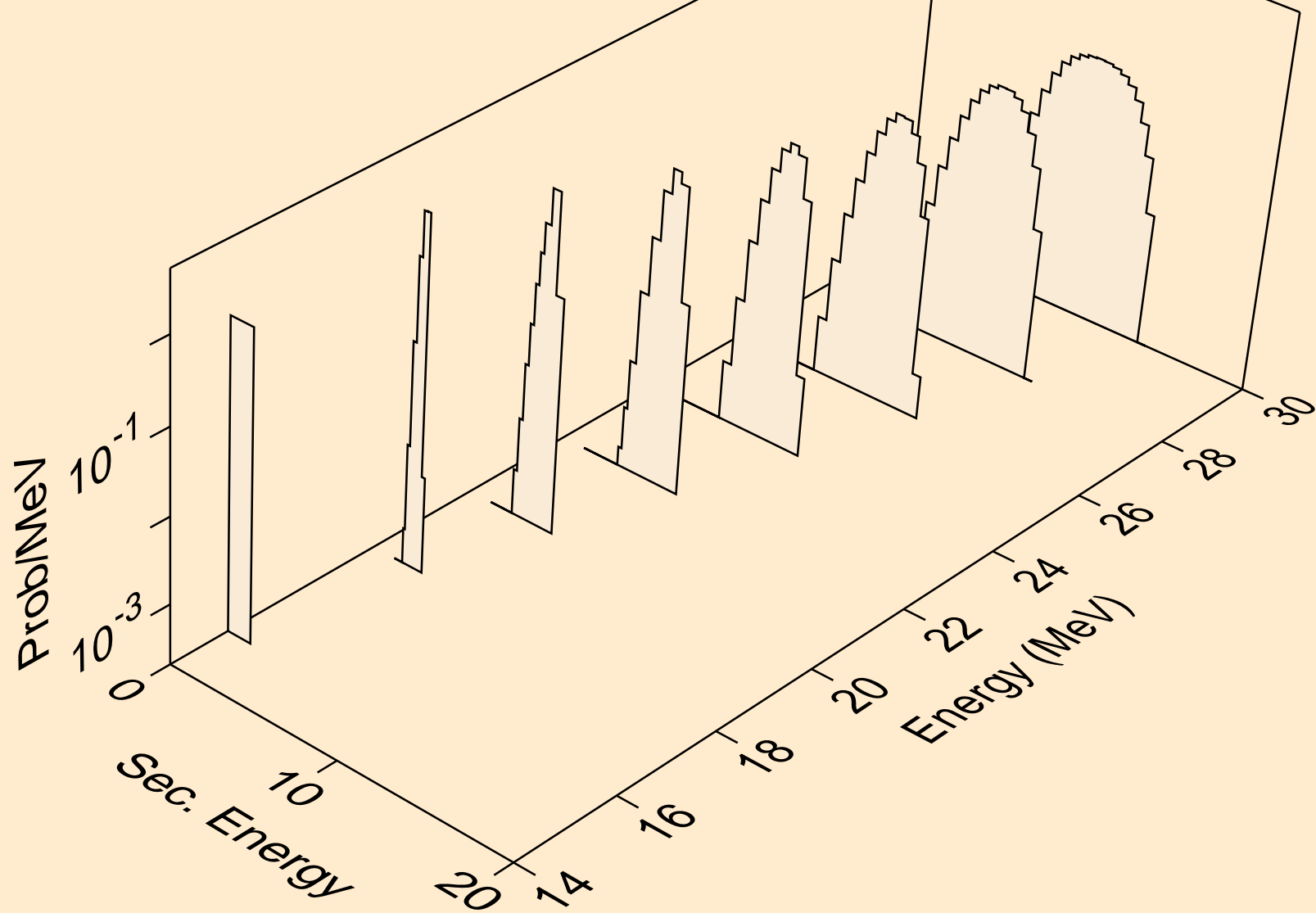

ZN072 NEUTRON ACER TENDL-2024 LIBRARY; T=293.6K
alphas from (n,3n)a

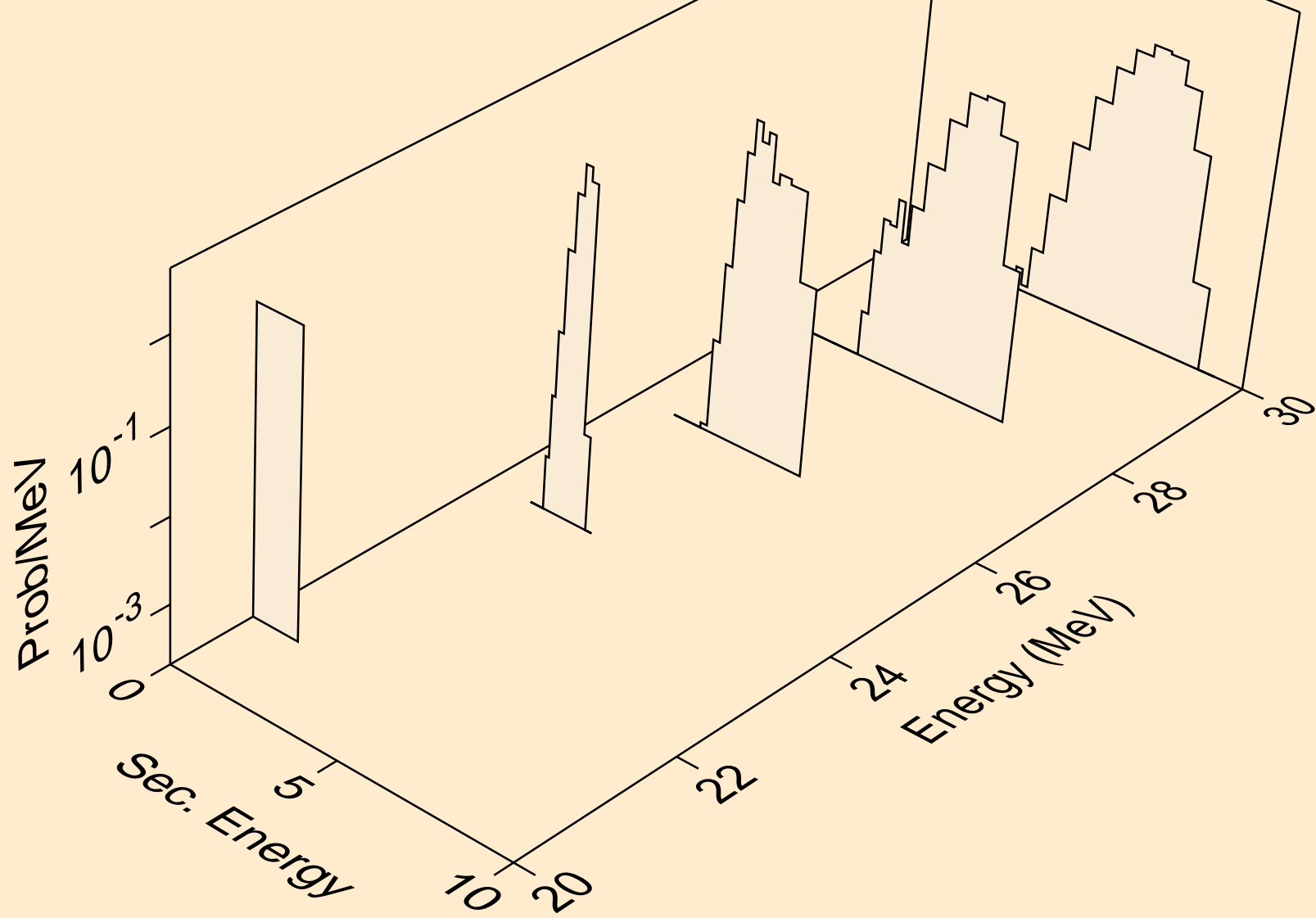

ZN072 NEUTRON ACER TENDL-2024 LIBRARY; T=293.6K
alphas from (n,a)

