

ZR080 NEUTRON ACER TENDL-2024 LIBRARY; T=293.6K

Principal cross sections

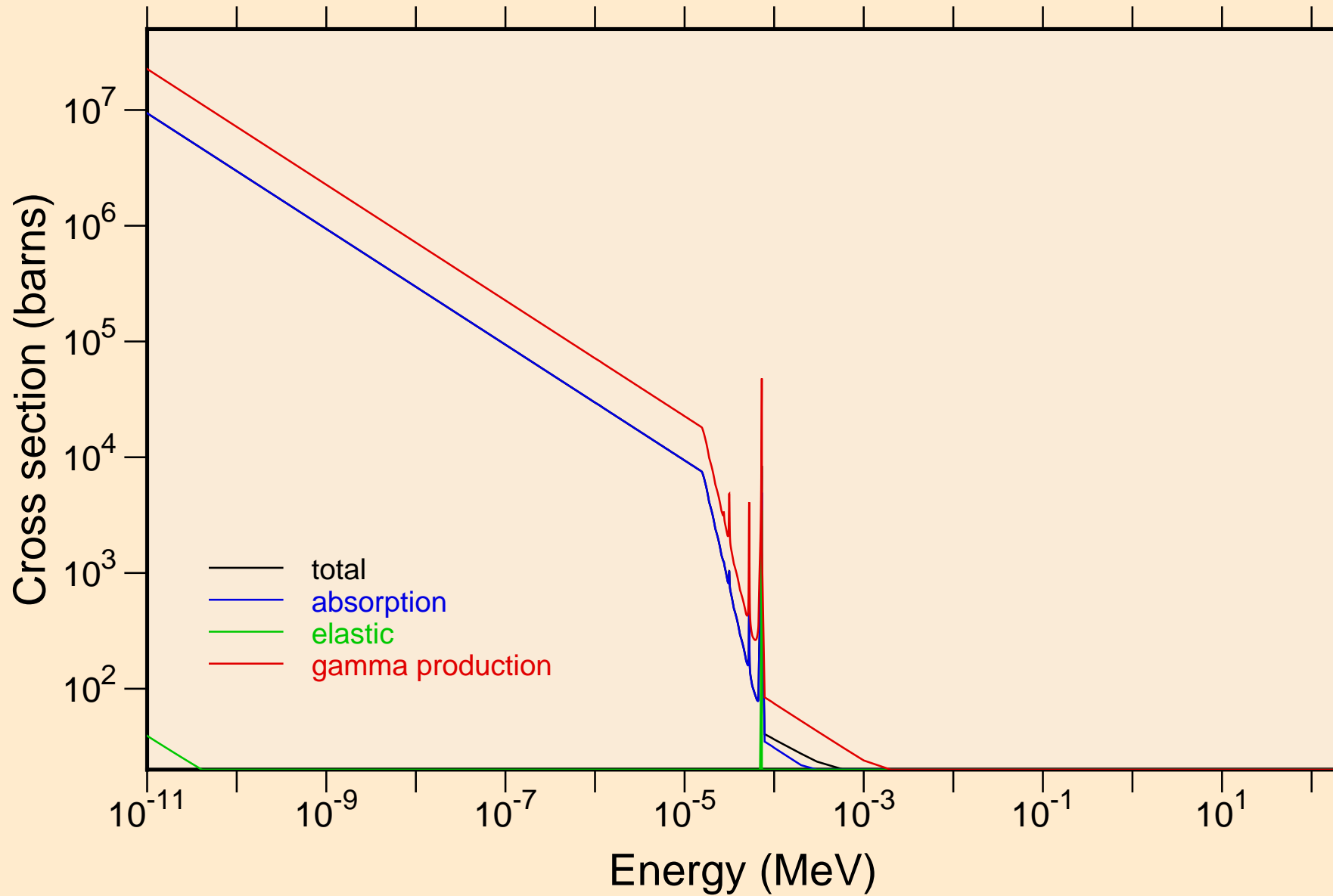

ZR080 NEUTRON ACER TENDL-2024 LIBRARY; T=293.6K
resonance total cross section

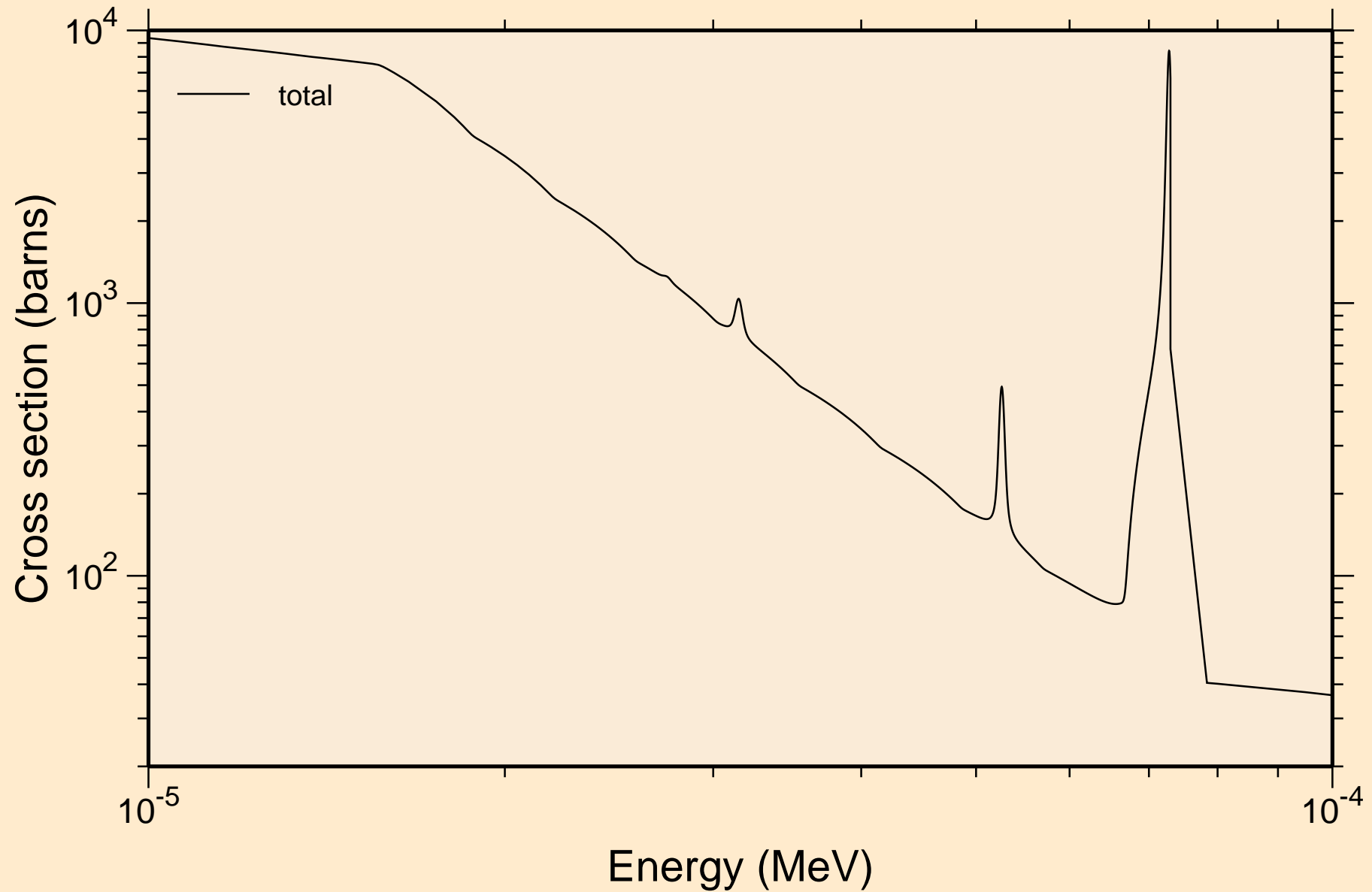

ZR080 NEUTRON ACER TENDL-2024 LIBRARY; T=293.6K
resonance total cross section

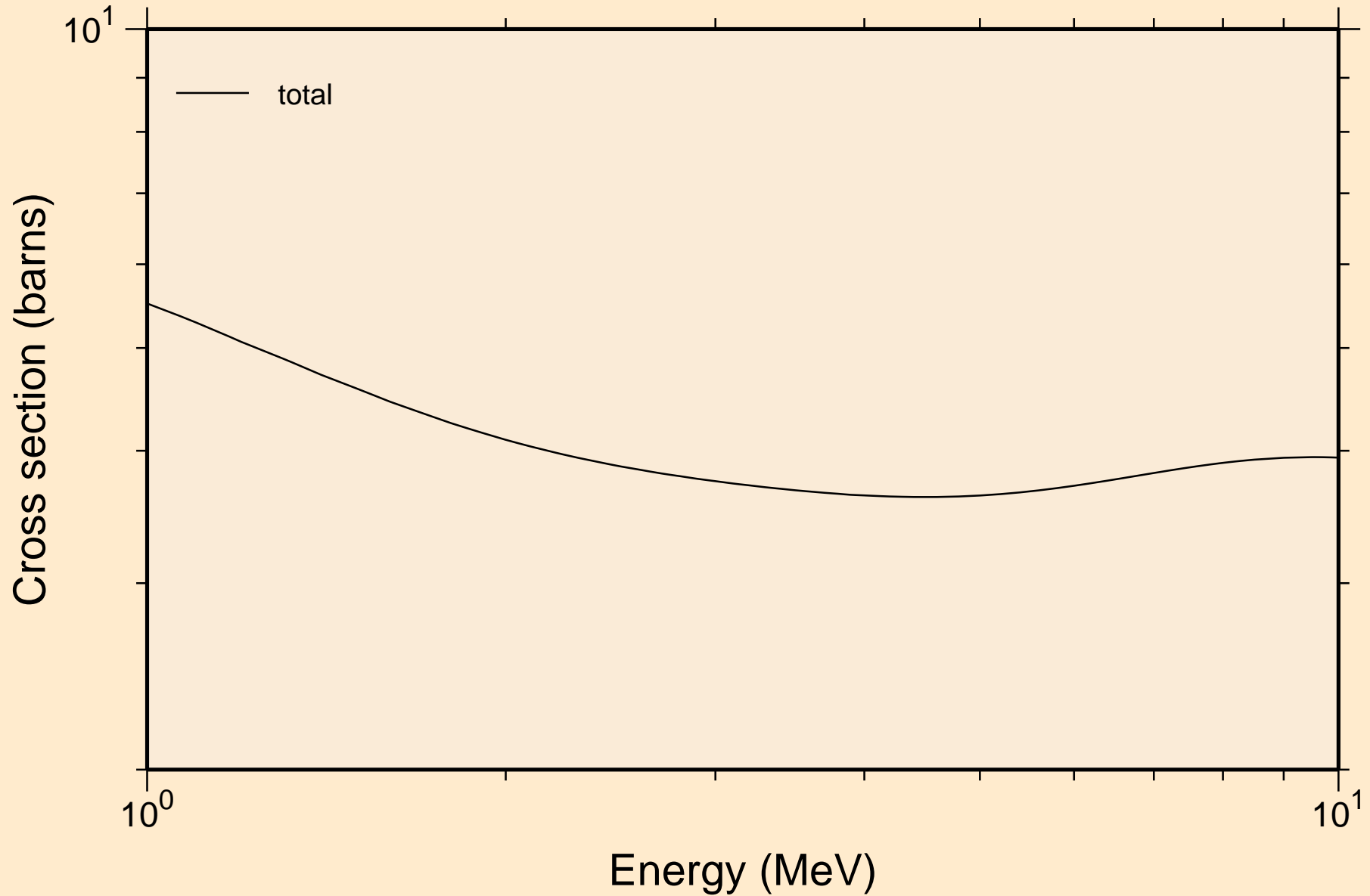

ZR080 NEUTRON ACER TENDL-2024 LIBRARY; T=293.6K
resonance absorption cross sections

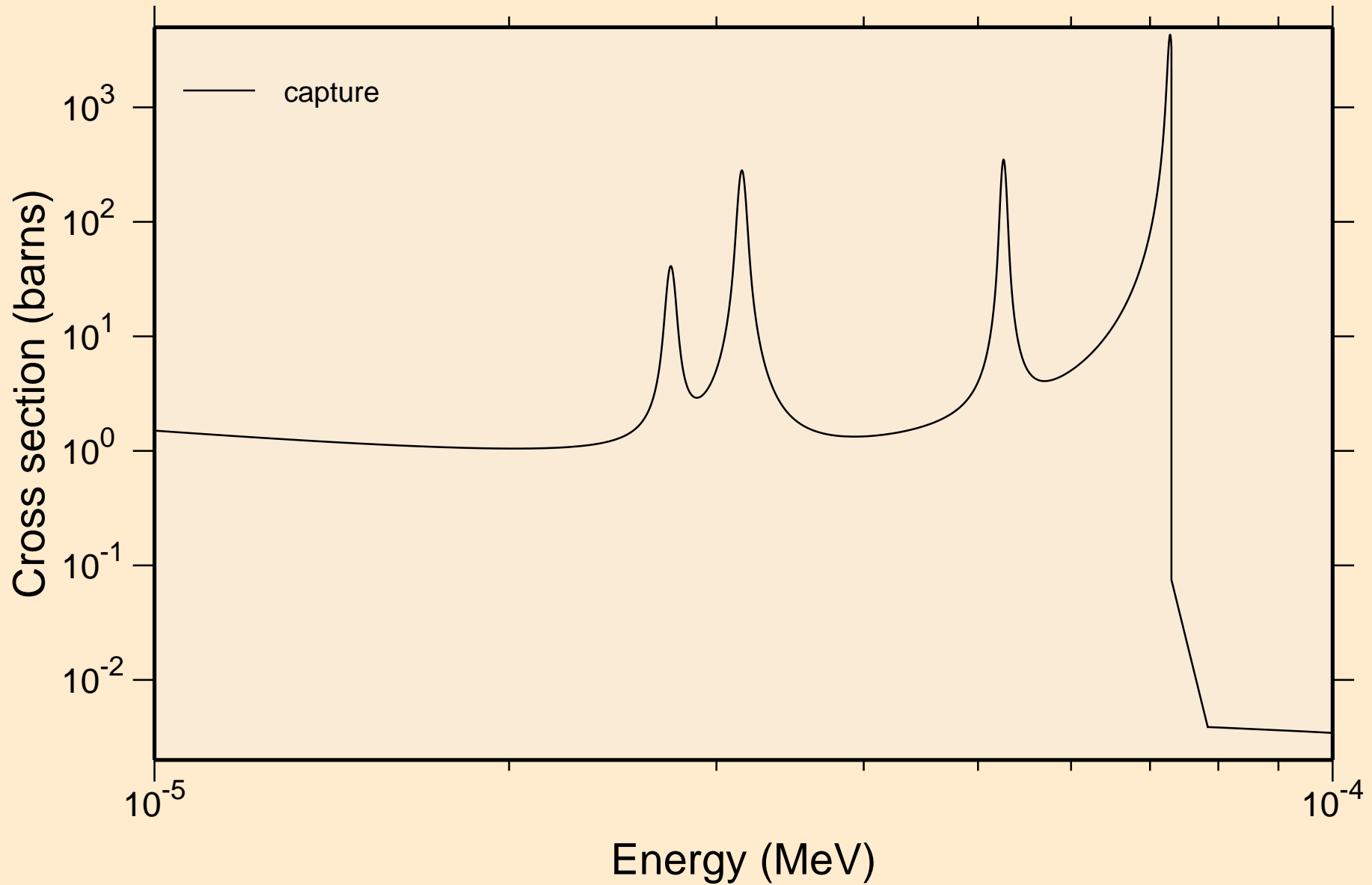

ZR080 NEUTRON ACER TENDL-2024 LIBRARY; T=293.6K
resonance absorption cross sections

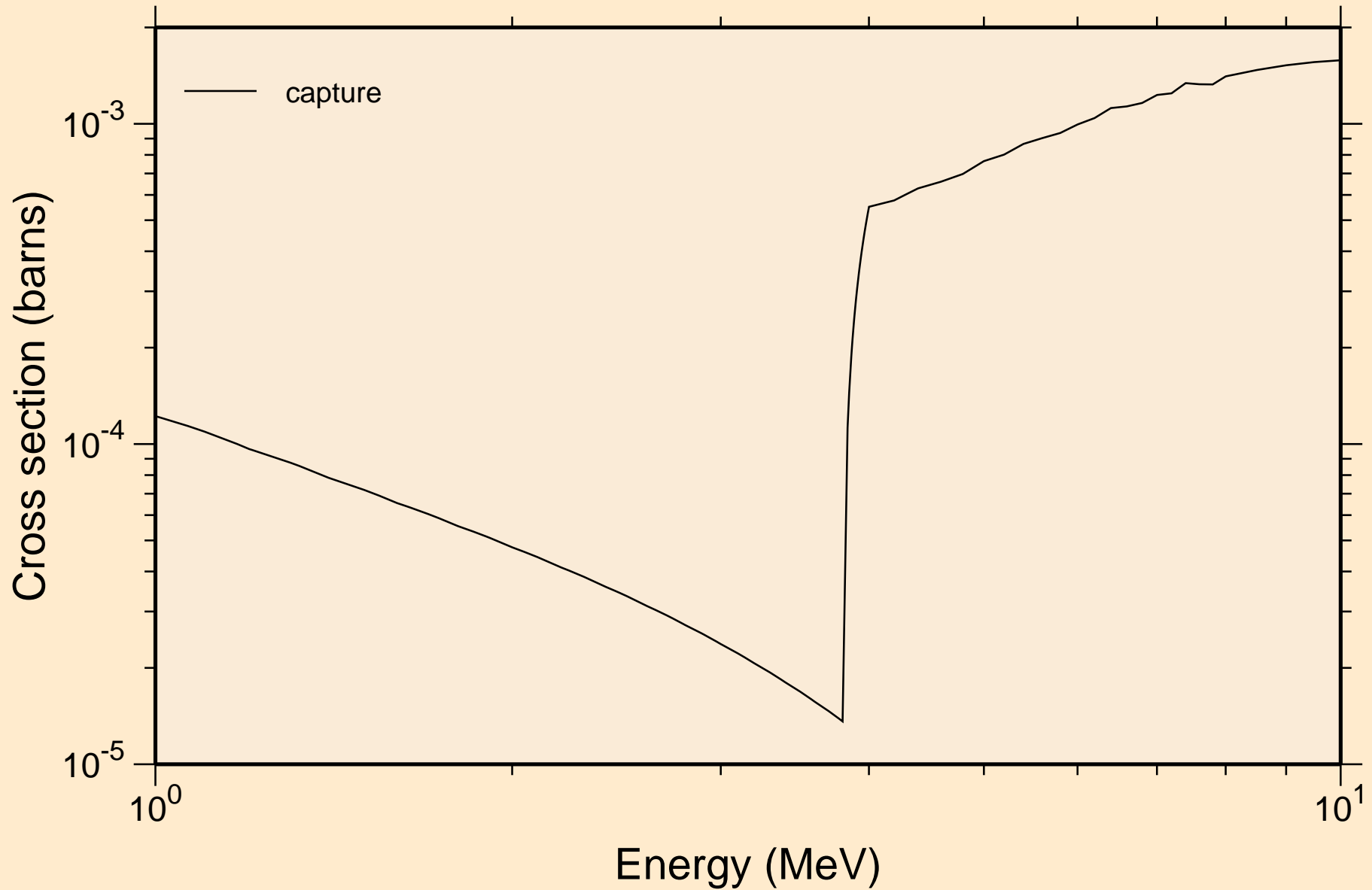

ZR080 NEUTRON ACER TENDL-2024 LIBRARY; T=293.6K

Heating

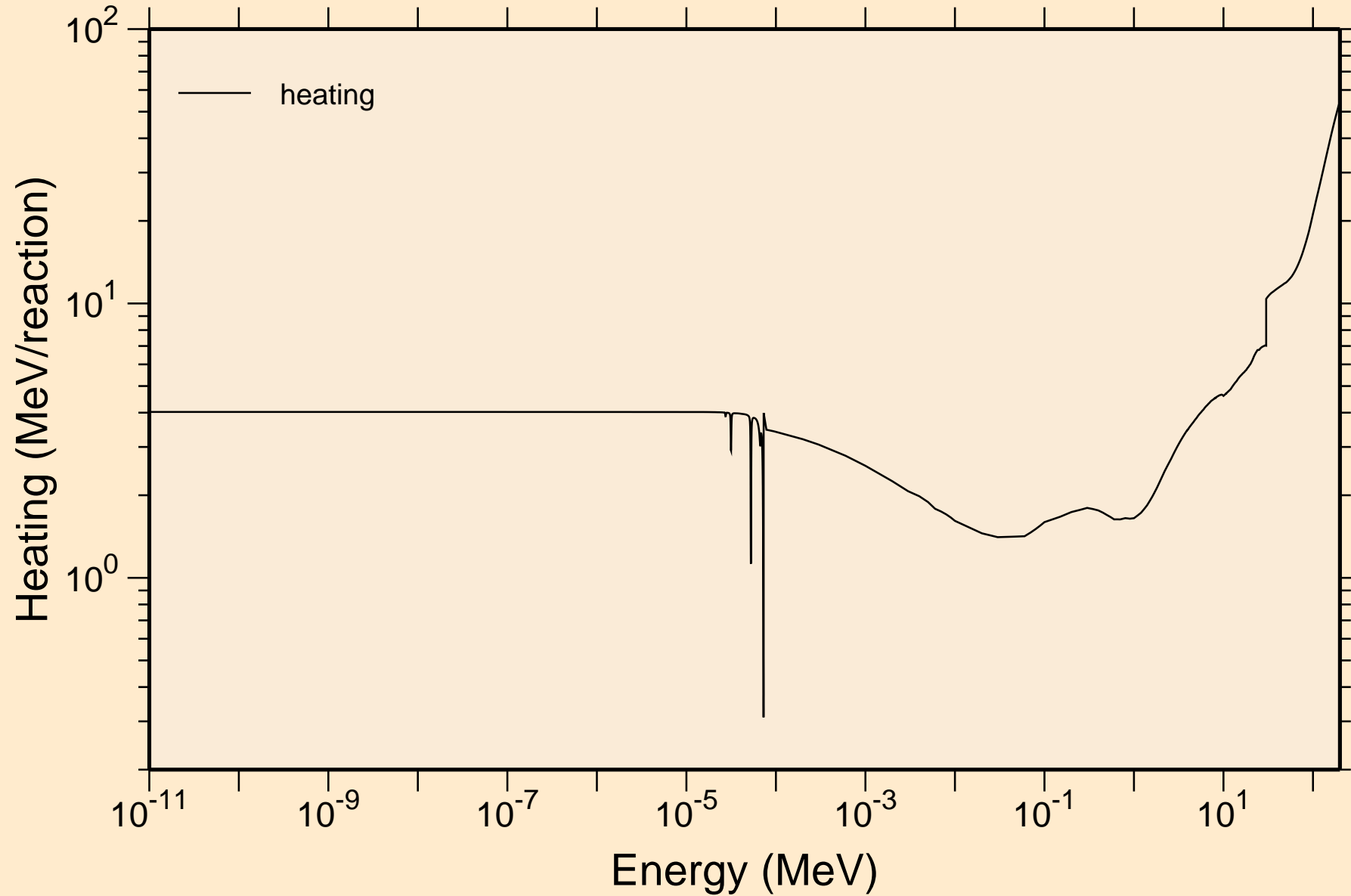

ZR080 NEUTRON ACER TENDL-2024 LIBRARY; T=293.6K
Damage

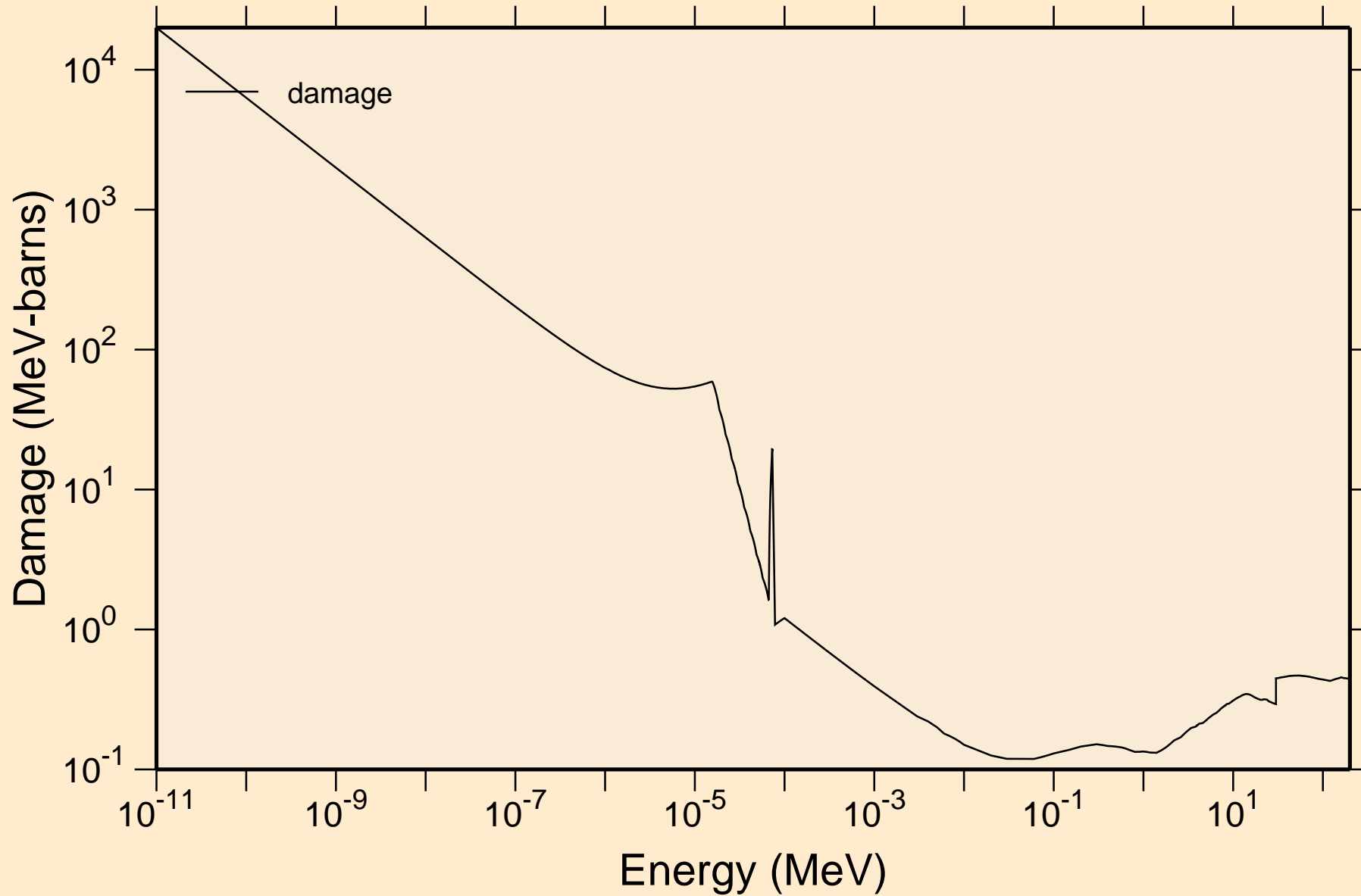

ZR080 NEUTRON ACER TENDL-2024 LIBRARY; T=293.6K
Non-threshold reactions

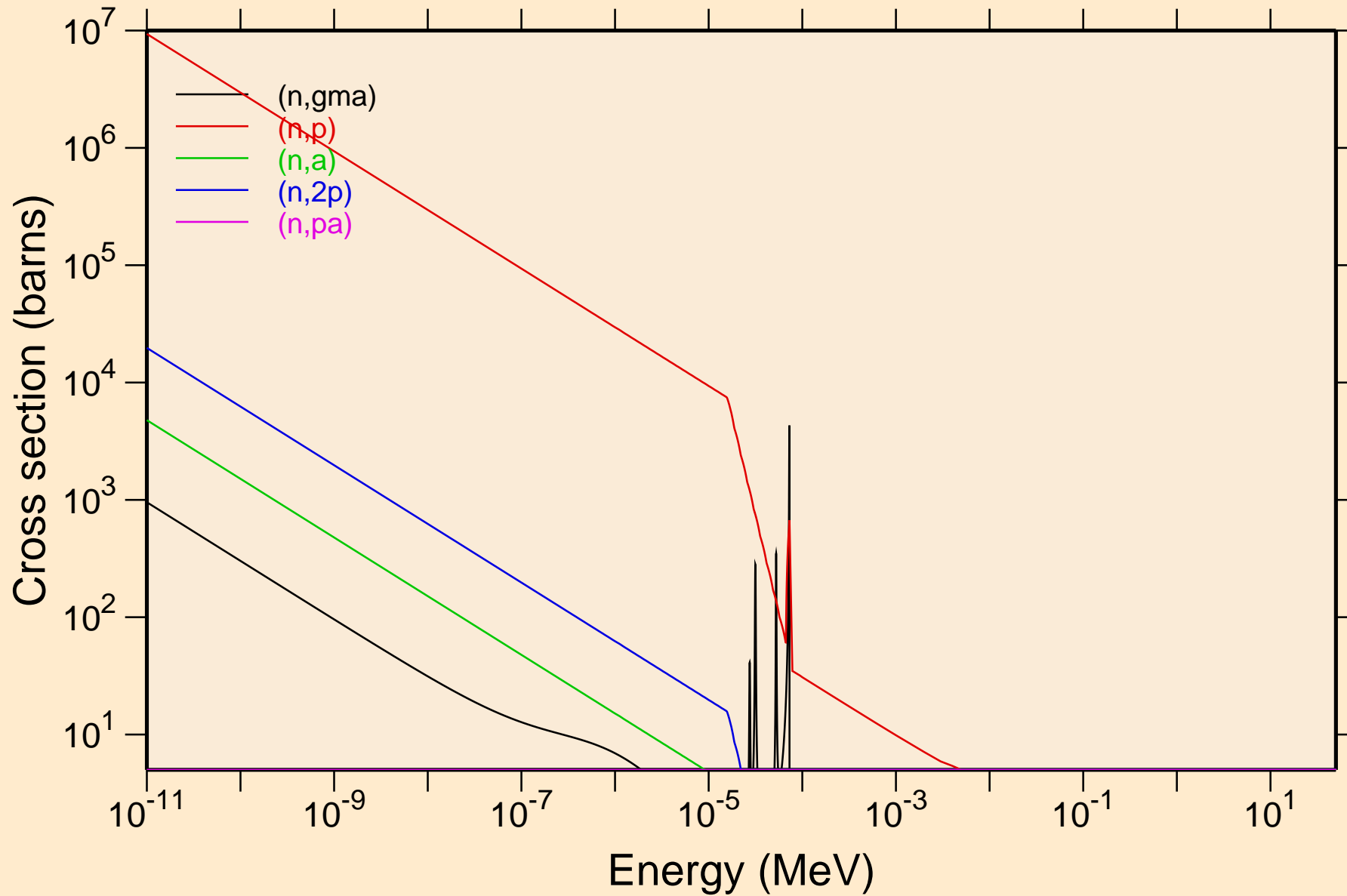

ZR080 NEUTRON ACER TENDL-2024 LIBRARY; T=293.6K
Non-threshold reactions

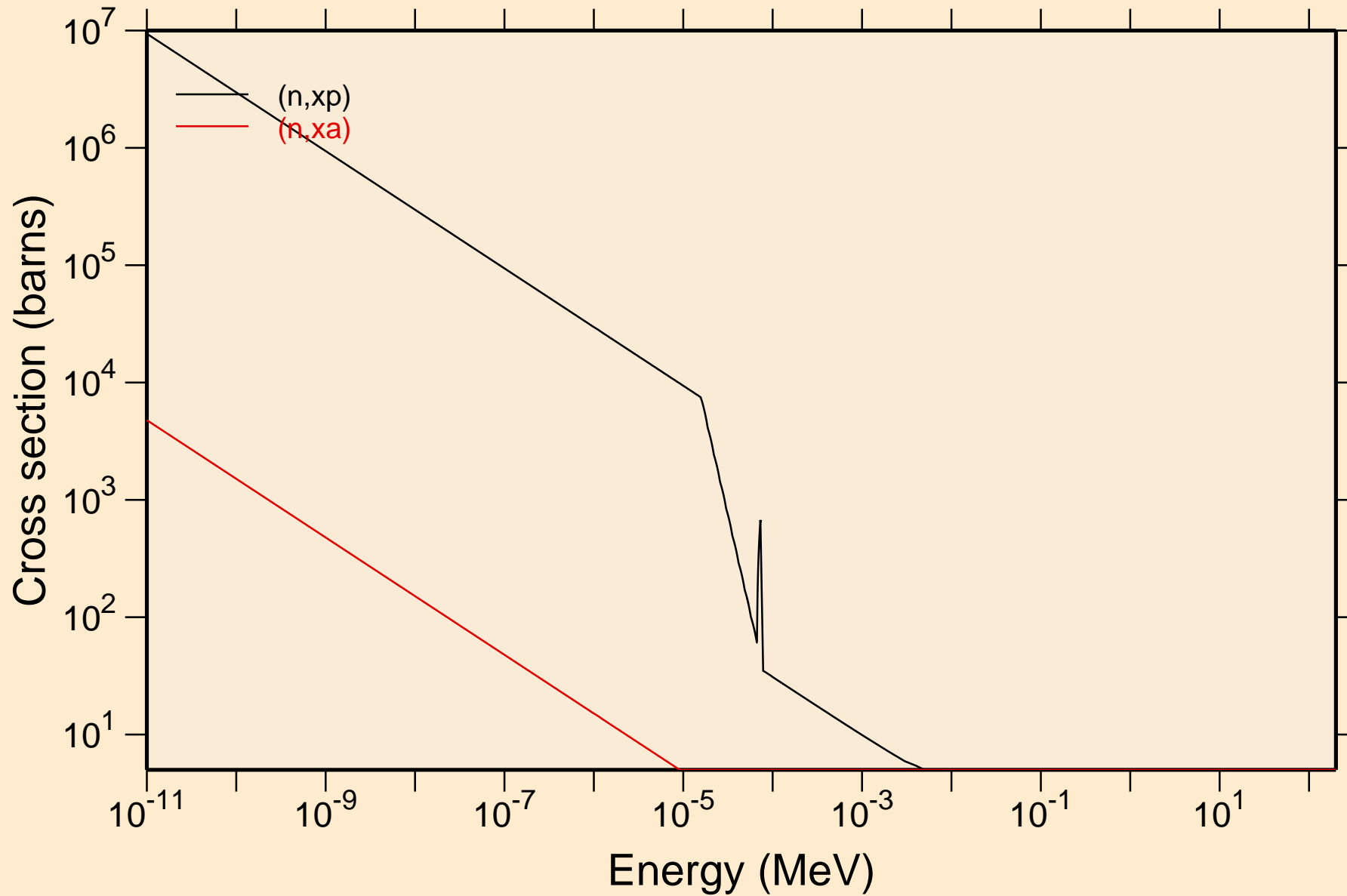

ZR080 NEUTRON ACER TENDL-2024 LIBRARY; T=293.6K

Principal cross sections

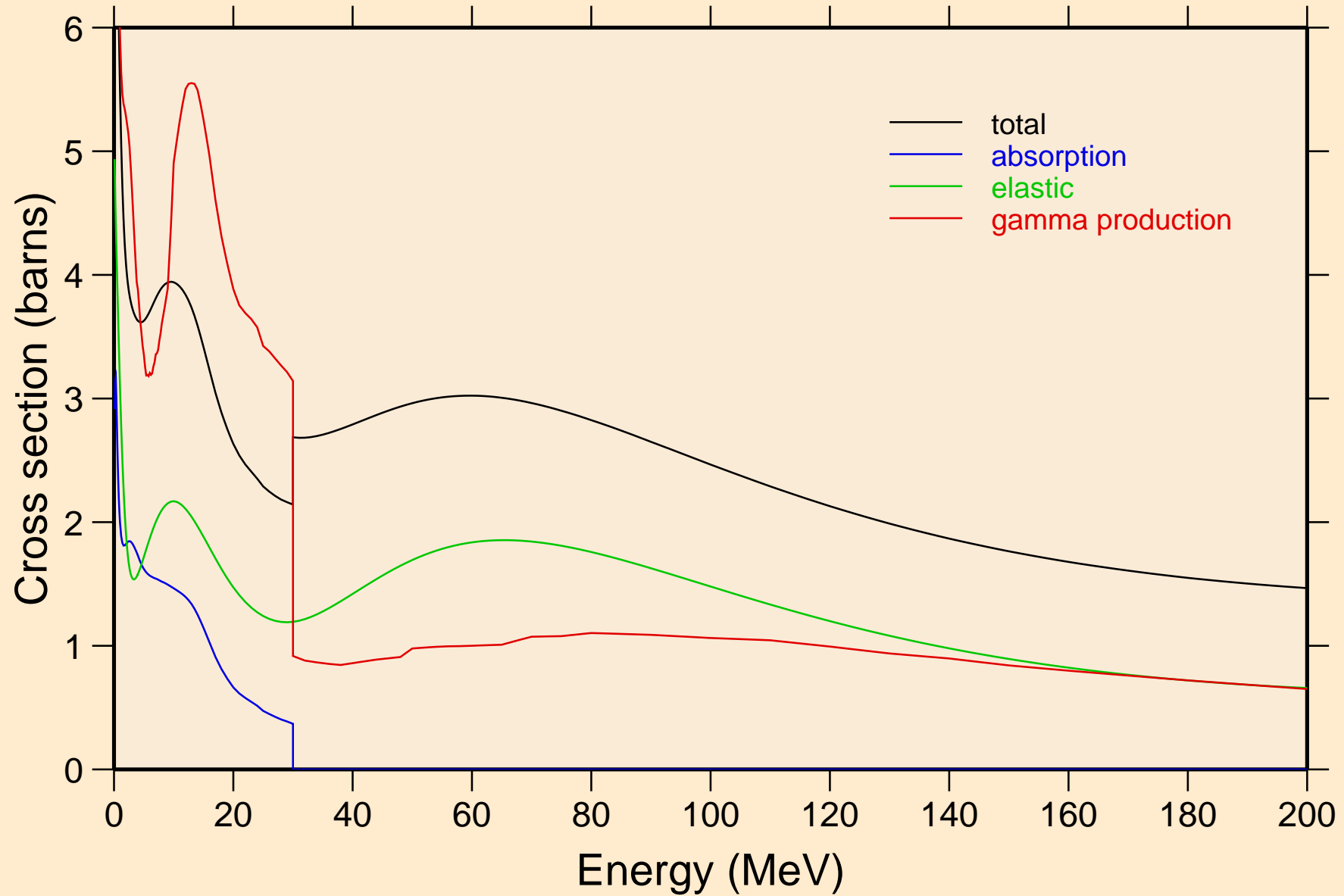

ZR080 NEUTRON ACER TENDL-2024 LIBRARY; T=293.6K

Heating

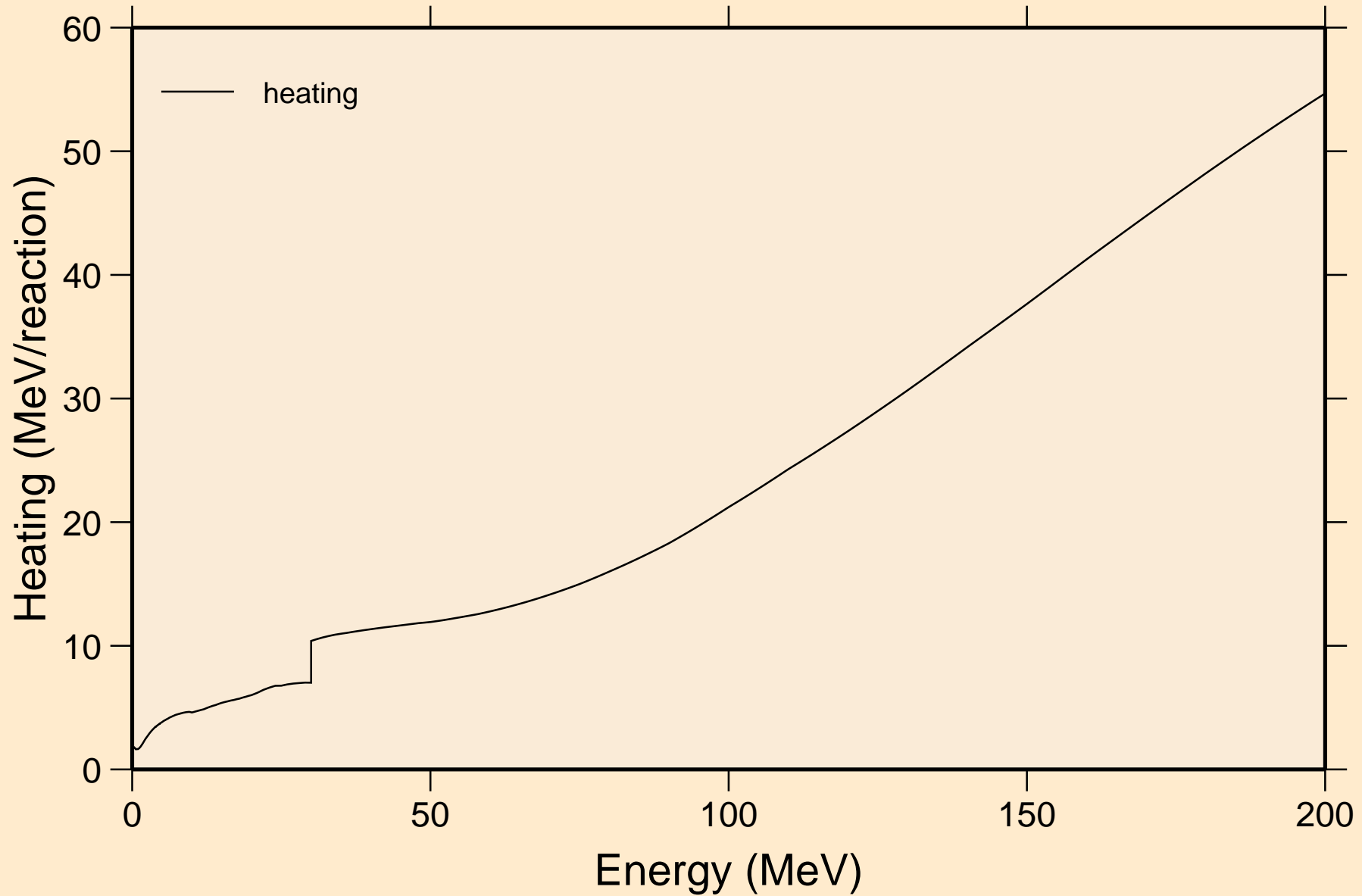

ZR080 NEUTRON ACER TENDL-2024 LIBRARY; T=293.6K

Damage

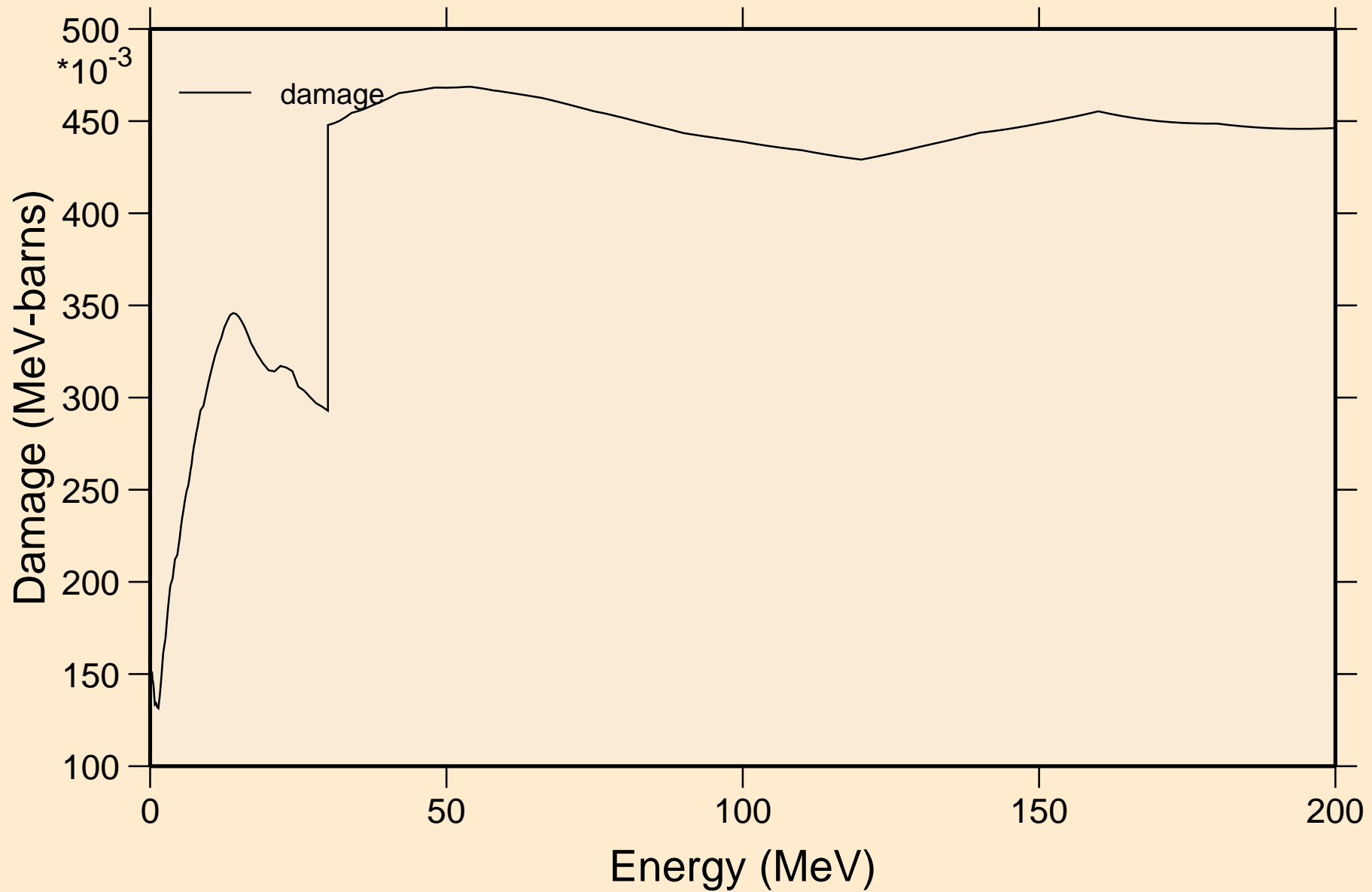

ZR080 NEUTRON ACER TENDL-2024 LIBRARY; T=293.6K
Non-threshold reactions

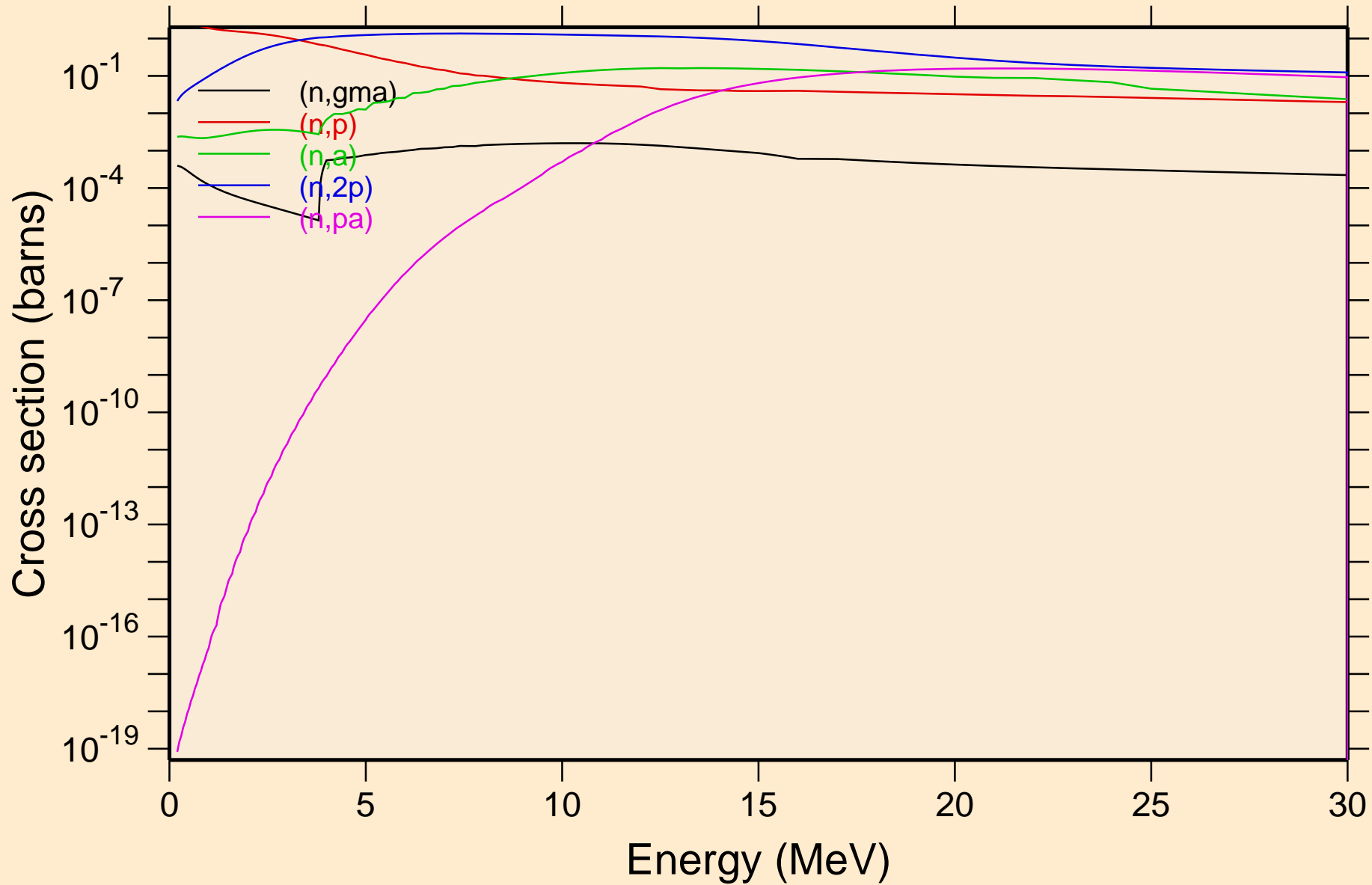

ZR080 NEUTRON ACER TENDL-2024 LIBRARY; T=293.6K
Non-threshold reactions

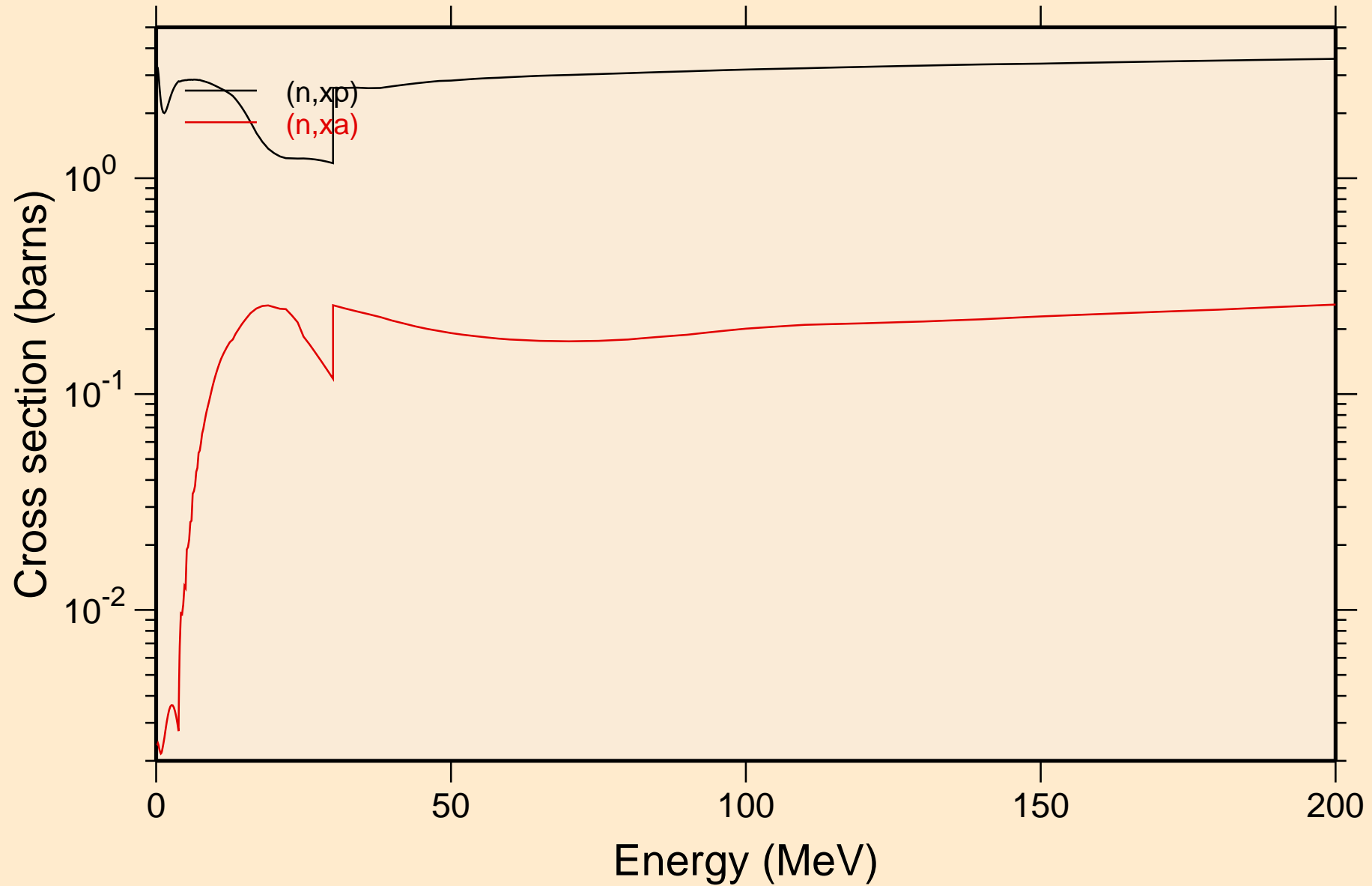

ZR080 NEUTRON ACER TENDL-2024 LIBRARY; T=293.6K
Inelastic levels

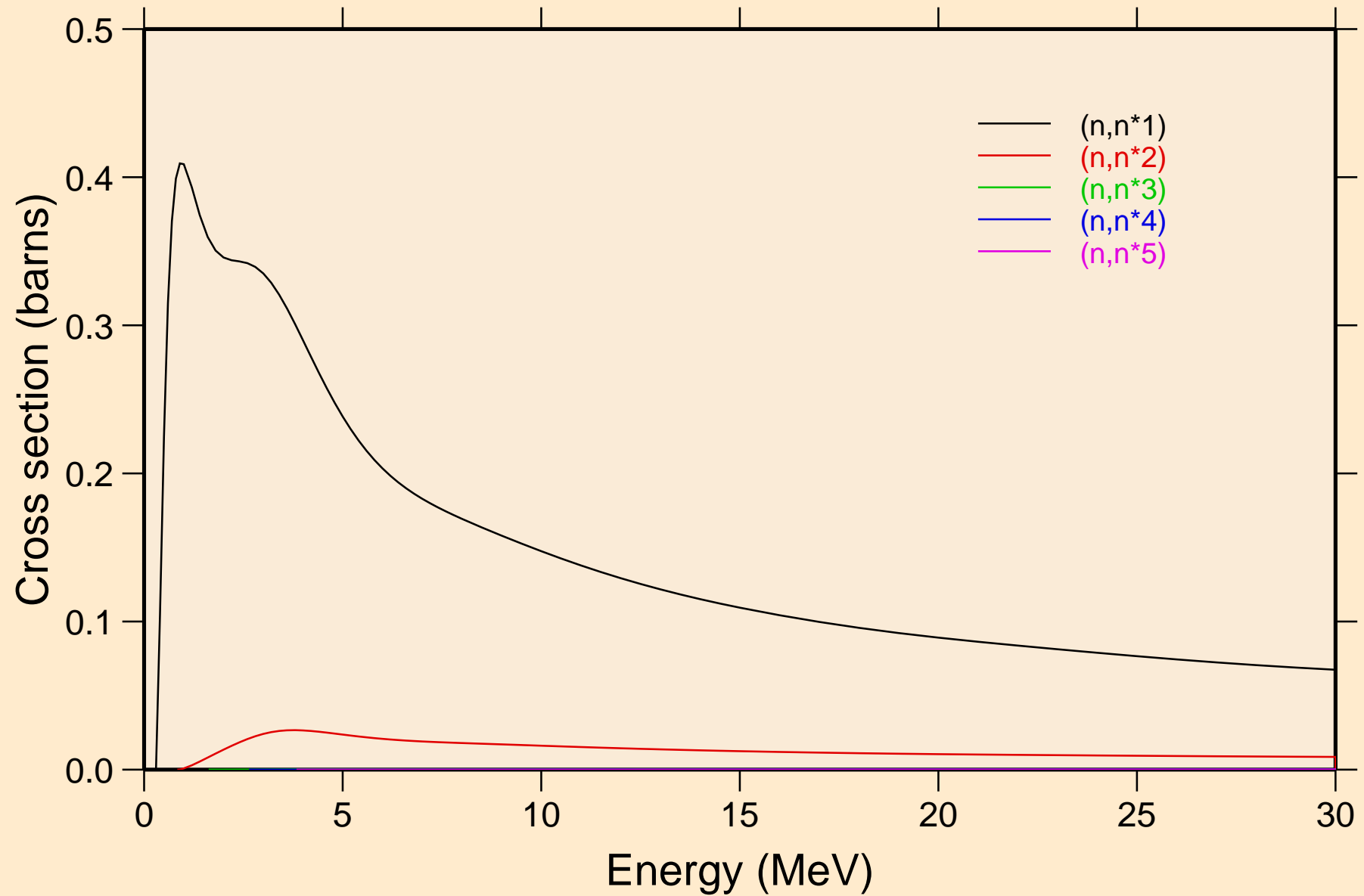

ZR080 NEUTRON ACER TENDL-2024 LIBRARY; T=293.6K
Inelastic levels

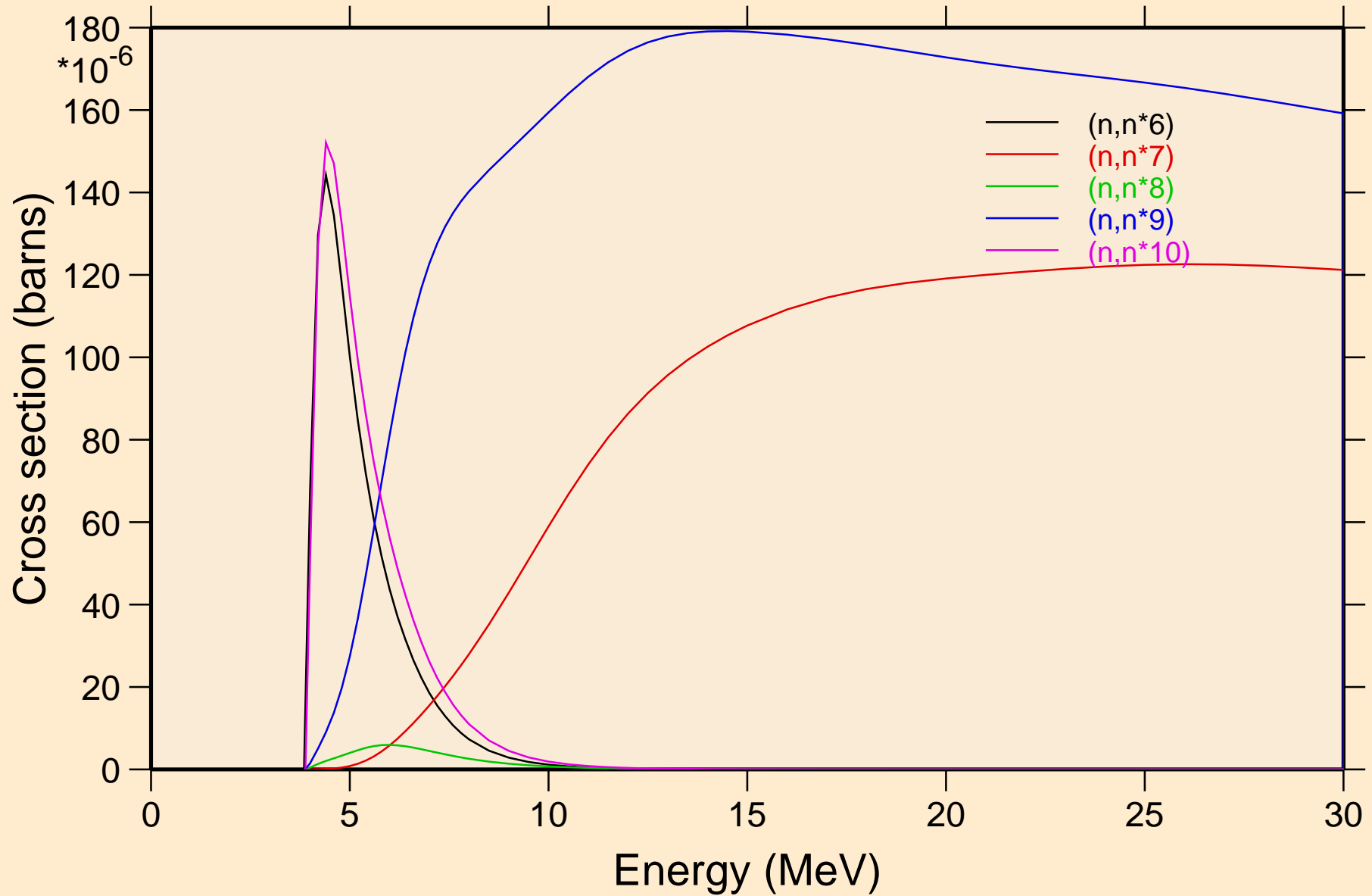

ZR080 NEUTRON ACER TENDL-2024 LIBRARY; T=293.6K
Inelastic levels

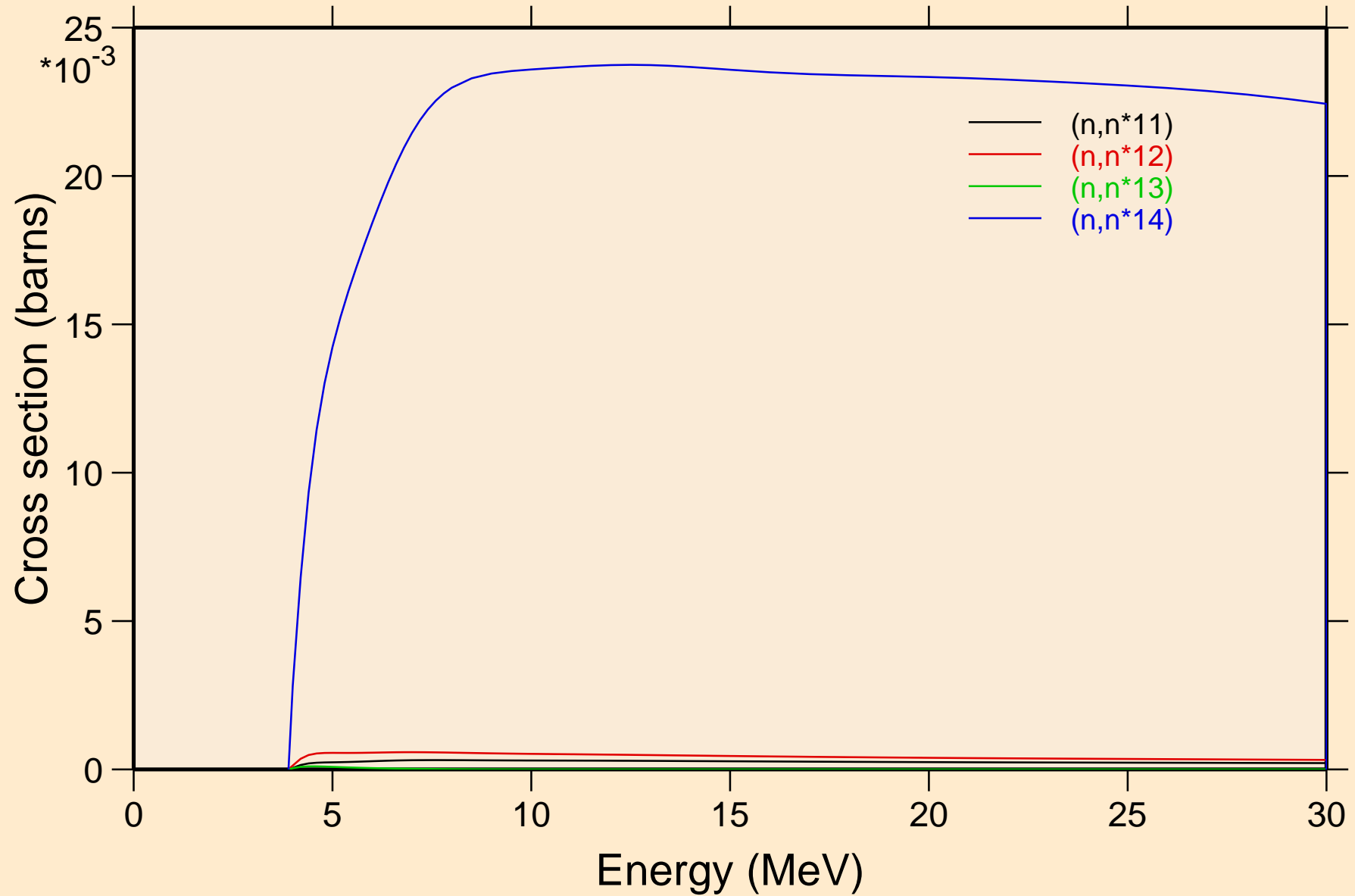

ZR080 NEUTRON ACER TENDL-2024 LIBRARY; T=293.6K
Threshold reactions

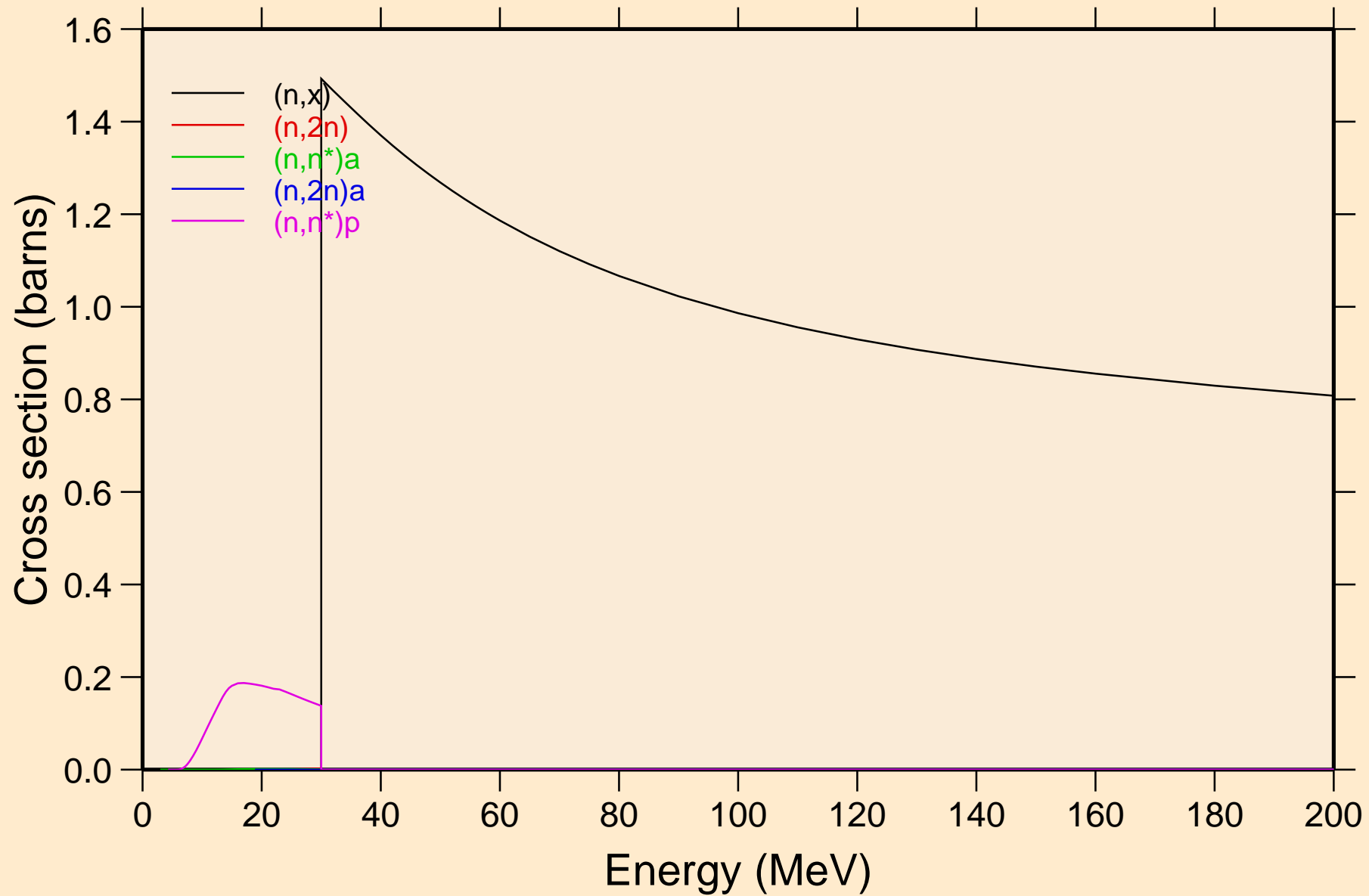

ZR080 NEUTRON ACER TENDL-2024 LIBRARY; T=293.6K

Threshold reactions

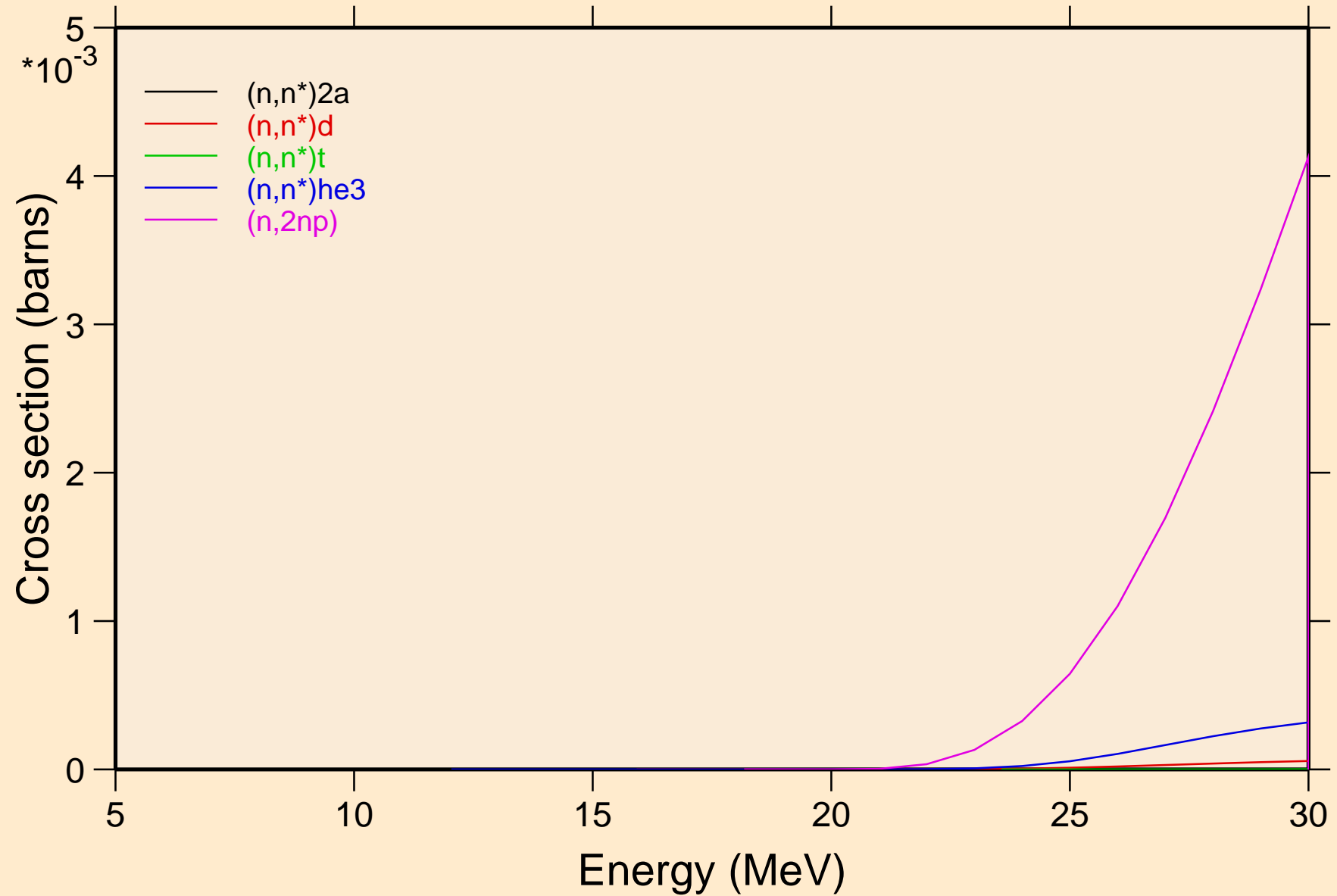

ZR080 NEUTRON ACER TENDL-2024 LIBRARY; T=293.6K
Threshold reactions

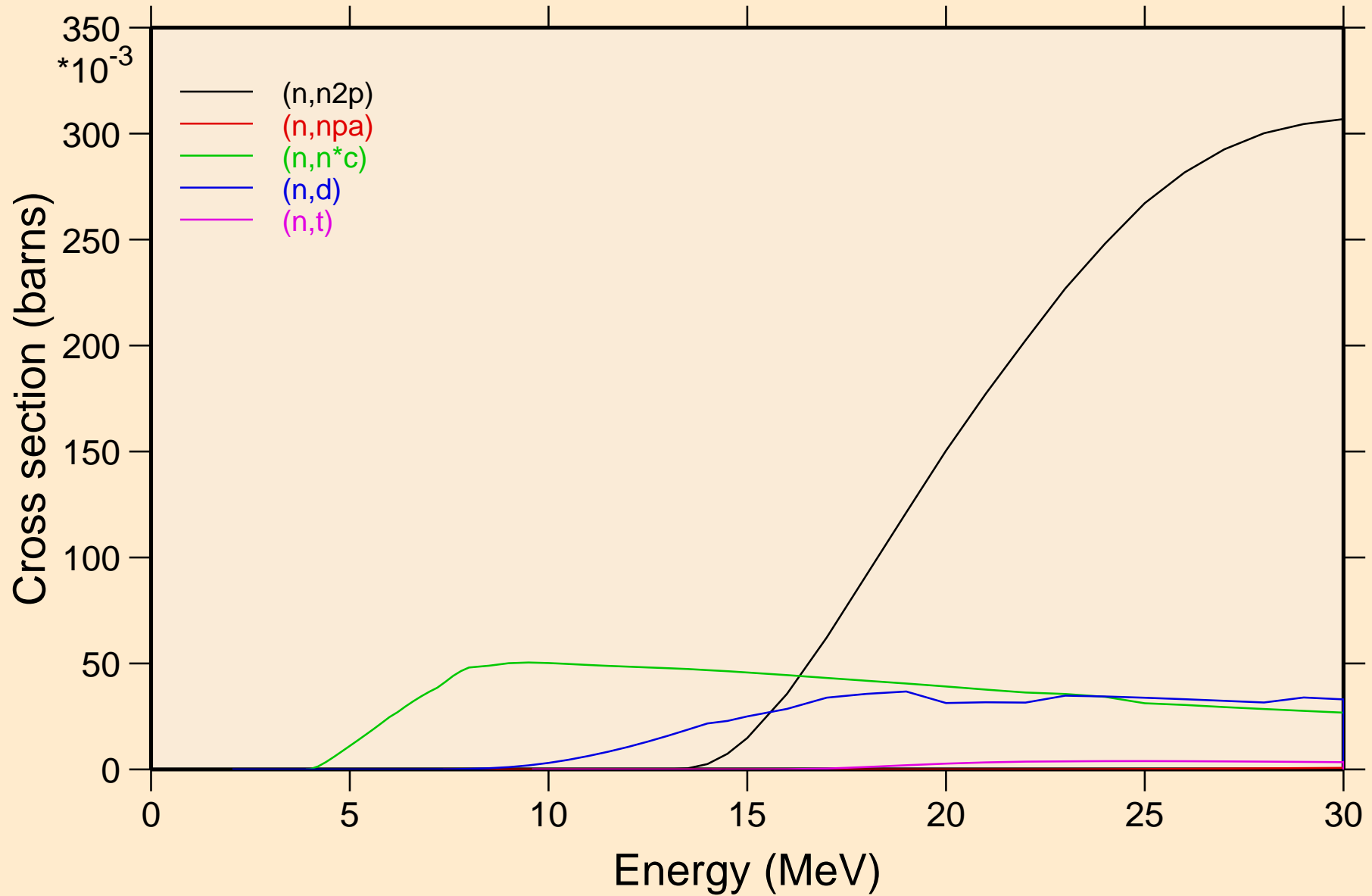

ZR080 NEUTRON ACER TENDL-2024 LIBRARY; T=293.6K
Threshold reactions

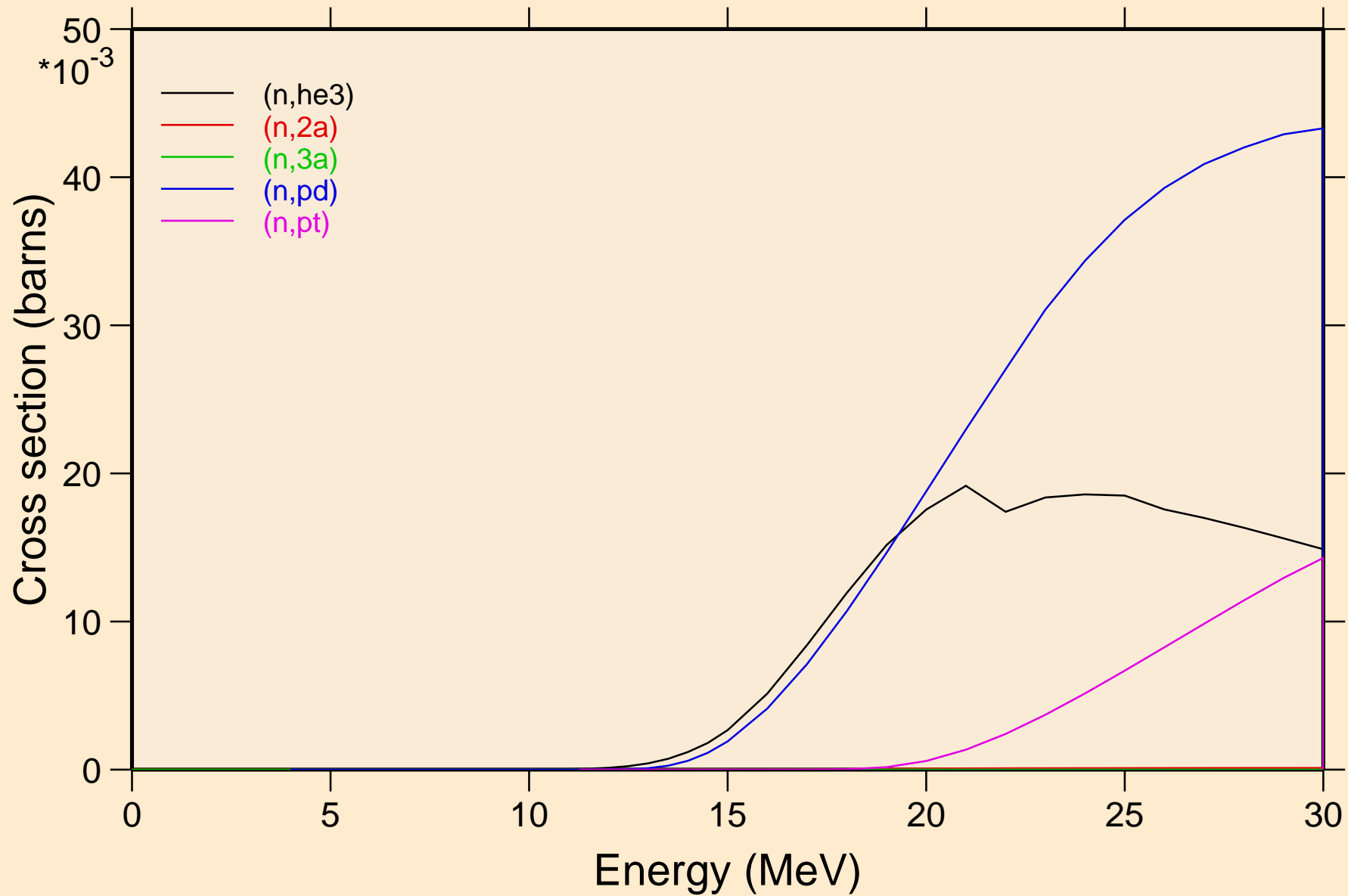

ZR080 NEUTRON ACER TENDL-2024 LIBRARY; T=293.6K
Threshold reactions

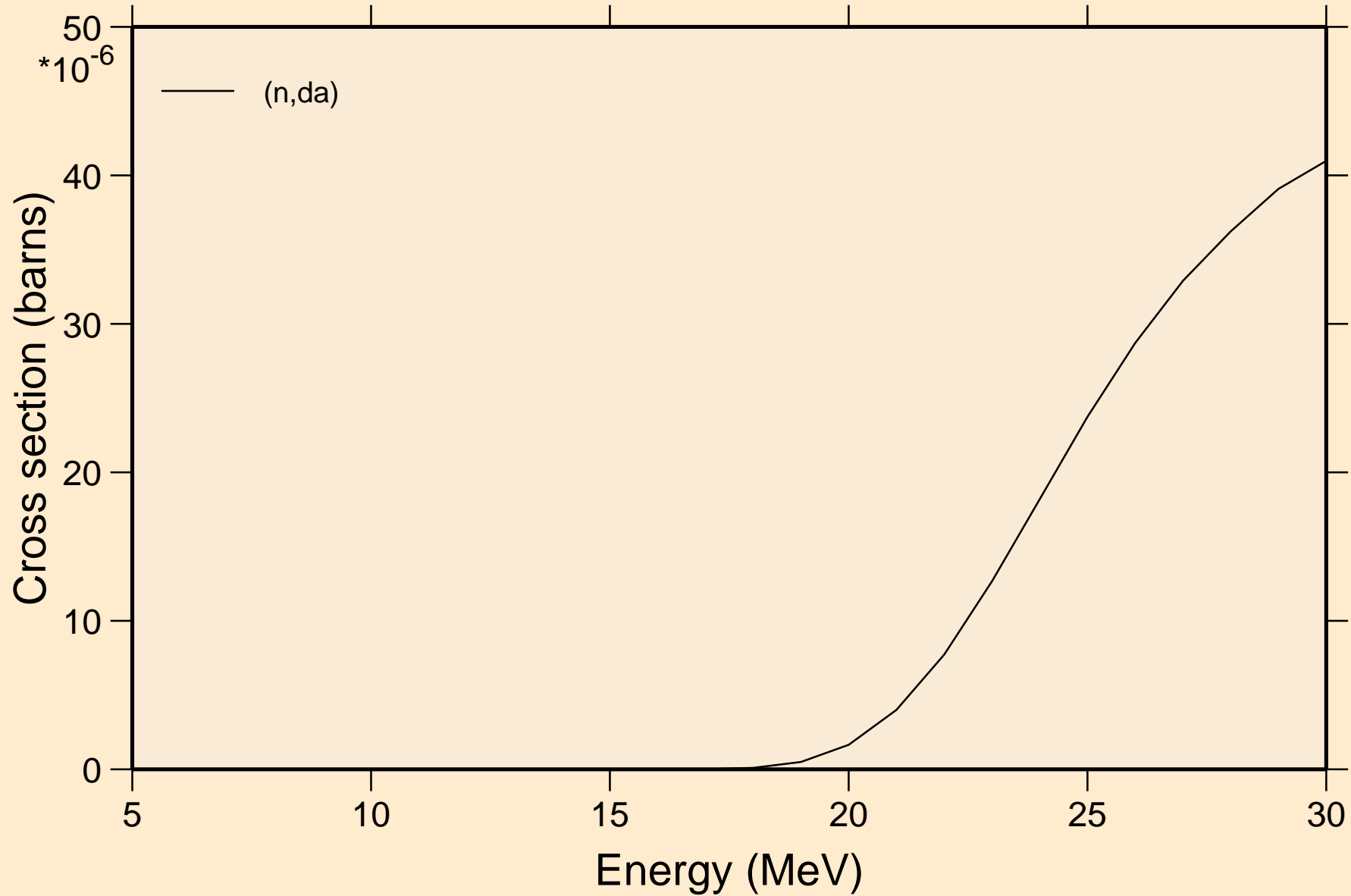

ZR080 NEUTRON ACER TENDL-2024 LIBRARY; T=293.6K

Threshold reactions

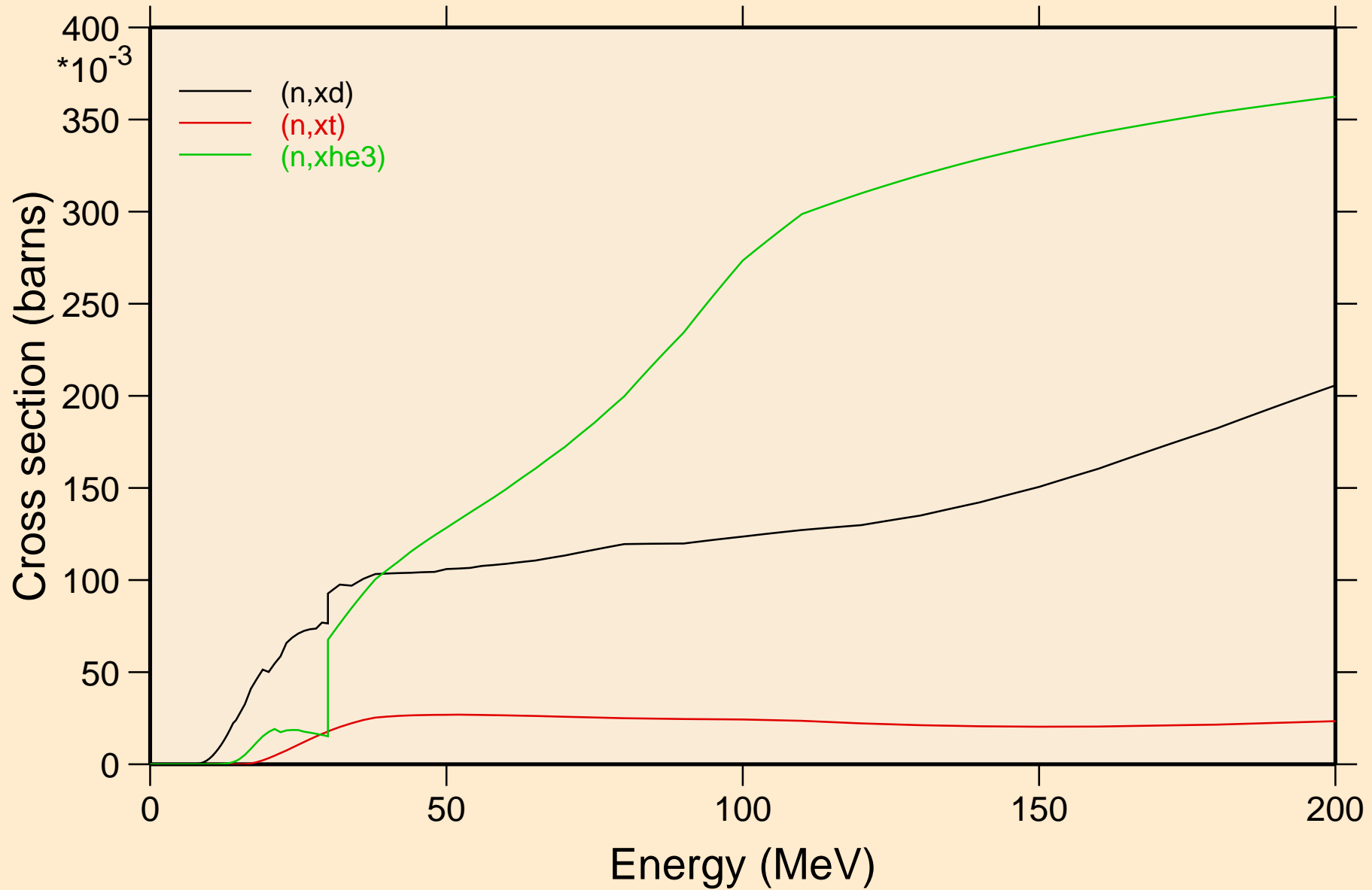

ZR080 NEUTRON ACER TENDL-2024 LIBRARY; T=293.6K
angular distribution for elastic

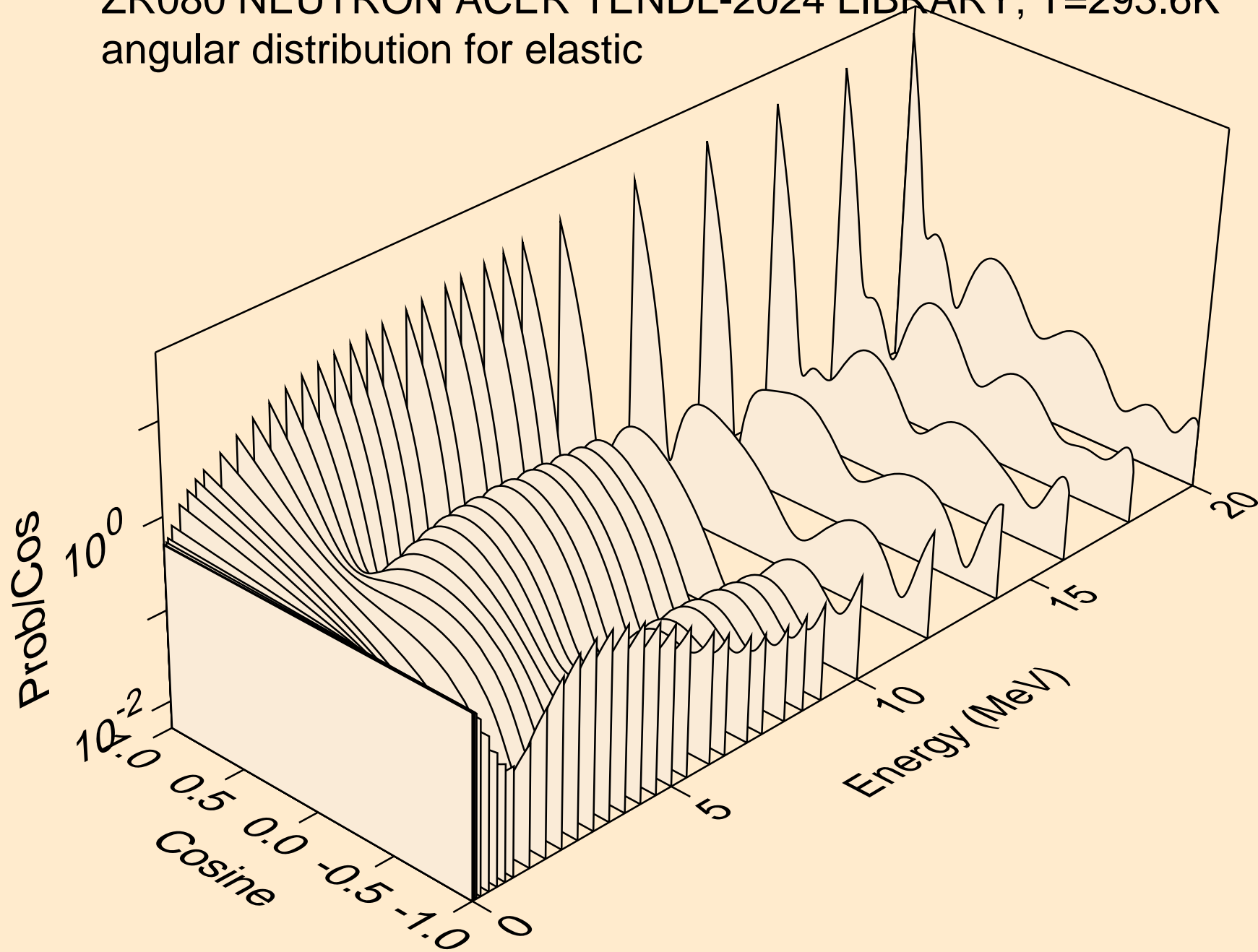

ZR080 NEUTRON ACER TENDL-2024 LIBRARY; T=293.6K
angular distribution for elastic

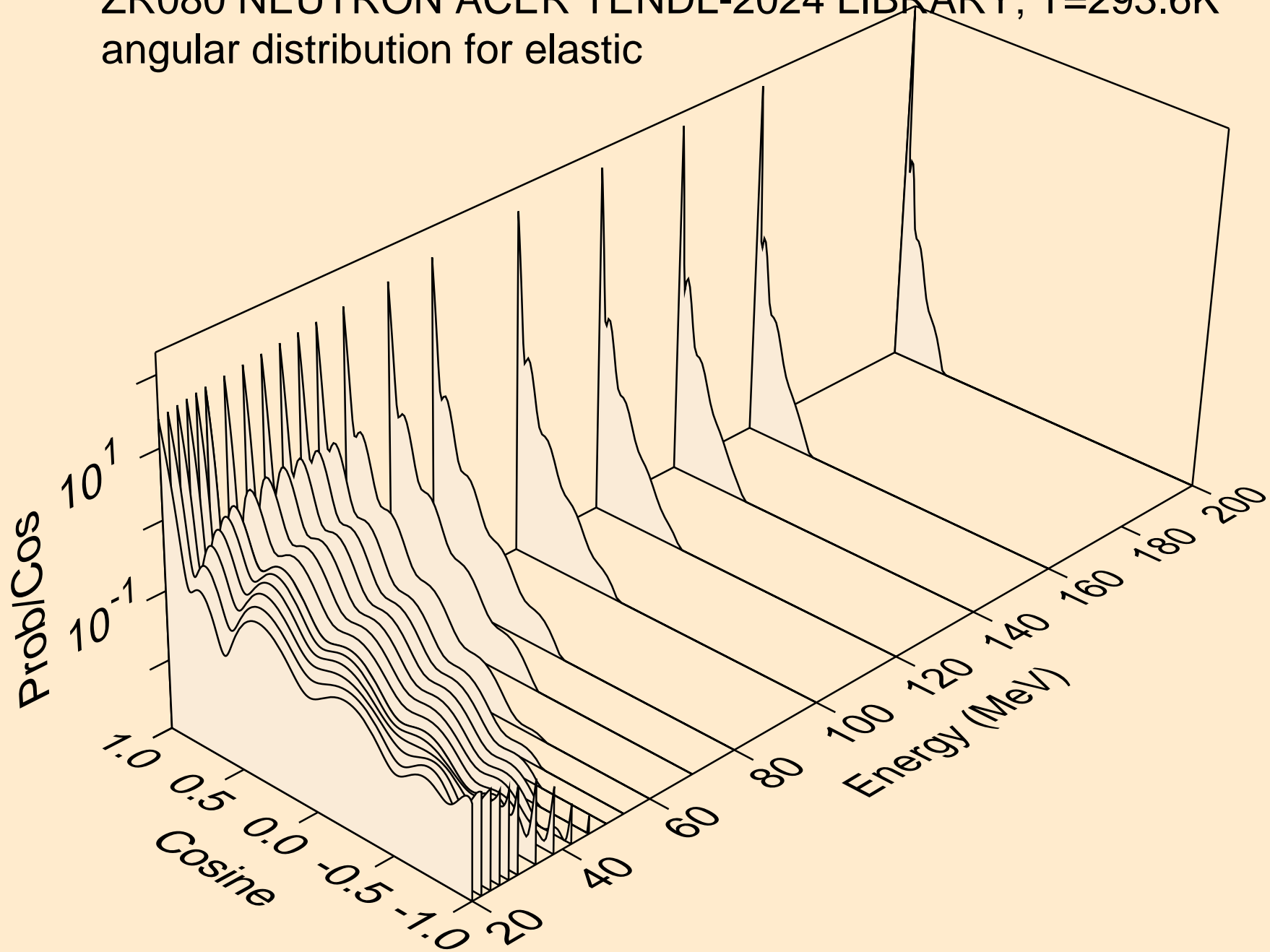

ZR080 NEUTRON ACER TENDL-2024 LIBRARY; T=293.6K
angular distribution for (n,n*1)

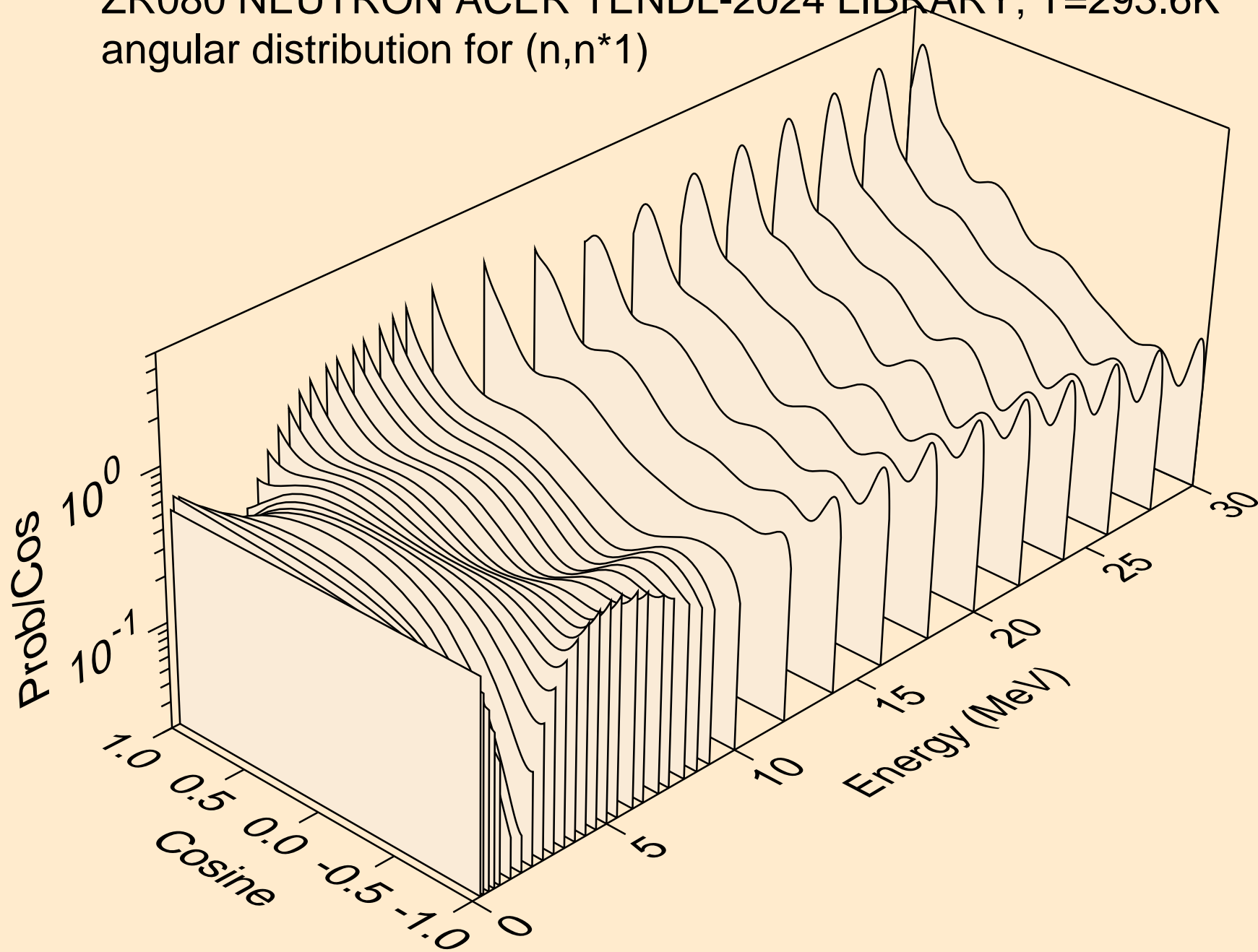

ZR080 NEUTRON ACER TENDL-2024 LIBRARY; T=293.6K
angular distribution for (n,n*2)

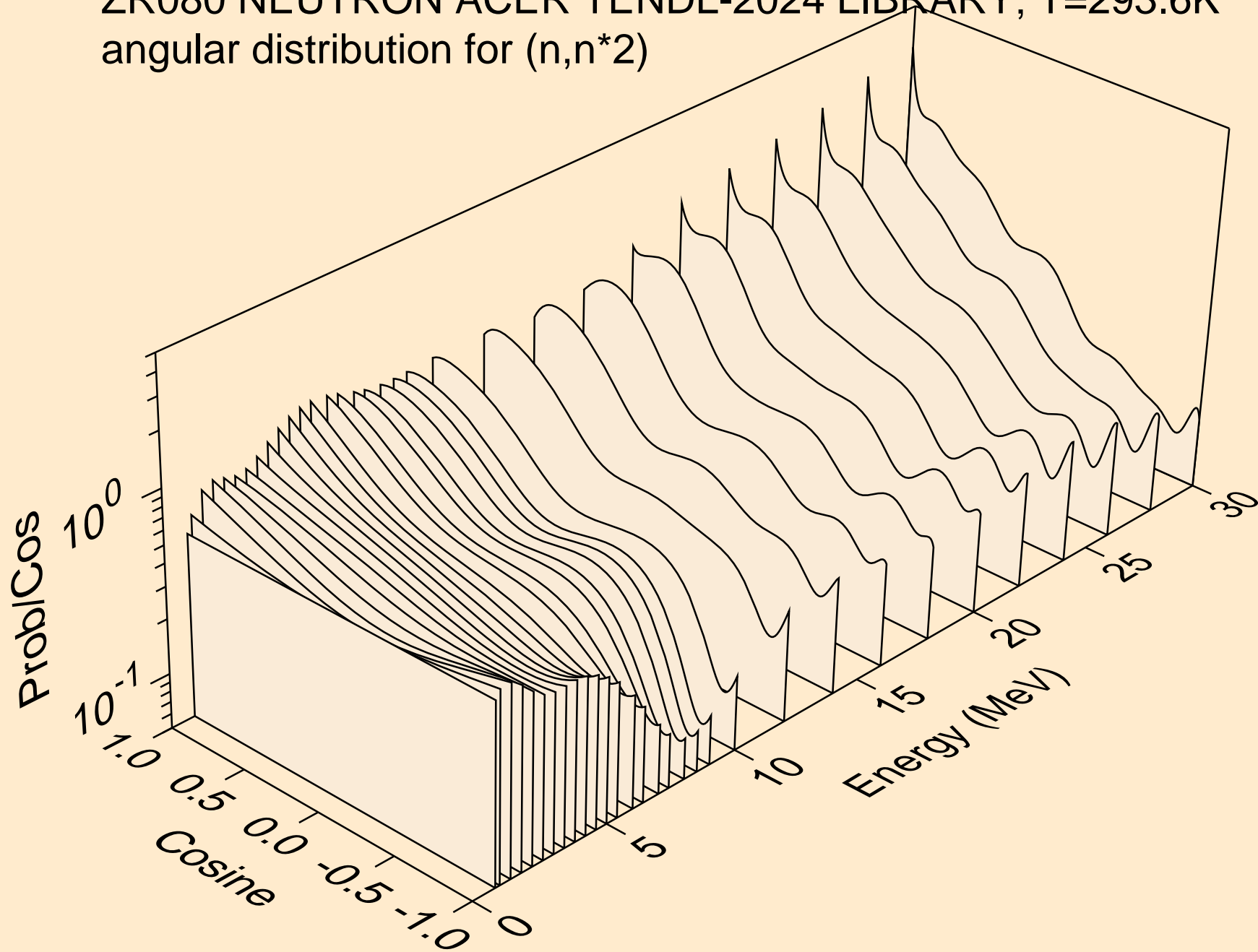

ZR080 NEUTRON ACER TENDL-2024 LIBRARY; T=293.6K
angular distribution for (n,n*3)

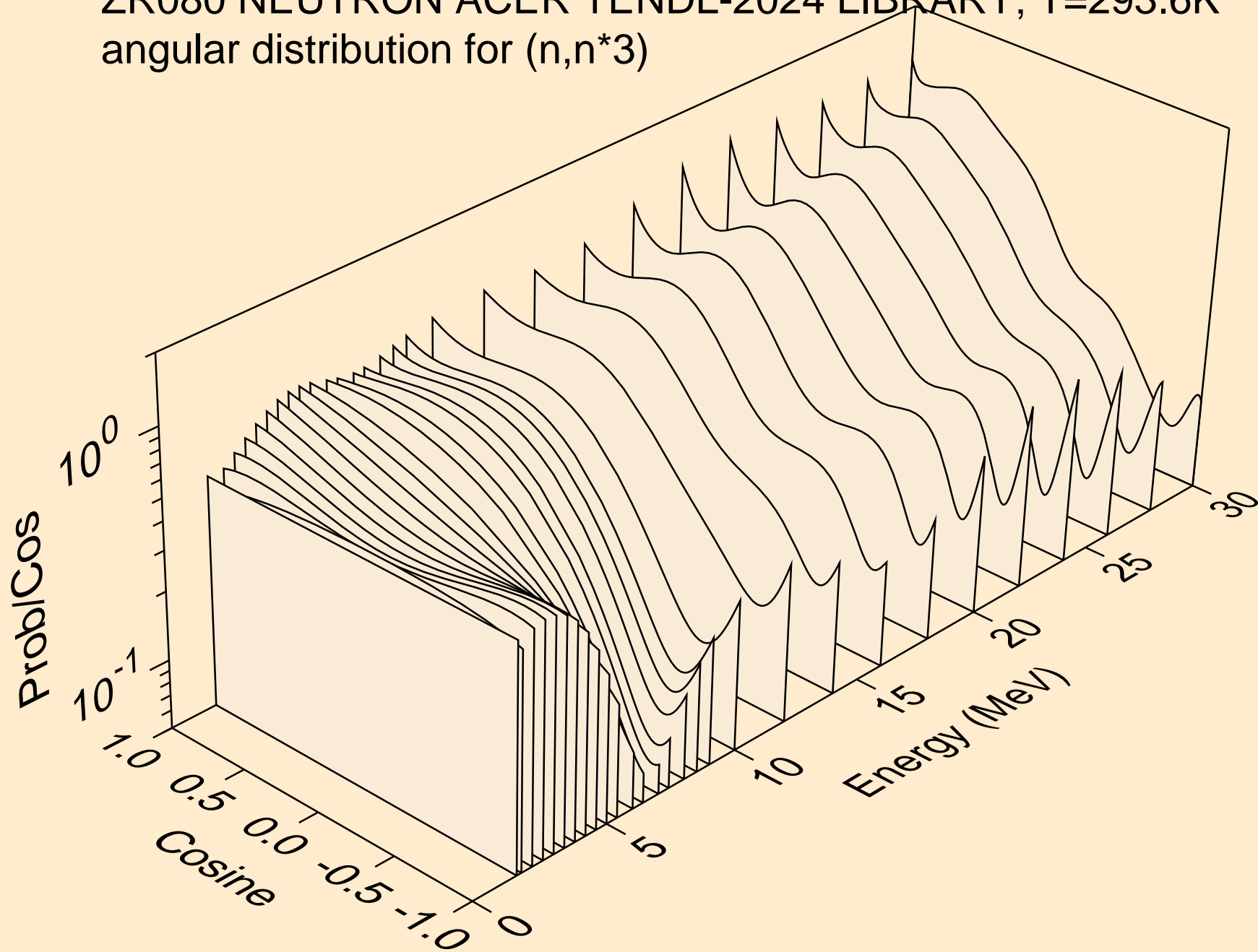

ZR080 NEUTRON ACER TENDL-2024 LIBRARY; T=293.6K
angular distribution for (n,n*4)

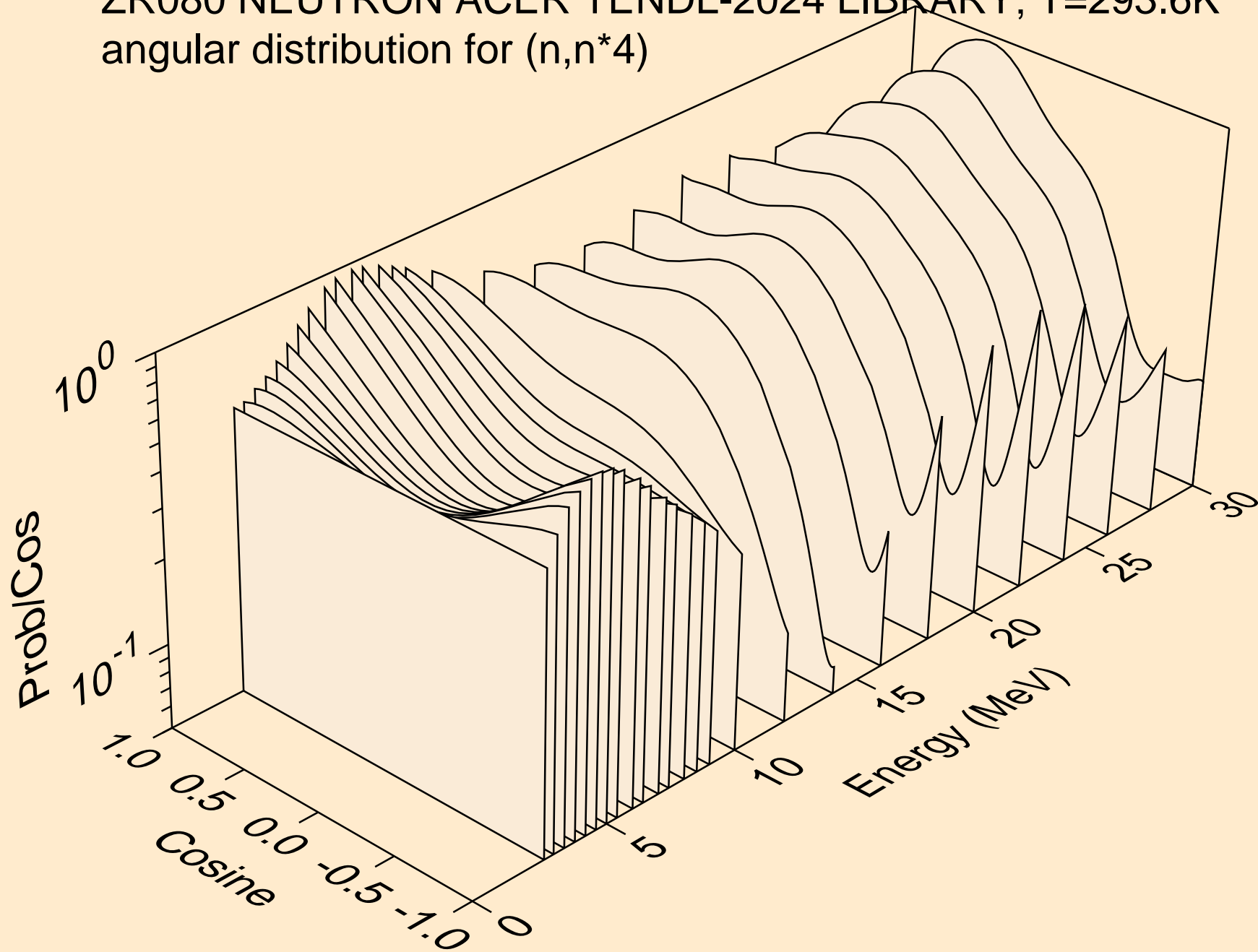

ZR080 NEUTRON ACER TENDL-2024 LIBRARY; T=293.6K
angular distribution for (n,n*5)

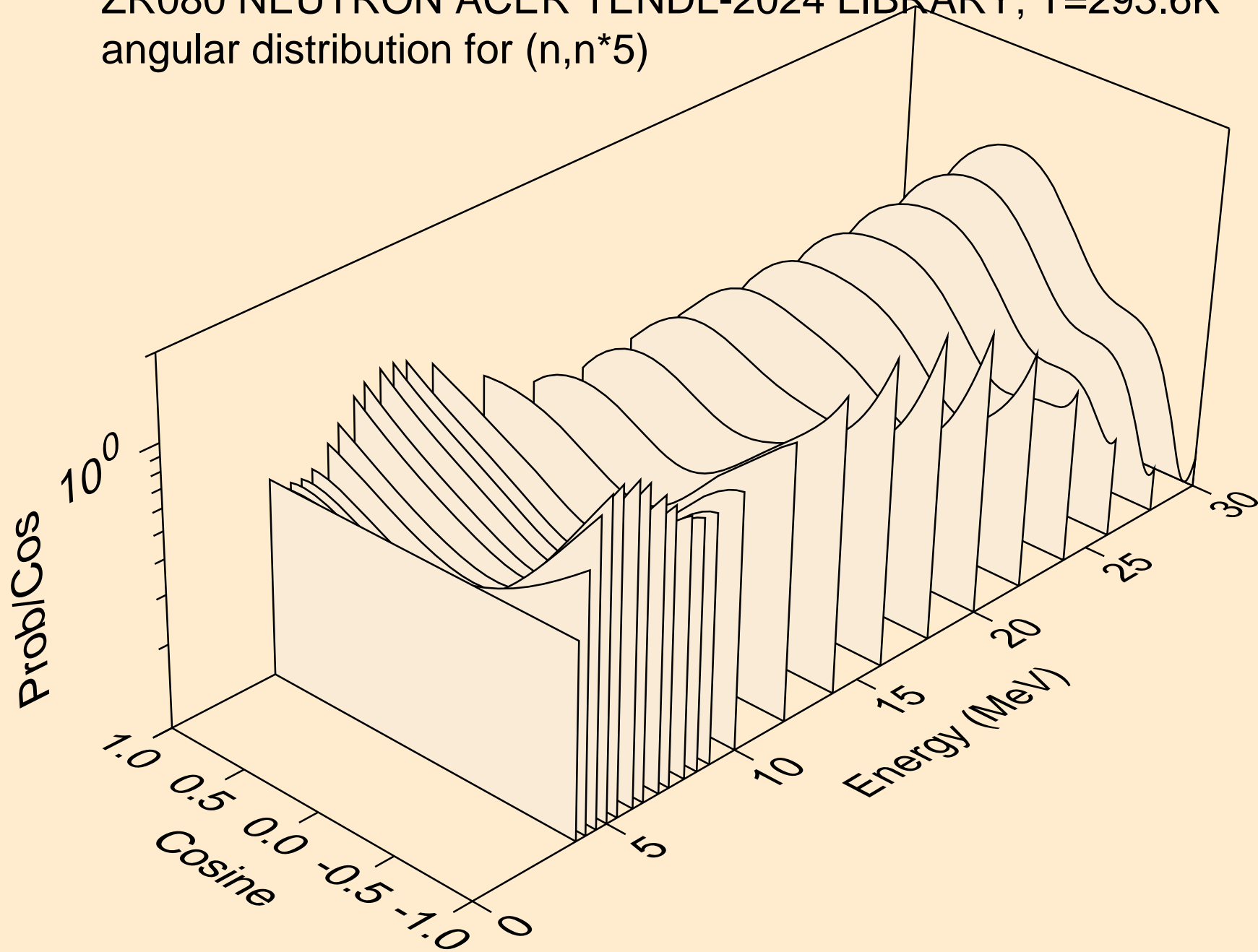

ZR080 NEUTRON ACER TENDL-2024 LIBRARY; T=293.6K
angular distribution for (n,n*6)

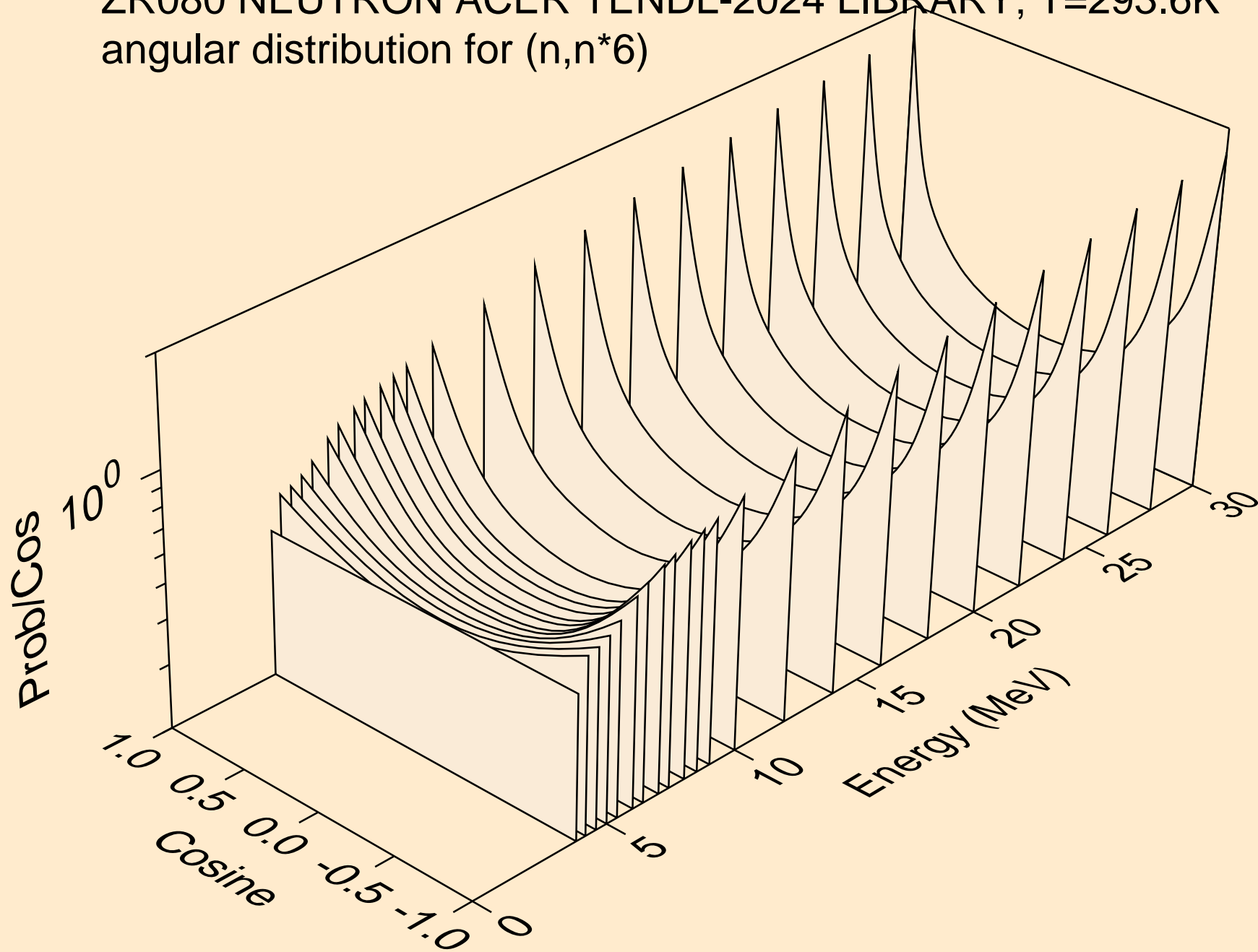

ZR080 NEUTRON ACER TENDL-2024 LIBRARY; T=293.6K
angular distribution for (n,n*7)

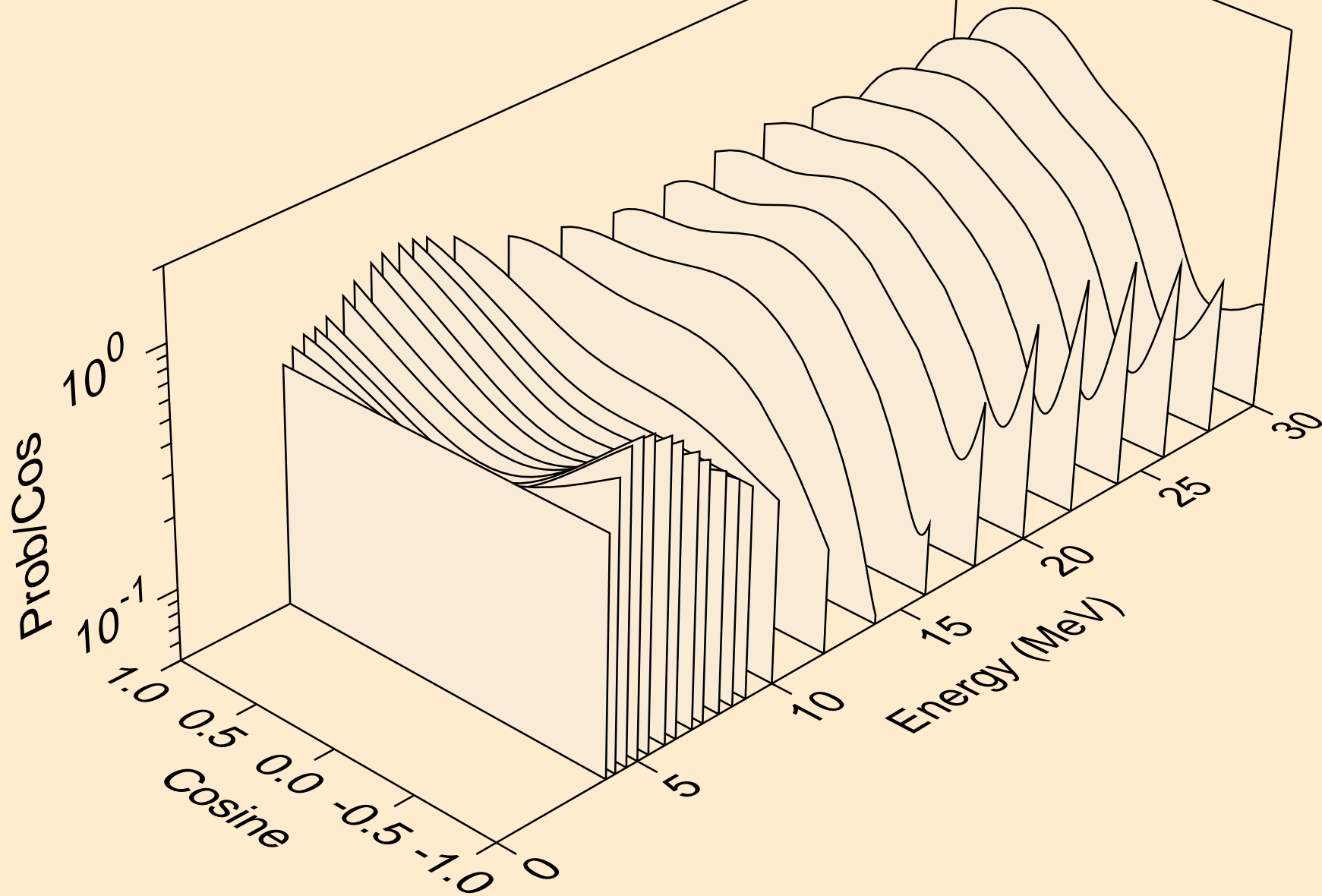

ZR080 NEUTRON ACER TENDL-2024 LIBRARY; T=293.6K
angular distribution for (n,n*8)

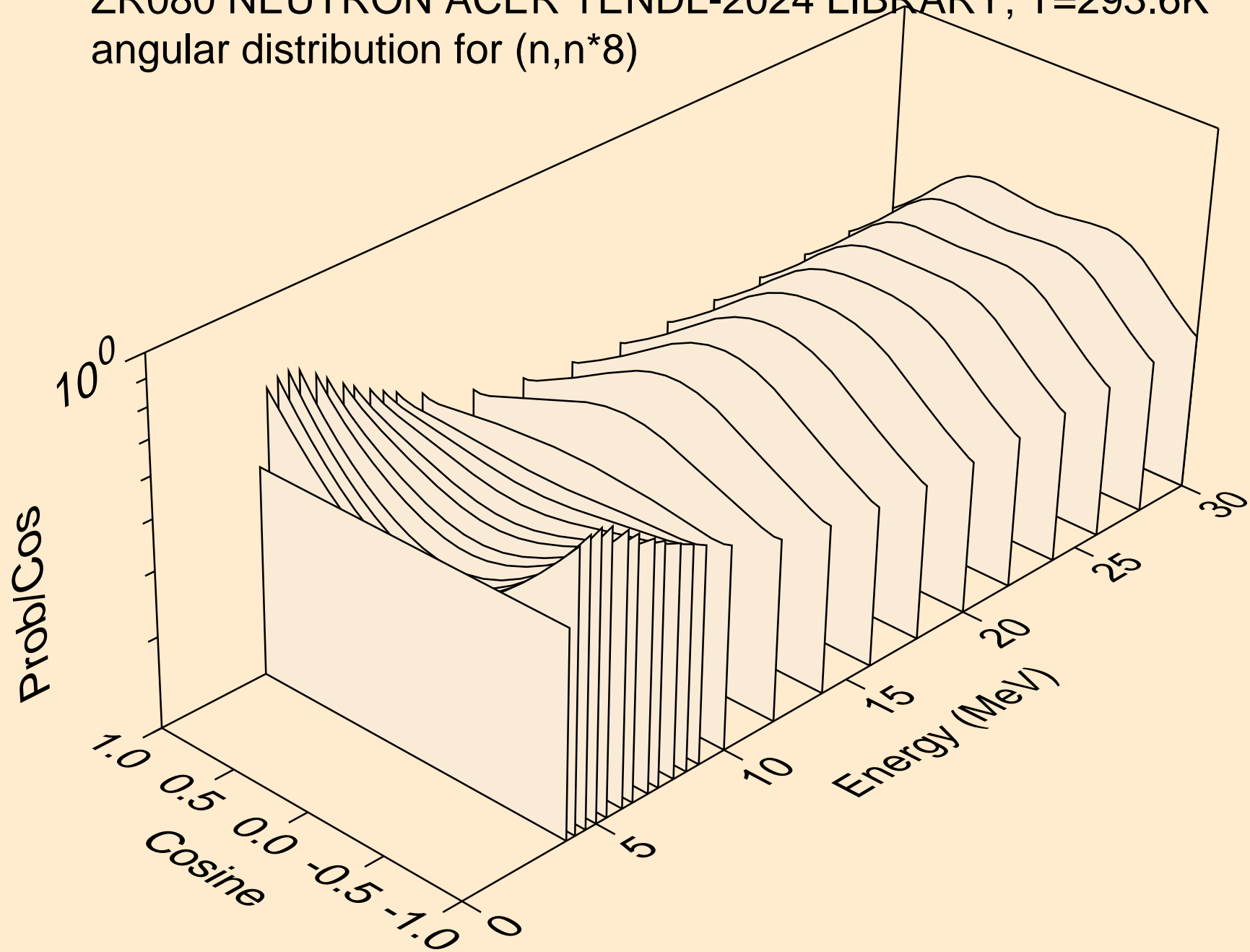

ZR080 NEUTRON ACER TENDL-2024 LIBRARY; T=293.6K
angular distribution for (n,n*9)

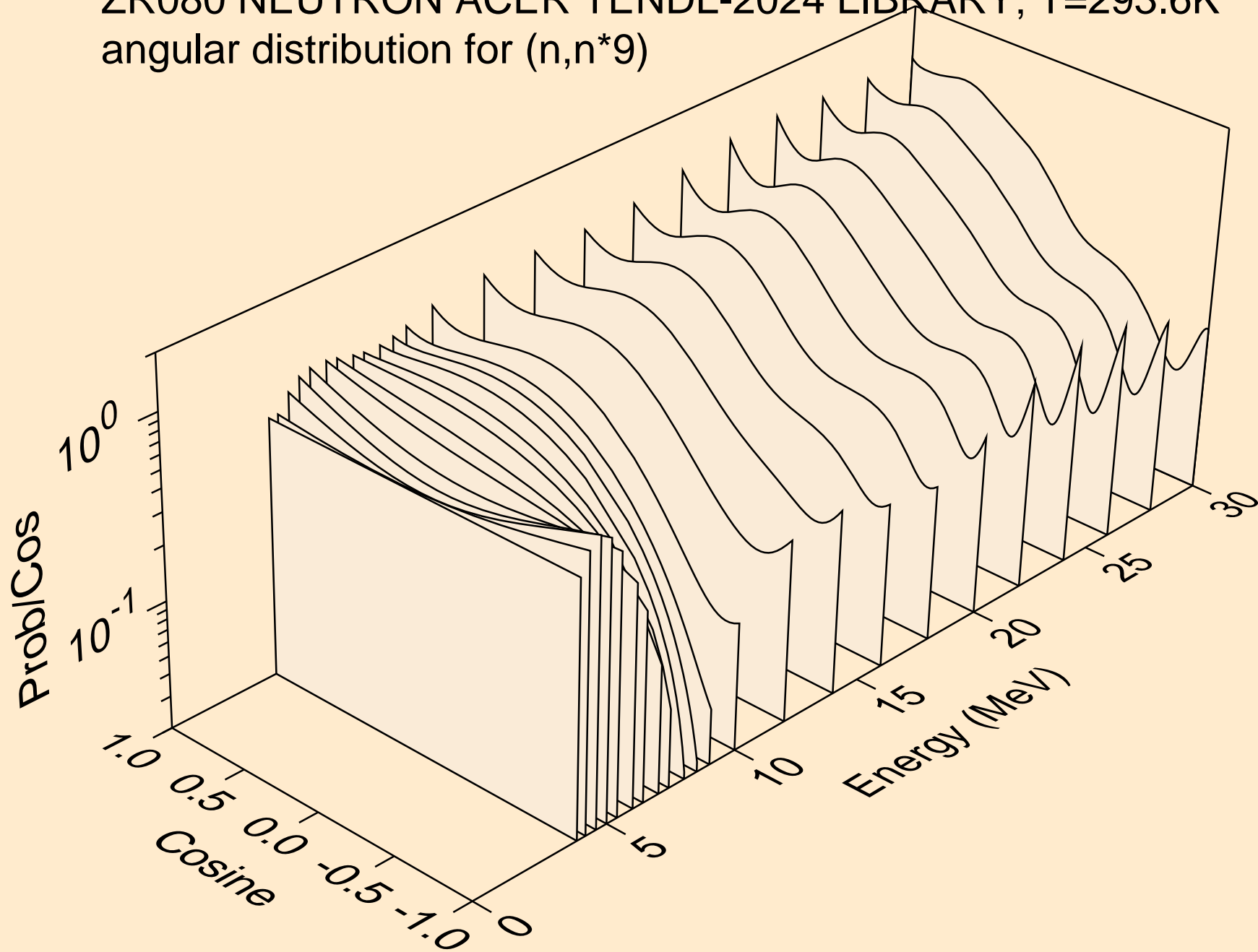

ZR080 NEUTRON ACER TENDL-2024 LIBRARY; T=293.6K
angular distribution for (n,n*10)

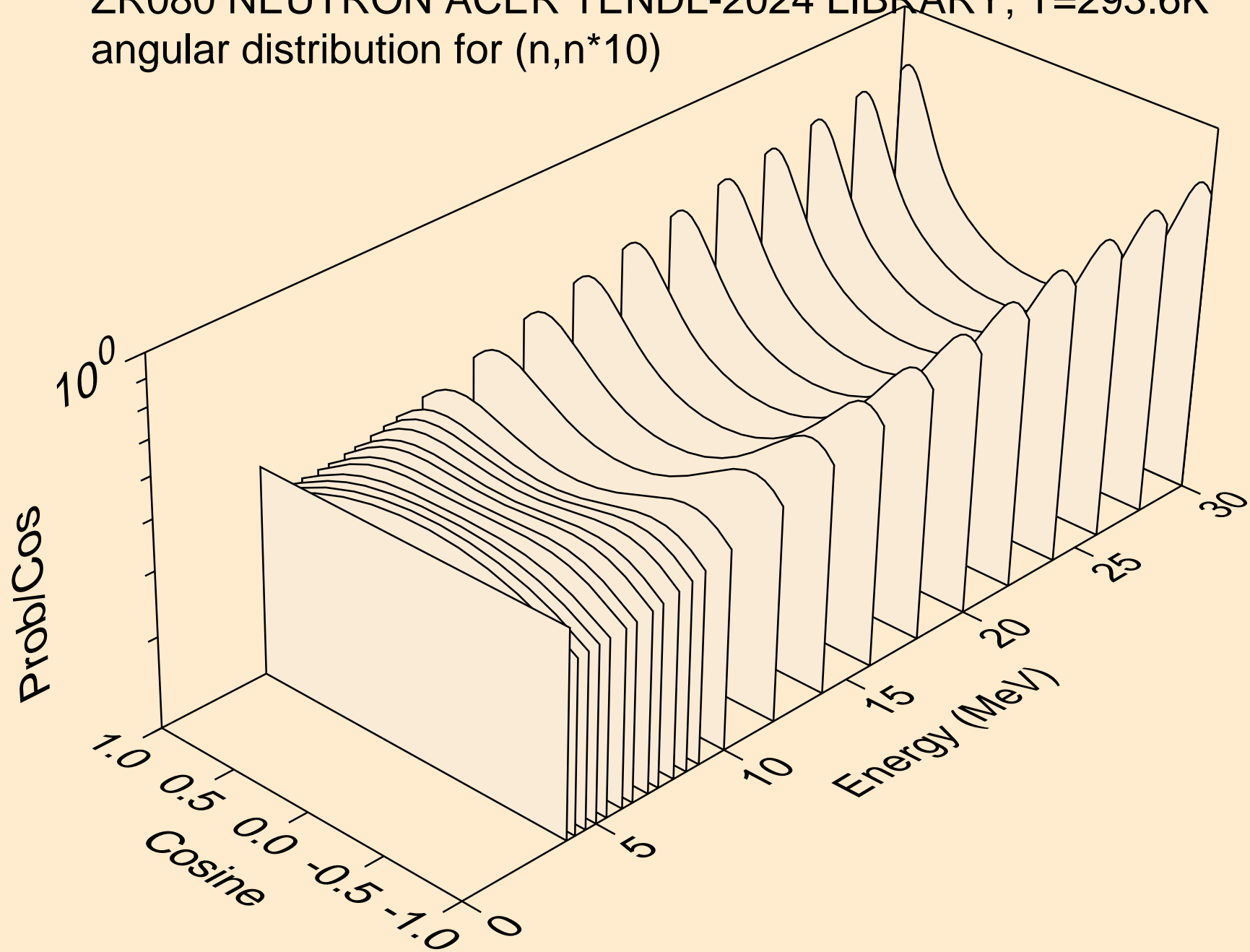

ZR080 NEUTRON ACER TENDL-2024 LIBRARY; T=293.6K
angular distribution for (n,n*11)

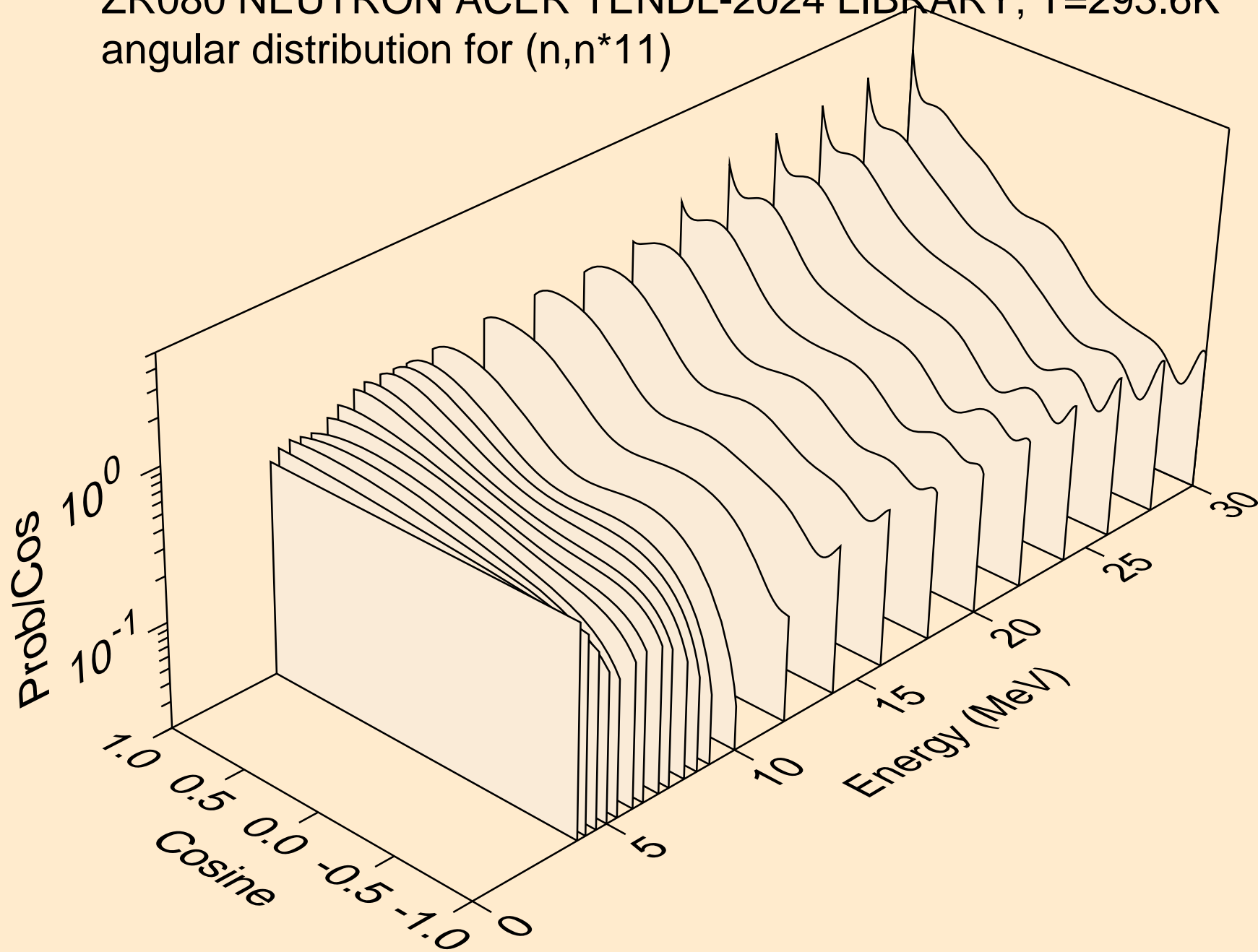

ZR080 NEUTRON ACER TENDL-2024 LIBRARY; T=293.6K
angular distribution for (n,n*12)

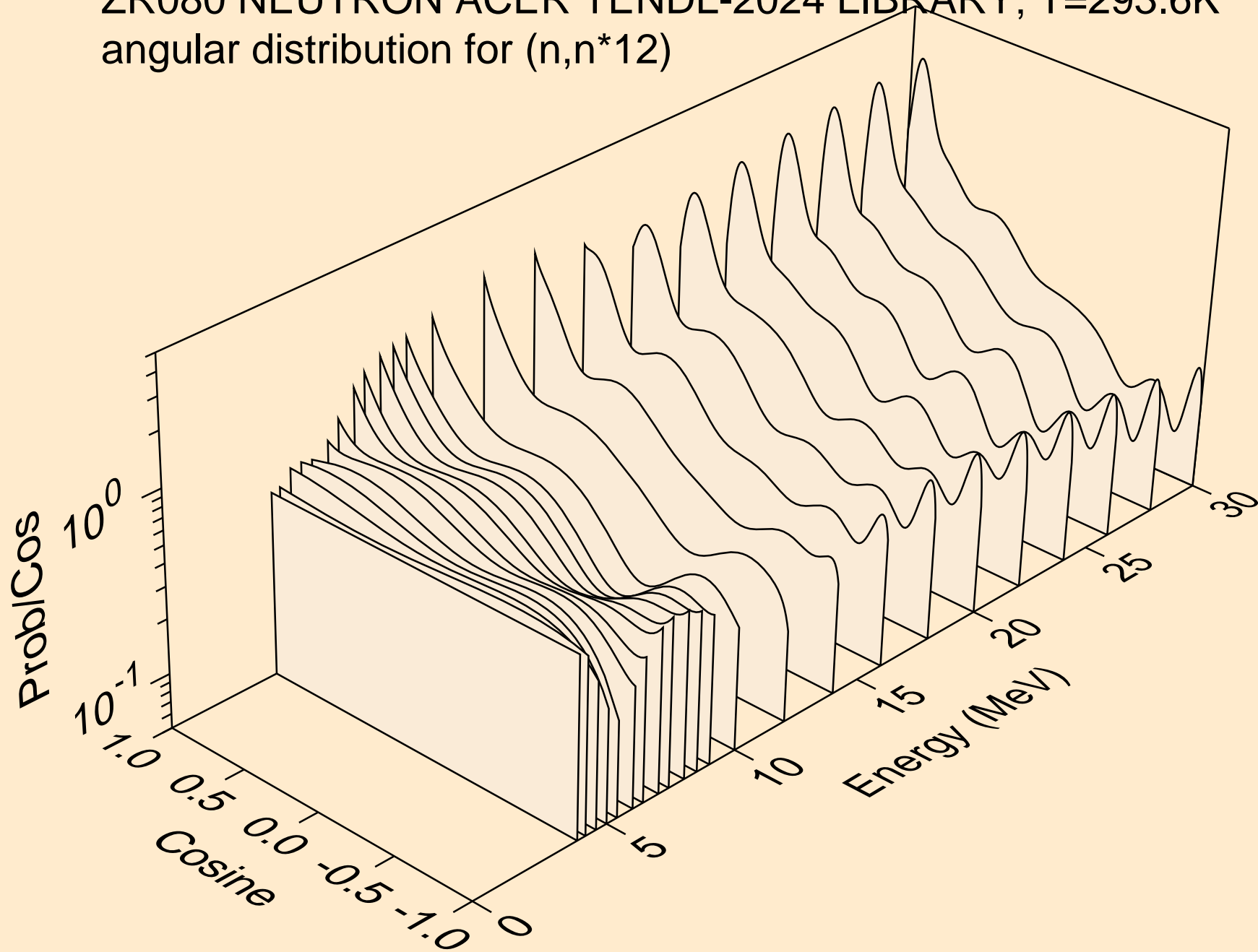

ZR080 NEUTRON ACER TENDL-2024 LIBRARY; T=293.6K
angular distribution for (n,n*13)

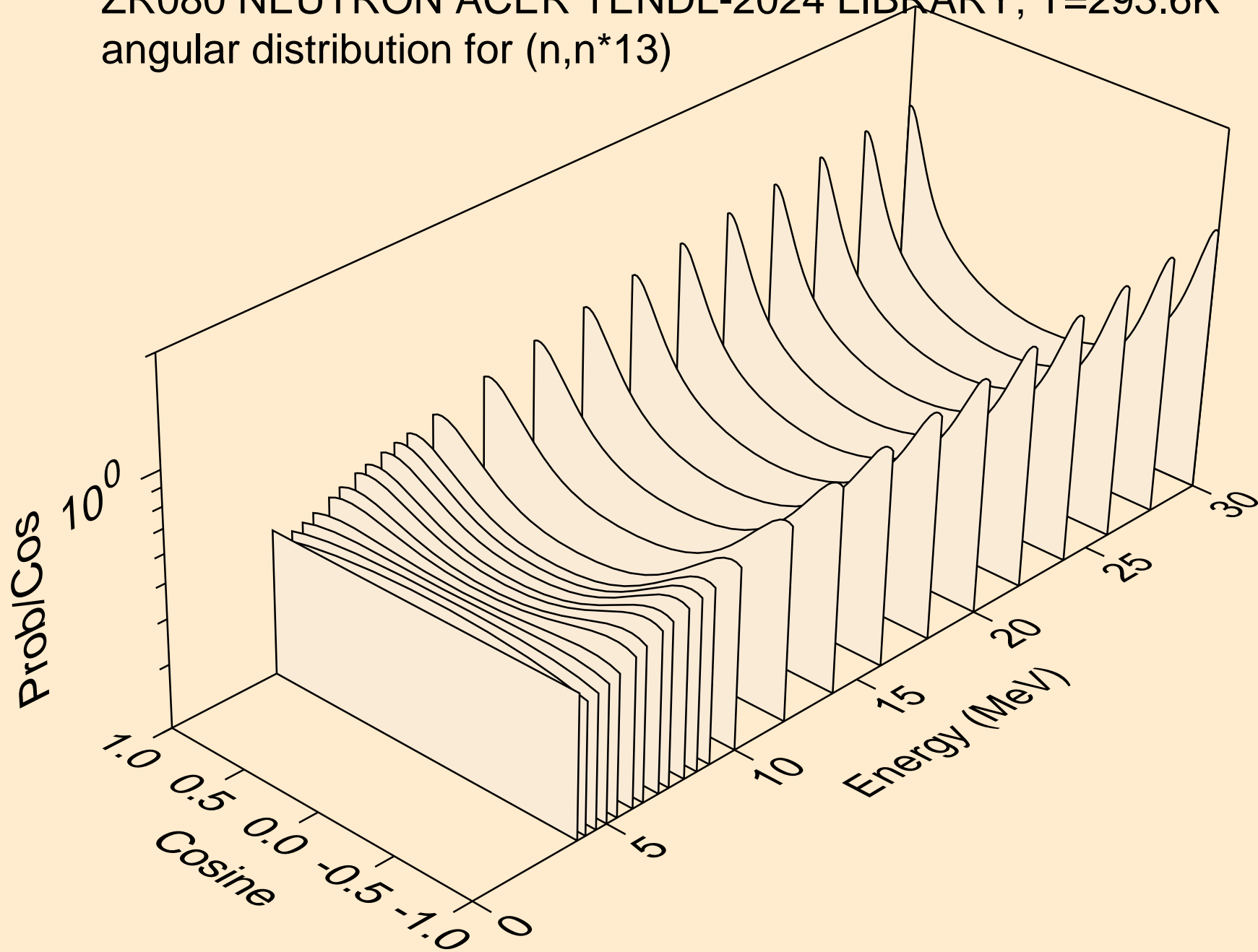

ZR080 NEUTRON ACER TENDL-2024 LIBRARY; T=293.6K
angular distribution for (n,n*14)

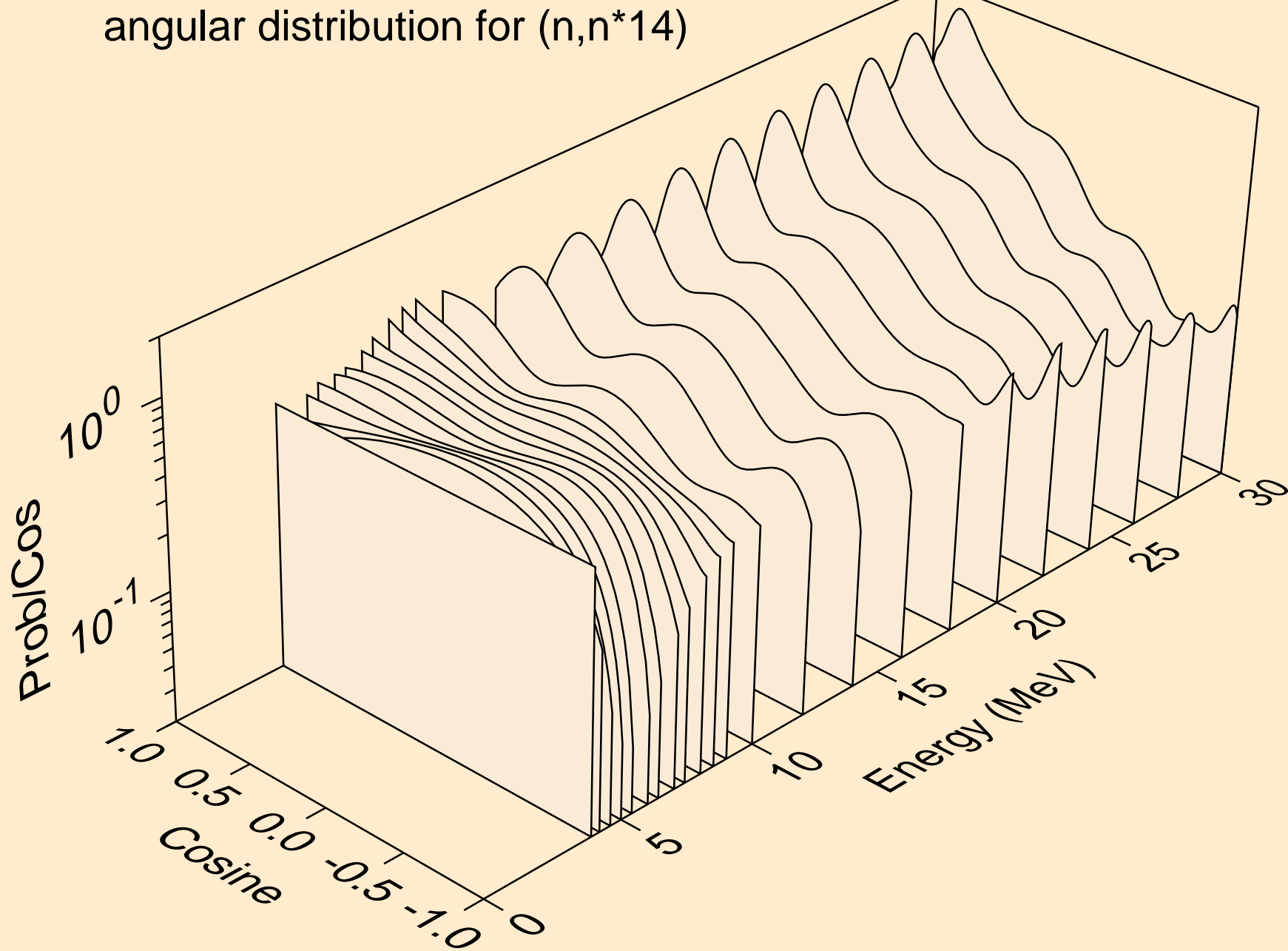

ZR080 NEUTRON ACER TENDL-2024 LIBRARY; T=293.6K
Neutron emission for (n,x)

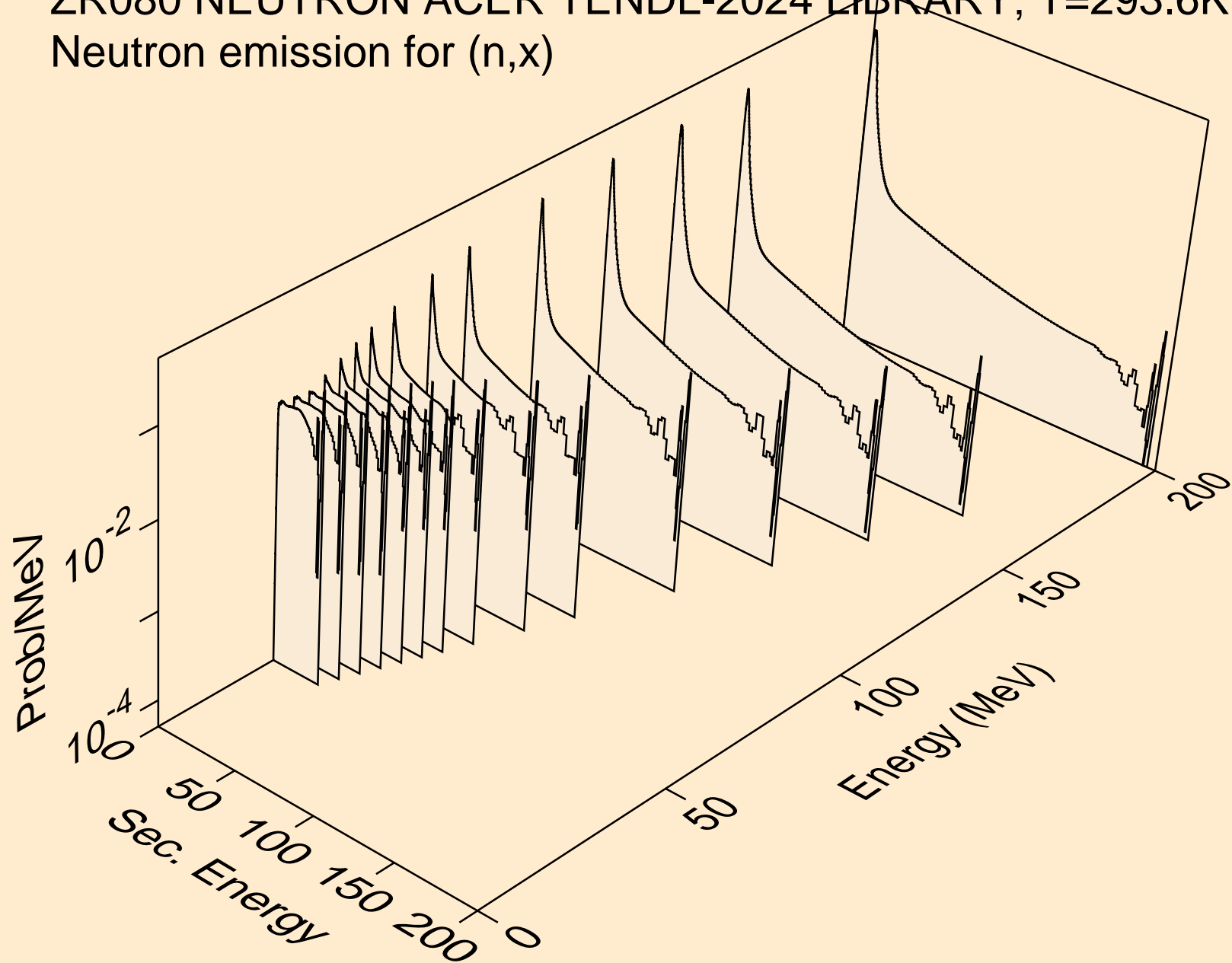

ZR080 NEUTRON ACER TENDL-2024 LIBRARY; T=293.6K
Neutron emission for (n,2n)

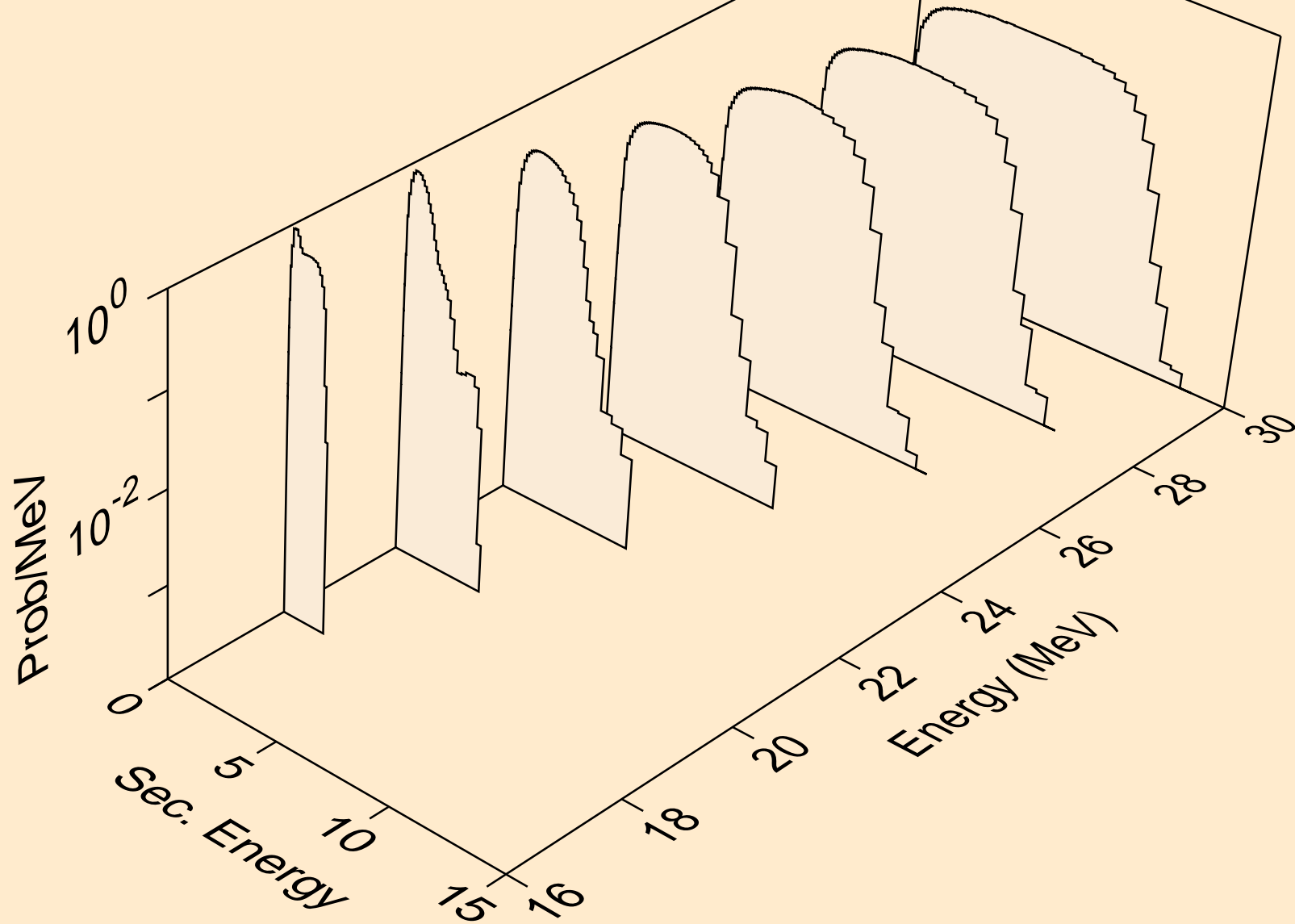

ZR080 NEUTRON ACER TENDL-2024 LIBRARY; T=293.6K
Neutron emission for (n,n*)a

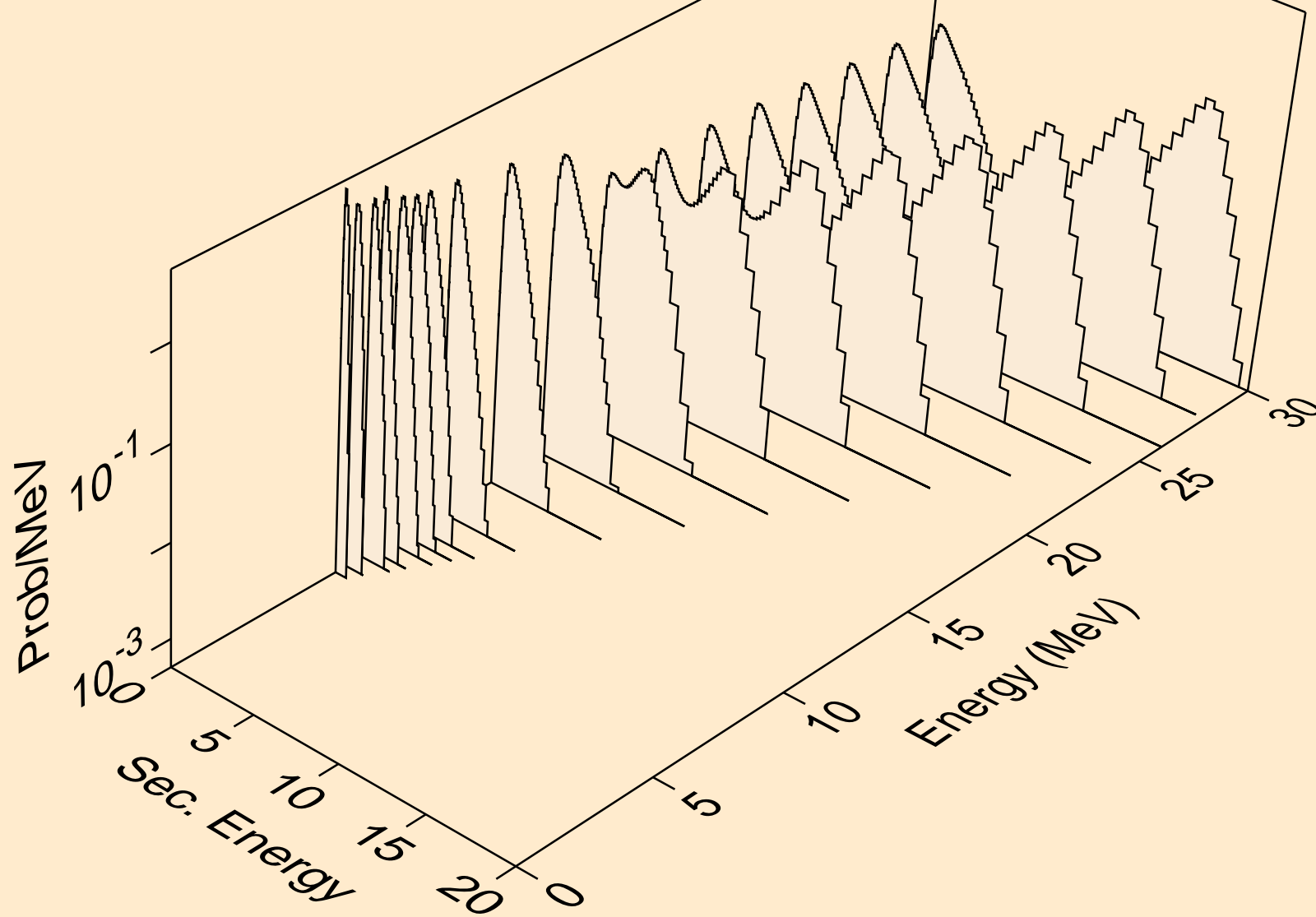

ZR080 NEUTRON ACER TENDL-2024 LIBRARY; T=293.6K
Neutron emission for (n,2n)_a

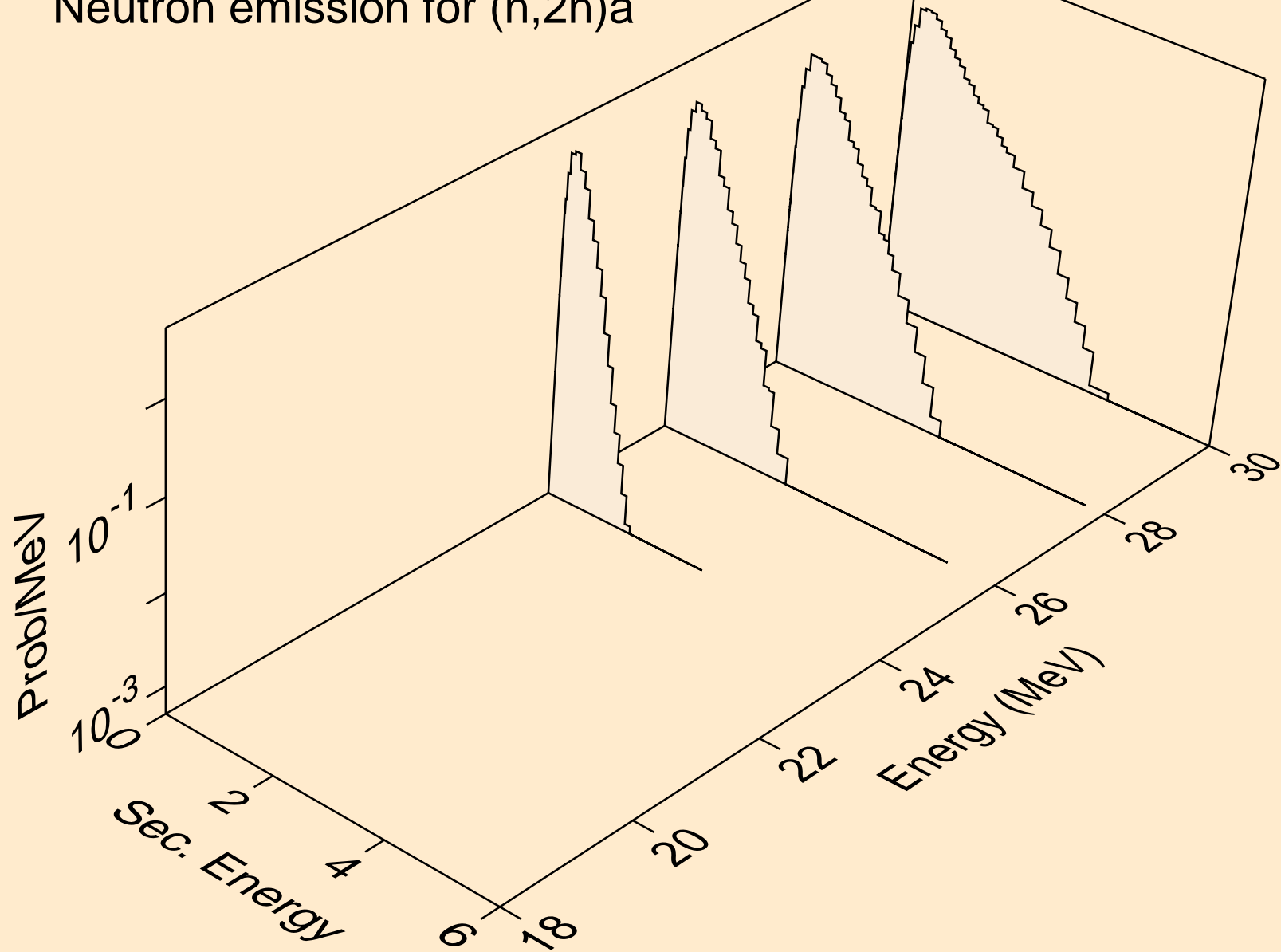

ZR080 NEUTRON ACER TENDL-2024 LIBRARY; T=293.6K
Neutron emission for (n,n*)p

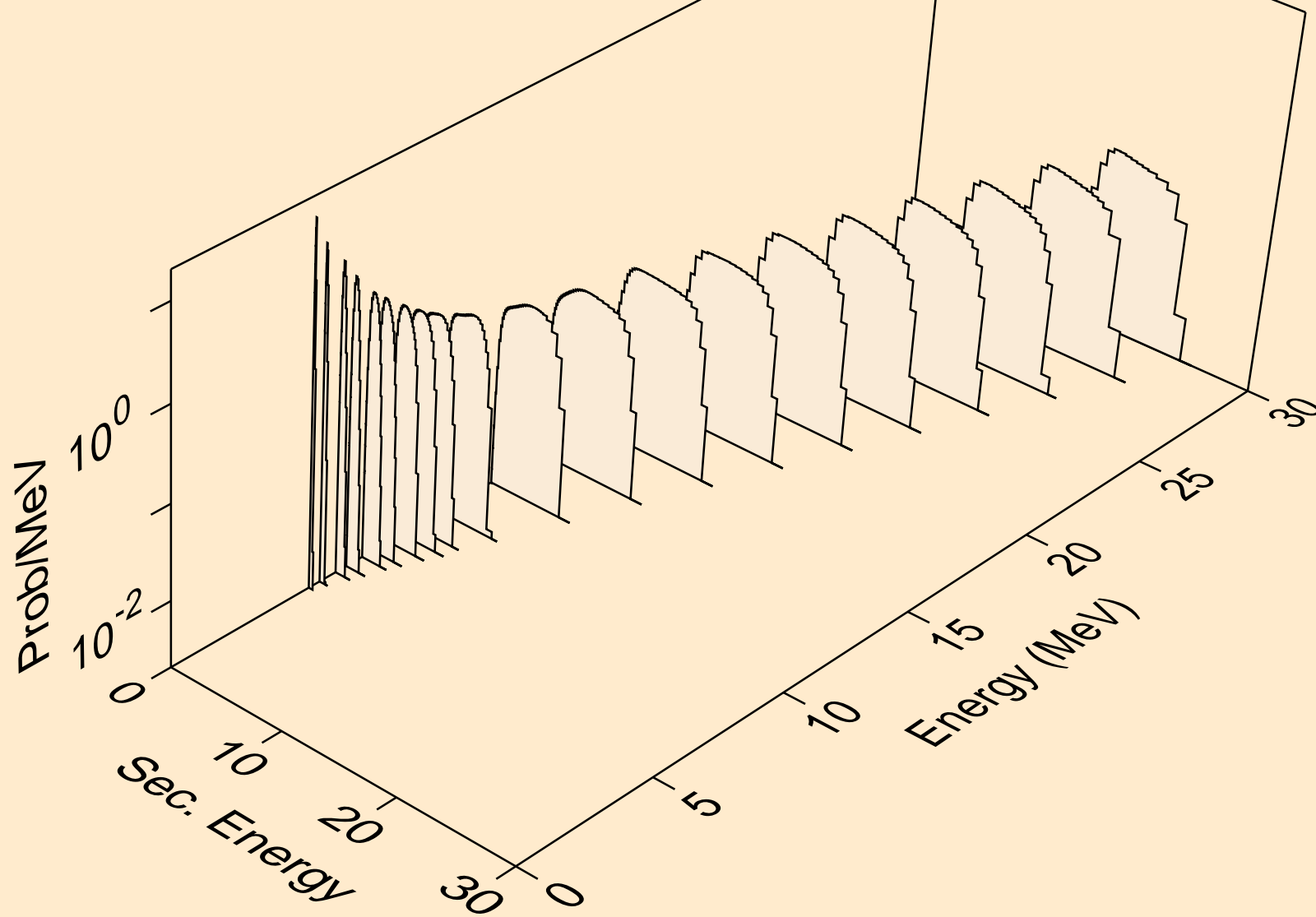

ZR080 NEUTRON ACER TENDL-2024 LIBRARY; T=293.6K
Neutron emission for (n,n*)2a

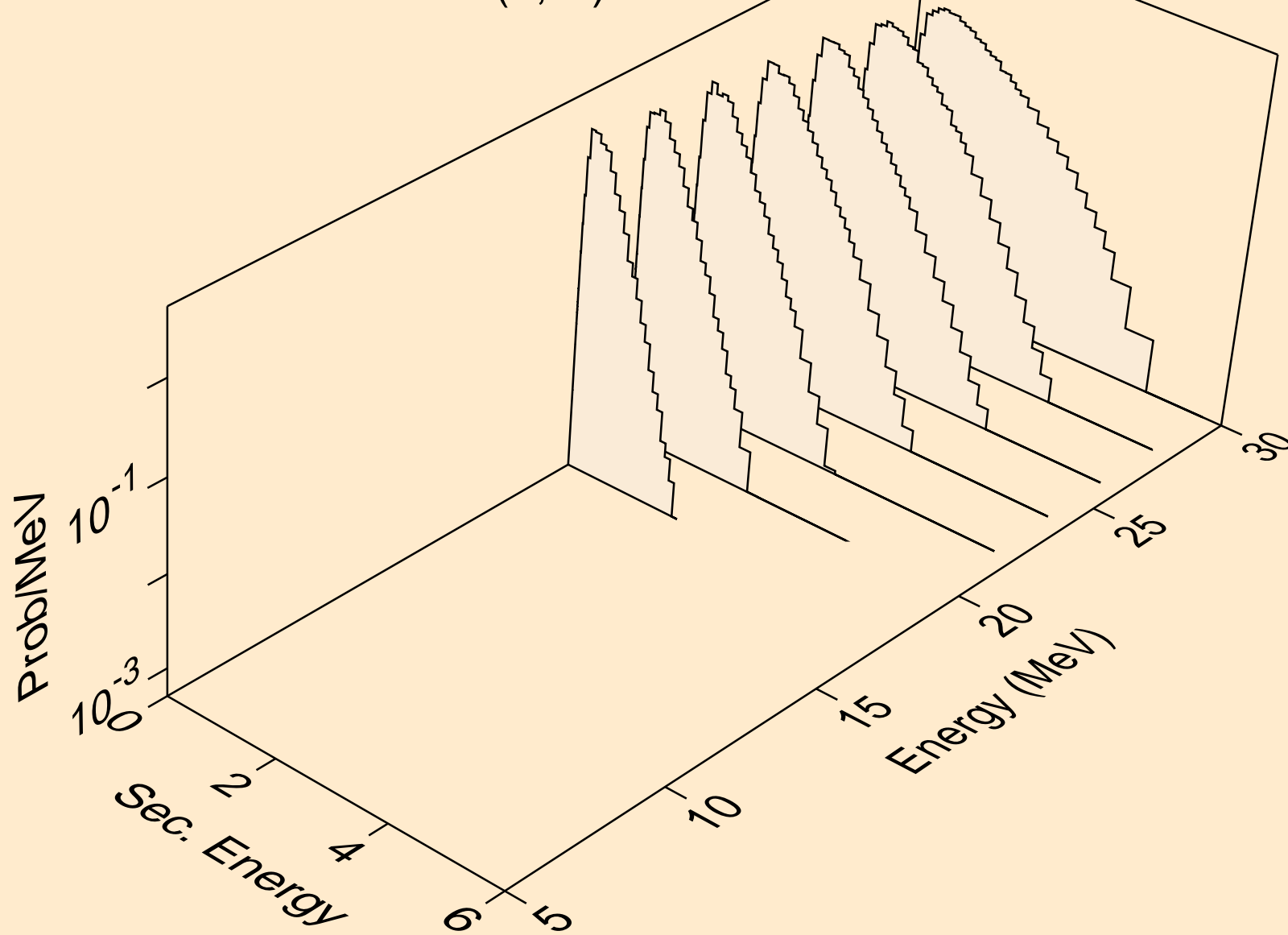

ZR080 NEUTRON ACER TENDL-2024 LIBRARY; T=293.6K
Neutron emission for (n,n*)d

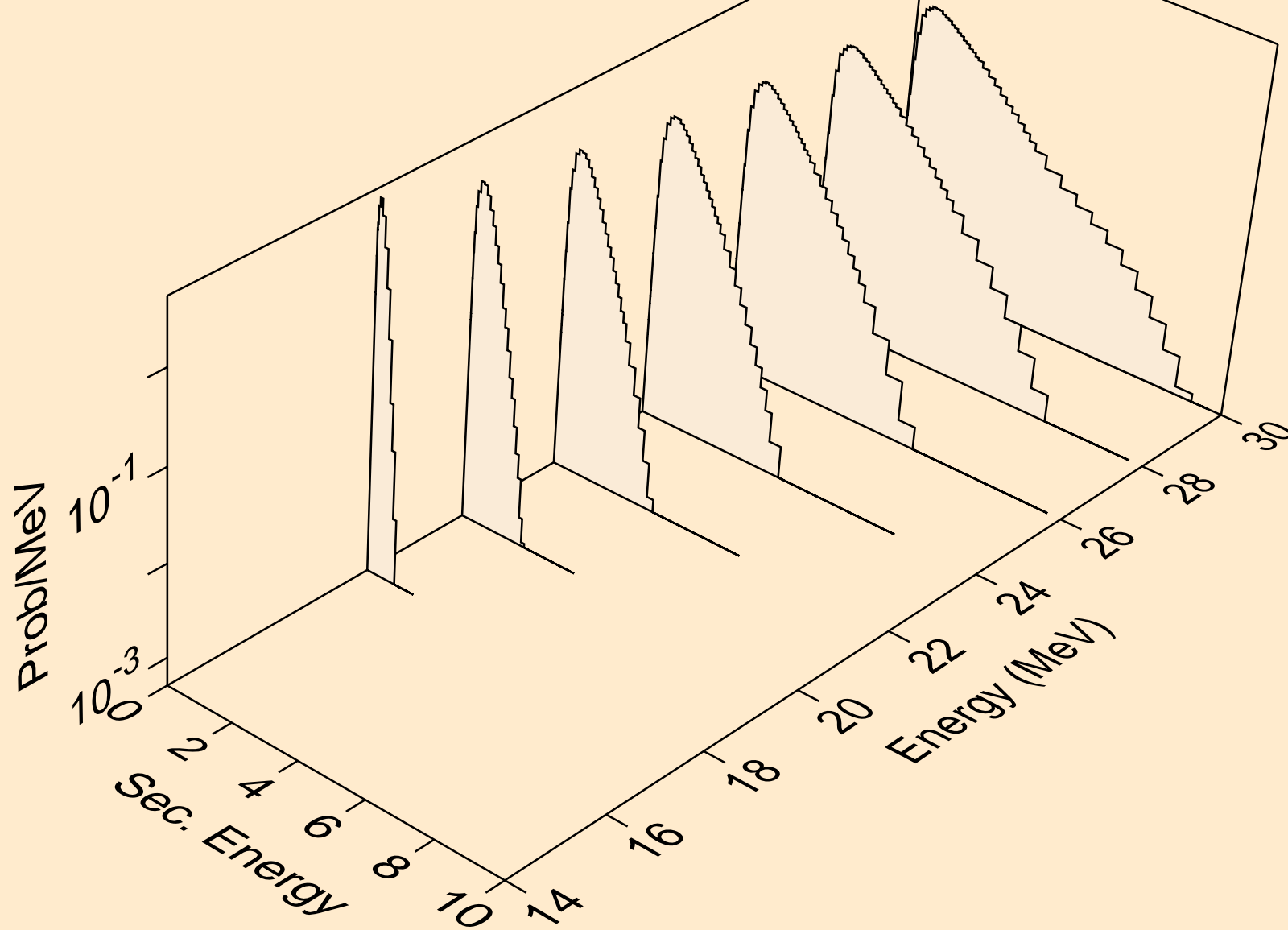

ZR080 NEUTRON ACER TENDL-2024 LIBRARY; T=293.6K
Neutron emission for (n,n*)t

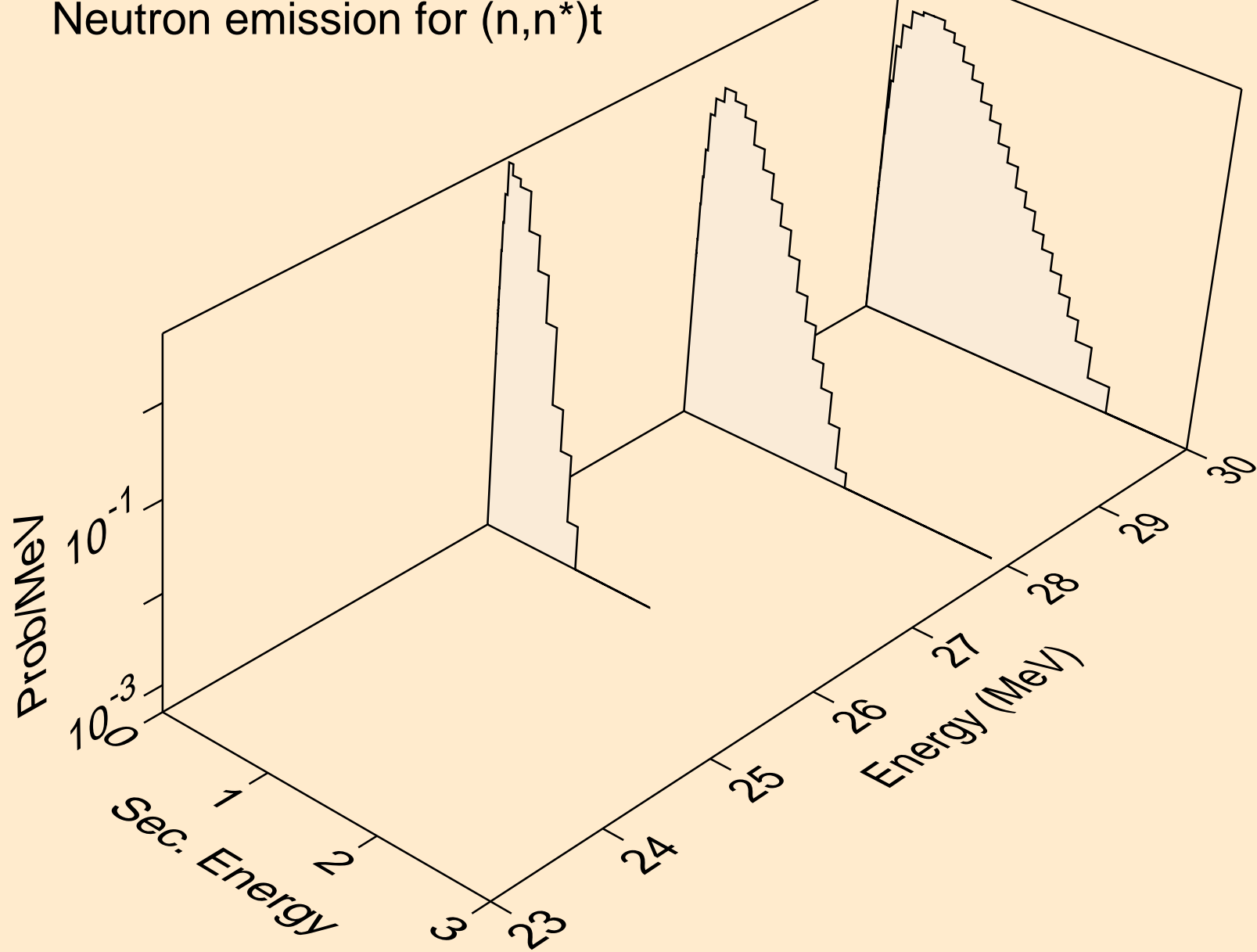

ZR080 NEUTRON ACER TENDL-2024 LIBRARY; T=293.6K
Neutron emission for (n,n*)he3

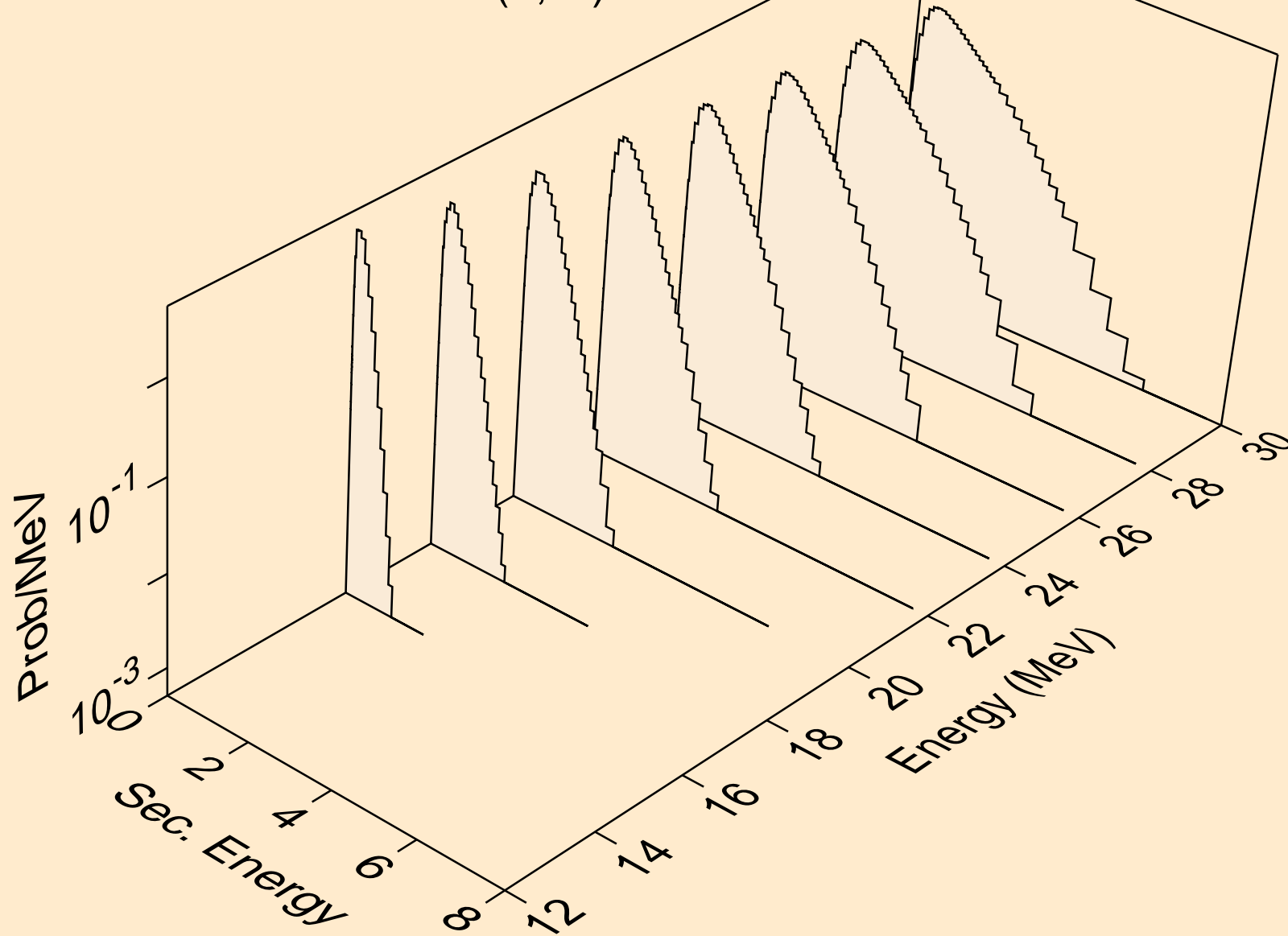

ZR080 NEUTRON ACER TENDL-2024 LIBRARY; T=293.6K
Neutron emission for (n,2np)

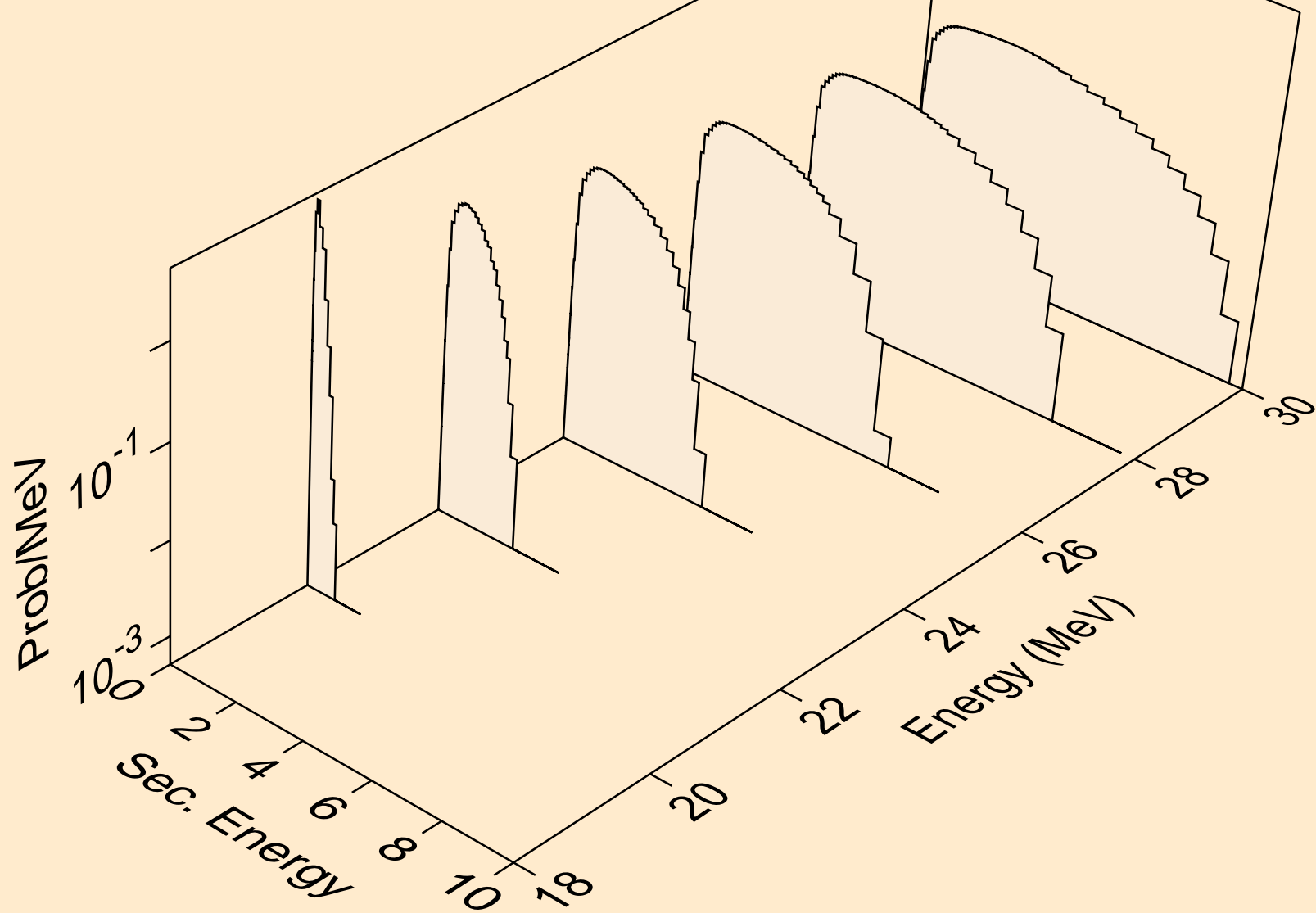

ZR080 NEUTRON ACER TENDL-2024 LIBRARY; T=293.6K
Neutron emission for (n,n2p)

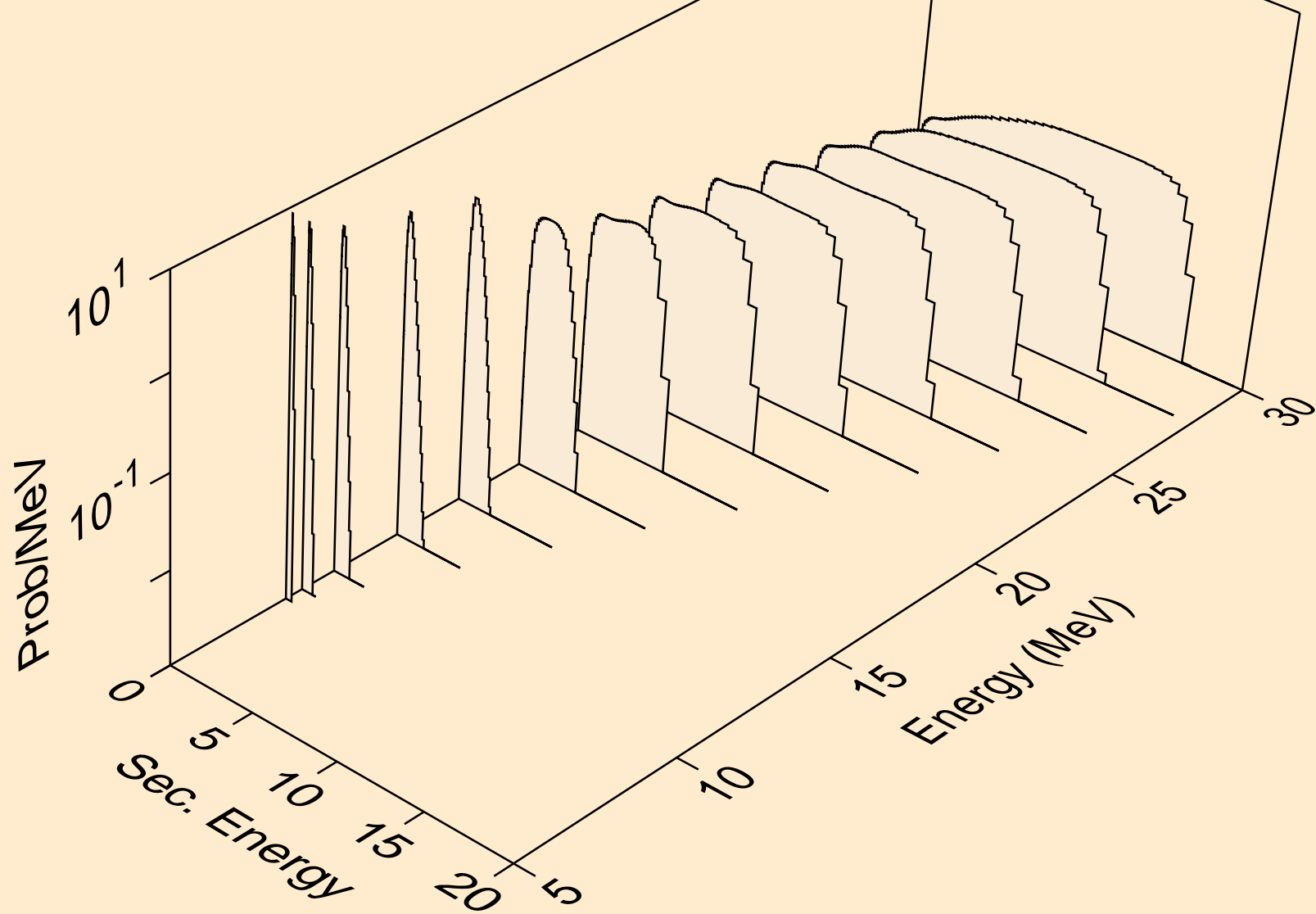

ZR080 NEUTRON ACER TENDL-2024 LIBRARY; T=293.6K
Neutron emission for (n,npa)

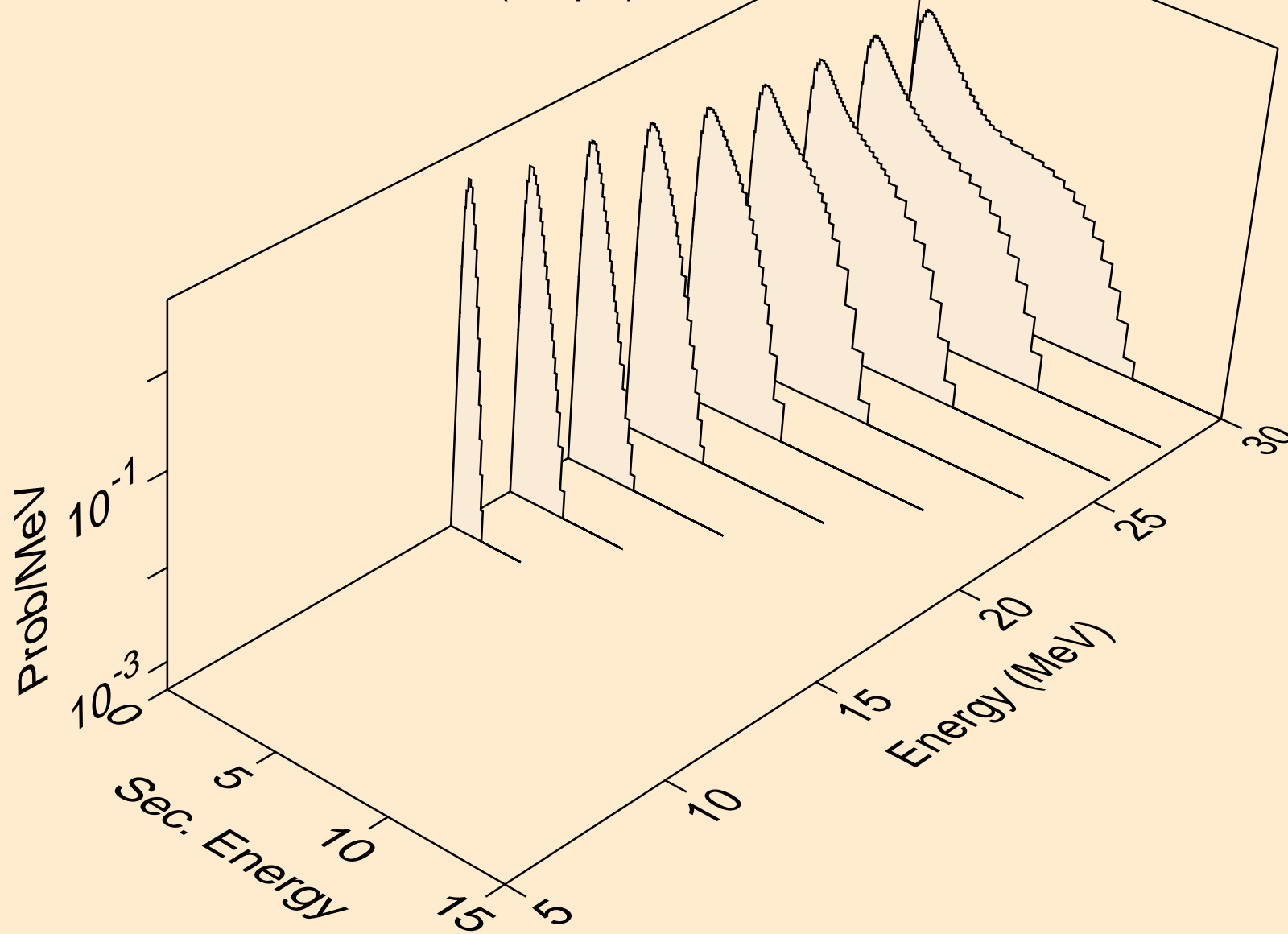

ZR080 NEUTRON ACER TENDL-2024 LIBRARY; T=293.6K
Neutron emission for (n,n*c)

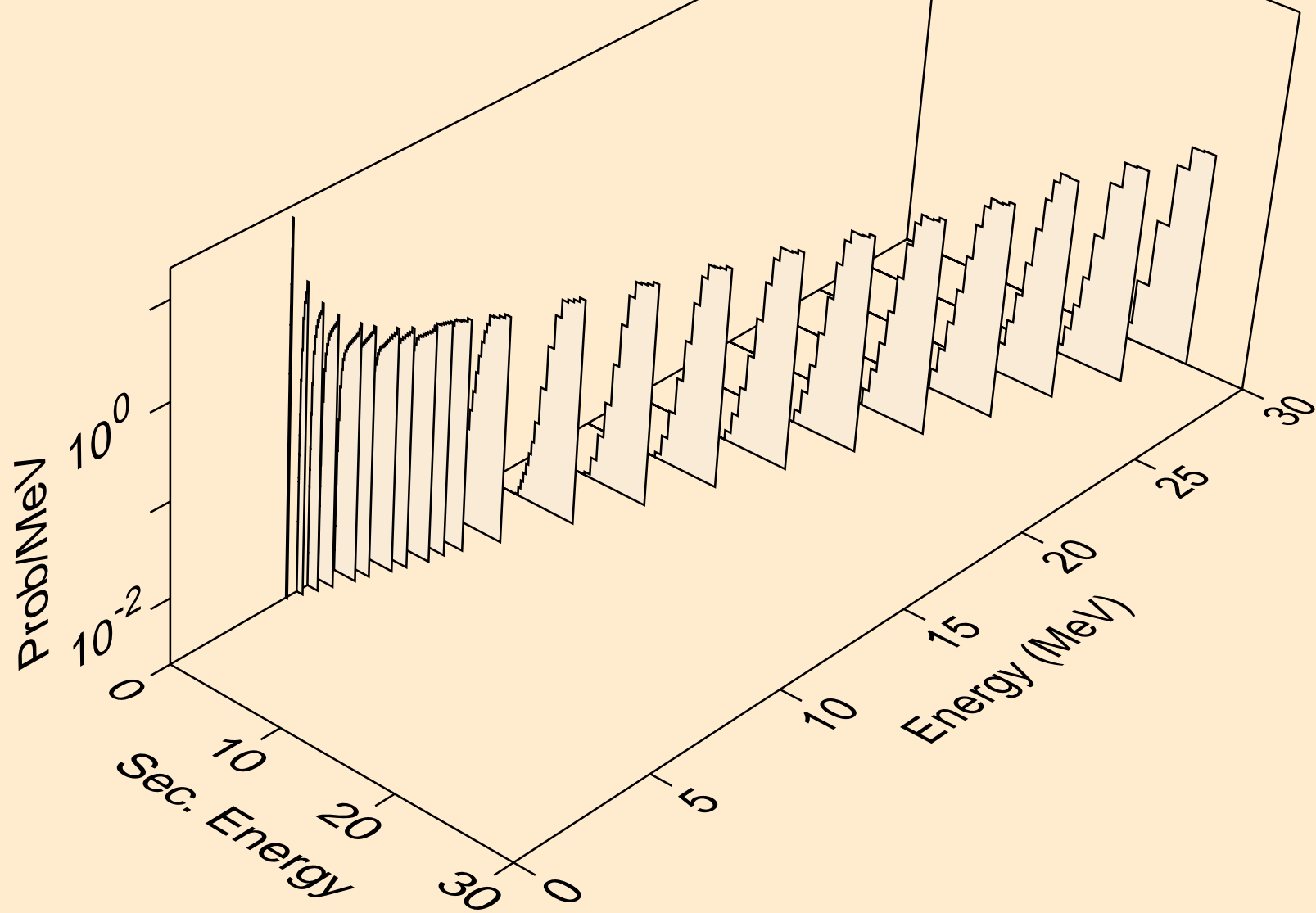

ZR080 NEUTRON ACER TENDL-2024 LIBRARY; T=293.6K
Photon emission for (n,x)

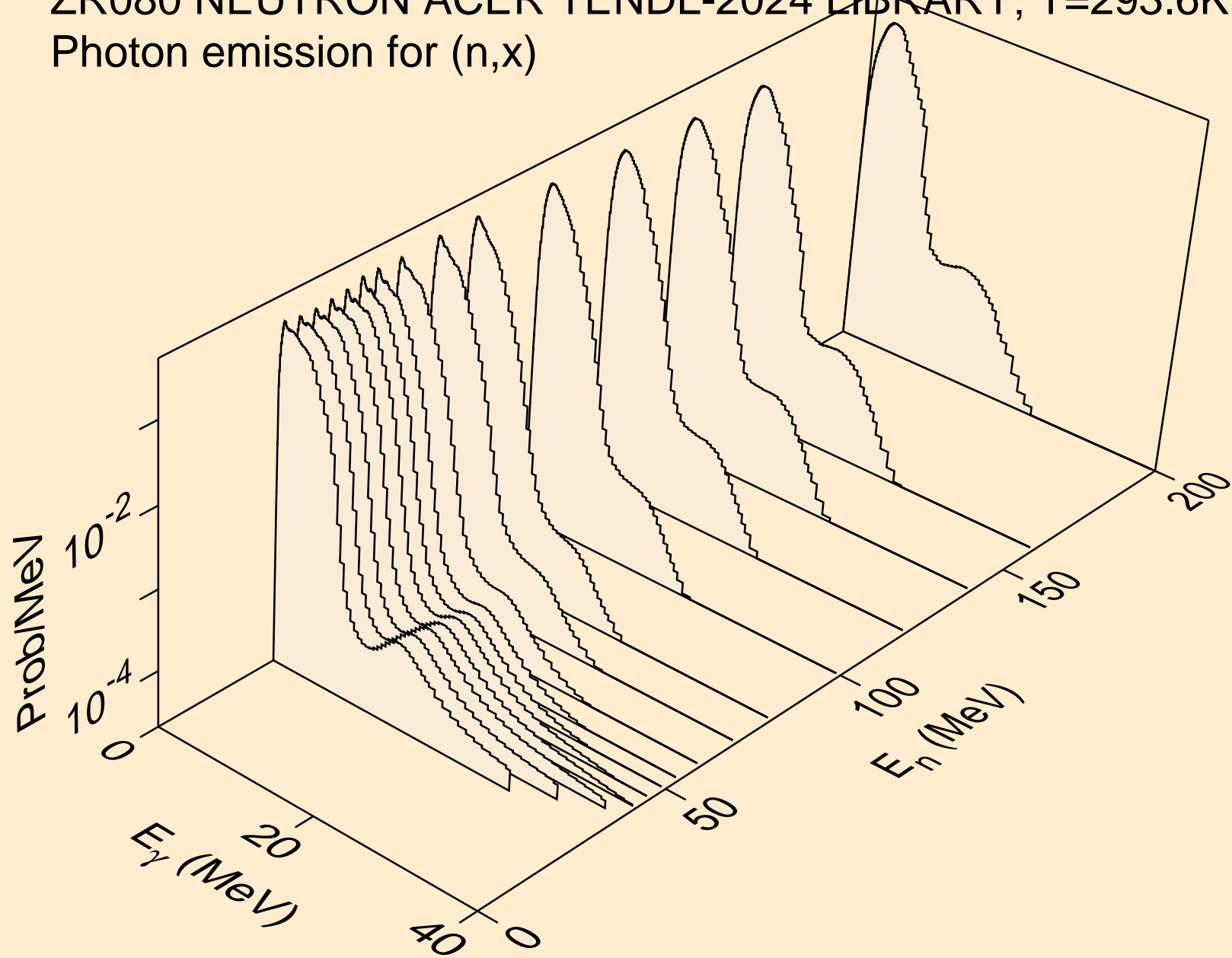

ZR080 NEUTRON ACER TENDL-2024 LIBRARY; T=293.6K
Photon emission for (n,2n)

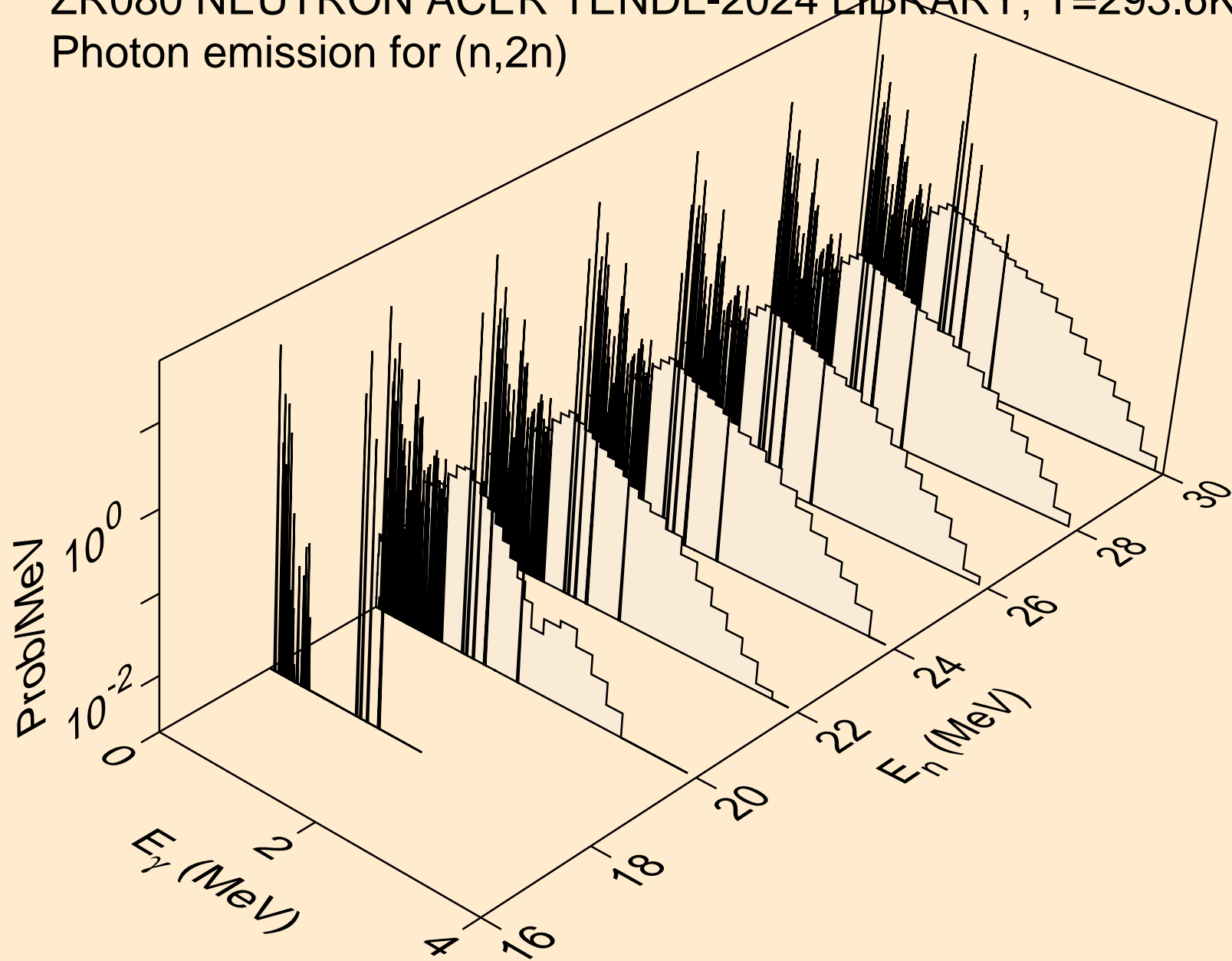

ZR080 NEUTRON ACER TENDL-2024 LIBRARY; T=293.6K
Photon emission for (n,n*)a

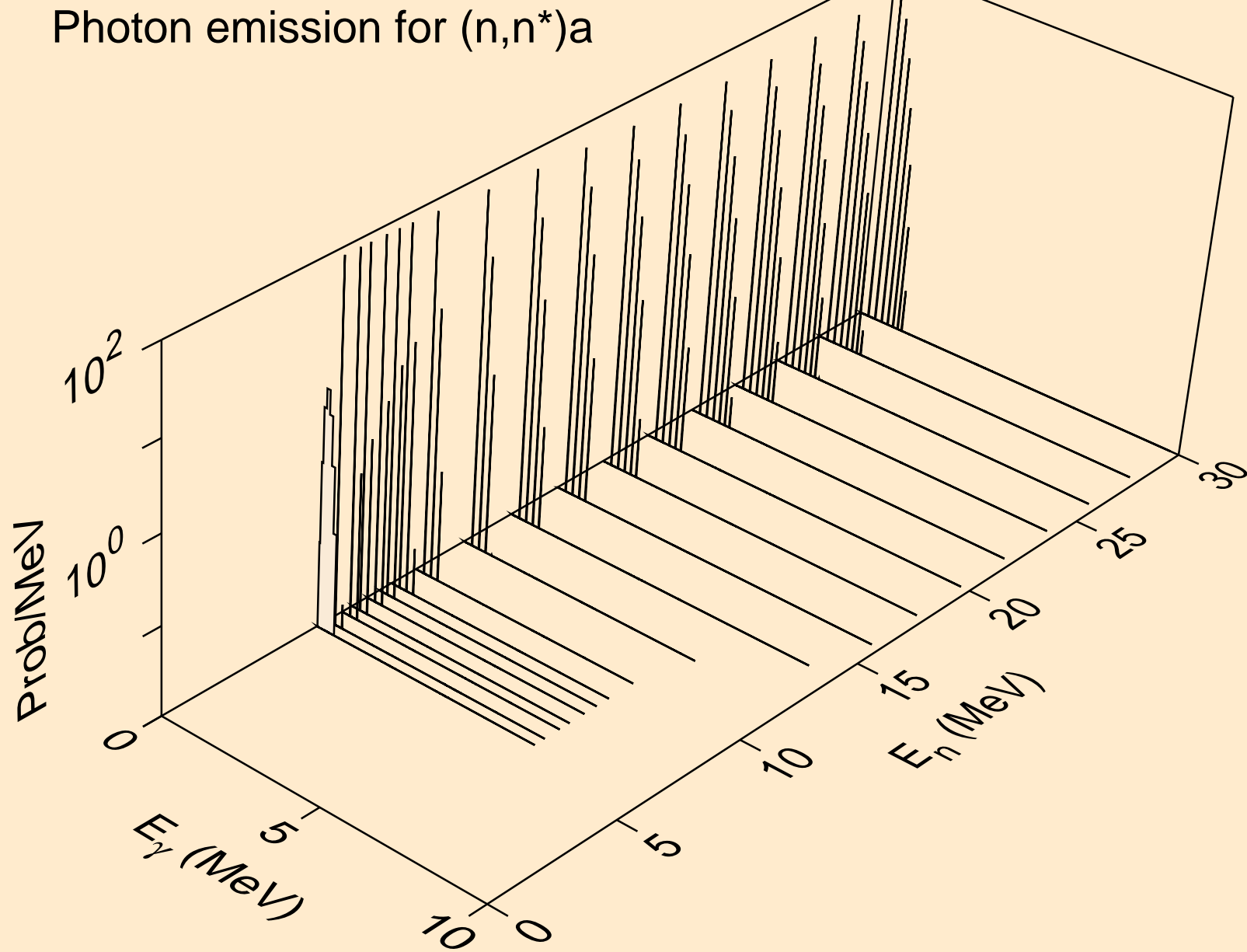

ZR080 NEUTRON ACER TENDL-2024 LIBRARY; T=293.6K
Photon emission for (n,2n)a

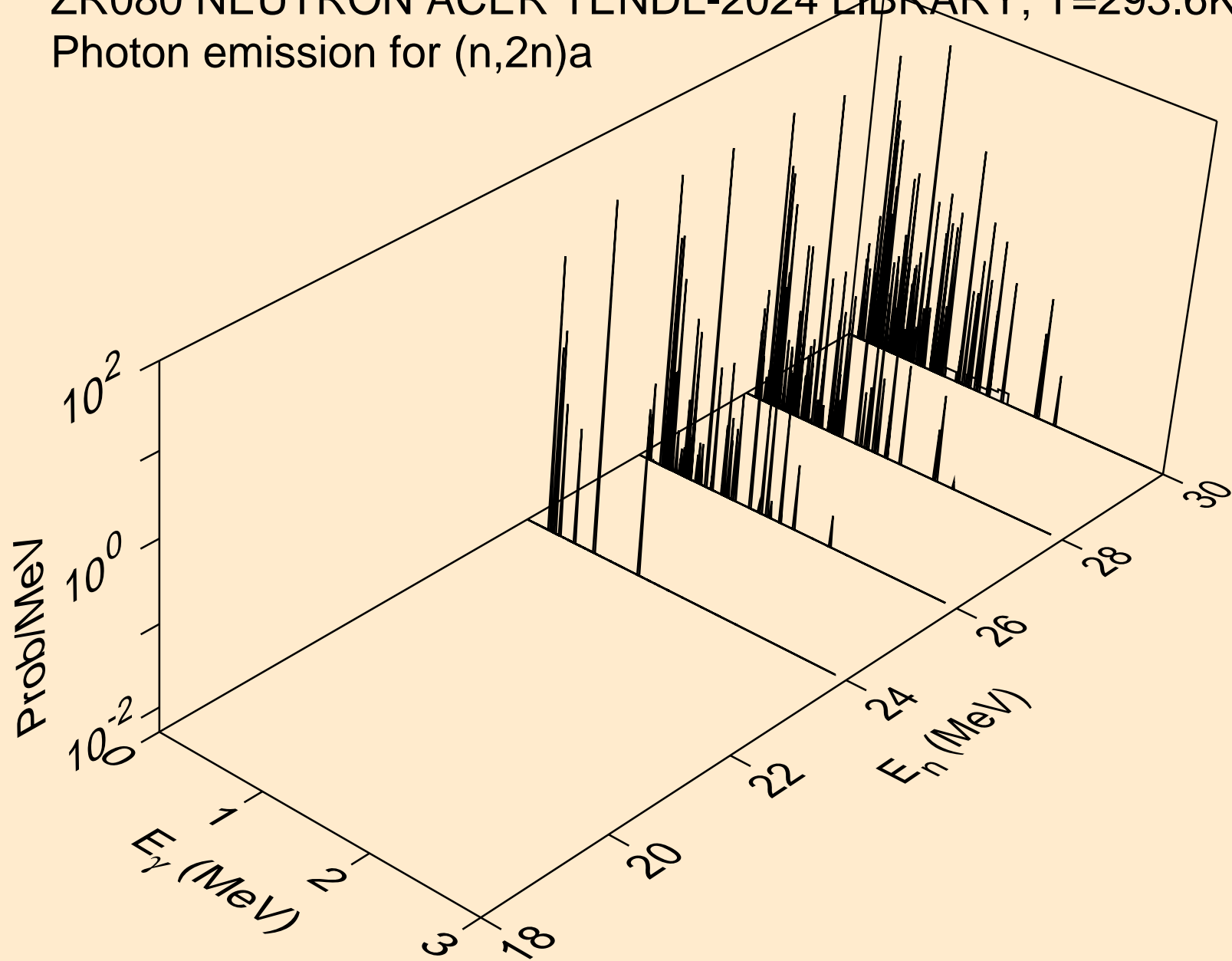

ZR080 NEUTRON ACER TENDL-2024 LIBRARY; T=293.6K
Photon emission for (n,n*)p

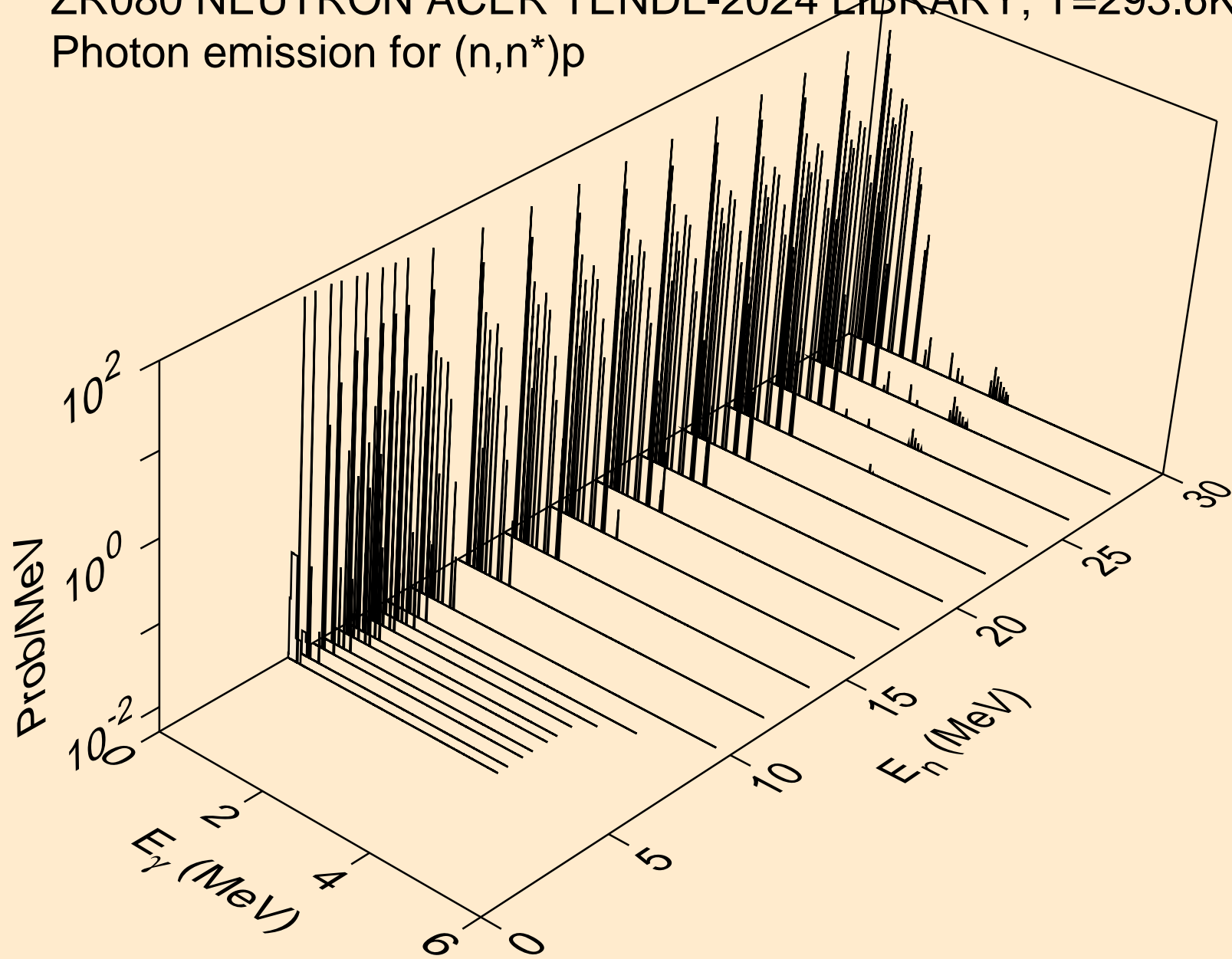

ZR080 NEUTRON ACER TENDL-2024 LIBRARY; T=293.6K
Photon emission for (n,n*)2a

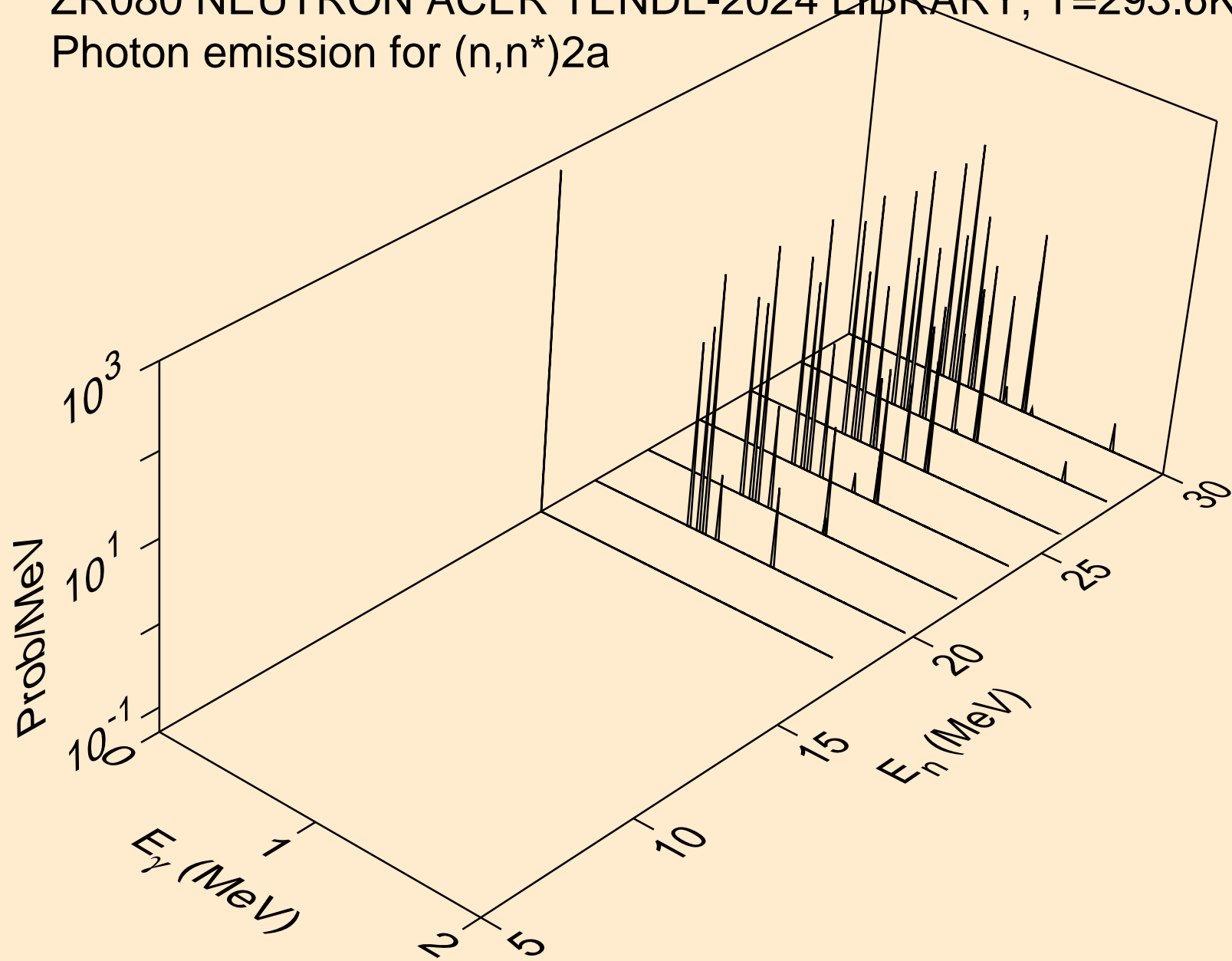

ZR080 NEUTRON ACER TENDL-2024 LIBRARY; T=293.6K
Photon emission for (n,n*)d

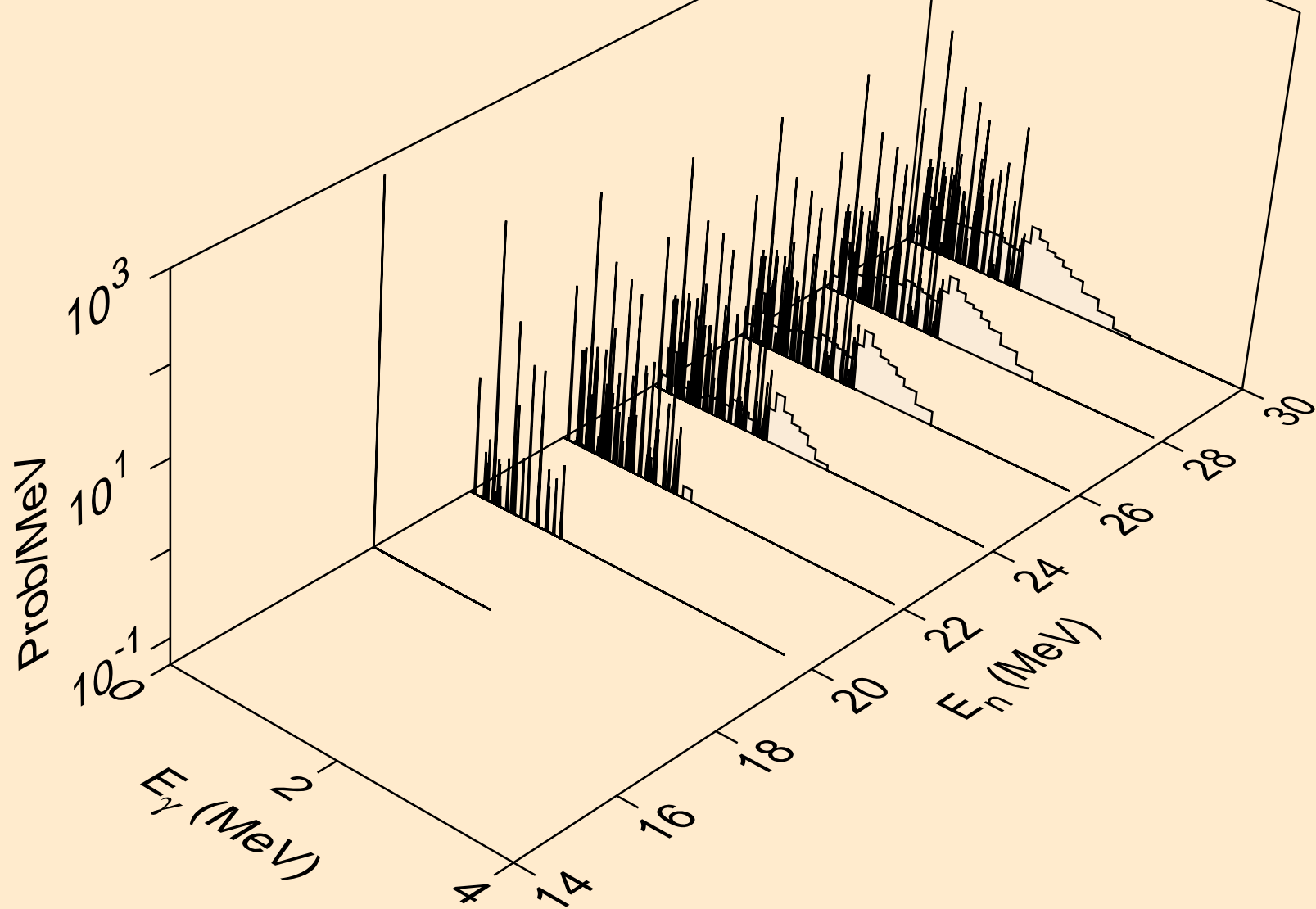

ZR080 NEUTRON ACER TENDL-2024 LIBRARY; T=293.6K
Photon emission for (n,n*)t

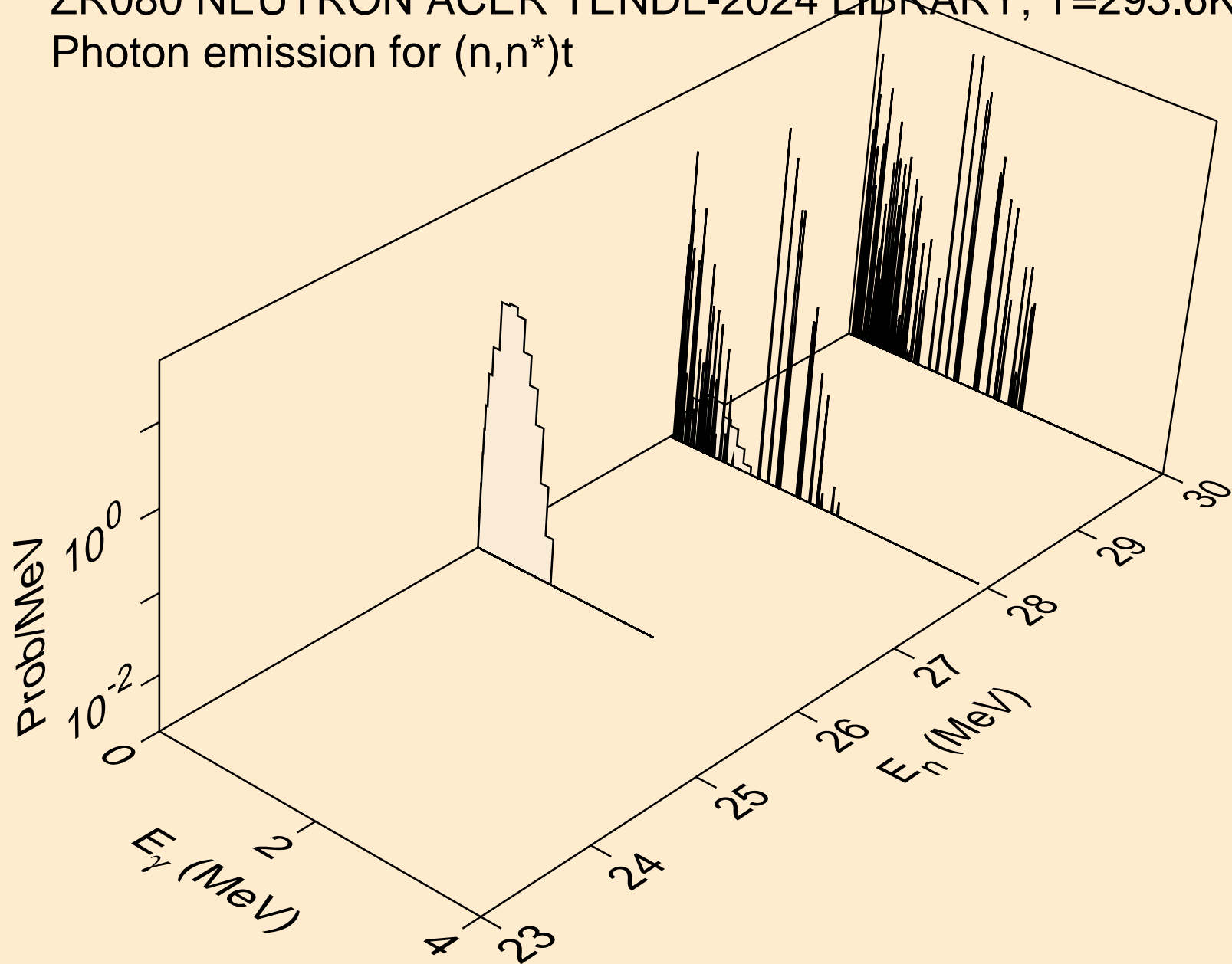

ZR080 NEUTRON ACER TENDL-2024 LIBRARY; T=293.6K
Photon emission for (n,n*)he3

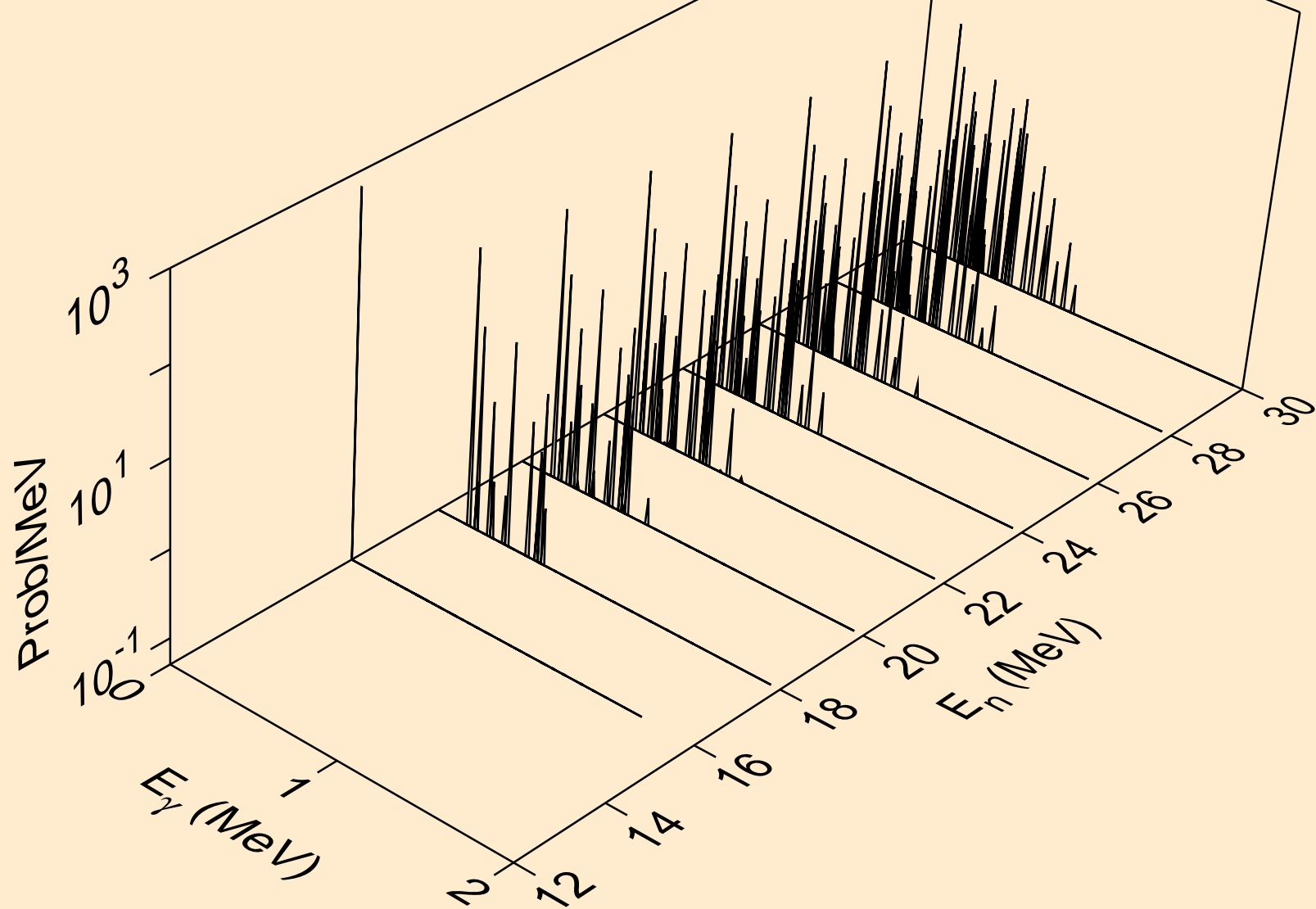

ZR080 NEUTRON ACER TENDL-2024 LIBRARY; T=293.6K
Photon emission for (n,2np)

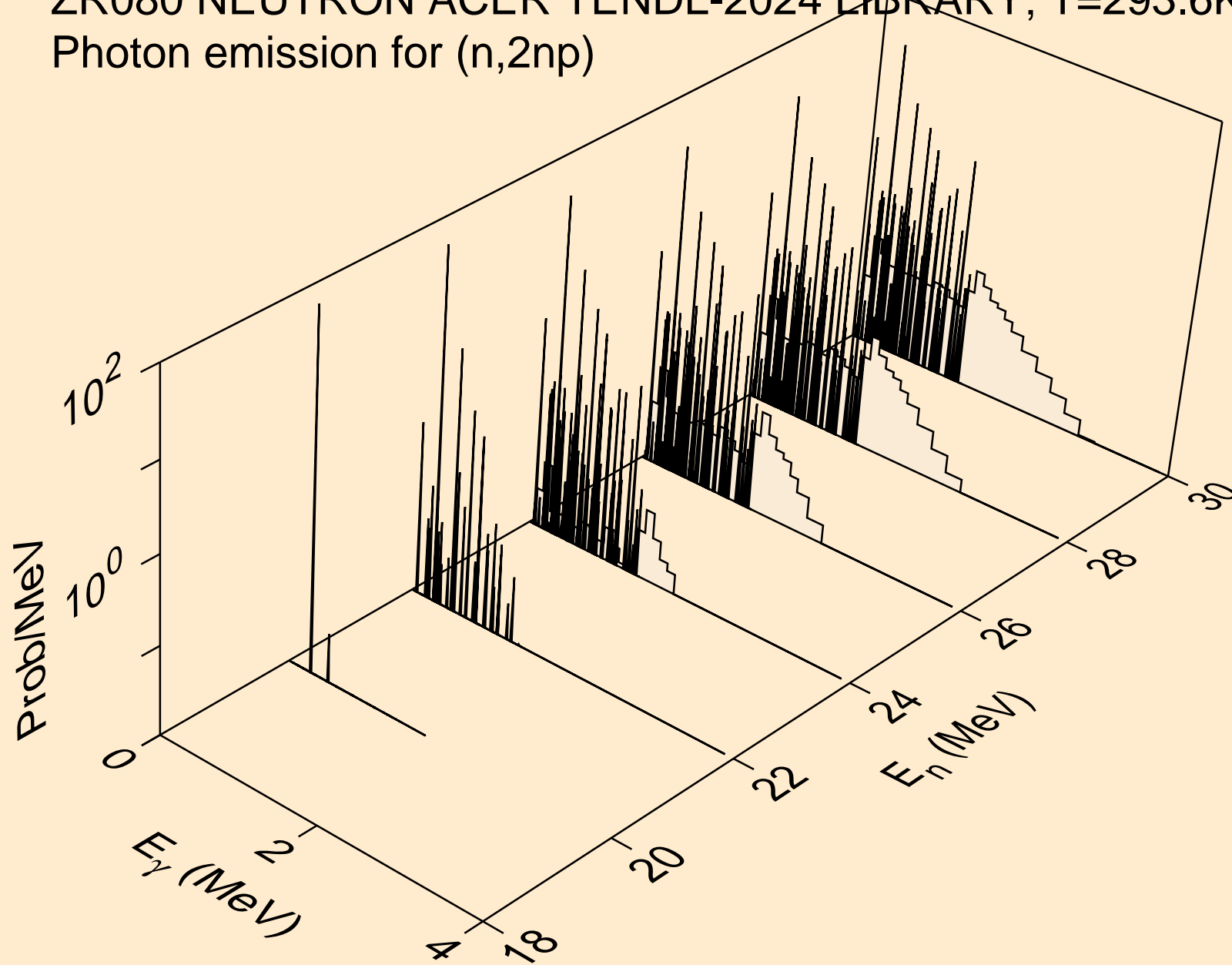

ZR080 NEUTRON ACER TENDL-2024 LIBRARY; T=293.6K
Photon emission for (n,n2p)

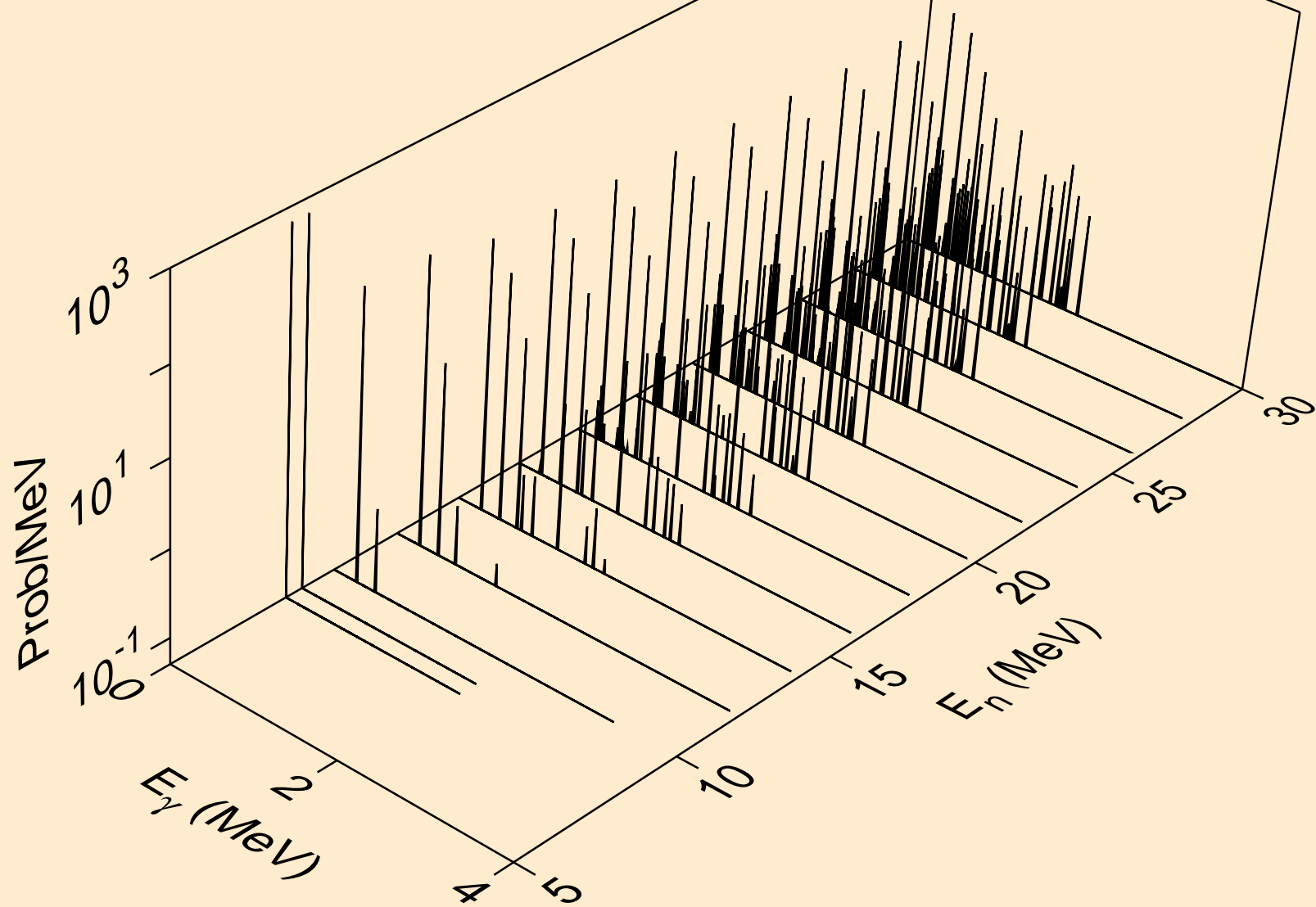

ZR080 NEUTRON ACER TENDL-2024 LIBRARY; T=293.6K
Photon emission for (n,npa)

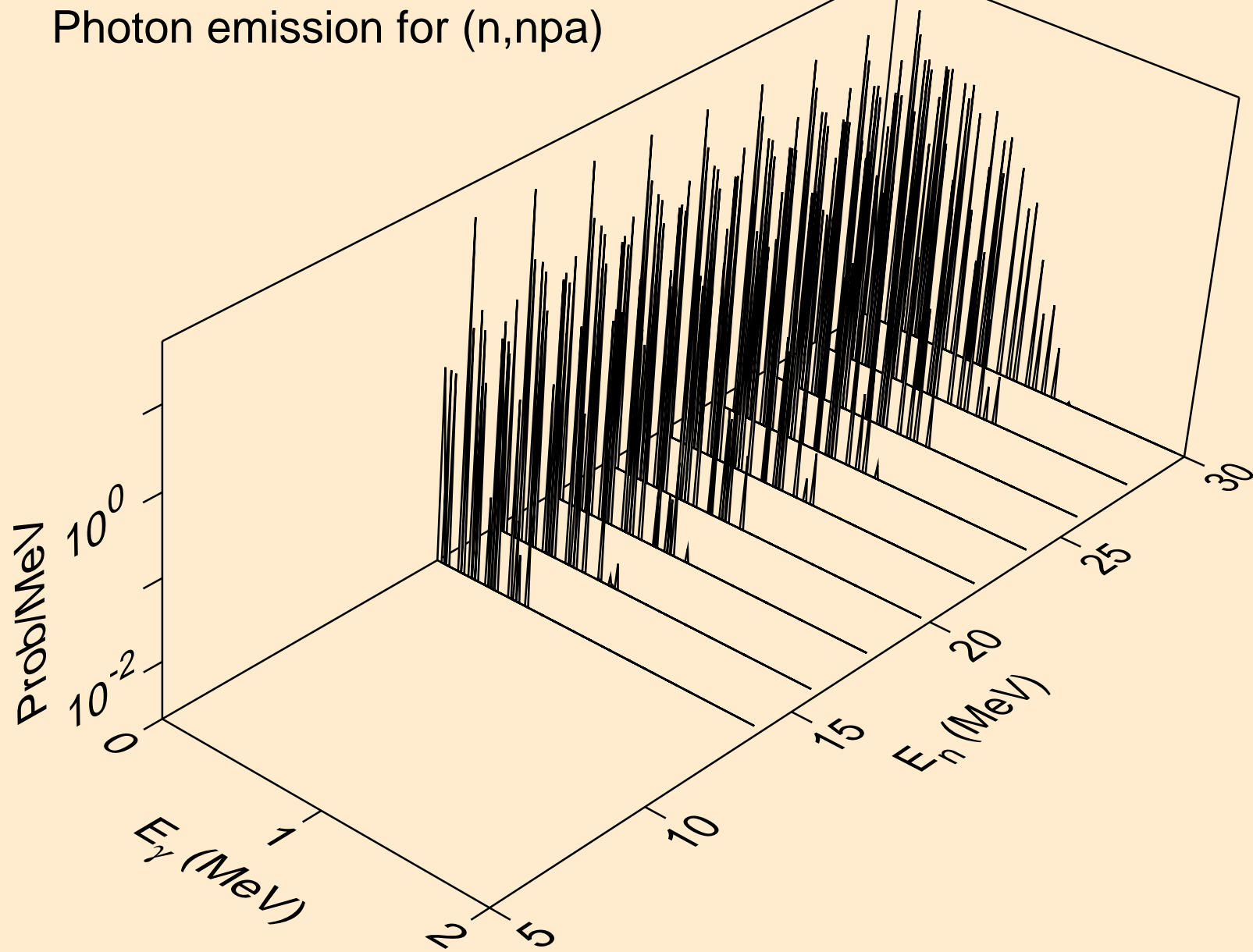

ZR080 NEUTRON ACER TENDL-2024 LIBRARY; T=293.6K
Photon emission for (n,n*c)

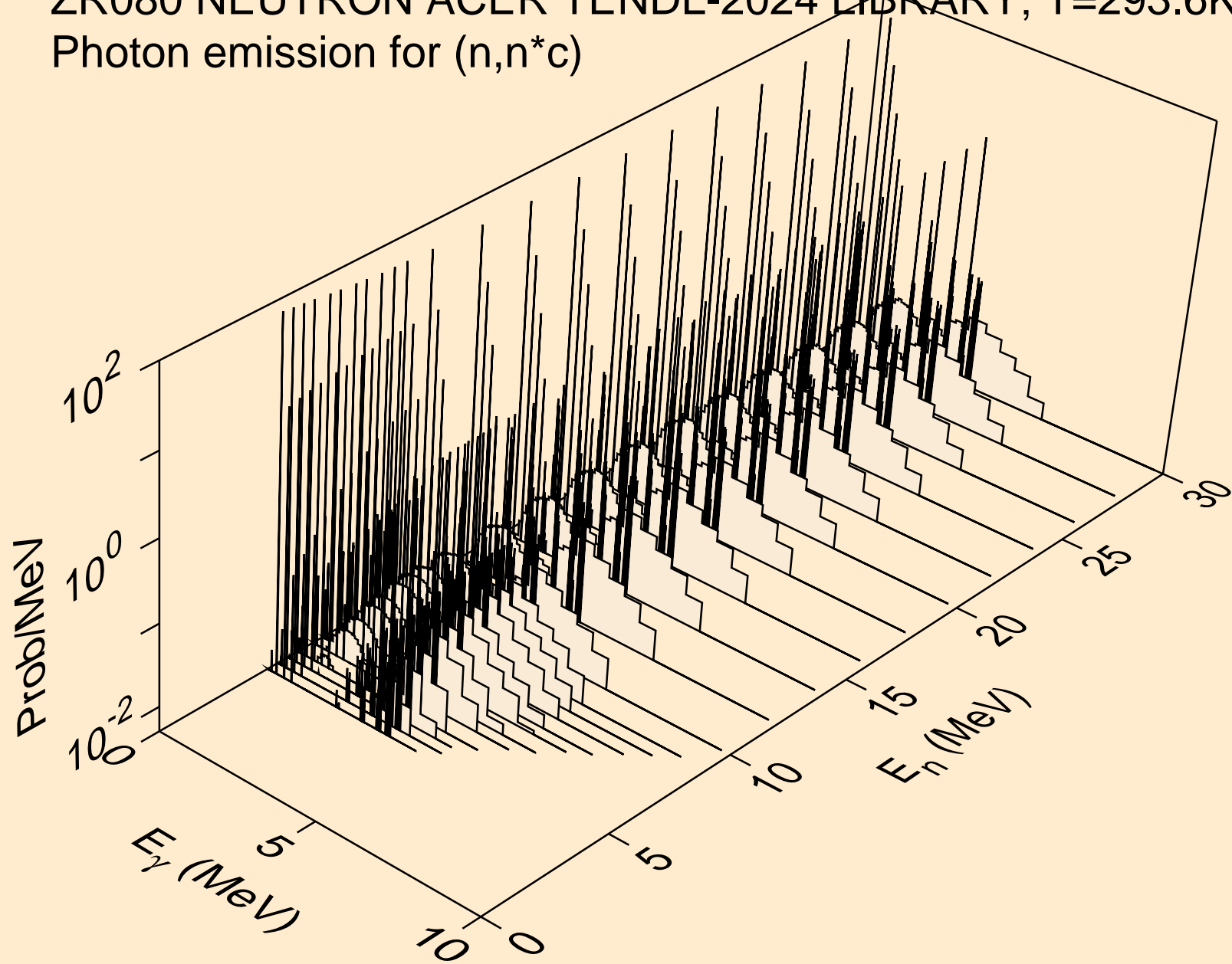

ZR080 NEUTRON ACER TENDL-2024 LIBRARY; T=293.6K
Photon emission for (n,gma)

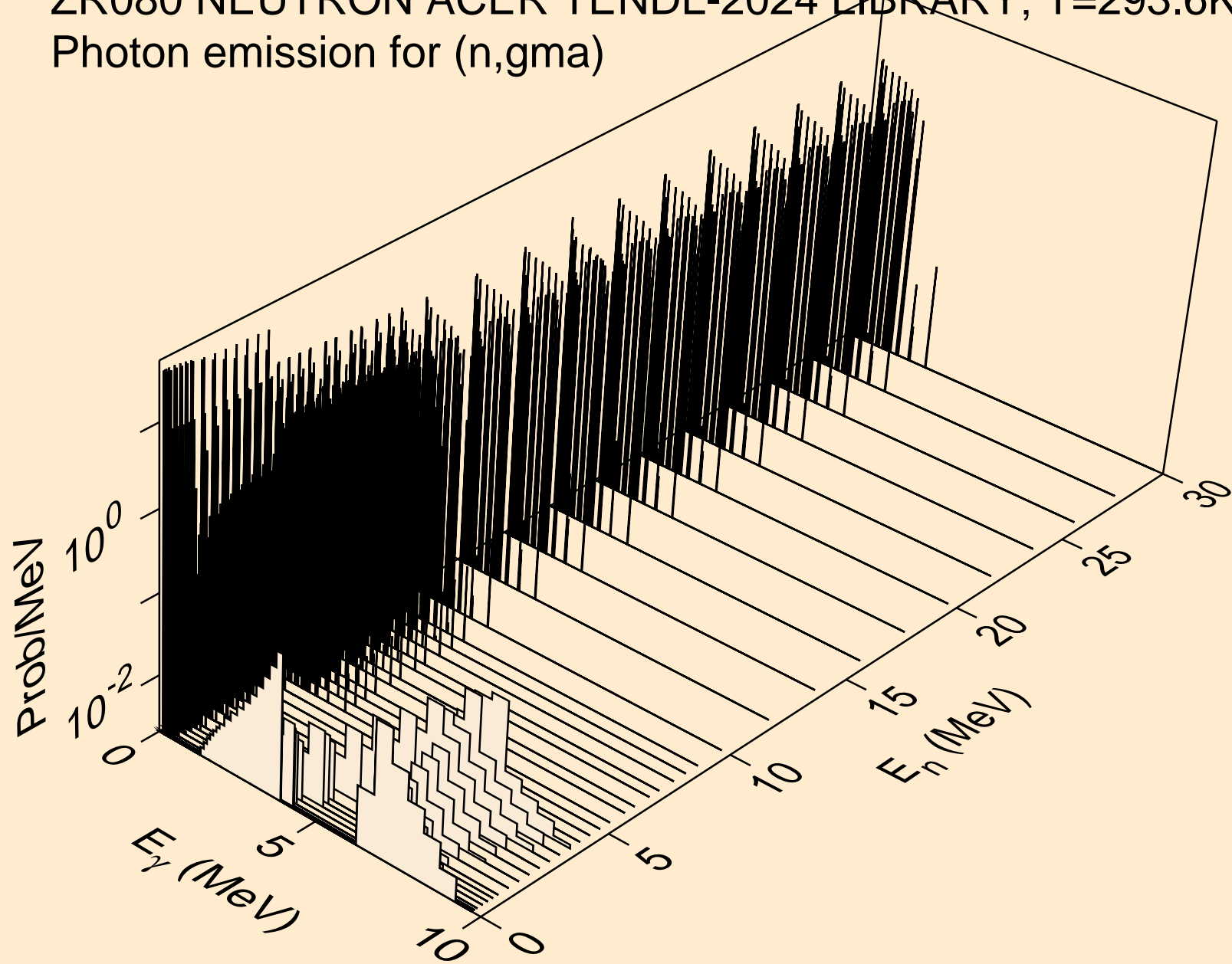

ZR080 NEUTRON ACER TENDL-2024 LIBRARY; T=293.6K
Photon emission for (n,p)

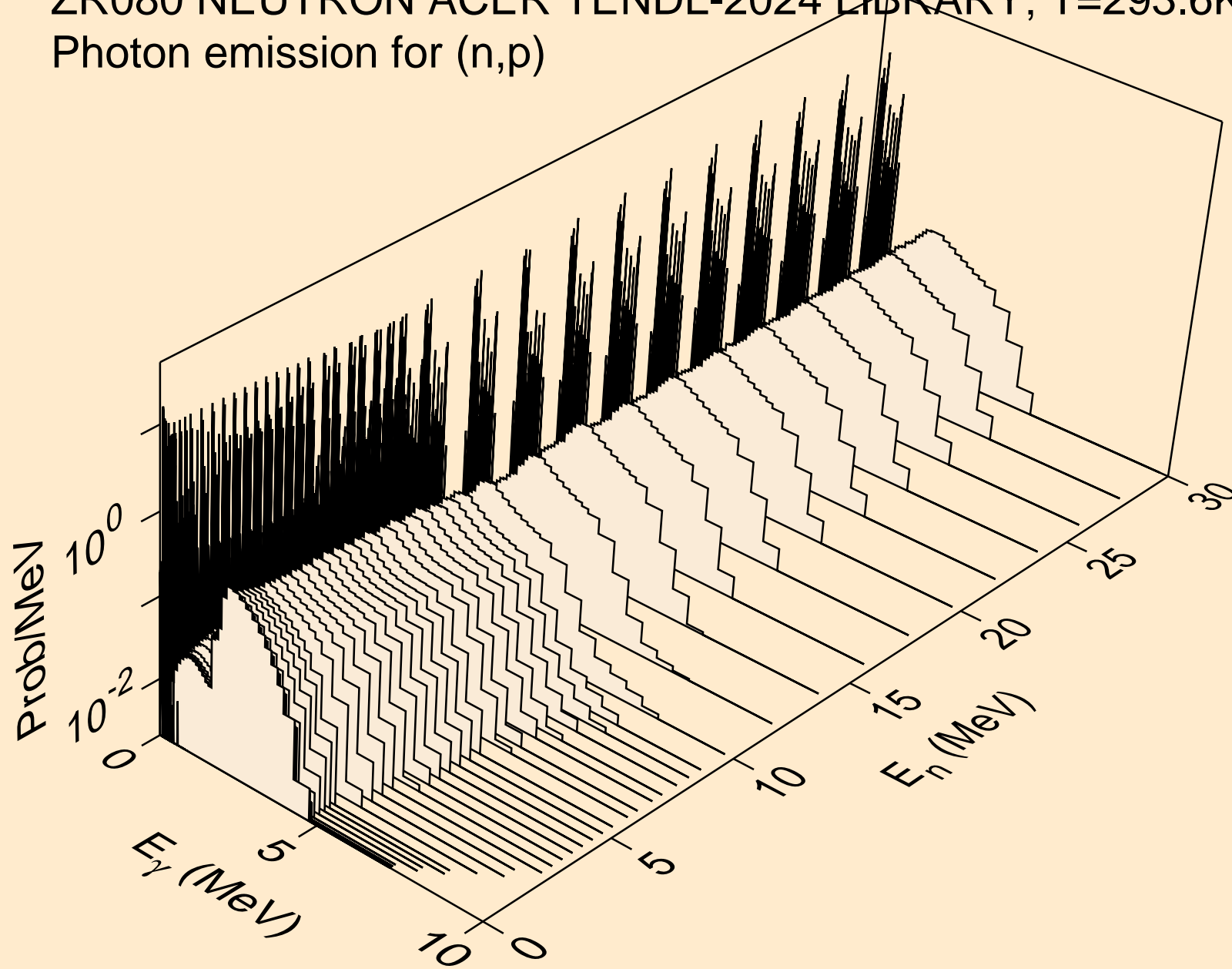

ZR080 NEUTRON ACER TENDL-2024 LIBRARY; T=293.6K
Photon emission for (n,d)

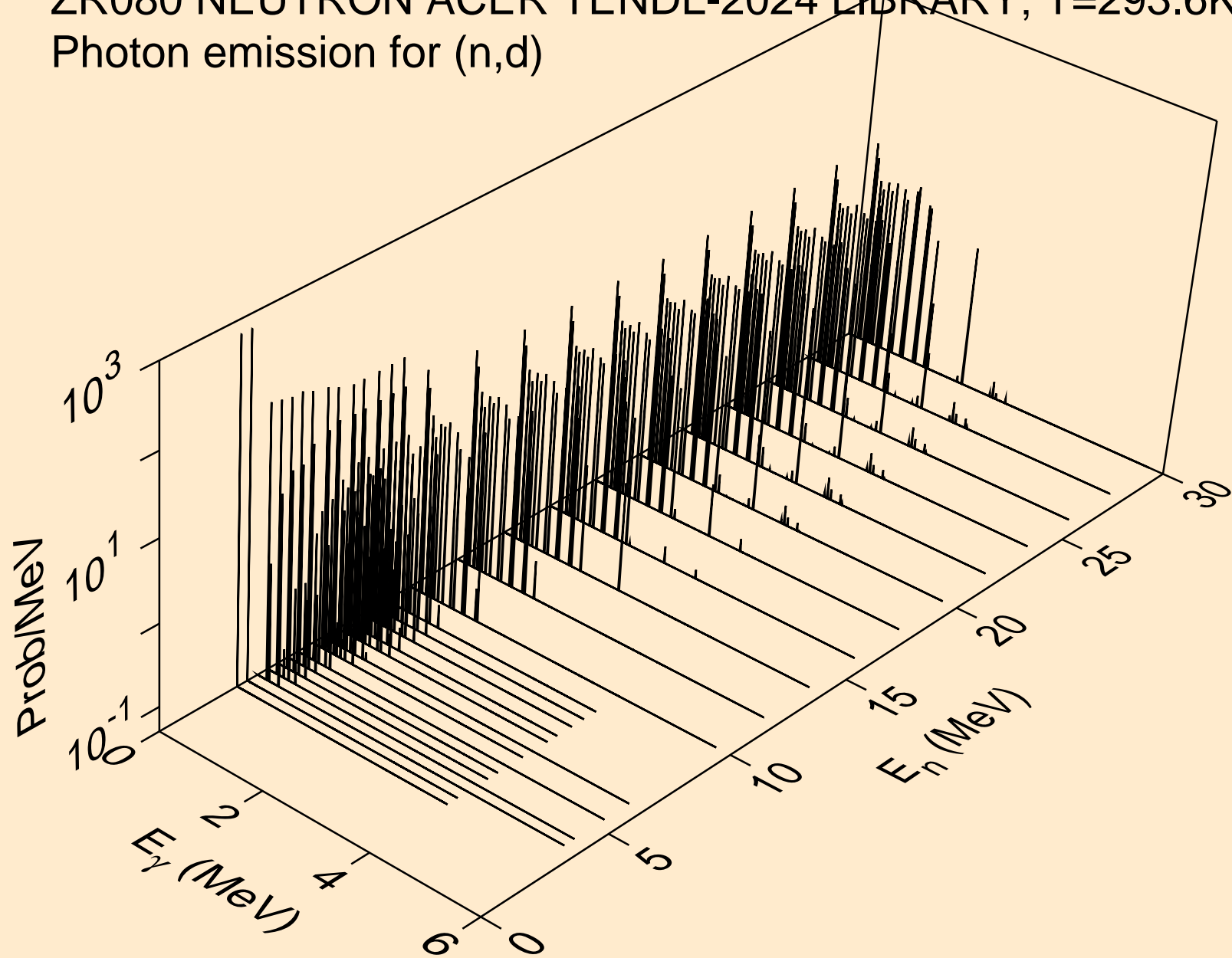

ZR080 NEUTRON ACER TENDL-2024 LIBRARY; T=293.6K
Photon emission for (n,t)

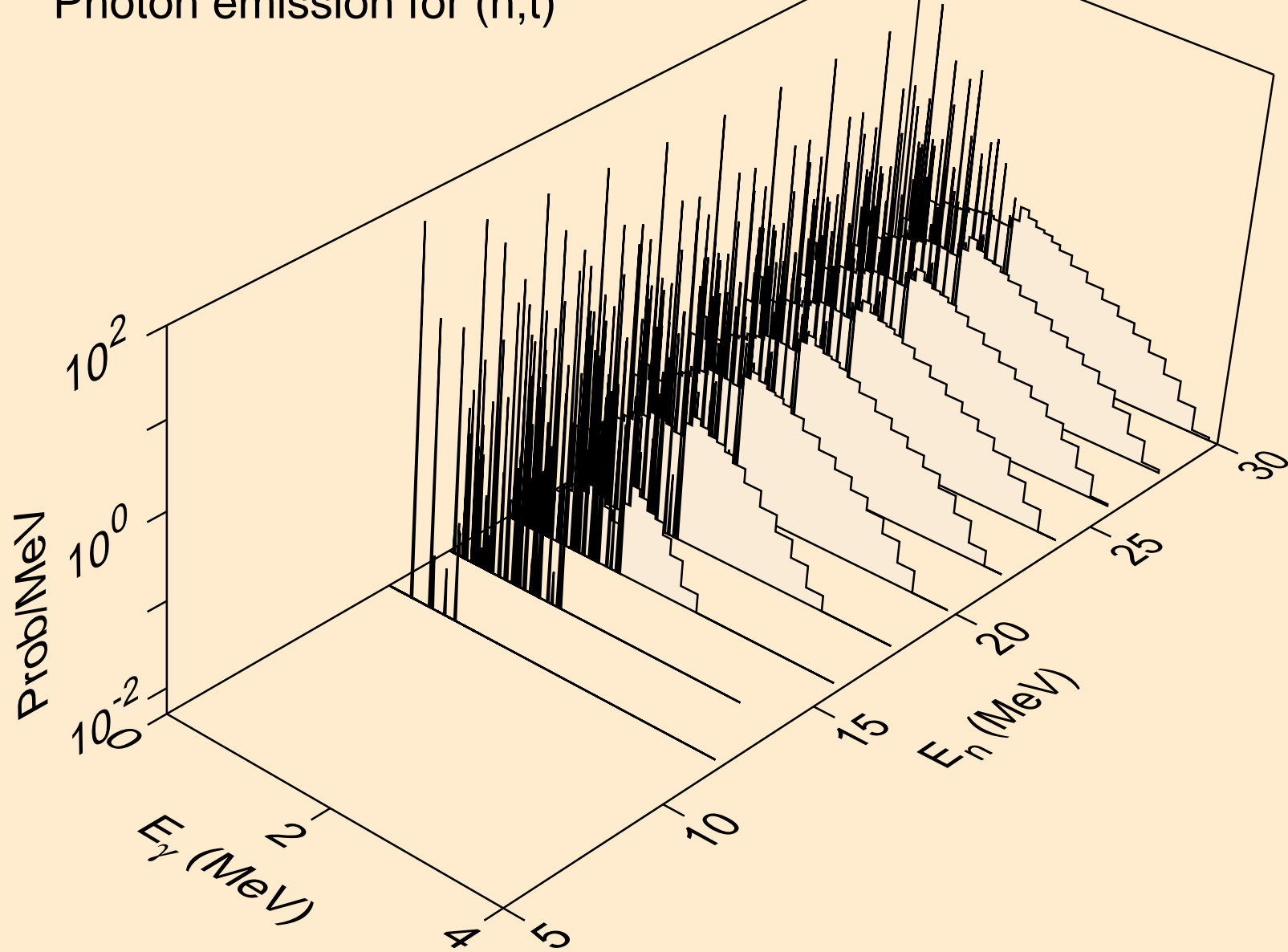

ZR080 NEUTRON ACER TENDL-2024 LIBRARY; T=293.6K
Photon emission for (n,he3)

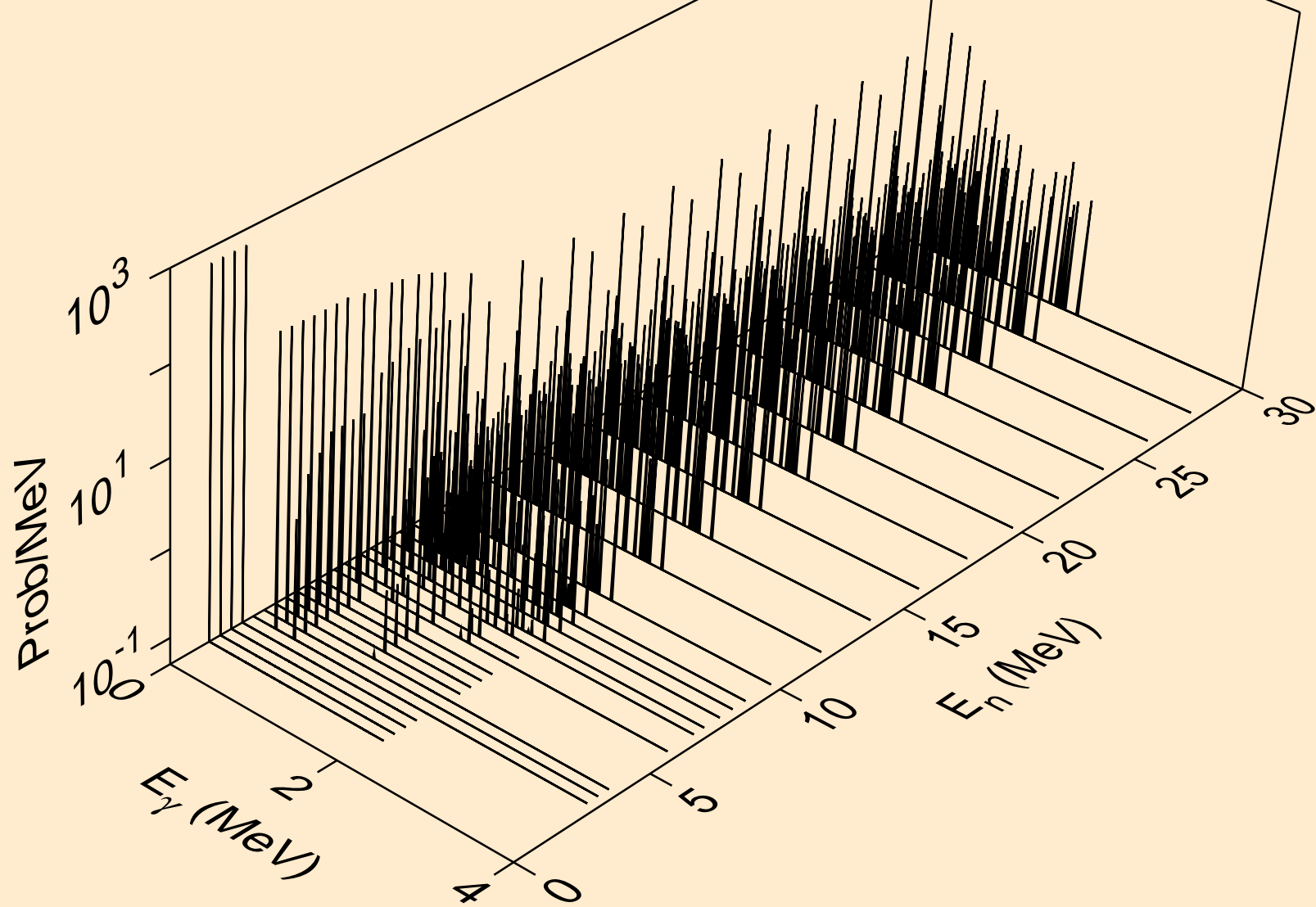

ZR080 NEUTRON ACER TENDL-2024 LIBRARY; T=293.6K
Photon emission for (n,a)

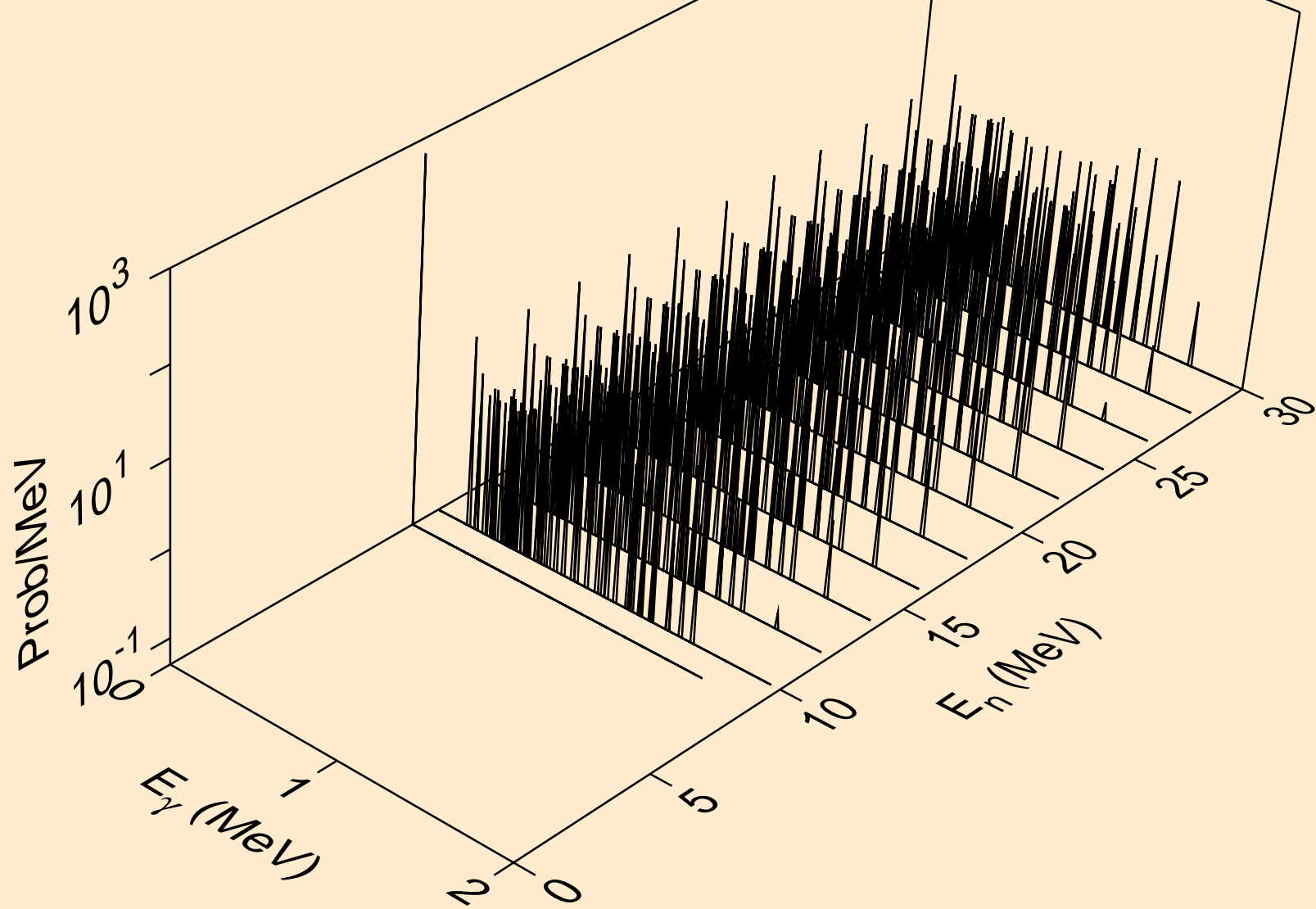

ZR080 NEUTRON ACER TENDL-2024 LIBRARY; T=293.6K
Photon emission for (n,2a)

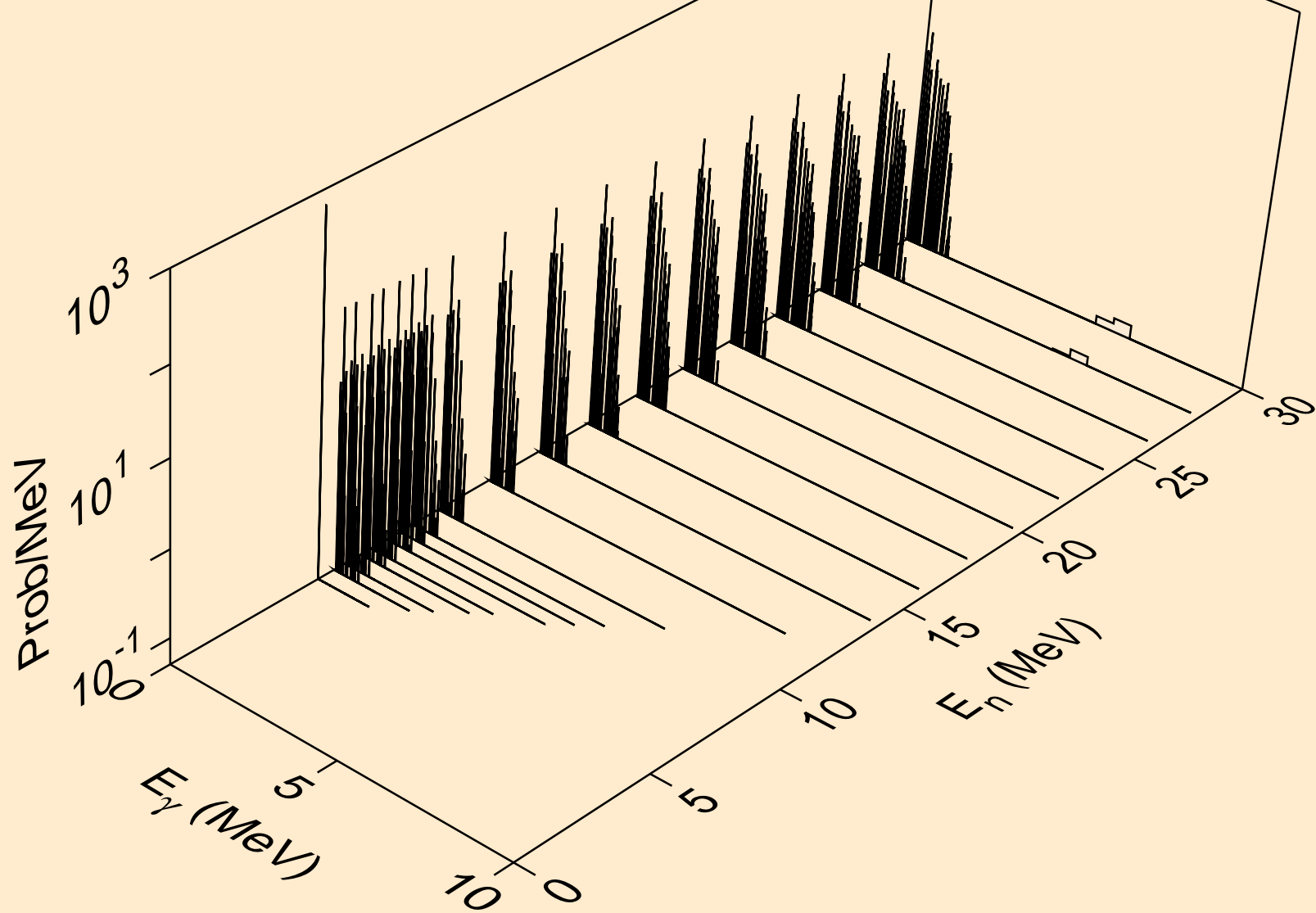

ZR080 NEUTRON ACER TENDL-2024 LIBRARY; T=293.6K
Photon emission for (n,3a)

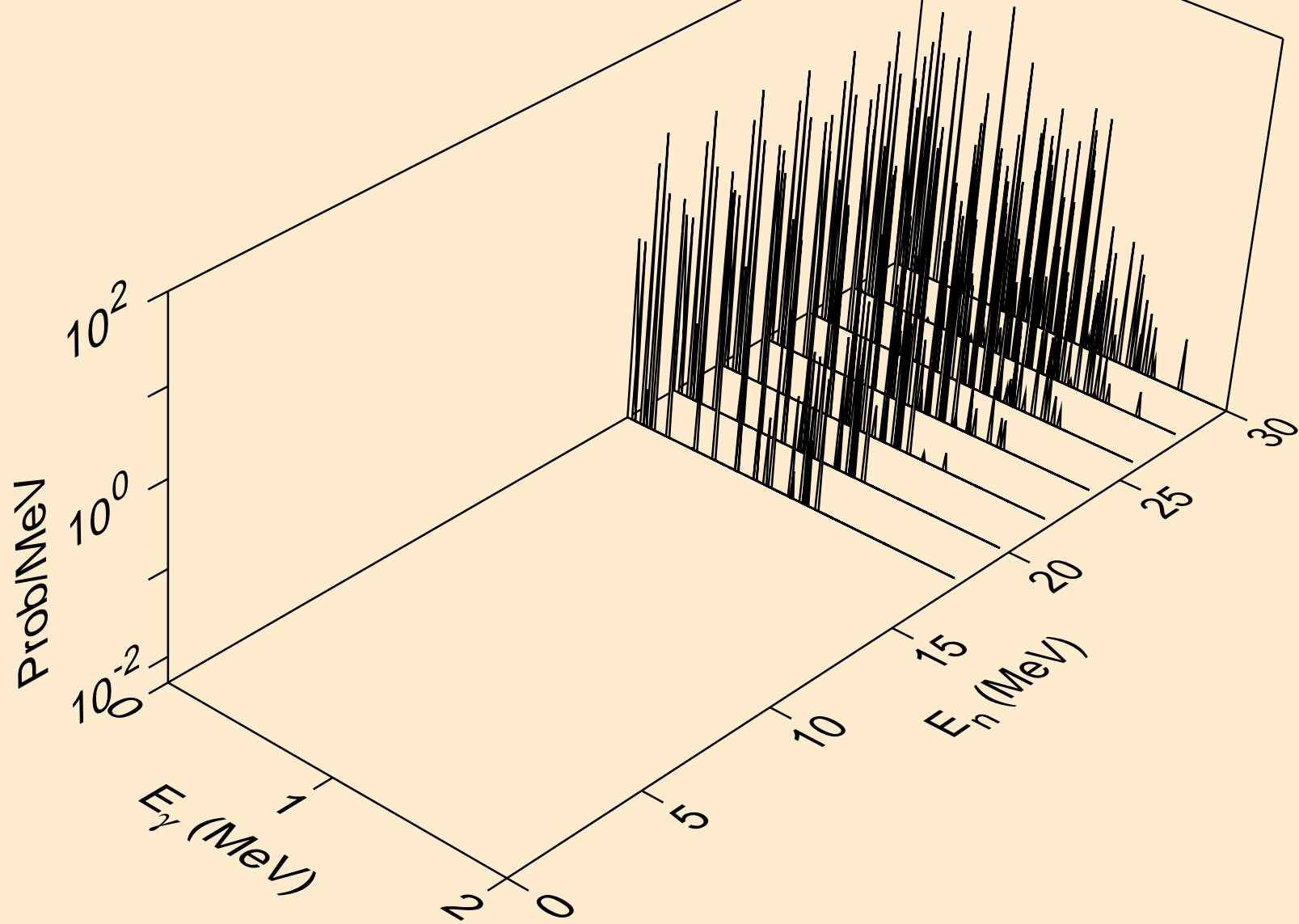

ZR080 NEUTRON ACER TENDL-2024 LIBRARY; T=293.6K
Photon emission for (n,2p)

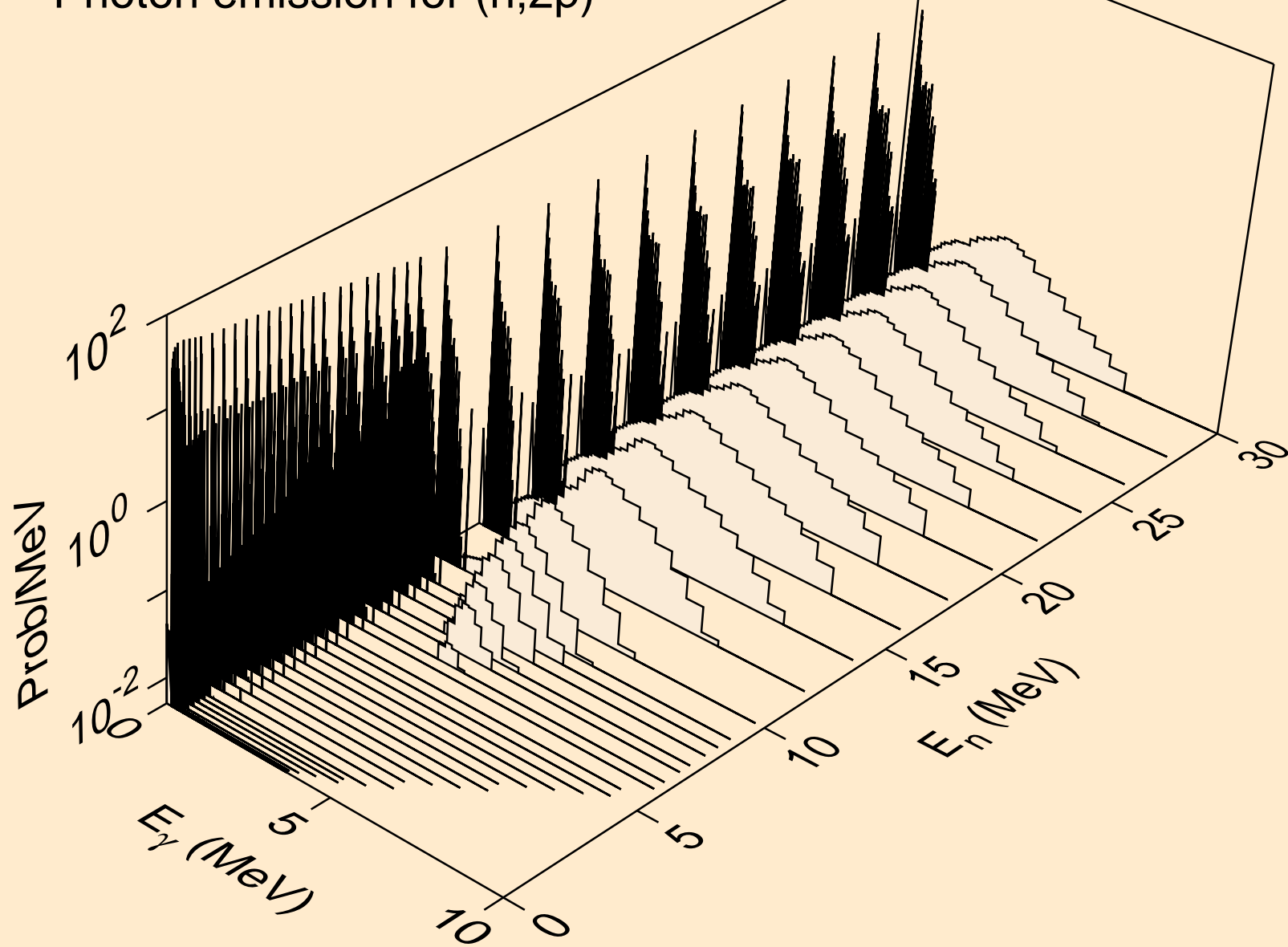

ZR080 NEUTRON ACER TENDL-2024 LIBRARY; T=293.6K
Photon emission for (n,p α)

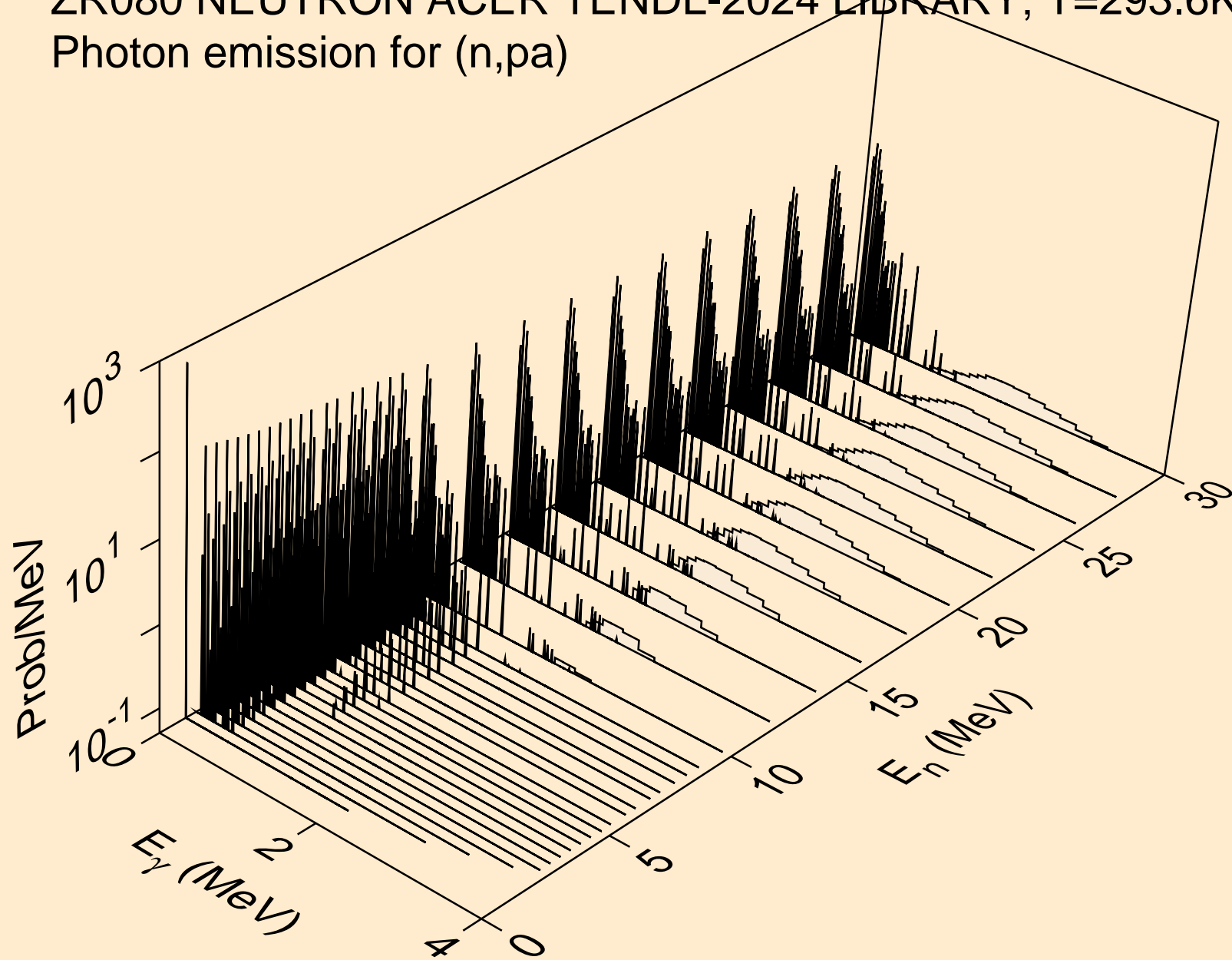

ZR080 NEUTRON ACER TENDL-2024 LIBRARY; T=293.6K
Photon emission for (n,pd)

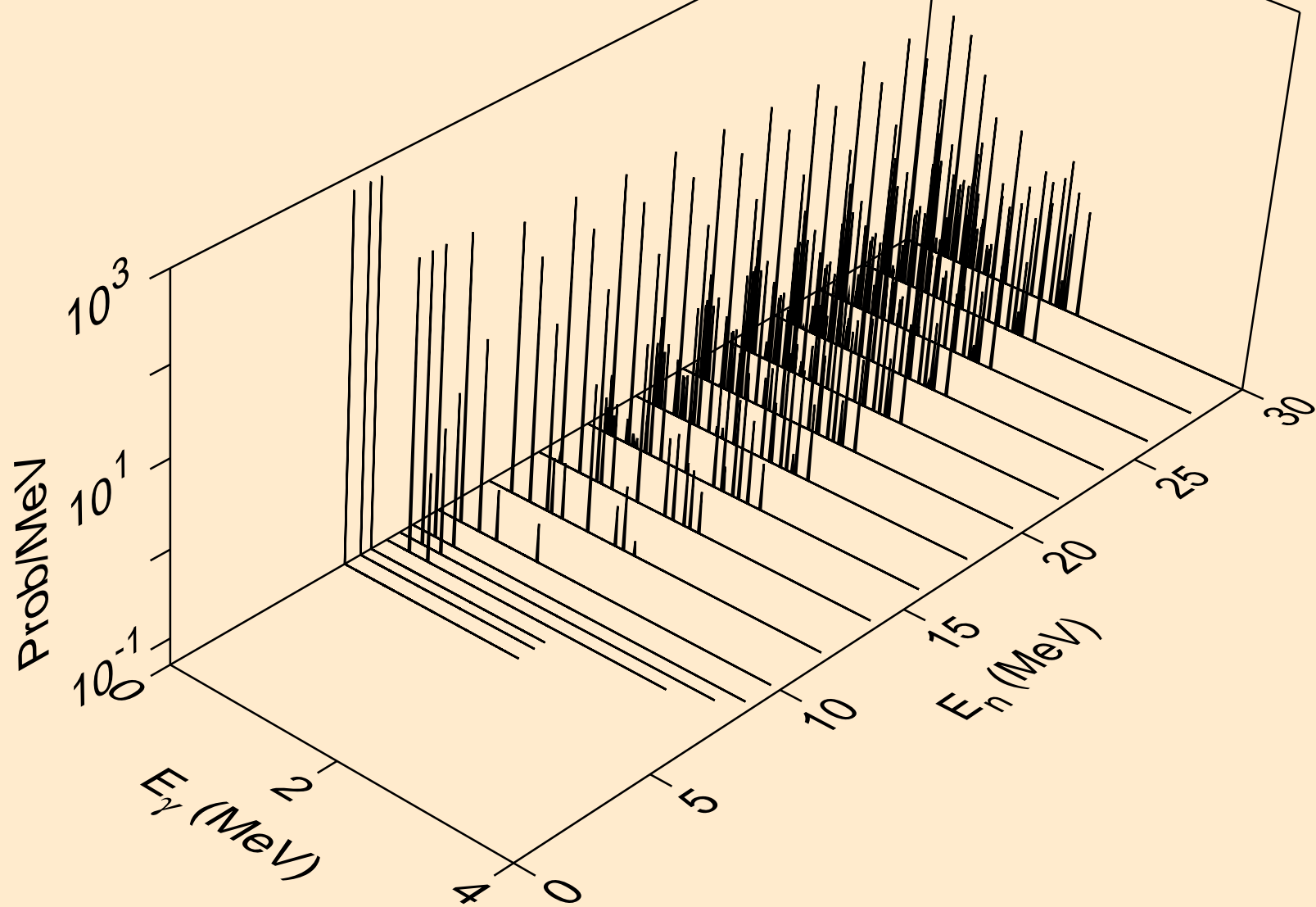

ZR080 NEUTRON ACER TENDL-2024 LIBRARY; T=293.6K
Photon emission for (n,pt)

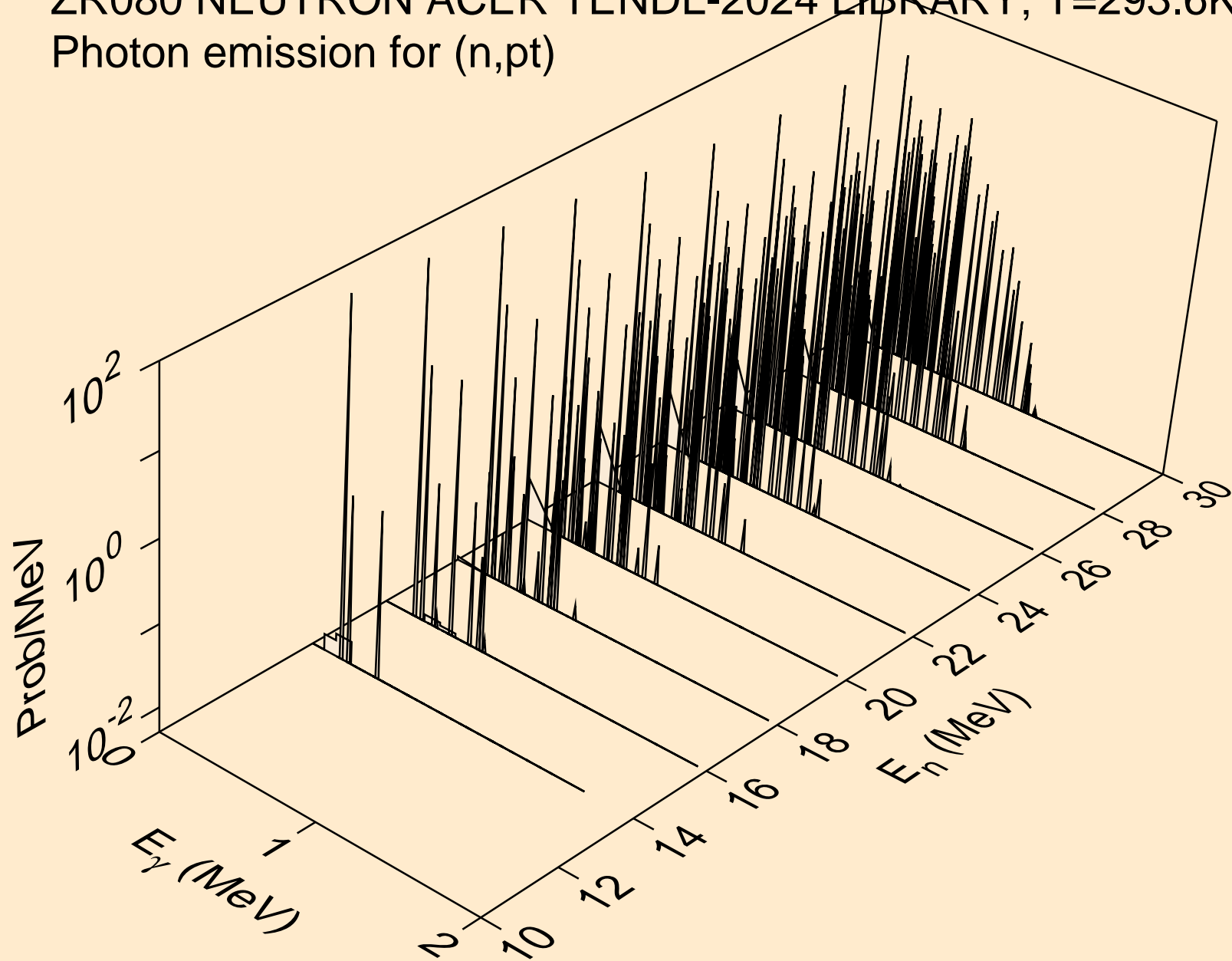

ZR080 NEUTRON ACER TENDL-2024 LIBRARY; T=293.6K
Photon emission for (n,da)

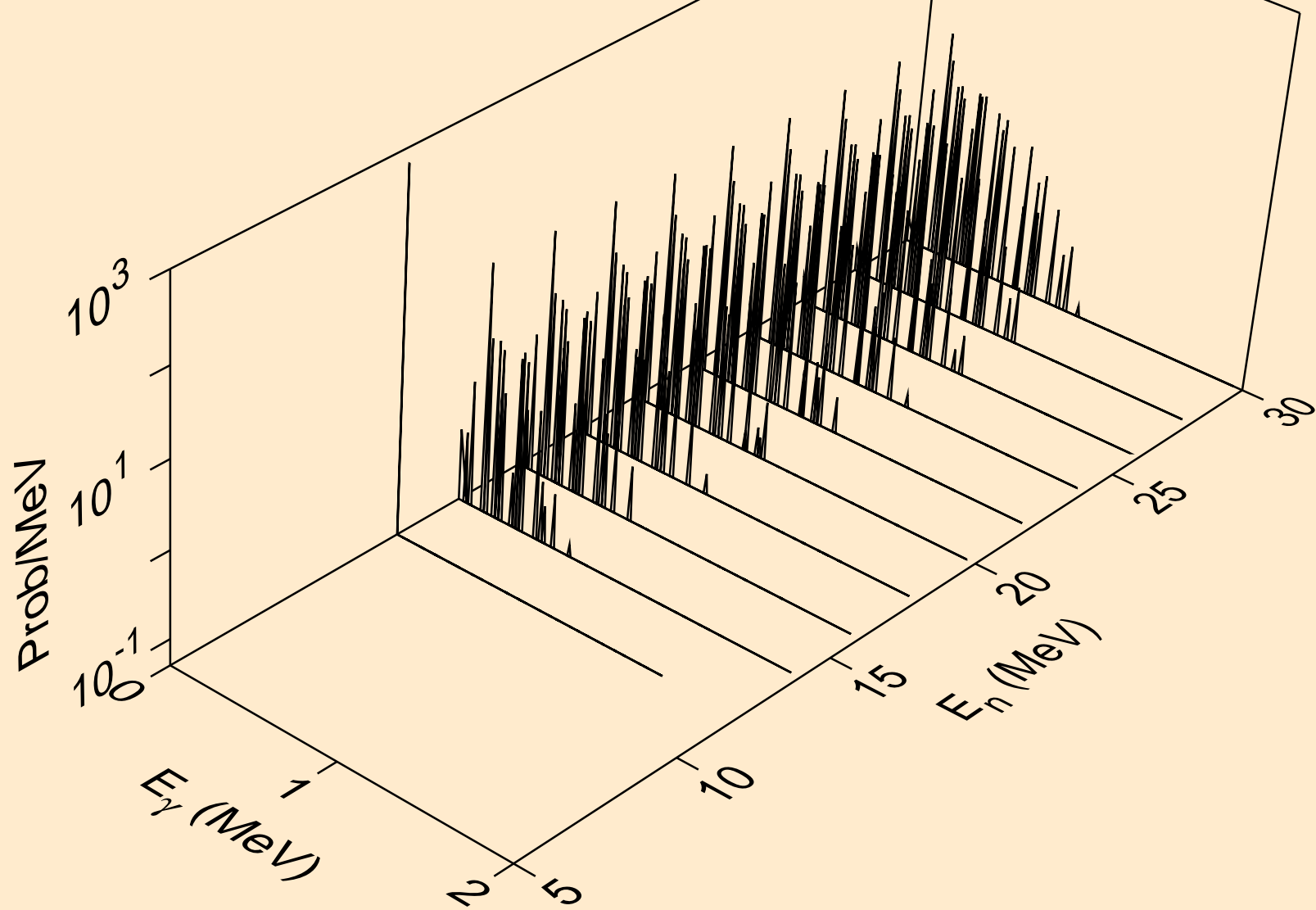

ZR080 NEUTRON ACER TENDL-2024 LIBRARY; T=293.6K
thermal capture photon spectrum

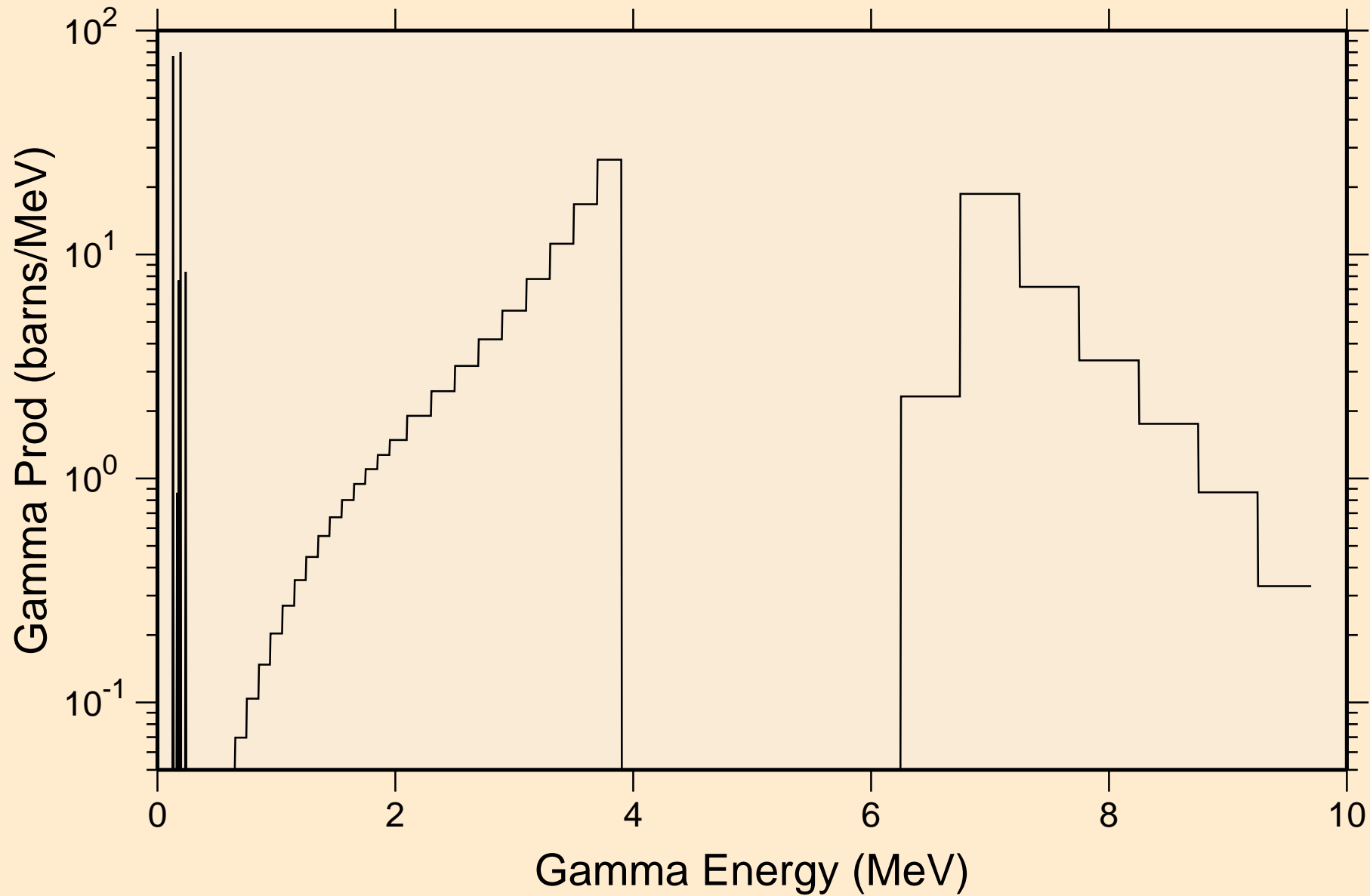

ZR080 NEUTRON ACER TENDL-2024 LIBRARY; T=293.6K
14 MeV photon spectrum

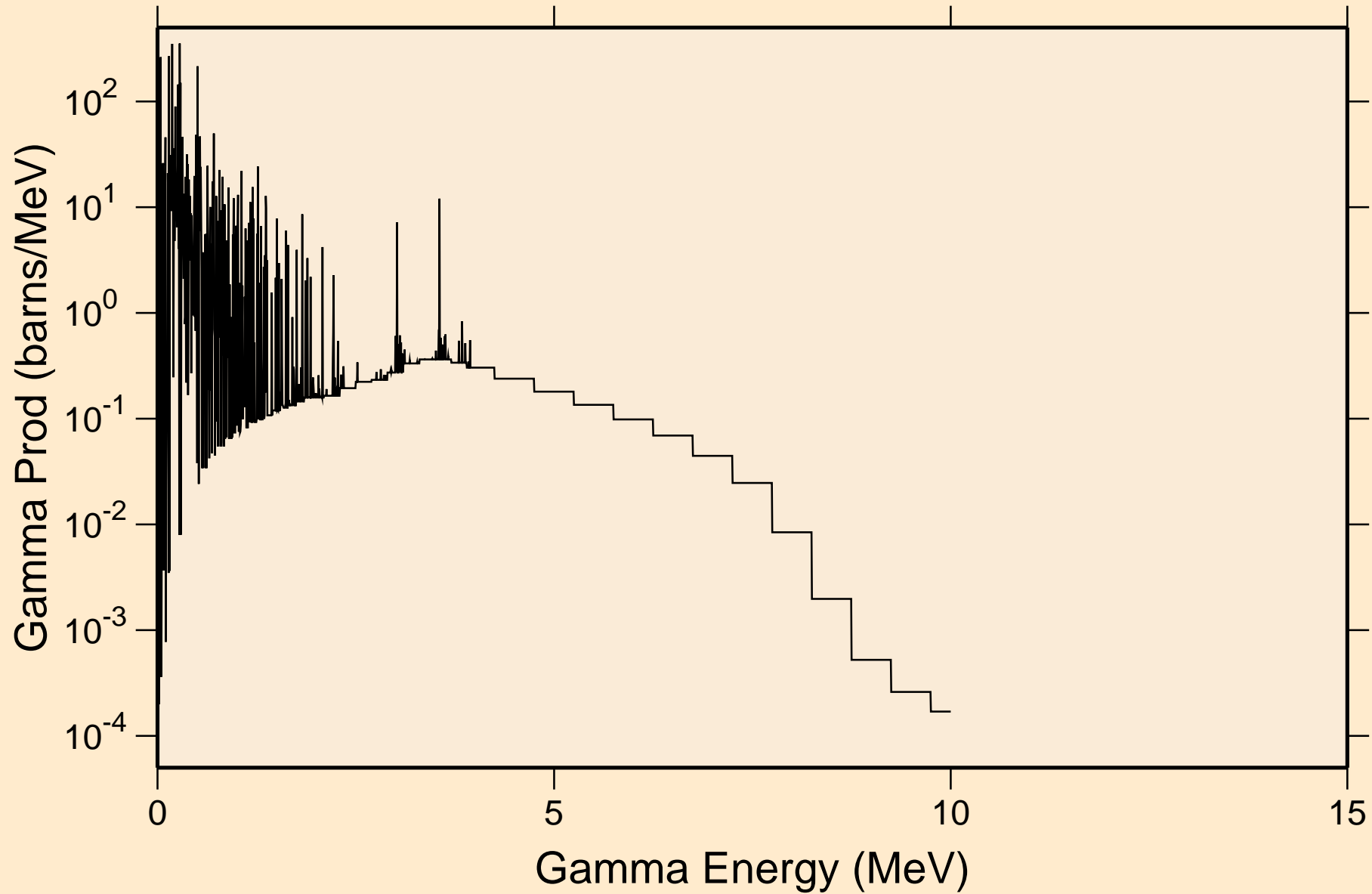

ZR080 NEUTRON ACER TENDL-2024 LIBRARY; T=293.6K

Particle heating contributions

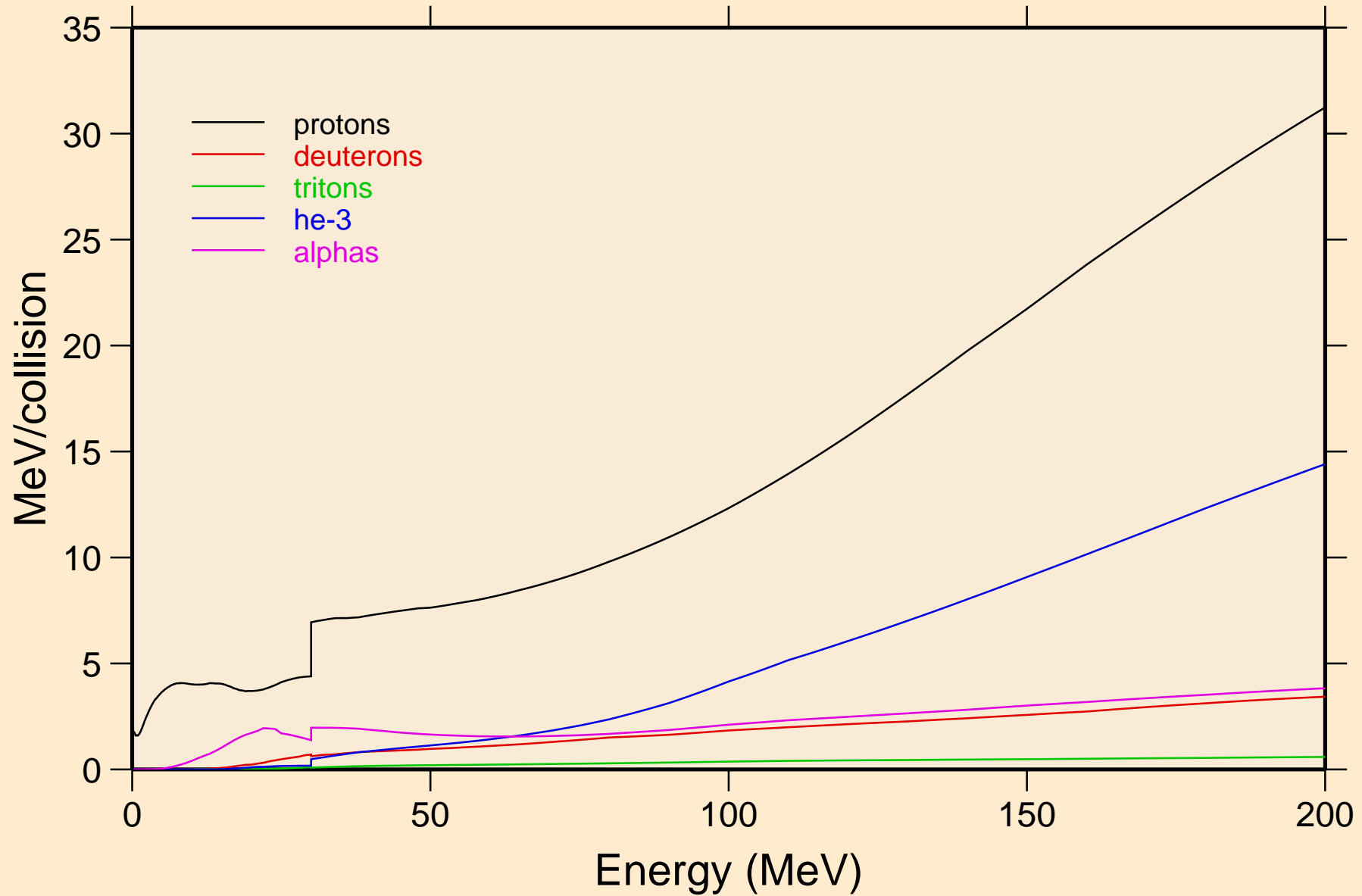

ZR080 NEUTRON ACER TENDL-2024 LIBRARY; T=293.6K
Recoil Heating

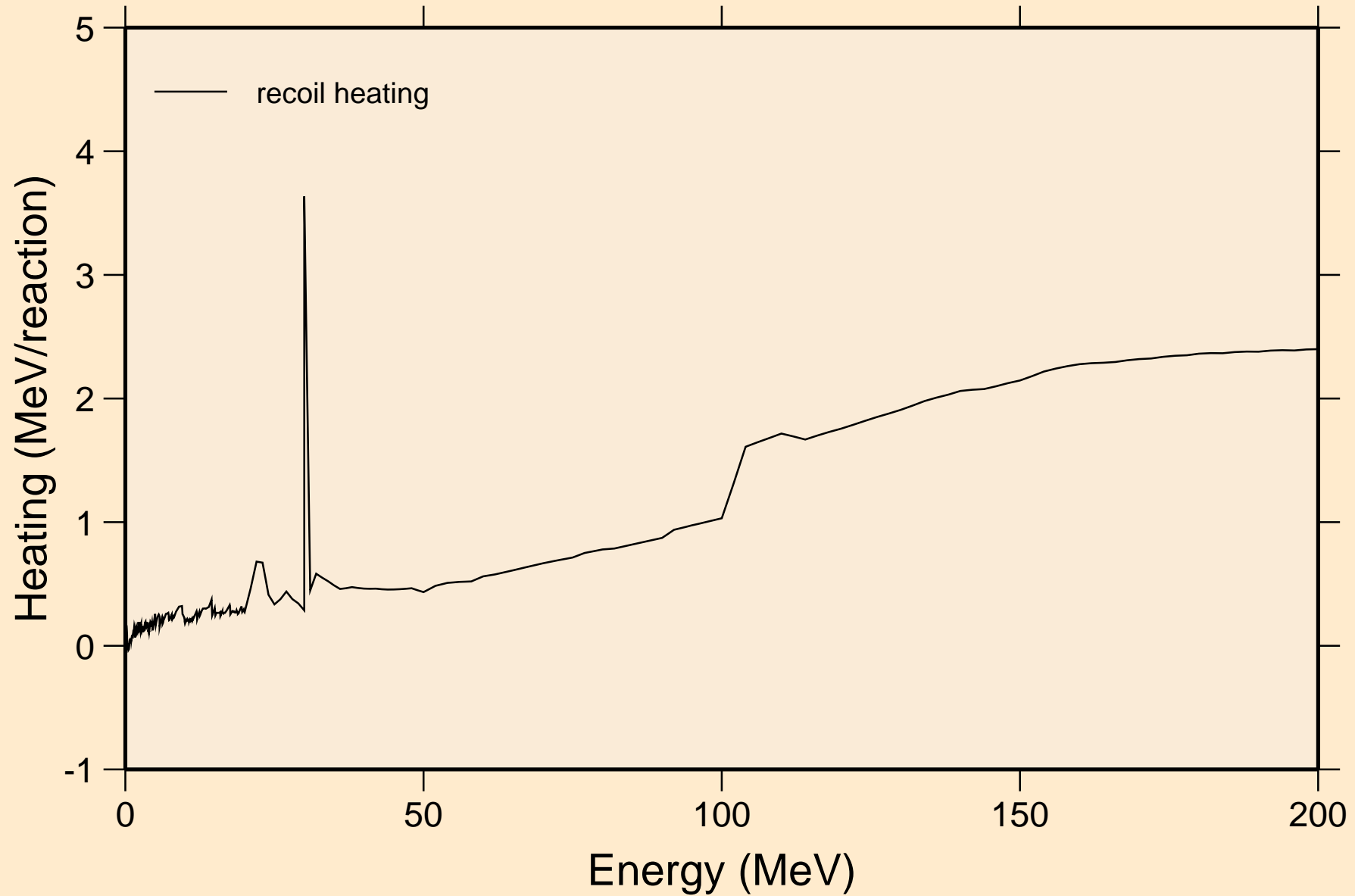

ZR080 NEUTRON ACER TENDL-2024 LIBRARY; T=293.6K

Particle production cross sections

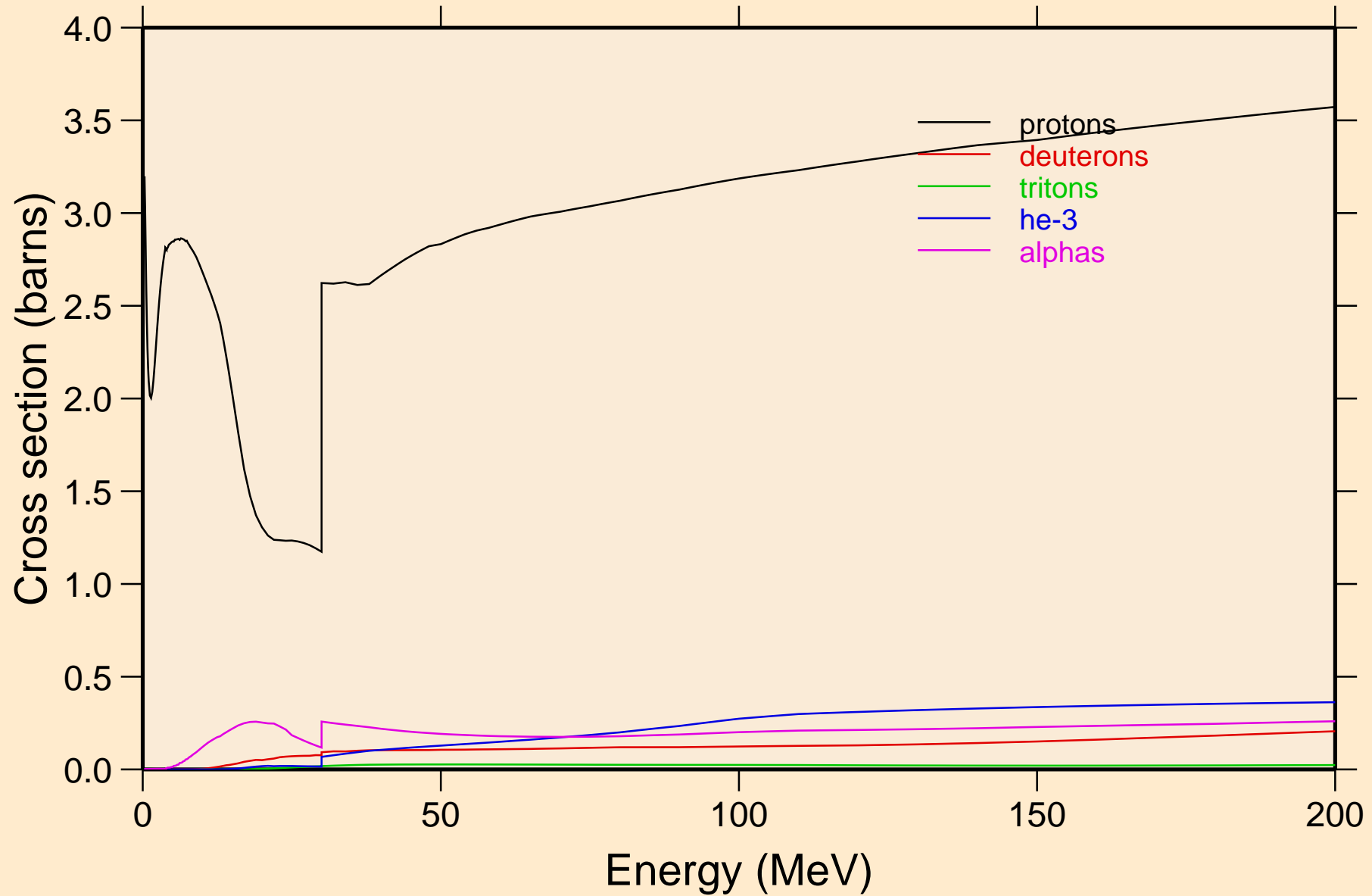

ZR080 NEUTRON ACER TENDL-2024 LIBRARY; T=293.6K
protons from (n,x)

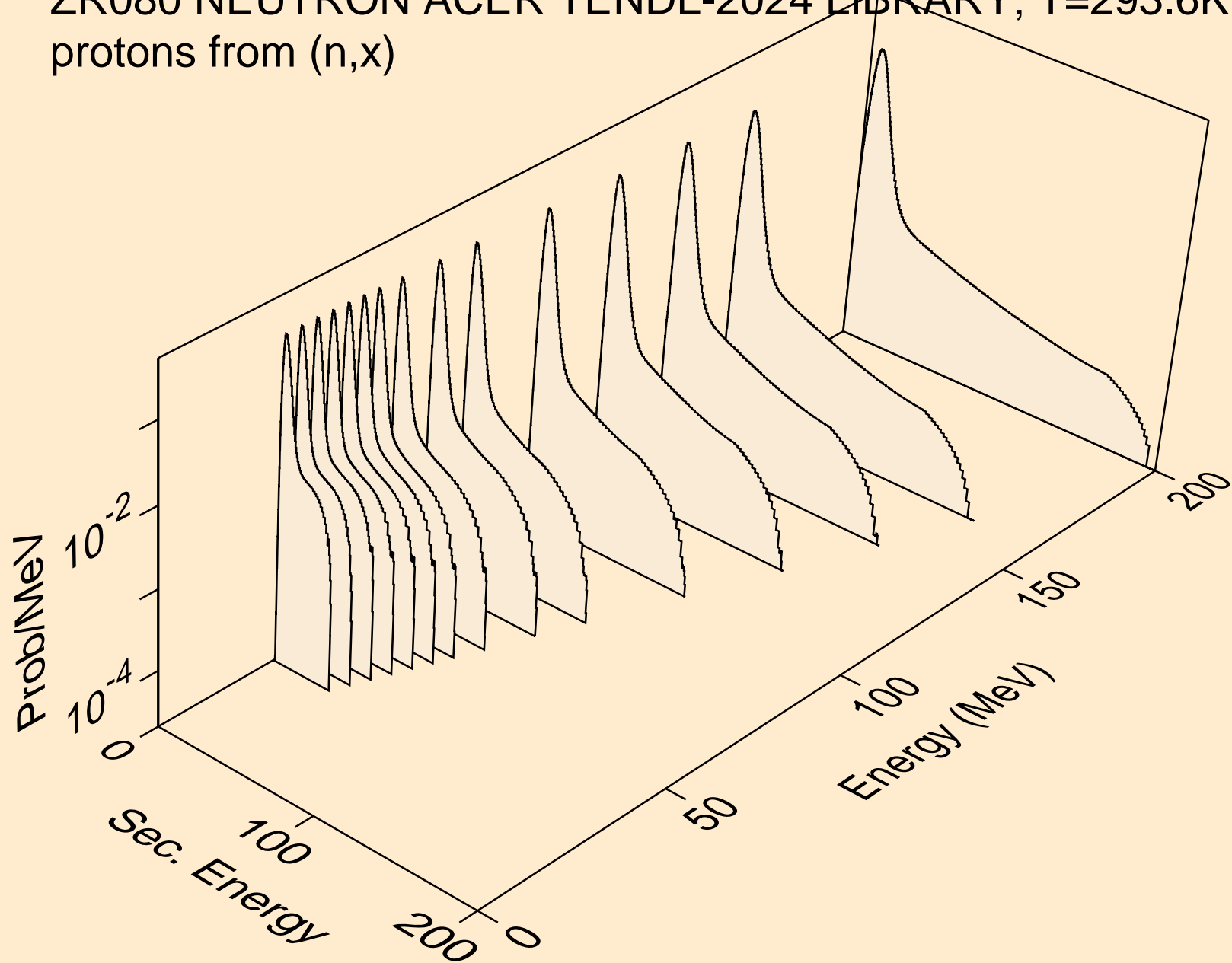

ZR080 NEUTRON ACER TENDL-2024 LIBRARY; T=293.6K
protons from (n,n*)p

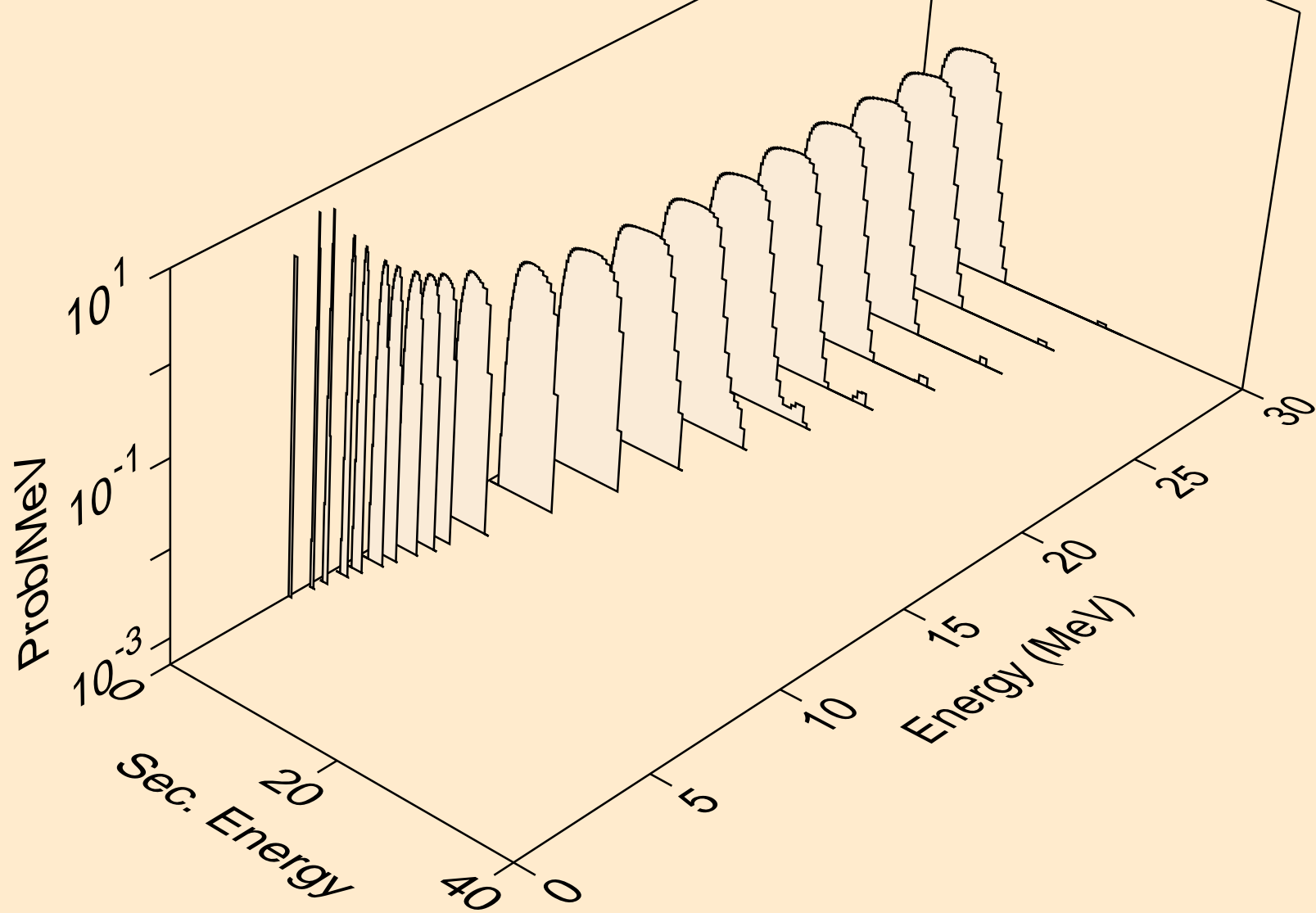

ZR080 NEUTRON ACER TENDL-2024 LIBRARY; T=293.6K
protons from (n,2np)

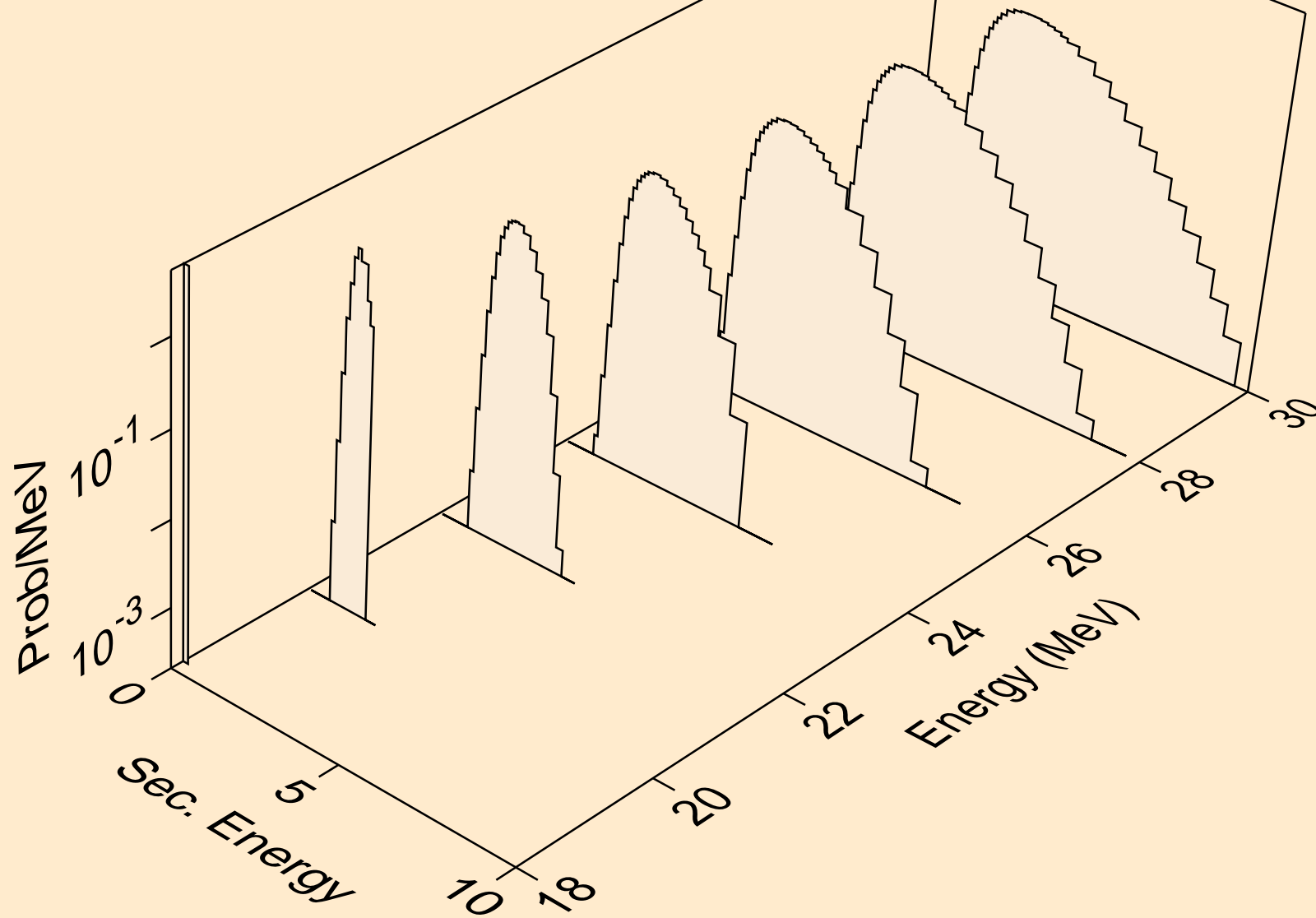

ZR080 NEUTRON ACER TENDL-2024 LIBRARY; T=293.6K
protons from (n,n2p)

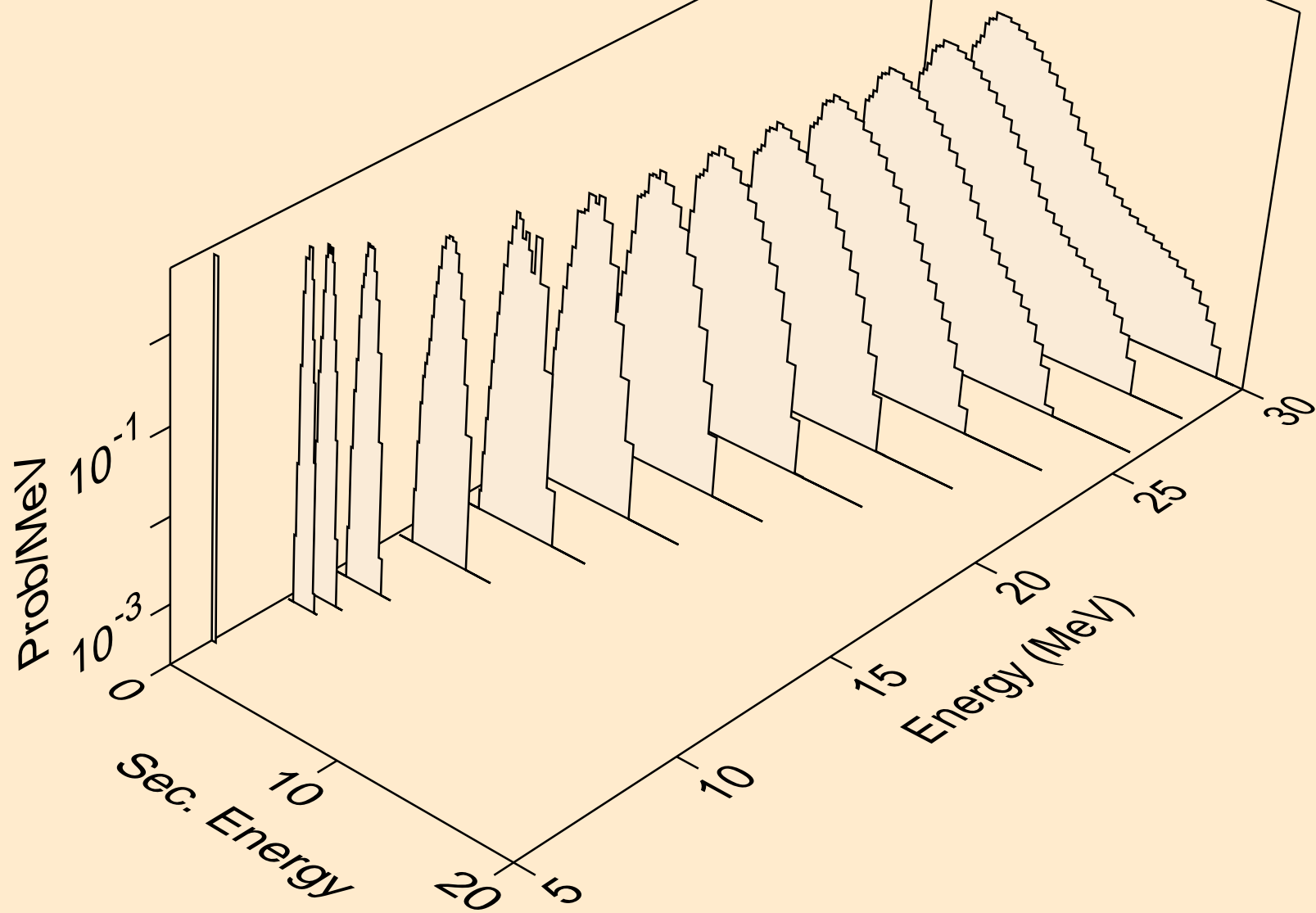

ZR080 NEUTRON ACER TENDL-2024 LIBRARY; T=293.6K
protons from (n,npa)

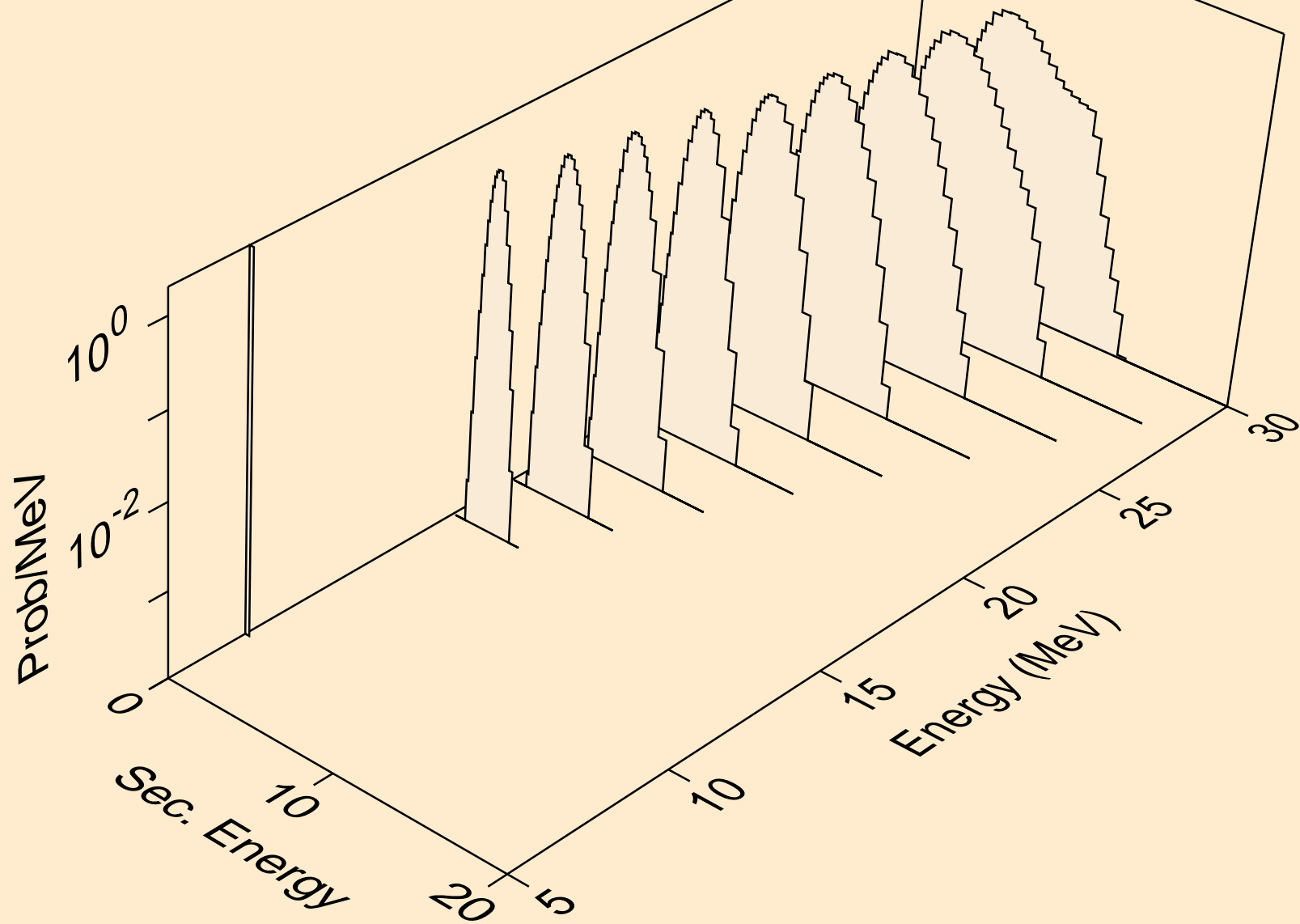

ZR080 NEUTRON ACER TENDL-2024 LIBRARY; T=293.6K
protons from (n,p)

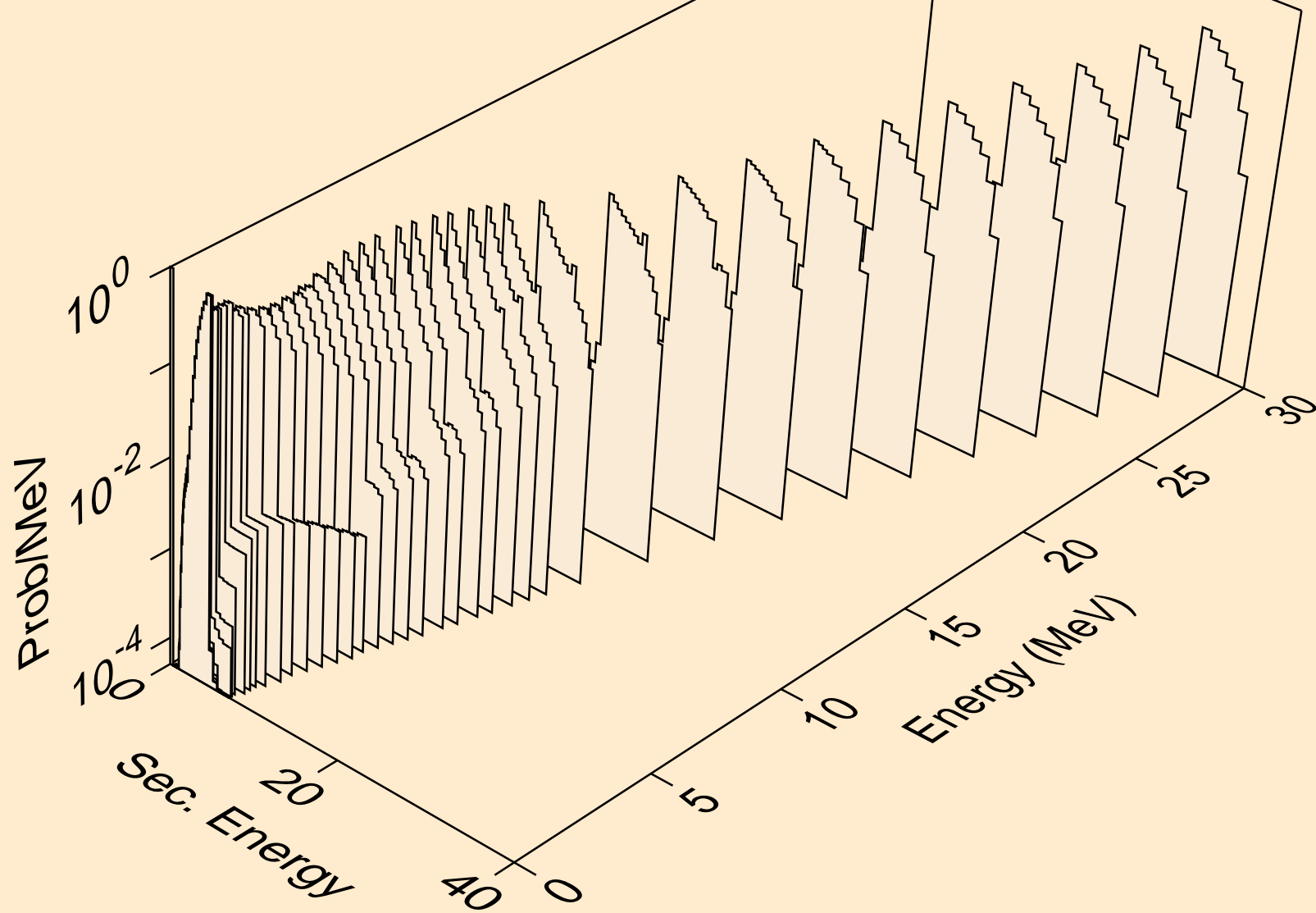

ZR080 NEUTRON ACER TENDL-2024 LIBRARY; T=293.6K
protons from (n,2p)

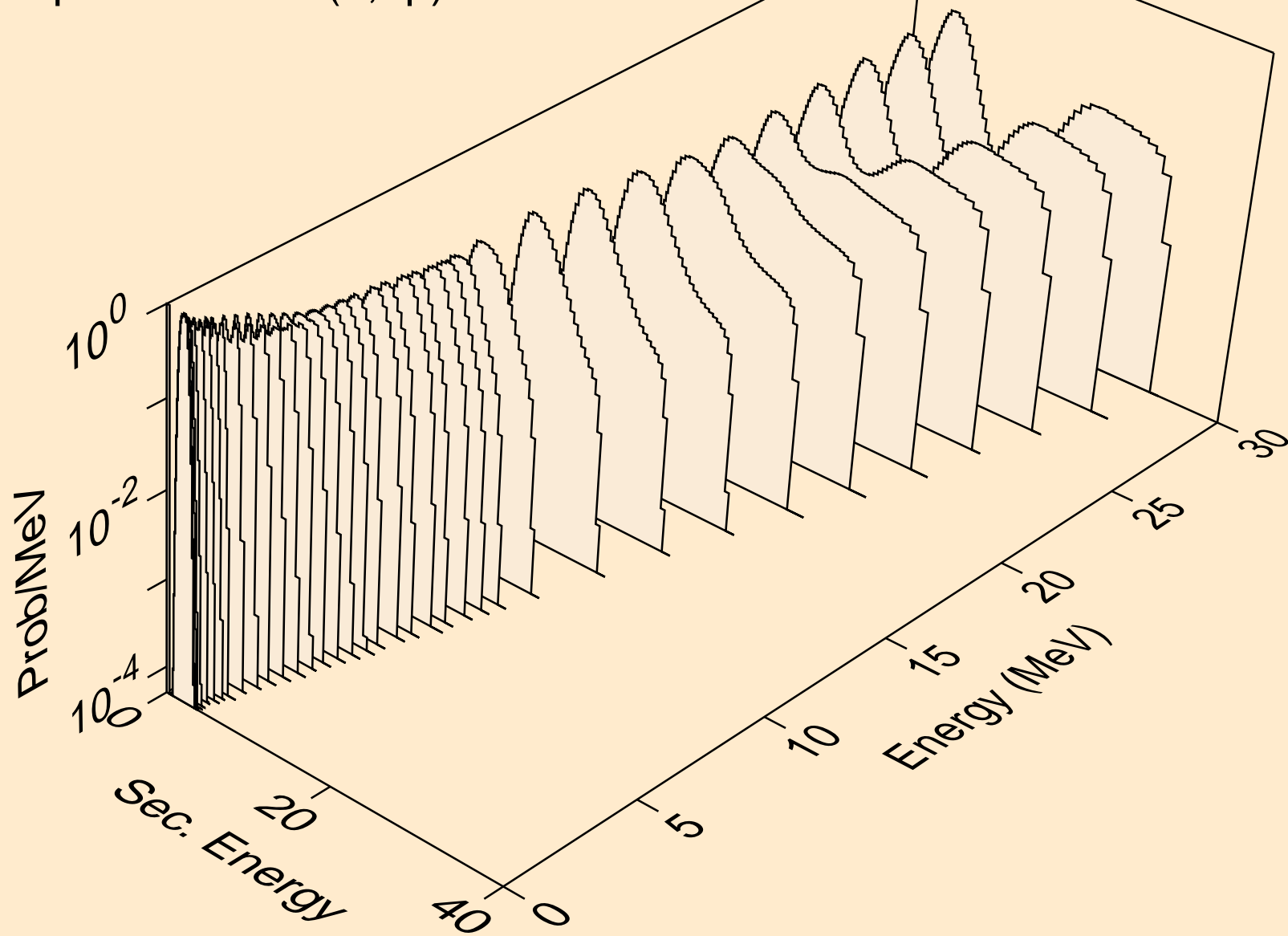

ZR080 NEUTRON ACER TENDL-2024 LIBRARY; T=293.6K
protons from (n,p)

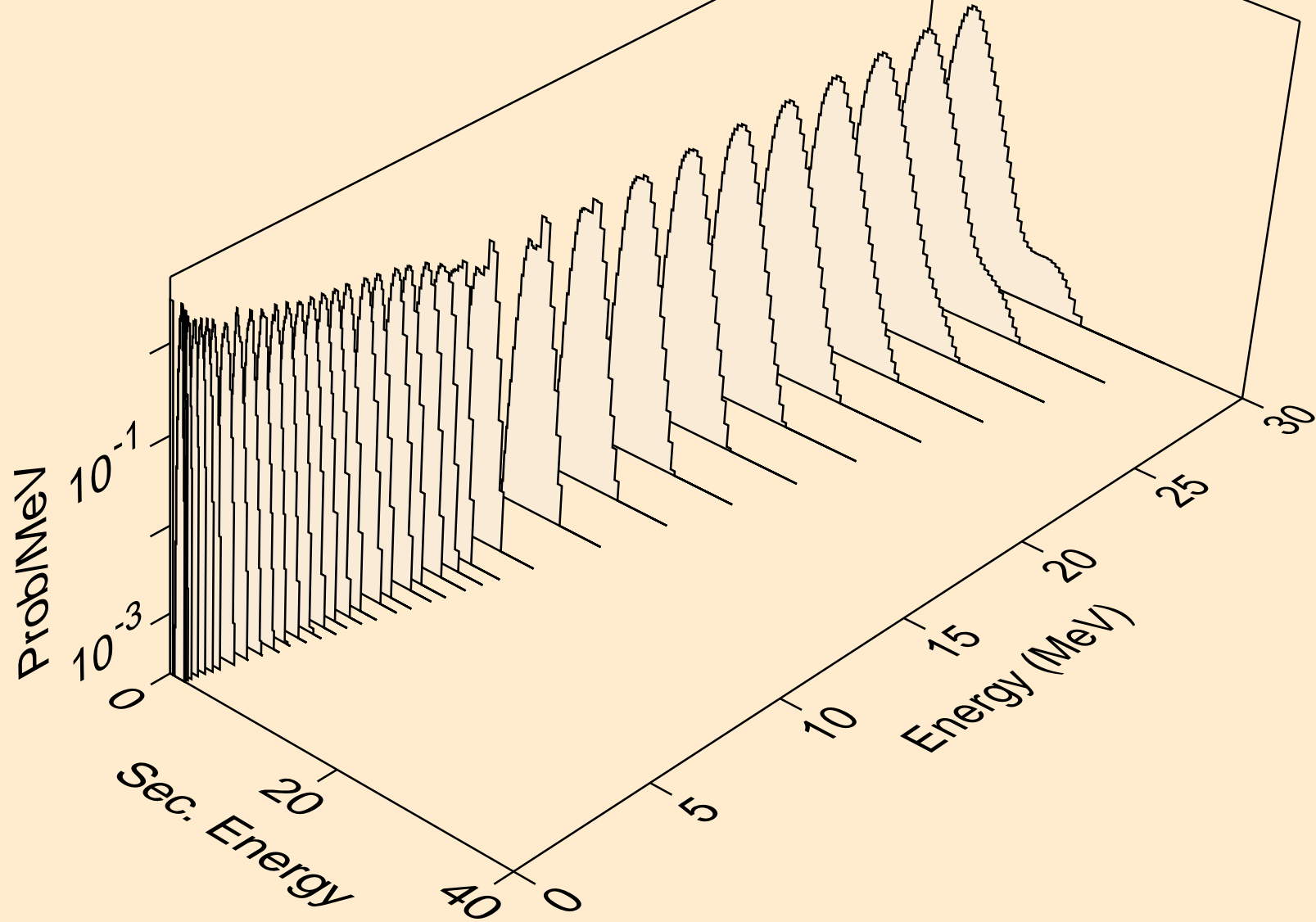

ZR080 NEUTRON ACER TENDL-2024 LIBRARY; T=293.6K
protons from (n,pd)

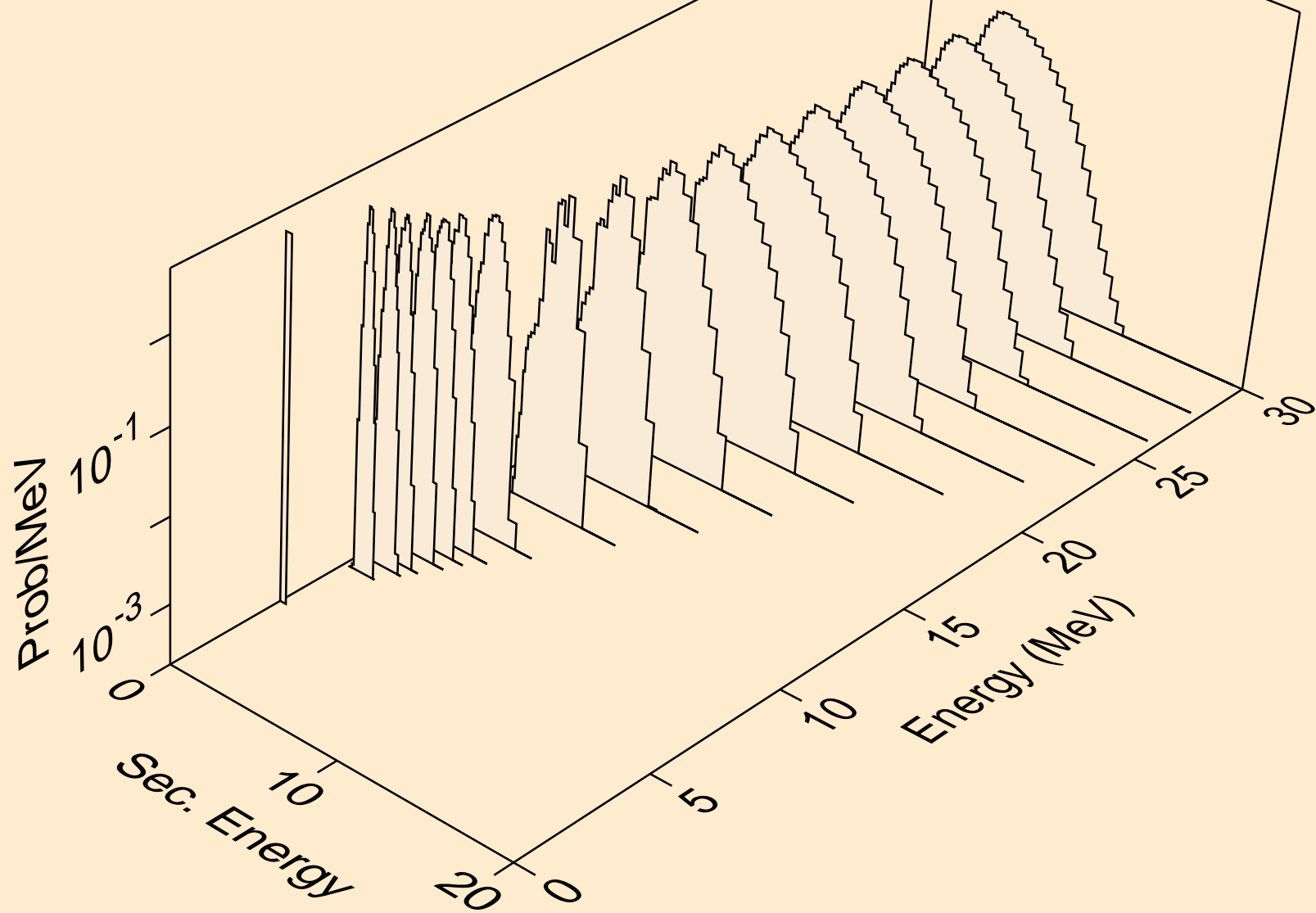

ZR080 NEUTRON ACER TENDL-2024 LIBRARY; T=293.6K
protons from (n,pt)

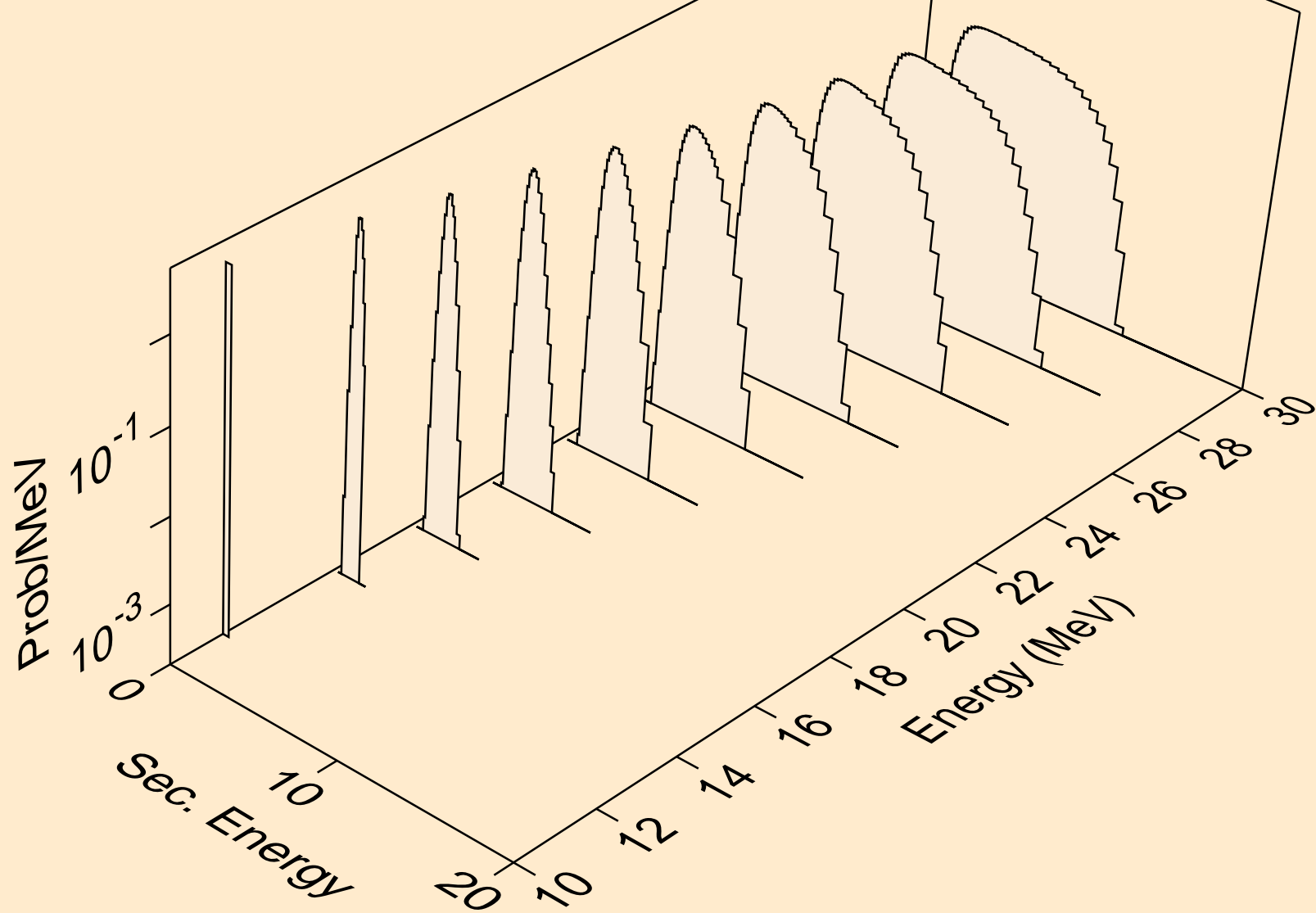

ZR080 NEUTRON ACER TENDL-2024 LIBRARY; T=293.6K
deuterons from (n,x)

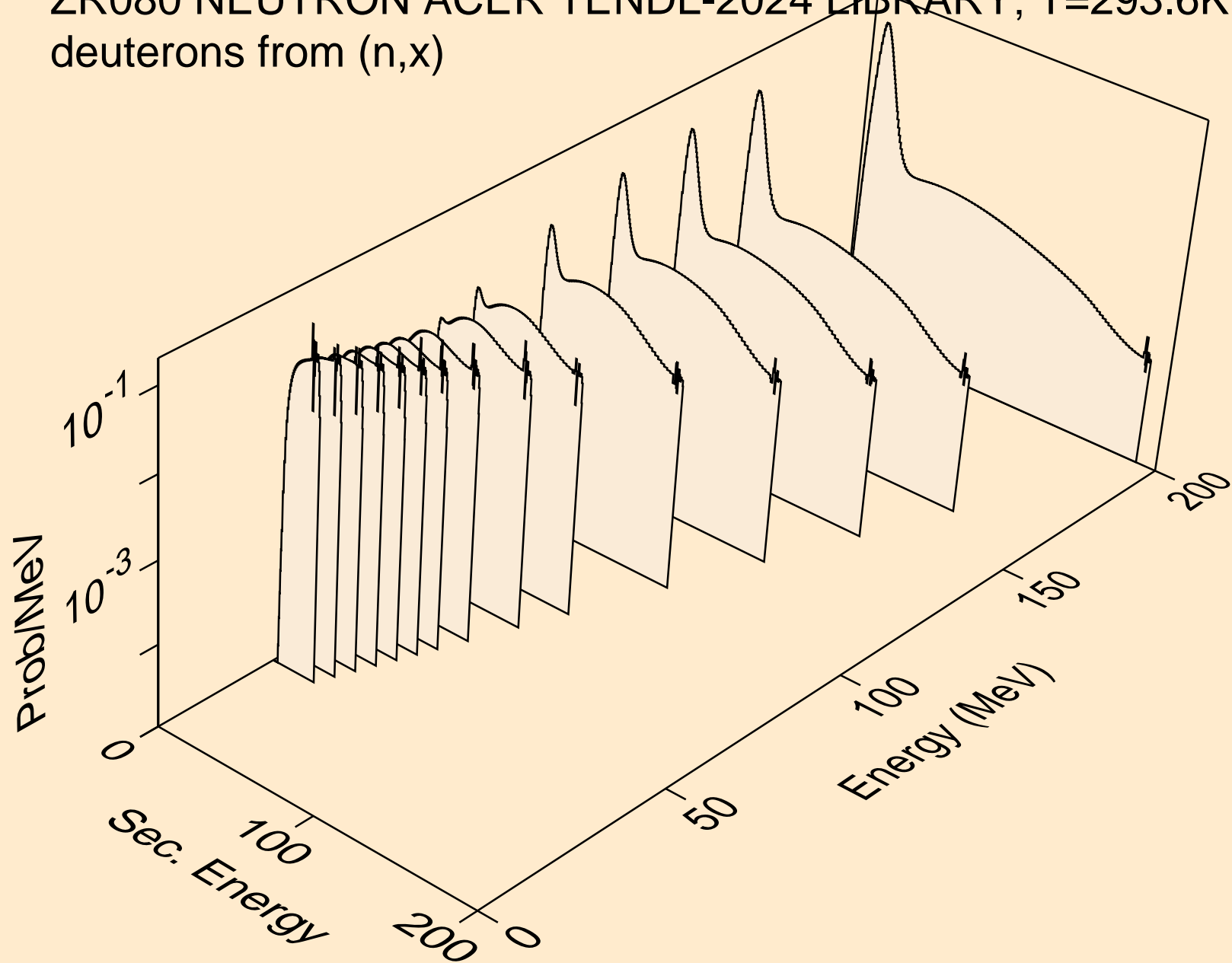

ZR080 NEUTRON ACER TENDL-2024 LIBRARY; T=293.6K
deuterons from (n,n*)d

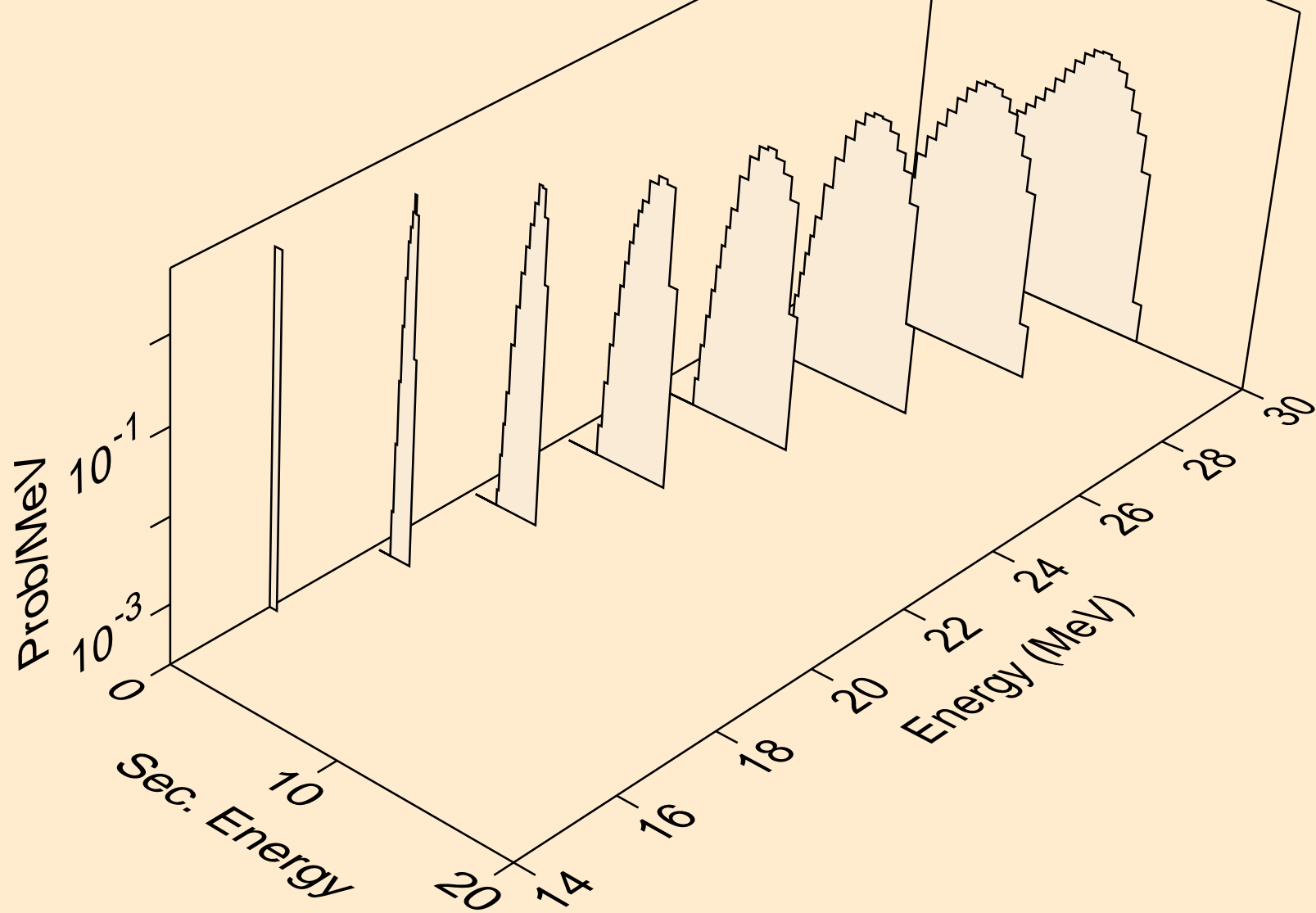

ZR080 NEUTRON ACER TENDL-2024 LIBRARY; T=293.6K
deuterons from (n,d)

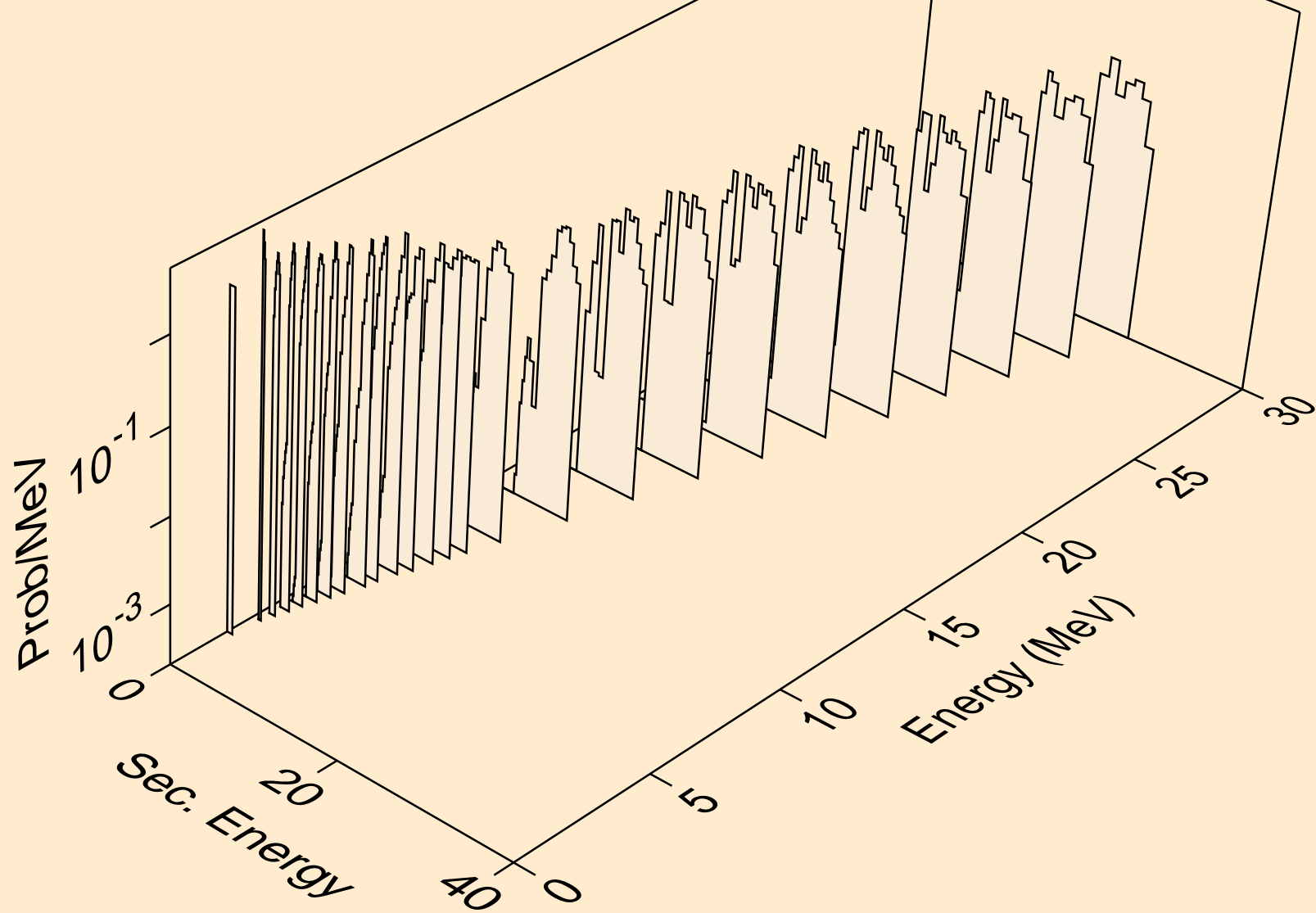

ZR080 NEUTRON ACER TENDL-2024 LIBRARY; T=293.6K
deuterons from (n,pd)

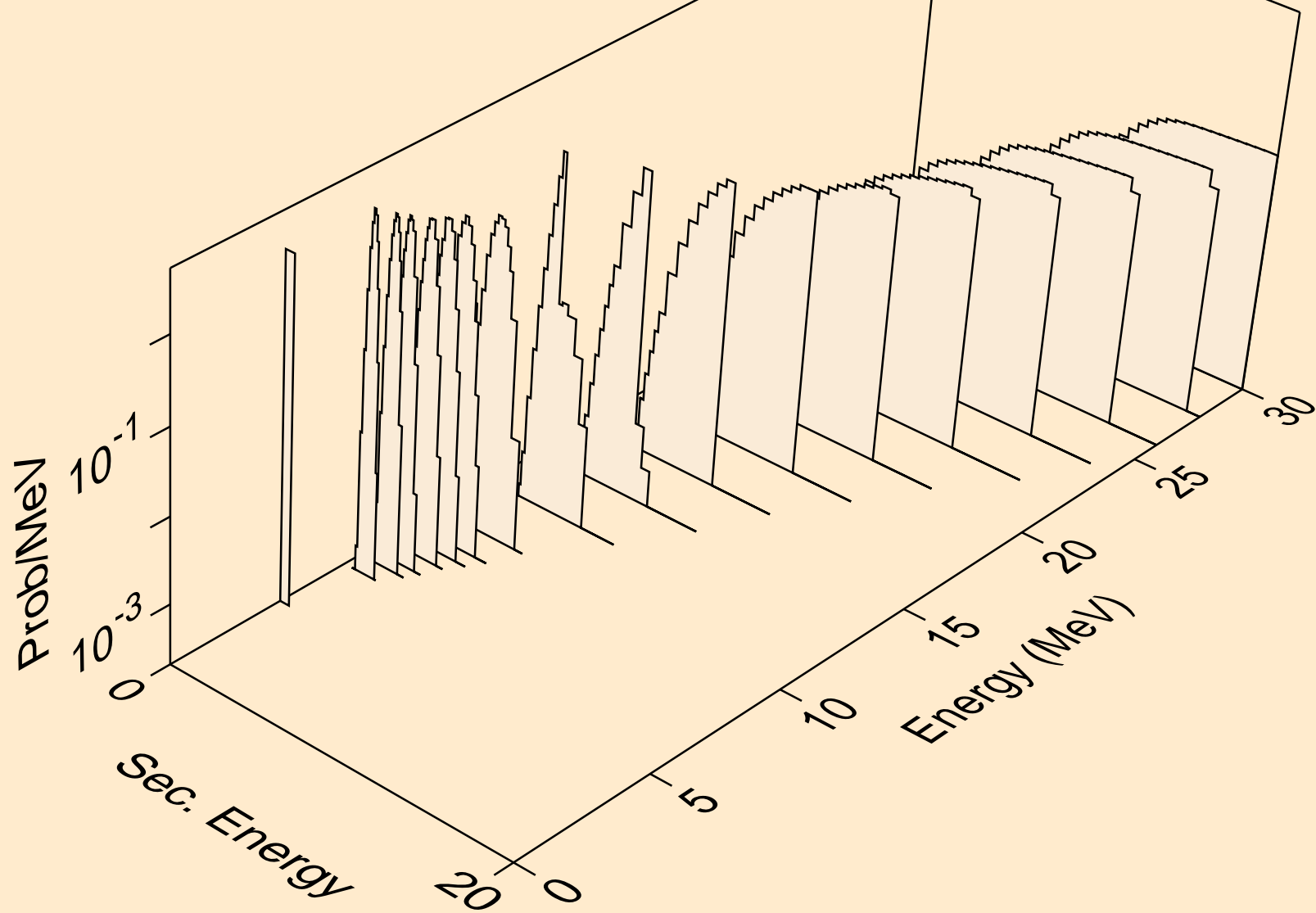

ZR080 NEUTRON ACER TENDL-2024 LIBRARY; T=293.6K
deuterons from (n,da)

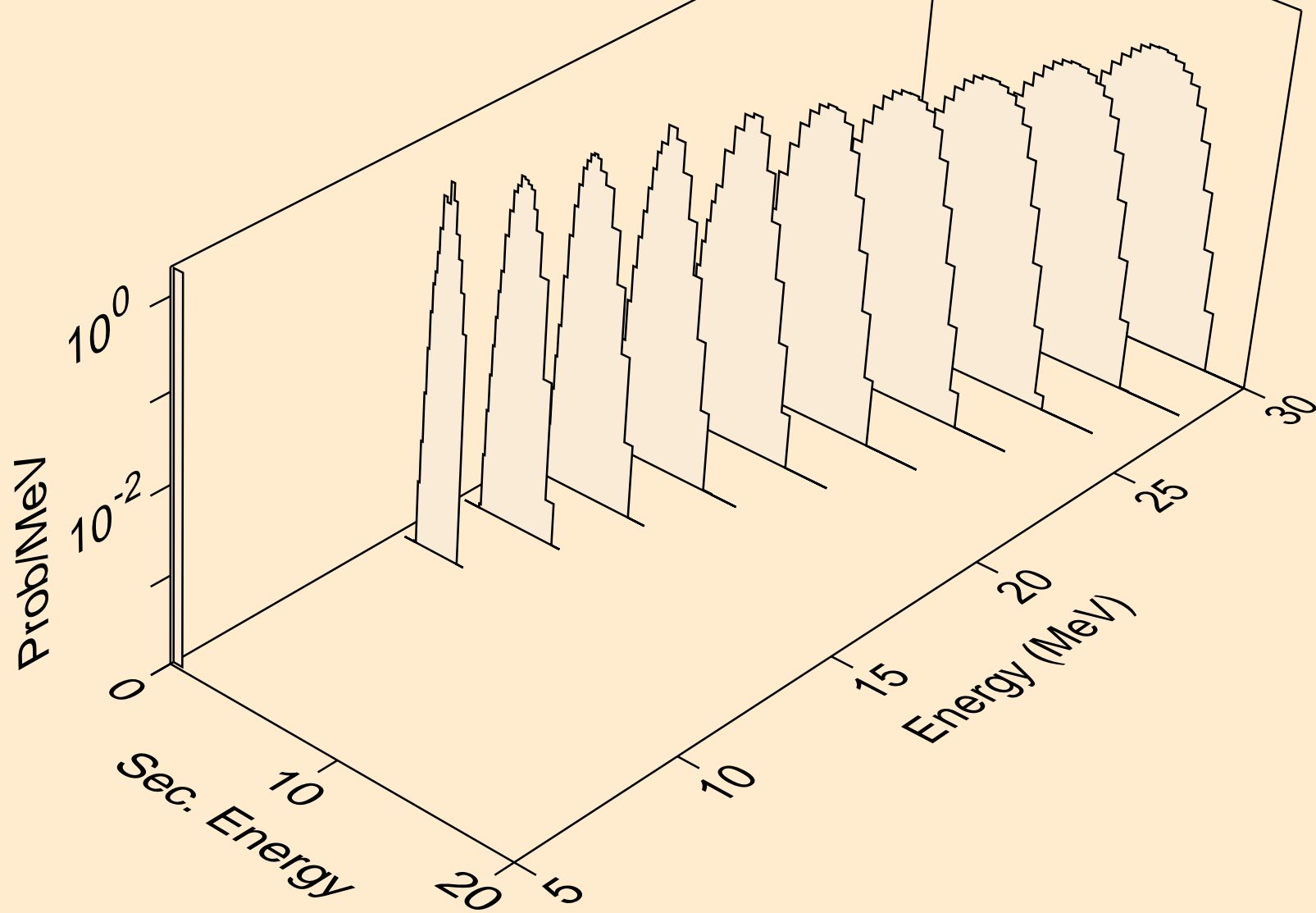

ZR080 NEUTRON ACER TENDL-2024 LIBRARY; T=293.6K
tritons from (n,x)

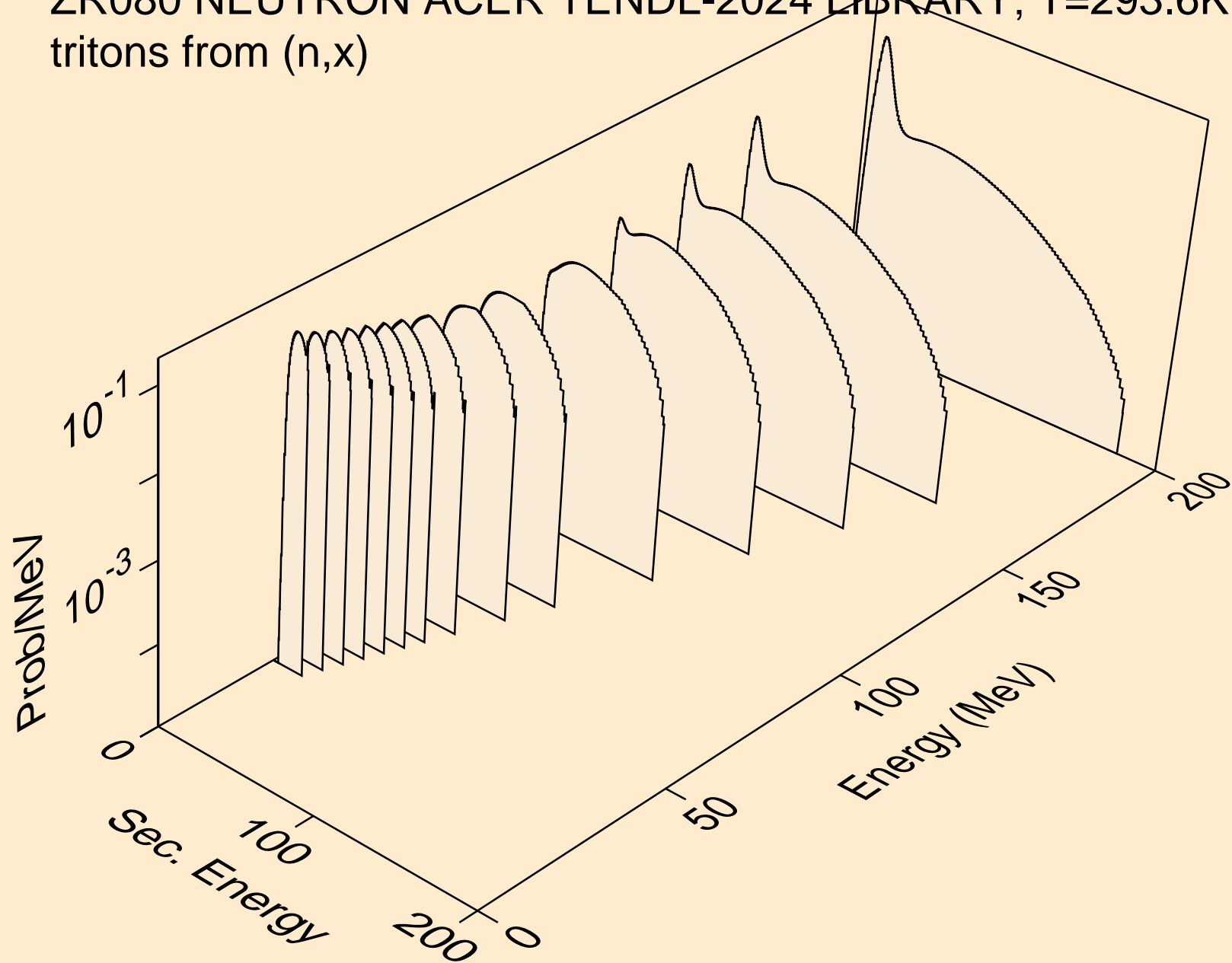

ZR080 NEUTRON ACER TENDL-2024 LIBRARY; T=293.6K
tritons from (n,n*)t

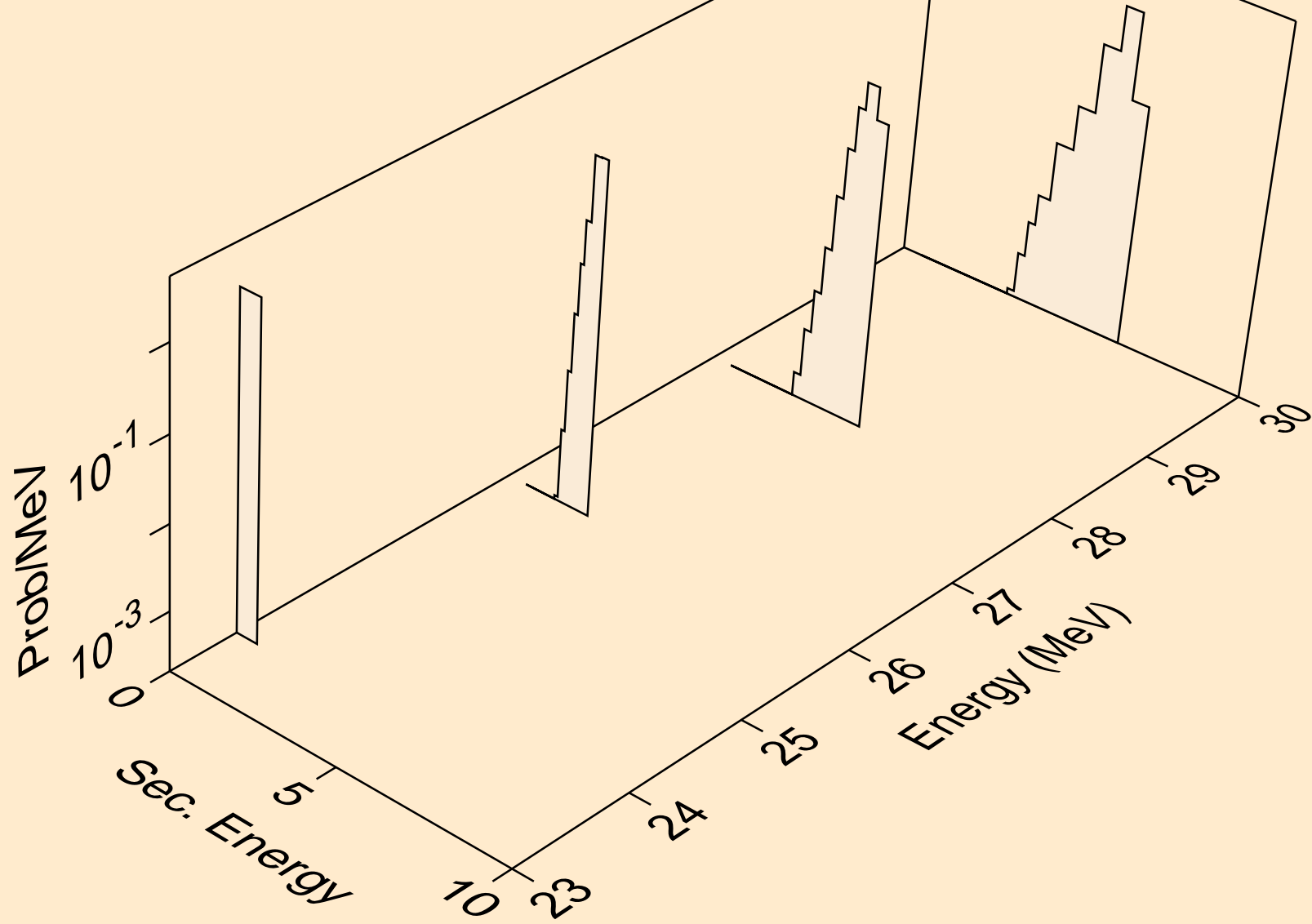

ZR080 NEUTRON ACER TENDL-2024 LIBRARY; T=293.6K
tritons from (n,t)

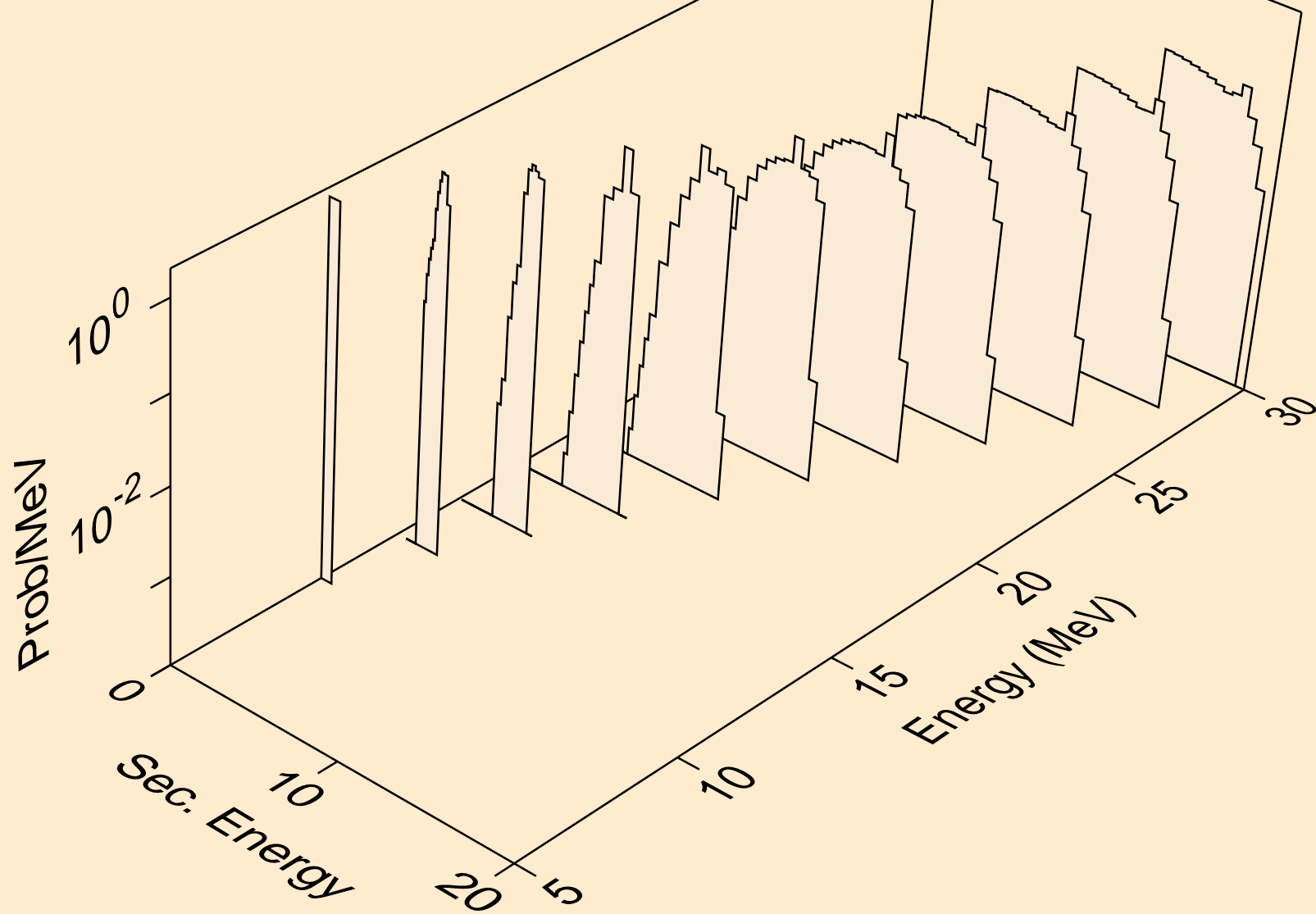

ZR080 NEUTRON ACER TENDL-2024 LIBRARY; T=293.6K
tritons from (n,pt)

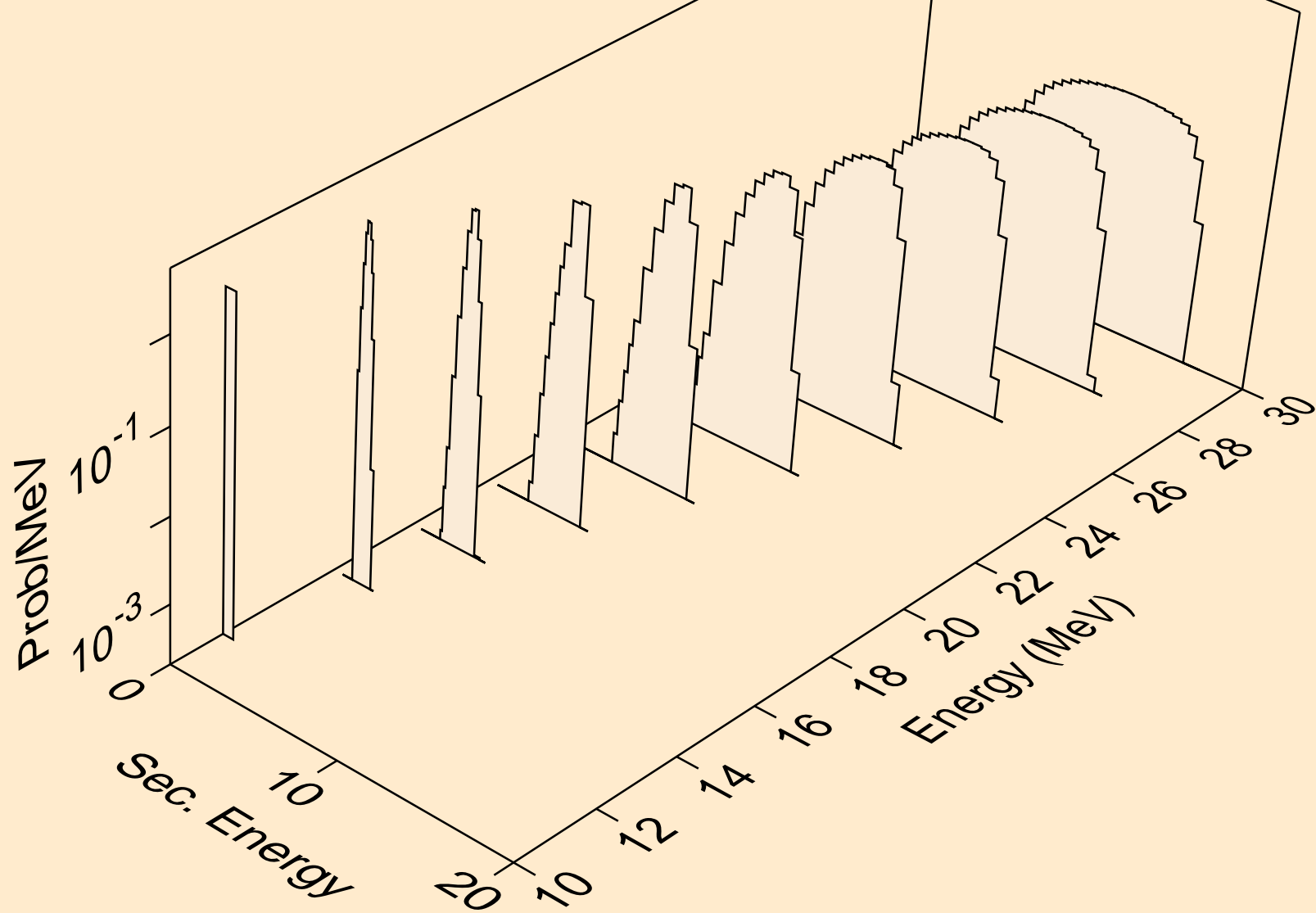

ZR080 NEUTRON ACER TENDL-2024 LIBRARY; T=293.6K
he3s from (n,x)

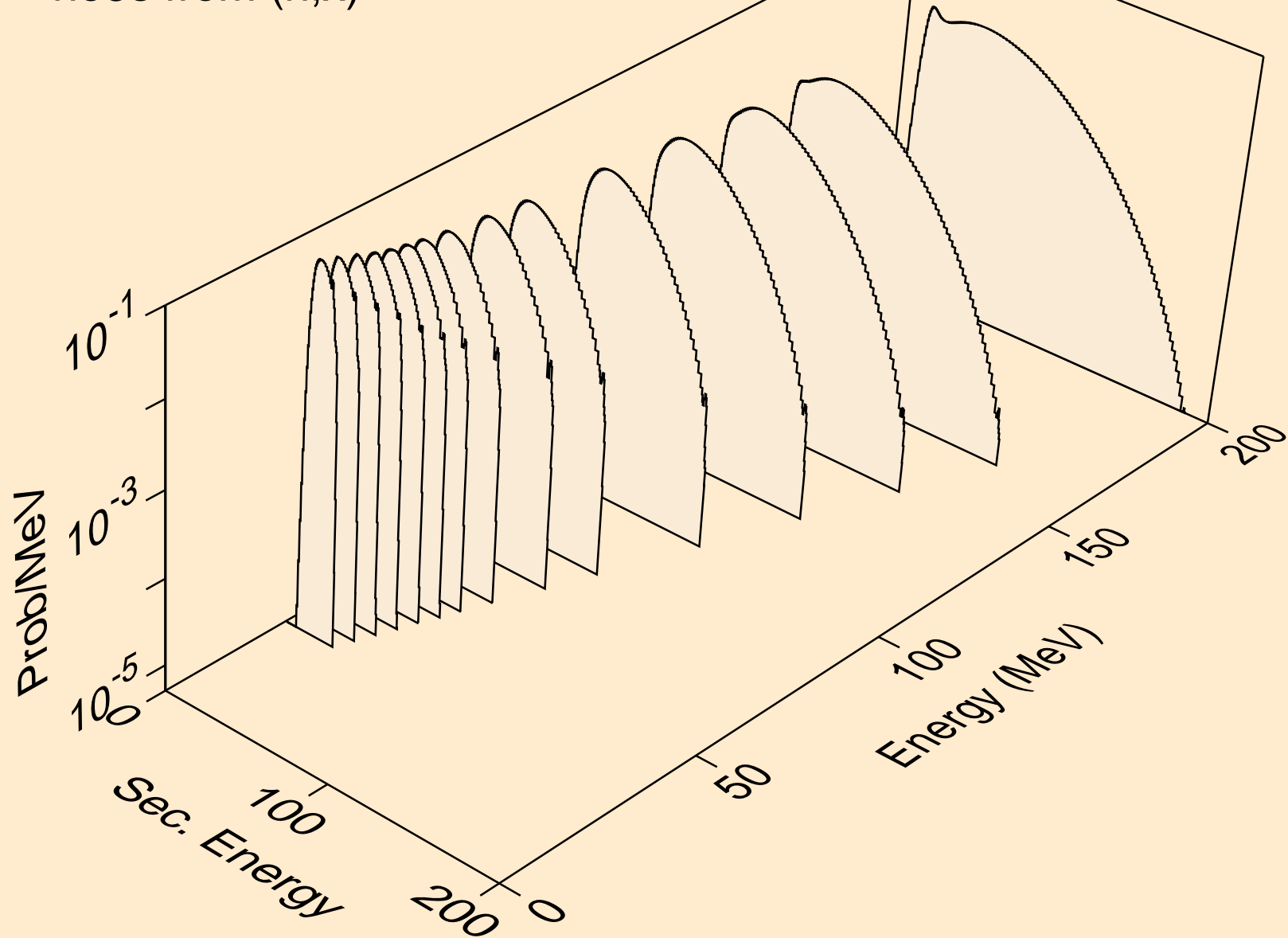

ZR080 NEUTRON ACER TENDL-2024 LIBRARY; T=293.6K
he3s from (n,n*)he3

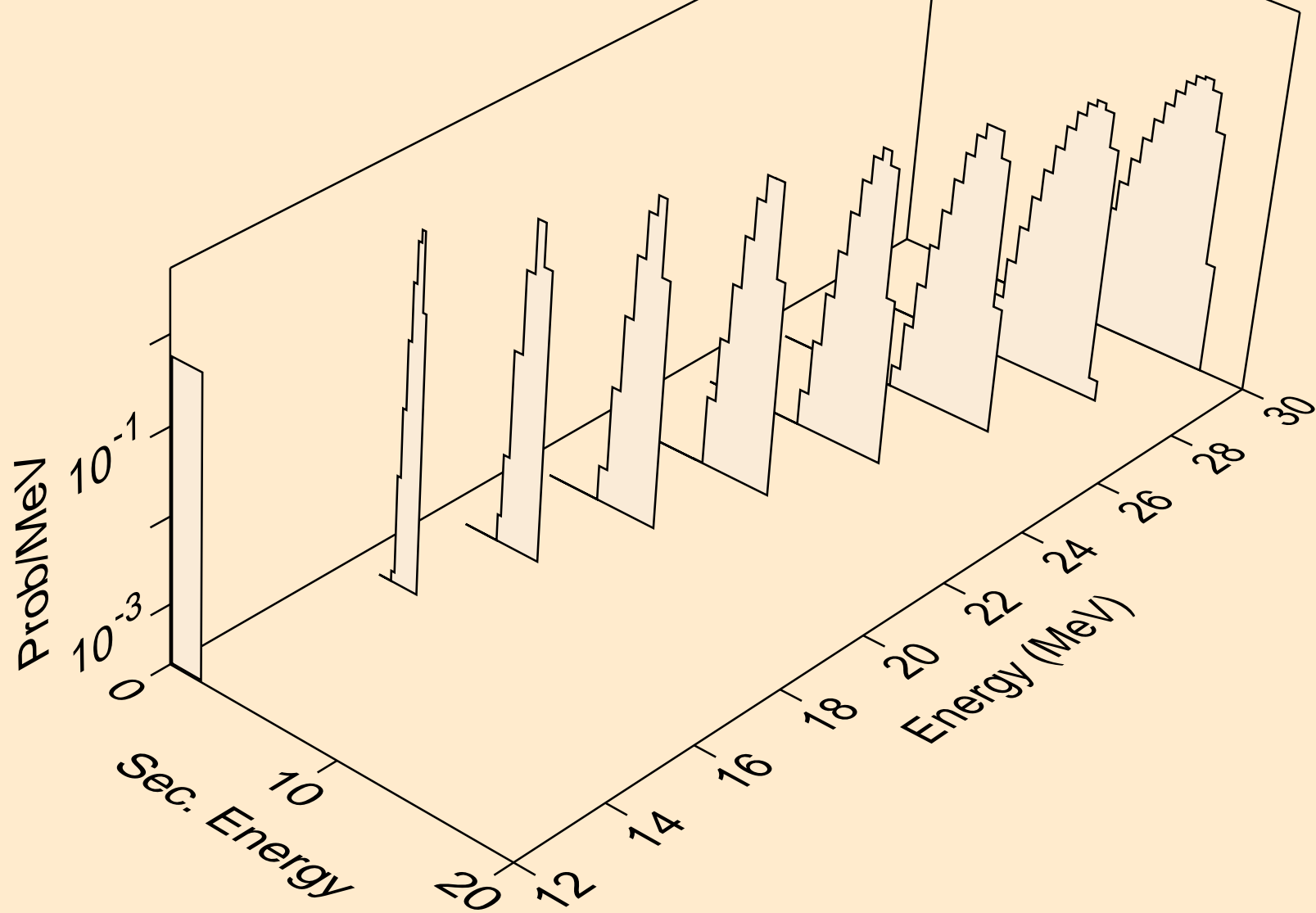

ZR080 NEUTRON ACER TENDL-2024 LIBRARY; T=293.6K
he3s from (n,he3)

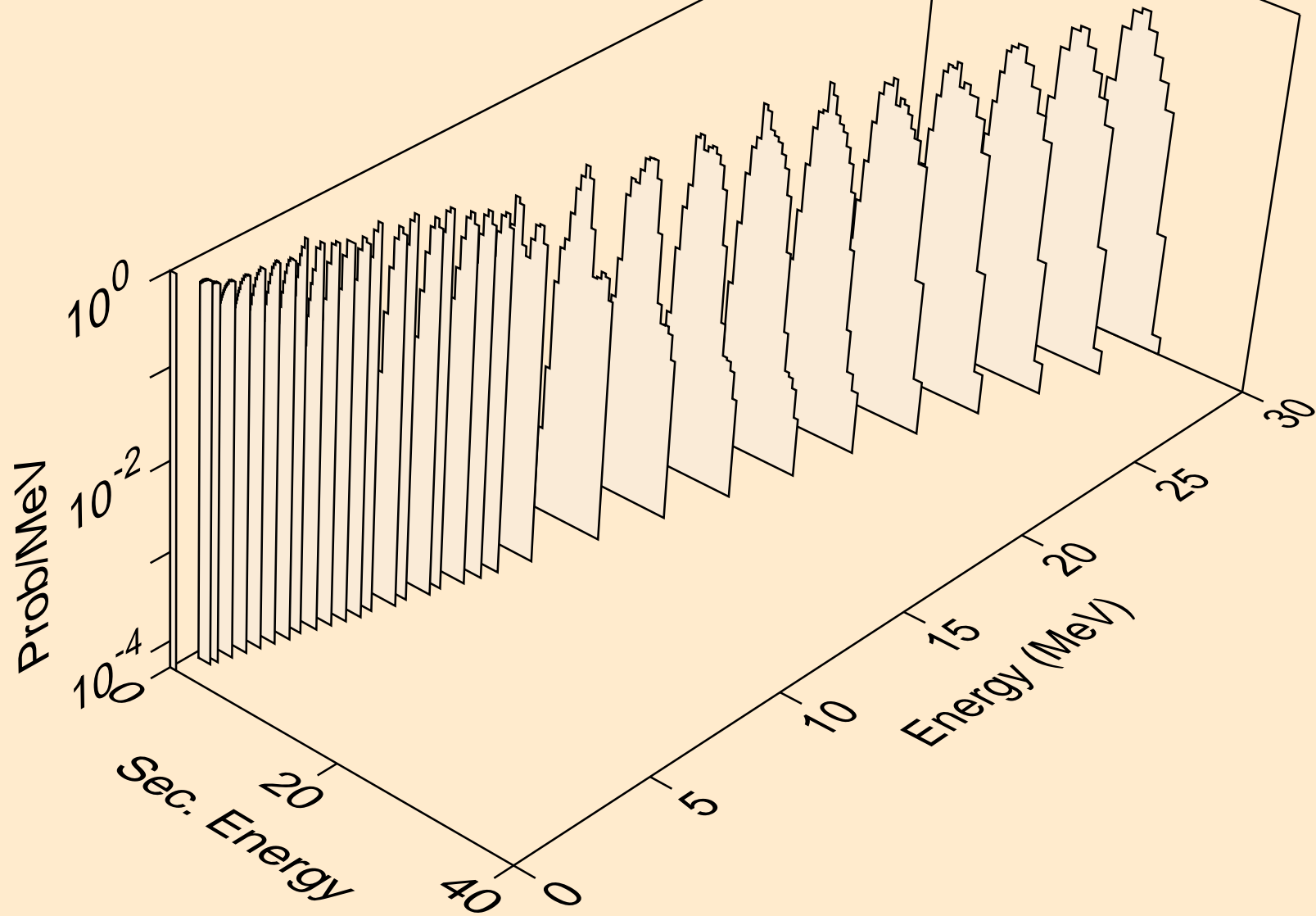

ZR080 NEUTRON ACER TENDL-2024 LIBRARY; T=293.6K
alphas from (n,x)

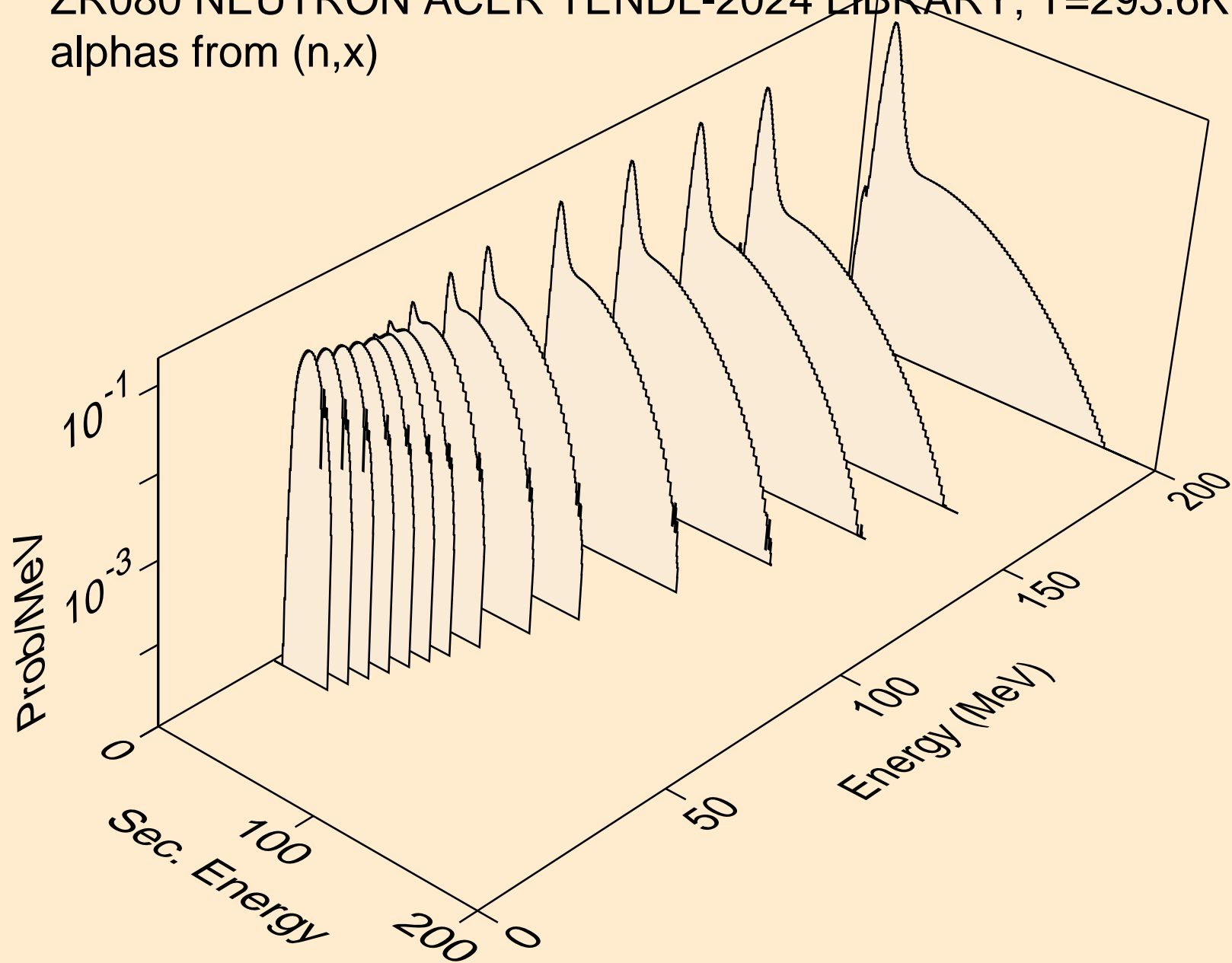

ZR080 NEUTRON ACER TENDL-2024 LIBRARY; T=293.6K
alphas from (n,n*)a

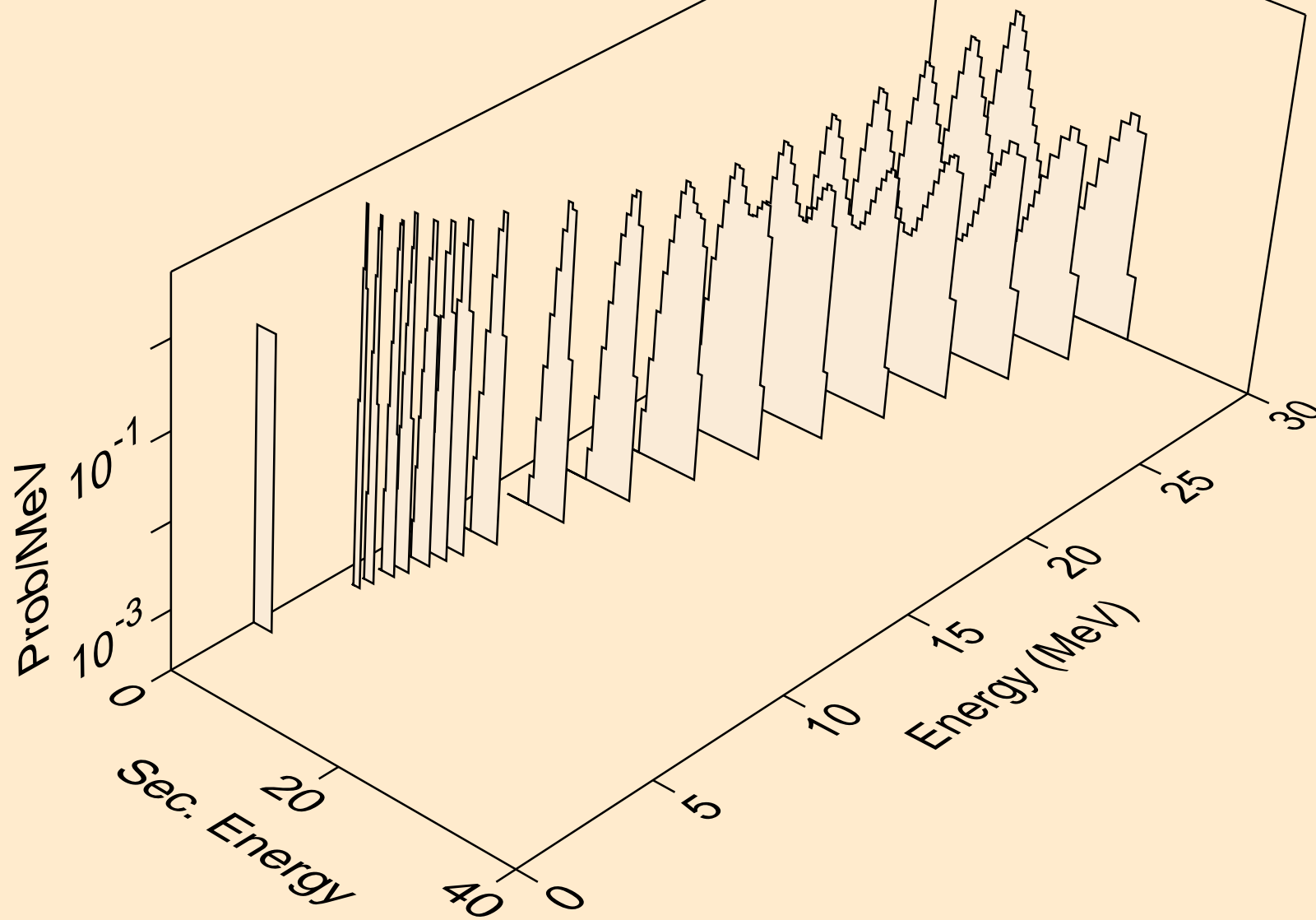

ZR080 NEUTRON ACER TENDL-2024 LIBRARY; T=293.6K
alphas from (n,2n)a

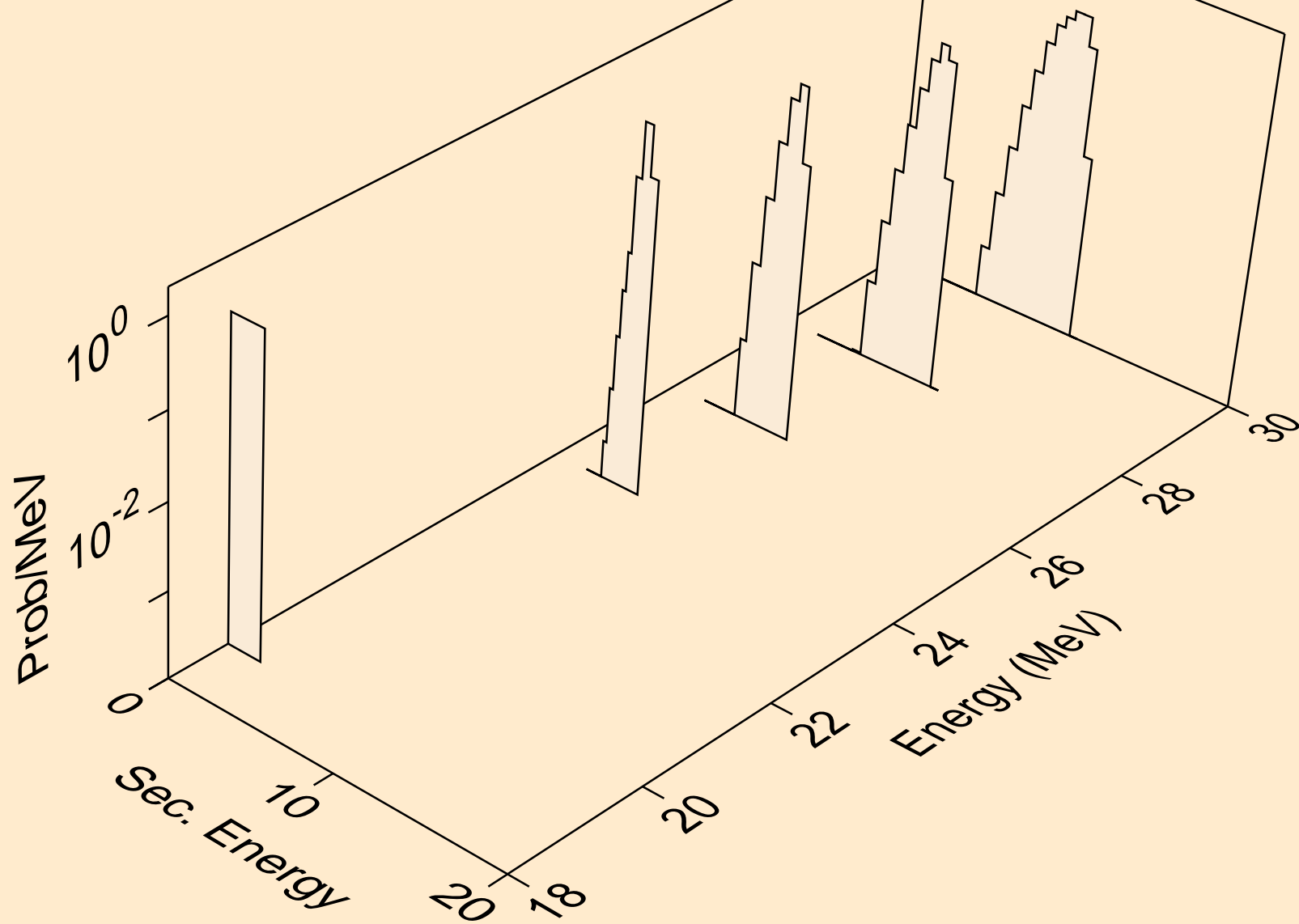

ZR080 NEUTRON ACER TENDL-2024 LIBRARY; T=293.6K
alphas from (n,n*)2a

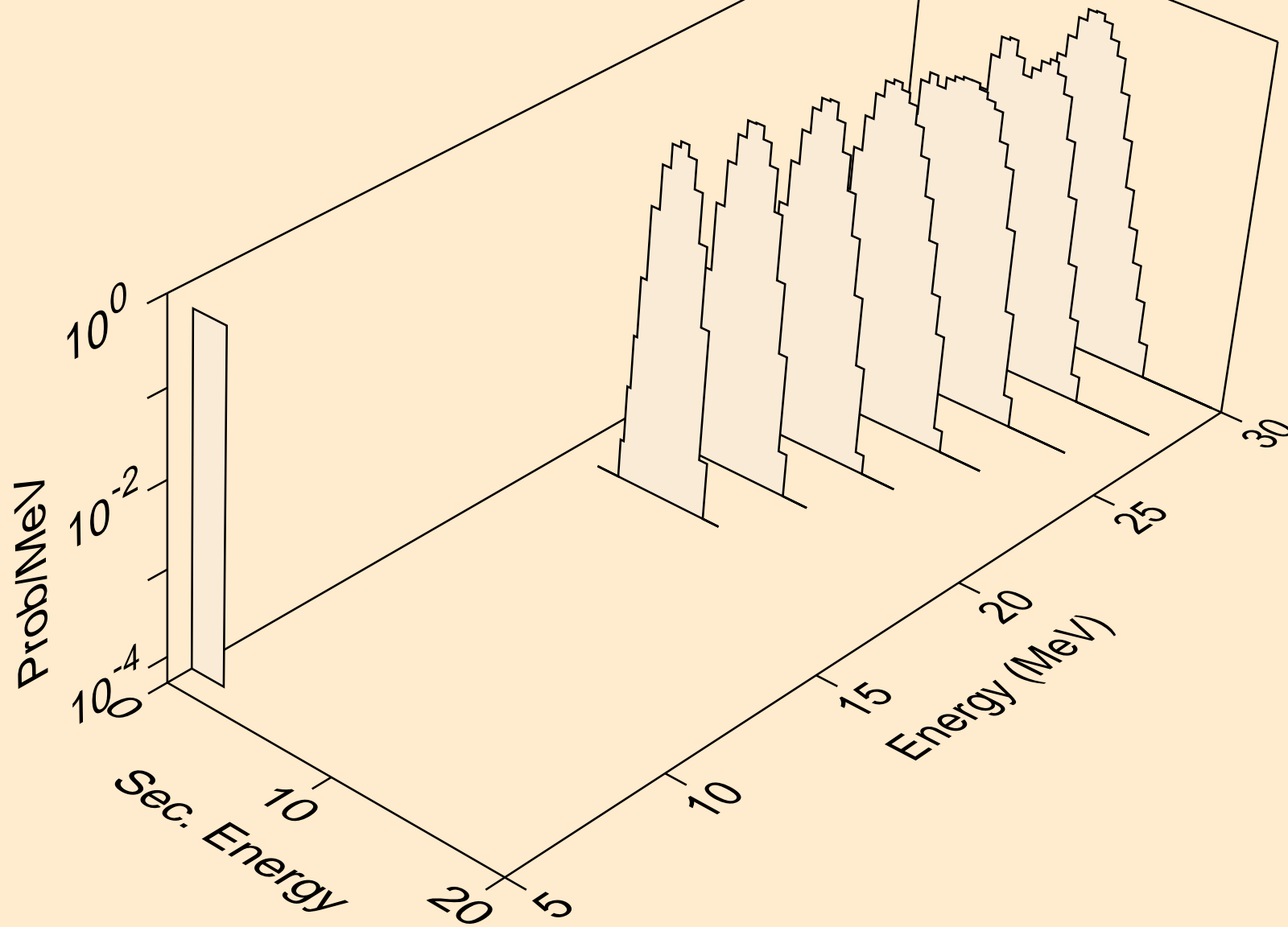

ZR080 NEUTRON ACER TENDL-2024 LIBRARY; T=293.6K
alphas from (n,npa)

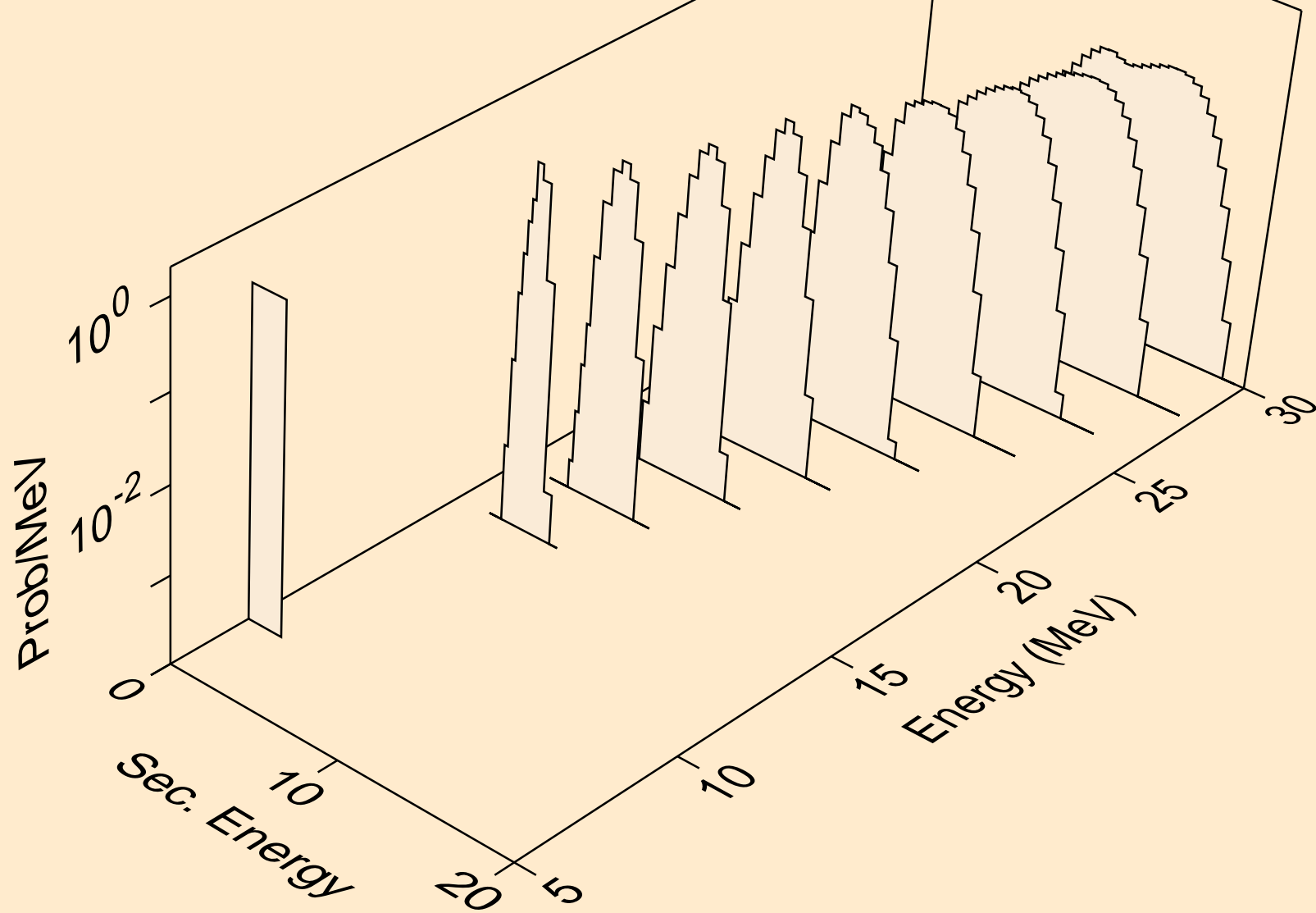

ZR080 NEUTRON ACER TENDL-2024 LIBRARY; T=293.6K
alphas from (n,a)

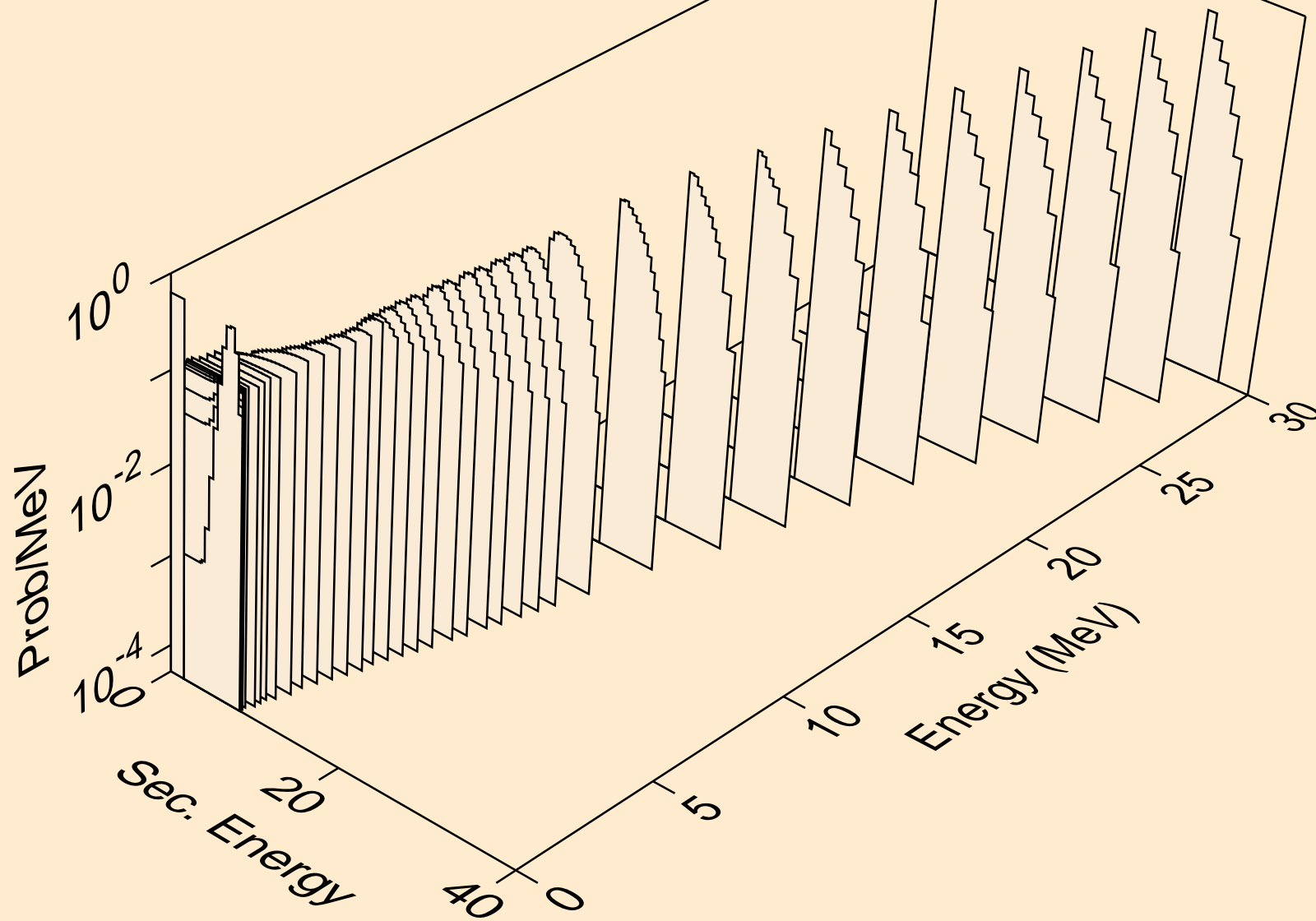

ZR080 NEUTRON ACER TENDL-2024 LIBRARY; T=293.6K
alphas from (n,2a)

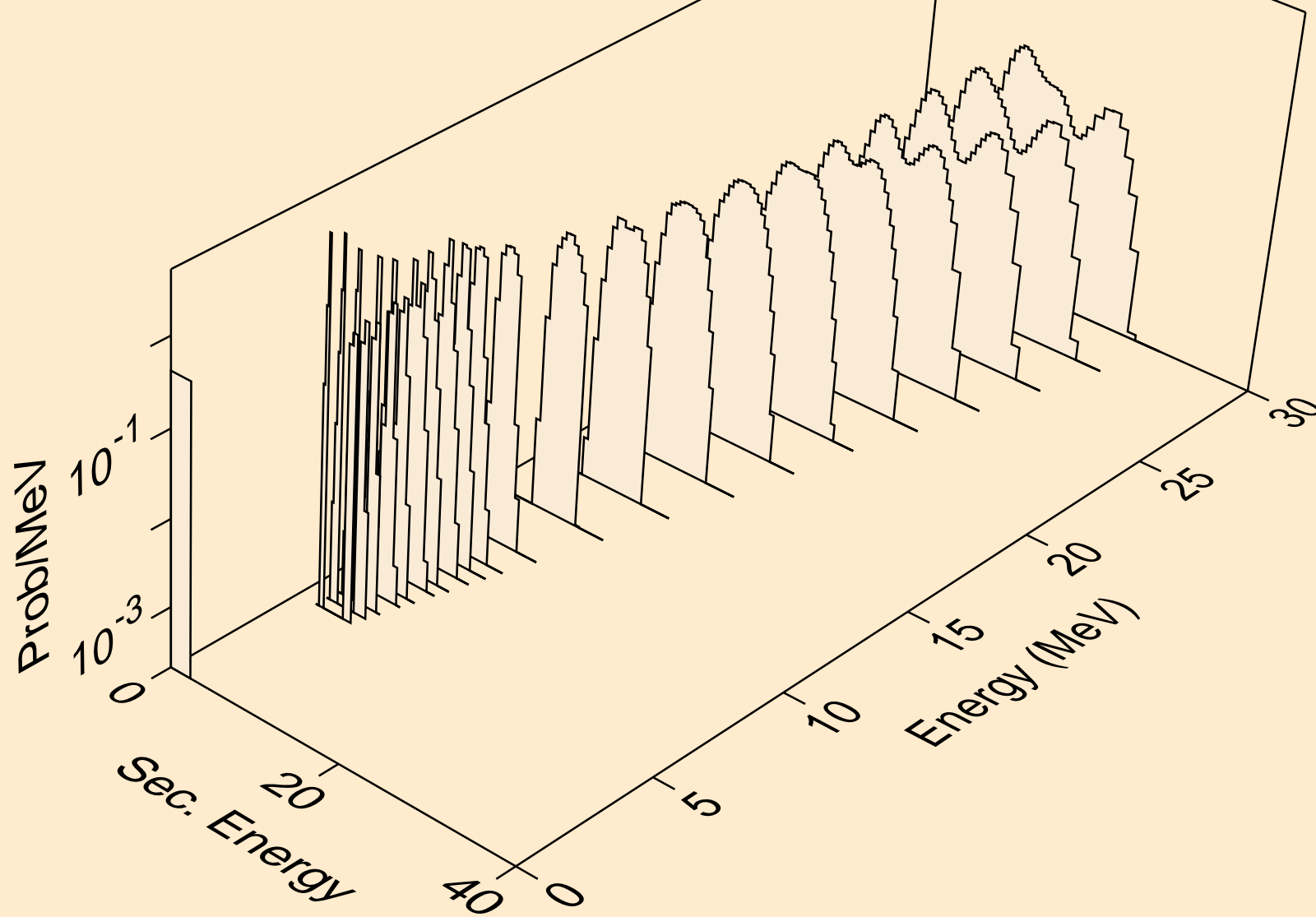

ZR080 NEUTRON ACER TENDL-2024 LIBRARY; T=293.6K
alphas from (n,3a)

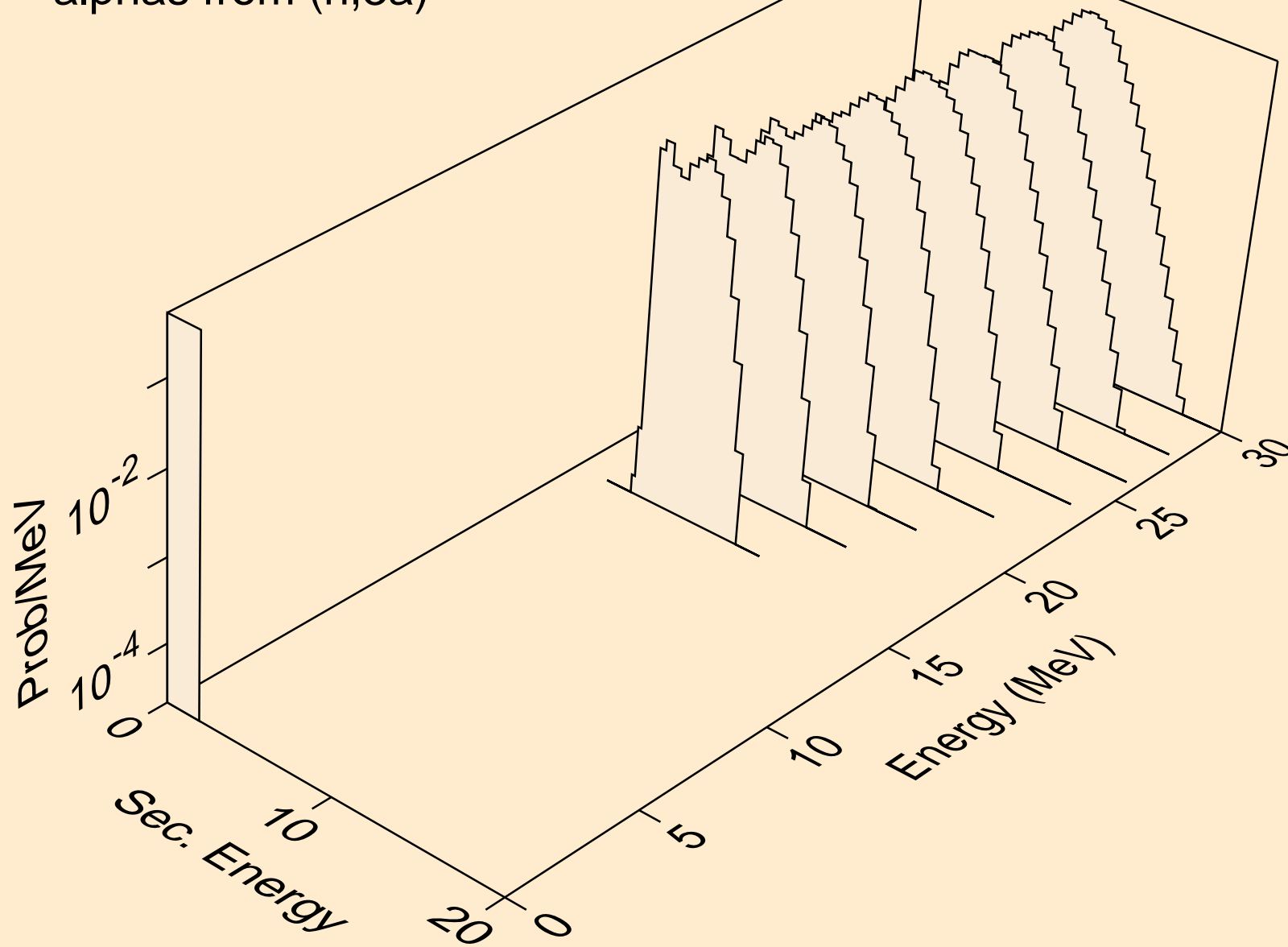

ZR080 NEUTRON ACER TENDL-2024 LIBRARY; T=293.6K
alphas from (n,pa)

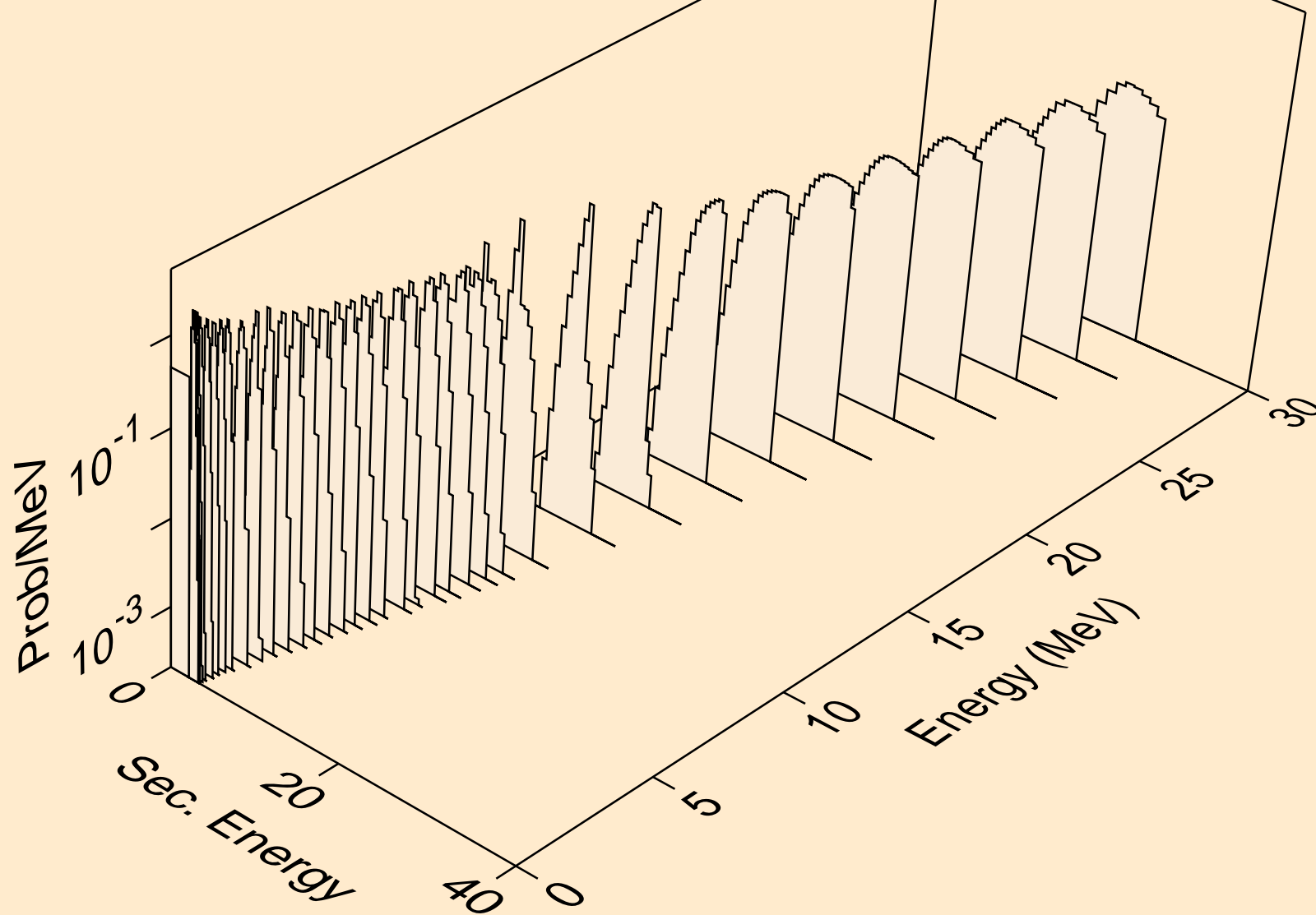

ZR080 NEUTRON ACER TENDL-2024 LIBRARY; T=293.6K
alphas from (n,da)

