

# AS075 PROTON ACER TENDL-2024 LIBRARY; T=0.K

## Principal cross sections

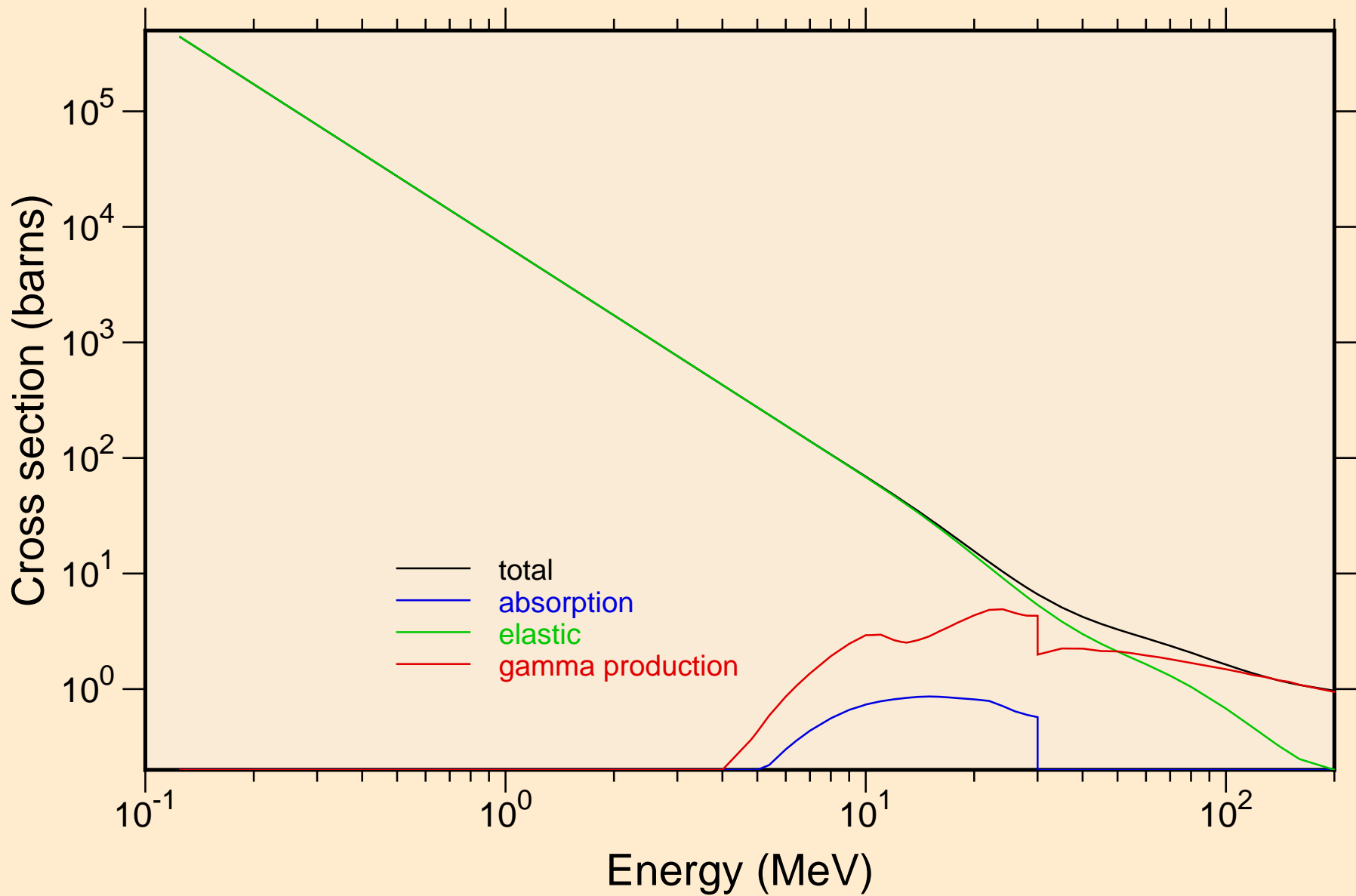

# AS075 PROTON ACER TENDL-2024 LIBRARY; T=0.K

## Heating

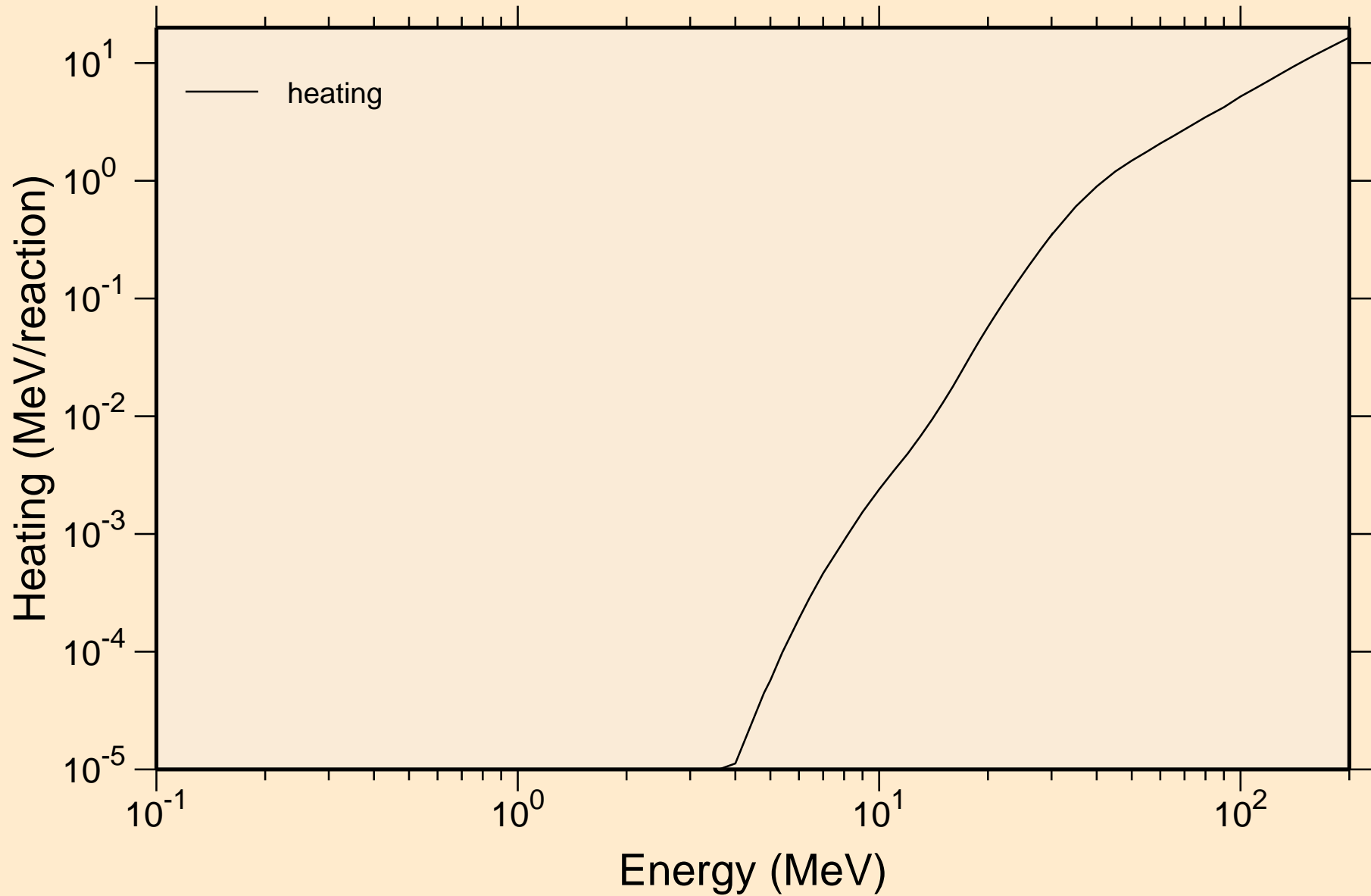

# AS075 PROTON ACER TENDL-2024 LIBRARY; T=0.K

## Principal cross sections

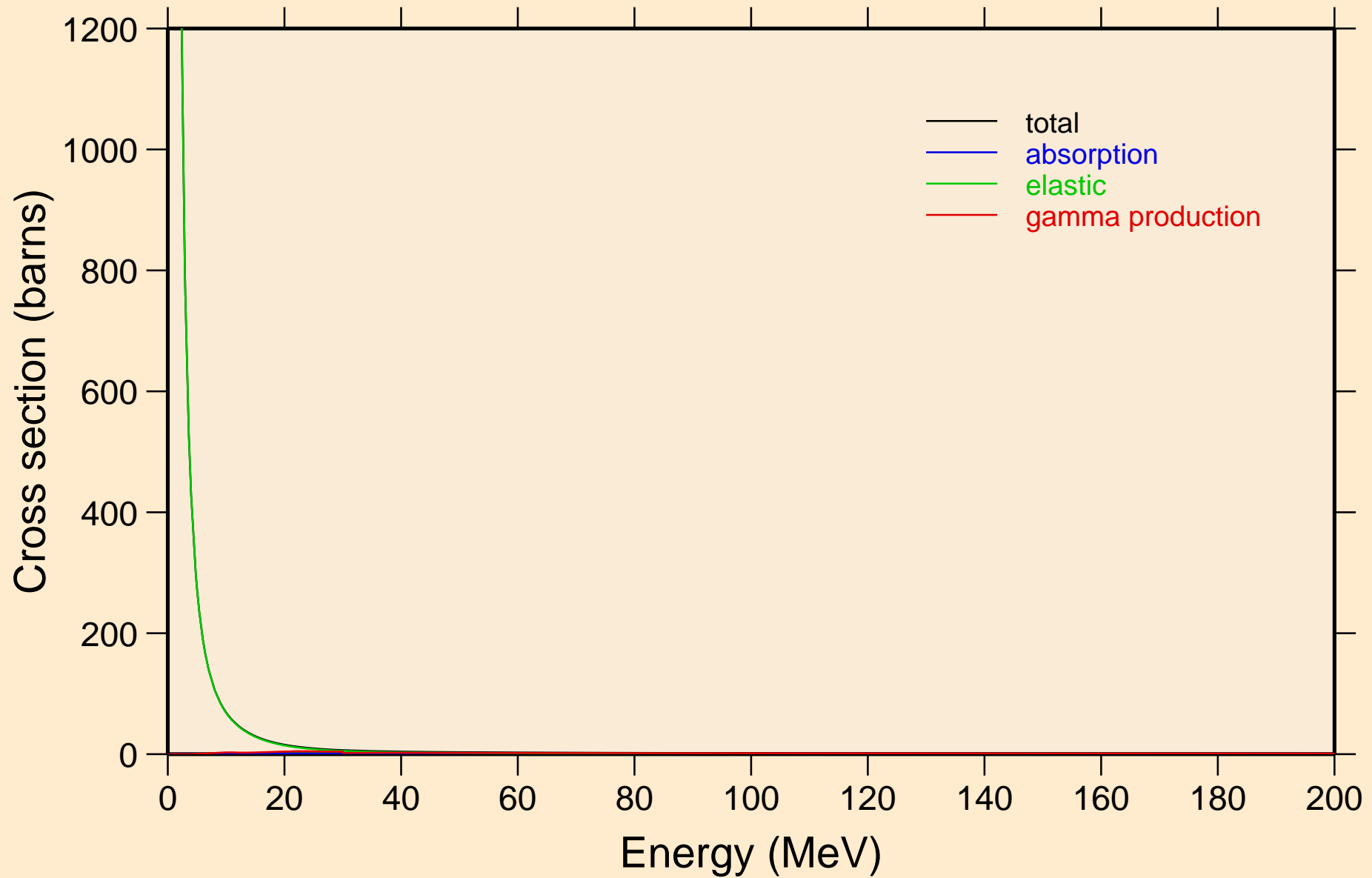

# AS075 PROTON ACER TENDL-2024 LIBRARY; T=0.K

## Heating

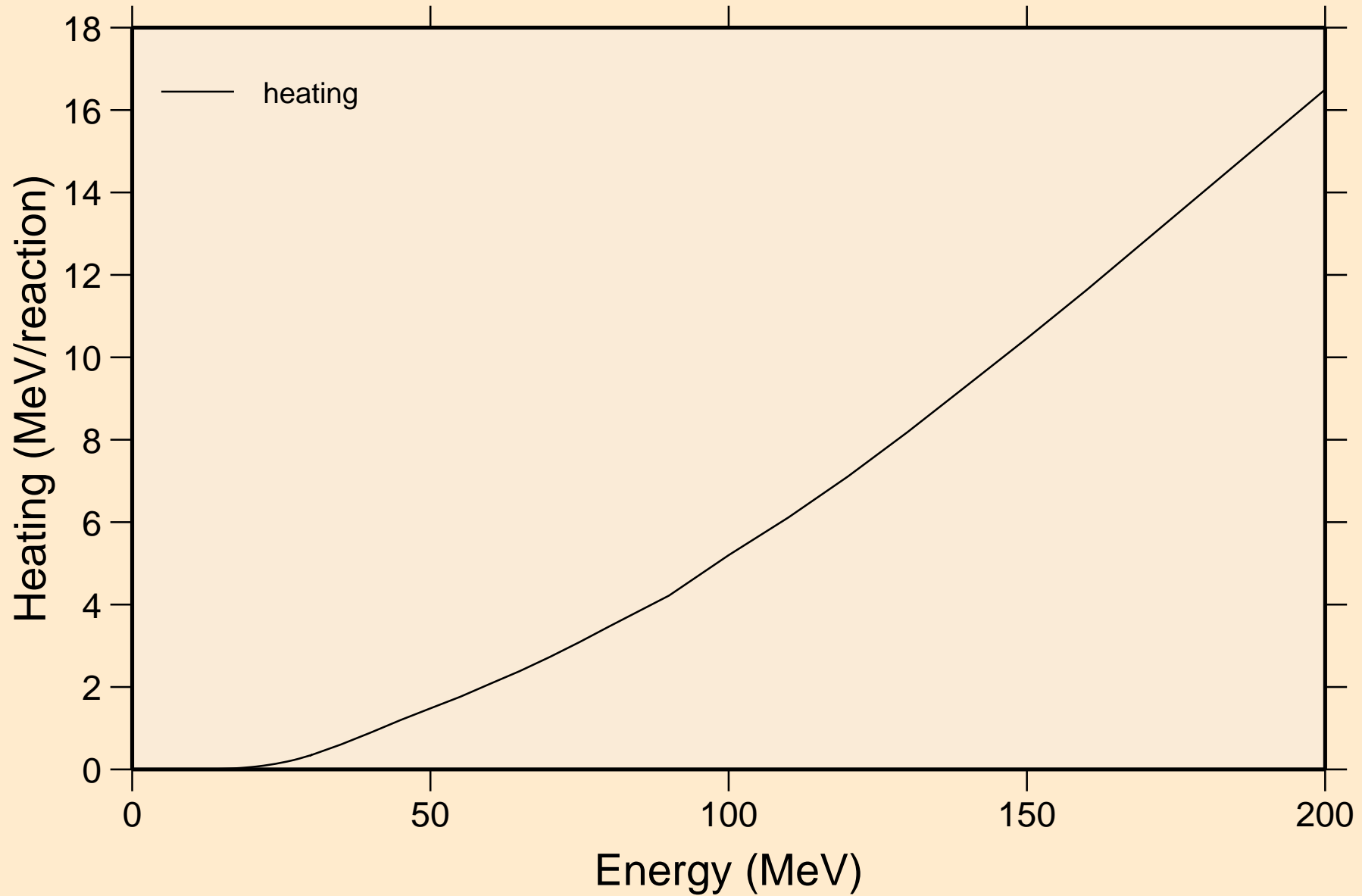

AS075 PROTON ACER TENDL-2024 LIBRARY; T=0.K  
Threshold reactions

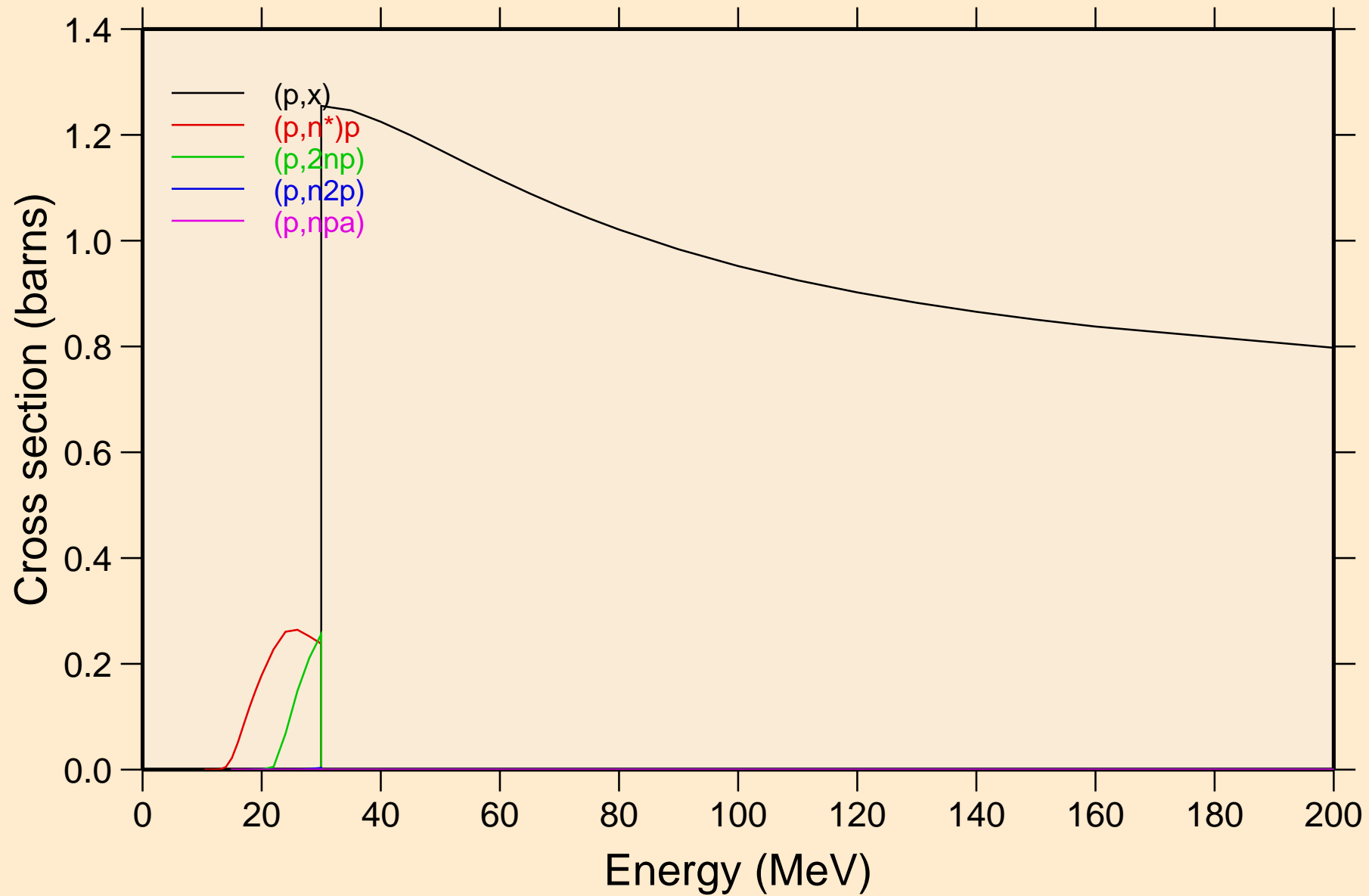

# AS075 PROTON ACER TENDL-2024 LIBRARY; T=0.K

## Threshold reactions

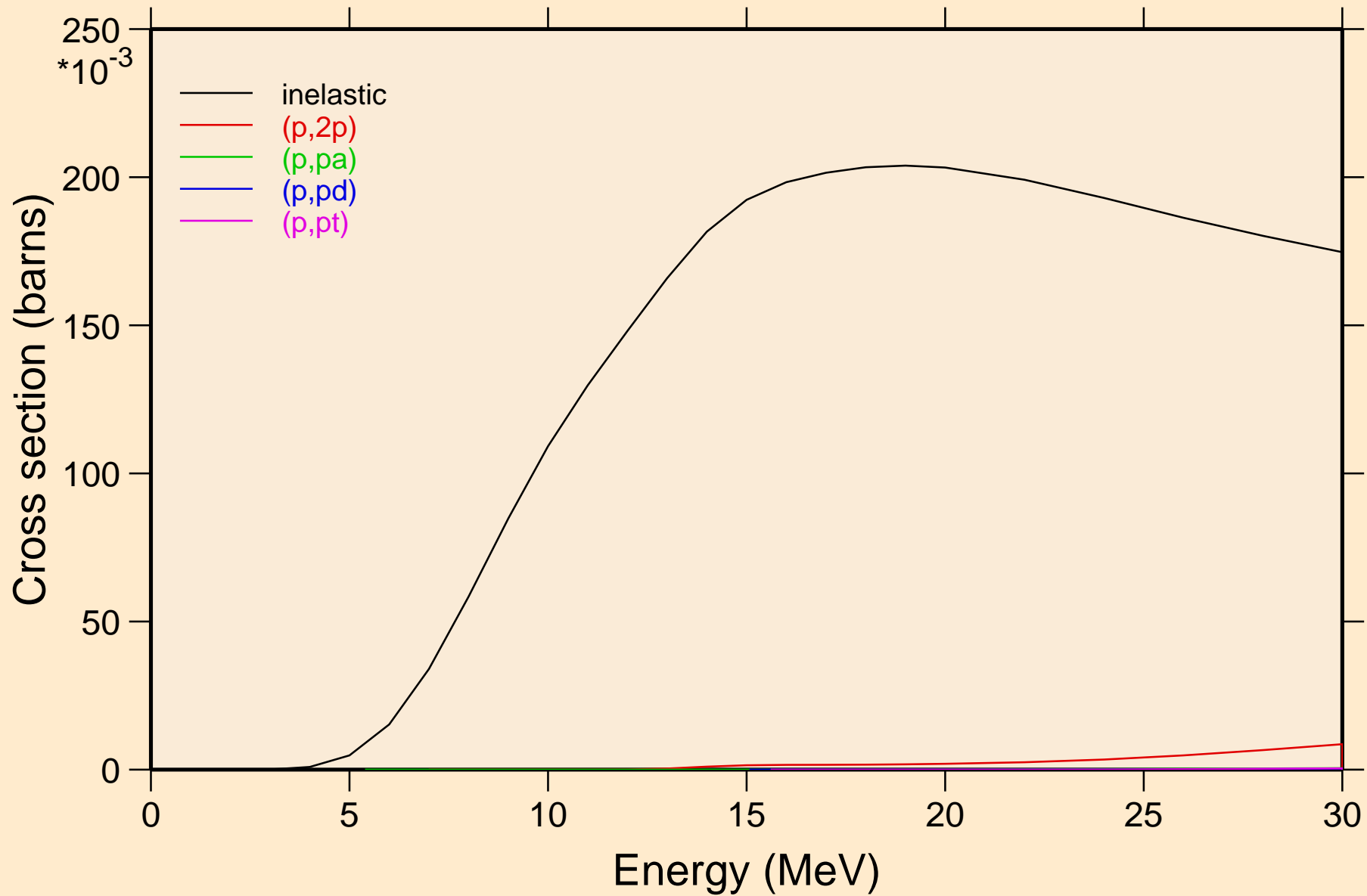

AS075 PROTON ACER TENDL-2024 LIBRARY; T=0.K  
Threshold reactions

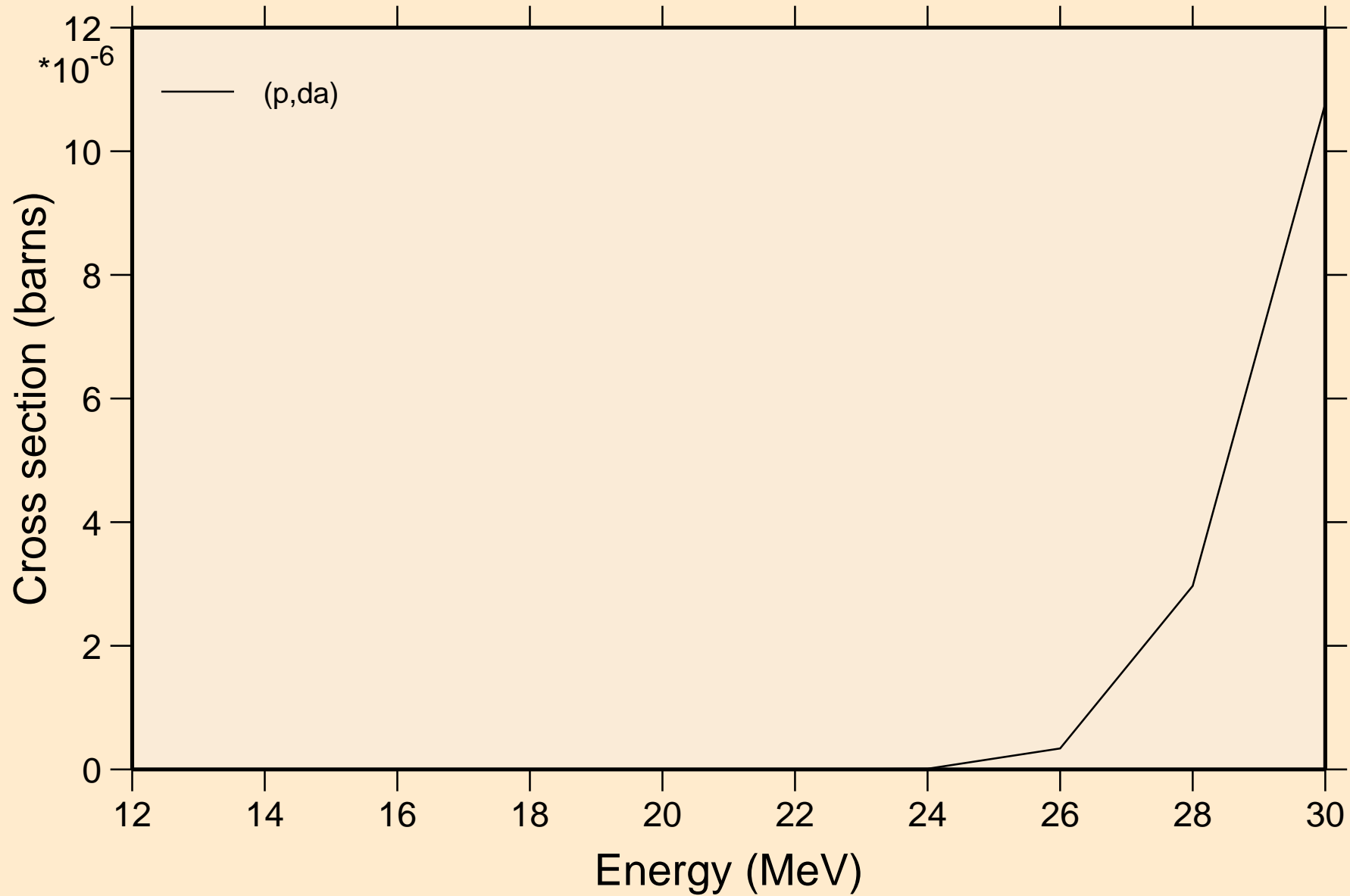

AS075 PROTON ACER TENDL-2024 LIBRARY; T=0.K  
angular distribution for elastic

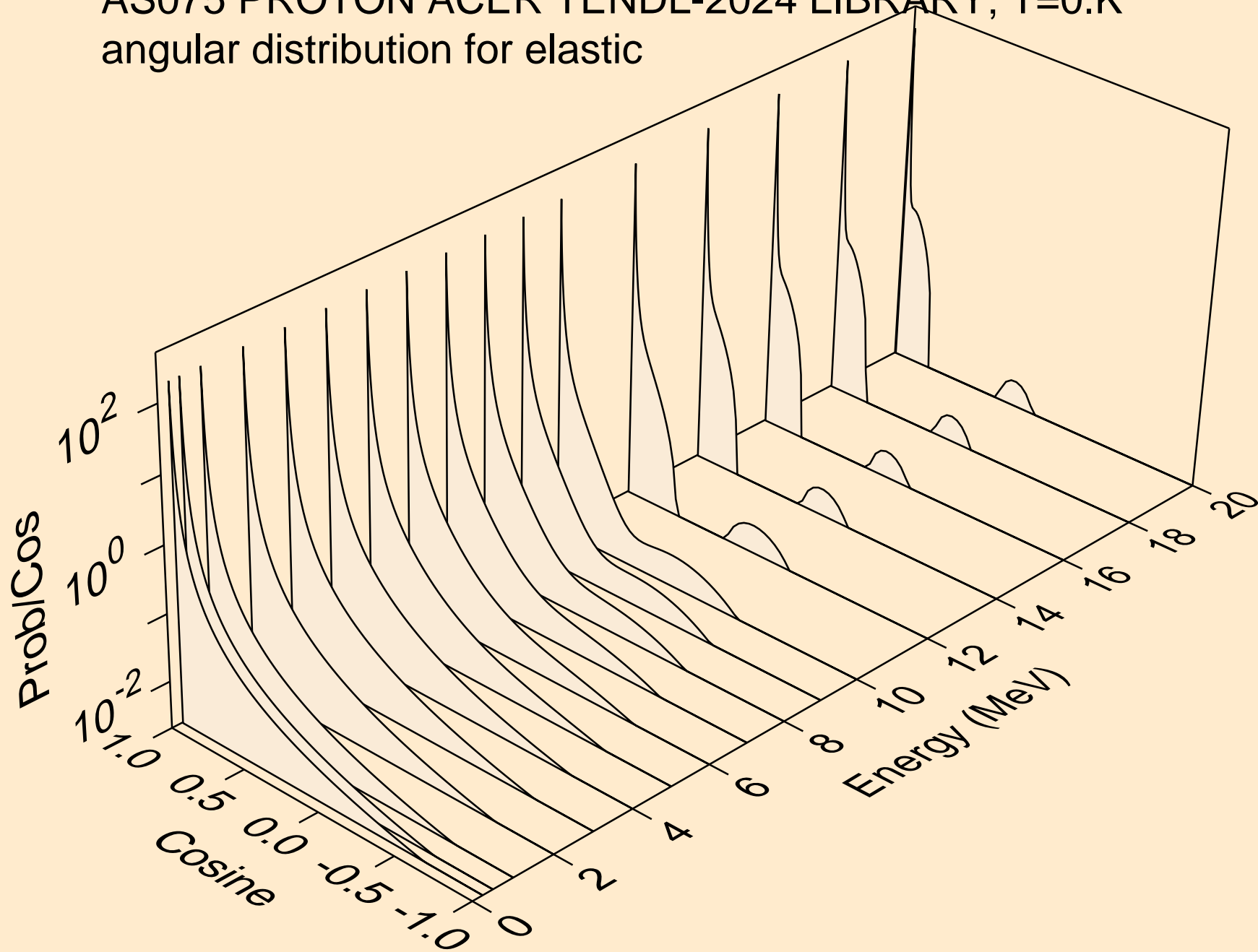

AS075 PROTON ACER TENDL-2024 LIBRARY; T=0.K  
angular distribution for elastic

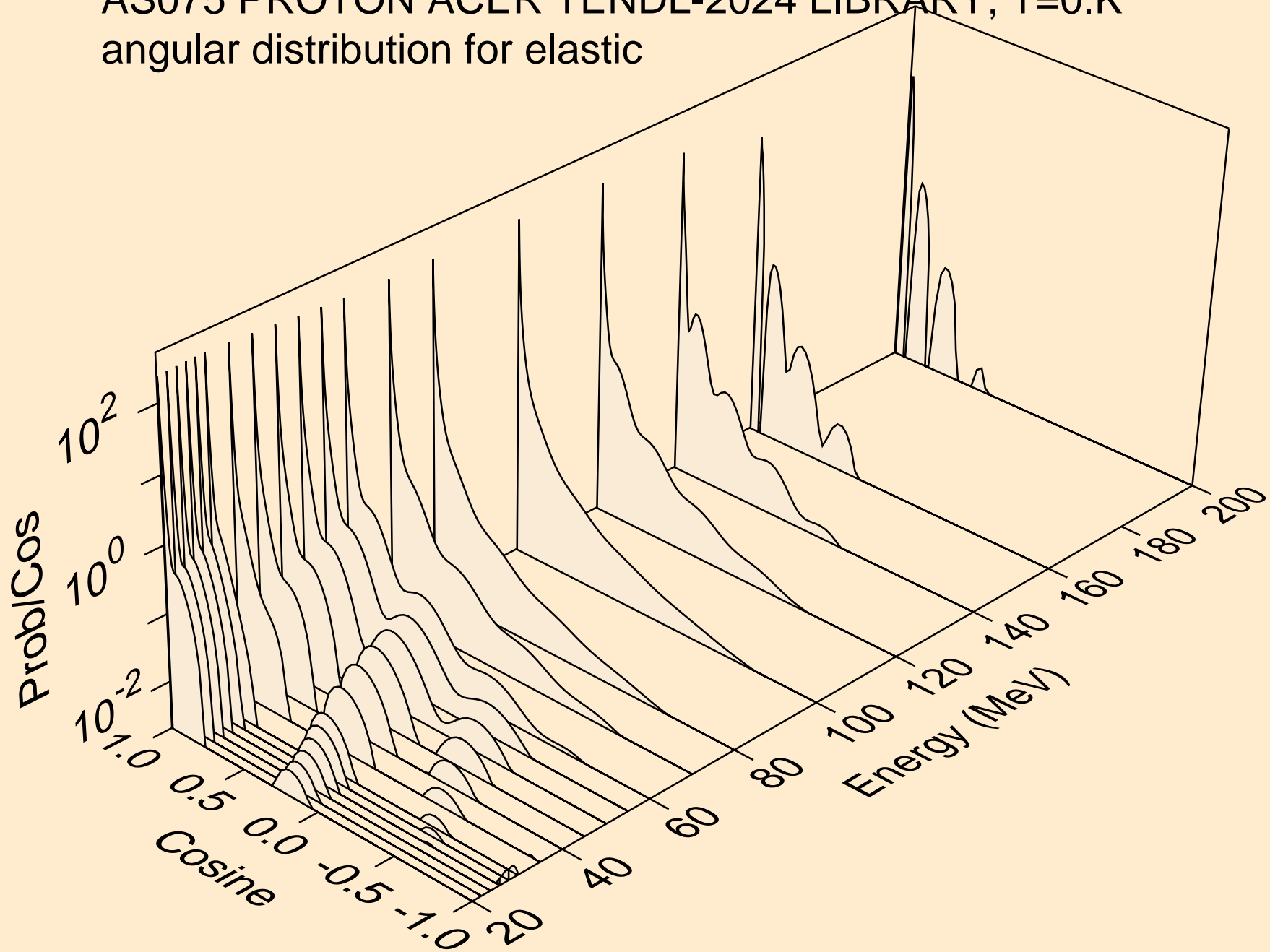

AS075 PROTON ACER TENDL-2024 LIBRARY; T=0.K  
Proton emission for (p,x)

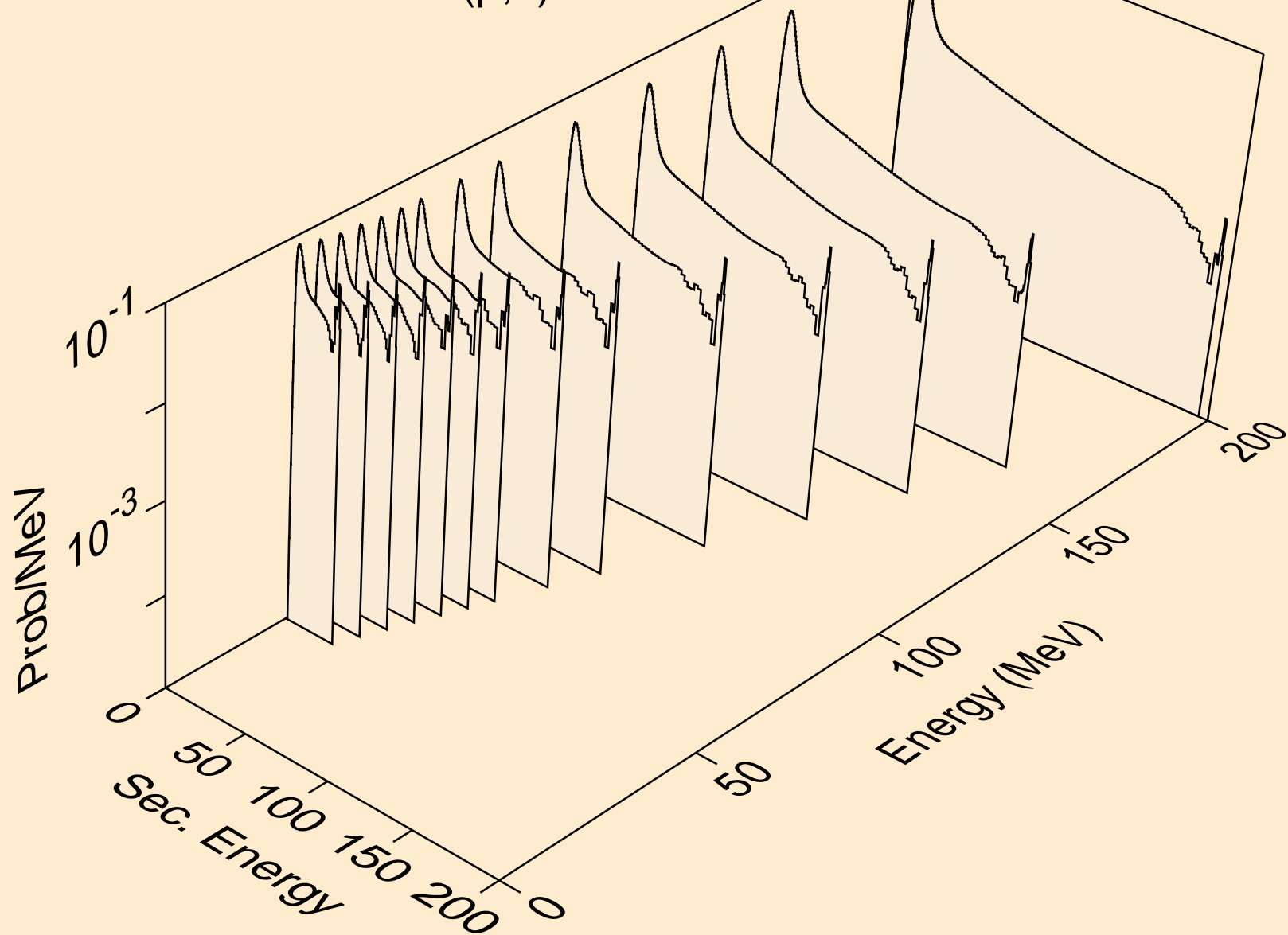

AS075 PROTON ACER TENDL-2024 LIBRARY; T=0.K  
Proton emission for (p,n\*)p

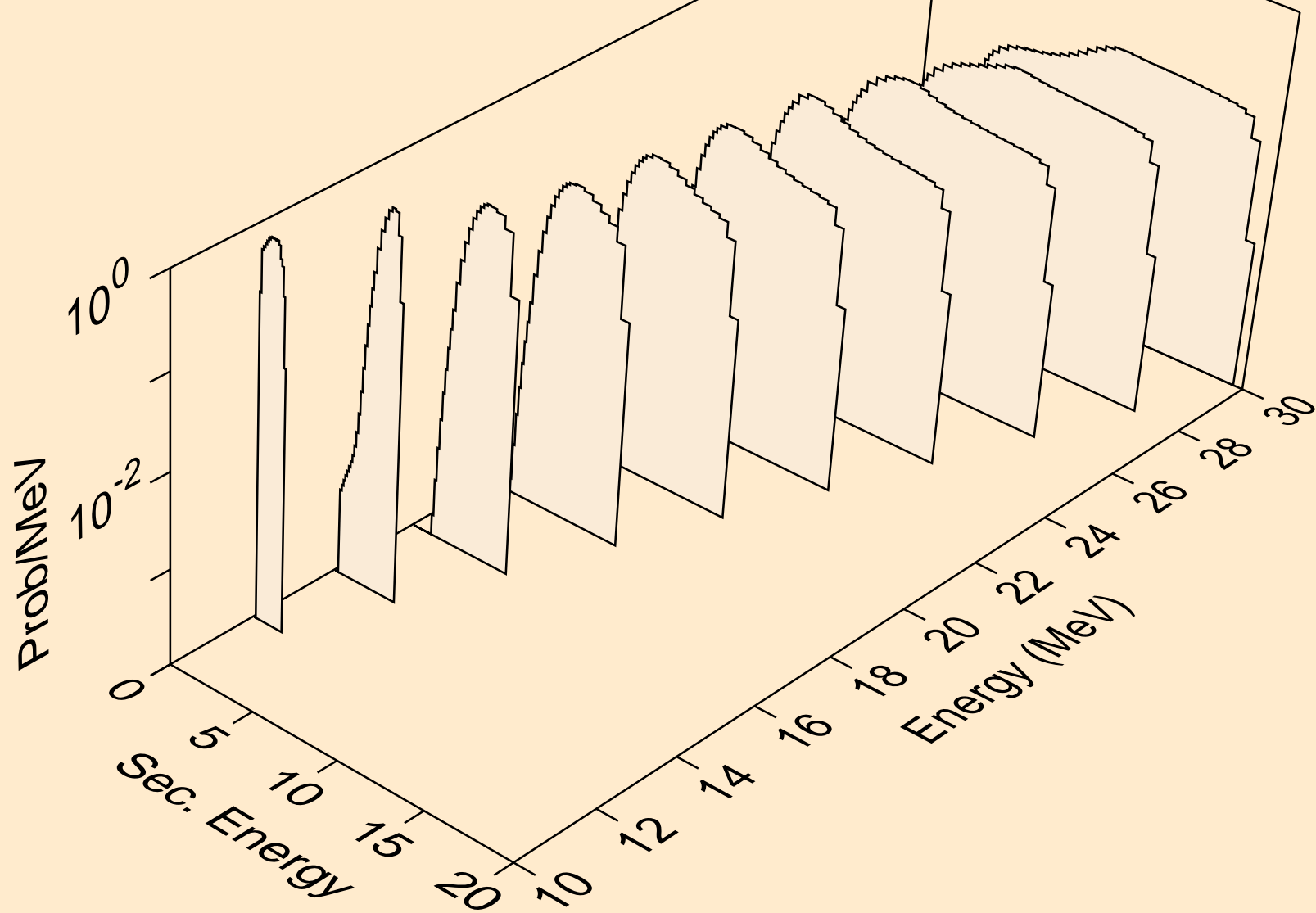

AS075 PROTON ACER TENDL-2024 LIBRARY; T=0.K  
Proton emission for (p,2np)

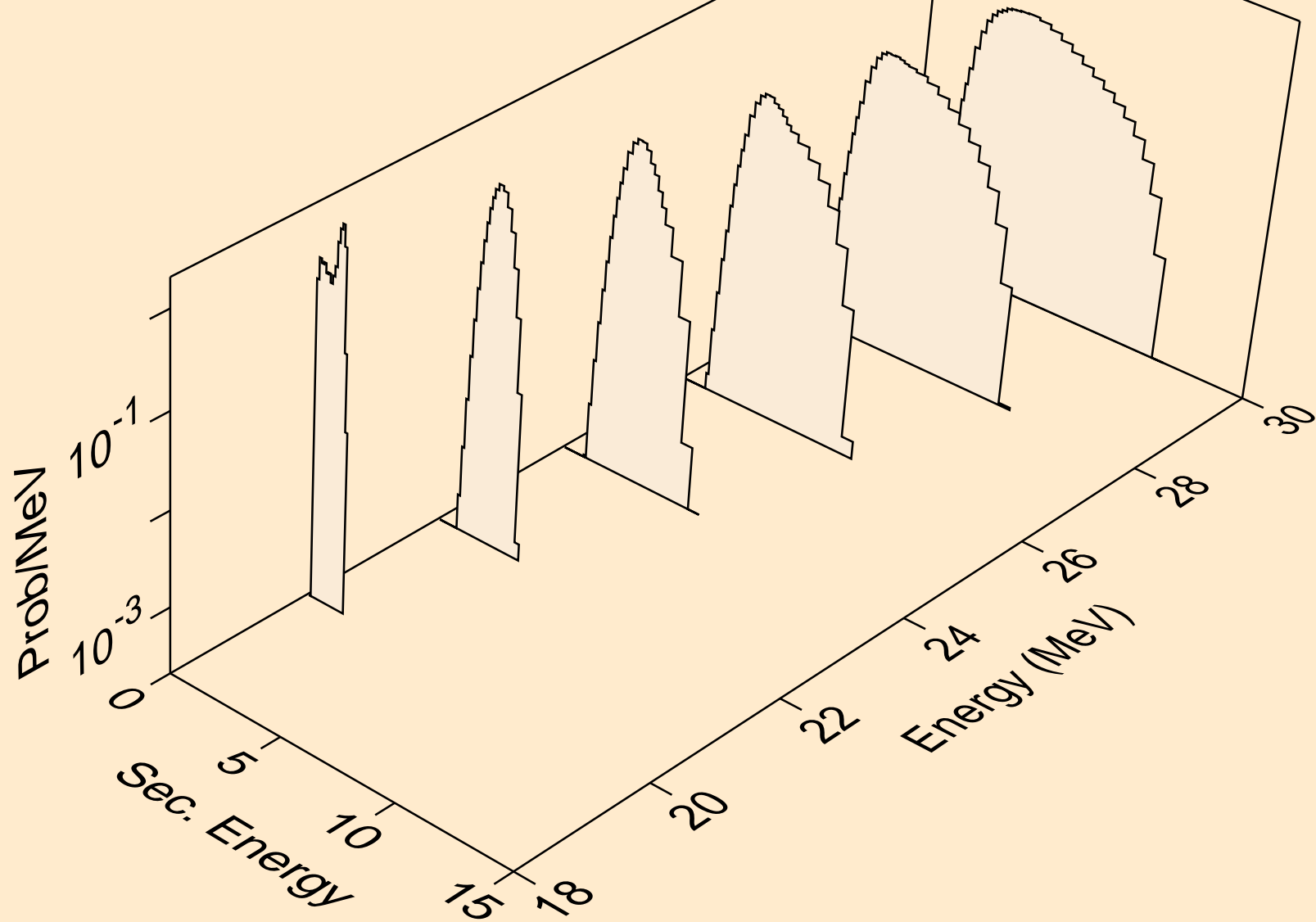

AS075 PROTON ACER TENDL-2024 LIBRARY; T=0.K  
Proton emission for (p,n2p)

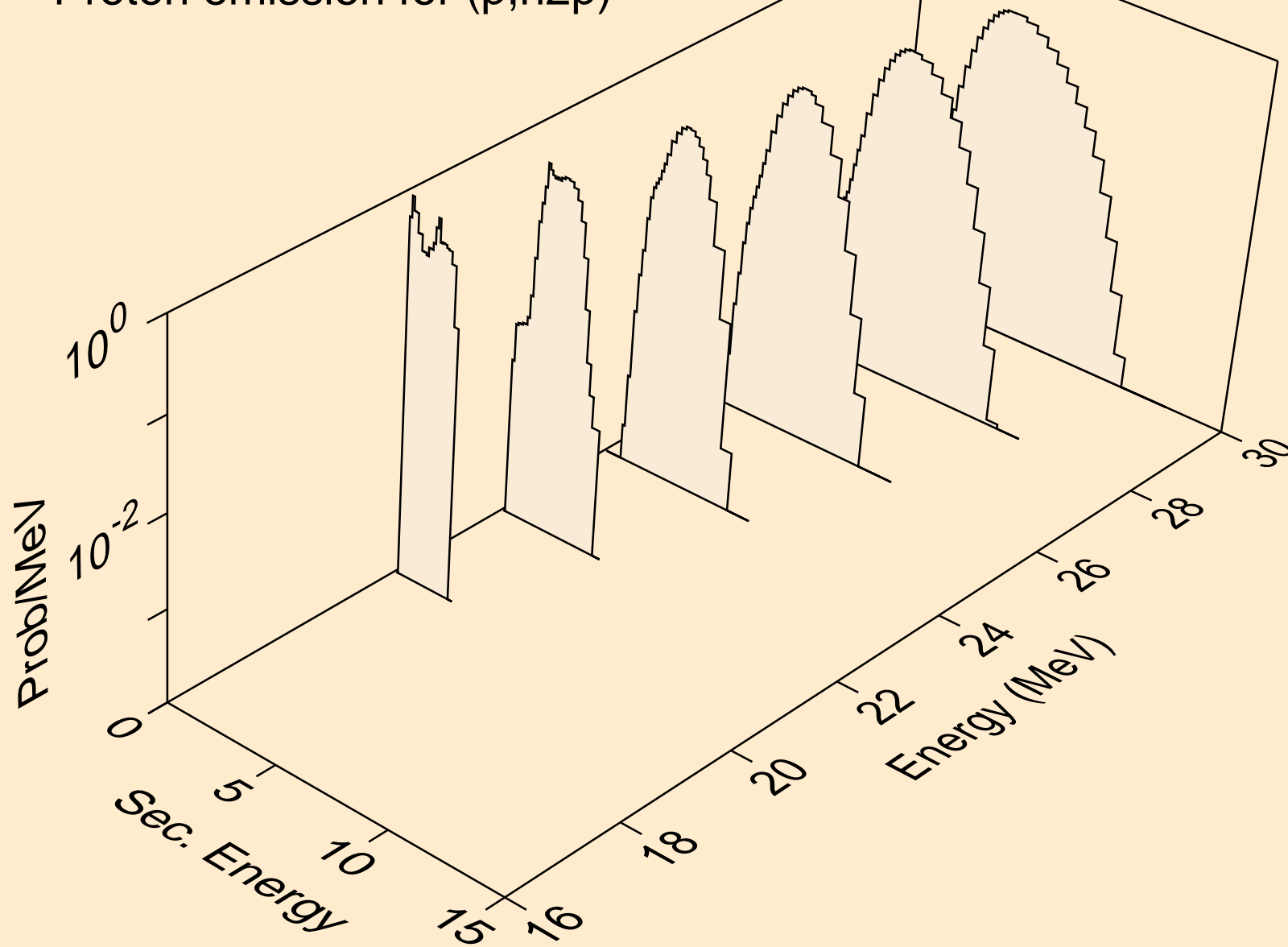

AS075 PROTON ACER TENDL-2024 LIBRARY; T=0.K  
Proton emission for (p,npa)

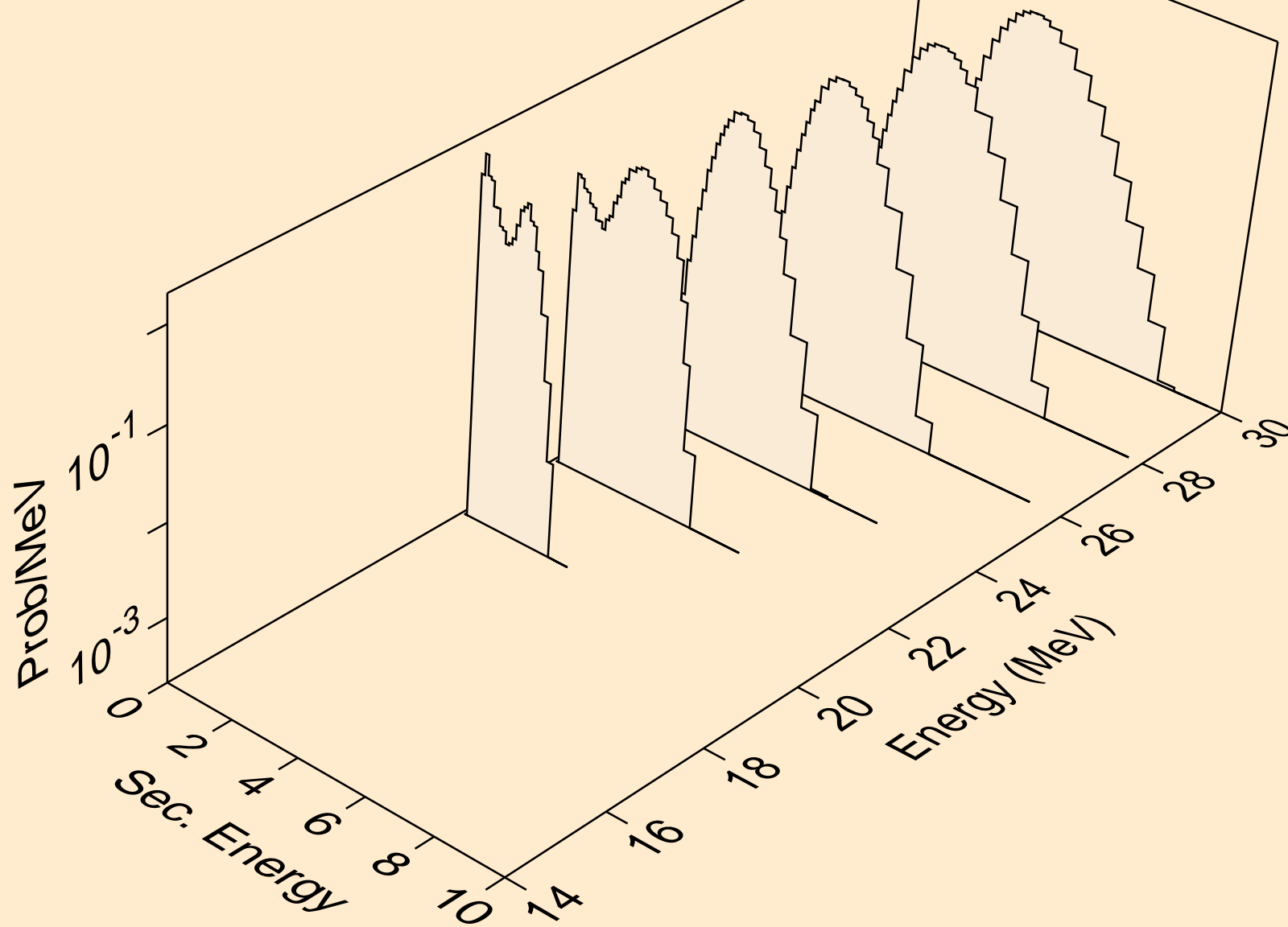

AS075 PROTON ACER TENDL-2024 LIBRARY; T=0.K  
Proton emission for inelastic

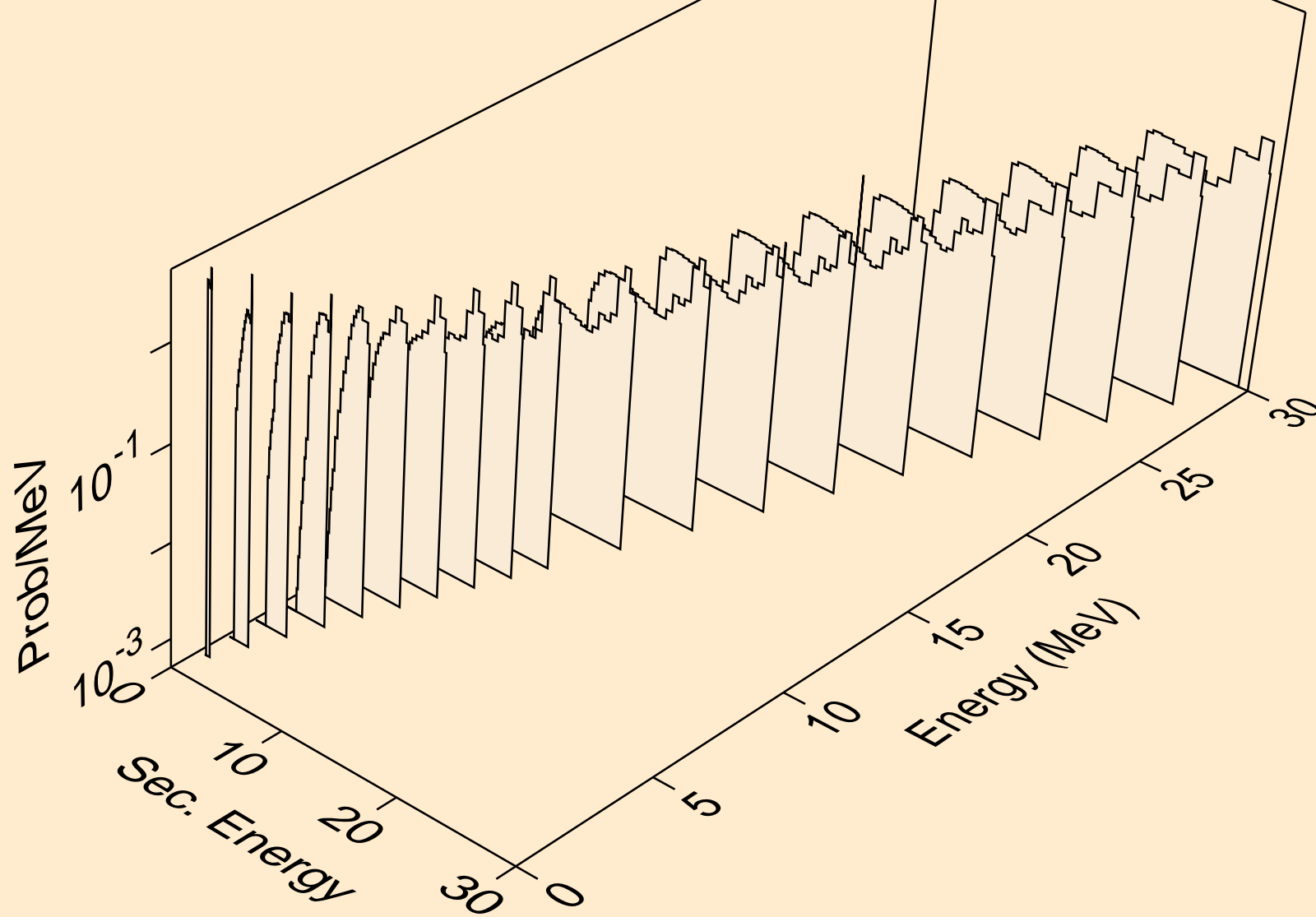

AS075 PROTON ACER TENDL-2024 LIBRARY; T=0.K  
Proton emission for (p,2p)

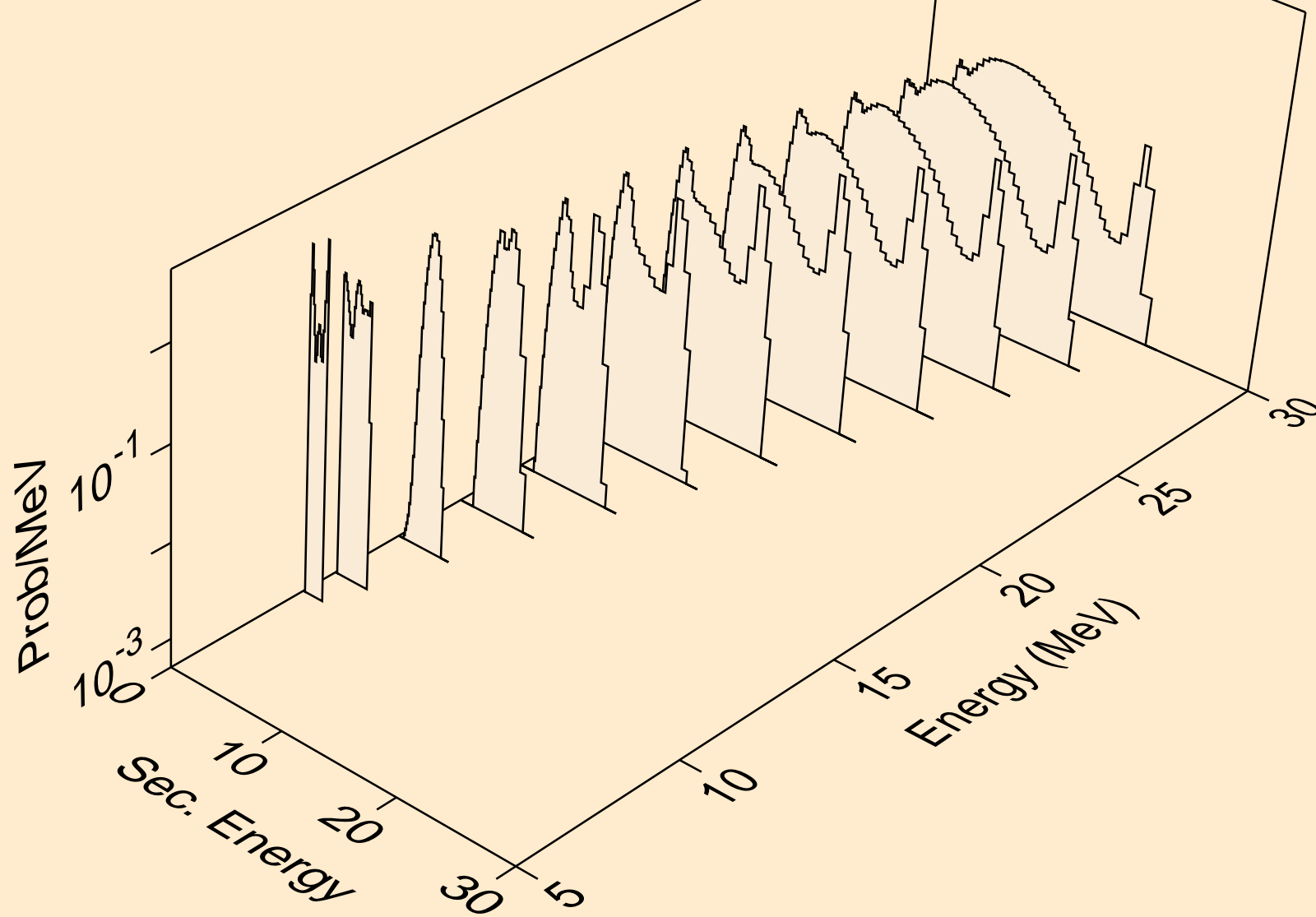

AS075 PROTON ACER TENDL-2024 LIBRARY; T=0.K  
Proton emission for (p,pa)

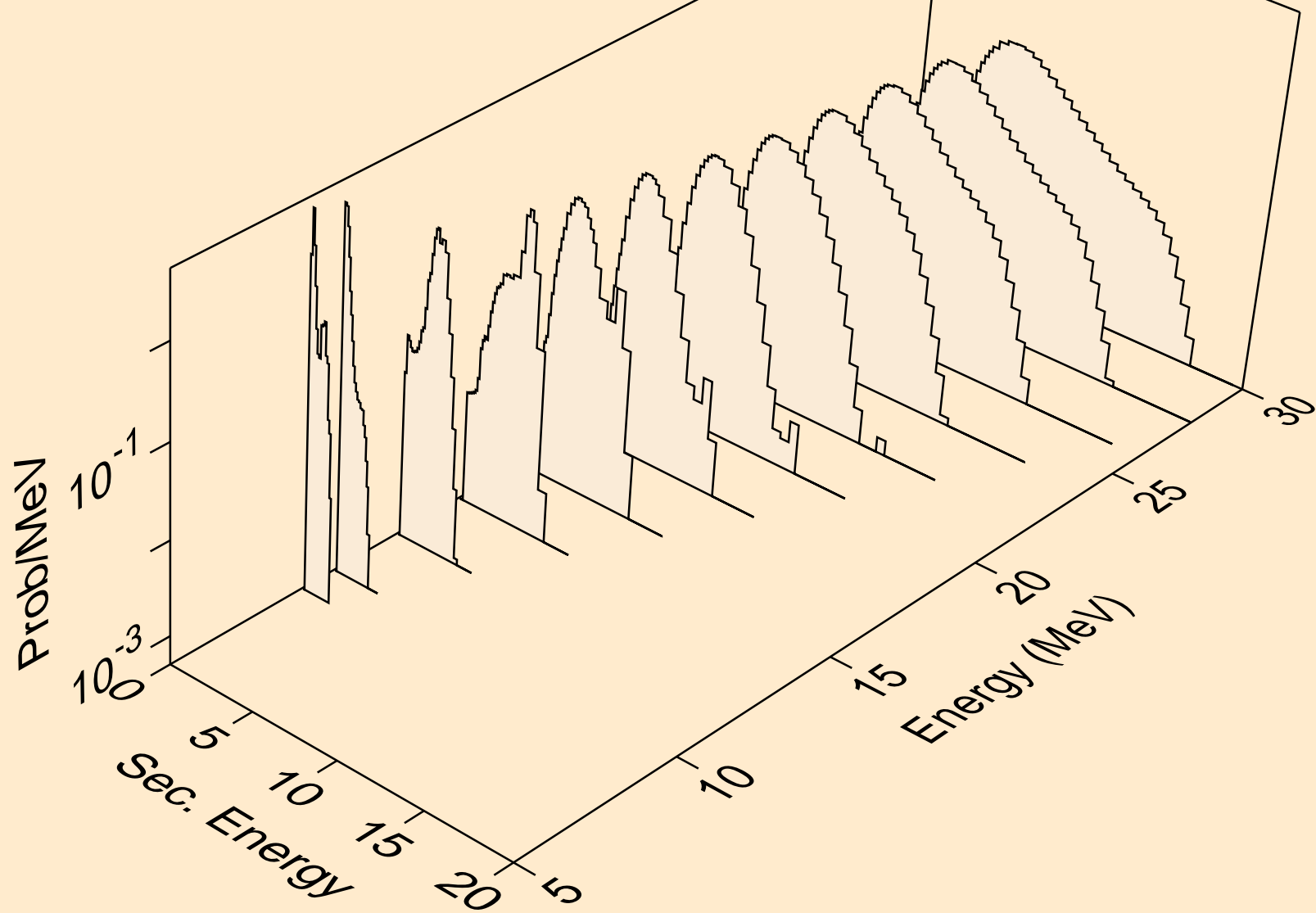

AS075 PROTON ACER TENDL-2024 LIBRARY; T=0.K  
Proton emission for (p,pd)

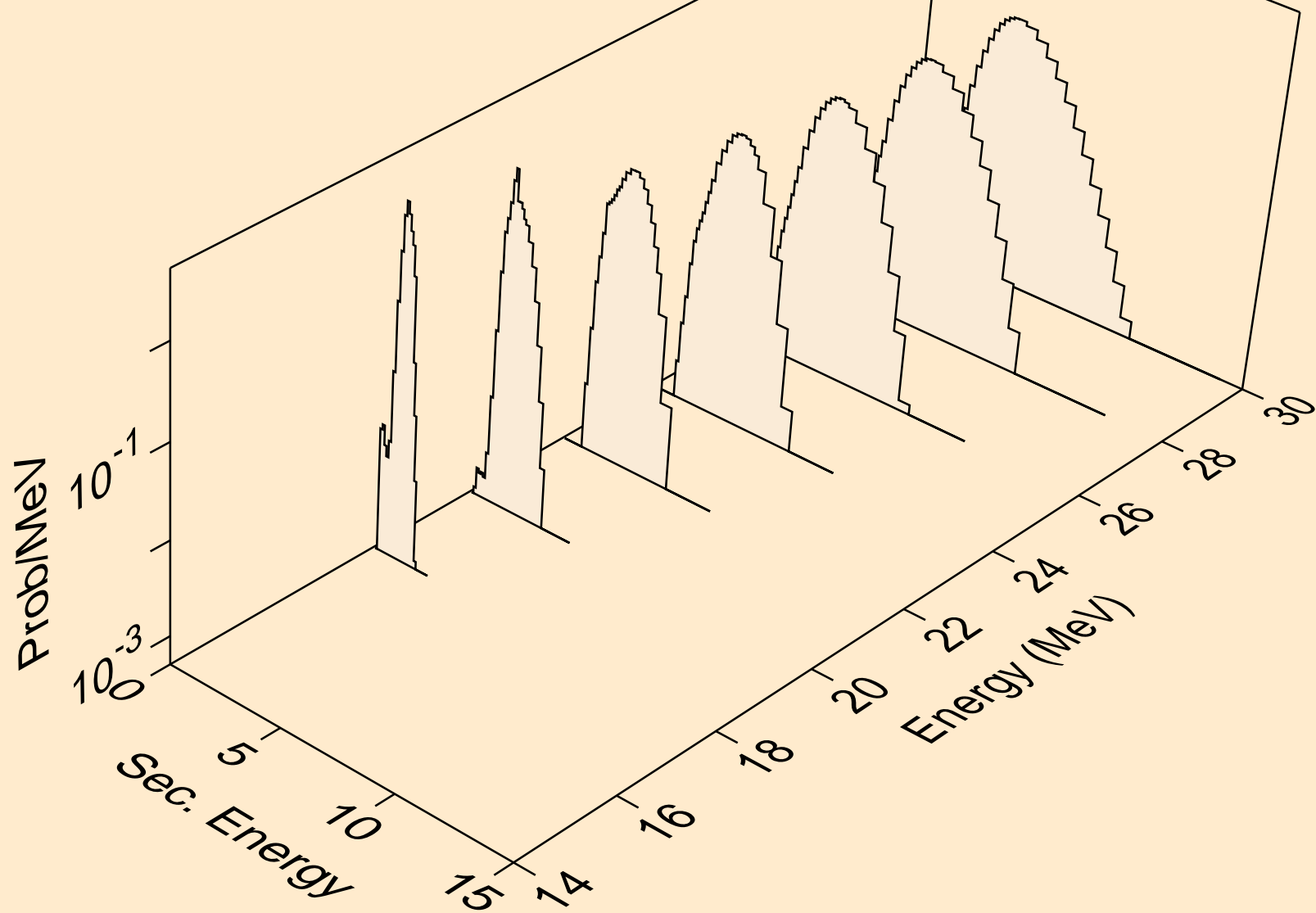

AS075 PROTON ACER TENDL-2024 LIBRARY; T=0.K  
Proton emission for (p,pt)

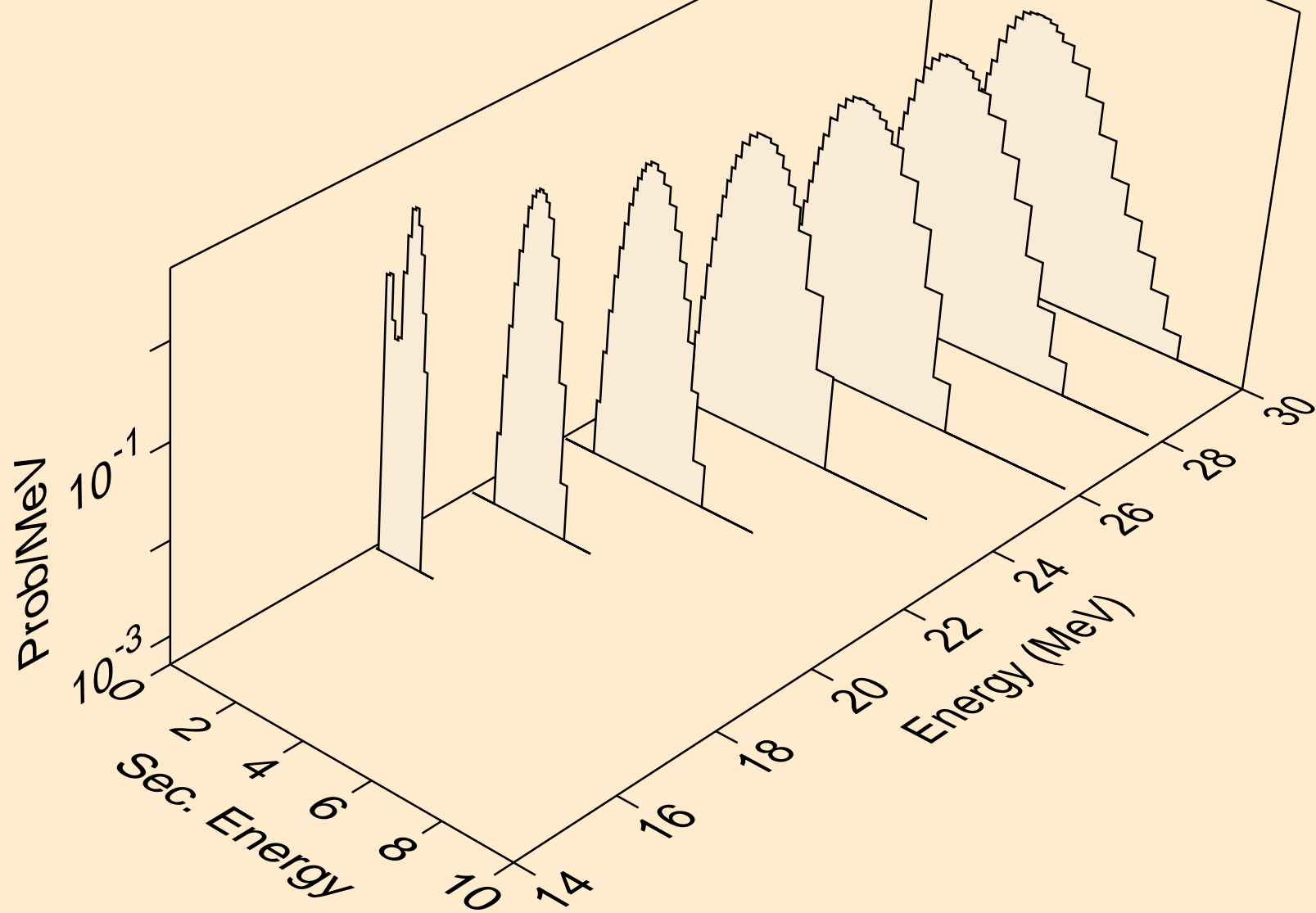

AS075 PROTON ACER TENDL-2024 LIBRARY; T=0.K  
Photon emission for (z,n)

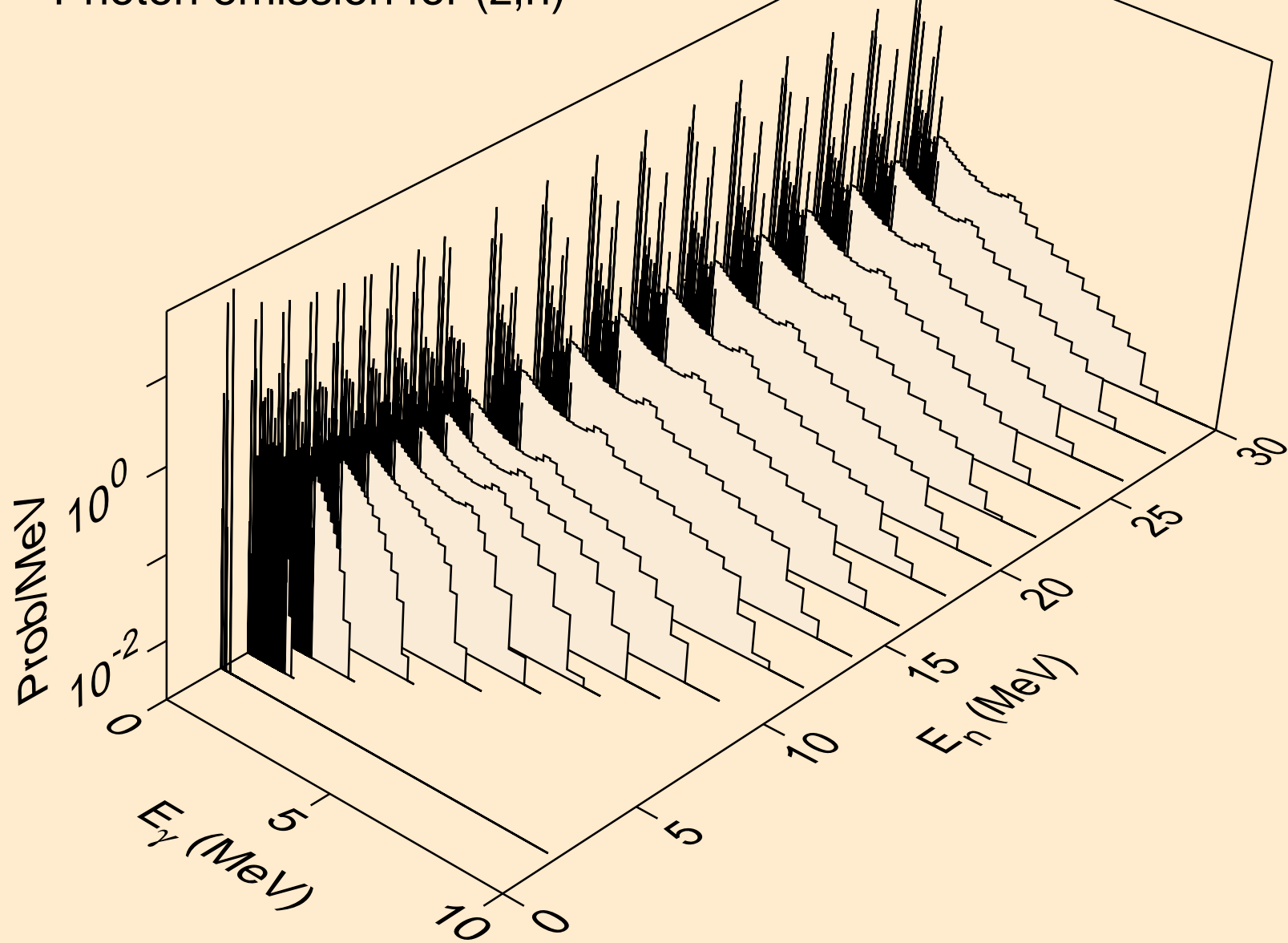

AS075 PROTON ACER TENDL-2024 LIBRARY; T=0.K  
Photon emission for (z,x)

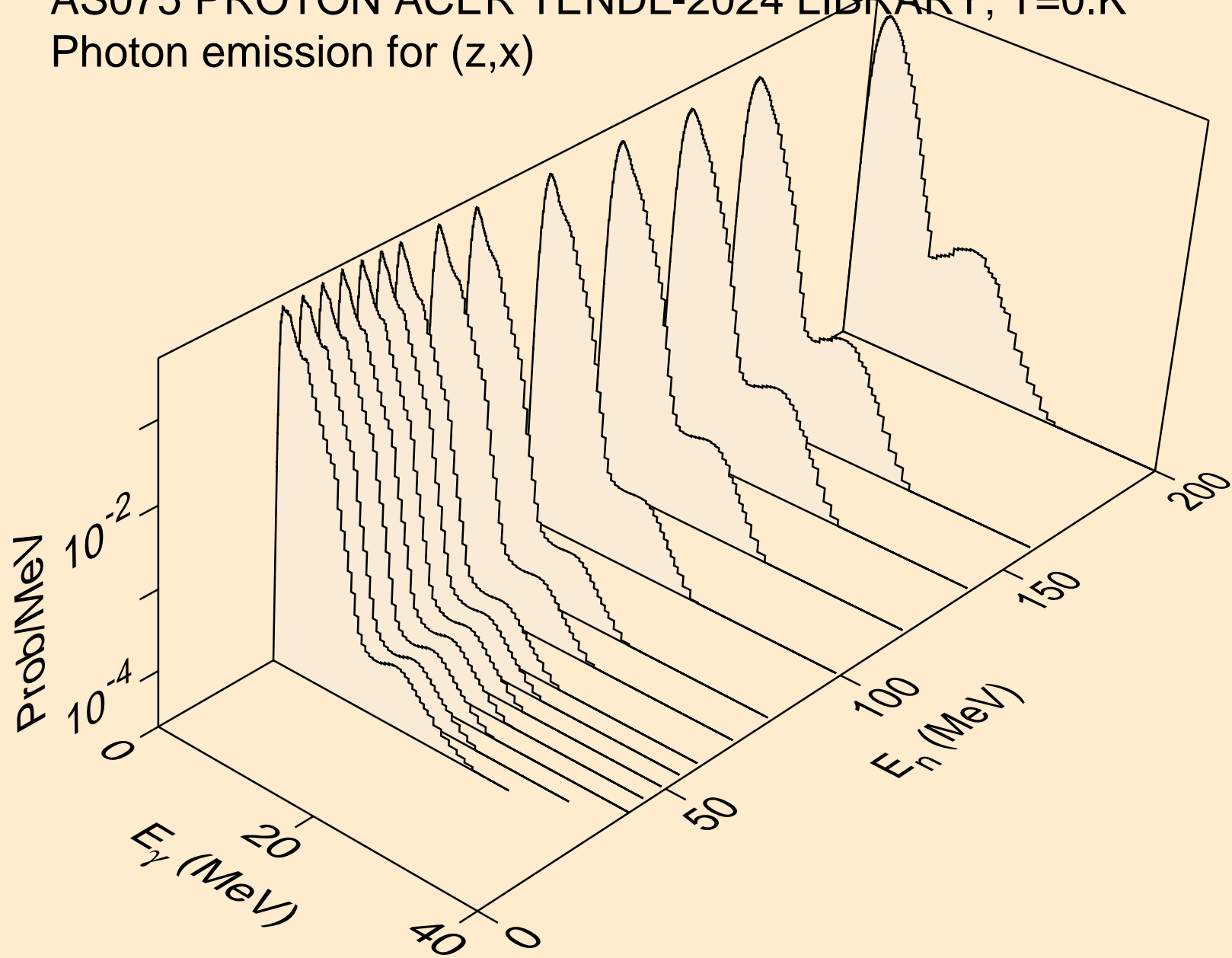

AS075 PROTON ACER TENDL-2024 LIBRARY; T=0.K  
Photon emission for (n,2nd)

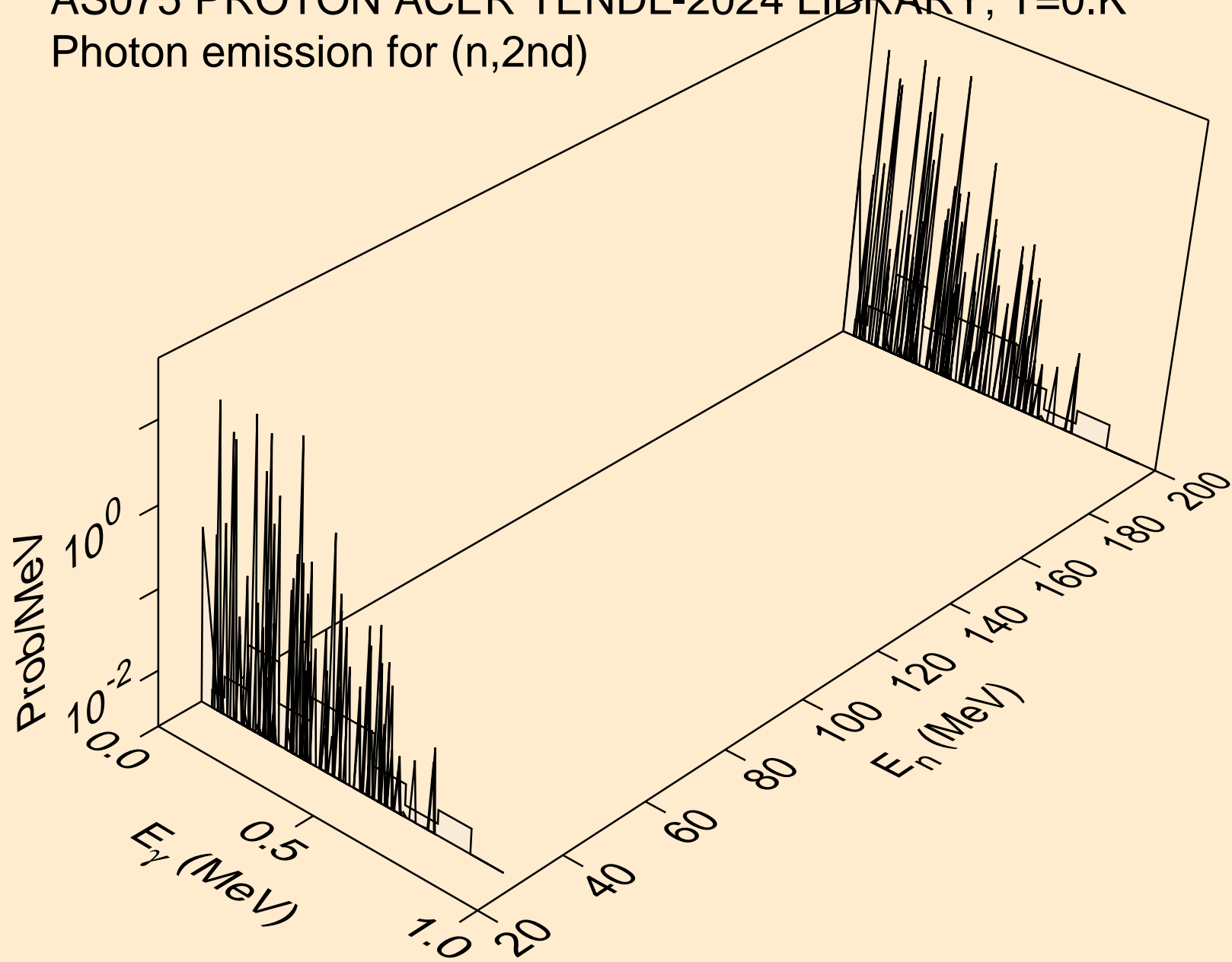

AS075 PROTON ACER TENDL-2024 LIBRARY; T=0.K  
Photon emission for (n,2n)

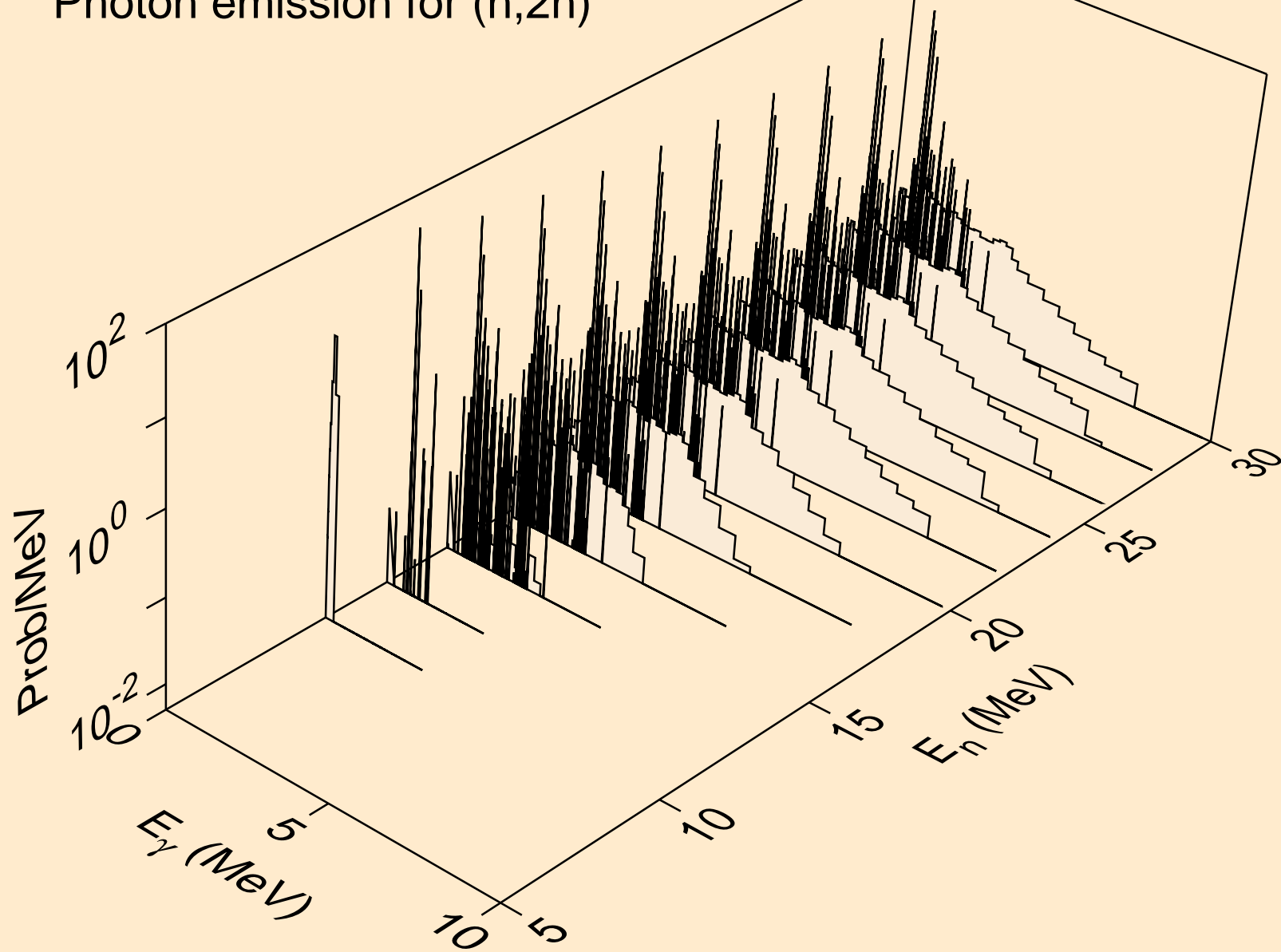

AS075 PROTON ACER TENDL-2024 LIBRARY; T=0.K  
Photon emission for (n,3n)

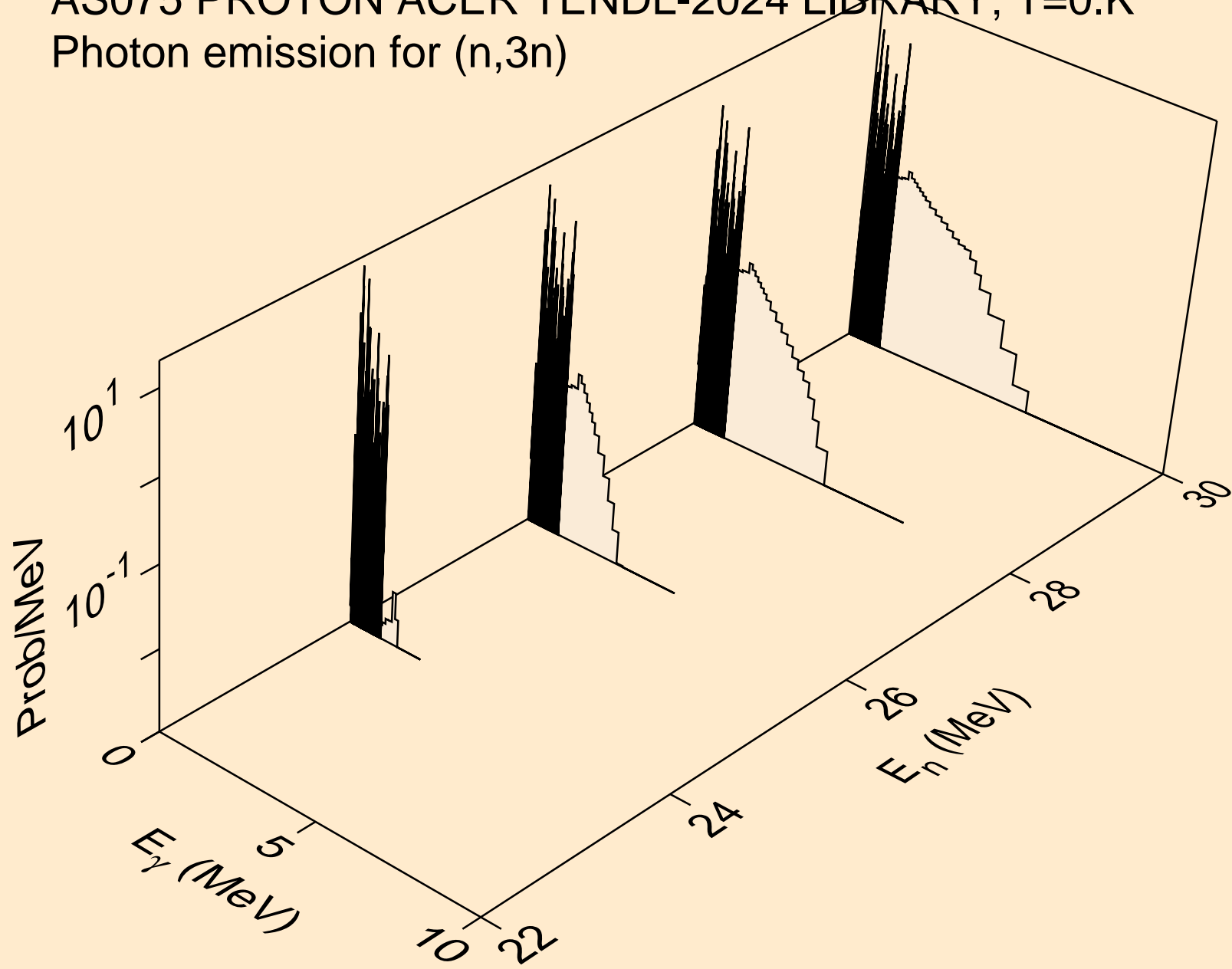

AS075 PROTON ACER TENDL-2024 LIBRARY; T=0.K  
Photon emission for (n,n\*)a

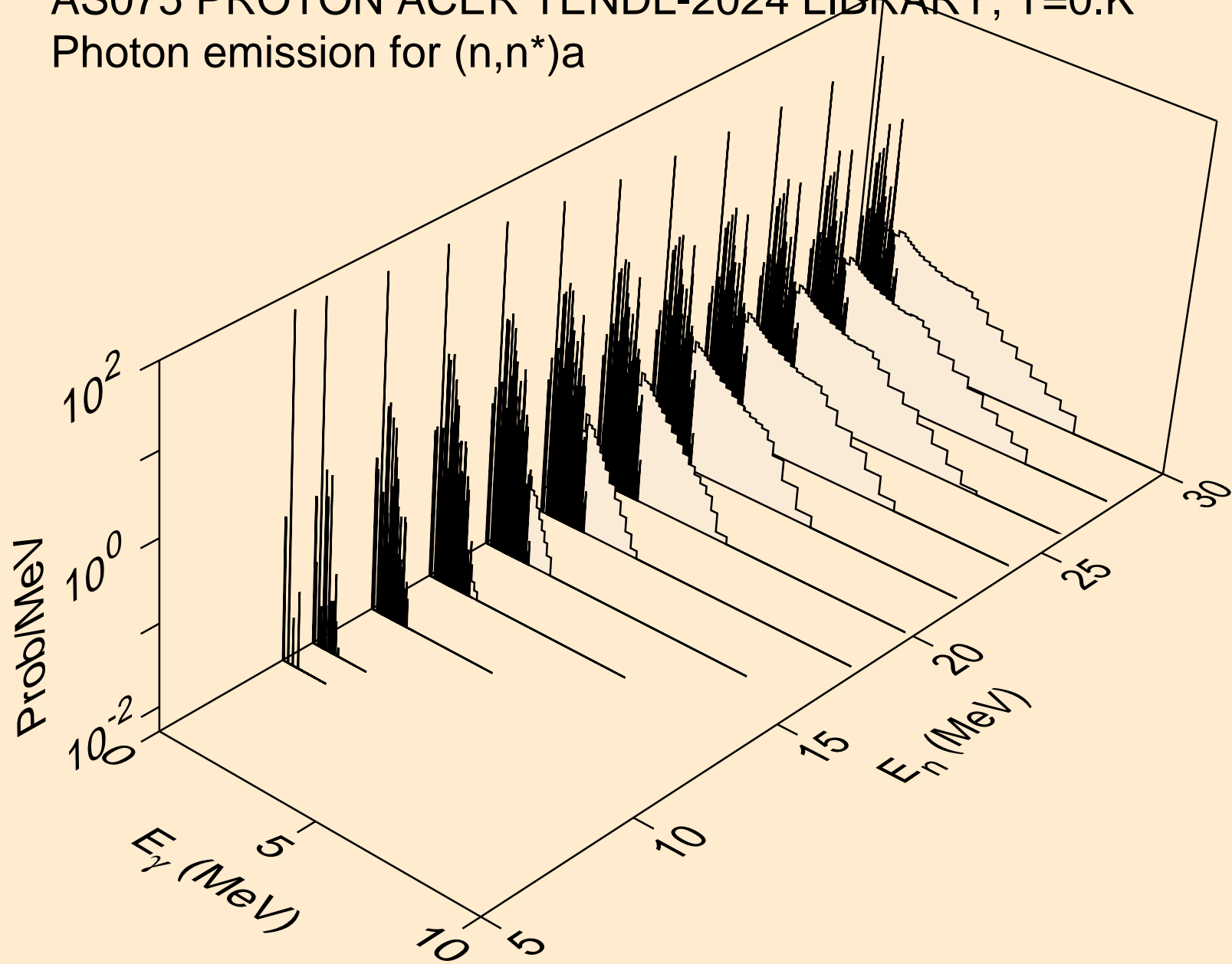

AS075 PROTON ACER TENDL-2024 LIBRARY; T=0.K  
Photon emission for (n,2n)a

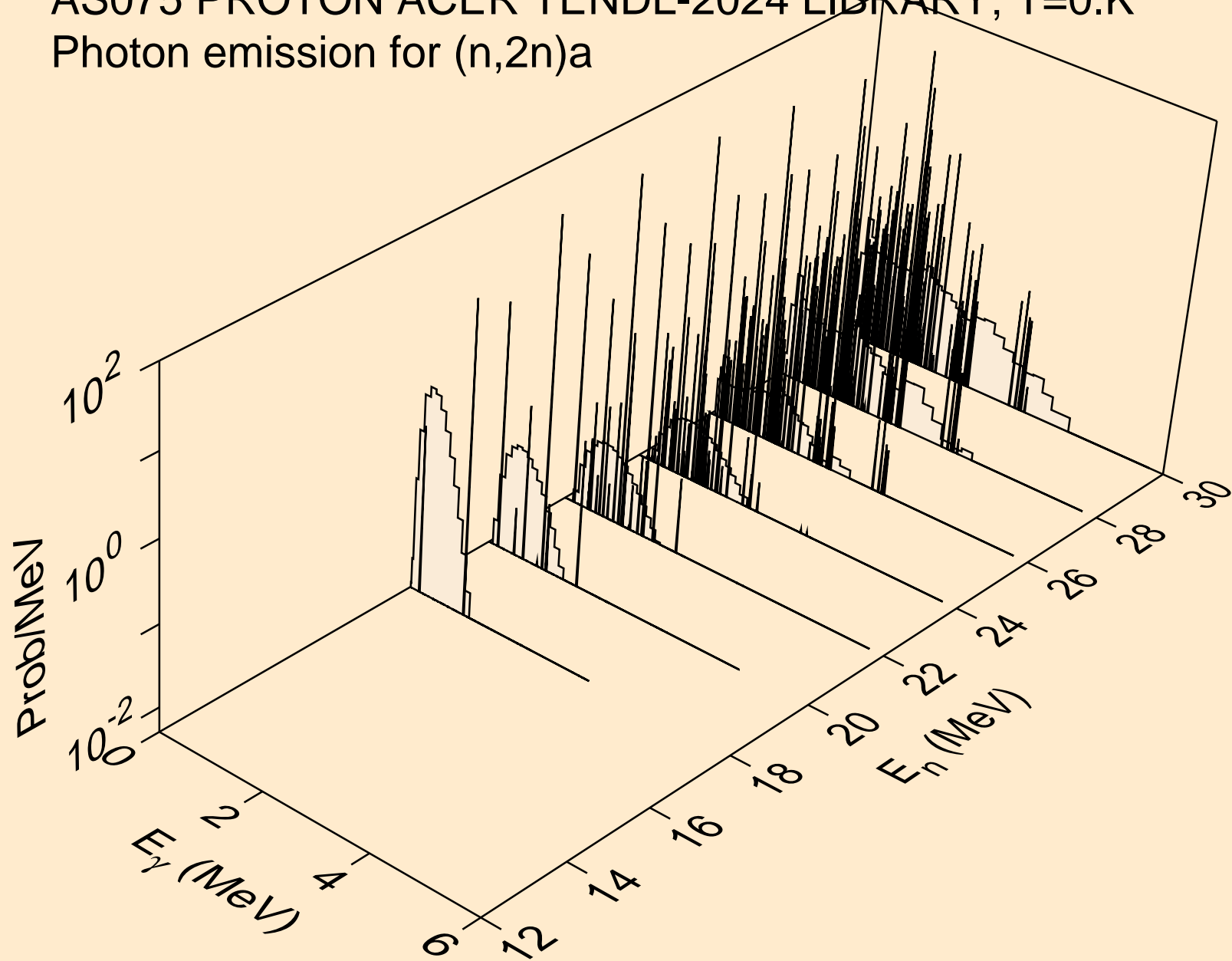

AS075 PROTON ACER TENDL-2024 LIBRARY; T=0.K  
Photon emission for (n,n\*)p

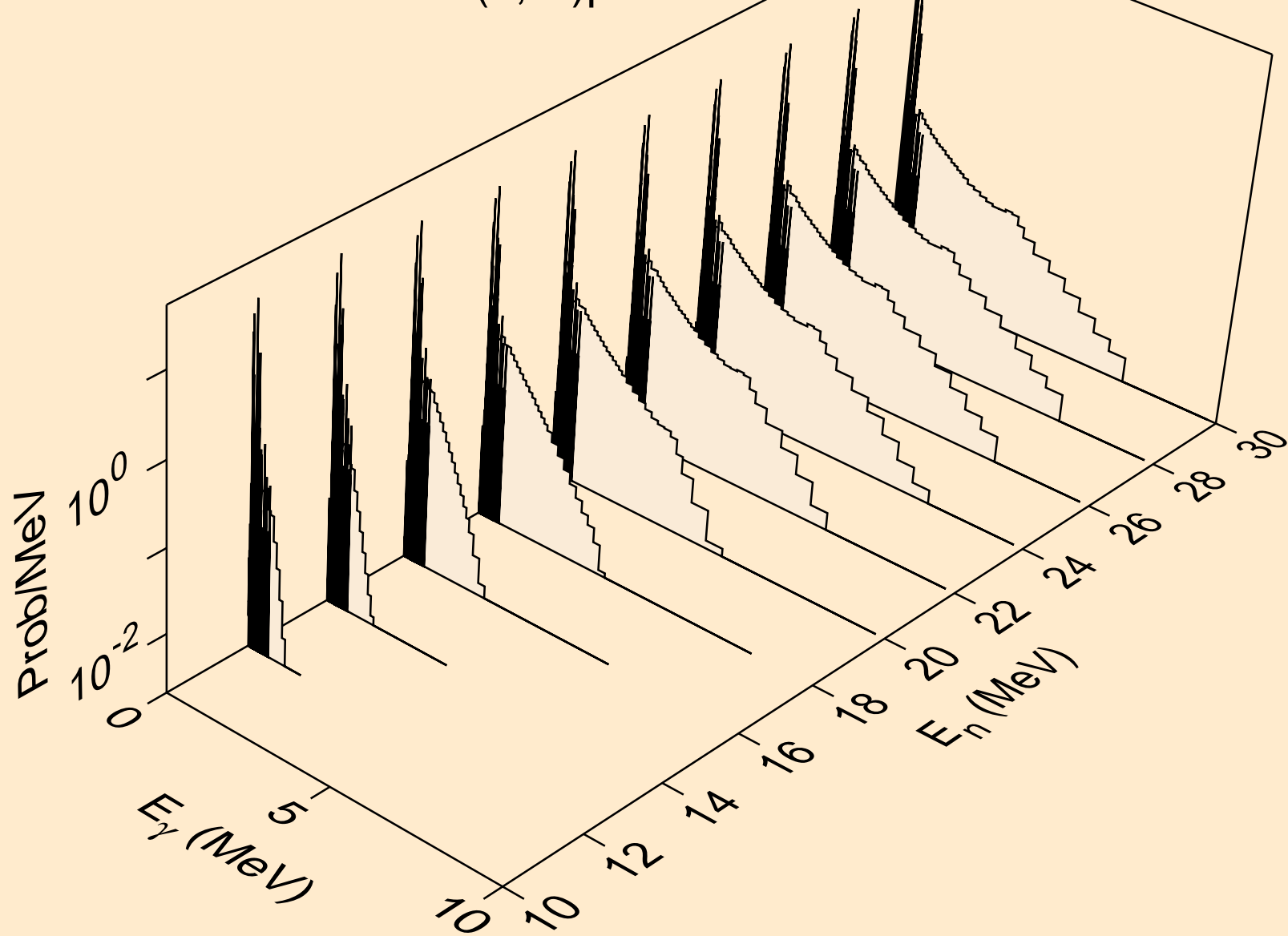

AS075 PROTON ACER TENDL-2024 LIBRARY; T=0.K  
Photon emission for (n,n\*)2a

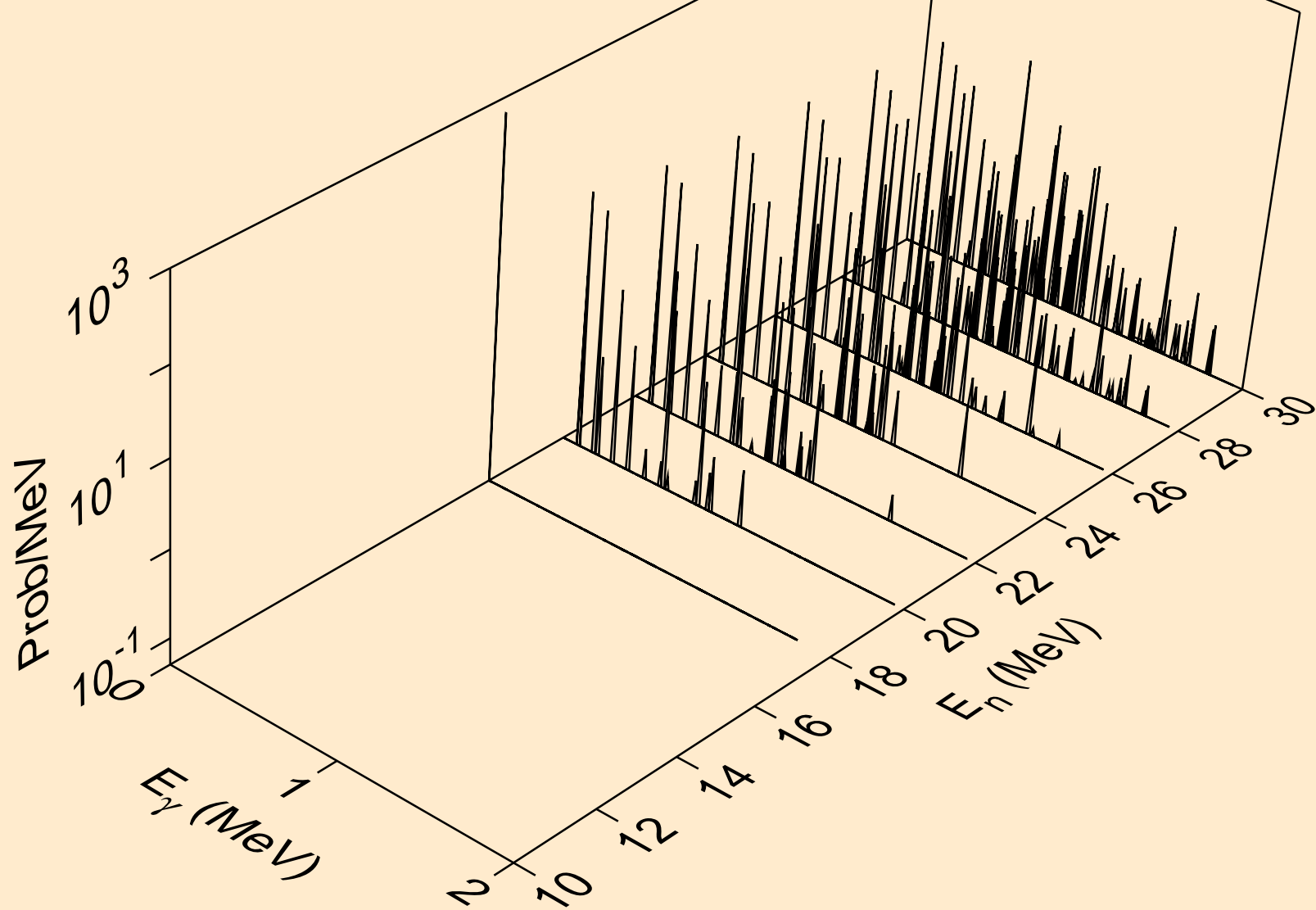

AS075 PROTON ACER TENDL-2024 LIBRARY; T=0.K  
Photon emission for (n,n\*)d

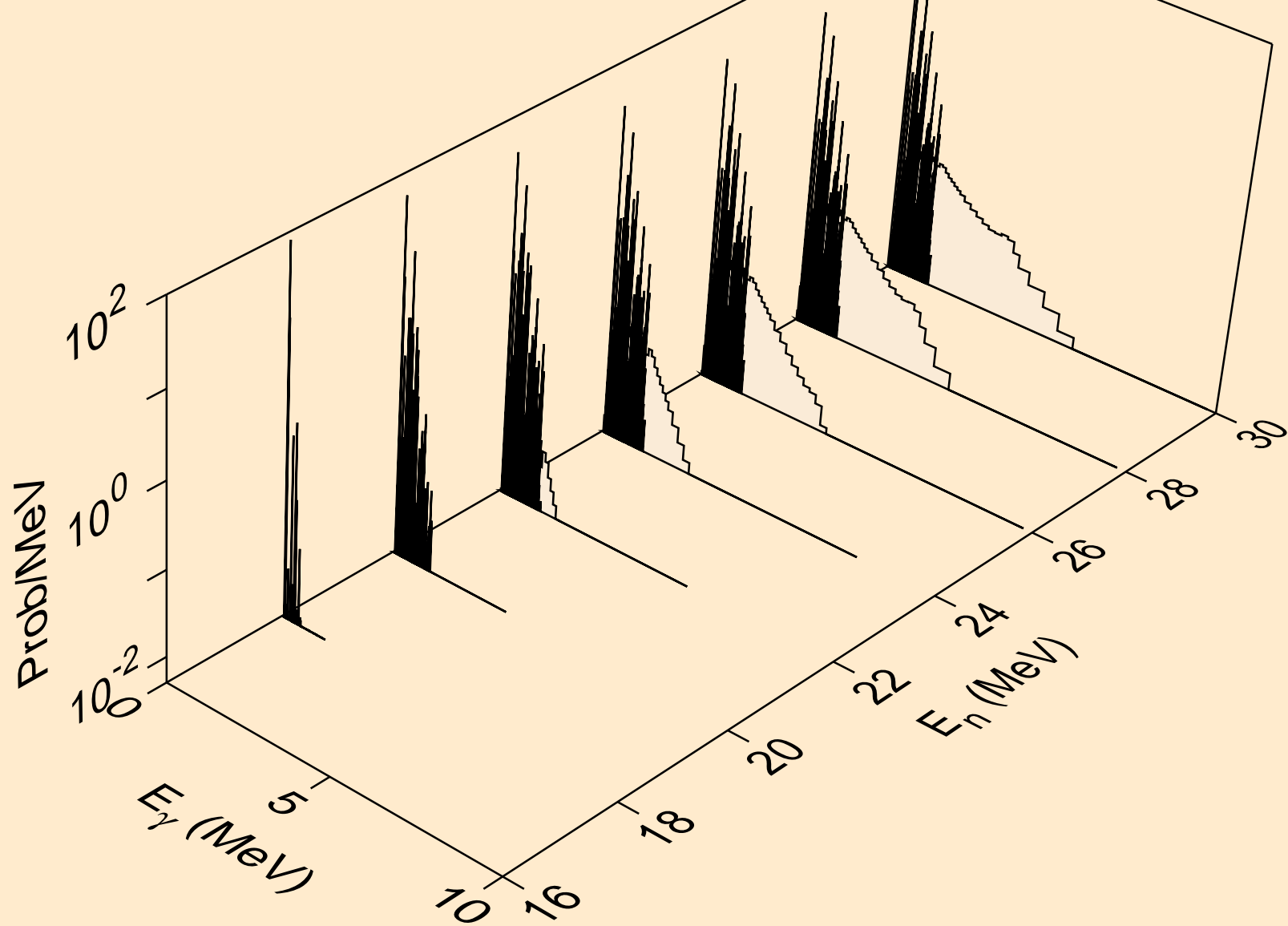

AS075 PROTON ACER TENDL-2024 LIBRARY; T=0.K  
Photon emission for (n,n\*)t

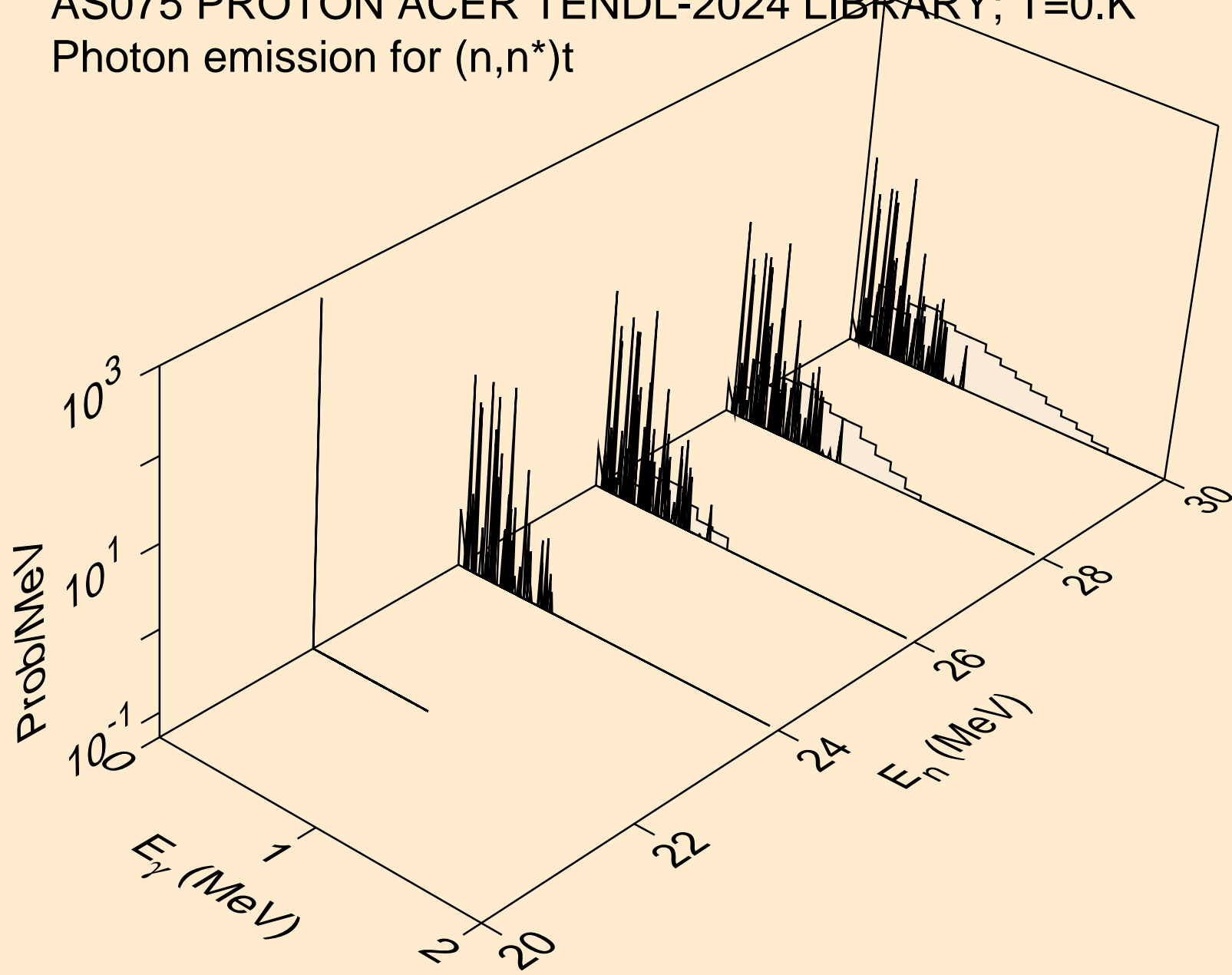

AS075 PROTON ACER TENDL-2024 LIBRARY; T=0.K  
Photon emission for (n,n\*)he3

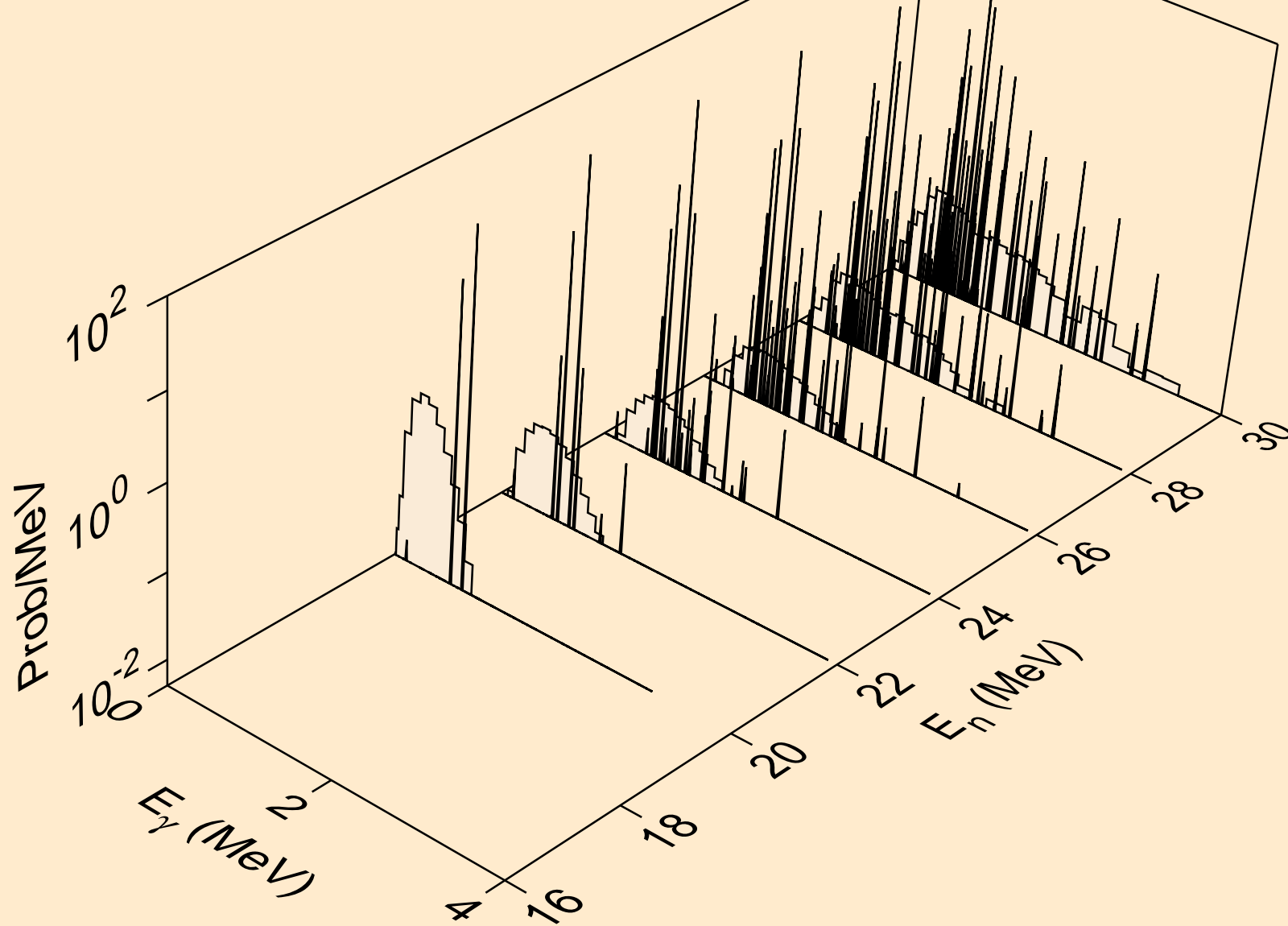

AS075 PROTON ACER TENDL-2024 LIBRARY; T=0.K  
Photon emission for (n,2np)

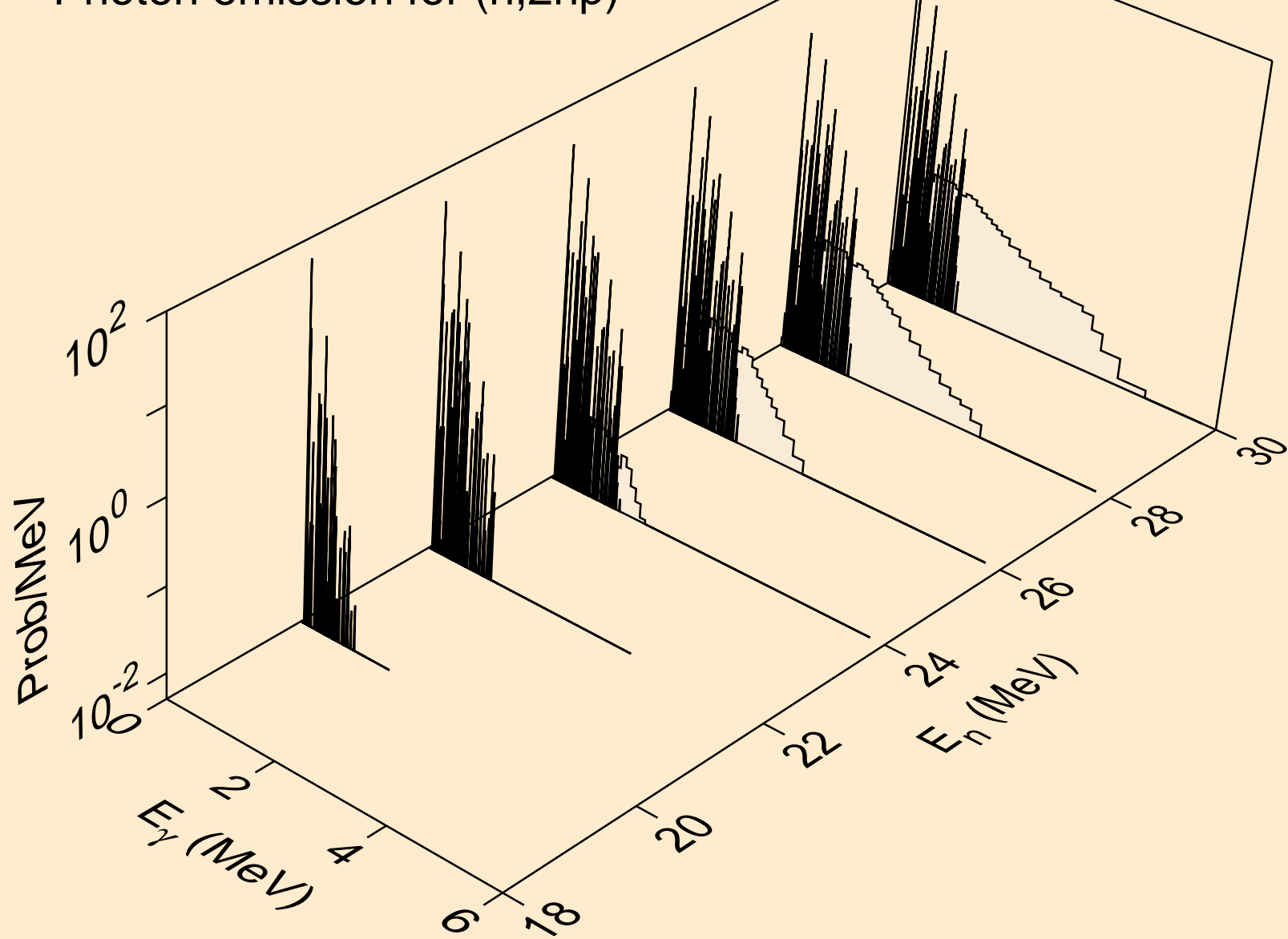

AS075 PROTON ACER TENDL-2024 LIBRARY; T=0.K  
Photon emission for (n,n2p)

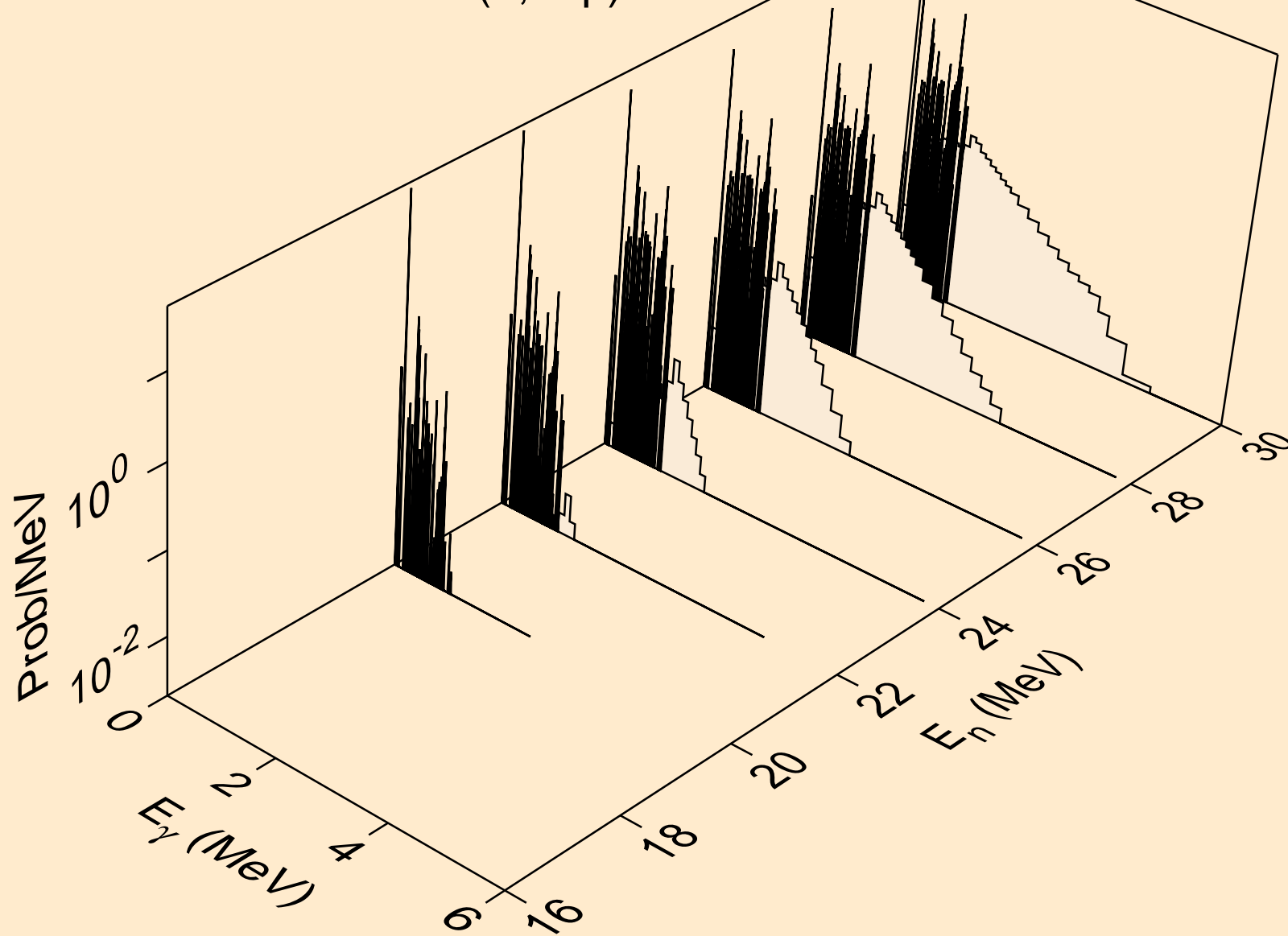

AS075 PROTON ACER TENDL-2024 LIBRARY; T=0.K  
Photon emission for (n,npa)

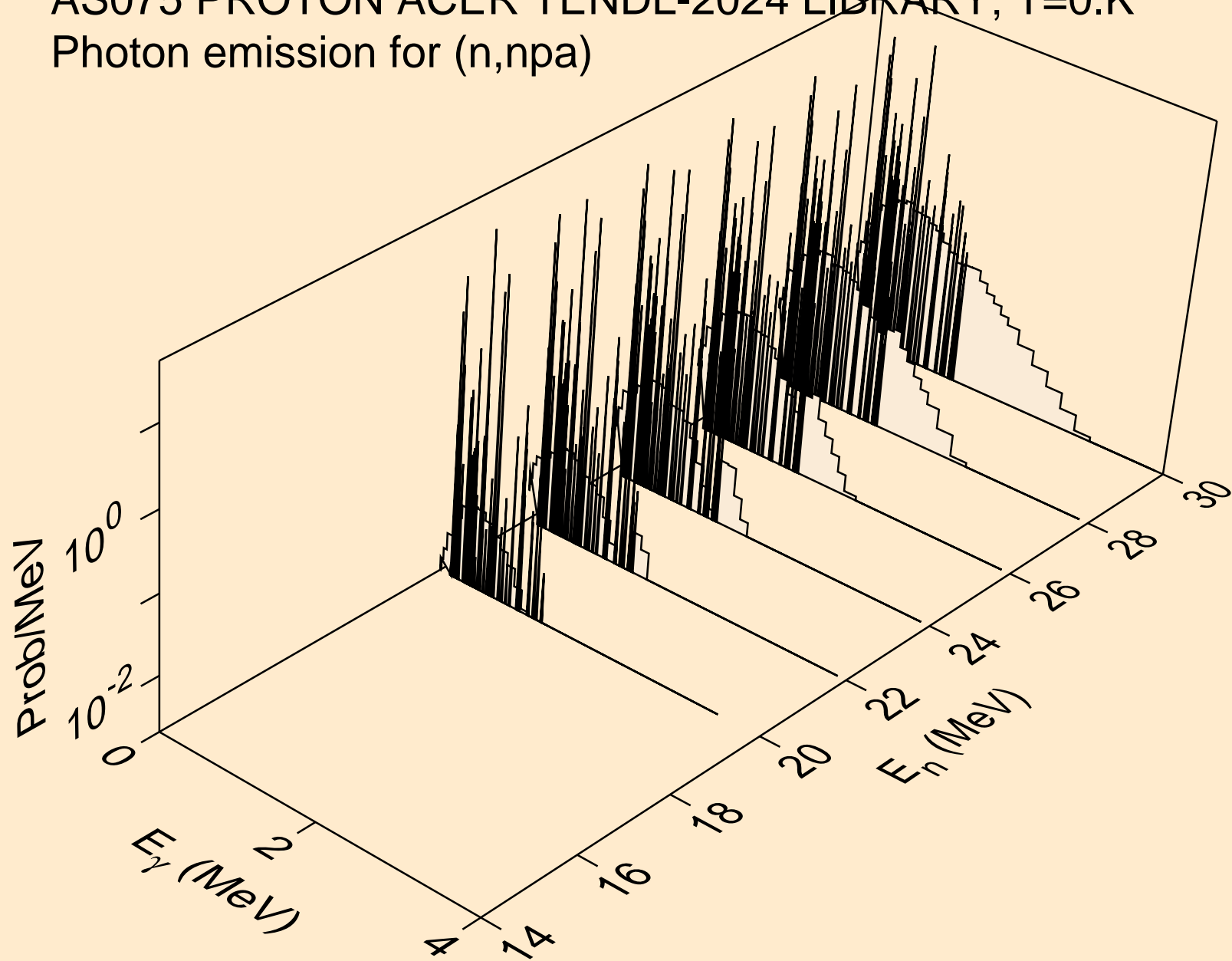

AS075 PROTON ACER TENDL-2024 LIBRARY; T=0.K  
Photon emission for (n,gma)

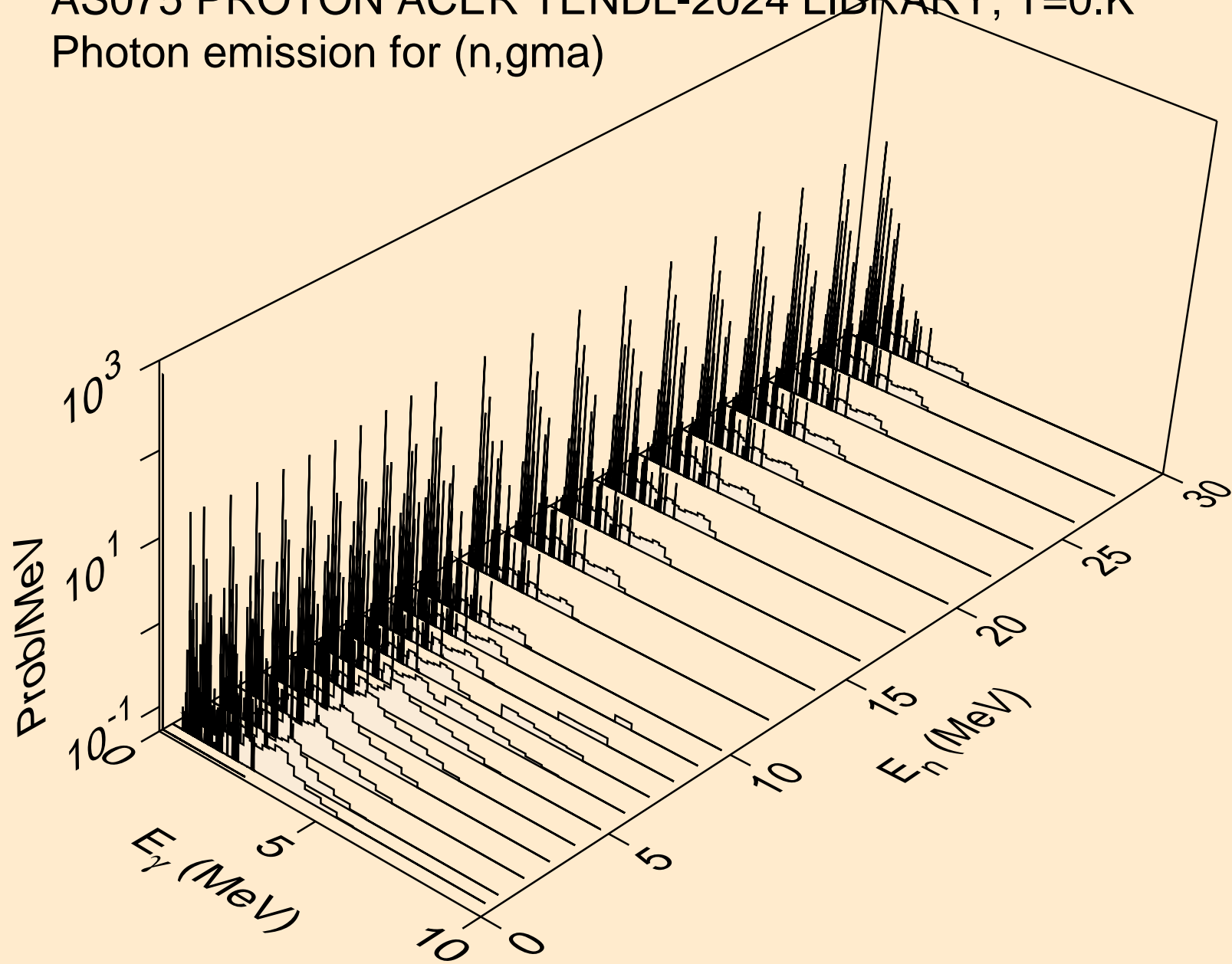

AS075 PROTON ACER TENDL-2024 LIBRARY; T=0.K  
Photon emission for inelastic

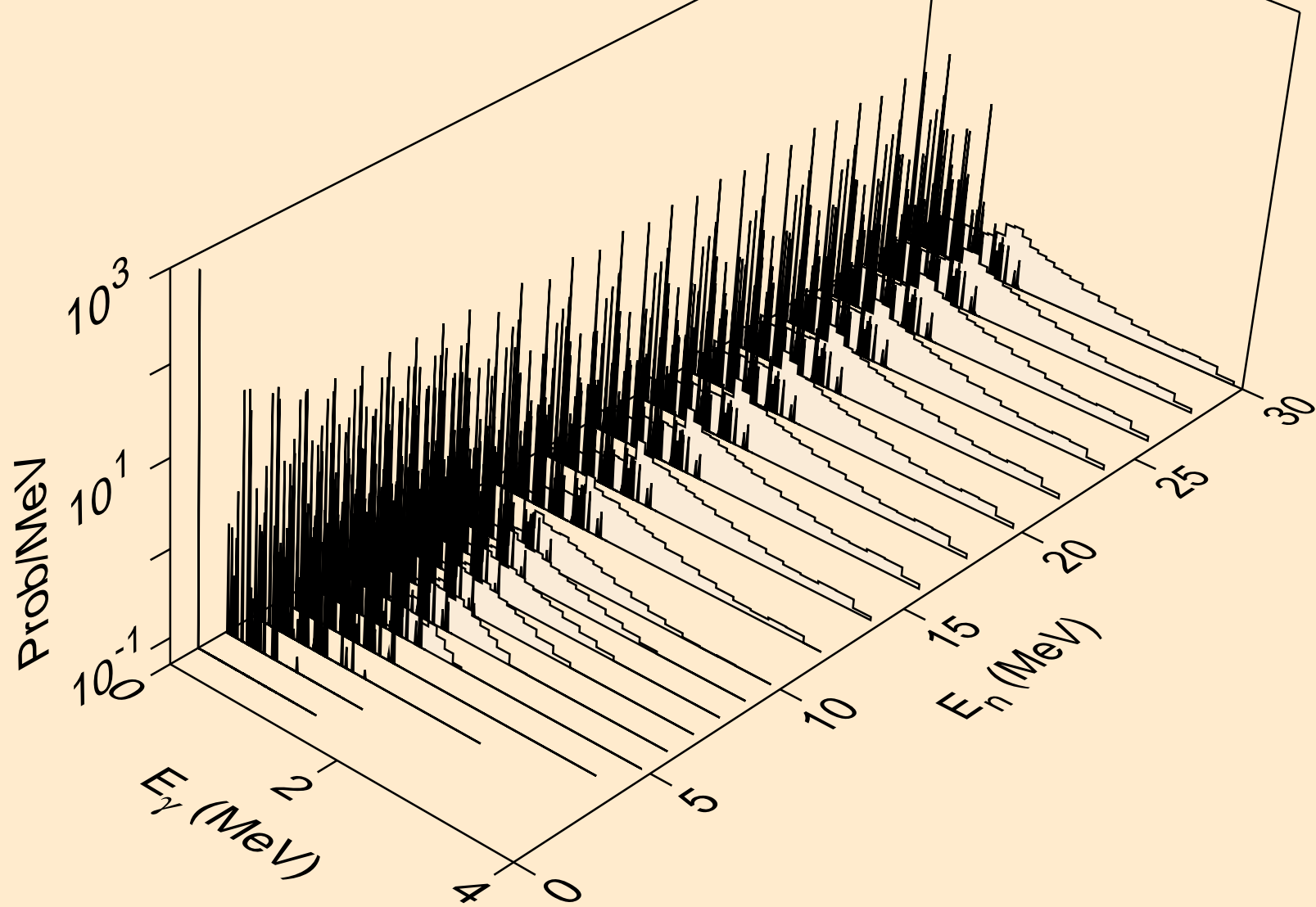

AS075 PROTON ACER TENDL-2024 LIBRARY; T=0.K  
Photon emission for (n,d)

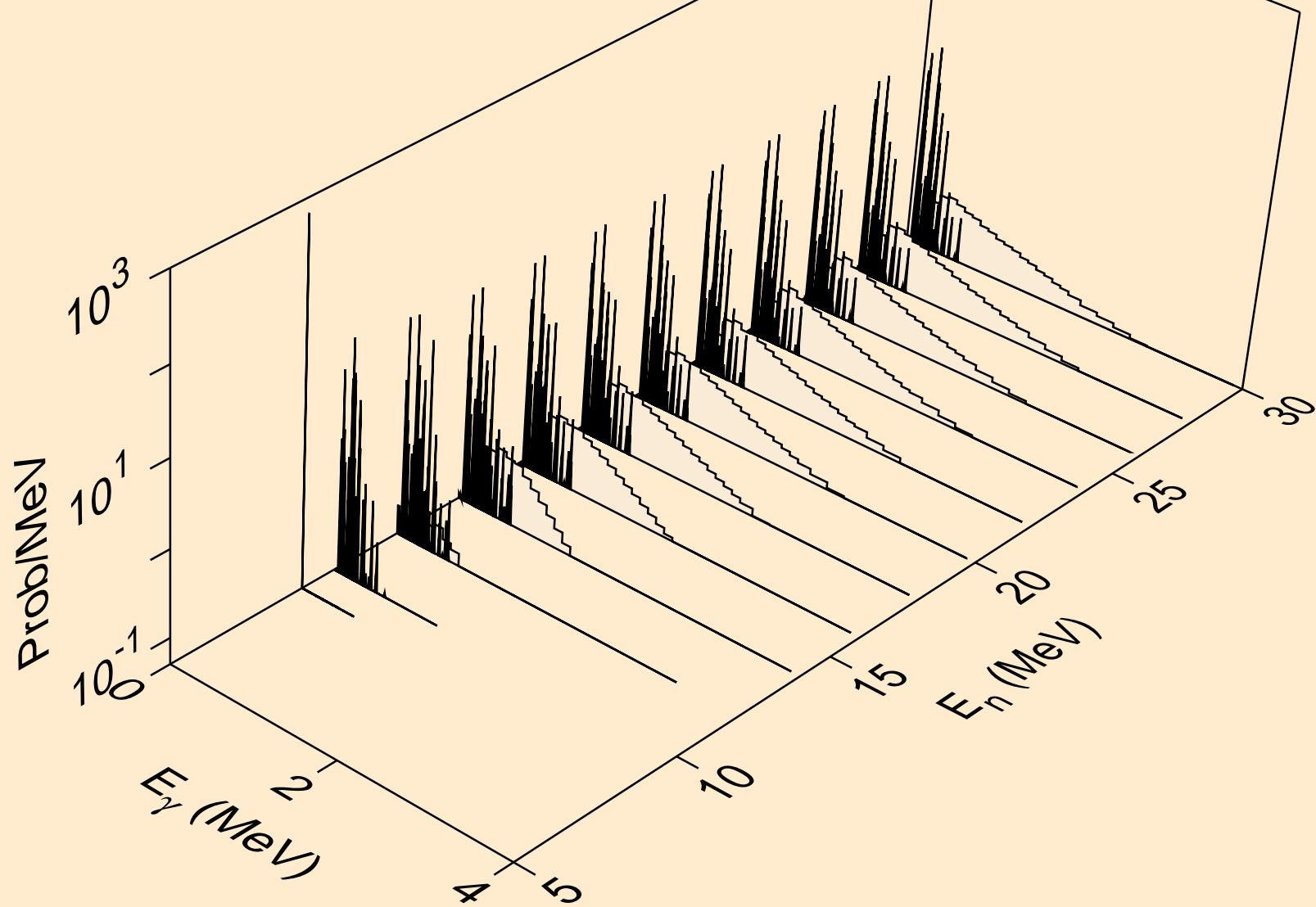

AS075 PROTON ACER TENDL-2024 LIBRARY; T=0.K  
Photon emission for (n,t)

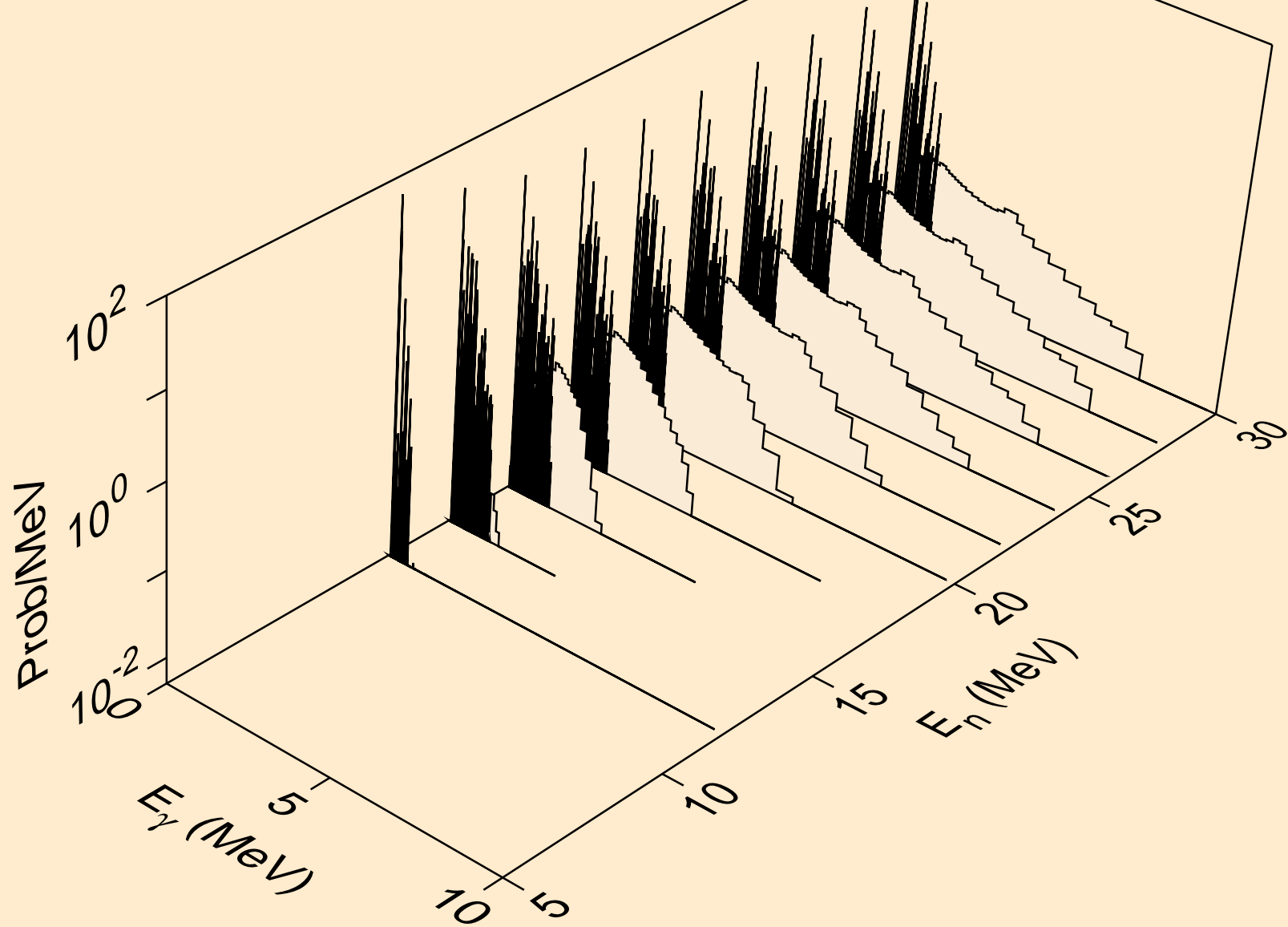

AS075 PROTON ACER TENDL-2024 LIBRARY; T=0.K  
Photon emission for (n,he3)

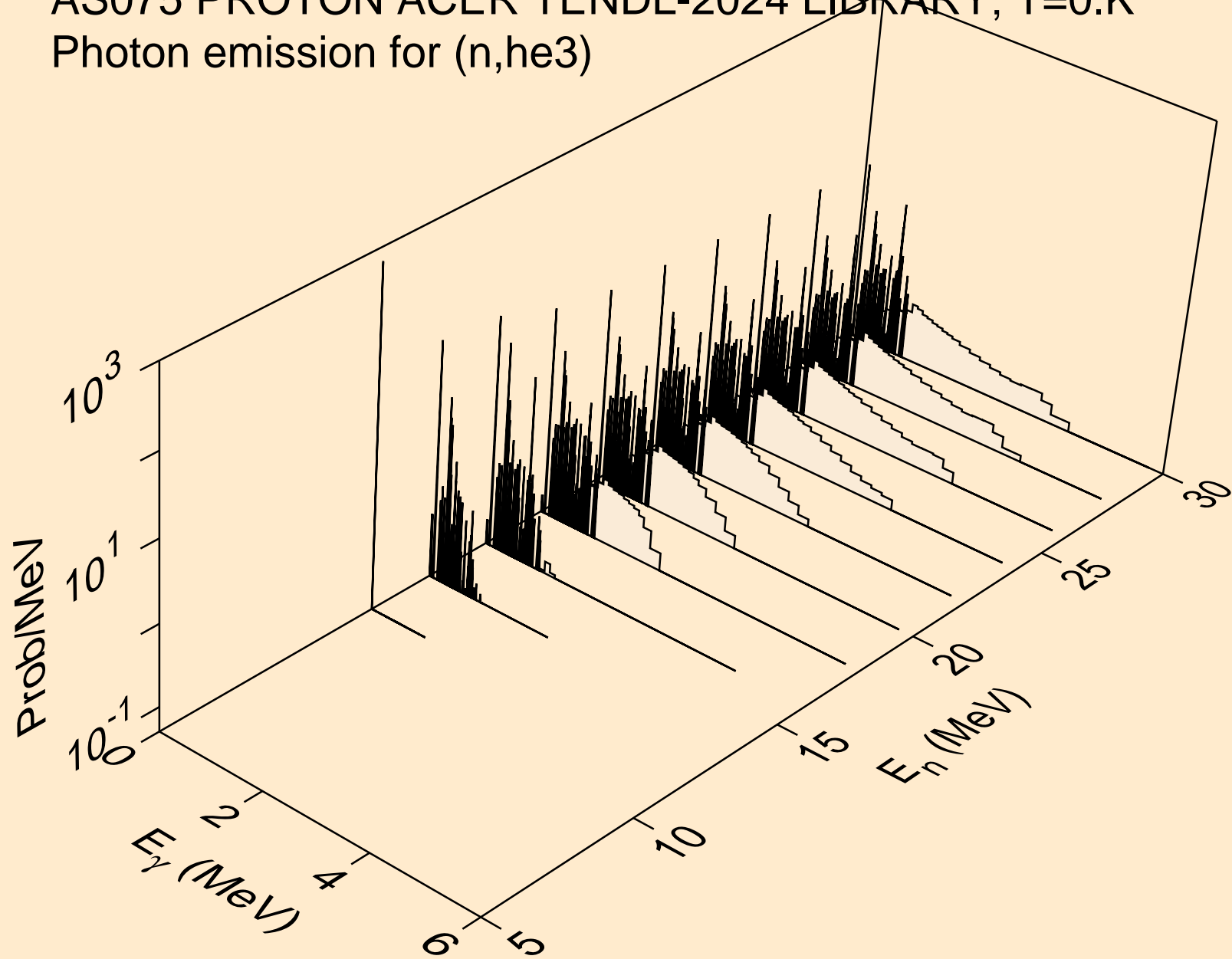

AS075 PROTON ACER TENDL-2024 LIBRARY; T=0.K  
Photon emission for (n,a)

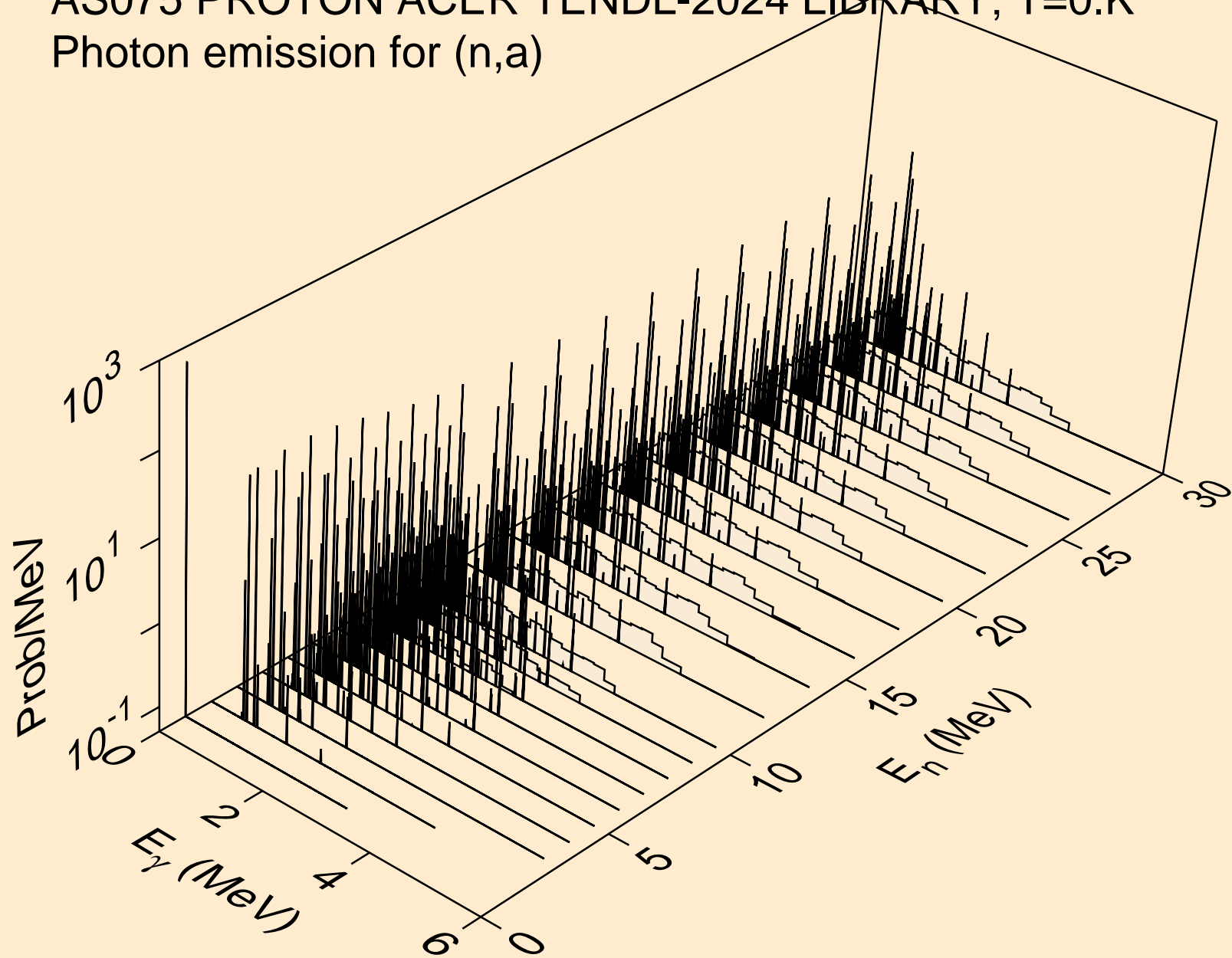

AS075 PROTON ACER TENDL-2024 LIBRARY; T=0.K  
Photon emission for (n,2a)

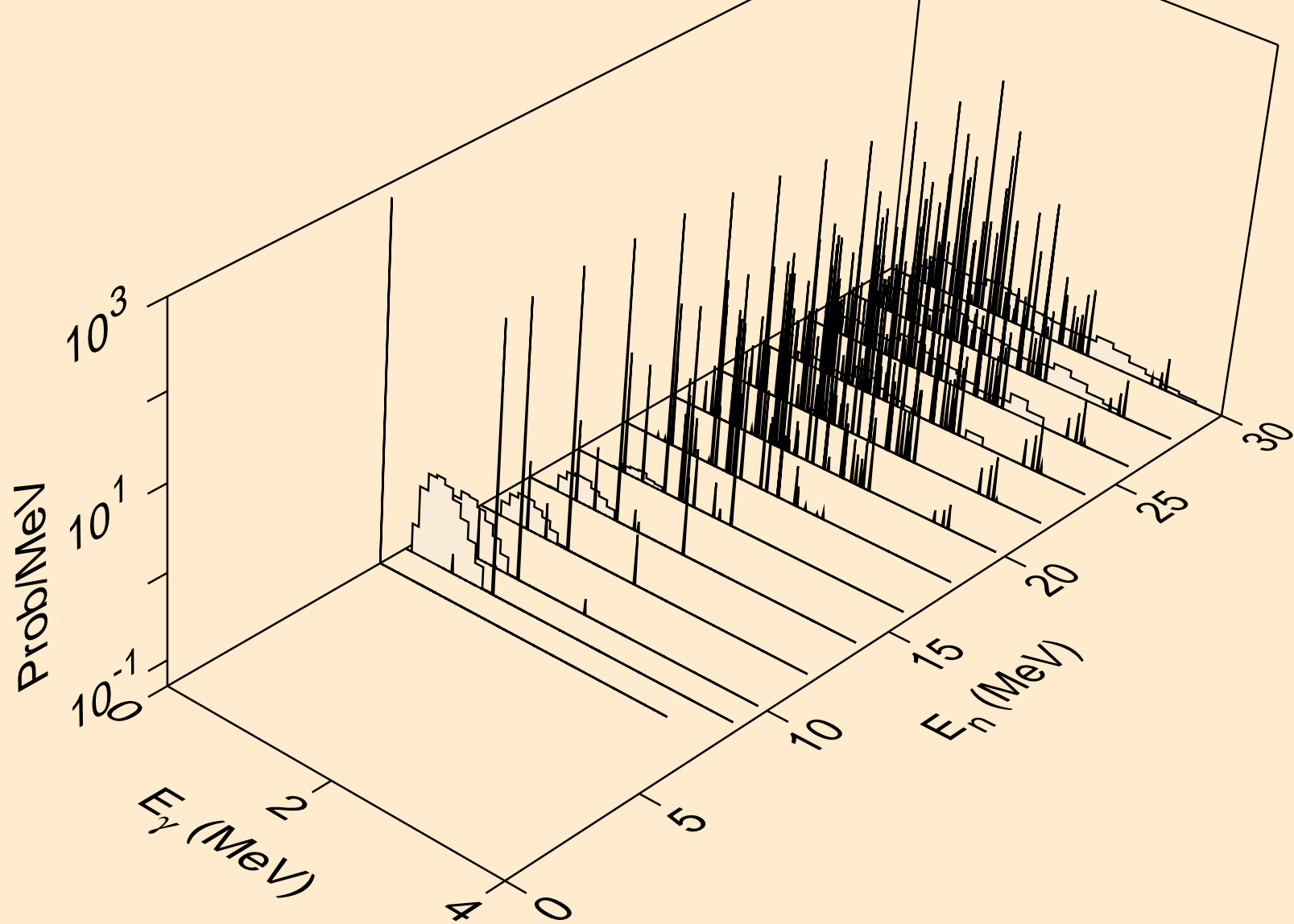

AS075 PROTON ACER TENDL-2024 LIBRARY; T=0.K  
Photon emission for (n,2p)

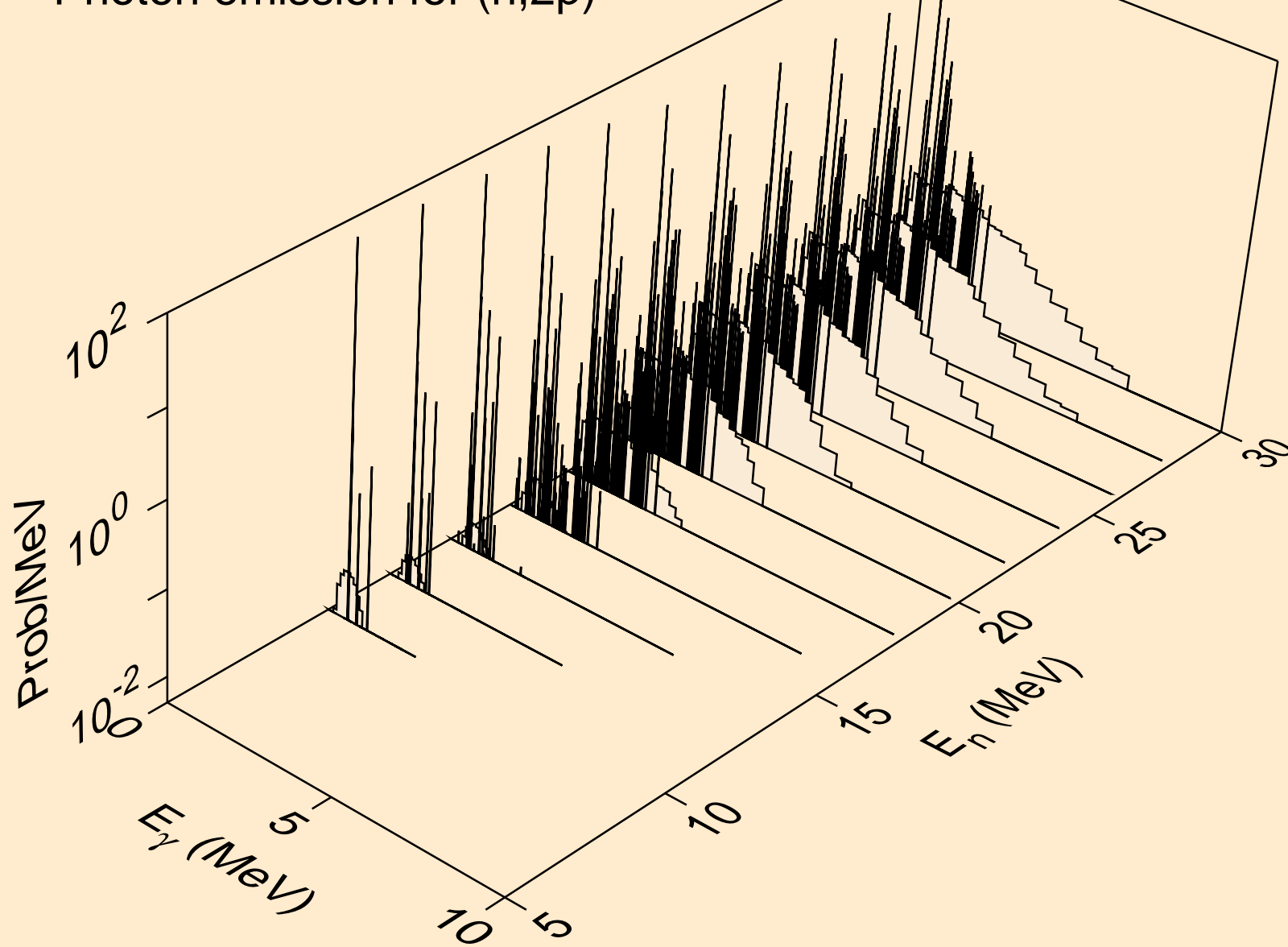

AS075 PROTON ACER TENDL-2024 LIBRARY; T=0.K  
Photon emission for (n,p $\alpha$ )

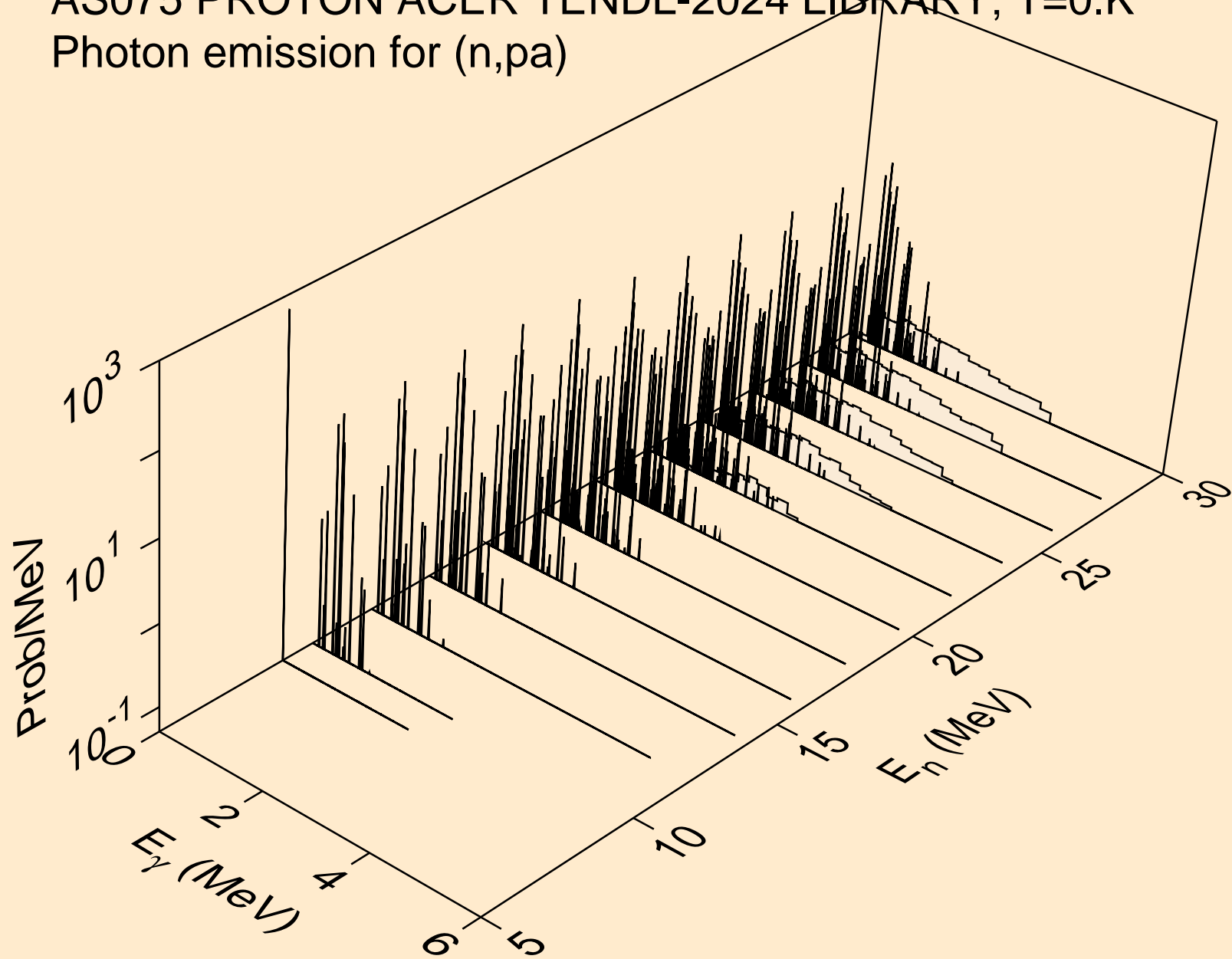

AS075 PROTON ACER TENDL-2024 LIBRARY; T=0.K  
Photon emission for (n,pd)

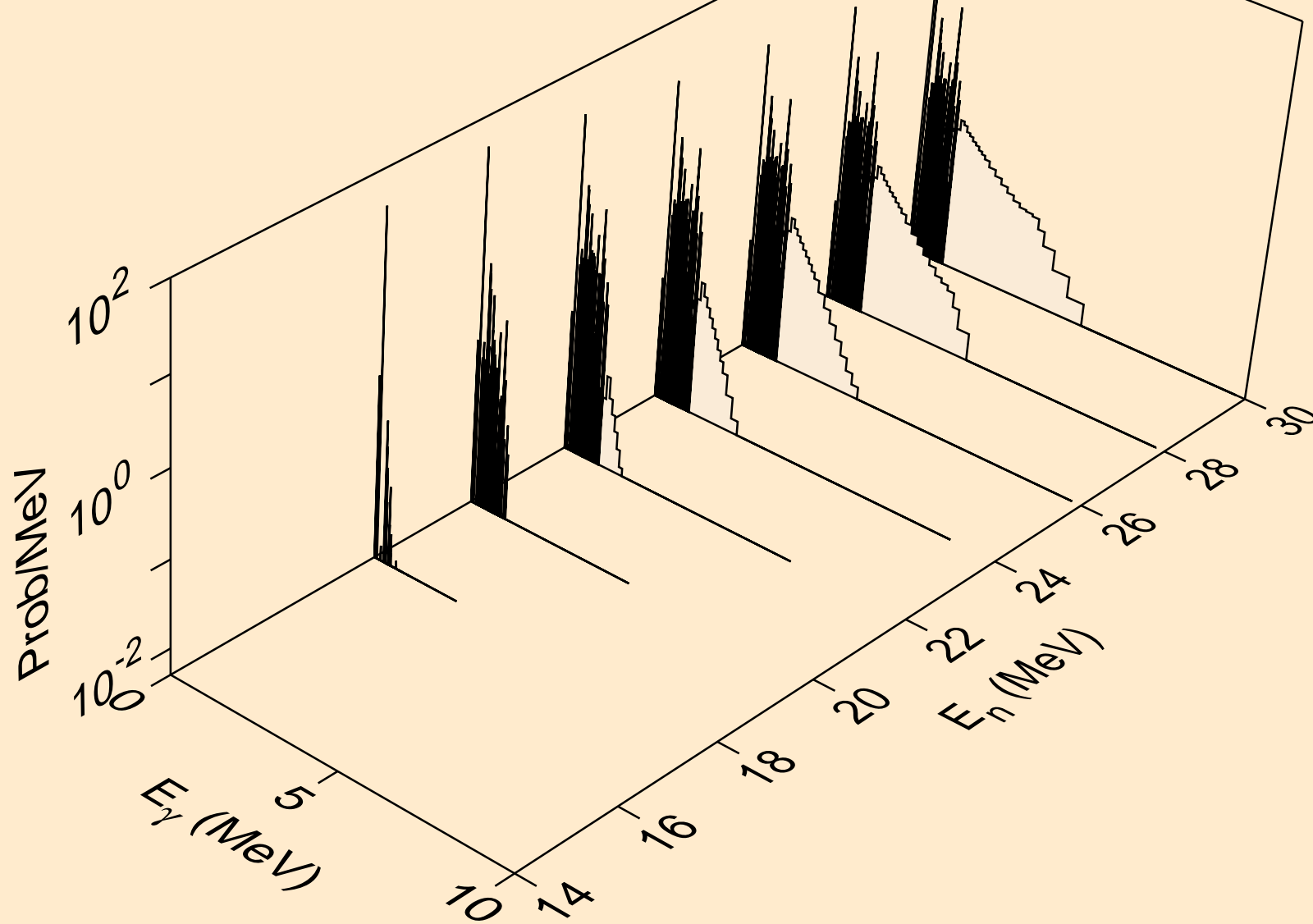

AS075 PROTON ACER TENDL-2024 LIBRARY; T=0.K  
Photon emission for (n,pt)

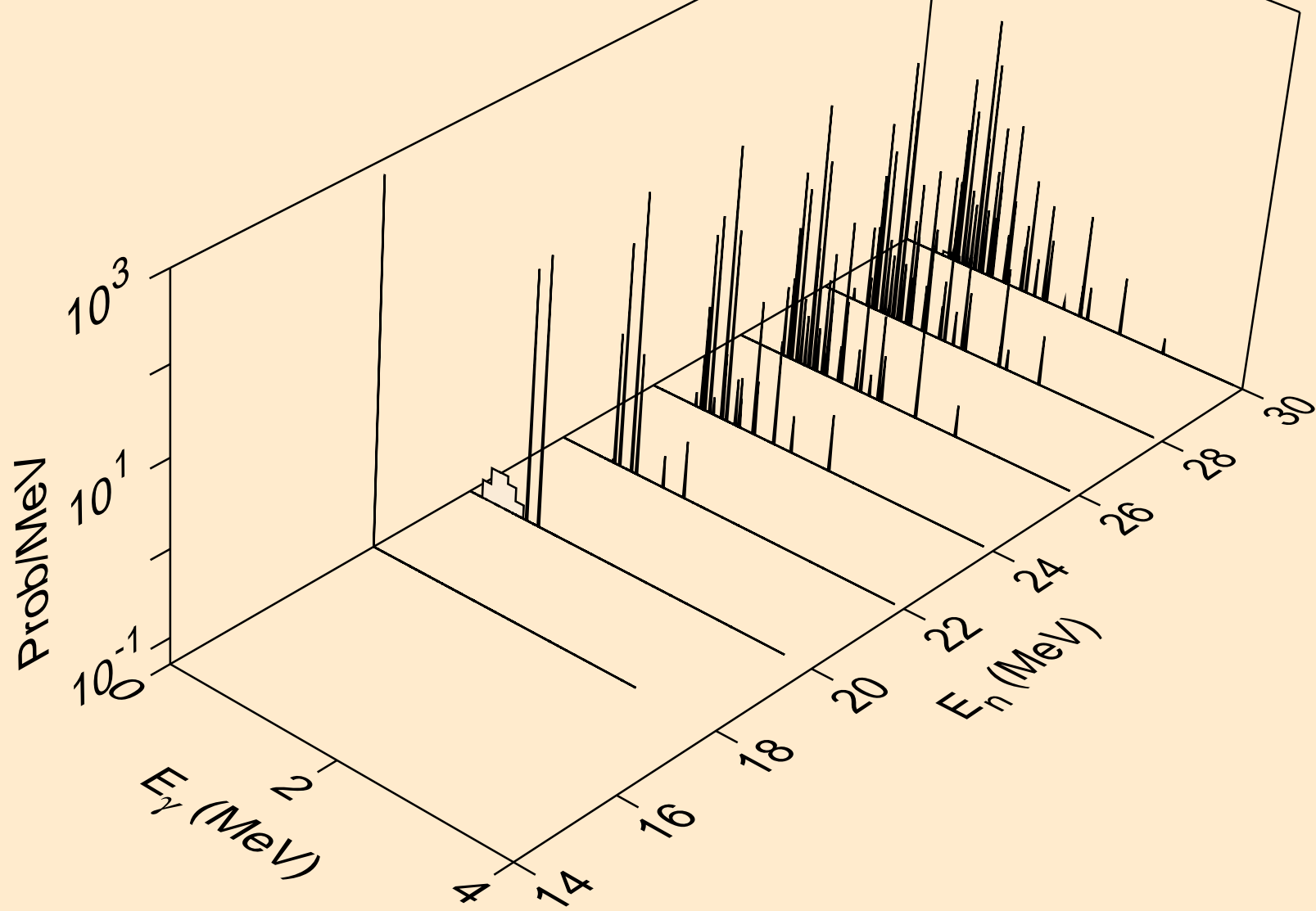

AS075 PROTON ACER TENDL-2024 LIBRARY; T=0.K  
Photon emission for (n,da)

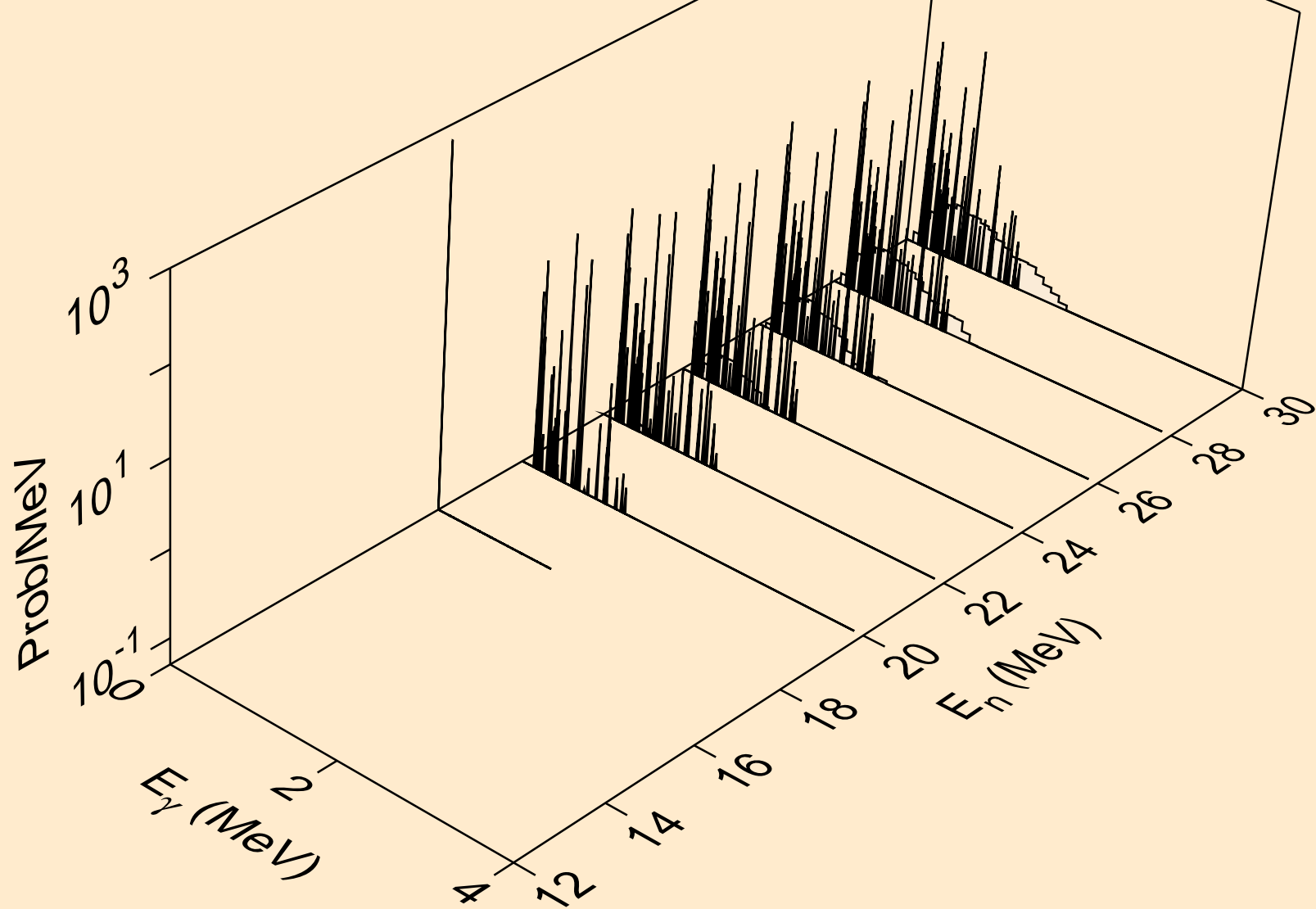

AS075 PROTON ACER TENDL-2024 LIBRARY; T=0.K  
Particle heating contributions

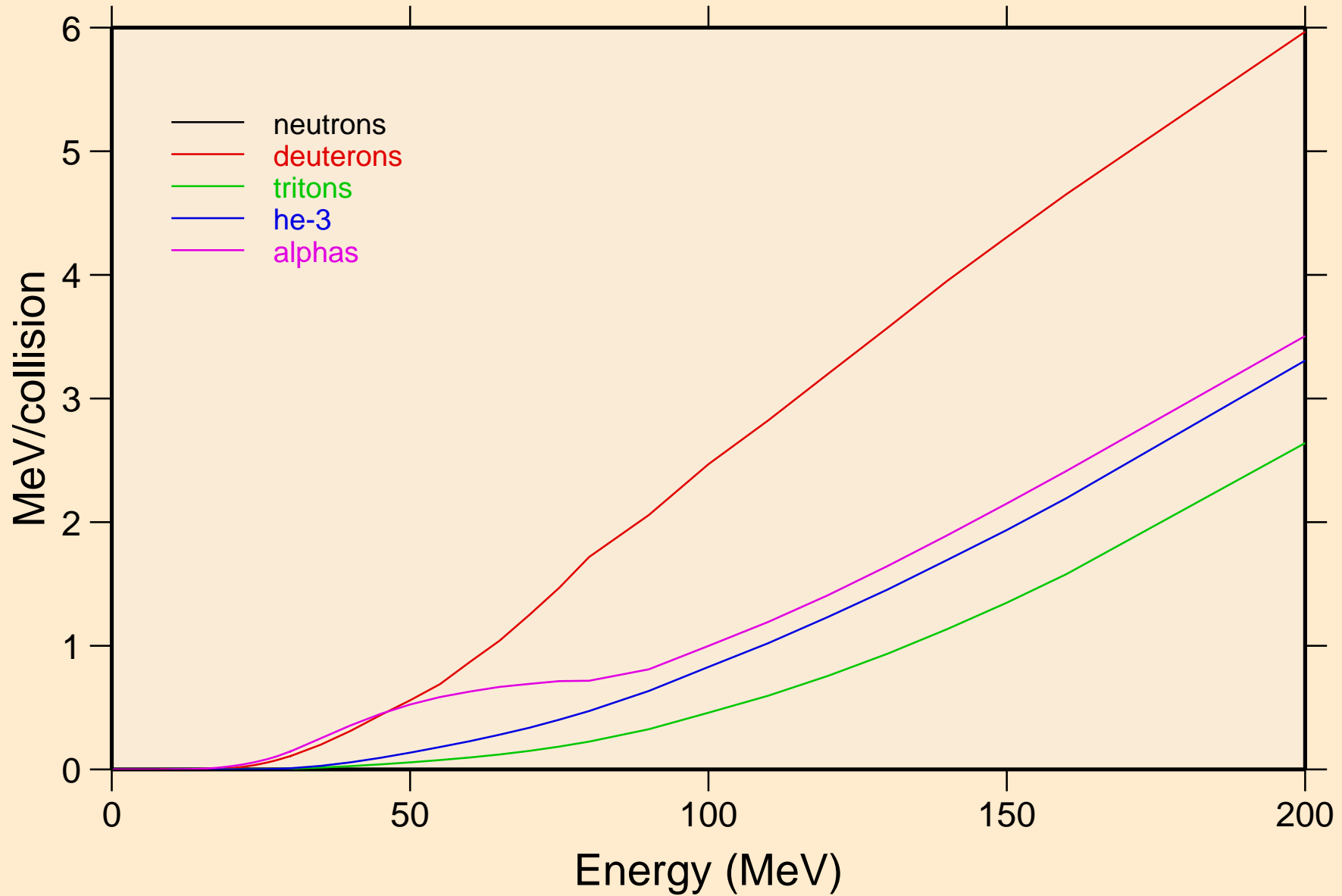

# AS075 PROTON ACER TENDL-2024 LIBRARY; T=0.K

## Recoil Heating

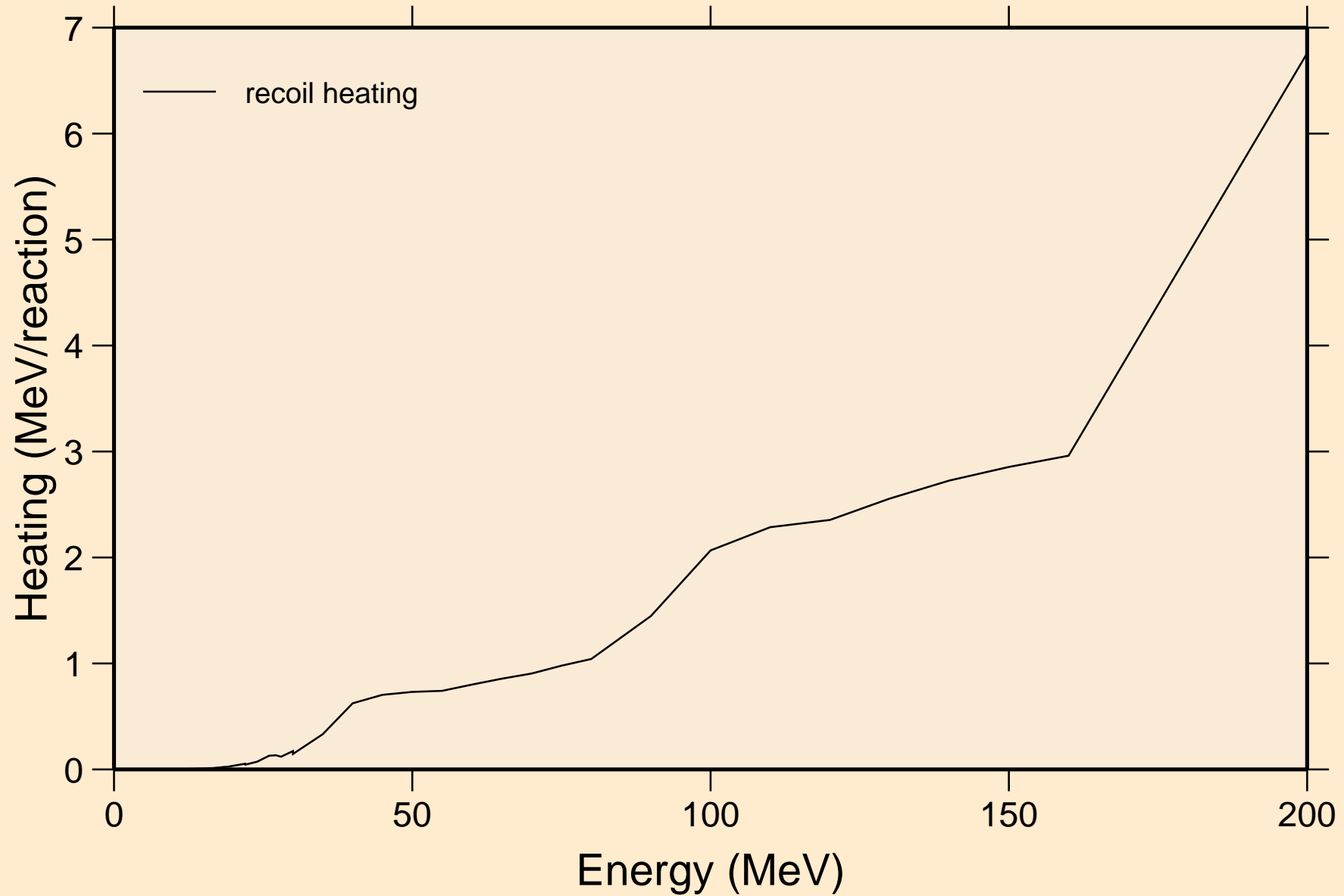

AS075 PROTON ACER TENDL-2024 LIBRARY; T=0.K  
Particle production cross sections

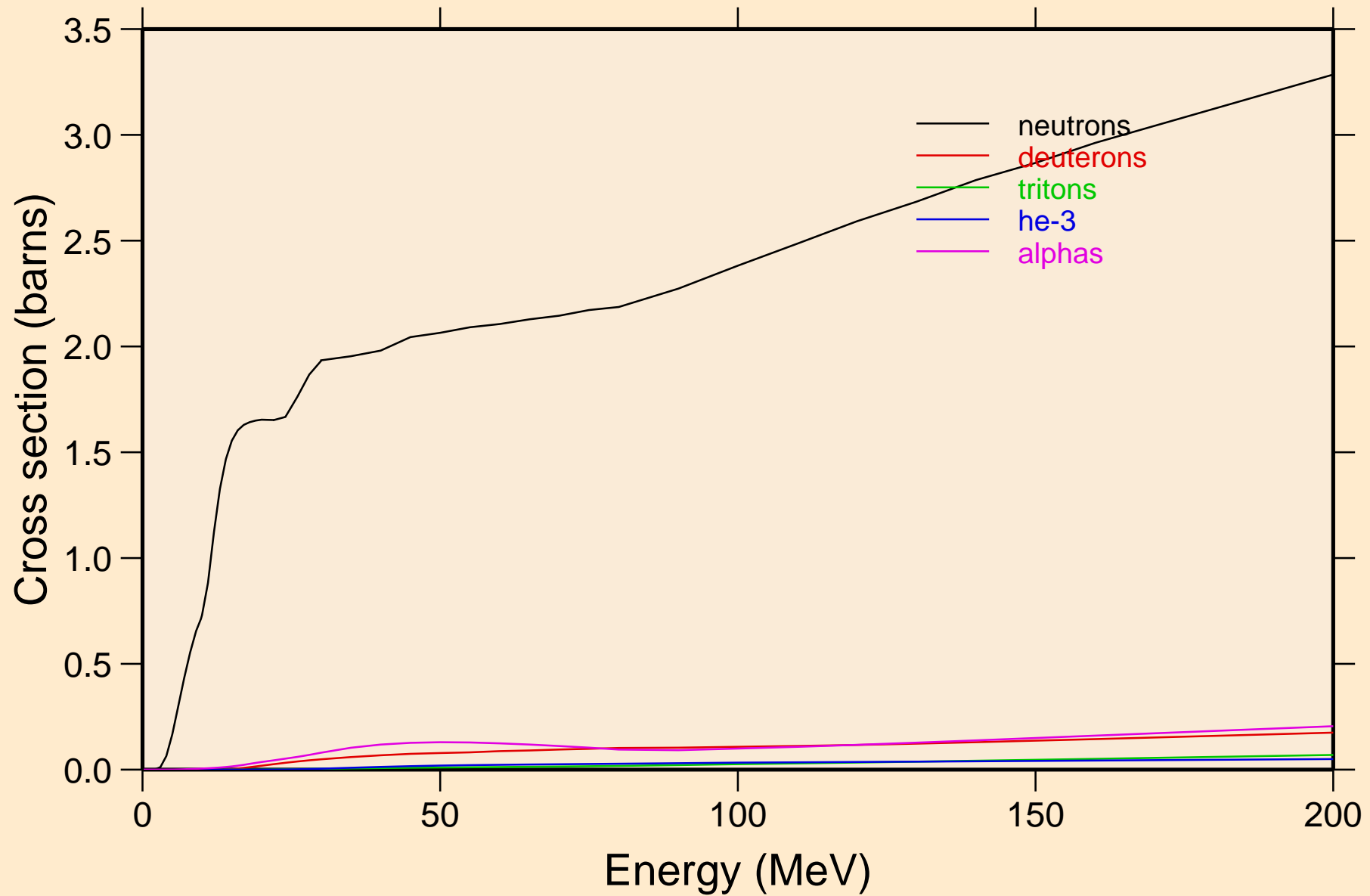

AS075 PROTON ACER TENDL-2024 LIBRARY; T=0.K  
neutrons from (p,n)

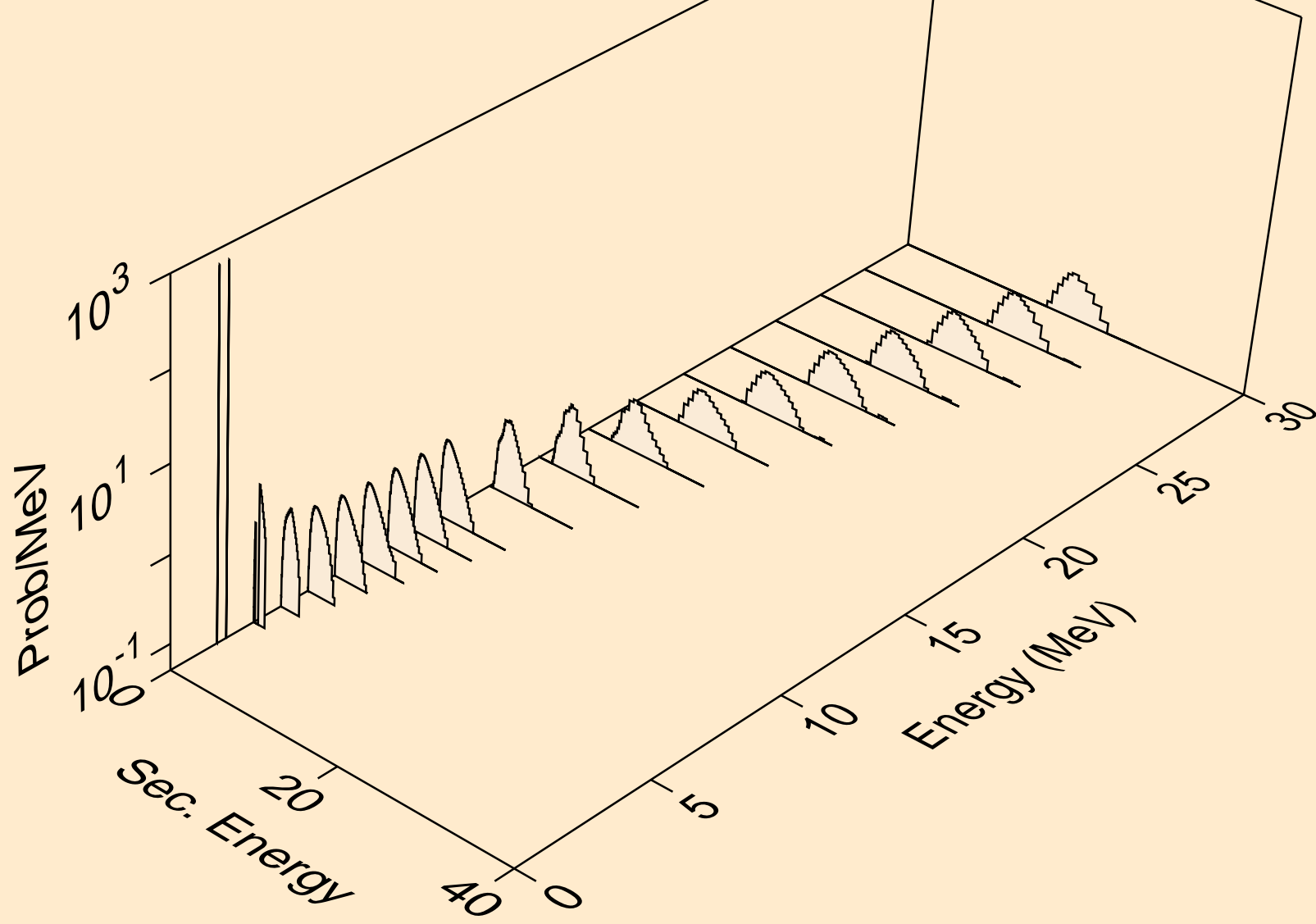

AS075 PROTON ACER TENDL-2024 LIBRARY; T=0.K  
neutrons from (p,x)

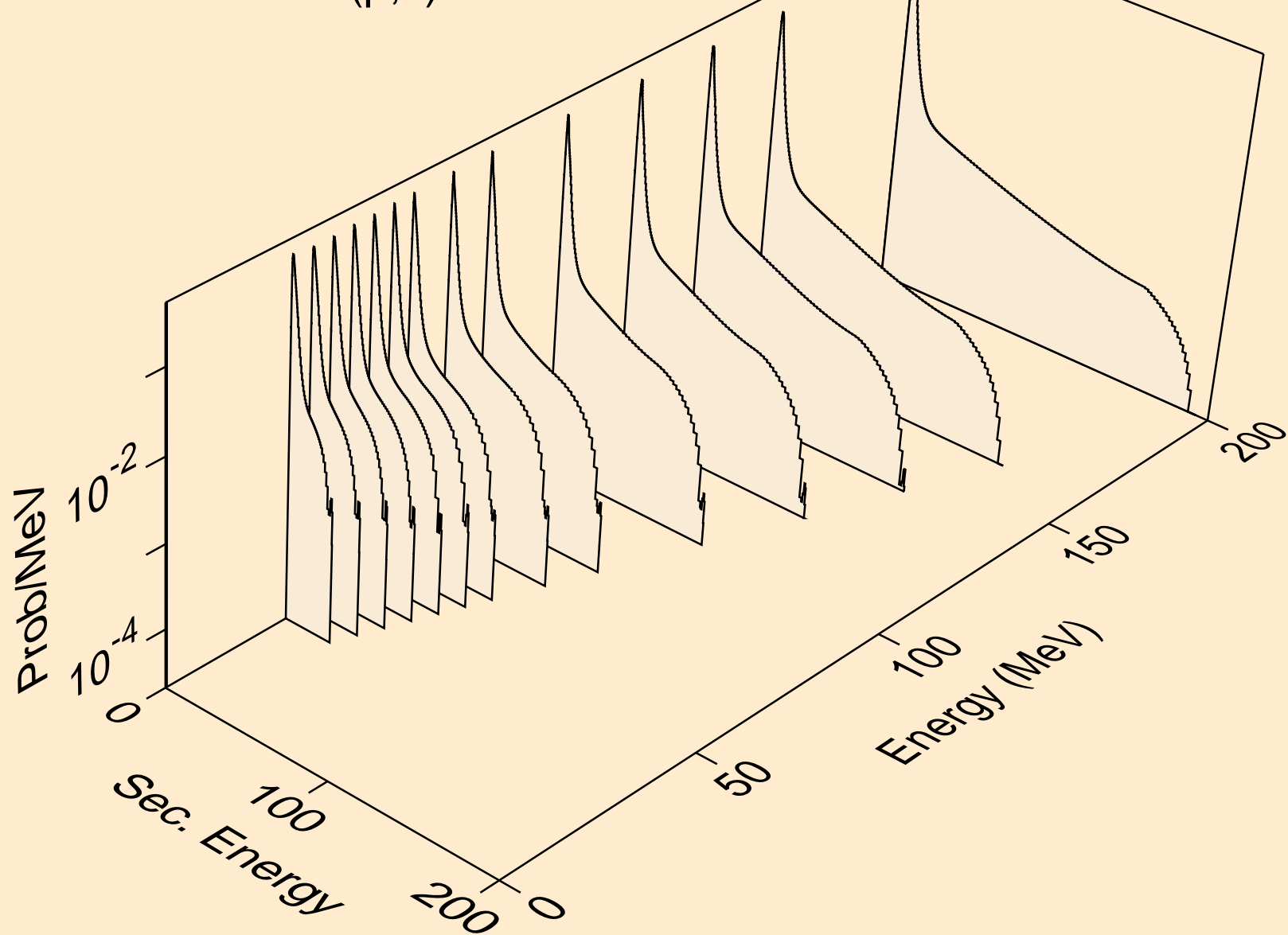

AS075 PROTON ACER TENDL-2024 LIBRARY; T=0.K  
neutrons from (p,2nd)

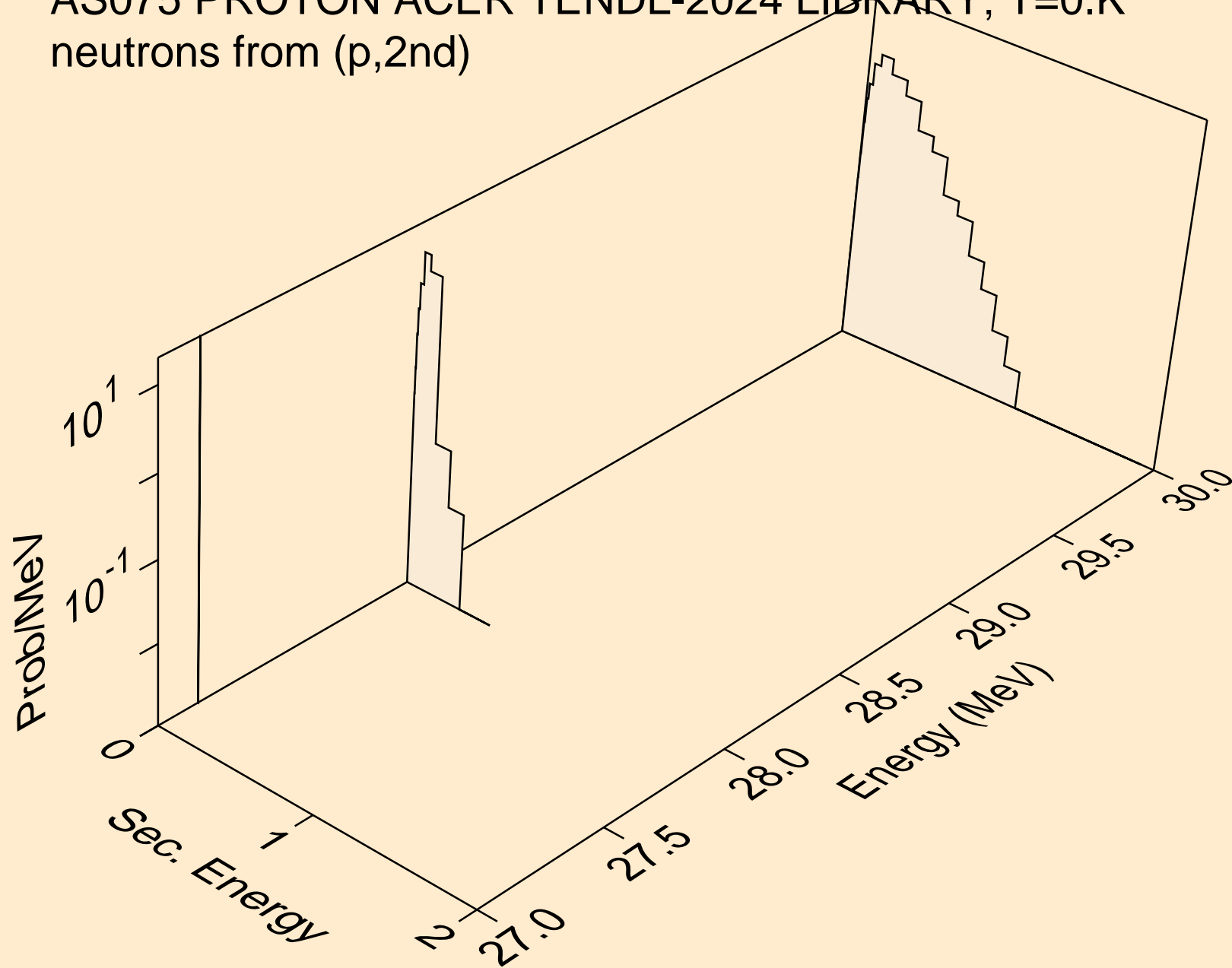

AS075 PROTON ACER TENDL-2024 LIBRARY; T=0.K  
neutrons from (p,2n)

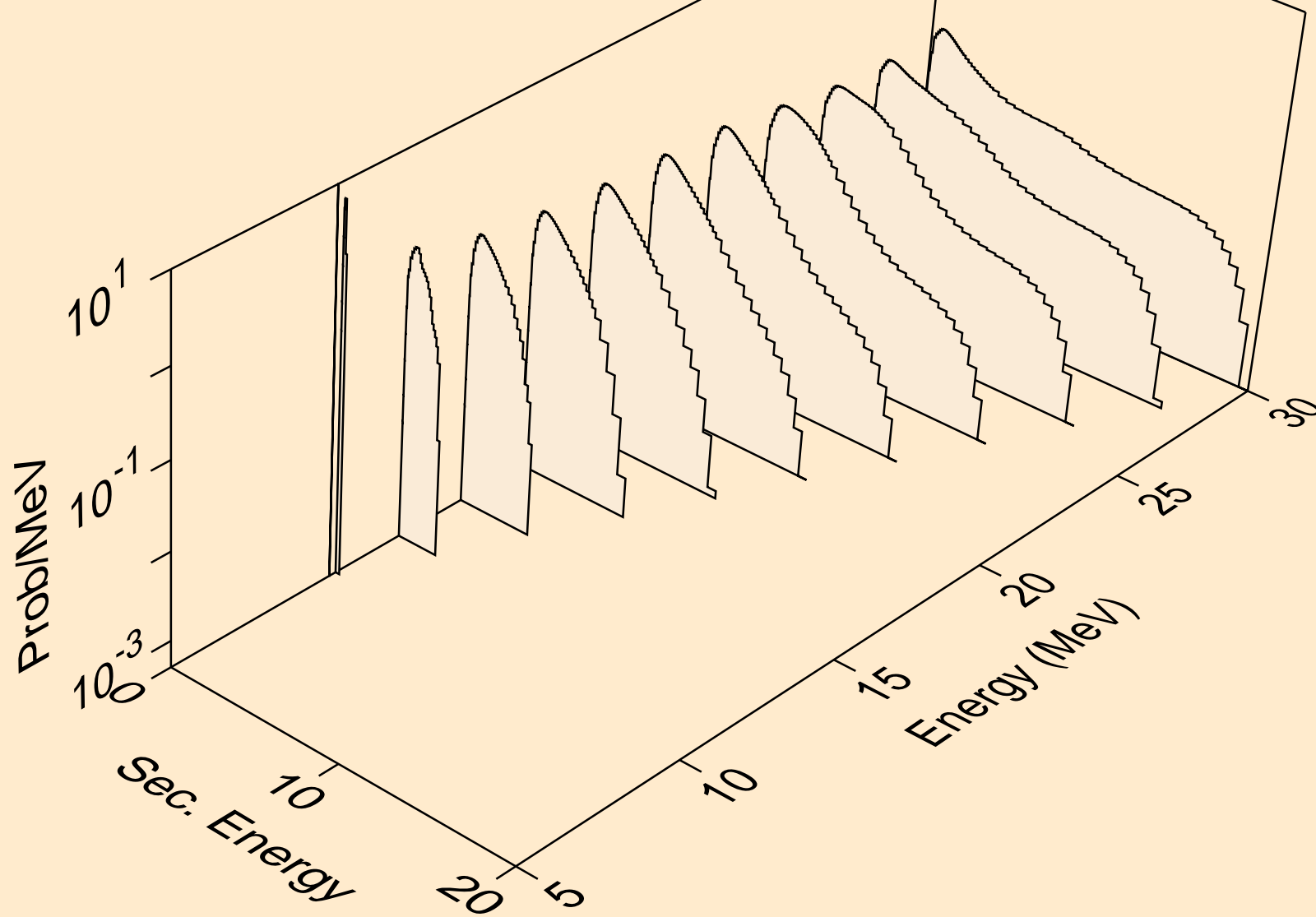

AS075 PROTON ACER TENDL-2024 LIBRARY; T=0.K  
neutrons from (p,3n)

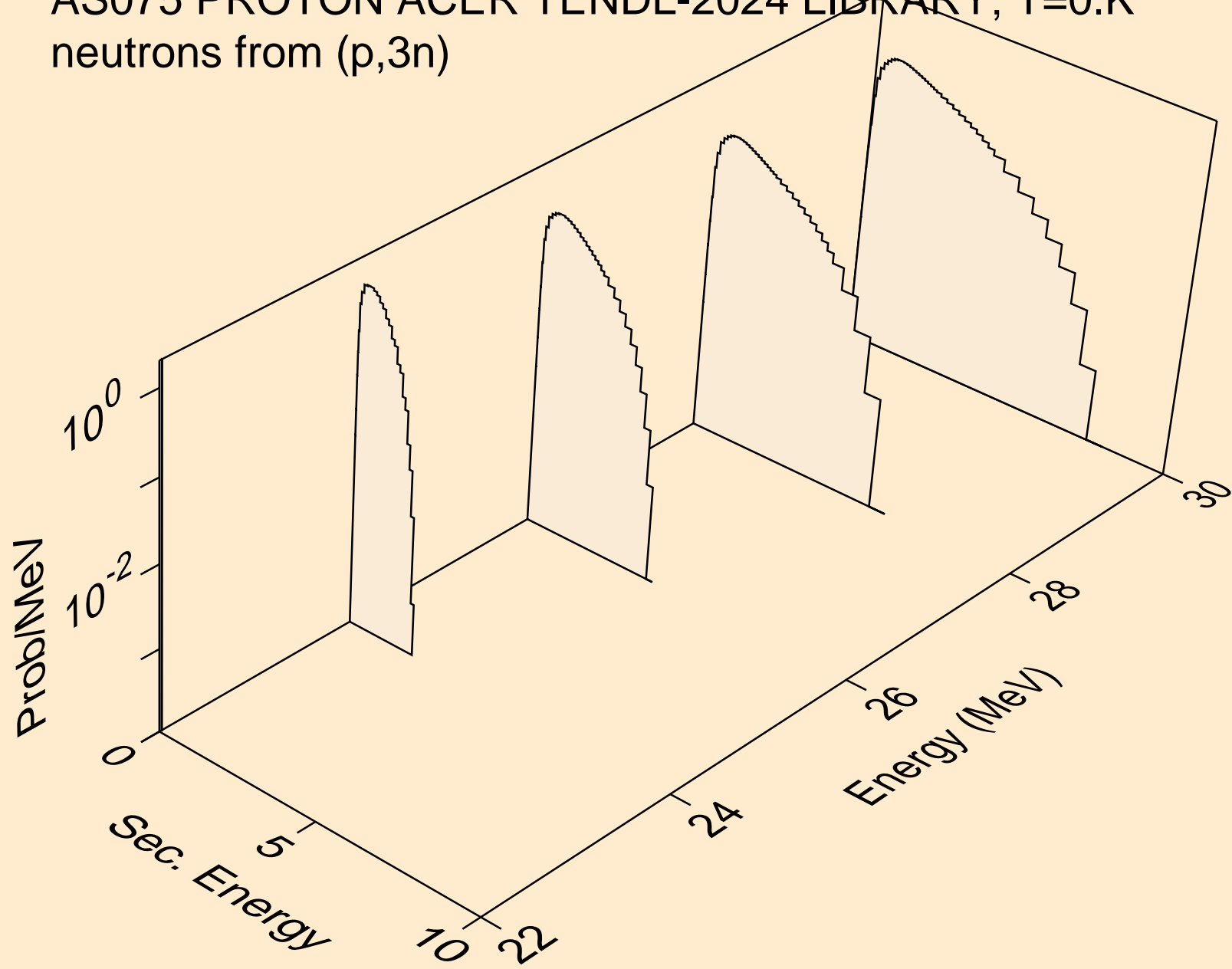

AS075 PROTON ACER TENDL-2024 LIBRARY; T=0.K  
neutrons from (p,n\*)a

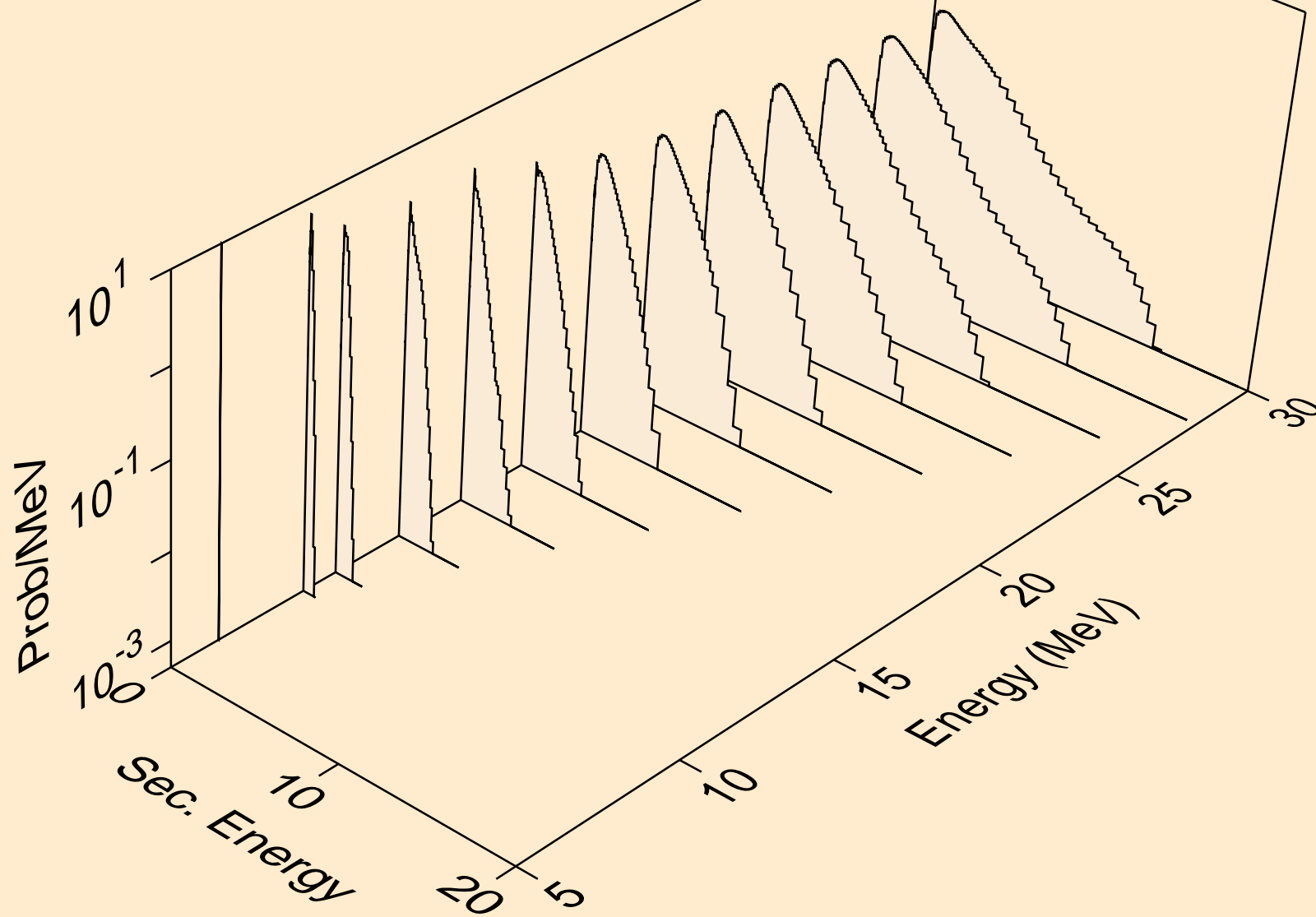

AS075 PROTON ACER TENDL-2024 LIBRARY; T=0.K  
neutrons from (p,2n)a

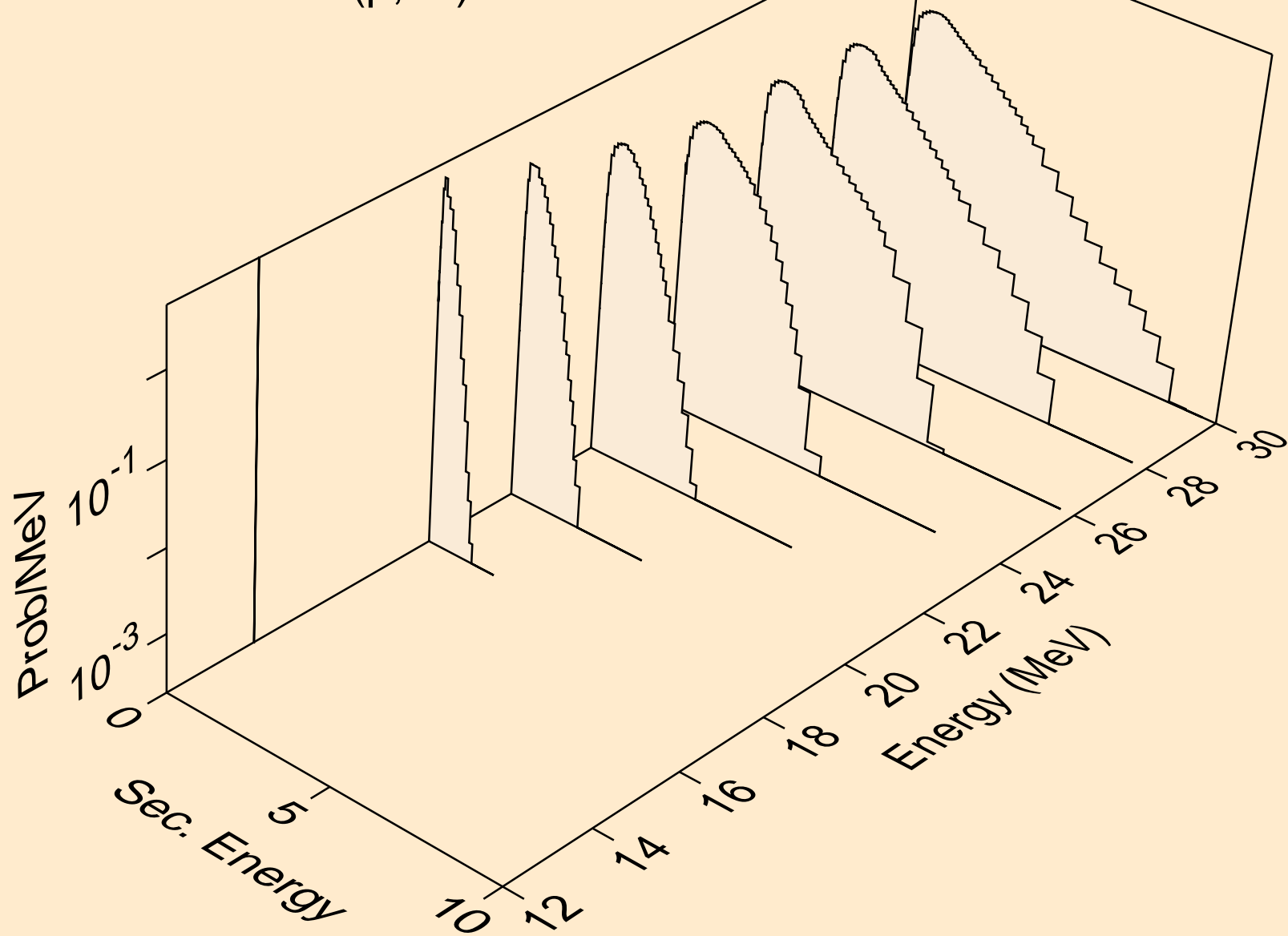

AS075 PROTON ACER TENDL-2024 LIBRARY; T=0.K  
neutrons from (p,n\*)p

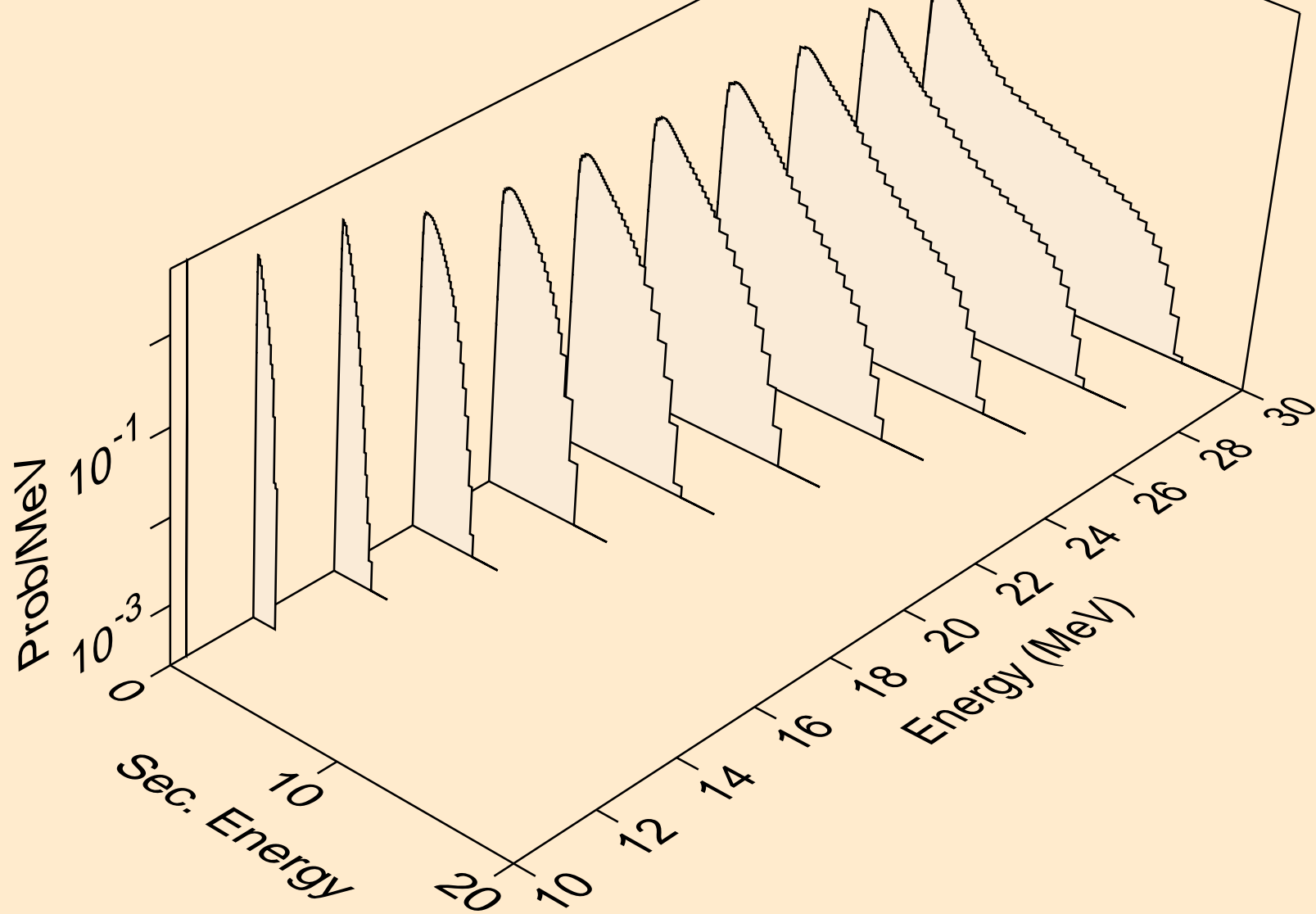

AS075 PROTON ACER TENDL-2024 LIBRARY; T=0.K  
neutrons from (p,n\*)2a

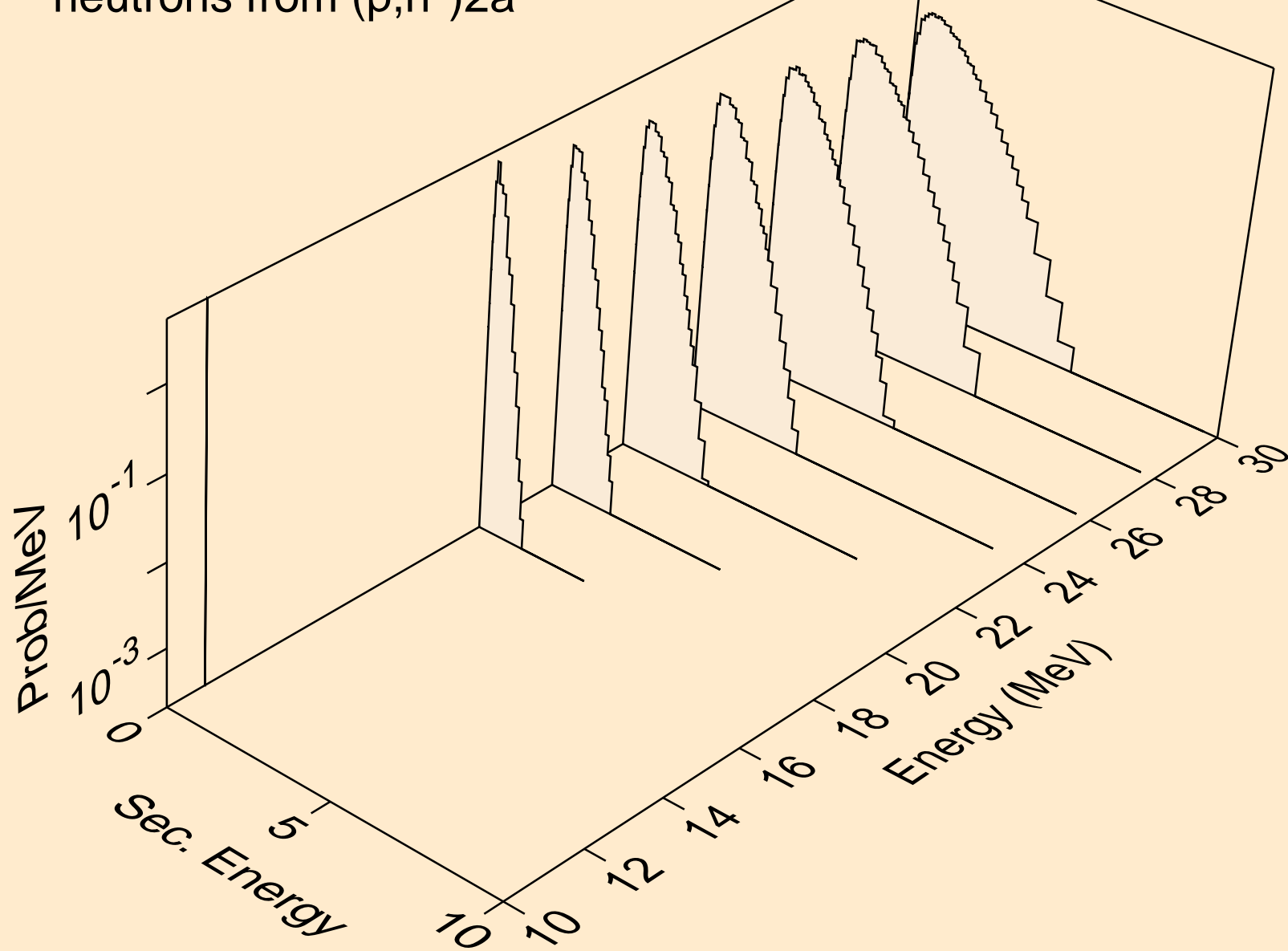

AS075 PROTON ACER TENDL-2024 LIBRARY; T=0.K  
neutrons from (p,n\*)d

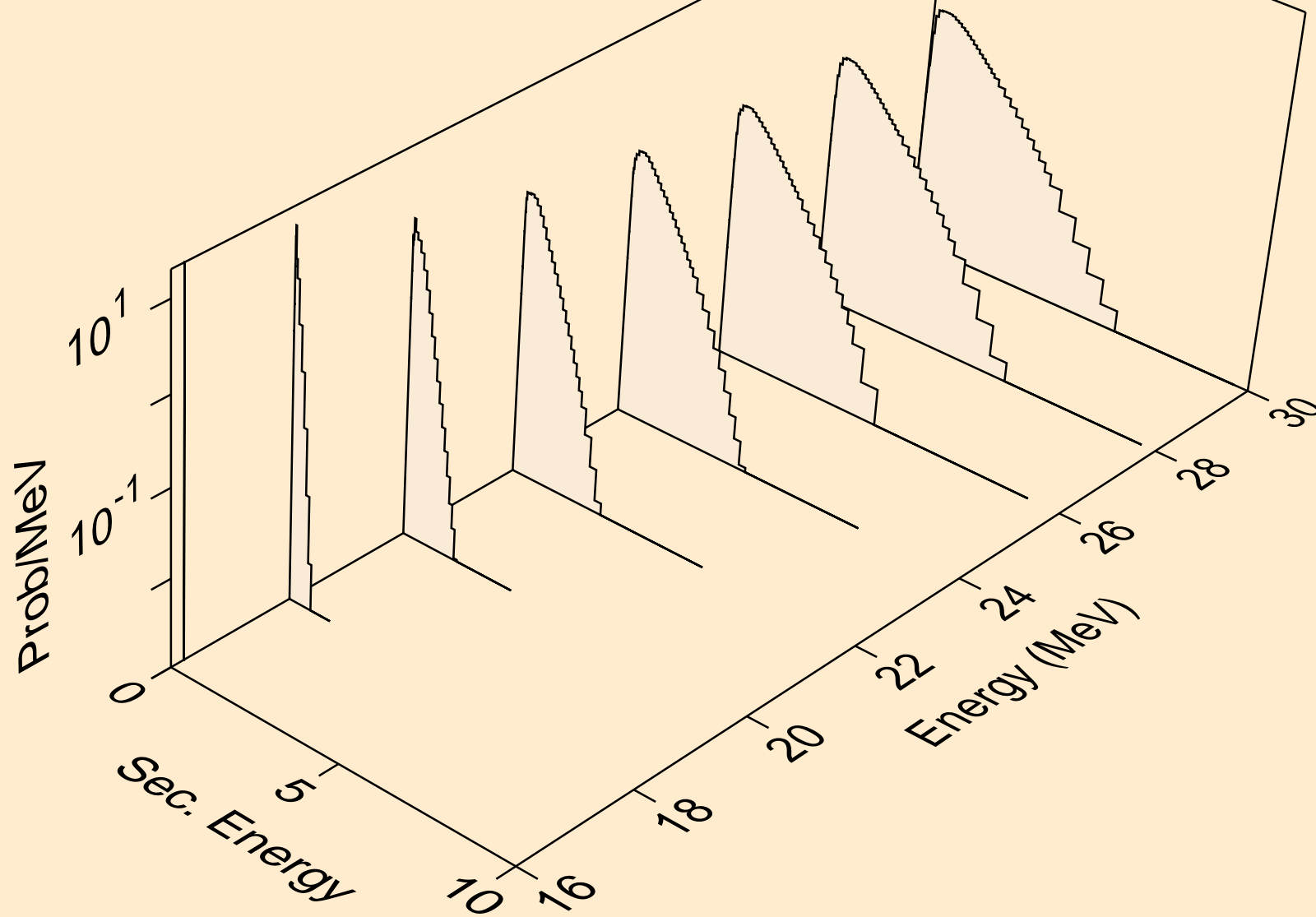

AS075 PROTON ACER TENDL-2024 LIBRARY; T=0.K  
neutrons from (p,n\*)t

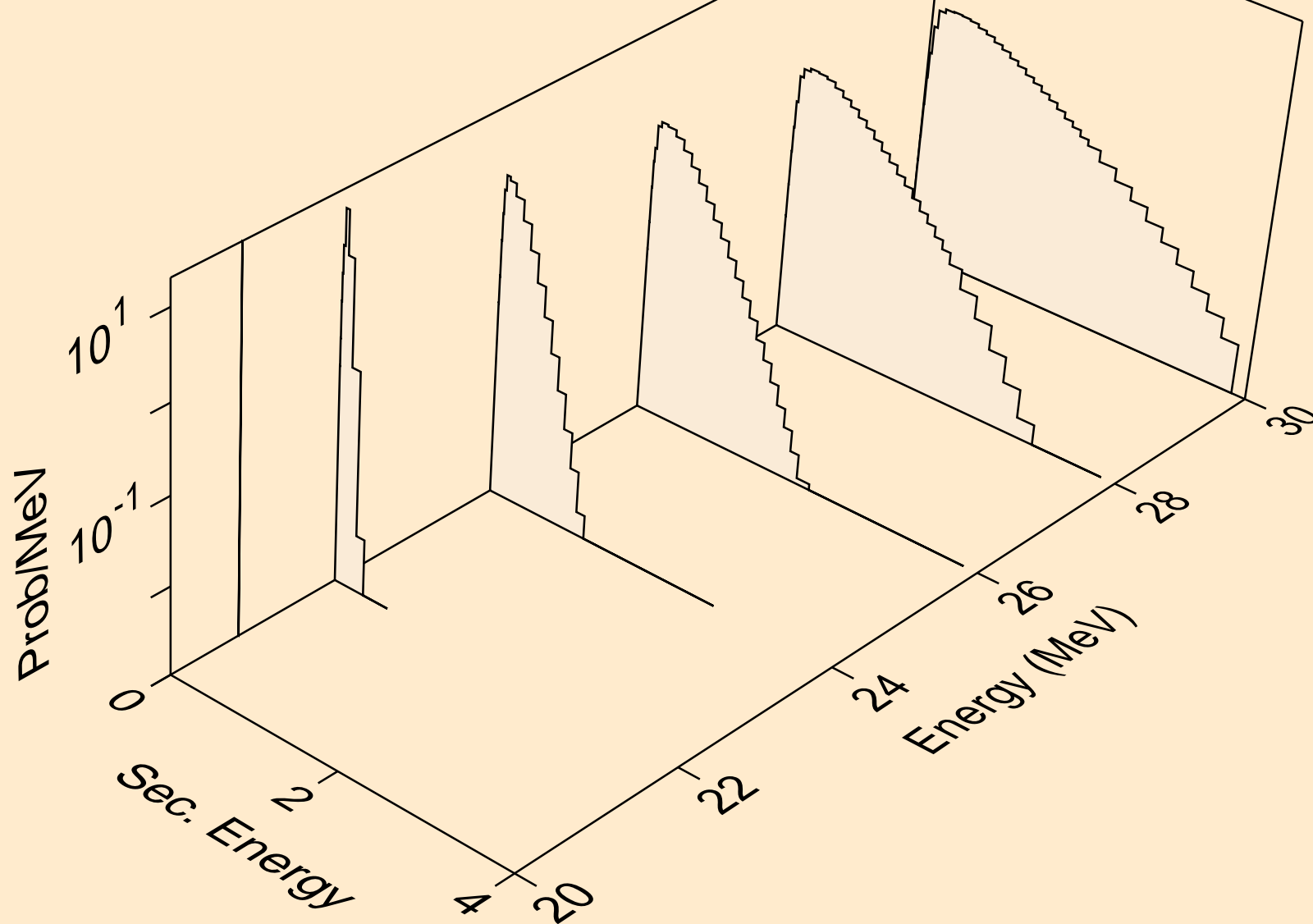

AS075 PROTON ACER TENDL-2024 LIBRARY; T=0.K  
neutrons from (p,n\*)he3

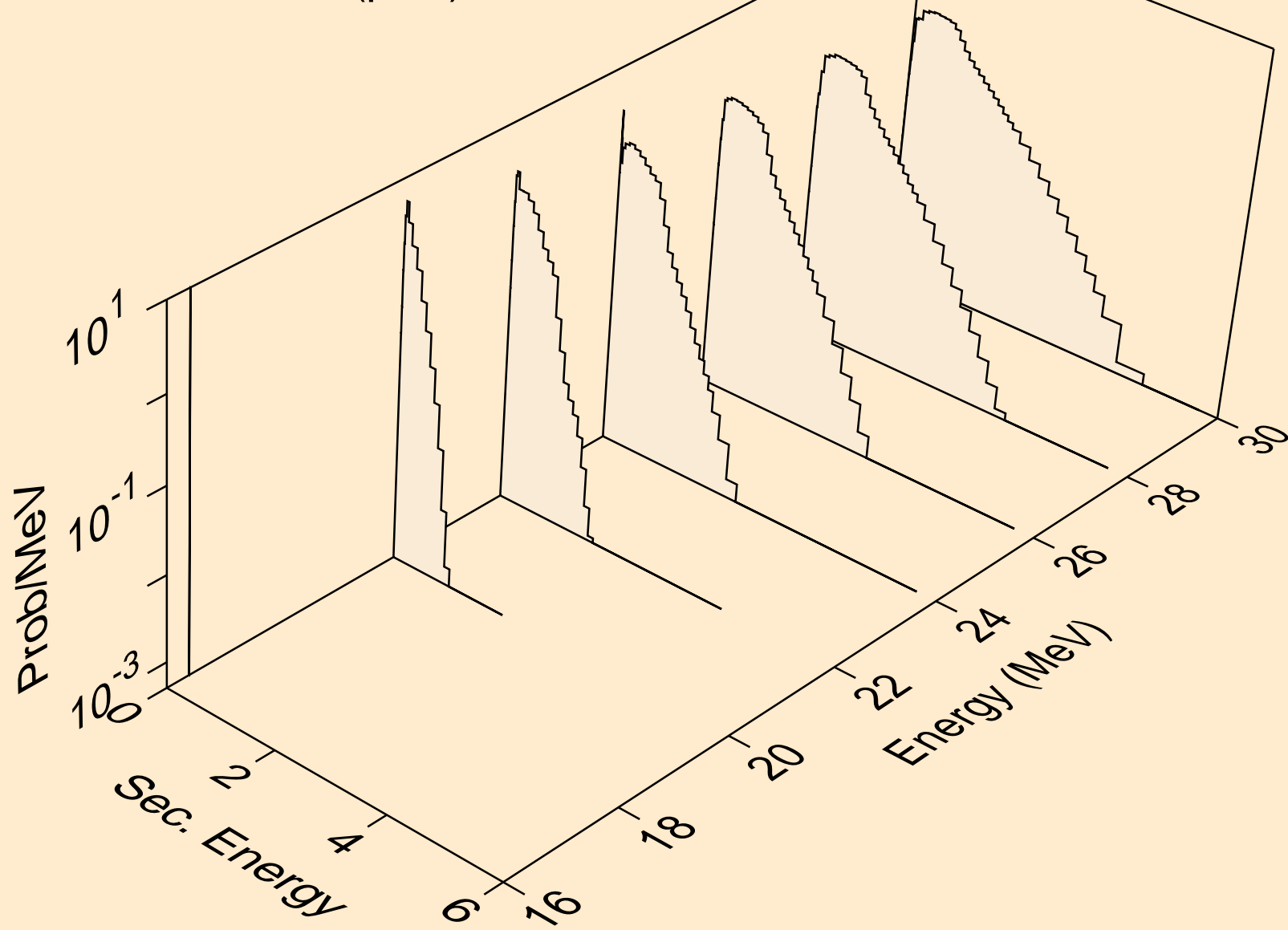

AS075 PROTON ACER TENDL-2024 LIBRARY; T=0.K  
neutrons from (p,2np)

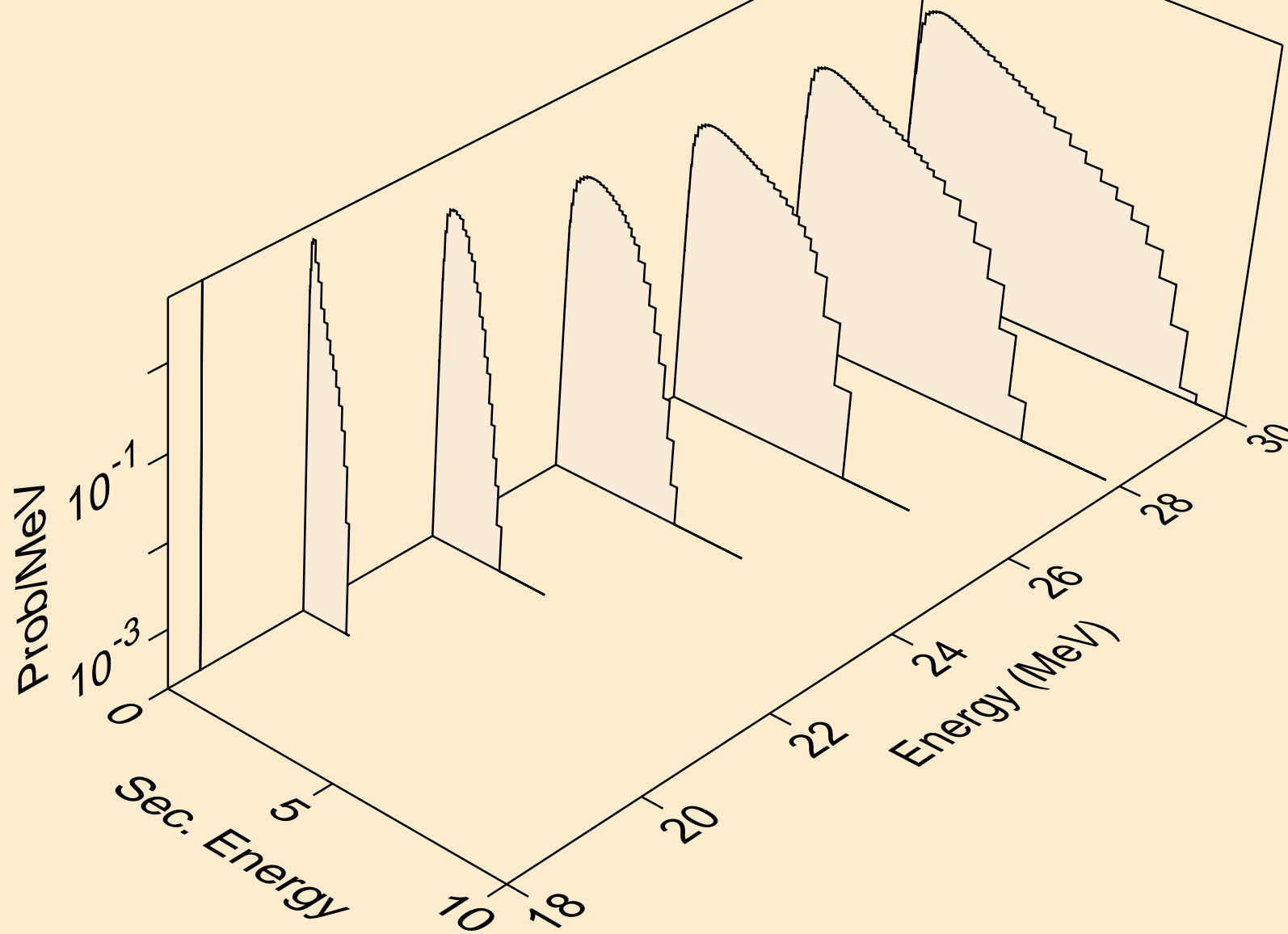

AS075 PROTON ACER TENDL-2024 LIBRARY; T=0.K  
neutrons from (p,n2p)

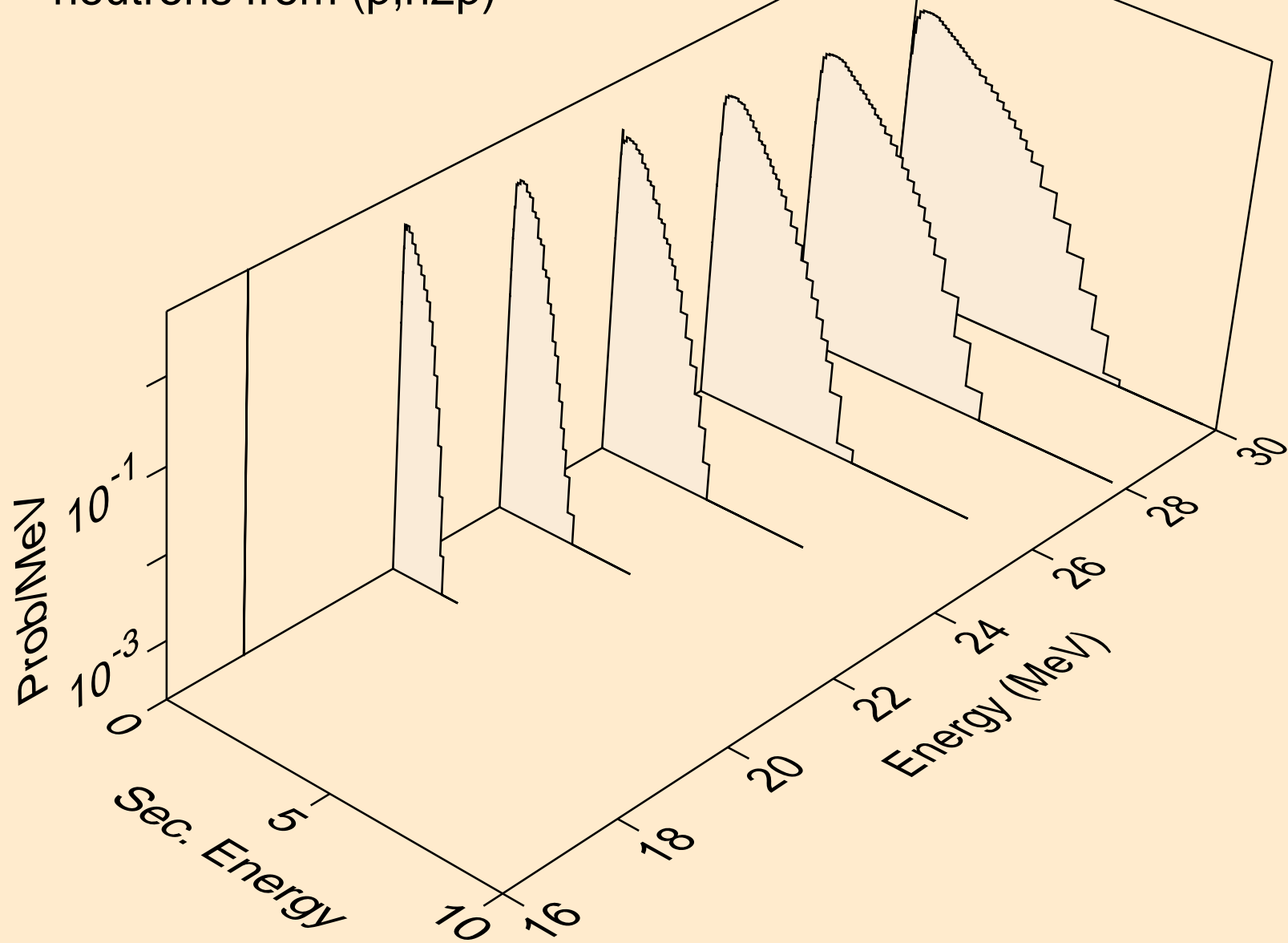

AS075 PROTON ACER TENDL-2024 LIBRARY; T=0.K  
neutrons from (p,npa)

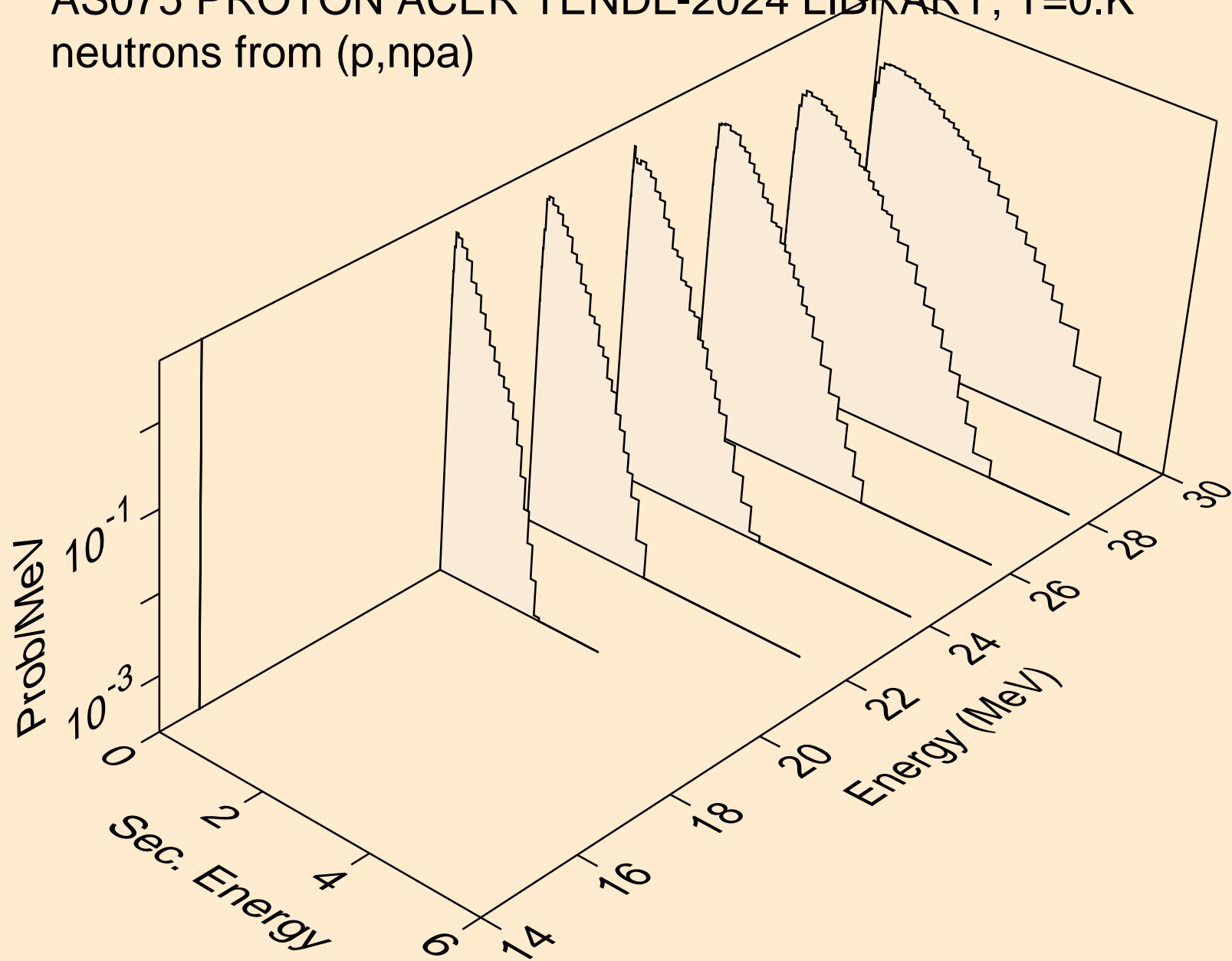

AS075 PROTON ACER TENDL-2024 LIBRARY; T=0.K  
deuterons from (p,x)

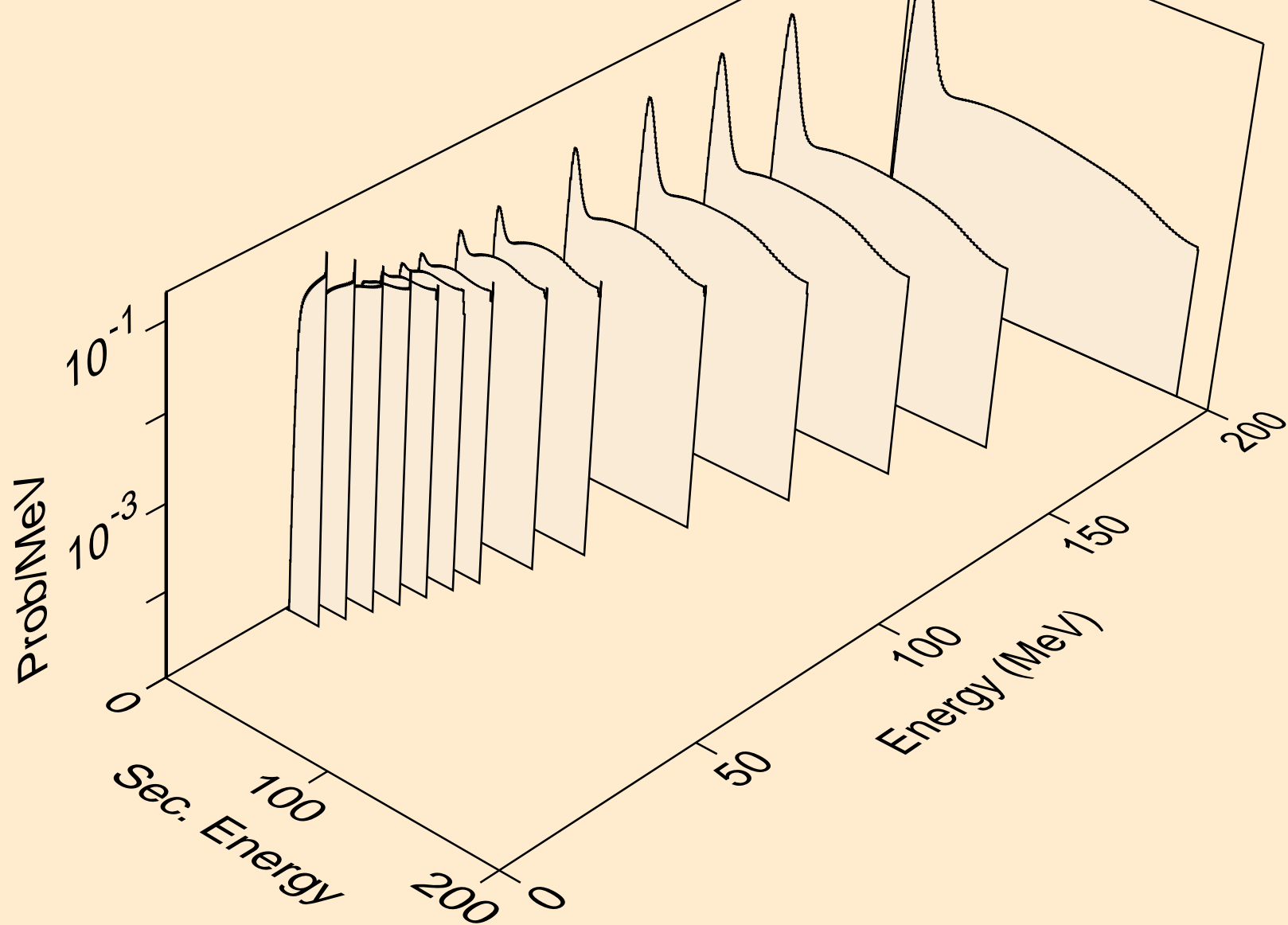

AS075 PROTON ACER TENDL-2024 LIBRARY; T=0.K  
deuterons from (p,2nd)

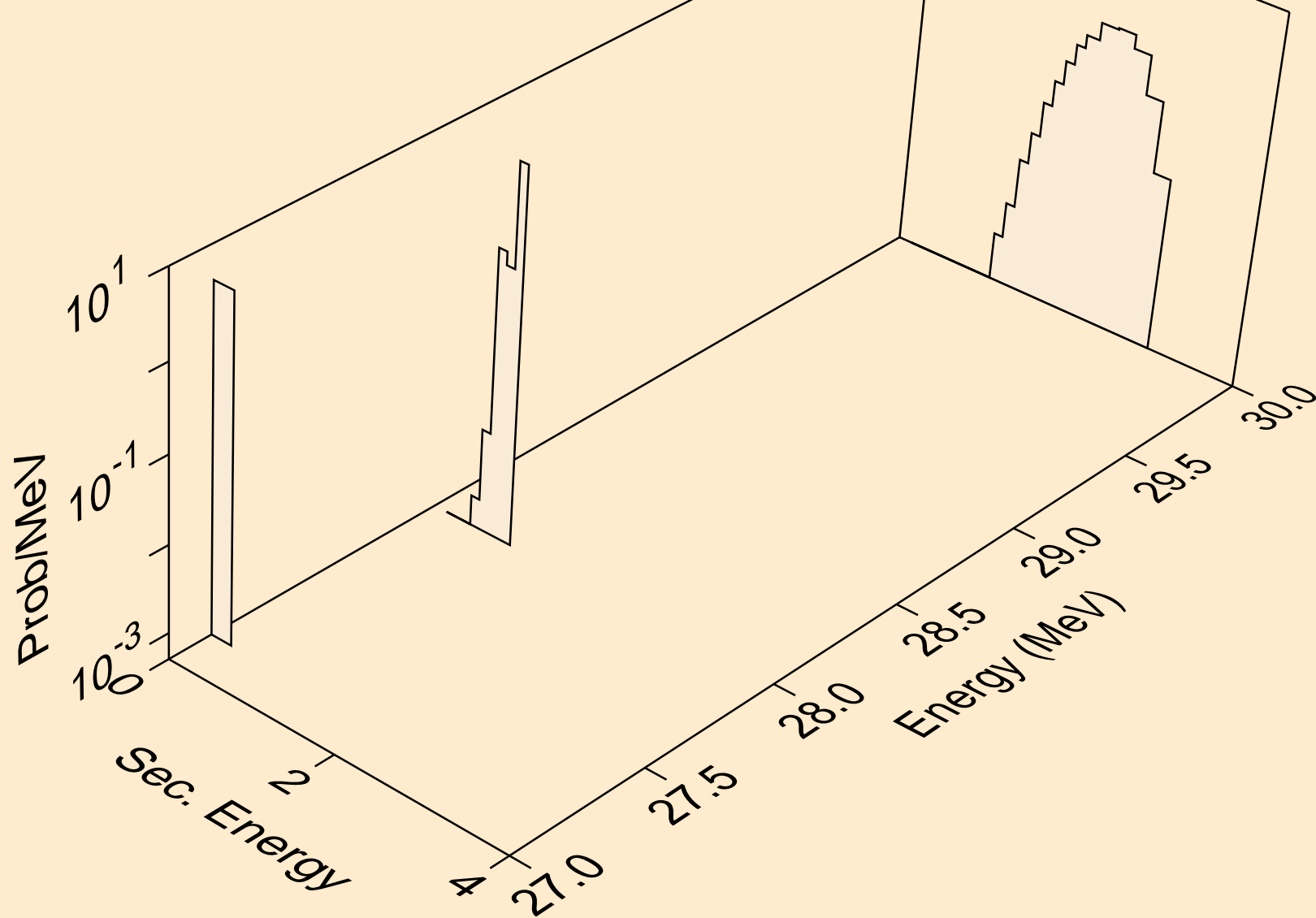

AS075 PROTON ACER TENDL-2024 LIBRARY; T=0.K  
deuterons from (p,n\*)d

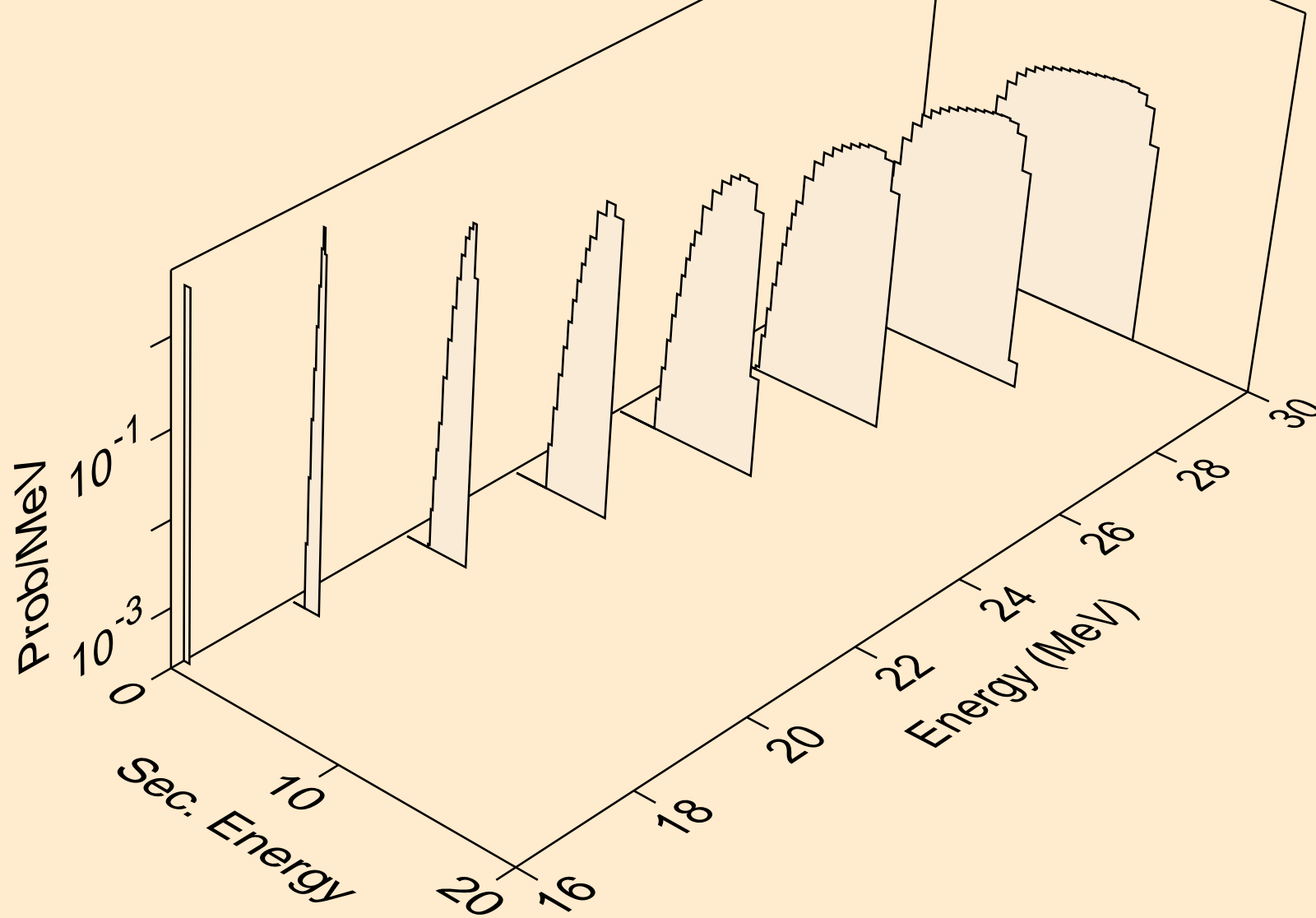

AS075 PROTON ACER TENDL-2024 LIBRARY; T=0.K  
deuterons from (p,d)

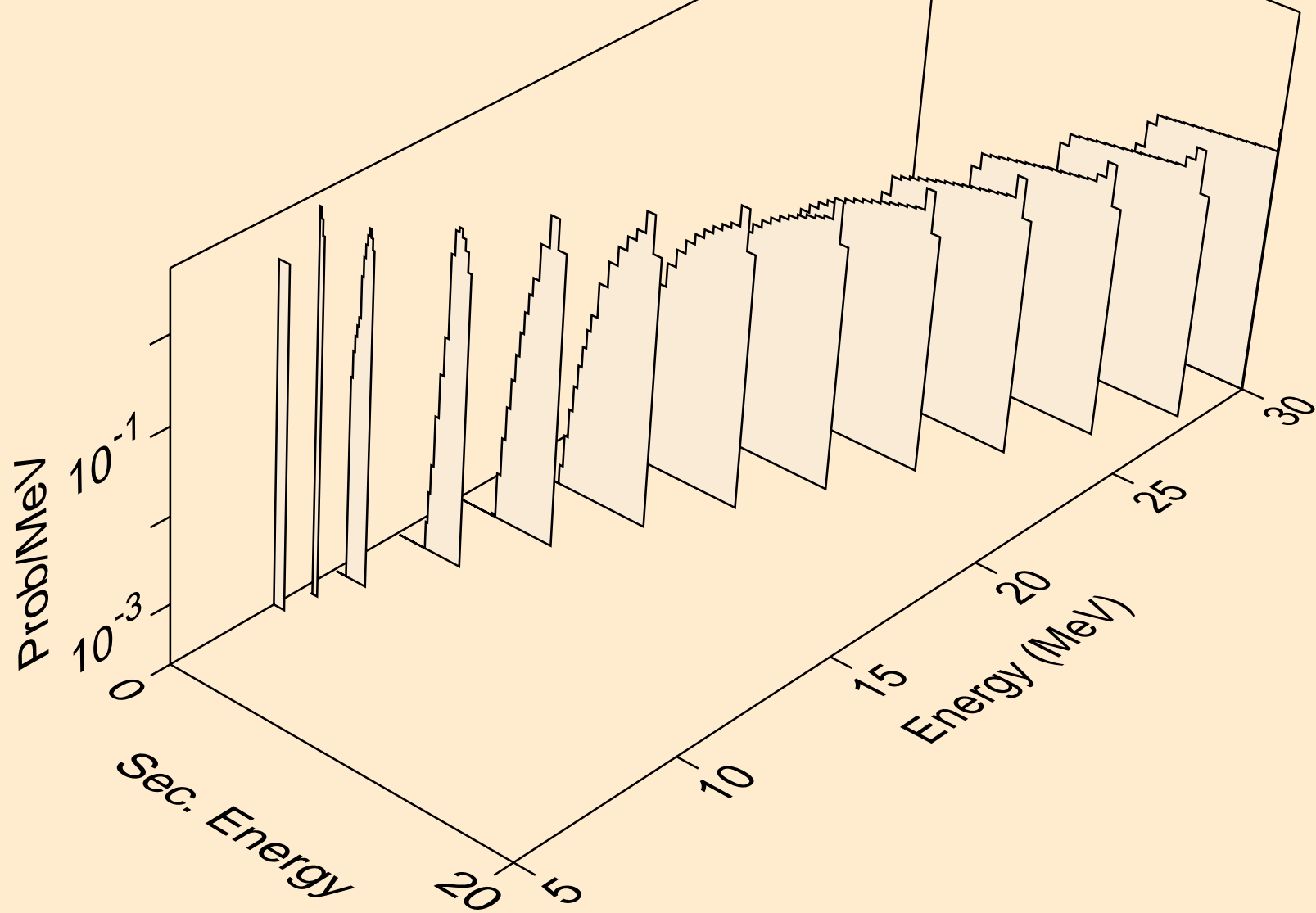

AS075 PROTON ACER TENDL-2024 LIBRARY; T=0.K  
deuterons from (p,pd)

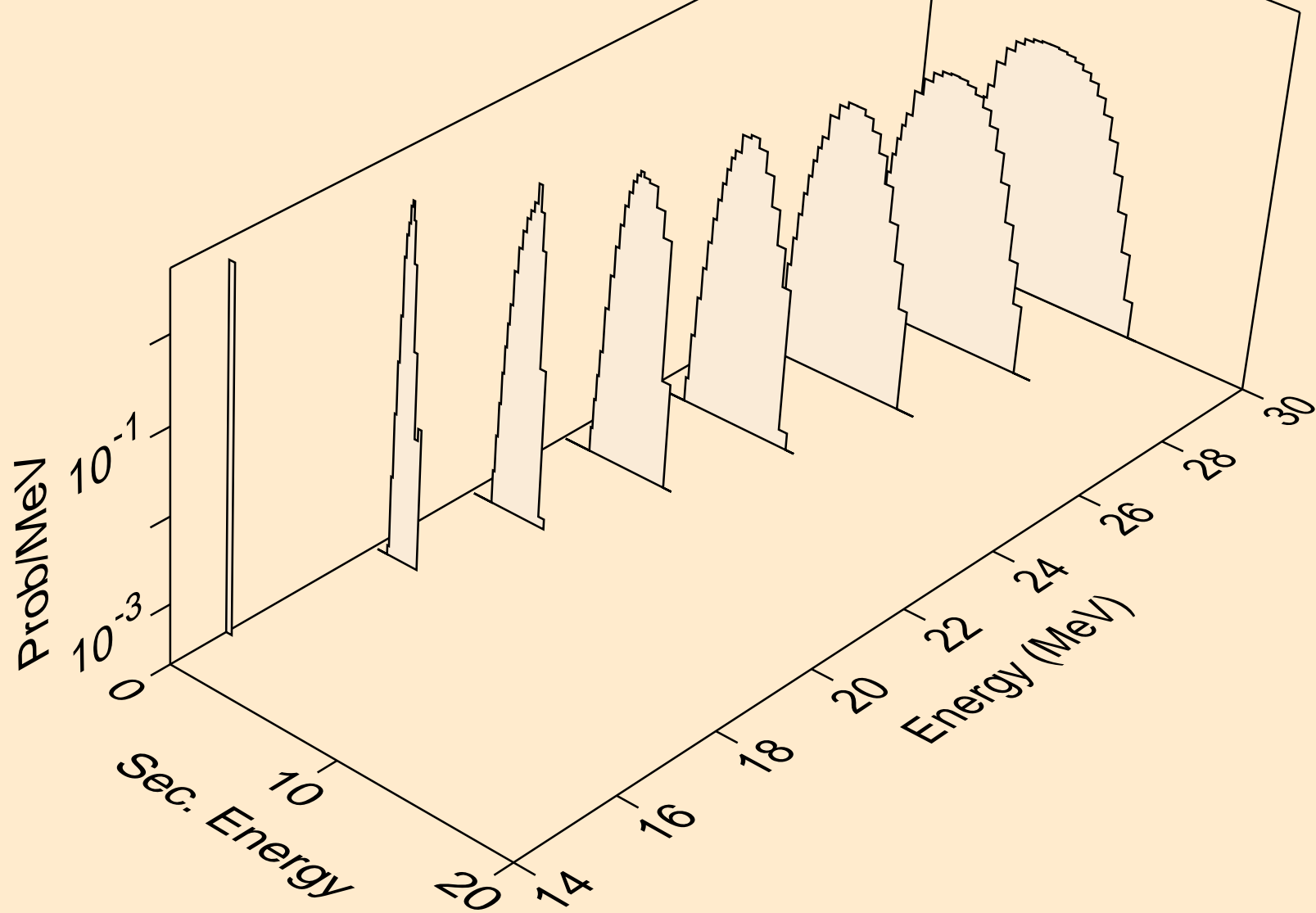

AS075 PROTON ACER TENDL-2024 LIBRARY; T=0.K  
deuterons from (p,da)

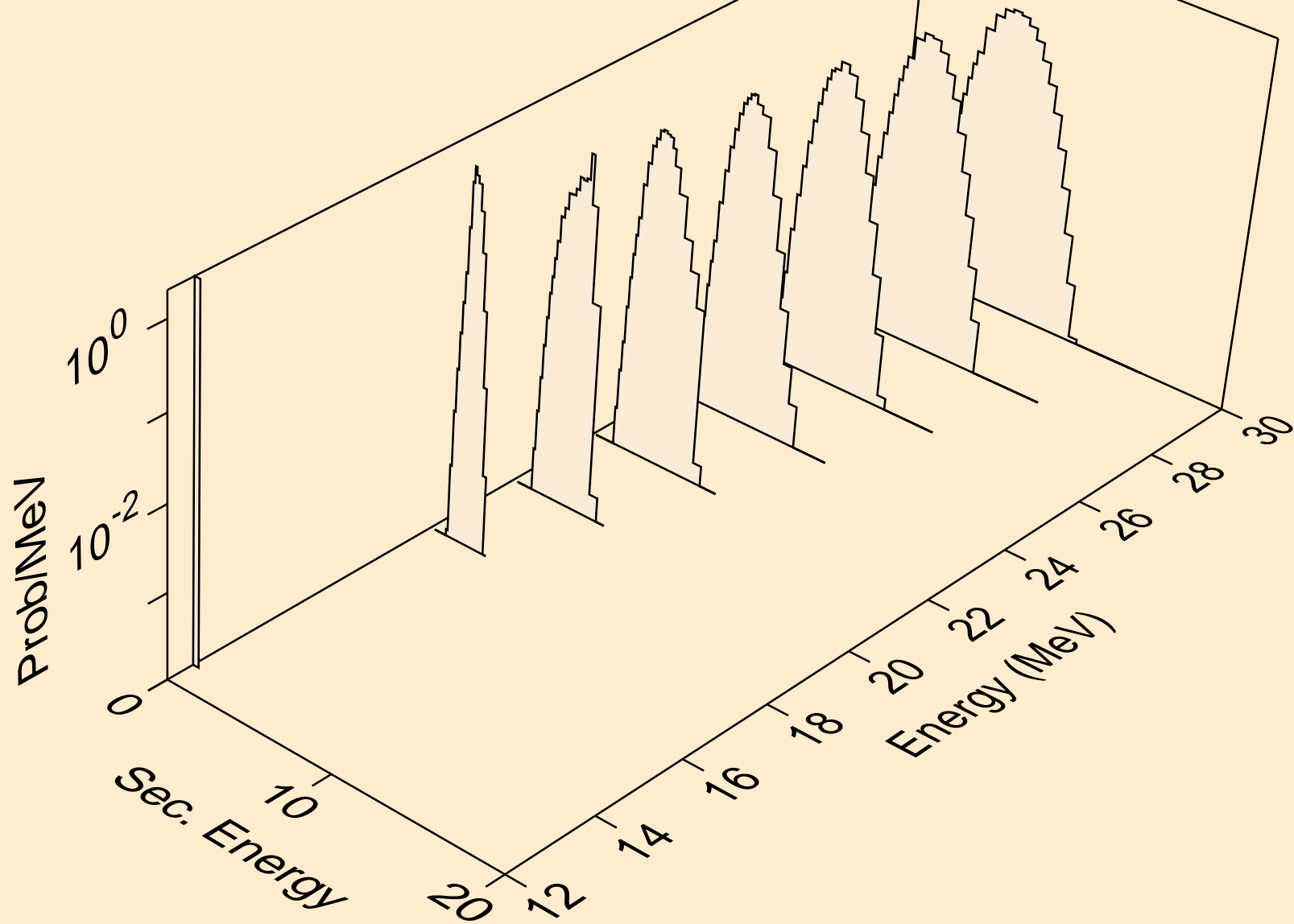

AS075 PROTON ACER TENDL-2024 LIBRARY; T=0.K  
tritons from (p,x)

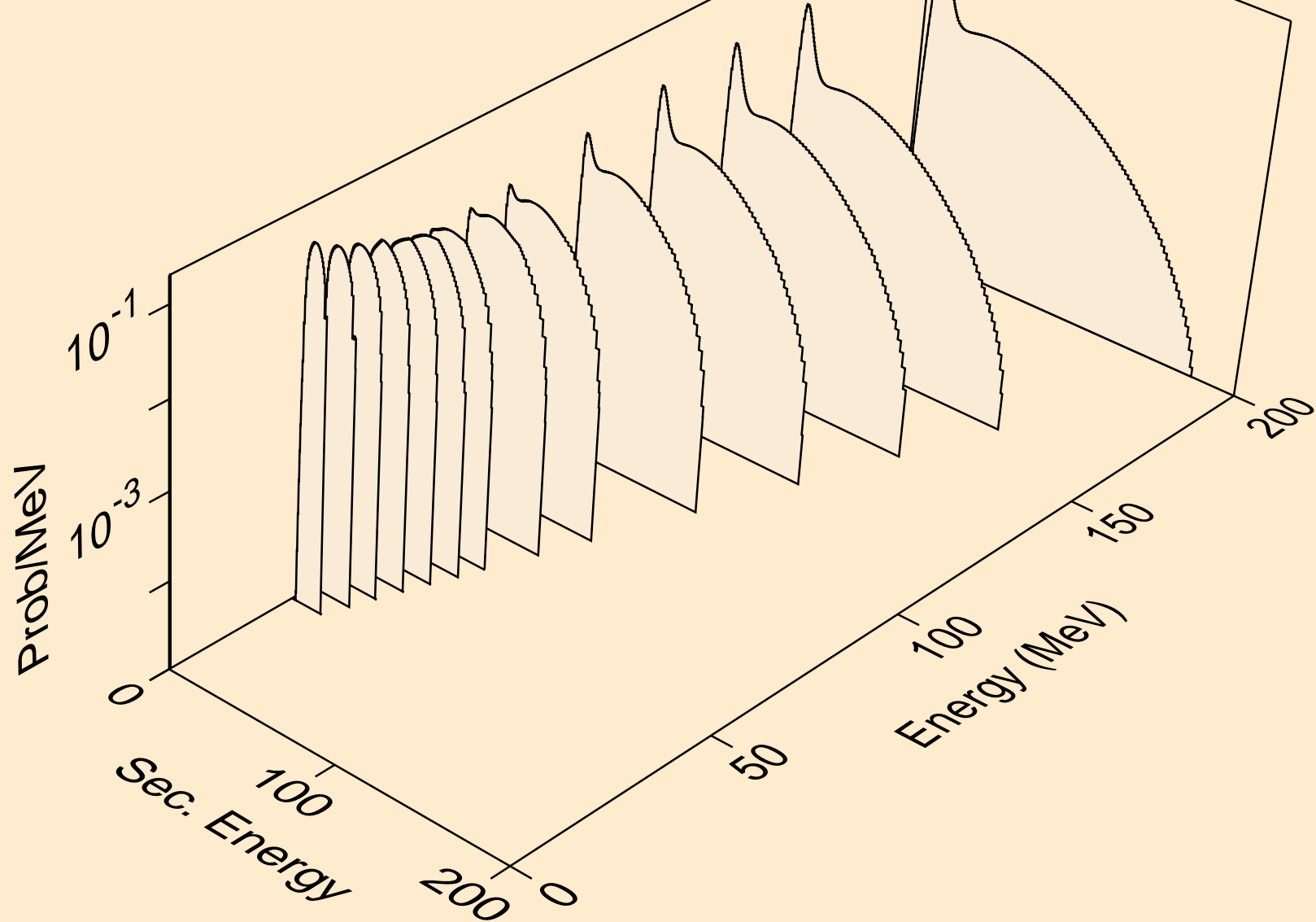

AS075 PROTON ACER TENDL-2024 LIBRARY; T=0.K  
tritons from (p,n\*)t

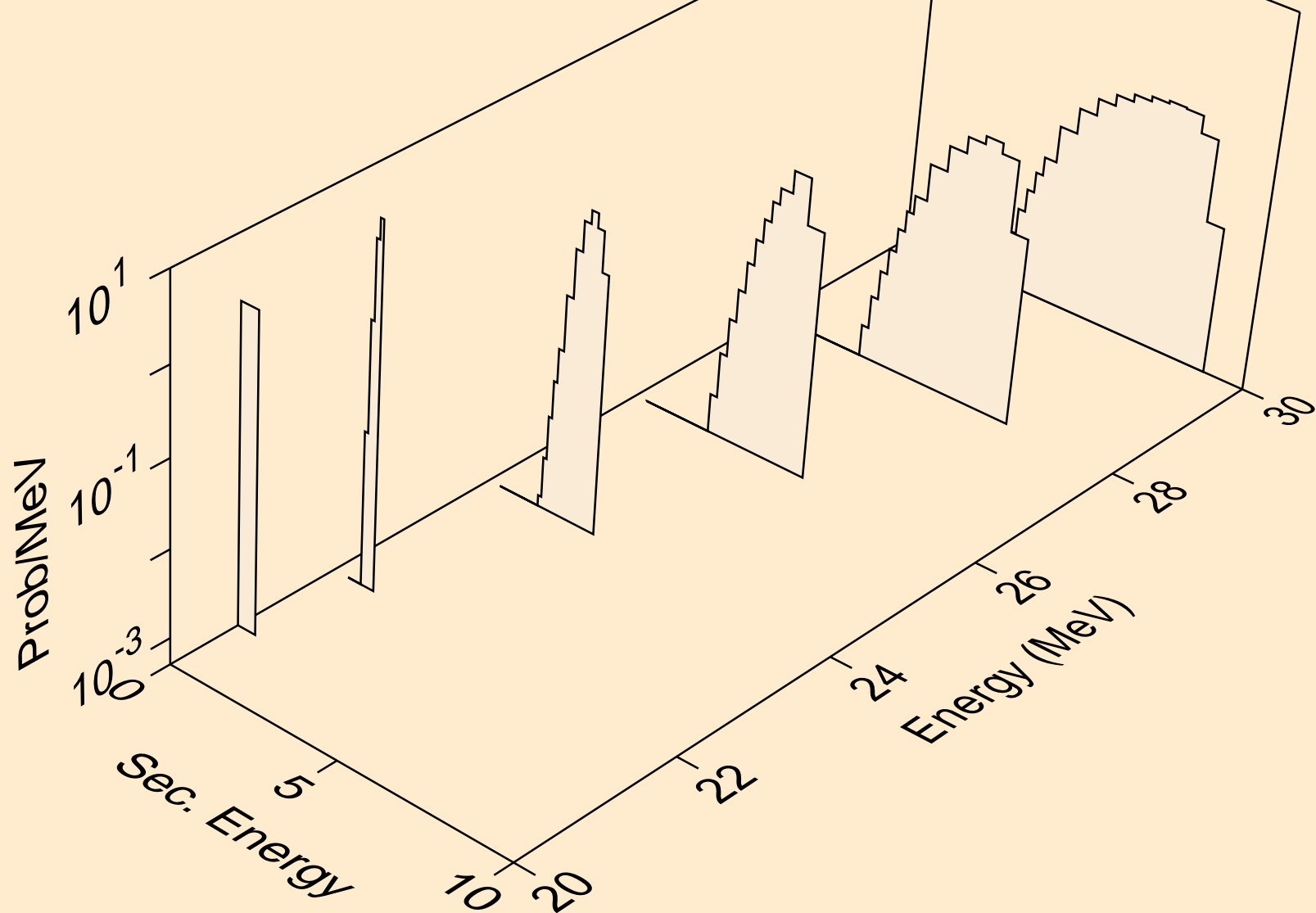

AS075 PROTON ACER TENDL-2024 LIBRARY; T=0.K  
tritons from (p,t)

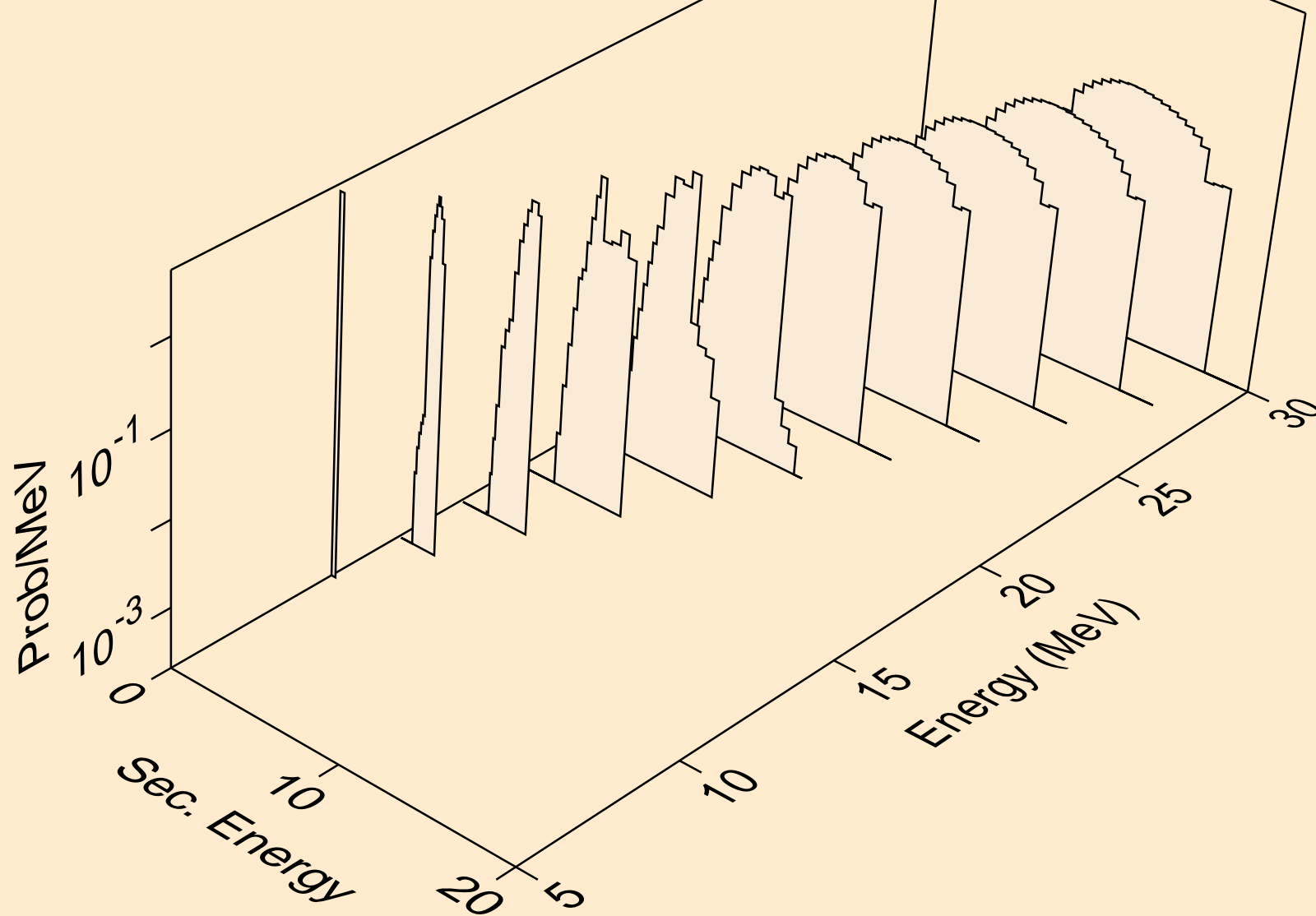

AS075 PROTON ACER TENDL-2024 LIBRARY; T=0.K  
tritons from (p,pt)

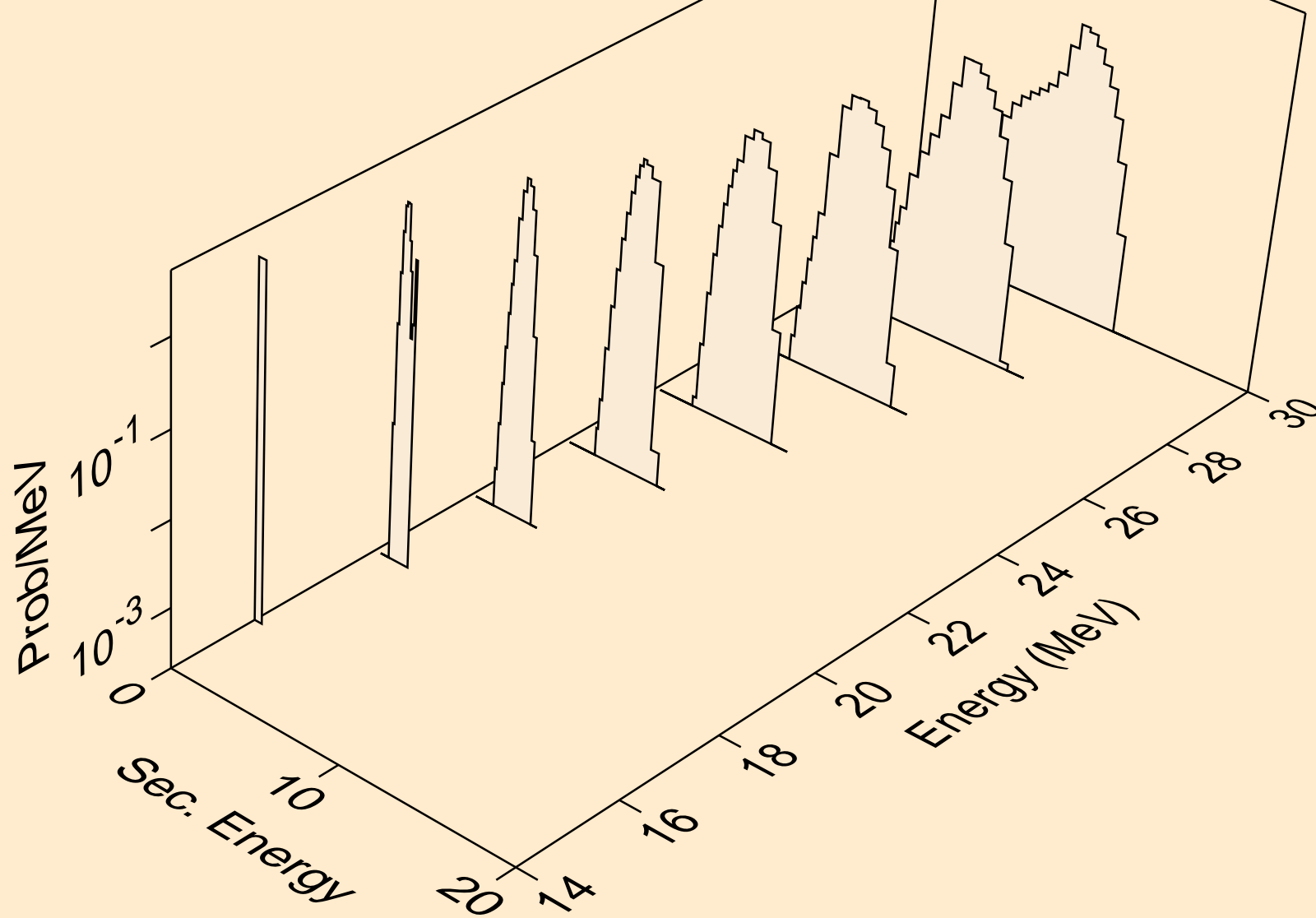

AS075 PROTON ACER TENDL-2024 LIBRARY; T=0.K  
he3s from (p,x)

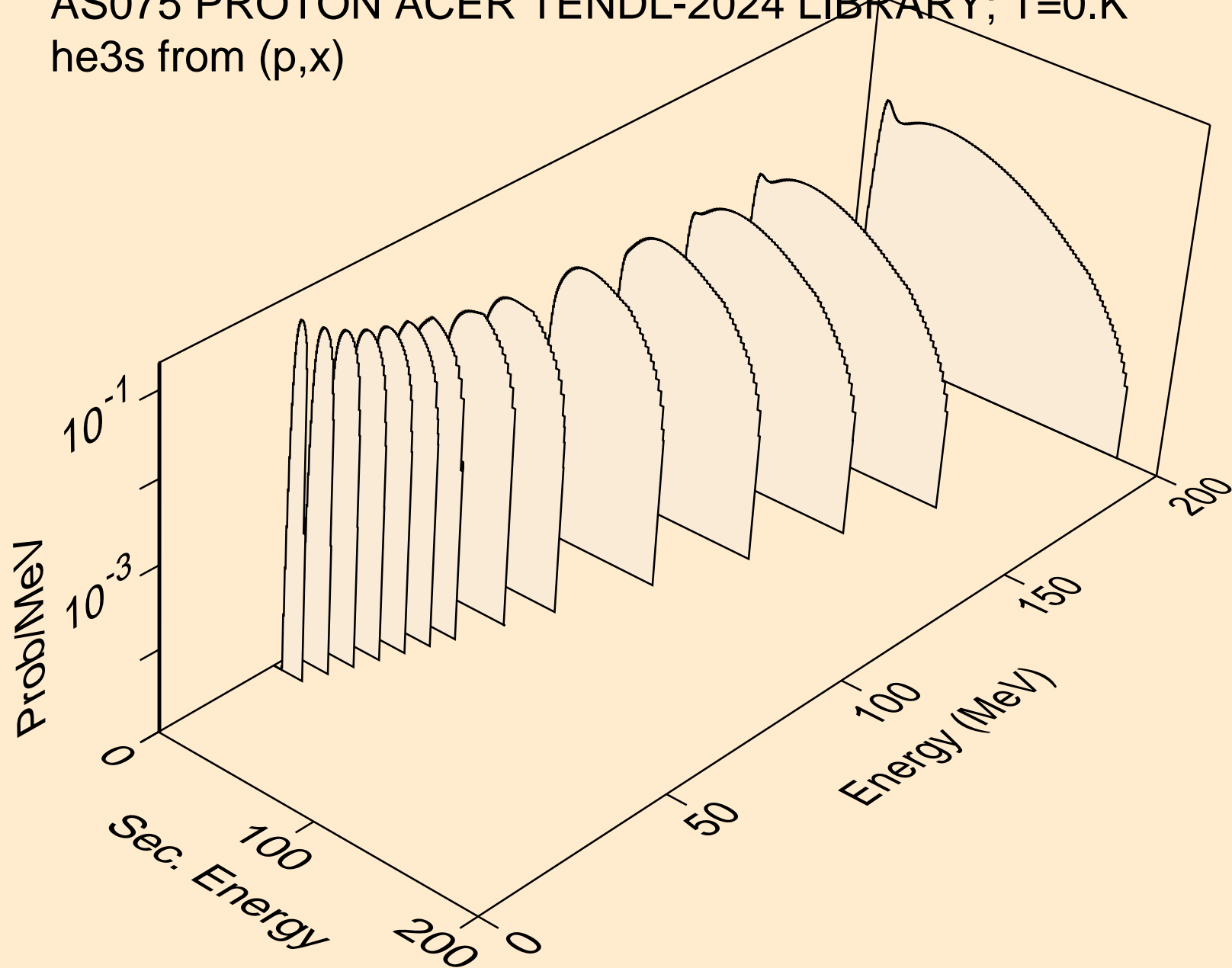

AS075 PROTON ACER TENDL-2024 LIBRARY; T=0.K  
he3s from (p,n\*)he3

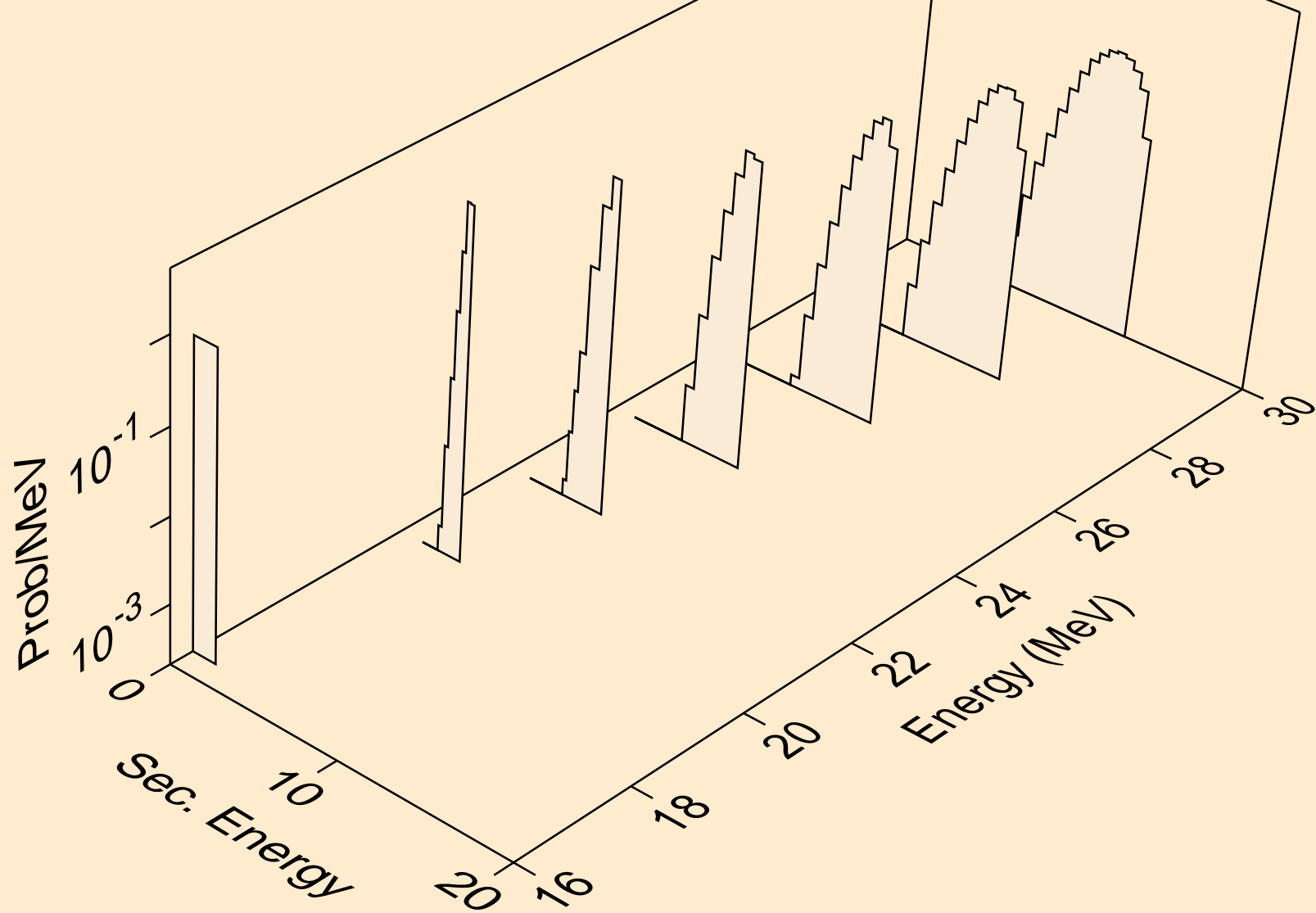

AS075 PROTON ACER TENDL-2024 LIBRARY; T=0.K  
he3s from (p,he3)

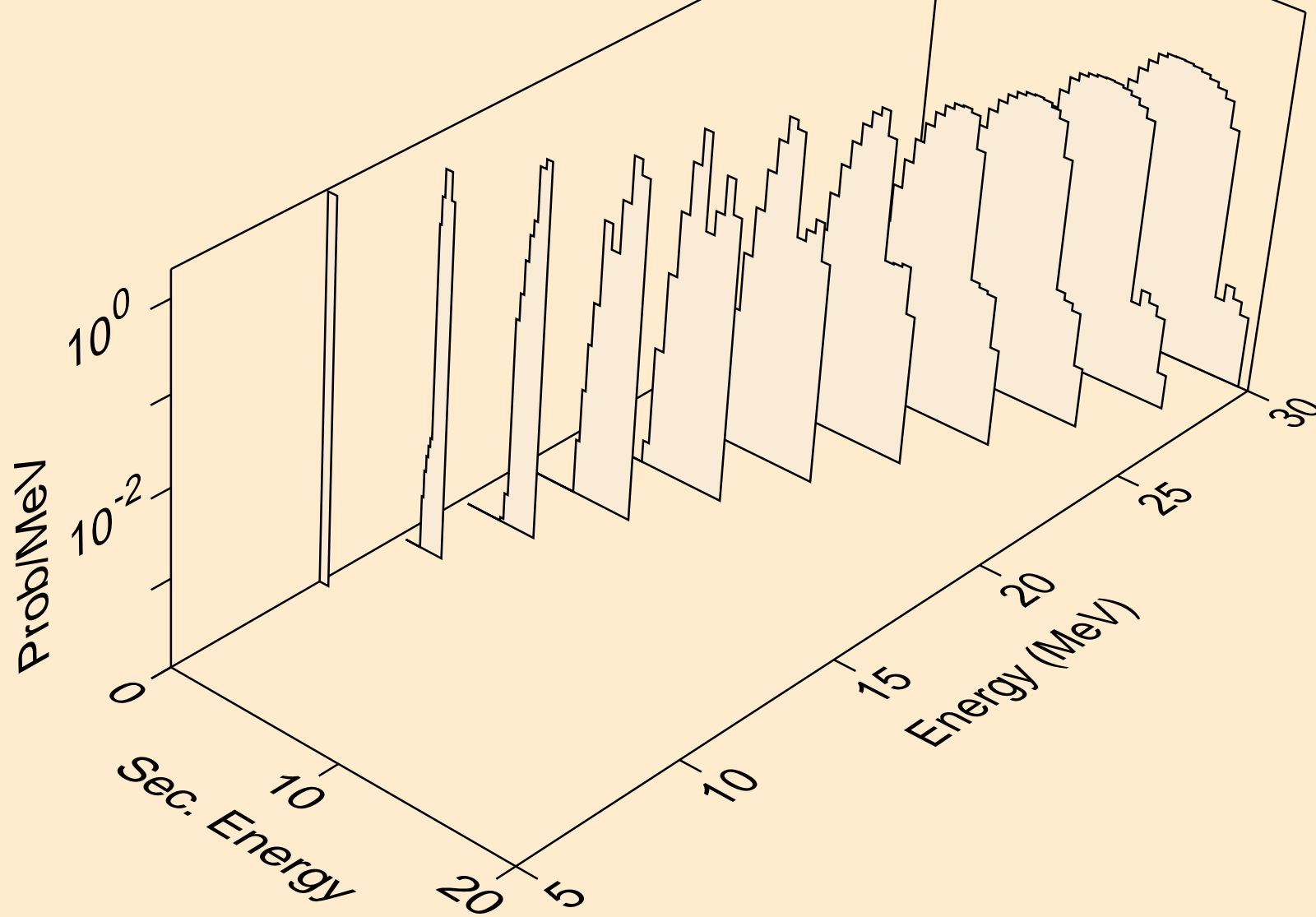

AS075 PROTON ACER TENDL-2024 LIBRARY; T=0.K  
alphas from (p,x)

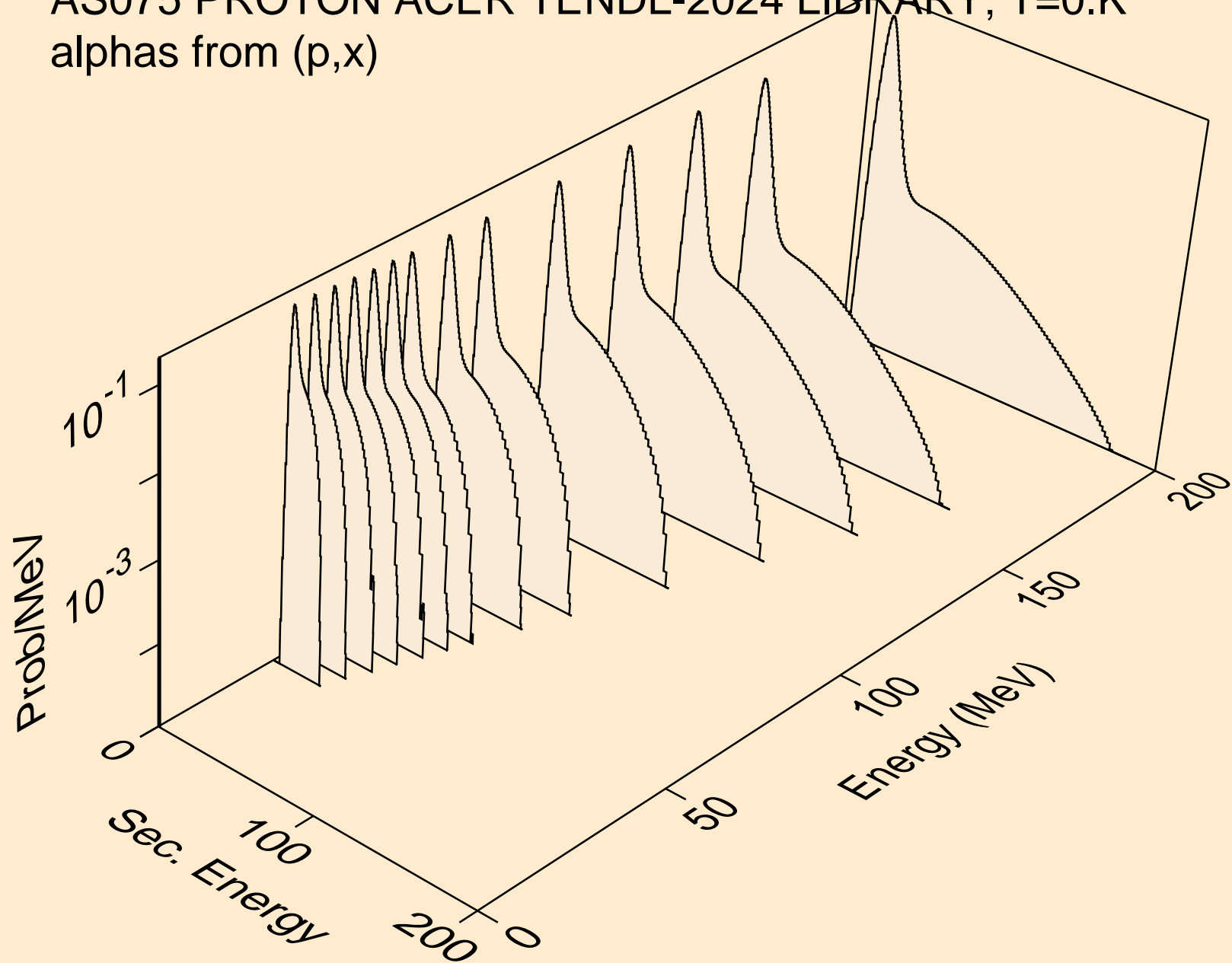

AS075 PROTON ACER TENDL-2024 LIBRARY; T=0.K  
alphas from (p,n\*)a

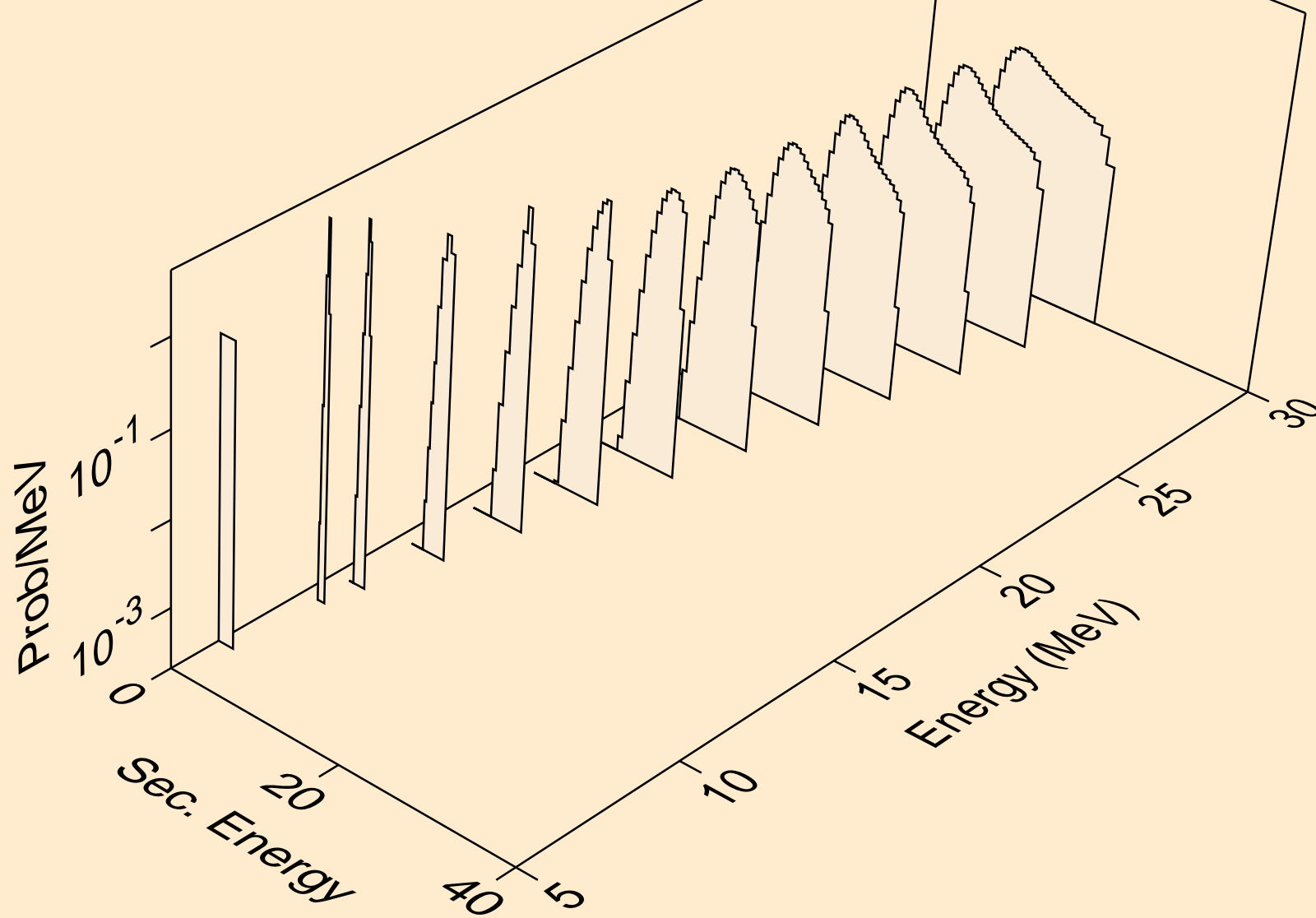

AS075 PROTON ACER TENDL-2024 LIBRARY; T=0.K  
alphas from (p,2n)a

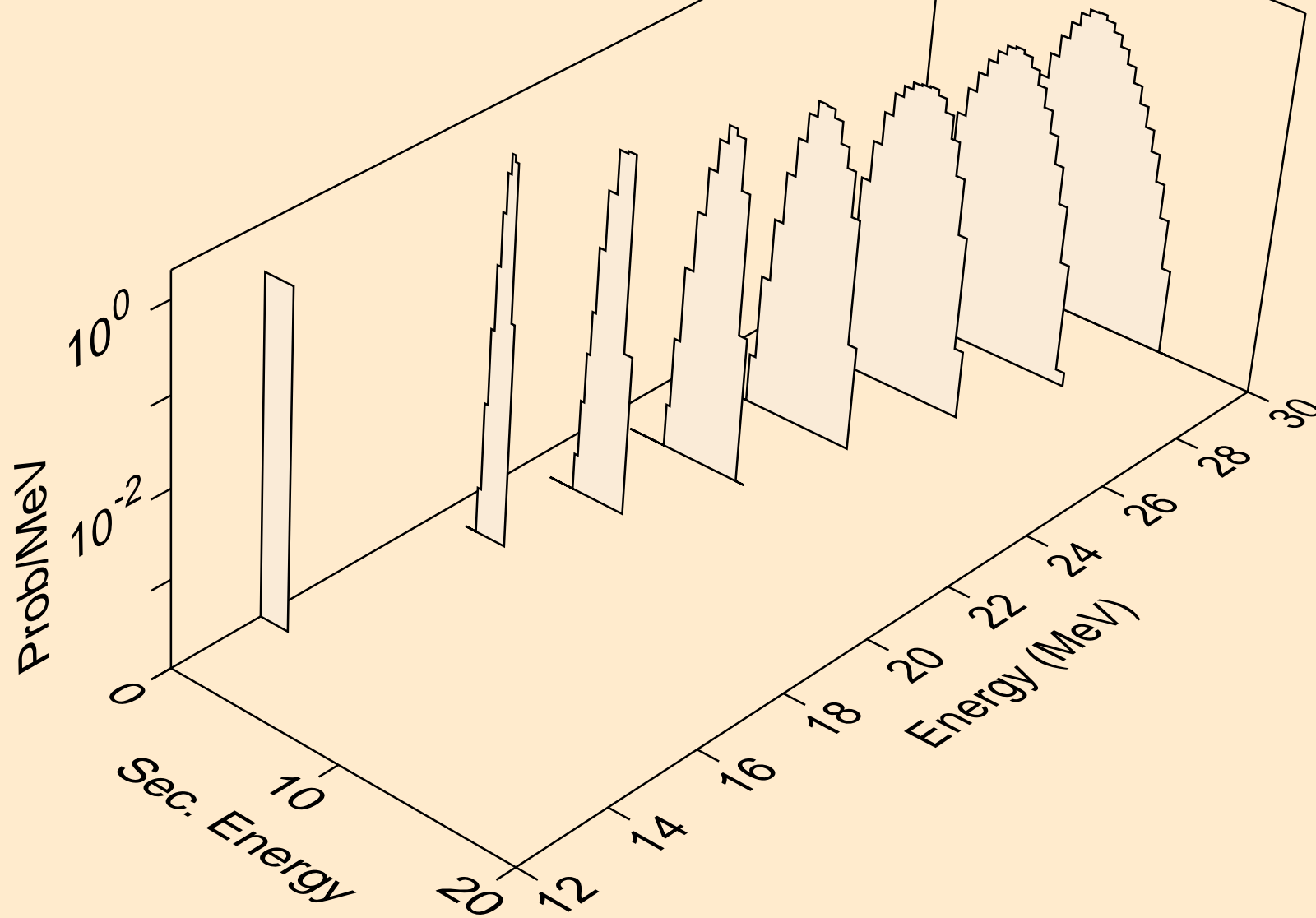

AS075 PROTON ACER TENDL-2024 LIBRARY; T=0.K  
alphas from (p,n\*)2a

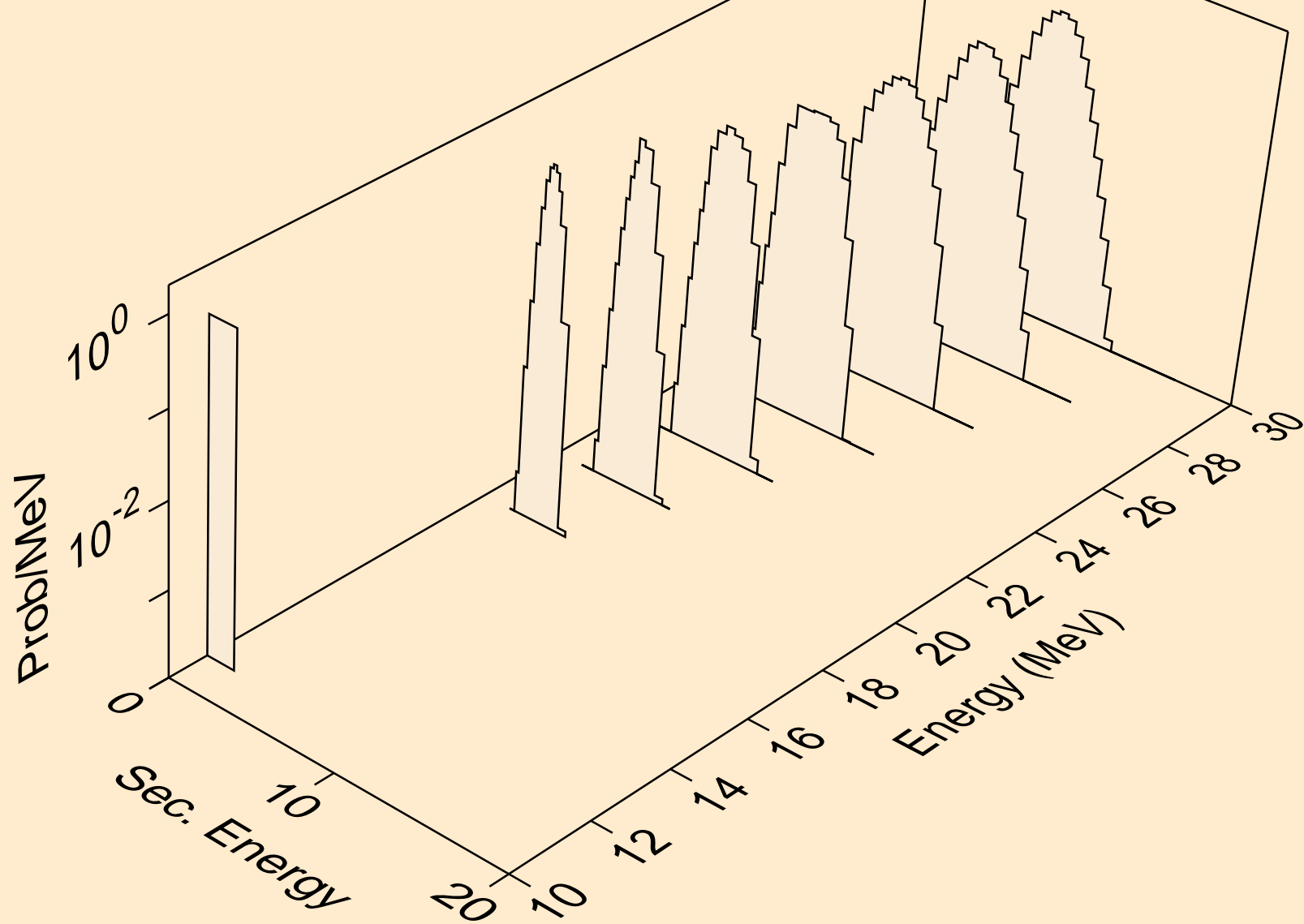

AS075 PROTON ACER TENDL-2024 LIBRARY; T=0.K  
alphas from (p,npa)

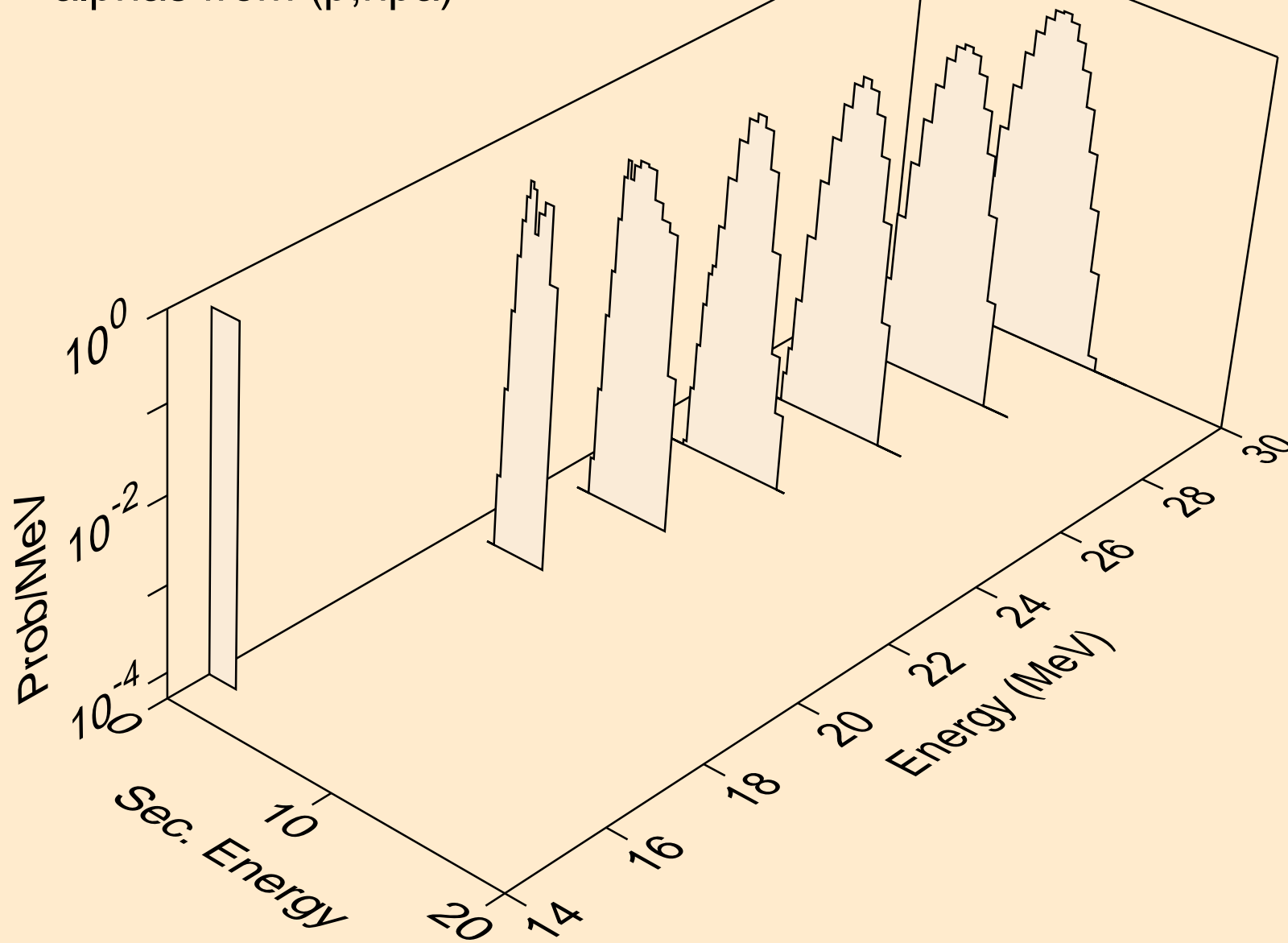

AS075 PROTON ACER TENDL-2024 LIBRARY; T=0.K  
alphas from (p,a)

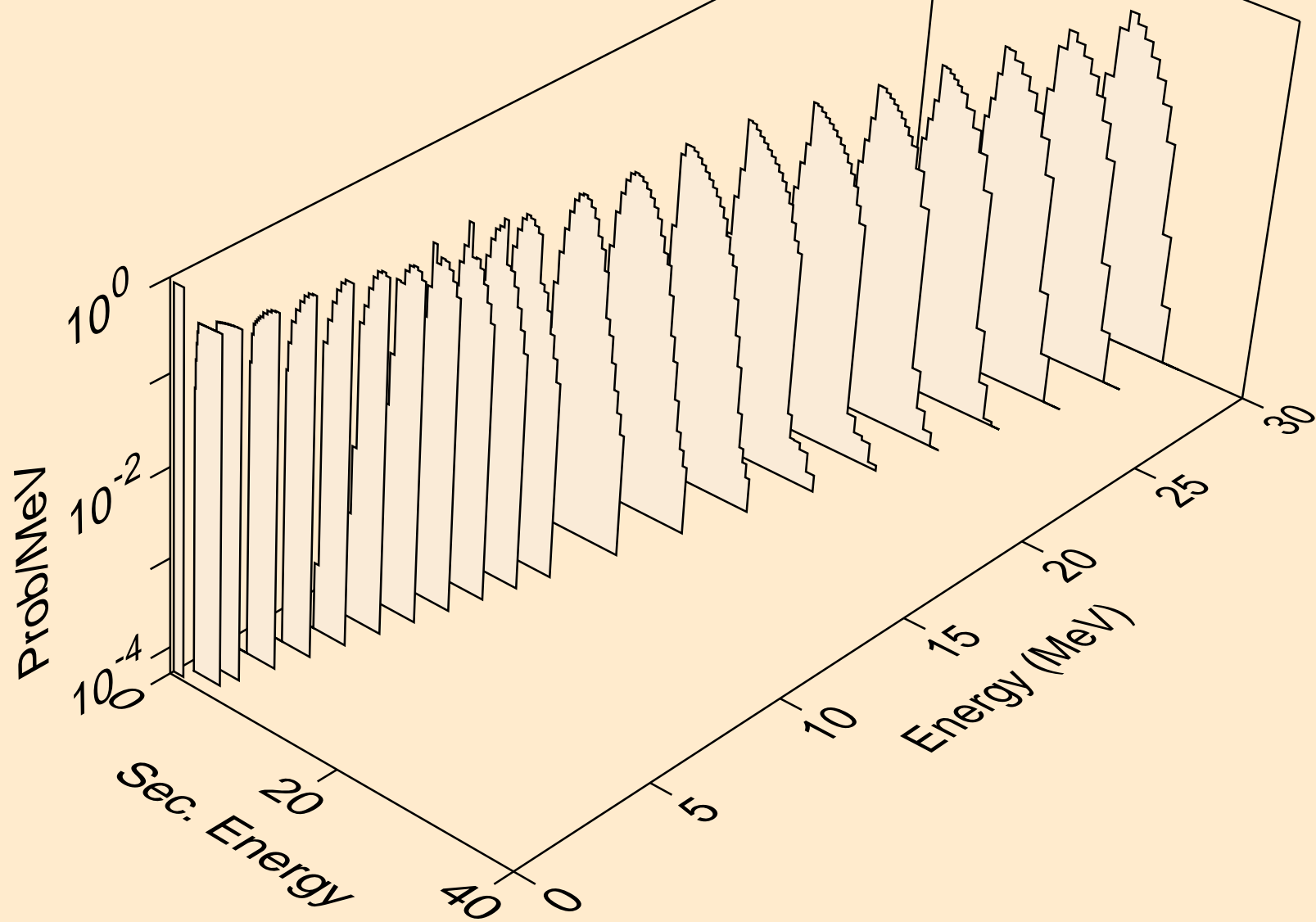

AS075 PROTON ACER TENDL-2024 LIBRARY; T=0.K  
alphas from (p,2a)

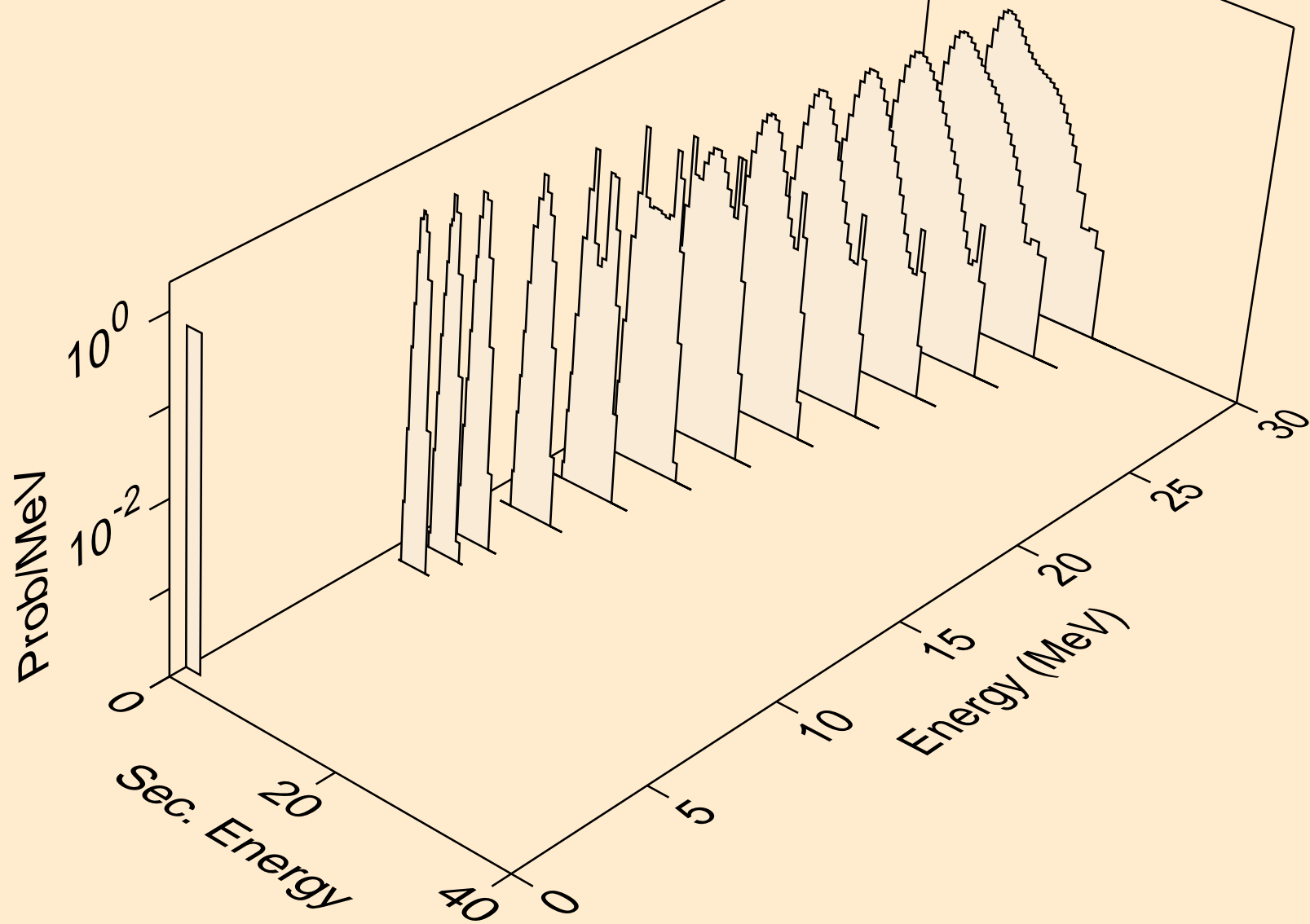

AS075 PROTON ACER TENDL-2024 LIBRARY; T=0.K  
alphas from (p,pa)

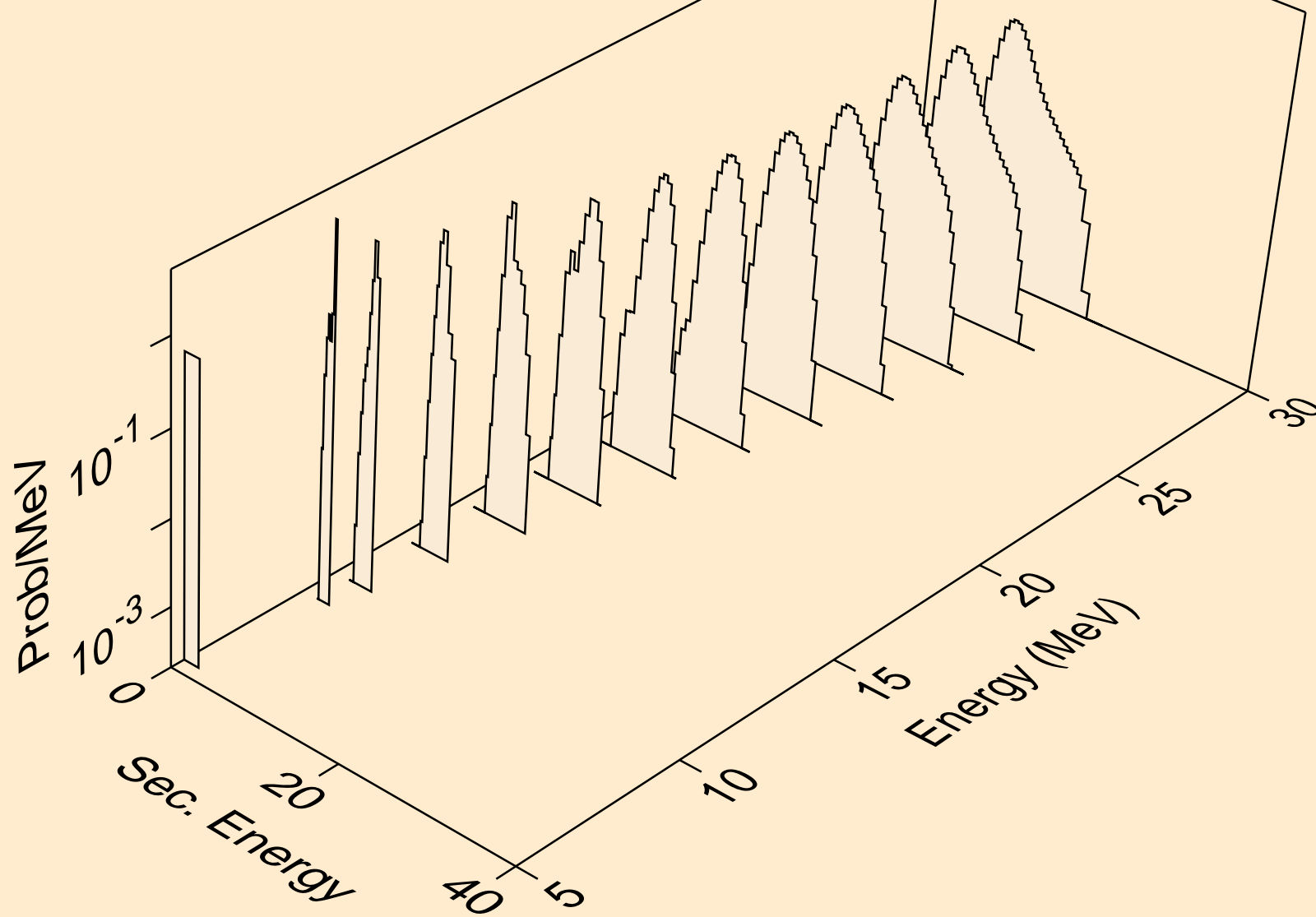

AS075 PROTON ACER TENDL-2024 LIBRARY; T=0.K  
alphas from (p,da)

