

DB258 PROTON ACER TENDL-2024 LIBRARY; T=0.K  
Principal cross sections

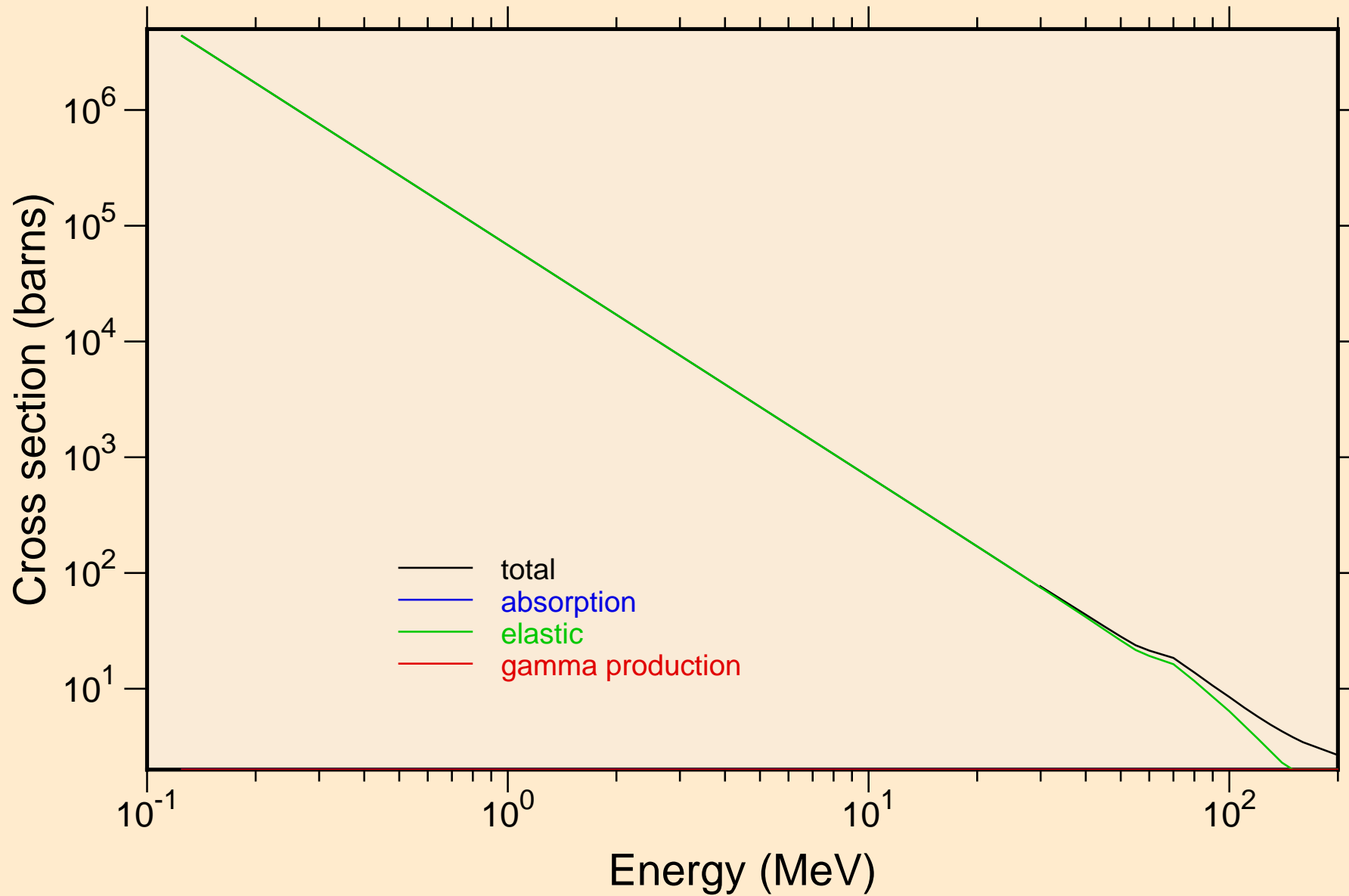

# DB258 PROTON ACER TENDL-2024 LIBRARY; T=0.K

## Heating

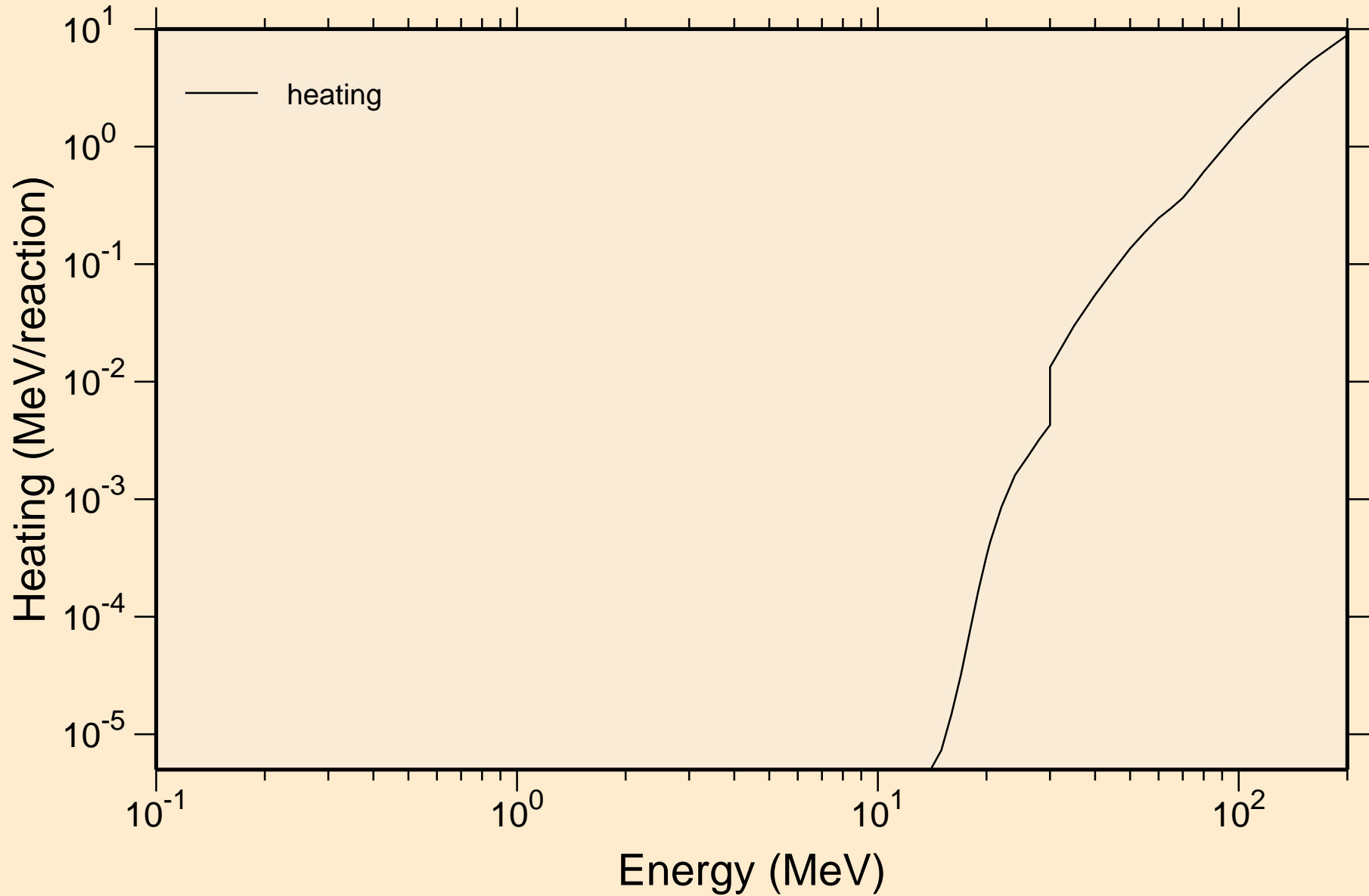

# DB258 PROTON ACER TENDL-2024 LIBRARY; T=0.K

## Principal cross sections

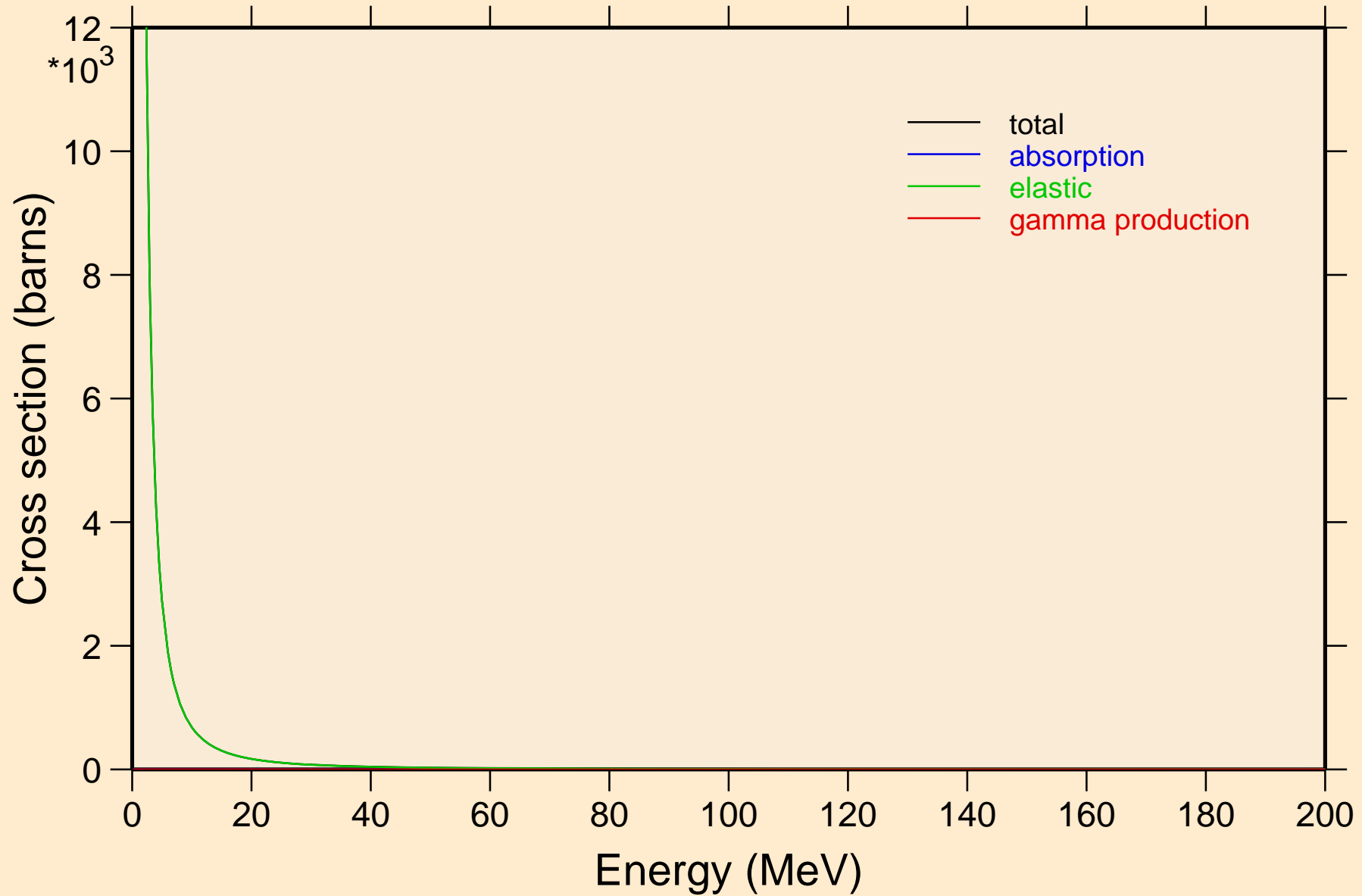

DB258 PROTON ACER TENDL-2024 LIBRARY; T=0.K

Heating

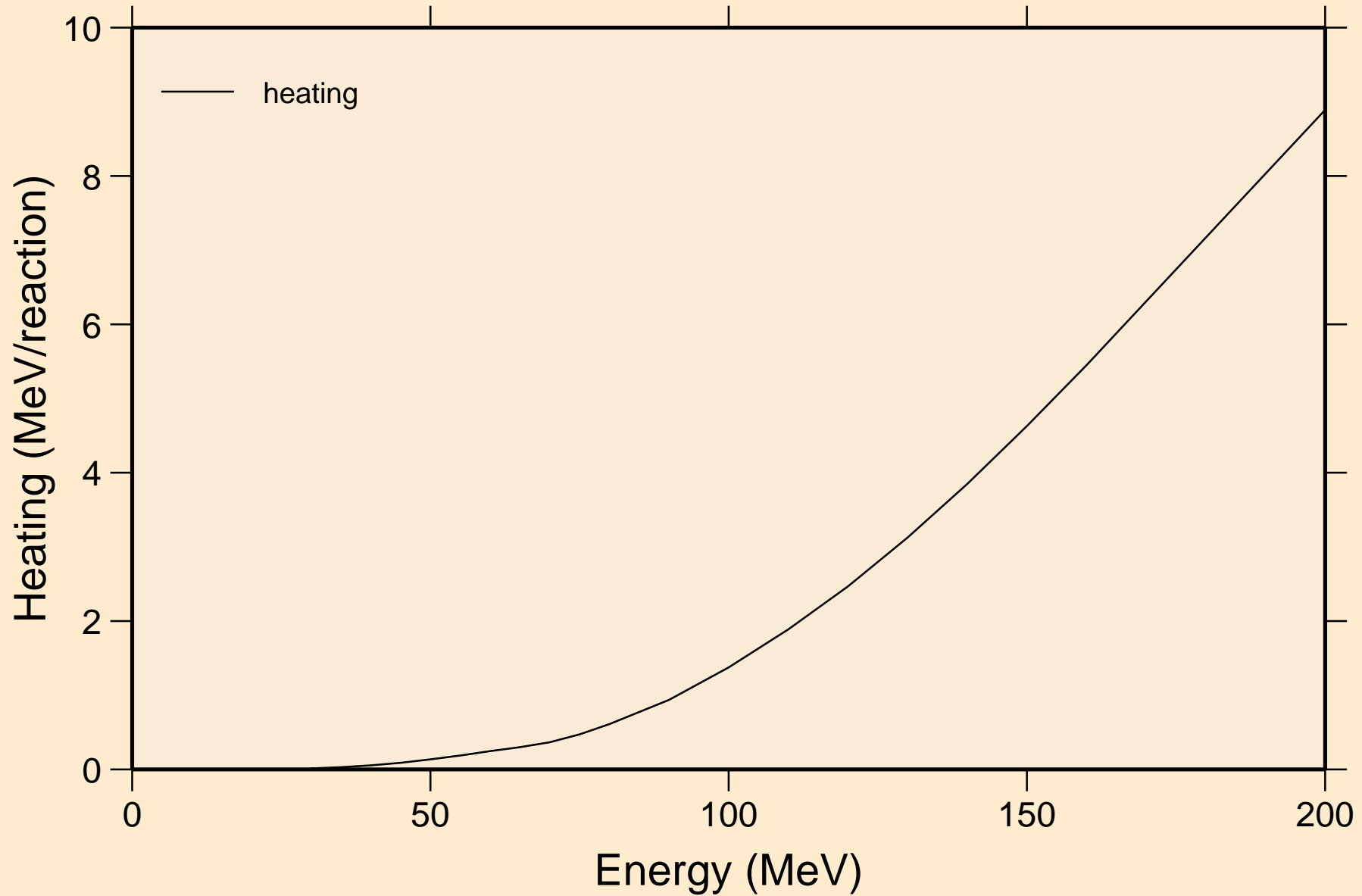

# DB258 PROTON ACER TENDL-2024 LIBRARY; T=0.K

## Threshold reactions

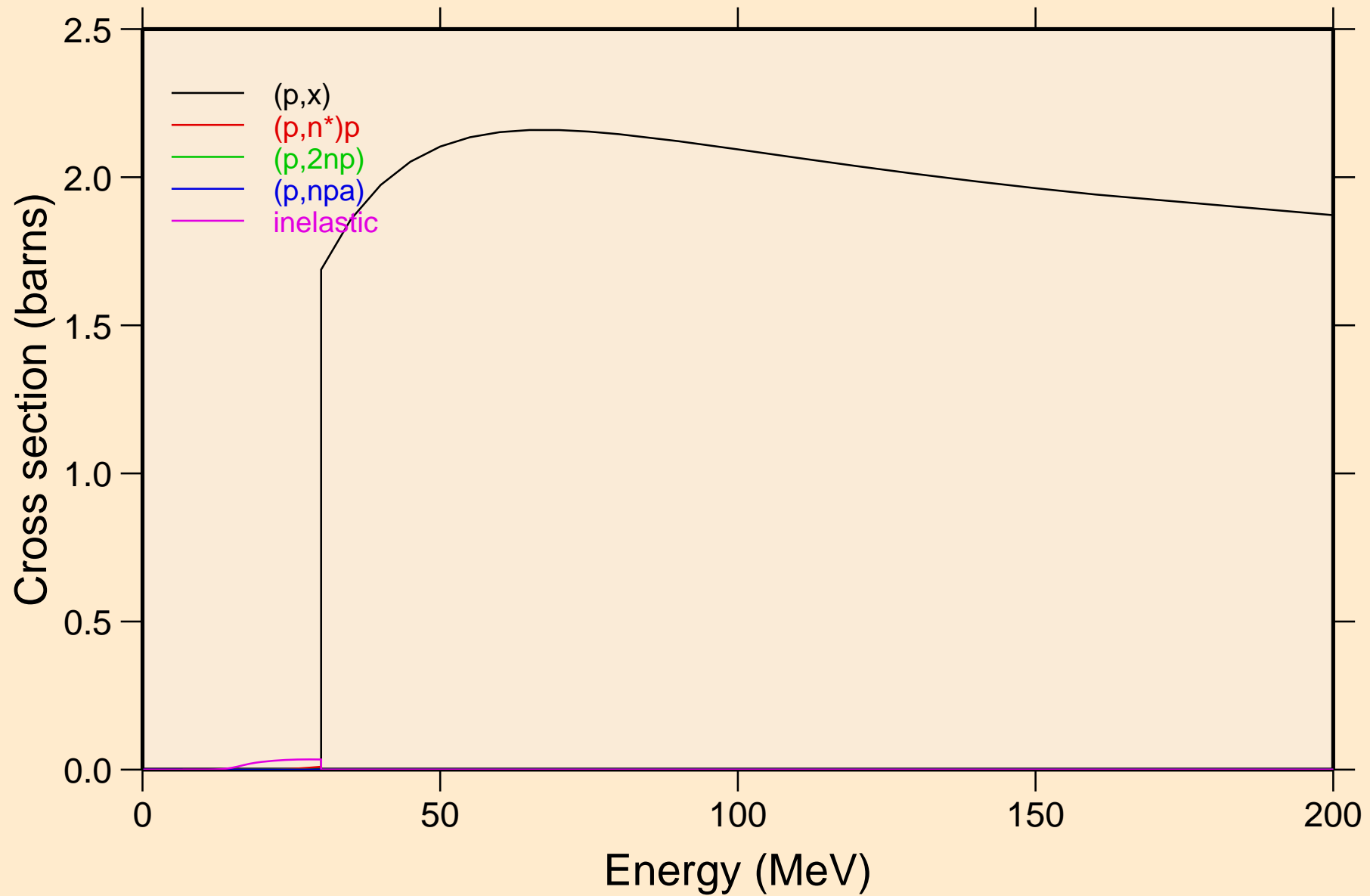

DB258 PROTON ACER TENDL-2024 LIBRARY; T=0.K  
Threshold reactions

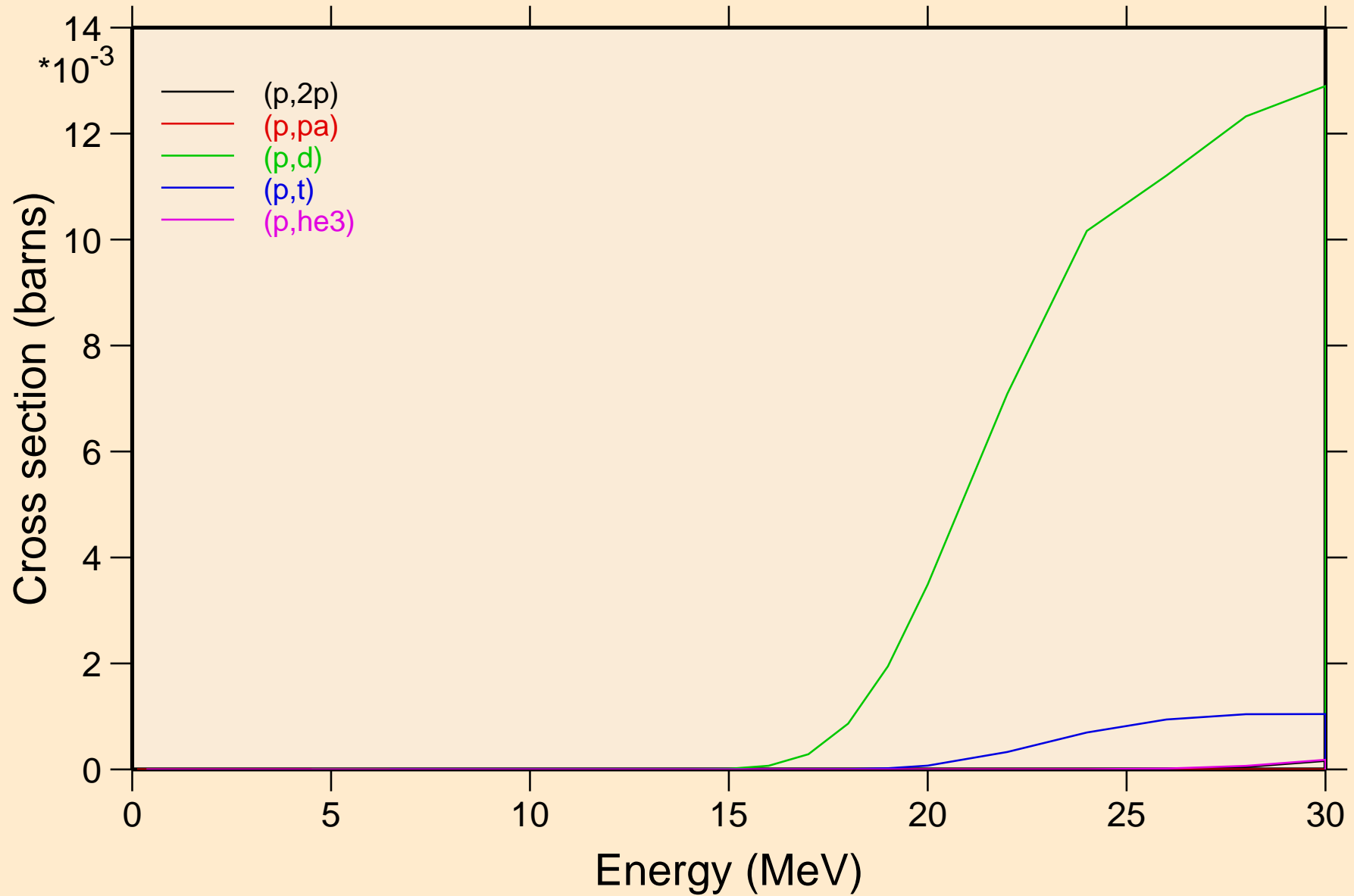

# DB258 PROTON ACER TENDL-2024 LIBRARY; T=0.K

## Threshold reactions

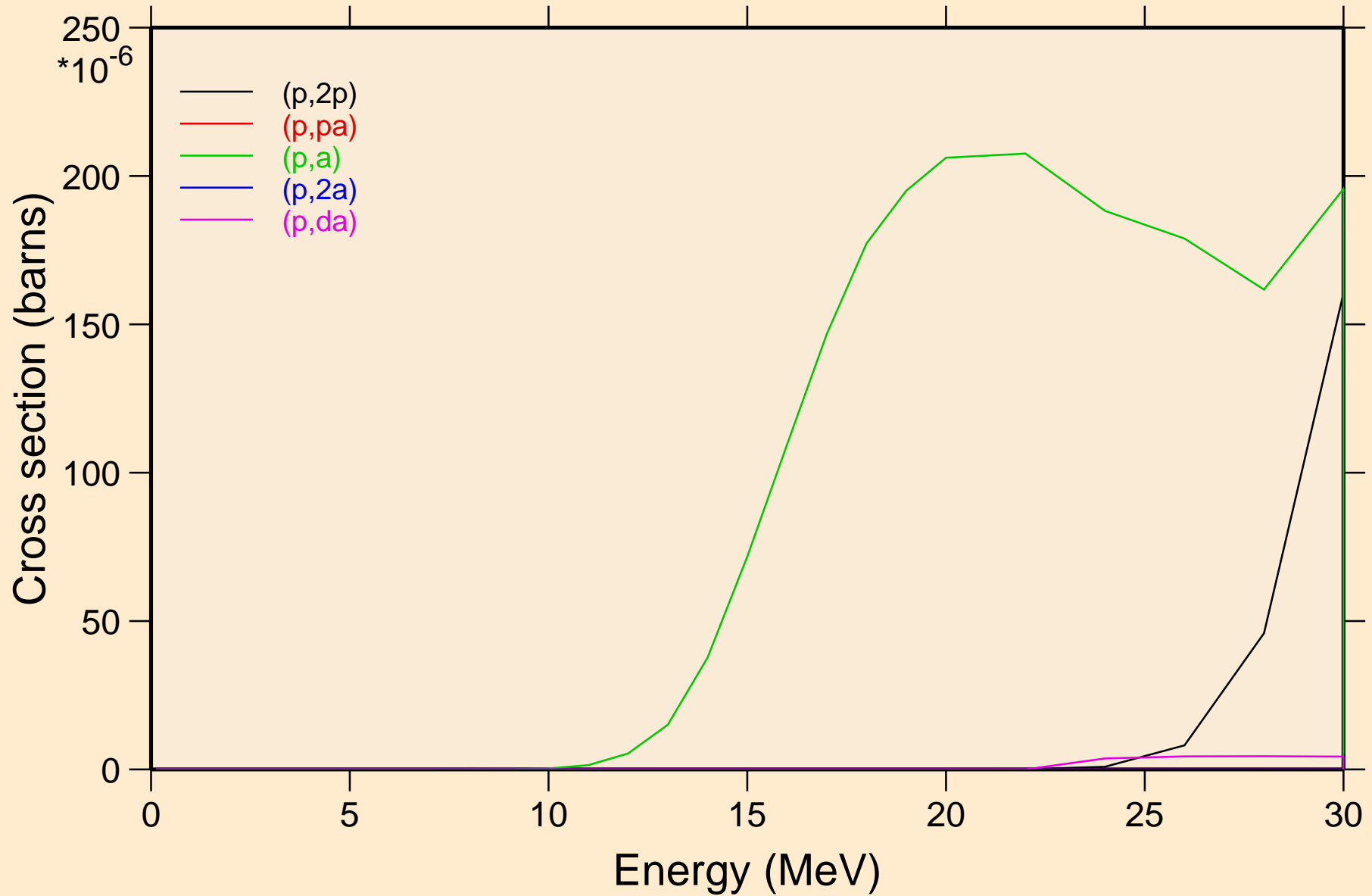

DB258 PROTON ACER TENDL-2024 LIBRARY; T=0.K  
angular distribution for elastic

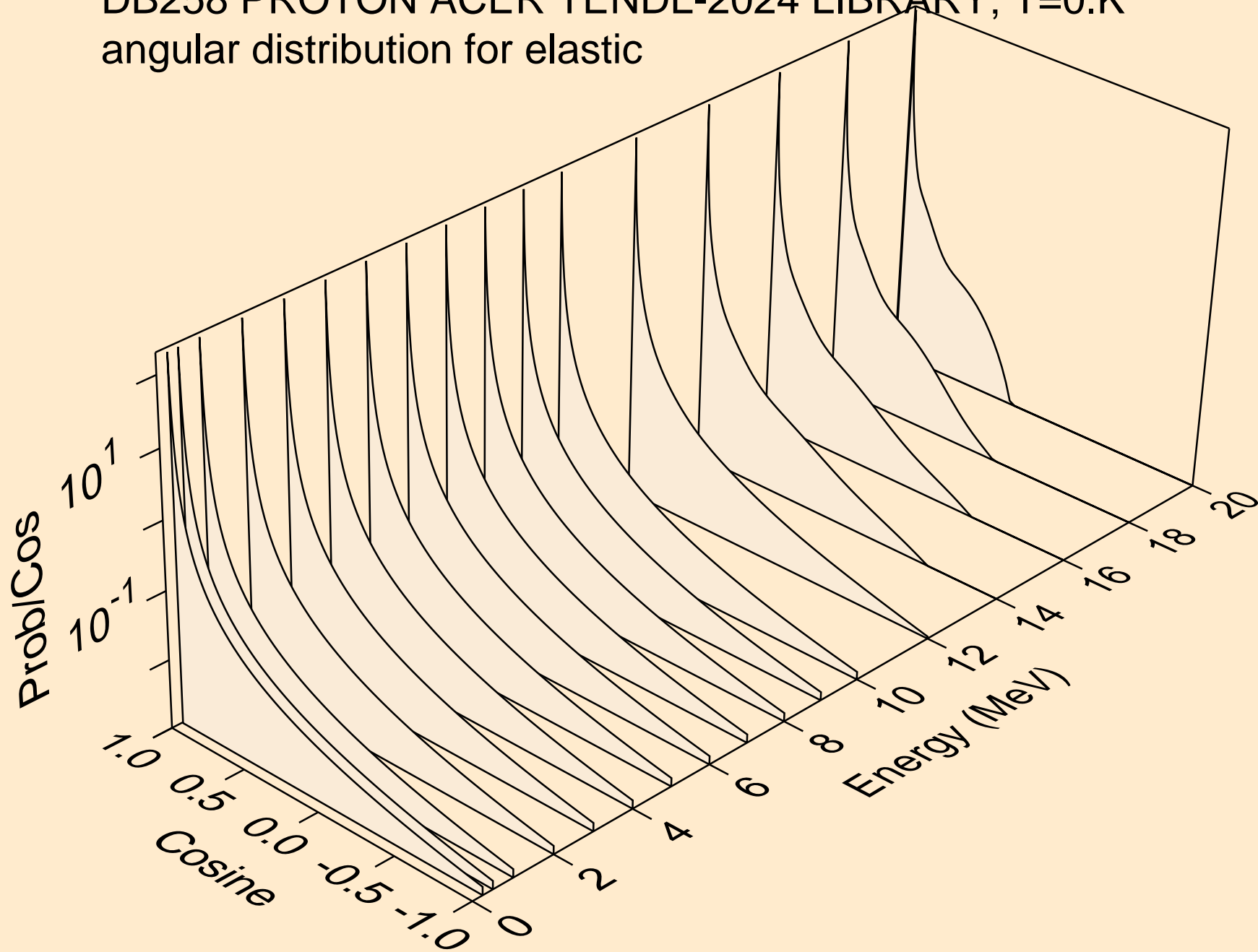

DB258 PROTON ACER TENDL-2024 LIBRARY; T=0.K  
angular distribution for elastic

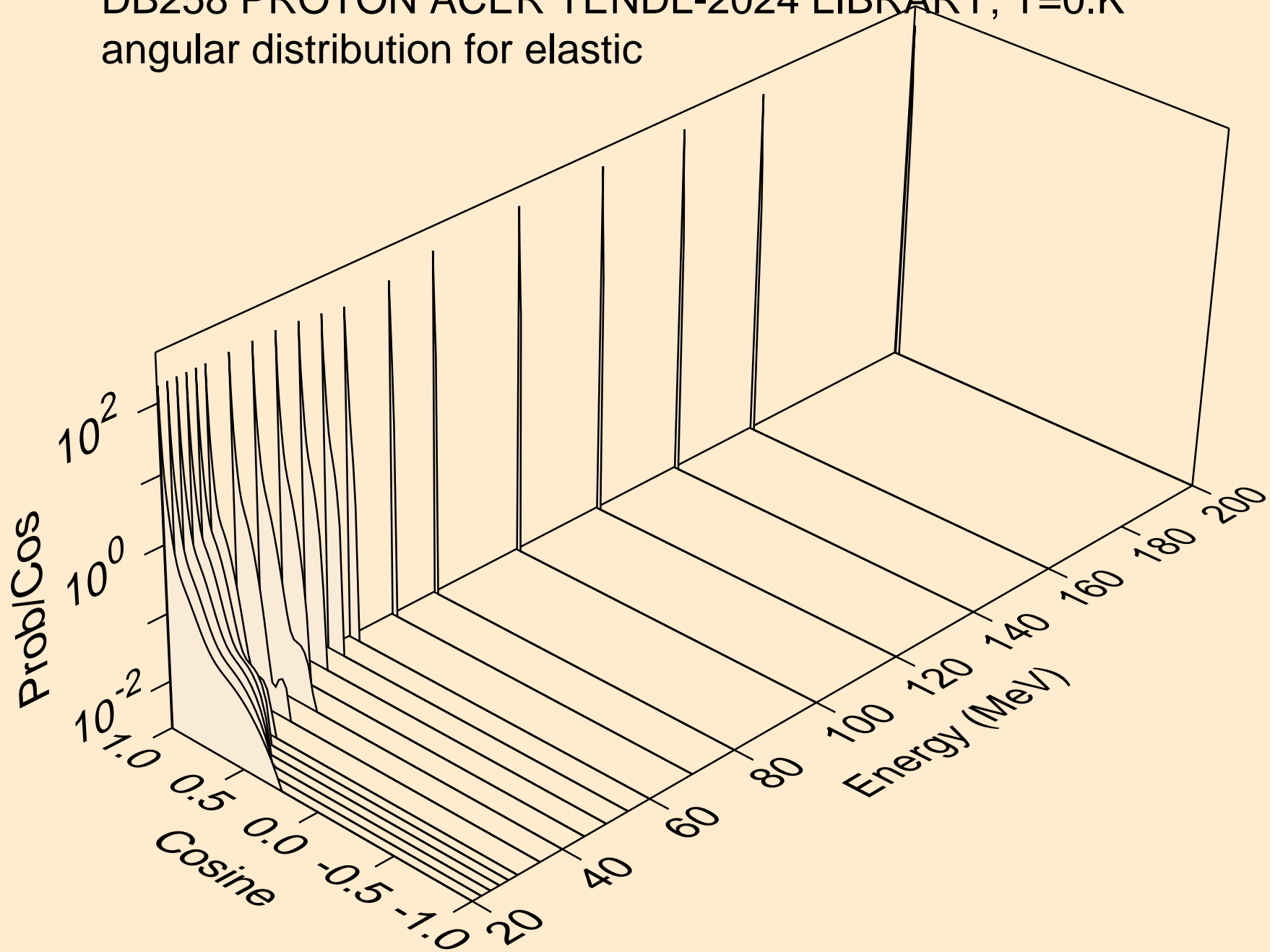

DB258 PROTON ACER TENDL-2024 LIBRARY; T=0.K  
Proton emission for (p,x)

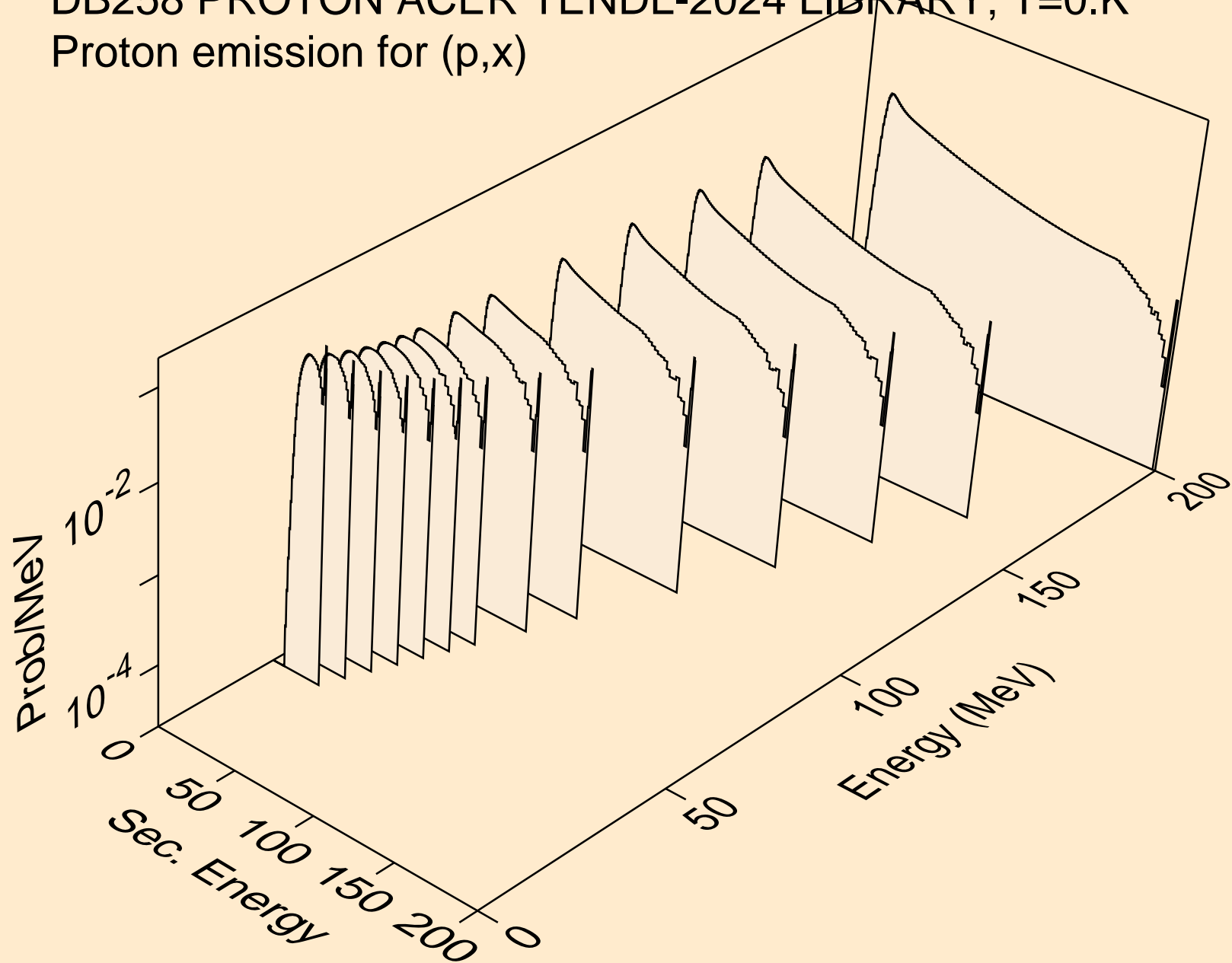

DB258 PROTON ACER TENDL-2024 LIBRARY; T=0.K  
Proton emission for (p,n\*)p

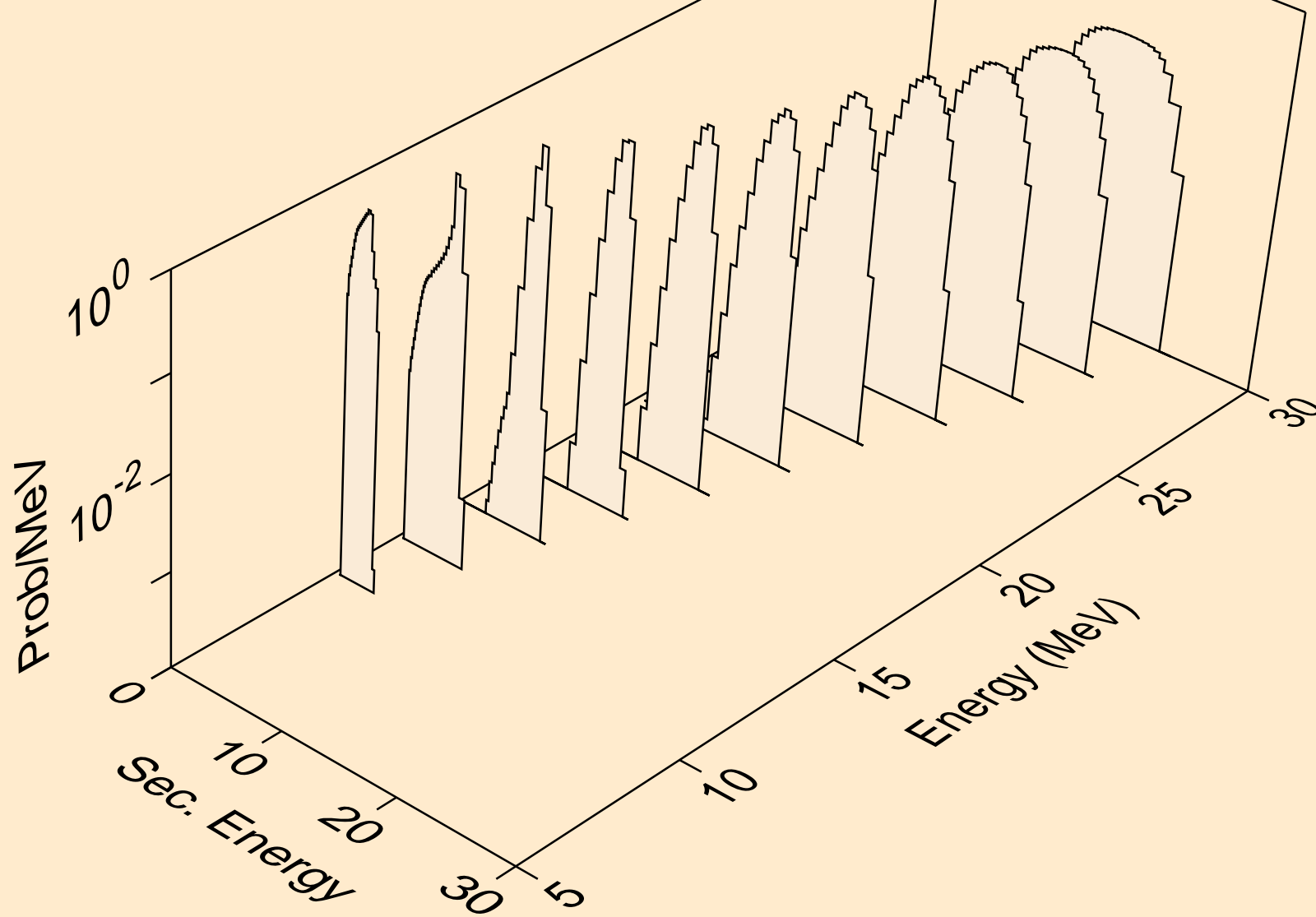

DB258 PROTON ACER TENDL-2024 LIBRARY; T=0.K  
Proton emission for (p,2np)

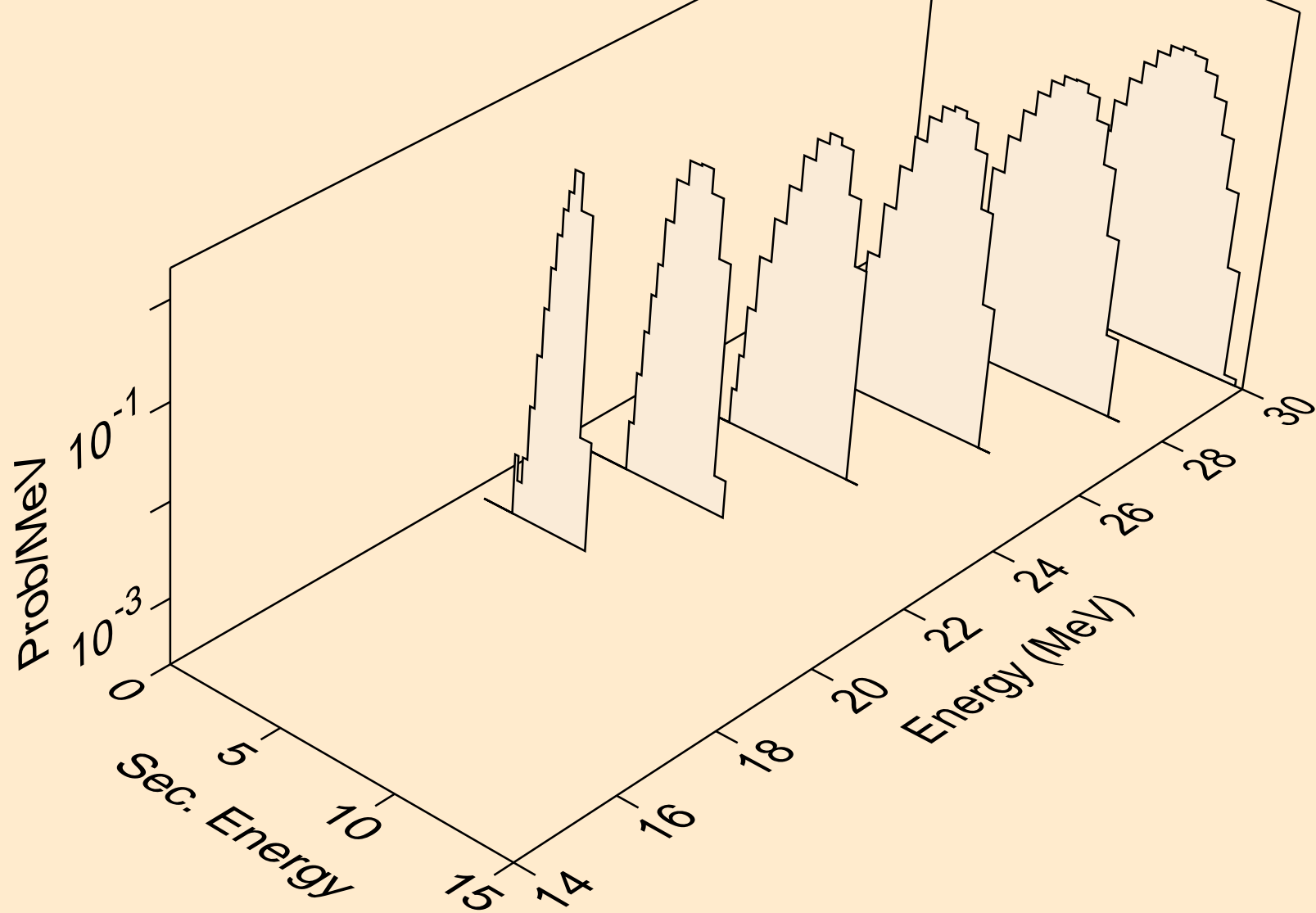

DB258 PROTON ACER TENDL-2024 LIBRARY; T=0.K  
Proton emission for (p,npa)

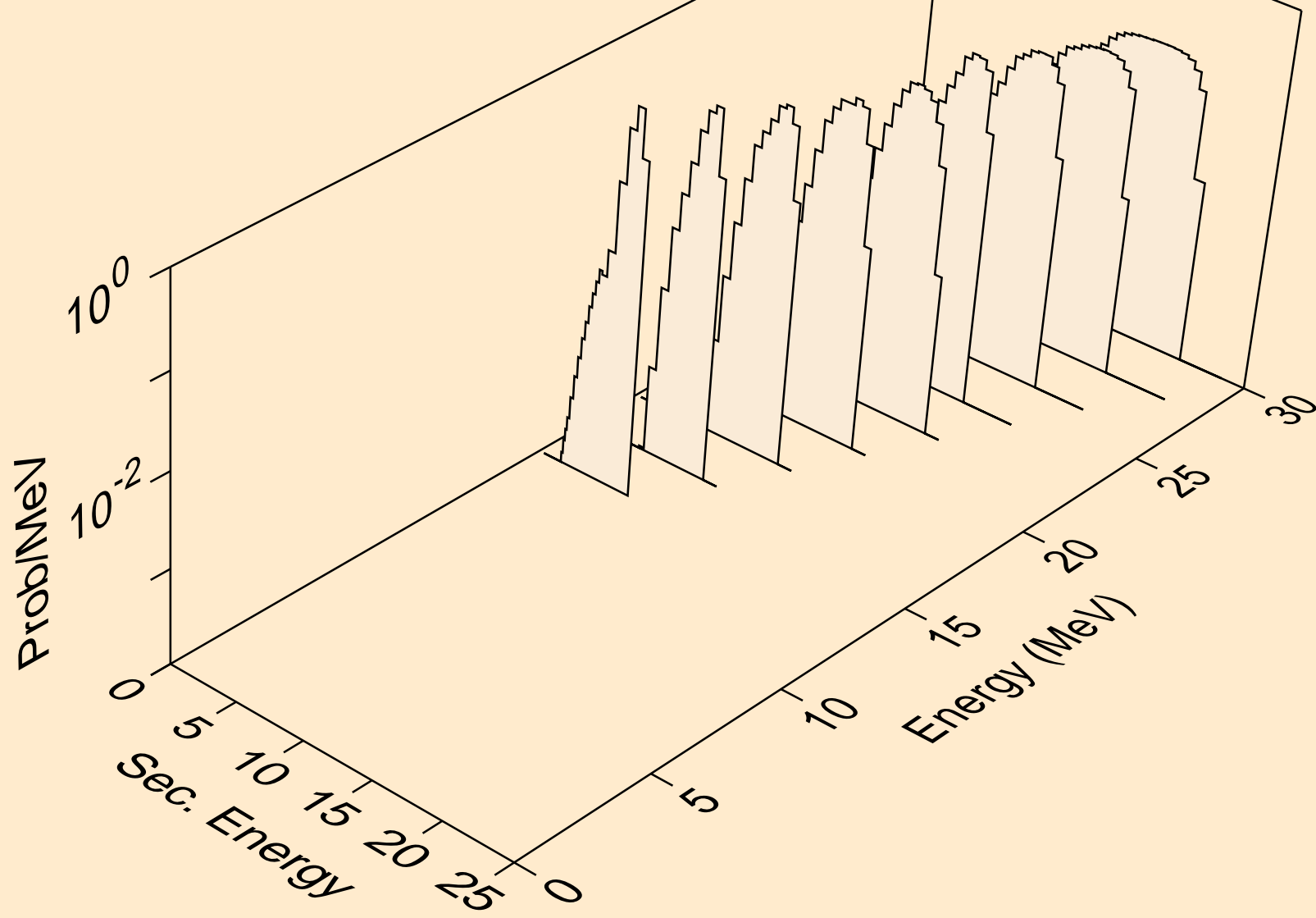

DB258 PROTON ACER TENDL-2024 LIBRARY; T=0.K  
Proton emission for inelastic

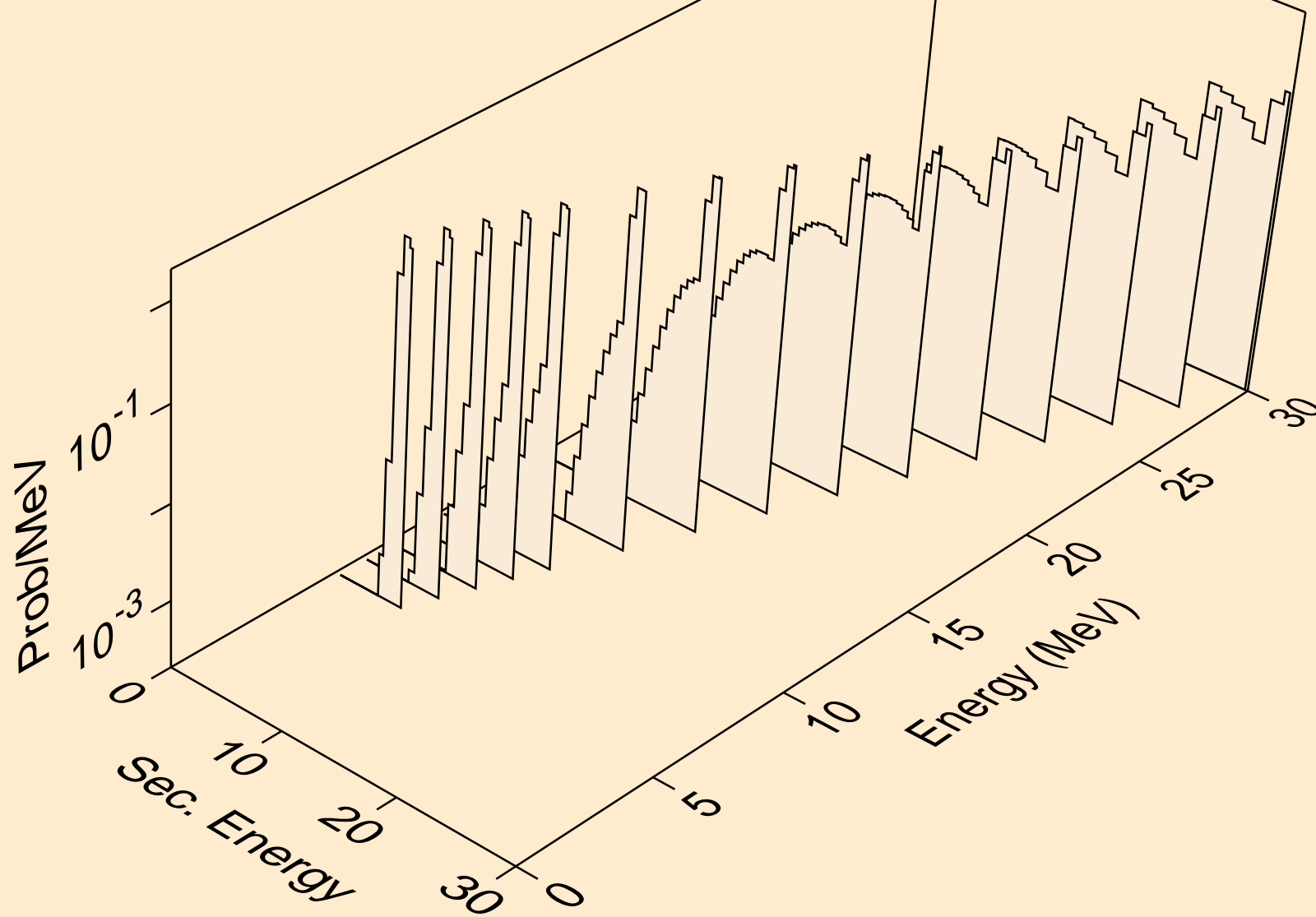

DB258 PROTON ACER TENDL-2024 LIBRARY; T=0.K  
Proton emission for (p,2p)

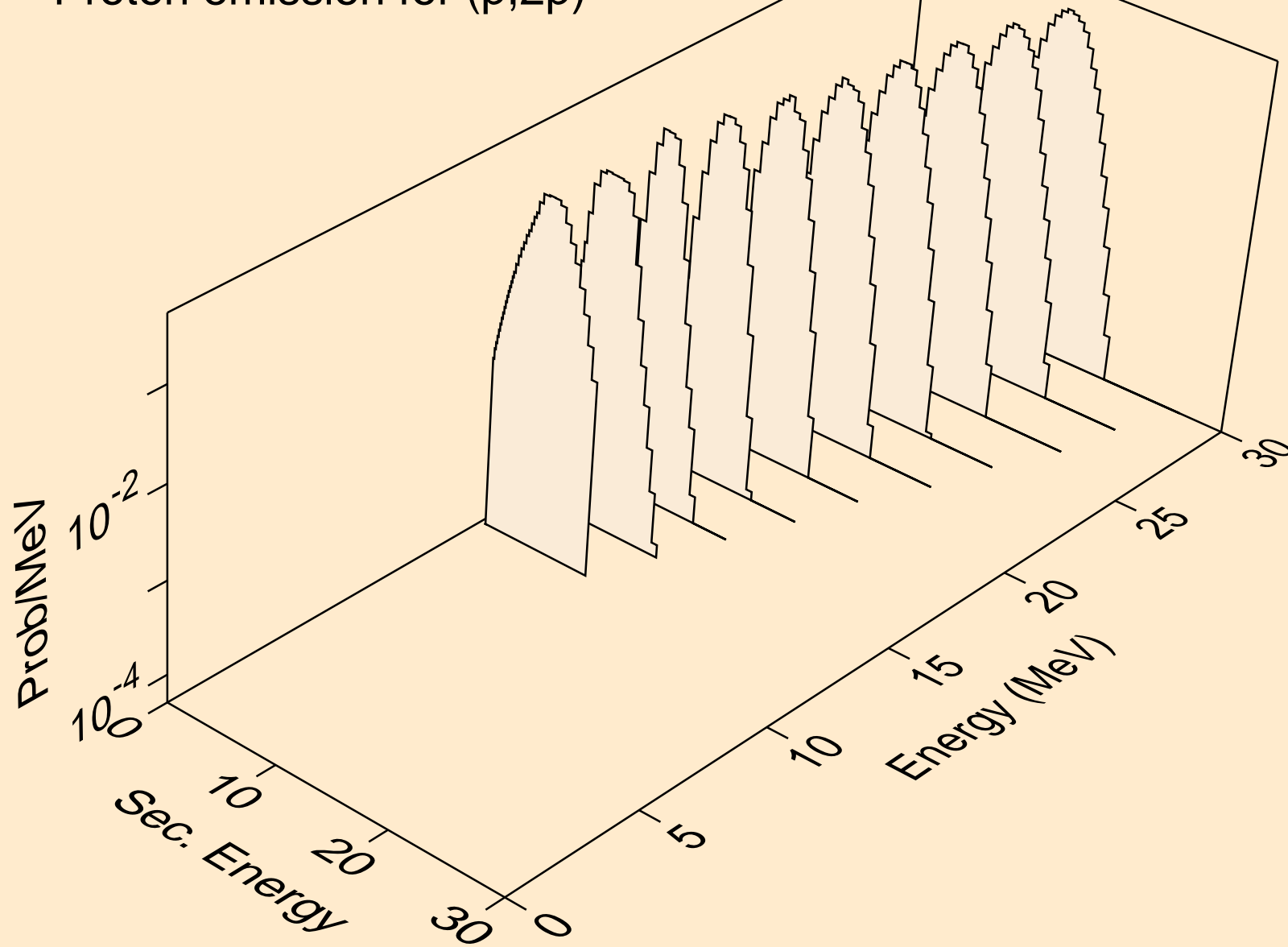

DB258 PROTON ACER TENDL-2024 LIBRARY; T=0.K  
Proton emission for (p,pa)

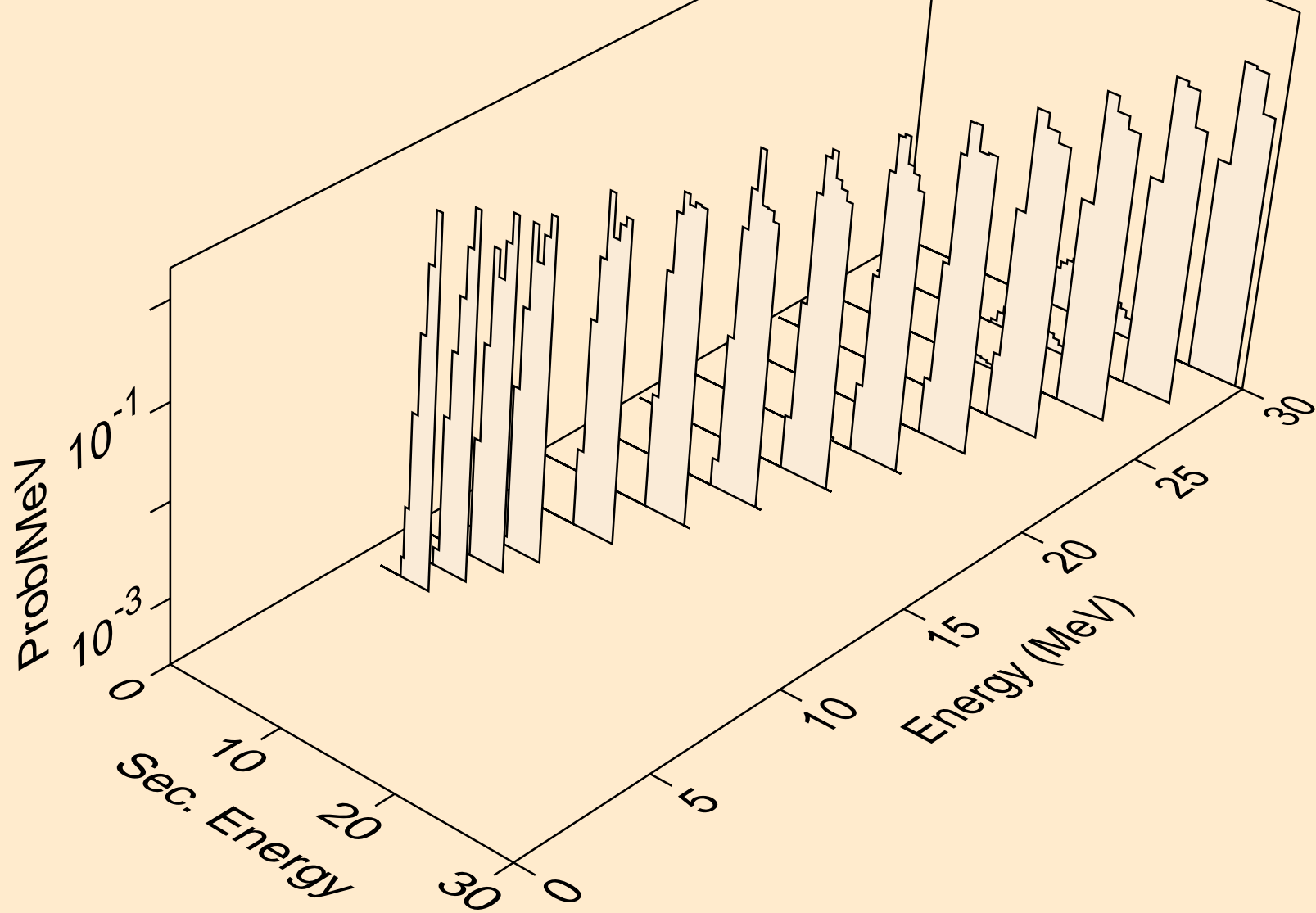

DB258 PROTON ACER TENDL-2024 LIBRARY; T=0.K  
Photon emission for (z,n)

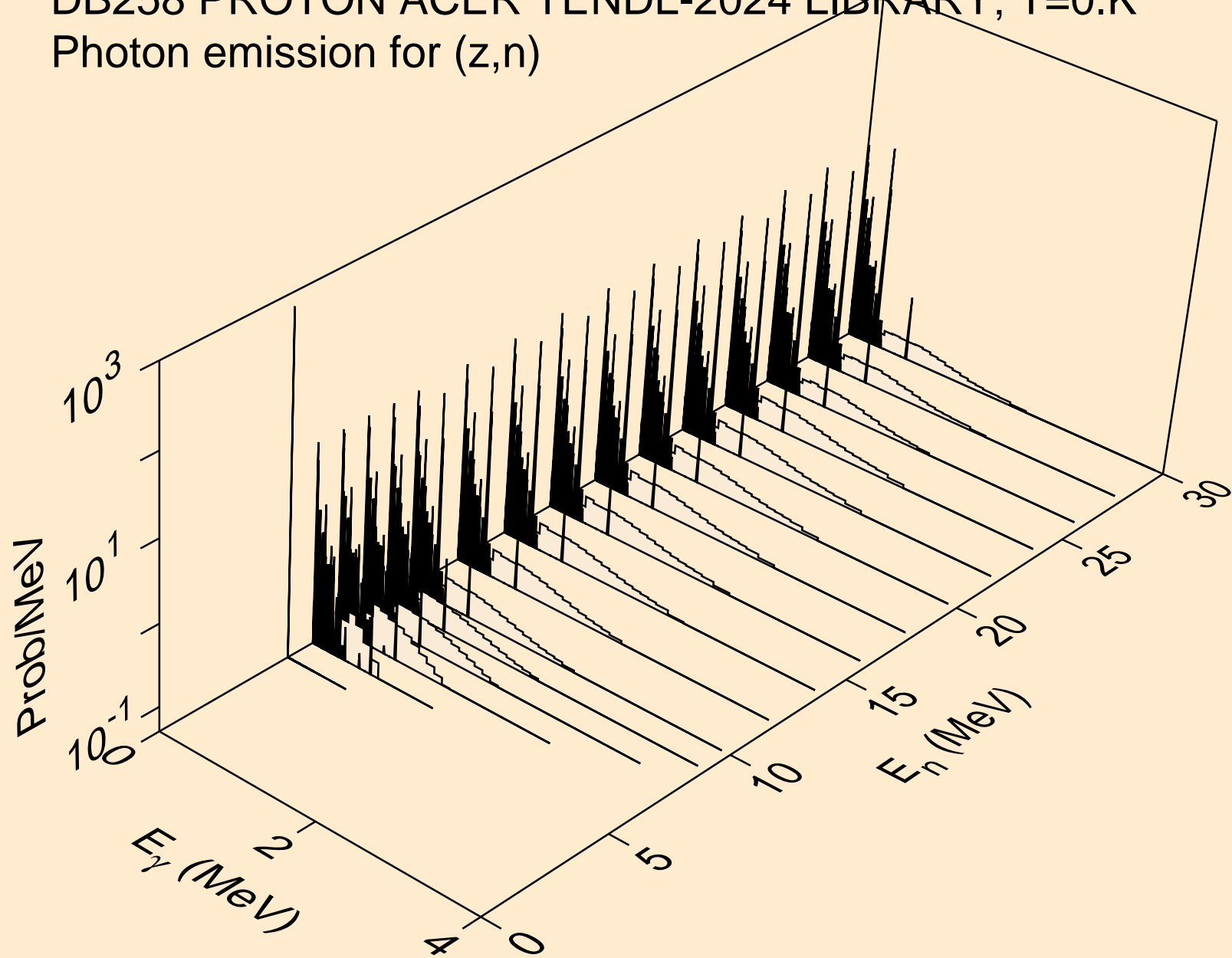

DB258 PROTON ACER TENDL-2024 LIBRARY; T=0.K  
Photon emission for (z,x)

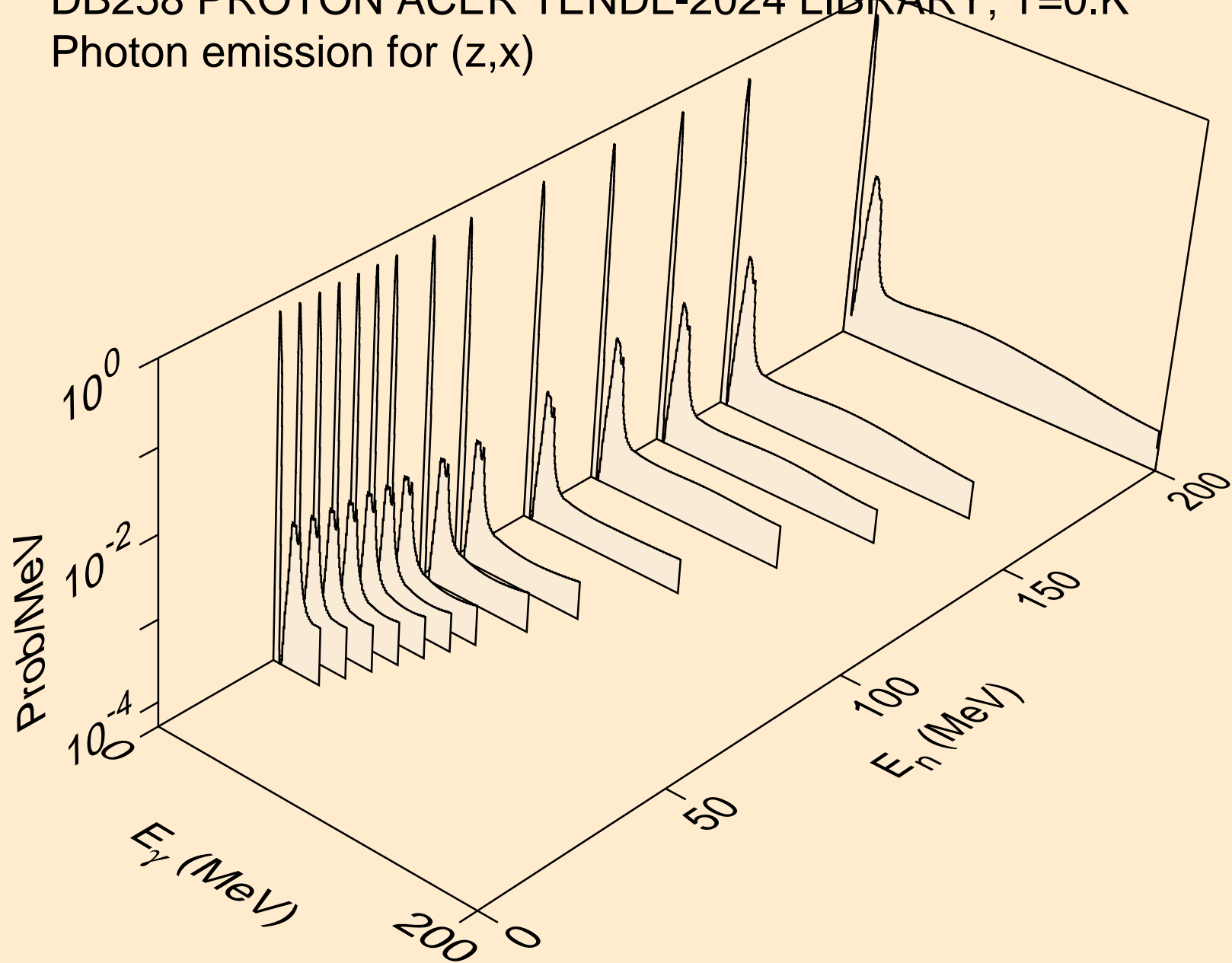

DB258 PROTON ACER TENDL-2024 LIBRARY; T=0.K  
Photon emission for (n,2n)

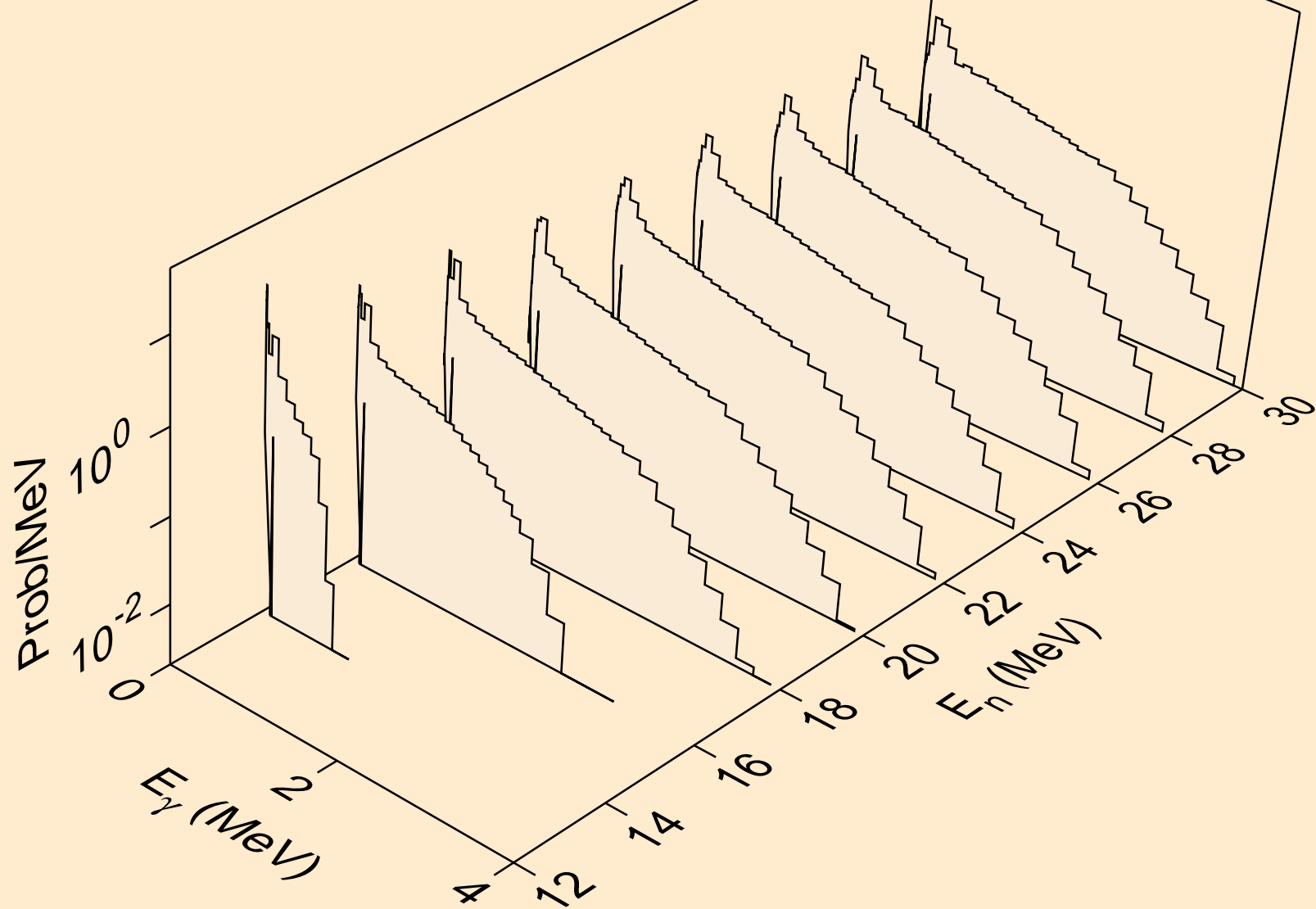

DB258 PROTON ACER TENDL-2024 LIBRARY; T=0.K  
Photon emission for (n,3n)

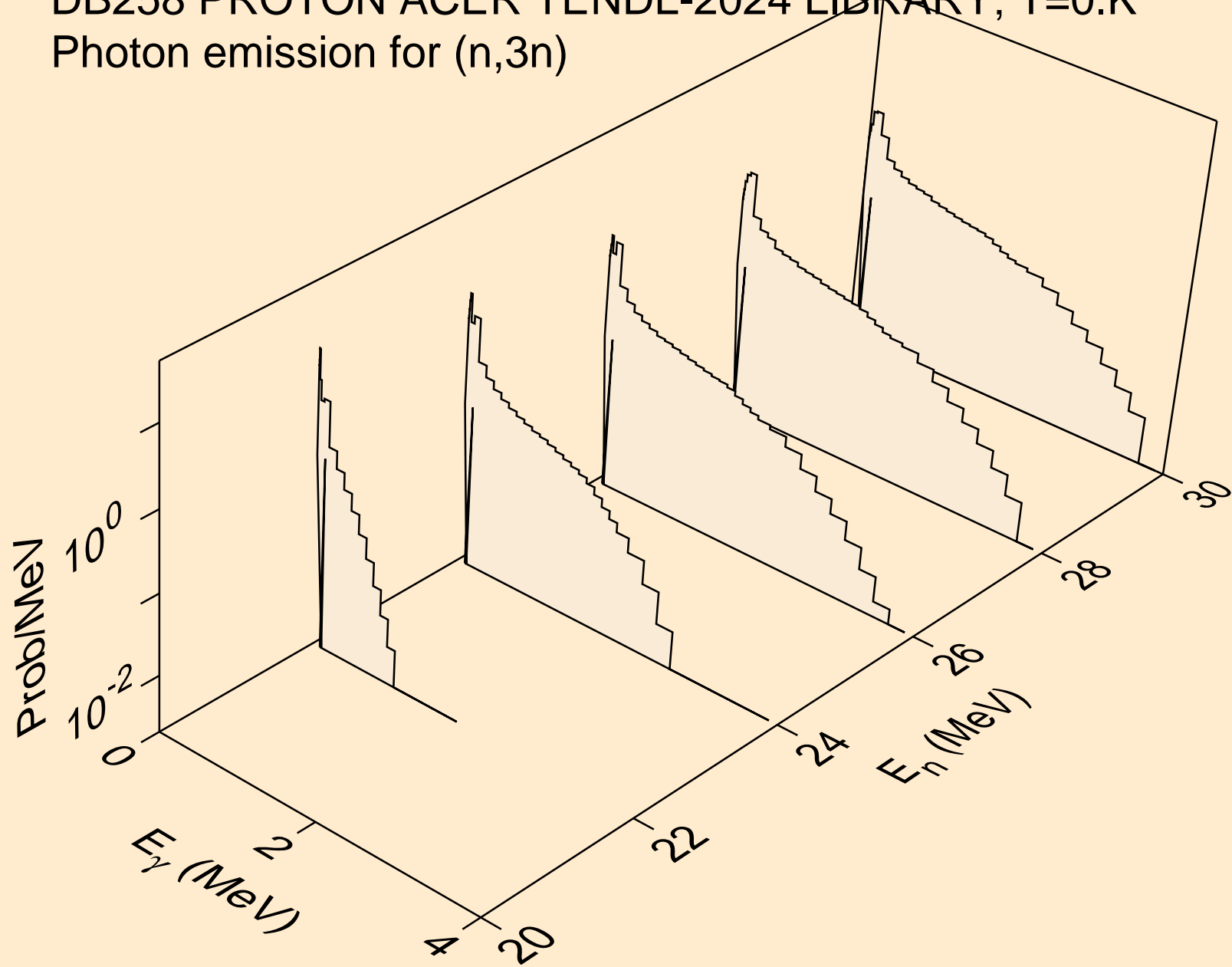

DB258 PROTON ACER TENDL-2024 LIBRARY; T=0.K  
Photon emission for (n,n\*)a

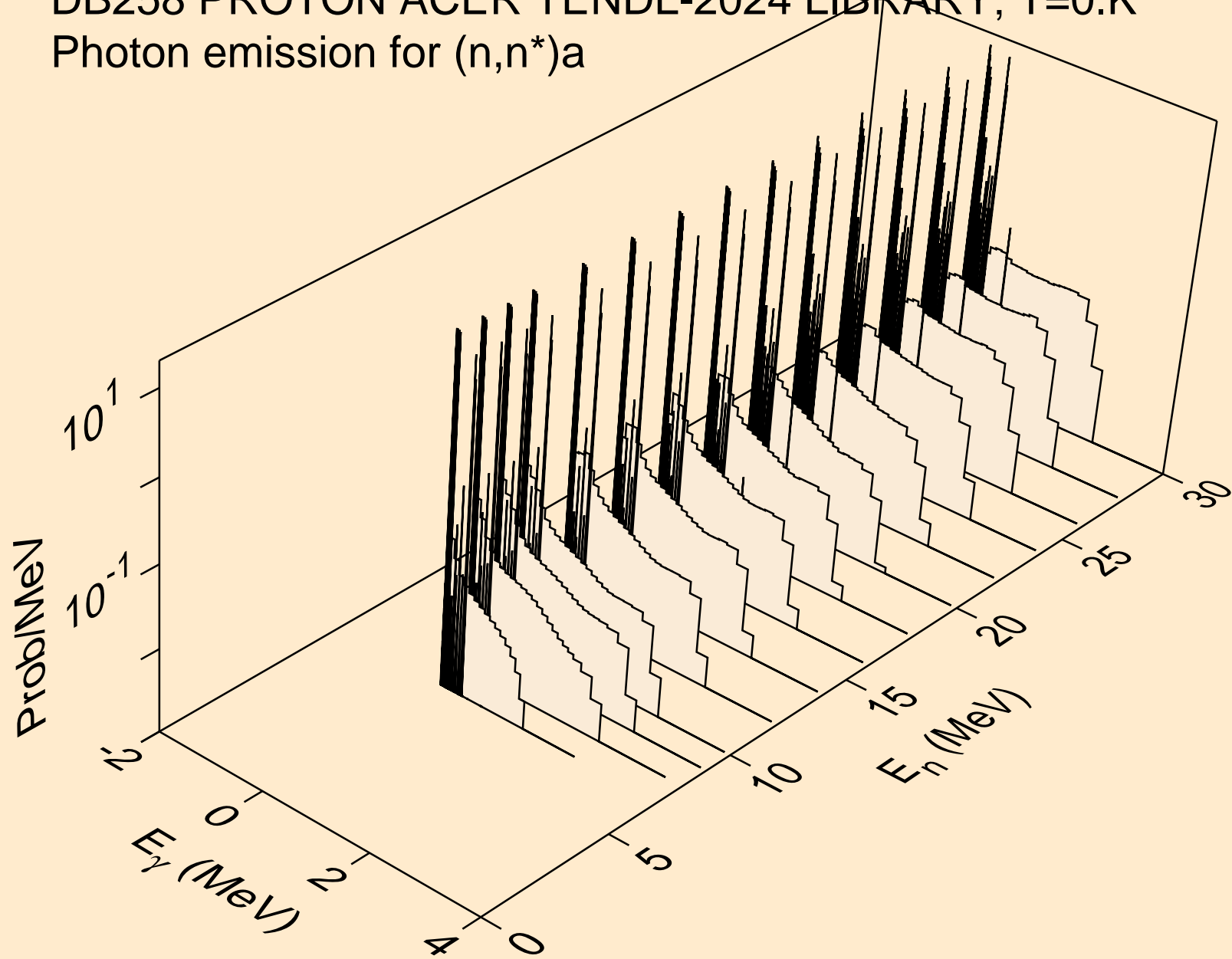

DB258 PROTON ACER TENDL-2024 LIBRARY; T=0.K  
Photon emission for (n,2n)a

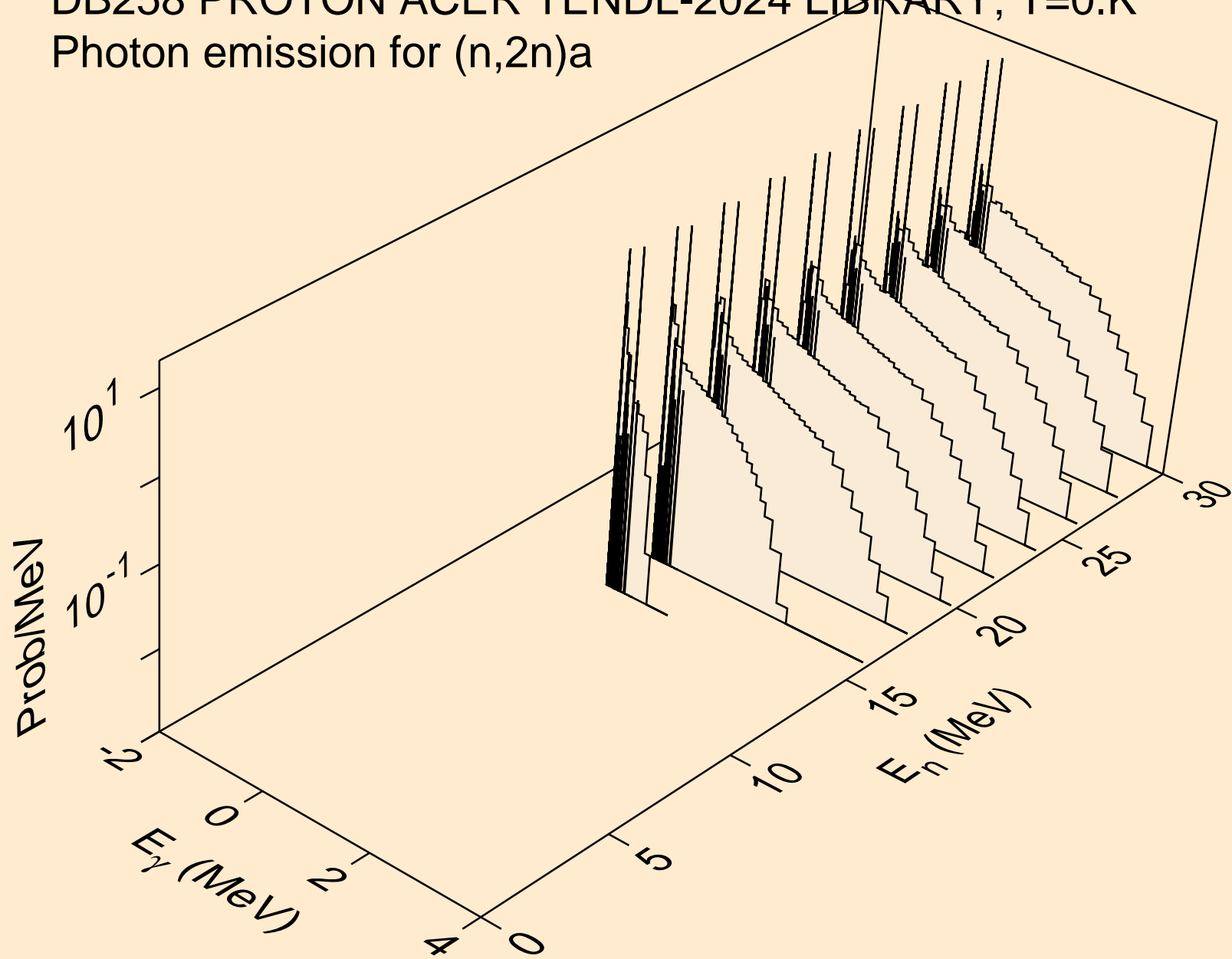

DB258 PROTON ACER TENDL-2024 LIBRARY; T=0.K  
Photon emission for (n,3n)a

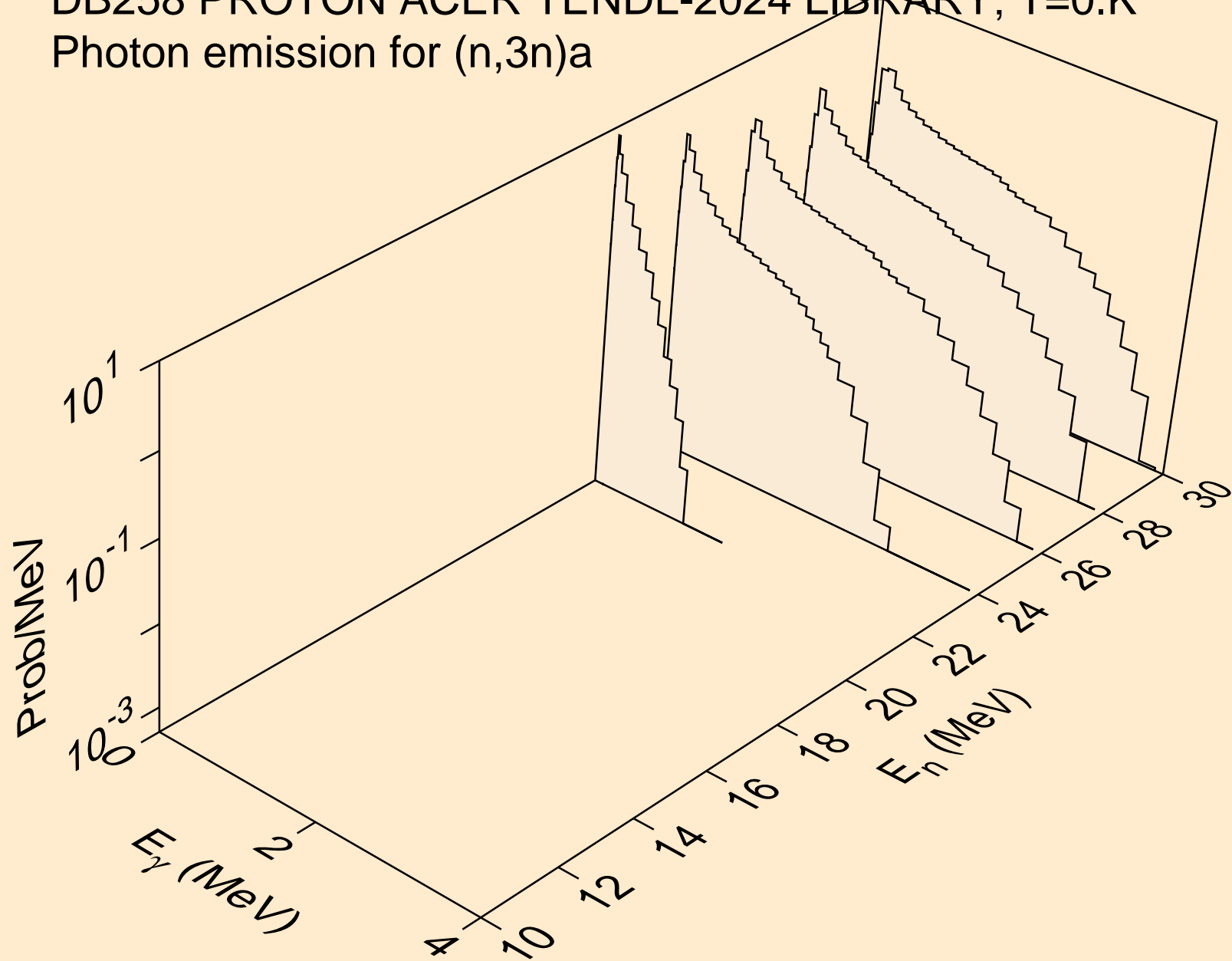

DB258 PROTON ACER TENDL-2024 LIBRARY; T=0.K  
Photon emission for (n,n\*)p

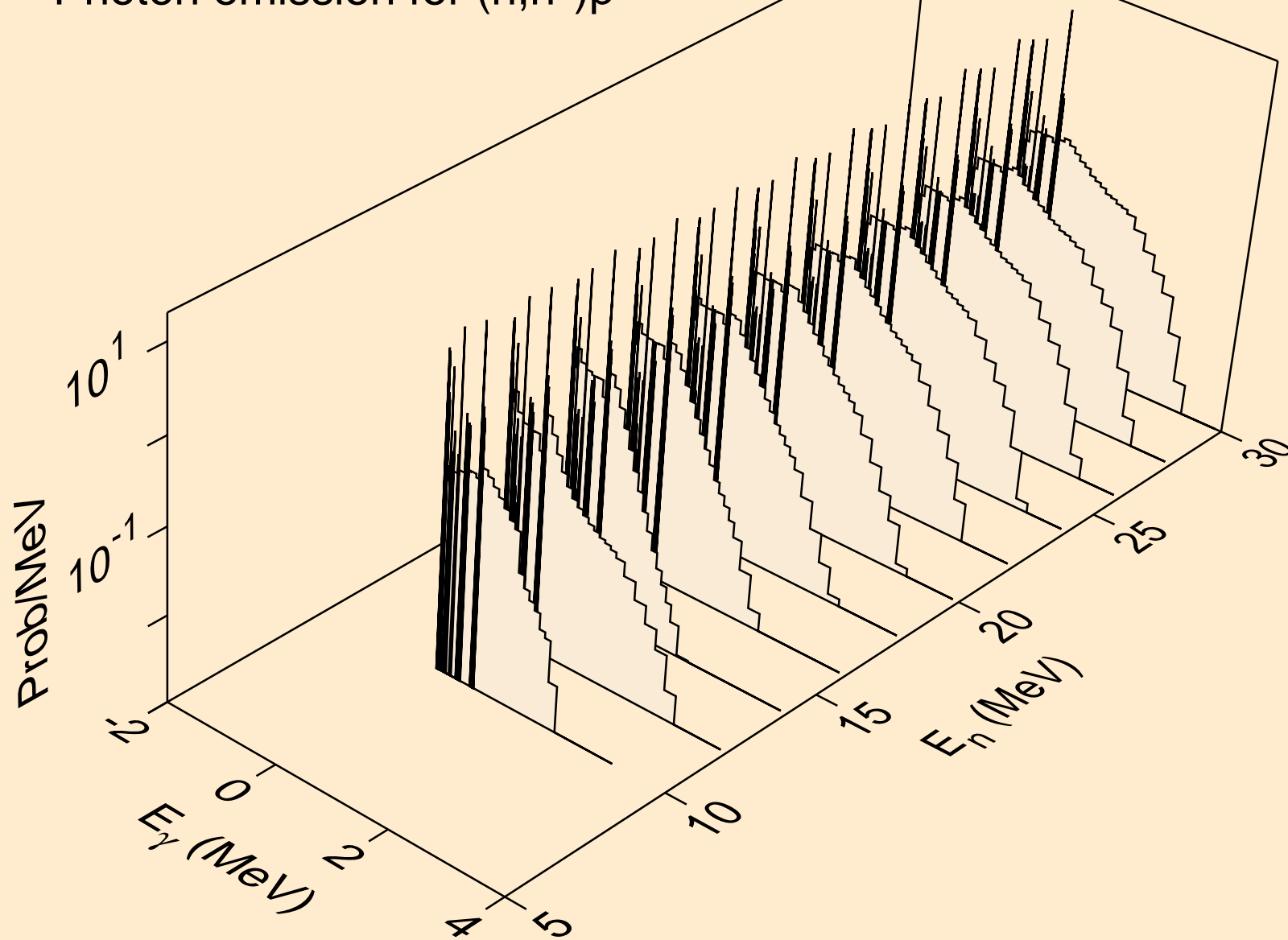

DB258 PROTON ACER TENDL-2024 LIBRARY; T=0.K  
Photon emission for (n,n\*)d

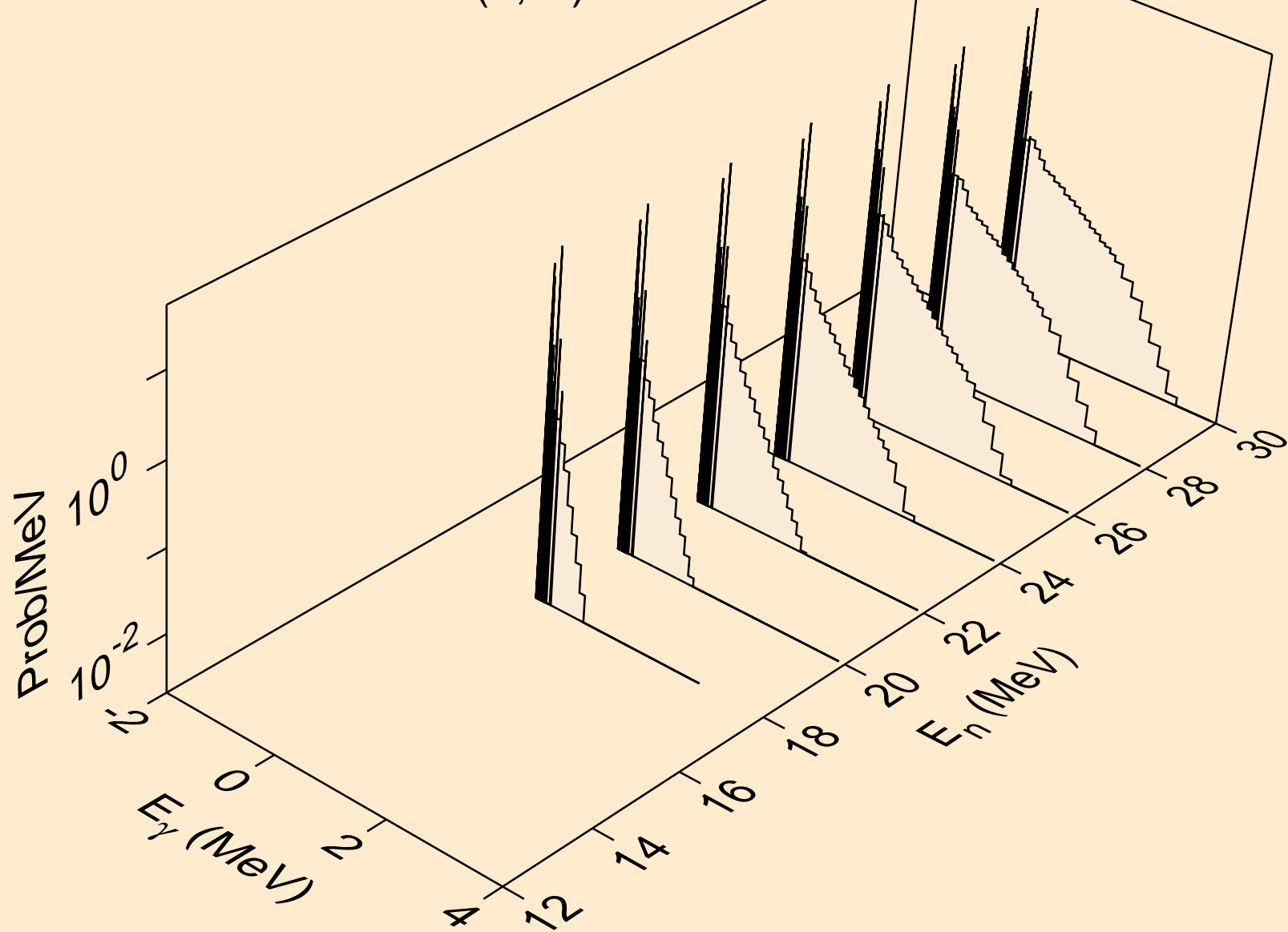

DB258 PROTON ACER TENDL-2024 LIBRARY; T=0.K  
Photon emission for (n,n\*)t

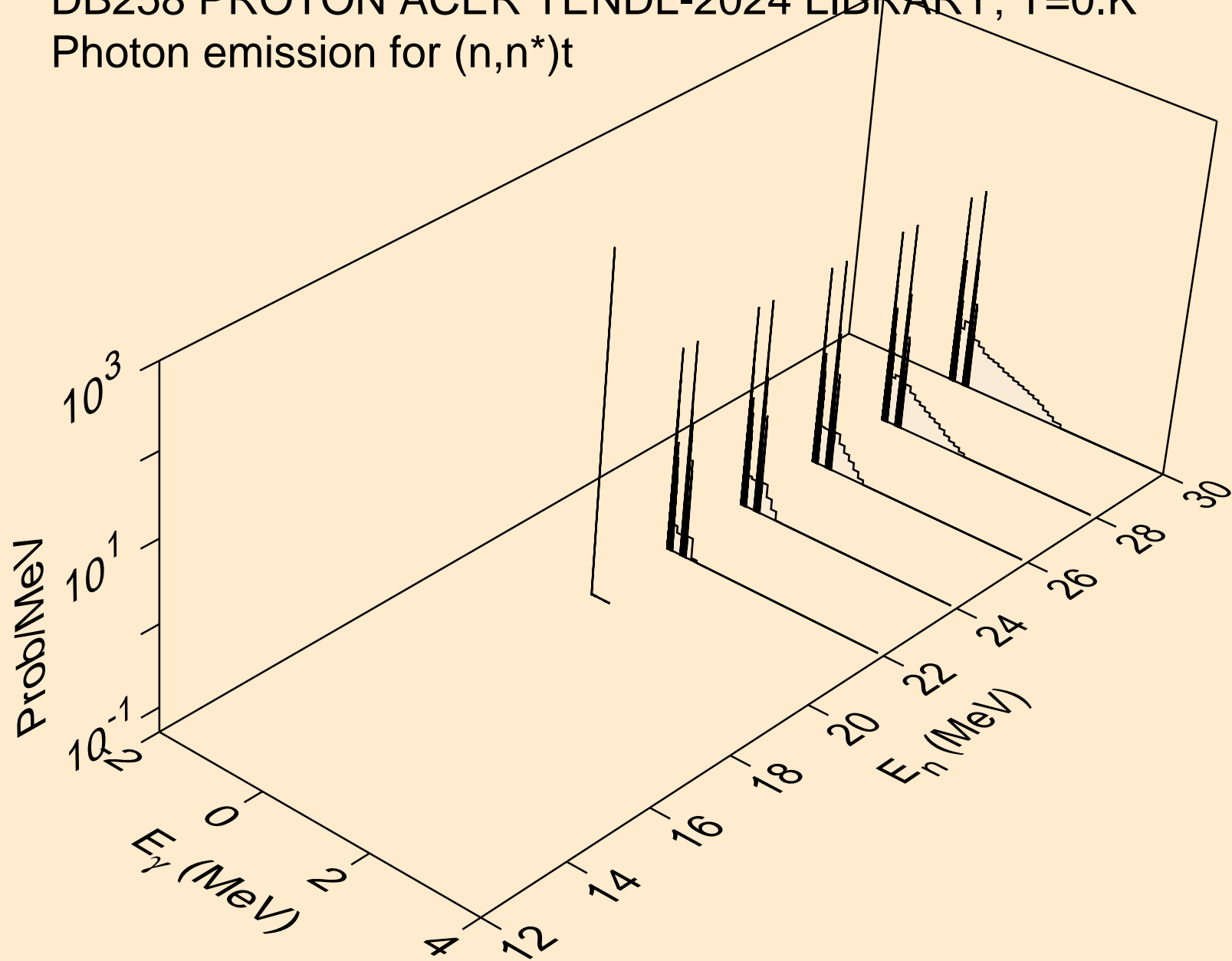

DB258 PROTON ACER TENDL-2024 LIBRARY; T=0.K  
Photon emission for (n,2np)

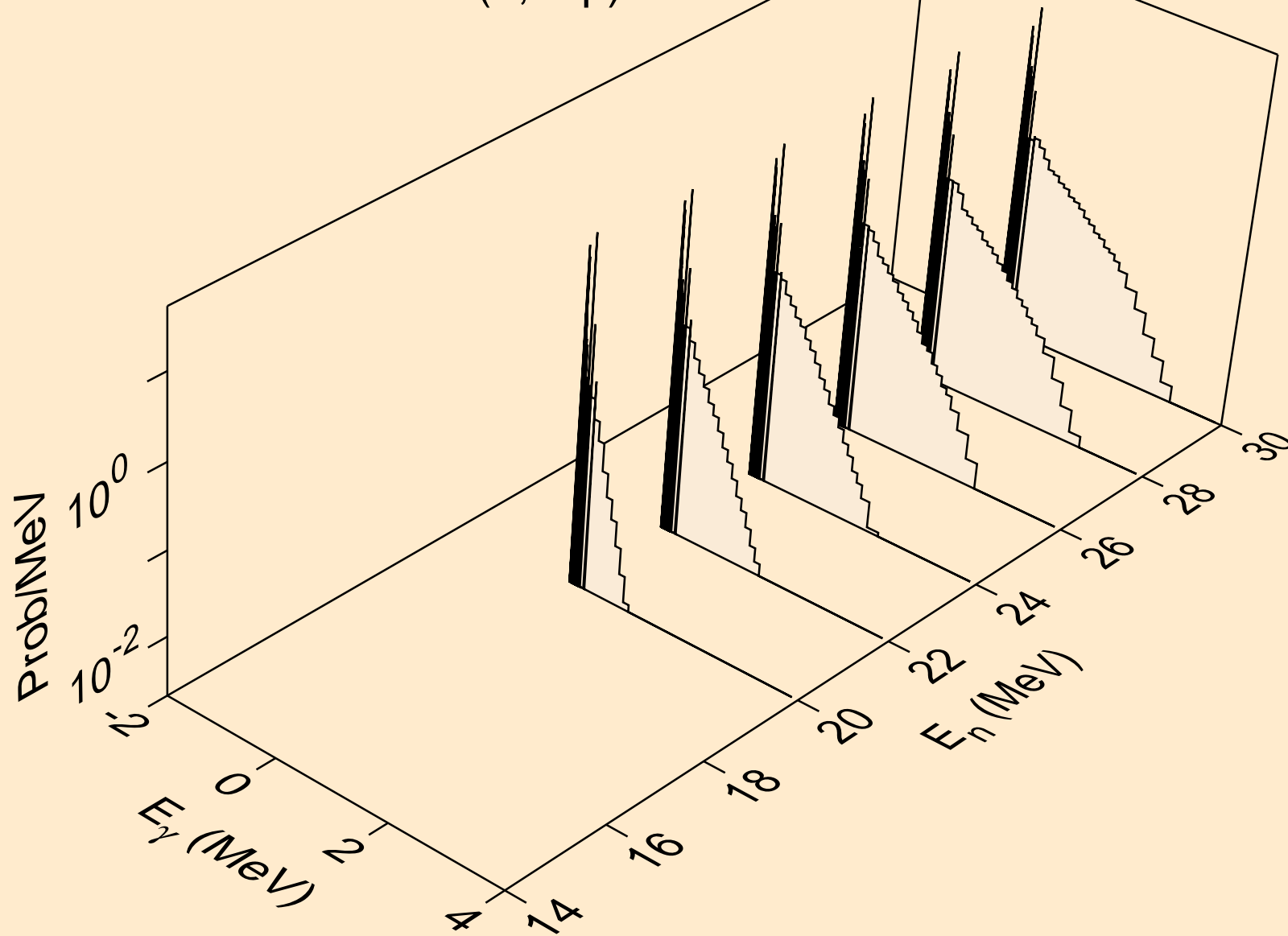

DB258 PROTON ACER TENDL-2024 LIBRARY; T=0.K  
Photon emission for (n,npa)

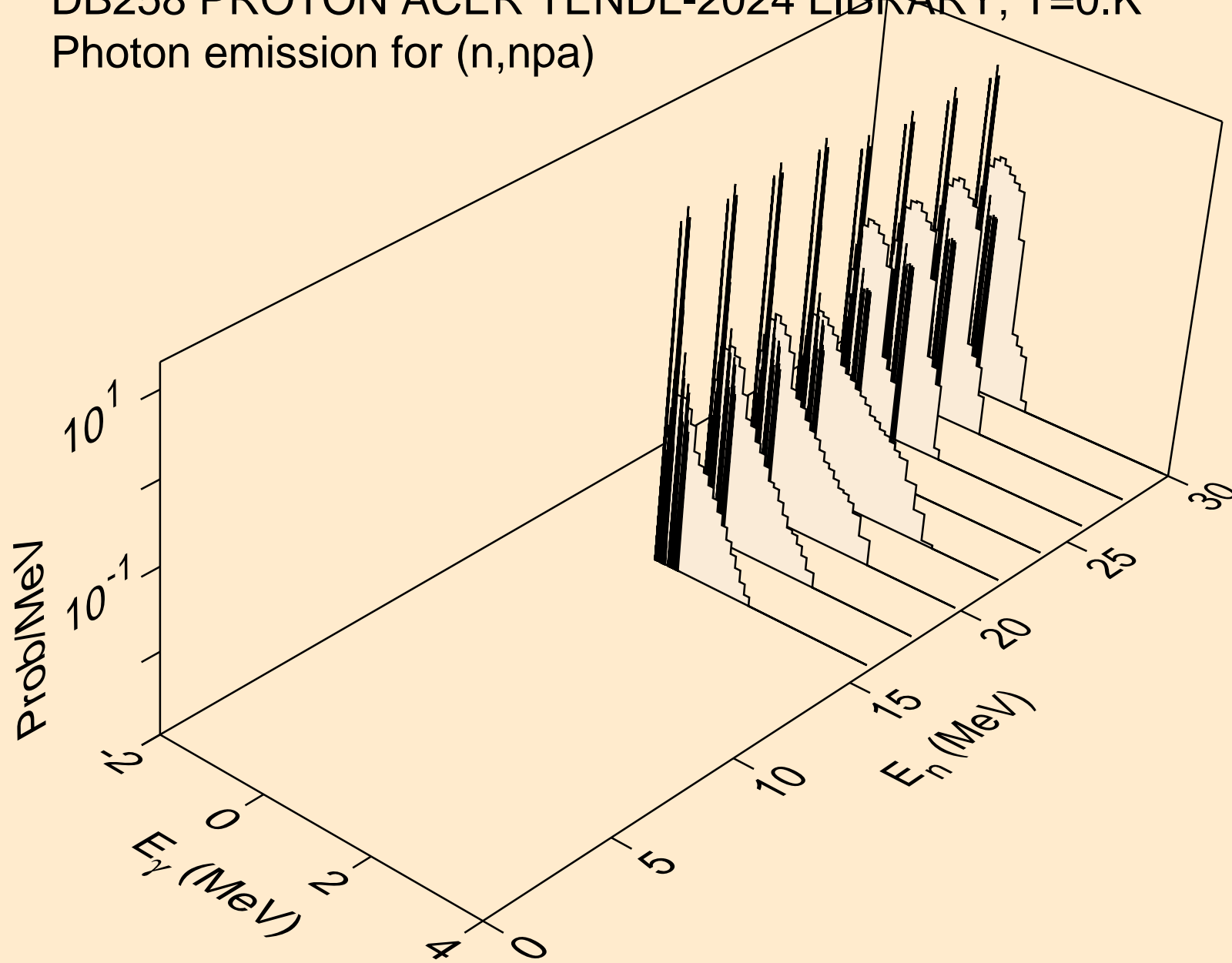

DB258 PROTON ACER TENDL-2024 LIBRARY; T=0.K  
Photon emission for (n,gma)

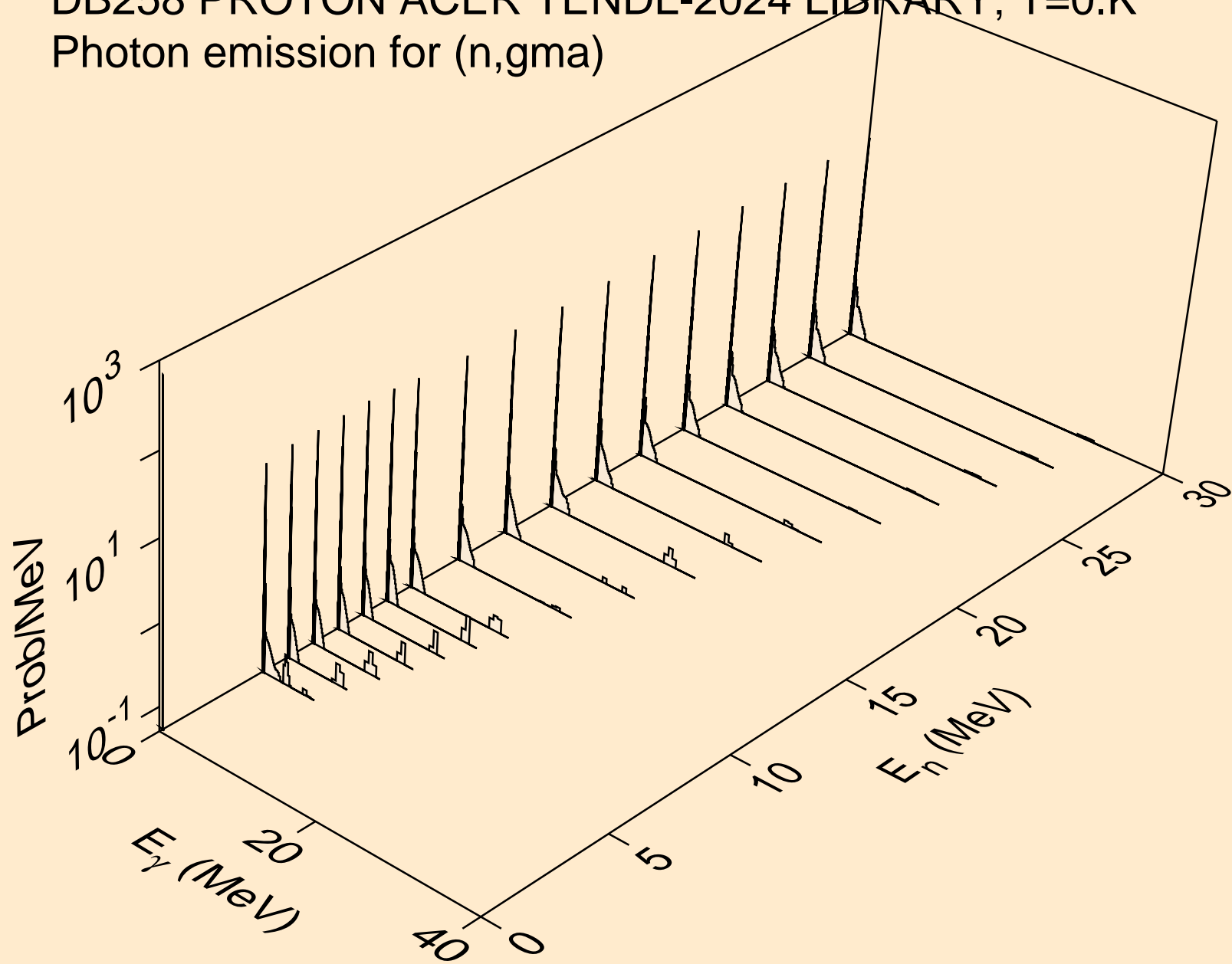

DB258 PROTON ACER TENDL-2024 LIBRARY; T=0.K  
Photon emission for inelastic

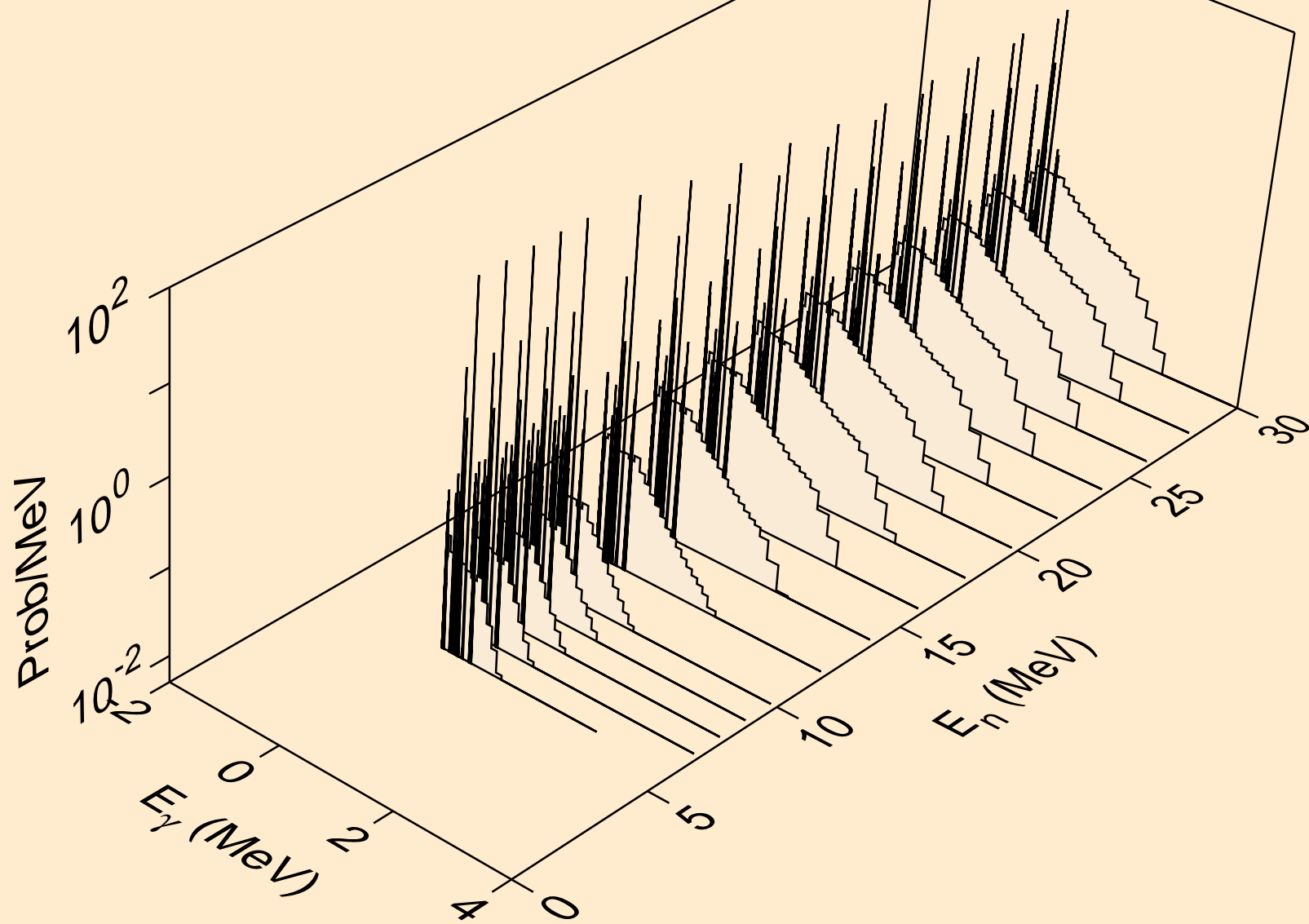

DB258 PROTON ACER TENDL-2024 LIBRARY; T=0.K  
Photon emission for (n,d)

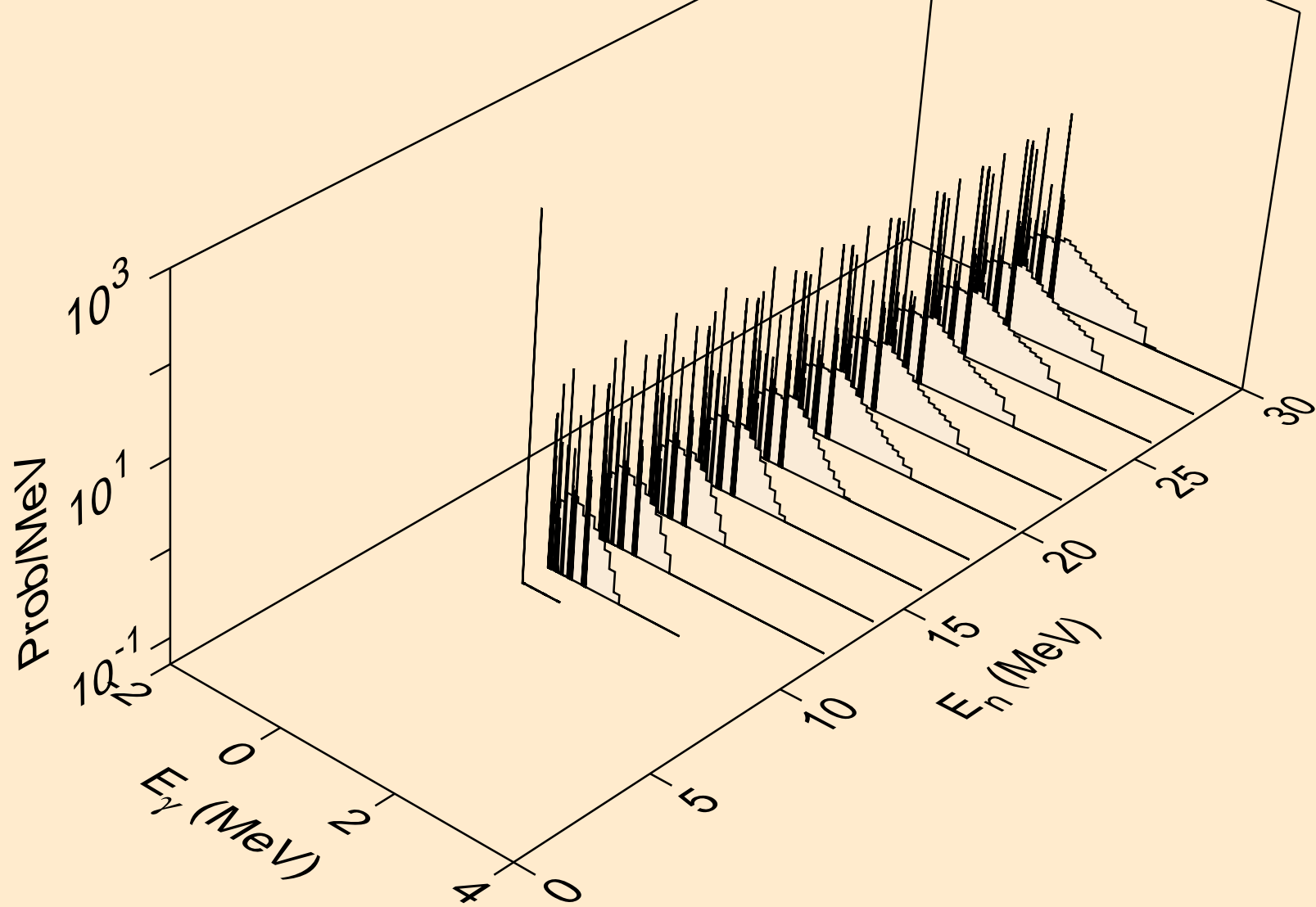

DB258 PROTON ACER TENDL-2024 LIBRARY; T=0.K  
Photon emission for (n,t)

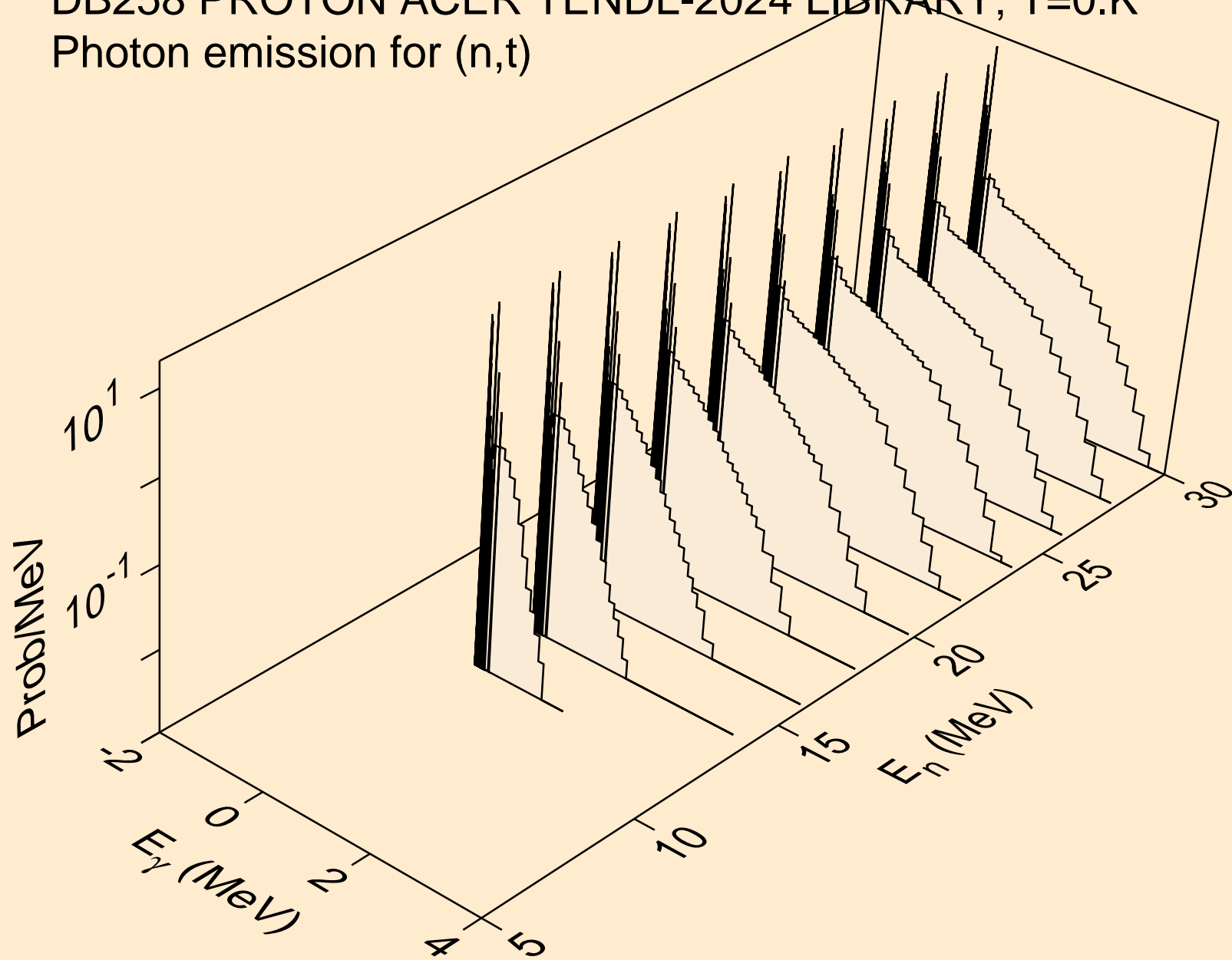

DB258 PROTON ACER TENDL-2024 LIBRARY; T=0.K  
Photon emission for (n,he3)

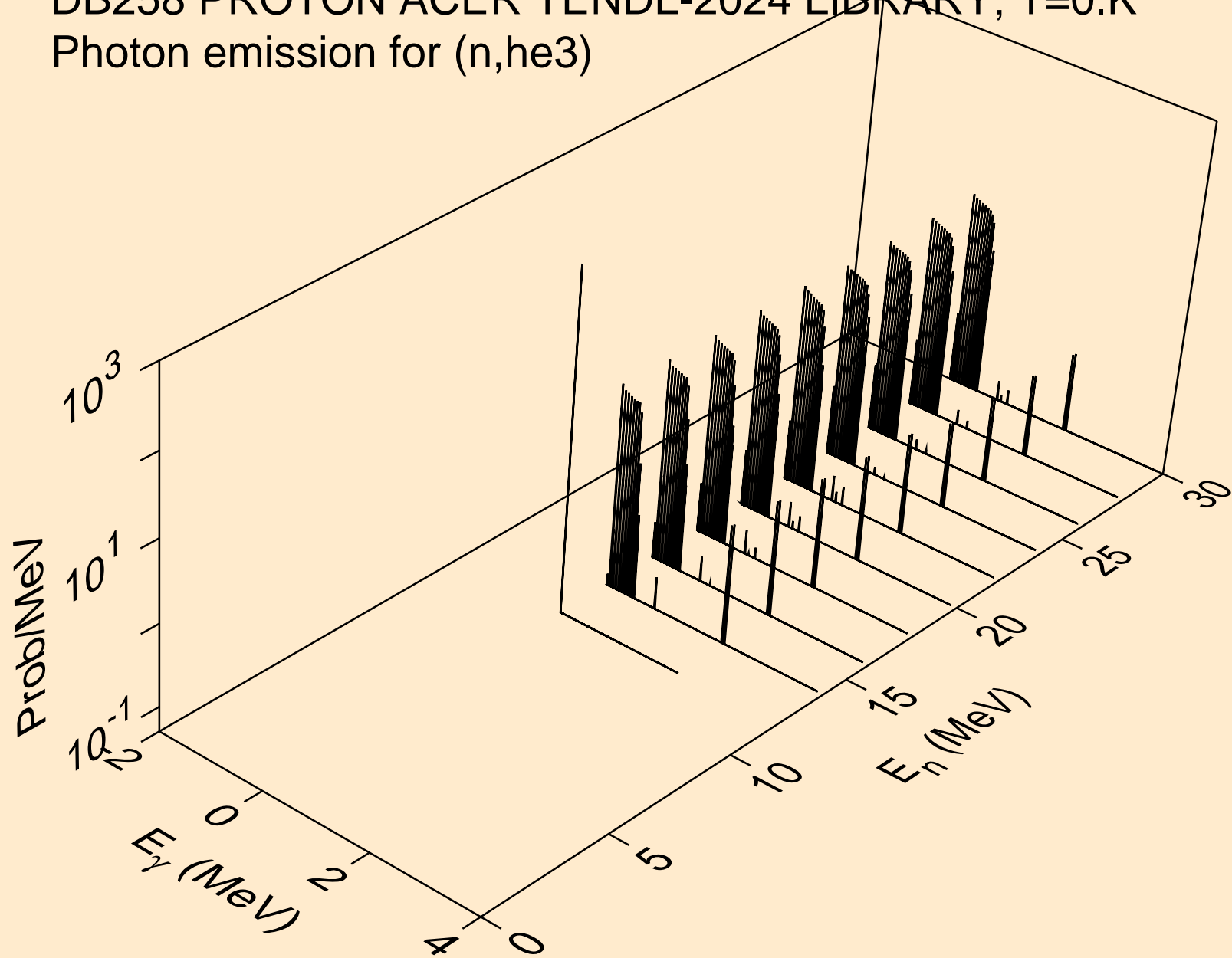

DB258 PROTON ACER TENDL-2024 LIBRARY; T=0.K  
Photon emission for (n,a)

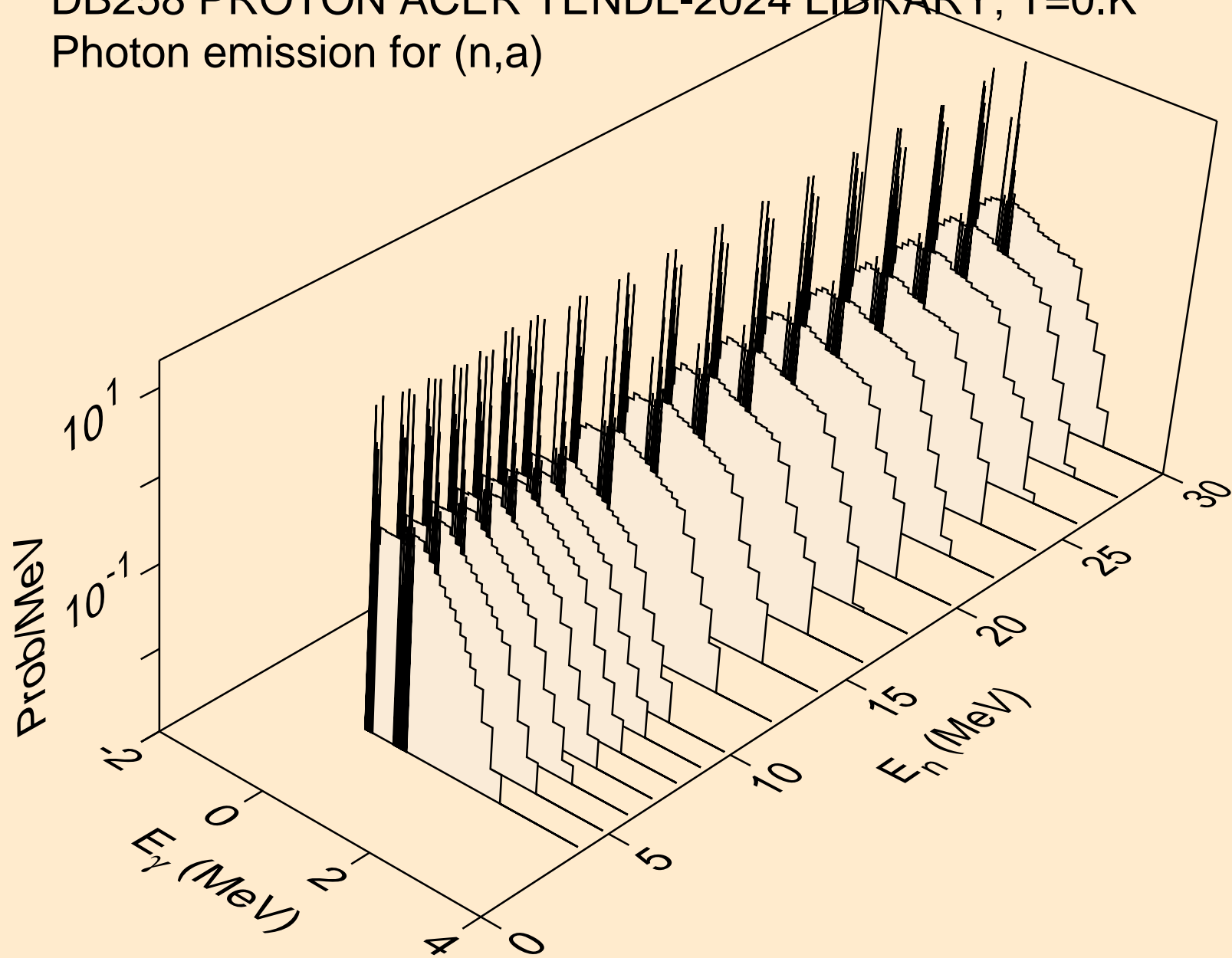

DB258 PROTON ACER TENDL-2024 LIBRARY; T=0.K  
Photon emission for (n,2a)

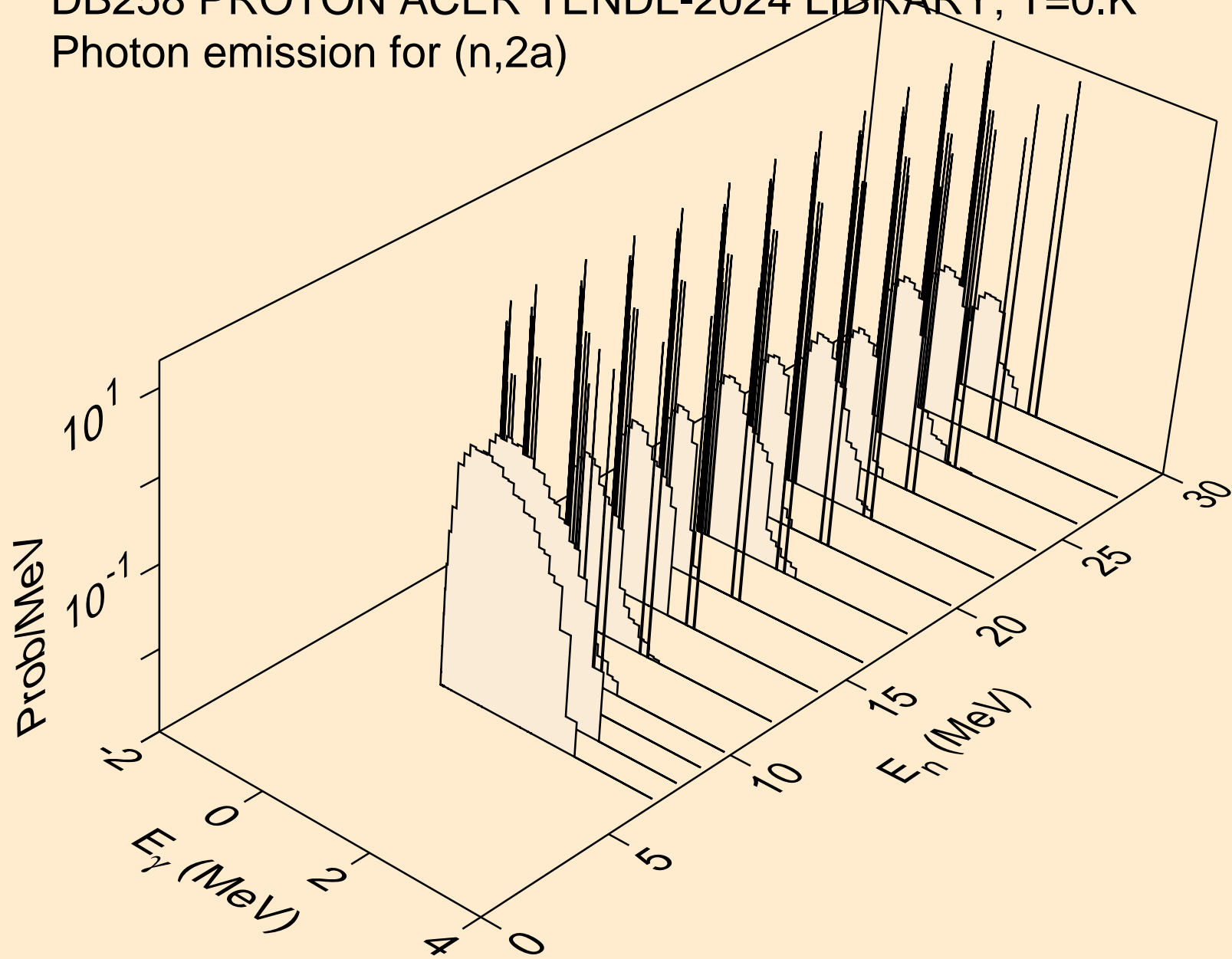

DB258 PROTON ACER TENDL-2024 LIBRARY; T=0.K  
Photon emission for (n,2p)

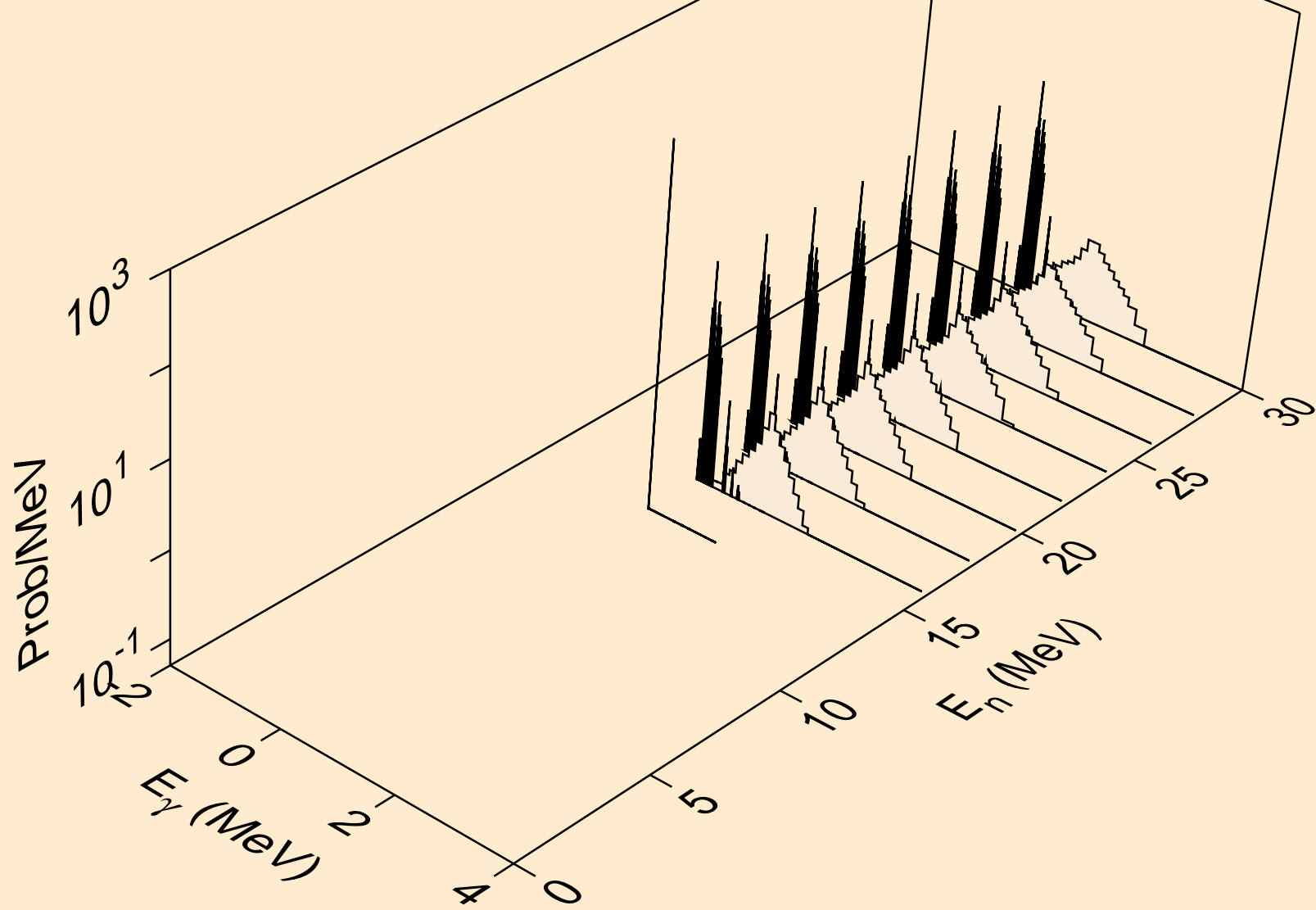

DB258 PROTON ACER TENDL-2024 LIBRARY; T=0.K  
Photon emission for (n,pa)

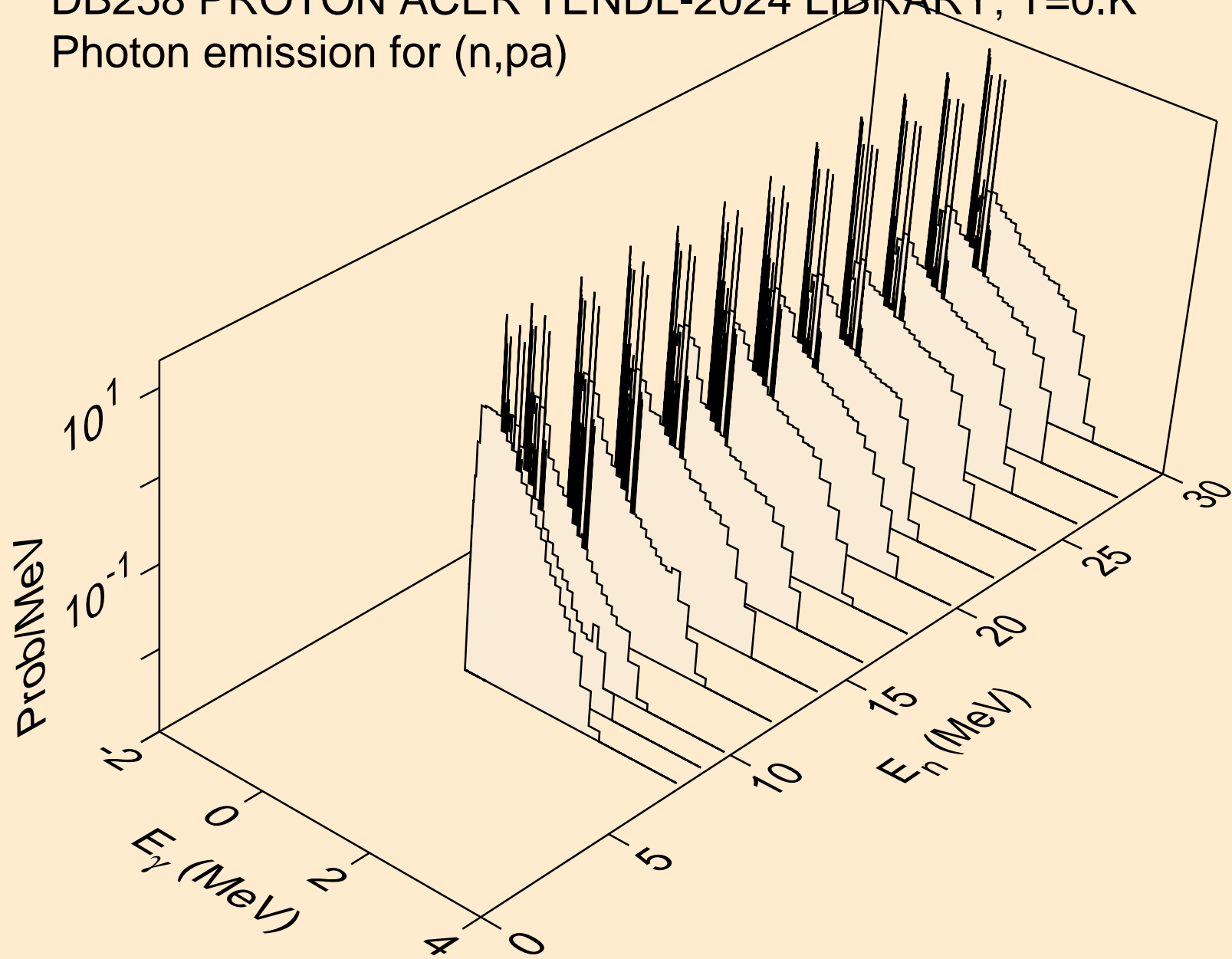

DB258 PROTON ACER TENDL-2024 LIBRARY; T=0.K  
Photon emission for (n,da)

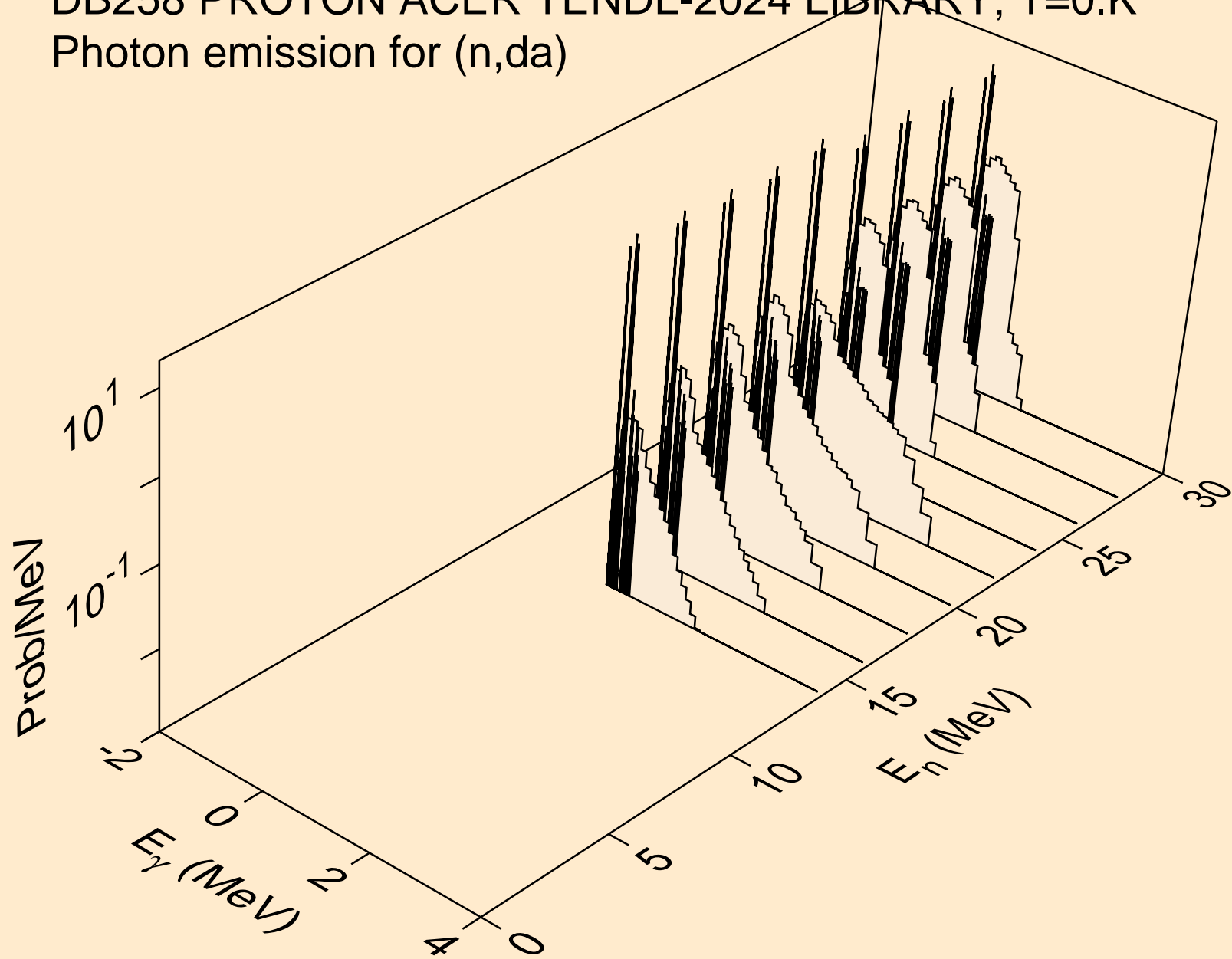

DB258 PROTON ACER TENDL-2024 LIBRARY; T=0.K  
Particle heating contributions

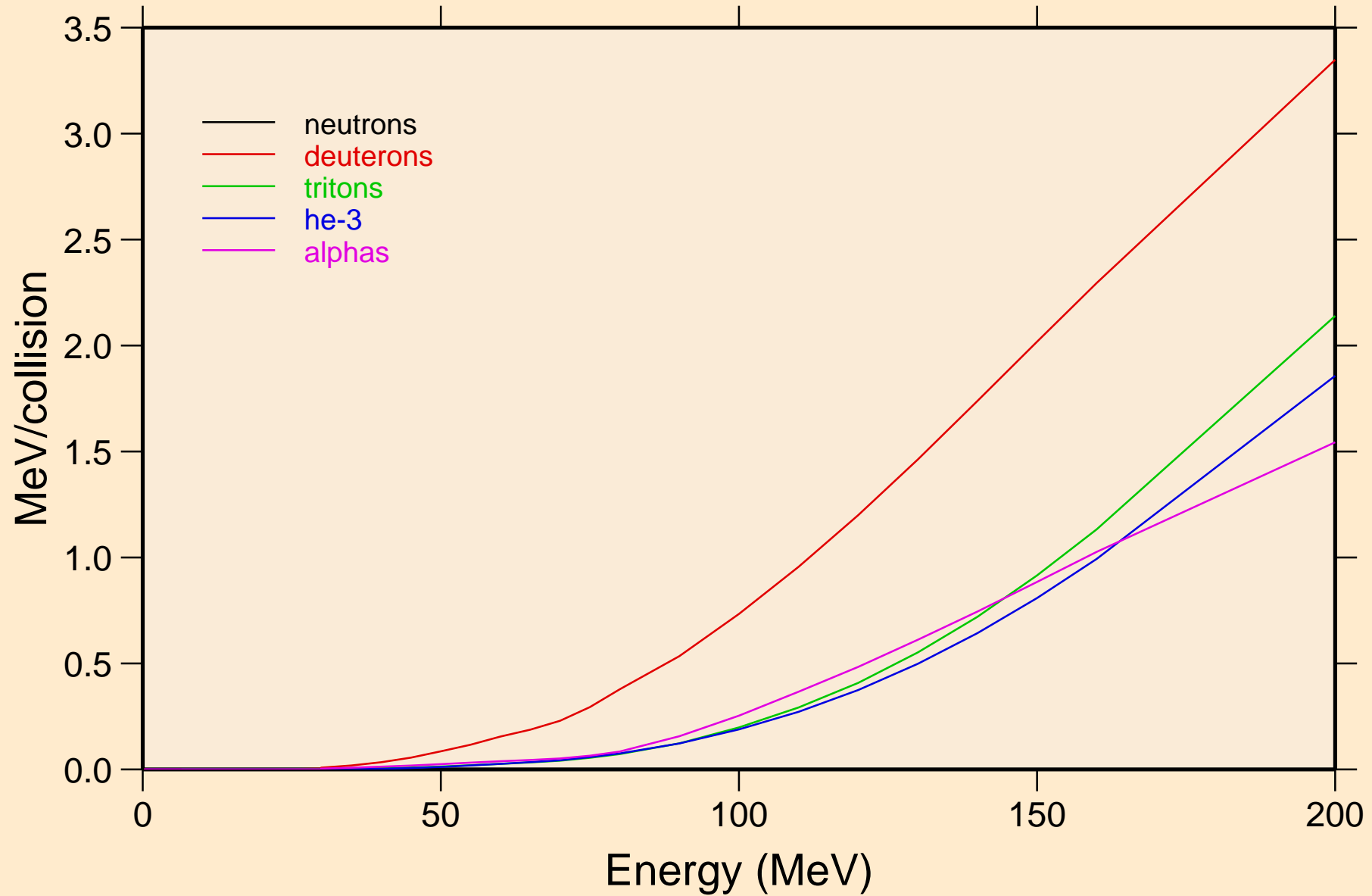

DB258 PROTON ACER TENDL-2024 LIBRARY; T=0.K  
Recoil Heating

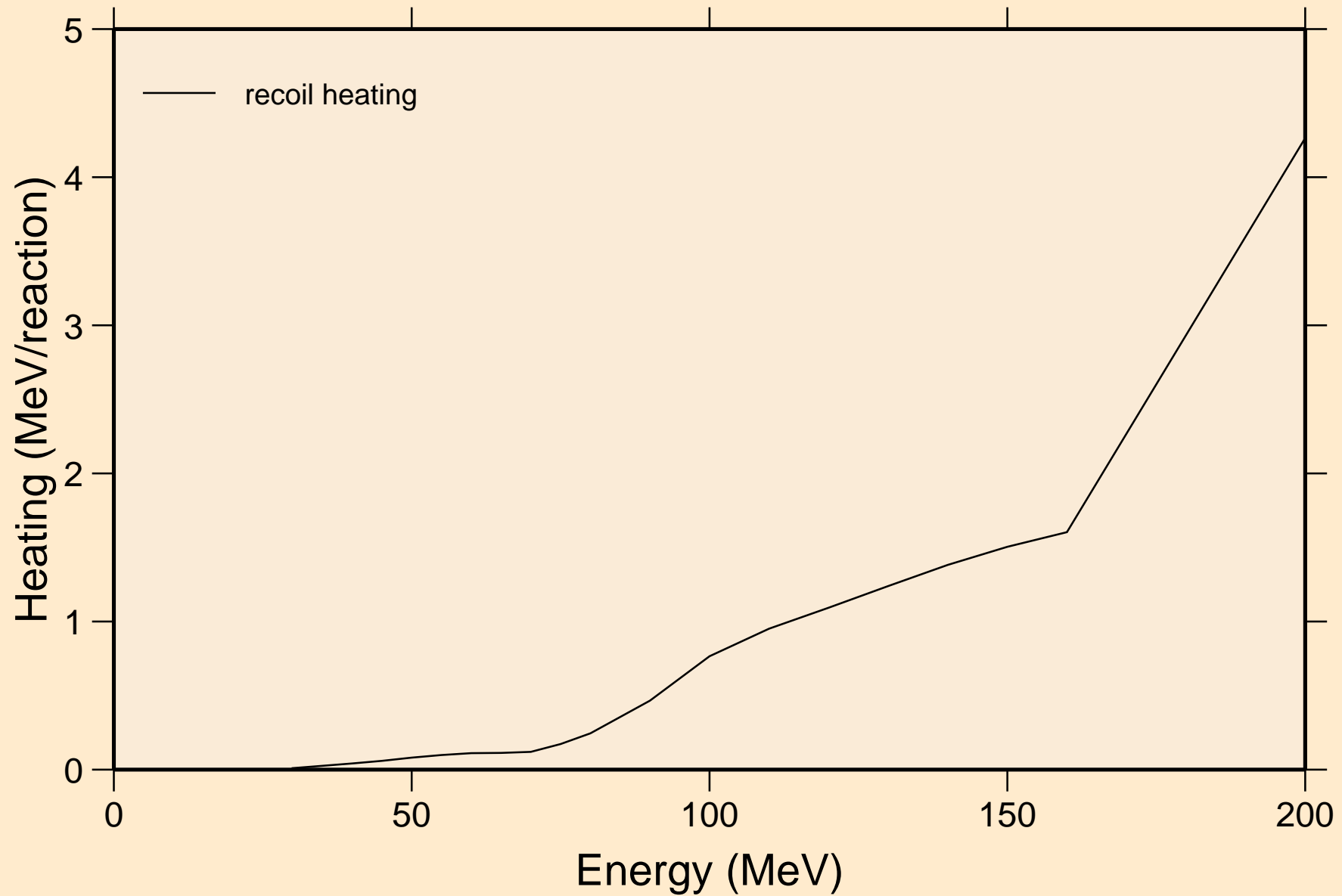

DB258 PROTON ACER TENDL-2024 LIBRARY; T=0.K  
Particle production cross sections

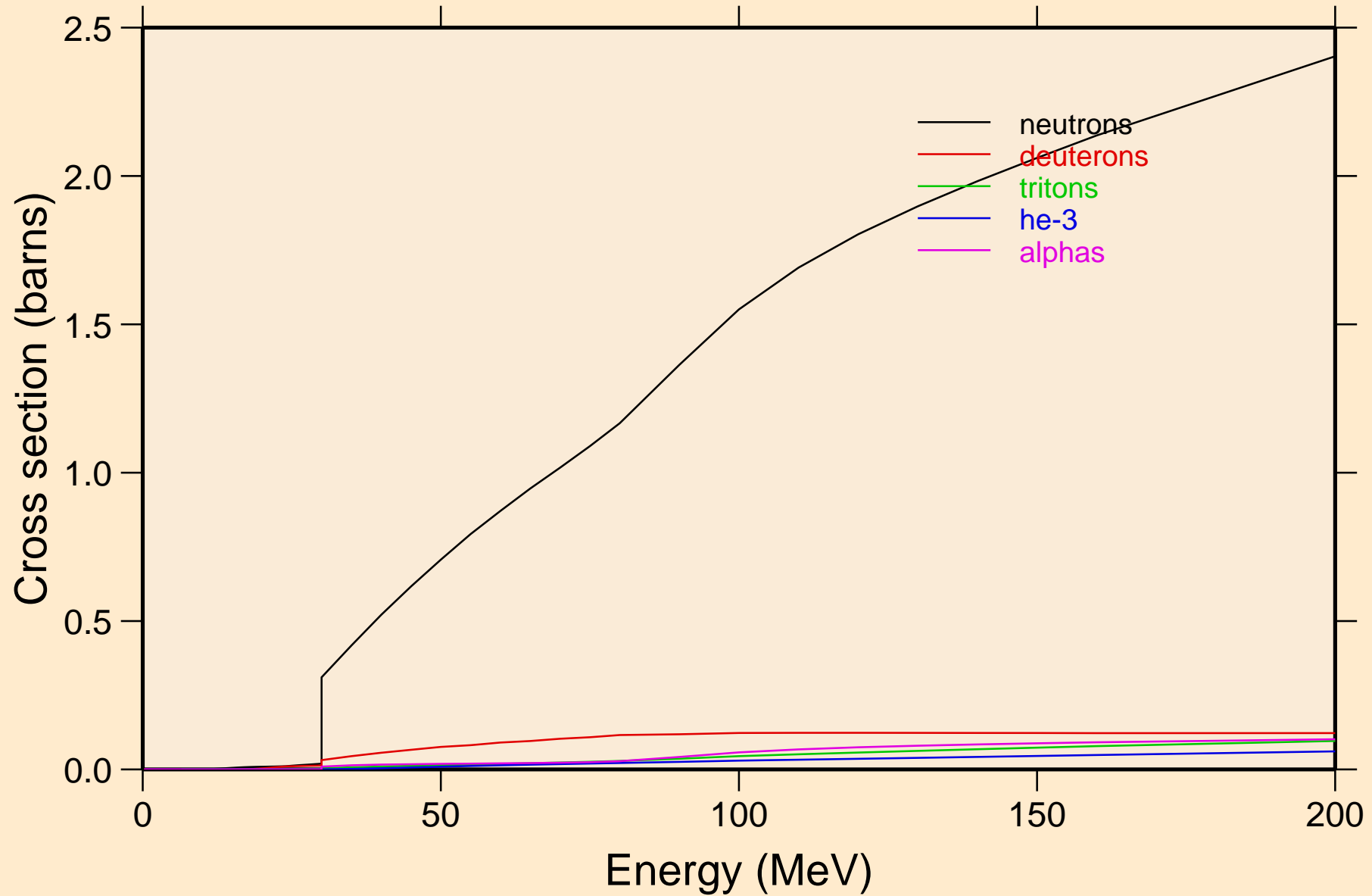

DB258 PROTON ACER TENDL-2024 LIBRARY; T=0.K  
neutrons from (p,n)

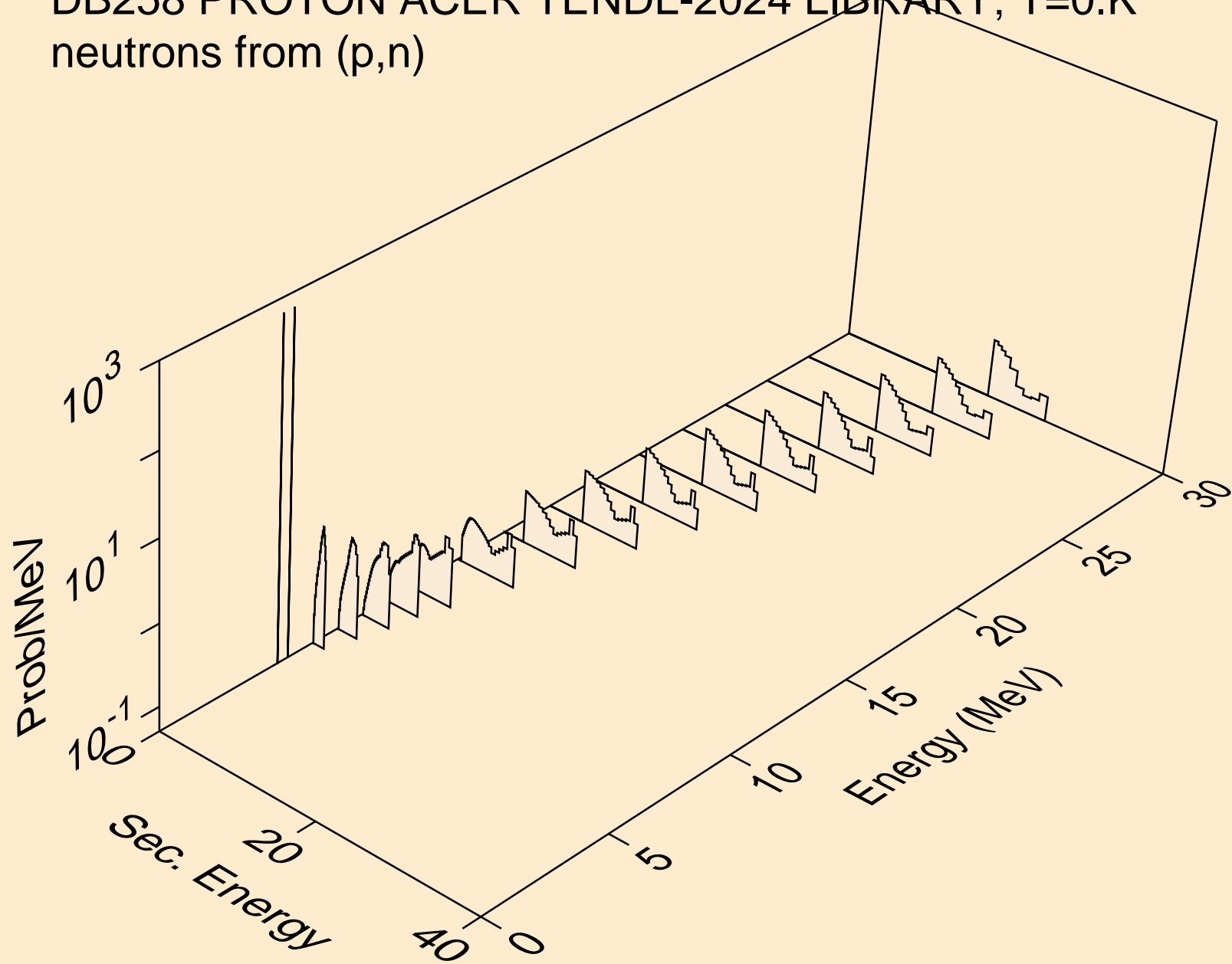

DB258 PROTON ACER TENDL-2024 LIBRARY; T=0.K  
neutrons from (p,x)

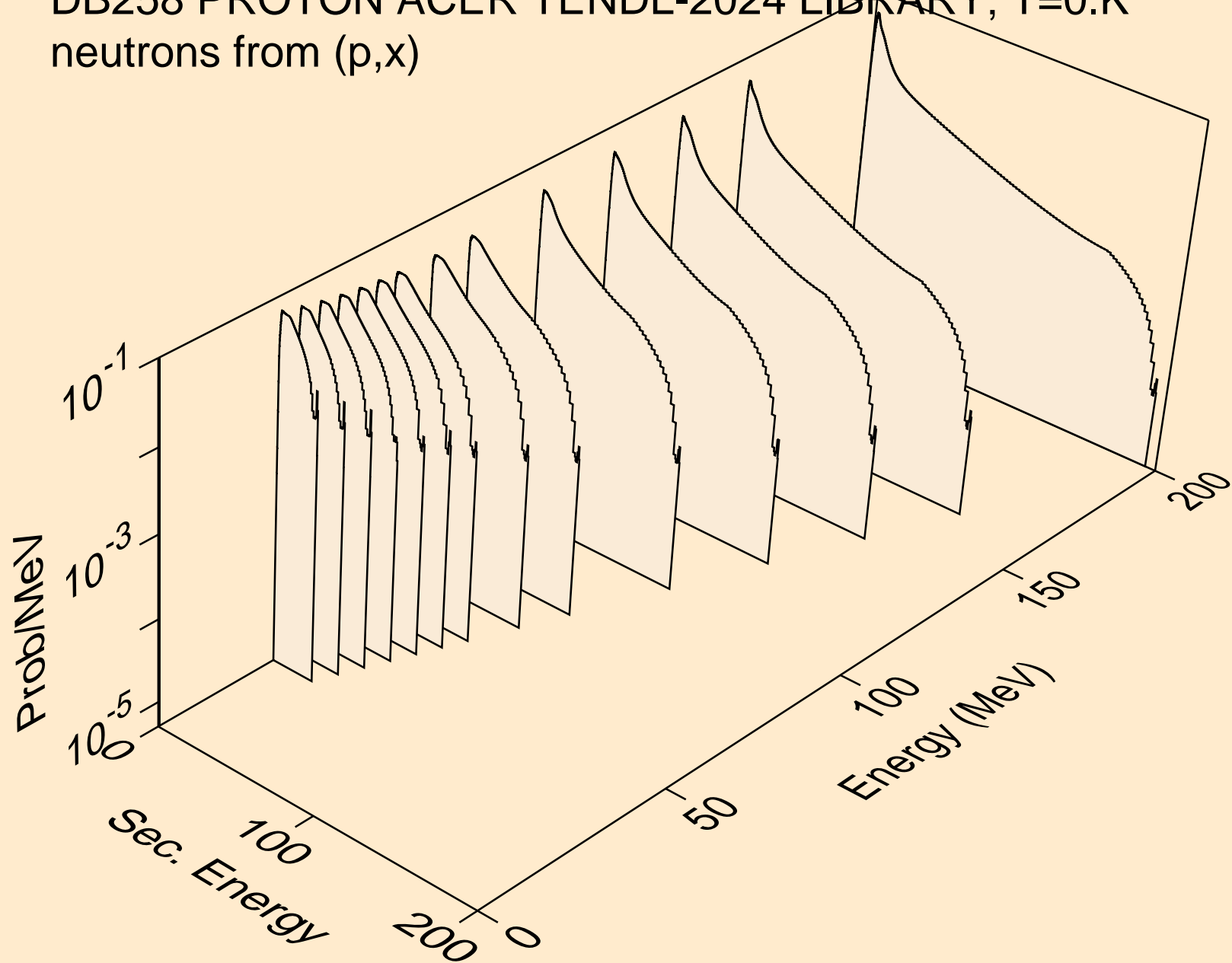

DB258 PROTON ACER TENDL-2024 LIBRARY; T=0.K  
neutrons from (p,2n)

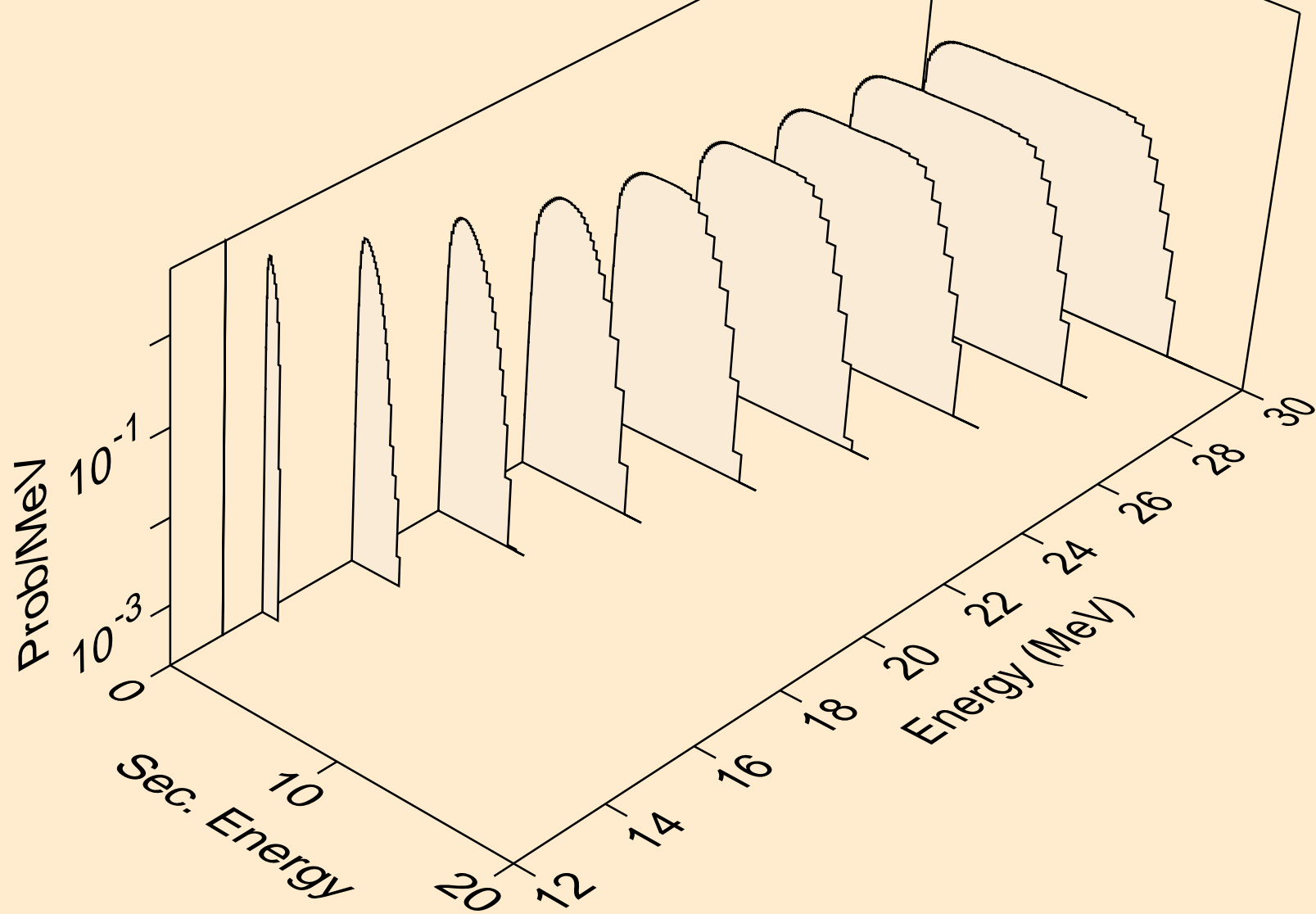

DB258 PROTON ACER TENDL-2024 LIBRARY; T=0.K  
neutrons from (p,3n)

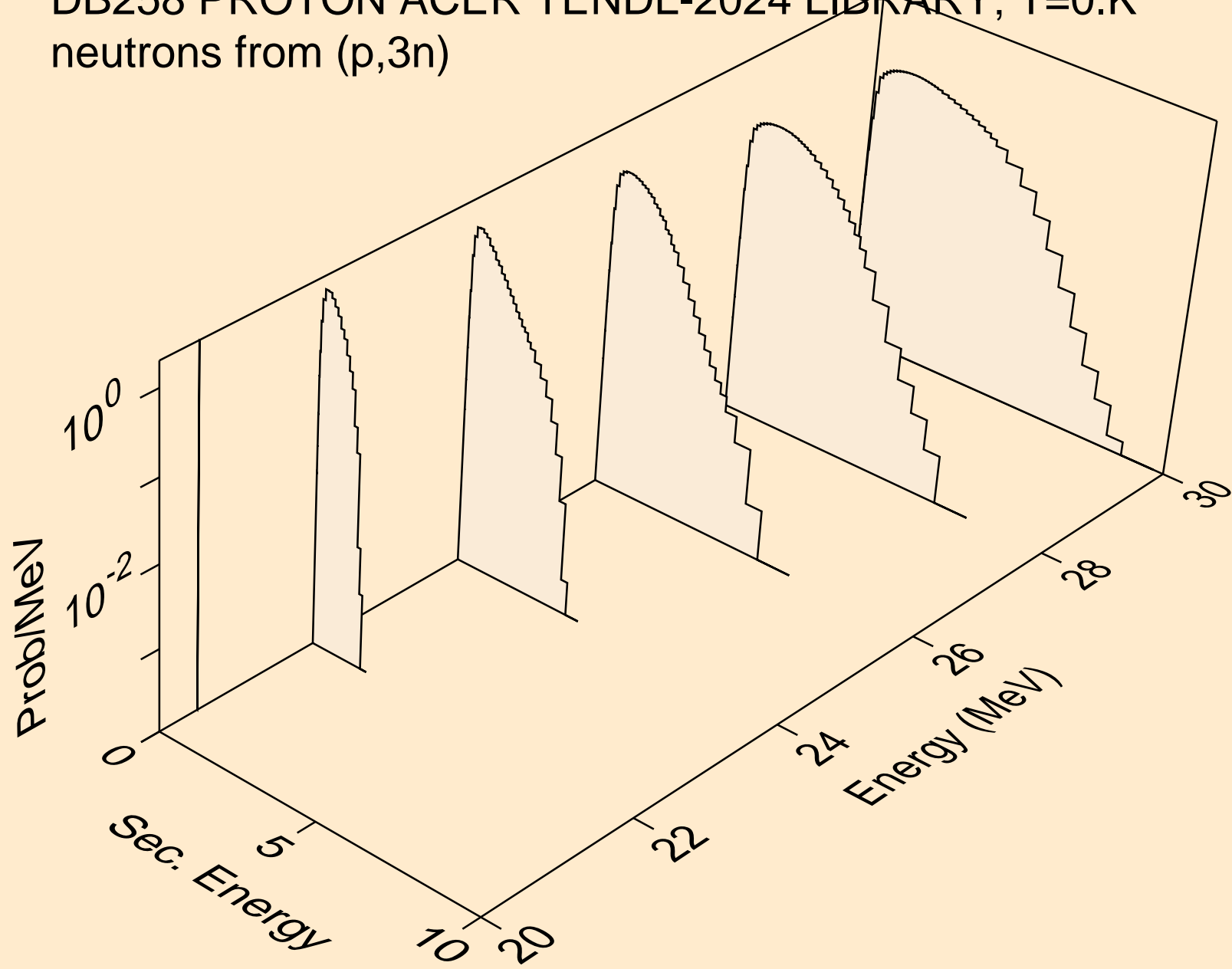

DB258 PROTON ACER TENDL-2024 LIBRARY; T=0.K  
neutrons from (p,n\*)a

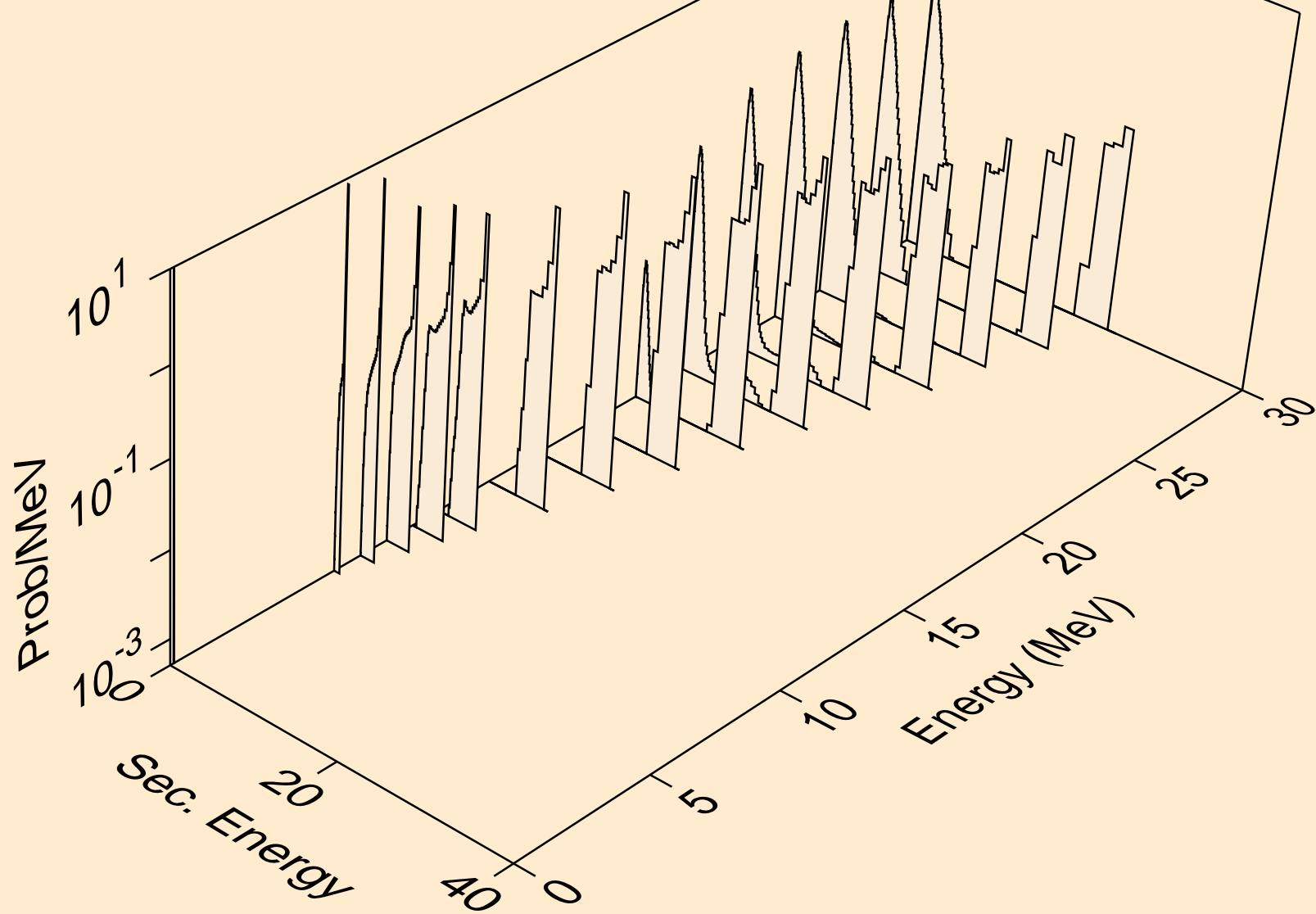

DB258 PROTON ACER TENDL-2024 LIBRARY; T=0.K  
neutrons from (p,2n)a

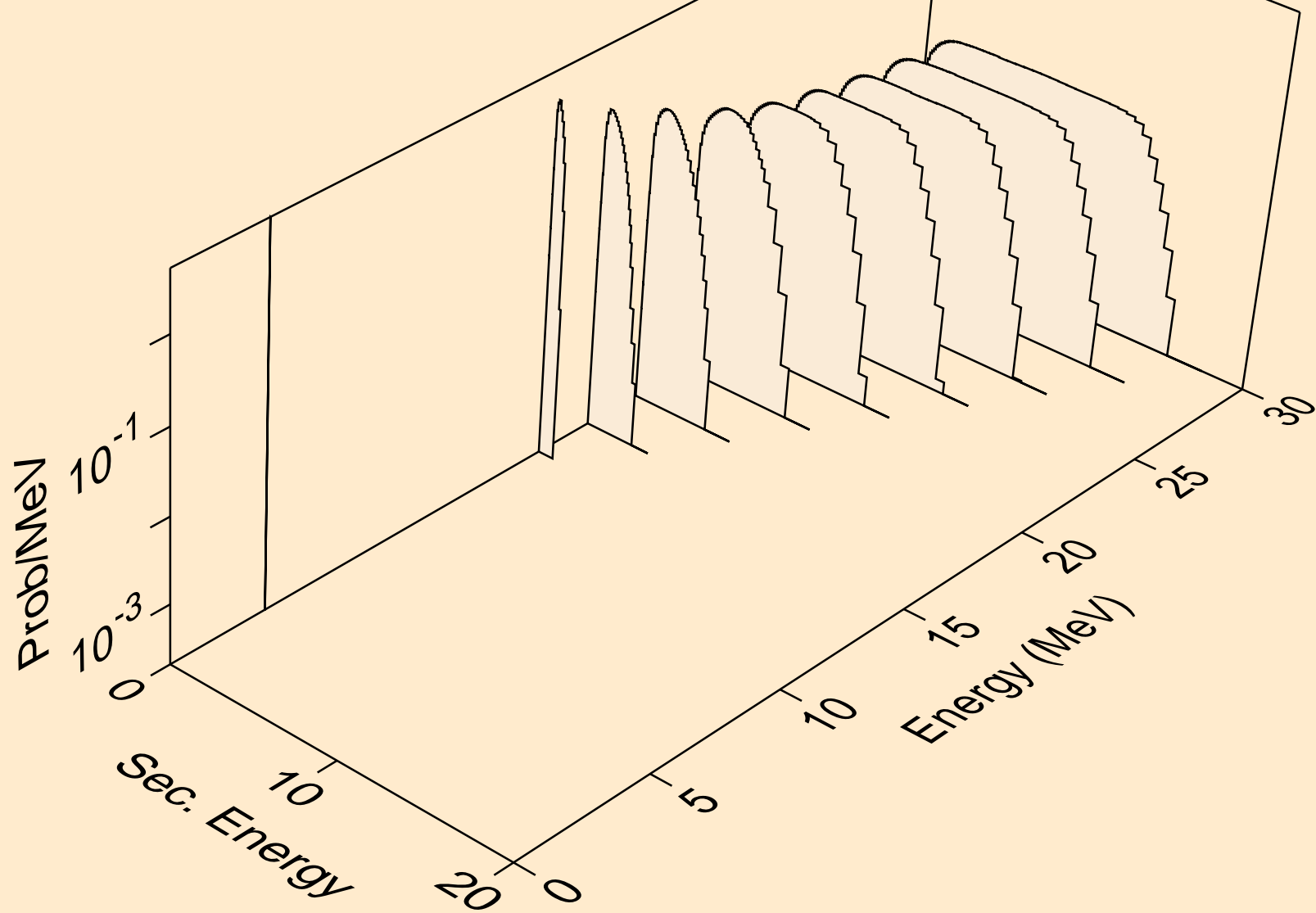

DB258 PROTON ACER TENDL-2024 LIBRARY; T=0.K  
neutrons from (p,3n)a

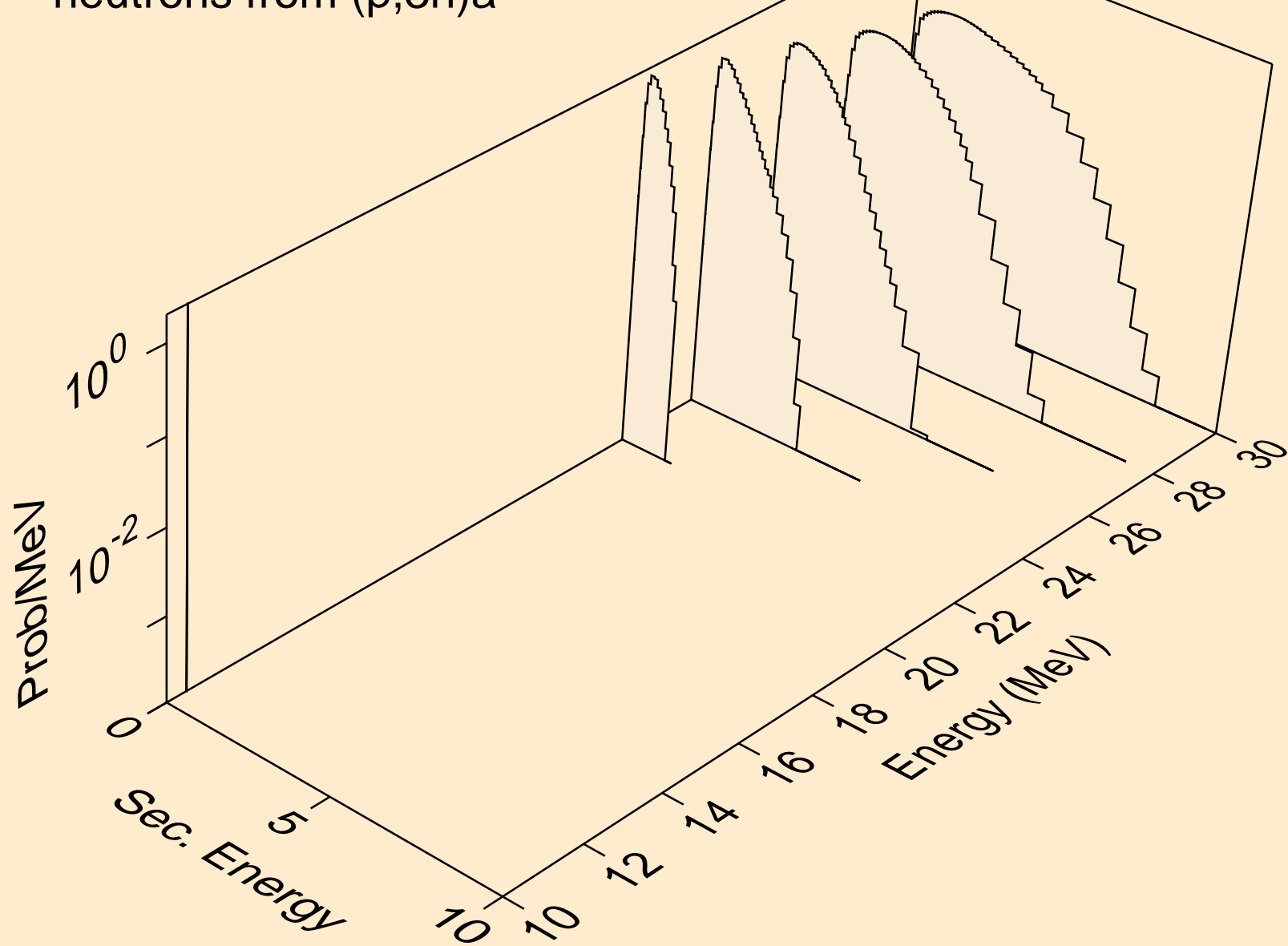

DB258 PROTON ACER TENDL-2024 LIBRARY; T=0.K  
neutrons from (p,n\*)p

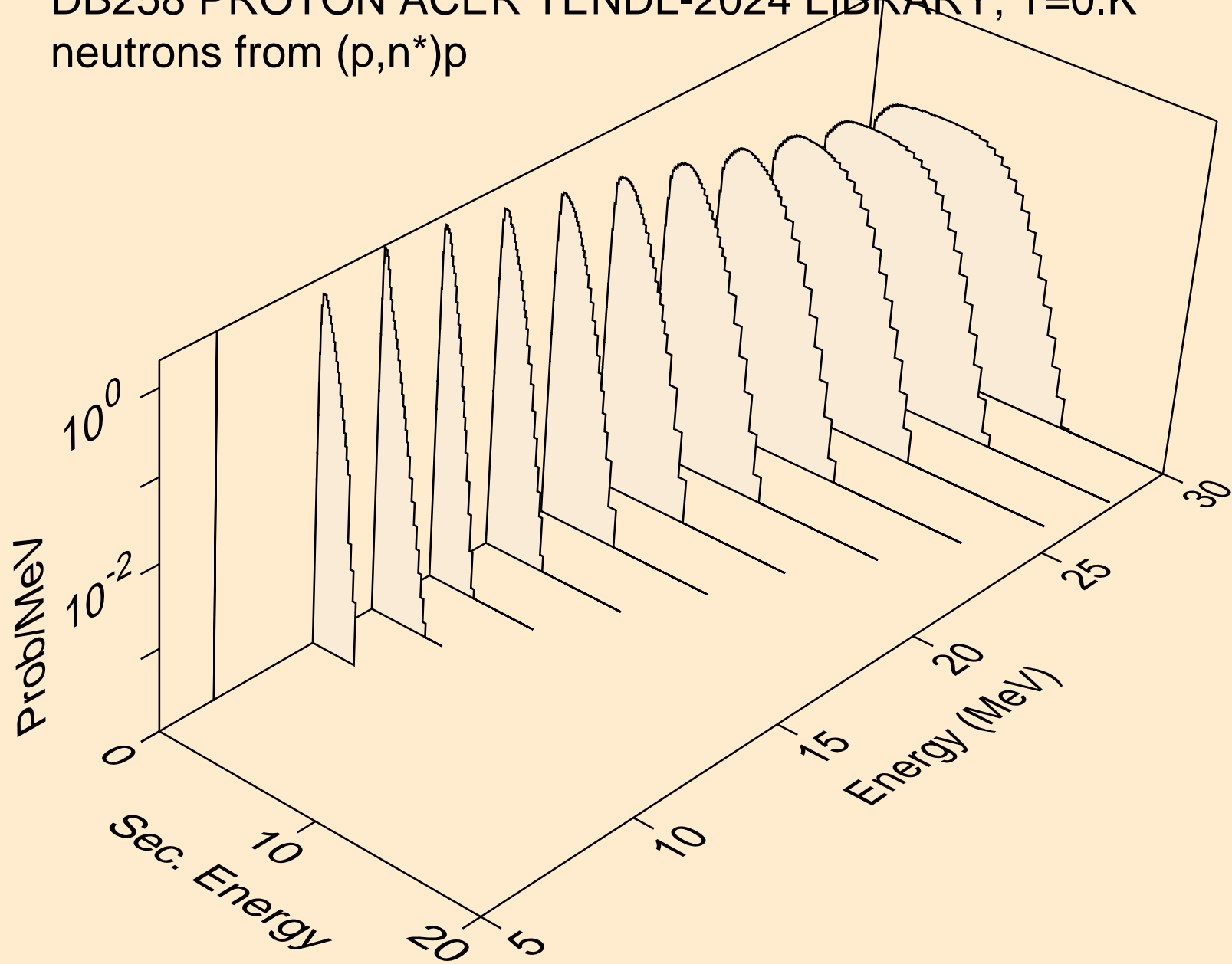

DB258 PROTON ACER TENDL-2024 LIBRARY; T=0.K  
neutrons from (p,n\*)d

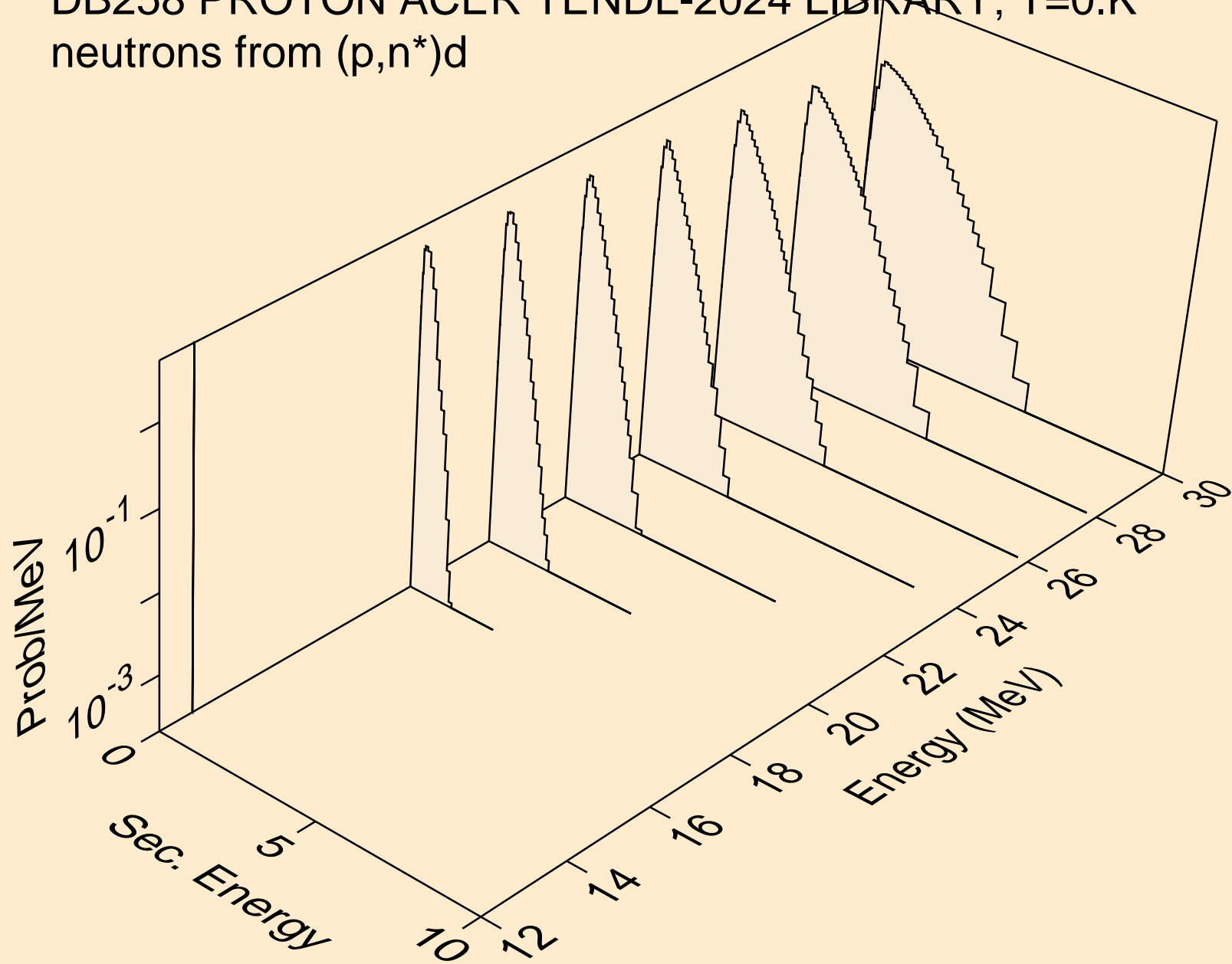

DB258 PROTON ACER TENDL-2024 LIBRARY; T=0.K  
neutrons from (p,n\*)t

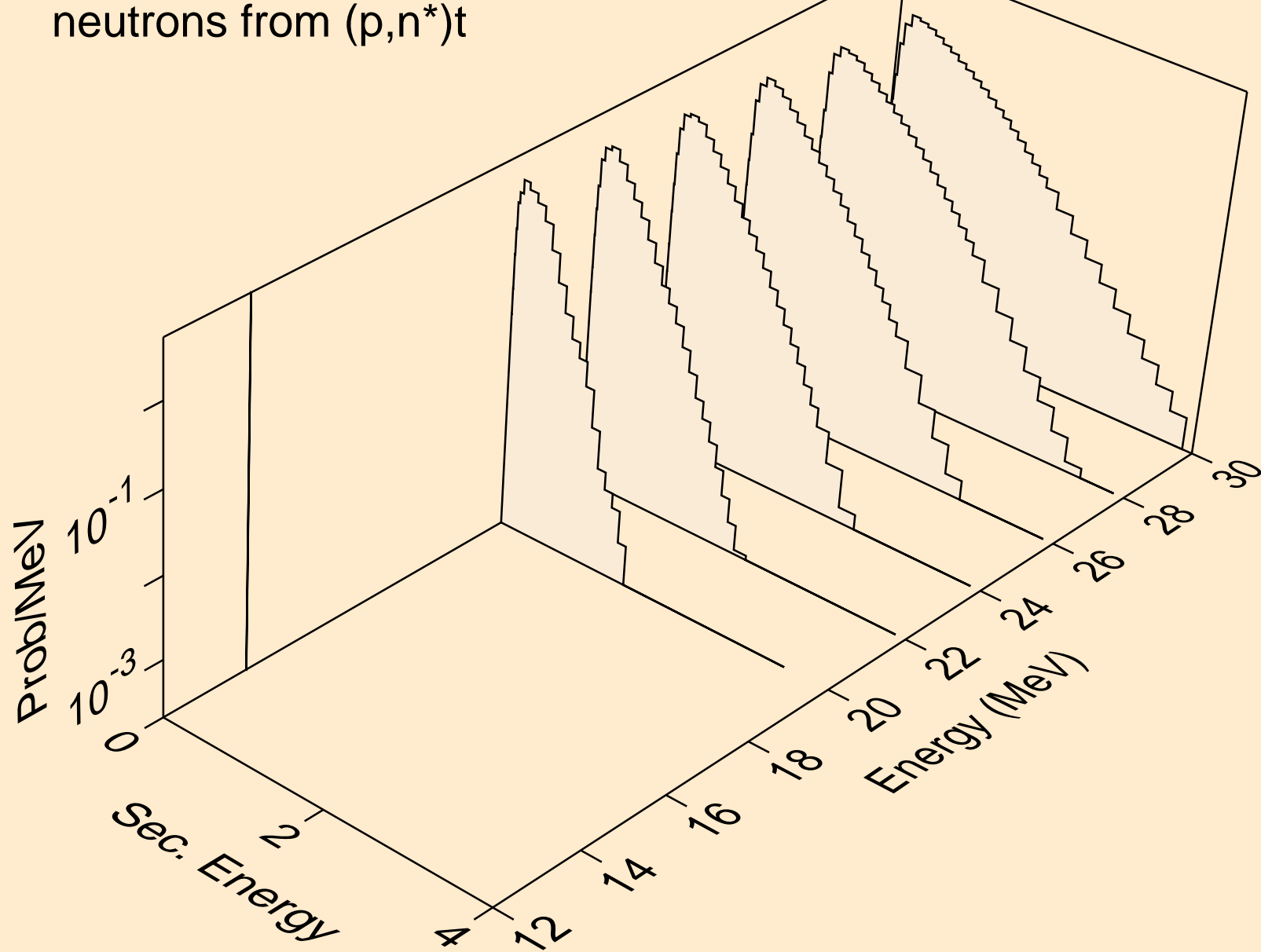

DB258 PROTON ACER TENDL-2024 LIBRARY; T=0.K  
neutrons from (p,2np)

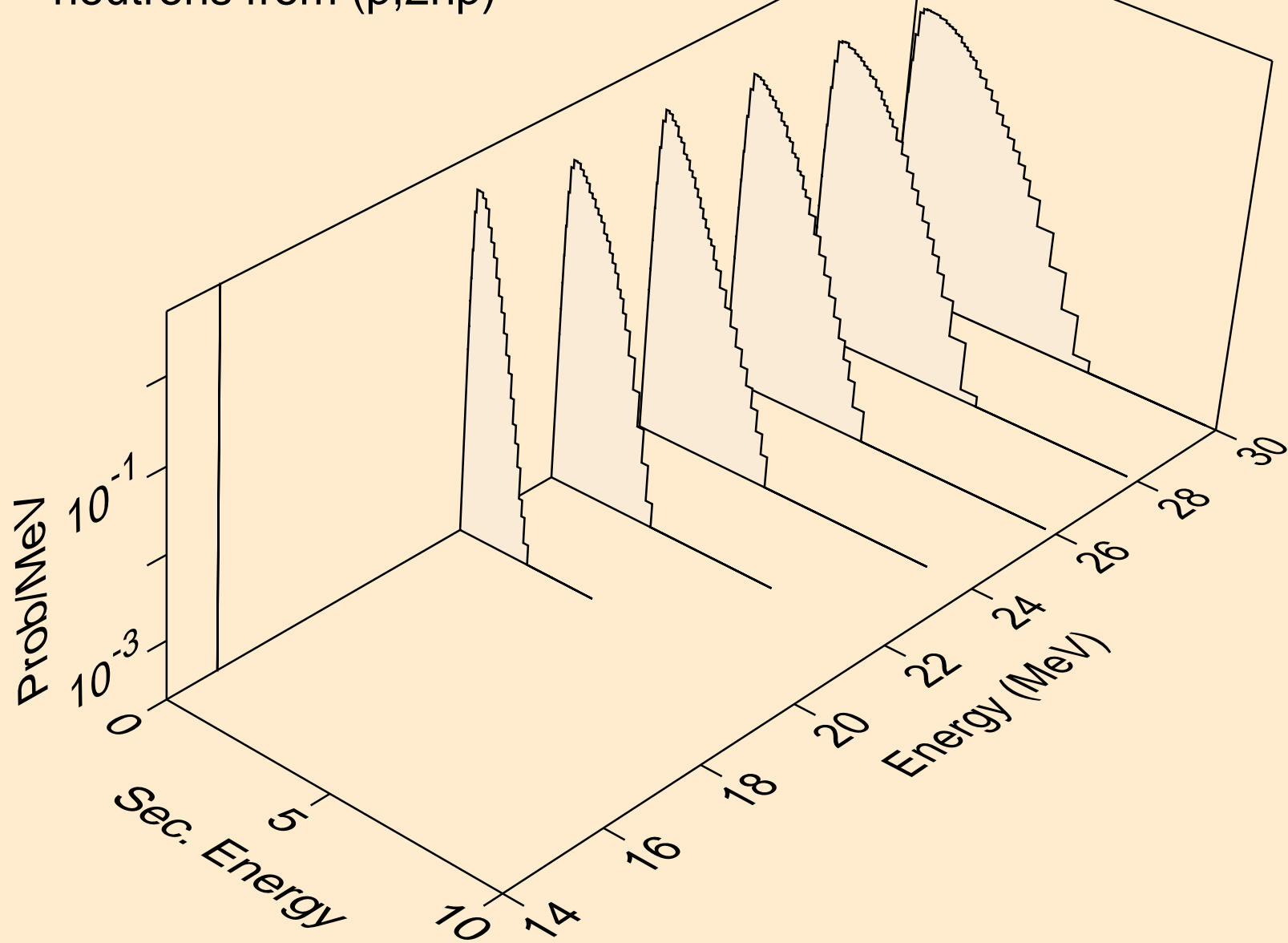

DB258 PROTON ACER TENDL-2024 LIBRARY; T=0.K  
neutrons from (p,npa)

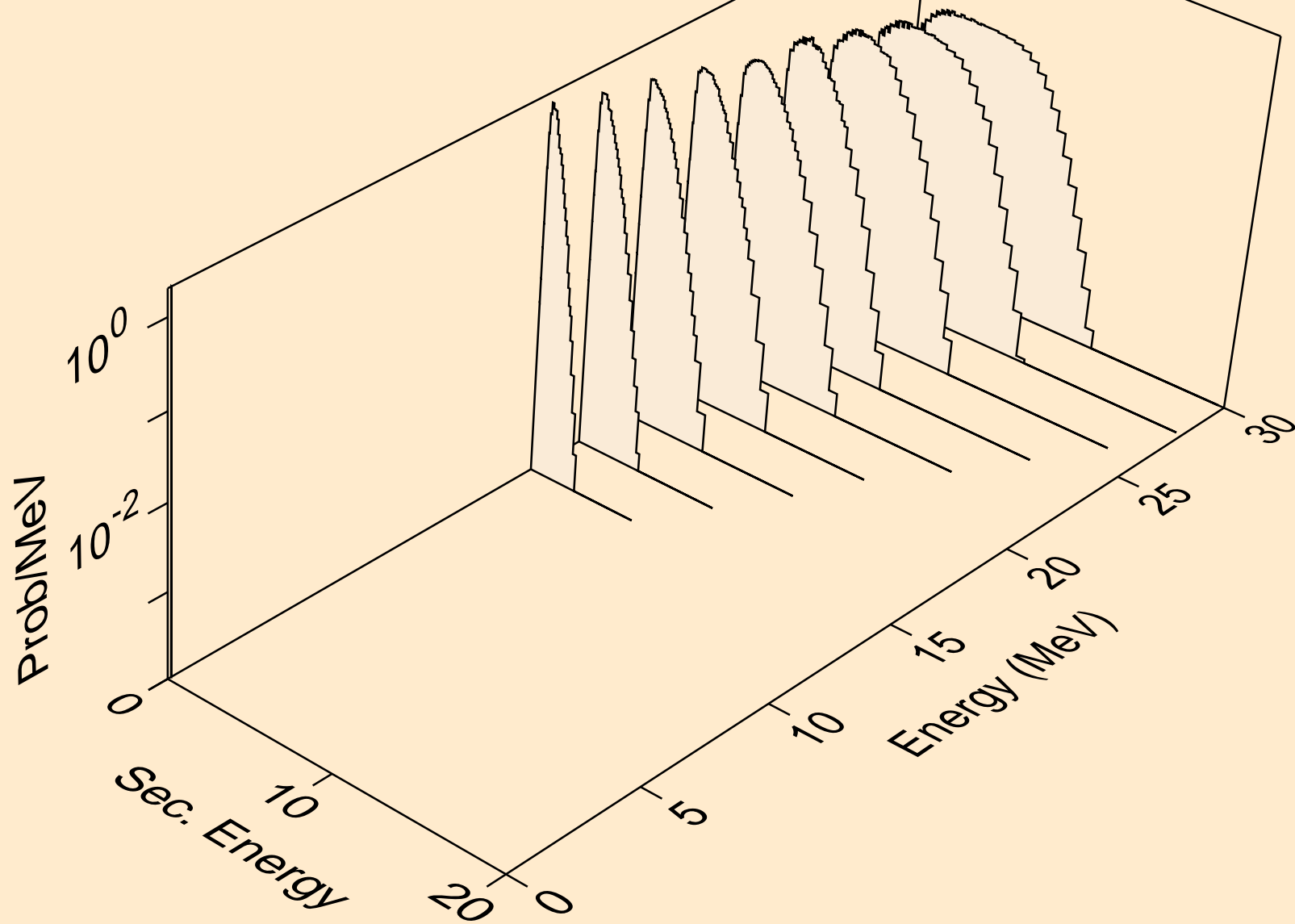

DB258 PROTON ACER TENDL-2024 LIBRARY; T=0.K  
deuterons from (p,x)

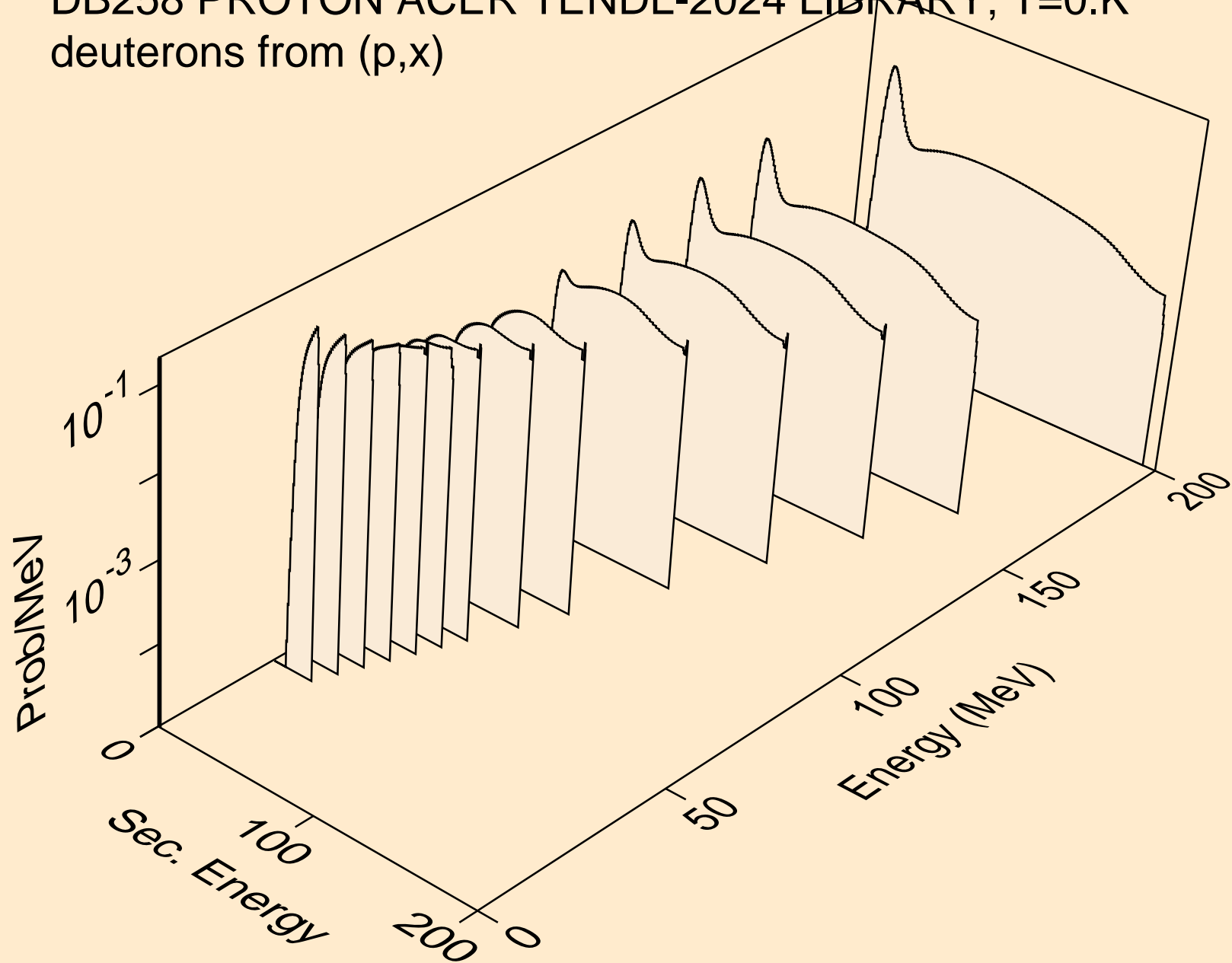

DB258 PROTON ACER TENDL-2024 LIBRARY; T=0.K  
deuterons from (p,n\*)d

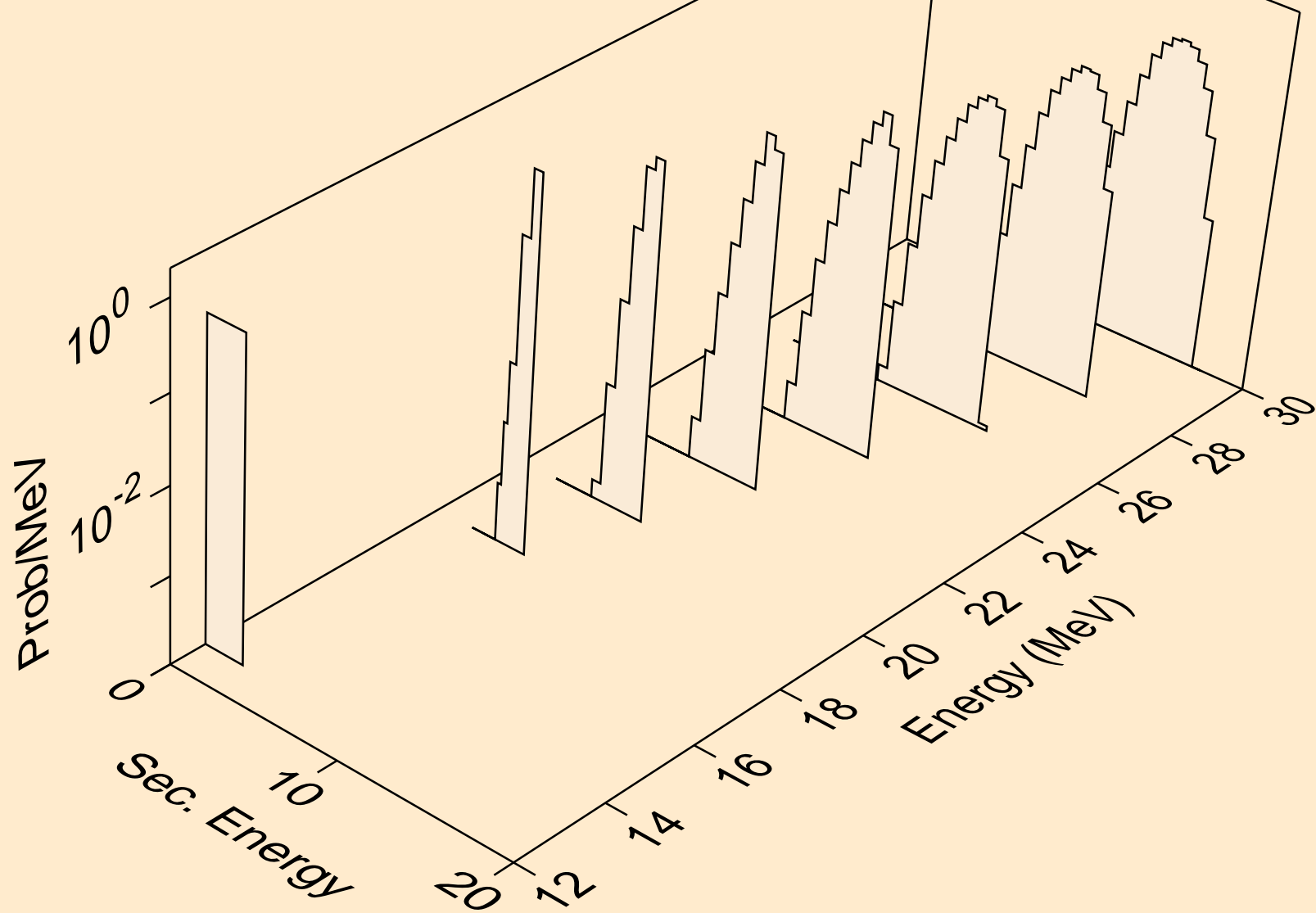

DB258 PROTON ACER TENDL-2024 LIBRARY; T=0.K  
deuterons from (p,d)

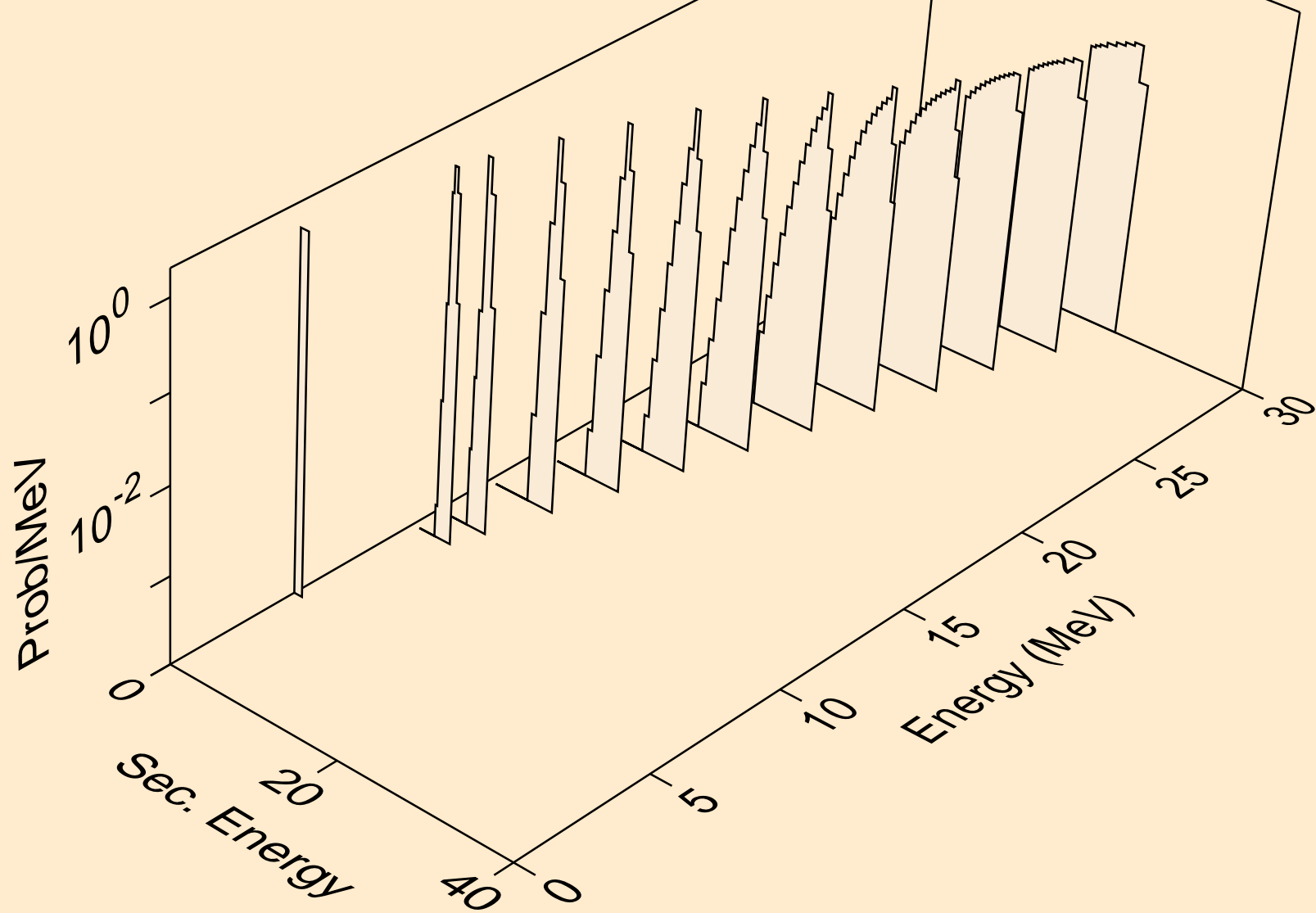

DB258 PROTON ACER TENDL-2024 LIBRARY; T=0.K  
deuterons from (p,da)

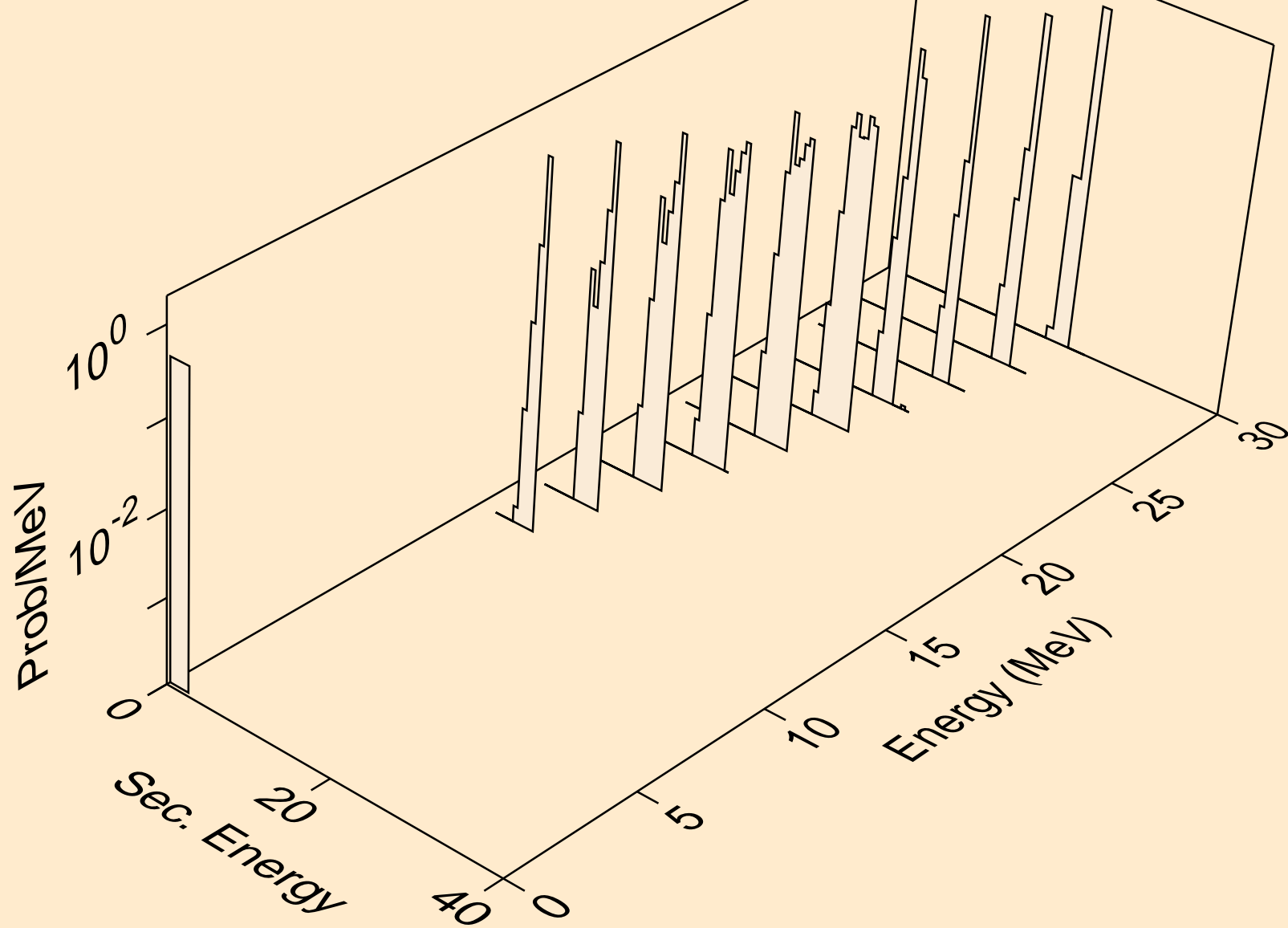

DB258 PROTON ACER TENDL-2024 LIBRARY; T=0.K  
tritons from (p,x)

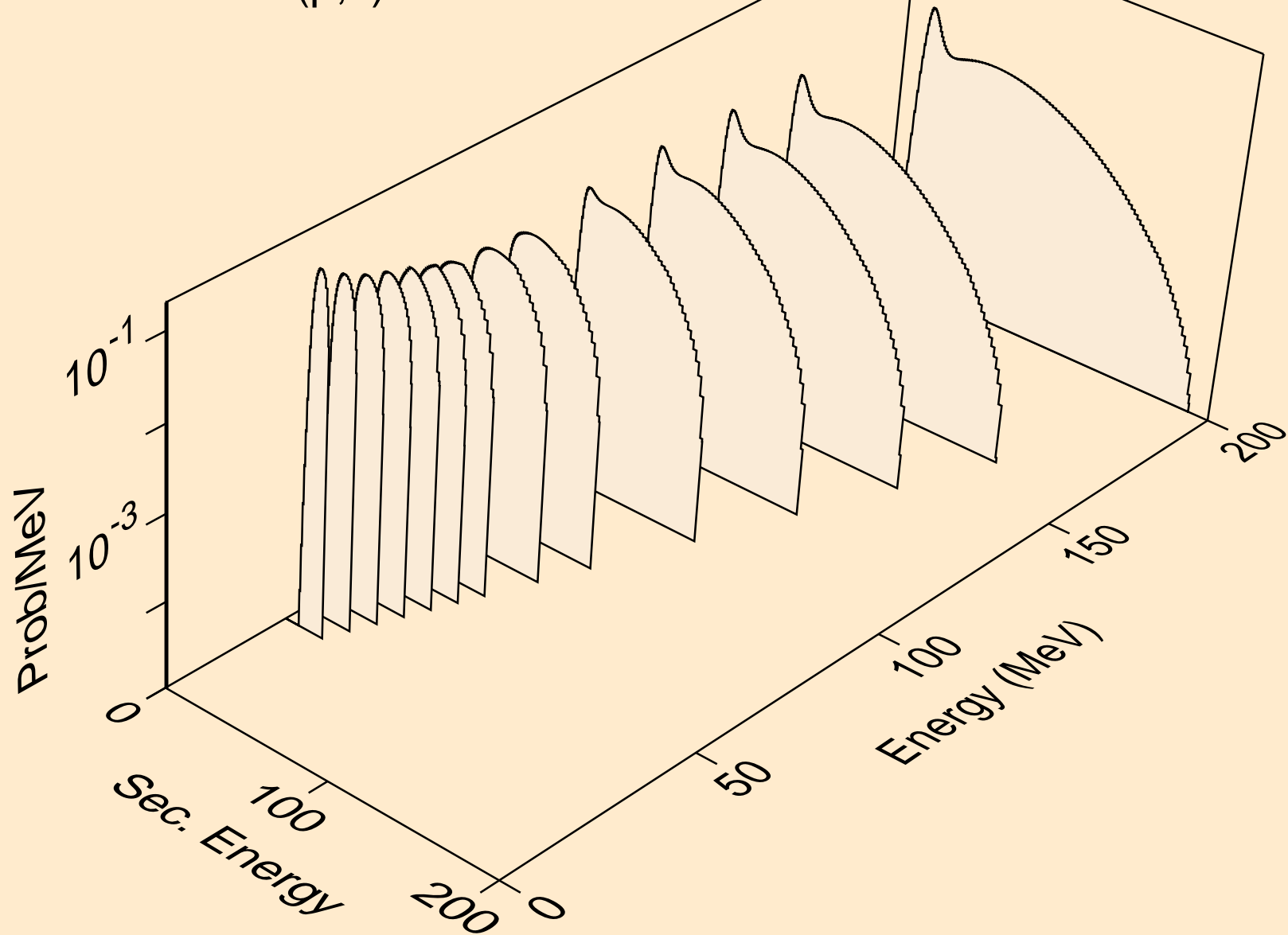

DB258 PROTON ACER TENDL-2024 LIBRARY; T=0.K  
tritons from (p,n\*)t

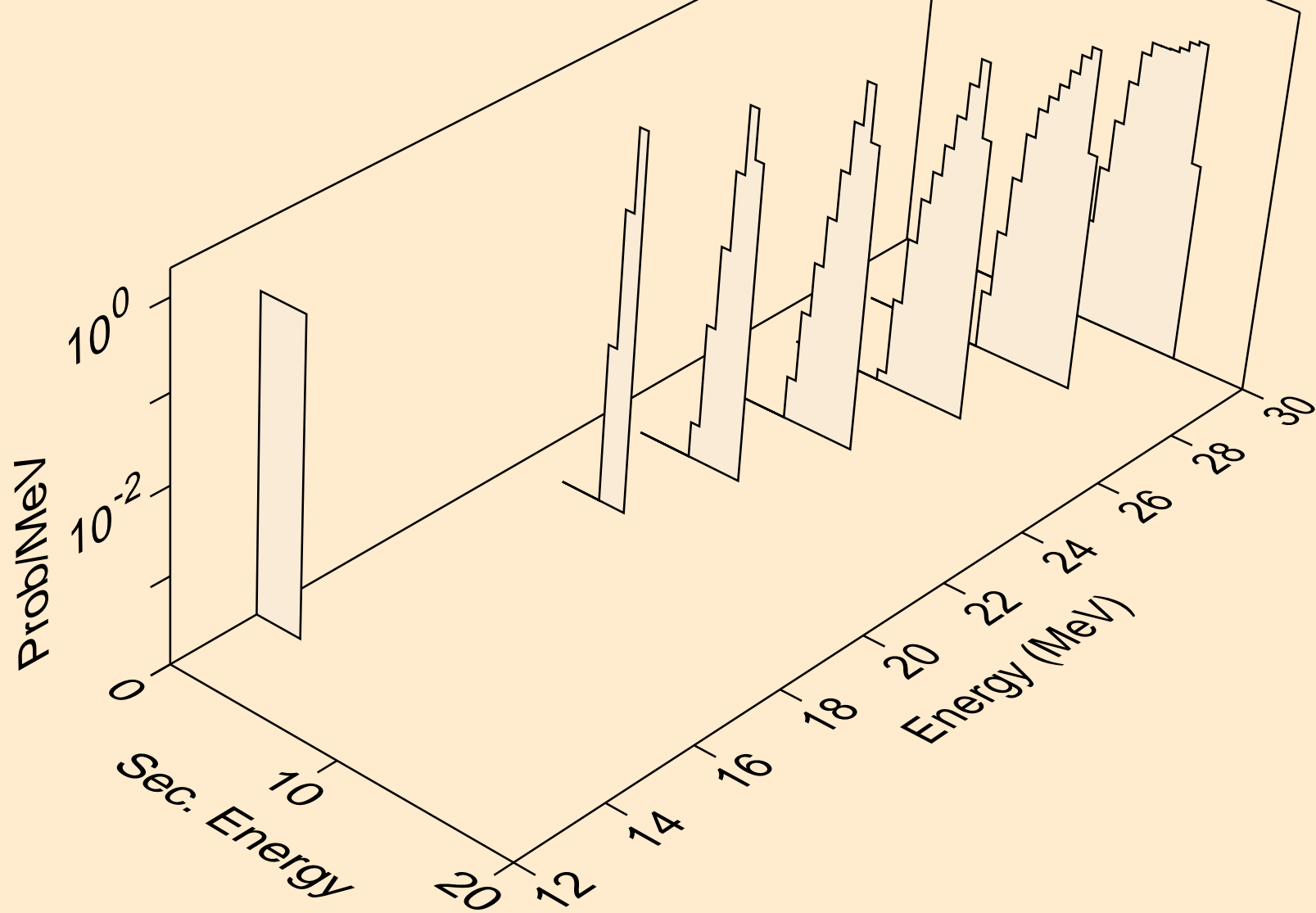

DB258 PROTON ACER TENDL-2024 LIBRARY; T=0.K  
tritons from (p,t)

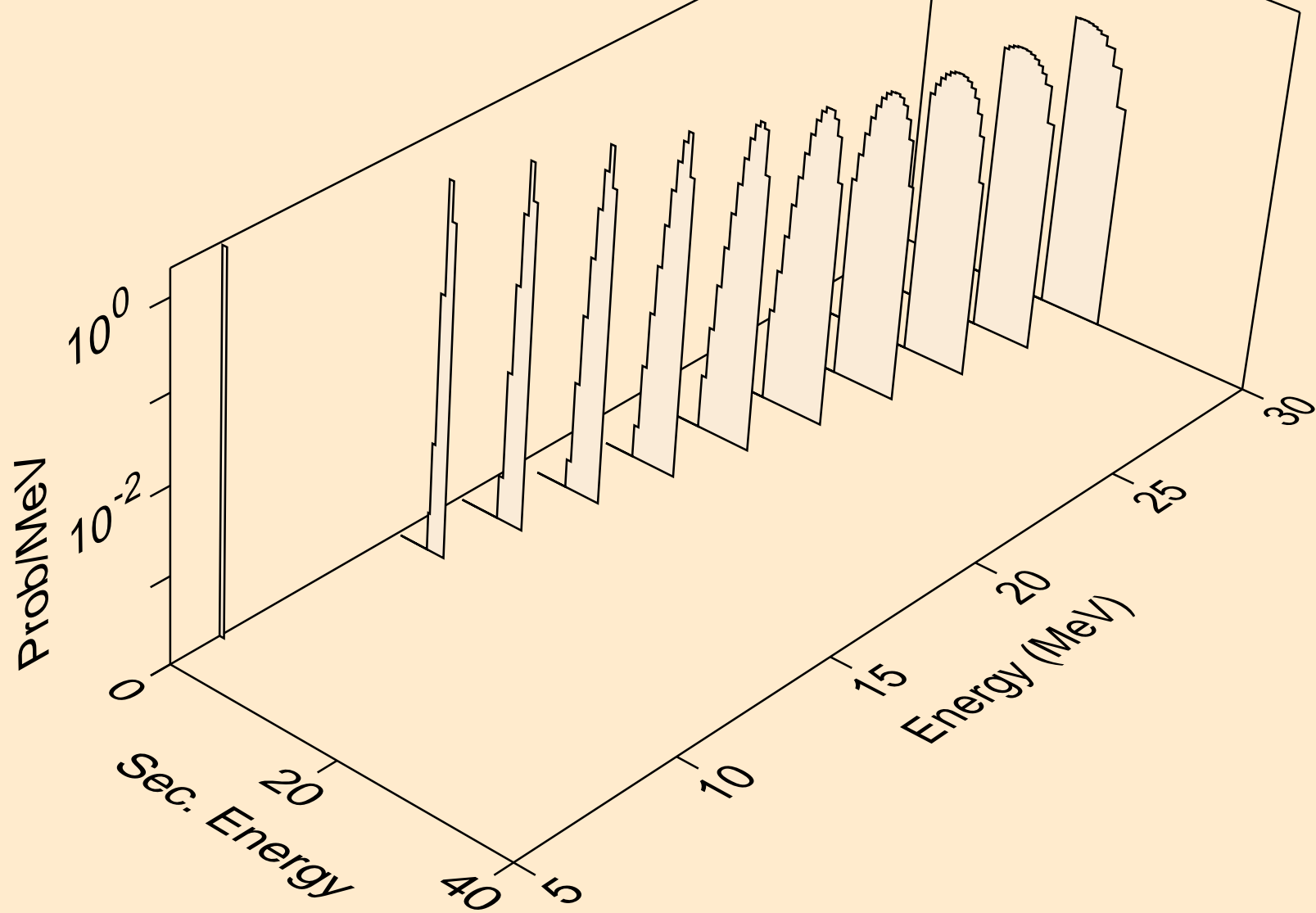

DB258 PROTON ACER TENDL-2024 LIBRARY; T=0.K  
he3s from (p,x)

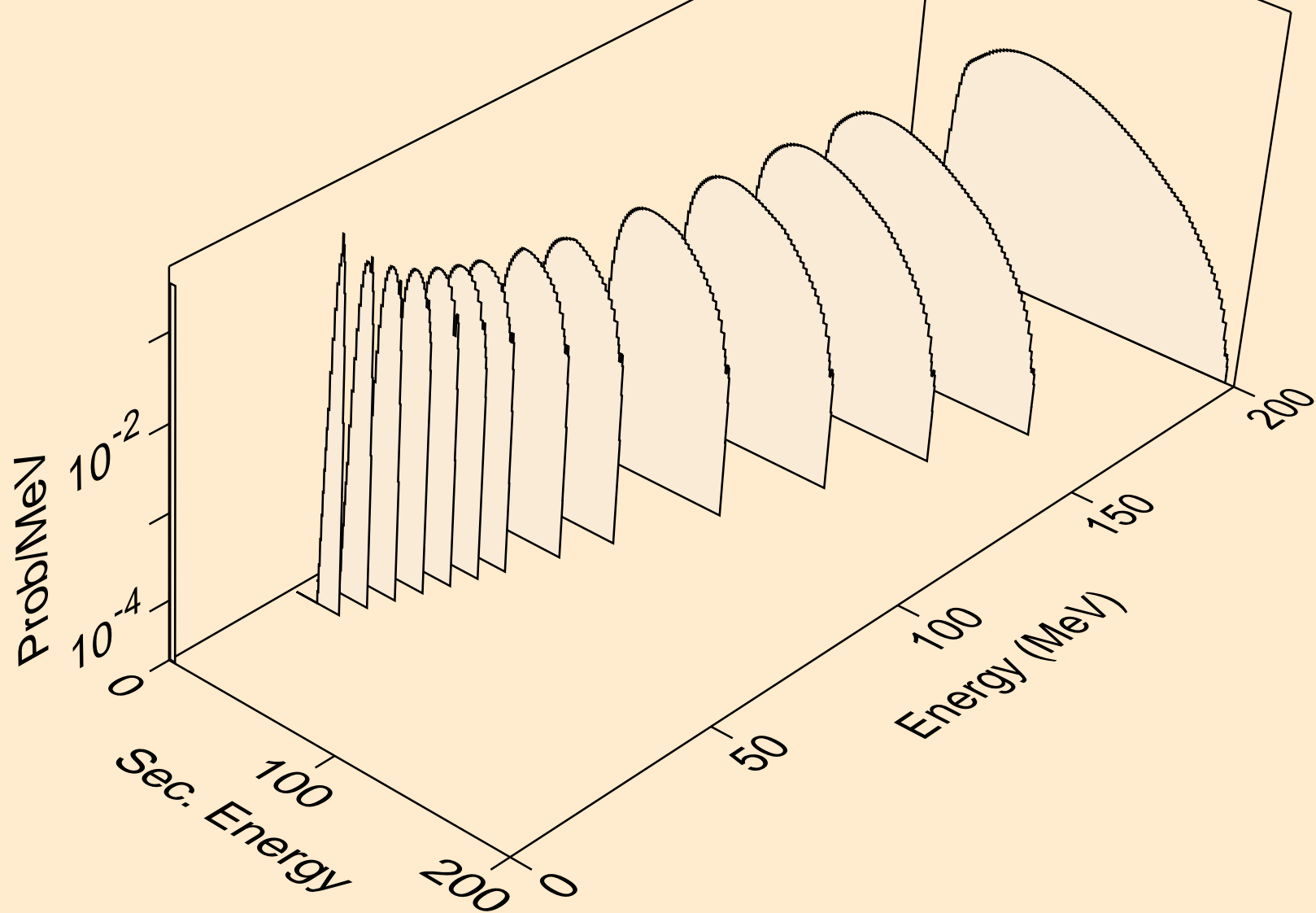

DB258 PROTON ACER TENDL-2024 LIBRARY; T=0.K  
he3s from (p,he3)

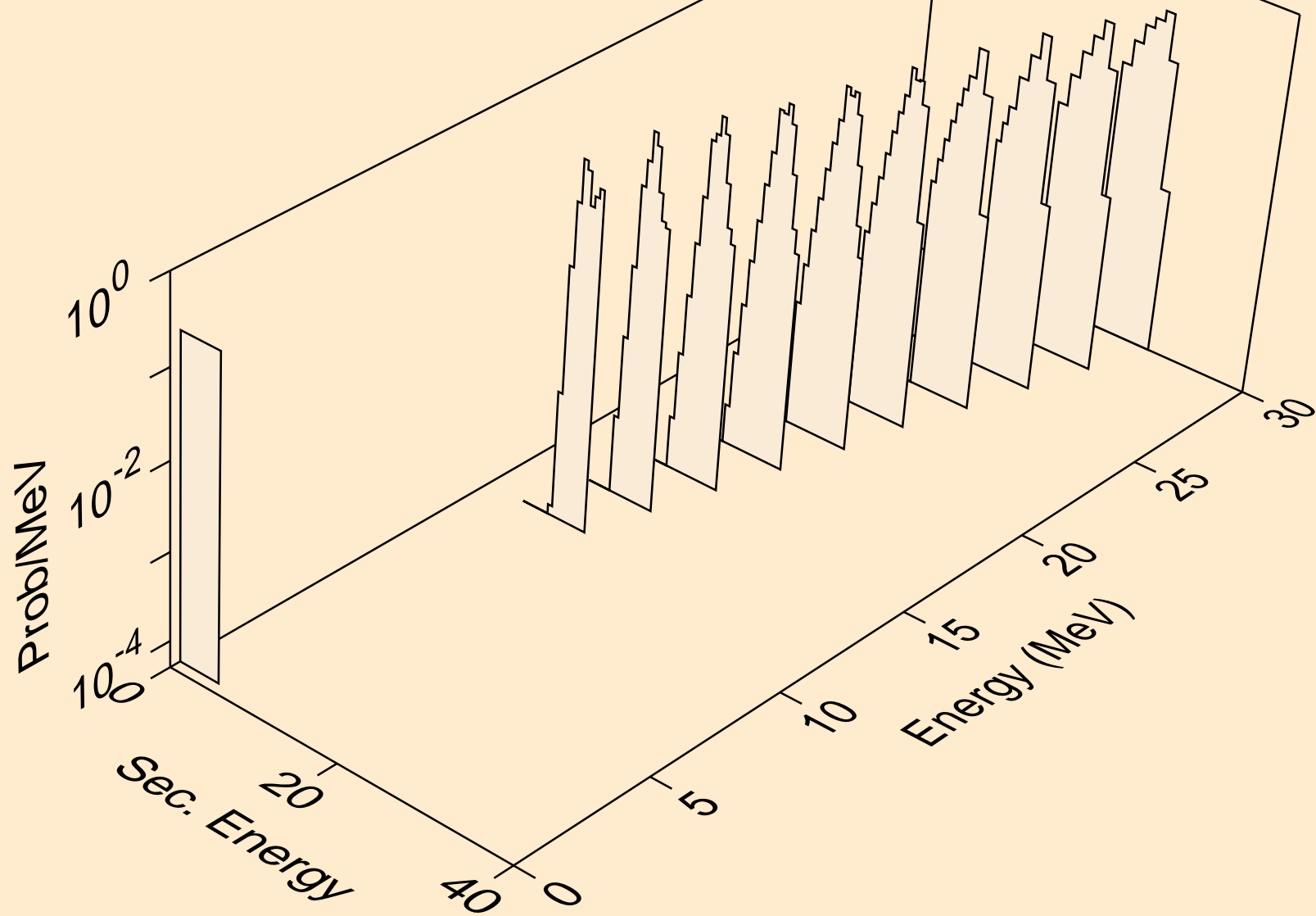

DB258 PROTON ACER TENDL-2024 LIBRARY; T=0.K  
alphas from (p,x)

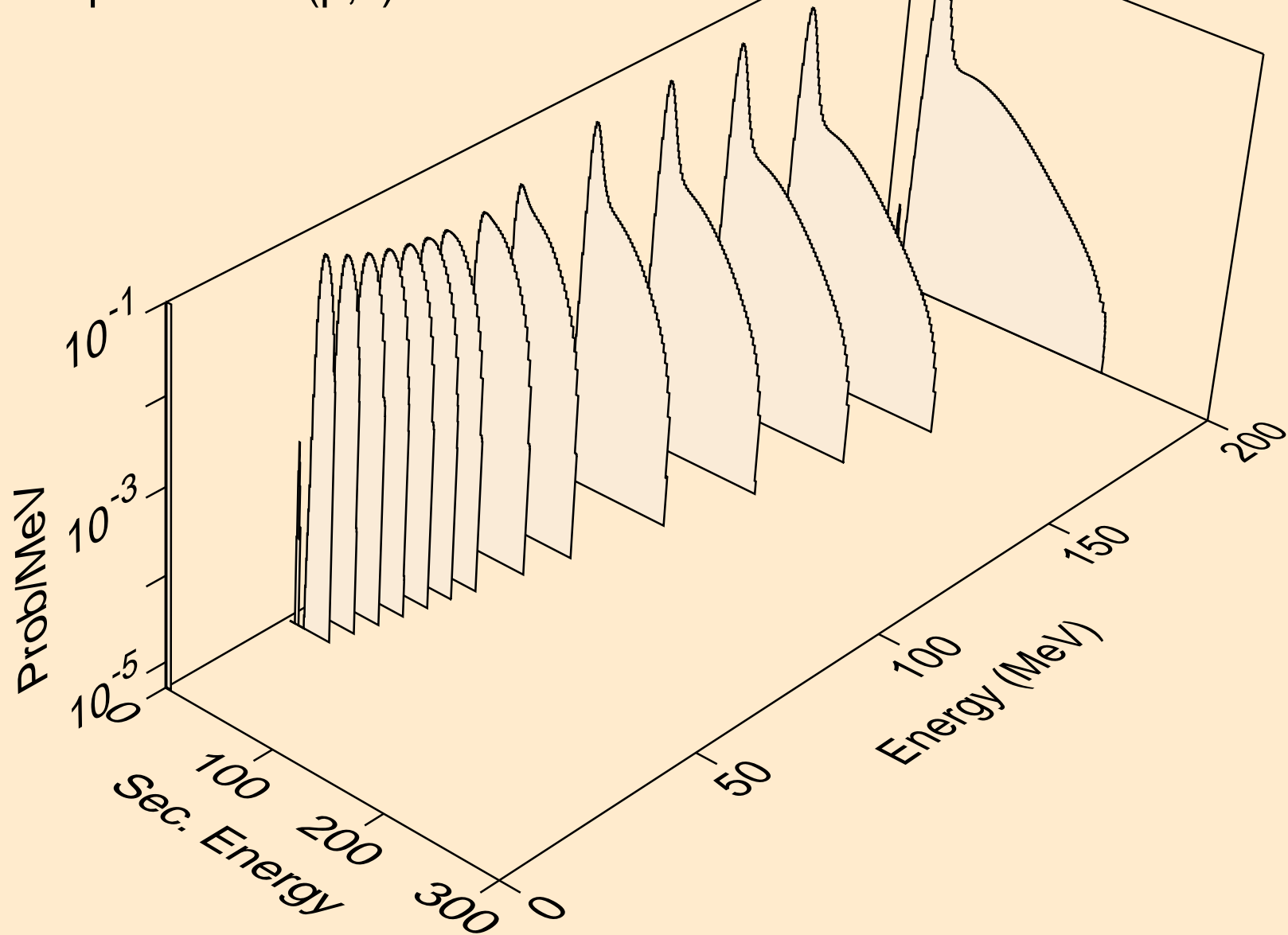

DB258 PROTON ACER TENDL-2024 LIBRARY; T=0.K  
alphas from (p,n\*)a

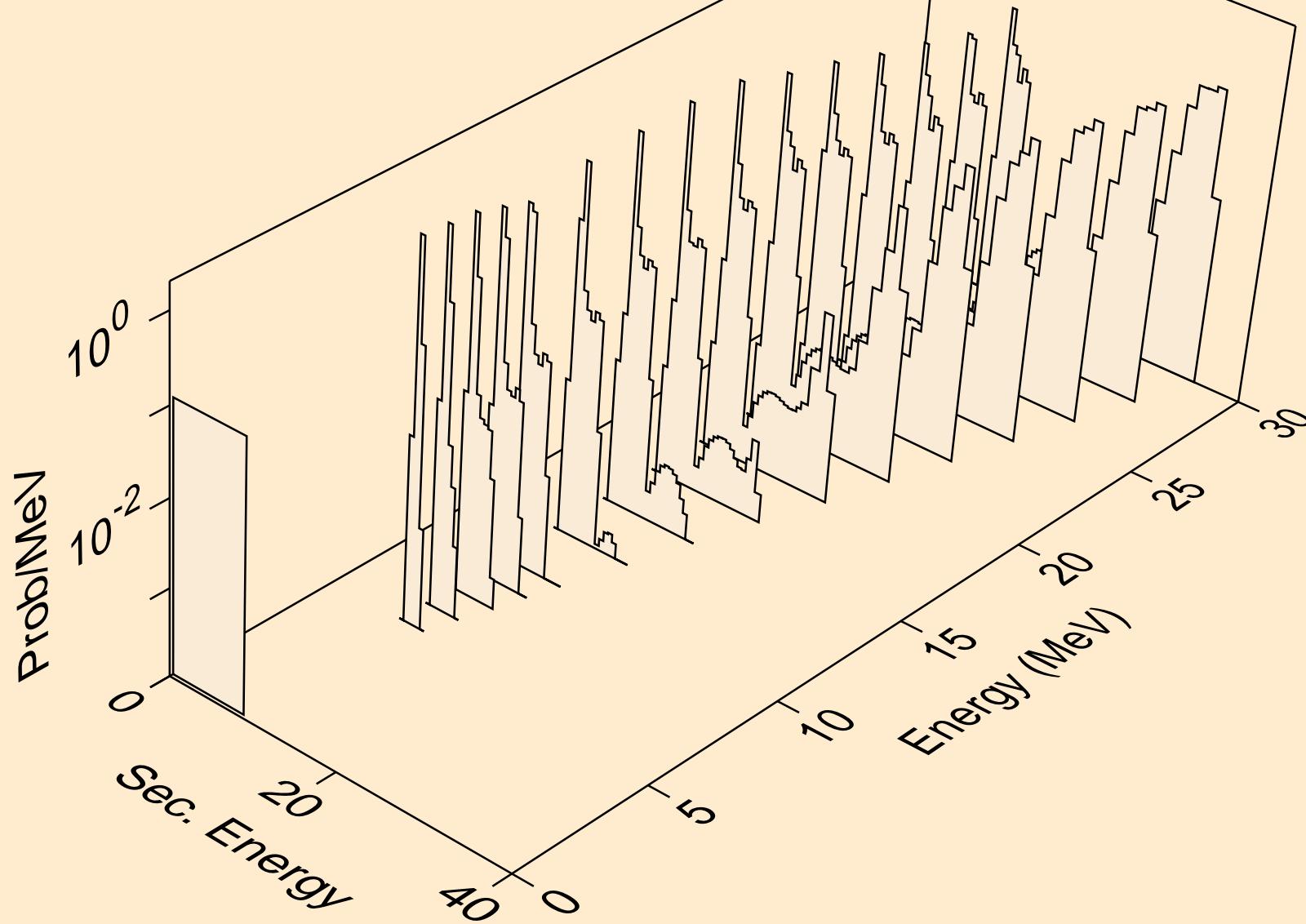

DB258 PROTON ACER TENDL-2024 LIBRARY; T=0.K  
alphas from (p,2n)a

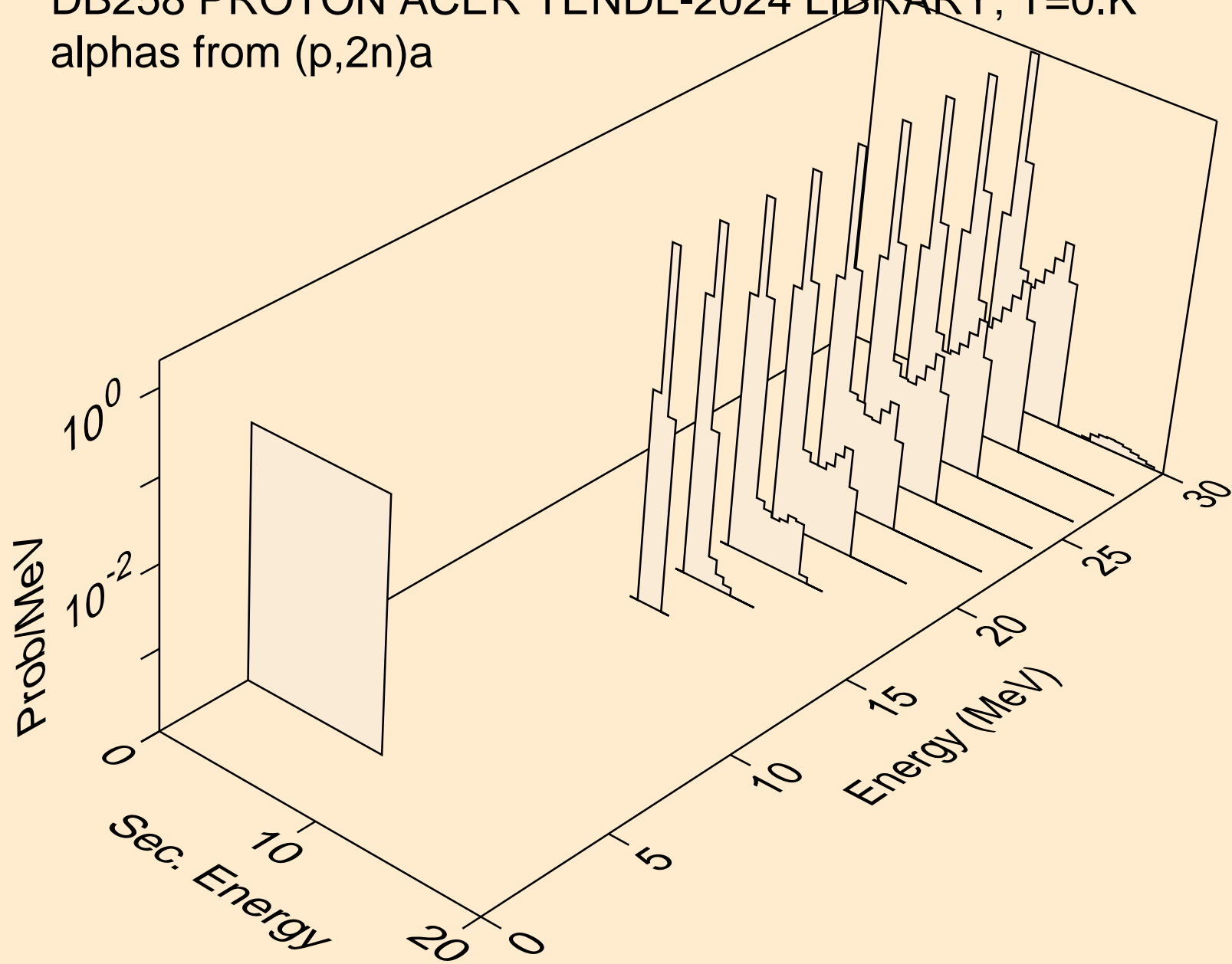

DB258 PROTON ACER TENDL-2024 LIBRARY; T=0.K  
alphas from (p,3n)a

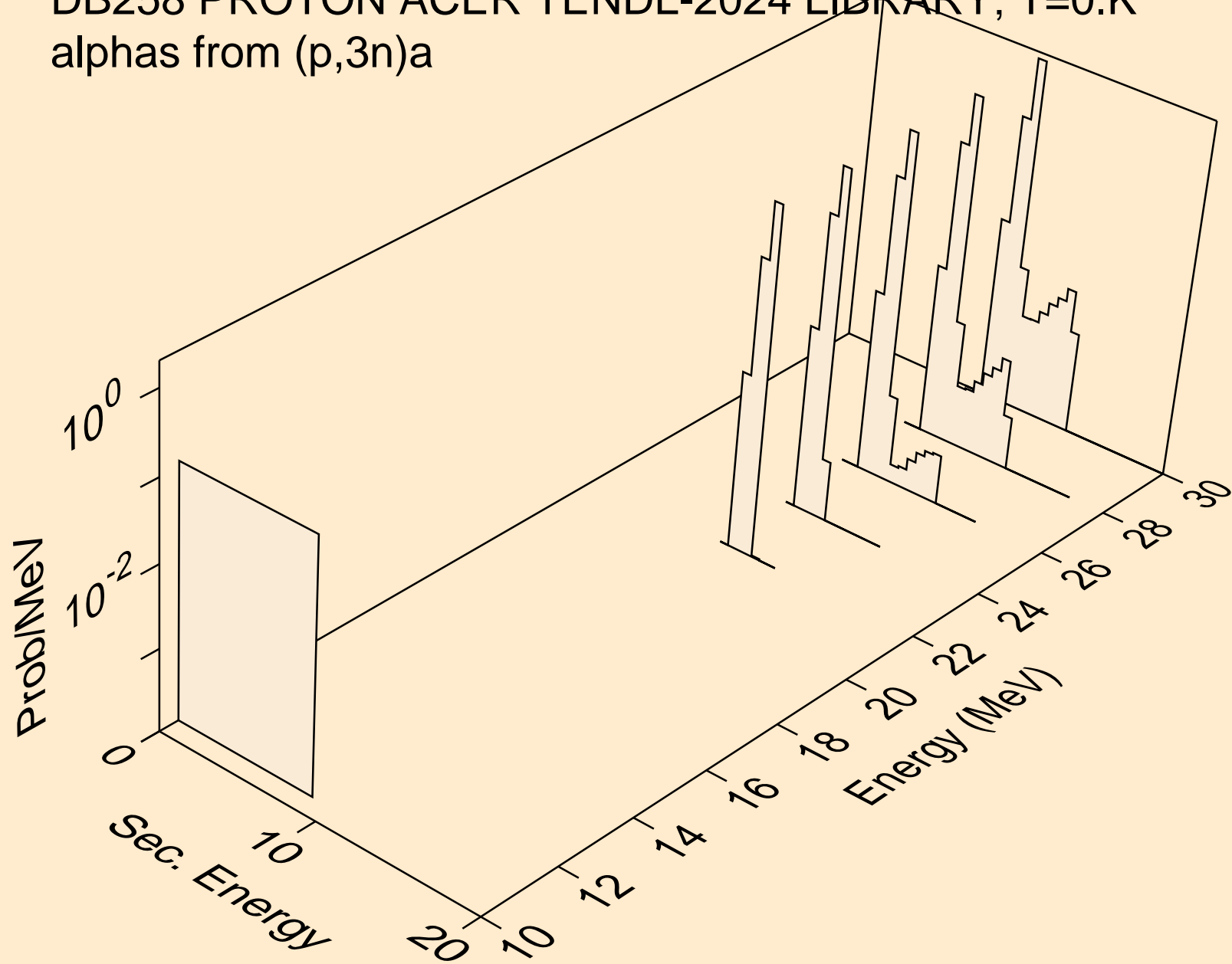

DB258 PROTON ACER TENDL-2024 LIBRARY; T=0.K  
alphas from (p,npa)

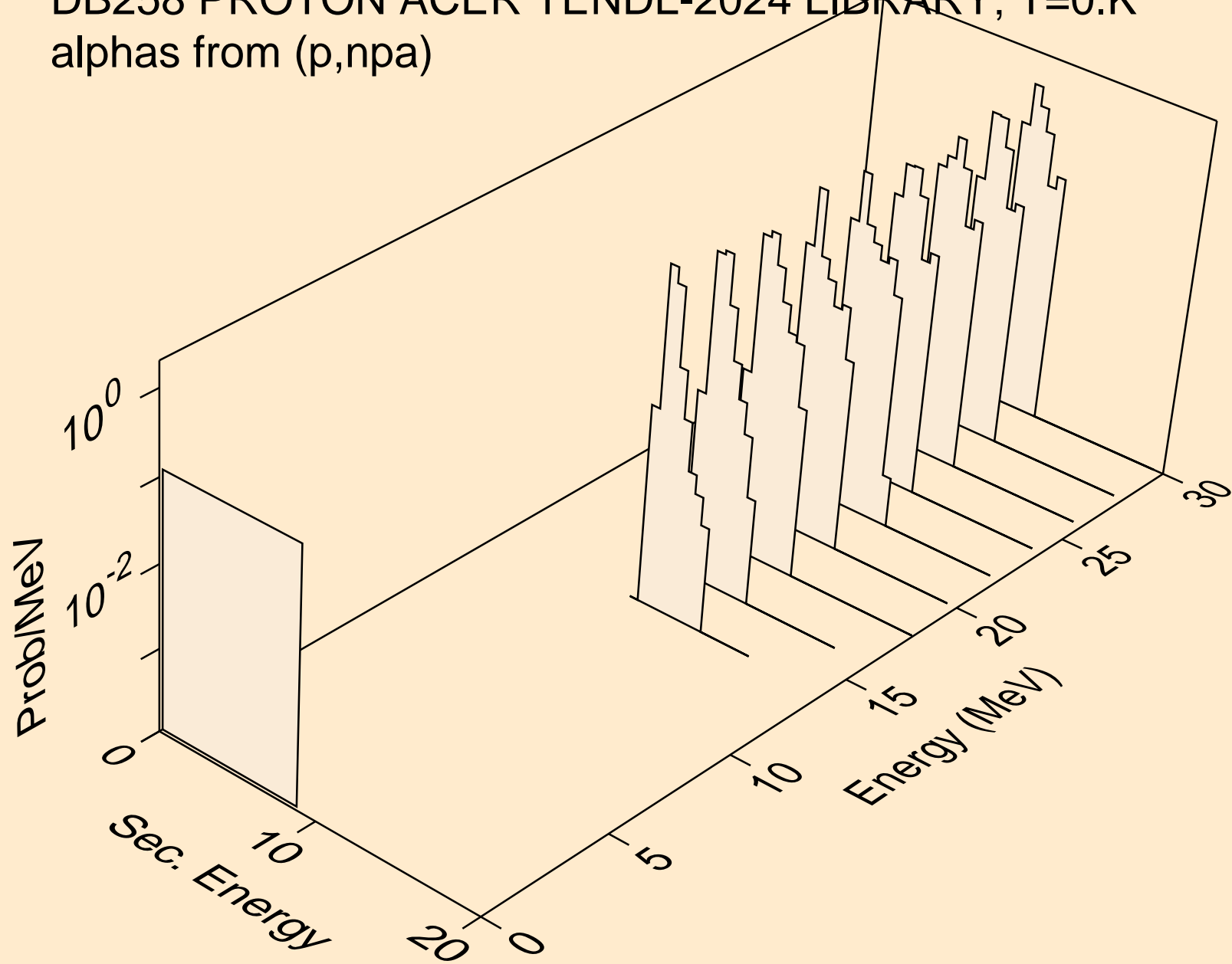

DB258 PROTON ACER TENDL-2024 LIBRARY; T=0.K  
alphas from (p,a)

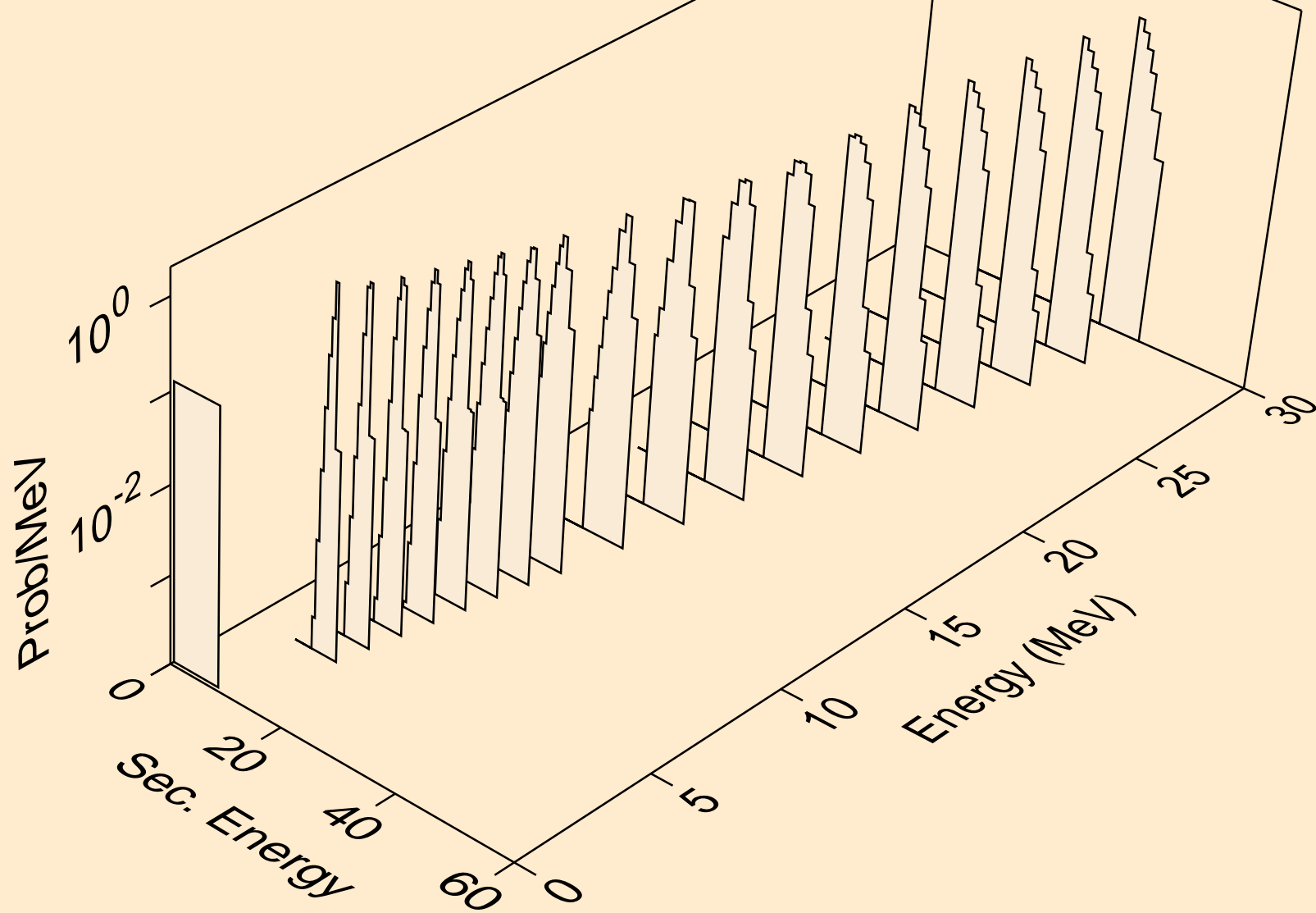

DB258 PROTON ACER TENDL-2024 LIBRARY; T=0.K  
alphas from (p,2a)

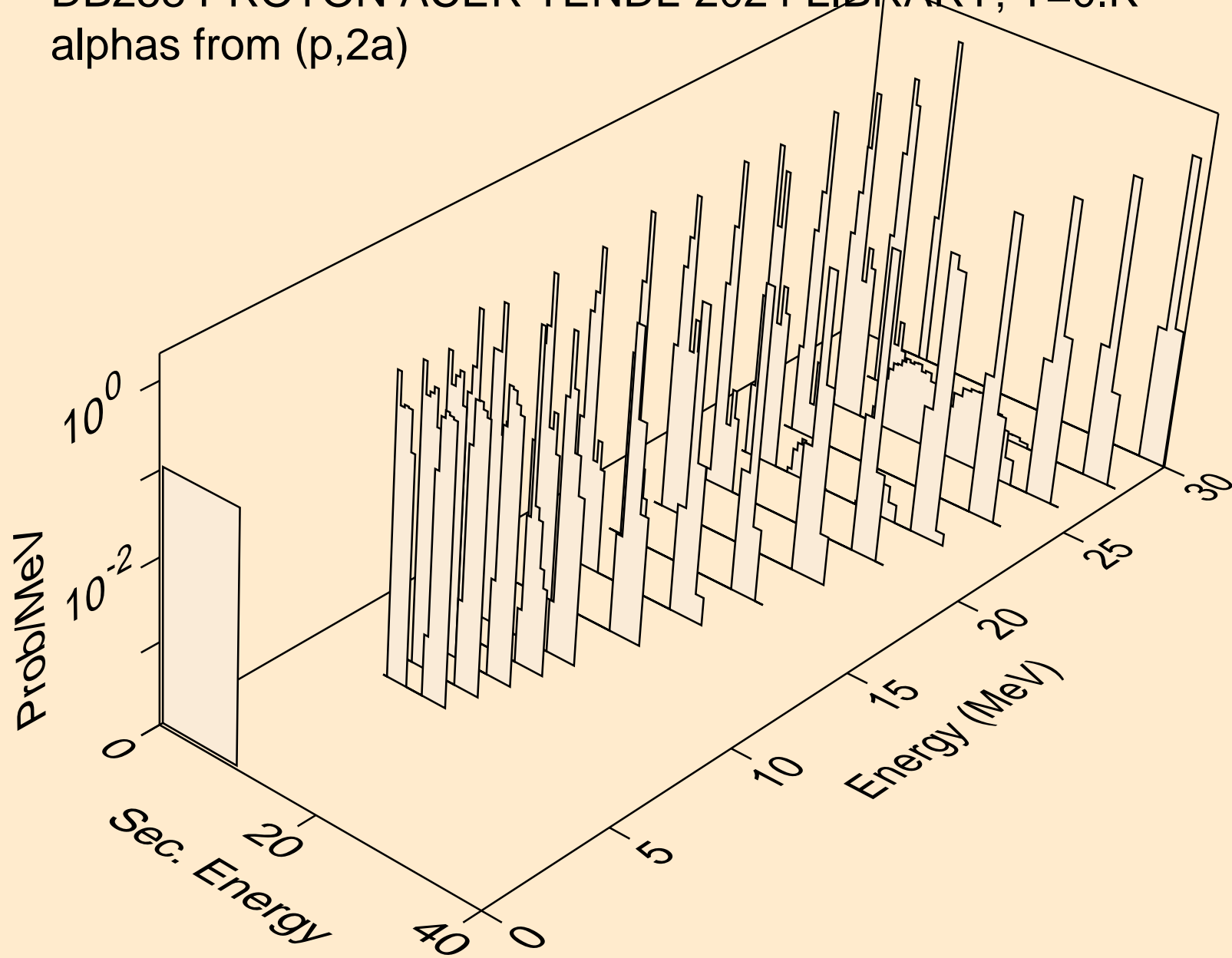

DB258 PROTON ACER TENDL-2024 LIBRARY; T=0.K  
alphas from (p,pa)

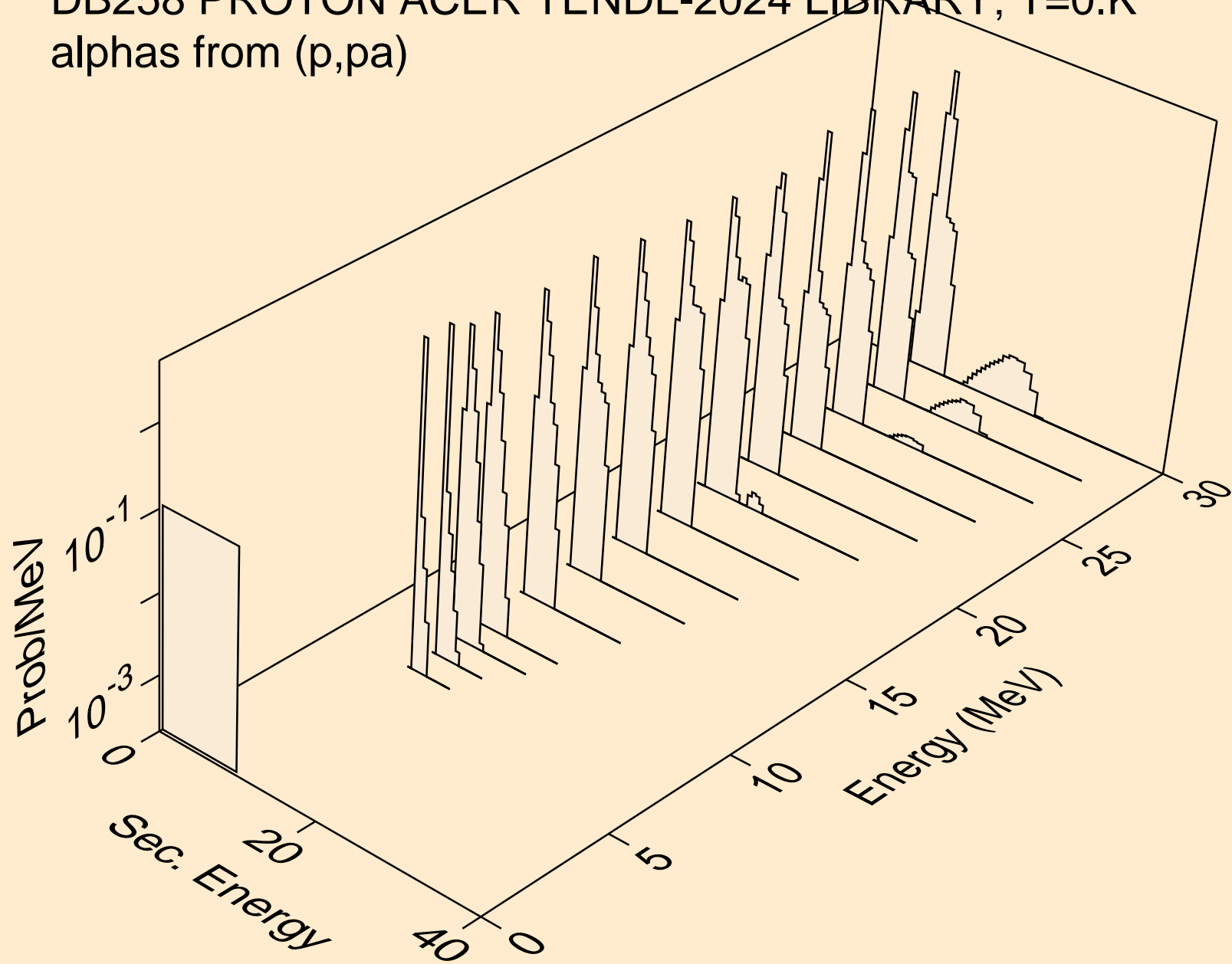

DB258 PROTON ACER TENDL-2024 LIBRARY; T=0.K  
alphas from (p,da)

