

# HF163 PROTON ACER TENDL-2024 LIBRARY; T=0.K

## Principal cross sections

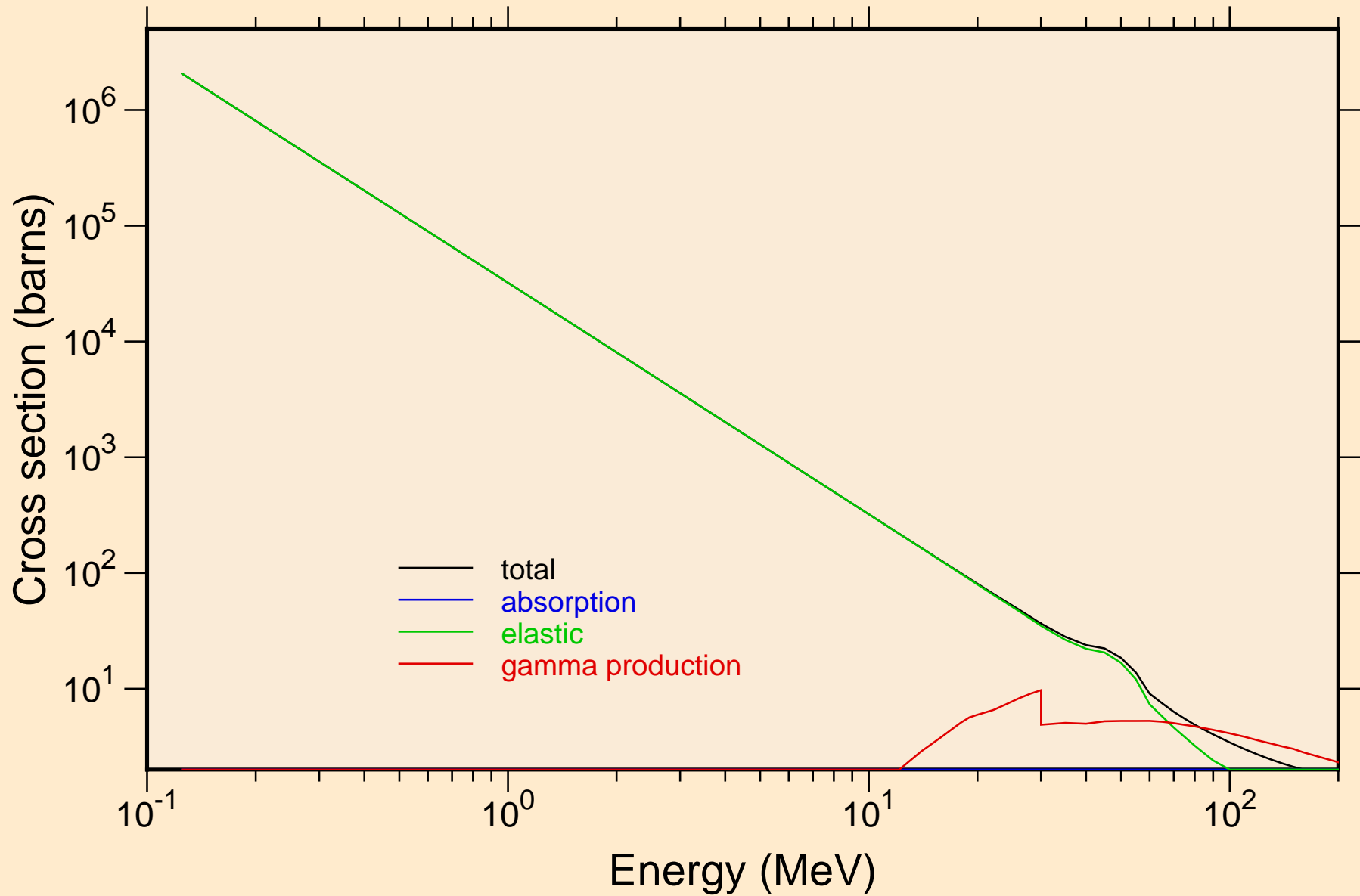

HF163 PROTON ACER TENDL-2024 LIBRARY; T=0.K  
Heating

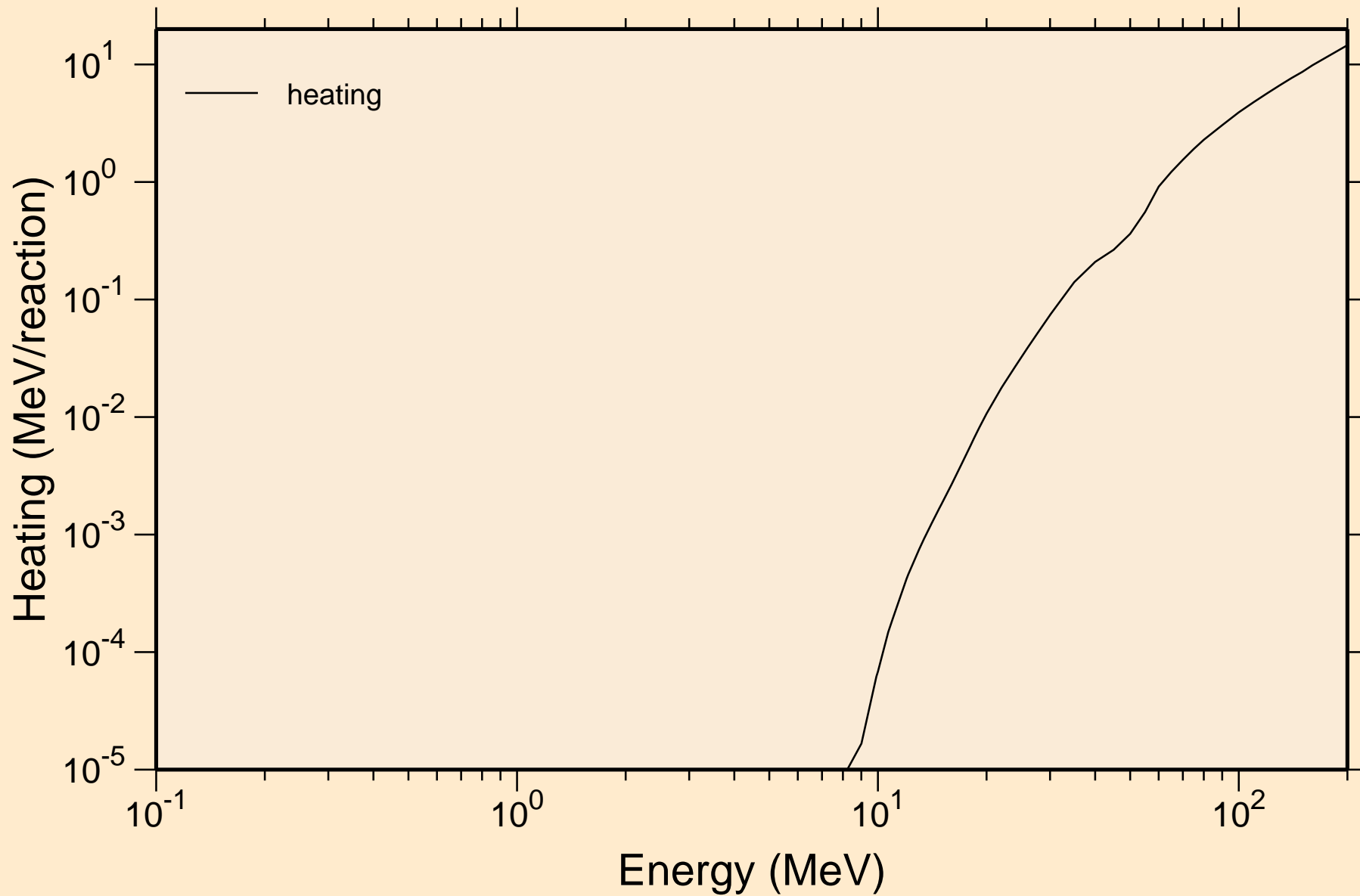

# HF163 PROTON ACER TENDL-2024 LIBRARY; T=0.K

## Principal cross sections

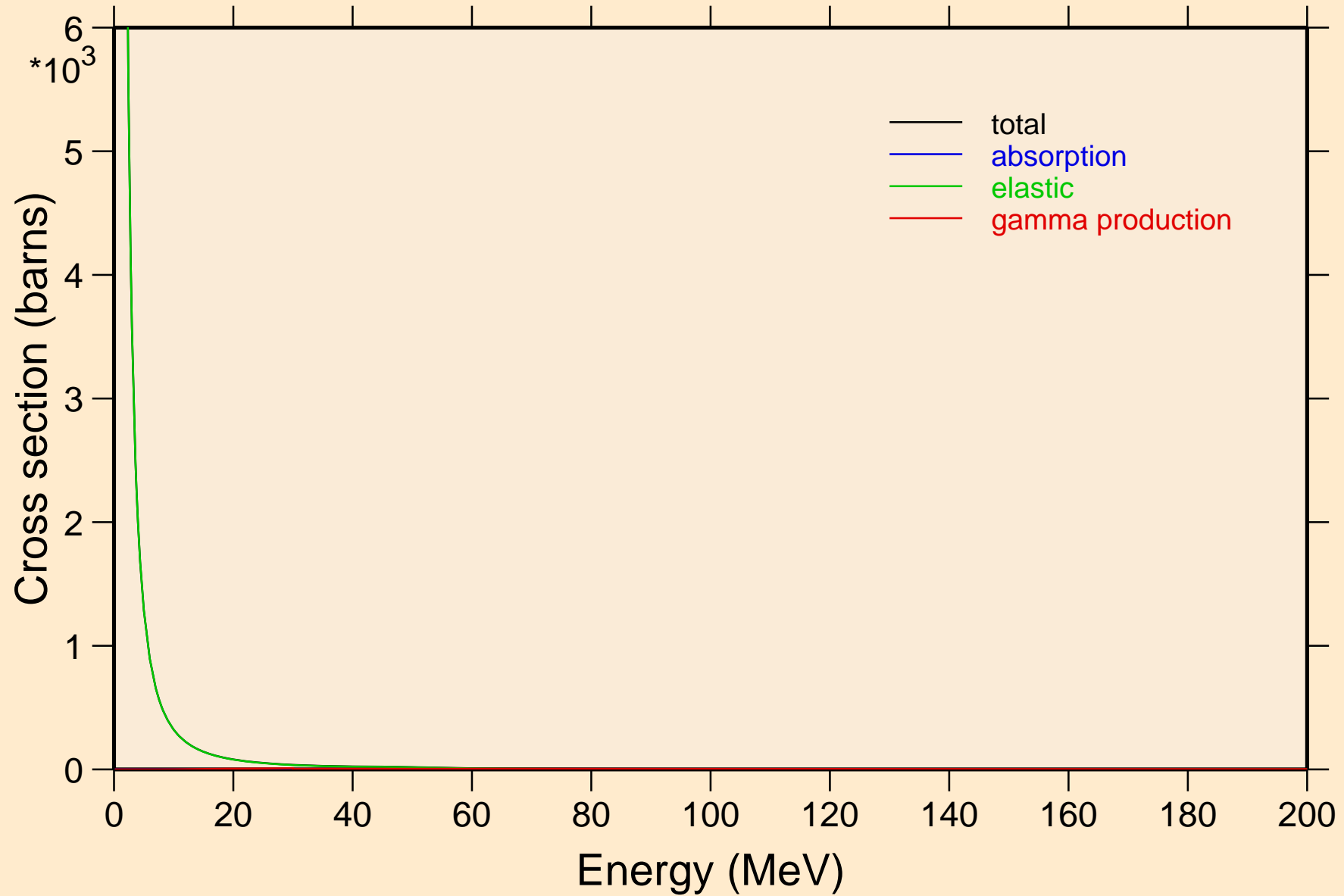

# HF163 PROTON ACER TENDL-2024 LIBRARY; T=0.K

## Heating

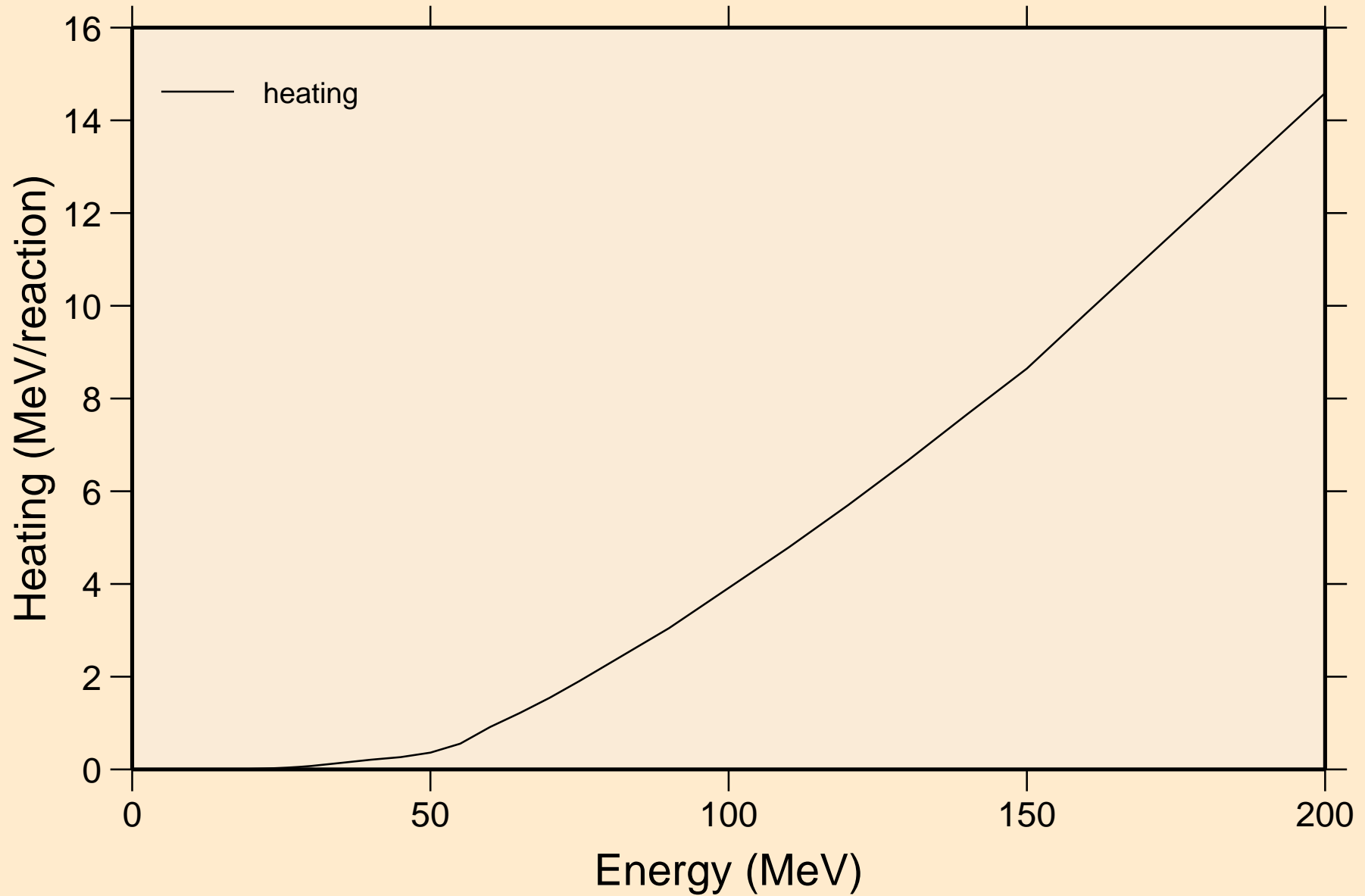

# HF163 PROTON ACER TENDL-2024 LIBRARY; T=0.K

## Threshold reactions

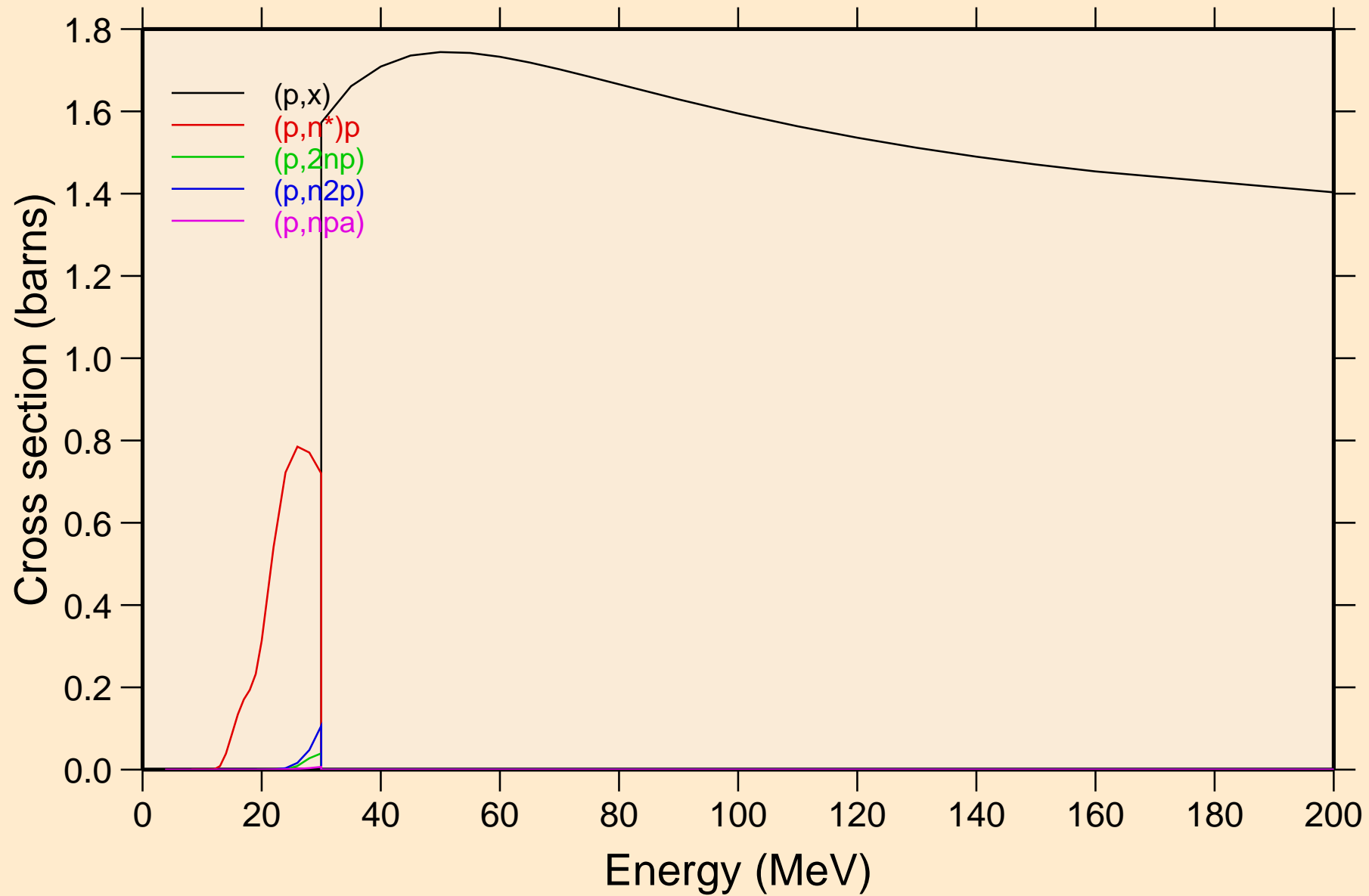

# HF163 PROTON ACER TENDL-2024 LIBRARY; T=0.K

## Threshold reactions

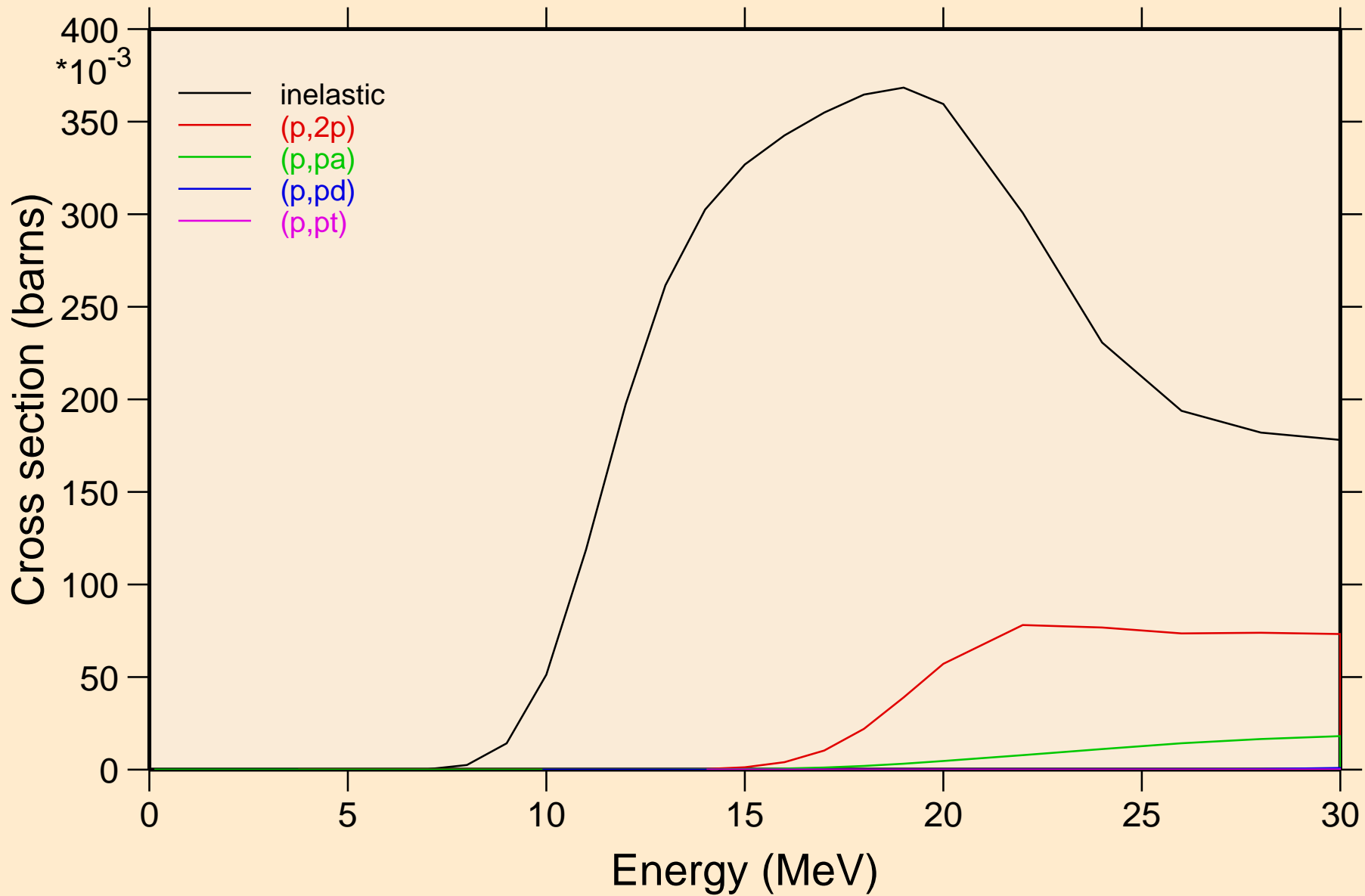

HF163 PROTON ACER TENDL-2024 LIBRARY; T=0.K  
Threshold reactions

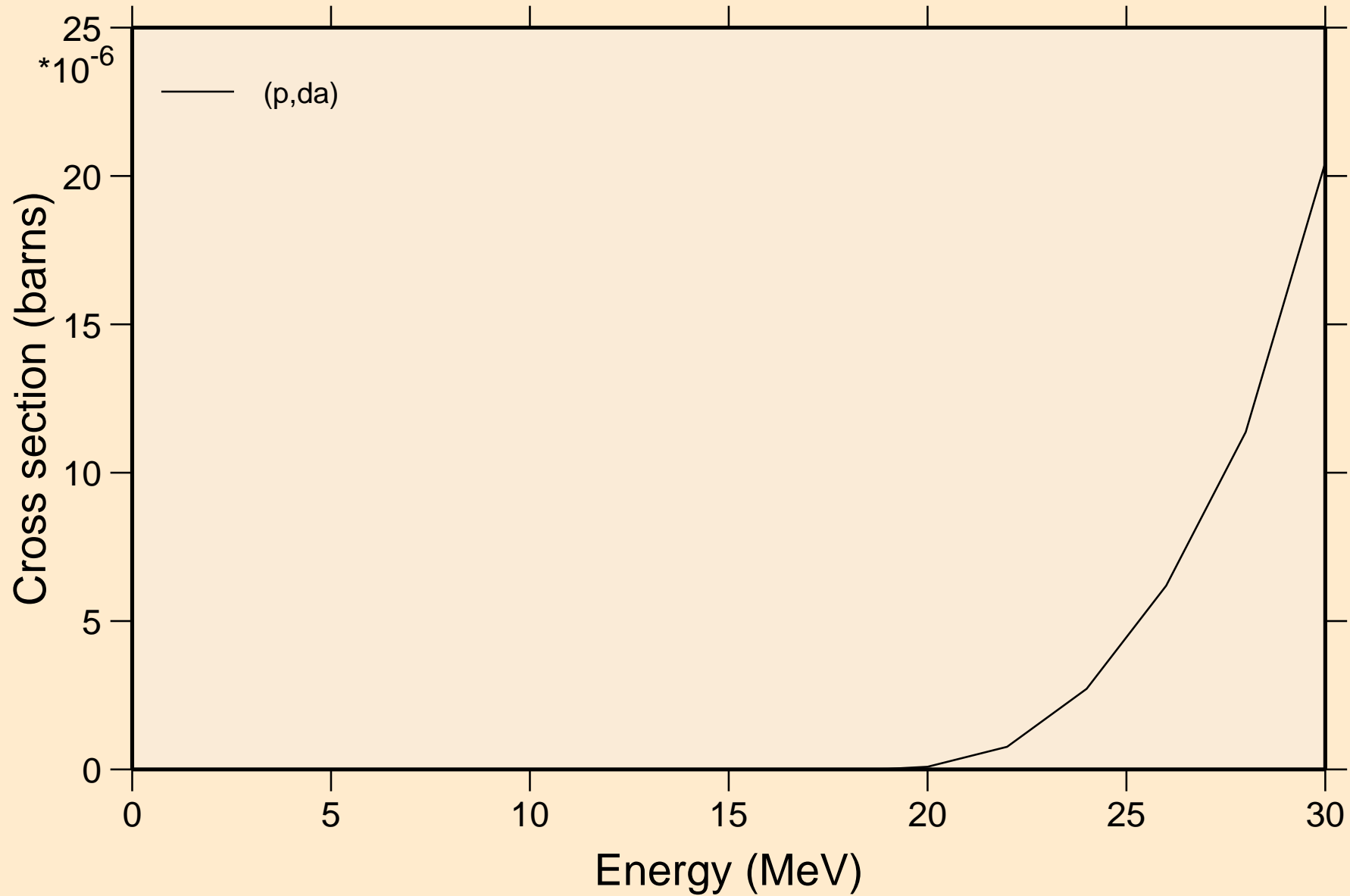

HF163 PROTON ACER TENDL-2024 LIBRARY; T=0.K  
angular distribution for elastic

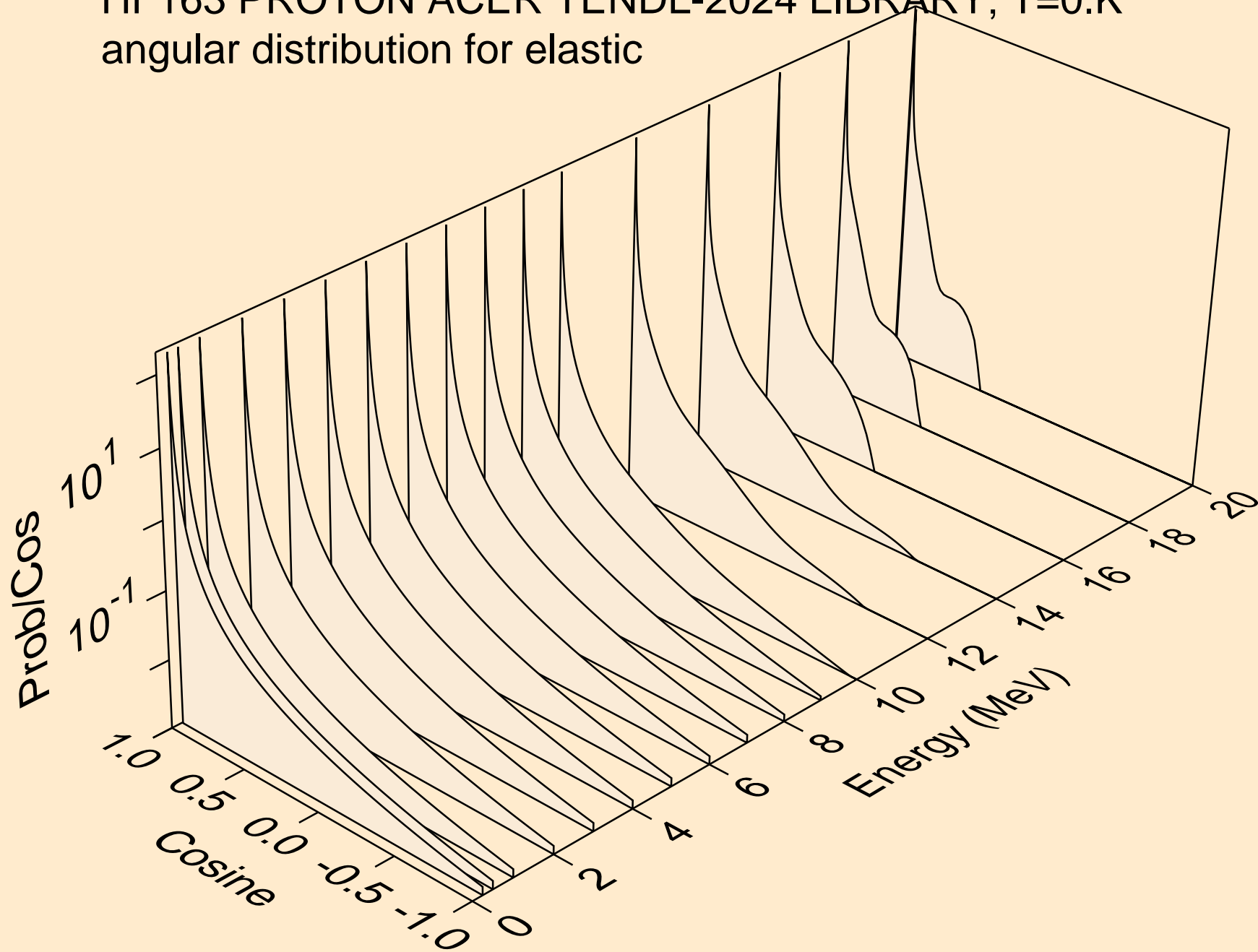

HF163 PROTON ACER TENDL-2024 LIBRARY; T=0.K  
angular distribution for elastic

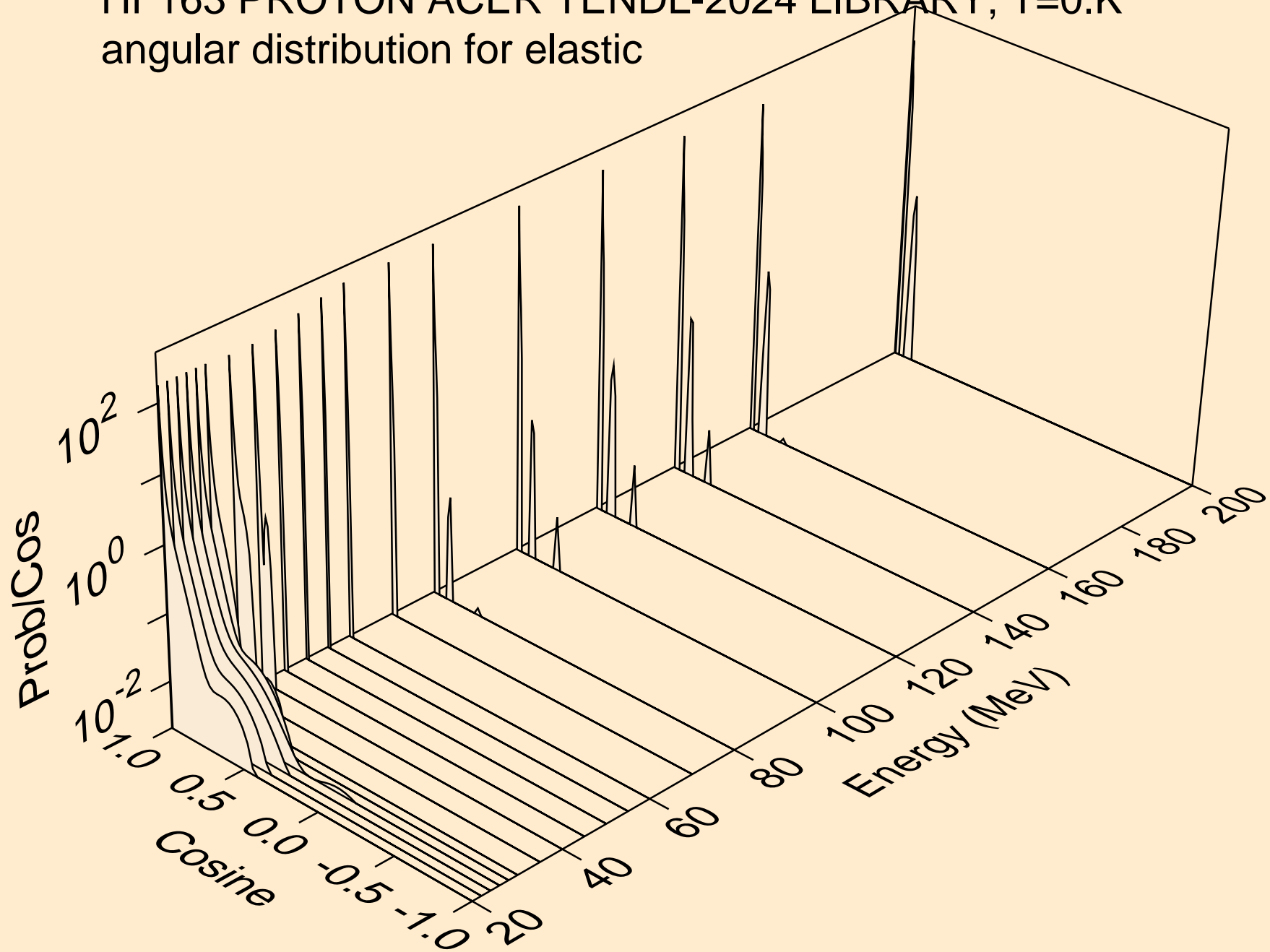

HF163 PROTON ACER TENDL-2024 LIBRARY; T=0.K  
Proton emission for (p,x)

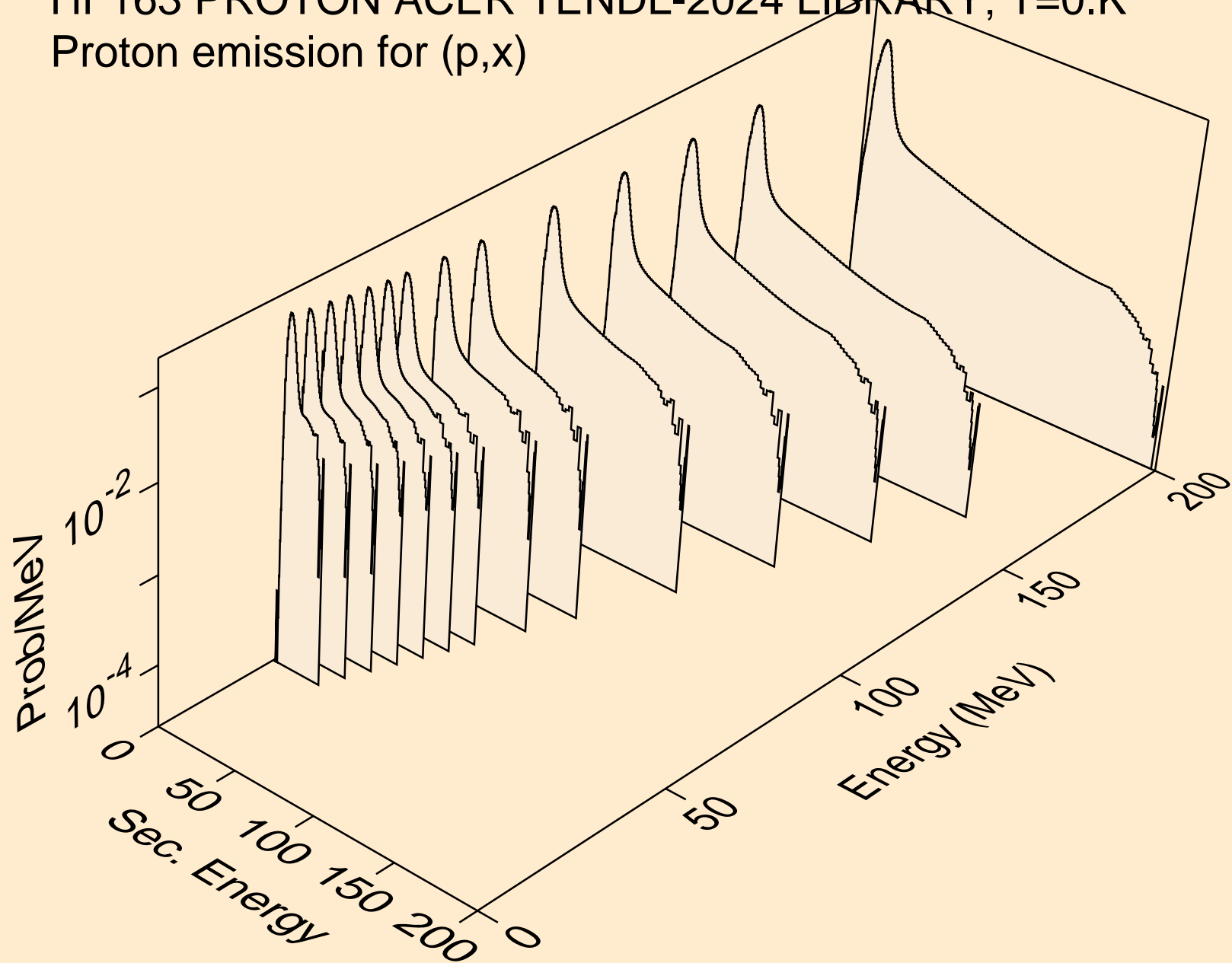

HF163 PROTON ACER TENDL-2024 LIBRARY; T=0.K  
Proton emission for (p,n\*)p

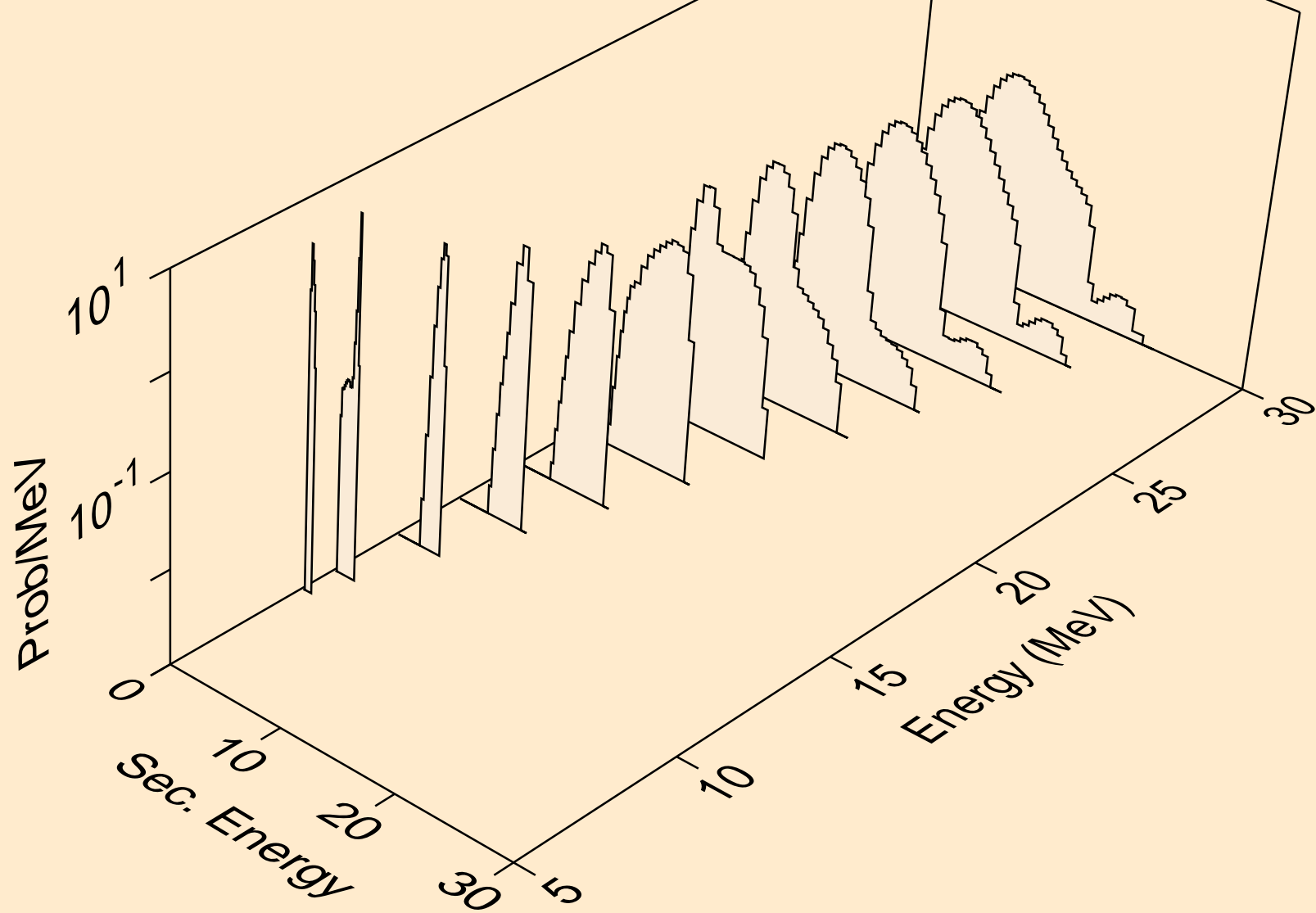

HF163 PROTON ACER TENDL-2024 LIBRARY; T=0.K  
Proton emission for (p,2np)

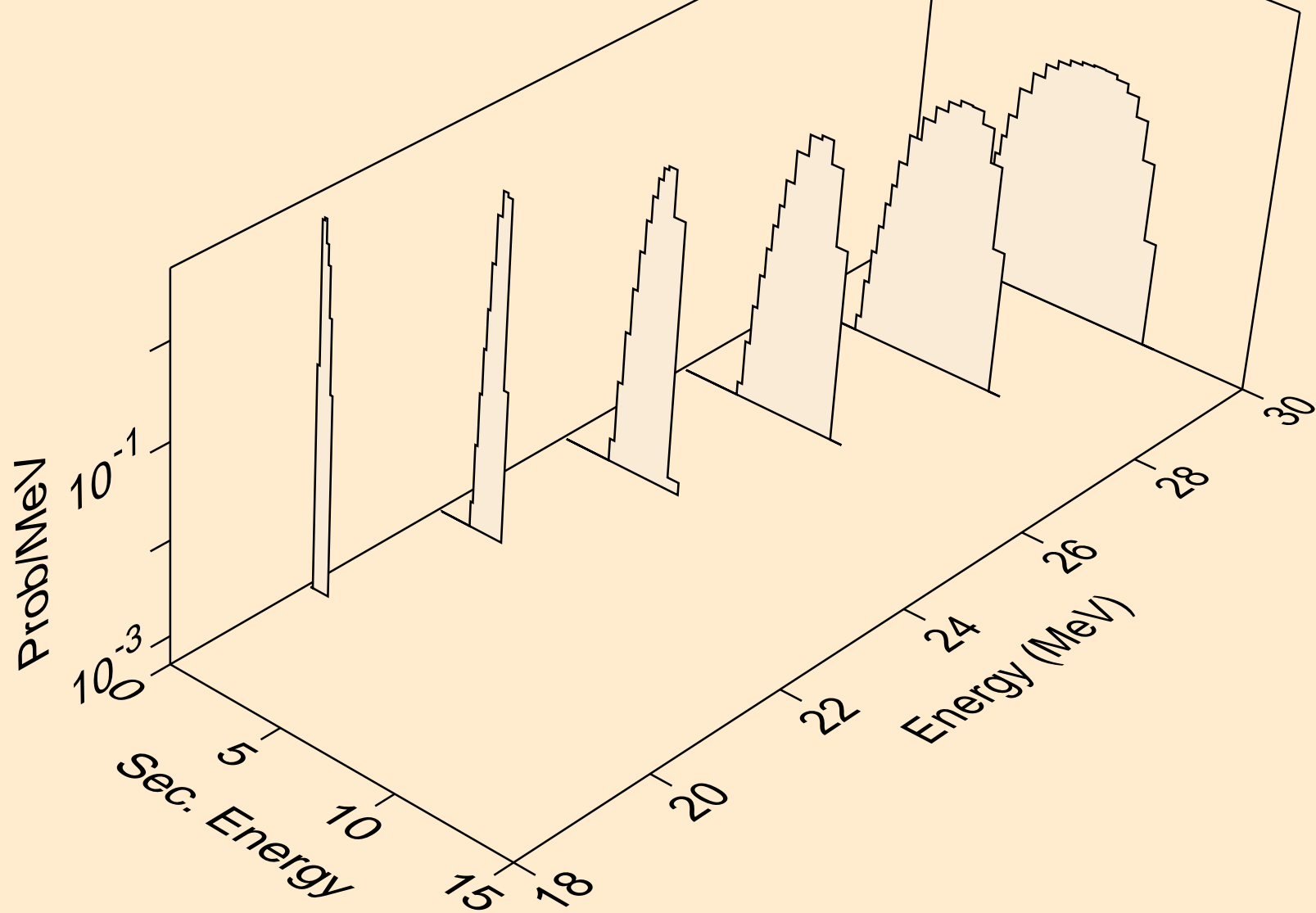

HF163 PROTON ACER TENDL-2024 LIBRARY; T=0.K  
Proton emission for (p,n2p)

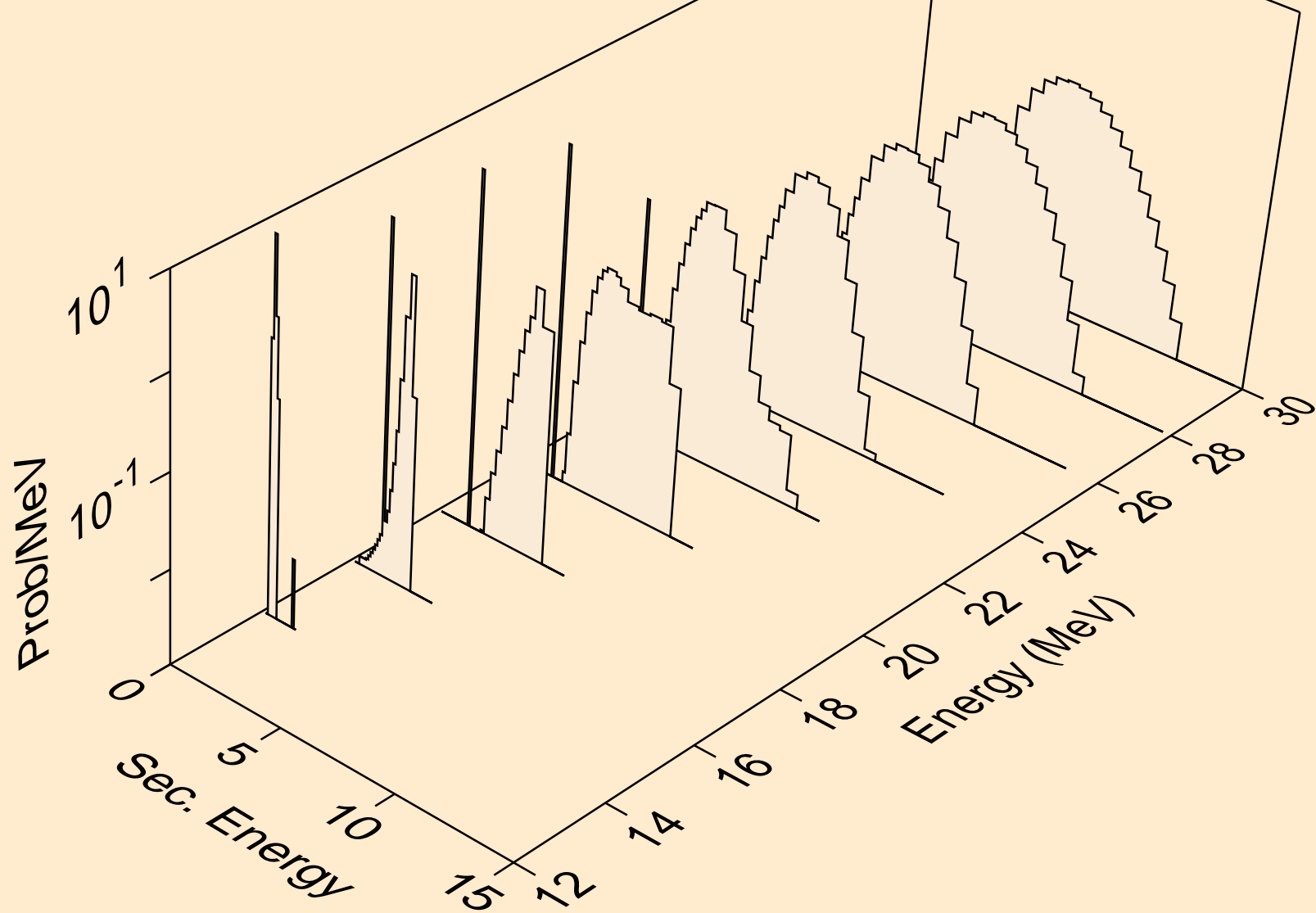

HF163 PROTON ACER TENDL-2024 LIBRARY; T=0.K  
Proton emission for (p,npa)

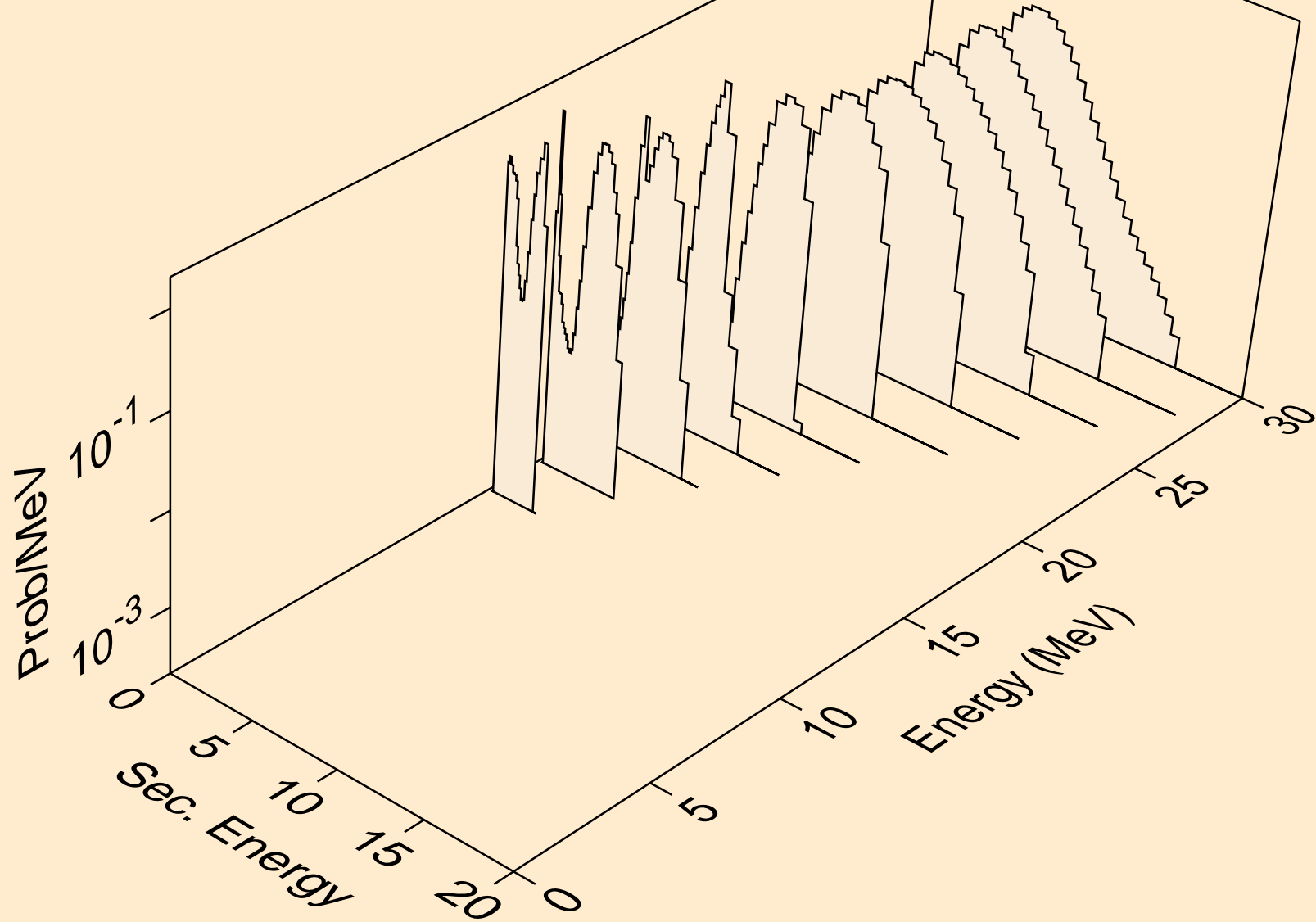

HF163 PROTON ACER TENDL-2024 LIBRARY; T=0.K  
Proton emission for inelastic

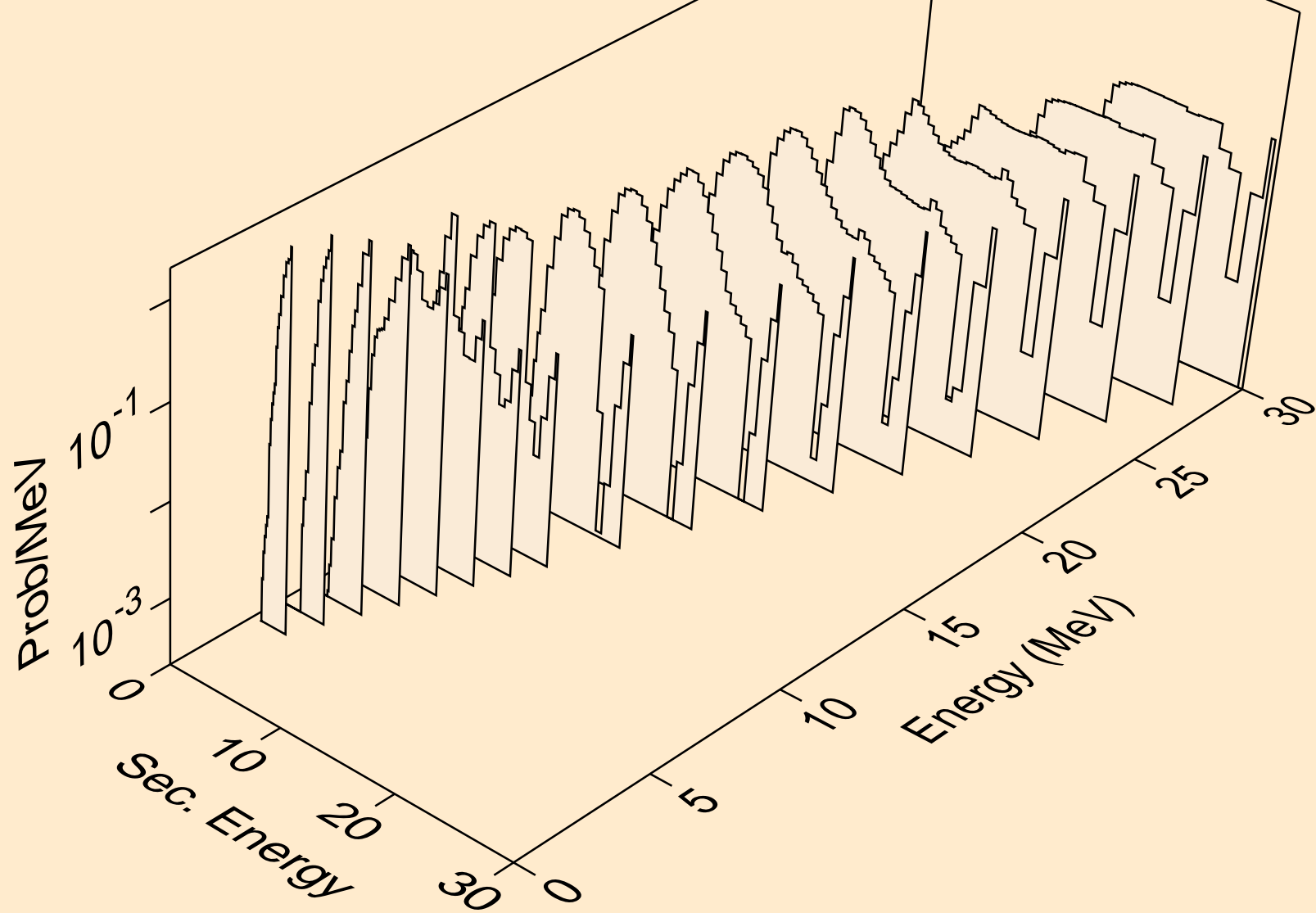

HF163 PROTON ACER TENDL-2024 LIBRARY; T=0.K  
Proton emission for (p,2p)

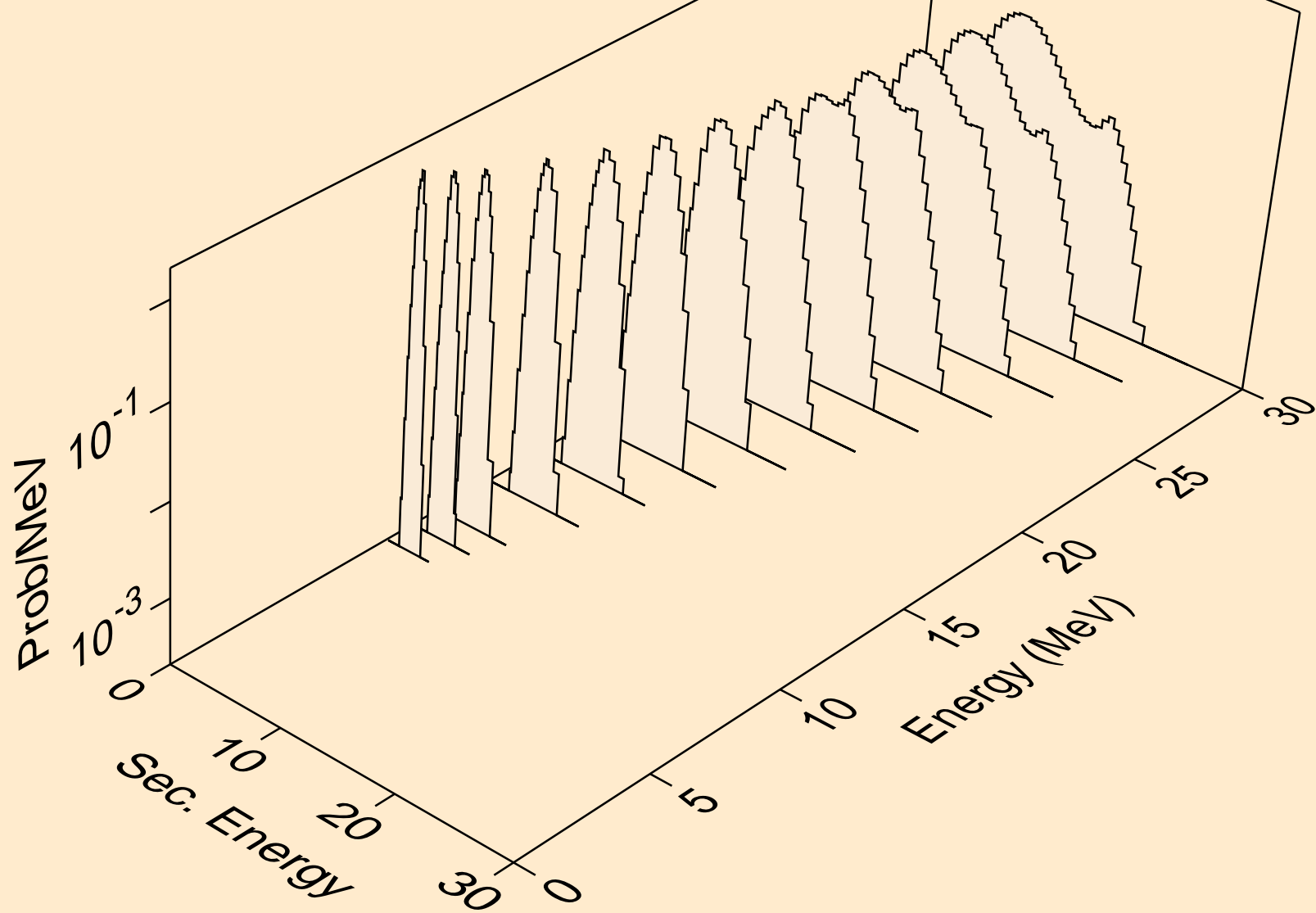

HF163 PROTON ACER TENDL-2024 LIBRARY; T=0.K  
Proton emission for (p,pa)

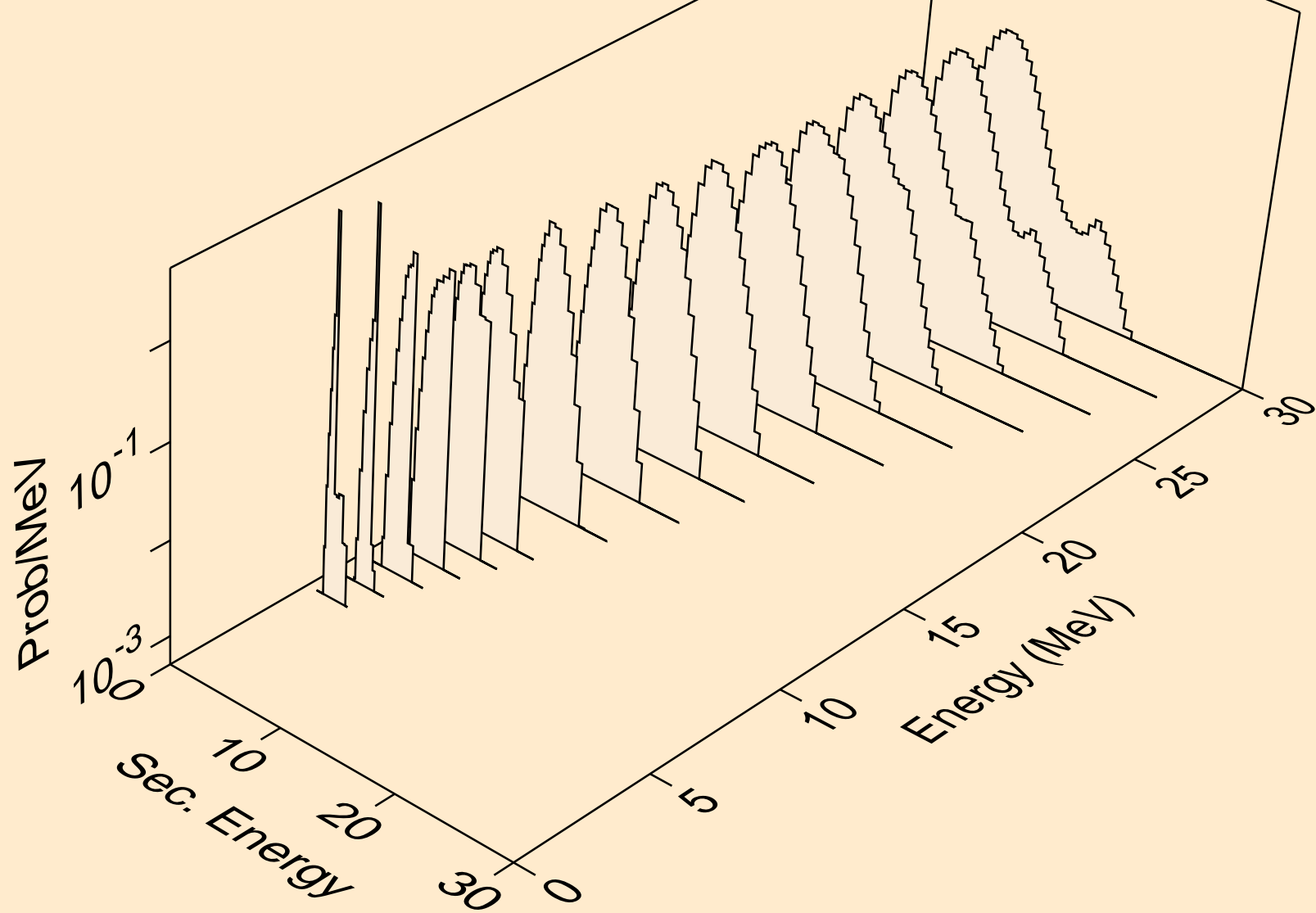

HF163 PROTON ACER TENDL-2024 LIBRARY; T=0.K  
Proton emission for (p,pd)

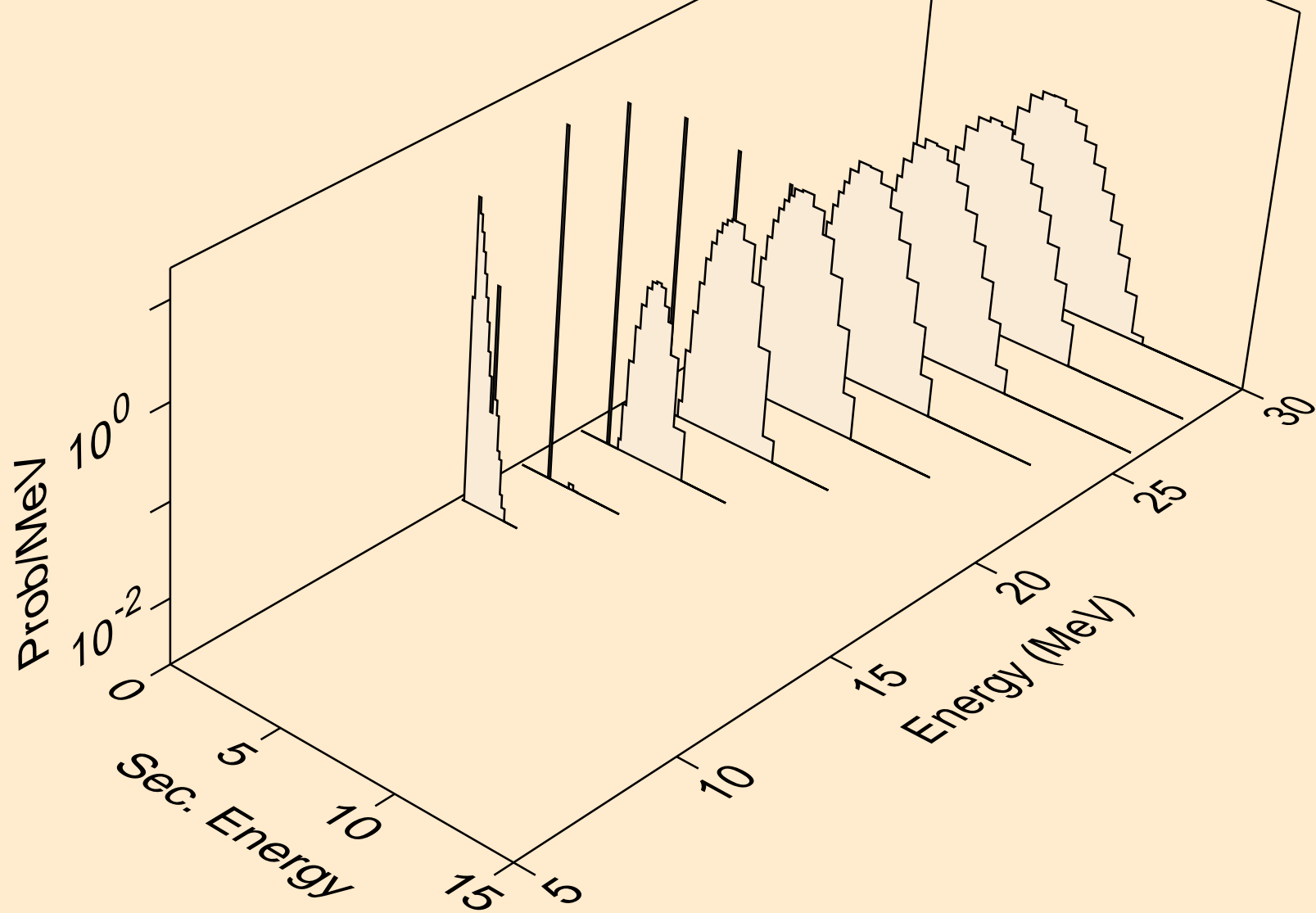

HF163 PROTON ACER TENDL-2024 LIBRARY; T=0.K  
Proton emission for (p,pt)

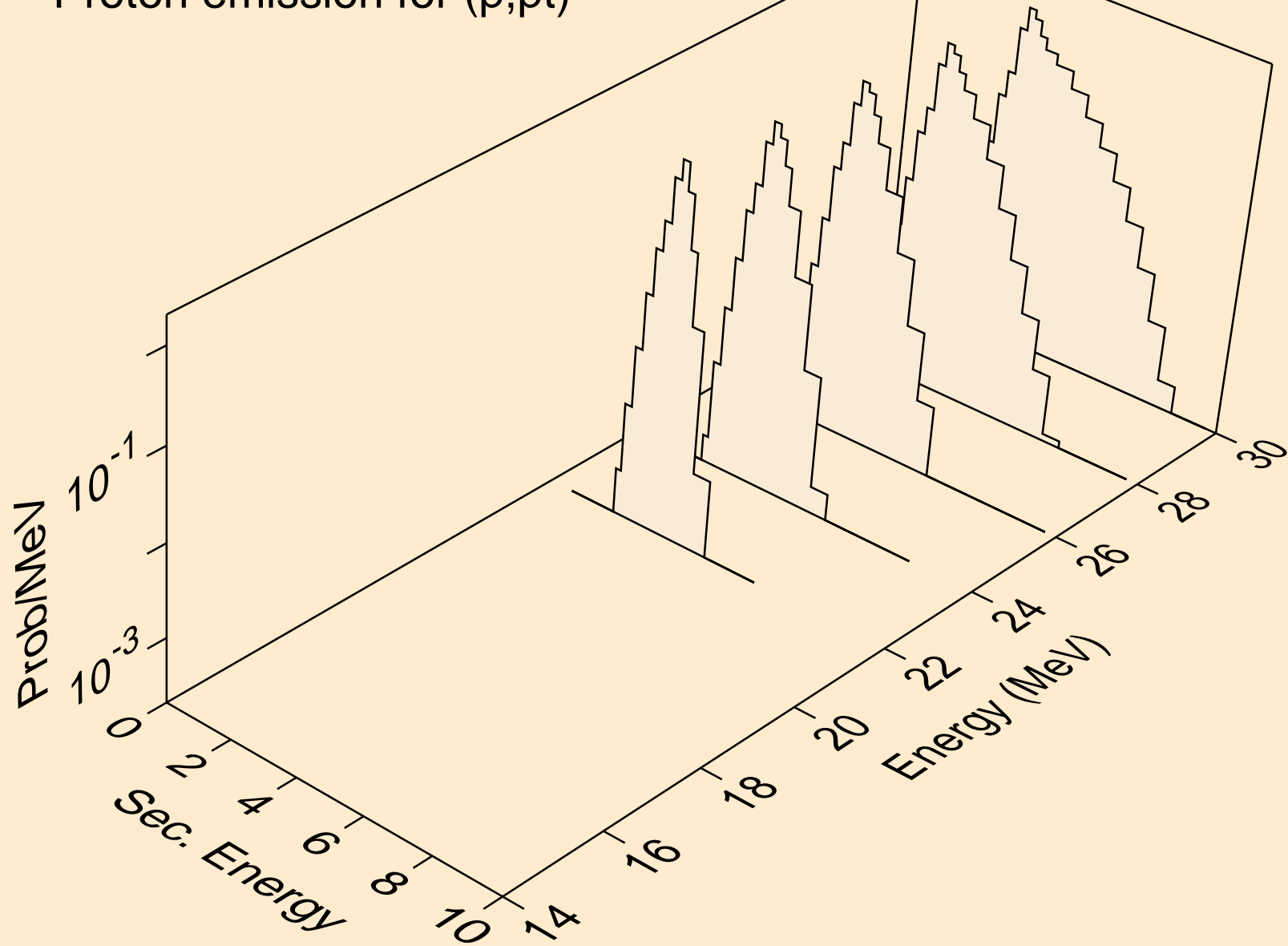

HF163 PROTON ACER TENDL-2024 LIBRARY; T=0.K  
Photon emission for (z,n)

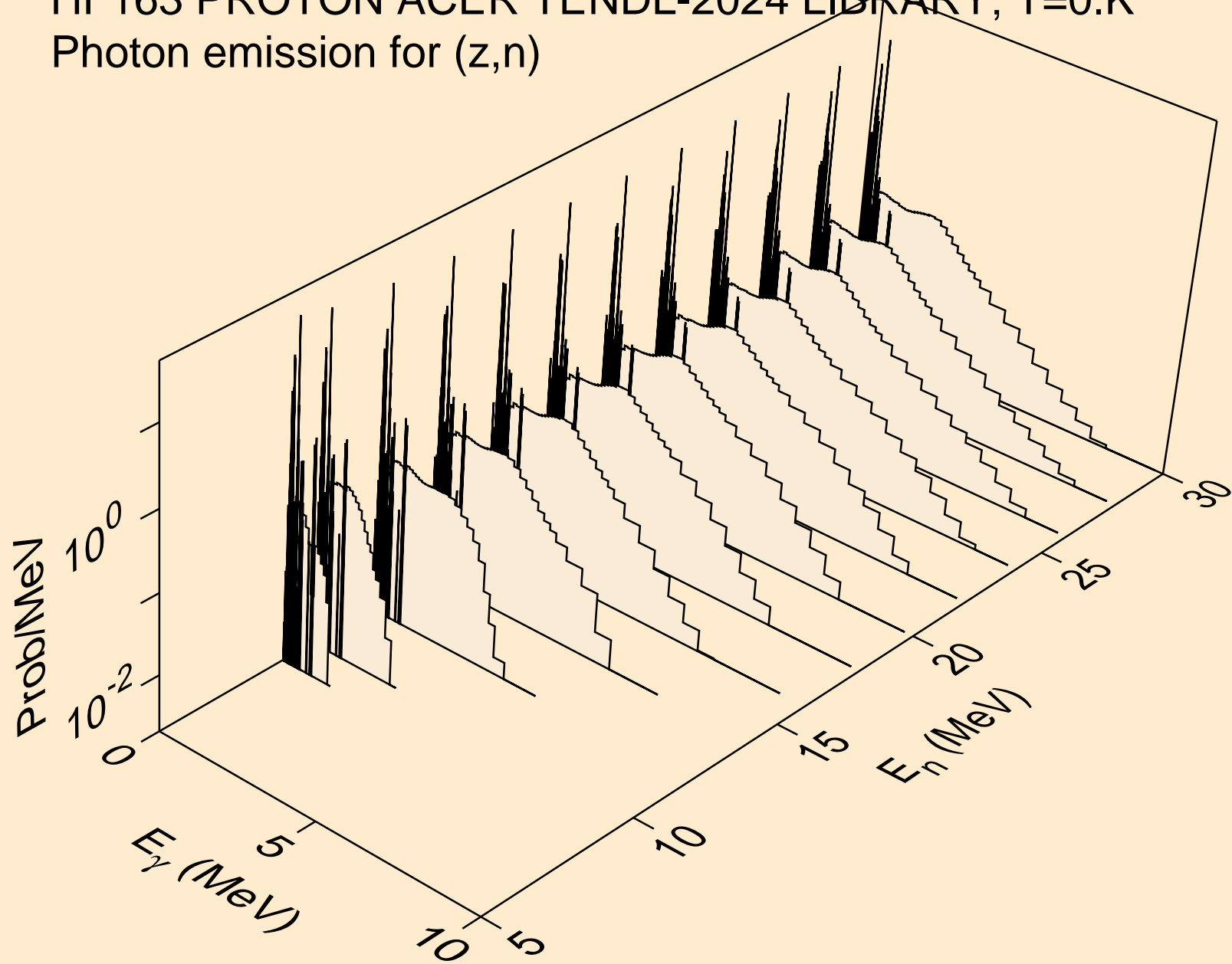

HF163 PROTON ACER TENDL-2024 LIBRARY; T=0.K  
Photon emission for (z,x)

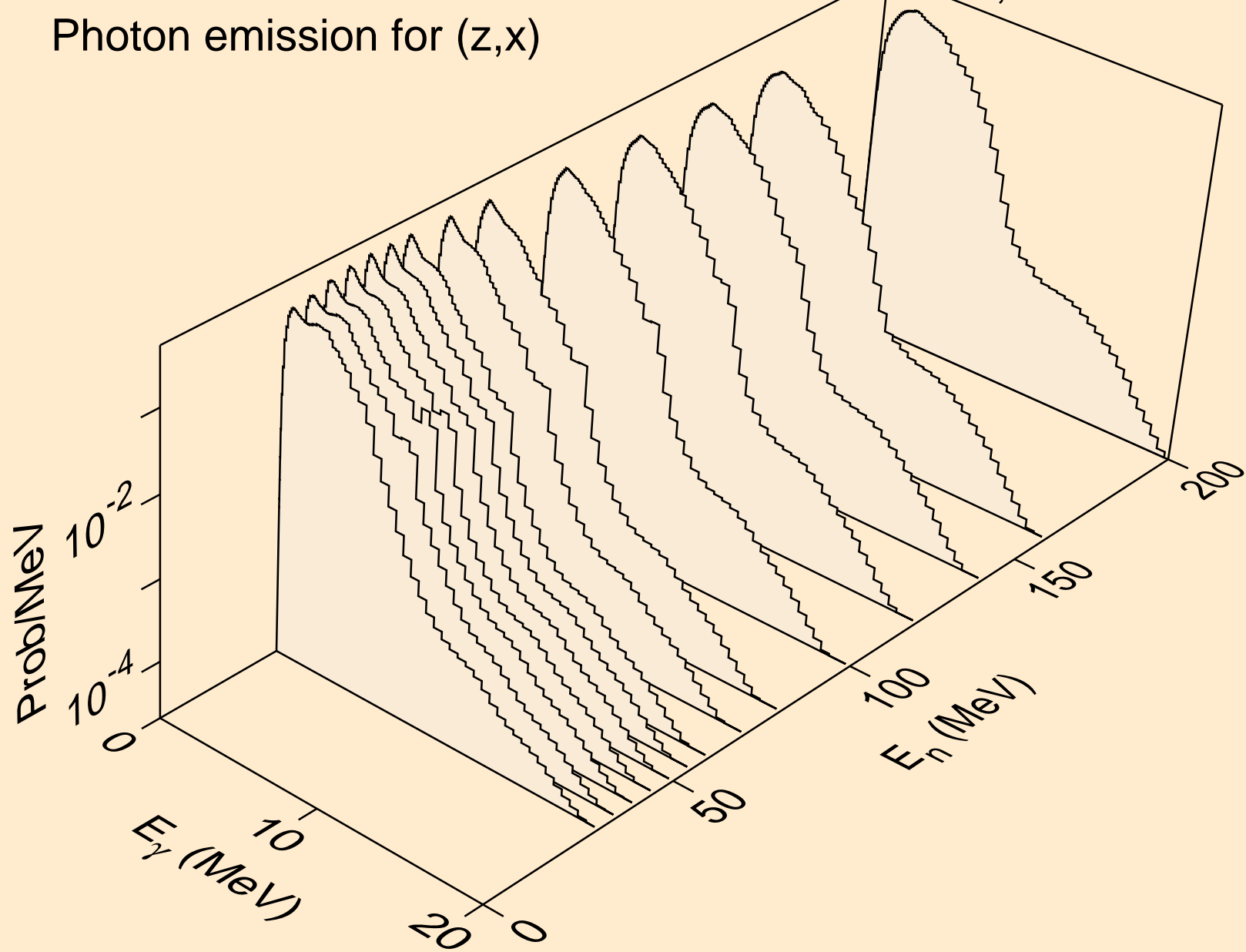

HF163 PROTON ACER TENDL-2024 LIBRARY; T=0.K  
Photon emission for (n,2n)

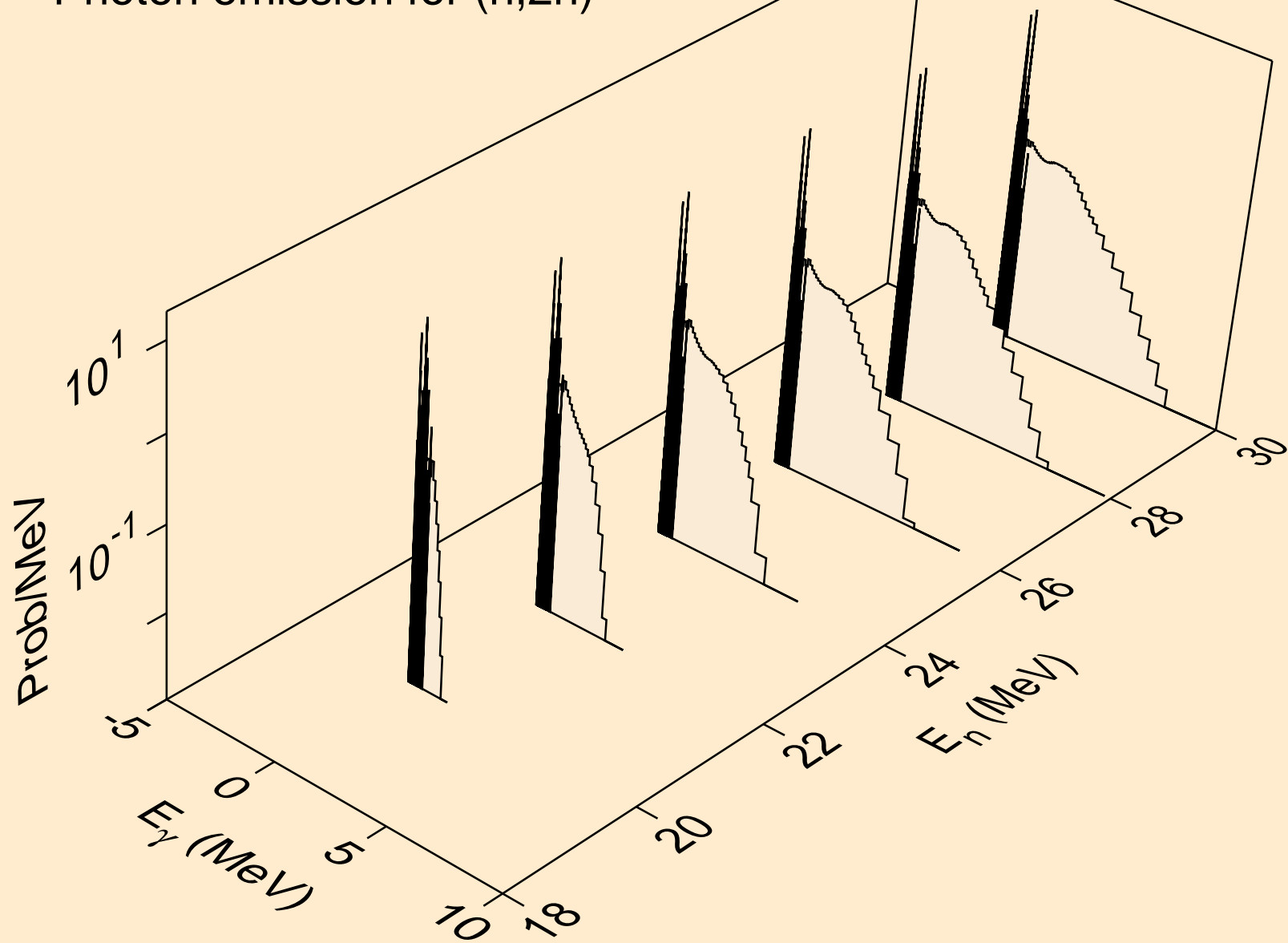

HF163 PROTON ACER TENDL-2024 LIBRARY; T=0.K  
Photon emission for (n,3n)

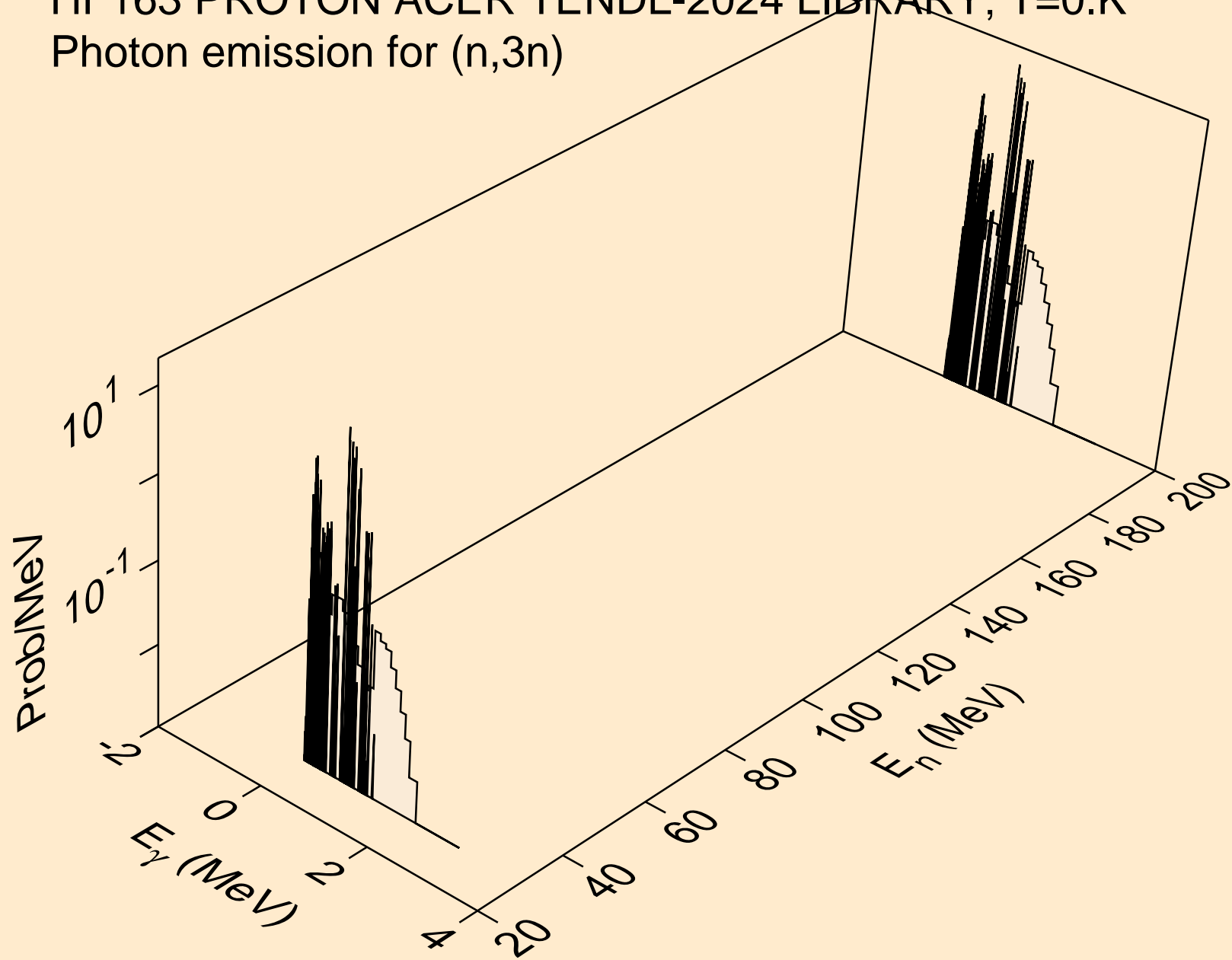

HF163 PROTON ACER TENDL-2024 LIBRARY; T=0.K  
Photon emission for (n,n\*)a

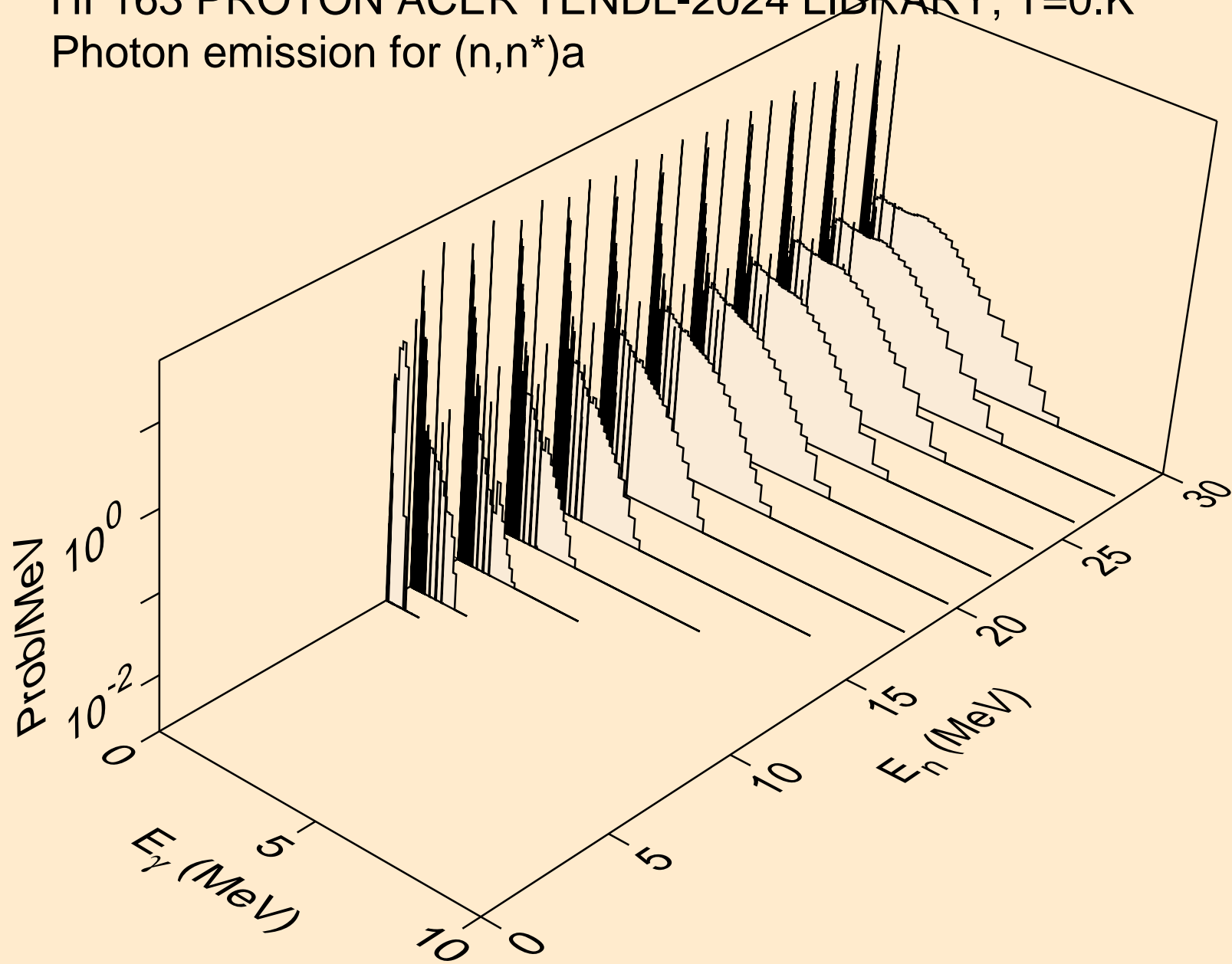

HF163 PROTON ACER TENDL-2024 LIBRARY; T=0.K  
Photon emission for (n,n\*)3a

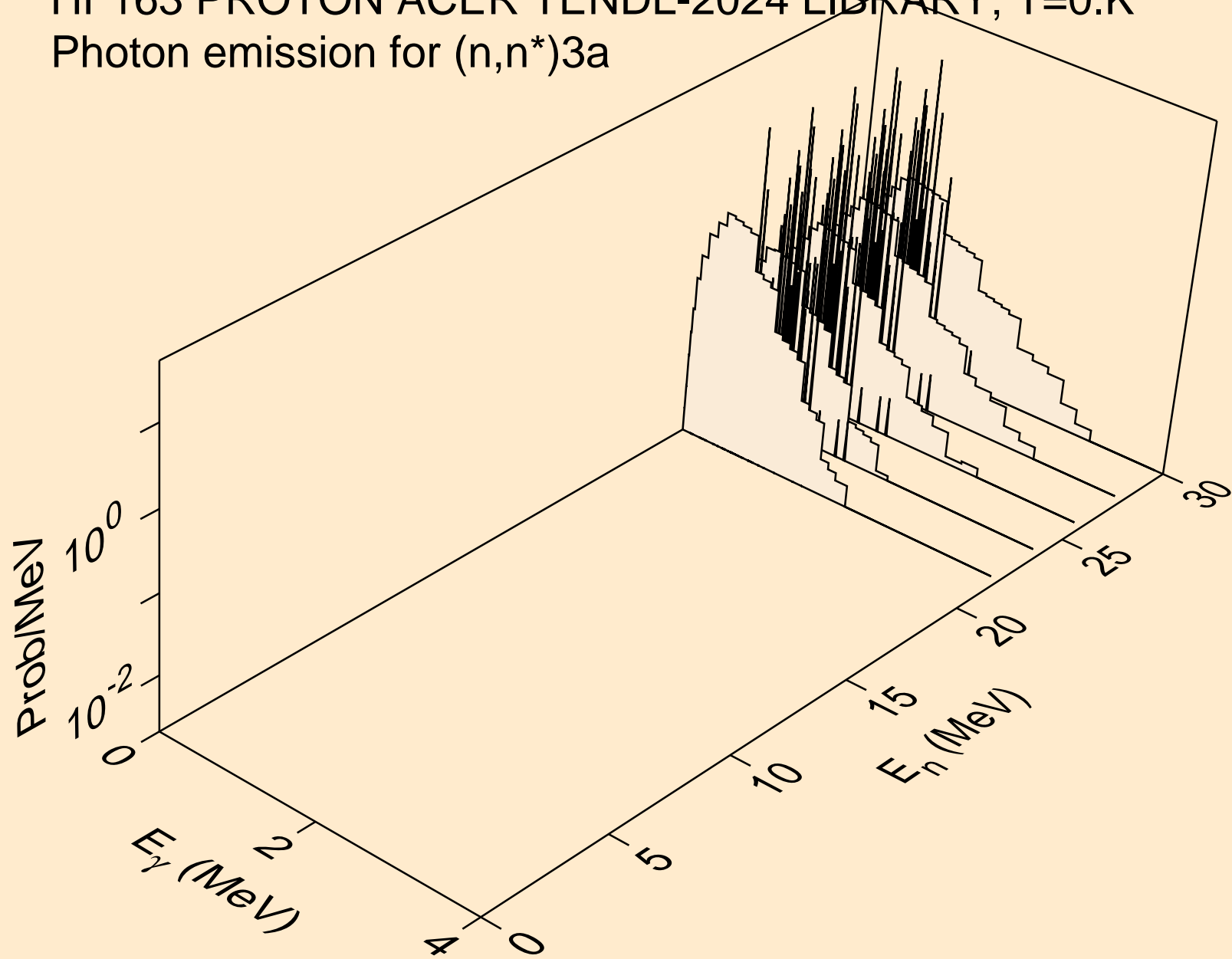

HF163 PROTON ACER TENDL-2024 LIBRARY; T=0.K  
Photon emission for (n,2n)a

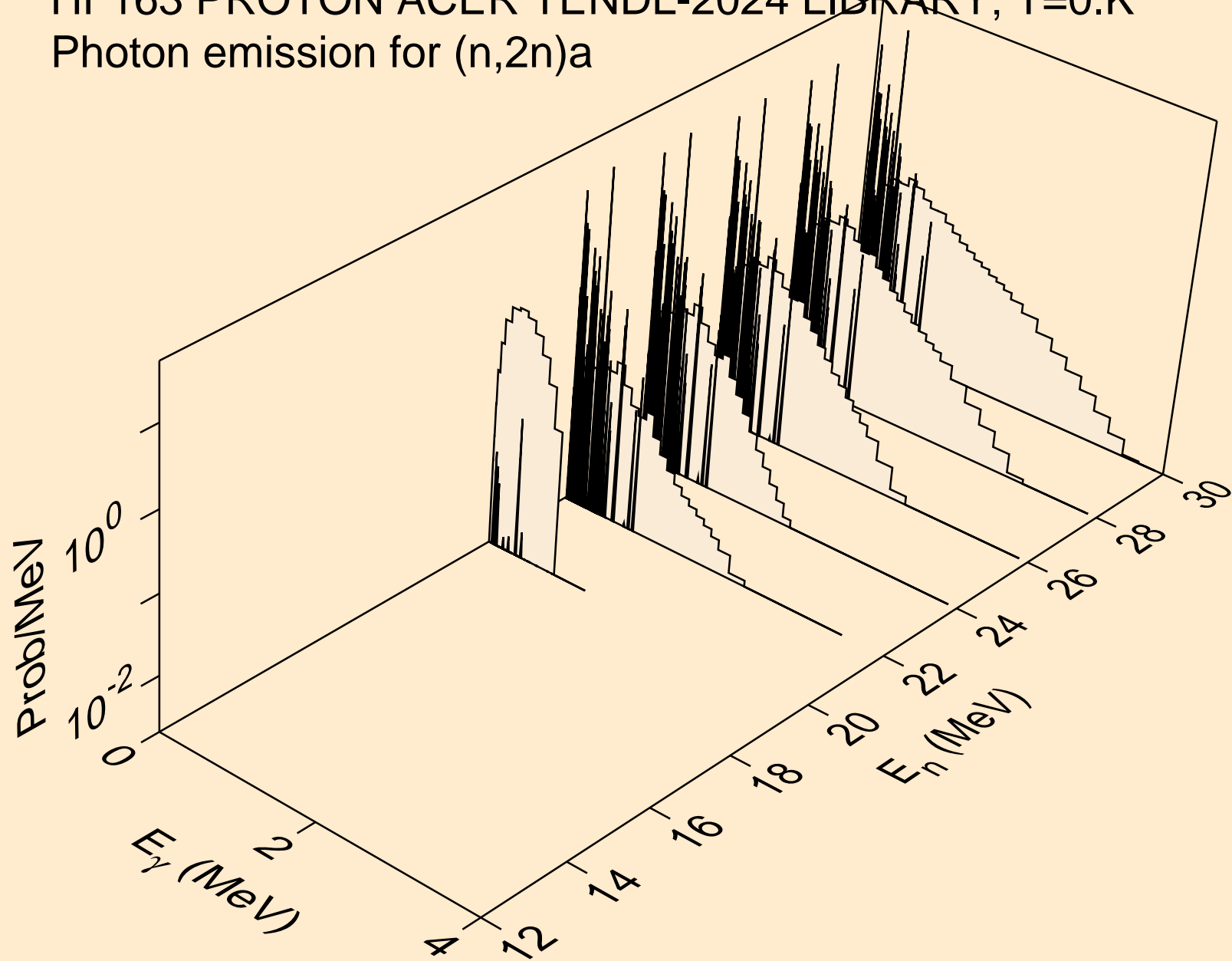

HF163 PROTON ACER TENDL-2024 LIBRARY; T=0.K  
Photon emission for (n,3n)a

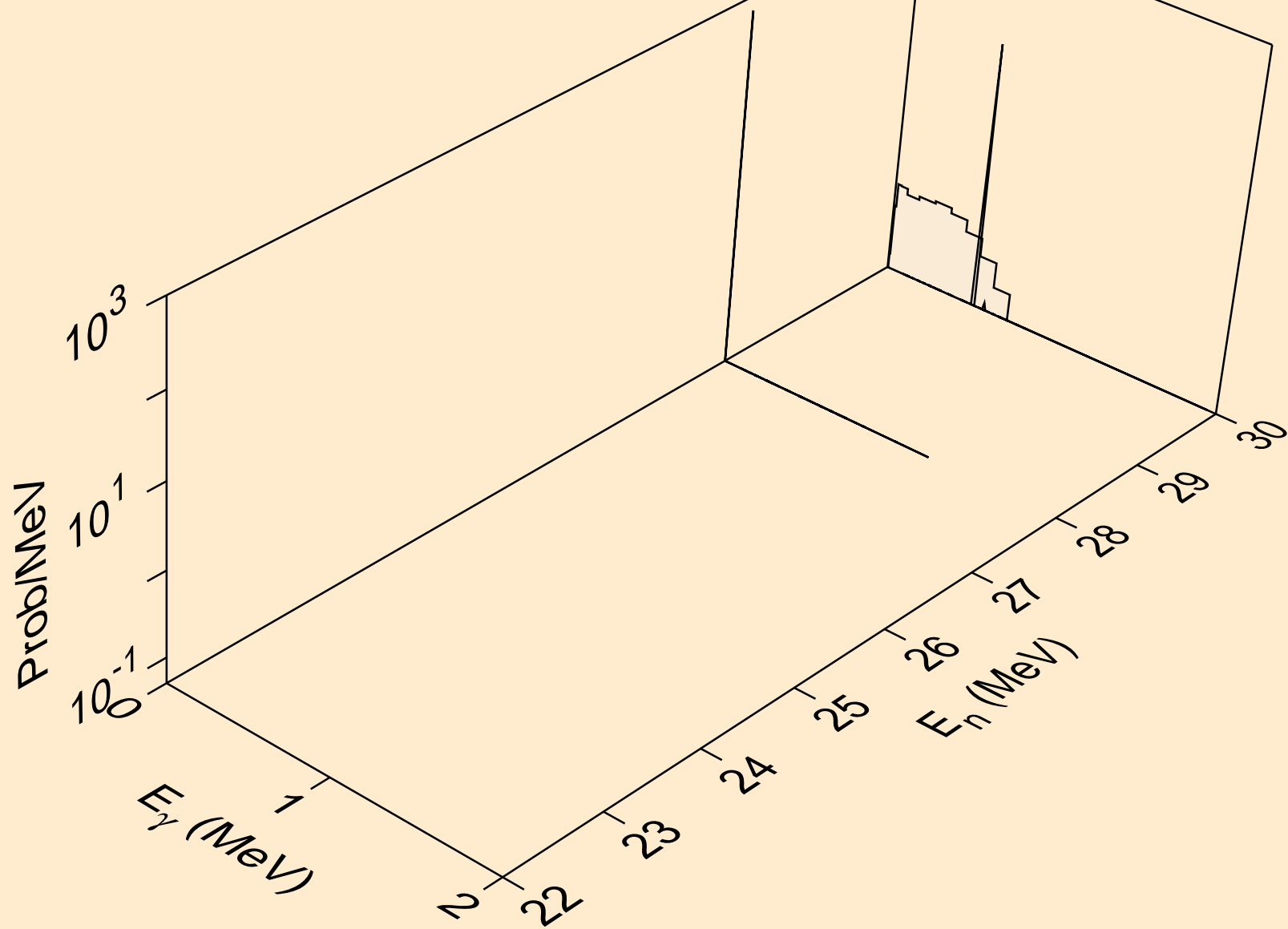

HF163 PROTON ACER TENDL-2024 LIBRARY; T=0.K  
Photon emission for (n,n\*)p

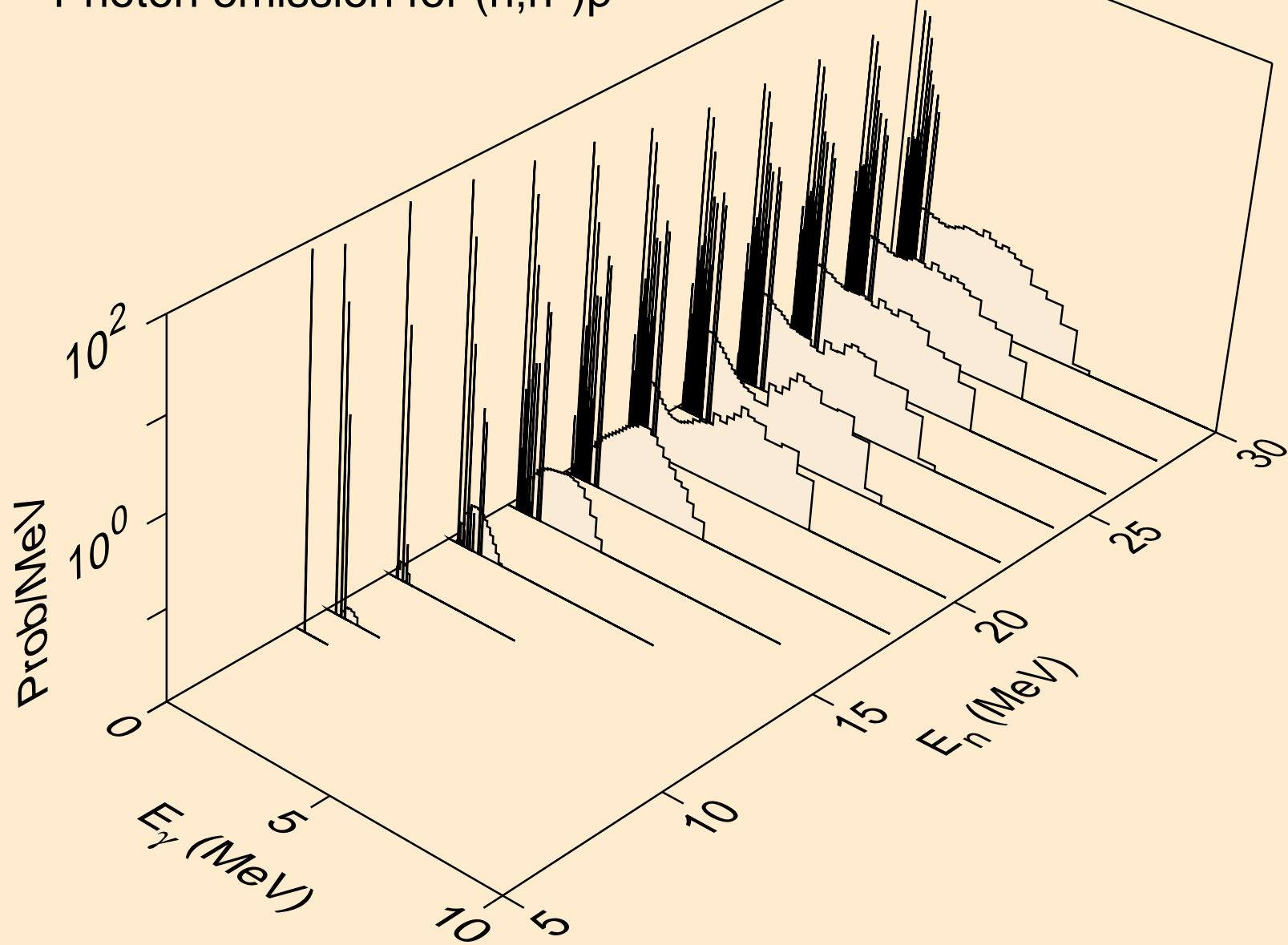

HF163 PROTON ACER TENDL-2024 LIBRARY; T=0.K  
Photon emission for (n,n\*)2a

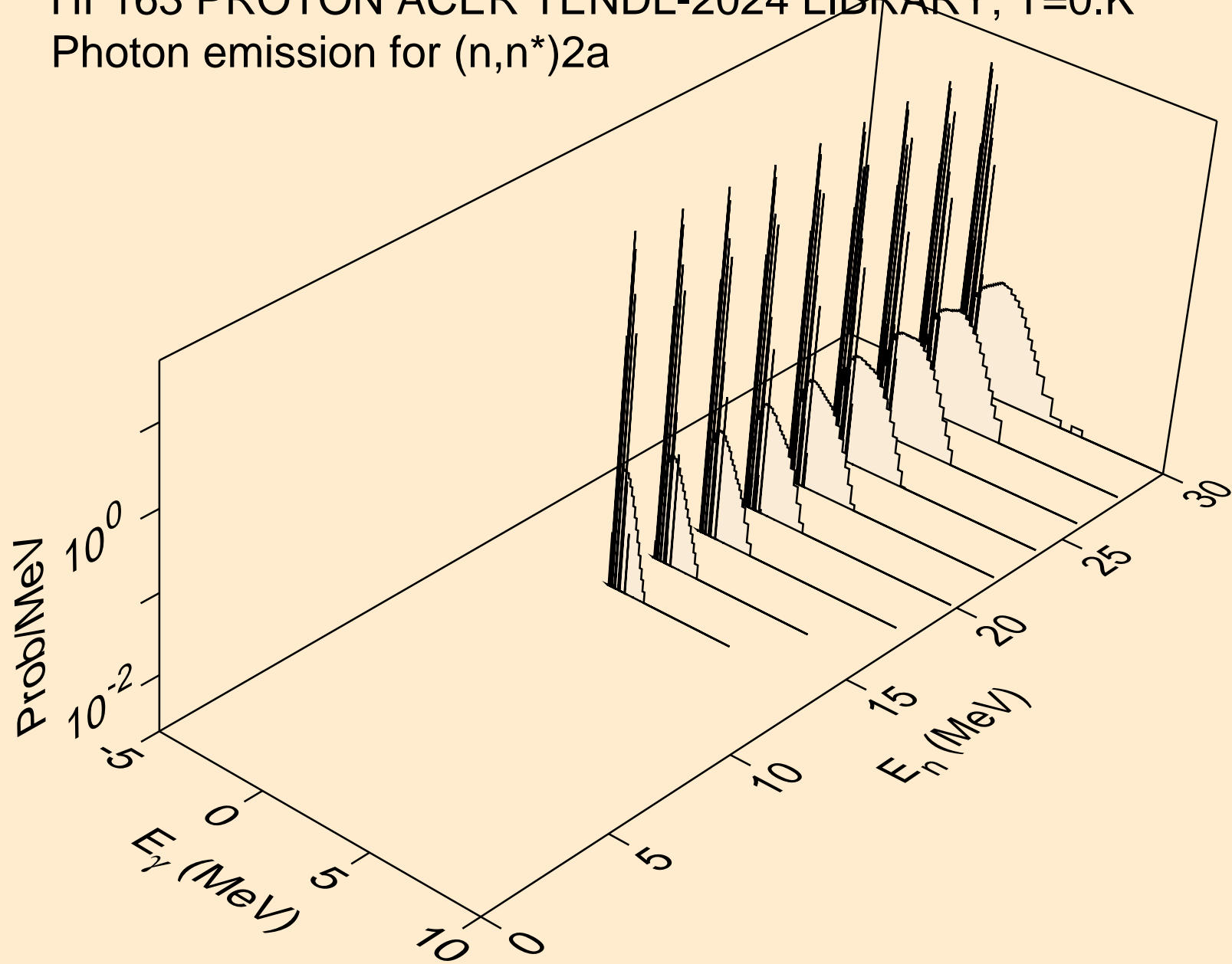

HF163 PROTON ACER TENDL-2024 LIBRARY; T=0.K  
Photon emission for (n,n\*)d

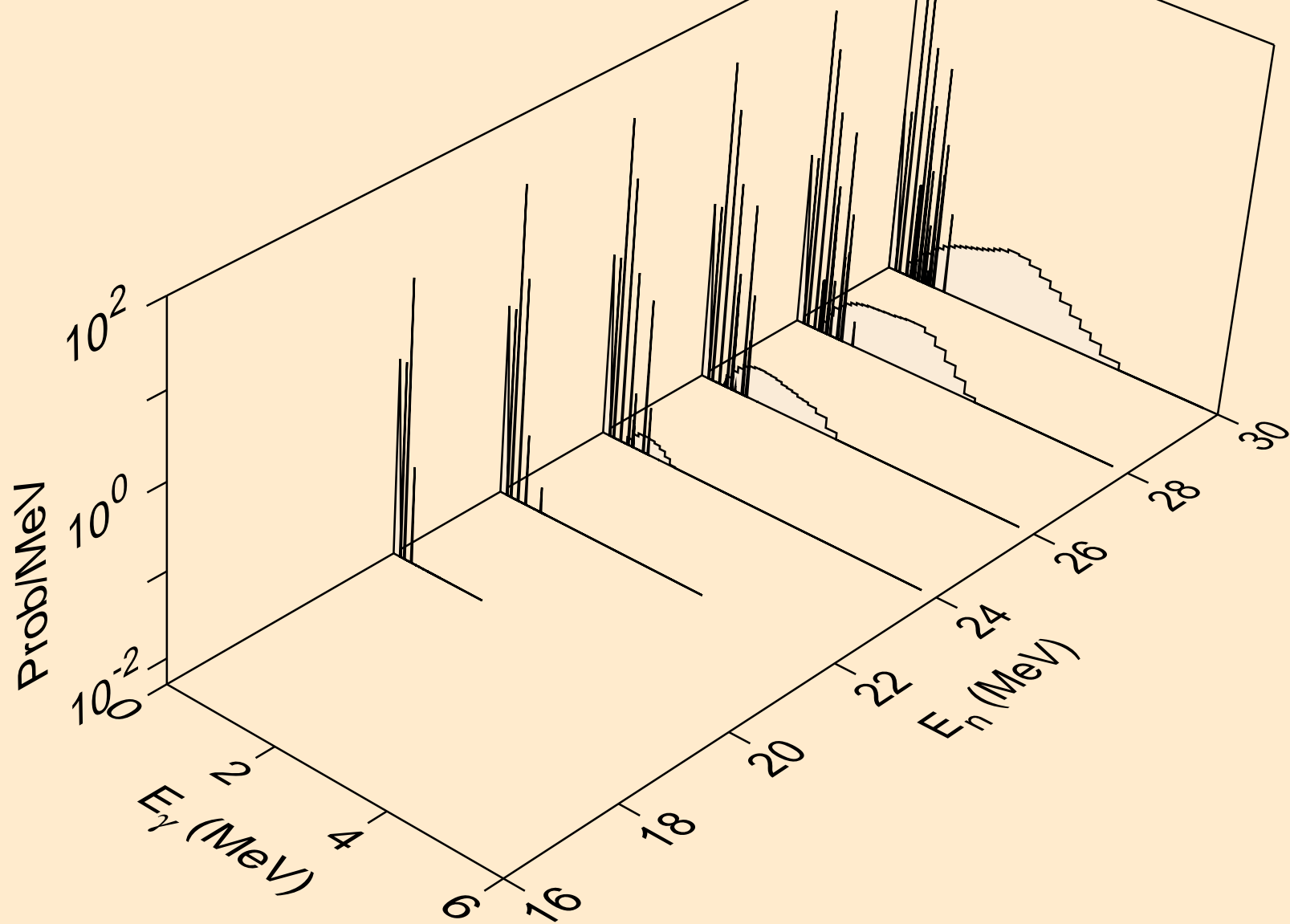

HF163 PROTON ACER TENDL-2024 LIBRARY; T=0.K  
Photon emission for (n,n\*)t

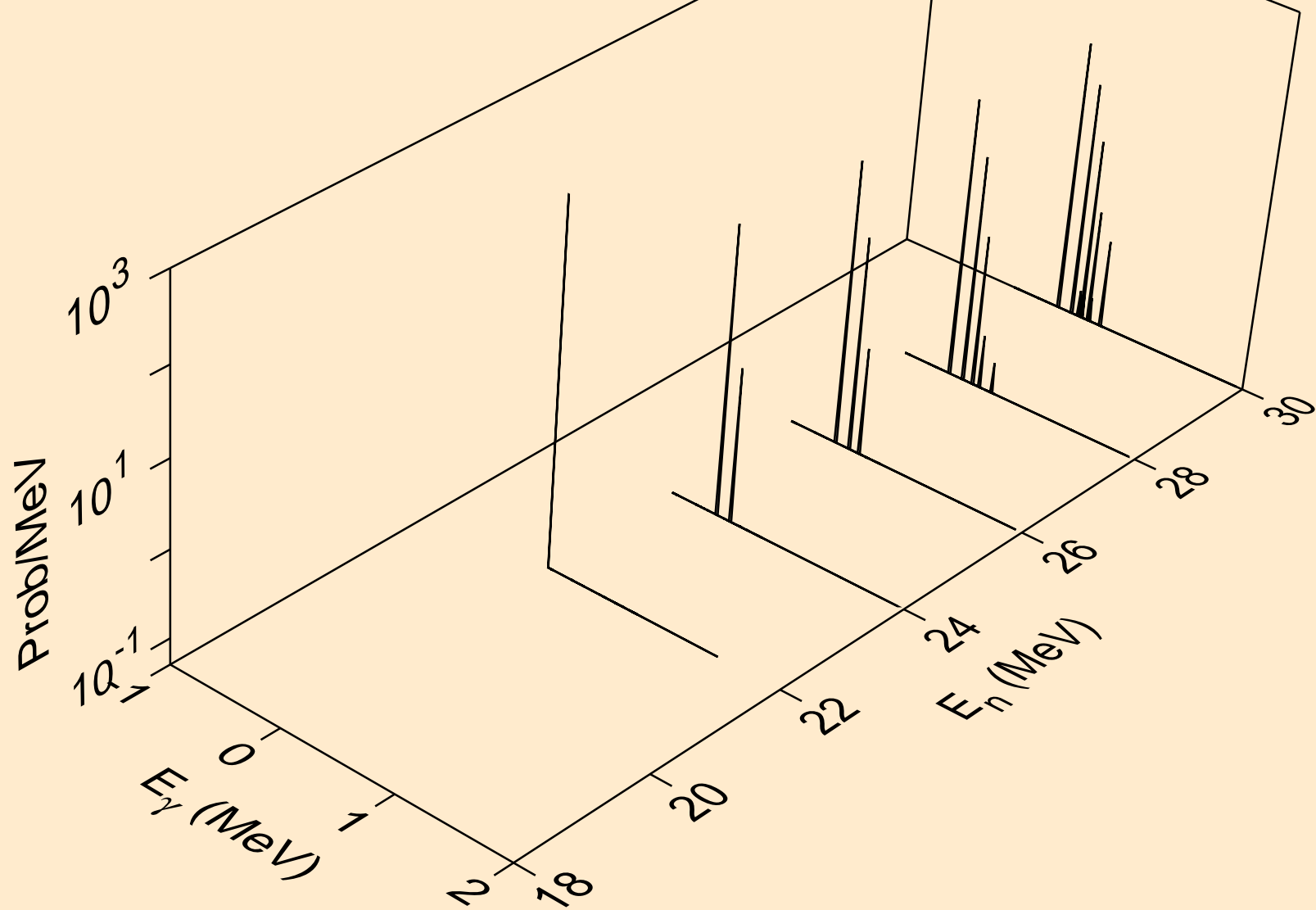

HF163 PROTON ACER TENDL-2024 LIBRARY; T=0.K  
Photon emission for (n,n\*)he3

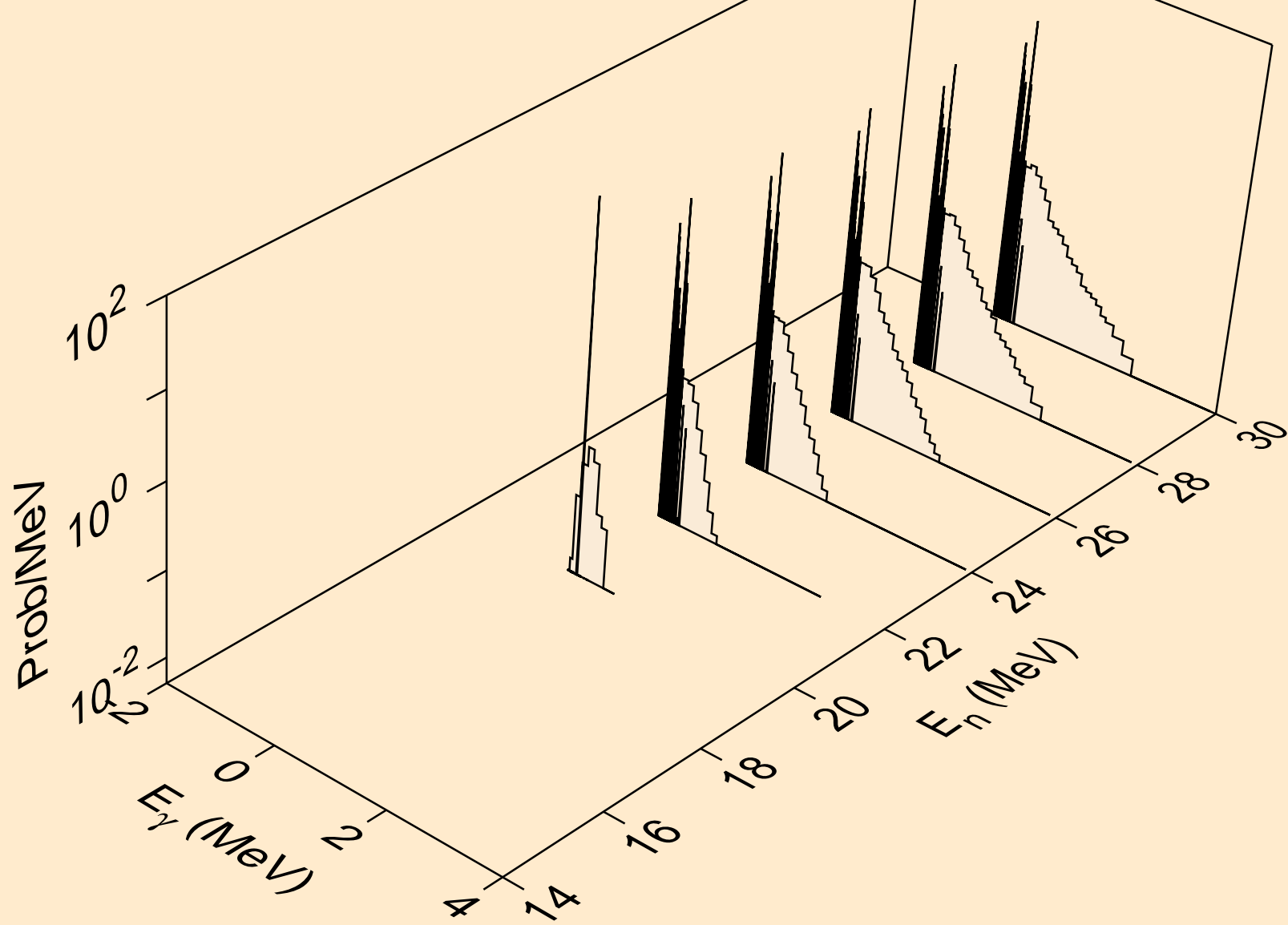

HF163 PROTON ACER TENDL-2024 LIBRARY; T=0.K  
Photon emission for (n,2np)

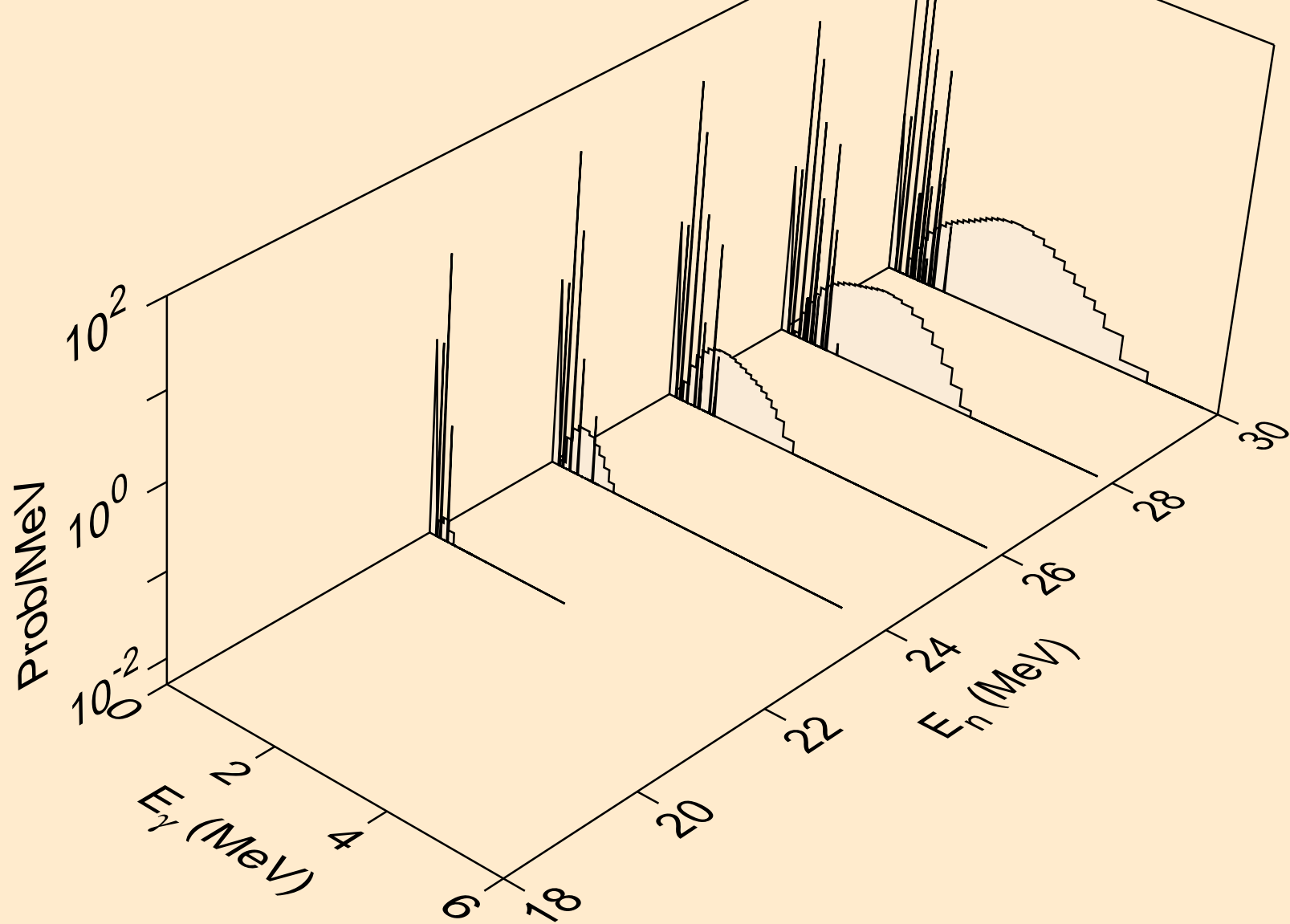

HF163 PROTON ACER TENDL-2024 LIBRARY; T=0.K  
Photon emission for (n,n2p)

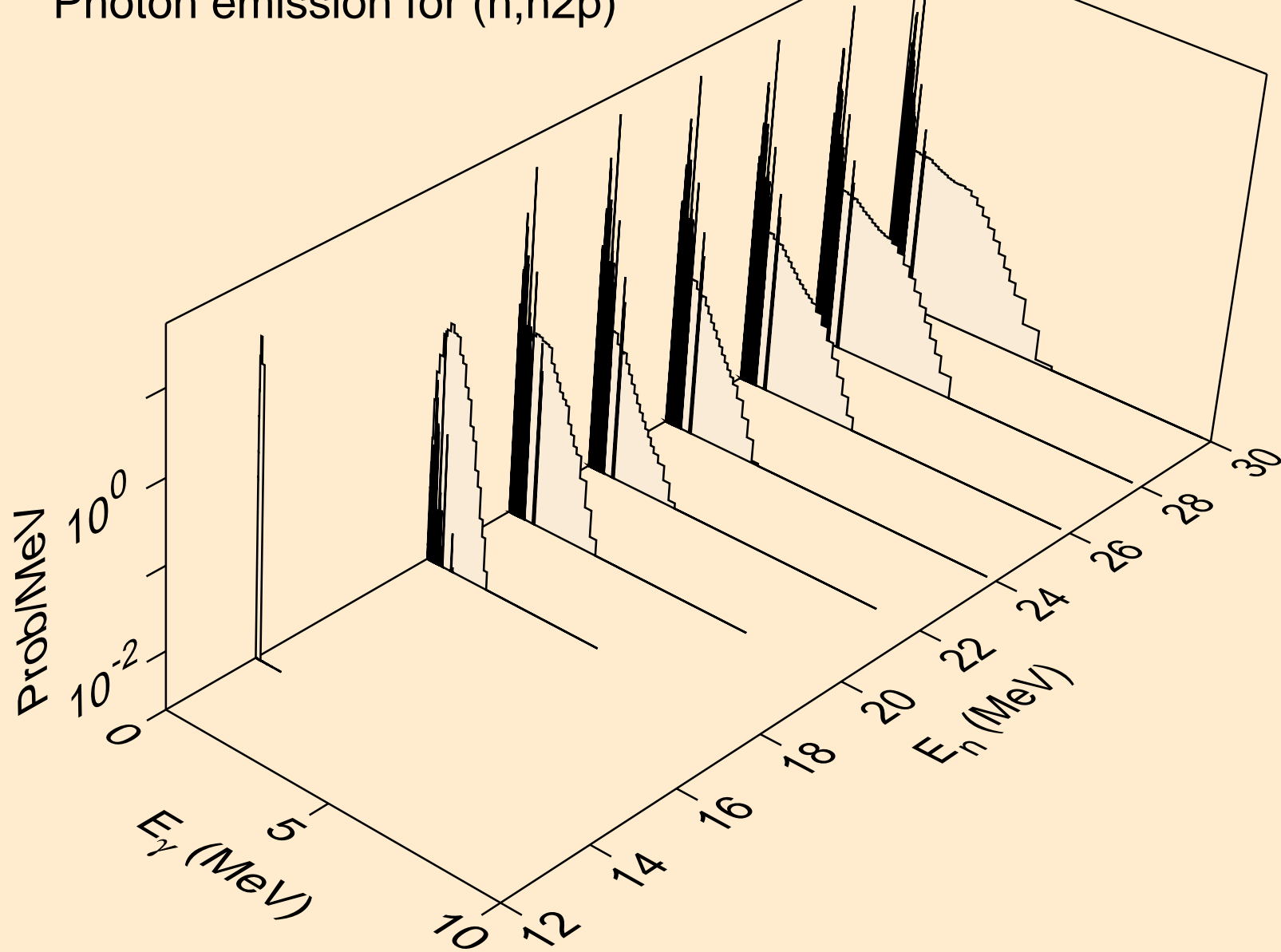

HF163 PROTON ACER TENDL-2024 LIBRARY; T=0.K  
Photon emission for (n,npa)

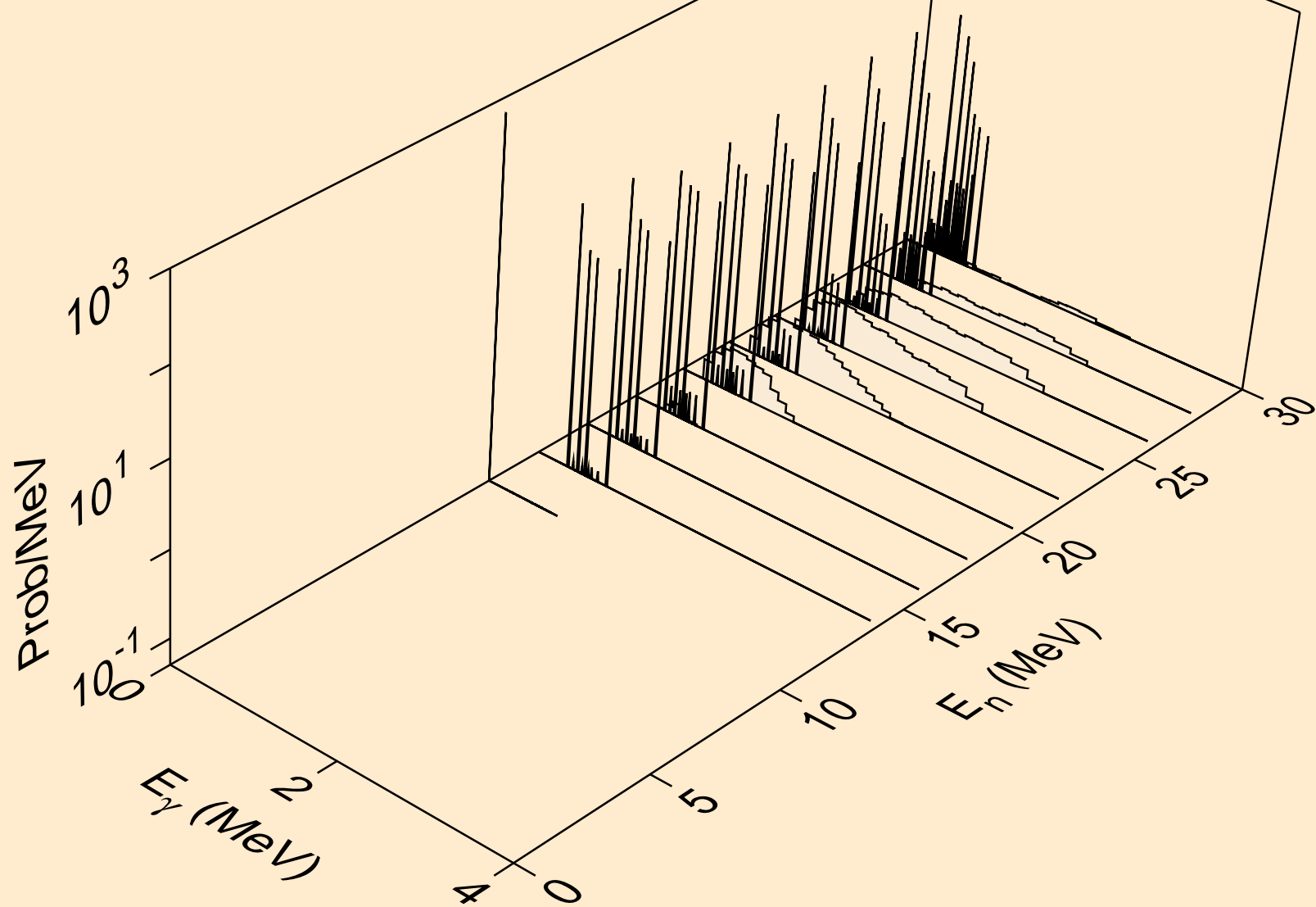

HF163 PROTON ACER TENDL-2024 LIBRARY; T=0.K  
Photon emission for (n,gma)

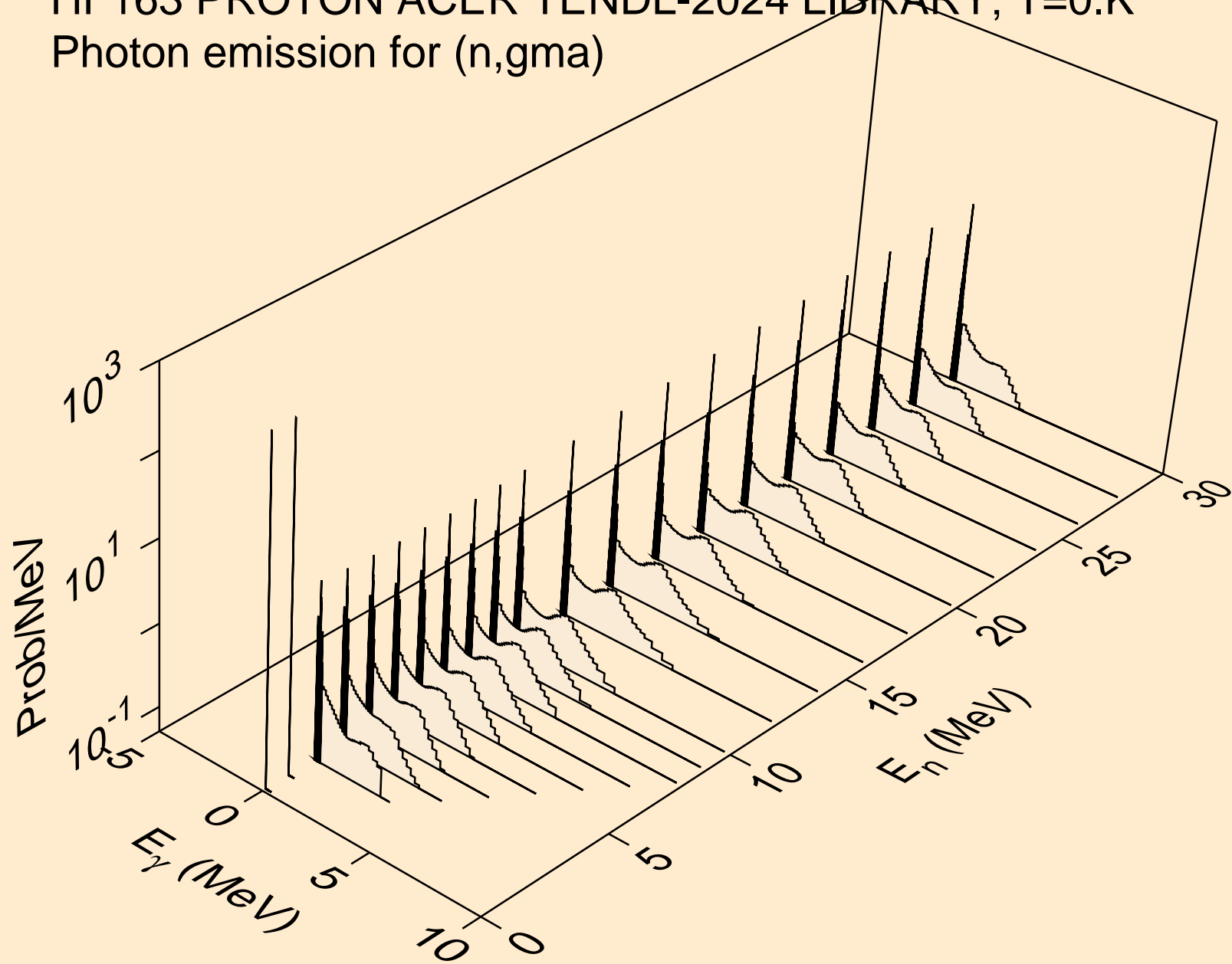

HF163 PROTON ACER TENDL-2024 LIBRARY; T=0.K  
Photon emission for inelastic

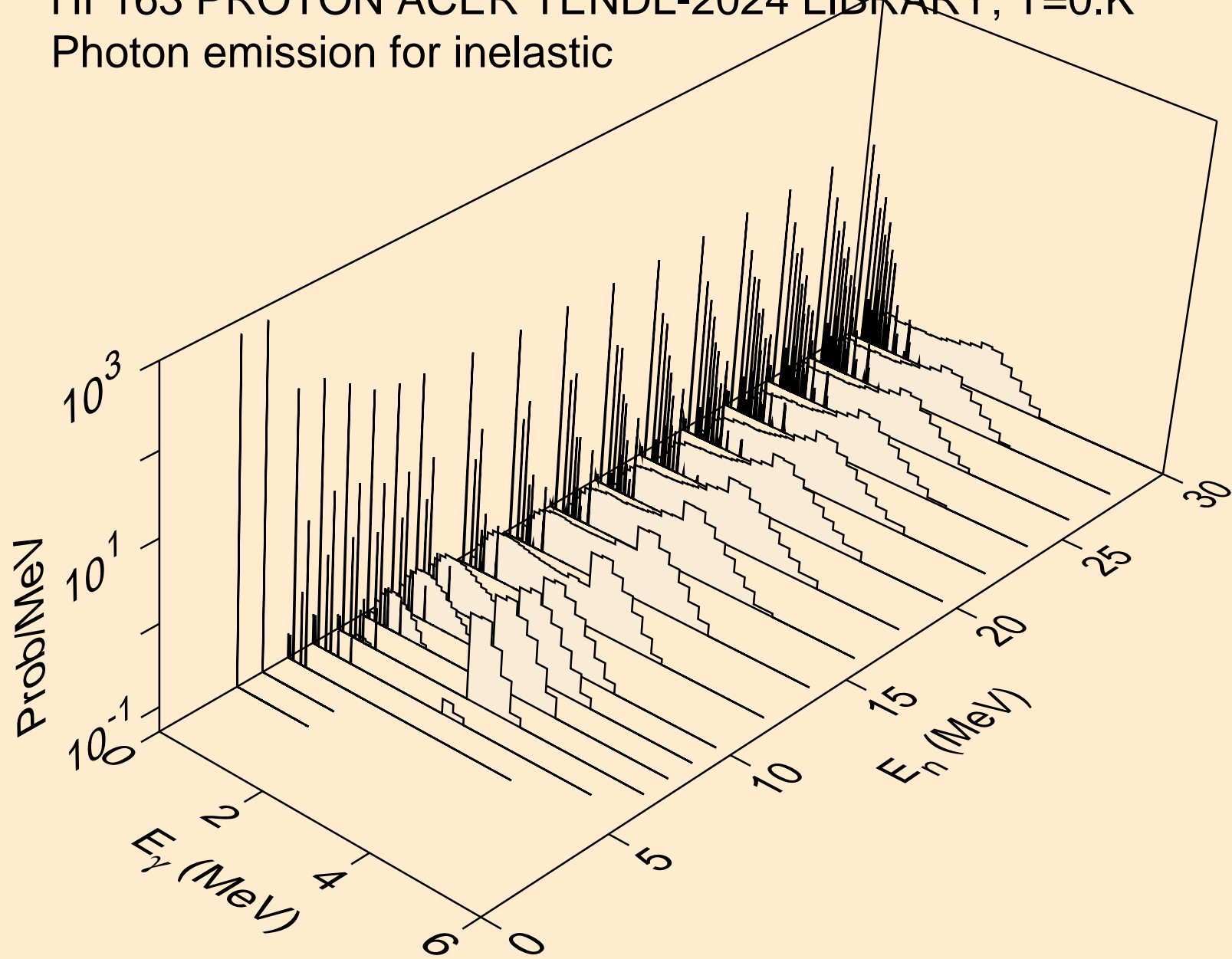

HF163 PROTON ACER TENDL-2024 LIBRARY; T=0.K  
Photon emission for (n,d)

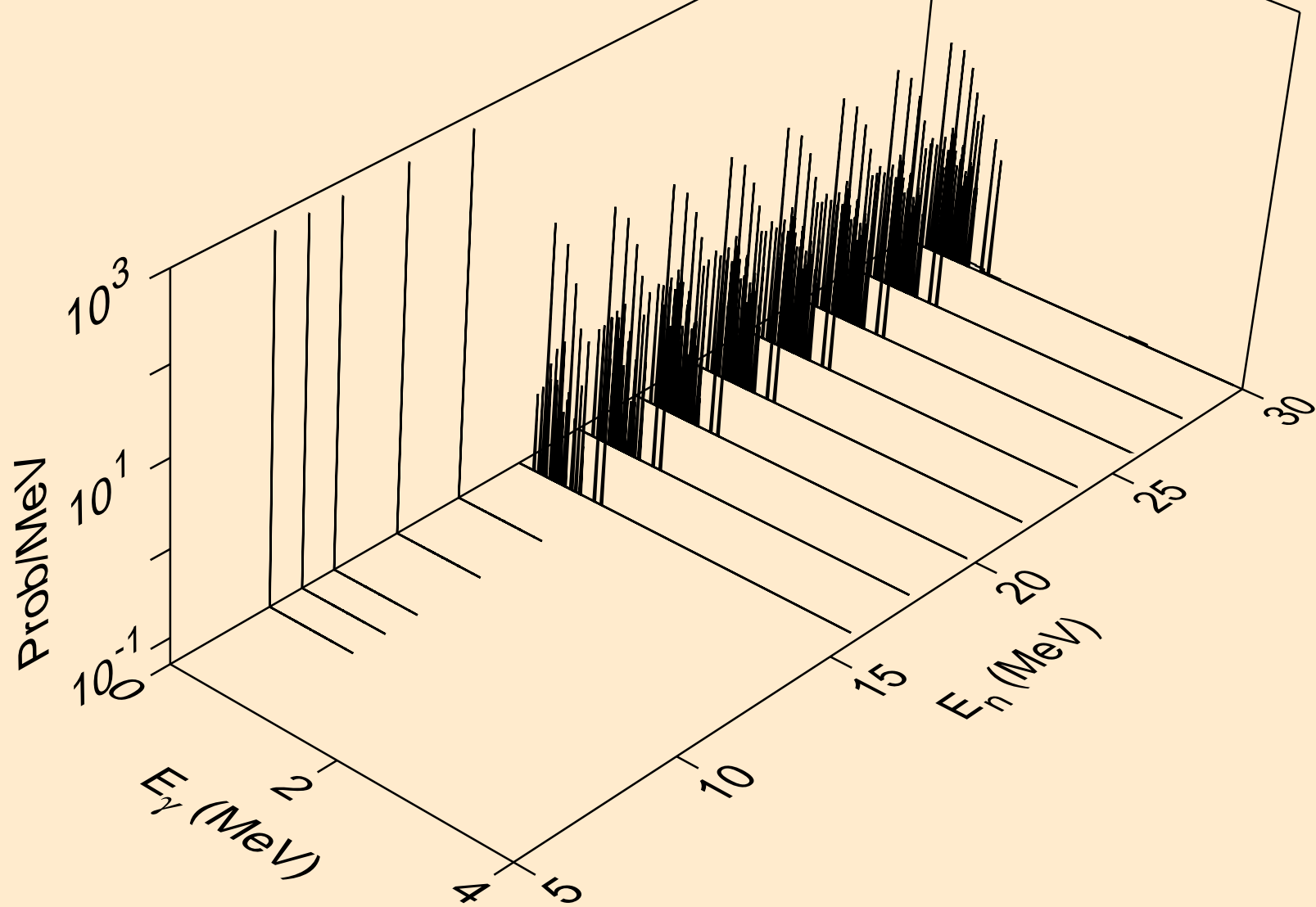

HF163 PROTON ACER TENDL-2024 LIBRARY; T=0.K  
Photon emission for (n,t)

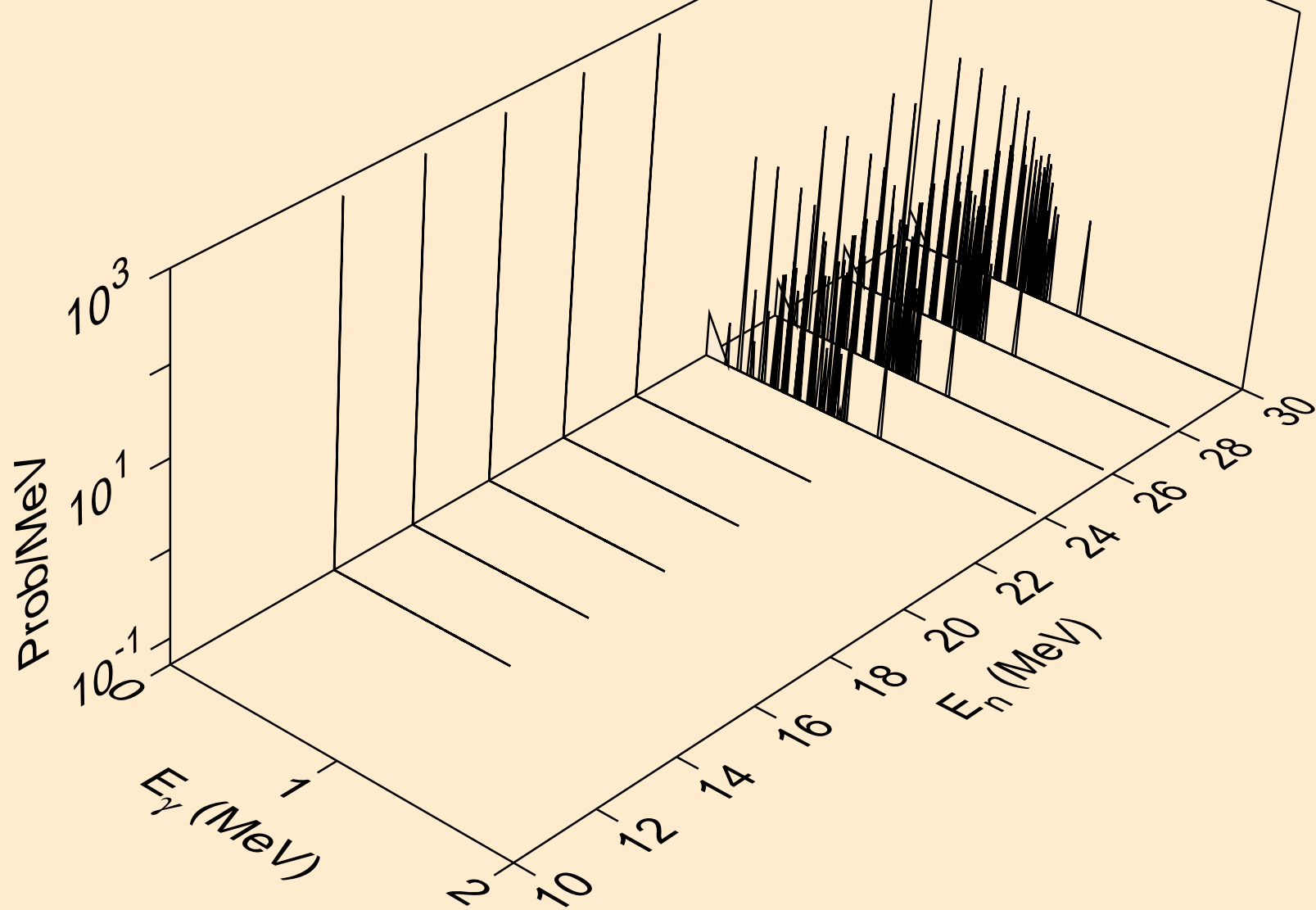

HF163 PROTON ACER TENDL-2024 LIBRARY; T=0.K  
Photon emission for (n,he3)

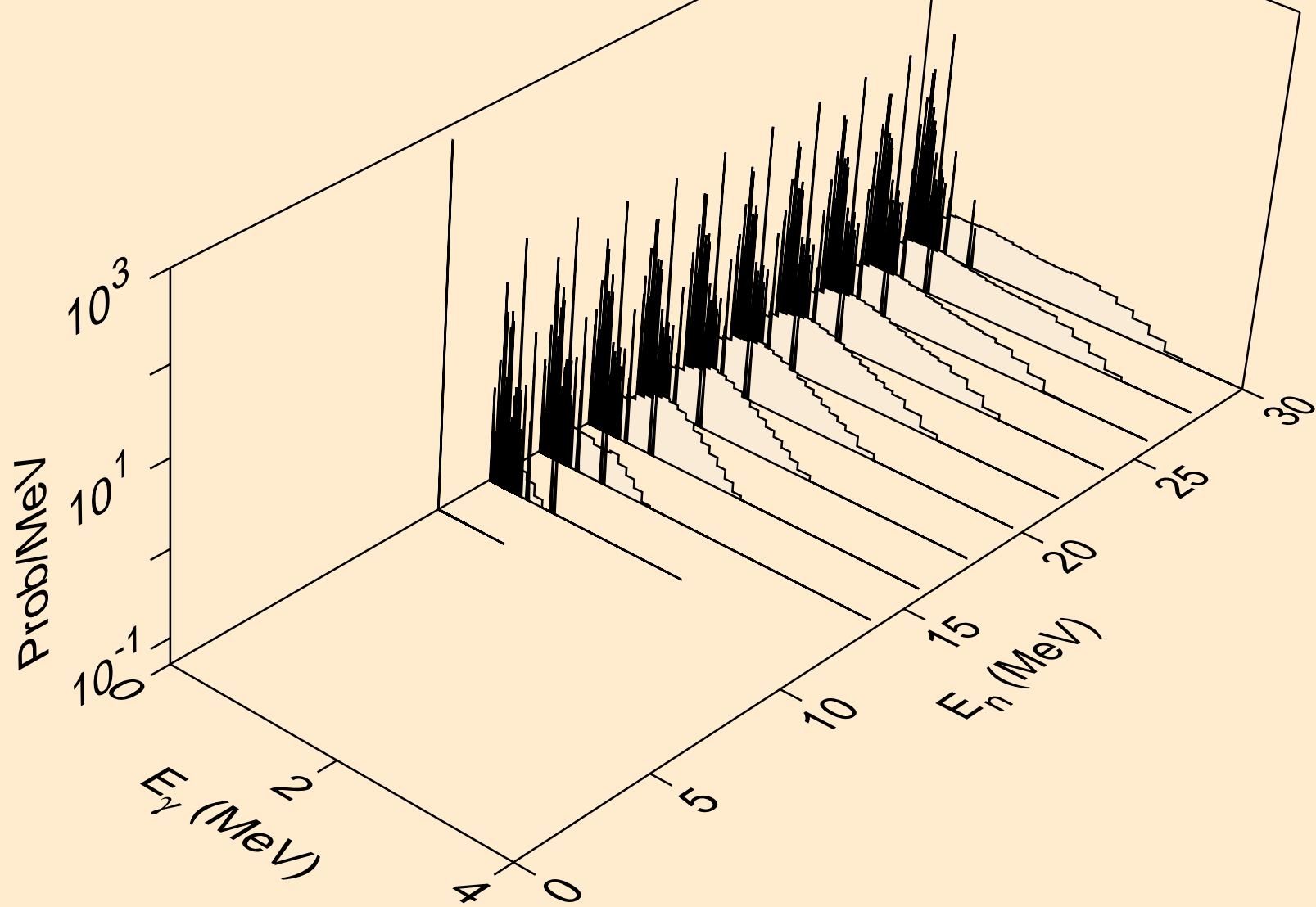

HF163 PROTON ACER TENDL-2024 LIBRARY; T=0.K  
Photon emission for (n,a)

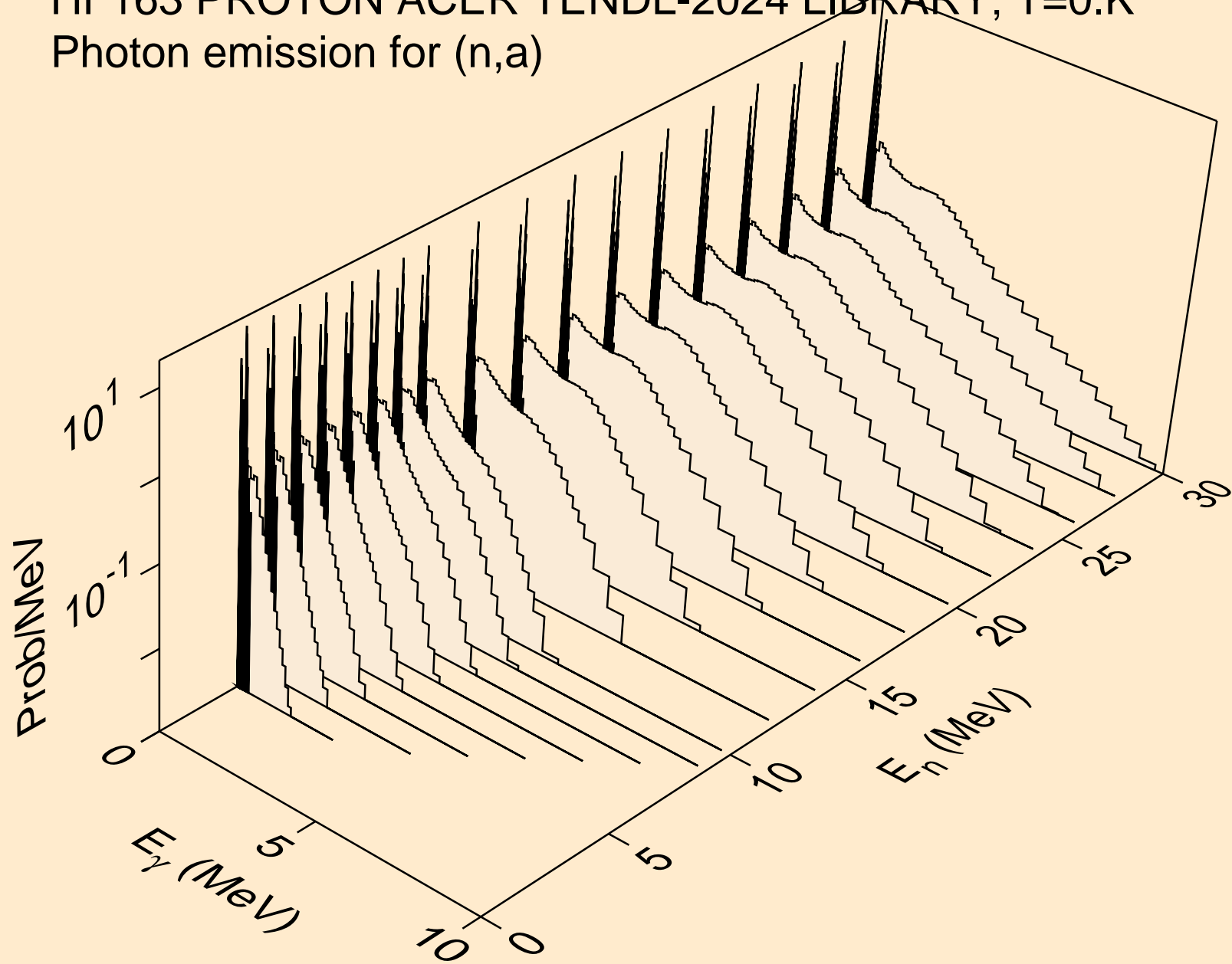

HF163 PROTON ACER TENDL-2024 LIBRARY; T=0.K  
Photon emission for (n,2a)

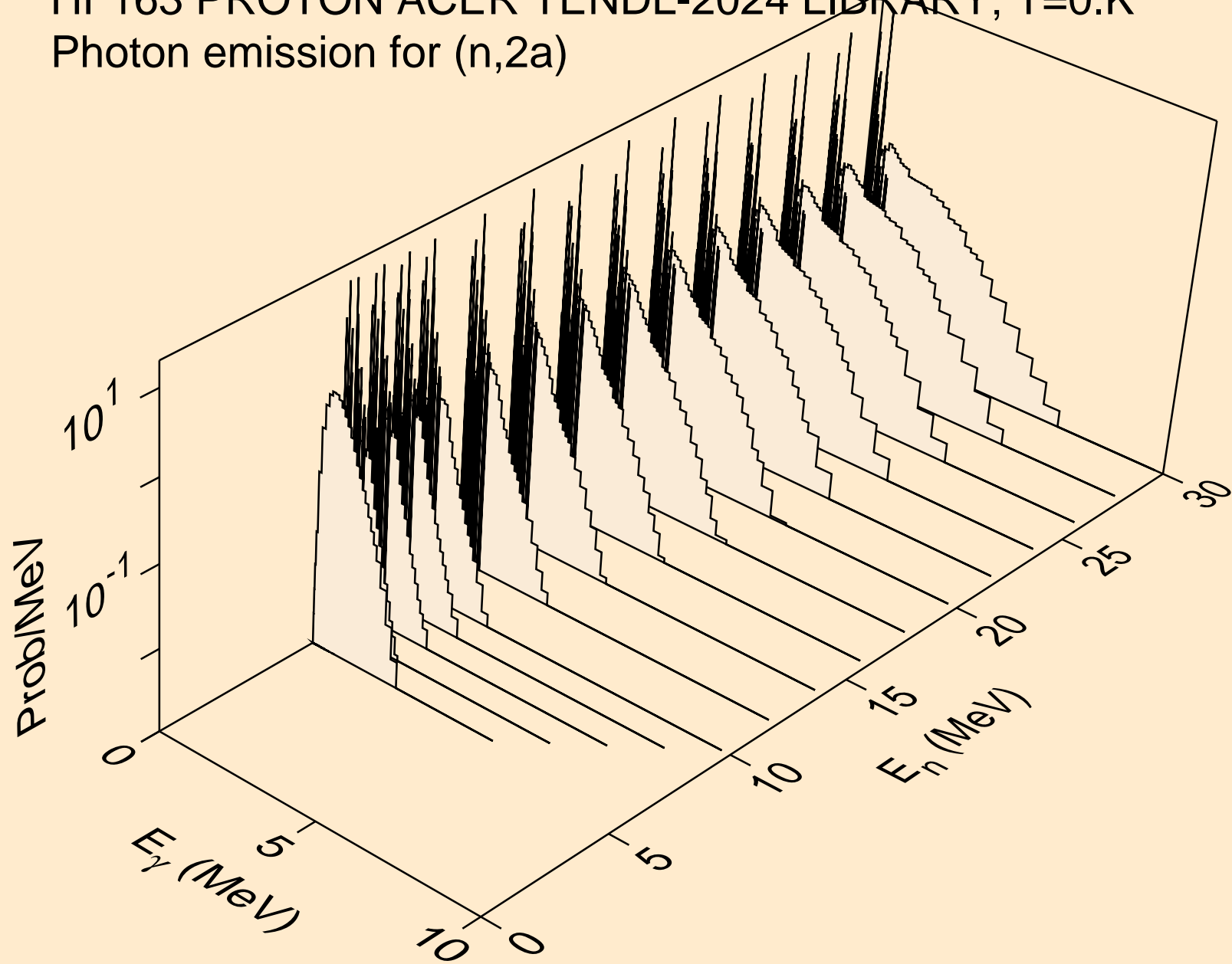

HF163 PROTON ACER TENDL-2024 LIBRARY; T=0.K  
Photon emission for (n,3a)

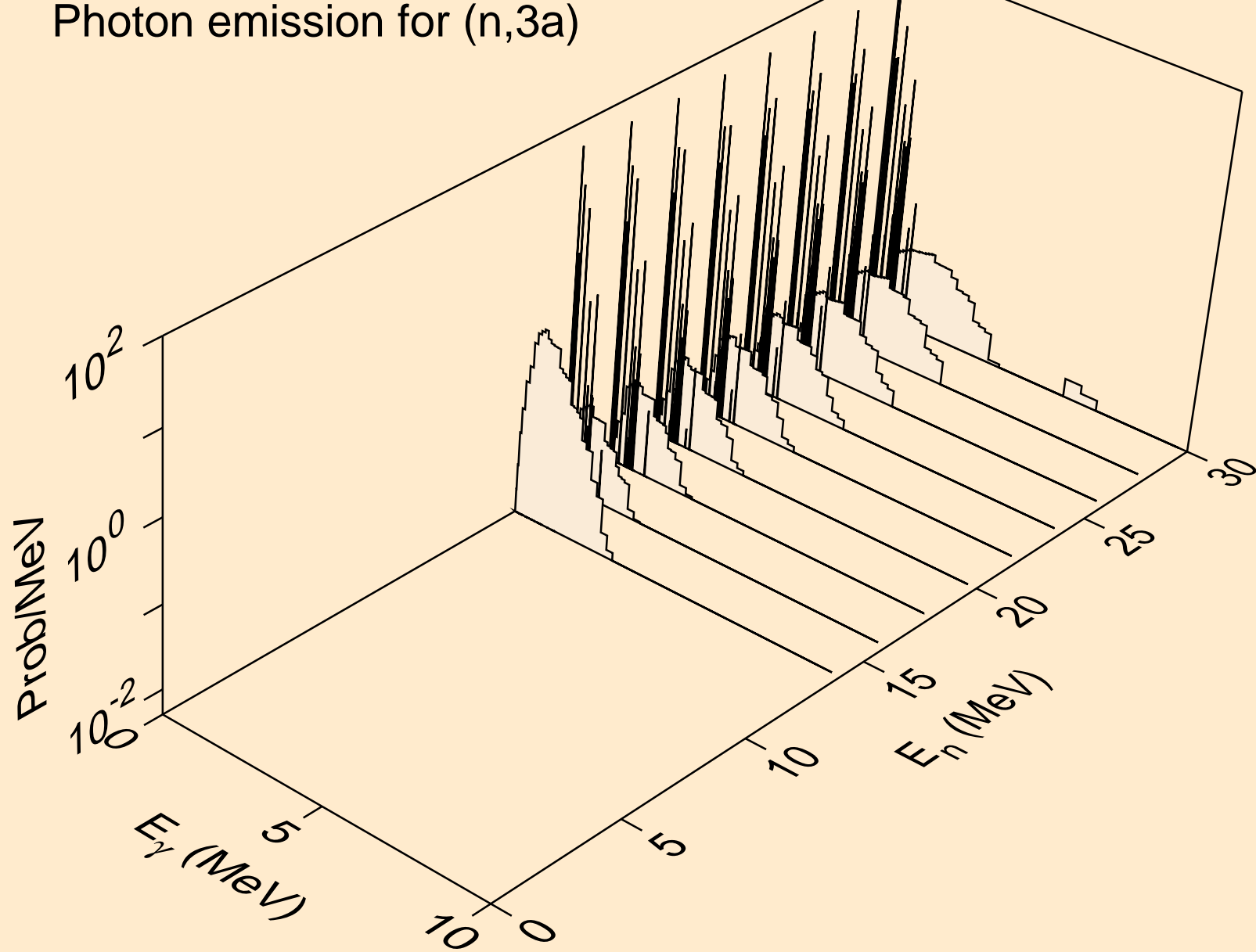

HF163 PROTON ACER TENDL-2024 LIBRARY; T=0.K  
Photon emission for (n,2p)

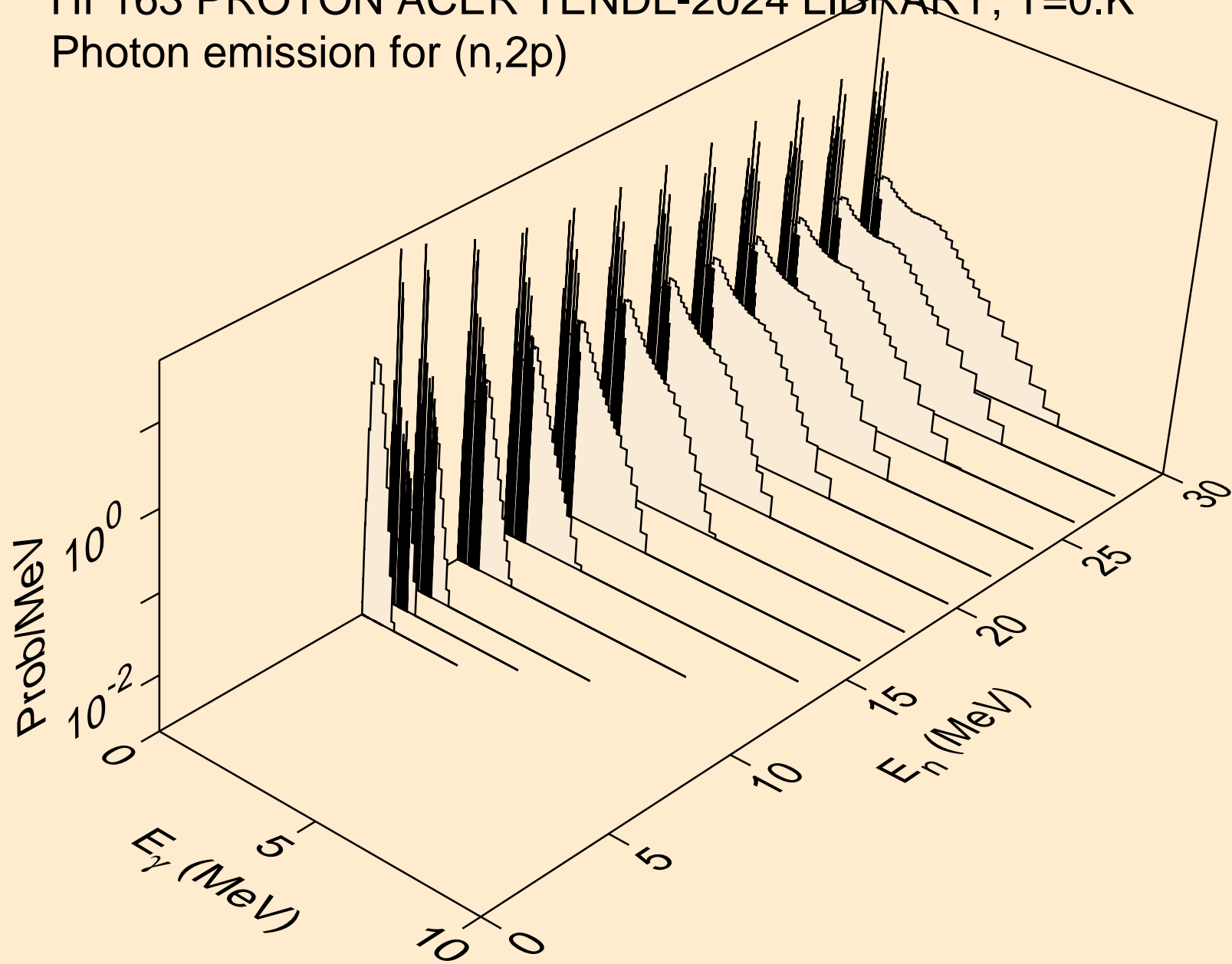

HF163 PROTON ACER TENDL-2024 LIBRARY; T=0.K  
Photon emission for (n,pa)

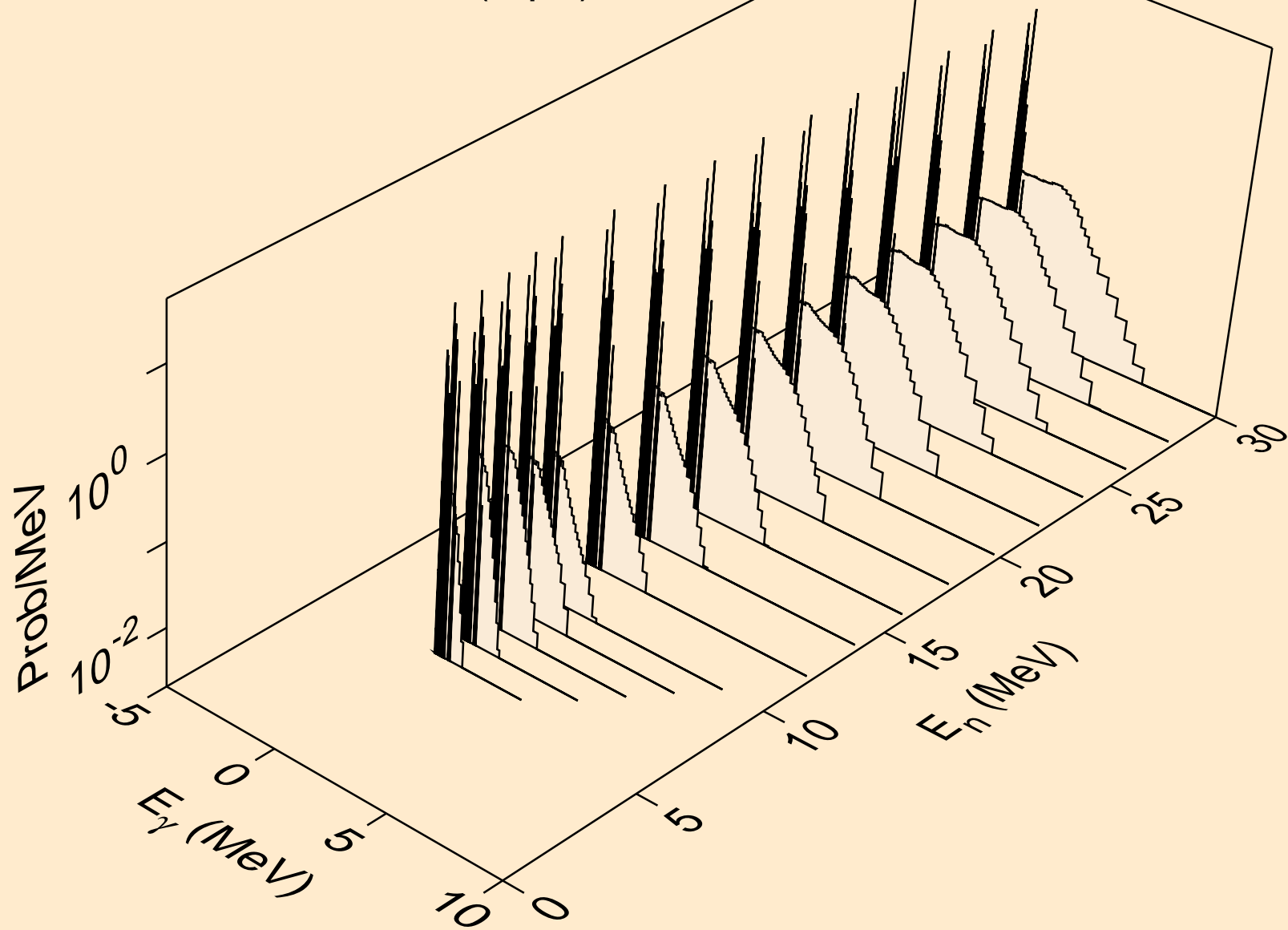

HF163 PROTON ACER TENDL-2024 LIBRARY; T=0.K  
Photon emission for (n,d2a)

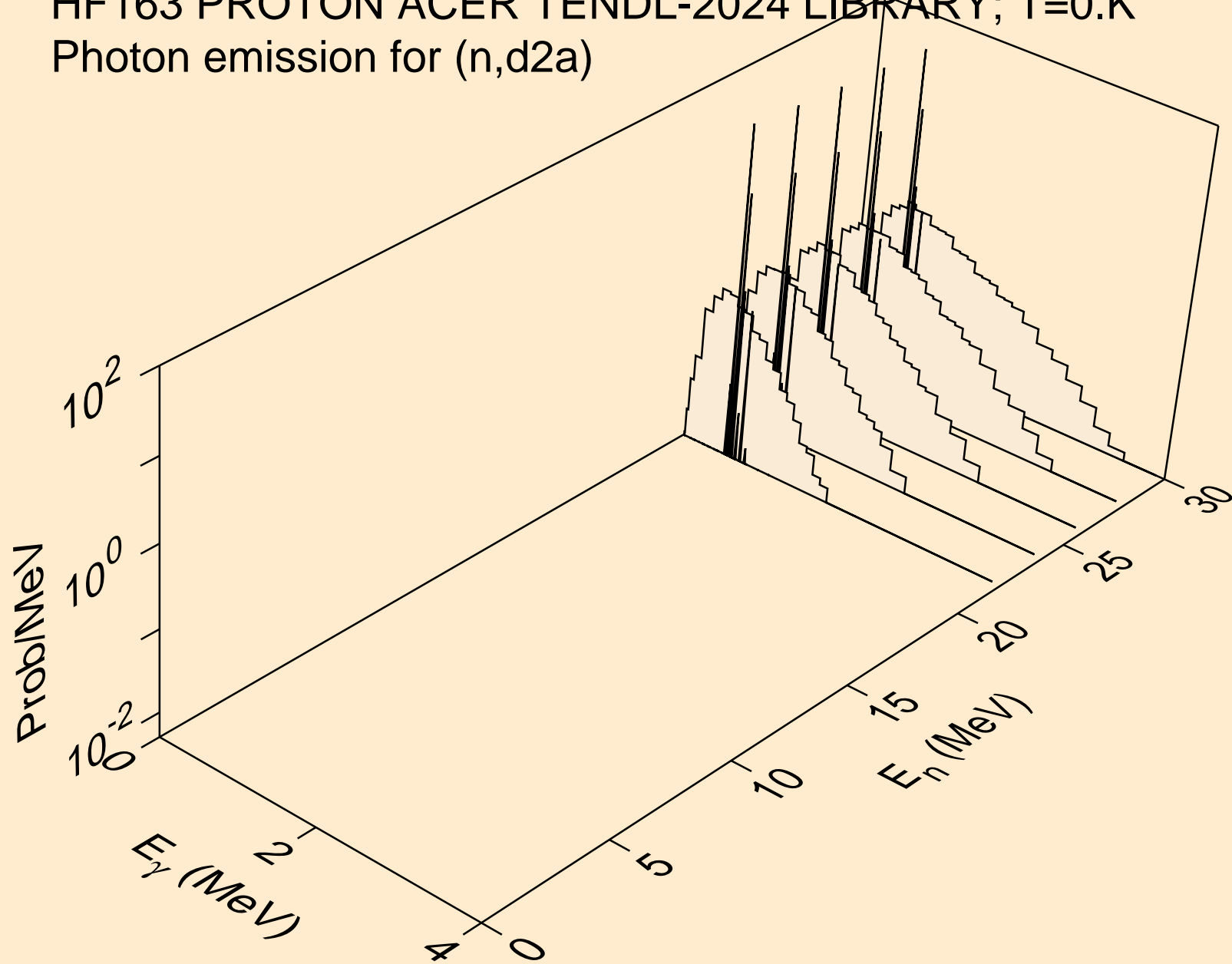

HF163 PROTON ACER TENDL-2024 LIBRARY; T=0.K  
Photon emission for (n,pd)

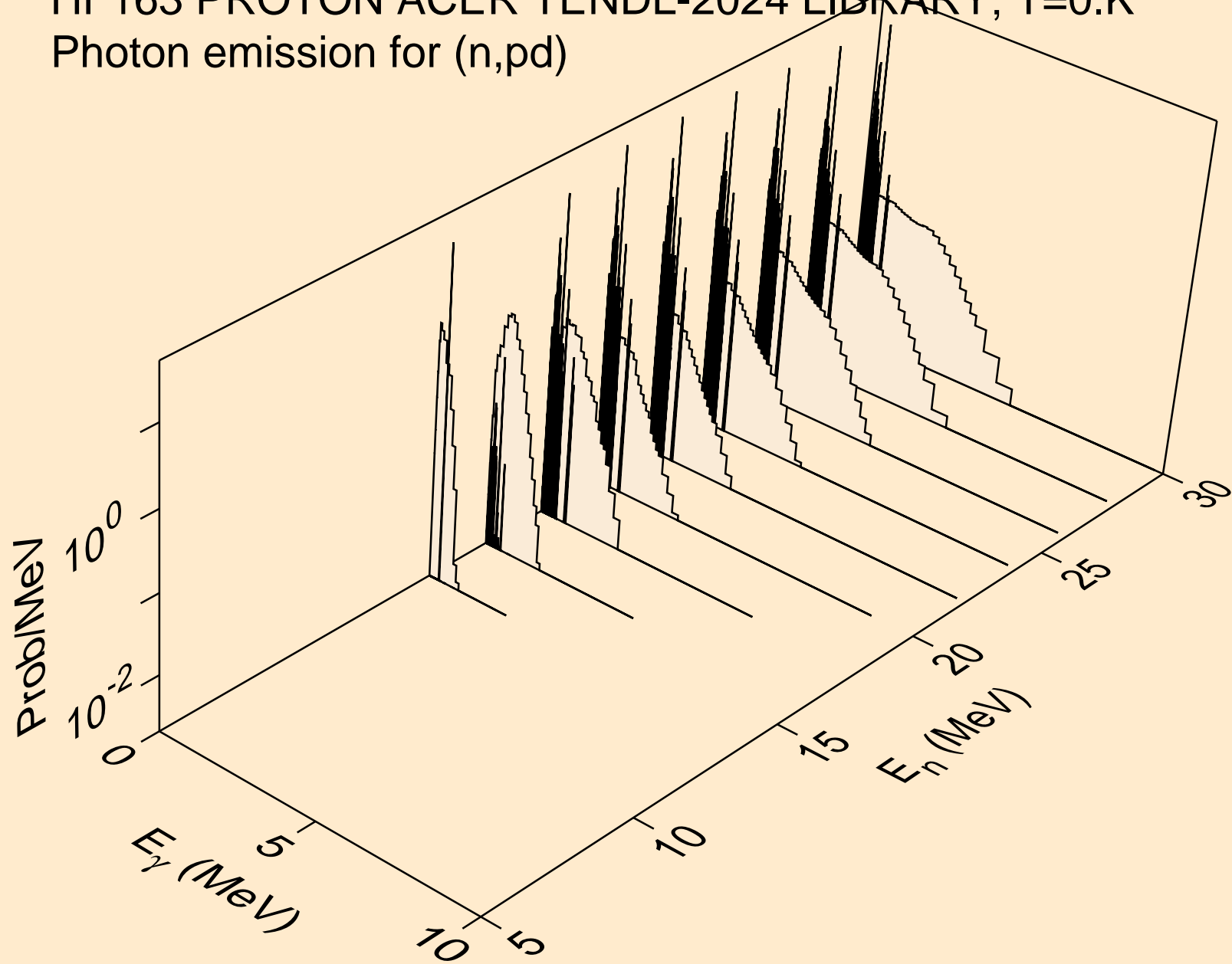

HF163 PROTON ACER TENDL-2024 LIBRARY; T=0.K  
Photon emission for (n,pt)

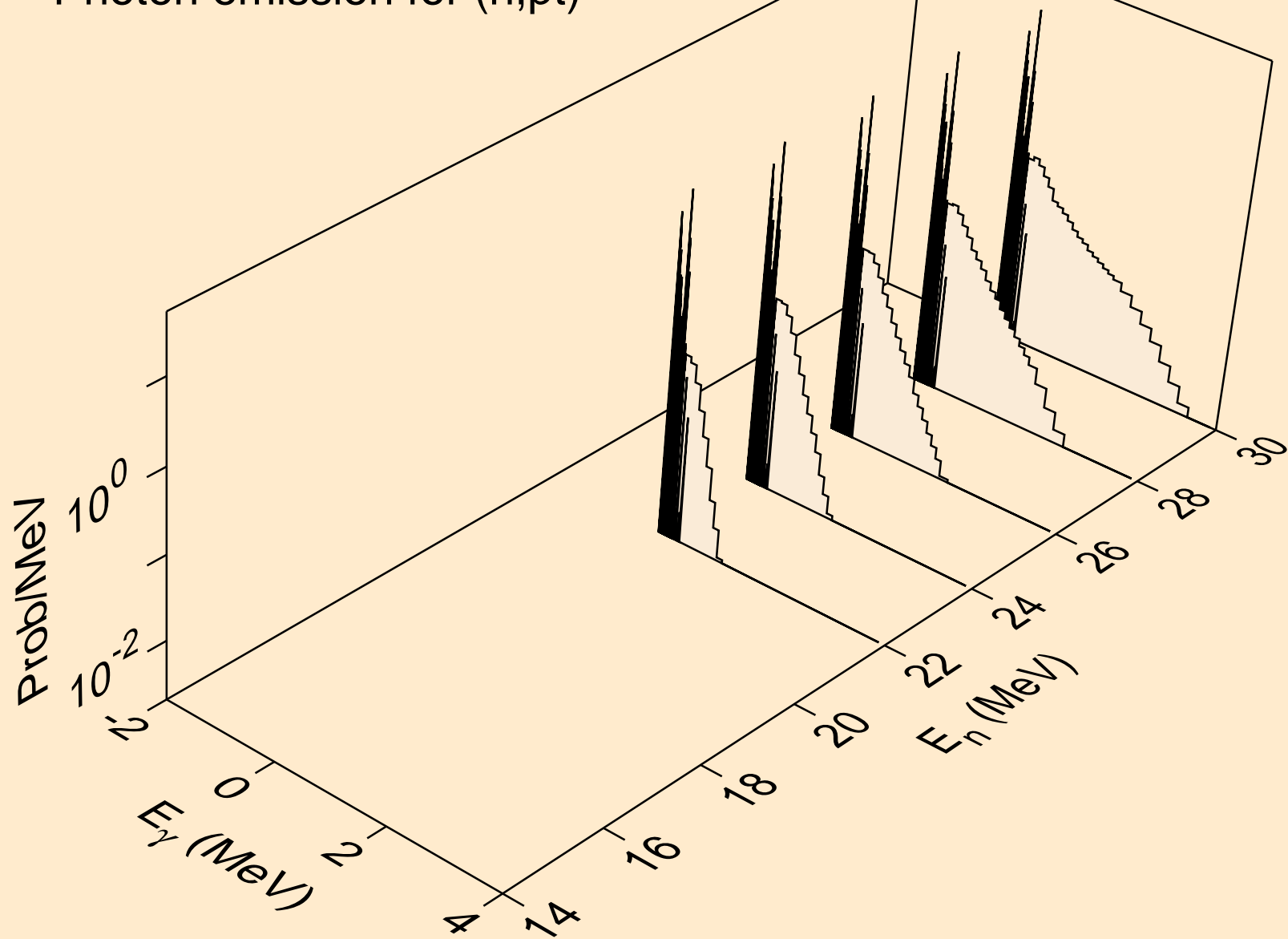

HF163 PROTON ACER TENDL-2024 LIBRARY; T=0.K  
Photon emission for (n,da)

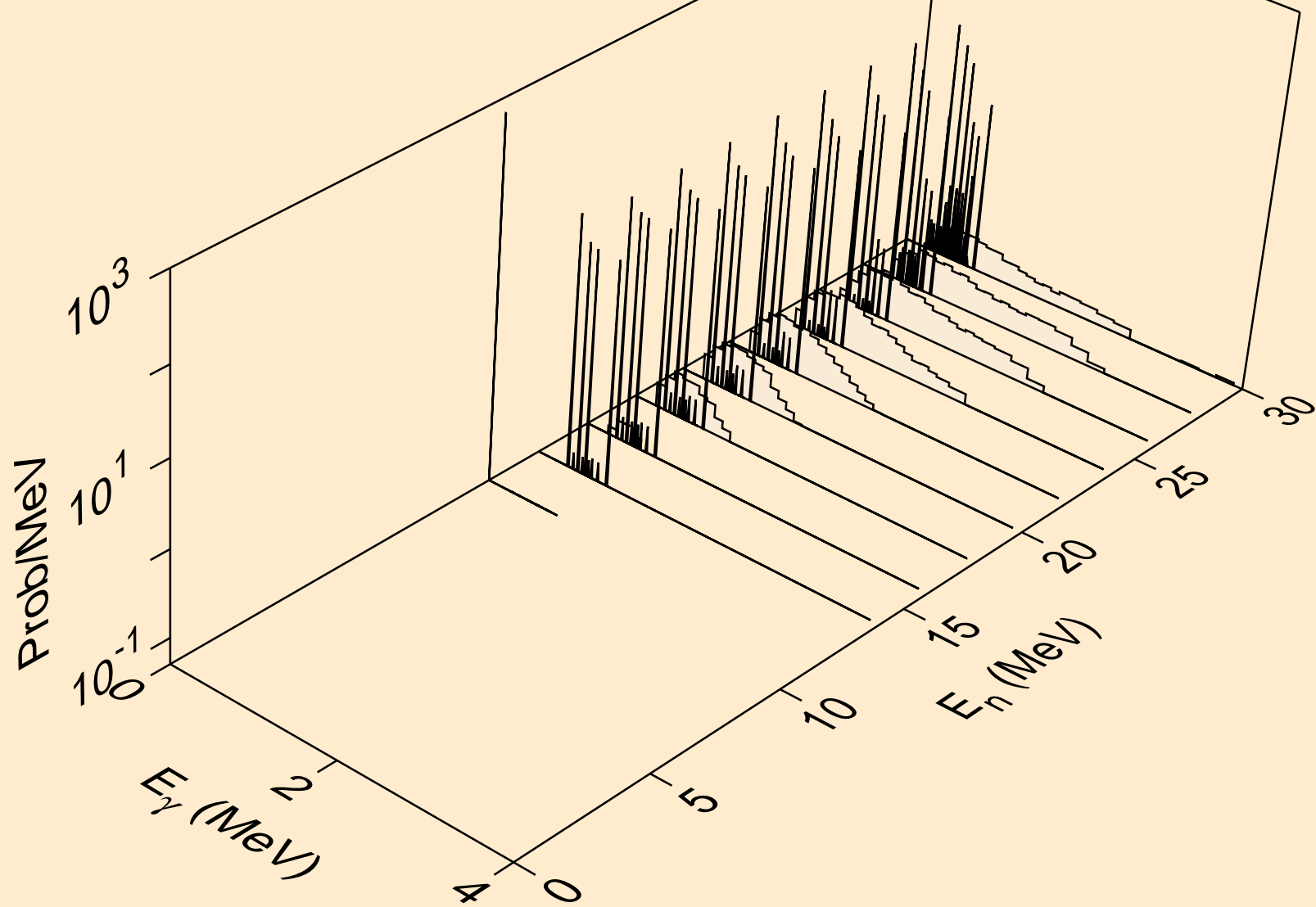

# HF163 PROTON ACER TENDL-2024 LIBRARY; T=0.K

## Particle heating contributions

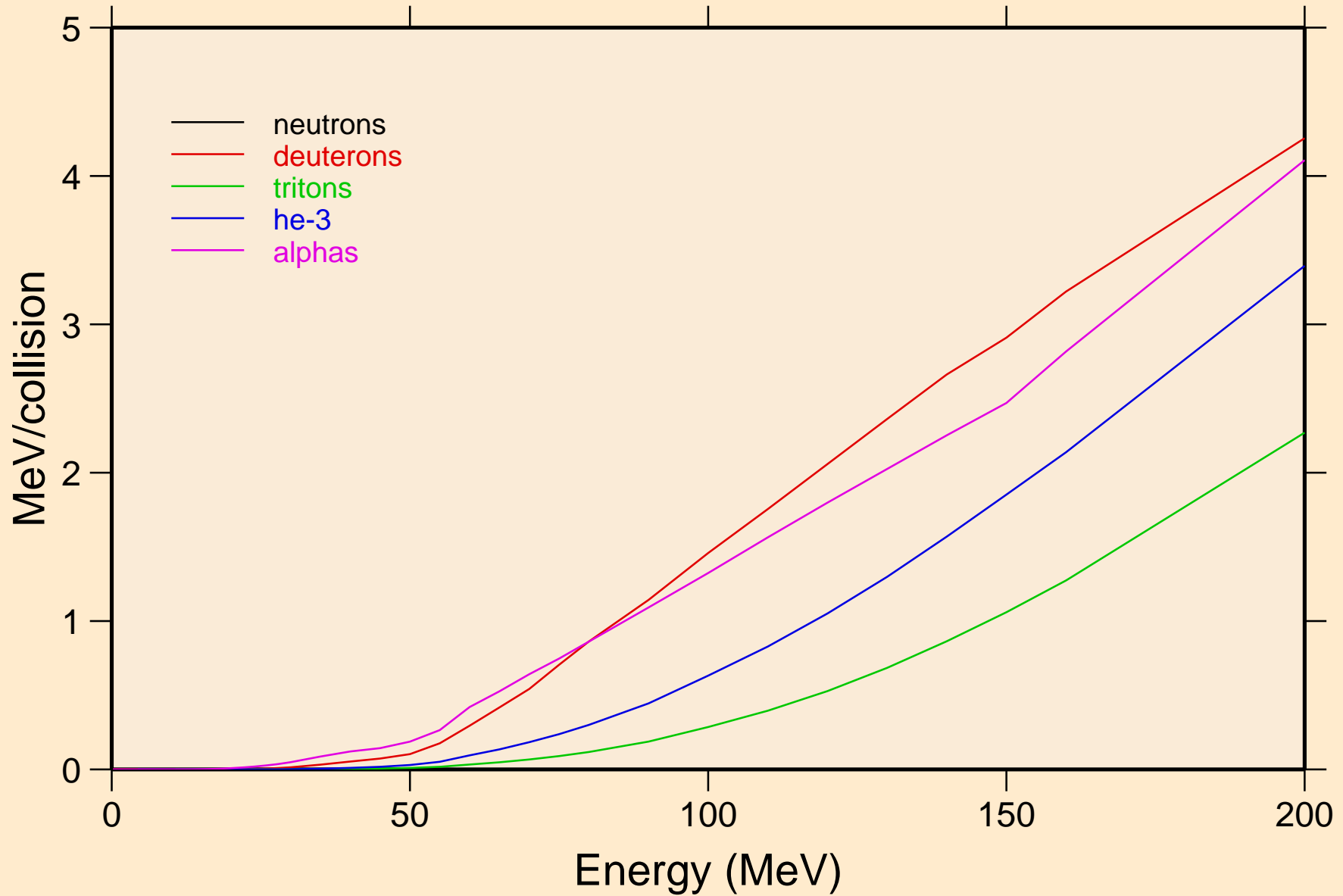

HF163 PROTON ACER TENDL-2024 LIBRARY; T=0.K  
Recoil Heating

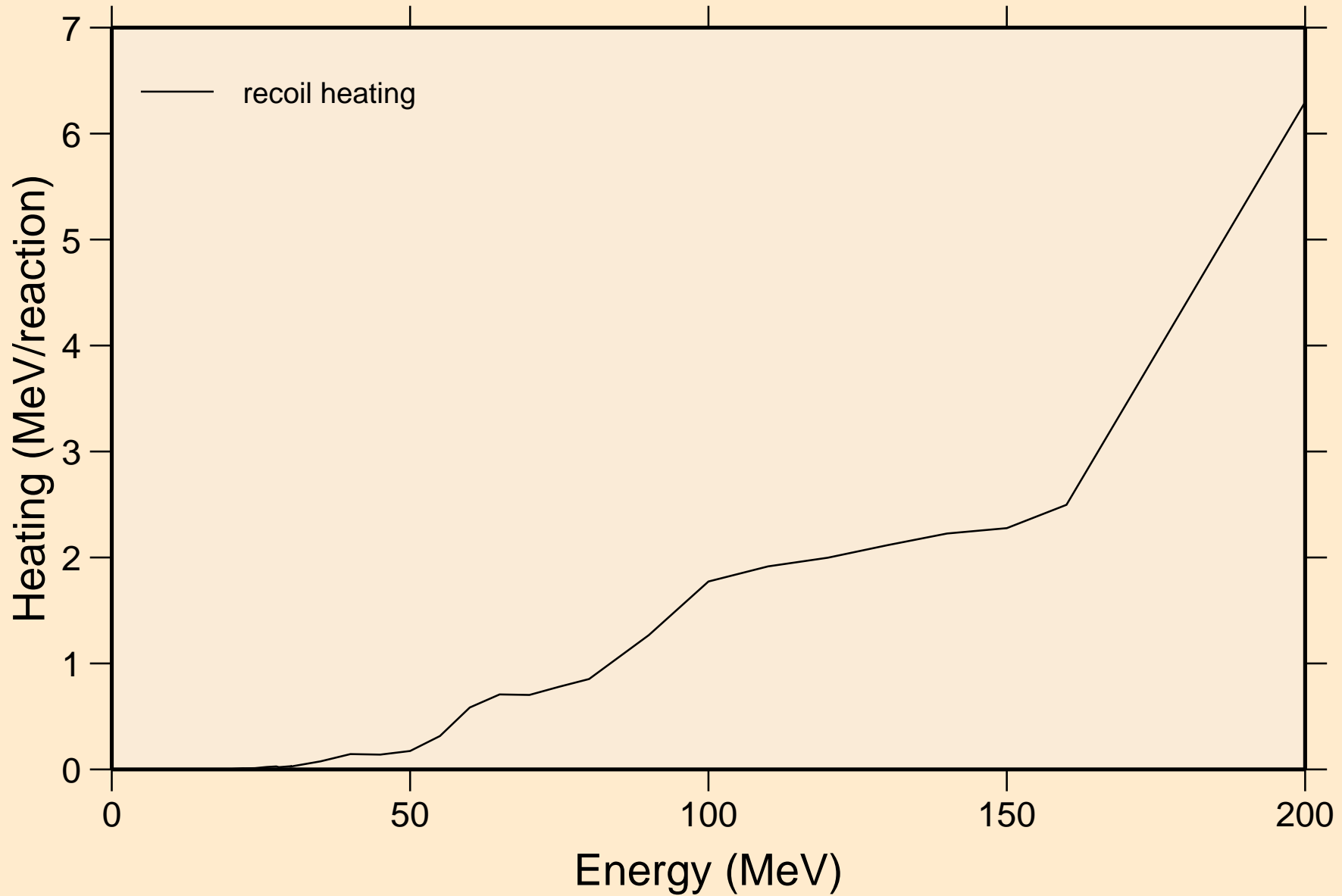

HF163 PROTON ACER TENDL-2024 LIBRARY; T=0.K  
Particle production cross sections

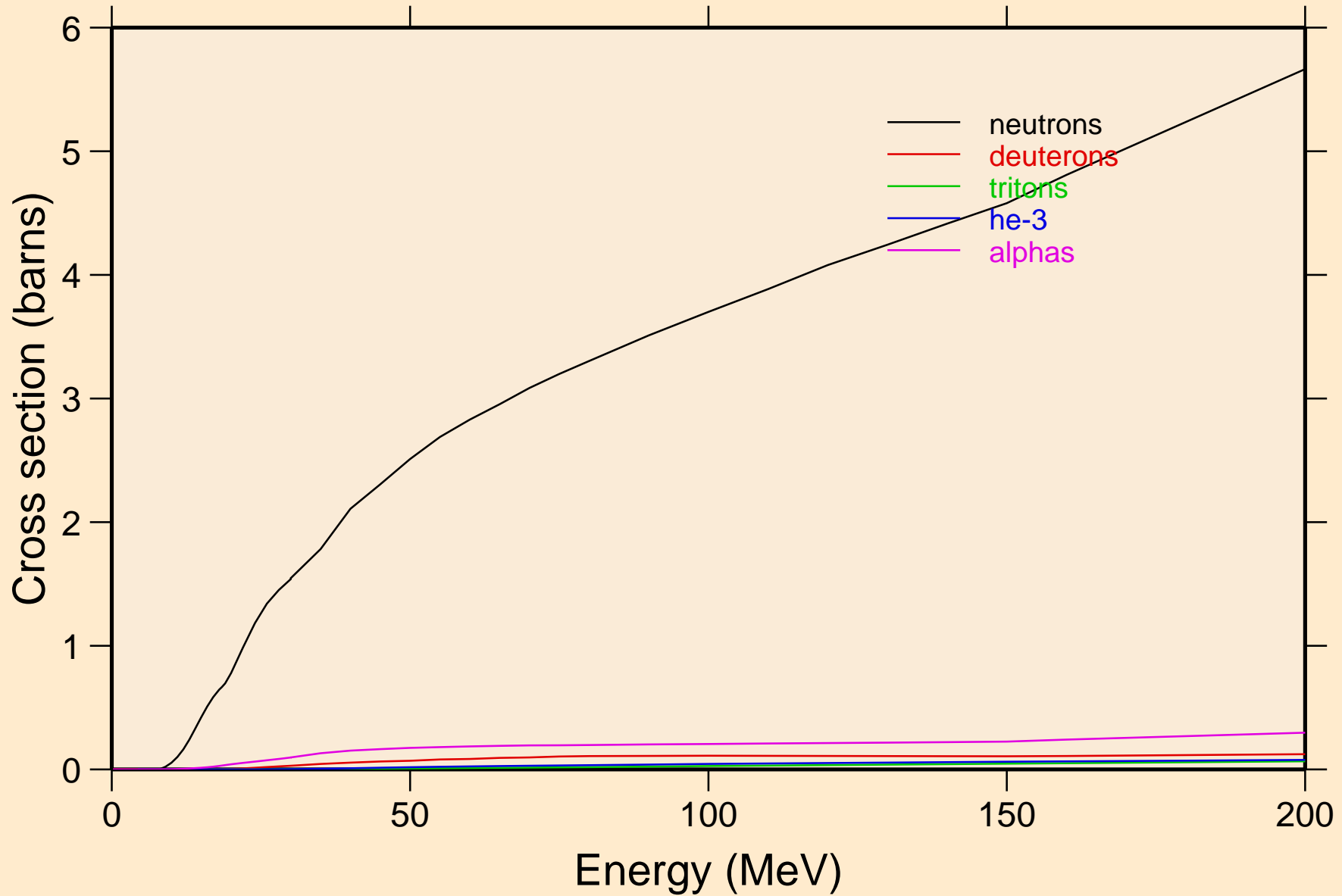

HF163 PROTON ACER TENDL-2024 LIBRARY; T=0.K  
neutrons from (p,n)

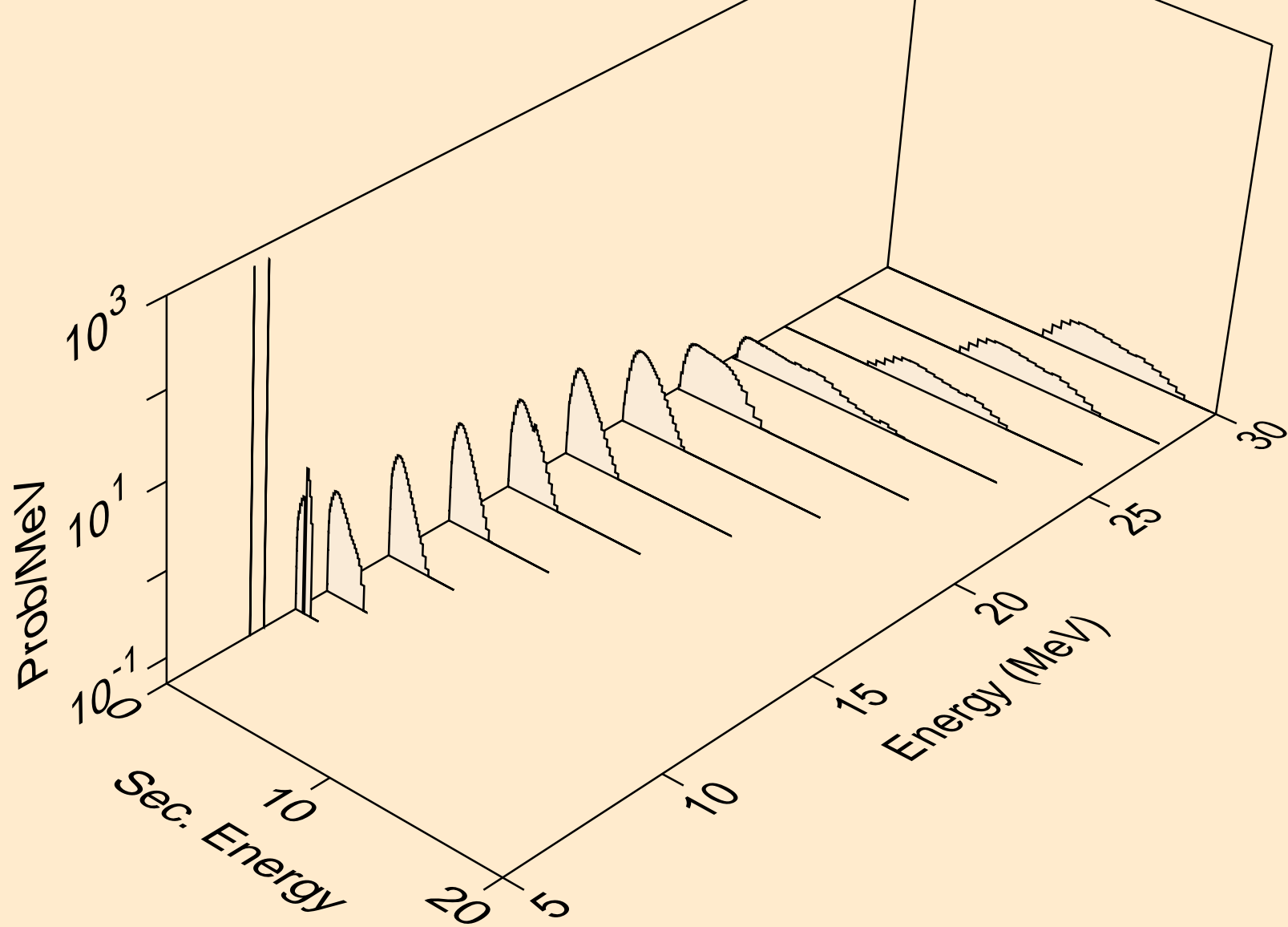

HF163 PROTON ACER TENDL-2024 LIBRARY; T=0.K  
neutrons from (p,x)

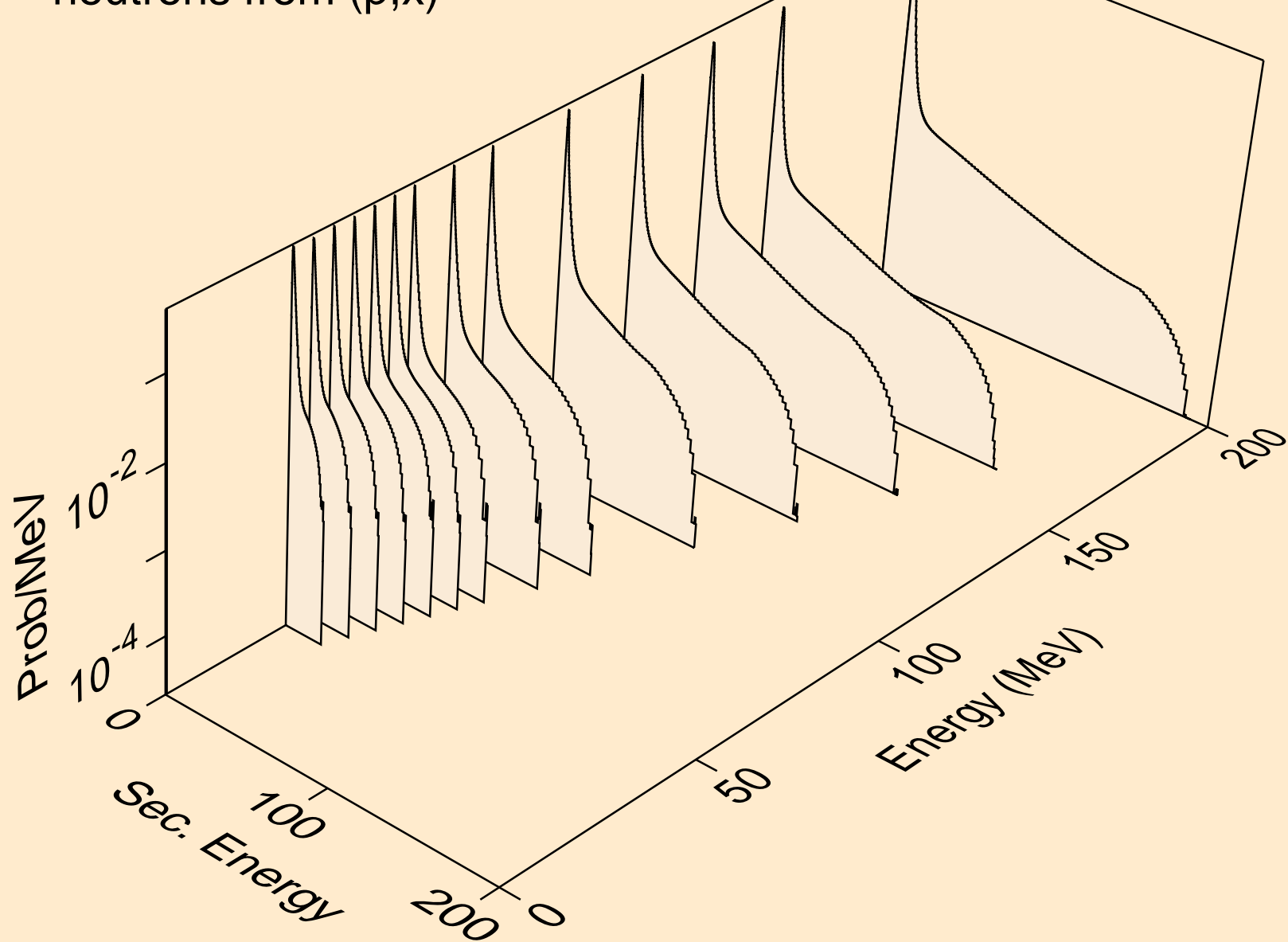

HF163 PROTON ACER TENDL-2024 LIBRARY; T=0.K  
neutrons from (p,2n)

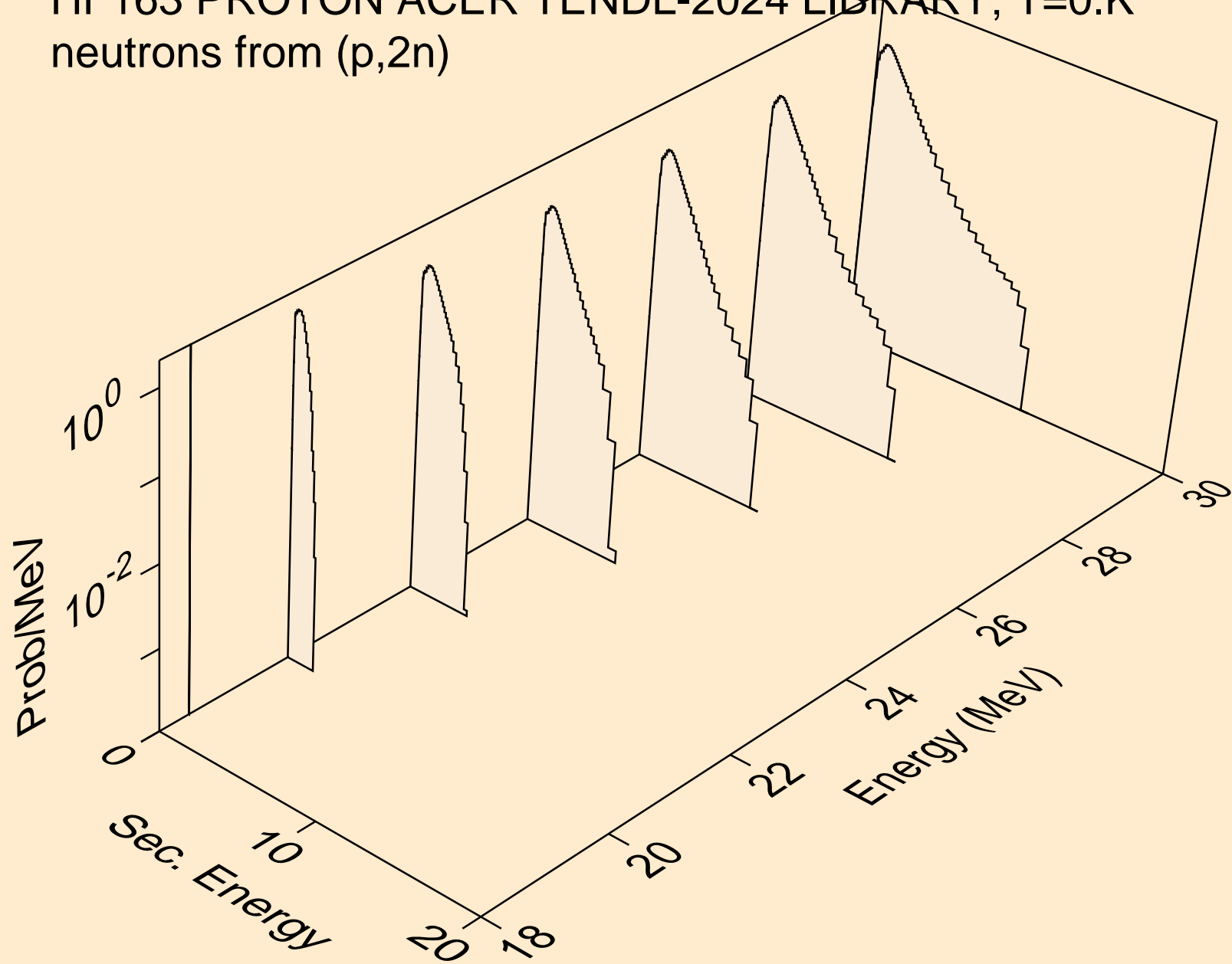

HF163 PROTON ACER TENDL-2024 LIBRARY; T=0.K  
neutrons from (p,3n)

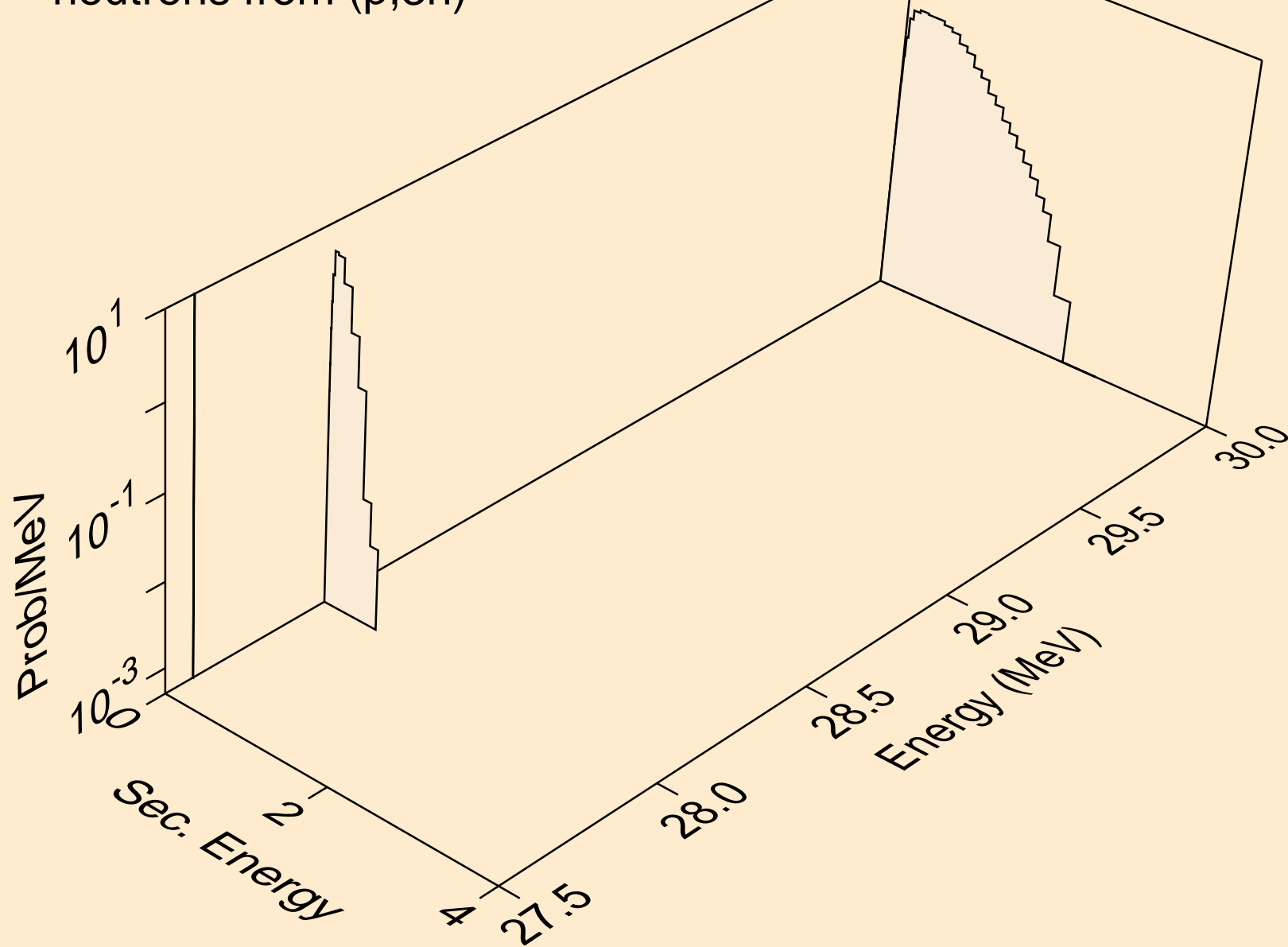

HF163 PROTON ACER TENDL-2024 LIBRARY; T=0.K  
neutrons from (p,n\*)a

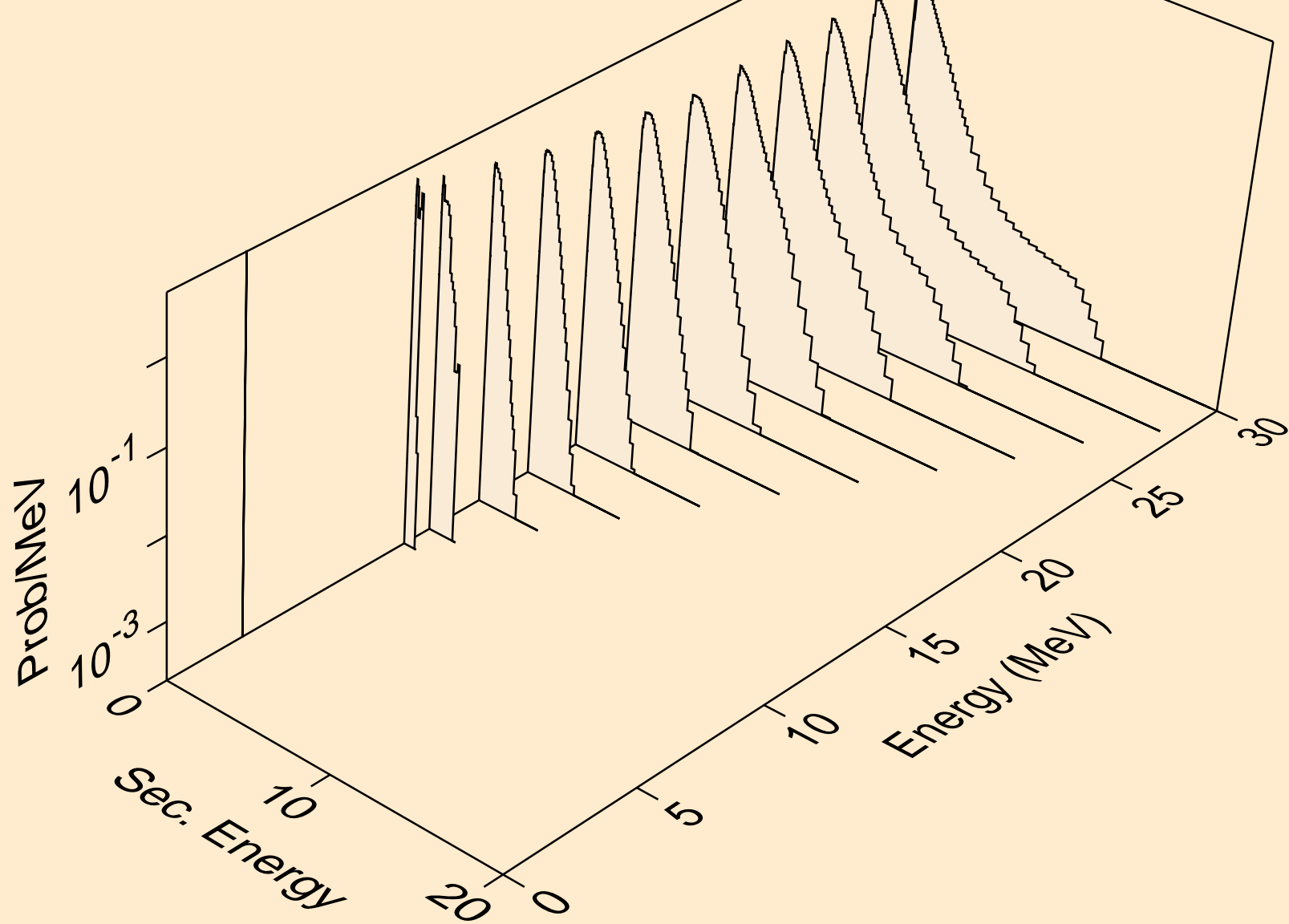

HF163 PROTON ACER TENDL-2024 LIBRARY; T=0.K  
neutrons from (p,n\*)3a

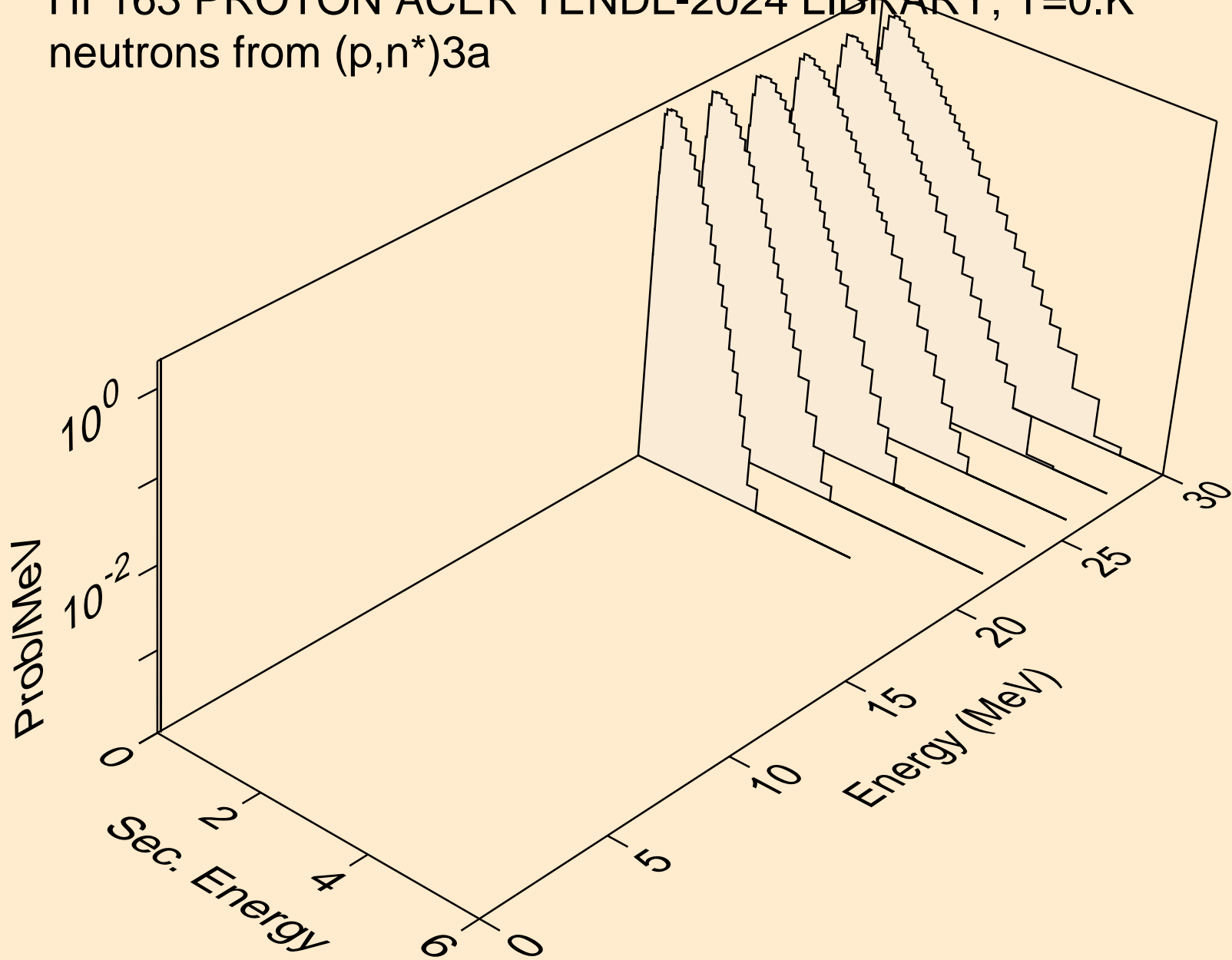

HF163 PROTON ACER TENDL-2024 LIBRARY; T=0.K  
neutrons from (p,2n)a

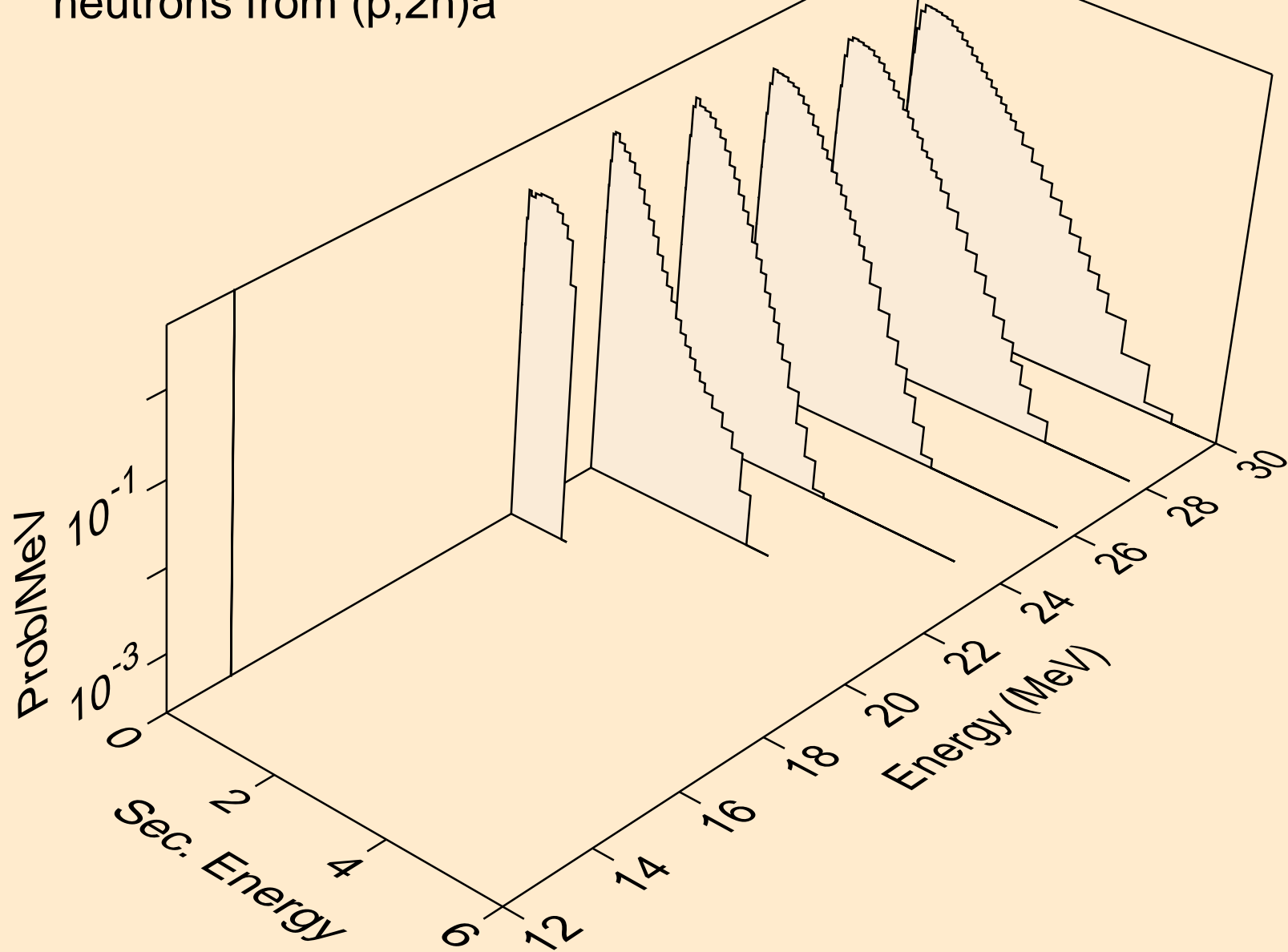

HF163 PROTON ACER TENDL-2024 LIBRARY; T=0.K  
neutrons from (p,3n)a

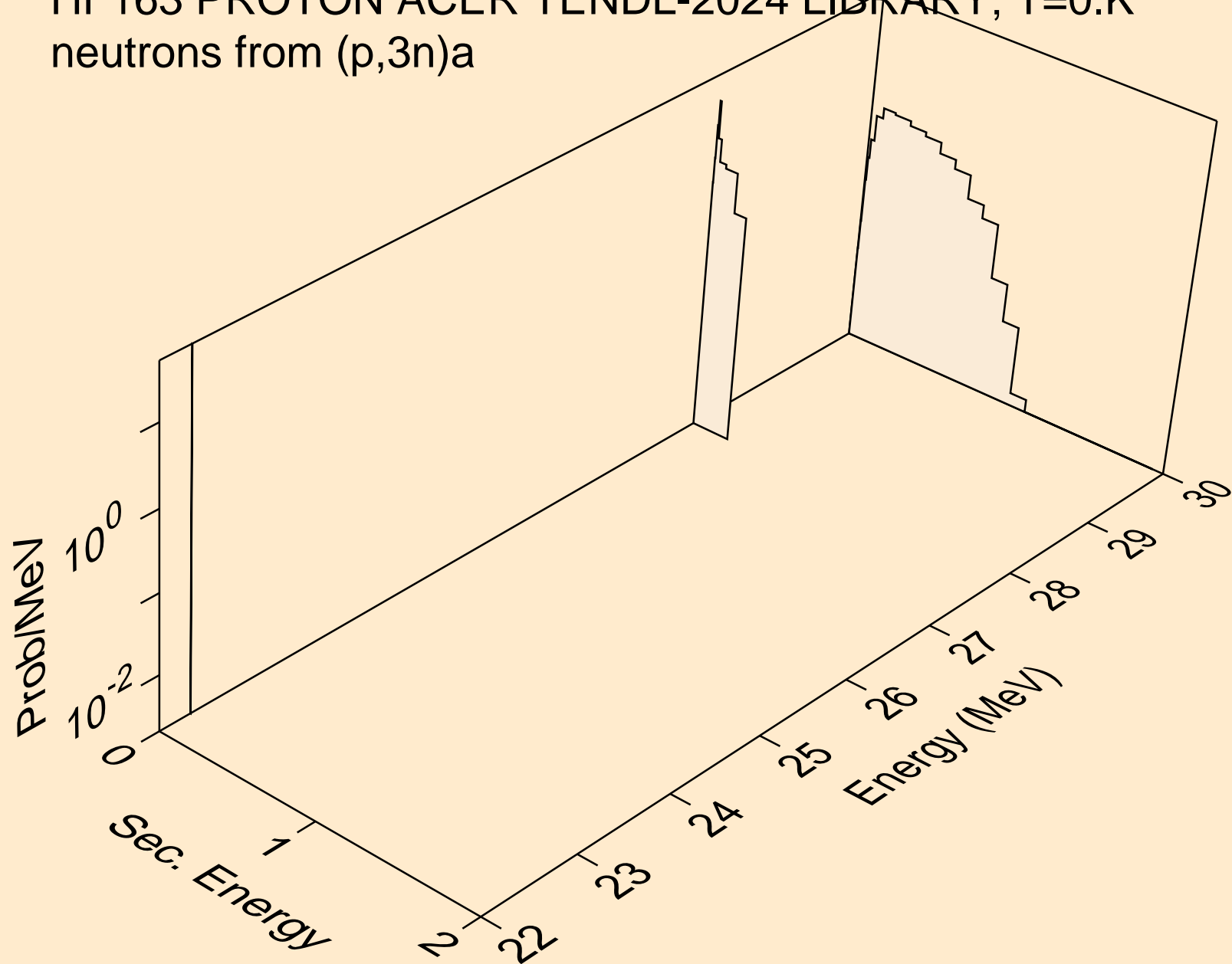

HF163 PROTON ACER TENDL-2024 LIBRARY; T=0.K  
neutrons from (p,n\*)p

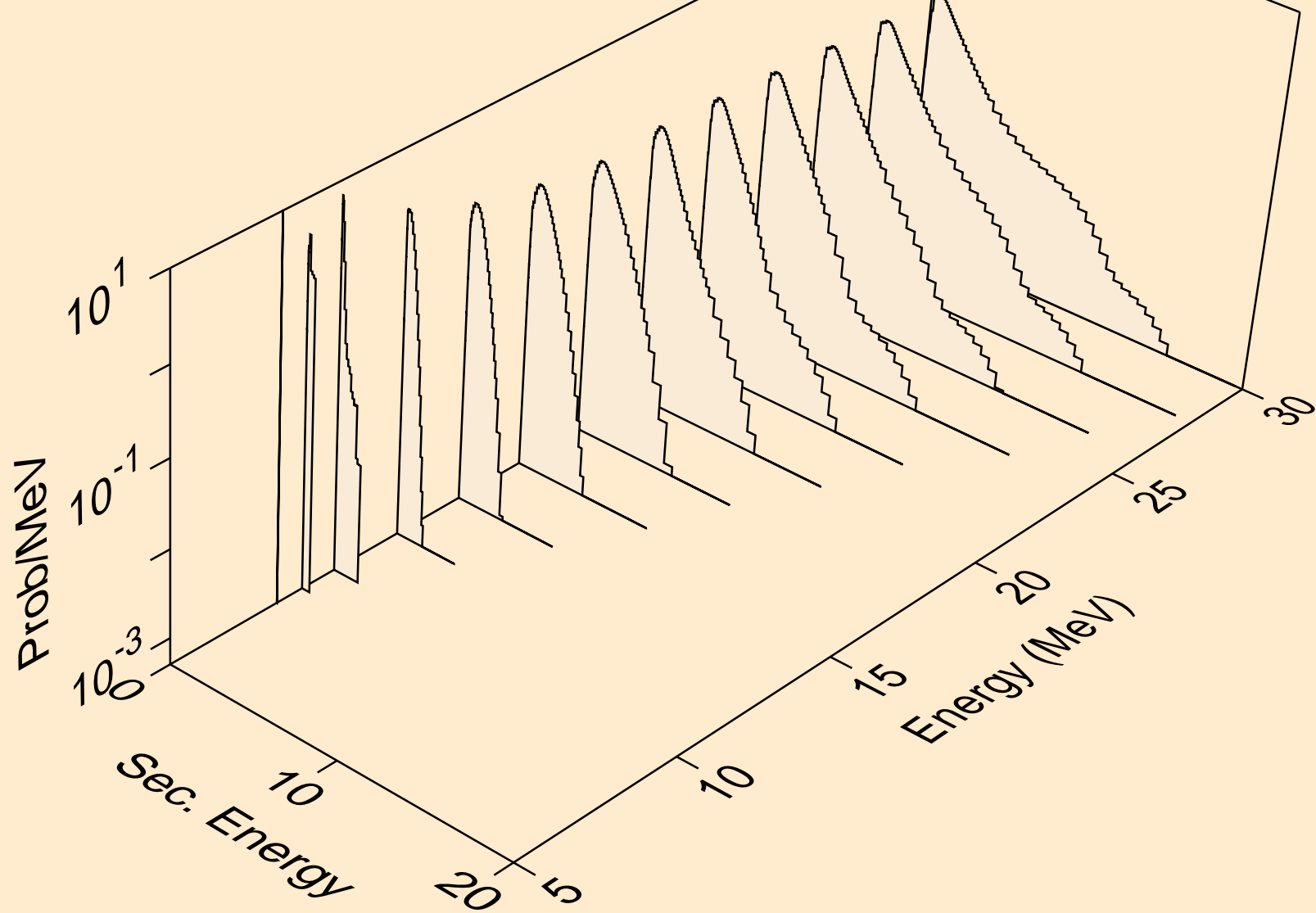

HF163 PROTON ACER TENDL-2024 LIBRARY; T=0.K  
neutrons from (p,n\*)2a

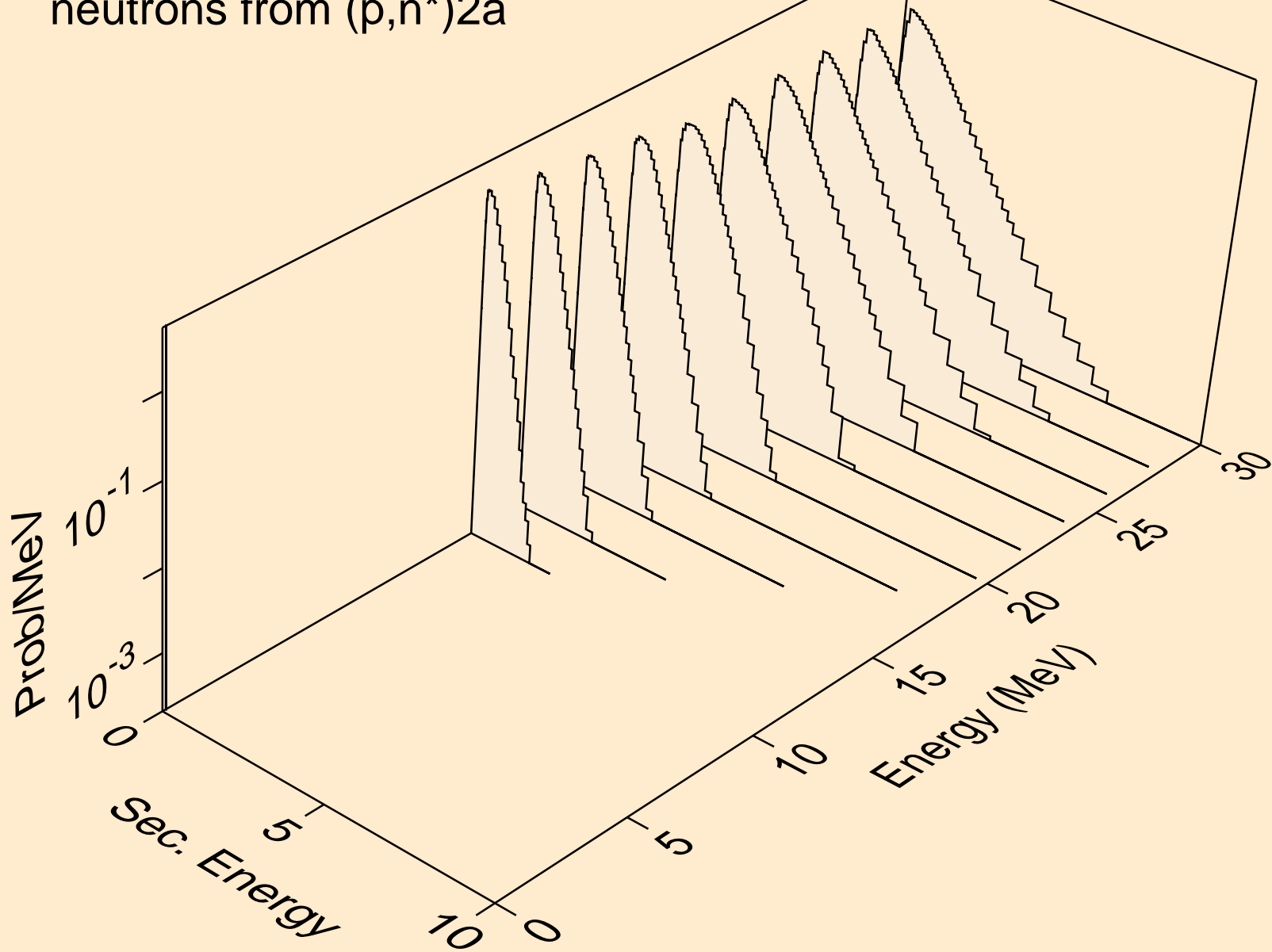

HF163 PROTON ACER TENDL-2024 LIBRARY; T=0.K  
neutrons from (p,n\*)d

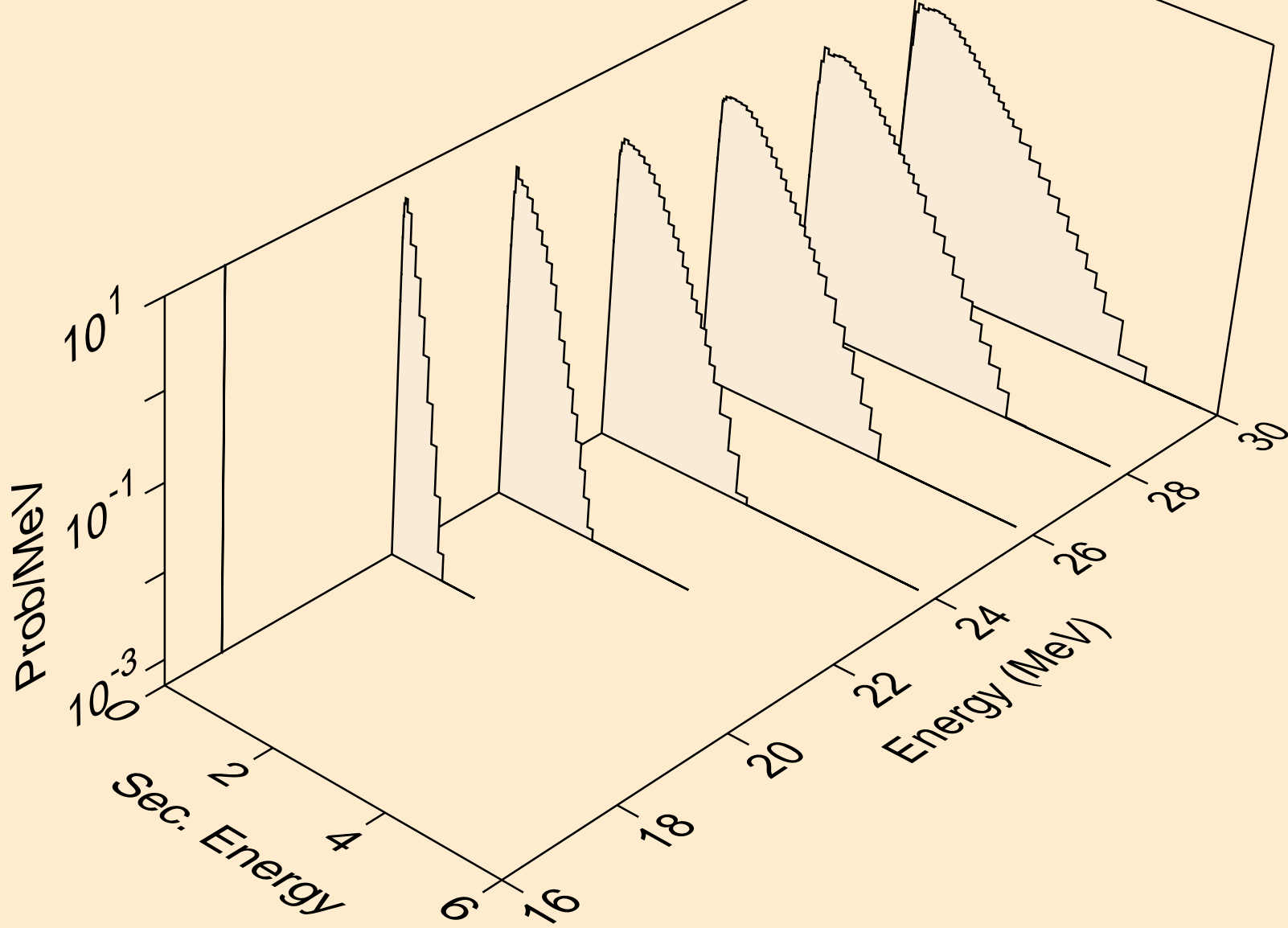

HF163 PROTON ACER TENDL-2024 LIBRARY; T=0.K  
neutrons from (p,n\*)t

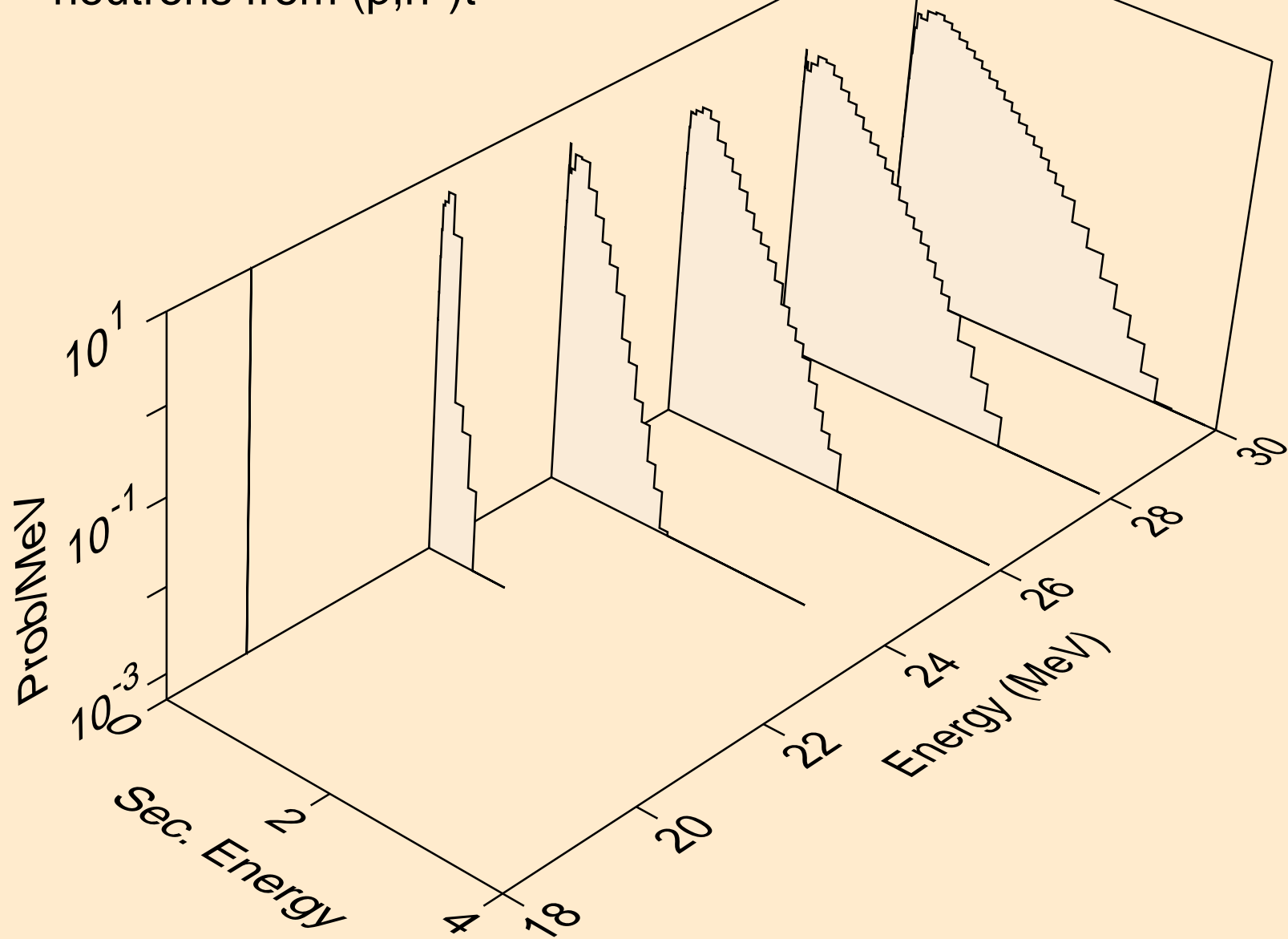

HF163 PROTON ACER TENDL-2024 LIBRARY; T=0.K  
neutrons from (p,n\*)he3

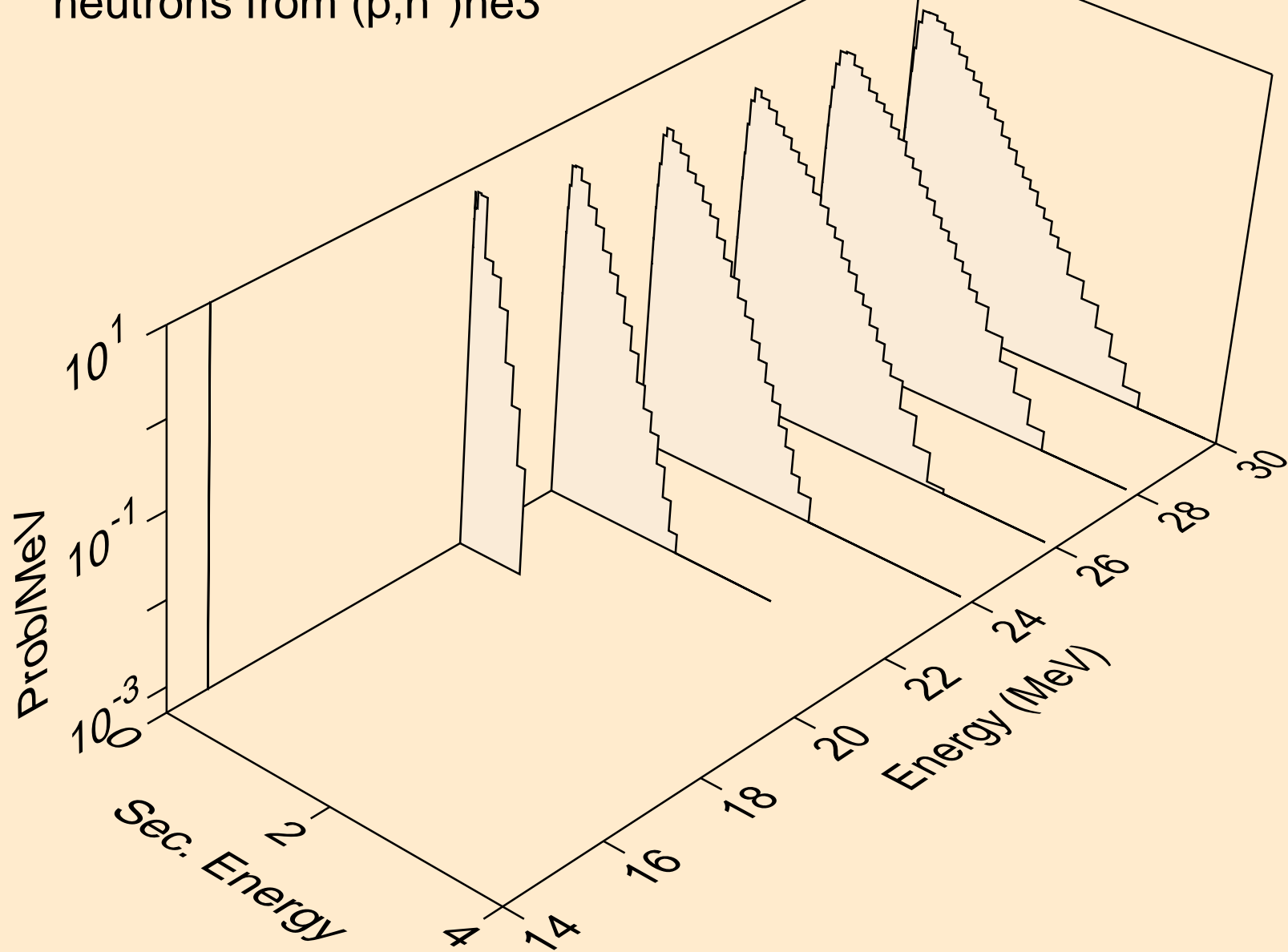

HF163 PROTON ACER TENDL-2024 LIBRARY; T=0.K  
neutrons from (p,2np)

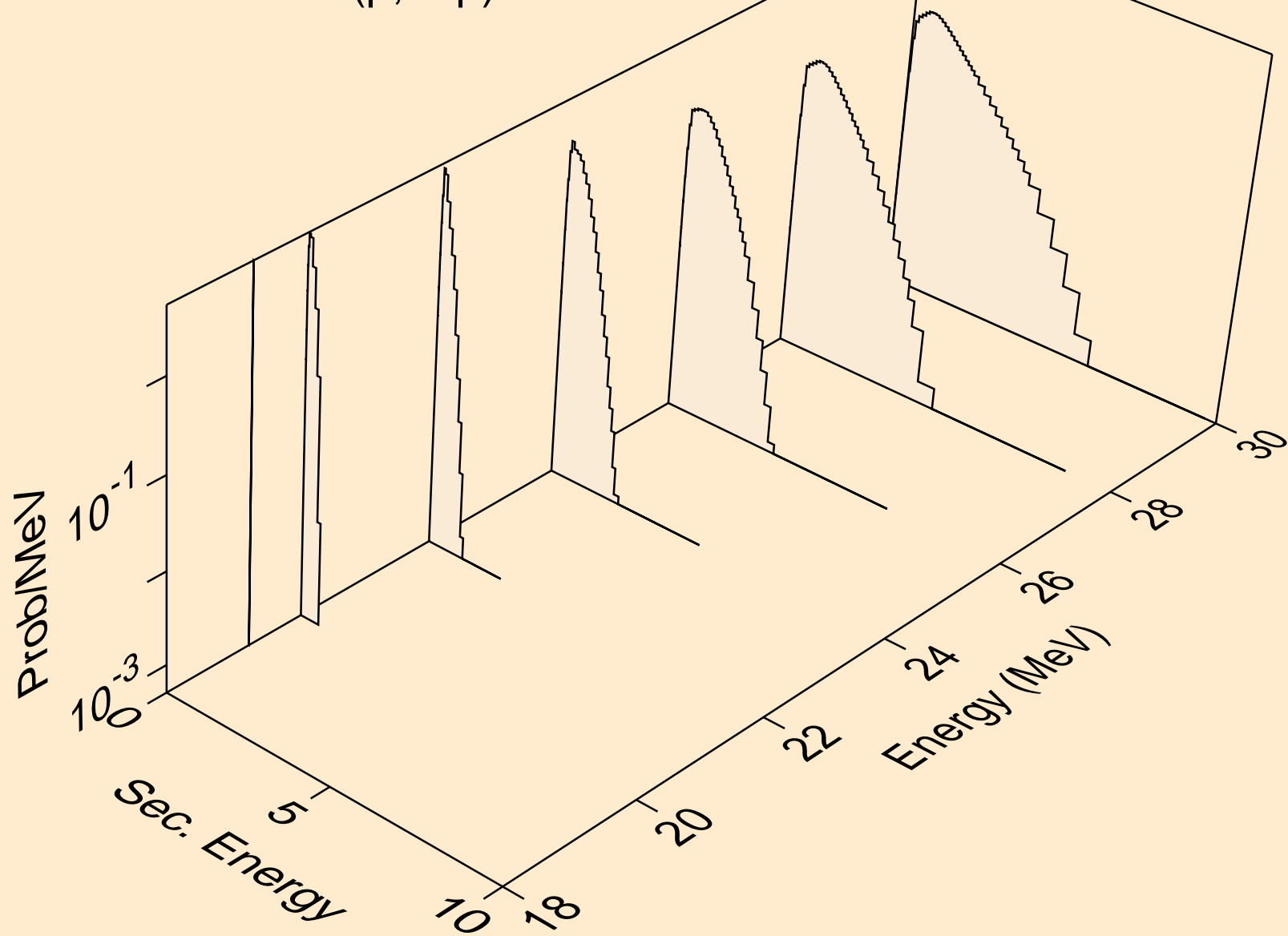

HF163 PROTON ACER TENDL-2024 LIBRARY; T=0.K  
neutrons from (p,n2p)

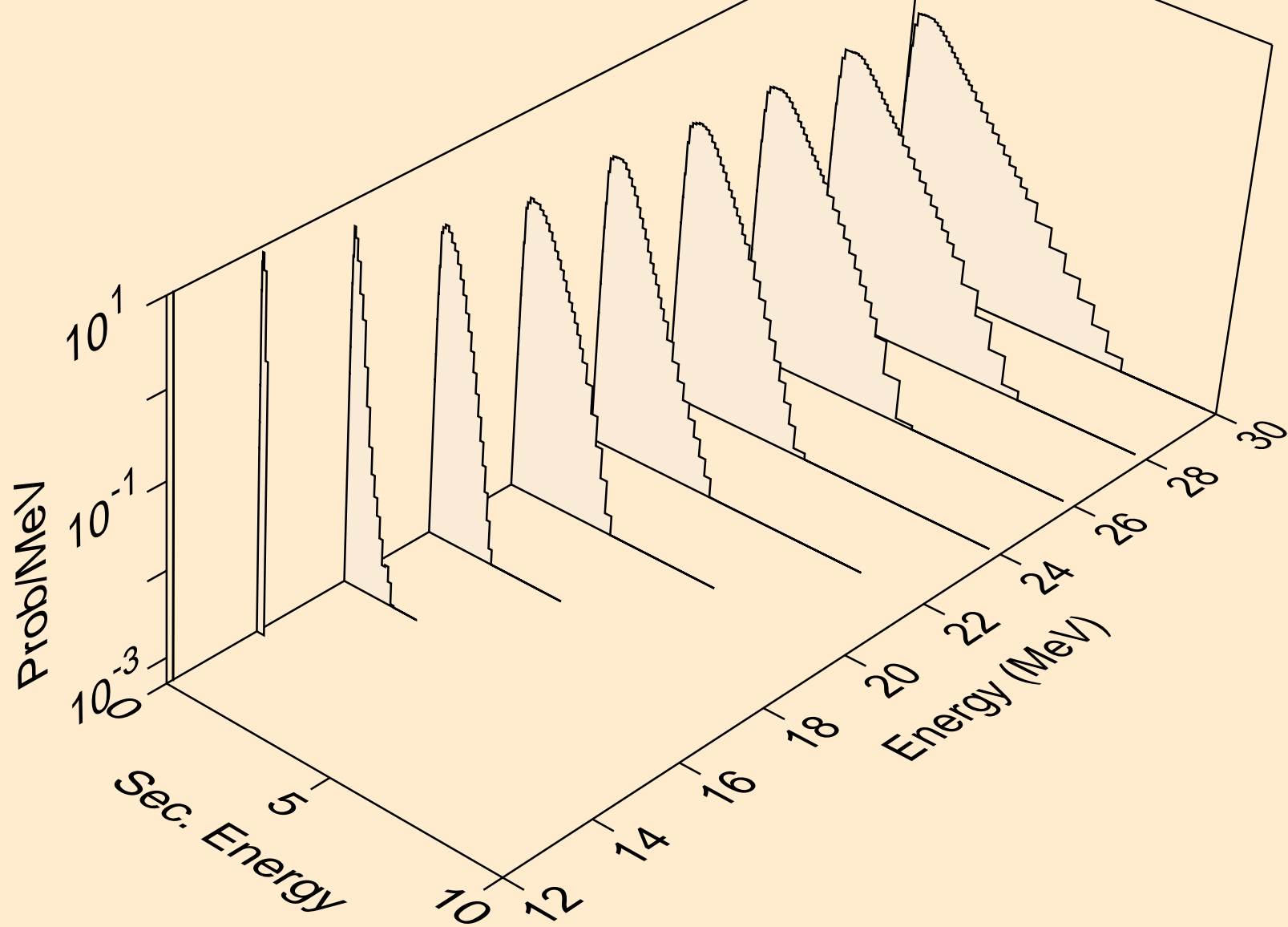

HF163 PROTON ACER TENDL-2024 LIBRARY; T=0.K  
neutrons from (p,npa)

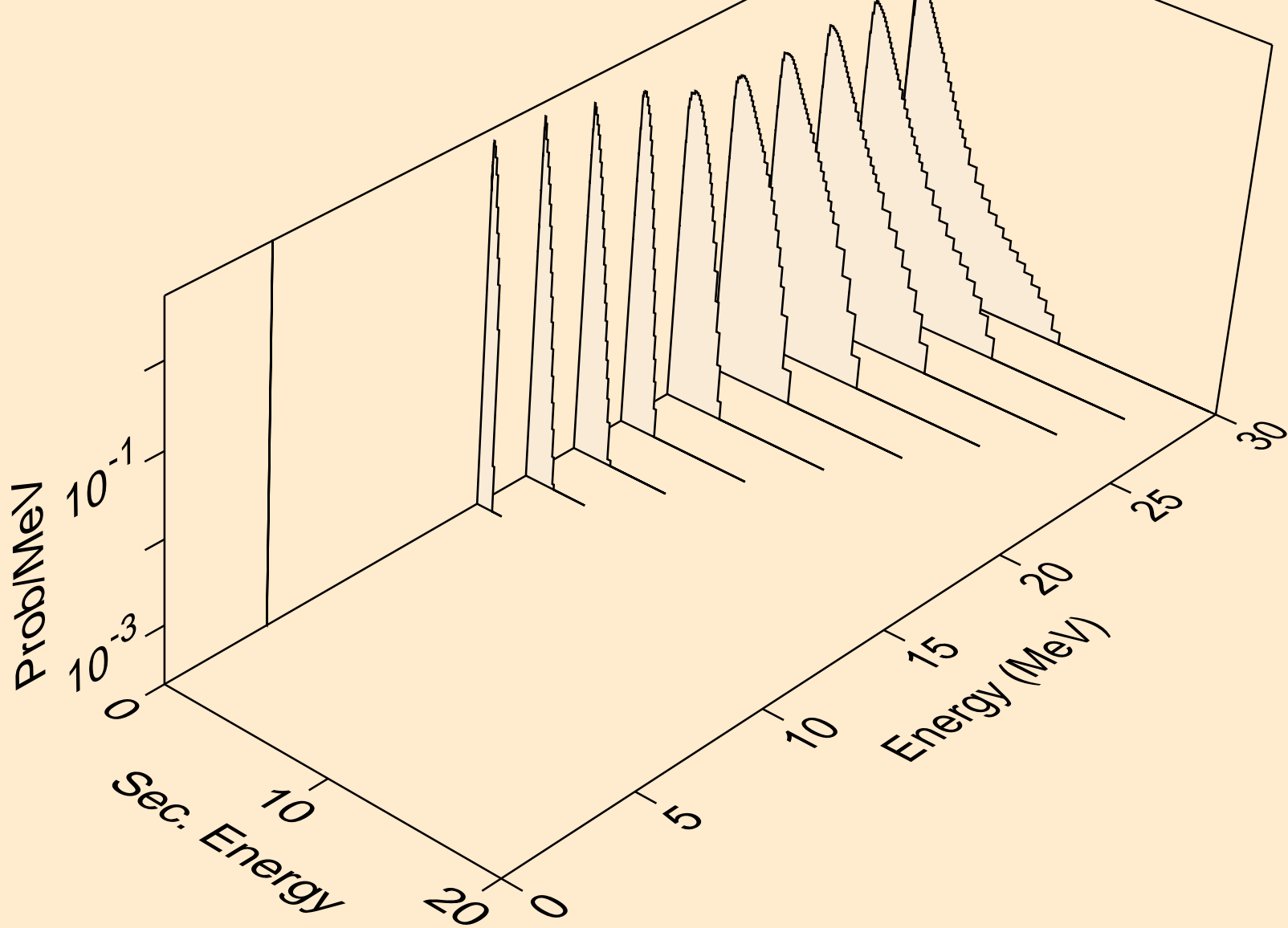

HF163 PROTON ACER TENDL-2024 LIBRARY; T=0.K  
deuterons from (p,x)

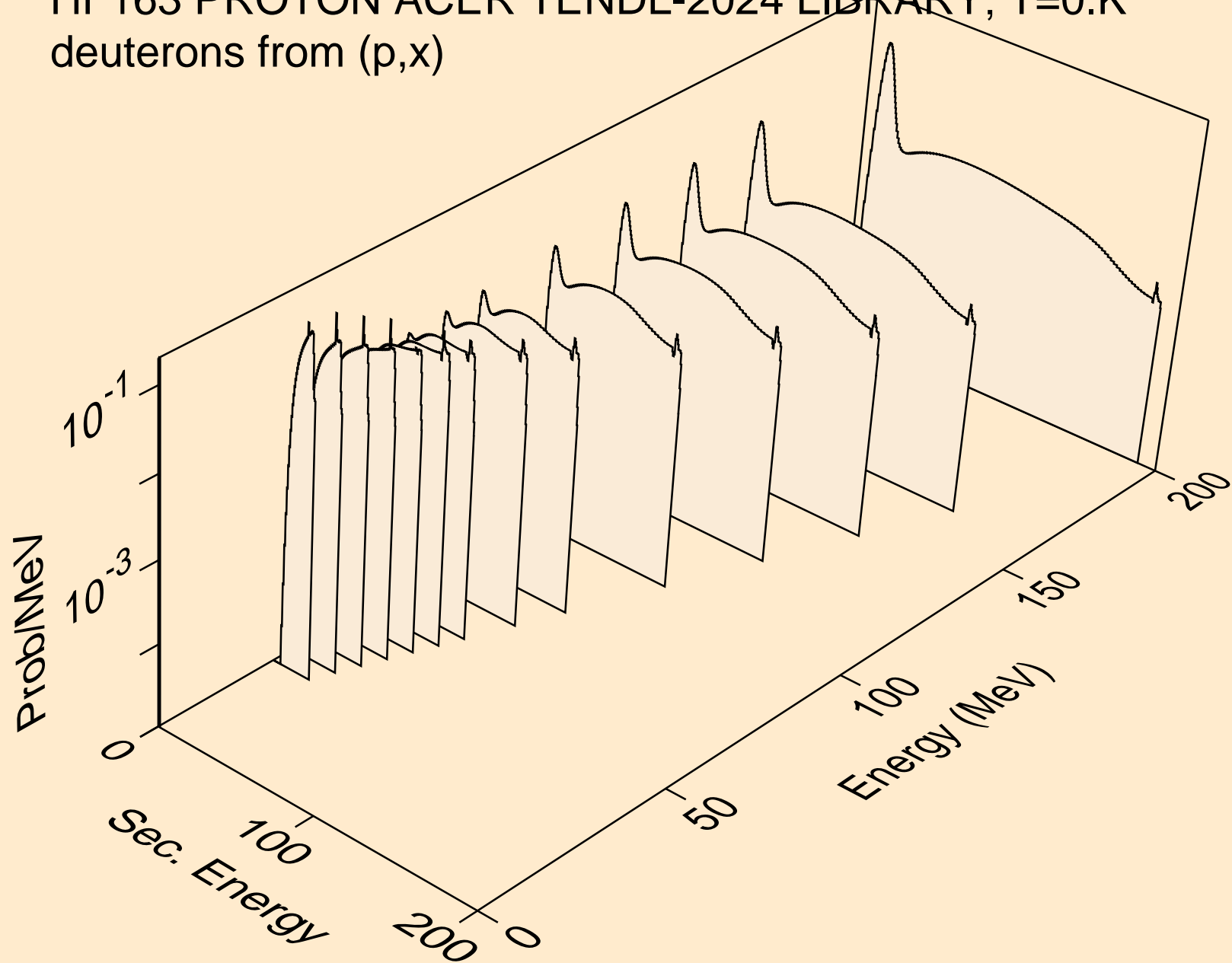

HF163 PROTON ACER TENDL-2024 LIBRARY; T=0.K  
deuterons from (p,n\*)d

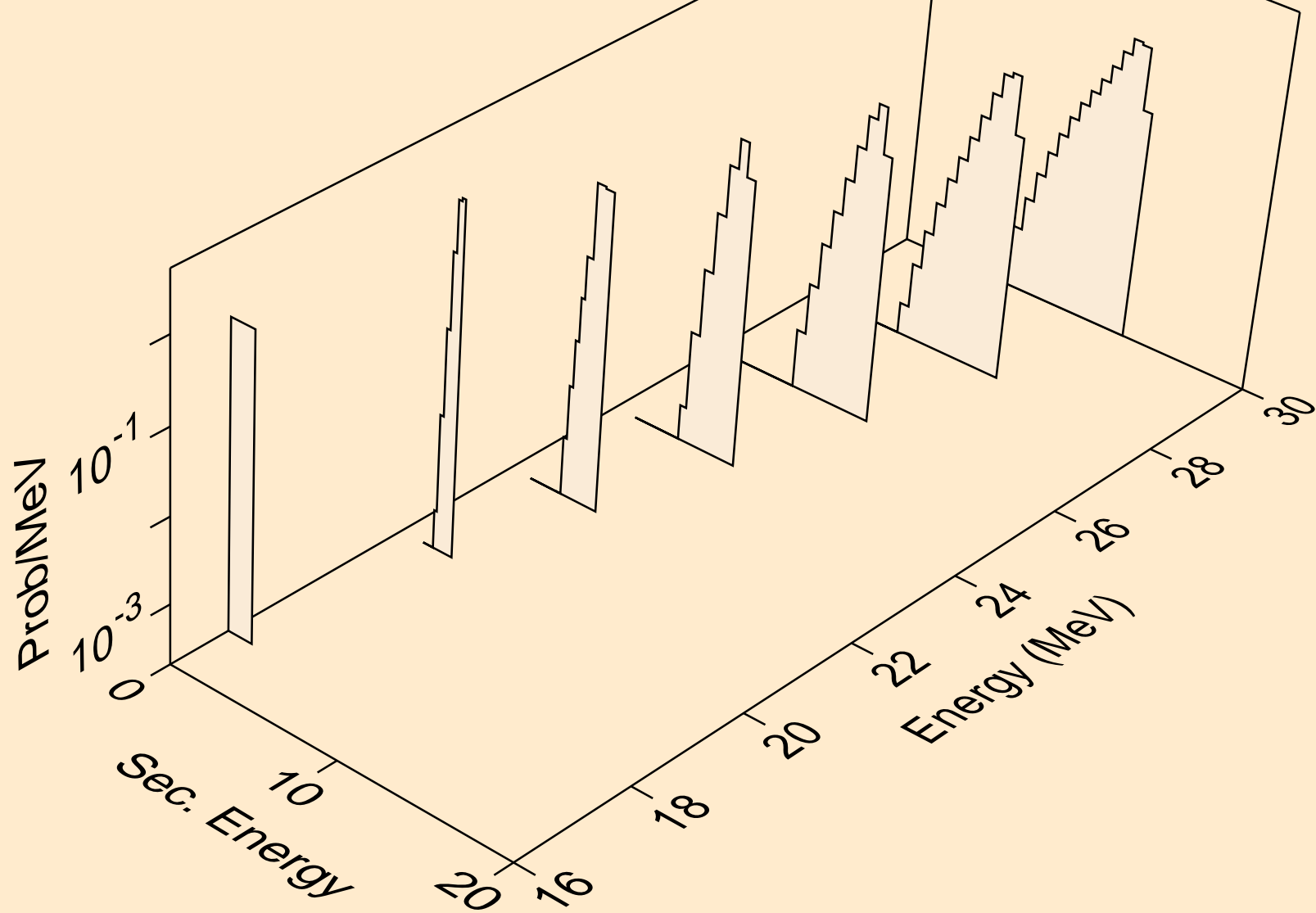

HF163 PROTON ACER TENDL-2024 LIBRARY; T=0.K  
deuterons from (p,d)

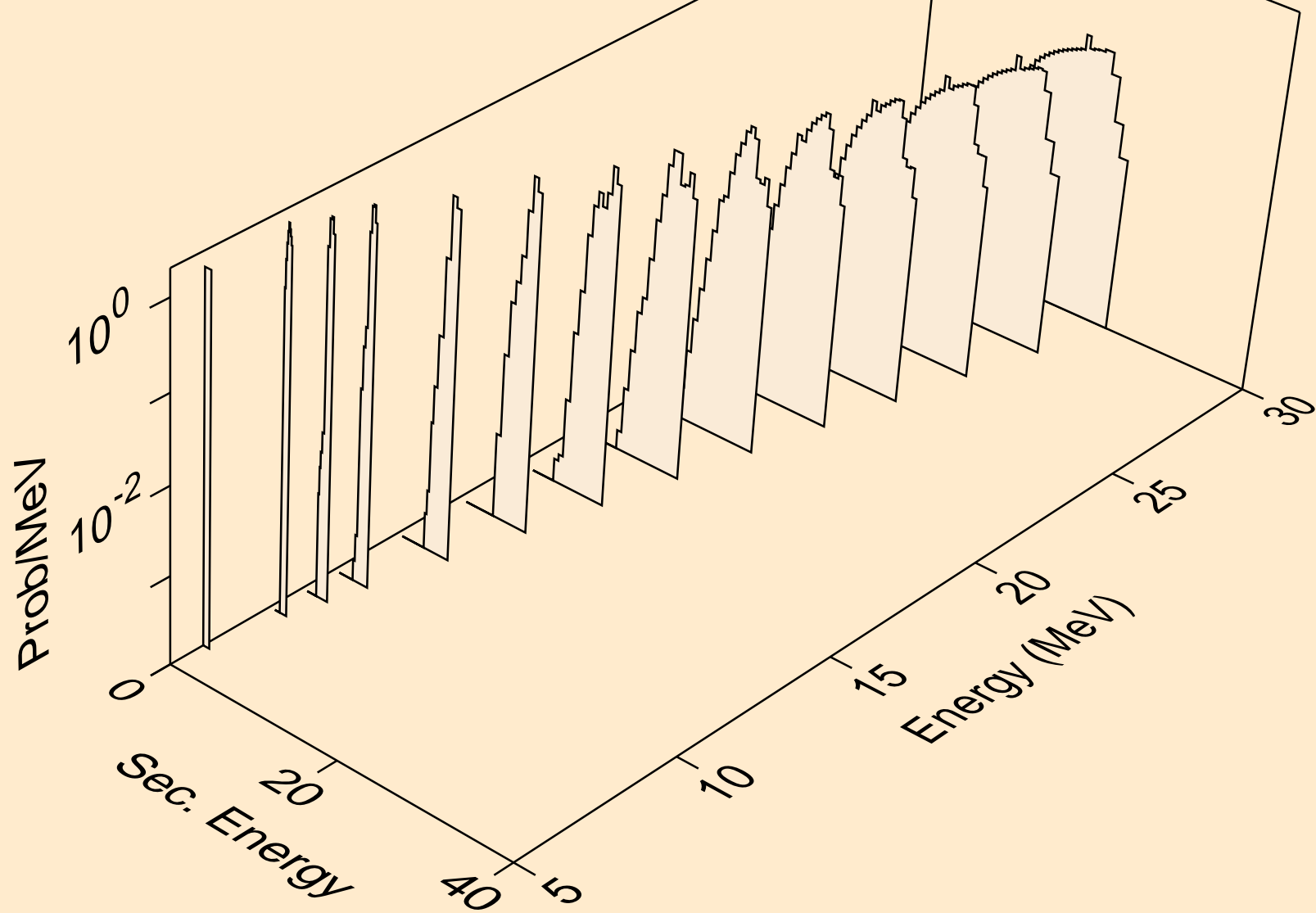

HF163 PROTON ACER TENDL-2024 LIBRARY; T=0.K  
deuterons from (p,d2a)

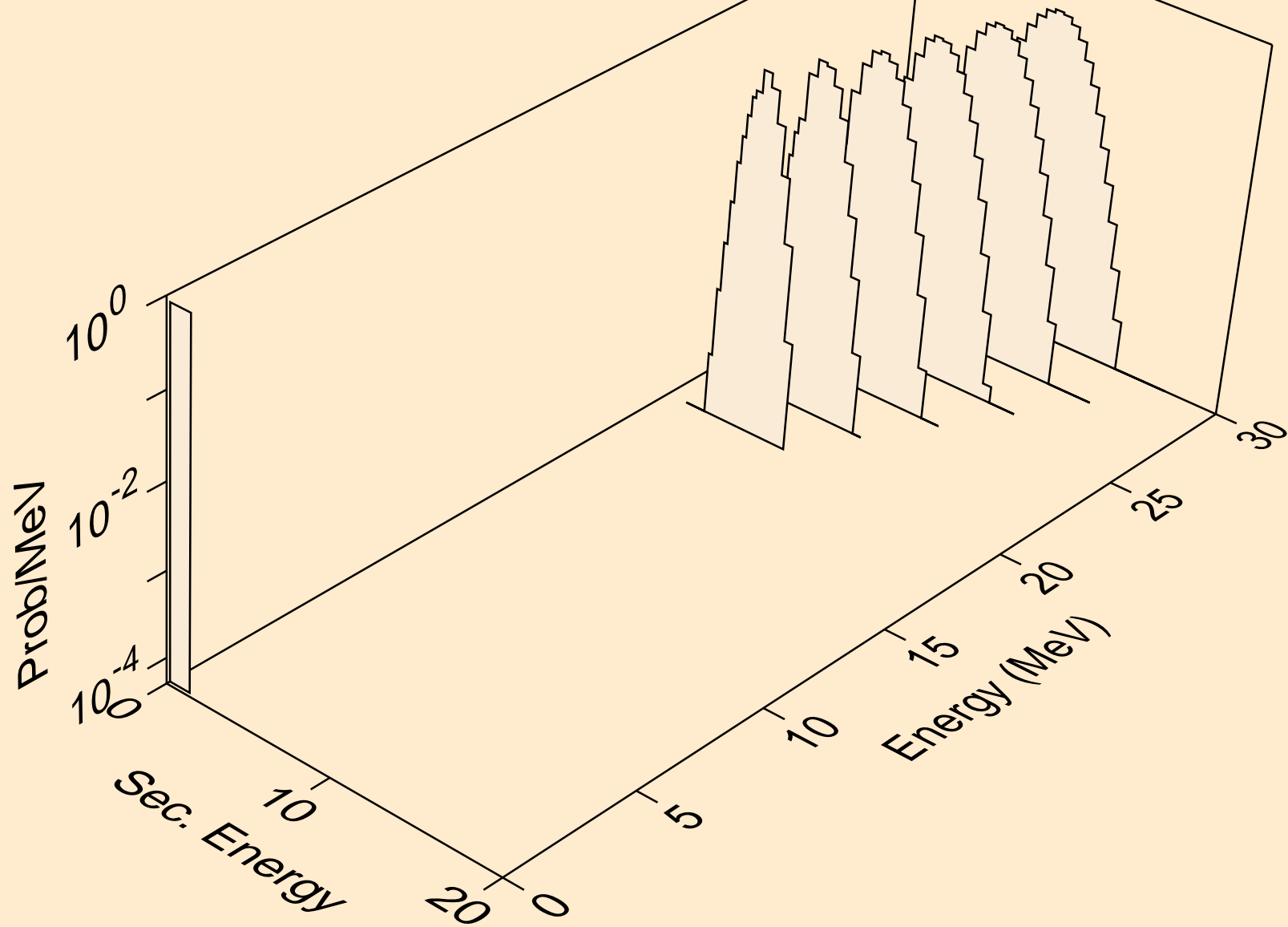

HF163 PROTON ACER TENDL-2024 LIBRARY; T=0.K  
deuterons from (p,pd)

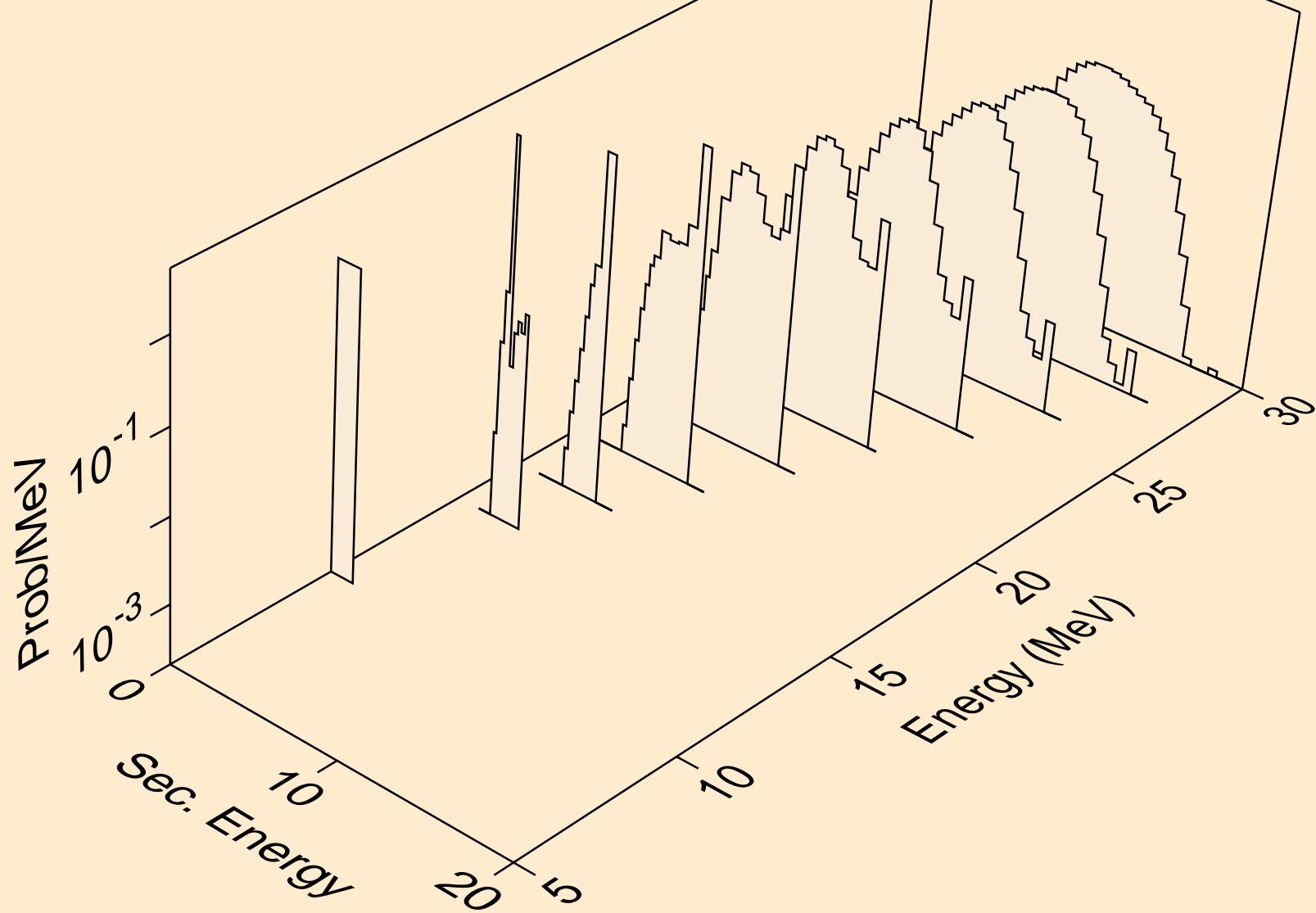

HF163 PROTON ACER TENDL-2024 LIBRARY; T=0.K  
deuterons from (p,da)

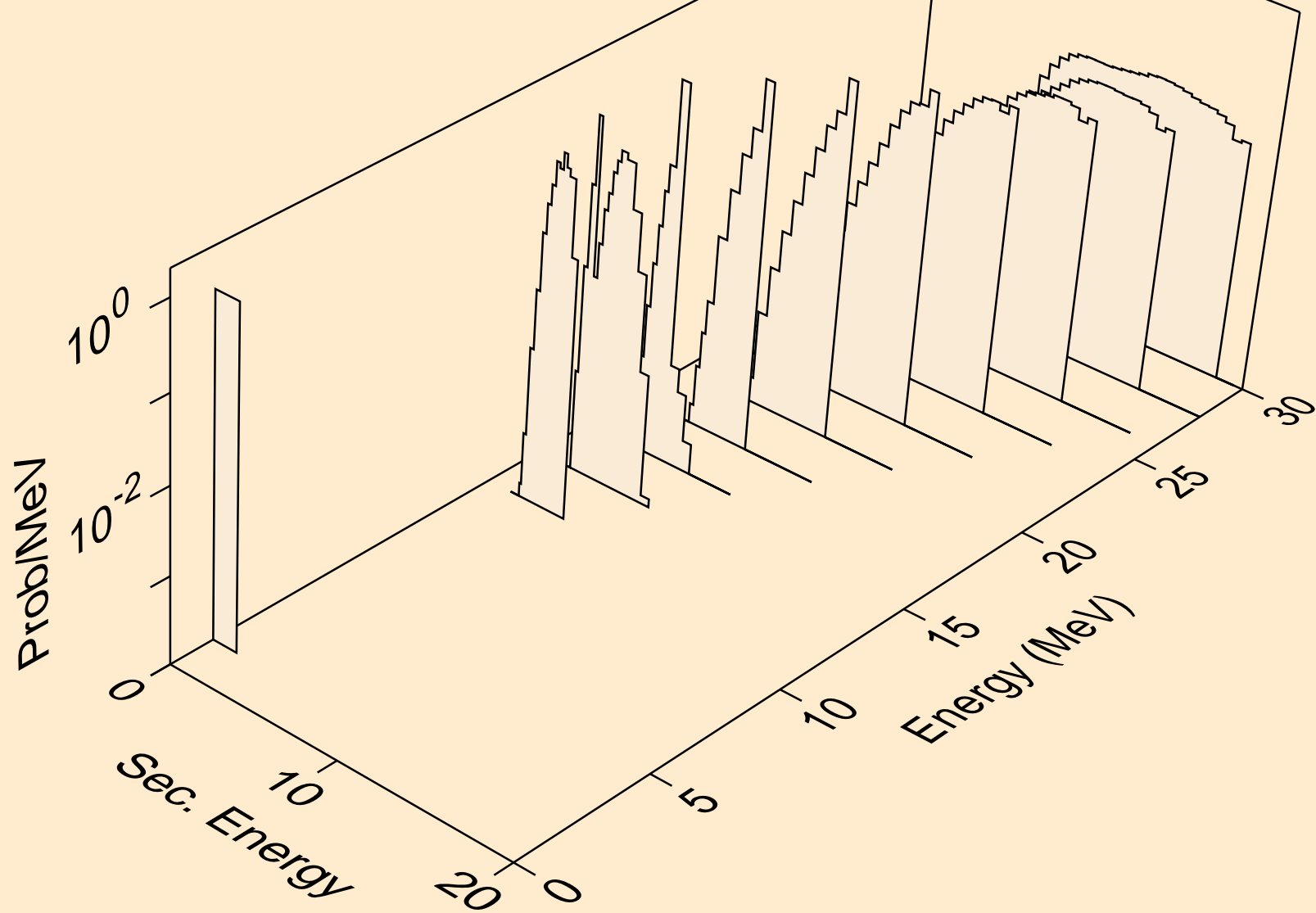

HF163 PROTON ACER TENDL-2024 LIBRARY; T=0.K  
tritons from (p,x)

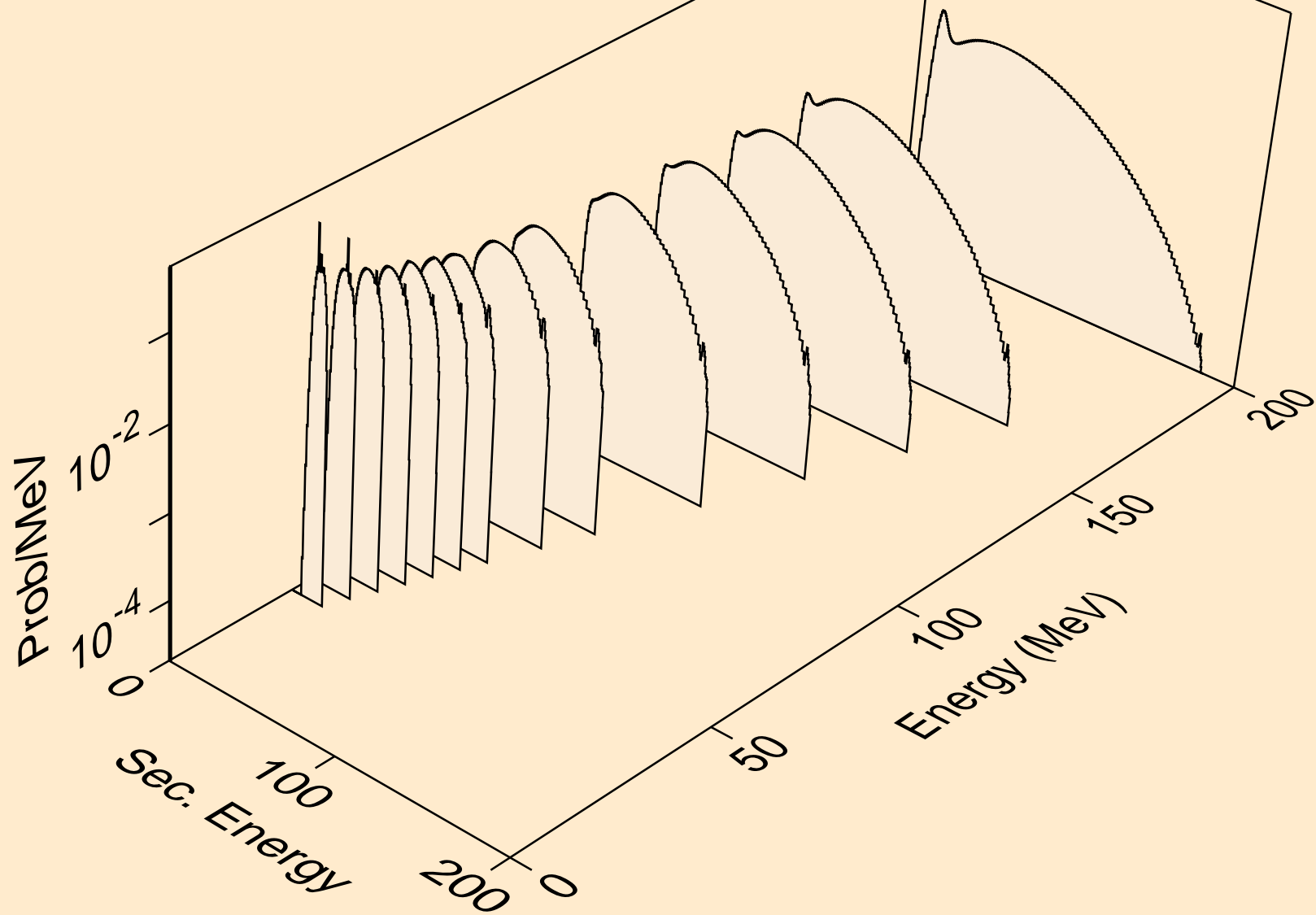

HF163 PROTON ACER TENDL-2024 LIBRARY; T=0.K  
tritons from (p,n\*)t

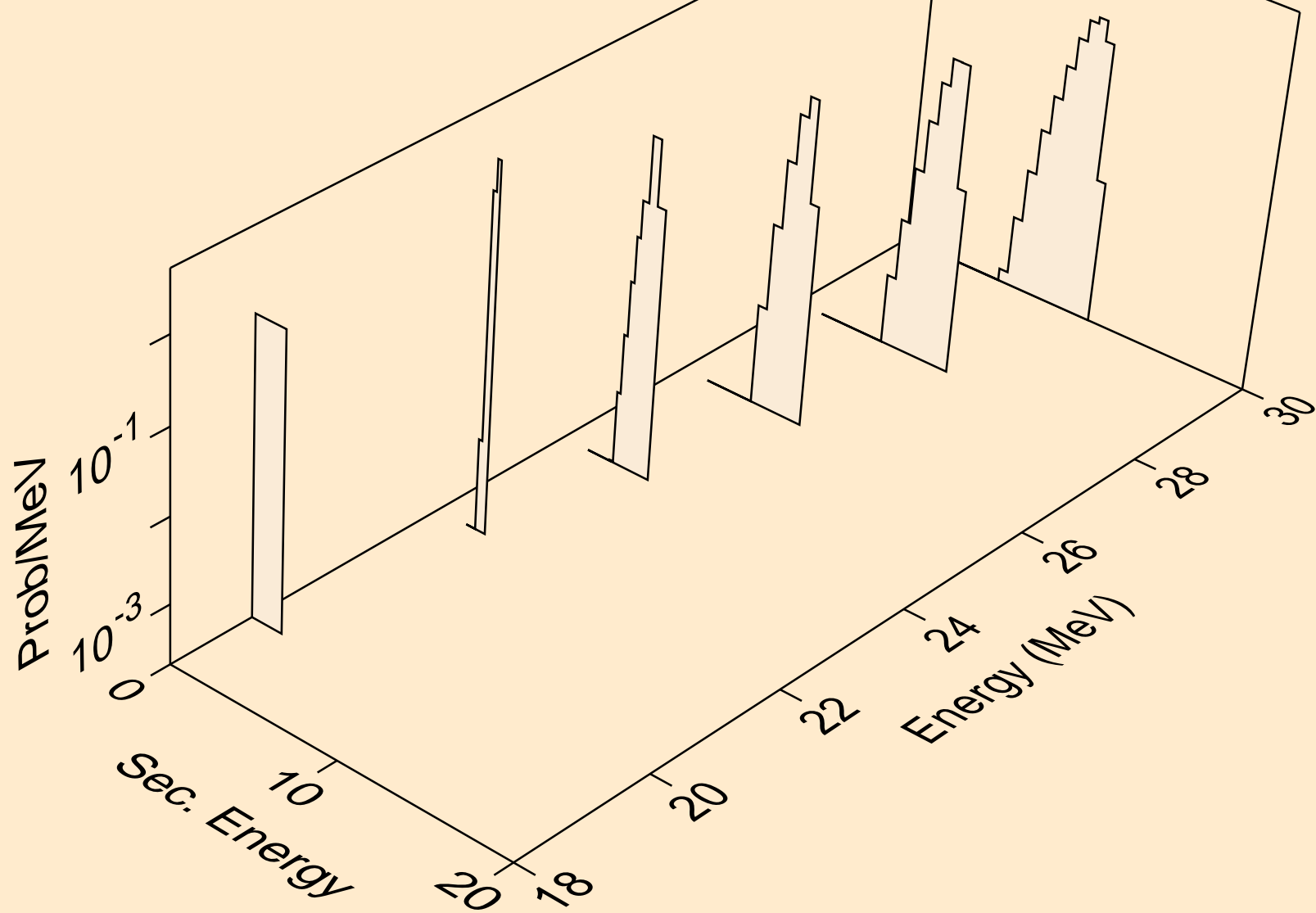

HF163 PROTON ACER TENDL-2024 LIBRARY; T=0.K  
tritons from (p,t)

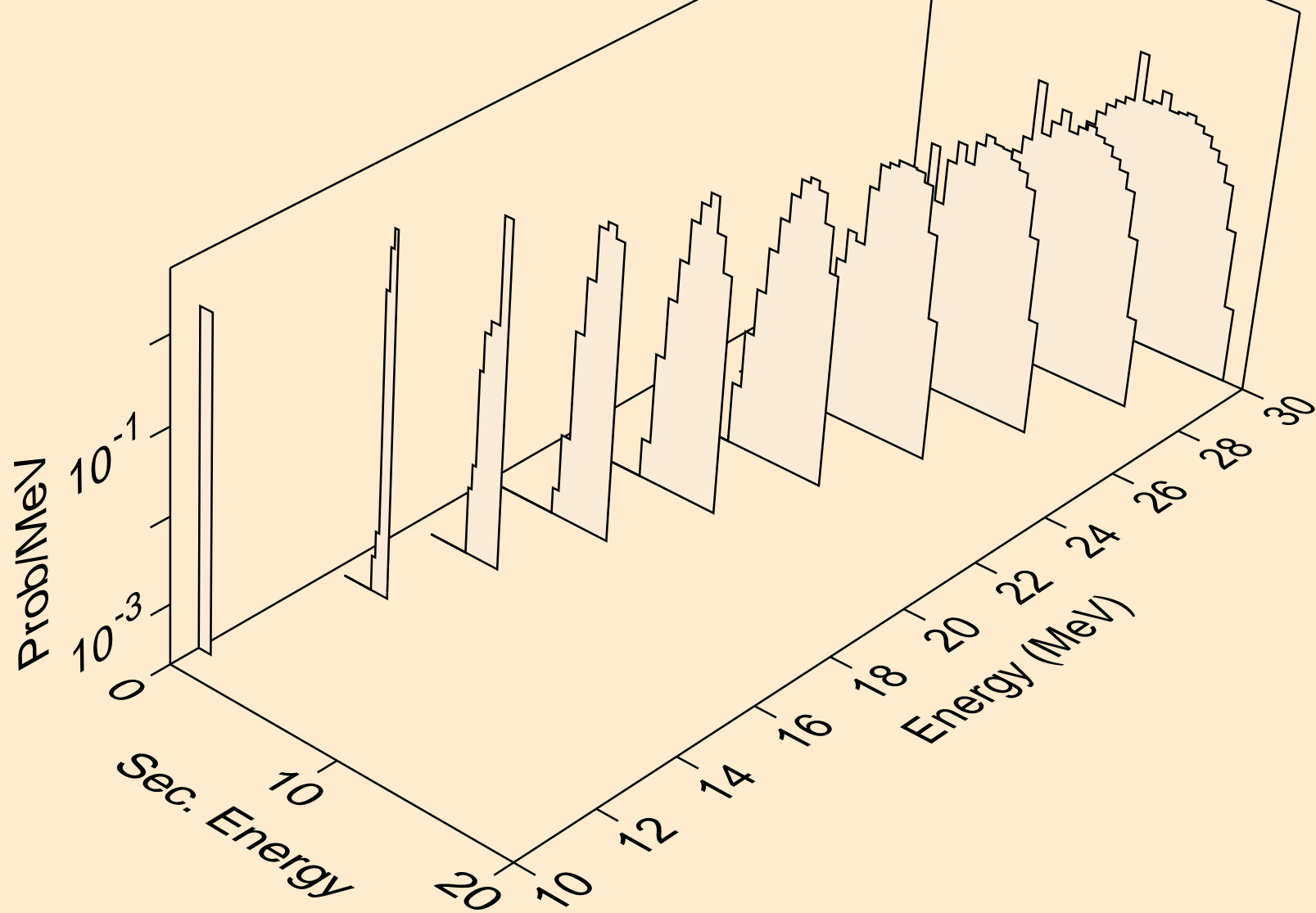

HF163 PROTON ACER TENDL-2024 LIBRARY; T=0.K  
tritons from (p,pt)

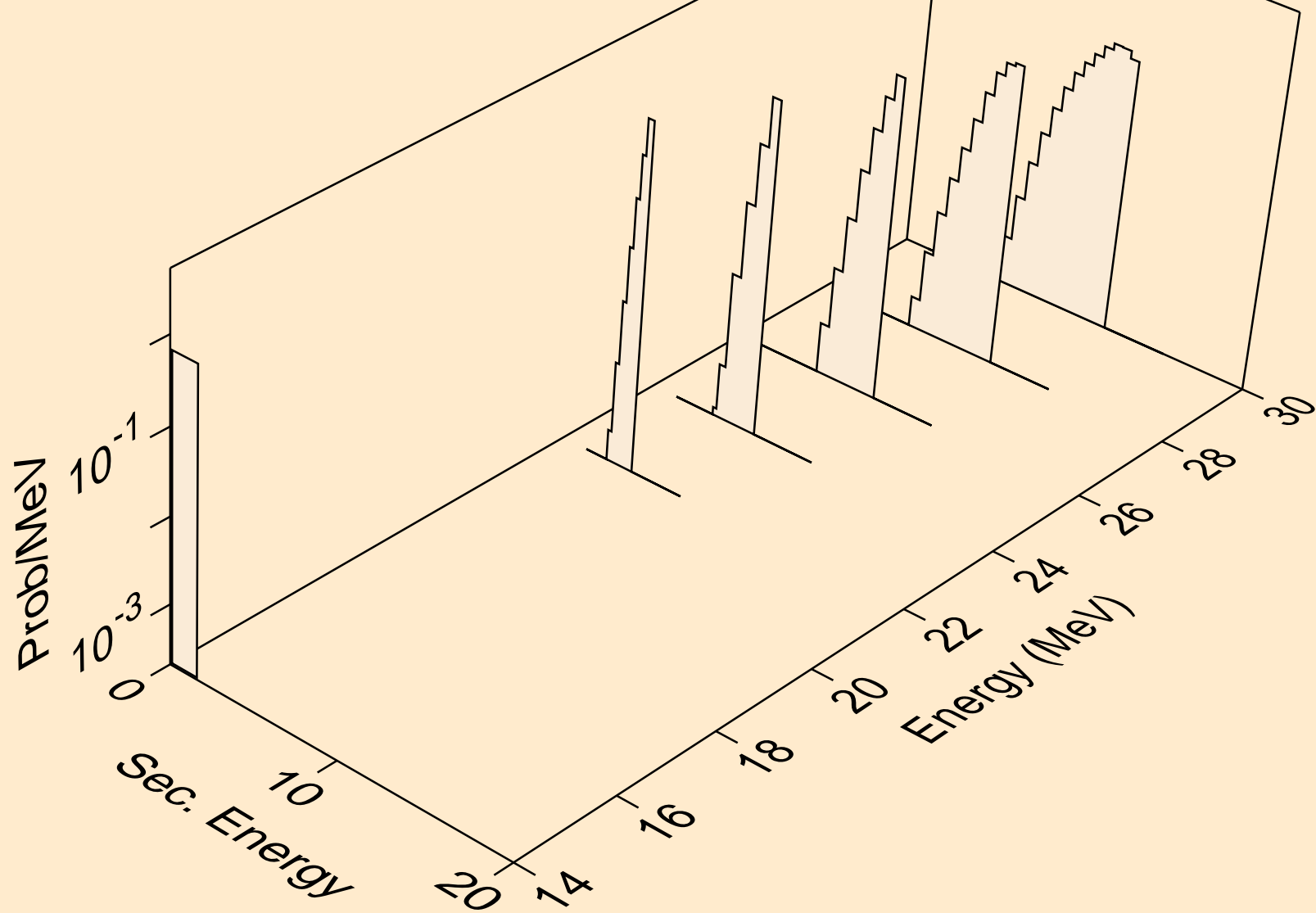

HF163 PROTON ACER TENDL-2024 LIBRARY; T=0.K  
he3s from (p,x)

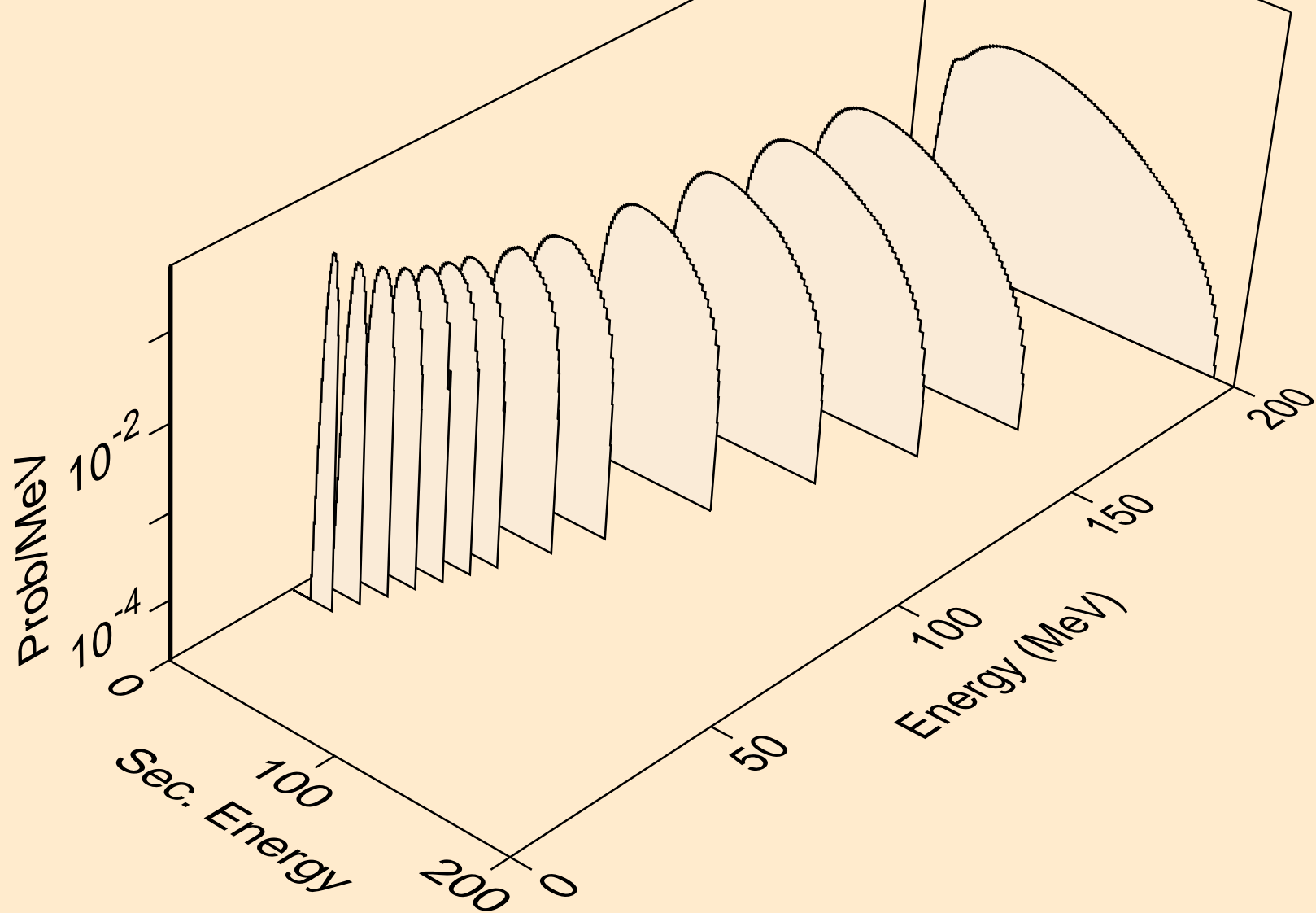

HF163 PROTON ACER TENDL-2024 LIBRARY; T=0.K  
he3s from (p,n\*)he3

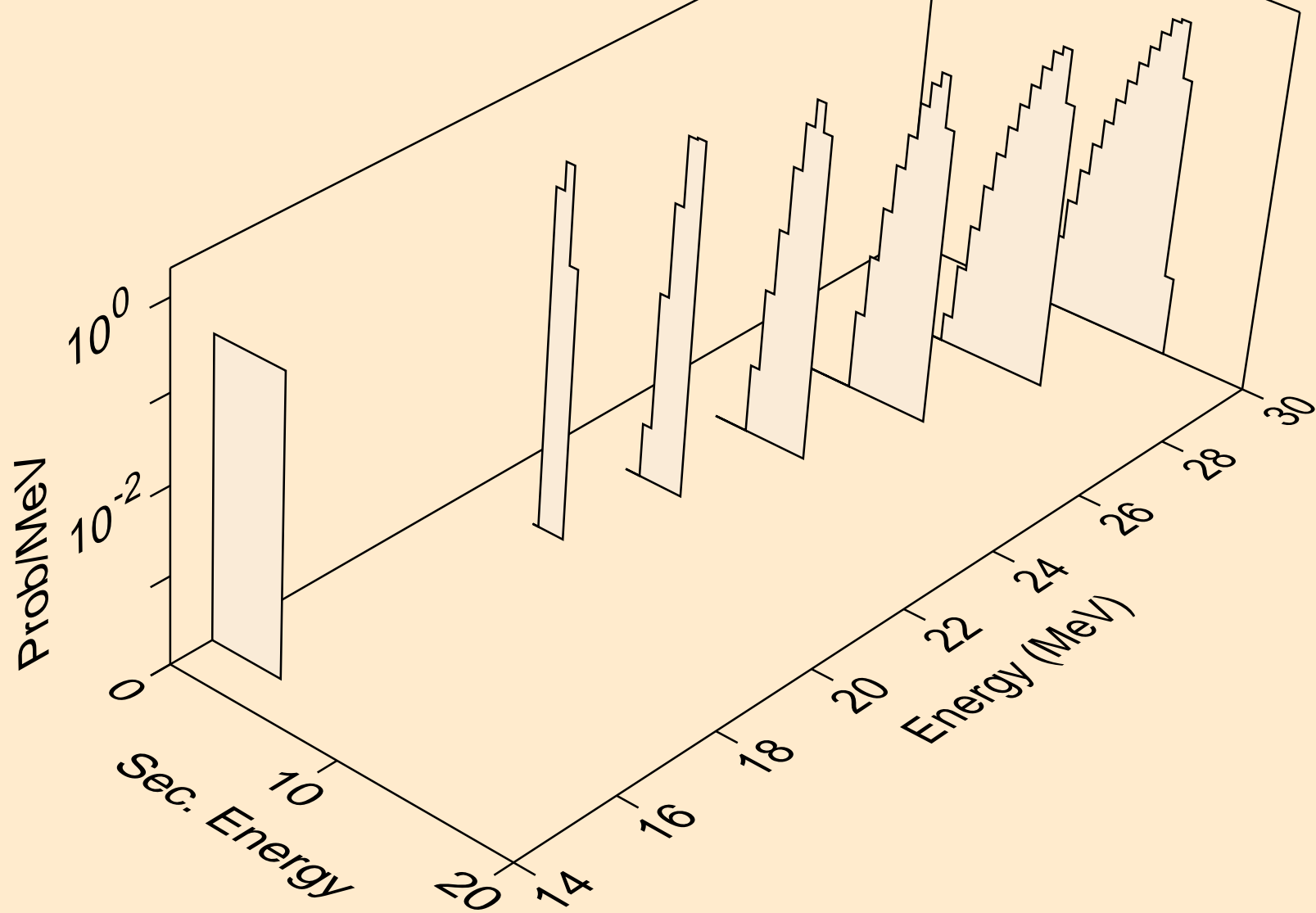

HF163 PROTON ACER TENDL-2024 LIBRARY; T=0.K  
he3s from (p,he3)

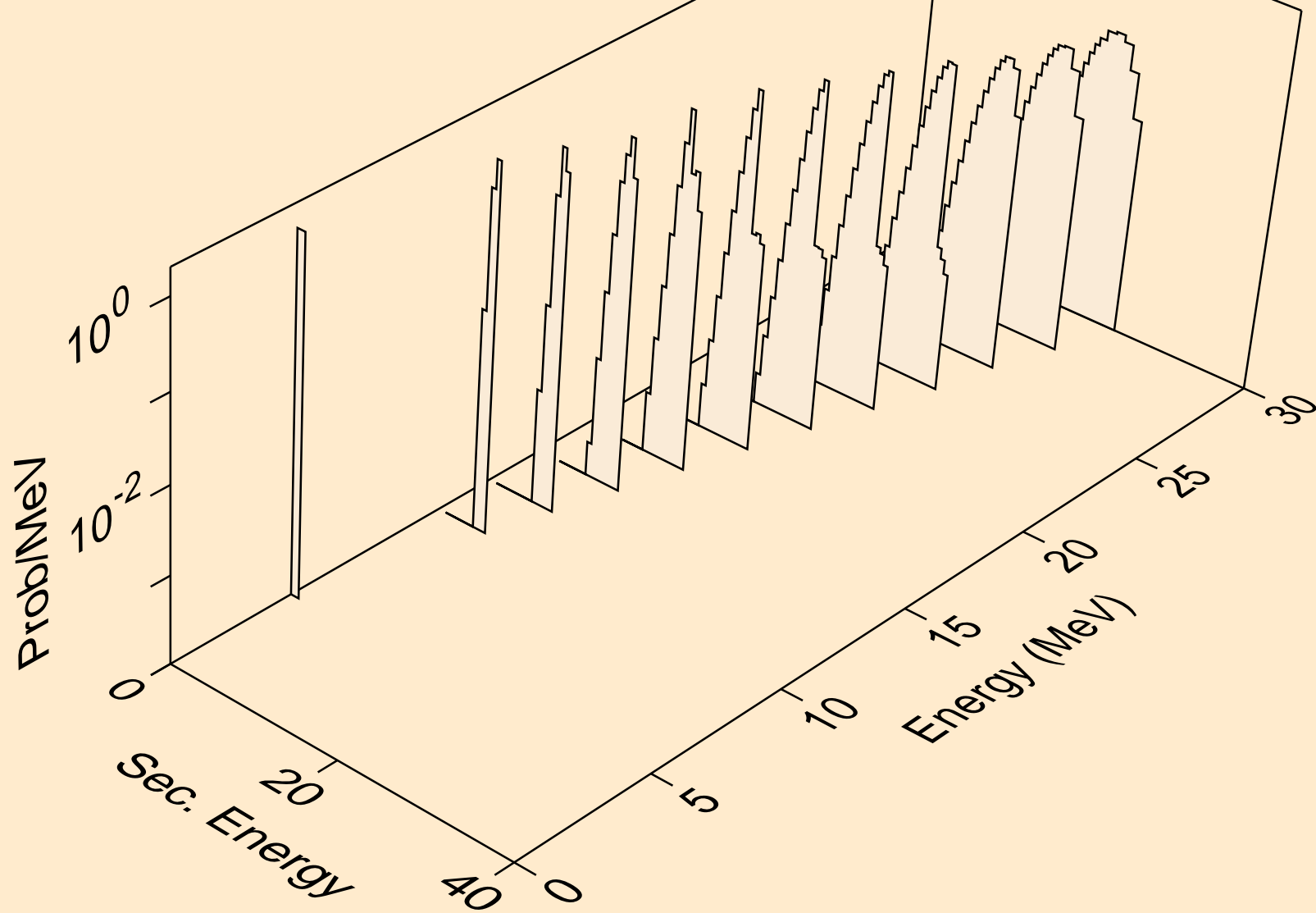

HF163 PROTON ACER TENDL-2024 LIBRARY; T=0.K  
alphas from (p,x)

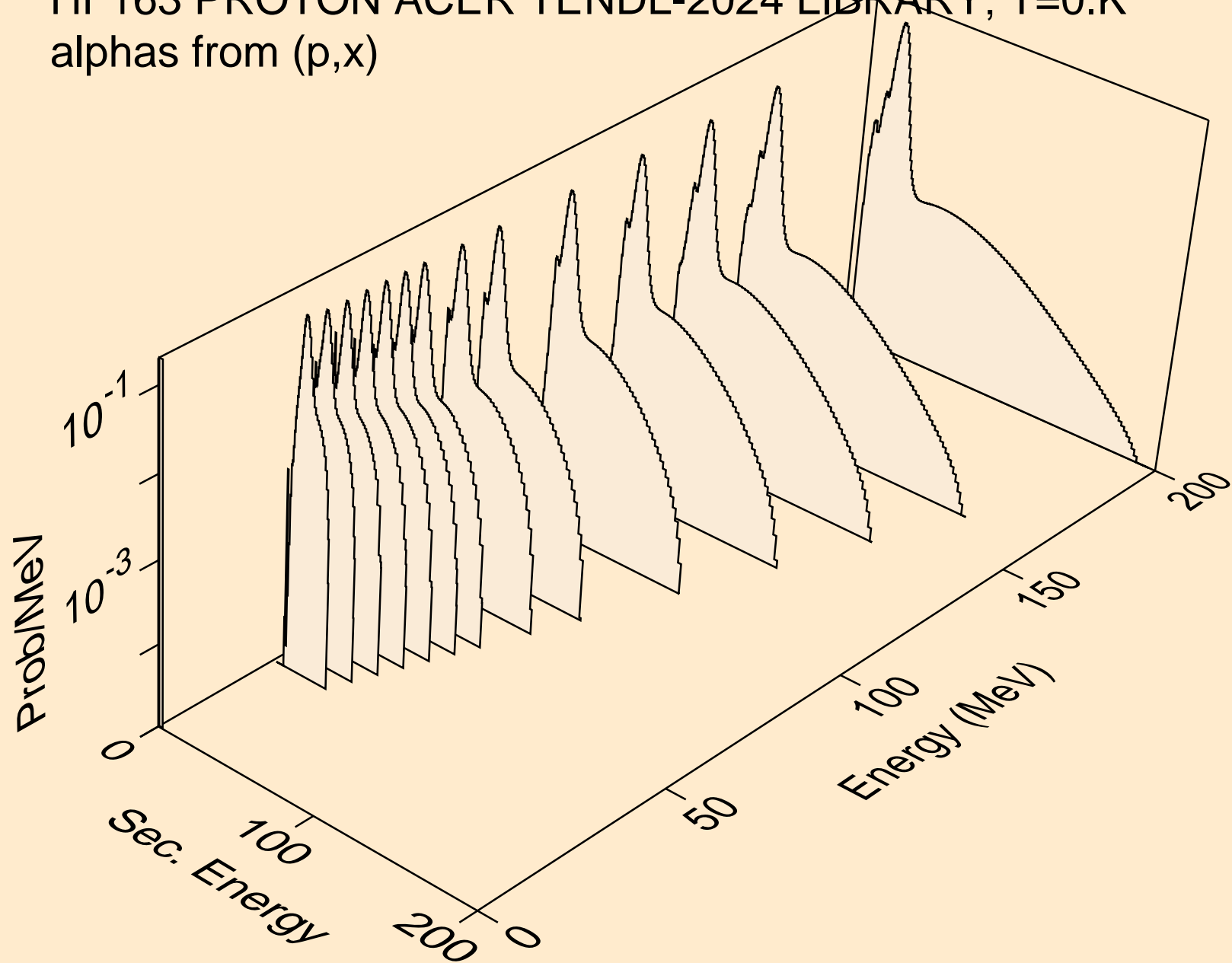

HF163 PROTON ACER TENDL-2024 LIBRARY; T=0.K  
alphas from (p,n\*)a

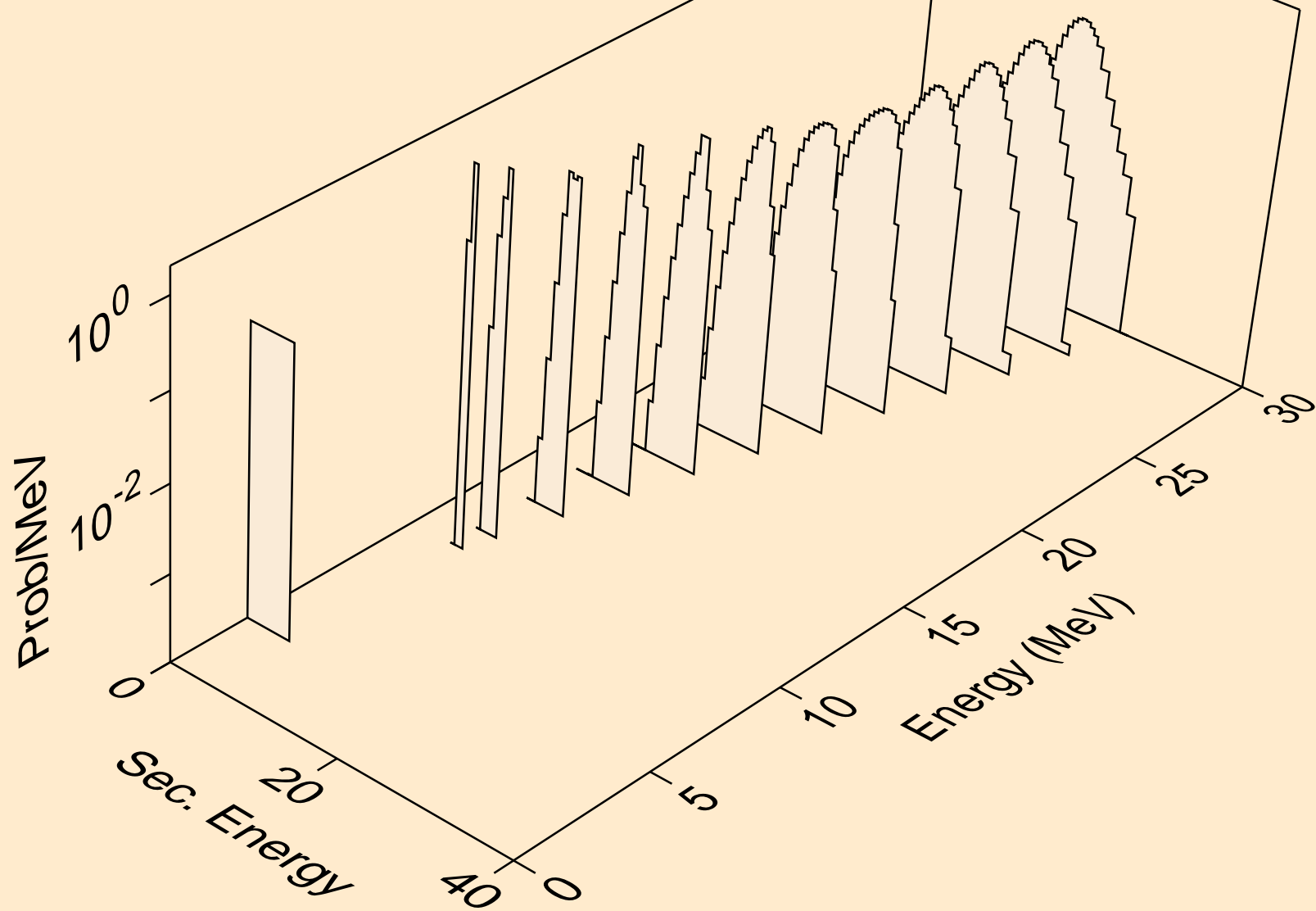

HF163 PROTON ACER TENDL-2024 LIBRARY; T=0.K  
alphas from (p,n\*)3a

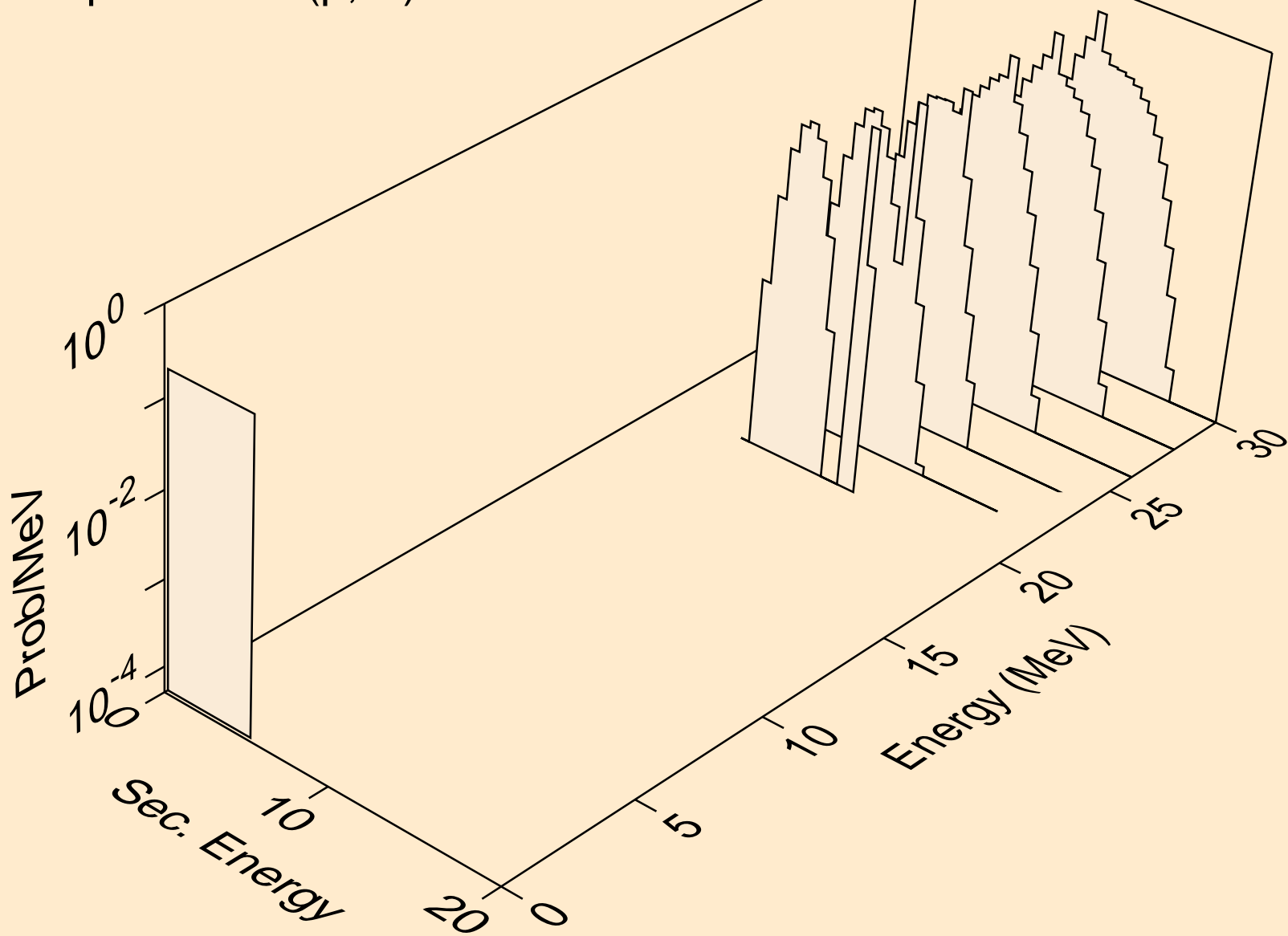

HF163 PROTON ACER TENDL-2024 LIBRARY; T=0.K  
alphas from (p,2n)a

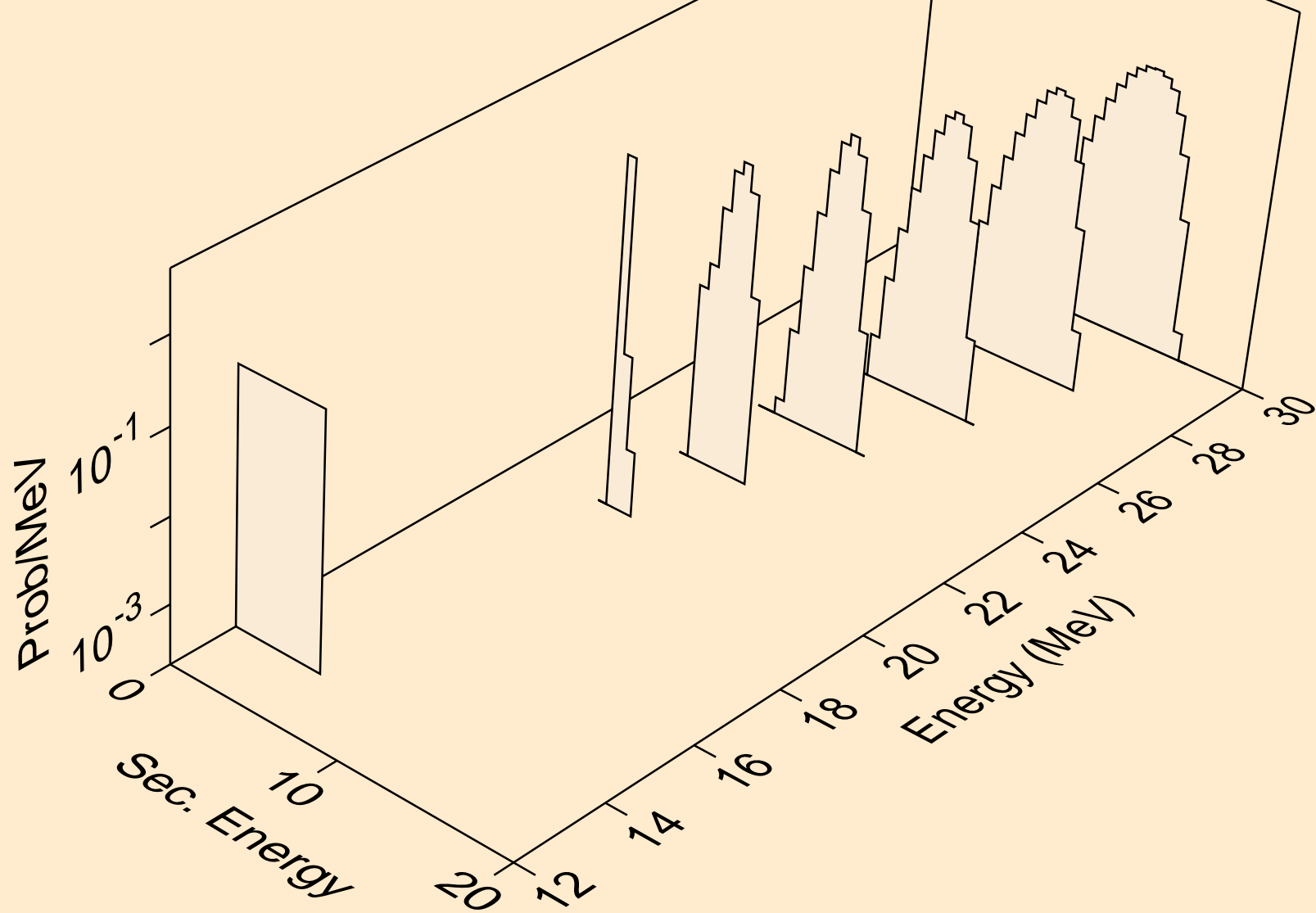

HF163 PROTON ACER TENDL-2024 LIBRARY; T=0.K  
alphas from (p,3n)a

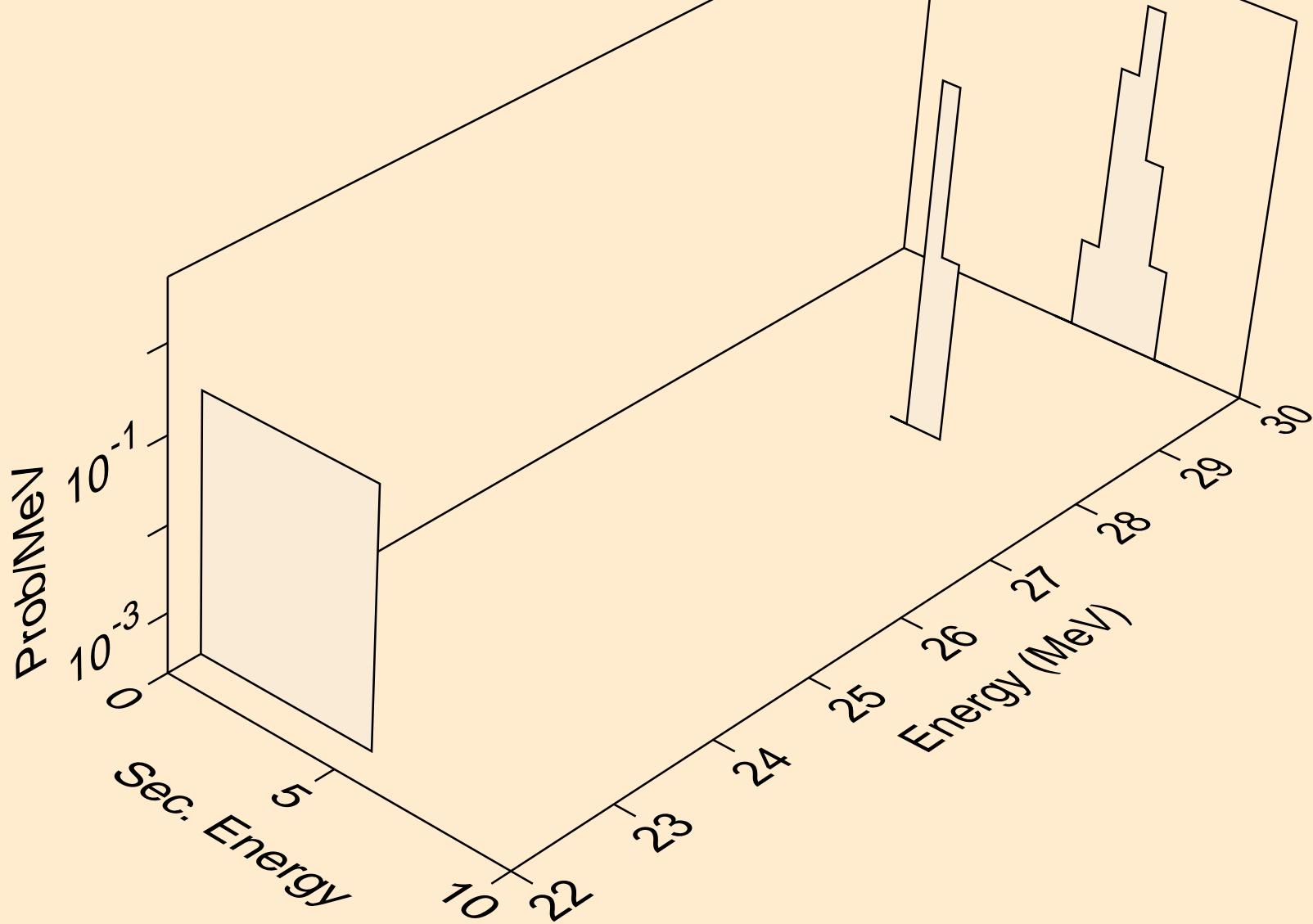

HF163 PROTON ACER TENDL-2024 LIBRARY; T=0.K  
alphas from (p,n\*)2a

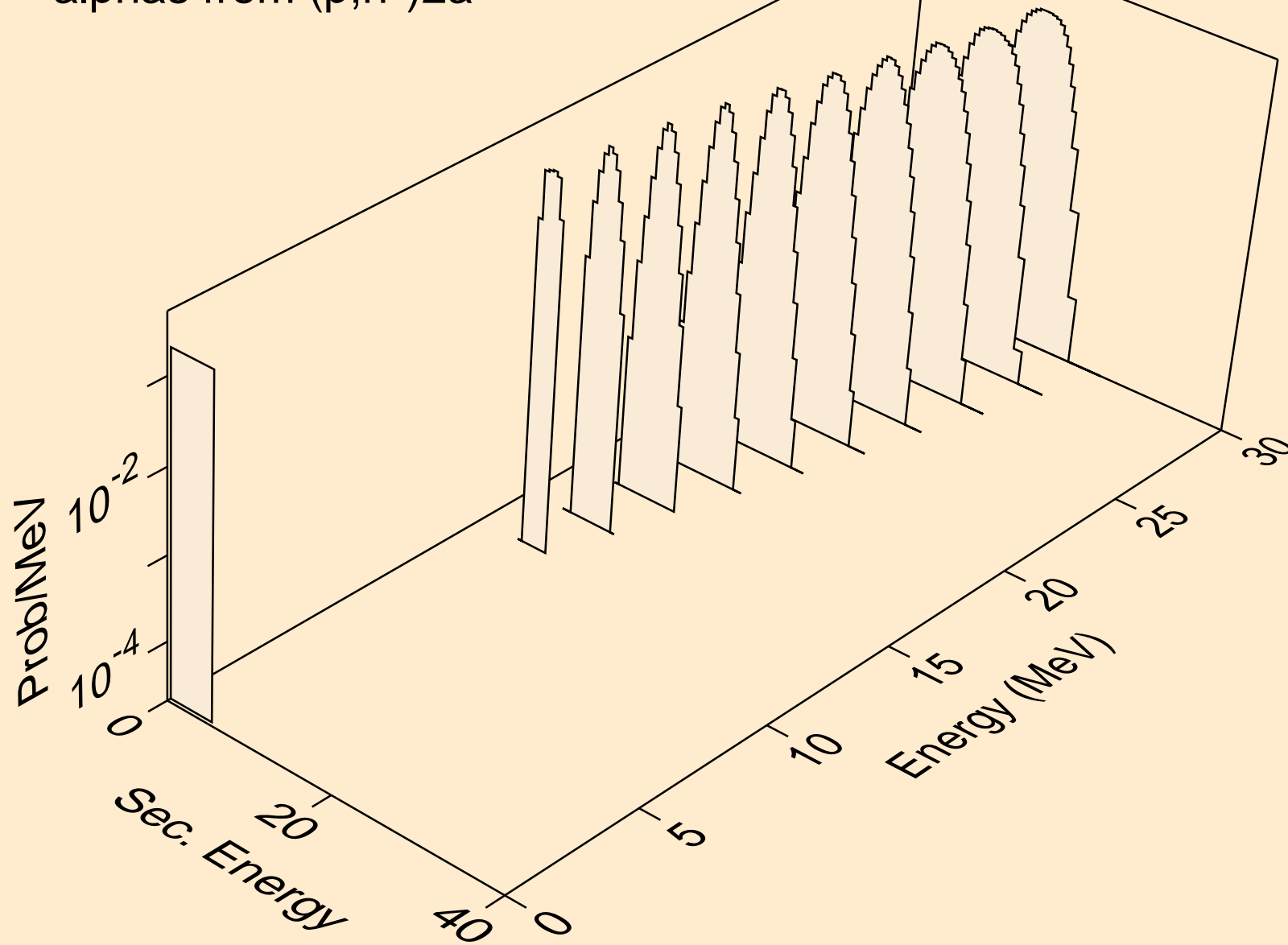

HF163 PROTON ACER TENDL-2024 LIBRARY; T=0.K  
alphas from (p,npa)

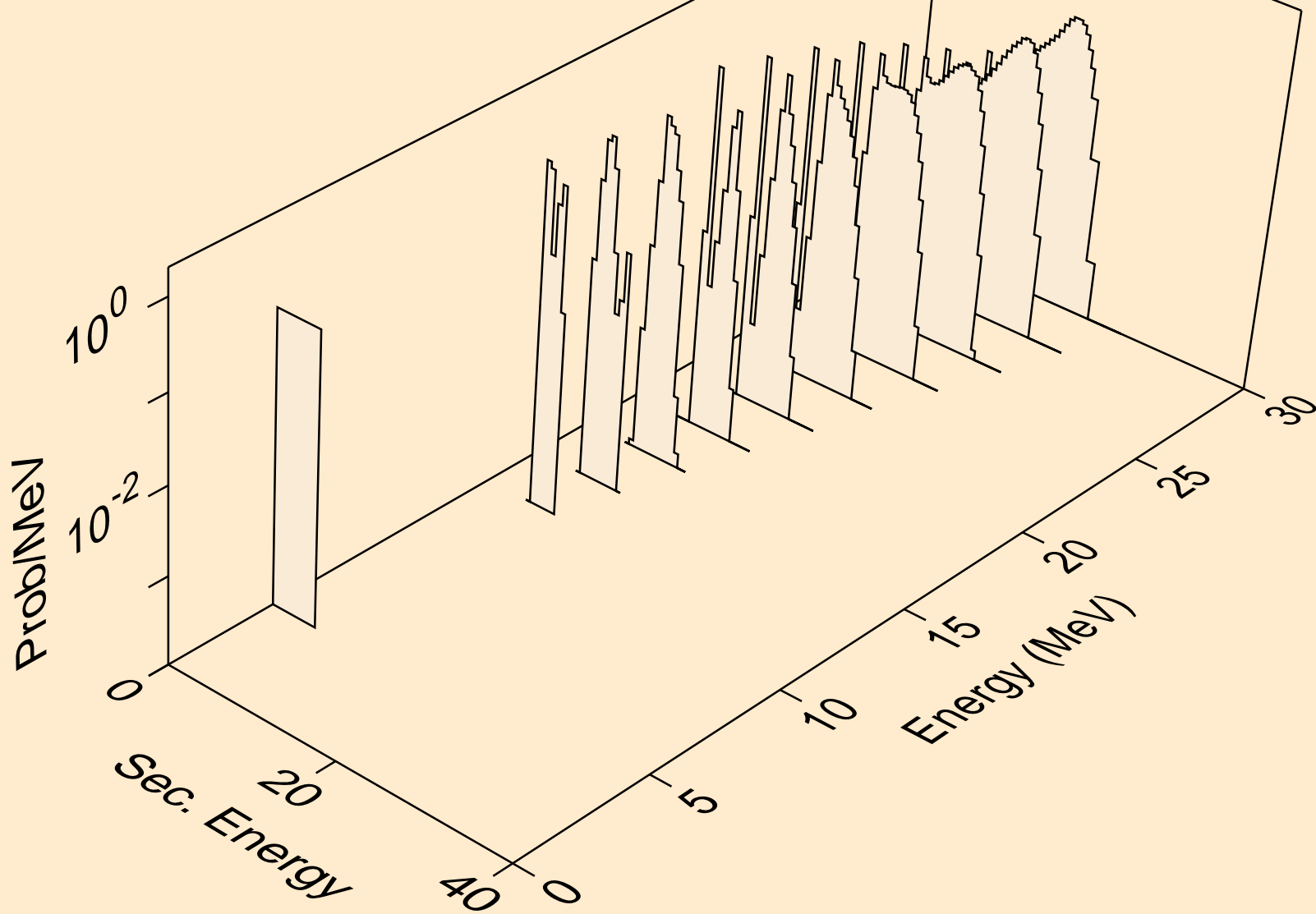

HF163 PROTON ACER TENDL-2024 LIBRARY; T=0.K  
alphas from (p,a)

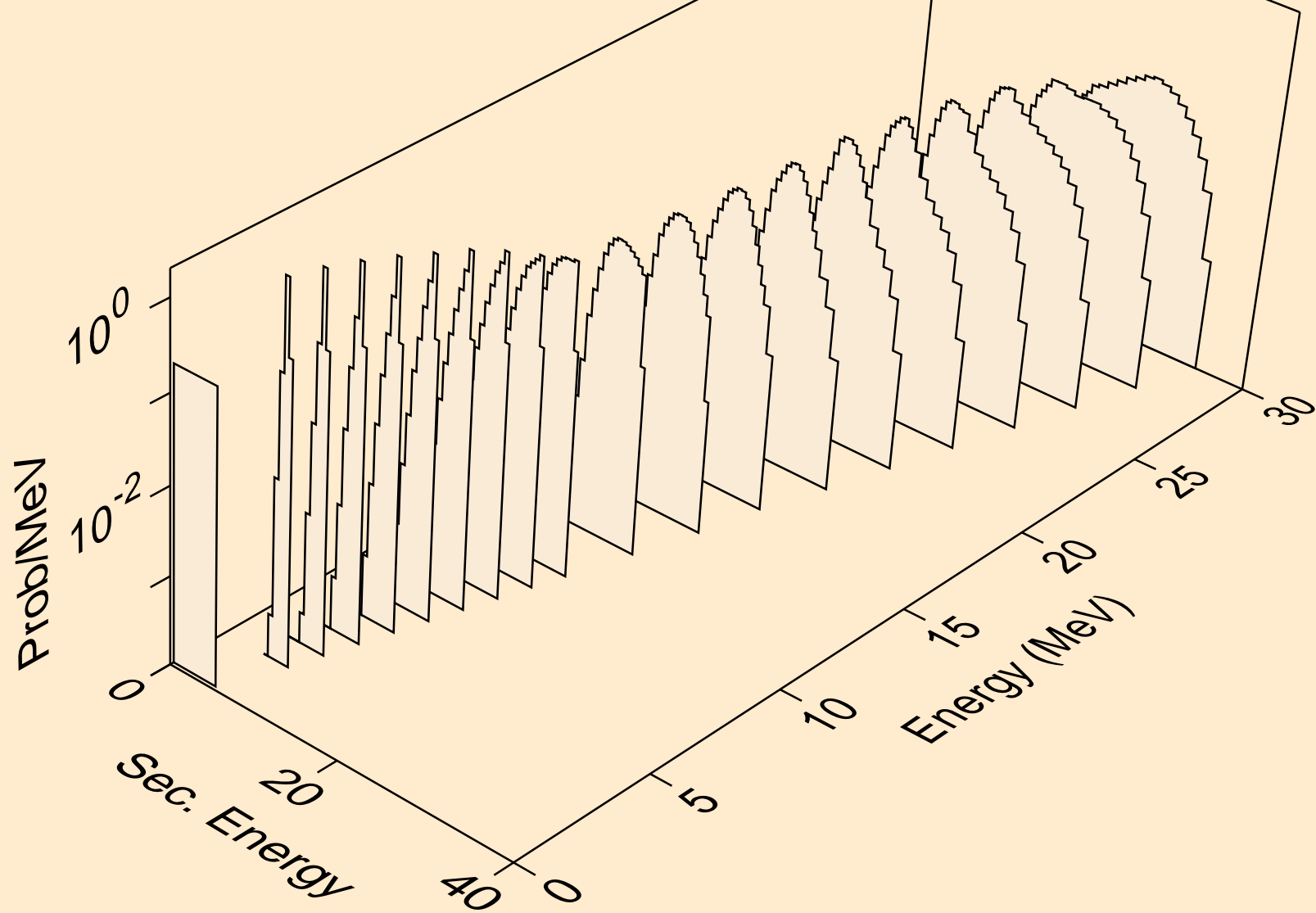

HF163 PROTON ACER TENDL-2024 LIBRARY; T=0.K  
alphas from (p,2a)

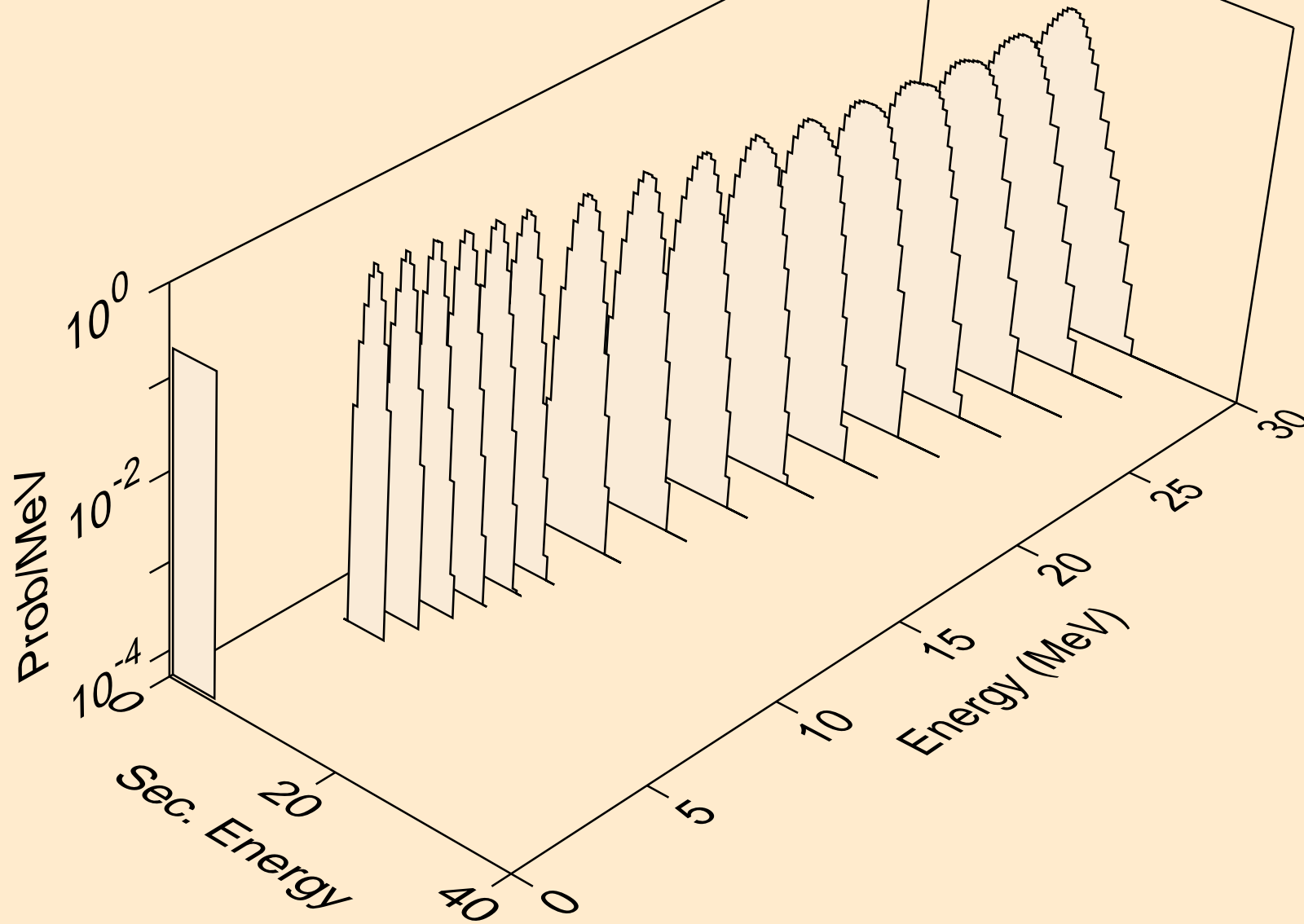

HF163 PROTON ACER TENDL-2024 LIBRARY; T=0.K  
alphas from (p,3a)

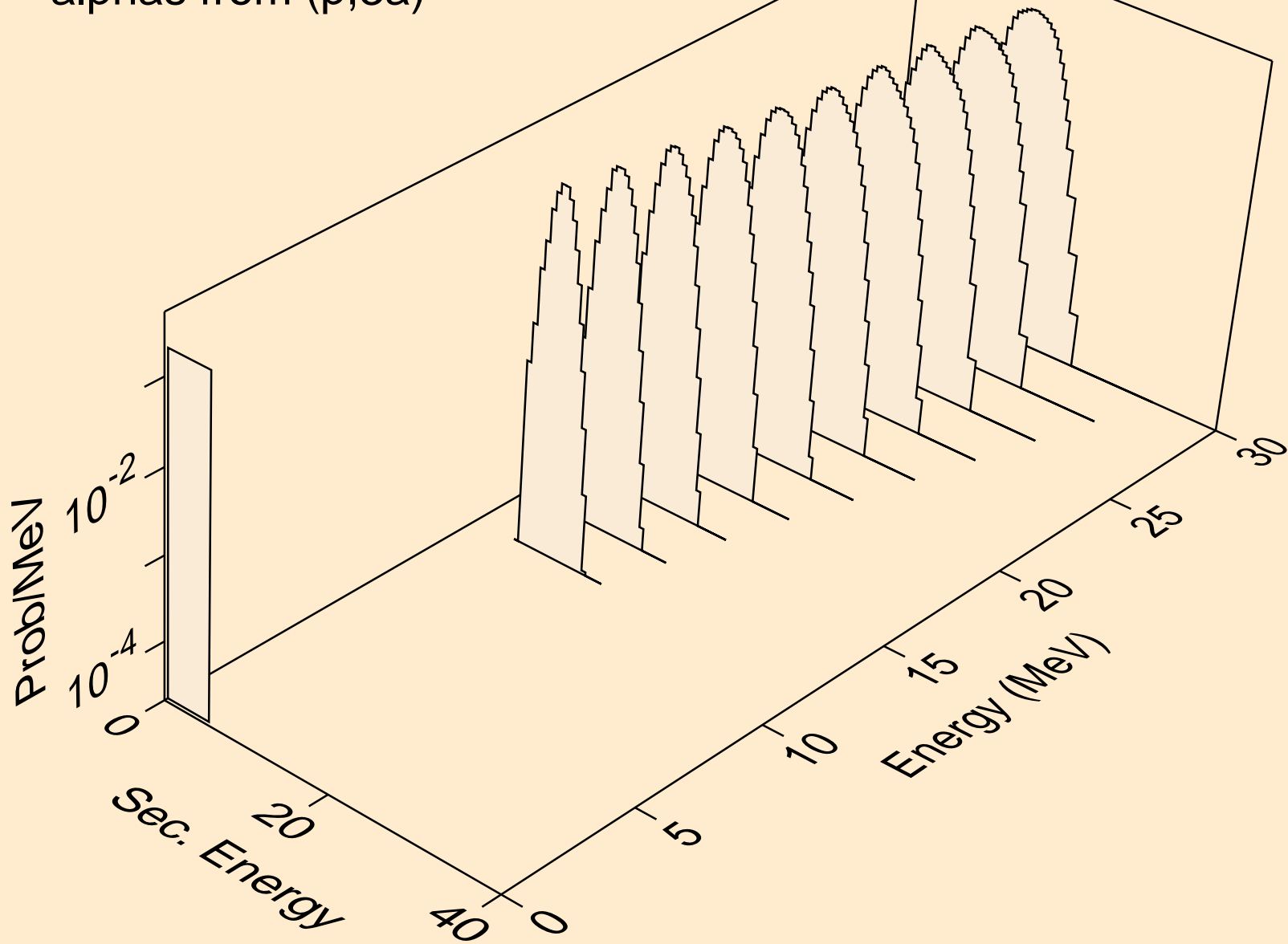

HF163 PROTON ACER TENDL-2024 LIBRARY; T=0.K  
alphas from (p,pa)

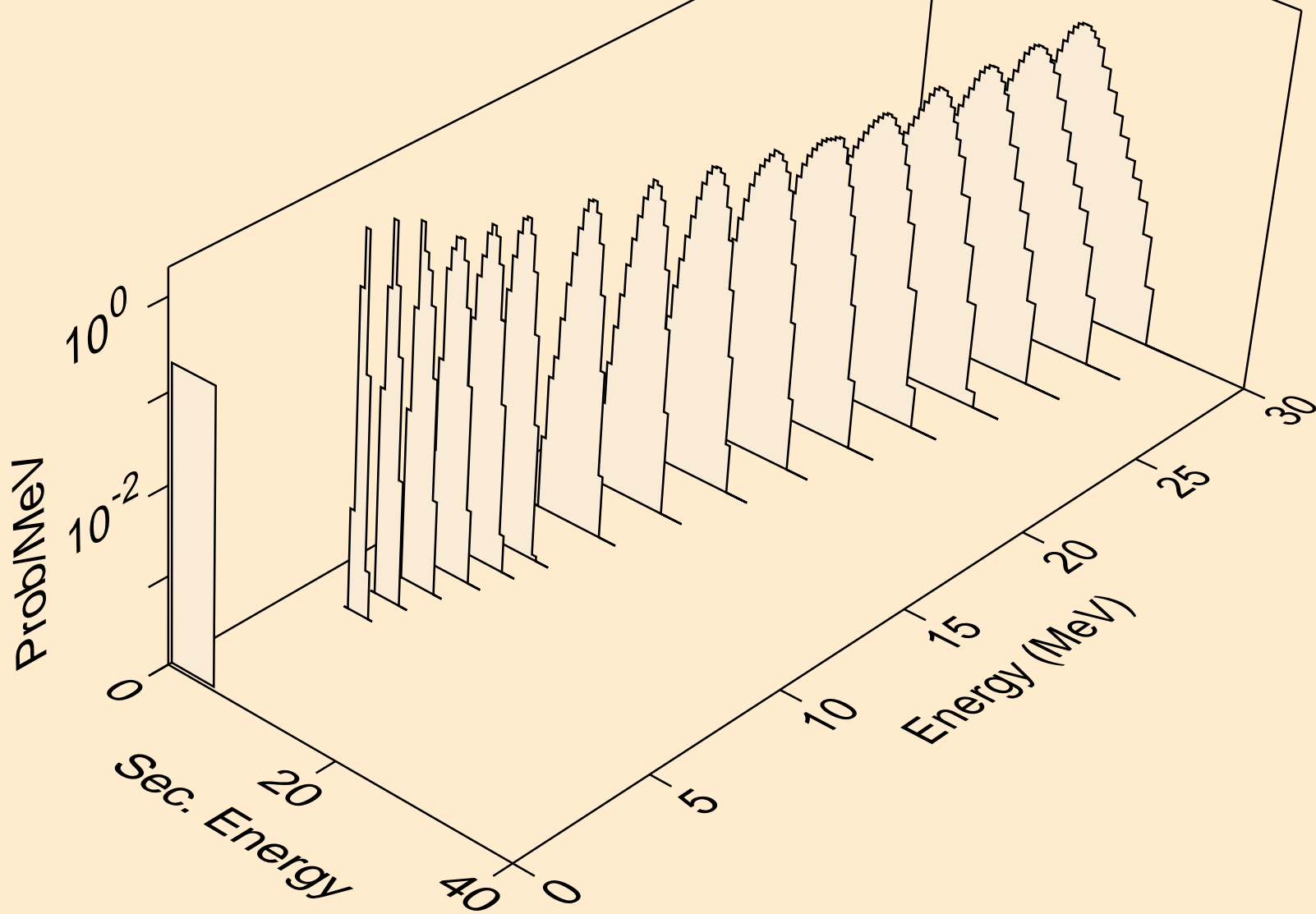

HF163 PROTON ACER TENDL-2024 LIBRARY; T=0.K  
alphas from (p,d2a)

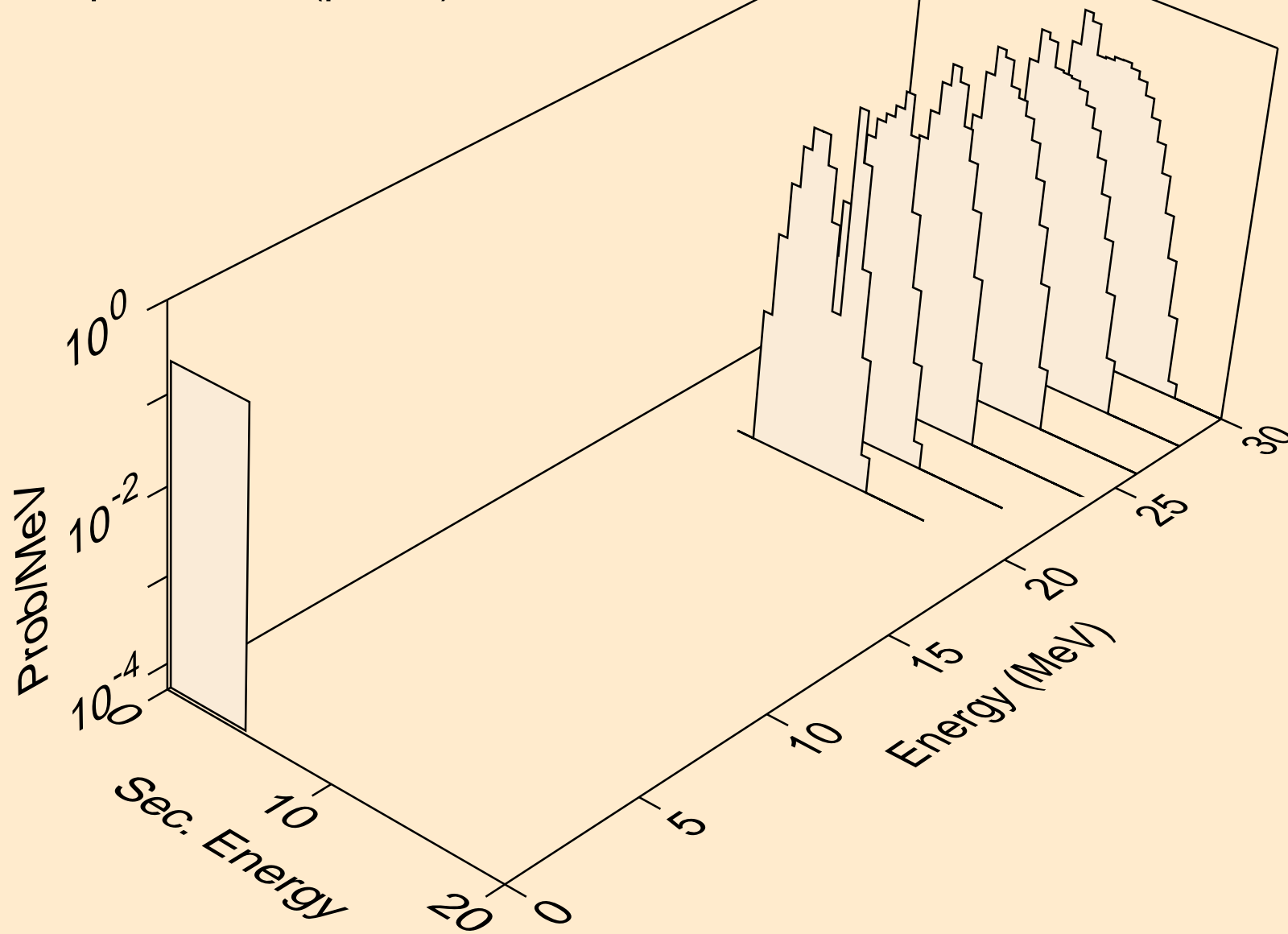

HF163 PROTON ACER TENDL-2024 LIBRARY; T=0.K  
alphas from (p,da)

