

HF184 PROTON ACER TENDL-2024 LIBRARY; T=0.K

Principal cross sections

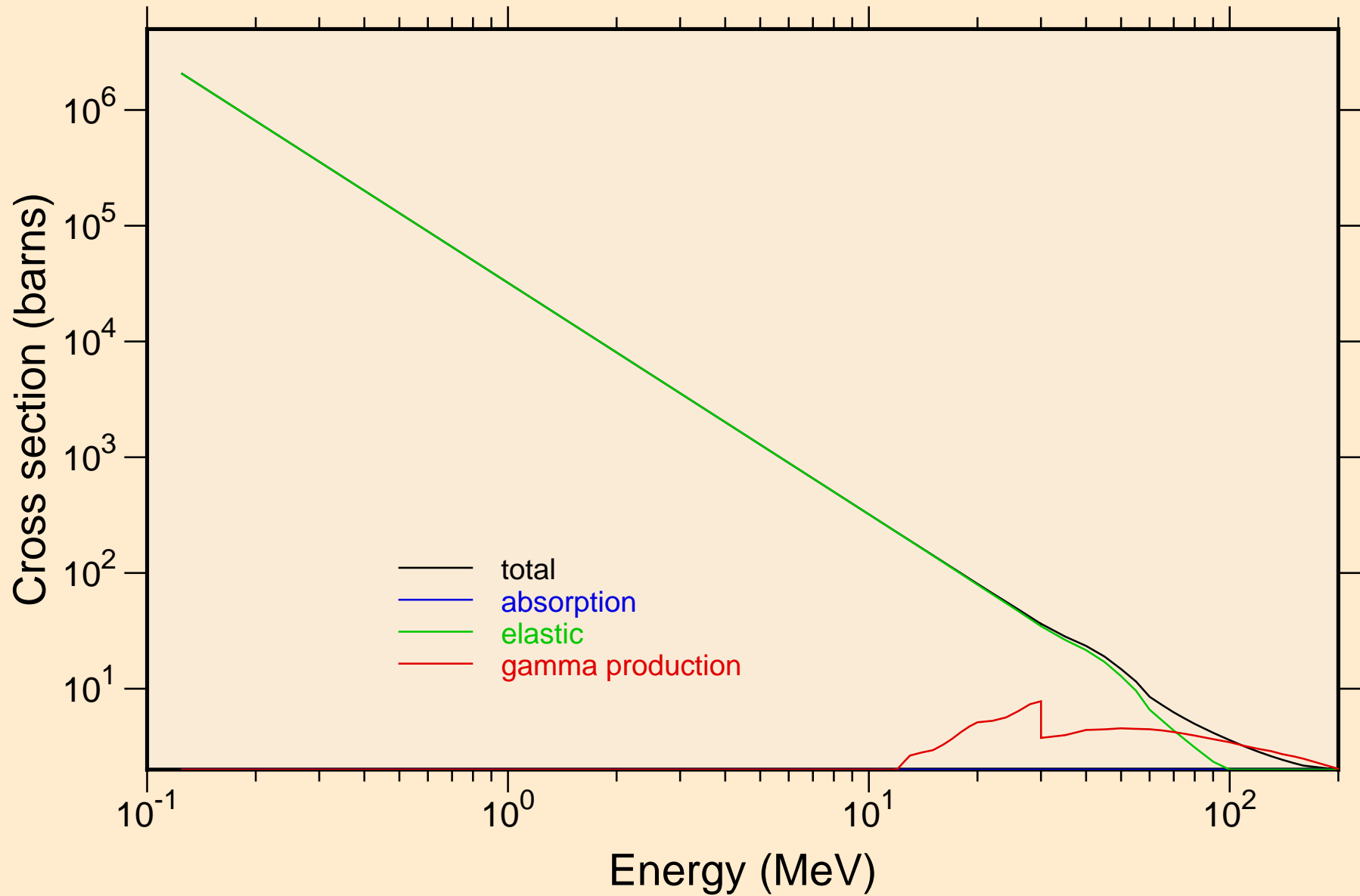

HF184 PROTON ACER TENDL-2024 LIBRARY; T=0.K
Heating

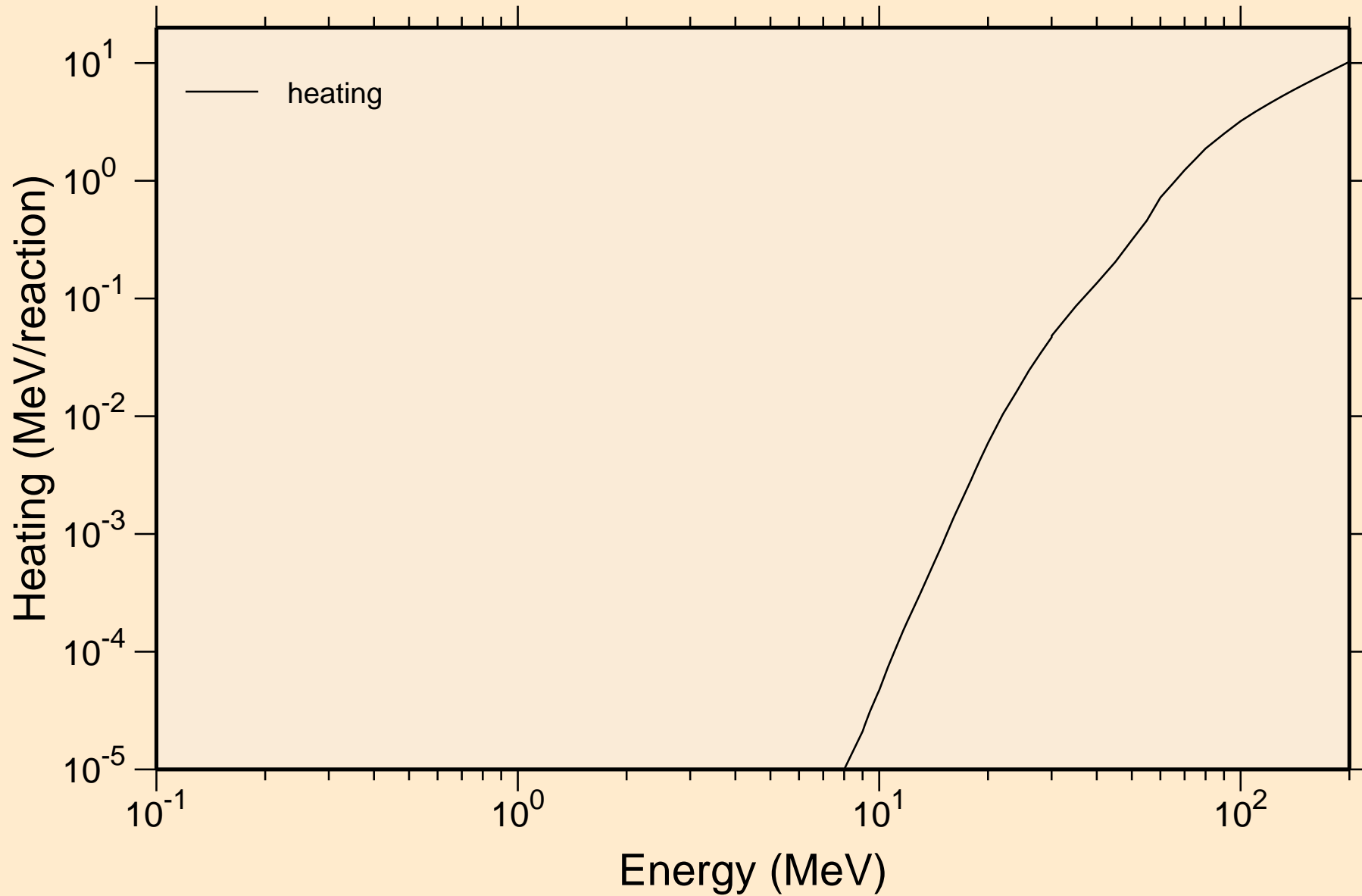

HF184 PROTON ACER TENDL-2024 LIBRARY; T=0.K

Principal cross sections

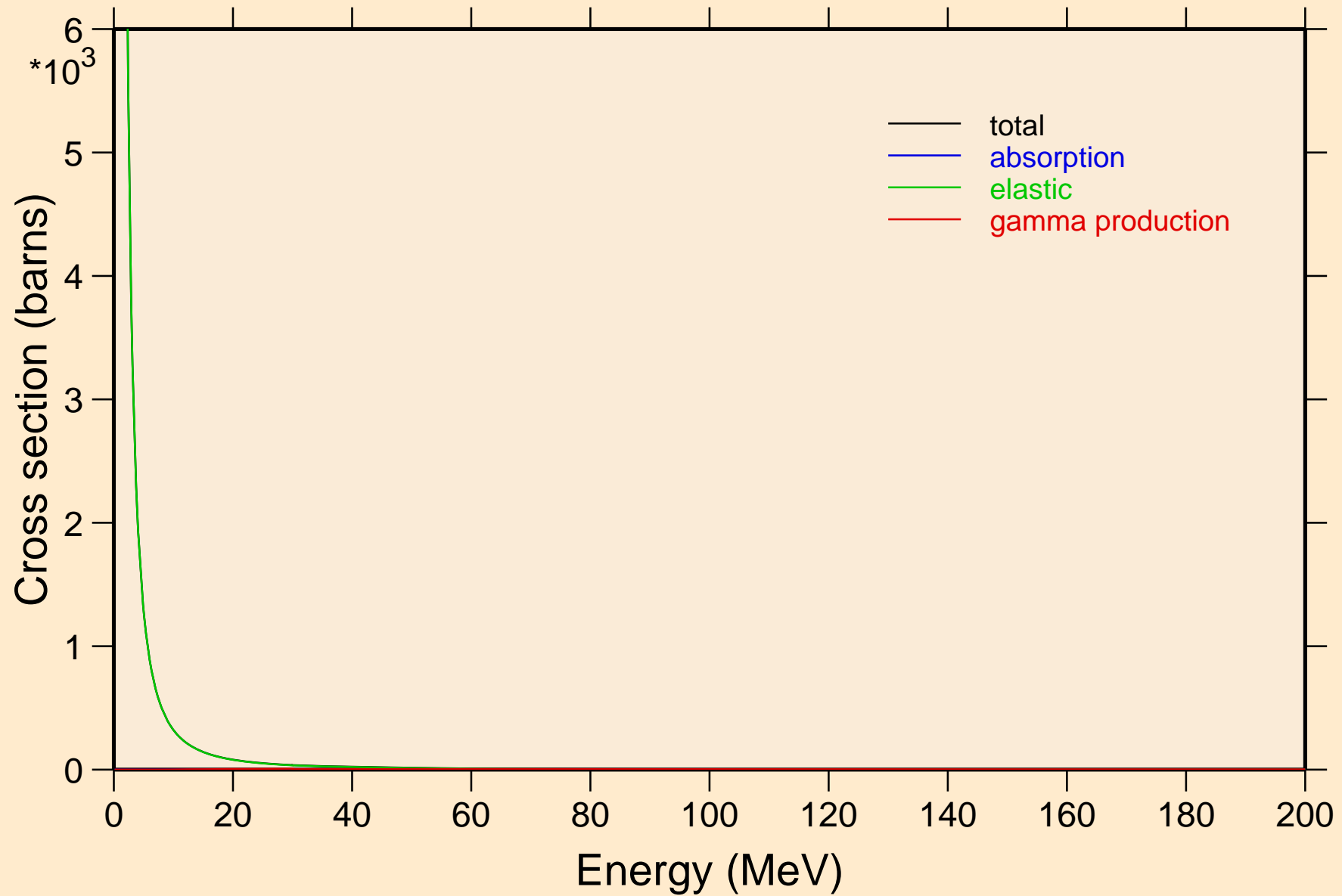

HF184 PROTON ACER TENDL-2024 LIBRARY; T=0.K

Heating

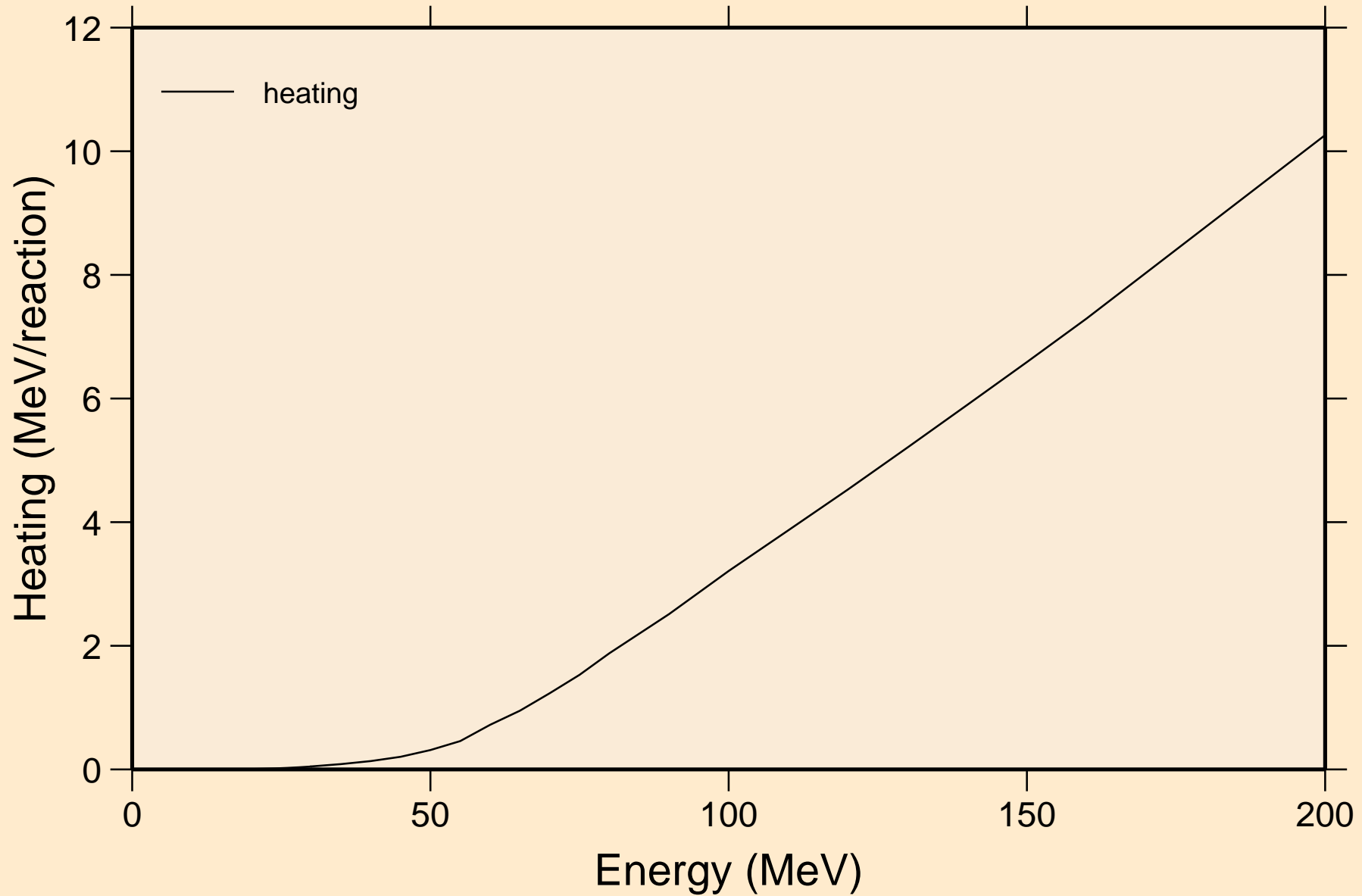

HF184 PROTON ACER TENDL-2024 LIBRARY; T=0.K

Threshold reactions

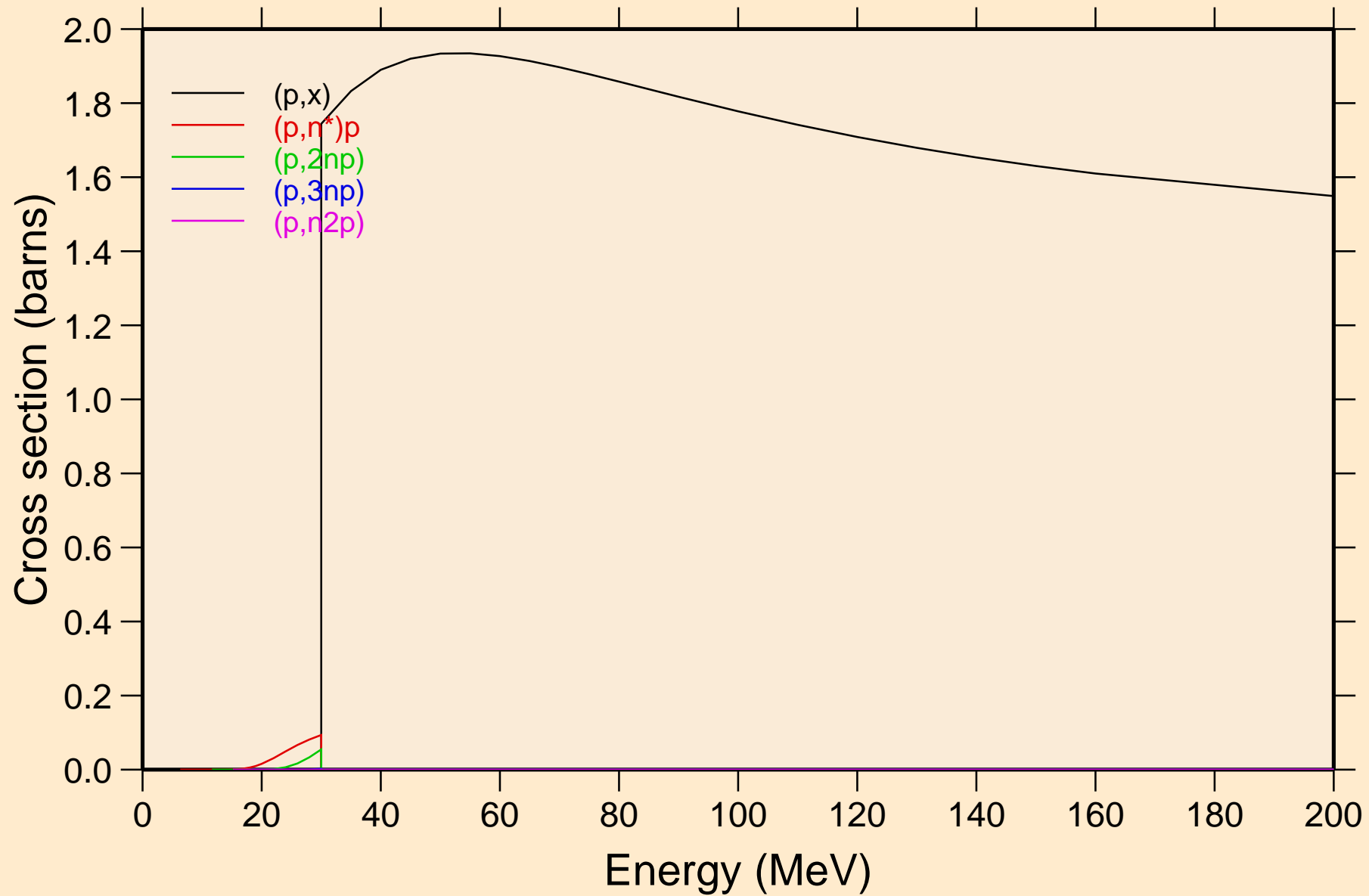

HF184 PROTON ACER TENDL-2024 LIBRARY; T=0.K

Threshold reactions

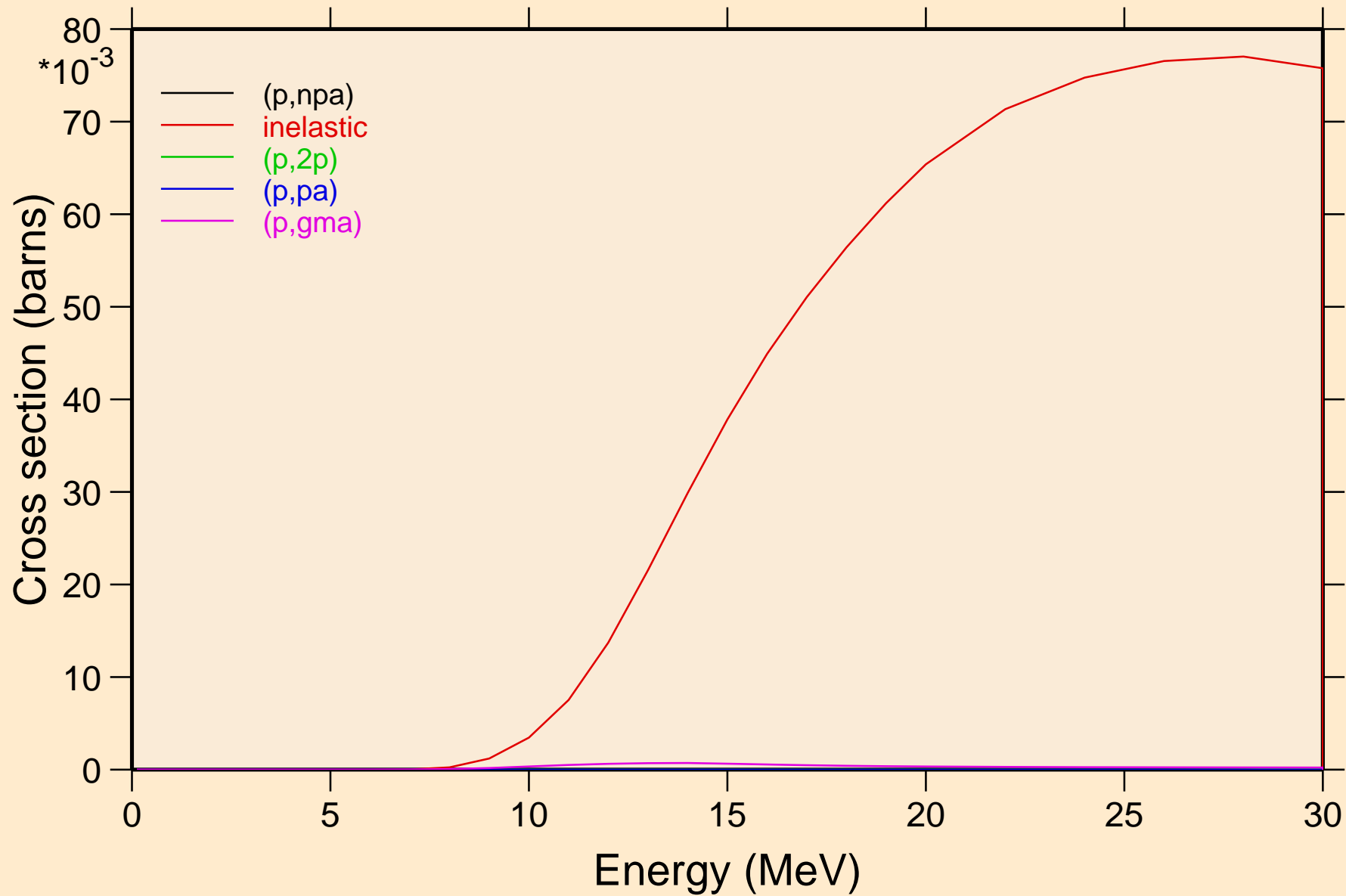

HF184 PROTON ACER TENDL-2024 LIBRARY; T=0.K

Threshold reactions

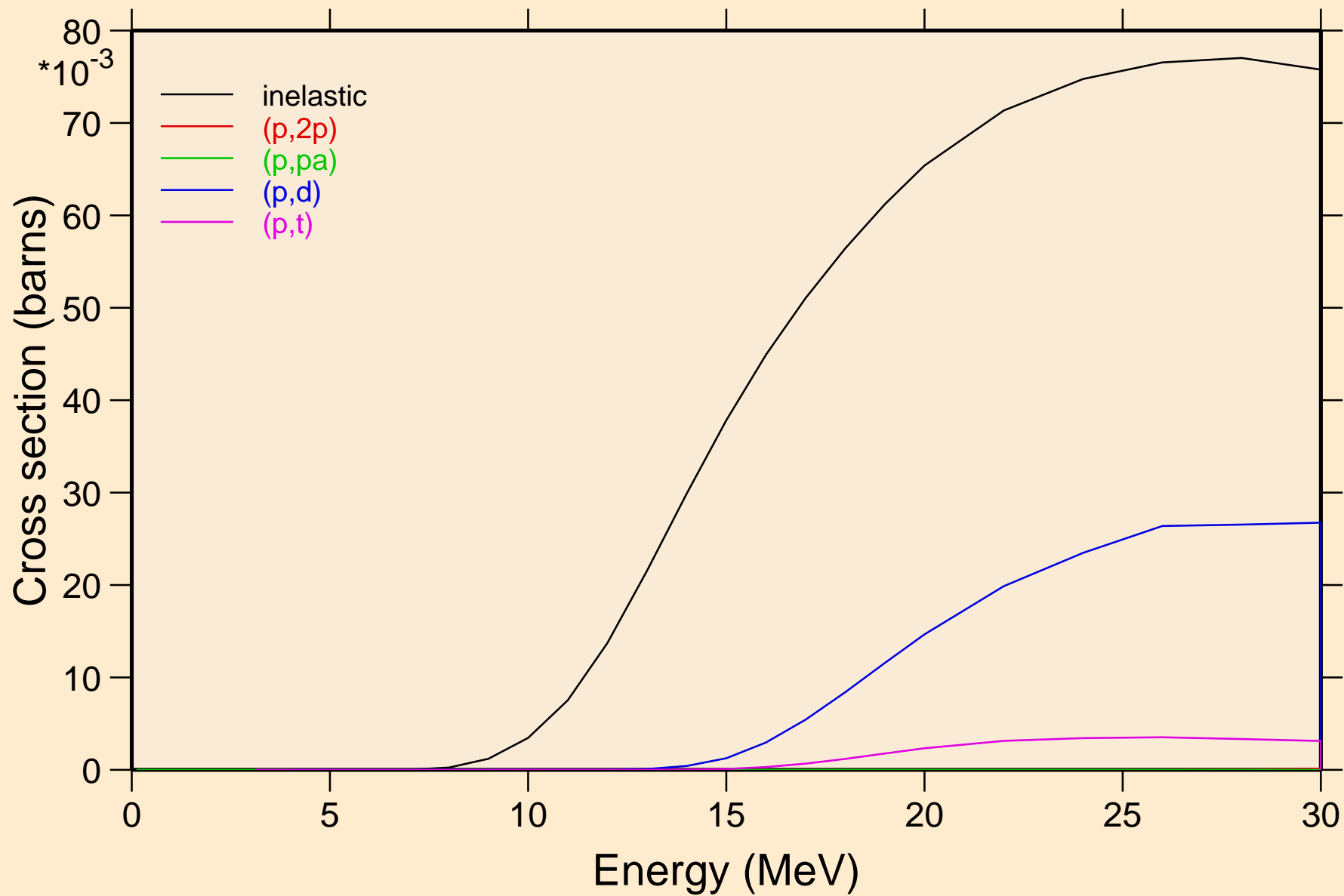

HF184 PROTON ACER TENDL-2024 LIBRARY; T=0.K

Threshold reactions

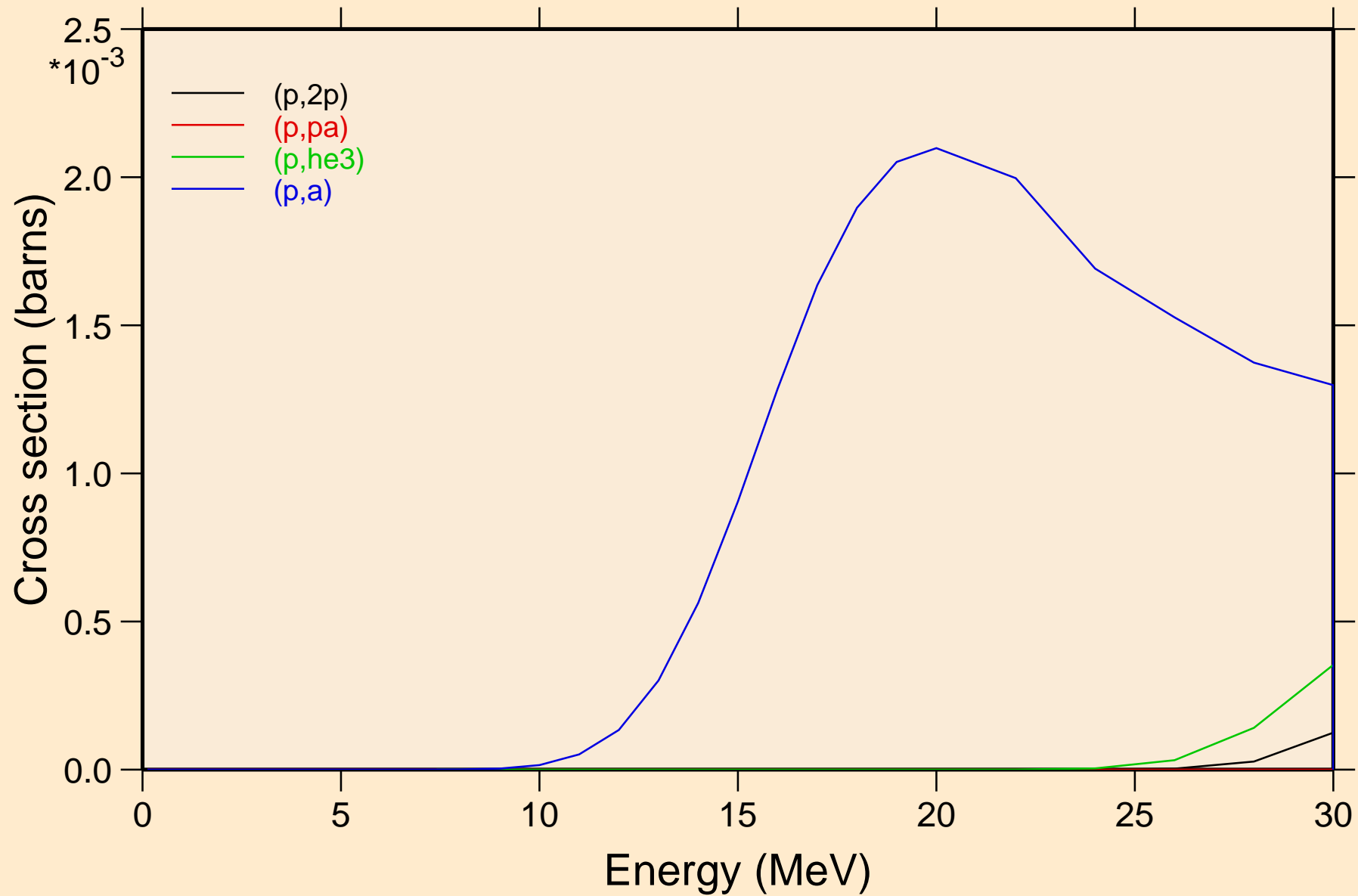

HF184 PROTON ACER TENDL-2024 LIBRARY; T=0.K
Threshold reactions

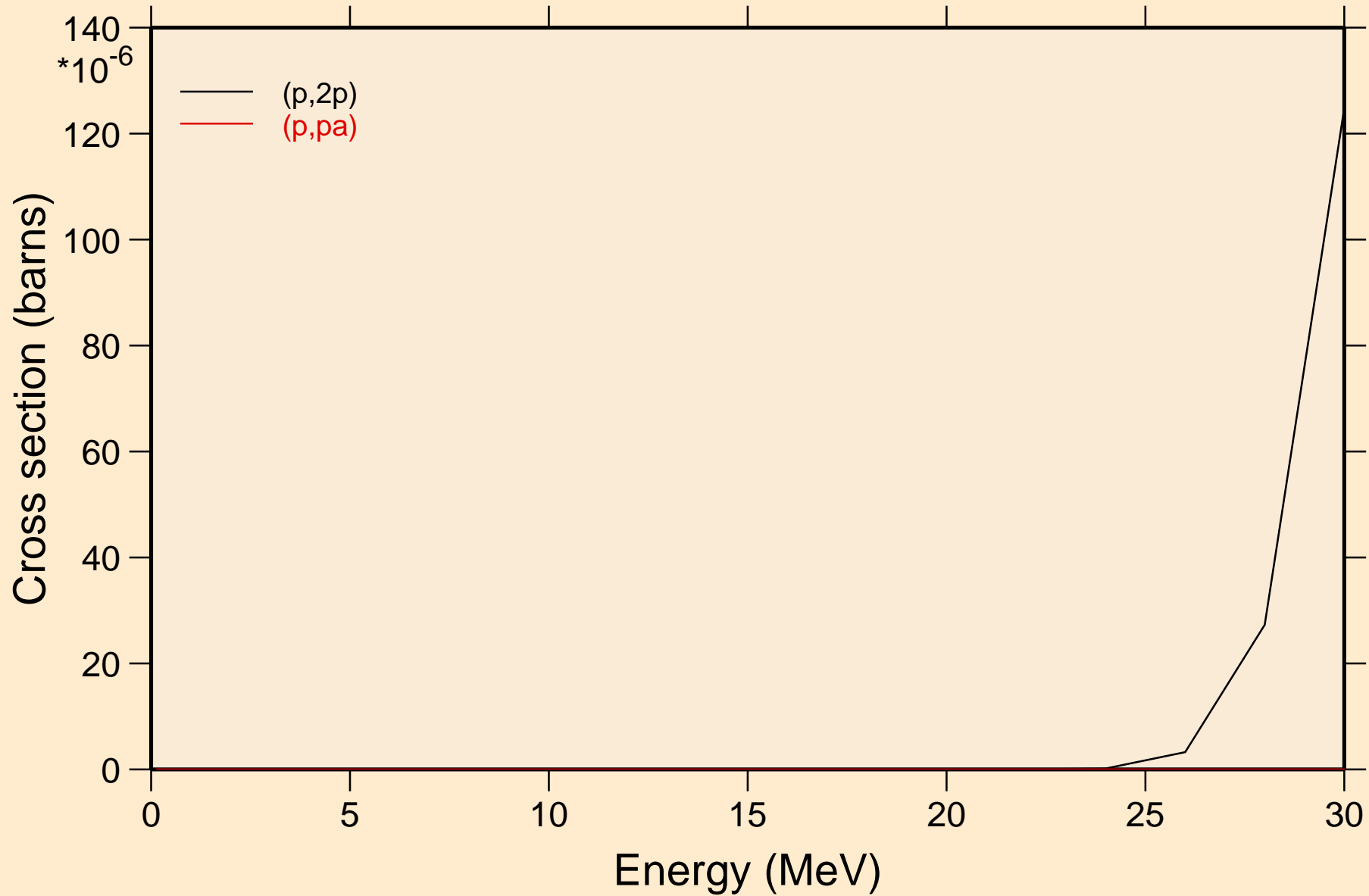

HF184 PROTON ACER TENDL-2024 LIBRARY; T=0.K
angular distribution for elastic

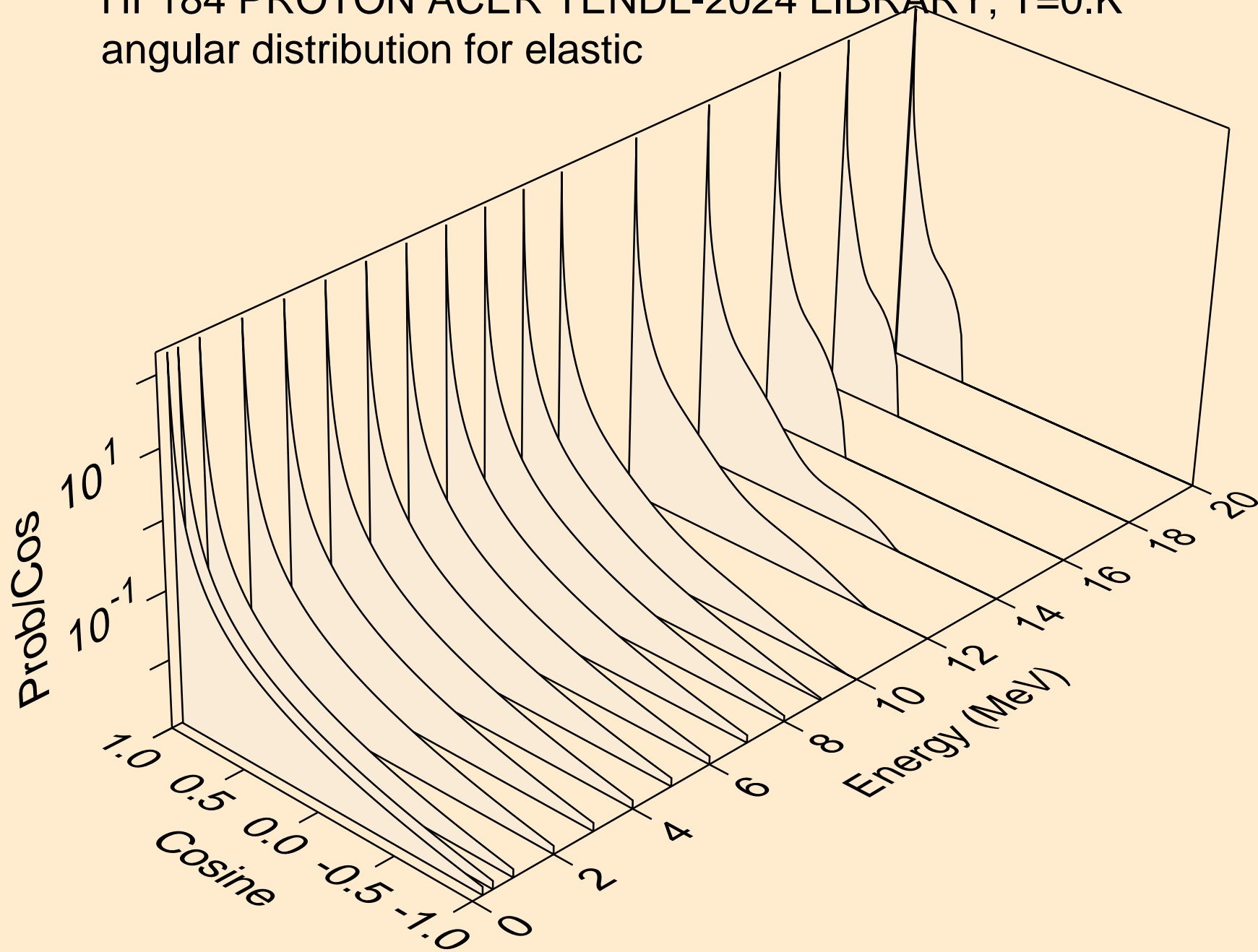

HF184 PROTON ACER TENDL-2024 LIBRARY; T=0.K
angular distribution for elastic

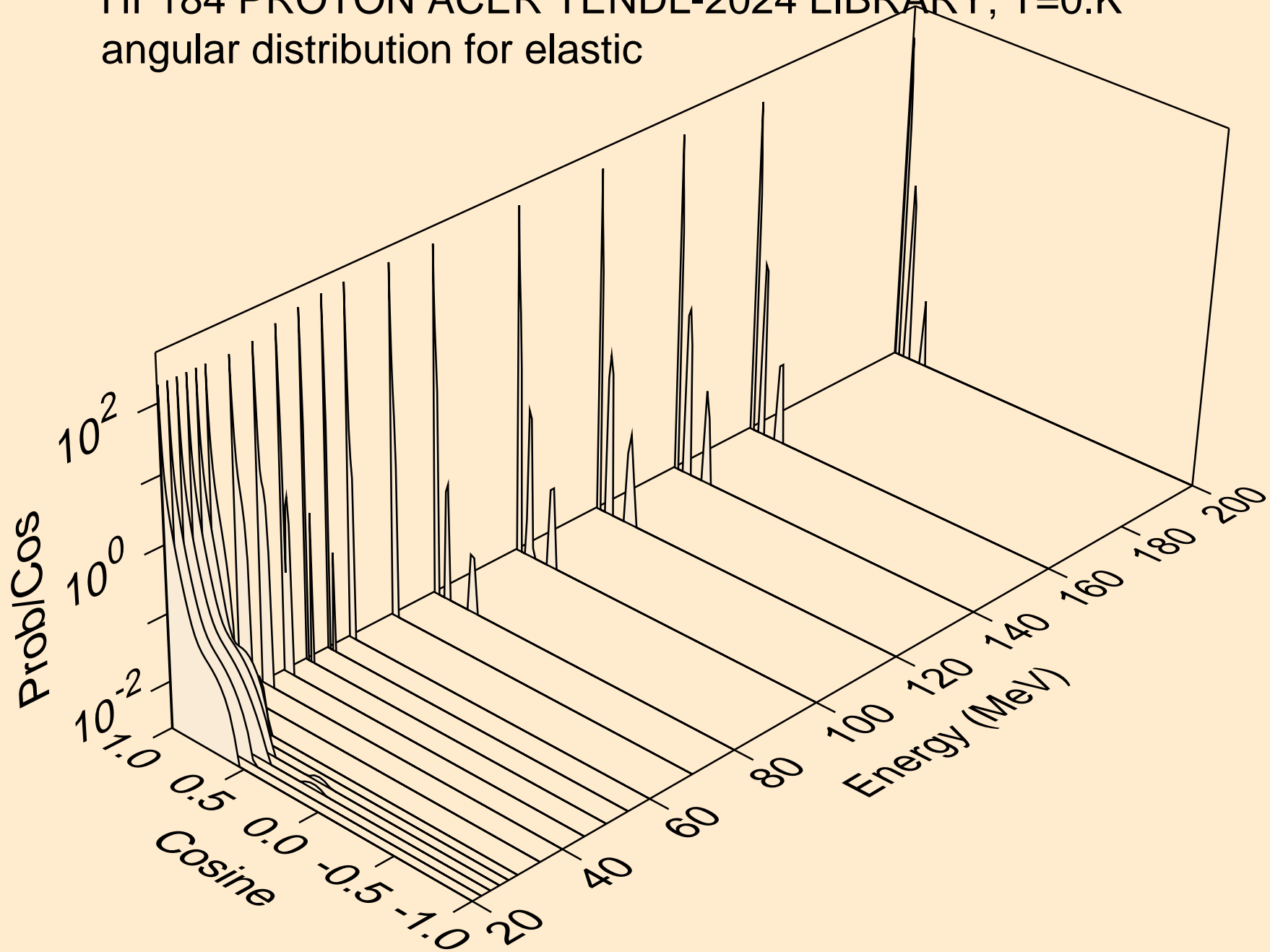

HF184 PROTON ACER TENDL-2024 LIBRARY; T=0.K
Proton emission for (p,x)

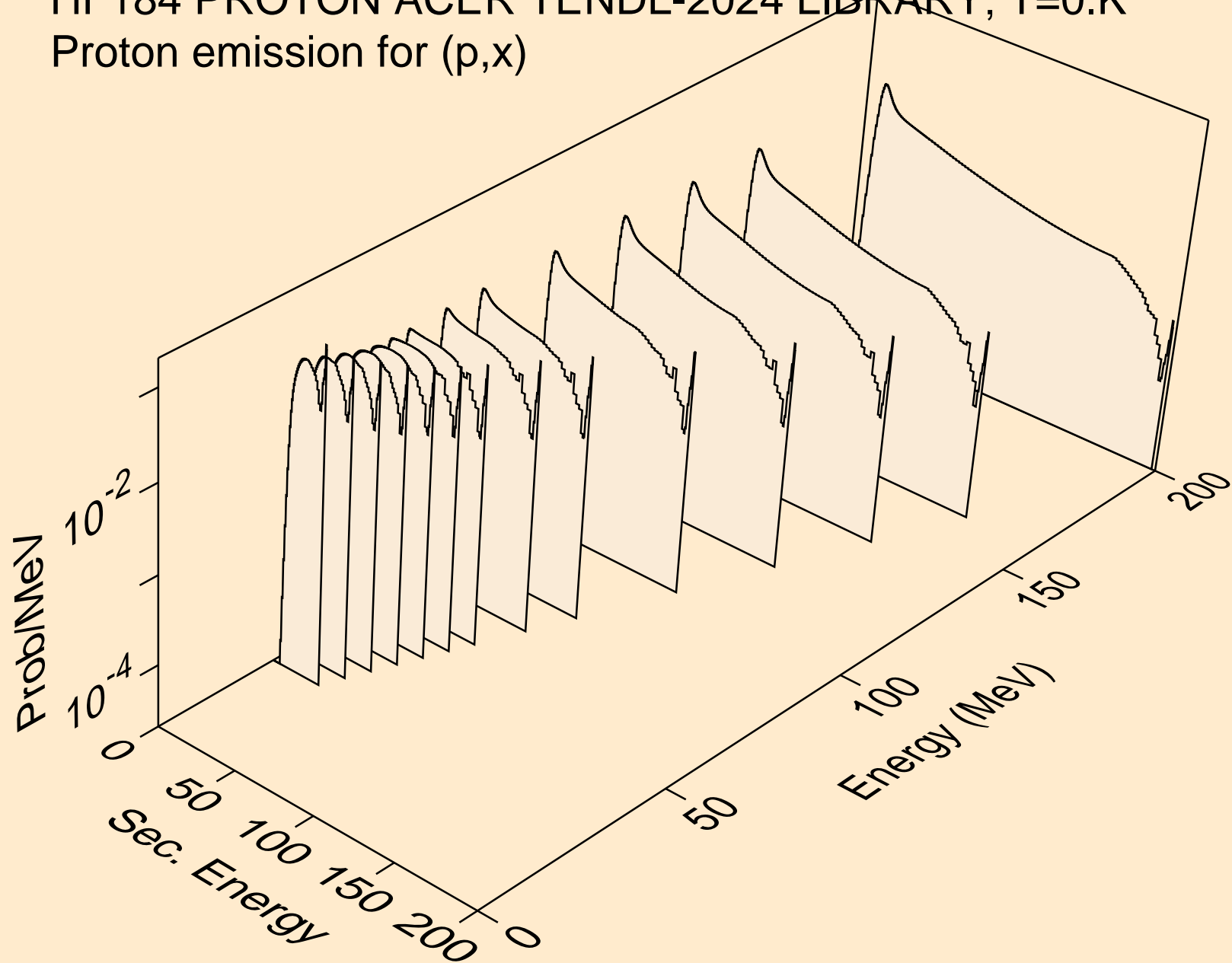

HF184 PROTON ACER TENDL-2024 LIBRARY; T=0.K
Proton emission for (p,n*)p

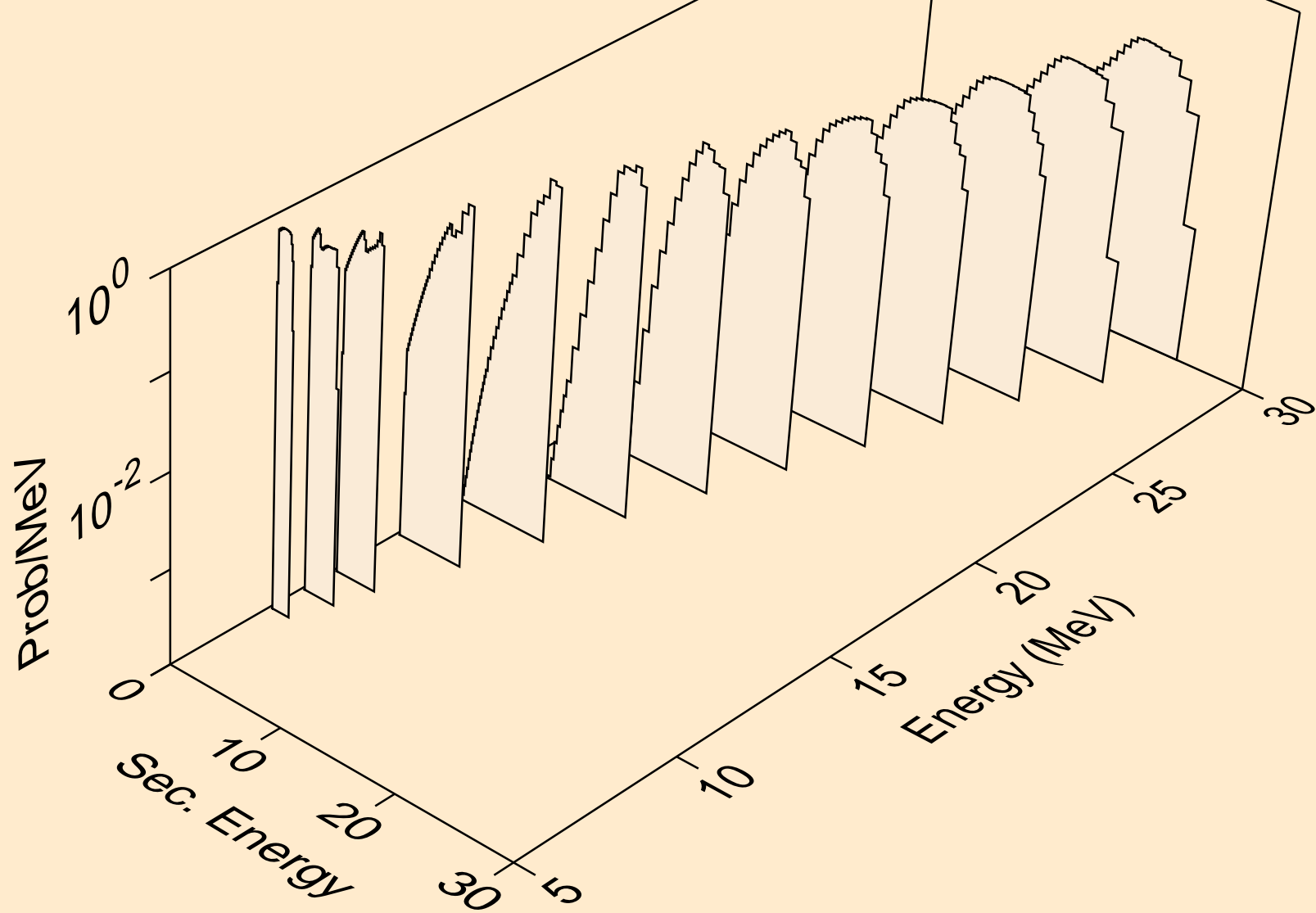

HF184 PROTON ACER TENDL-2024 LIBRARY; T=0.K
Proton emission for (p,2np)

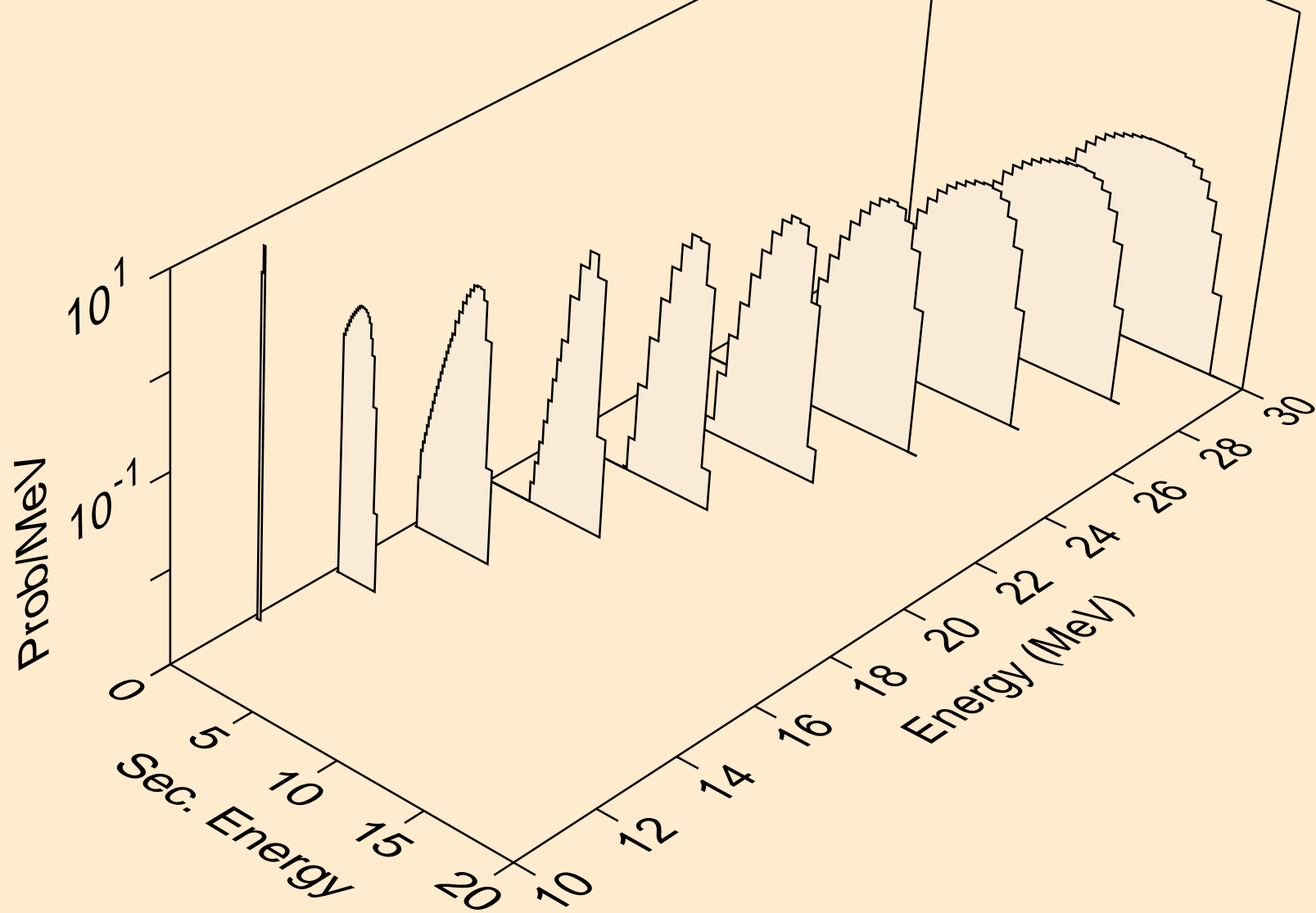

HF184 PROTON ACER TENDL-2024 LIBRARY; T=0.K
Proton emission for (p,3np)

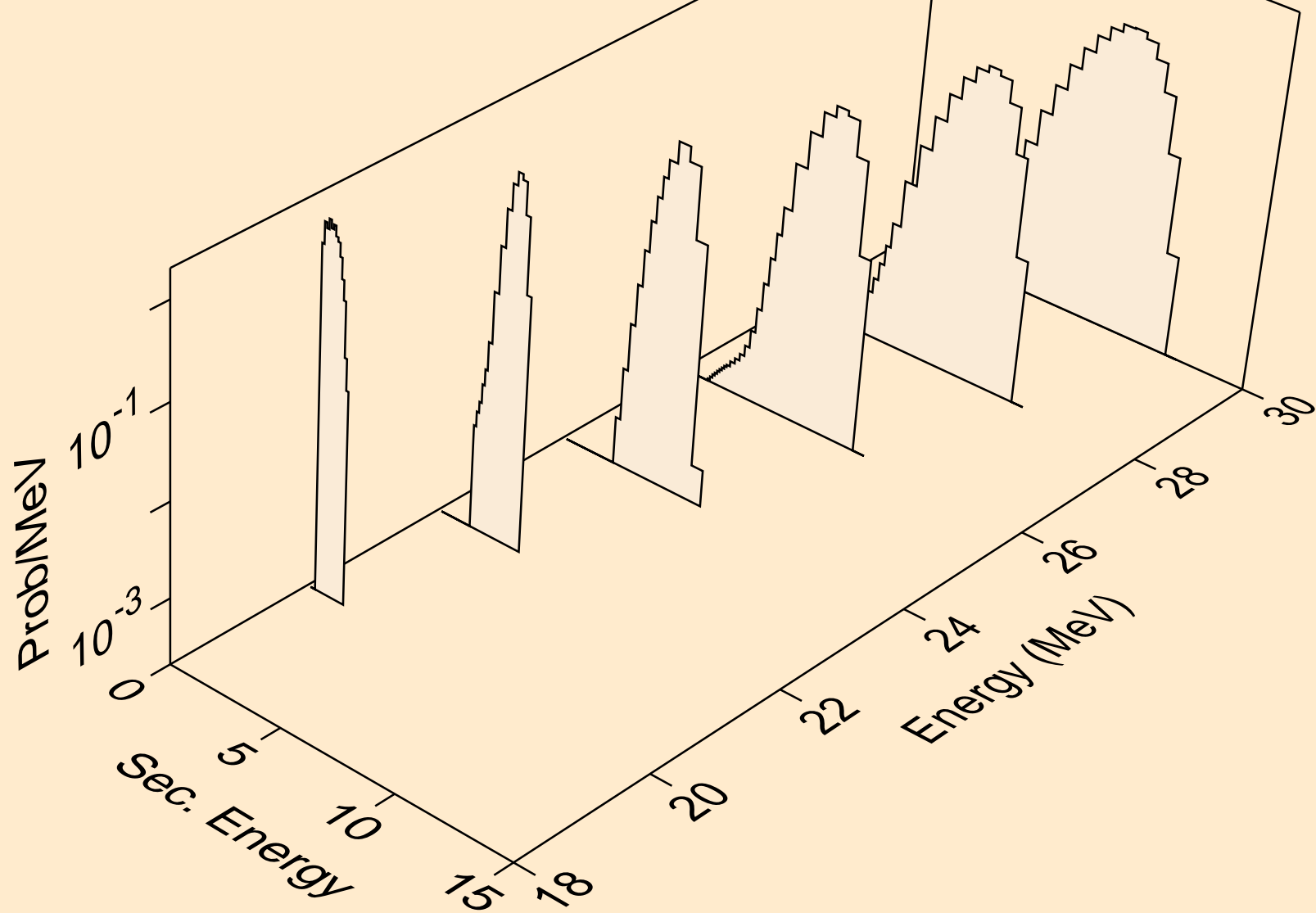

HF184 PROTON ACER TENDL-2024 LIBRARY; T=0.K
Proton emission for (p,n2p)

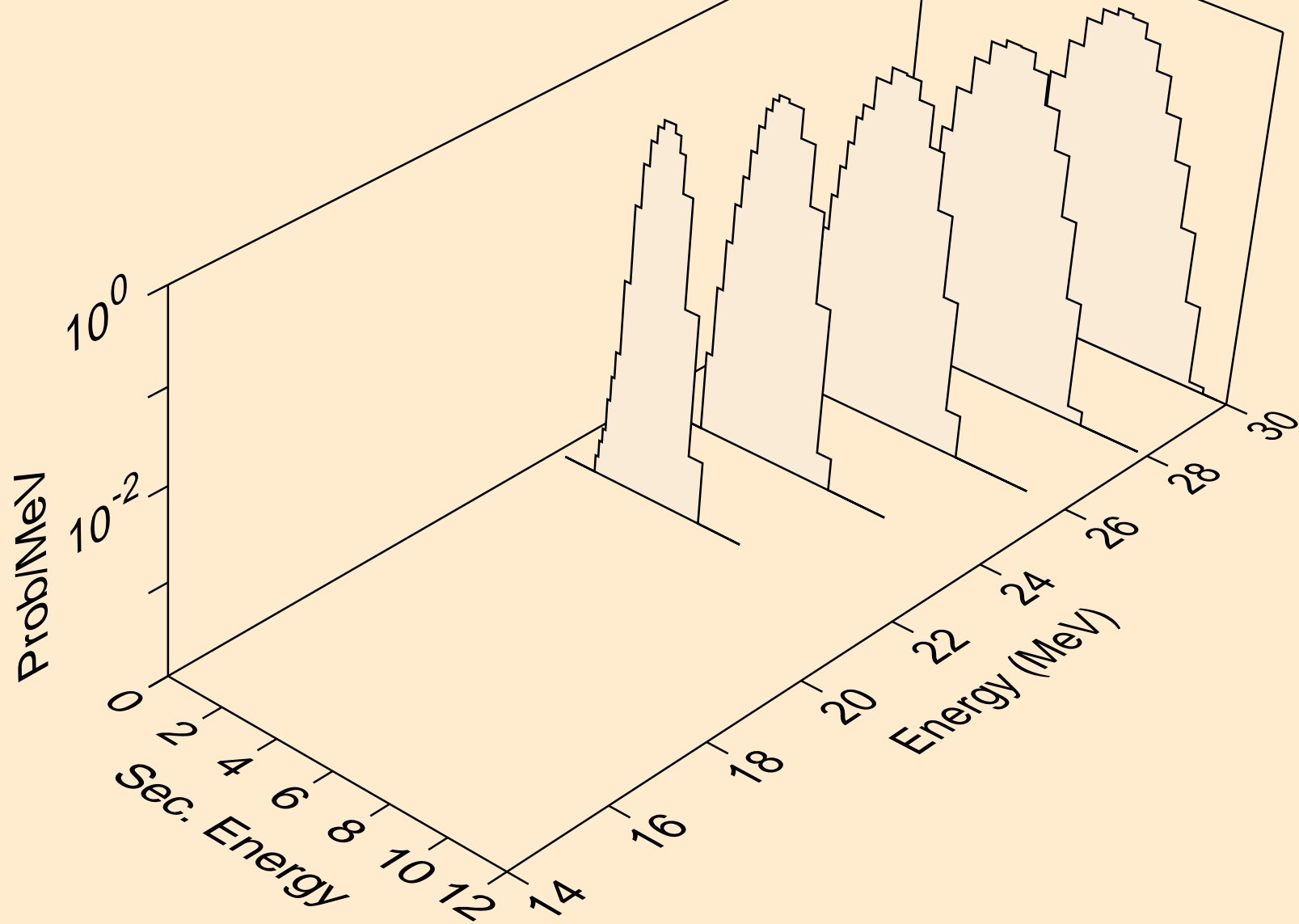

HF184 PROTON ACER TENDL-2024 LIBRARY; T=0.K
Proton emission for (p,npa)

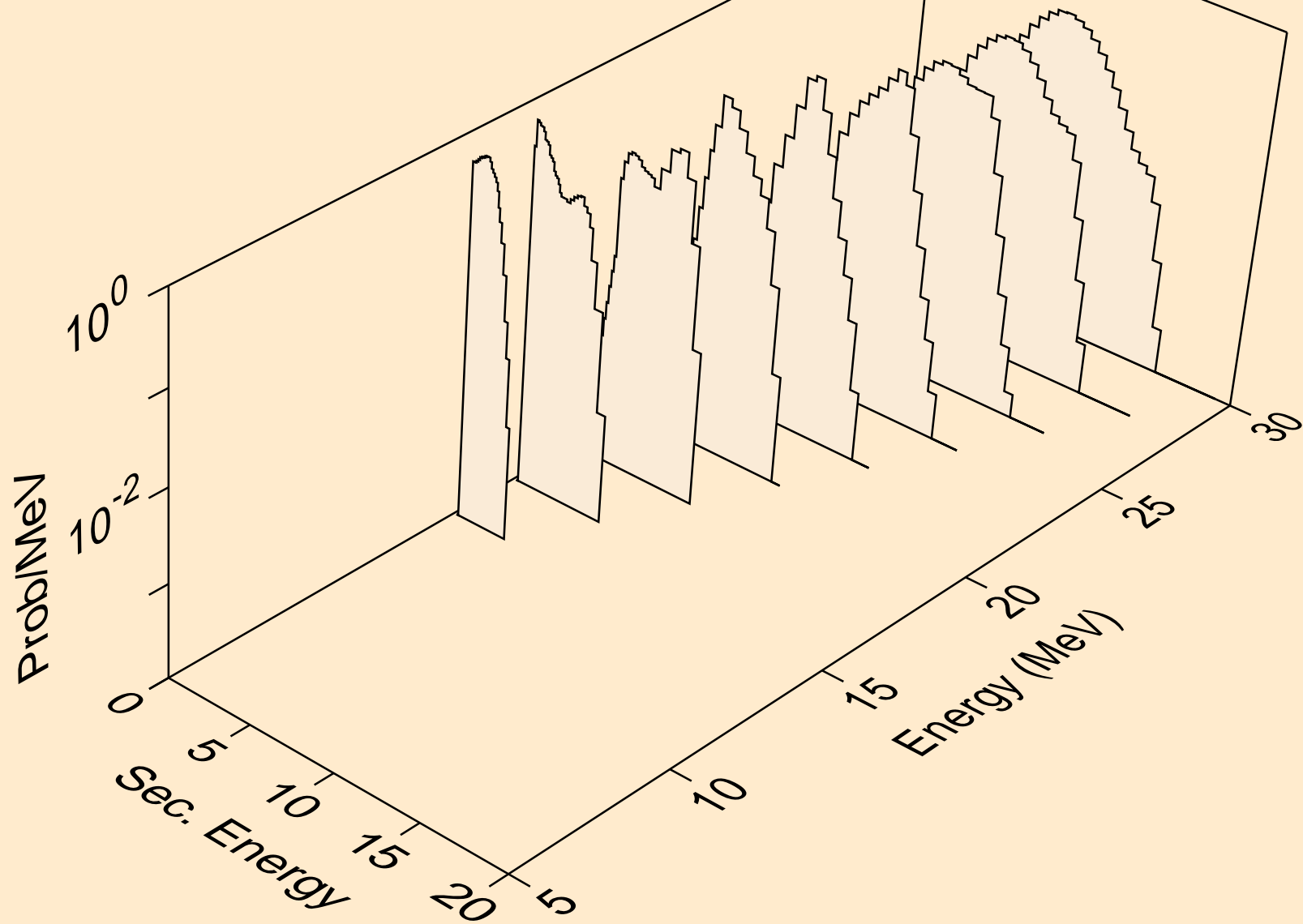

HF184 PROTON ACER TENDL-2024 LIBRARY; T=0.K
Proton emission for inelastic

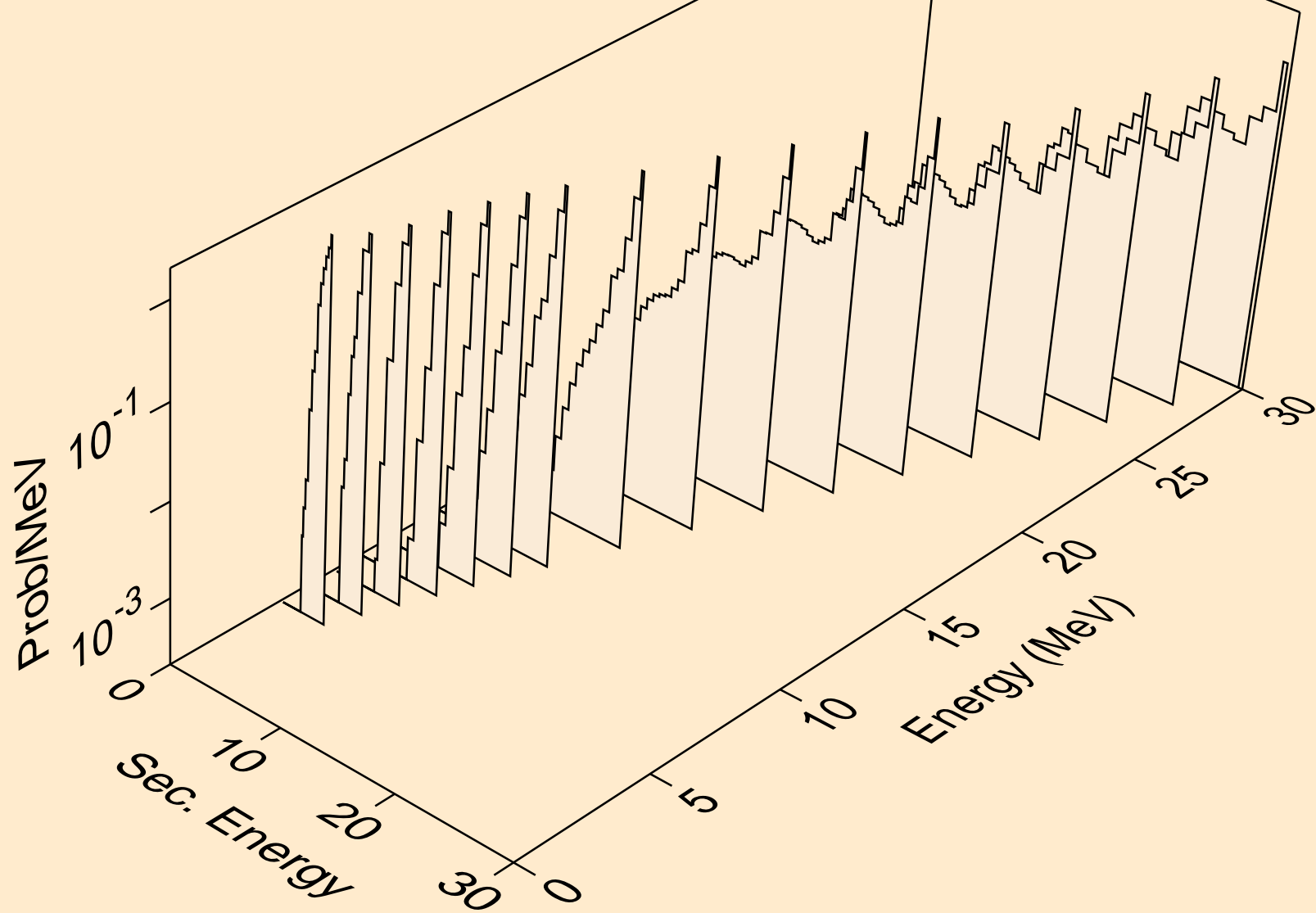

HF184 PROTON ACER TENDL-2024 LIBRARY; T=0.K
Proton emission for (p,2p)

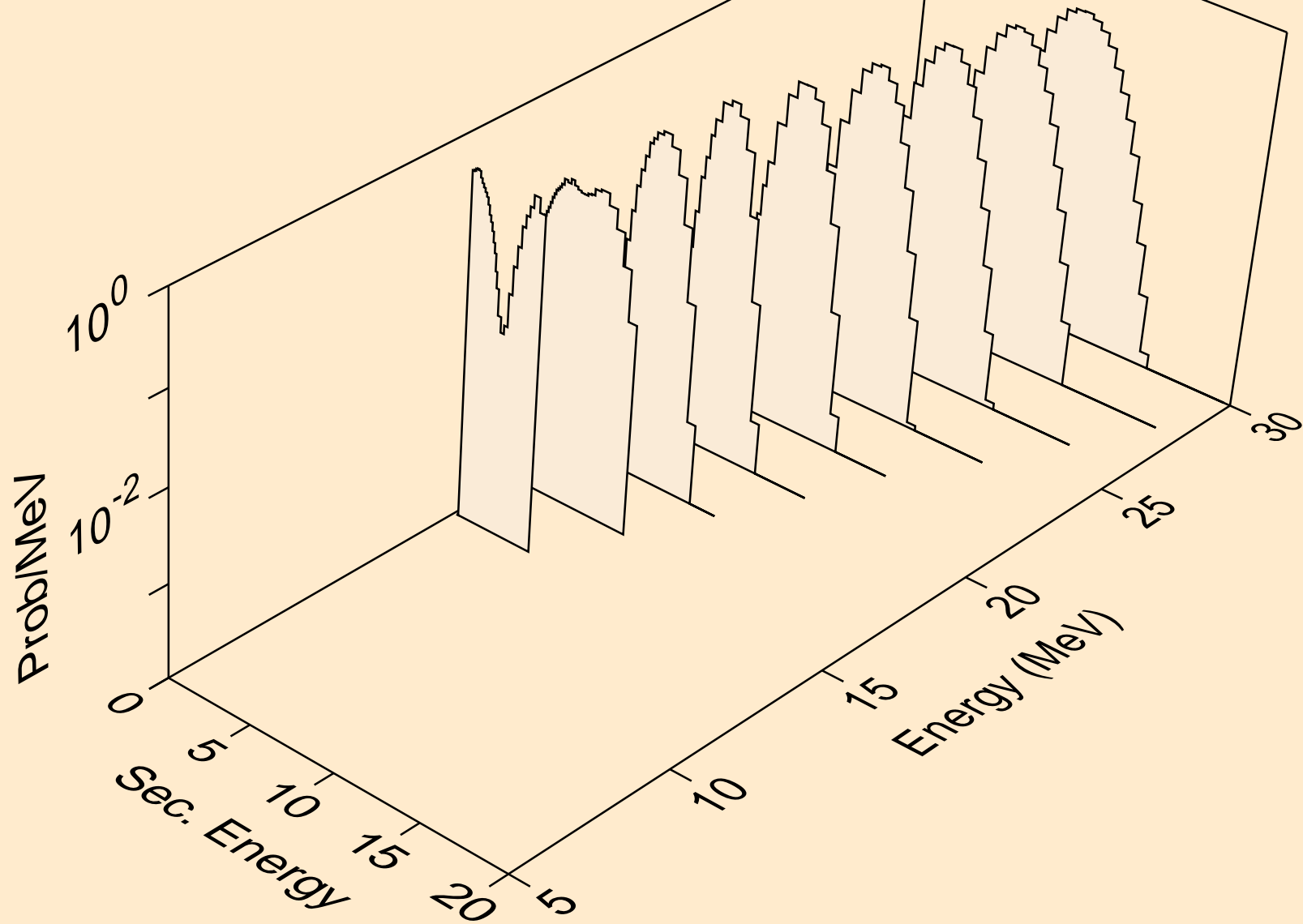

HF184 PROTON ACER TENDL-2024 LIBRARY; T=0.K
Proton emission for (p,pa)

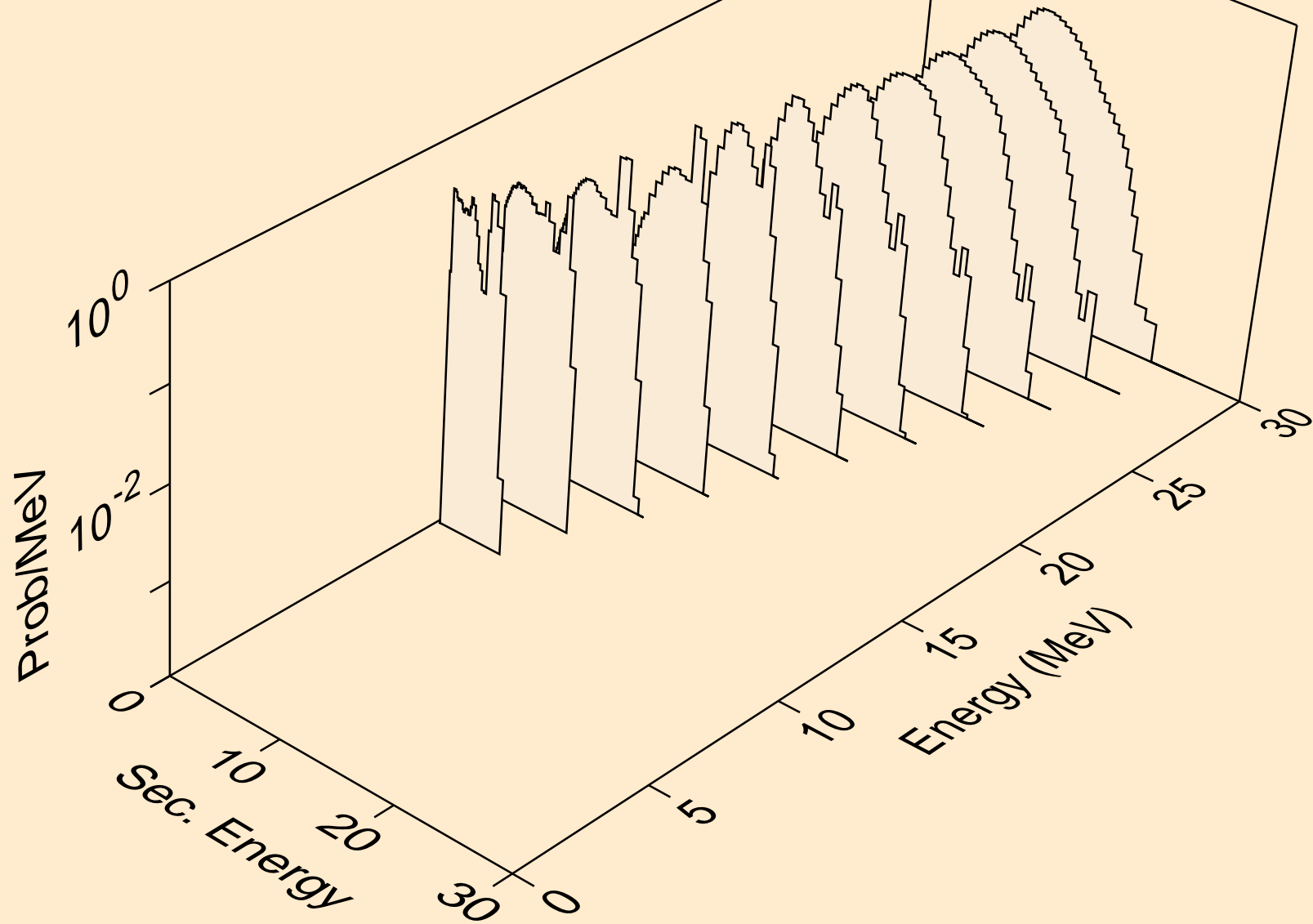

HF184 PROTON ACER TENDL-2024 LIBRARY; T=0.K
Photon emission for (z,n)

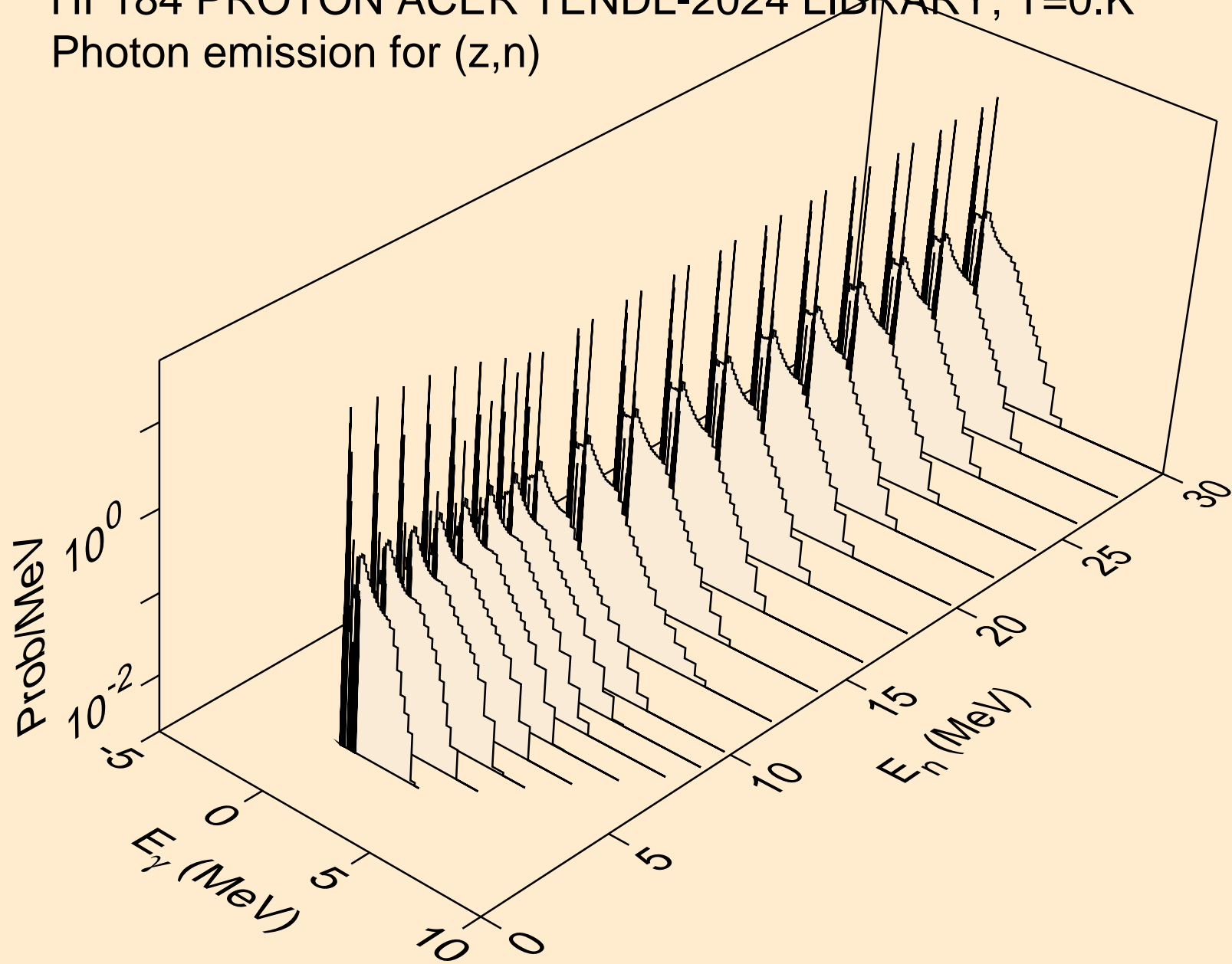

HF184 PROTON ACER TENDL-2024 LIBRARY; T=0.K
Photon emission for (z,x)

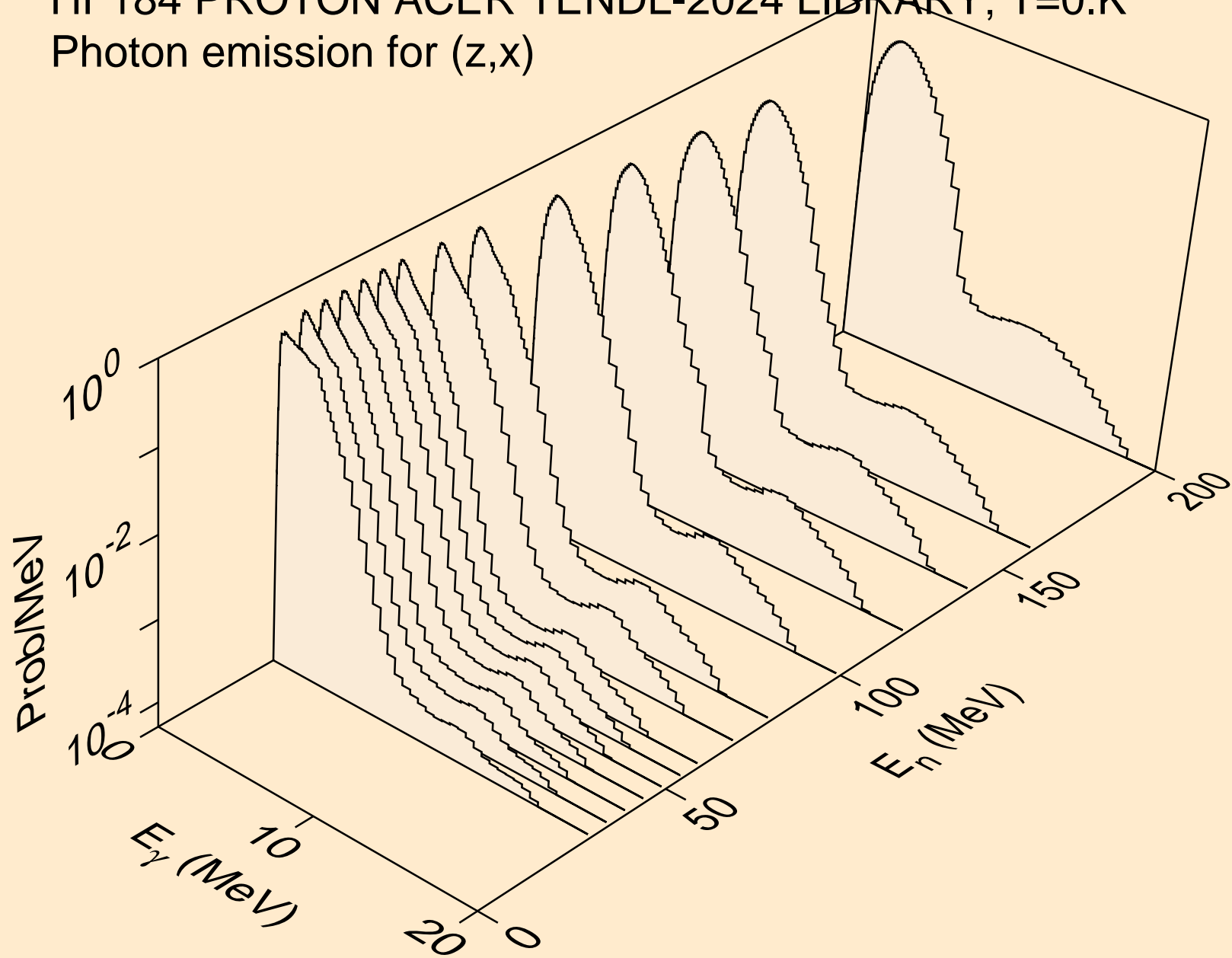

HF184 PROTON ACER TENDL-2024 LIBRARY; T=0.K
Photon emission for (n,2nd)

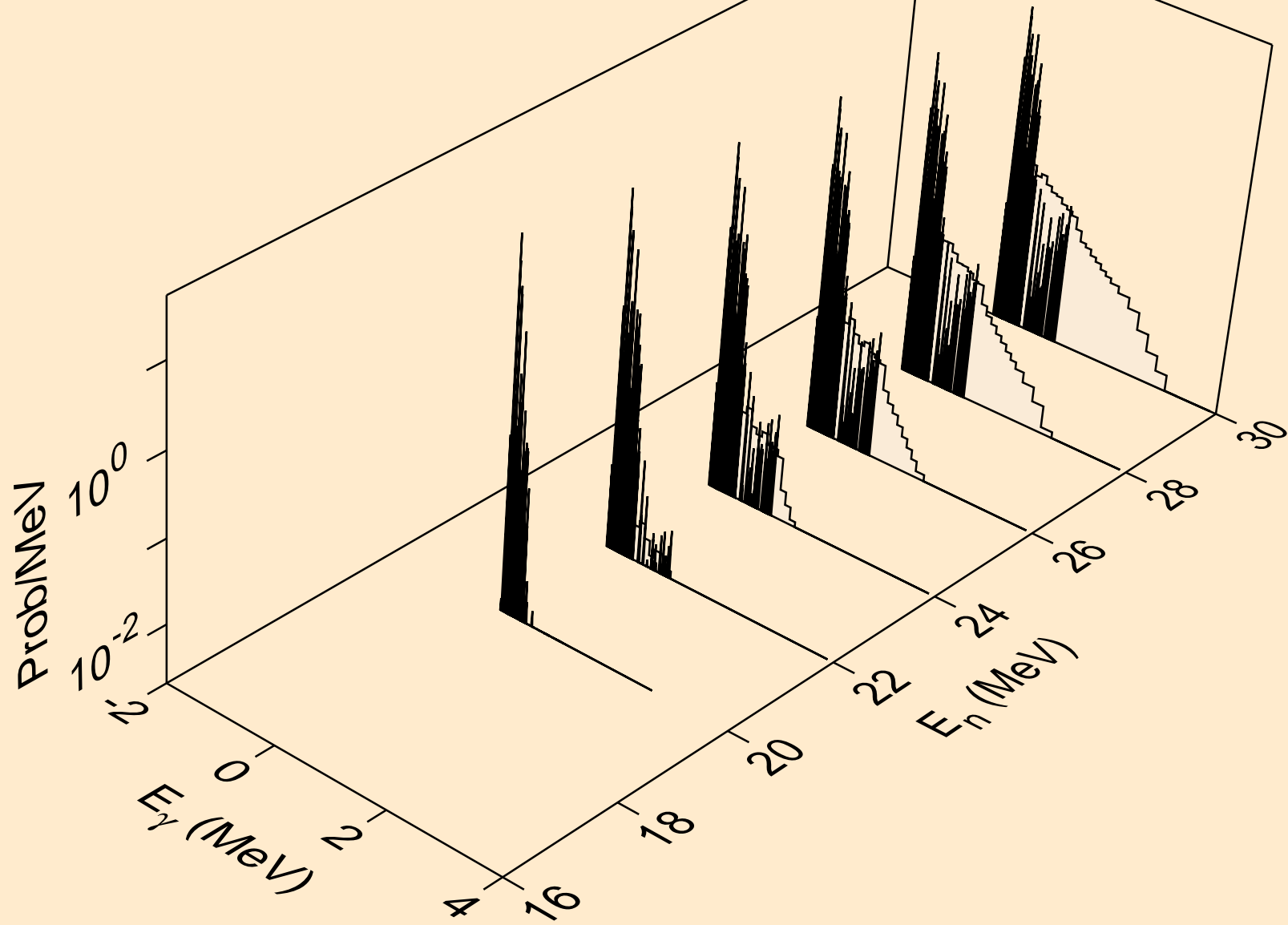

HF184 PROTON ACER TENDL-2024 LIBRARY; T=0.K
Photon emission for (n,2n)

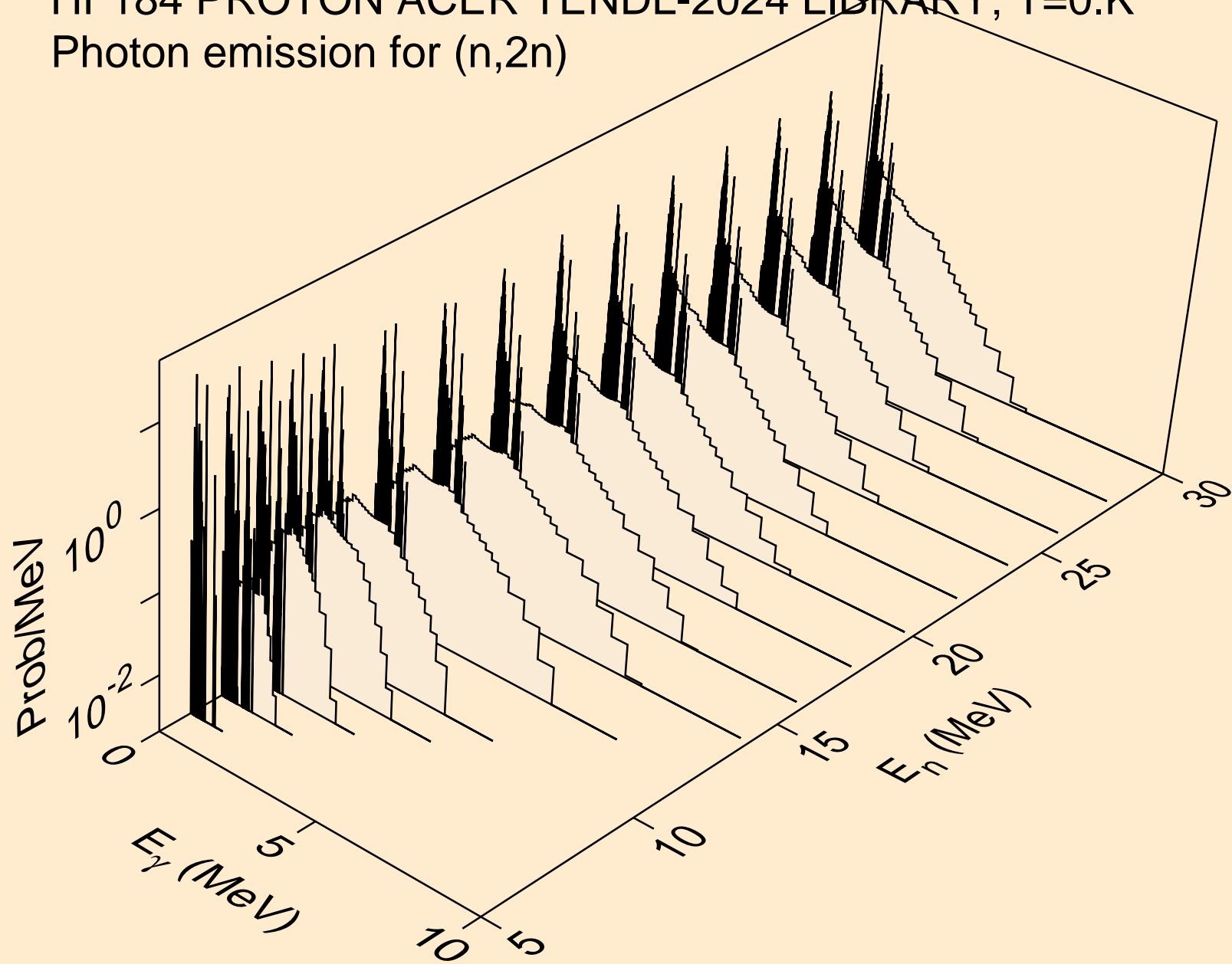

HF184 PROTON ACER TENDL-2024 LIBRARY; T=0.K
Photon emission for (n,3n)

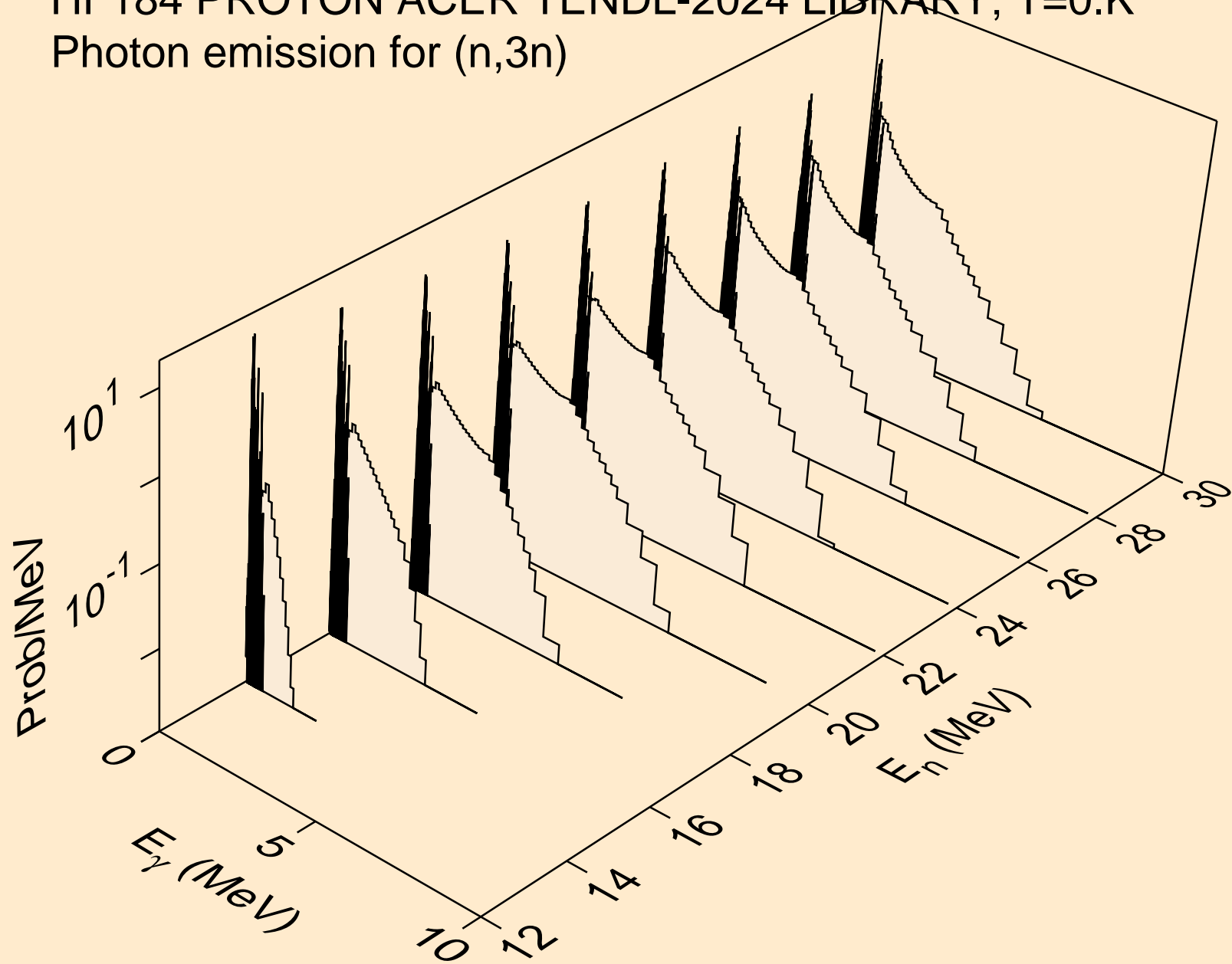

HF184 PROTON ACER TENDL-2024 LIBRARY; T=0.K
Photon emission for (n,n*)a

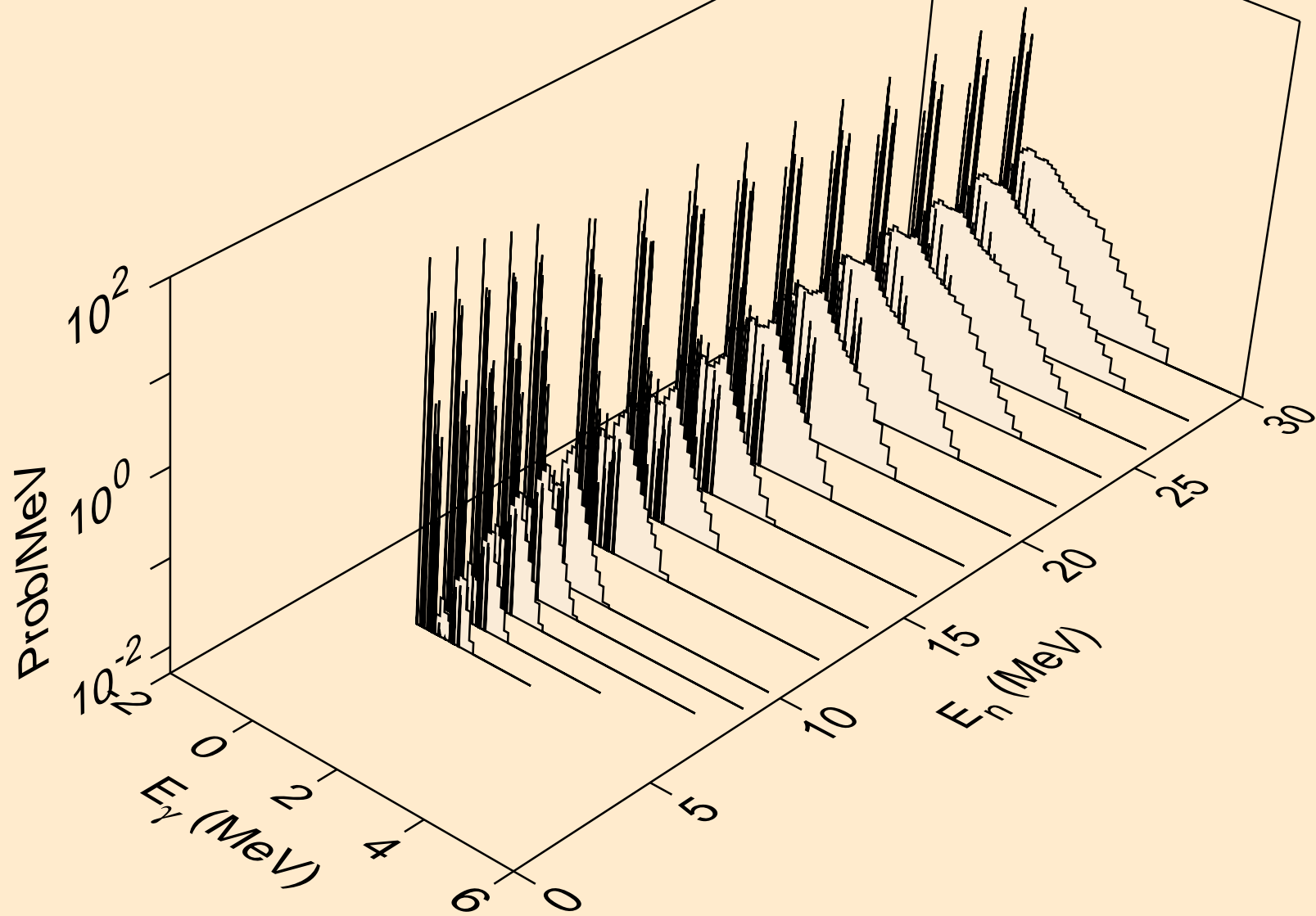

HF184 PROTON ACER TENDL-2024 LIBRARY; T=0.K
Photon emission for (n,2n)a

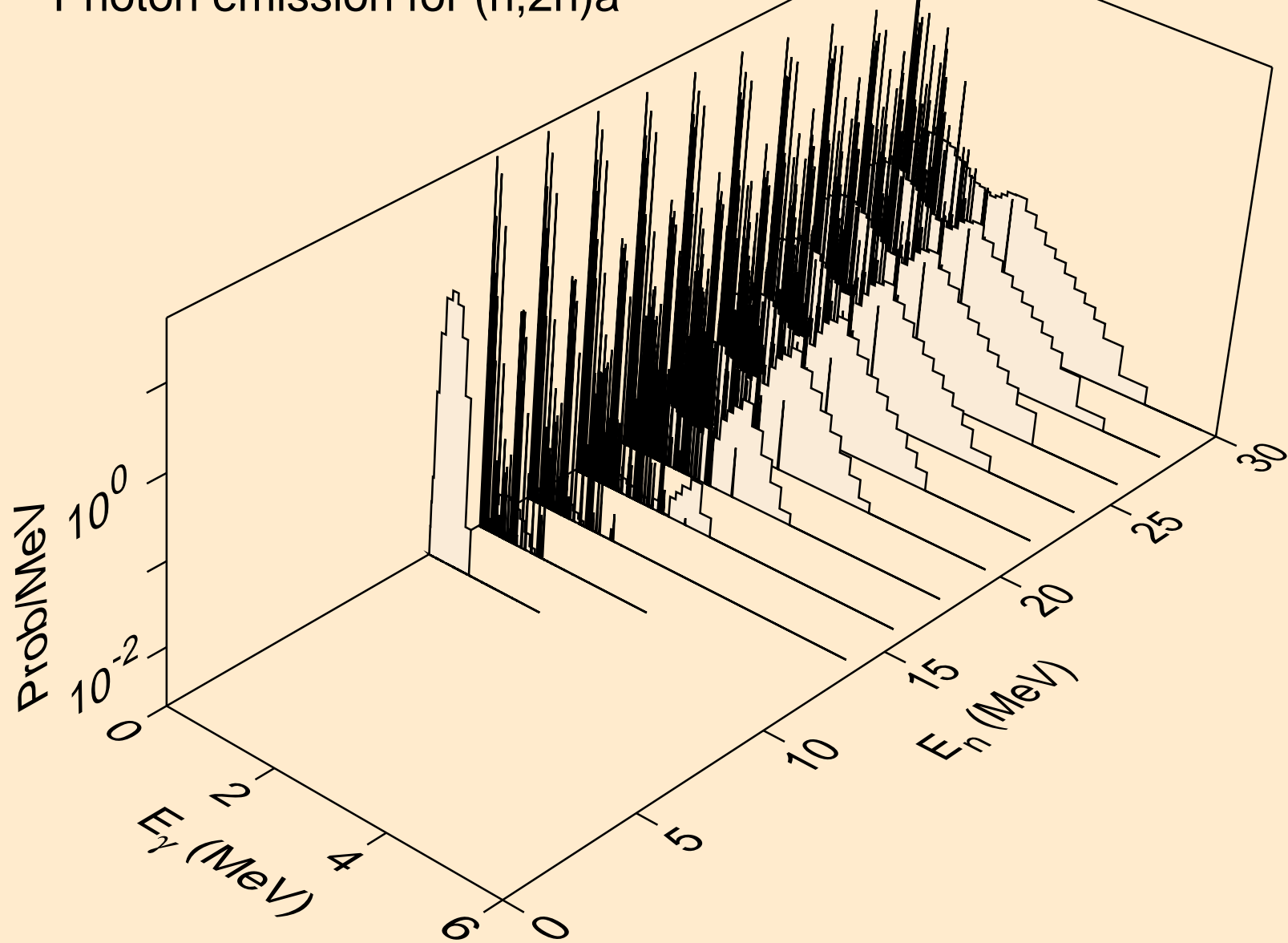

HF184 PROTON ACER TENDL-2024 LIBRARY; T=0.K
Photon emission for (n,3n)a

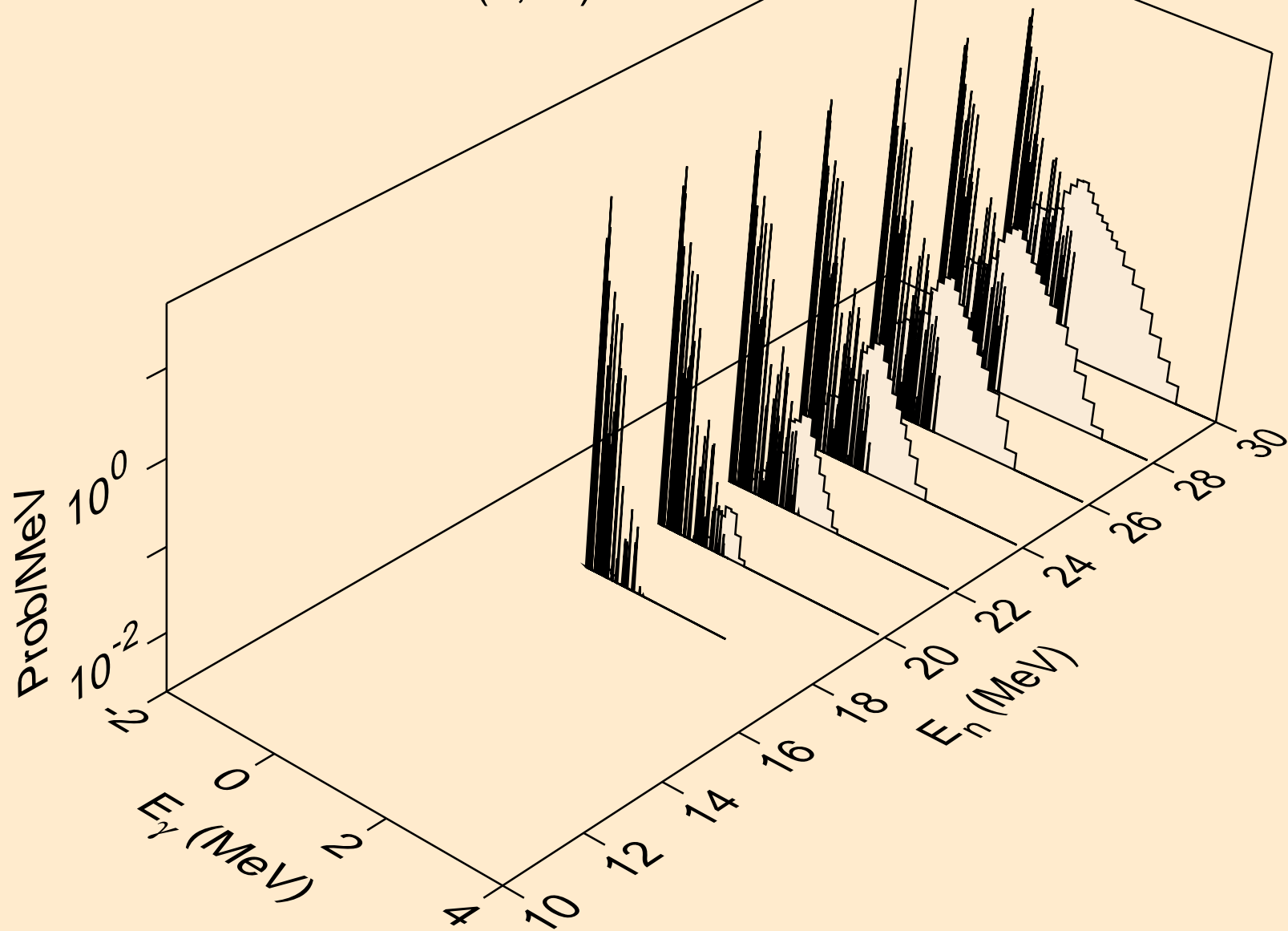

HF184 PROTON ACER TENDL-2024 LIBRARY; T=0.K
Photon emission for (n,n*)p

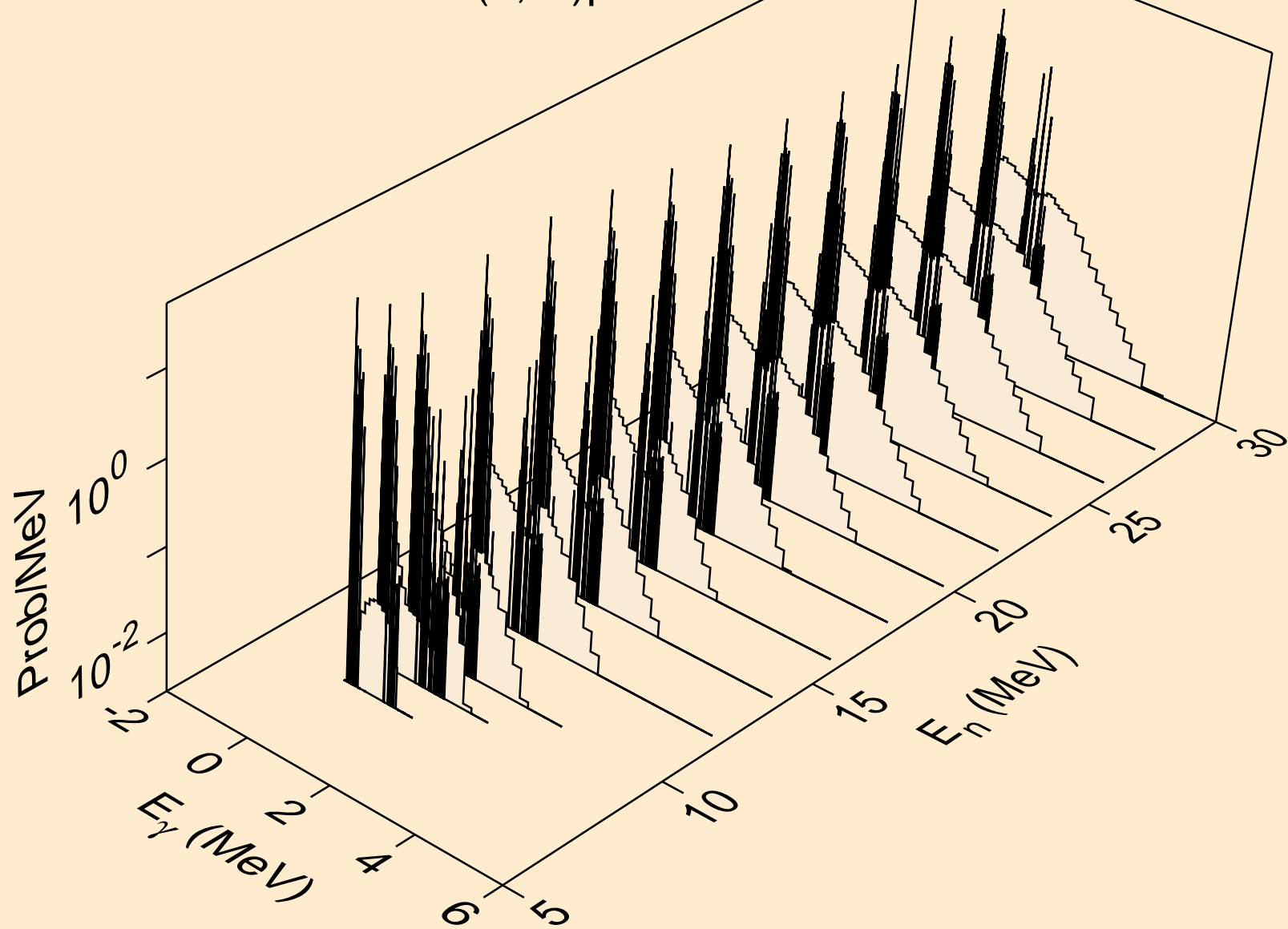

HF184 PROTON ACER TENDL-2024 LIBRARY; T=0.K
Photon emission for (n,n*)d

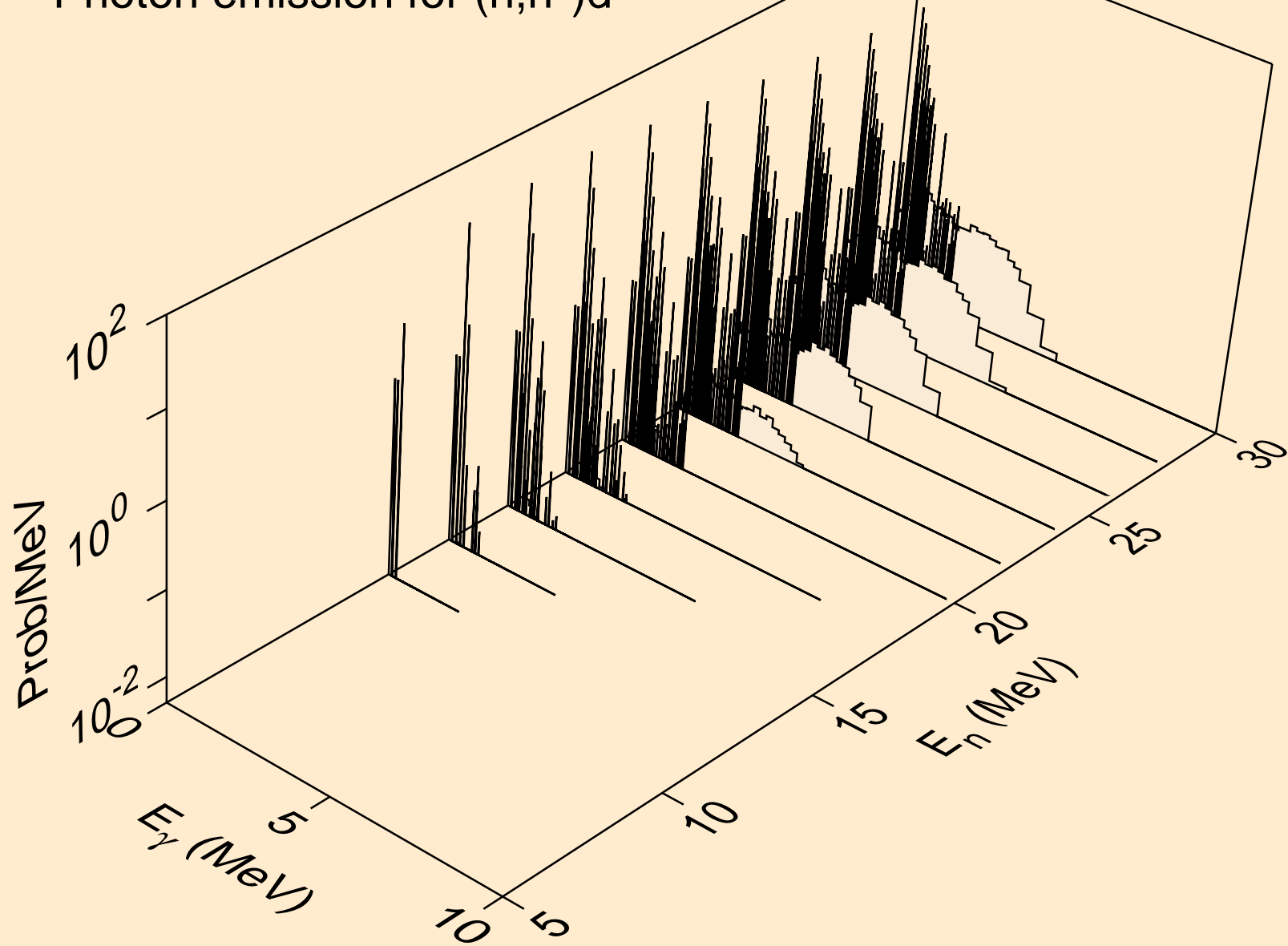

HF184 PROTON ACER TENDL-2024 LIBRARY; T=0.K
Photon emission for (n,n*)t

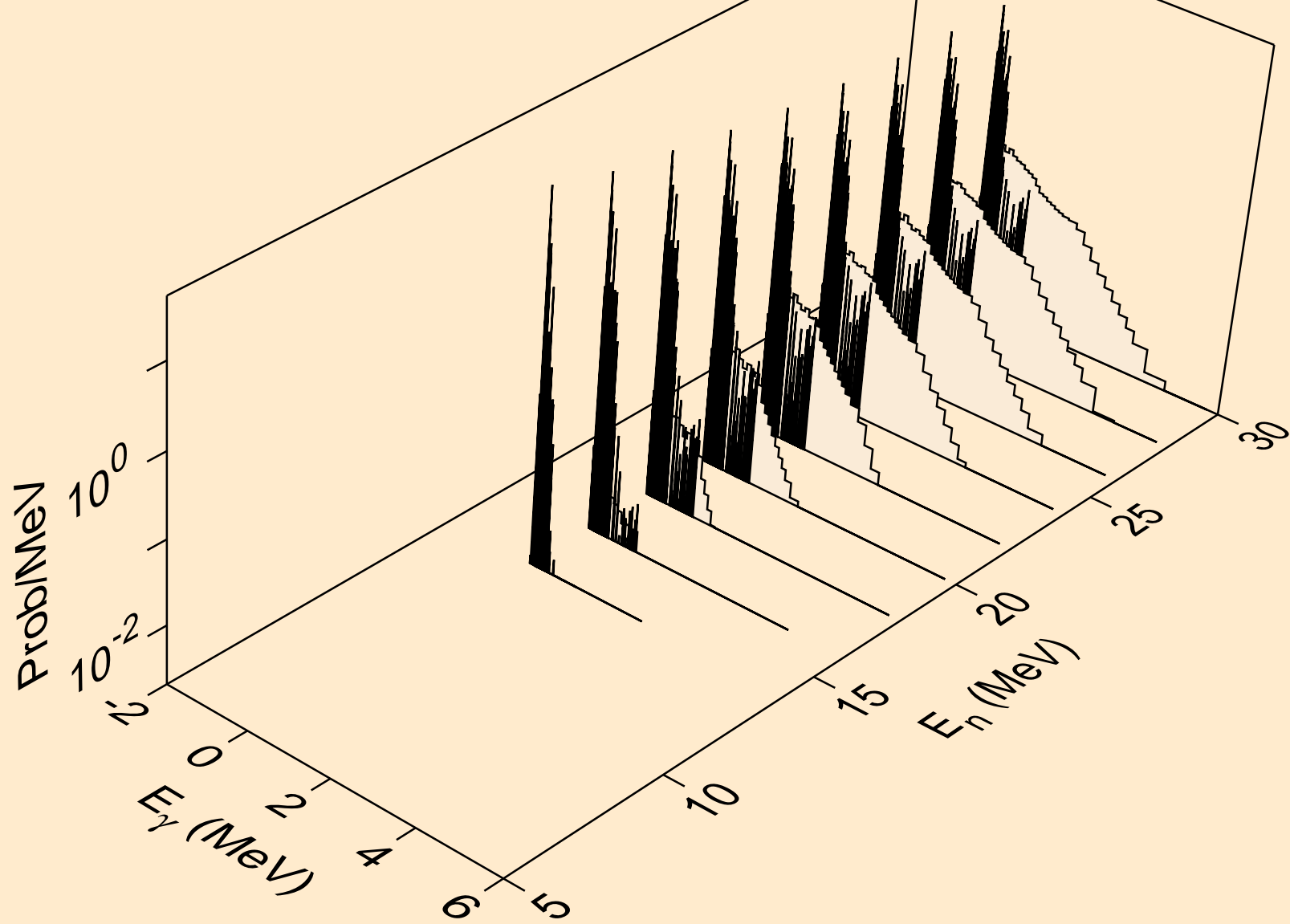

HF184 PROTON ACER TENDL-2024 LIBRARY; T=0.K
Photon emission for (n,n*)he3

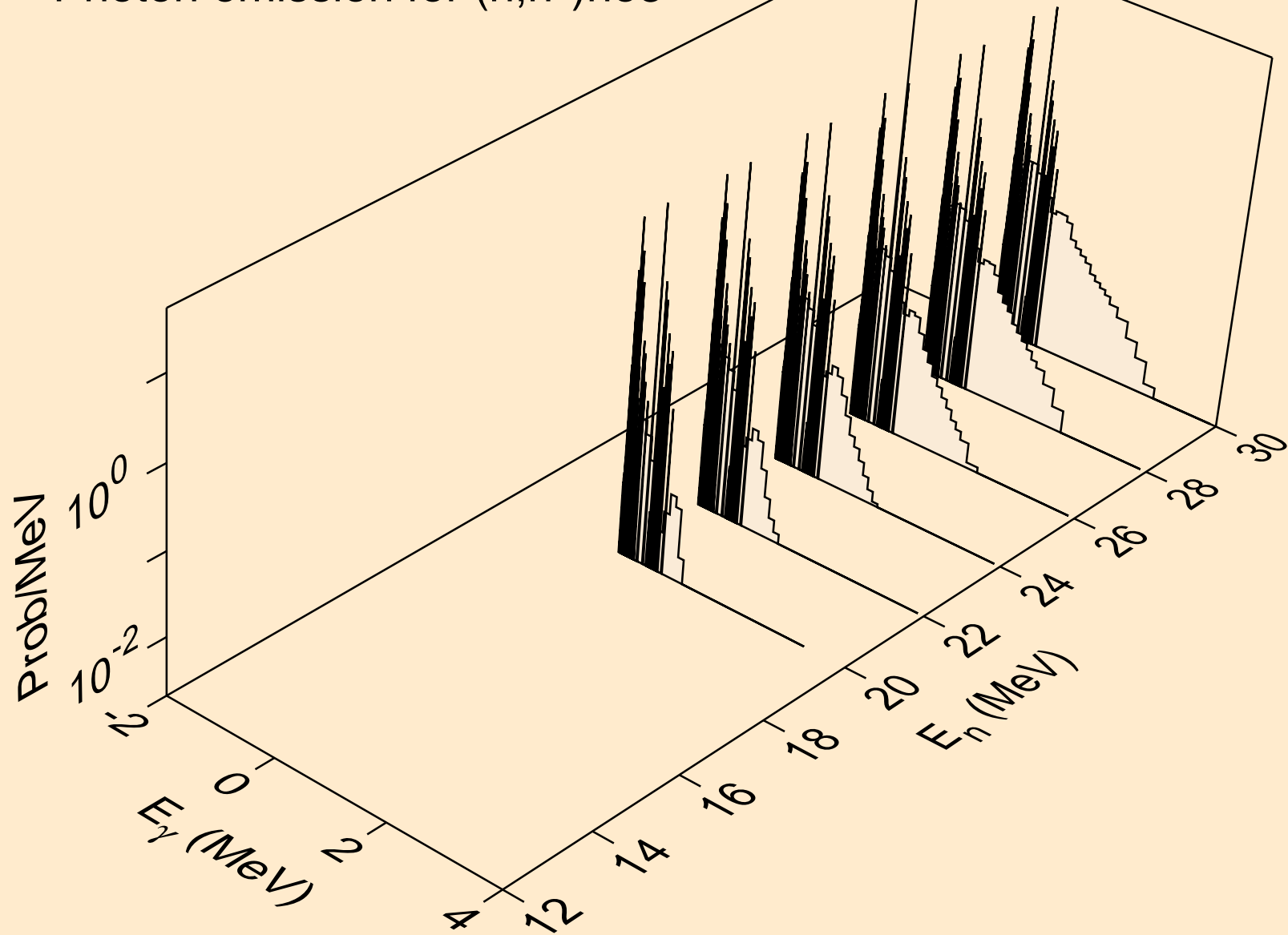

HF184 PROTON ACER TENDL-2024 LIBRARY; T=0.K
Photon emission for (n,4n)

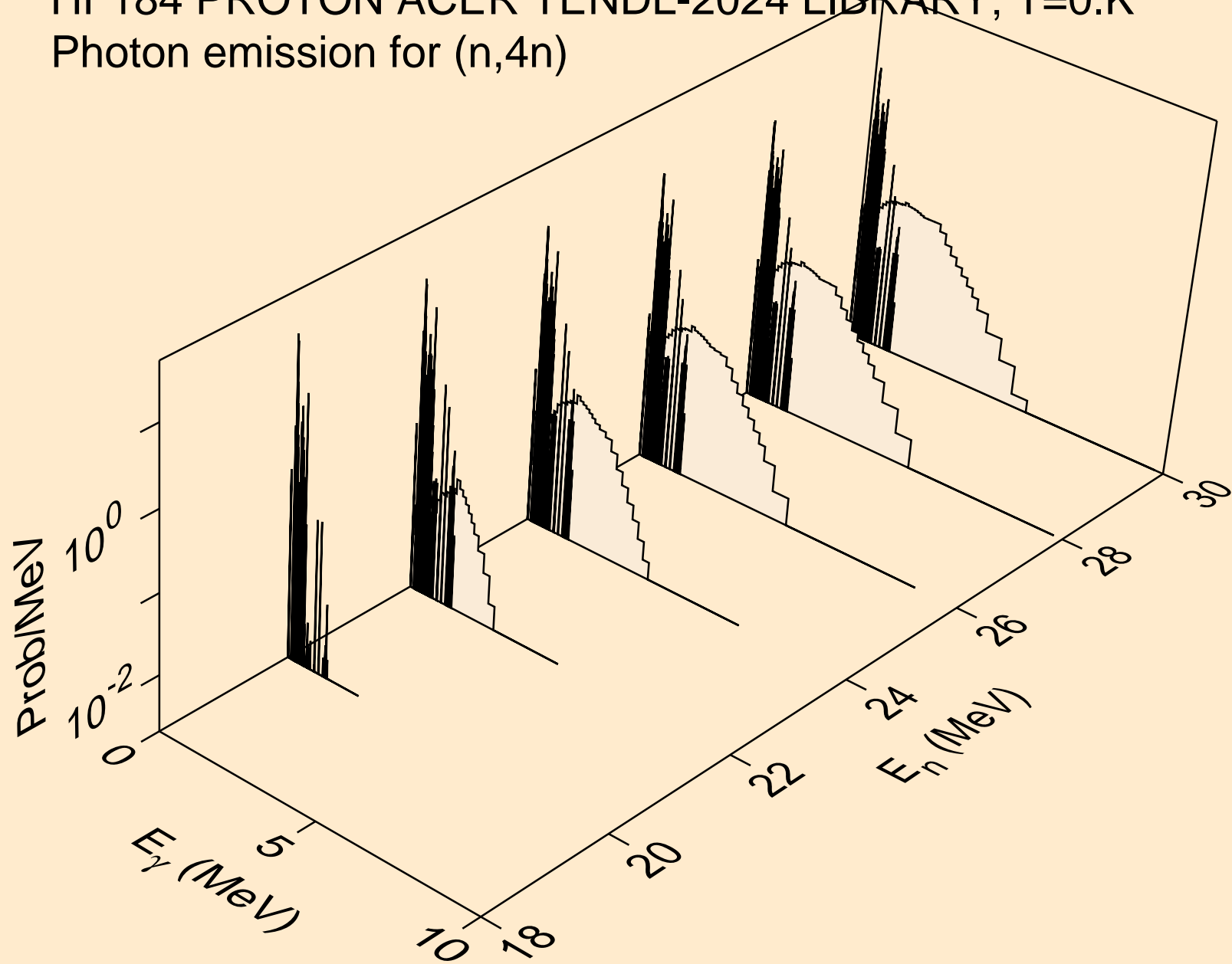

HF184 PROTON ACER TENDL-2024 LIBRARY; T=0.K
Photon emission for (n,2np)

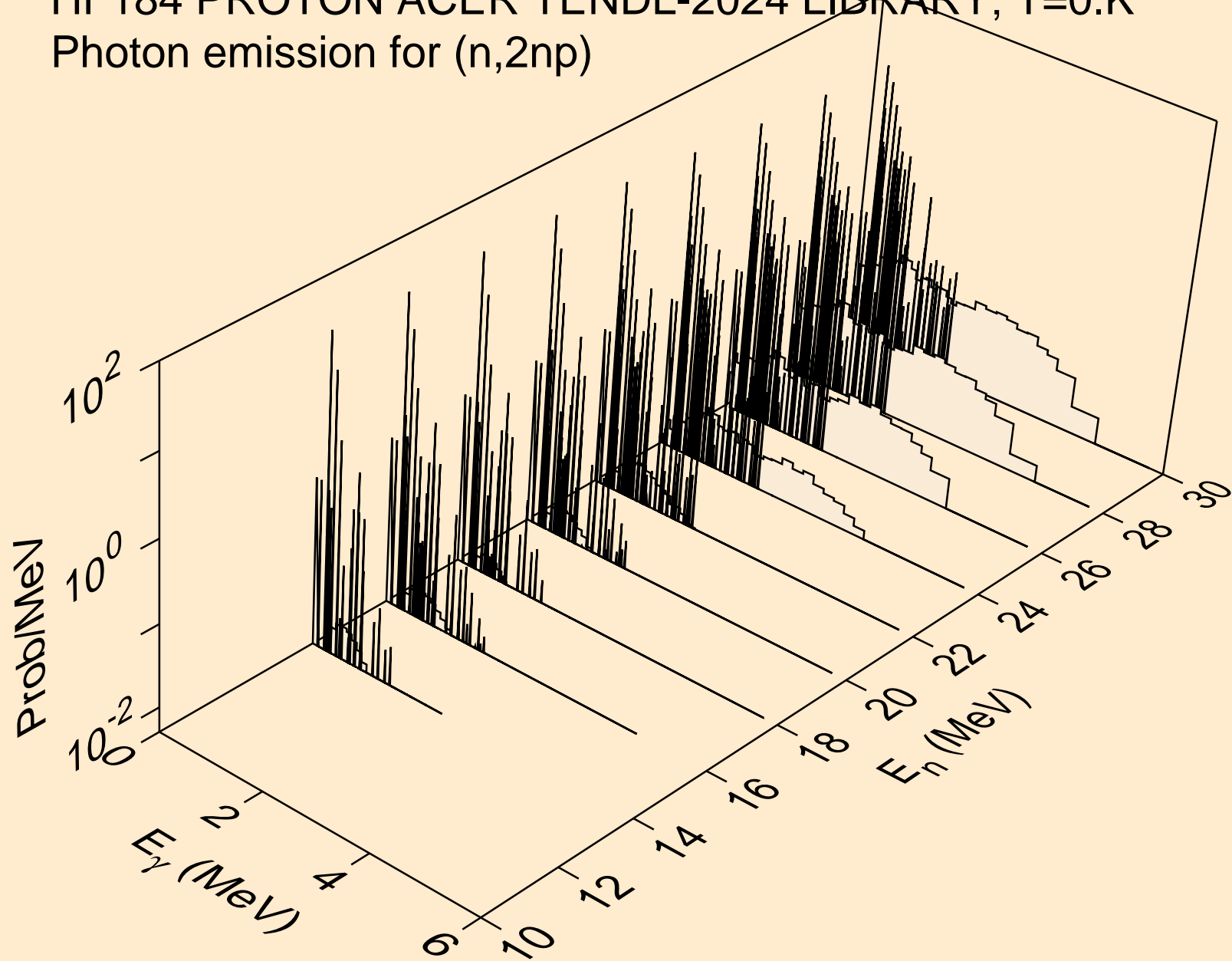

HF184 PROTON ACER TENDL-2024 LIBRARY; T=0.K
Photon emission for (n,3np)

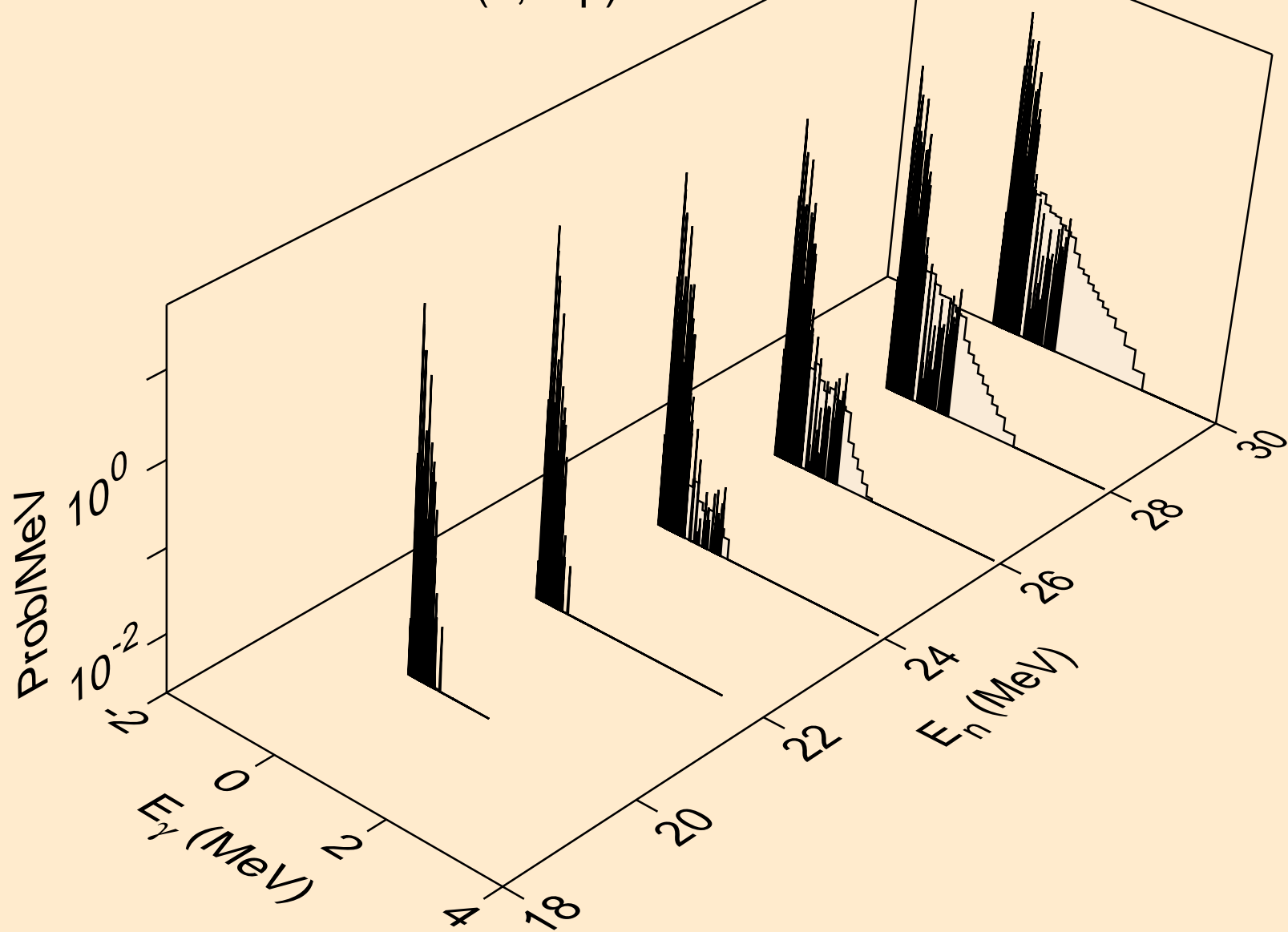

HF184 PROTON ACER TENDL-2024 LIBRARY; T=0.K
Photon emission for (n,n2p)

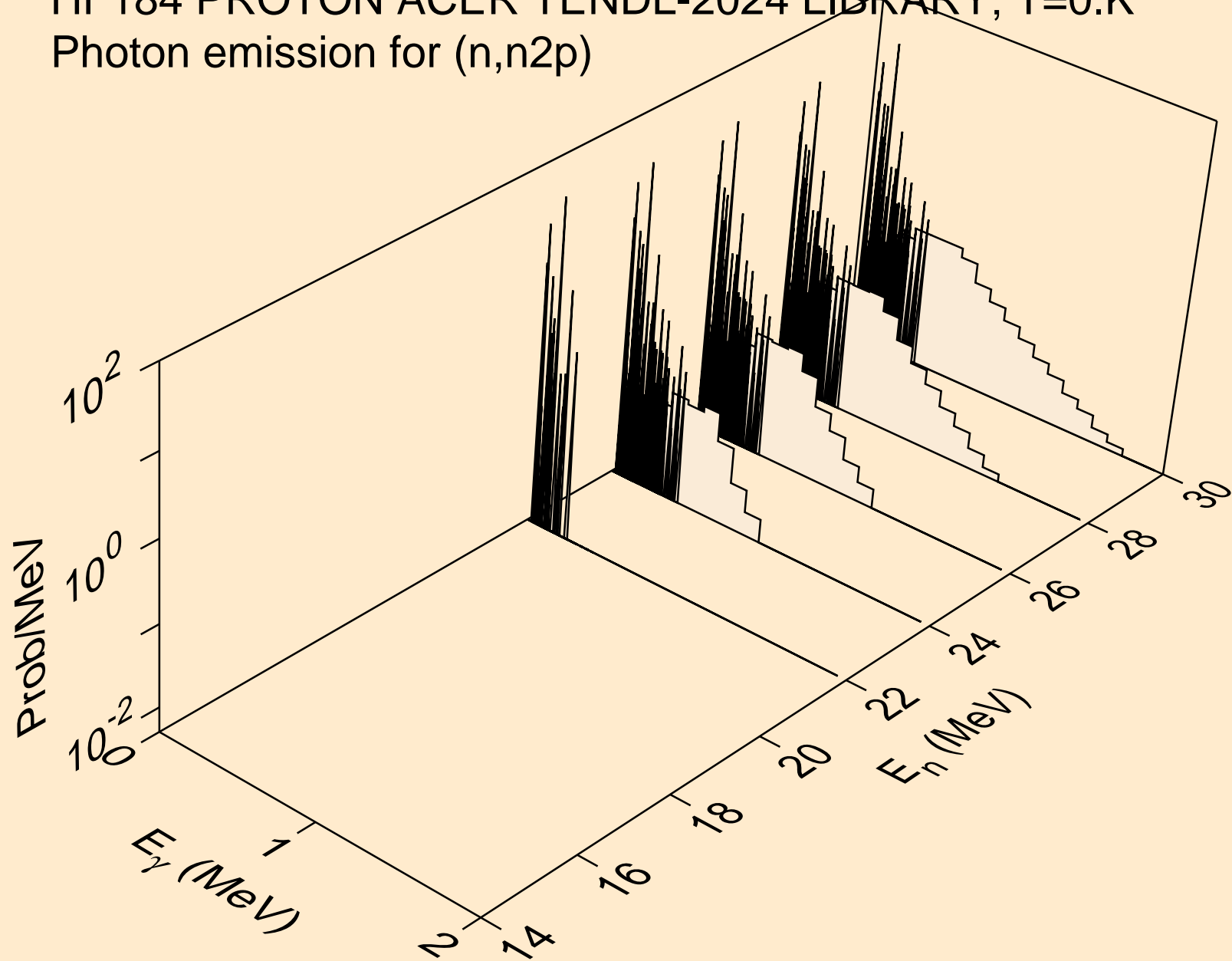

HF184 PROTON ACER TENDL-2024 LIBRARY; T=0.K
Photon emission for (n,npa)

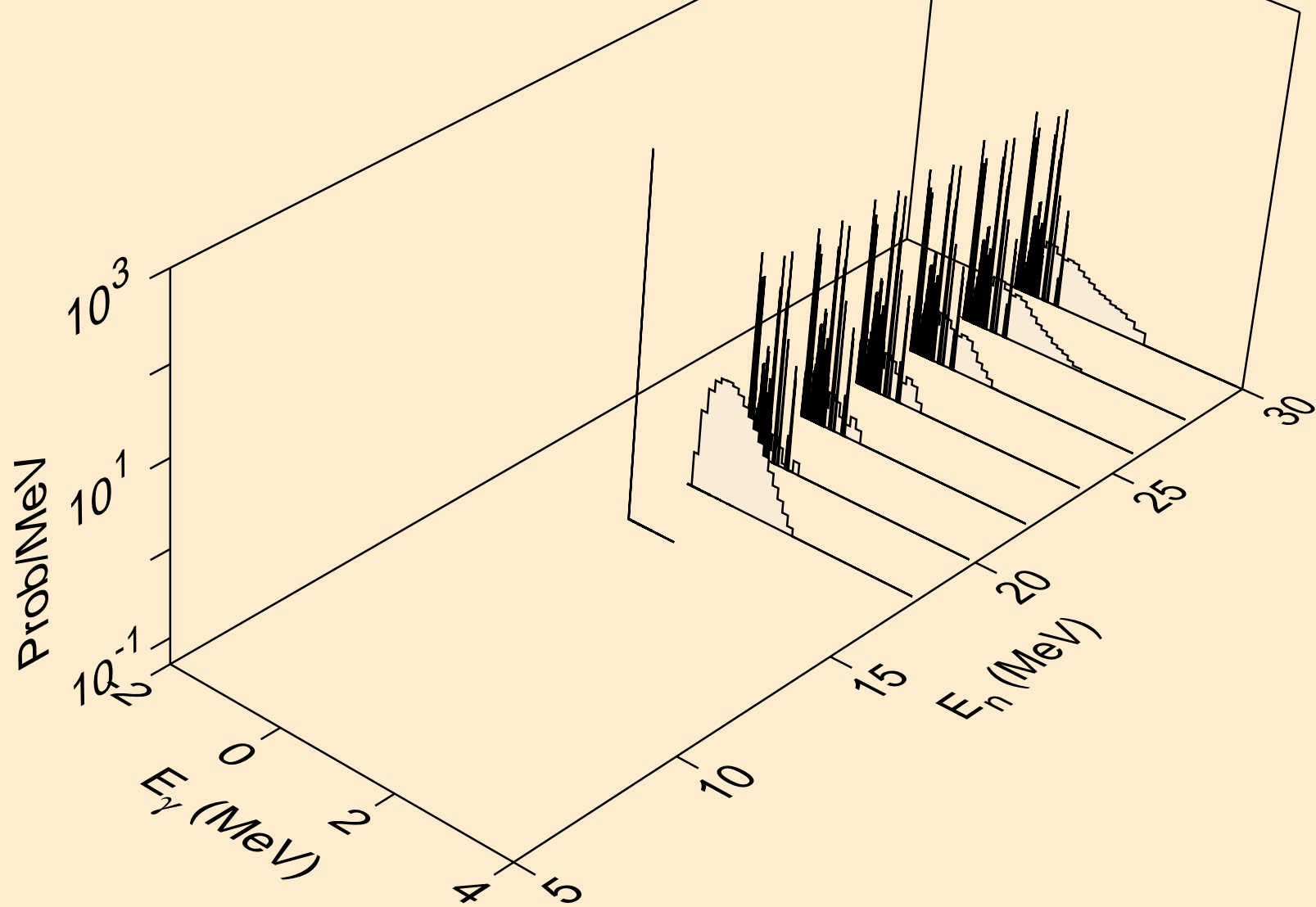

HF184 PROTON ACER TENDL-2024 LIBRARY; T=0.K
Photon emission for (n,gma)

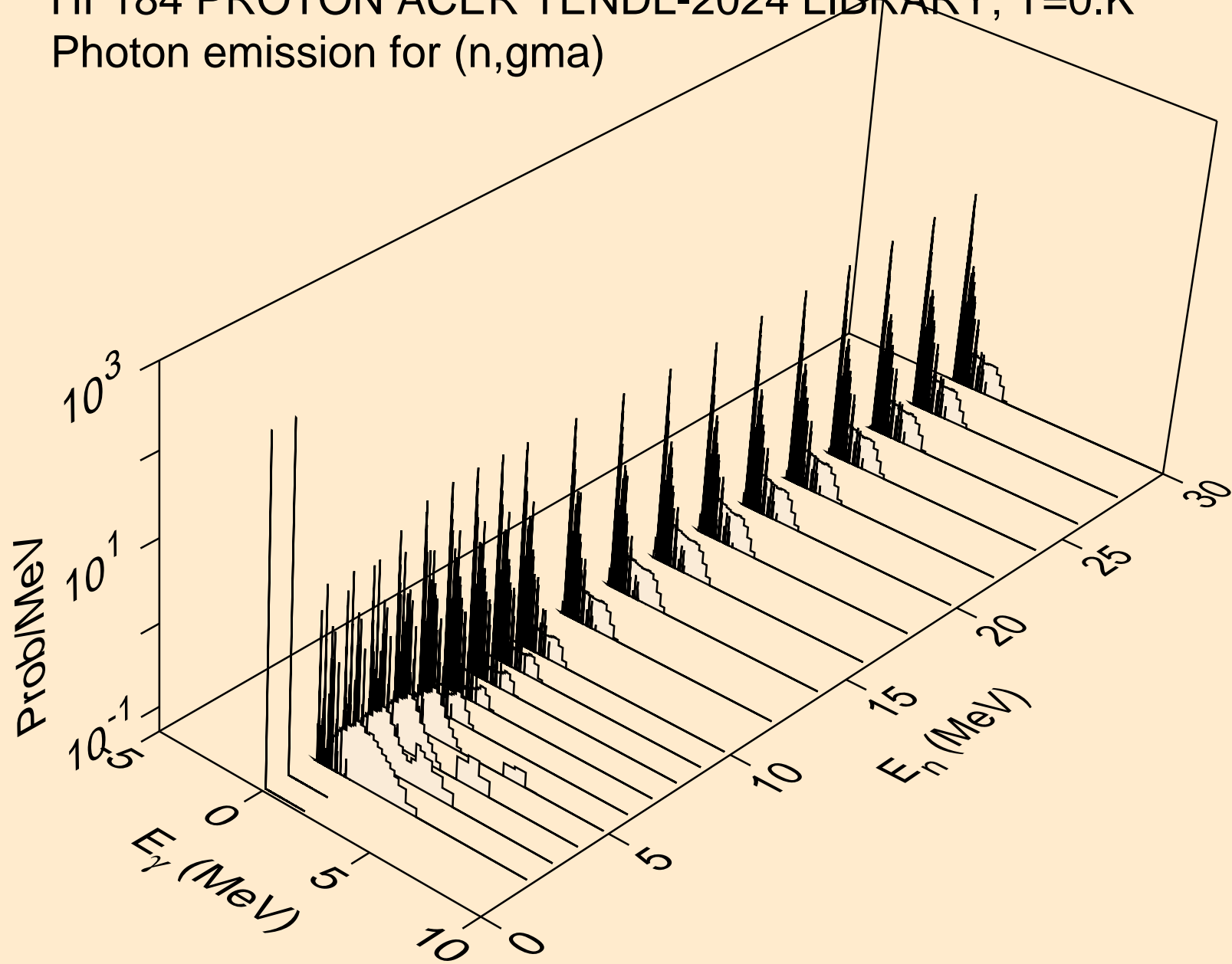

HF184 PROTON ACER TENDL-2024 LIBRARY; T=0.K
Photon emission for inelastic

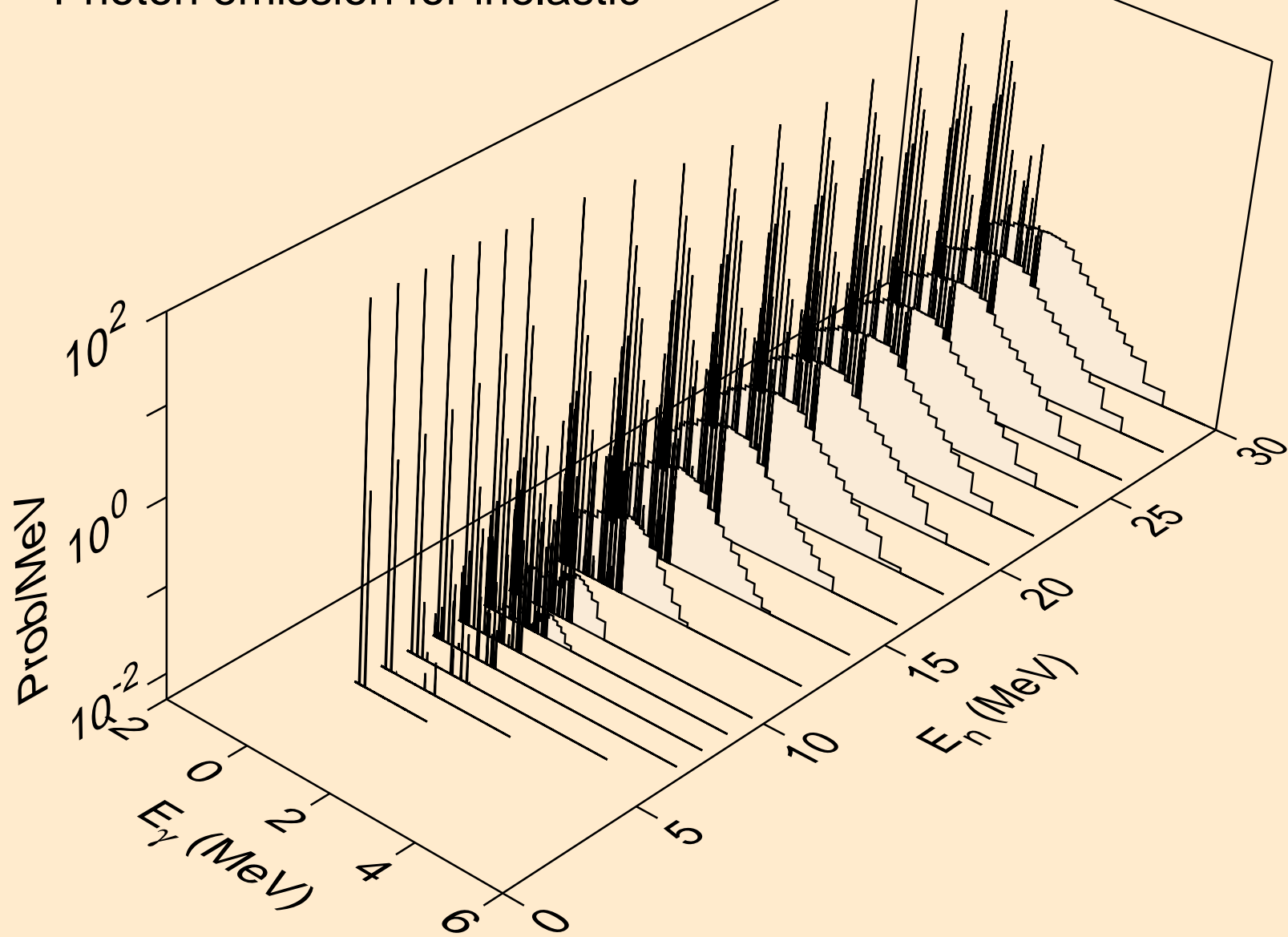

HF184 PROTON ACER TENDL-2024 LIBRARY; T=0.K
Photon emission for (n,d)

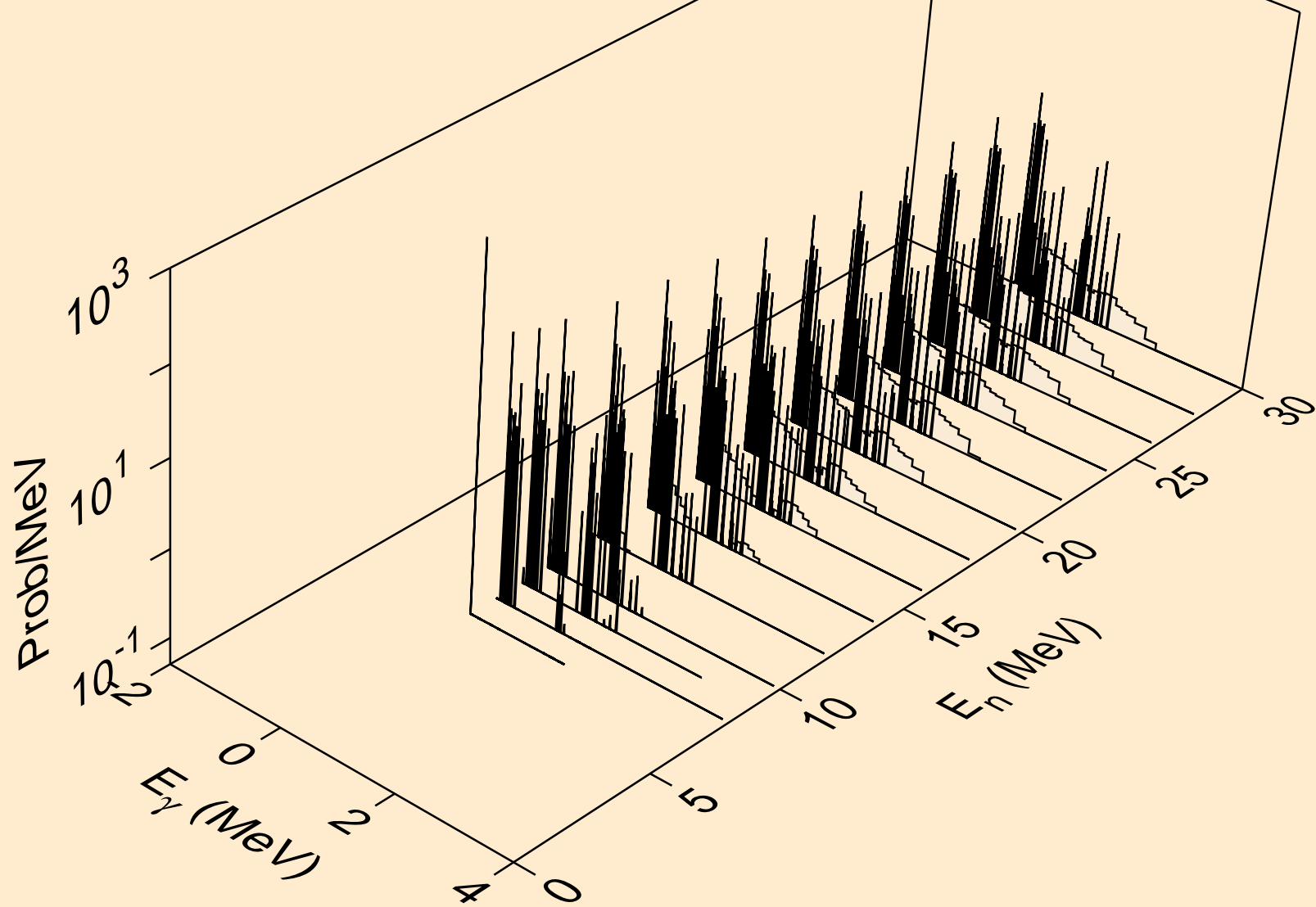

HF184 PROTON ACER TENDL-2024 LIBRARY; T=0.K
Photon emission for (n,t)

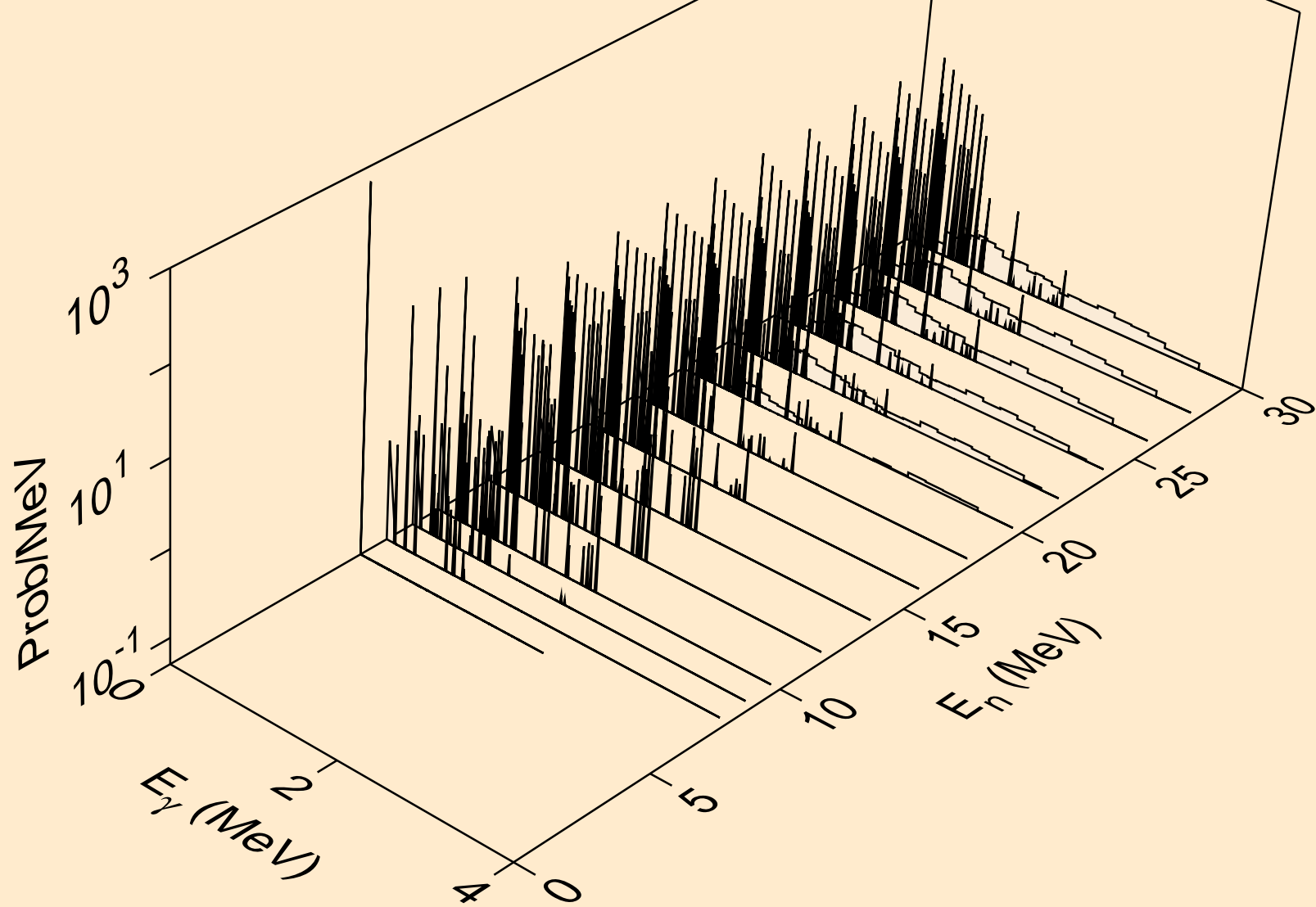

HF184 PROTON ACER TENDL-2024 LIBRARY; T=0.K
Photon emission for (n,he3)

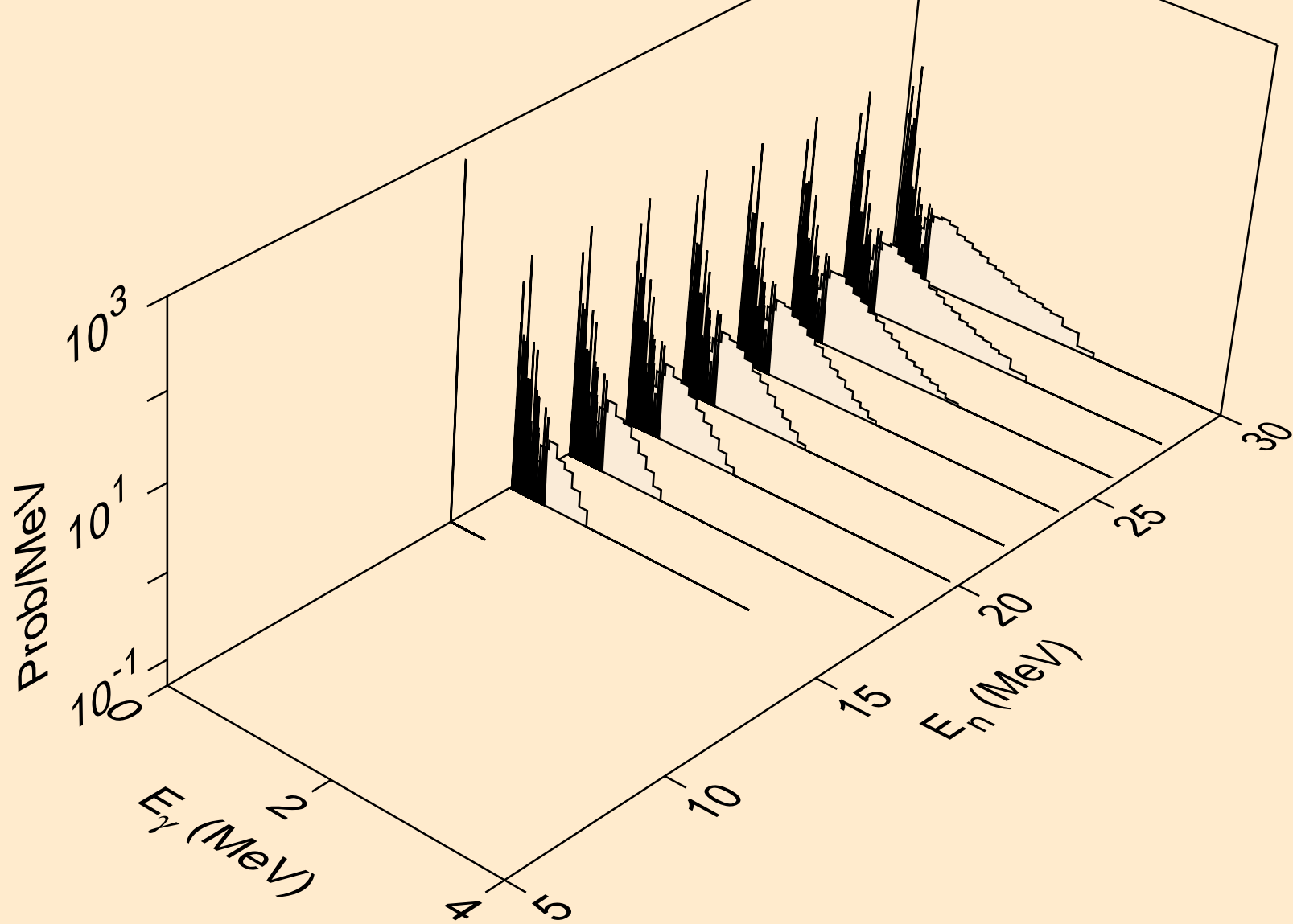

HF184 PROTON ACER TENDL-2024 LIBRARY; T=0.K
Photon emission for (n,a)

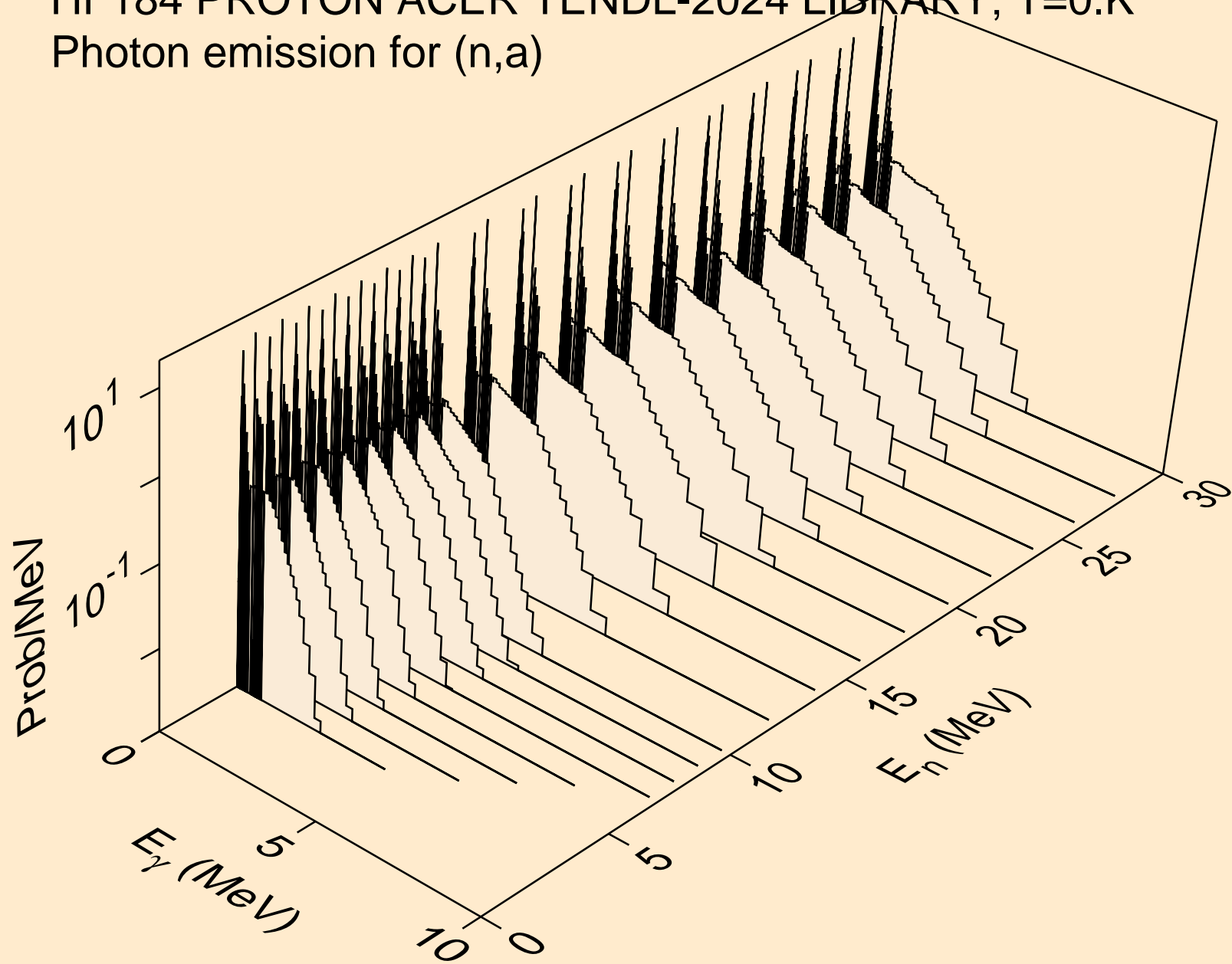

HF184 PROTON ACER TENDL-2024 LIBRARY; T=0.K
Photon emission for (n,2p)

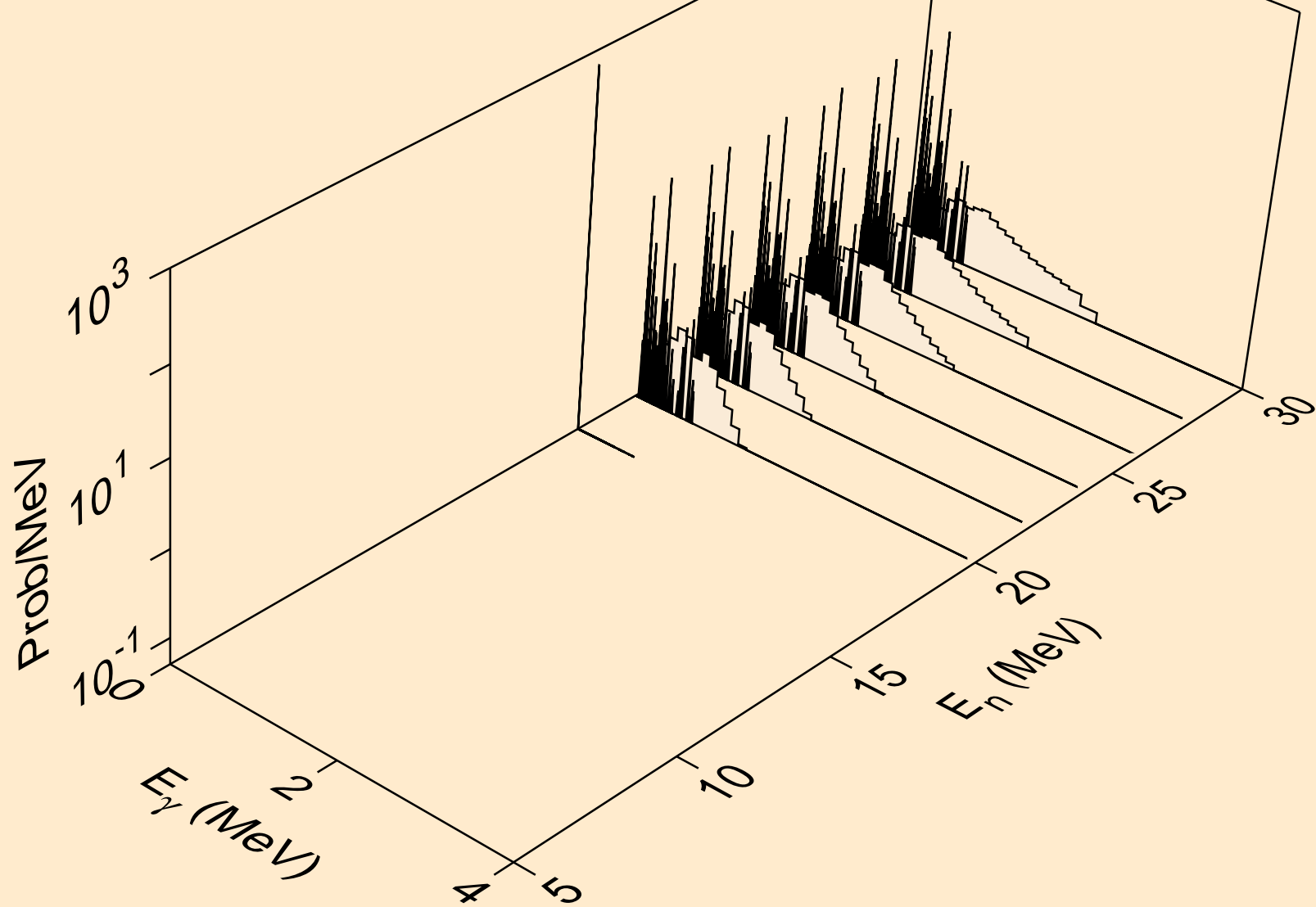

HF184 PROTON ACER TENDL-2024 LIBRARY; T=0.K
Photon emission for (n,pa)

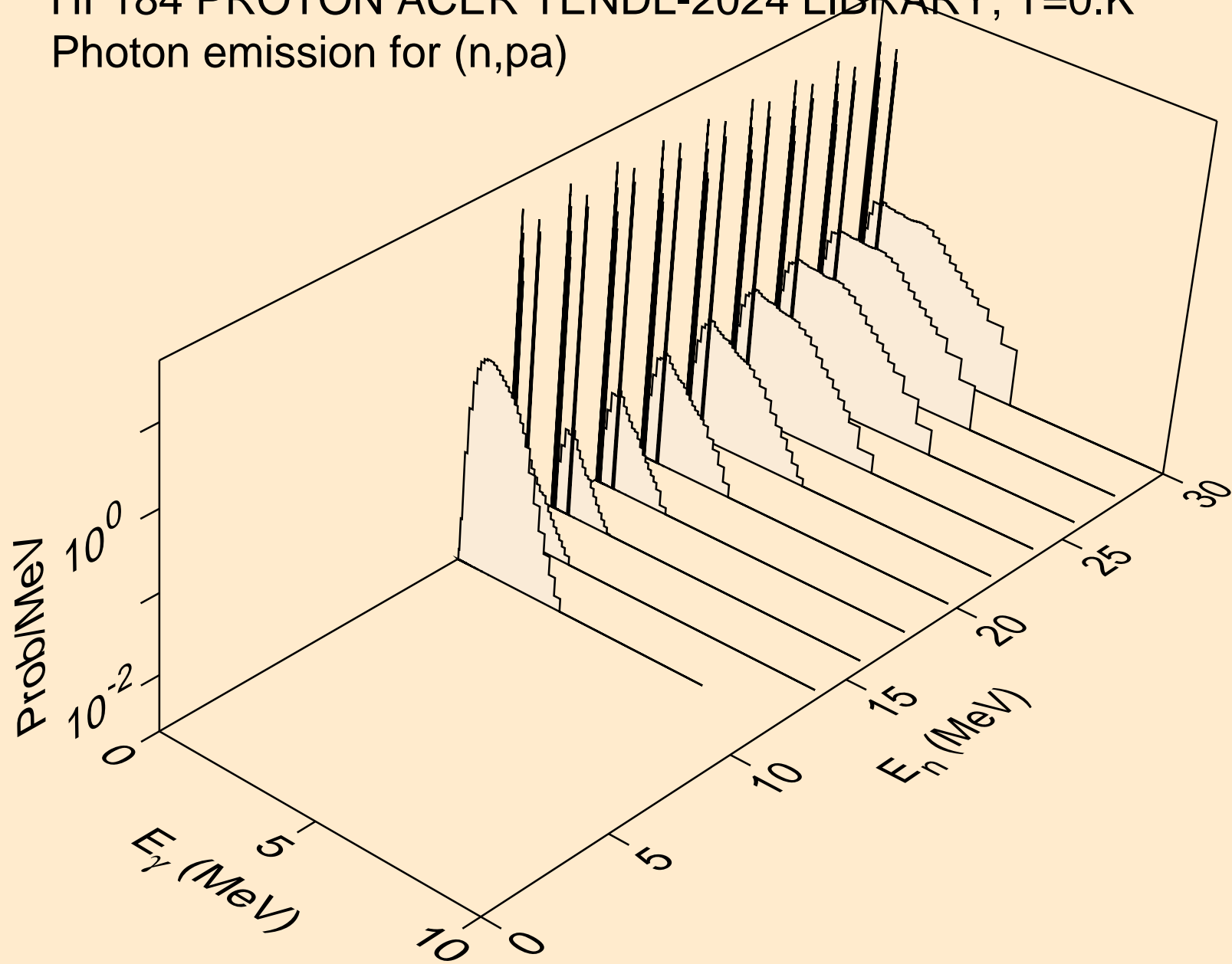

HF184 PROTON ACER TENDL-2024 LIBRARY; T=0.K

Particle heating contributions

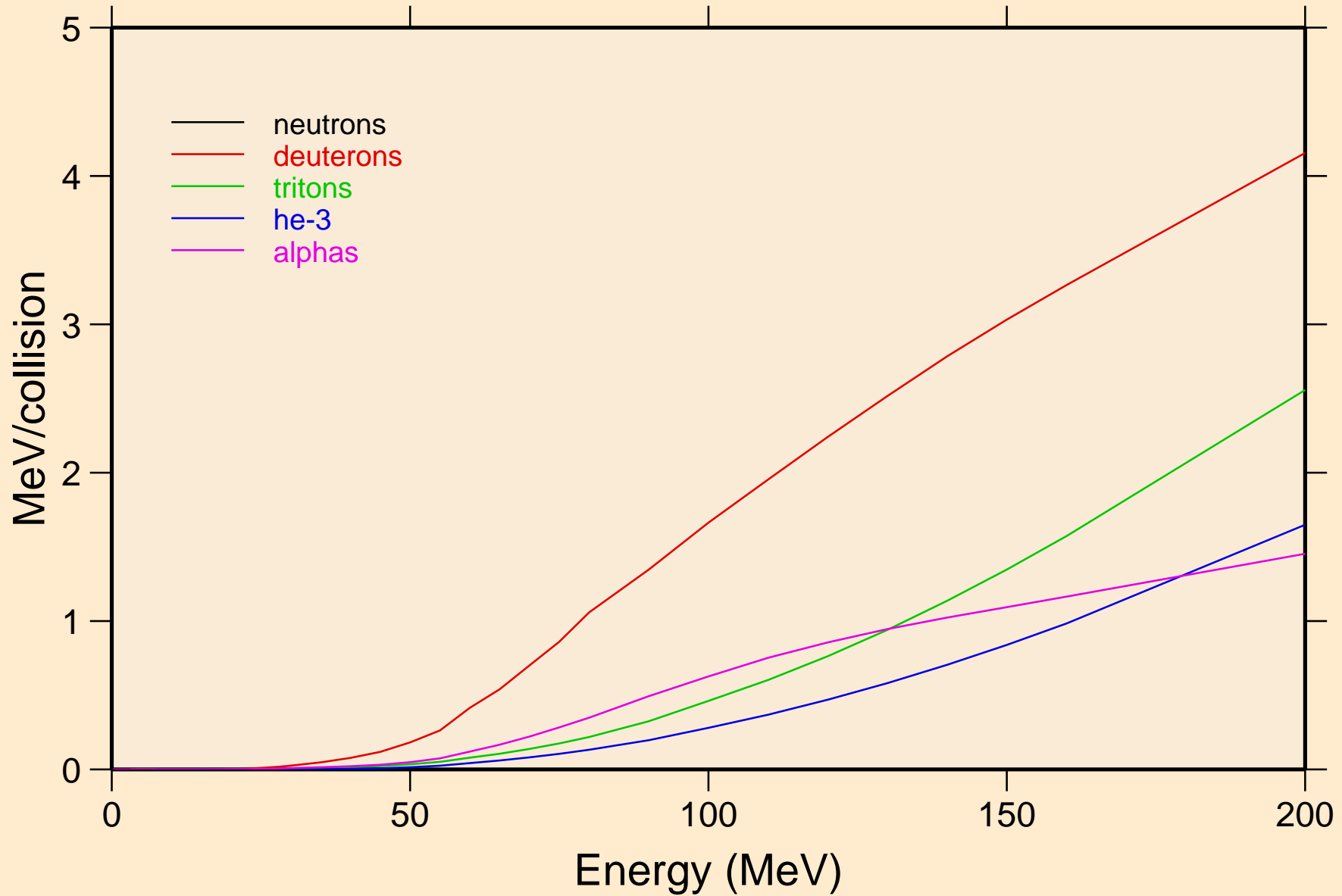

HF184 PROTON ACER TENDL-2024 LIBRARY; T=0.K

Recoil Heating

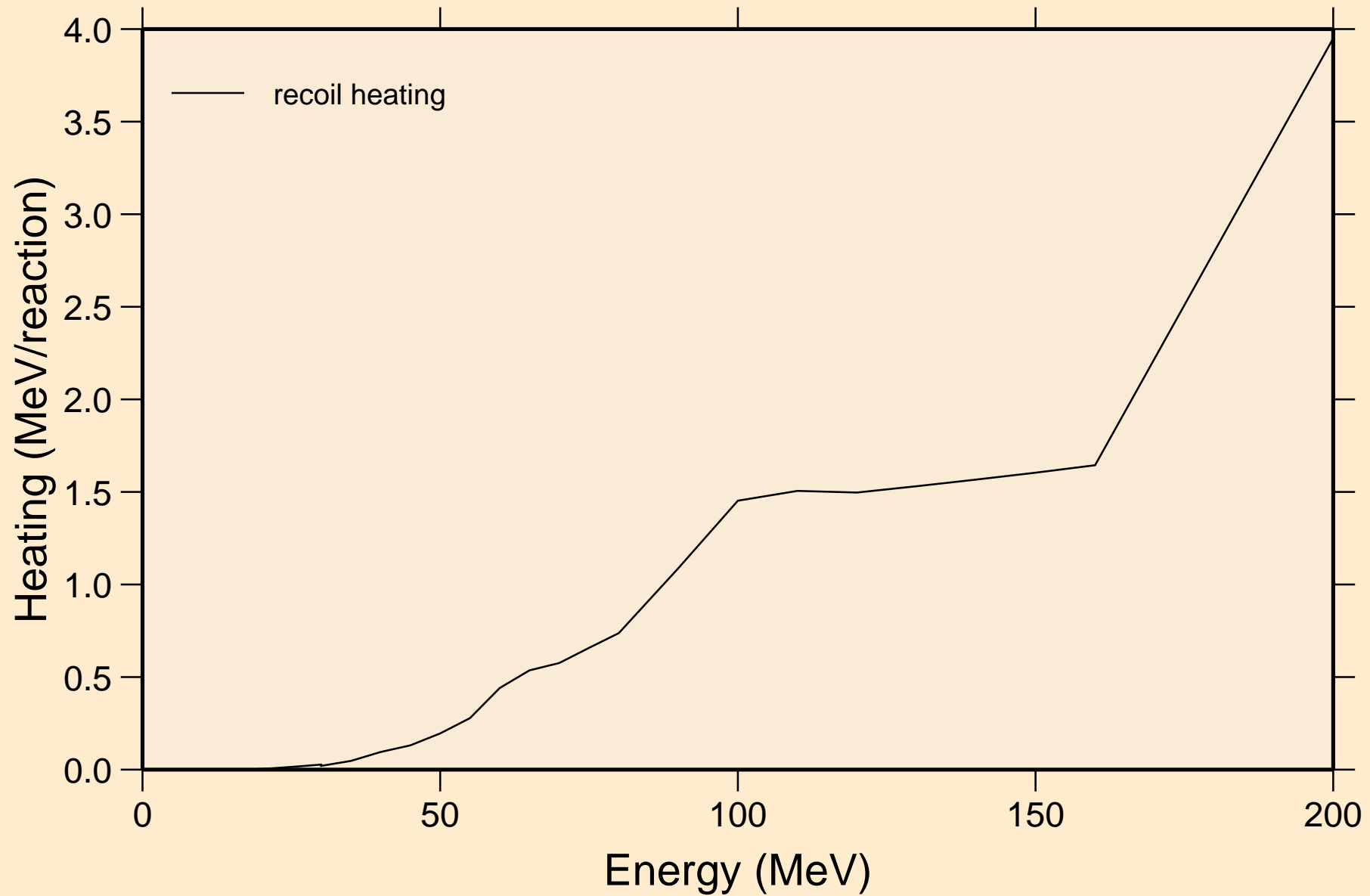

HF184 PROTON ACER TENDL-2024 LIBRARY; T=0.K

Particle production cross sections

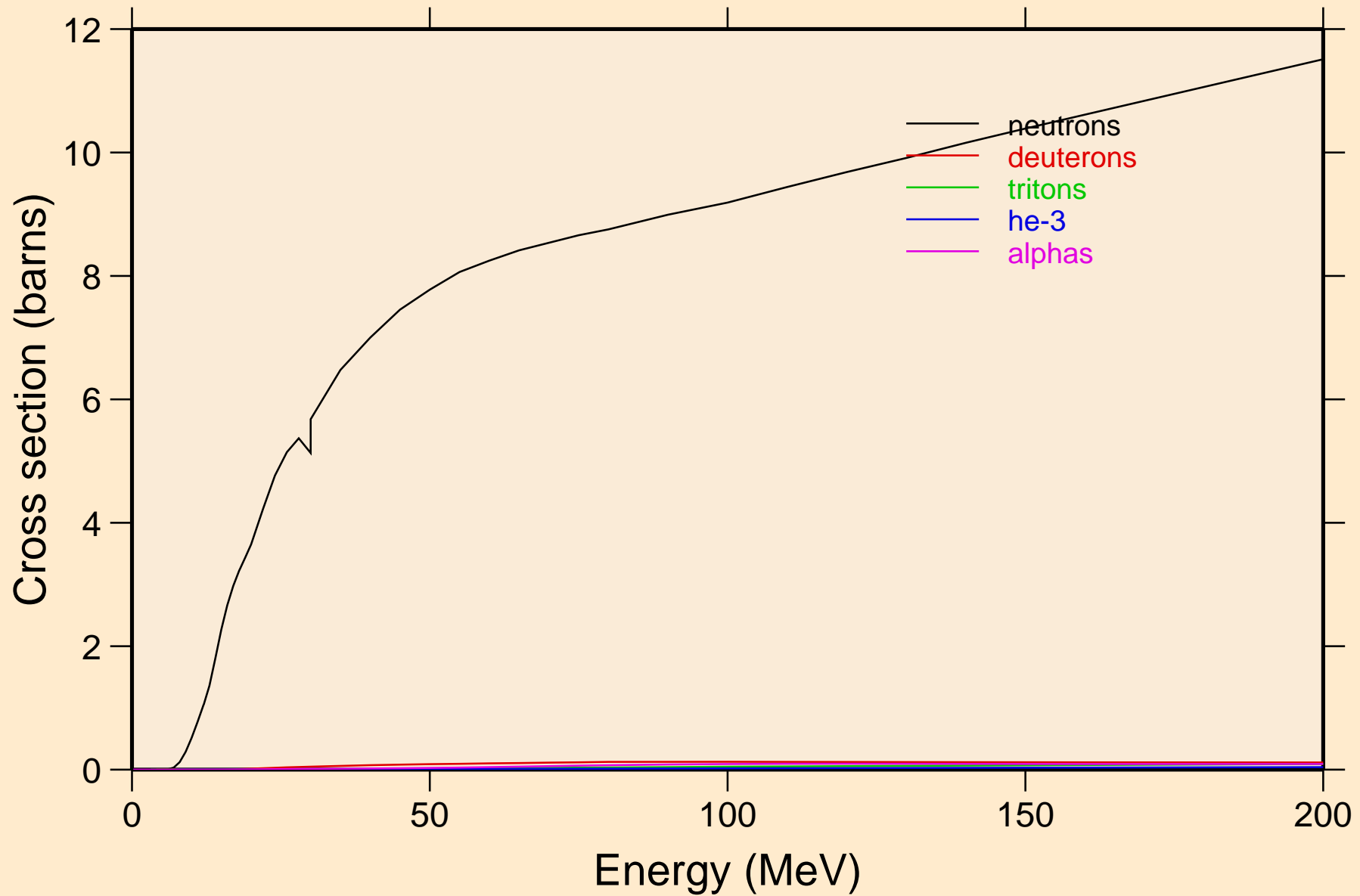

HF184 PROTON ACER TENDL-2024 LIBRARY; T=0.K
neutrons from (p,n)

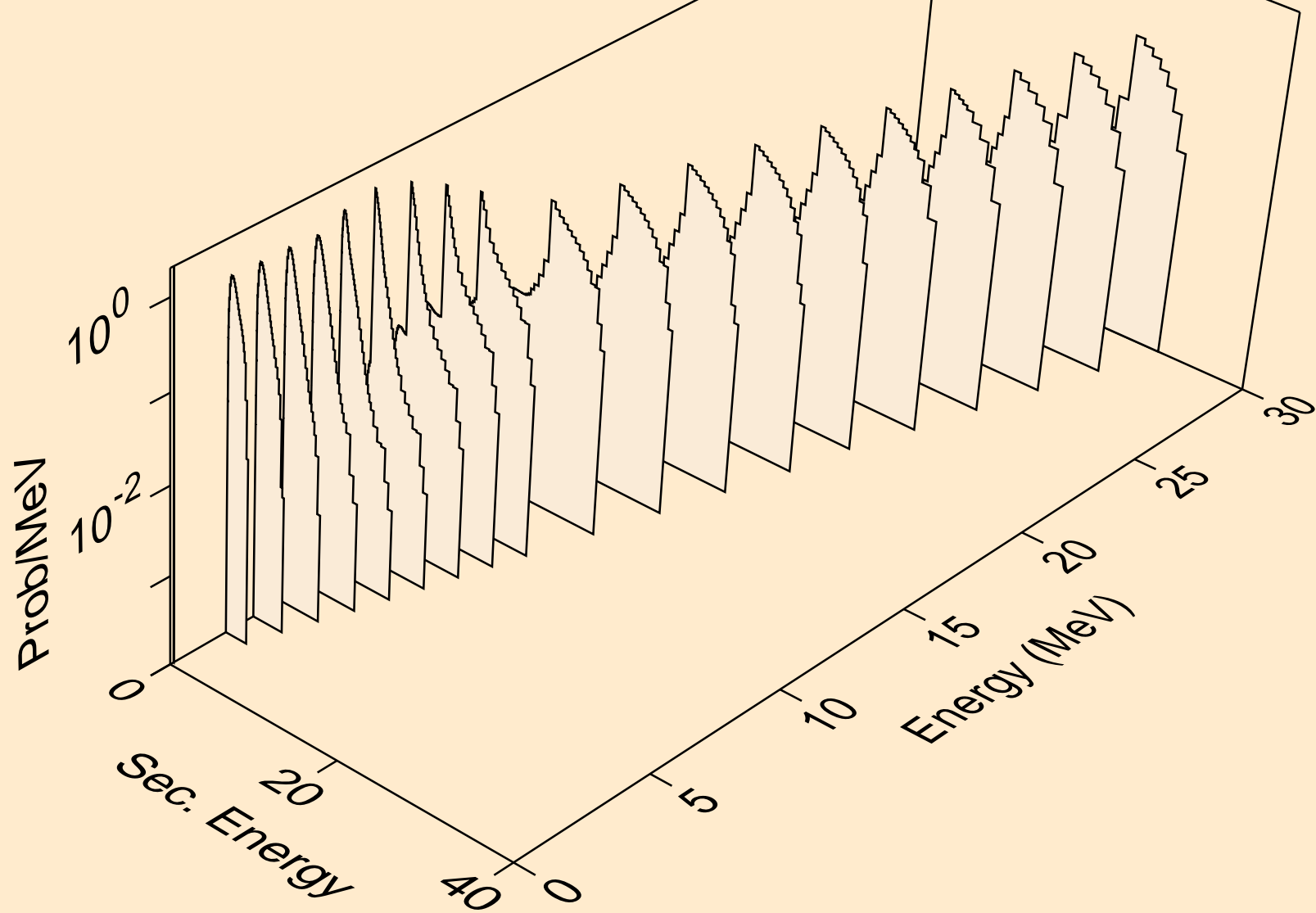

HF184 PROTON ACER TENDL-2024 LIBRARY; T=0.K
neutrons from (p,x)

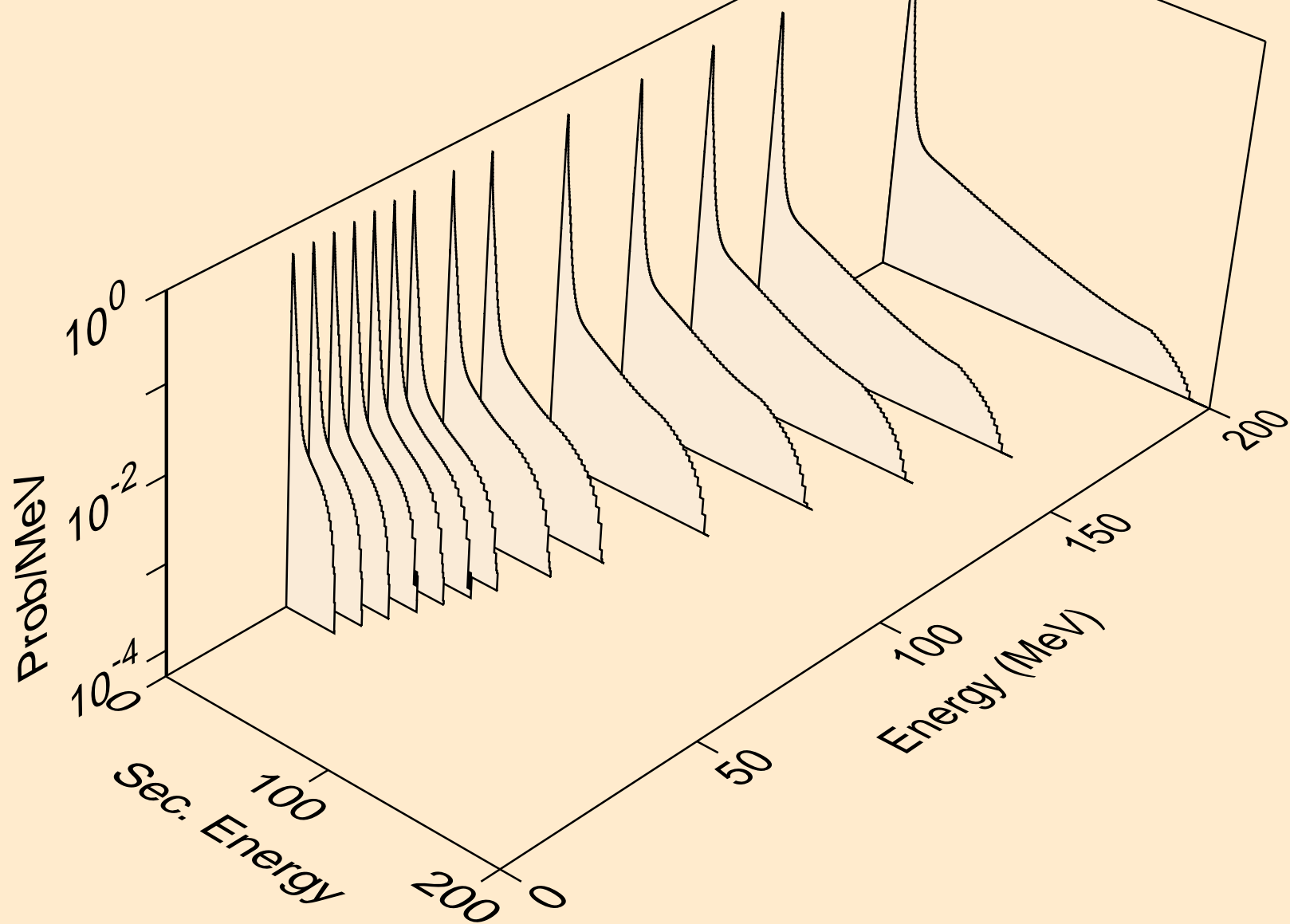

HF184 PROTON ACER TENDL-2024 LIBRARY; T=0.K
neutrons from (p,2nd)

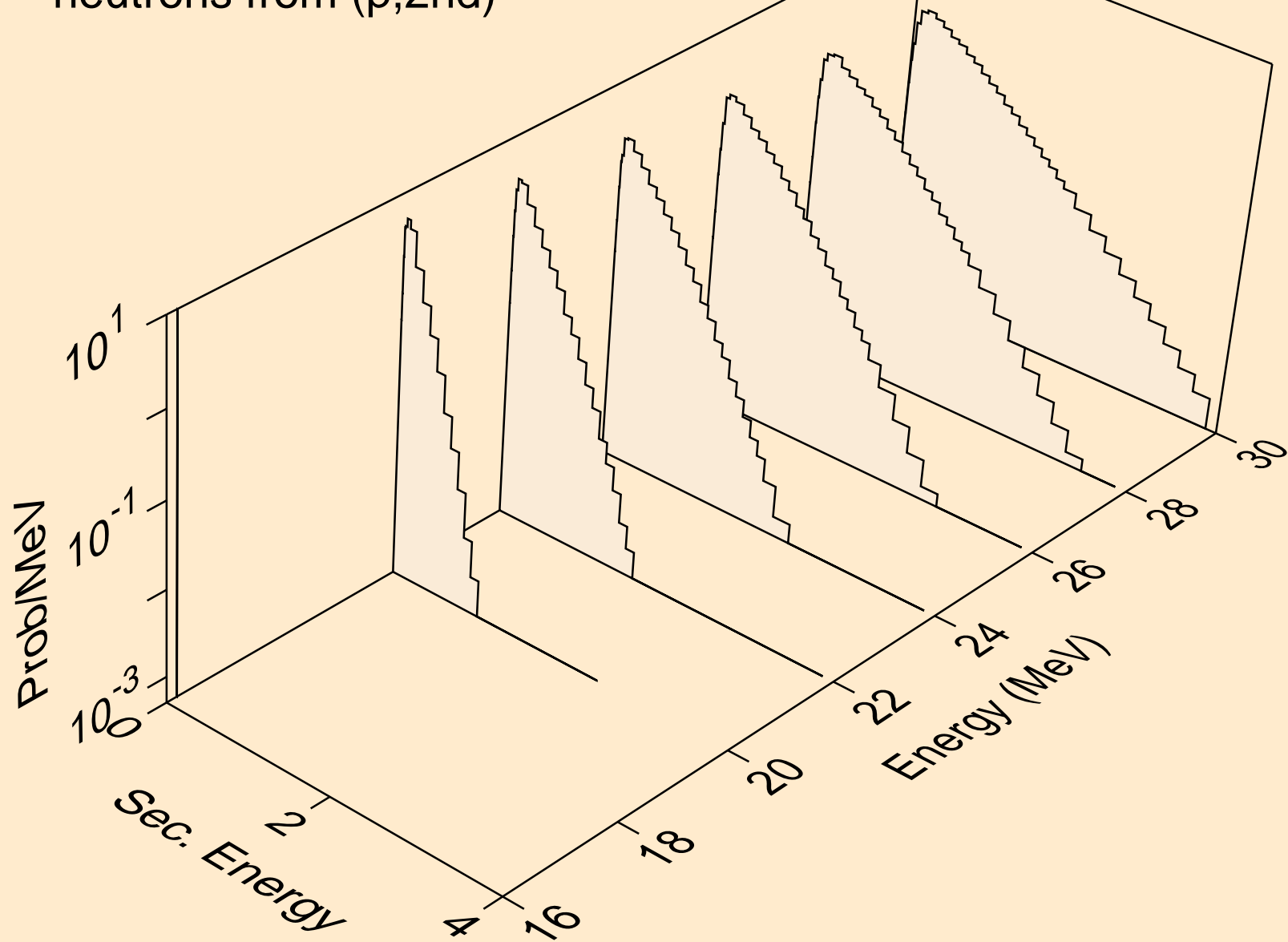

HF184 PROTON ACER TENDL-2024 LIBRARY; T=0.K
neutrons from (p,2n)

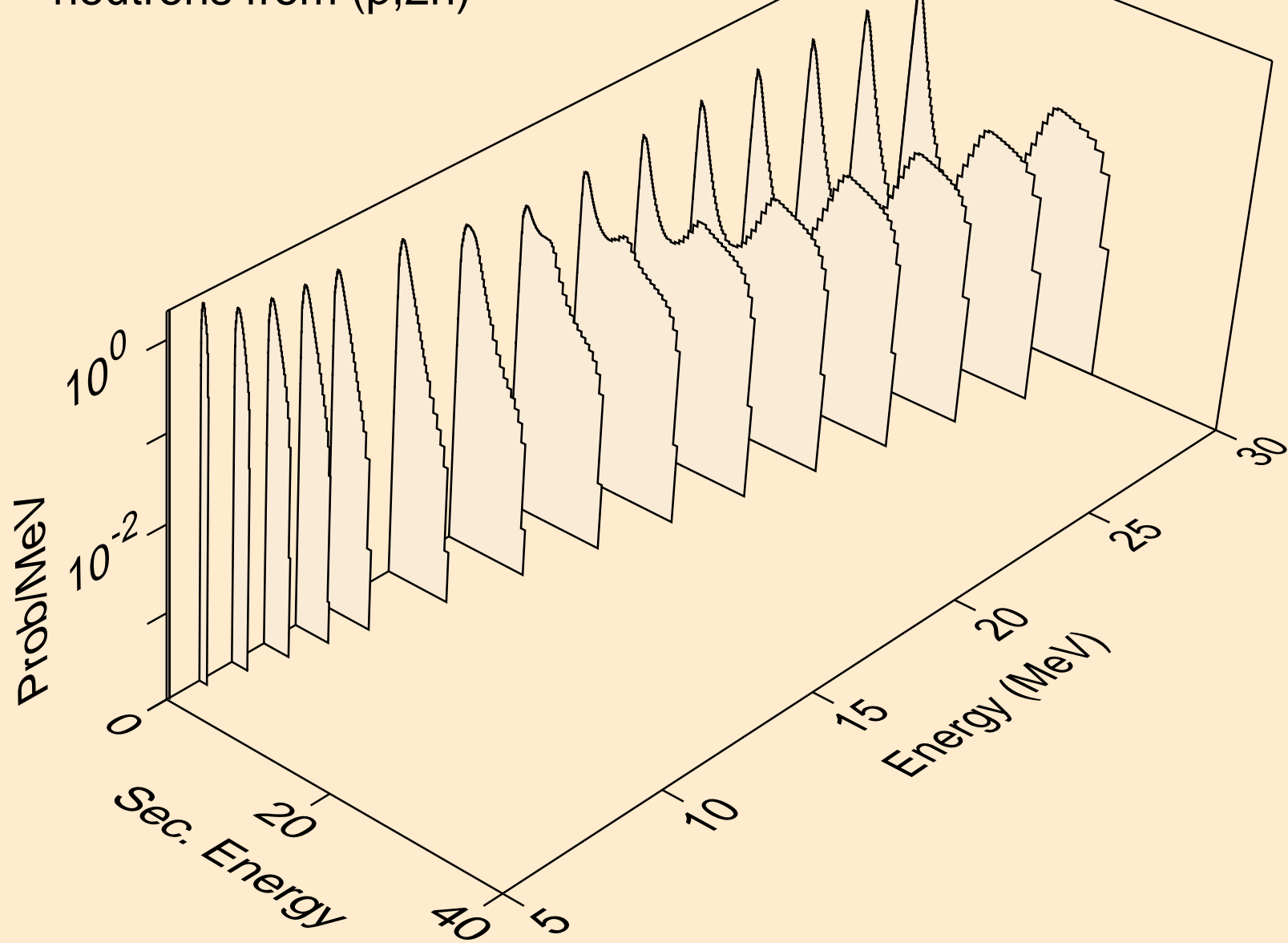

HF184 PROTON ACER TENDL-2024 LIBRARY; T=0.K
neutrons from (p,3n)

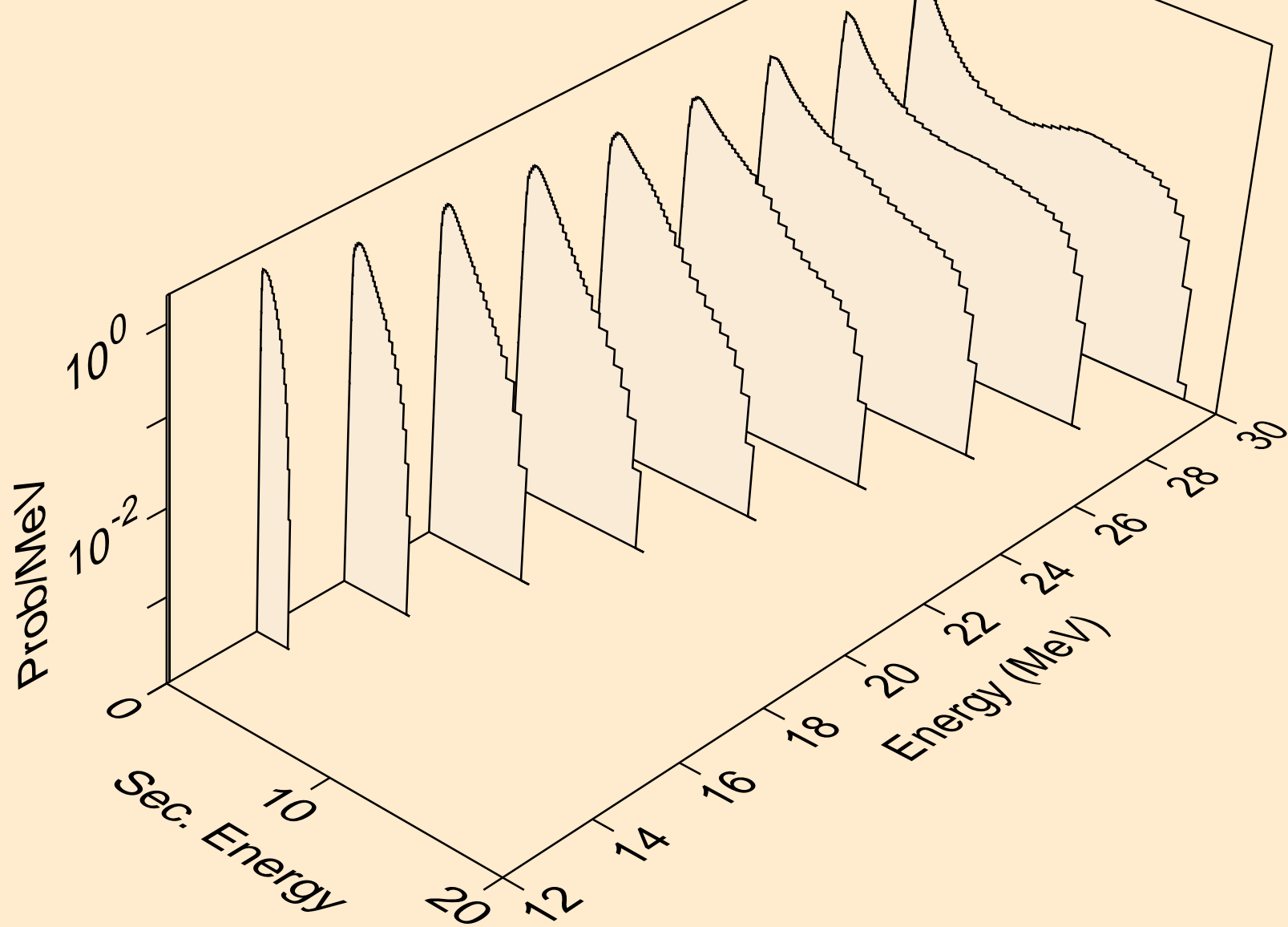

HF184 PROTON ACER TENDL-2024 LIBRARY; T=0.K
neutrons from (p,n*)a

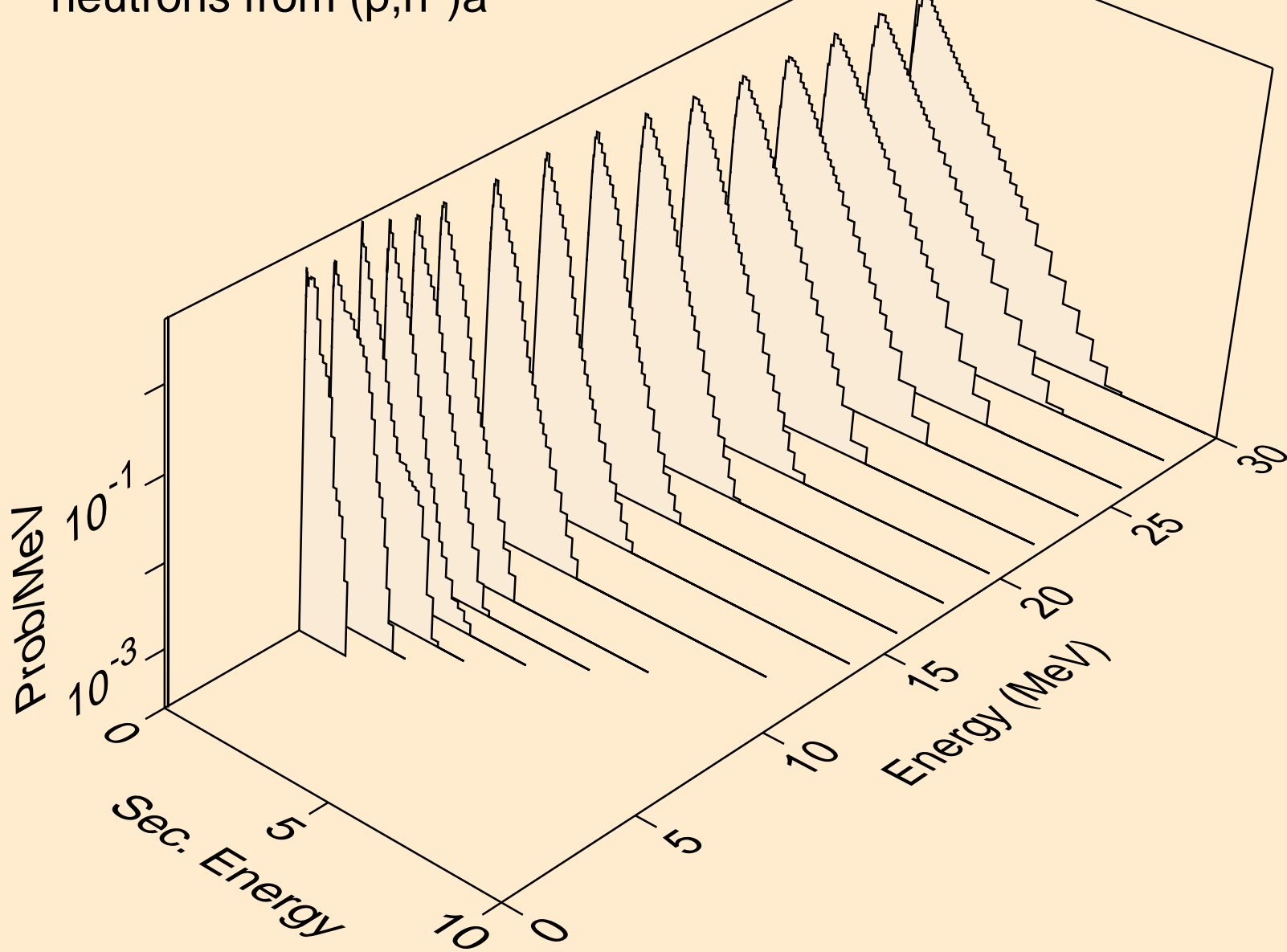

HF184 PROTON ACER TENDL-2024 LIBRARY; T=0.K
neutrons from (p,2n)a

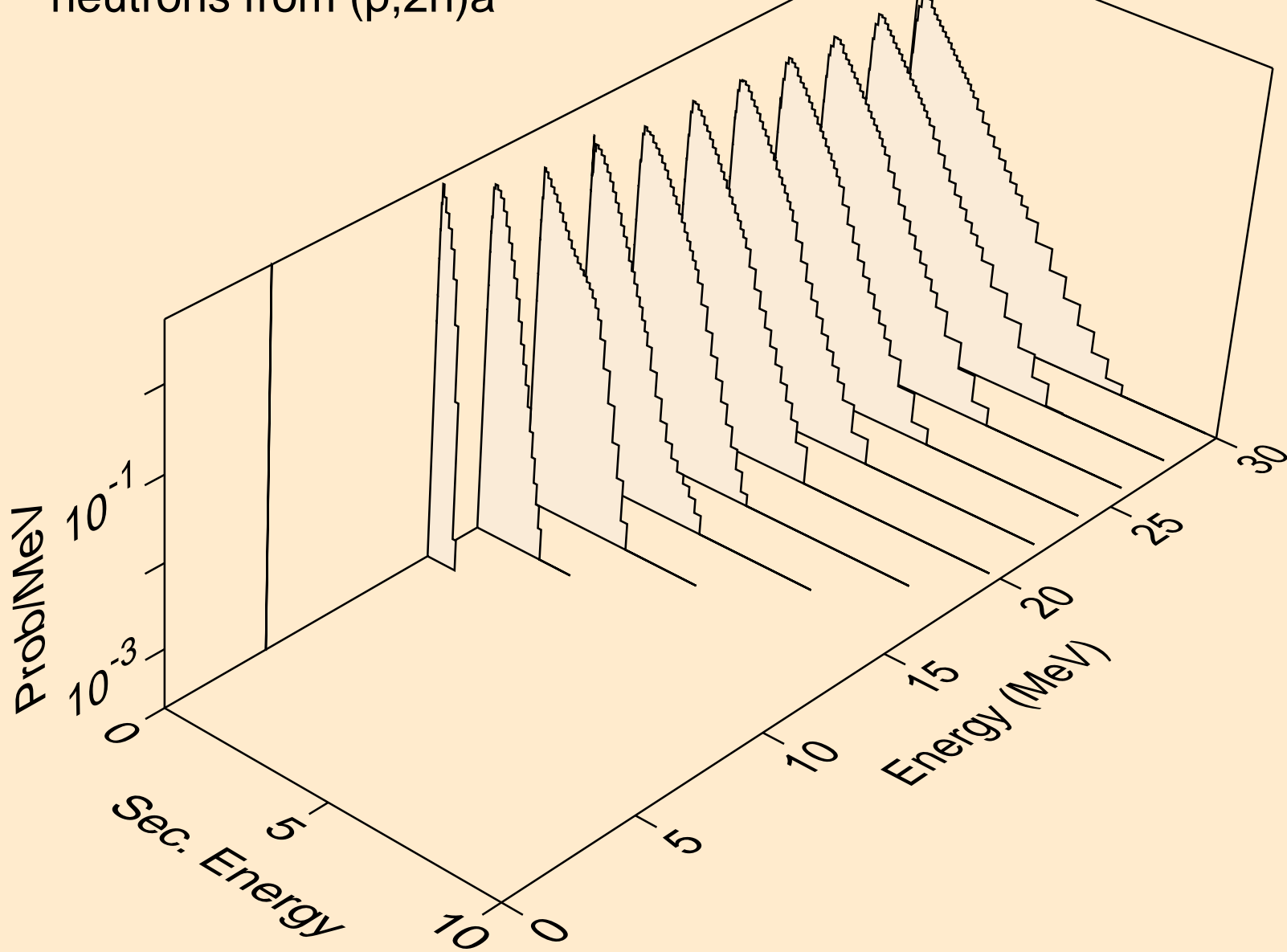

HF184 PROTON ACER TENDL-2024 LIBRARY; T=0.K
neutrons from (p,3n)a

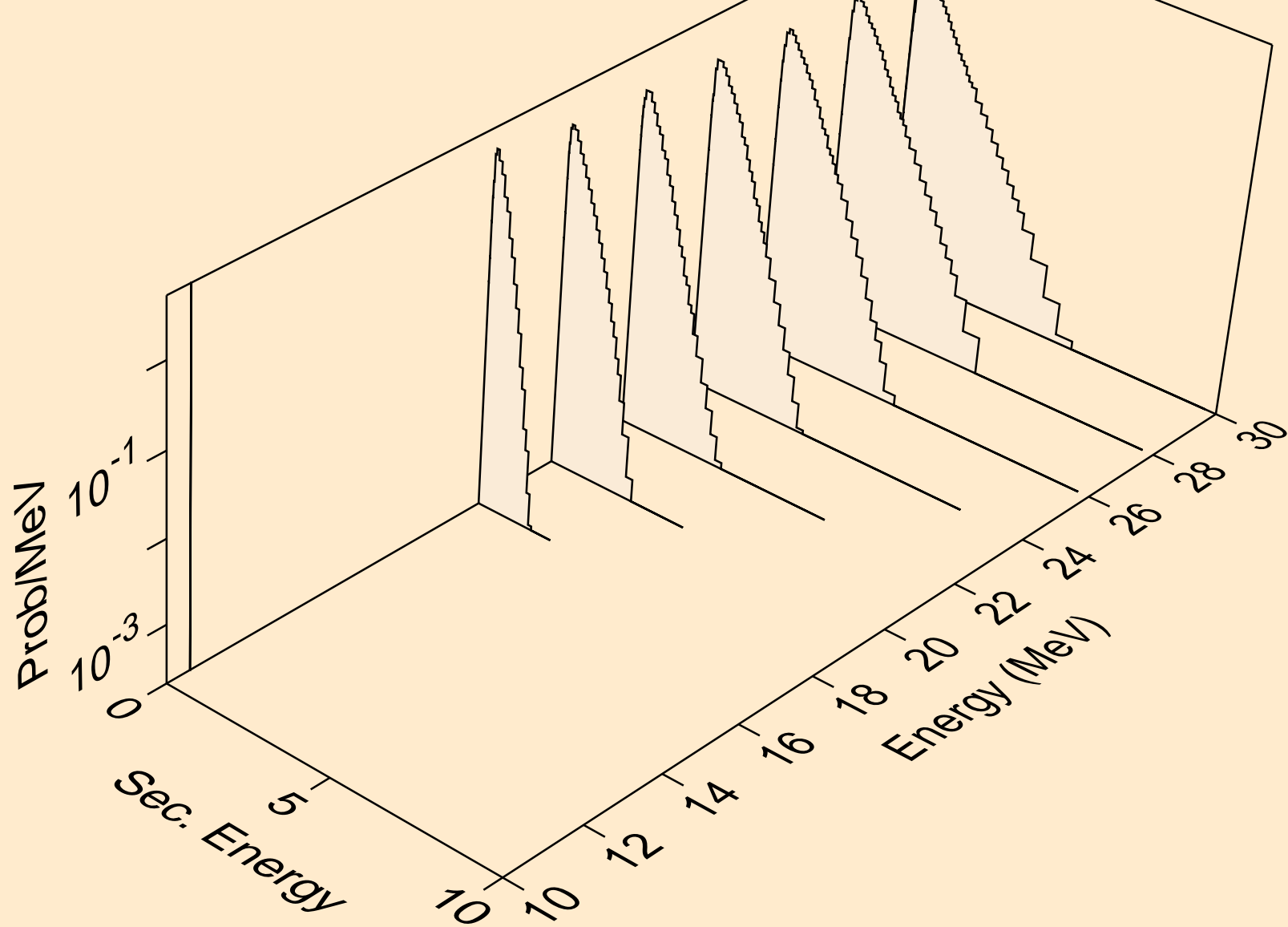

HF184 PROTON ACER TENDL-2024 LIBRARY; T=0.K
neutrons from (p,n*)p

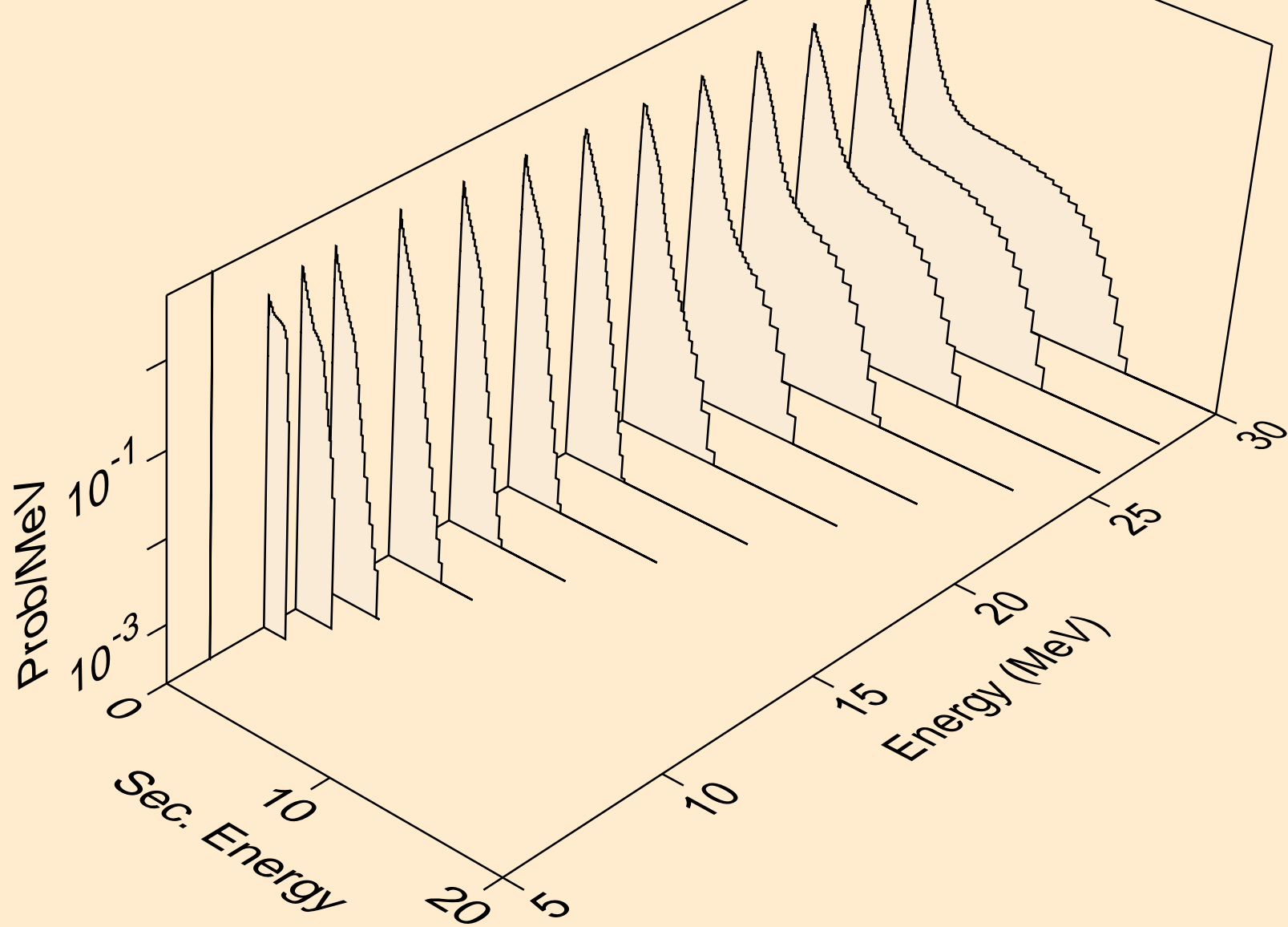

HF184 PROTON ACER TENDL-2024 LIBRARY; T=0.K
neutrons from (p,n*)d

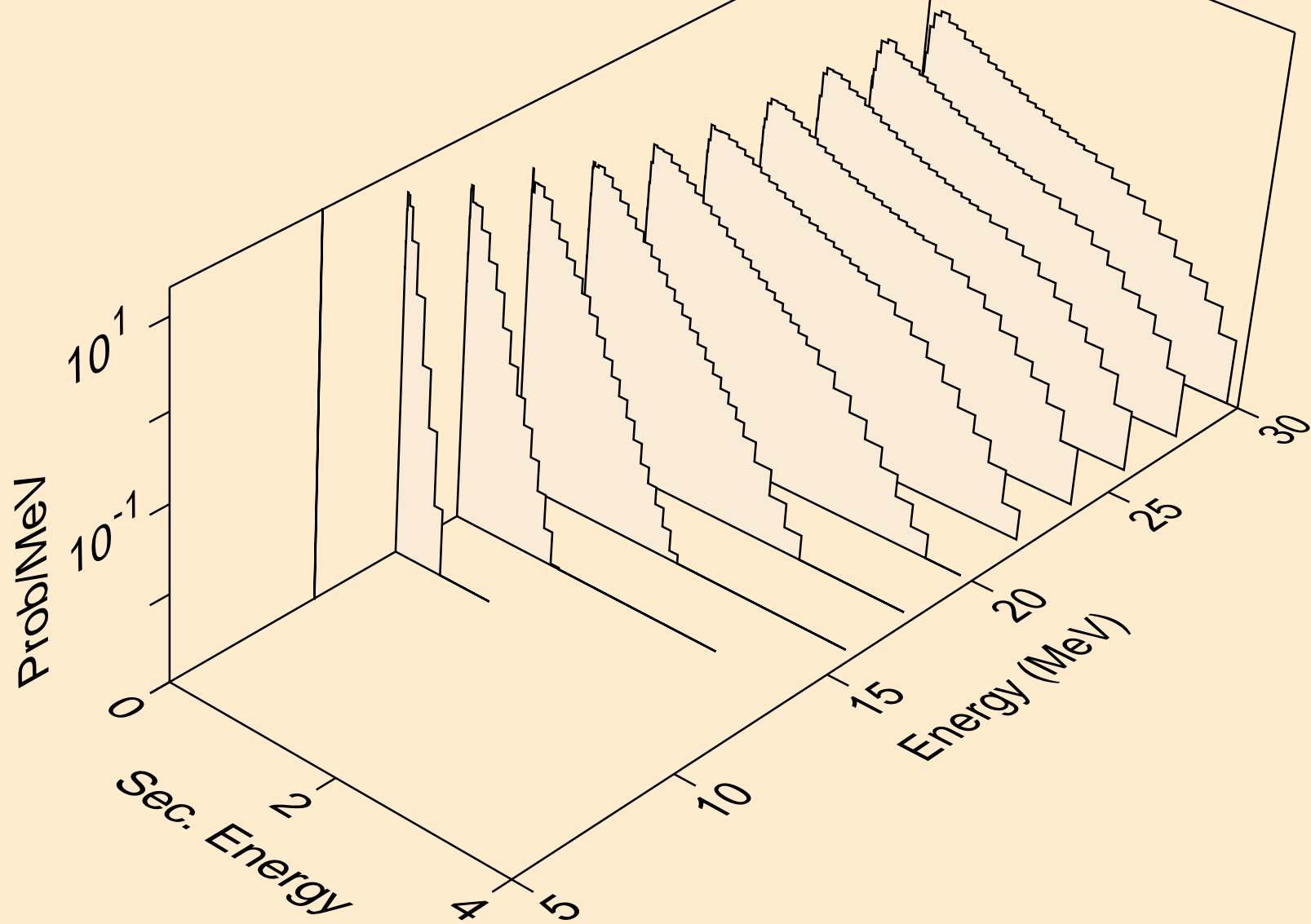

HF184 PROTON ACER TENDL-2024 LIBRARY; T=0.K
neutrons from (p,n*)t

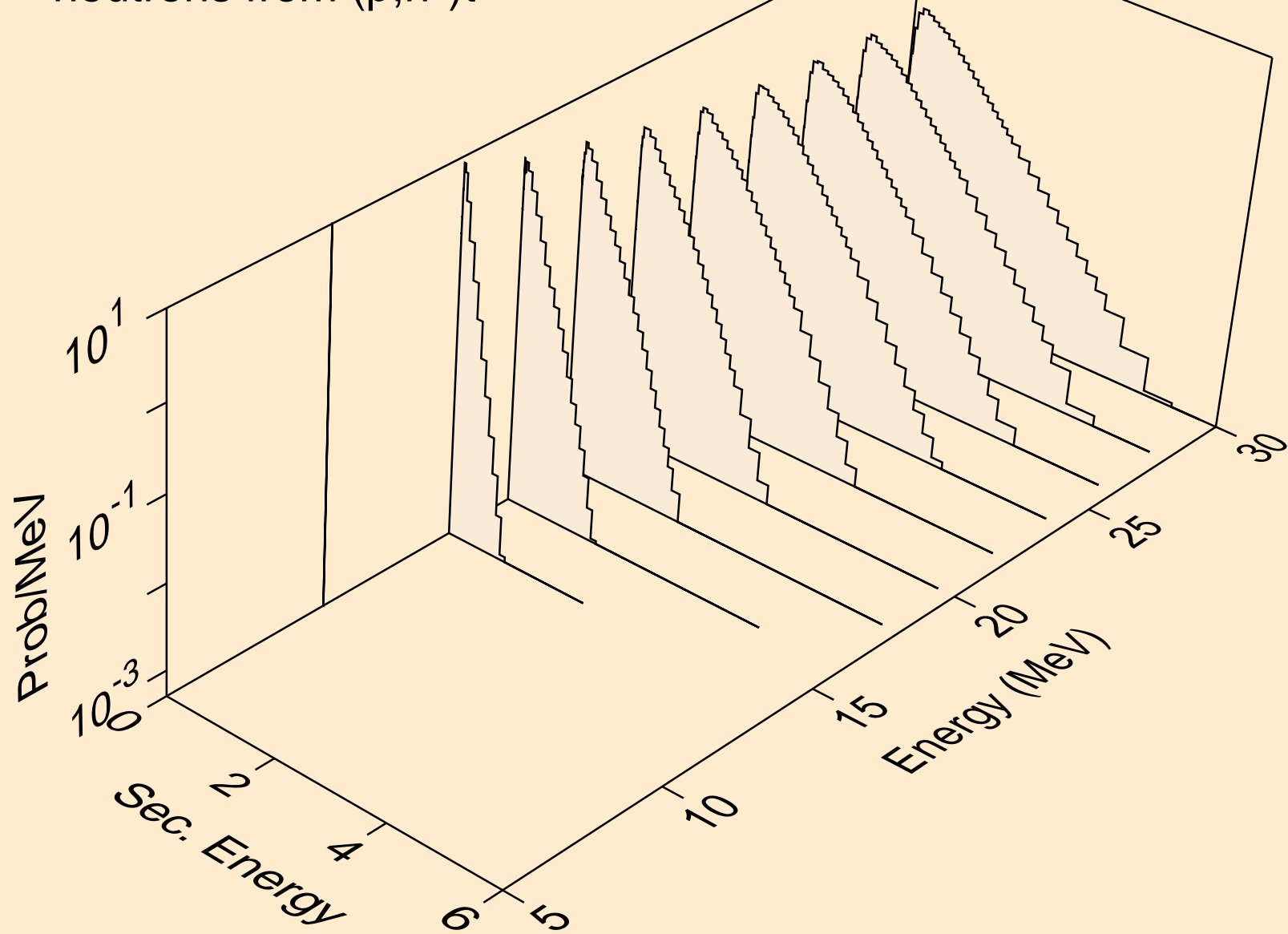

HF184 PROTON ACER TENDL-2024 LIBRARY; T=0.K
neutrons from (p,n*)he3

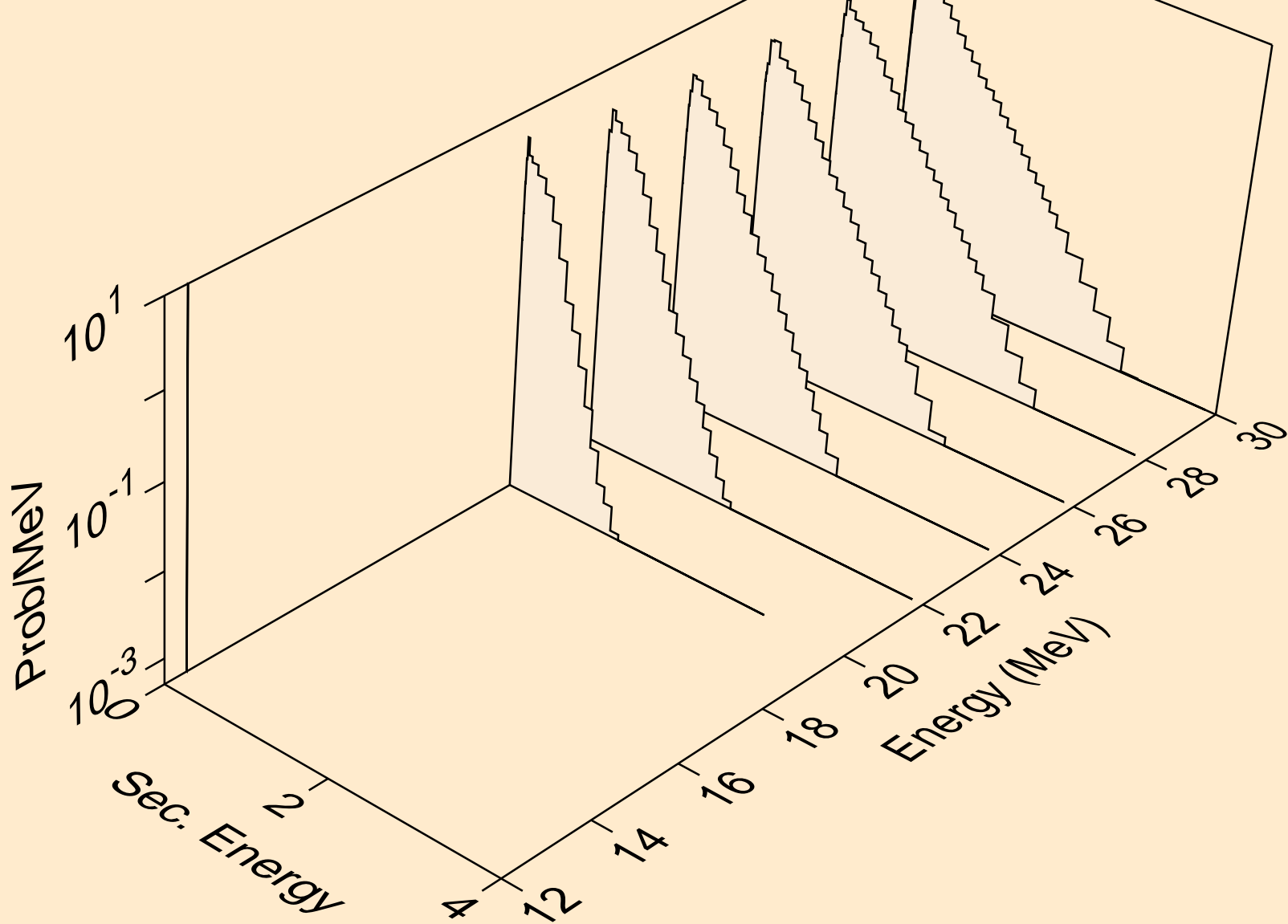

HF184 PROTON ACER TENDL-2024 LIBRARY; T=0.K
neutrons from (p,4n)

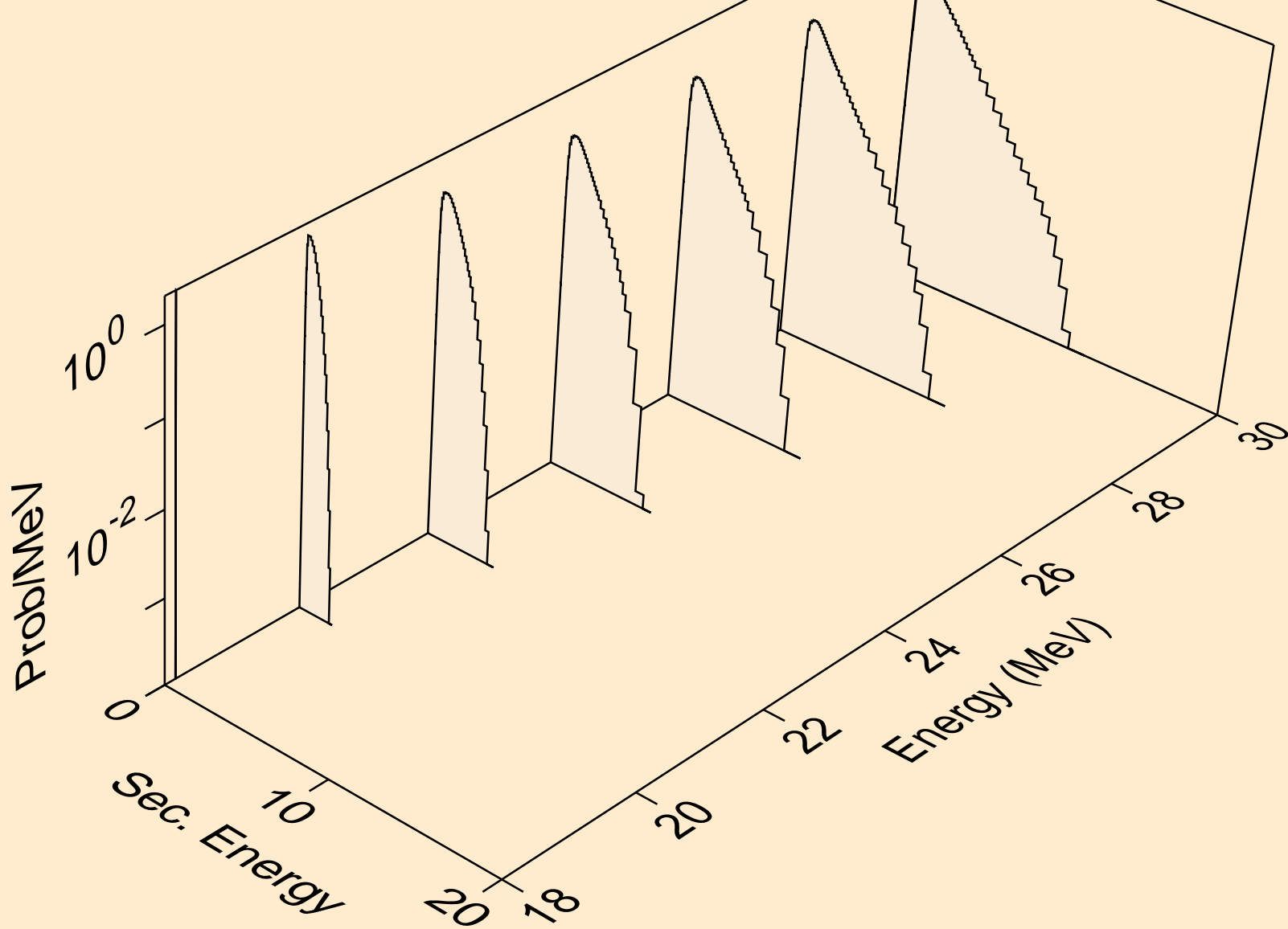

HF184 PROTON ACER TENDL-2024 LIBRARY; T=0.K
neutrons from (p,2np)

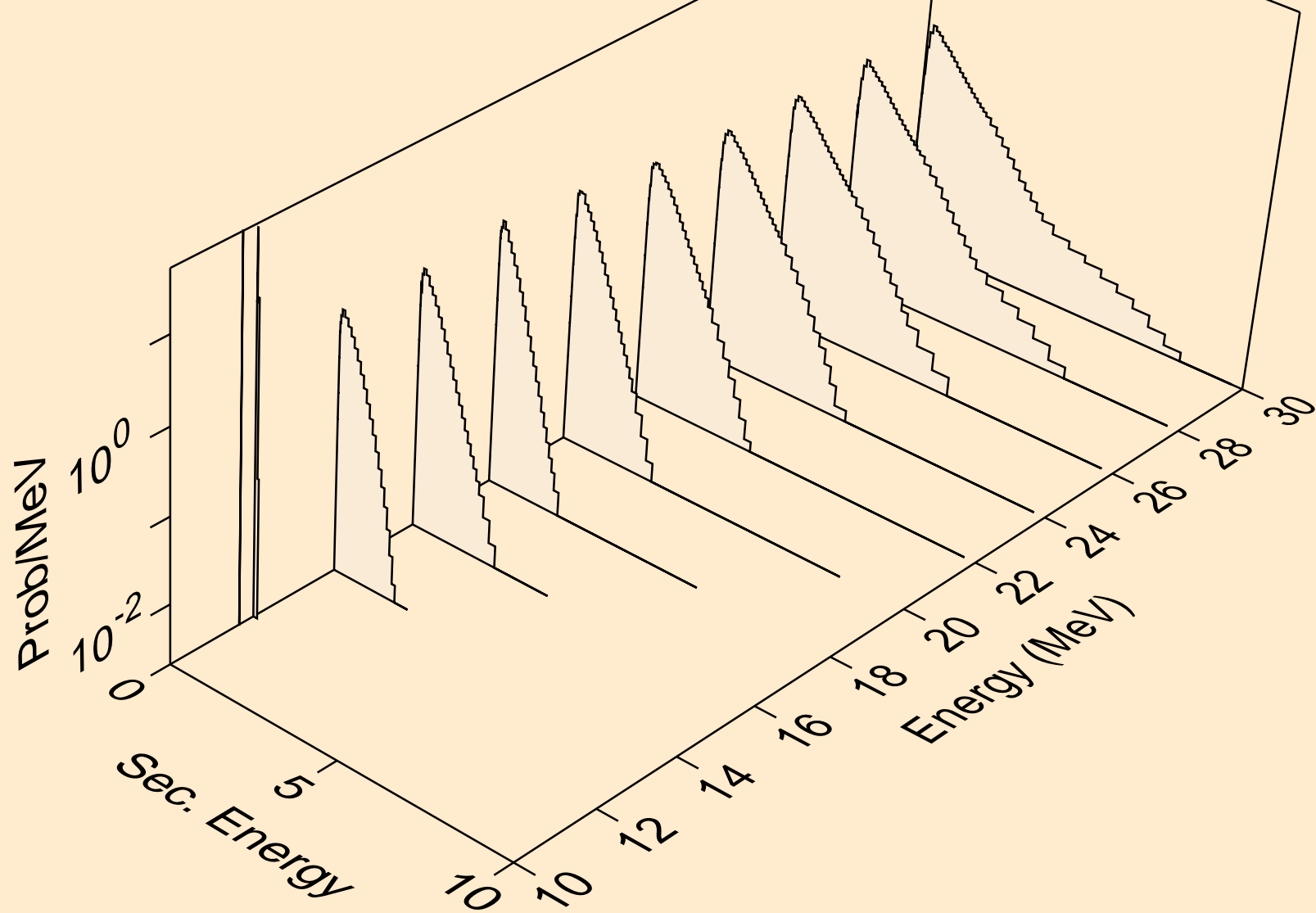

HF184 PROTON ACER TENDL-2024 LIBRARY; T=0.K
neutrons from (p,3np)

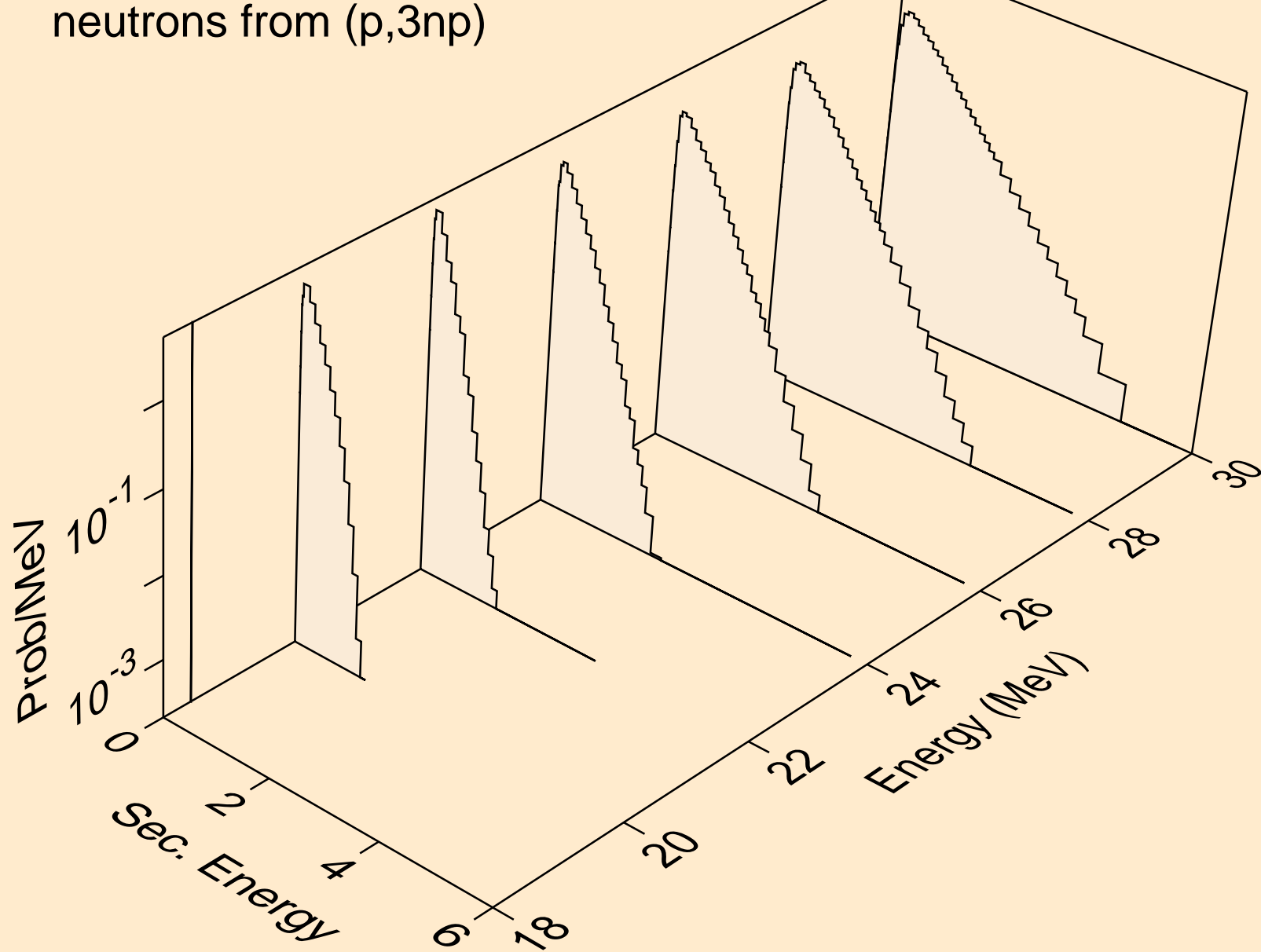

HF184 PROTON ACER TENDL-2024 LIBRARY; T=0.K
neutrons from (p,n2p)

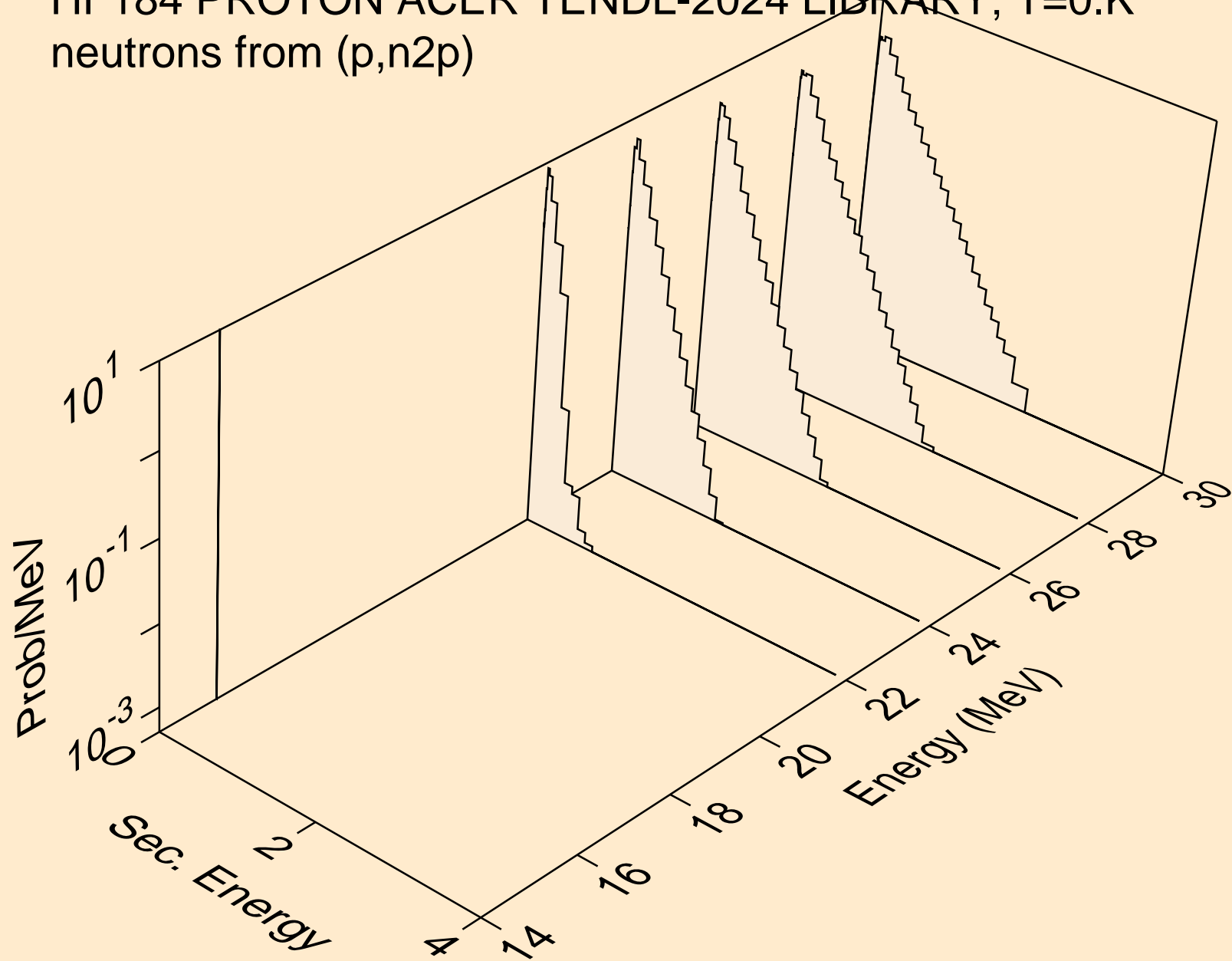

HF184 PROTON ACER TENDL-2024 LIBRARY; T=0.K
neutrons from (p,npa)

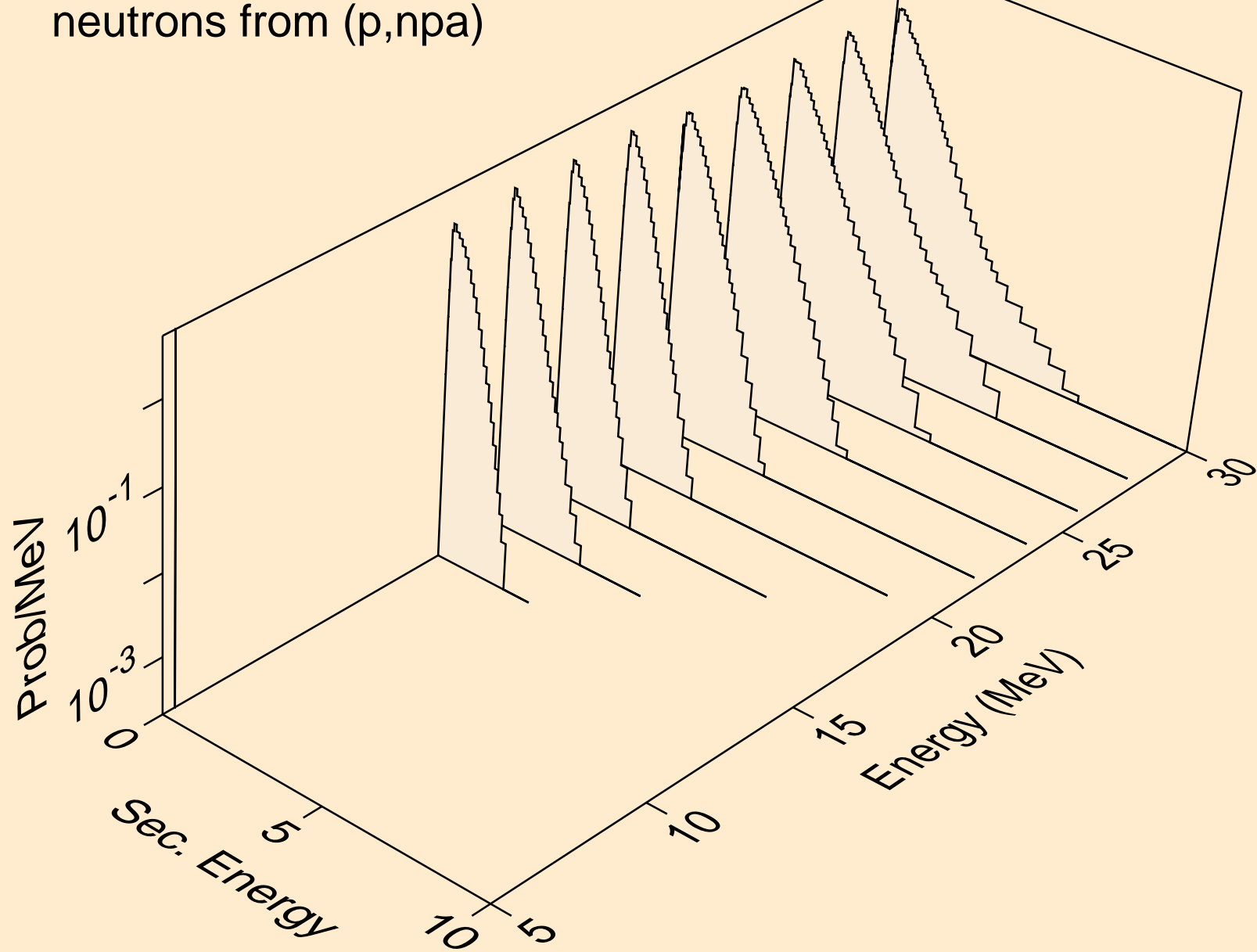

HF184 PROTON ACER TENDL-2024 LIBRARY; T=0.K
deuterons from (p,x)

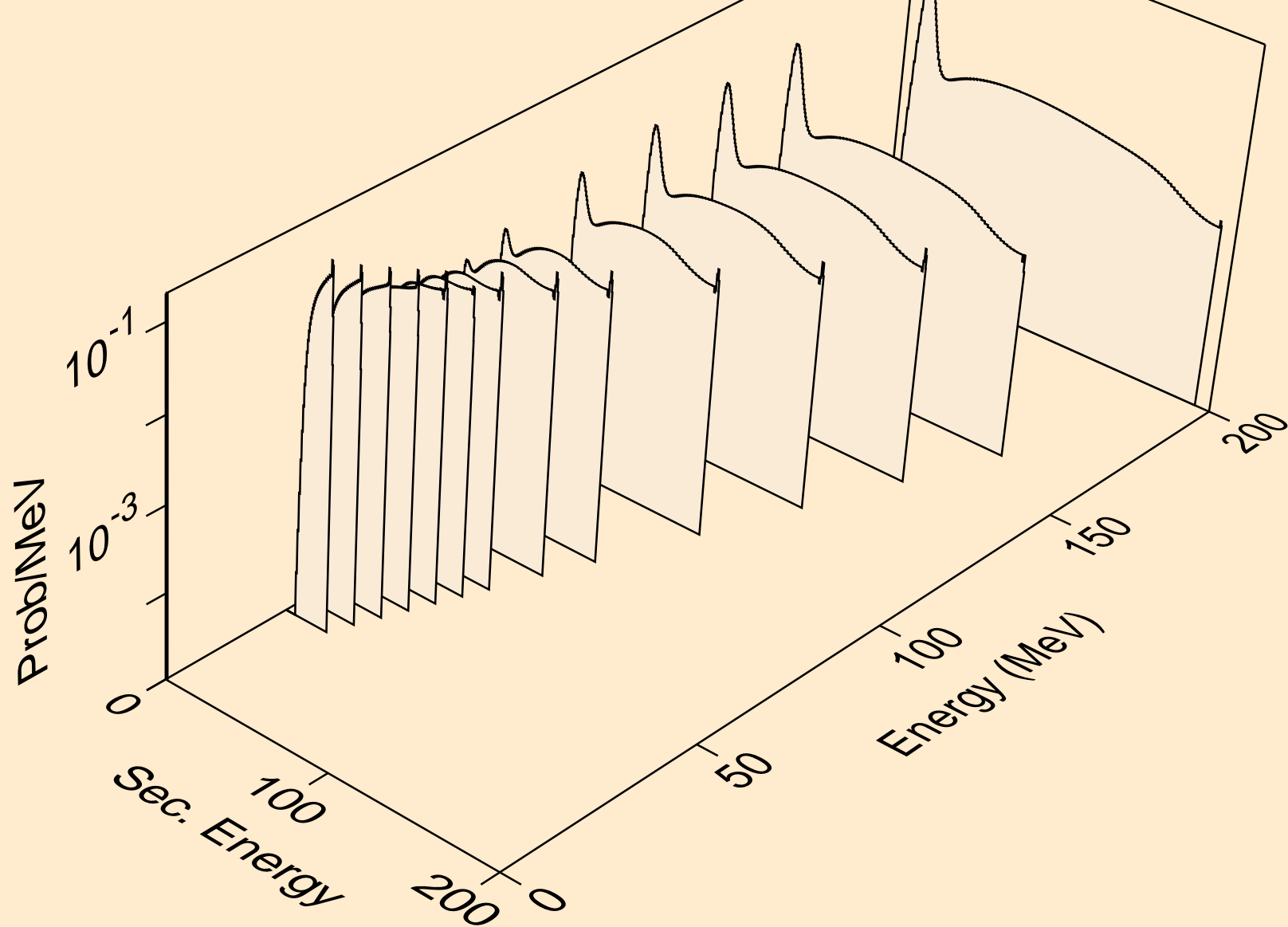

HF184 PROTON ACER TENDL-2024 LIBRARY; T=0.K
deuterons from (p,2nd)

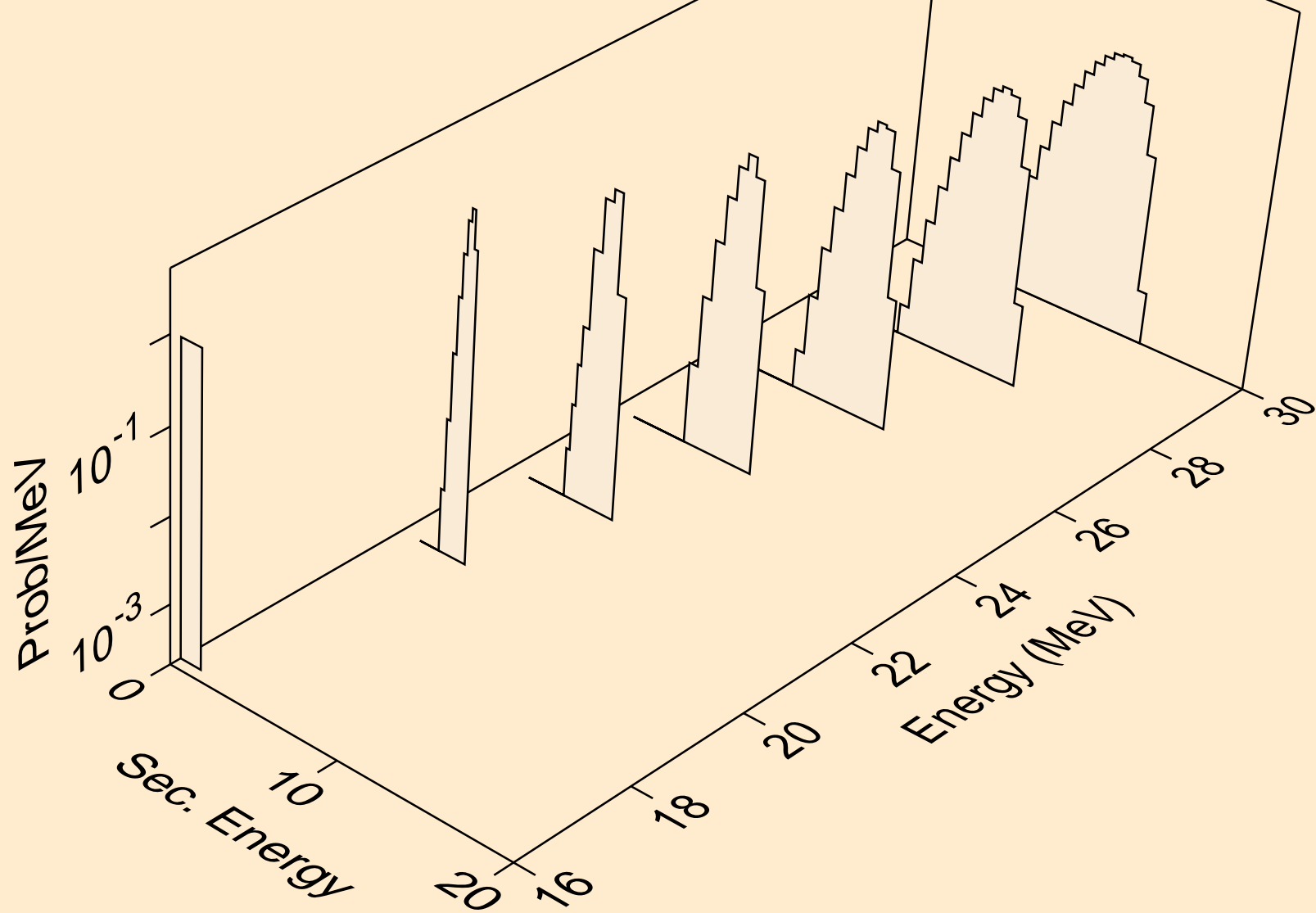

HF184 PROTON ACER TENDL-2024 LIBRARY; T=0.K
deuterons from (p,n*)d

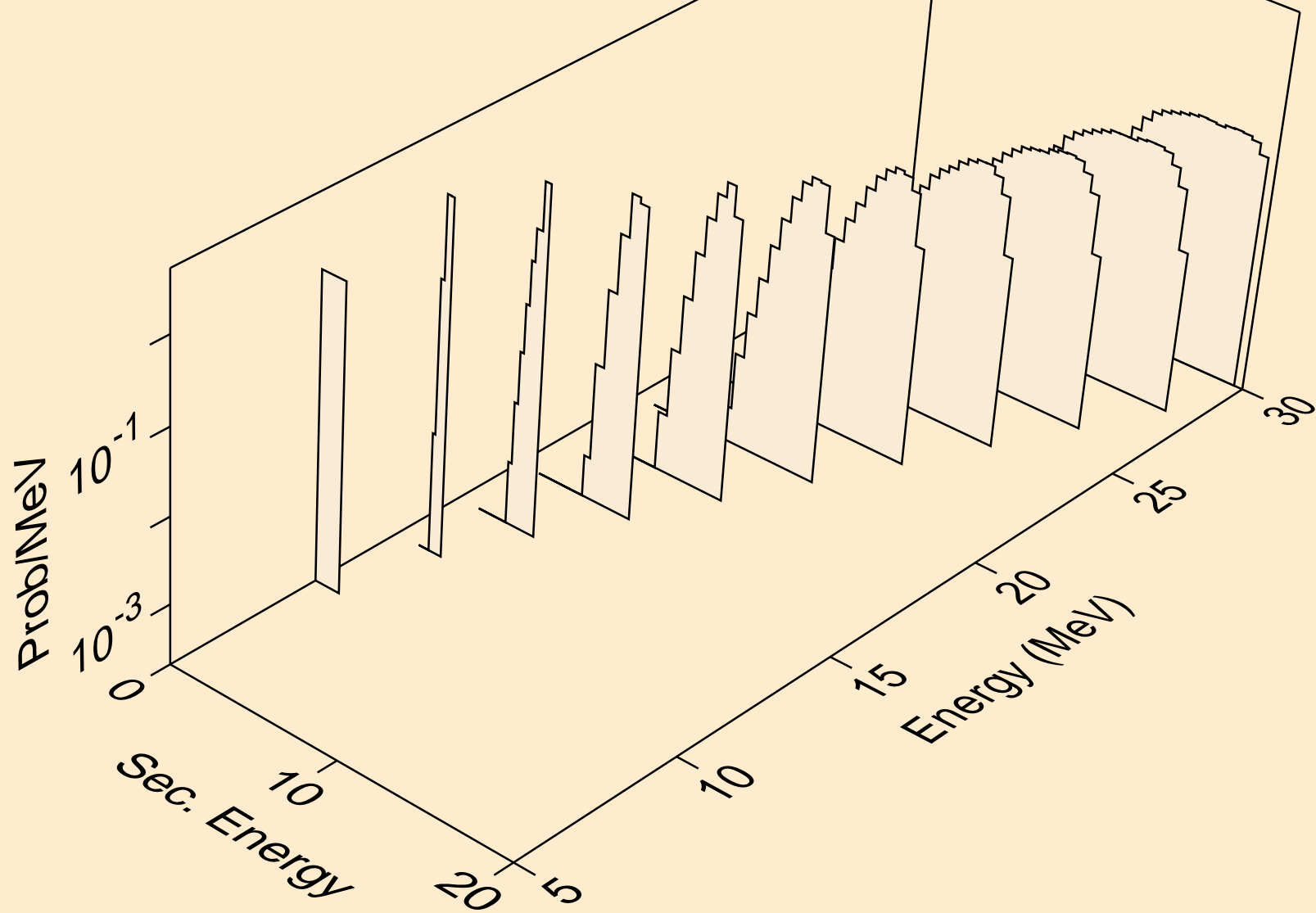

HF184 PROTON ACER TENDL-2024 LIBRARY; T=0.K
deuterons from (p,d)

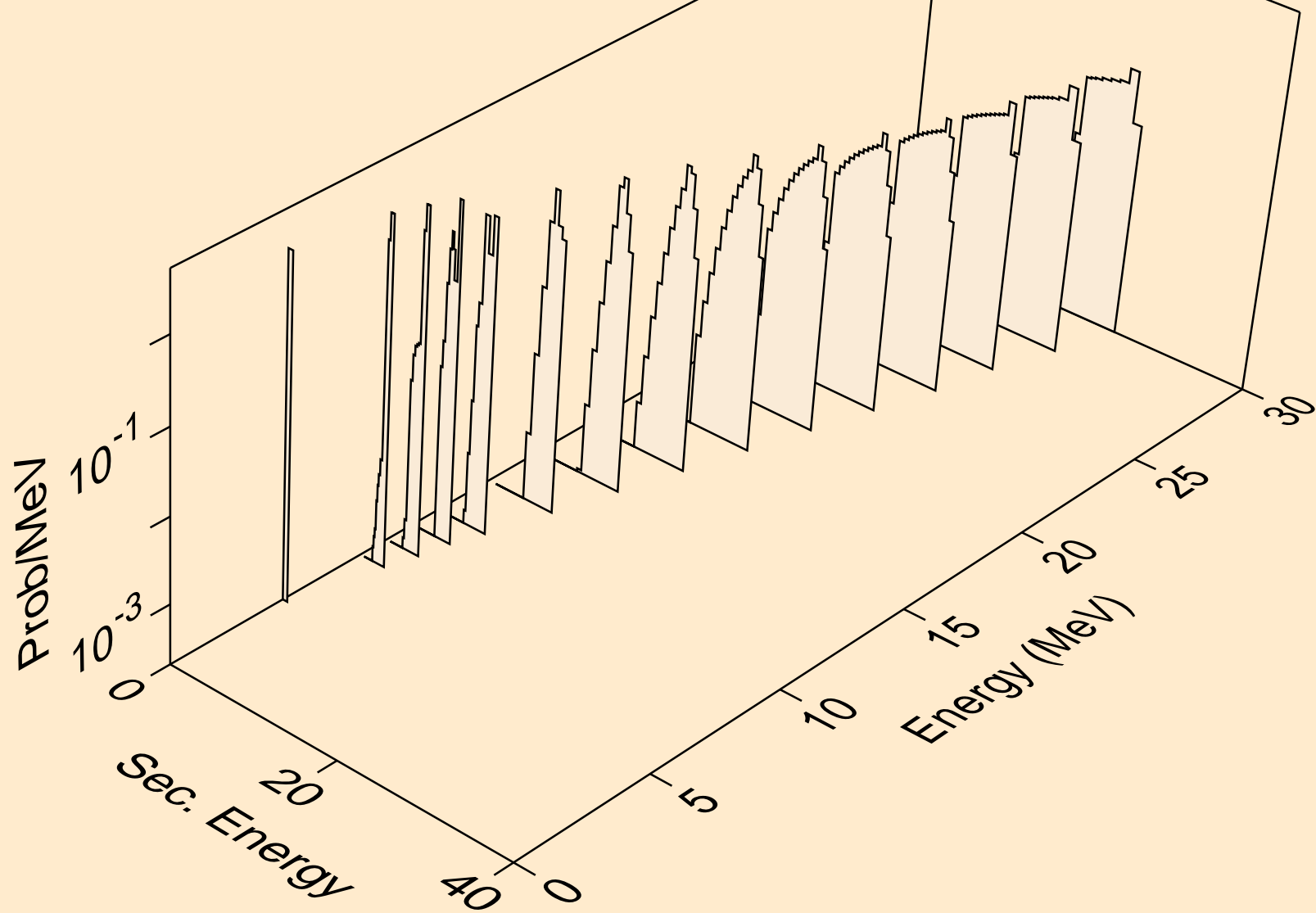

HF184 PROTON ACER TENDL-2024 LIBRARY; T=0.K
tritons from (p,x)

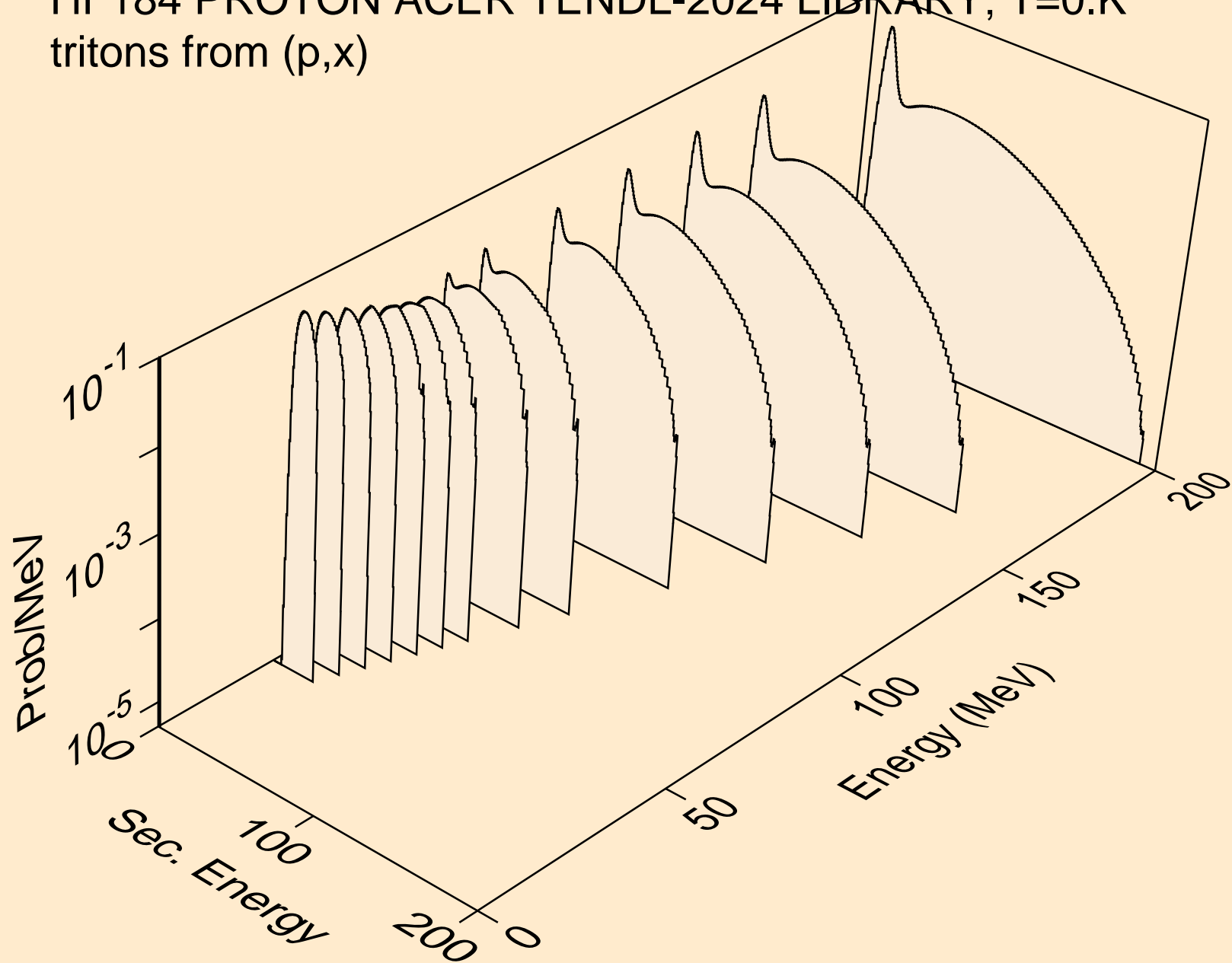

HF184 PROTON ACER TENDL-2024 LIBRARY; T=0.K
tritons from (p,n*)t

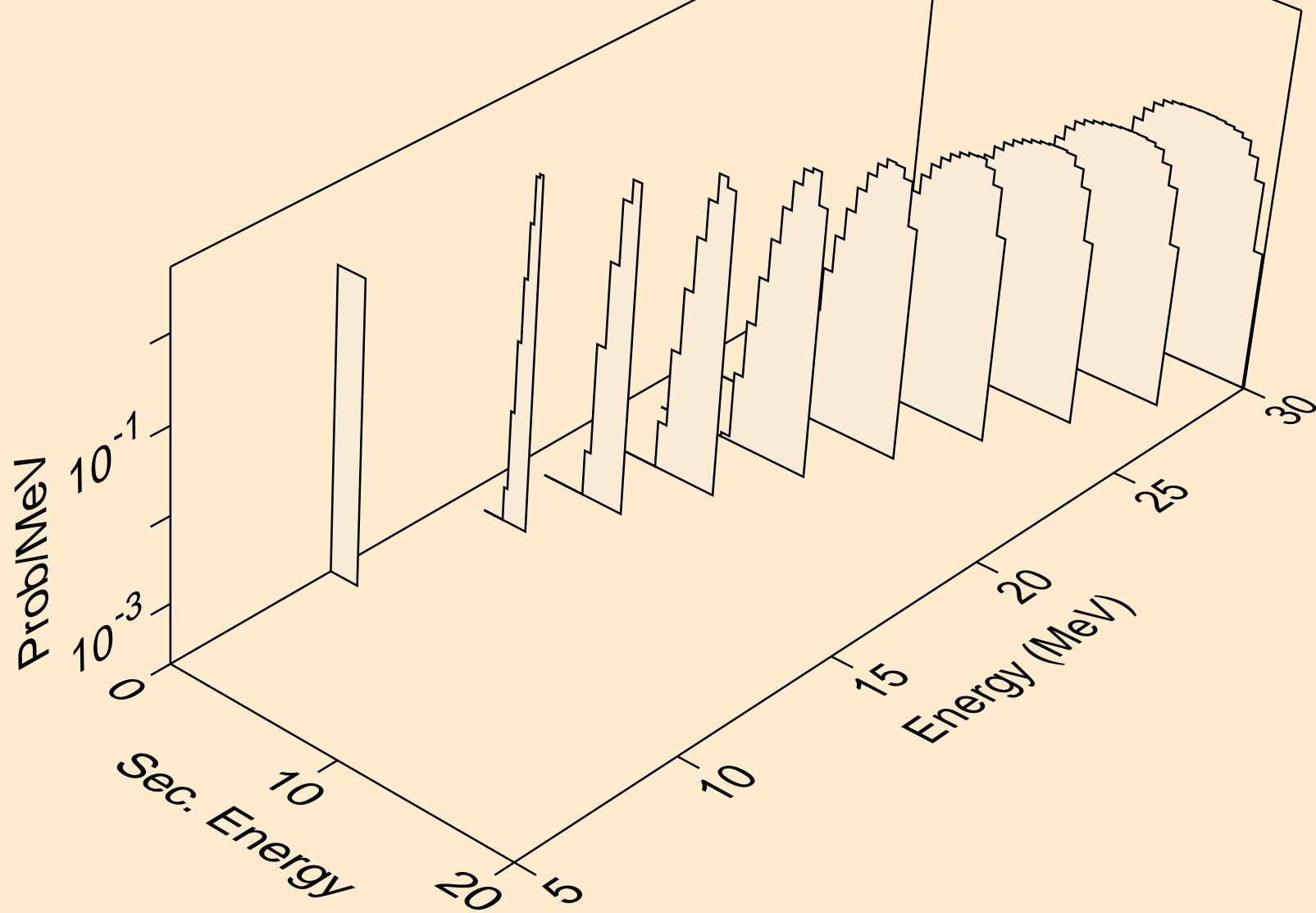

HF184 PROTON ACER TENDL-2024 LIBRARY; T=0.K
tritons from (p,t)

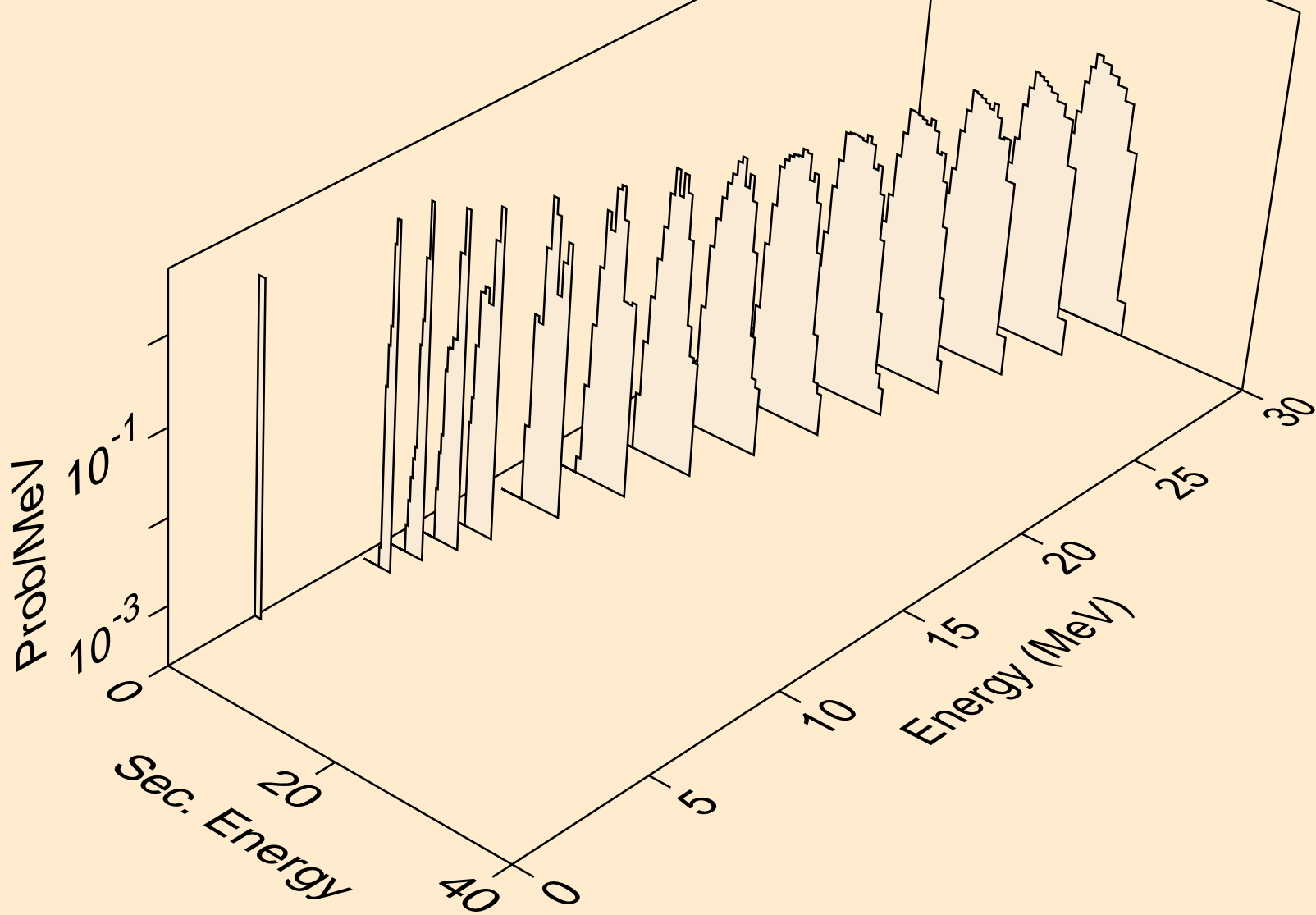

HF184 PROTON ACER TENDL-2024 LIBRARY; T=0.K
he3s from (p,x)

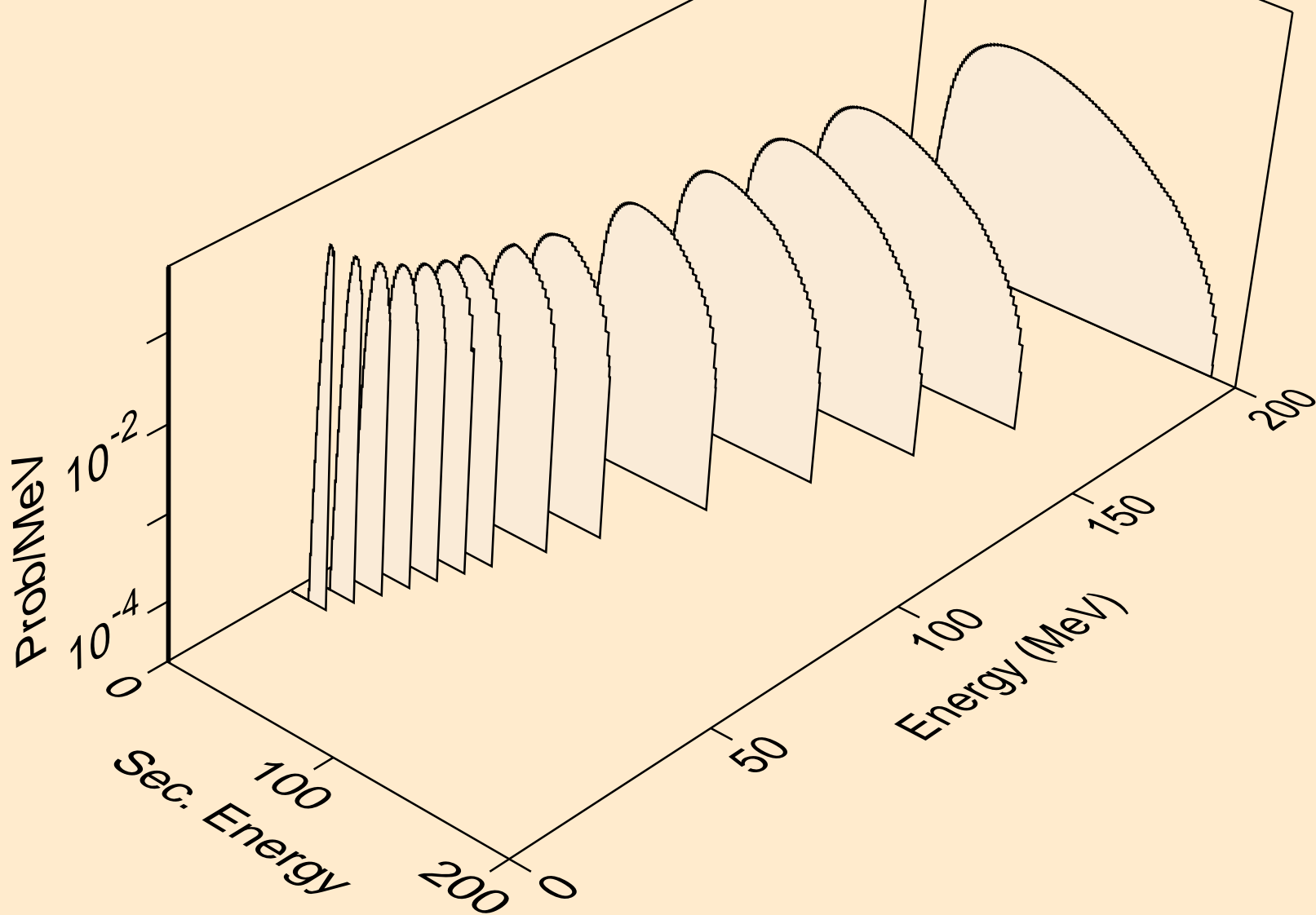

HF184 PROTON ACER TENDL-2024 LIBRARY; T=0.K
he3s from (p,n*)he3

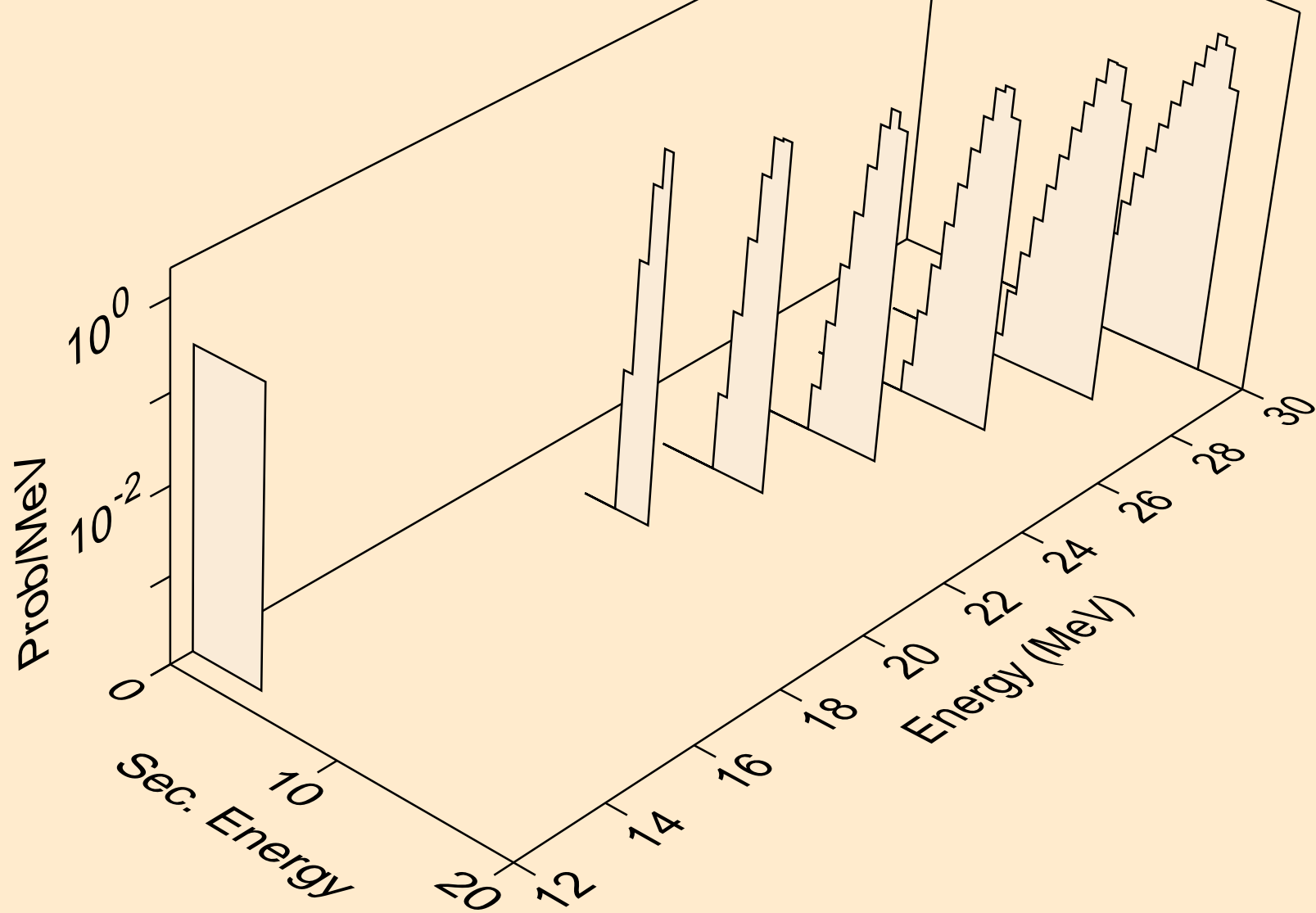

HF184 PROTON ACER TENDL-2024 LIBRARY; T=0.K
he3s from (p,he3)

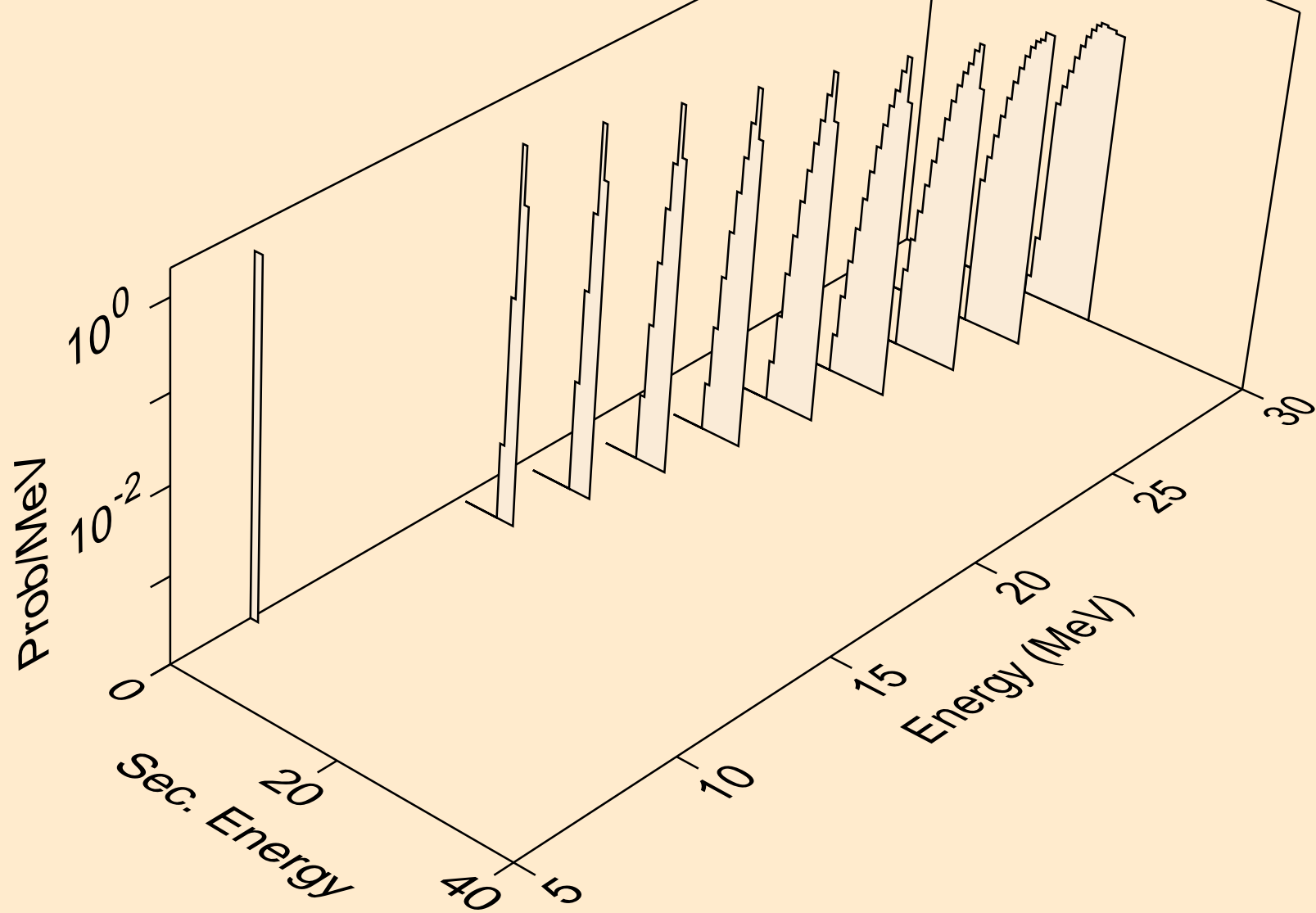

HF184 PROTON ACER TENDL-2024 LIBRARY; T=0.K
alphas from (p,x)

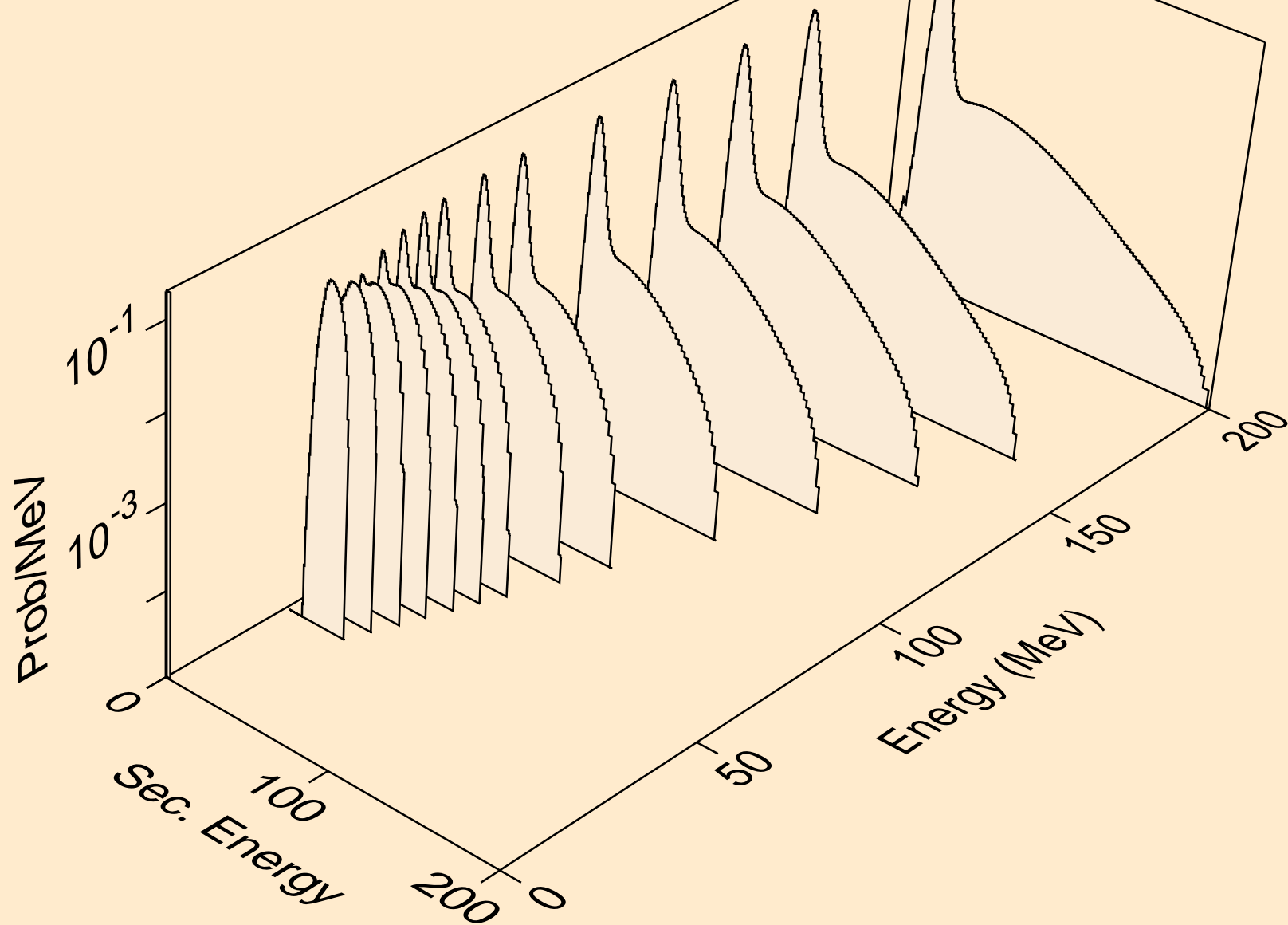

HF184 PROTON ACER TENDL-2024 LIBRARY; T=0.K
alphas from (p,n*)a

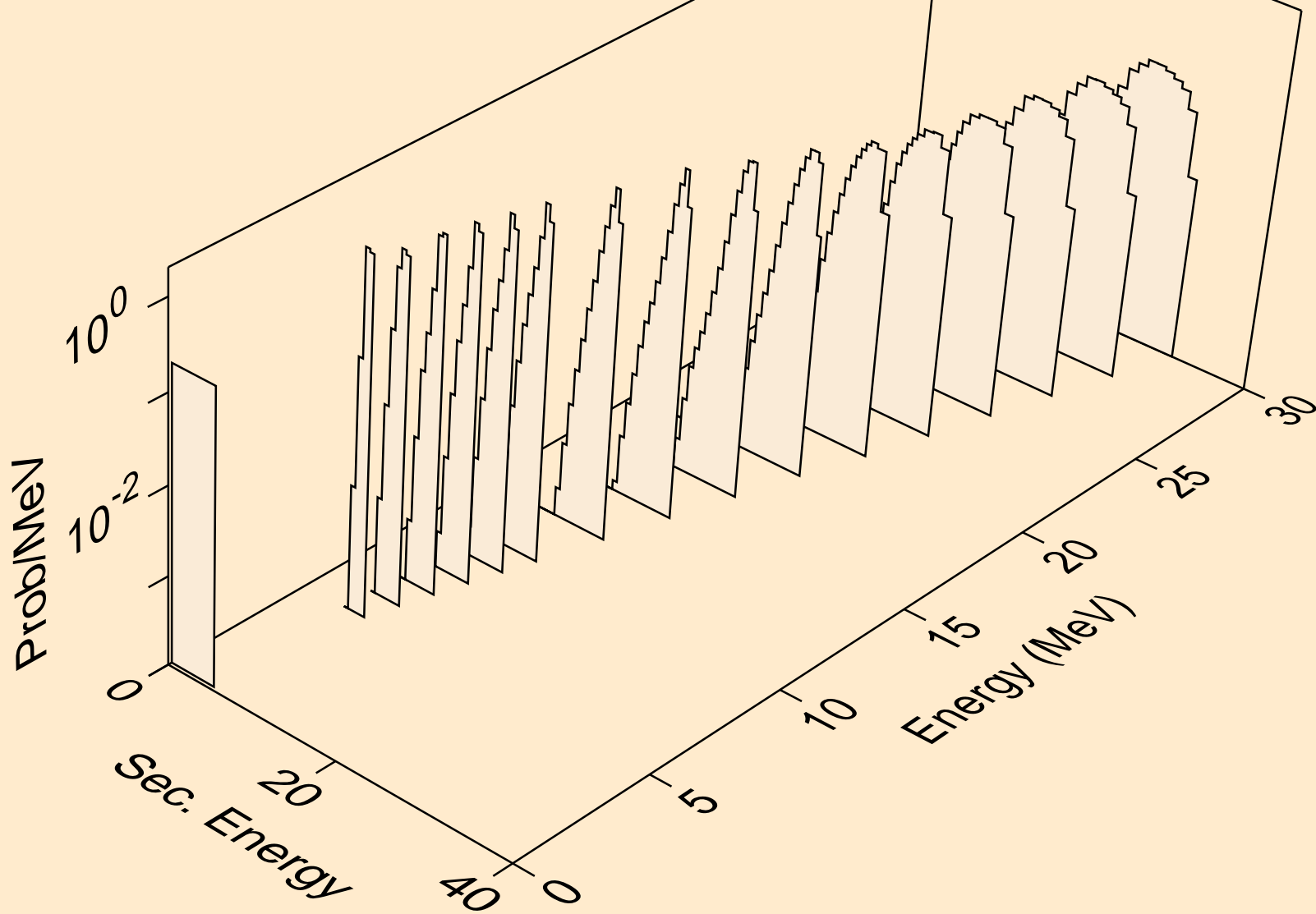

HF184 PROTON ACER TENDL-2024 LIBRARY; T=0.K
alphas from (p,2n)a

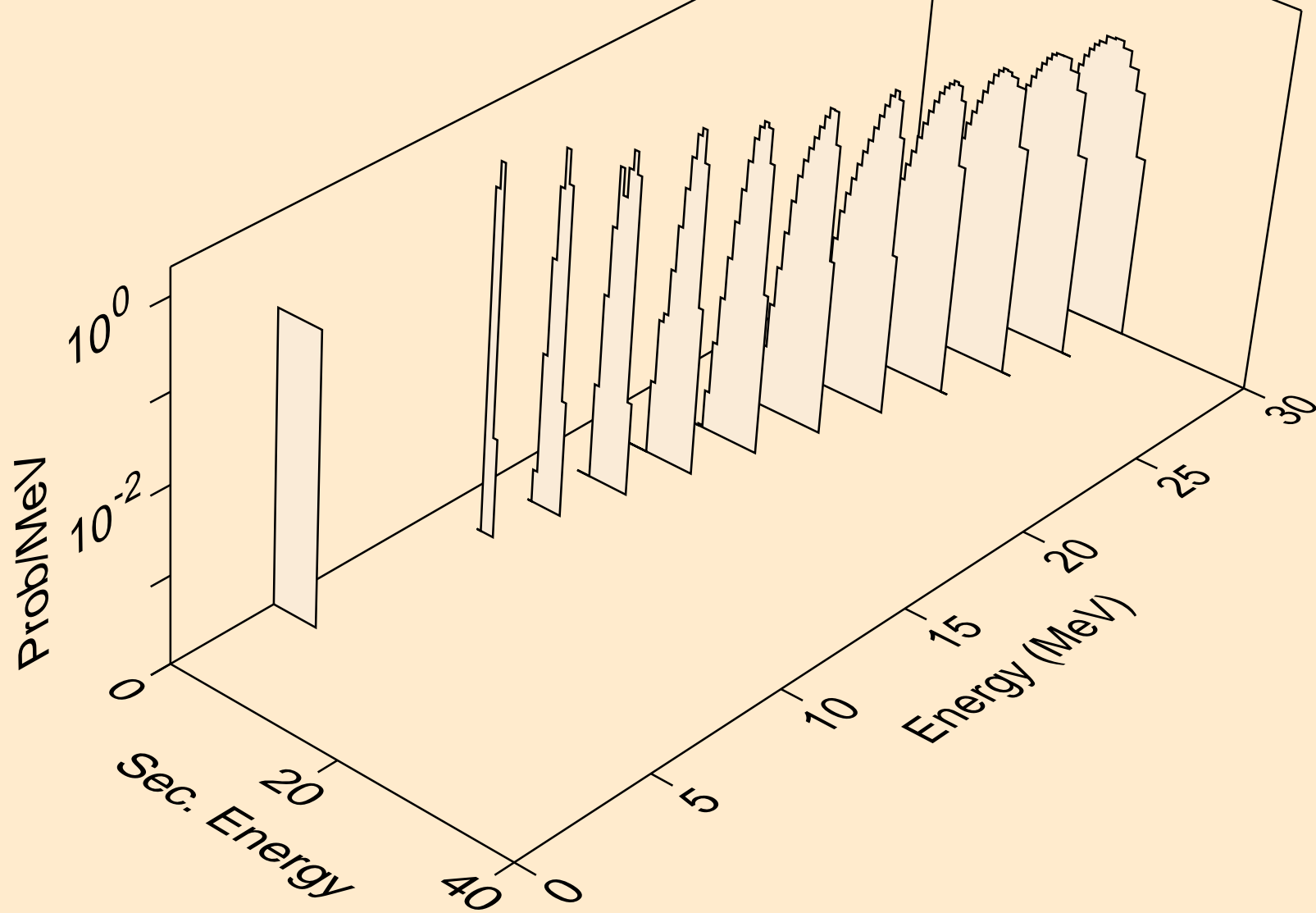

HF184 PROTON ACER TENDL-2024 LIBRARY; T=0.K
alphas from (p,3n)a

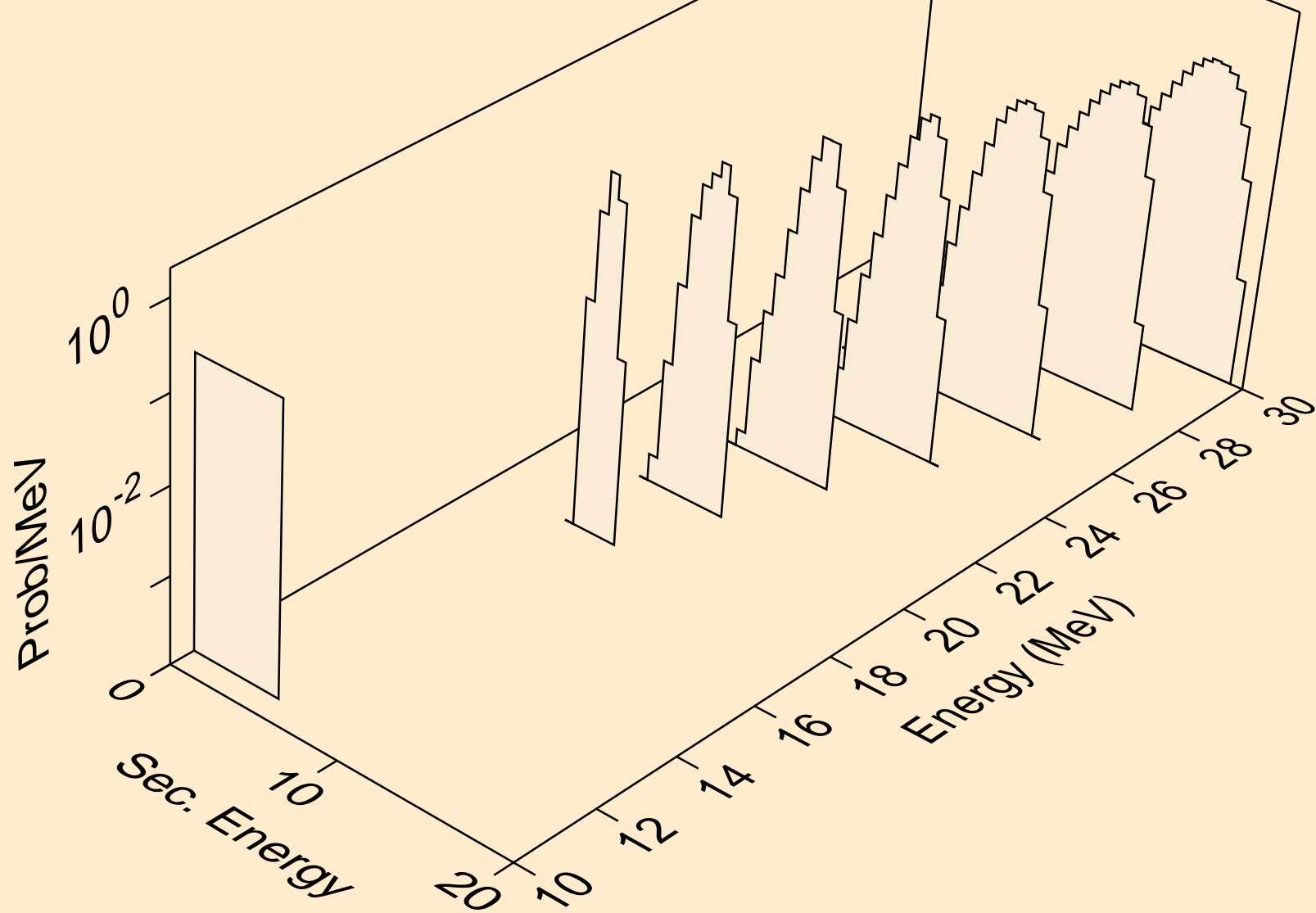

HF184 PROTON ACER TENDL-2024 LIBRARY; T=0.K
alphas from (p,npa)

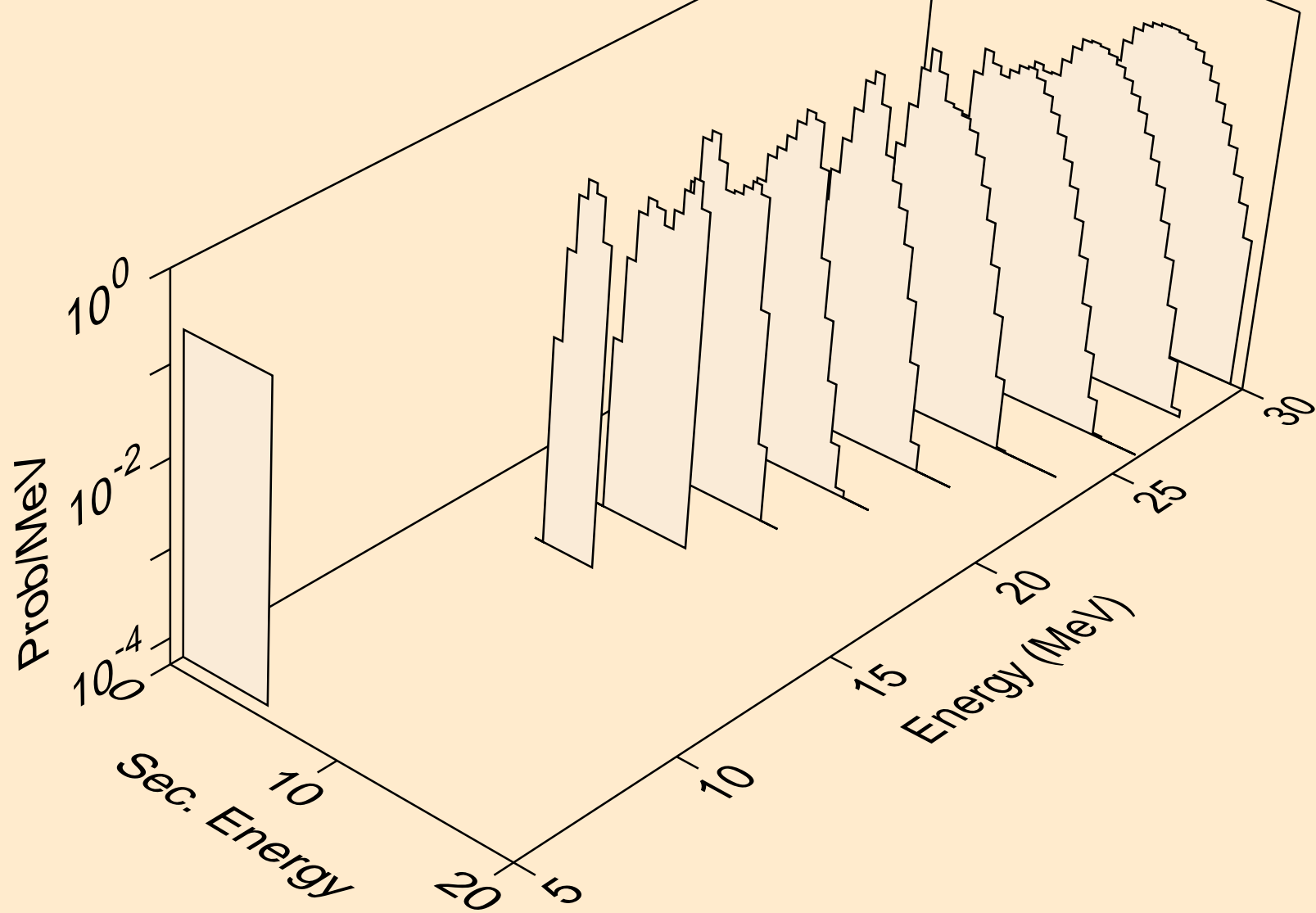

HF184 PROTON ACER TENDL-2024 LIBRARY; T=0.K
alphas from (p,a)

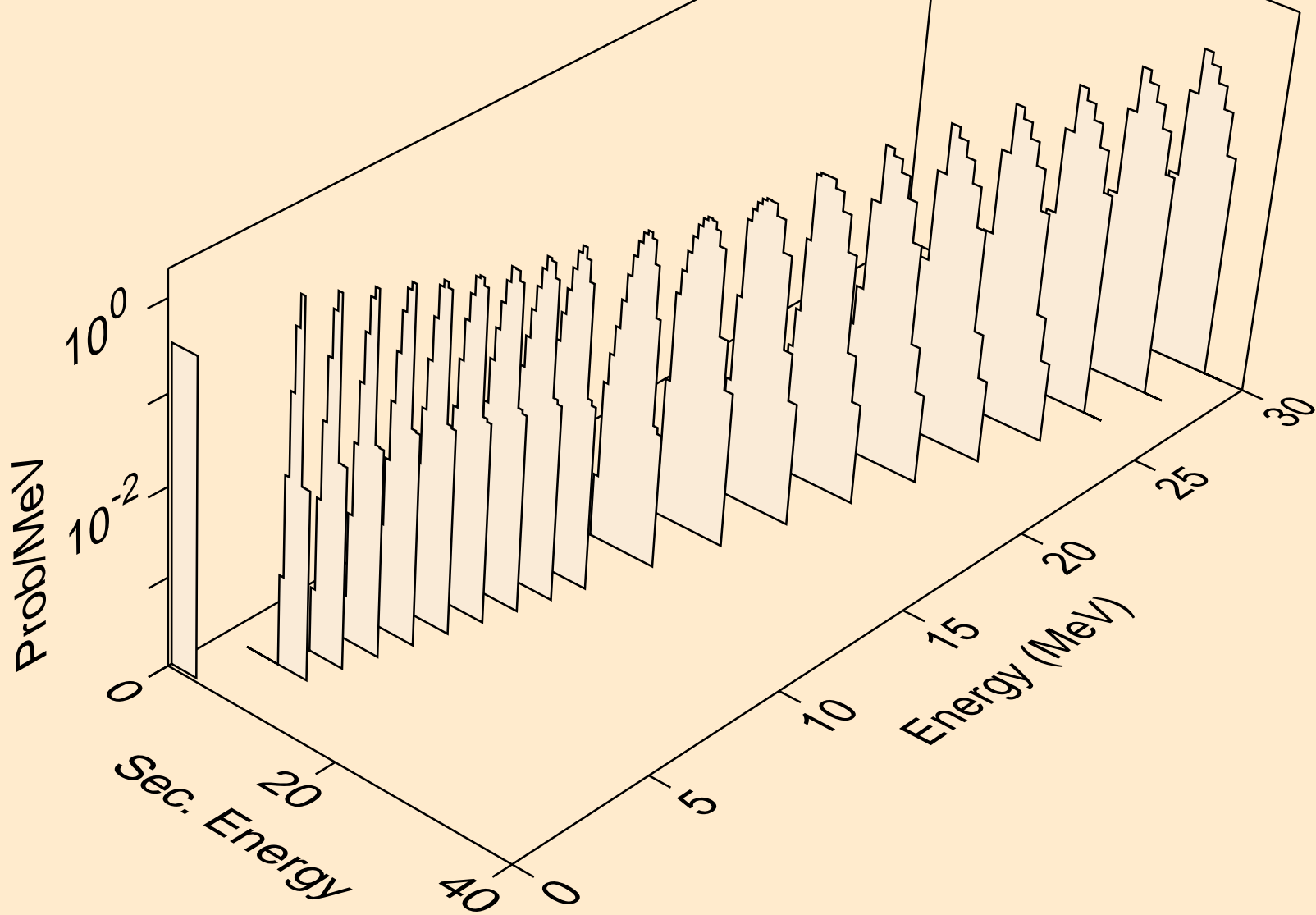

HF184 PROTON ACER TENDL-2024 LIBRARY; T=0.K
alphas from (p,pa)

