

# IR202 PROTON ACER TENDL-2024 LIBRARY; T=0.K

## Principal cross sections

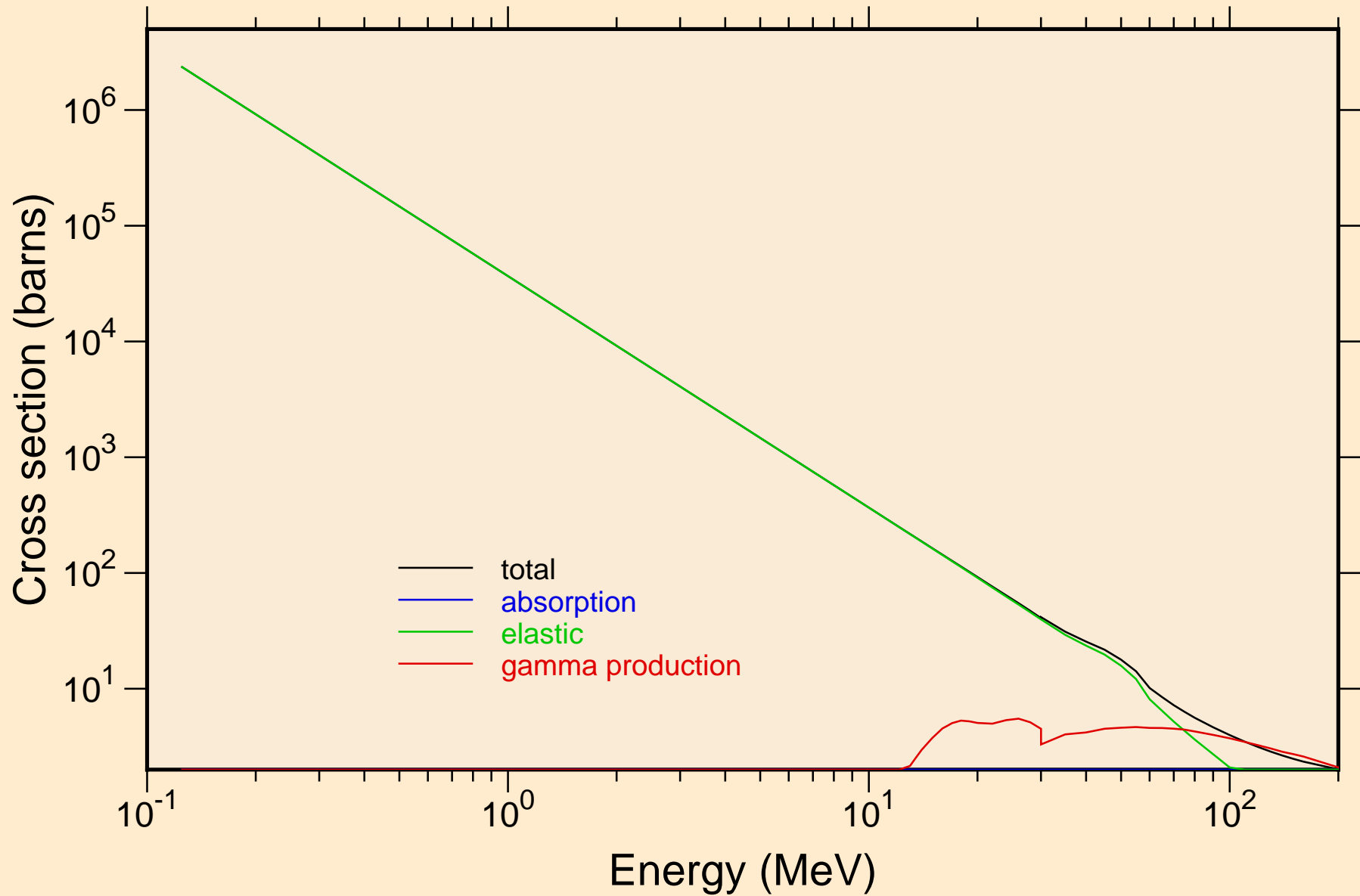

# IR202 PROTON ACER TENDL-2024 LIBRARY; T=0.K

## Heating

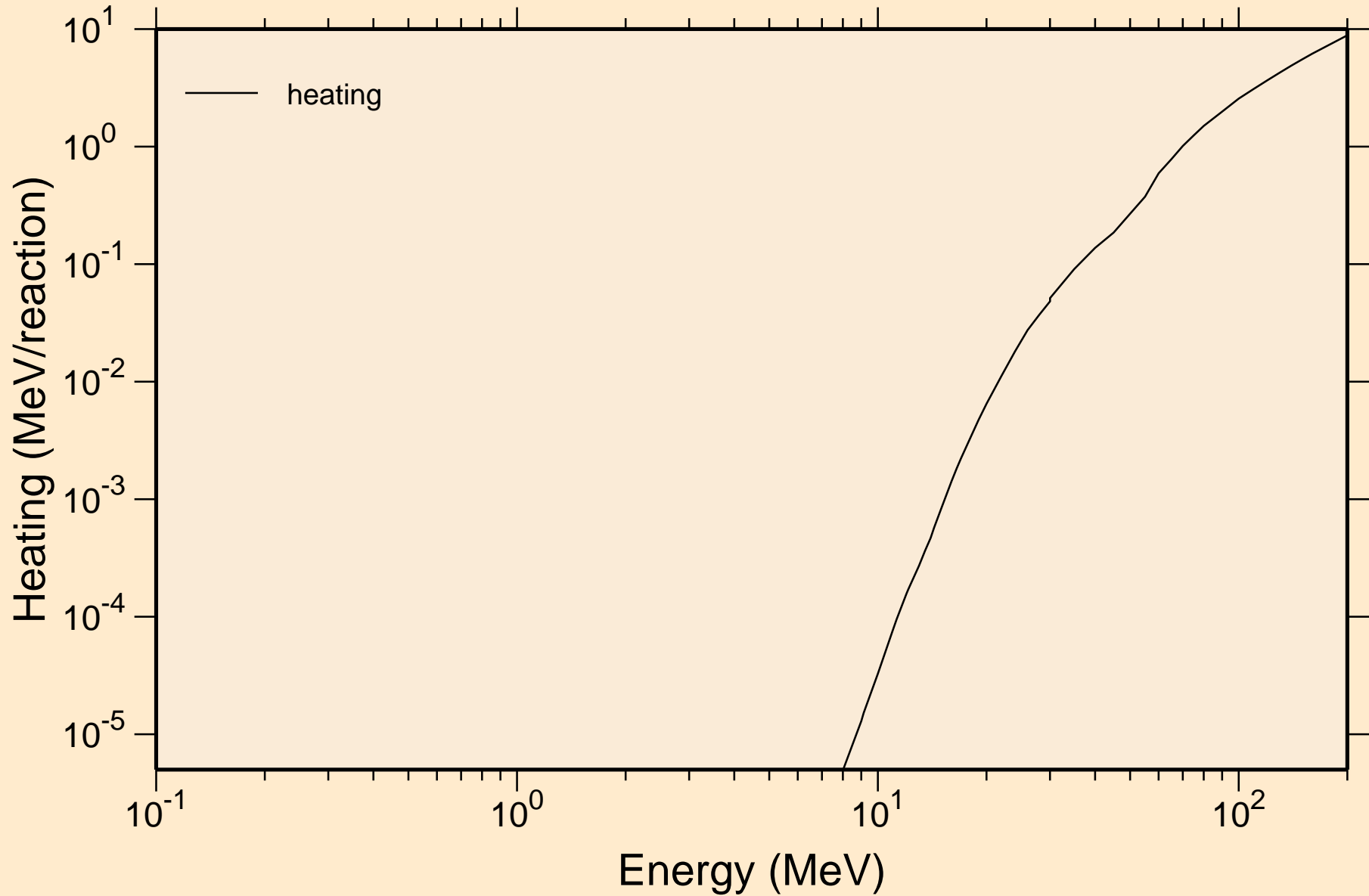

# IR202 PROTON ACER TENDL-2024 LIBRARY; T=0.K

## Principal cross sections

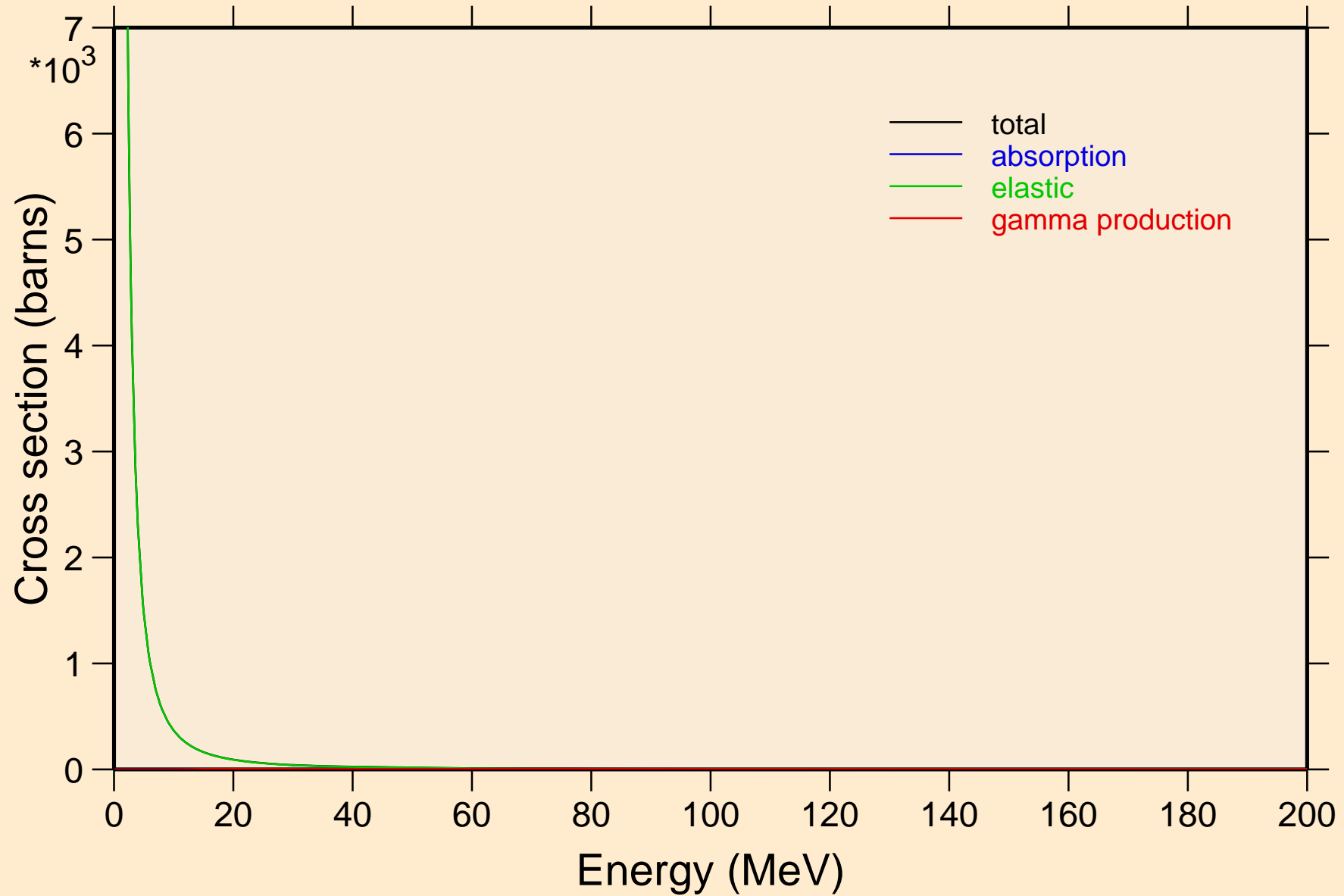

IR202 PROTON ACER TENDL-2024 LIBRARY; T=0.K

Heating

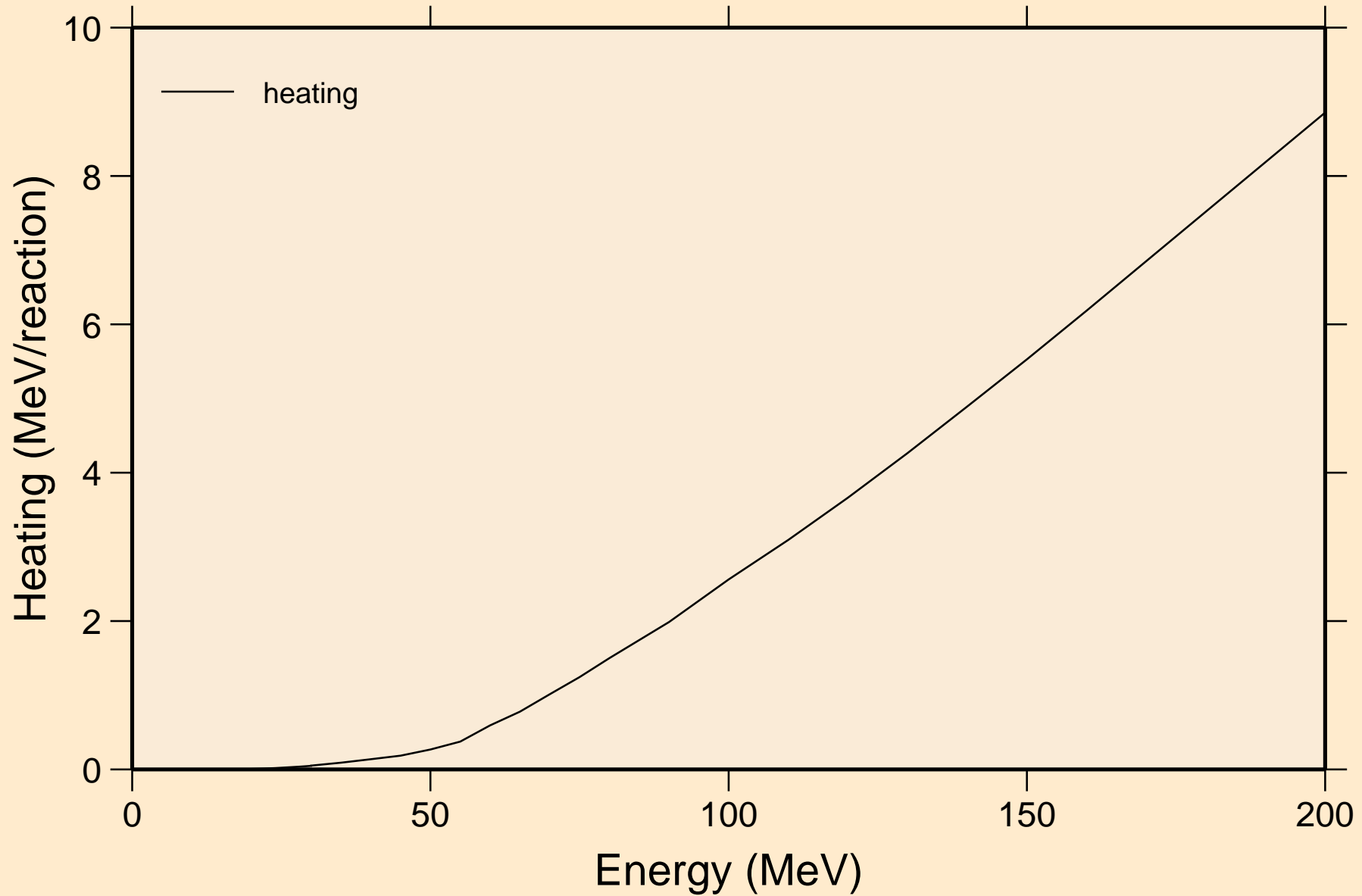

IR202 PROTON ACER TENDL-2024 LIBRARY; T=0.K  
Threshold reactions

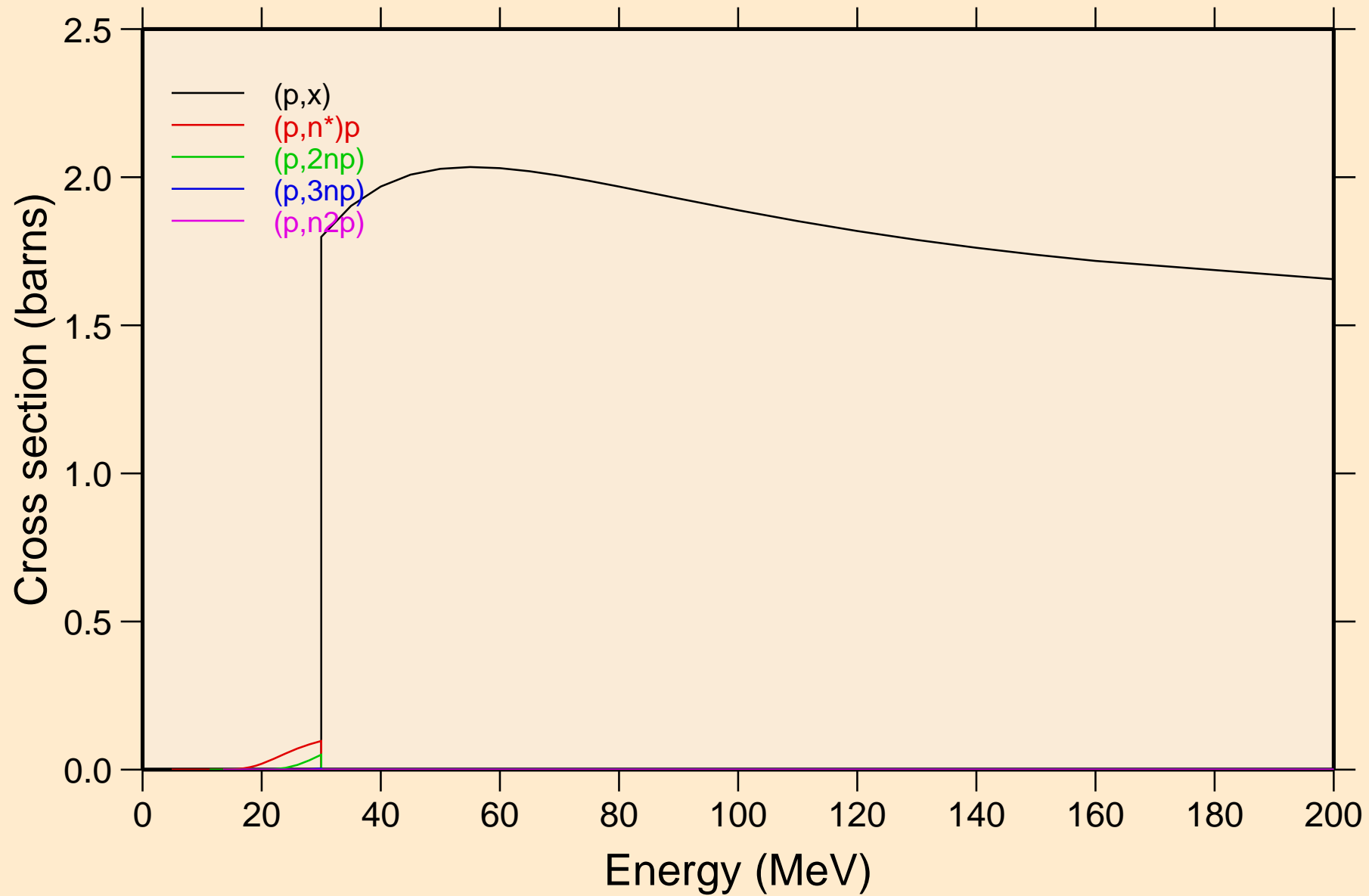

# IR202 PROTON ACER TENDL-2024 LIBRARY; T=0.K

## Threshold reactions

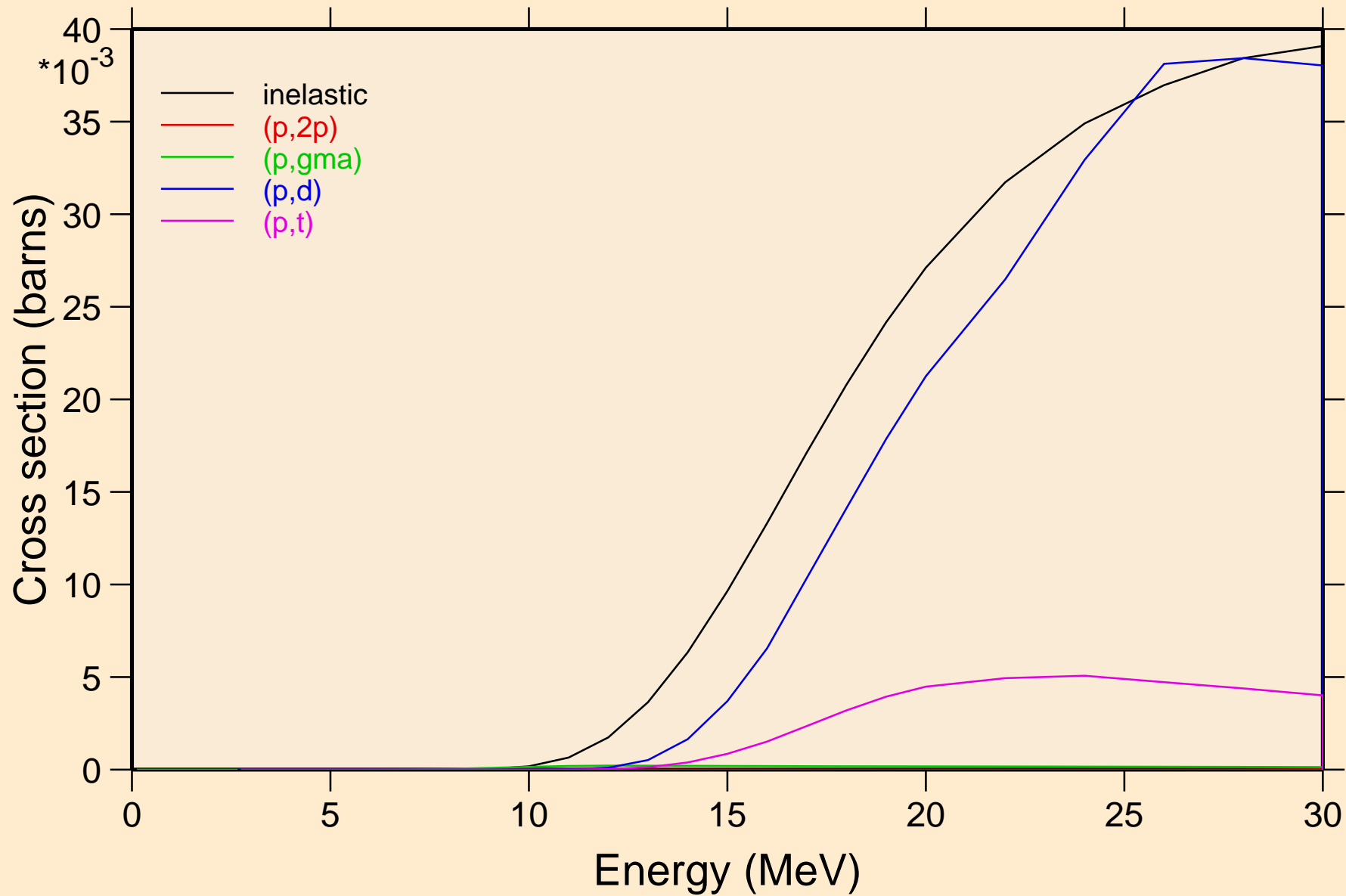

# IR202 PROTON ACER TENDL-2024 LIBRARY; T=0.K

## Threshold reactions

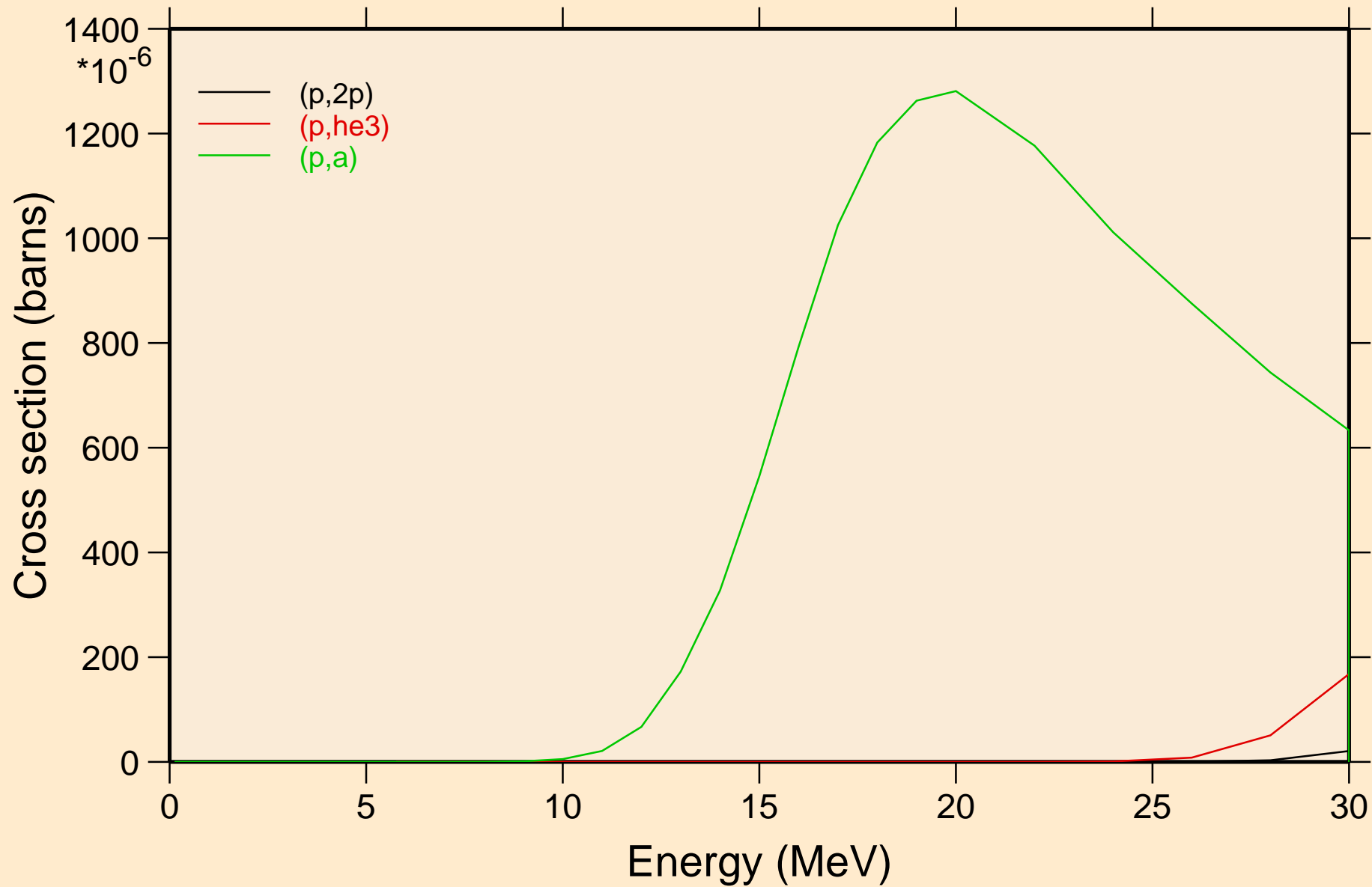

IR202 PROTON ACER TENDL-2024 LIBRARY; T=0.K  
Threshold reactions

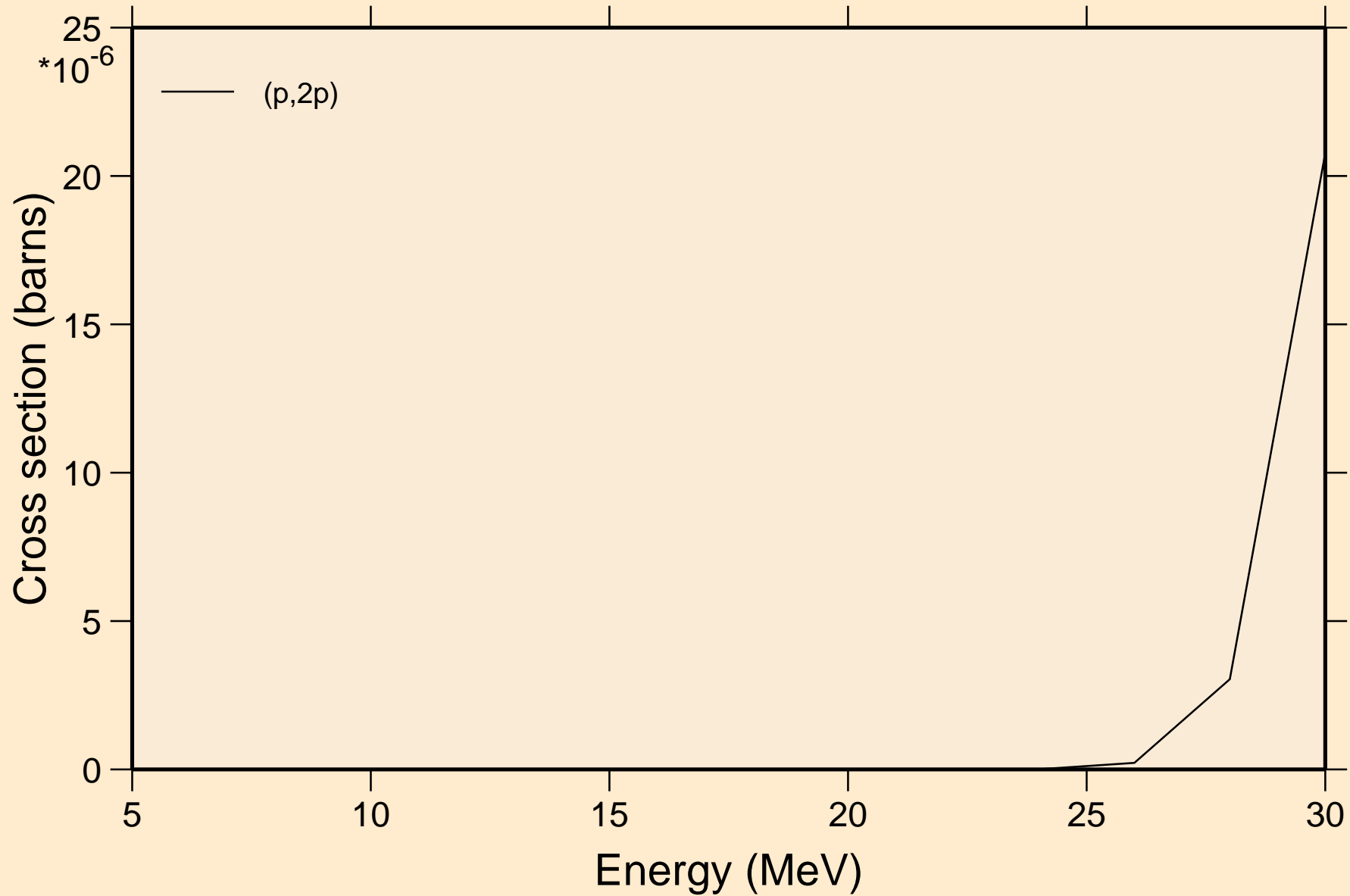

IR202 PROTON ACER TENDL-2024 LIBRARY; T=0.K  
angular distribution for elastic

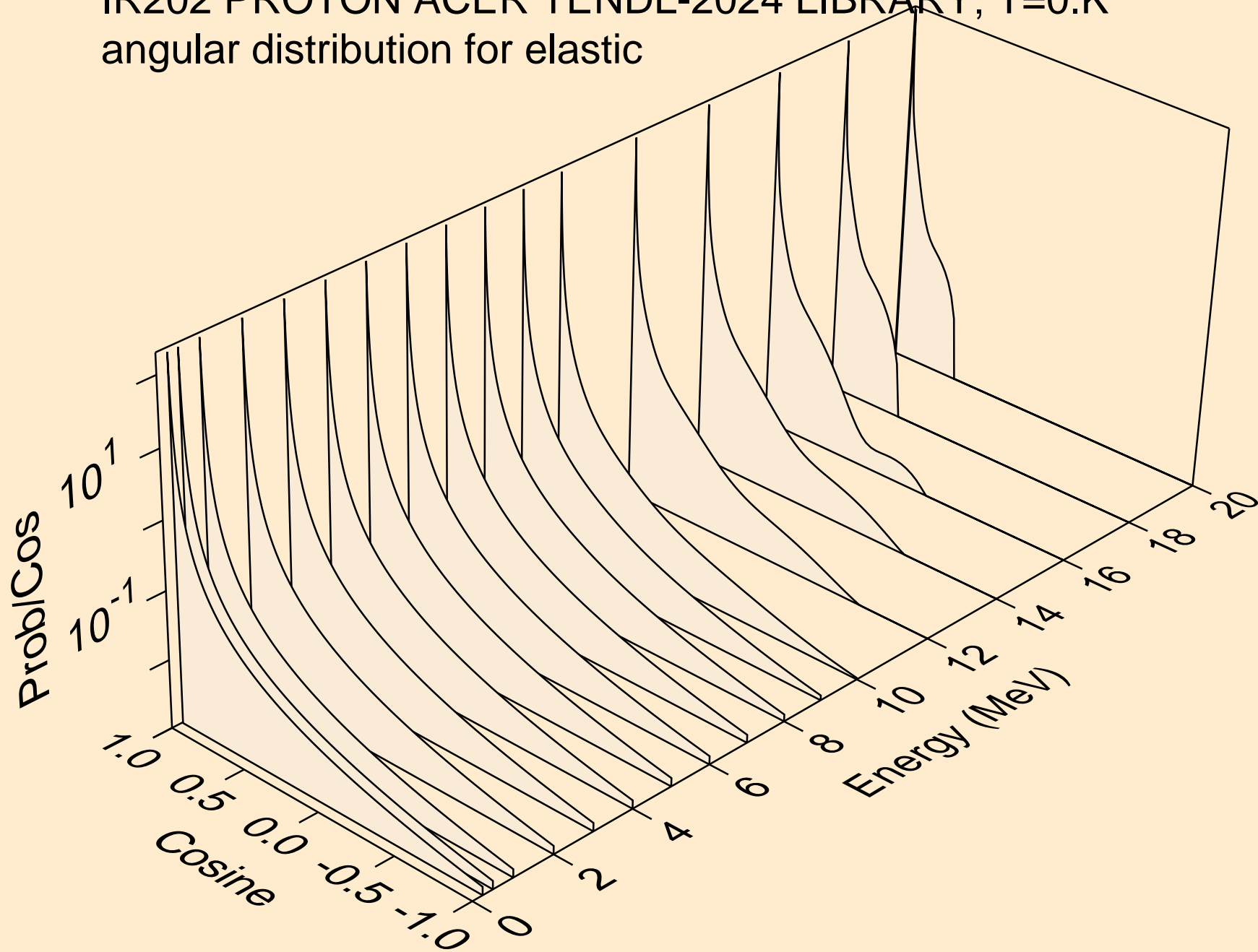

IR202 PROTON ACER TENDL-2024 LIBRARY; T=0.K  
angular distribution for elastic

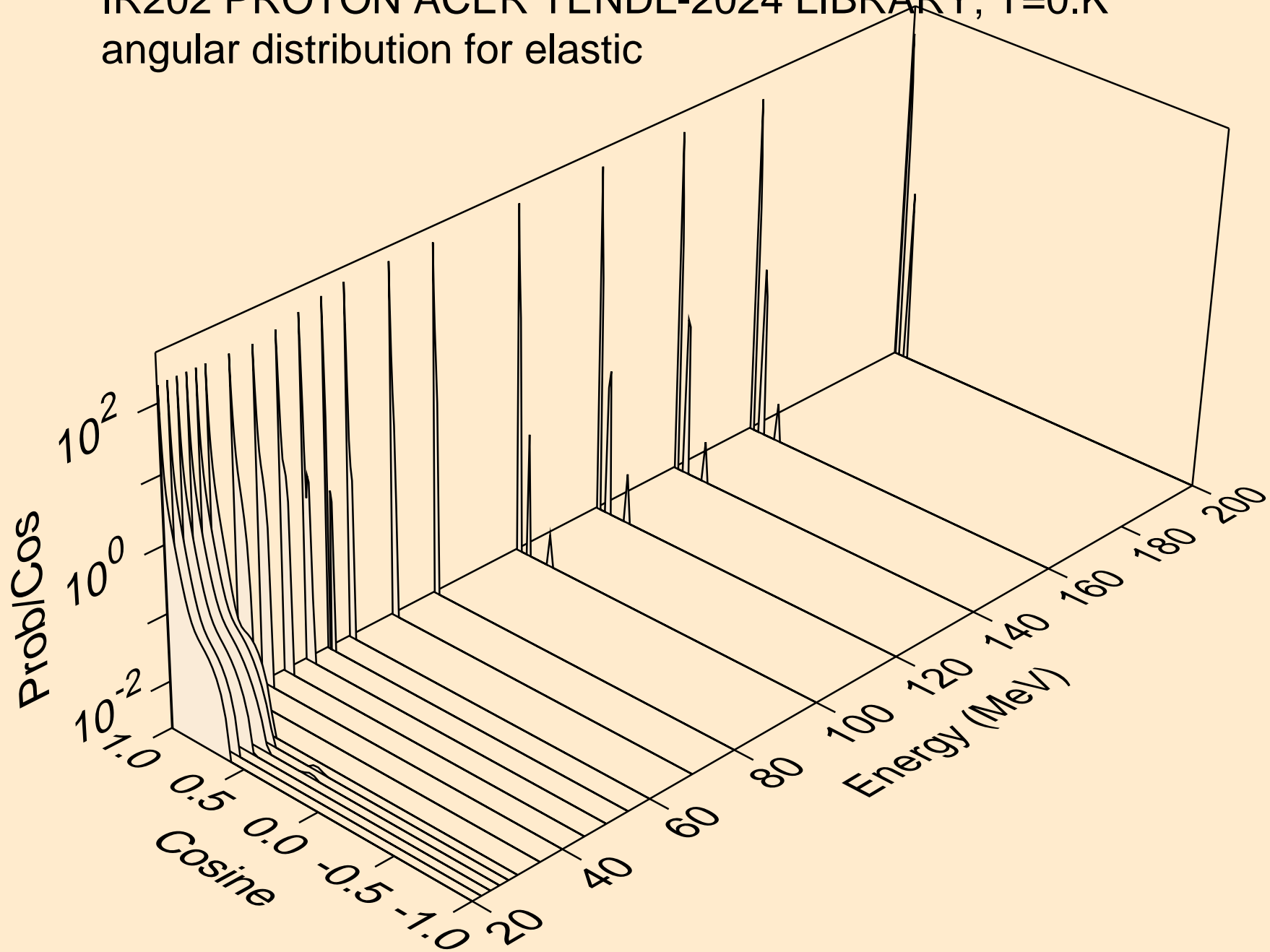

IR202 PROTON ACER TENDL-2024 LIBRARY; T=0.K  
Proton emission for (p,x)

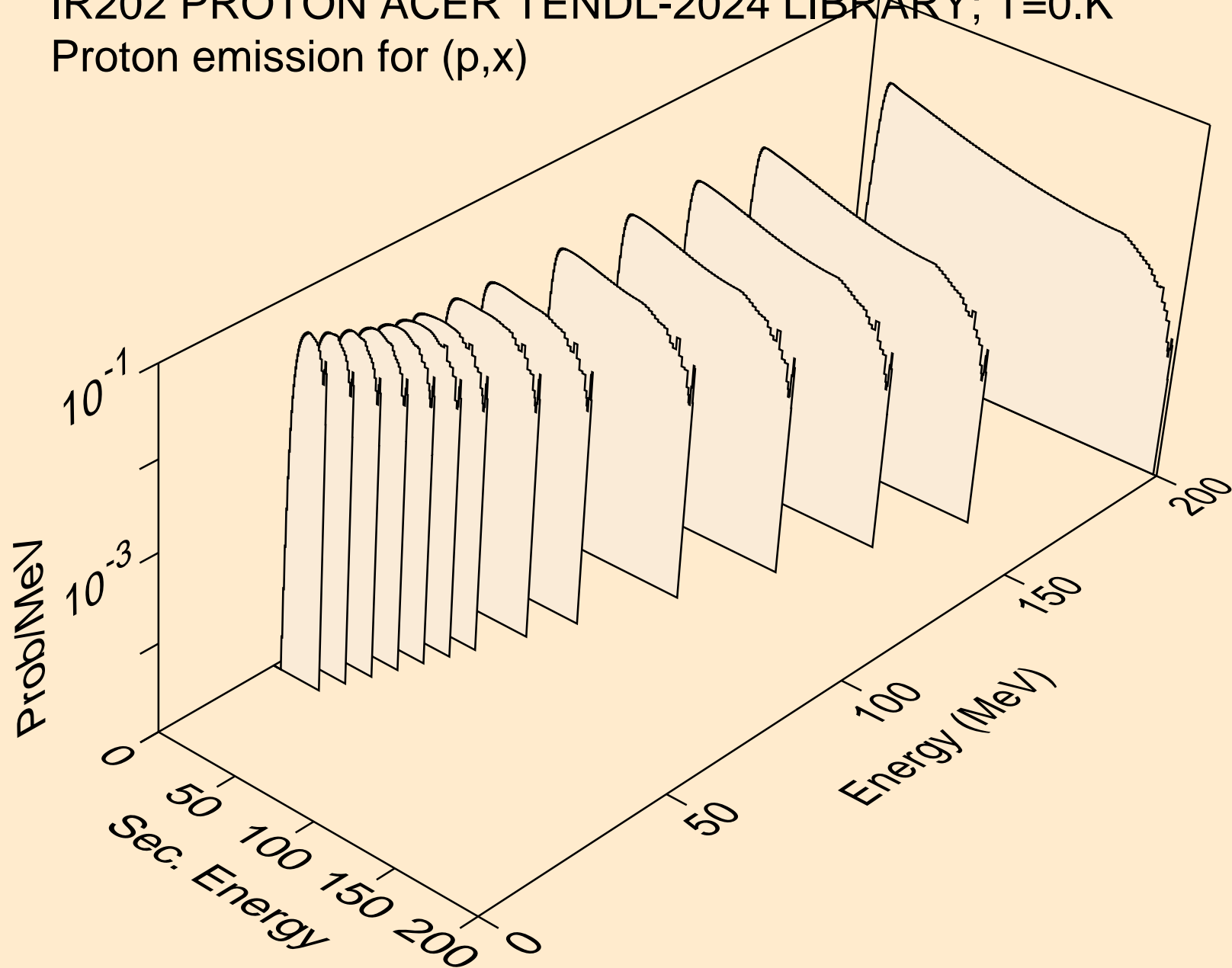

IR202 PROTON ACER TENDL-2024 LIBRARY; T=0.K  
Proton emission for (p,n\*)p

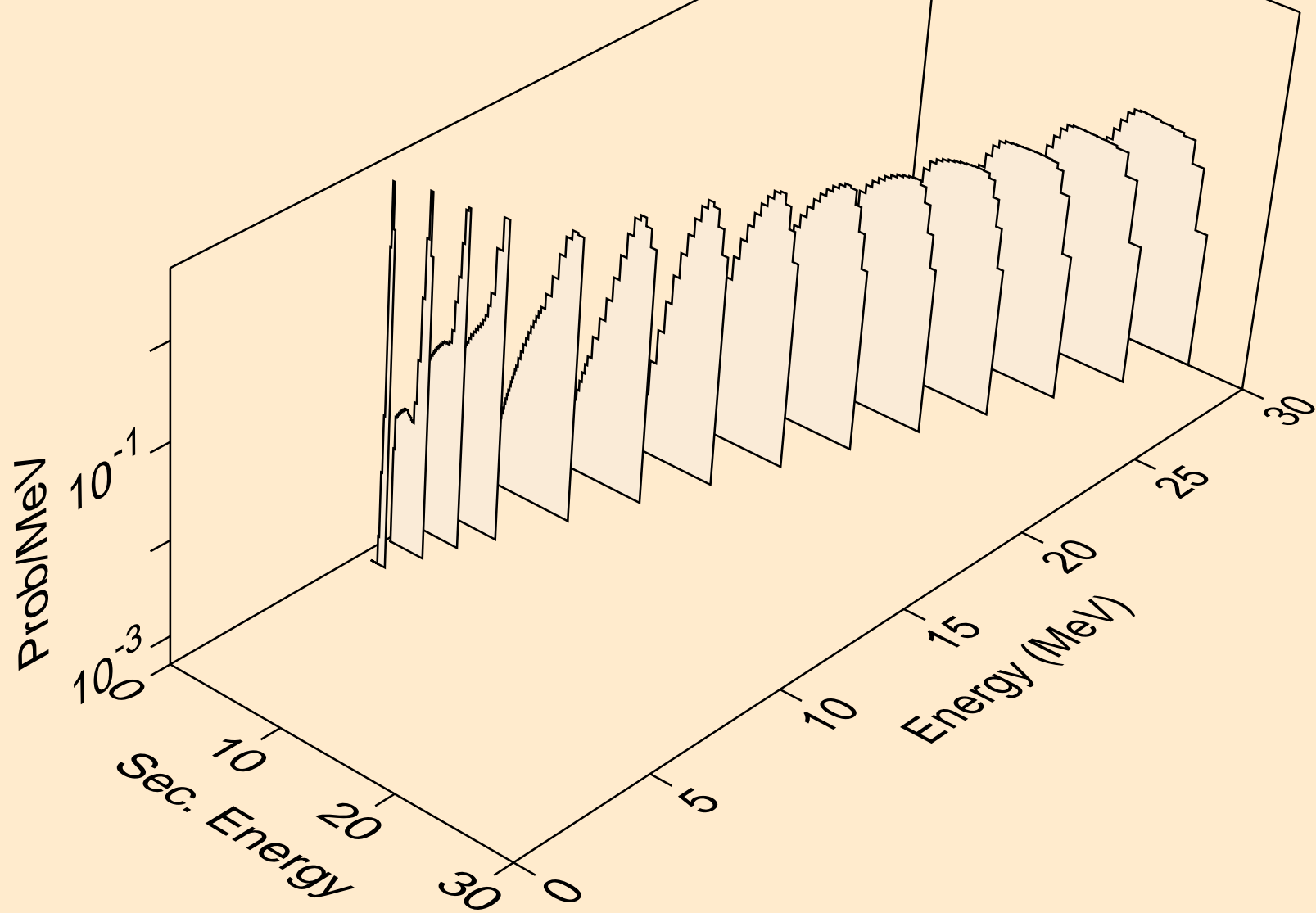

IR202 PROTON ACER TENDL-2024 LIBRARY; T=0.K  
Proton emission for (p,2np)

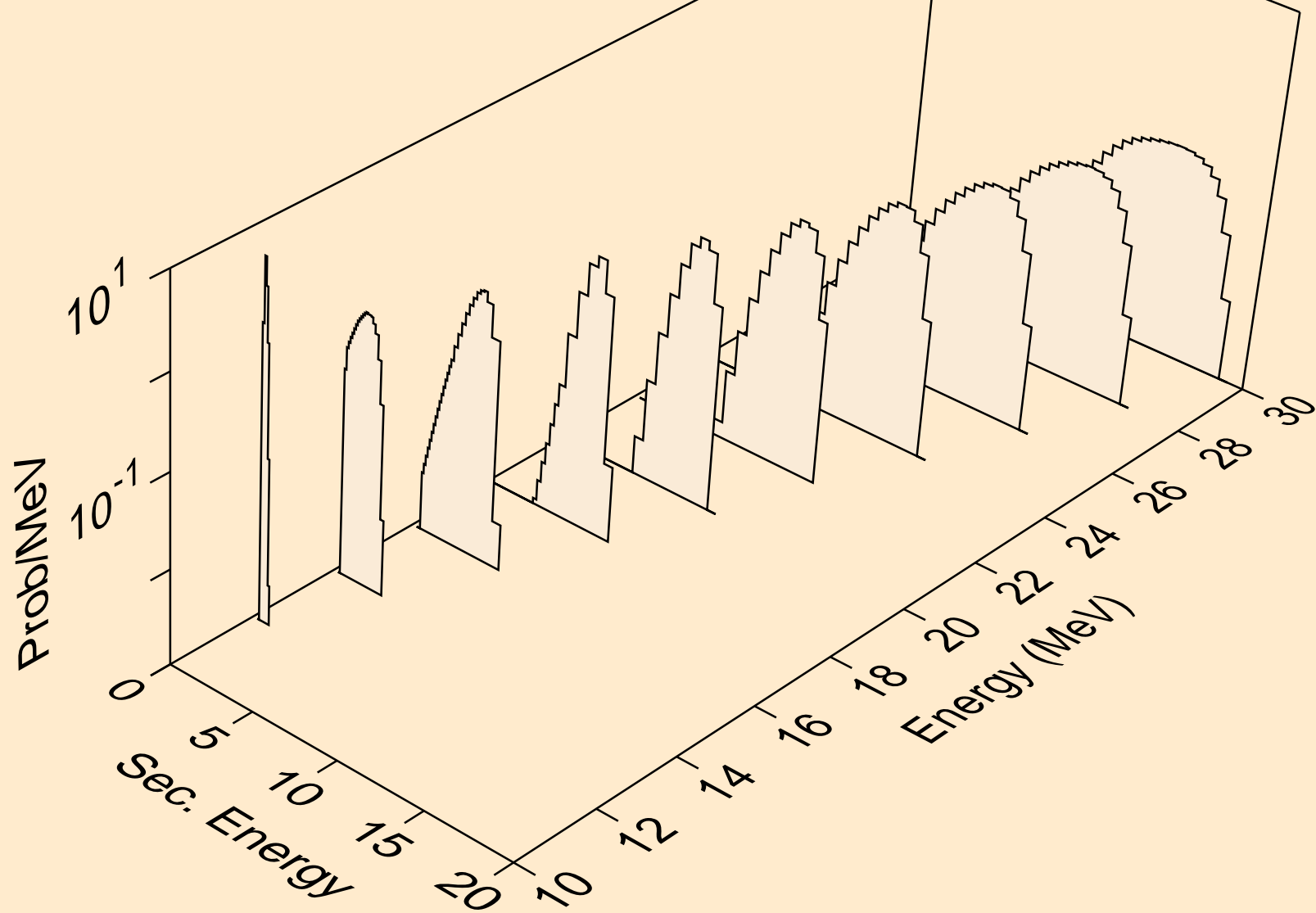

IR202 PROTON ACER TENDL-2024 LIBRARY; T=0.K  
Proton emission for (p,3np)

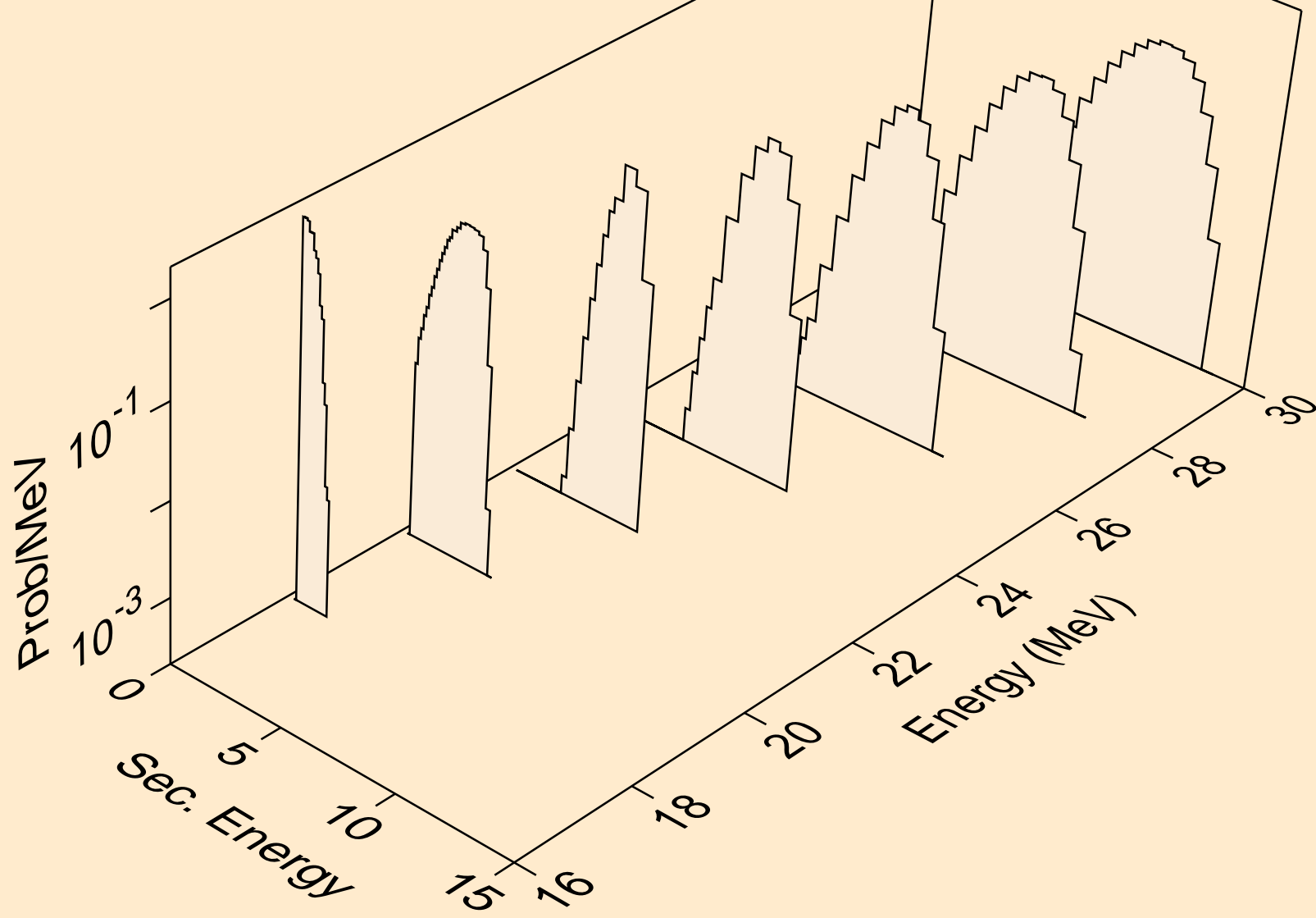

IR202 PROTON ACER TENDL-2024 LIBRARY; T=0.K  
Proton emission for (p,n2p)

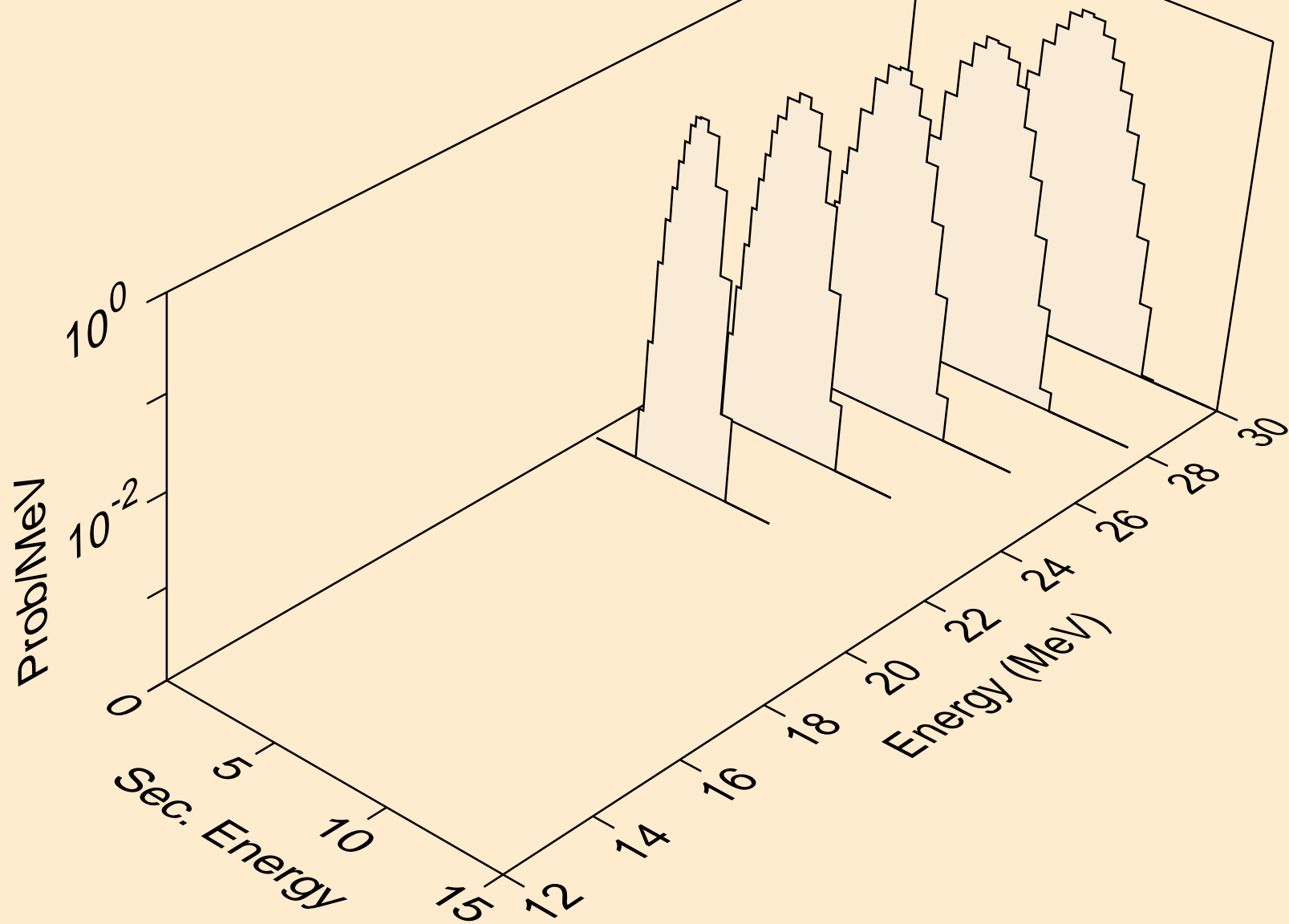

IR202 PROTON ACER TENDL-2024 LIBRARY; T=0.K  
Proton emission for inelastic

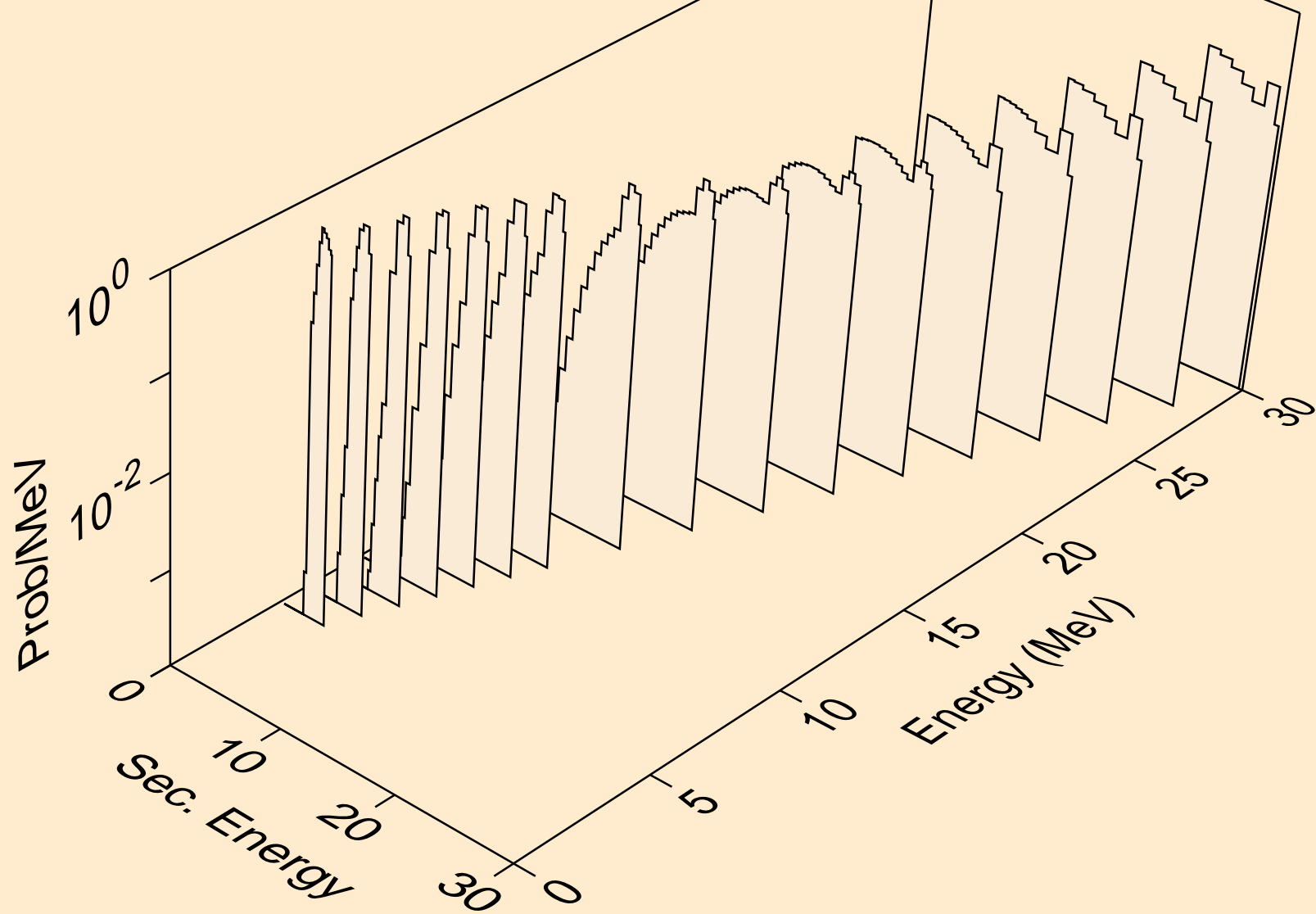

IR202 PROTON ACER TENDL-2024 LIBRARY; T=0.K  
Proton emission for (p,2p)

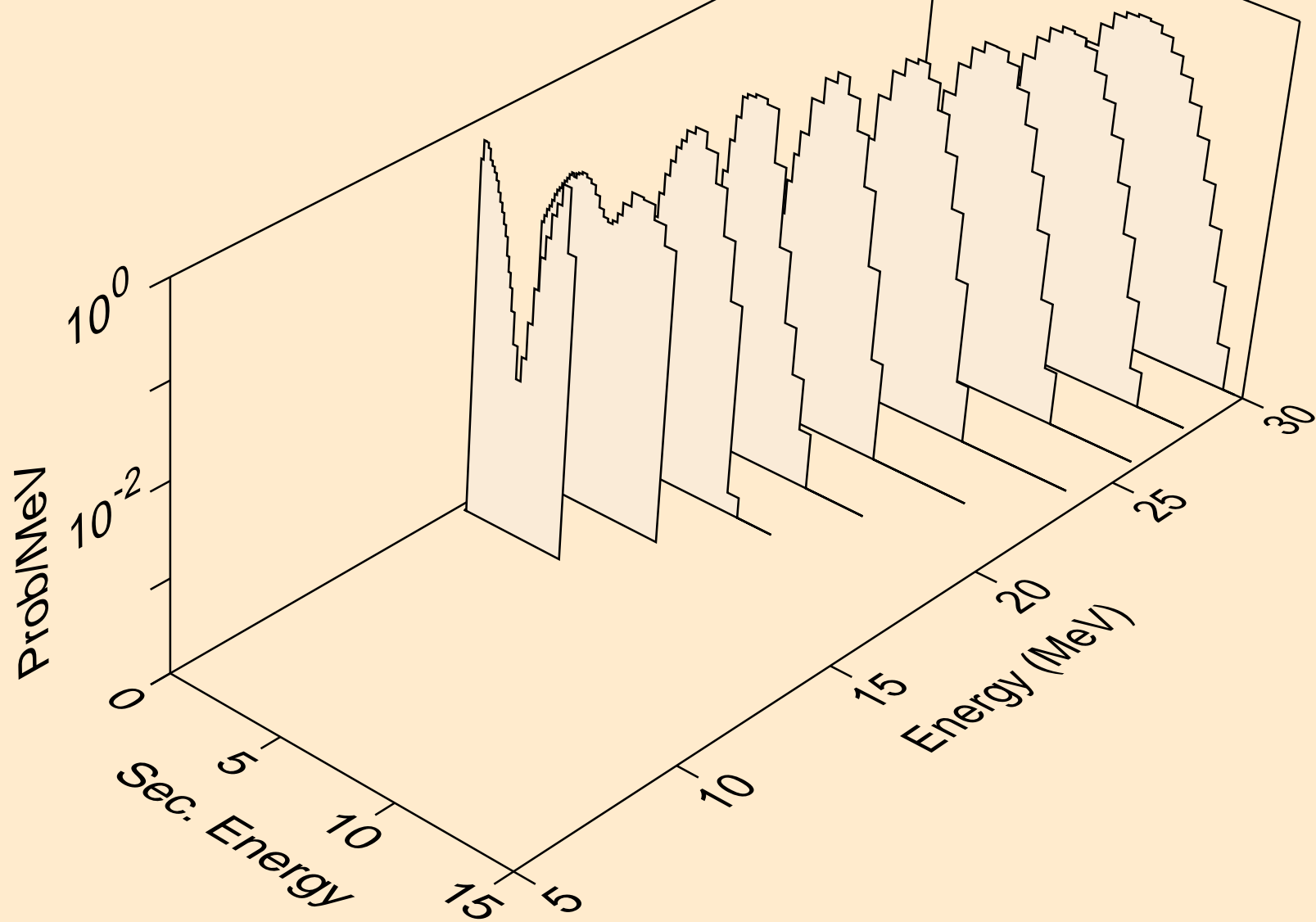

IR202 PROTON ACER TENDL-2024 LIBRARY; T=0.K  
Photon emission for (z,n)

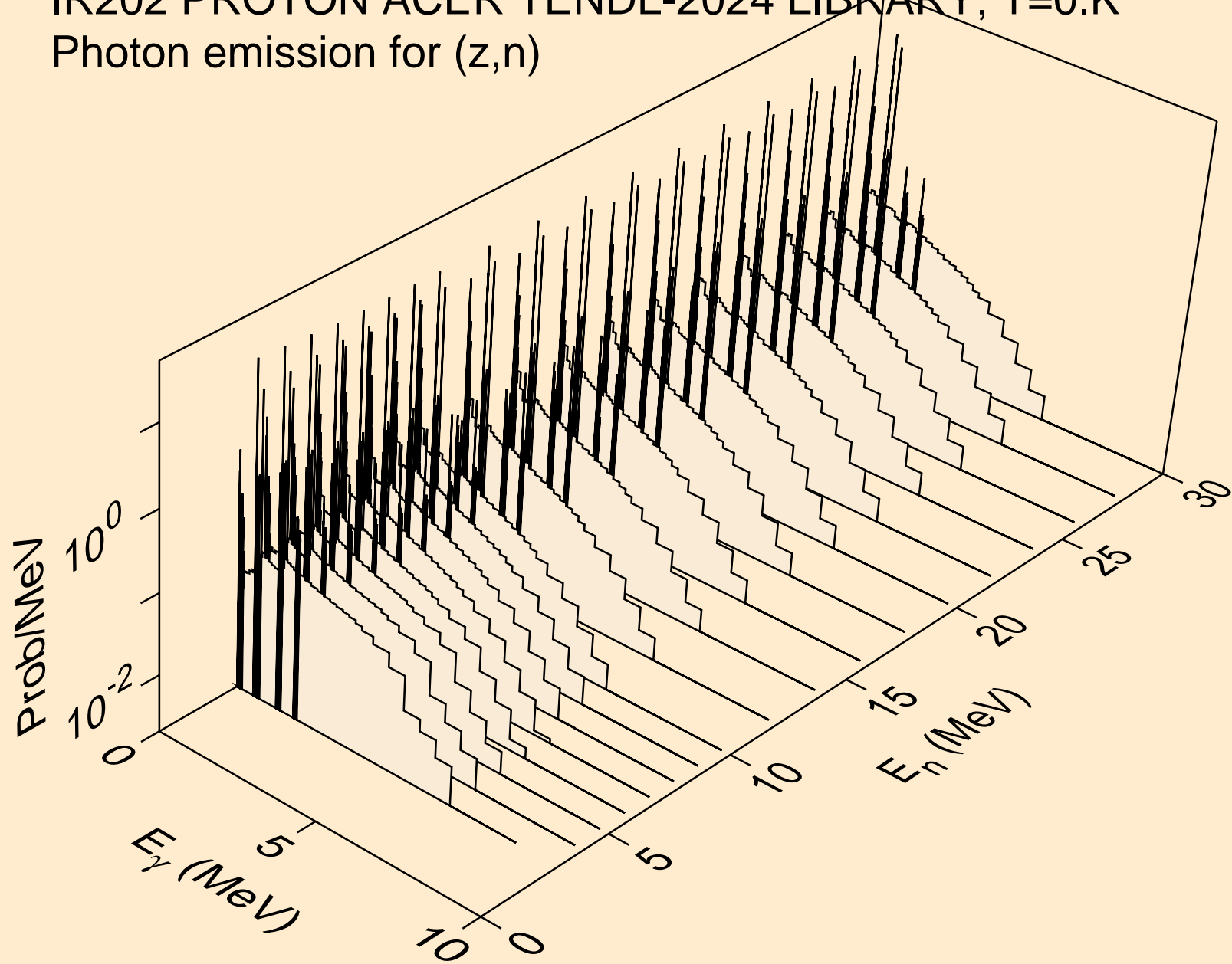

IR202 PROTON ACER TENDL-2024 LIBRARY; T=0.K  
Photon emission for (z,x)

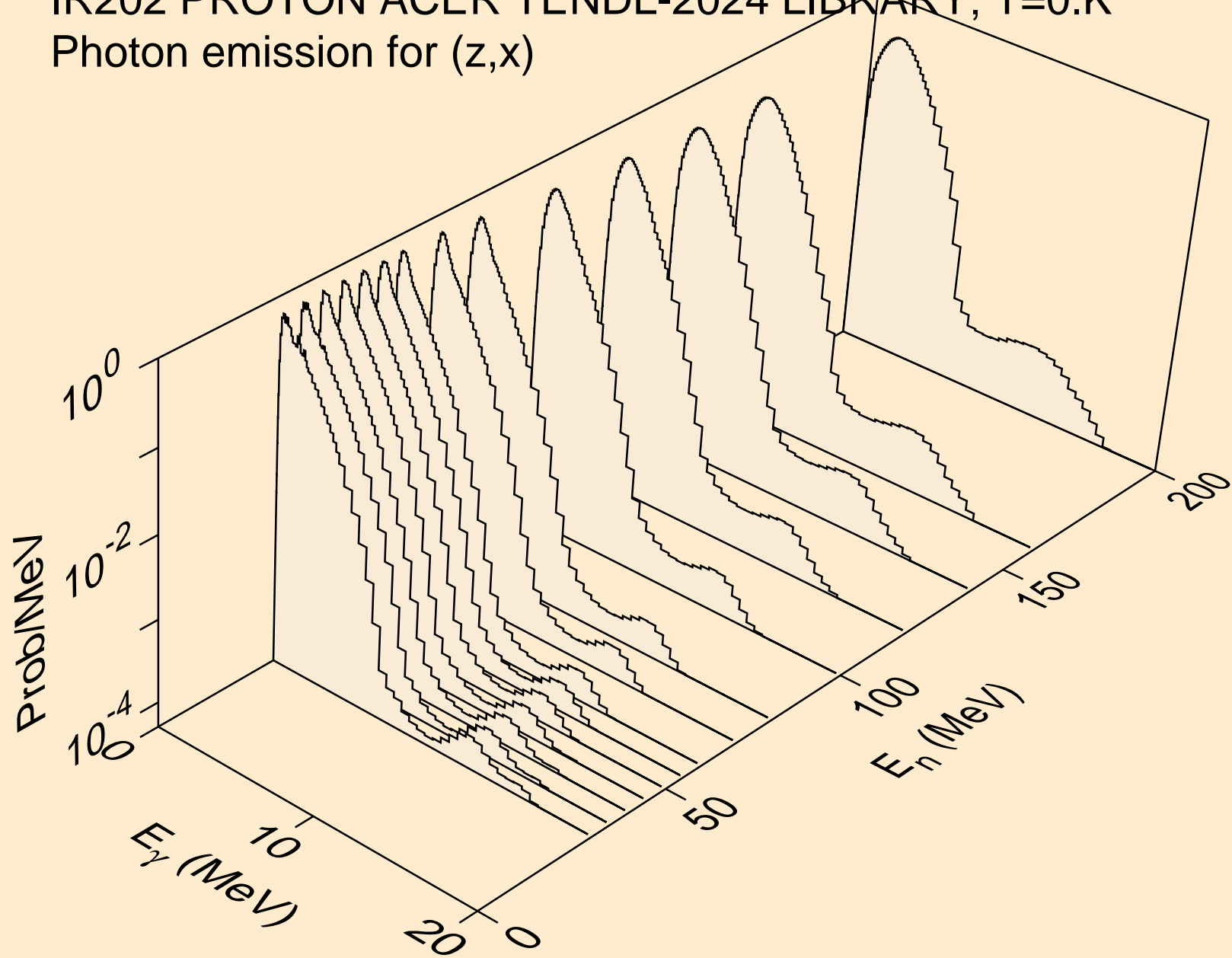

IR202 PROTON ACER TENDL-2024 LIBRARY; T=0.K  
Photon emission for (n,2nd)

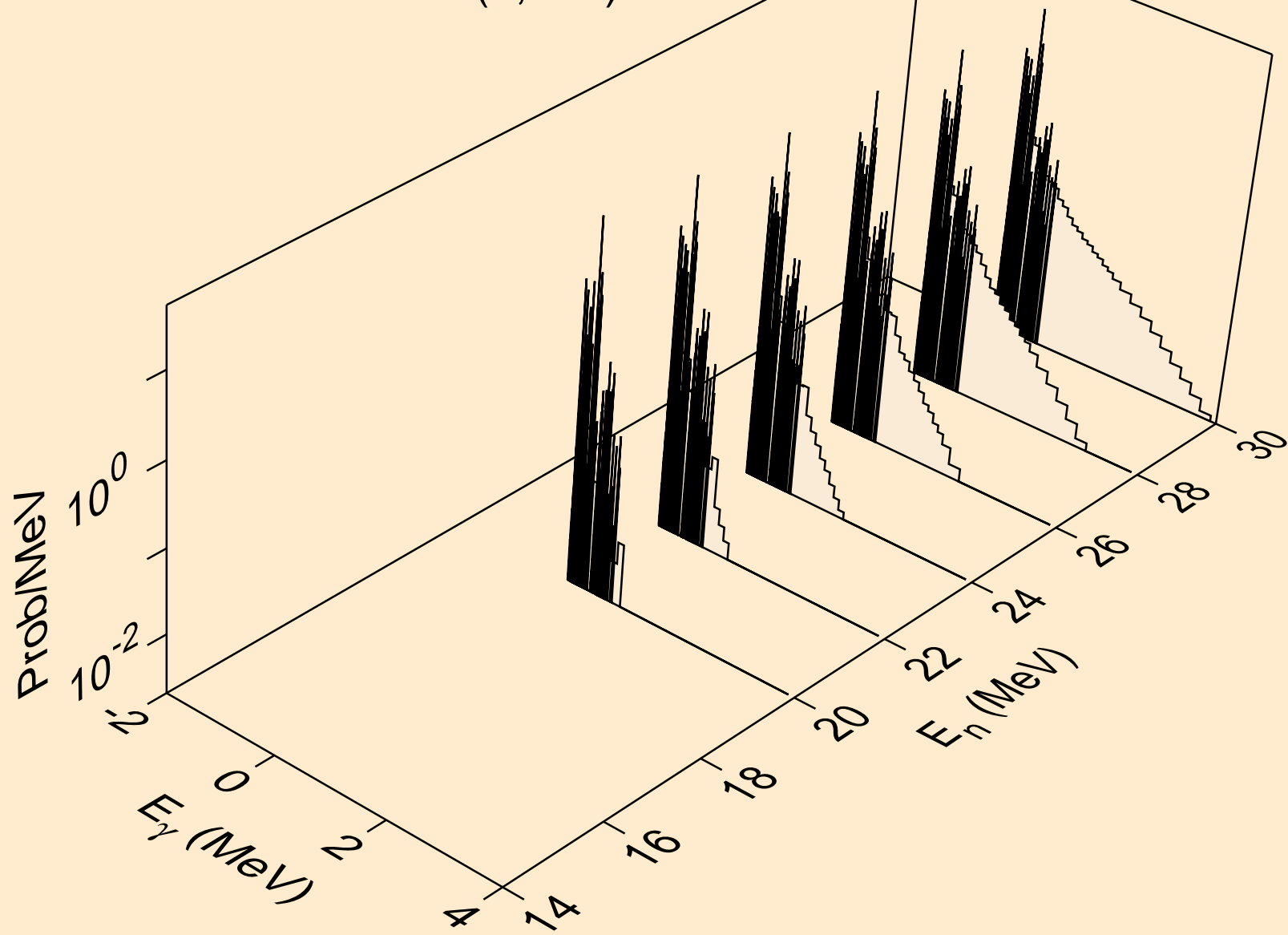

IR202 PROTON ACER TENDL-2024 LIBRARY; T=0.K  
Photon emission for (n,2n)

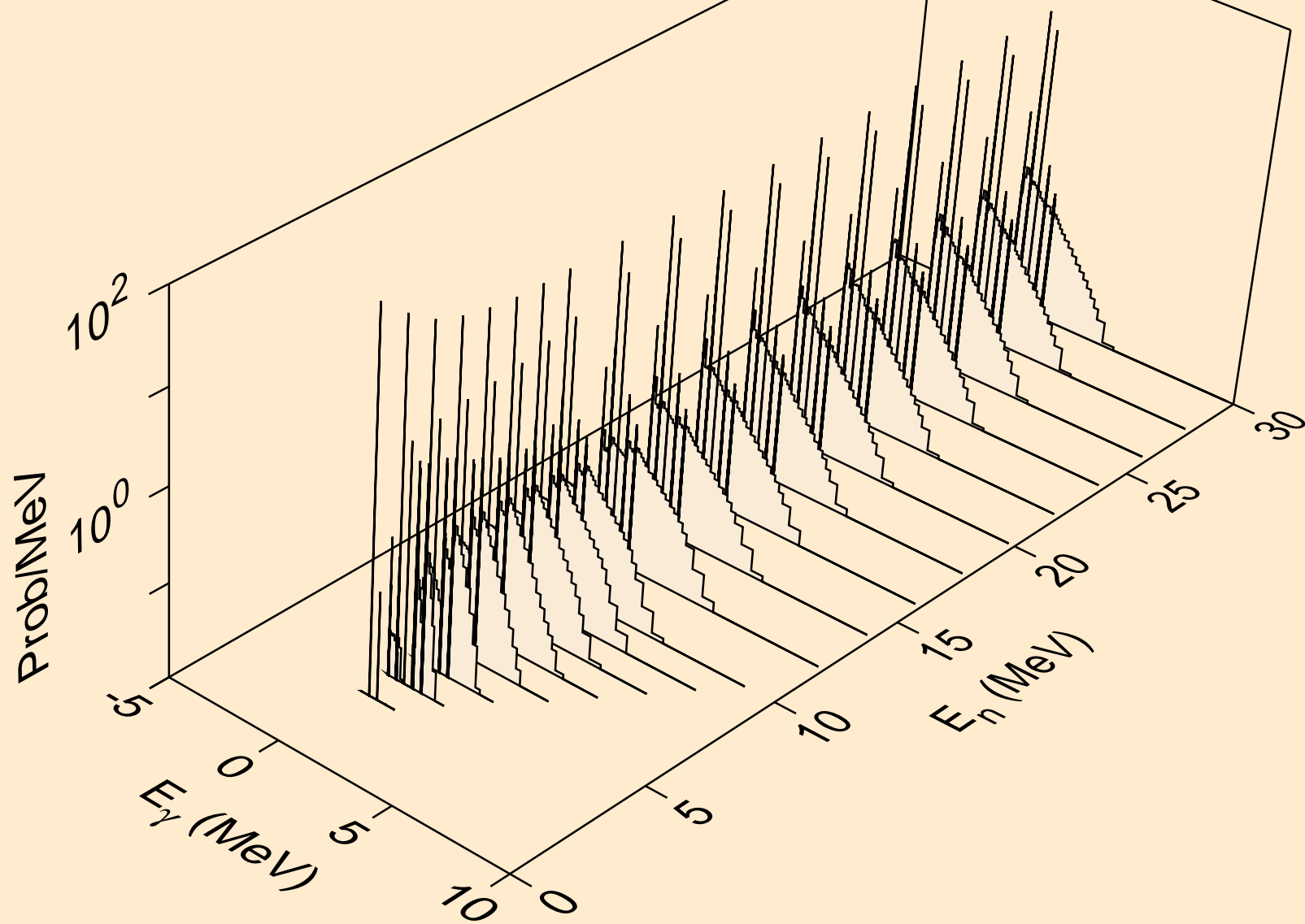

IR202 PROTON ACER TENDL-2024 LIBRARY; T=0.K  
Photon emission for (n,3n)

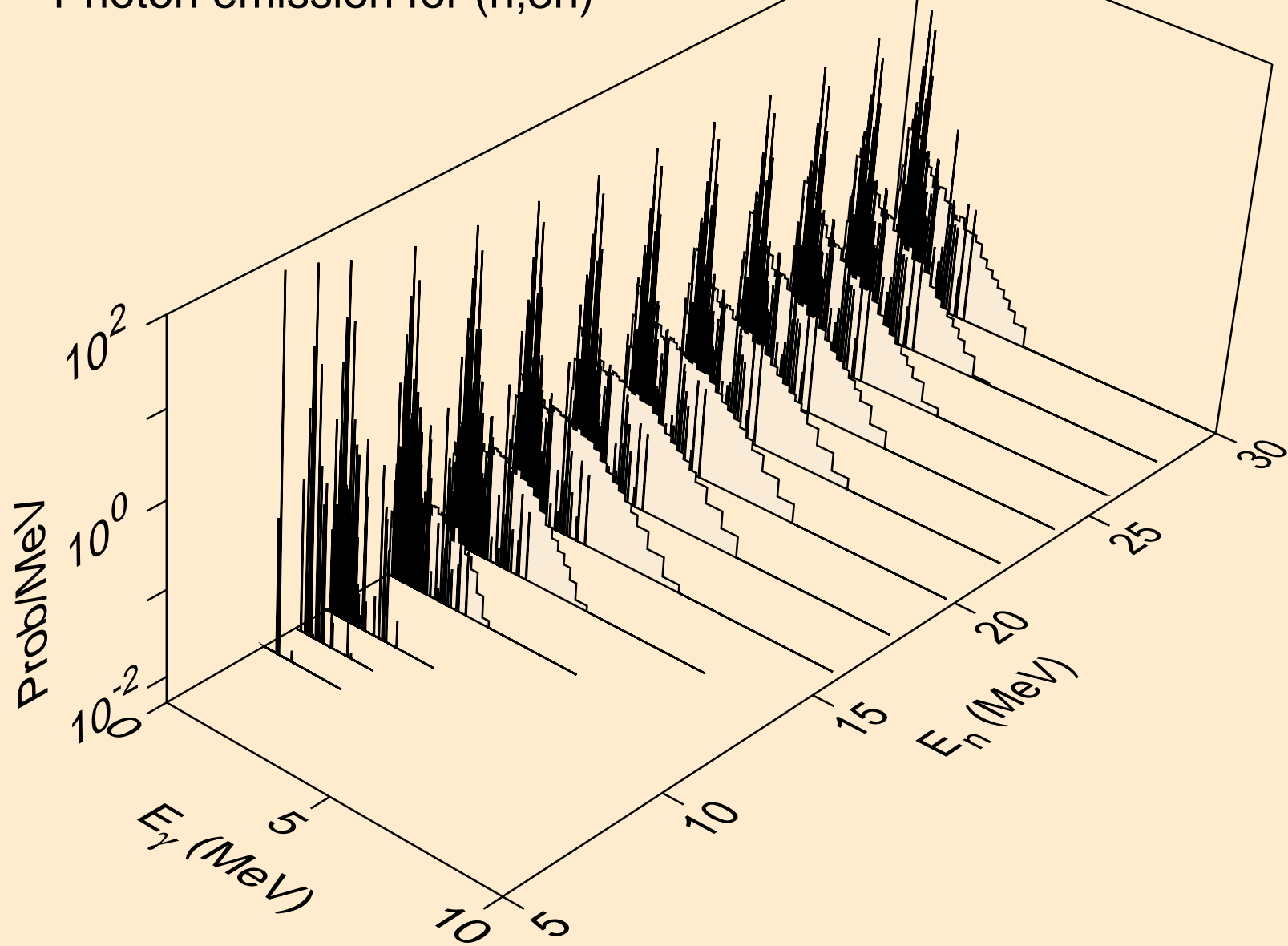

IR202 PROTON ACER TENDL-2024 LIBRARY; T=0.K  
Photon emission for (n,n\*)a

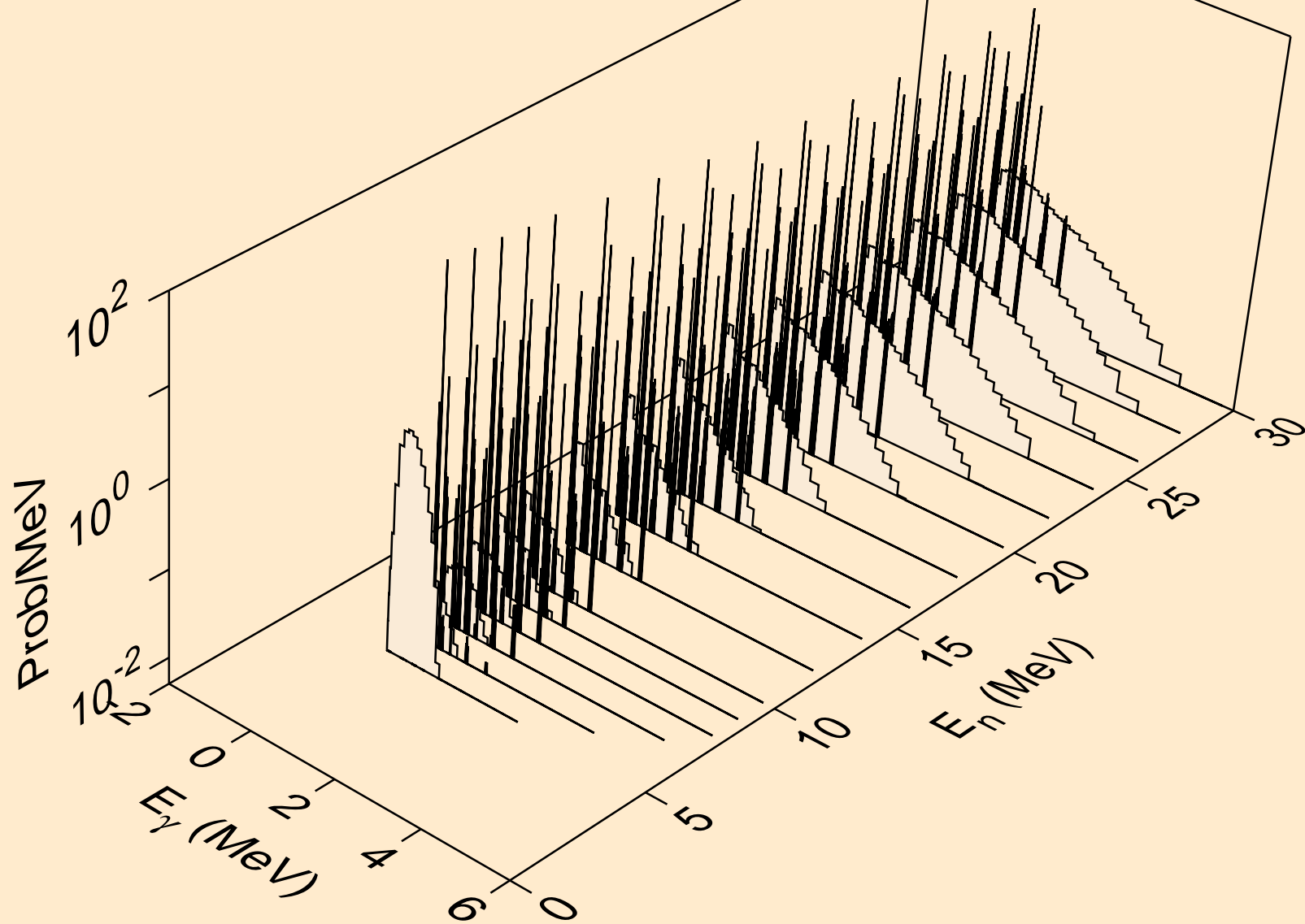

IR202 PROTON ACER TENDL-2024 LIBRARY; T=0.K  
Photon emission for (n,2n)a

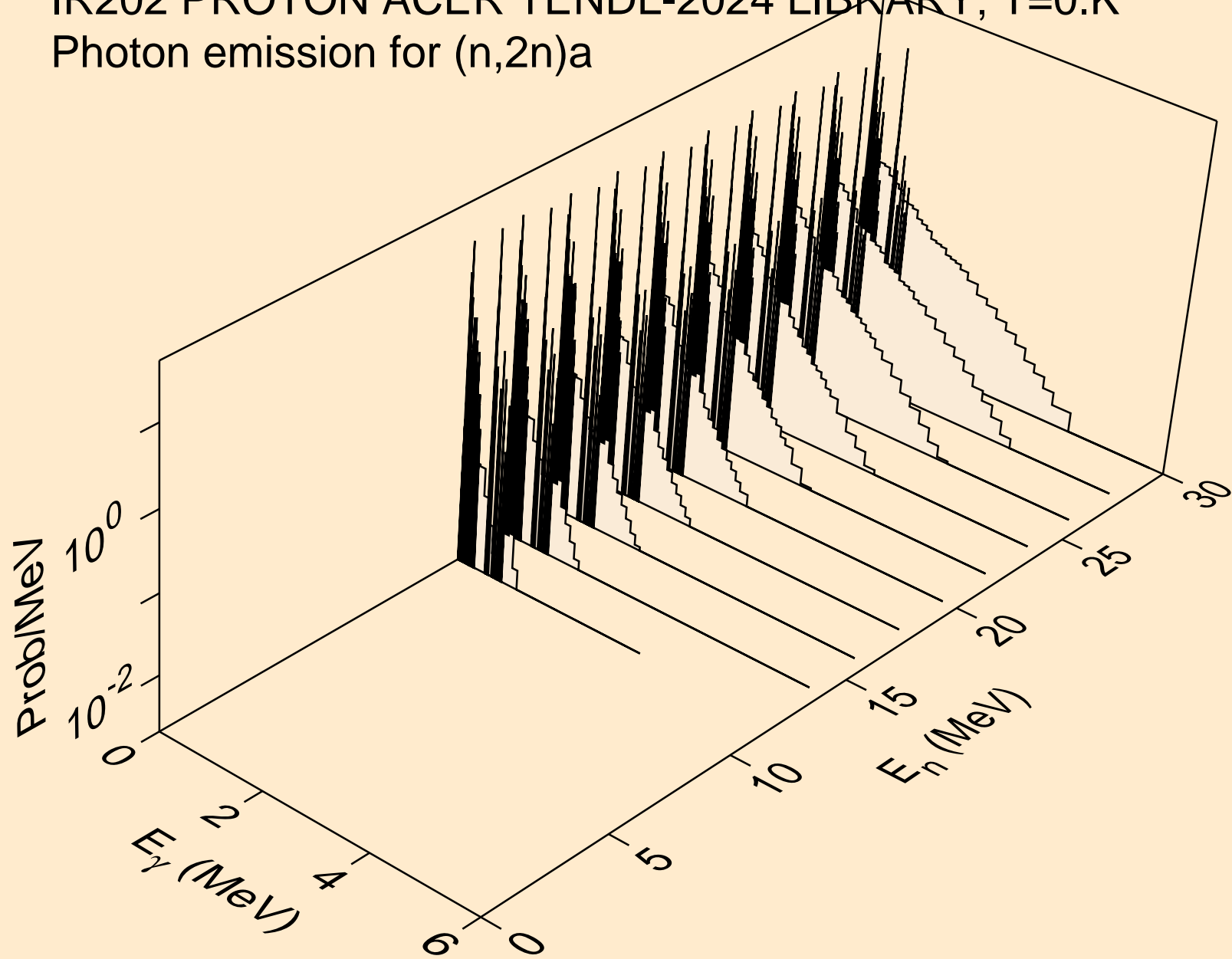

IR202 PROTON ACER TENDL-2024 LIBRARY; T=0.K  
Photon emission for (n,3n)a

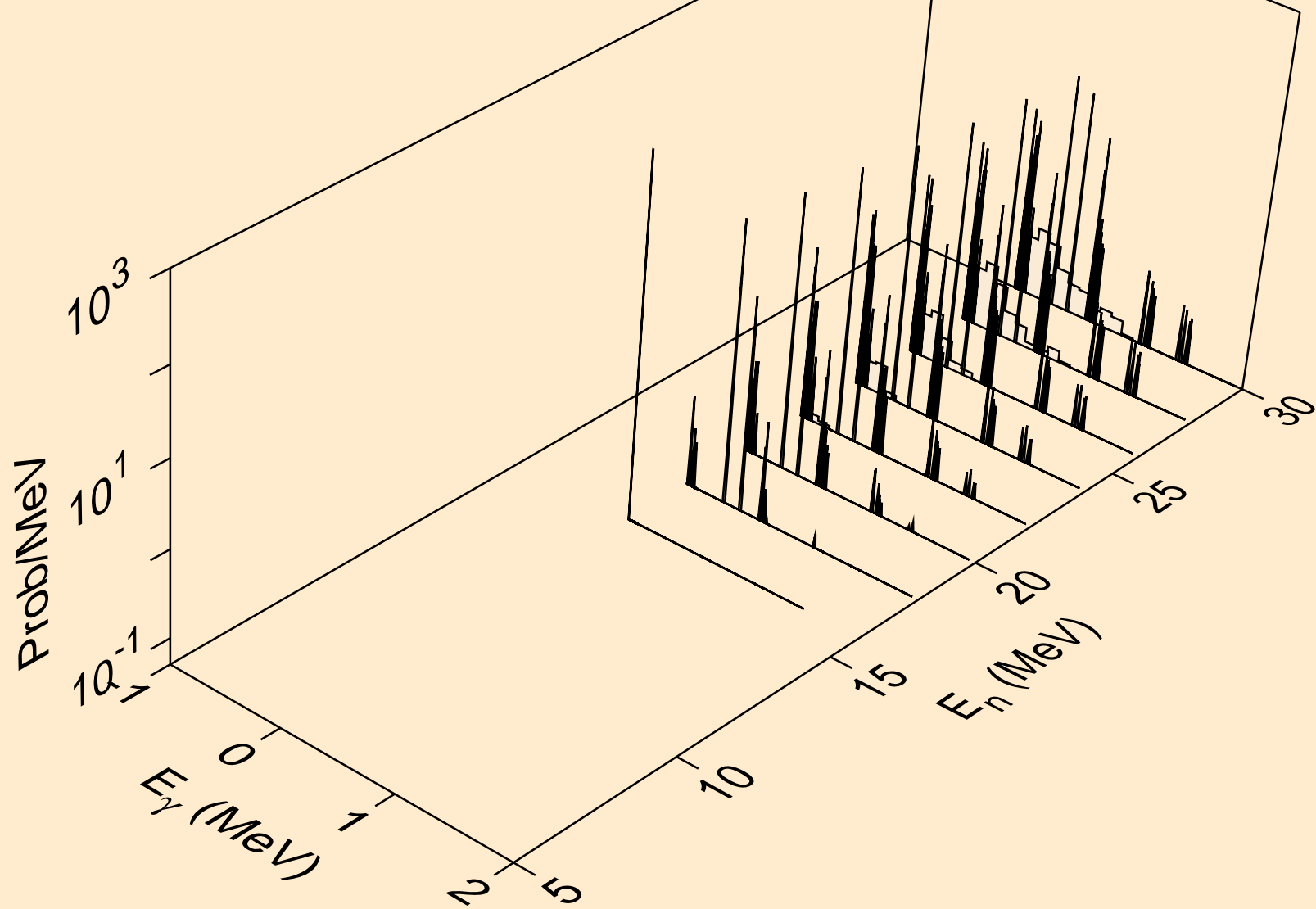

IR202 PROTON ACER TENDL-2024 LIBRARY; T=0.K  
Photon emission for (n,n\*)p

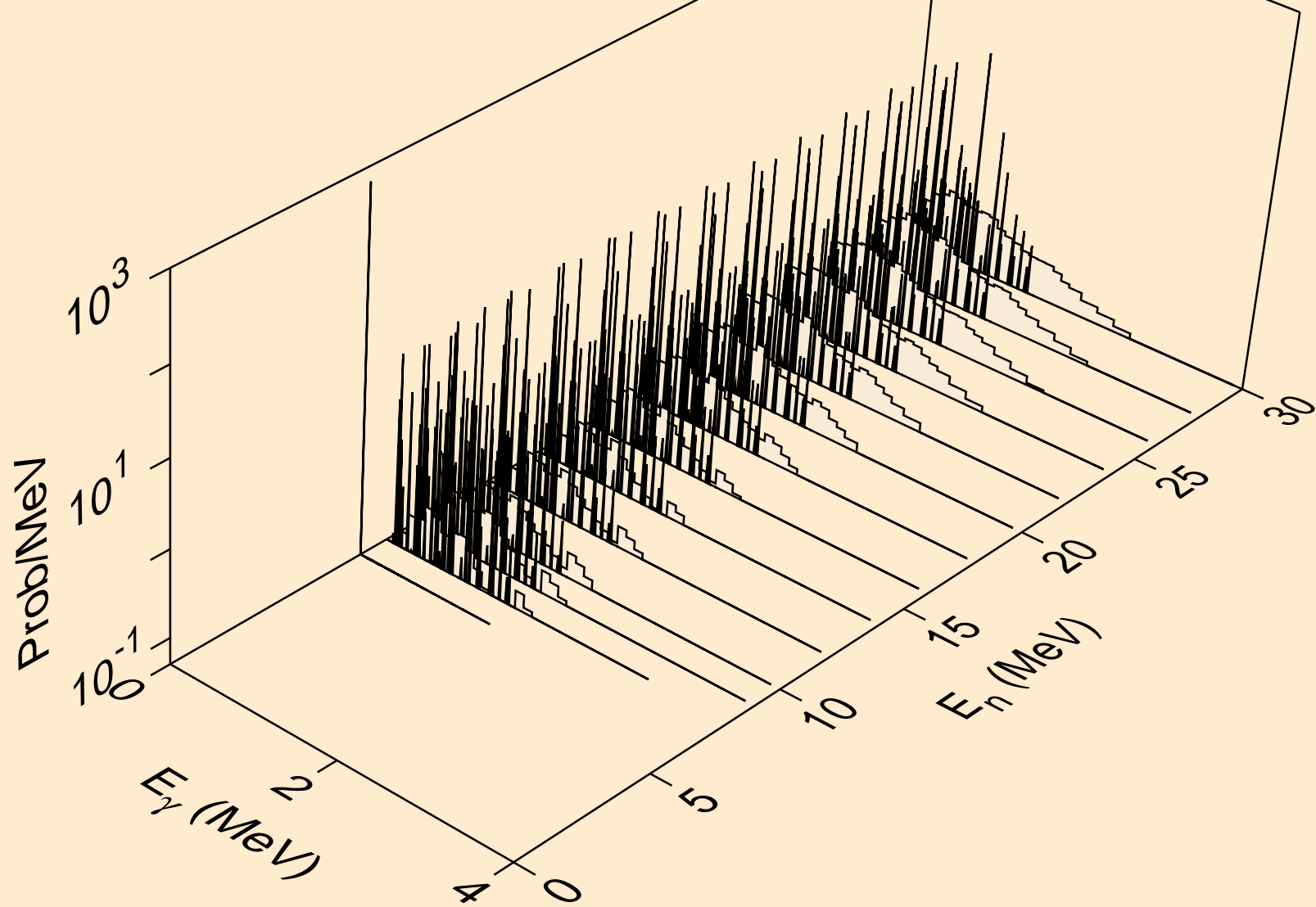

IR202 PROTON ACER TENDL-2024 LIBRARY; T=0.K  
Photon emission for (n,n\*)d

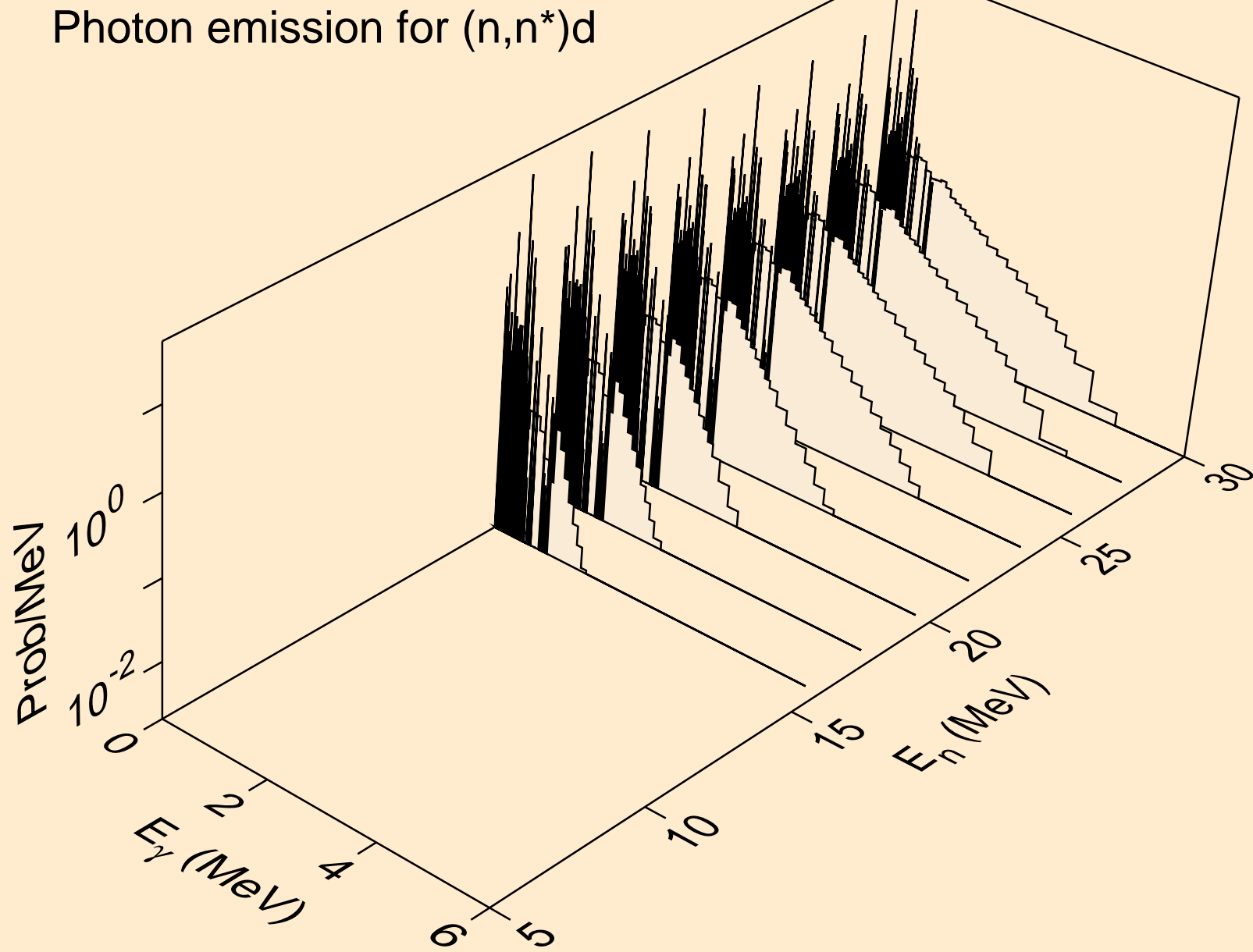

IR202 PROTON ACER TENDL-2024 LIBRARY; T=0.K  
Photon emission for (n,n\*)t

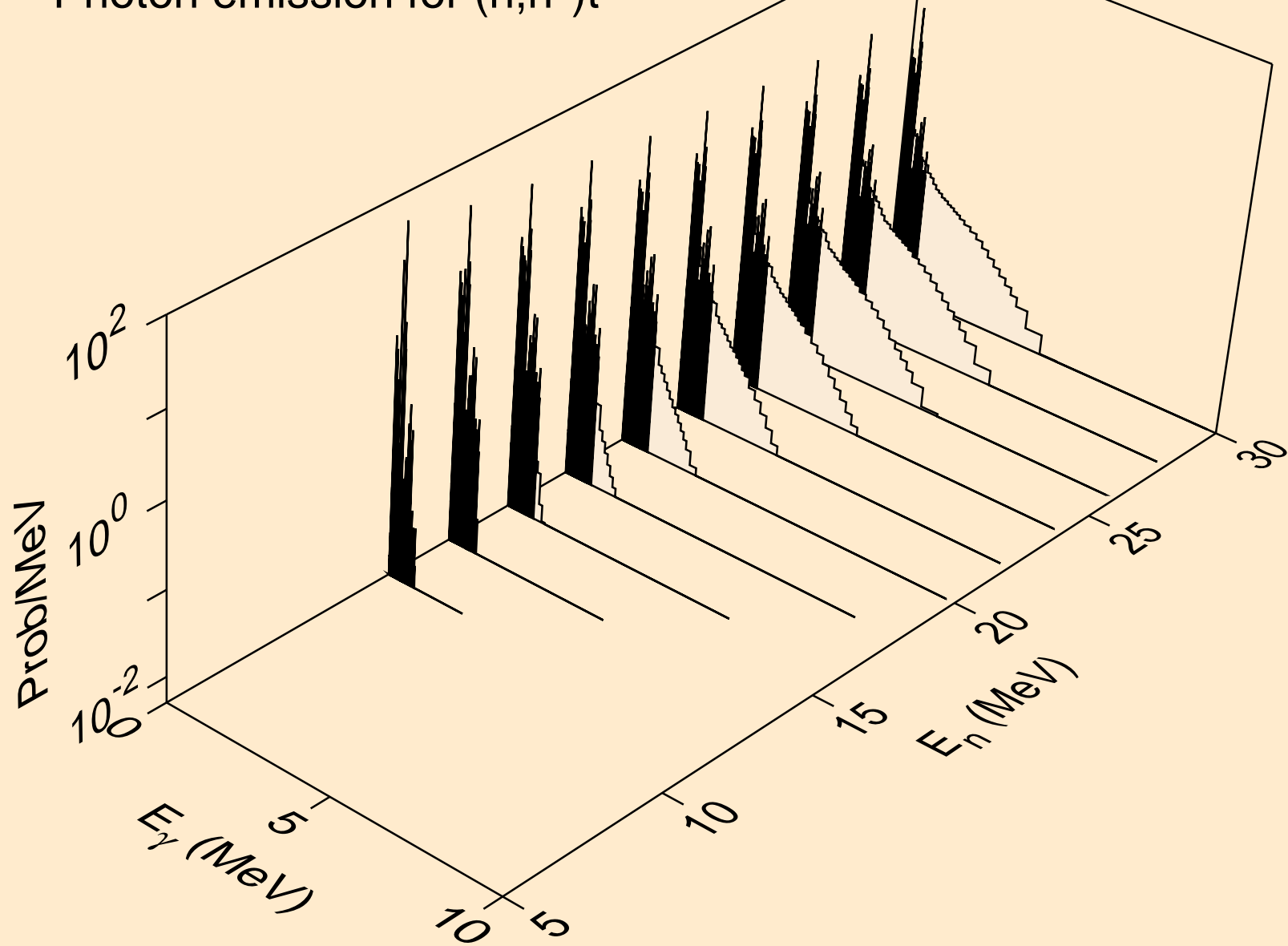

IR202 PROTON ACER TENDL-2024 LIBRARY; T=0.K  
Photon emission for (n,n\*)he3

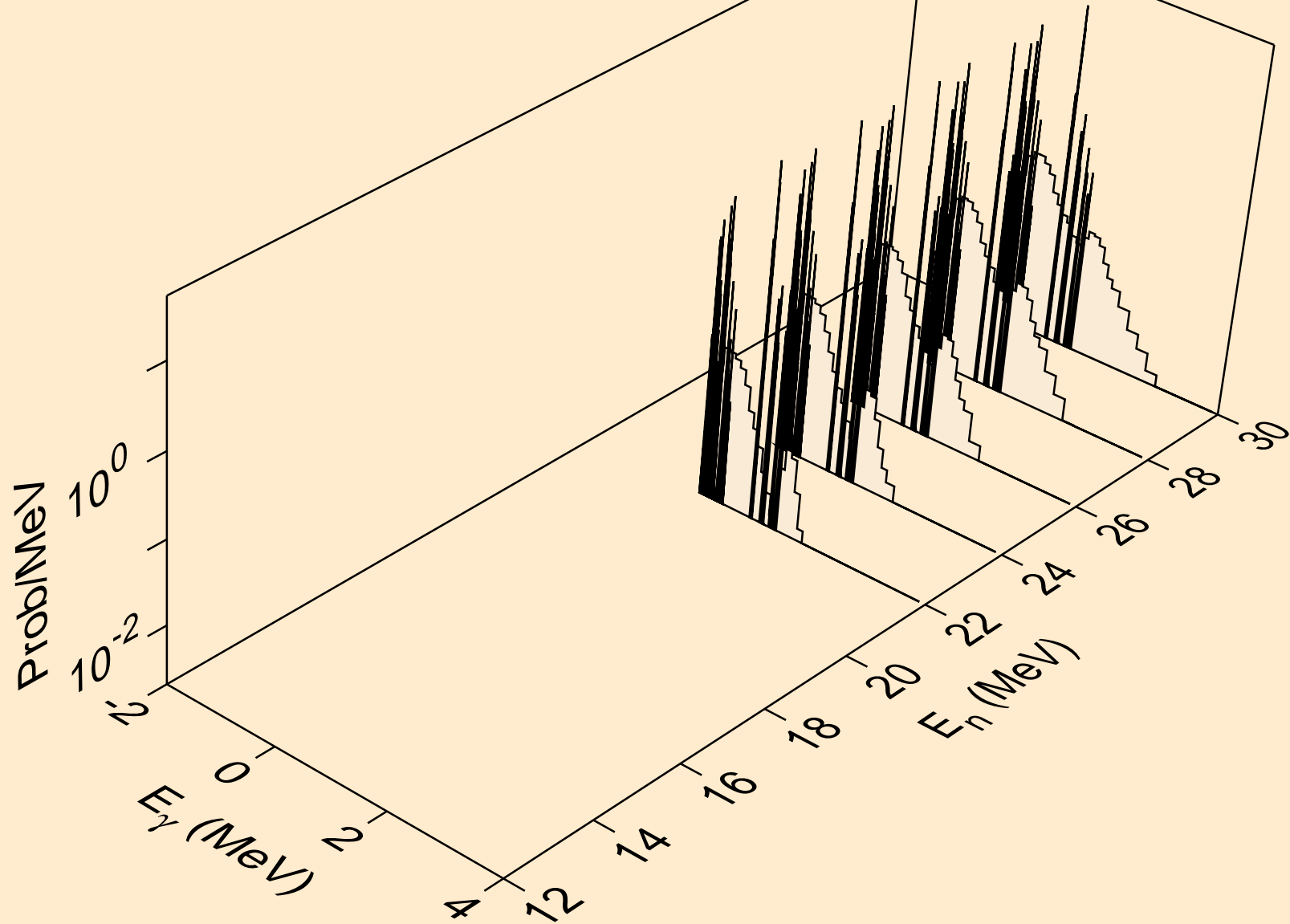

IR202 PROTON ACER TENDL-2024 LIBRARY; T=0.K  
Photon emission for (n,4n)

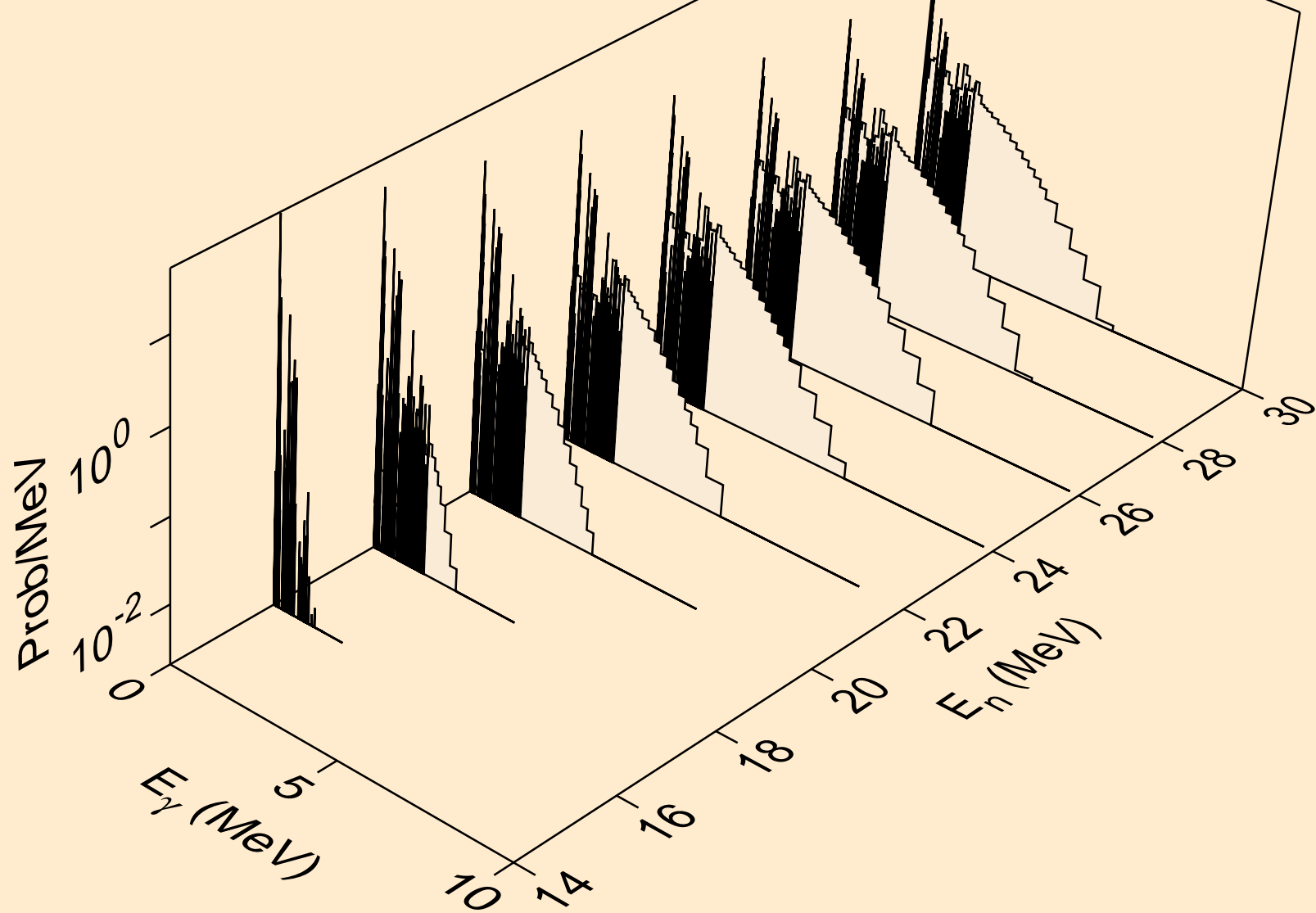

IR202 PROTON ACER TENDL-2024 LIBRARY; T=0.K  
Photon emission for (n,2np)

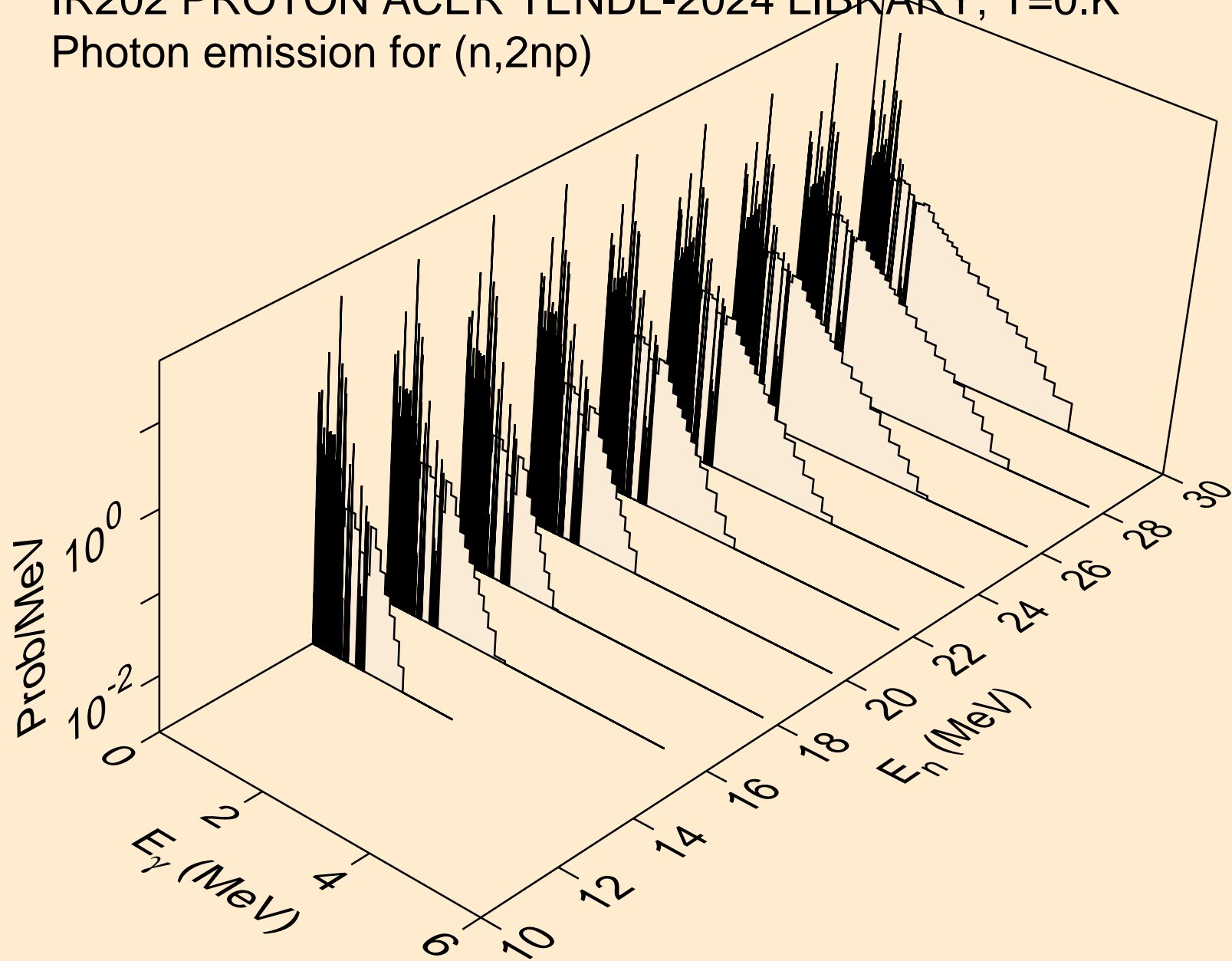

IR202 PROTON ACER TENDL-2024 LIBRARY; T=0.K  
Photon emission for (n,3np)

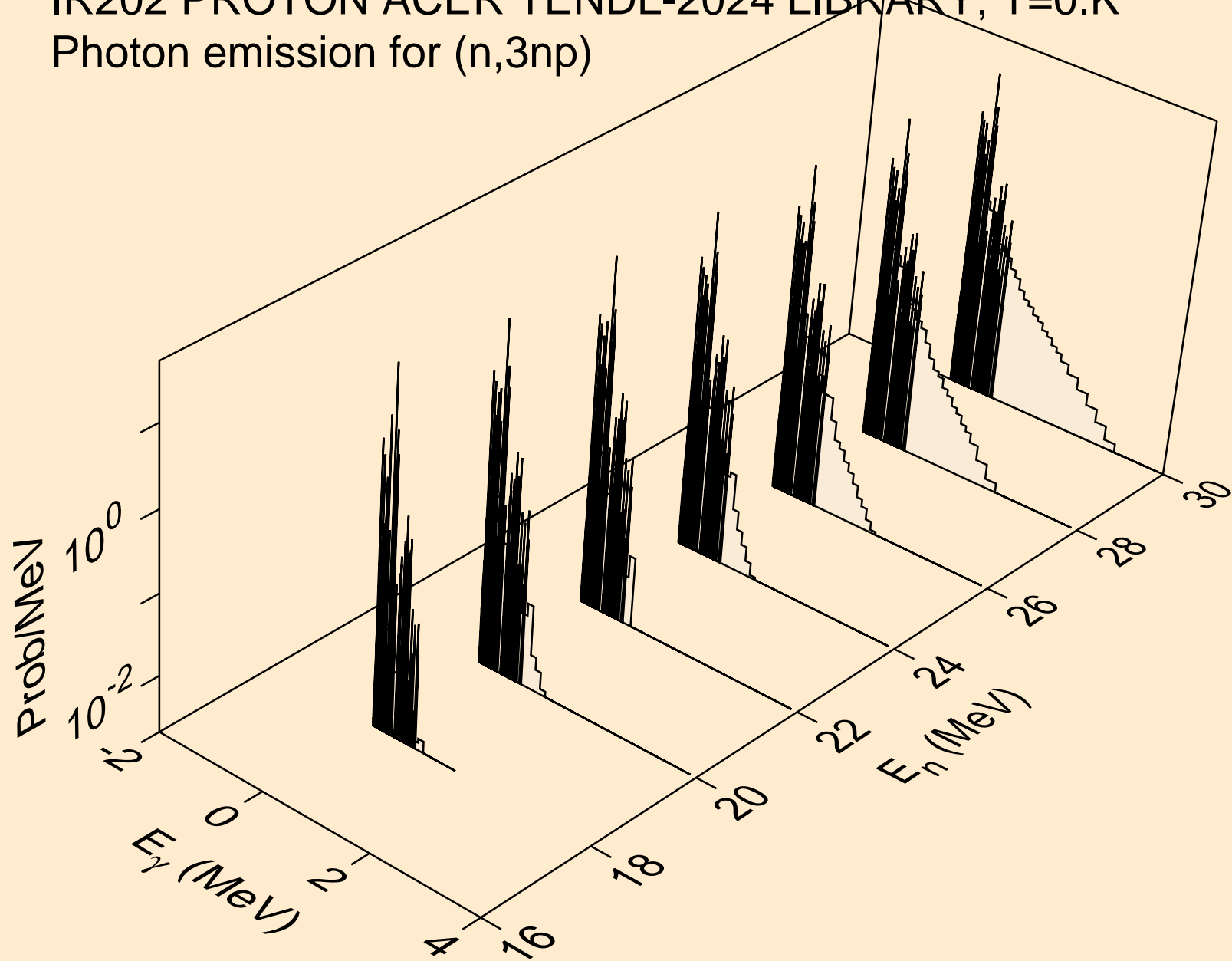

IR202 PROTON ACER TENDL-2024 LIBRARY; T=0.K  
Photon emission for (n,n2p)

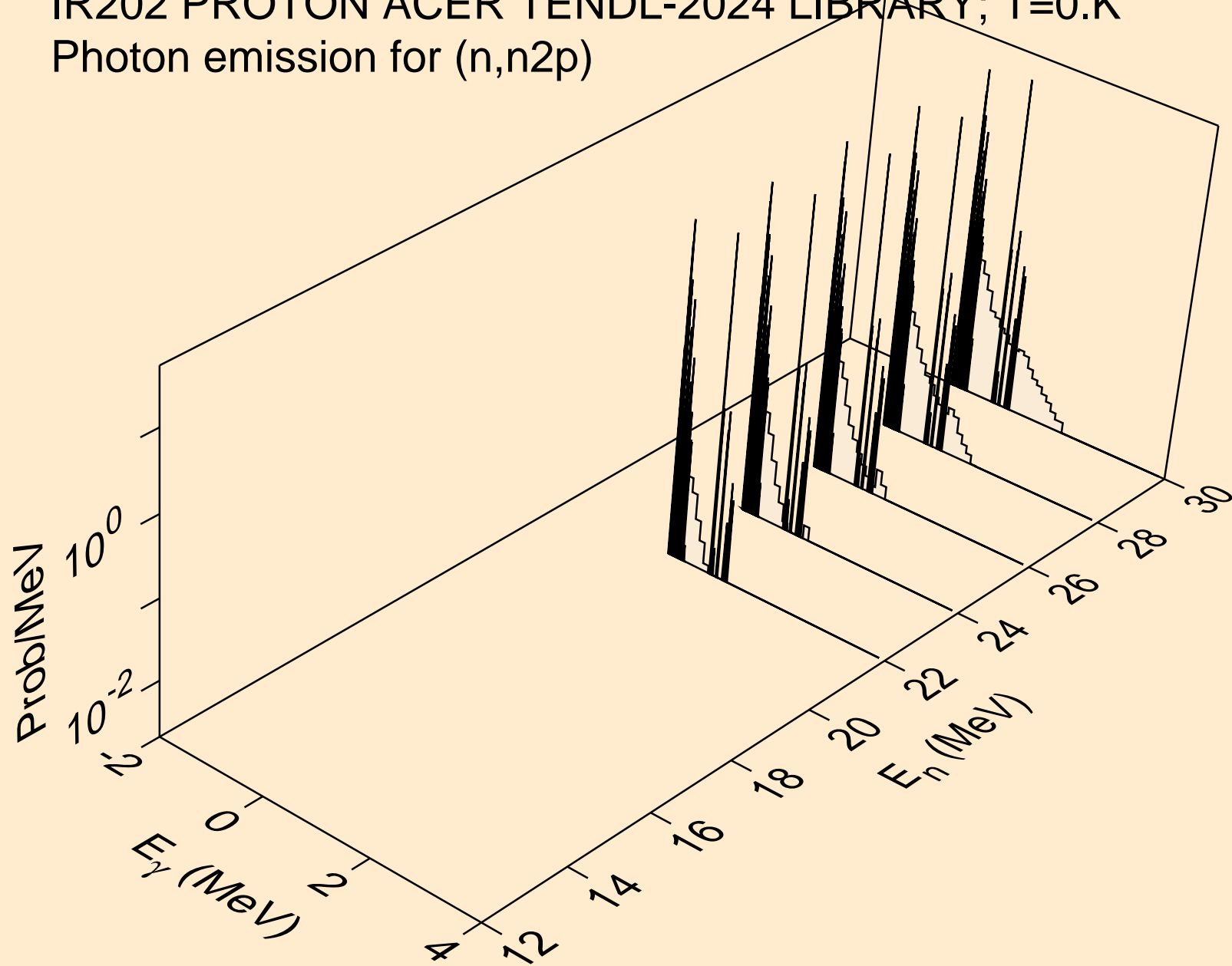

IR202 PROTON ACER TENDL-2024 LIBRARY; T=0.K  
Photon emission for (n,gma)

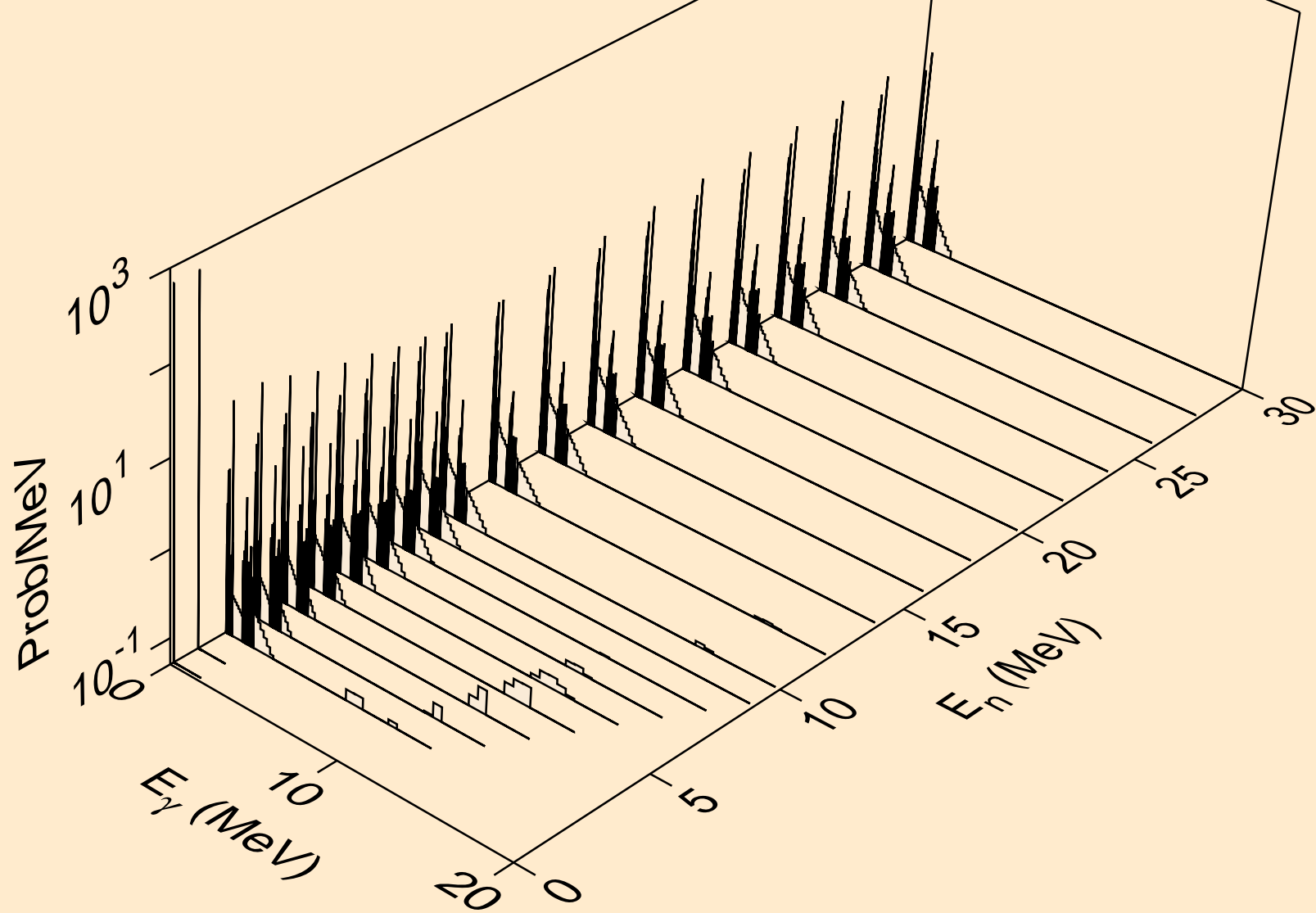

IR202 PROTON ACER TENDL-2024 LIBRARY; T=0.K  
Photon emission for inelastic

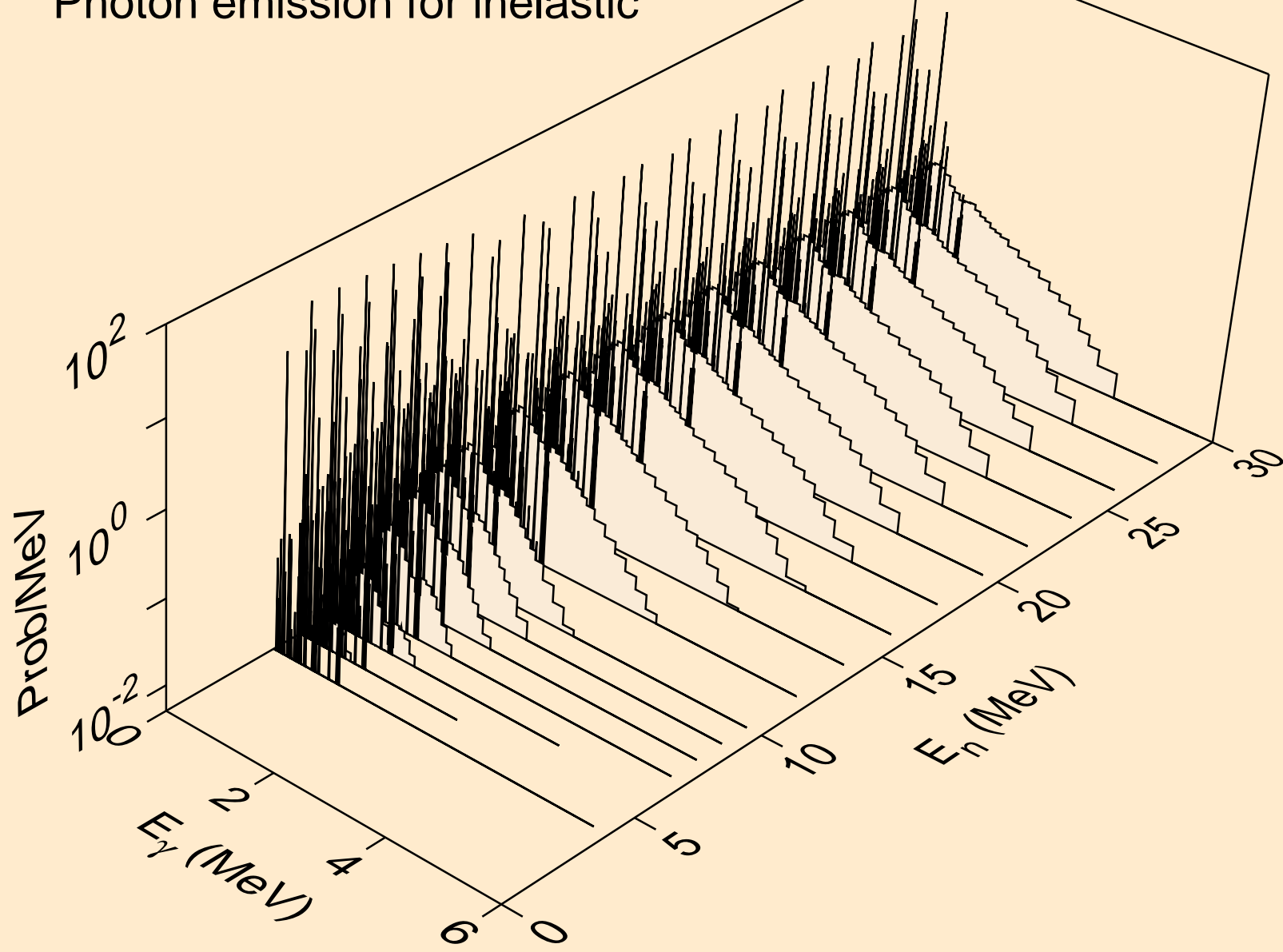

IR202 PROTON ACER TENDL-2024 LIBRARY; T=0.K  
Photon emission for (n,d)

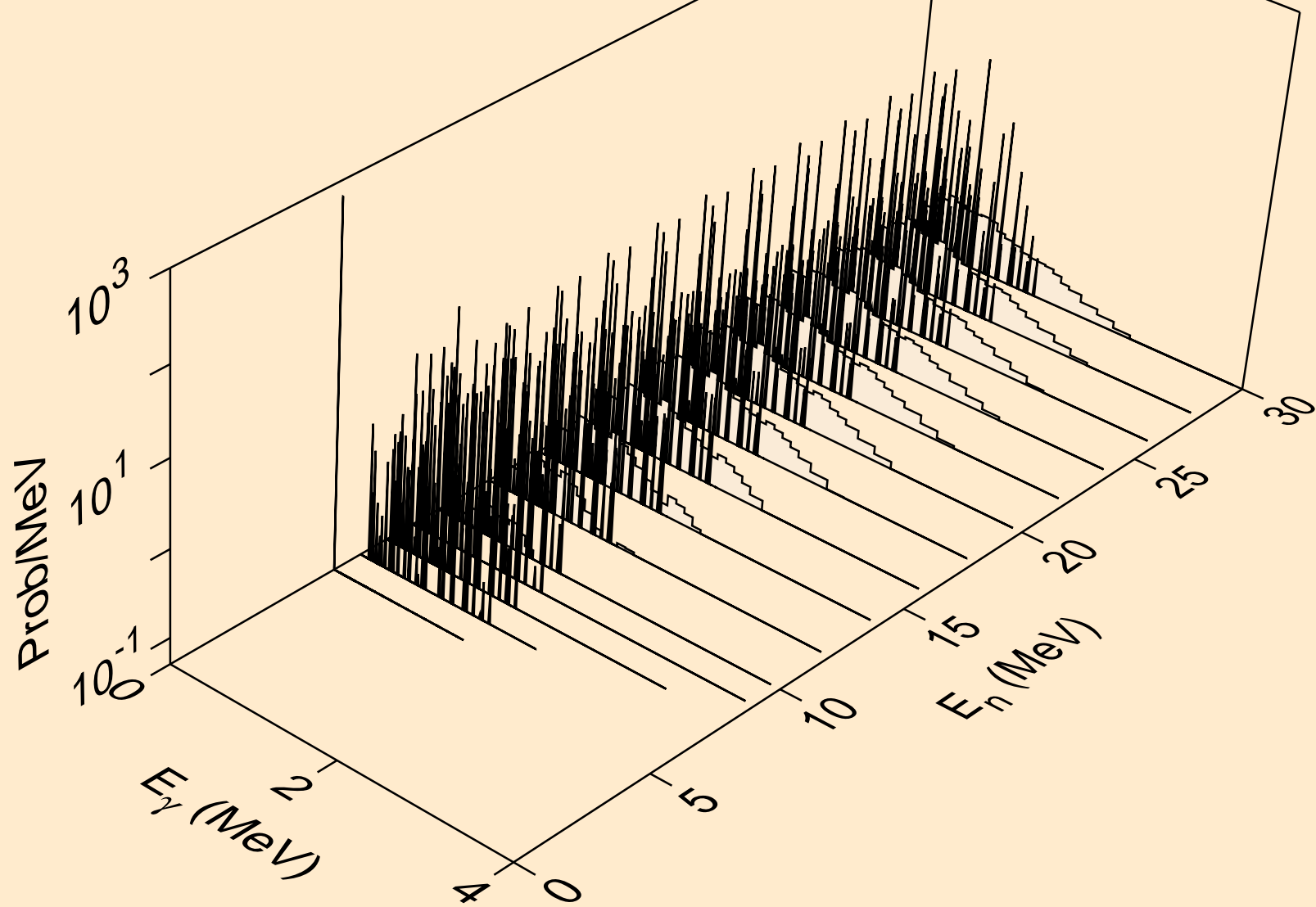

IR202 PROTON ACER TENDL-2024 LIBRARY; T=0.K  
Photon emission for (n,t)

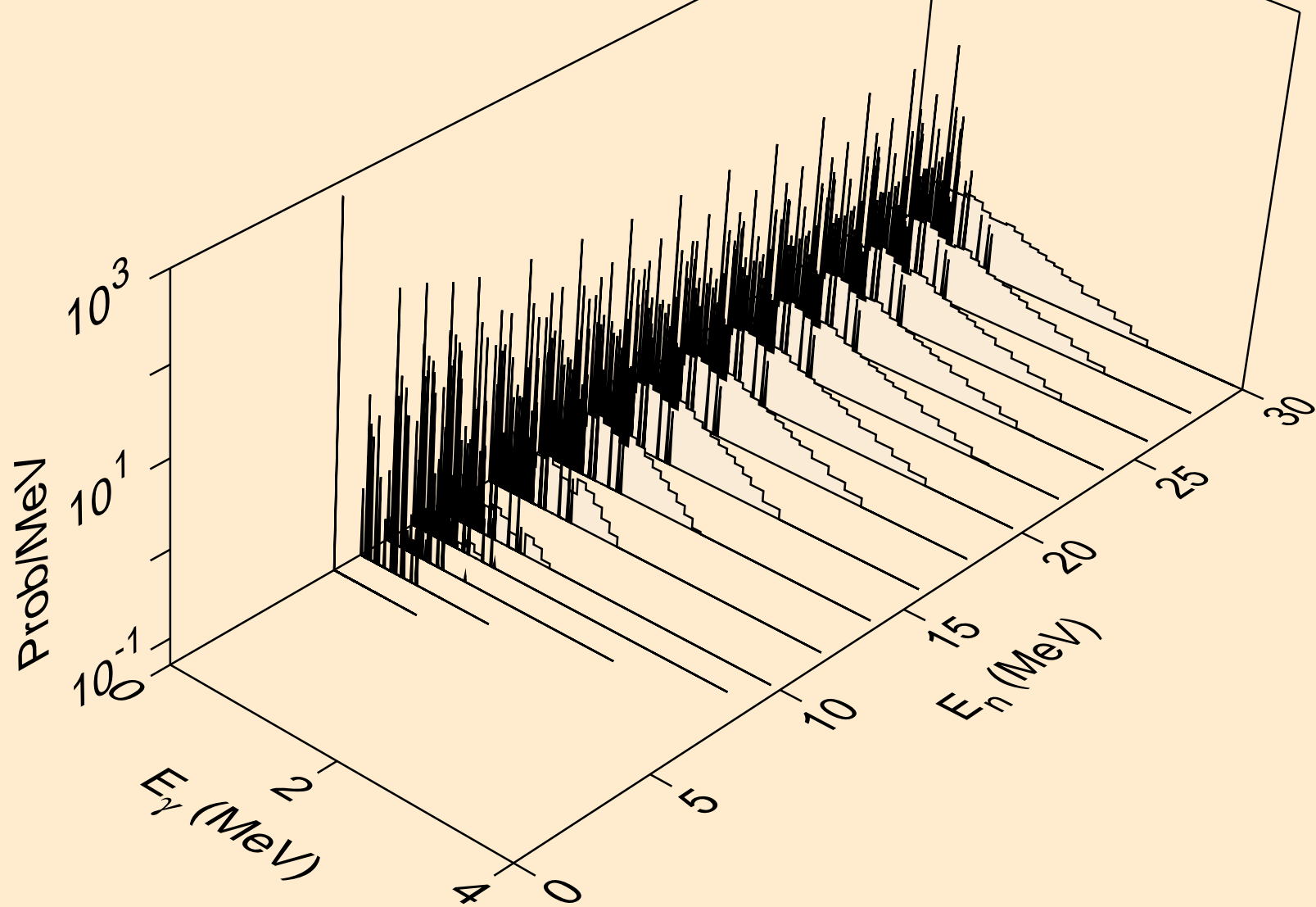

IR202 PROTON ACER TENDL-2024 LIBRARY; T=0.K  
Photon emission for (n,he3)

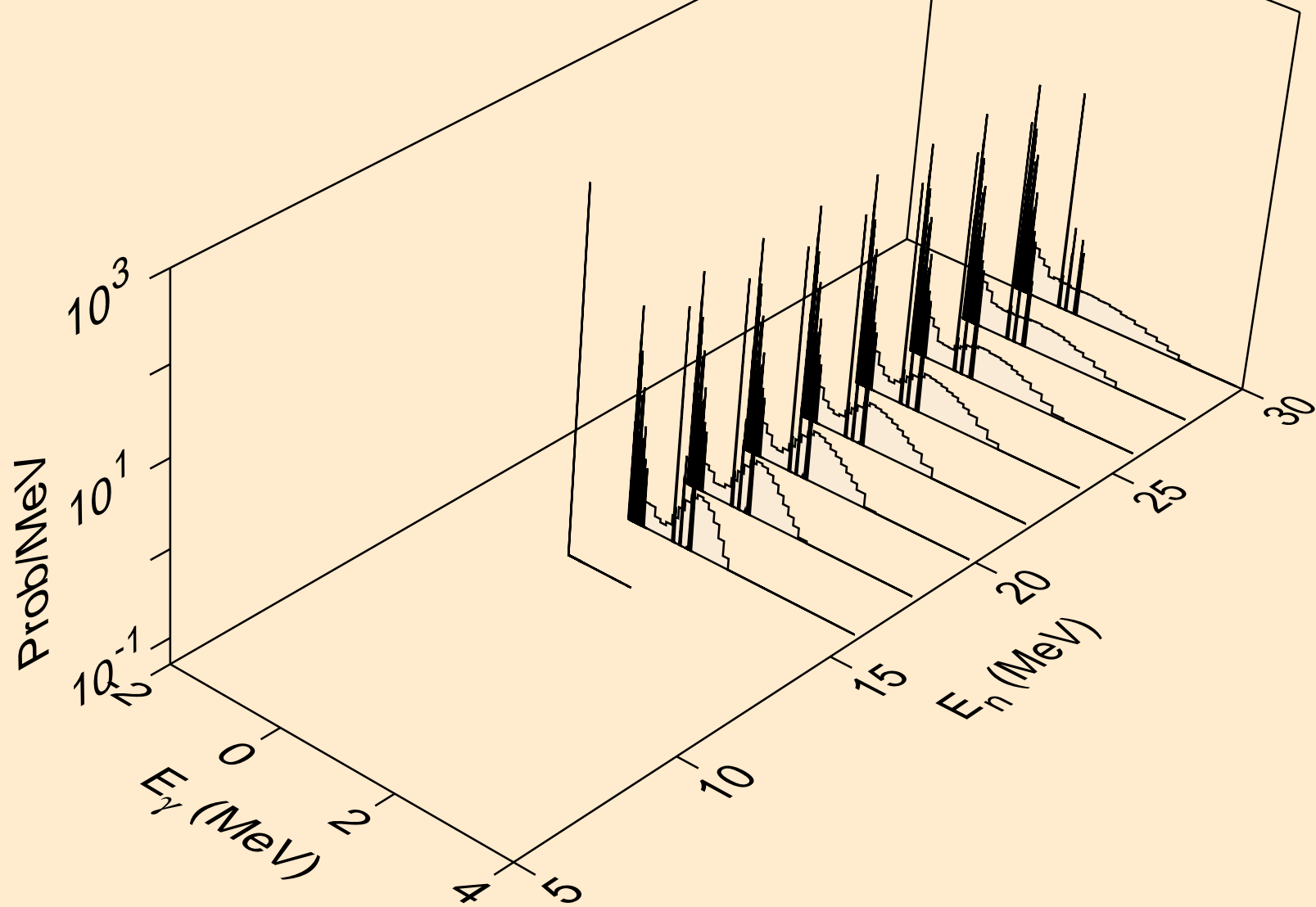

IR202 PROTON ACER TENDL-2024 LIBRARY; T=0.K  
Photon emission for (n,a)

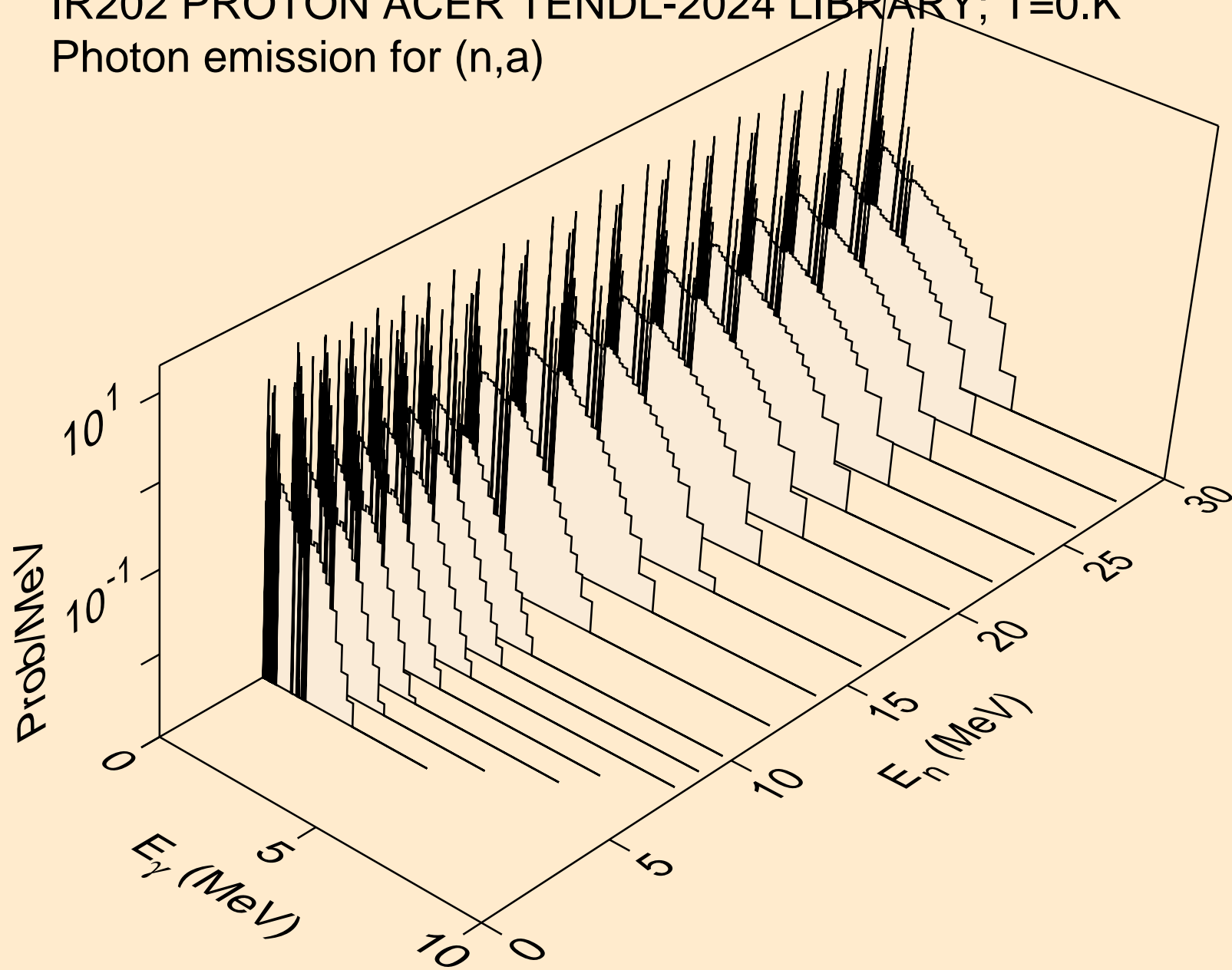

IR202 PROTON ACER TENDL-2024 LIBRARY; T=0.K  
Photon emission for (n,2p)

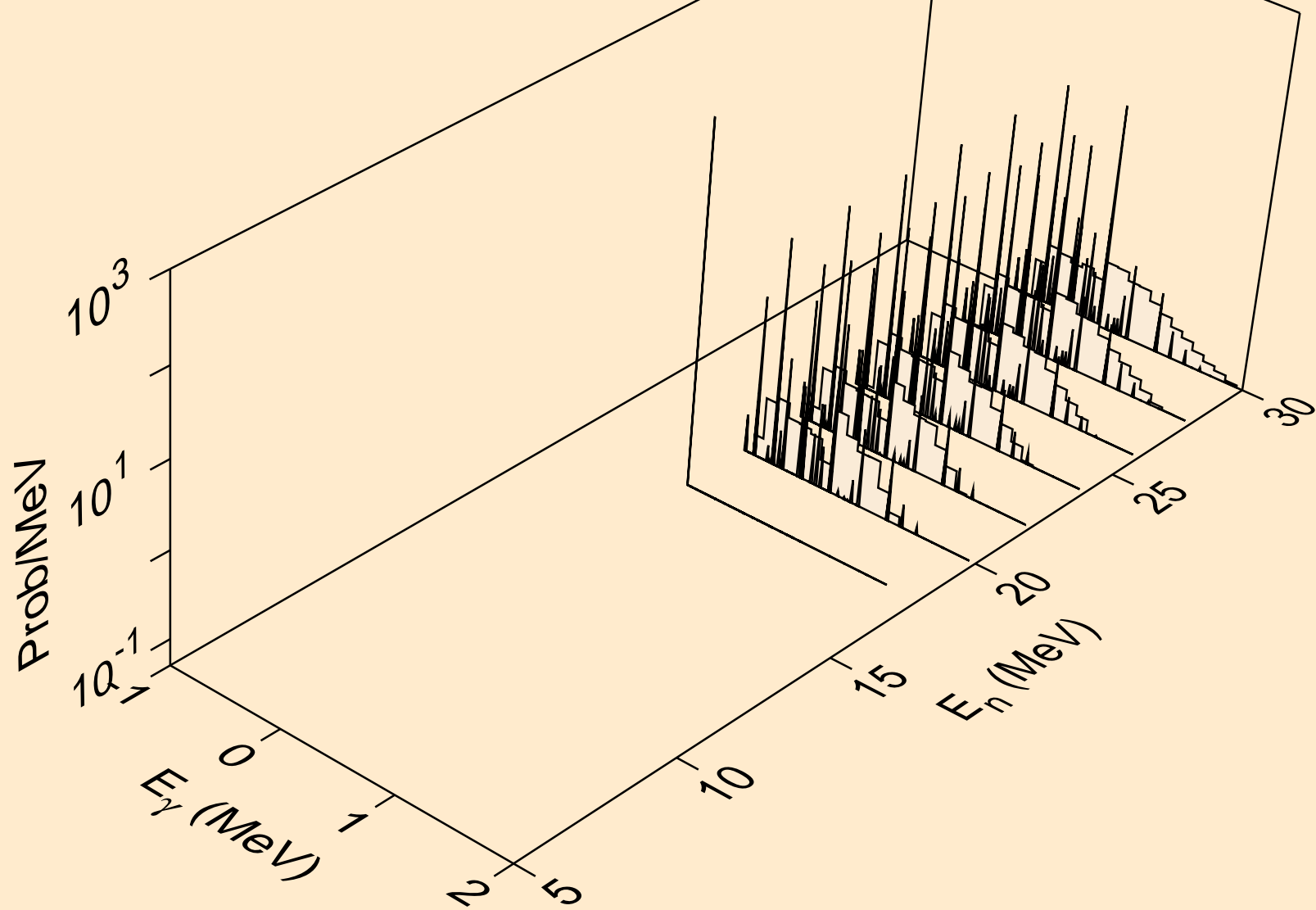

# IR202 PROTON ACER TENDL-2024 LIBRARY; T=0.K

## Particle heating contributions

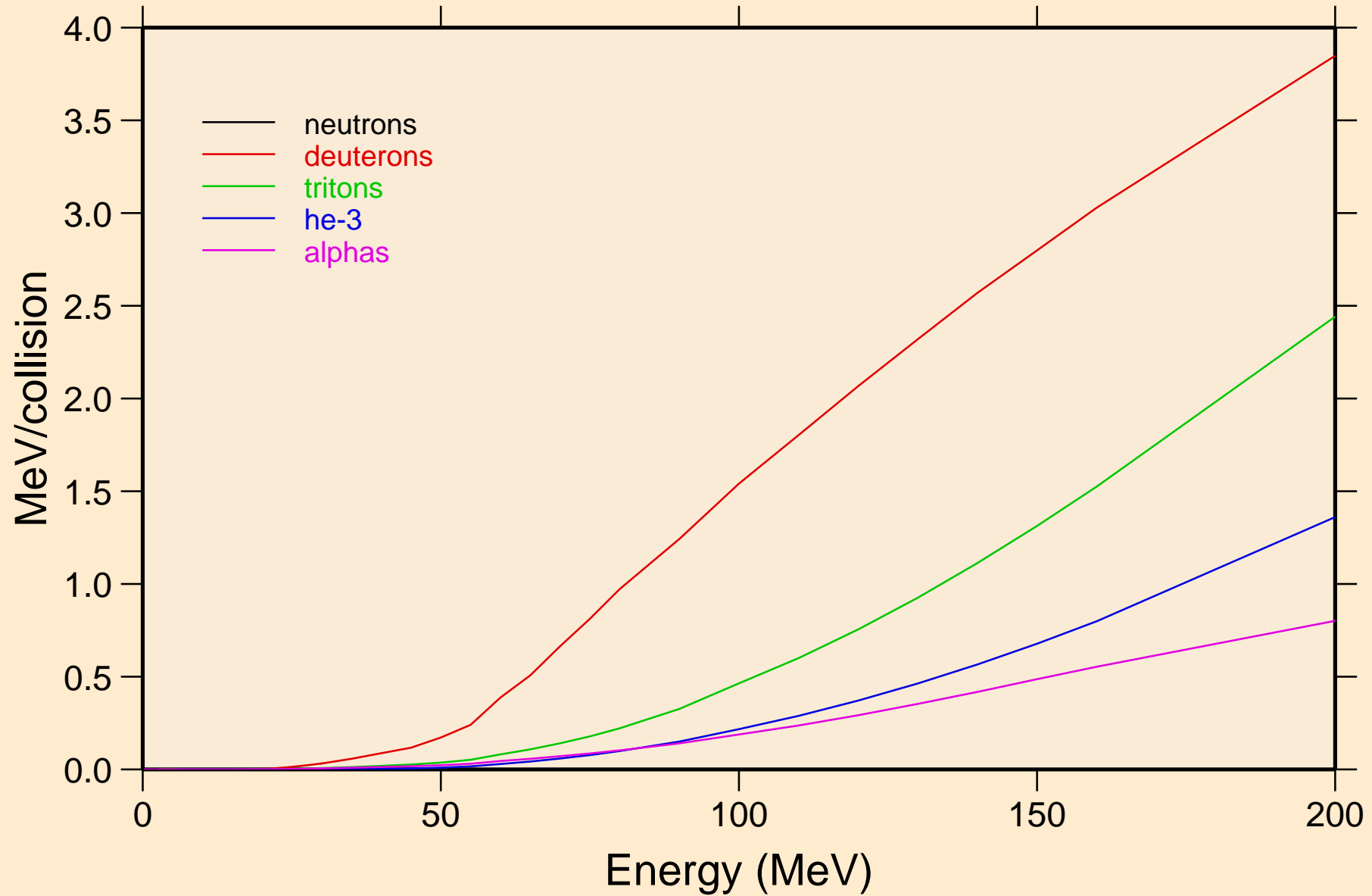

IR202 PROTON ACER TENDL-2024 LIBRARY; T=0.K  
Recoil Heating

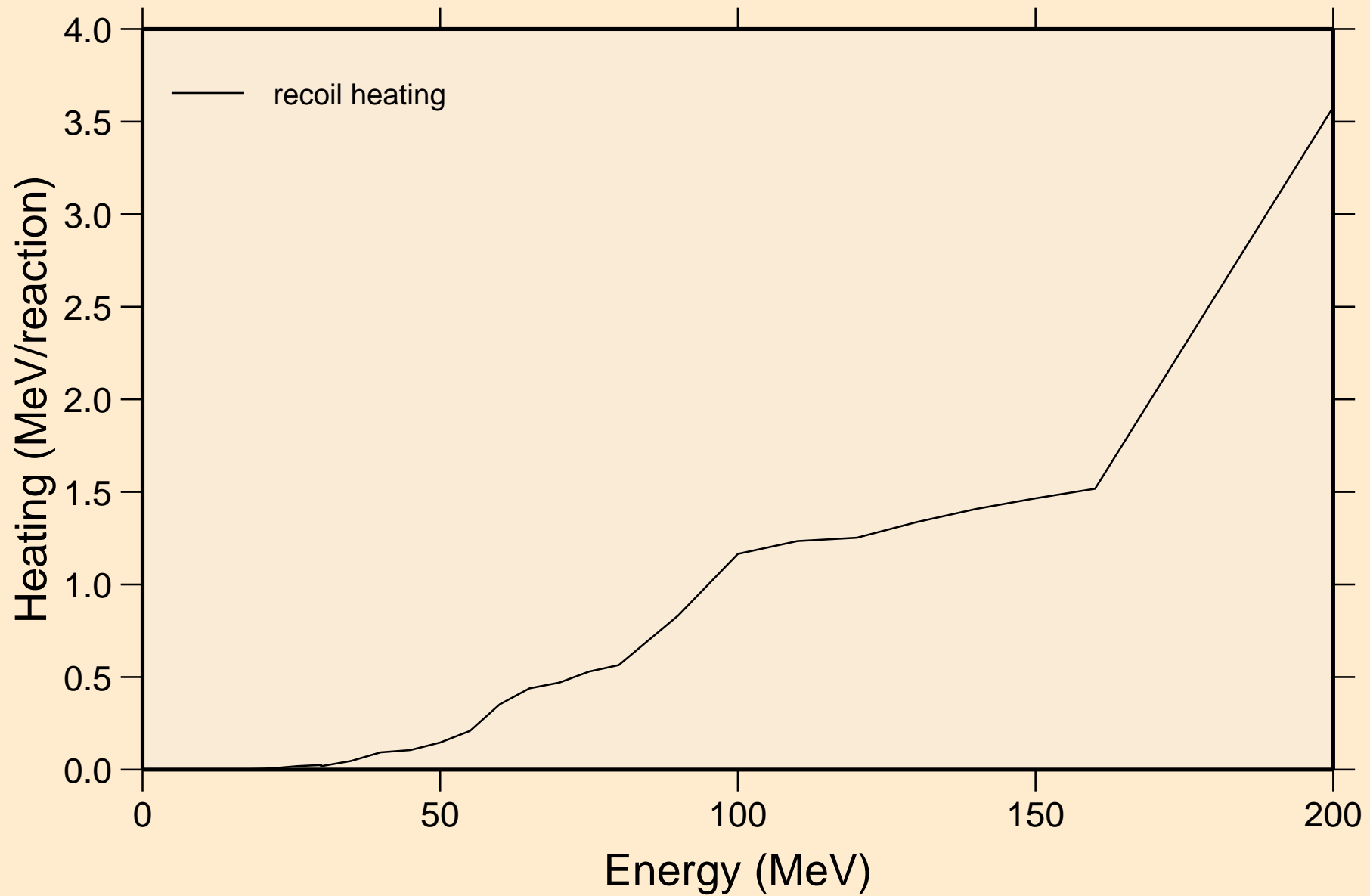

IR202 PROTON ACER TENDL-2024 LIBRARY; T=0.K  
Particle production cross sections

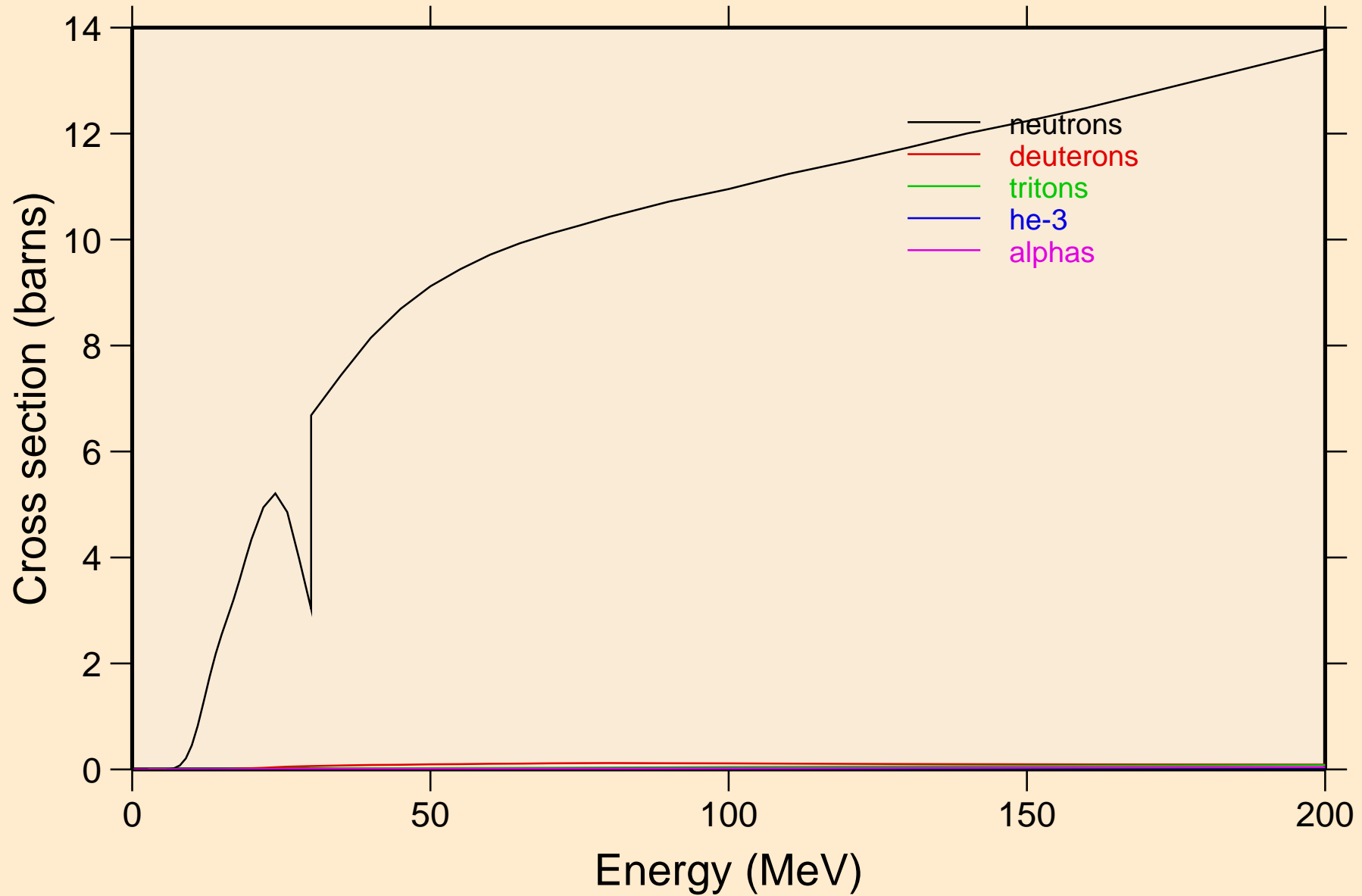

IR202 PROTON ACER TENDL-2024 LIBRARY; T=0.K  
neutrons from (p,n)

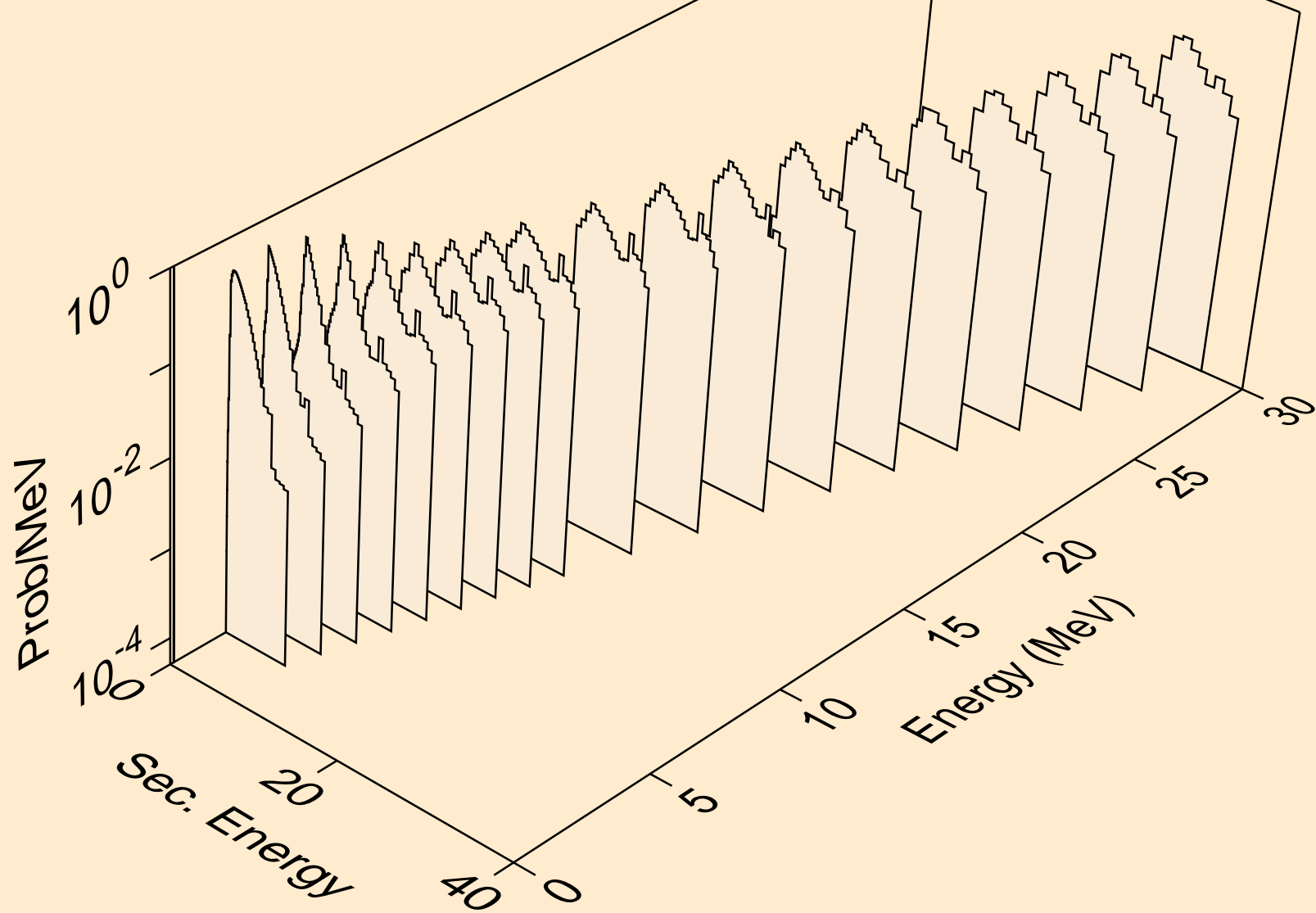

IR202 PROTON ACER TENDL-2024 LIBRARY; T=0.K  
neutrons from (p,x)

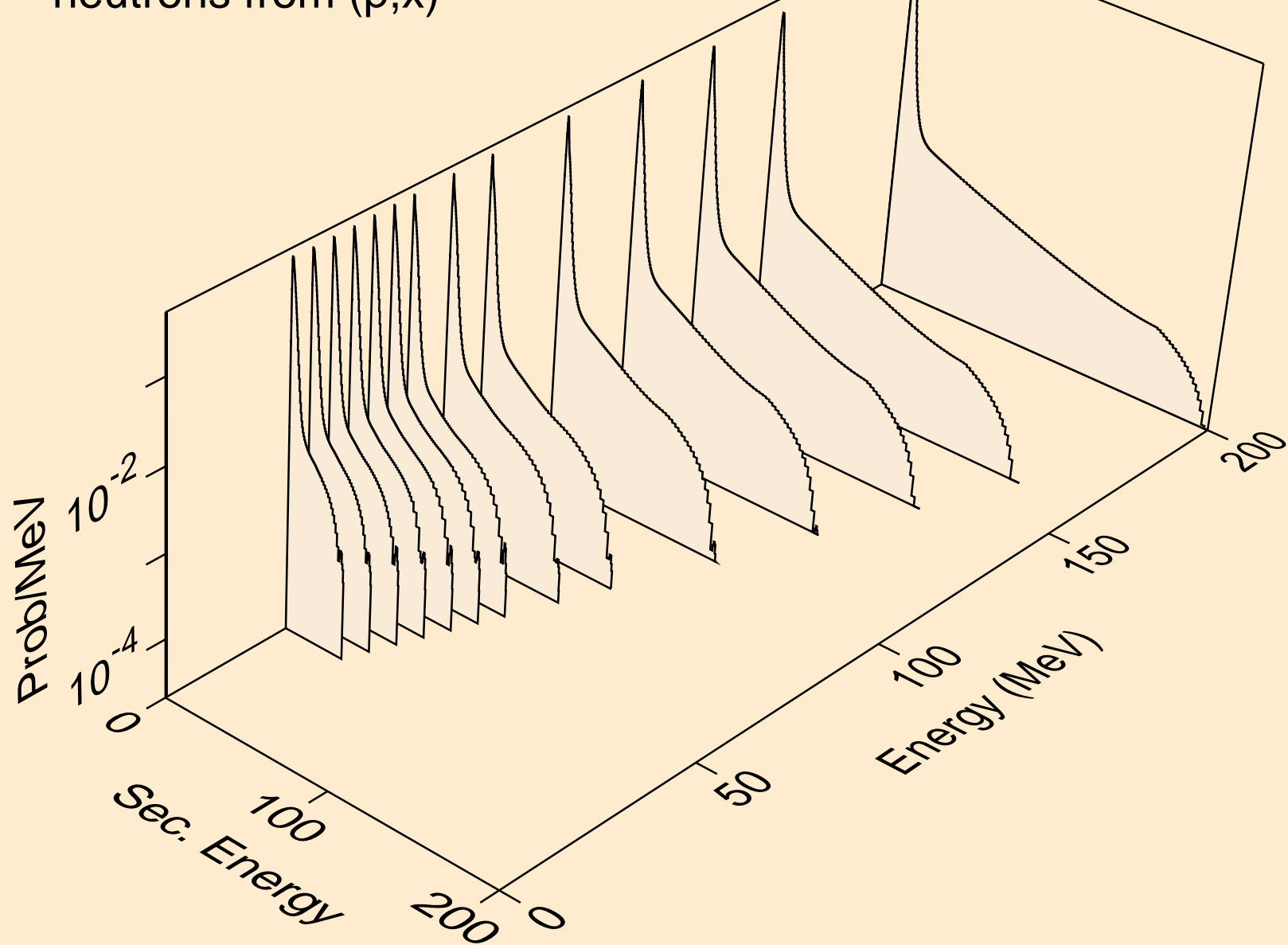

IR202 PROTON ACER TENDL-2024 LIBRARY; T=0.K  
neutrons from (p,2nd)

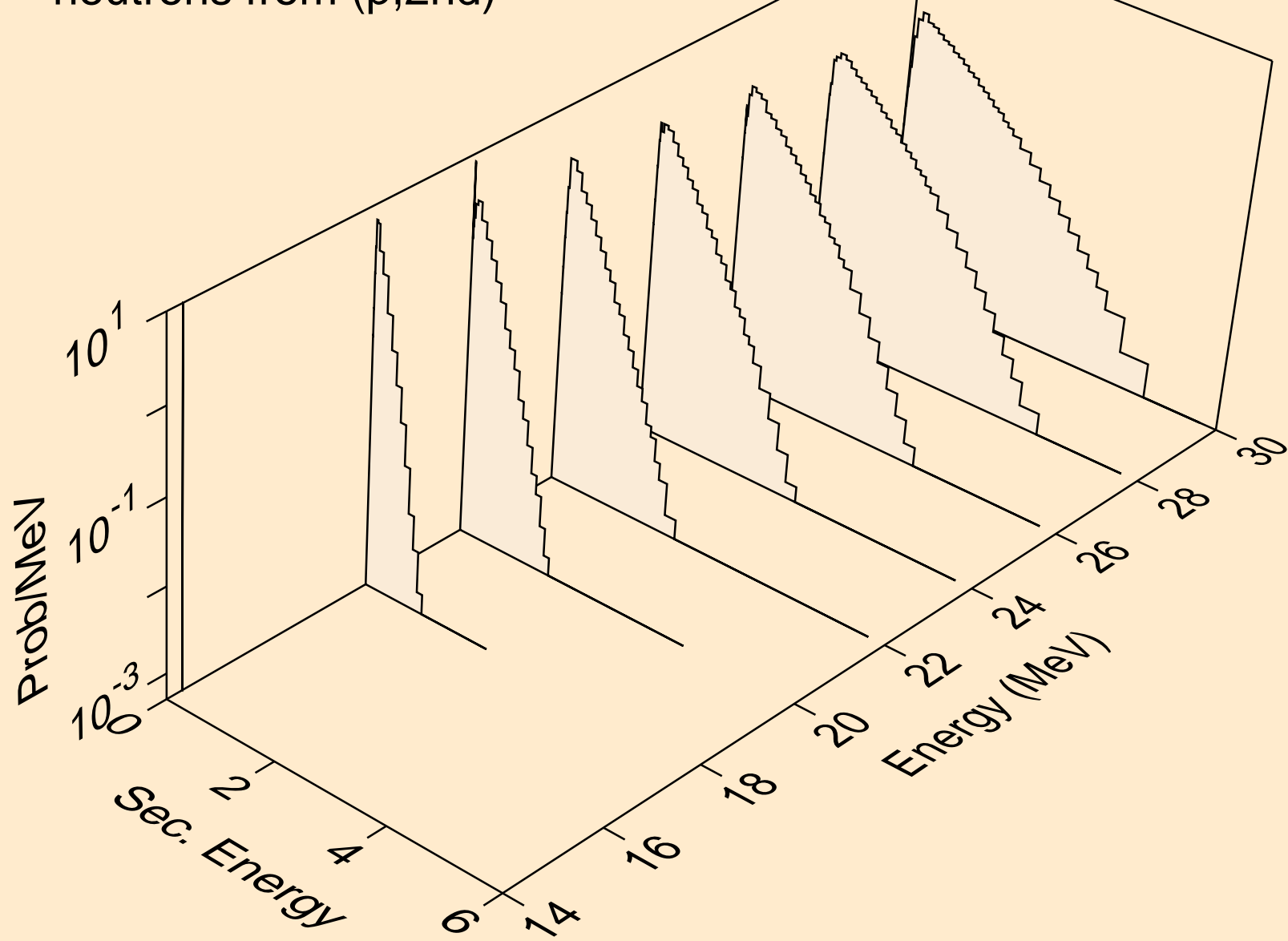

IR202 PROTON ACER TENDL-2024 LIBRARY; T=0.K  
neutrons from (p,2n)

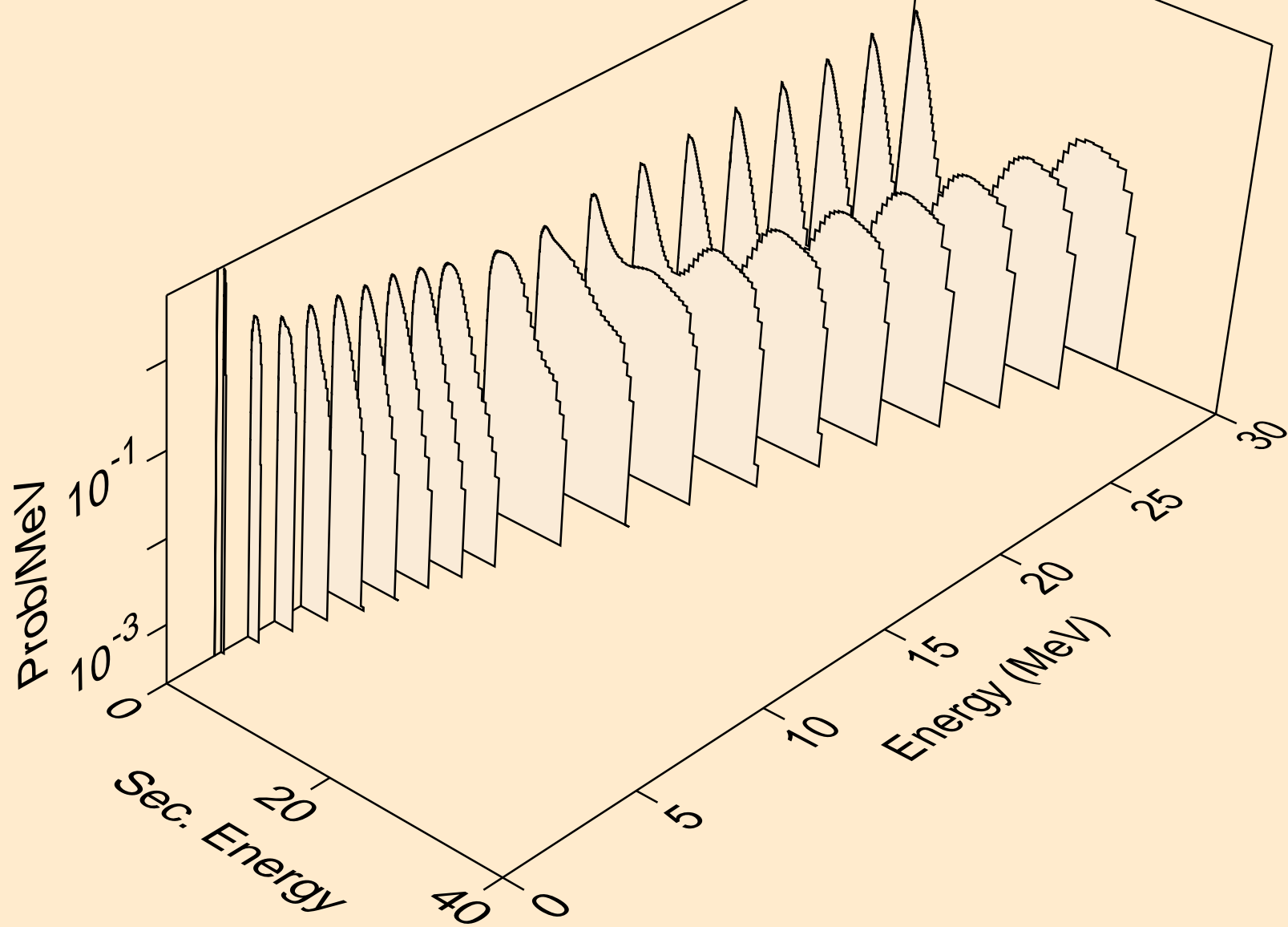

IR202 PROTON ACER TENDL-2024 LIBRARY; T=0.K  
neutrons from (p,3n)

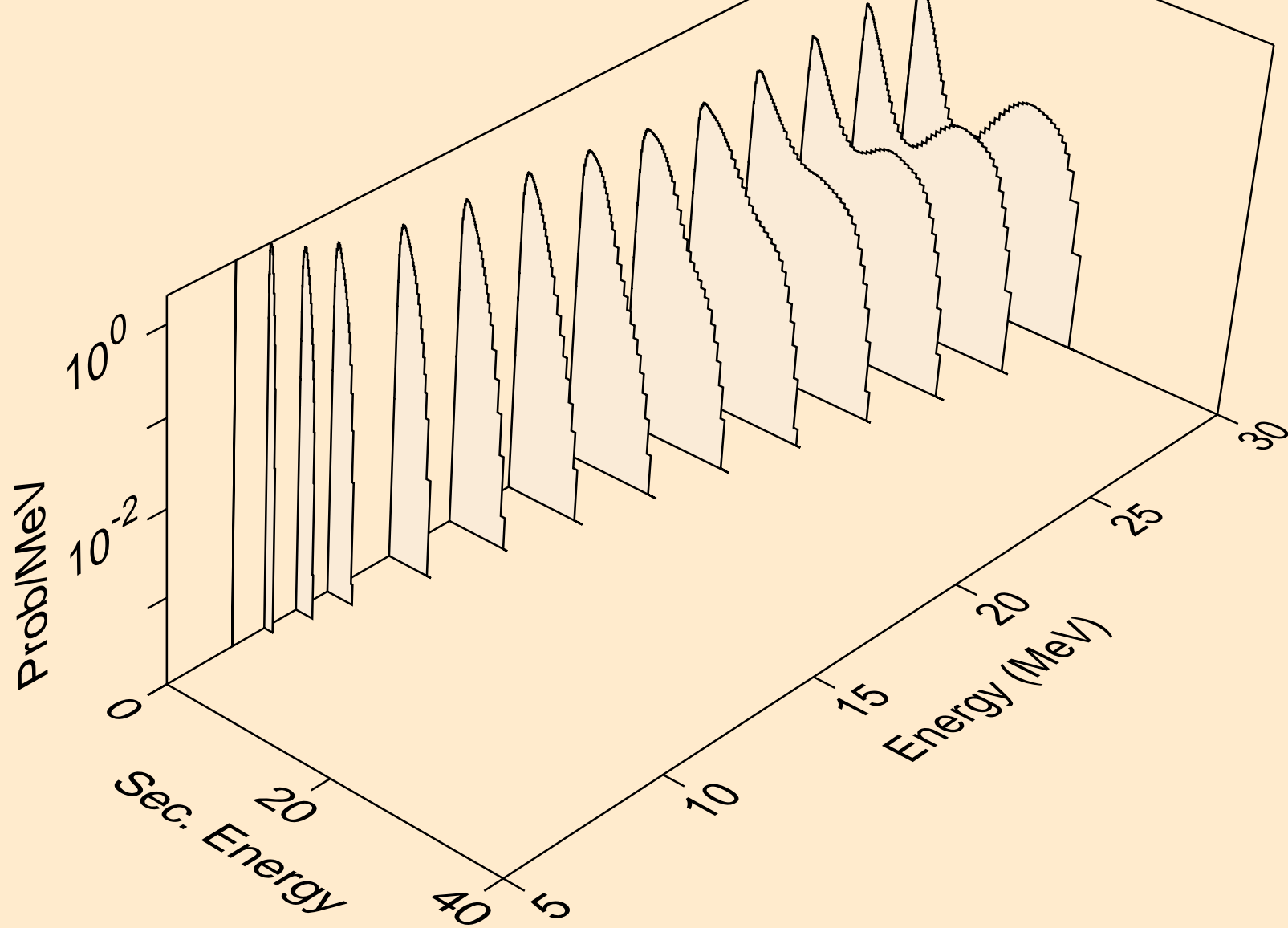

IR202 PROTON ACER TENDL-2024 LIBRARY; T=0.K  
neutrons from (p,n\*)a

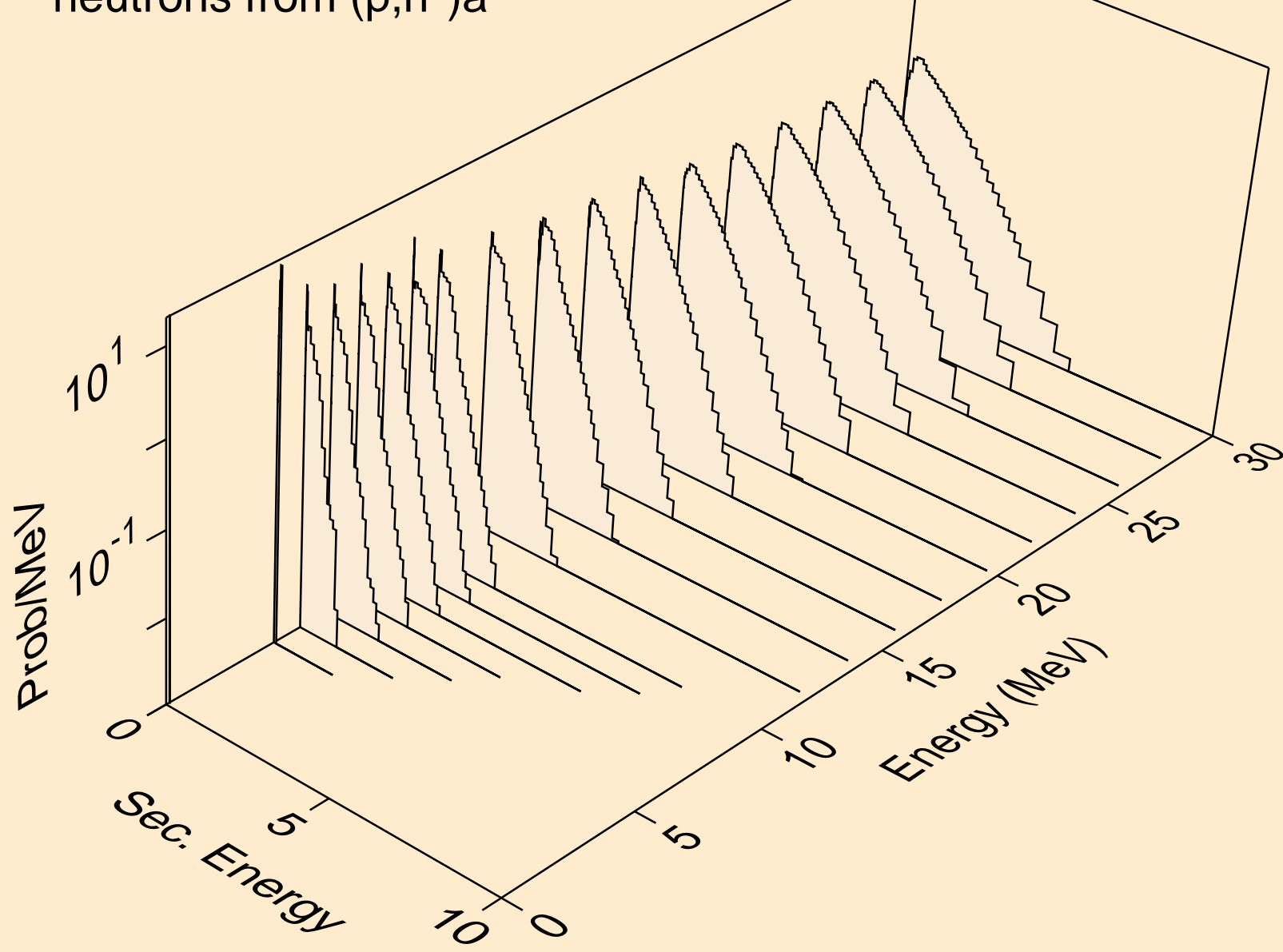

IR202 PROTON ACER TENDL-2024 LIBRARY; T=0.K  
neutrons from (p,2n)a

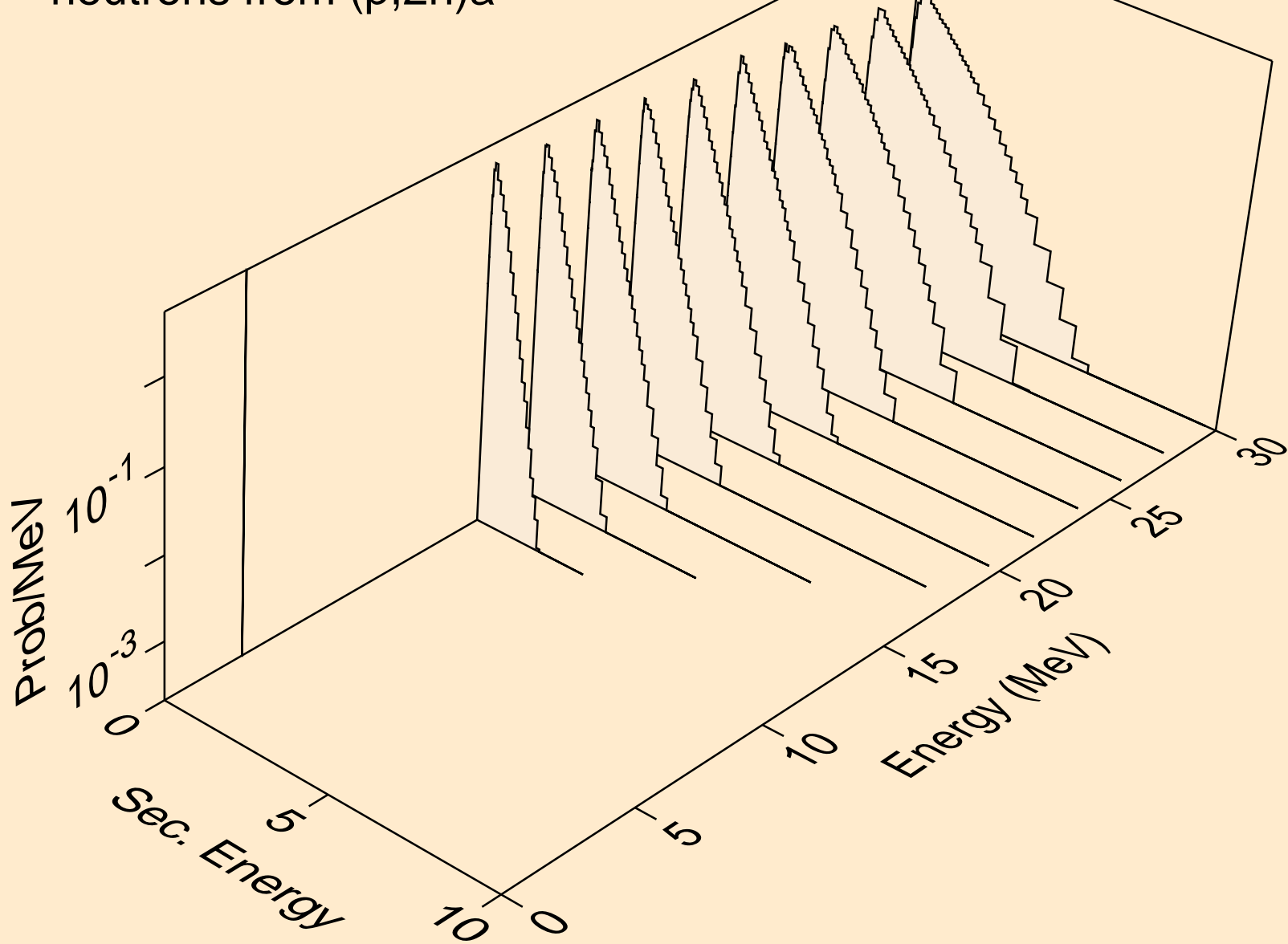

IR202 PROTON ACER TENDL-2024 LIBRARY; T=0.K  
neutrons from (p,3n)a

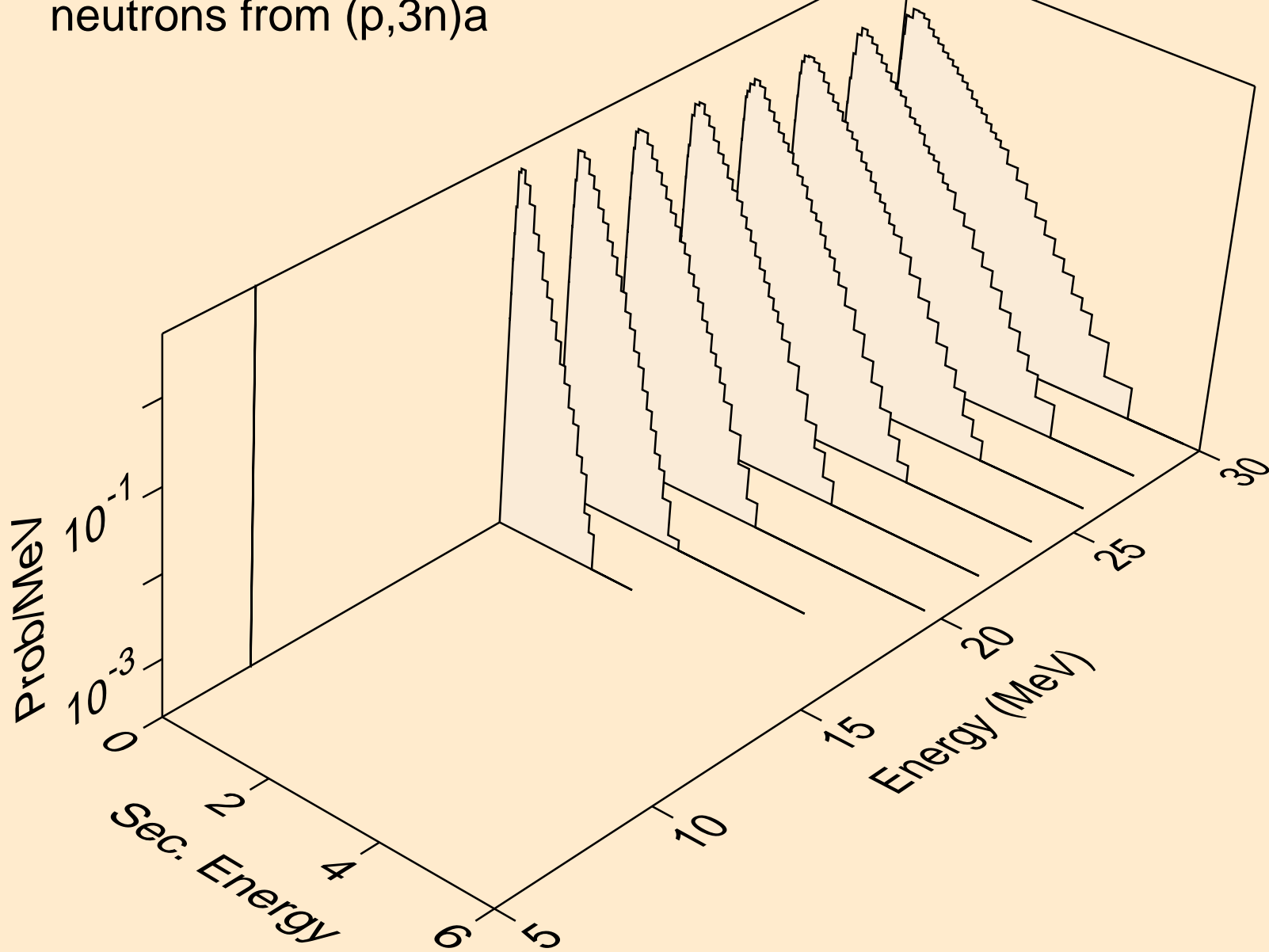

IR202 PROTON ACER TENDL-2024 LIBRARY; T=0.K  
neutrons from (p,n\*)p

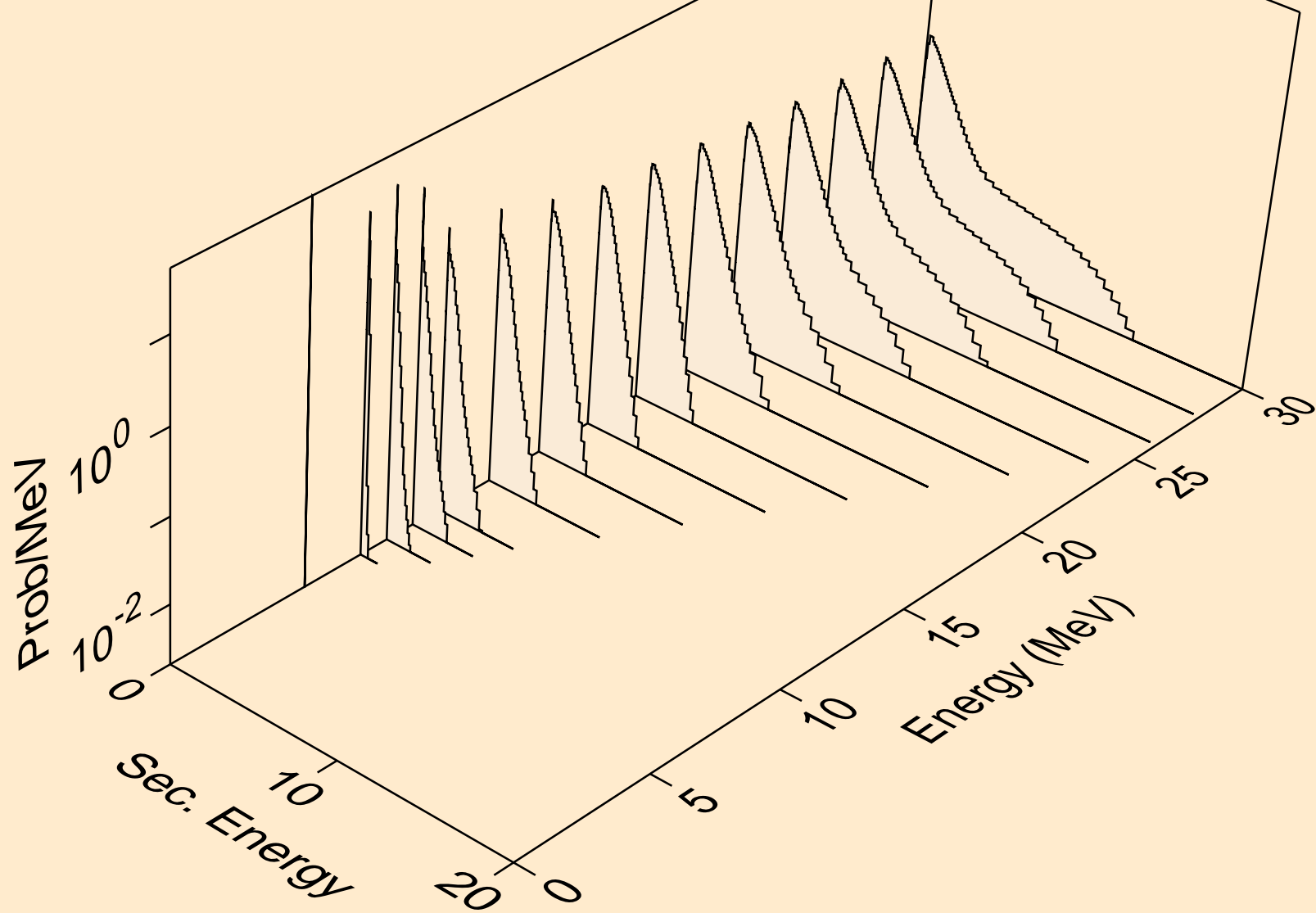

IR202 PROTON ACER TENDL-2024 LIBRARY; T=0.K  
neutrons from (p,n\*)d

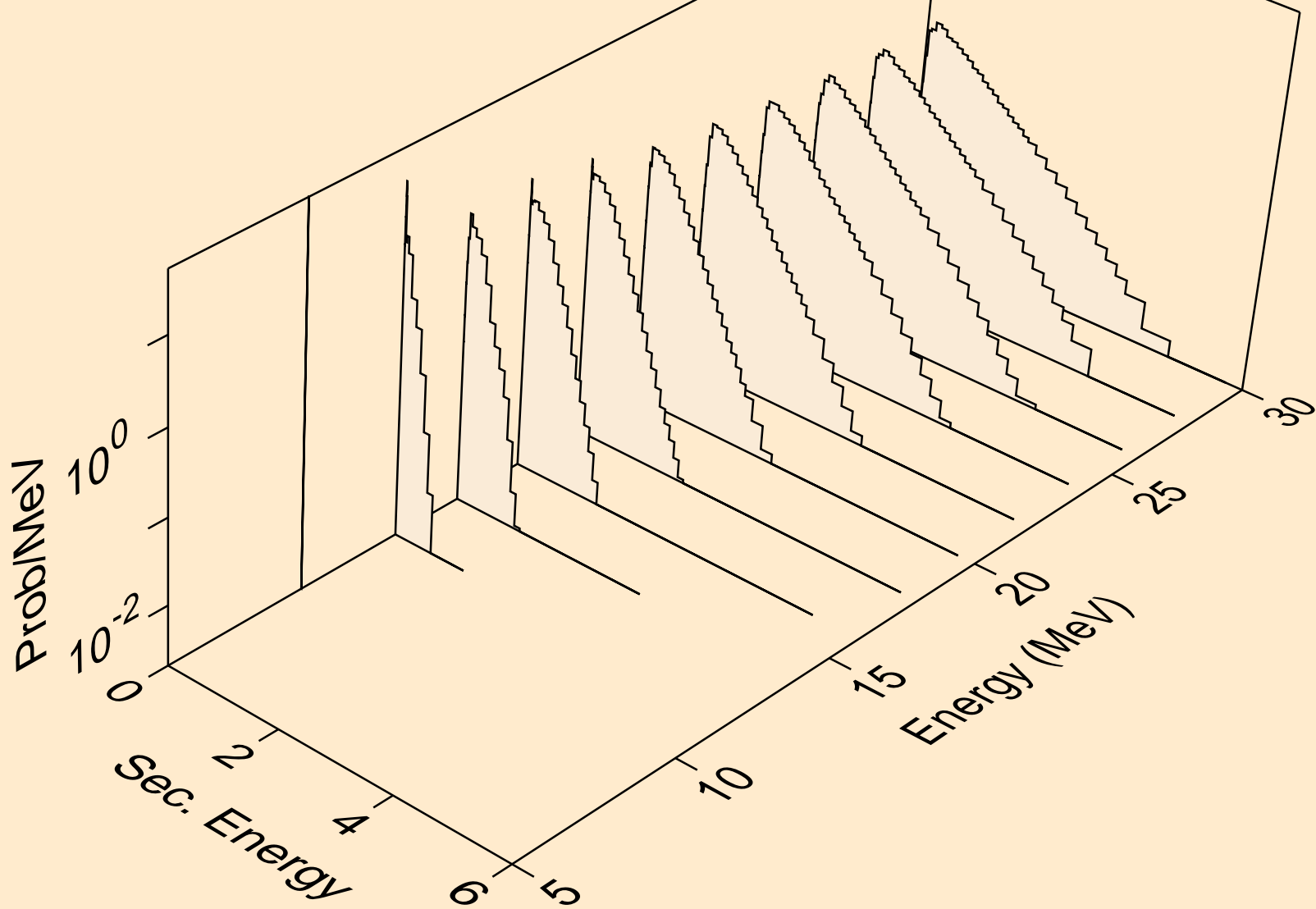

IR202 PROTON ACER TENDL-2024 LIBRARY; T=0.K  
neutrons from (p,n\*)t

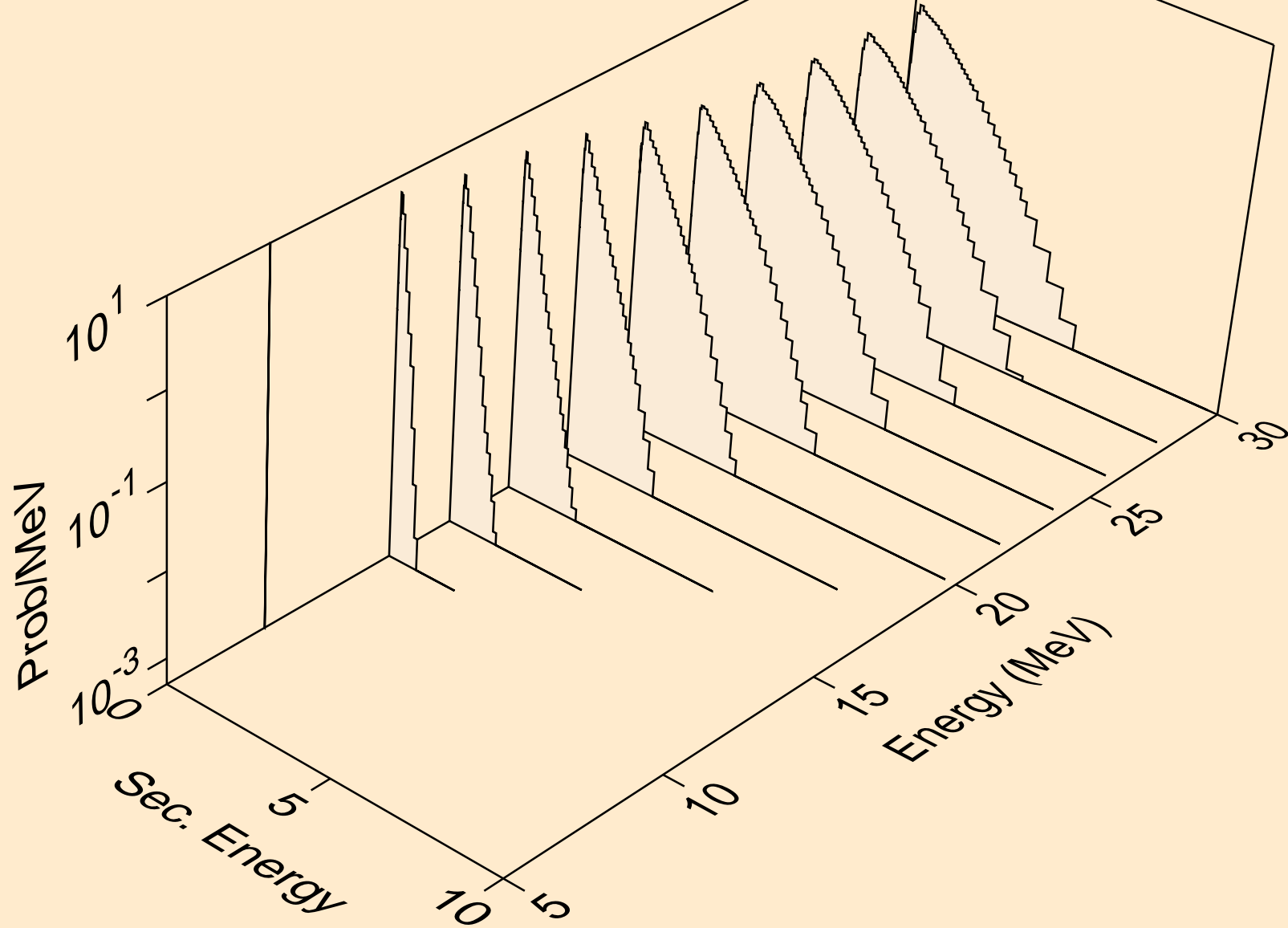

IR202 PROTON ACER TENDL-2024 LIBRARY; T=0.K  
neutrons from (p,n\*)he3

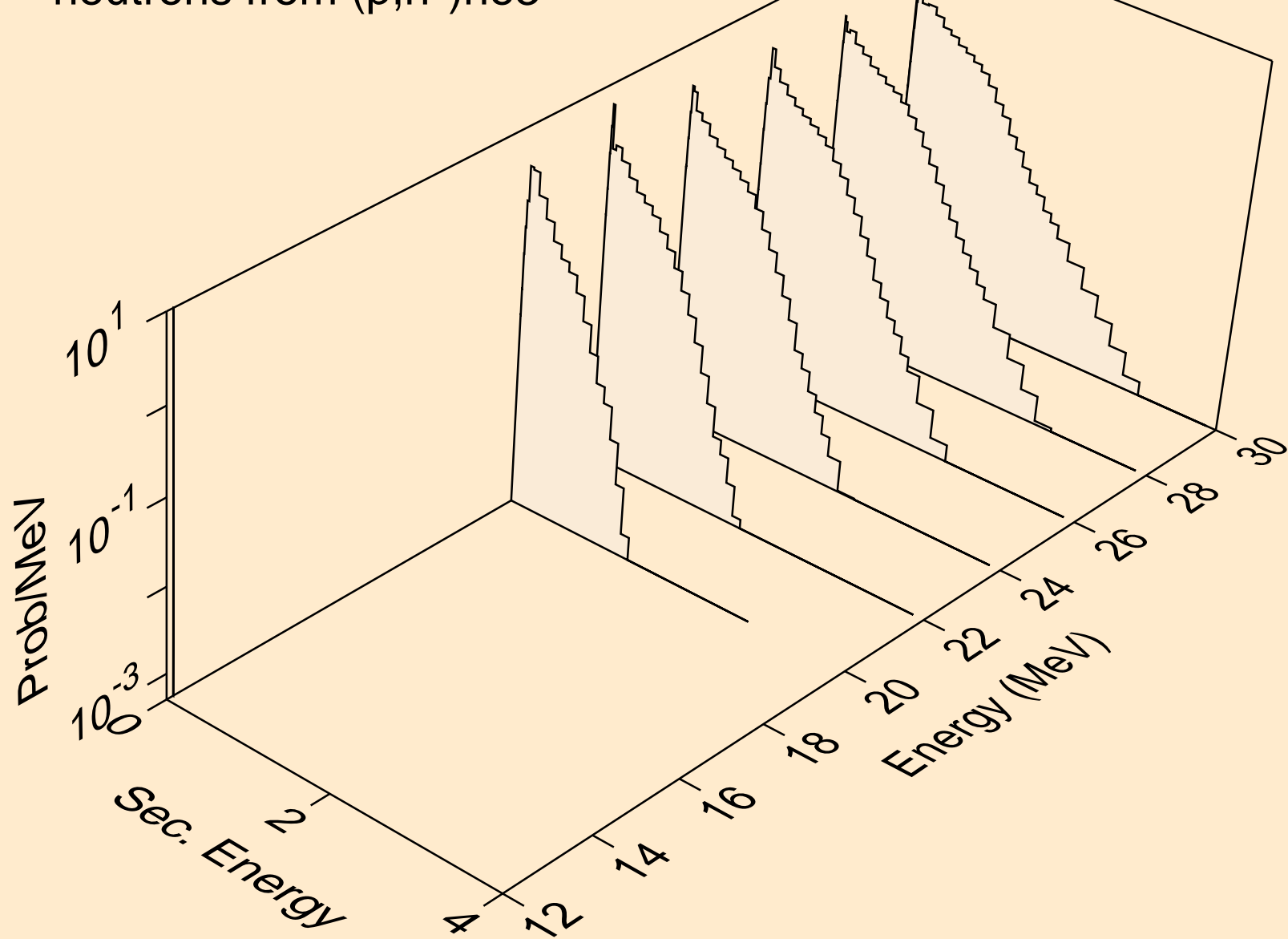

IR202 PROTON ACER TENDL-2024 LIBRARY; T=0.K  
neutrons from (p,4n)

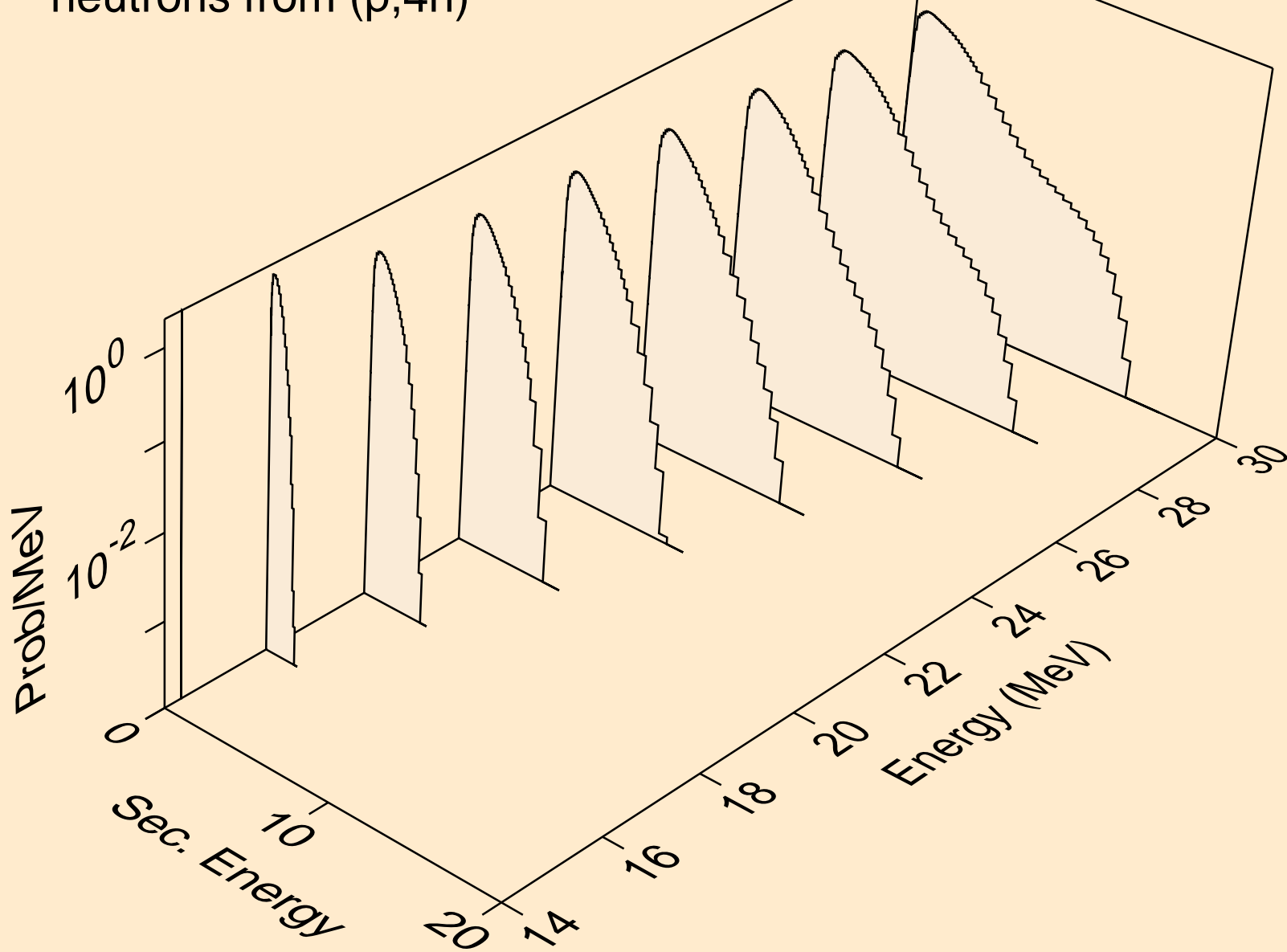

IR202 PROTON ACER TENDL-2024 LIBRARY; T=0.K  
neutrons from (p,2np)

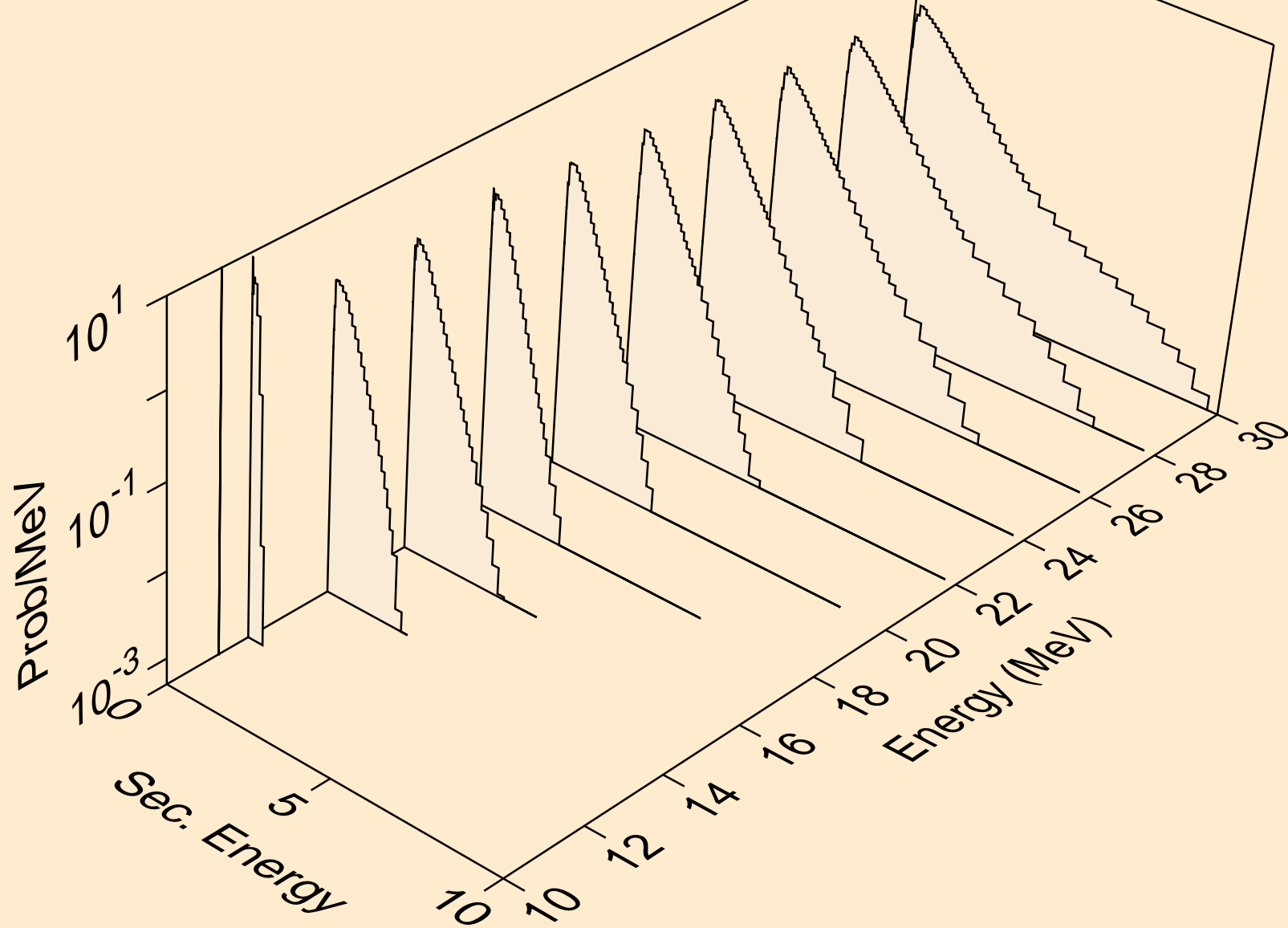

IR202 PROTON ACER TENDL-2024 LIBRARY; T=0.K  
neutrons from (p,3np)

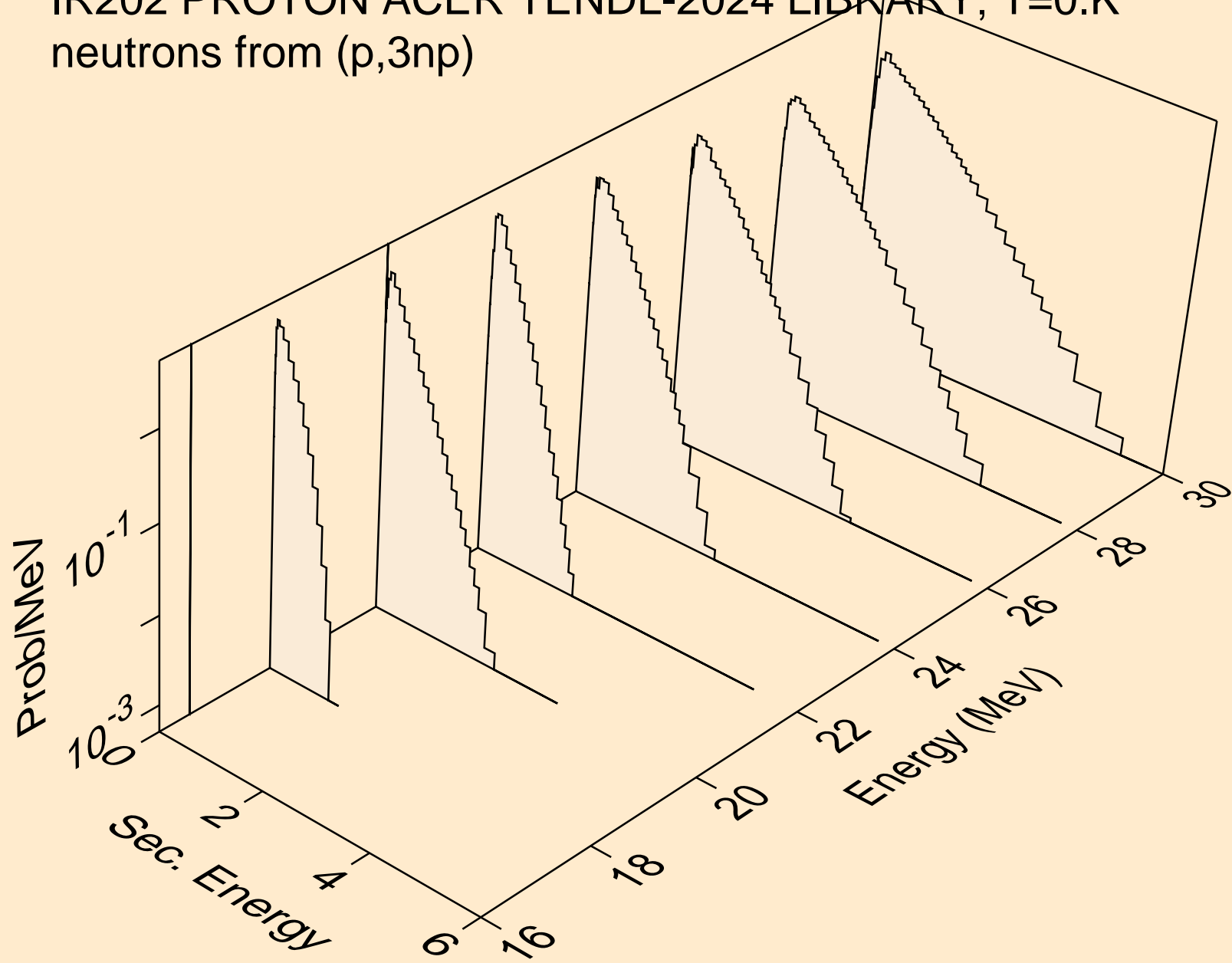

IR202 PROTON ACER TENDL-2024 LIBRARY; T=0.K  
neutrons from (p,n2p)

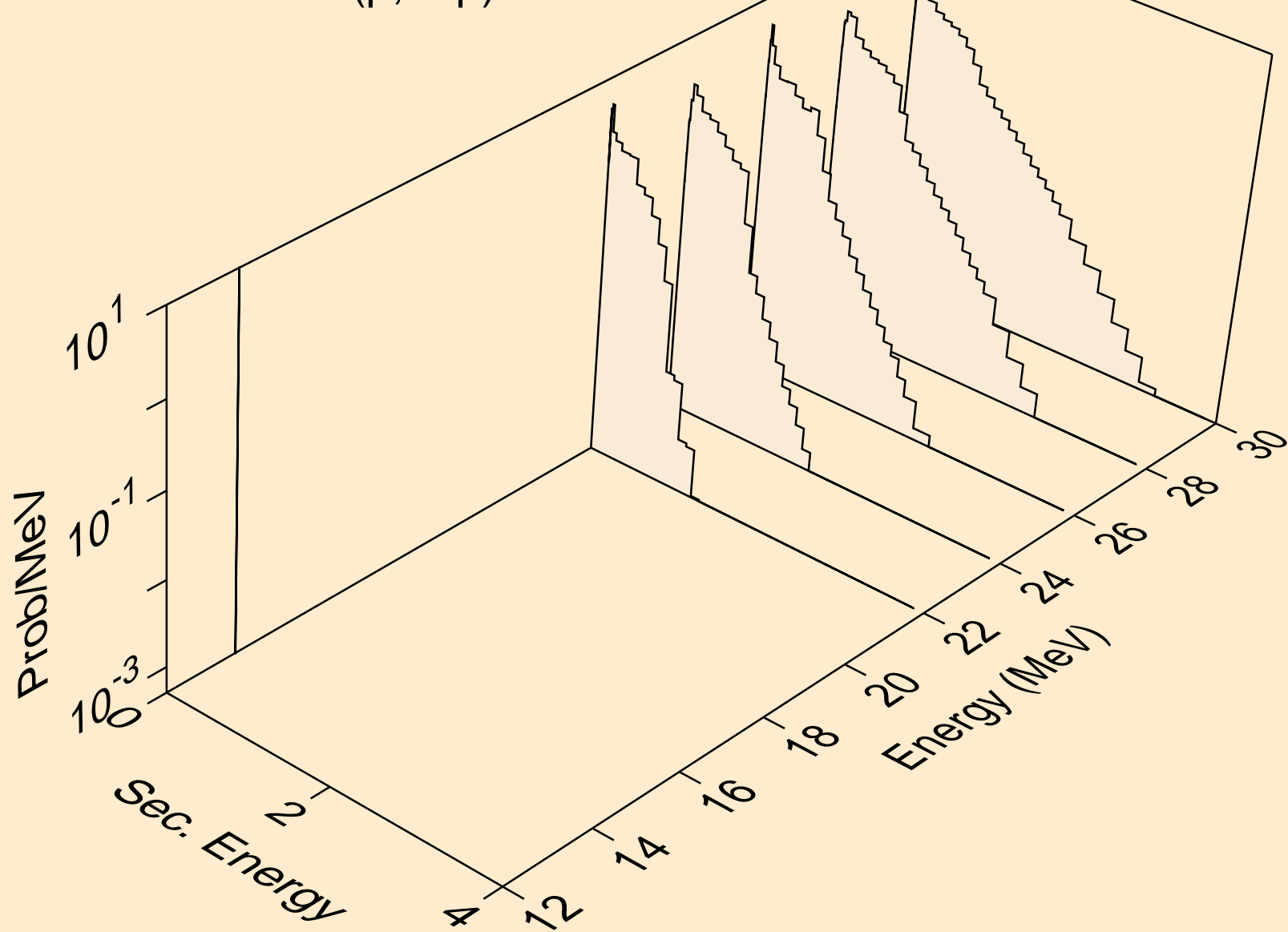

IR202 PROTON ACER TENDL-2024 LIBRARY; T=0.K  
deuterons from (p,x)

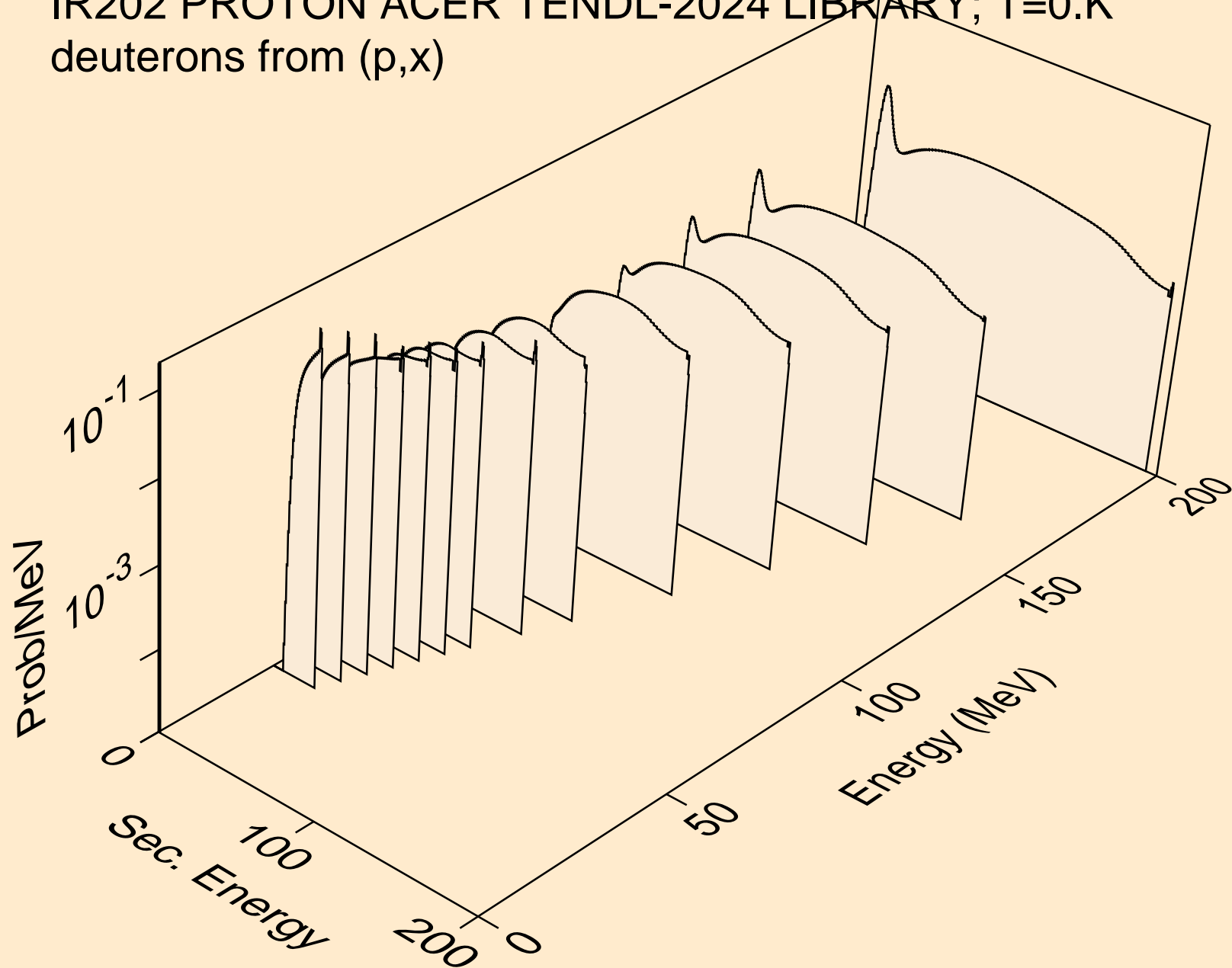

IR202 PROTON ACER TENDL-2024 LIBRARY; T=0.K  
deuterons from (p,2nd)

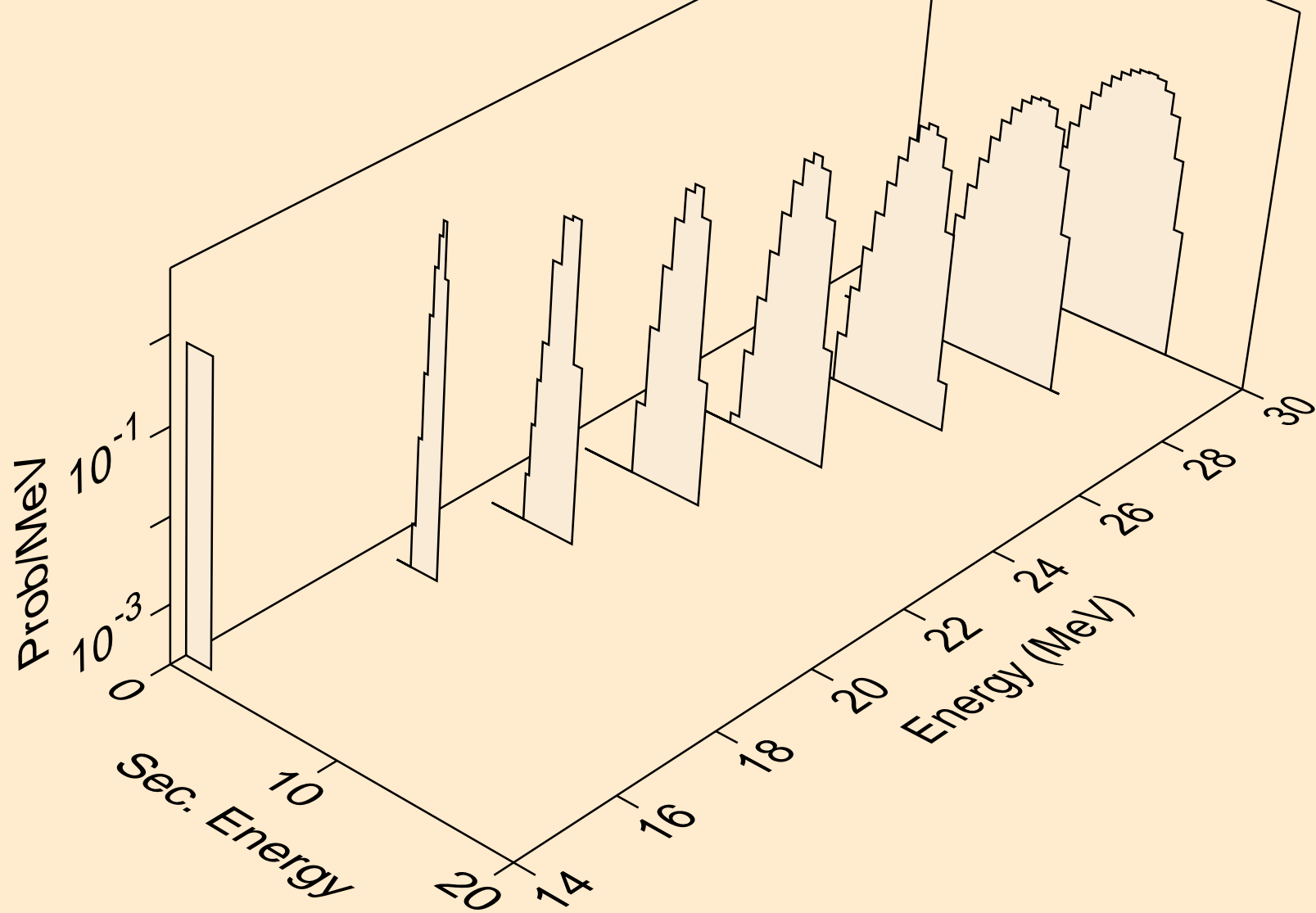

IR202 PROTON ACER TENDL-2024 LIBRARY; T=0.K  
deuterons from (p,n\*)d

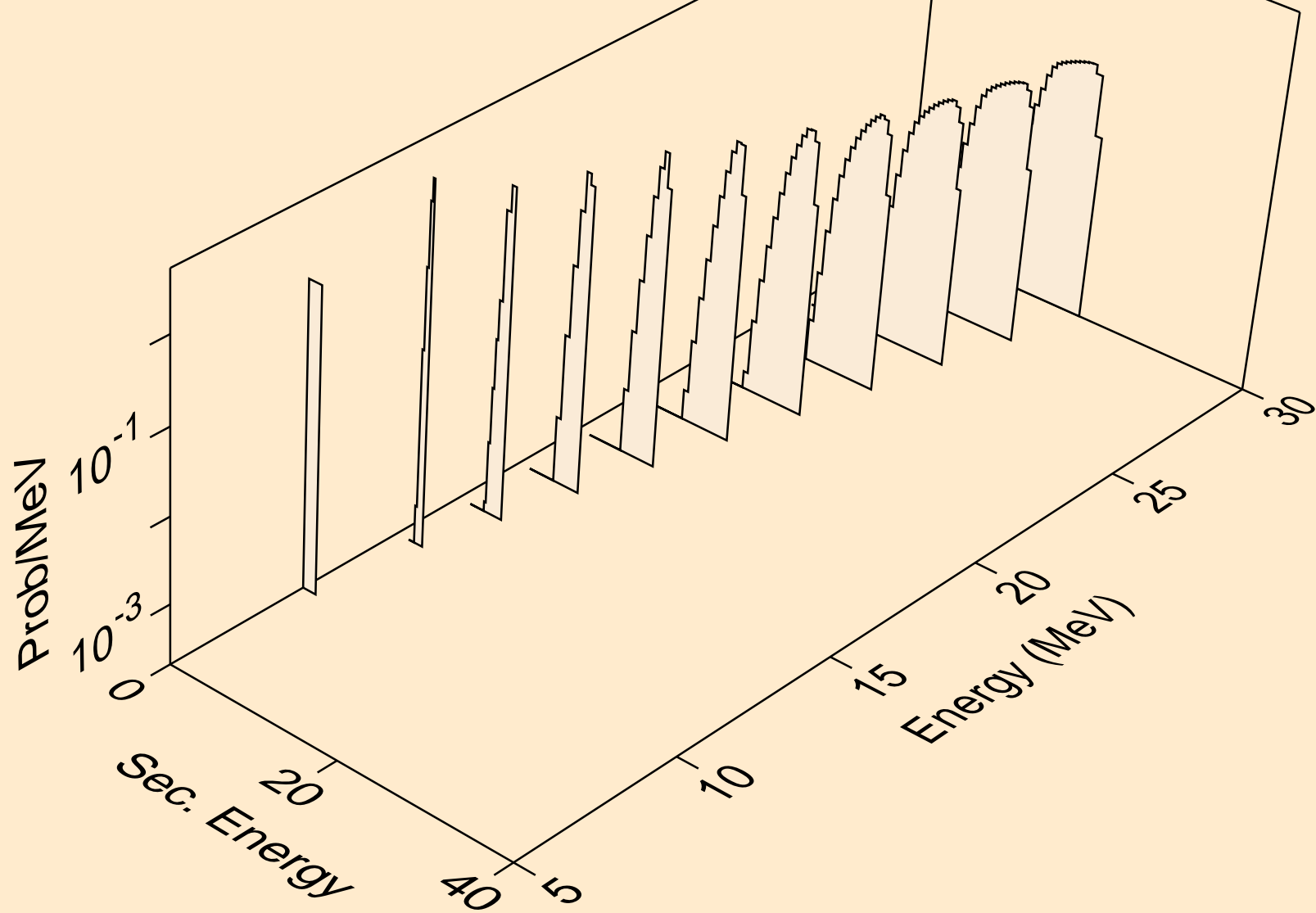

IR202 PROTON ACER TENDL-2024 LIBRARY; T=0.K  
deuterons from (p,d)

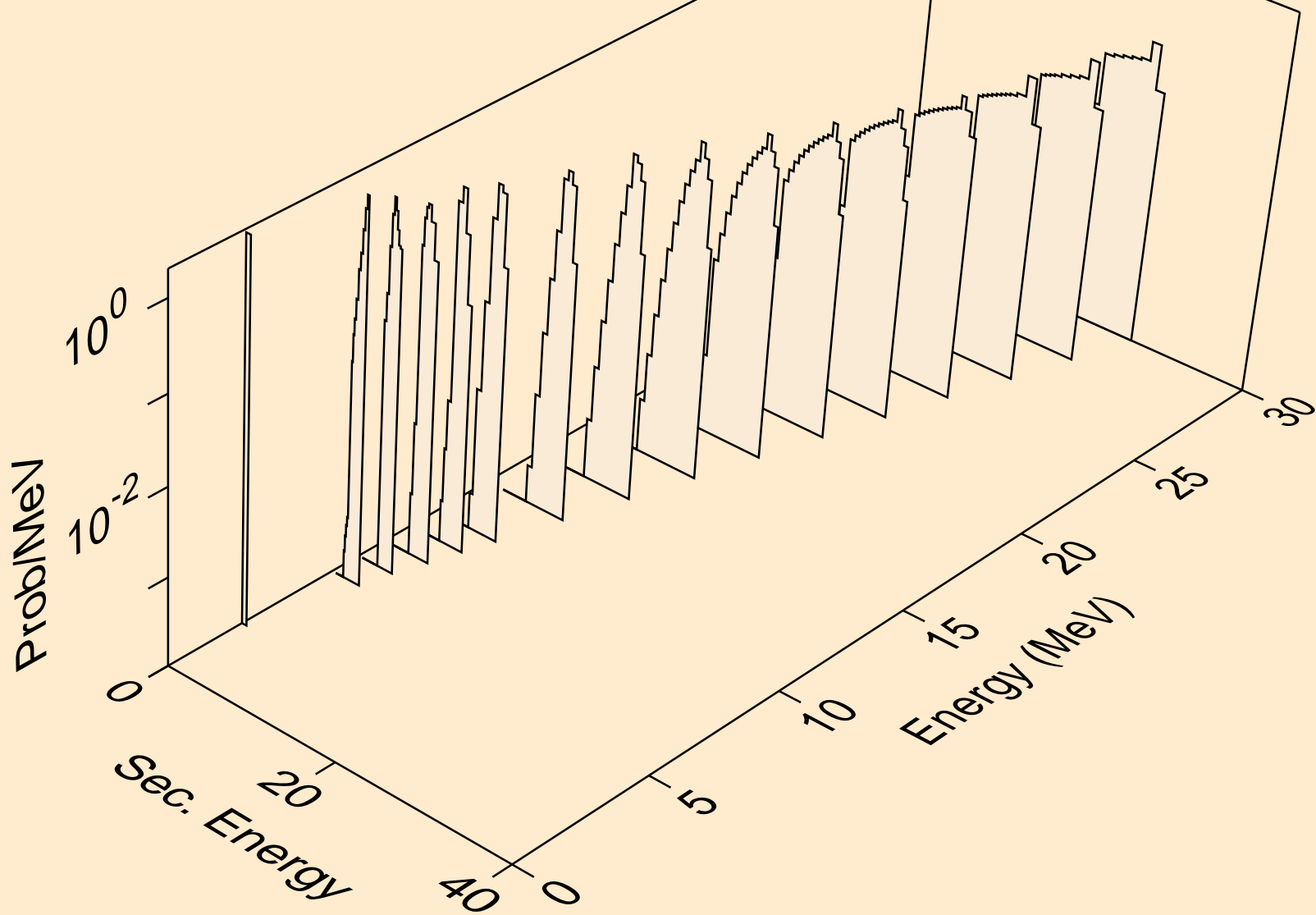

IR202 PROTON ACER TENDL-2024 LIBRARY; T=0.K  
tritons from (p,x)

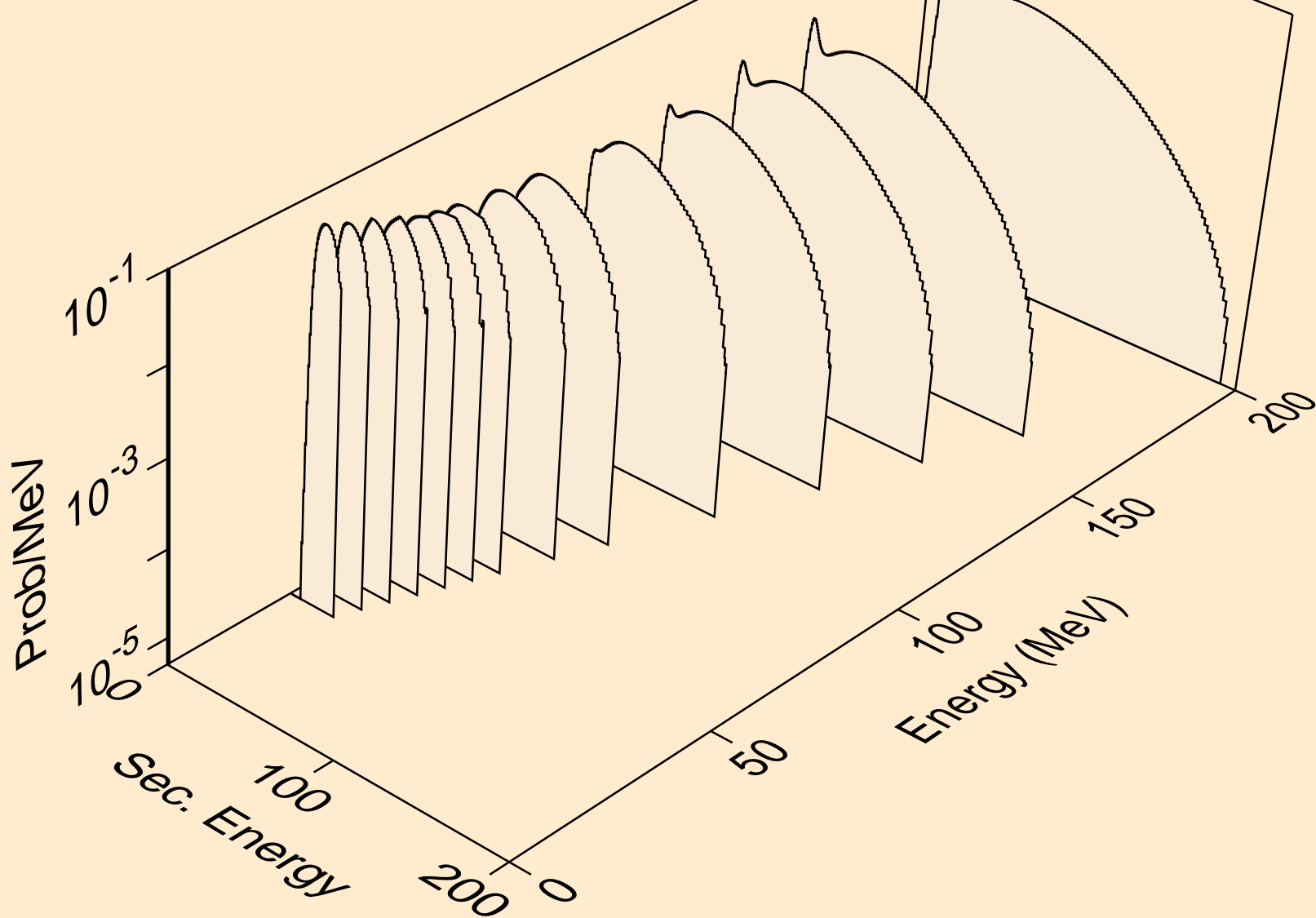

IR202 PROTON ACER TENDL-2024 LIBRARY; T=0.K  
tritons from (p,n\*)t

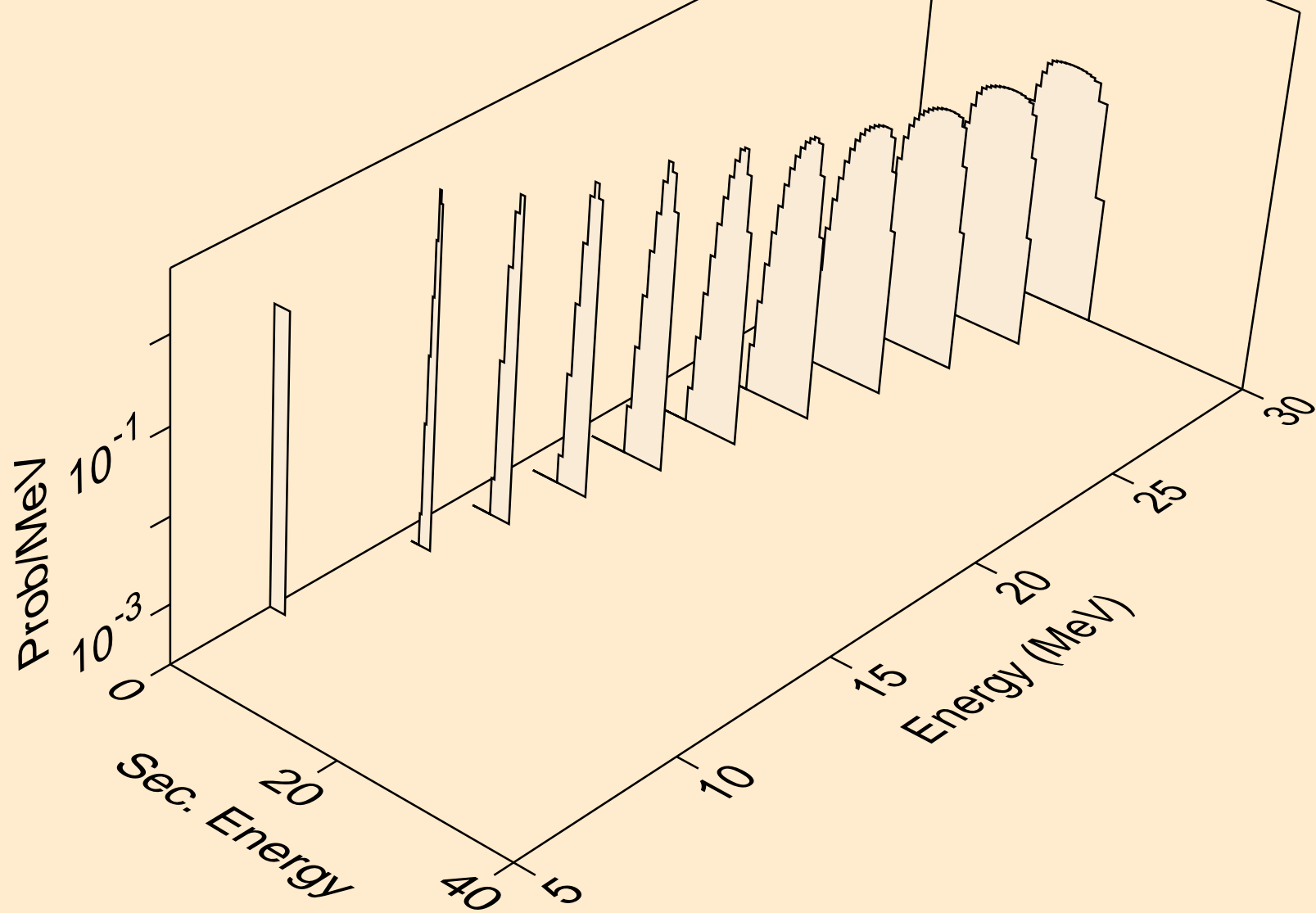

IR202 PROTON ACER TENDL-2024 LIBRARY; T=0.K  
tritons from (p,t)

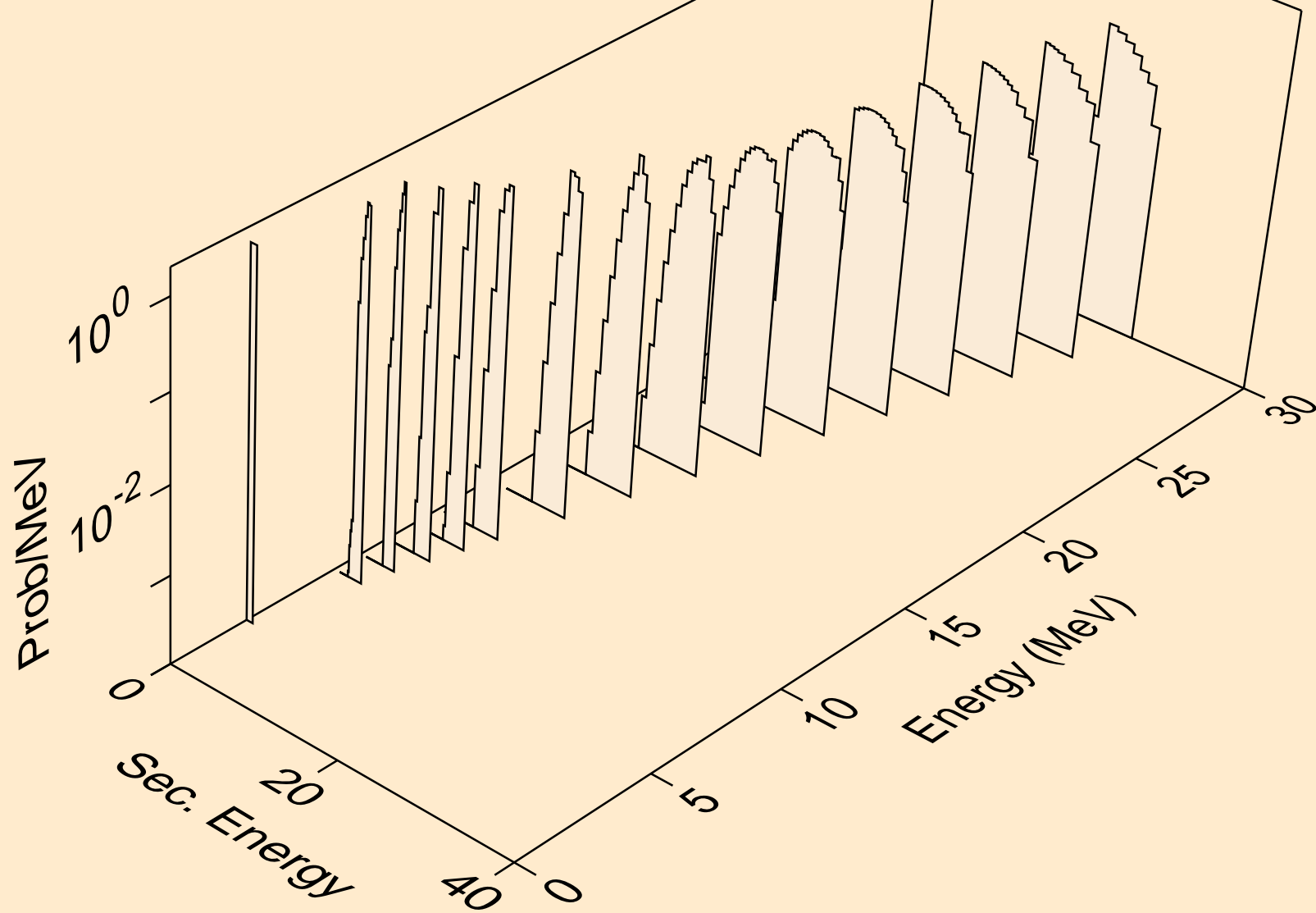

IR202 PROTON ACER TENDL-2024 LIBRARY; T=0.K  
he3s from (p,x)

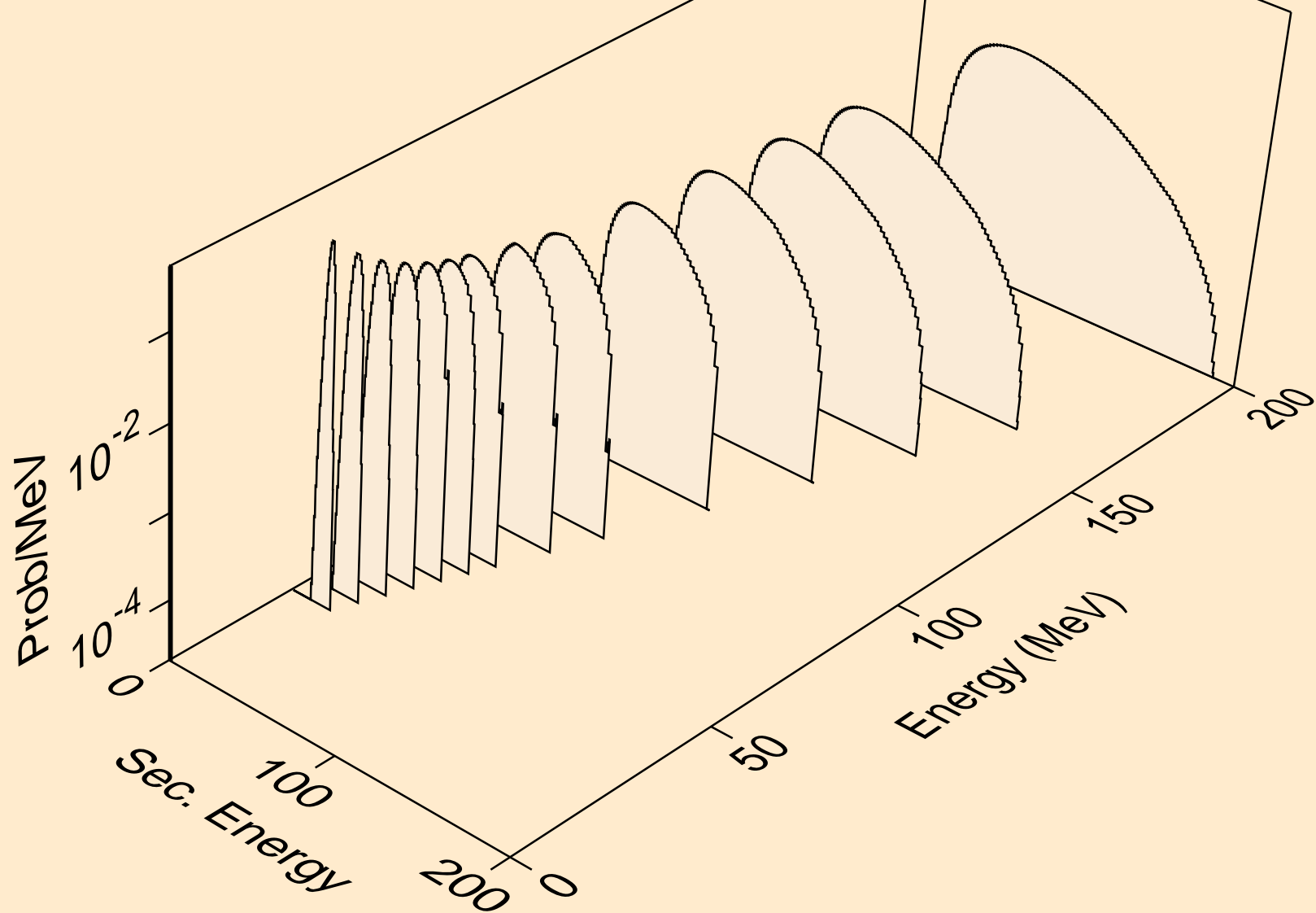

IR202 PROTON ACER TENDL-2024 LIBRARY; T=0.K  
he3s from (p,n\*)he3

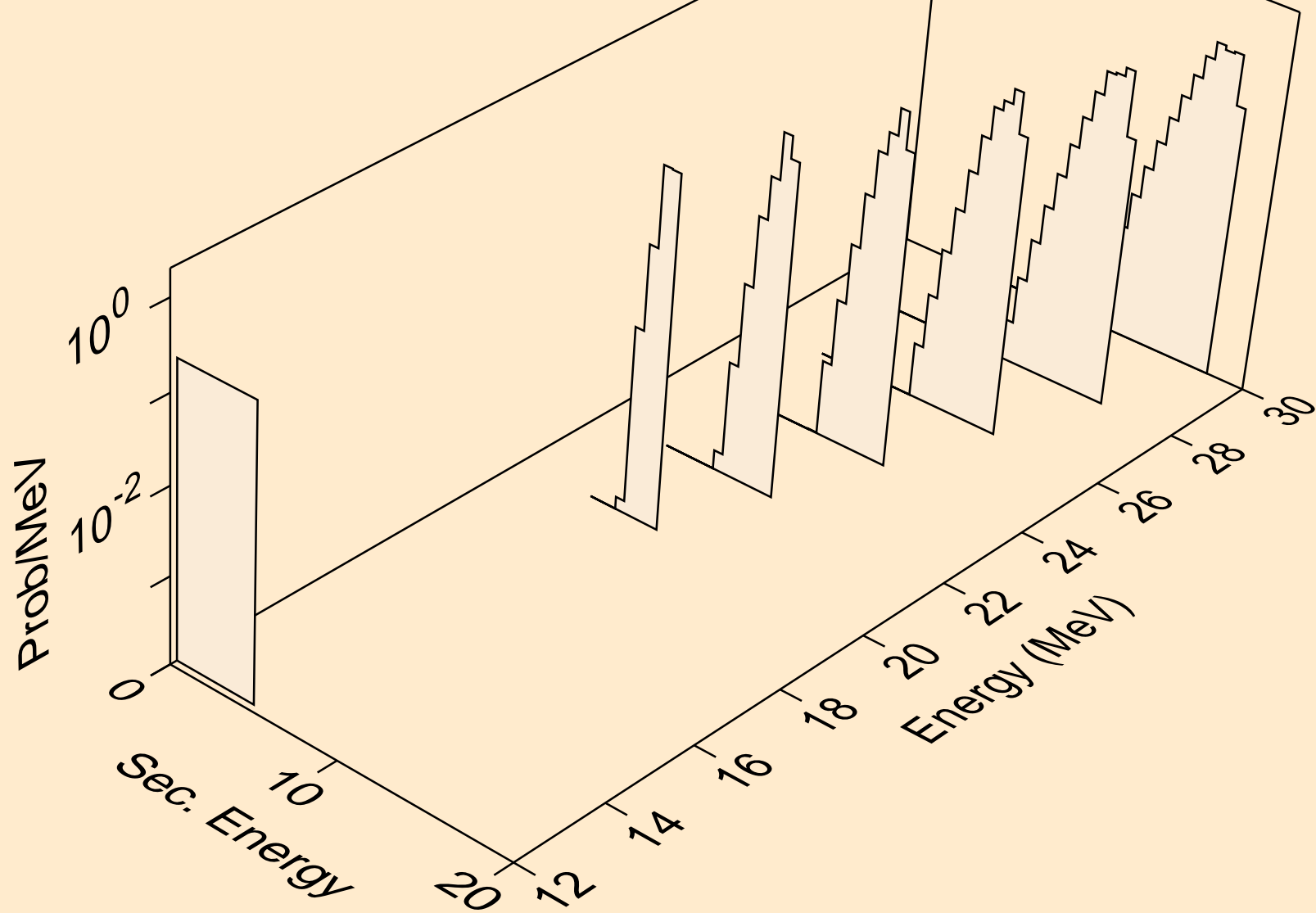

IR202 PROTON ACER TENDL-2024 LIBRARY; T=0.K  
he3s from (p,he3)

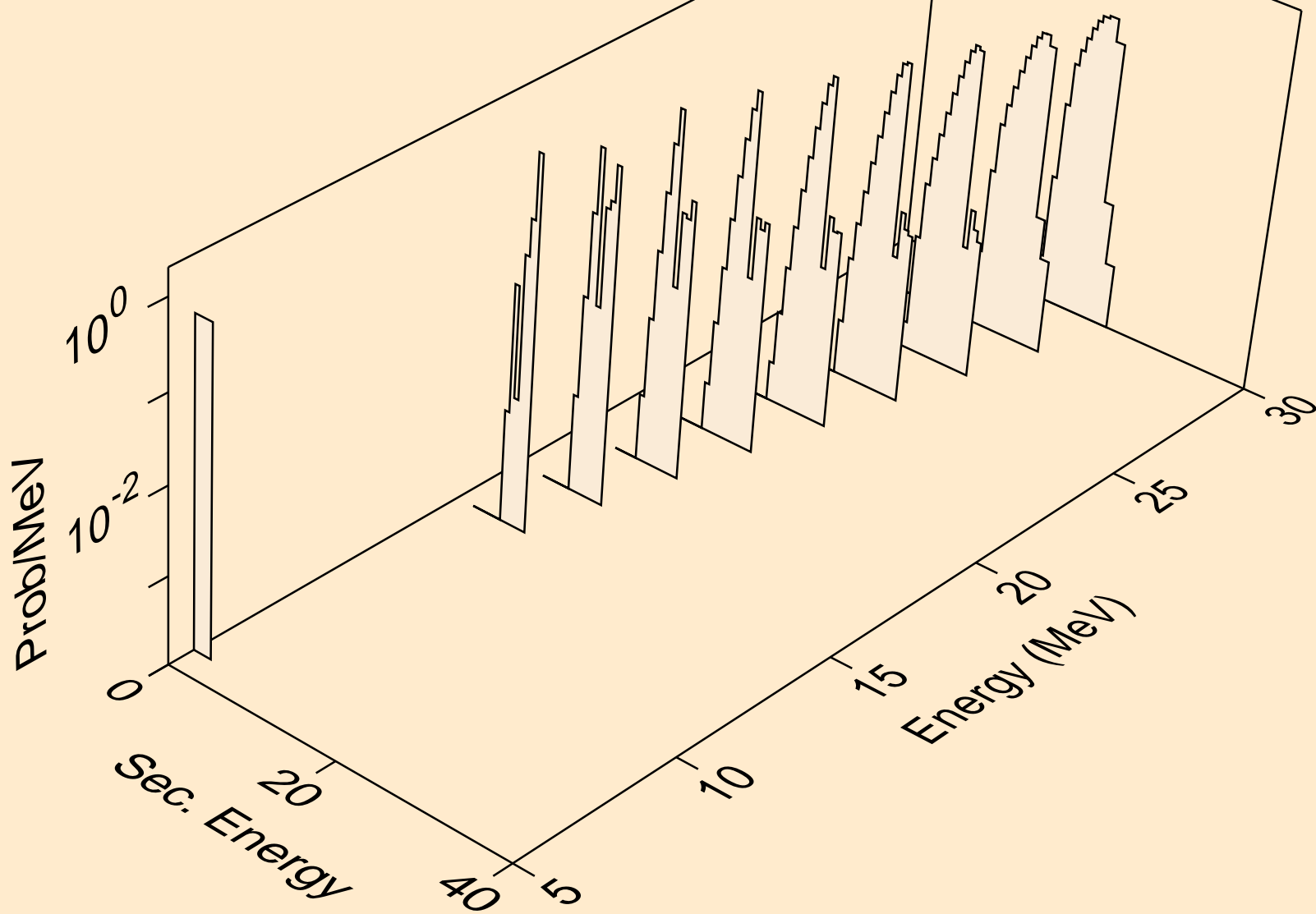

IR202 PROTON ACER TENDL-2024 LIBRARY; T=0.K  
alphas from (p,x)

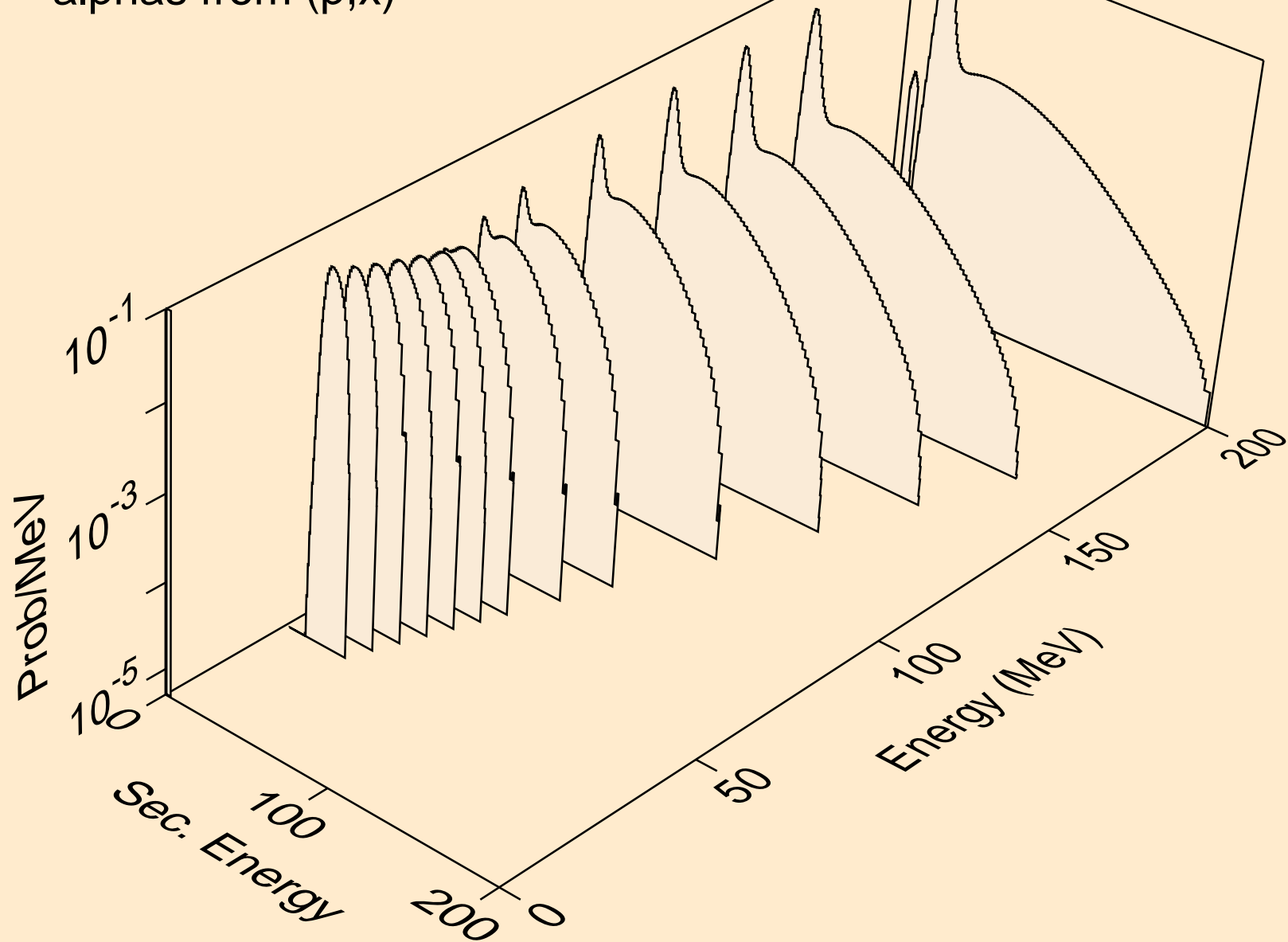

IR202 PROTON ACER TENDL-2024 LIBRARY; T=0.K  
alphas from (p,n\*)a

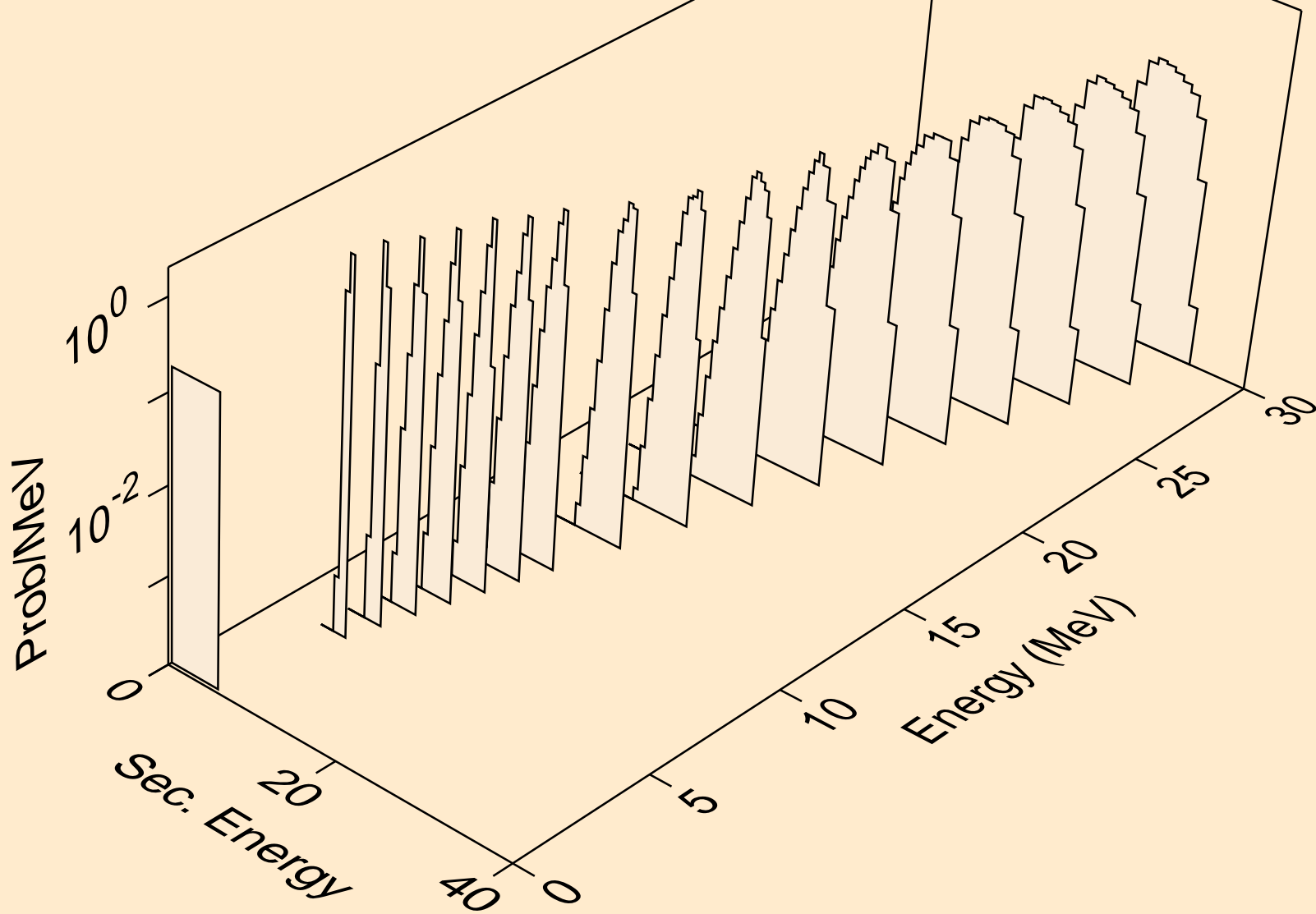

IR202 PROTON ACER TENDL-2024 LIBRARY; T=0.K  
alphas from (p,2n)a

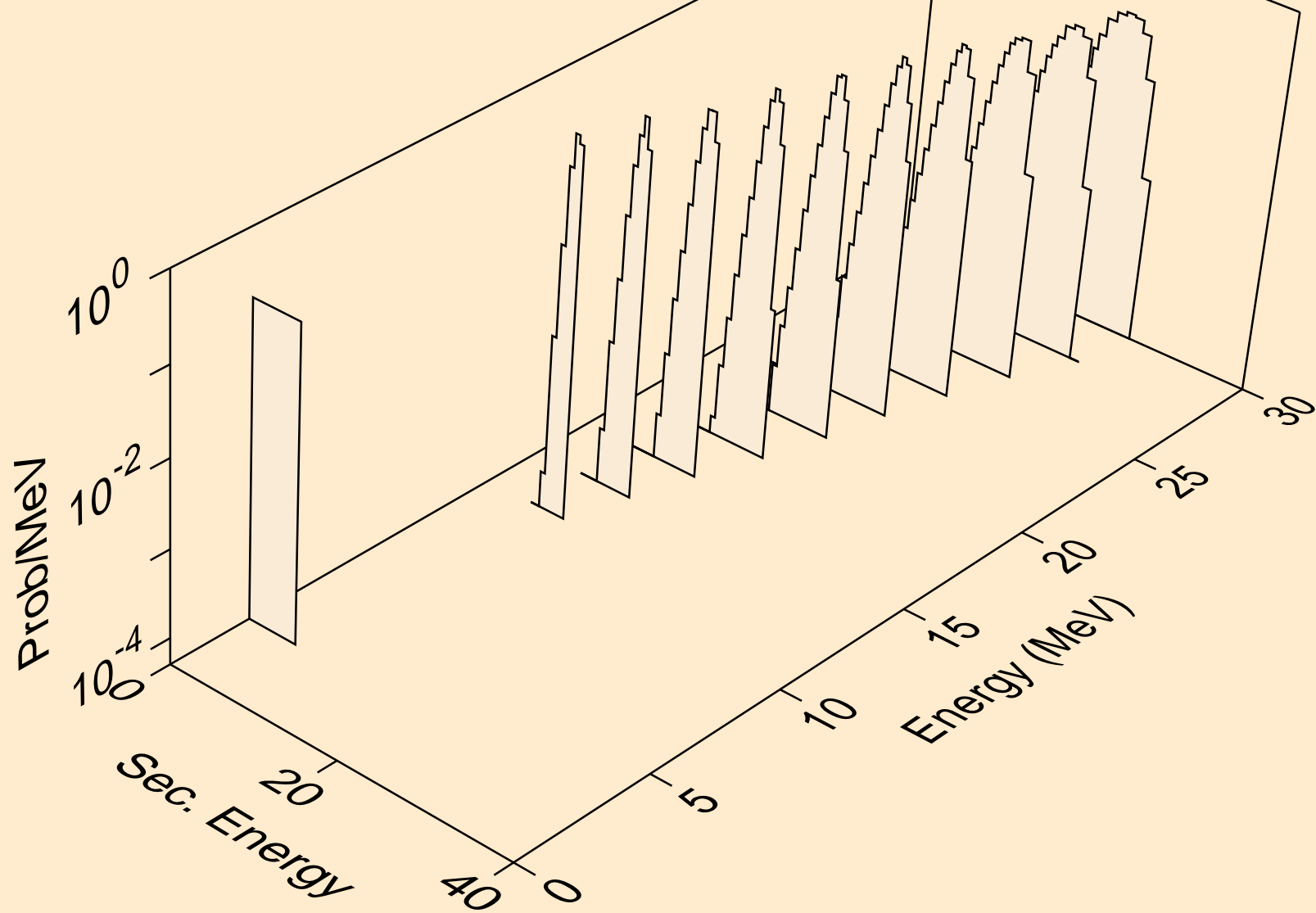

IR202 PROTON ACER TENDL-2024 LIBRARY; T=0.K  
alphas from (p,3n)a

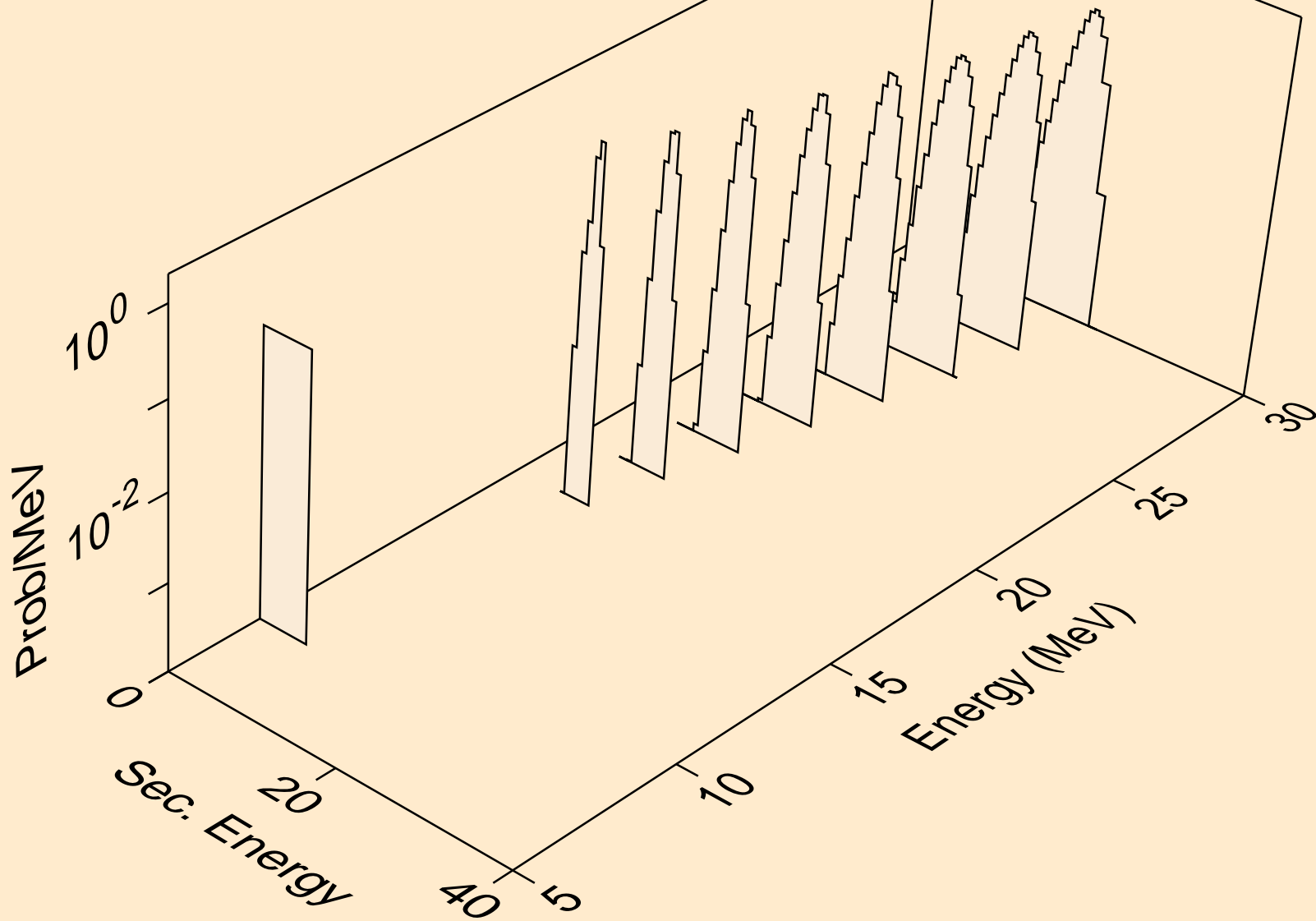

IR202 PROTON ACER TENDL-2024 LIBRARY; T=0.K  
alphas from (p,a)

