

MG026 PROTON ACER TENDL-2024 LIBRARY; T=0.K

Principal cross sections

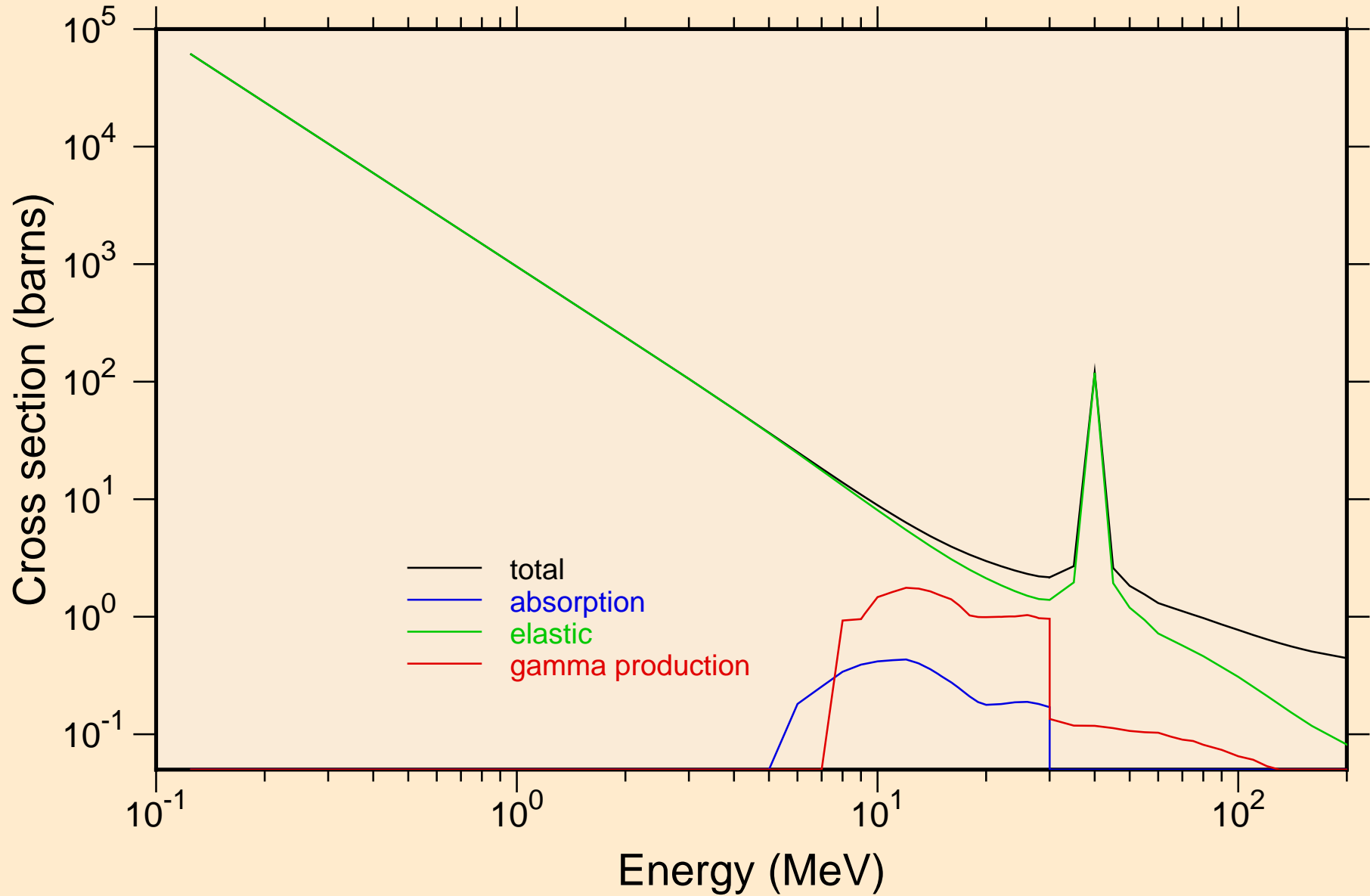

MG026 PROTON ACER TENDL-2024 LIBRARY; T=0.K

Heating

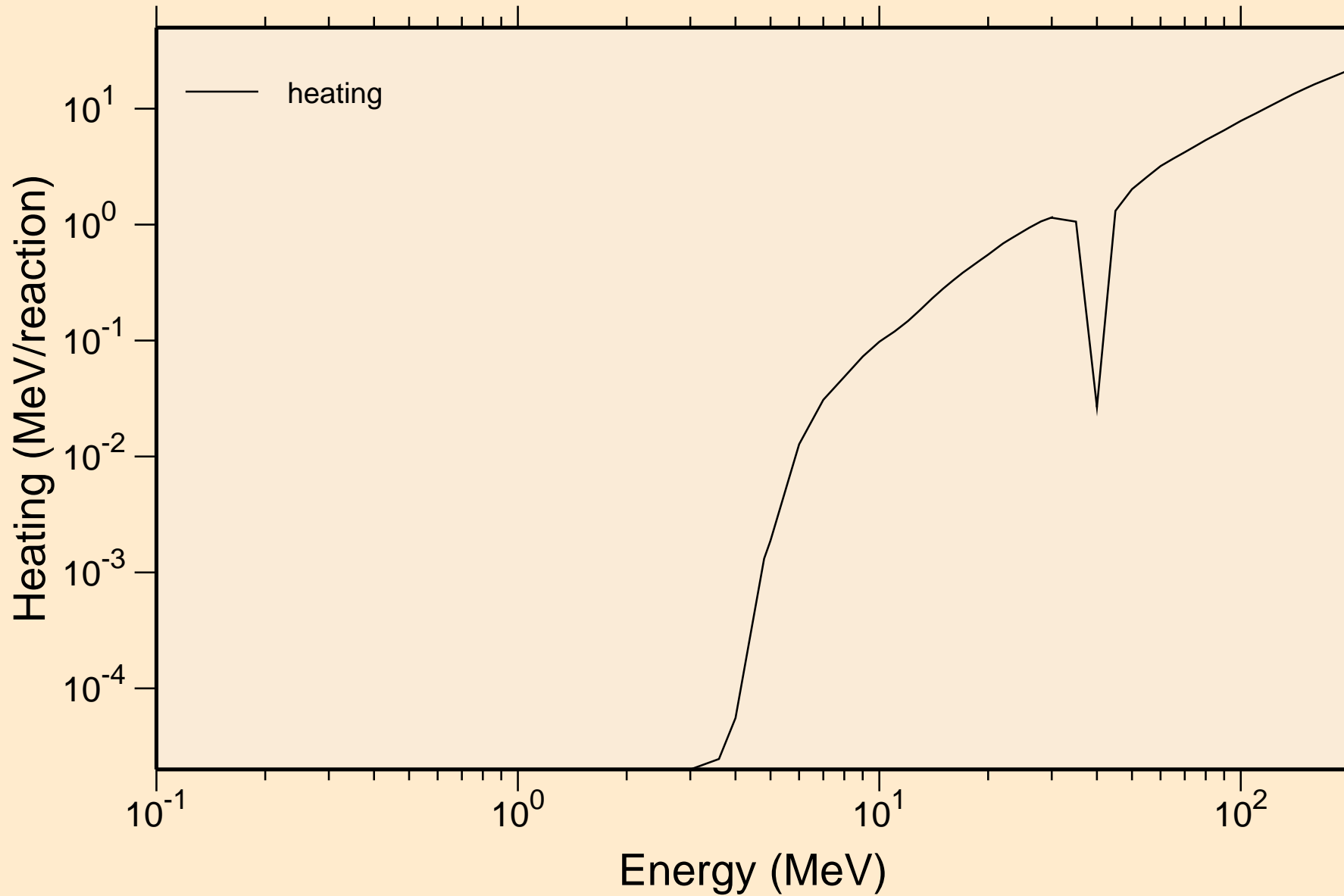

MG026 PROTON ACER TENDL-2024 LIBRARY; T=0.K

Principal cross sections

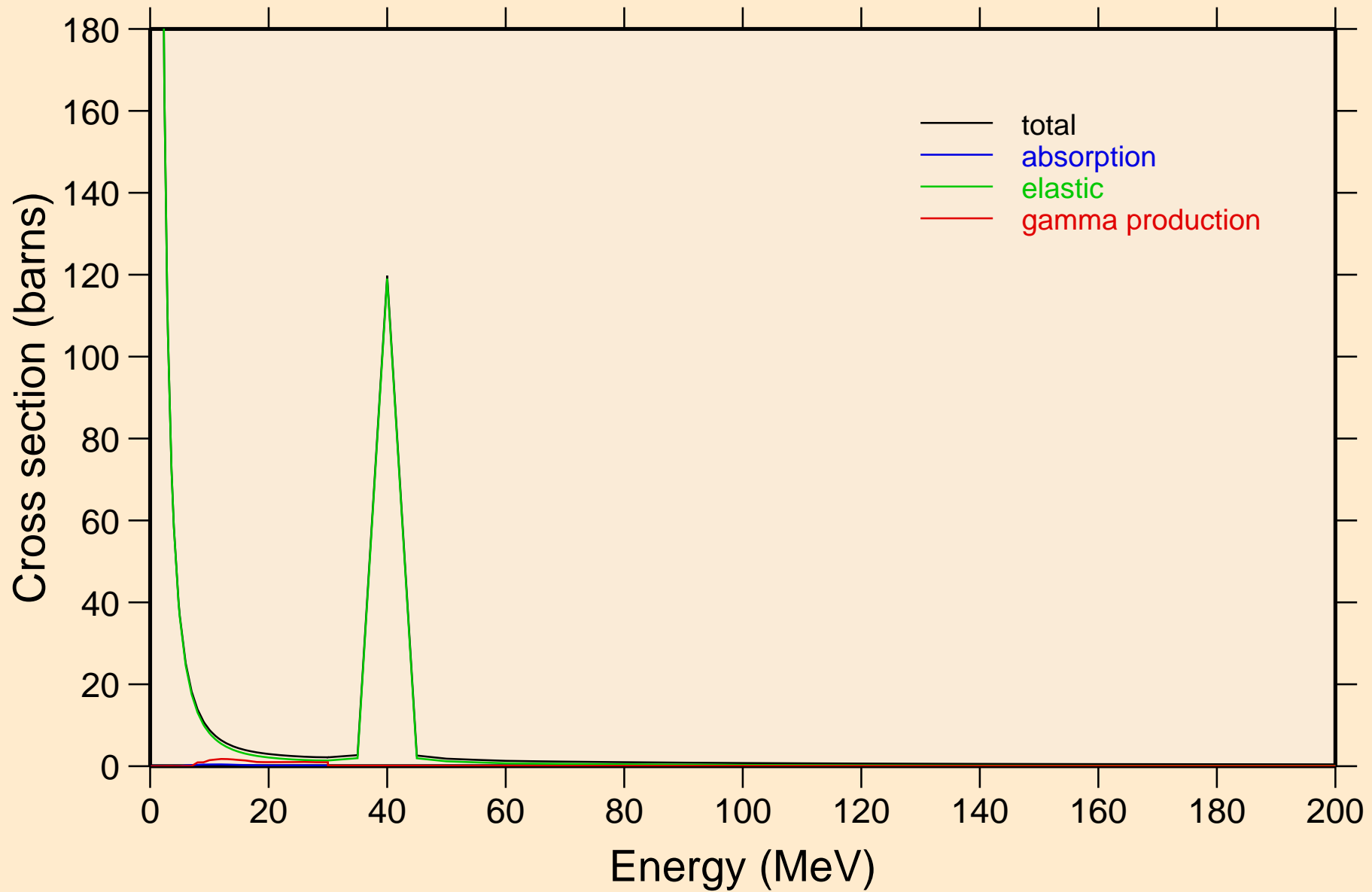

MG026 PROTON ACER TENDL-2024 LIBRARY; T=0.K

Heating

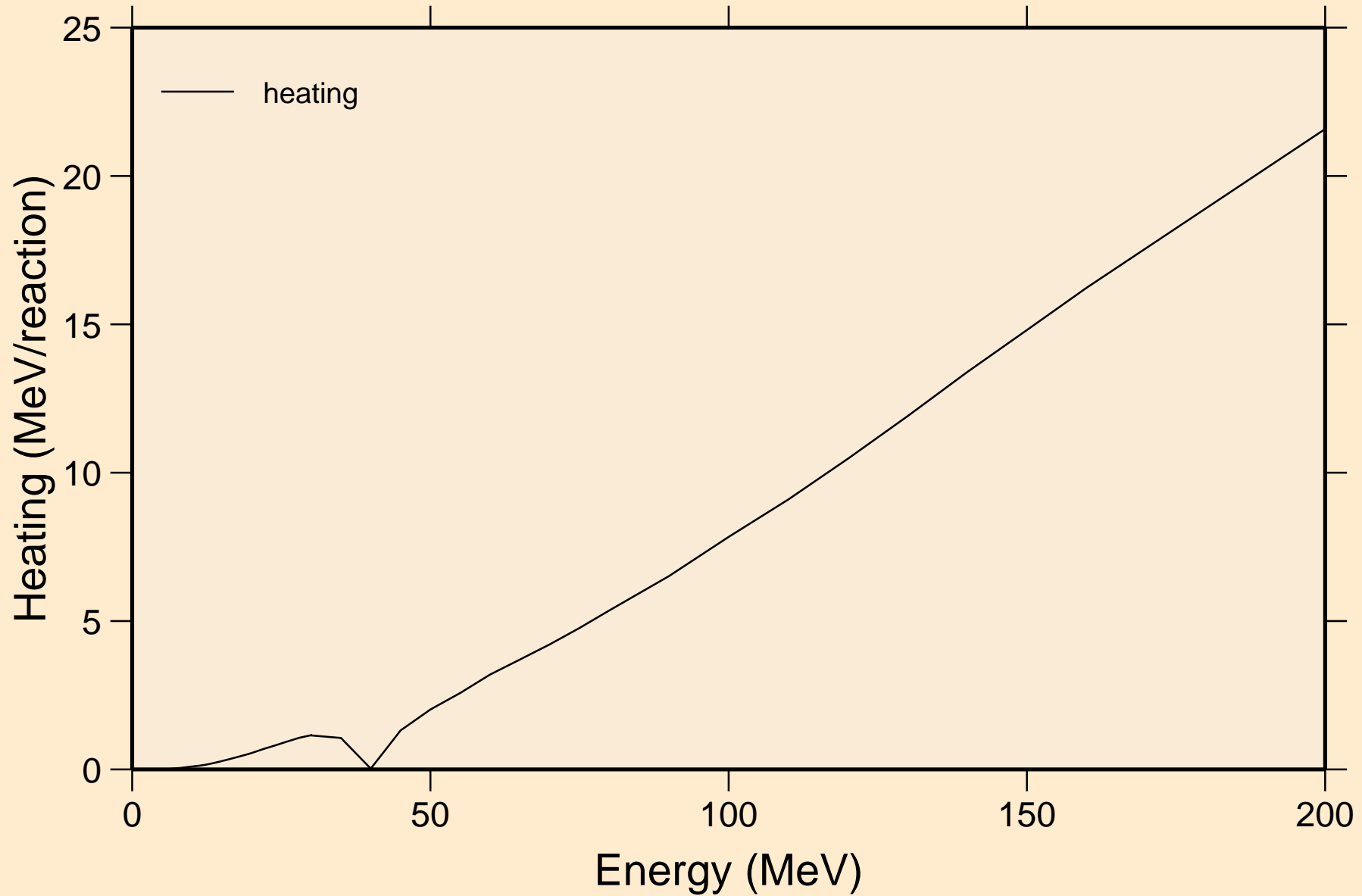

MG026 PROTON ACER TENDL-2024 LIBRARY; T=0.K

Threshold reactions

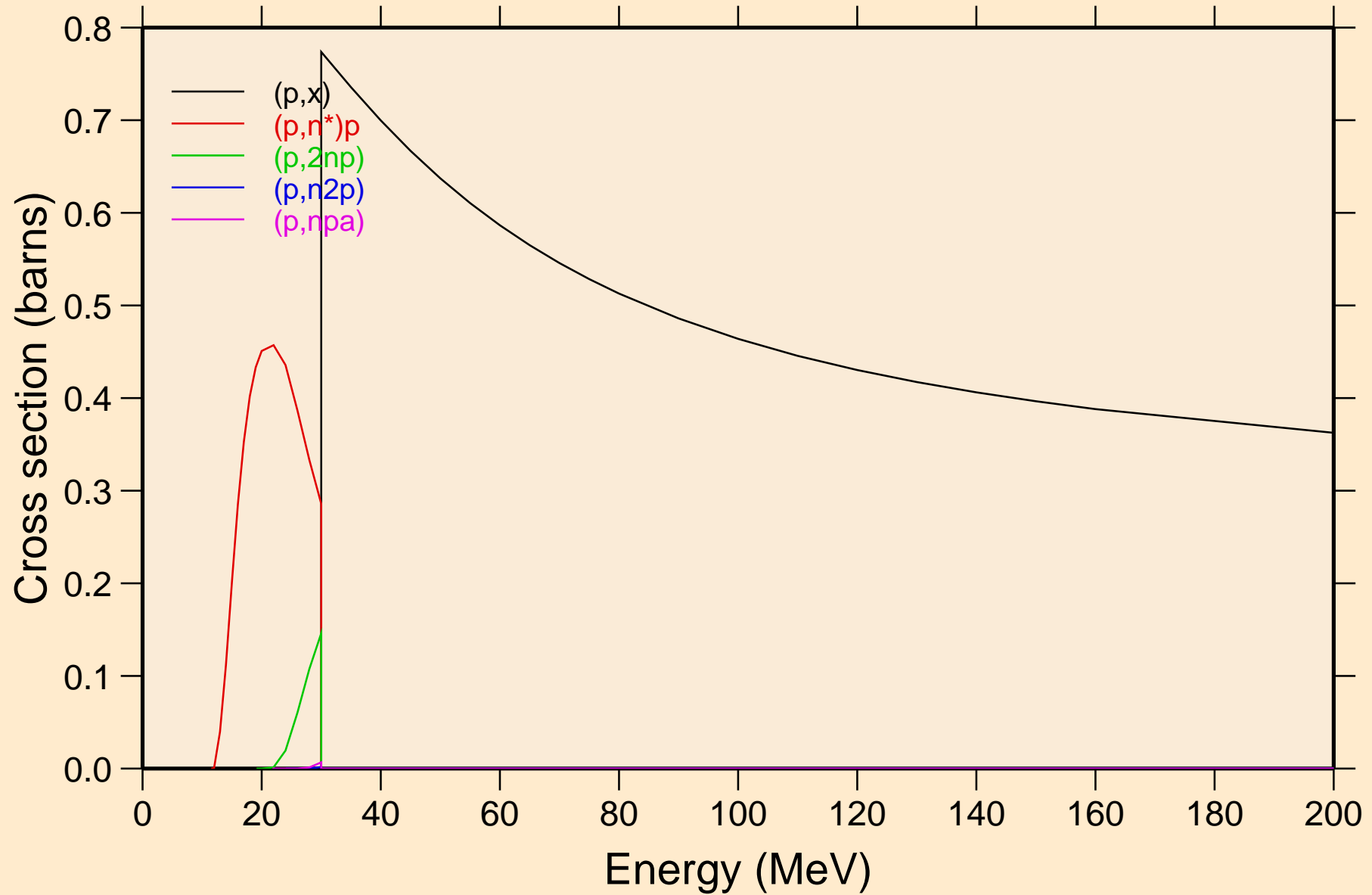

MG026 PROTON ACER TENDL-2024 LIBRARY; T=0.K
Threshold reactions

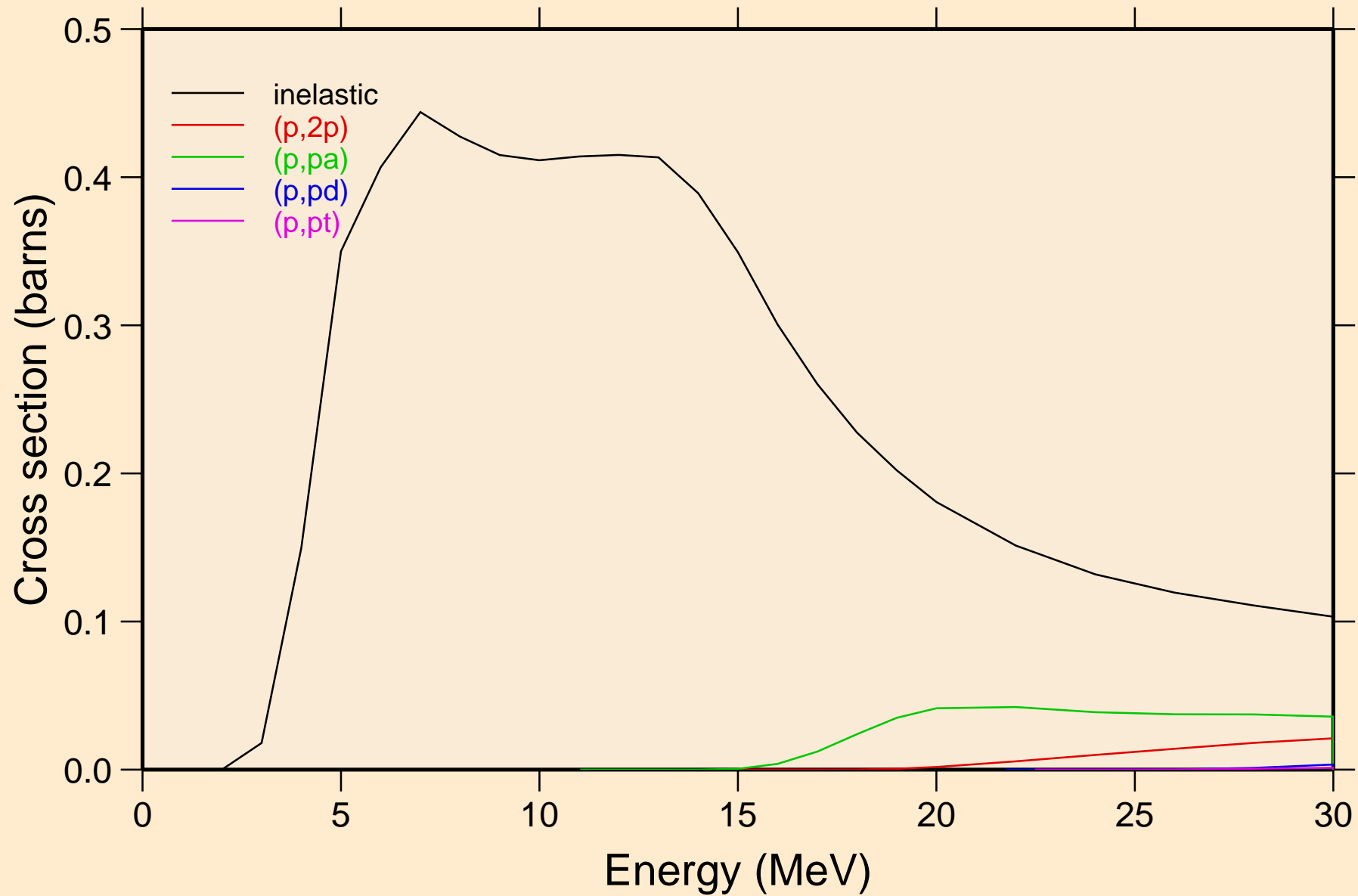

MG026 PROTON ACER TENDL-2024 LIBRARY; T=0.K
Threshold reactions

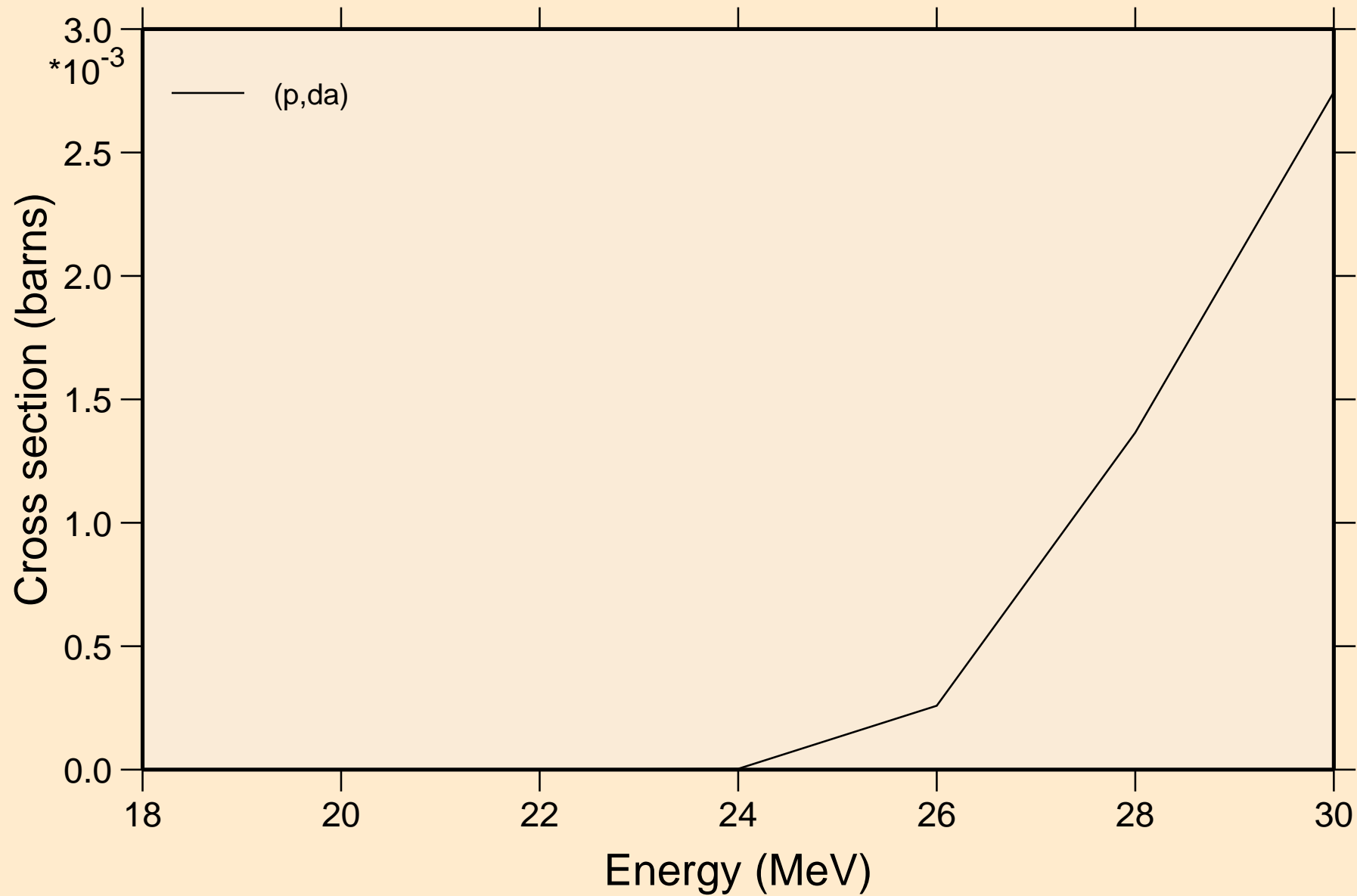

MG026 PROTON ACER TENDL-2024 LIBRARY; T=0.K
angular distribution for elastic

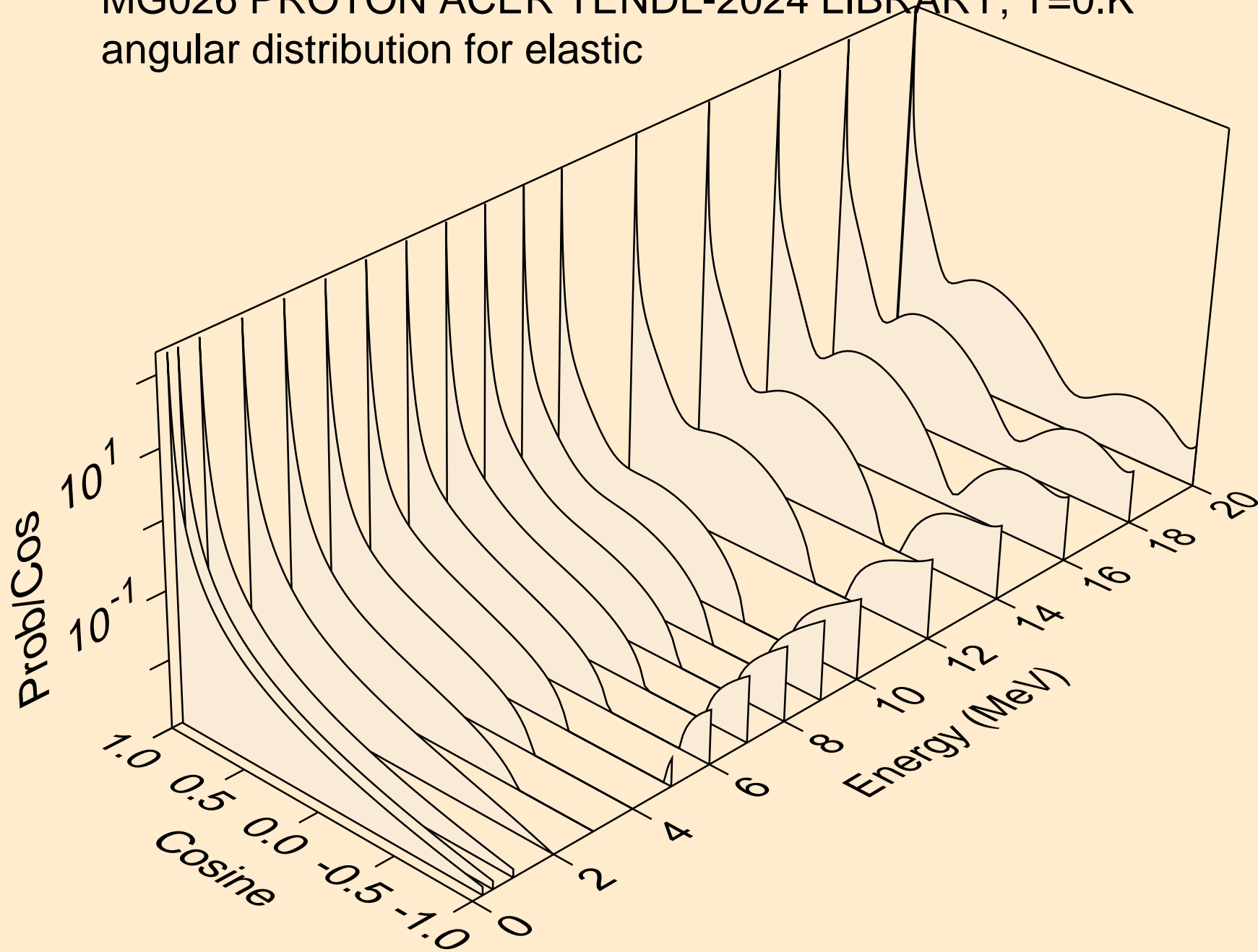

MG026 PROTON ACER TENDL-2024 LIBRARY; T=0.K
angular distribution for elastic

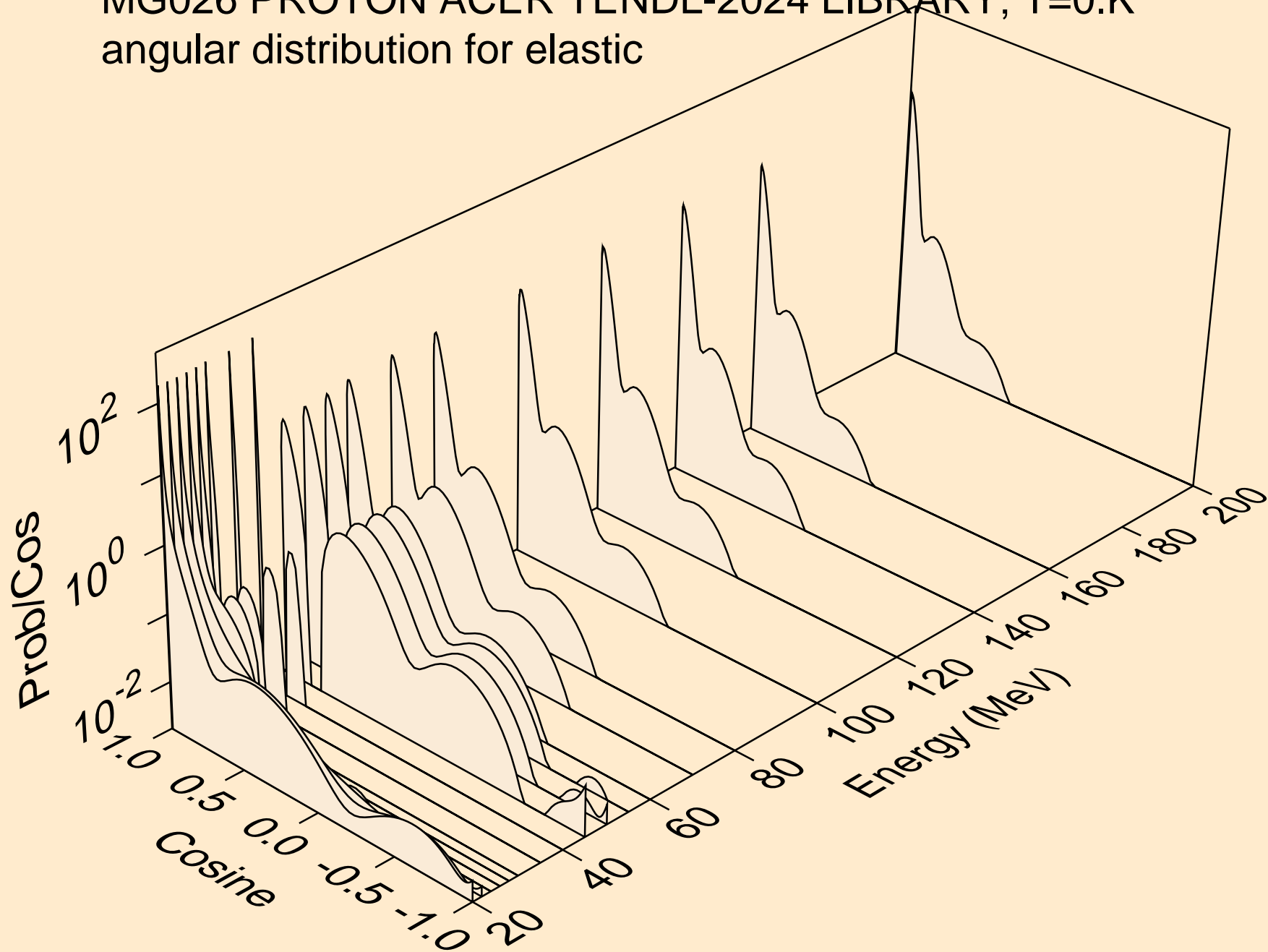

MG026 PROTON ACER TENDL-2024 LIBRARY; T=0.K
Proton emission for (p,x)

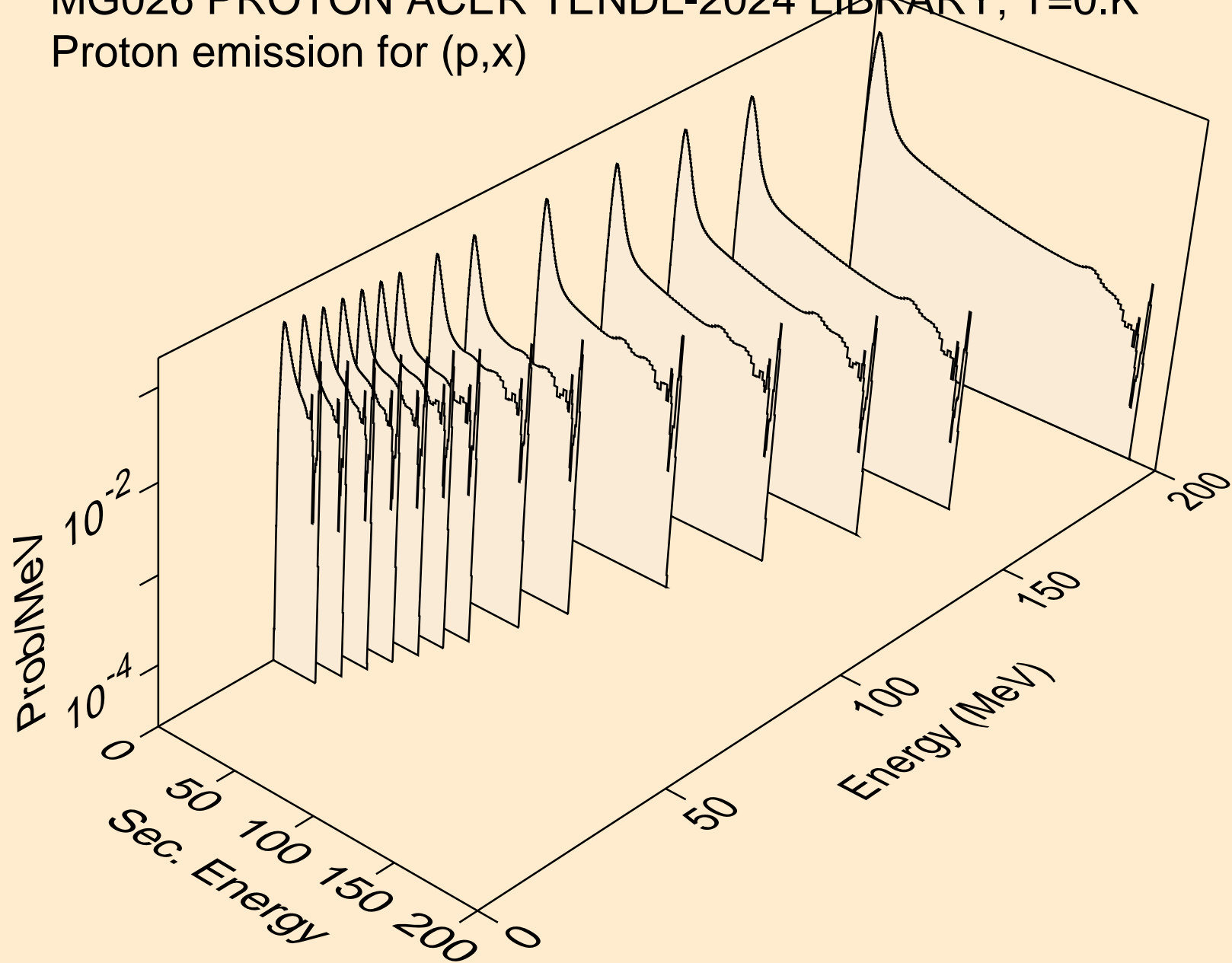

MG026 PROTON ACER TENDL-2024 LIBRARY; T=0.K
Proton emission for (p,n*)p

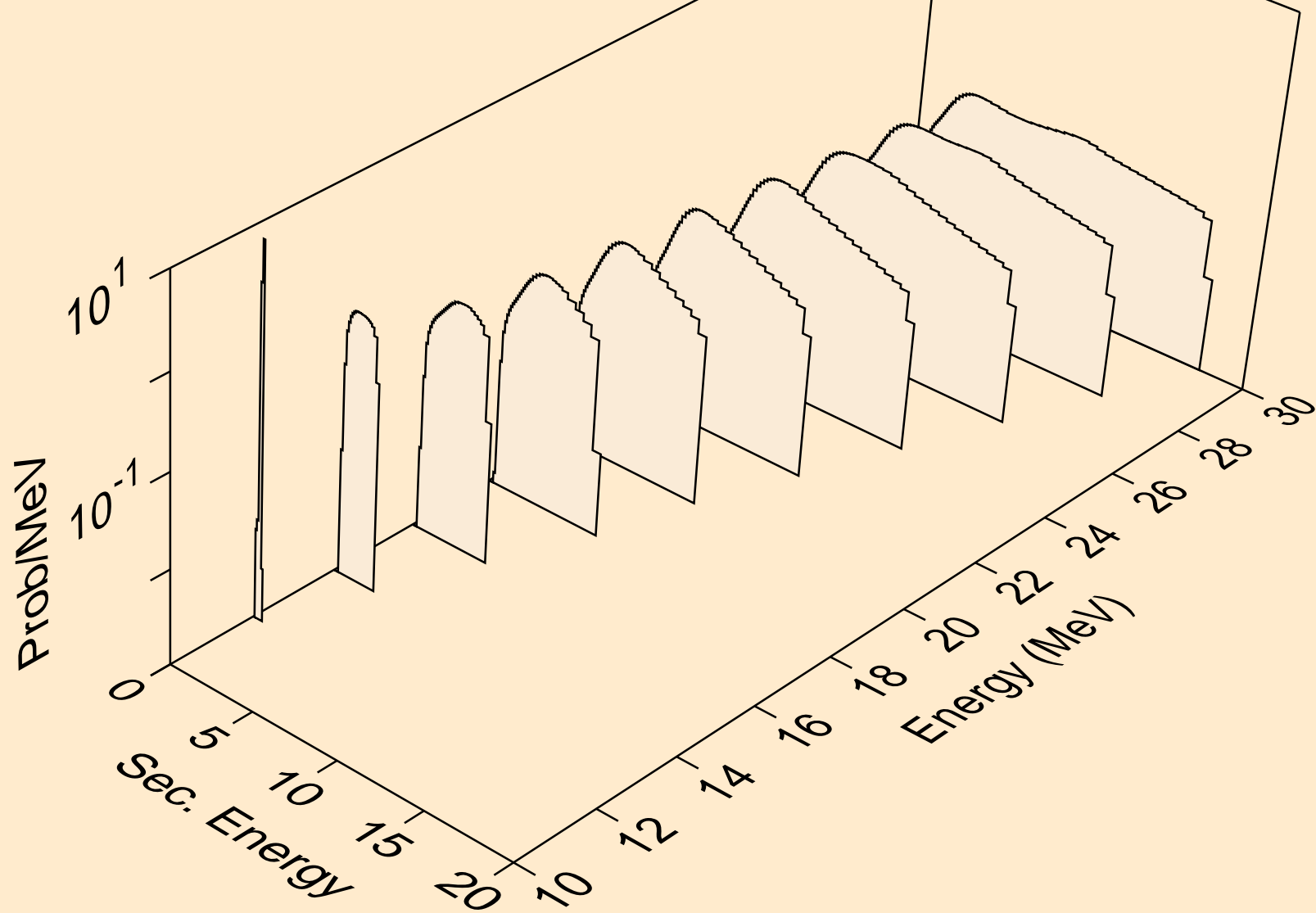

MG026 PROTON ACER TENDL-2024 LIBRARY; T=0.K
Proton emission for (p,2np)

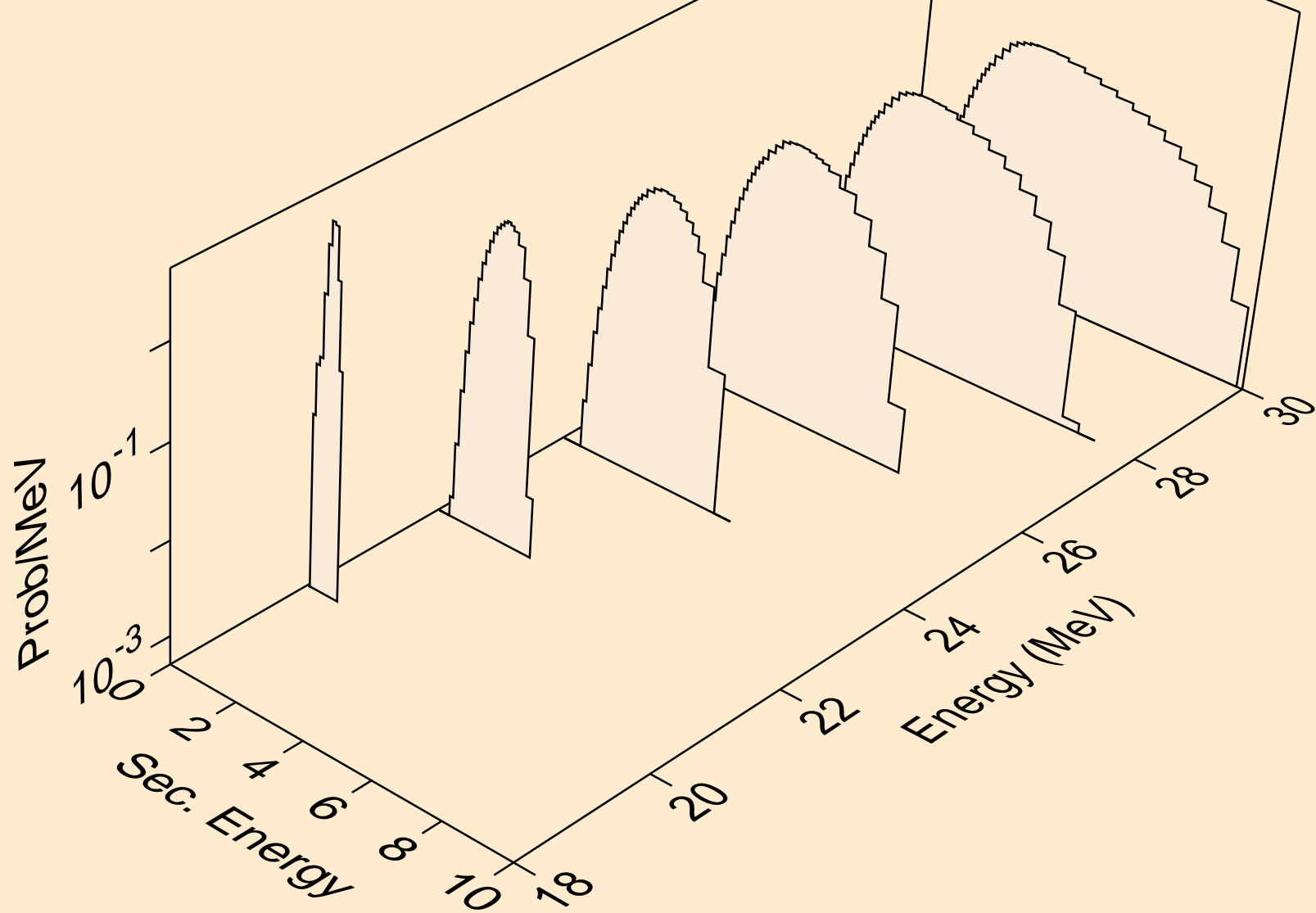

MG026 PROTON ACER TENDL-2024 LIBRARY; T=0.K
Proton emission for (p,n2p)

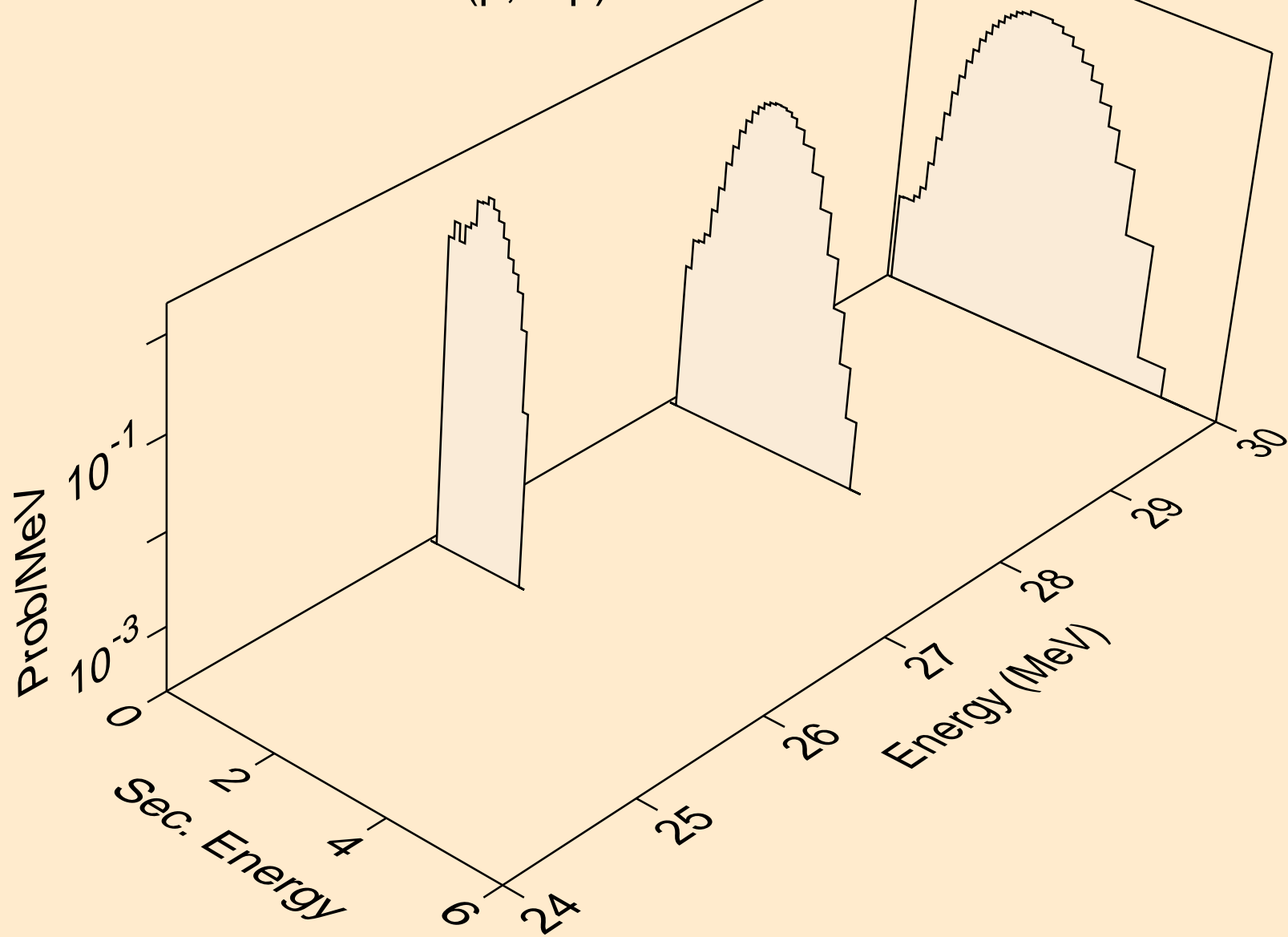

MG026 PROTON ACER TENDL-2024 LIBRARY; T=0.K
Proton emission for (p,npa)

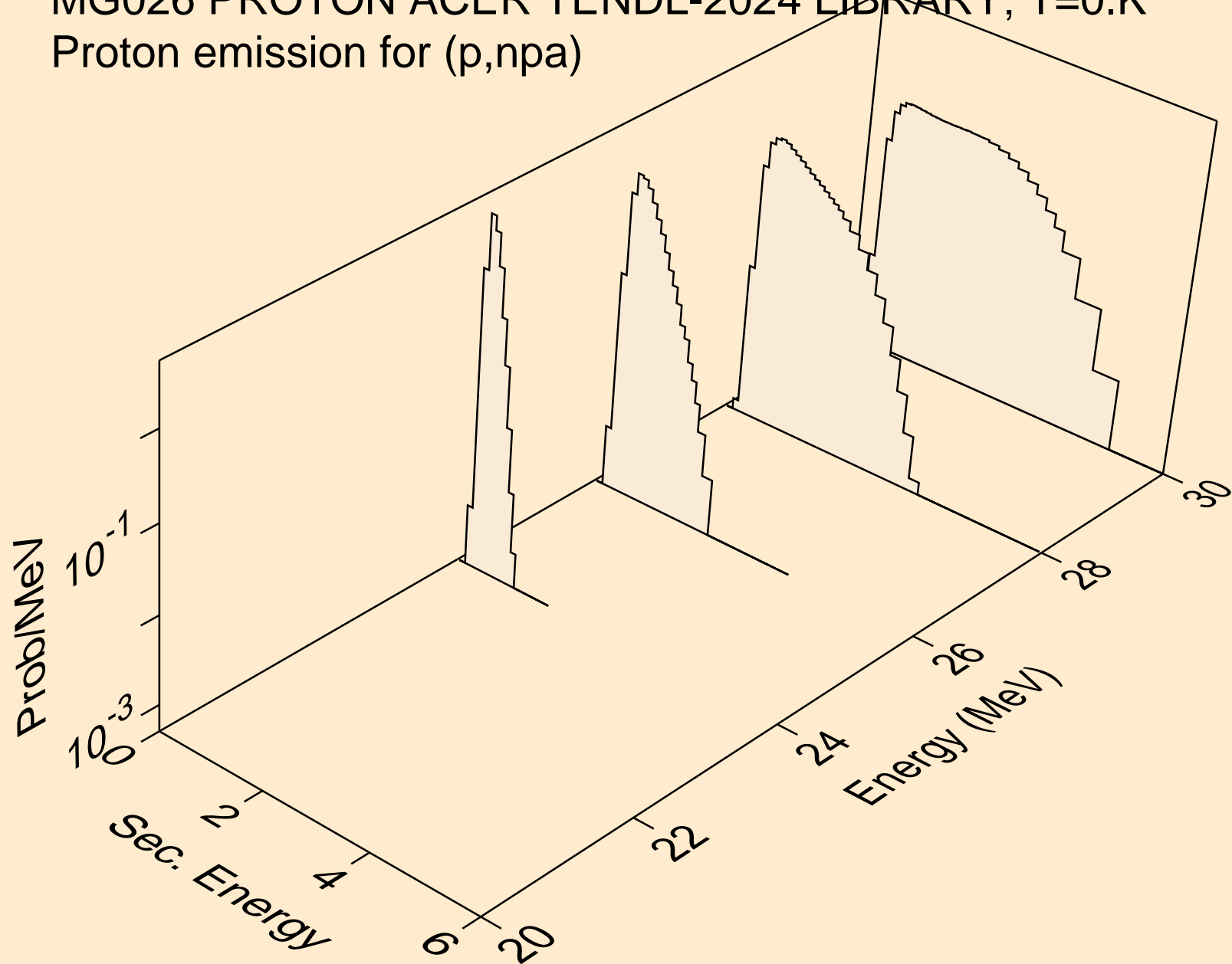

MG026 PROTON ACER TENDL-2024 LIBRARY; T=0.K
Proton emission for inelastic

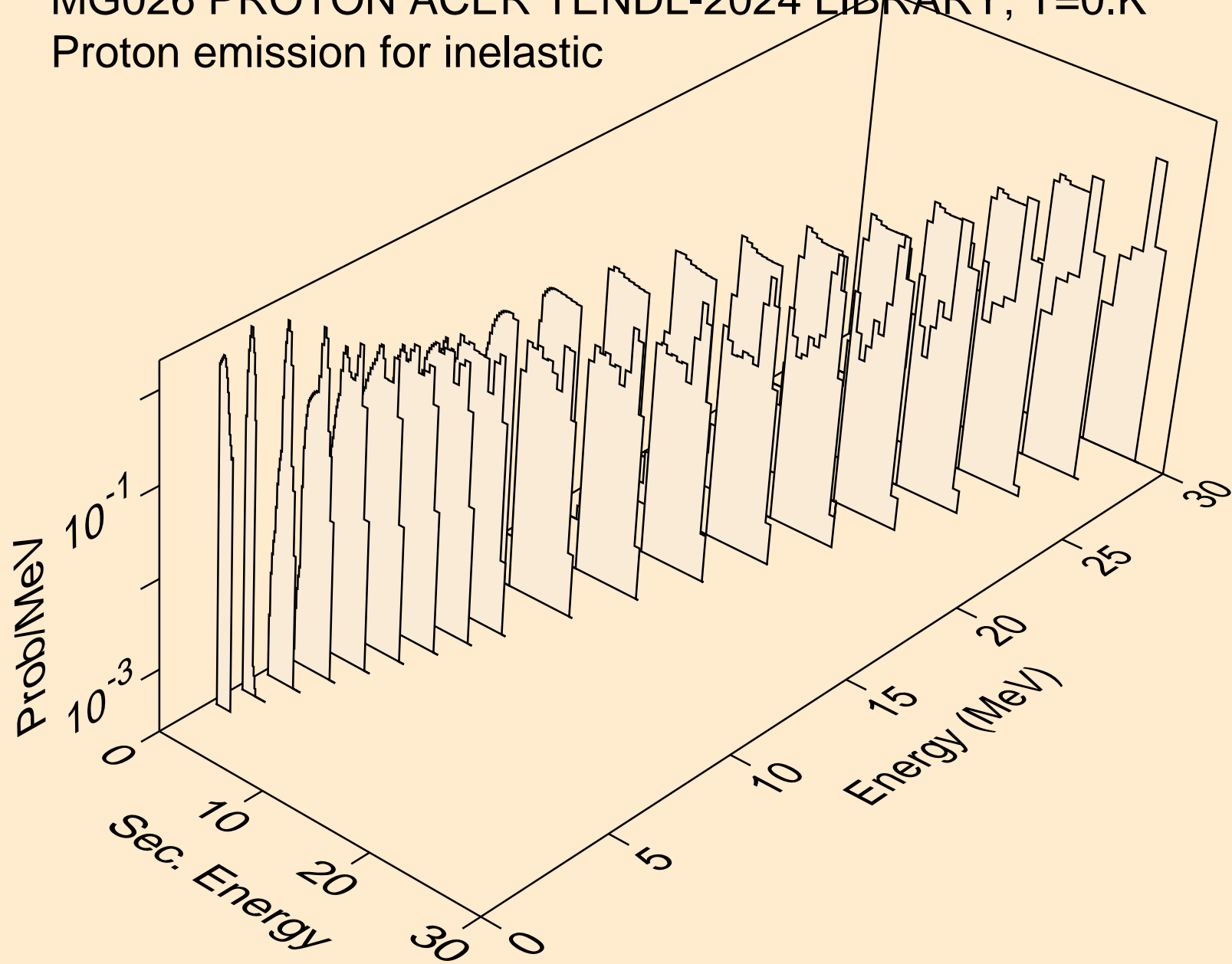

MG026 PROTON ACER TENDL-2024 LIBRARY; T=0.K
Proton emission for (p,2p)

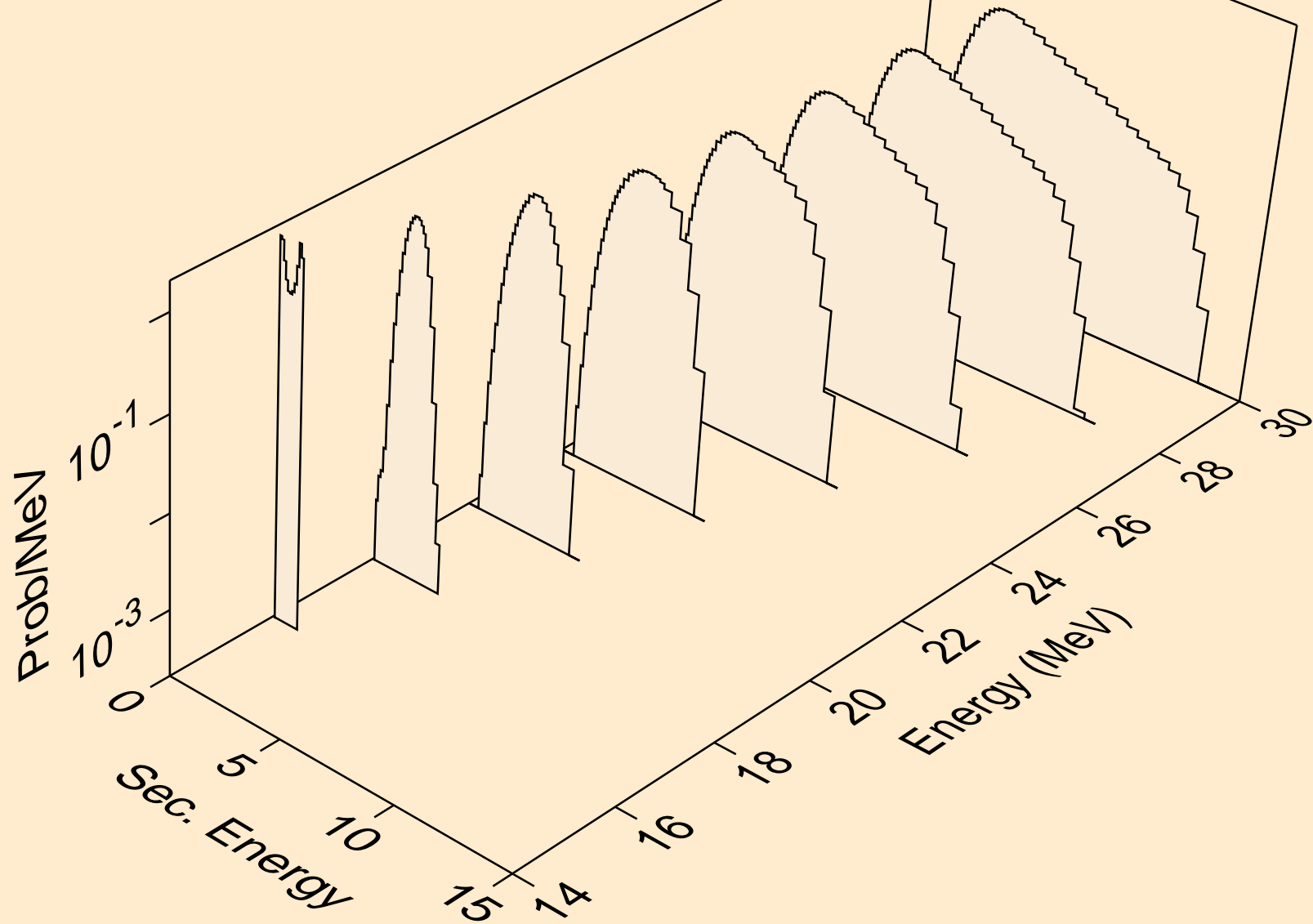

MG026 PROTON ACER TENDL-2024 LIBRARY; T=0.K
Proton emission for (p,pa)

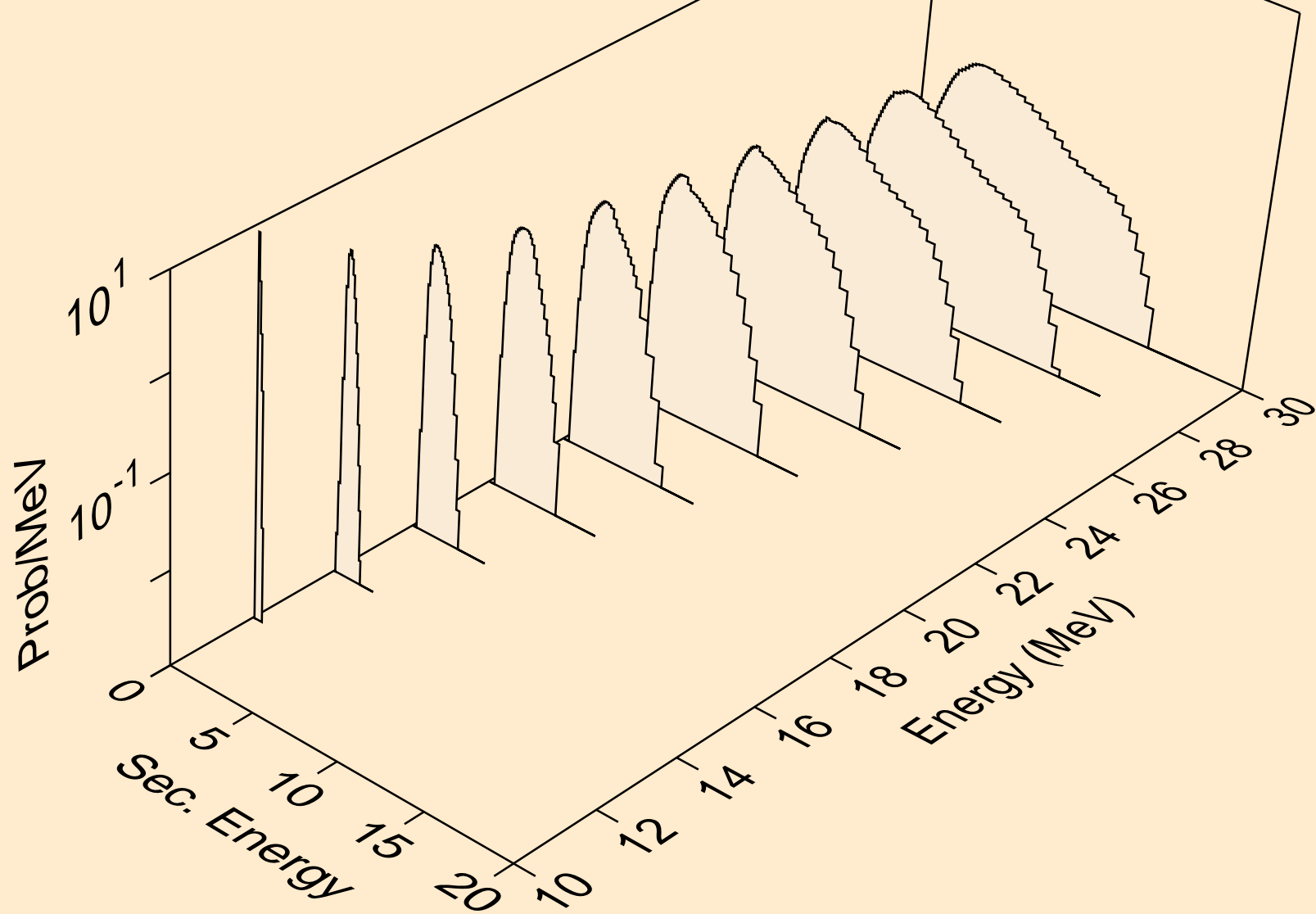

MG026 PROTON ACER TENDL-2024 LIBRARY; T=0.K
Proton emission for (p,pd)

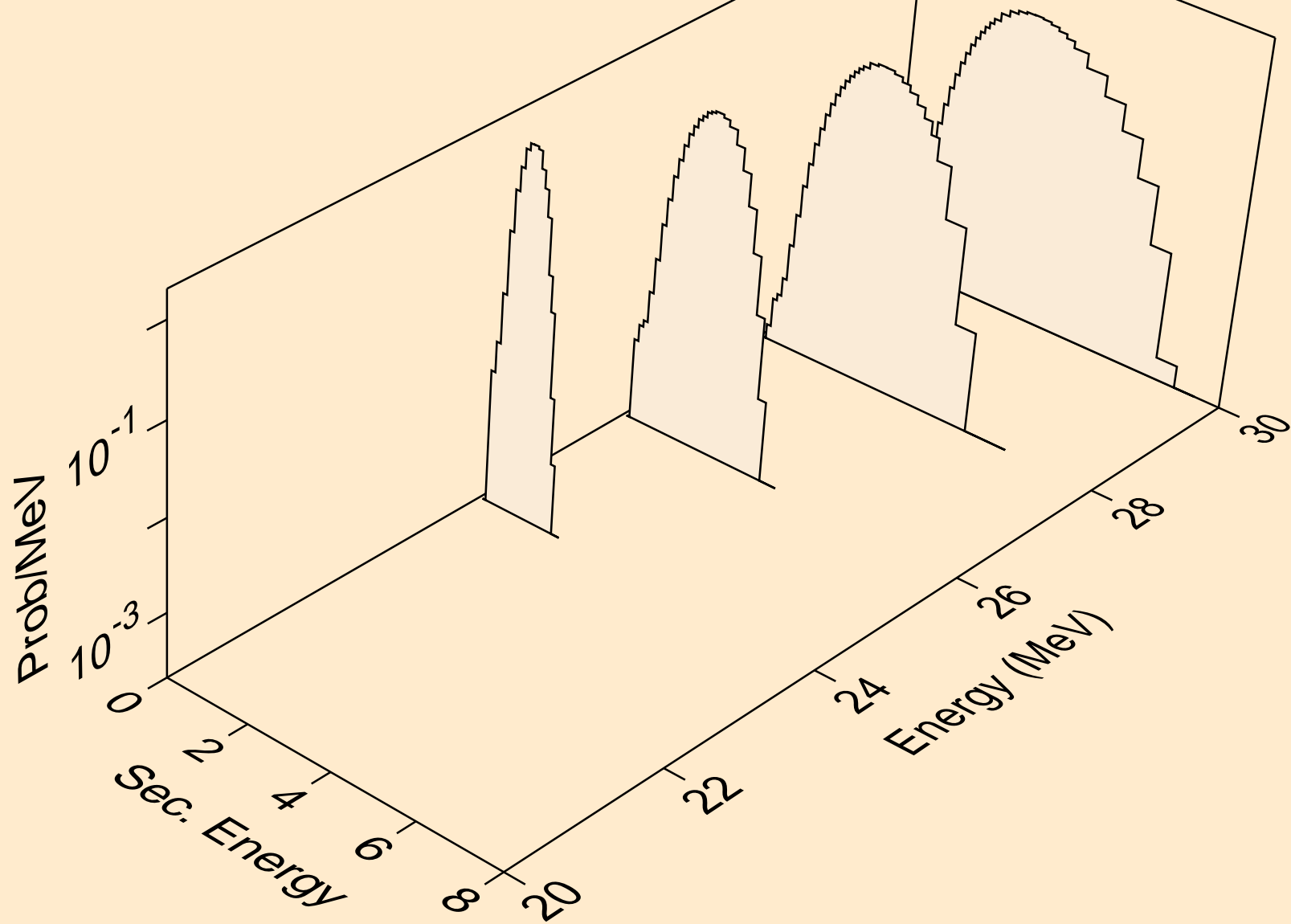

MG026 PROTON ACER TENDL-2024 LIBRARY; T=0.K
Proton emission for (p,pt)

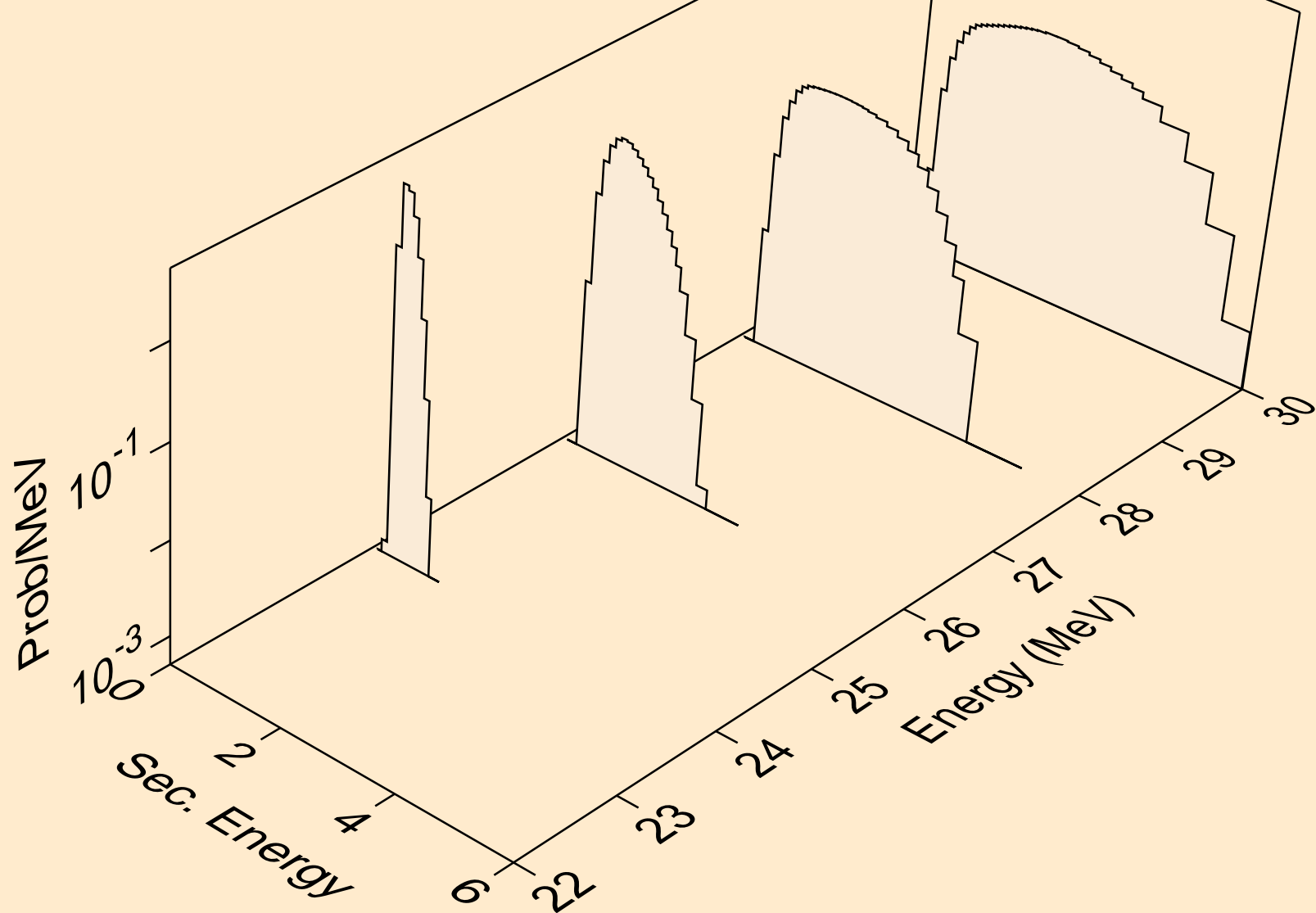

MG026 PROTON ACER TENDL-2024 LIBRARY; T=0.K
Photon emission for (z,n)

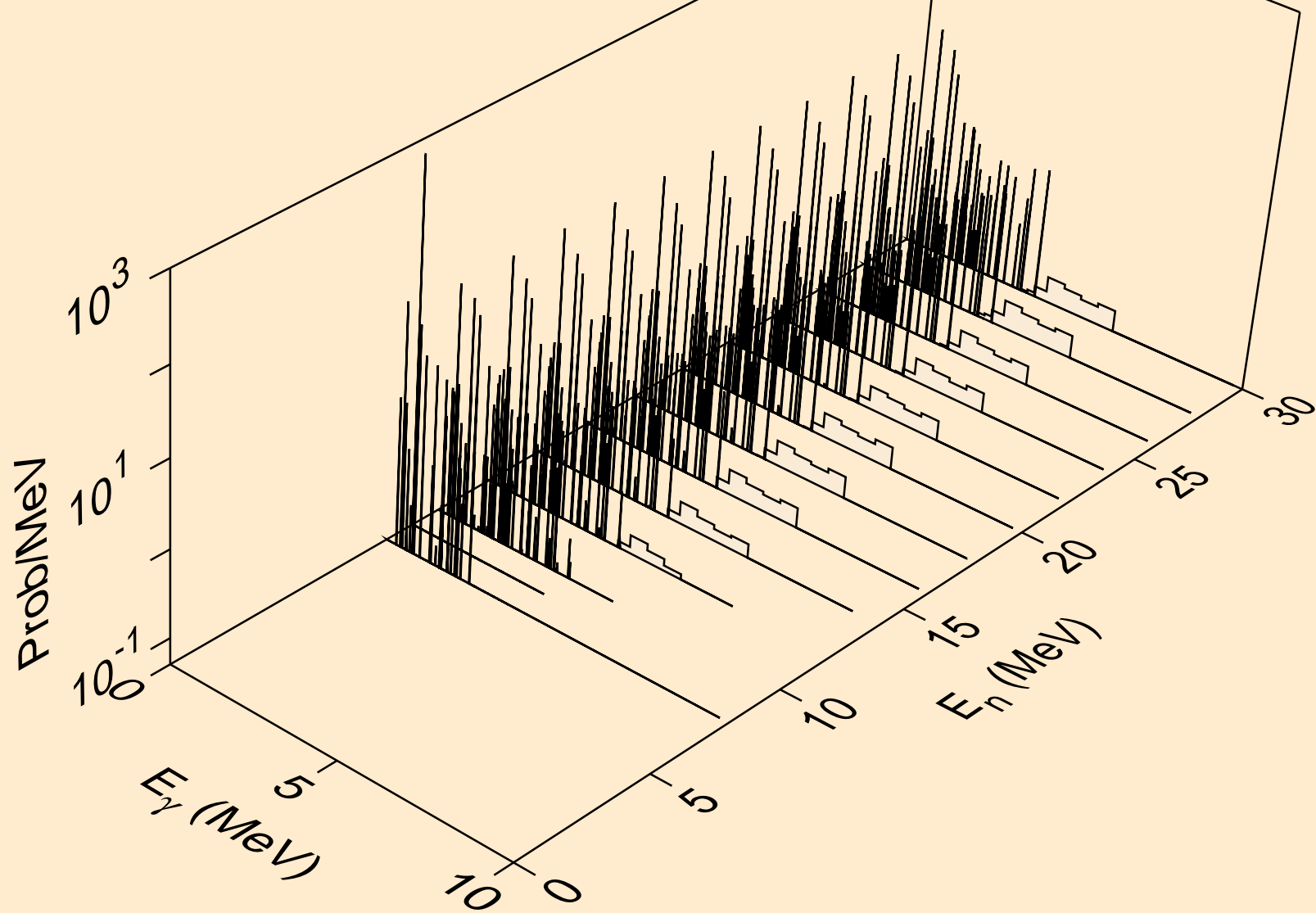

MG026 PROTON ACER TENDL-2024 LIBRARY; T=0.K
Photon emission for (z,x)

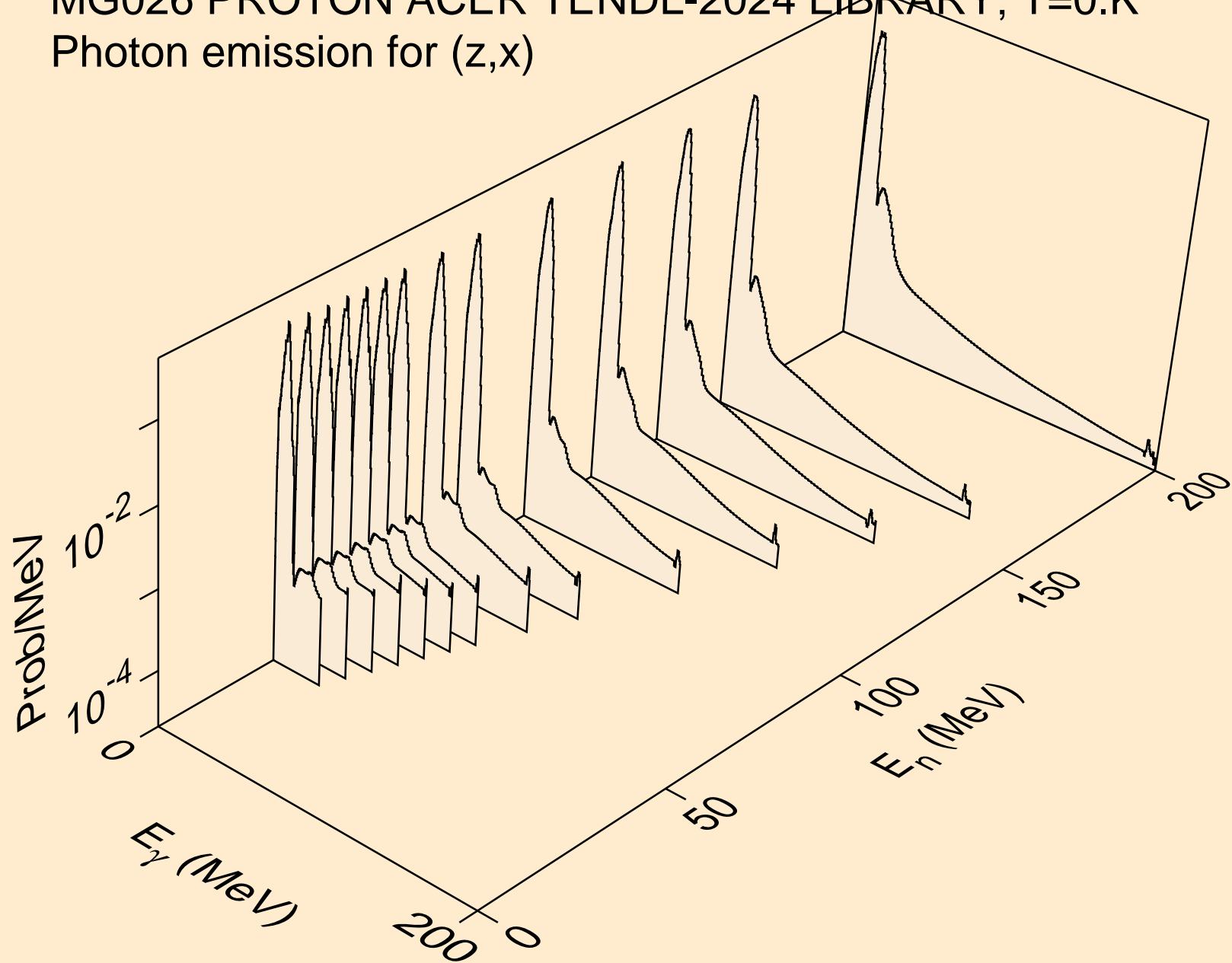

MG026 PROTON ACER TENDL-2024 LIBRARY; T=0.K
Photon emission for (n,2n)

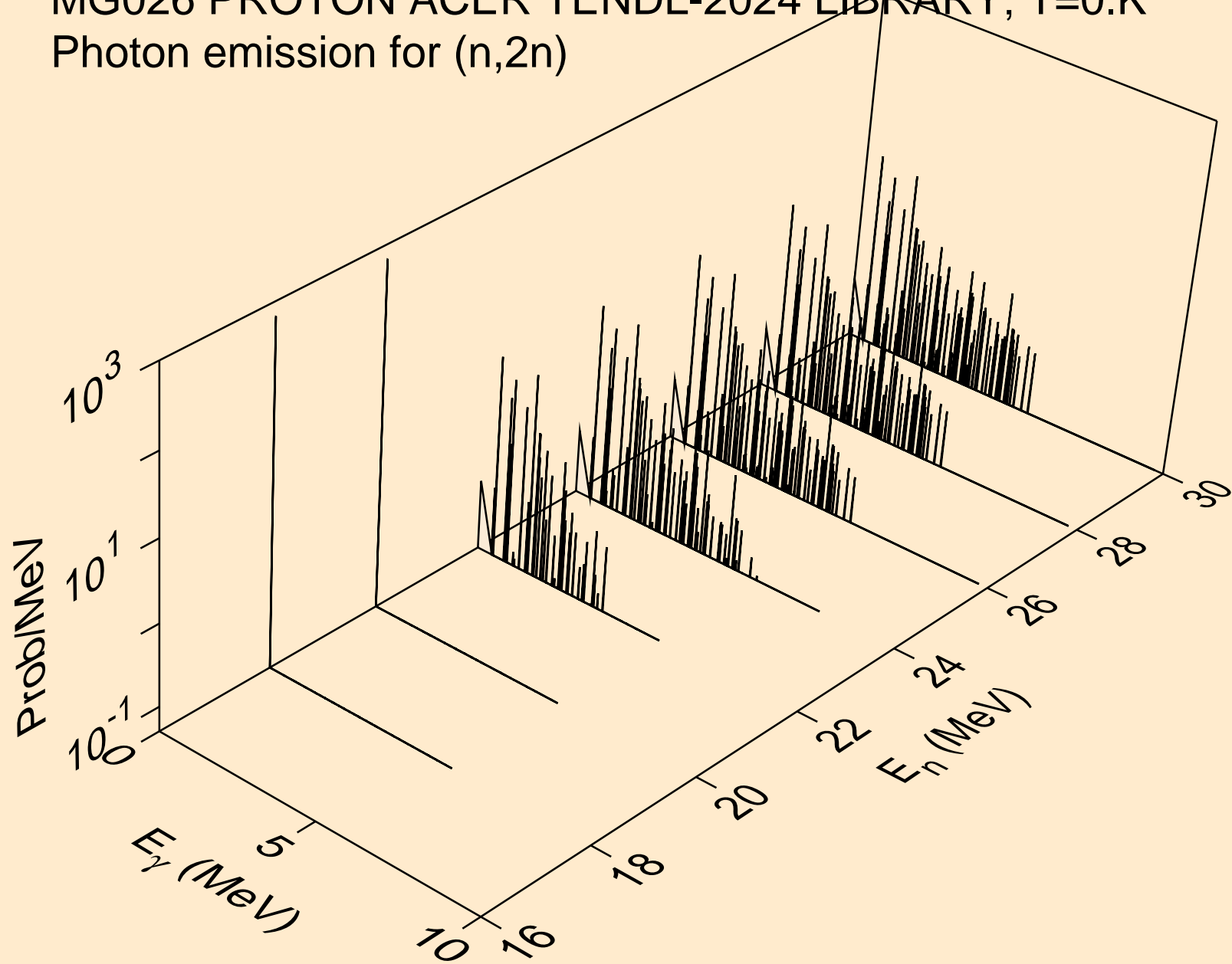

MG026 PROTON ACER TENDL-2024 LIBRARY; T=0.K
Photon emission for (n,n*)a

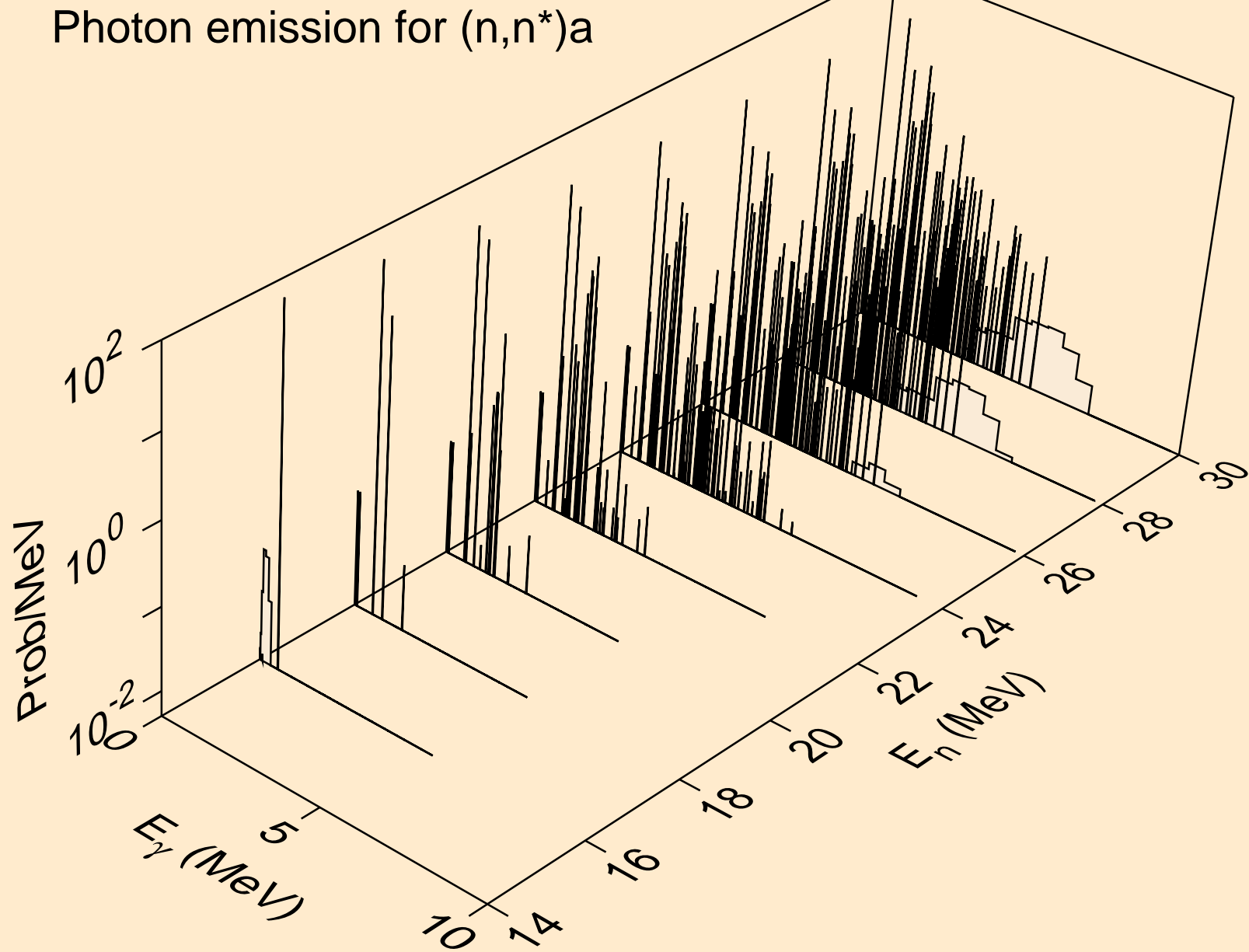

MG026 PROTON ACER TENDL-2024 LIBRARY; T=0.K
Photon emission for (n,2n)a

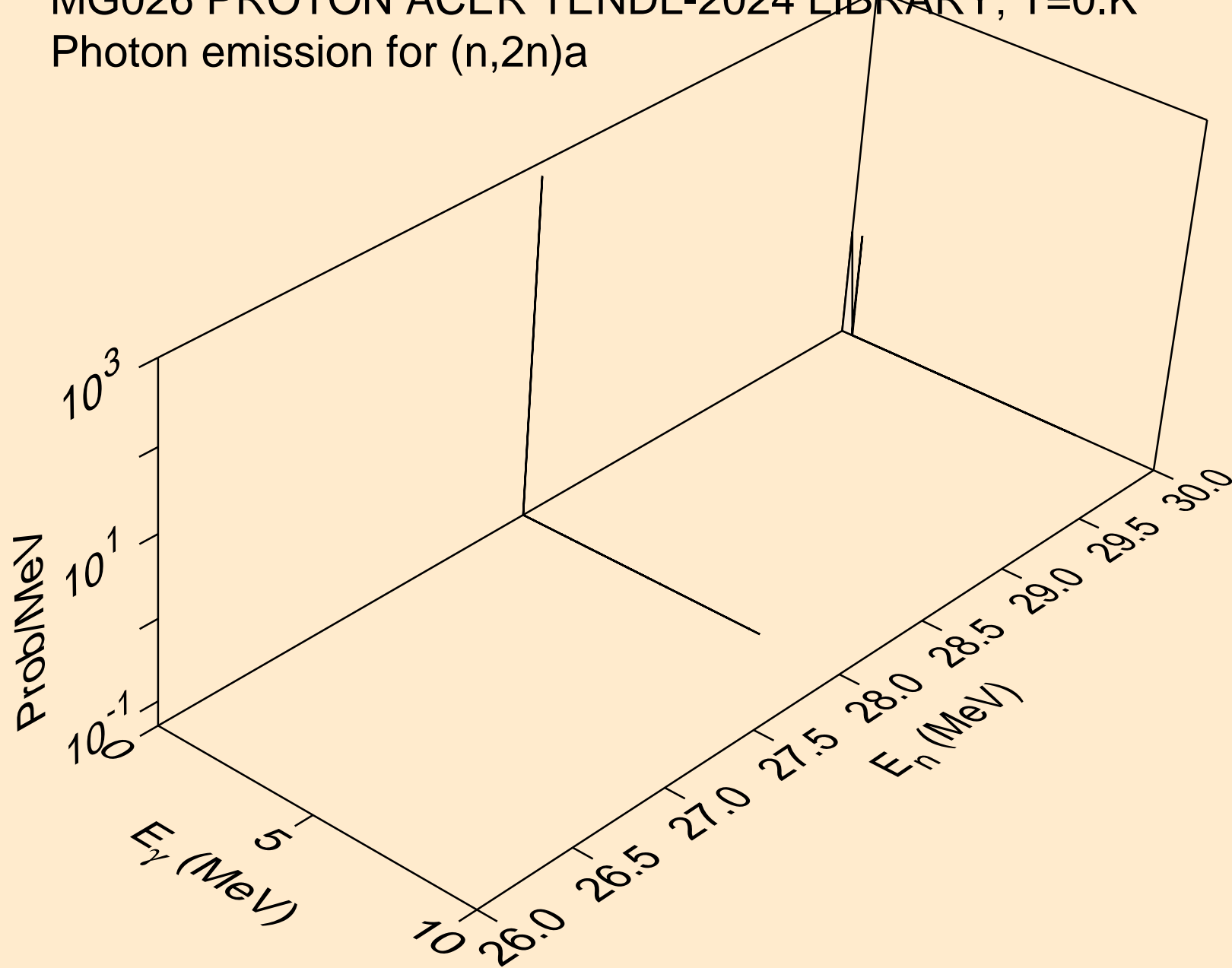

MG026 PROTON ACER TENDL-2024 LIBRARY; T=0.K
Photon emission for (n,n*)p

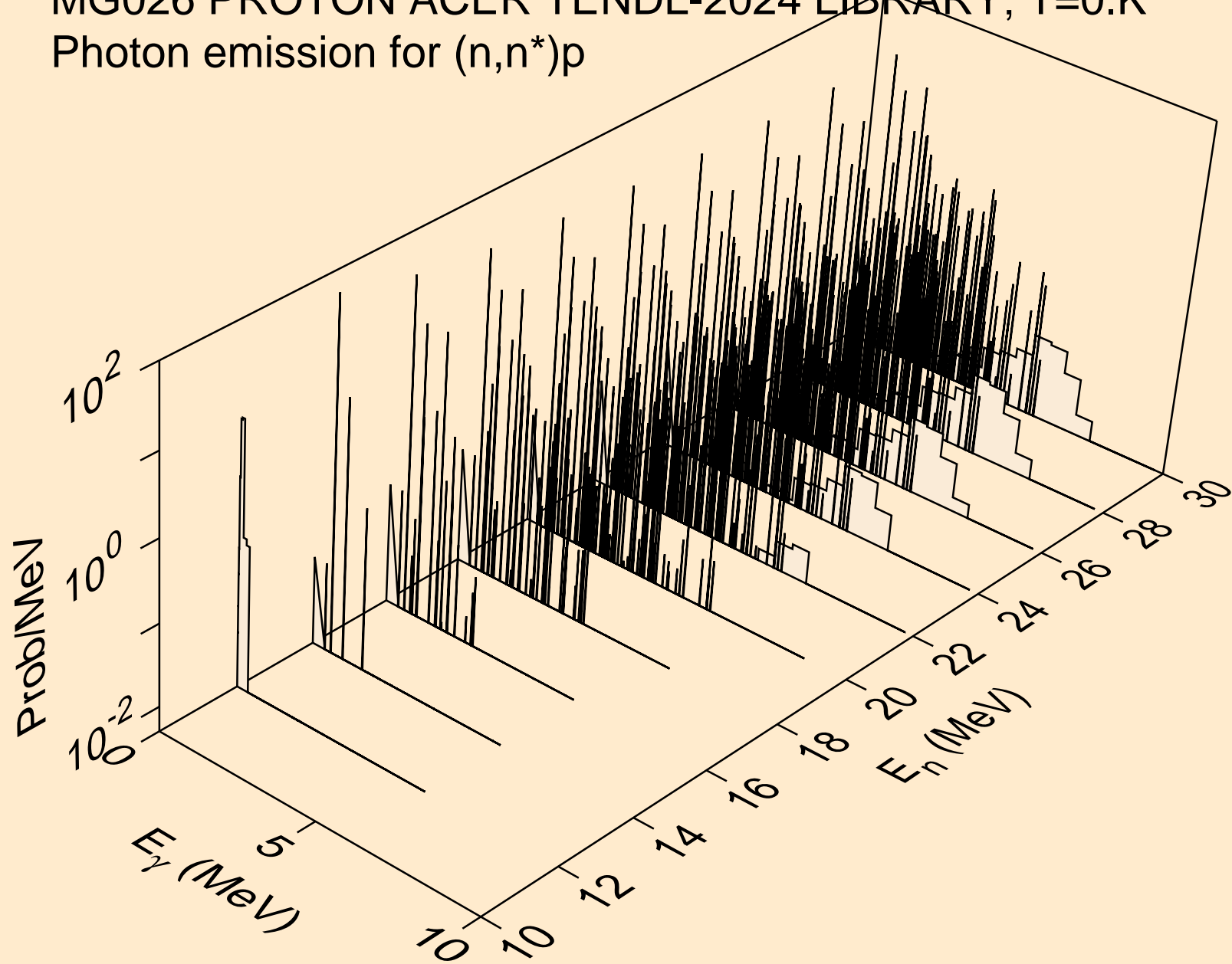

MG026 PROTON ACER TENDL-2024 LIBRARY; T=0.K
Photon emission for (n,n*)2a

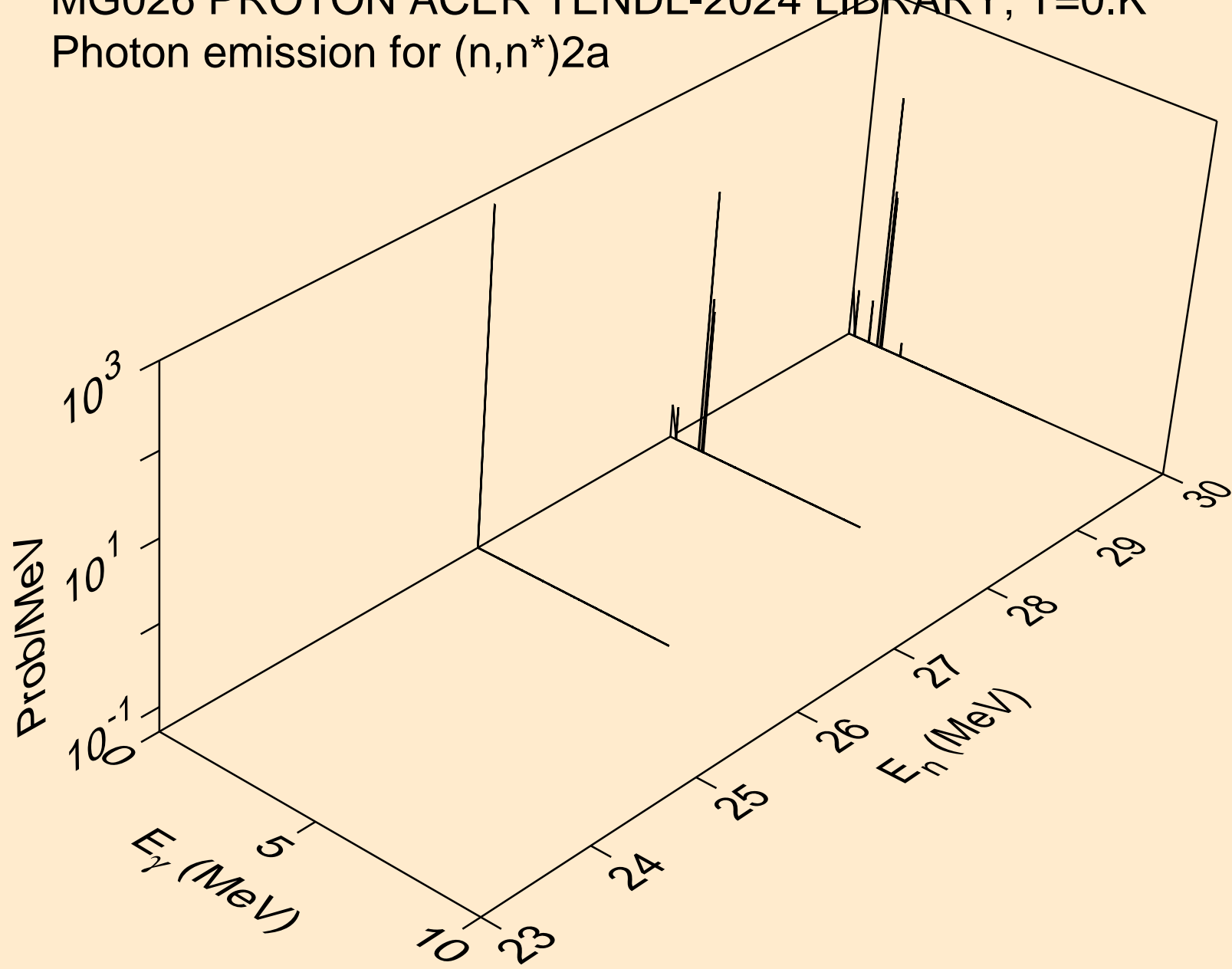

MG026 PROTON ACER TENDL-2024 LIBRARY; T=0.K
Photon emission for (n,n*)d

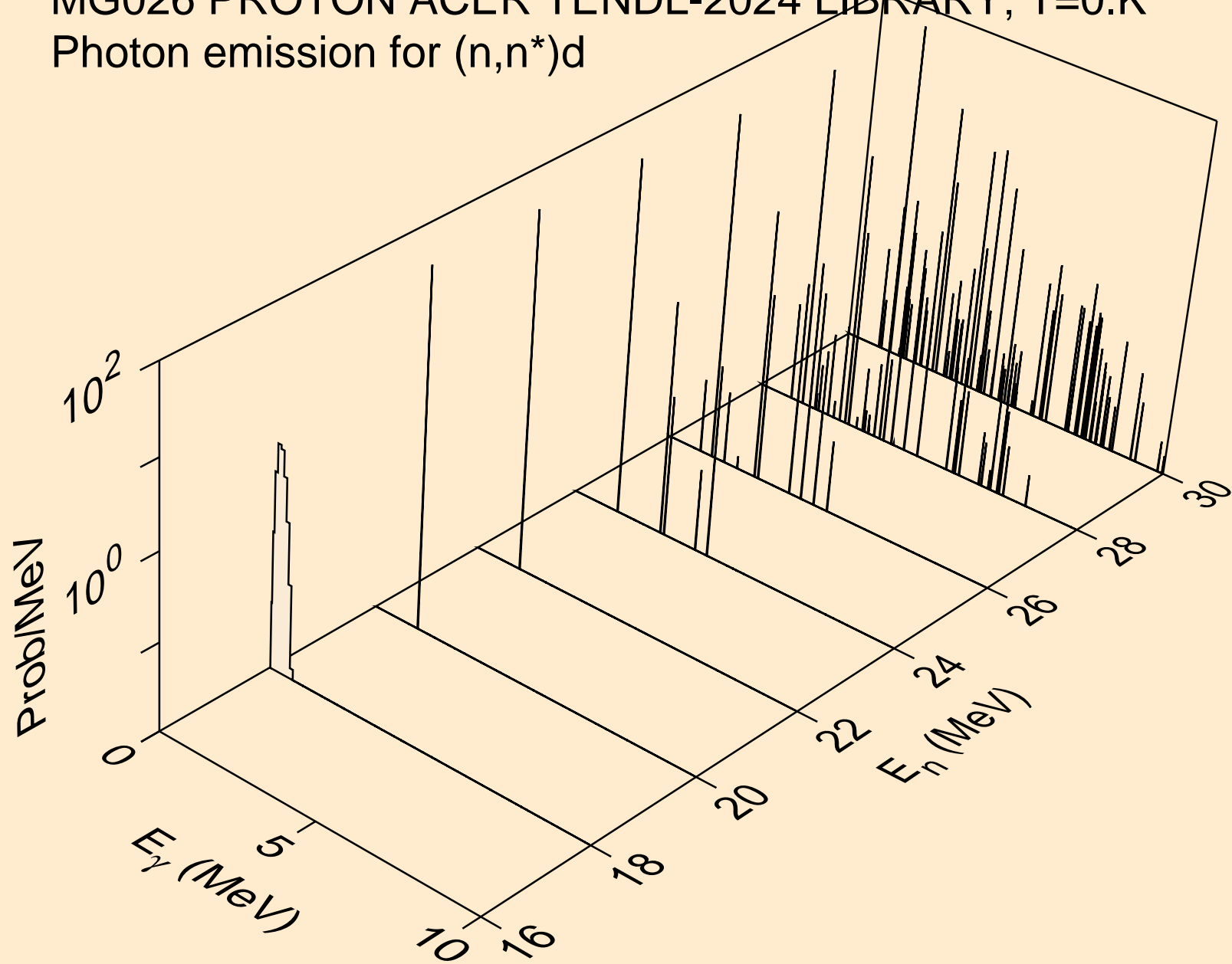

MG026 PROTON ACER TENDL-2024 LIBRARY; T=0.K
Photon emission for (n,n*)t

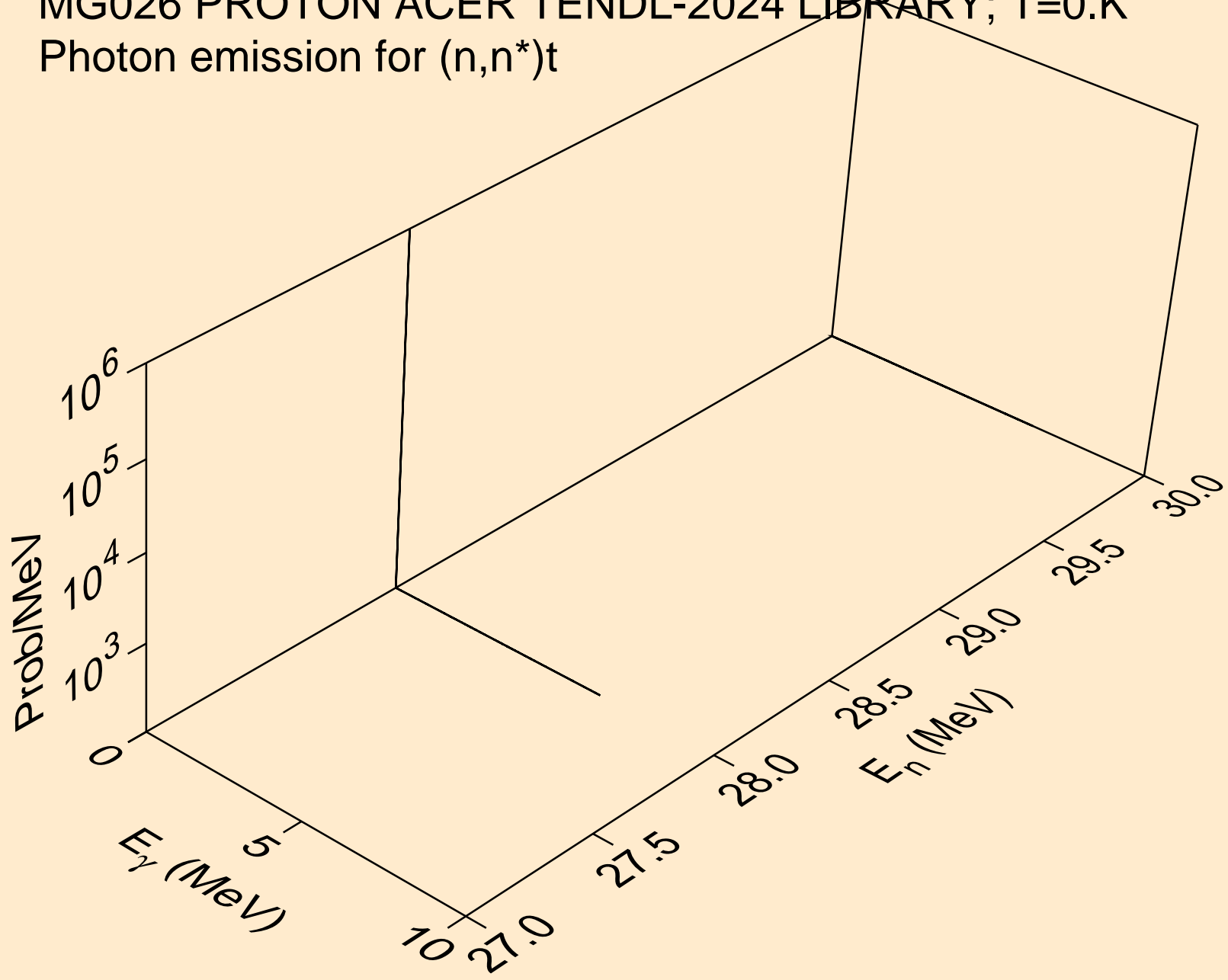

MG026 PROTON ACER TENDL-2024 LIBRARY; T=0.K
Photon emission for (n,n*)he3

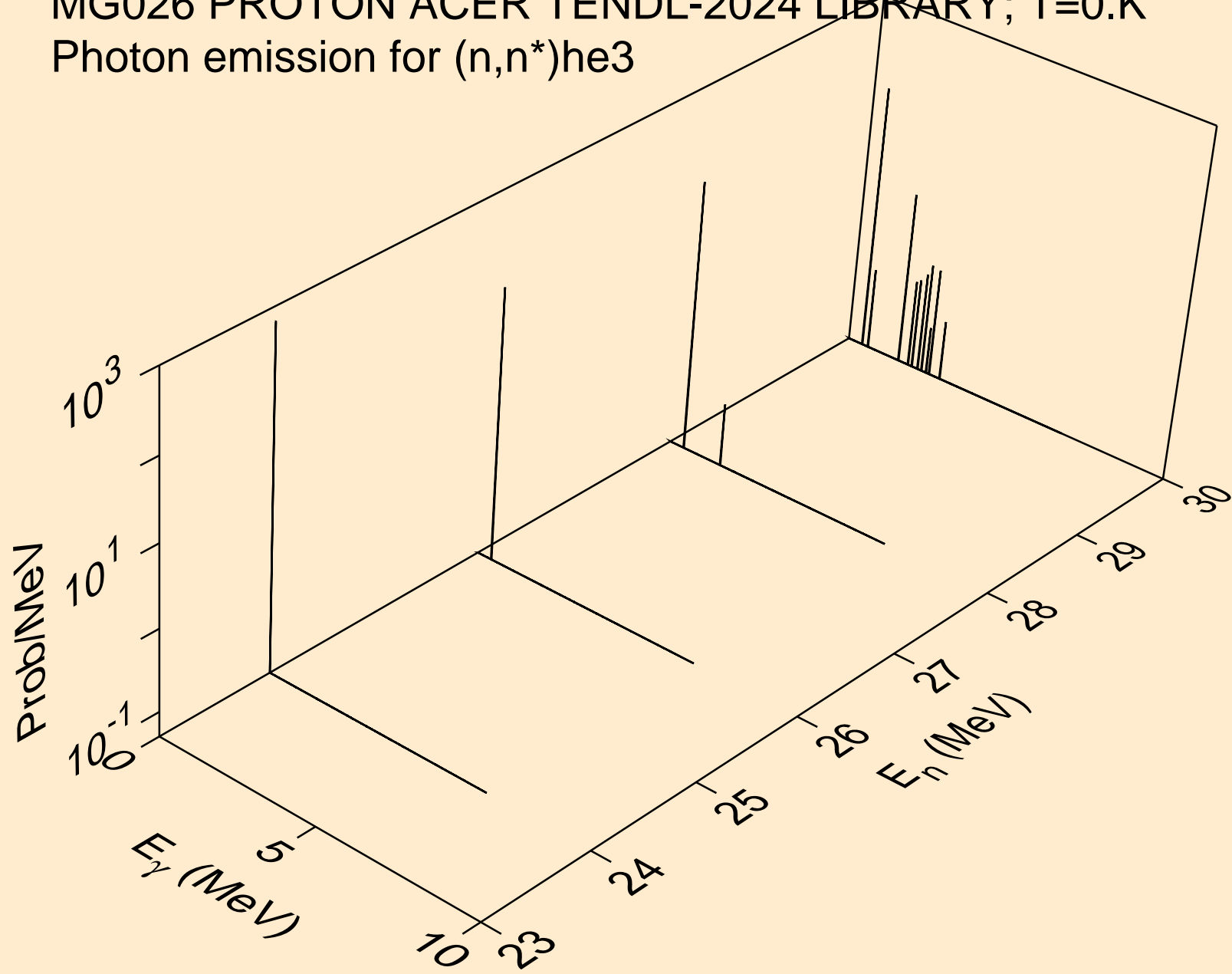

MG026 PROTON ACER TENDL-2024 LIBRARY; T=0.K
Photon emission for (n,2np)

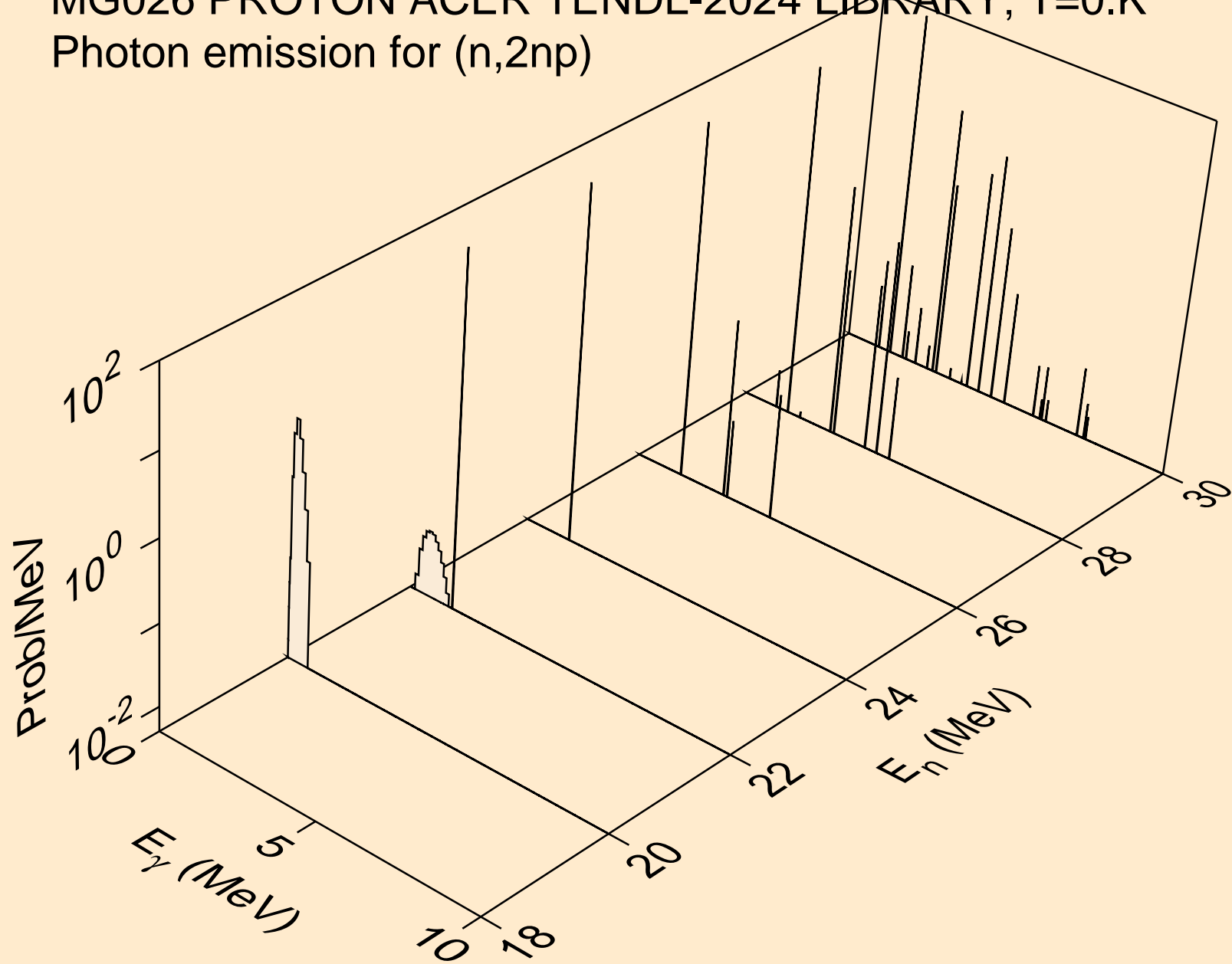

MG026 PROTON ACER TENDL-2024 LIBRARY; T=0.K
Photon emission for (n,n2p)

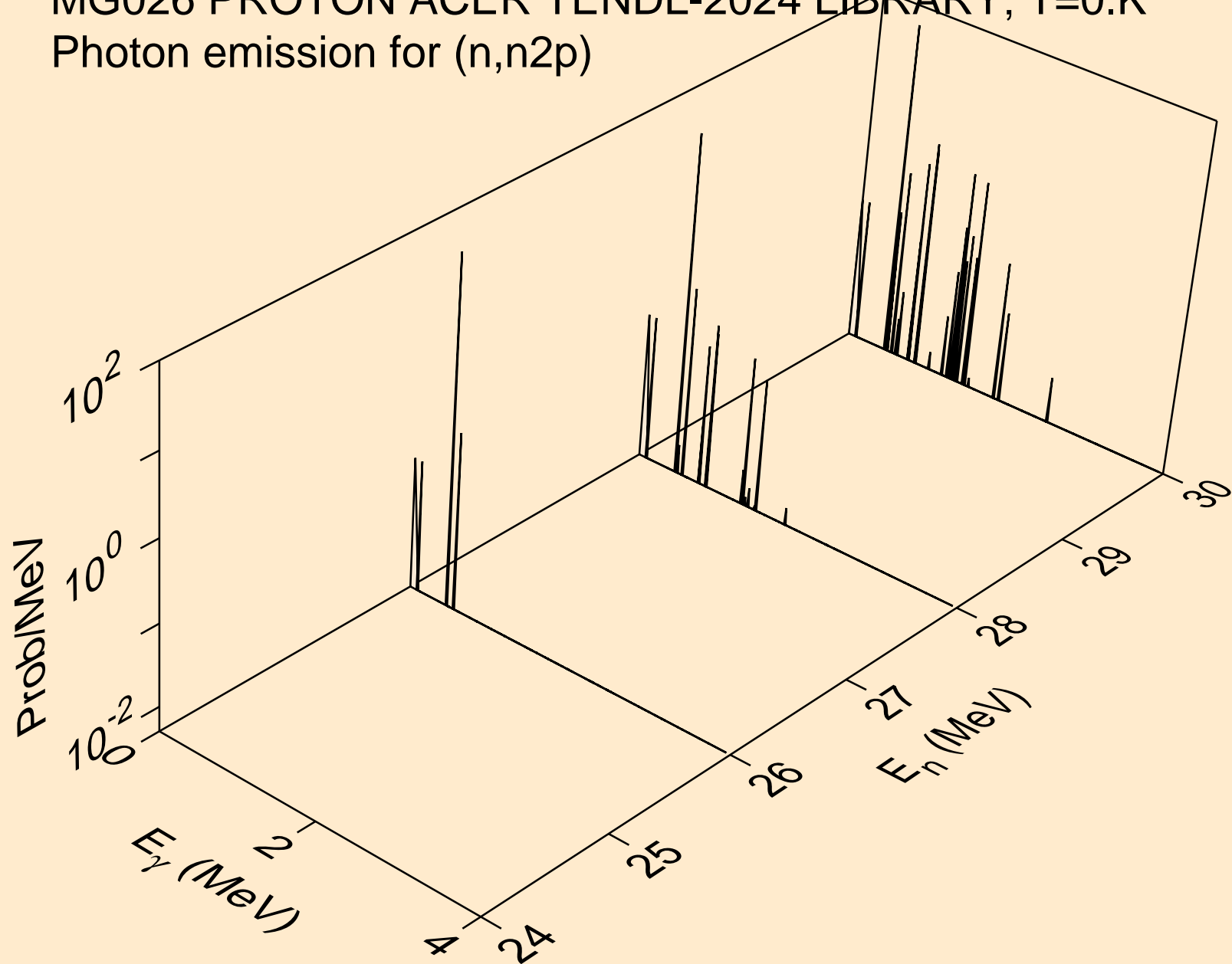

MG026 PROTON ACER TENDL-2024 LIBRARY; T=0.K
Photon emission for (n,npa)

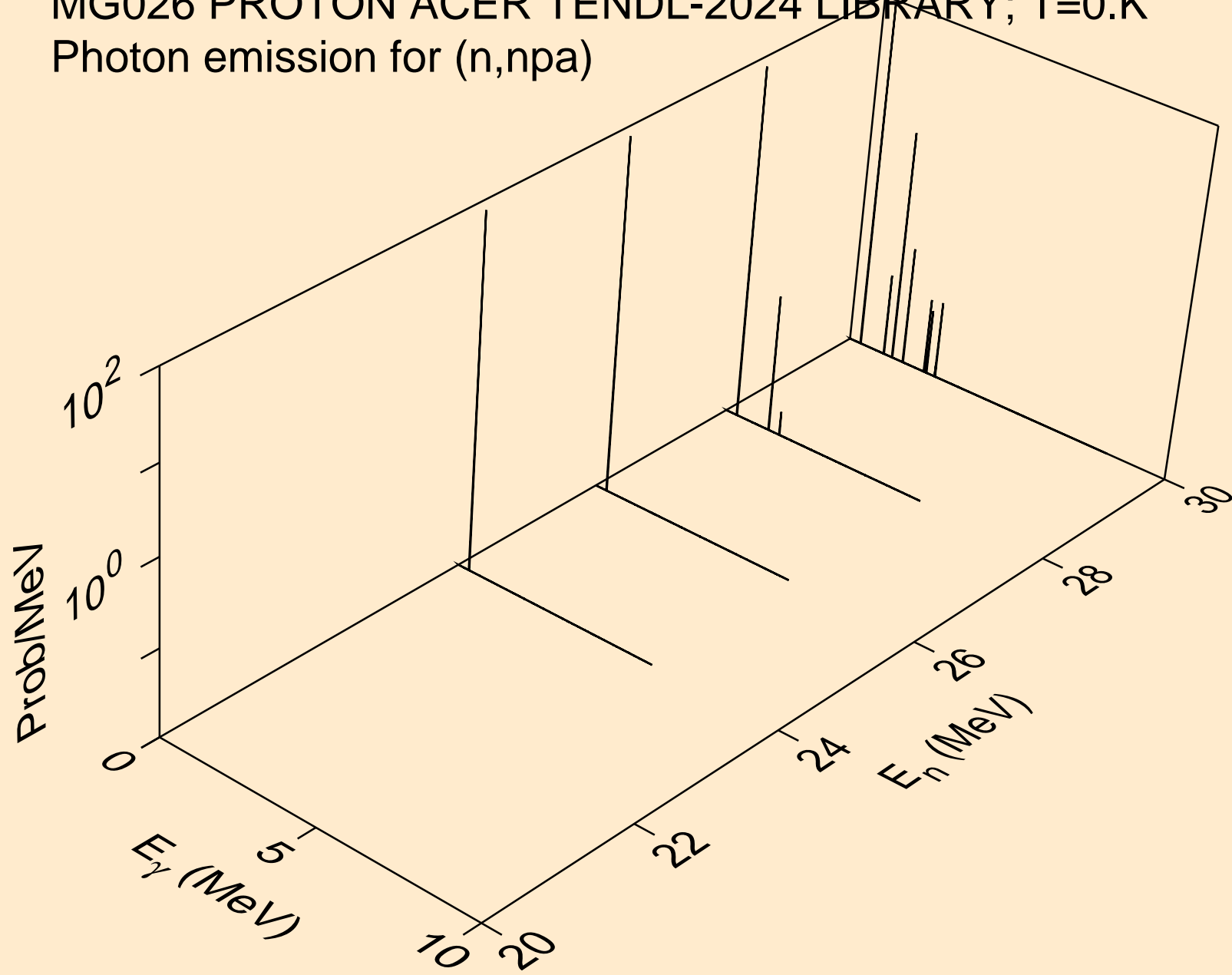

MG026 PROTON ACER TENDL-2024 LIBRARY; T=0.K
Photon emission for (n,gma)

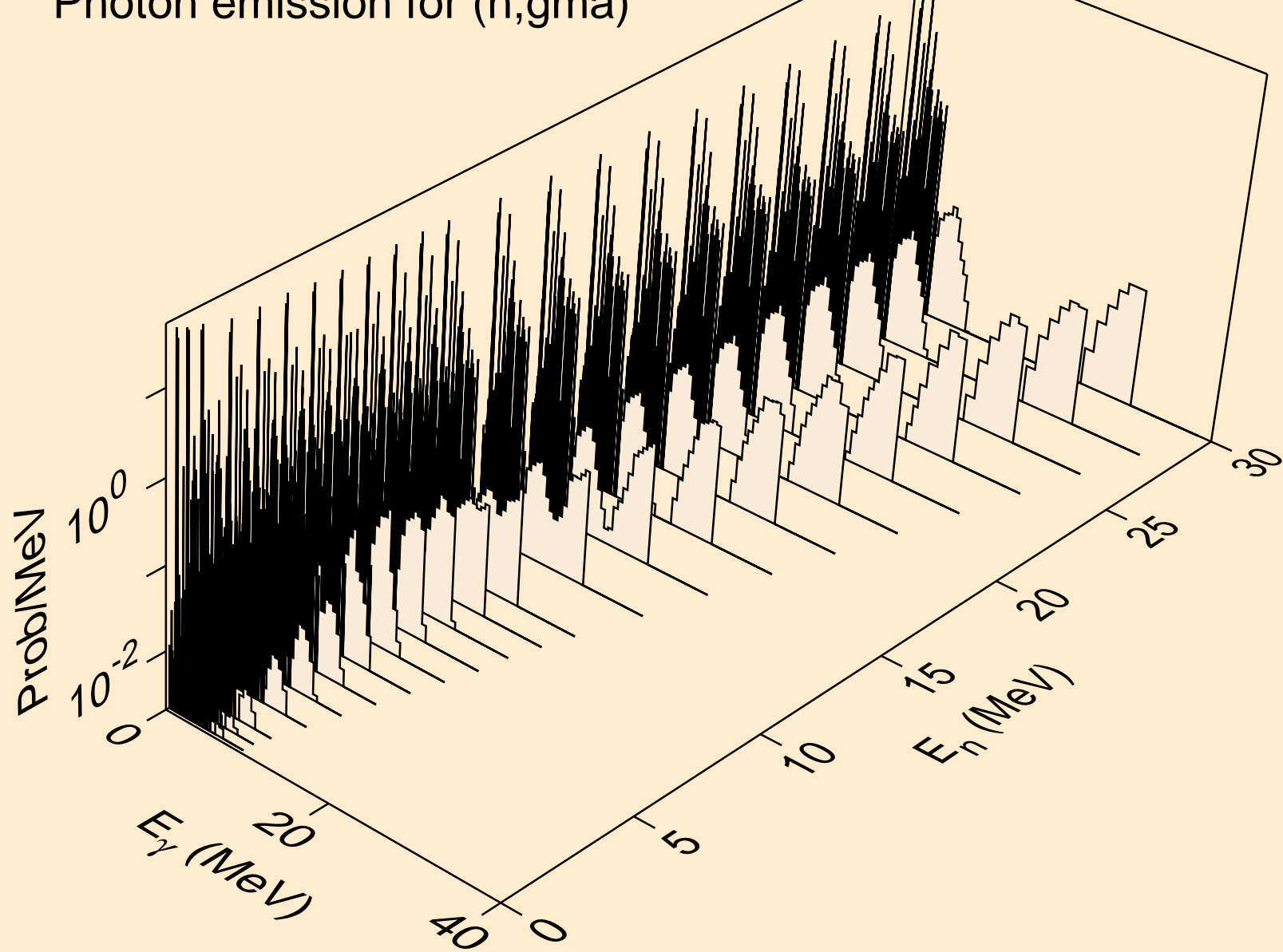

MG026 PROTON ACER TENDL-2024 LIBRARY; T=0.K
Photon emission for inelastic

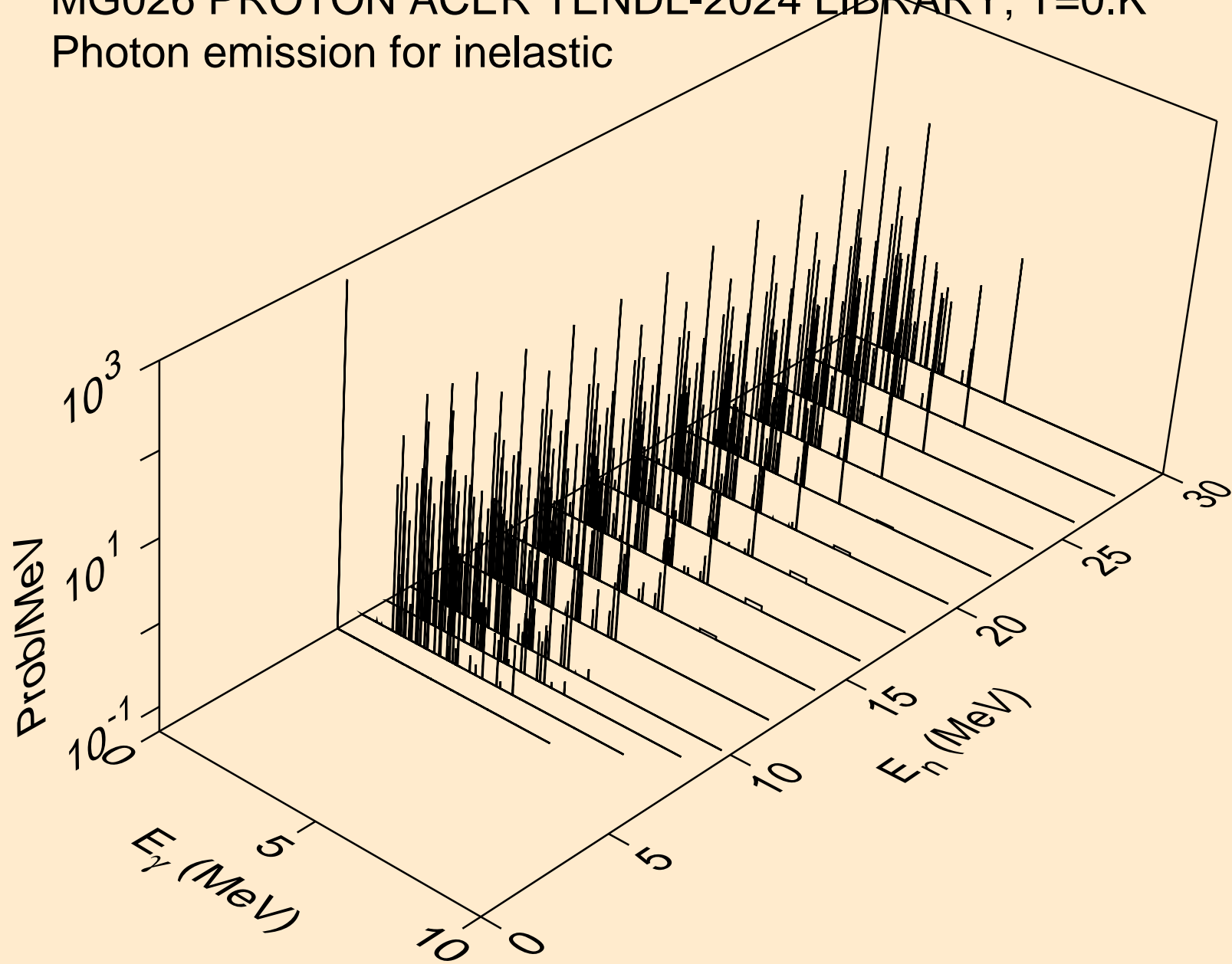

MG026 PROTON ACER TENDL-2024 LIBRARY; T=0.K
Photon emission for (n,d)

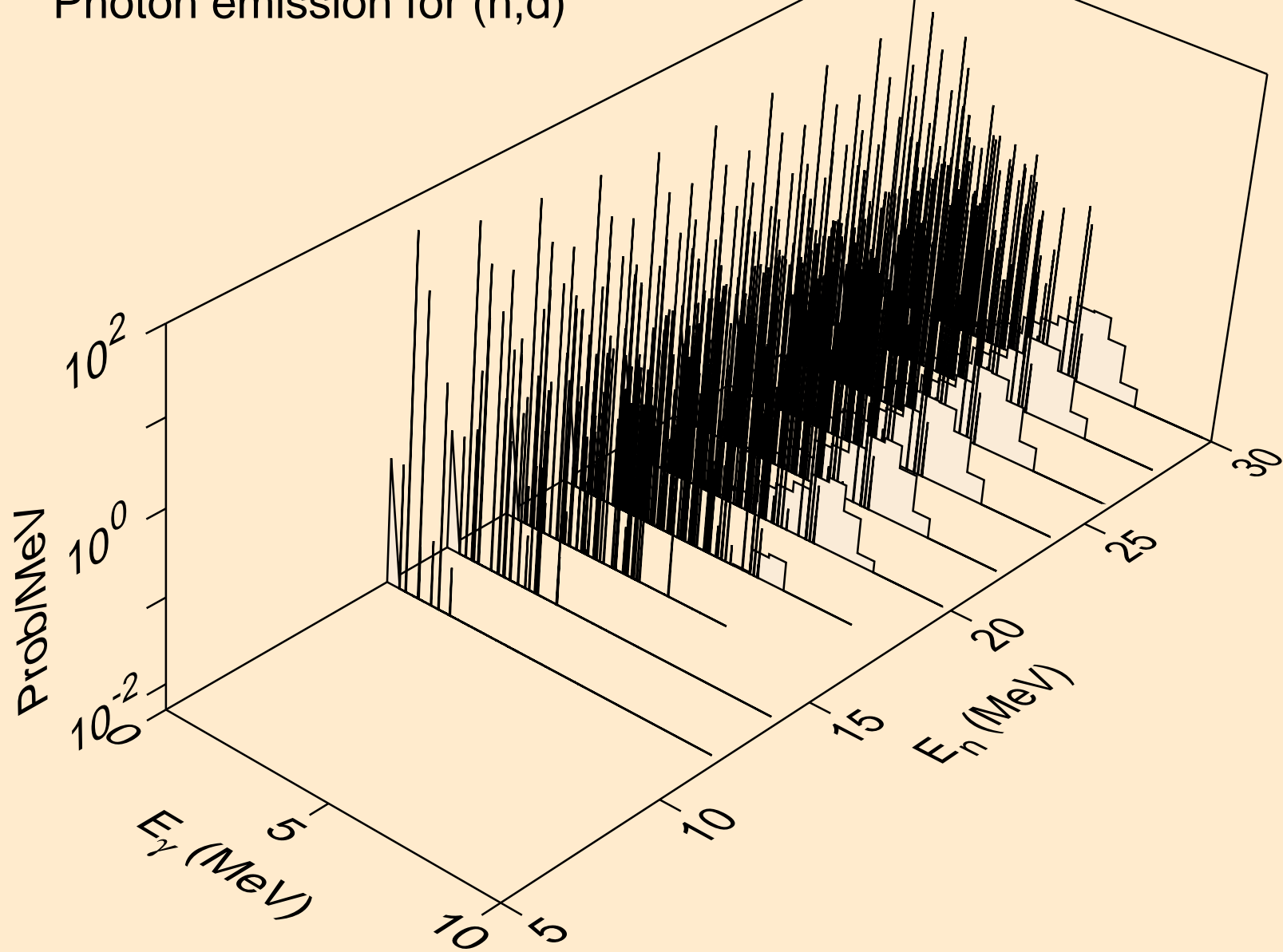

MG026 PROTON ACER TENDL-2024 LIBRARY; T=0.K
Photon emission for (n,t)

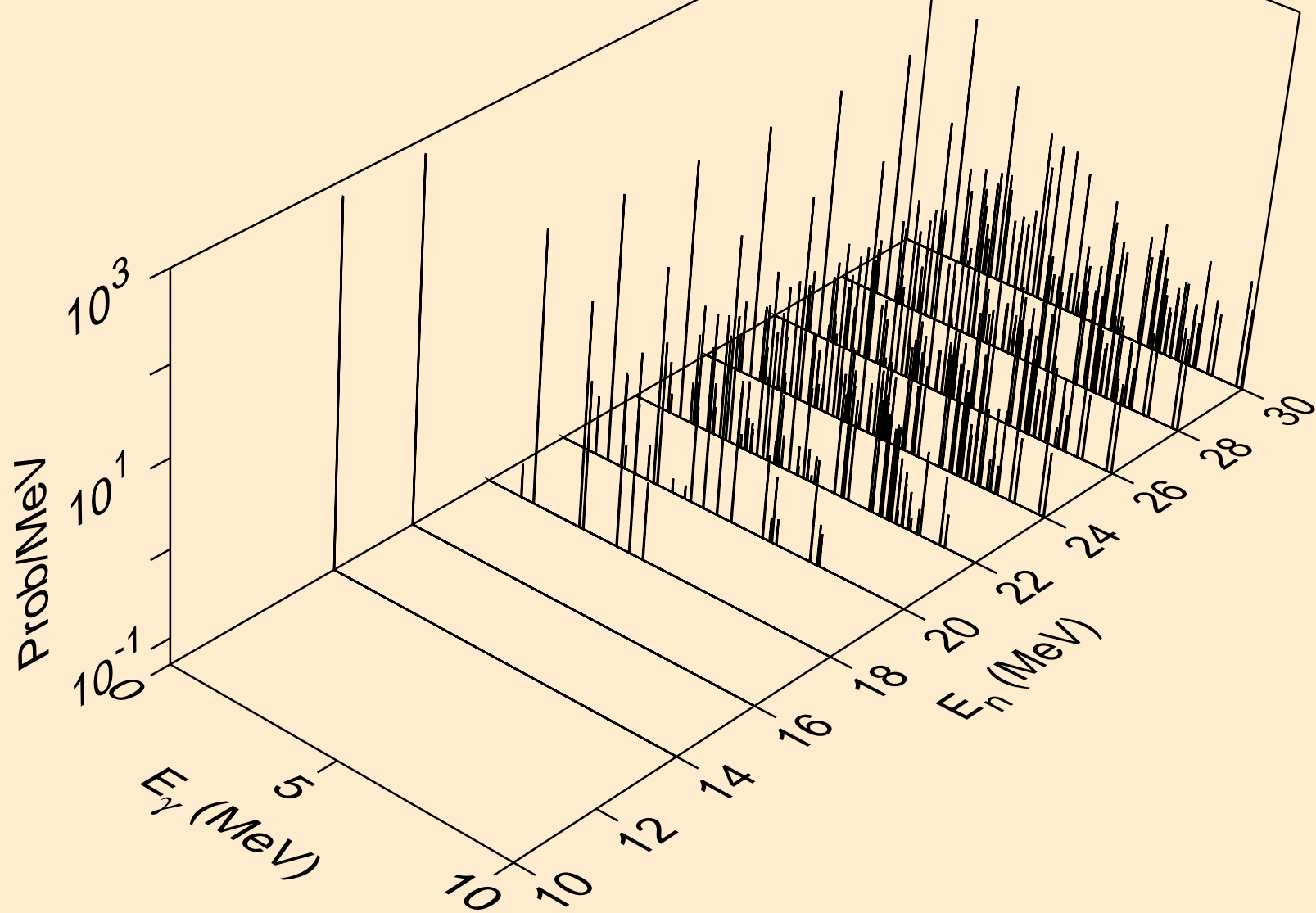

MG026 PROTON ACER TENDL-2024 LIBRARY; T=0.K
Photon emission for (n,he3)

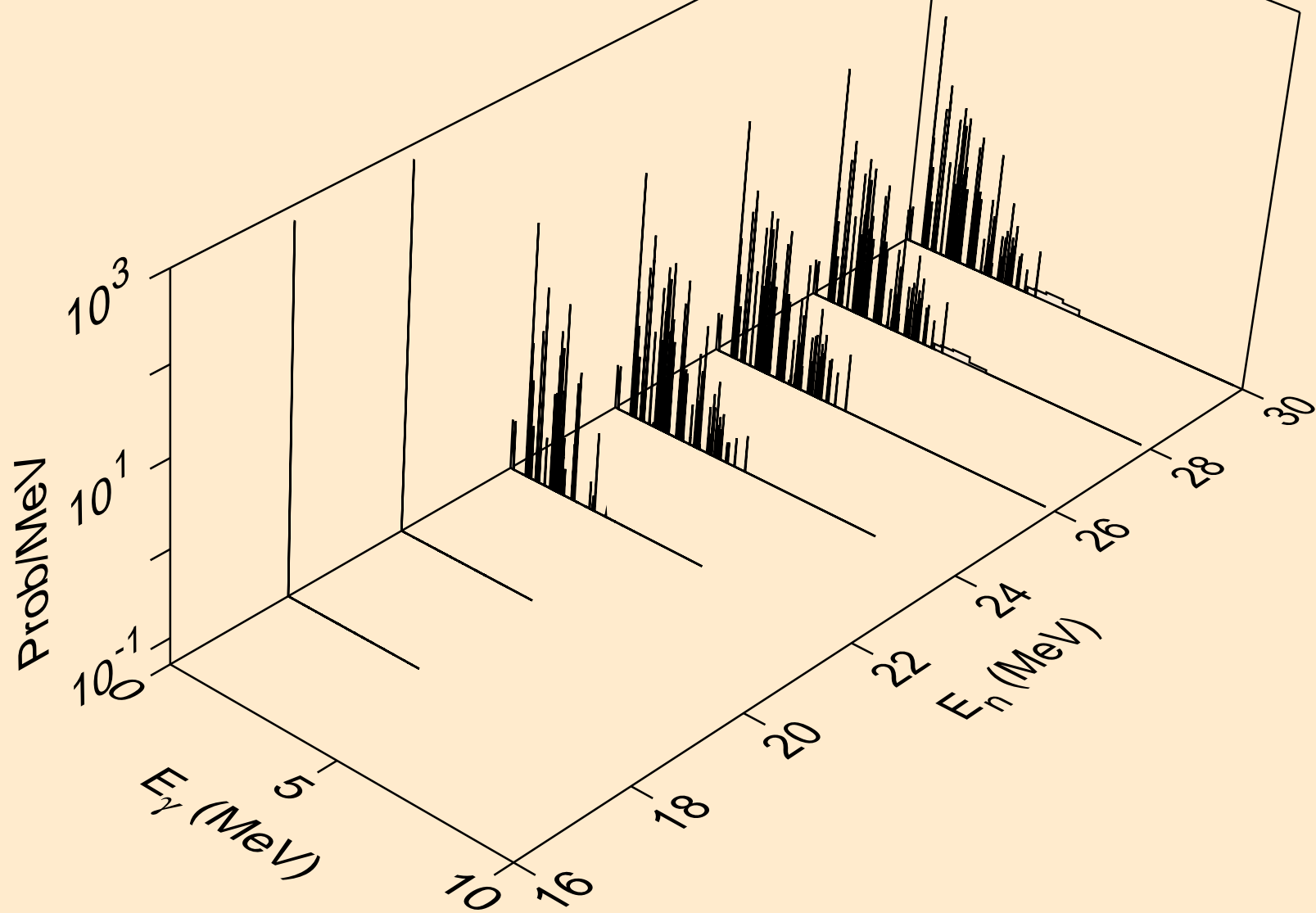

MG026 PROTON ACER TENDL-2024 LIBRARY; T=0.K
Photon emission for (n,a)

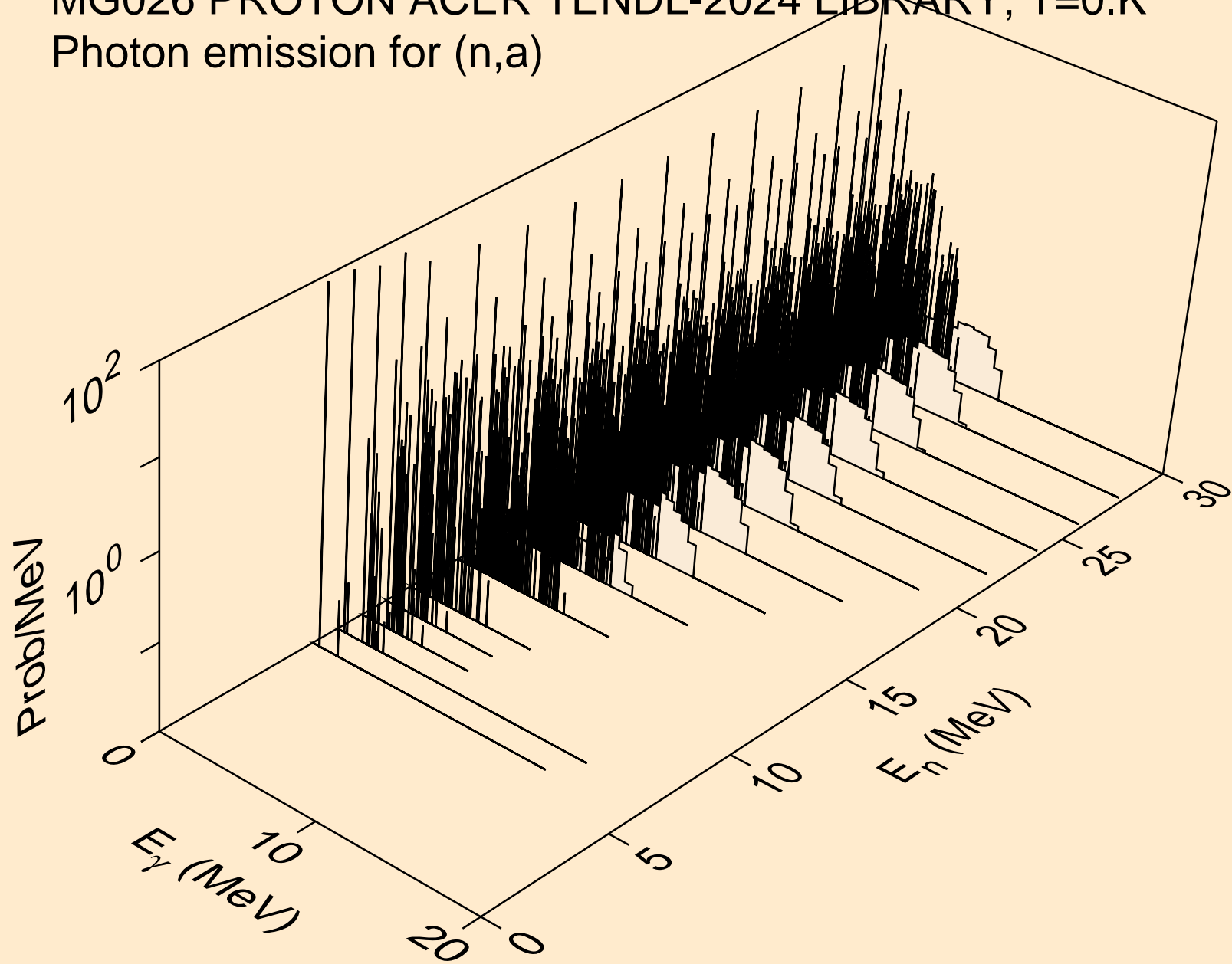

MG026 PROTON ACER TENDL-2024 LIBRARY; T=0.K
Photon emission for (n,2a)

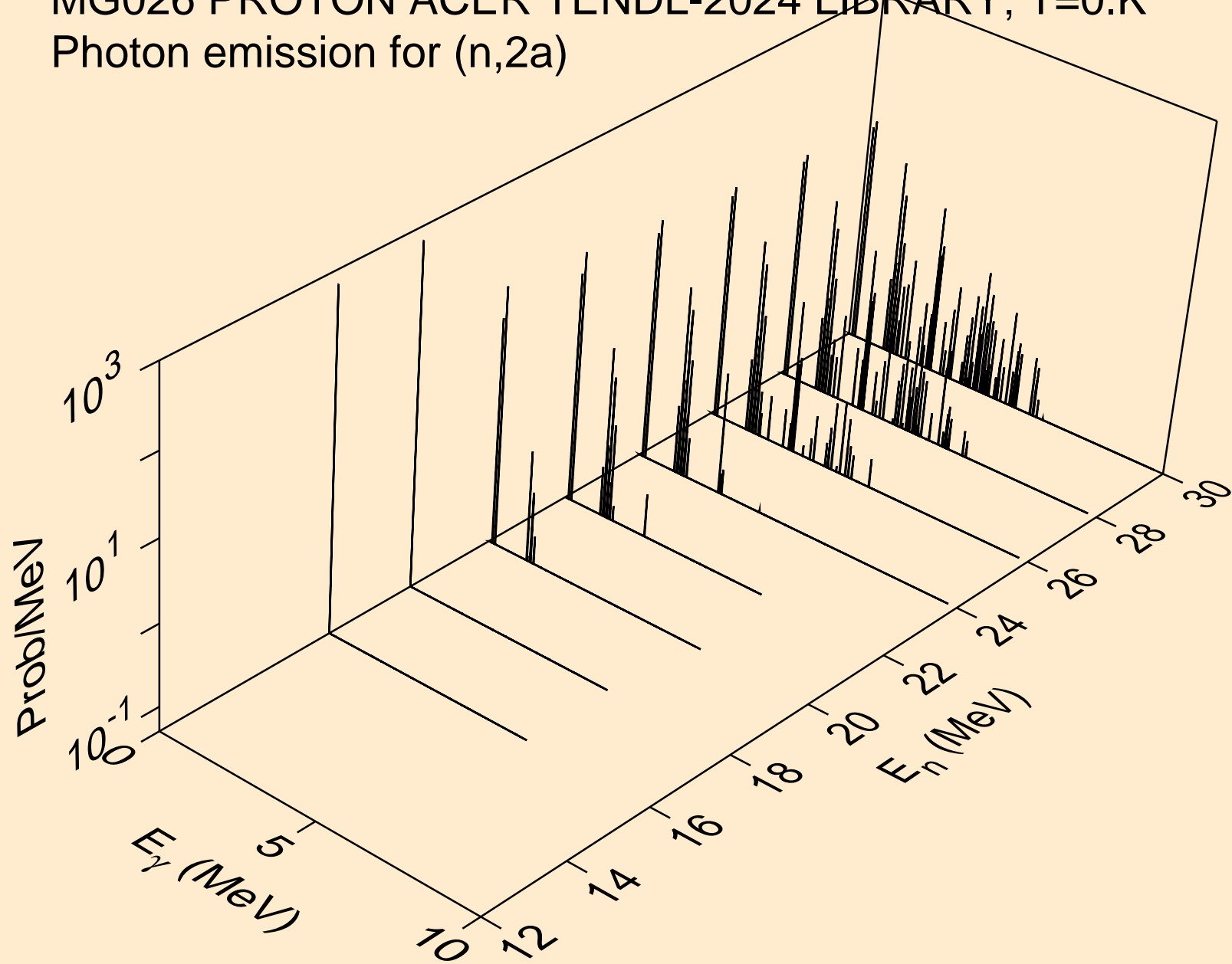

MG026 PROTON ACER TENDL-2024 LIBRARY; T=0.K
Photon emission for (n,3a)

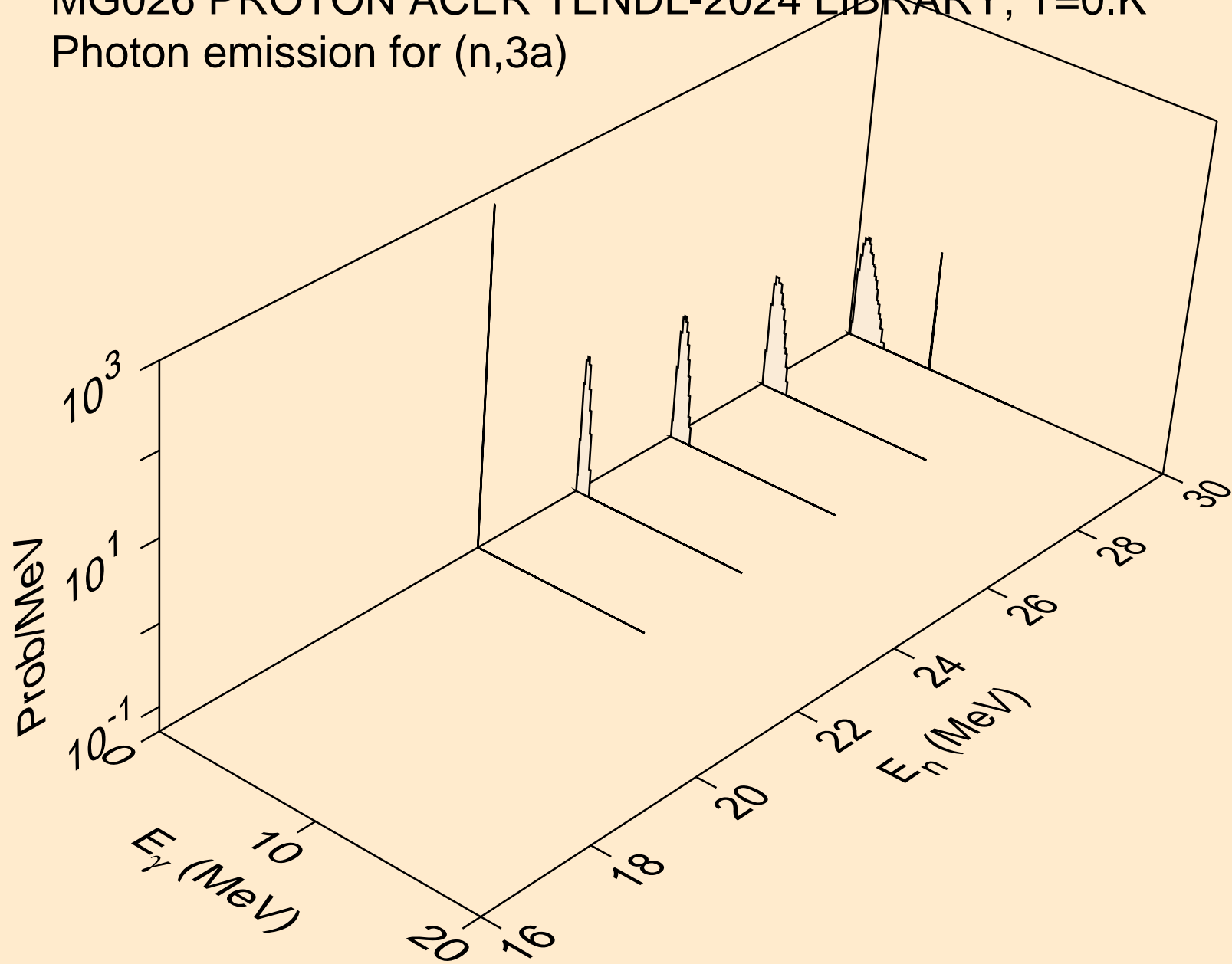

MG026 PROTON ACER TENDL-2024 LIBRARY; T=0.K
Photon emission for (n,2p)

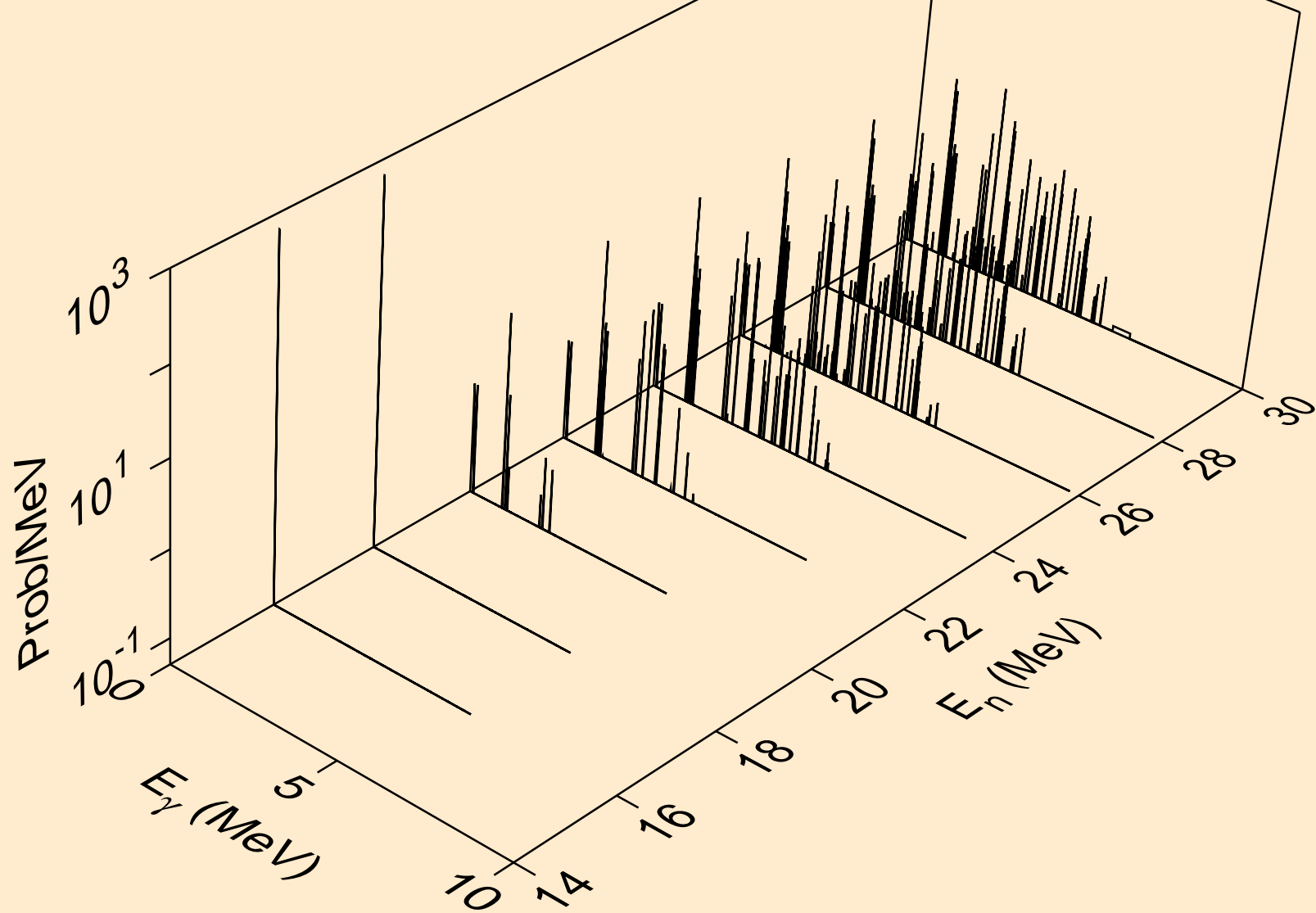

MG026 PROTON ACER TENDL-2024 LIBRARY; T=0.K
Photon emission for (n,pa)

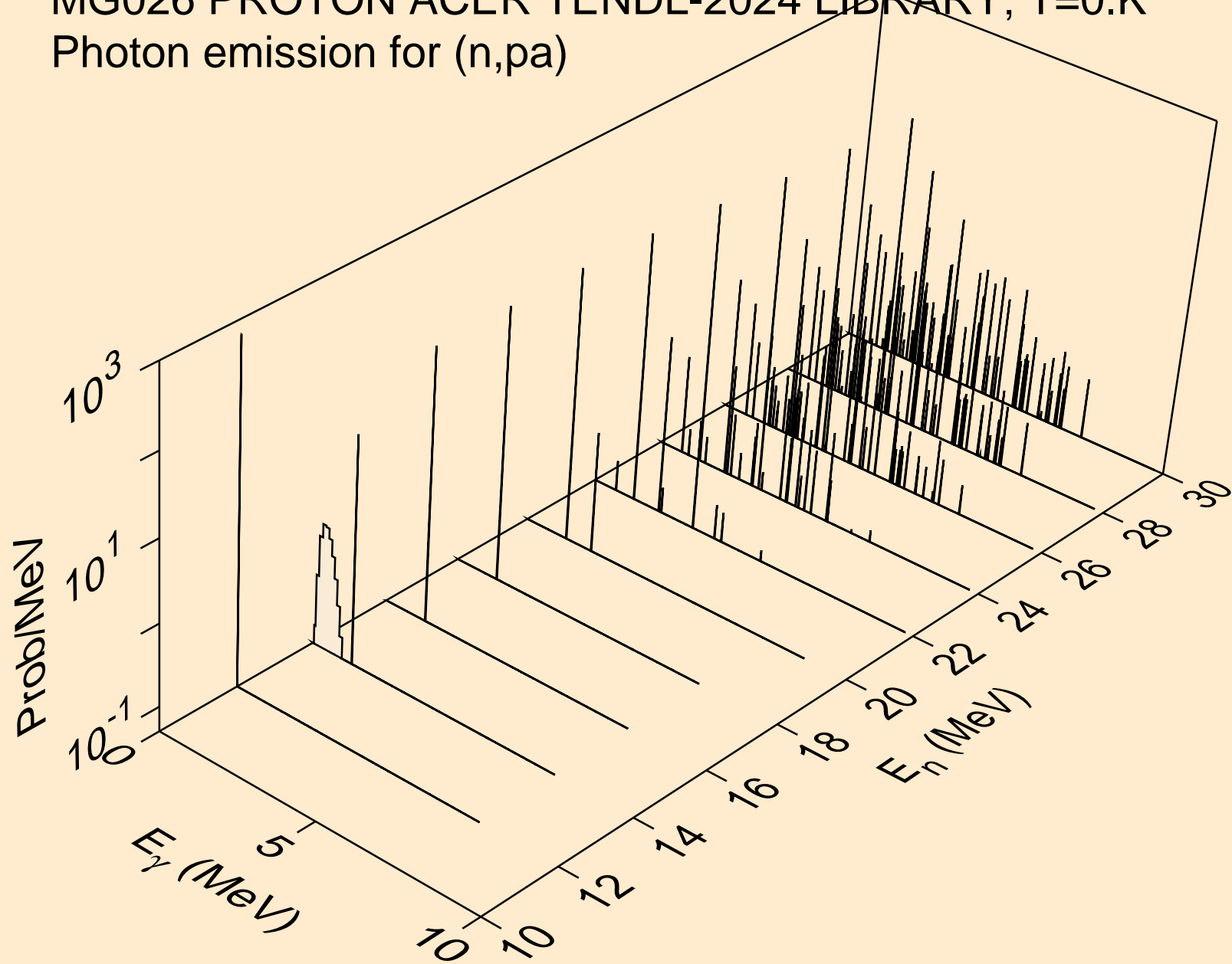

MG026 PROTON ACER TENDL-2024 LIBRARY; T=0.K
Photon emission for (n,pd)

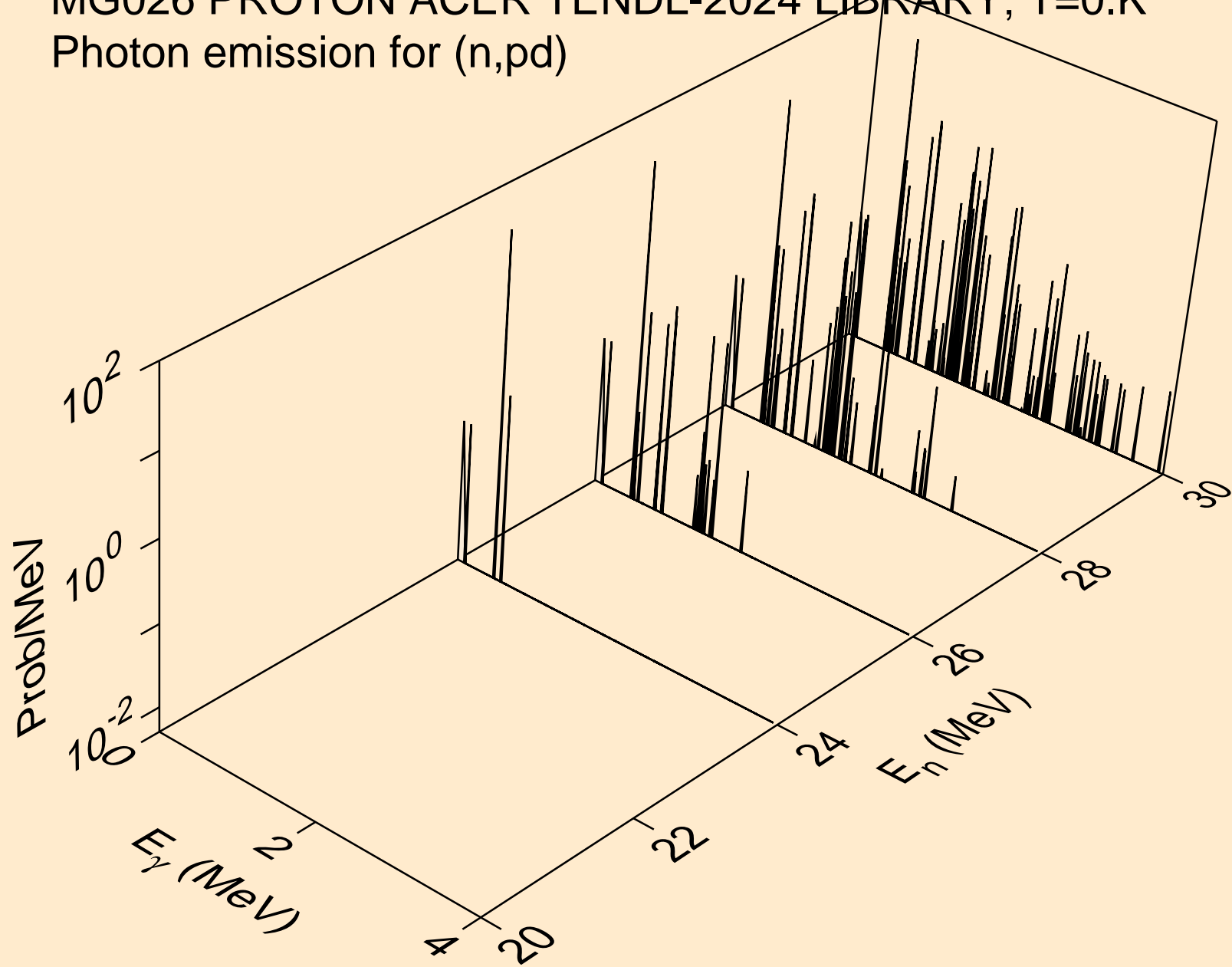

MG026 PROTON ACER TENDL-2024 LIBRARY; T=0.K
Photon emission for (n,pt)

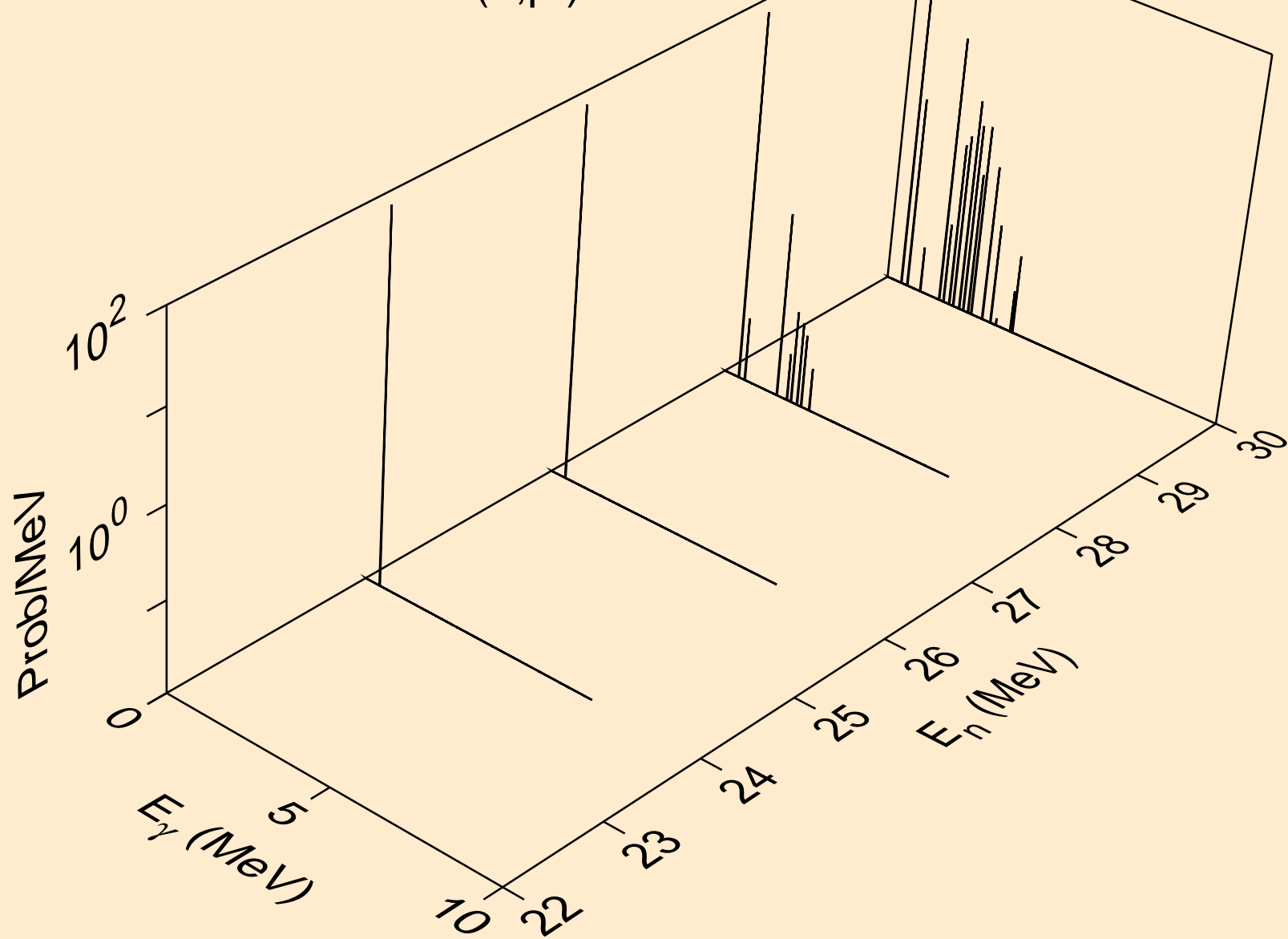

MG026 PROTON ACER TENDL-2024 LIBRARY; T=0.K
Photon emission for (n,da)

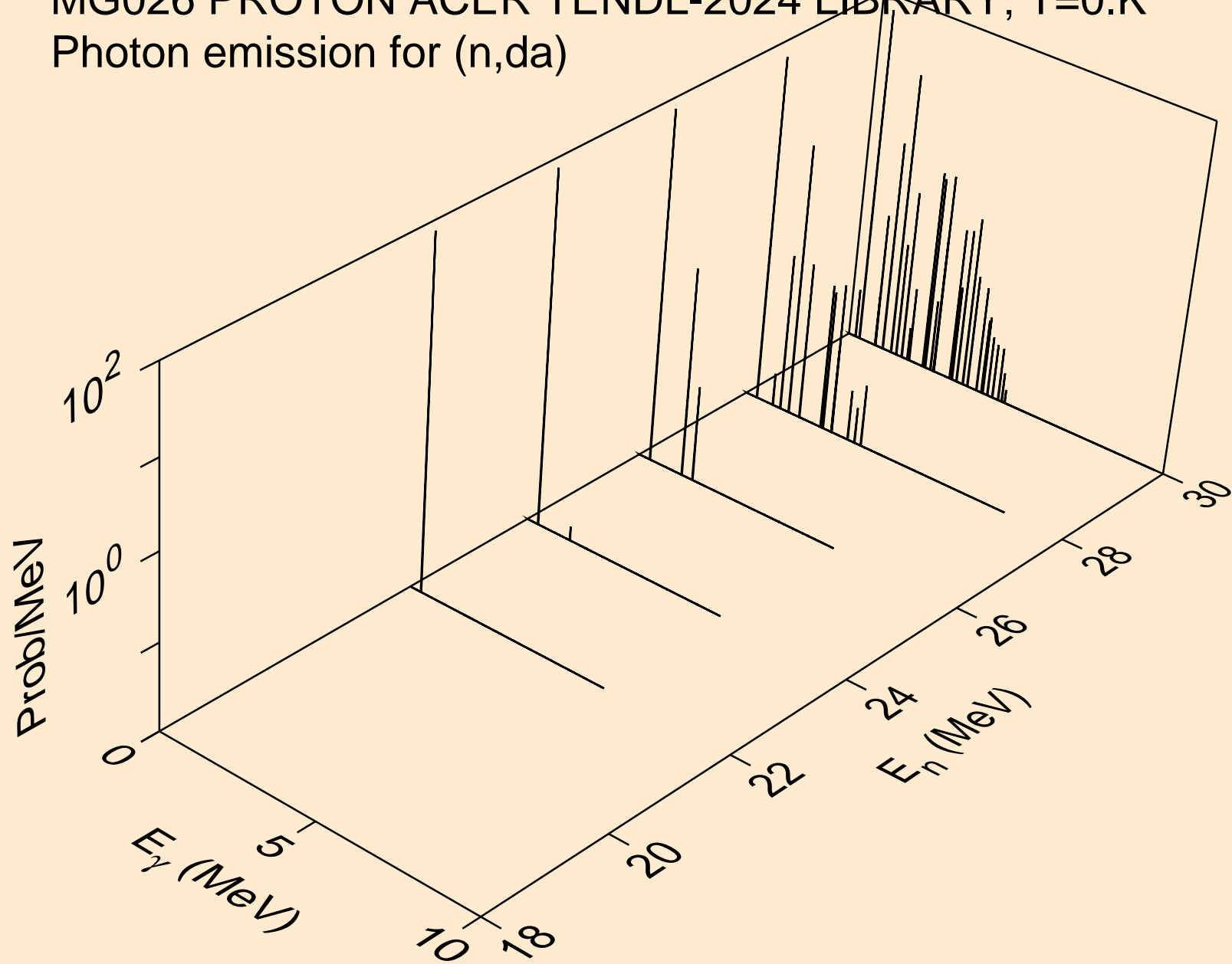

MG026 PROTON ACER TENDL-2024 LIBRARY; T=0.K

Particle heating contributions

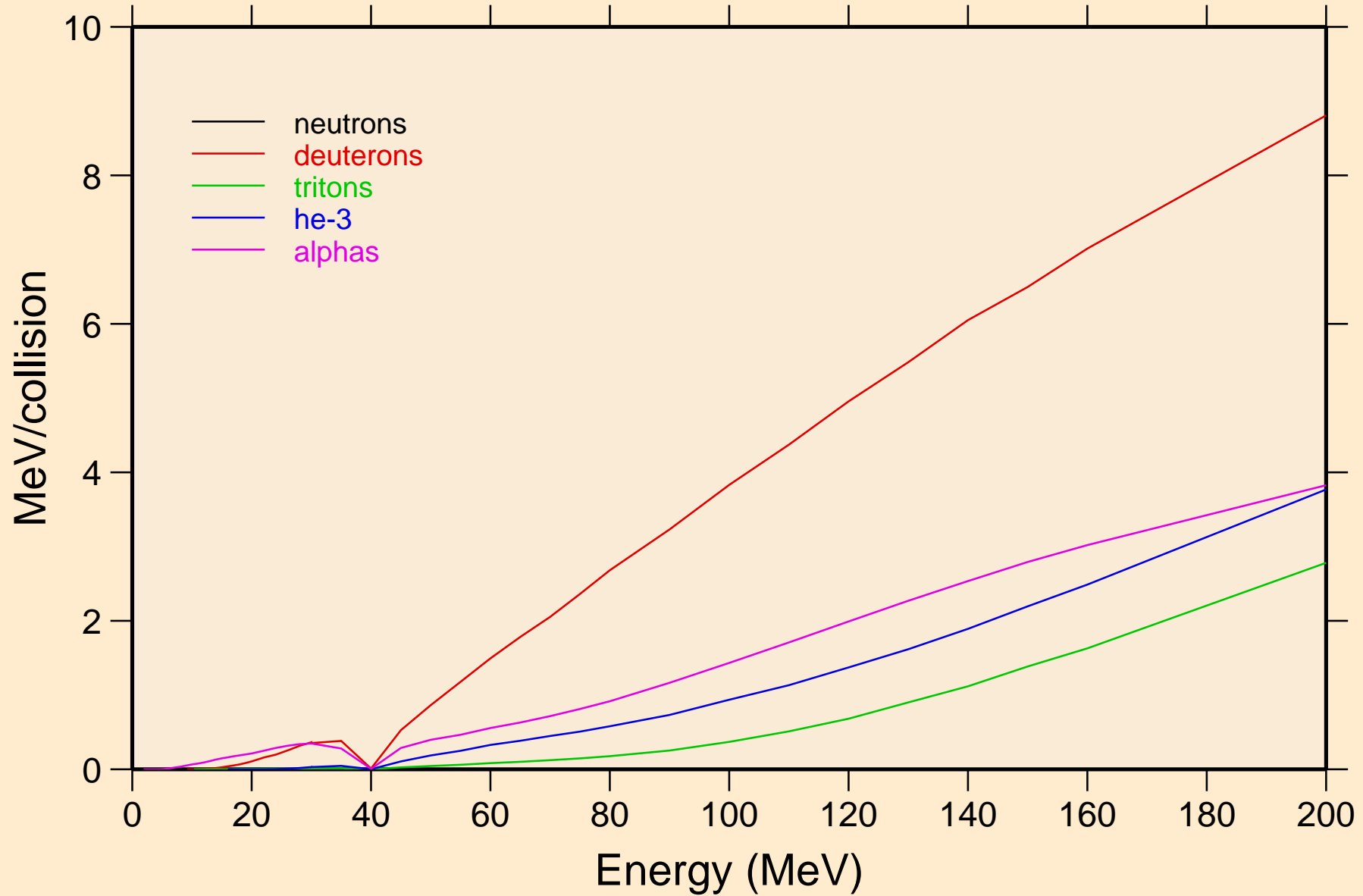

MG026 PROTON ACER TENDL-2024 LIBRARY; T=0.K
Recoil Heating

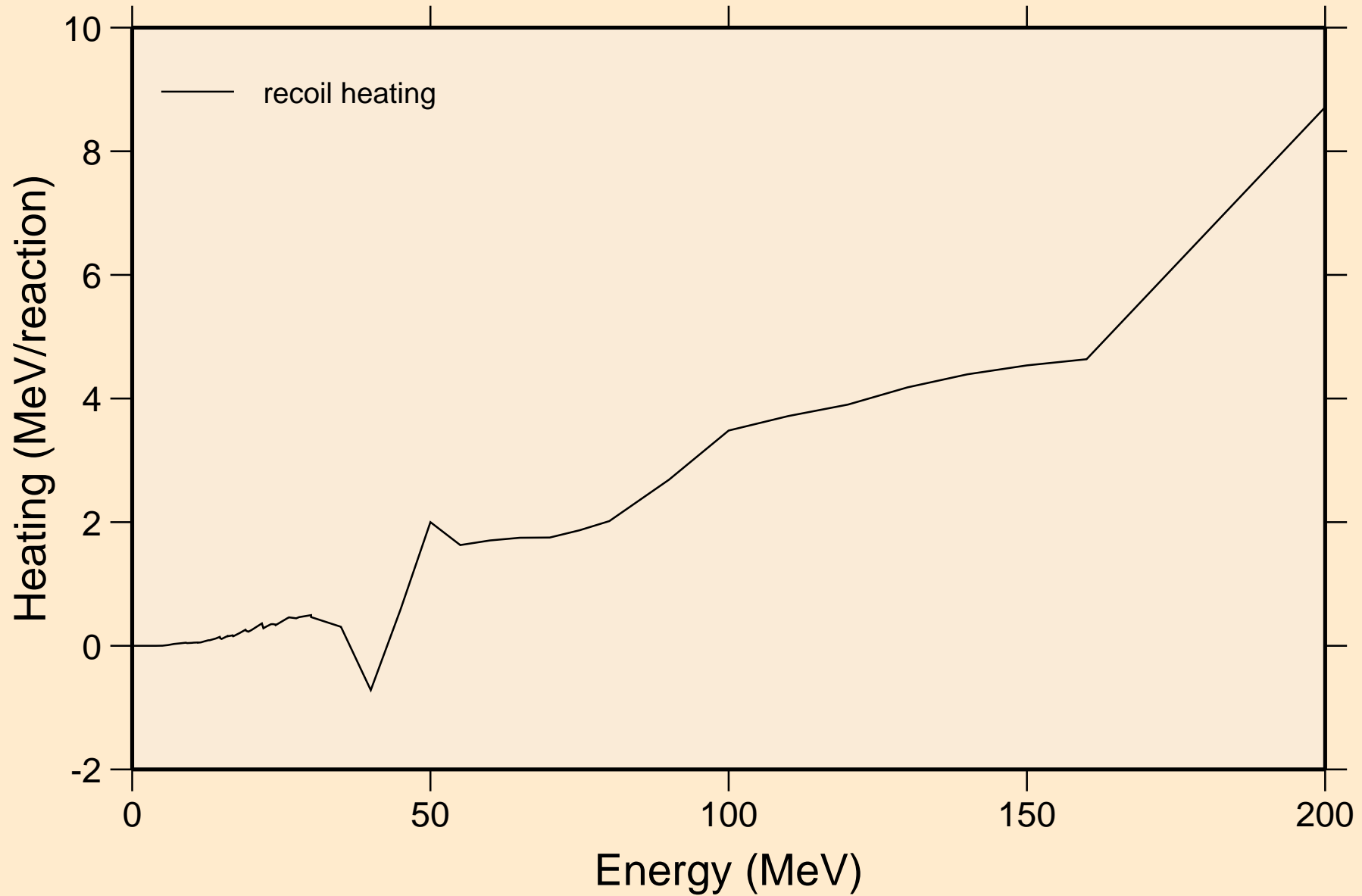

MG026 PROTON ACER TENDL-2024 LIBRARY; T=0.K
Particle production cross sections

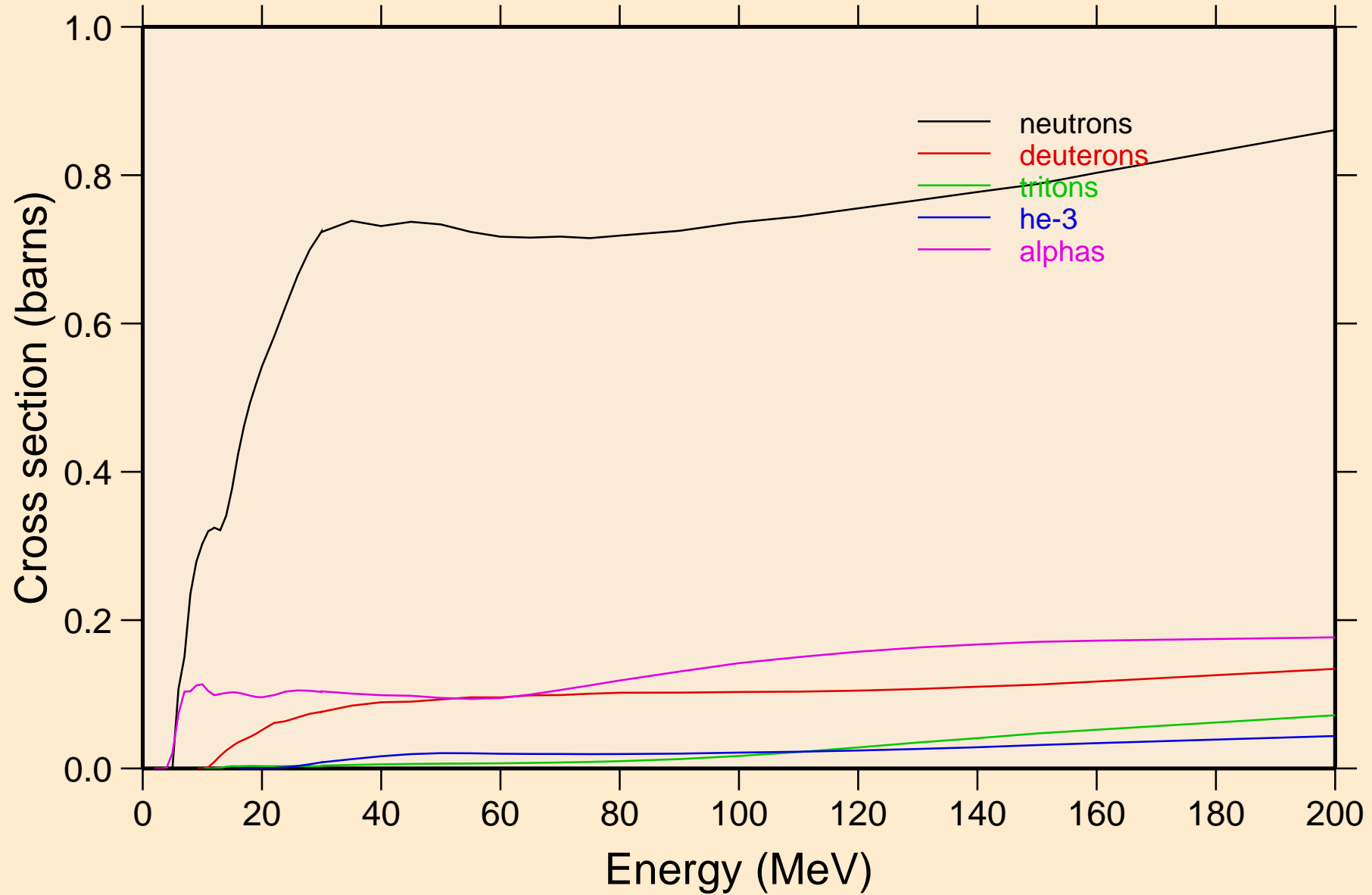

MG026 PROTON ACER TENDL-2024 LIBRARY; T=0.K
neutrons from (p,n)

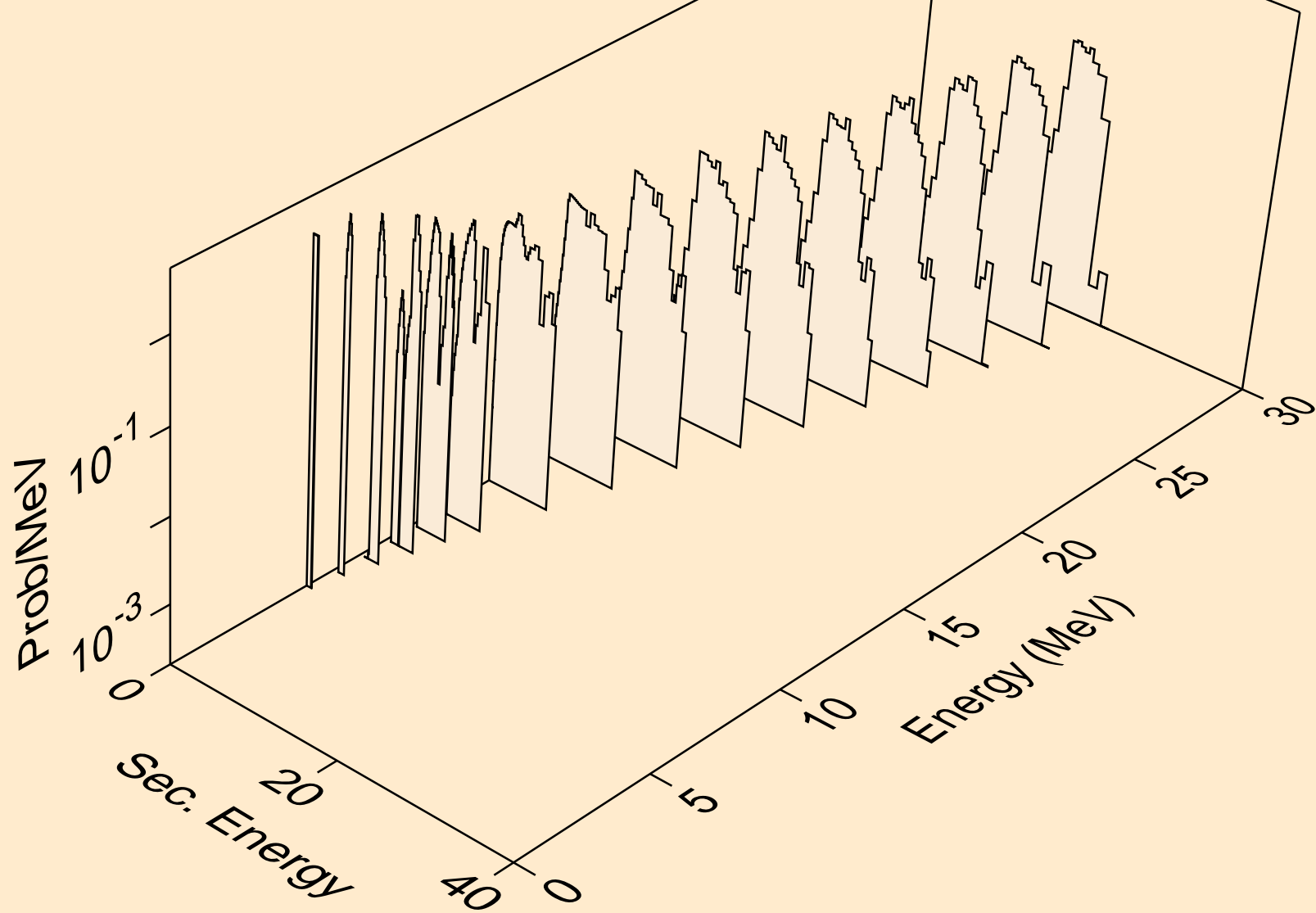

MG026 PROTON ACER TENDL-2024 LIBRARY; T=0.K
neutrons from (p,x)

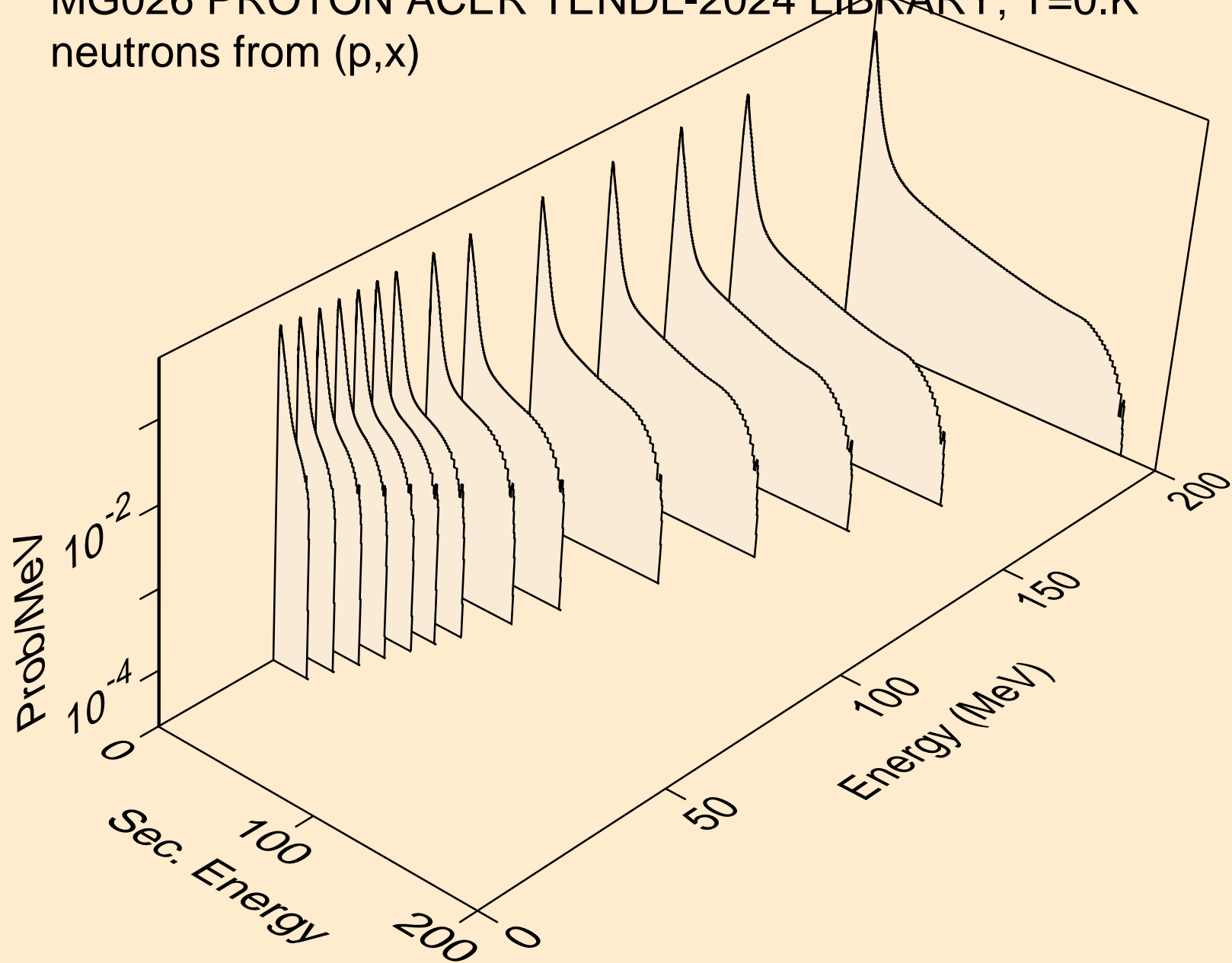

MG026 PROTON ACER TENDL-2024 LIBRARY; T=0.K
neutrons from (p,2n)

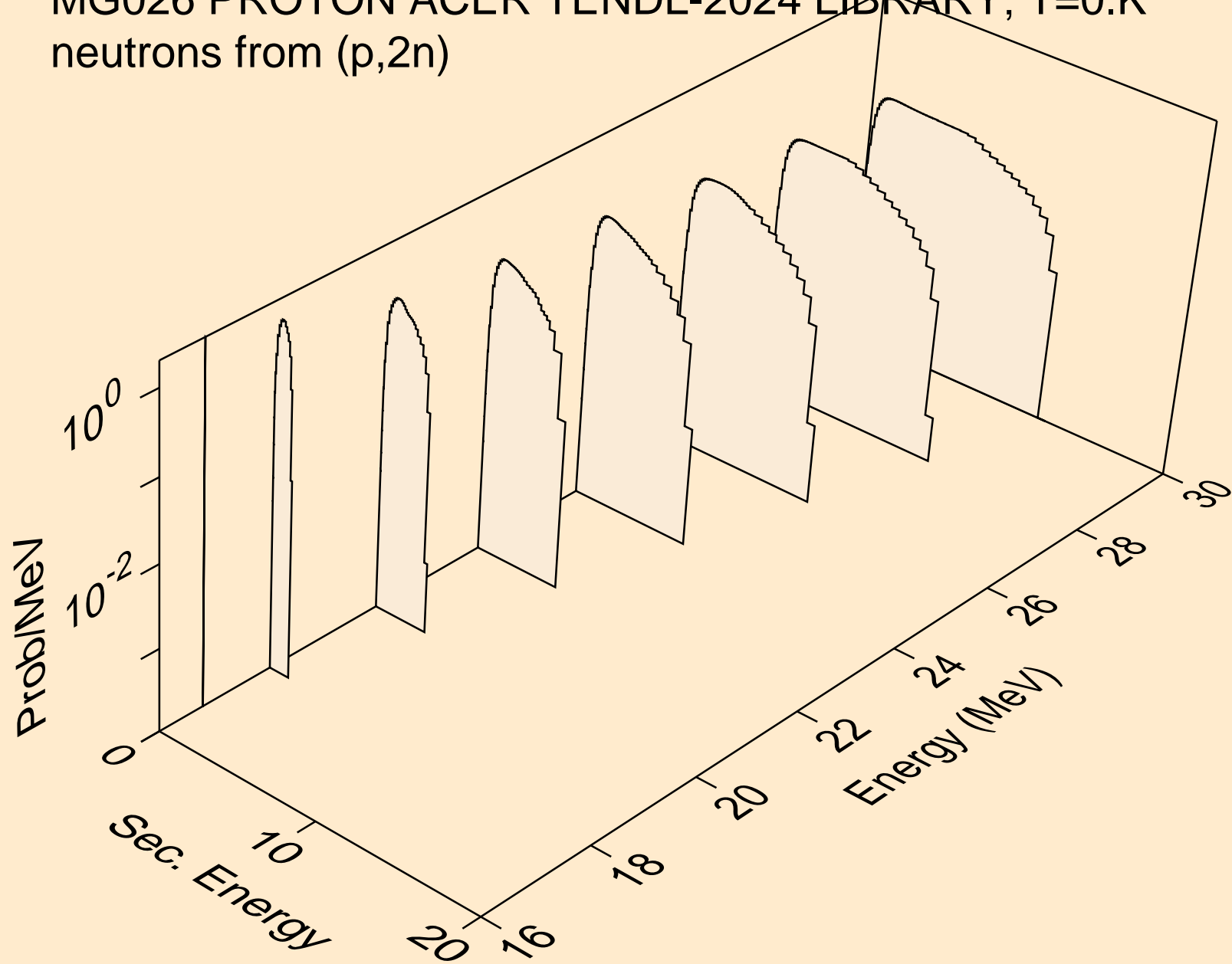

MG026 PROTON ACER TENDL-2024 LIBRARY; T=0.K
neutrons from (p,n*)a

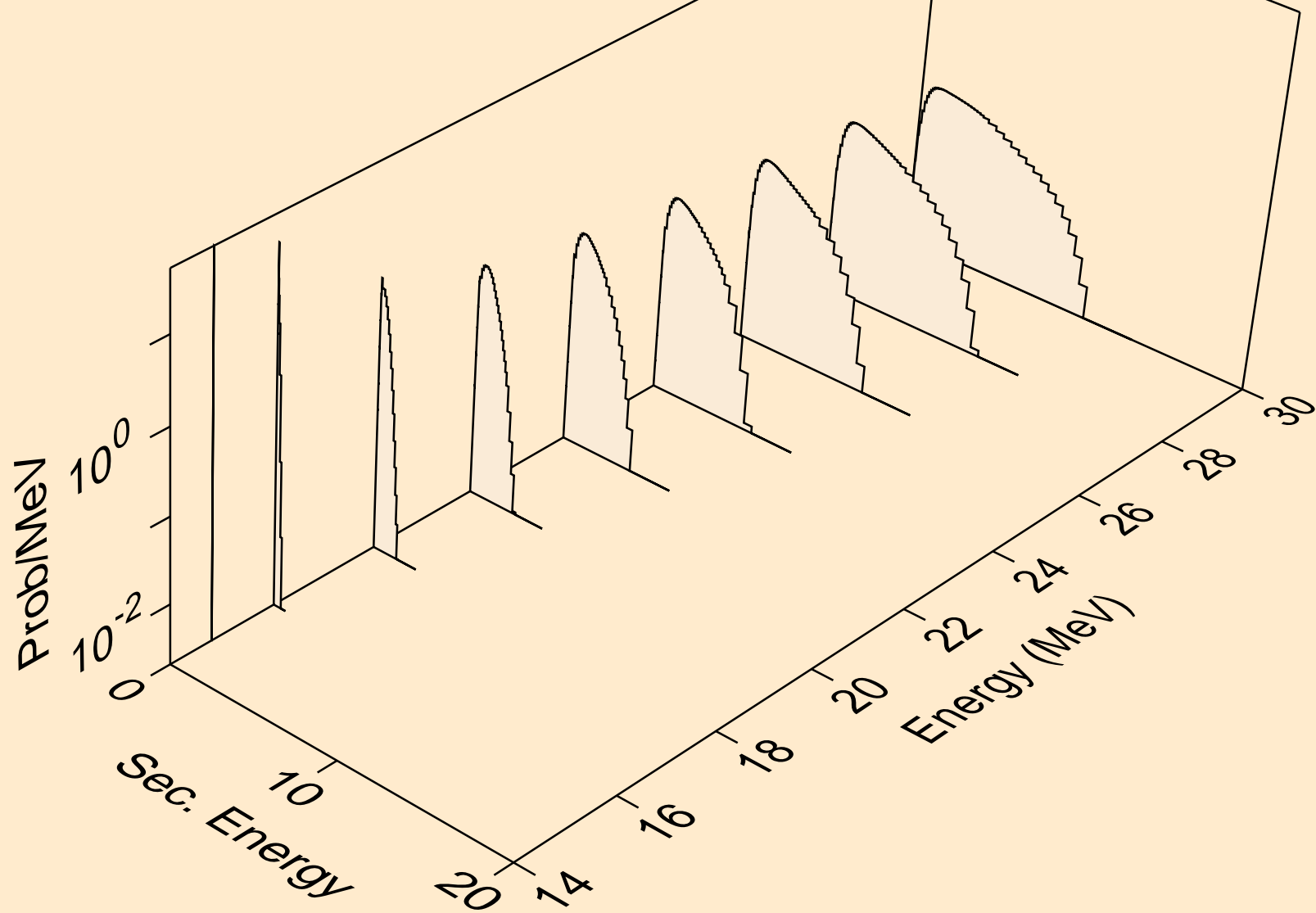

MG026 PROTON ACER TENDL-2024 LIBRARY; T=0.K
neutrons from (p,2n)a

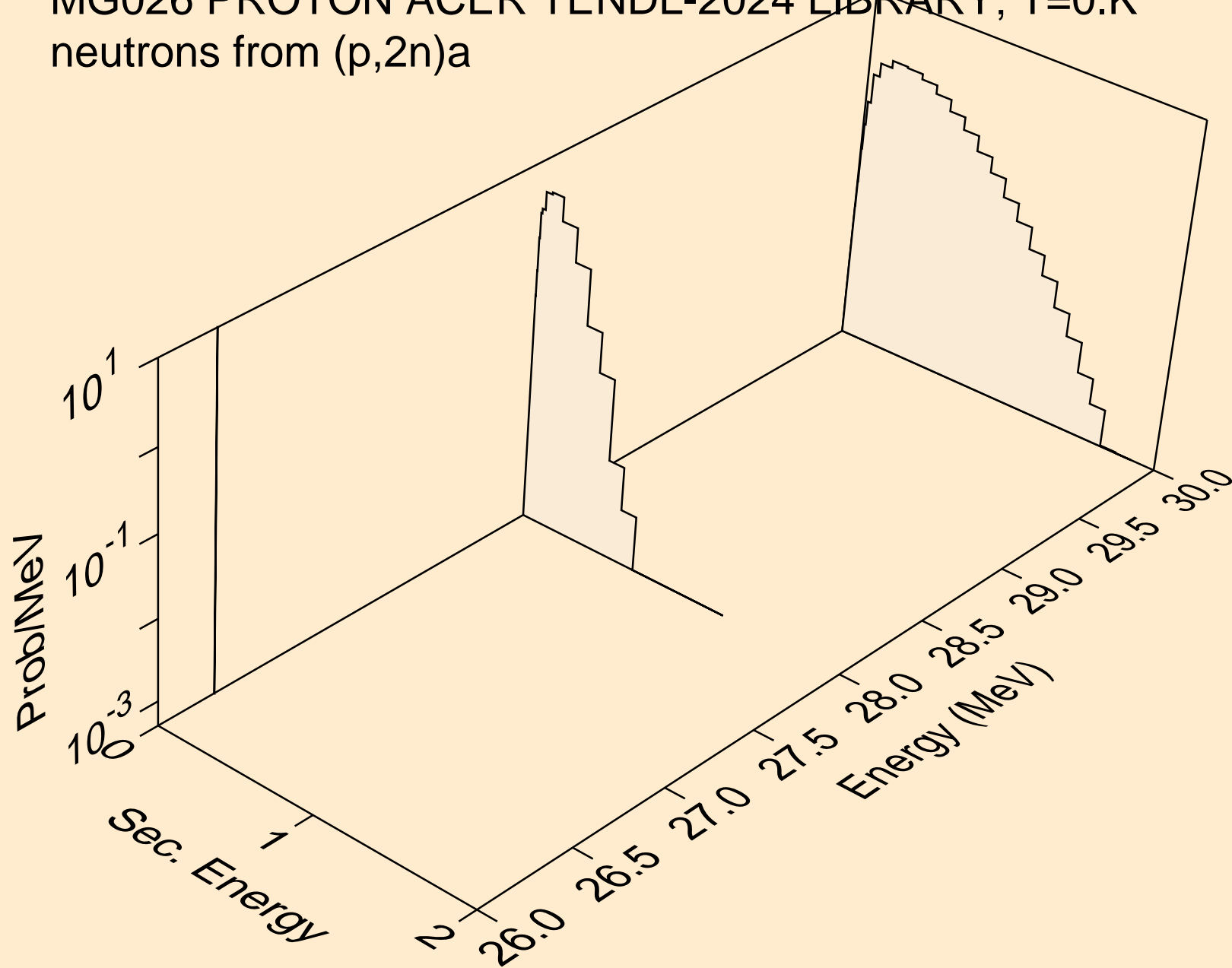

MG026 PROTON ACER TENDL-2024 LIBRARY; T=0.K
neutrons from (p,n*)p

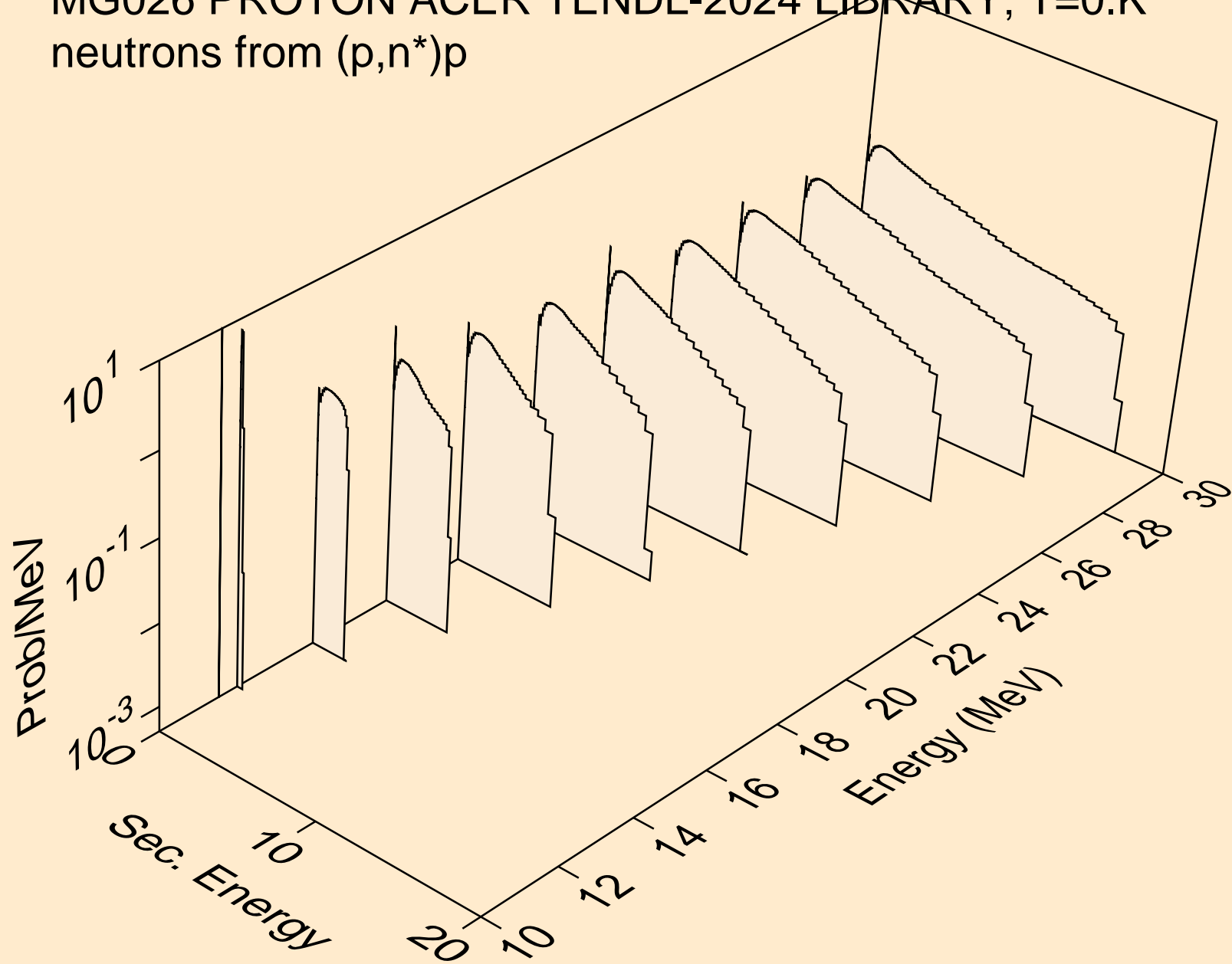

MG026 PROTON ACER TENDL-2024 LIBRARY; T=0.K
neutrons from (p,n*)2a

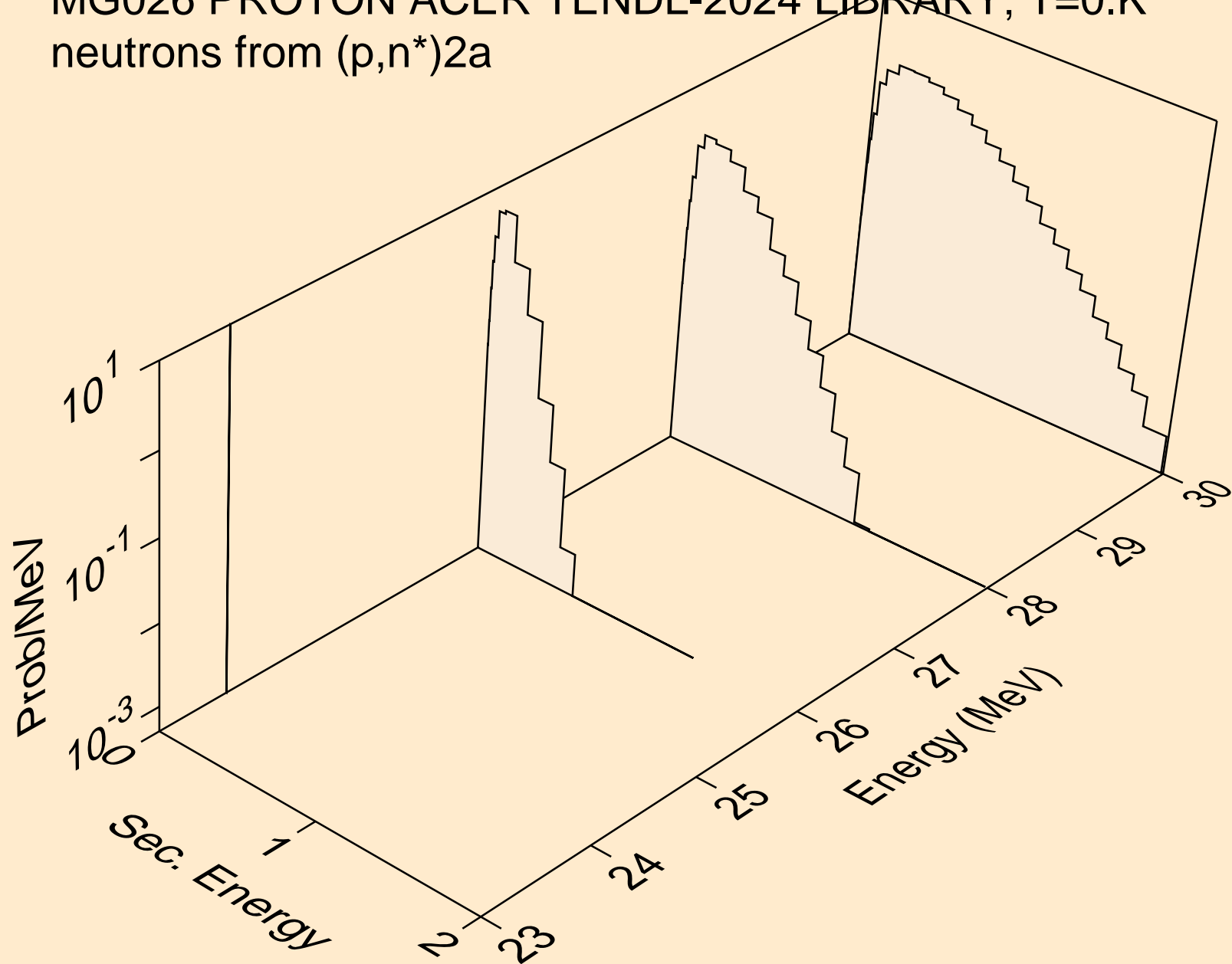

MG026 PROTON ACER TENDL-2024 LIBRARY; T=0.K
neutrons from (p,n*)d

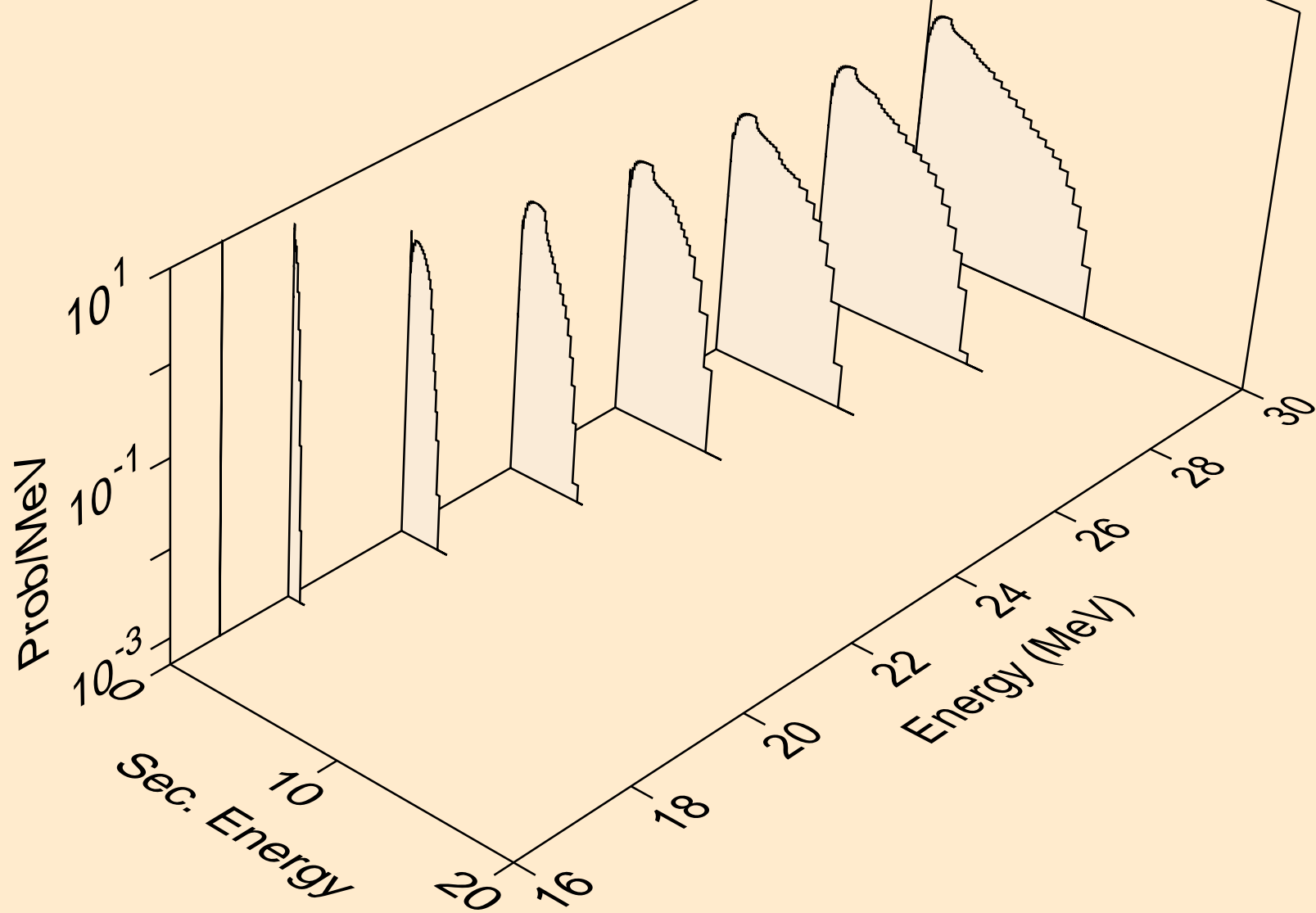

MG026 PROTON ACER TENDL-2024 LIBRARY; T=0.K
neutrons from (p,n*)t

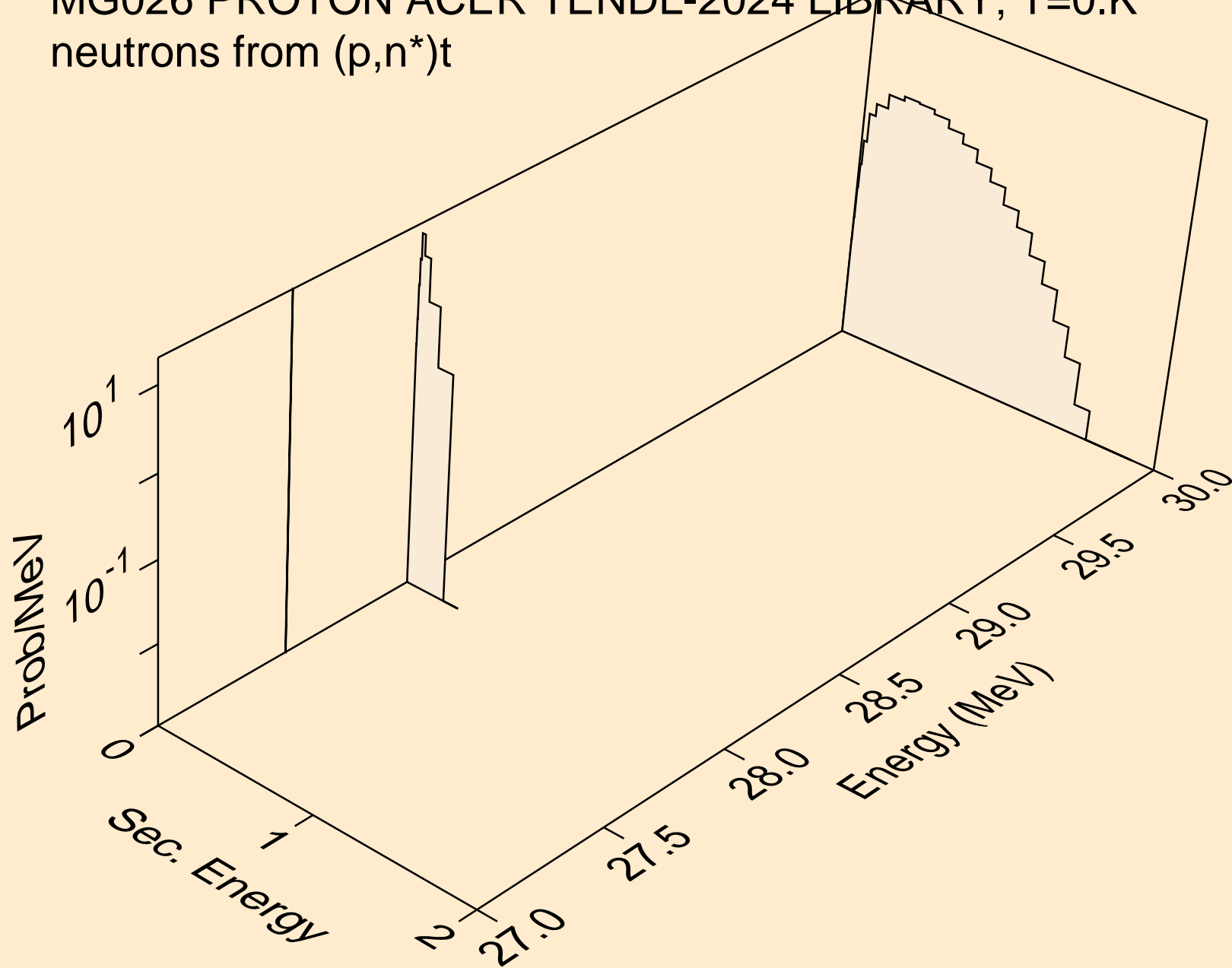

MG026 PROTON ACER TENDL-2024 LIBRARY; T=0.K
neutrons from (p,n*)he3

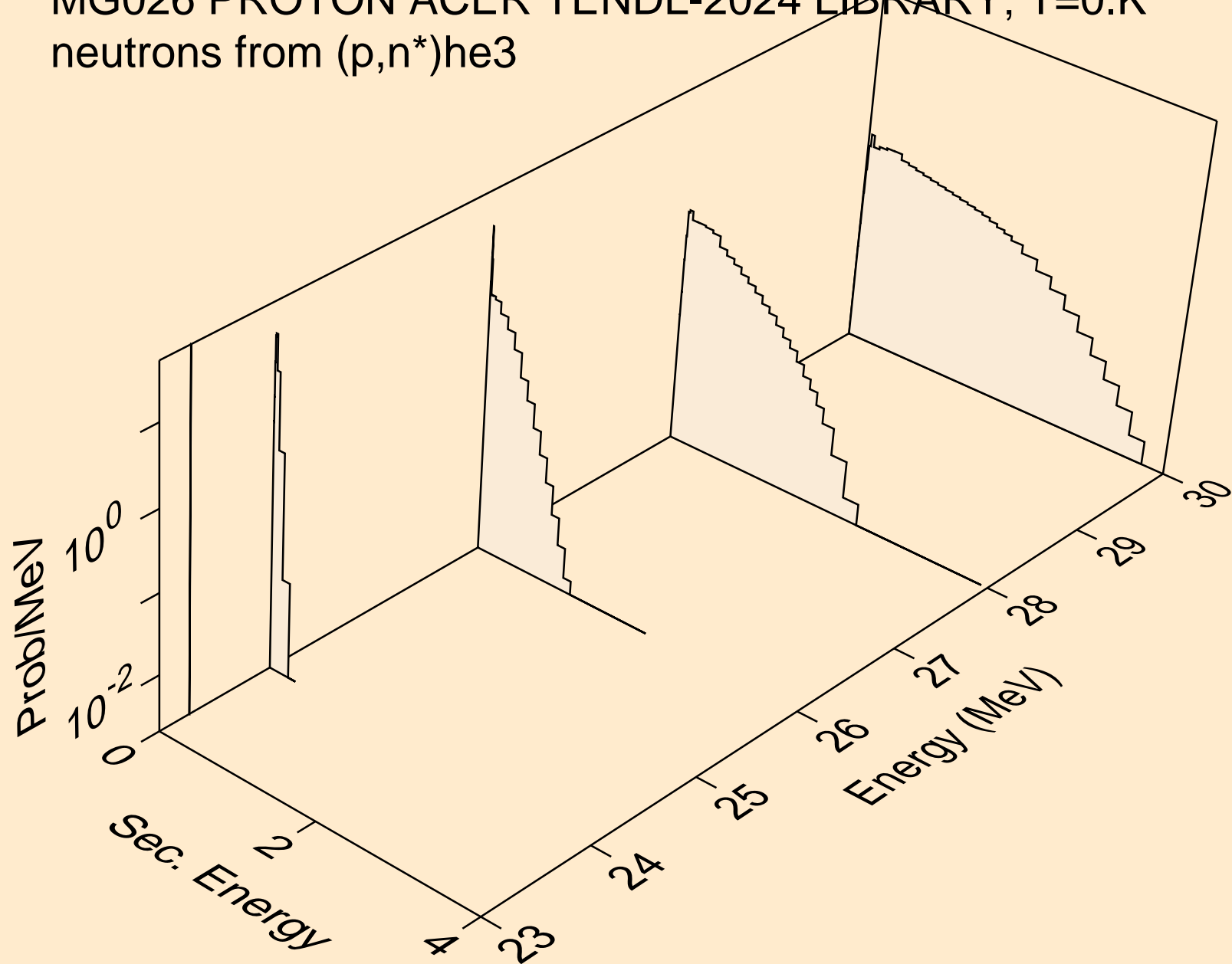

MG026 PROTON ACER TENDL-2024 LIBRARY; T=0.K
neutrons from (p,2np)

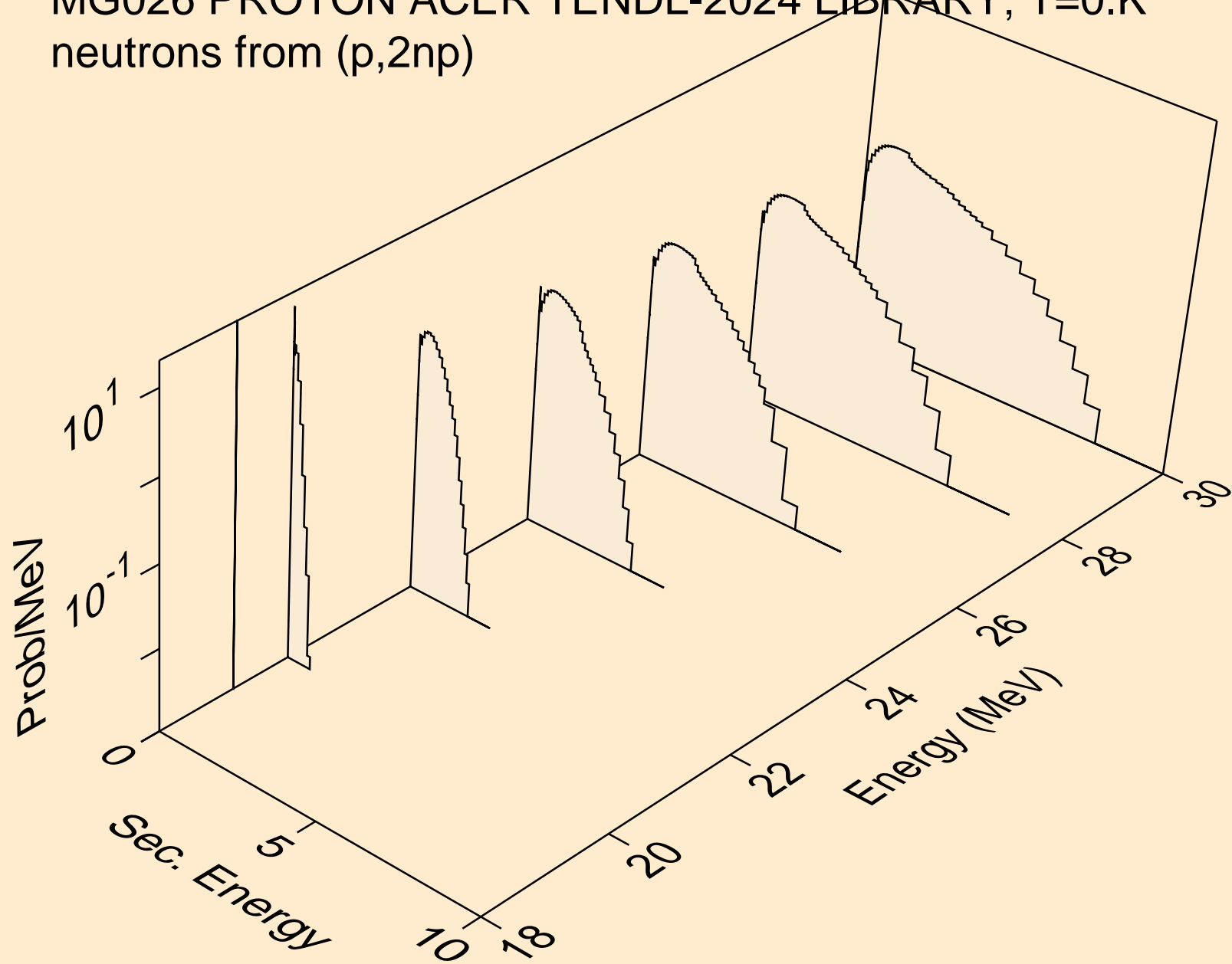

MG026 PROTON ACER TENDL-2024 LIBRARY; T=0.K
neutrons from (p,n2p)

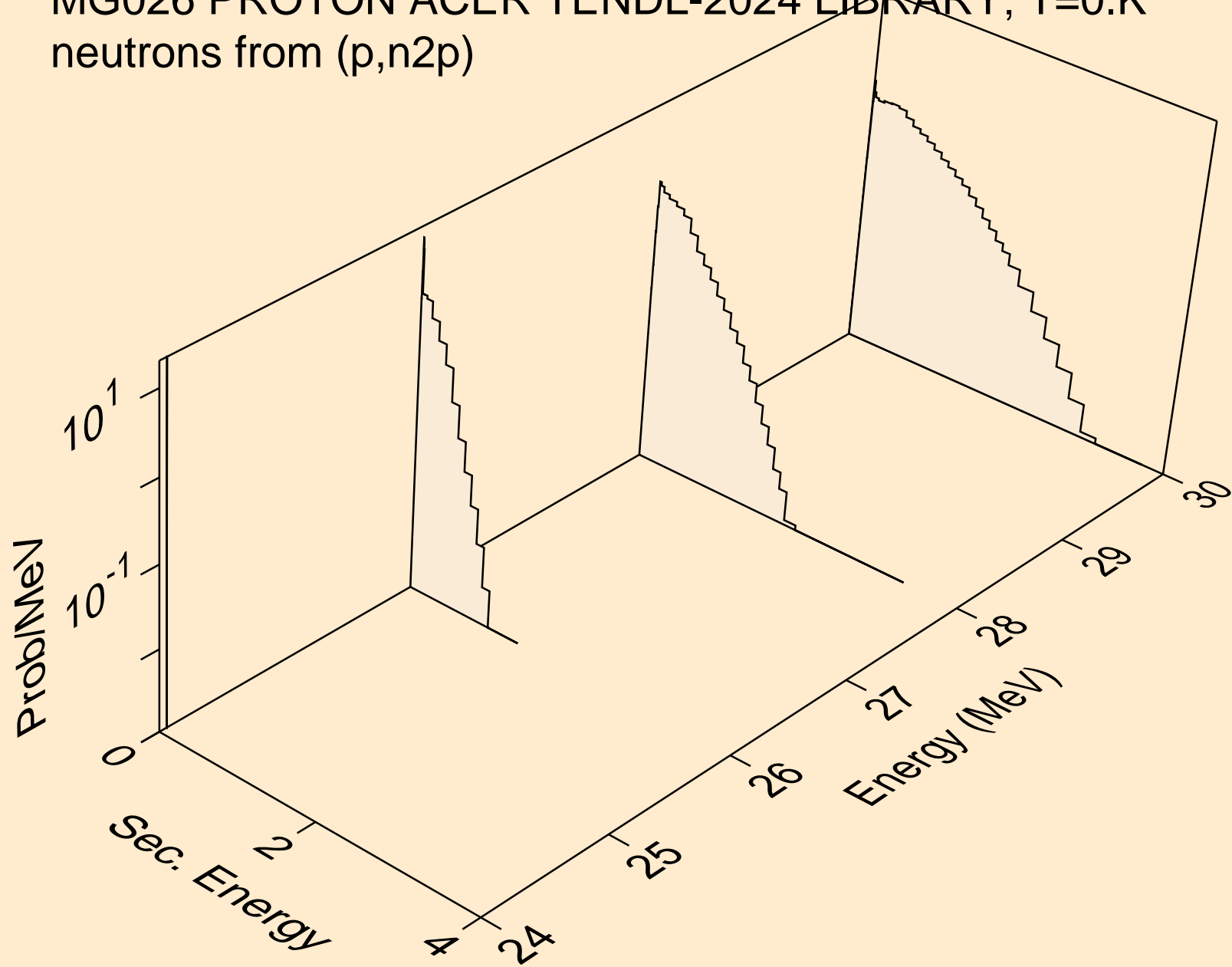

MG026 PROTON ACER TENDL-2024 LIBRARY; T=0.K
neutrons from (p,npa)

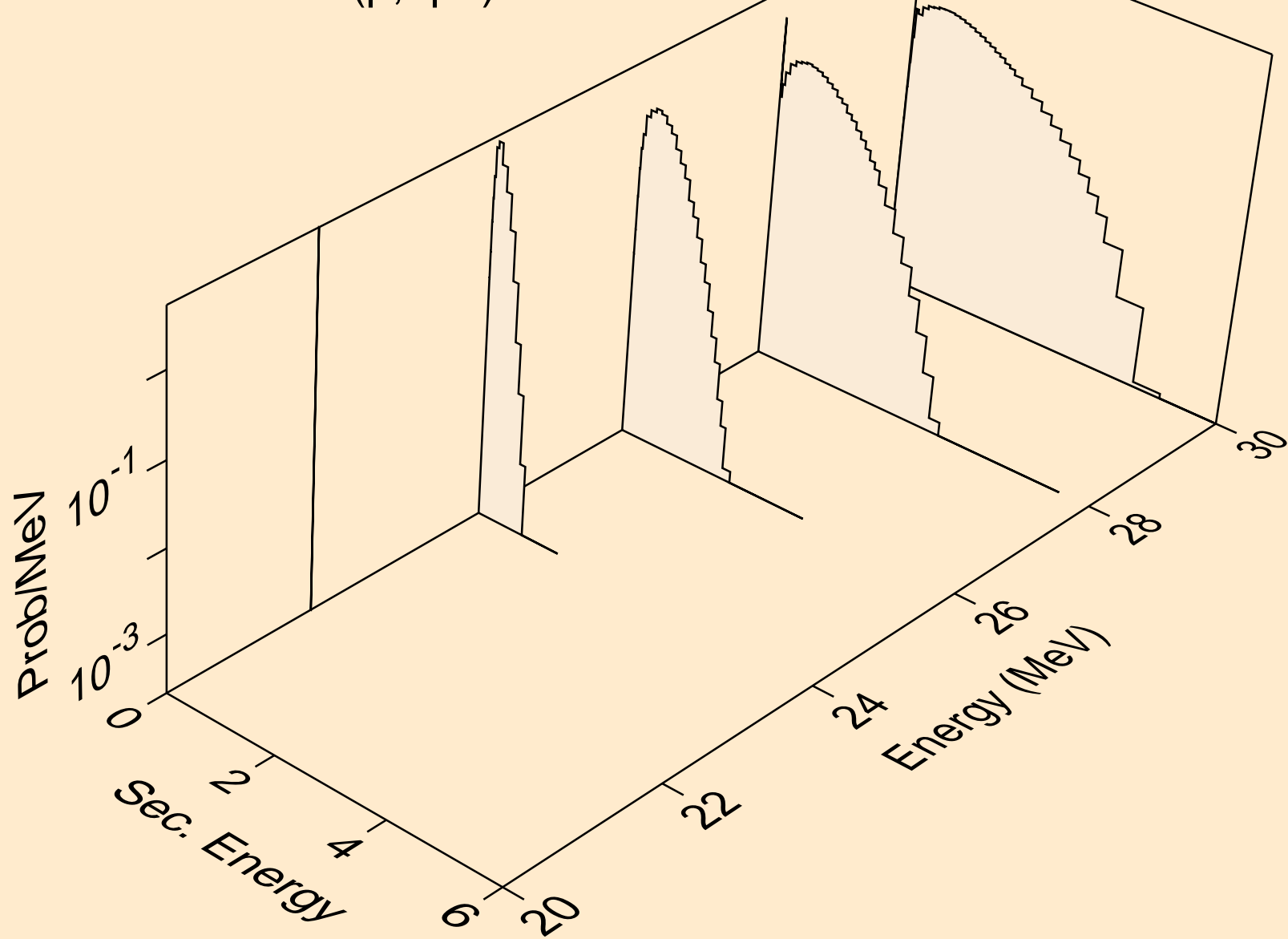

MG026 PROTON ACER TENDL-2024 LIBRARY; T=0.K
deuterons from (p,x)

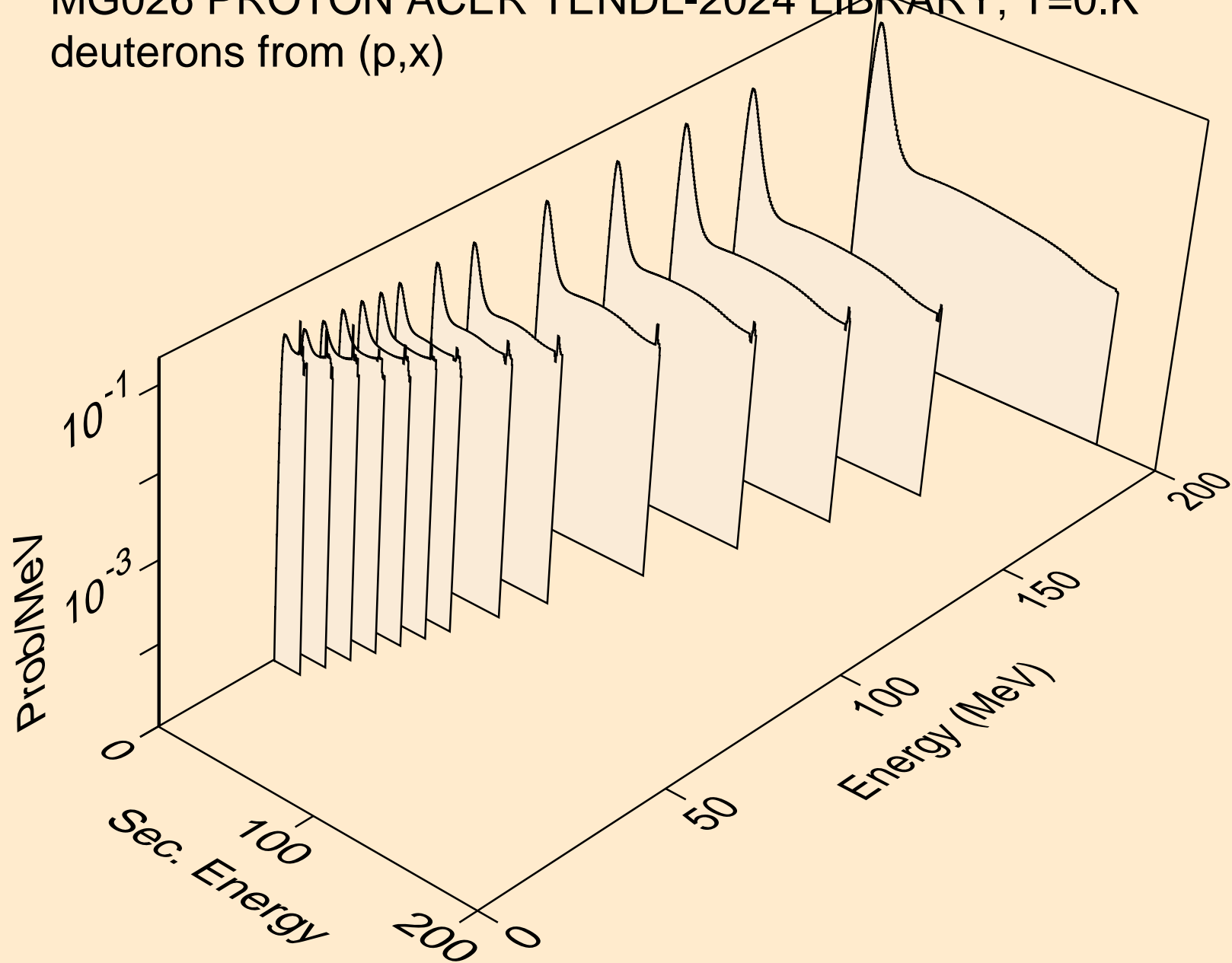

MG026 PROTON ACER TENDL-2024 LIBRARY; T=0.K
deuterons from (p,n*)d

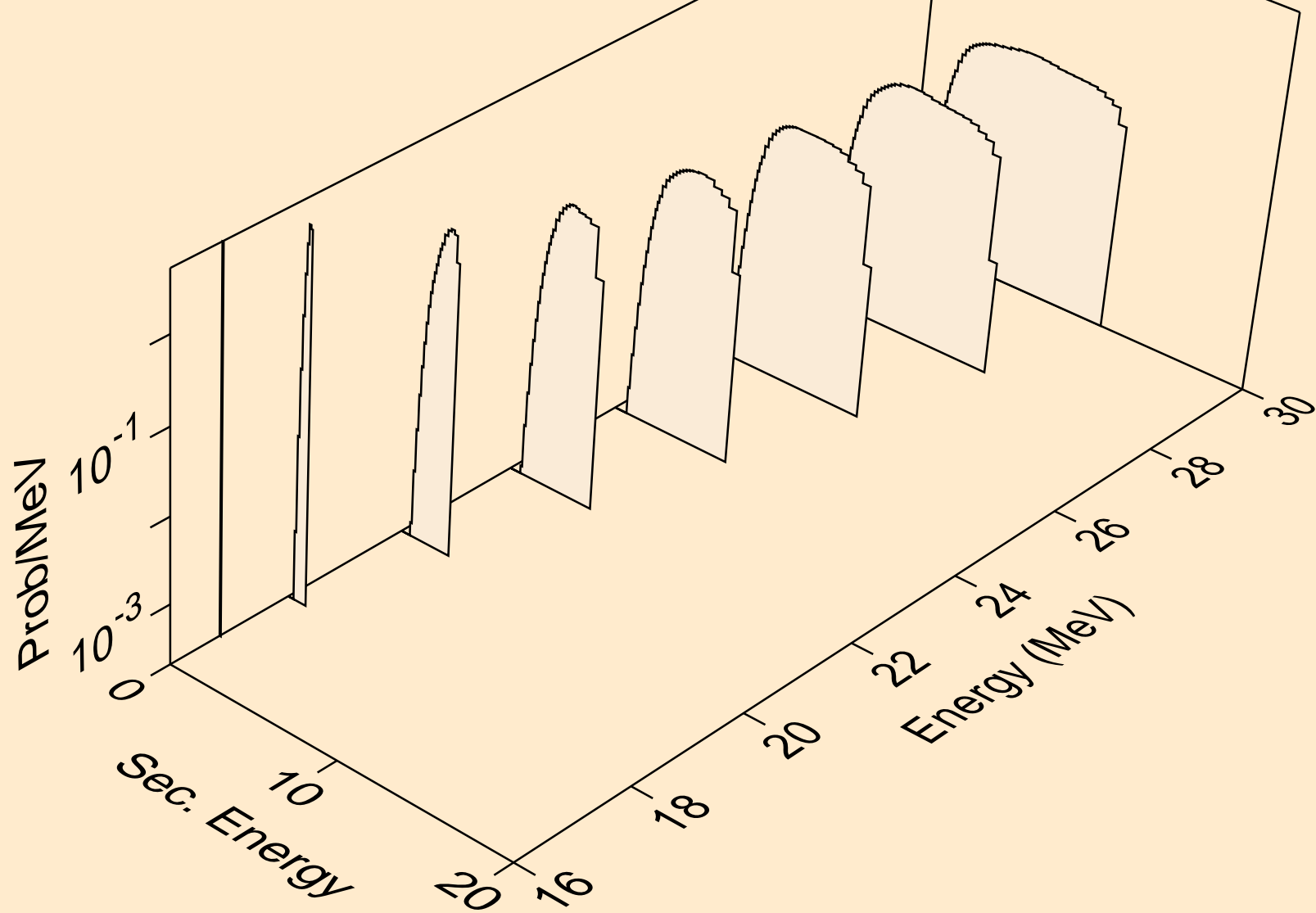

MG026 PROTON ACER TENDL-2024 LIBRARY; T=0.K
deuterons from (p,d)

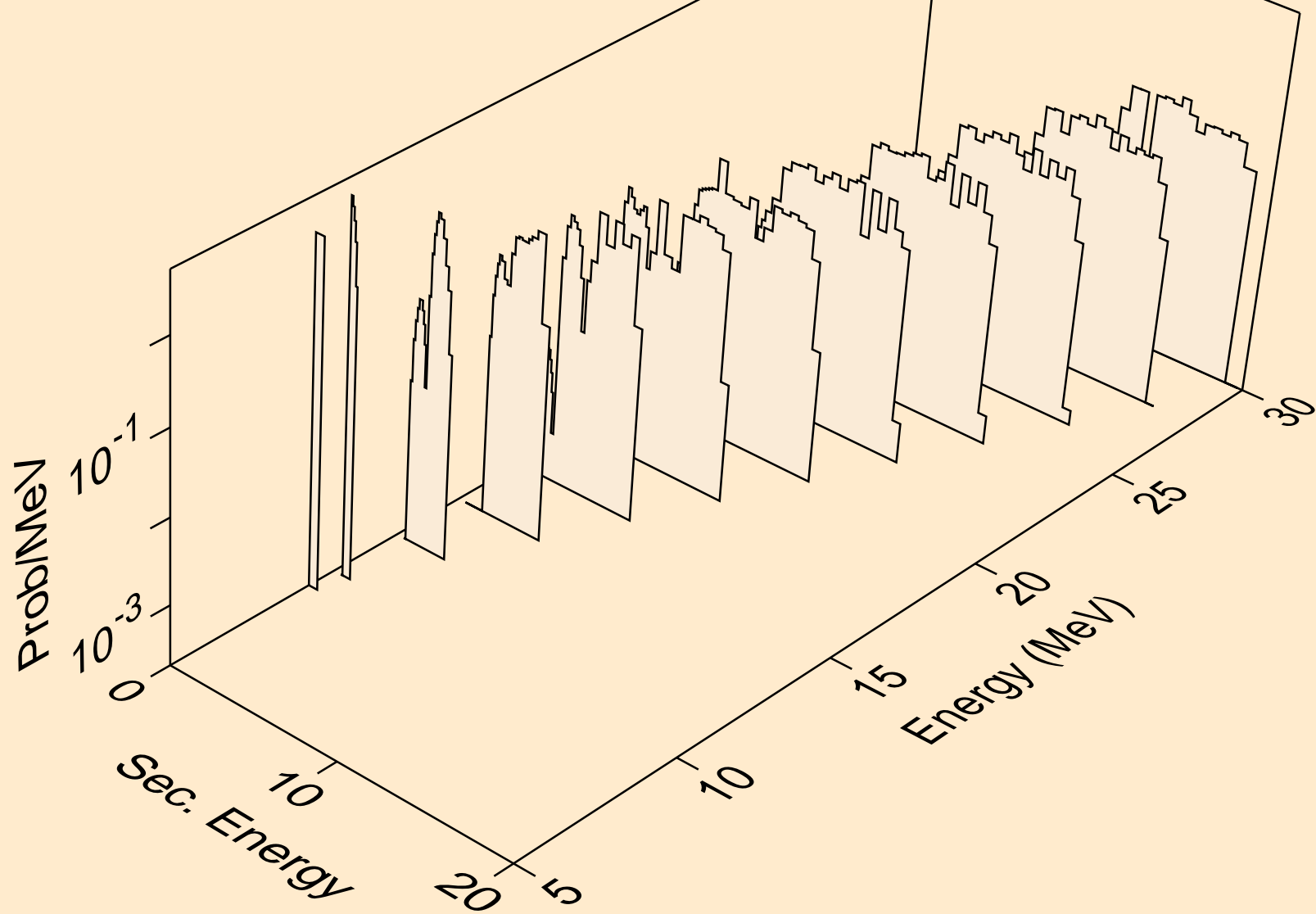

MG026 PROTON ACER TENDL-2024 LIBRARY; T=0.K
deuterons from (p,pd)

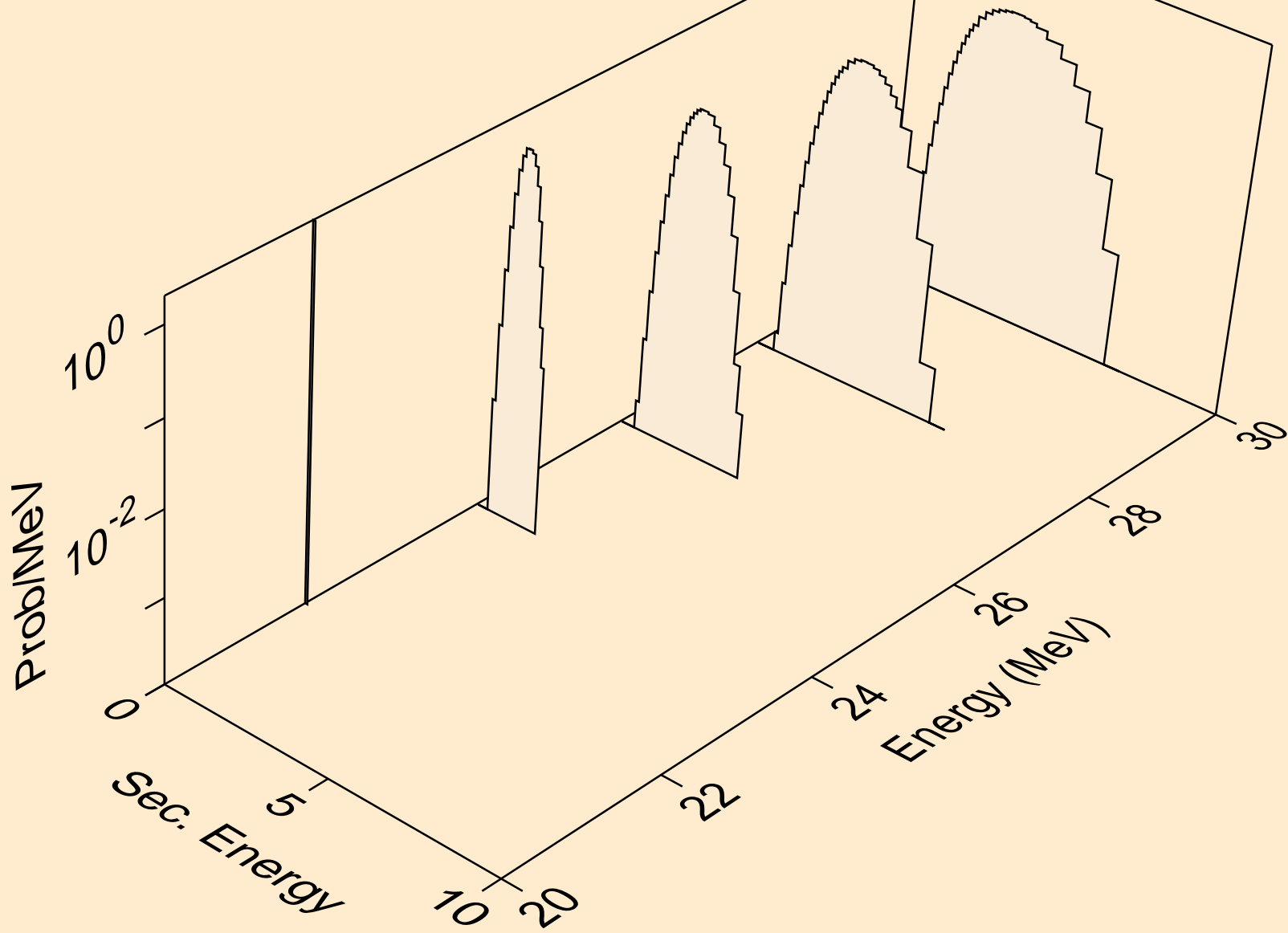

MG026 PROTON ACER TENDL-2024 LIBRARY; T=0.K
deuterons from (p,da)

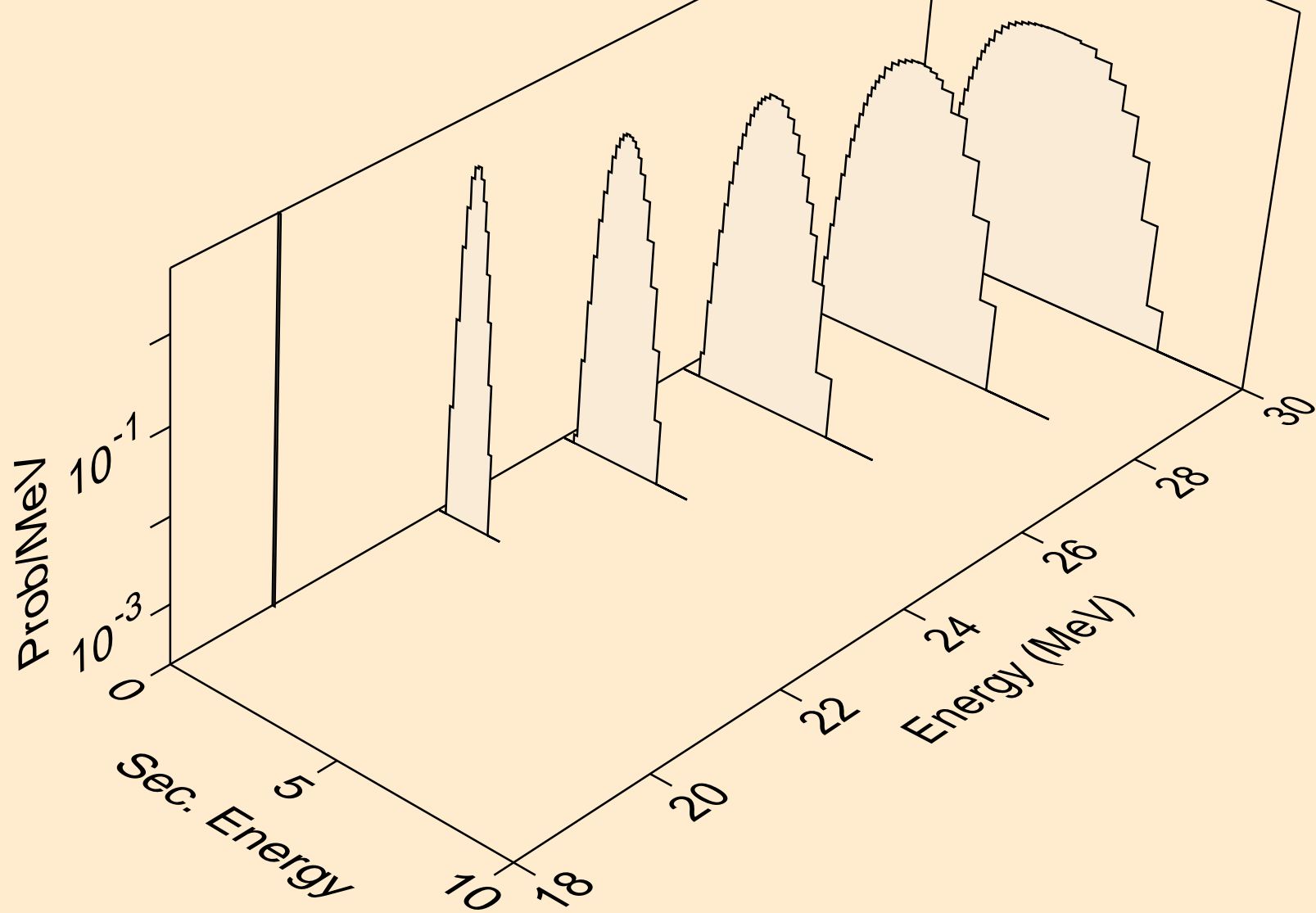

MG026 PROTON ACER TENDL-2024 LIBRARY; T=0.K
tritons from (p,x)

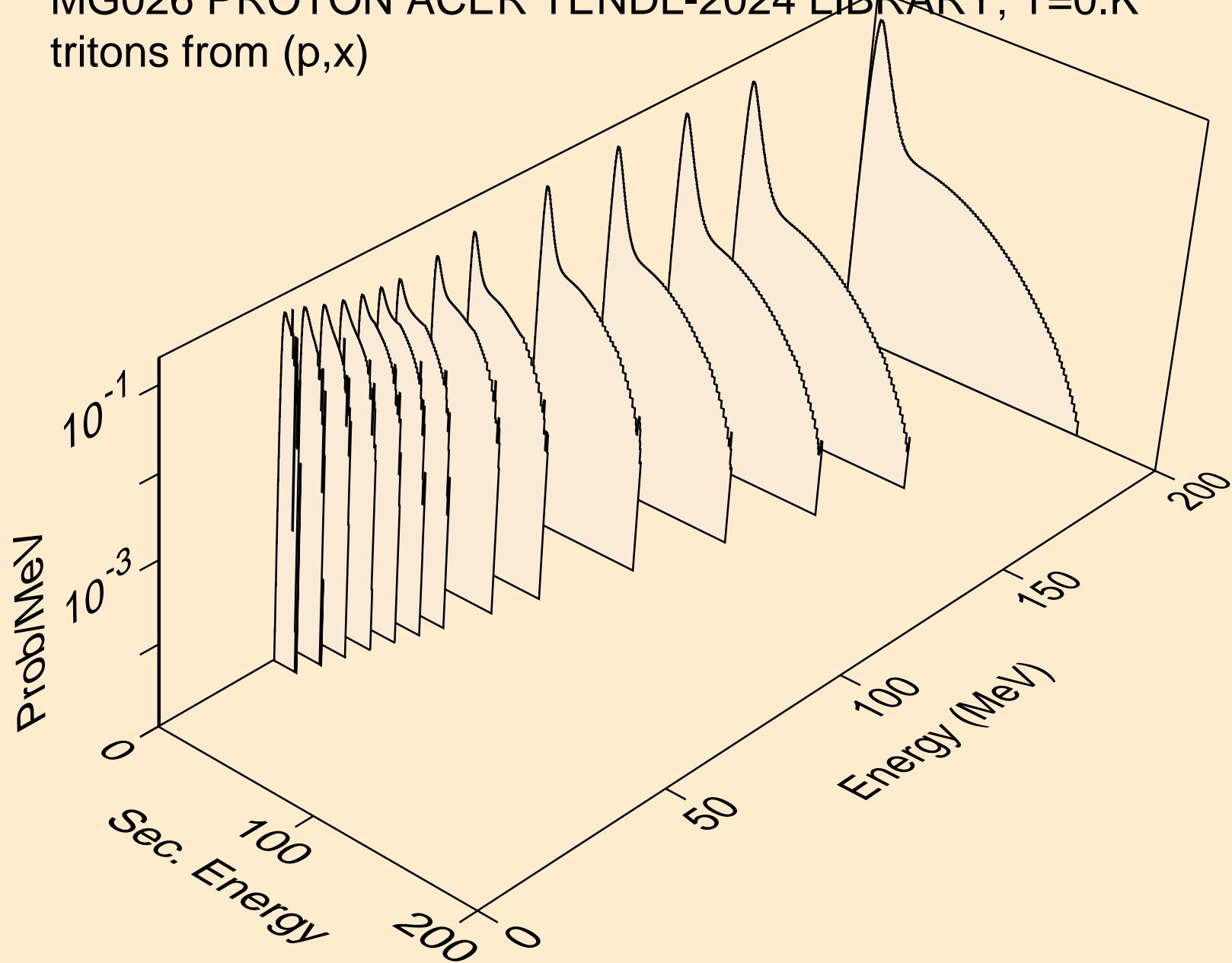

MG026 PROTON ACER TENDL-2024 LIBRARY; T=0.K
tritons from (p,n*)t

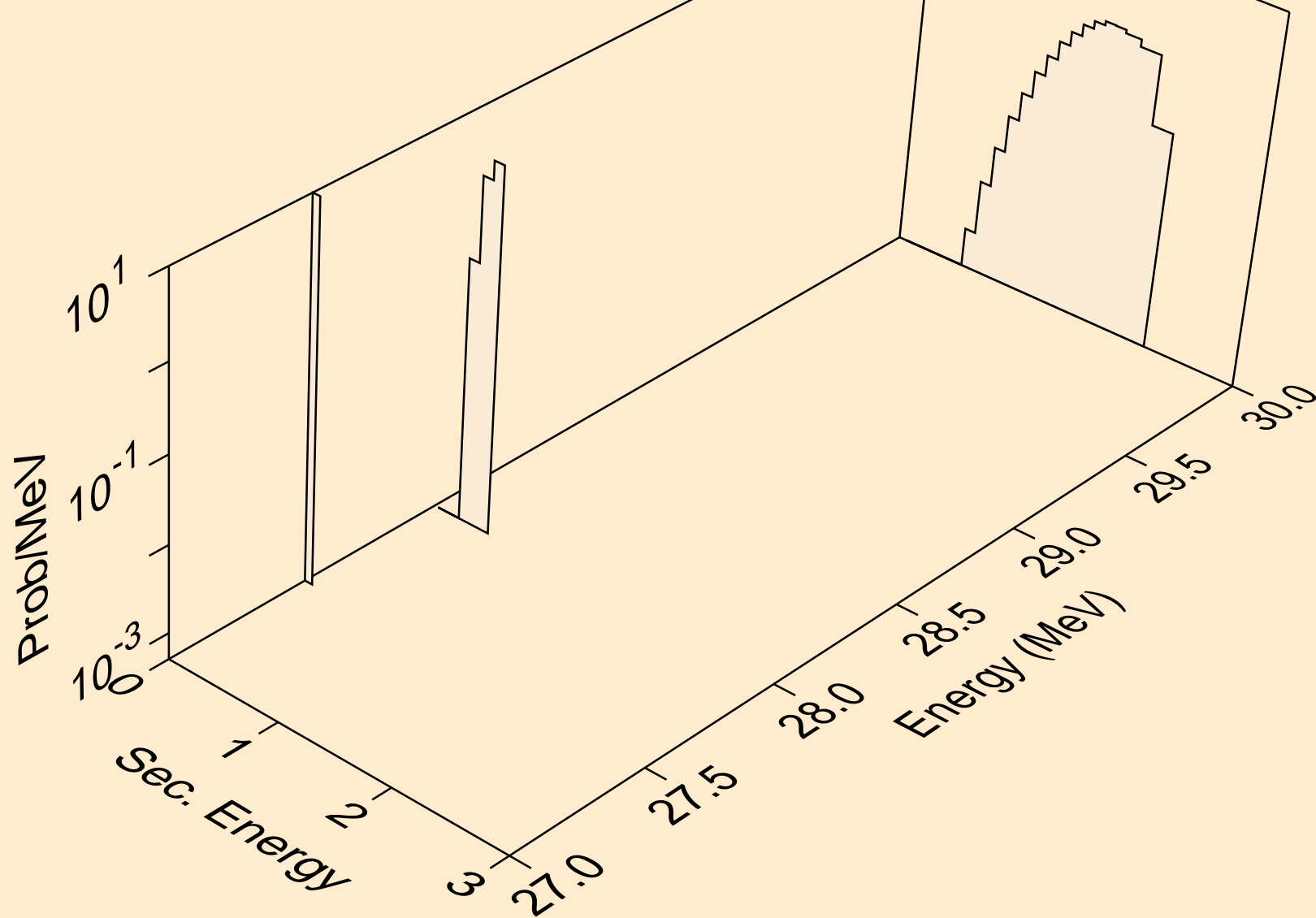

MG026 PROTON ACER TENDL-2024 LIBRARY; T=0.K
tritons from (p,t)

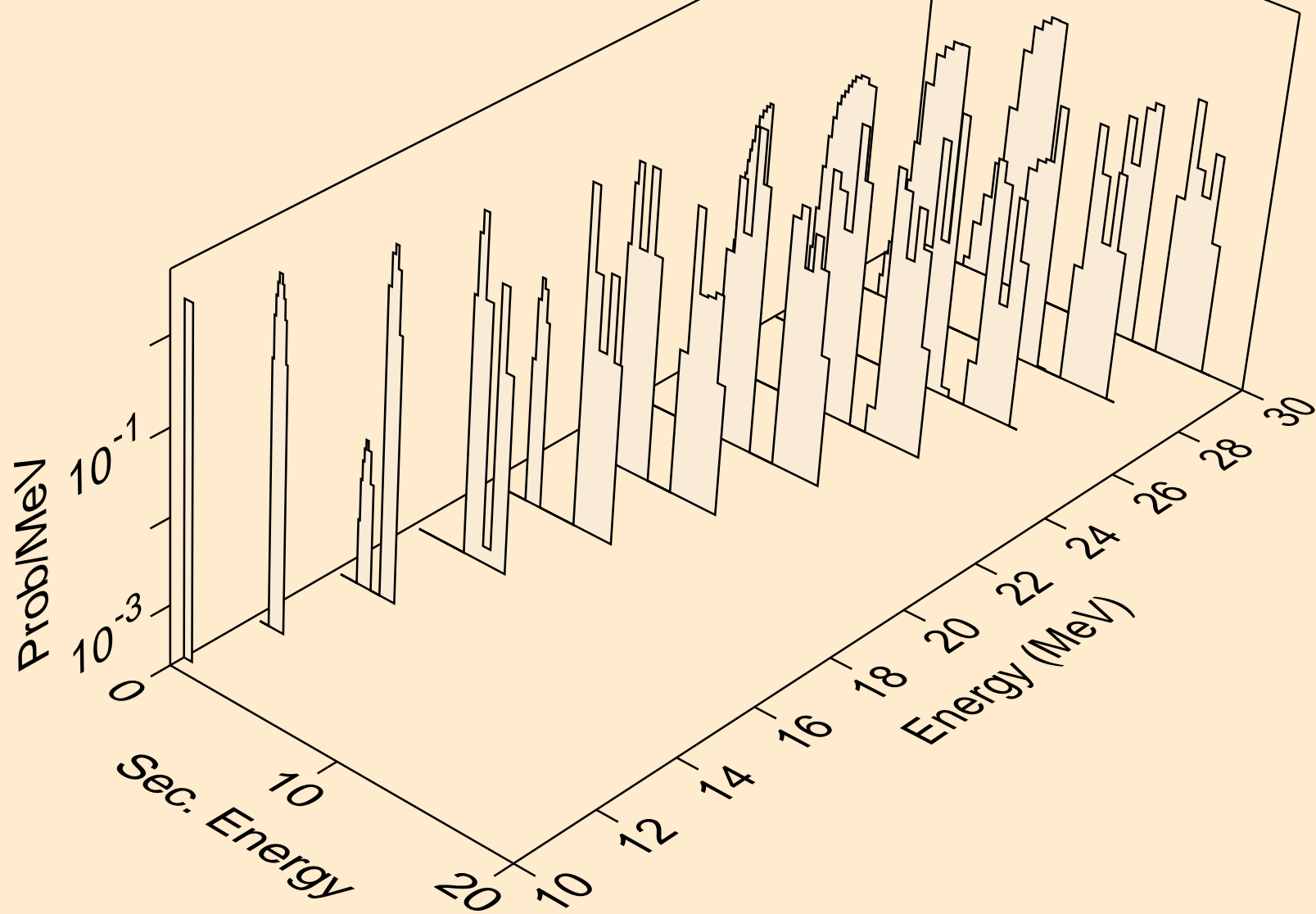

MG026 PROTON ACER TENDL-2024 LIBRARY; T=0.K
tritons from (p,pt)

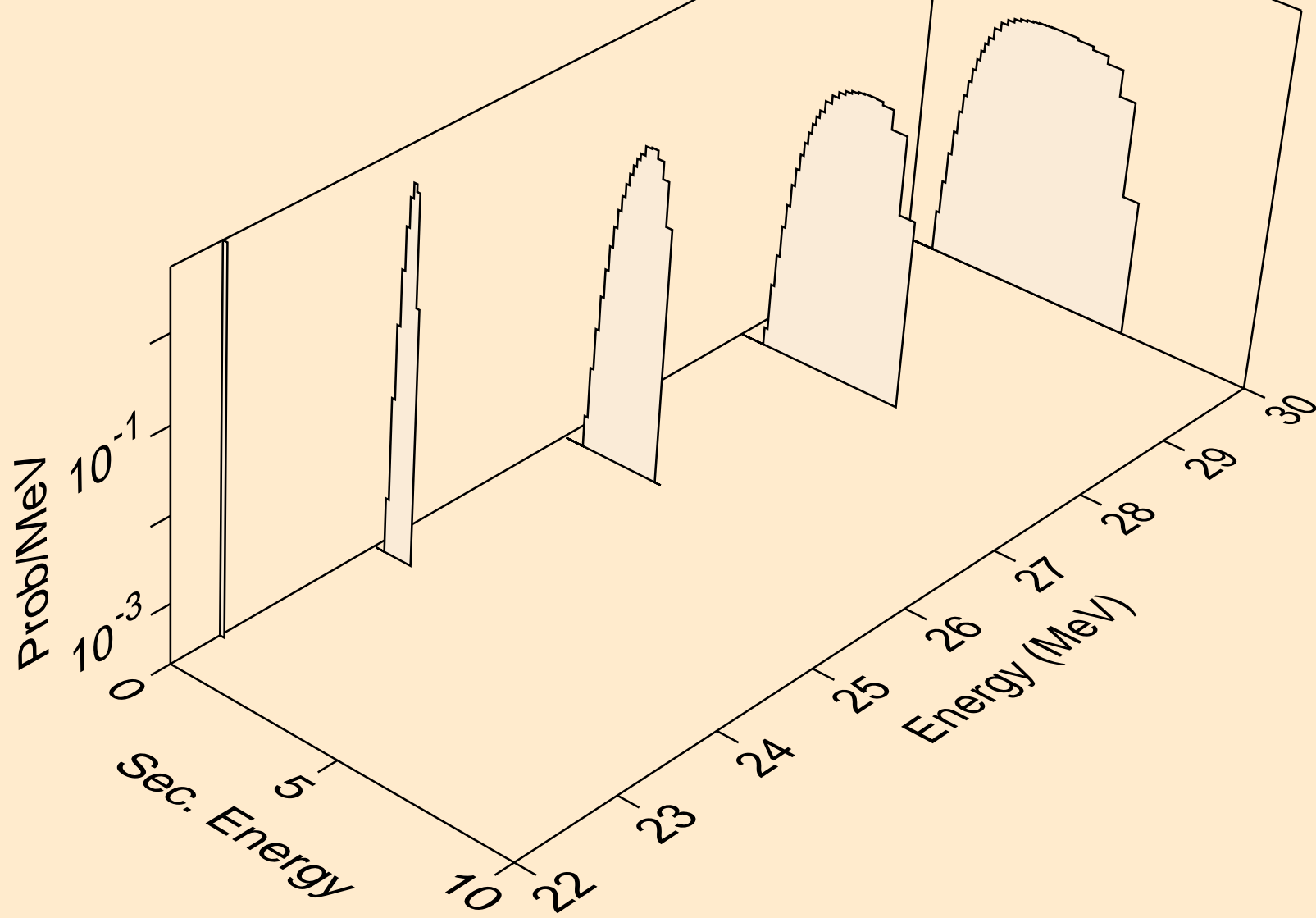

MG026 PROTON ACER TENDL-2024 LIBRARY; T=0.K
he3s from (p,x)

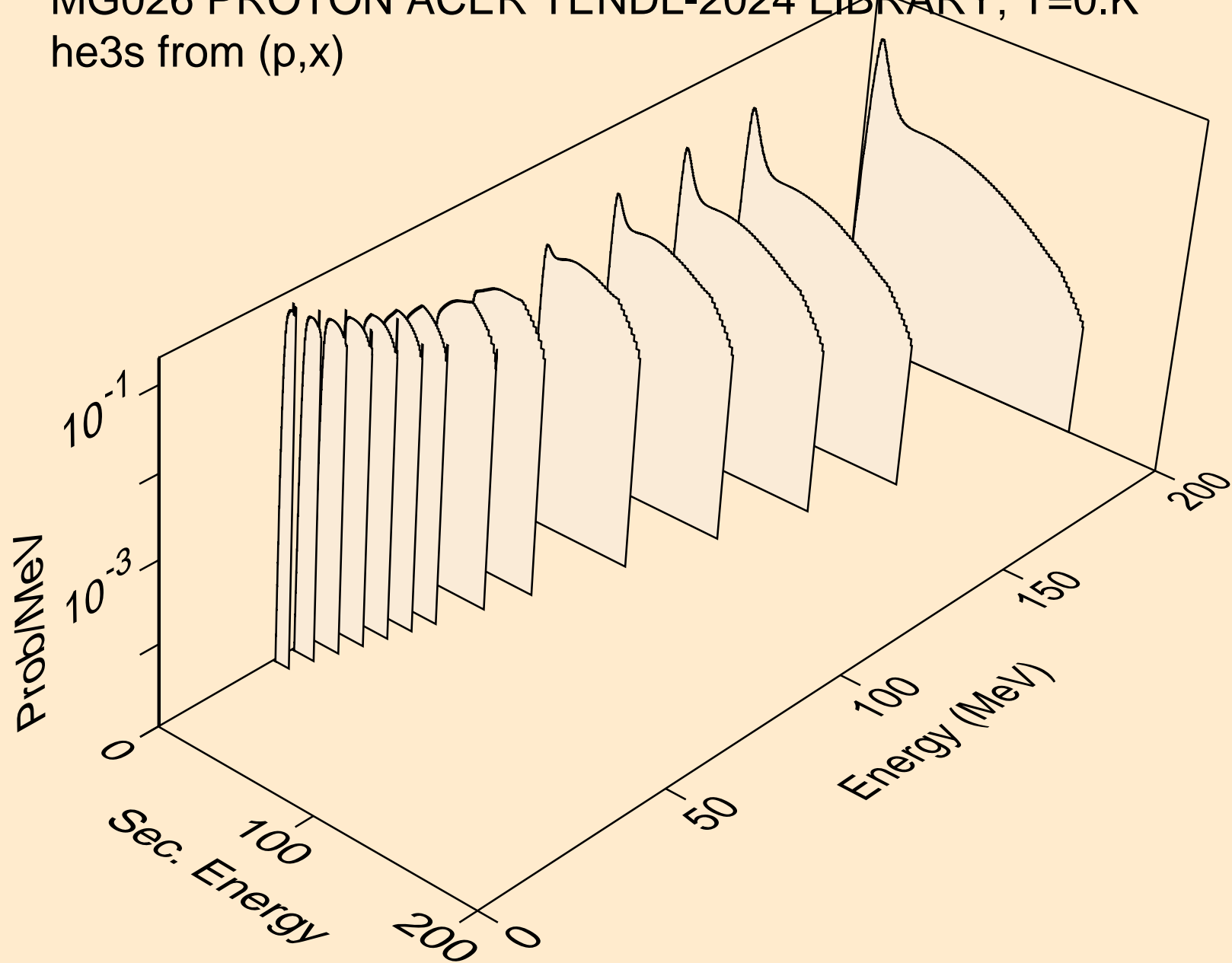

MG026 PROTON ACER TENDL-2024 LIBRARY; T=0.K
he3s from (p,n*)he3

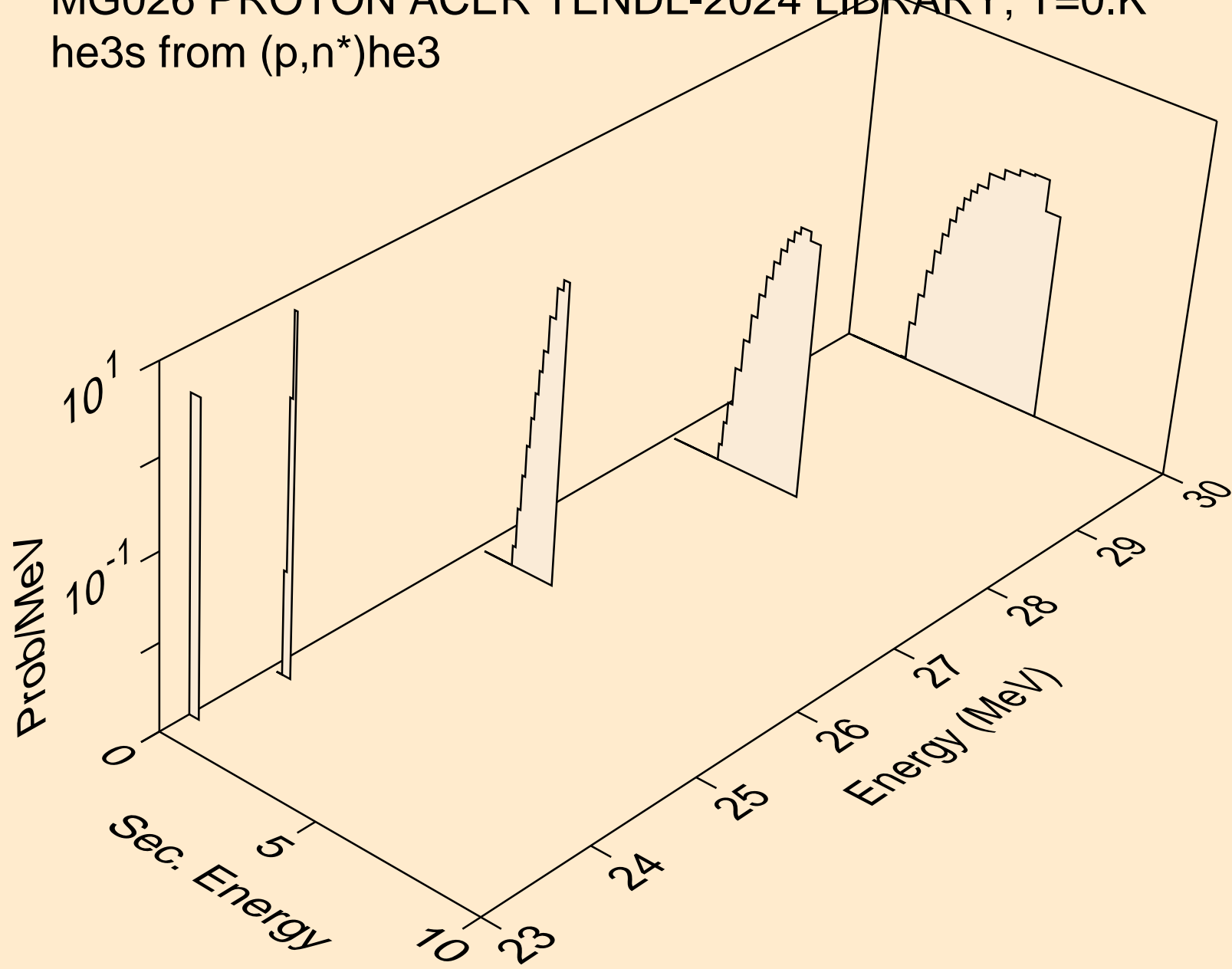

MG026 PROTON ACER TENDL-2024 LIBRARY; T=0.K
he3s from (p,he3)

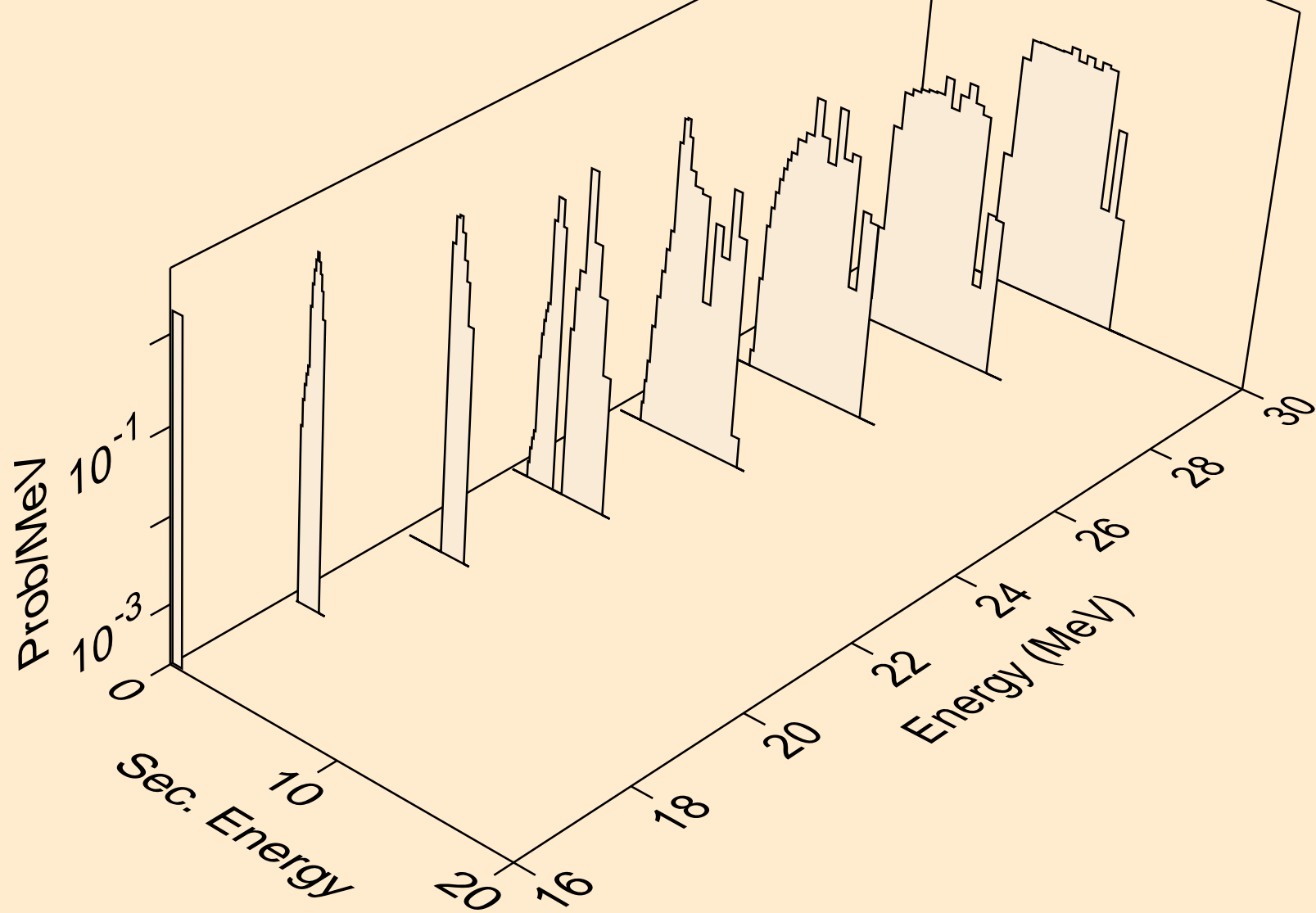

MG026 PROTON ACER TENDL-2024 LIBRARY; T=0.K
alphas from (p,x)

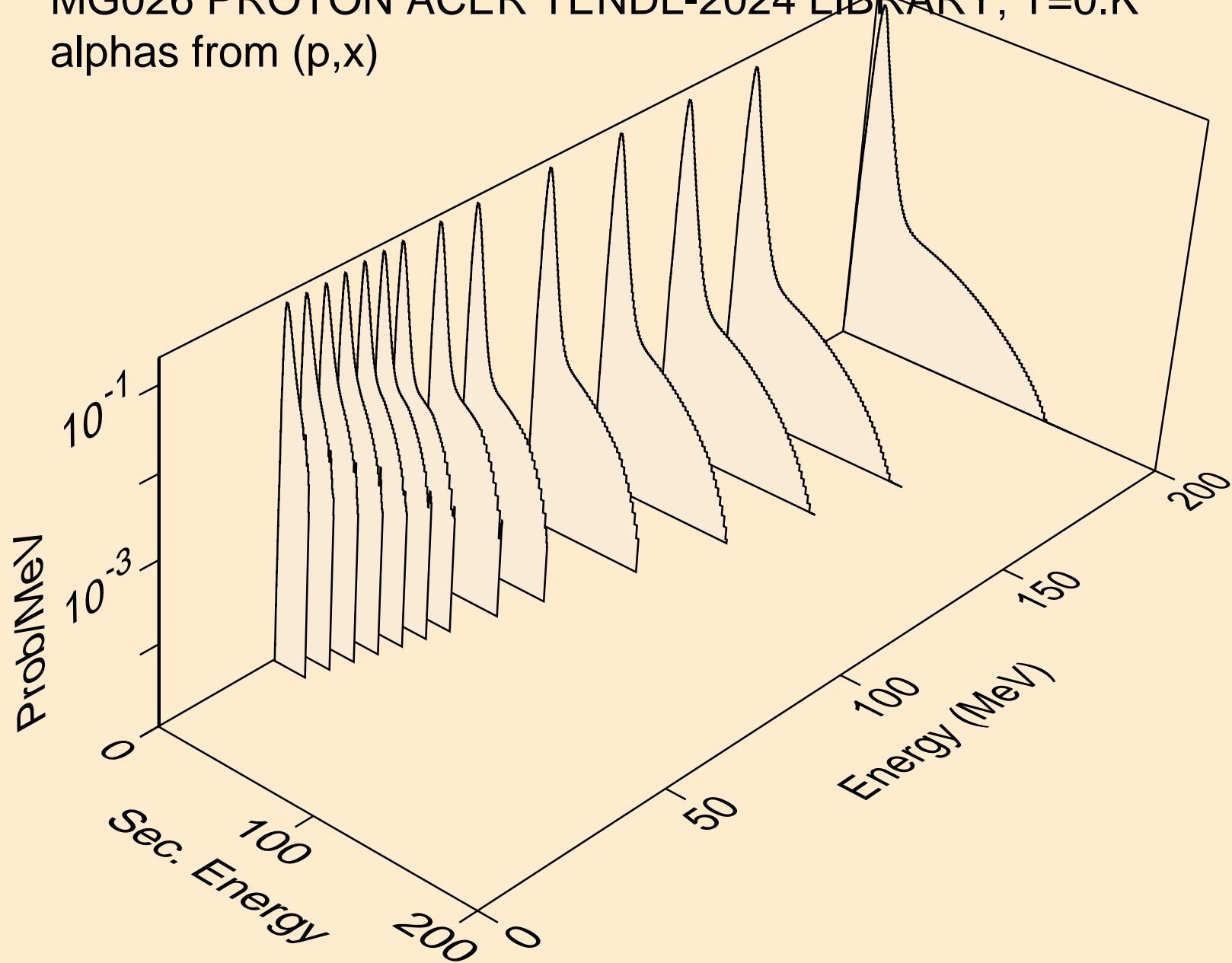

MG026 PROTON ACER TENDL-2024 LIBRARY; T=0.K
alphas from (p,n*)a

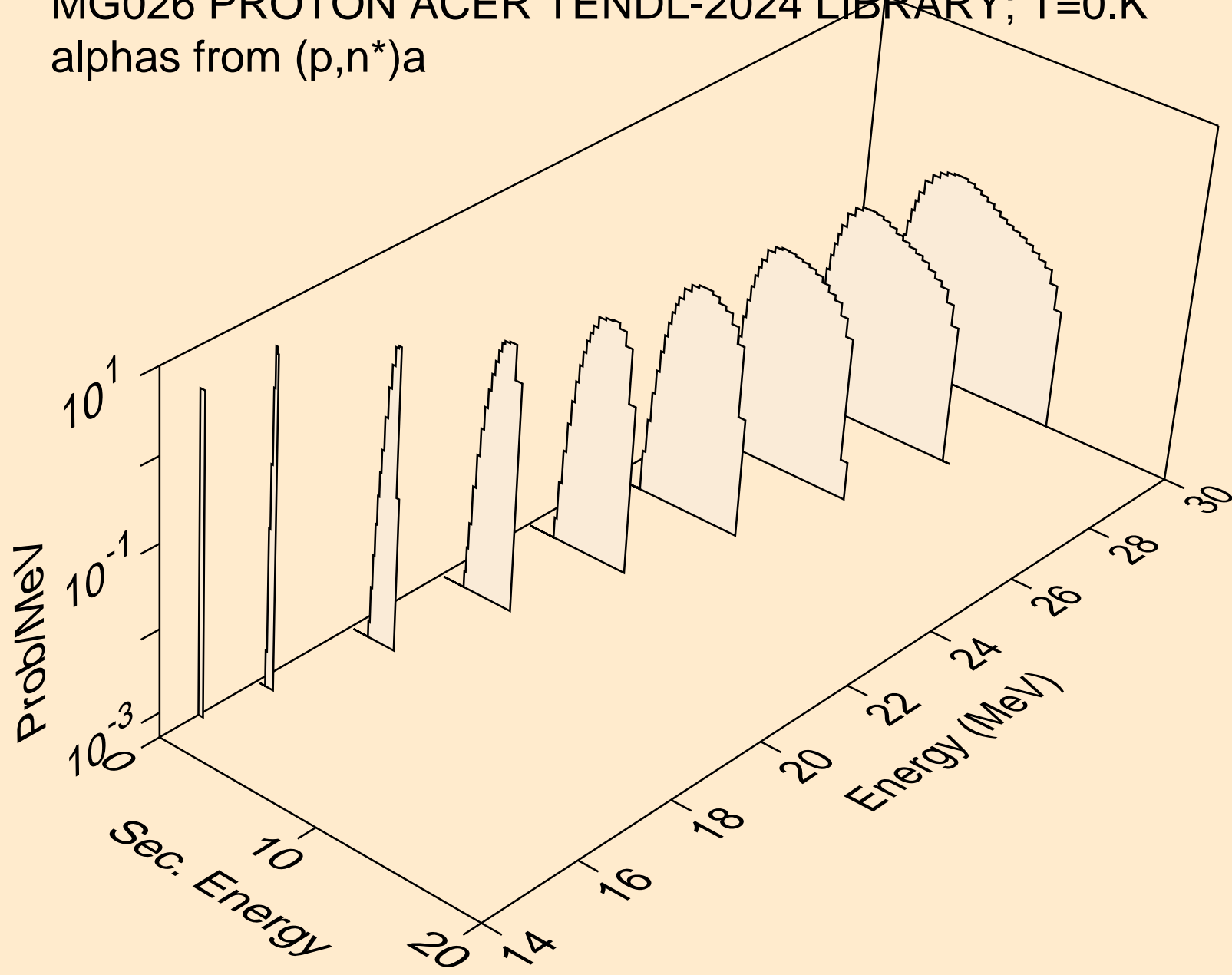

MG026 PROTON ACER TENDL-2024 LIBRARY; T=0.K
alphas from (p,2n)a

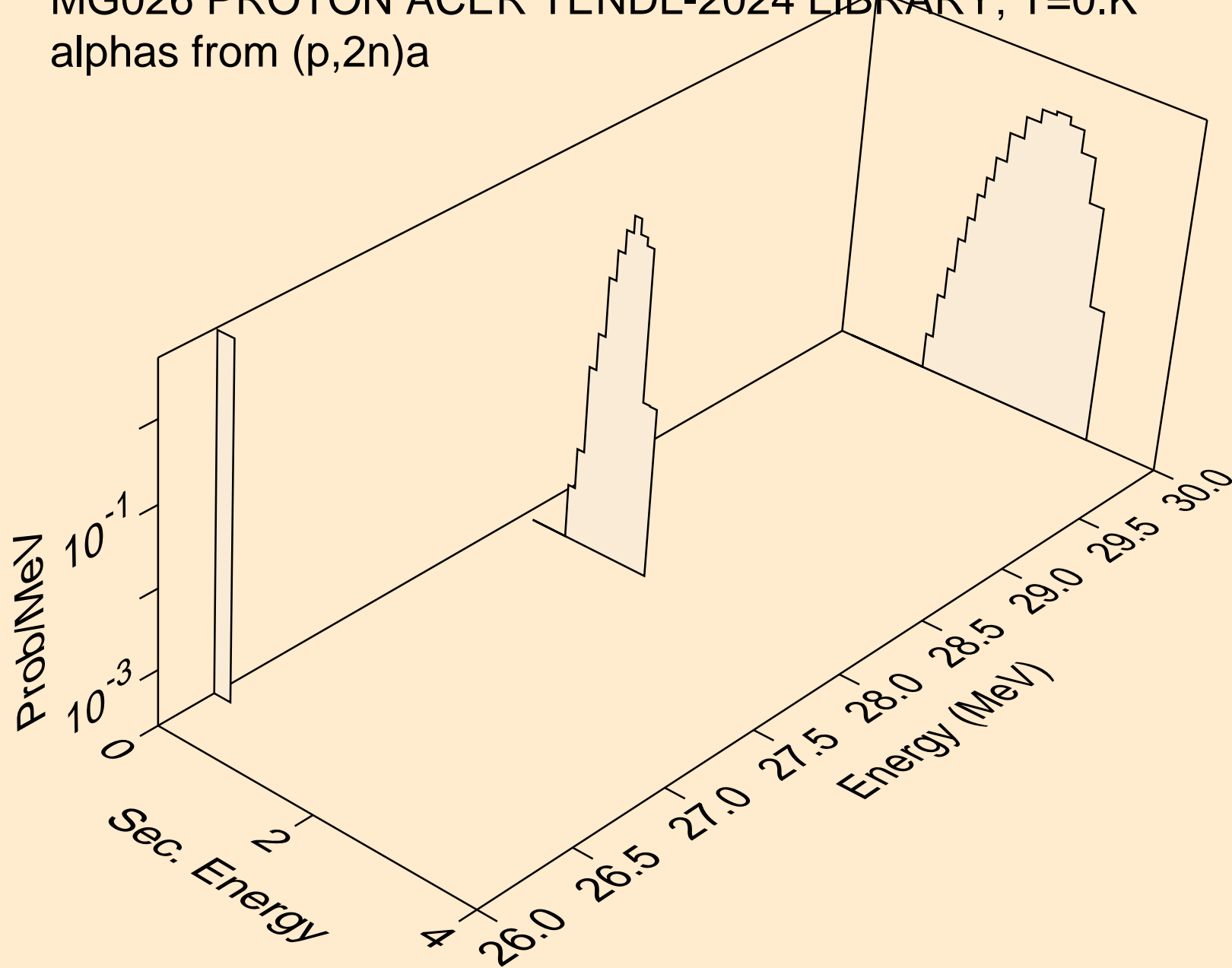

MG026 PROTON ACER TENDL-2024 LIBRARY; T=0.K
alphas from (p,n*)2a

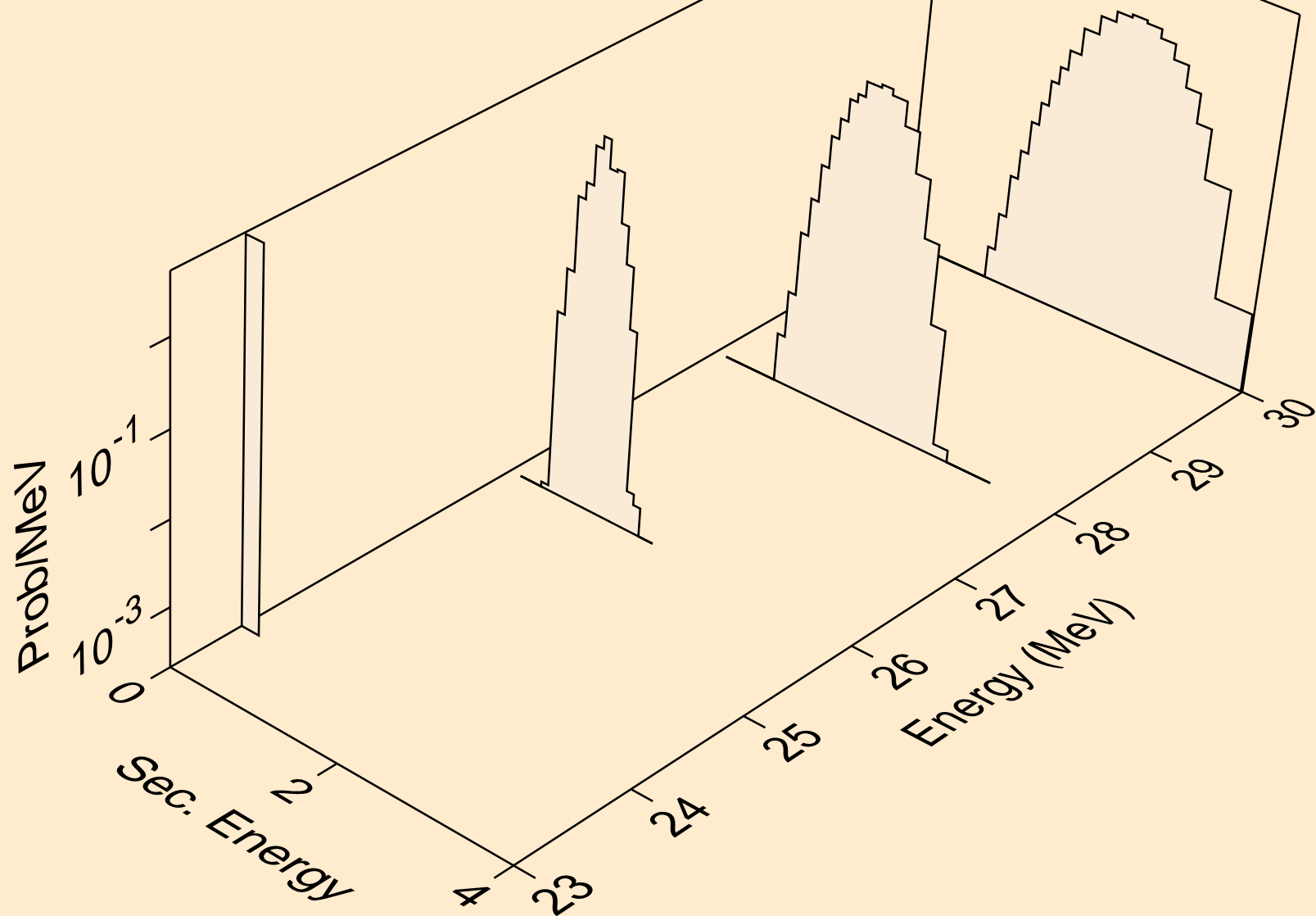

MG026 PROTON ACER TENDL-2024 LIBRARY; T=0.K
alphas from (p,npa)

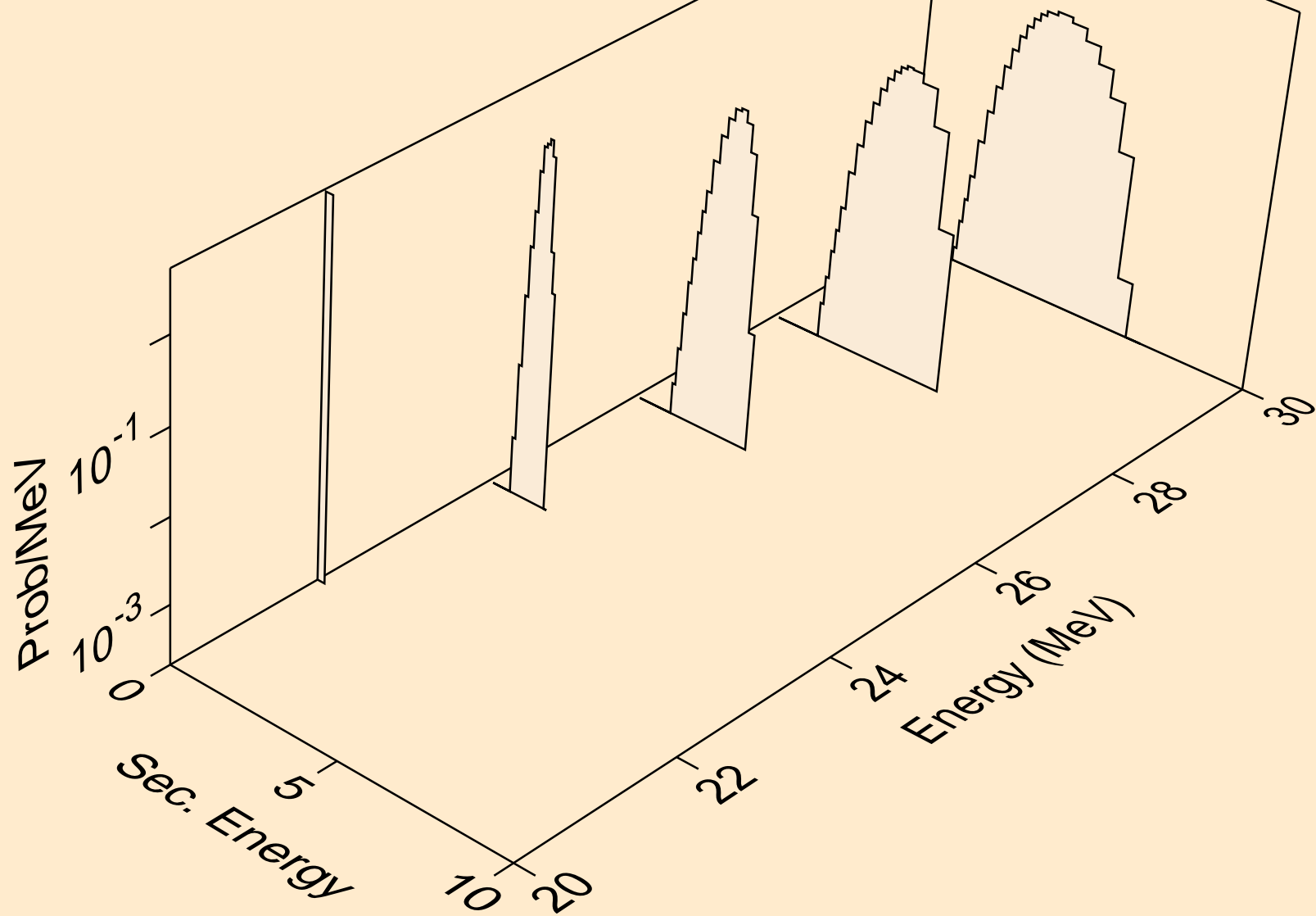

MG026 PROTON ACER TENDL-2024 LIBRARY; T=0.K
alphas from (p,a)

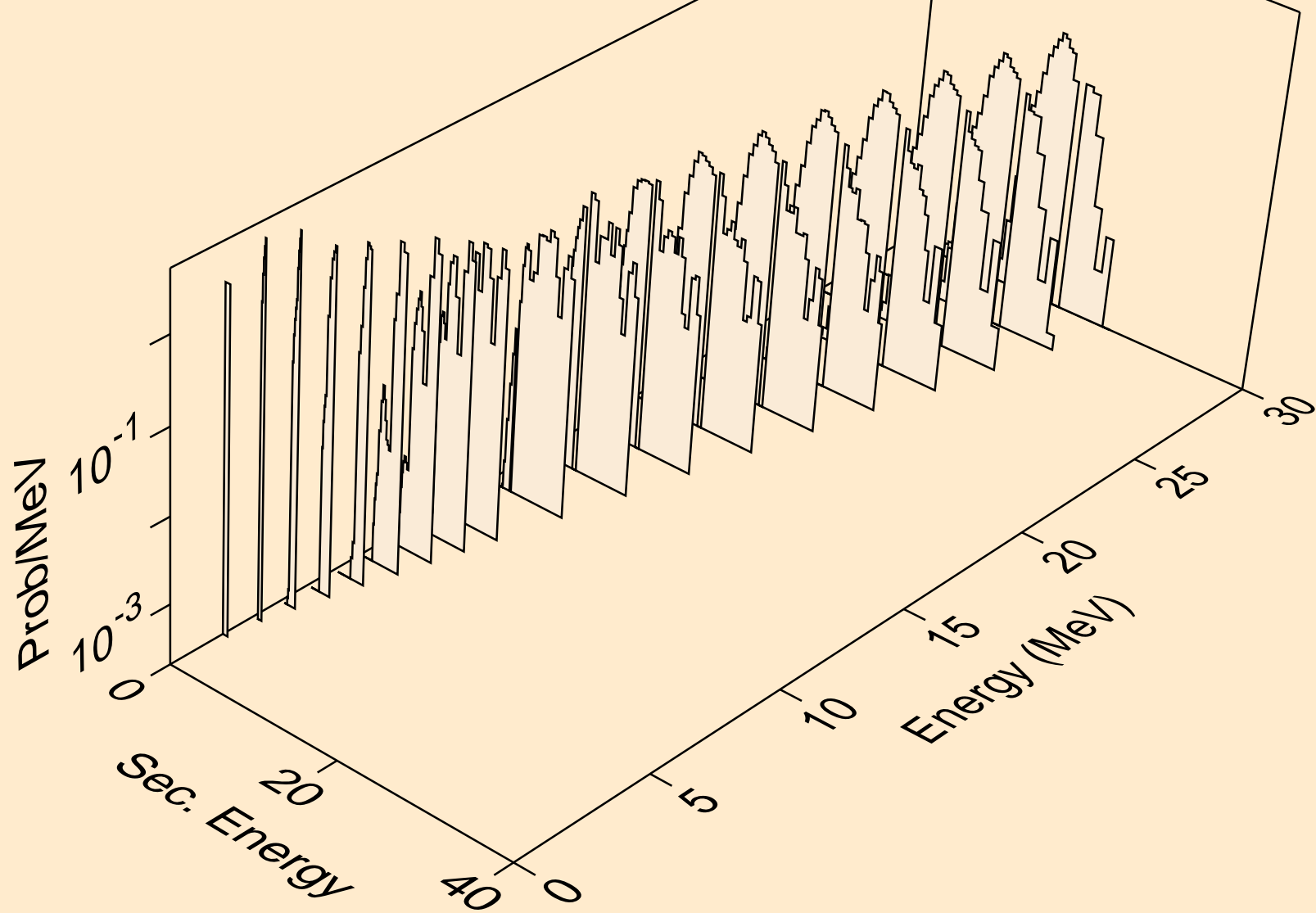

MG026 PROTON ACER TENDL-2024 LIBRARY; T=0.K
alphas from (p,2a)

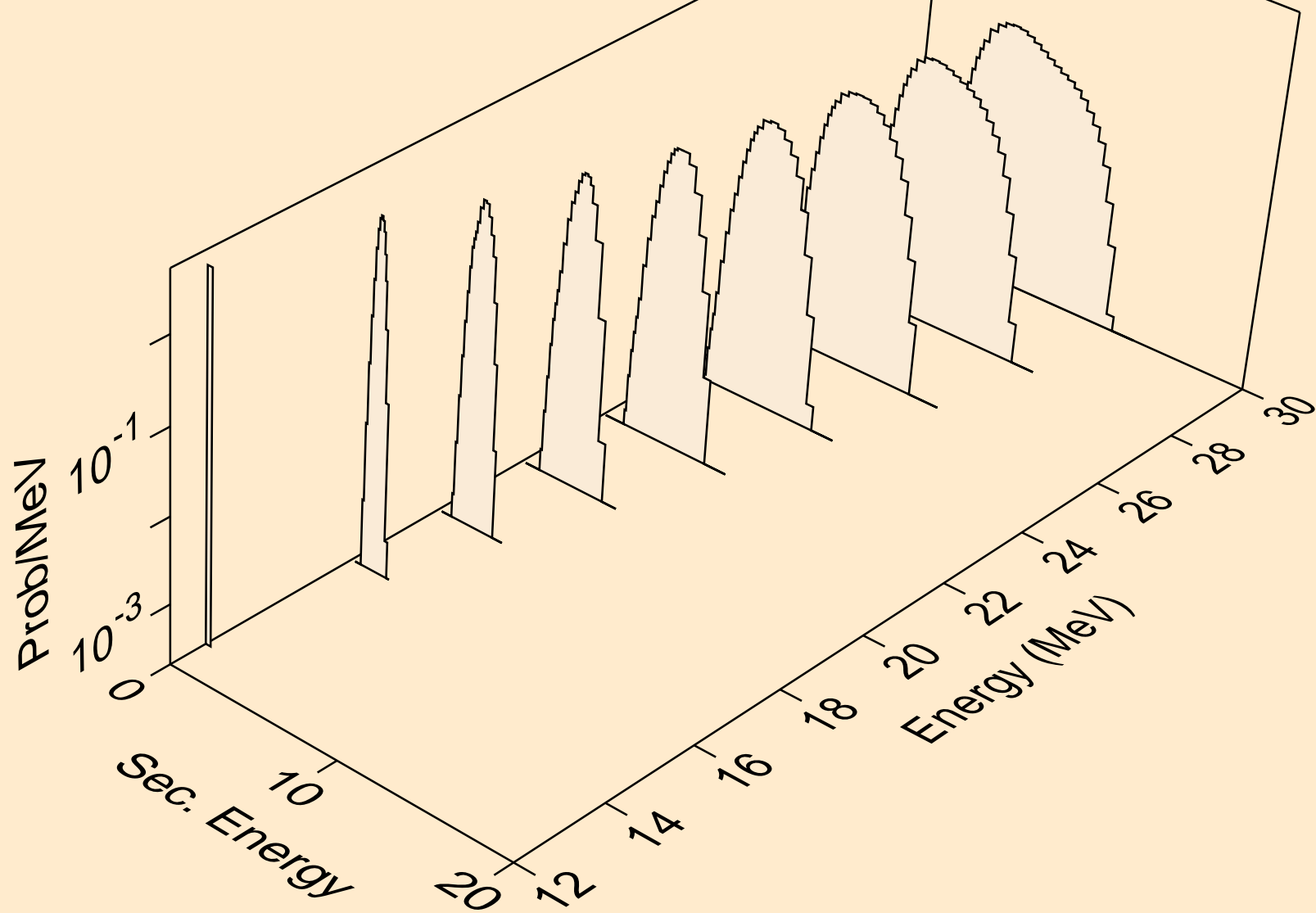

MG026 PROTON ACER TENDL-2024 LIBRARY; T=0.K
alphas from (p,3a)

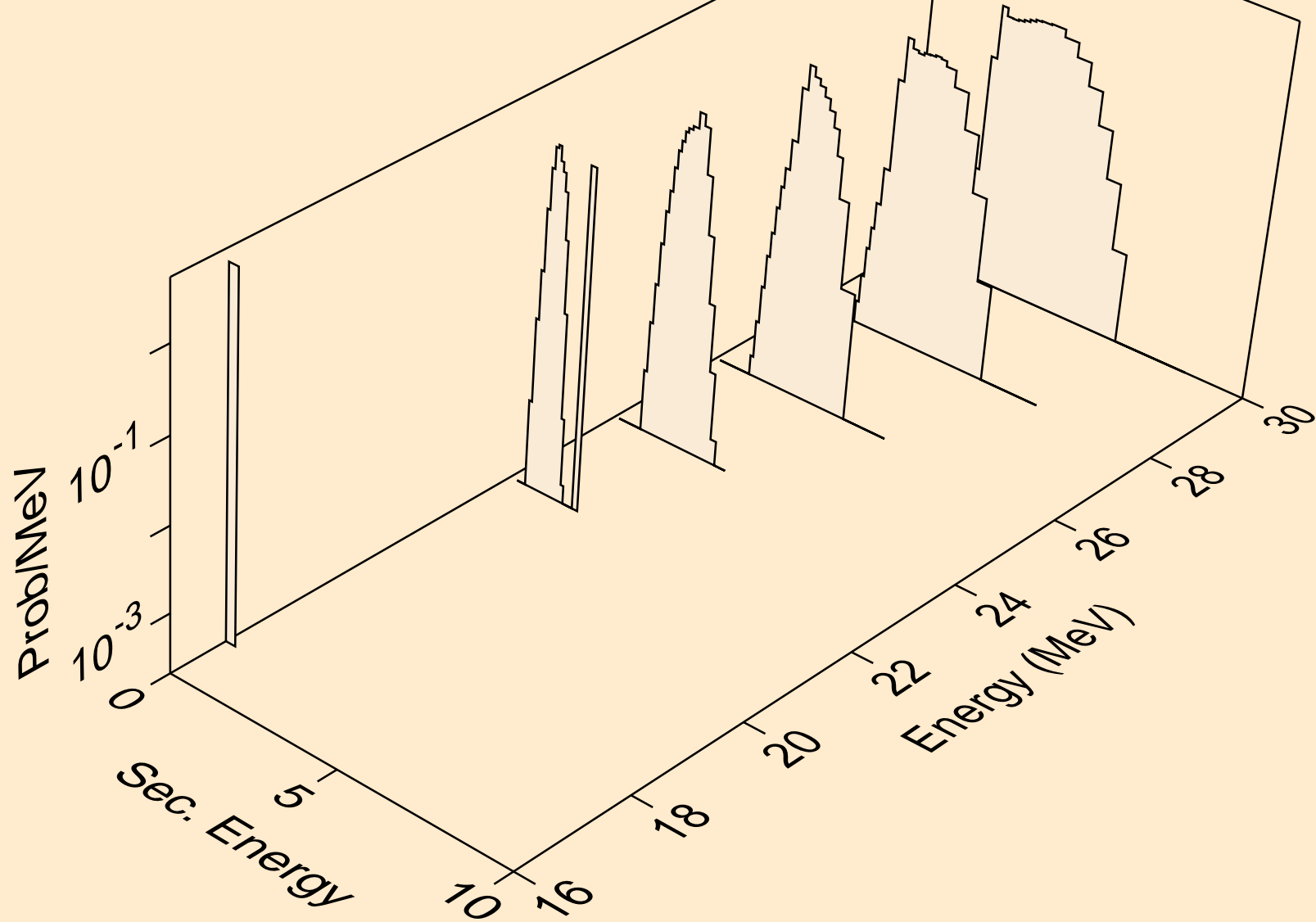

MG026 PROTON ACER TENDL-2024 LIBRARY; T=0.K
alphas from (p,pa)

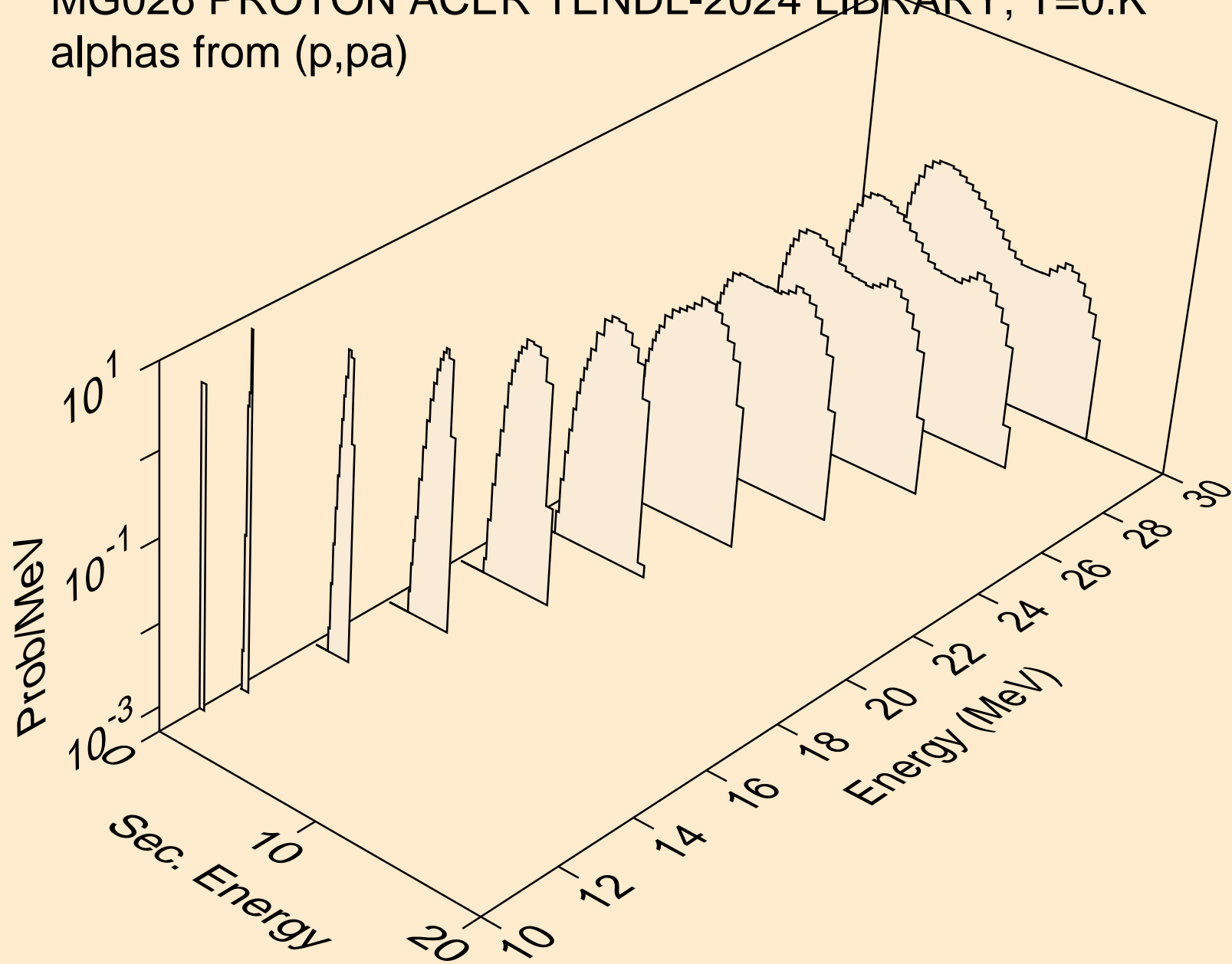

MG026 PROTON ACER TENDL-2024 LIBRARY; T=0.K
alphas from (p,da)

