

# NE023 PROTON ACER TENDL-2024 LIBRARY; T=0.K

## Principal cross sections

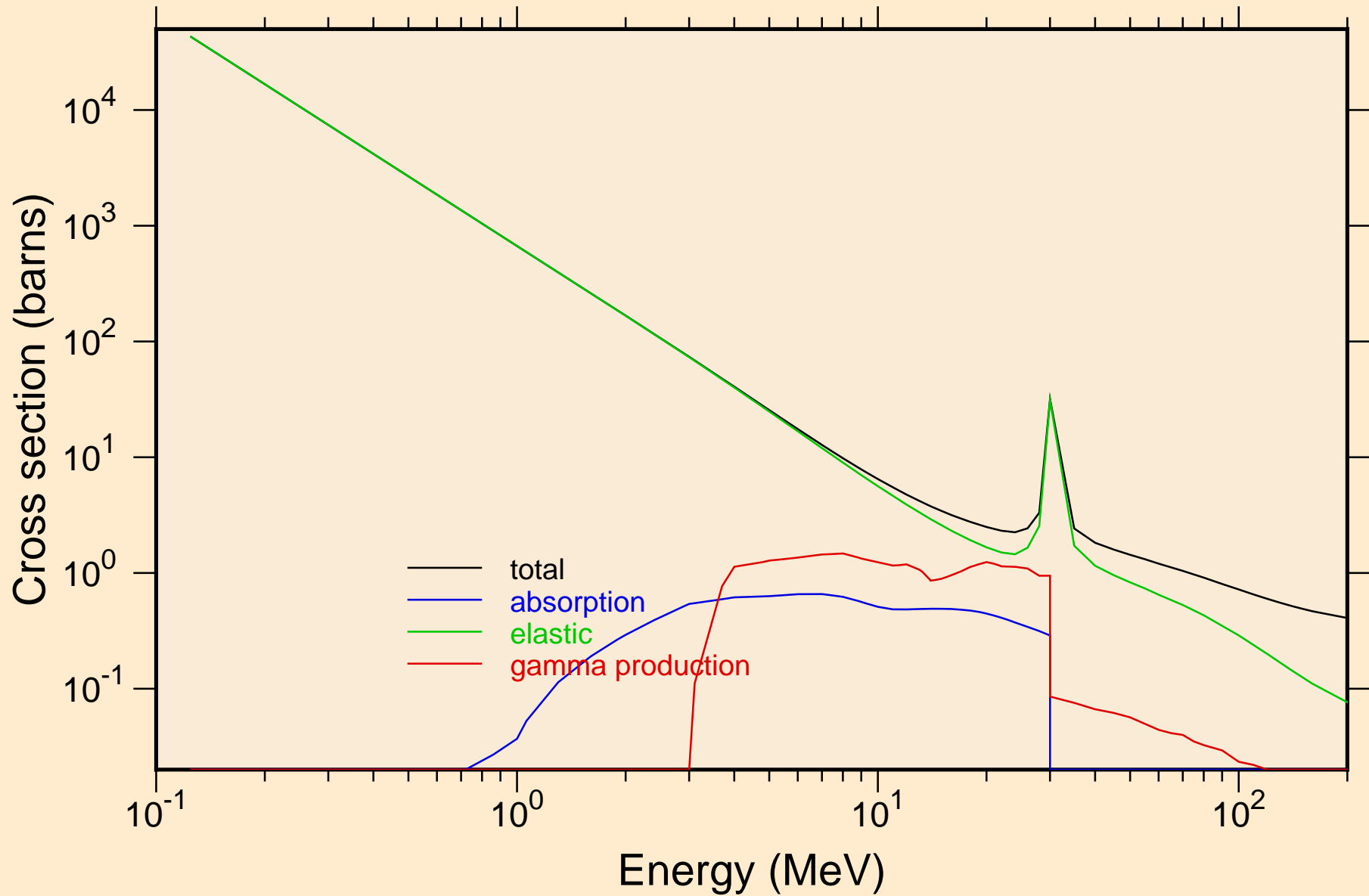

# NE023 PROTON ACER TENDL-2024 LIBRARY; T=0.K

## Heating

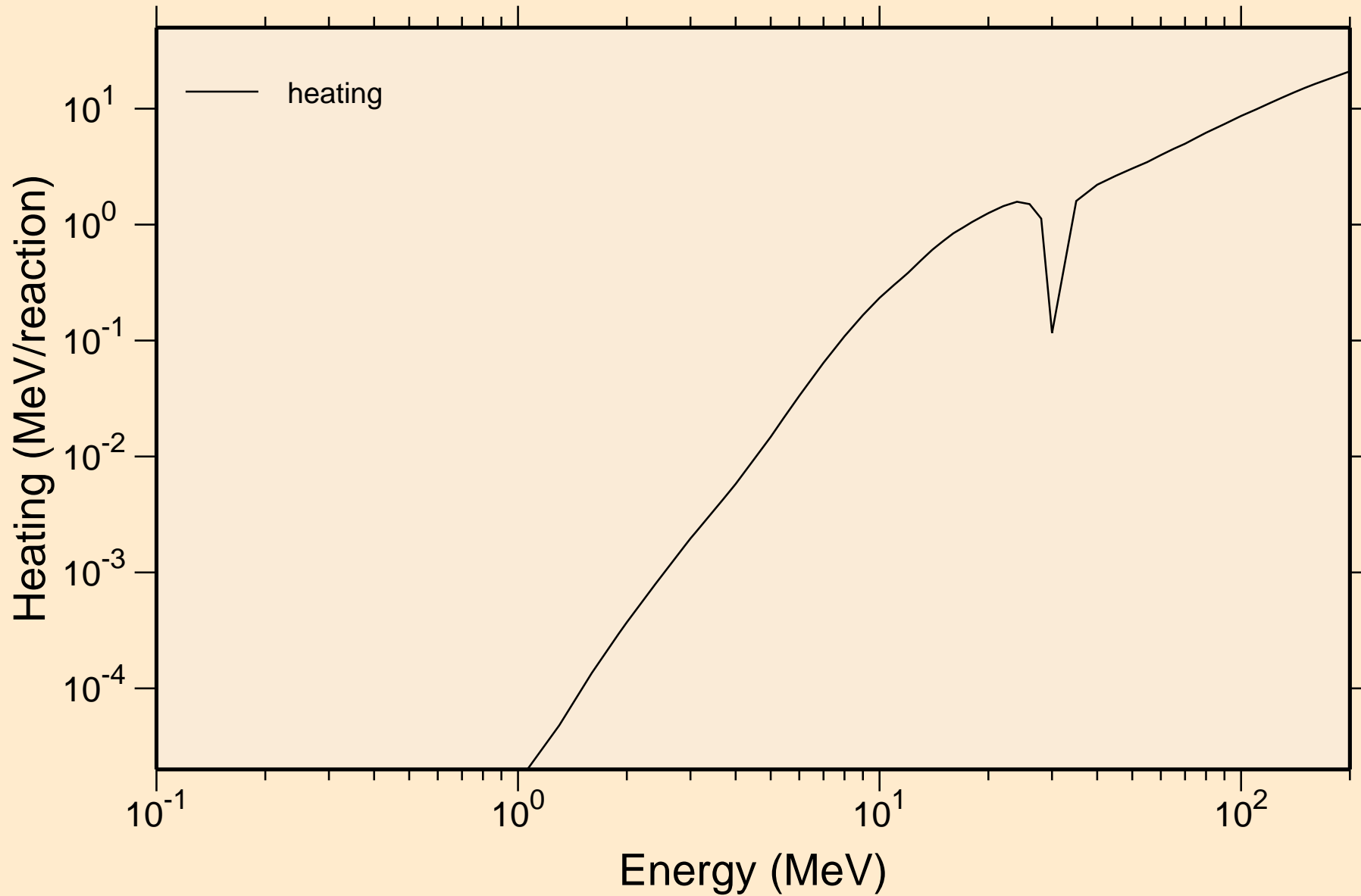

# NE023 PROTON ACER TENDL-2024 LIBRARY; T=0.K

## Principal cross sections

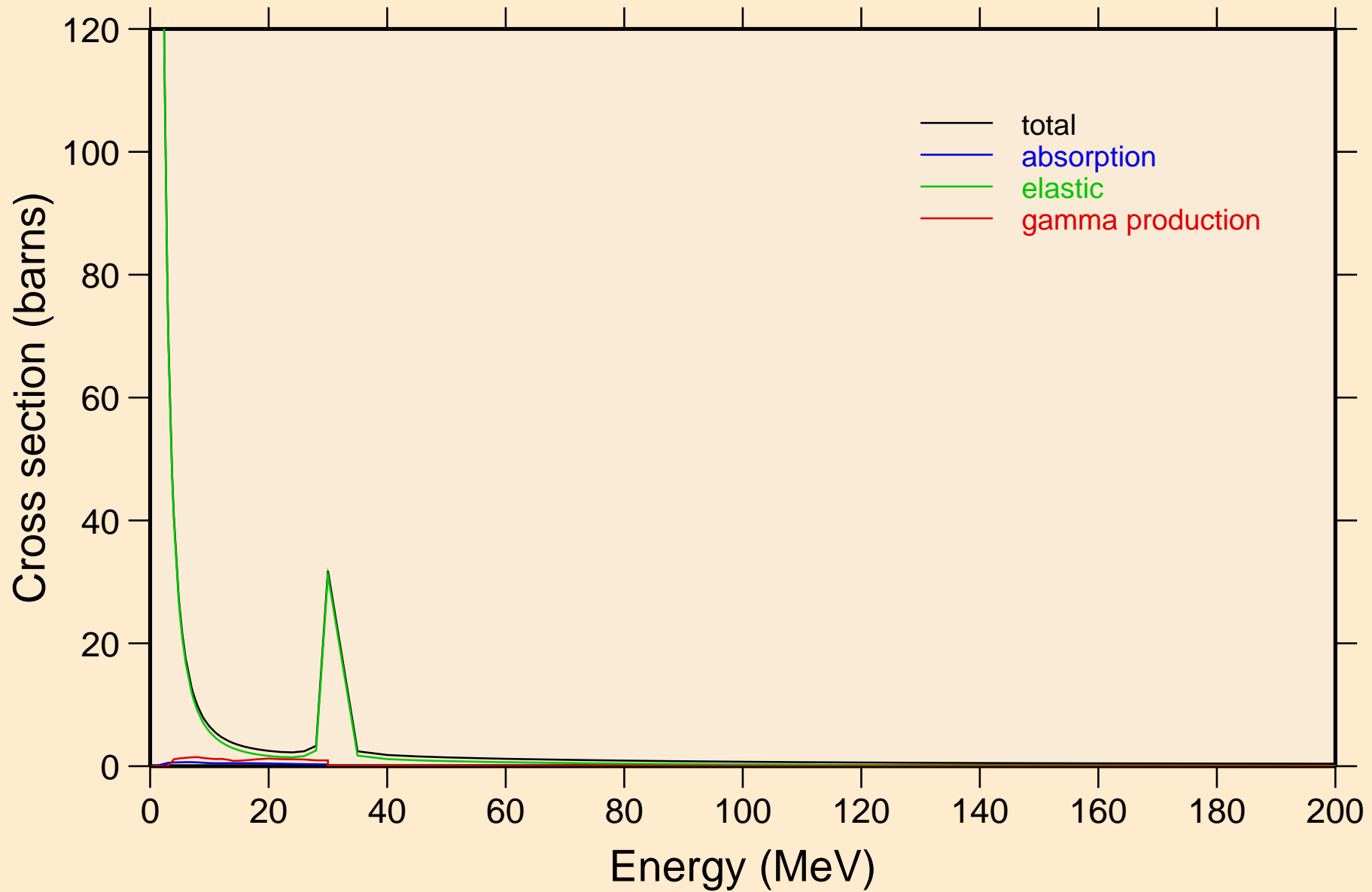

# NE023 PROTON ACER TENDL-2024 LIBRARY; T=0.K

## Heating

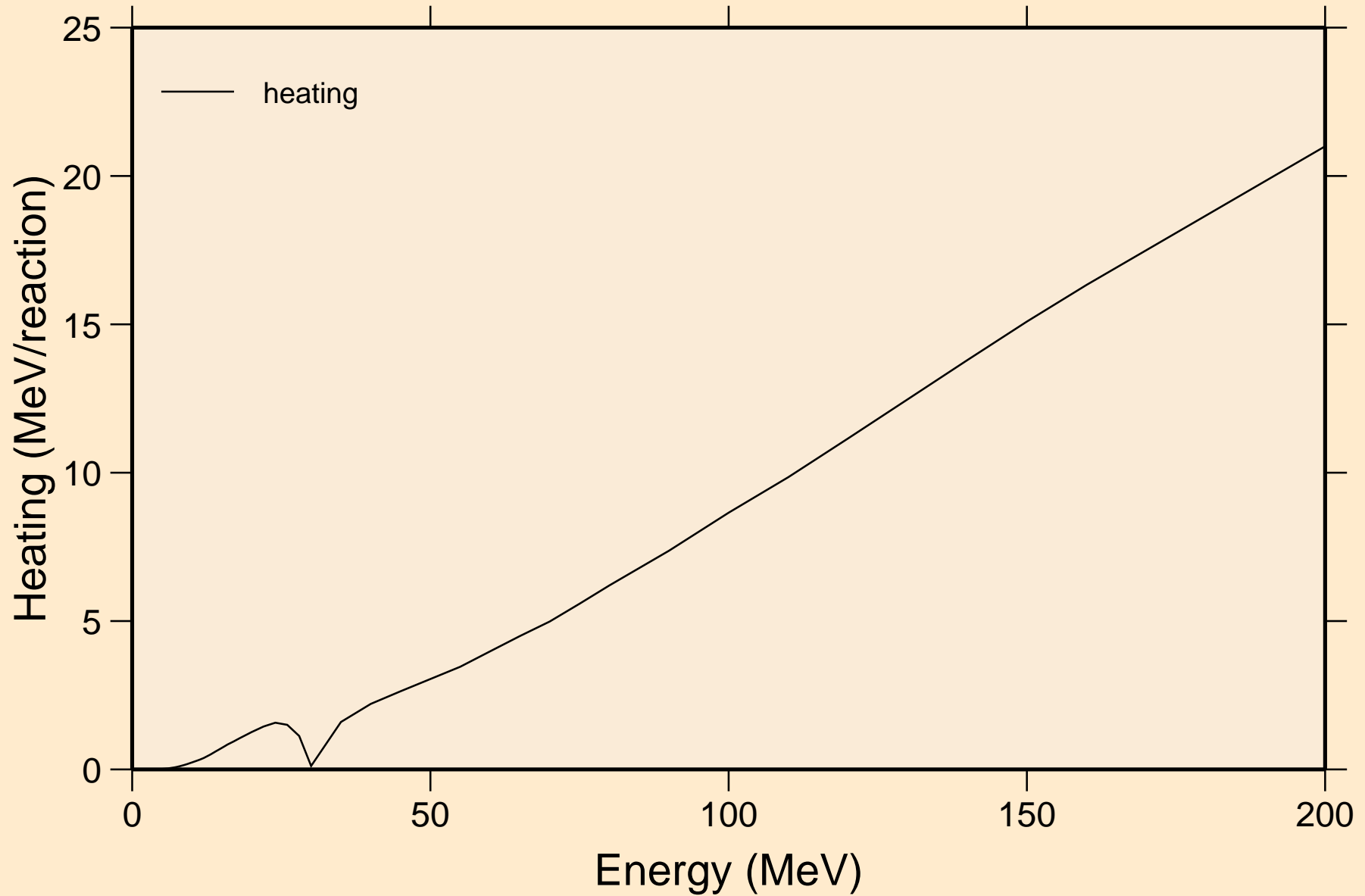

# NE023 PROTON ACER TENDL-2024 LIBRARY; T=0.K

## Threshold reactions

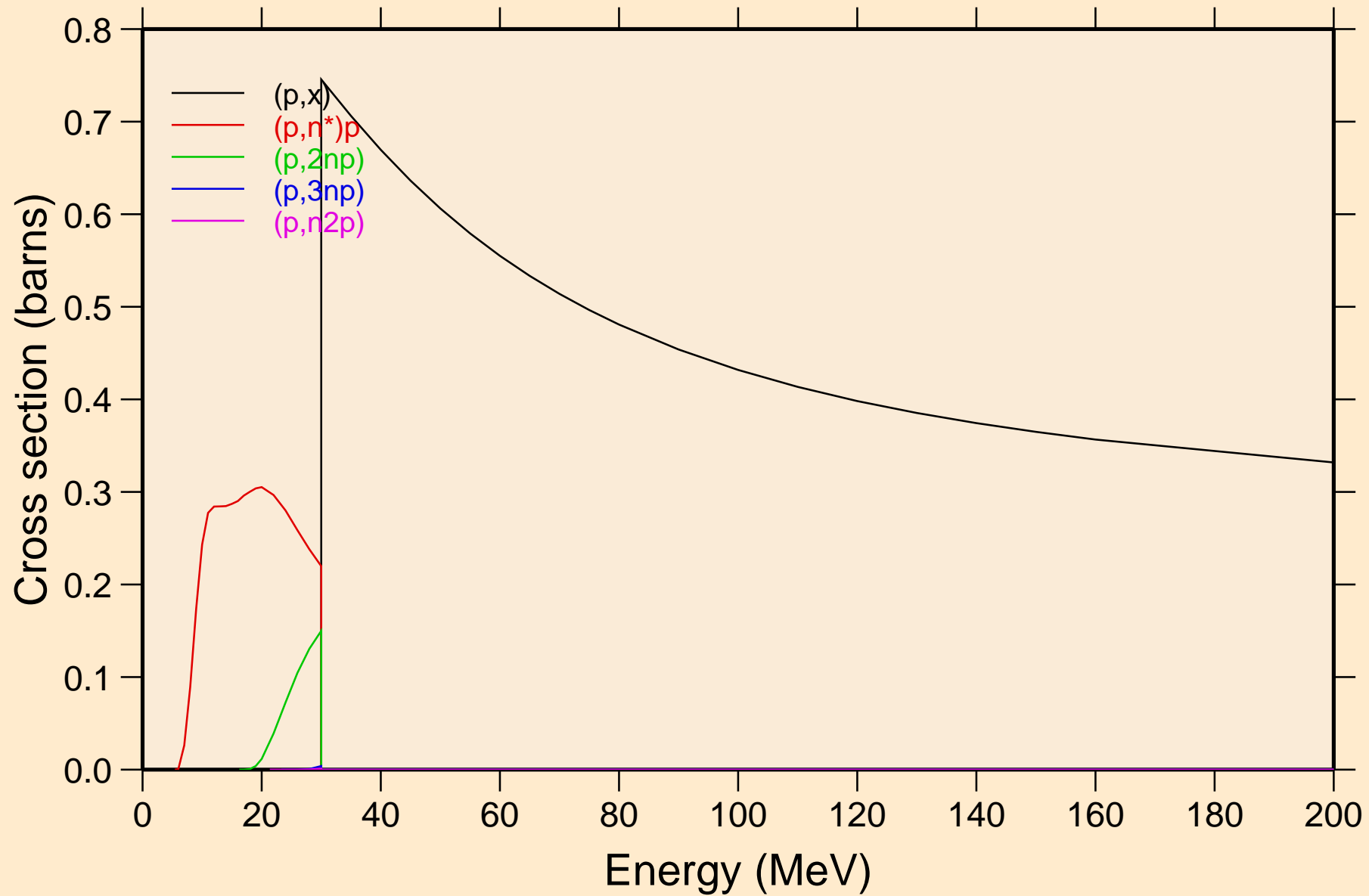

# NE023 PROTON ACER TENDL-2024 LIBRARY; T=0.K

## Threshold reactions

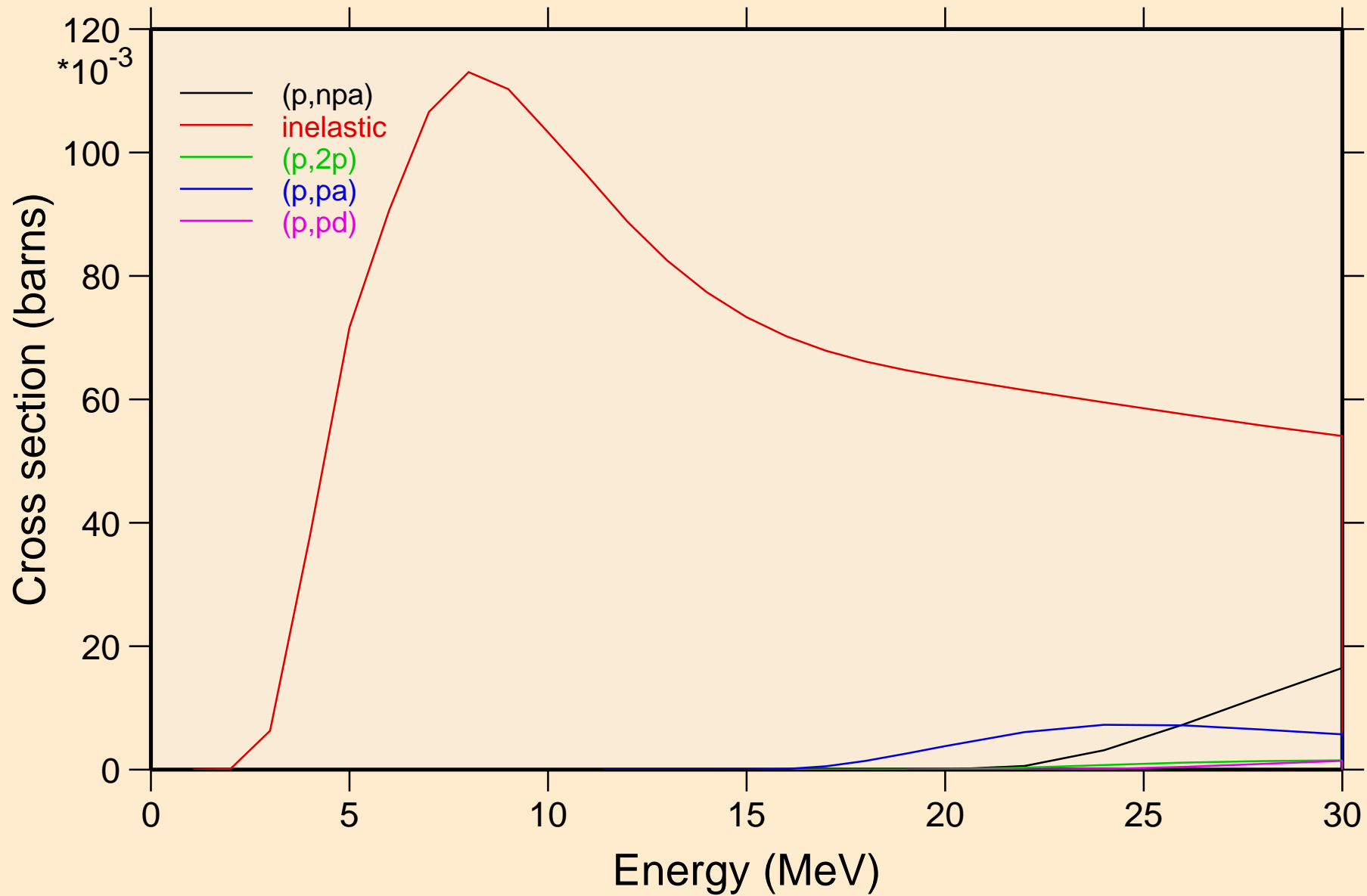

# NE023 PROTON ACER TENDL-2024 LIBRARY; T=0.K

## Threshold reactions

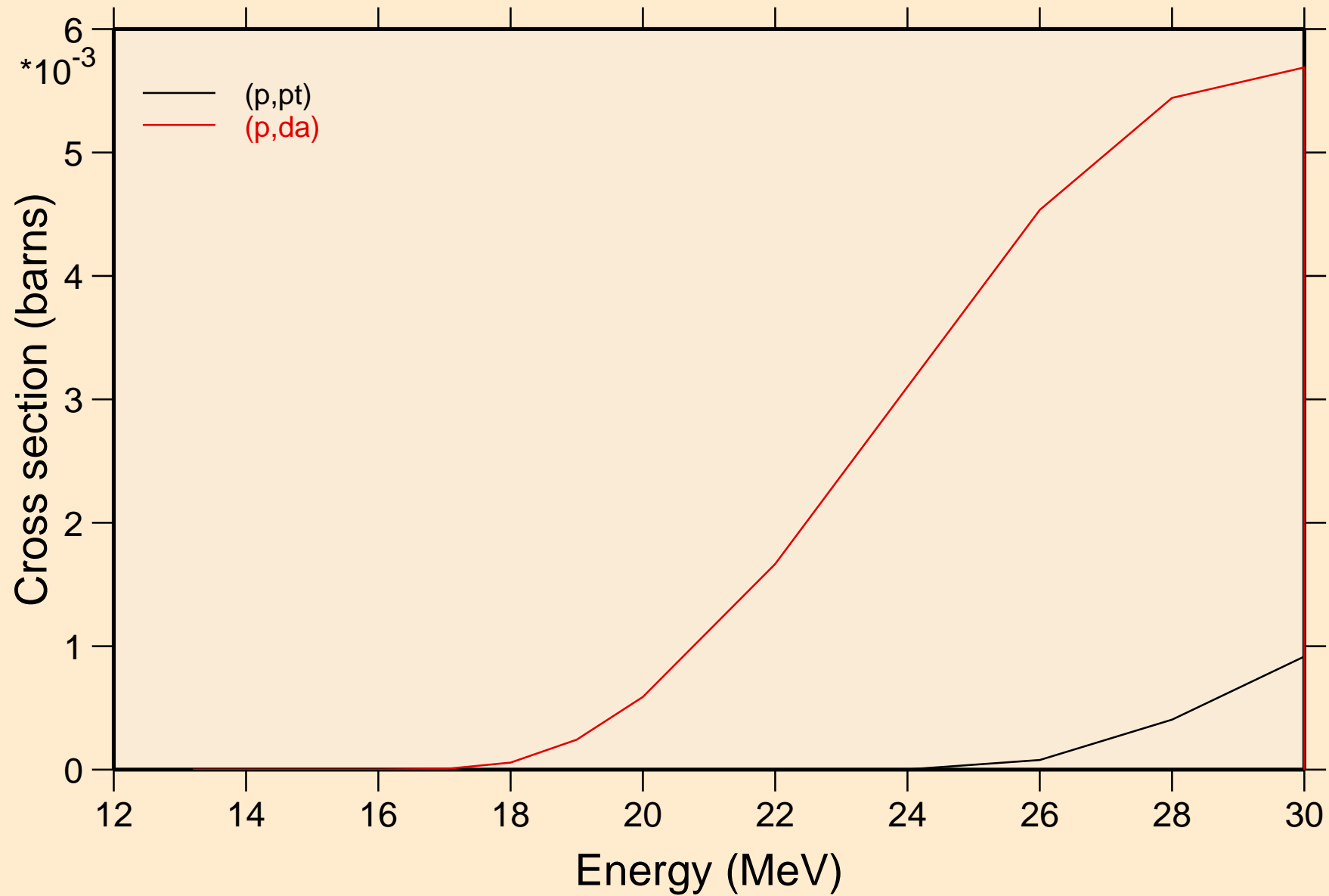

NE023 PROTON ACER TENDL-2024 LIBRARY; T=0.K  
angular distribution for elastic

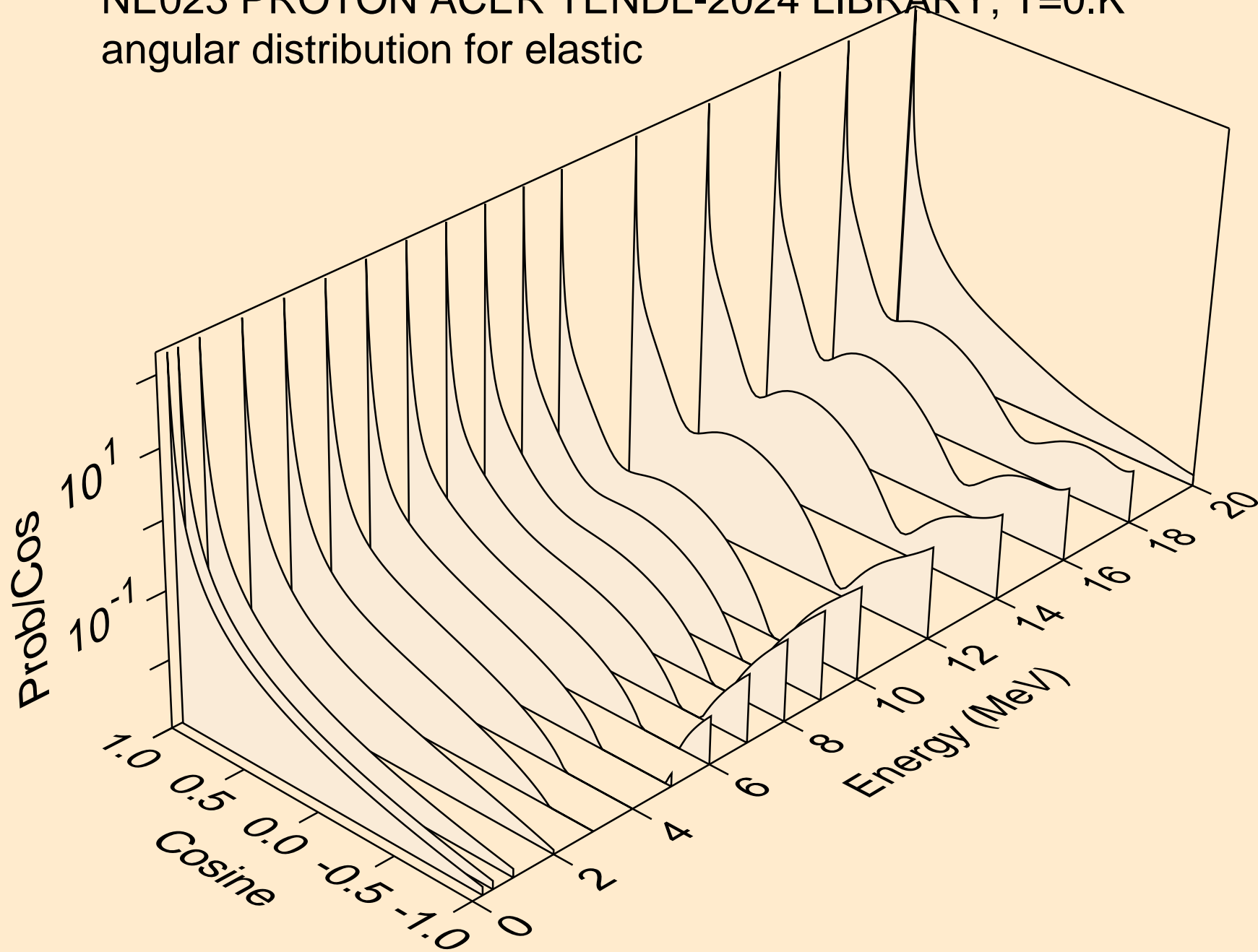

NE023 PROTON ACER TENDL-2024 LIBRARY; T=0.K  
angular distribution for elastic

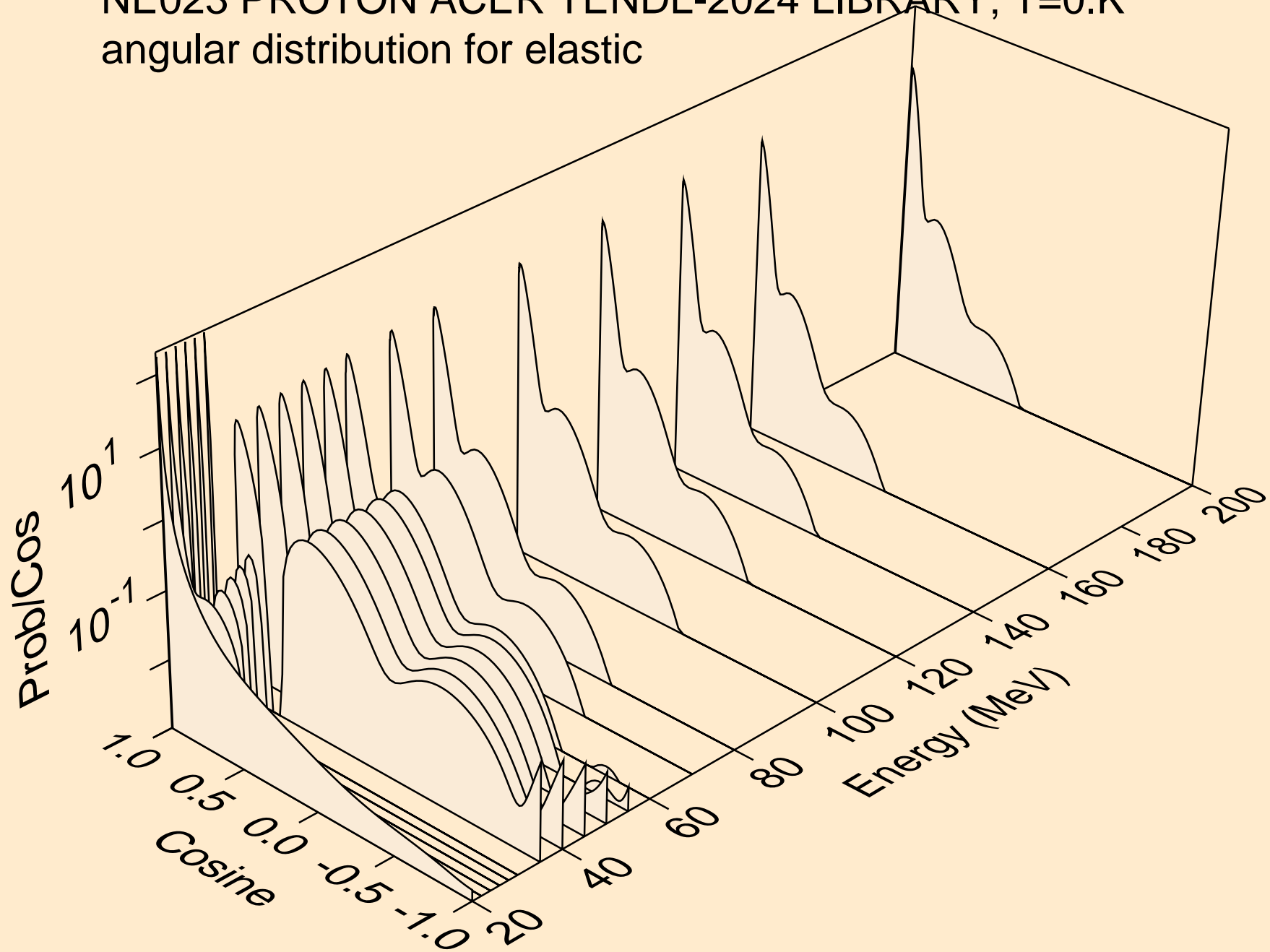

NE023 PROTON ACER TENDL-2024 LIBRARY; T=0.K  
Proton emission for (p,x)

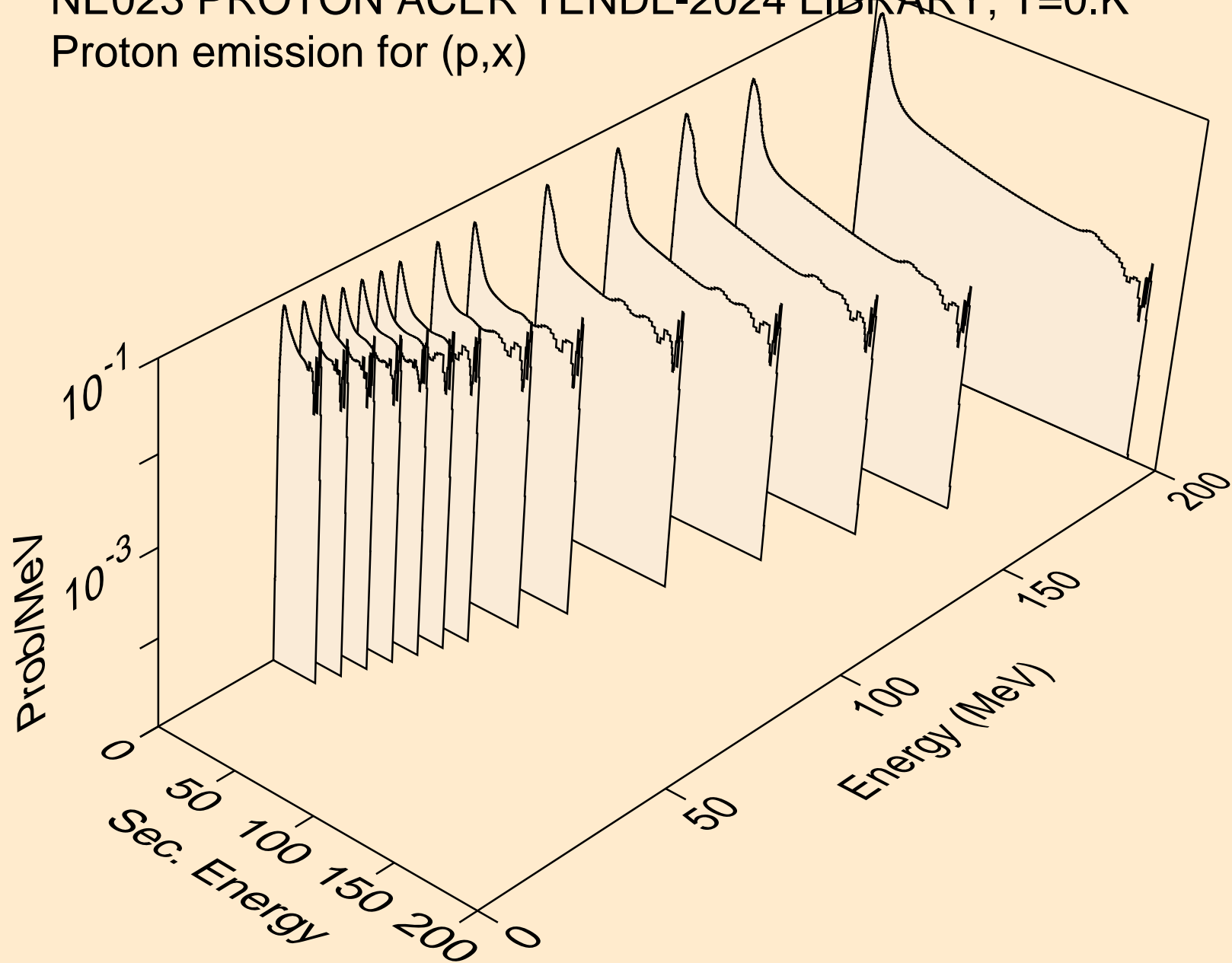

NE023 PROTON ACER TENDL-2024 LIBRARY; T=0.K  
Proton emission for (p,n\*)p

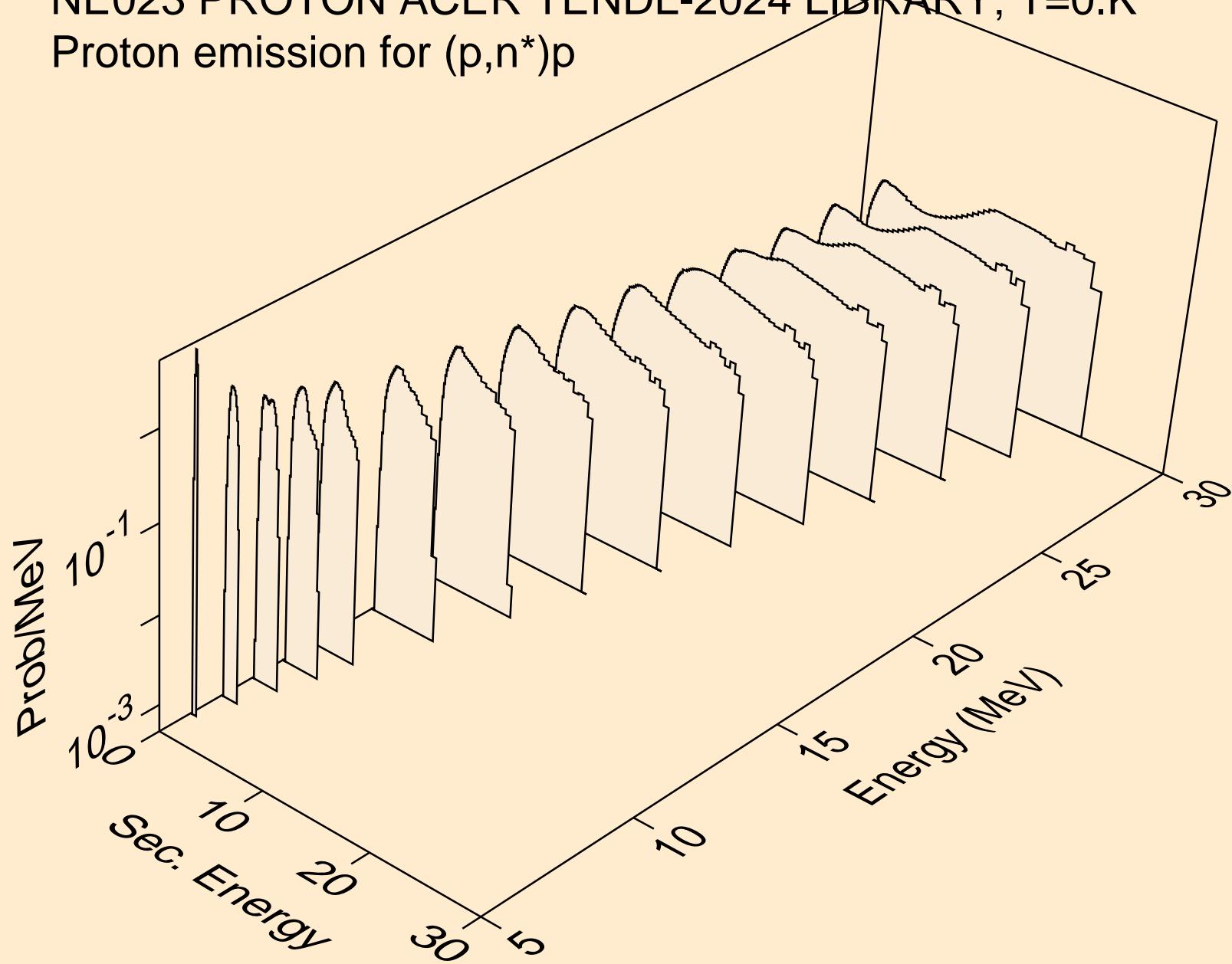

NE023 PROTON ACER TENDL-2024 LIBRARY; T=0.K  
Proton emission for (p,2np)

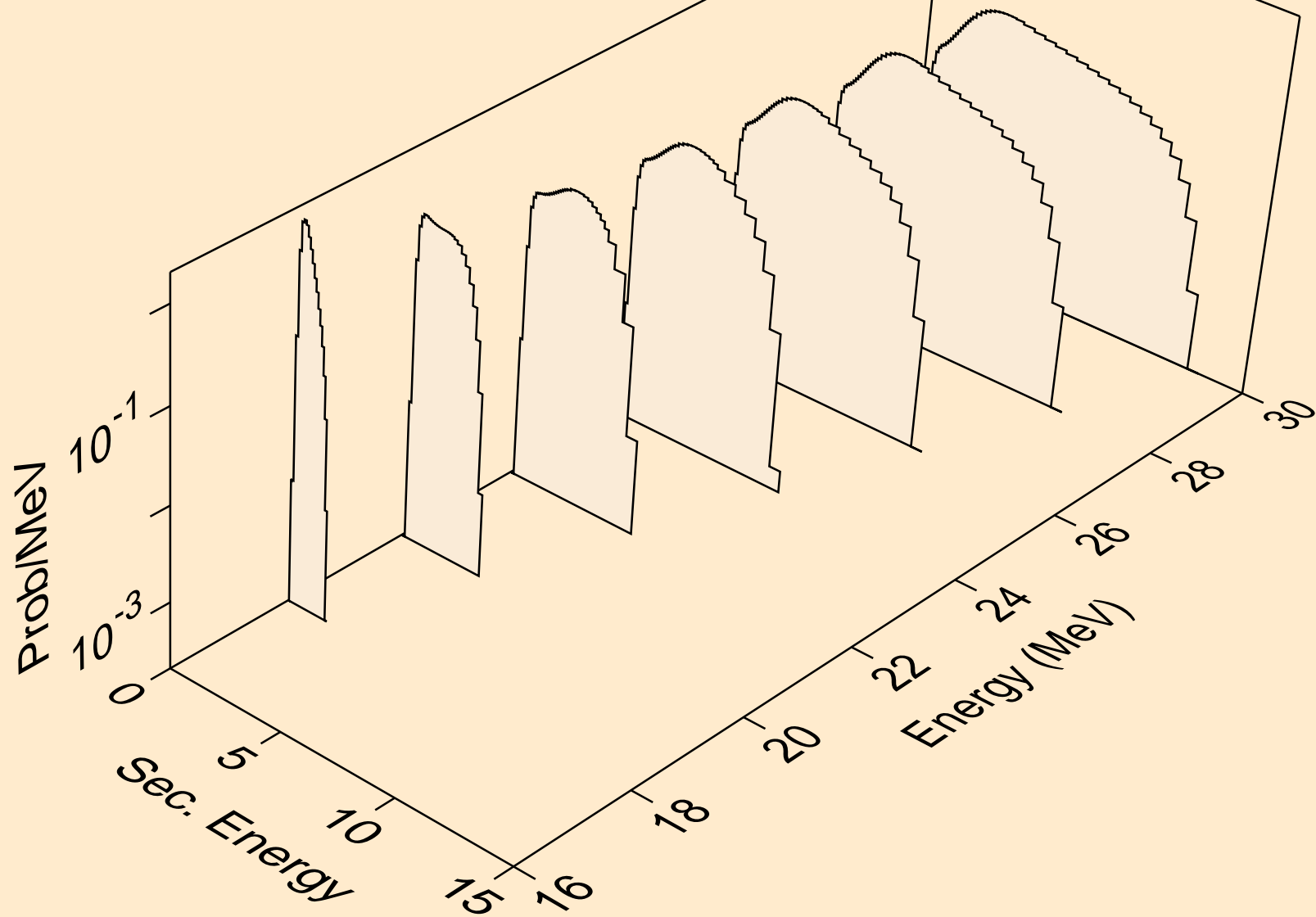

NE023 PROTON ACER TENDL-2024 LIBRARY; T=0.K  
Proton emission for (p,3np)

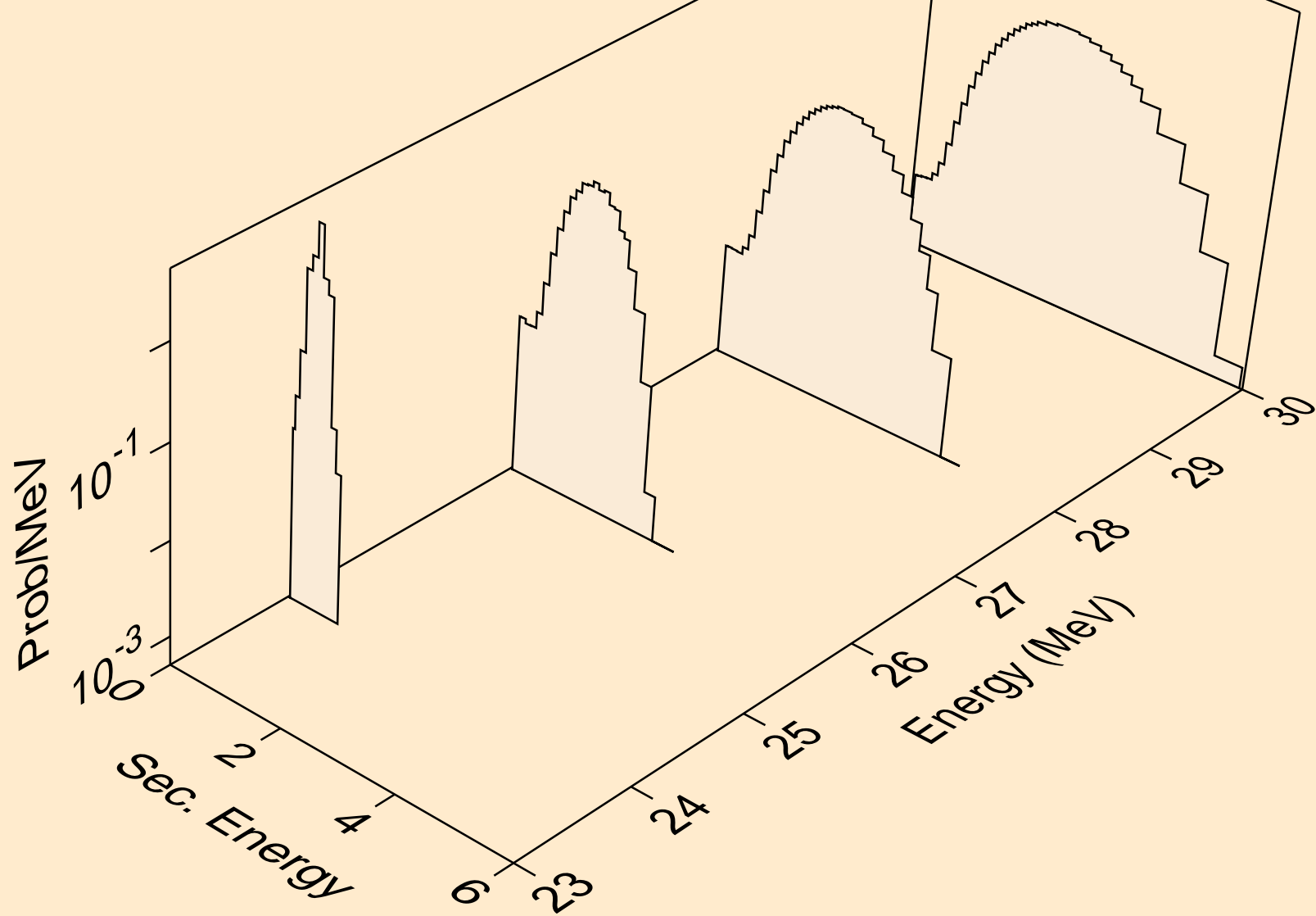

NE023 PROTON ACER TENDL-2024 LIBRARY; T=0.K  
Proton emission for (p,n2p)

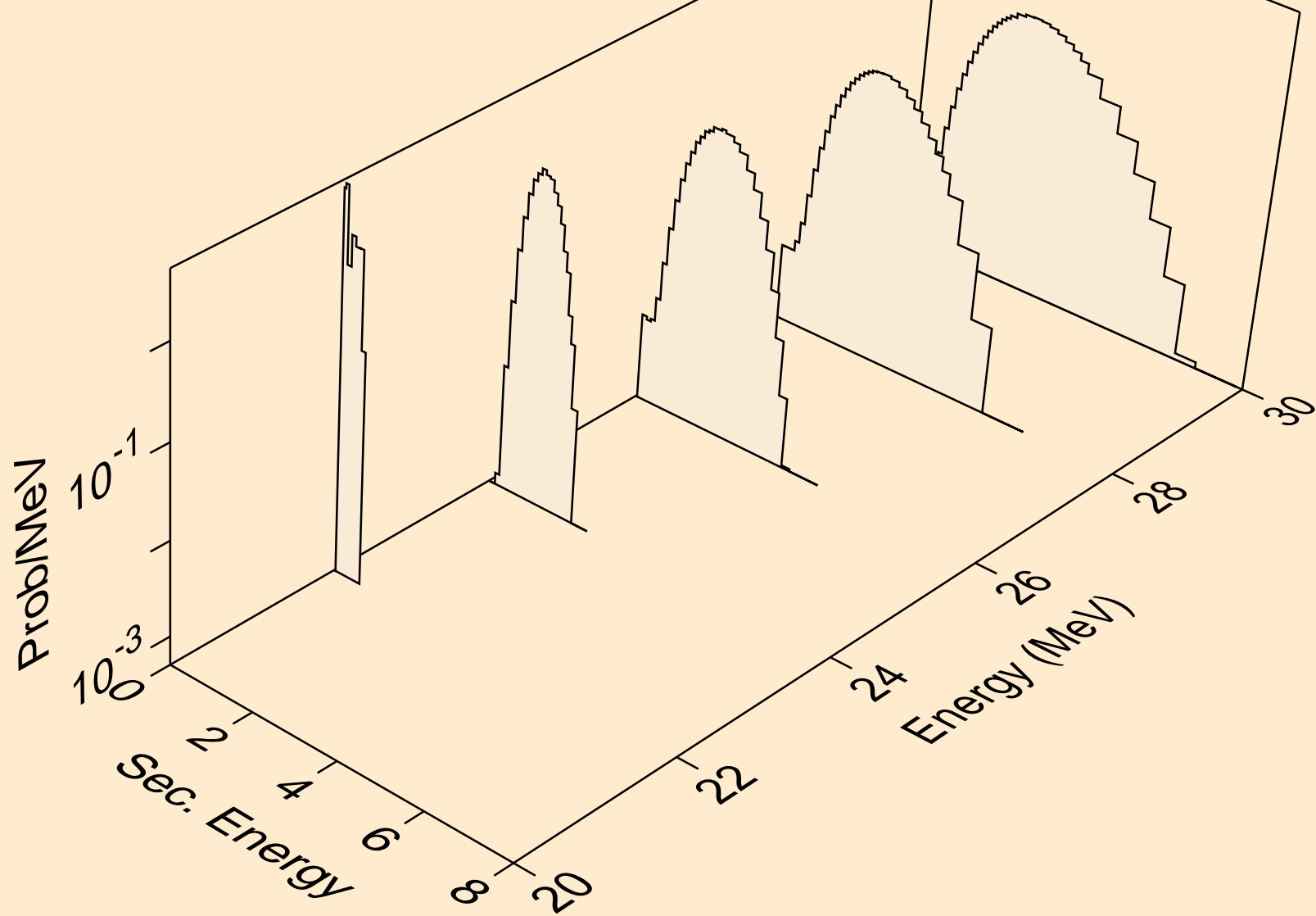

NE023 PROTON ACER TENDL-2024 LIBRARY; T=0.K  
Proton emission for (p,npa)

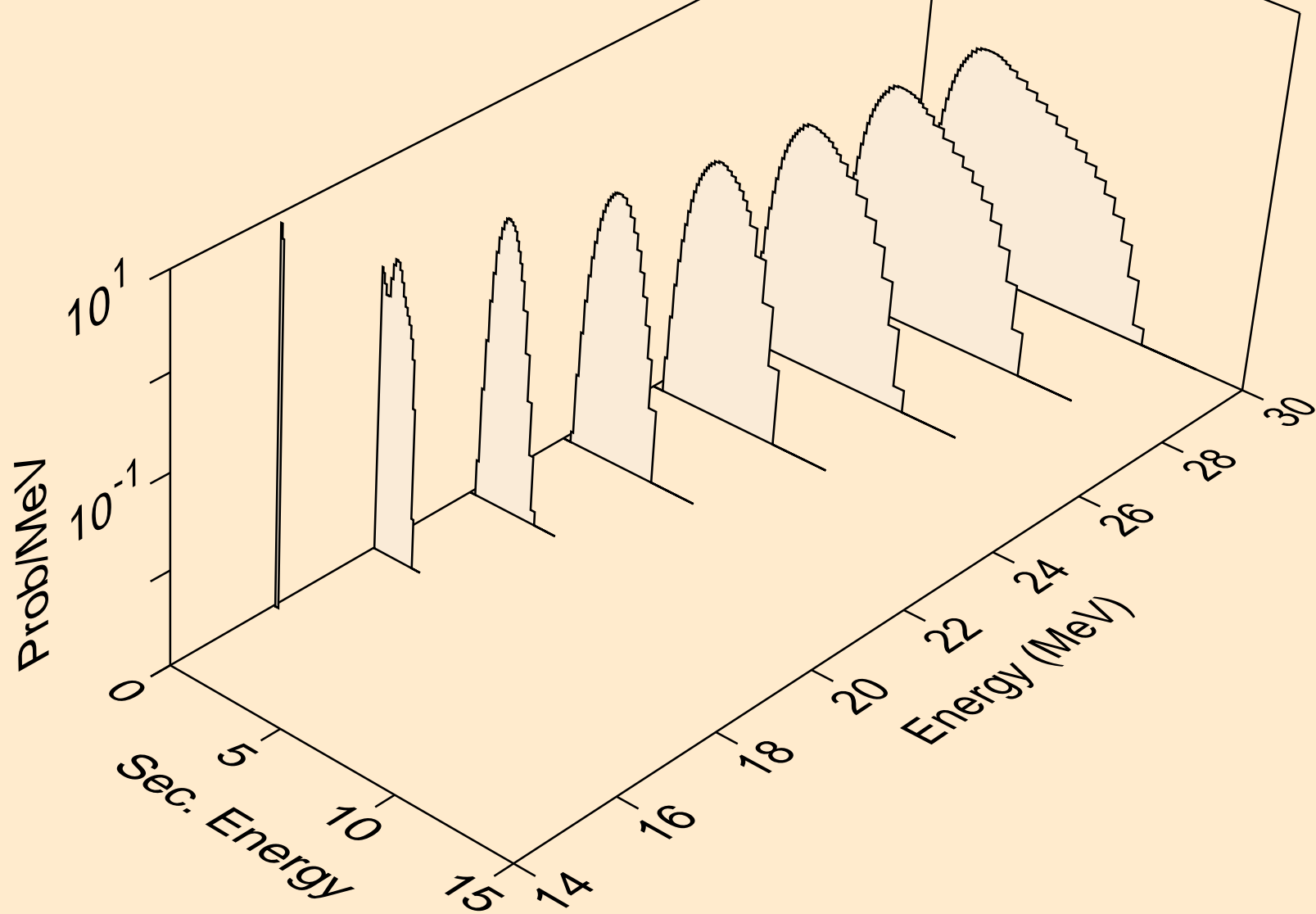

NE023 PROTON ACER TENDL-2024 LIBRARY; T=0.K  
Proton emission for inelastic

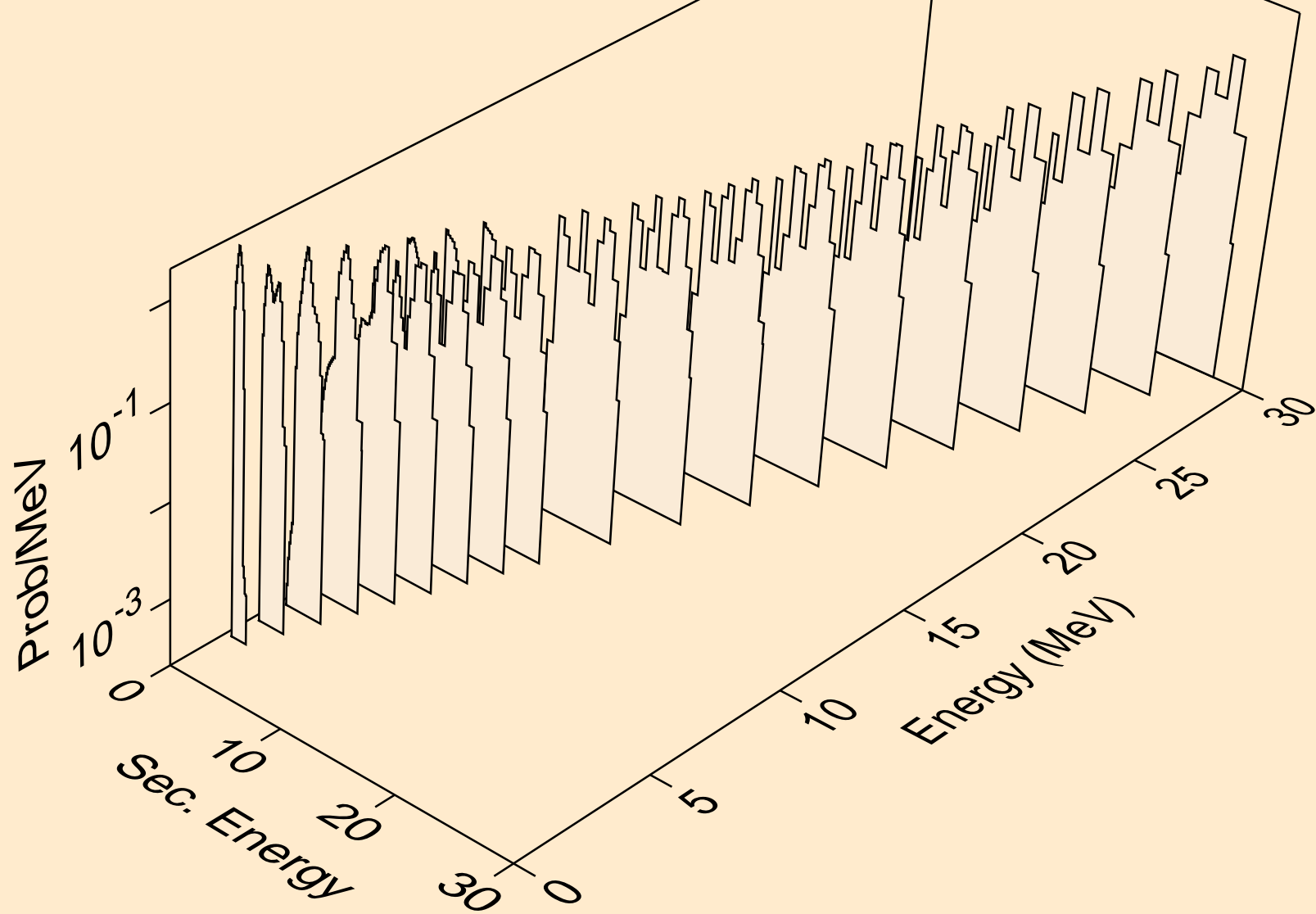

NE023 PROTON ACER TENDL-2024 LIBRARY; T=0.K  
Proton emission for (p,2p)

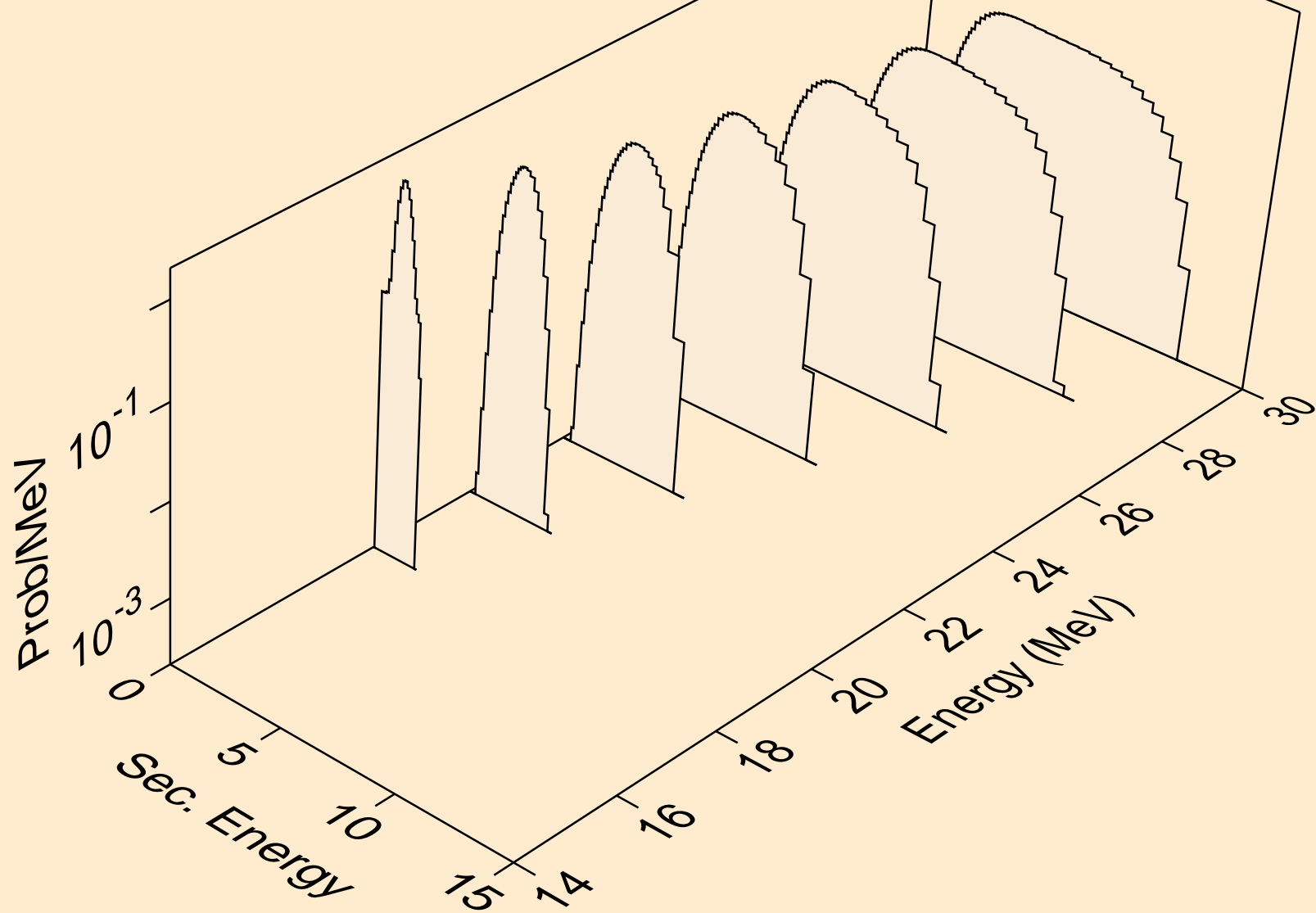

NE023 PROTON ACER TENDL-2024 LIBRARY; T=0.K  
Proton emission for (p,pa)

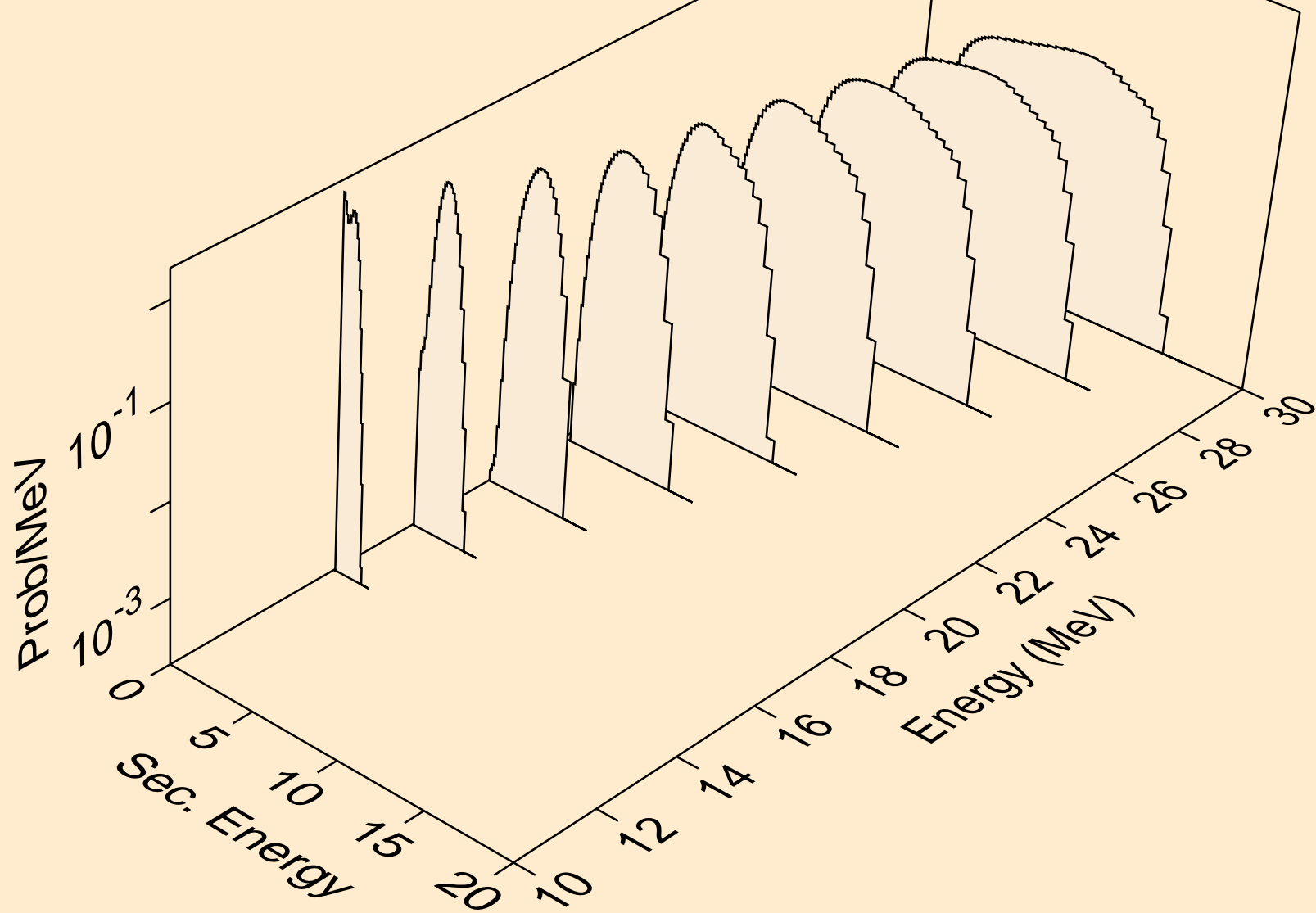

NE023 PROTON ACER TENDL-2024 LIBRARY; T=0.K  
Proton emission for (p,pd)

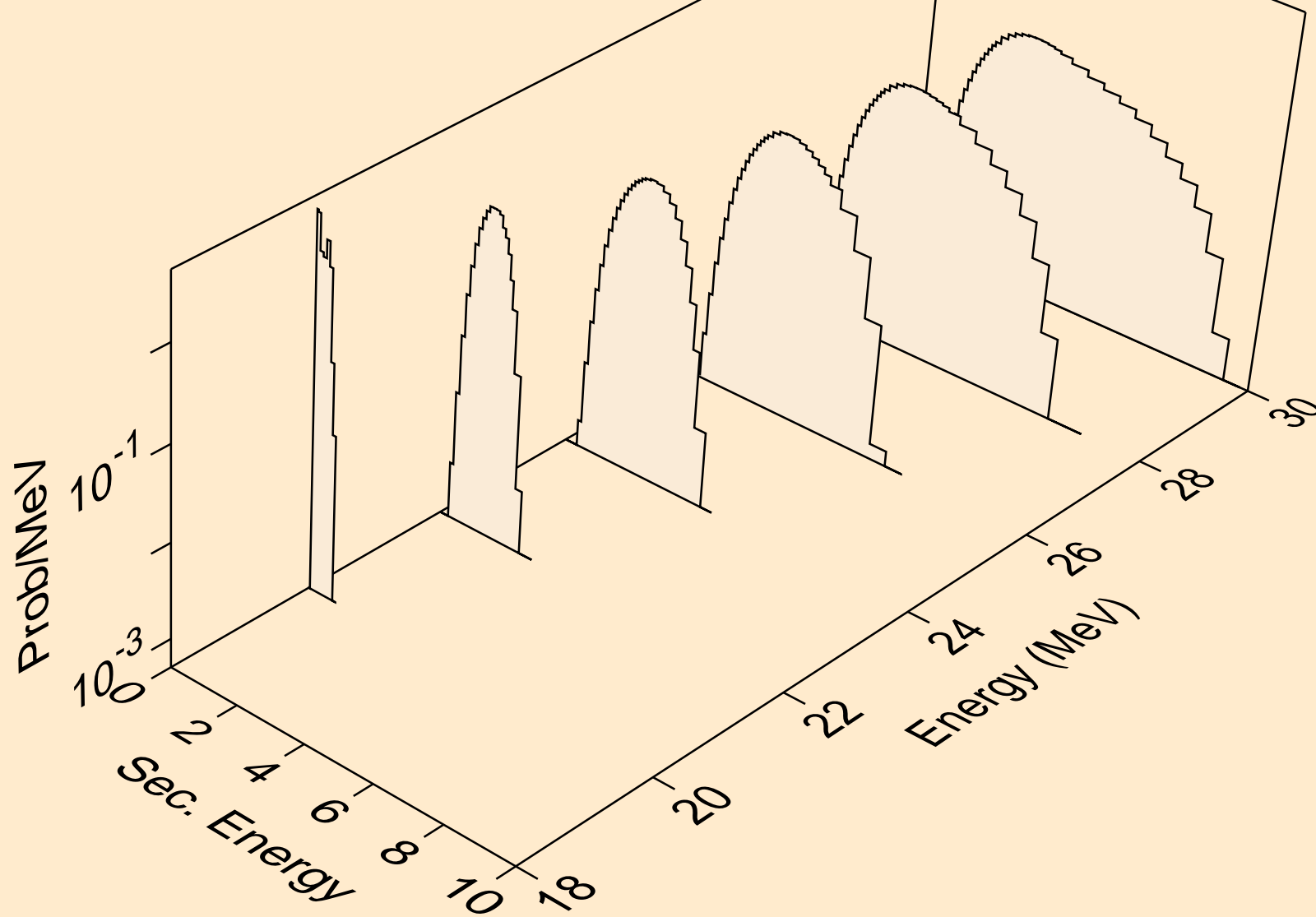

NE023 PROTON ACER TENDL-2024 LIBRARY; T=0.K  
Proton emission for (p,pt)

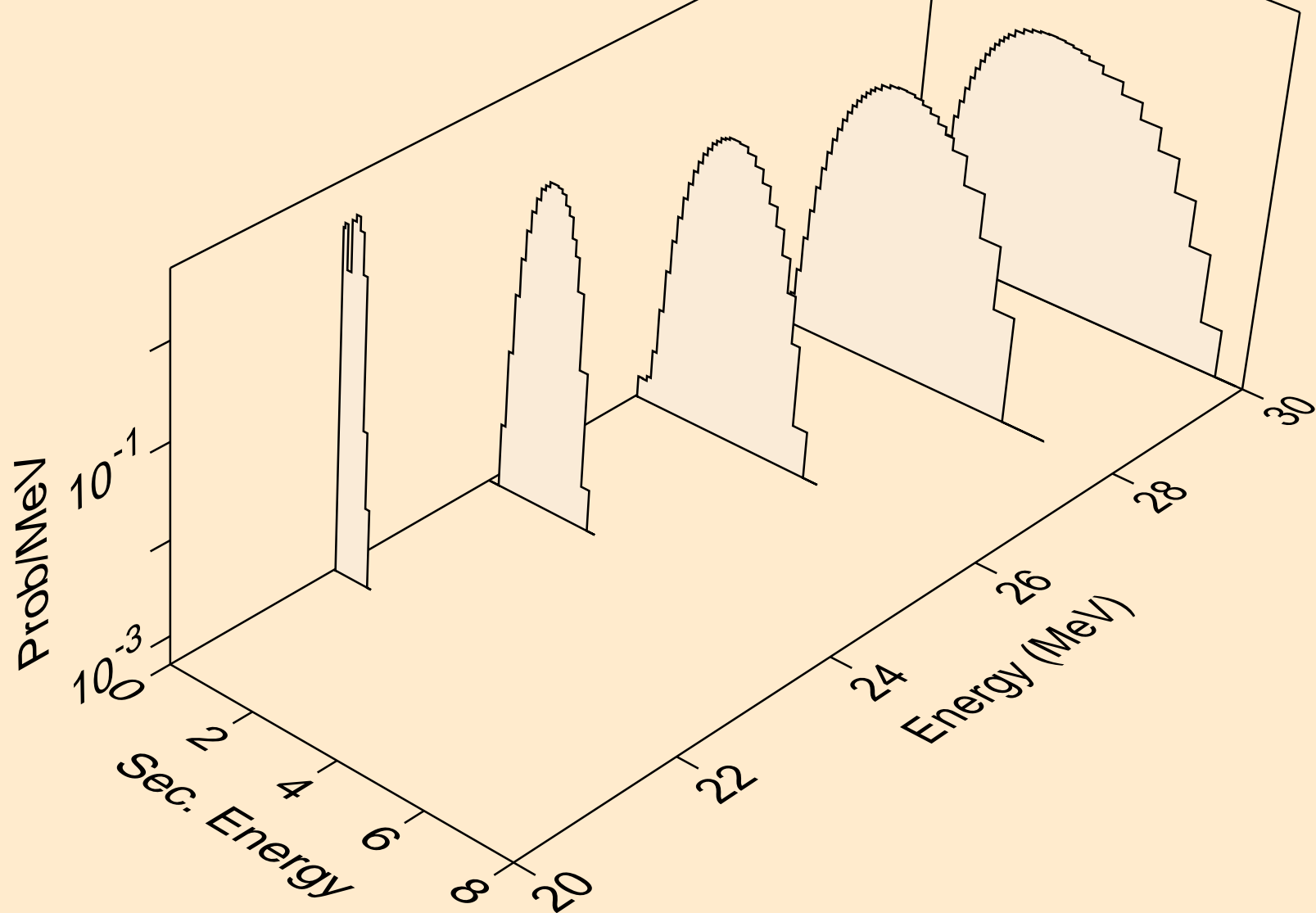

NE023 PROTON ACER TENDL-2024 LIBRARY; T=0.K  
Photon emission for (z,n)

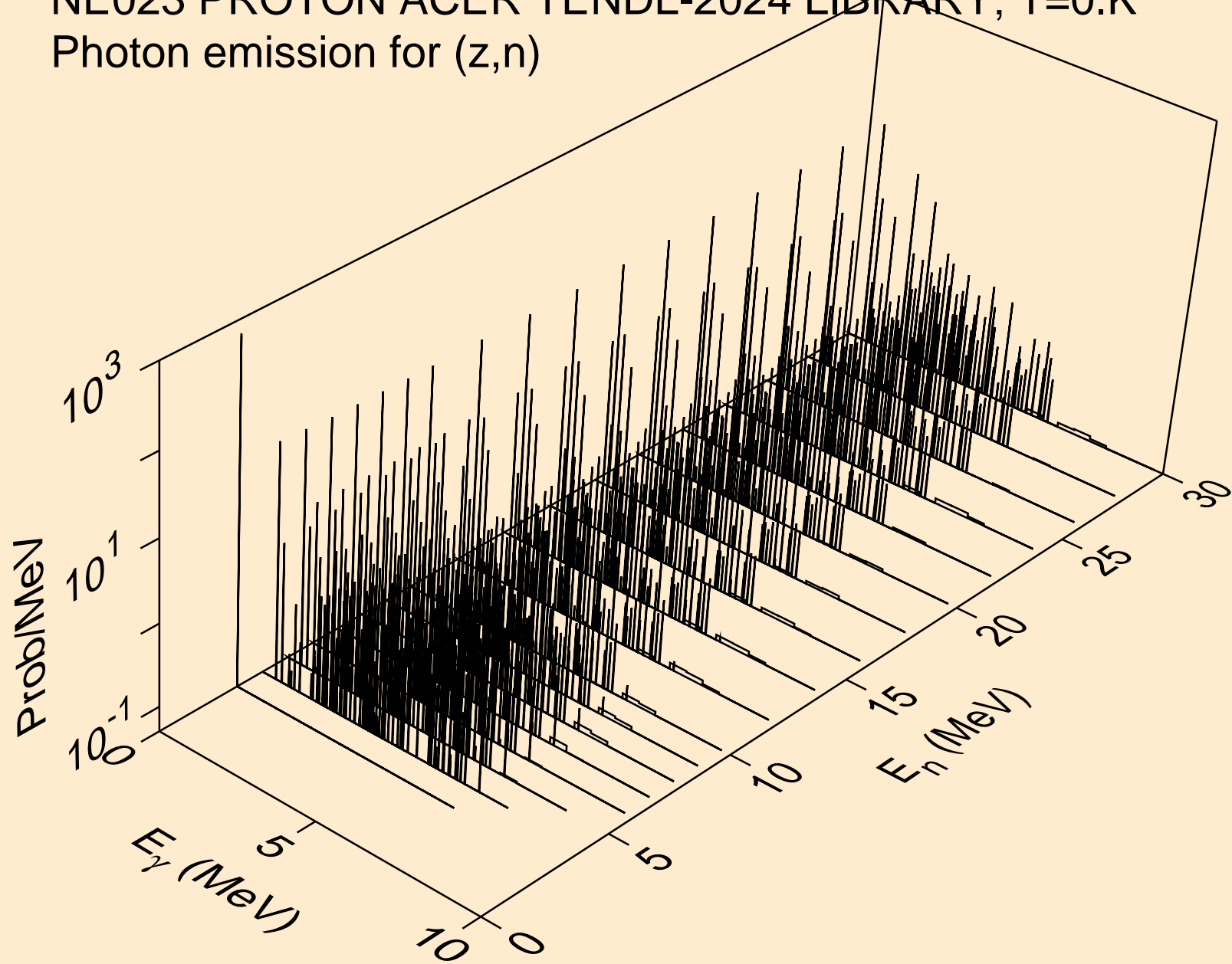

NE023 PROTON ACER TENDL-2024 LIBRARY; T=0.K  
Photon emission for (z,x)

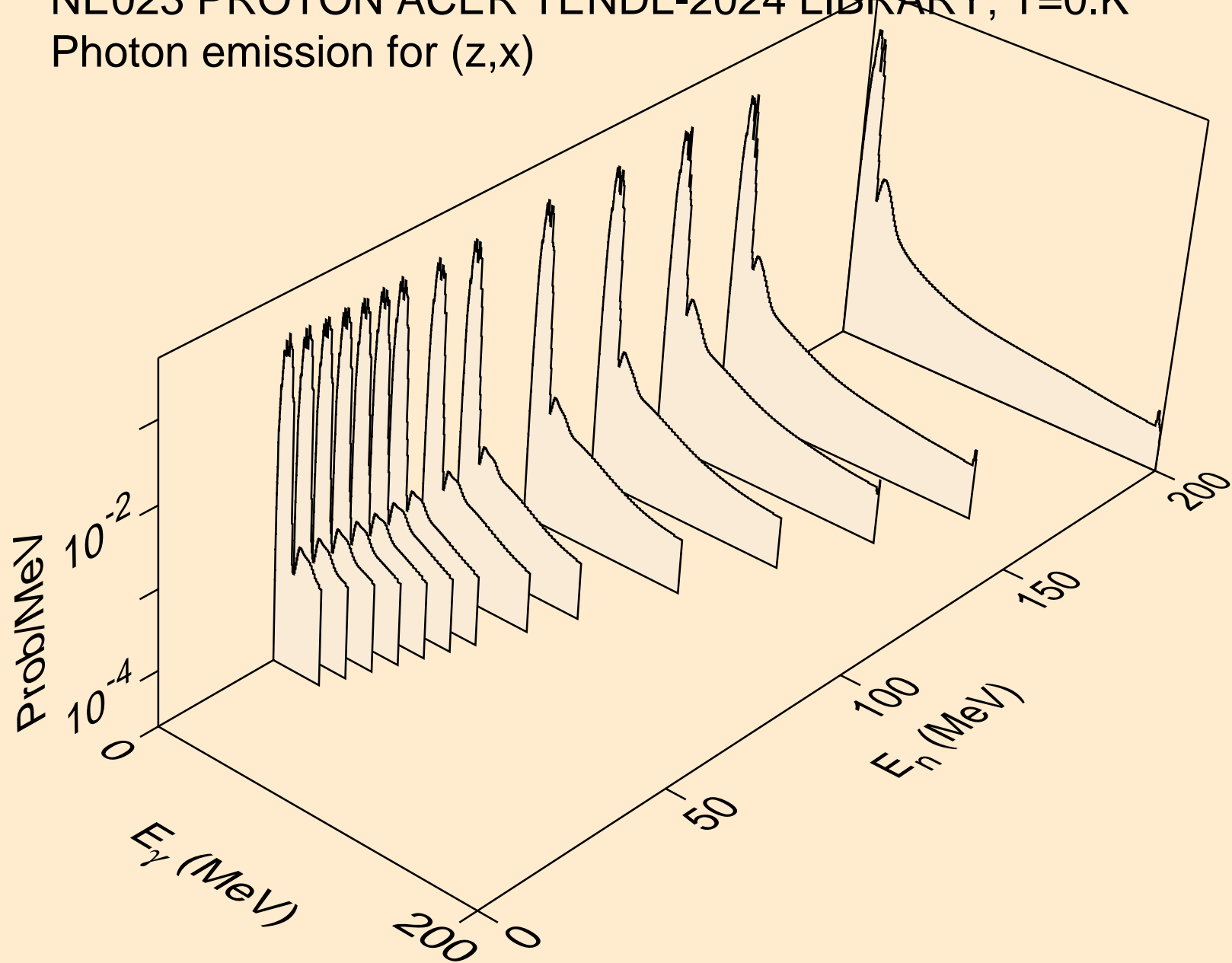

NE023 PROTON ACER TENDL-2024 LIBRARY; T=0.K  
Photon emission for (n,2nd)

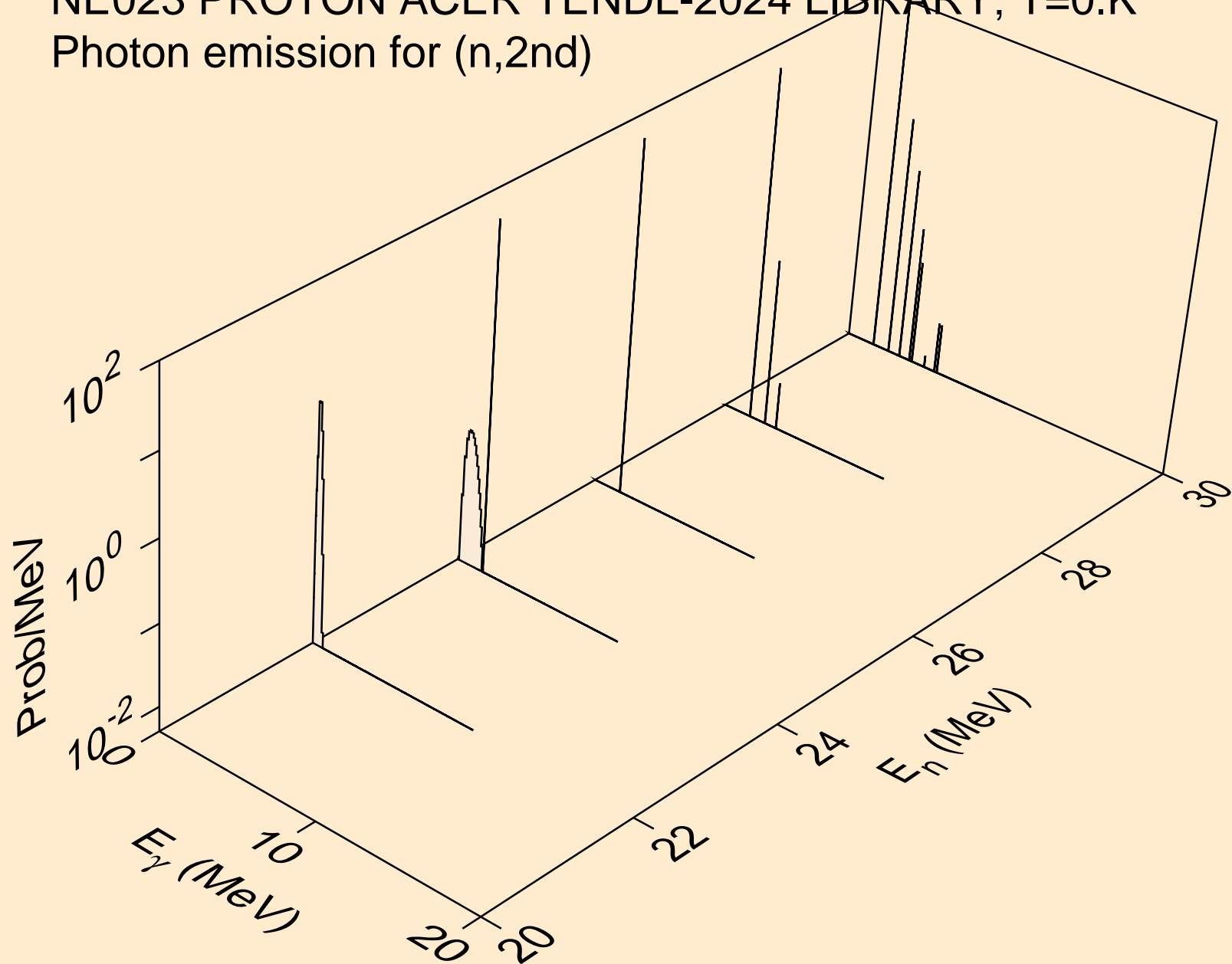

NE023 PROTON ACER TENDL-2024 LIBRARY; T=0.K  
Photon emission for (n,2n)

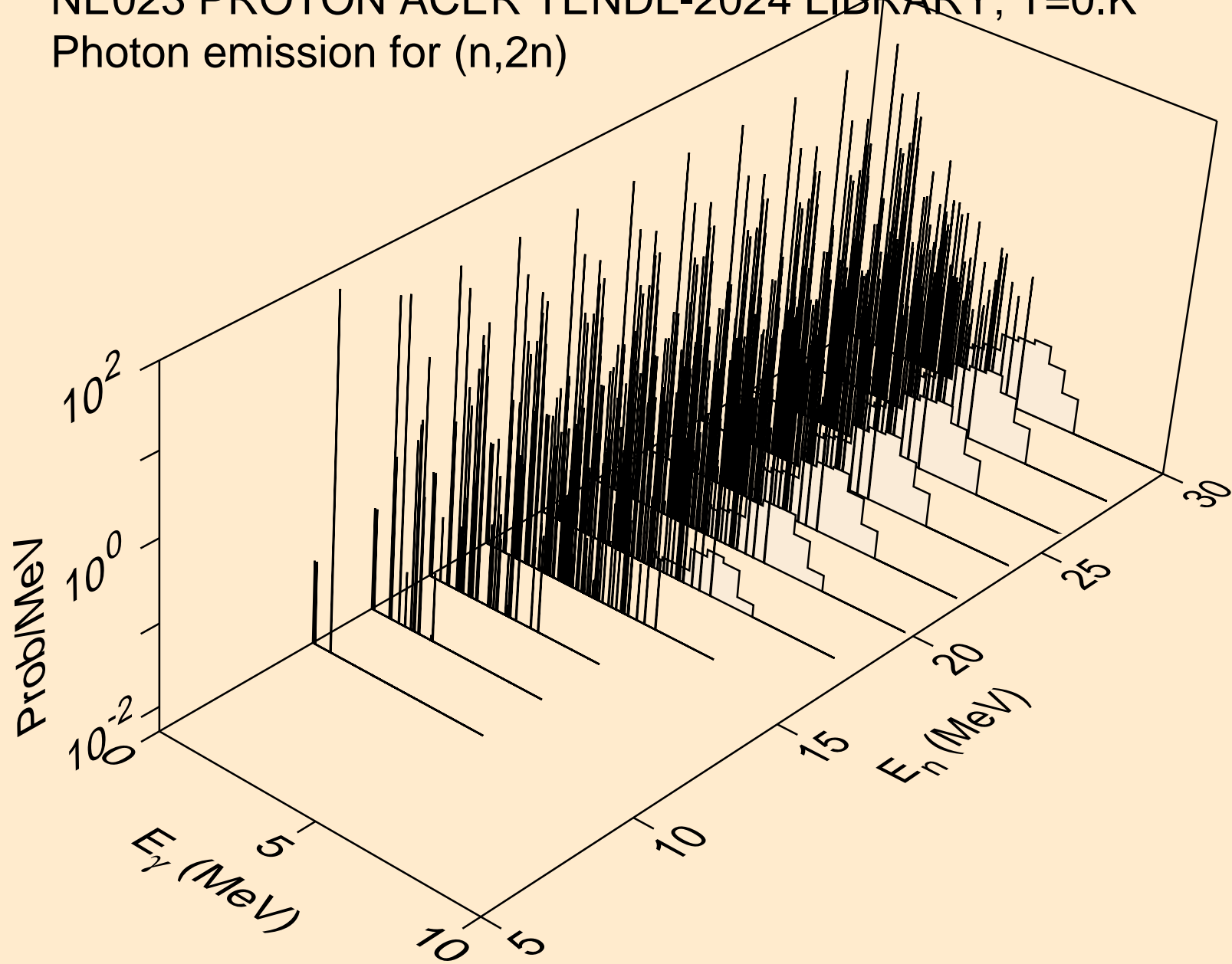

NE023 PROTON ACER TENDL-2024 LIBRARY; T=0.K  
Photon emission for (n,3n)

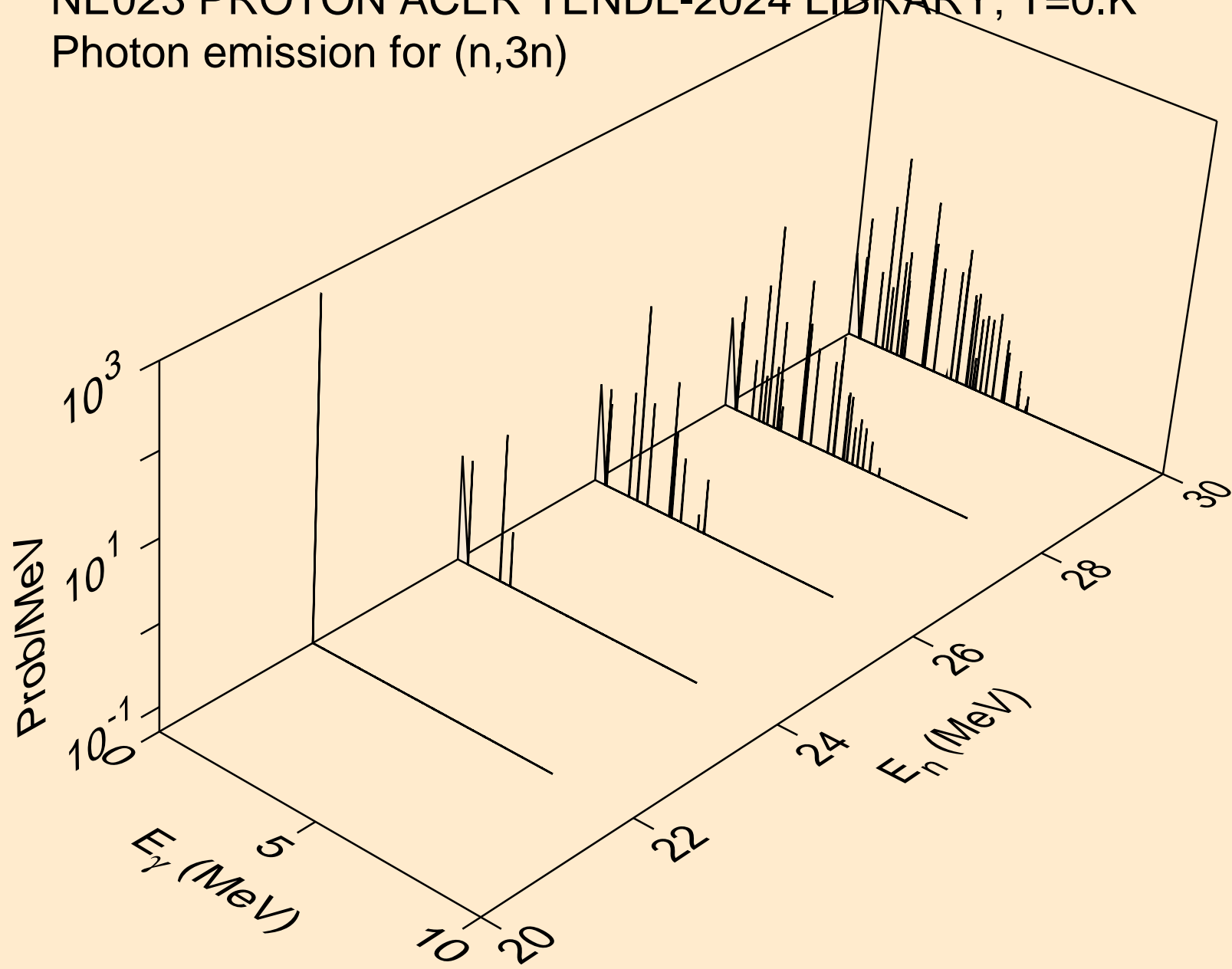

NE023 PROTON ACER TENDL-2024 LIBRARY; T=0.K  
Photon emission for (n,n\*)a

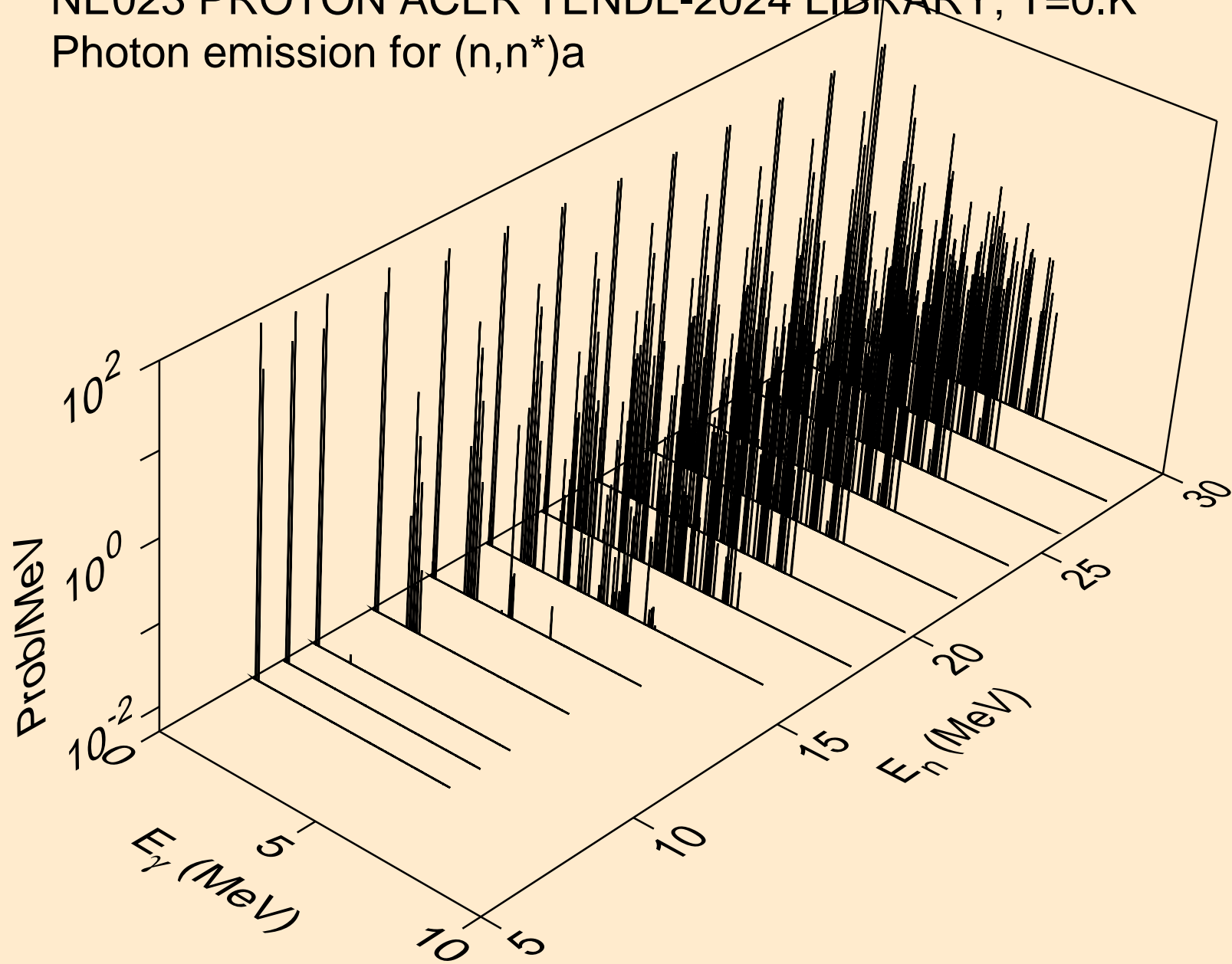

NE023 PROTON ACER TENDL-2024 LIBRARY; T=0.K  
Photon emission for (n,n\*)3a

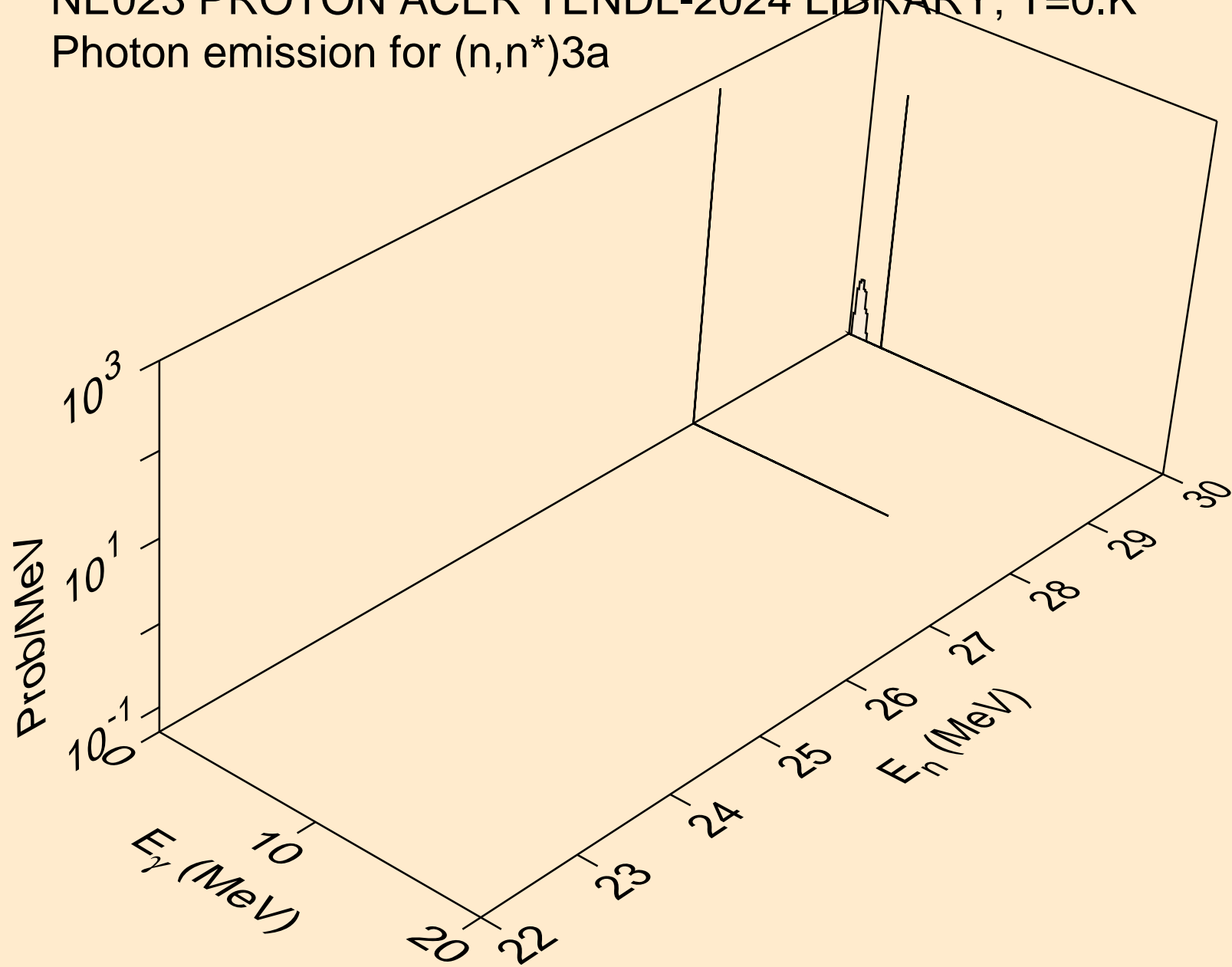

NE023 PROTON ACER TENDL-2024 LIBRARY; T=0.K  
Photon emission for (n,2n)a

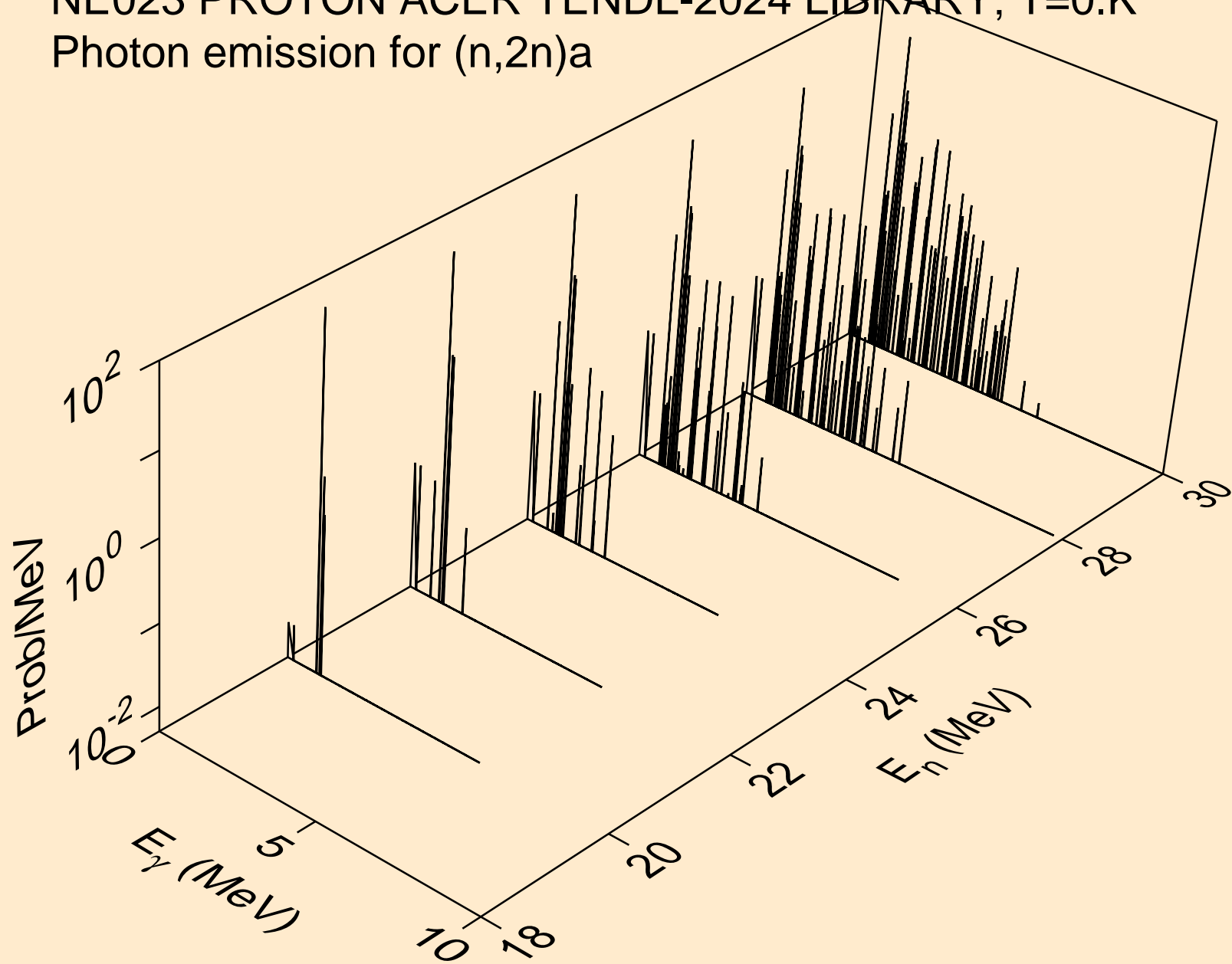

NE023 PROTON ACER TENDL-2024 LIBRARY; T=0.K  
Photon emission for (n,n\*)p

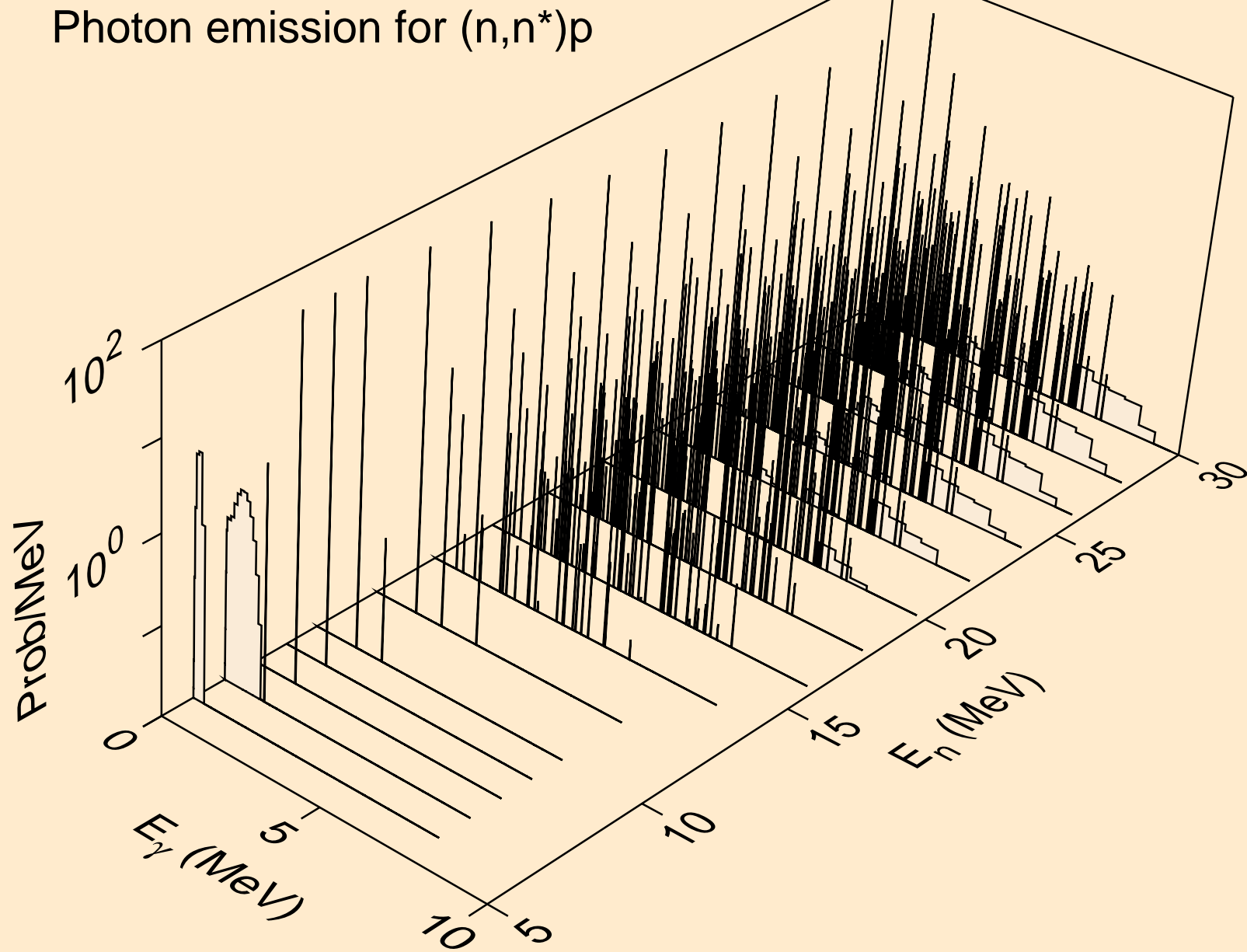

NE023 PROTON ACER TENDL-2024 LIBRARY; T=0.K  
Photon emission for (n,n\*)2a

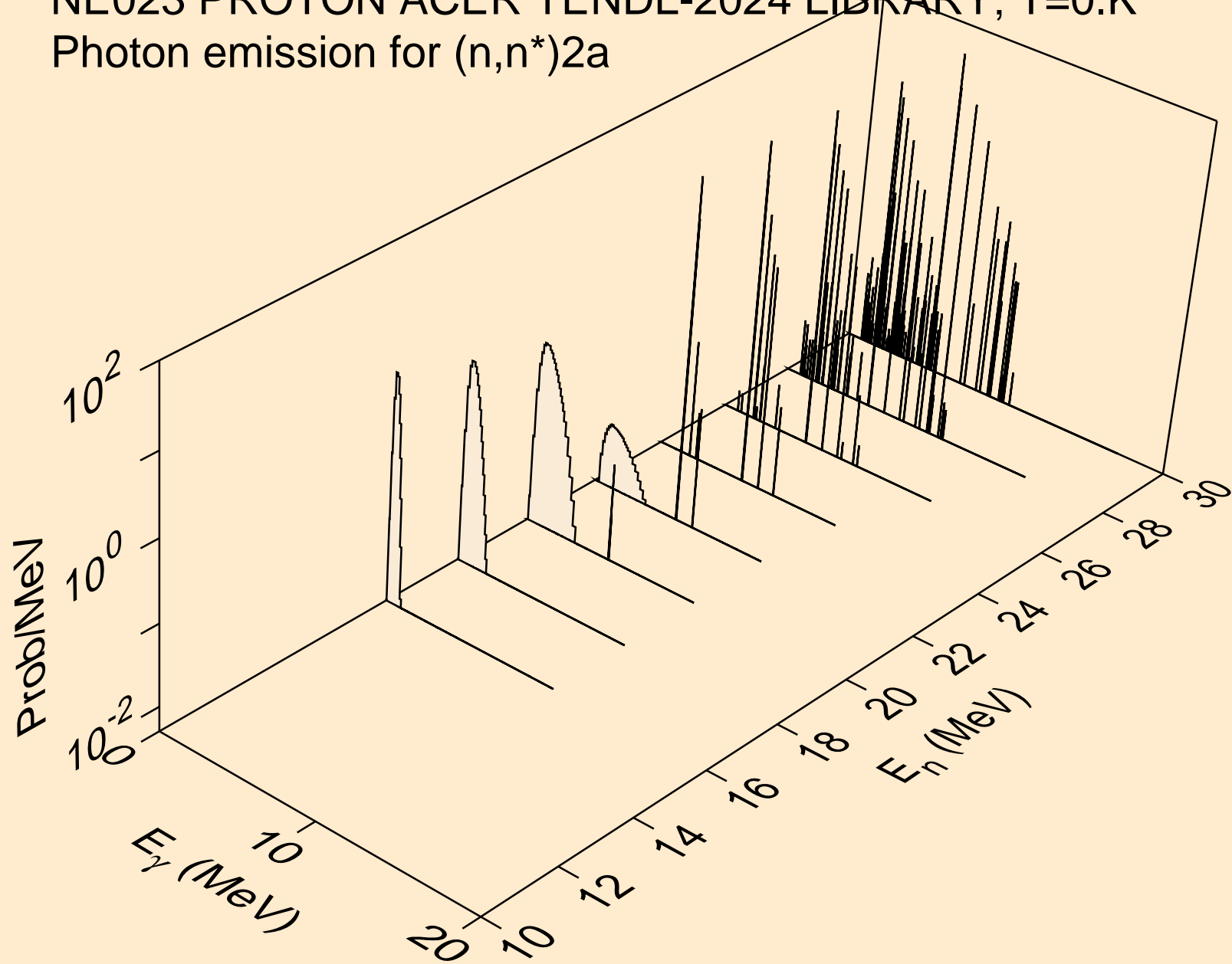

NE023 PROTON ACER TENDL-2024 LIBRARY; T=0.K  
Photon emission for (n,2n)2a

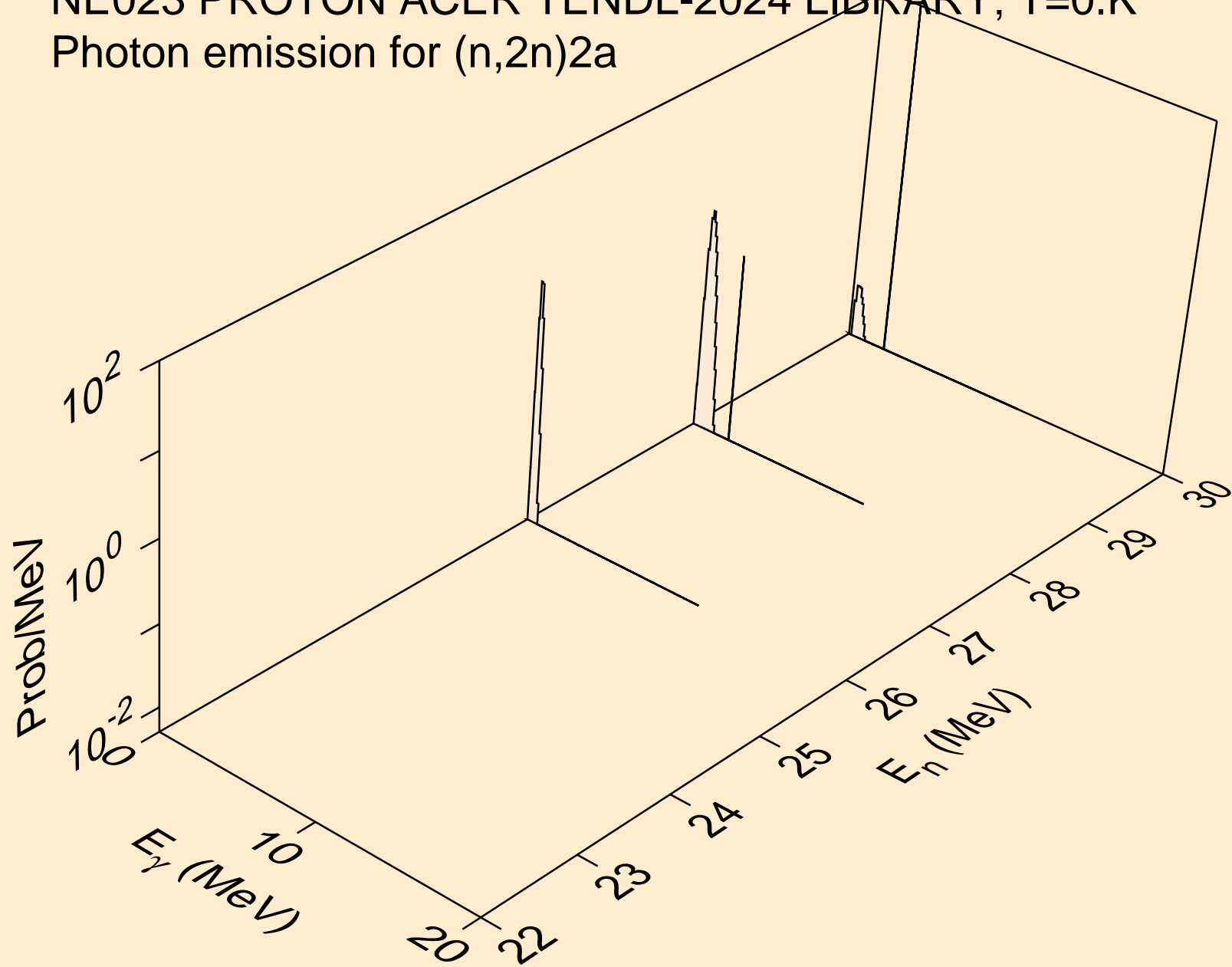

NE023 PROTON ACER TENDL-2024 LIBRARY; T=0.K  
Photon emission for (n,n\*)d

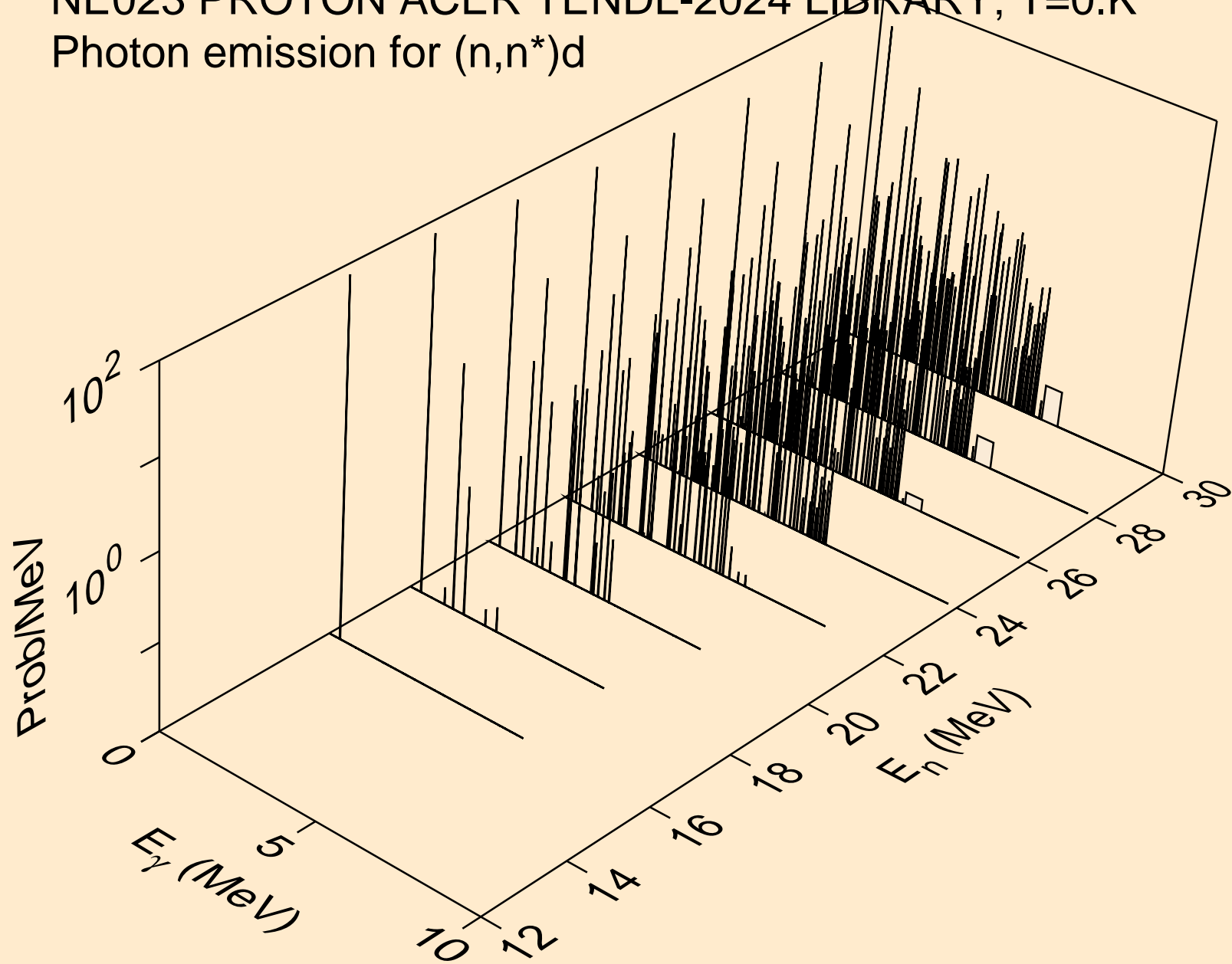

NE023 PROTON ACER TENDL-2024 LIBRARY; T=0.K  
Photon emission for (n,n\*)t

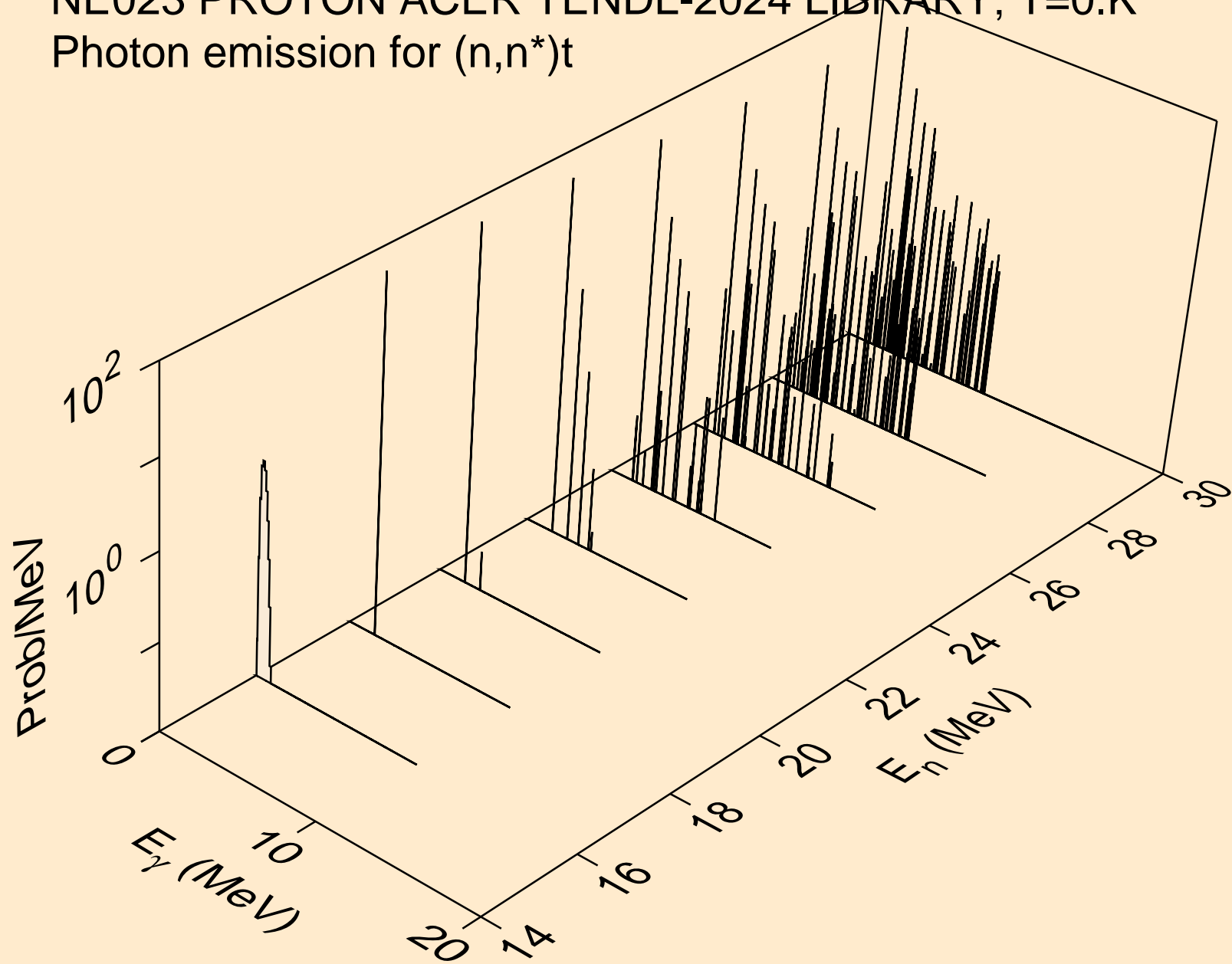

NE023 PROTON ACER TENDL-2024 LIBRARY; T=0.K  
Photon emission for (n,n\*)he3

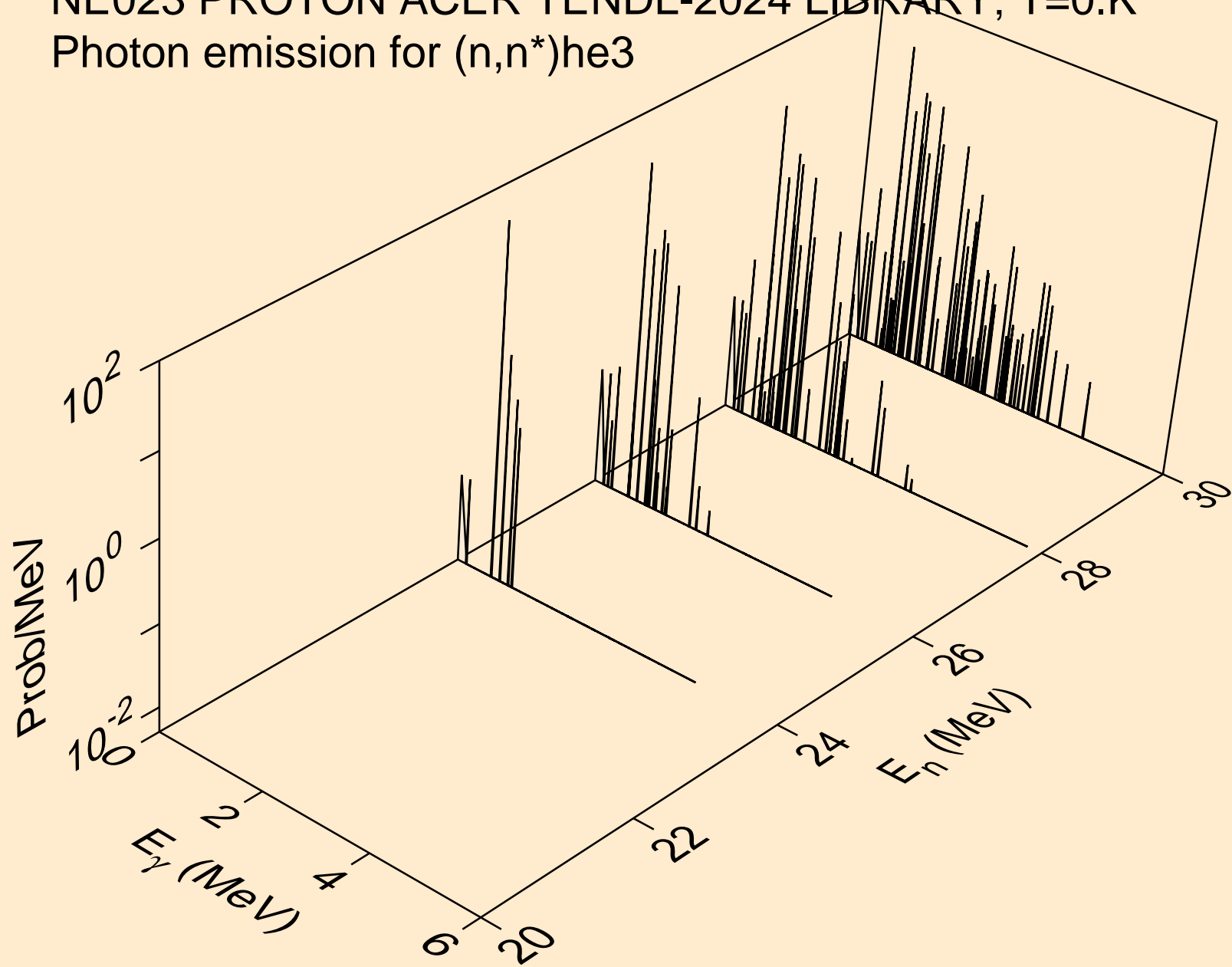

NE023 PROTON ACER TENDL-2024 LIBRARY; T=0.K  
Photon emission for (n,2np)

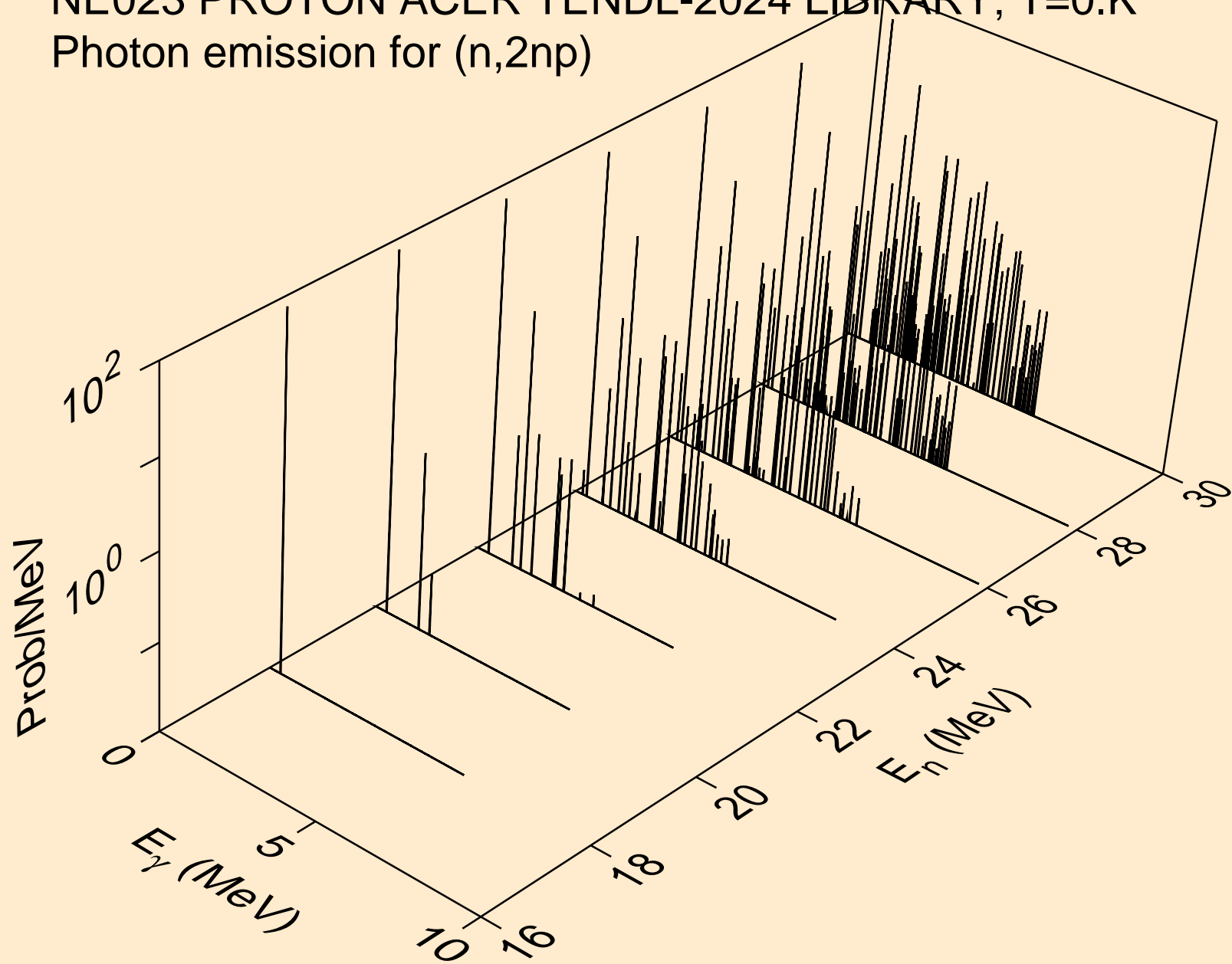

NE023 PROTON ACER TENDL-2024 LIBRARY; T=0.K  
Photon emission for (n,3np)

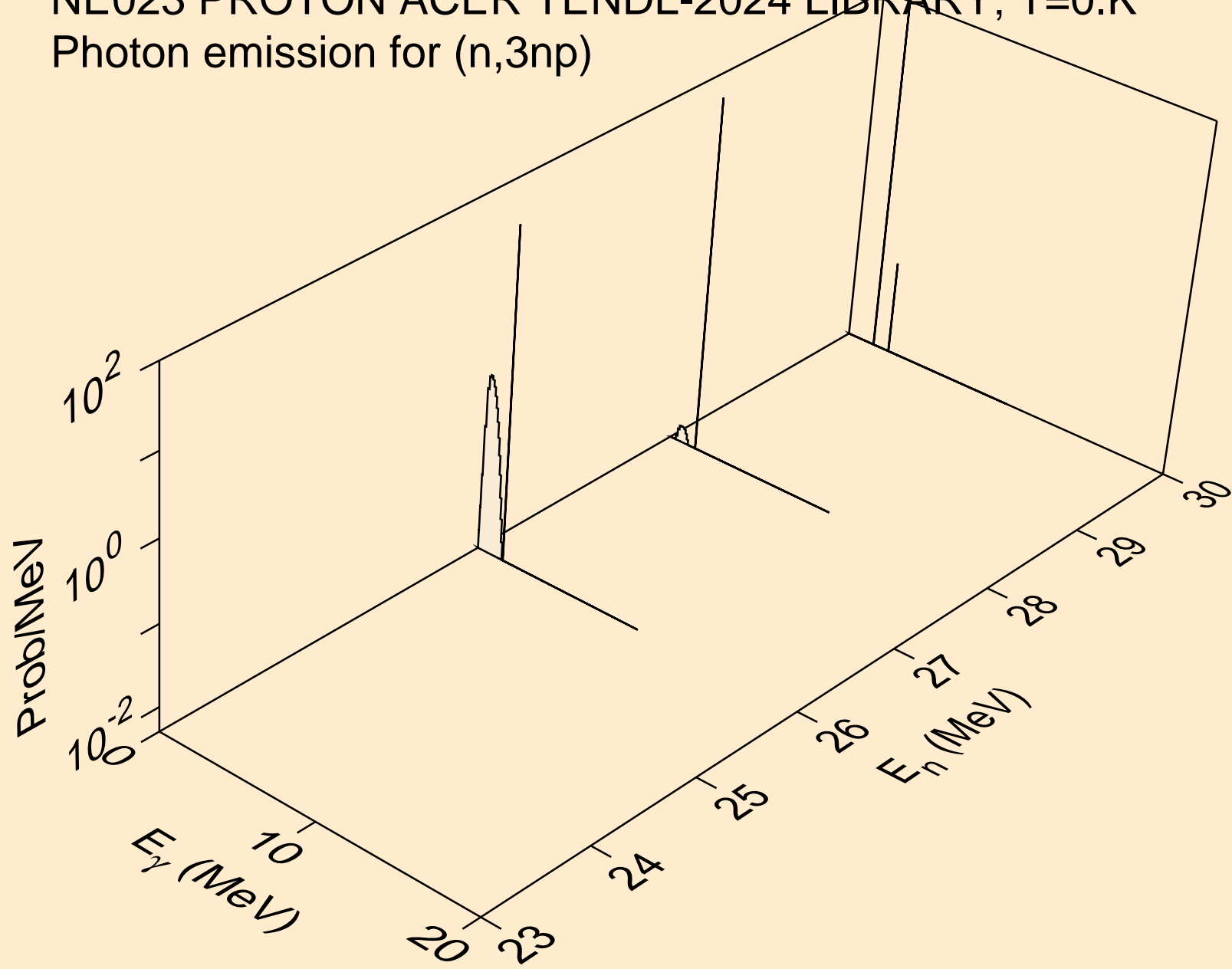

NE023 PROTON ACER TENDL-2024 LIBRARY; T=0.K  
Photon emission for (n,n2p)

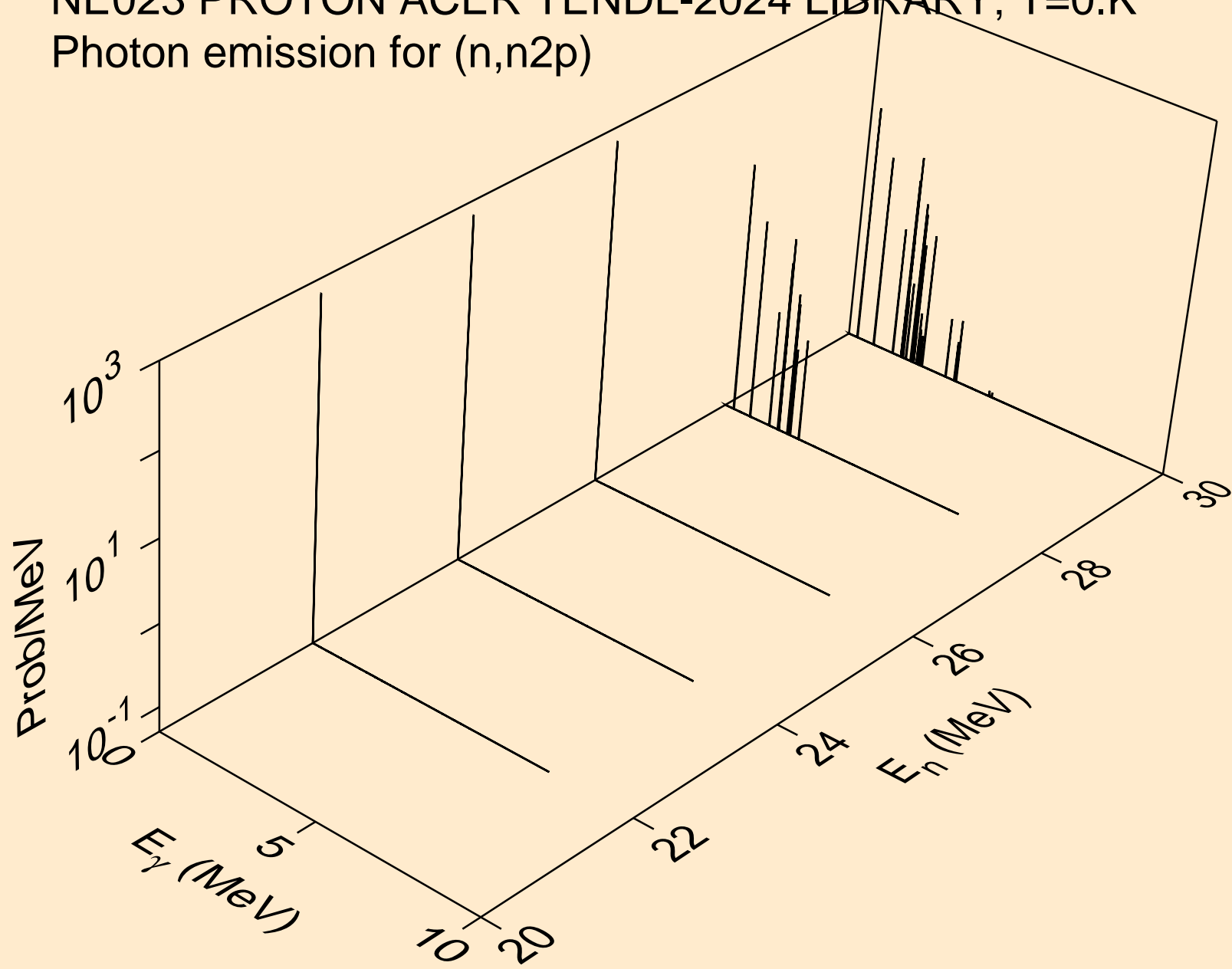

NE023 PROTON ACER TENDL-2024 LIBRARY; T=0.K  
Photon emission for (n,npa)

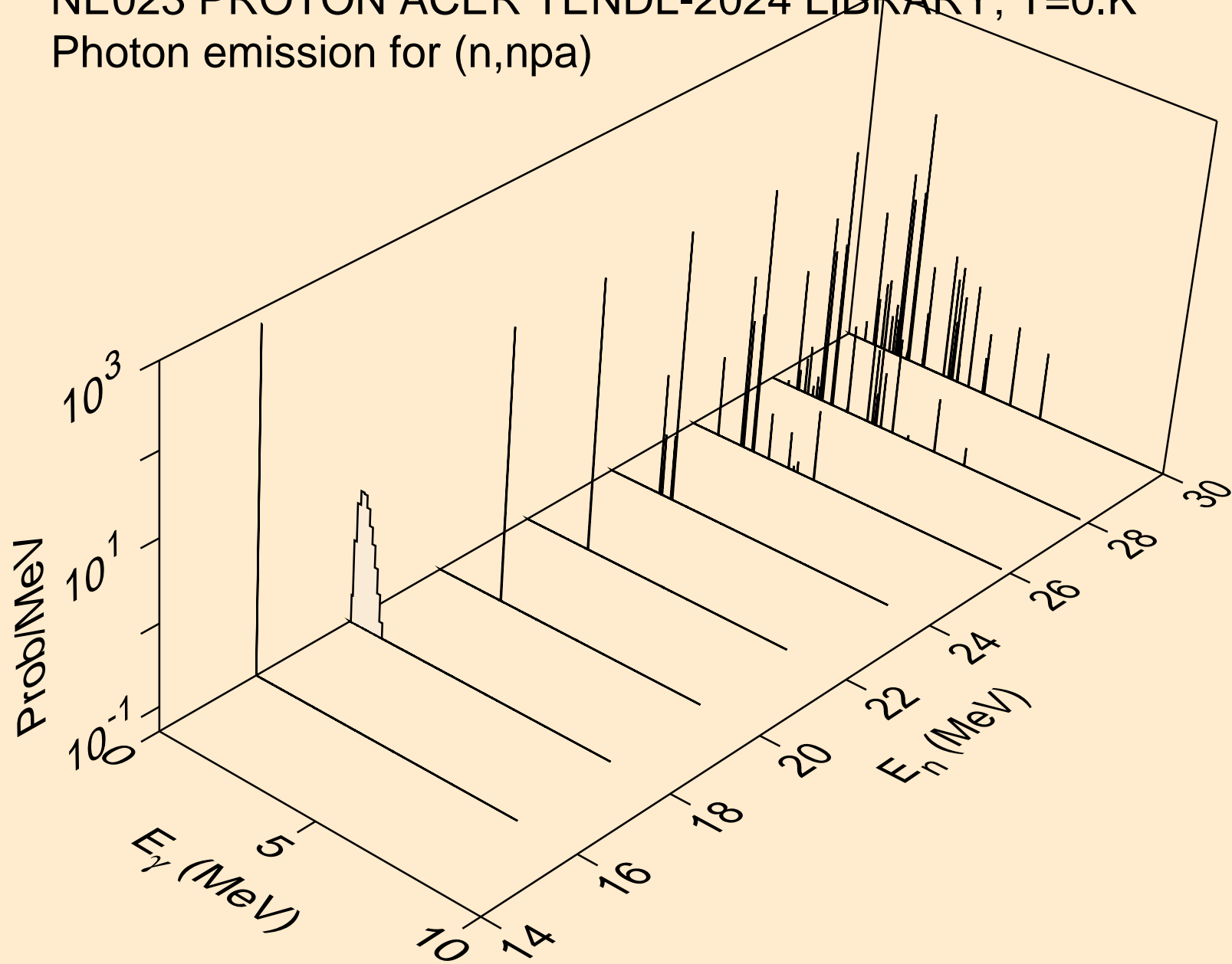

NE023 PROTON ACER TENDL-2024 LIBRARY; T=0.K  
Photon emission for (n,gma)

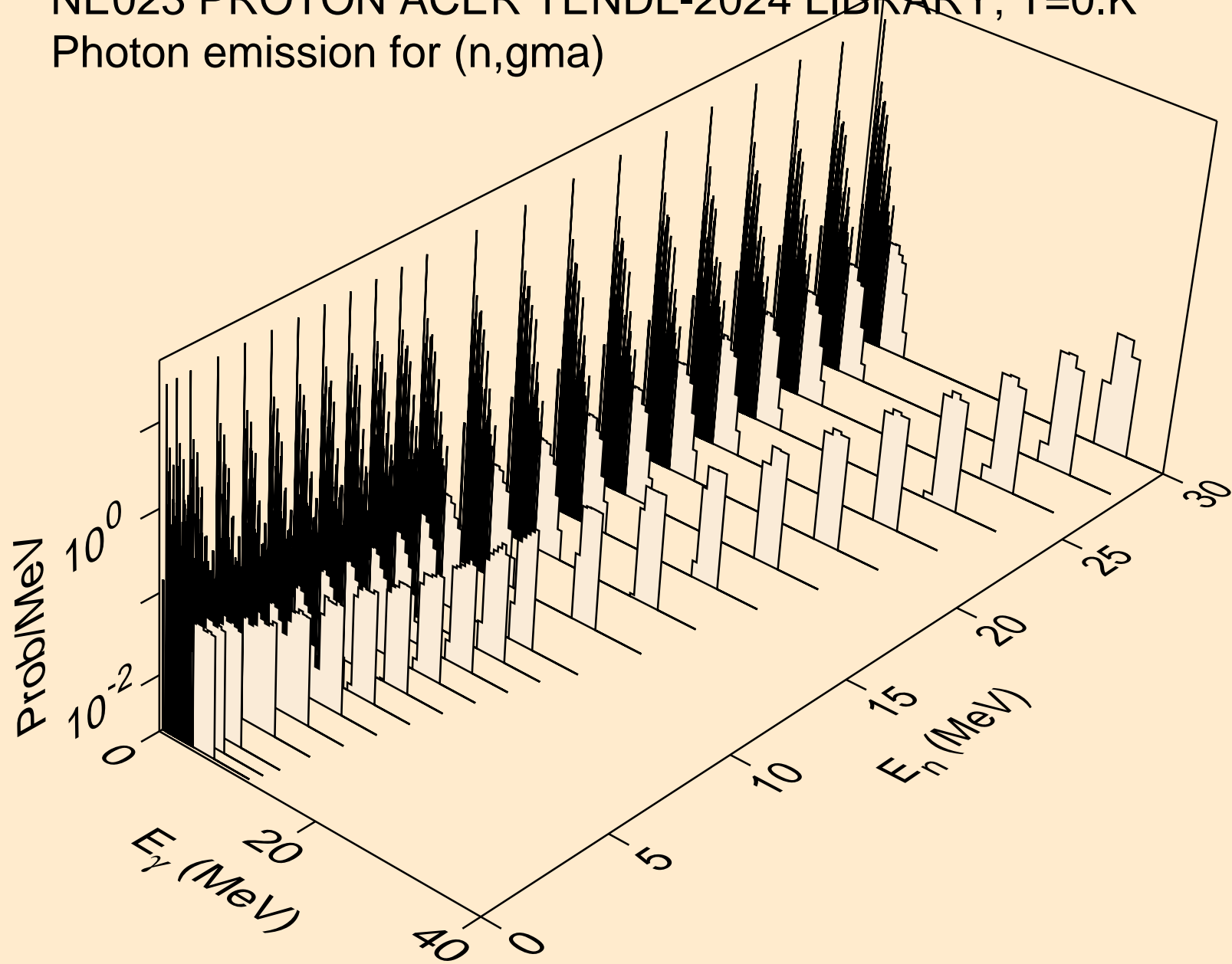

NE023 PROTON ACER TENDL-2024 LIBRARY; T=0.K  
Photon emission for inelastic

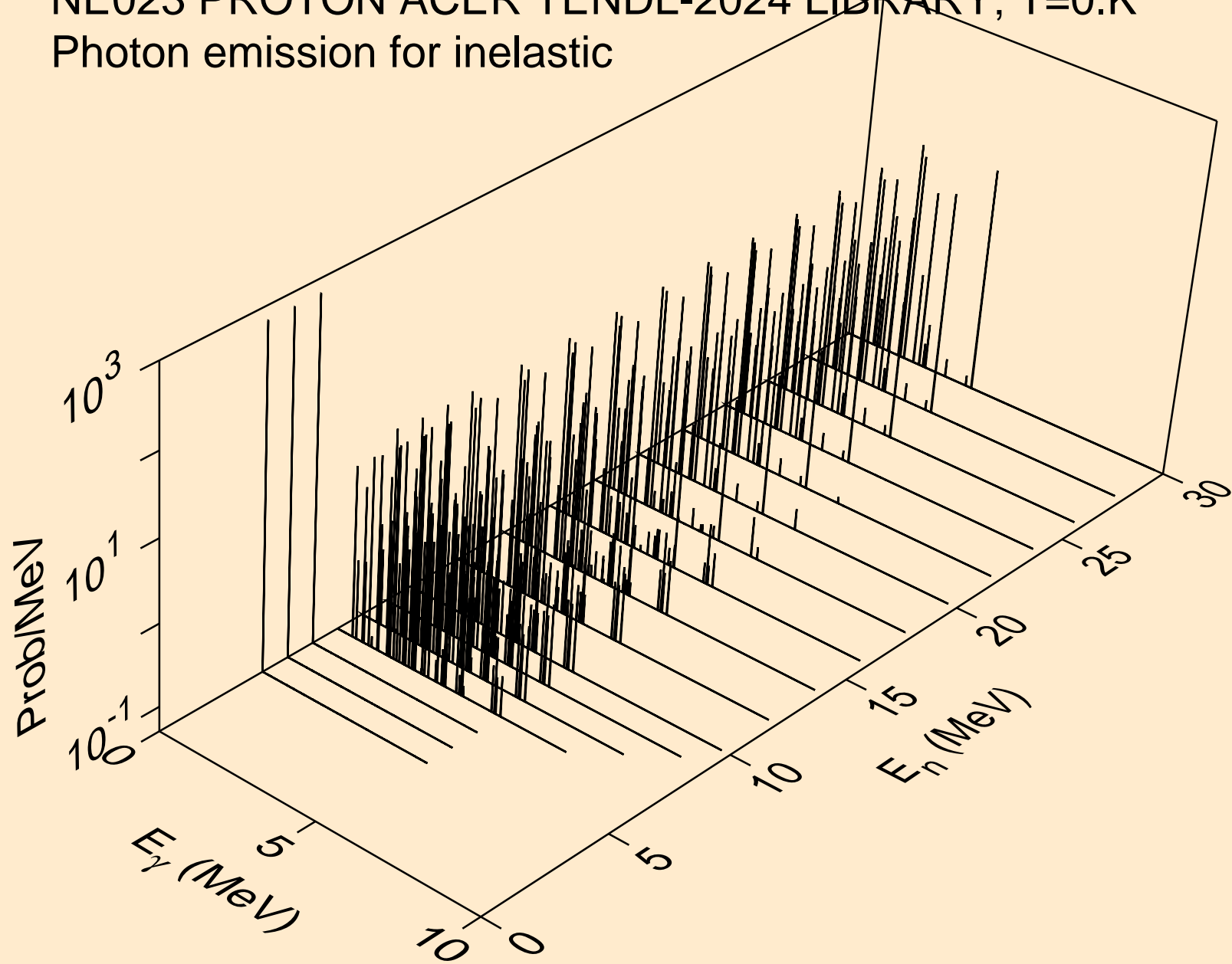

NE023 PROTON ACER TENDL-2024 LIBRARY; T=0.K  
Photon emission for (n,d)

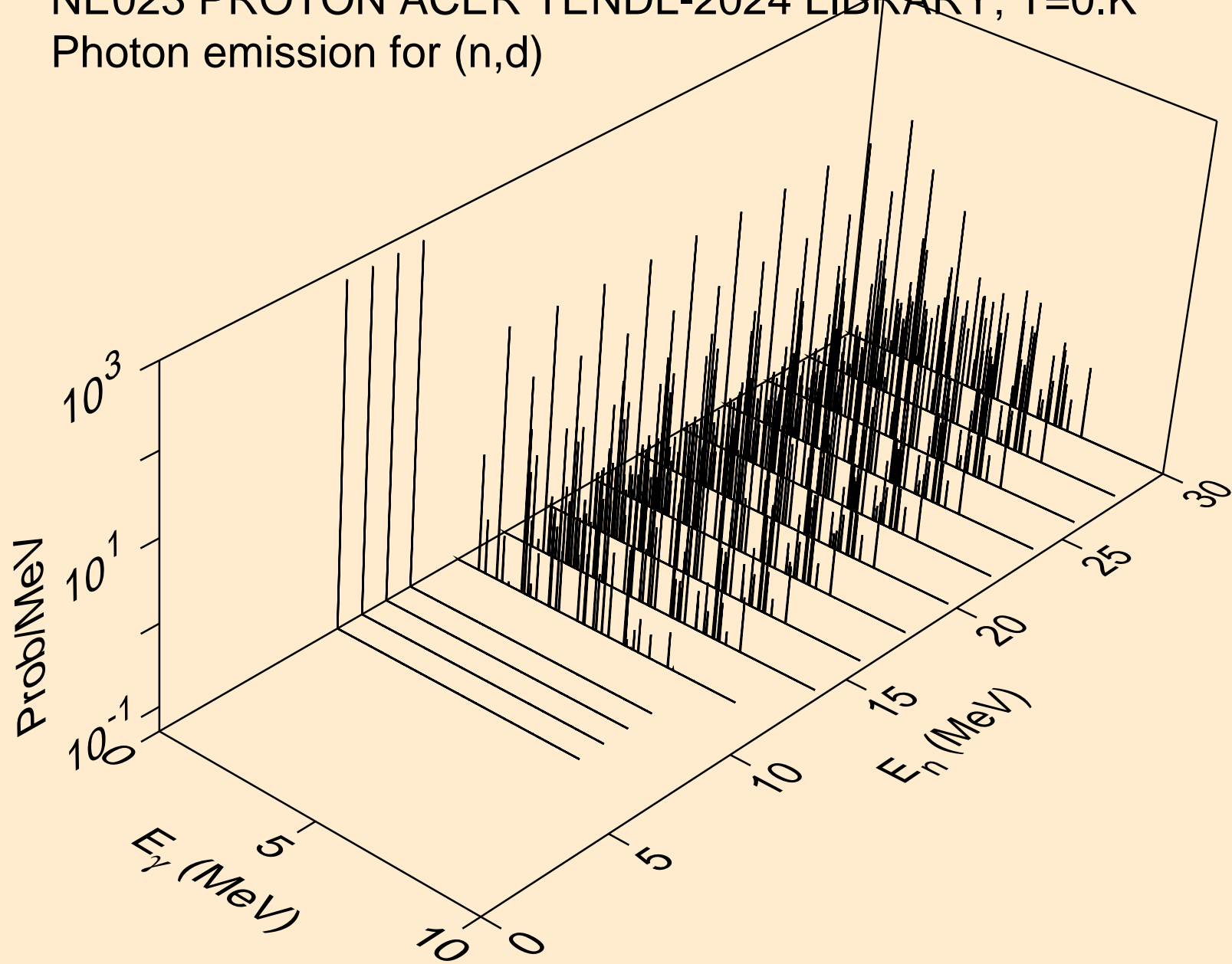

NE023 PROTON ACER TENDL-2024 LIBRARY; T=0.K  
Photon emission for (n,t)

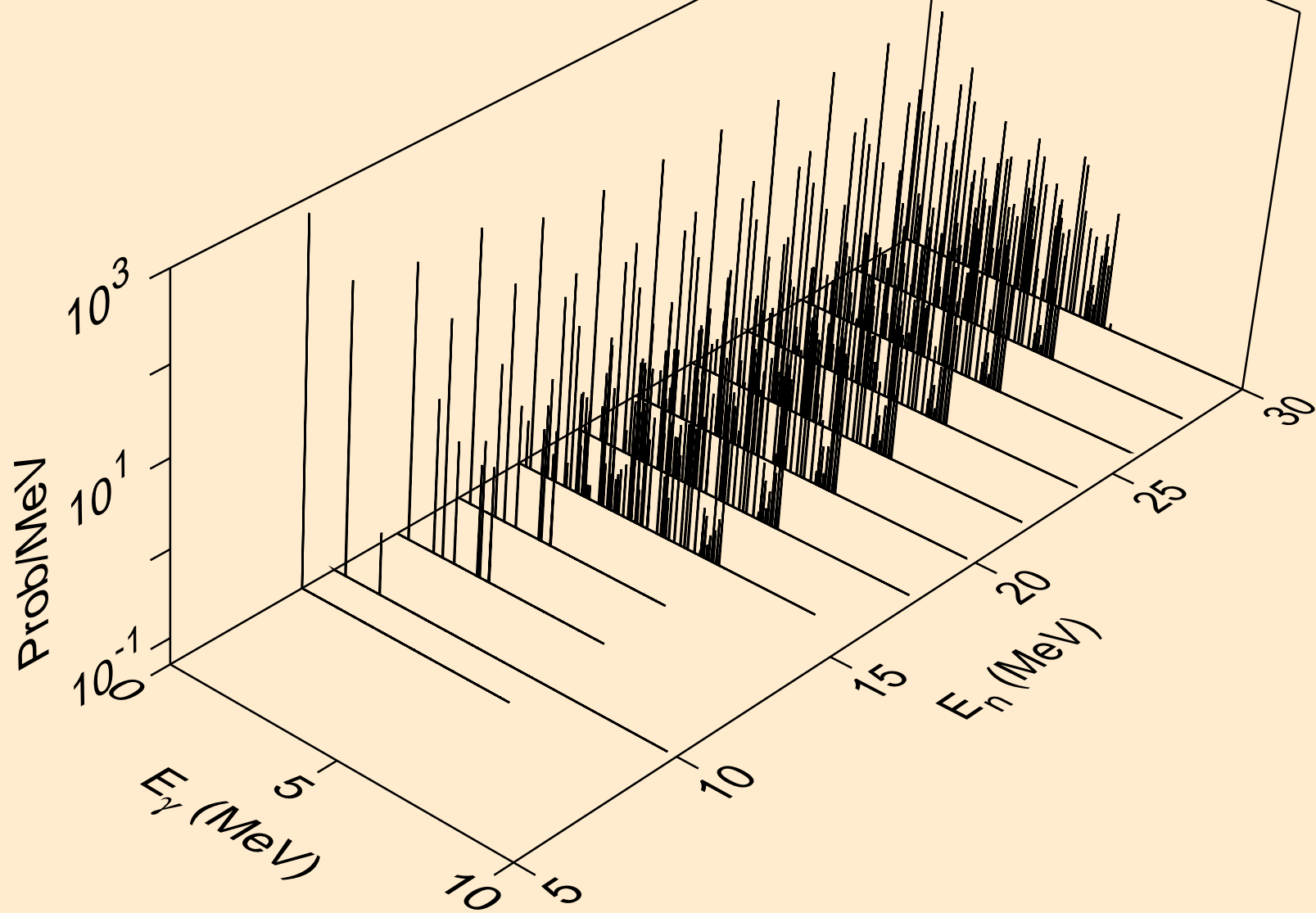

NE023 PROTON ACER TENDL-2024 LIBRARY; T=0.K  
Photon emission for (n,he3)

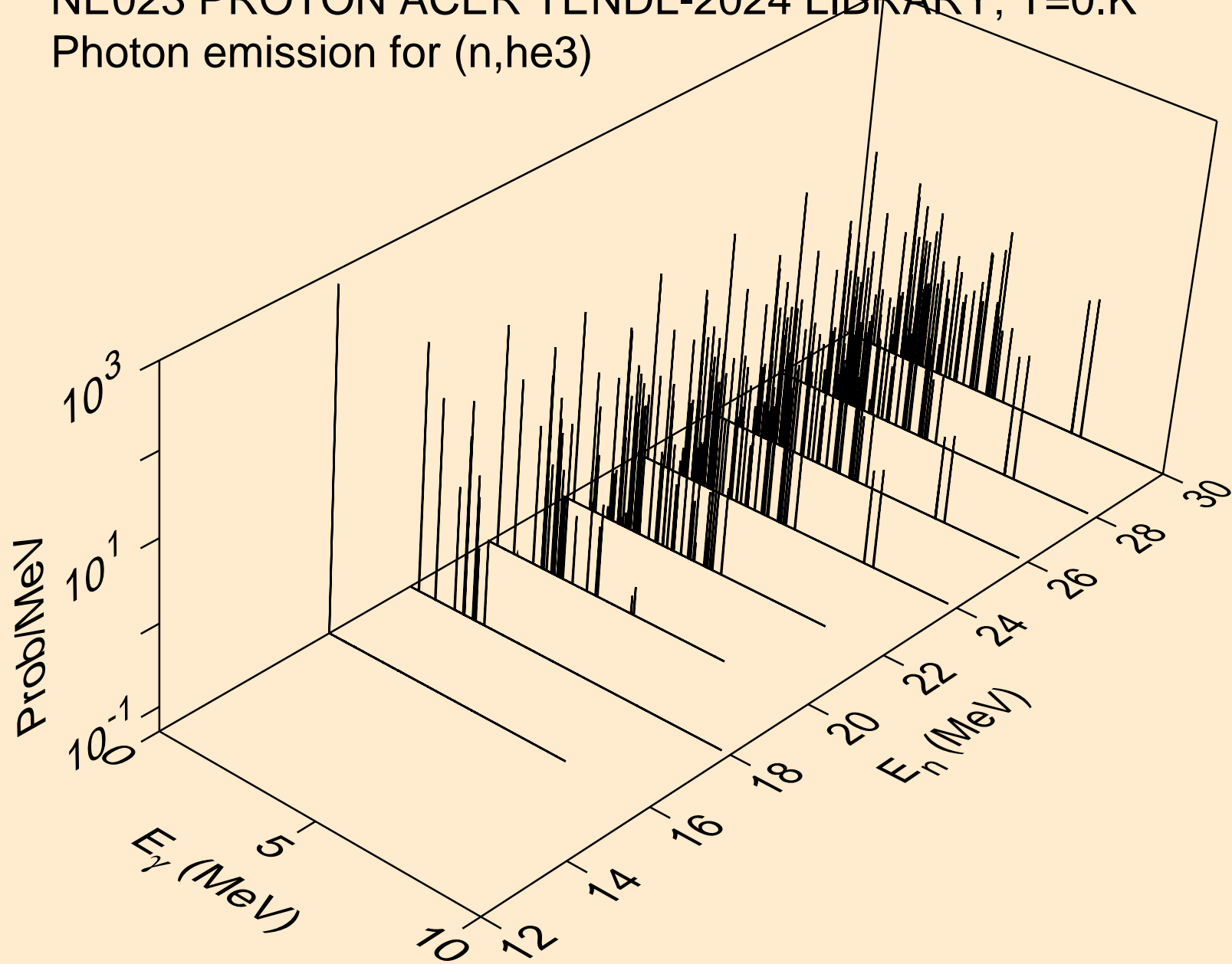

NE023 PROTON ACER TENDL-2024 LIBRARY; T=0.K  
Photon emission for (n,a)

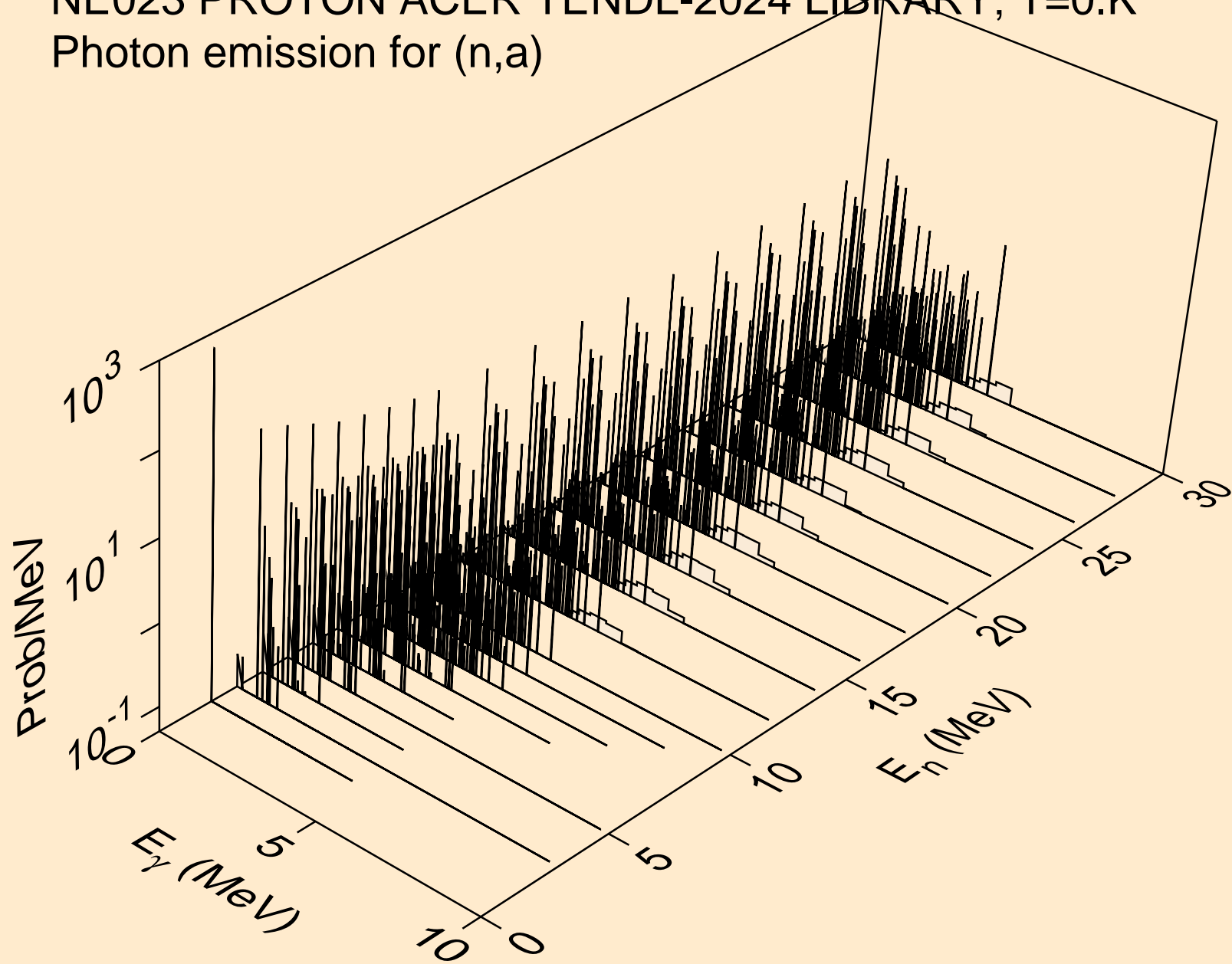

NE023 PROTON ACER TENDL-2024 LIBRARY; T=0.K  
Photon emission for (n,2a)

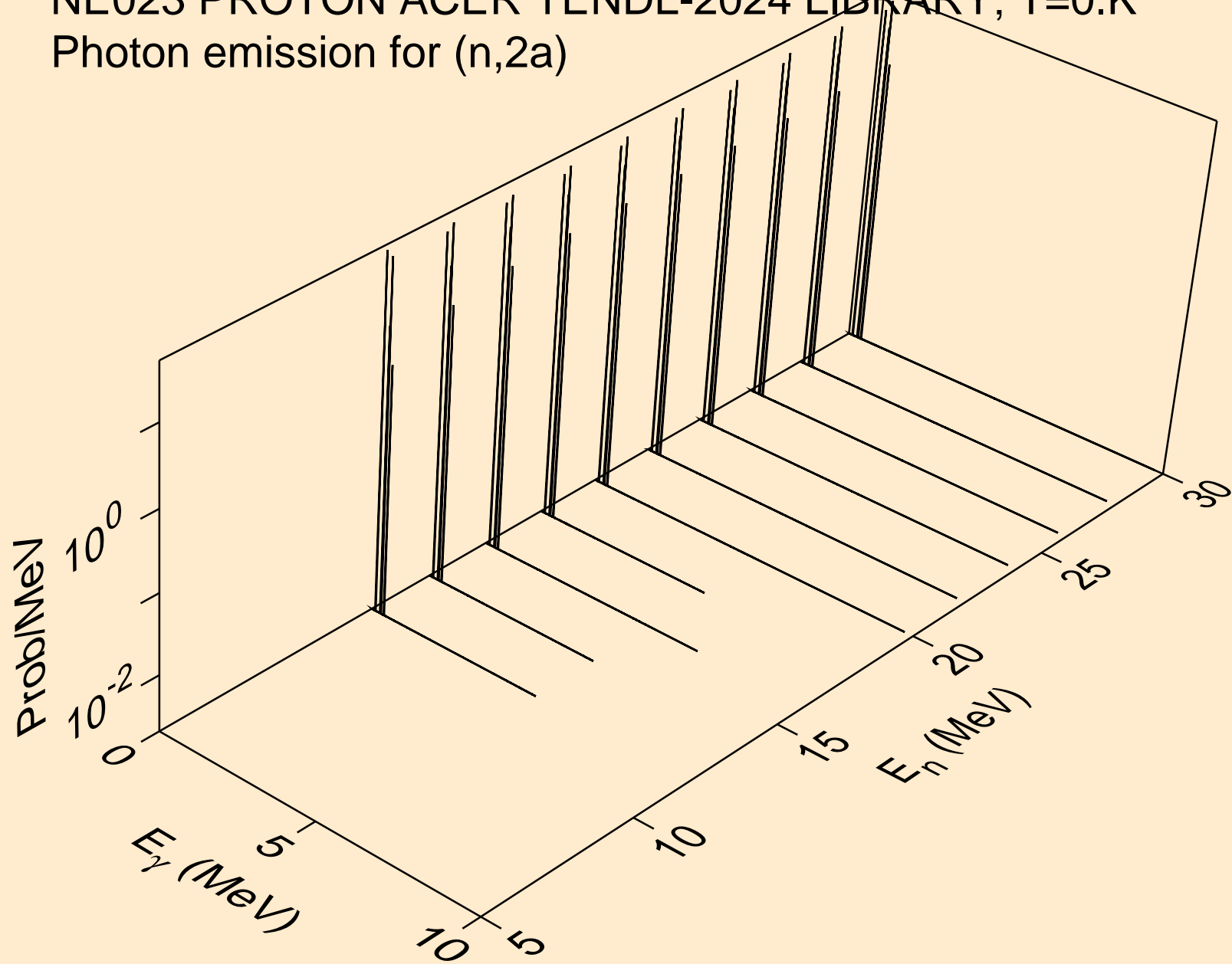

NE023 PROTON ACER TENDL-2024 LIBRARY; T=0.K  
Photon emission for (n,3a)

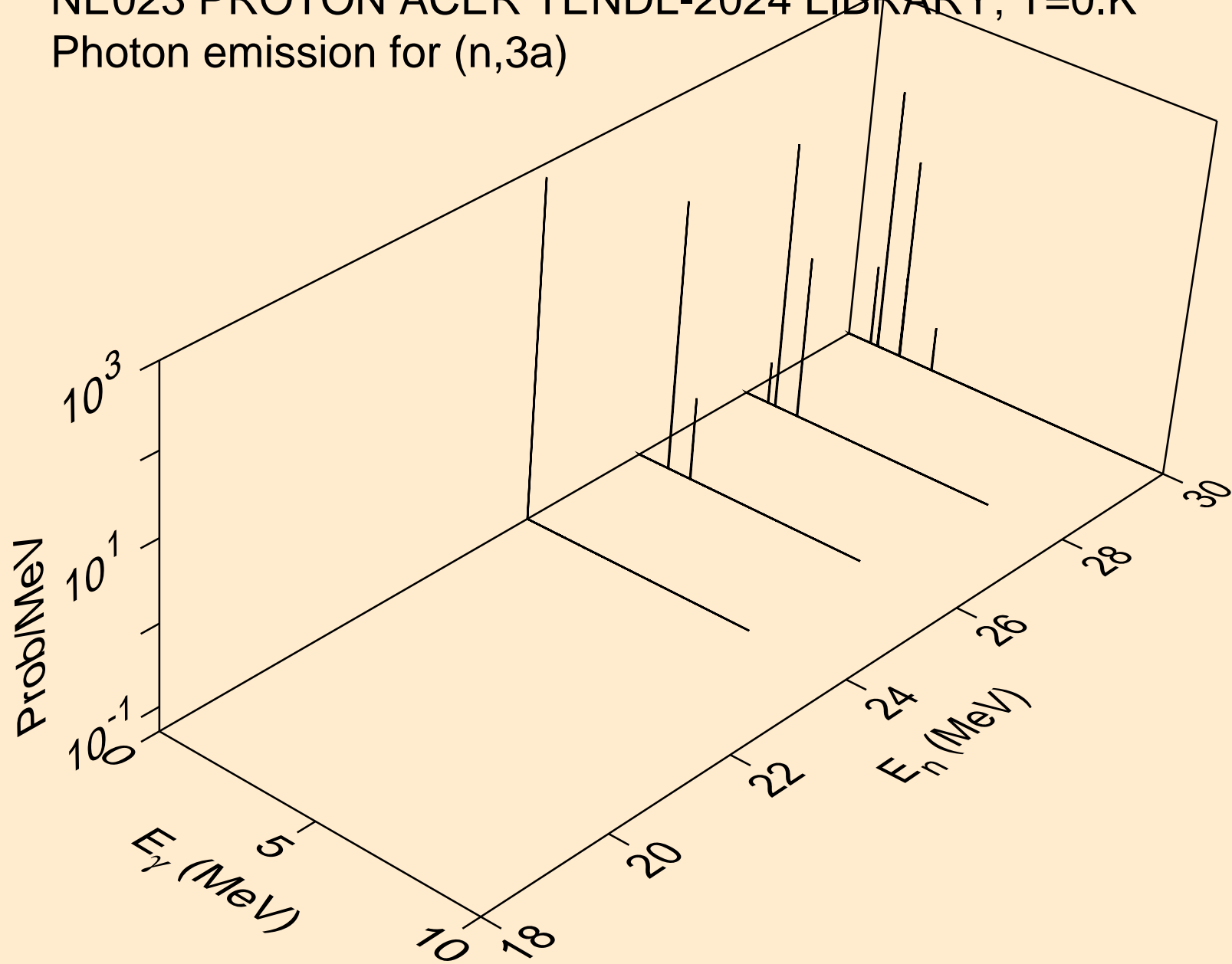

NE023 PROTON ACER TENDL-2024 LIBRARY; T=0.K  
Photon emission for (n,2p)

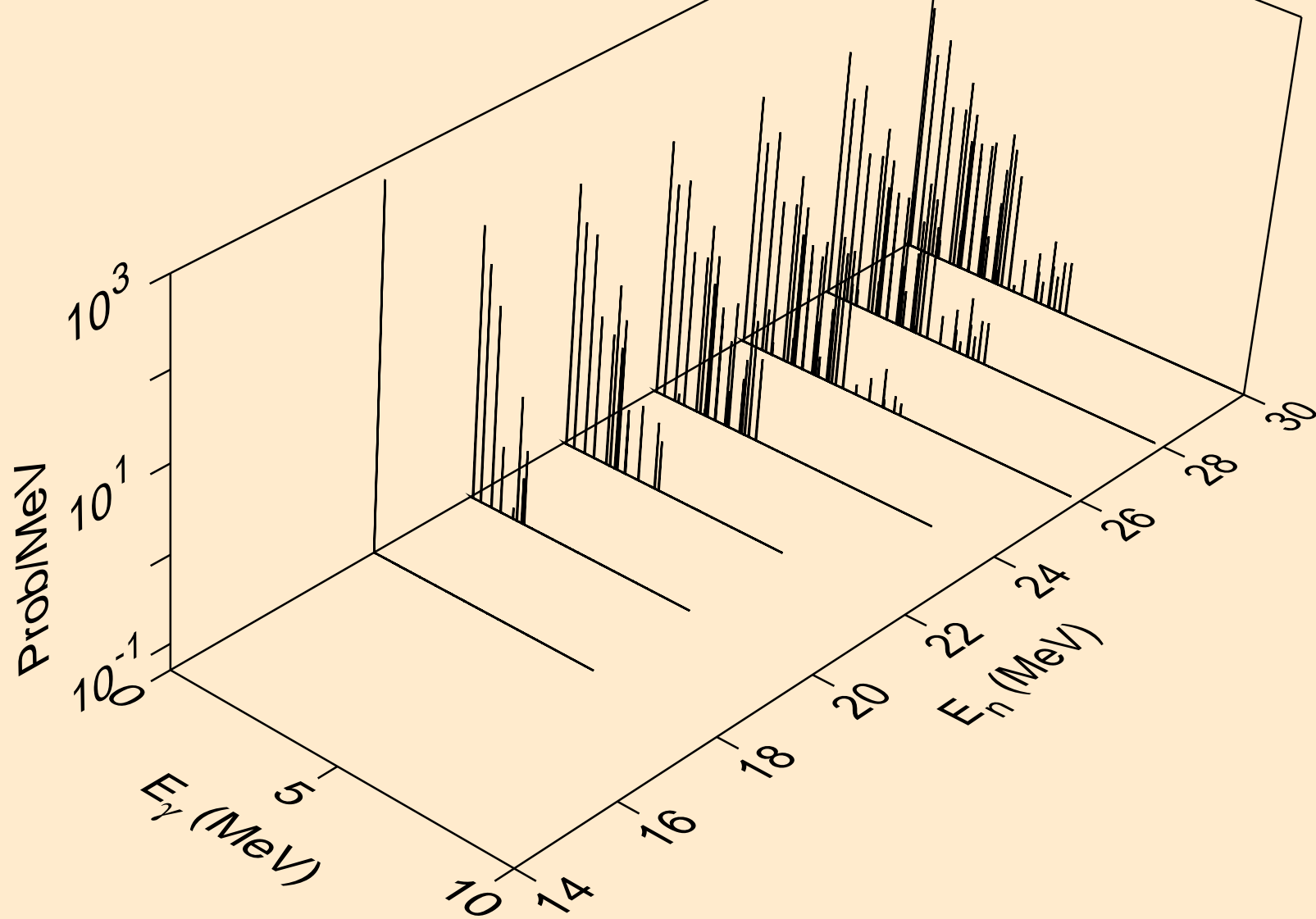

NE023 PROTON ACER TENDL-2024 LIBRARY; T=0.K  
Photon emission for (n,pa)

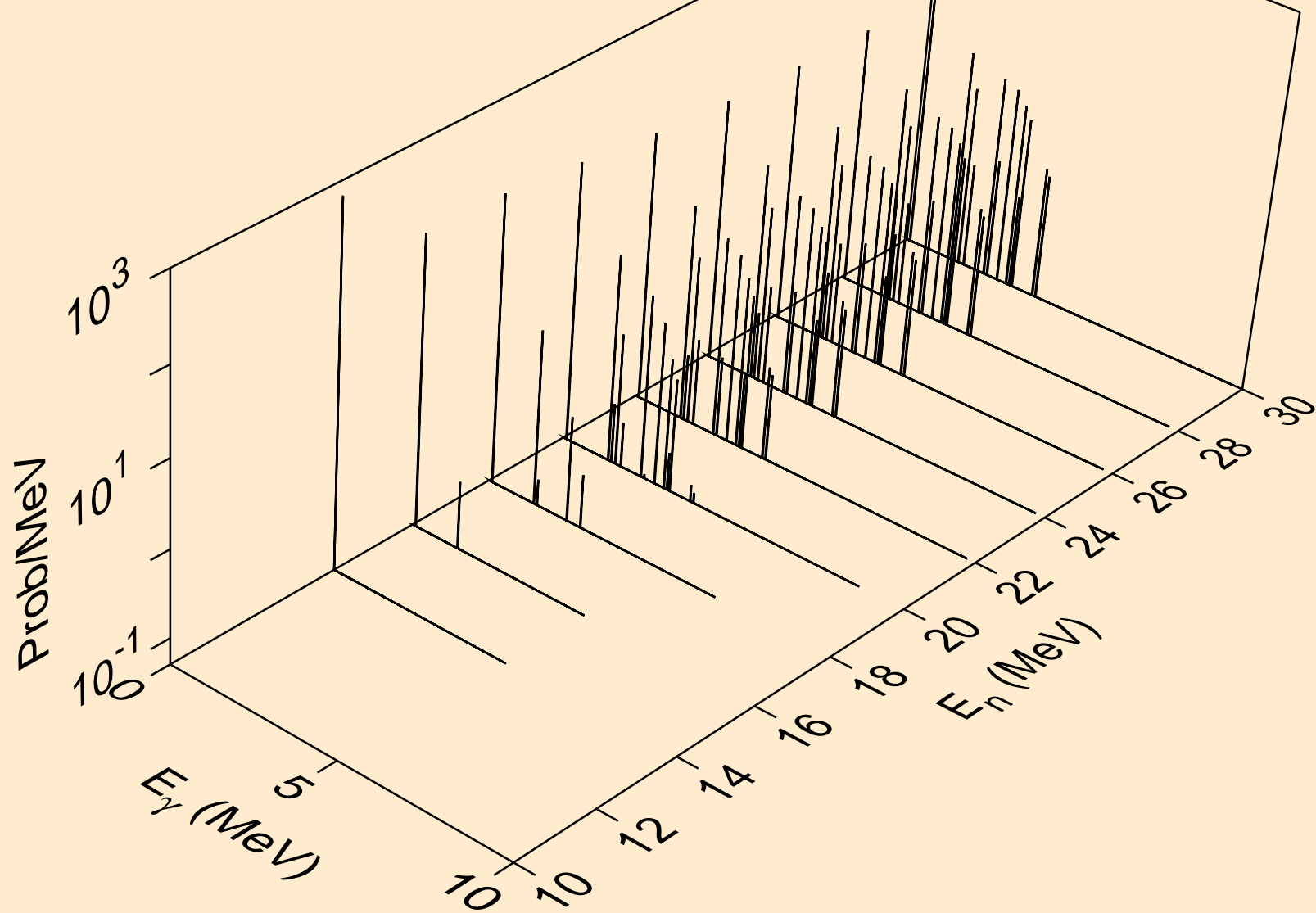

NE023 PROTON ACER TENDL-2024 LIBRARY; T=0.K  
Photon emission for (n,t2a)

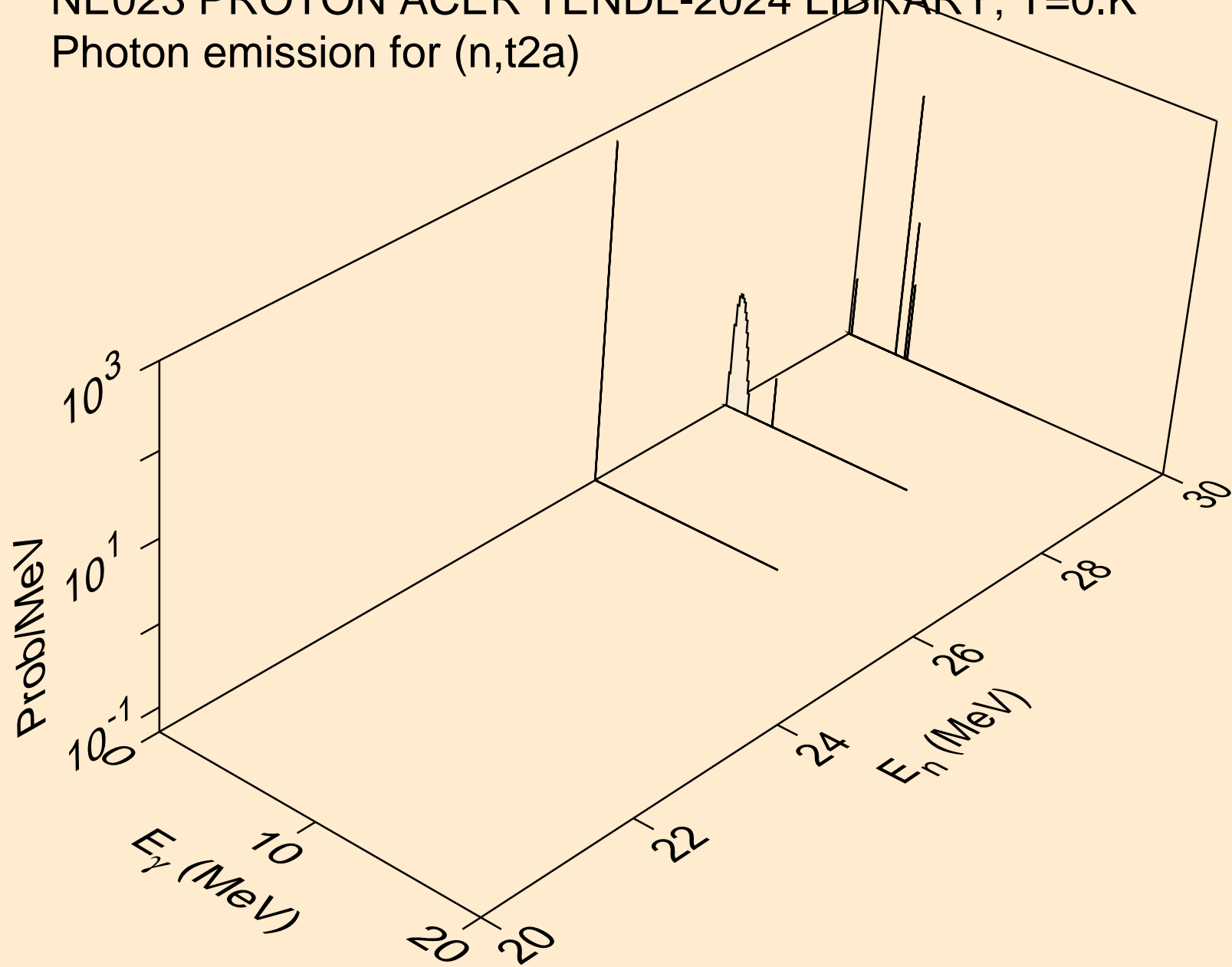

NE023 PROTON ACER TENDL-2024 LIBRARY; T=0.K  
Photon emission for (n,d2a)

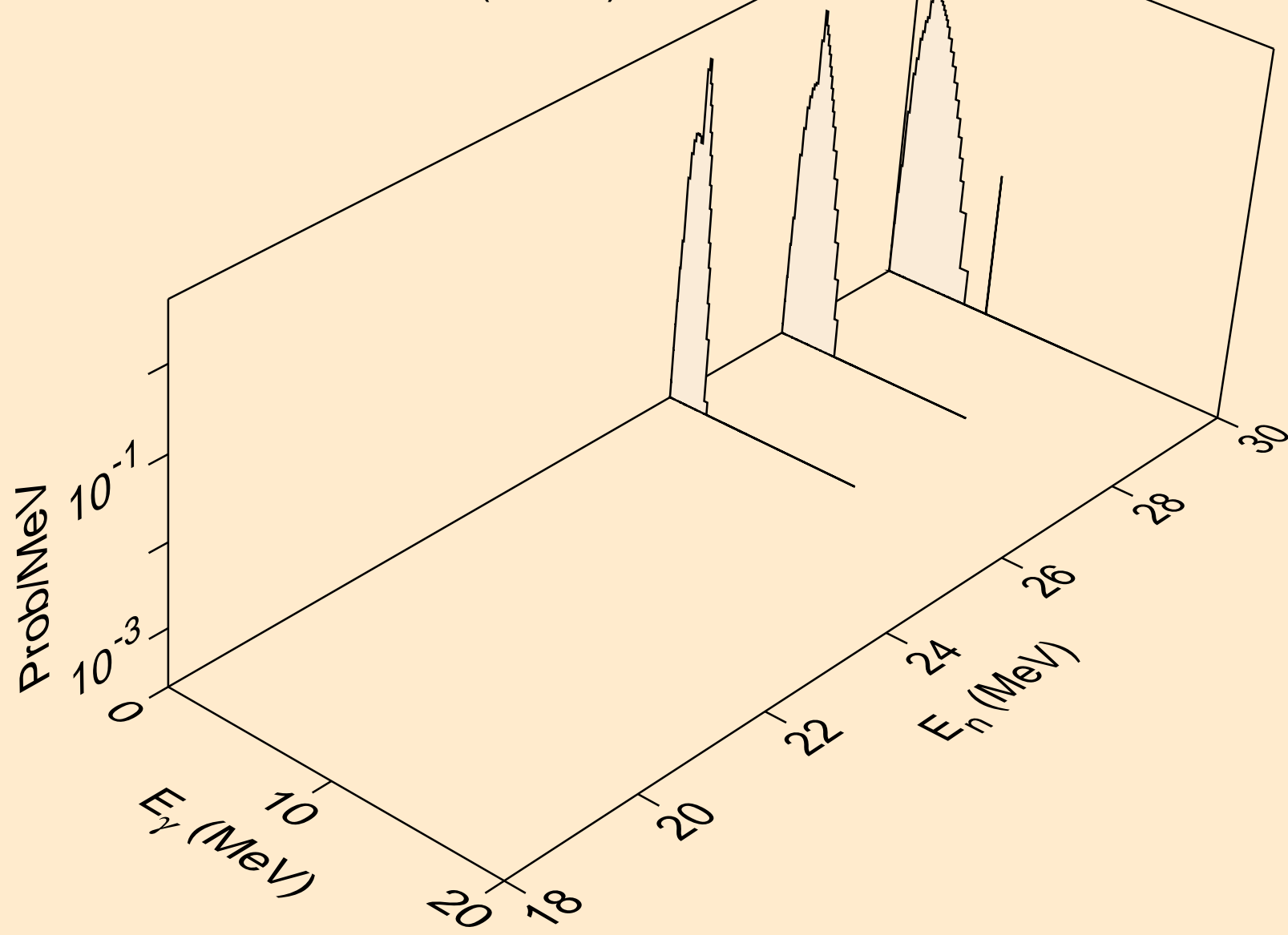

NE023 PROTON ACER TENDL-2024 LIBRARY; T=0.K  
Photon emission for (n,pd)

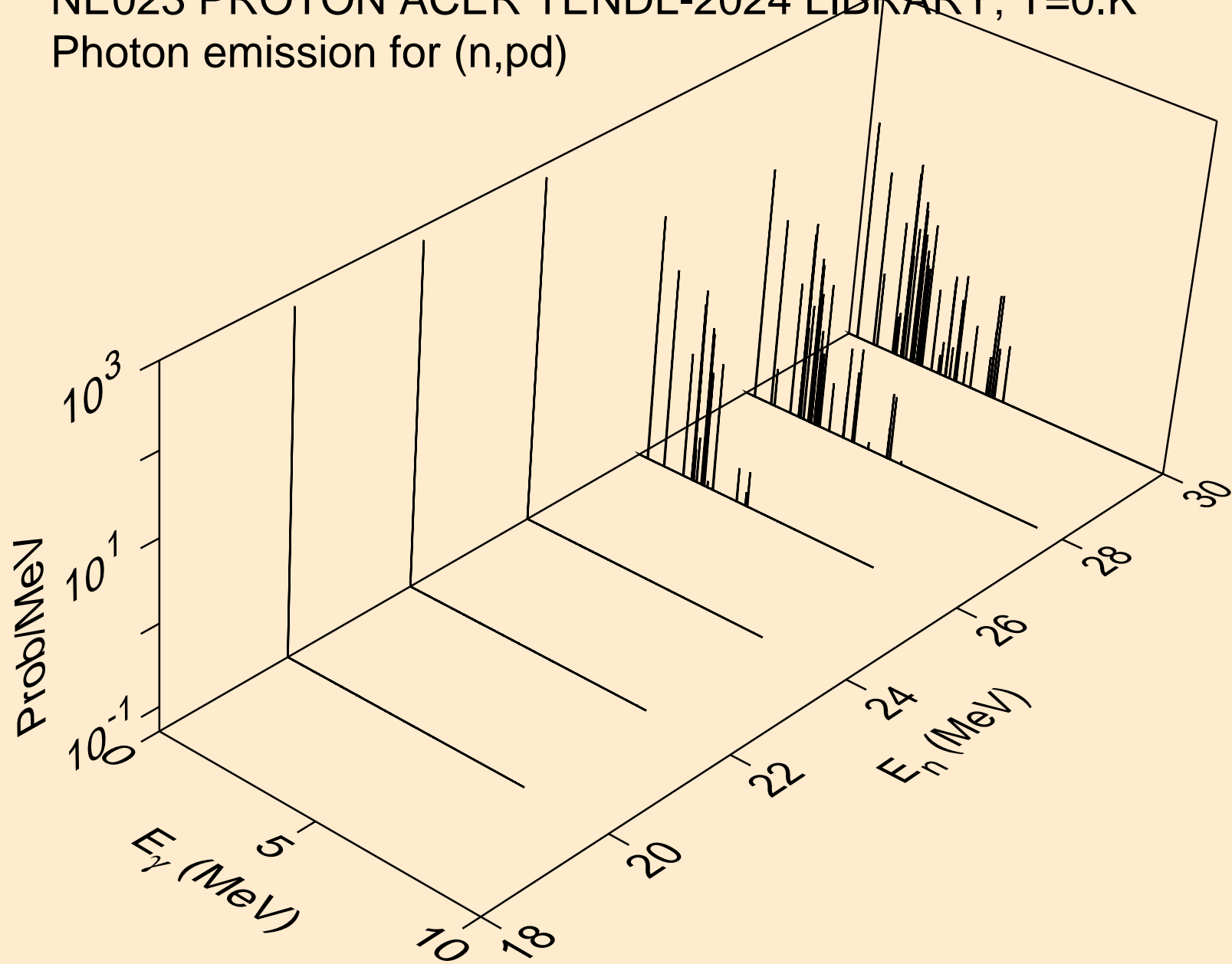

NE023 PROTON ACER TENDL-2024 LIBRARY; T=0.K  
Photon emission for (n,pt)

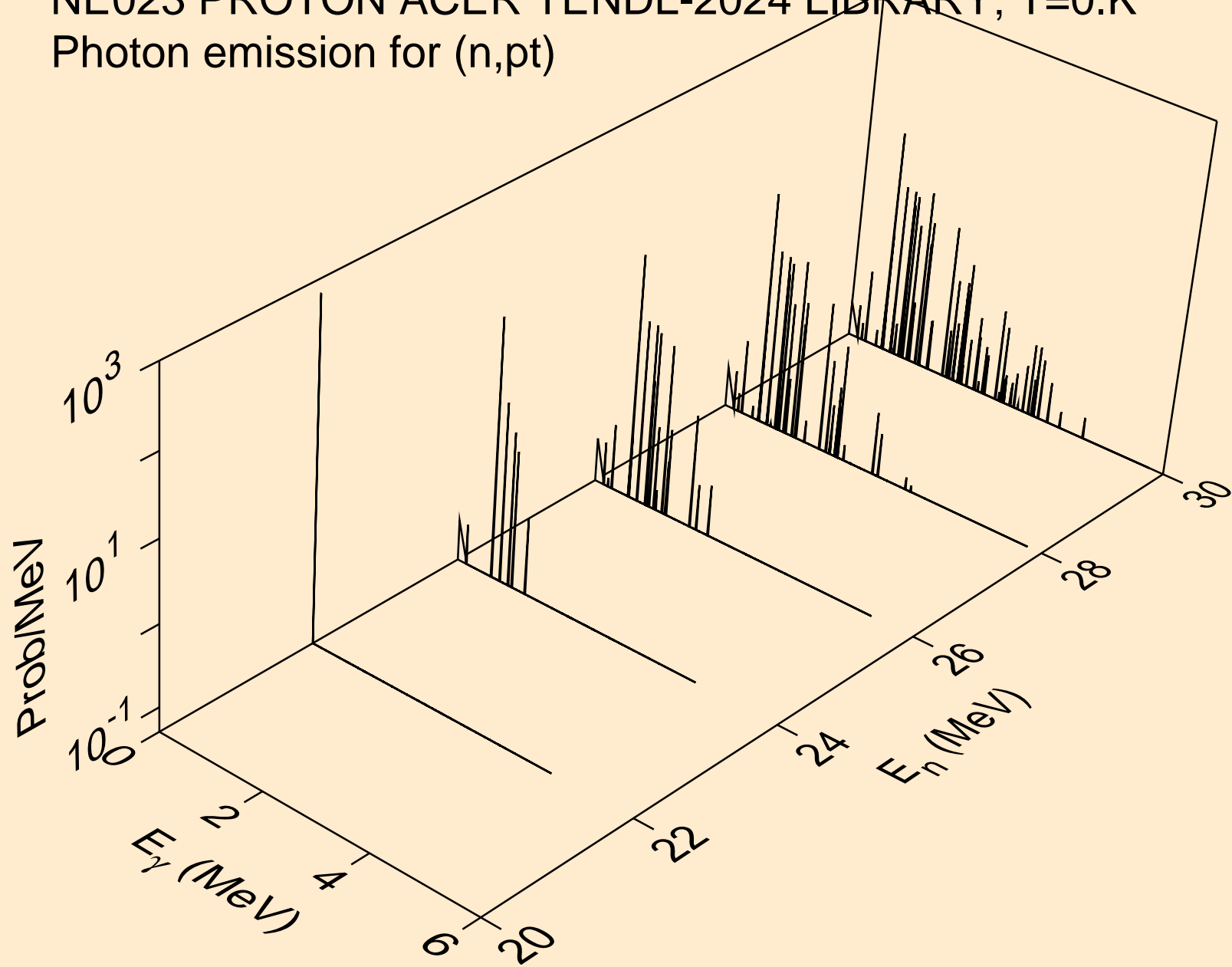

NE023 PROTON ACER TENDL-2024 LIBRARY; T=0.K  
Photon emission for (n,da)

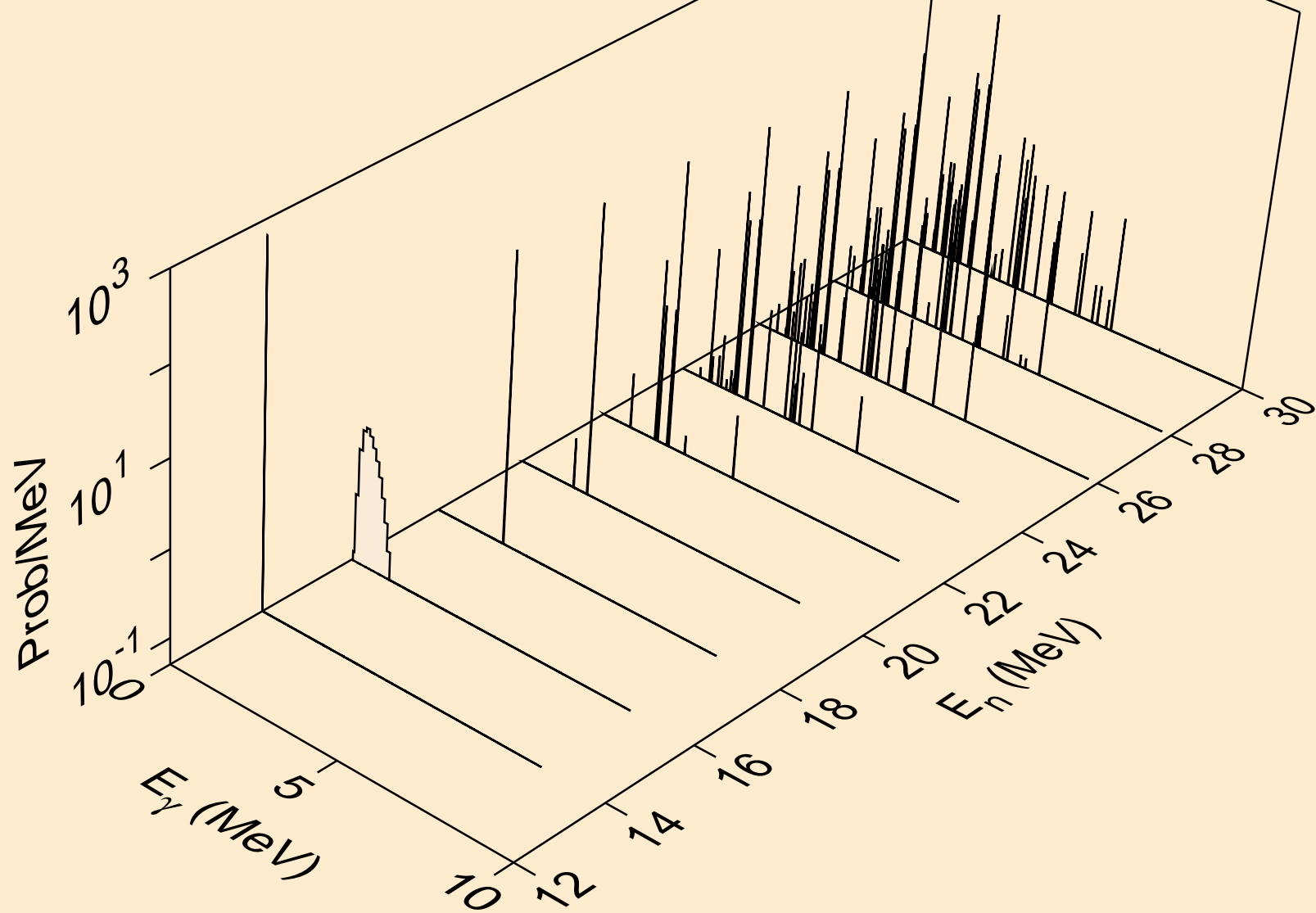

NE023 PROTON ACER TENDL-2024 LIBRARY; T=0.K  
Particle heating contributions

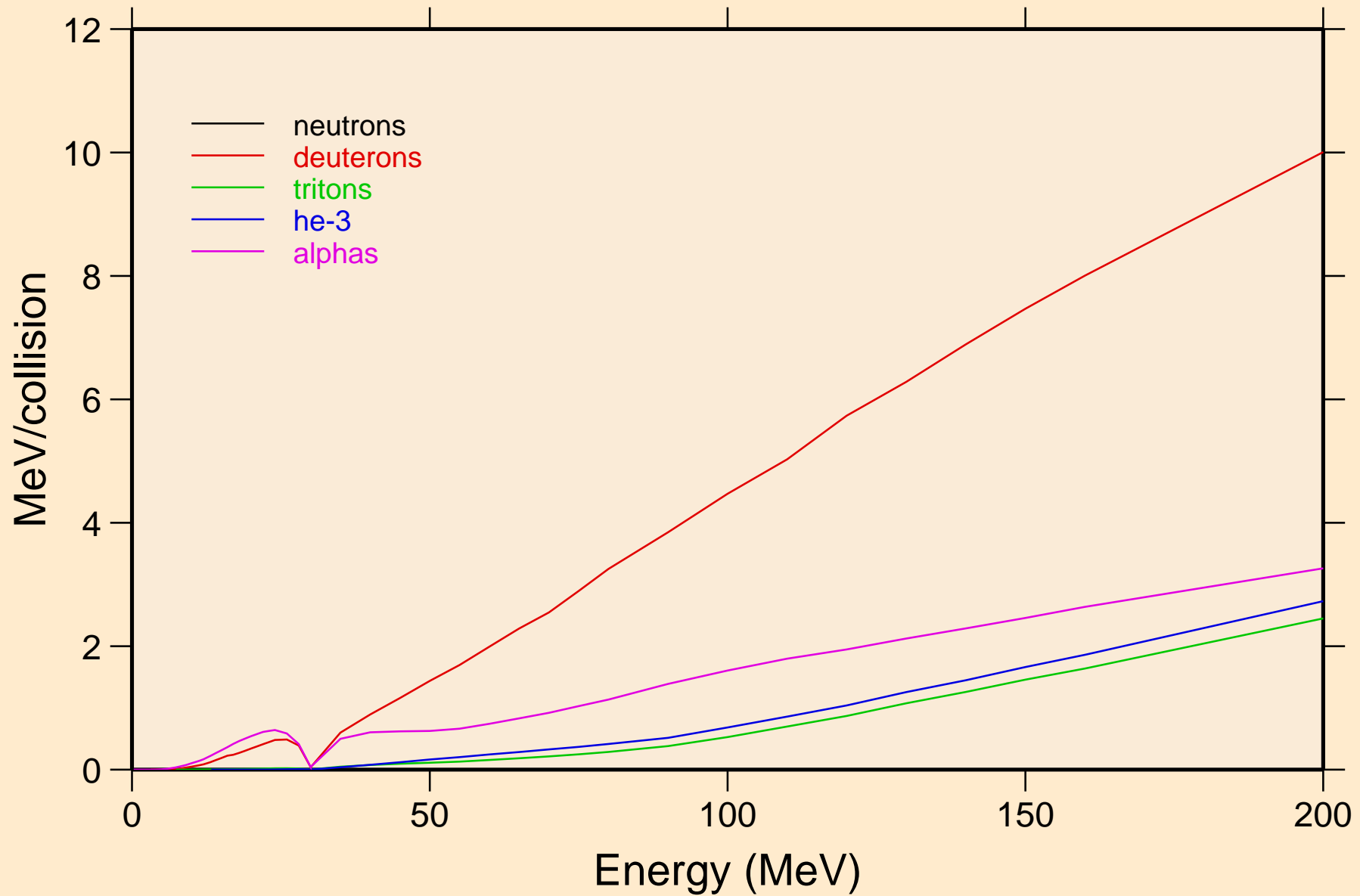

# NE023 PROTON ACER TENDL-2024 LIBRARY; T=0.K

## Recoil Heating

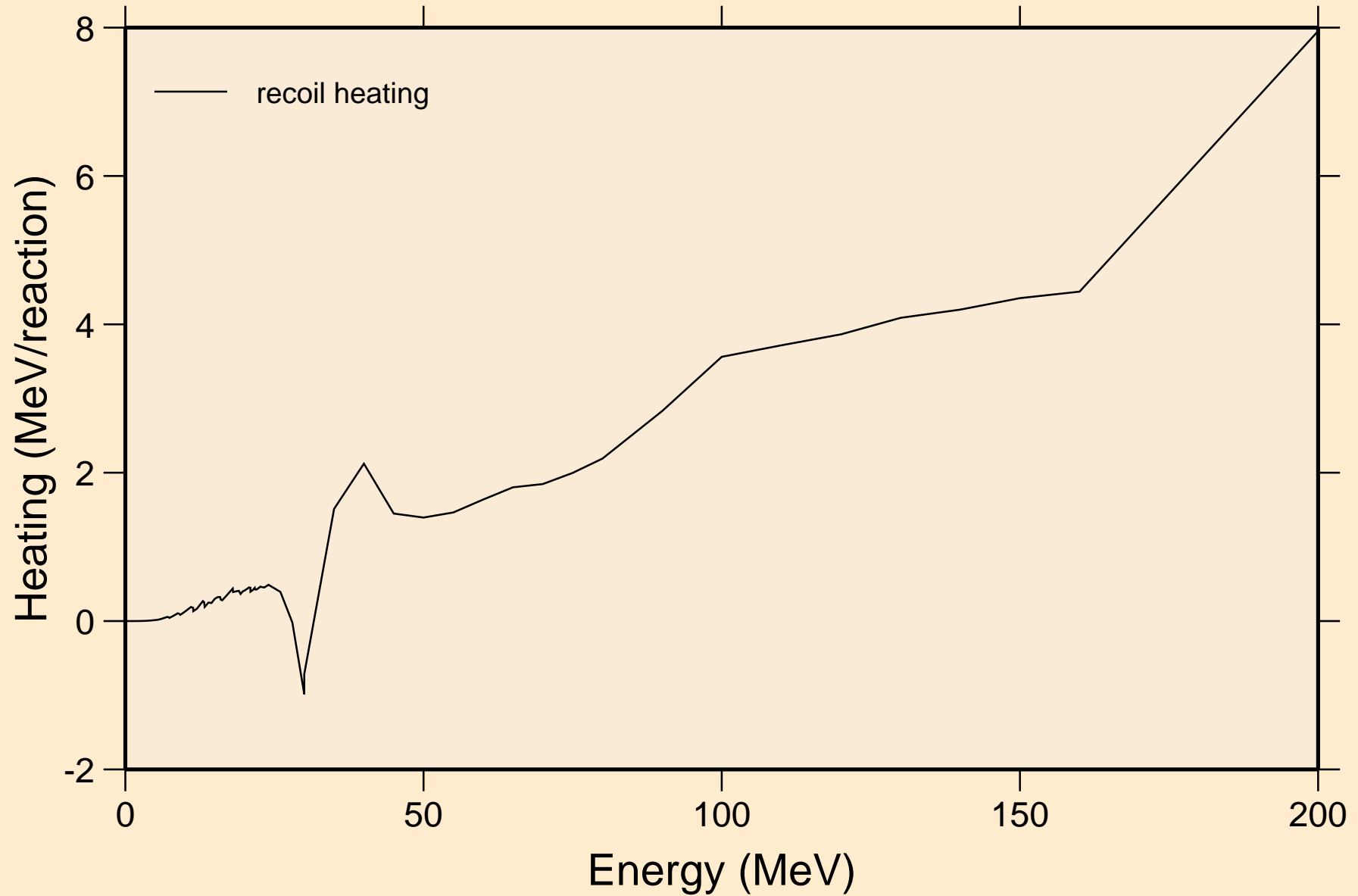

# NE023 PROTON ACER TENDL-2024 LIBRARY; T=0.K

## Particle production cross sections

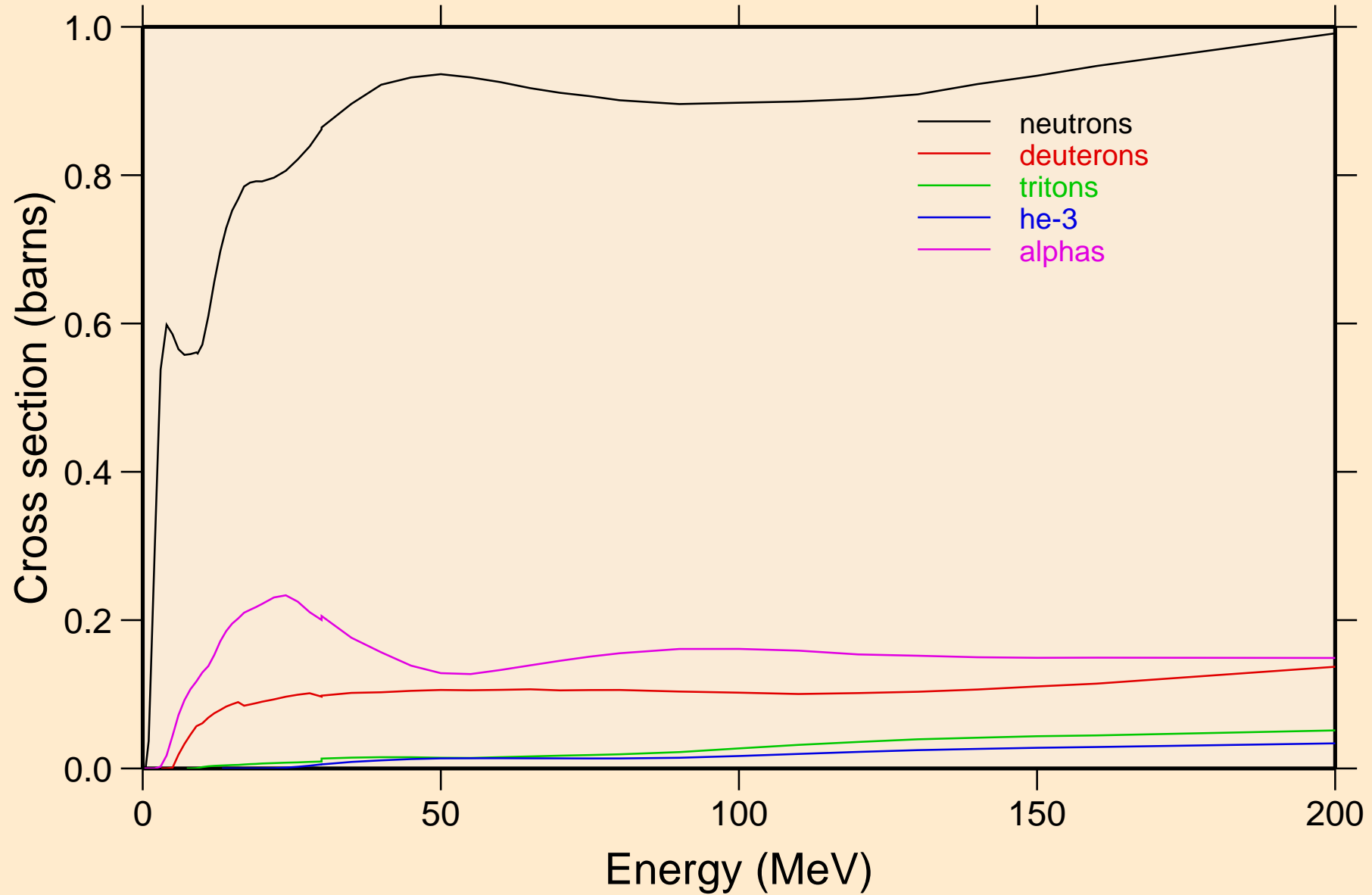

NE023 PROTON ACER TENDL-2024 LIBRARY; T=0.K  
neutrons from (p,n)

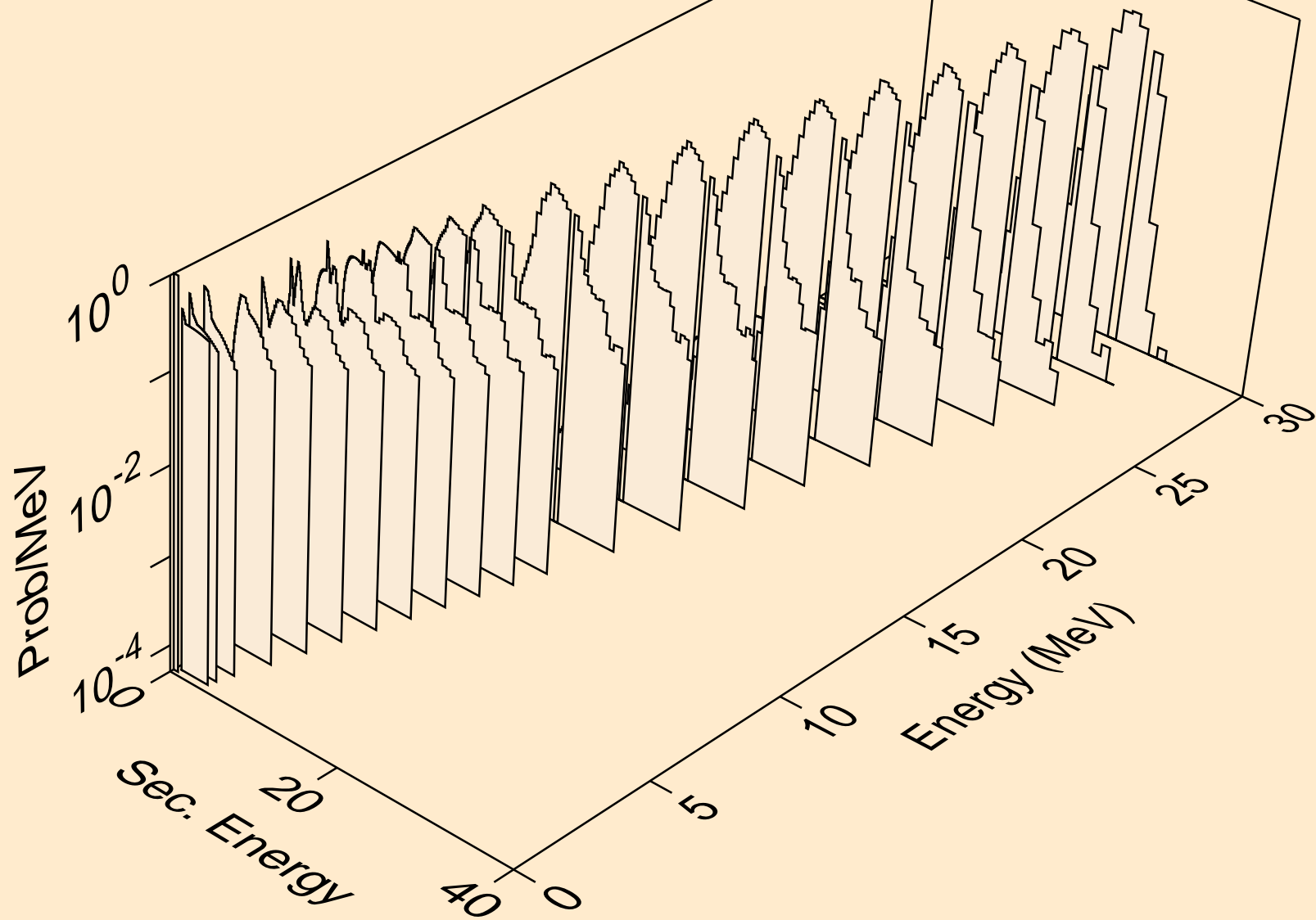

NE023 PROTON ACER TENDL-2024 LIBRARY; T=0.K  
neutrons from (p,x)

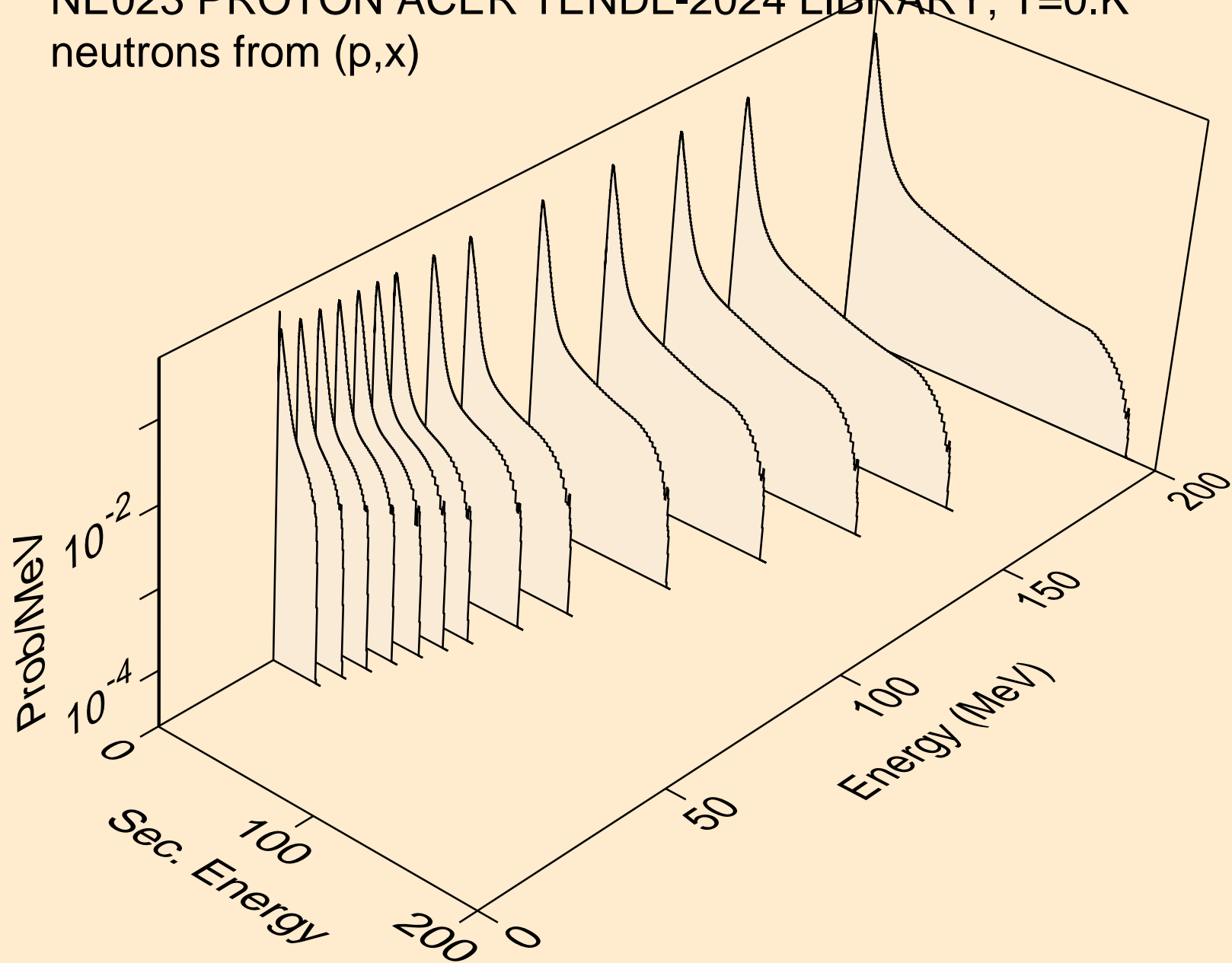

NE023 PROTON ACER TENDL-2024 LIBRARY; T=0.K  
neutrons from (p,2nd)

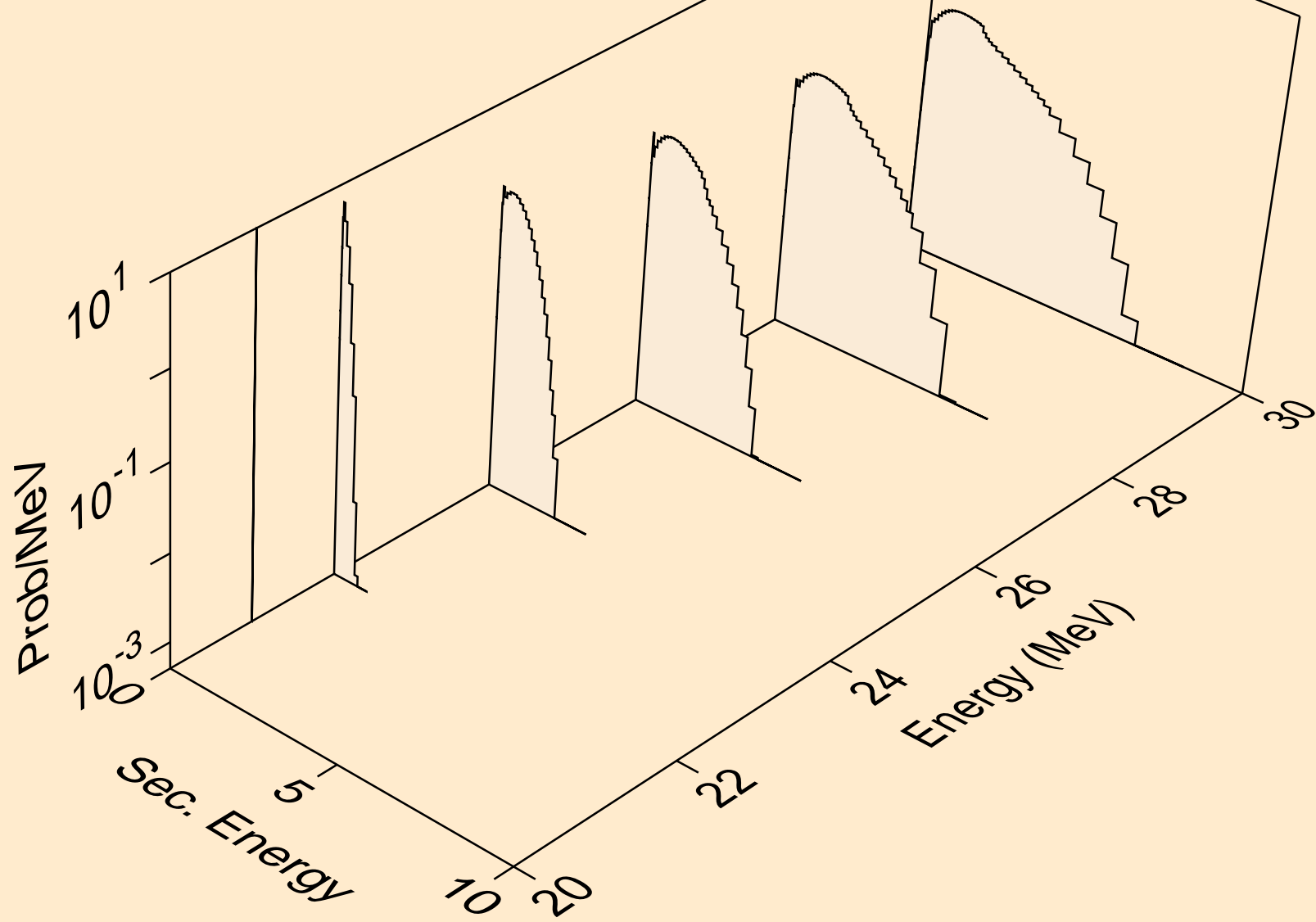

NE023 PROTON ACER TENDL-2024 LIBRARY; T=0.K  
neutrons from (p,2n)

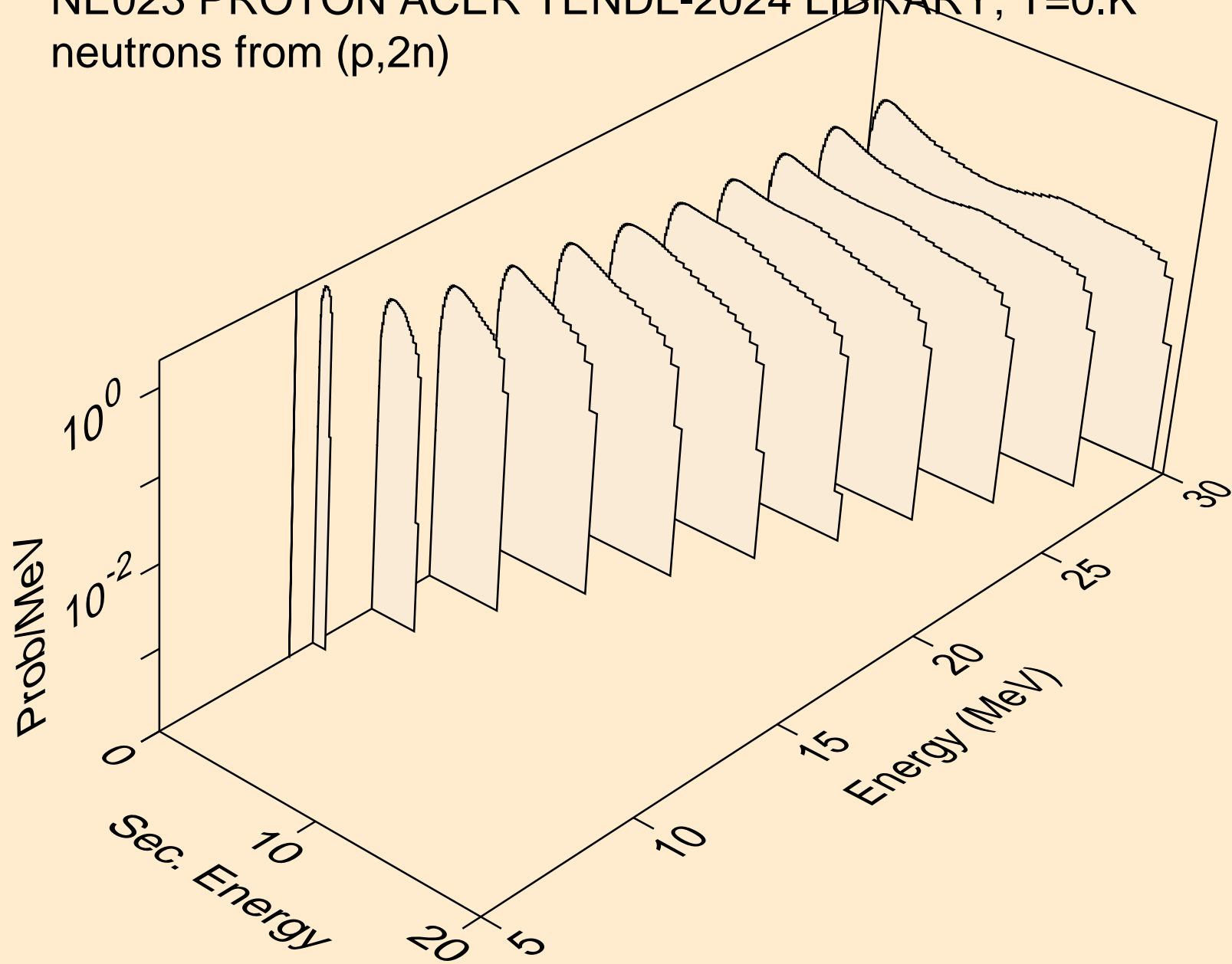

NE023 PROTON ACER TENDL-2024 LIBRARY; T=0.K  
neutrons from (p,3n)

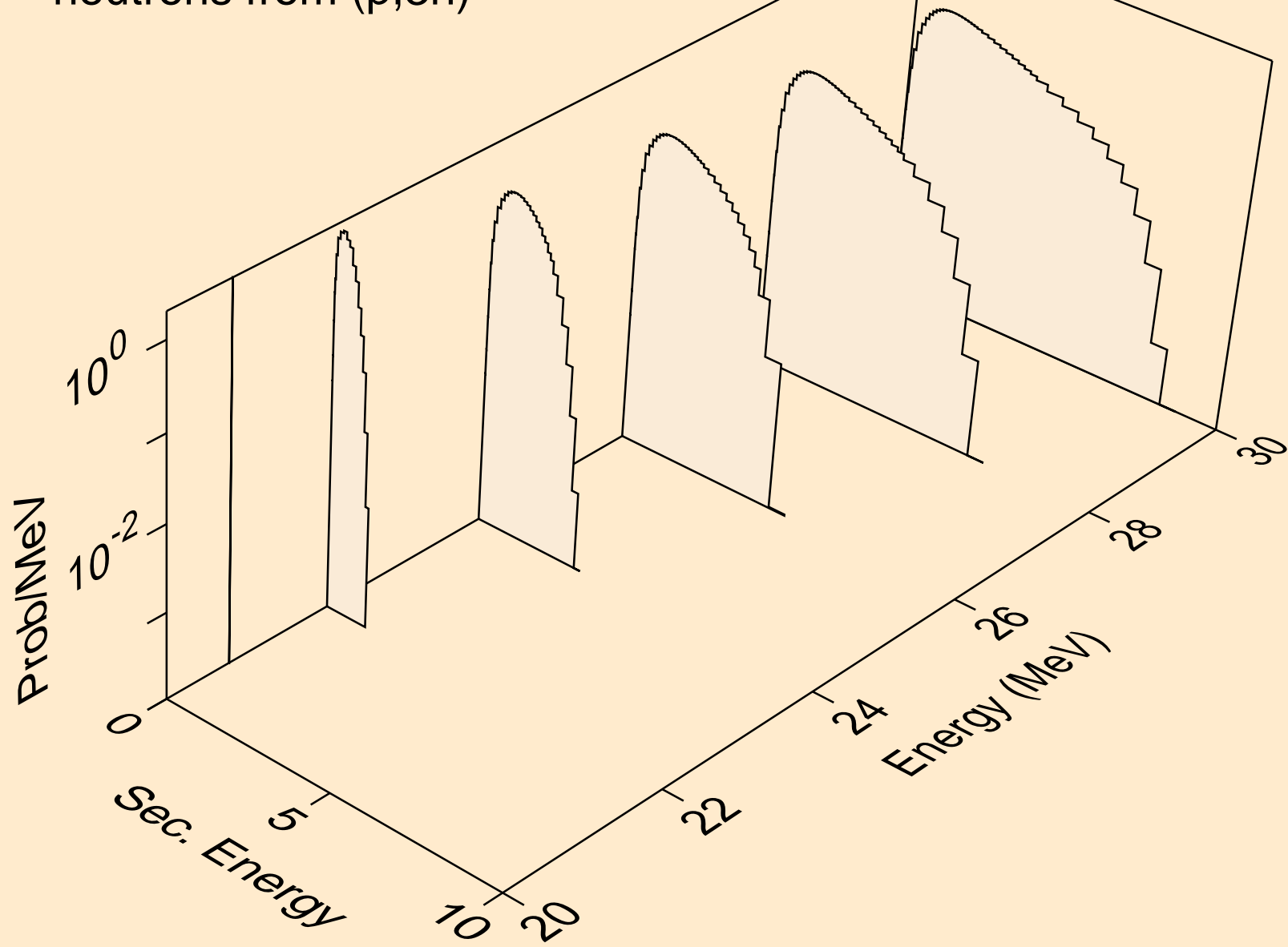

NE023 PROTON ACER TENDL-2024 LIBRARY; T=0.K  
neutrons from (p,n\*)a

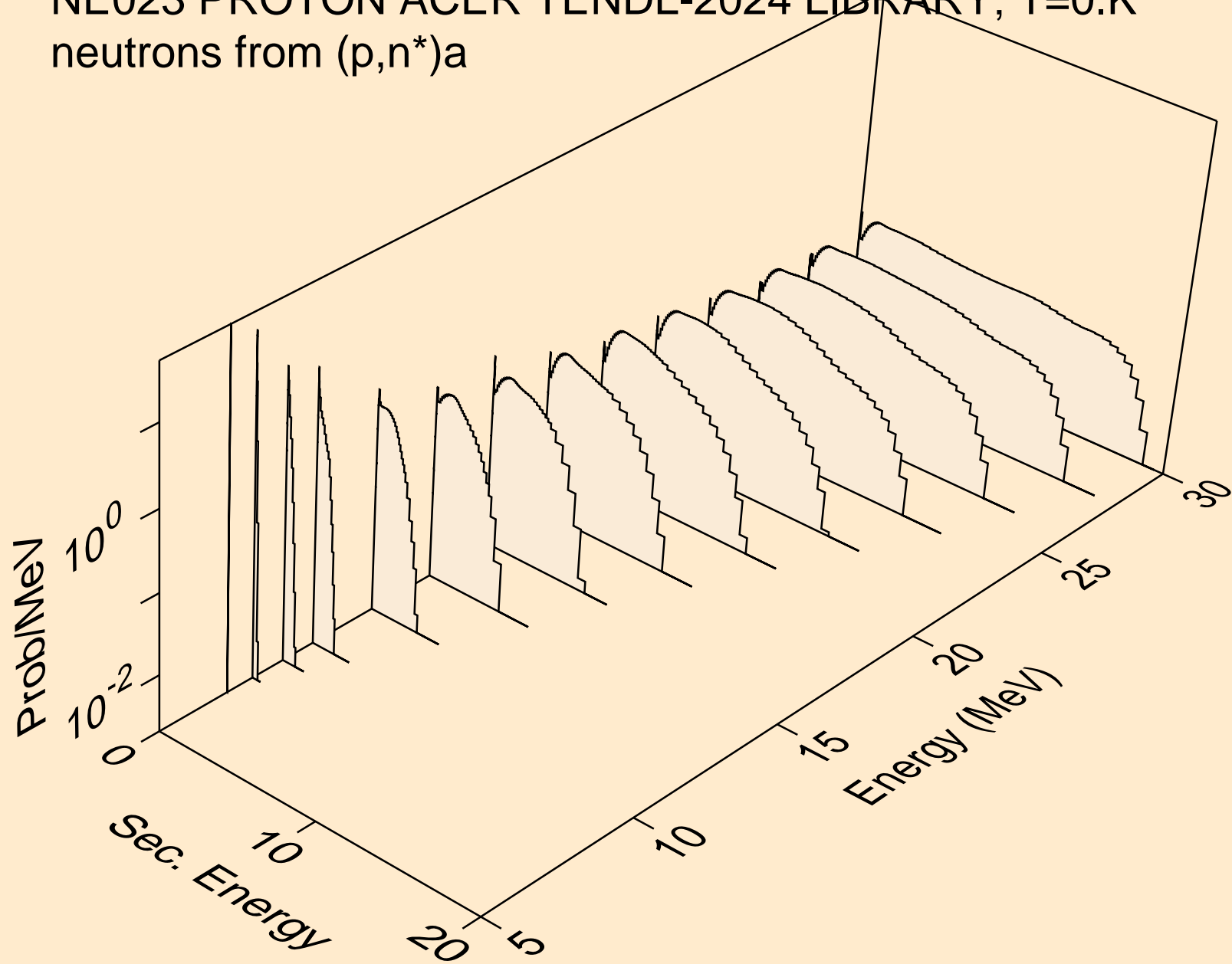

NE023 PROTON ACER TENDL-2024 LIBRARY; T=0.K  
neutrons from (p,n\*)3a

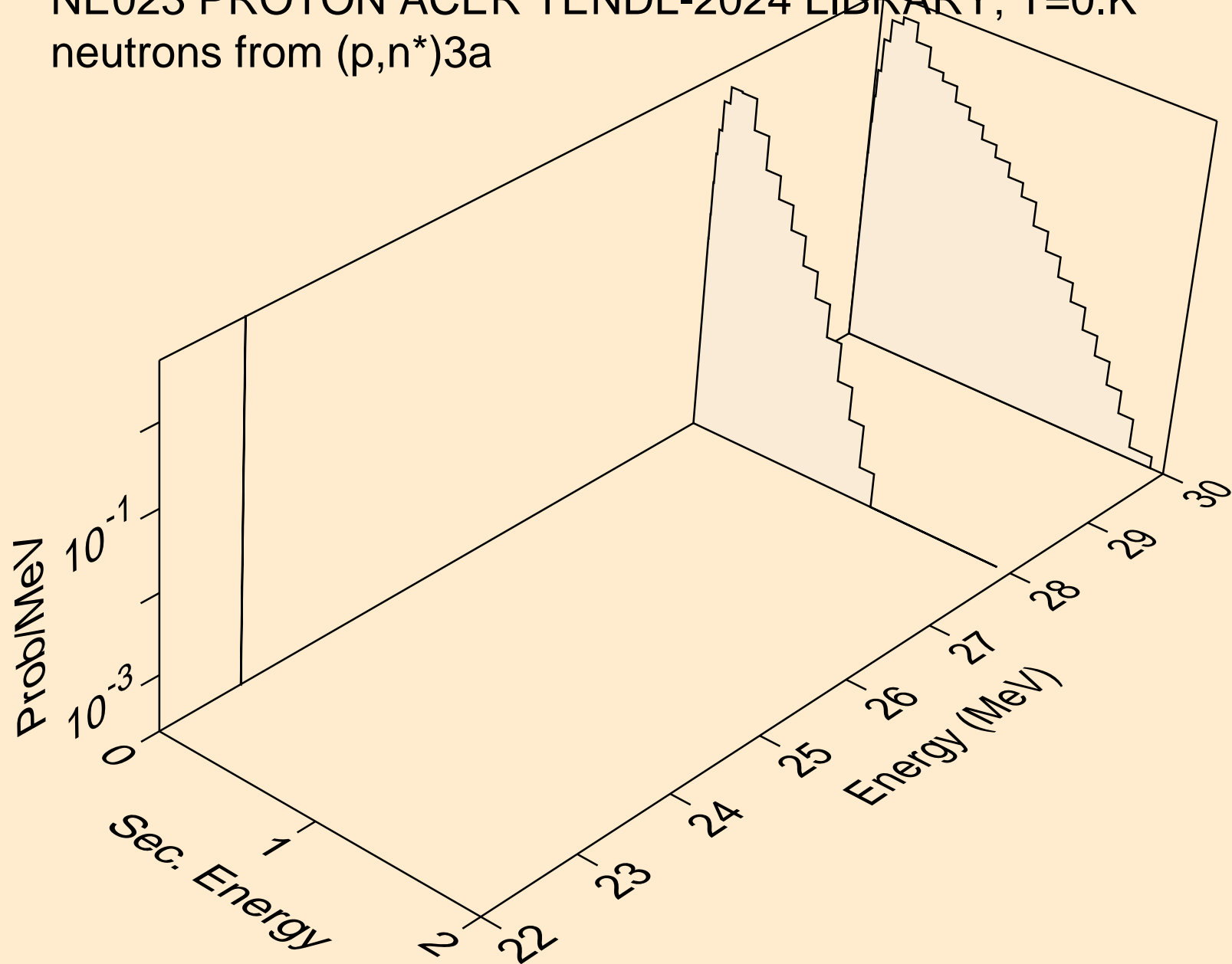

NE023 PROTON ACER TENDL-2024 LIBRARY; T=0.K  
neutrons from (p,2n)a

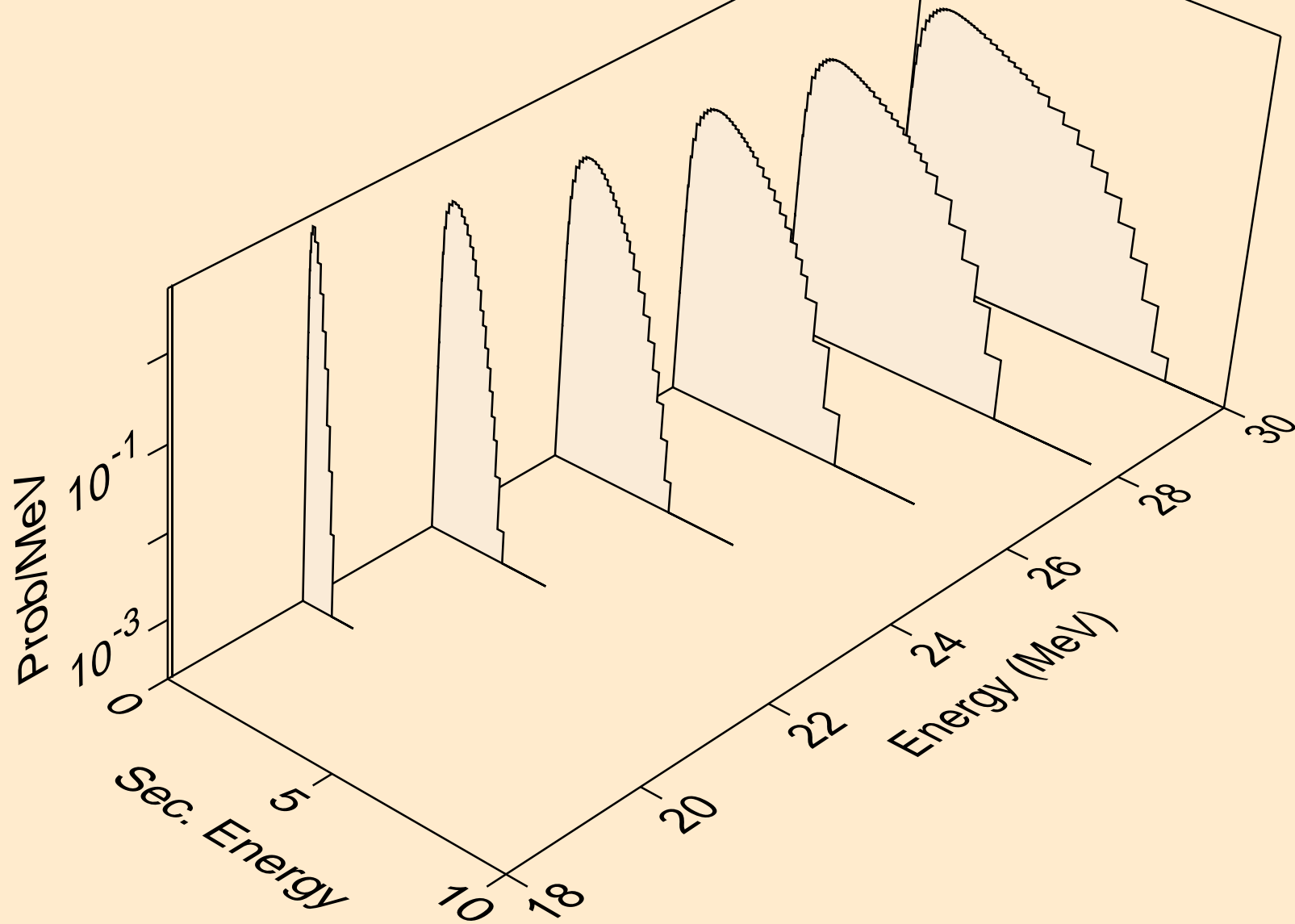

NE023 PROTON ACER TENDL-2024 LIBRARY; T=0.K  
neutrons from (p,n\*)p

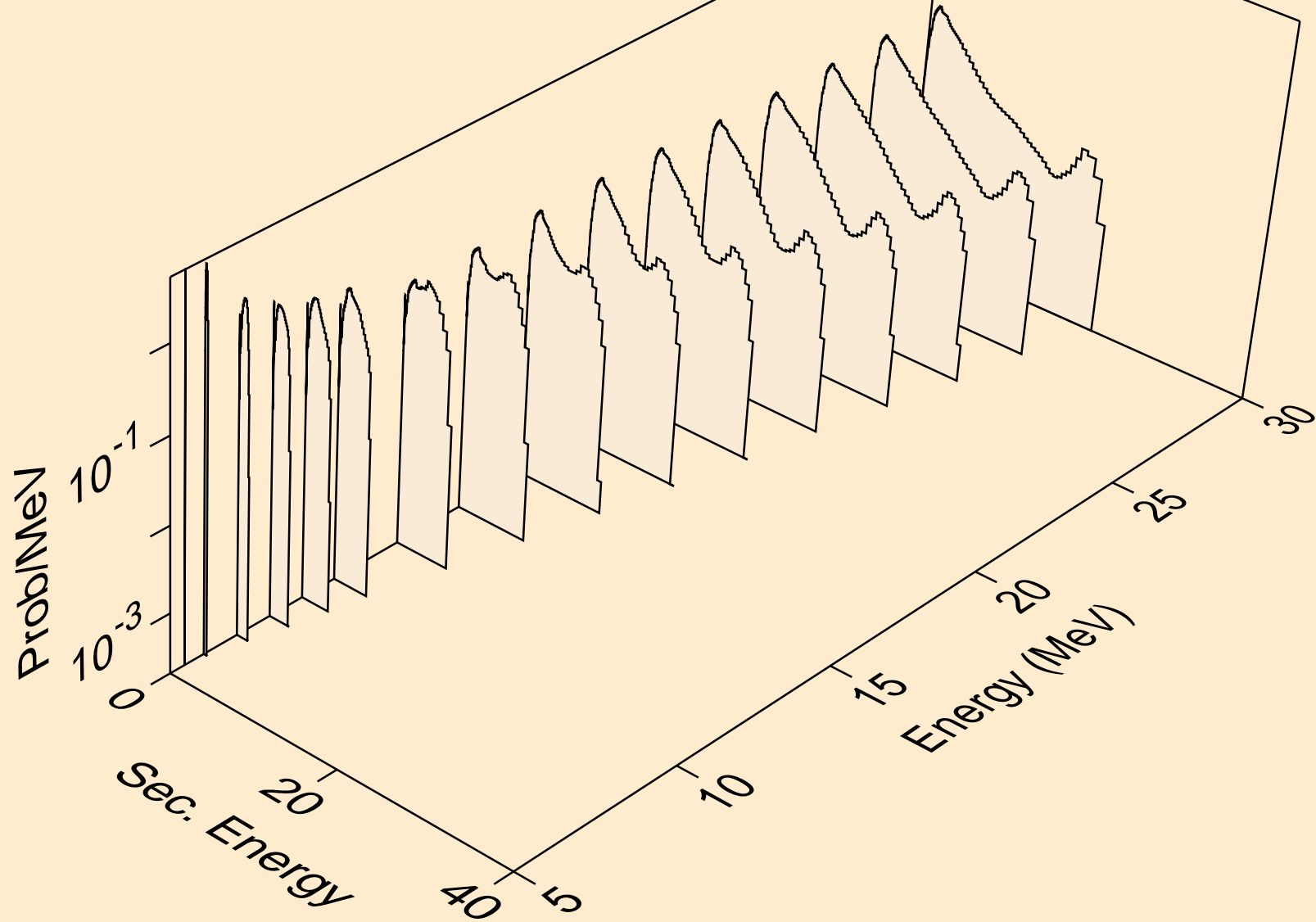

NE023 PROTON ACER TENDL-2024 LIBRARY; T=0.K  
neutrons from (p,n\*)2a

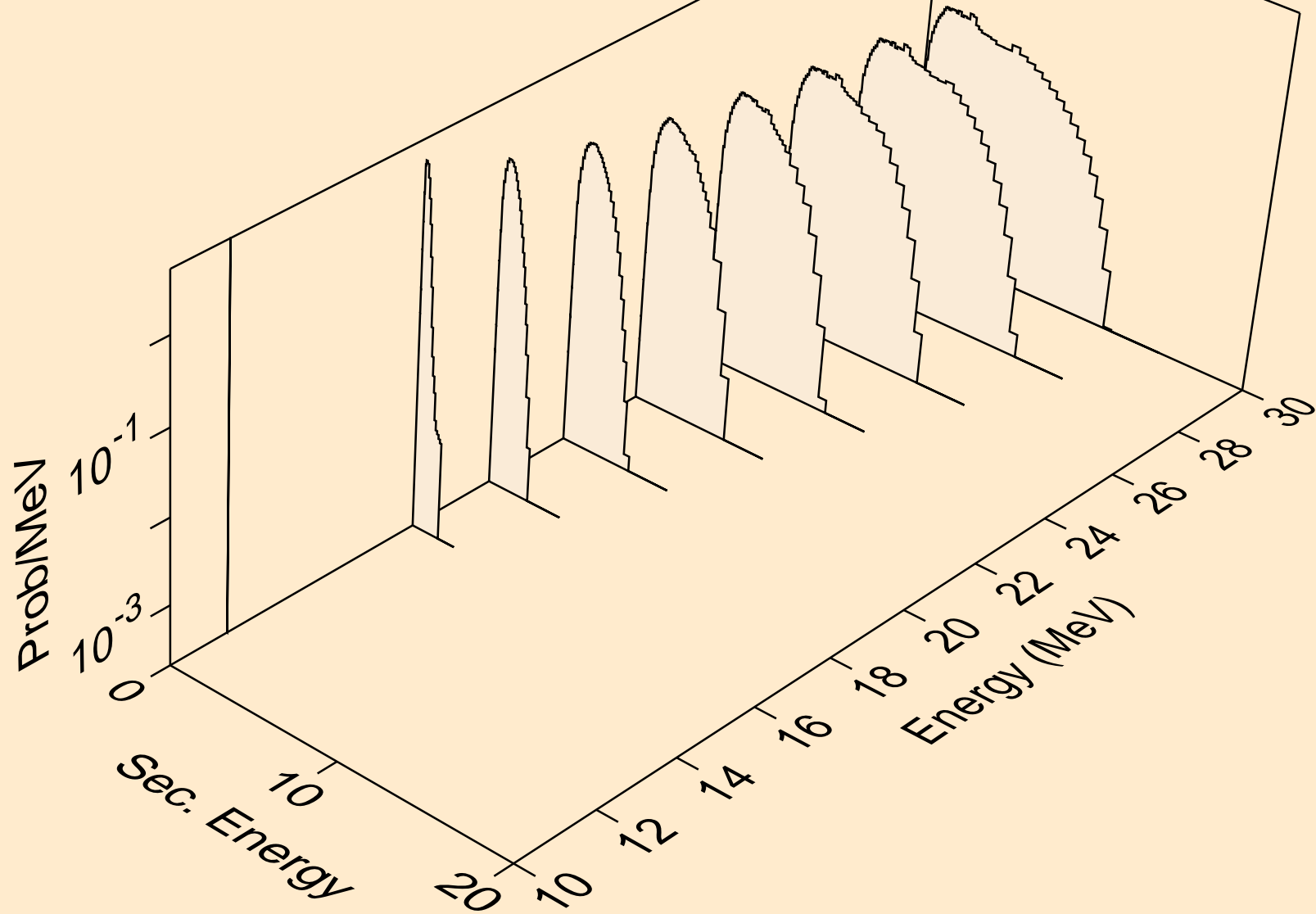

NE023 PROTON ACER TENDL-2024 LIBRARY; T=0.K  
neutrons from (p,2n)2a

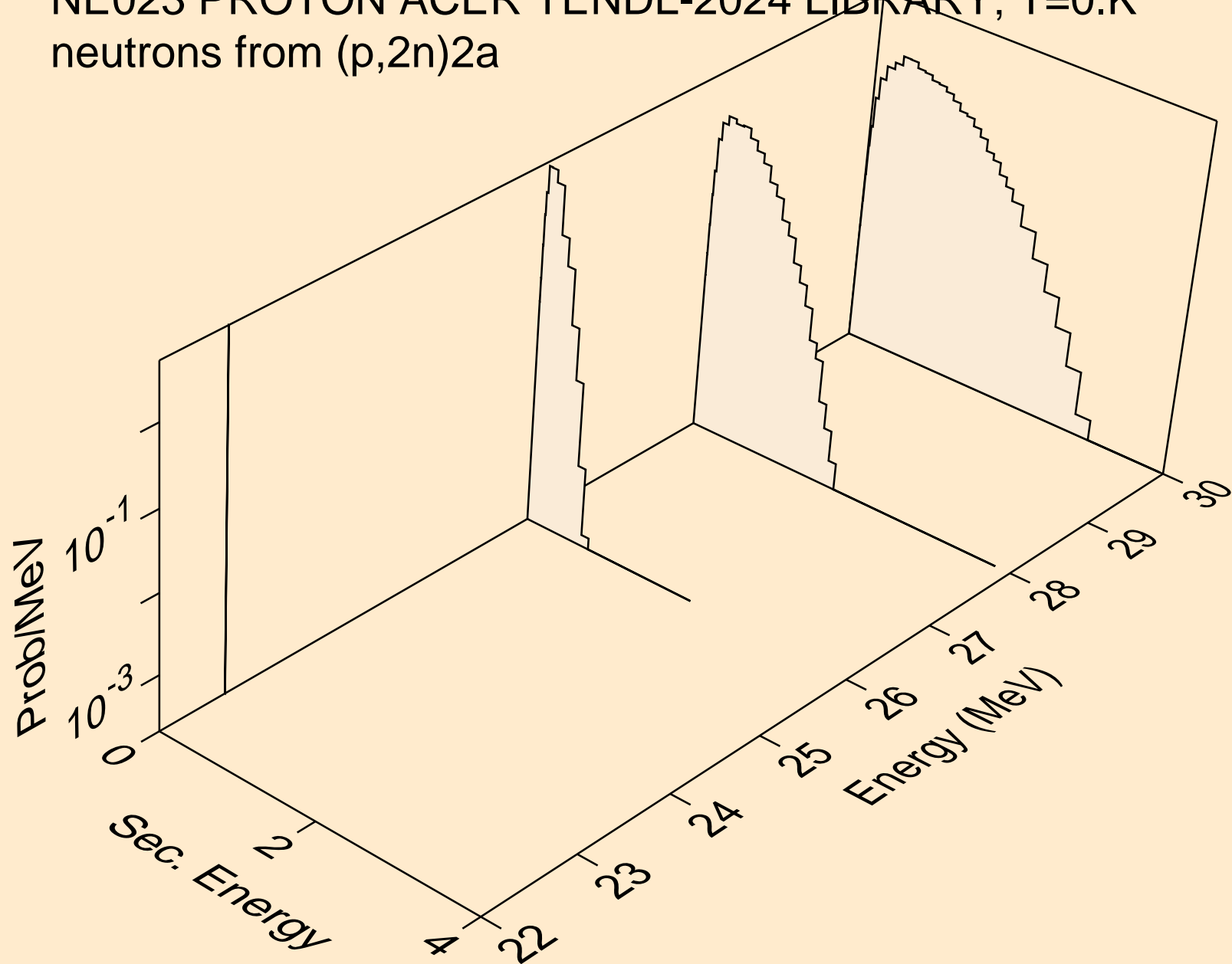

NE023 PROTON ACER TENDL-2024 LIBRARY; T=0.K  
neutrons from (p,n\*)d

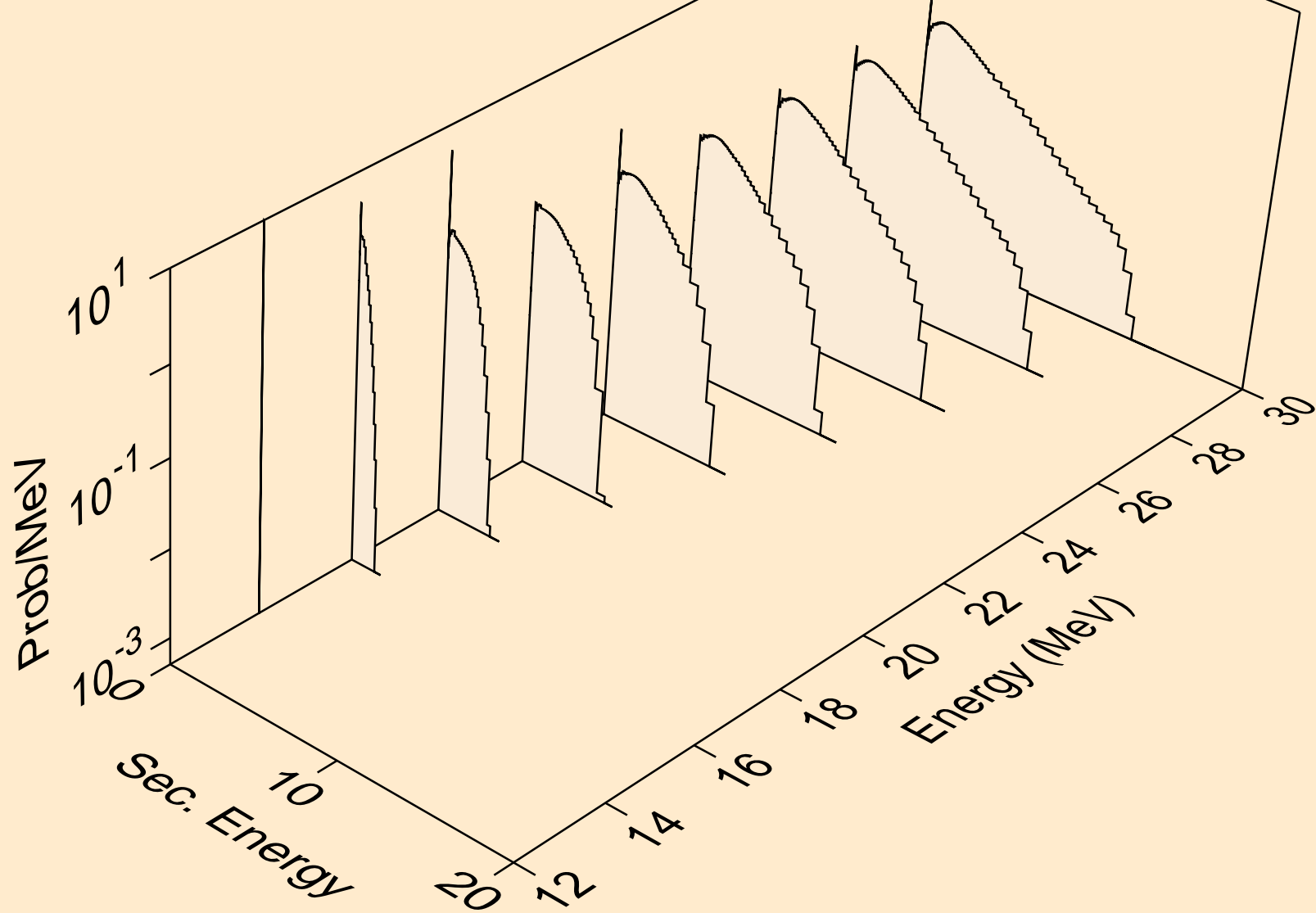

NE023 PROTON ACER TENDL-2024 LIBRARY; T=0.K  
neutrons from (p,n\*)t

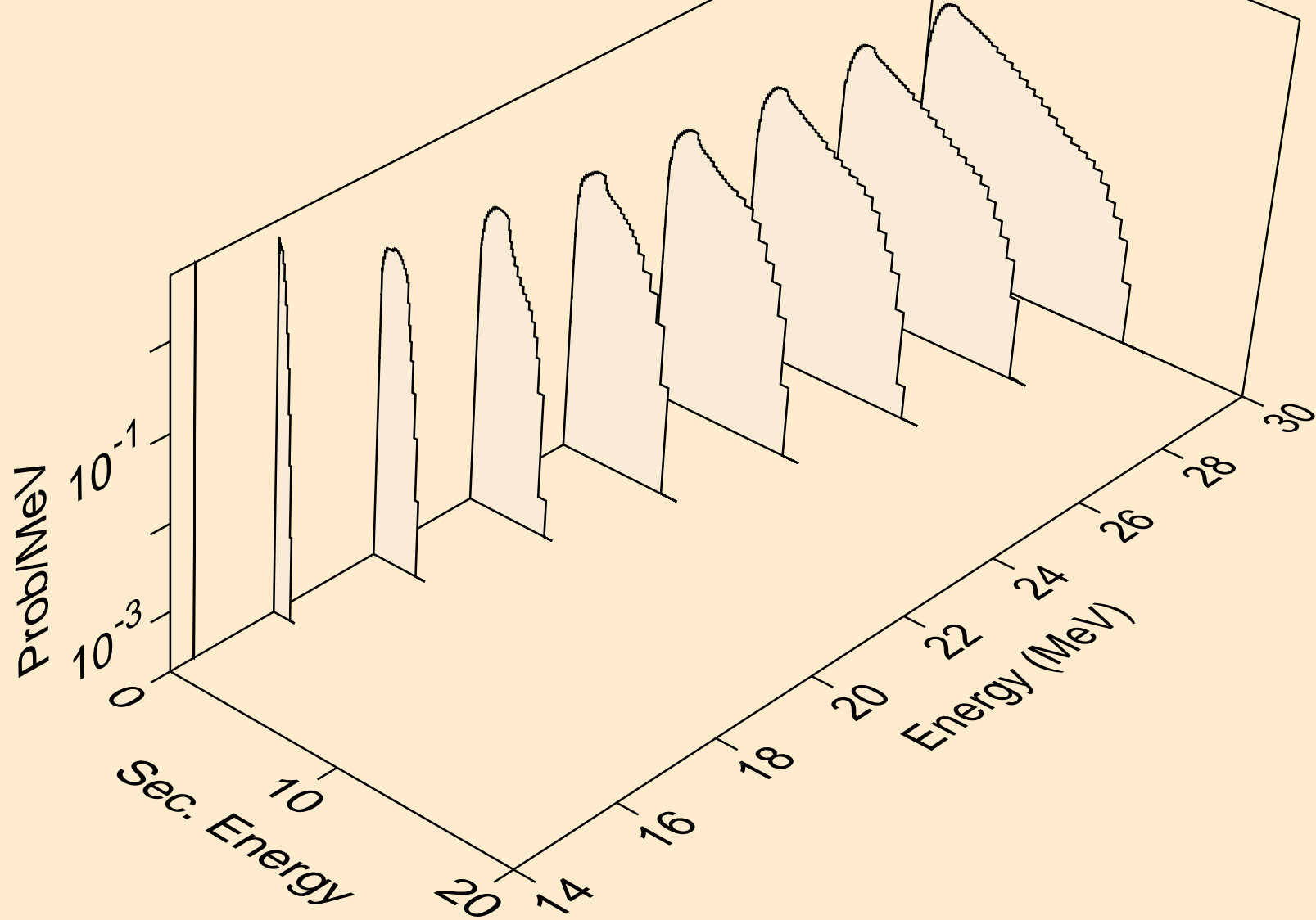

NE023 PROTON ACER TENDL-2024 LIBRARY; T=0.K  
neutrons from (p,n\*)he3

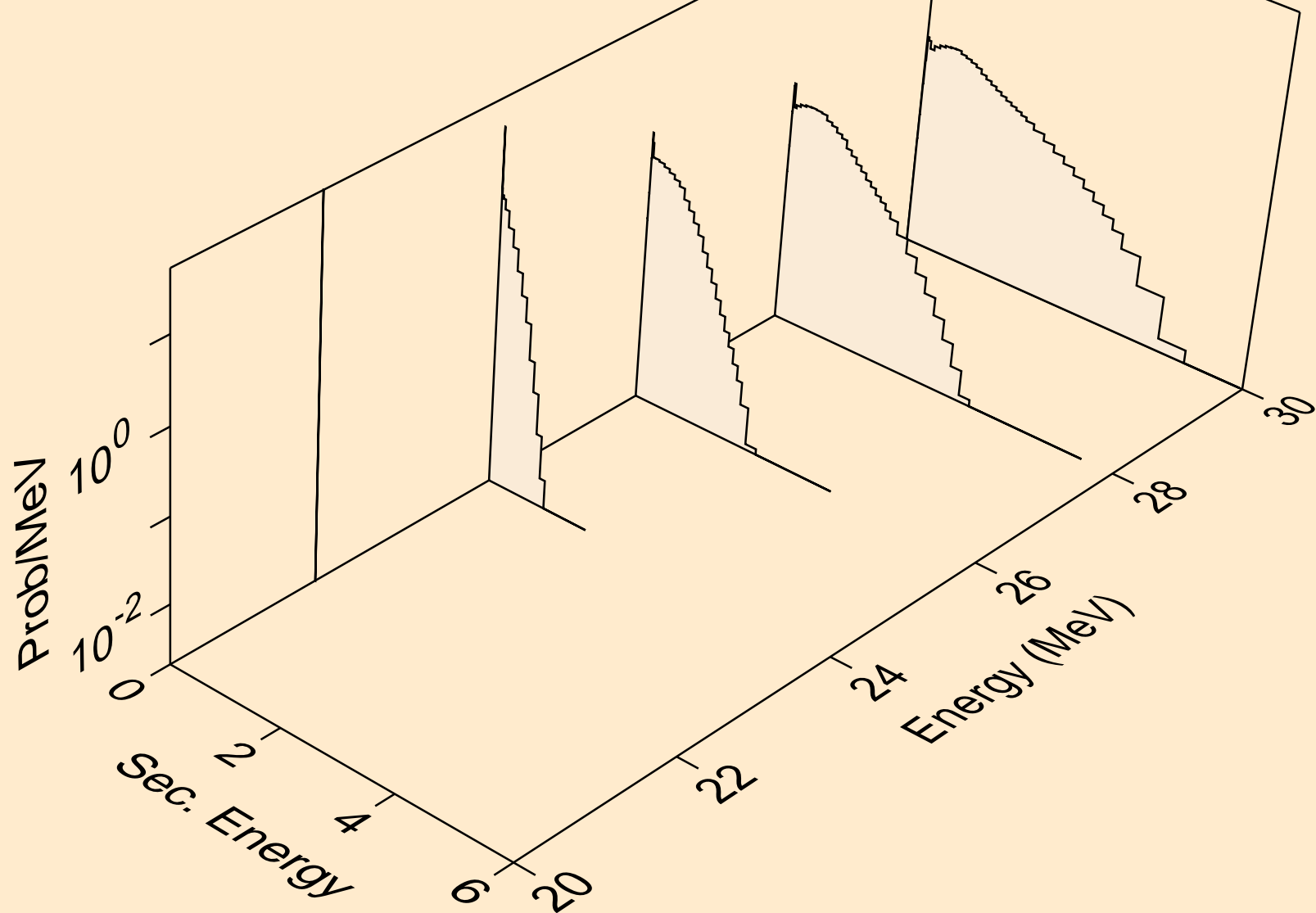

NE023 PROTON ACER TENDL-2024 LIBRARY; T=0.K  
neutrons from (p,2np)

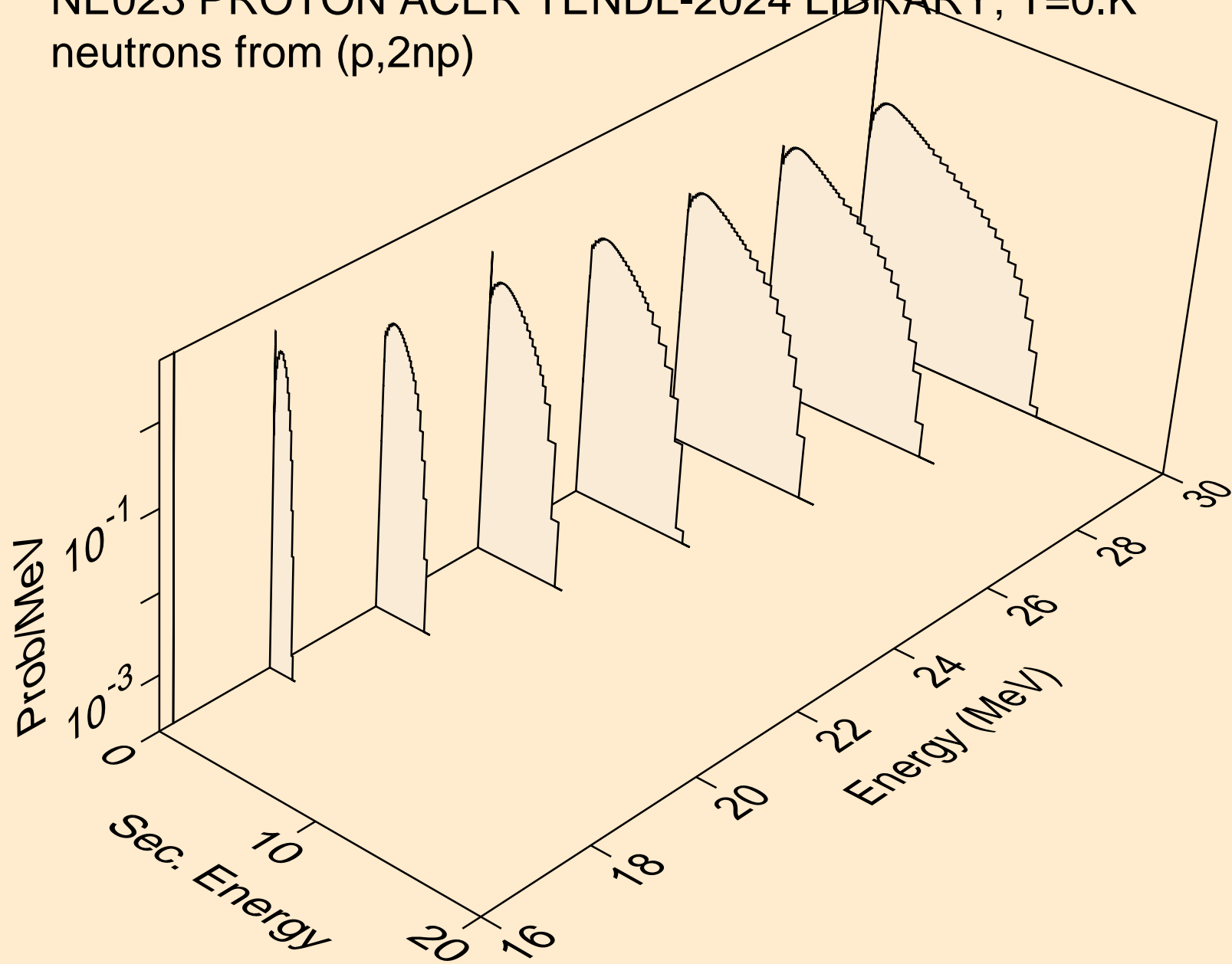

NE023 PROTON ACER TENDL-2024 LIBRARY; T=0.K  
neutrons from (p,3np)

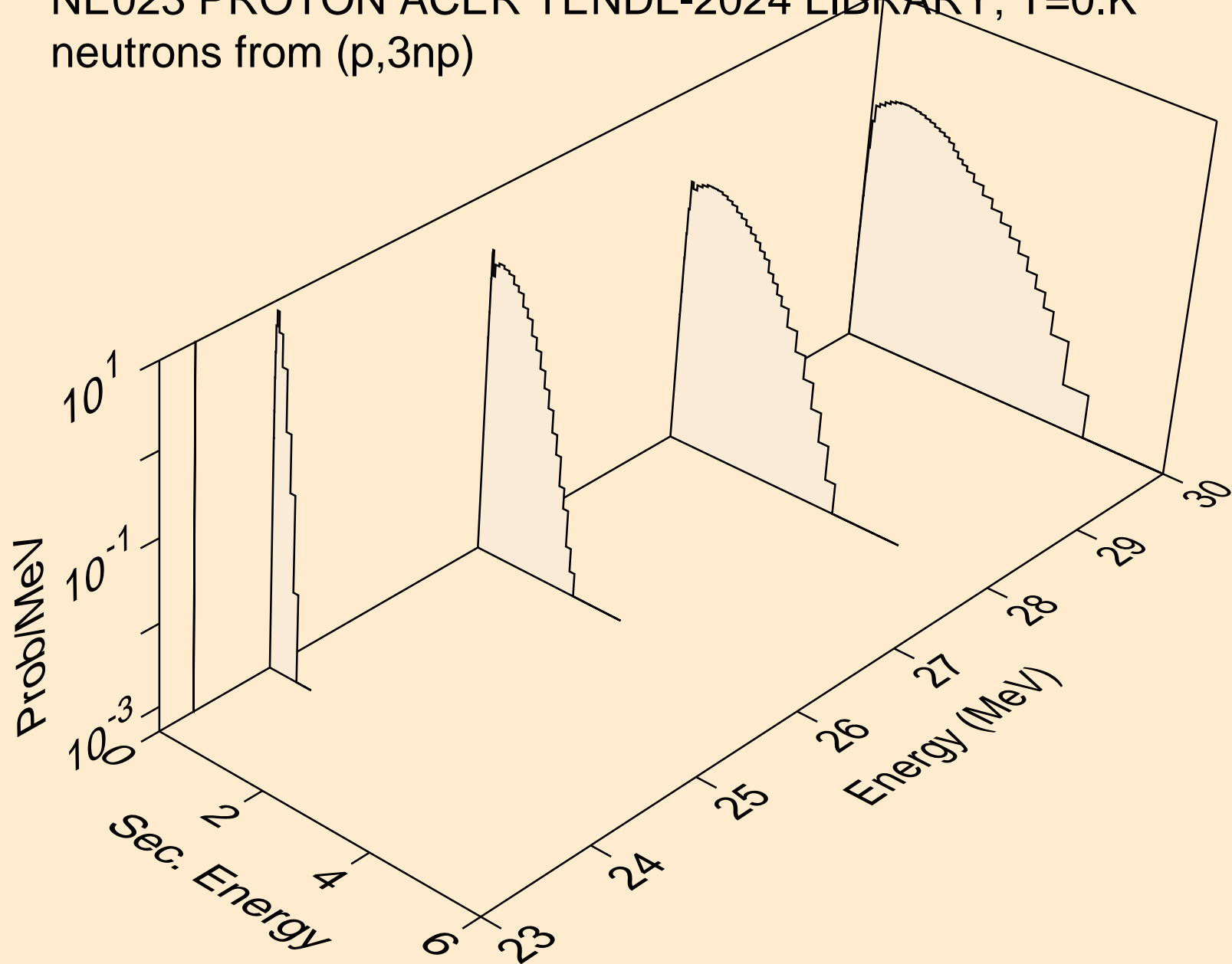

NE023 PROTON ACER TENDL-2024 LIBRARY; T=0.K  
neutrons from (p,n2p)

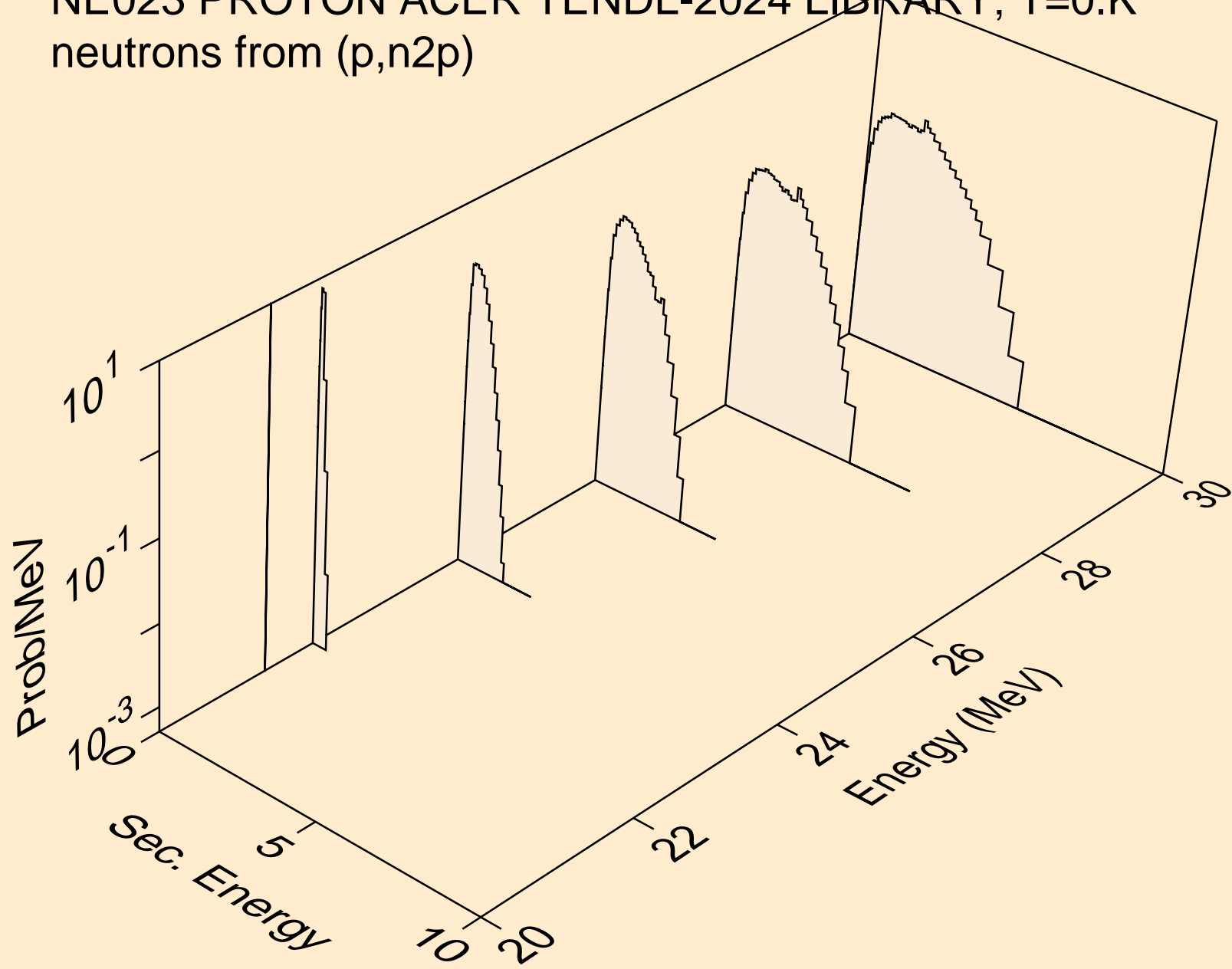

NE023 PROTON ACER TENDL-2024 LIBRARY; T=0.K  
neutrons from (p,npa)

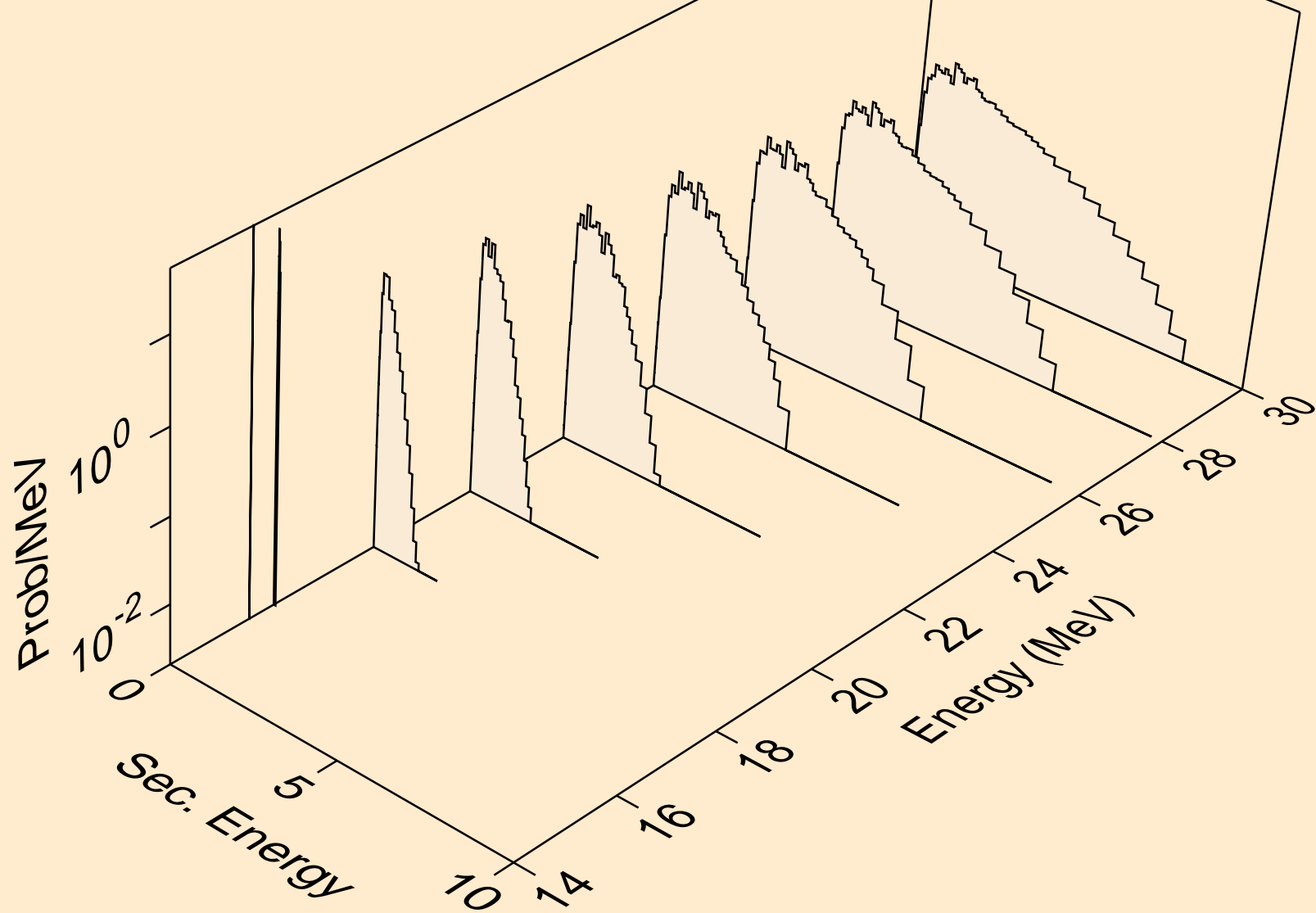

NE023 PROTON ACER TENDL-2024 LIBRARY; T=0.K  
deuterons from (p,x)

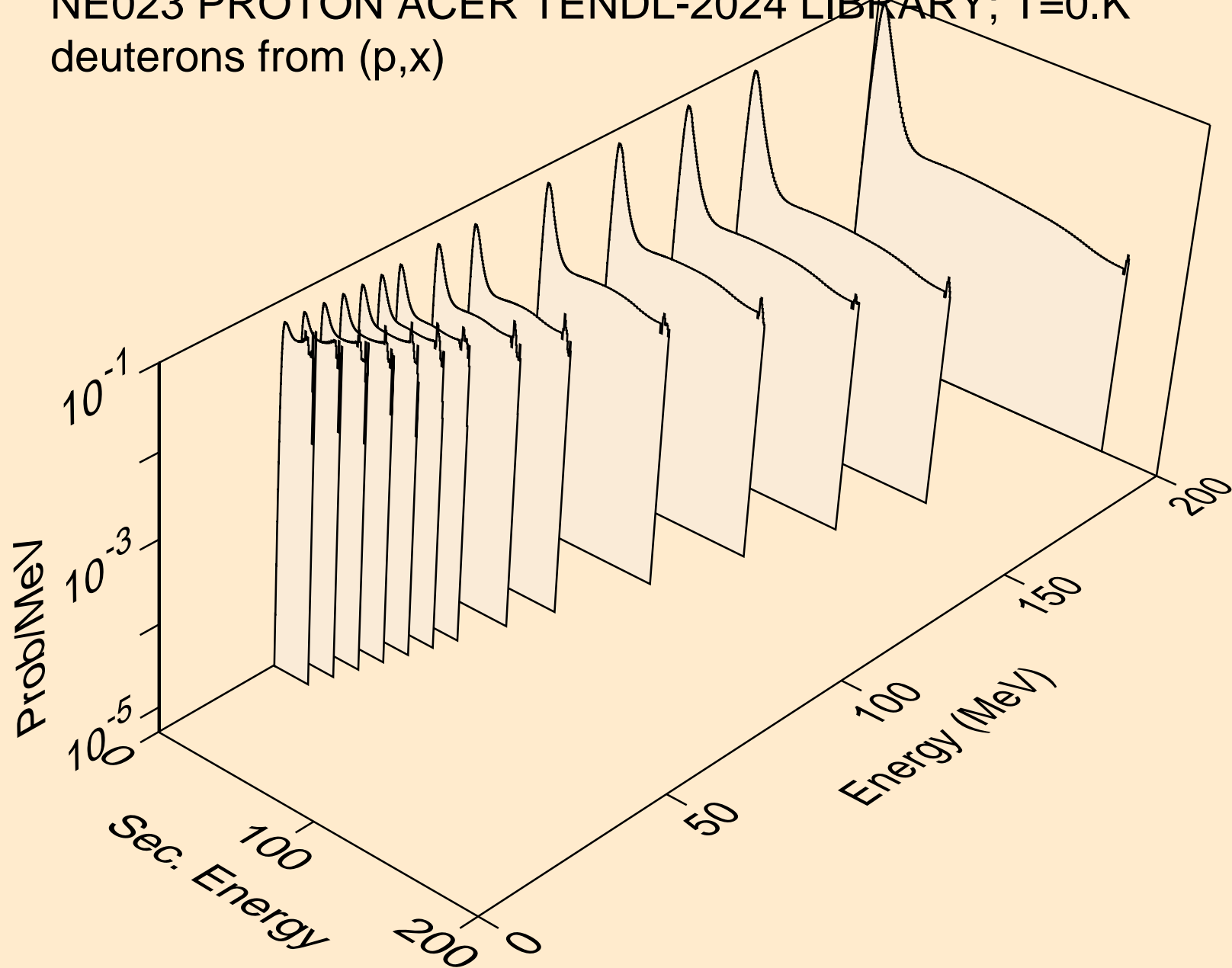

NE023 PROTON ACER TENDL-2024 LIBRARY; T=0.K  
deuterons from (p,2nd)

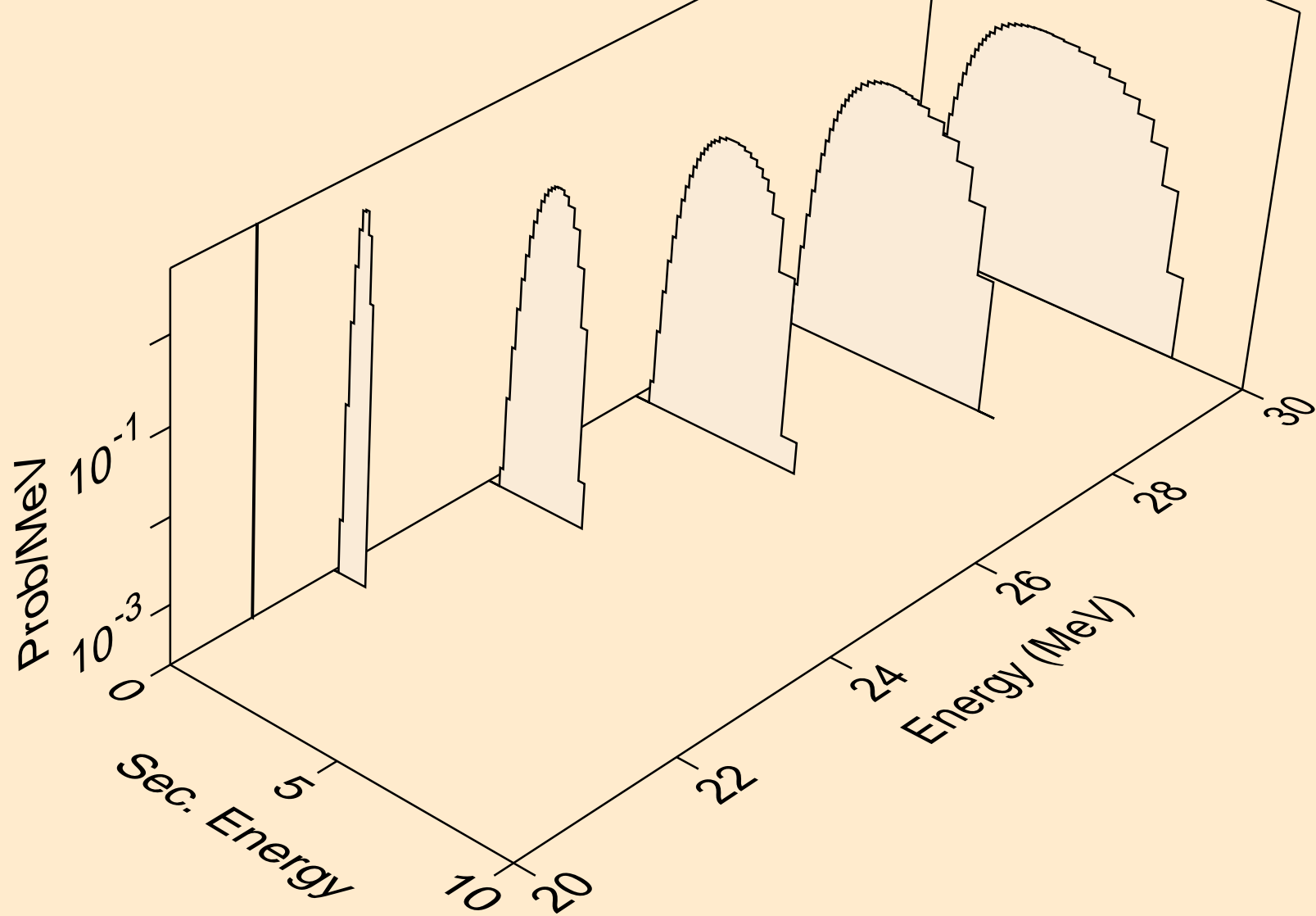

NE023 PROTON ACER TENDL-2024 LIBRARY; T=0.K  
deuterons from (p,n\*)d

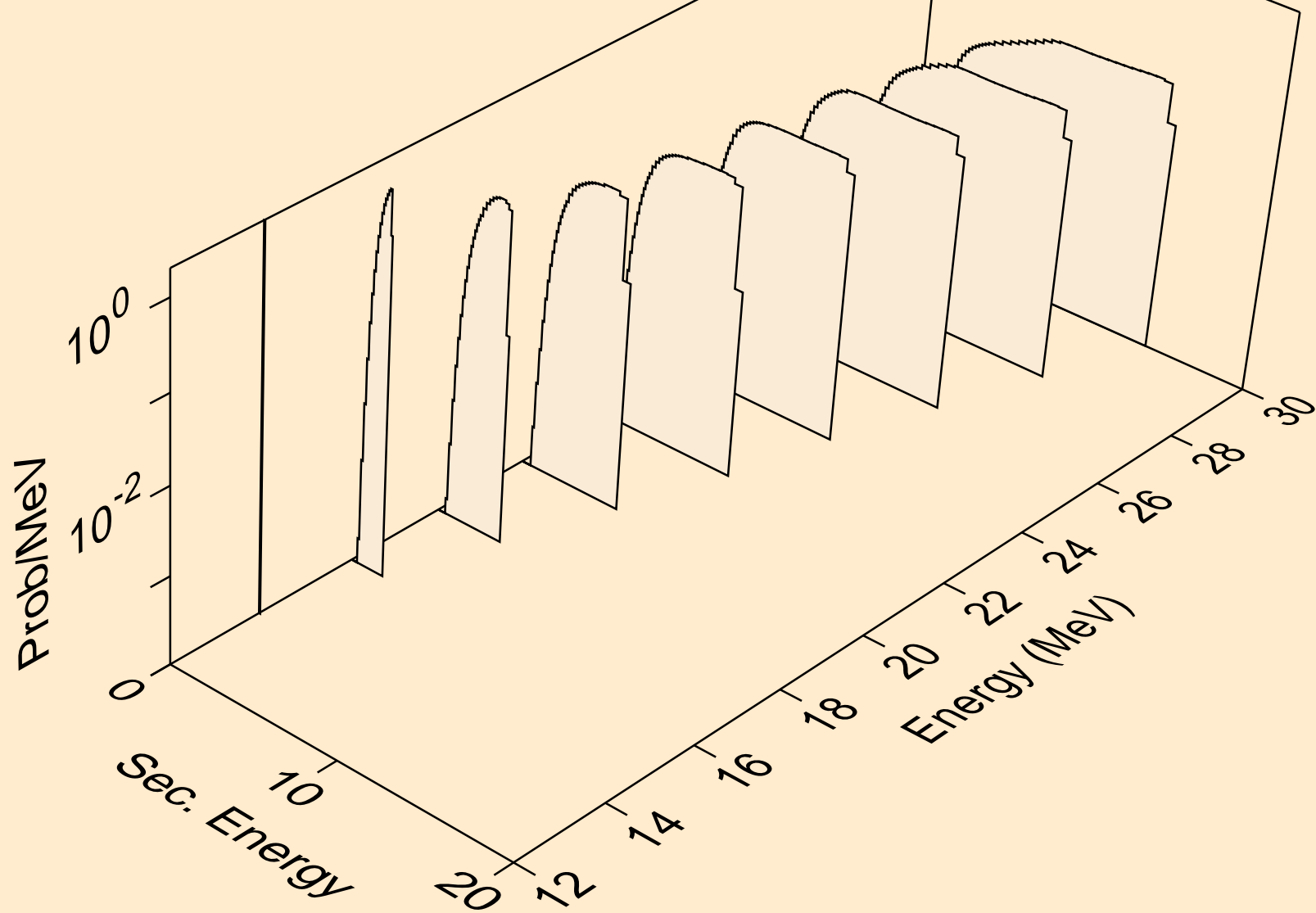

NE023 PROTON ACER TENDL-2024 LIBRARY; T=0.K  
deuterons from (p,d)

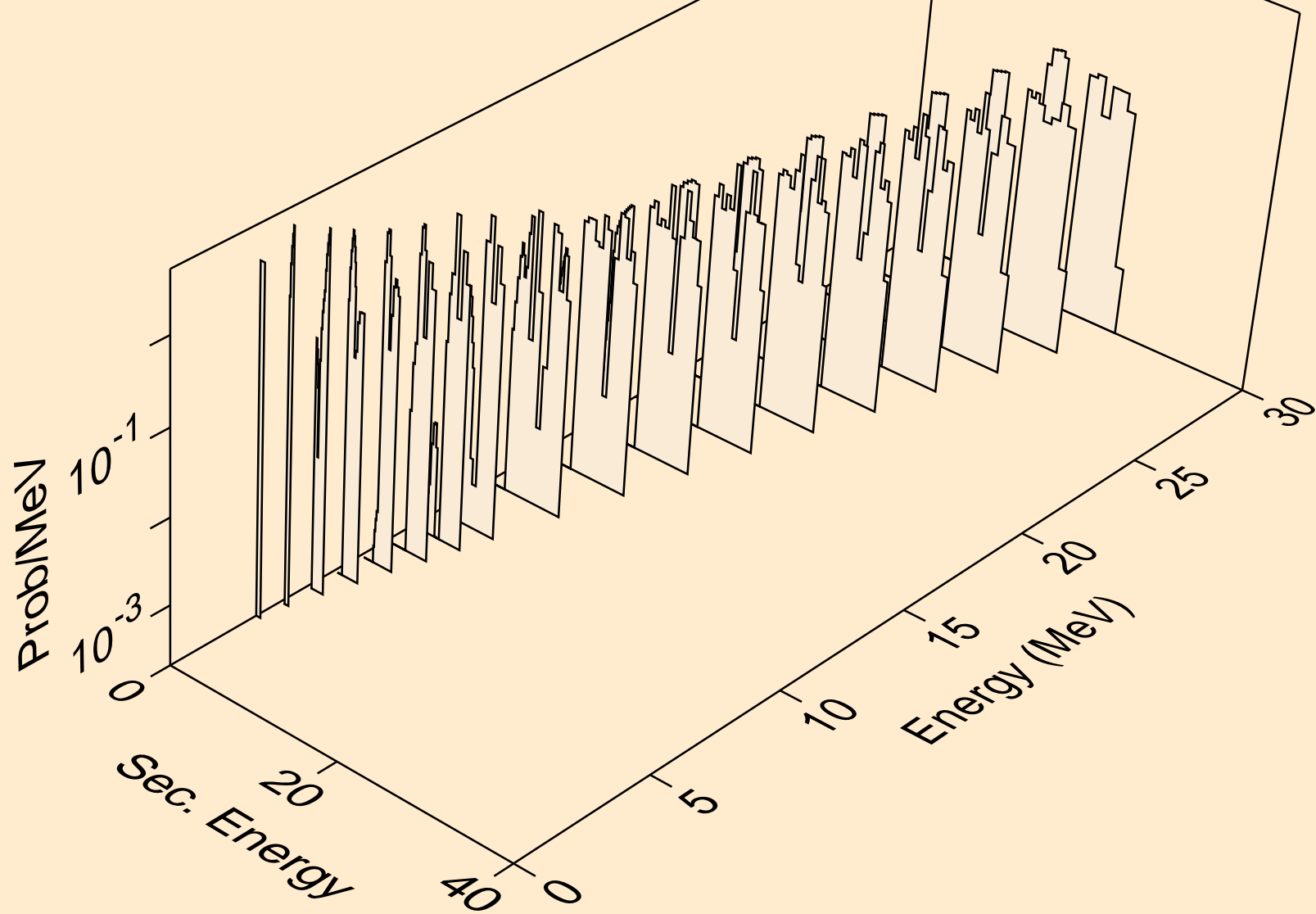

NE023 PROTON ACER TENDL-2024 LIBRARY; T=0.K  
deuterons from (p,d2a)

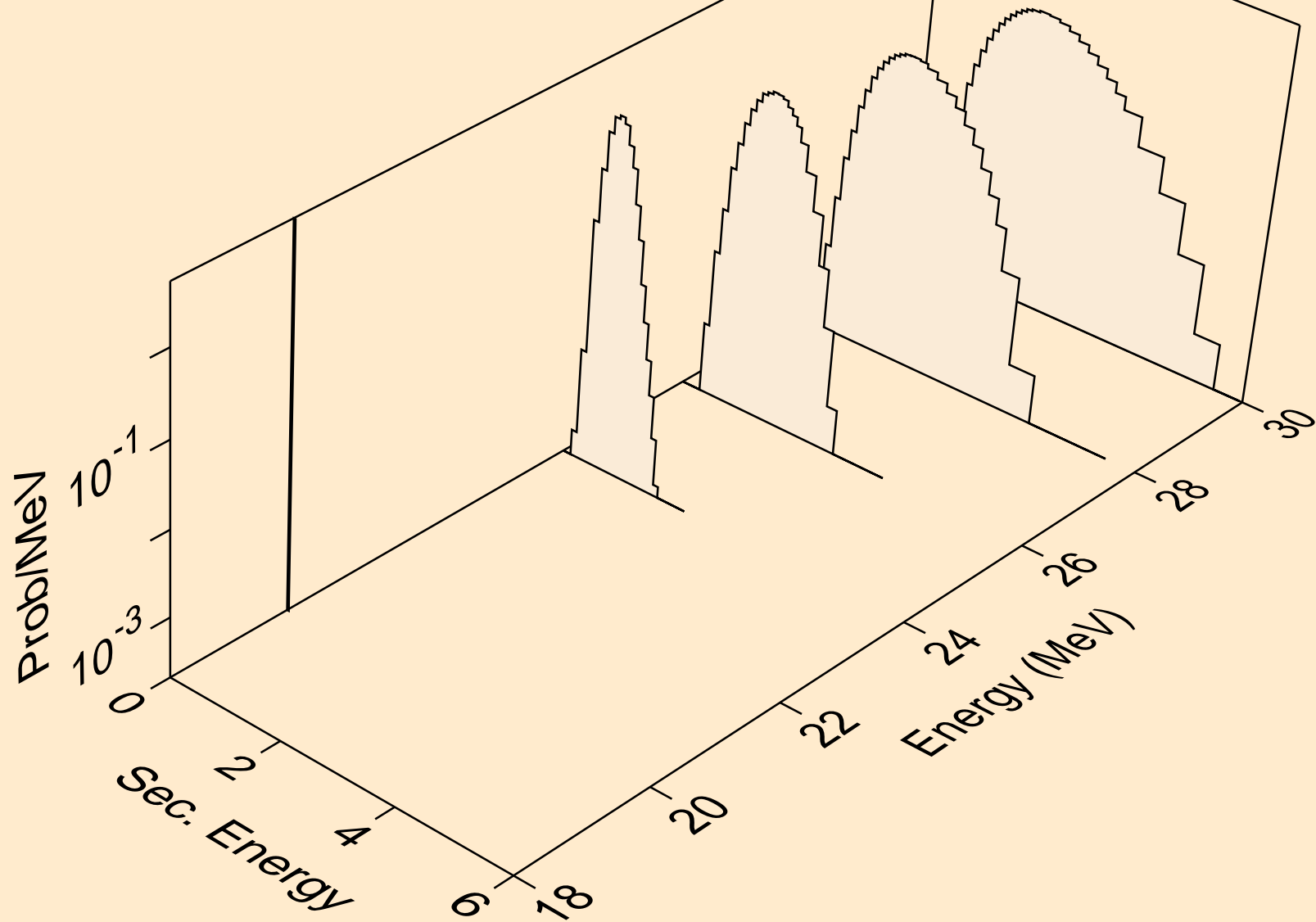

NE023 PROTON ACER TENDL-2024 LIBRARY; T=0.K  
deuterons from (p,pd)

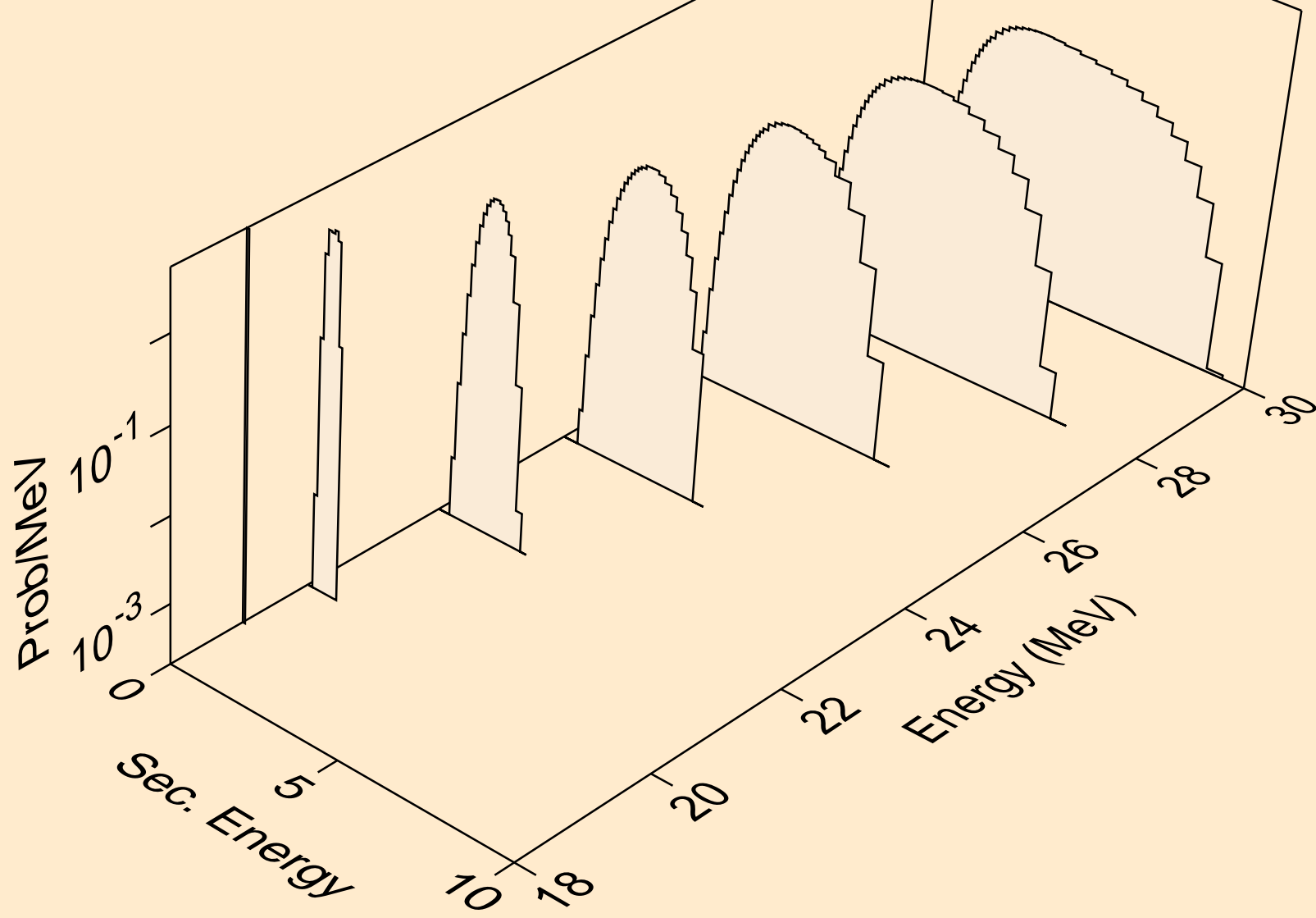

NE023 PROTON ACER TENDL-2024 LIBRARY; T=0.K  
deuterons from (p,da)

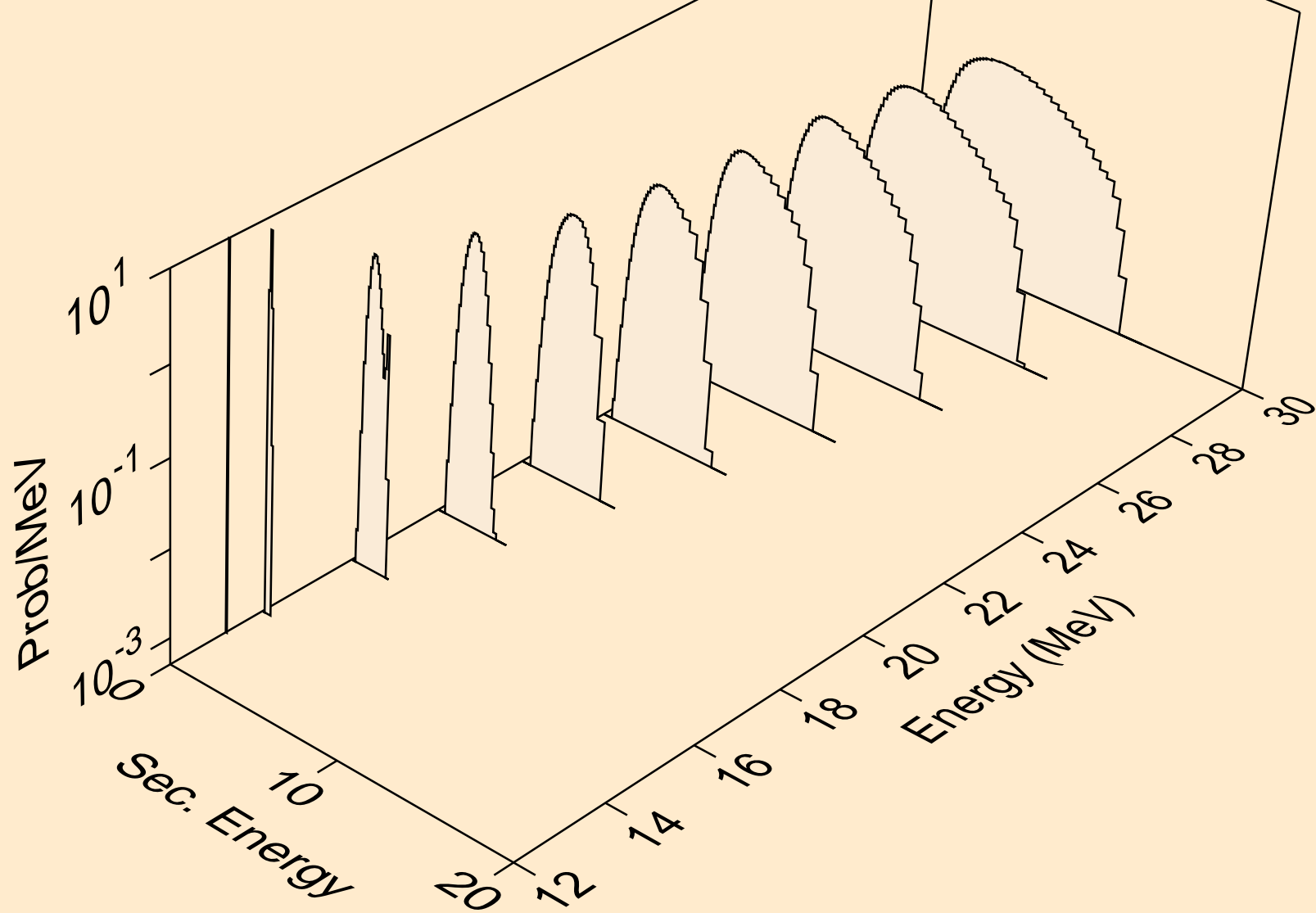

NE023 PROTON ACER TENDL-2024 LIBRARY; T=0.K  
tritons from (p,x)

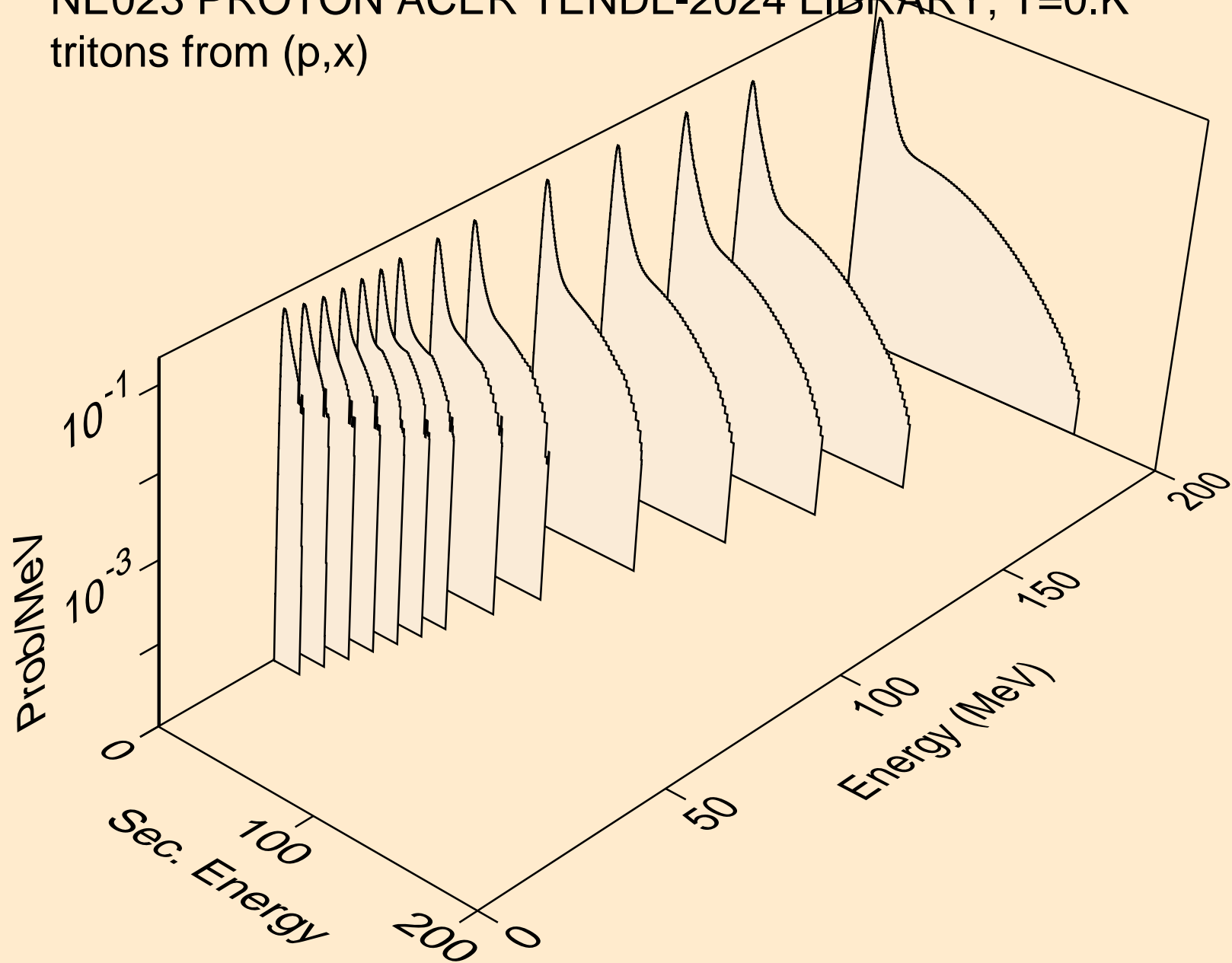

NE023 PROTON ACER TENDL-2024 LIBRARY; T=0.K  
tritons from (p,n\*)t

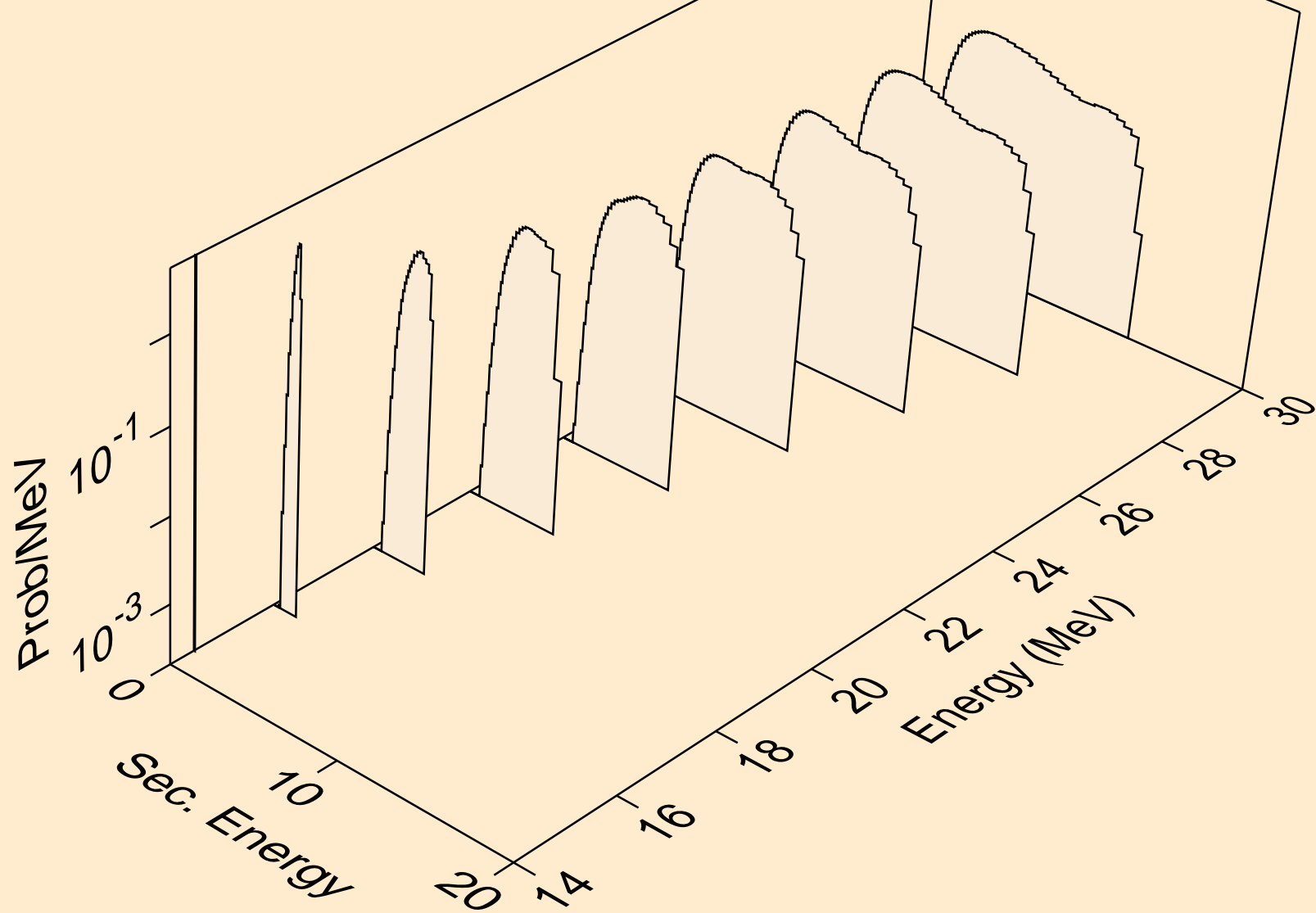

NE023 PROTON ACER TENDL-2024 LIBRARY; T=0.K  
tritons from (p,t)

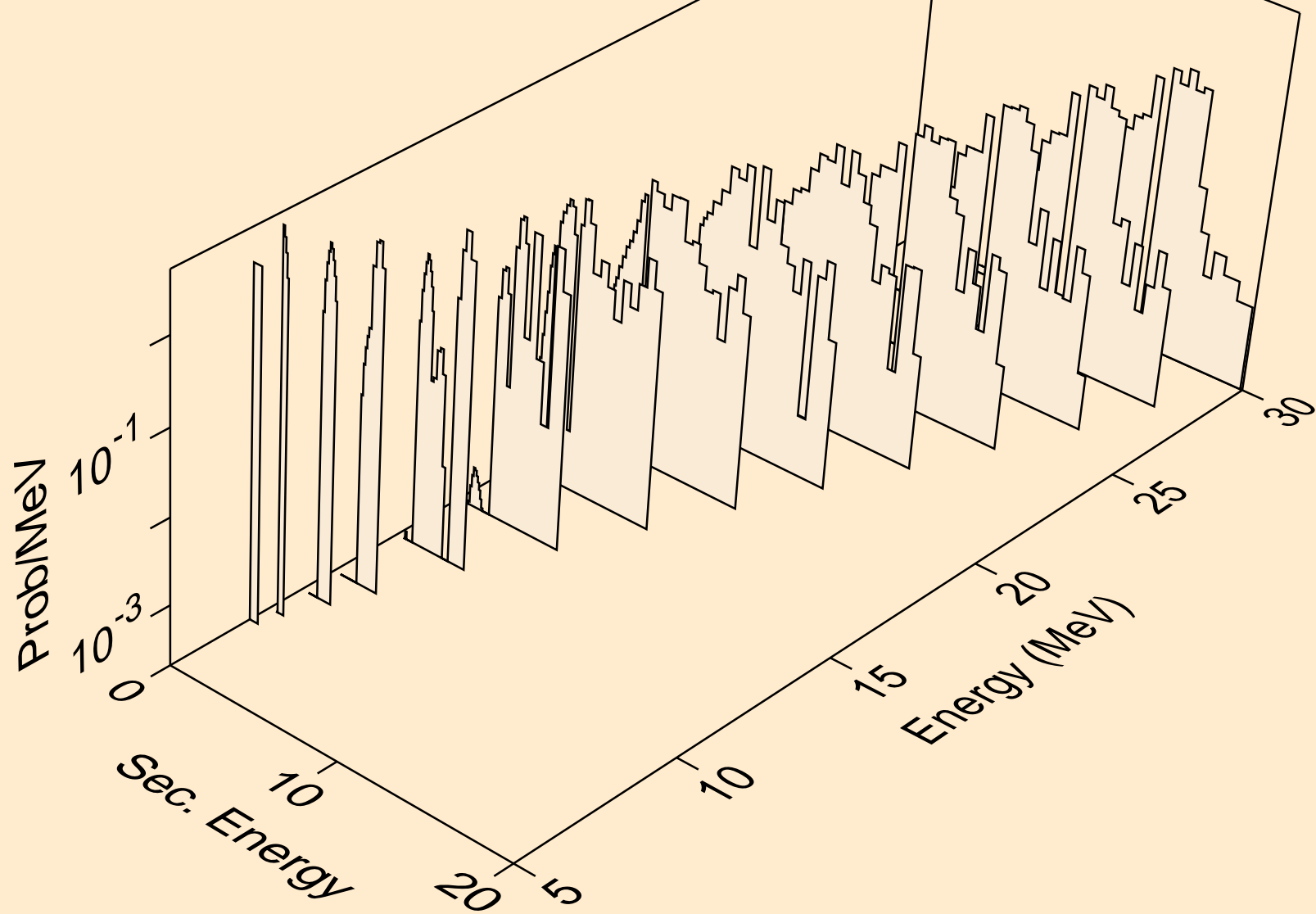

NE023 PROTON ACER TENDL-2024 LIBRARY; T=0.K  
tritons from (p,t2a)

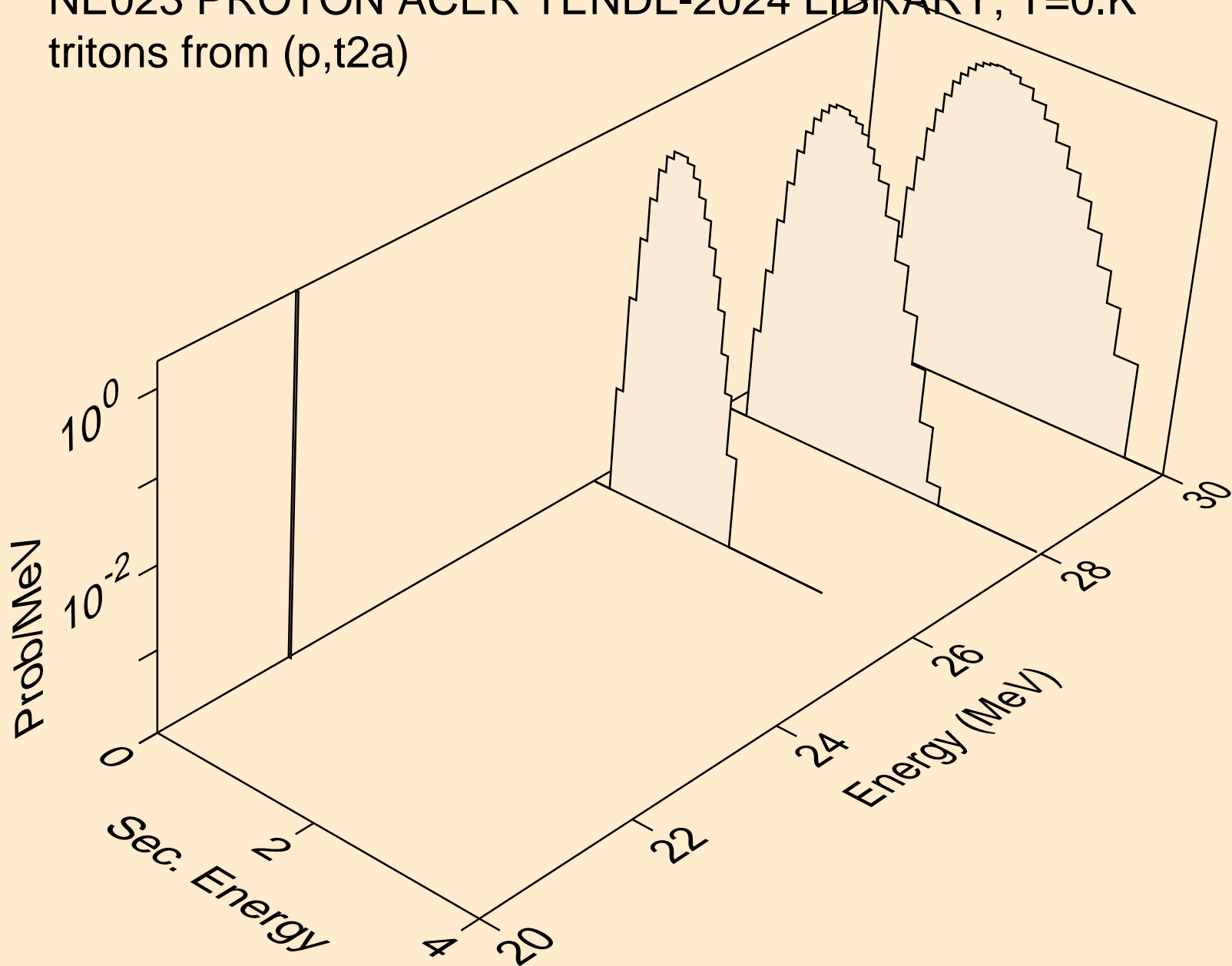

NE023 PROTON ACER TENDL-2024 LIBRARY; T=0.K  
tritons from (p,pt)

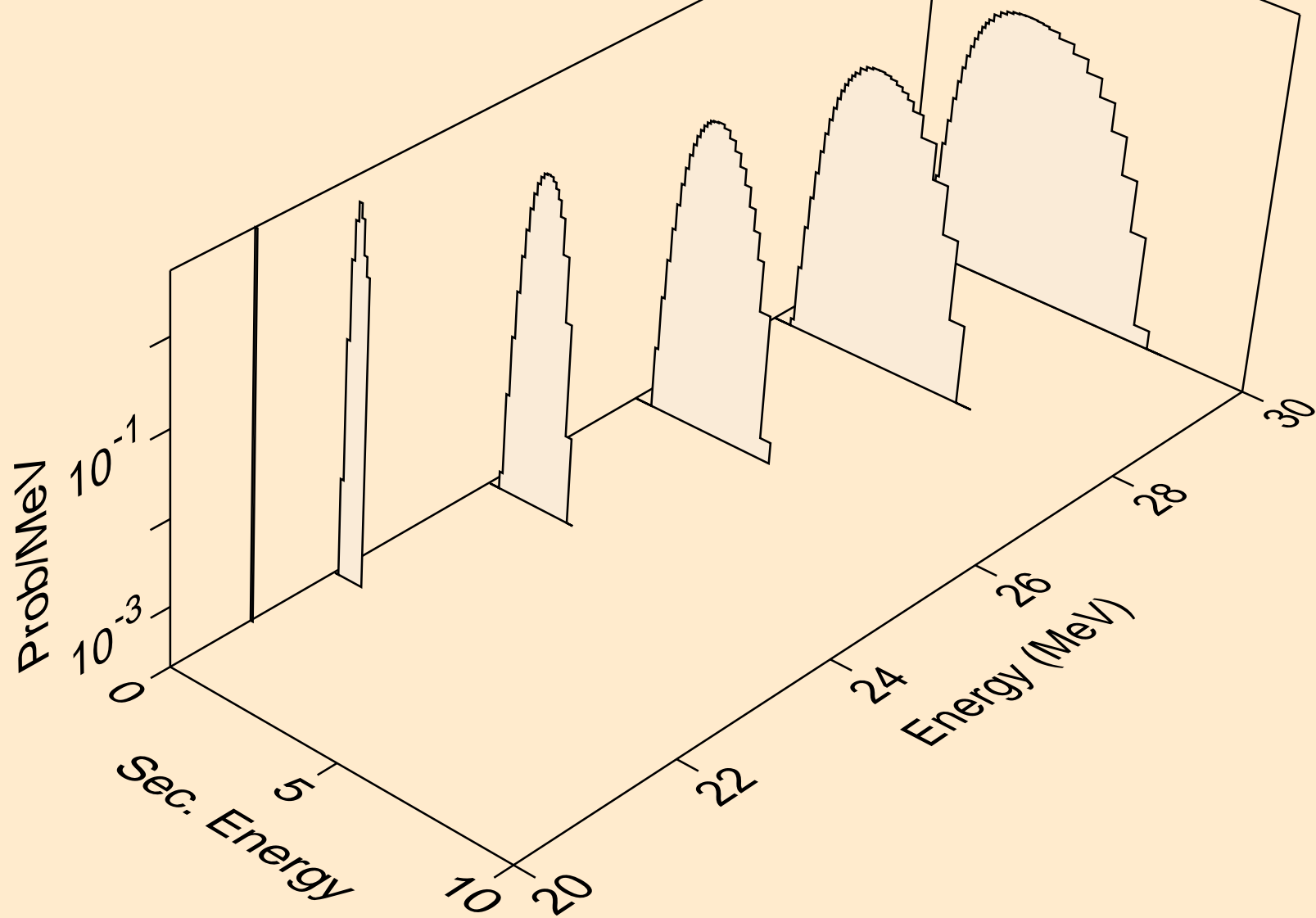

NE023 PROTON ACER TENDL-2024 LIBRARY; T=0.K  
he3s from (p,x)

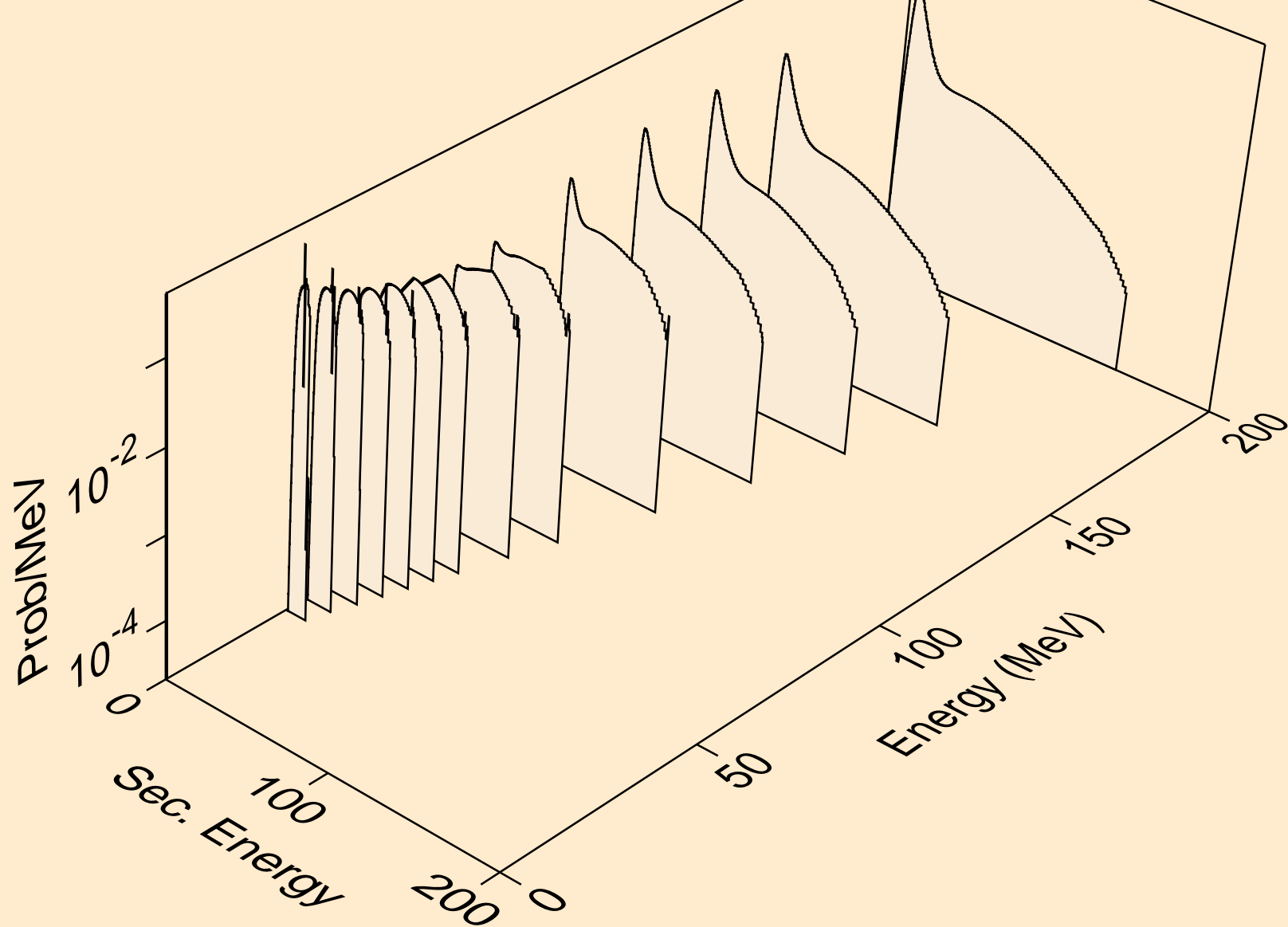

NE023 PROTON ACER TENDL-2024 LIBRARY; T=0.K  
he3s from (p,n\*)he3

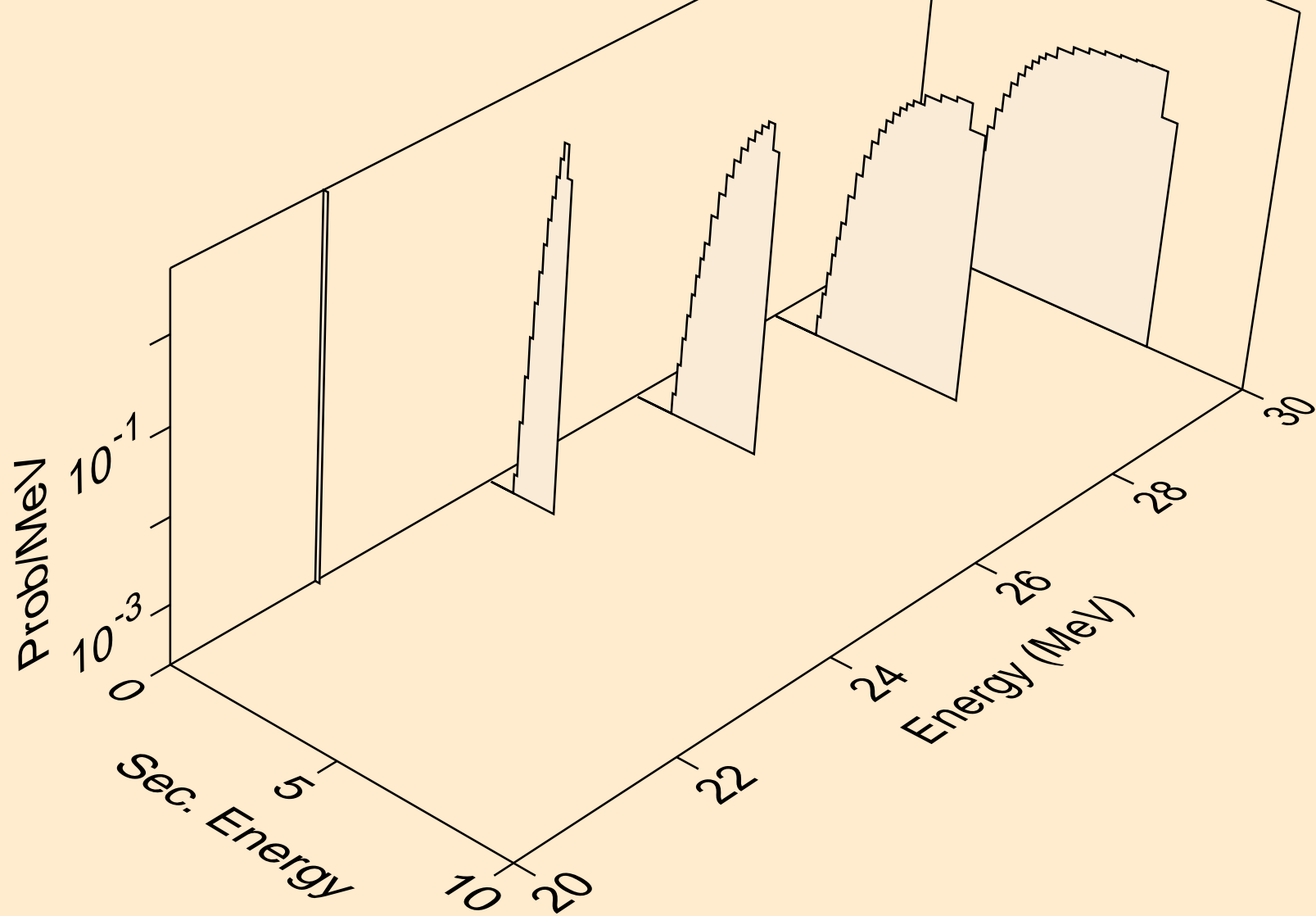

NE023 PROTON ACER TENDL-2024 LIBRARY; T=0.K  
he3s from (p,he3)

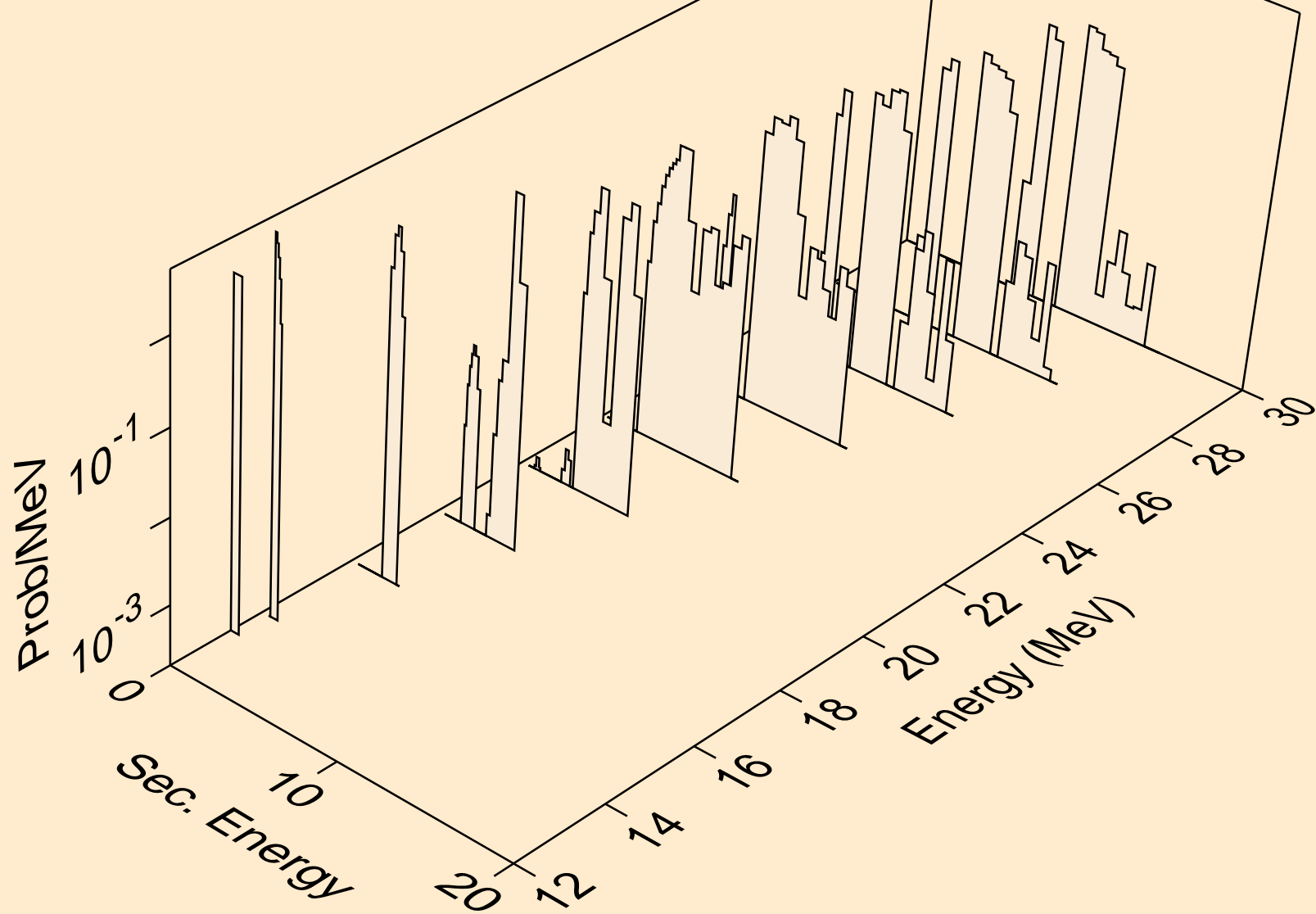

NE023 PROTON ACER TENDL-2024 LIBRARY; T=0.K  
alphas from (p,x)

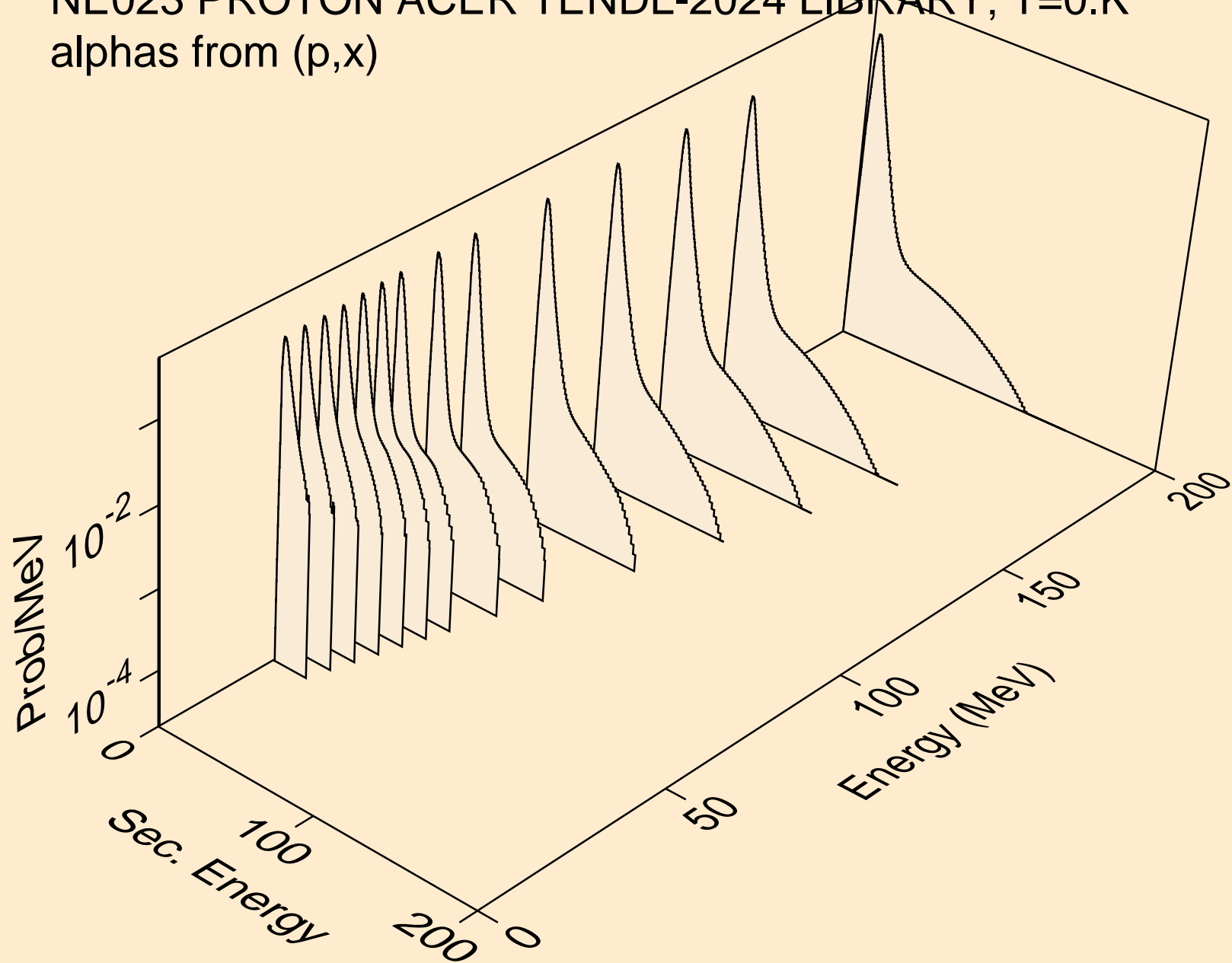

NE023 PROTON ACER TENDL-2024 LIBRARY; T=0.K  
alphas from (p,n\*)a

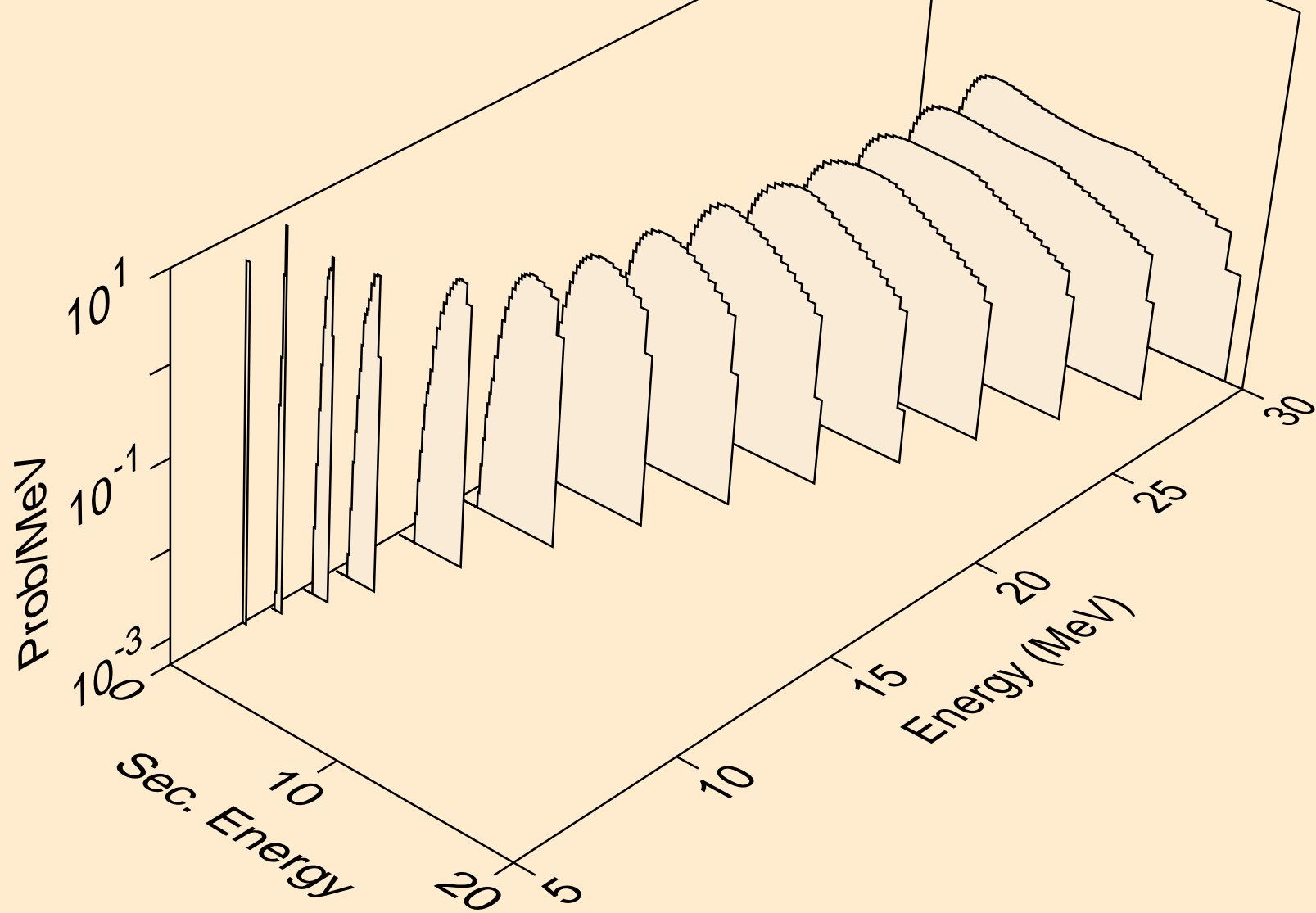

NE023 PROTON ACER TENDL-2024 LIBRARY; T=0.K  
alphas from (p,n\*)3a

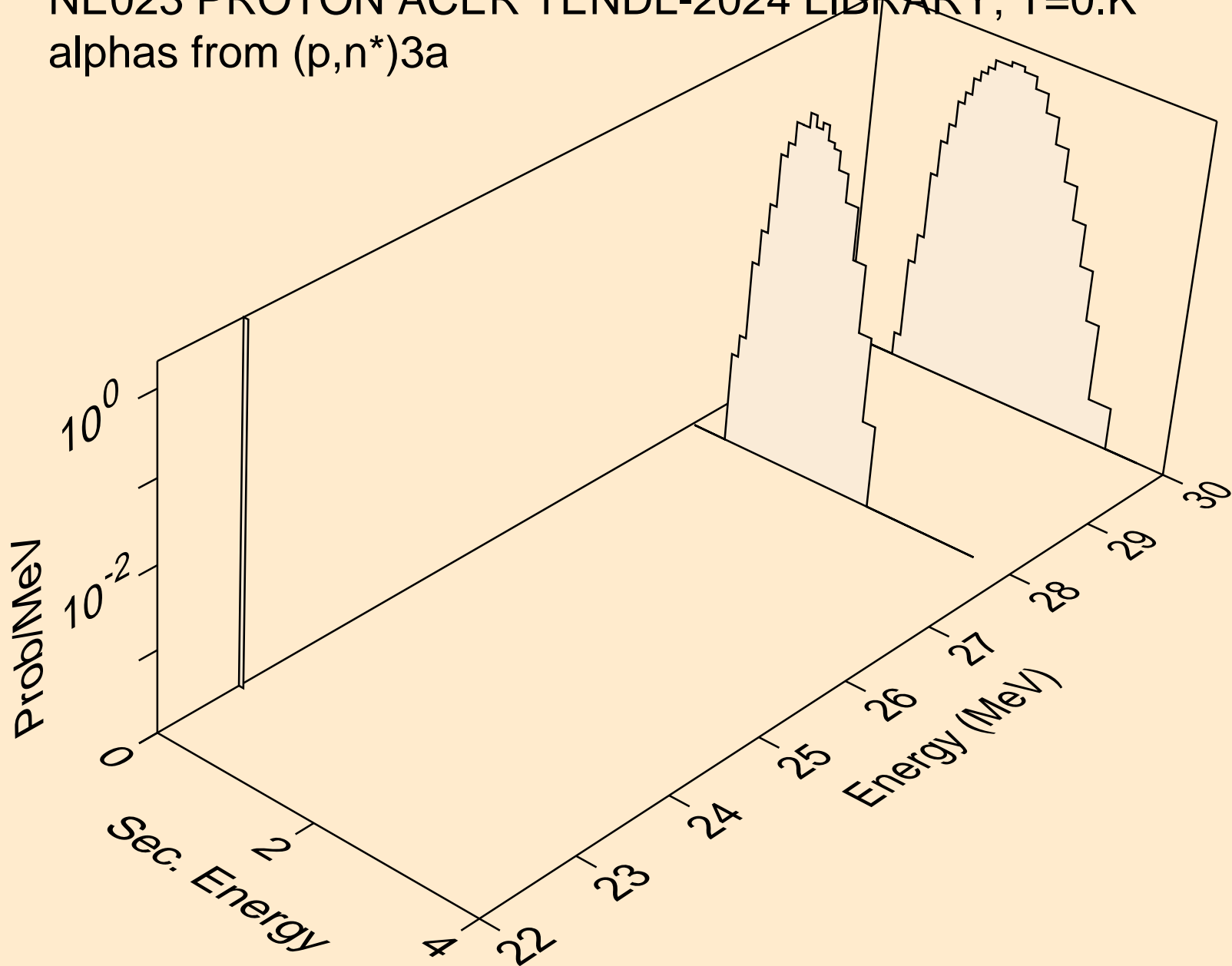

NE023 PROTON ACER TENDL-2024 LIBRARY; T=0.K  
alphas from (p,2n)a

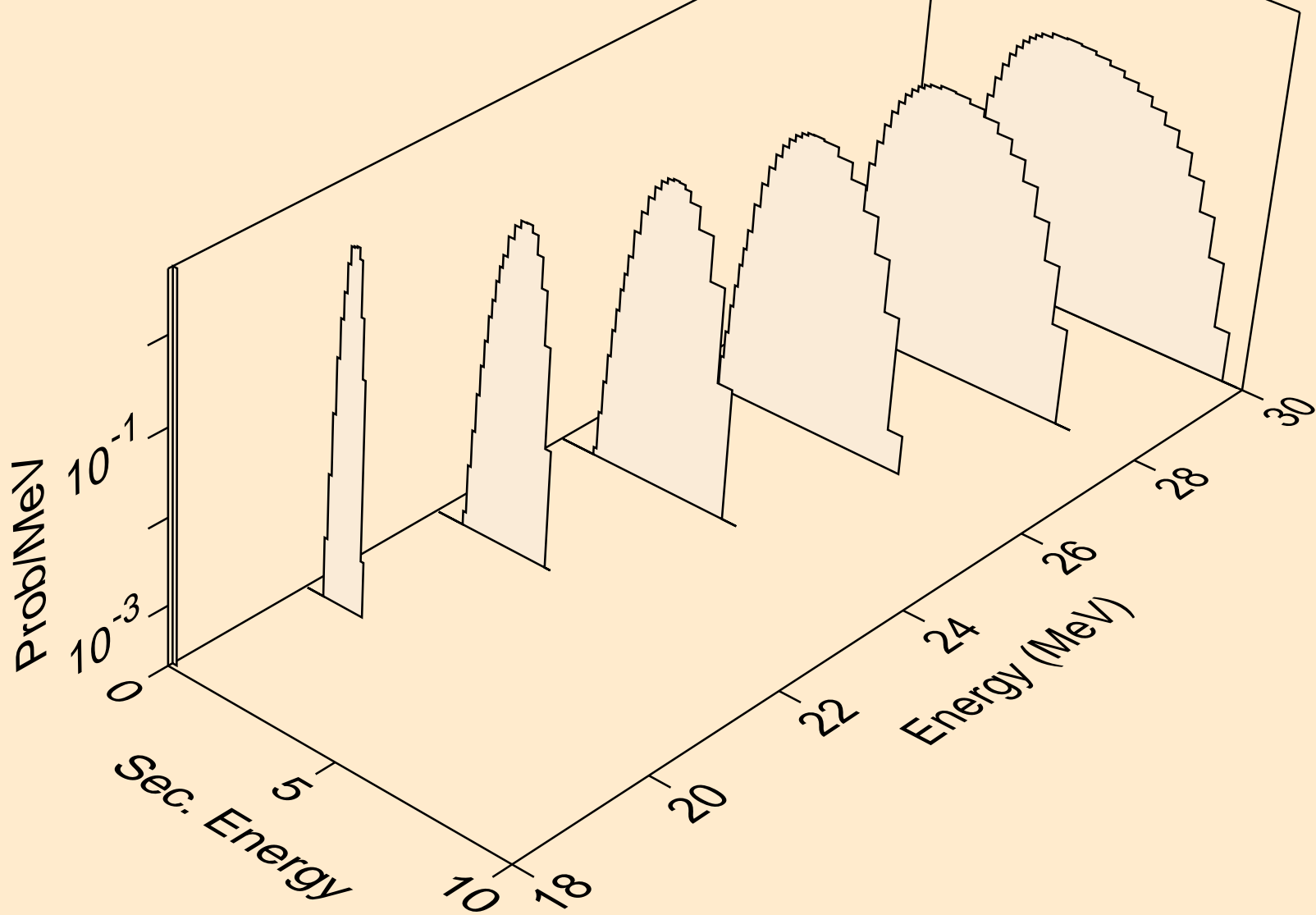

NE023 PROTON ACER TENDL-2024 LIBRARY; T=0.K  
alphas from (p,n\*)2a

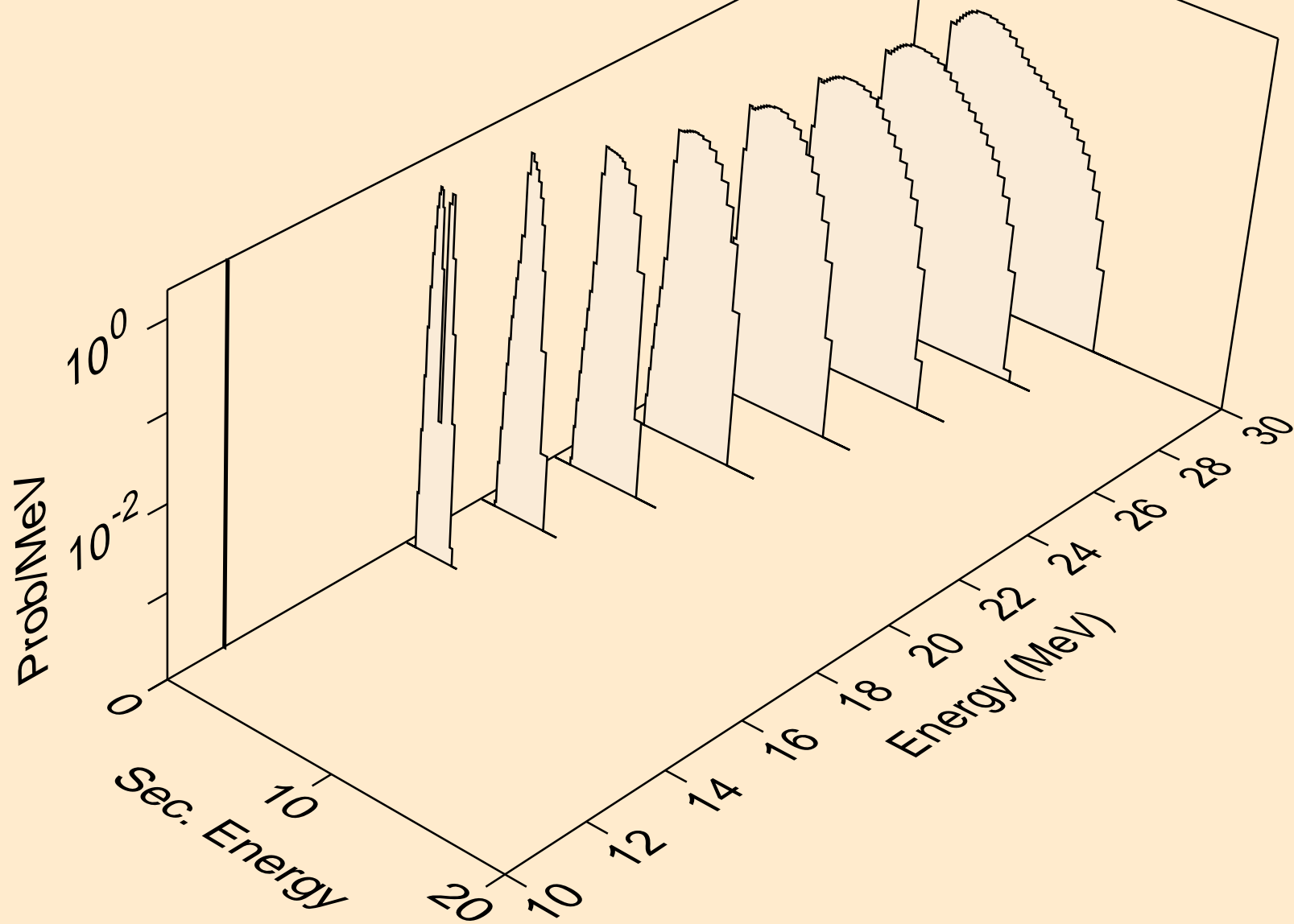

NE023 PROTON ACER TENDL-2024 LIBRARY; T=0.K  
alphas from (p,2n)2a

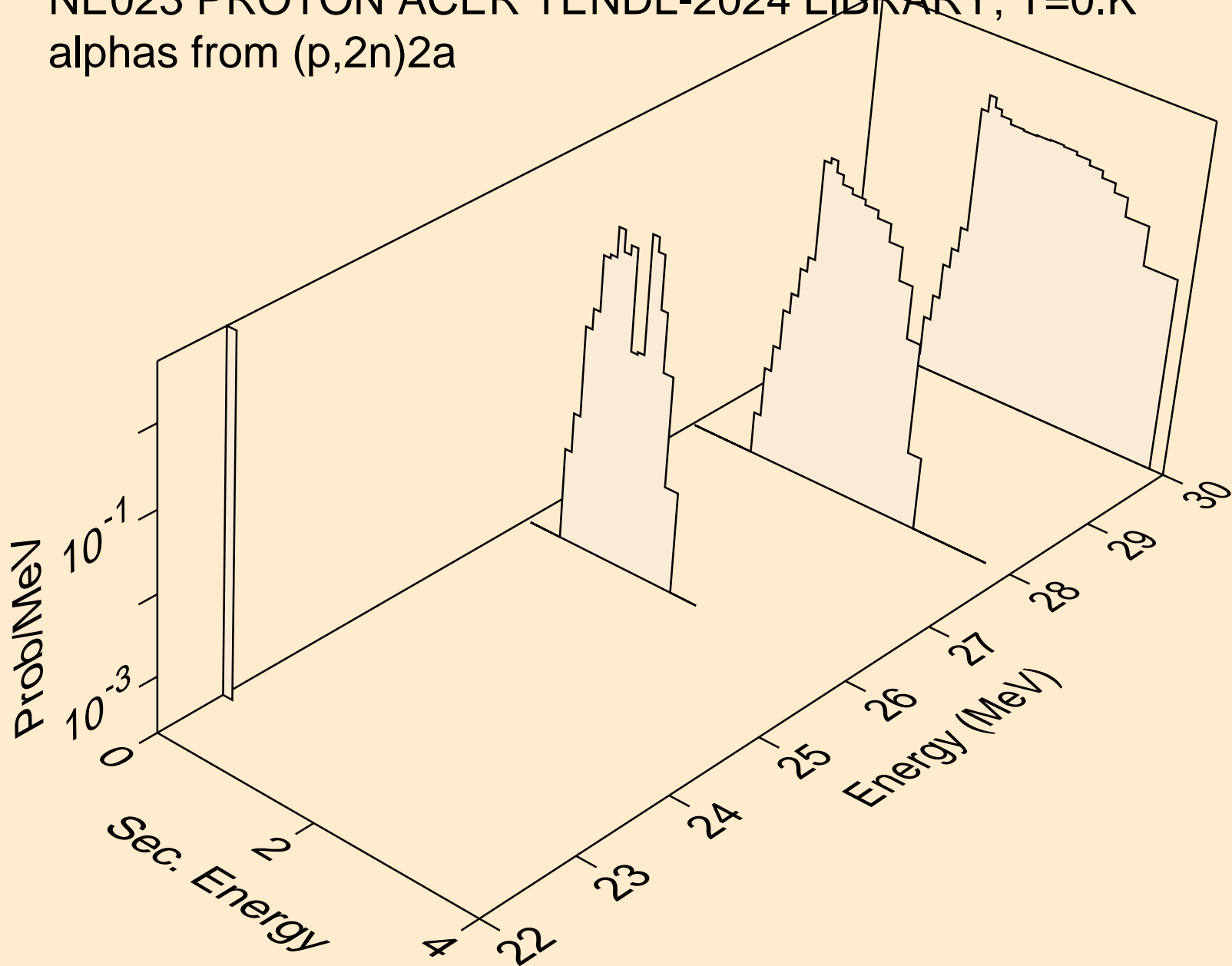

NE023 PROTON ACER TENDL-2024 LIBRARY; T=0.K  
alphas from (p,npa)

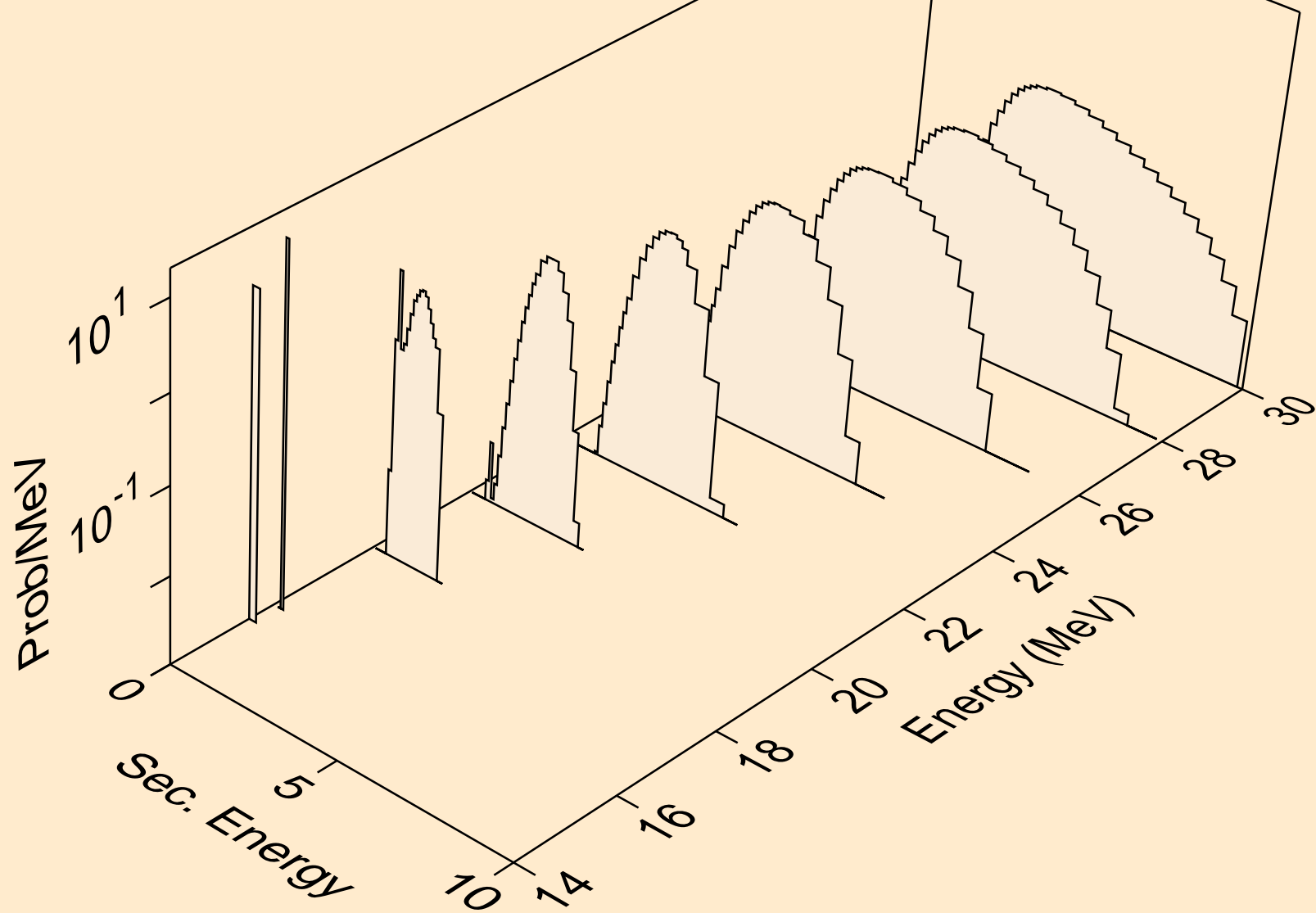

NE023 PROTON ACER TENDL-2024 LIBRARY; T=0.K  
alphas from (p,a)

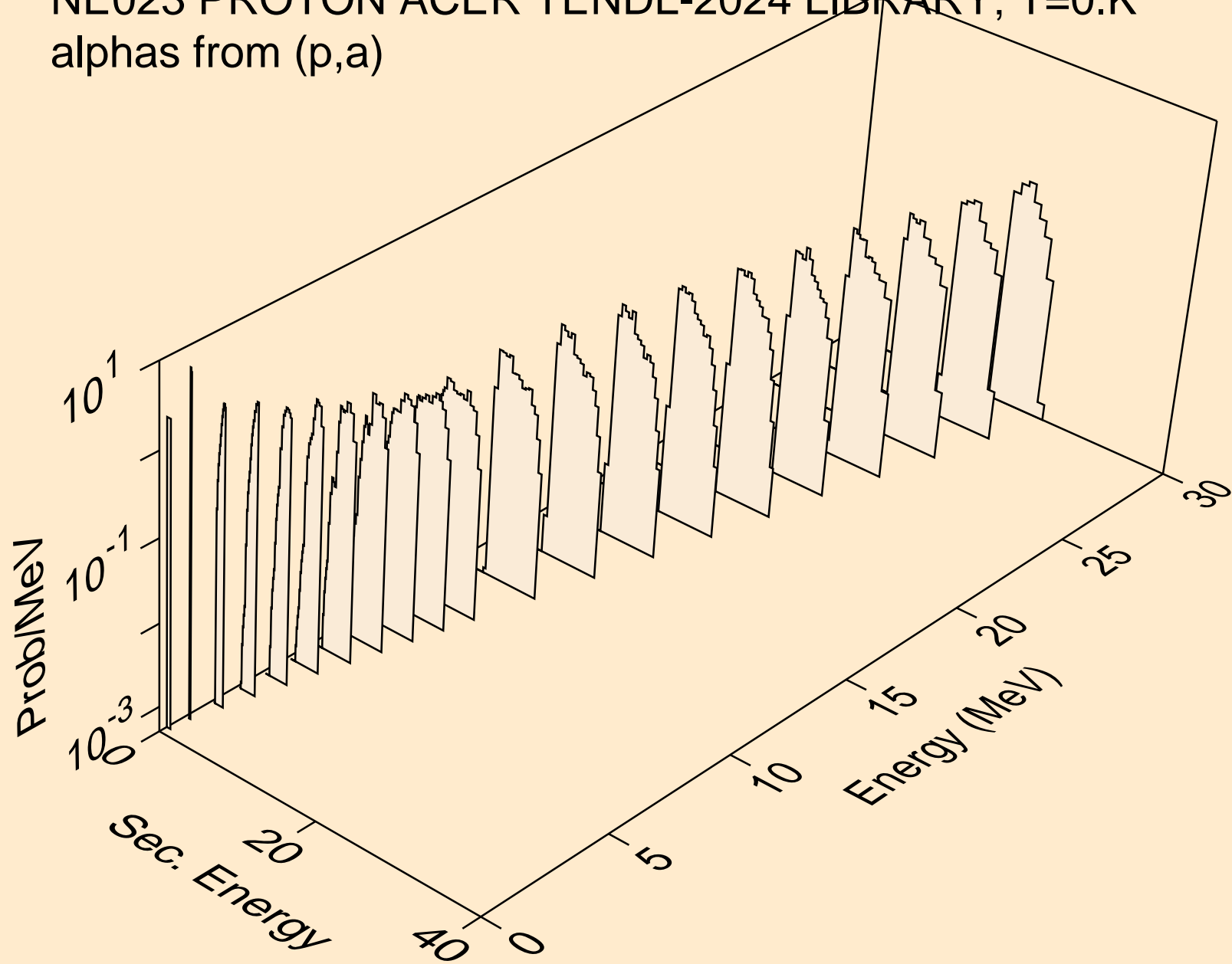

NE023 PROTON ACER TENDL-2024 LIBRARY; T=0.K  
alphas from (p,2a)

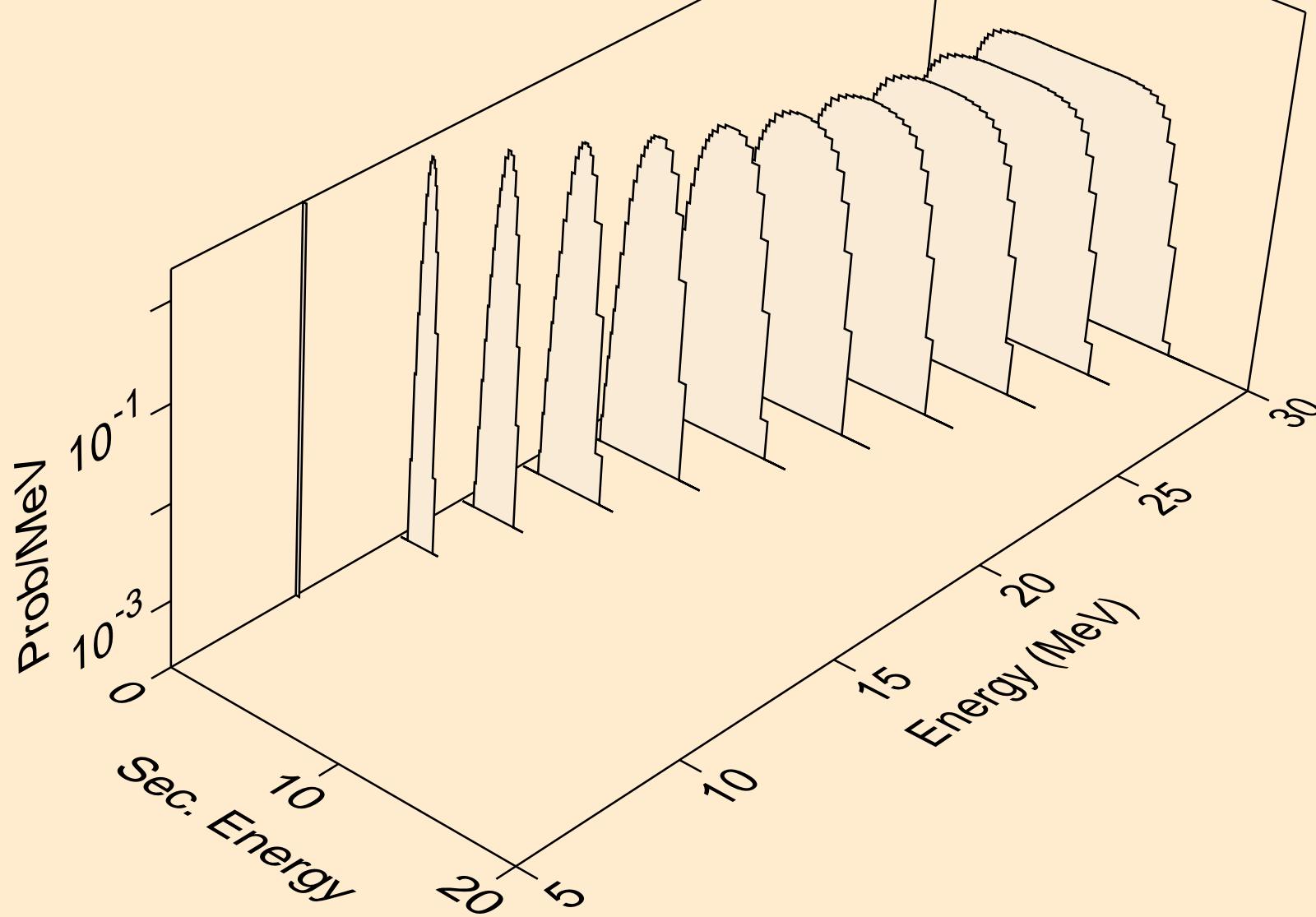

NE023 PROTON ACER TENDL-2024 LIBRARY; T=0.K  
alphas from (p,3a)

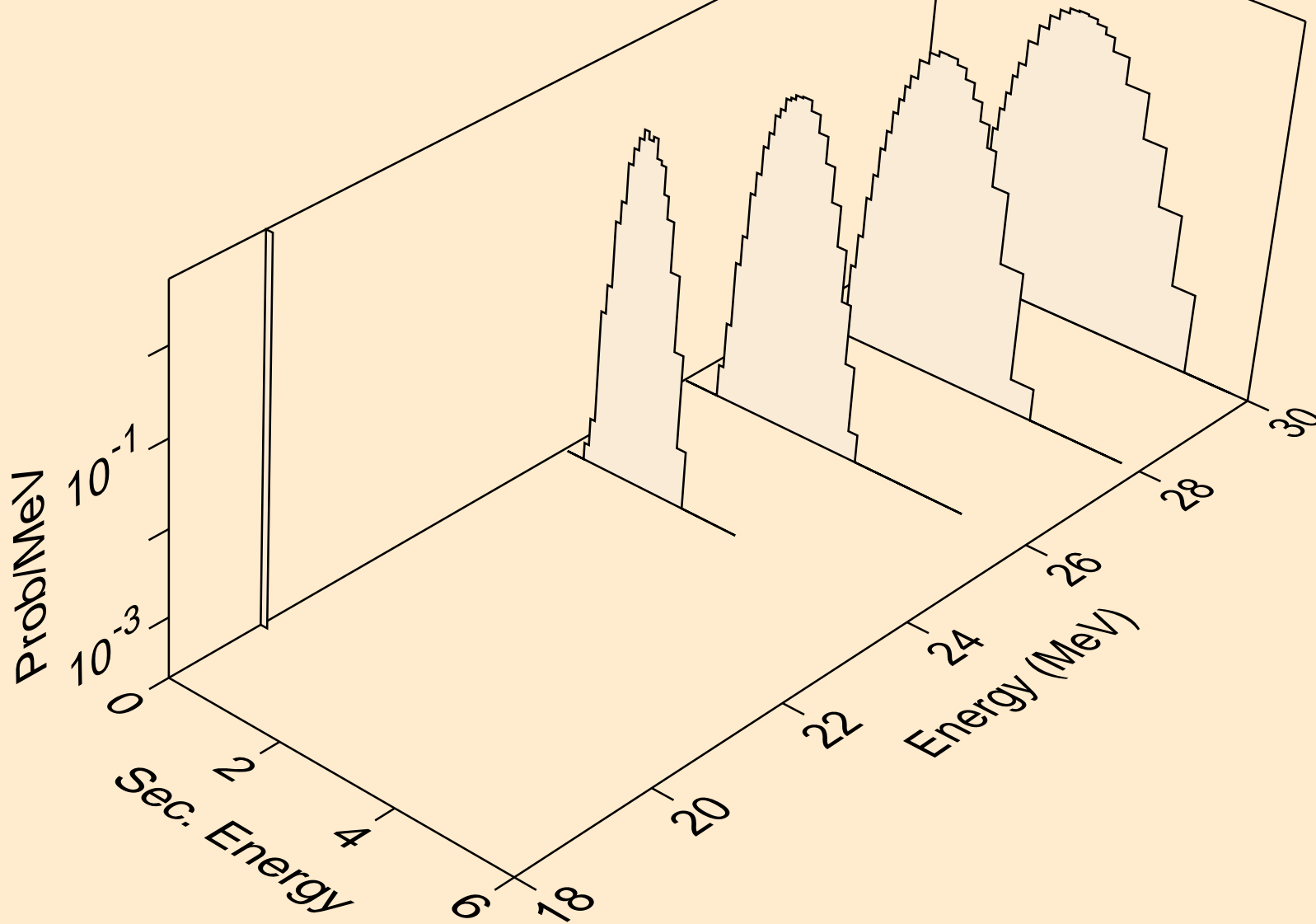

NE023 PROTON ACER TENDL-2024 LIBRARY; T=0.K  
alphas from (p,pa)

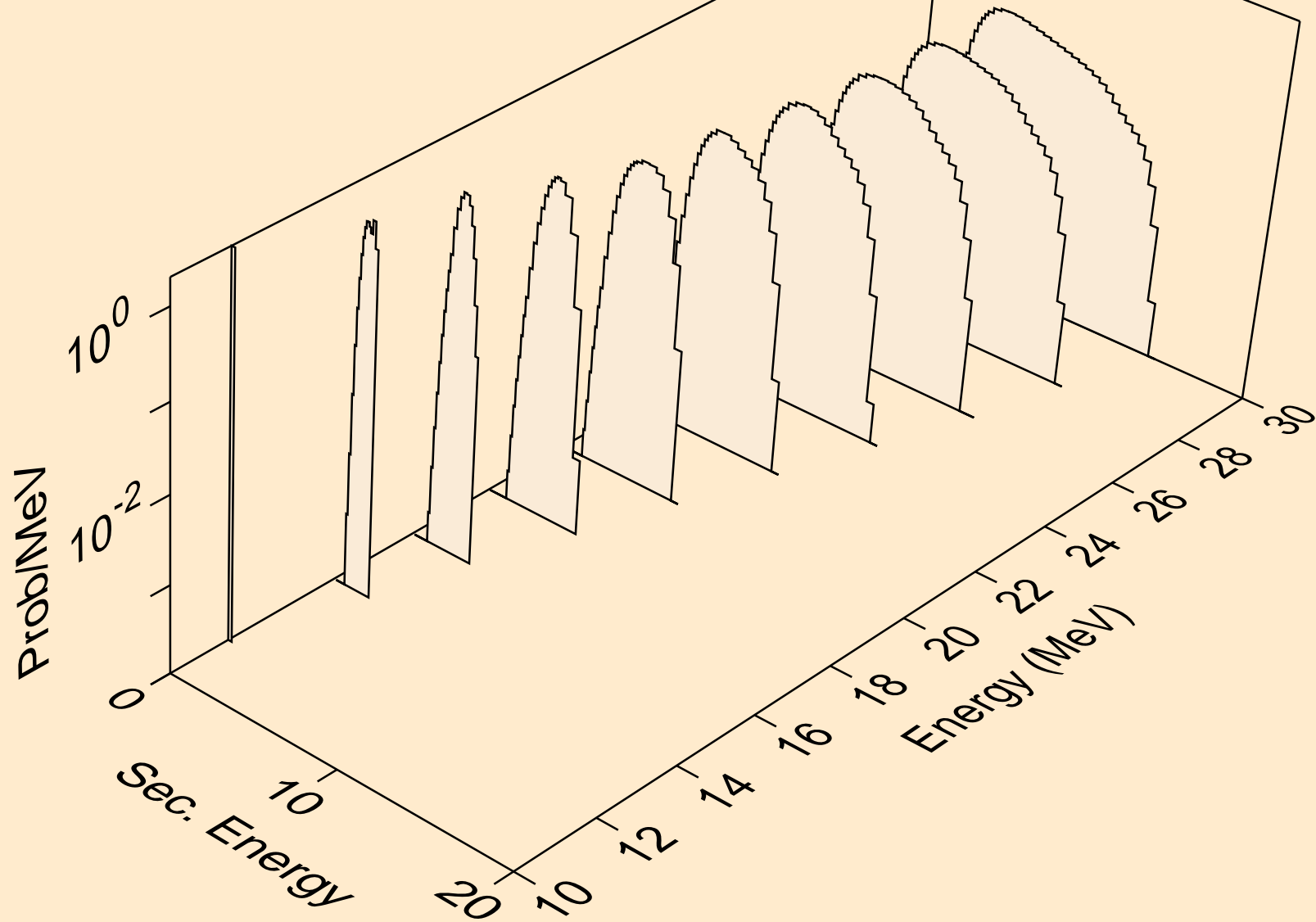

NE023 PROTON ACER TENDL-2024 LIBRARY; T=0.K  
alphas from (p,t2a)

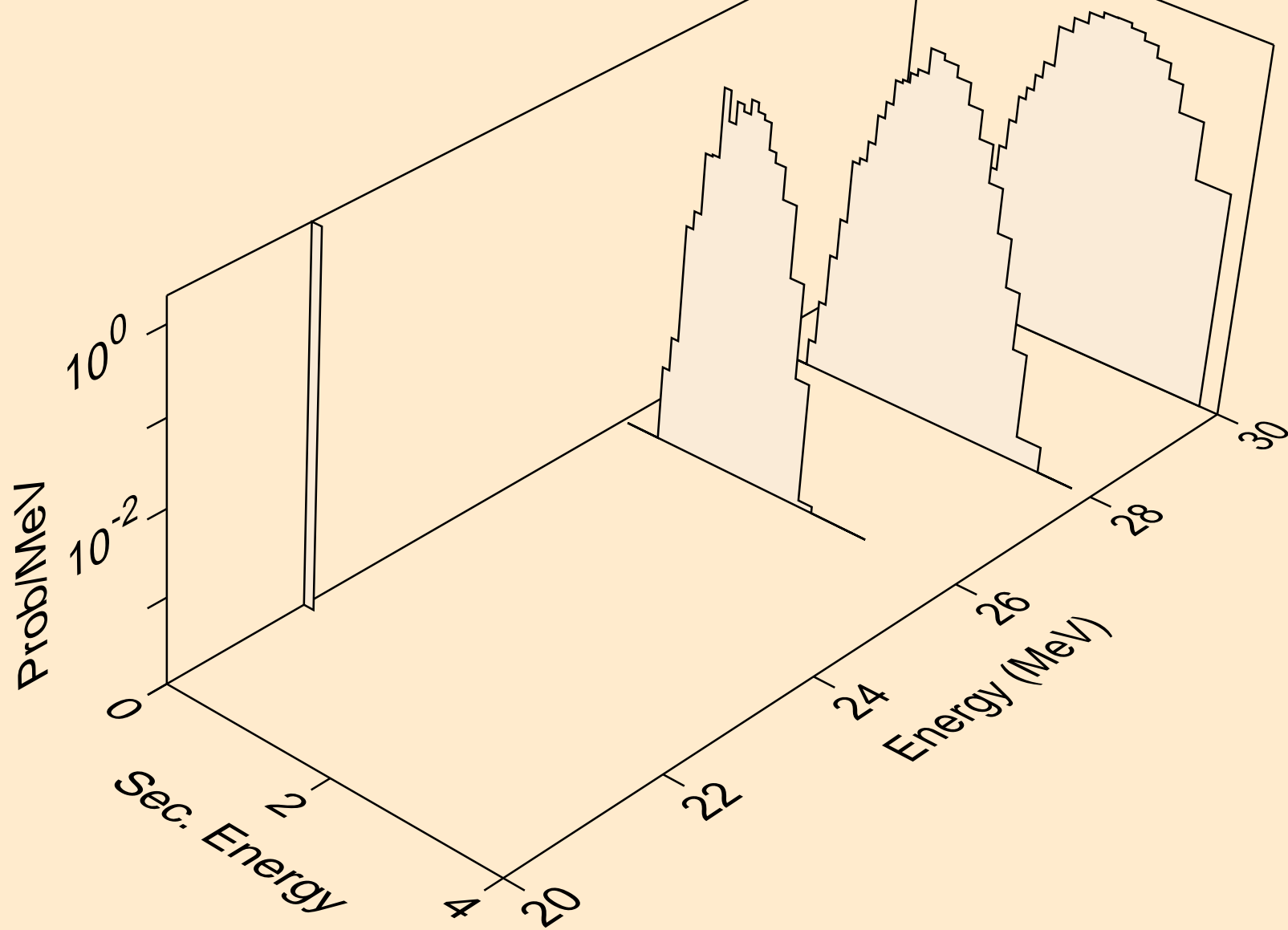

NE023 PROTON ACER TENDL-2024 LIBRARY; T=0.K  
alphas from (p,d2a)

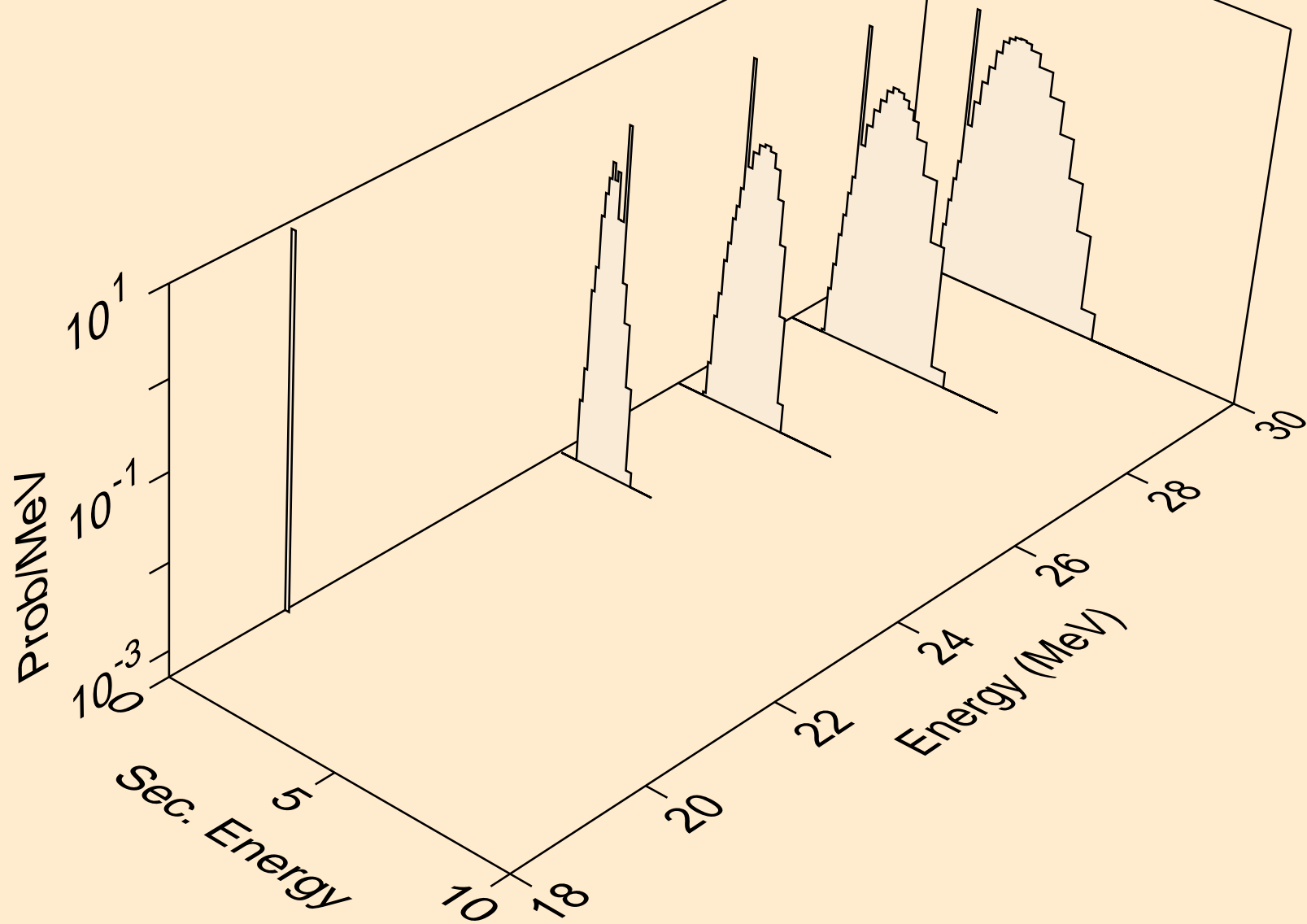

NE023 PROTON ACER TENDL-2024 LIBRARY; T=0.K  
alphas from (p,da)

