

PM128 PROTON ACER TENDL-2024 LIBRARY; T=0.K  
Principal cross sections

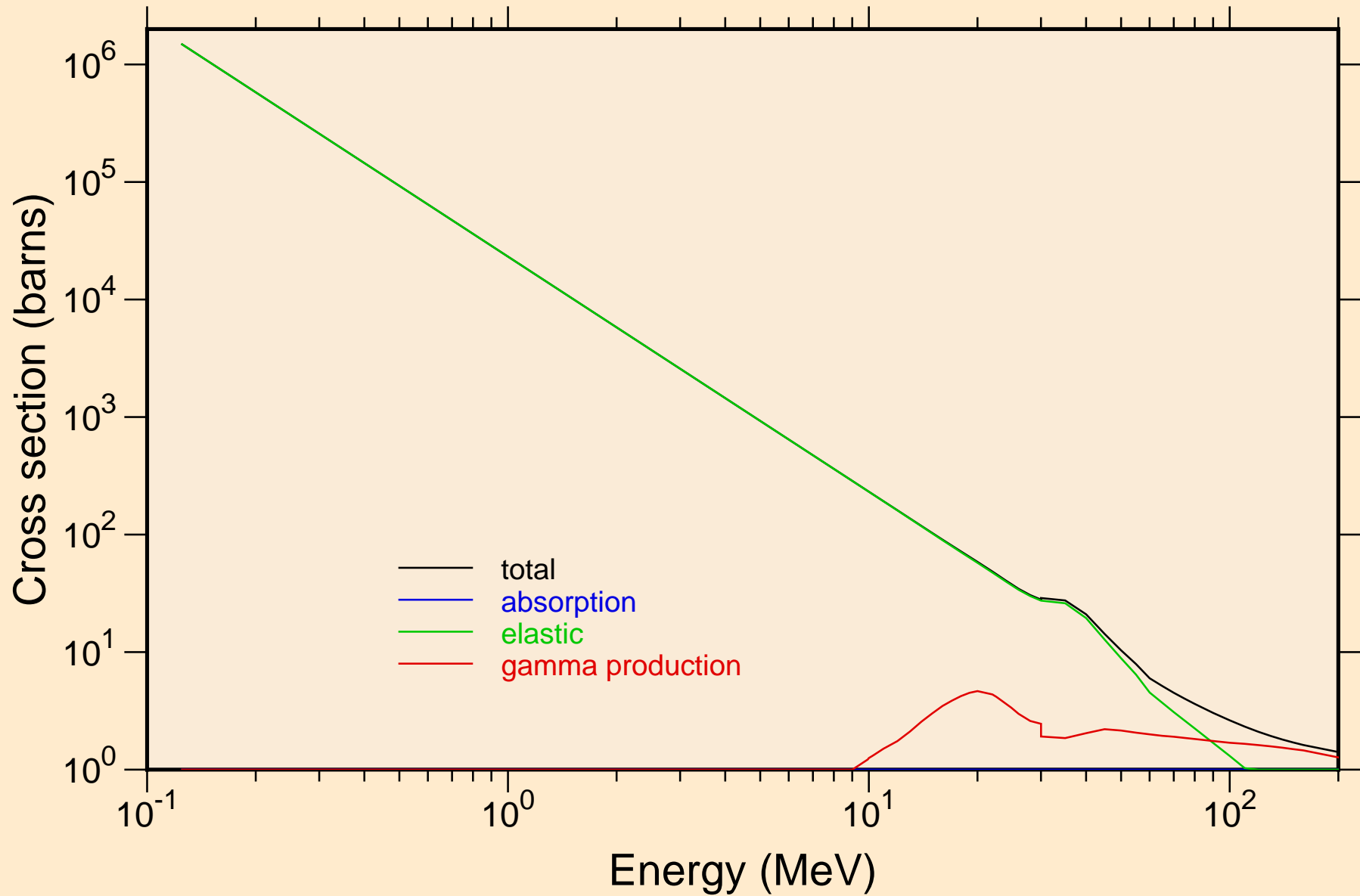

# PM128 PROTON ACER TENDL-2024 LIBRARY; T=0.K

## Heating

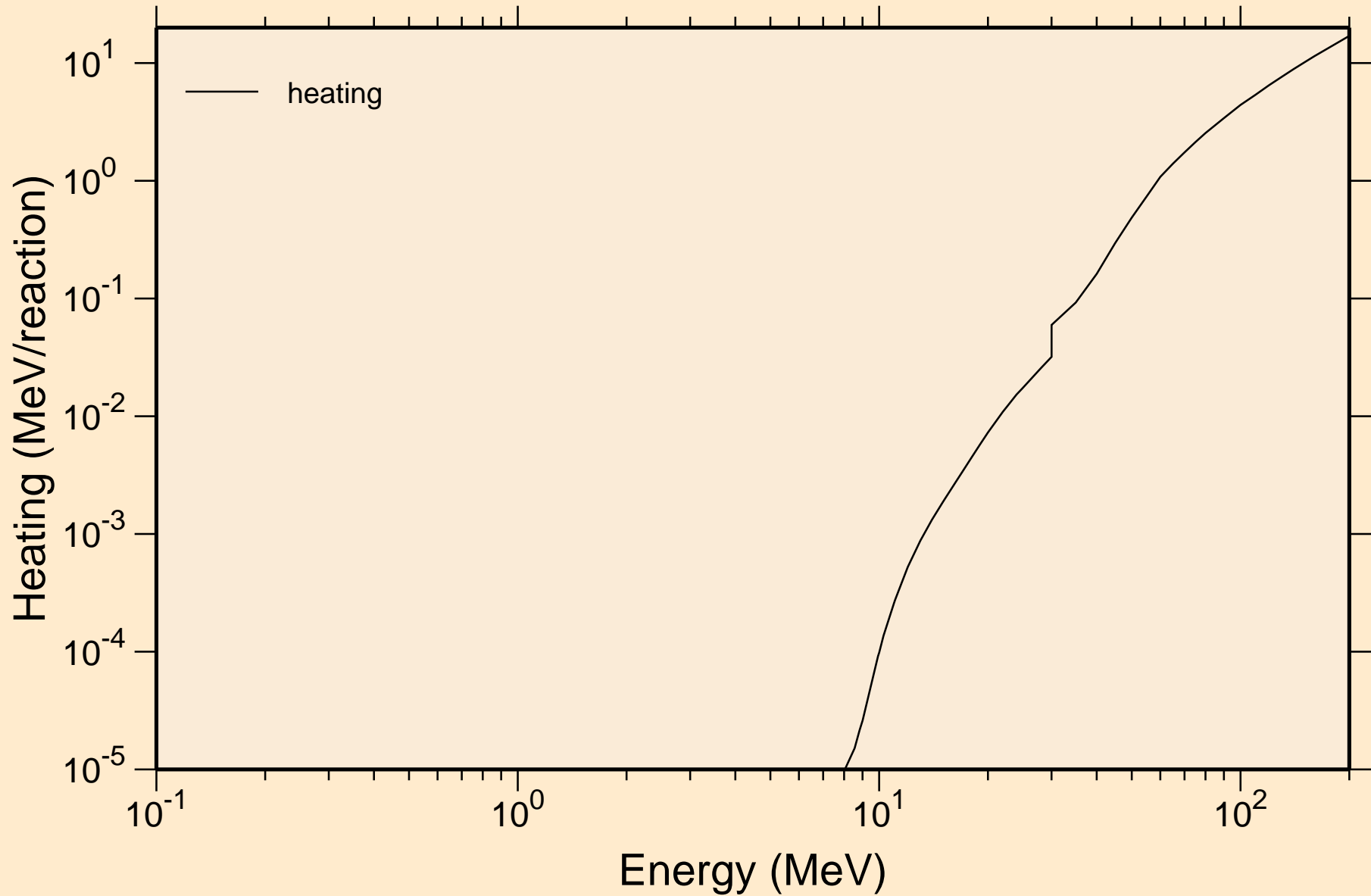

# PM128 PROTON ACER TENDL-2024 LIBRARY; T=0.K

## Principal cross sections

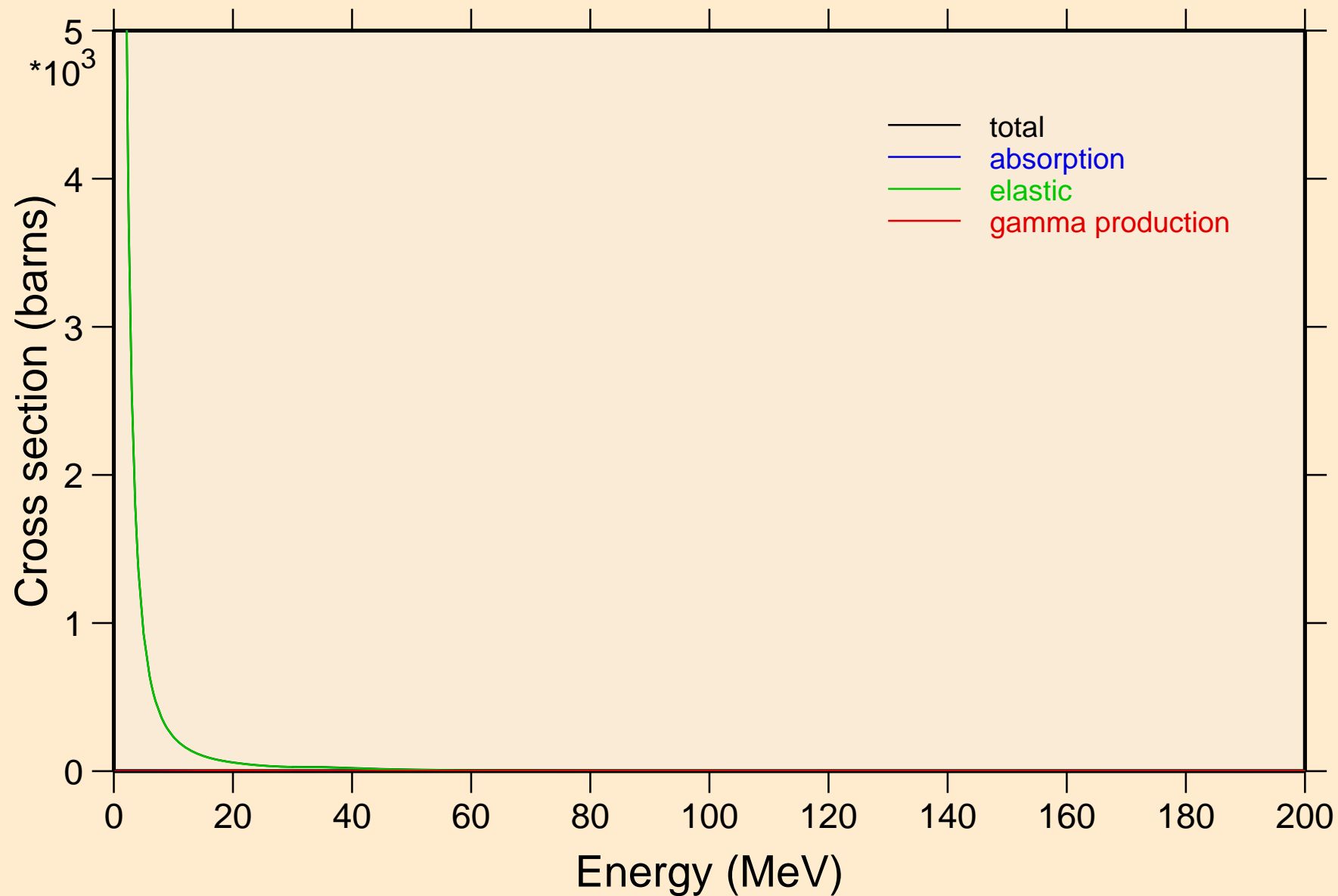

# PM128 PROTON ACER TENDL-2024 LIBRARY; T=0.K

## Heating

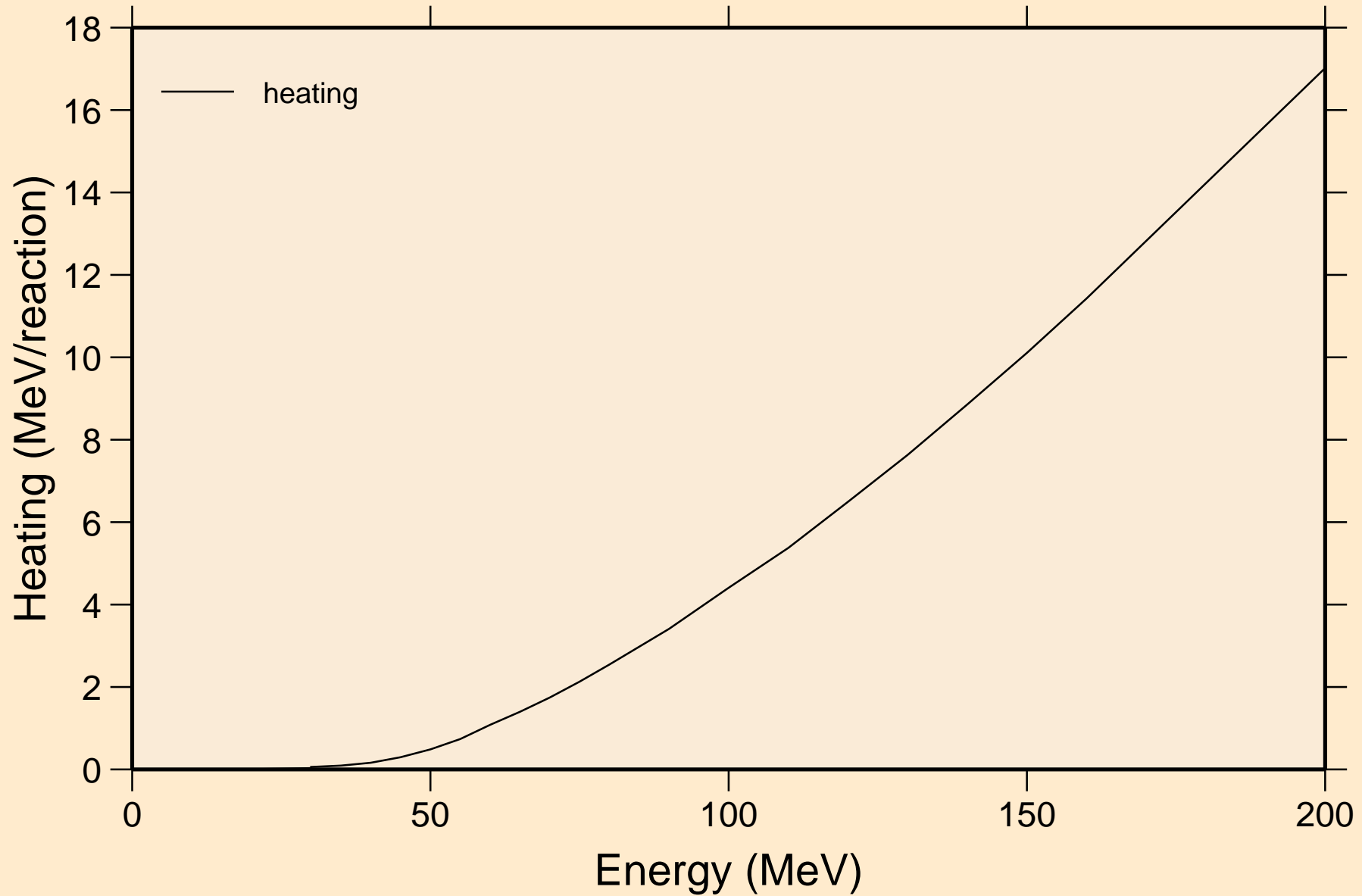

# PM128 PROTON ACER TENDL-2024 LIBRARY; T=0.K

## Threshold reactions

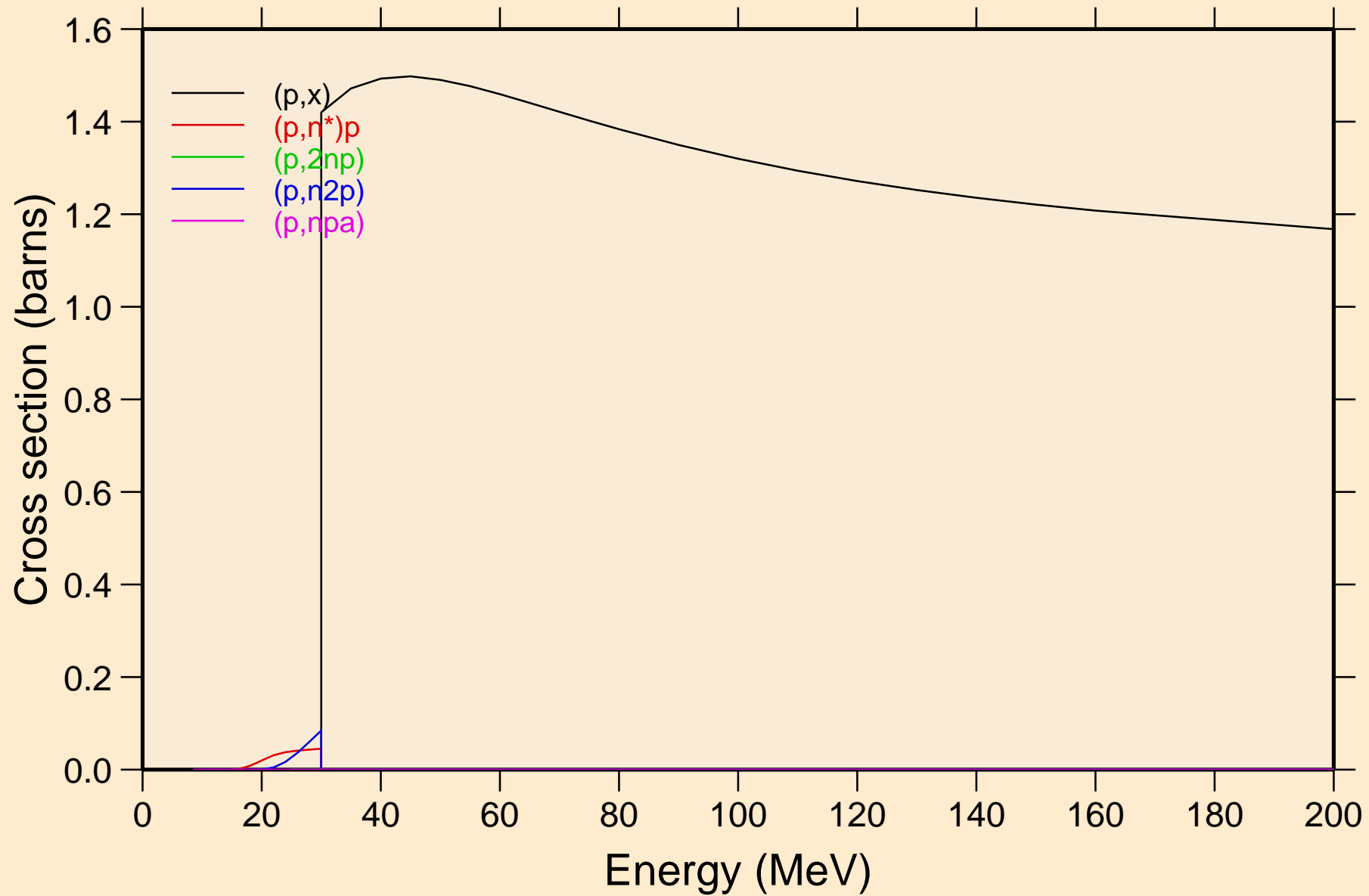

PM128 PROTON ACER TENDL-2024 LIBRARY; T=0.K  
Threshold reactions

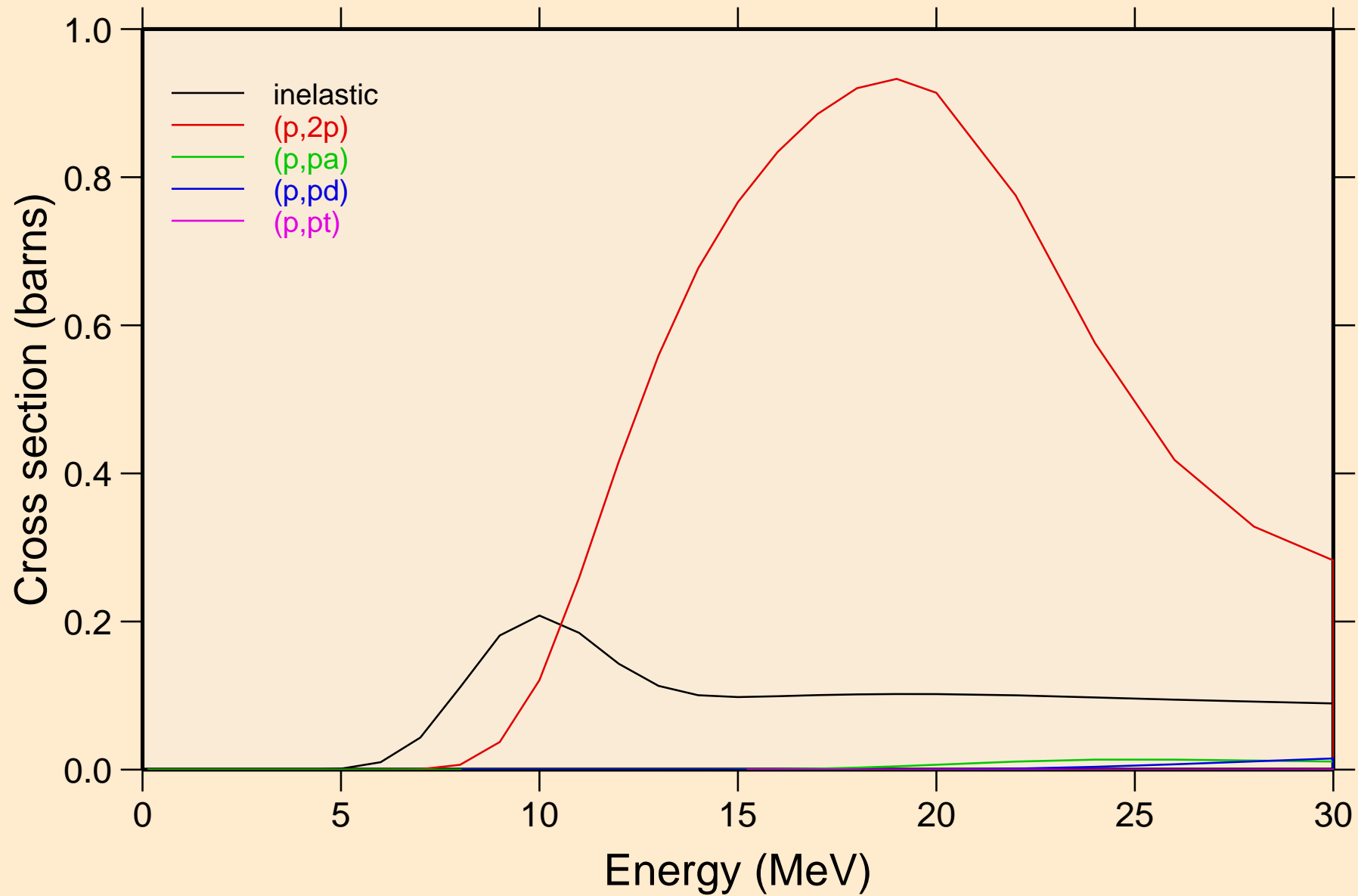

PM128 PROTON ACER TENDL-2024 LIBRARY; T=0.K  
Threshold reactions

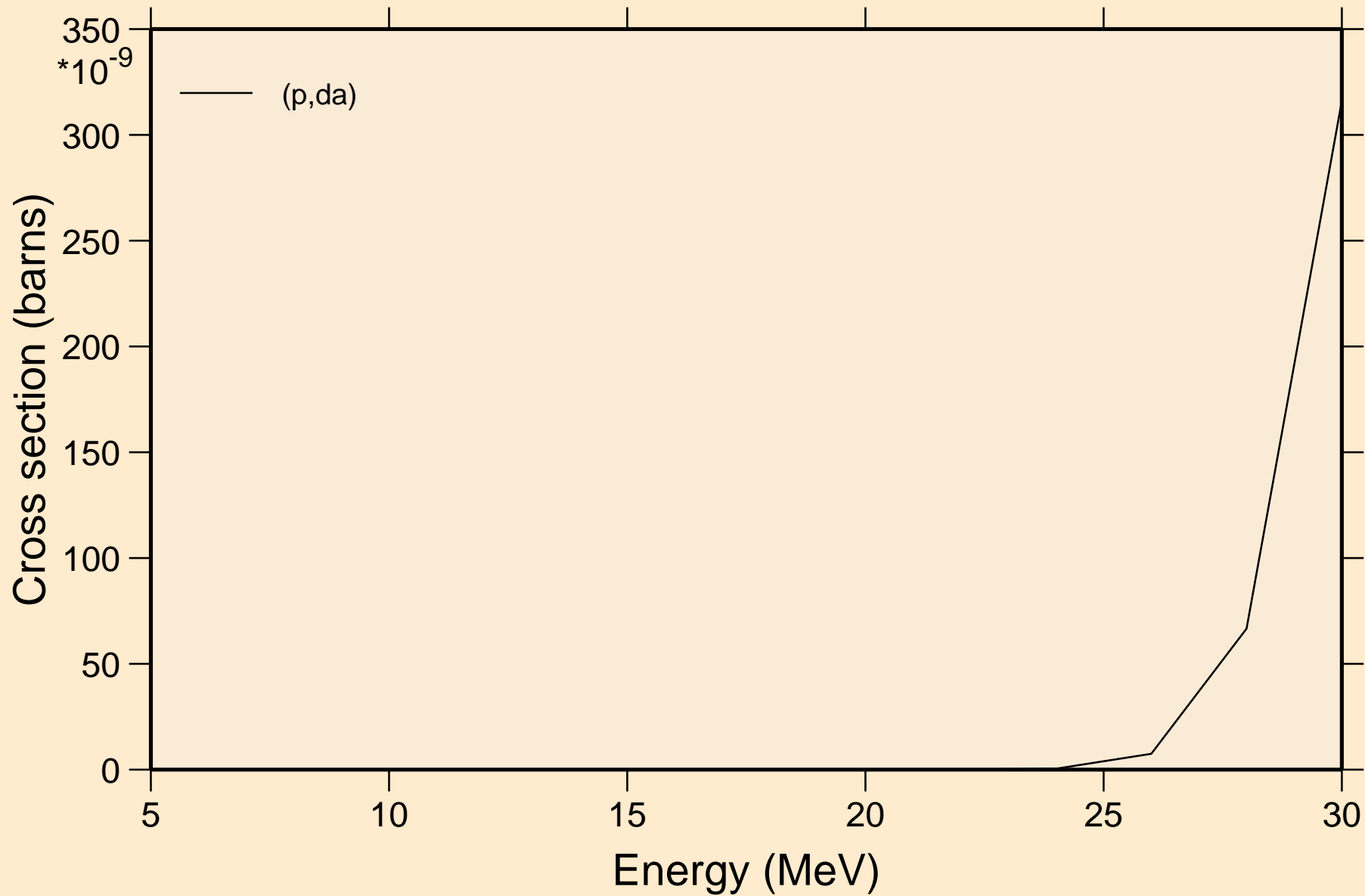

PM128 PROTON ACER TENDL-2024 LIBRARY; T=0.K  
angular distribution for elastic

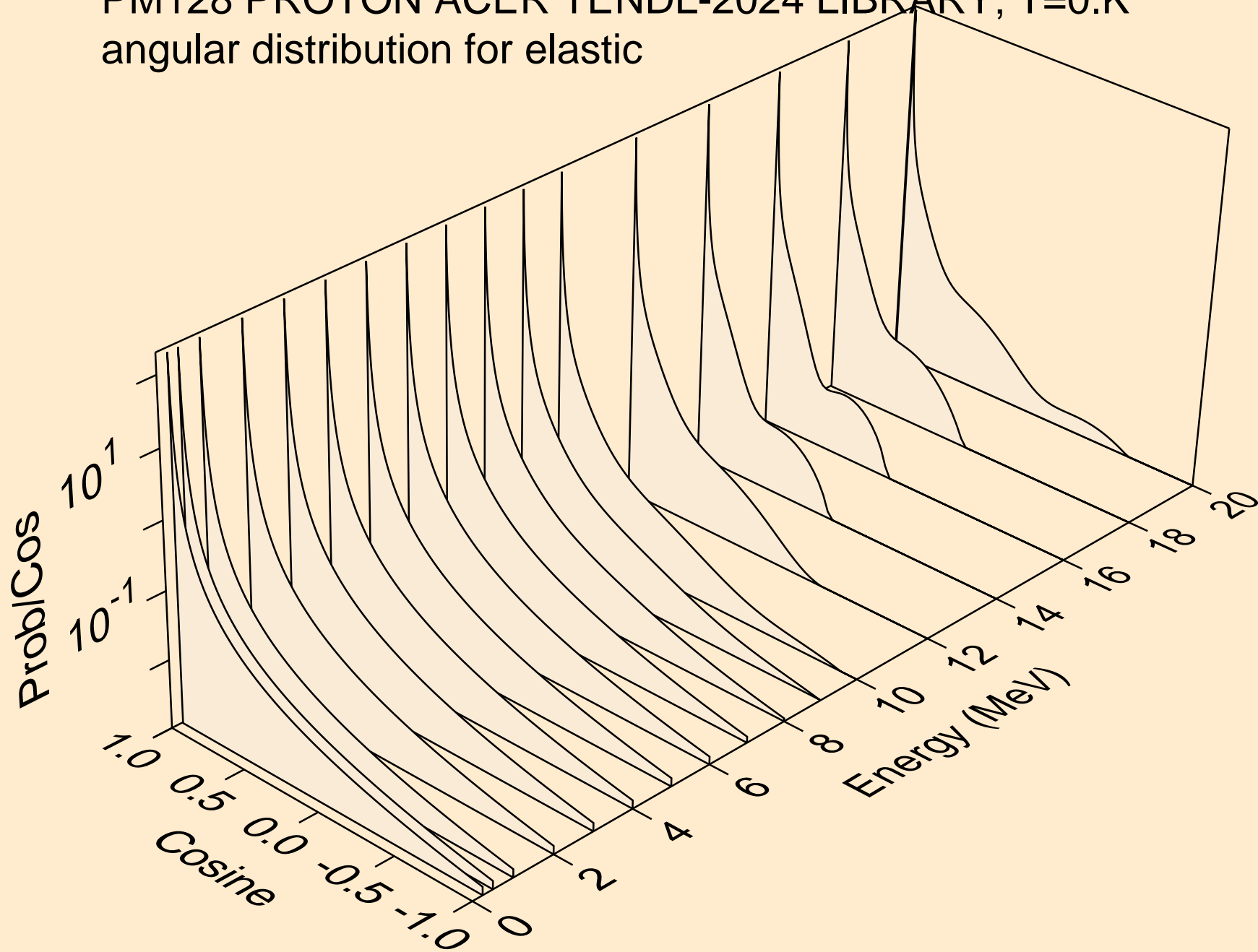

PM128 PROTON ACER TENDL-2024 LIBRARY; T=0.K  
angular distribution for elastic

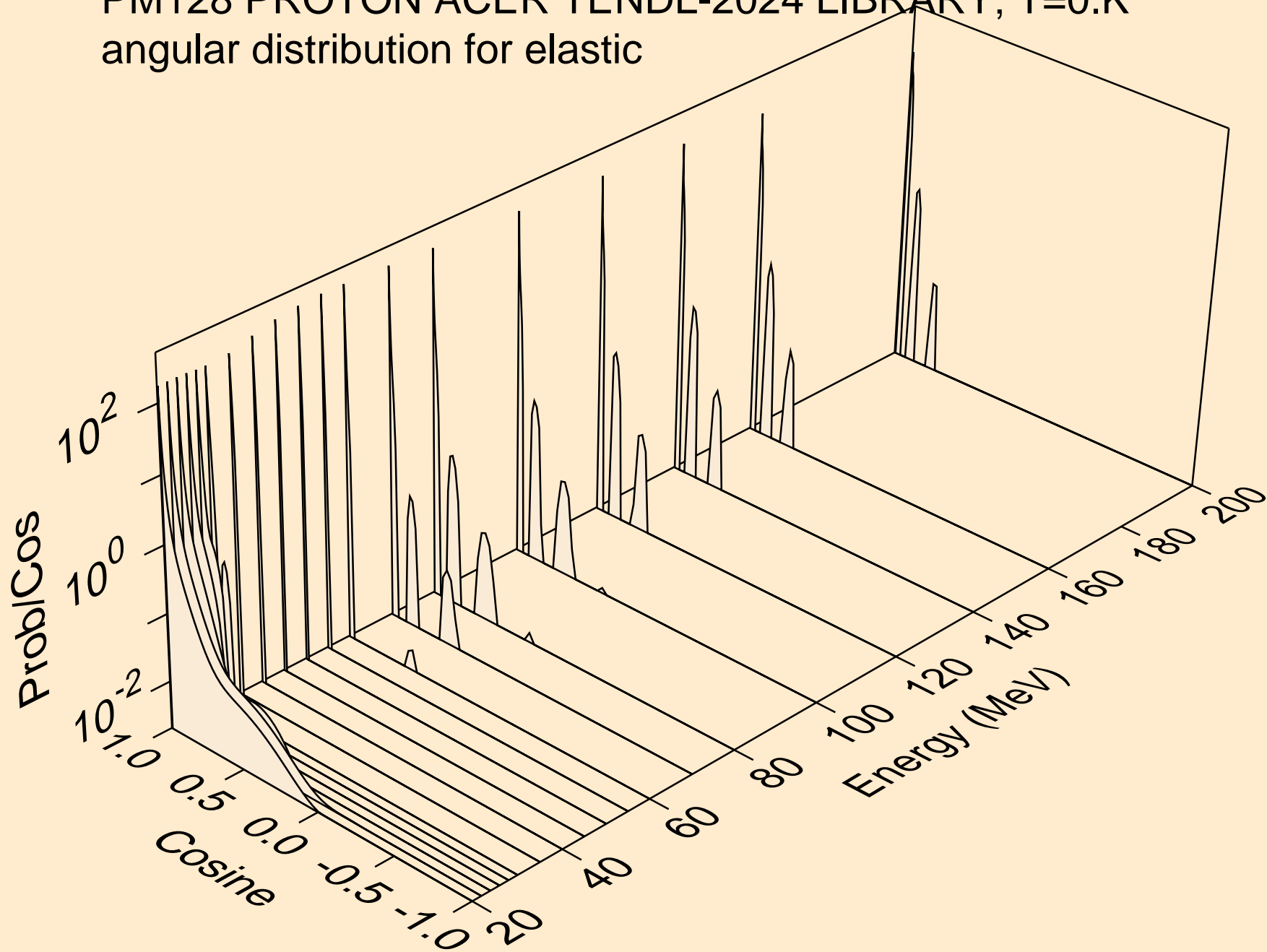

PM128 PROTON ACER TENDL-2024 LIBRARY; T=0.K  
Proton emission for (p,x)

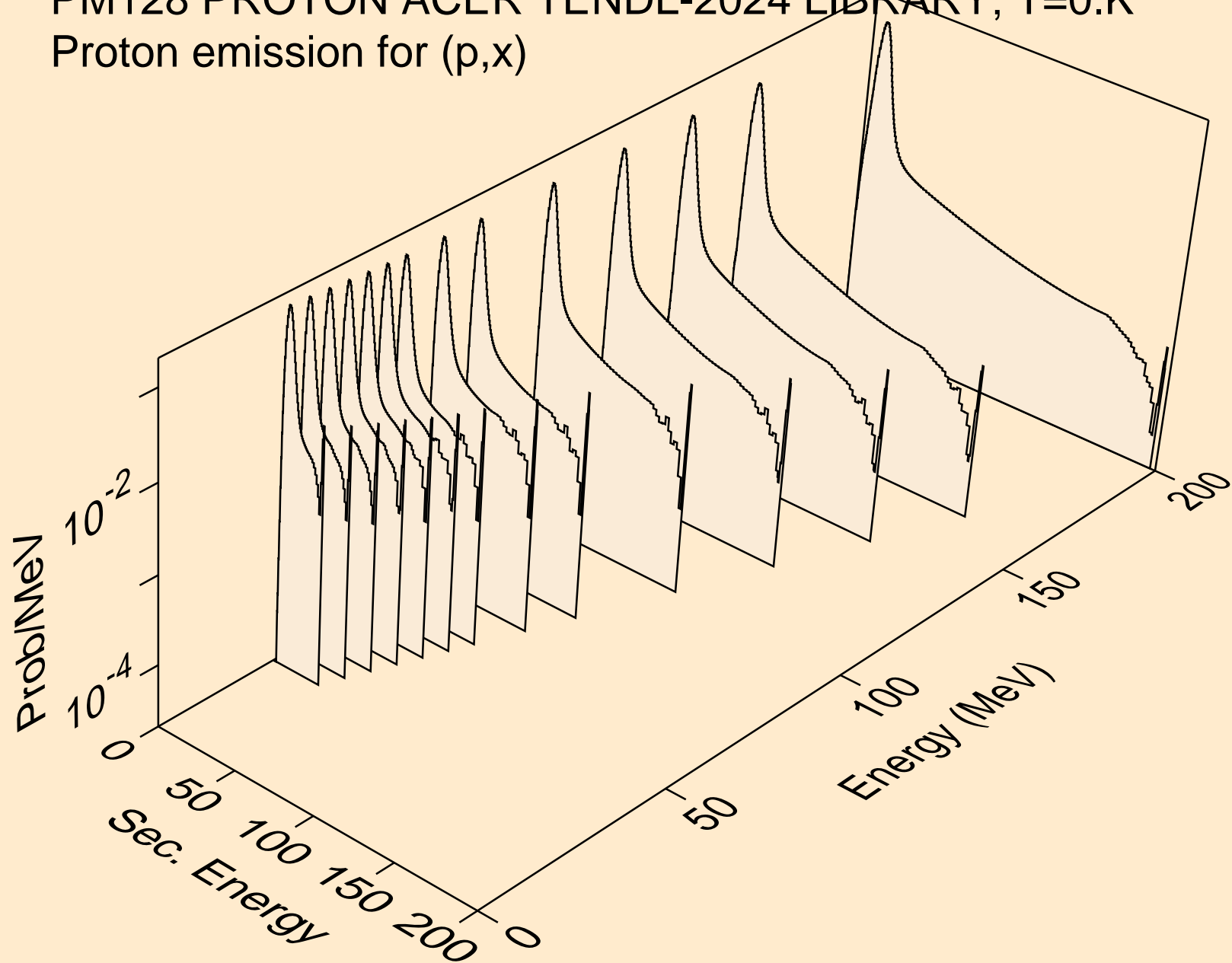

PM128 PROTON ACER TENDL-2024 LIBRARY; T=0.K  
Proton emission for (p,n\*)p

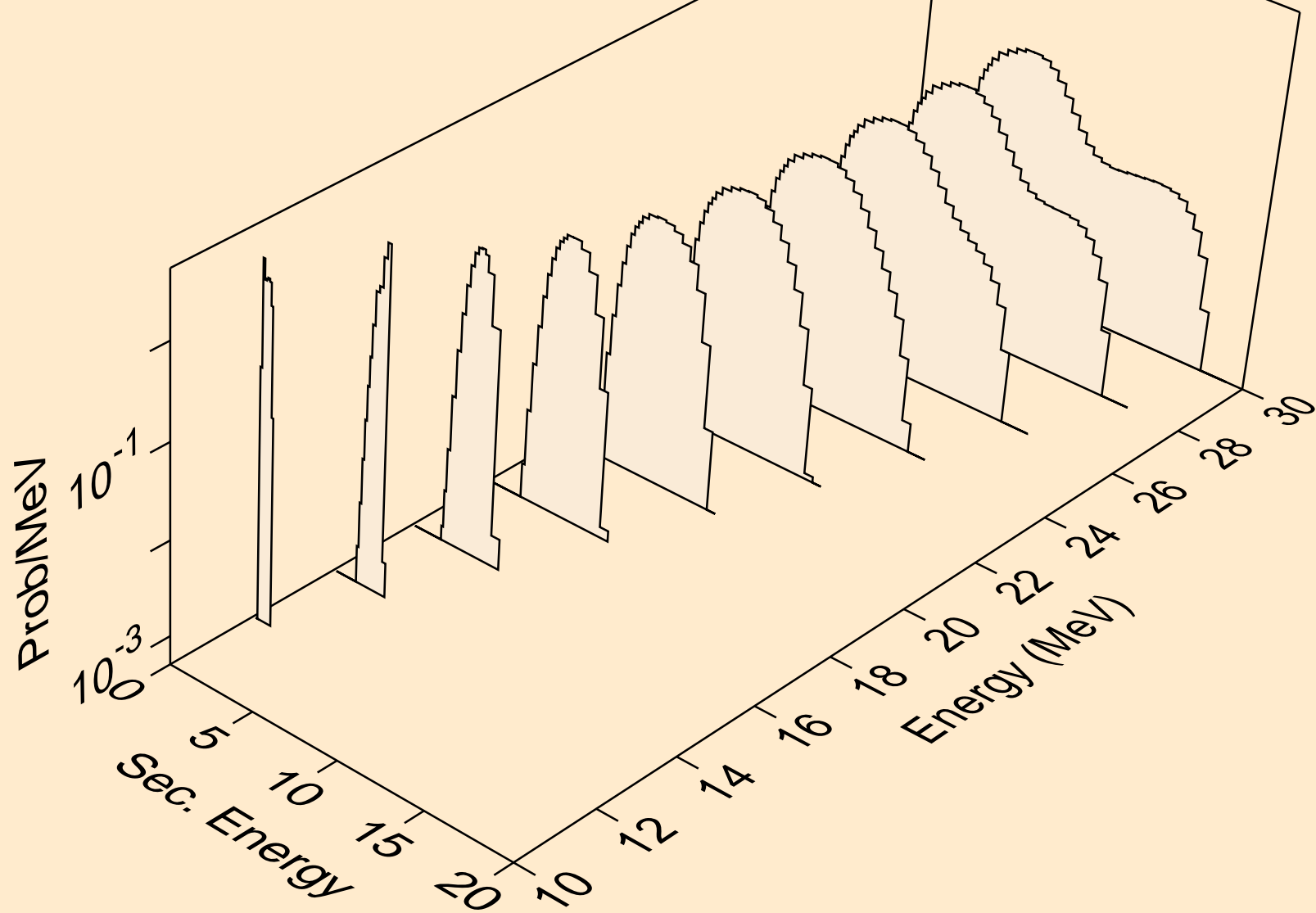

PM128 PROTON ACER TENDL-2024 LIBRARY; T=0.K  
Proton emission for (p,2np)

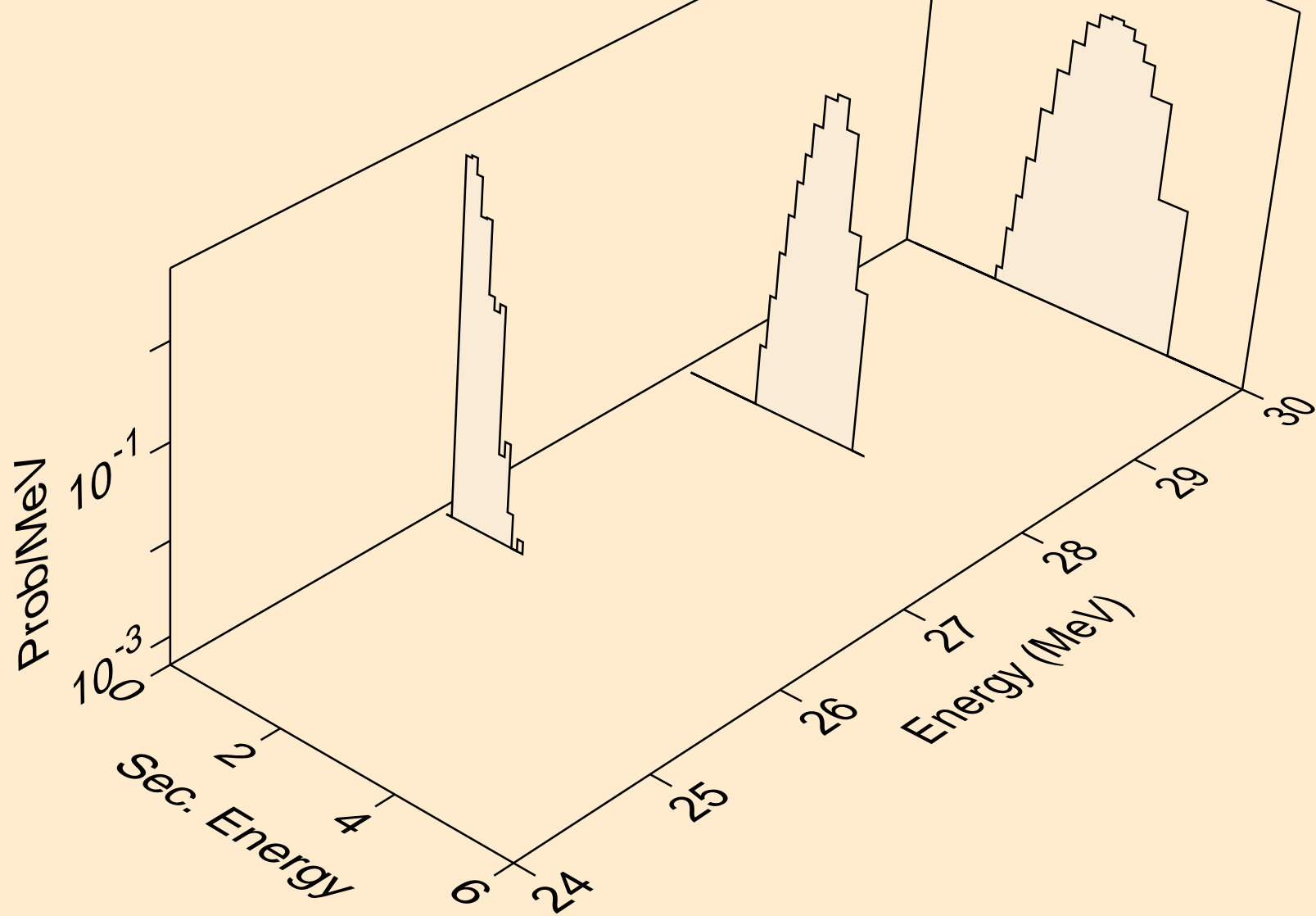

PM128 PROTON ACER TENDL-2024 LIBRARY; T=0.K  
Proton emission for (p,n2p)

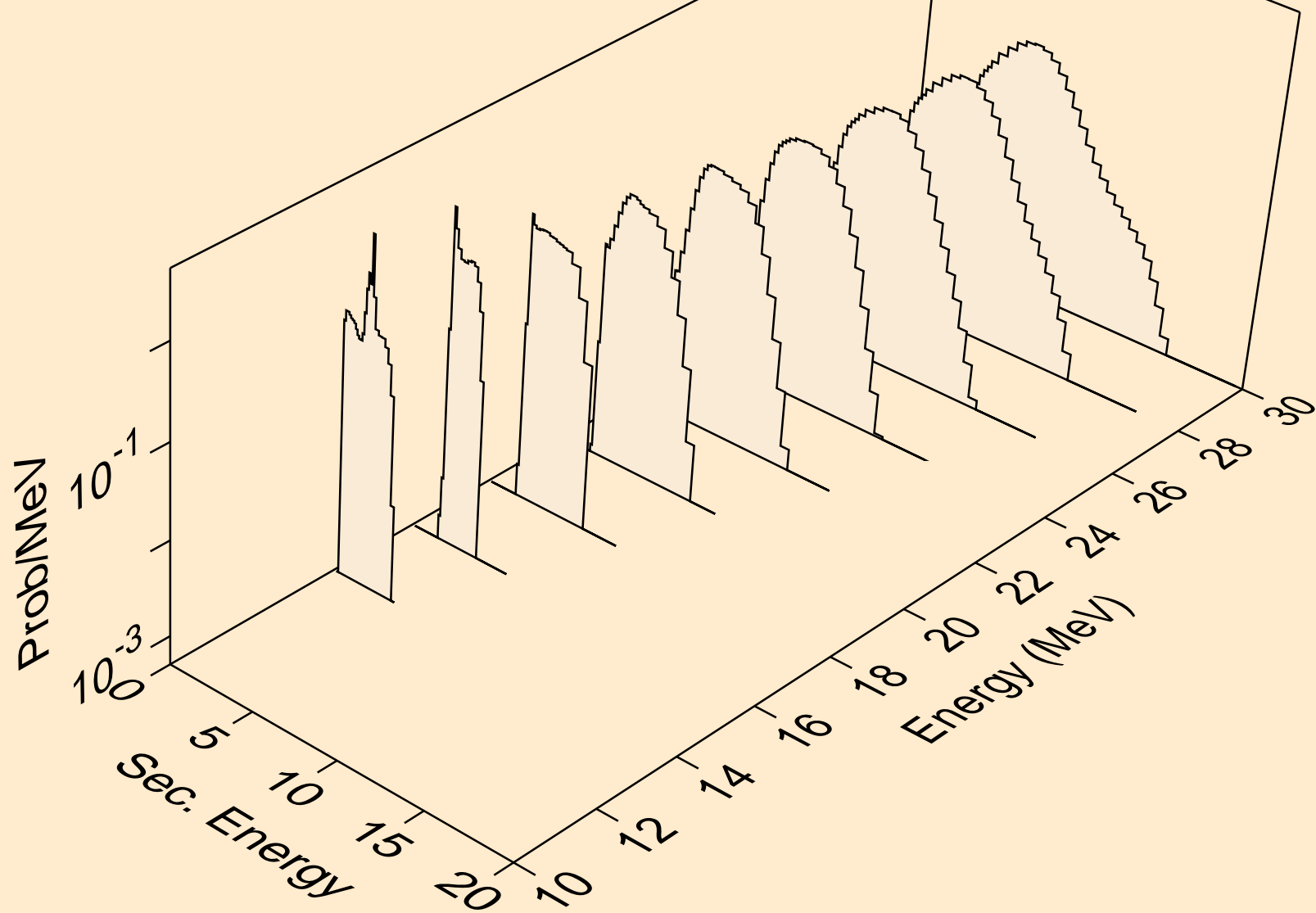

PM128 PROTON ACER TENDL-2024 LIBRARY; T=0.K  
Proton emission for (p,npa)

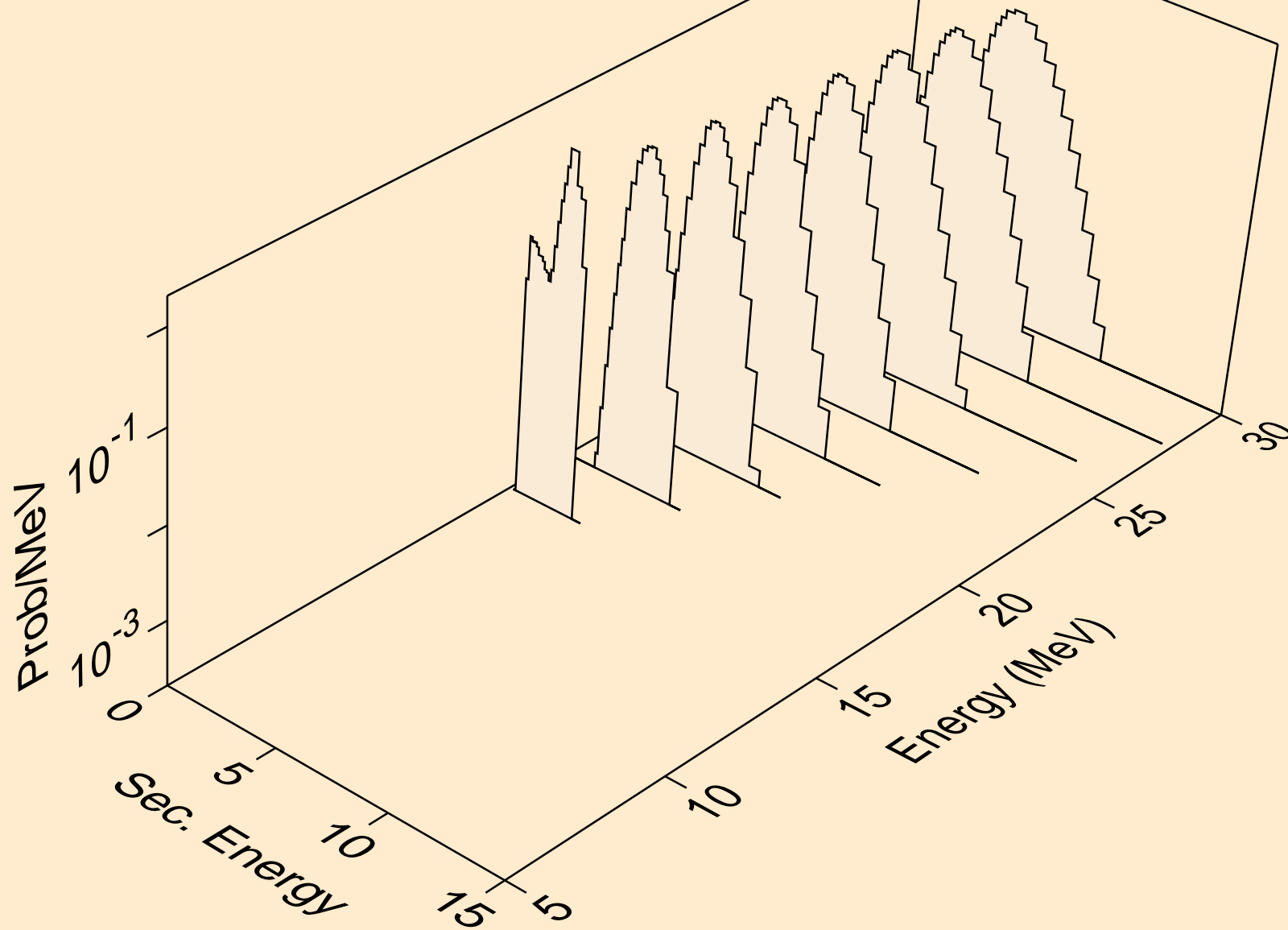

PM128 PROTON ACER TENDL-2024 LIBRARY; T=0.K  
Proton emission for inelastic

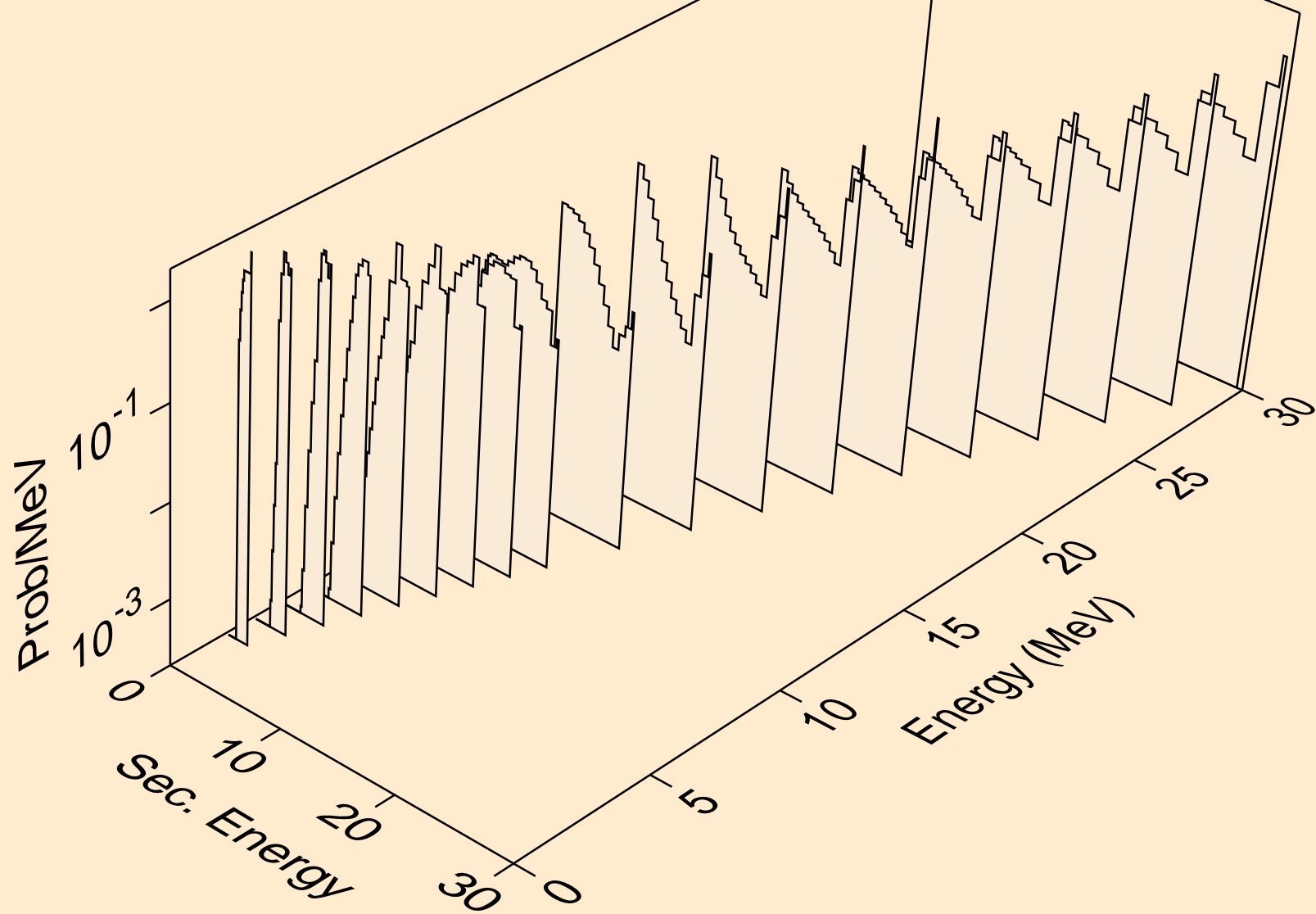

PM128 PROTON ACER TENDL-2024 LIBRARY; T=0.K  
Proton emission for (p,2p)

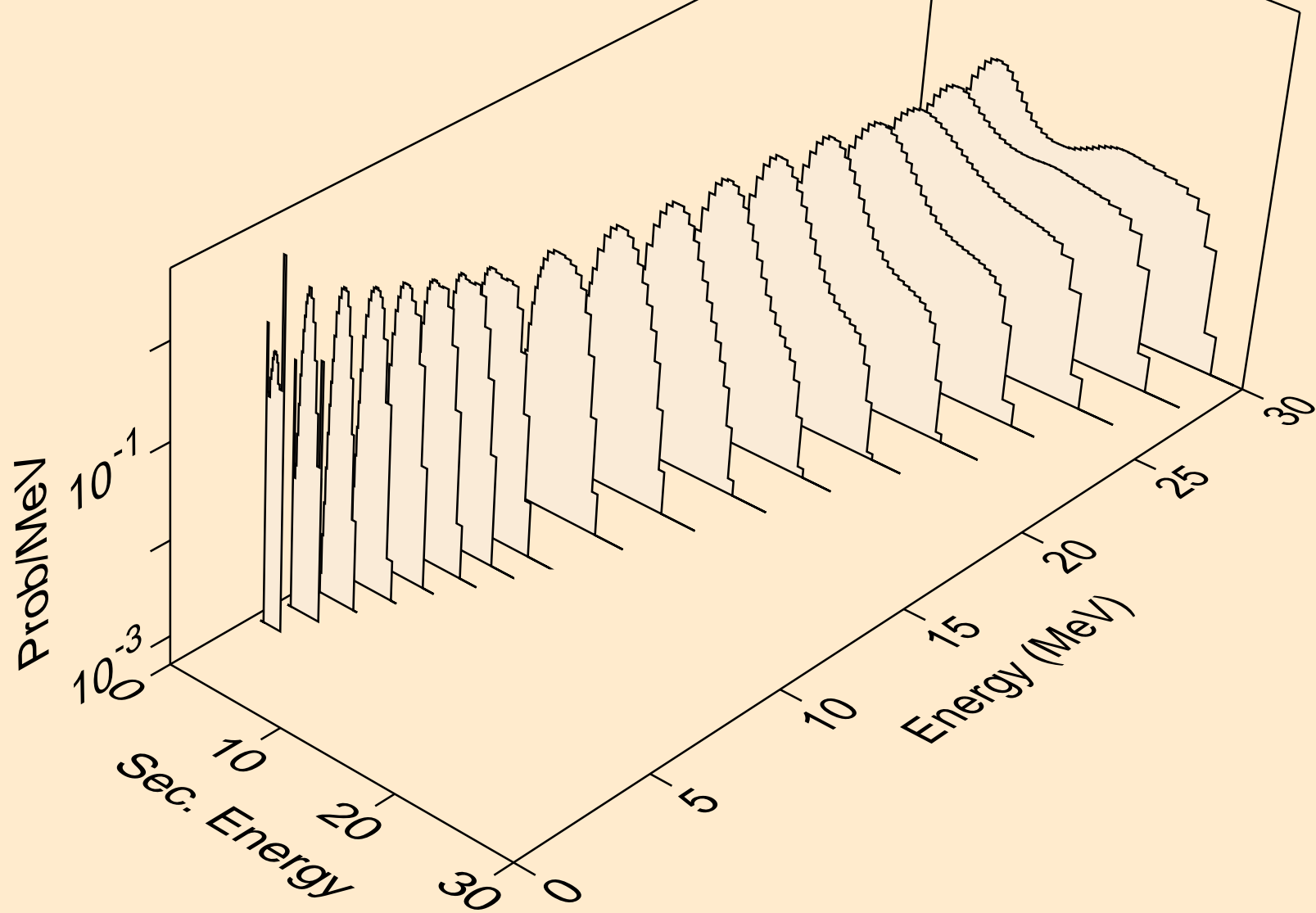

PM128 PROTON ACER TENDL-2024 LIBRARY; T=0.K  
Proton emission for (p,pa)

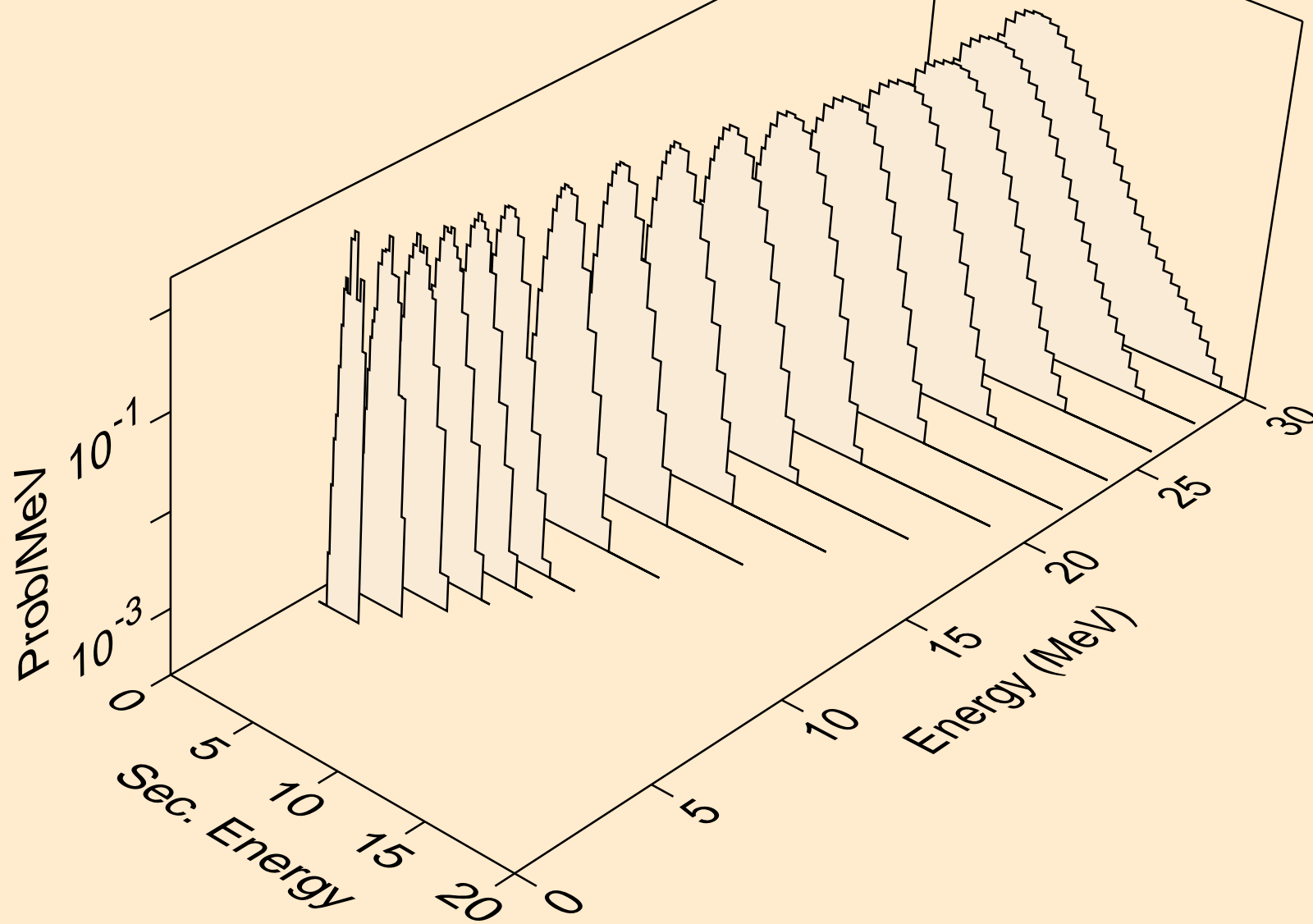

PM128 PROTON ACER TENDL-2024 LIBRARY; T=0.K  
Proton emission for (p,pd)

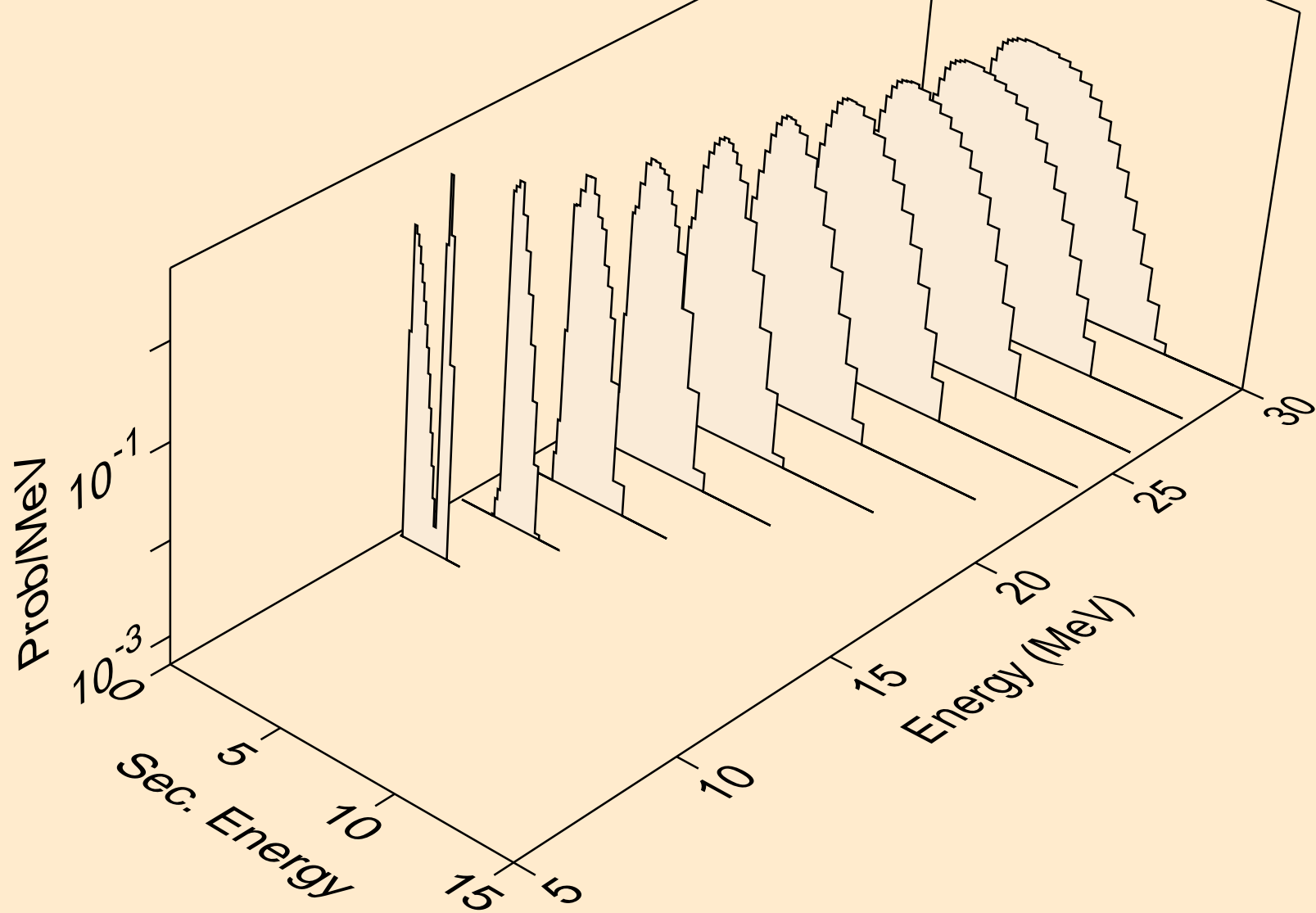

PM128 PROTON ACER TENDL-2024 LIBRARY; T=0.K  
Proton emission for (p,pt)

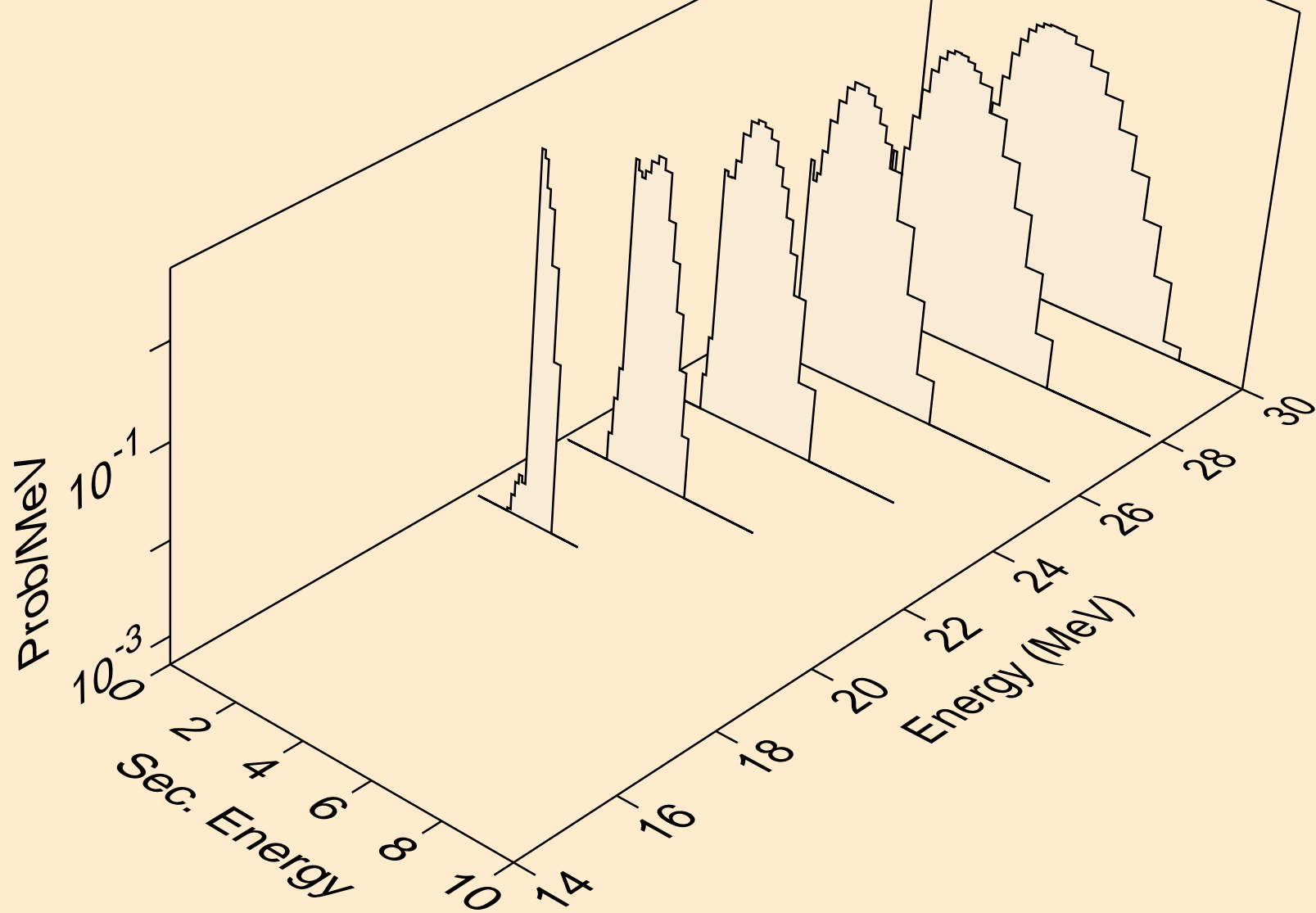

PM128 PROTON ACER TENDL-2024 LIBRARY; T=0.K  
Photon emission for (z,n)

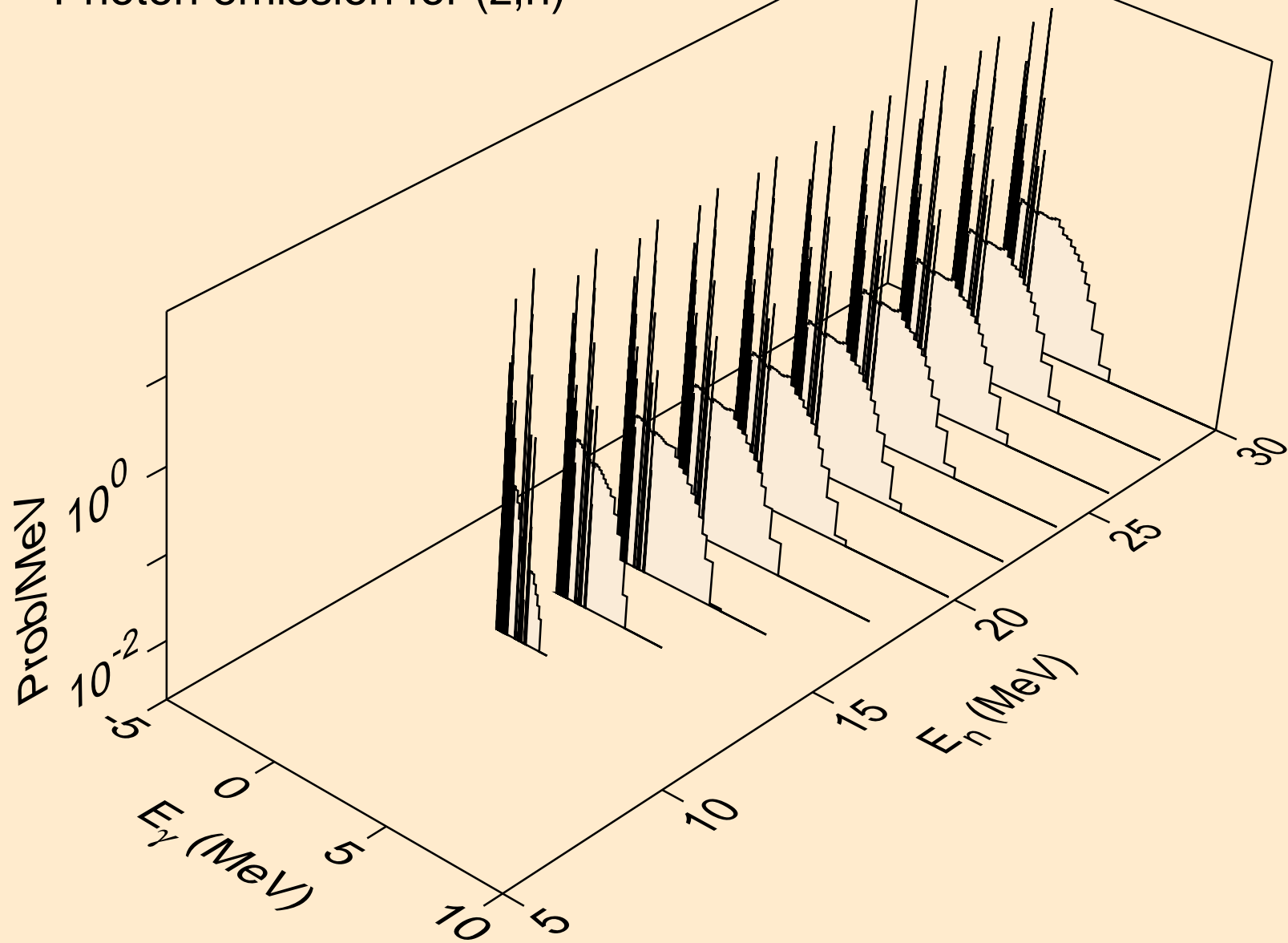

PM128 PROTON ACER TENDL-2024 LIBRARY; T=0.K  
Photon emission for (z,x)

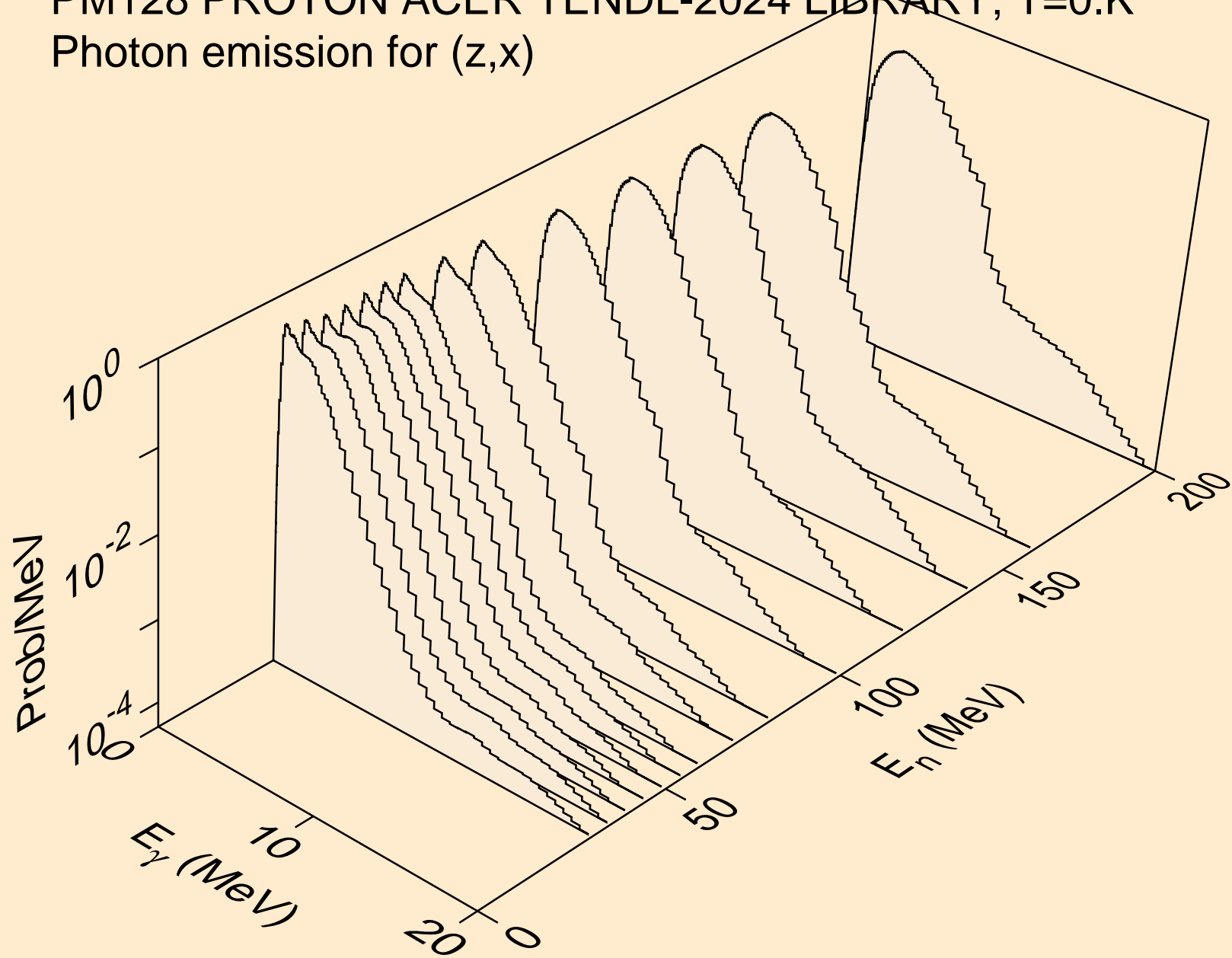

PM128 PROTON ACER TENDL-2024 LIBRARY; T=0.K  
Photon emission for (n,2n)

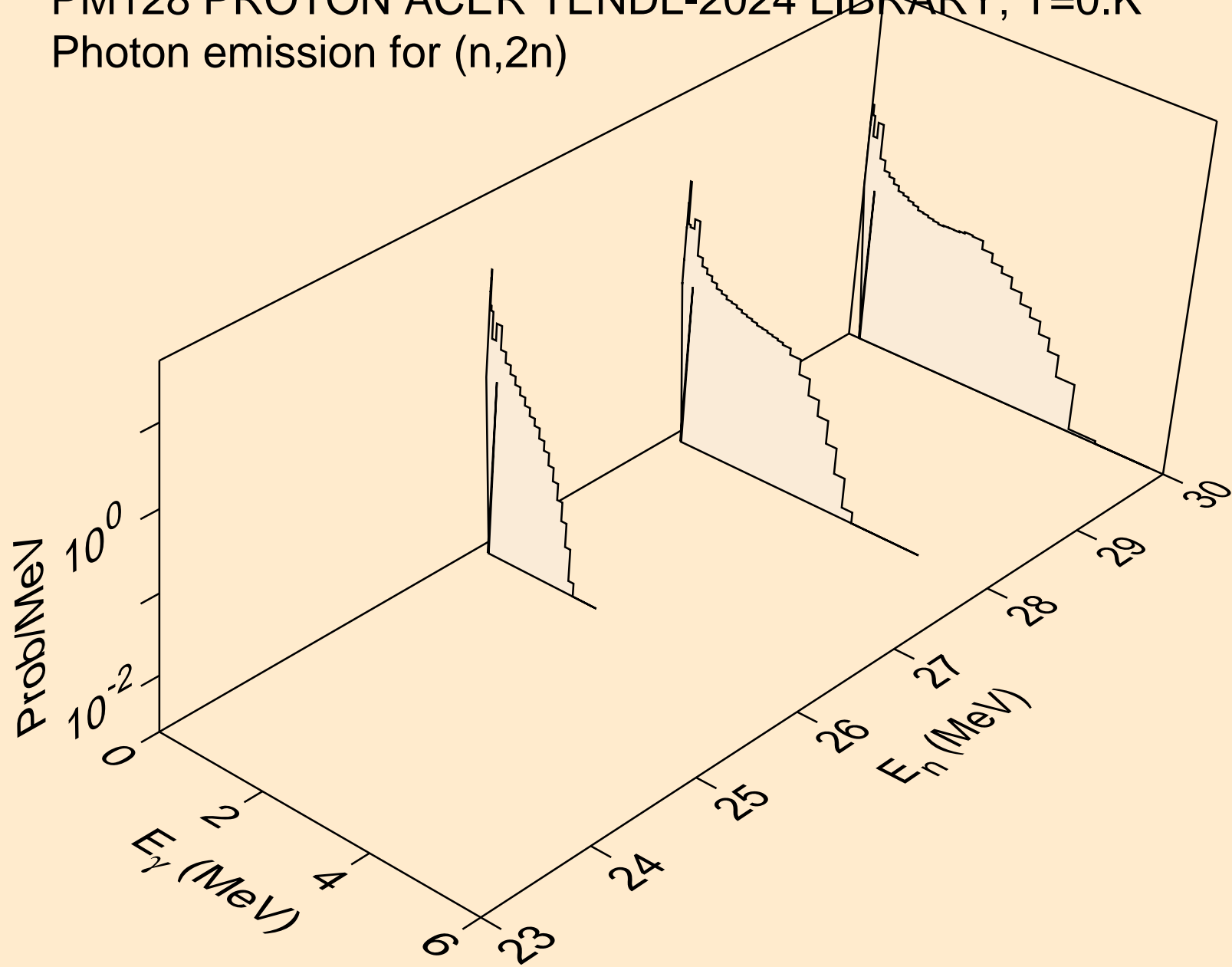

PM128 PROTON ACER TENDL-2024 LIBRARY; T=0.K  
Photon emission for (n,n\*)a

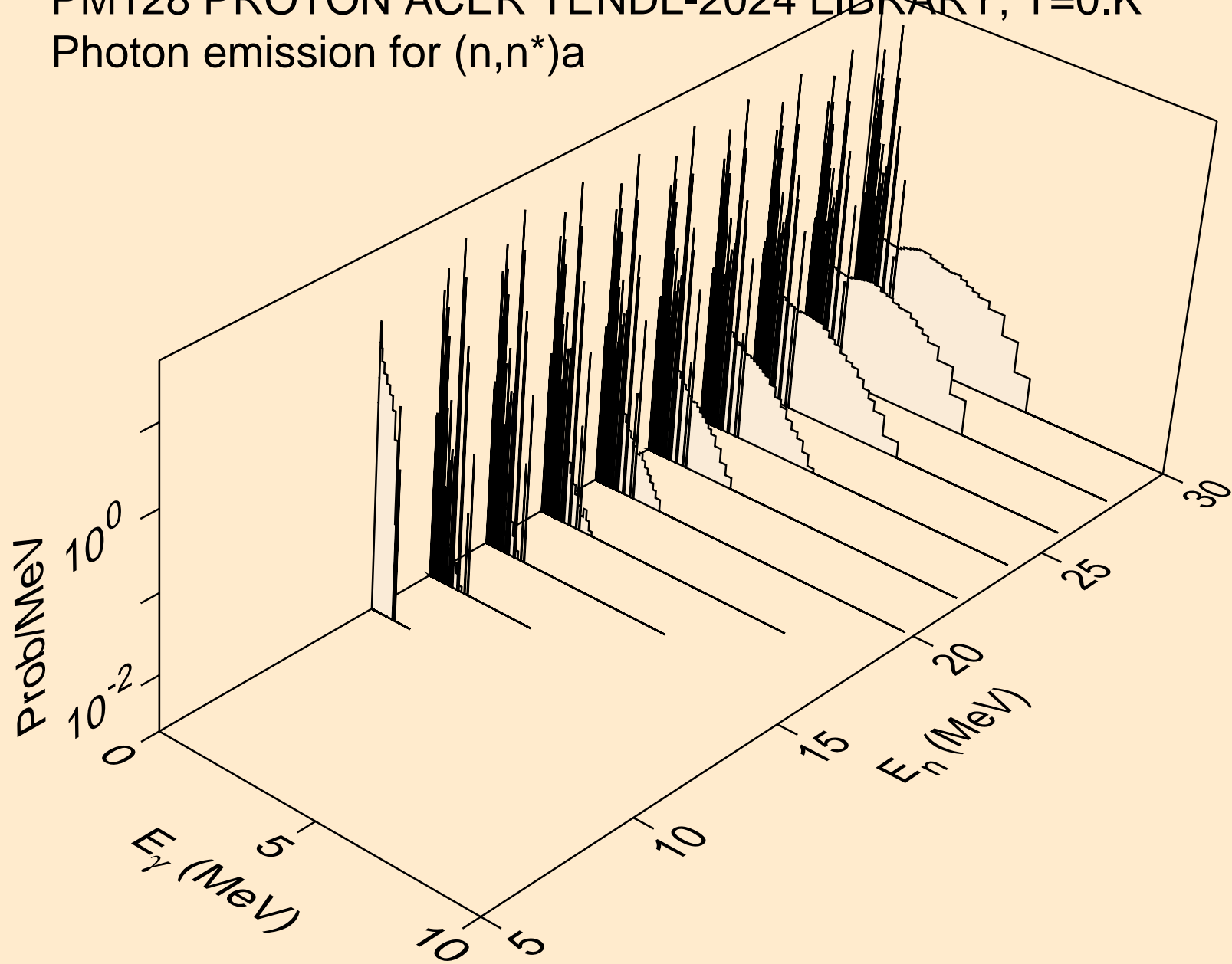

PM128 PROTON ACER TENDL-2024 LIBRARY; T=0.K  
Photon emission for (n,n\*)p

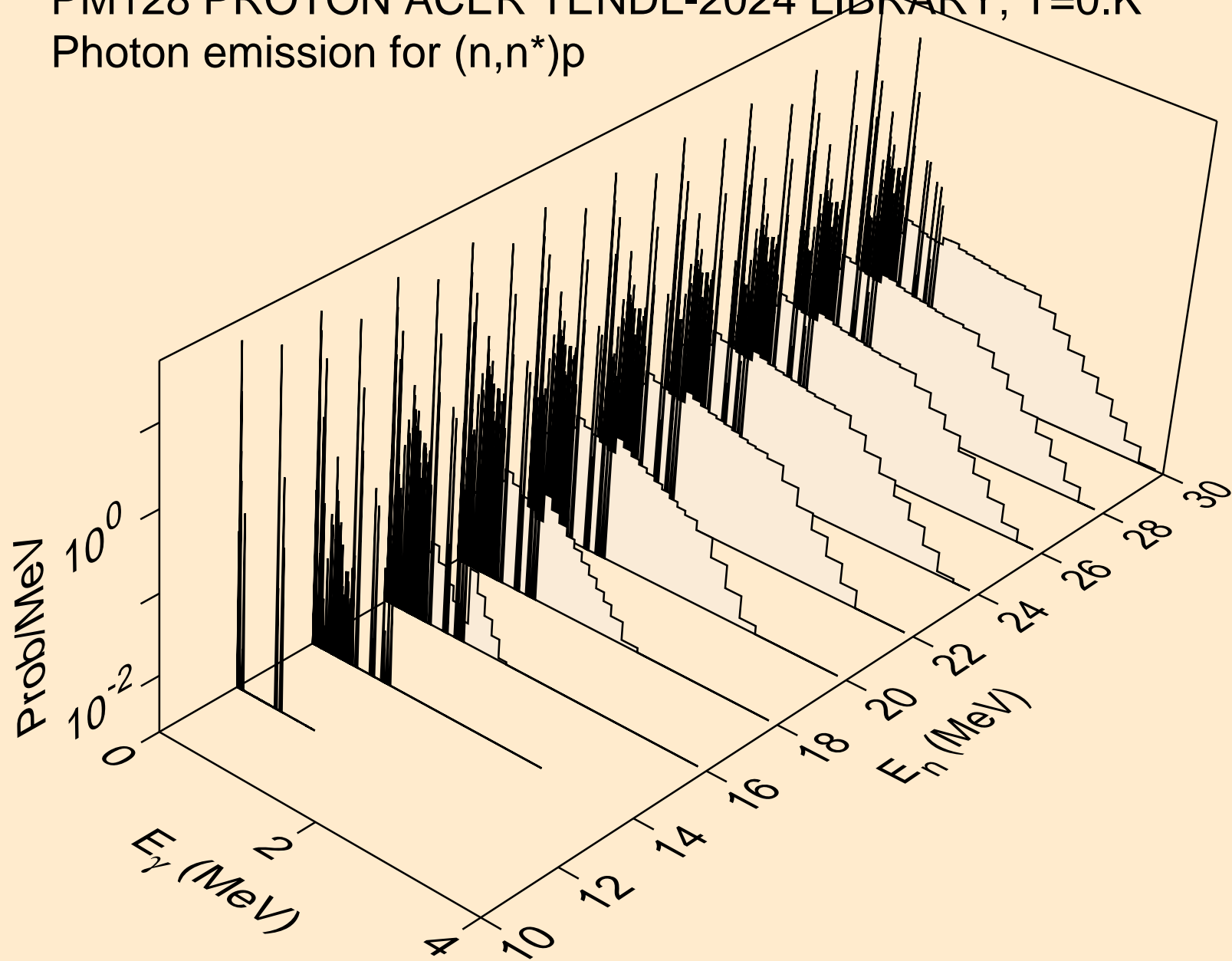

PM128 PROTON ACER TENDL-2024 LIBRARY; T=0.K  
Photon emission for (n,n\*)2a

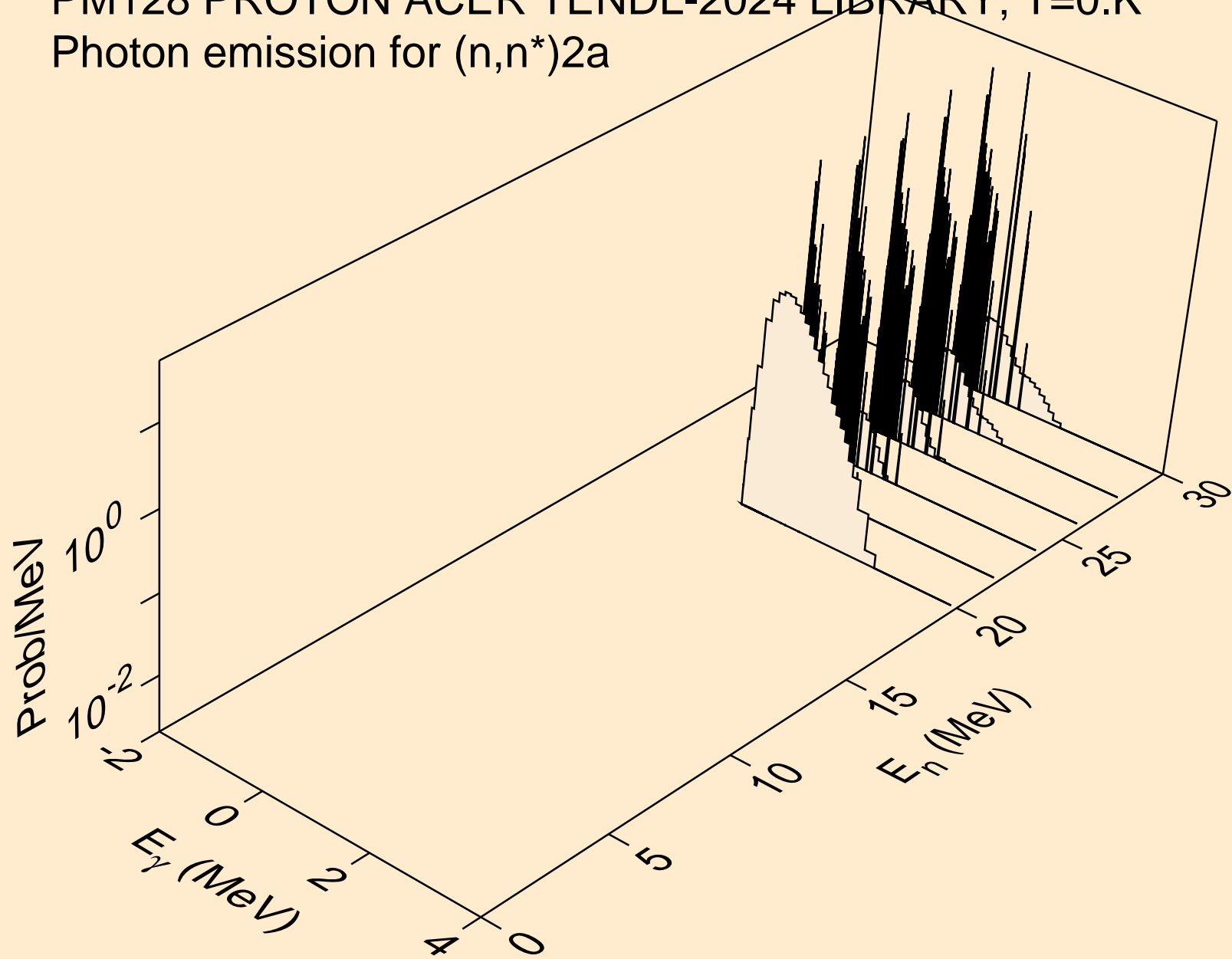

PM128 PROTON ACER TENDL-2024 LIBRARY; T=0.K  
Photon emission for (n,n\*)d

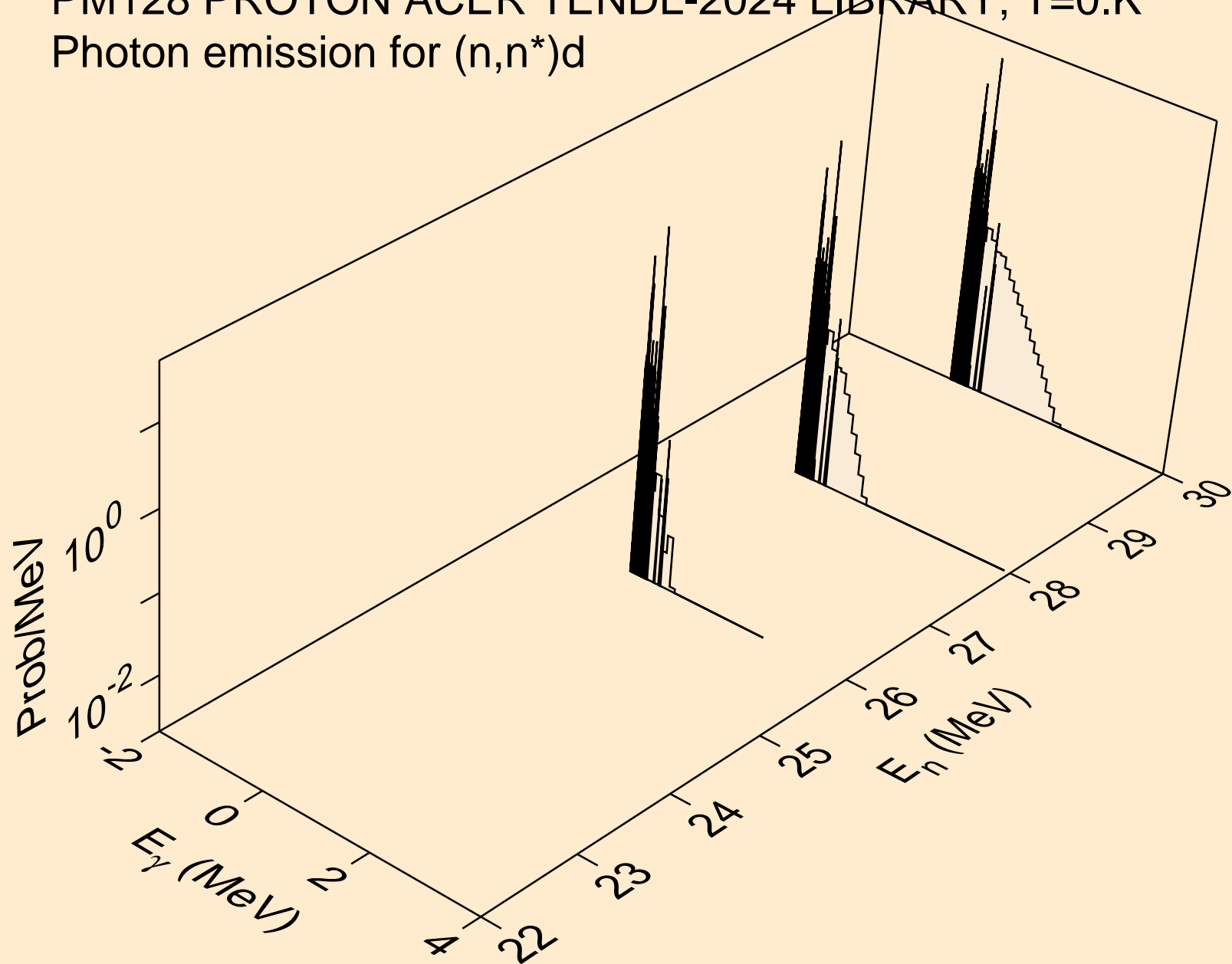

PM128 PROTON ACER TENDL-2024 LIBRARY; T=0.K  
Photon emission for (n,n\*)he3

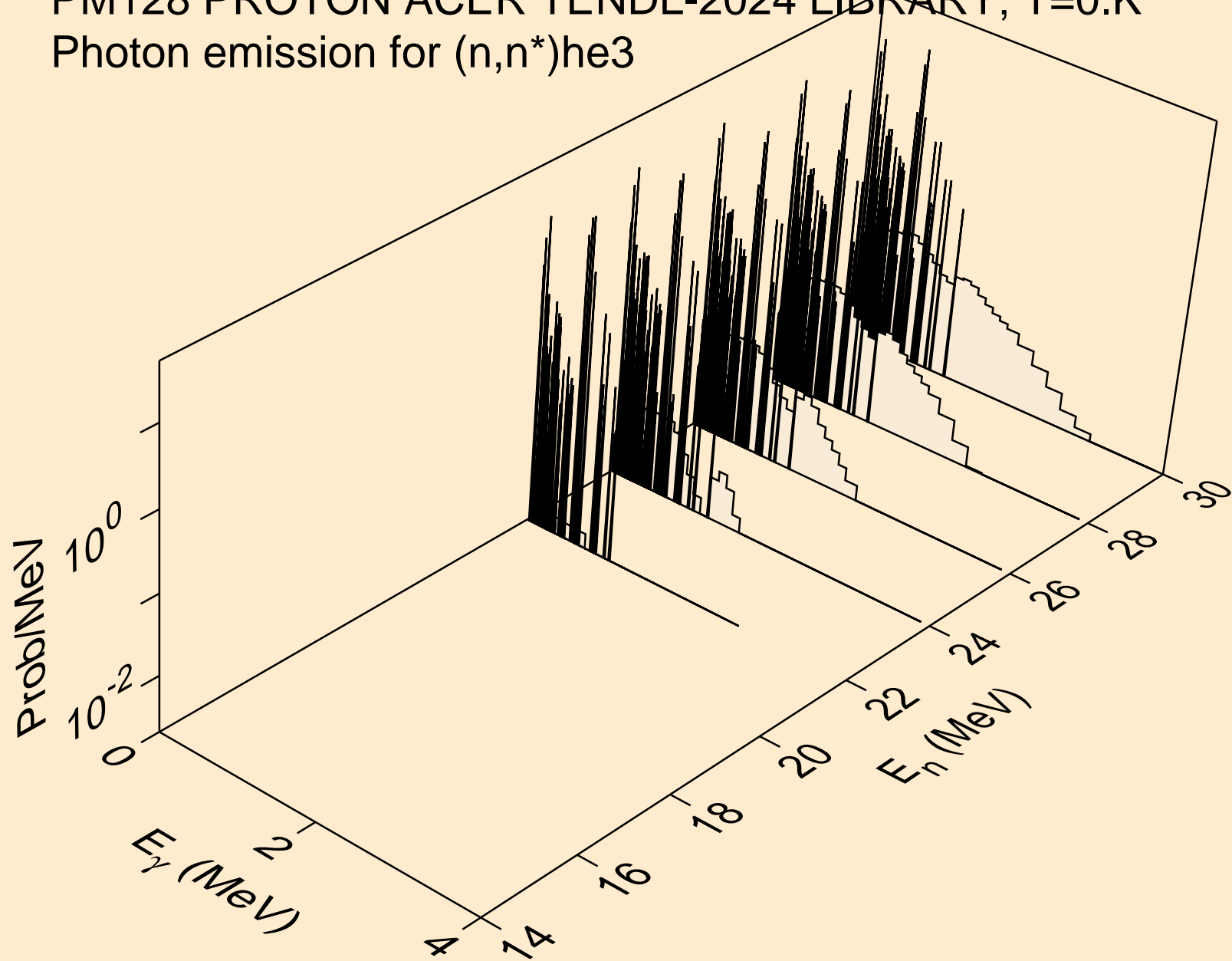

PM128 PROTON ACER TENDL-2024 LIBRARY; T=0.K  
Photon emission for (n,2np)

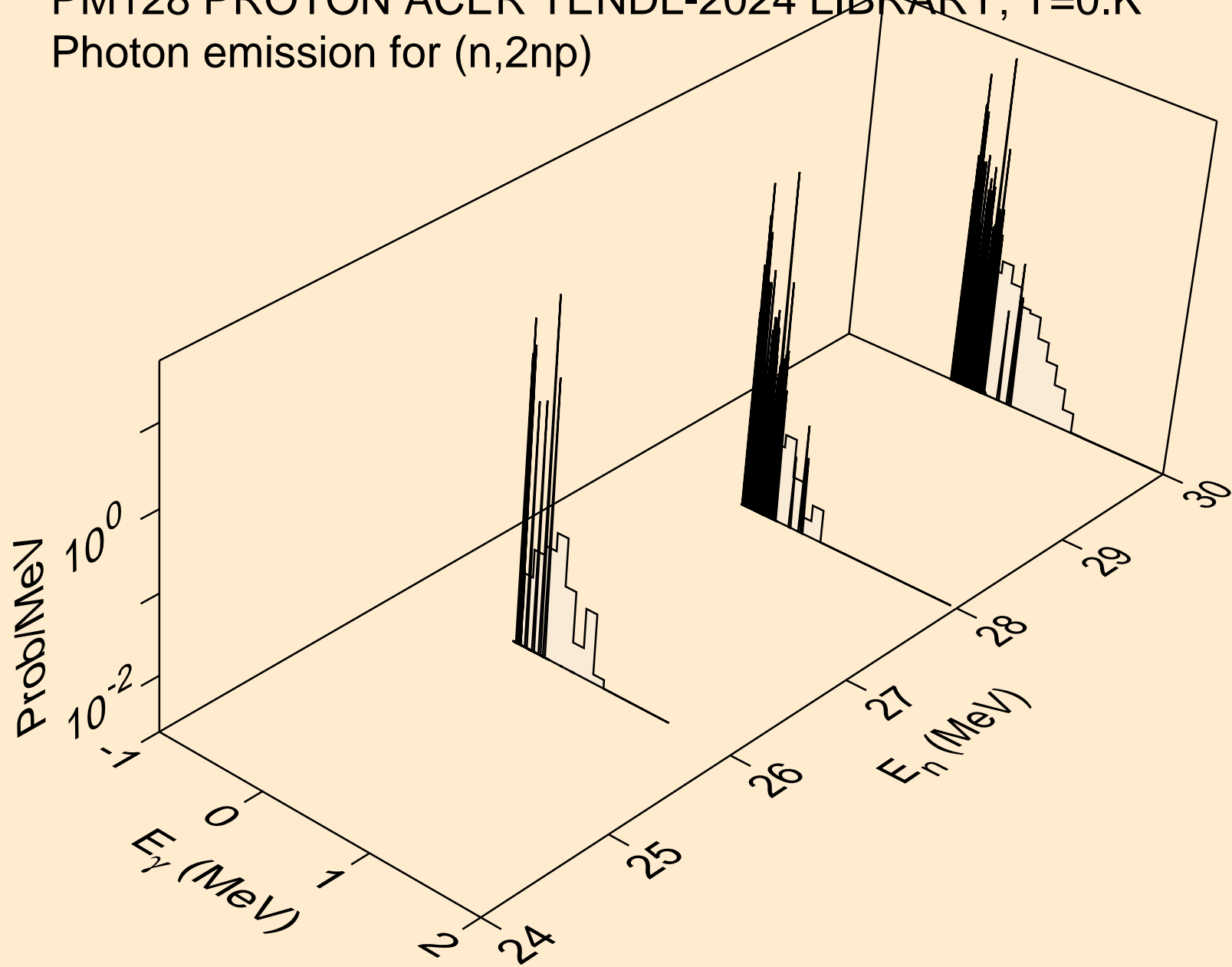

PM128 PROTON ACER TENDL-2024 LIBRARY; T=0.K  
Photon emission for (n,n2p)

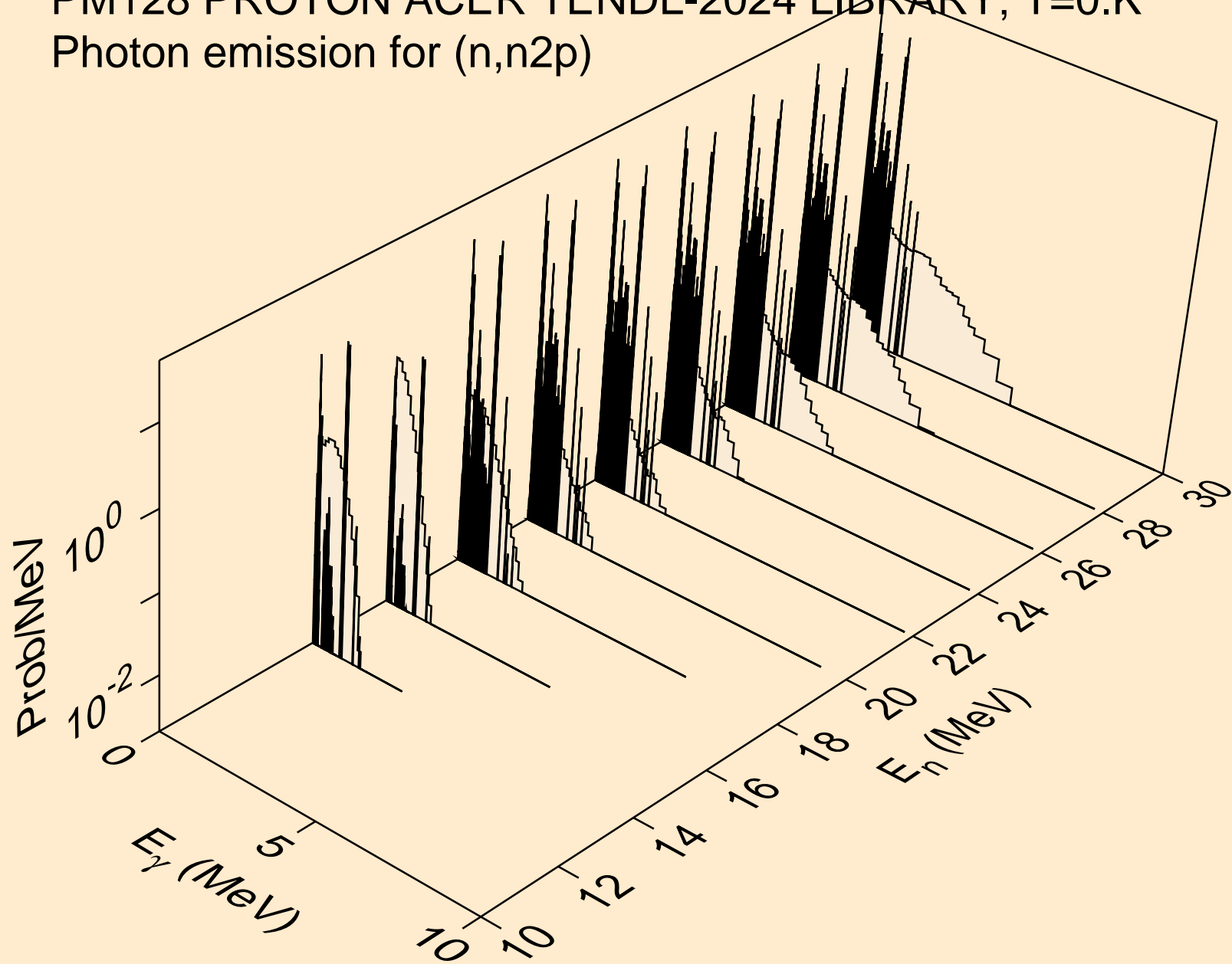

PM128 PROTON ACER TENDL-2024 LIBRARY; T=0.K  
Photon emission for (n,npa)

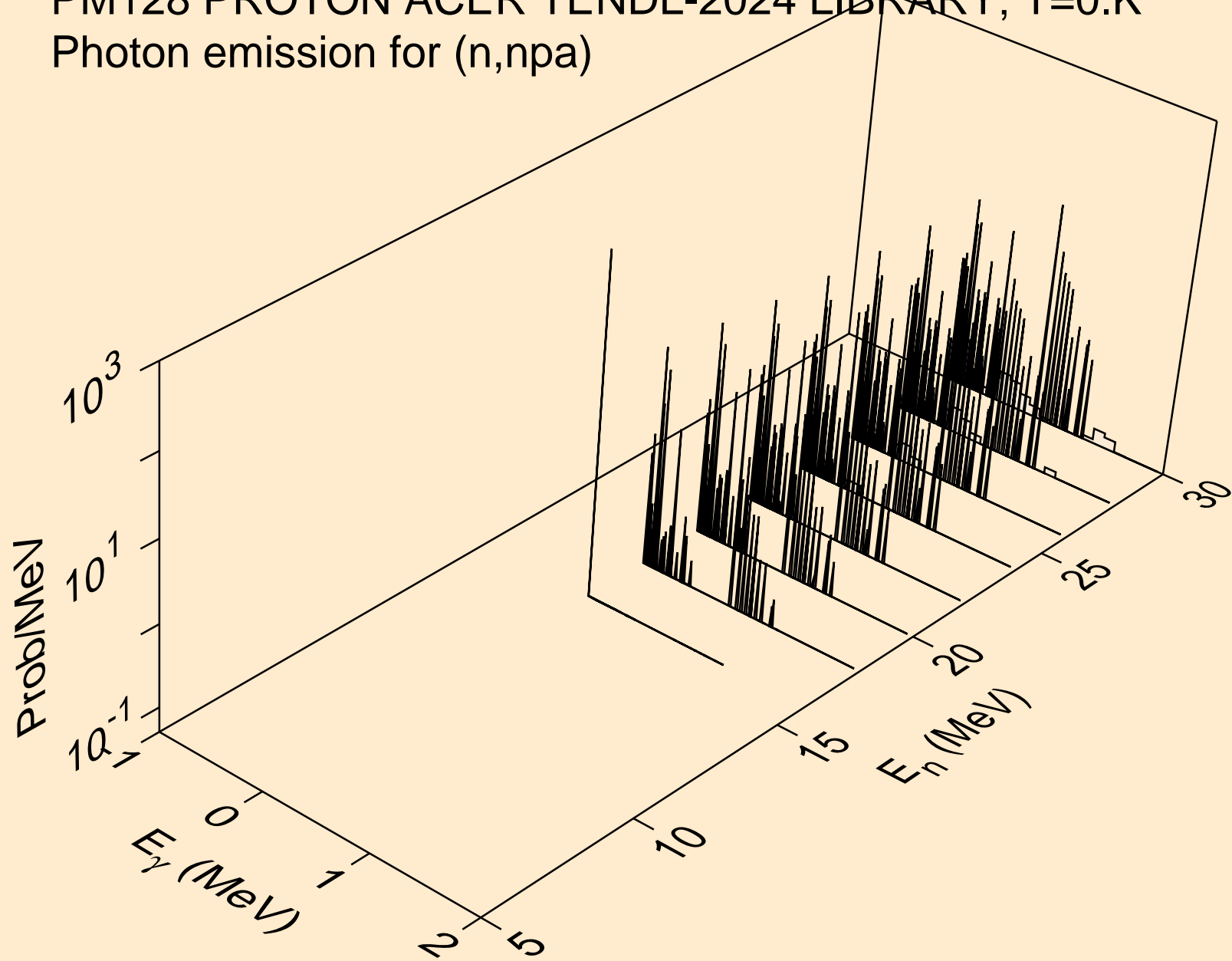

PM128 PROTON ACER TENDL-2024 LIBRARY; T=0.K  
Photon emission for (n,gma)

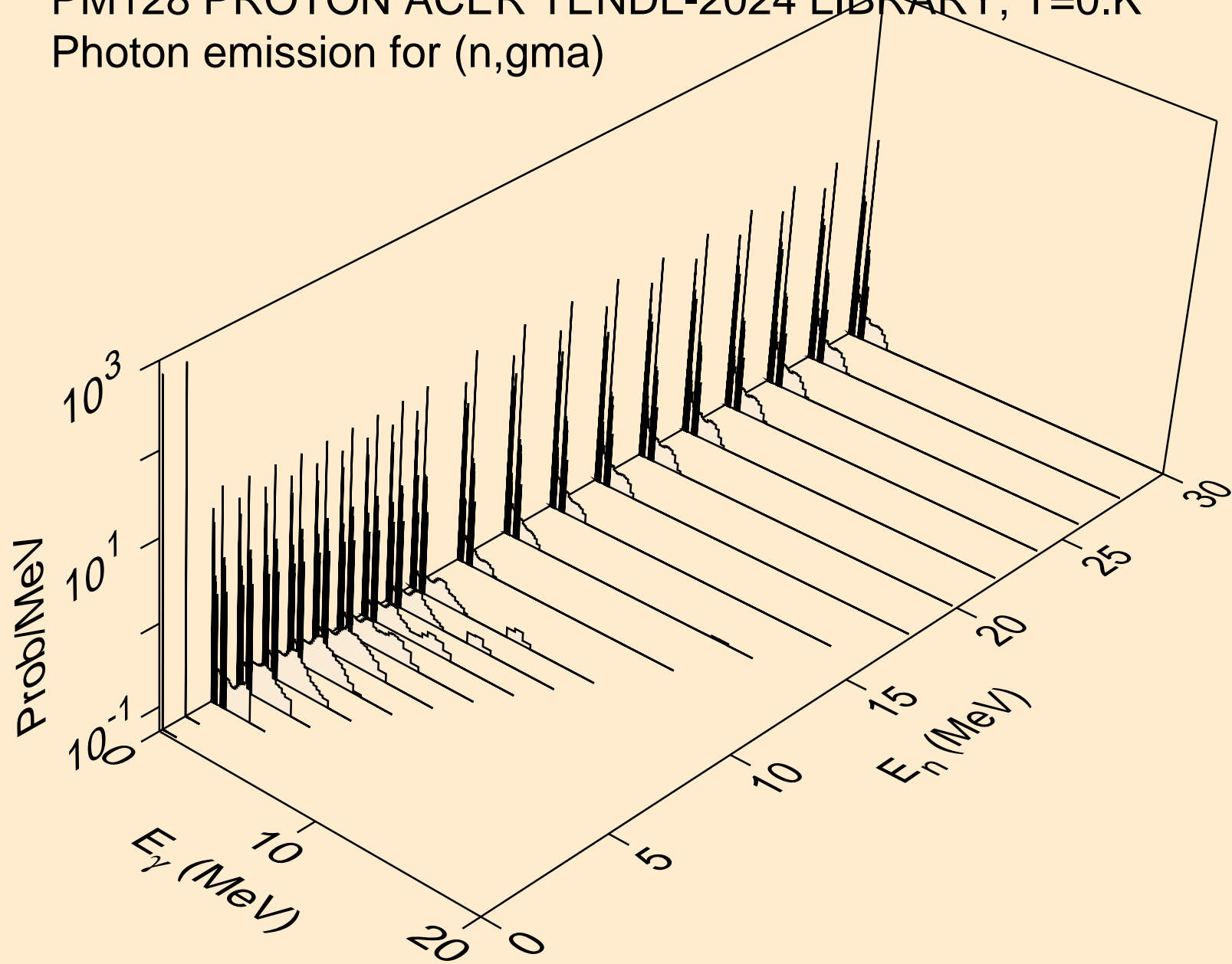

PM128 PROTON ACER TENDL-2024 LIBRARY; T=0.K  
Photon emission for inelastic

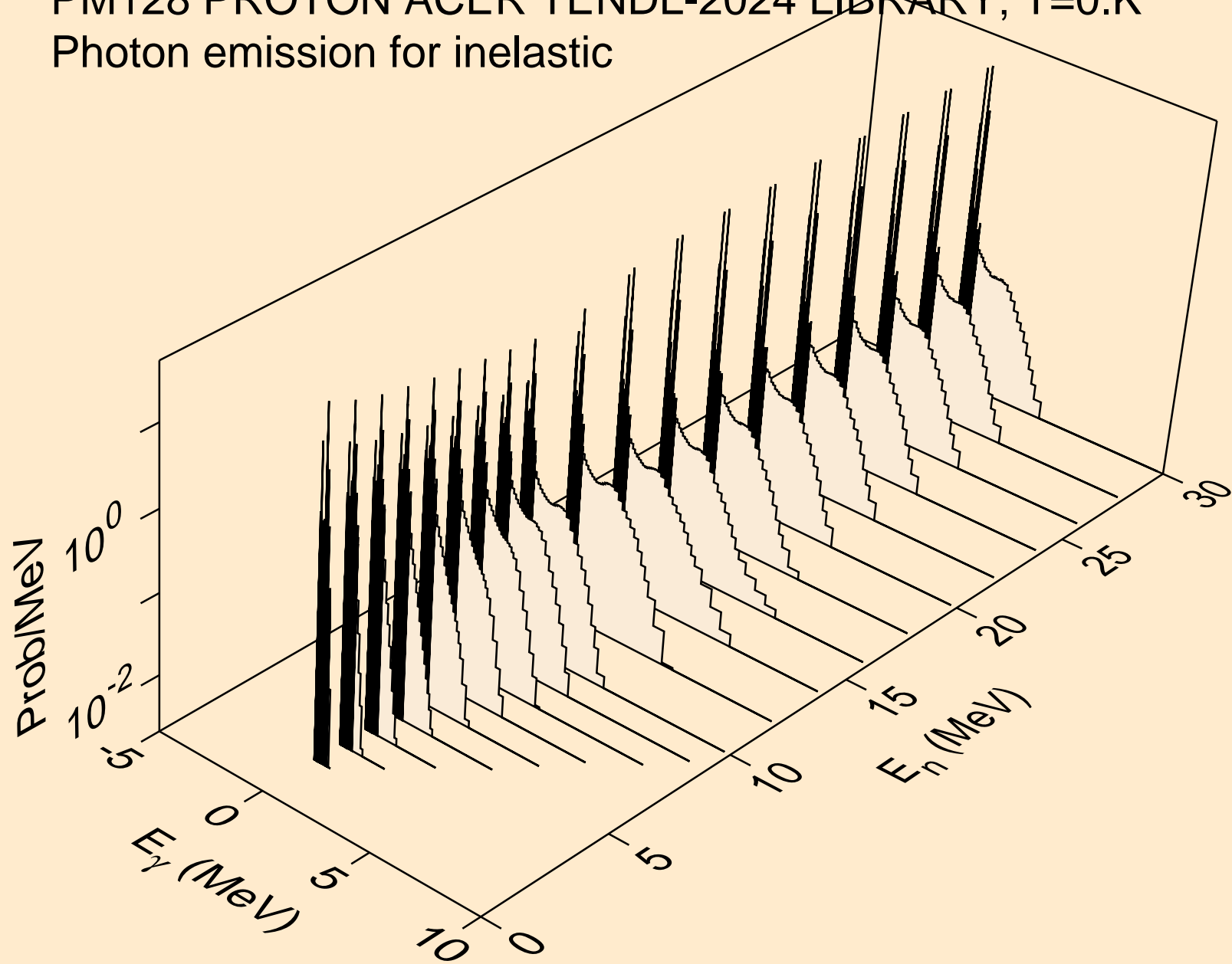

PM128 PROTON ACER TENDL-2024 LIBRARY; T=0.K  
Photon emission for (n,d)

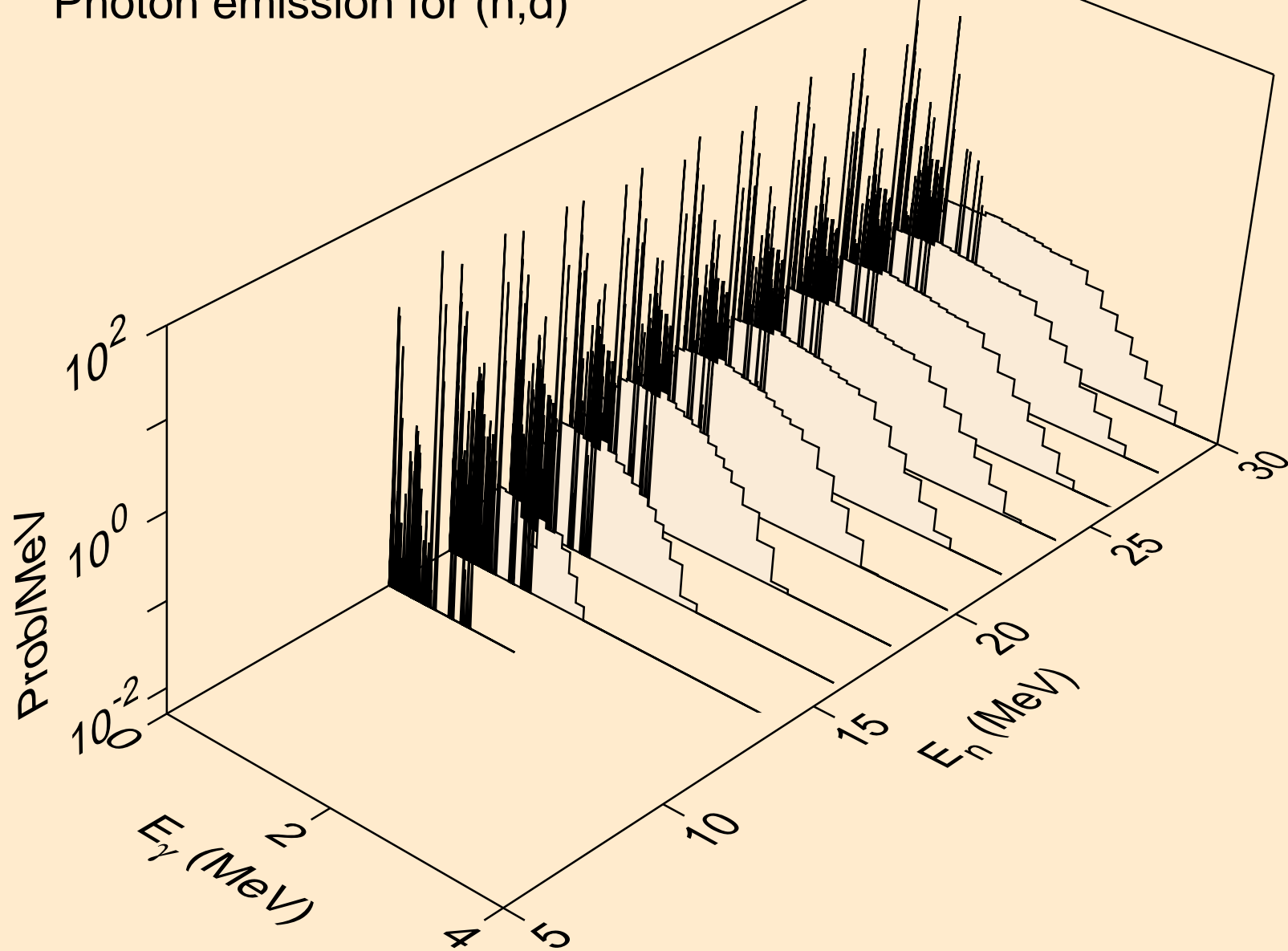

PM128 PROTON ACER TENDL-2024 LIBRARY; T=0.K  
Photon emission for (n,t)

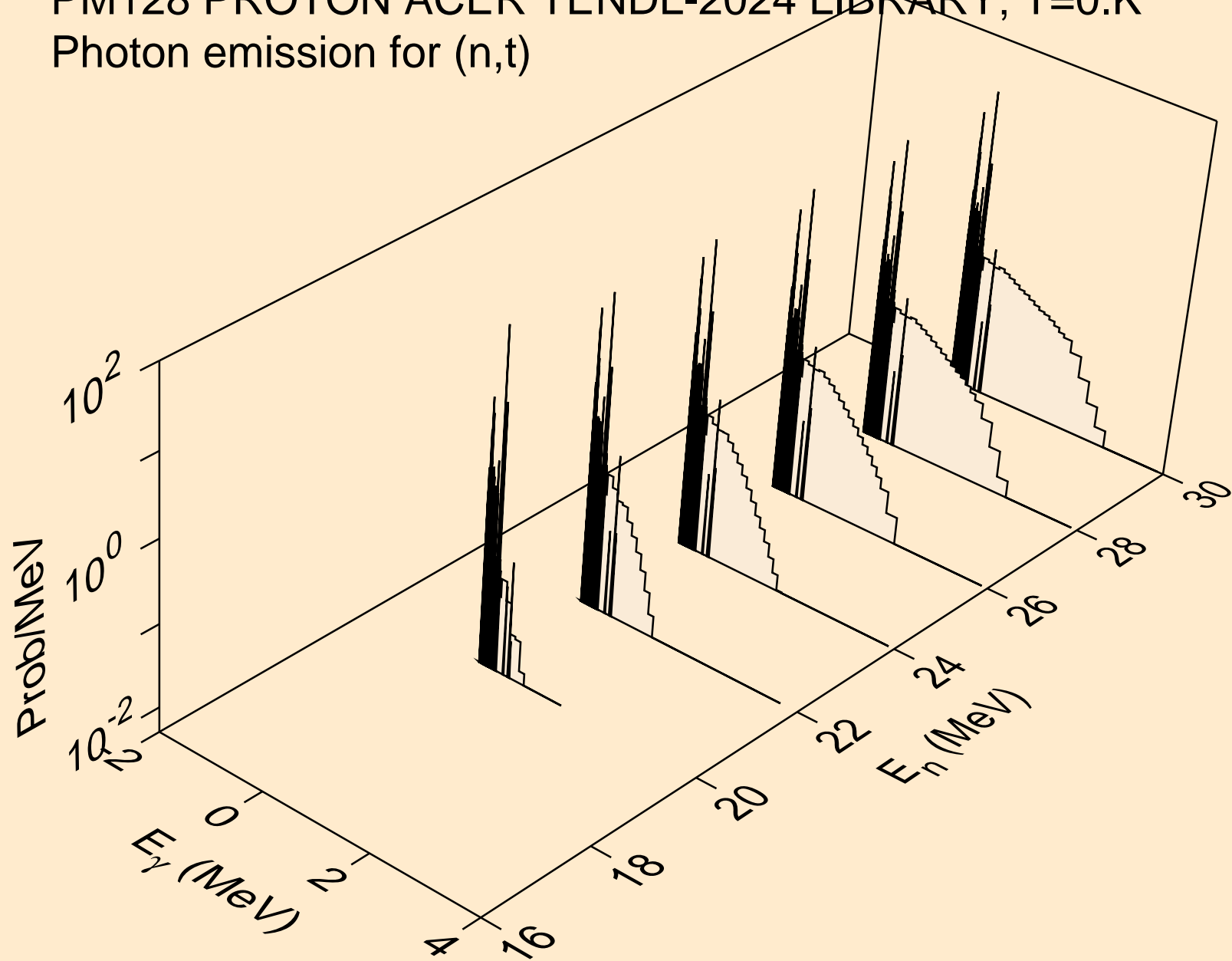

PM128 PROTON ACER TENDL-2024 LIBRARY; T=0.K  
Photon emission for (n,he3)

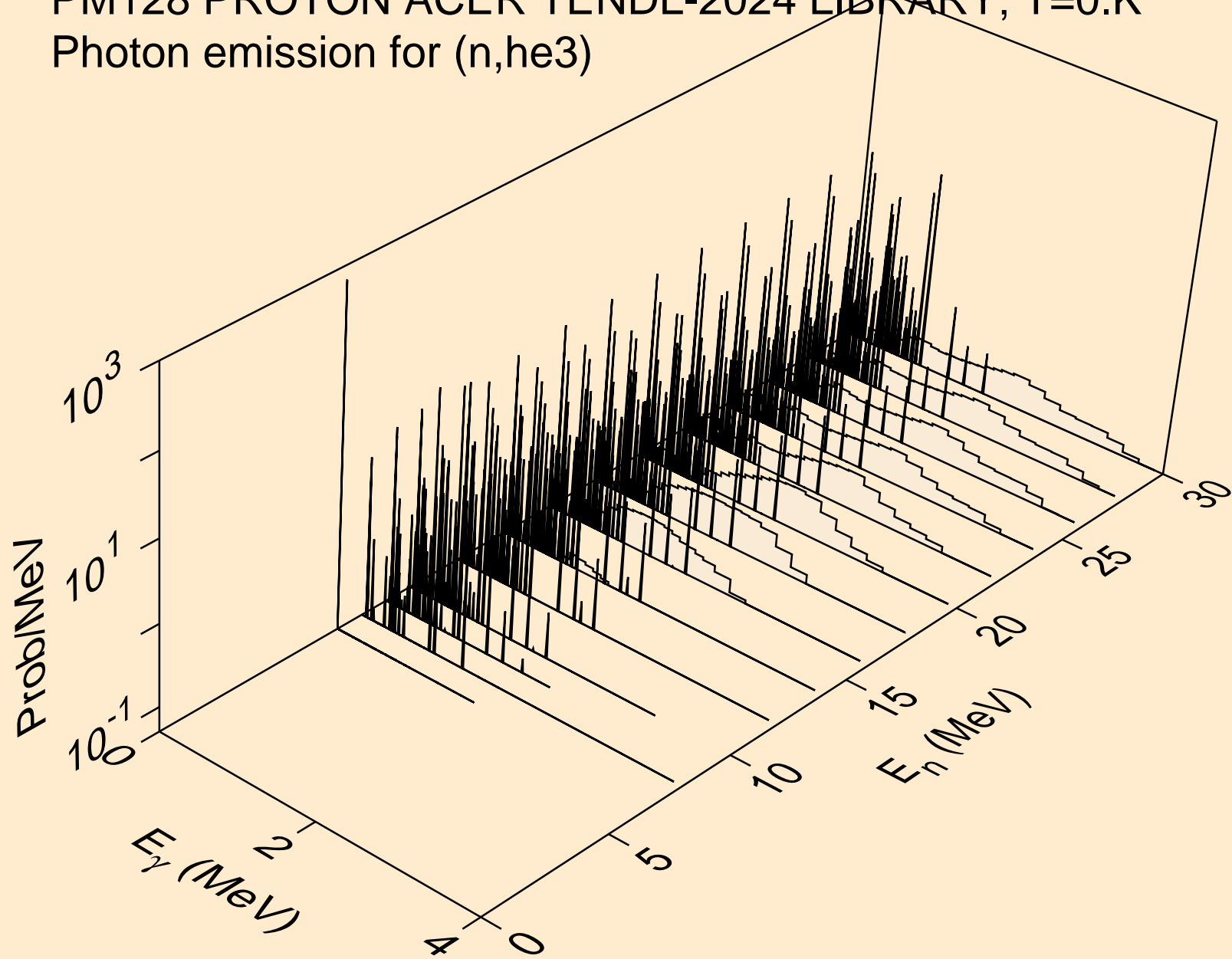

PM128 PROTON ACER TENDL-2024 LIBRARY; T=0.K  
Photon emission for (n,a)

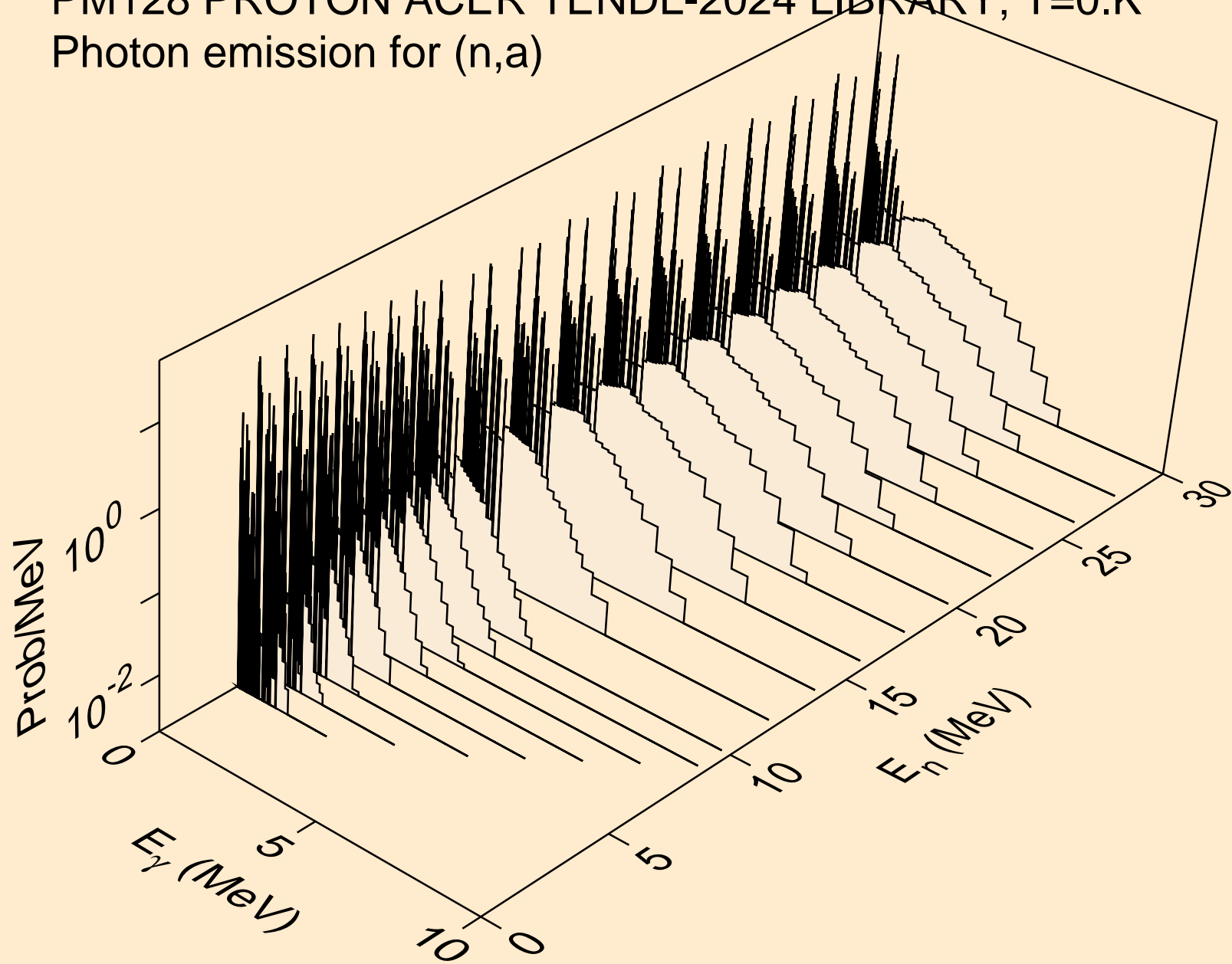

PM128 PROTON ACER TENDL-2024 LIBRARY; T=0.K  
Photon emission for (n,2a)

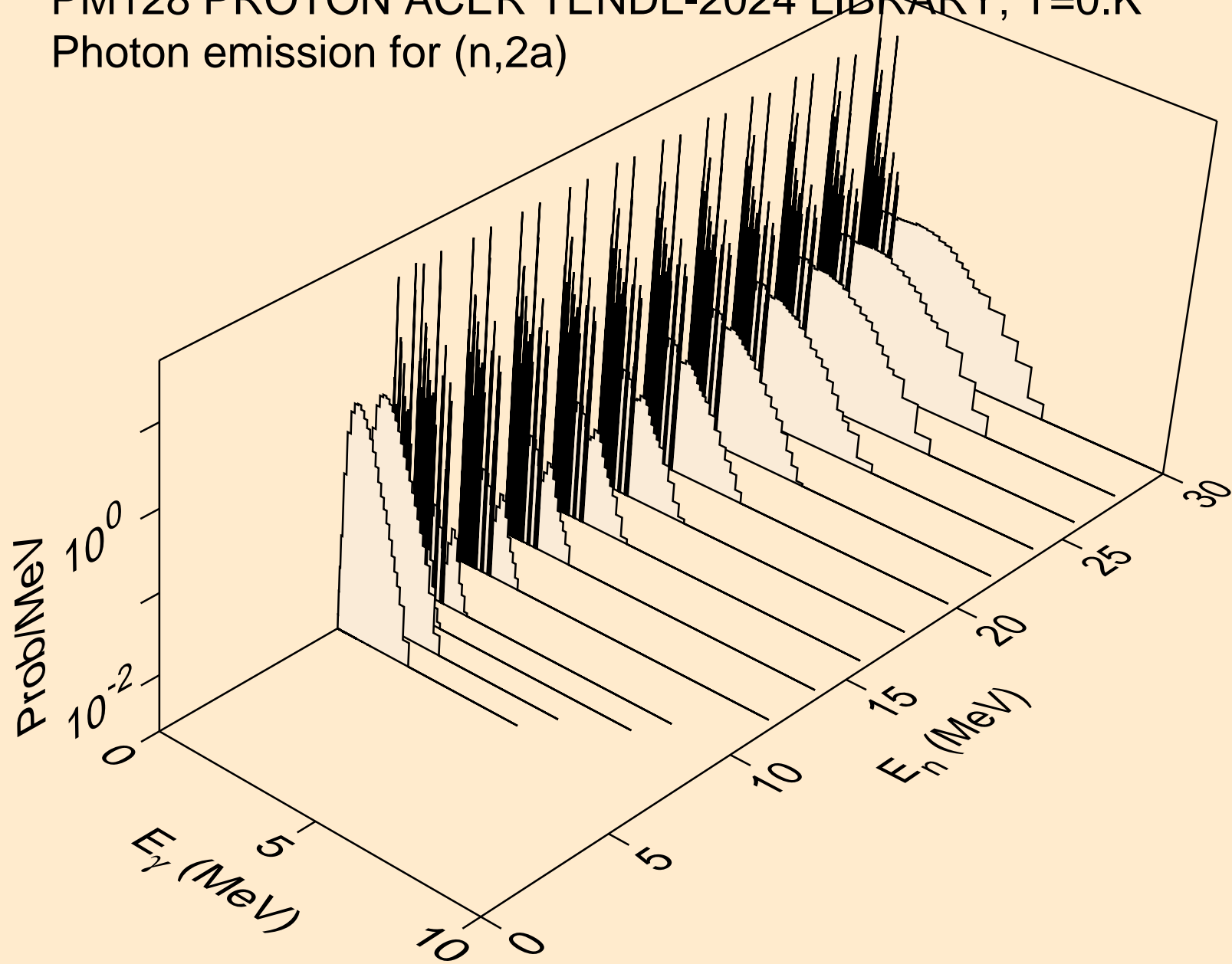

PM128 PROTON ACER TENDL-2024 LIBRARY; T=0.K  
Photon emission for (n,2p)

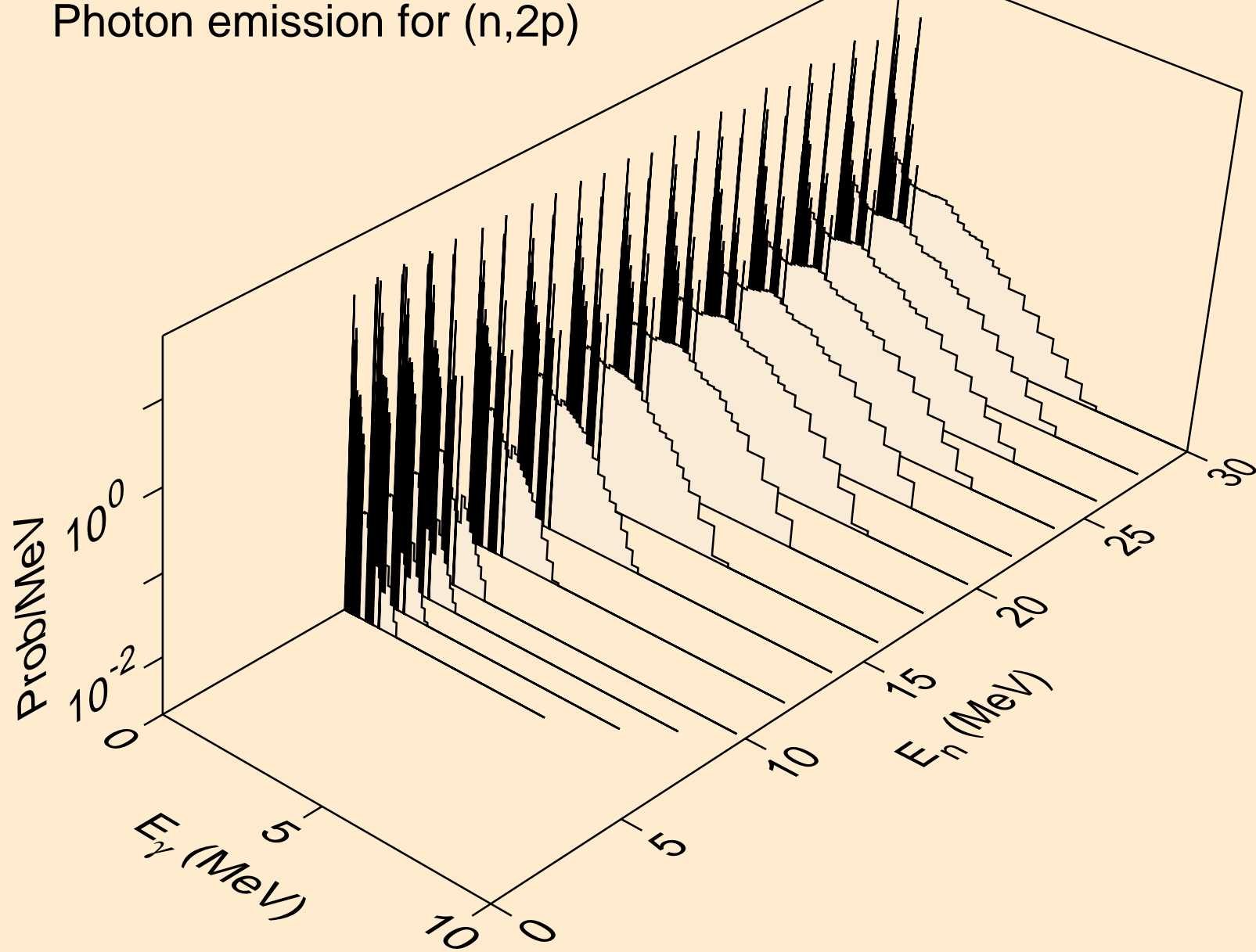

PM128 PROTON ACER TENDL-2024 LIBRARY; T=0.K  
Photon emission for (n,pa)

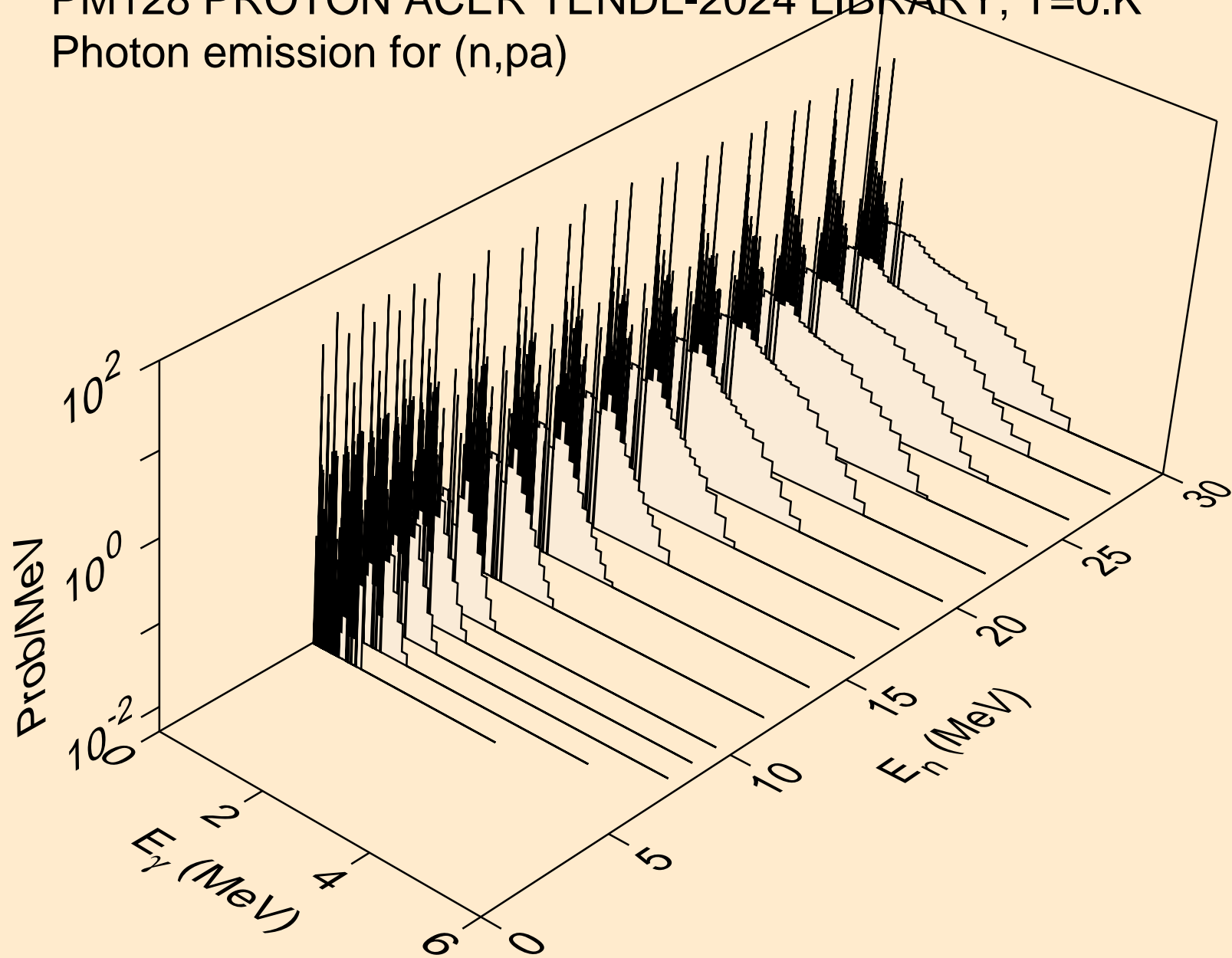

PM128 PROTON ACER TENDL-2024 LIBRARY; T=0.K  
Photon emission for (n,pd)

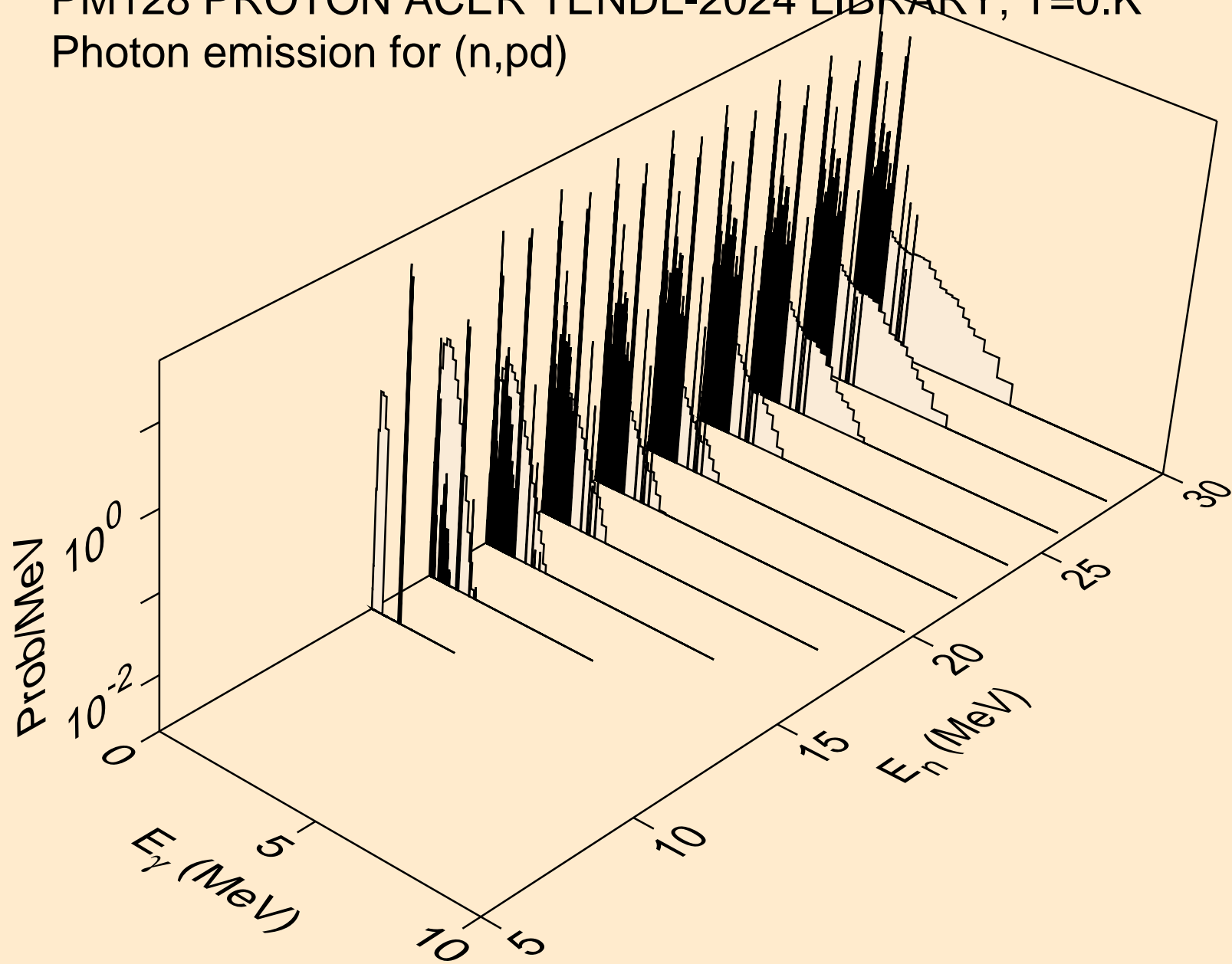

PM128 PROTON ACER TENDL-2024 LIBRARY; T=0.K  
Photon emission for (n,pt)

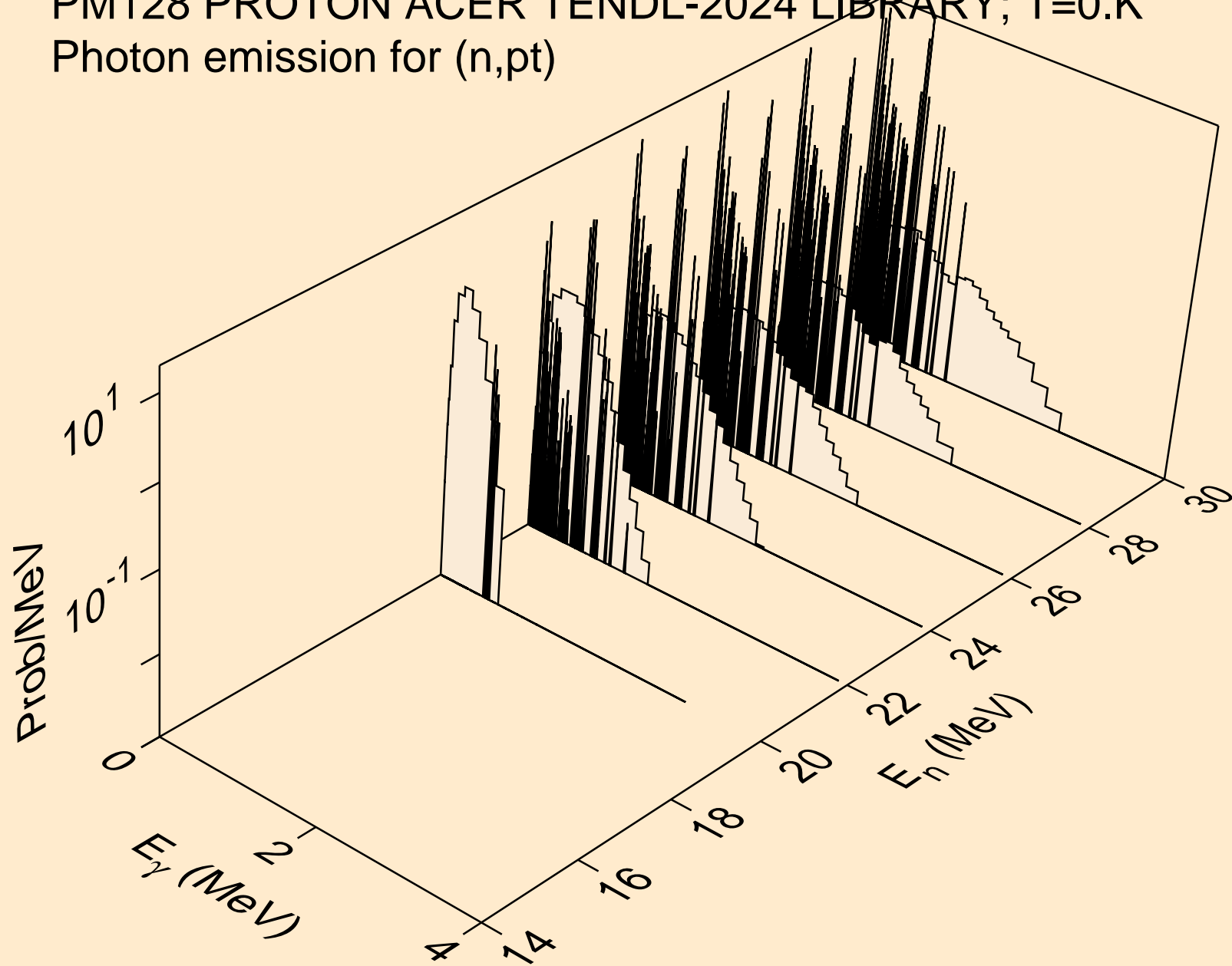

PM128 PROTON ACER TENDL-2024 LIBRARY; T=0.K  
Photon emission for (n,da)

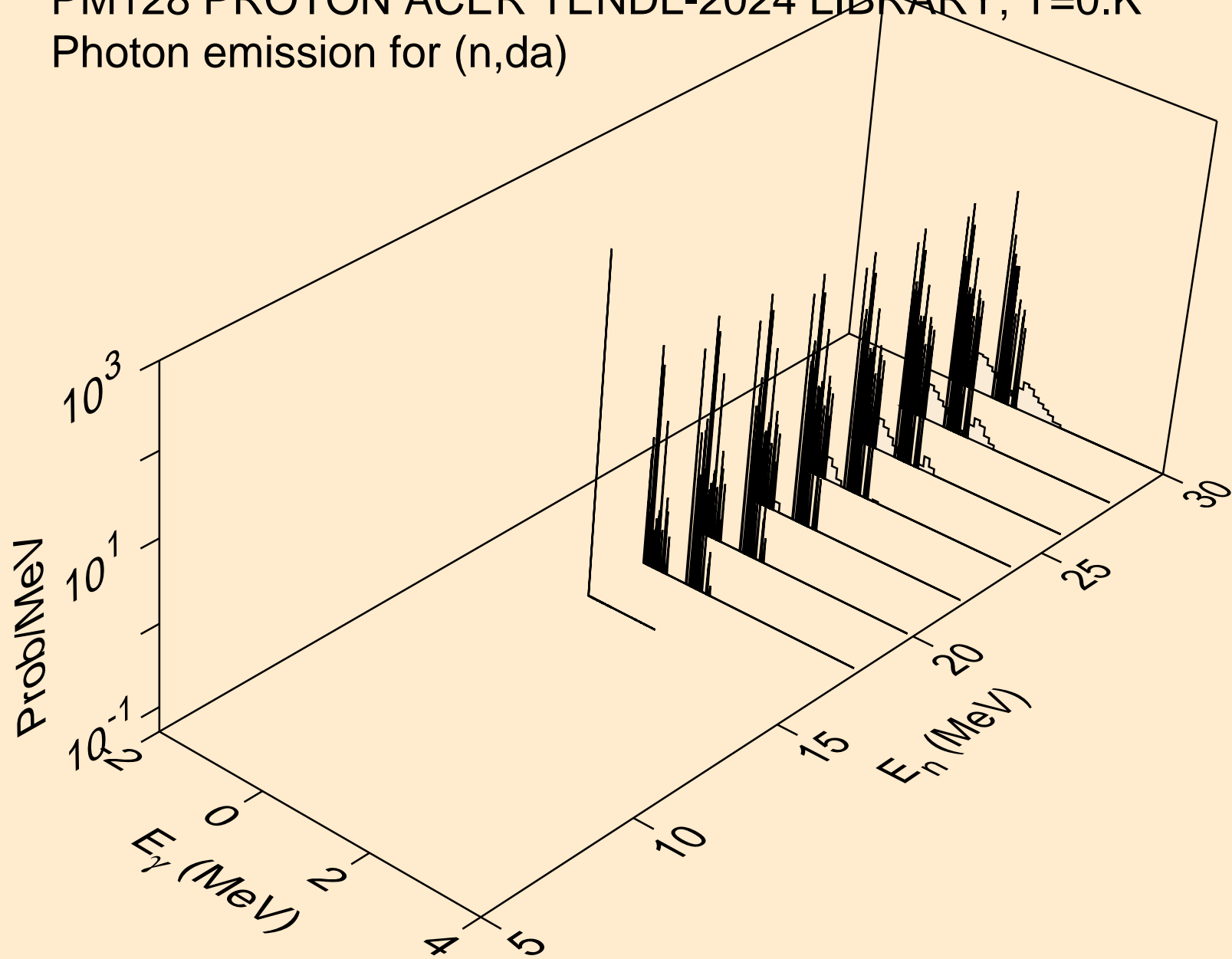

# PM128 PROTON ACER TENDL-2024 LIBRARY; T=0.K

## Particle heating contributions

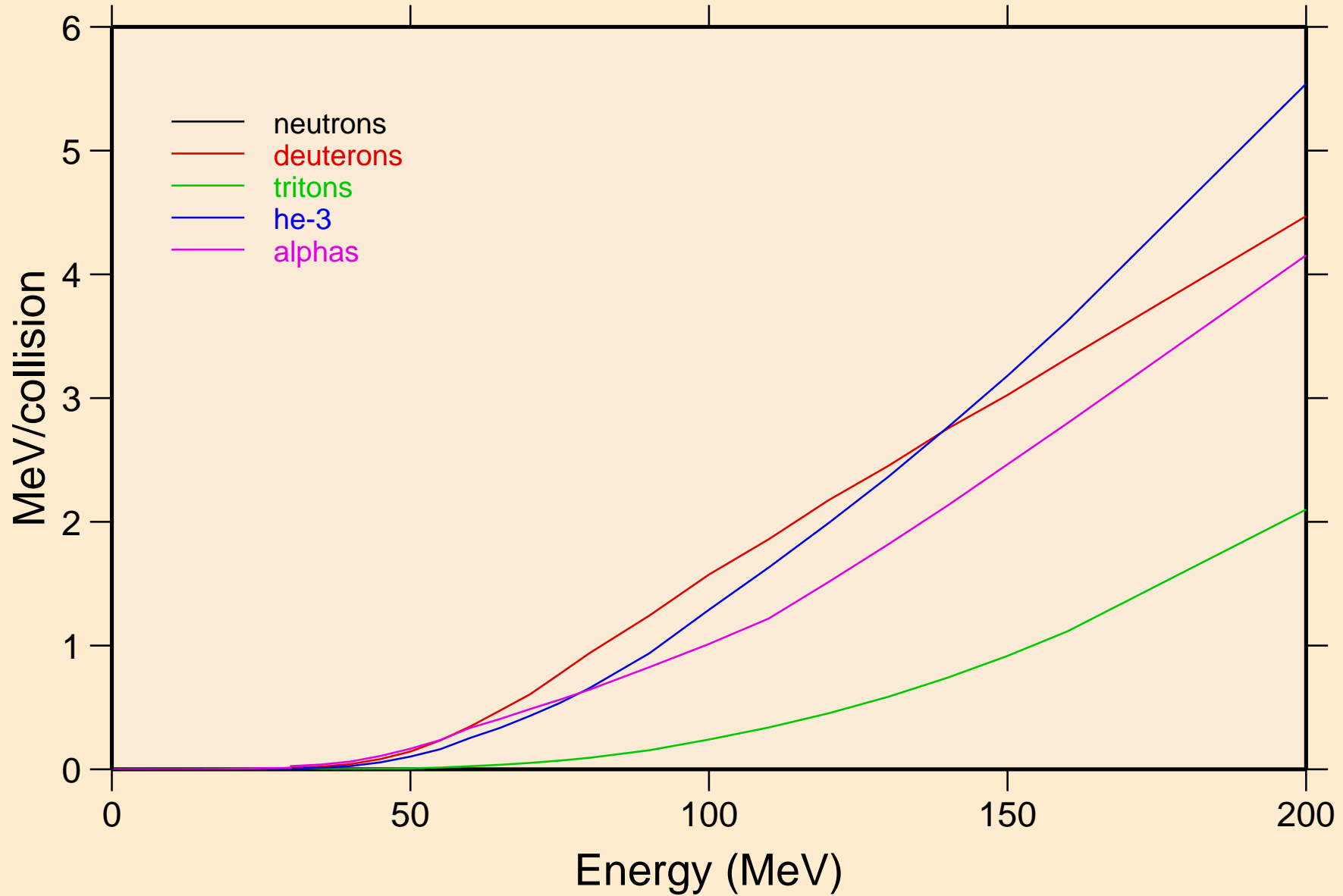

PM128 PROTON ACER TENDL-2024 LIBRARY; T=0.K  
Recoil Heating

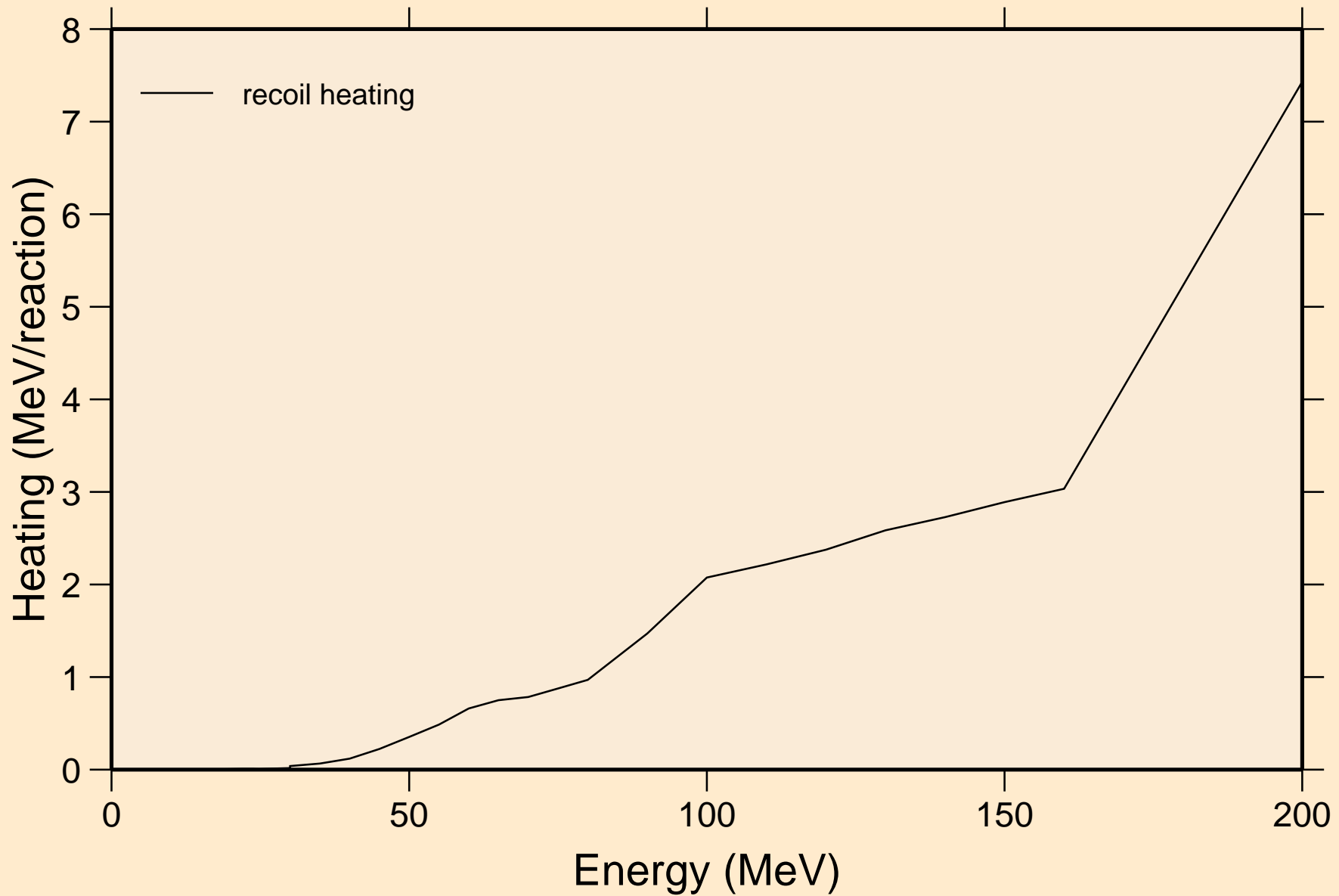

PM128 PROTON ACER TENDL-2024 LIBRARY; T=0.K  
Particle production cross sections

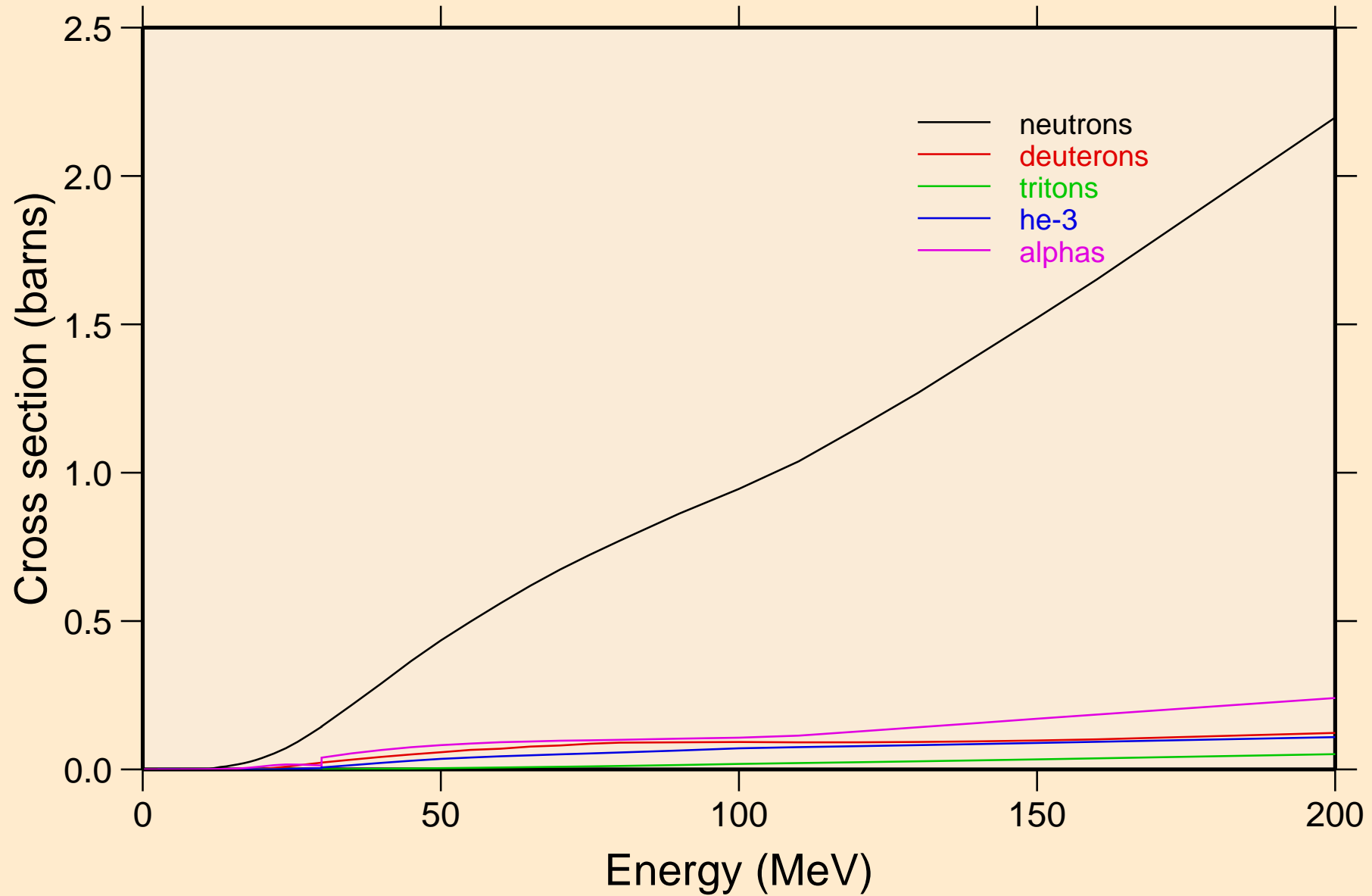

PM128 PROTON ACER TENDL-2024 LIBRARY; T=0.K  
neutrons from (p,n)

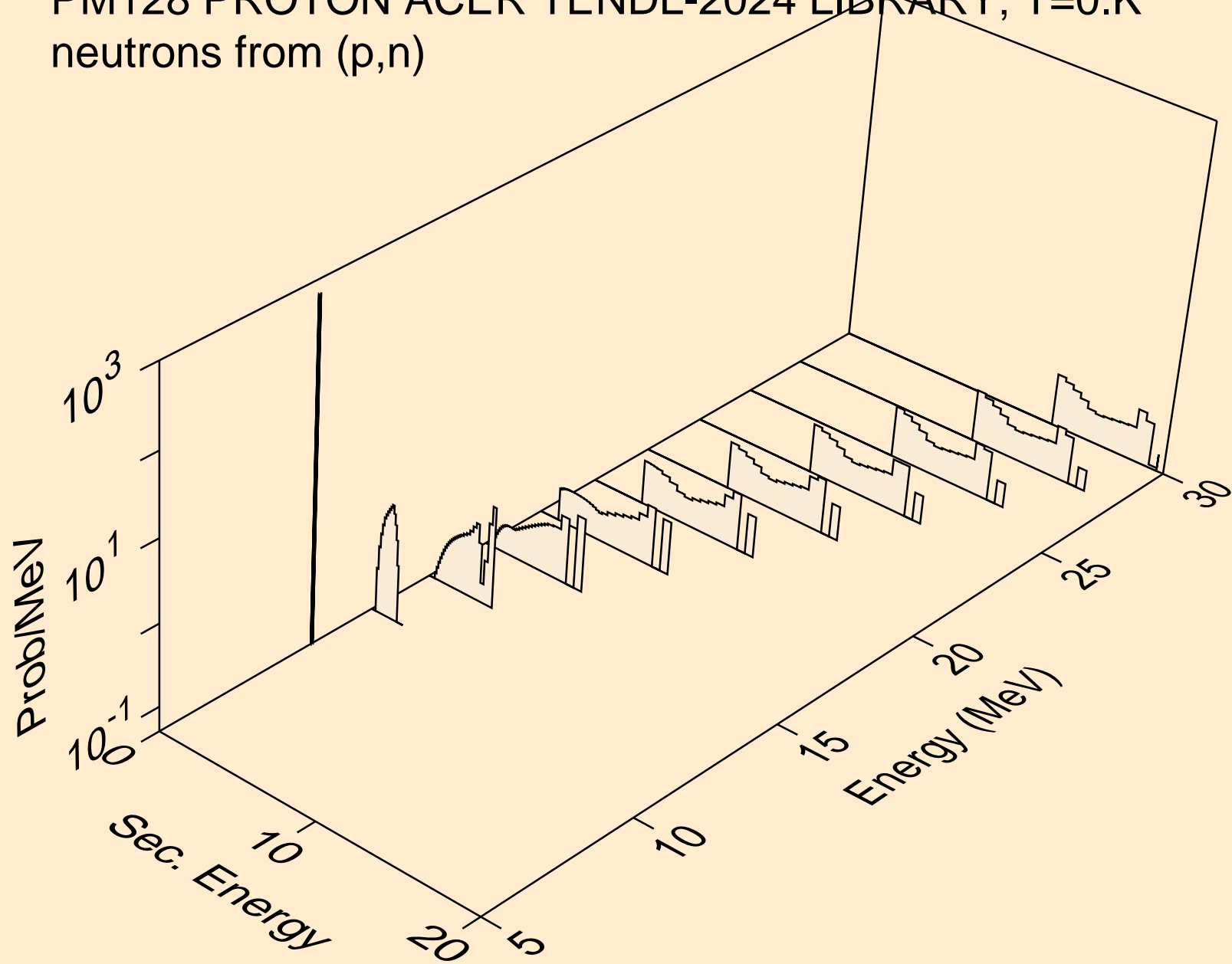

PM128 PROTON ACER TENDL-2024 LIBRARY; T=0.K  
neutrons from (p,x)

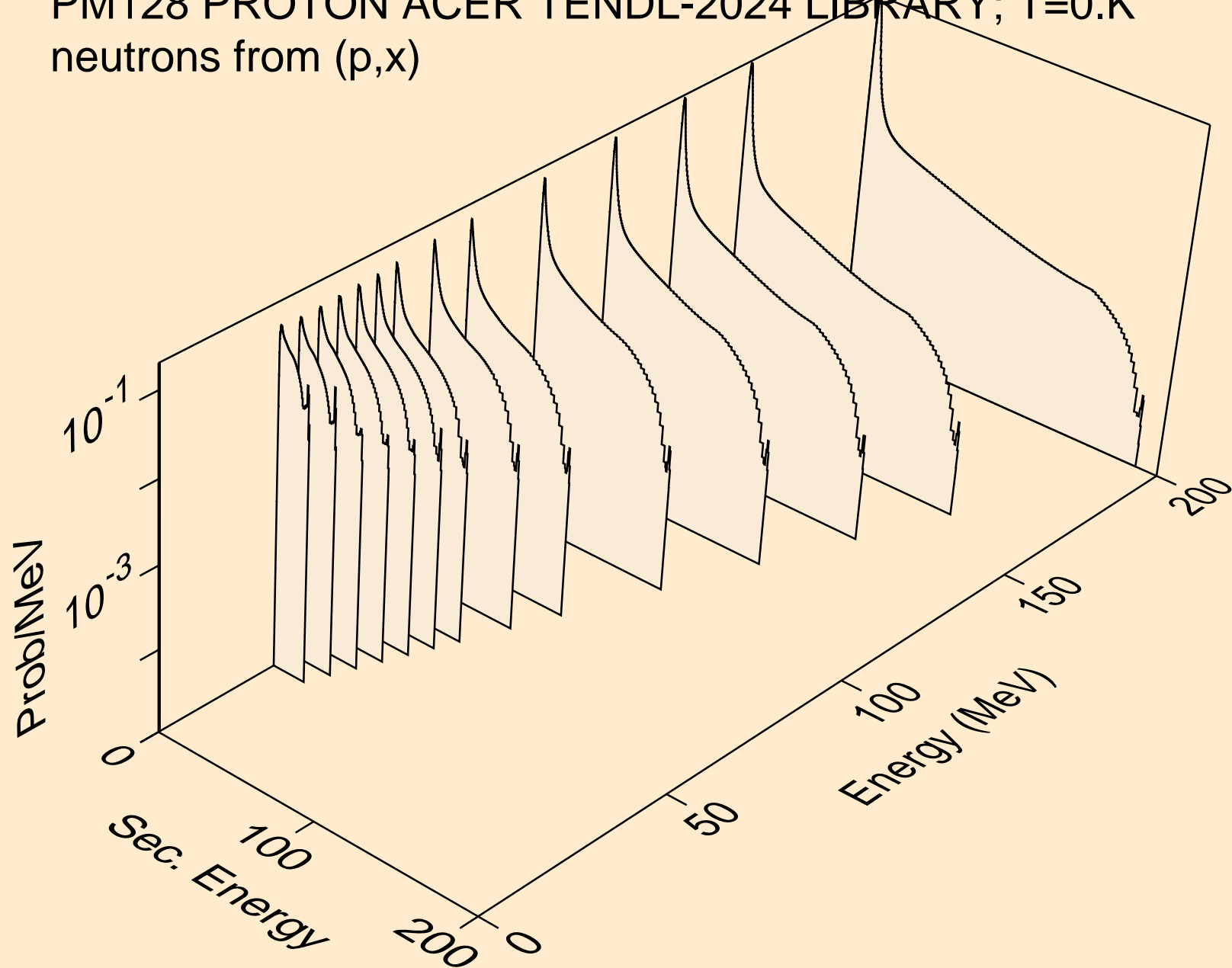

PM128 PROTON ACER TENDL-2024 LIBRARY; T=0.K  
neutrons from (p,2n)

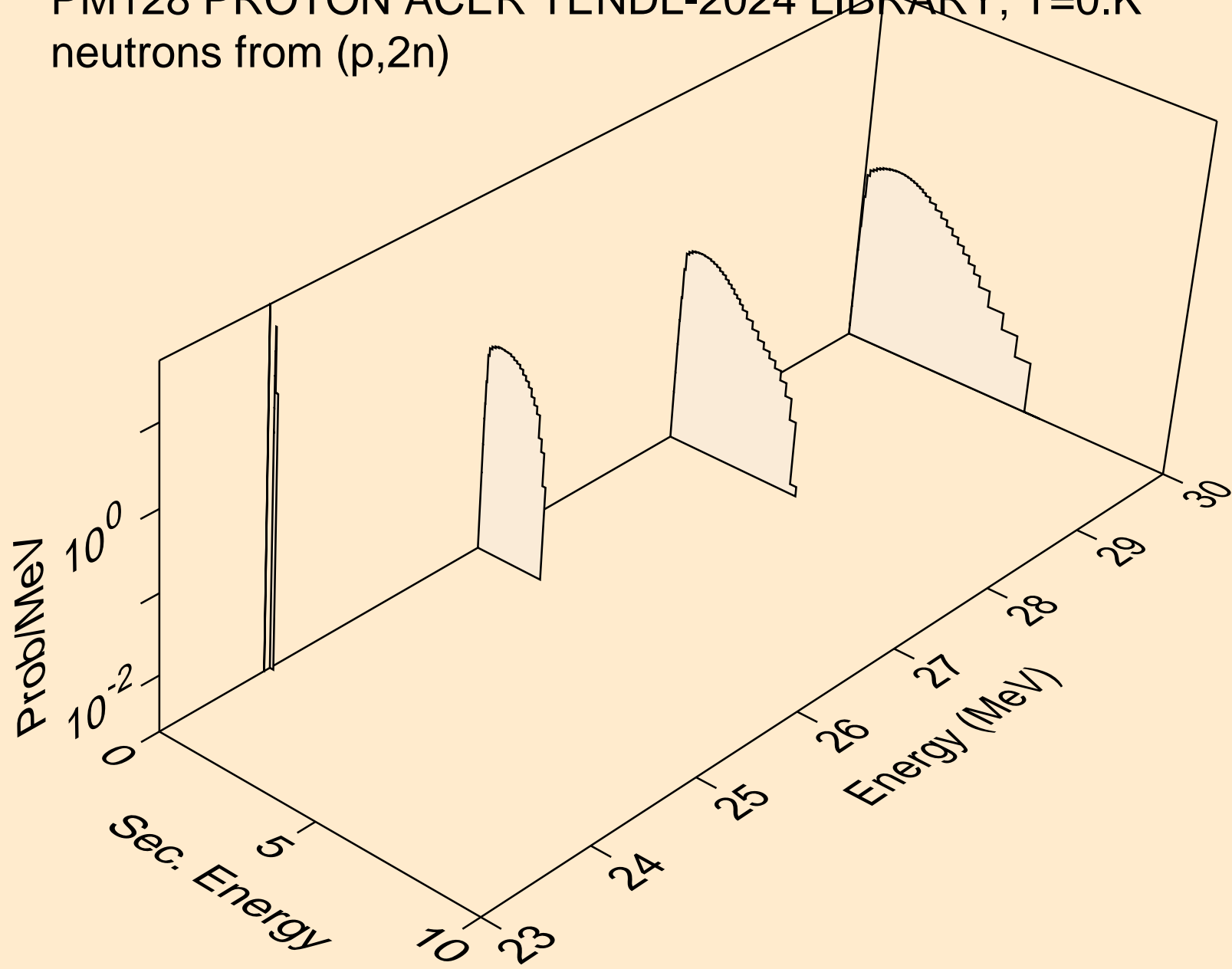

PM128 PROTON ACER TENDL-2024 LIBRARY; T=0.K  
neutrons from (p,n\*)a

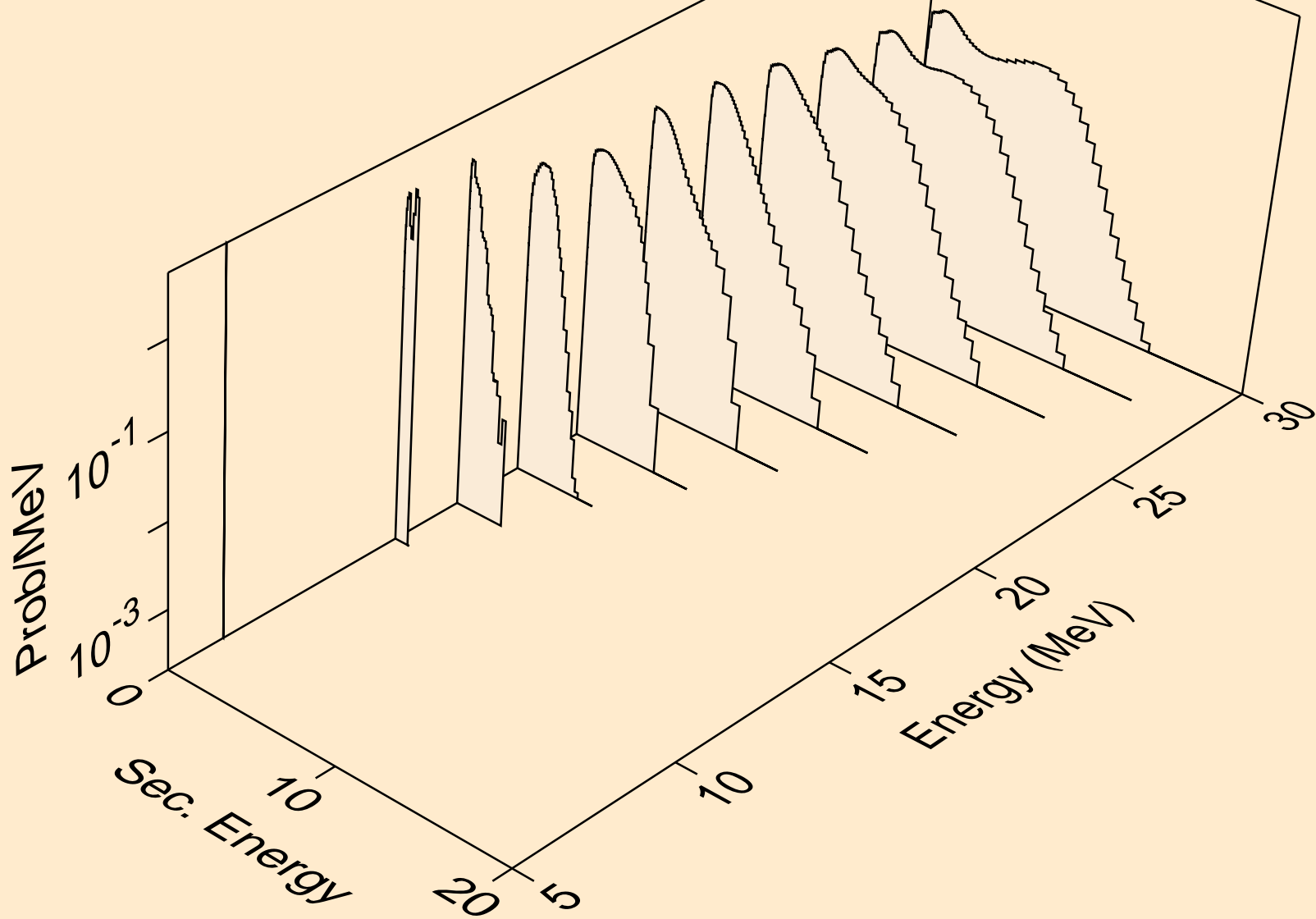

PM128 PROTON ACER TENDL-2024 LIBRARY; T=0.K  
neutrons from (p,n\*)p

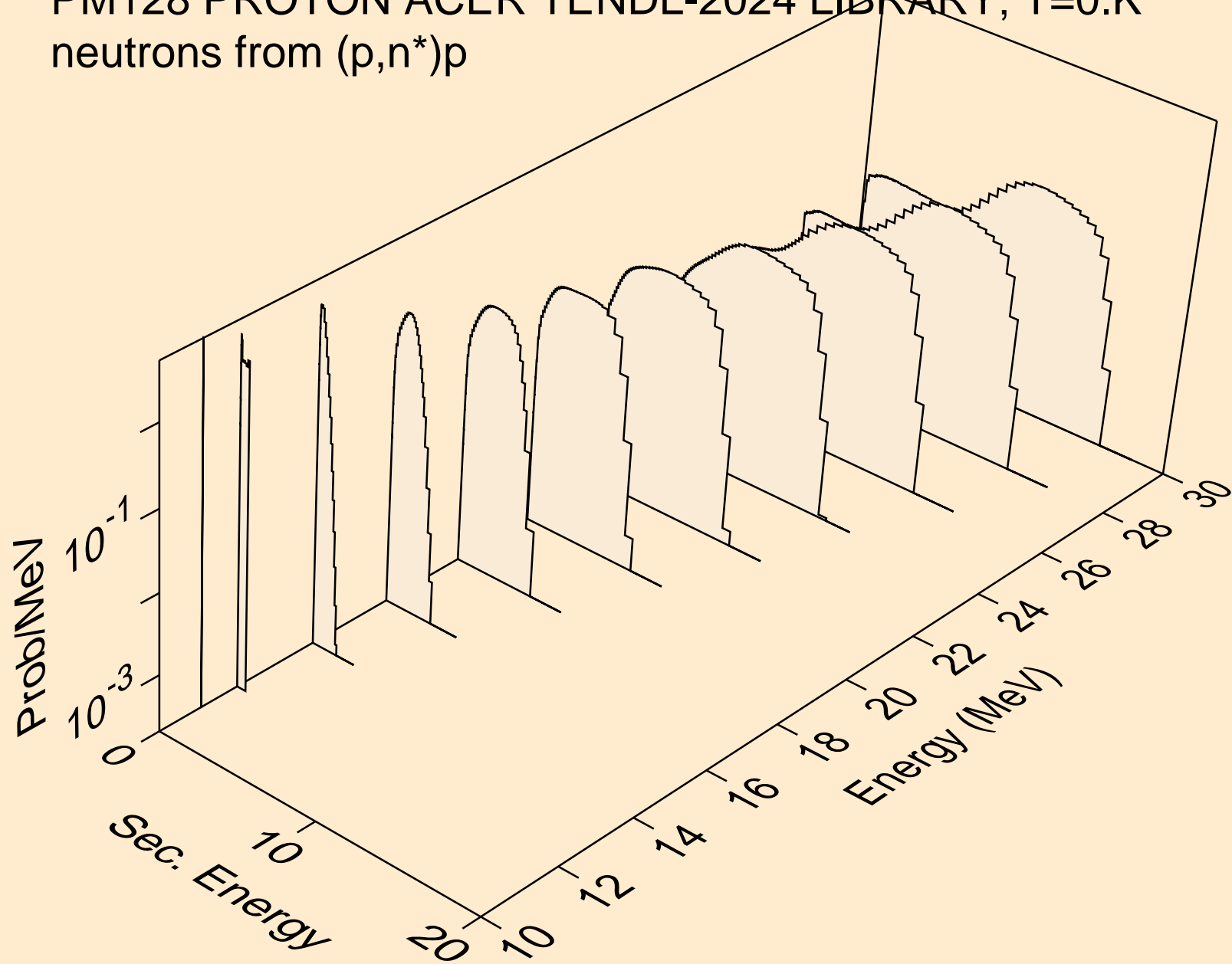

PM128 PROTON ACER TENDL-2024 LIBRARY; T=0.K  
neutrons from (p,n\*)2a

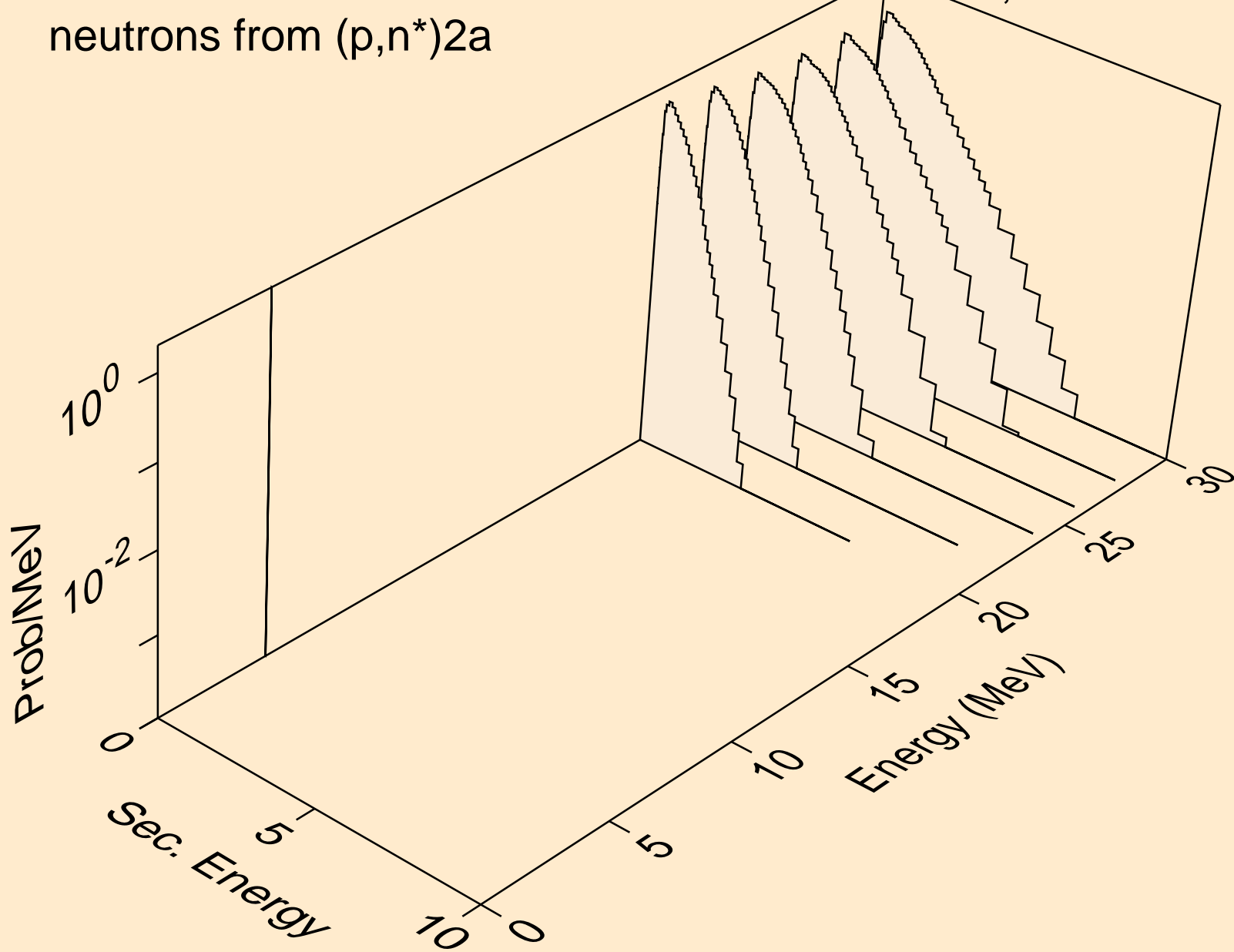

PM128 PROTON ACER TENDL-2024 LIBRARY; T=0.K  
neutrons from (p,n\*)d

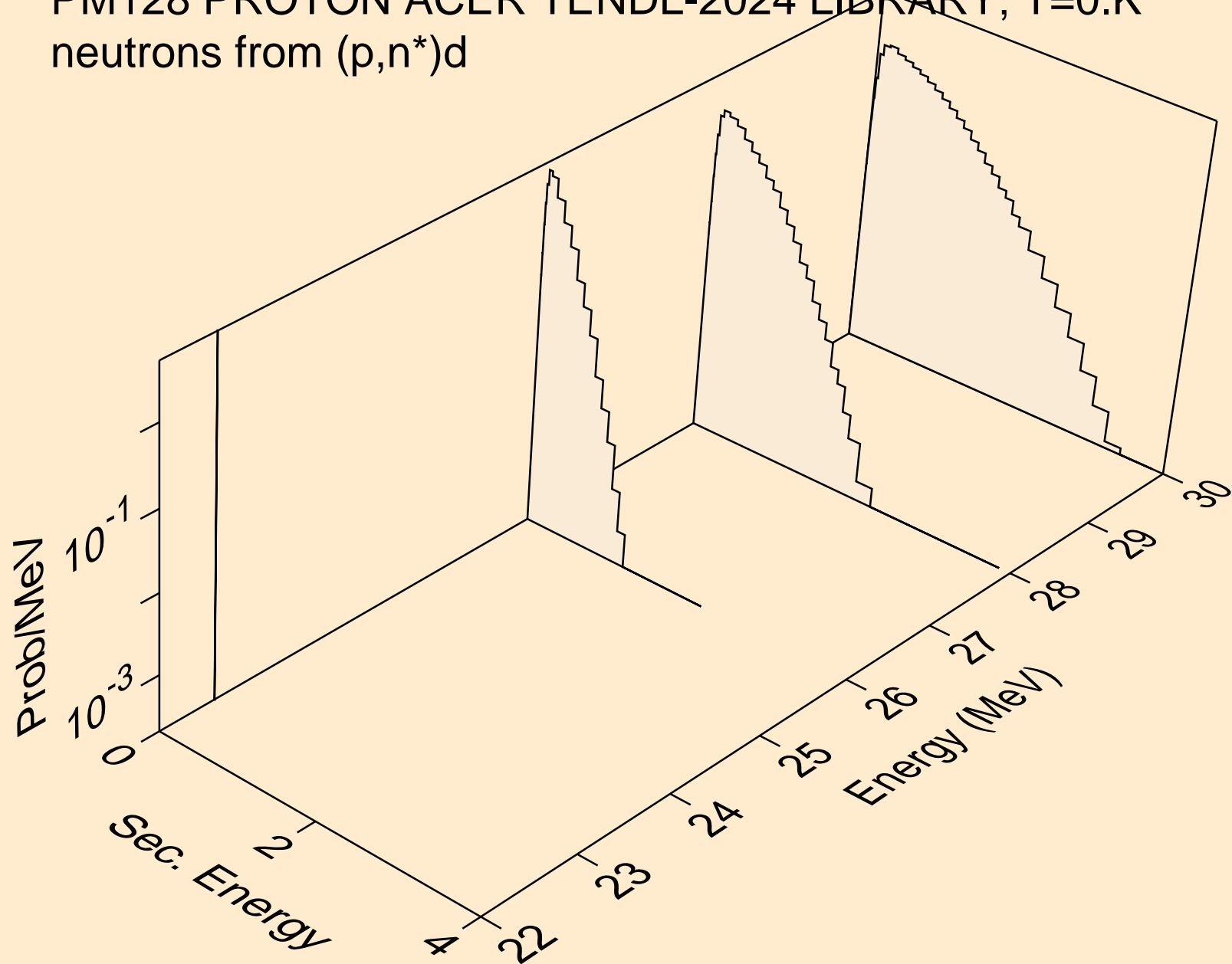

PM128 PROTON ACER TENDL-2024 LIBRARY; T=0.K  
neutrons from (p,n\*)he3

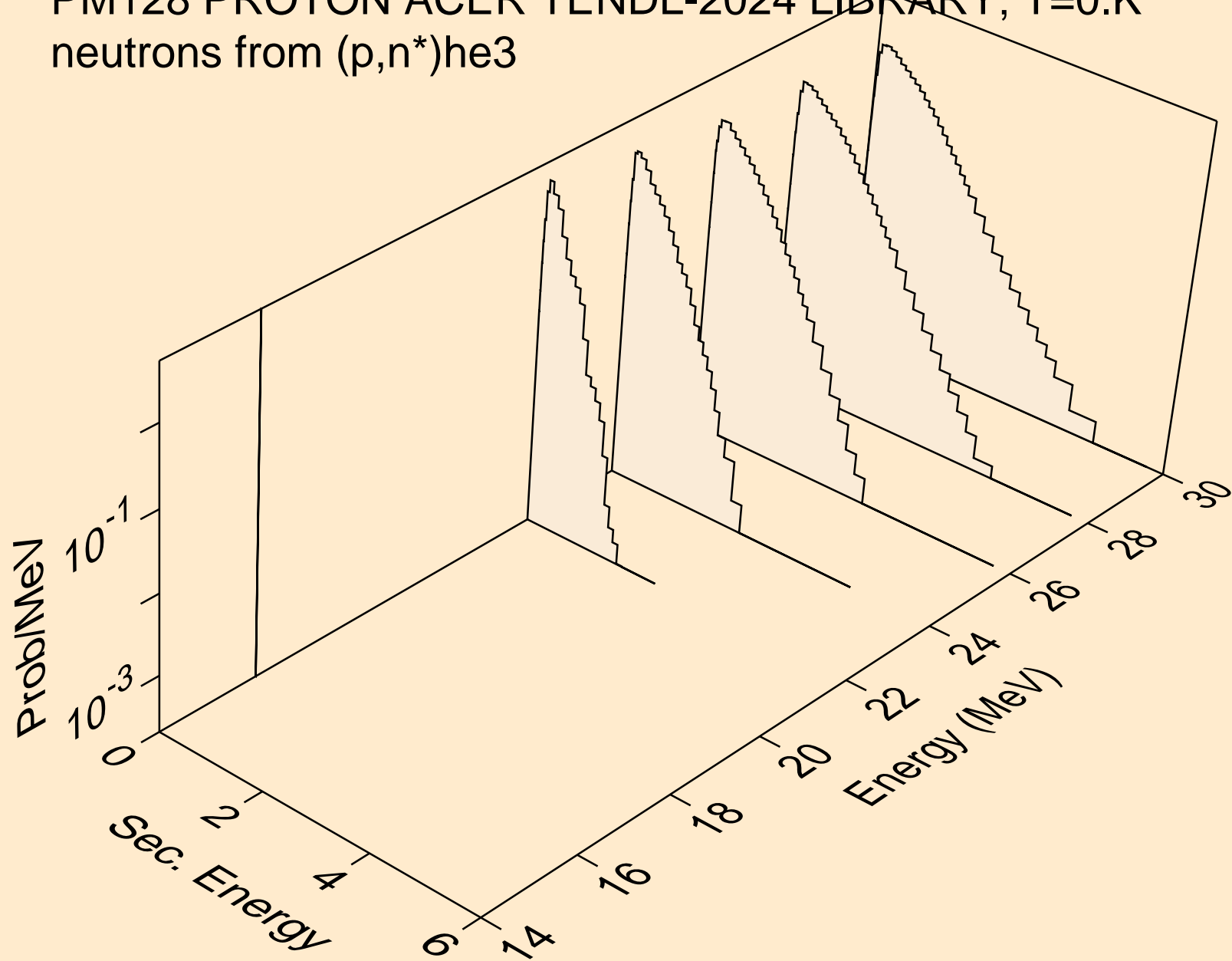

PM128 PROTON ACER TENDL-2024 LIBRARY; T=0.K  
neutrons from (p,2np)

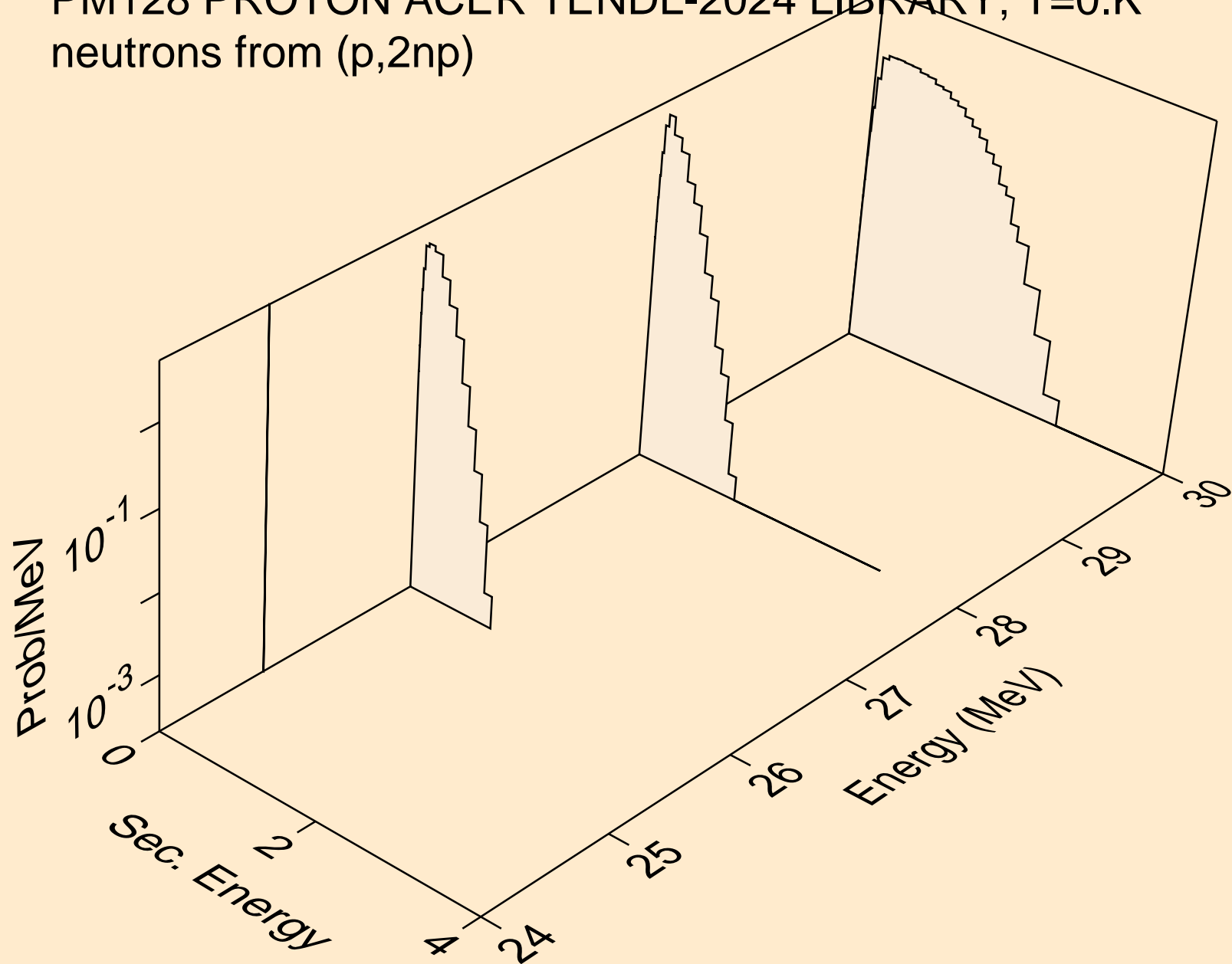

PM128 PROTON ACER TENDL-2024 LIBRARY; T=0.K  
neutrons from (p,n2p)

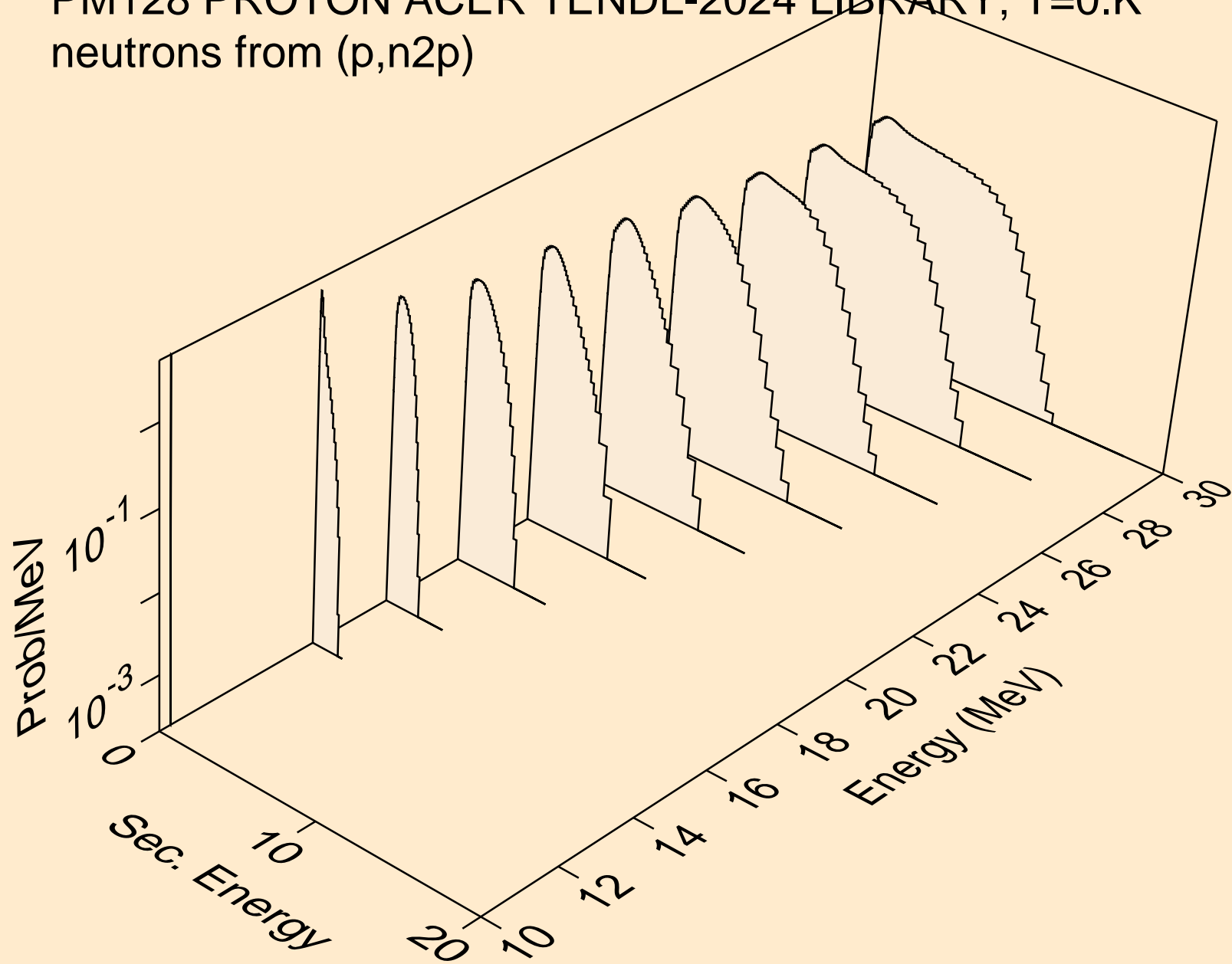

PM128 PROTON ACER TENDL-2024 LIBRARY; T=0.K  
neutrons from (p,npa)

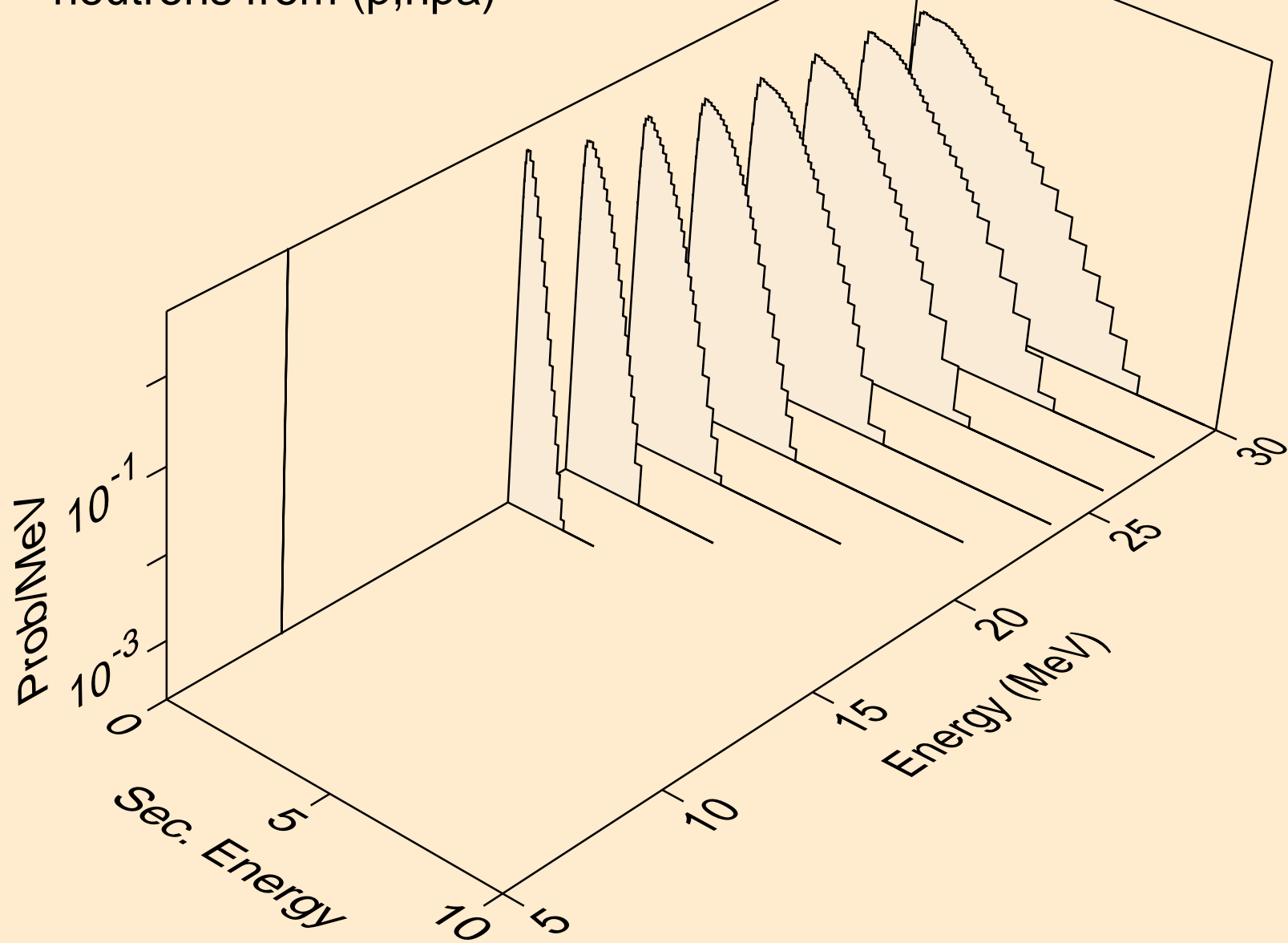

PM128 PROTON ACER TENDL-2024 LIBRARY; T=0.K  
deuterons from (p,x)

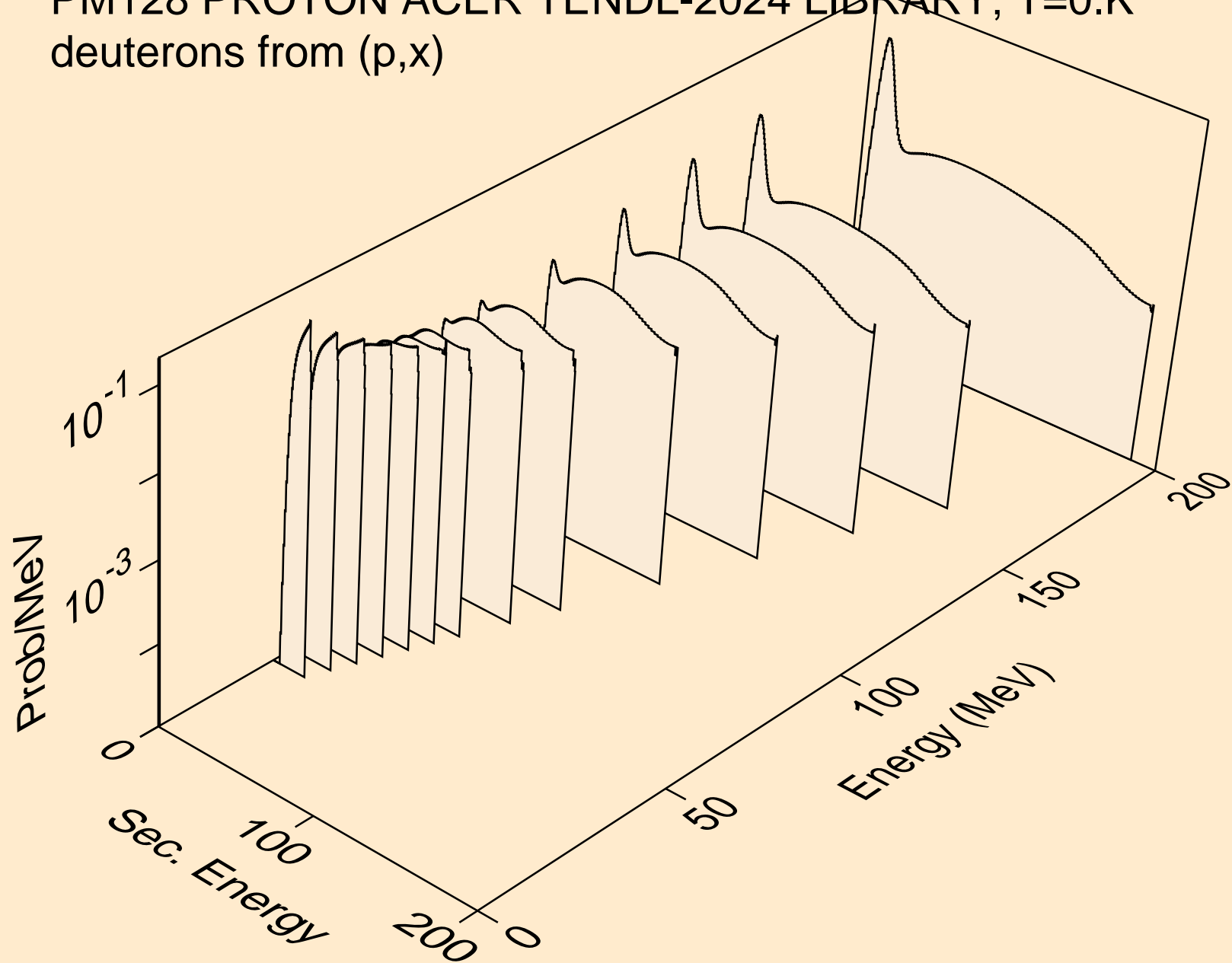

PM128 PROTON ACER TENDL-2024 LIBRARY; T=0.K  
deuterons from (p,n\*)d

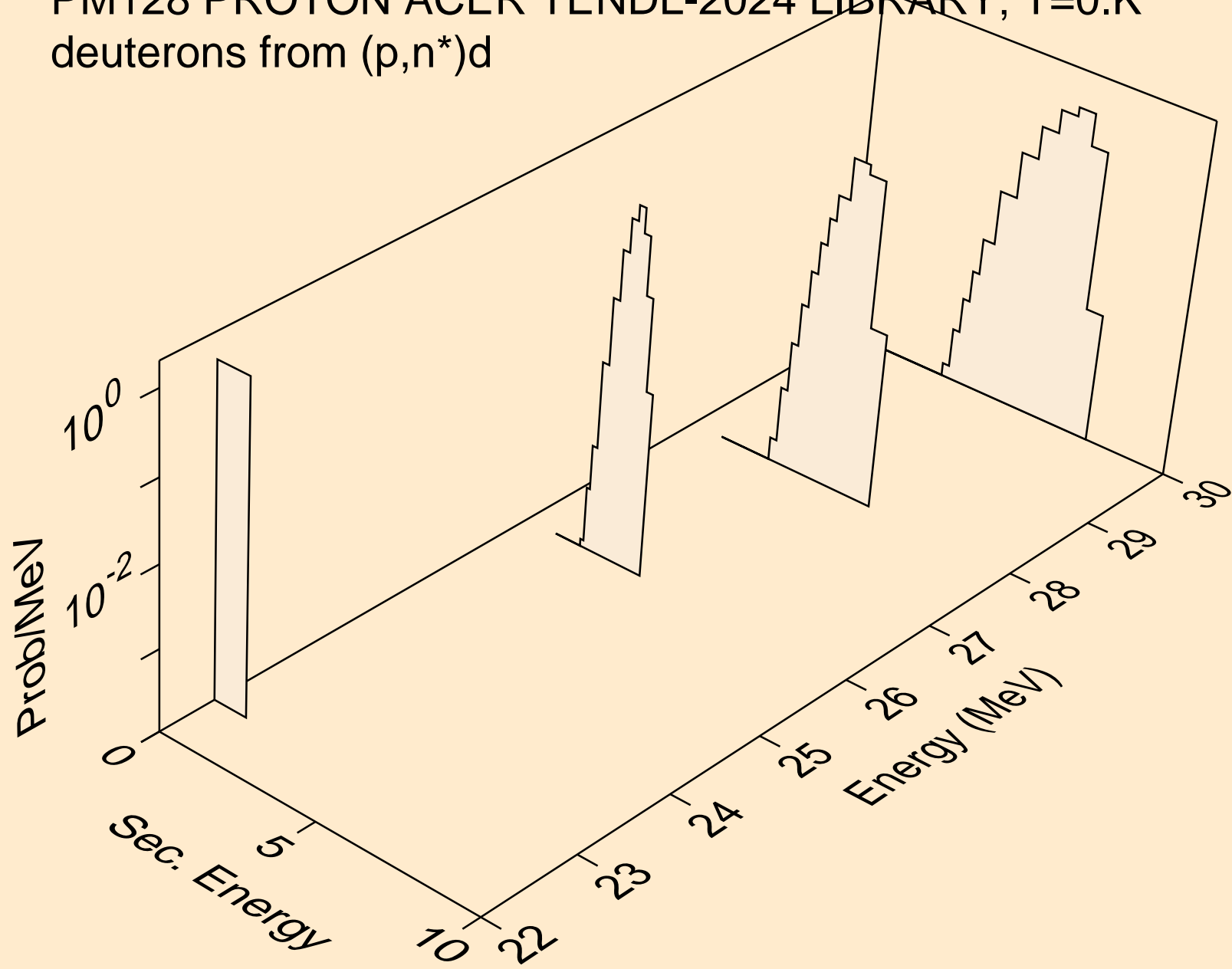

PM128 PROTON ACER TENDL-2024 LIBRARY; T=0.K  
deuterons from (p,d)

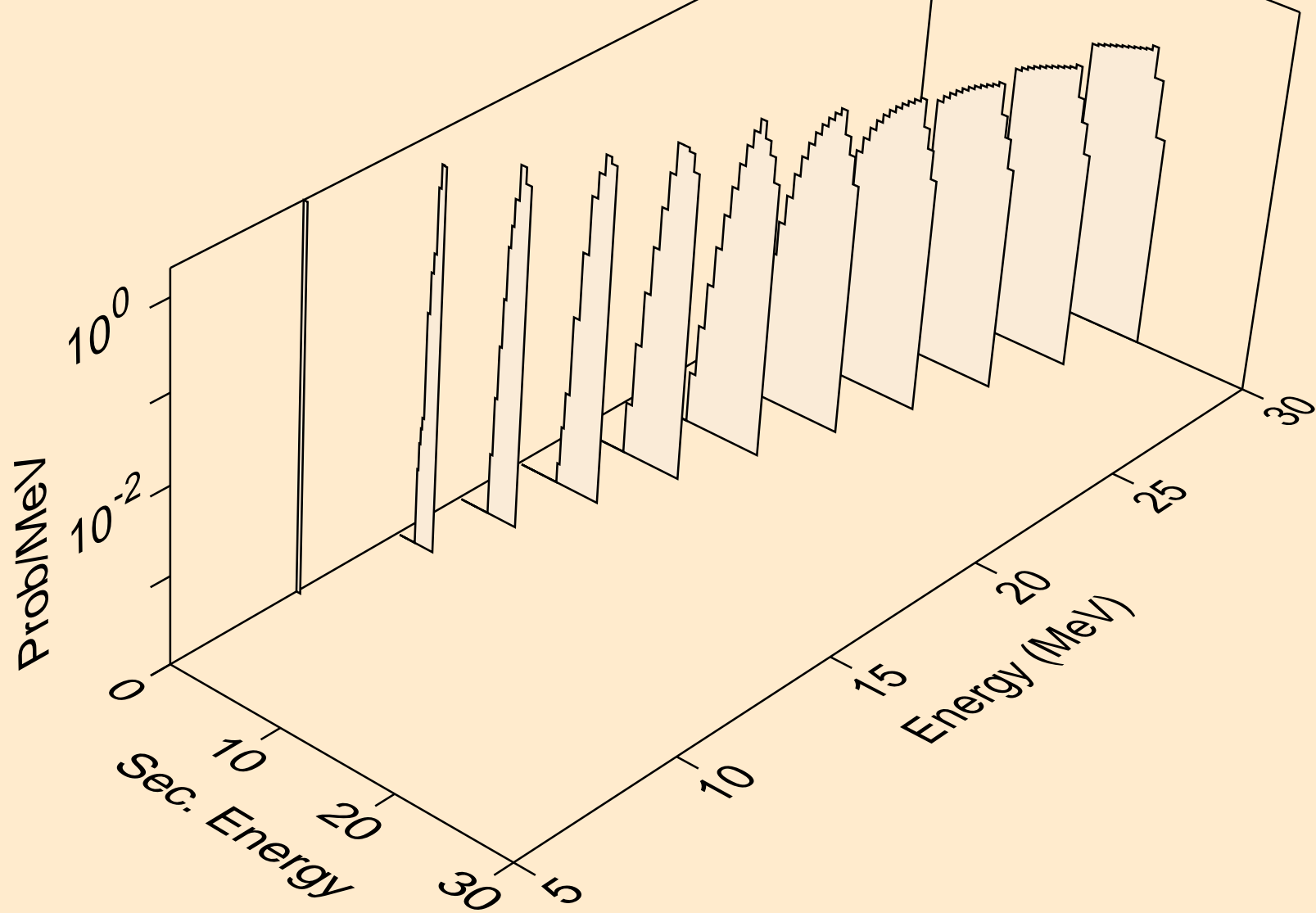

PM128 PROTON ACER TENDL-2024 LIBRARY; T=0.K  
deuterons from (p,pd)

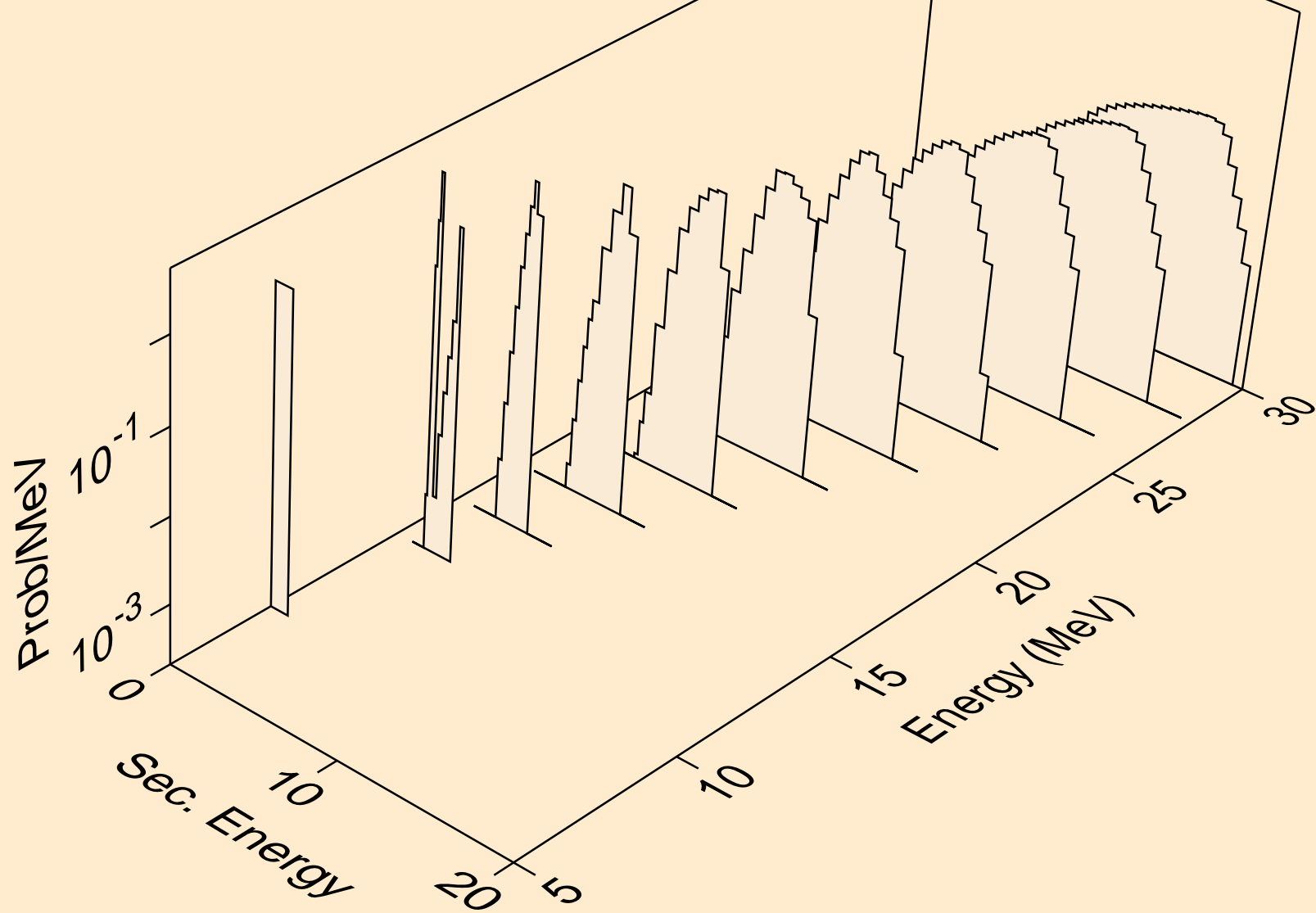

PM128 PROTON ACER TENDL-2024 LIBRARY; T=0.K  
deuterons from (p,da)

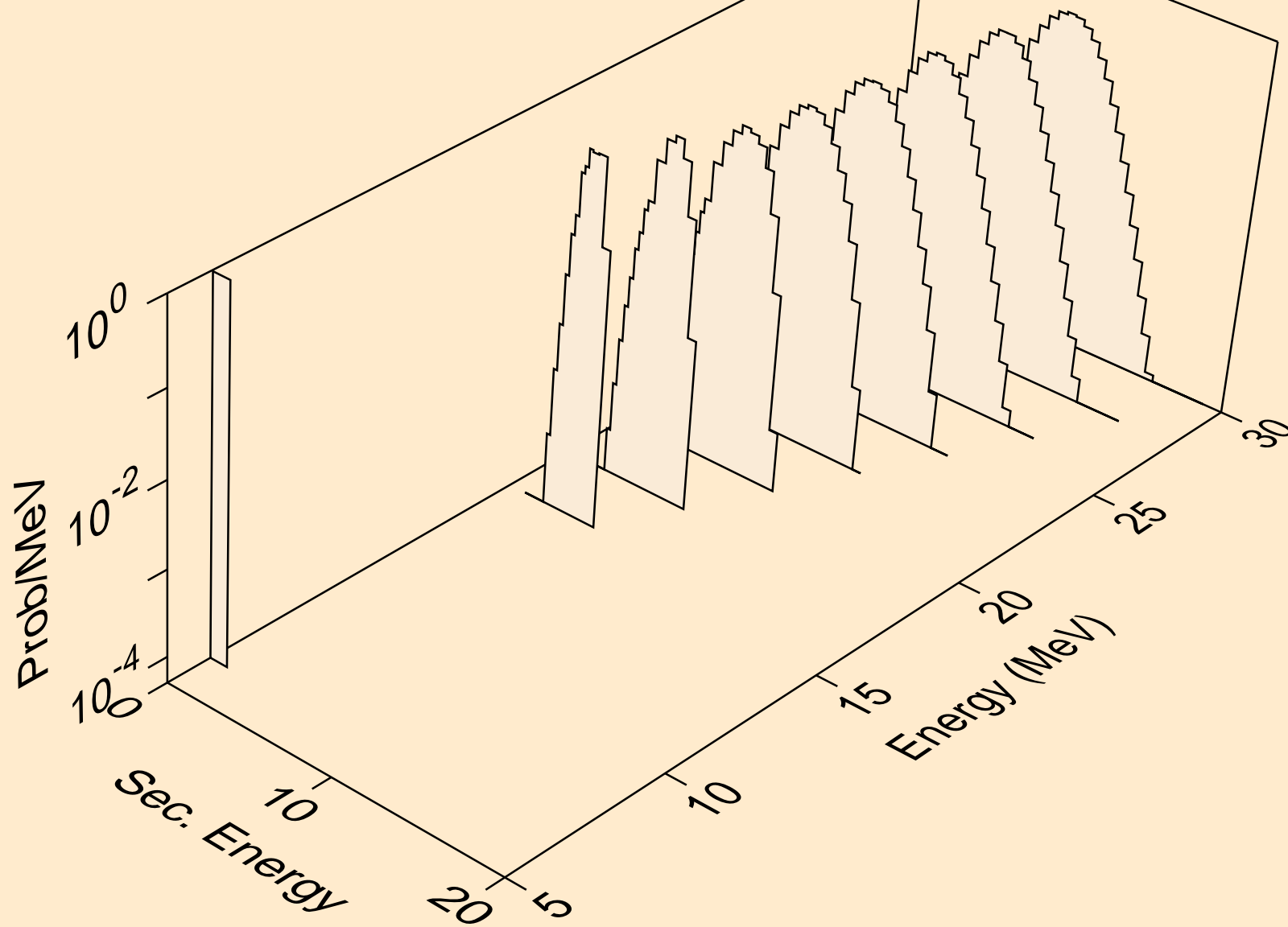

PM128 PROTON ACER TENDL-2024 LIBRARY; T=0.K  
tritons from (p,x)

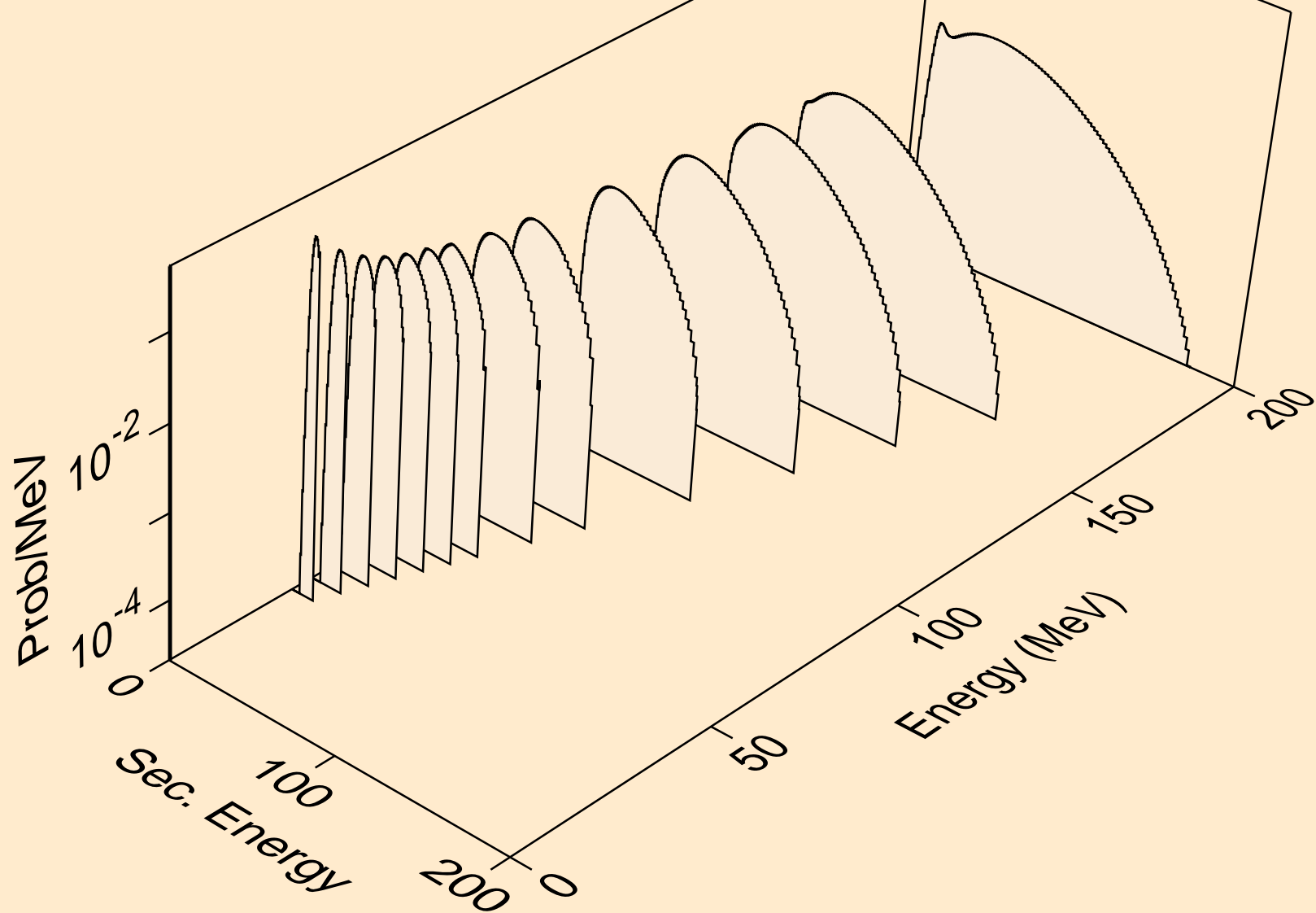

PM128 PROTON ACER TENDL-2024 LIBRARY; T=0.K  
tritons from (p,t)

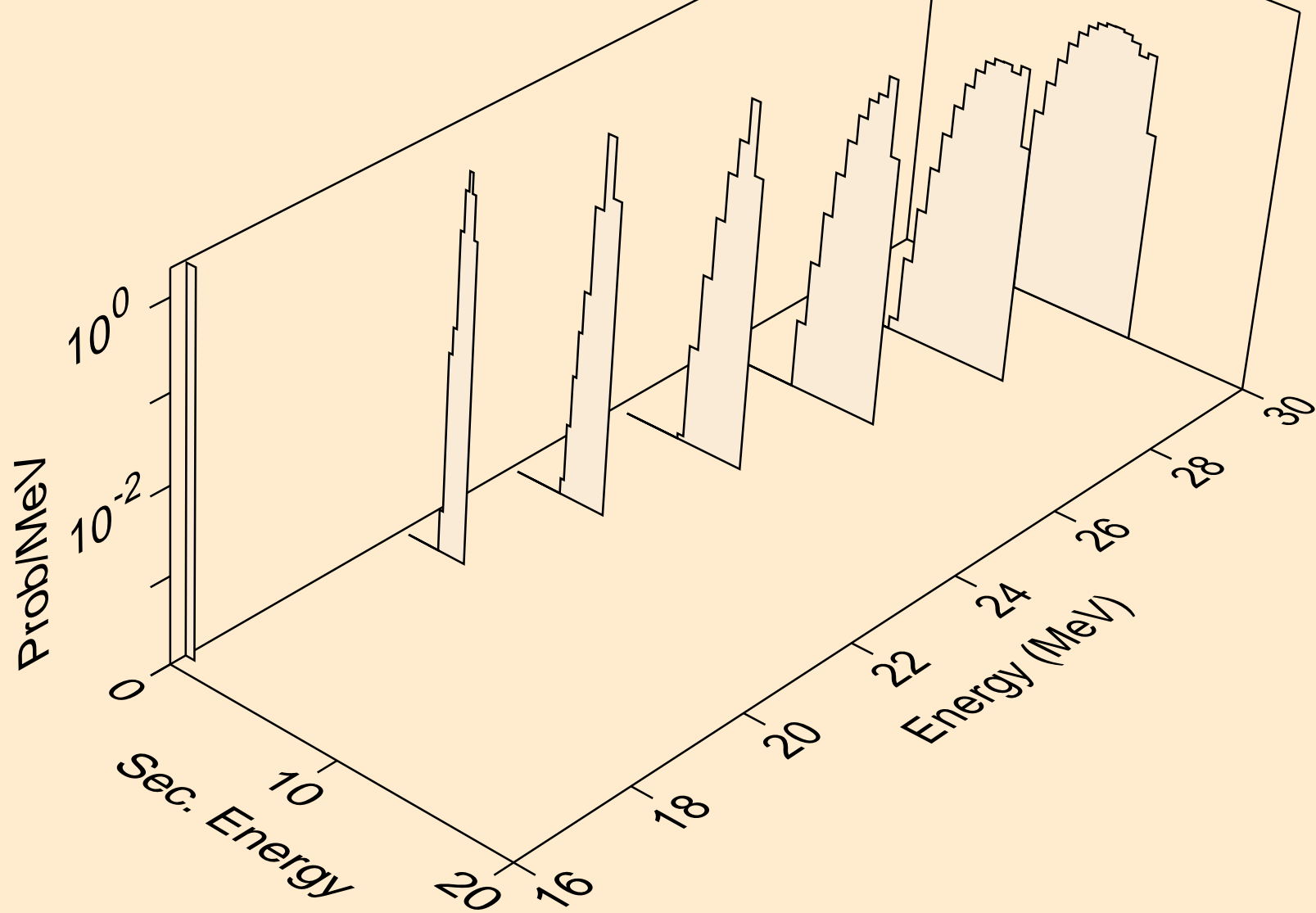

PM128 PROTON ACER TENDL-2024 LIBRARY; T=0.K  
tritons from (p,pt)

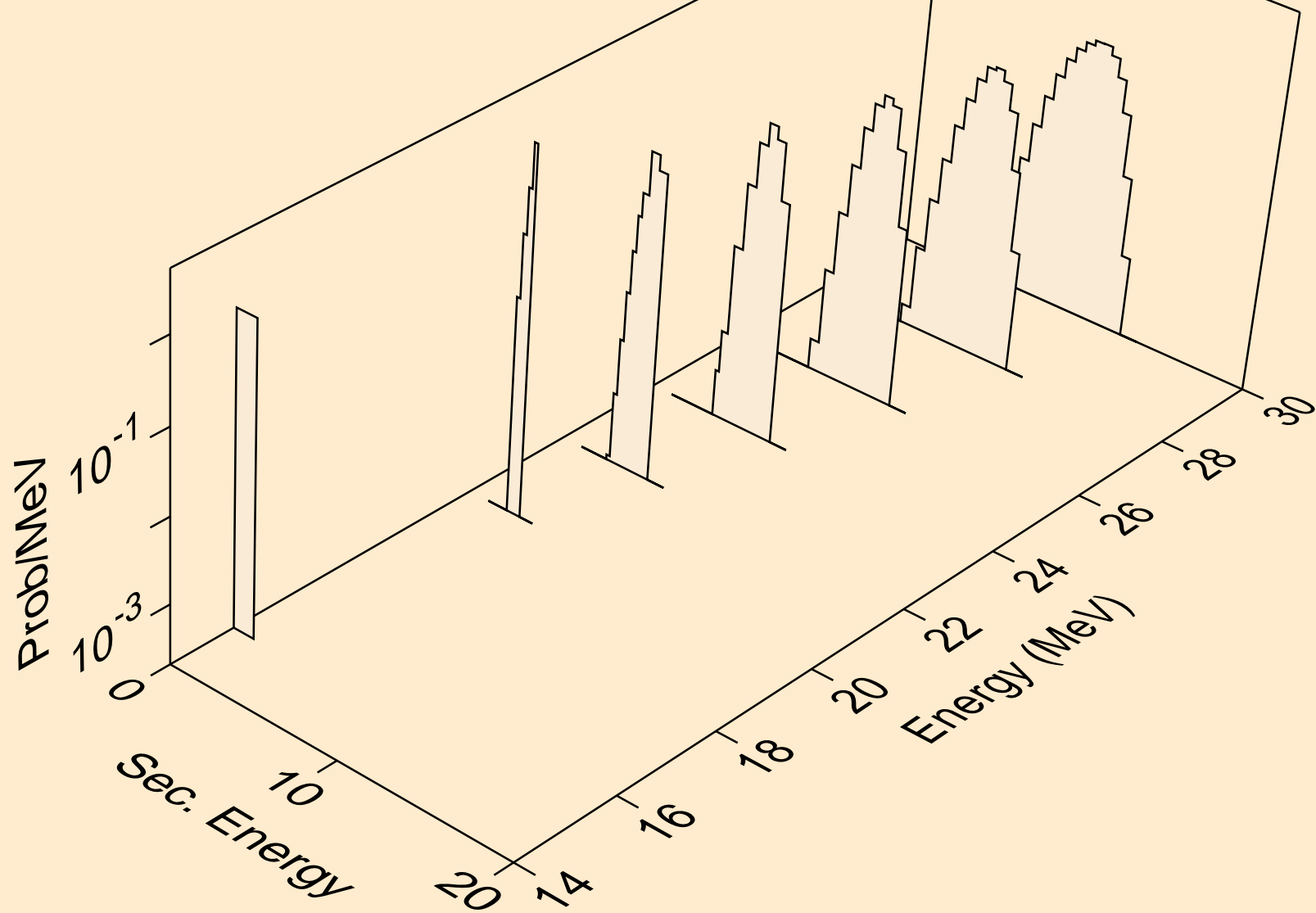

PM128 PROTON ACER TENDL-2024 LIBRARY; T=0.K  
he3s from (p,x)

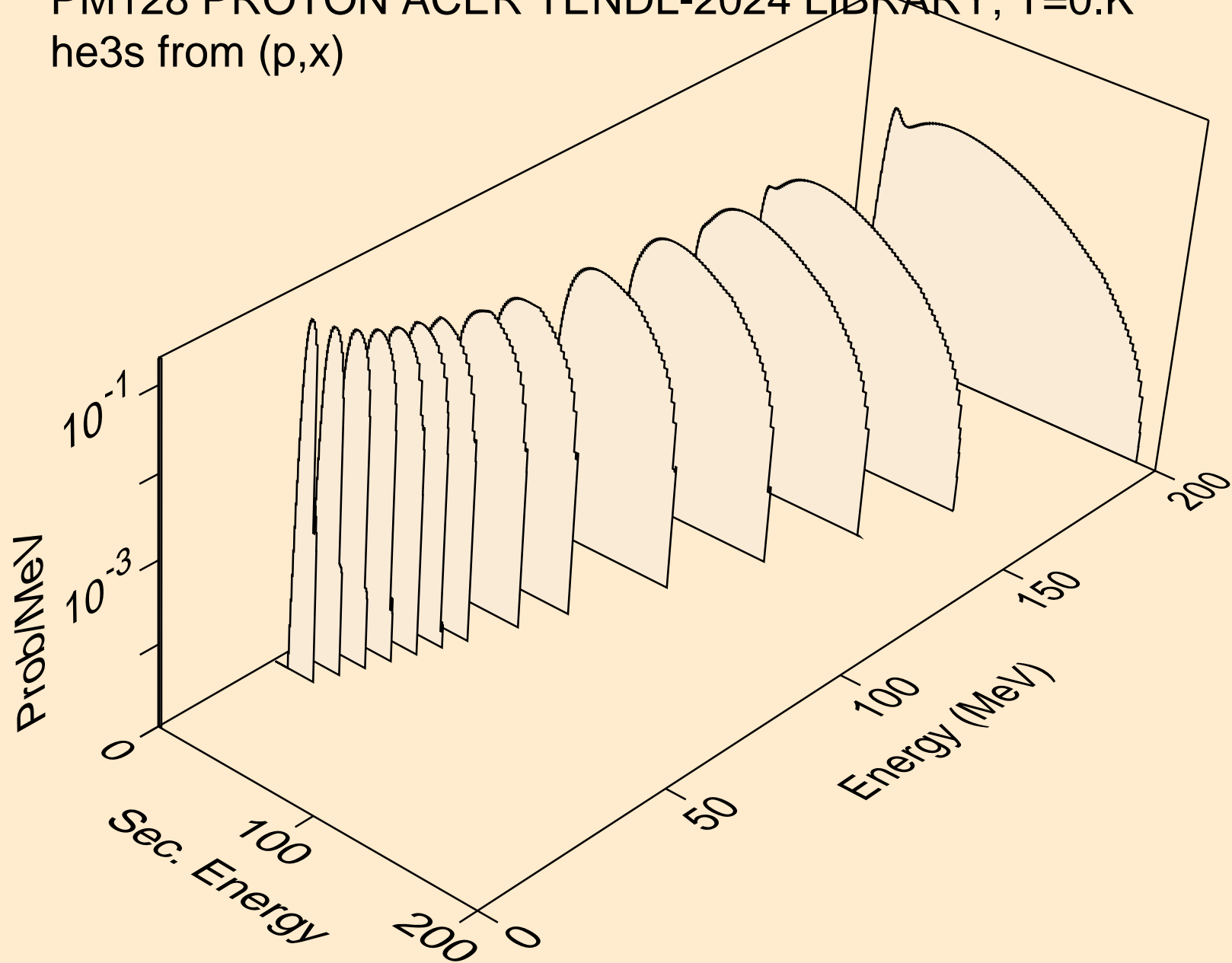

PM128 PROTON ACER TENDL-2024 LIBRARY; T=0.K  
he3s from (p,n\*)he3

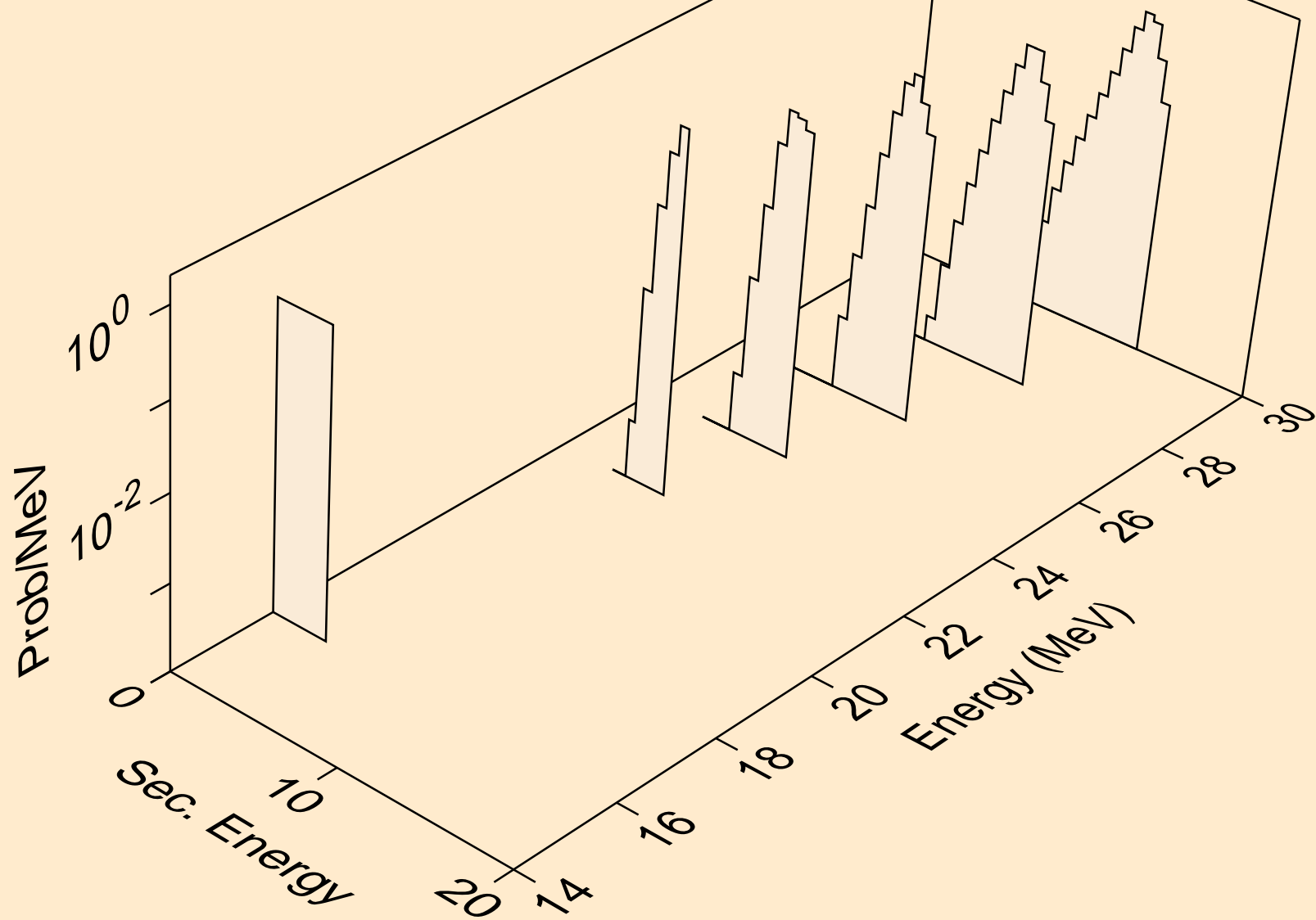

PM128 PROTON ACER TENDL-2024 LIBRARY; T=0.K  
he3s from (p,he3)

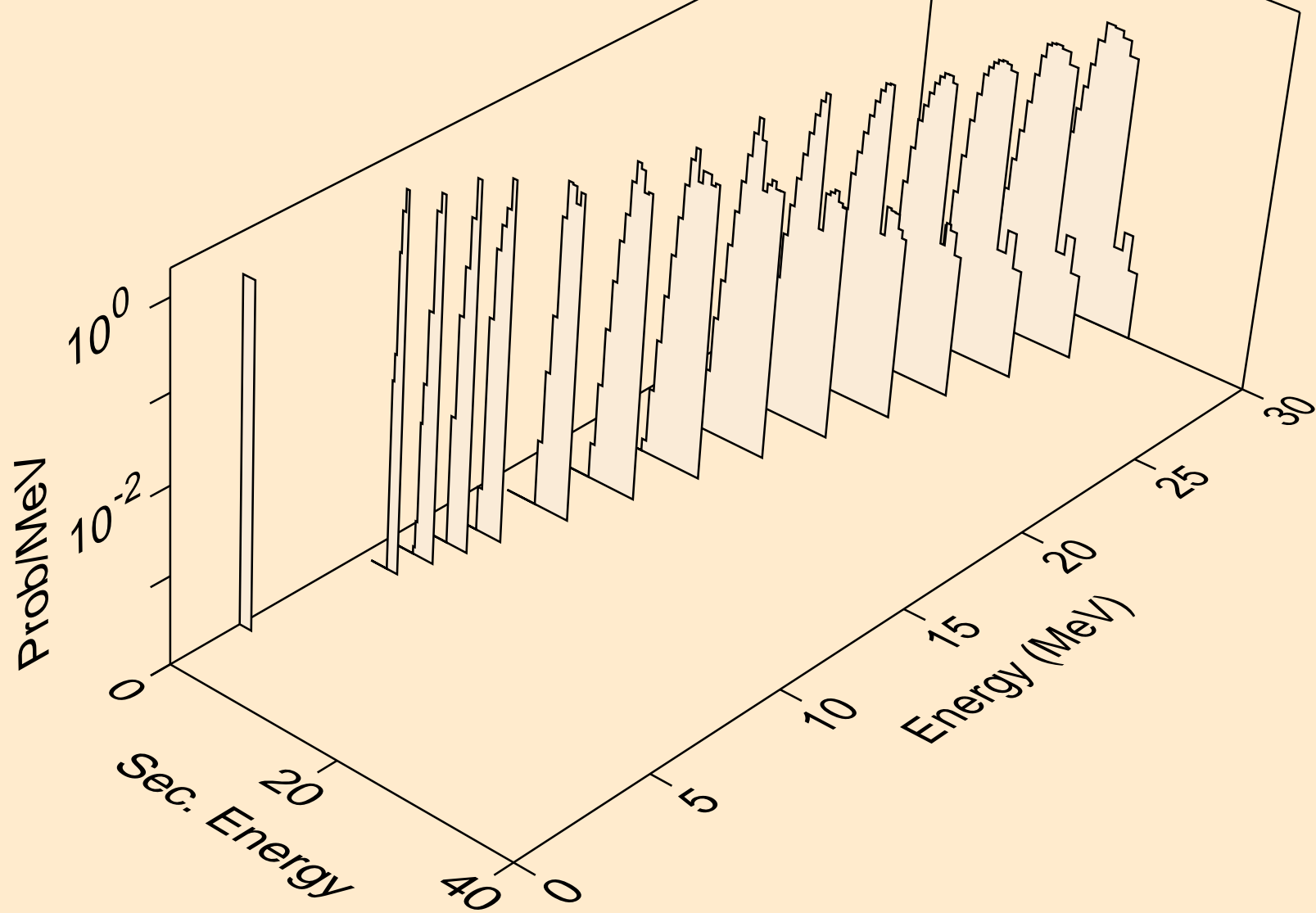

PM128 PROTON ACER TENDL-2024 LIBRARY; T=0.K  
alphas from (p,x)

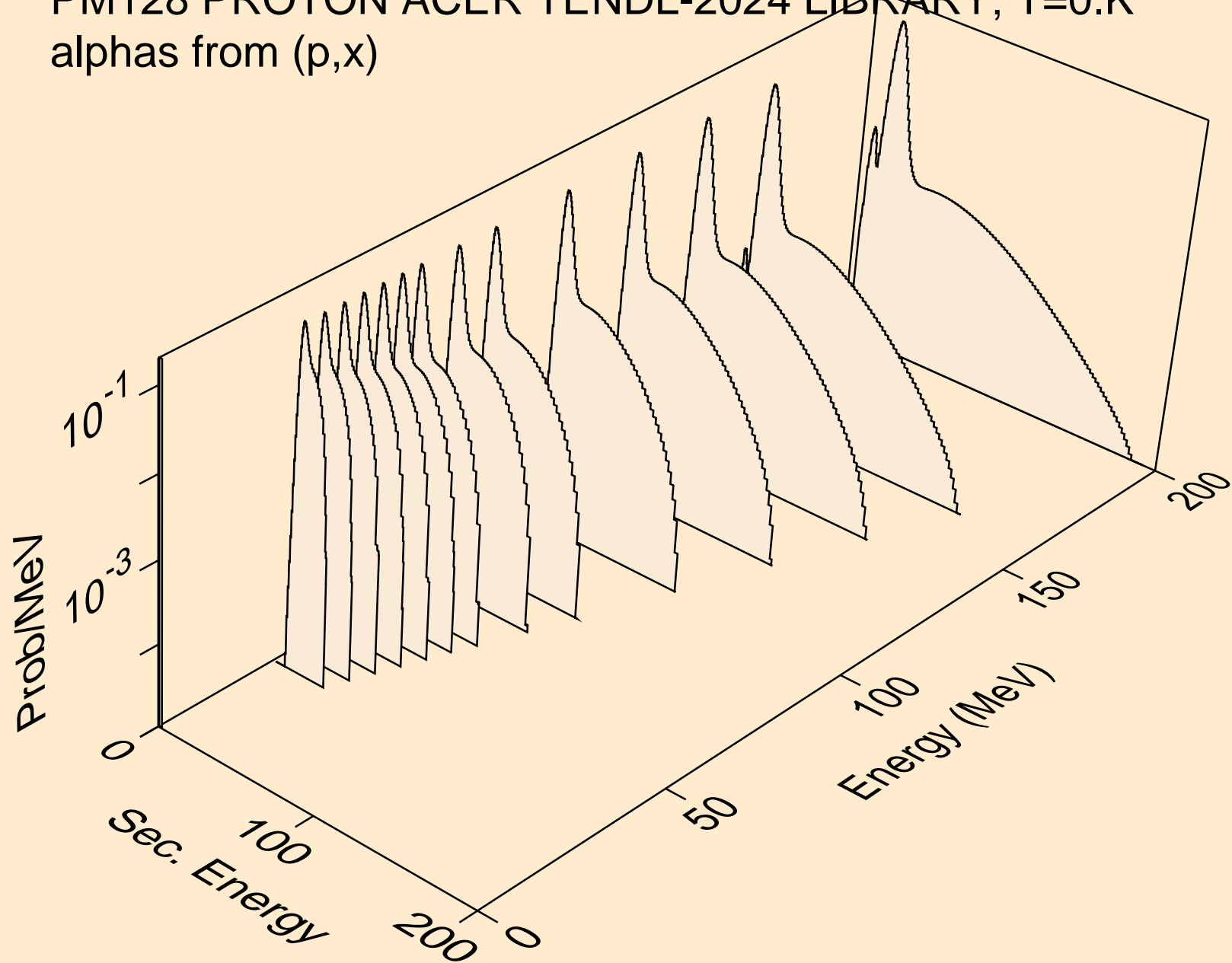

PM128 PROTON ACER TENDL-2024 LIBRARY; T=0.K  
alphas from (p,n\*)a

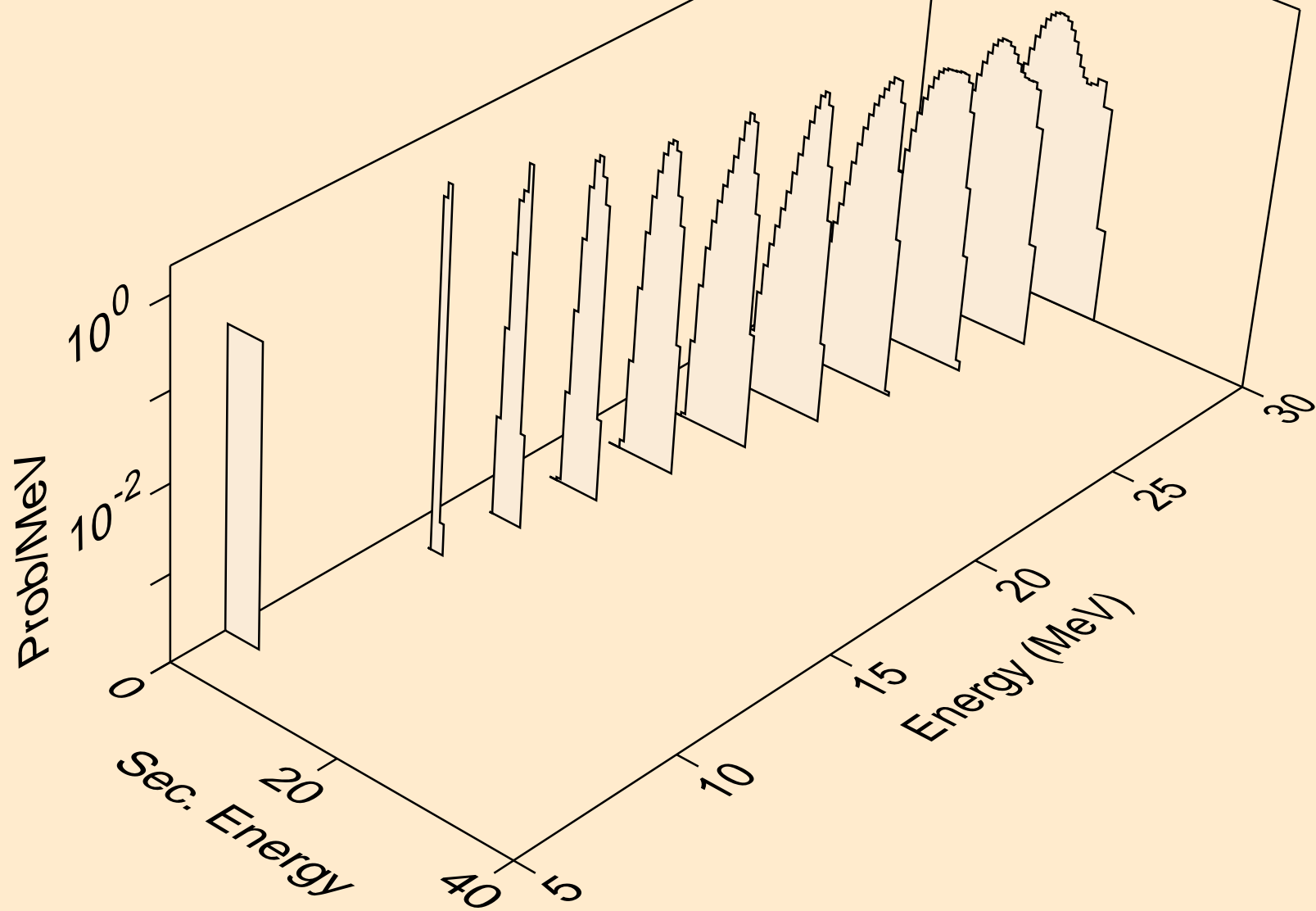

PM128 PROTON ACER TENDL-2024 LIBRARY; T=0.K  
alphas from (p,n\*)2a

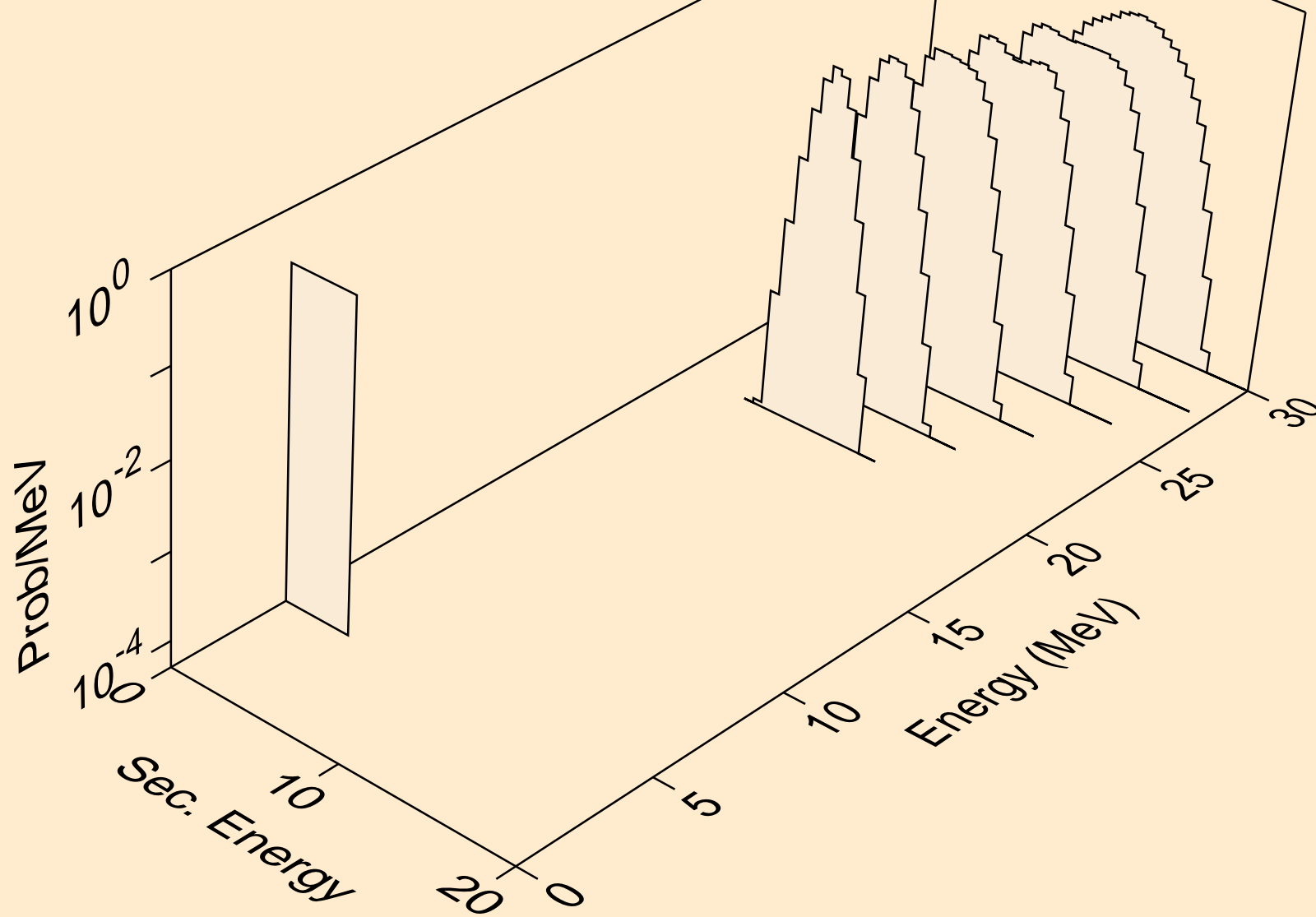

PM128 PROTON ACER TENDL-2024 LIBRARY; T=0.K  
alphas from (p,npa)

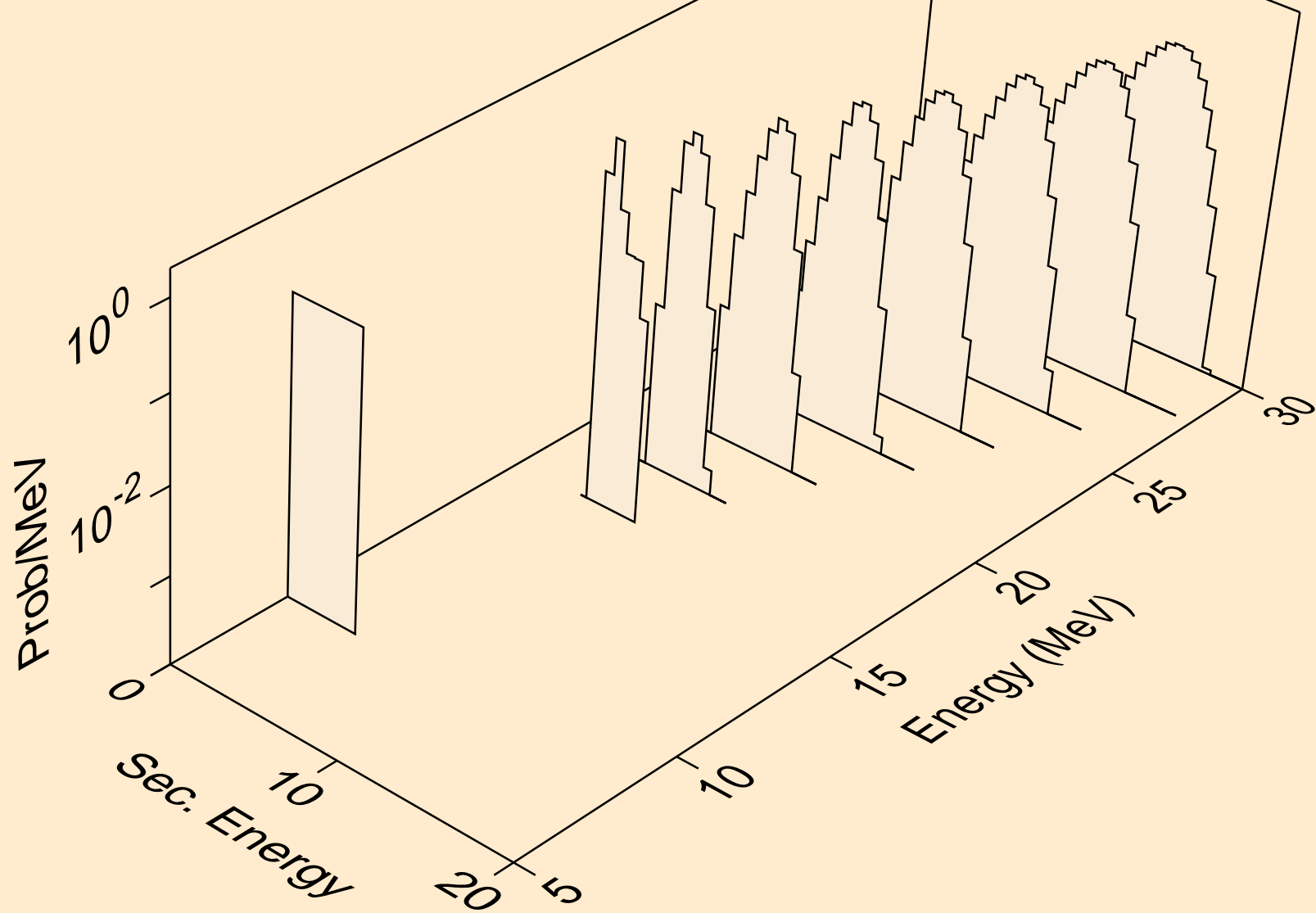

PM128 PROTON ACER TENDL-2024 LIBRARY; T=0.K  
alphas from (p,a)

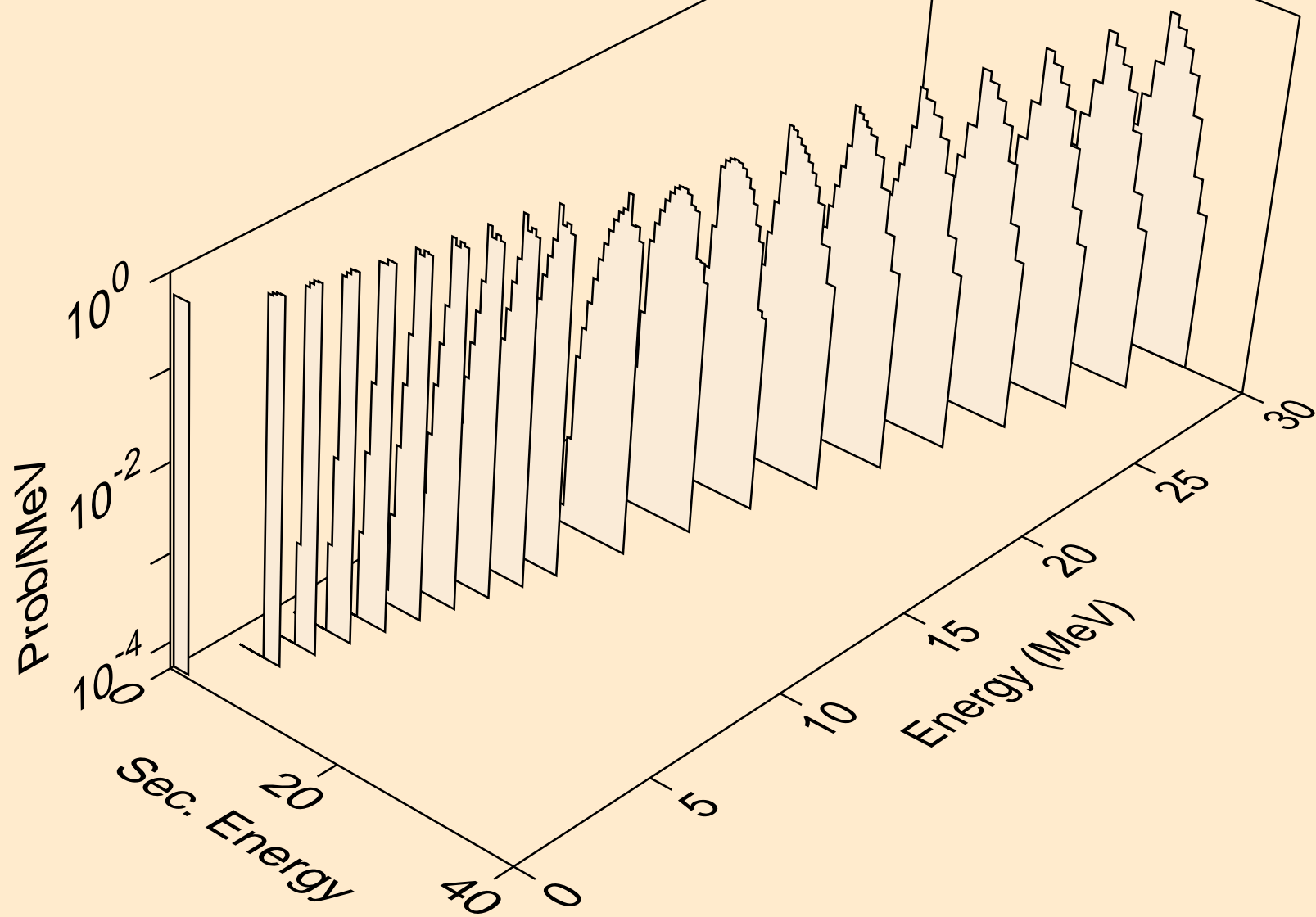

PM128 PROTON ACER TENDL-2024 LIBRARY; T=0.K  
alphas from (p,2a)

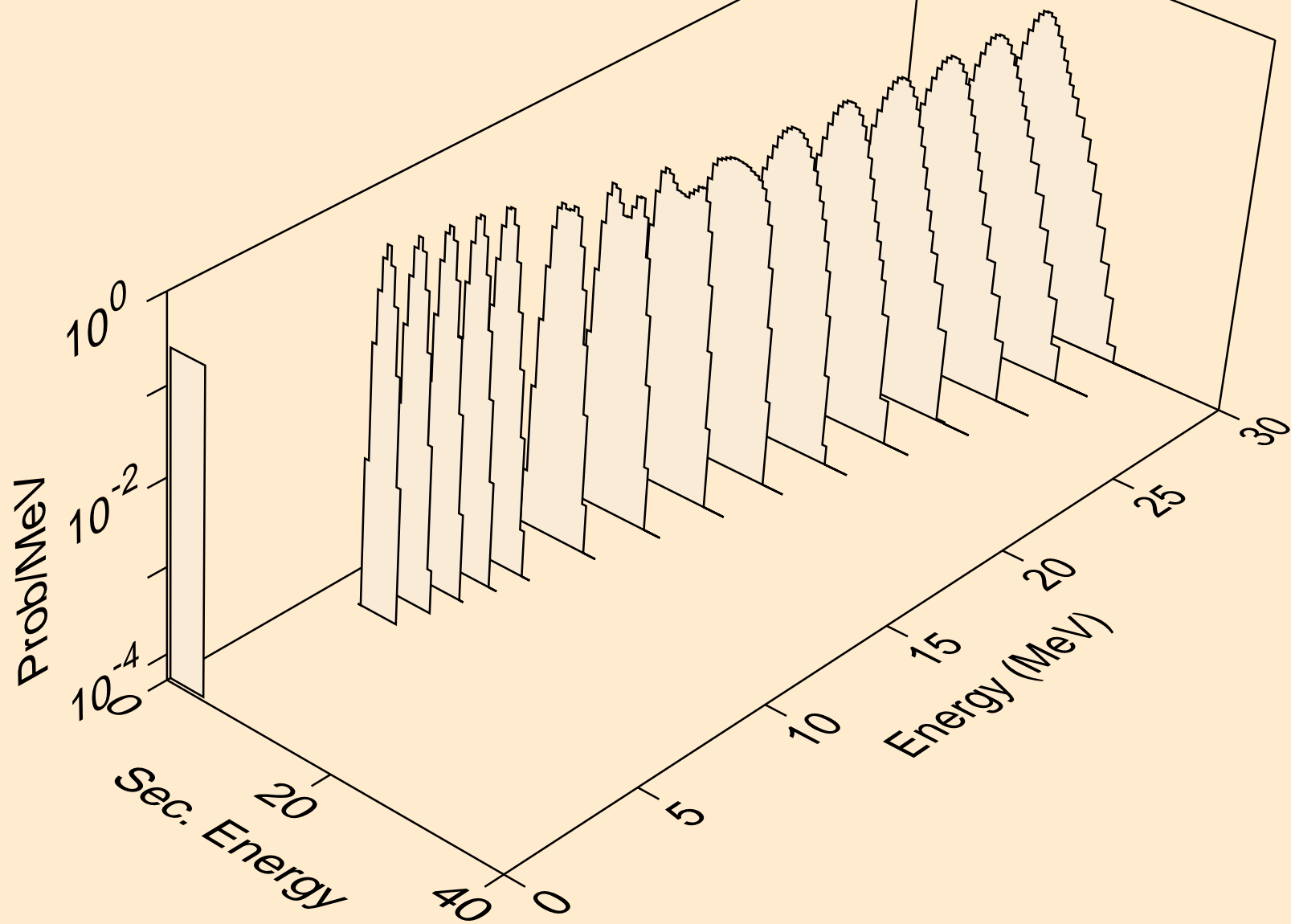

PM128 PROTON ACER TENDL-2024 LIBRARY; T=0.K  
alphas from (p,pa)

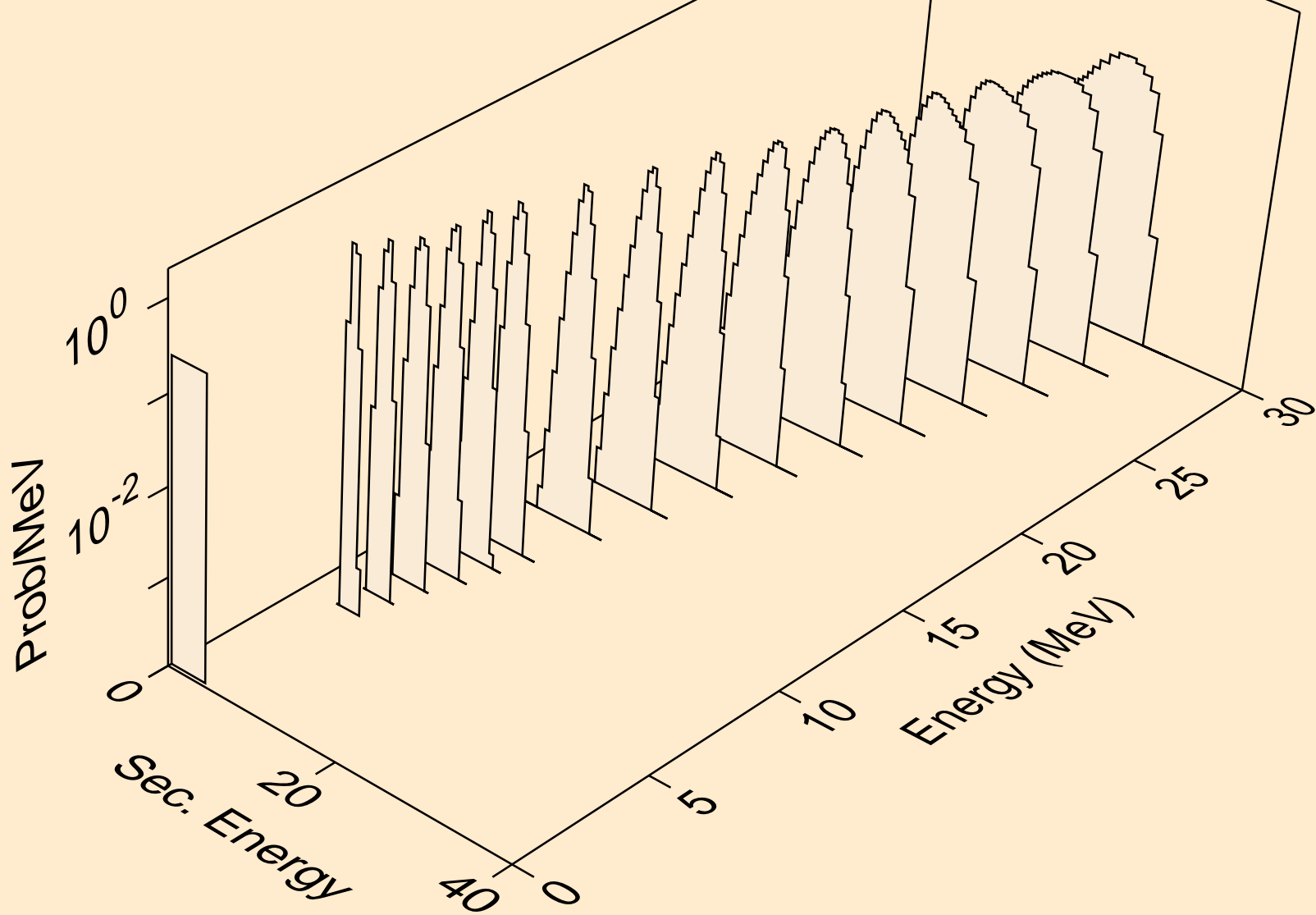

PM128 PROTON ACER TENDL-2024 LIBRARY; T=0.K  
alphas from (p,da)

