

PT195M PROTON ACER TENDL-2024 LIBRARY; T=0.K  
Principal cross sections

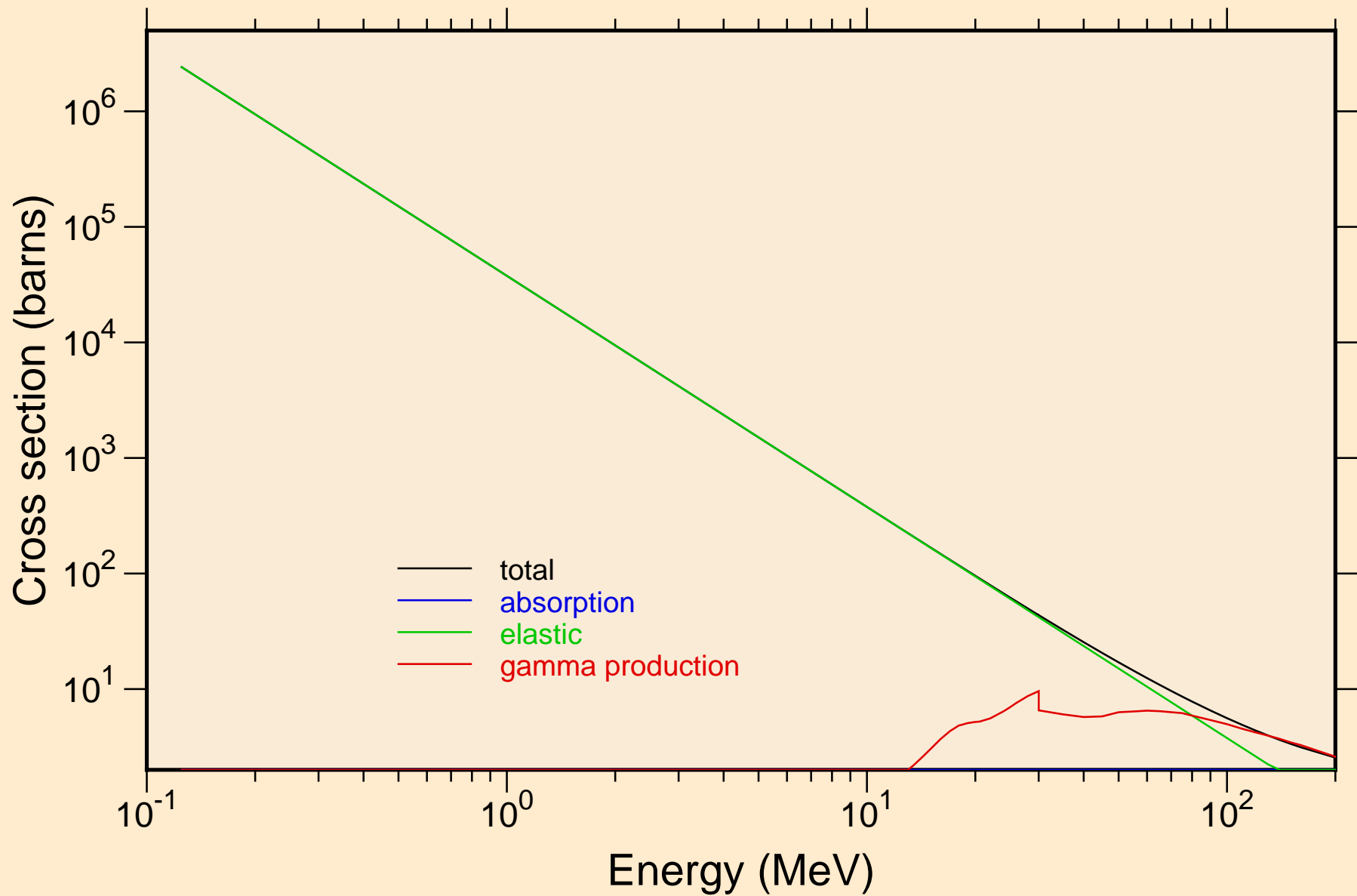

PT195M PROTON ACER TENDL-2024 LIBRARY; T=0.K

Heating

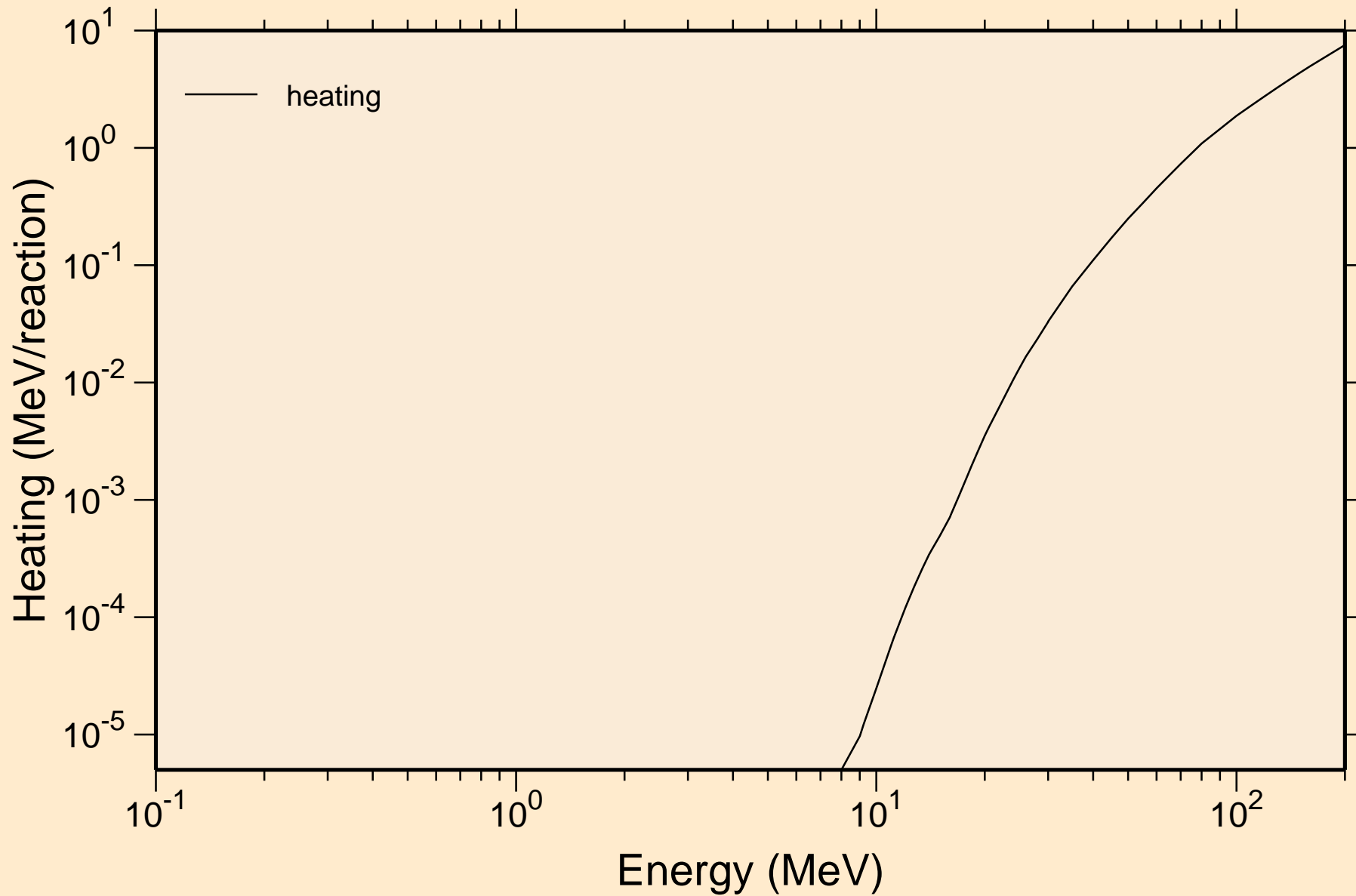

PT195M PROTON ACER TENDL-2024 LIBRARY; T=0.K  
Principal cross sections

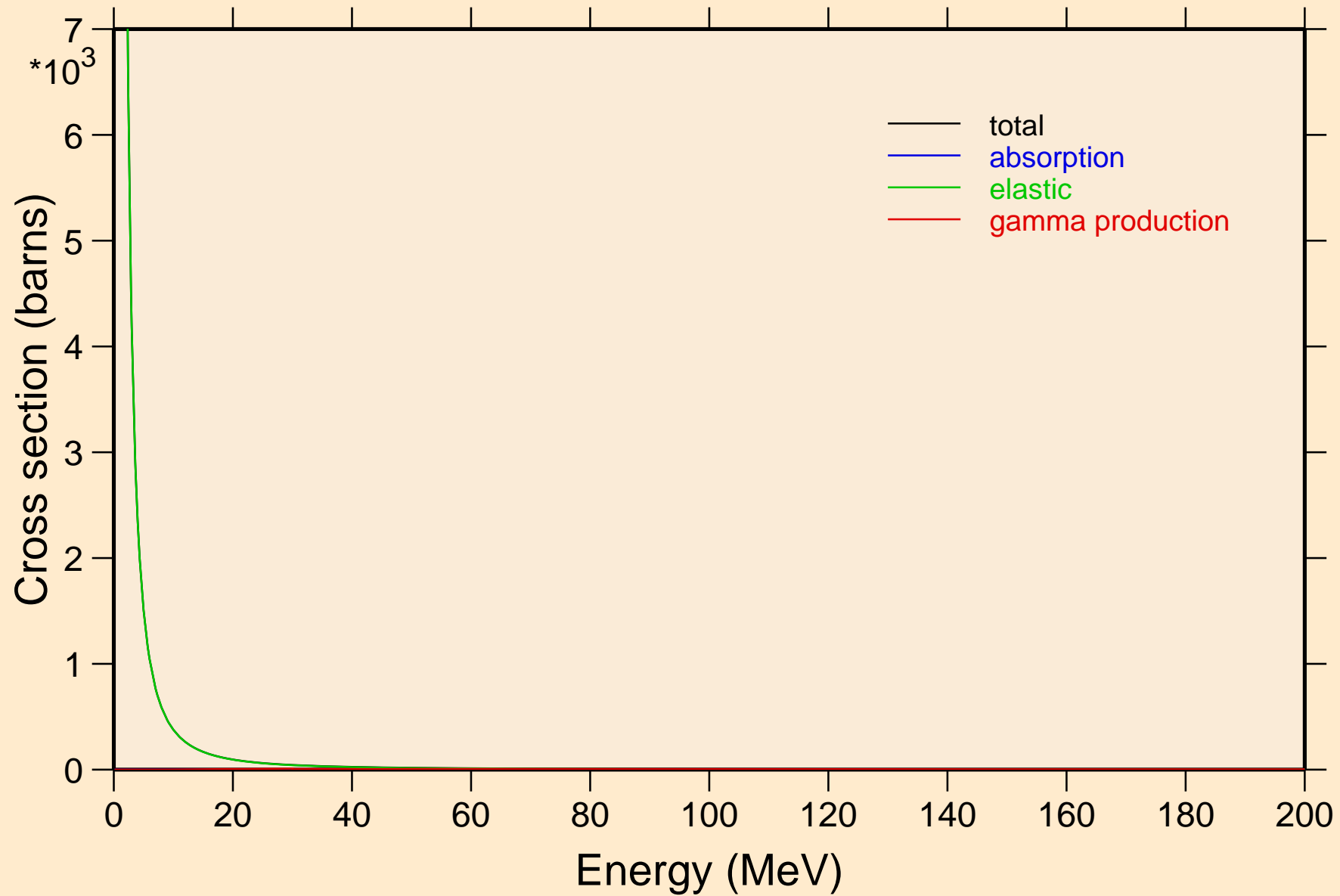

PT195M PROTON ACER TENDL-2024 LIBRARY; T=0.K

Heating

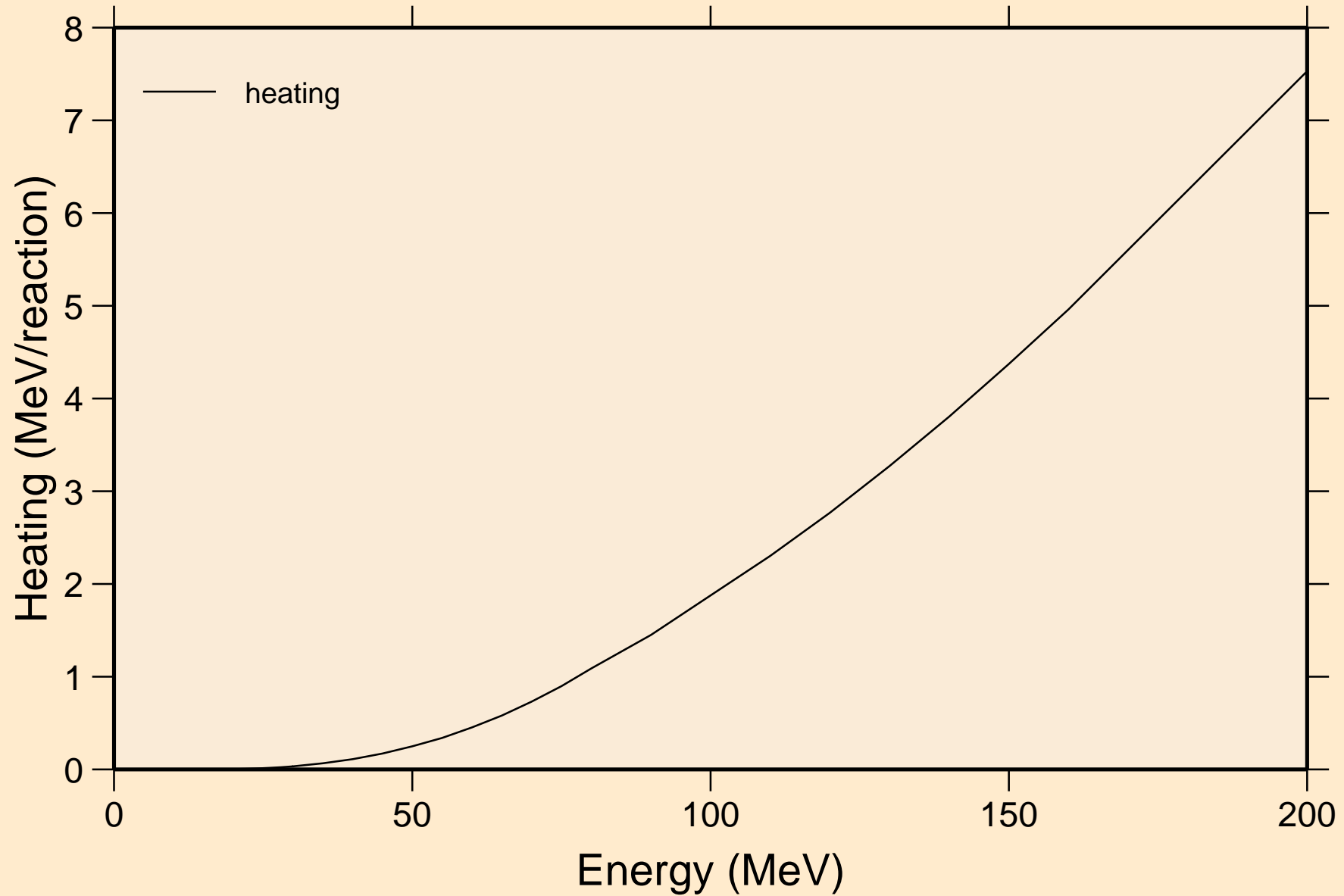

PT195M PROTON ACER TENDL-2024 LIBRARY; T=0.K  
Threshold reactions

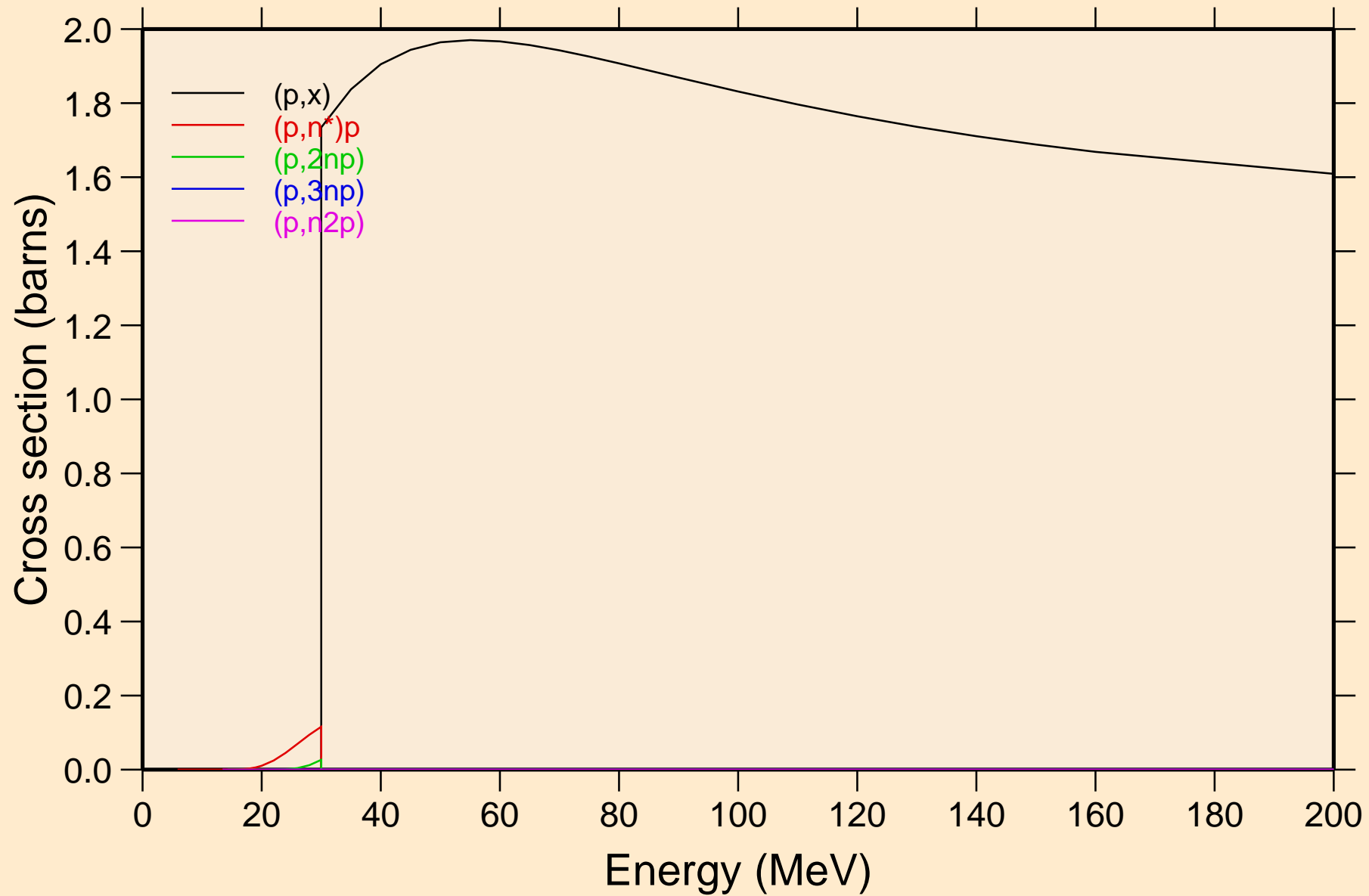

PT195M PROTON ACER TENDL-2024 LIBRARY; T=0.K  
Threshold reactions

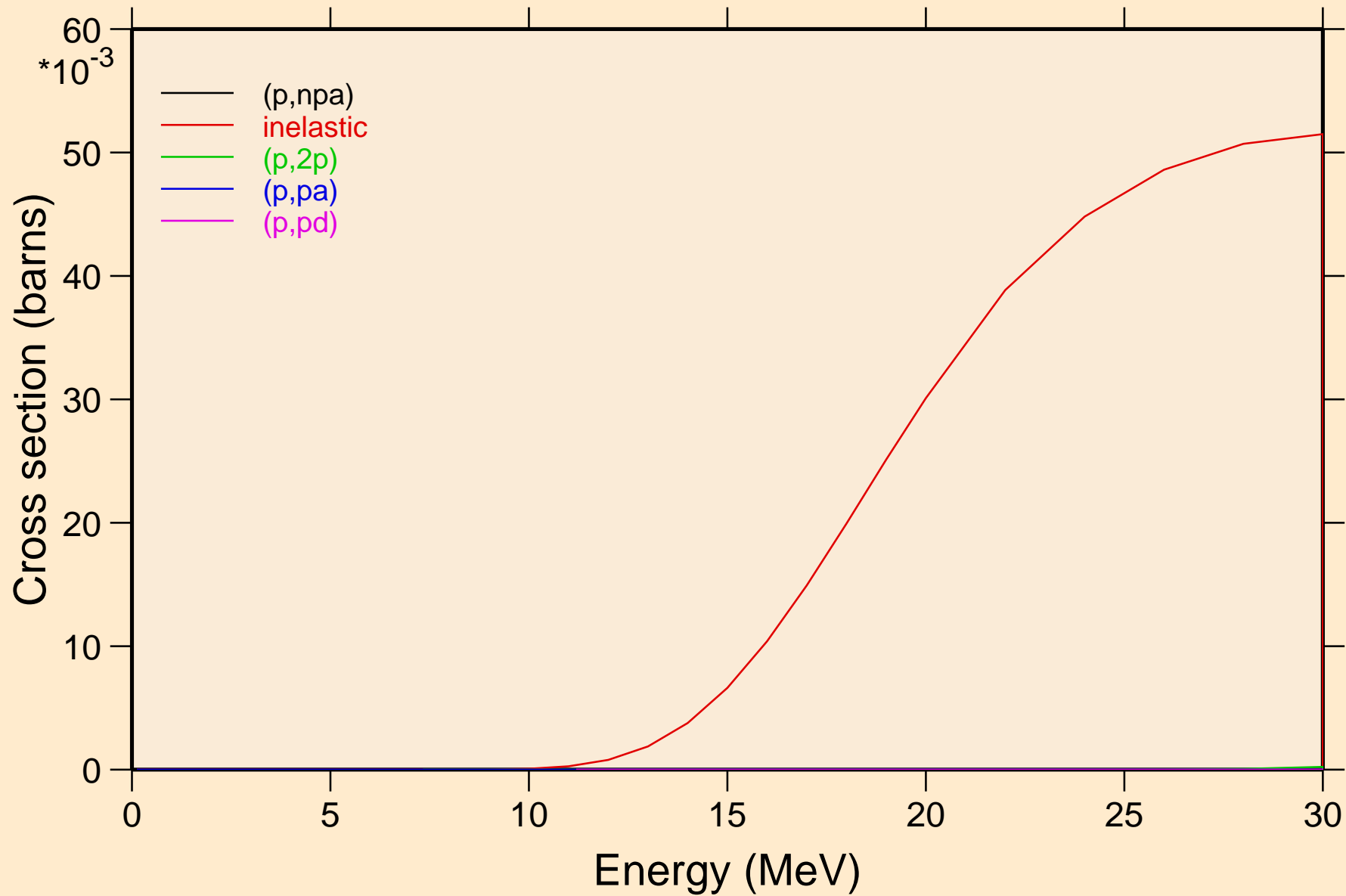

PT195M PROTON ACER TENDL-2024 LIBRARY; T=0.K  
Threshold reactions

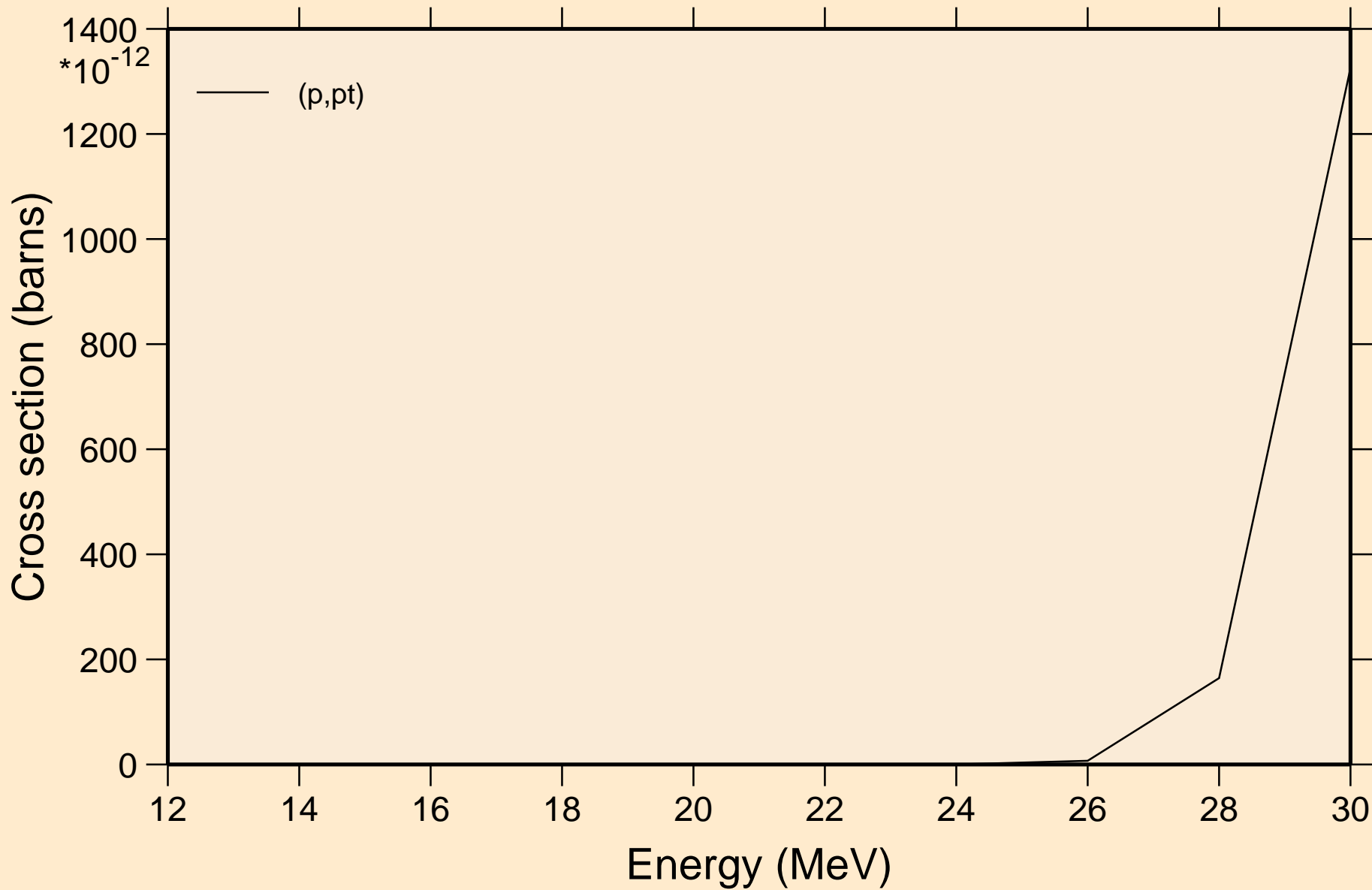

PT195M PROTON ACER TENDL-2024 LIBRARY; T=0.K  
angular distribution for elastic

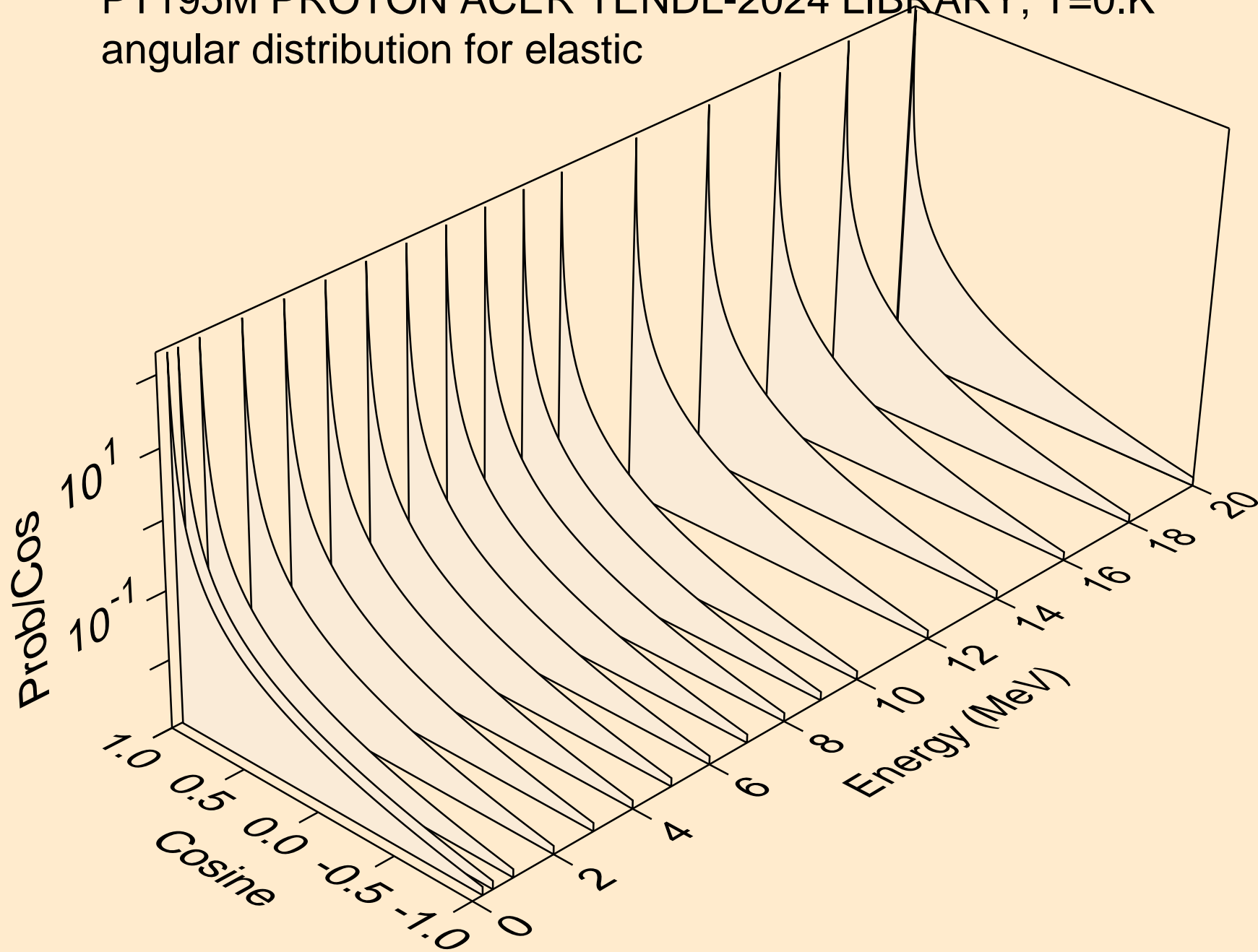

PT195M PROTON ACER TENDL-2024 LIBRARY; T=0.K  
angular distribution for elastic

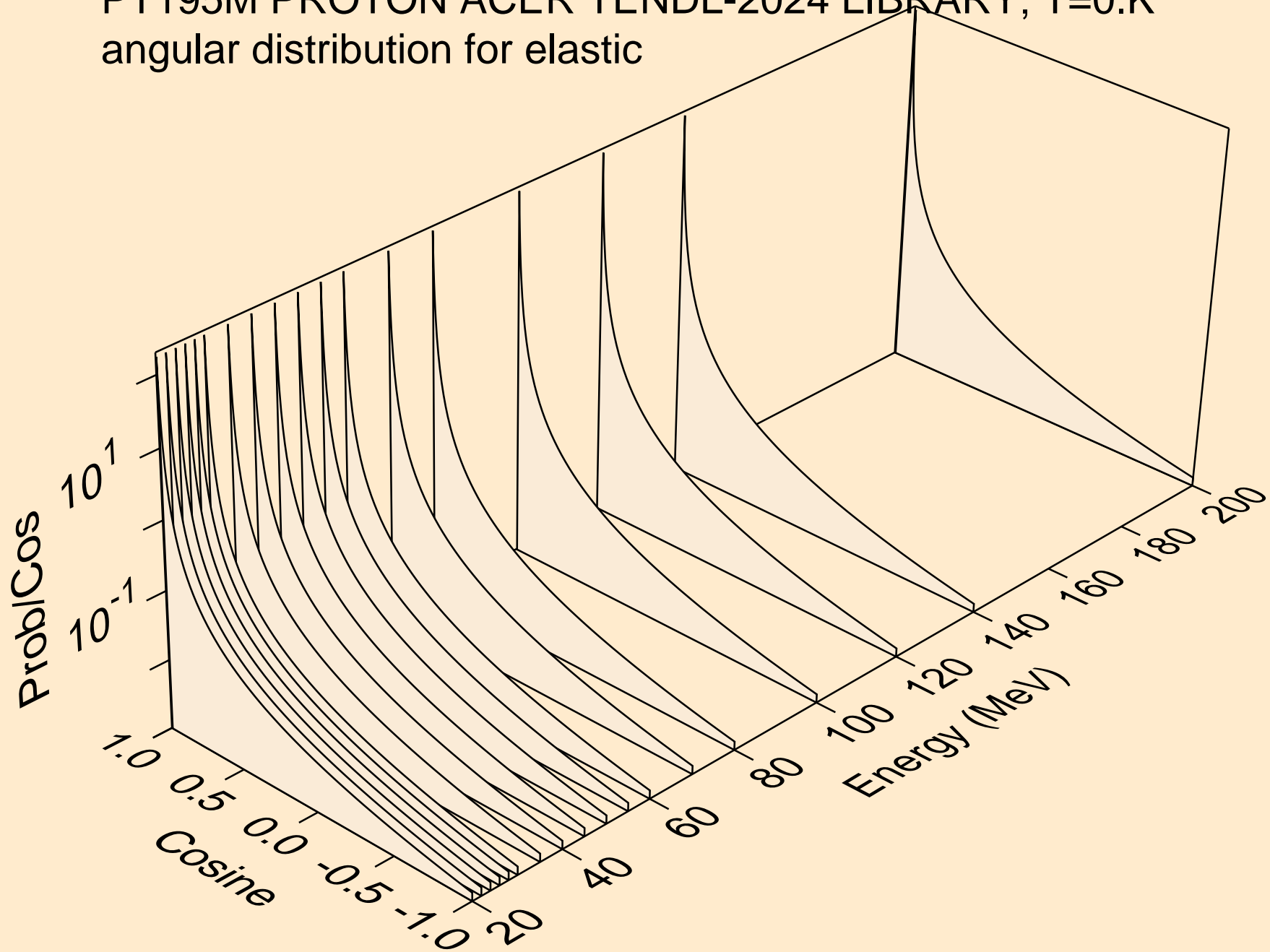

PT195M PROTON ACER TENDL-2024 LIBRARY; T=0.K  
Proton emission for (p,x)

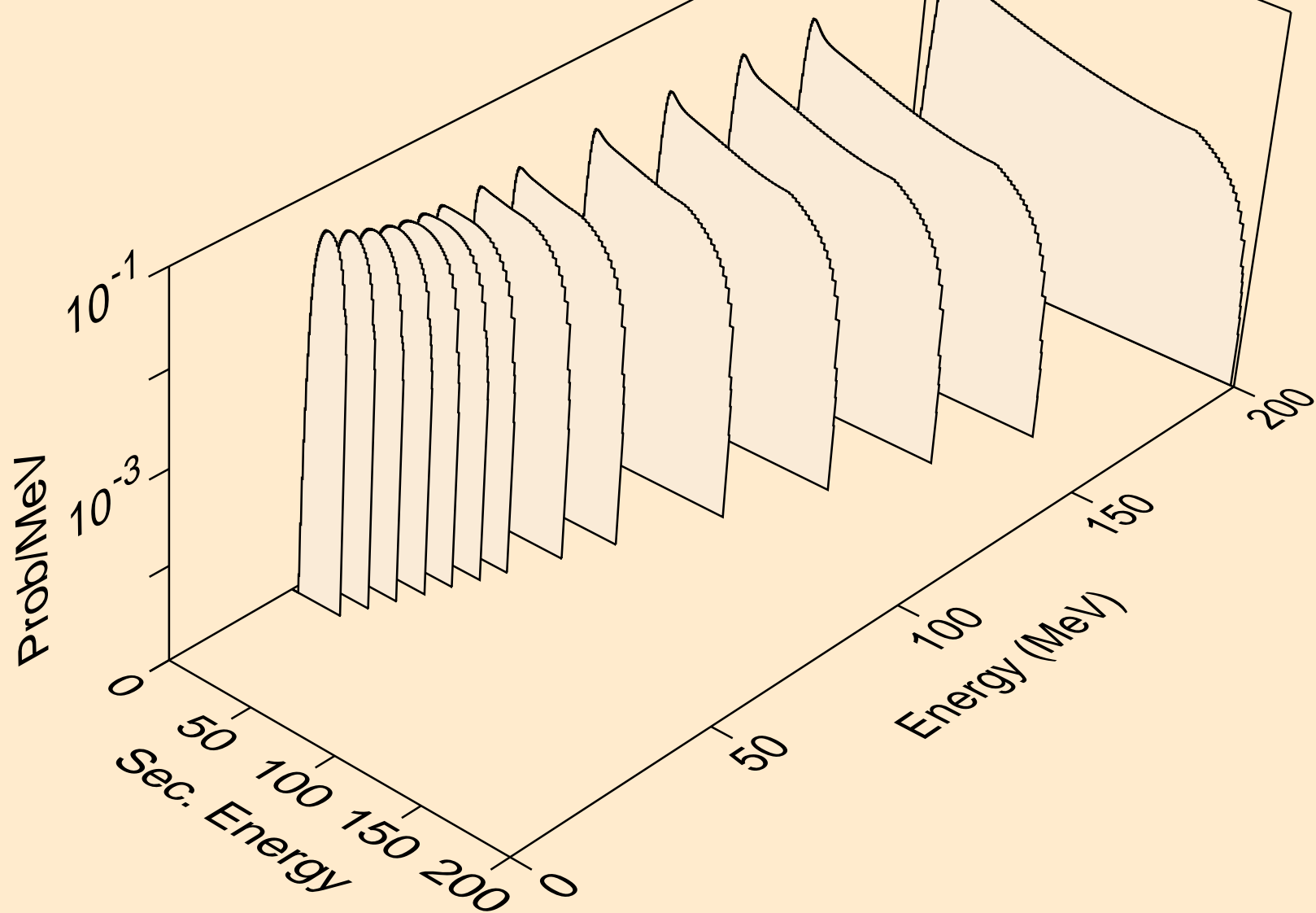

PT195M PROTON ACER TENDL-2024 LIBRARY; T=0.K  
Proton emission for (p,n\*)p

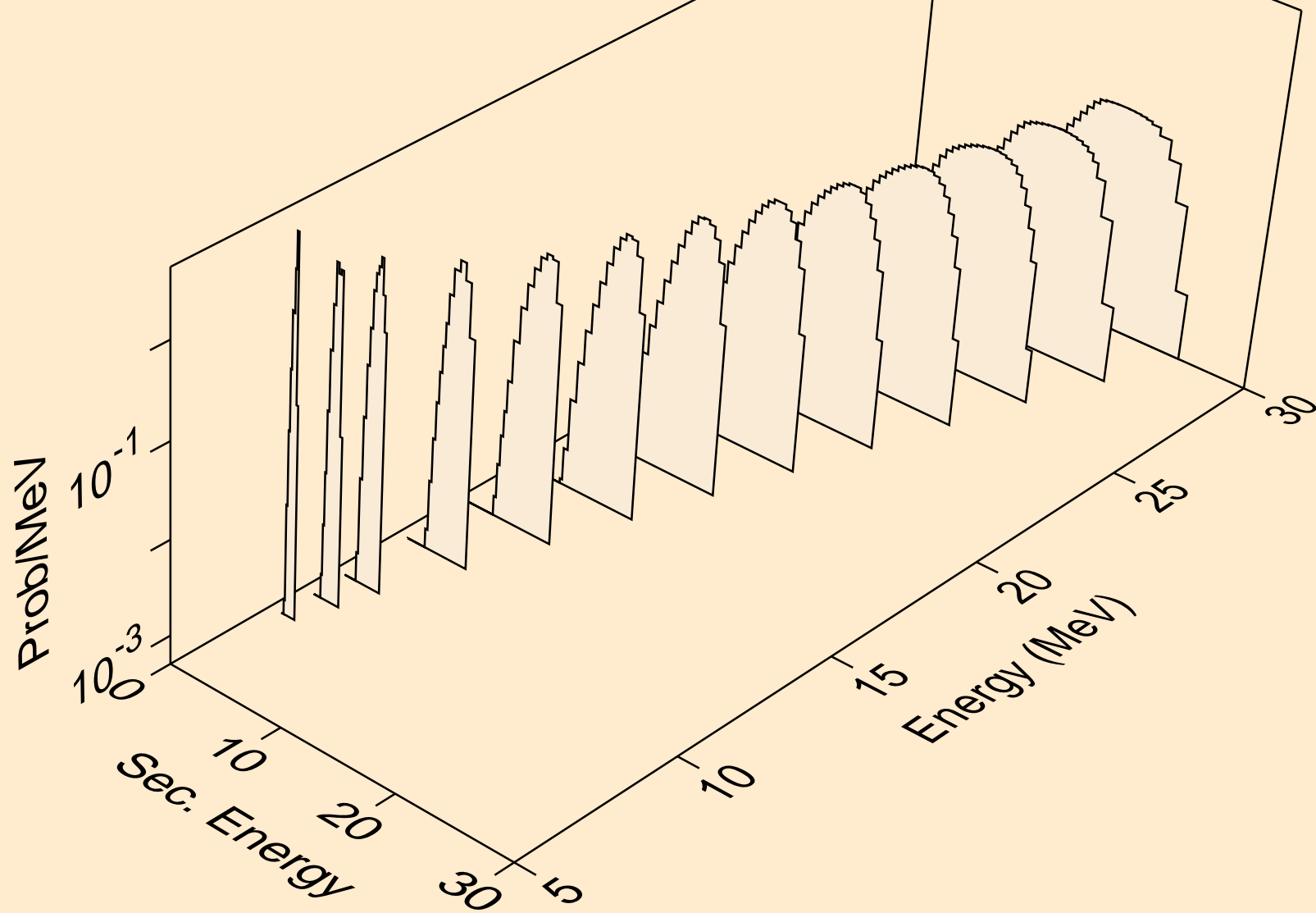

PT195M PROTON ACER TENDL-2024 LIBRARY; T=0.K  
Proton emission for (p,2np)

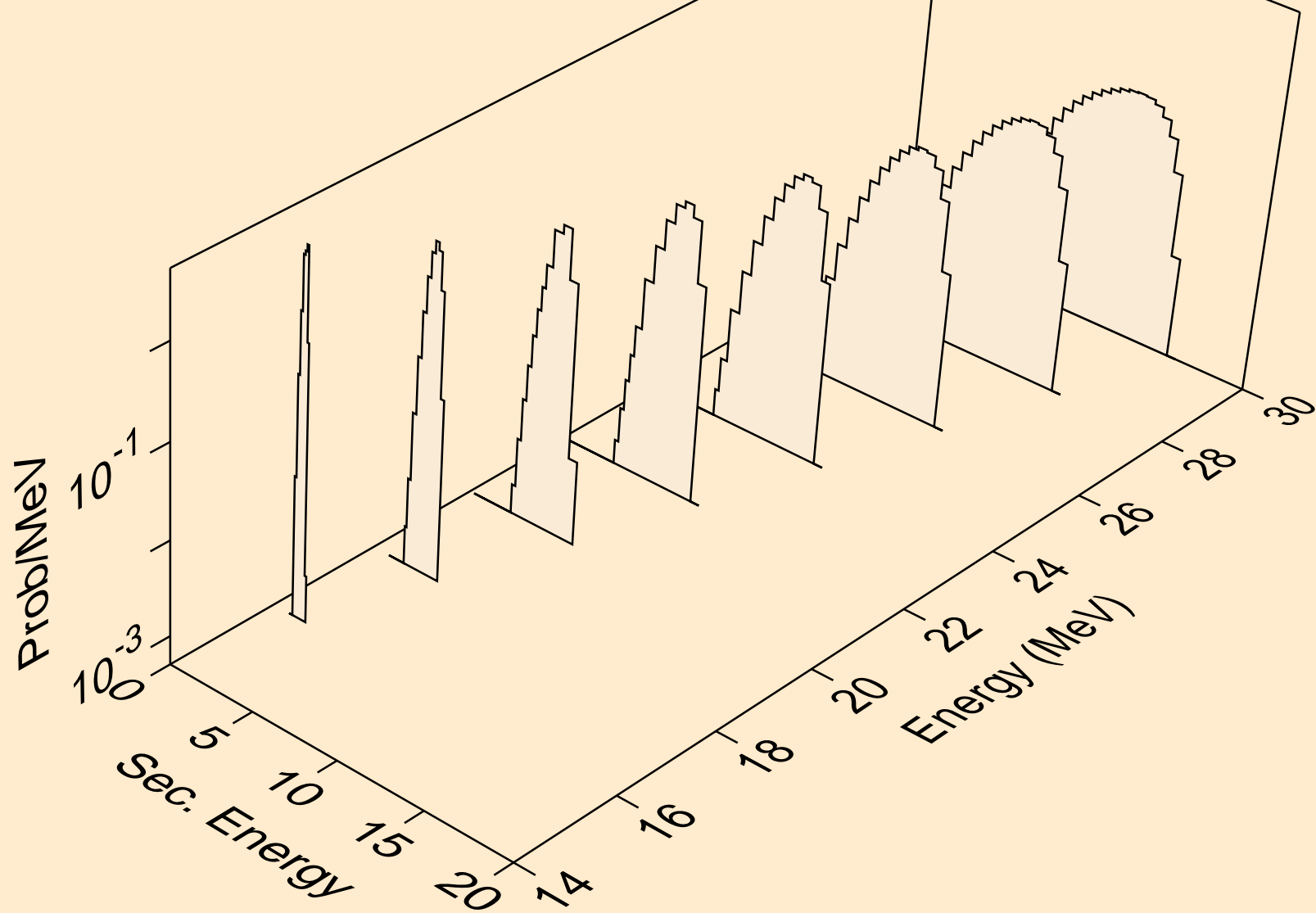

PT195M PROTON ACER TENDL-2024 LIBRARY; T=0.K  
Proton emission for (p,3np)

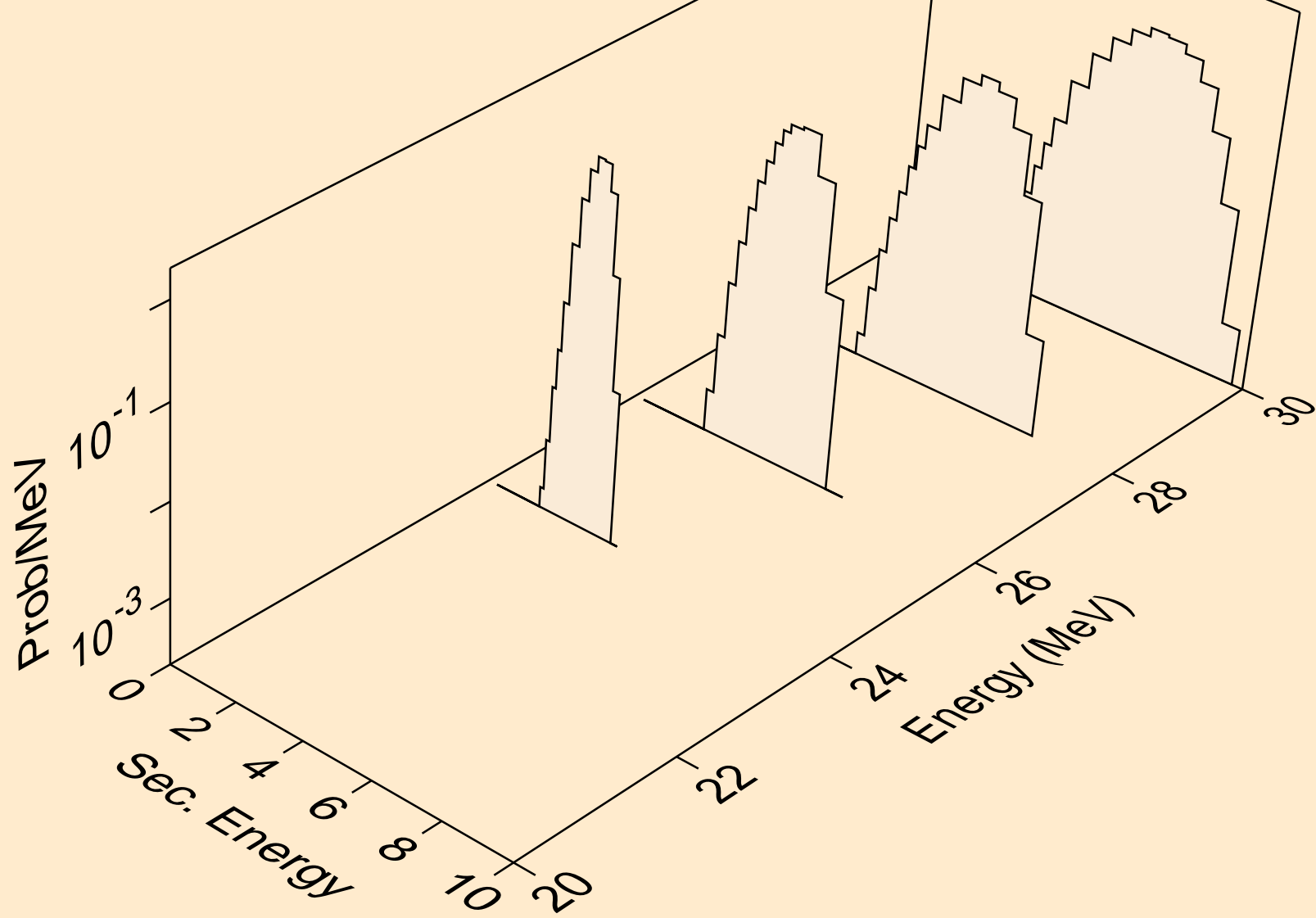

PT195M PROTON ACER TENDL-2024 LIBRARY; T=0.K  
Proton emission for (p,n2p)

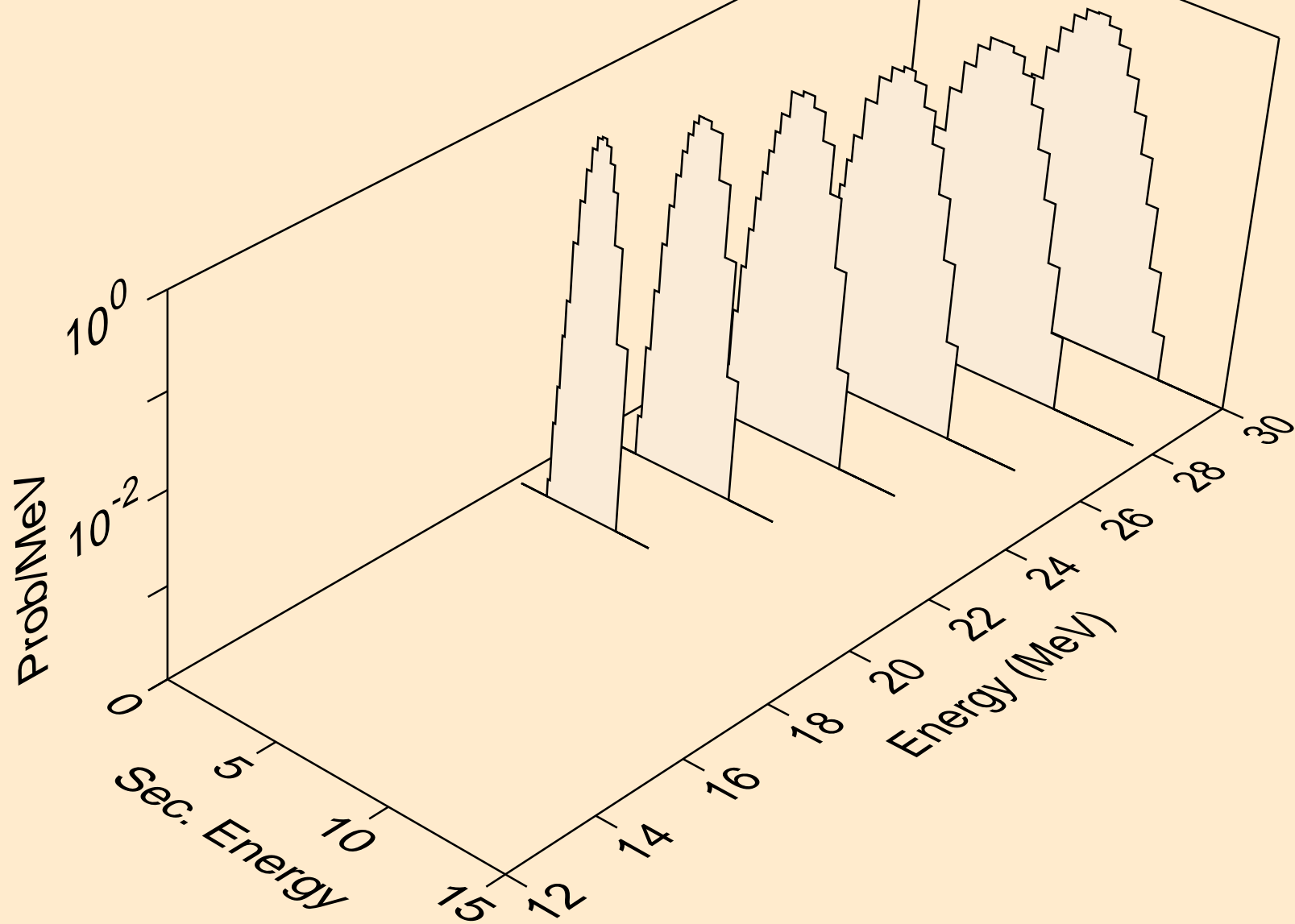

PT195M PROTON ACER TENDL-2024 LIBRARY; T=0.K  
Proton emission for (p,npa)

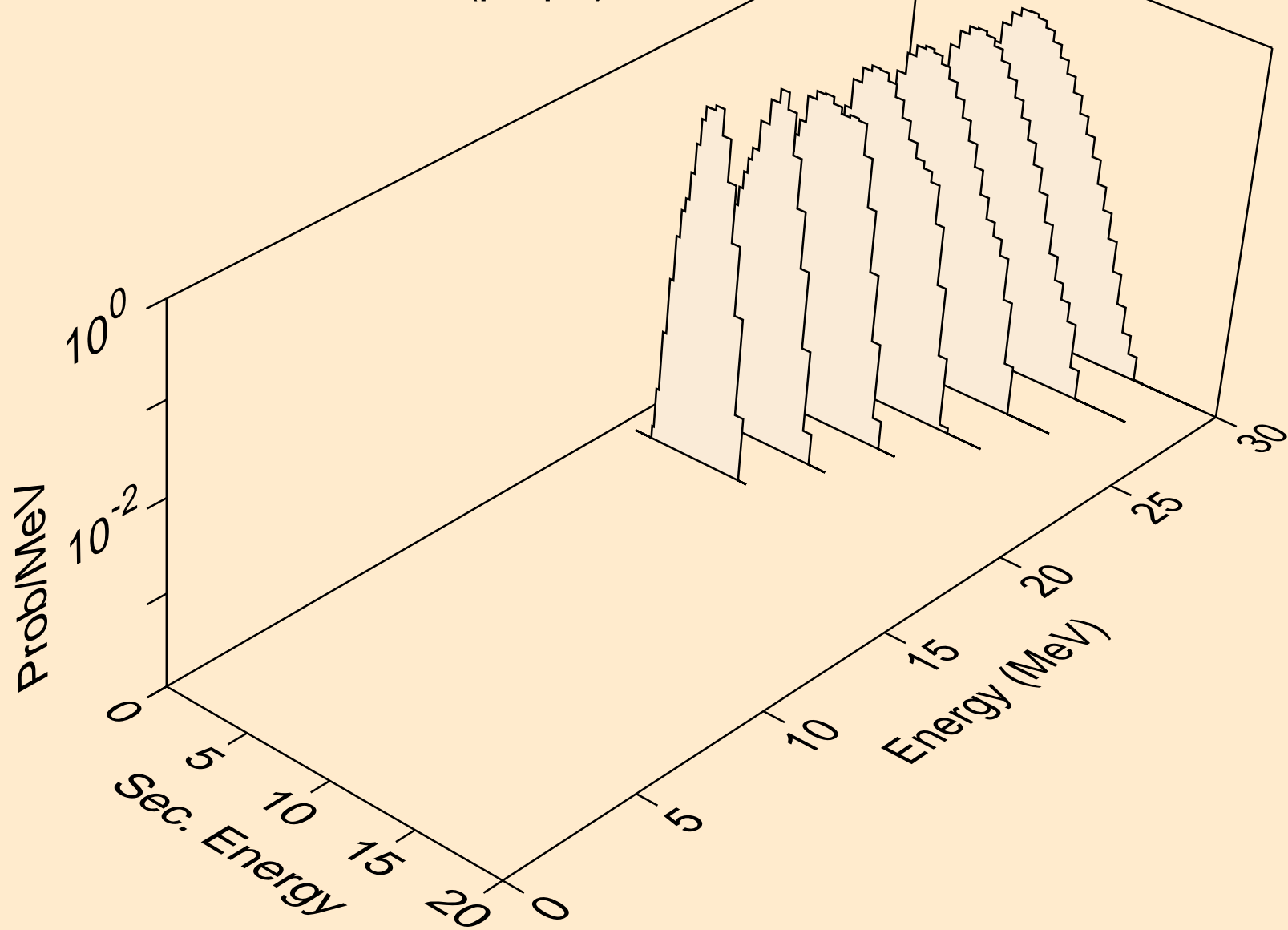

PT195M PROTON ACER TENDL-2024 LIBRARY; T=0.K  
Proton emission for inelastic

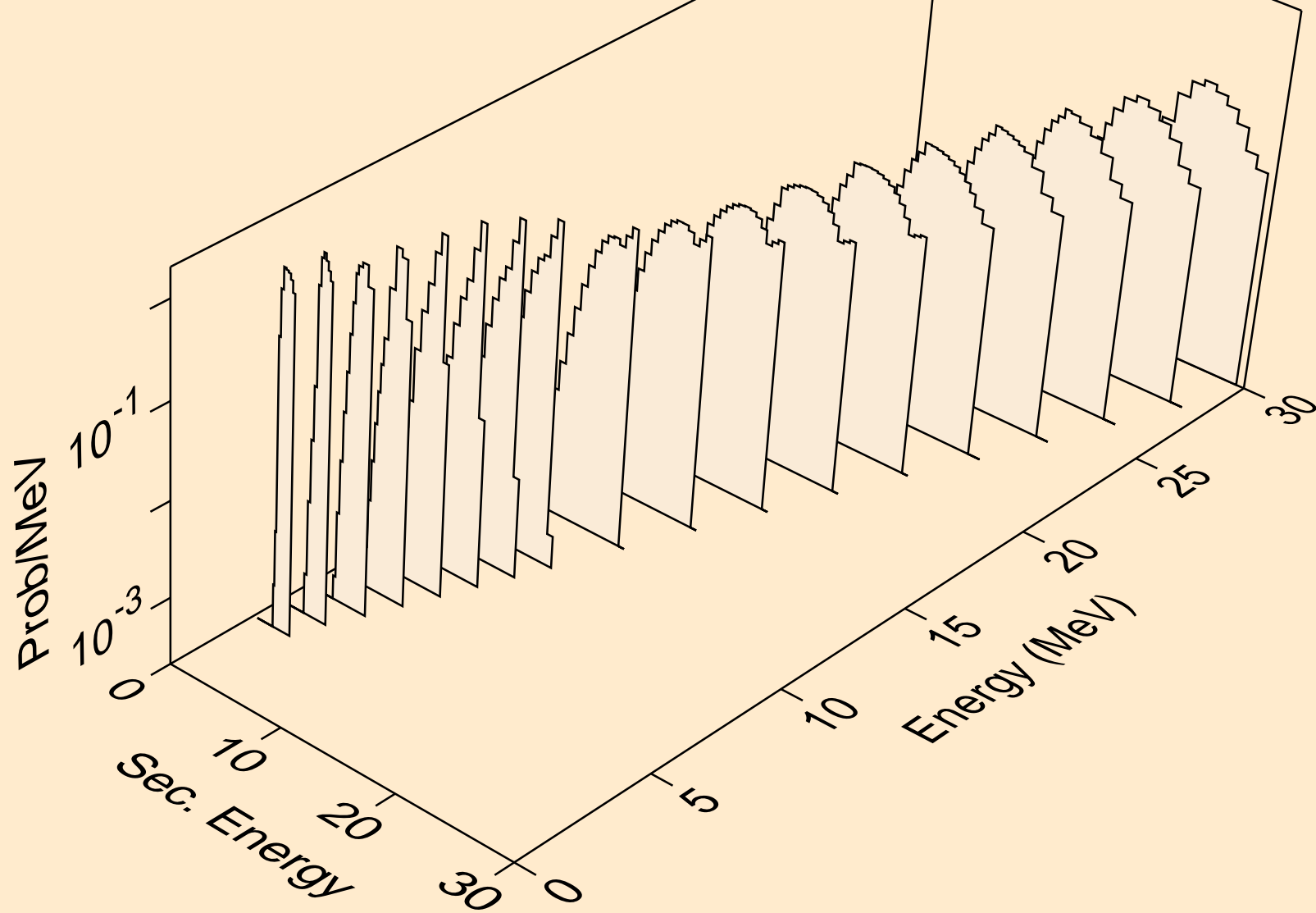

PT195M PROTON ACER TENDL-2024 LIBRARY; T=0.K  
Proton emission for (p,2p)

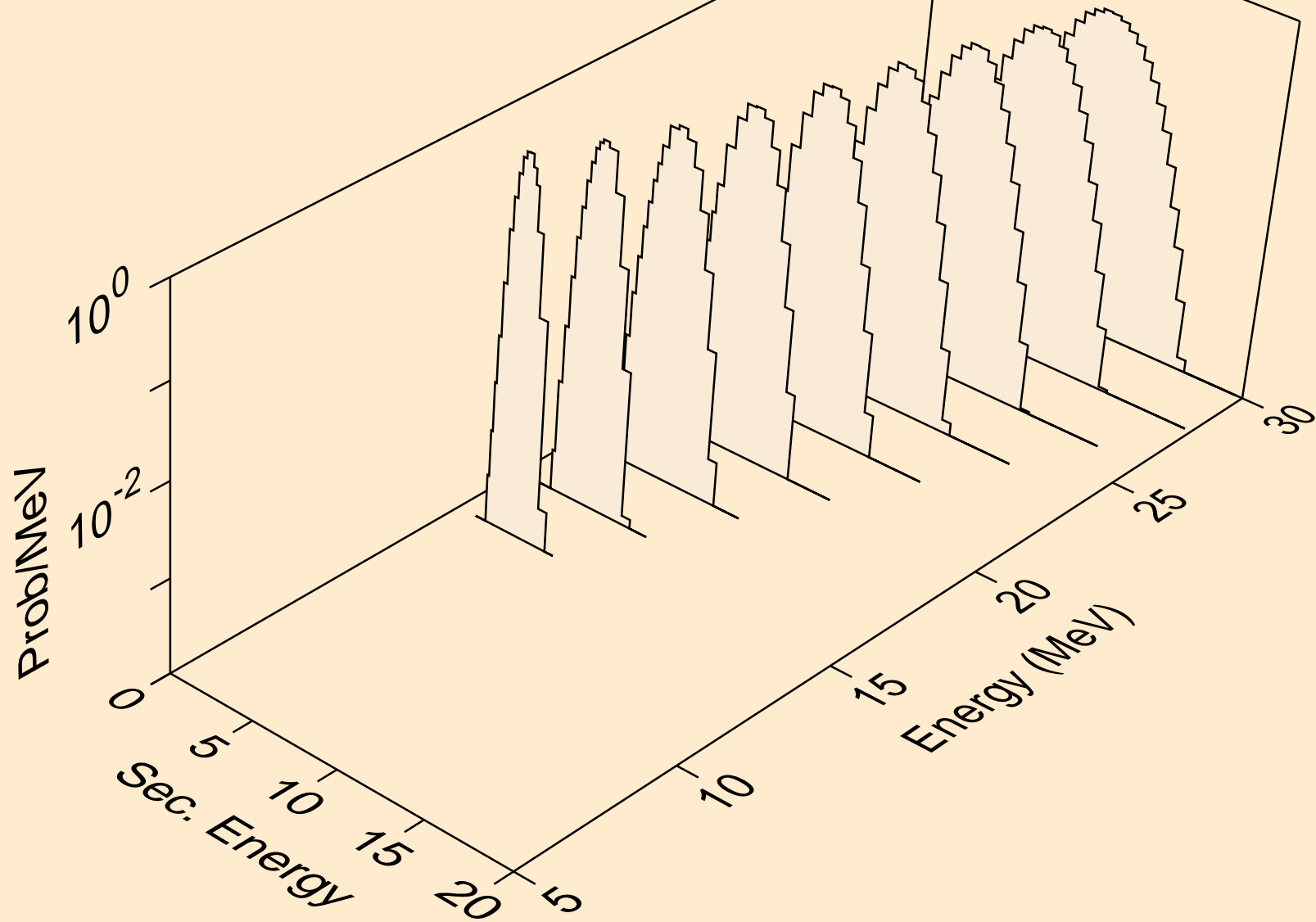

PT195M PROTON ACER TENDL-2024 LIBRARY; T=0.K  
Proton emission for (p,pa)

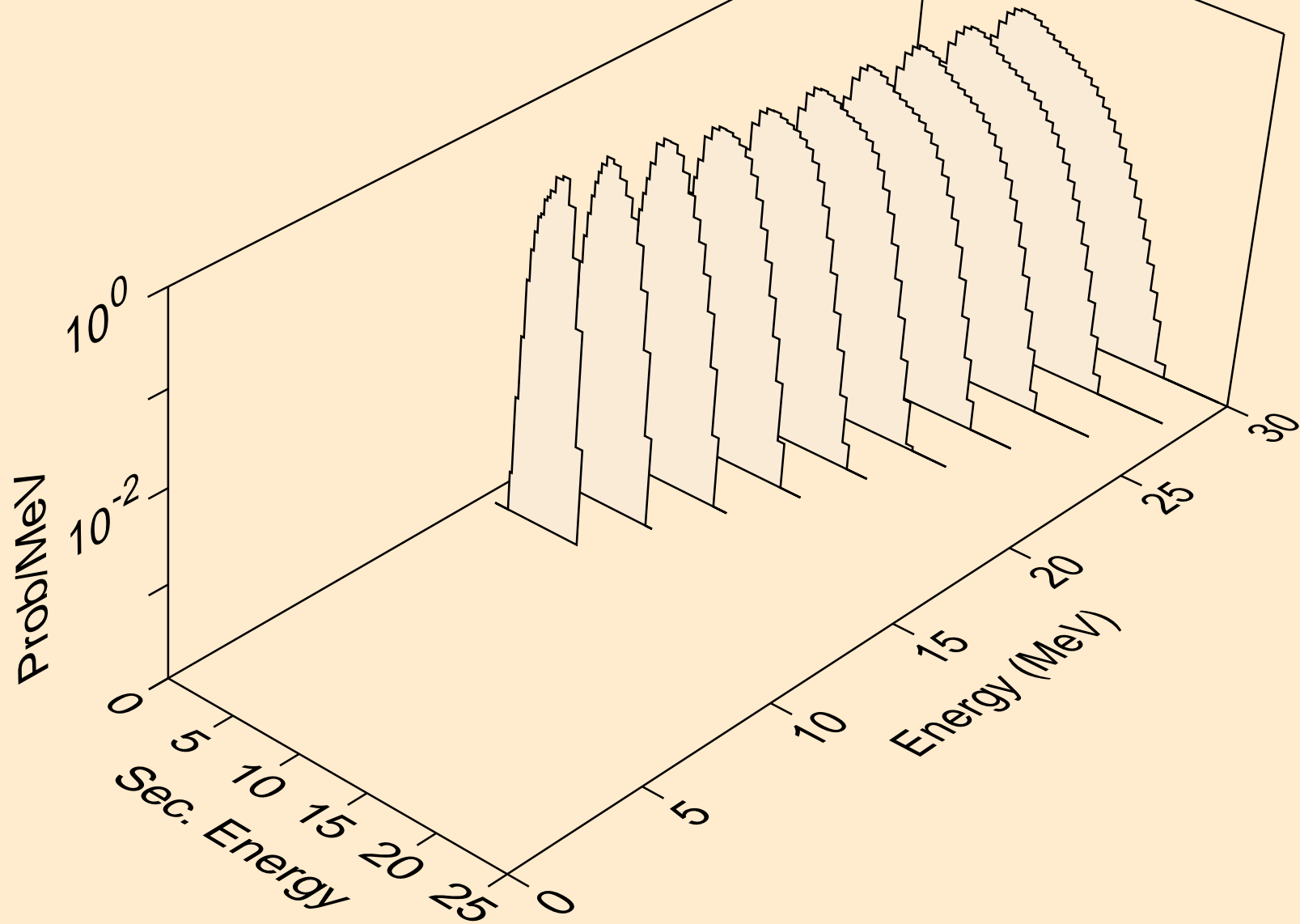

PT195M PROTON ACER TENDL-2024 LIBRARY; T=0.K  
Proton emission for (p,pd)

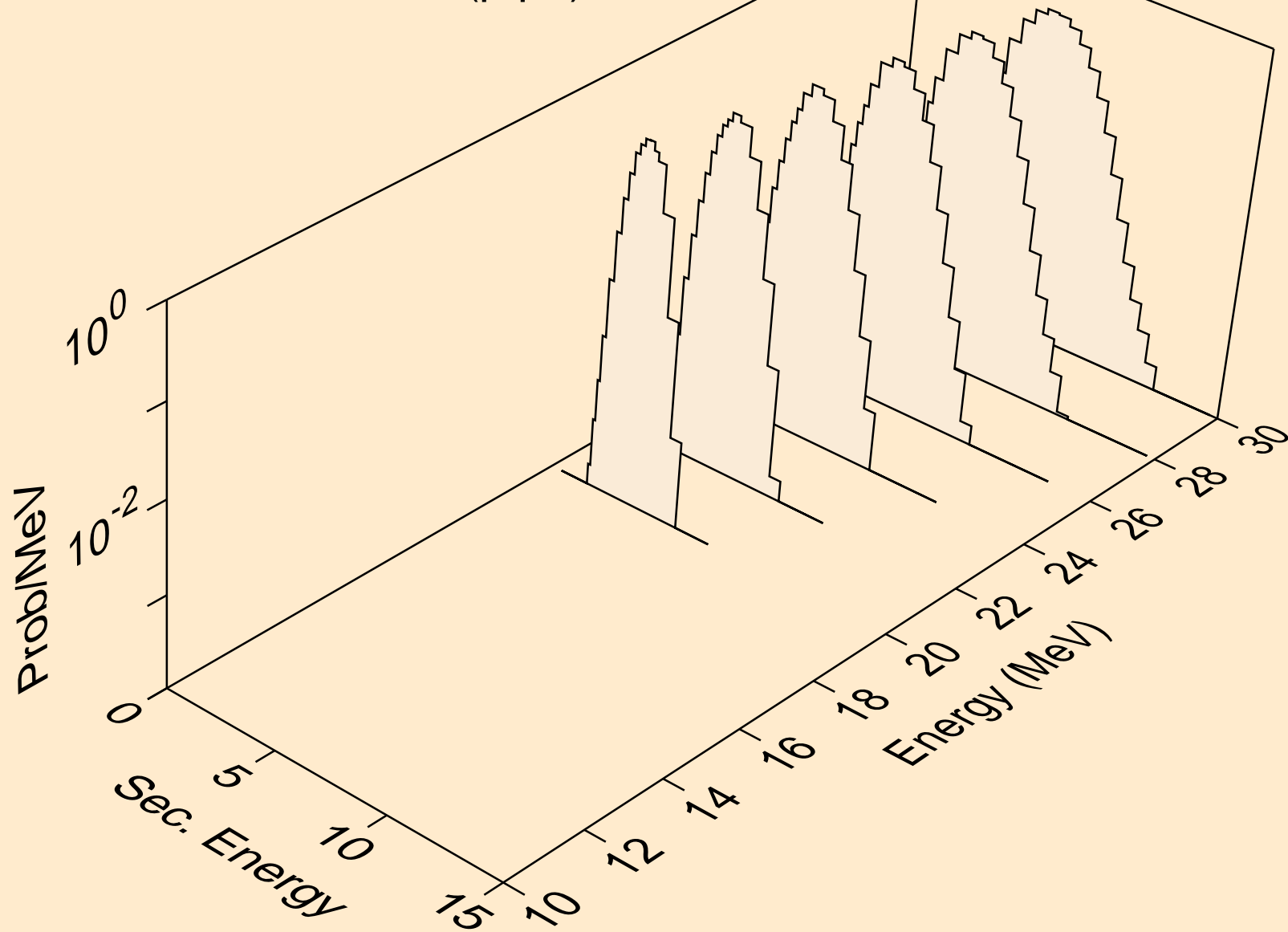

PT195M PROTON ACER TENDL-2024 LIBRARY; T=0.K  
Proton emission for (p,pt)

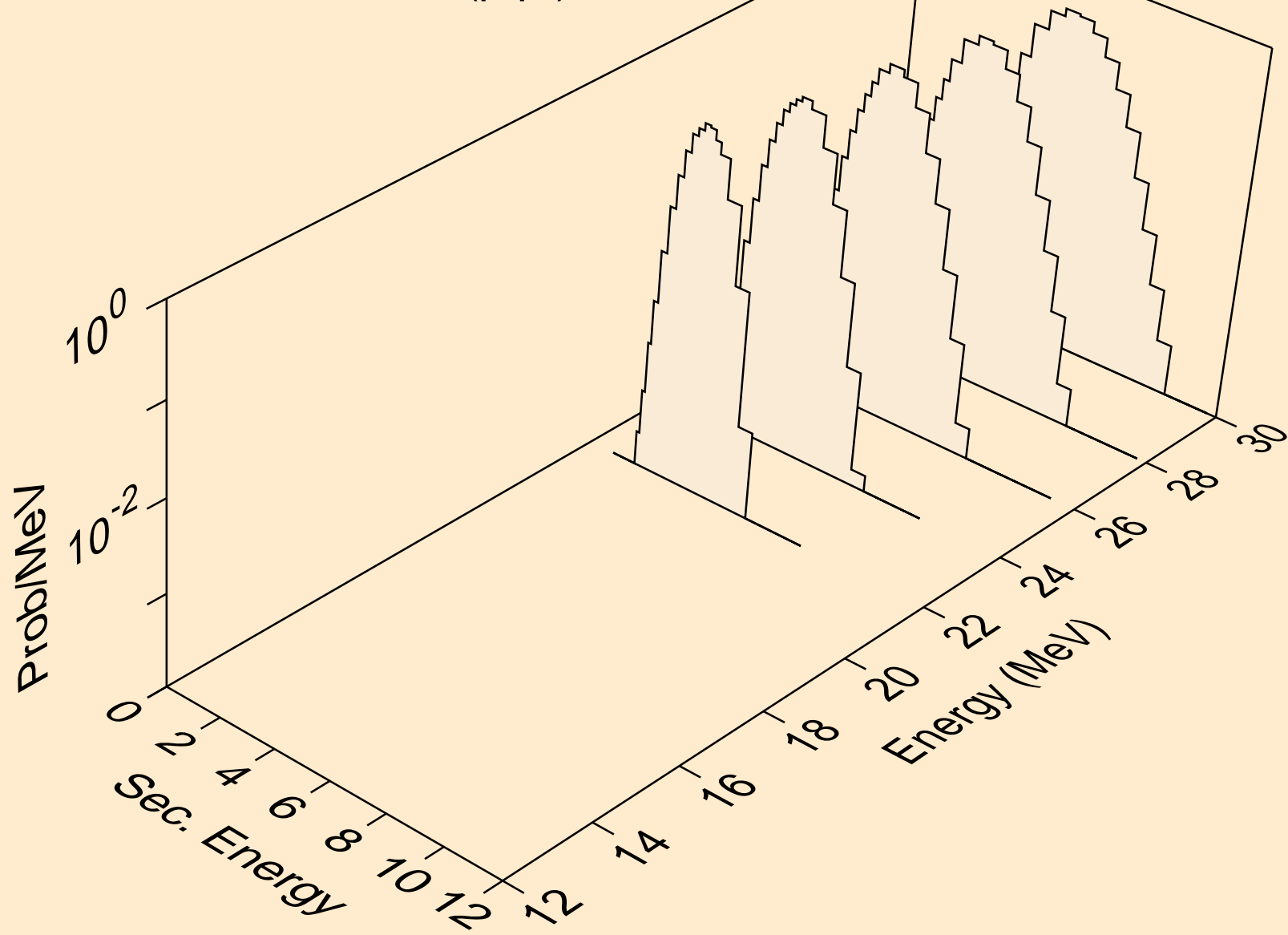

PT195M PROTON ACER TENDL-2024 LIBRARY; T=0.K  
Photon emission for (z,n)

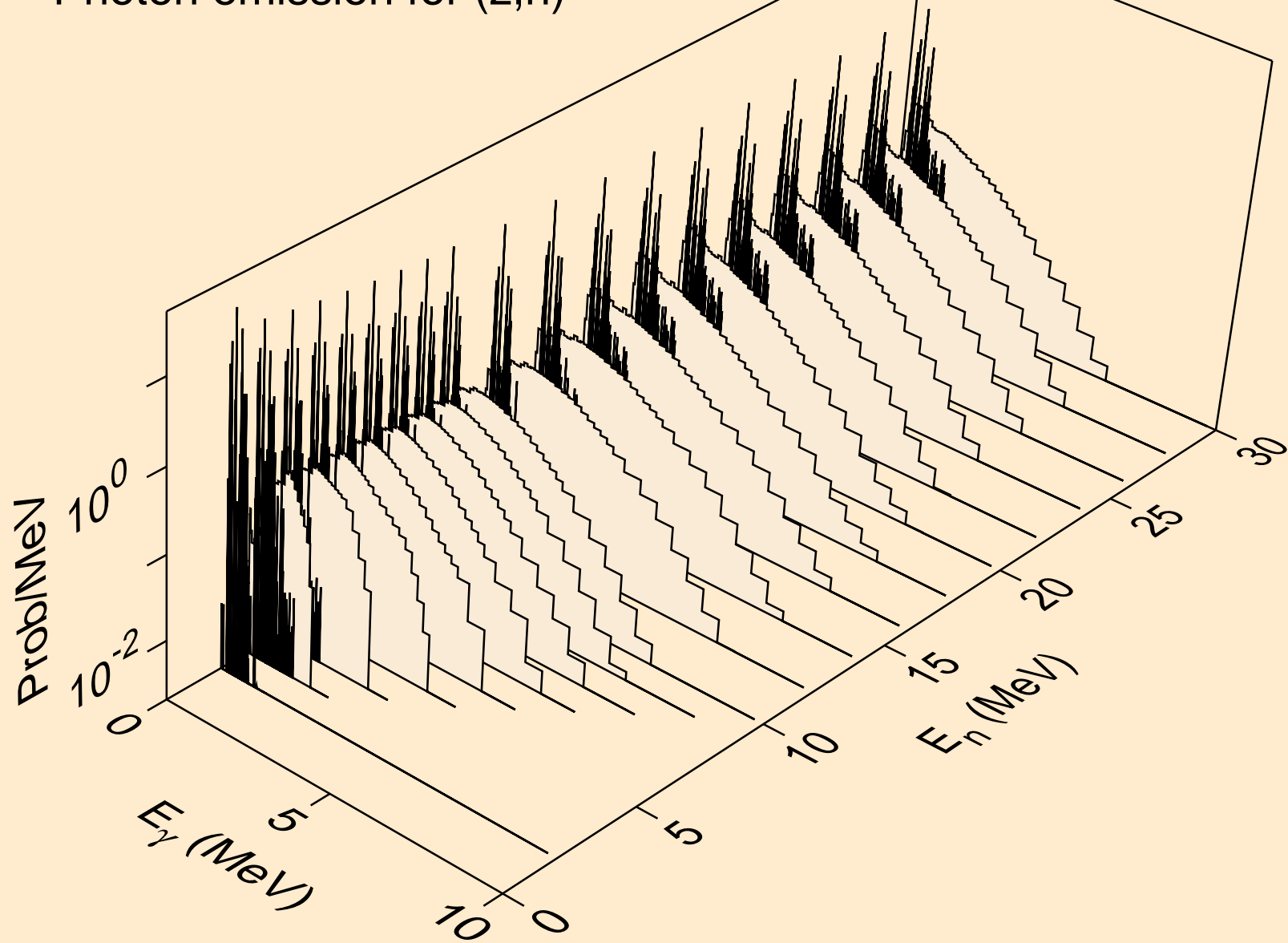

PT195M PROTON ACER TENDL-2024 LIBRARY; T=0.K  
Photon emission for (z,x)

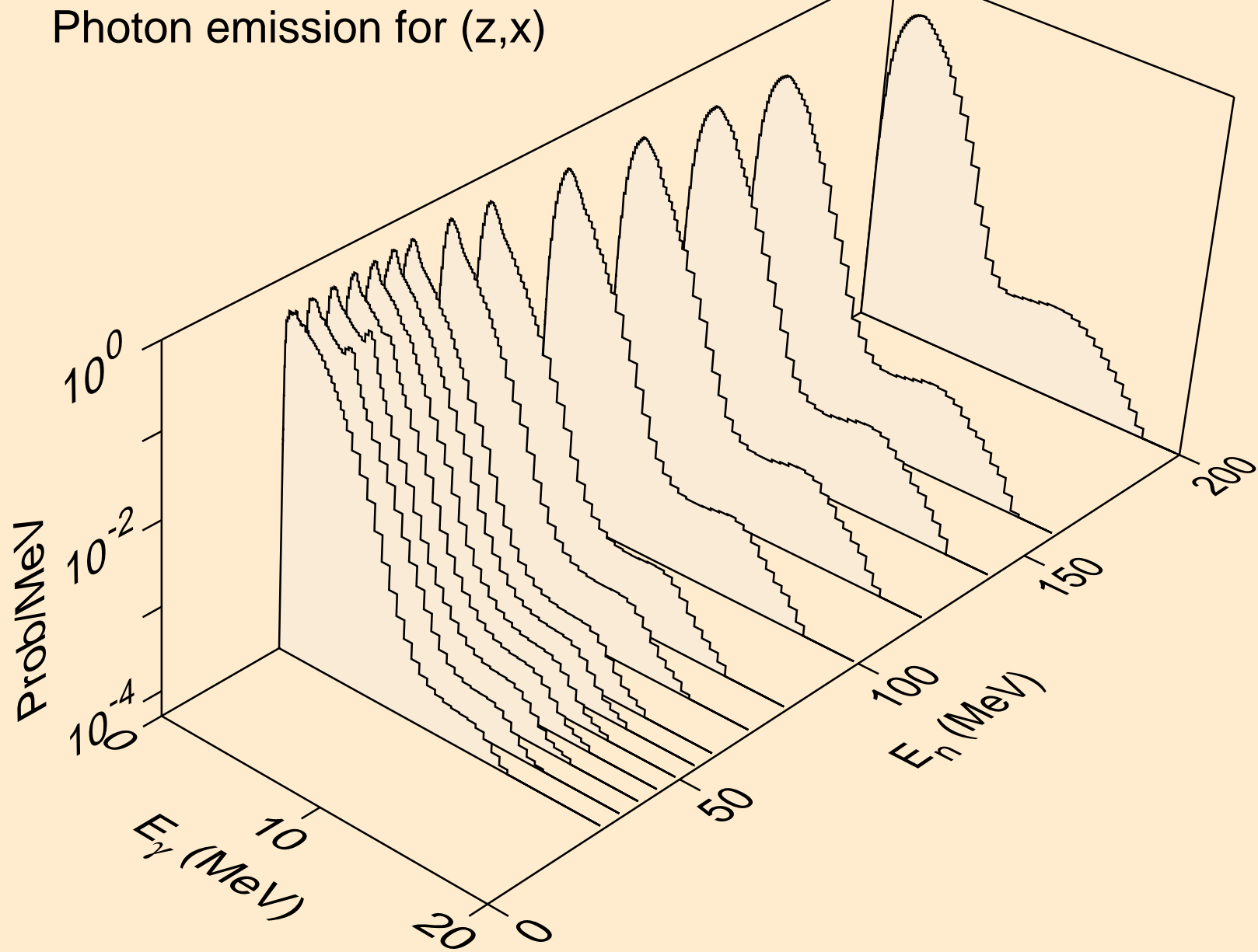

PT195M PROTON ACER TENDL-2024 LIBRARY; T=0.K  
Photon emission for (n,2nd)

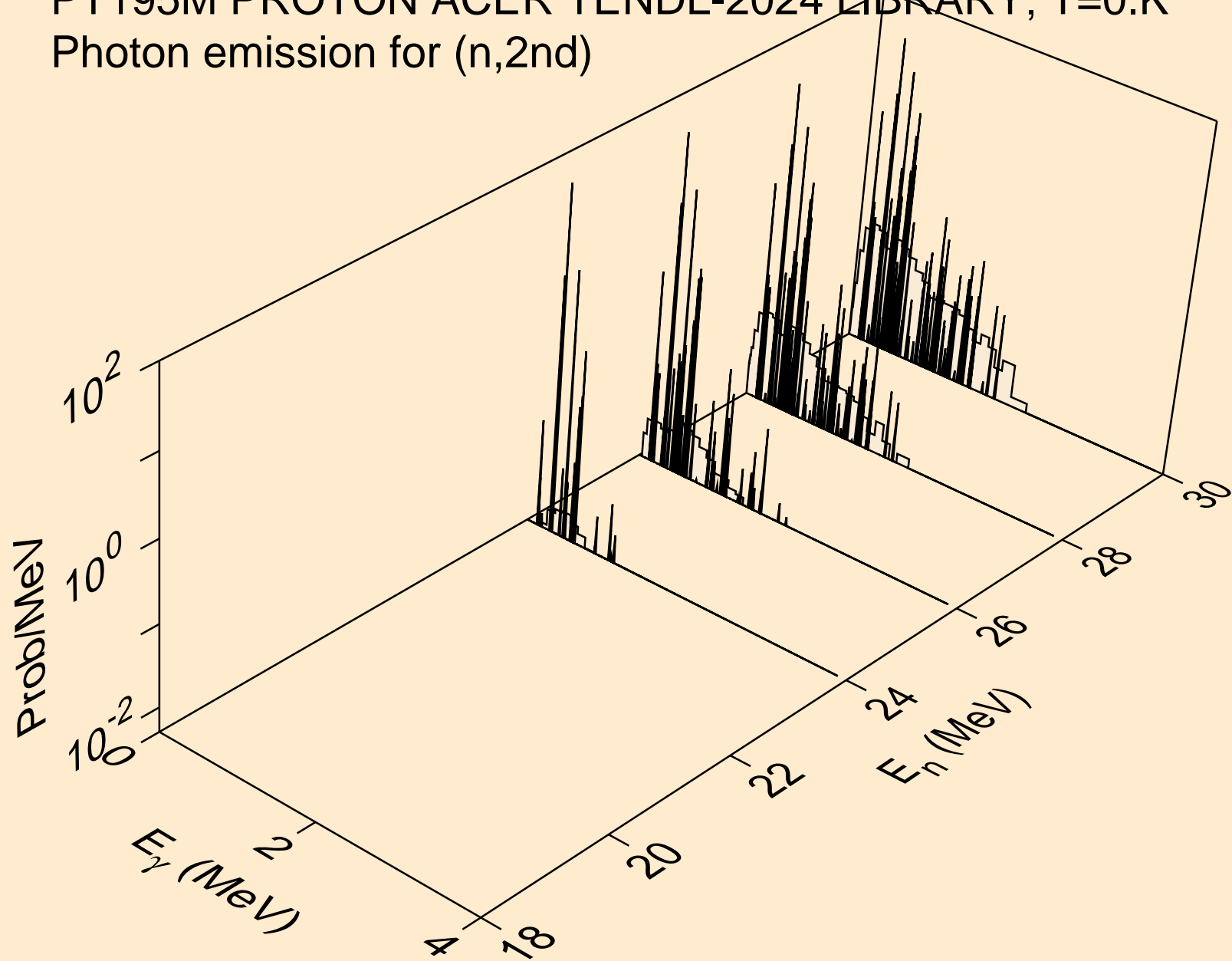

PT195M PROTON ACER TENDL-2024 LIBRARY; T=0.K  
Photon emission for (n,2n)

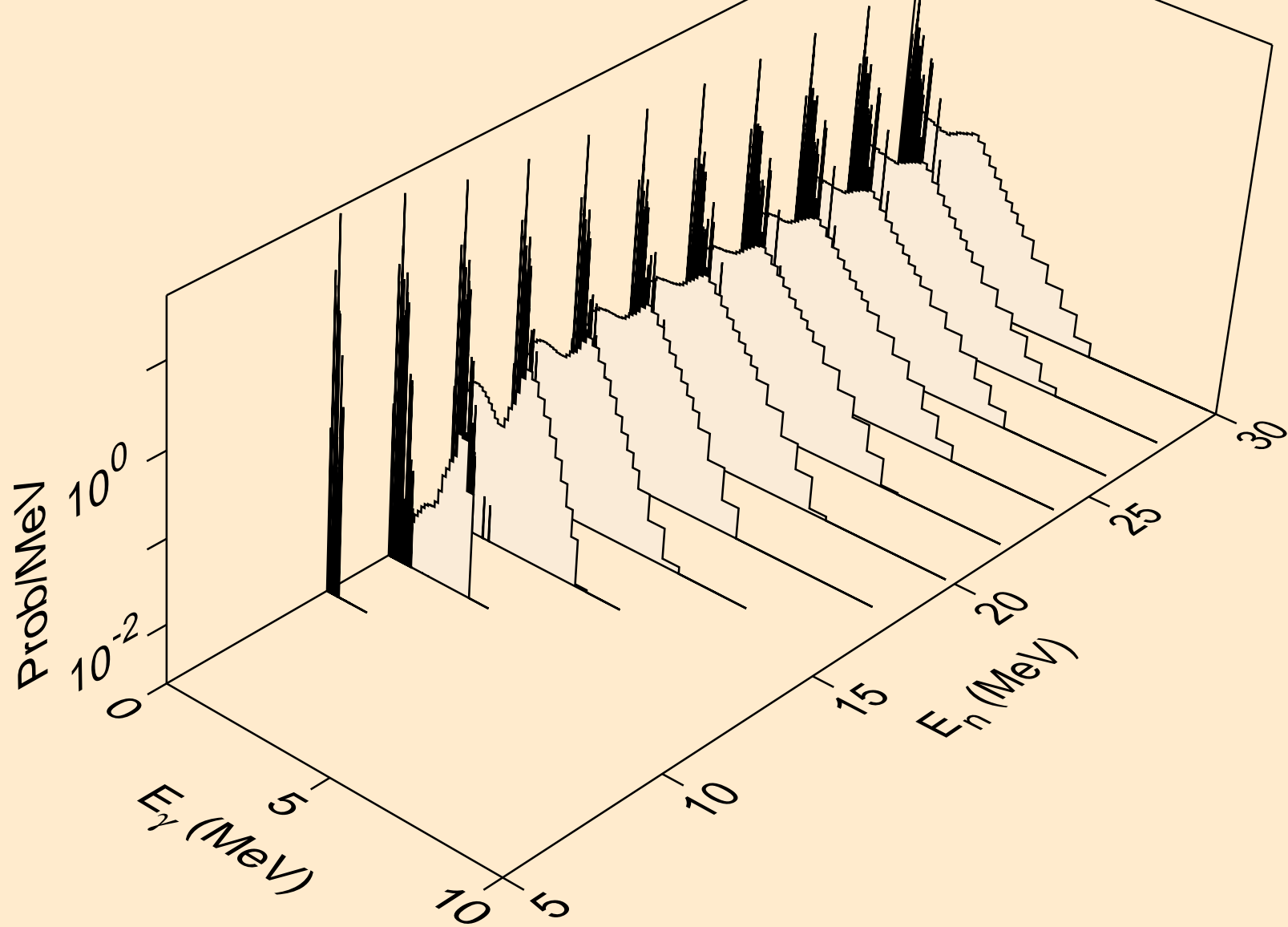

PT195M PROTON ACER TENDL-2024 LIBRARY; T=0.K  
Photon emission for (n,3n)

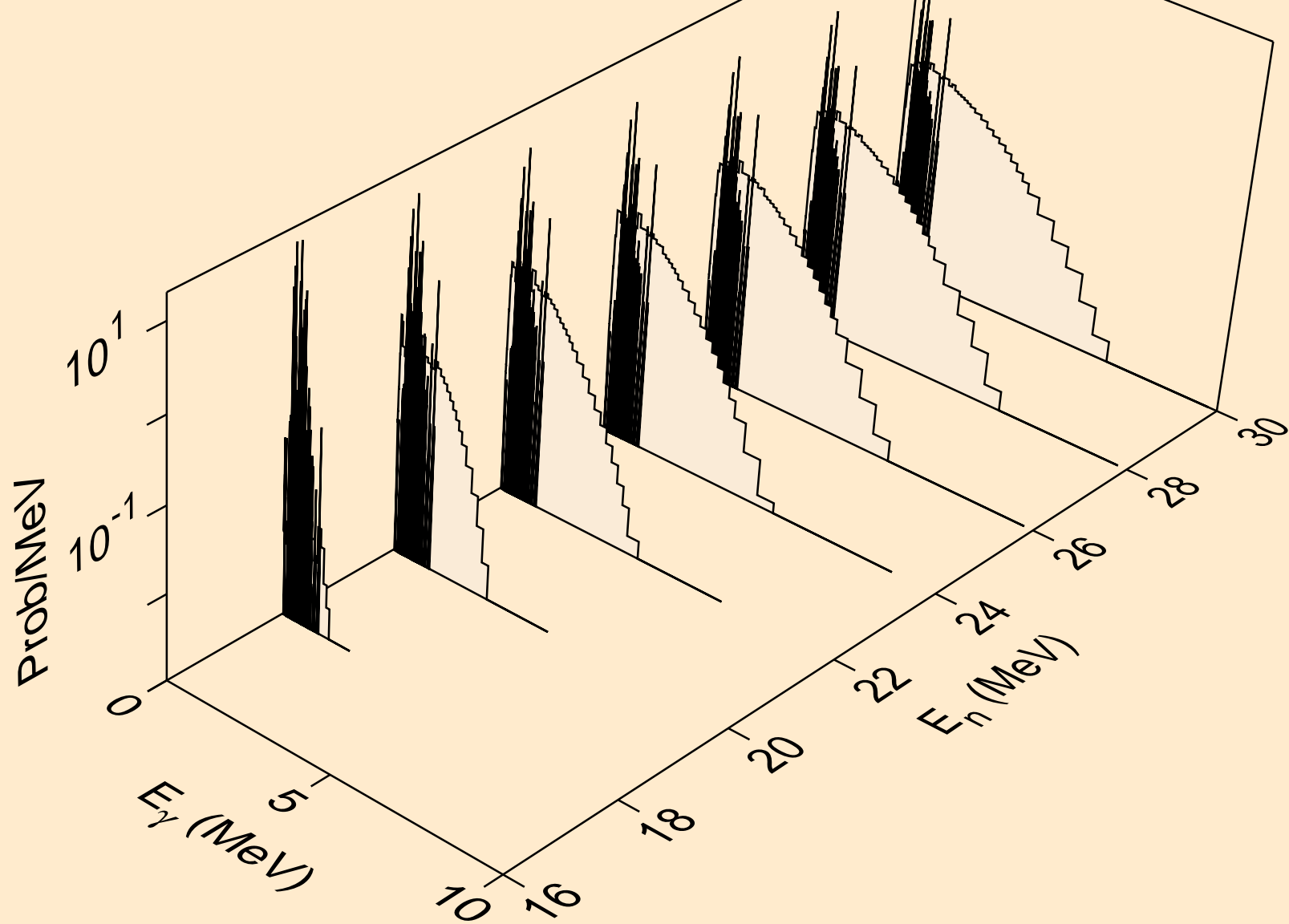

PT195M PROTON ACER TENDL-2024 LIBRARY; T=0.K  
Photon emission for (n,n\*)a

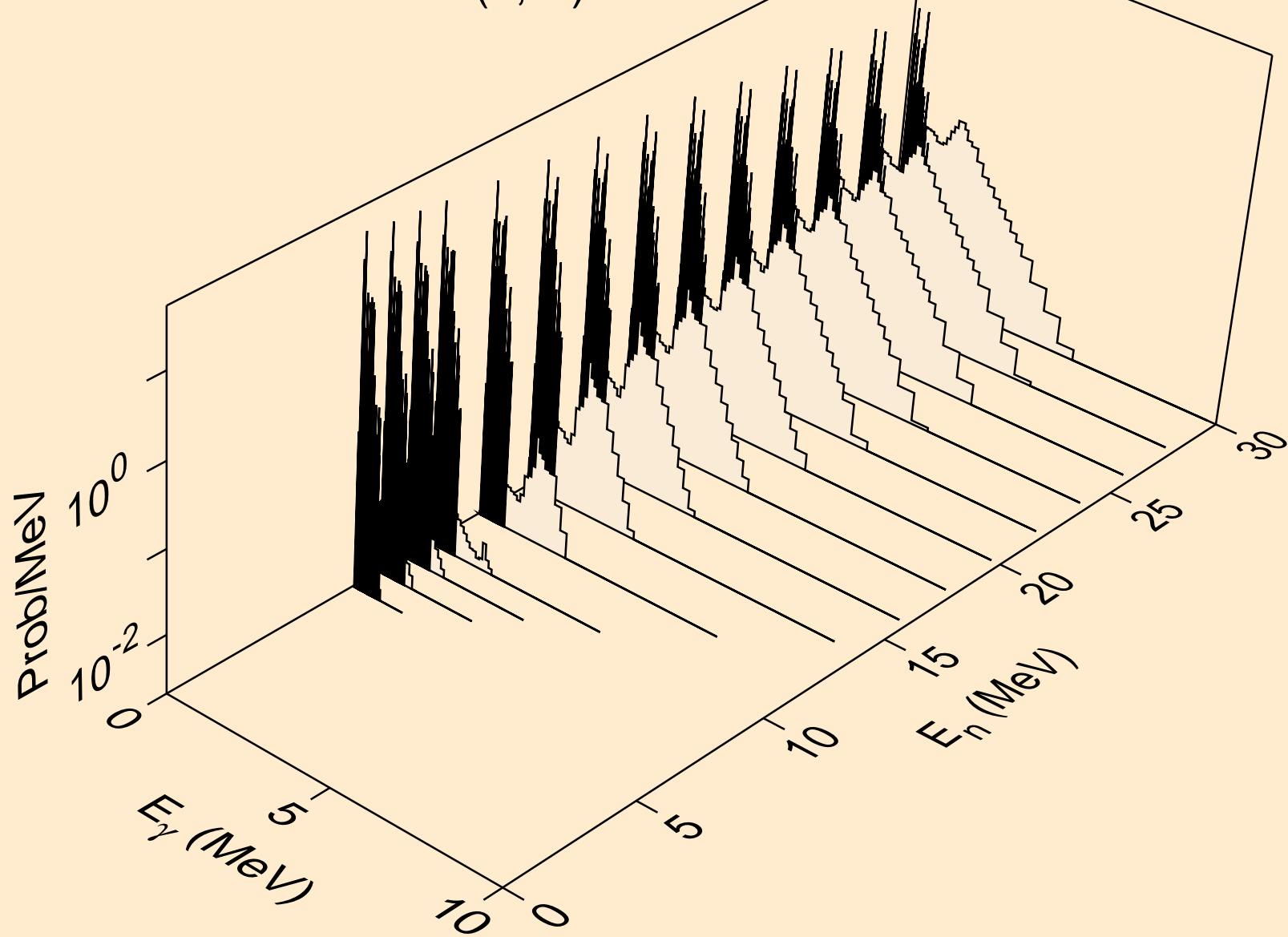

PT195M PROTON ACER TENDL-2024 LIBRARY; T=0.K  
Photon emission for (n,2n)a

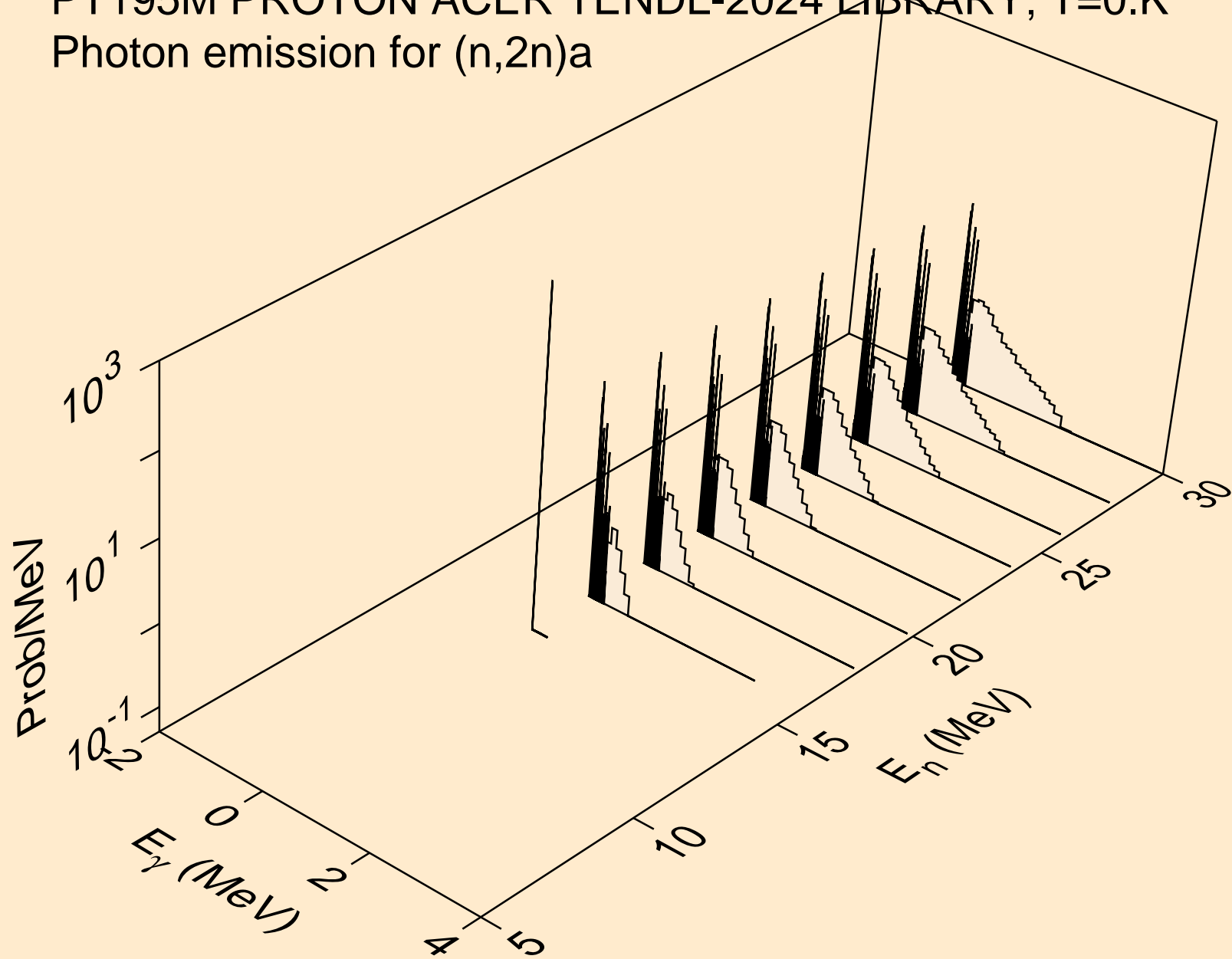

PT195M PROTON ACER TENDL-2024 LIBRARY; T=0.K  
Photon emission for (n,3n)a

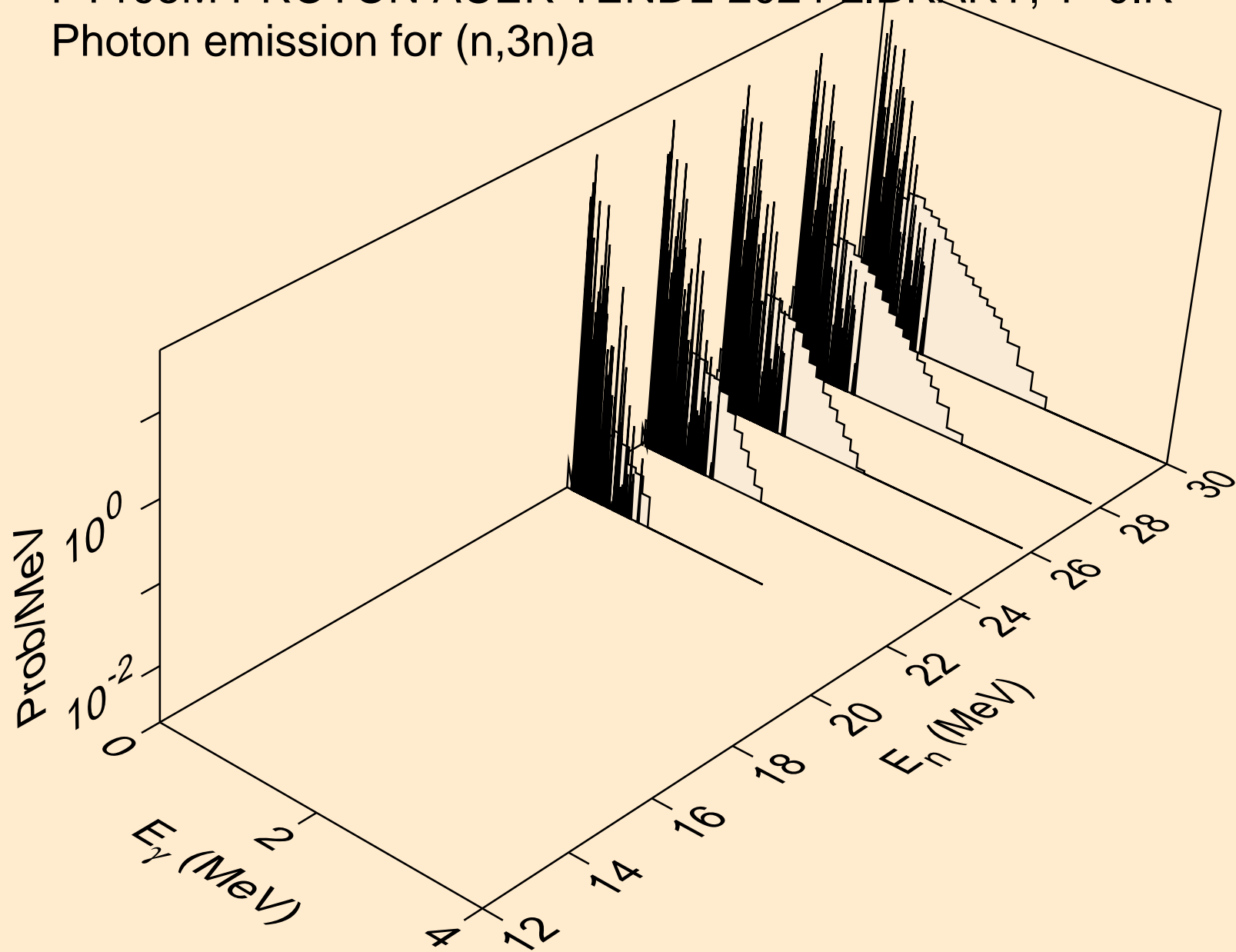

PT195M PROTON ACER TENDL-2024 LIBRARY; T=0.K  
Photon emission for (n,n\*)p

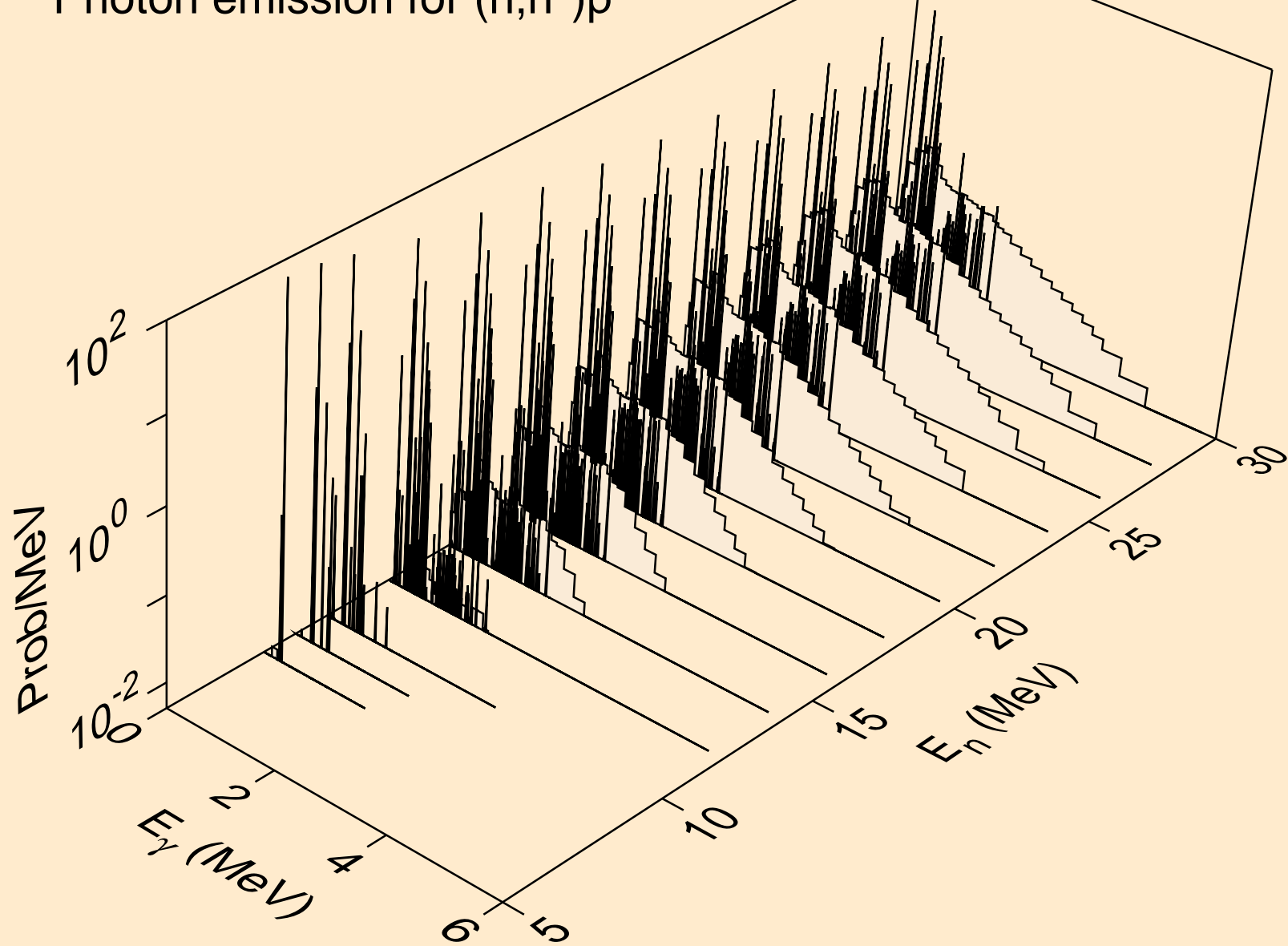

PT195M PROTON ACER TENDL-2024 LIBRARY; T=0.K  
Photon emission for (n,n\*)d

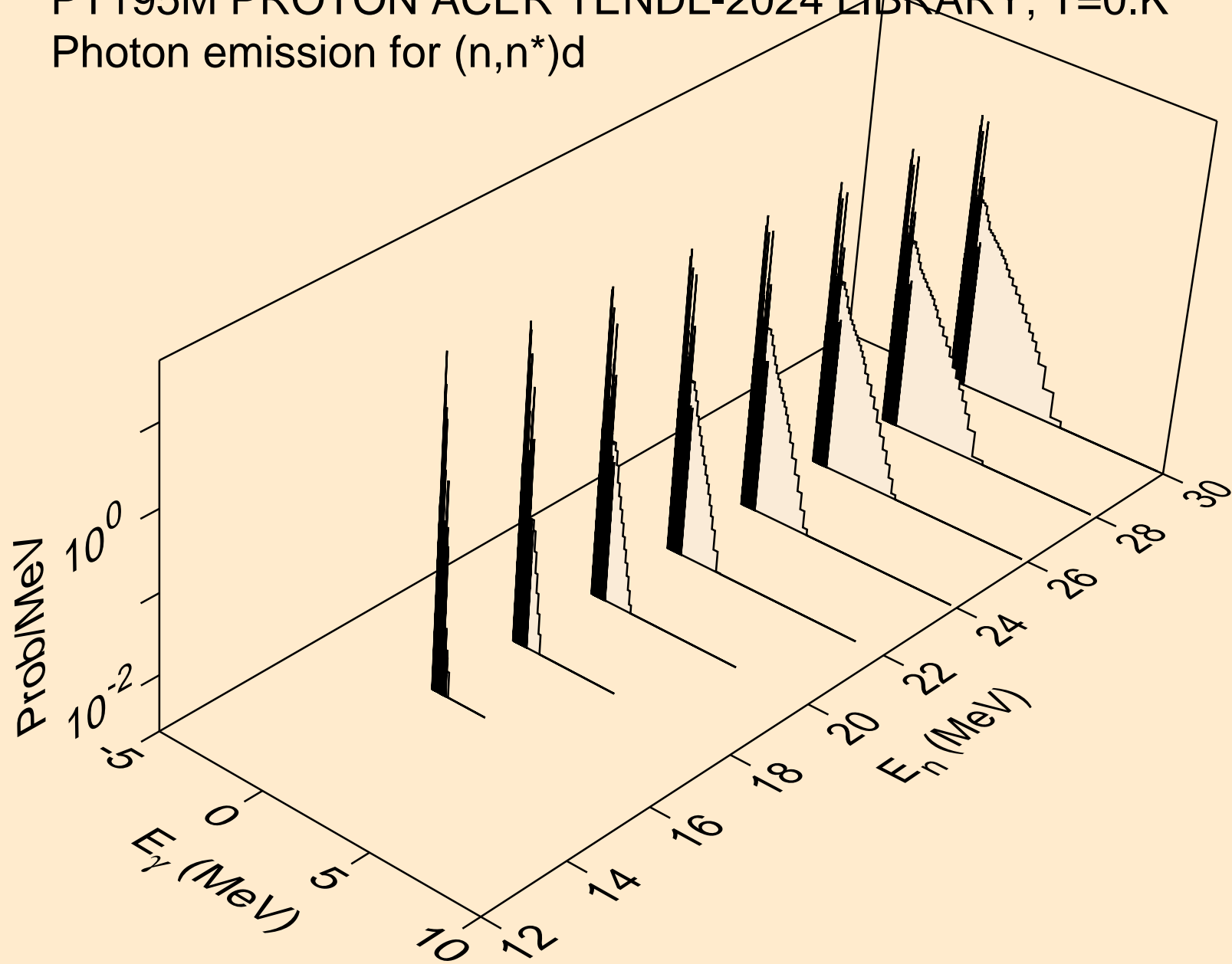

PT195M PROTON ACER TENDL-2024 LIBRARY; T=0.K  
Photon emission for (n,n\*)t

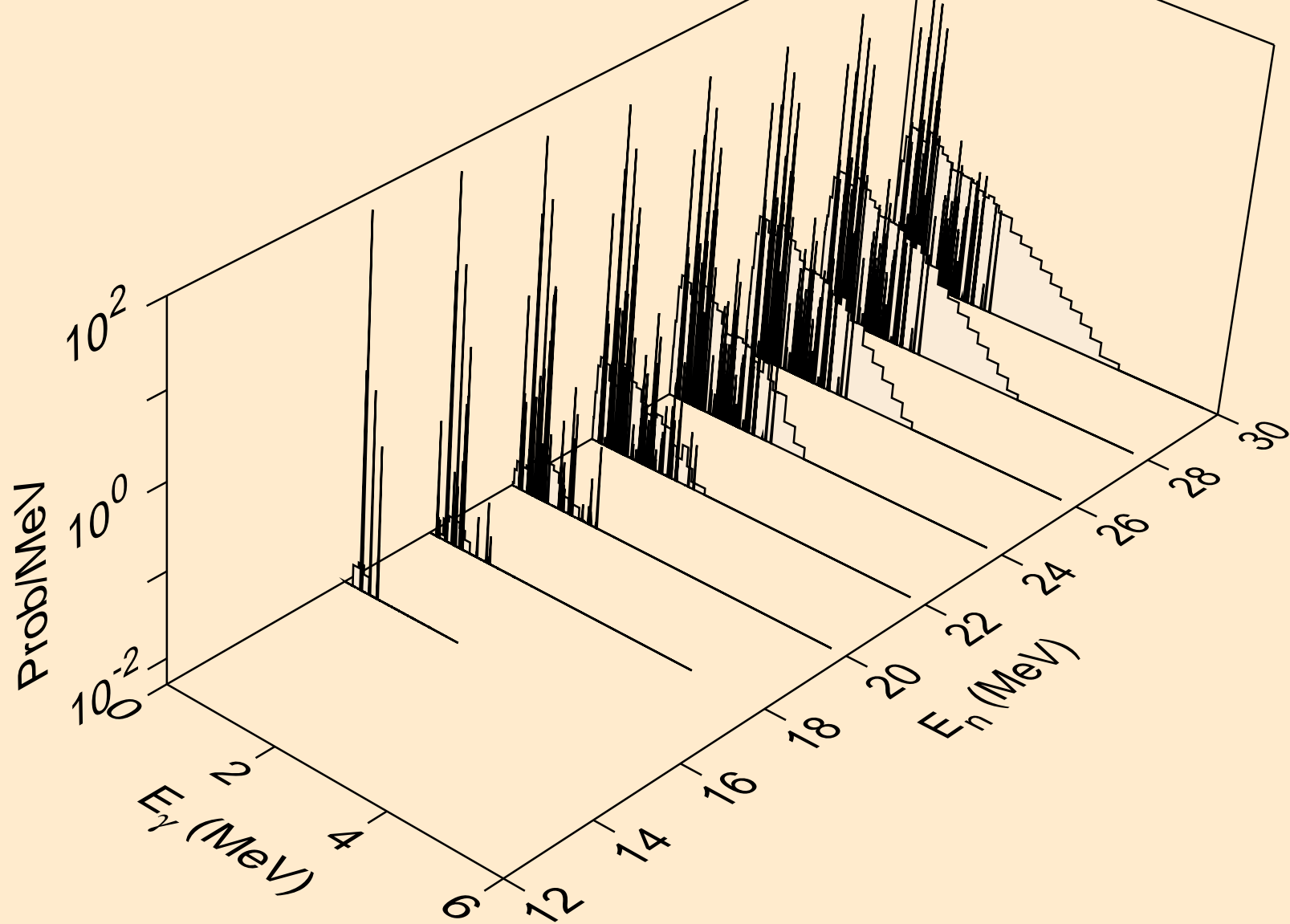

PT195M PROTON ACER TENDL-2024 LIBRARY; T=0.K  
Photon emission for (n,n\*)he3

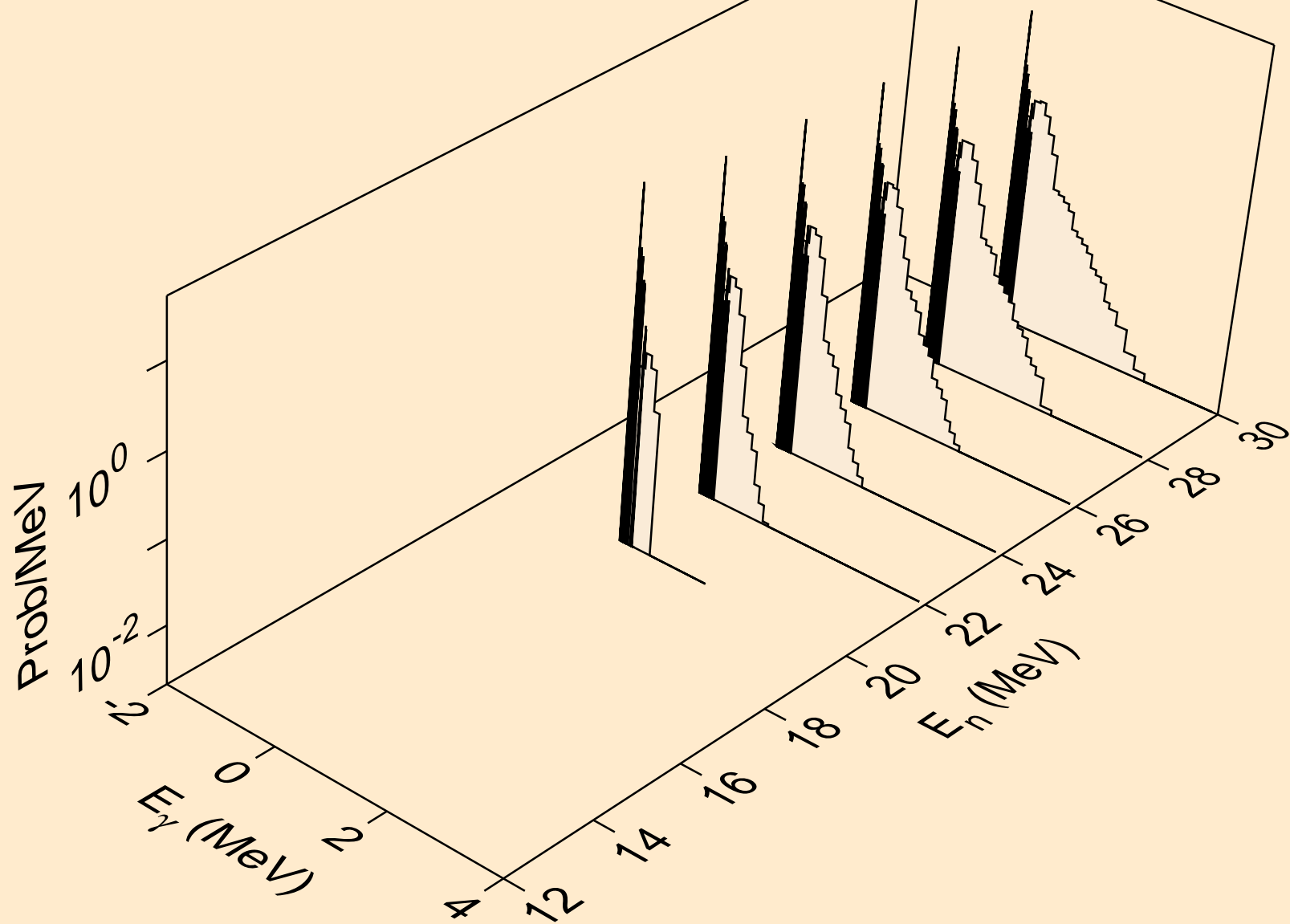

PT195M PROTON ACER TENDL-2024 LIBRARY; T=0.K  
Photon emission for (n,4n)

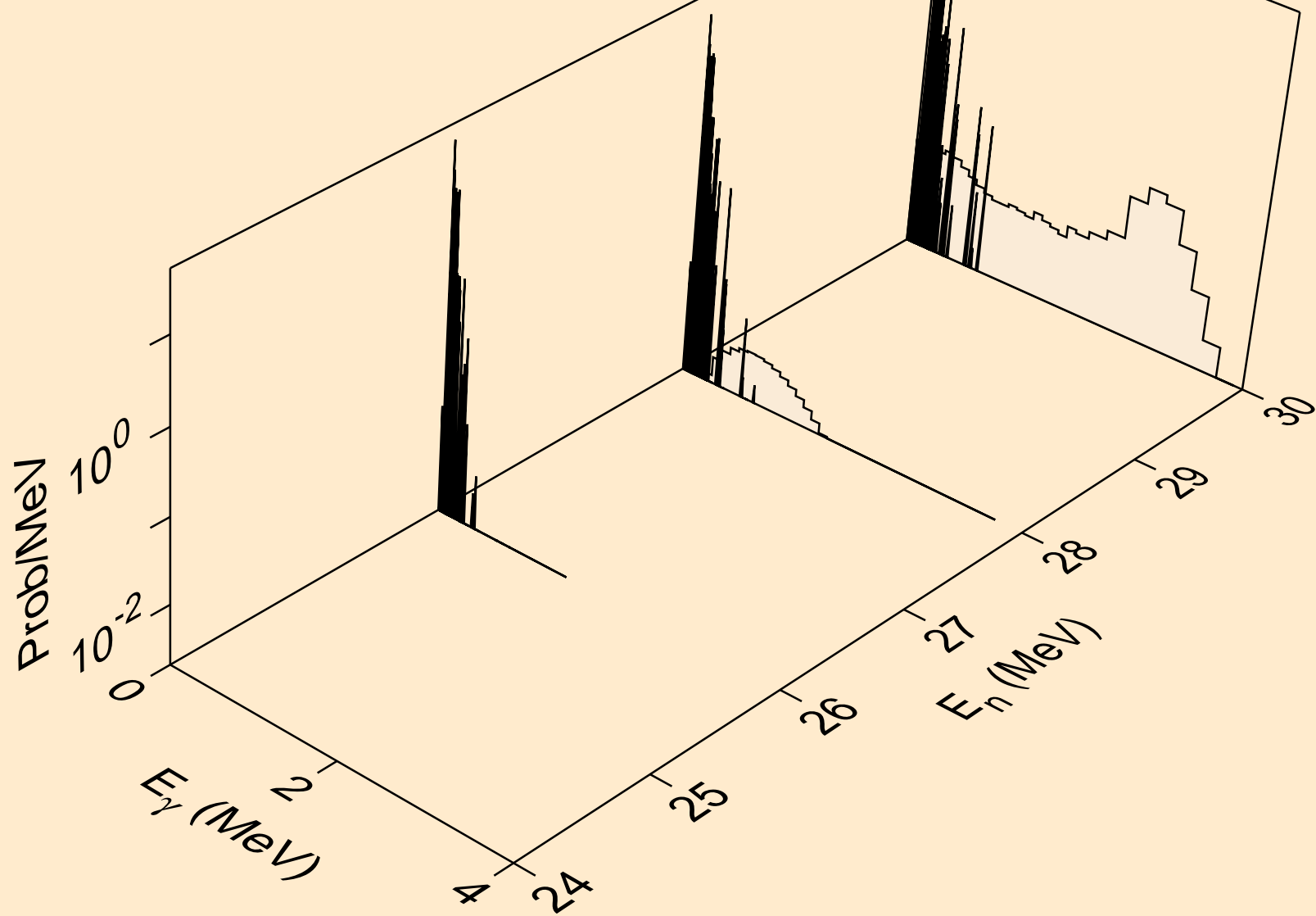

PT195M PROTON ACER TENDL-2024 LIBRARY; T=0.K  
Photon emission for (n,2np)

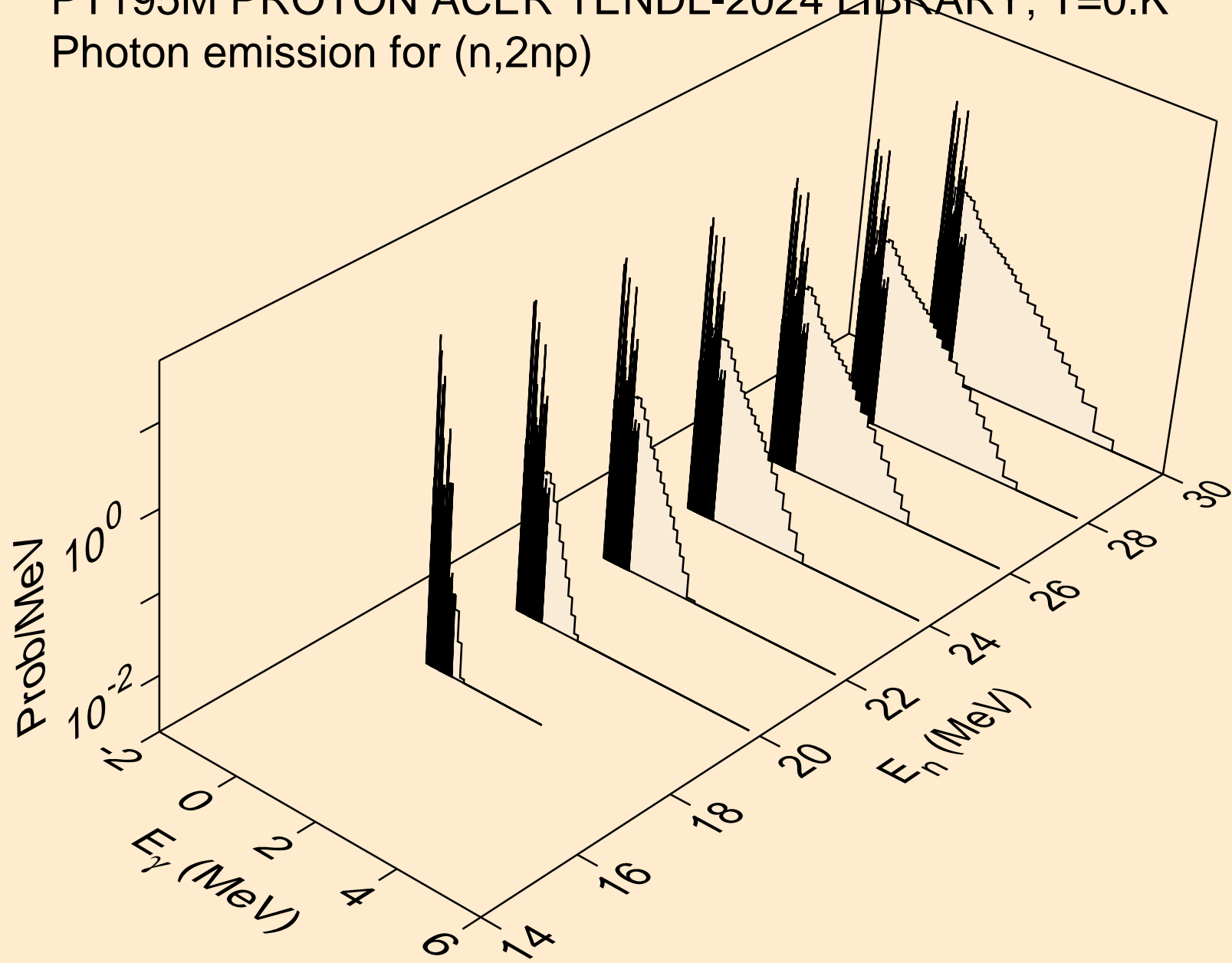

PT195M PROTON ACER TENDL-2024 LIBRARY; T=0.K  
Photon emission for (n,3np)

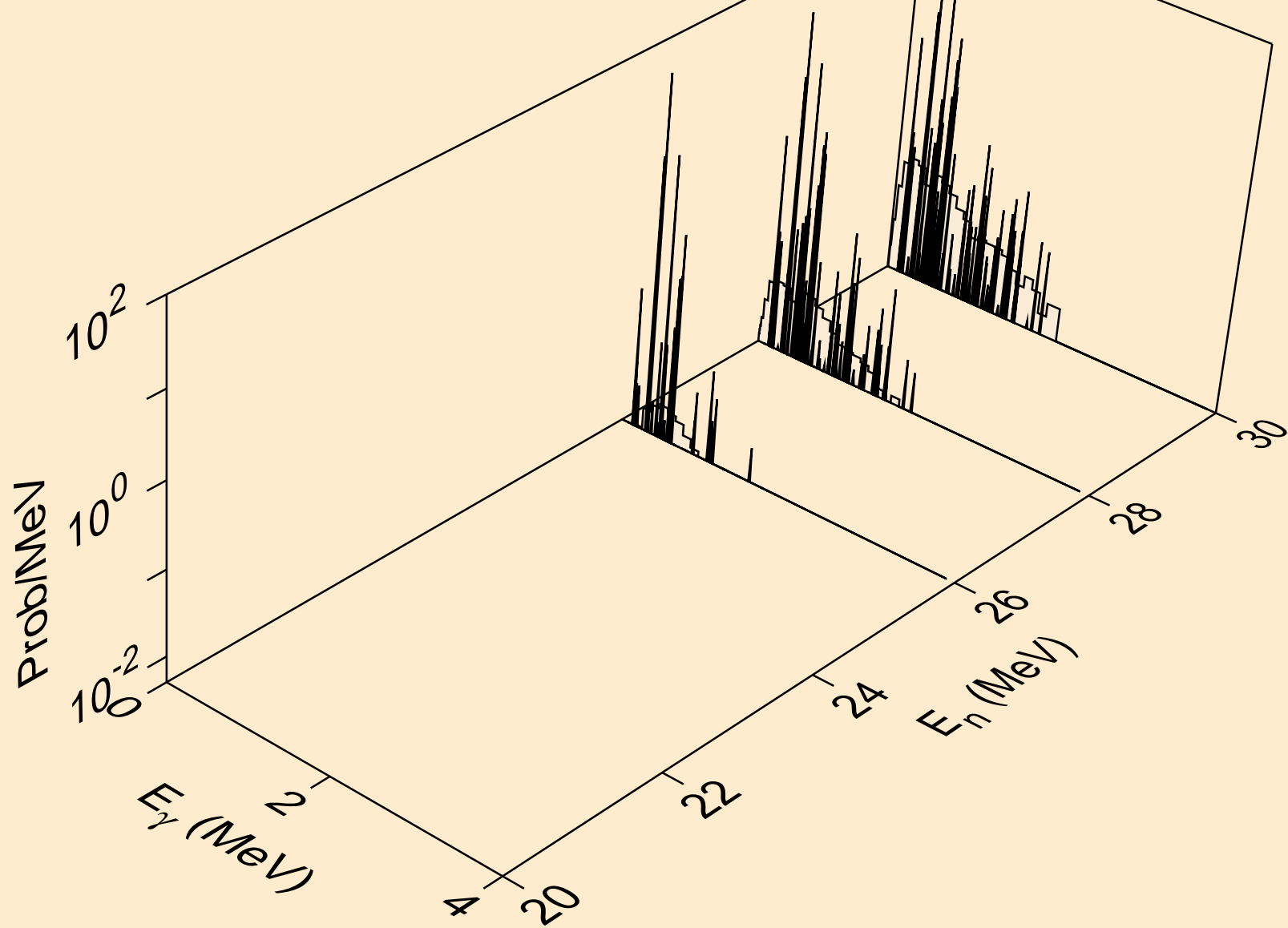

PT195M PROTON ACER TENDL-2024 LIBRARY; T=0.K  
Photon emission for (n,n2p)

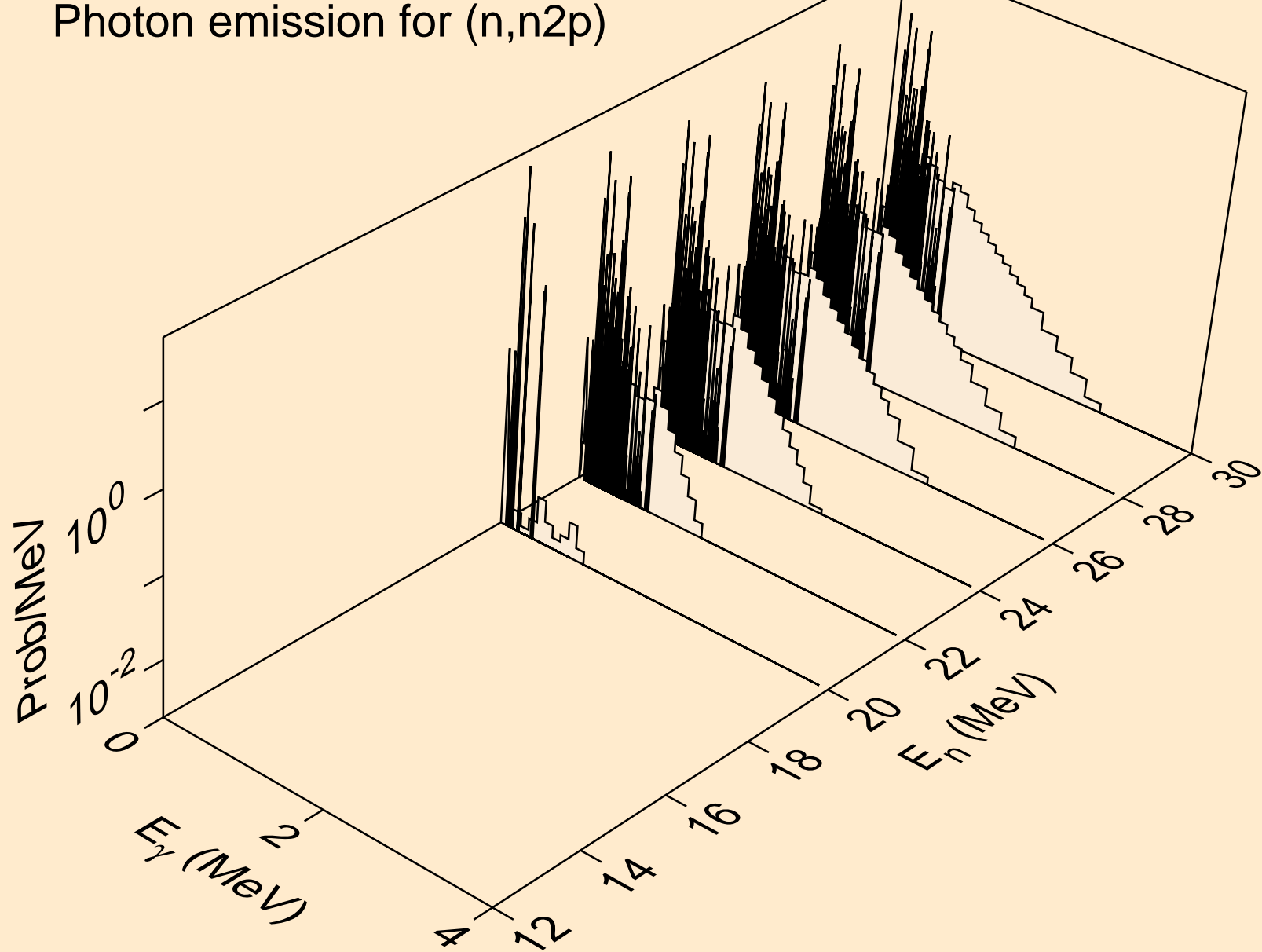

PT195M PROTON ACER TENDL-2024 LIBRARY; T=0.K  
Photon emission for (n,npa)

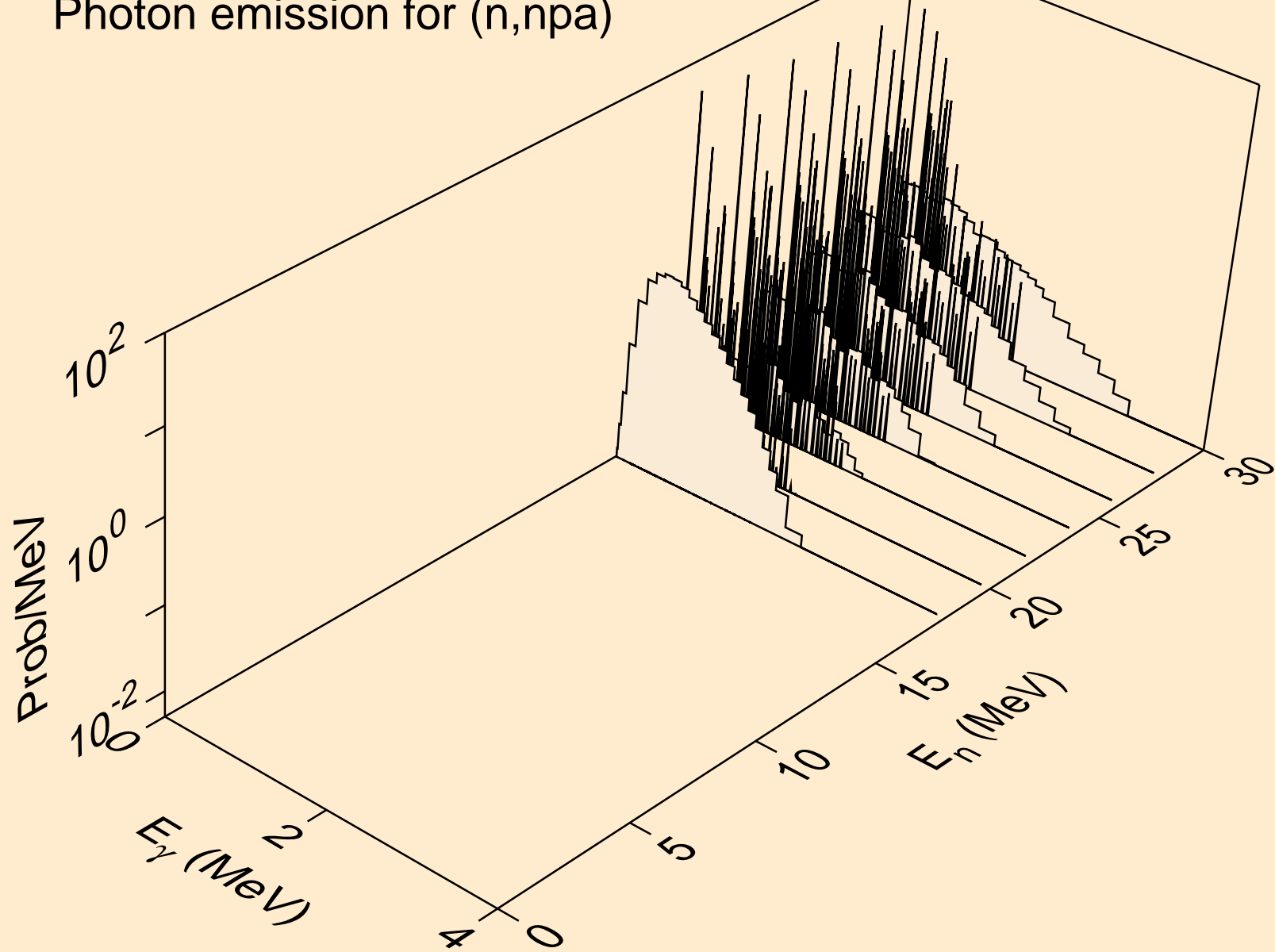

PT195M PROTON ACER TENDL-2024 LIBRARY; T=0.K  
Photon emission for (n,gma)

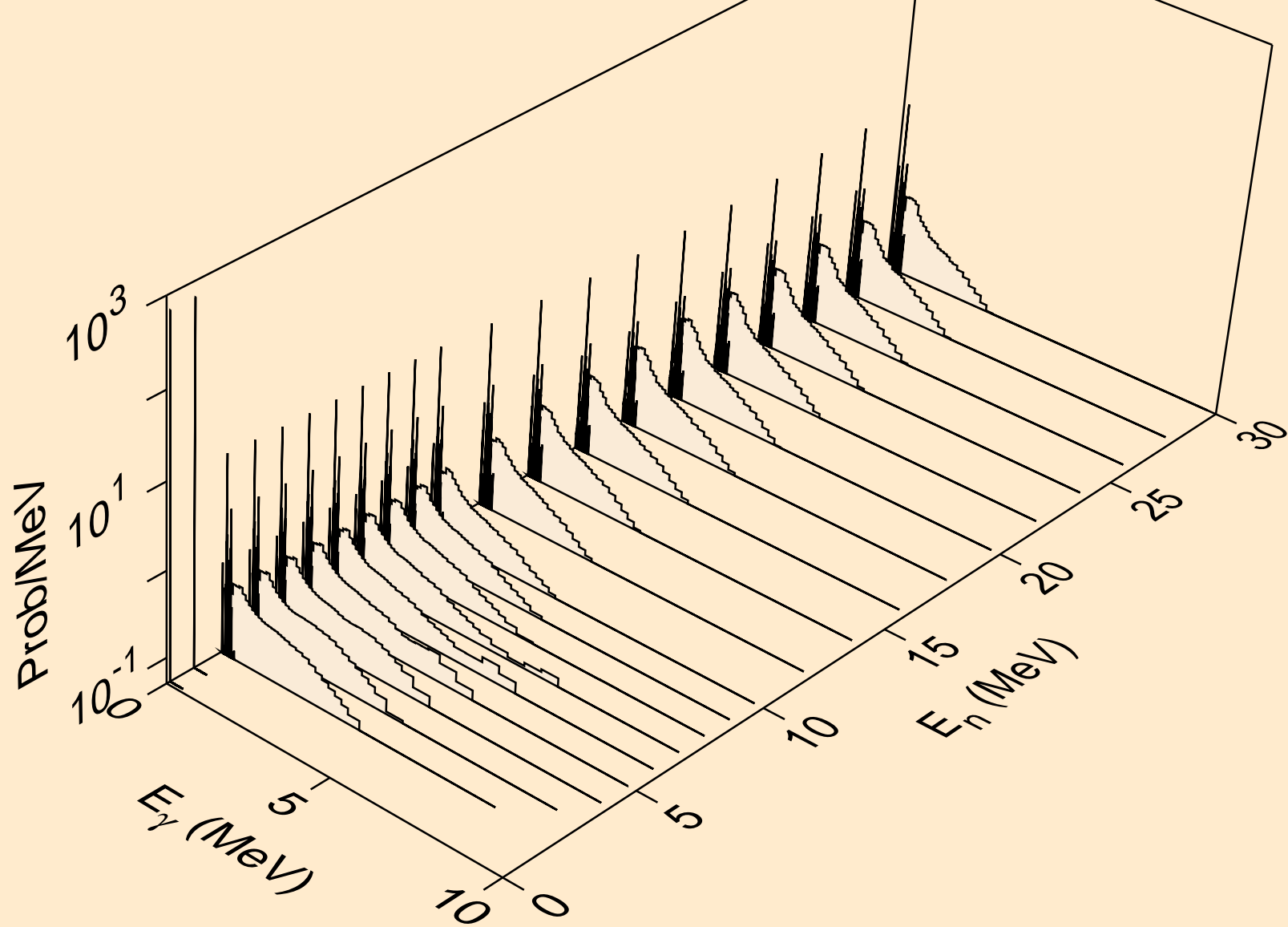

PT195M PROTON ACER TENDL-2024 LIBRARY; T=0.K  
Photon emission for inelastic

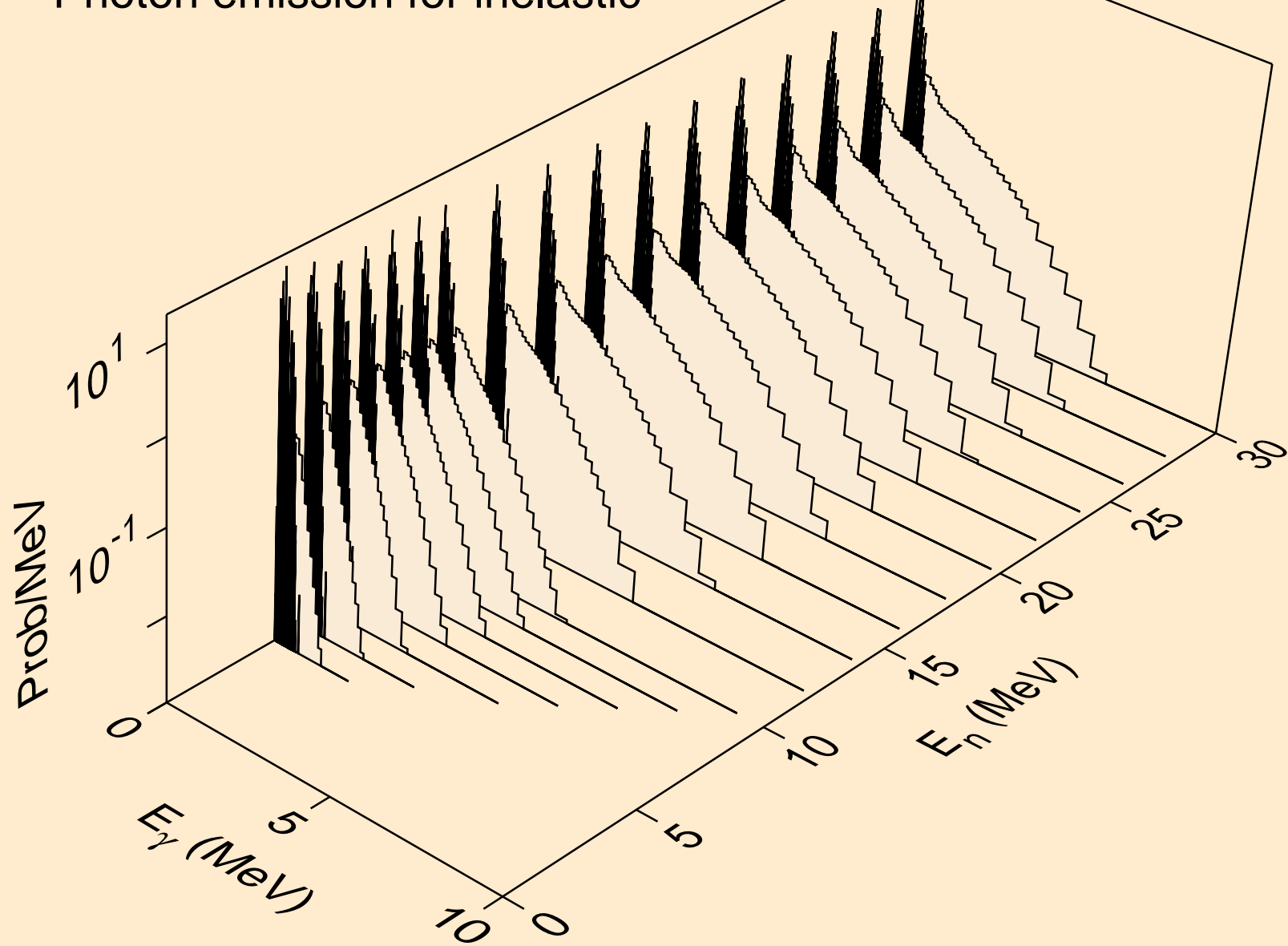

PT195M PROTON ACER TENDL-2024 LIBRARY; T=0.K  
Photon emission for (n,d)

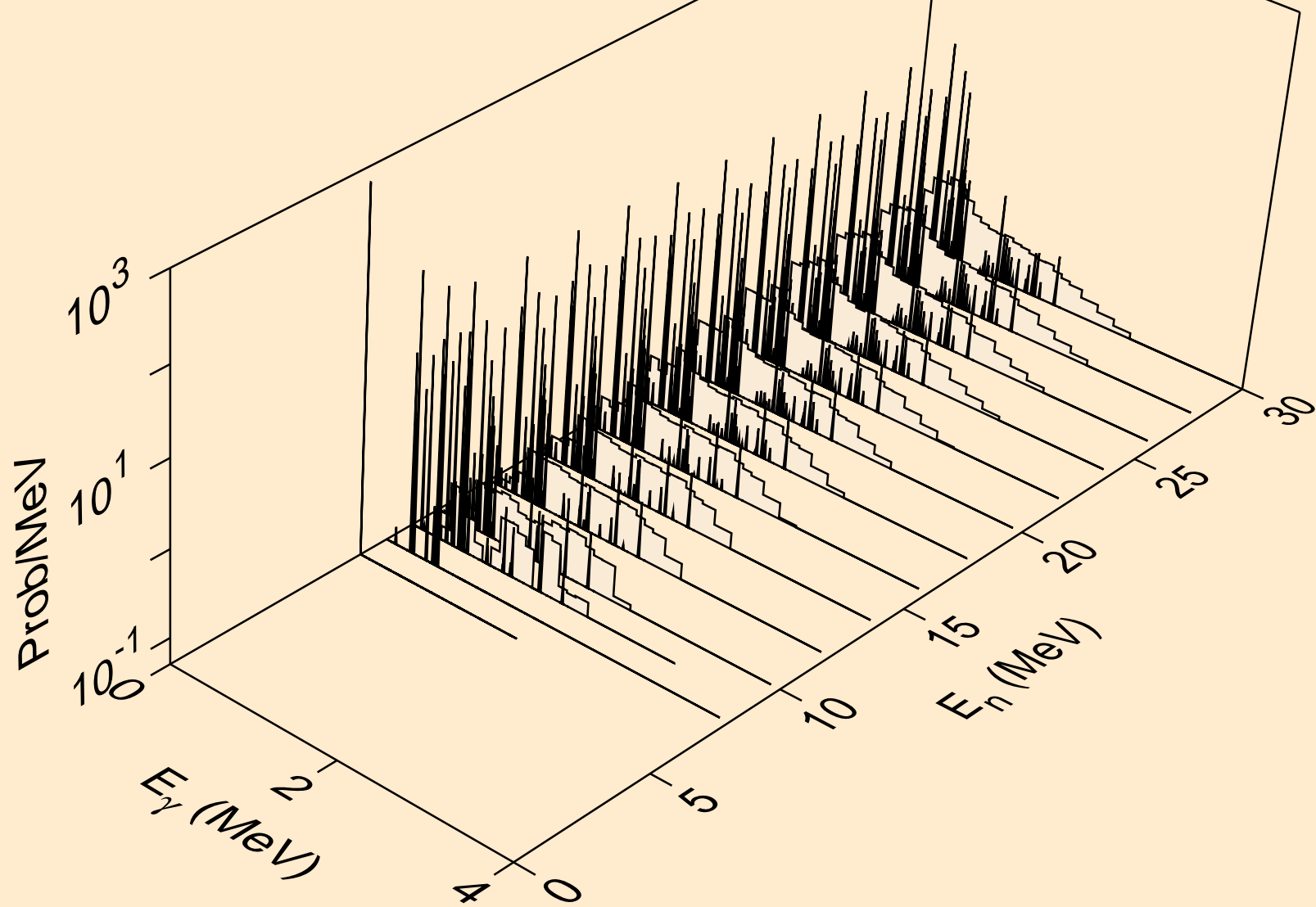

PT195M PROTON ACER TENDL-2024 LIBRARY; T=0.K  
Photon emission for (n,t)

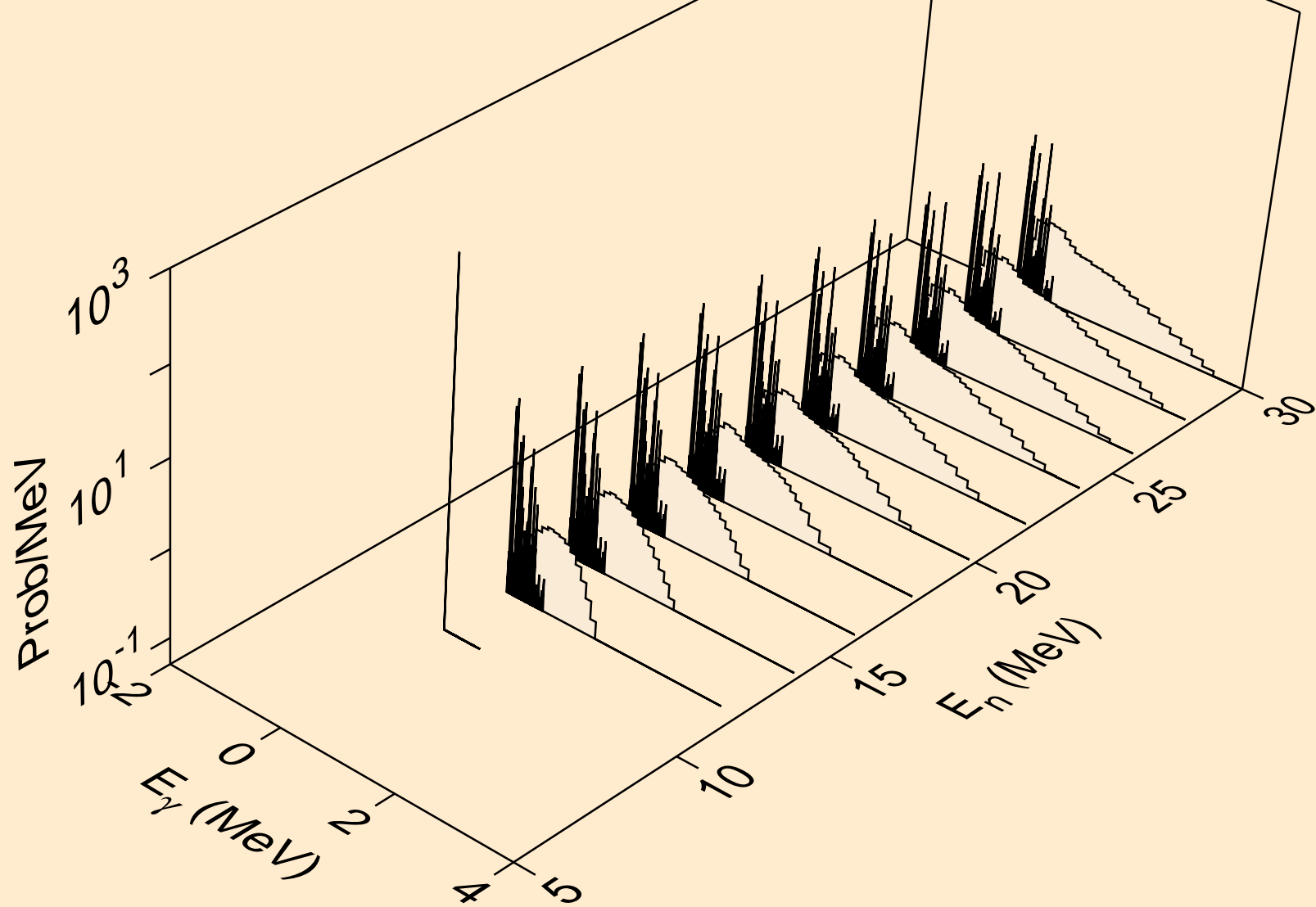

PT195M PROTON ACER TENDL-2024 LIBRARY; T=0.K  
Photon emission for (n,he3)

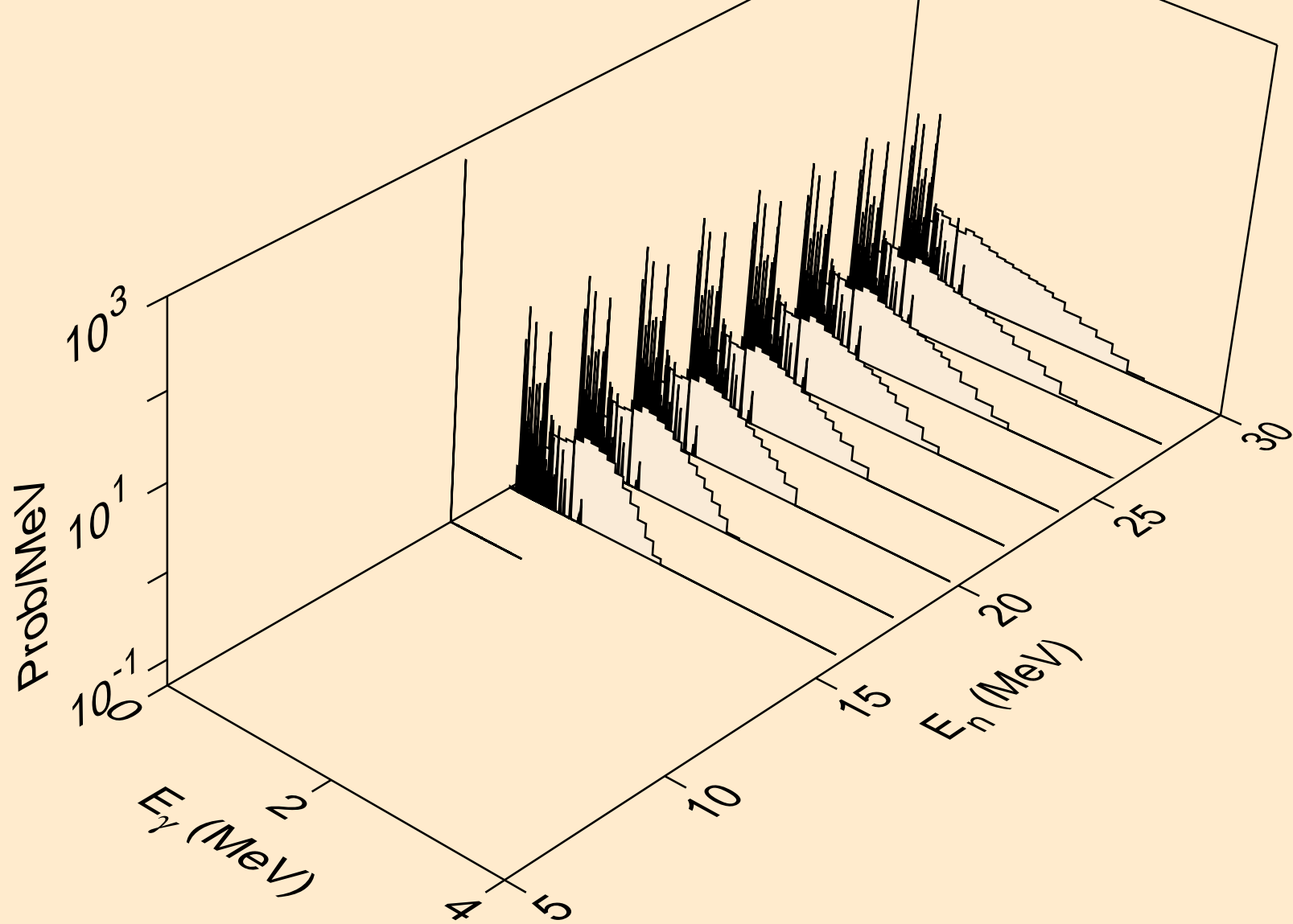

PT195M PROTON ACER TENDL-2024 LIBRARY; T=0.K  
Photon emission for (n,a)

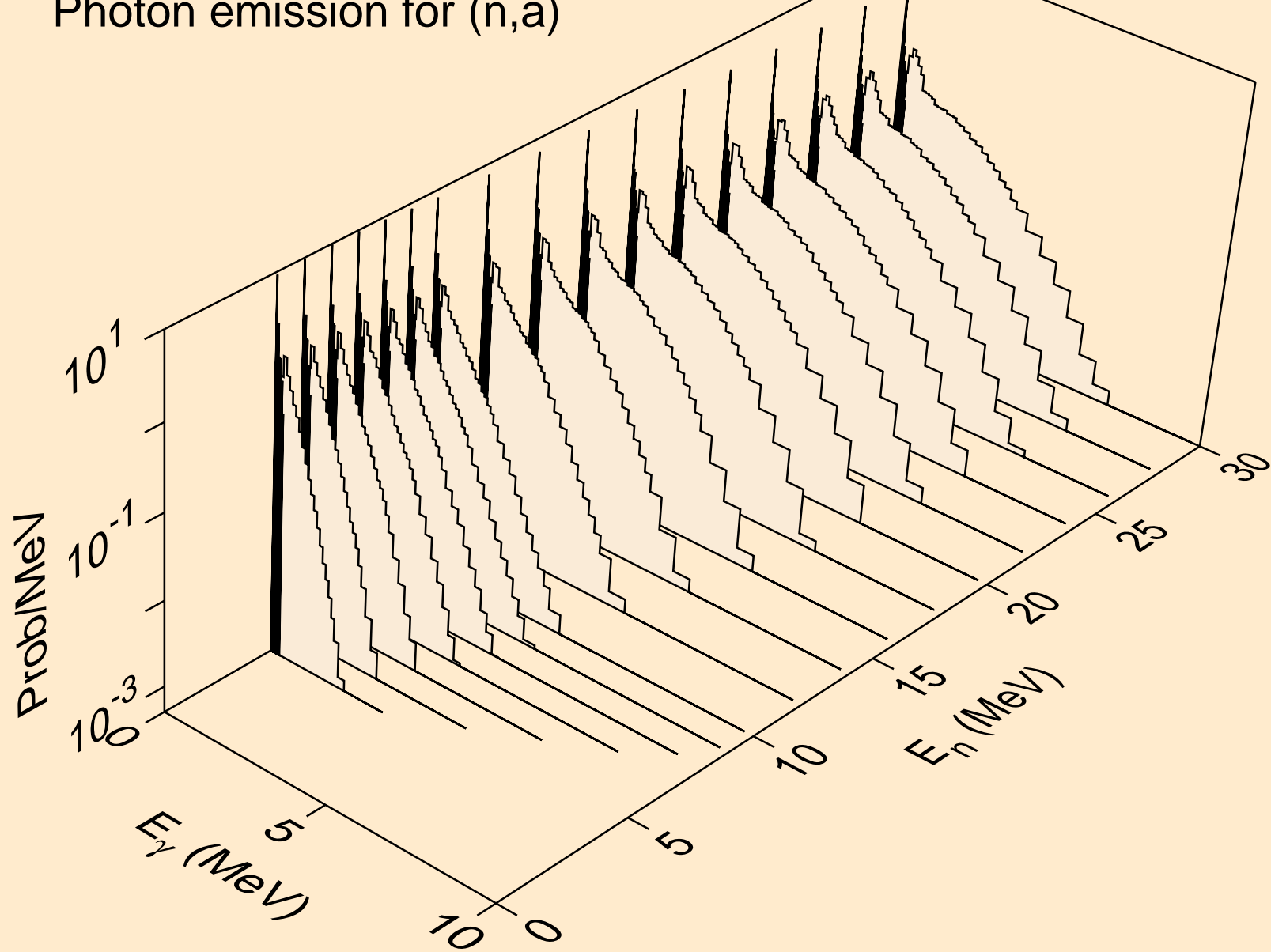

PT195M PROTON ACER TENDL-2024 LIBRARY; T=0.K  
Photon emission for (n,2a)

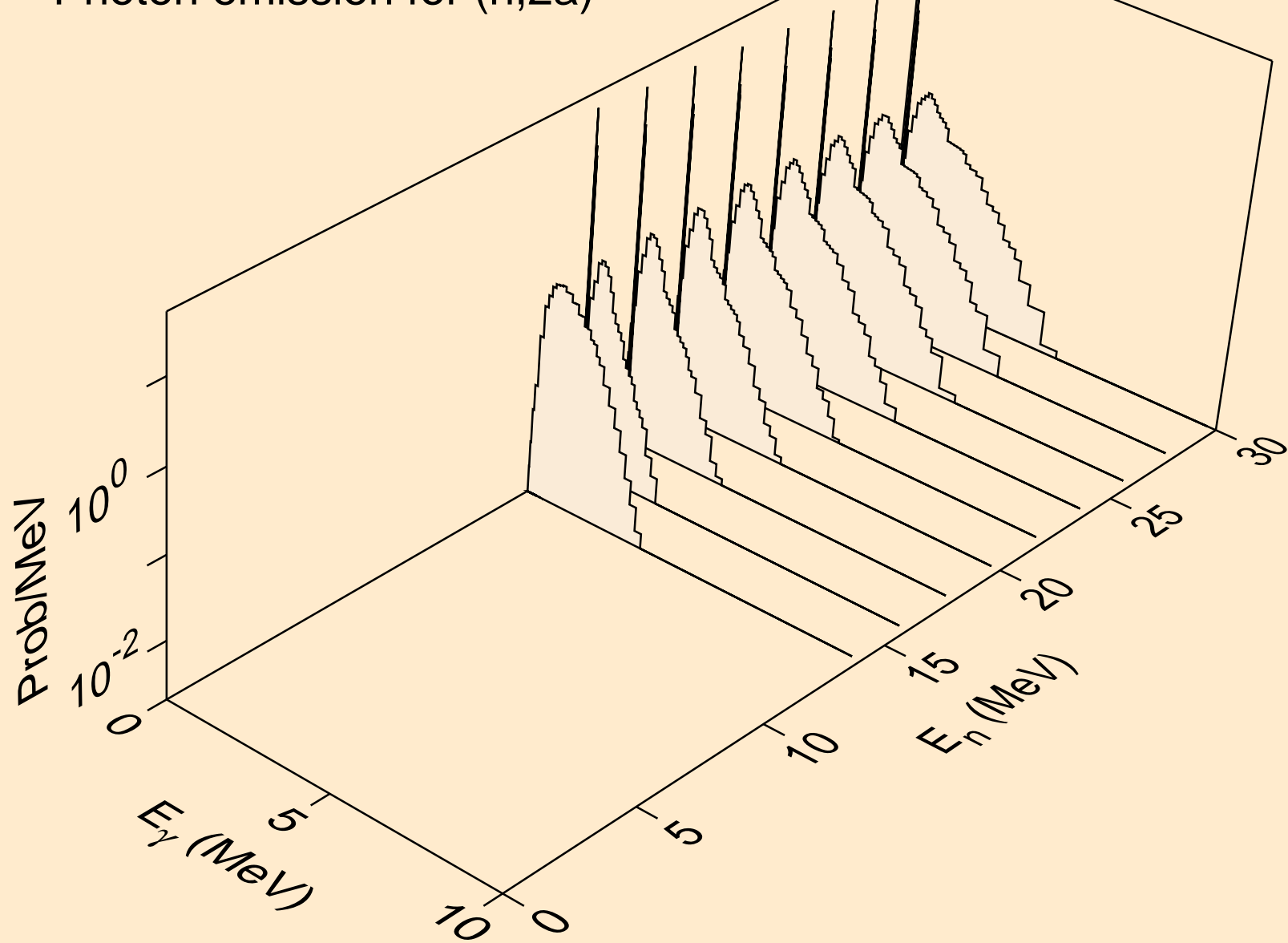

PT195M PROTON ACER TENDL-2024 LIBRARY; T=0.K  
Photon emission for (n,2p)

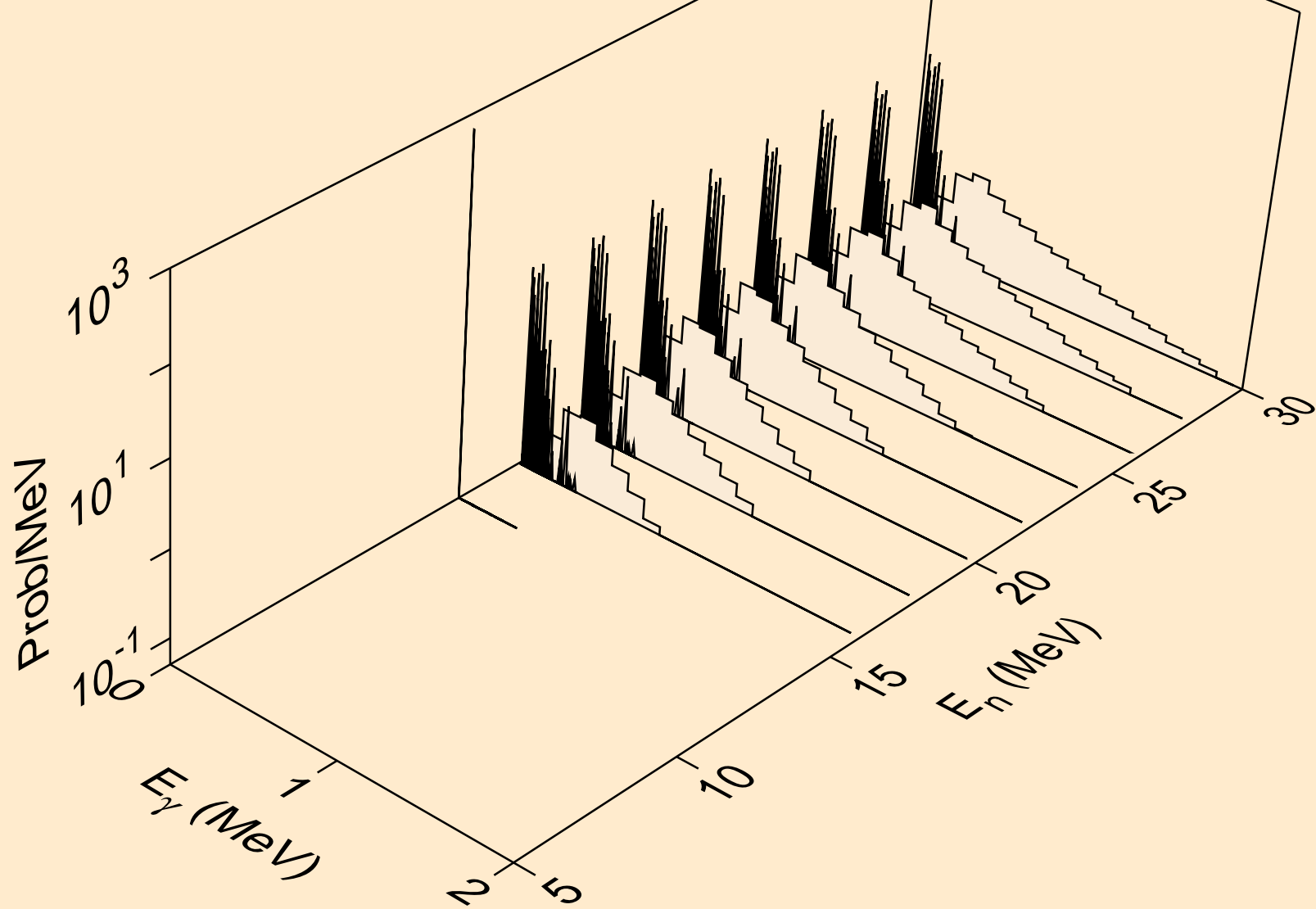

PT195M PROTON ACER TENDL-2024 LIBRARY; T=0.K  
Photon emission for (n,pa)

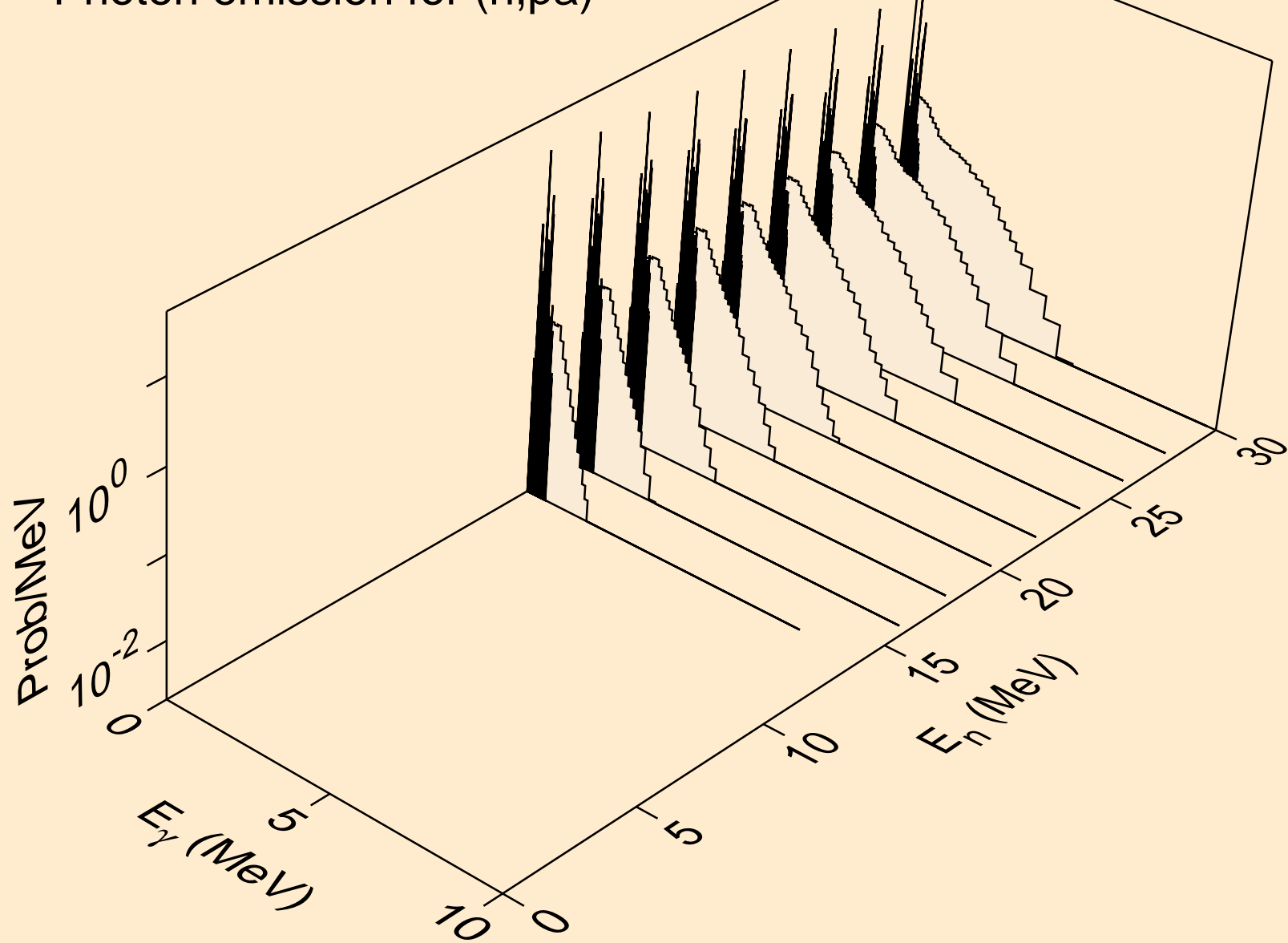

PT195M PROTON ACER TENDL-2024 LIBRARY; T=0.K  
Photon emission for (n,pd)

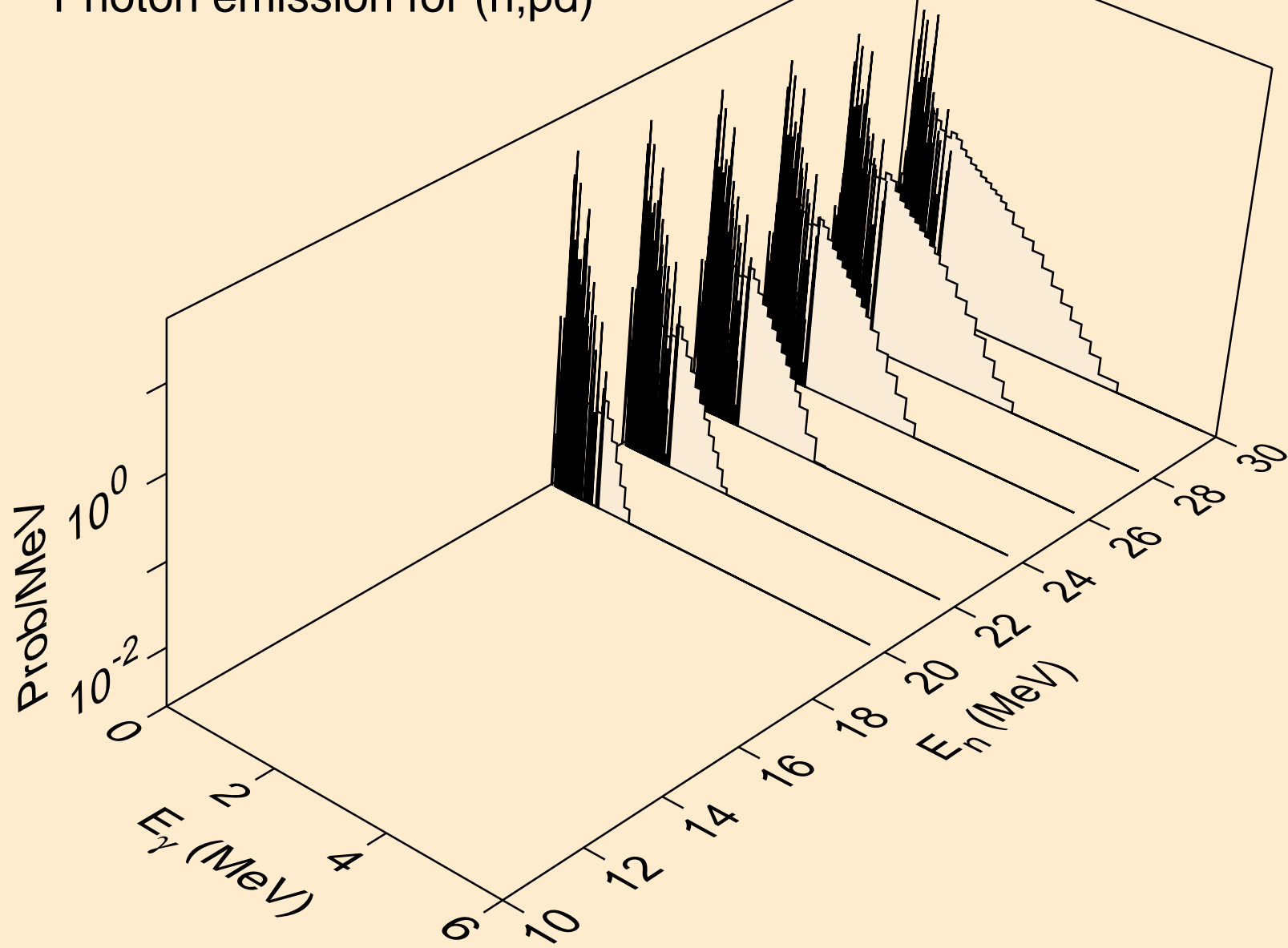

PT195M PROTON ACER TENDL-2024 LIBRARY; T=0.K  
Photon emission for (n,pt)

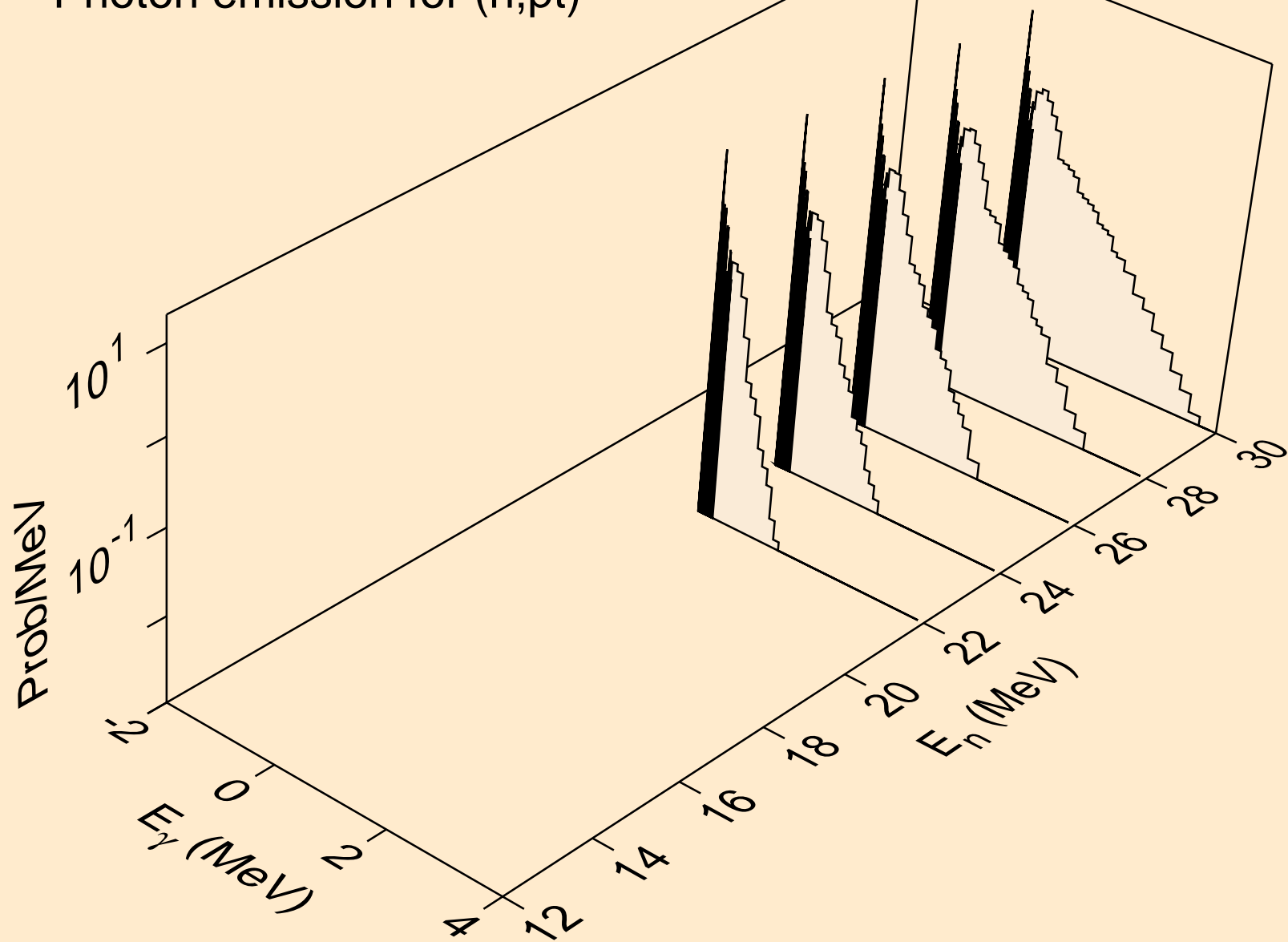

PT195M PROTON ACER TENDL-2024 LIBRARY; T=0.K  
Particle heating contributions

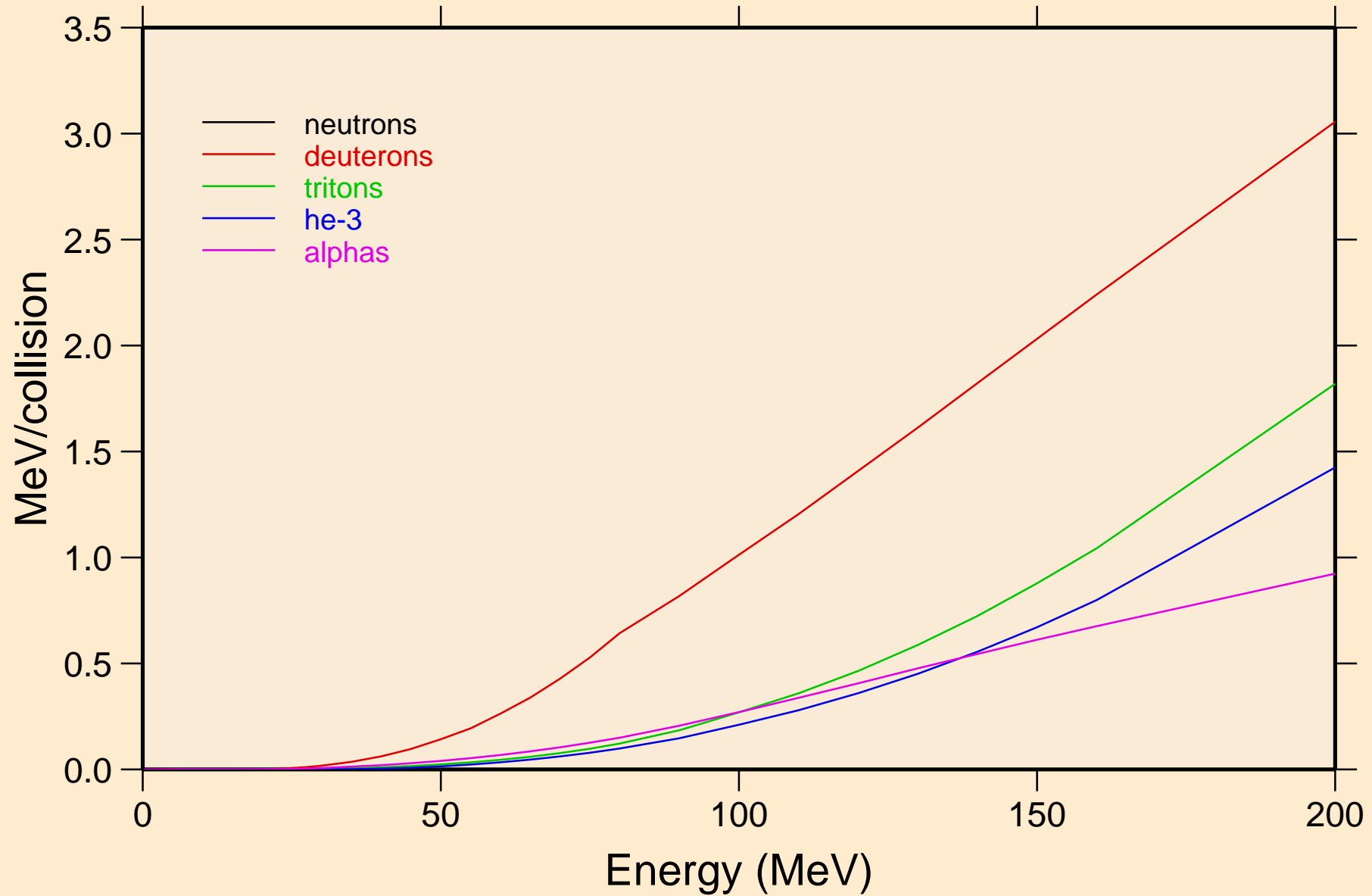

PT195M PROTON ACER TENDL-2024 LIBRARY; T=0.K  
Recoil Heating

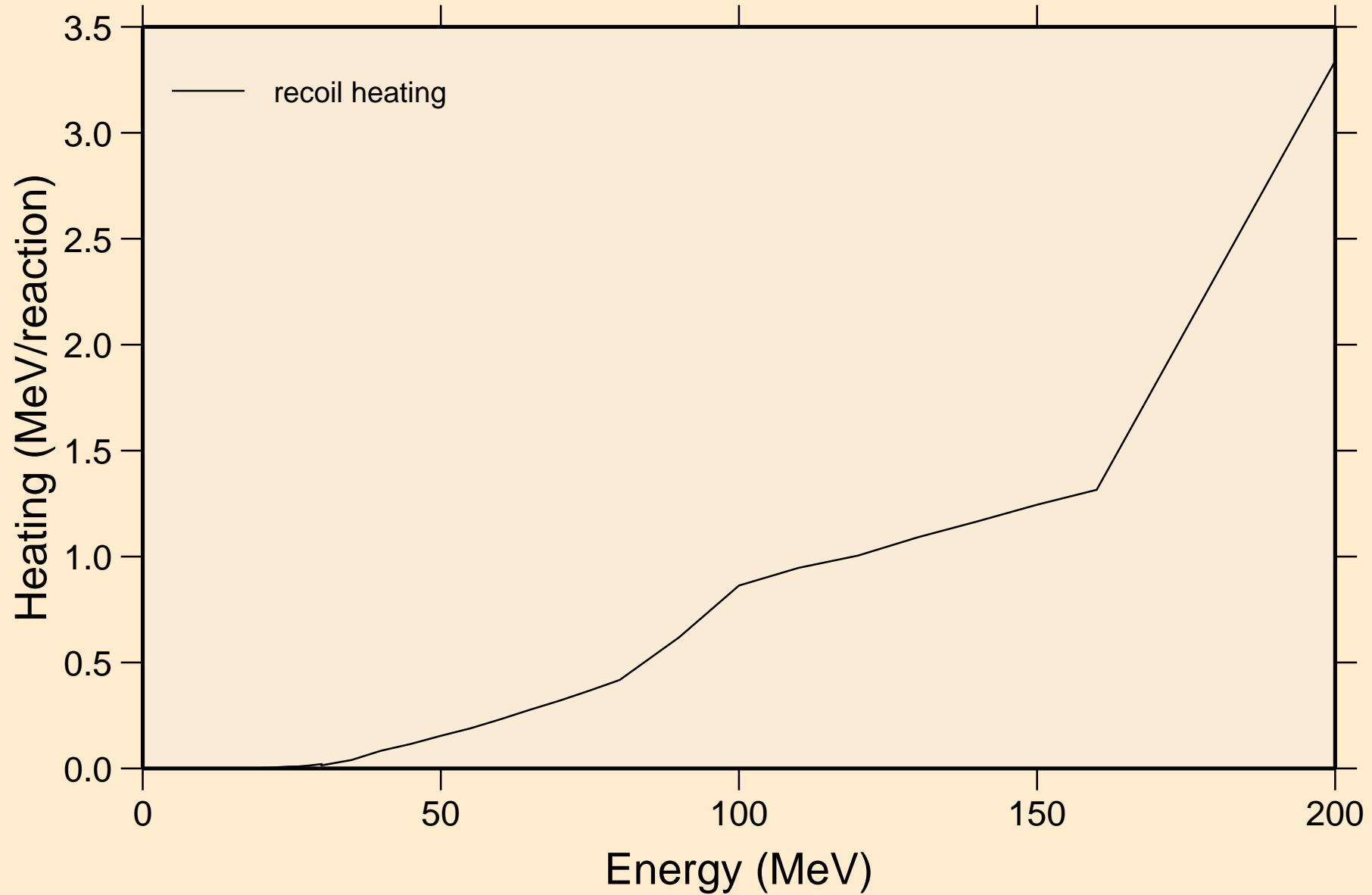

PT195M PROTON ACER TENDL-2024 LIBRARY; T=0.K  
Particle production cross sections

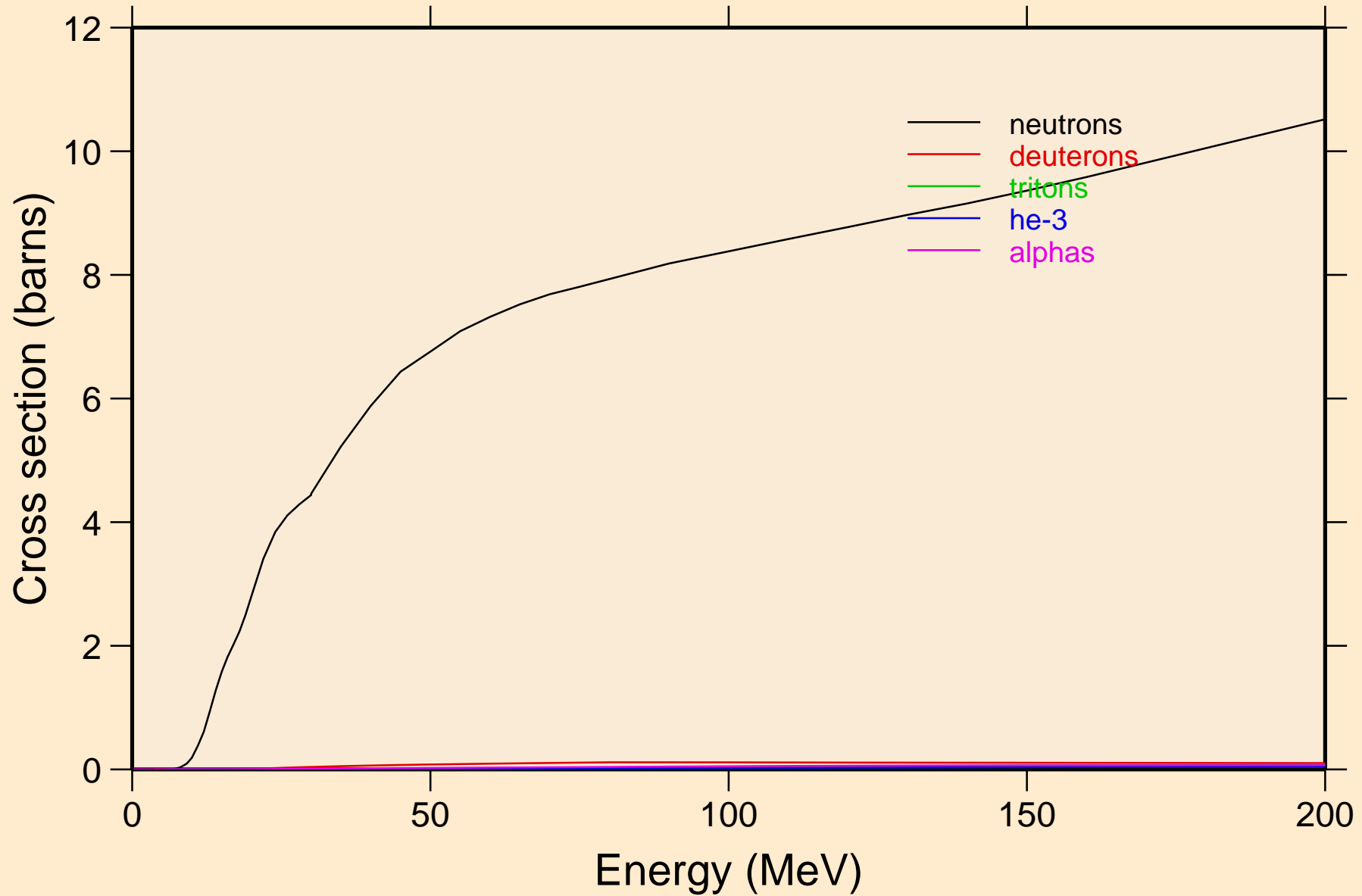

PT195M PROTON ACER TENDL-2024 LIBRARY; T=0.K  
neutrons from (p,n)

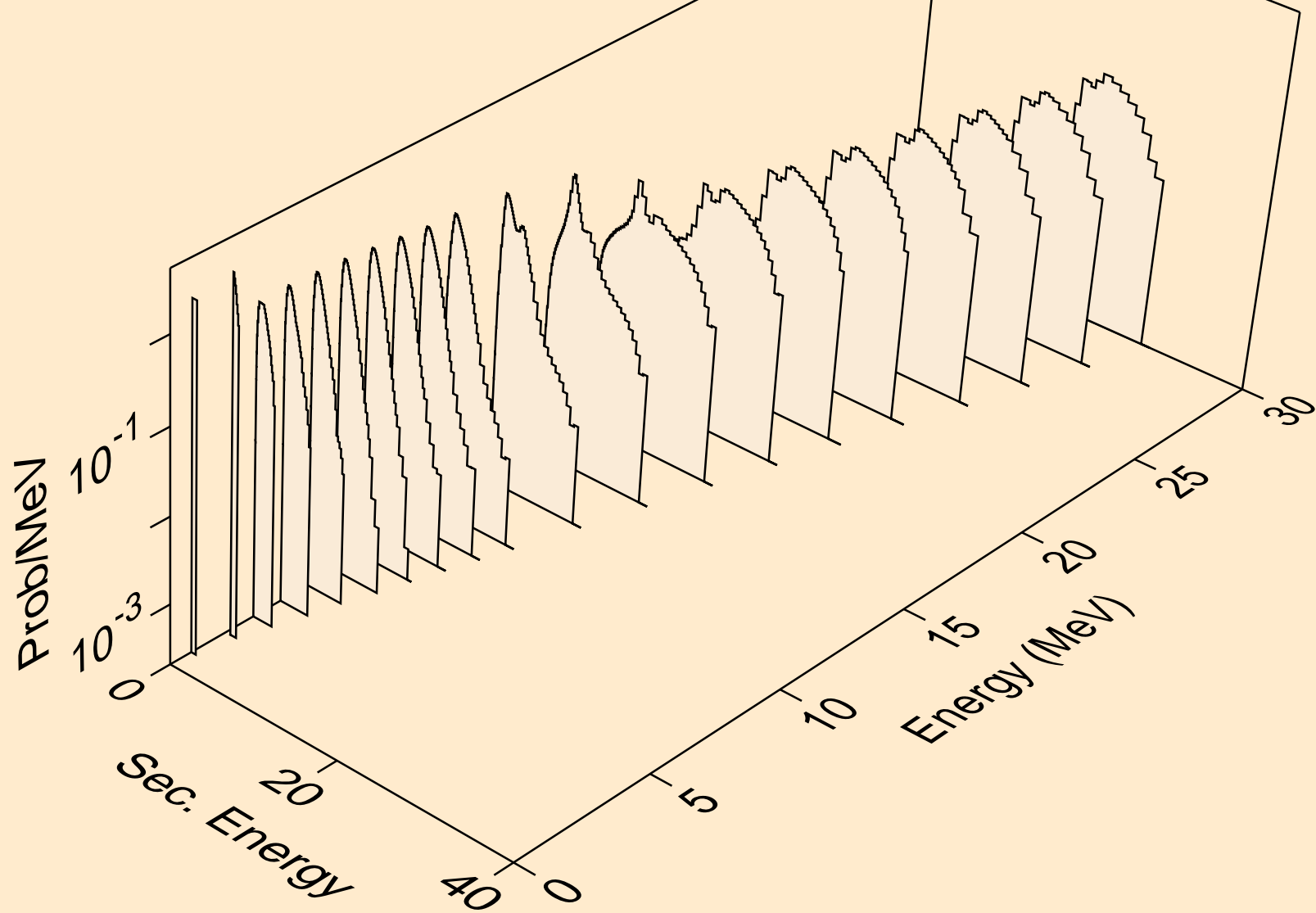

PT195M PROTON ACER TENDL-2024 LIBRARY; T=0.K  
neutrons from (p,x)

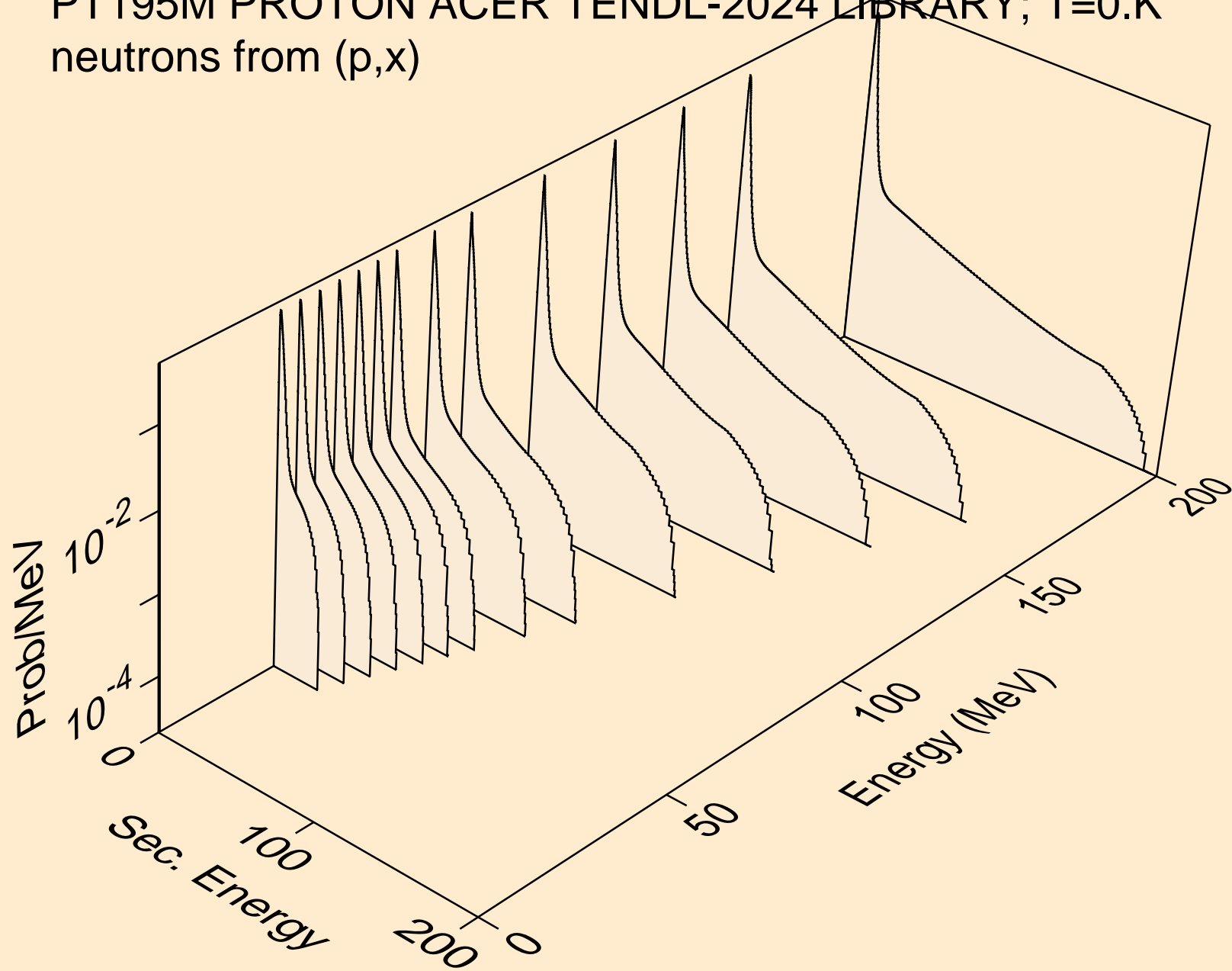

PT195M PROTON ACER TENDL-2024 LIBRARY; T=0.K  
neutrons from (p,2nd)

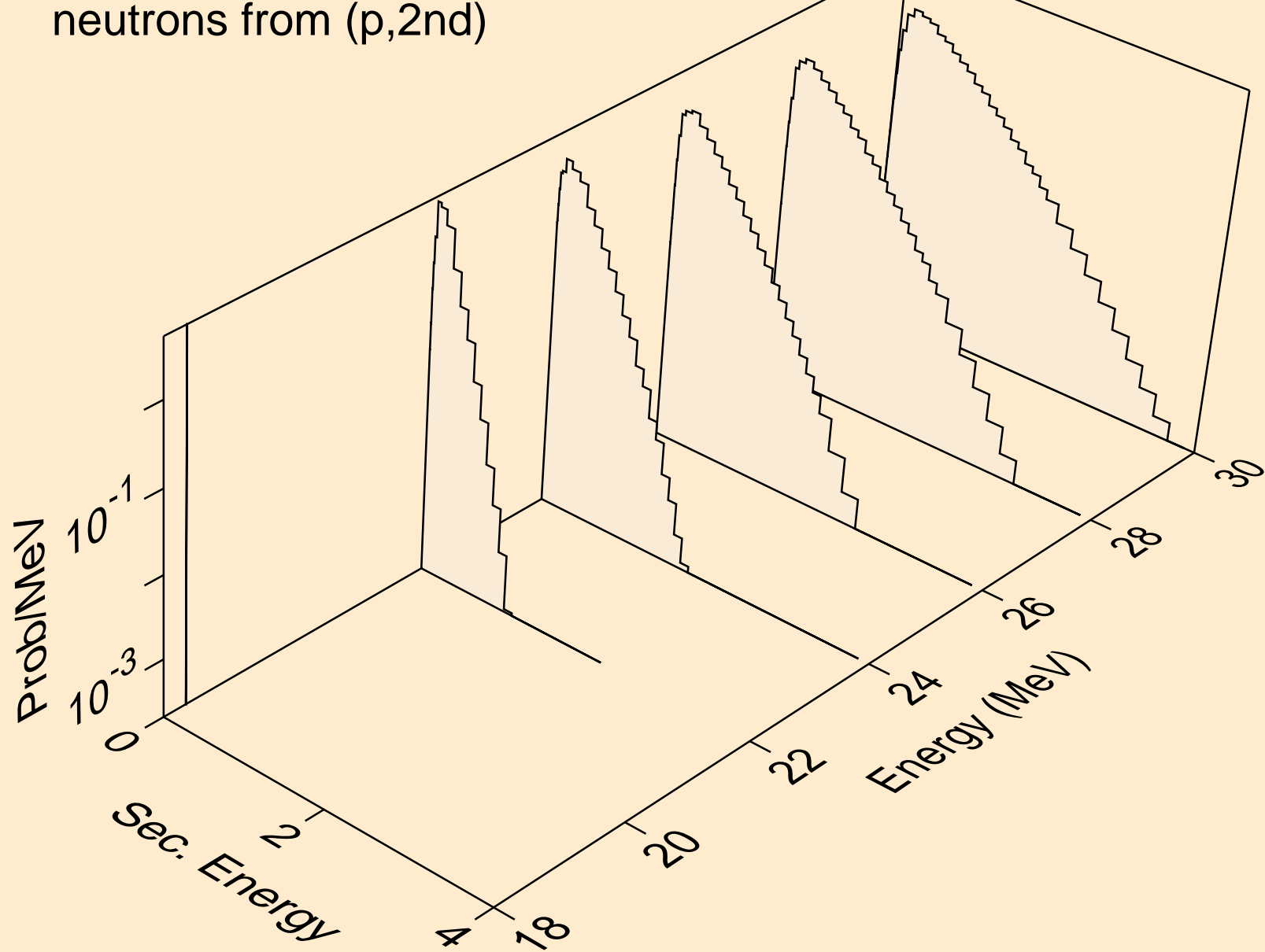

PT195M PROTON ACER TENDL-2024 LIBRARY; T=0.K  
neutrons from (p,2n)

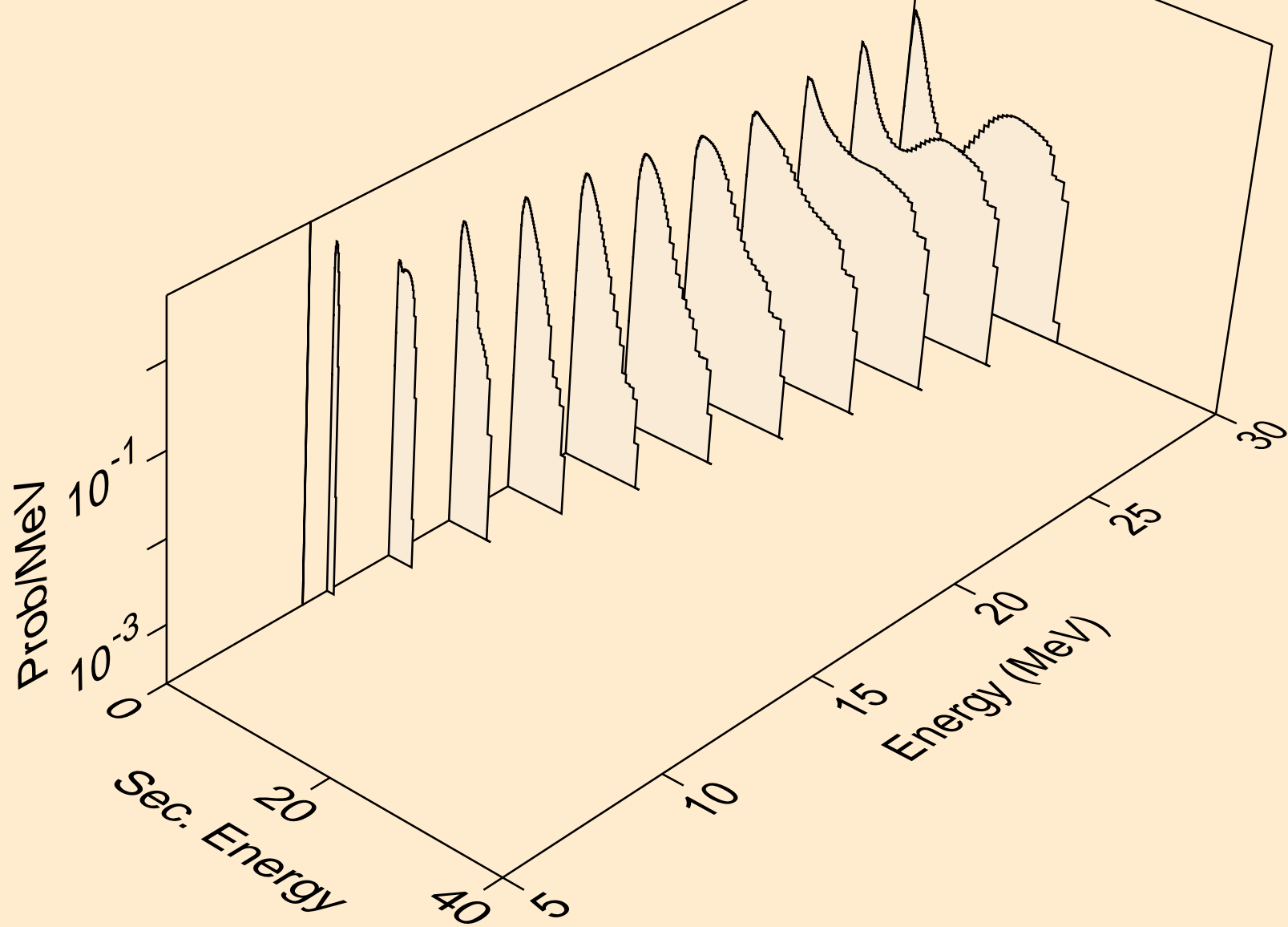

PT195M PROTON ACER TENDL-2024 LIBRARY; T=0.K  
neutrons from (p,3n)

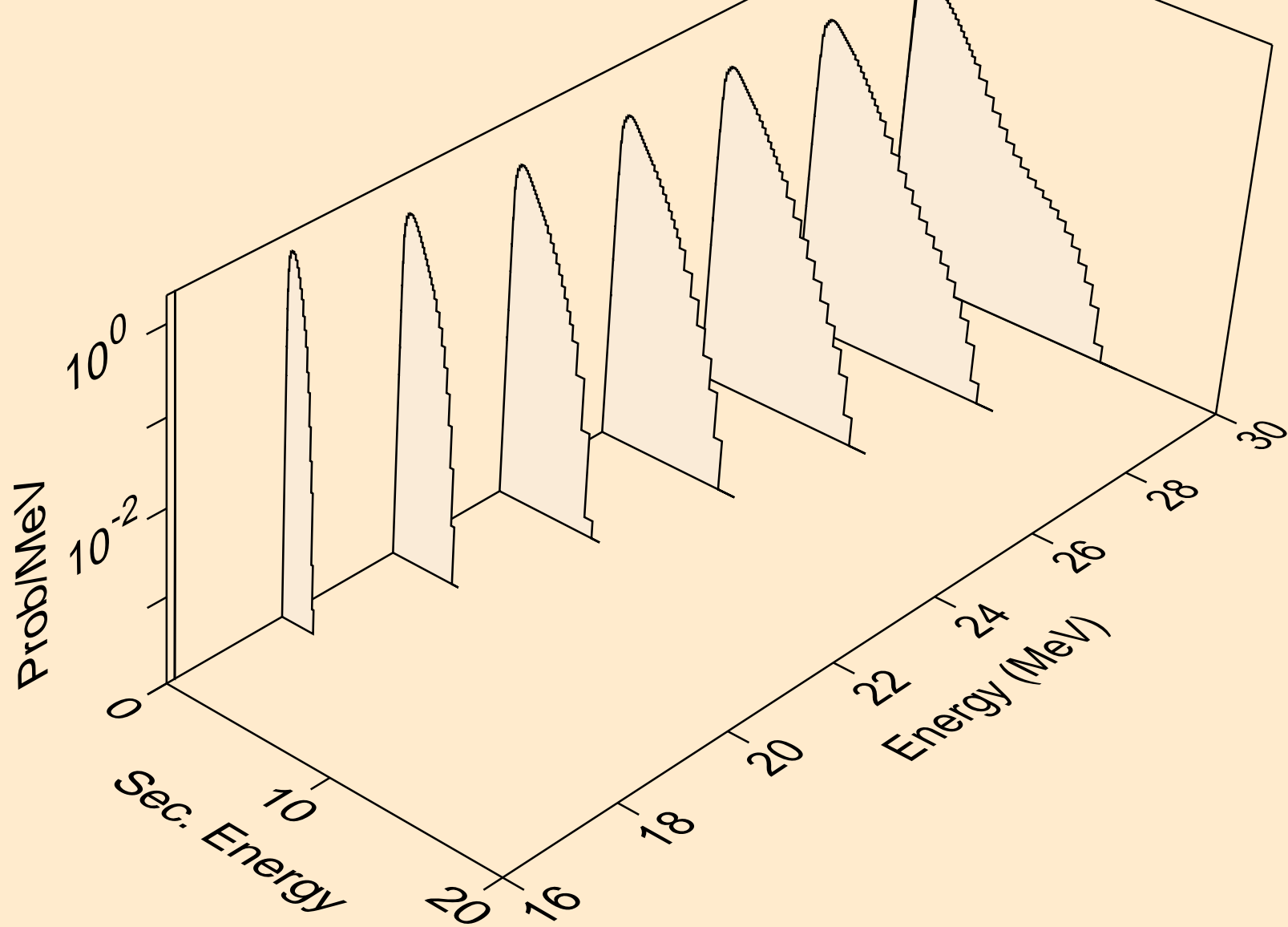

PT195M PROTON ACER TENDL-2024 LIBRARY; T=0.K  
neutrons from (p,n\*)a

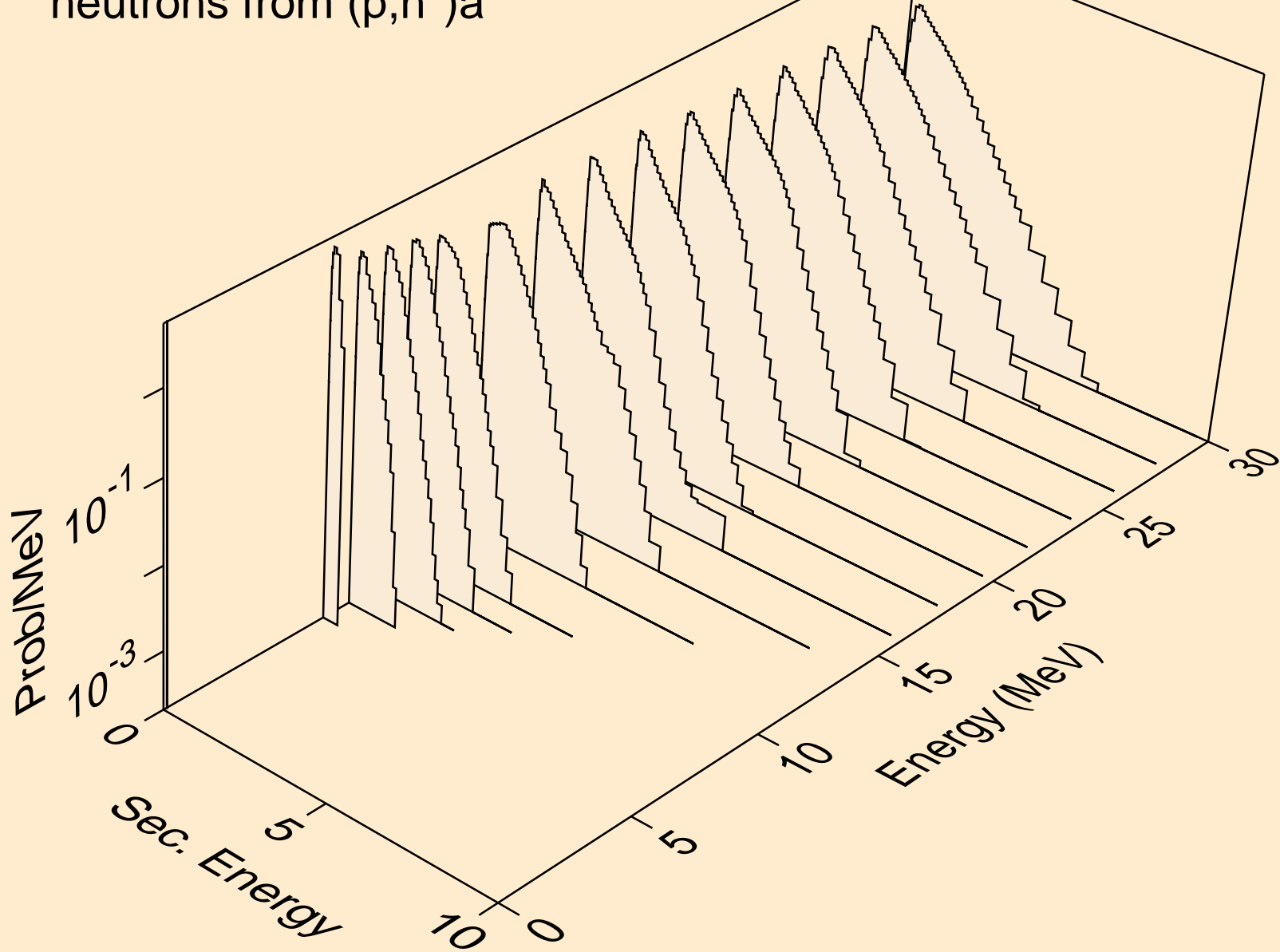

PT195M PROTON ACER TENDL-2024 LIBRARY; T=0.K  
neutrons from (p,2n)a

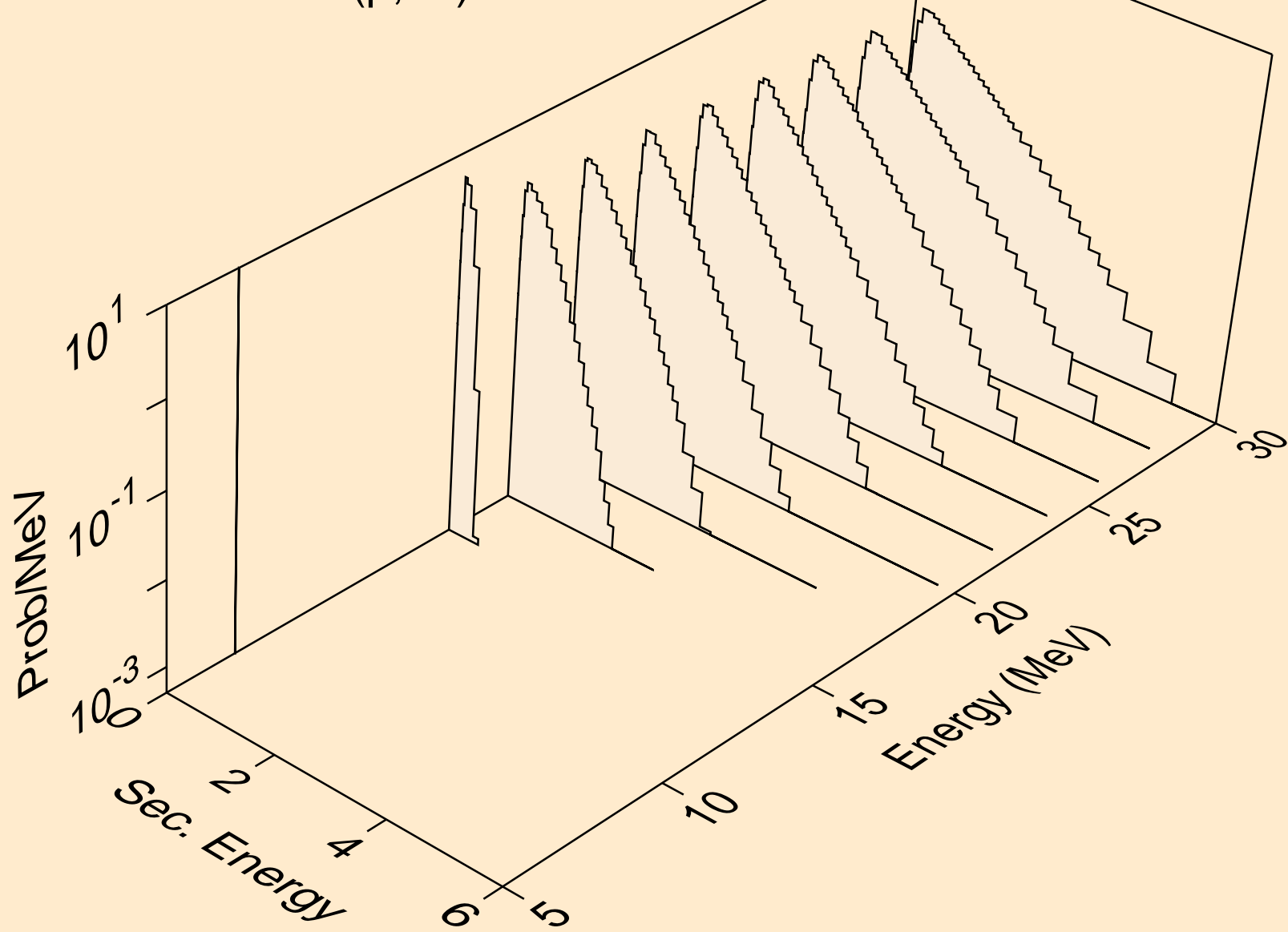

PT195M PROTON ACER TENDL-2024 LIBRARY; T=0.K  
neutrons from (p,3n)a

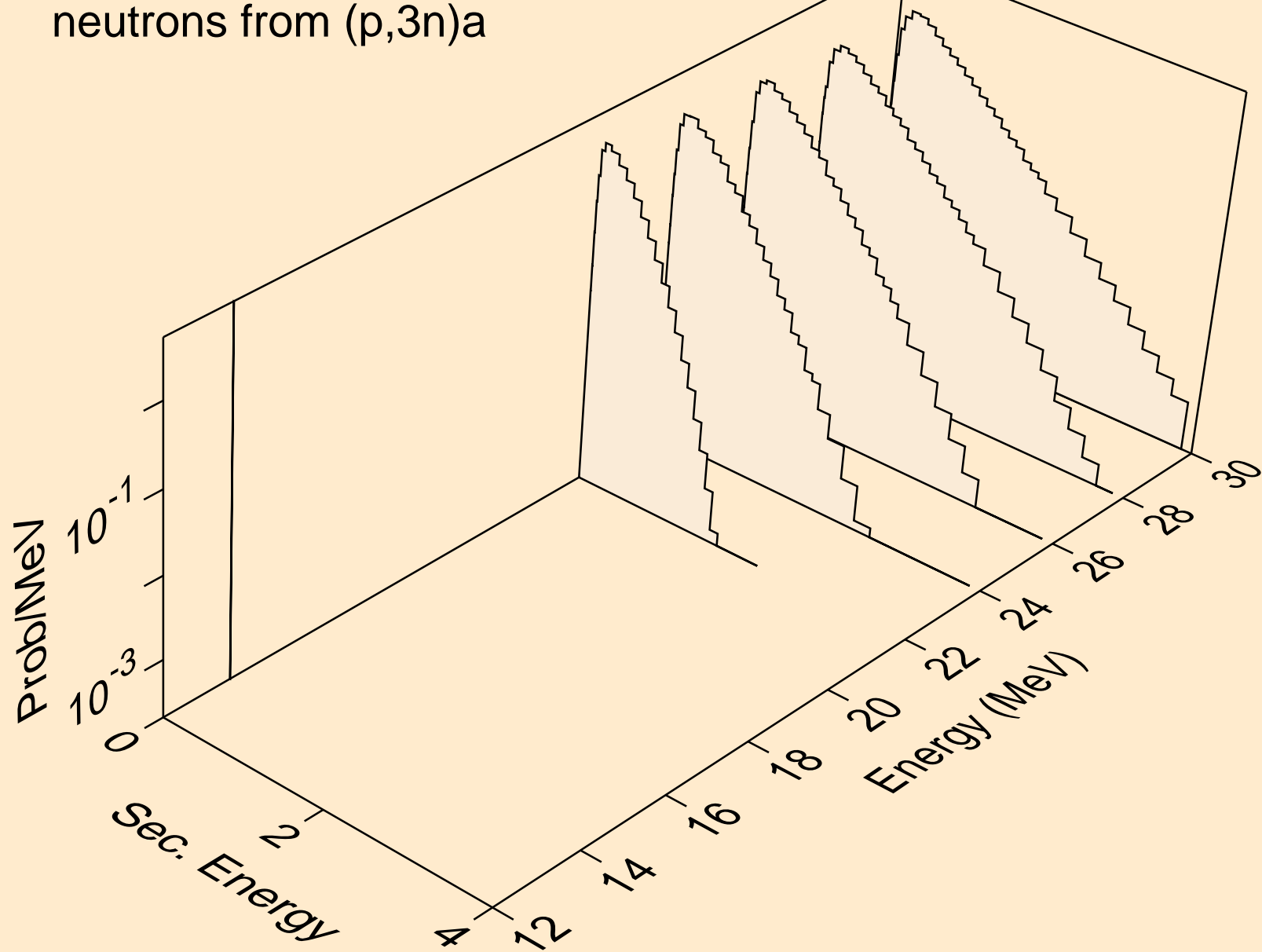

PT195M PROTON ACER TENDL-2024 LIBRARY; T=0.K  
neutrons from (p,n\*)p

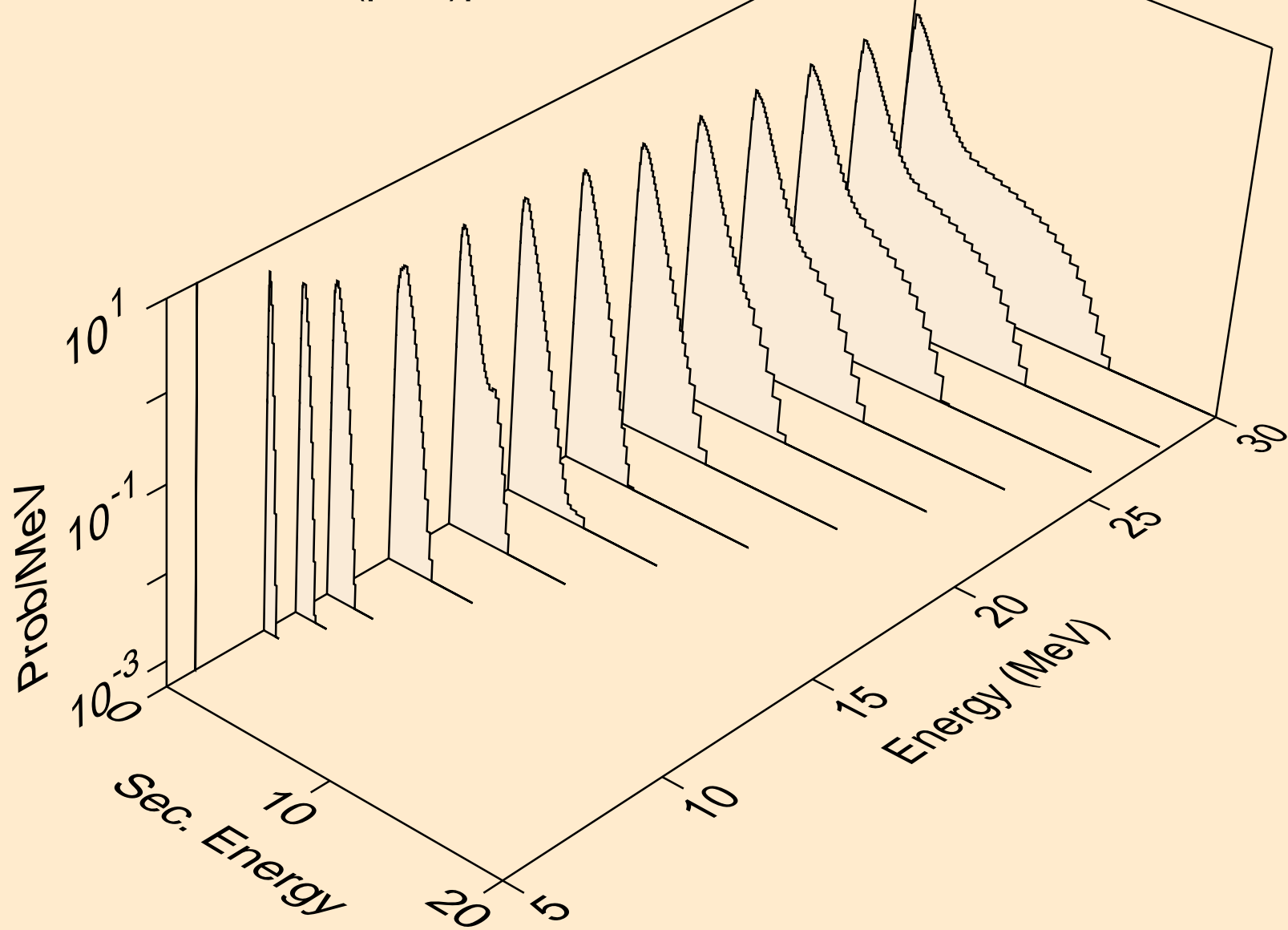

PT195M PROTON ACER TENDL-2024 LIBRARY; T=0.K  
neutrons from (p,n\*)d

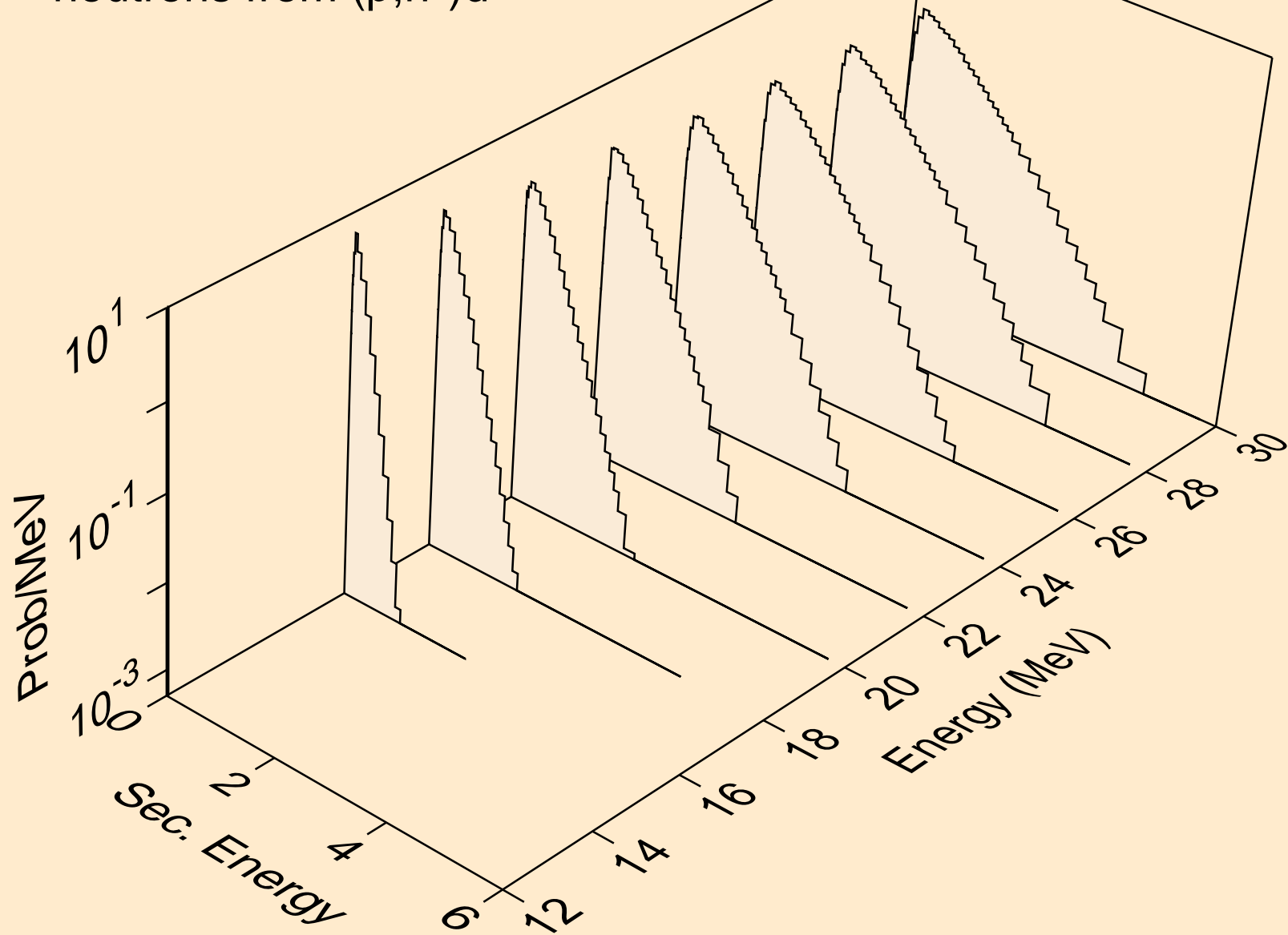

PT195M PROTON ACER TENDL-2024 LIBRARY; T=0.K  
neutrons from (p,n\*)t

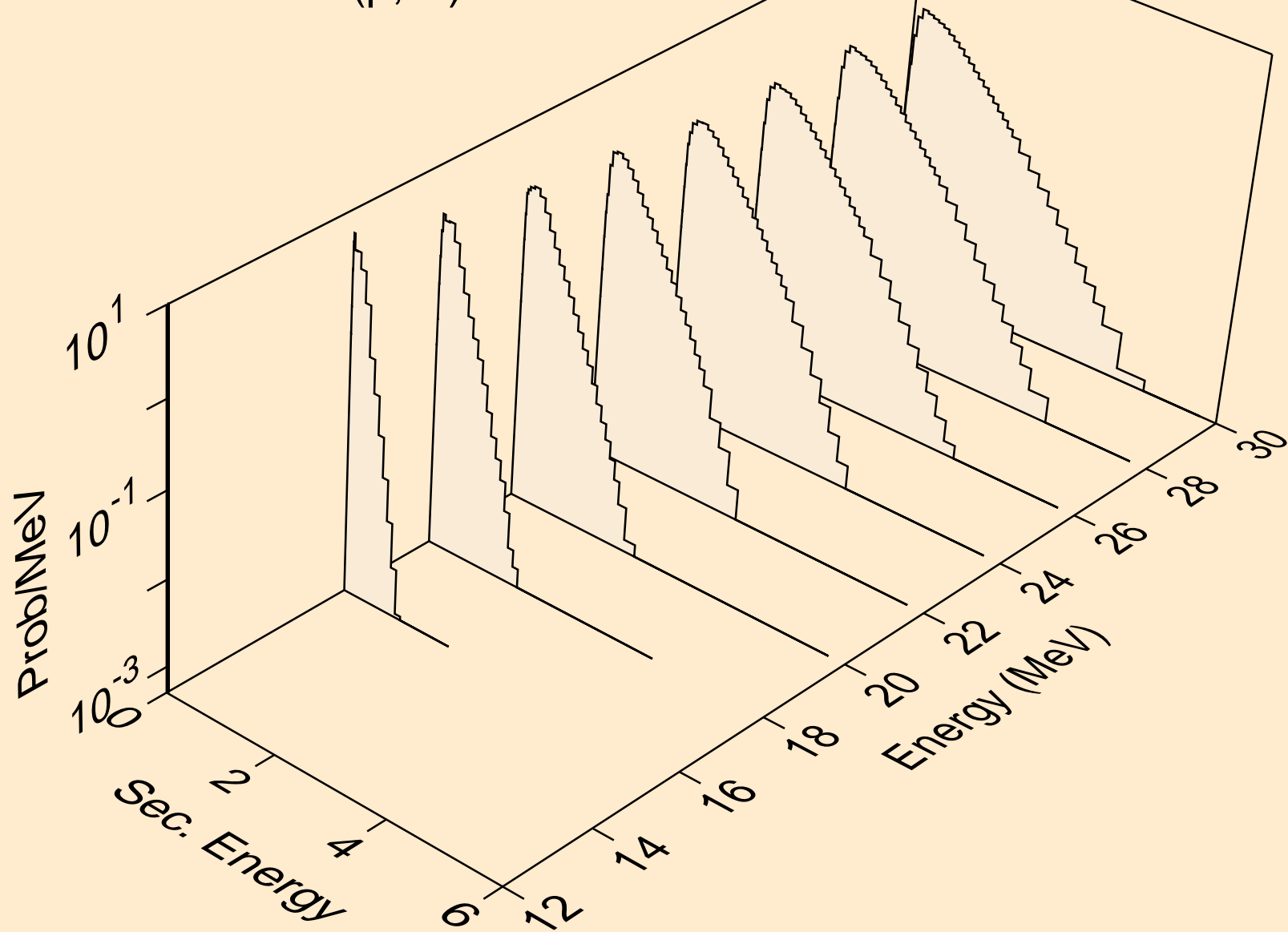

PT195M PROTON ACER TENDL-2024 LIBRARY; T=0.K  
neutrons from (p,n\*)he3

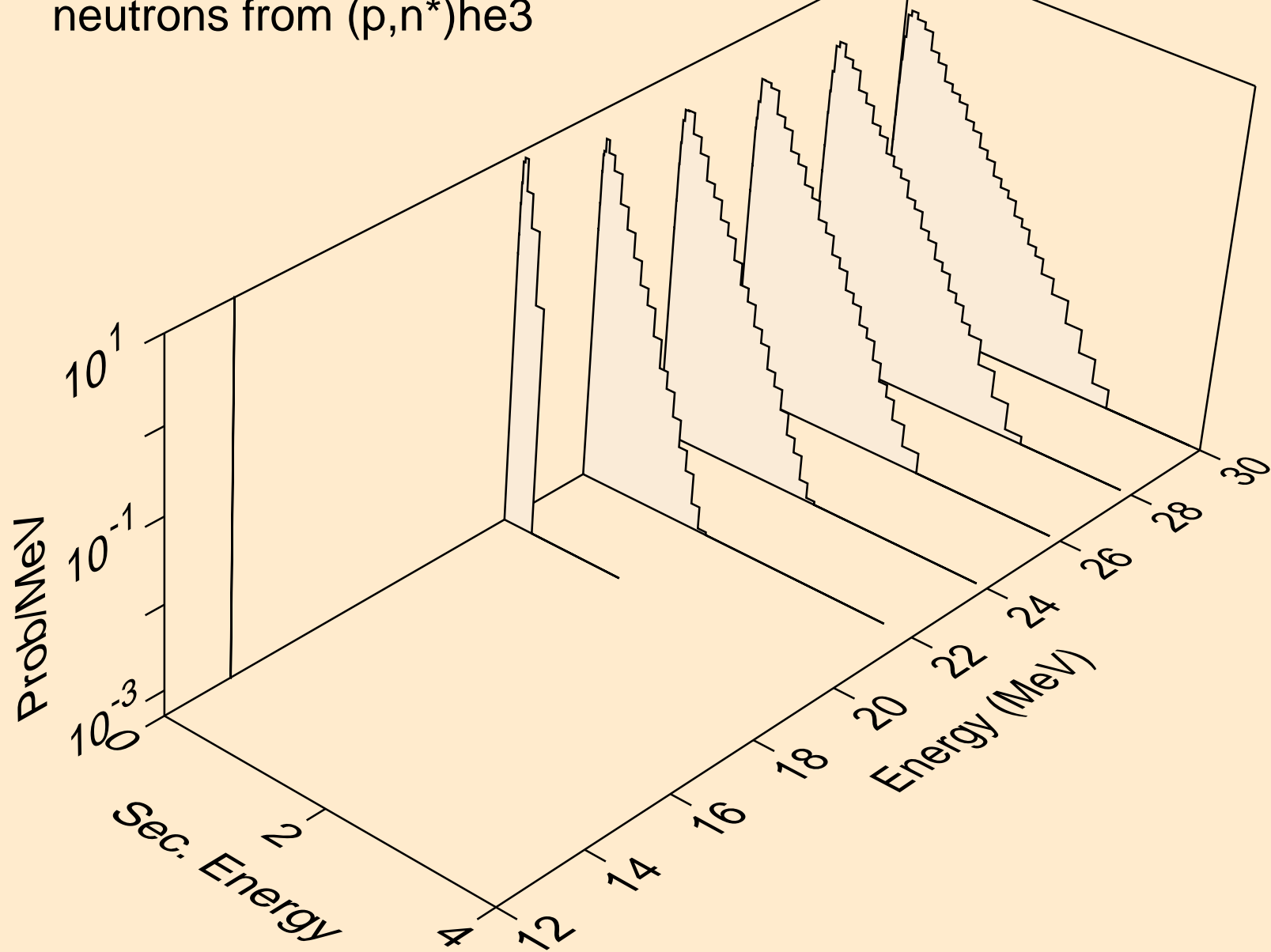

PT195M PROTON ACER TENDL-2024 LIBRARY; T=0.K  
neutrons from (p,4n)

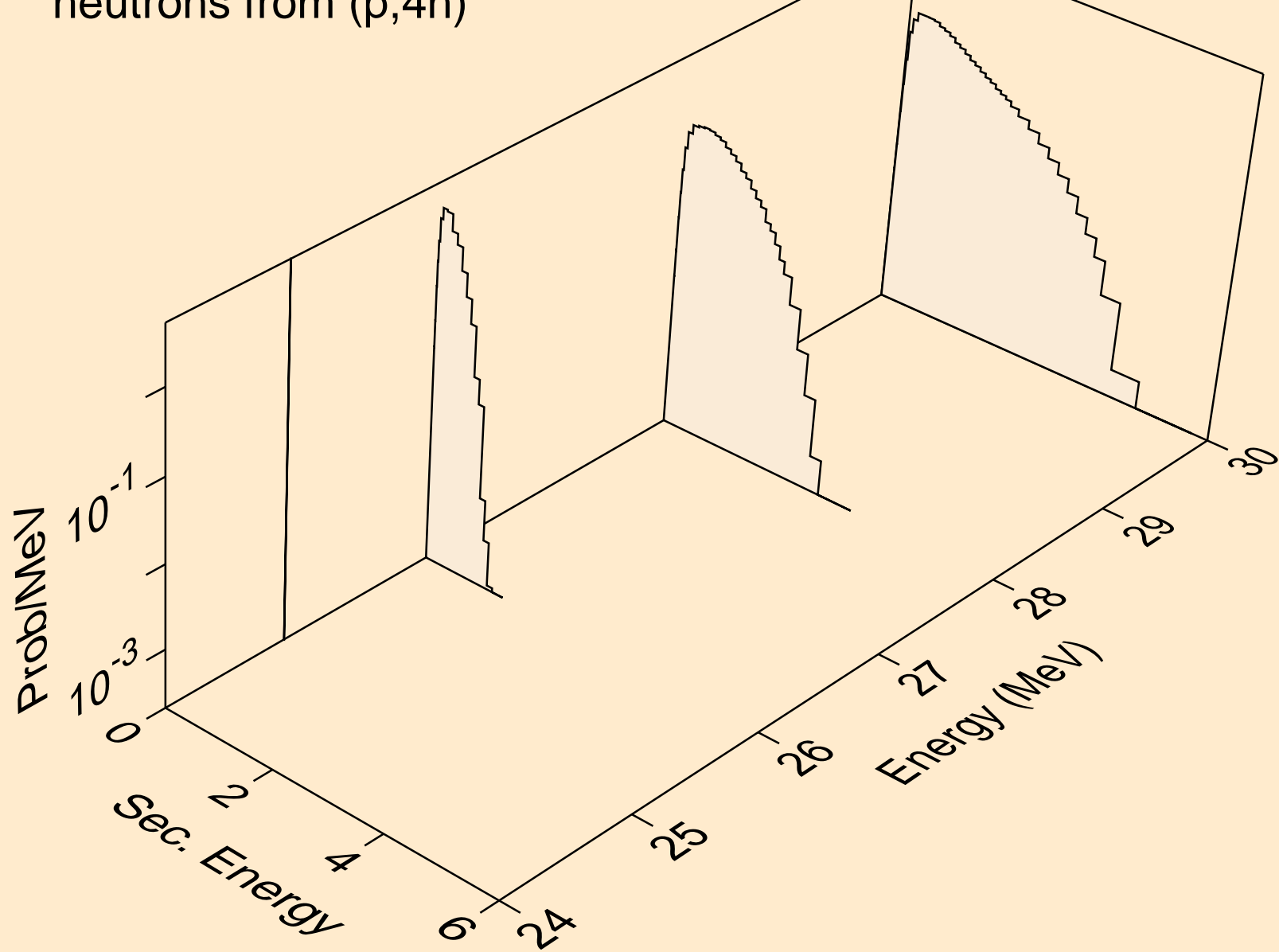

PT195M PROTON ACER TENDL-2024 LIBRARY; T=0.K  
neutrons from (p,2np)

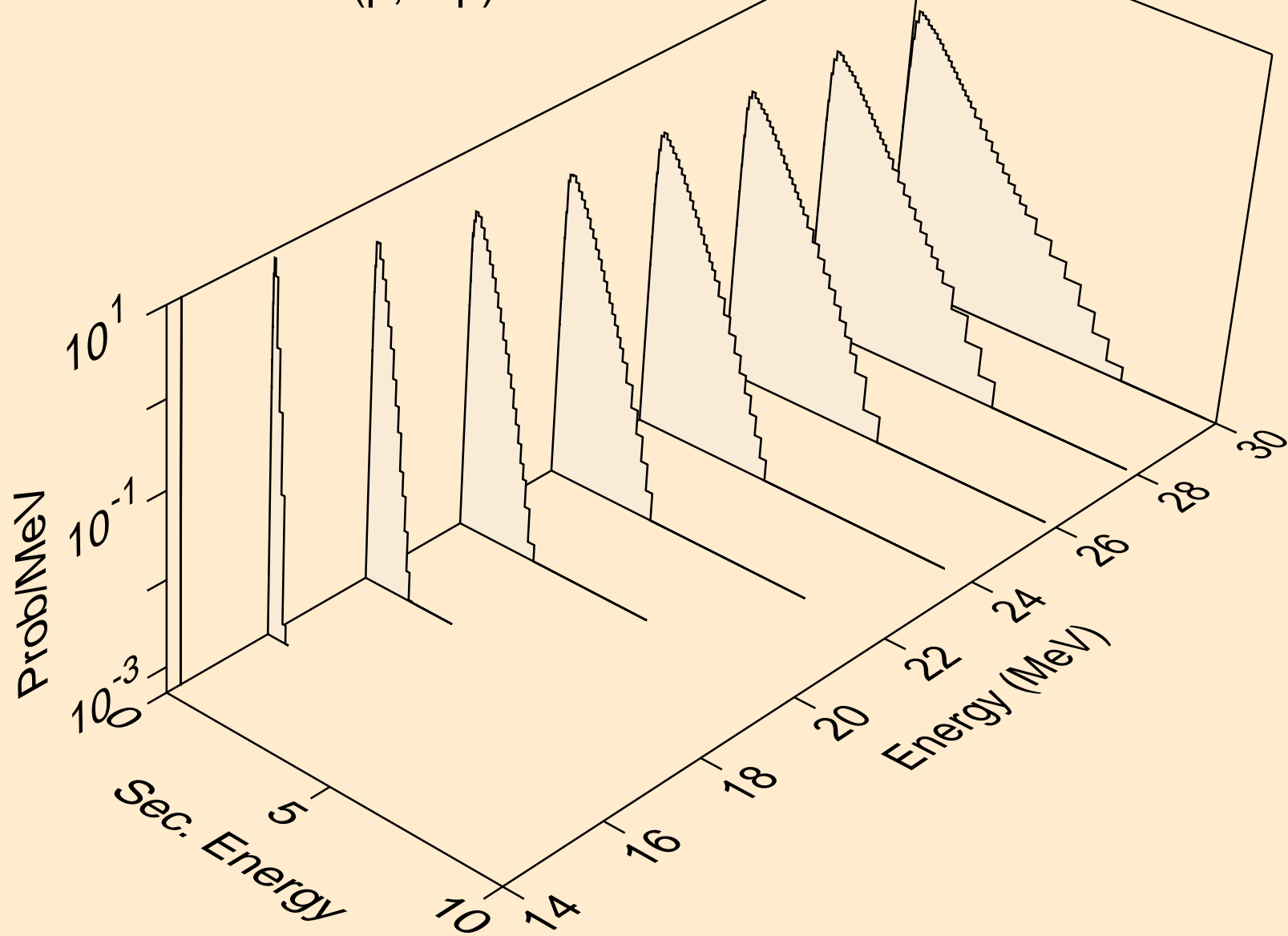

PT195M PROTON ACER TENDL-2024 LIBRARY; T=0.K  
neutrons from (p,3np)

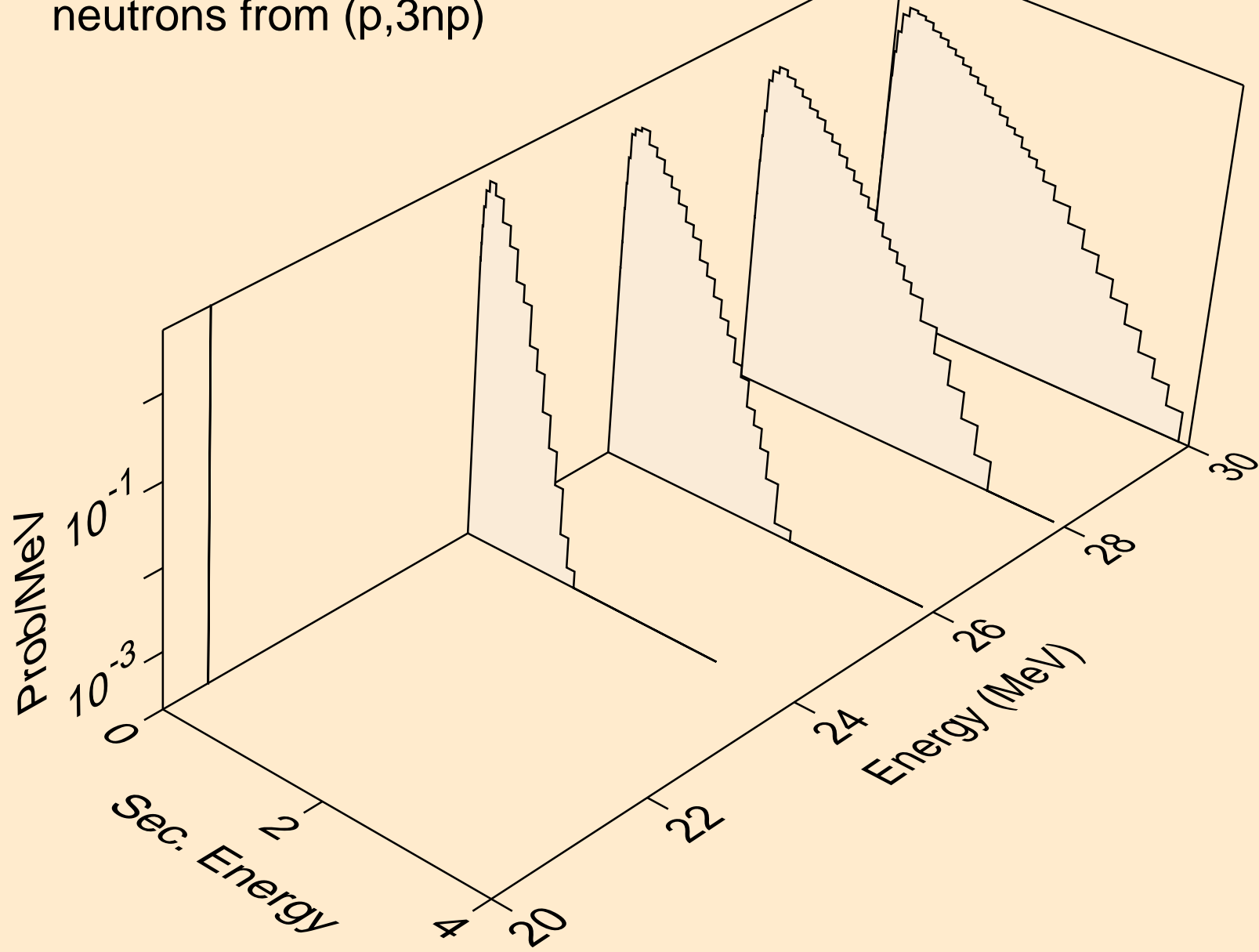

PT195M PROTON ACER TENDL-2024 LIBRARY; T=0.K  
neutrons from (p,n2p)

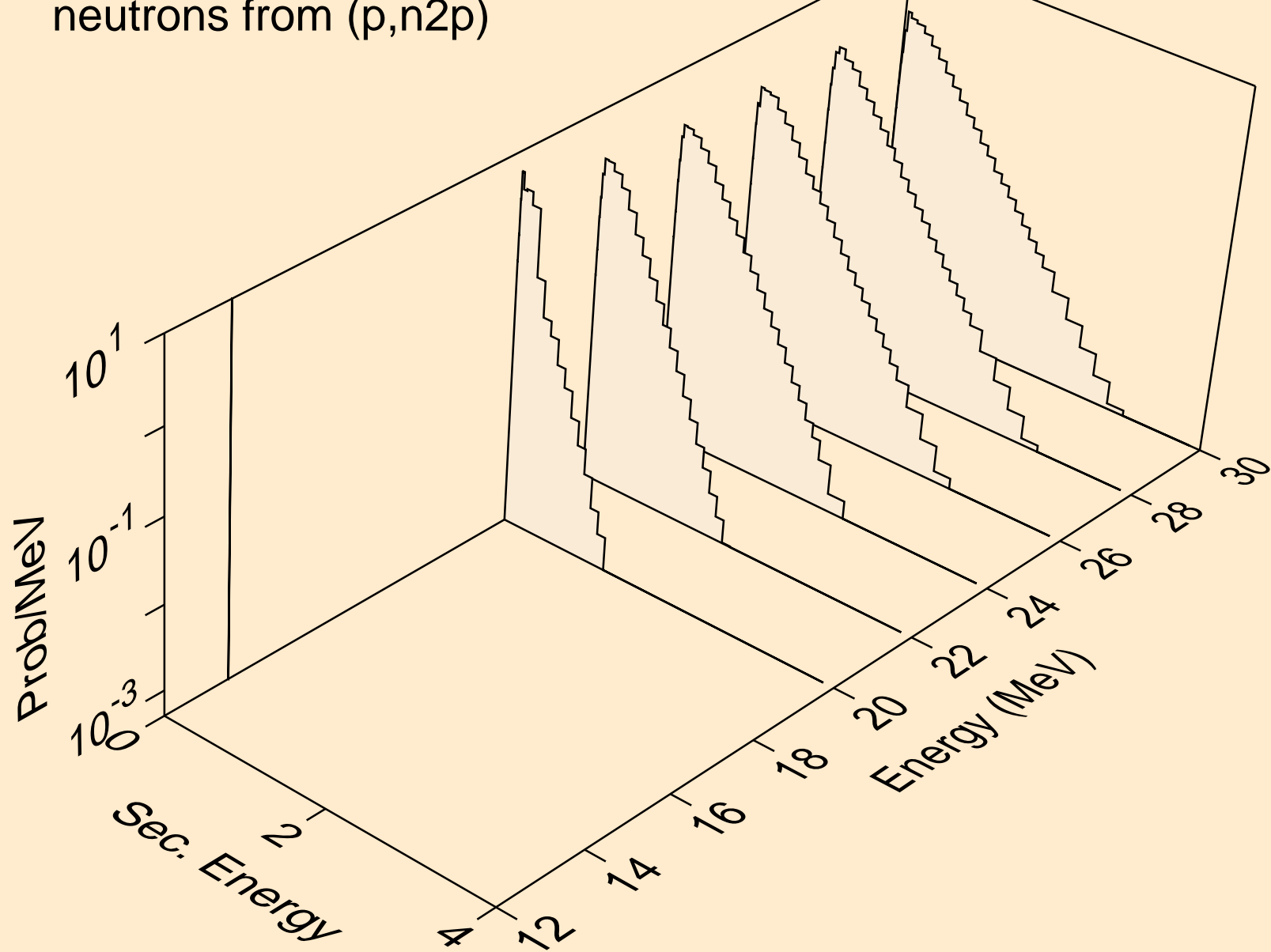

PT195M PROTON ACER TENDL-2024 LIBRARY; T=0.K  
neutrons from (p,npa)

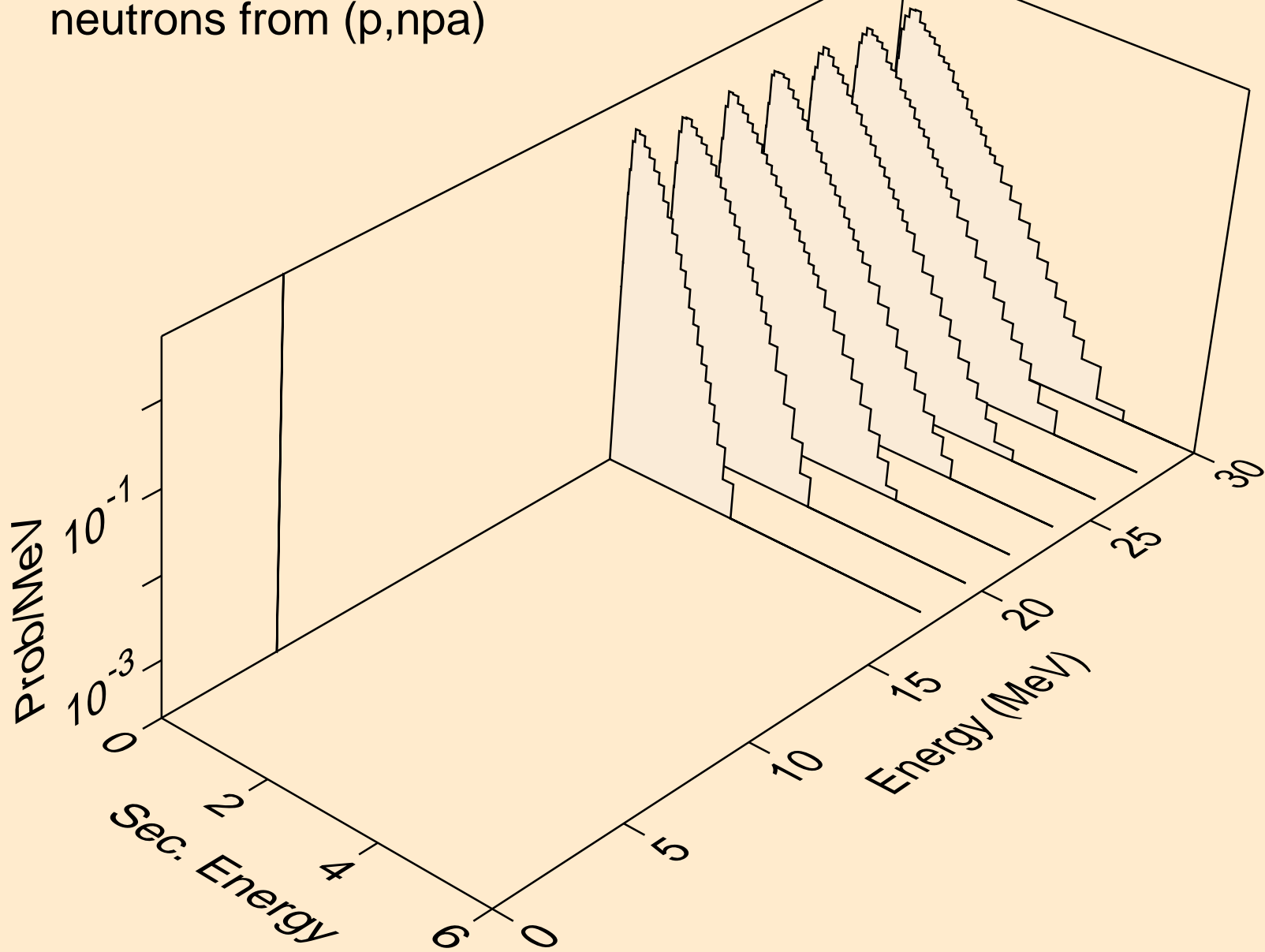

PT195M PROTON ACER TENDL-2024 LIBRARY; T=0.K  
deuterons from (p,x)

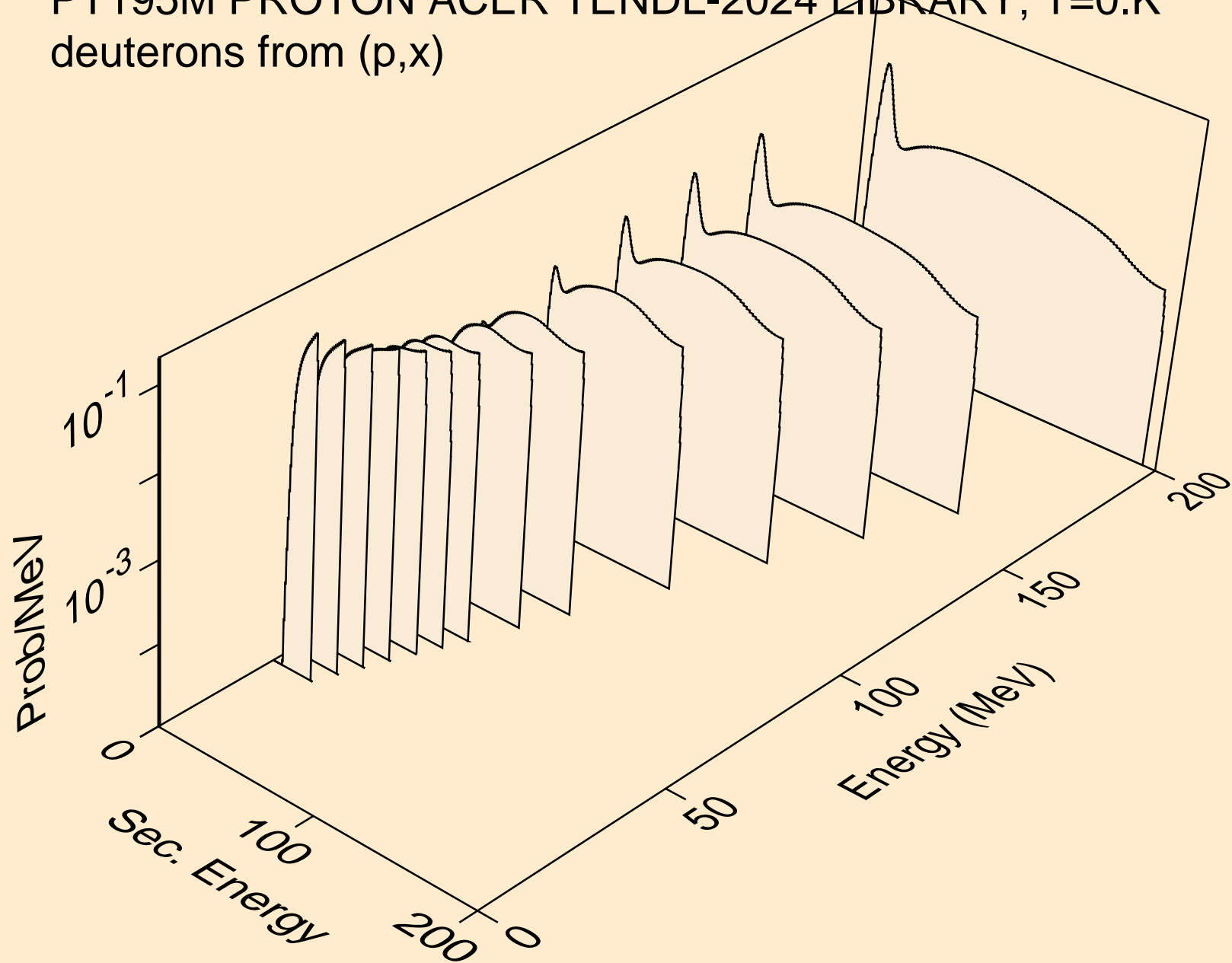

PT195M PROTON ACER TENDL-2024 LIBRARY; T=0.K  
deuterons from (p,2nd)

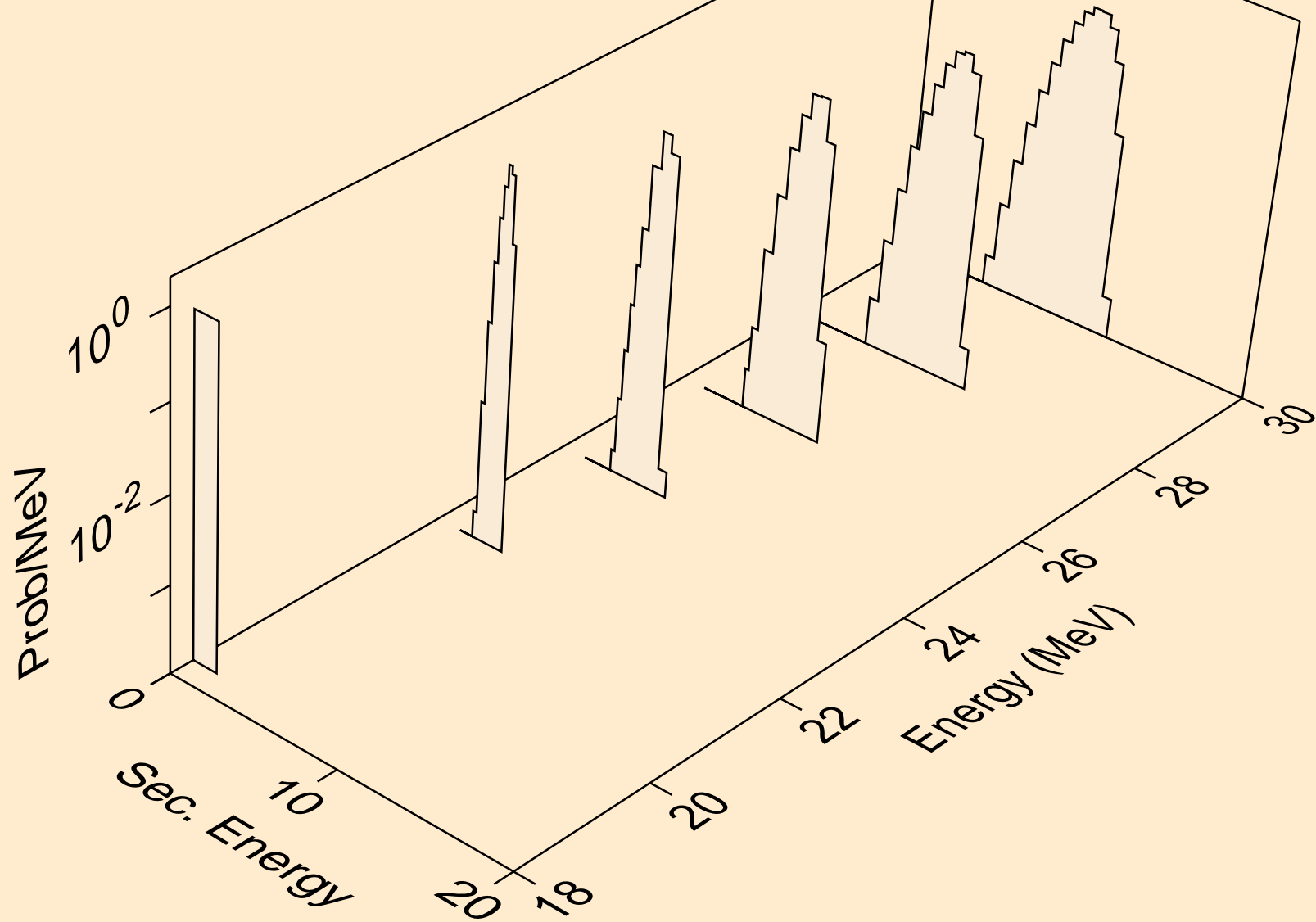

PT195M PROTON ACER TENDL-2024 LIBRARY; T=0.K  
deuterons from (p,n\*)d

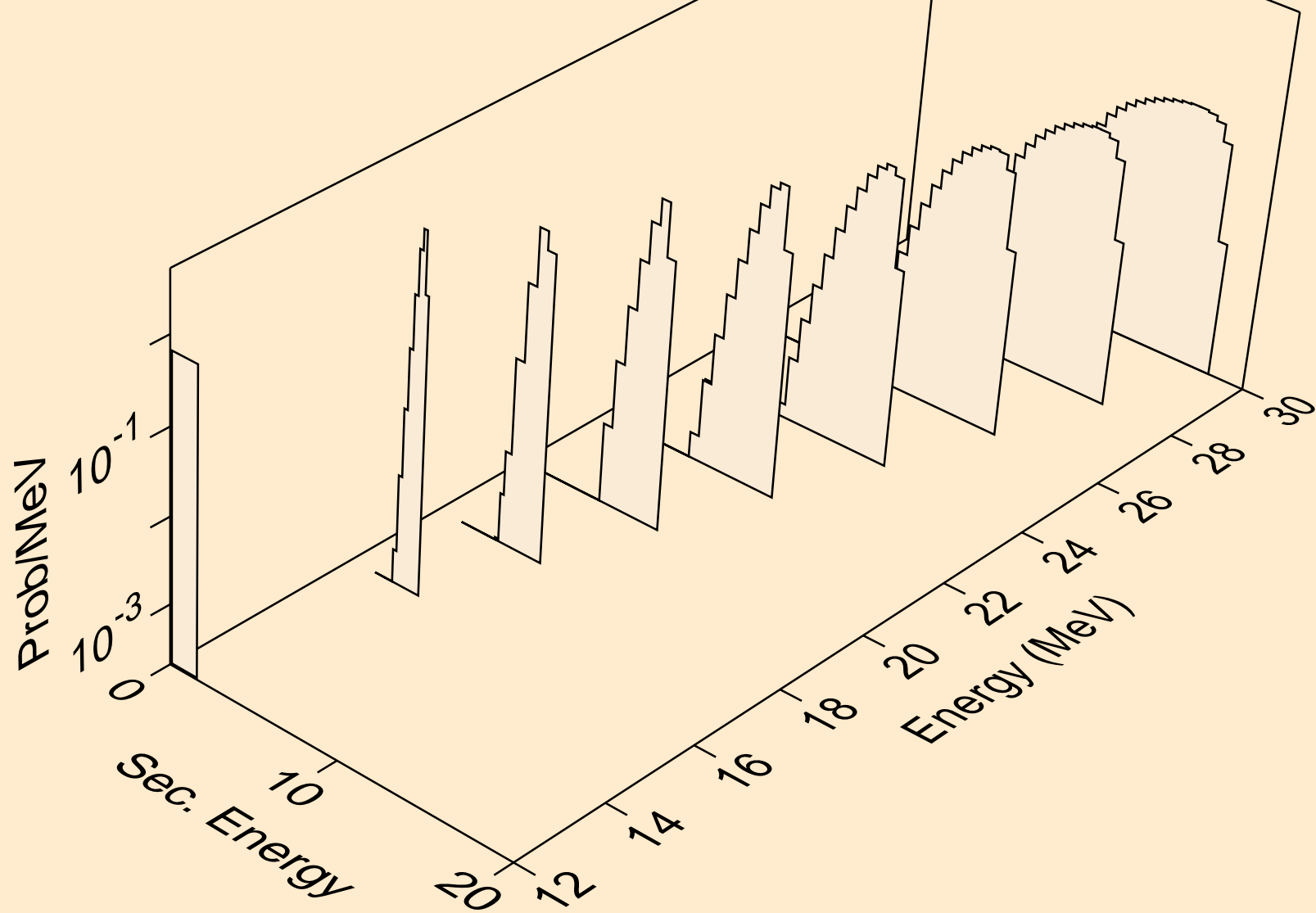

PT195M PROTON ACER TENDL-2024 LIBRARY; T=0.K  
deuterons from (p,d)

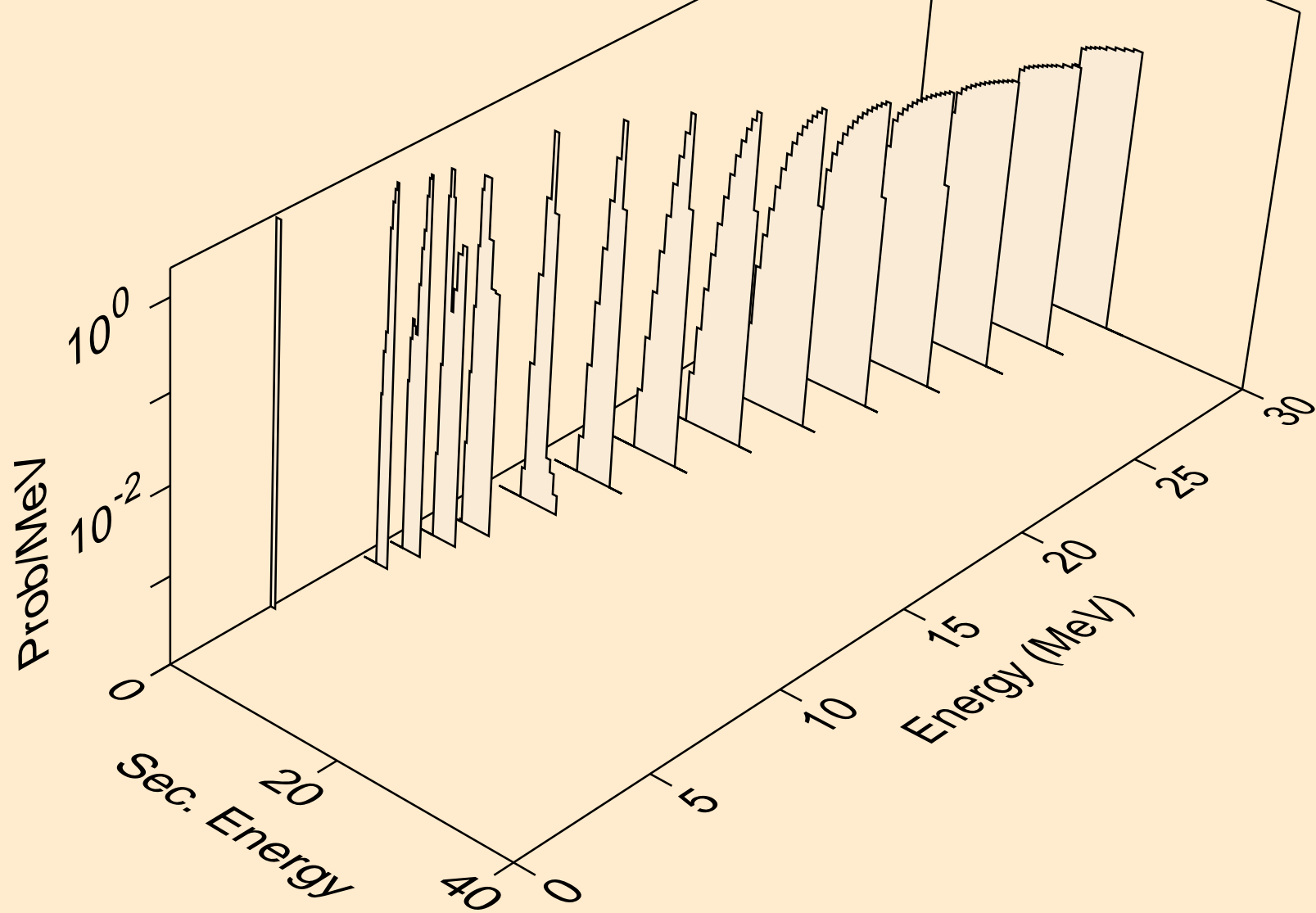

PT195M PROTON ACER TENDL-2024 LIBRARY; T=0.K  
deuterons from (p,pd)

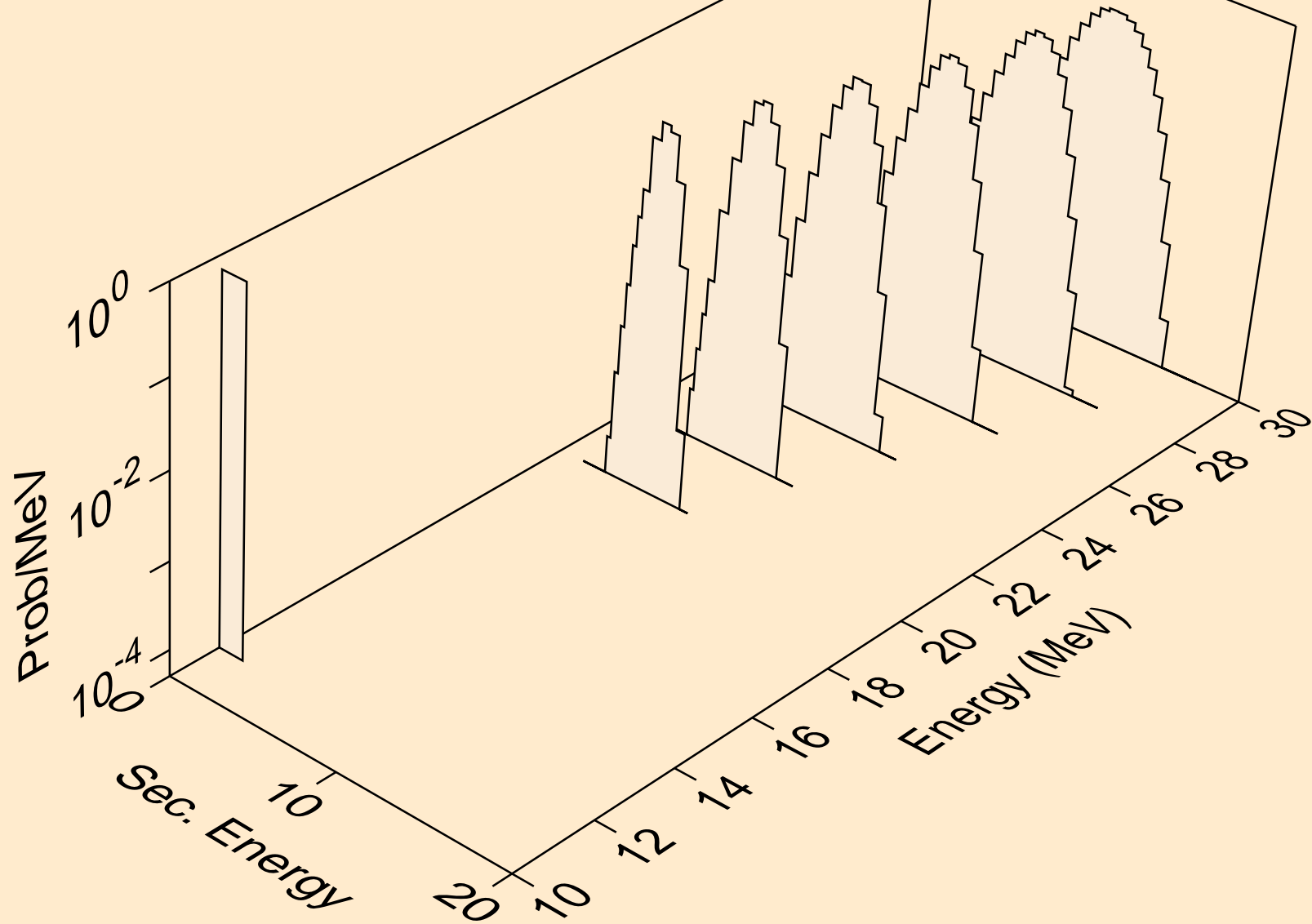

PT195M PROTON ACER TENDL-2024 LIBRARY; T=0.K  
tritons from (p,x)

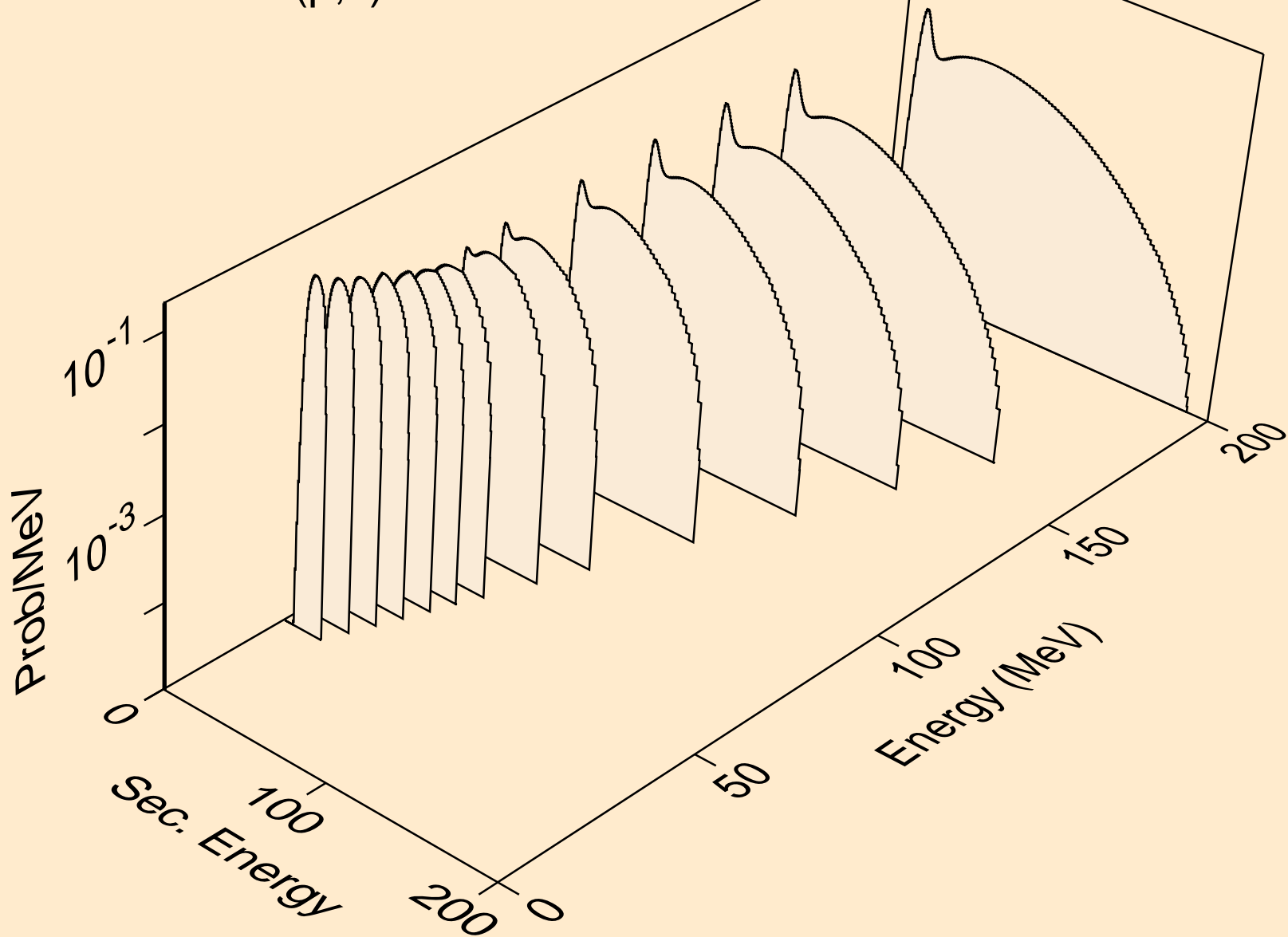

PT195M PROTON ACER TENDL-2024 LIBRARY; T=0.K  
tritons from (p,n\*)t

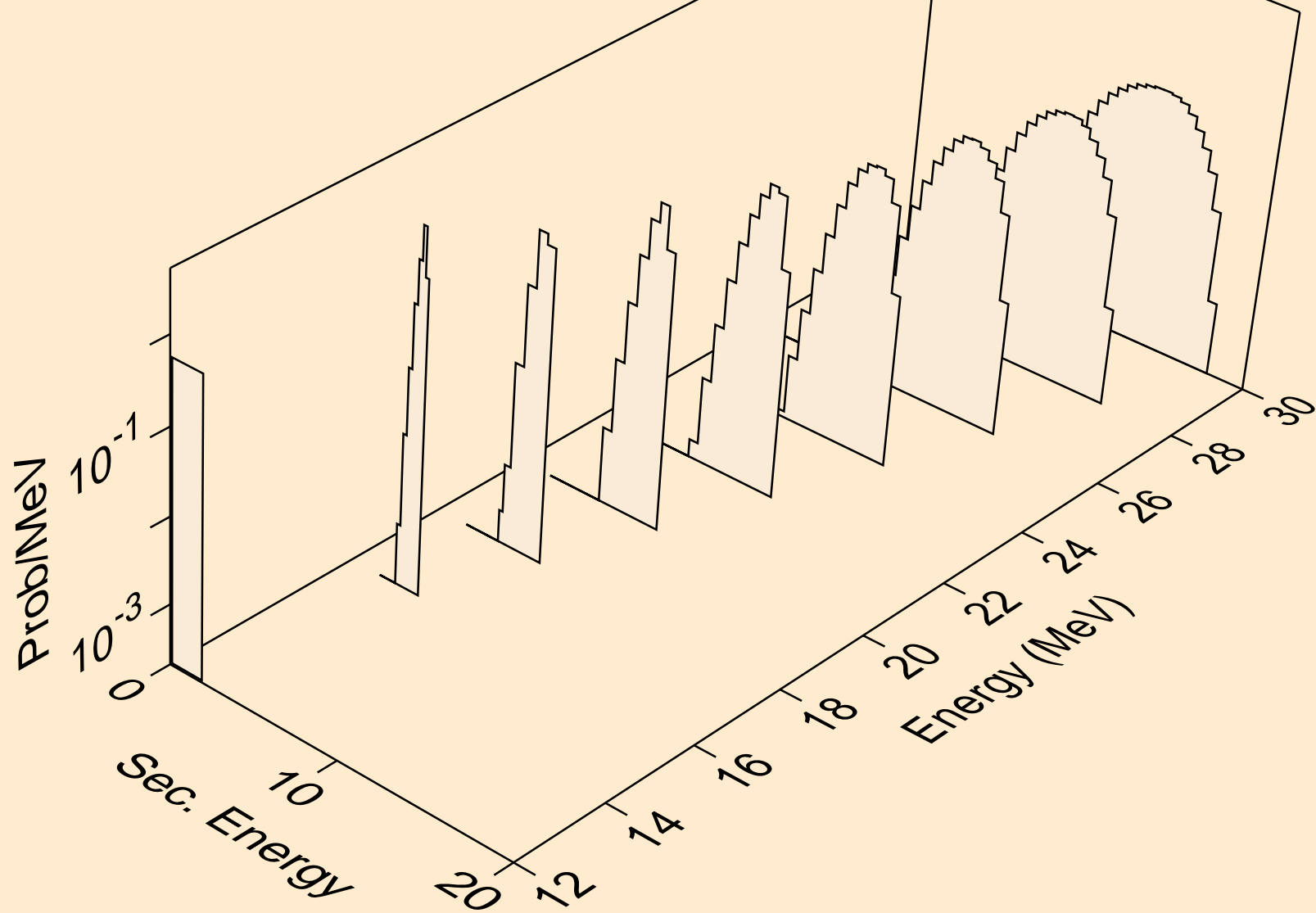

PT195M PROTON ACER TENDL-2024 LIBRARY; T=0.K  
tritons from (p,t)

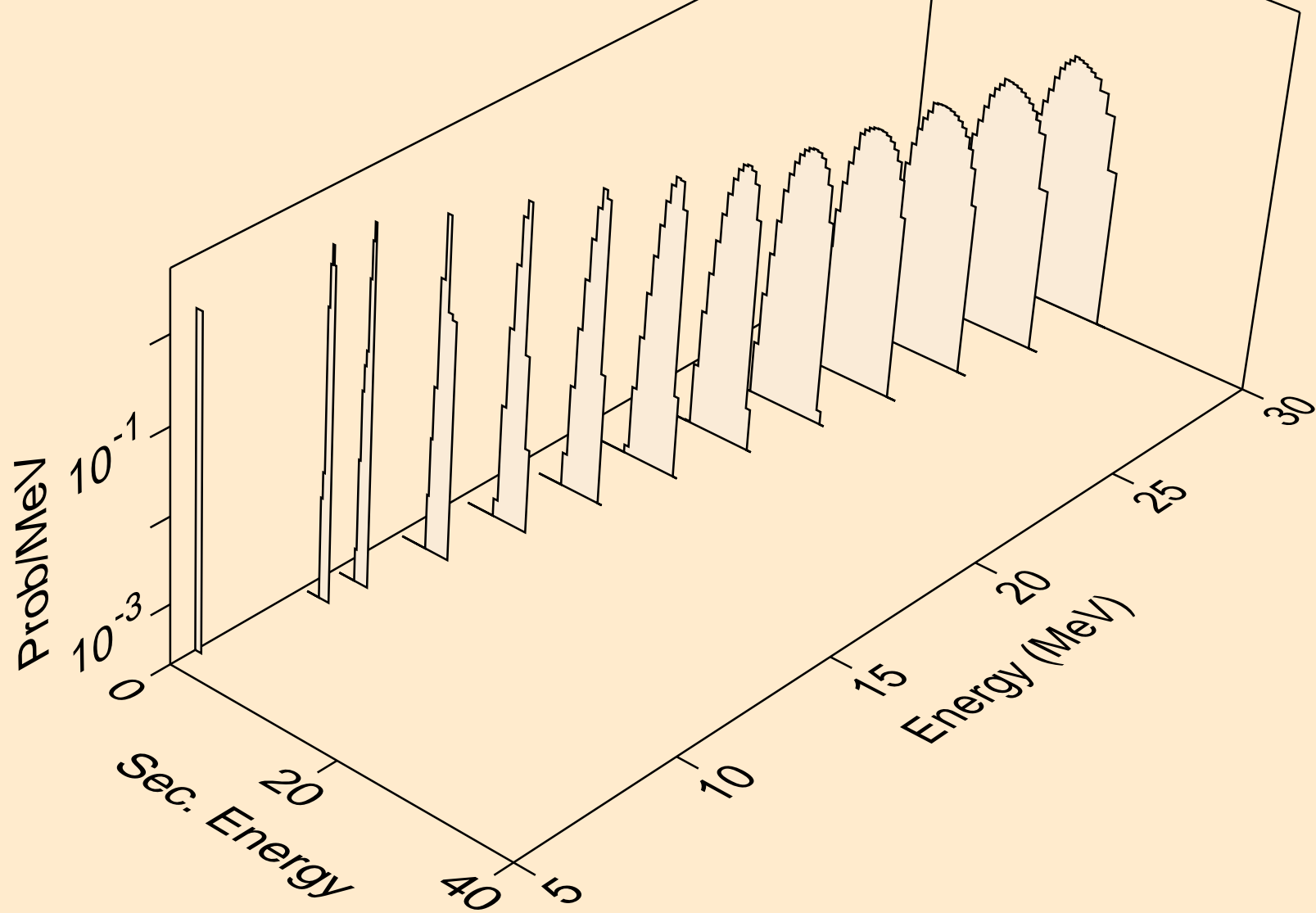

PT195M PROTON ACER TENDL-2024 LIBRARY; T=0.K  
tritons from (p,pt)

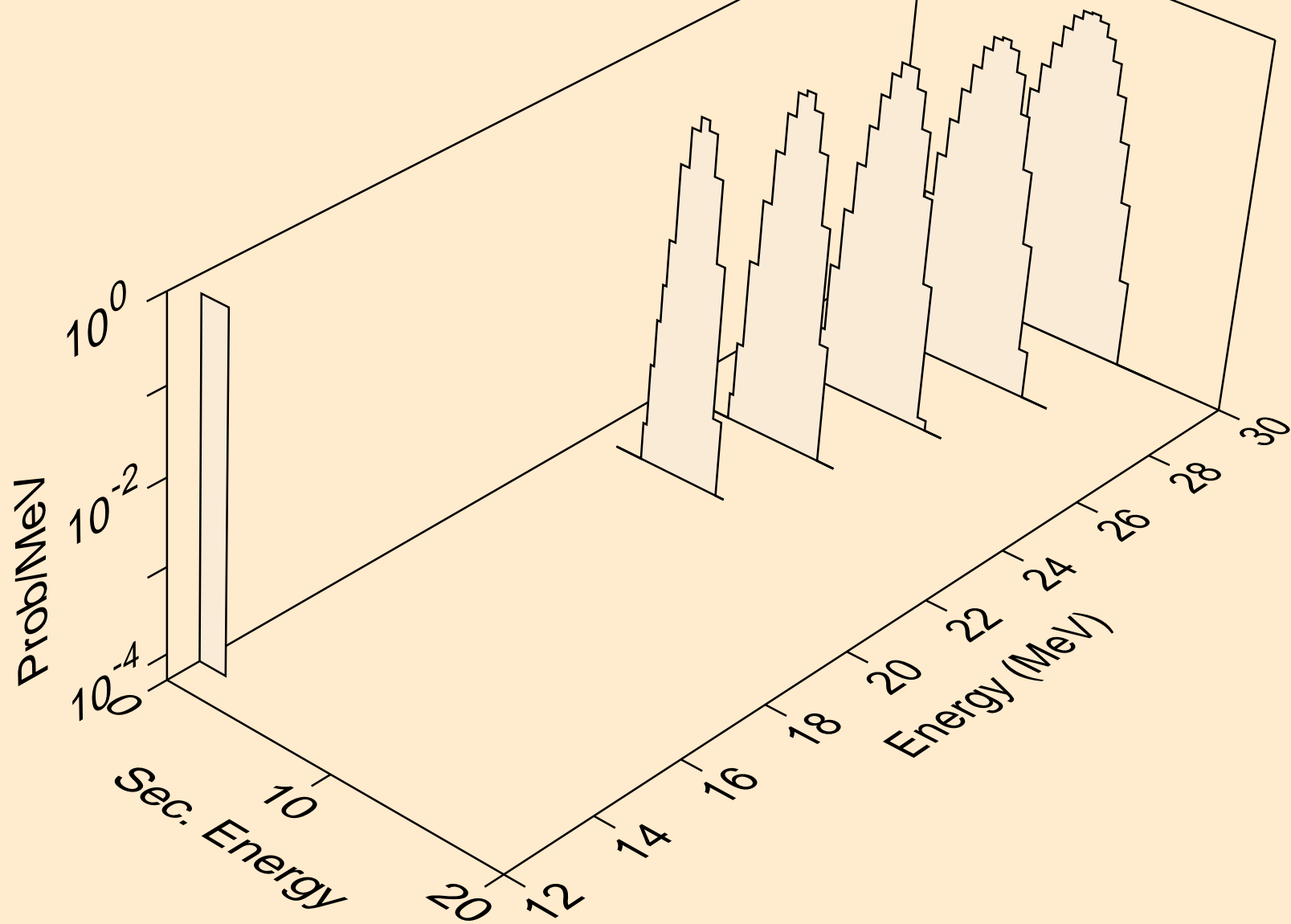

PT195M PROTON ACER TENDL-2024 LIBRARY; T=0.K  
he3s from (p,x)

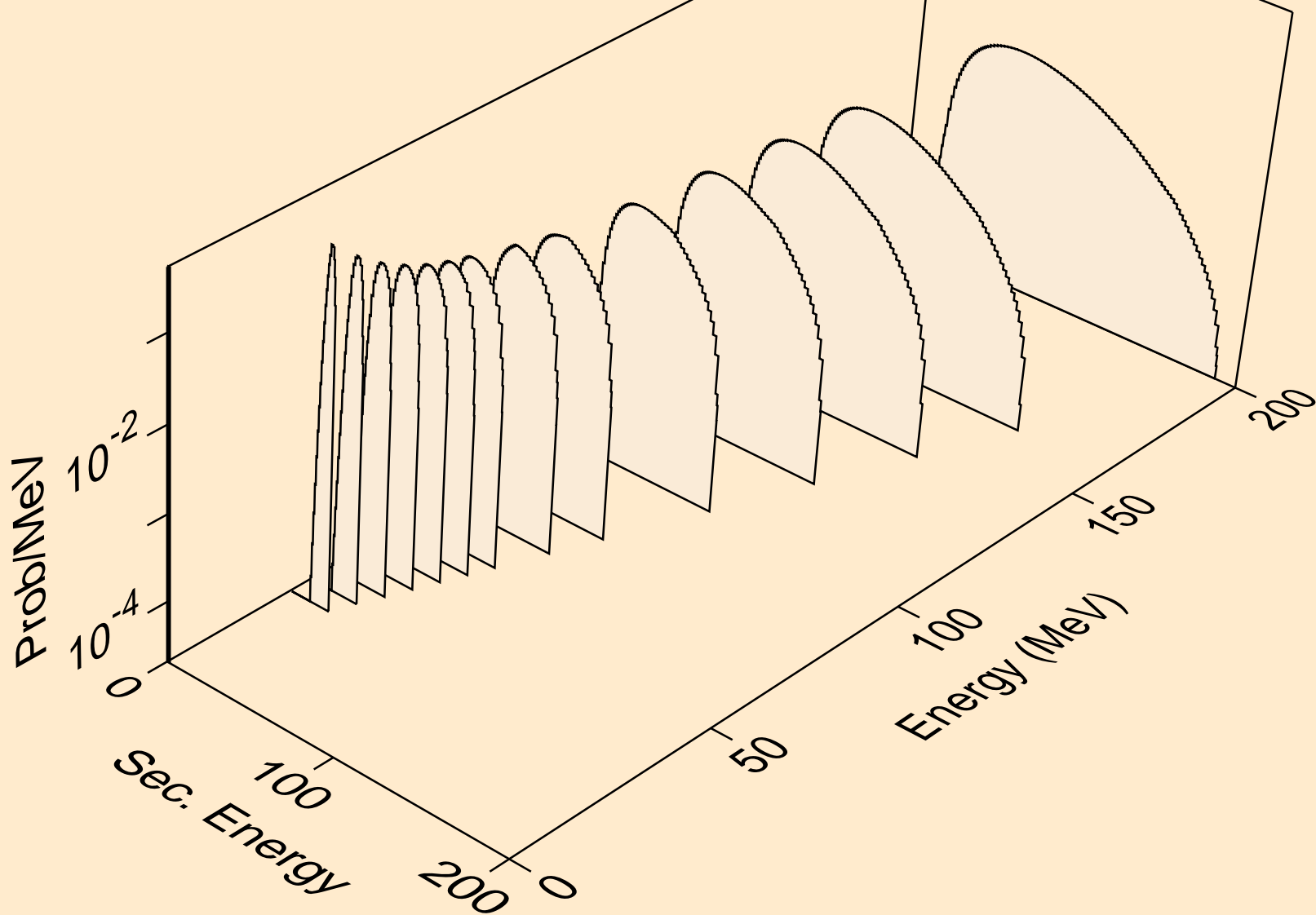

PT195M PROTON ACER TENDL-2024 LIBRARY; T=0.K  
he3s from (p,n\*)he3

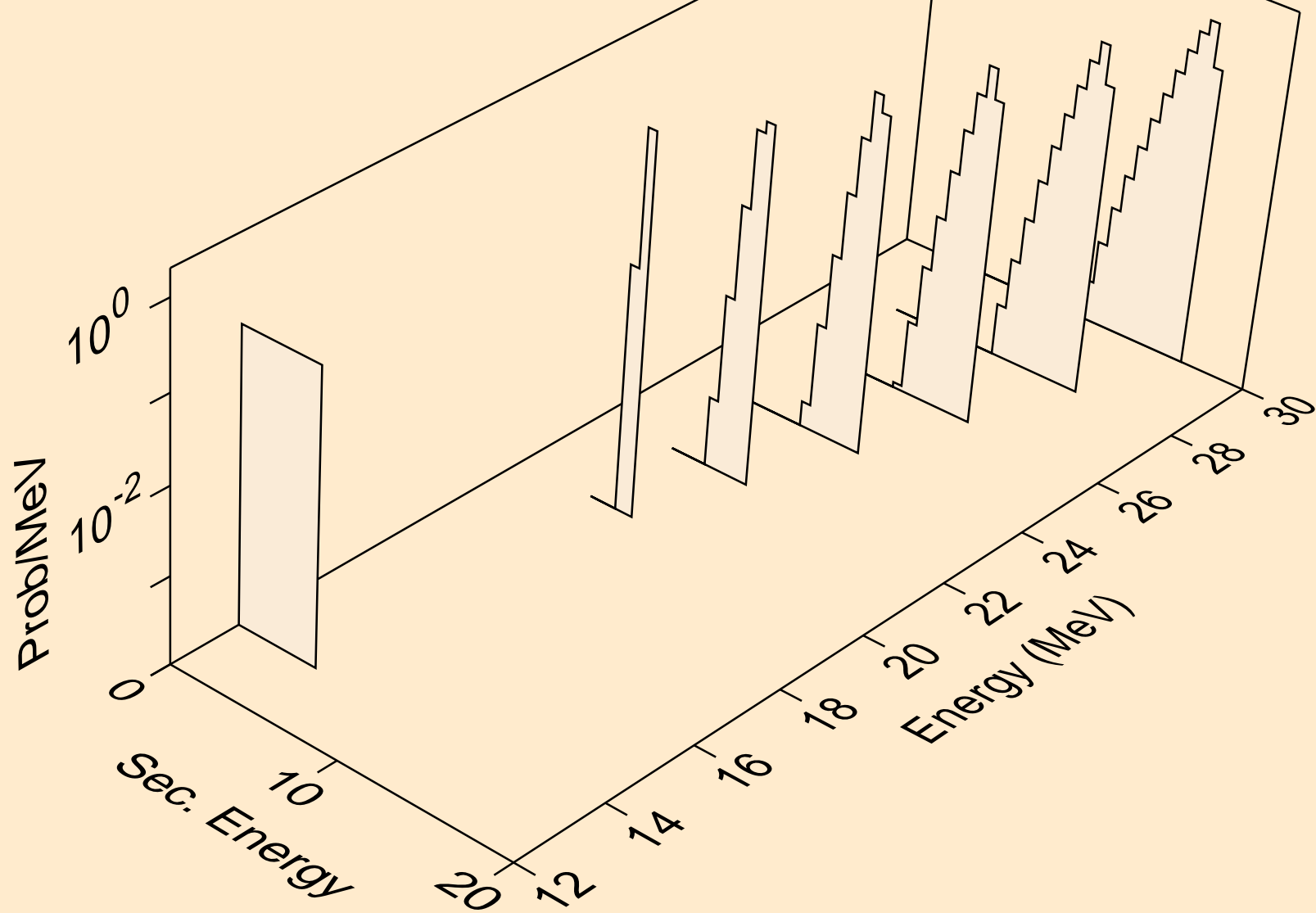

PT195M PROTON ACER TENDL-2024 LIBRARY; T=0.K  
he3s from (p,he3)

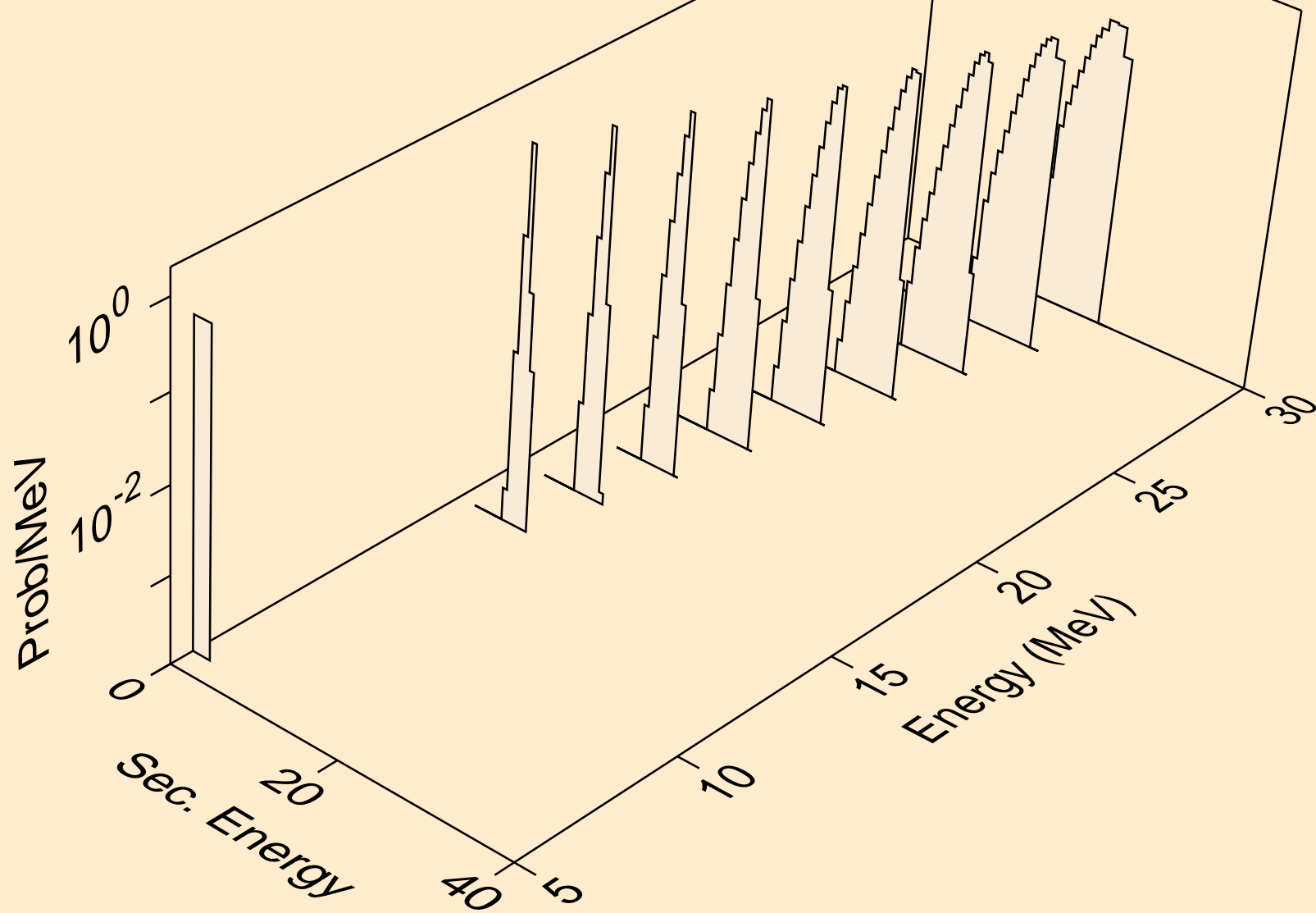

PT195M PROTON ACER TENDL-2024 LIBRARY; T=0.K  
alphas from (p,x)

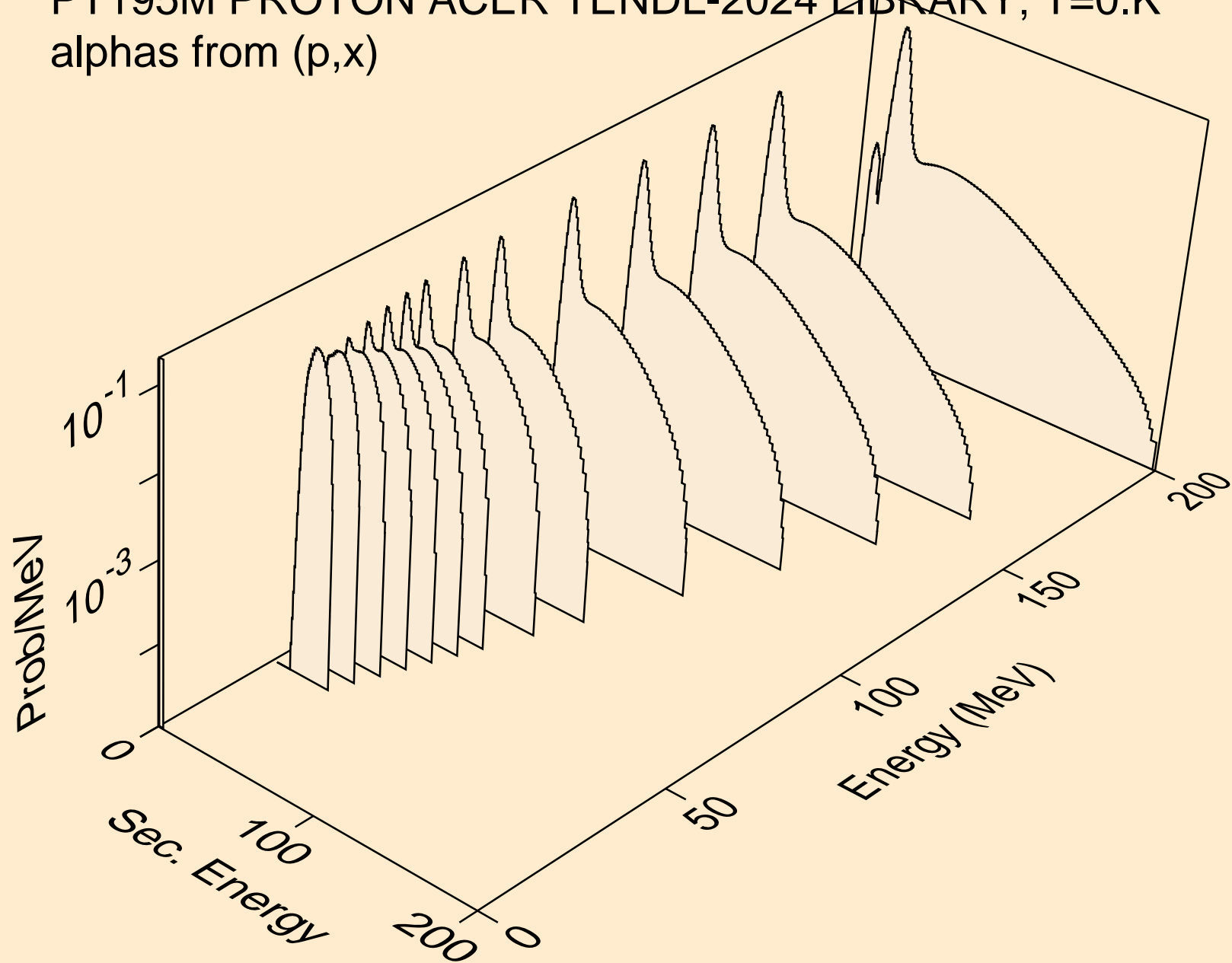

PT195M PROTON ACER TENDL-2024 LIBRARY; T=0.K  
alphas from (p,n\*)a

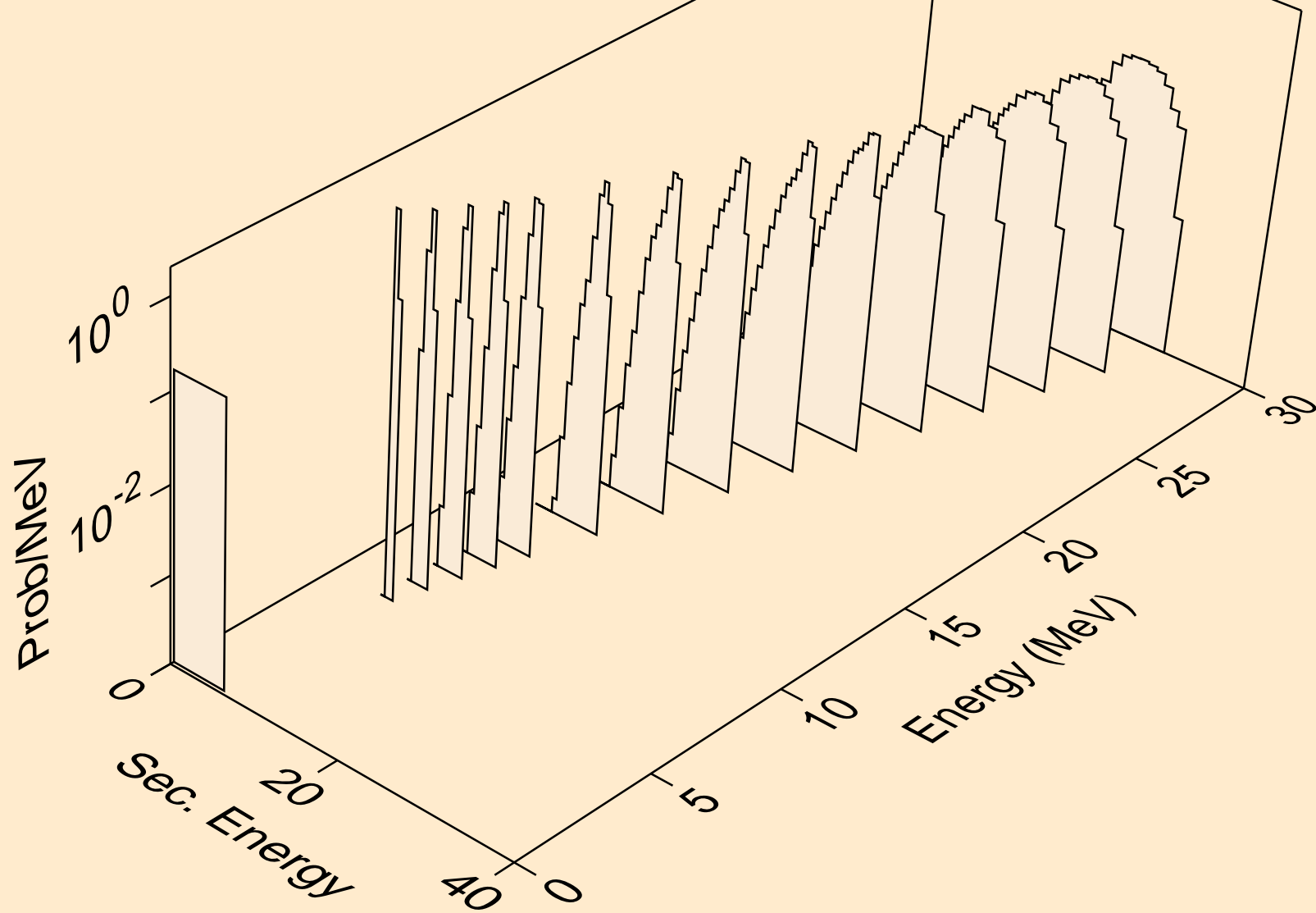

PT195M PROTON ACER TENDL-2024 LIBRARY; T=0.K  
alphas from (p,2n)a

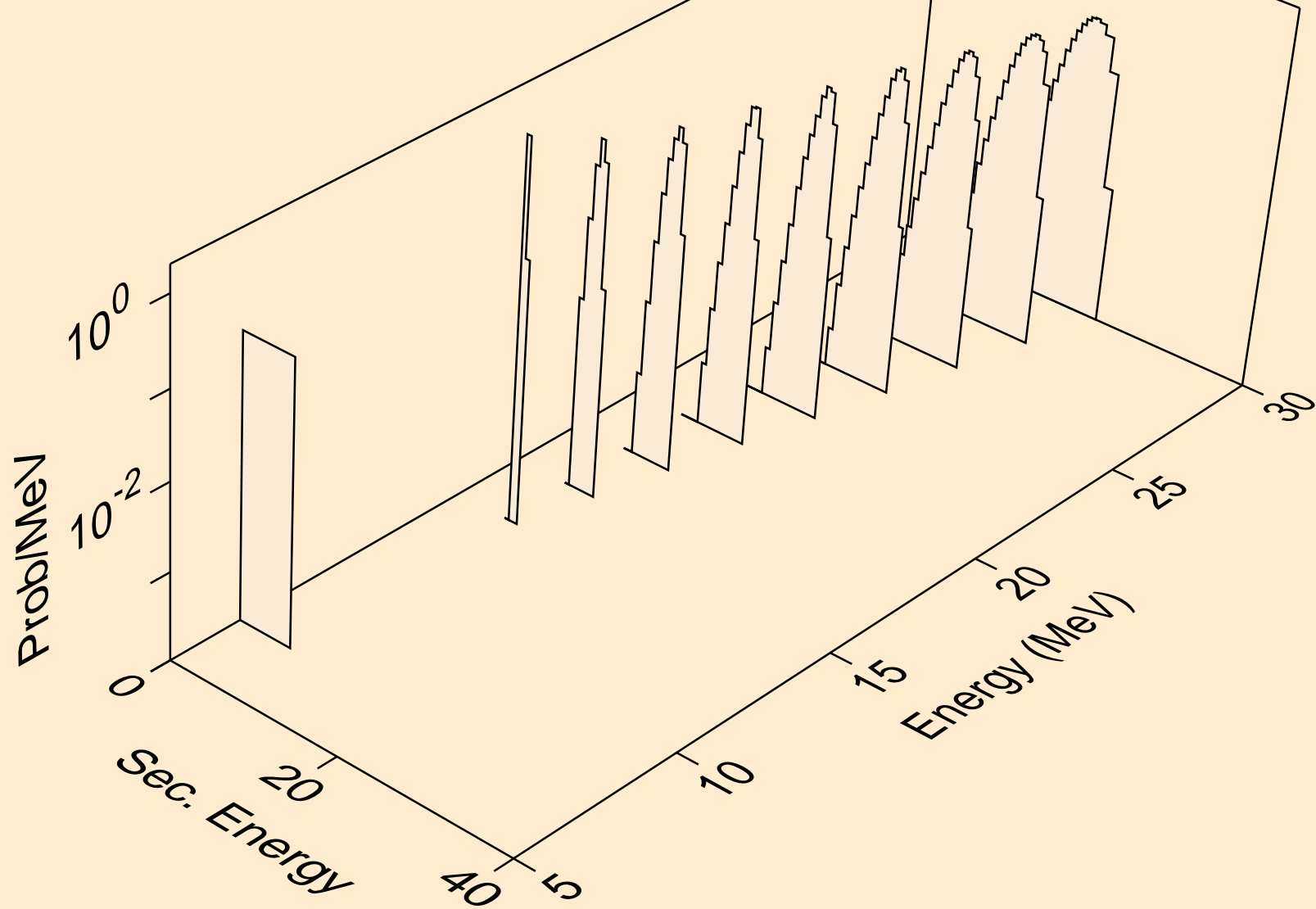

PT195M PROTON ACER TENDL-2024 LIBRARY; T=0.K  
alphas from (p,3n)a

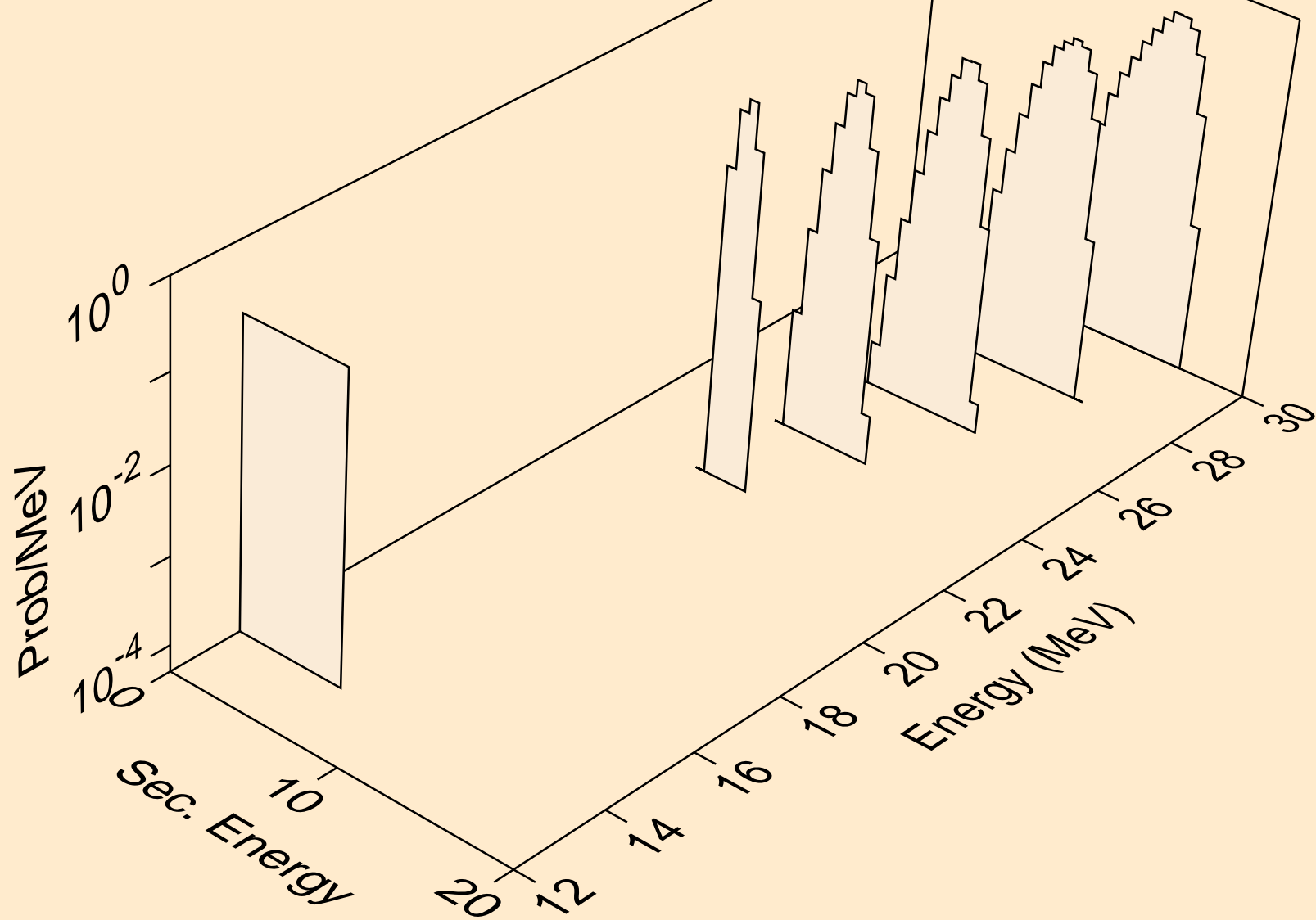

PT195M PROTON ACER TENDL-2024 LIBRARY; T=0.K  
alphas from (p,npa)

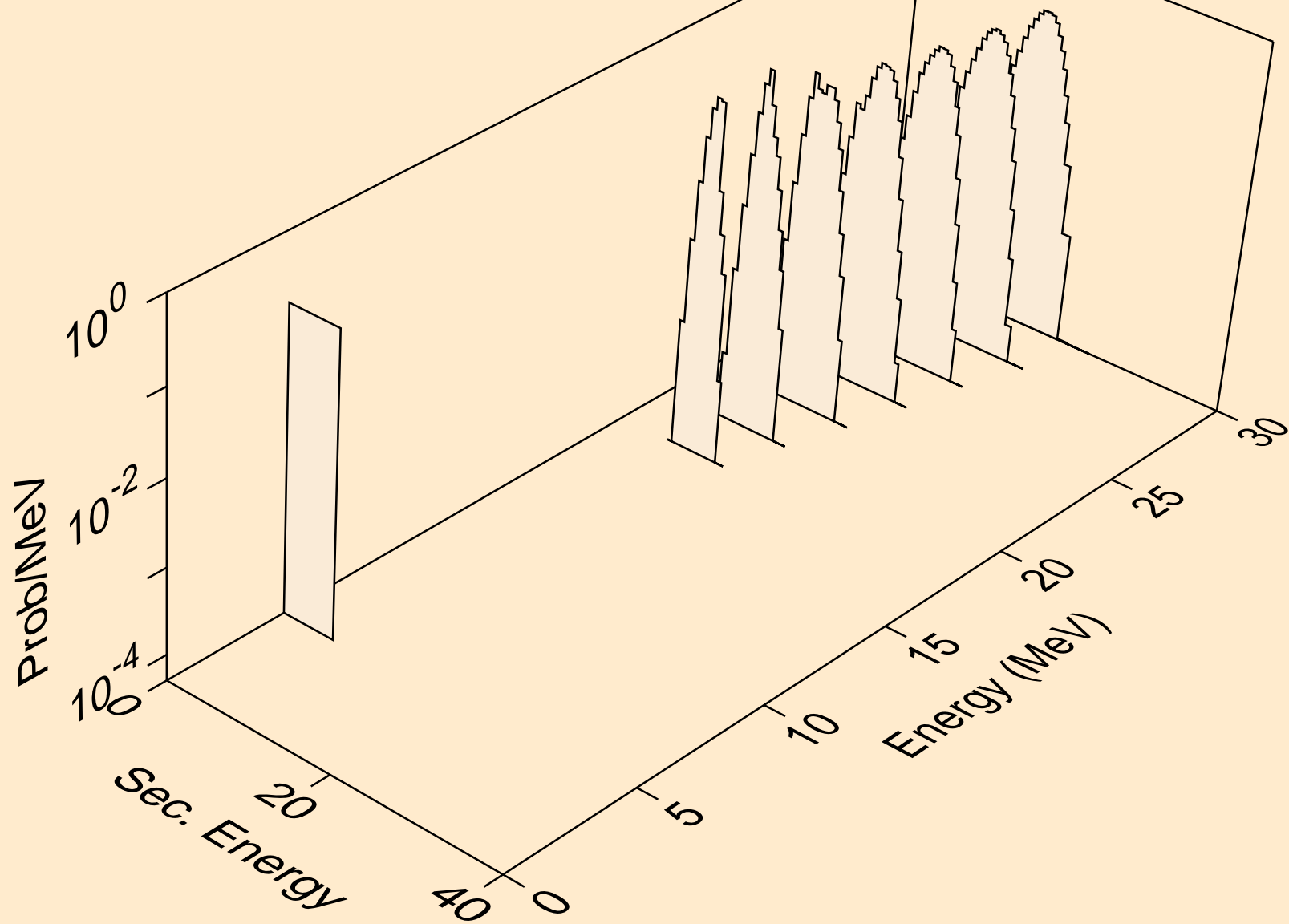

PT195M PROTON ACER TENDL-2024 LIBRARY; T=0.K  
alphas from (p,a)

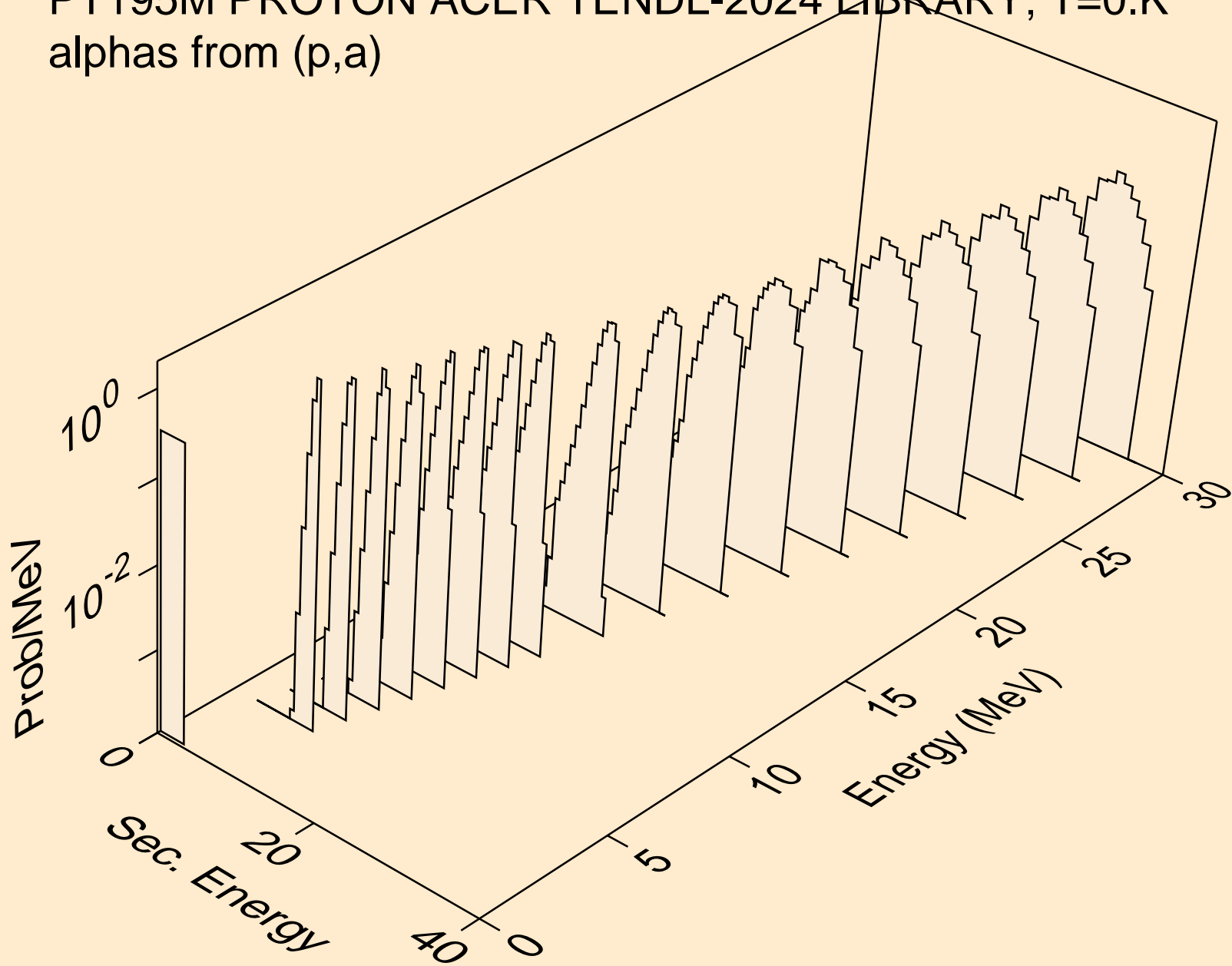

PT195M PROTON ACER TENDL-2024 LIBRARY; T=0.K  
alphas from (p,2a)

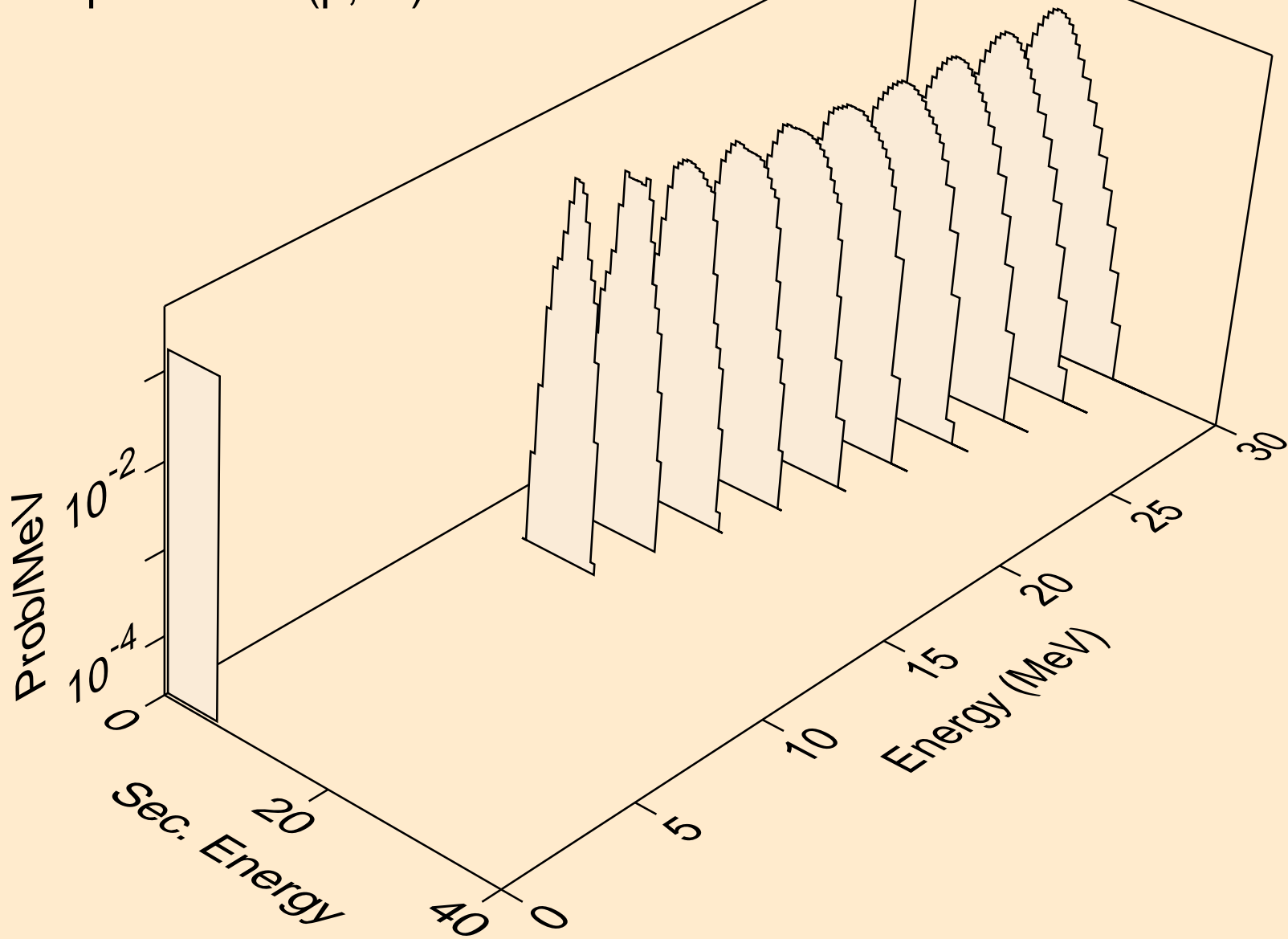

PT195M PROTON ACER TENDL-2024 LIBRARY; T=0.K  
alphas from (p,pa)

