

# SC048 PROTON ACER TENDL-2024 LIBRARY; T=0.K

## Principal cross sections

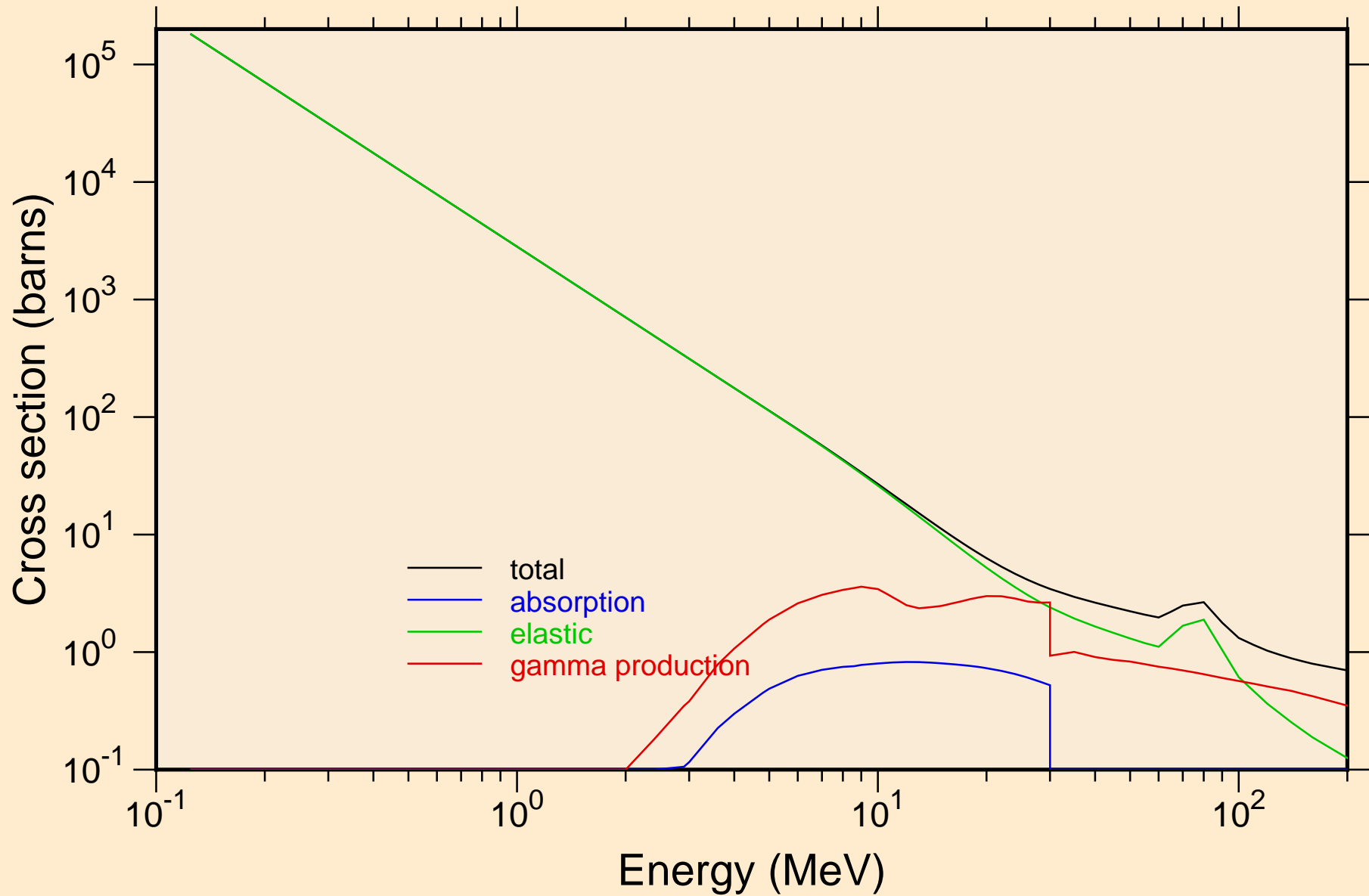

# SC048 PROTON ACER TENDL-2024 LIBRARY; T=0.K

## Heating

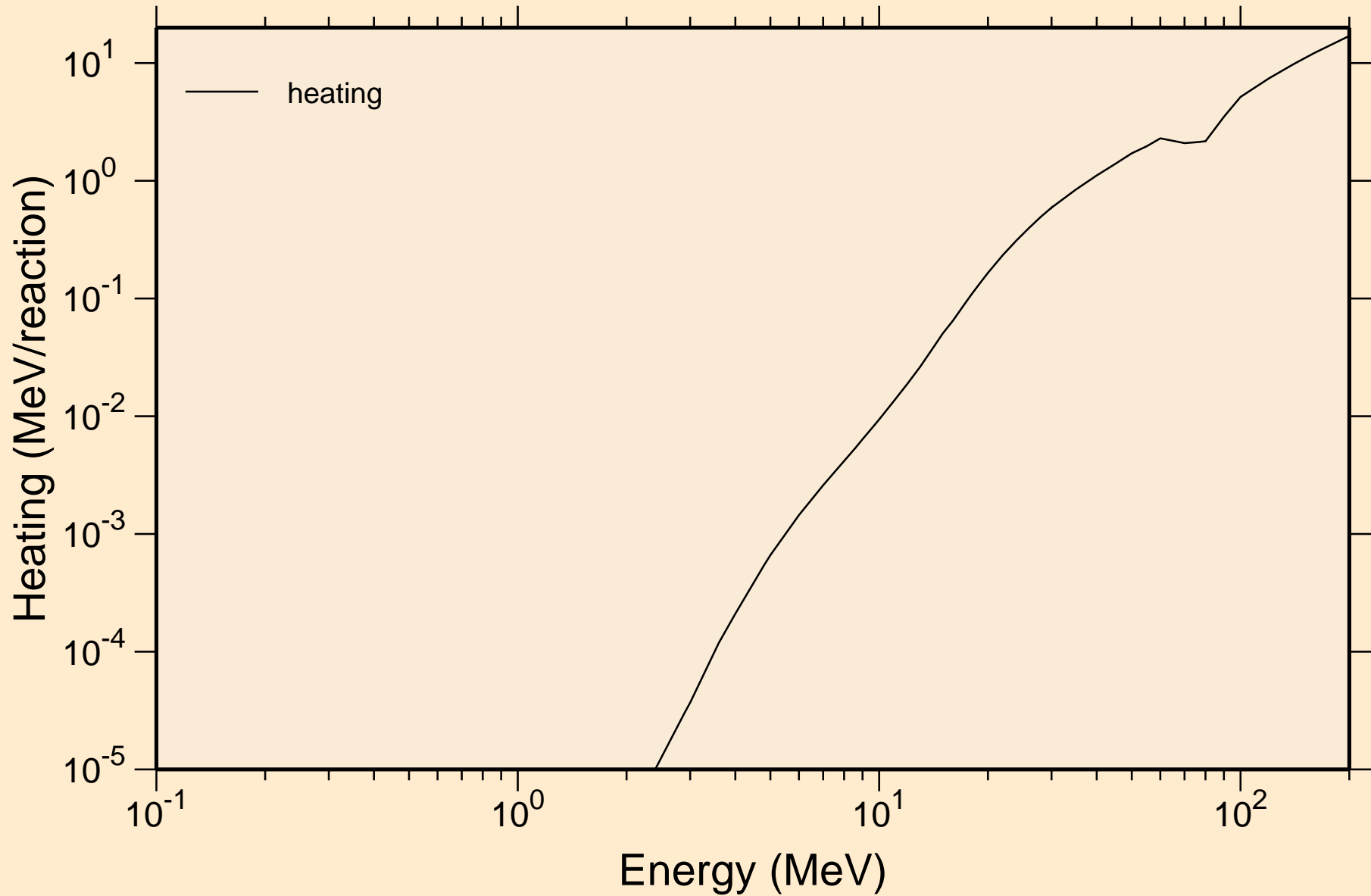

# SC048 PROTON ACER TENDL-2024 LIBRARY; T=0.K

## Principal cross sections

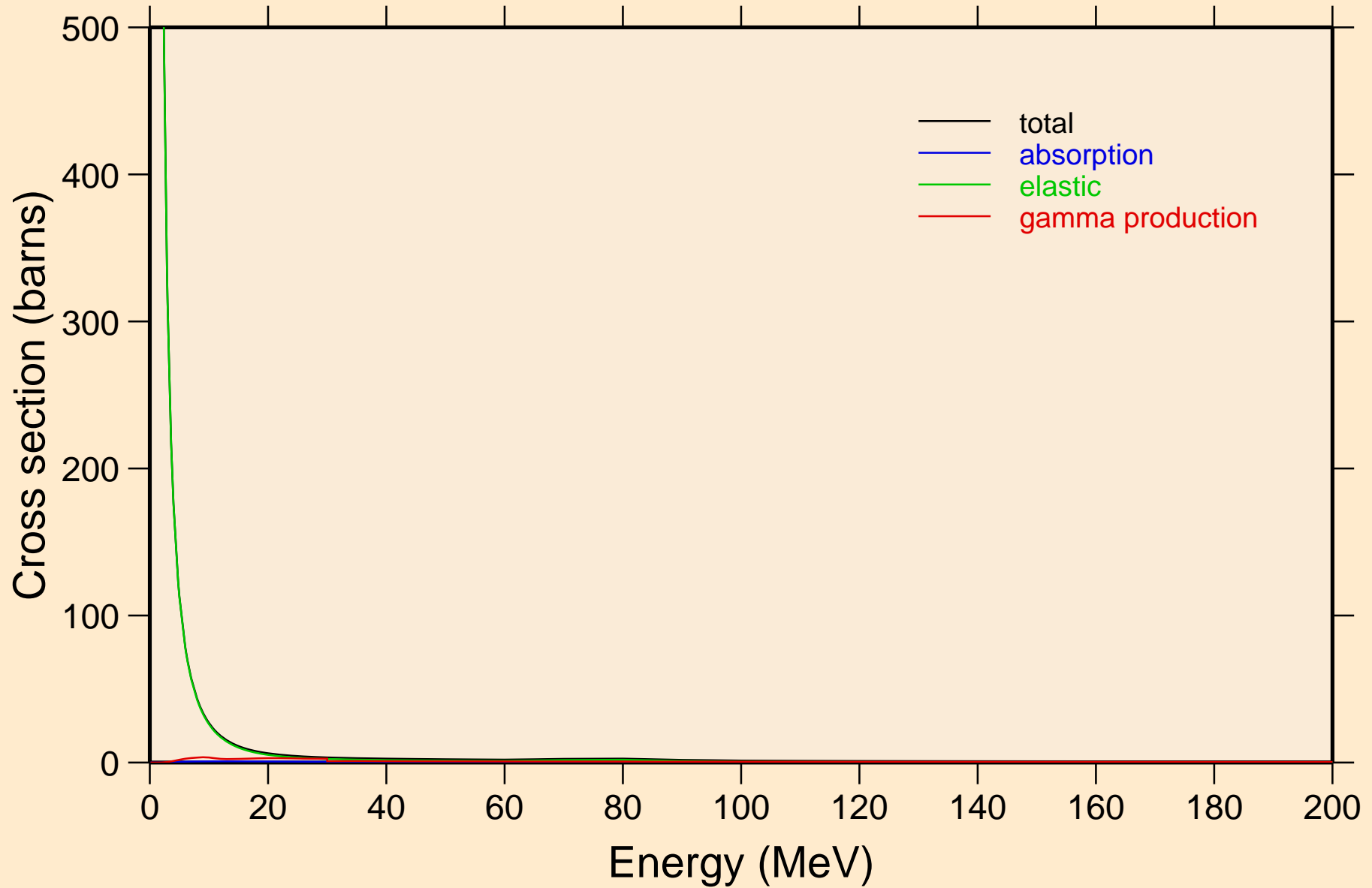

# SC048 PROTON ACER TENDL-2024 LIBRARY; T=0.K

## Heating

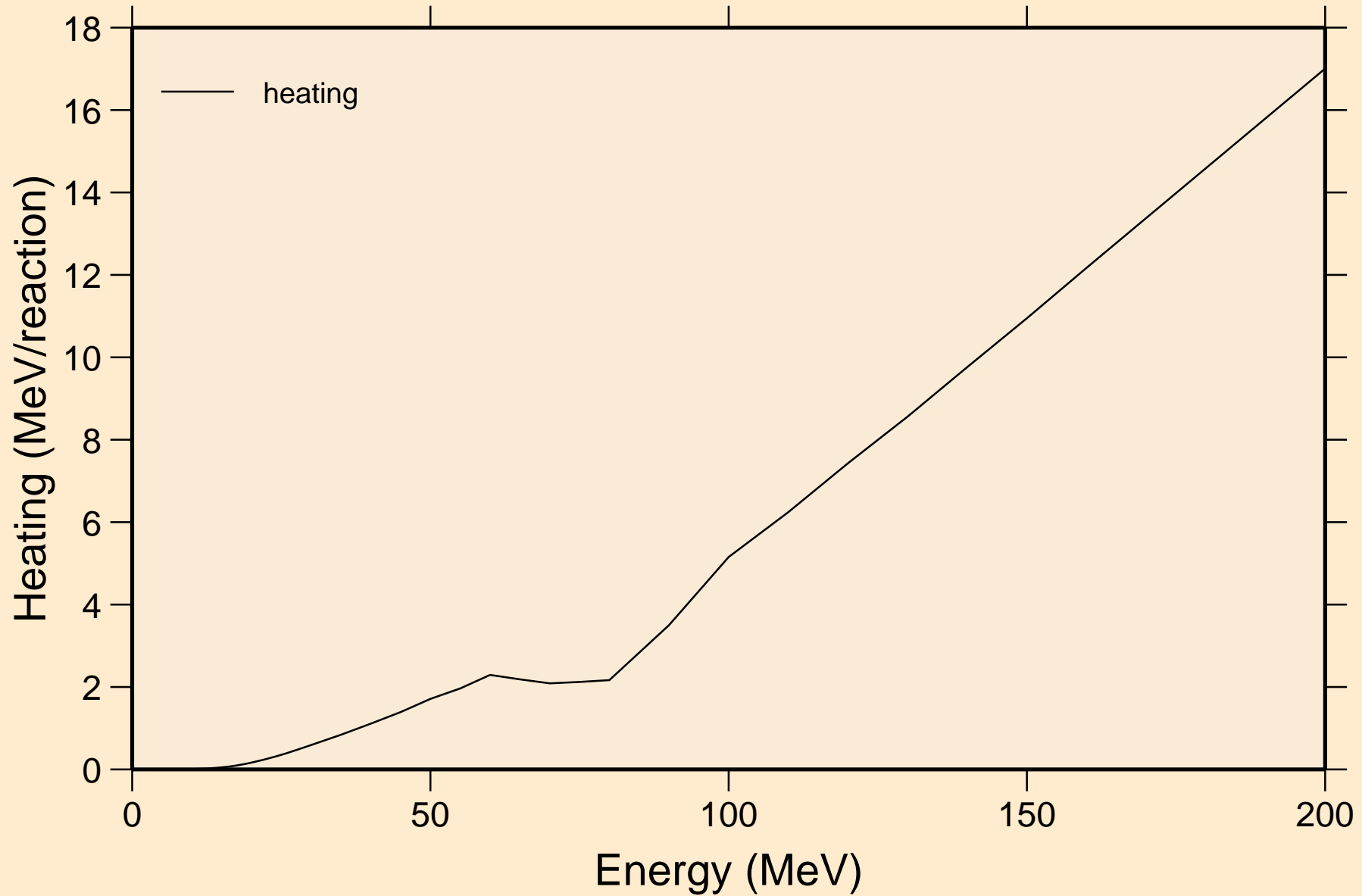

# SC048 PROTON ACER TENDL-2024 LIBRARY; T=0.K

## Threshold reactions

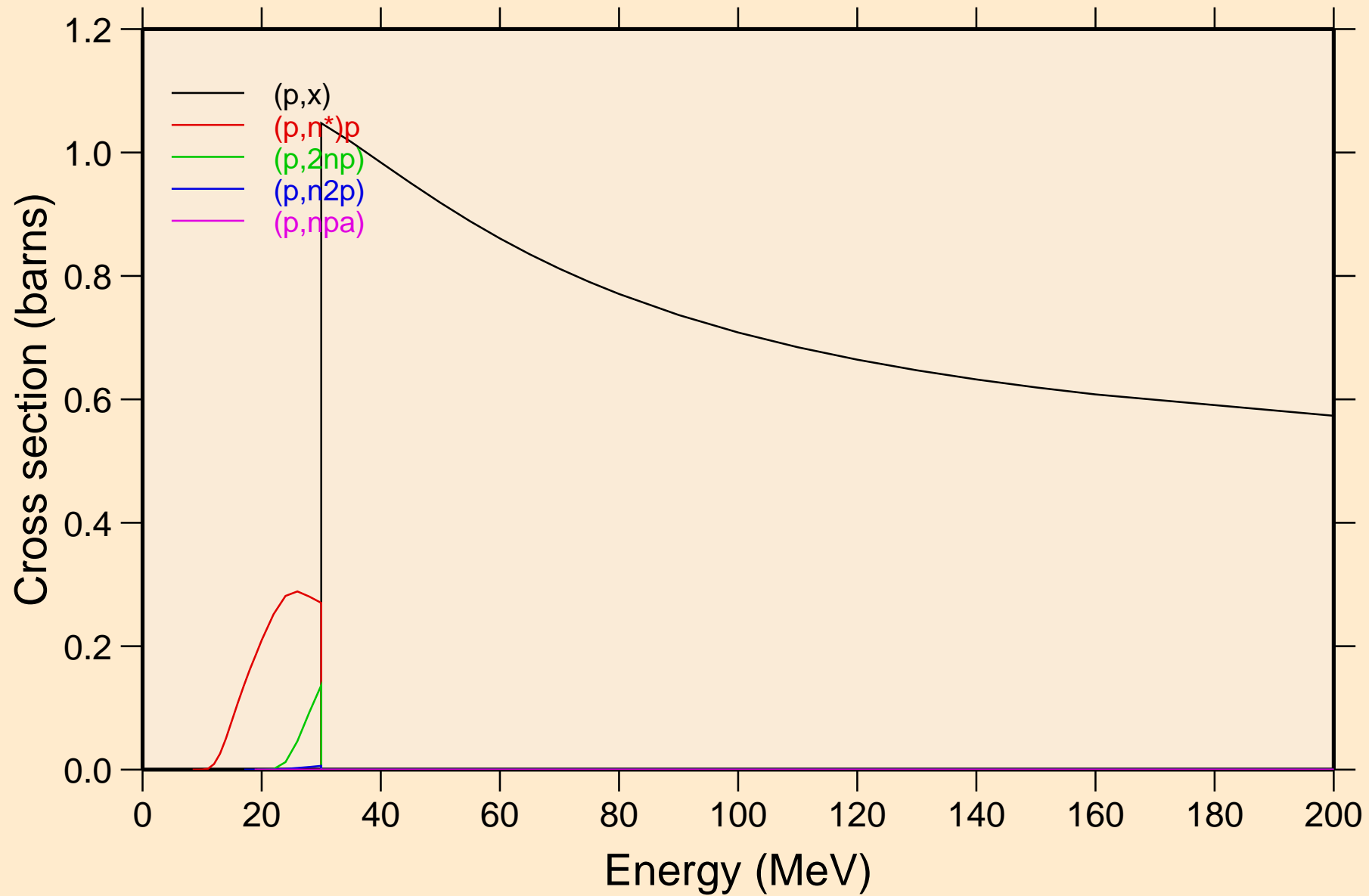

# SC048 PROTON ACER TENDL-2024 LIBRARY; T=0.K

## Threshold reactions

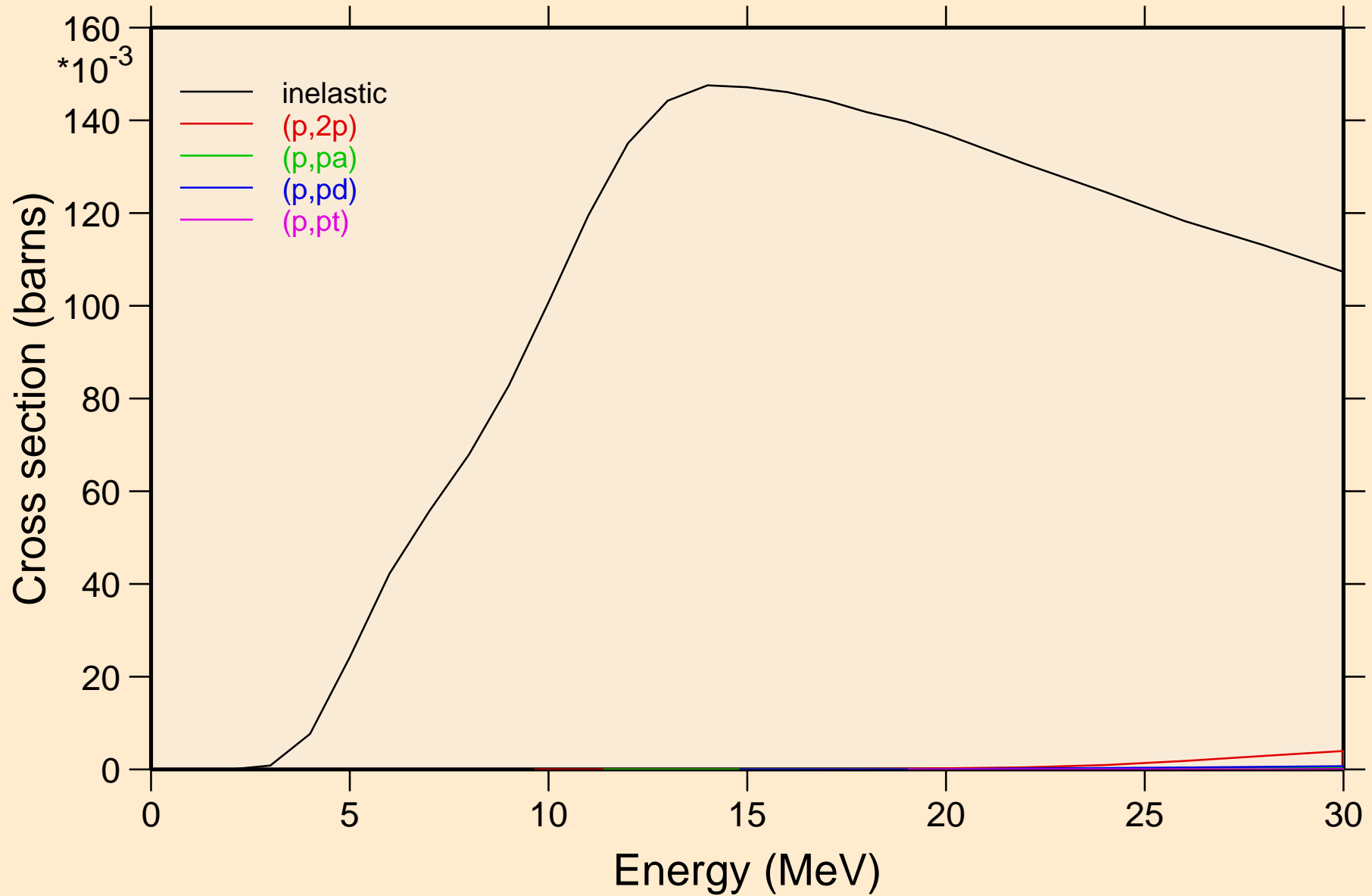

SC048 PROTON ACER TENDL-2024 LIBRARY; T=0.K  
Threshold reactions

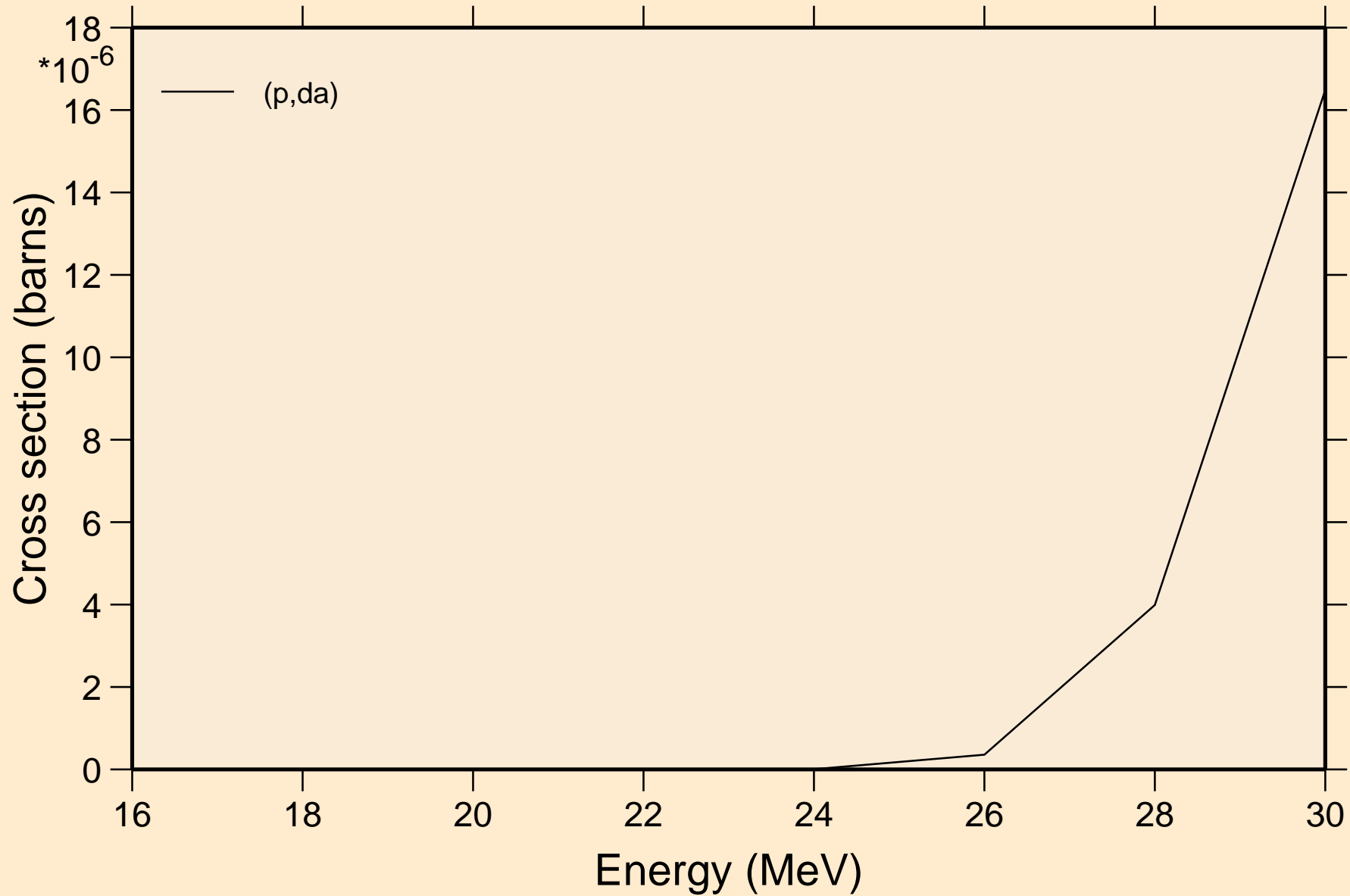

SC048 PROTON ACER TENDL-2024 LIBRARY; T=0.K  
angular distribution for elastic

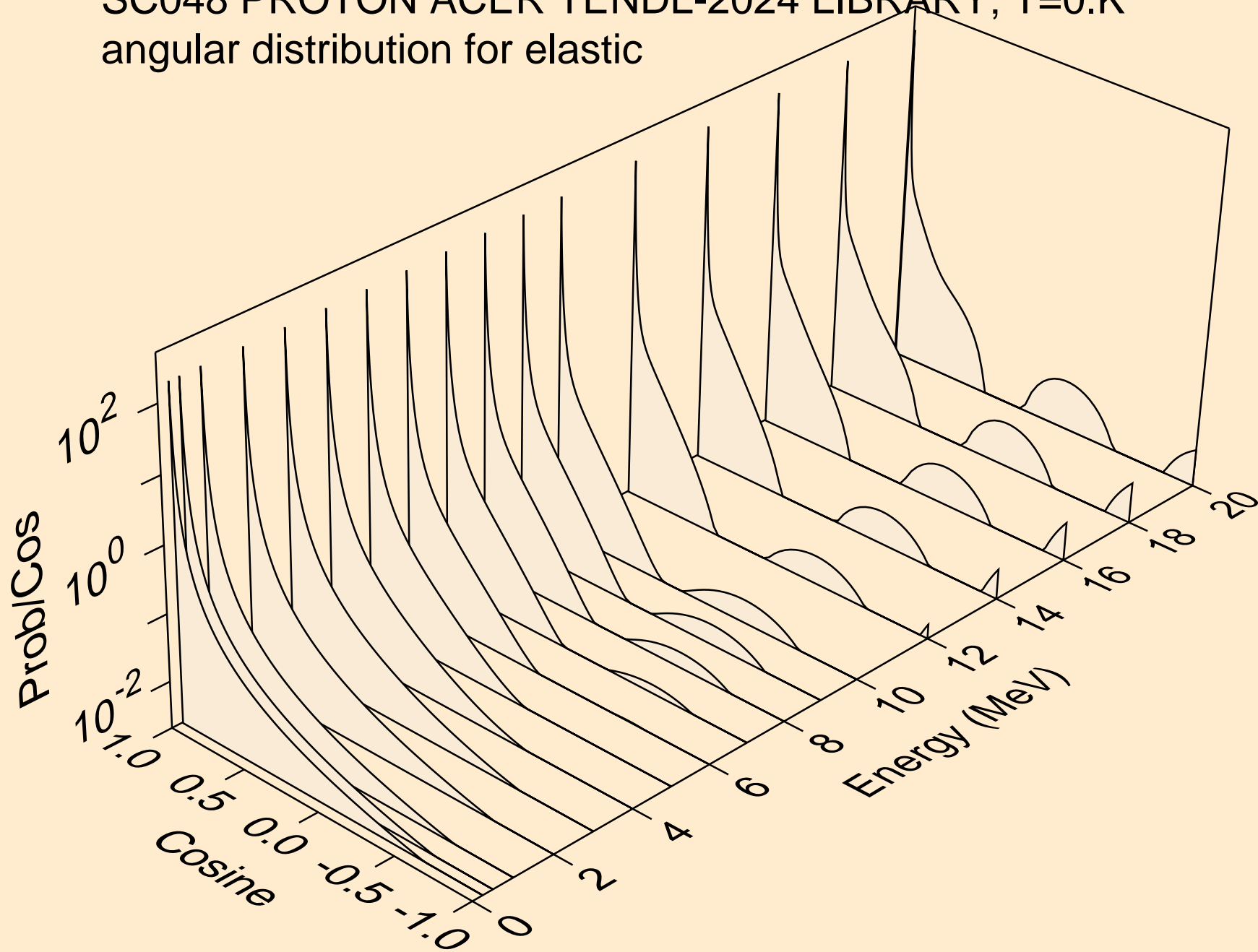

SC048 PROTON ACER TENDL-2024 LIBRARY; T=0.K  
angular distribution for elastic

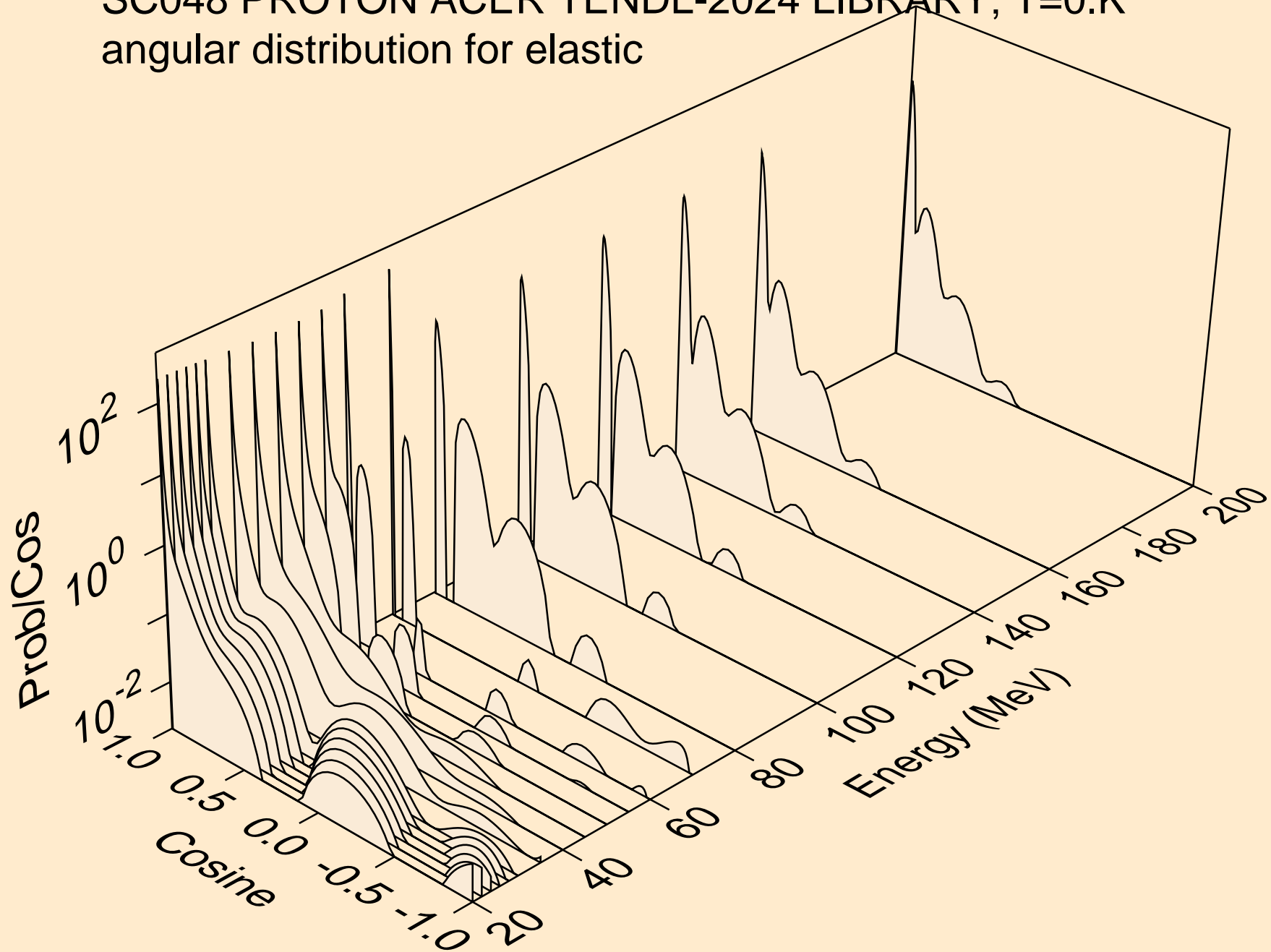

SC048 PROTON ACER TENDL-2024 LIBRARY; T=0.K  
Proton emission for (p,x)

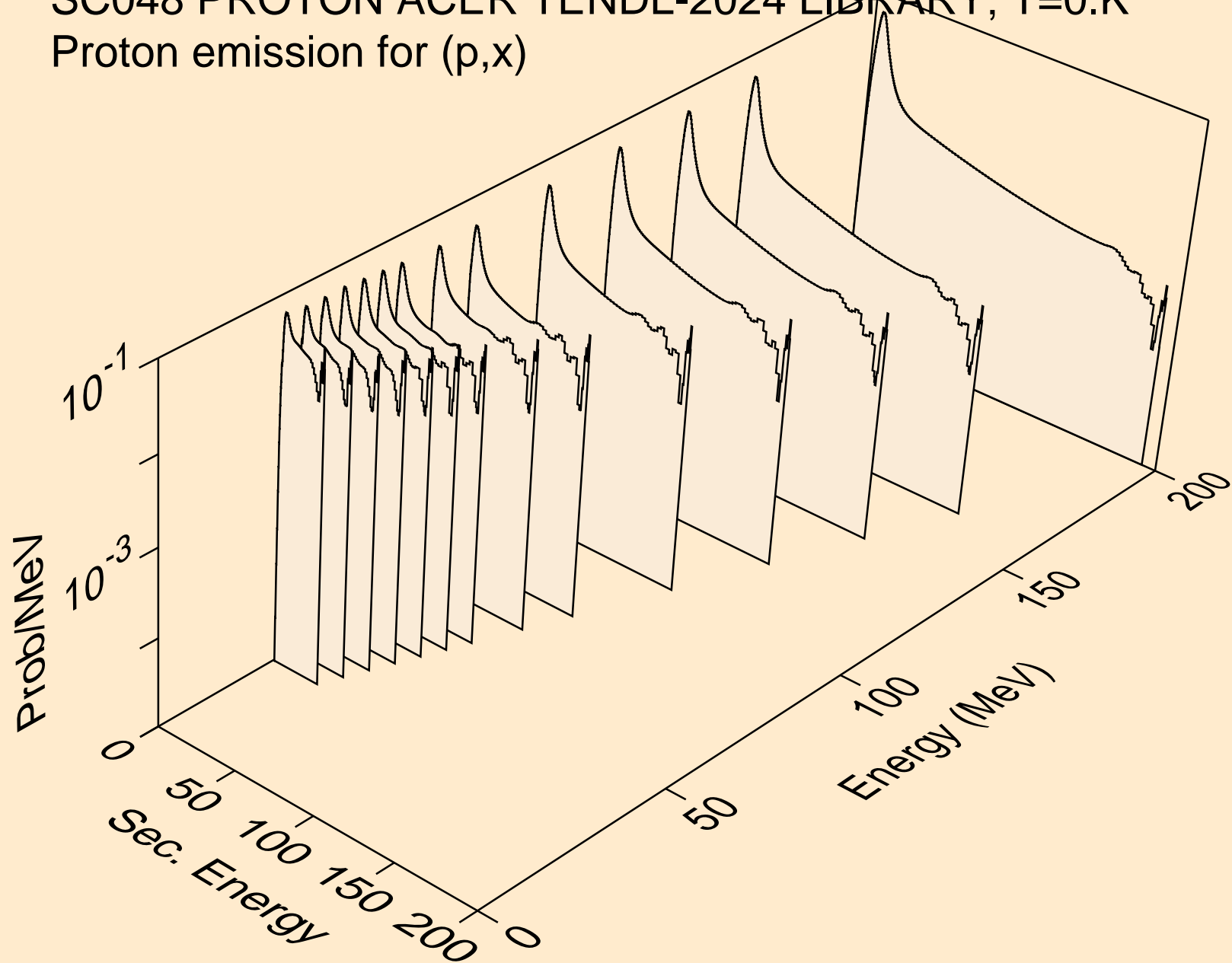

SC048 PROTON ACER TENDL-2024 LIBRARY; T=0.K  
Proton emission for (p,n\*)p

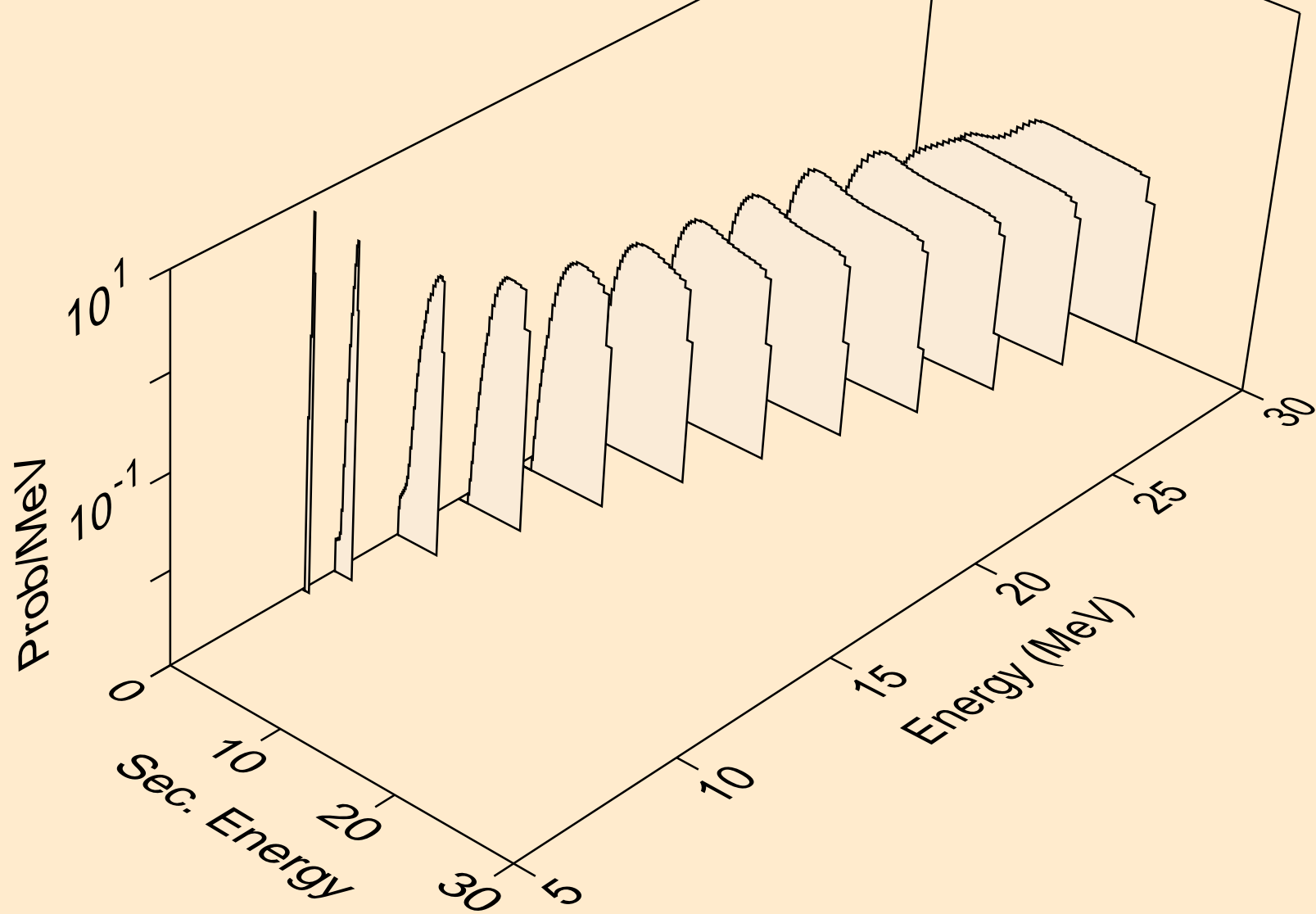

SC048 PROTON ACER TENDL-2024 LIBRARY; T=0.K  
Proton emission for (p,2np)

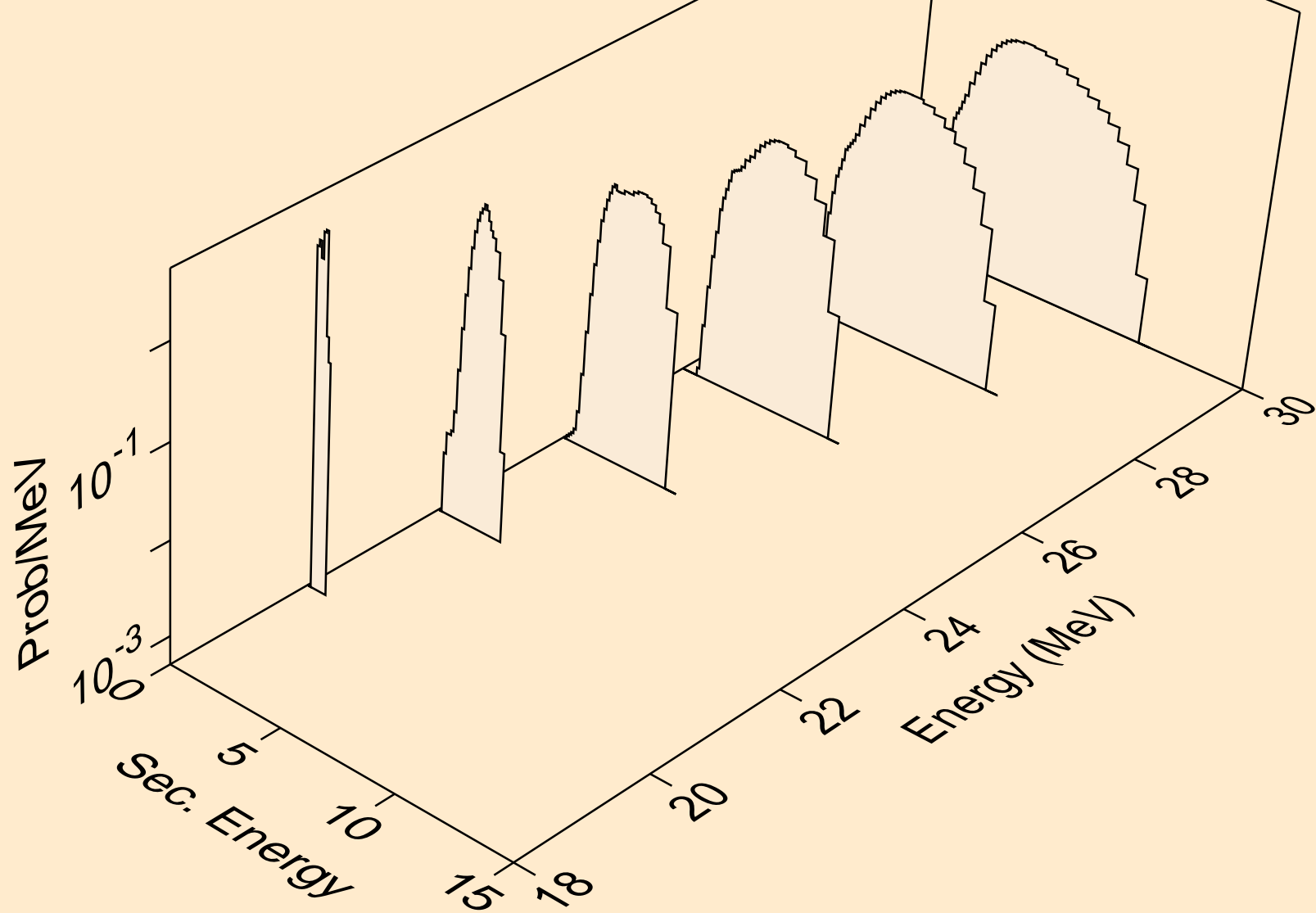

SC048 PROTON ACER TENDL-2024 LIBRARY; T=0.K  
Proton emission for (p,n2p)

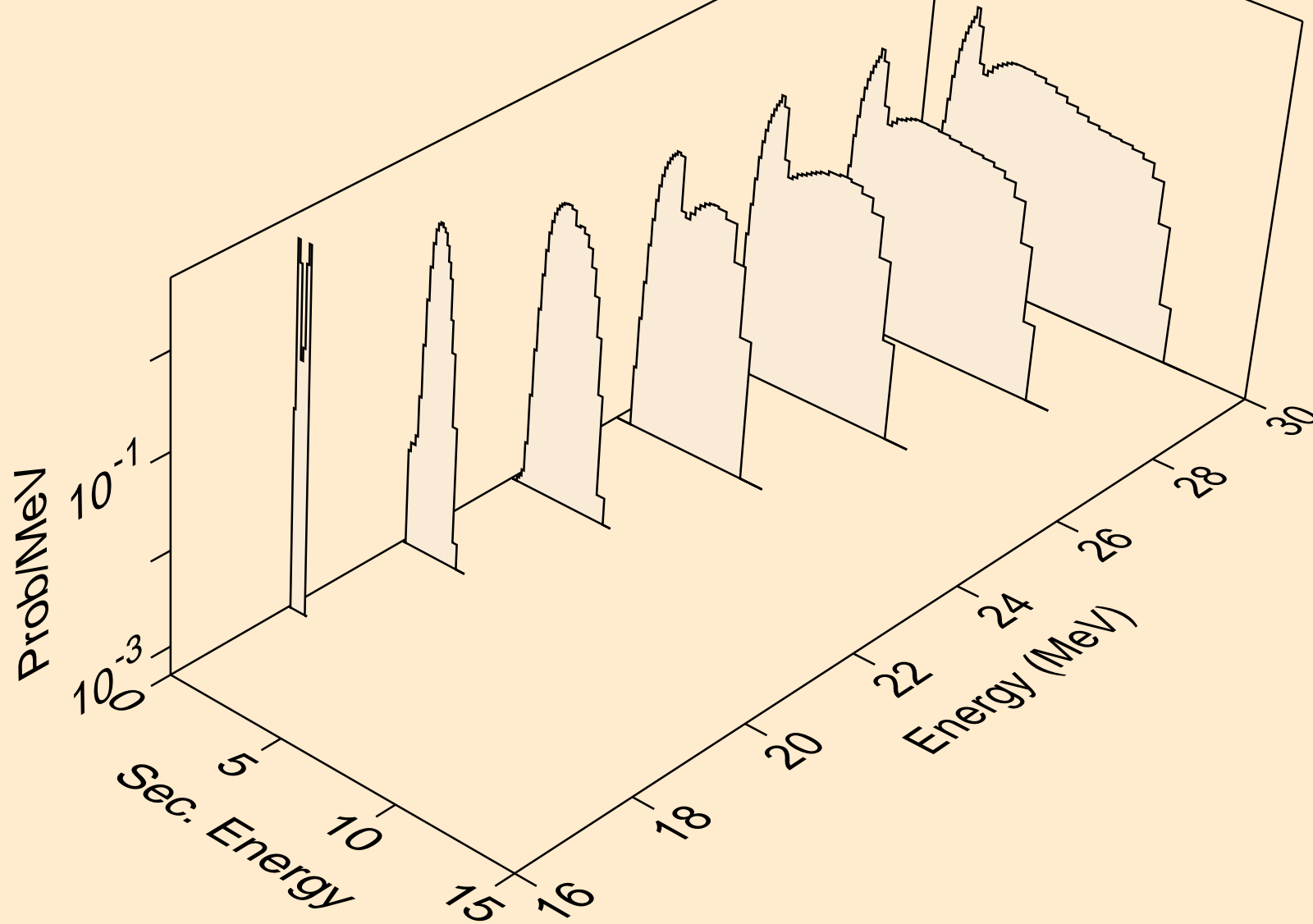

SC048 PROTON ACER TENDL-2024 LIBRARY; T=0.K  
Proton emission for (p,npa)

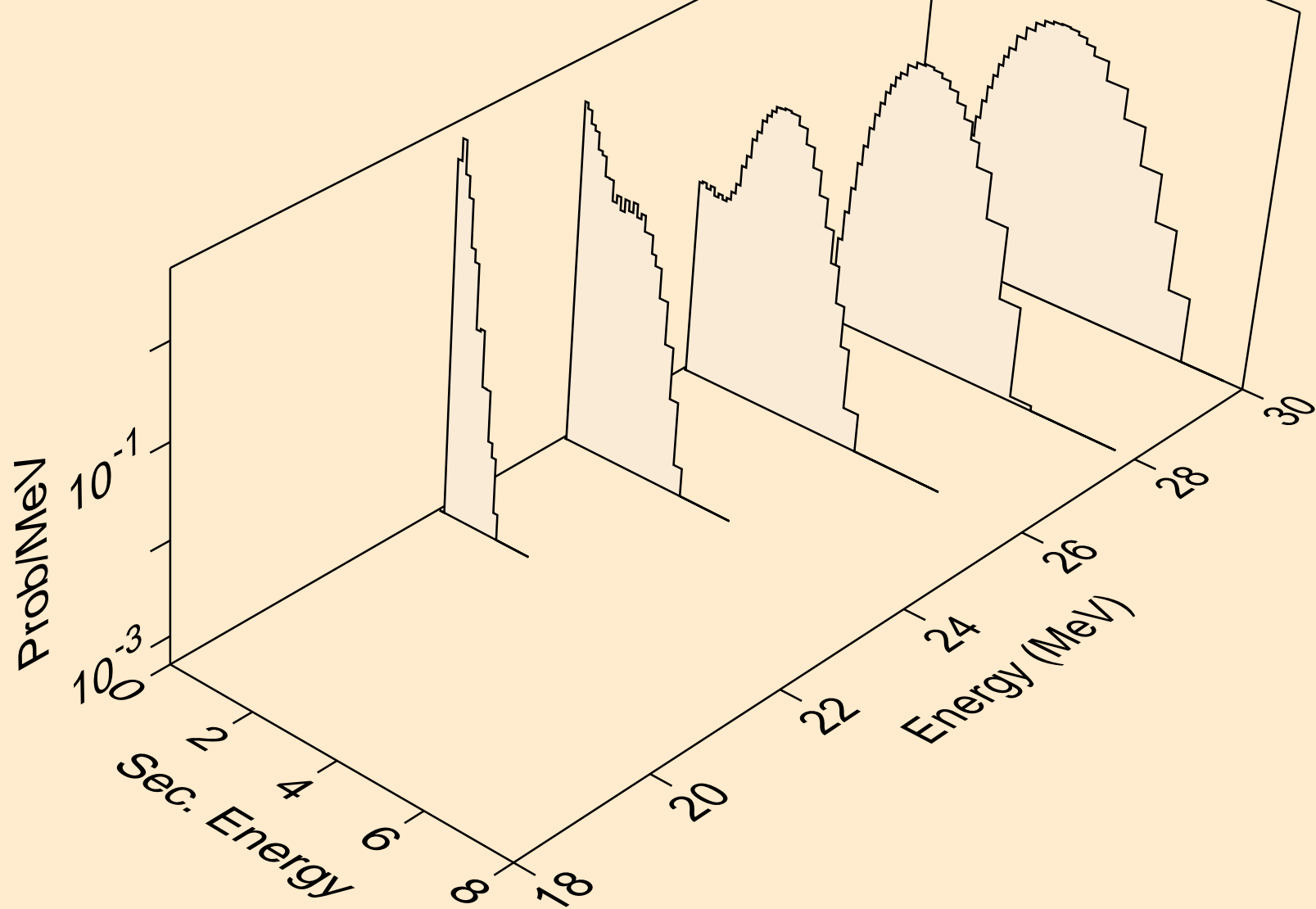

SC048 PROTON ACER TENDL-2024 LIBRARY; T=0.K  
Proton emission for inelastic

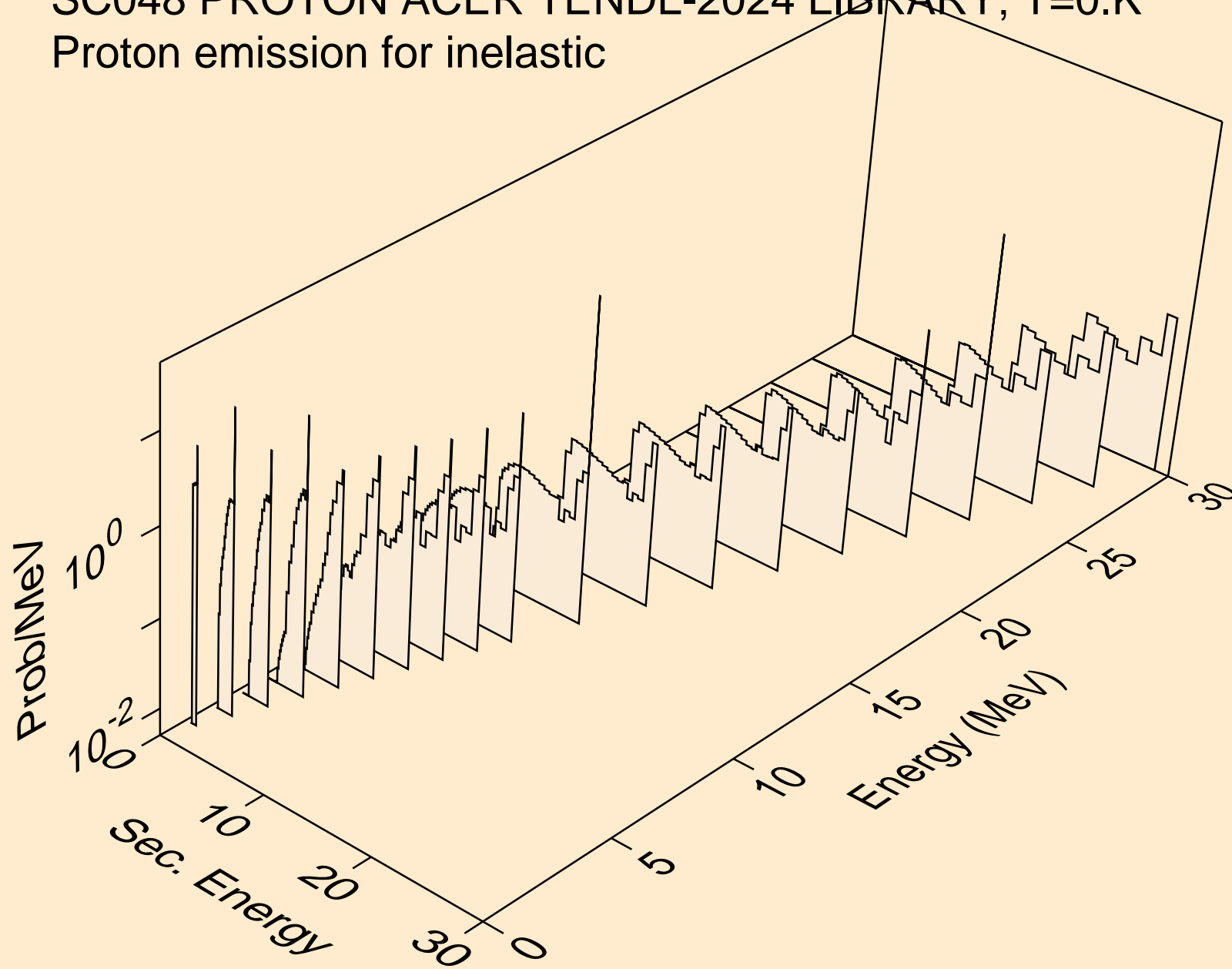

SC048 PROTON ACER TENDL-2024 LIBRARY; T=0.K  
Proton emission for (p,2p)

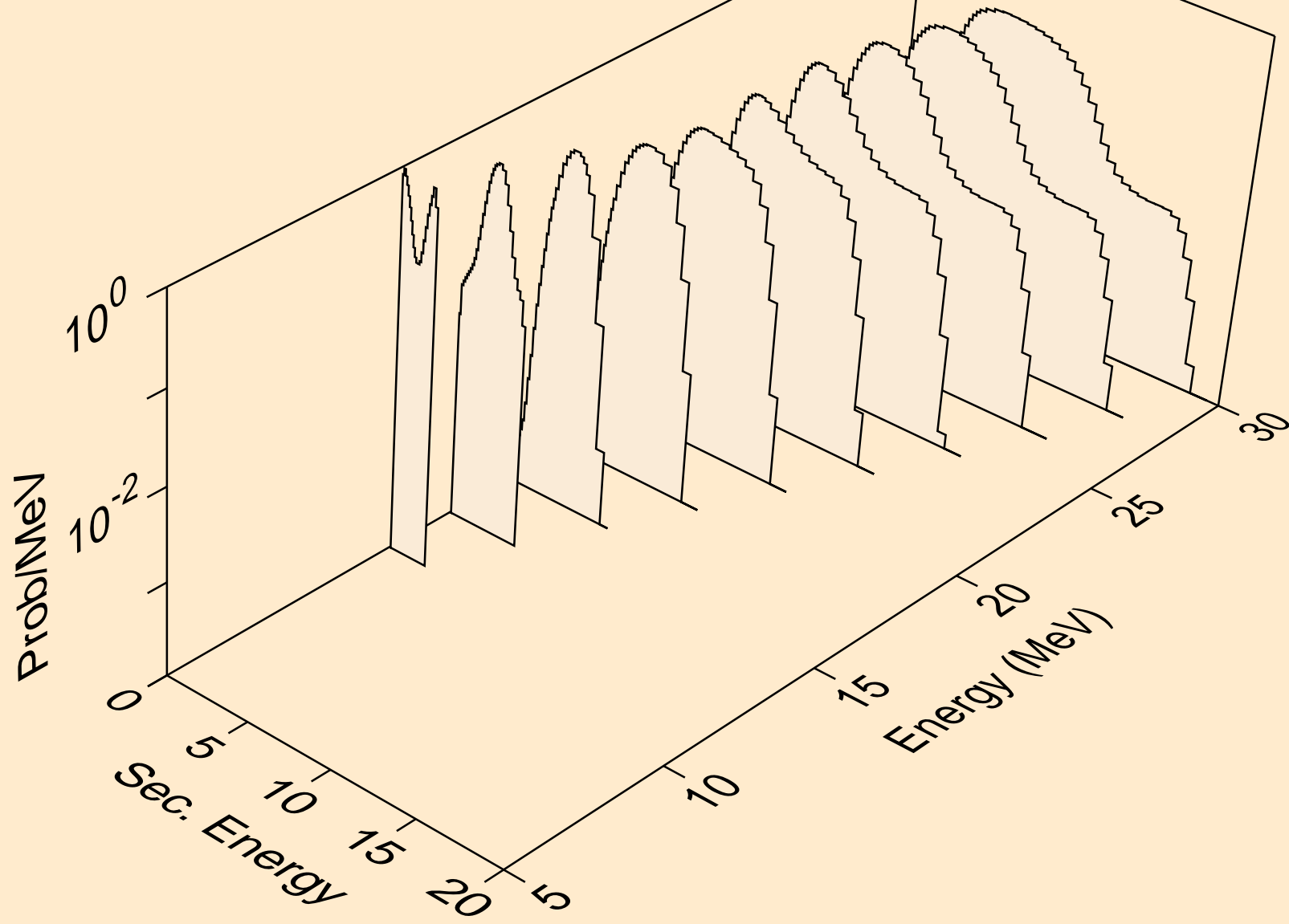

SC048 PROTON ACER TENDL-2024 LIBRARY; T=0.K  
Proton emission for (p,pa)

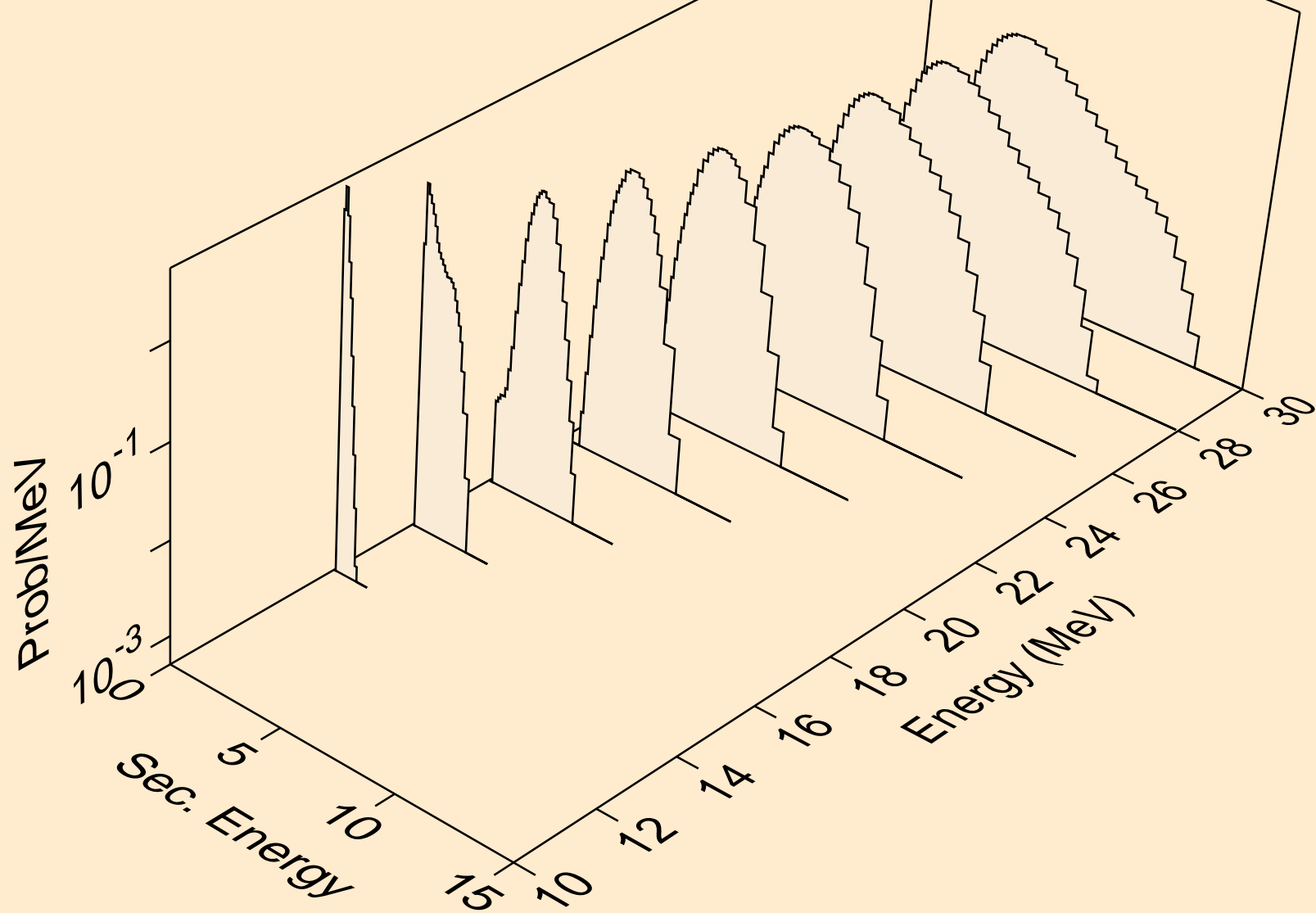

SC048 PROTON ACER TENDL-2024 LIBRARY; T=0.K  
Proton emission for (p,pd)

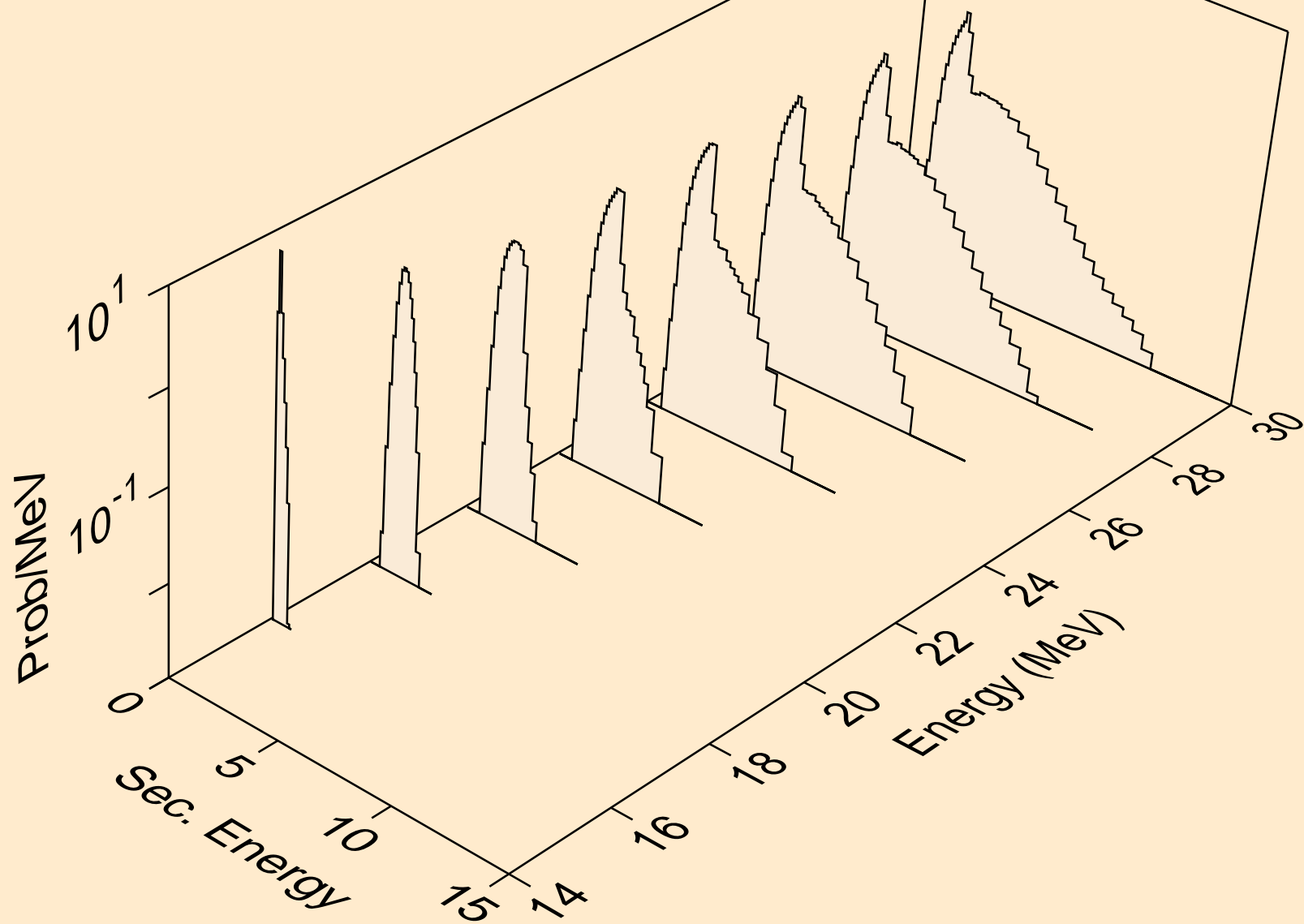

SC048 PROTON ACER TENDL-2024 LIBRARY; T=0.K  
Proton emission for (p,pt)

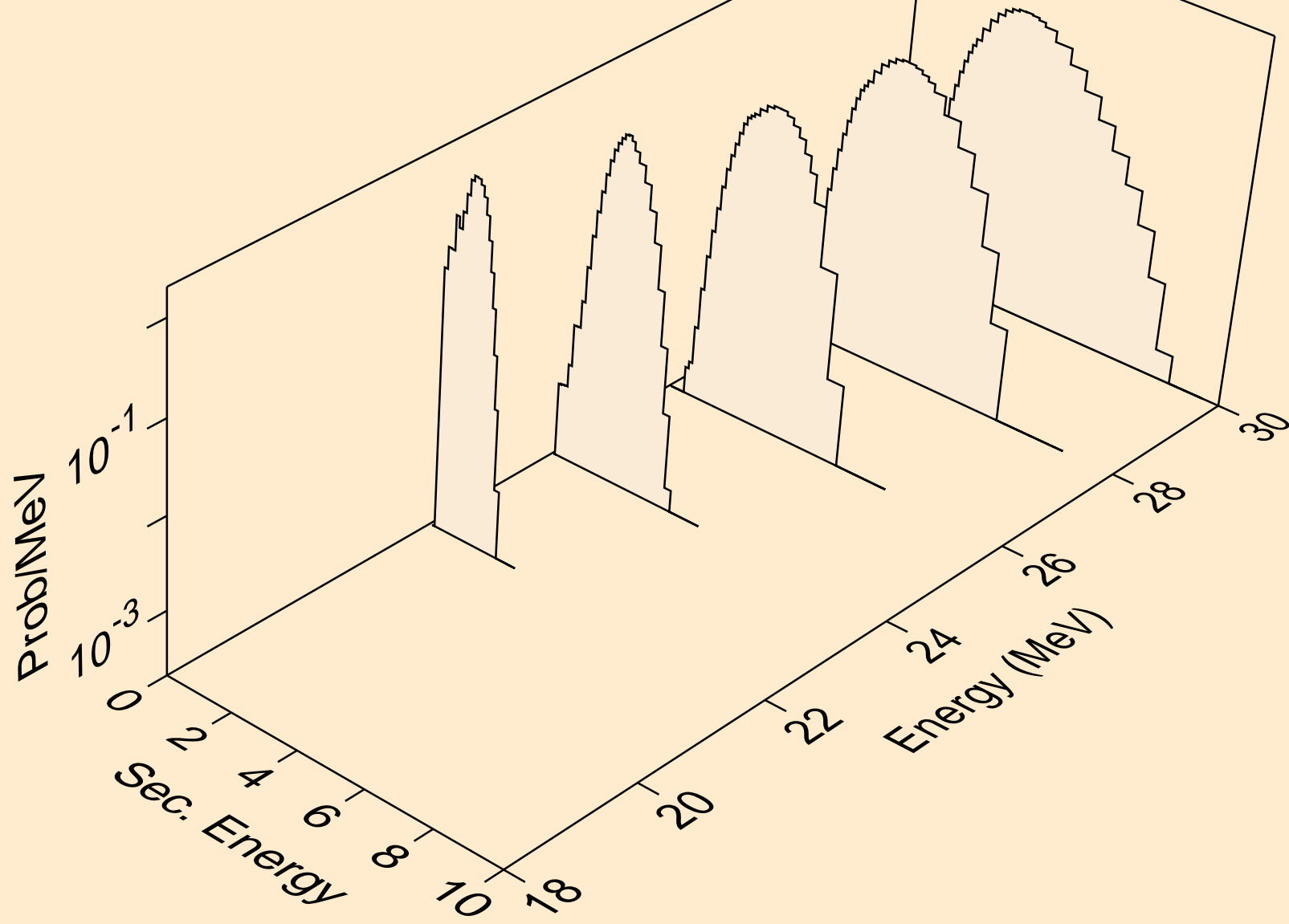

SC048 PROTON ACER TENDL-2024 LIBRARY; T=0.K  
Photon emission for (z,n)

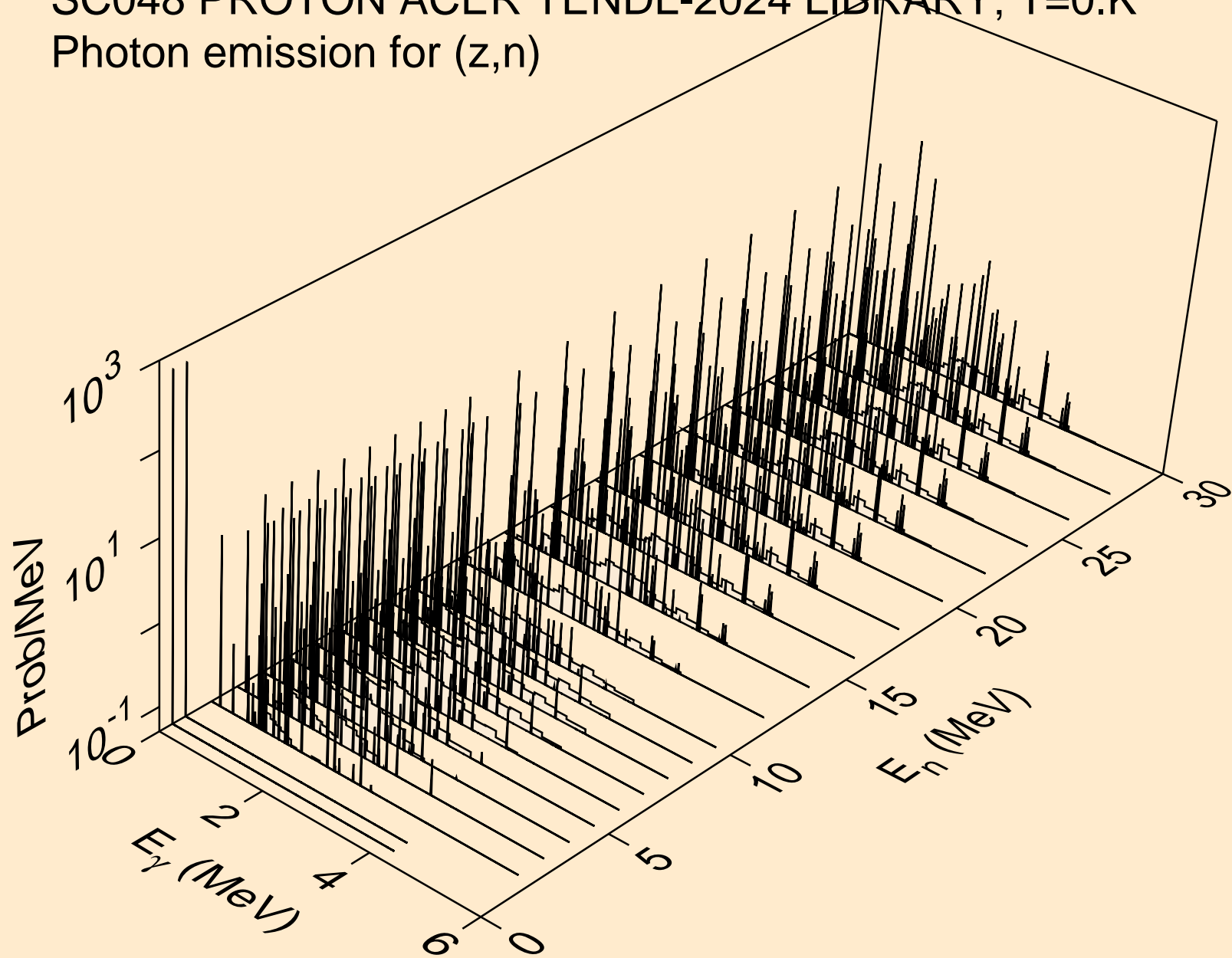

SC048 PROTON ACER TENDL-2024 LIBRARY; T=0.K  
Photon emission for (z,x)

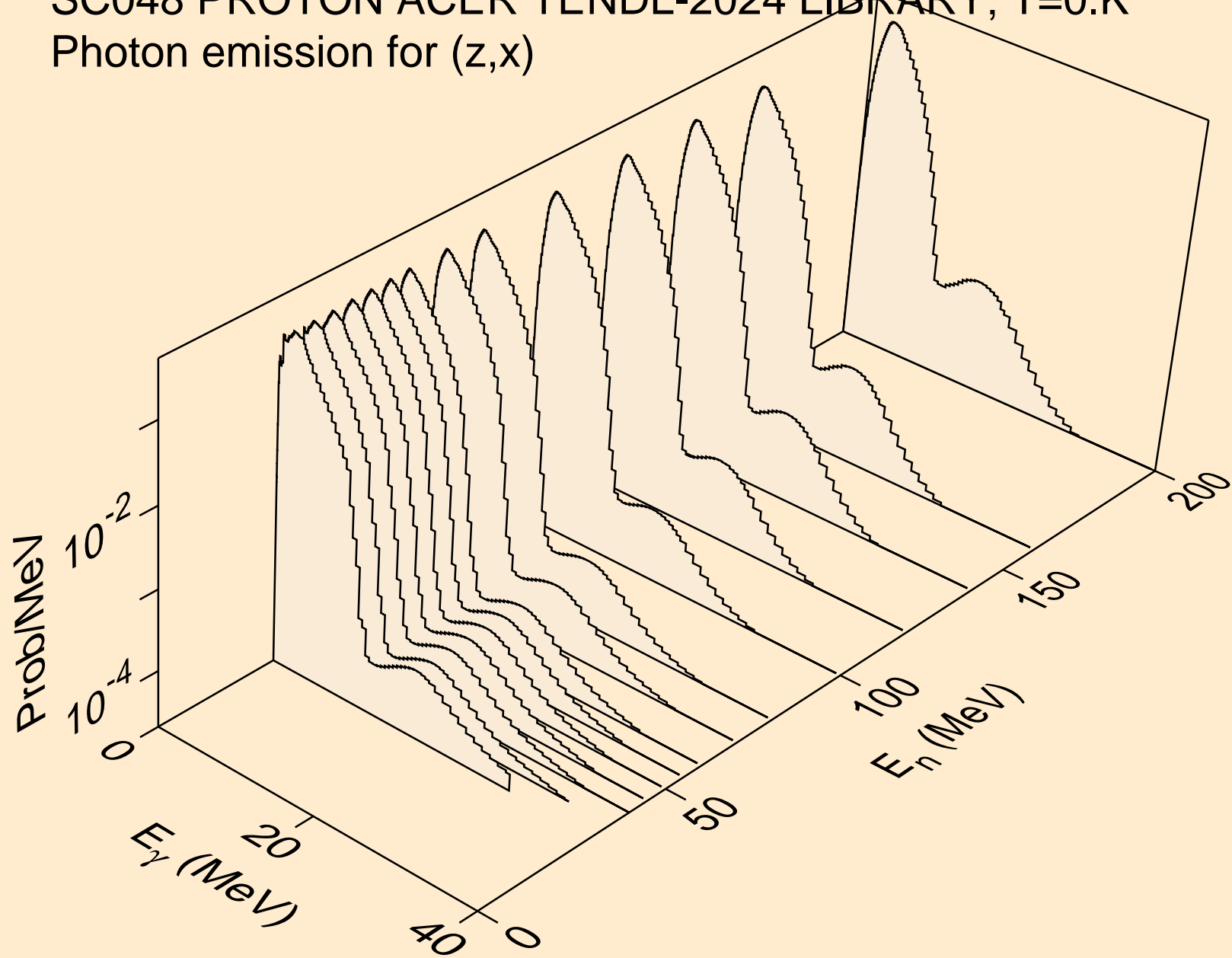

SC048 PROTON ACER TENDL-2024 LIBRARY; T=0.K  
Photon emission for (n,2nd)

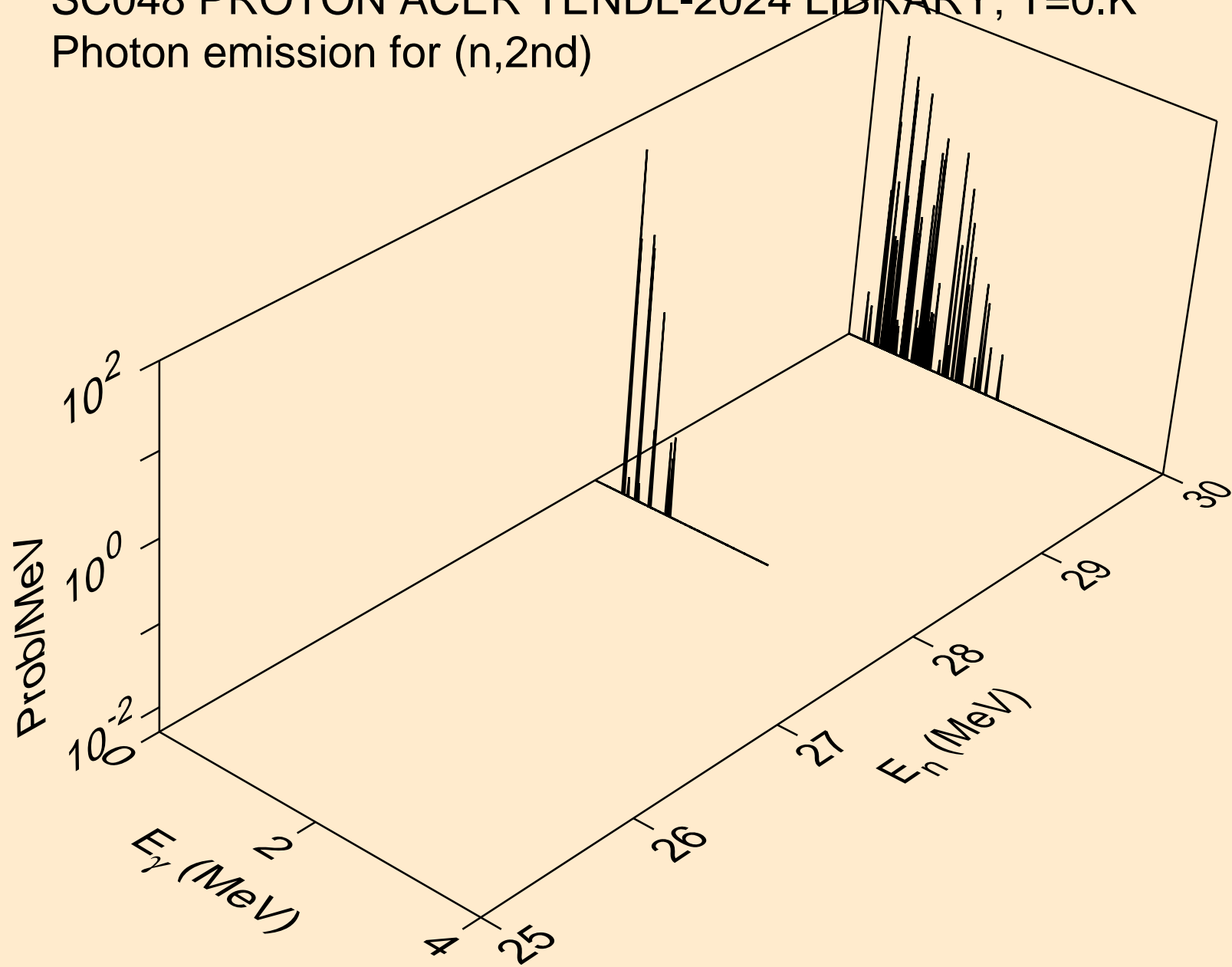

SC048 PROTON ACER TENDL-2024 LIBRARY; T=0.K  
Photon emission for (n,2n)

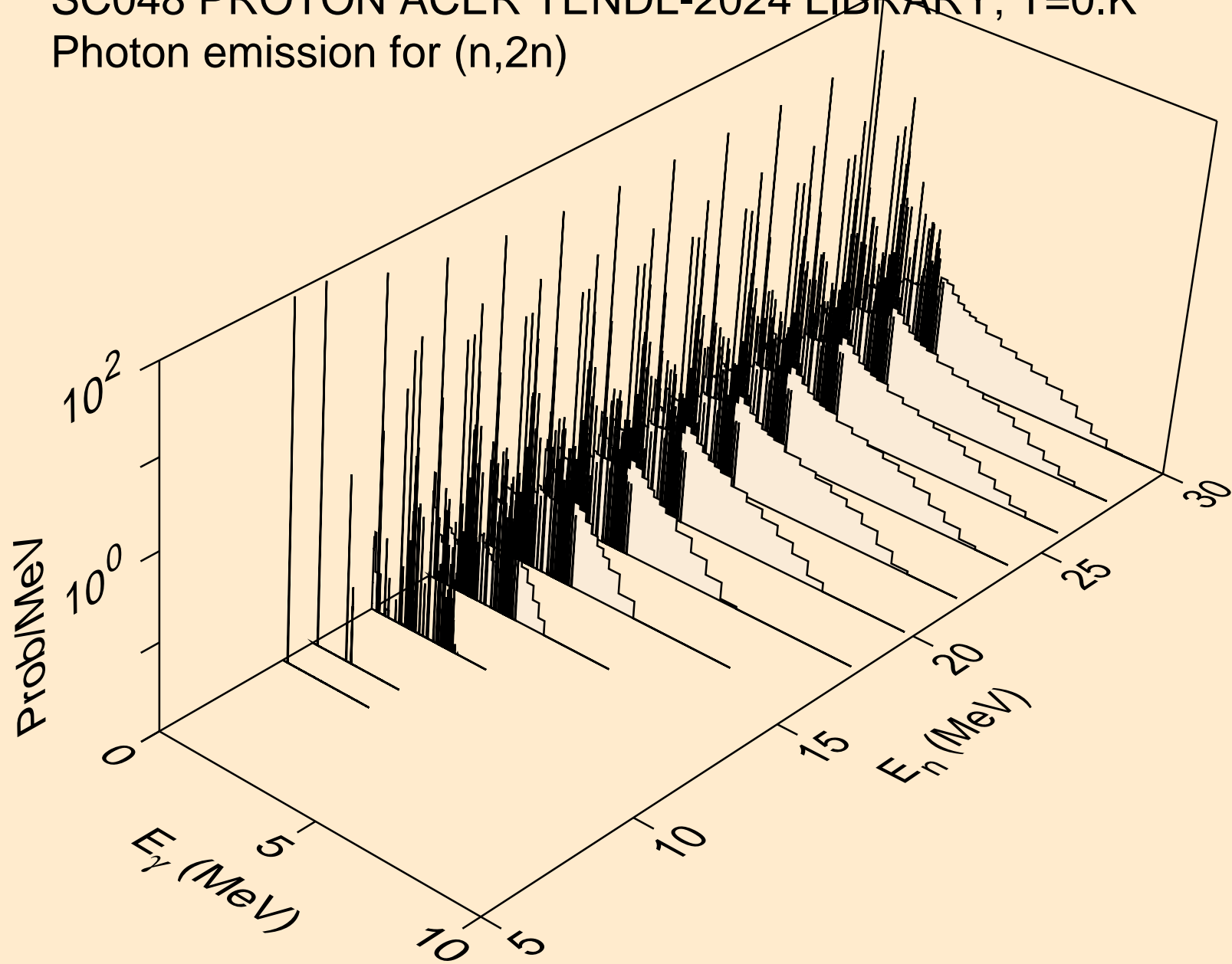

SC048 PROTON ACER TENDL-2024 LIBRARY; T=0.K  
Photon emission for (n,3n)

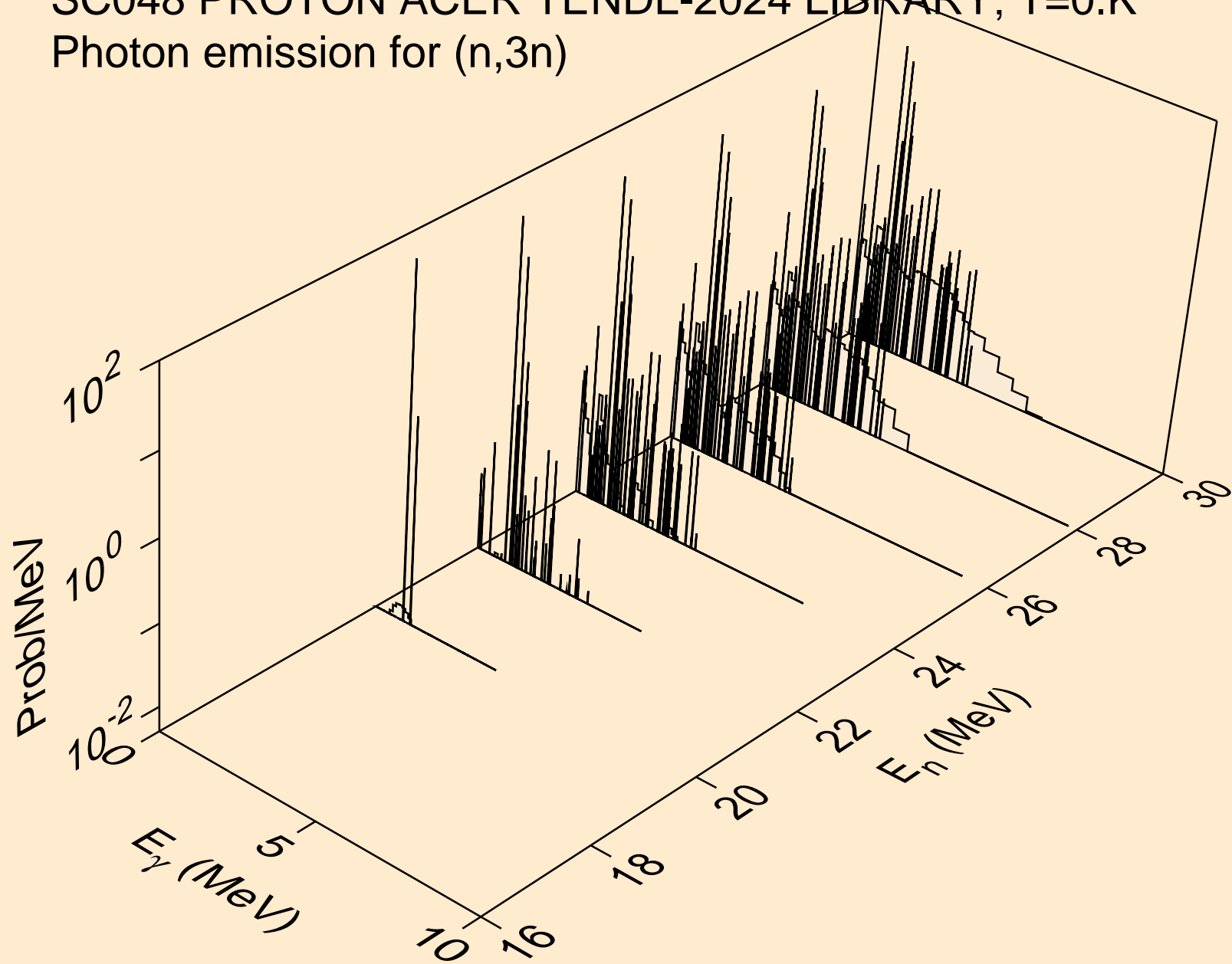

SC048 PROTON ACER TENDL-2024 LIBRARY; T=0.K  
Photon emission for (n,n\*)a

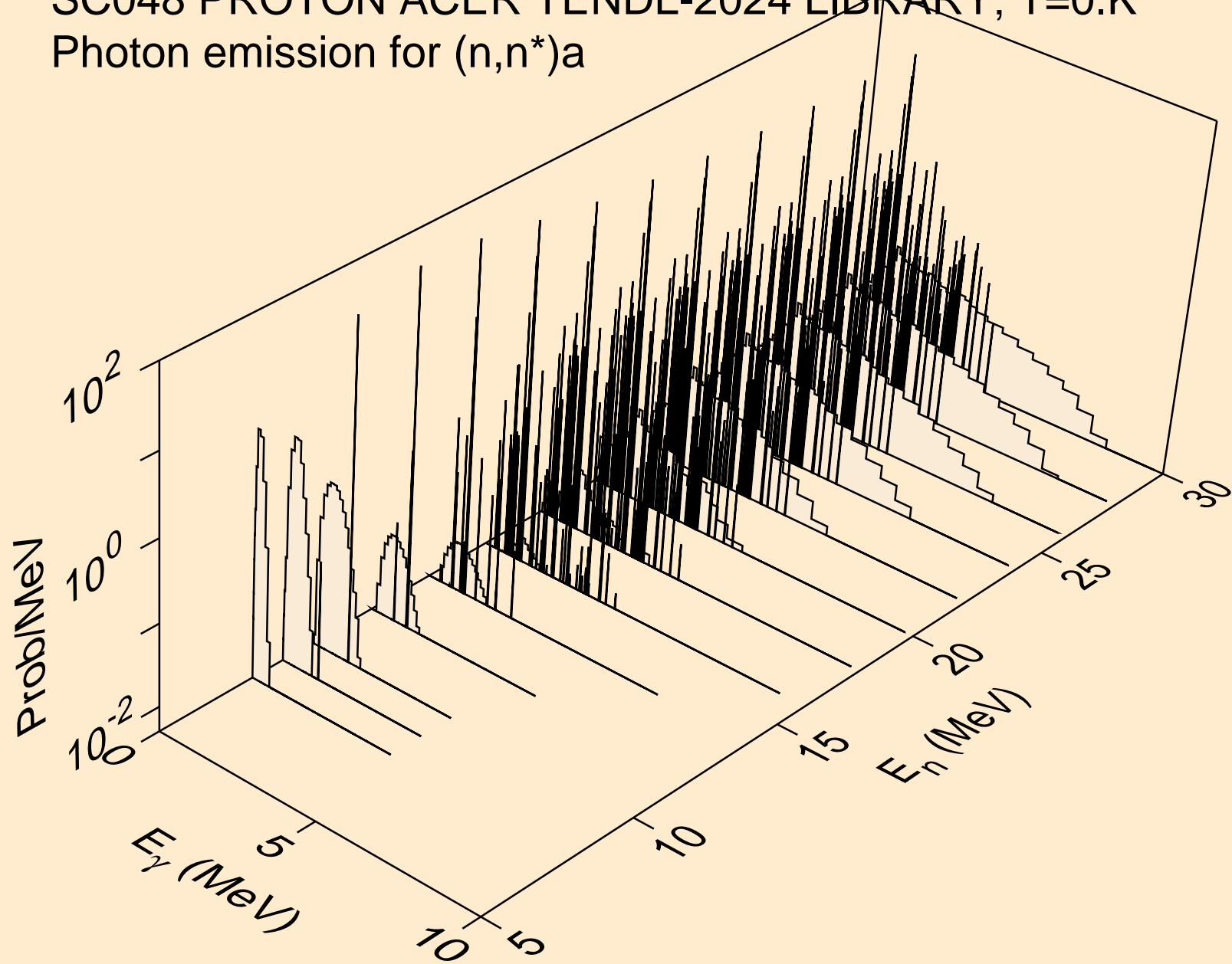

SC048 PROTON ACER TENDL-2024 LIBRARY; T=0.K  
Photon emission for (n,2n)a

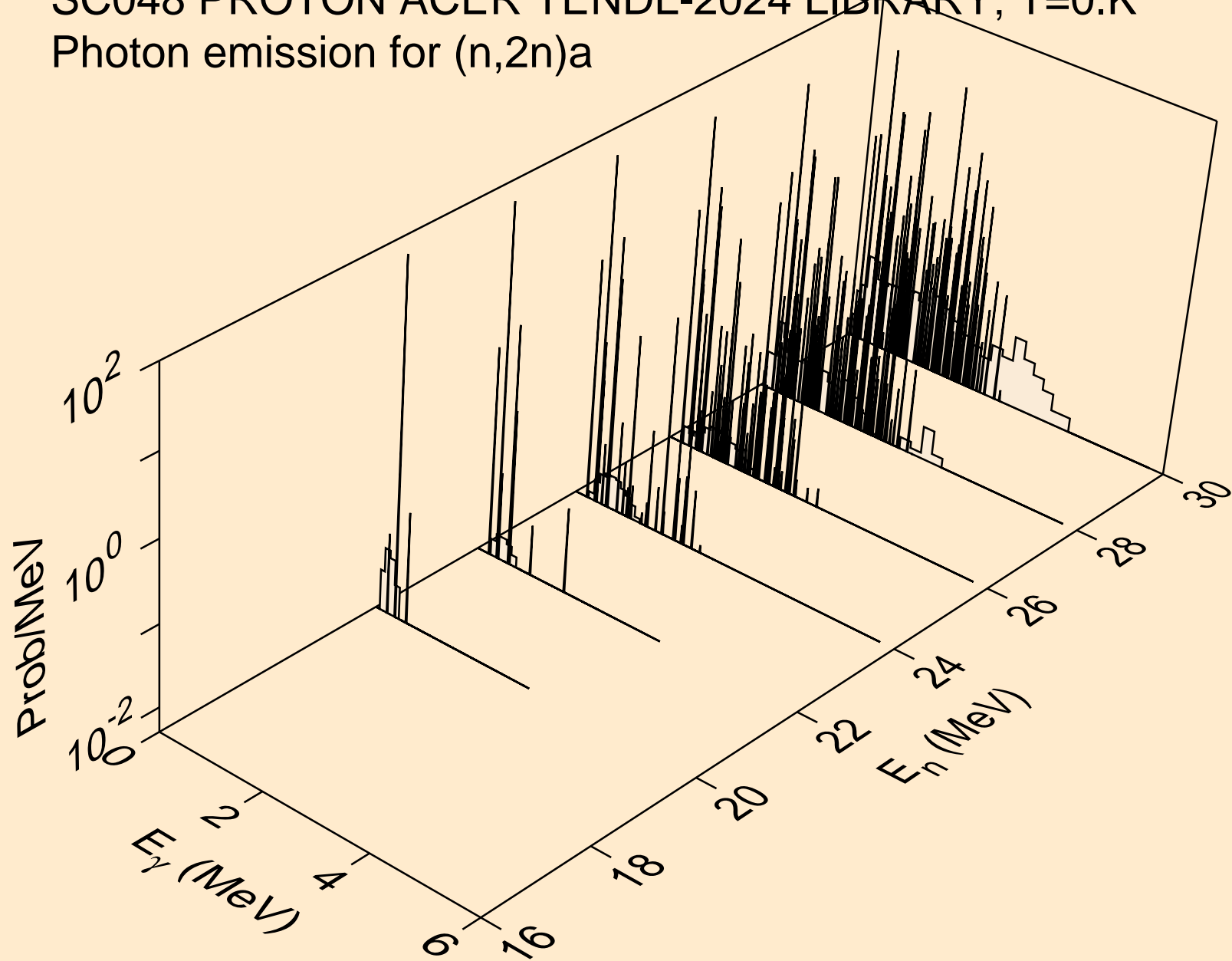

SC048 PROTON ACER TENDL-2024 LIBRARY; T=0.K  
Photon emission for (n,3n)a

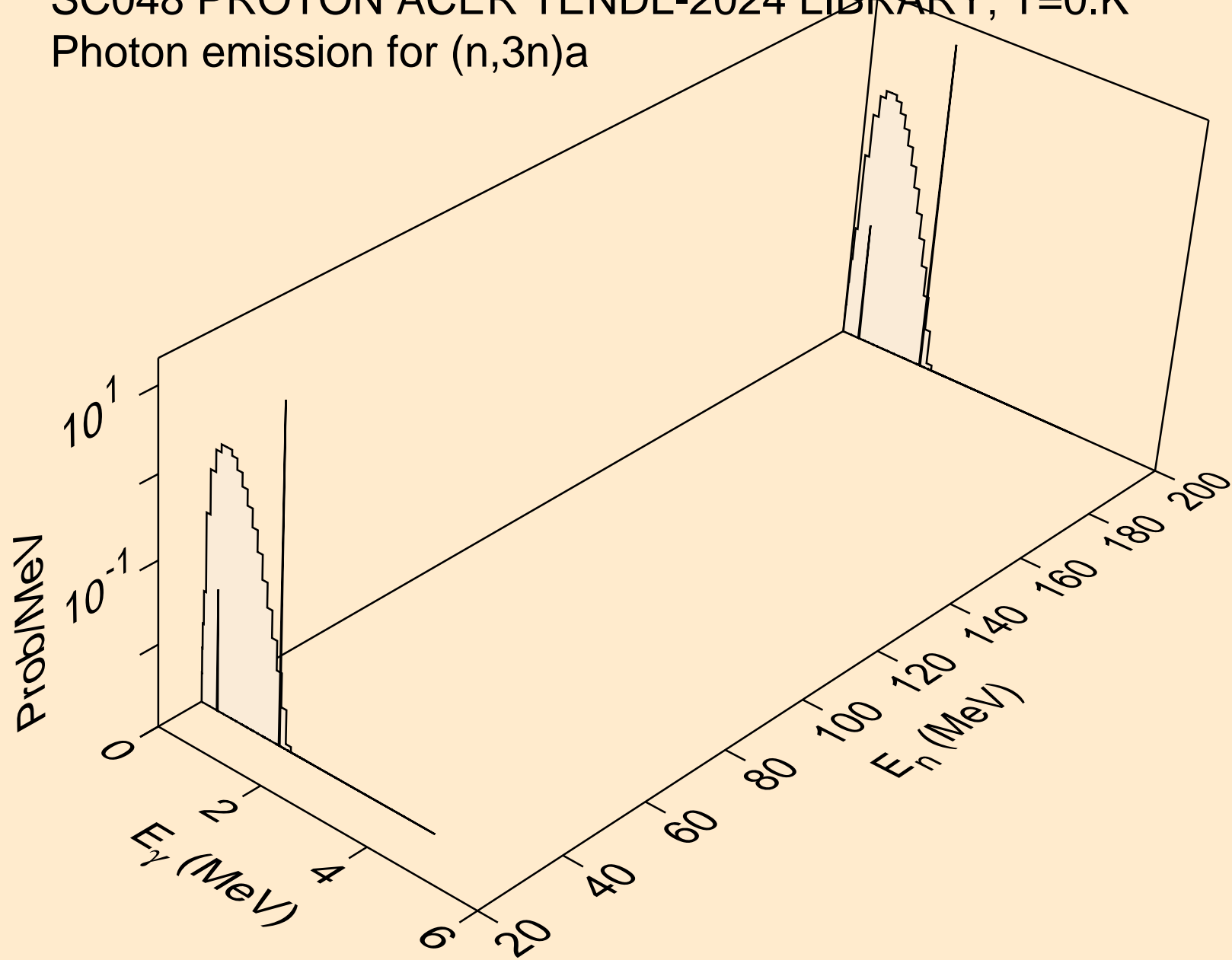

SC048 PROTON ACER TENDL-2024 LIBRARY; T=0.K  
Photon emission for (n,n\*)p

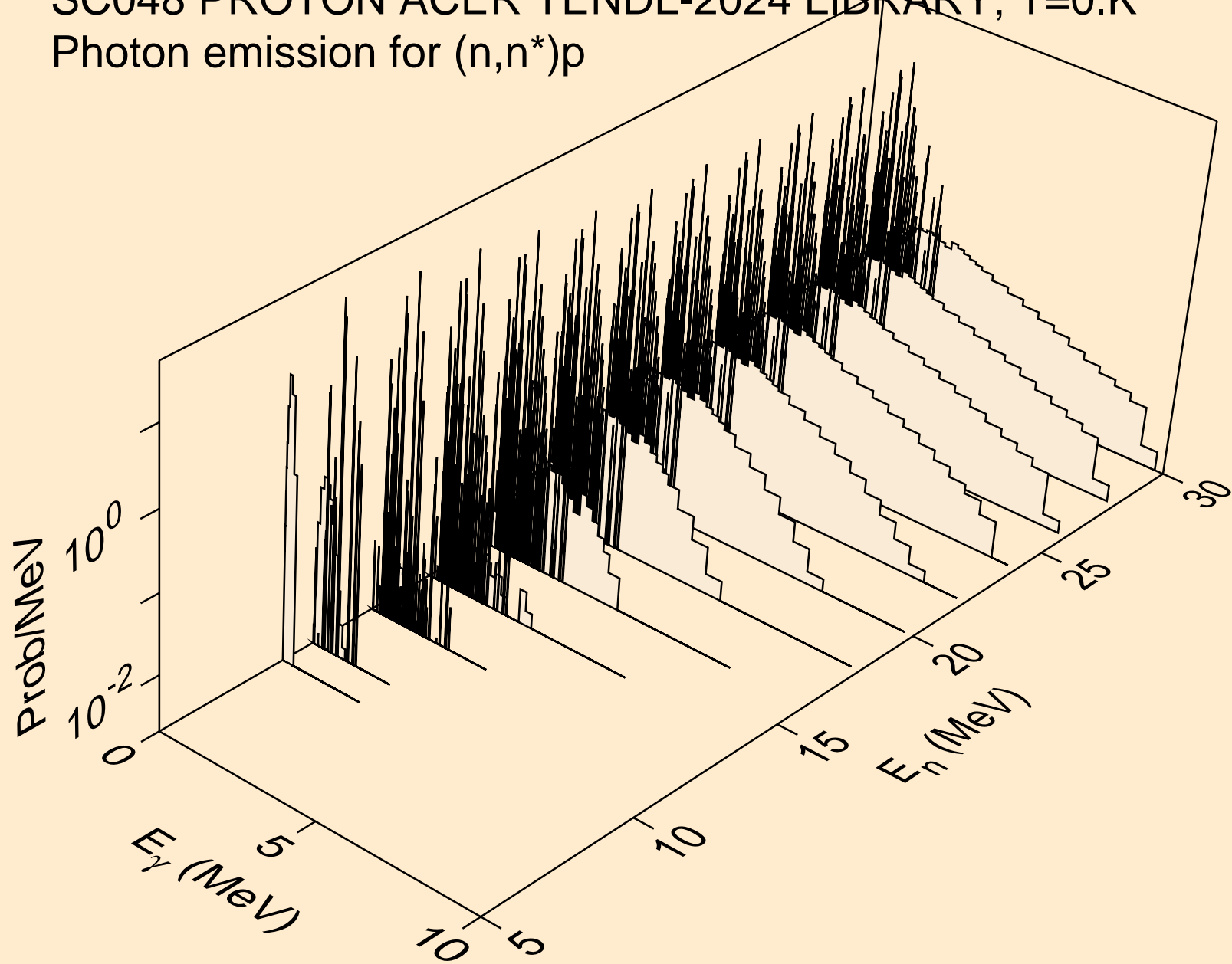

SC048 PROTON ACER TENDL-2024 LIBRARY; T=0.K  
Photon emission for (n,n\*)2a

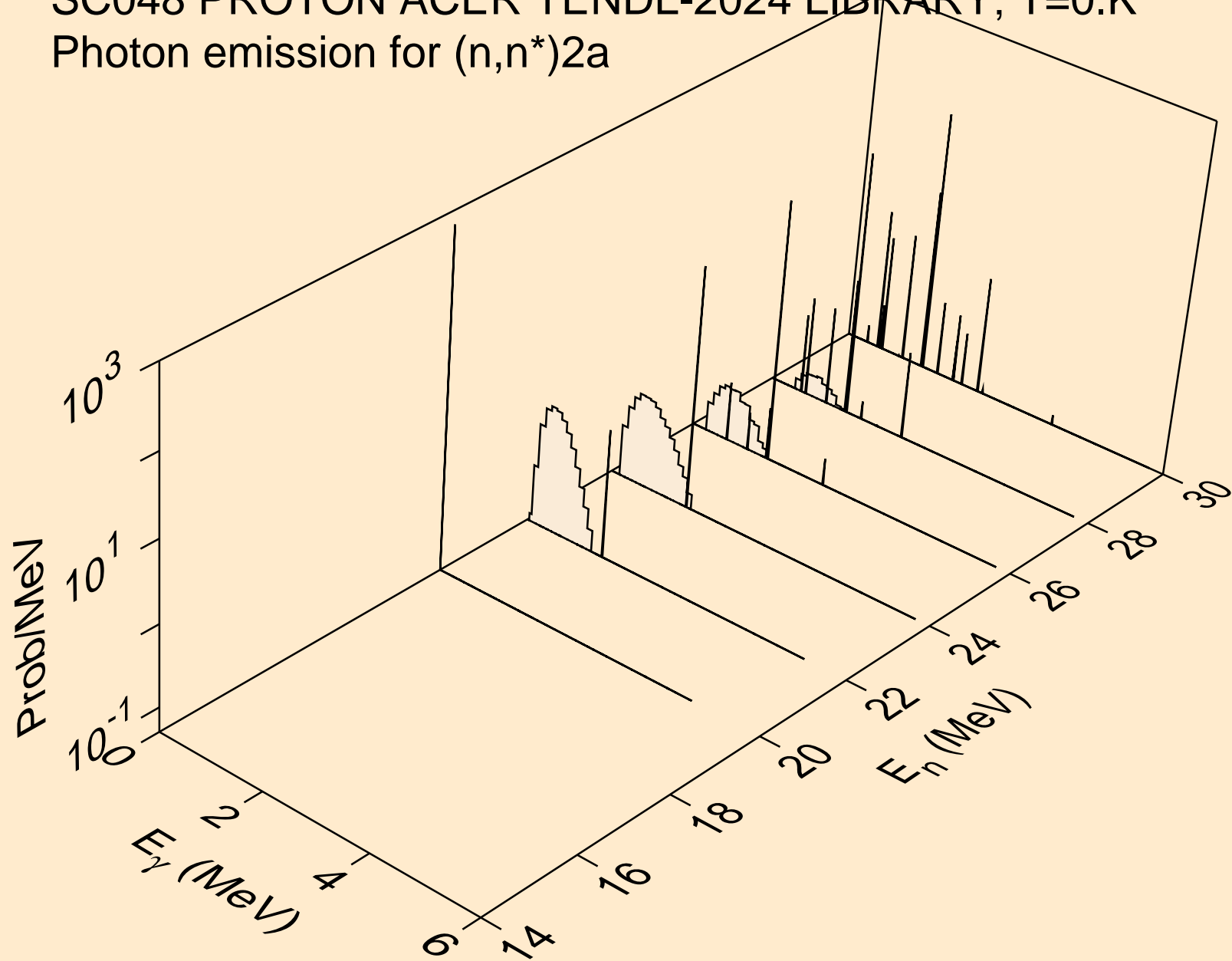

SC048 PROTON ACER TENDL-2024 LIBRARY; T=0.K  
Photon emission for (n,n\*)d

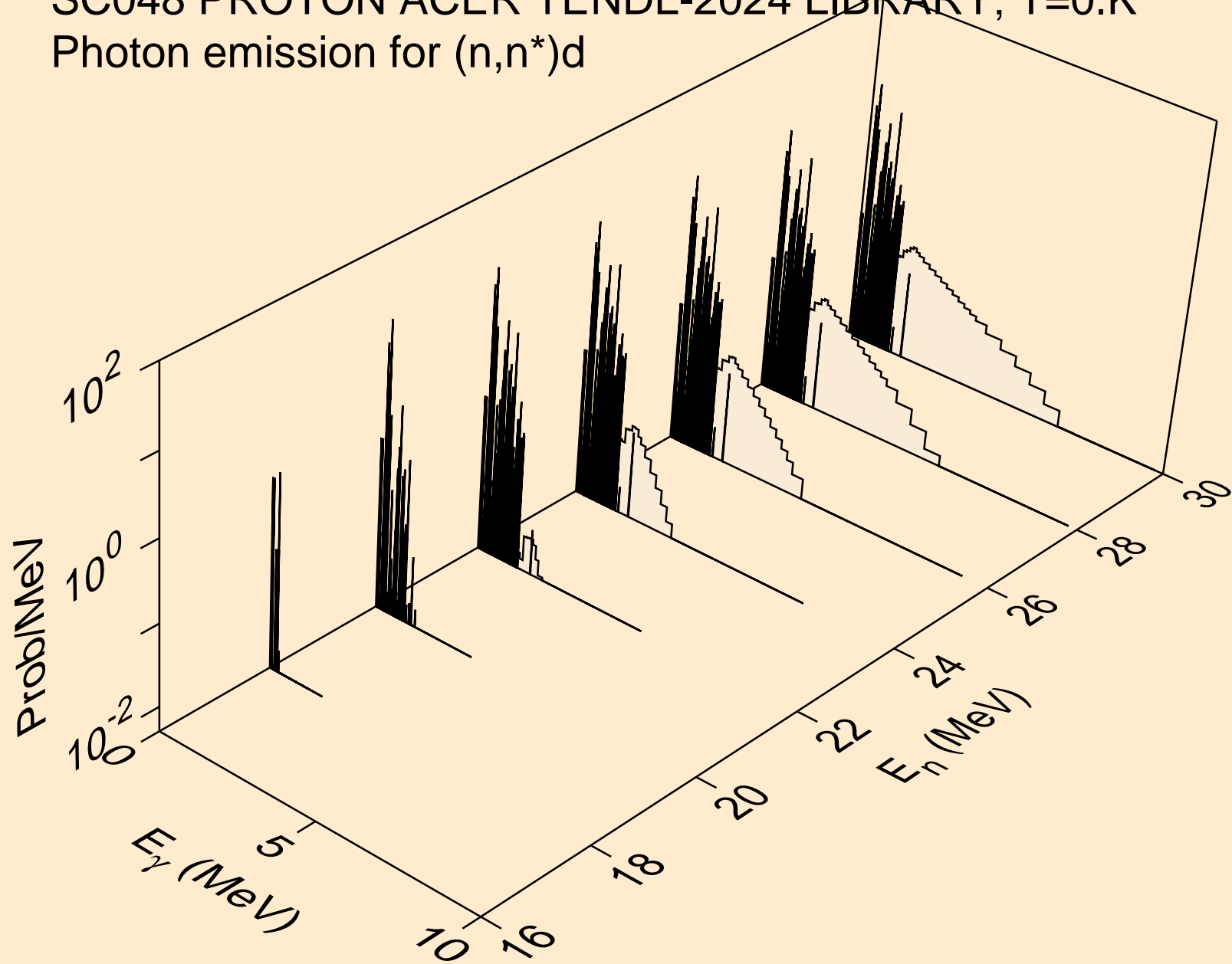

SC048 PROTON ACER TENDL-2024 LIBRARY; T=0.K  
Photon emission for (n,n\*)t

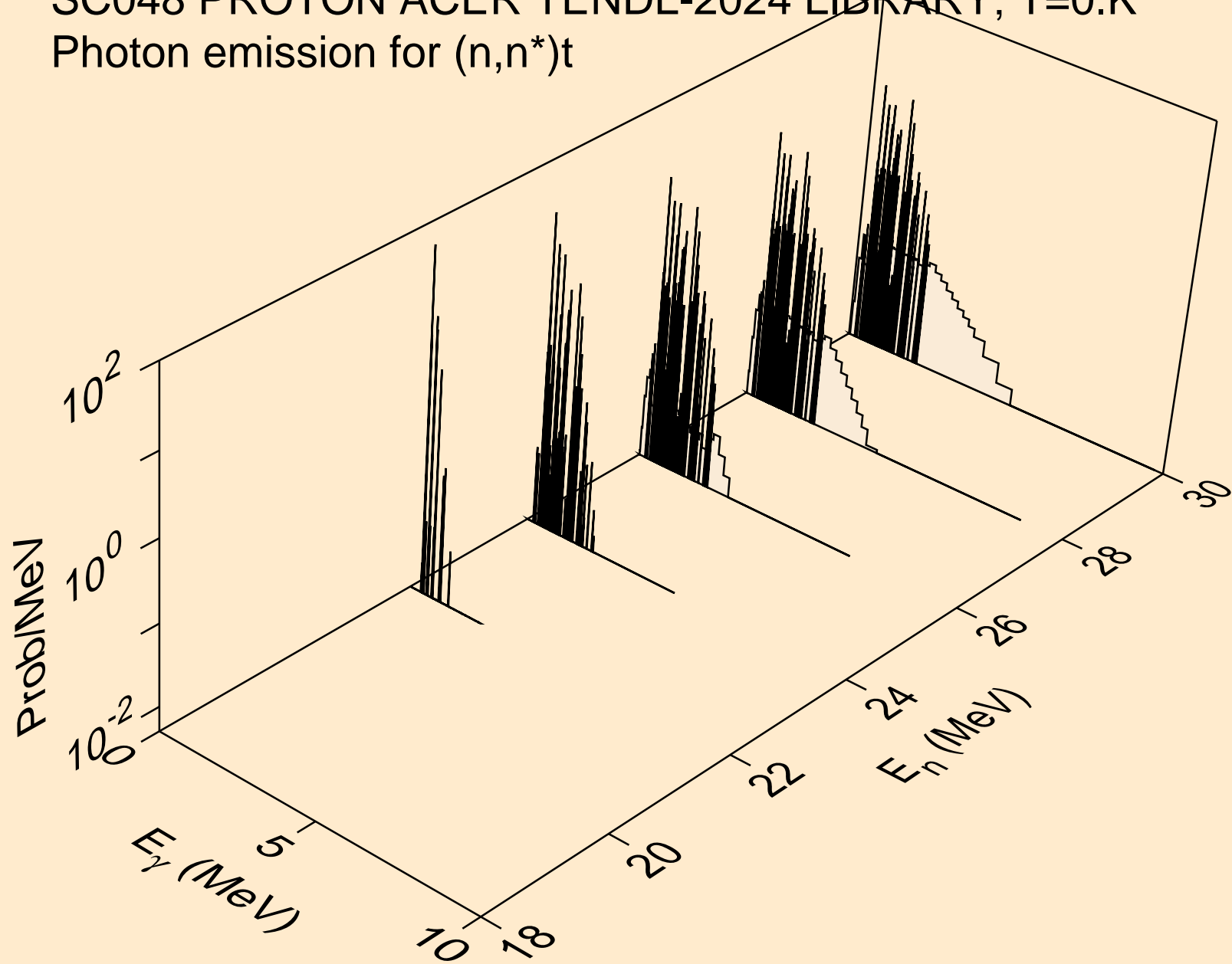

SC048 PROTON ACER TENDL-2024 LIBRARY; T=0.K  
Photon emission for (n,n\*)he3

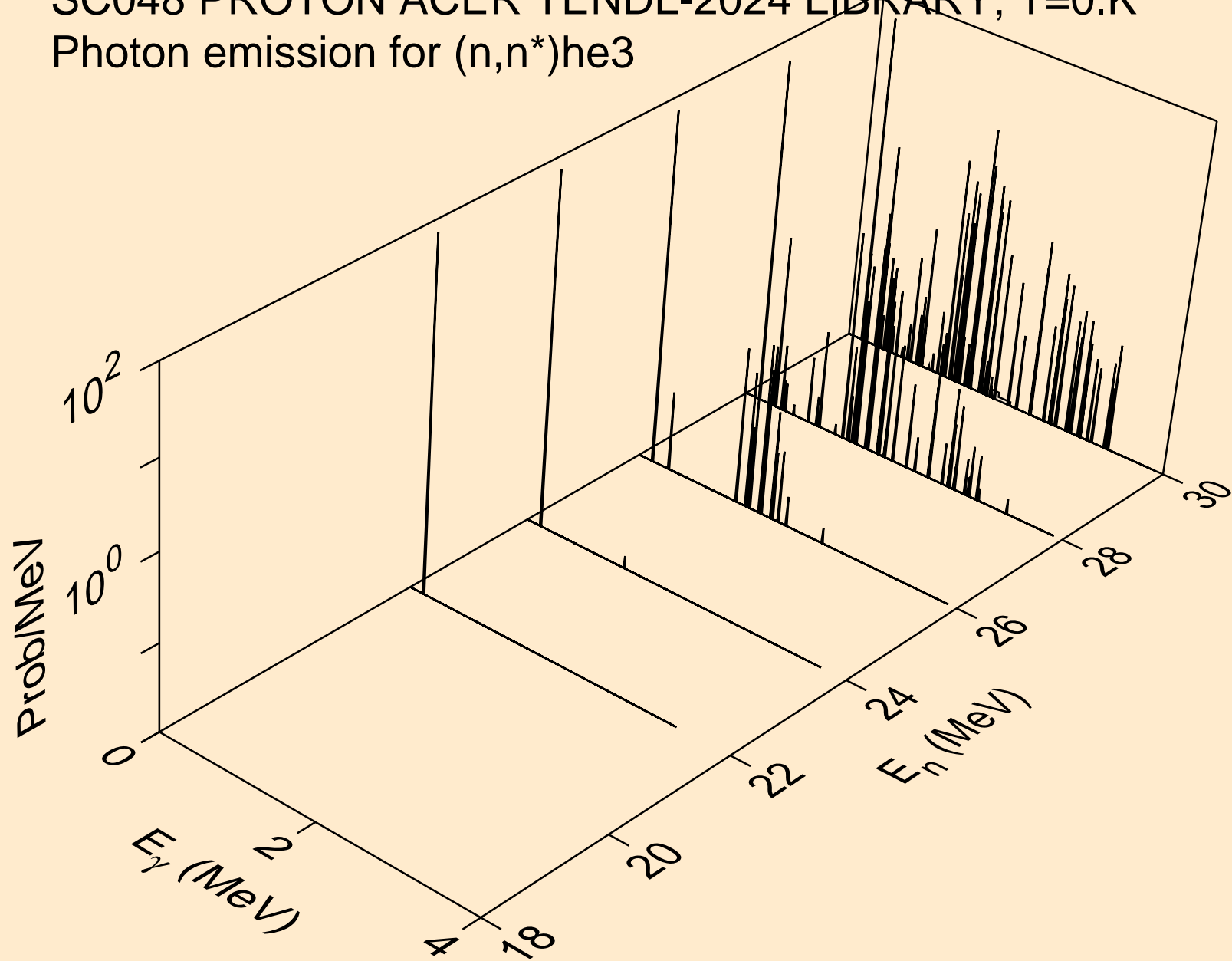

SC048 PROTON ACER TENDL-2024 LIBRARY; T=0.K  
Photon emission for (n,2np)

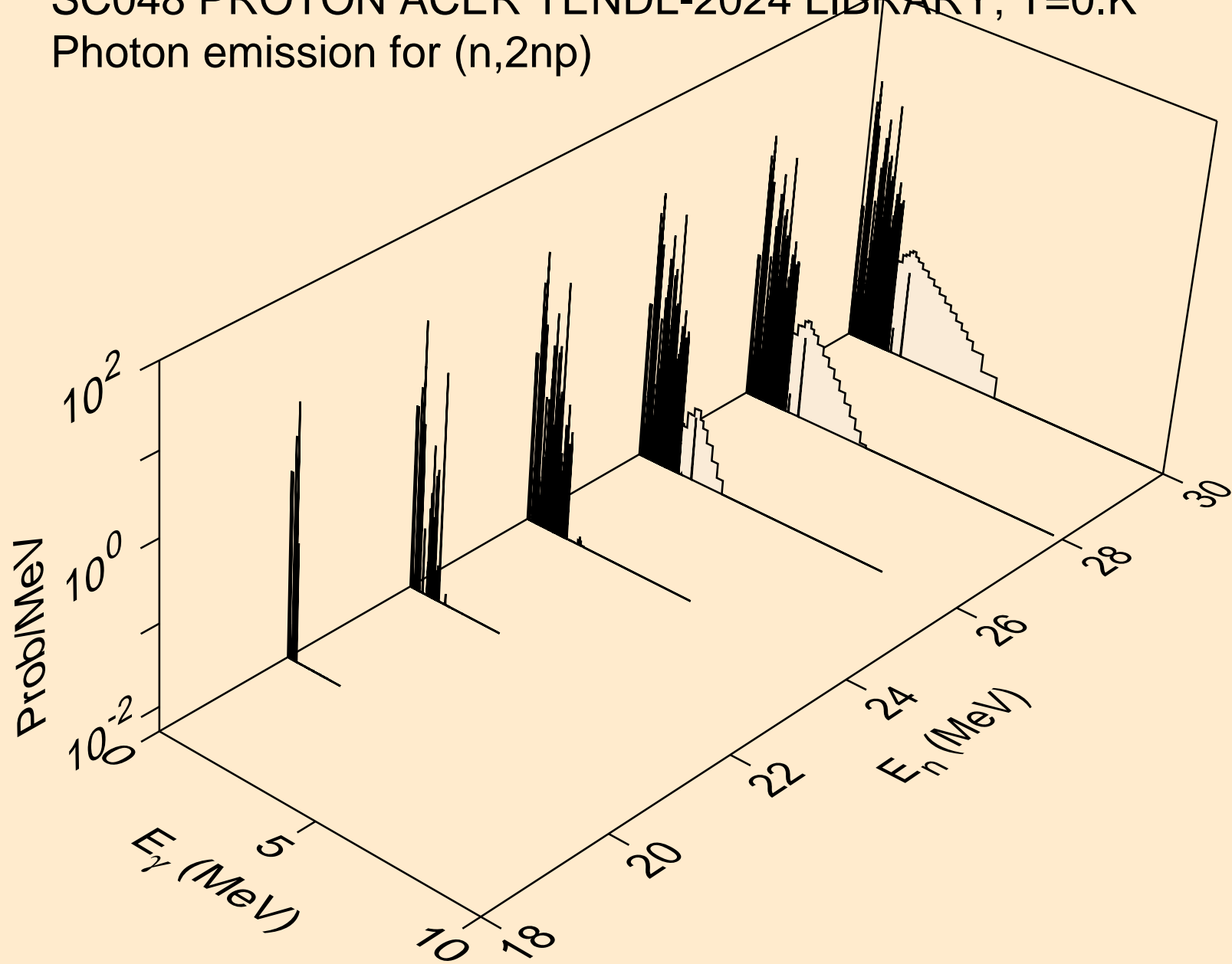

SC048 PROTON ACER TENDL-2024 LIBRARY; T=0.K  
Photon emission for (n,n2p)

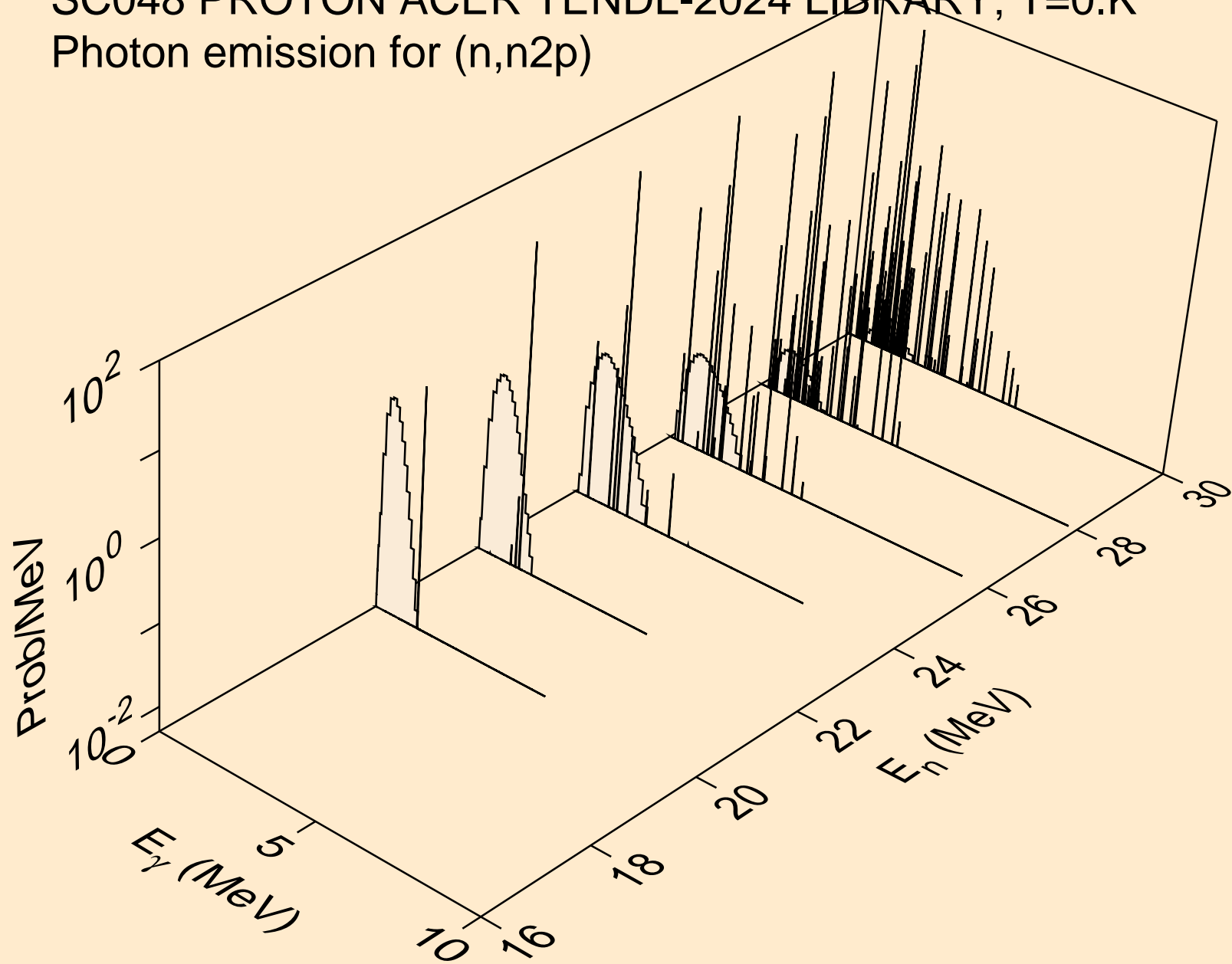

SC048 PROTON ACER TENDL-2024 LIBRARY; T=0.K  
Photon emission for (n,npa)

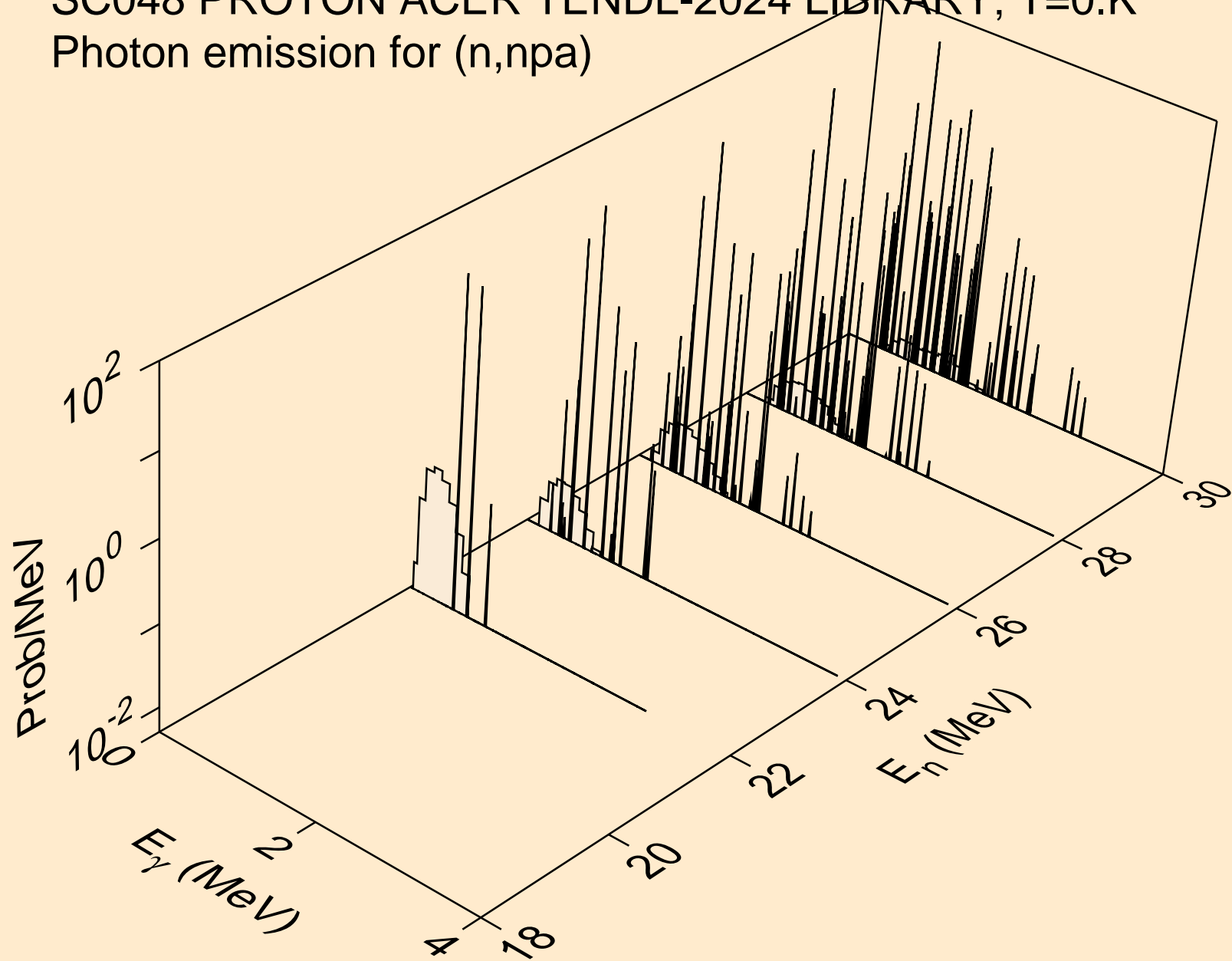

SC048 PROTON ACER TENDL-2024 LIBRARY; T=0.K  
Photon emission for (n,gma)

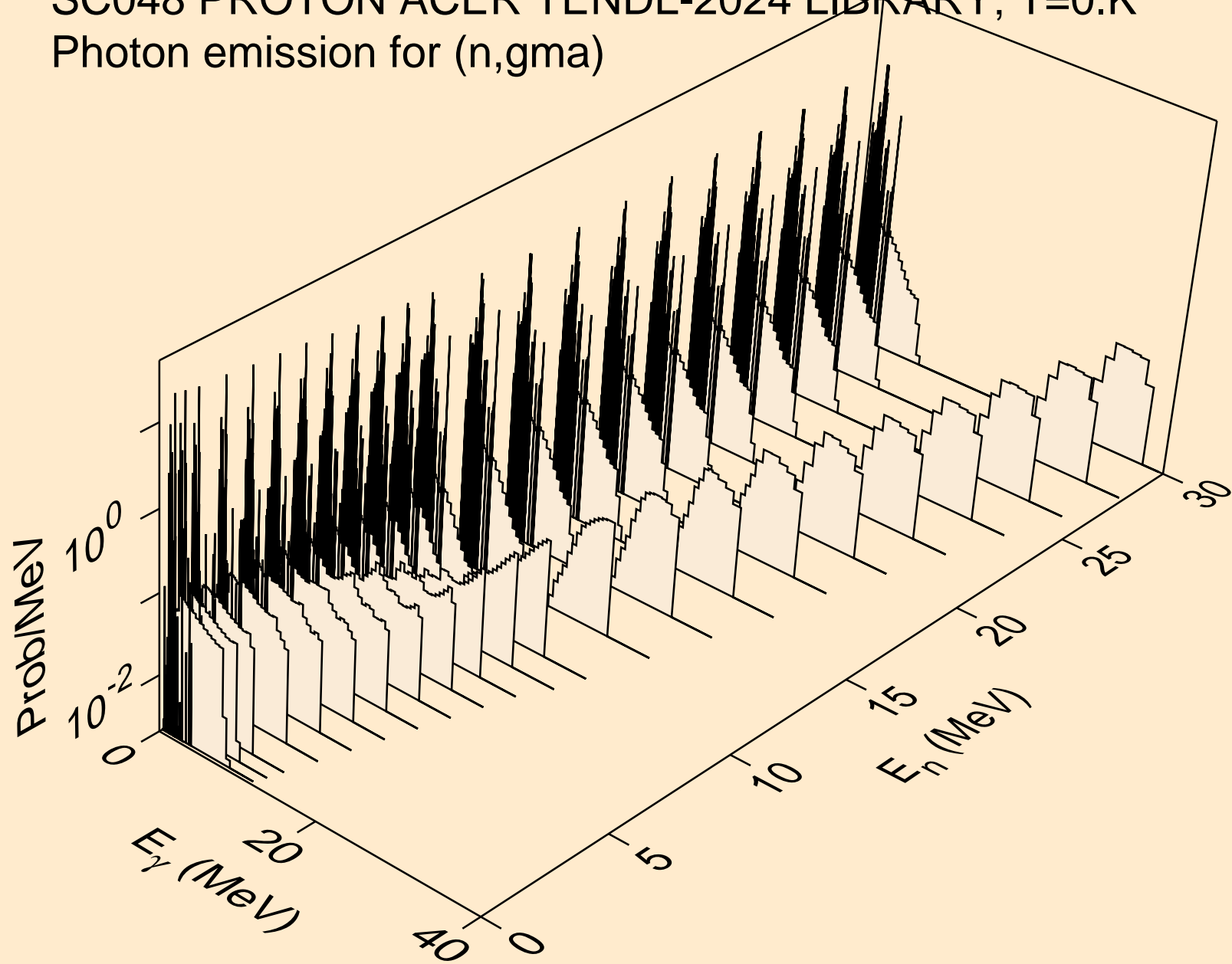

SC048 PROTON ACER TENDL-2024 LIBRARY; T=0.K  
Photon emission for inelastic

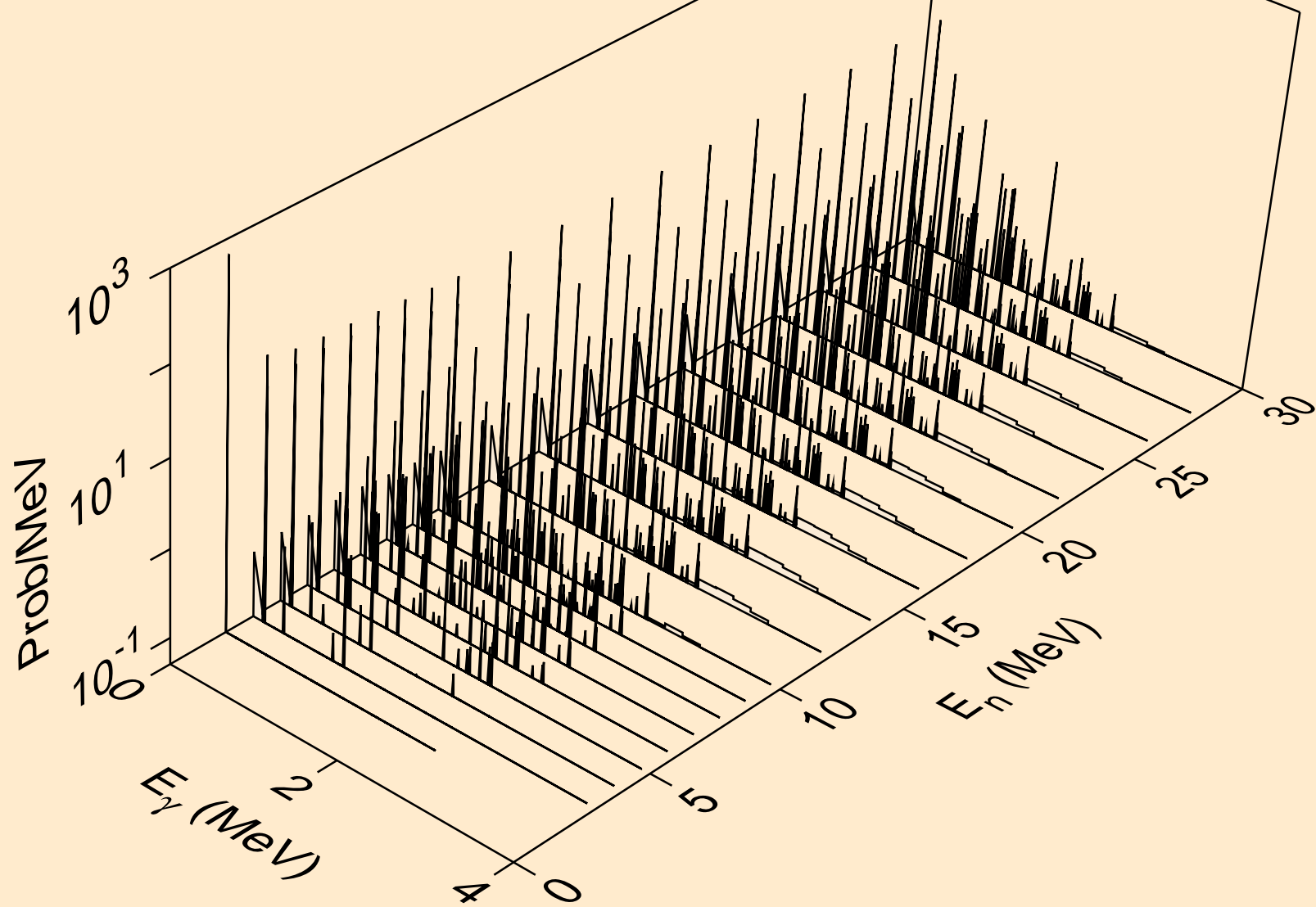

SC048 PROTON ACER TENDL-2024 LIBRARY; T=0.K  
Photon emission for (n,d)

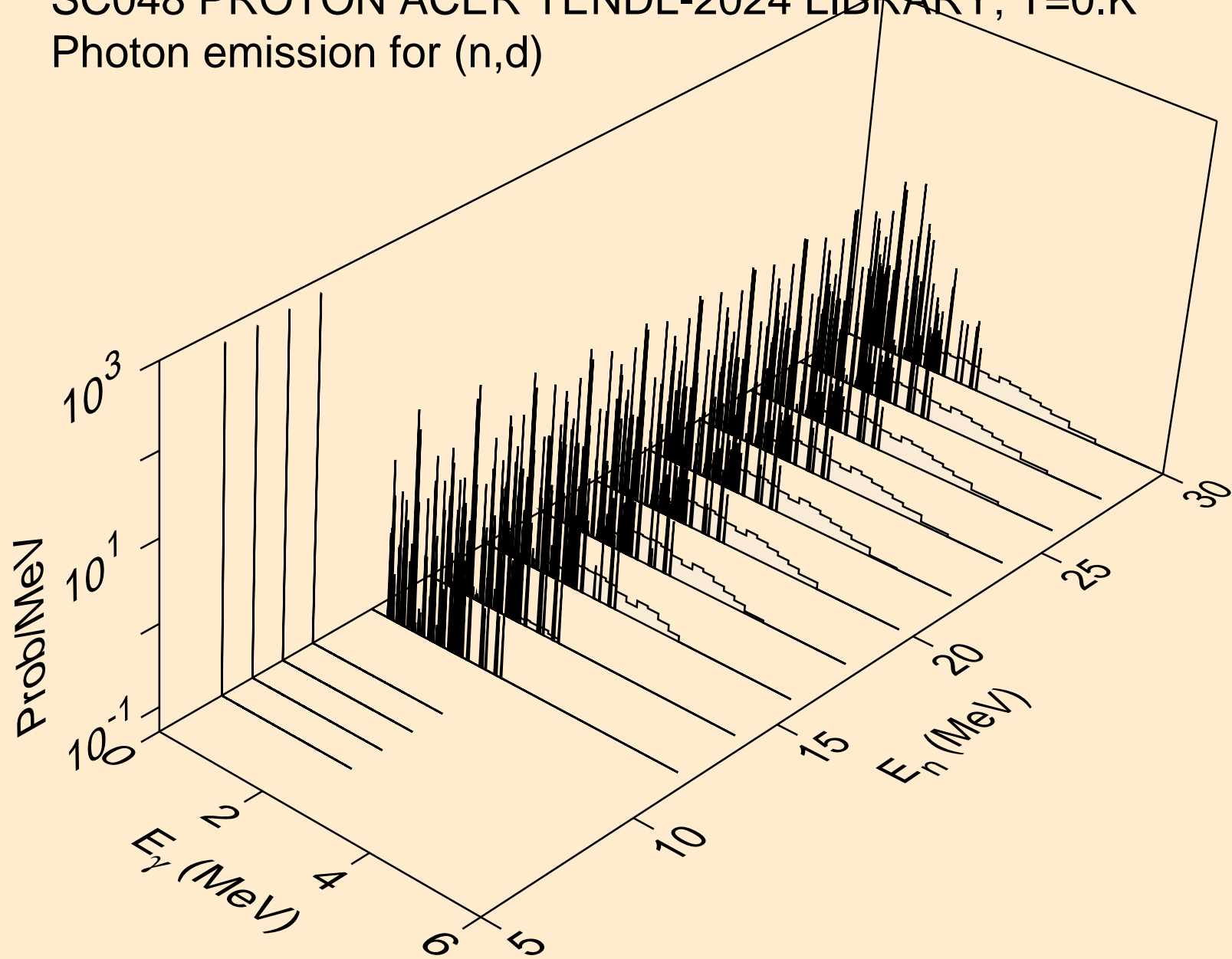

SC048 PROTON ACER TENDL-2024 LIBRARY; T=0.K  
Photon emission for (n,t)

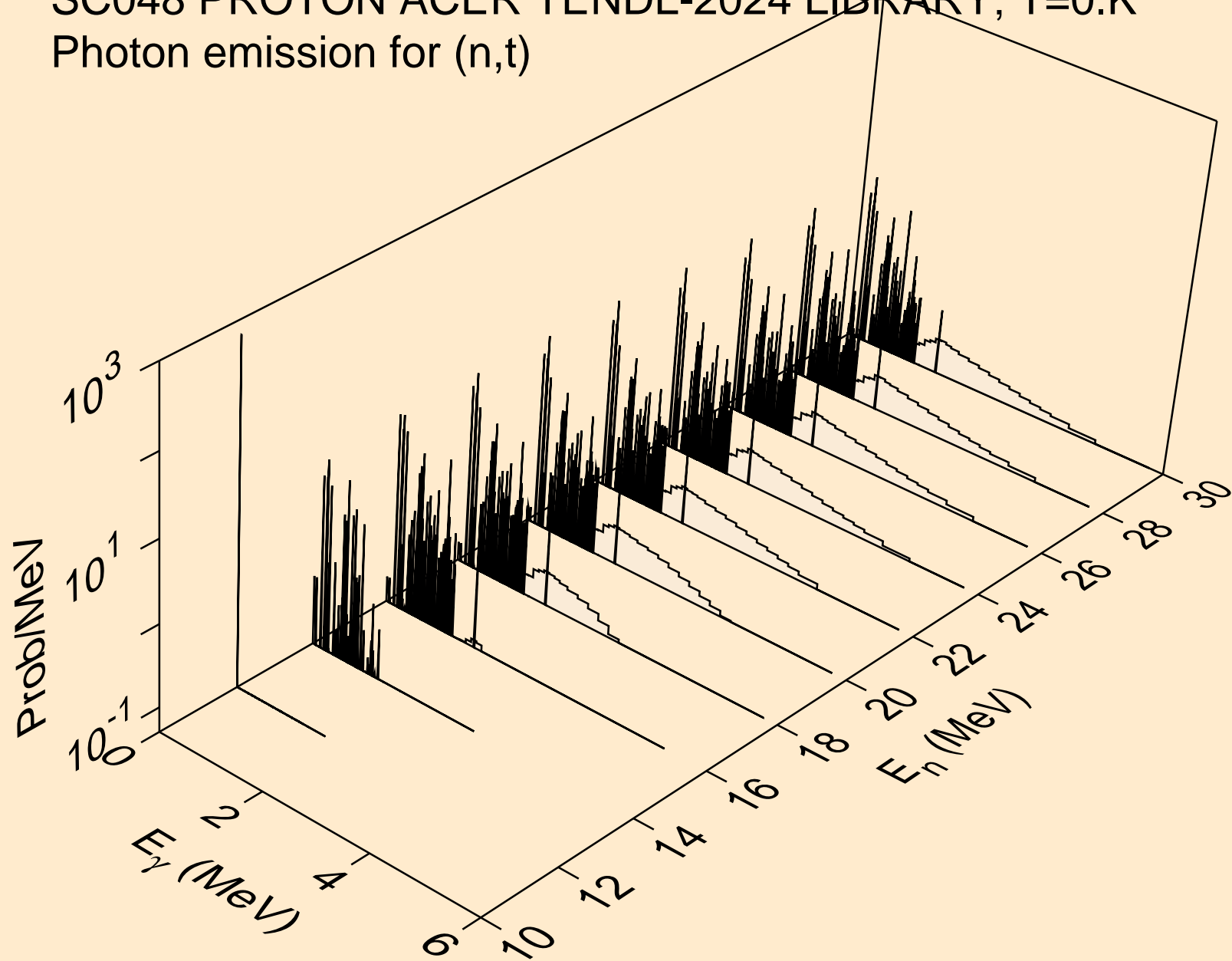

SC048 PROTON ACER TENDL-2024 LIBRARY; T=0.K  
Photon emission for (n,he3)

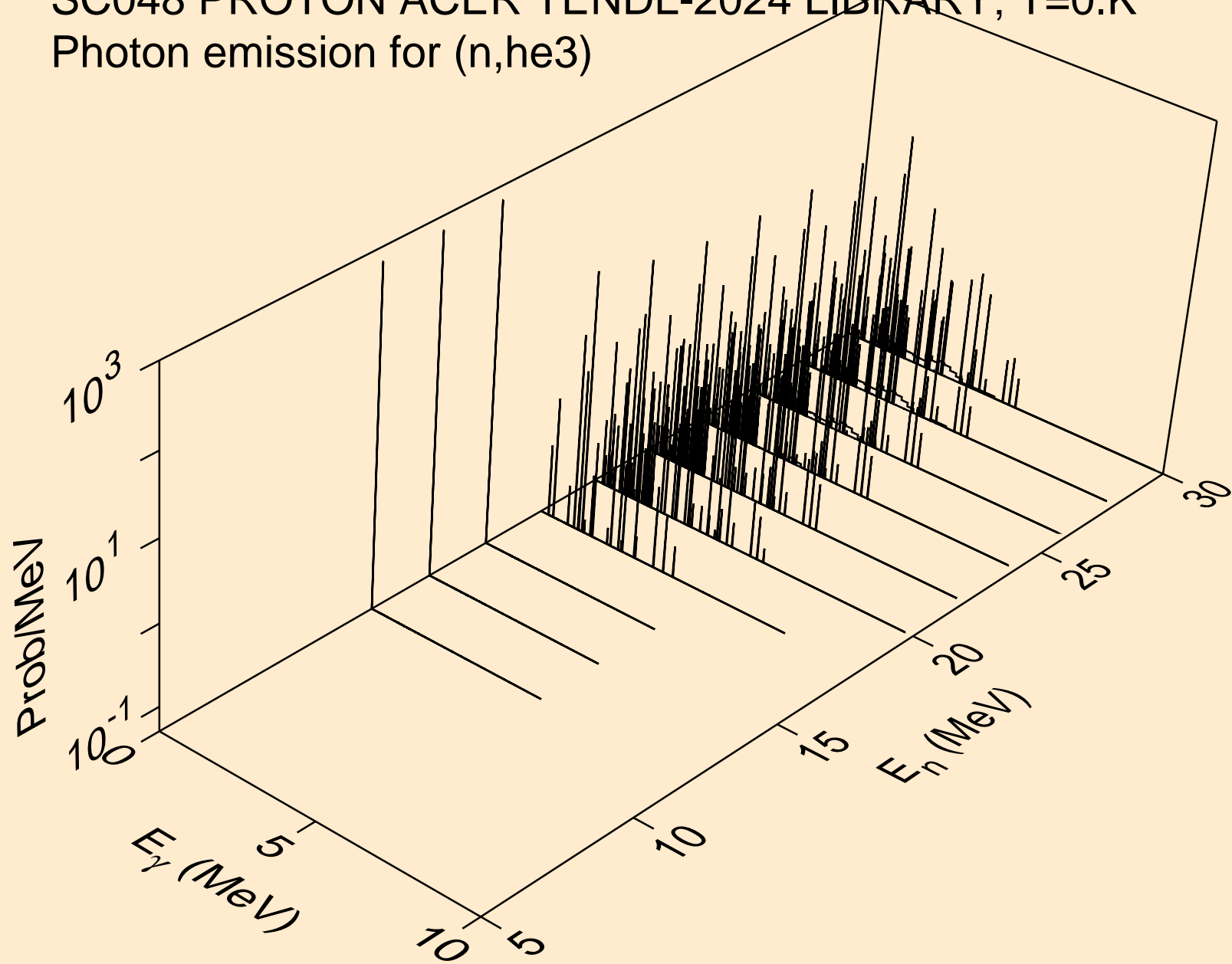

SC048 PROTON ACER TENDL-2024 LIBRARY; T=0.K  
Photon emission for (n,a)

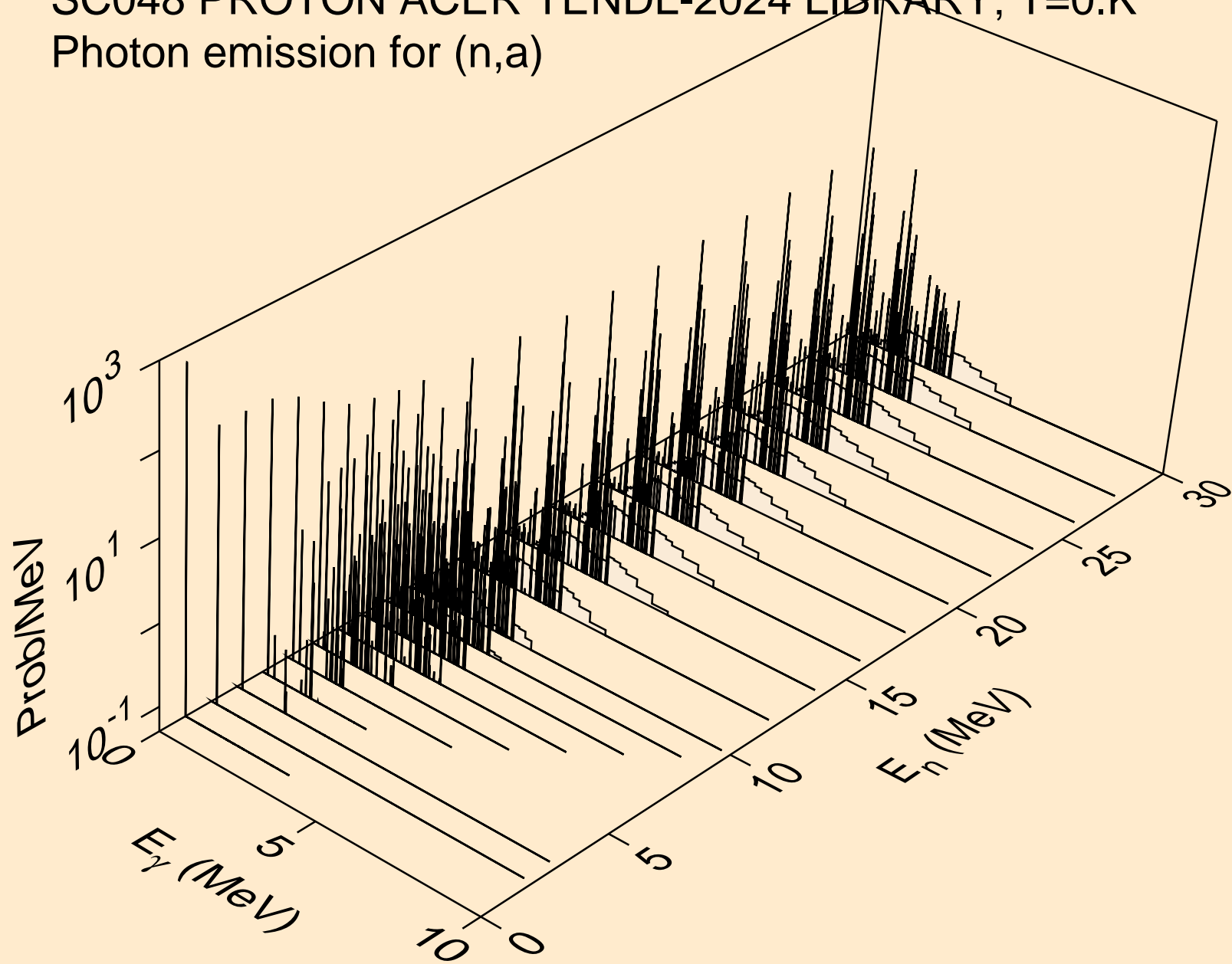

SC048 PROTON ACER TENDL-2024 LIBRARY; T=0.K  
Photon emission for (n,2a)

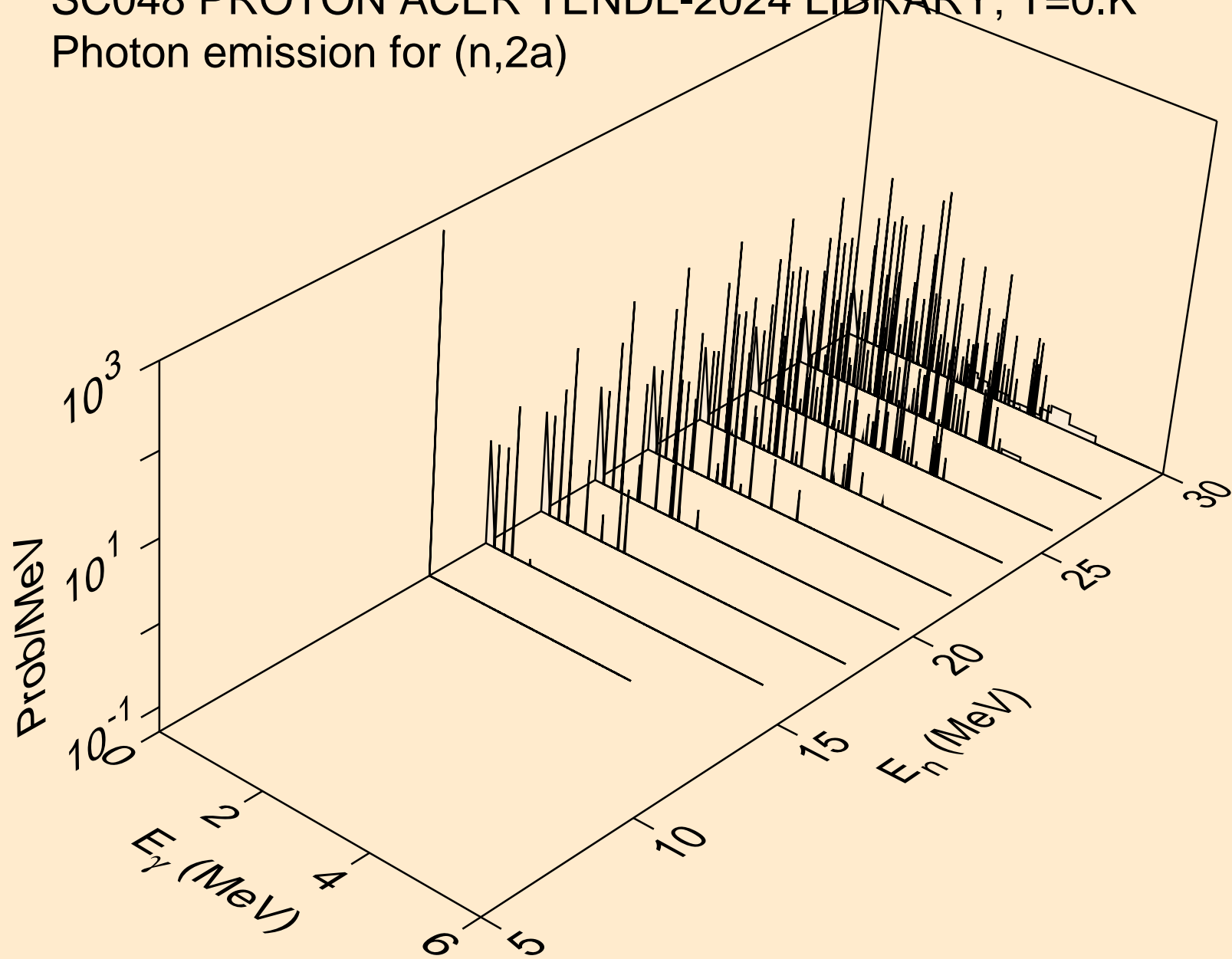

SC048 PROTON ACER TENDL-2024 LIBRARY; T=0.K  
Photon emission for (n,2p)

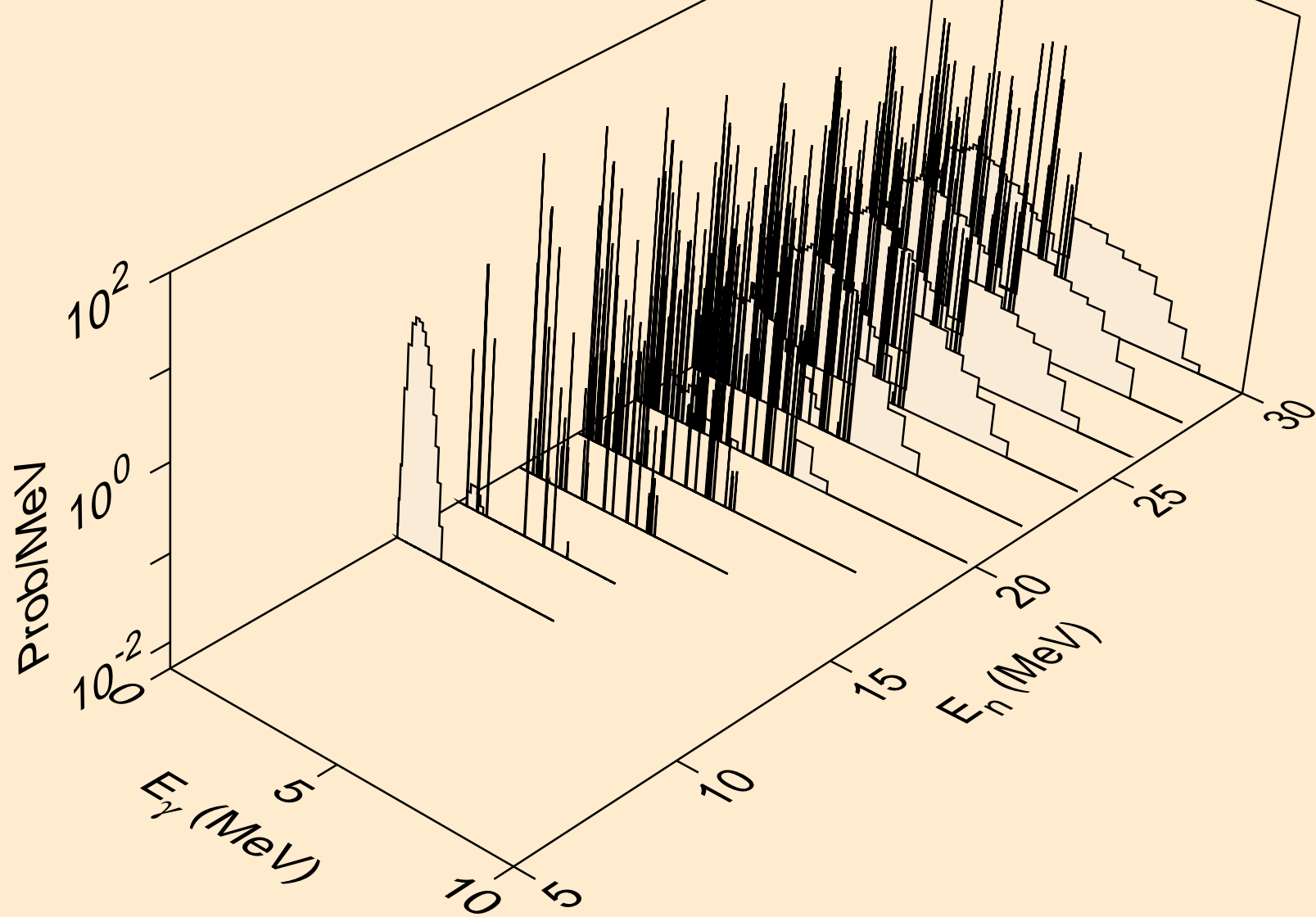

SC048 PROTON ACER TENDL-2024 LIBRARY; T=0.K  
Photon emission for (n,pa)

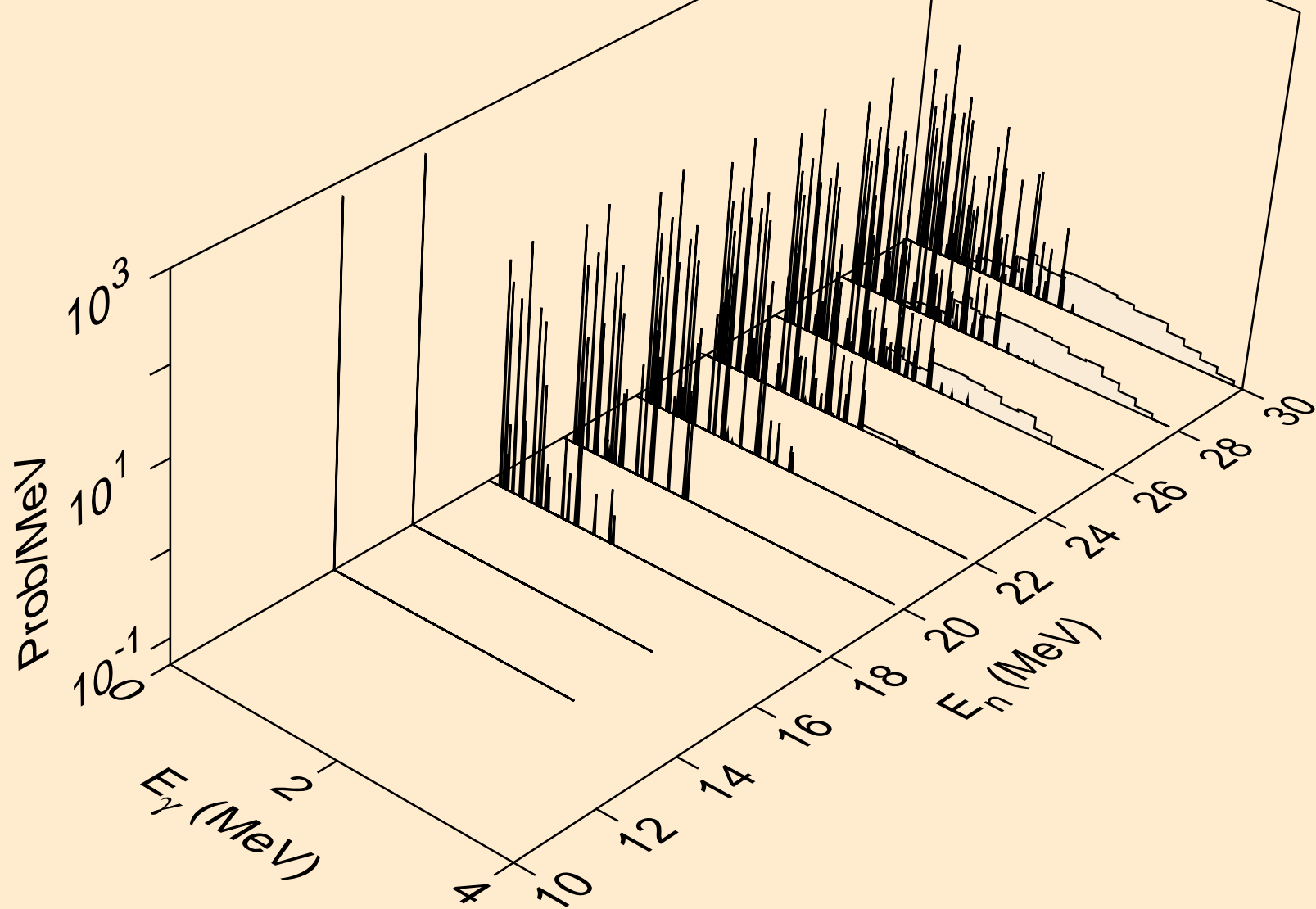

SC048 PROTON ACER TENDL-2024 LIBRARY; T=0.K  
Photon emission for (n,pd)

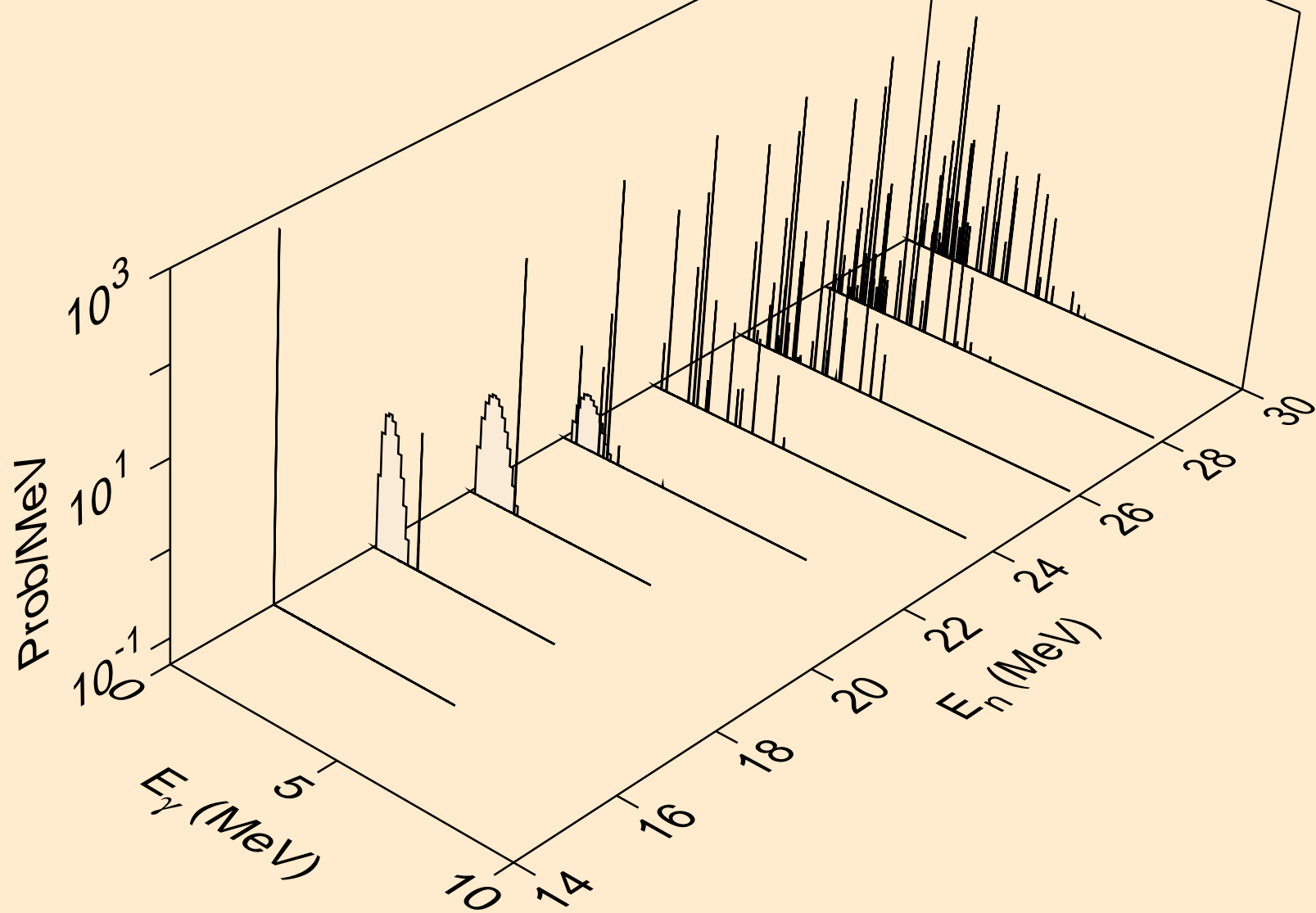

SC048 PROTON ACER TENDL-2024 LIBRARY; T=0.K  
Photon emission for (n,pt)

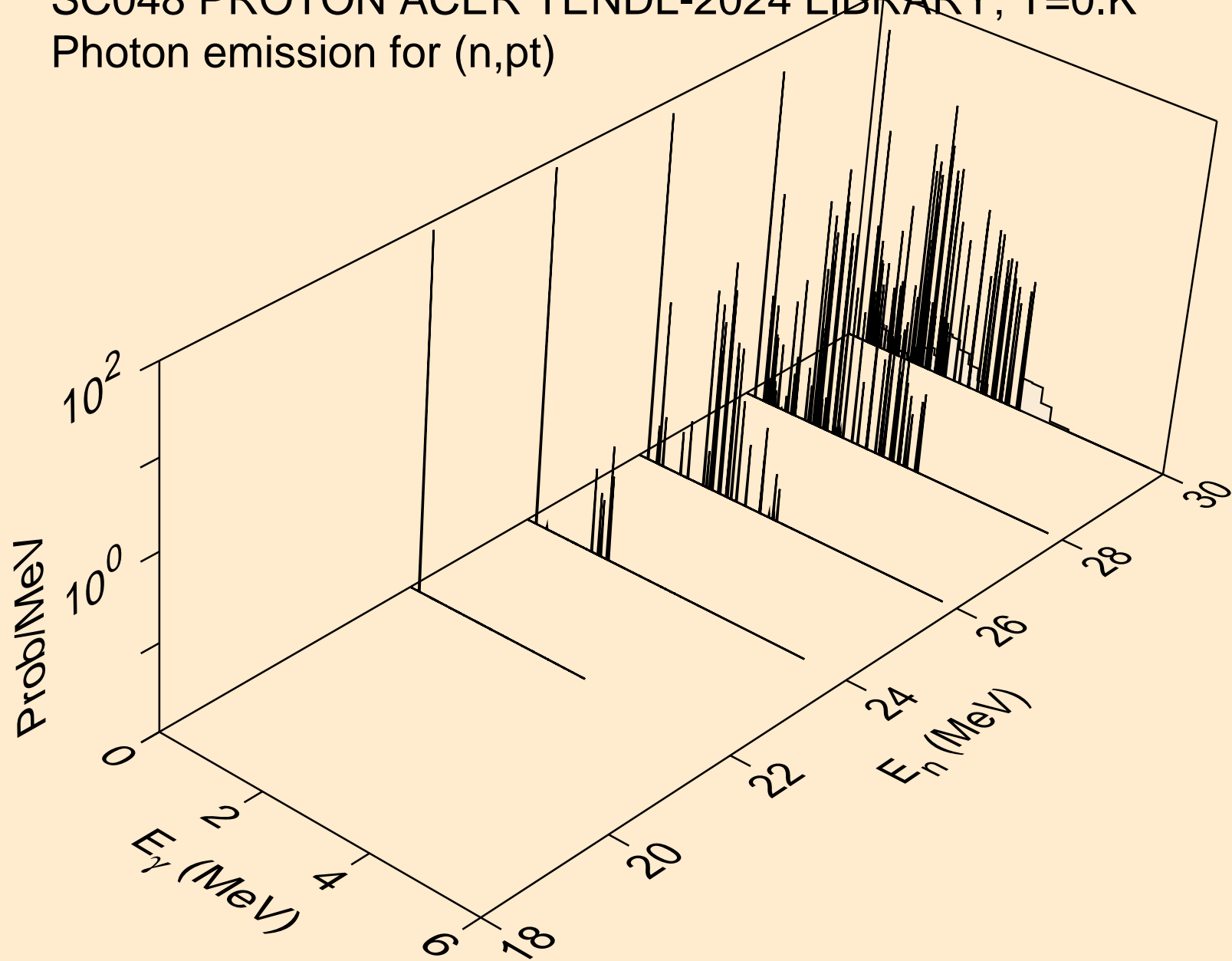

SC048 PROTON ACER TENDL-2024 LIBRARY; T=0.K  
Photon emission for (n,da)

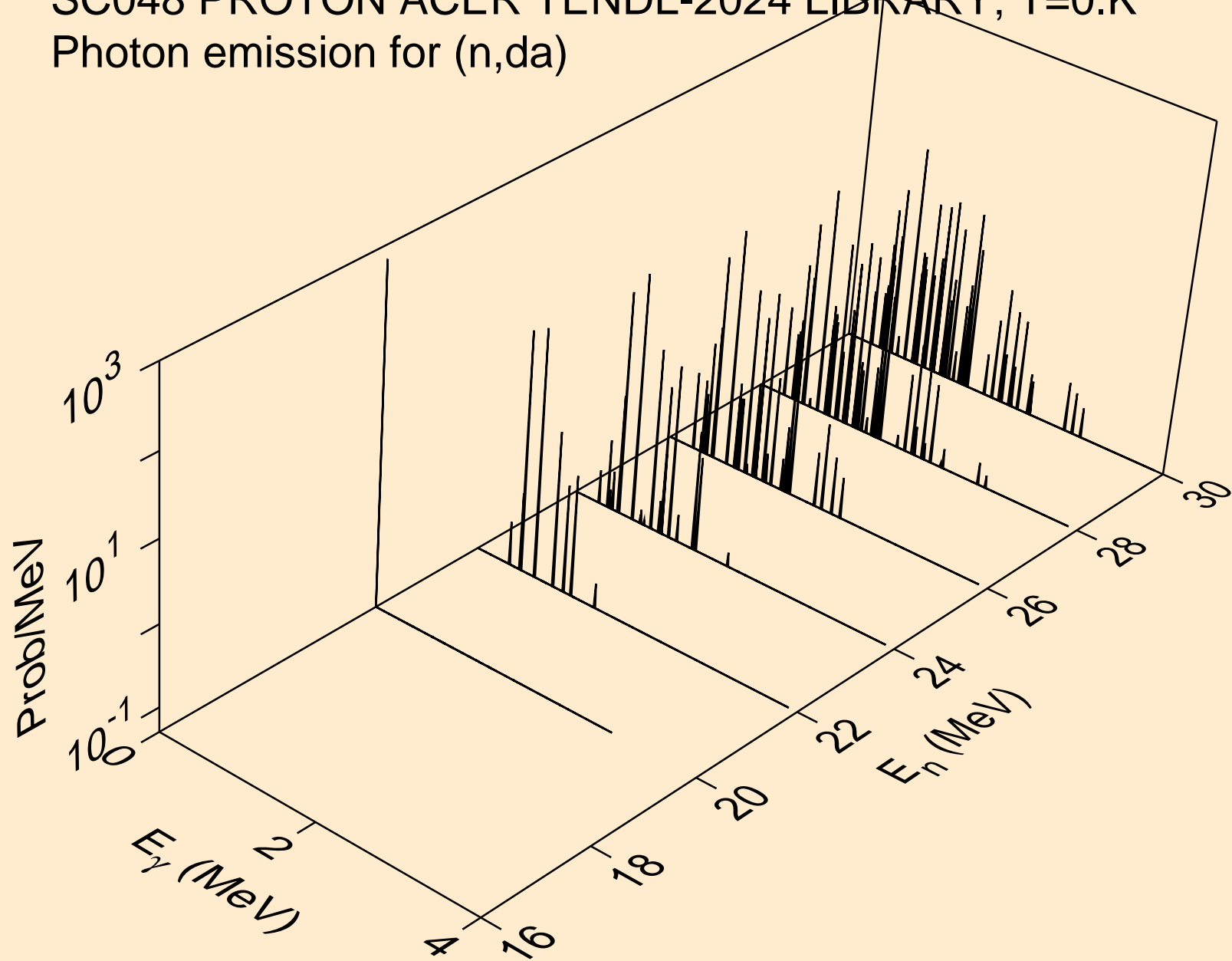

SC048 PROTON ACER TENDL-2024 LIBRARY; T=0.K  
Particle heating contributions

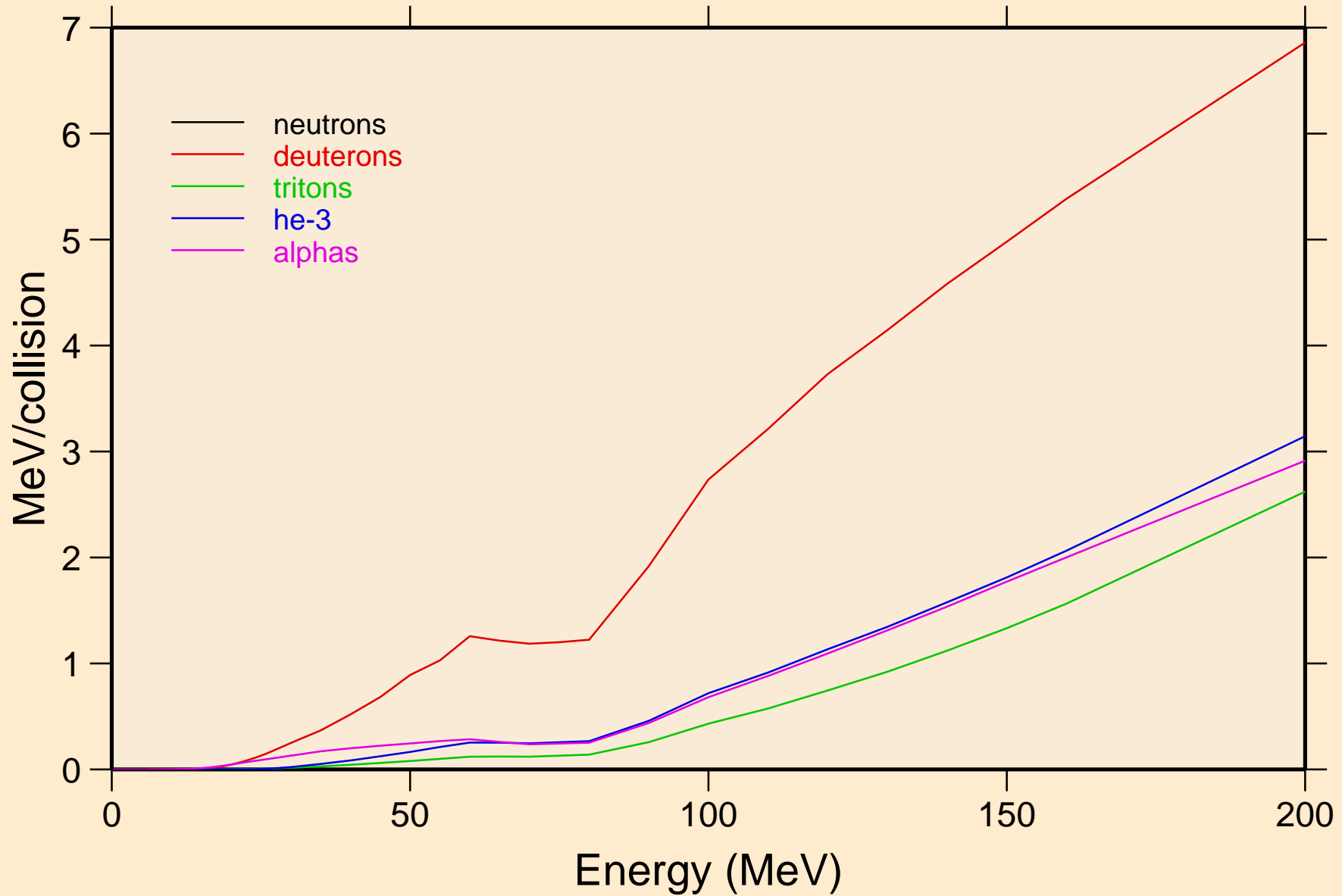

# SC048 PROTON ACER TENDL-2024 LIBRARY; T=0.K

## Recoil Heating

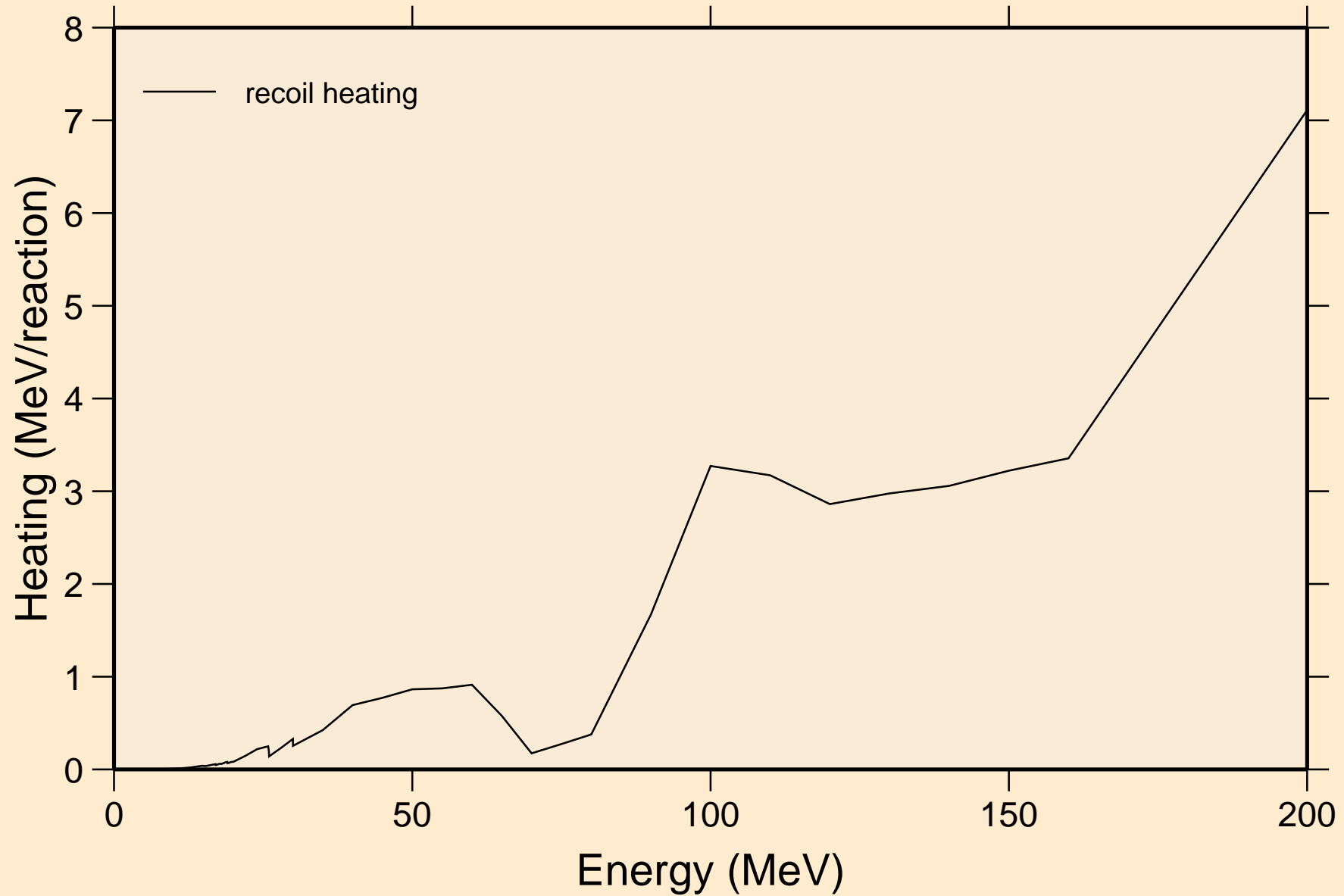

SC048 PROTON ACER TENDL-2024 LIBRARY; T=0.K  
Particle production cross sections

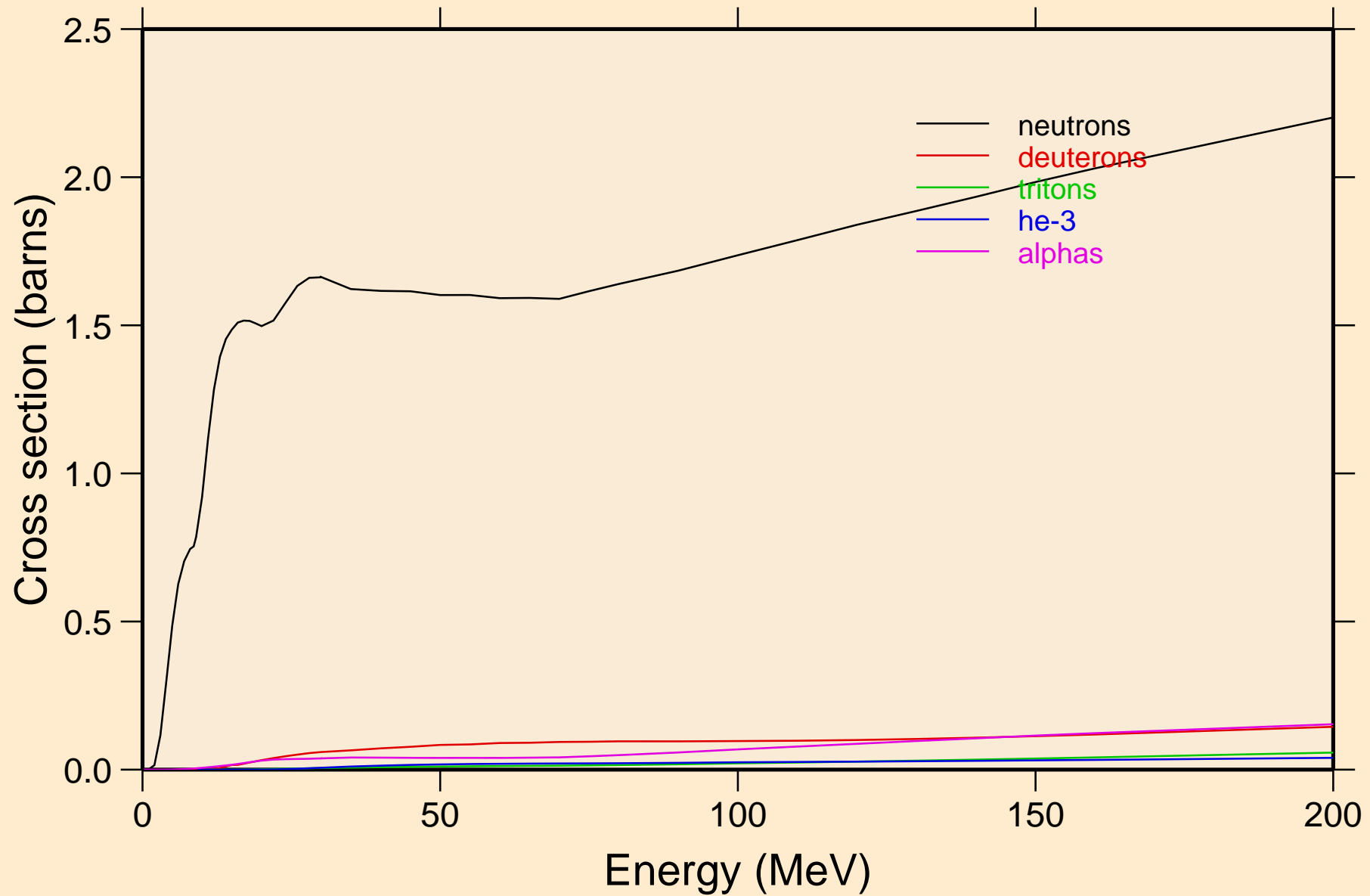

SC048 PROTON ACER TENDL-2024 LIBRARY; T=0.K  
neutrons from (p,n)

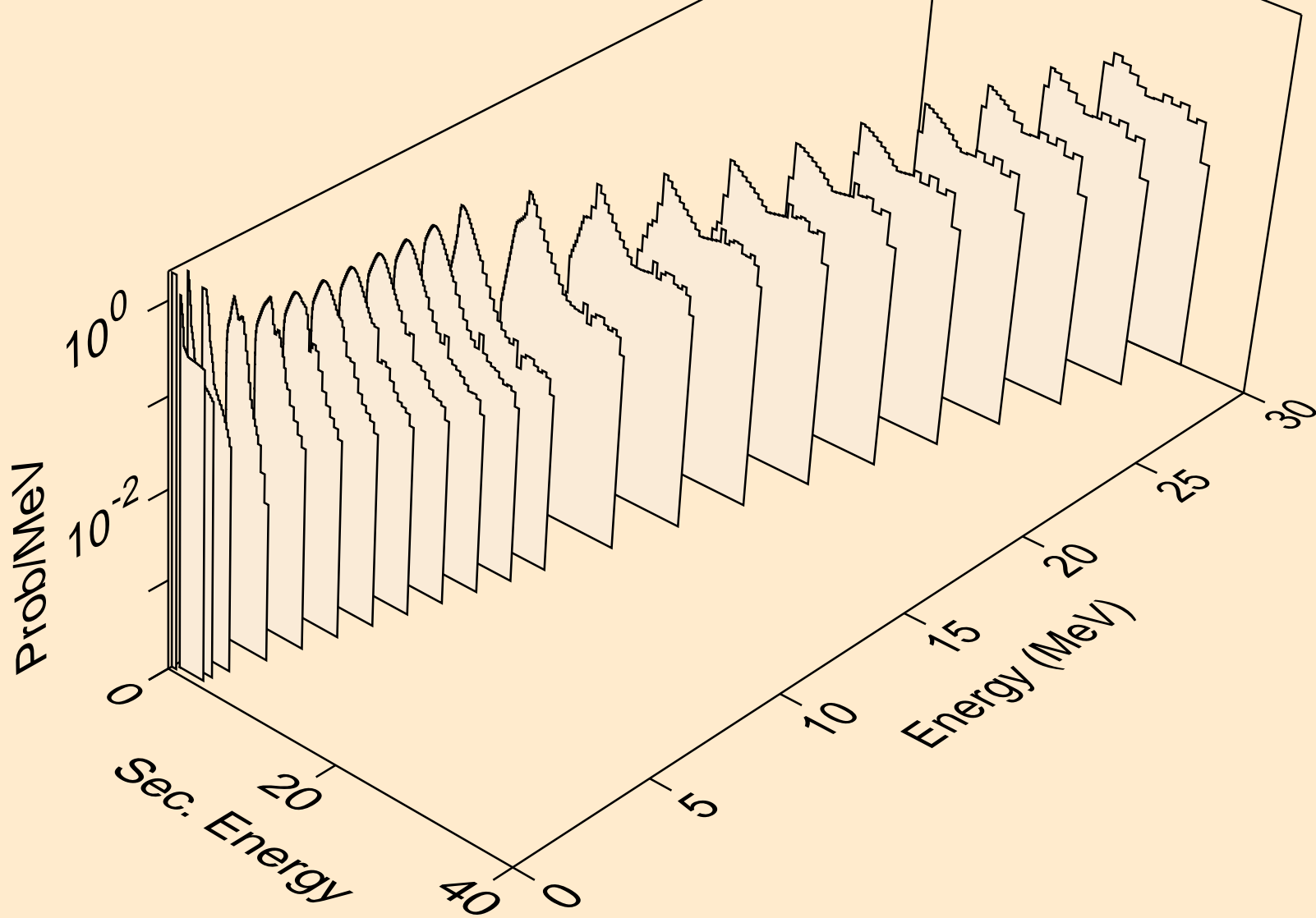

SC048 PROTON ACER TENDL-2024 LIBRARY; T=0.K  
neutrons from (p,x)

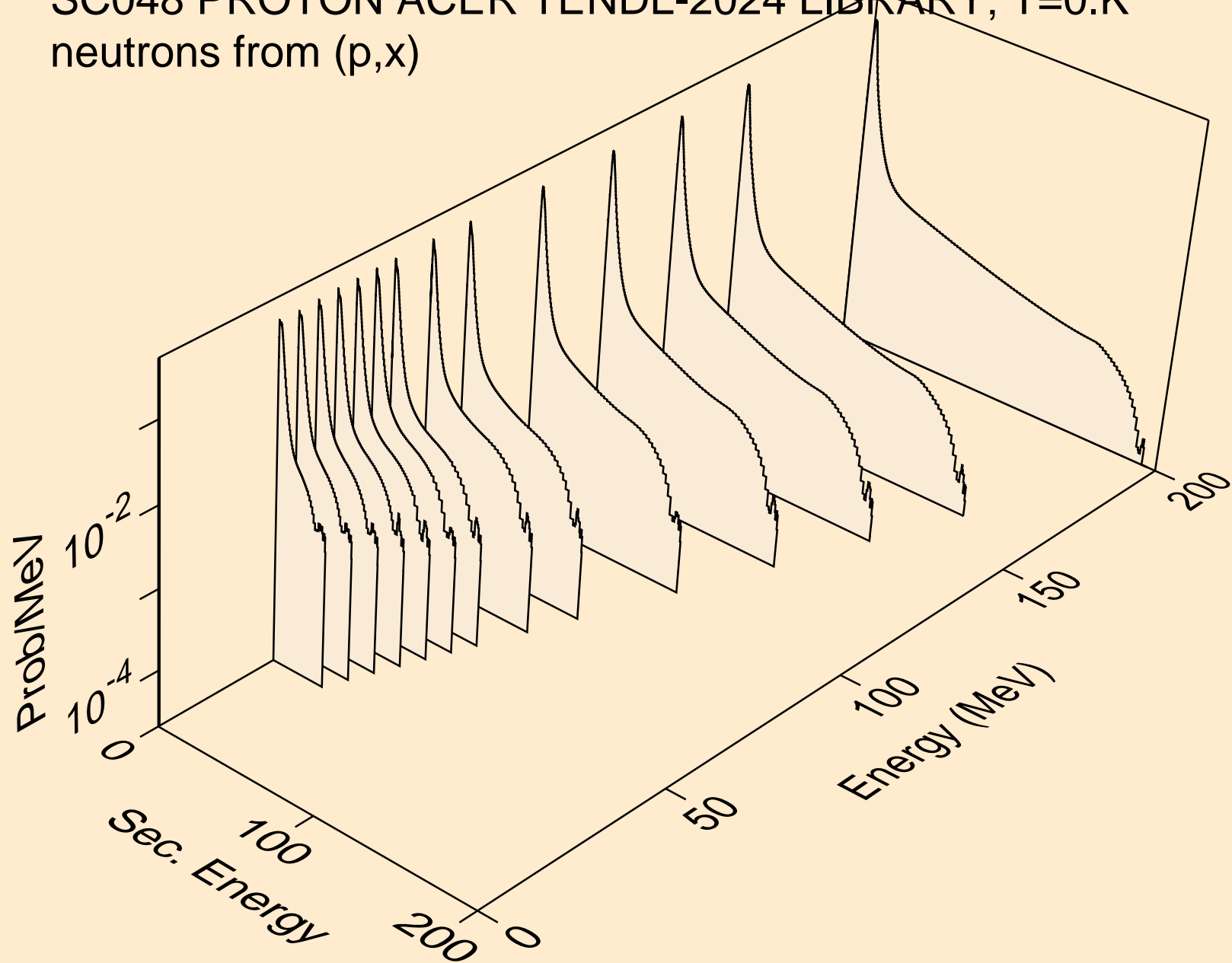

SC048 PROTON ACER TENDL-2024 LIBRARY; T=0.K  
neutrons from (p,2nd)

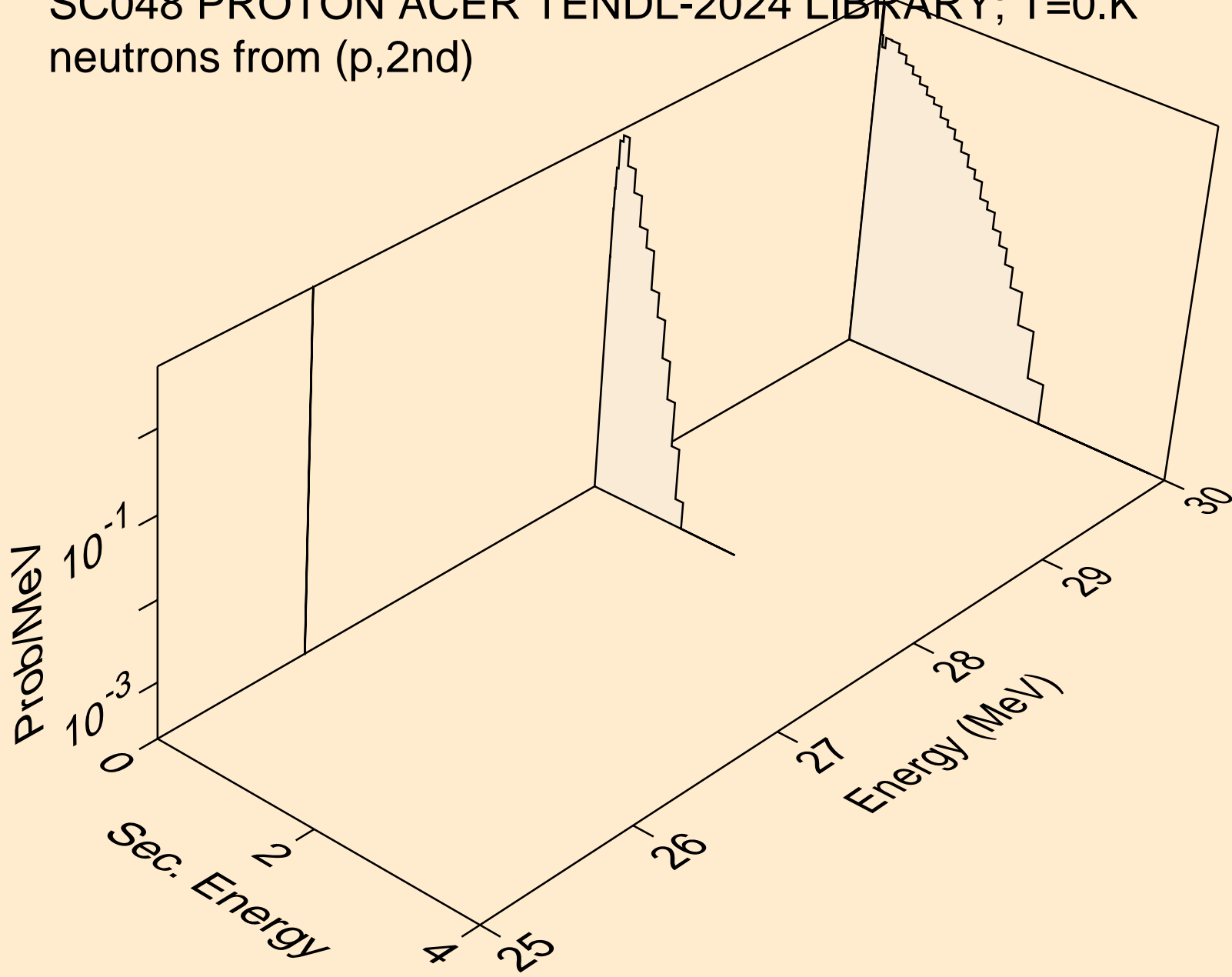

SC048 PROTON ACER TENDL-2024 LIBRARY; T=0.K  
neutrons from (p,2n)

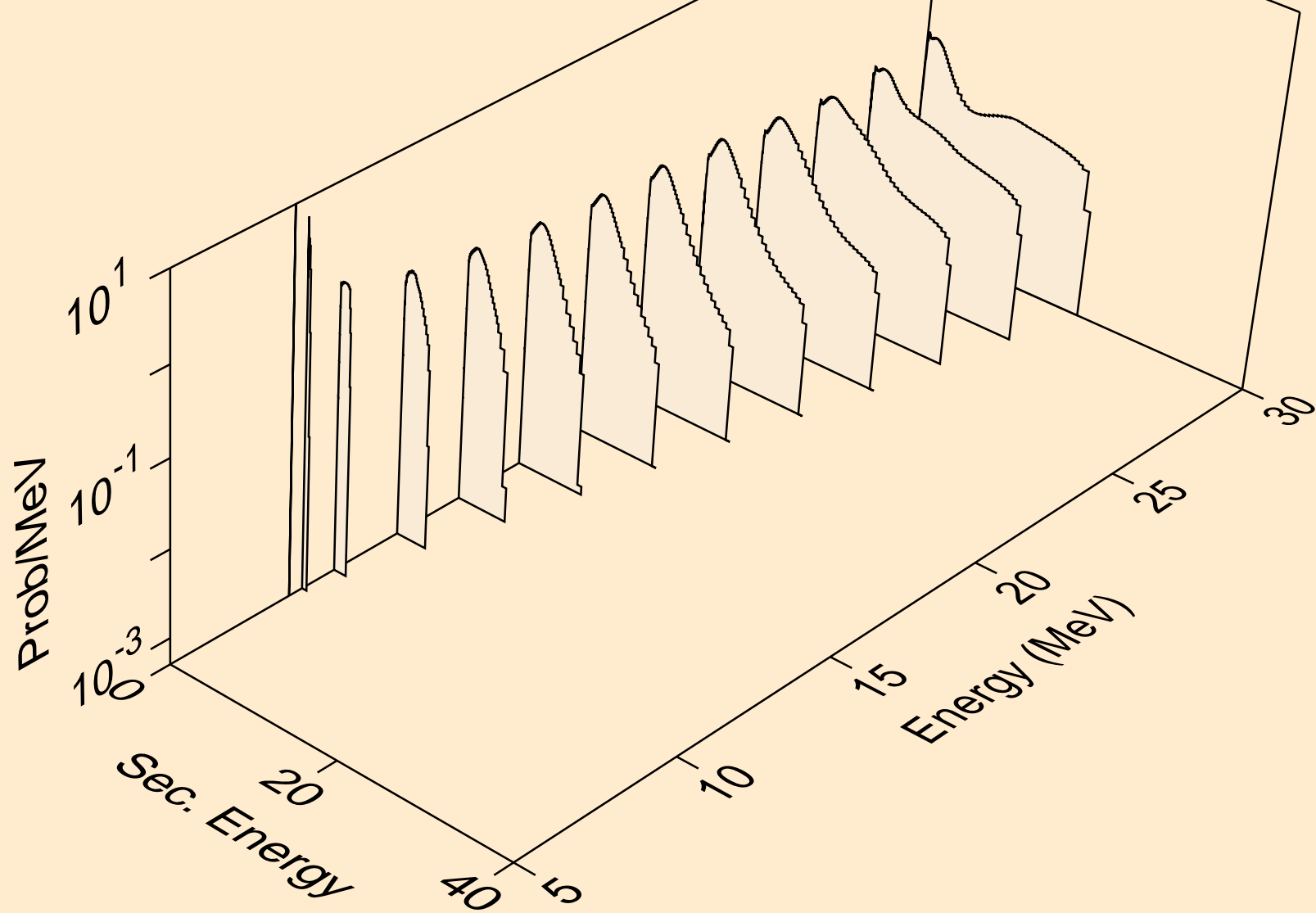

SC048 PROTON ACER TENDL-2024 LIBRARY; T=0.K  
neutrons from (p,3n)

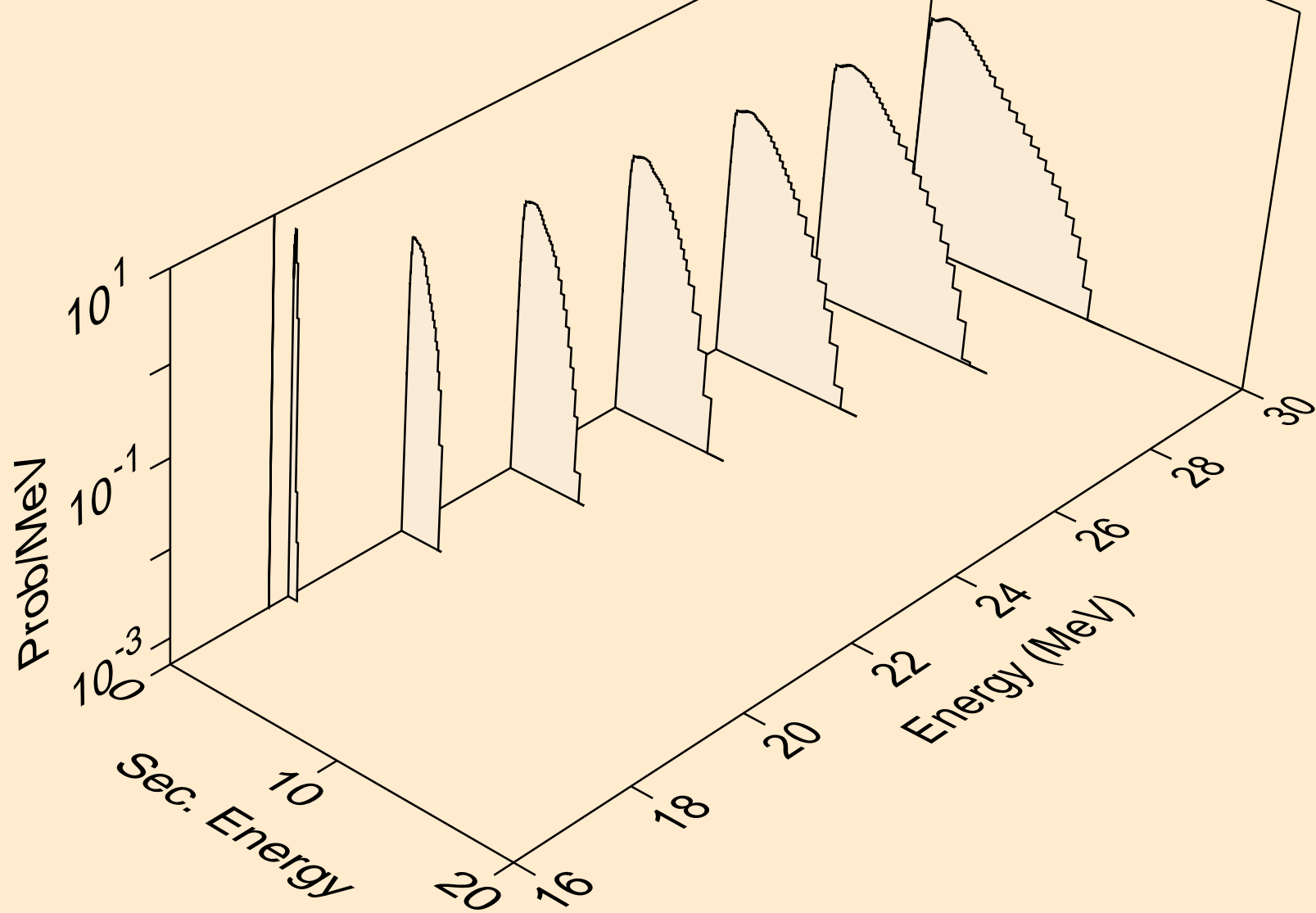

SC048 PROTON ACER TENDL-2024 LIBRARY; T=0.K  
neutrons from (p,n\*)a

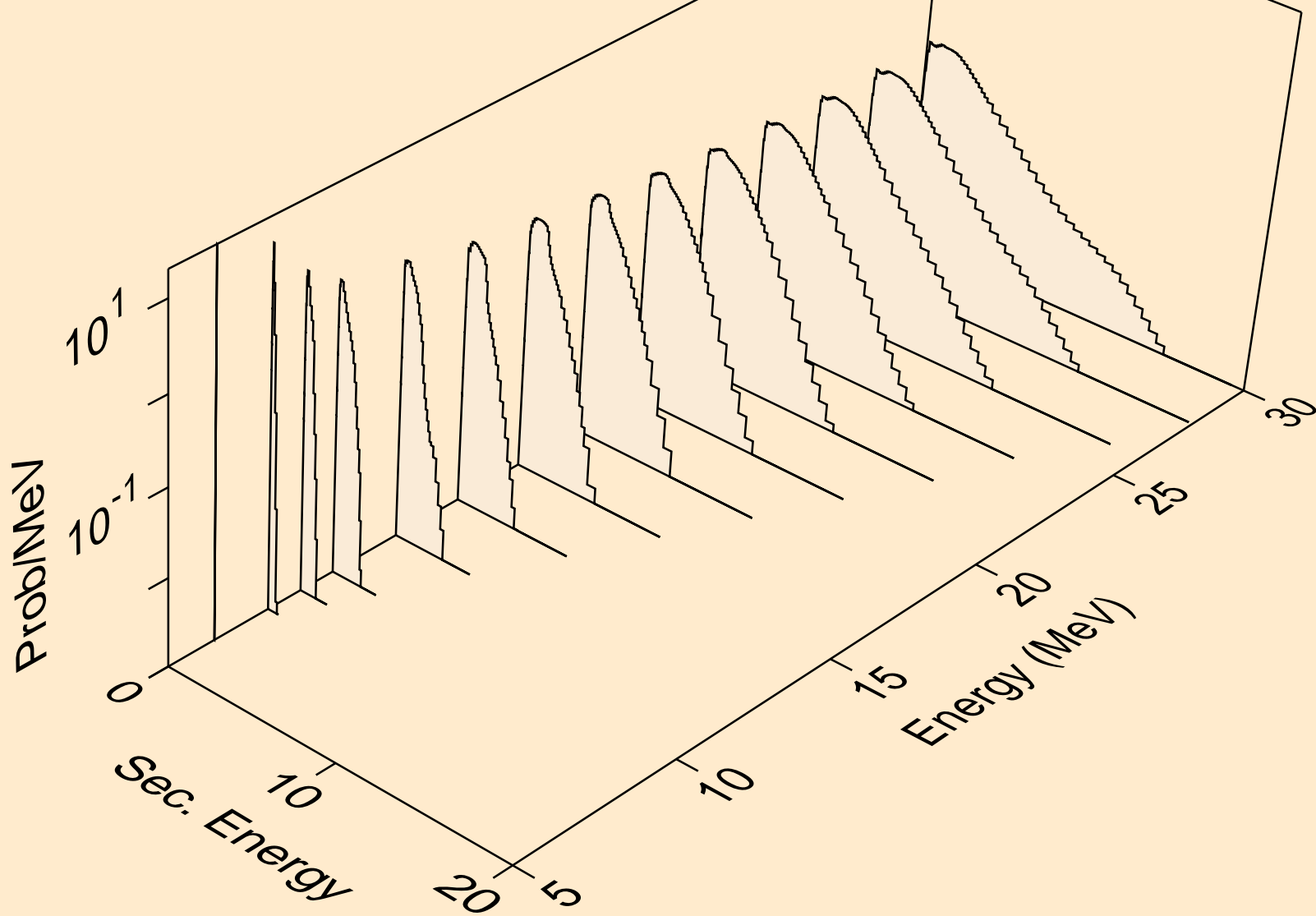

SC048 PROTON ACER TENDL-2024 LIBRARY; T=0.K  
neutrons from (p,2n)a

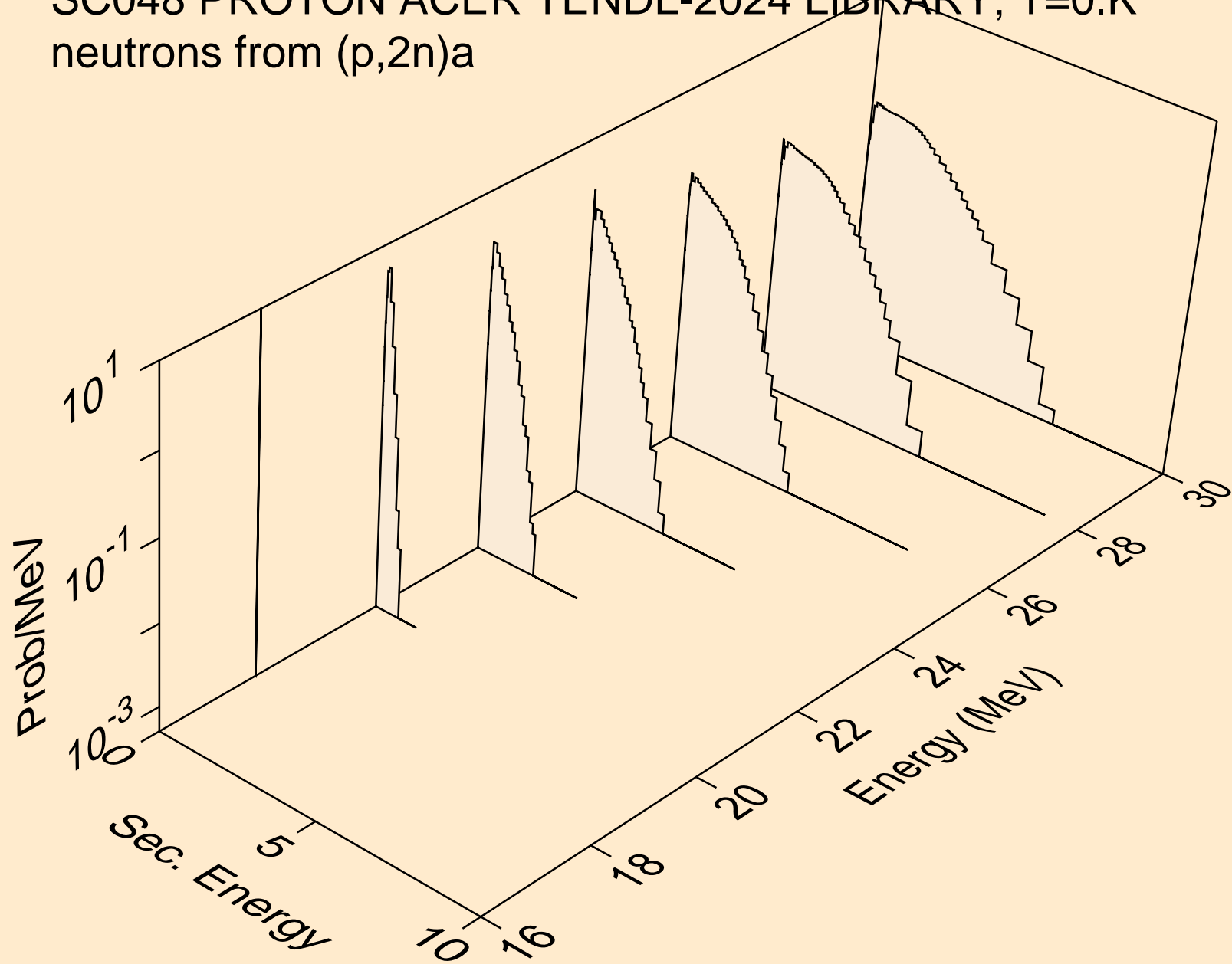

SC048 PROTON ACER TENDL-2024 LIBRARY; T=0.K  
neutrons from (p,3n)a

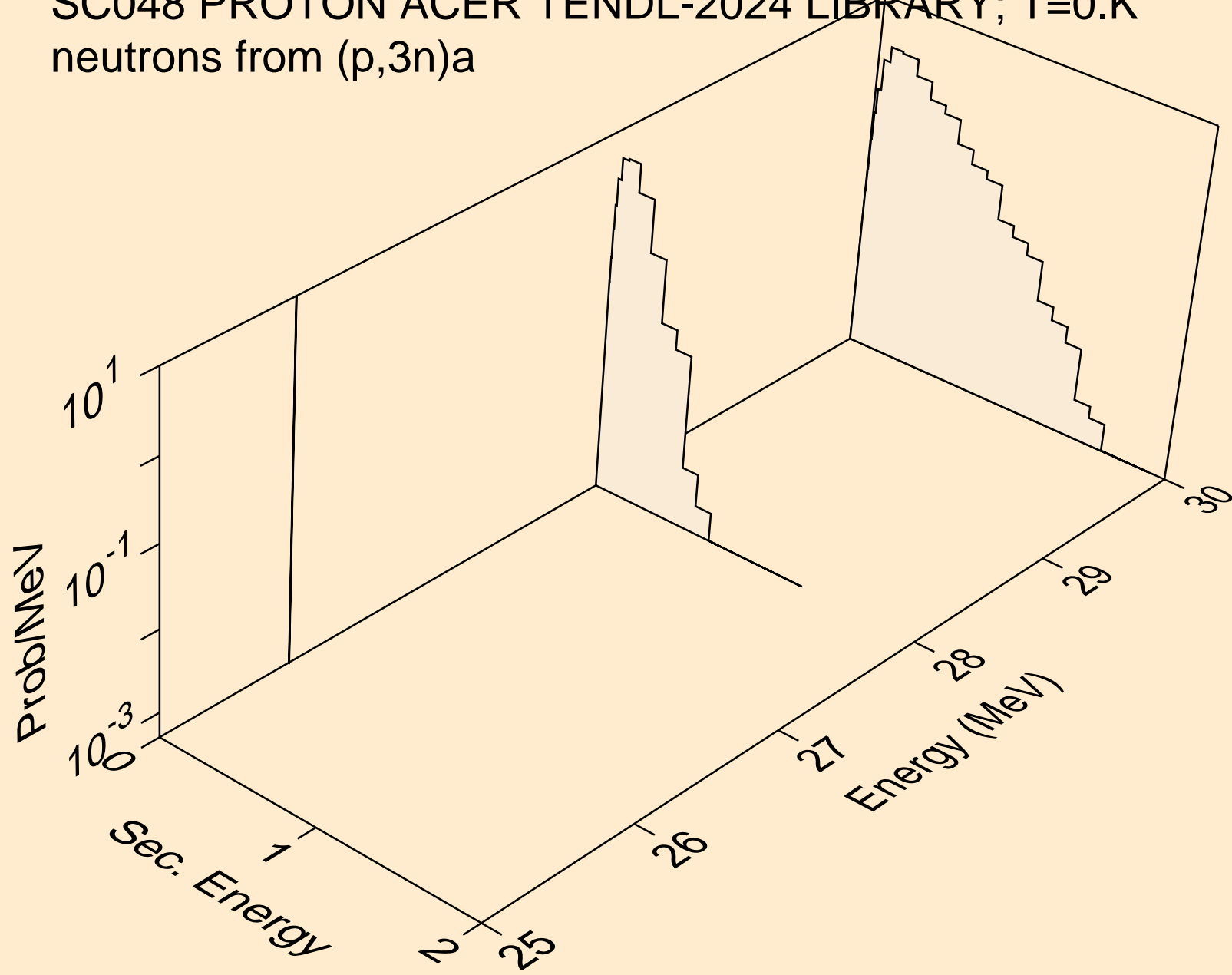

SC048 PROTON ACER TENDL-2024 LIBRARY; T=0.K  
neutrons from (p,n\*)p

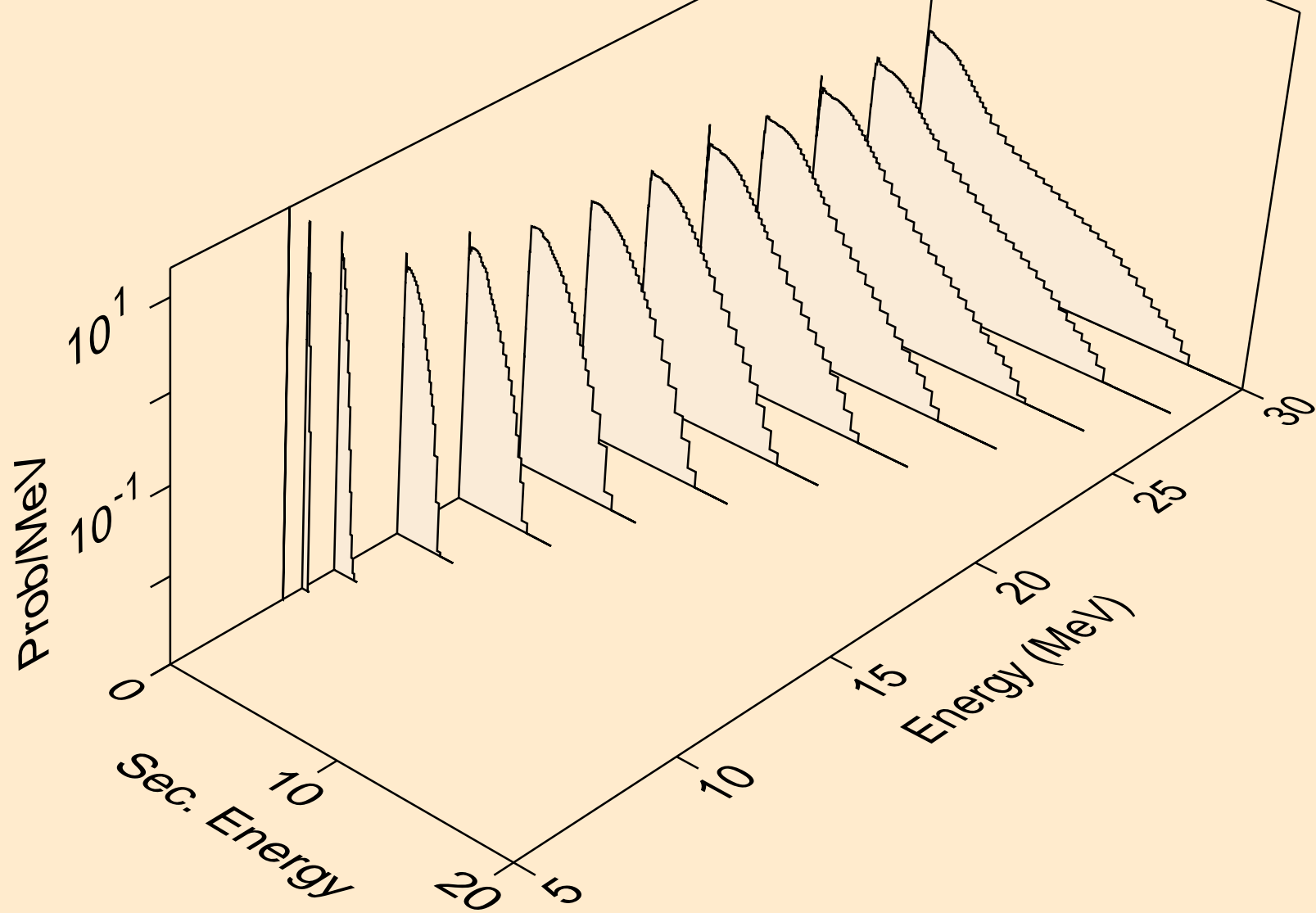

SC048 PROTON ACER TENDL-2024 LIBRARY; T=0.K  
neutrons from (p,n\*)2a

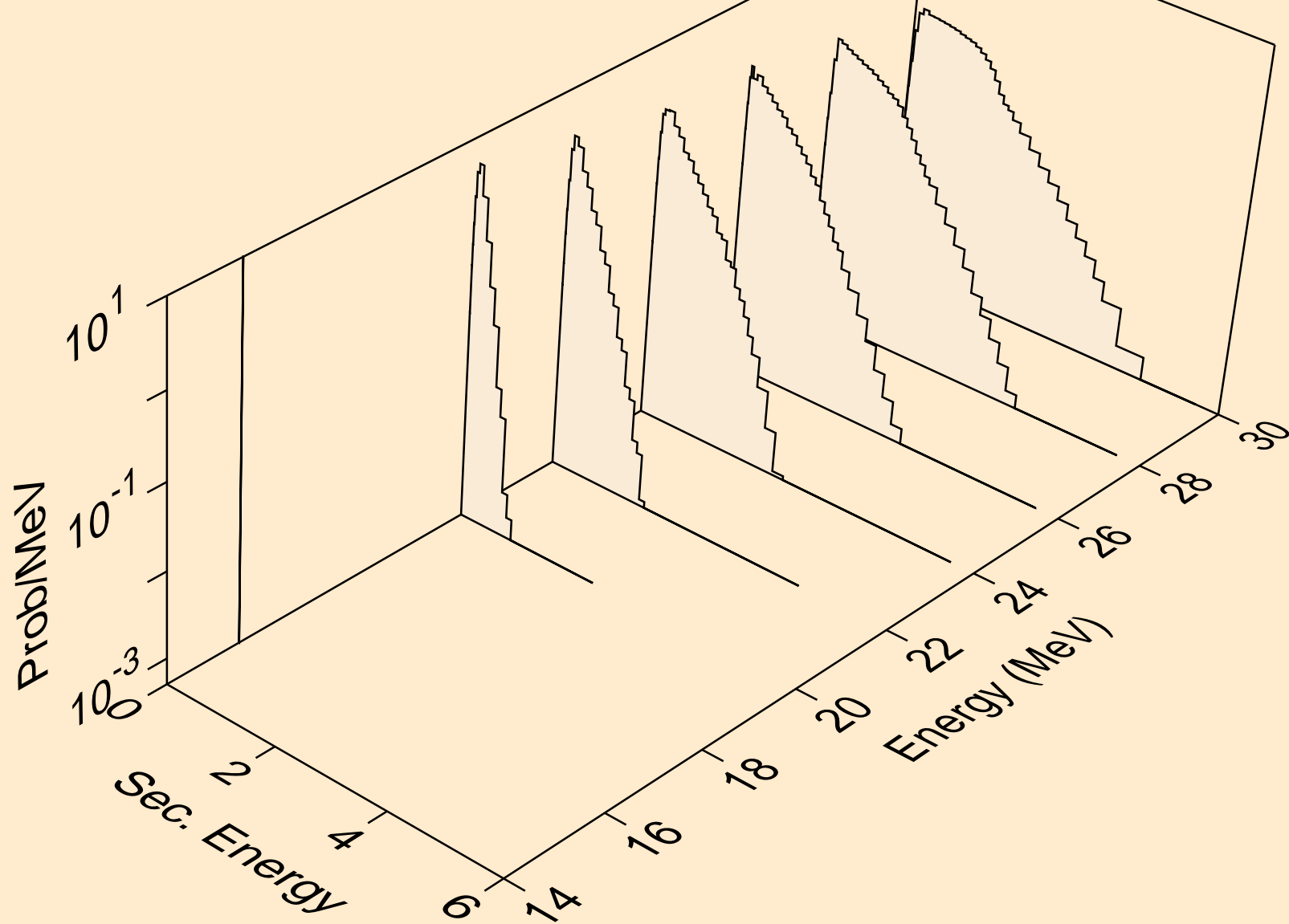

SC048 PROTON ACER TENDL-2024 LIBRARY; T=0.K  
neutrons from (p,n\*)d

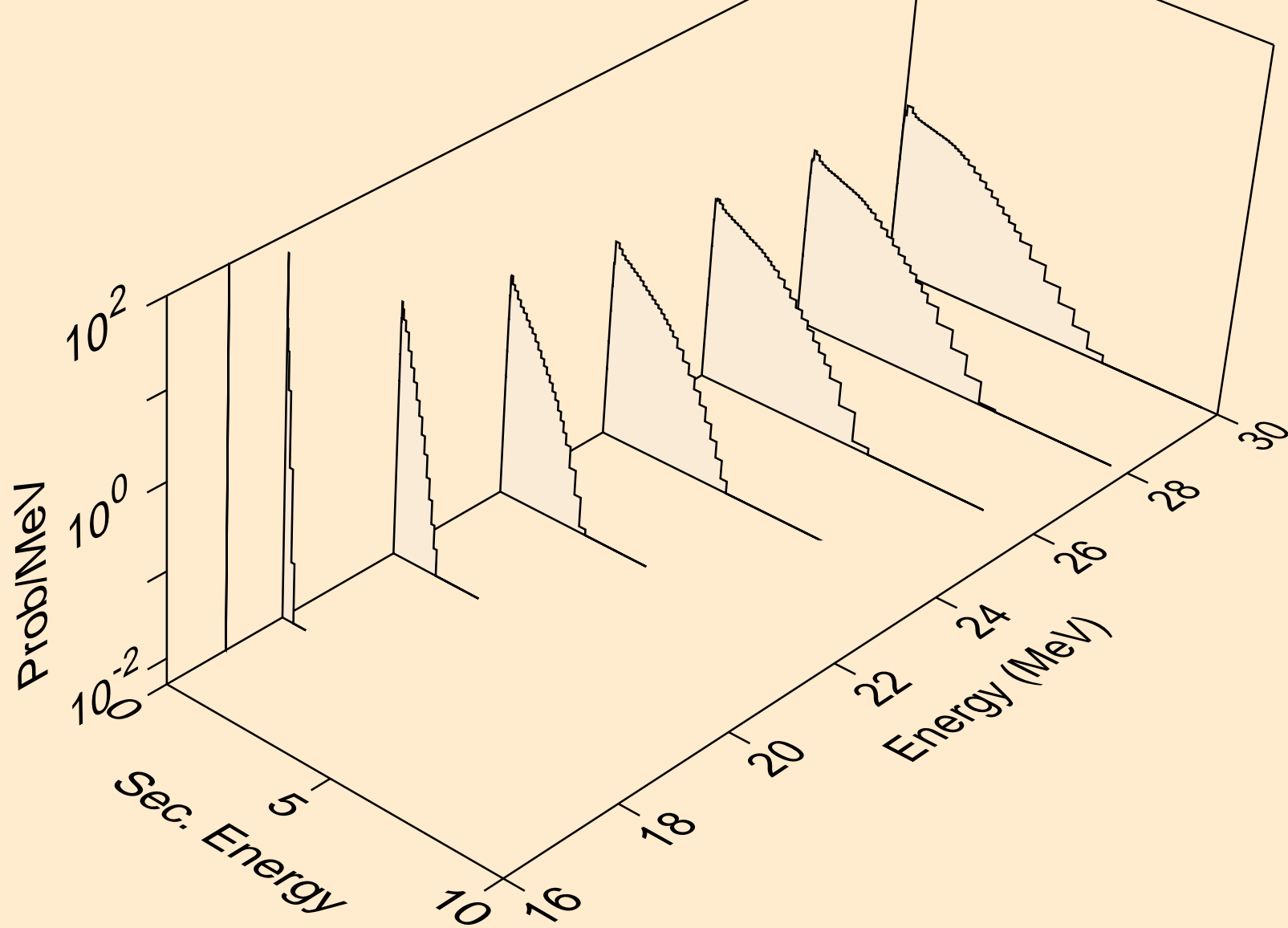

SC048 PROTON ACER TENDL-2024 LIBRARY; T=0.K  
neutrons from (p,n\*)t

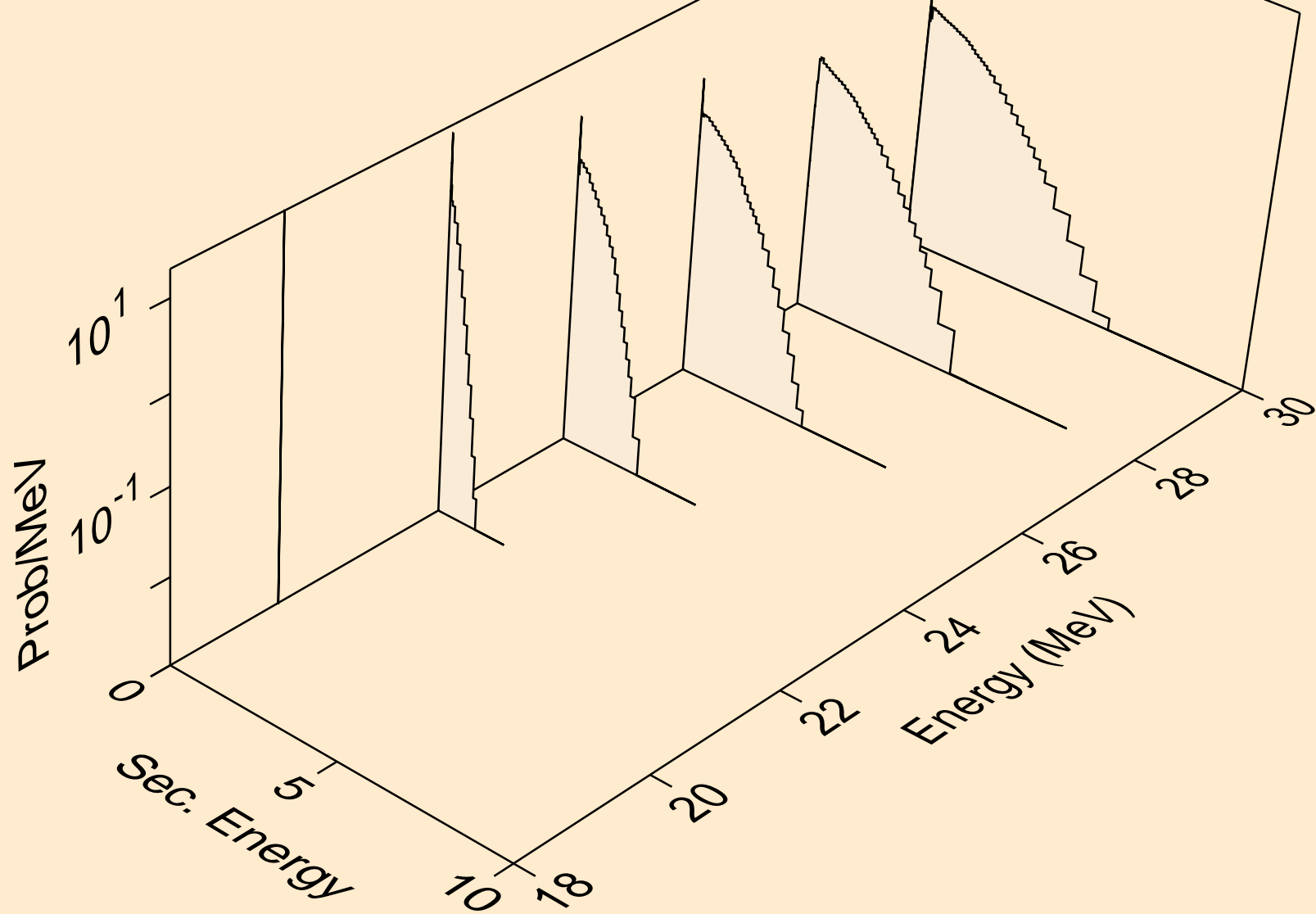

SC048 PROTON ACER TENDL-2024 LIBRARY; T=0.K  
neutrons from (p,n\*)he3

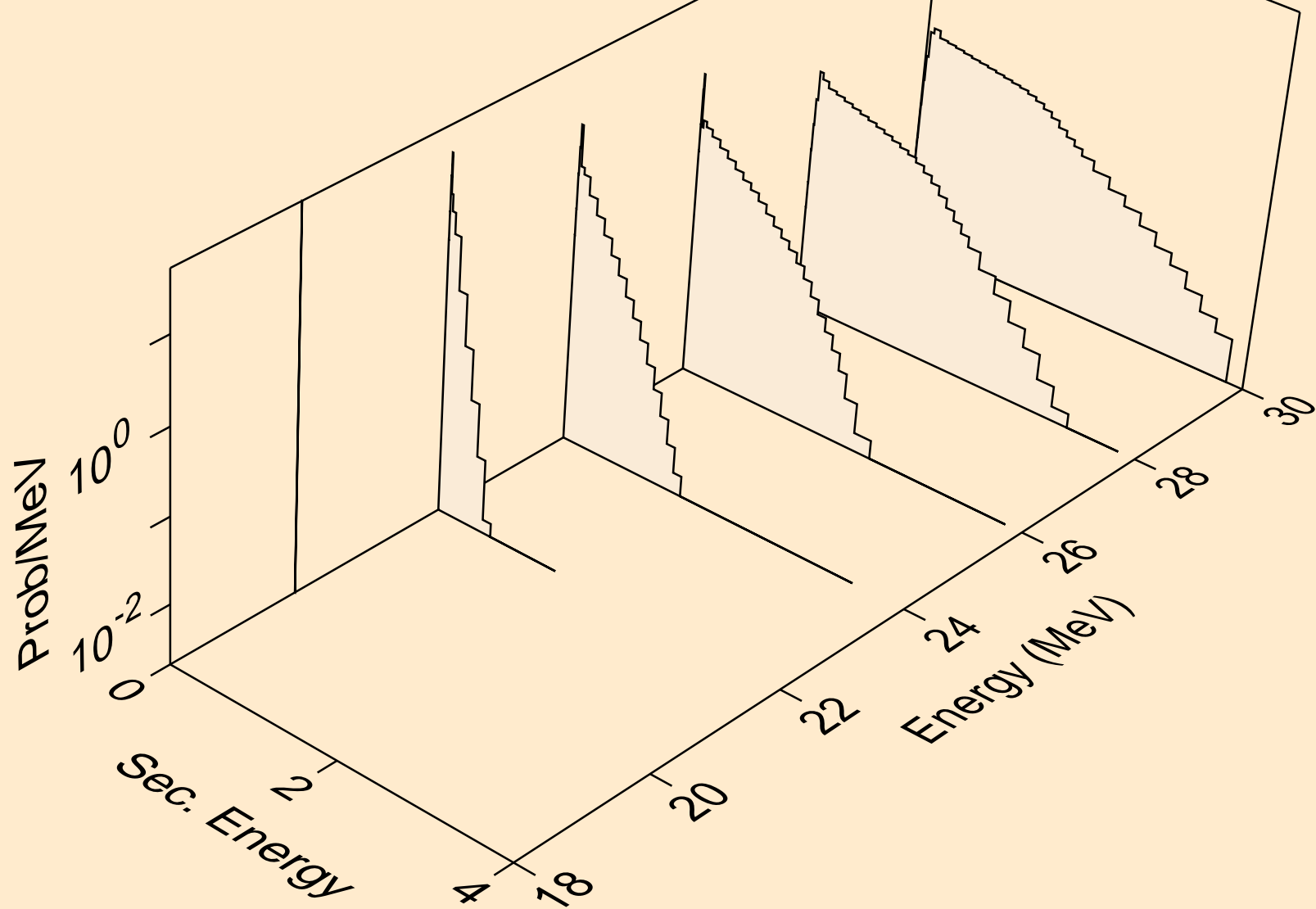

SC048 PROTON ACER TENDL-2024 LIBRARY; T=0.K  
neutrons from (p,2np)

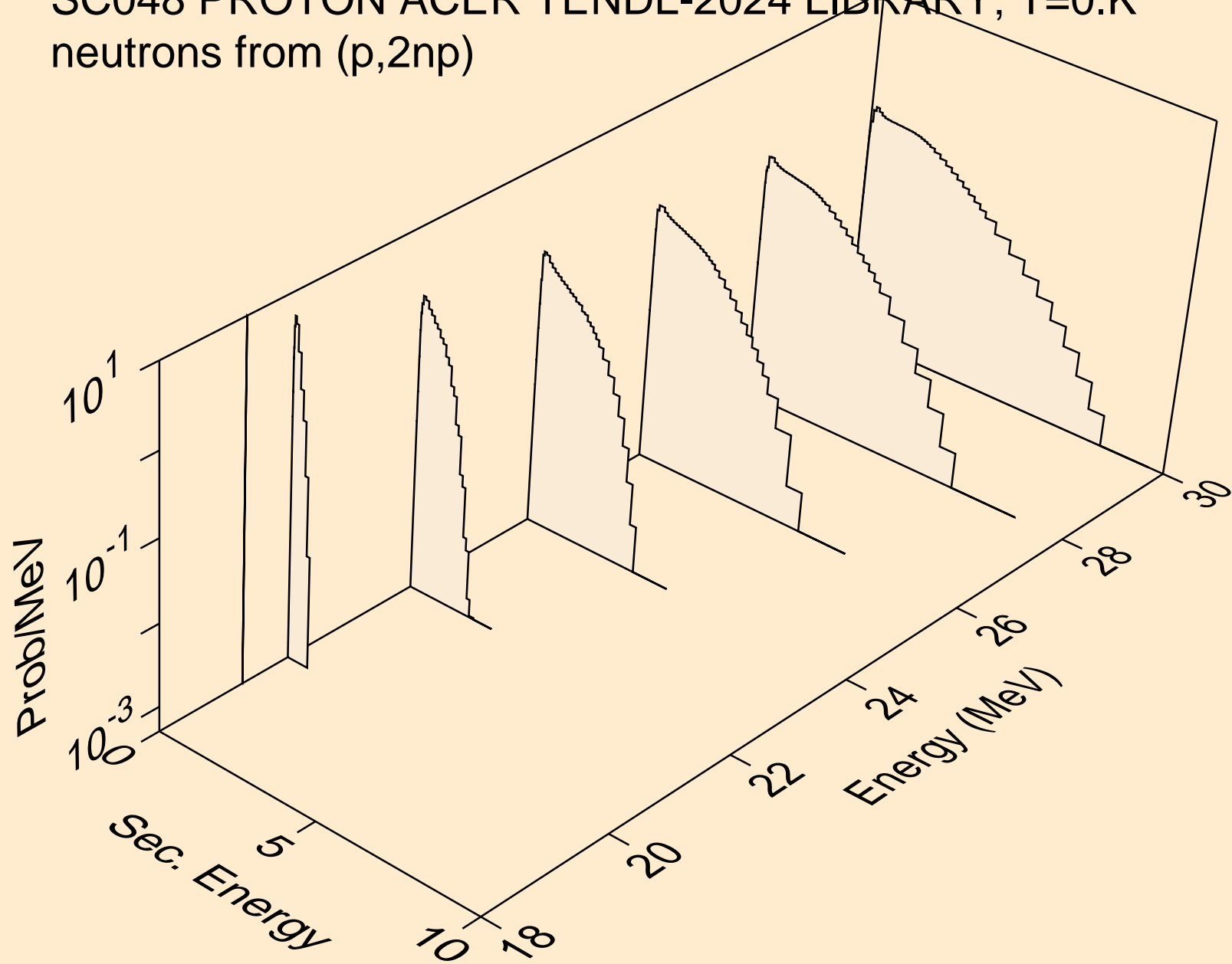

SC048 PROTON ACER TENDL-2024 LIBRARY; T=0.K  
neutrons from (p,n2p)

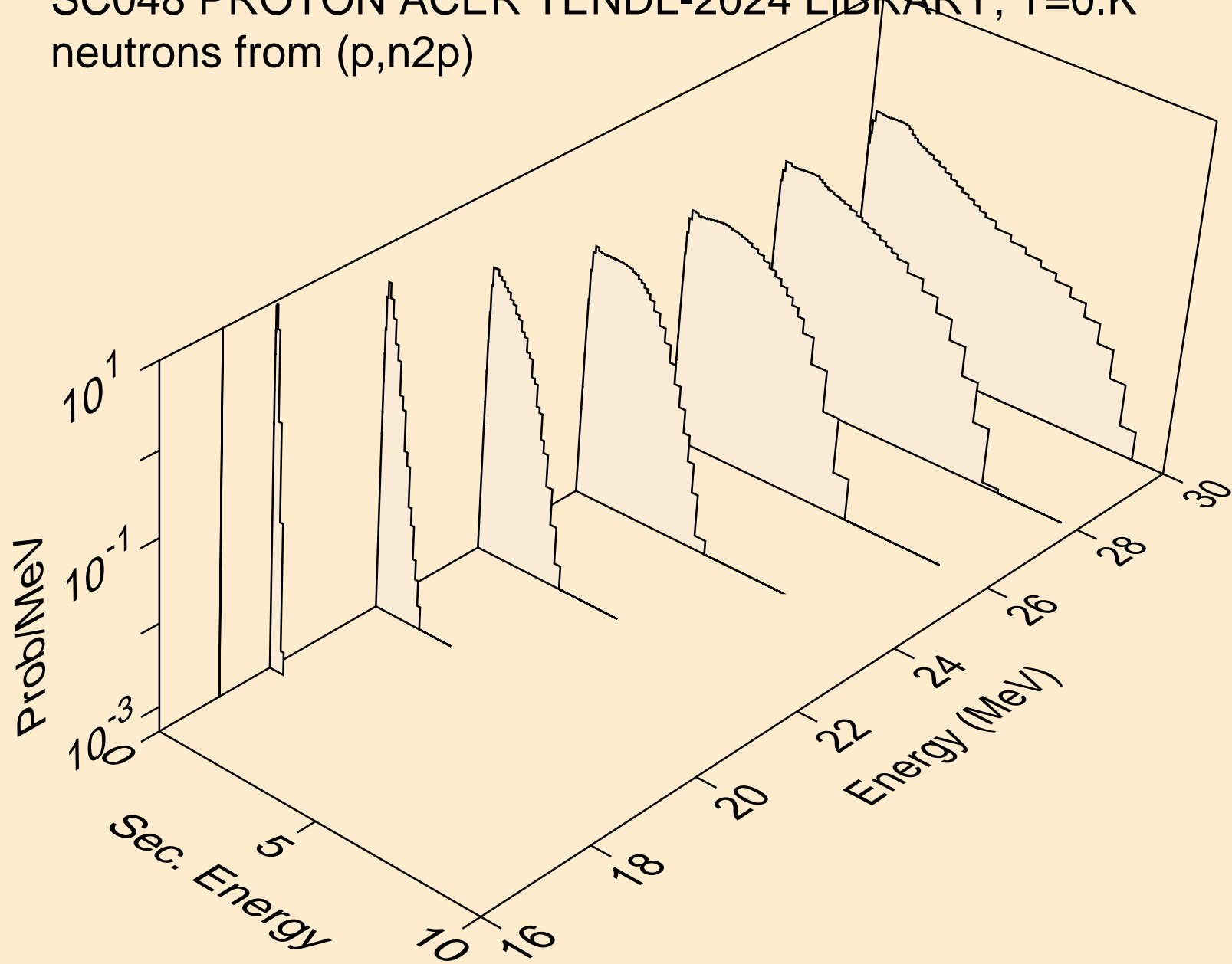

SC048 PROTON ACER TENDL-2024 LIBRARY; T=0.K  
neutrons from (p,npa)

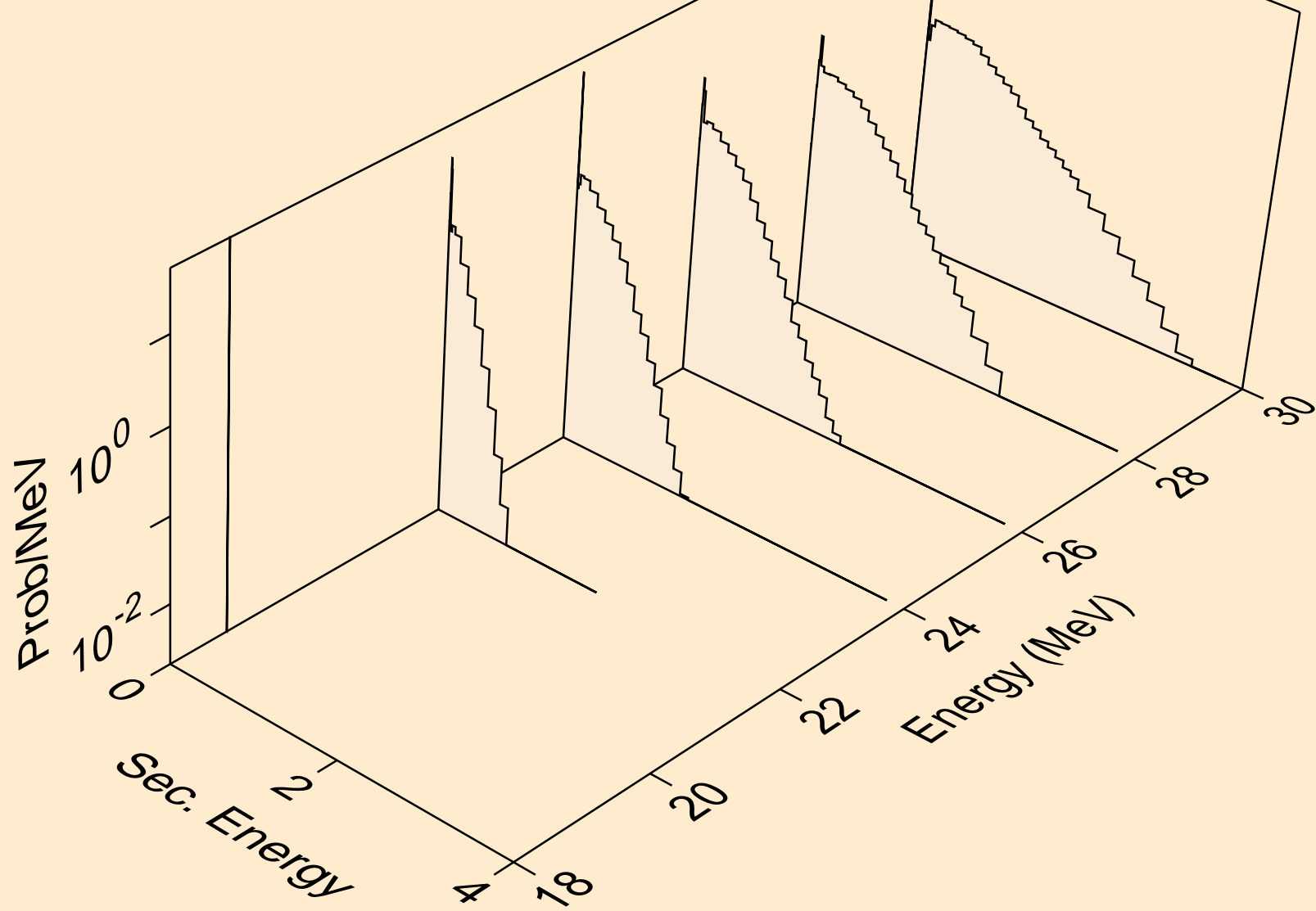

SC048 PROTON ACER TENDL-2024 LIBRARY; T=0.K  
deuterons from (p,x)

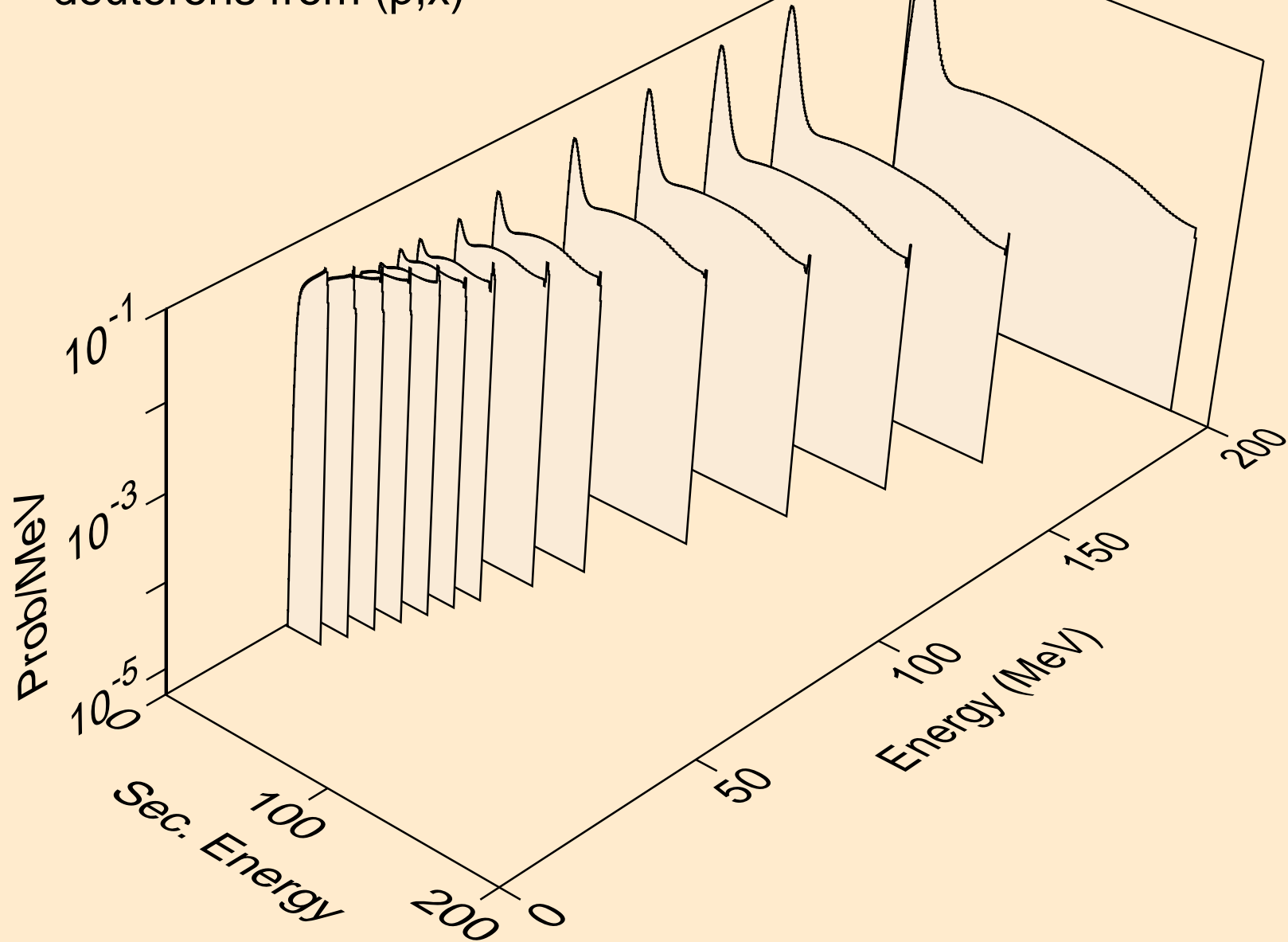

SC048 PROTON ACER TENDL-2024 LIBRARY; T=0.K  
deuterons from (p,2nd)

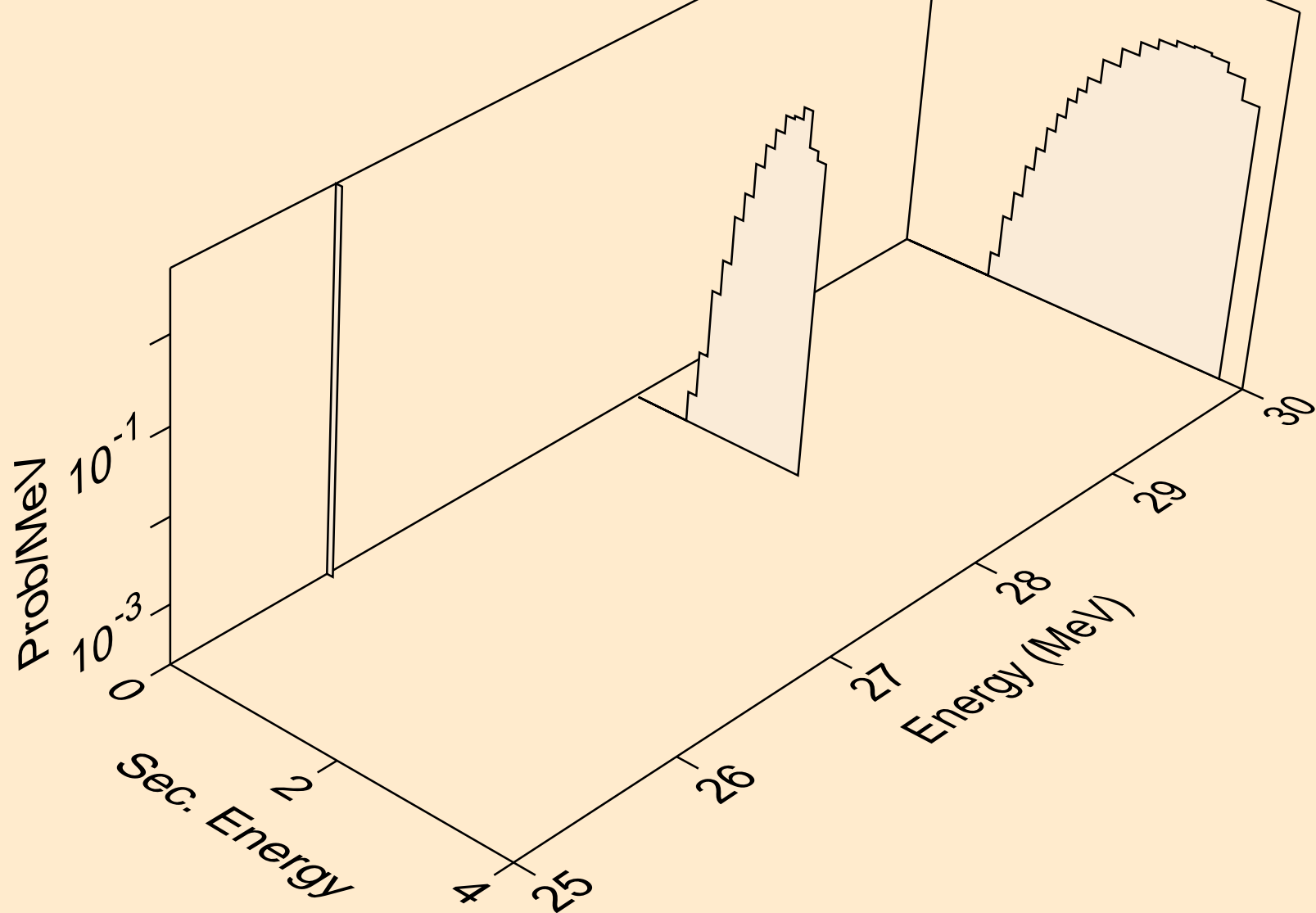

SC048 PROTON ACER TENDL-2024 LIBRARY; T=0.K  
deuterons from (p,n\*)d

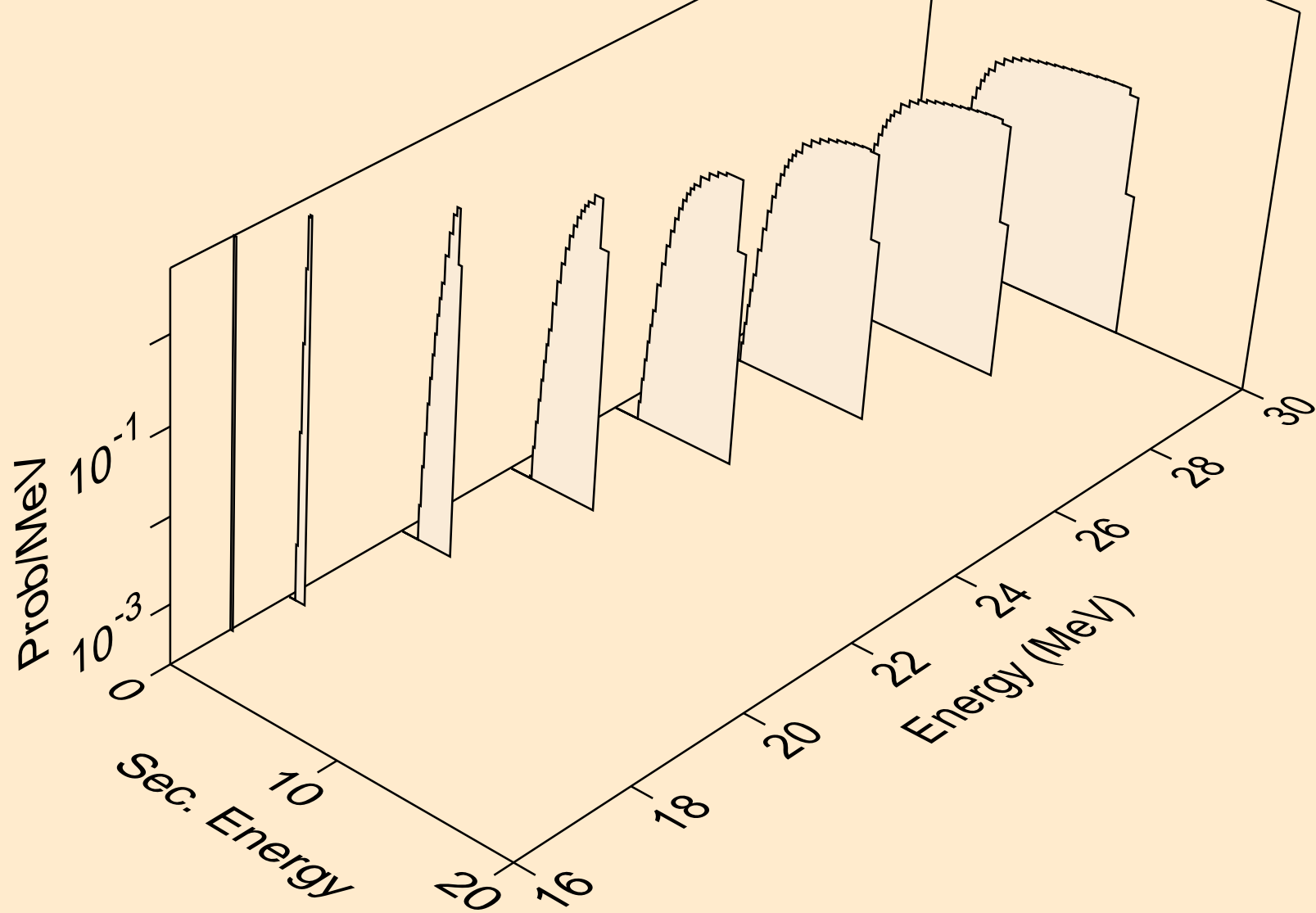

SC048 PROTON ACER TENDL-2024 LIBRARY; T=0.K  
deuterons from (p,d)

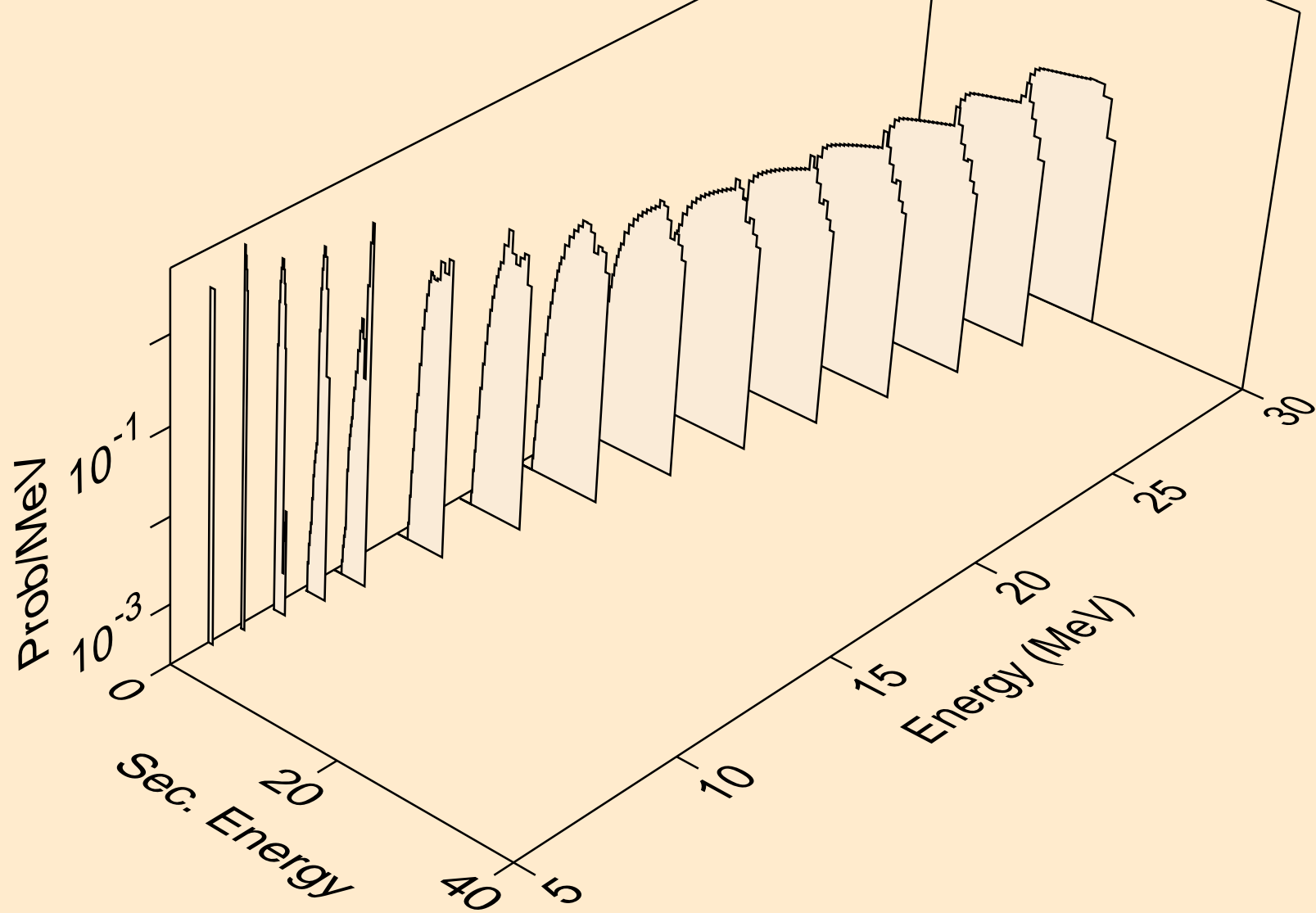

SC048 PROTON ACER TENDL-2024 LIBRARY; T=0.K  
deuterons from (p,pd)

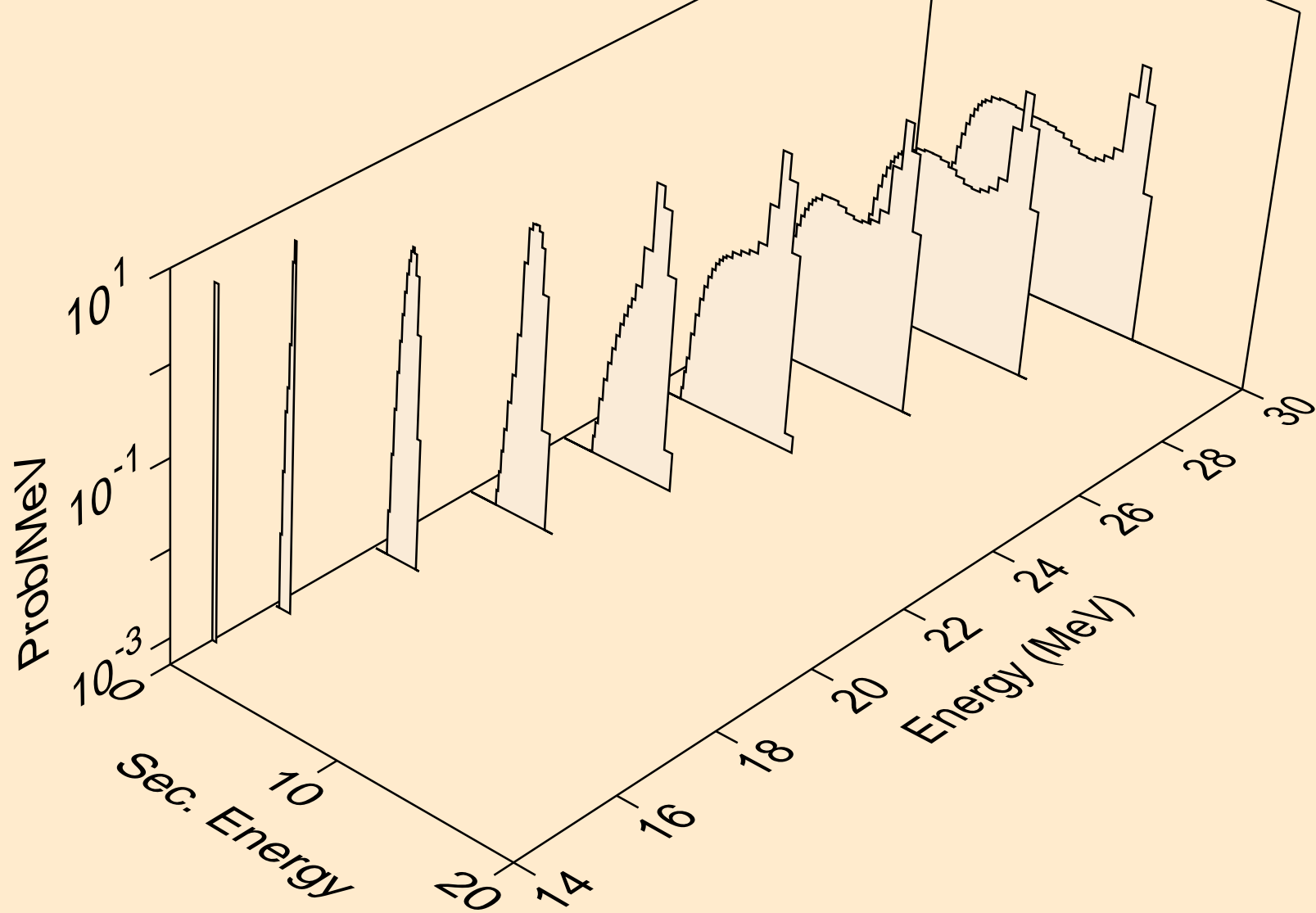

SC048 PROTON ACER TENDL-2024 LIBRARY; T=0.K  
deuterons from (p,da)

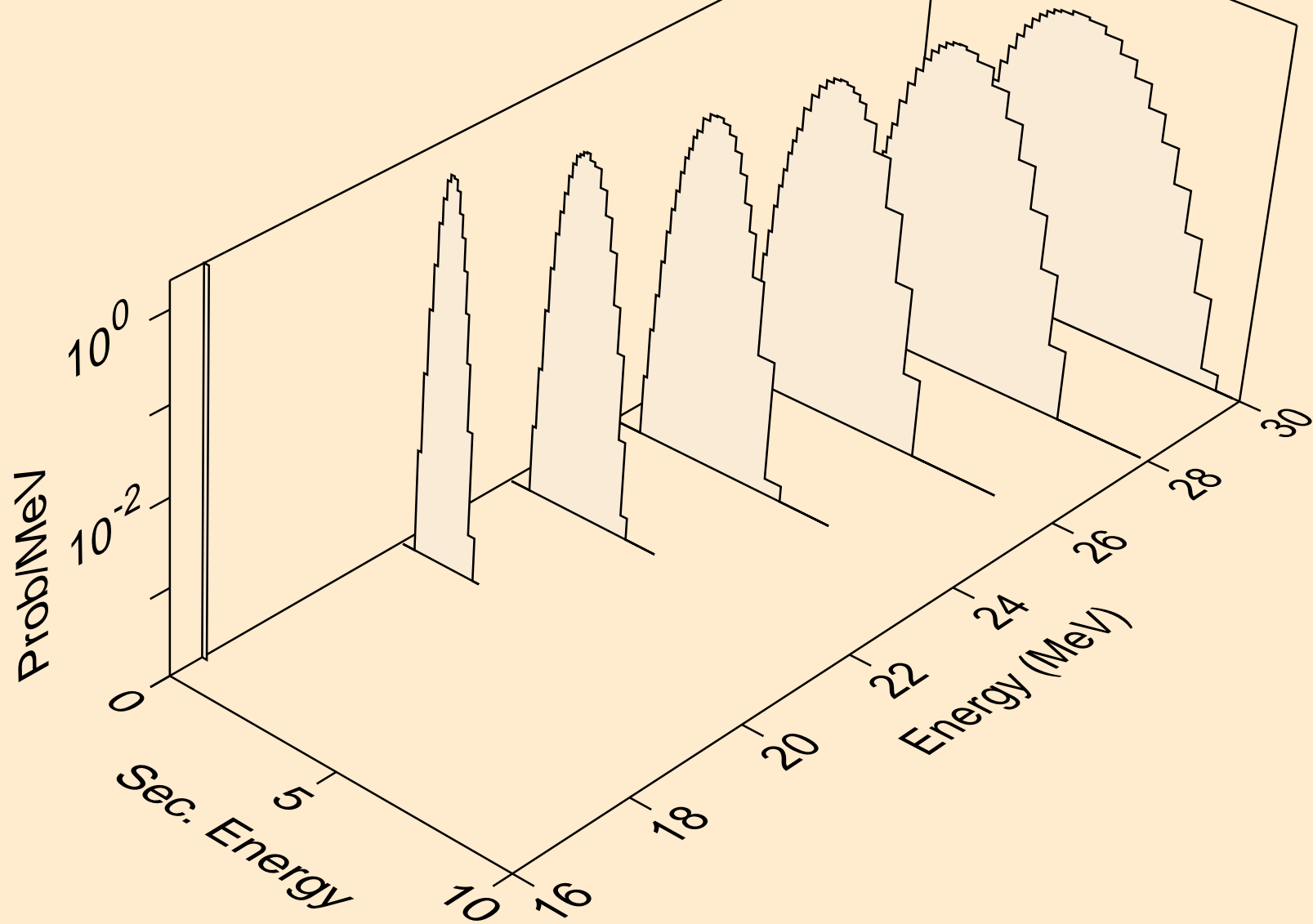

SC048 PROTON ACER TENDL-2024 LIBRARY; T=0.K  
tritons from (p,x)

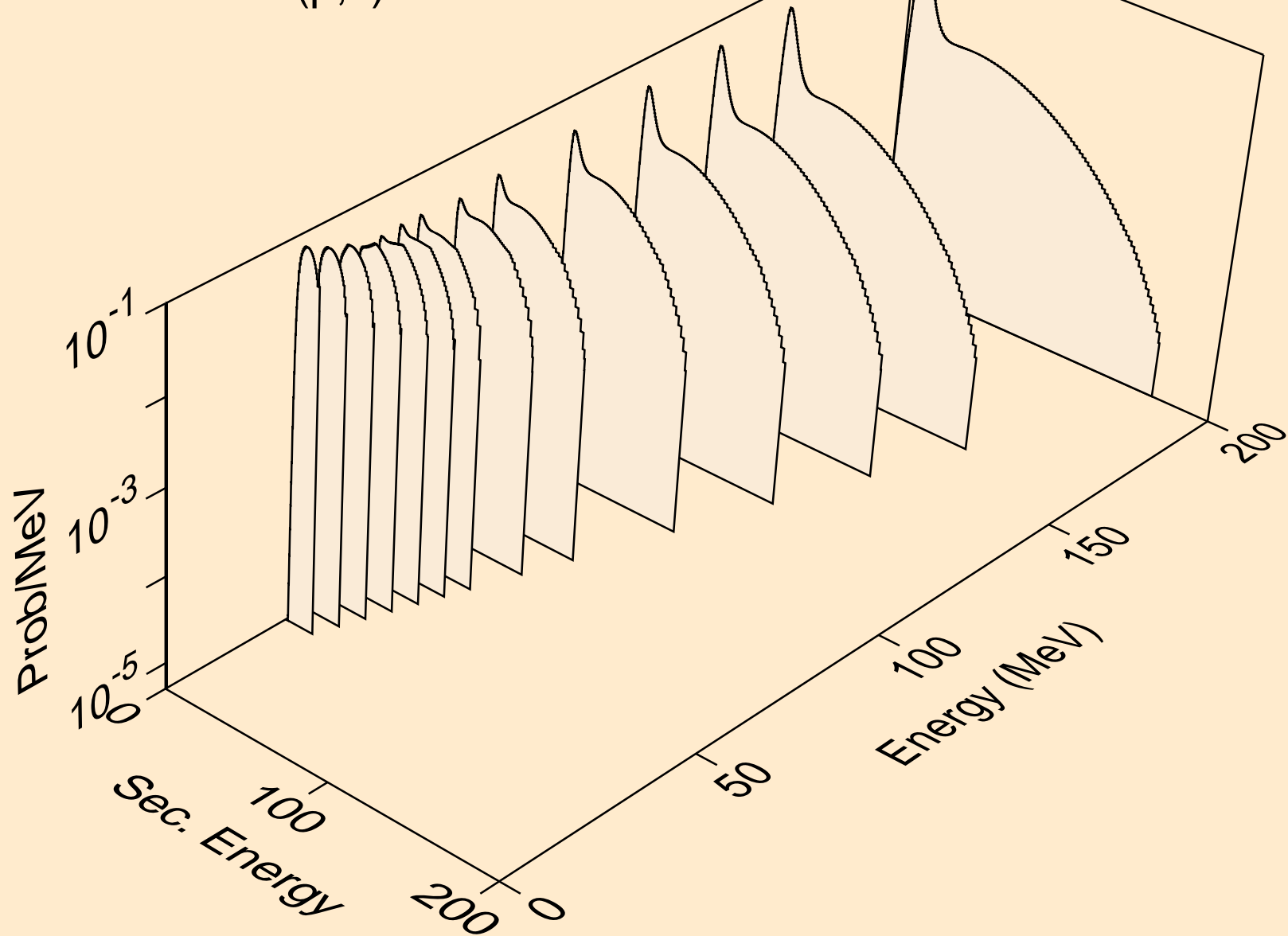

SC048 PROTON ACER TENDL-2024 LIBRARY; T=0.K  
tritons from (p,n\*)t

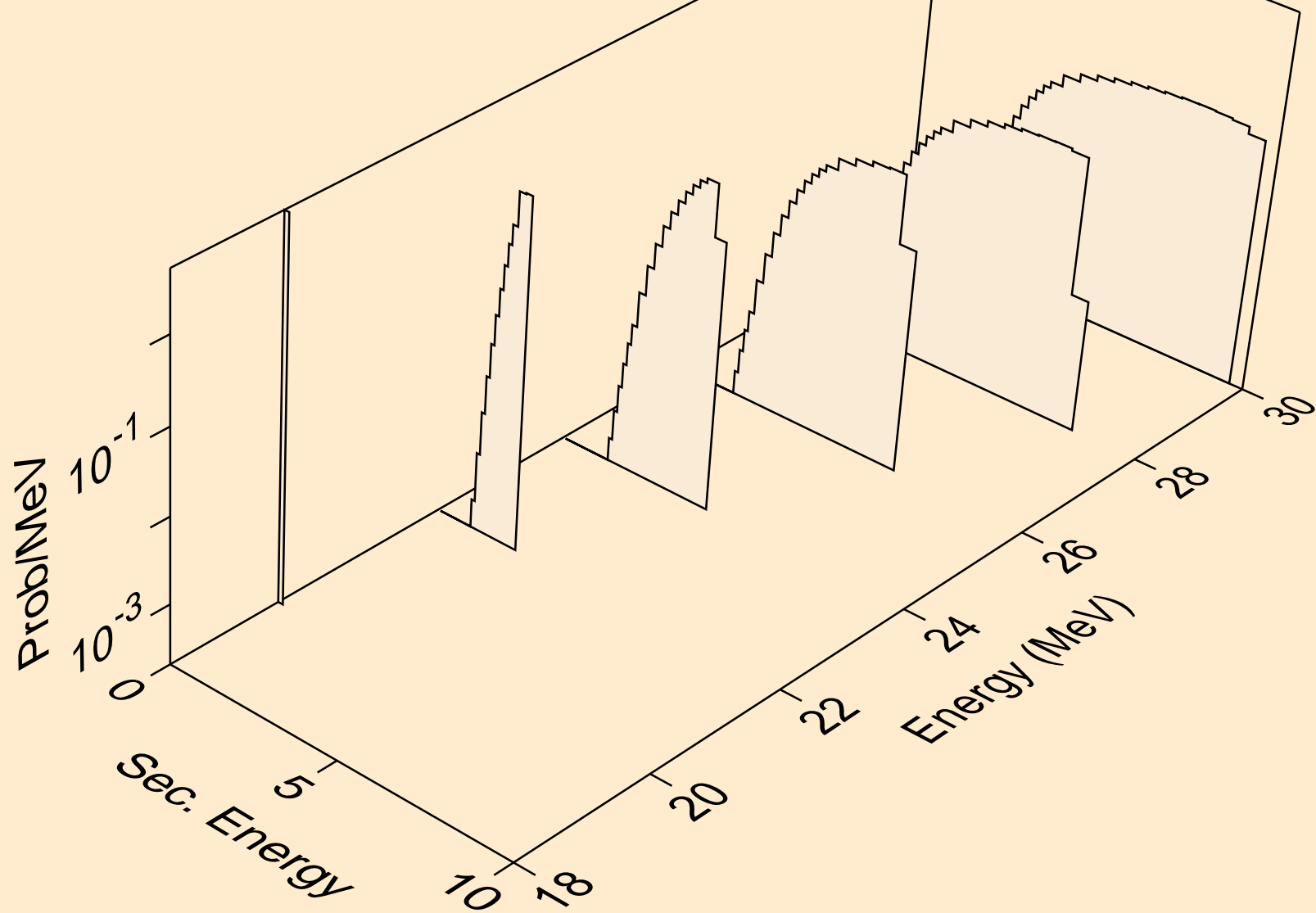

SC048 PROTON ACER TENDL-2024 LIBRARY; T=0.K  
tritons from (p,t)

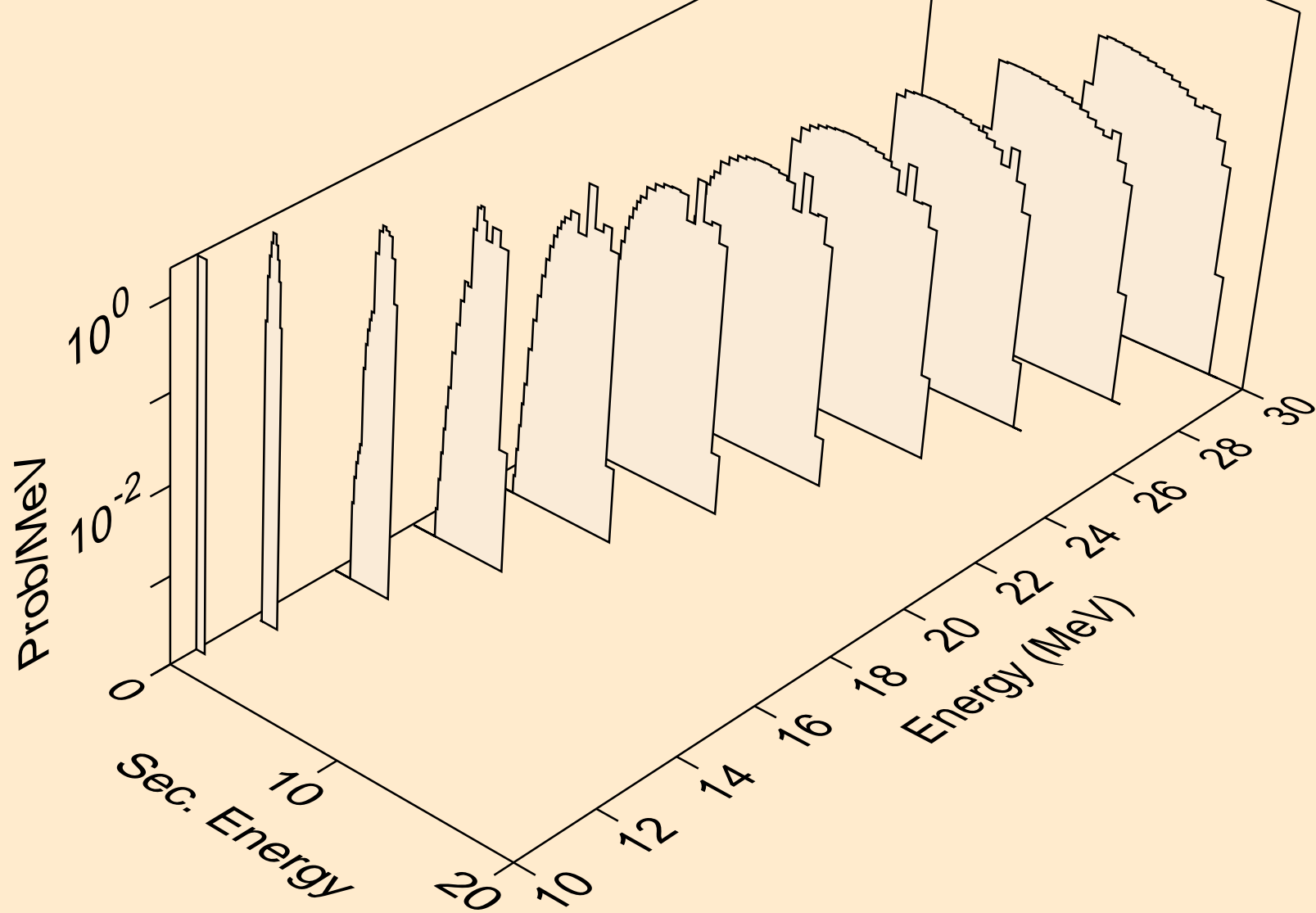

SC048 PROTON ACER TENDL-2024 LIBRARY; T=0.K  
tritons from (p,pt)

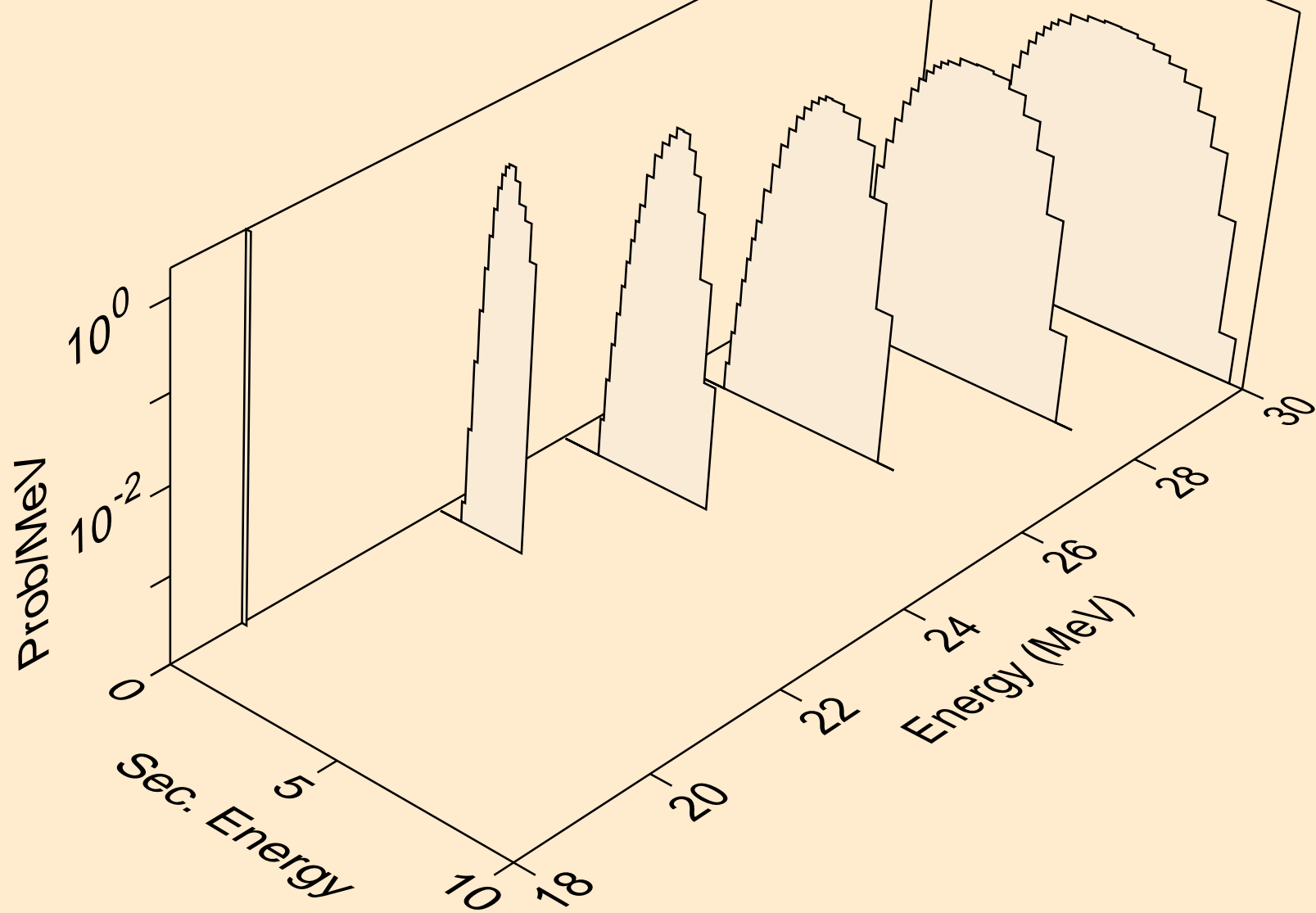

SC048 PROTON ACER TENDL-2024 LIBRARY; T=0.K  
he3s from (p,x)

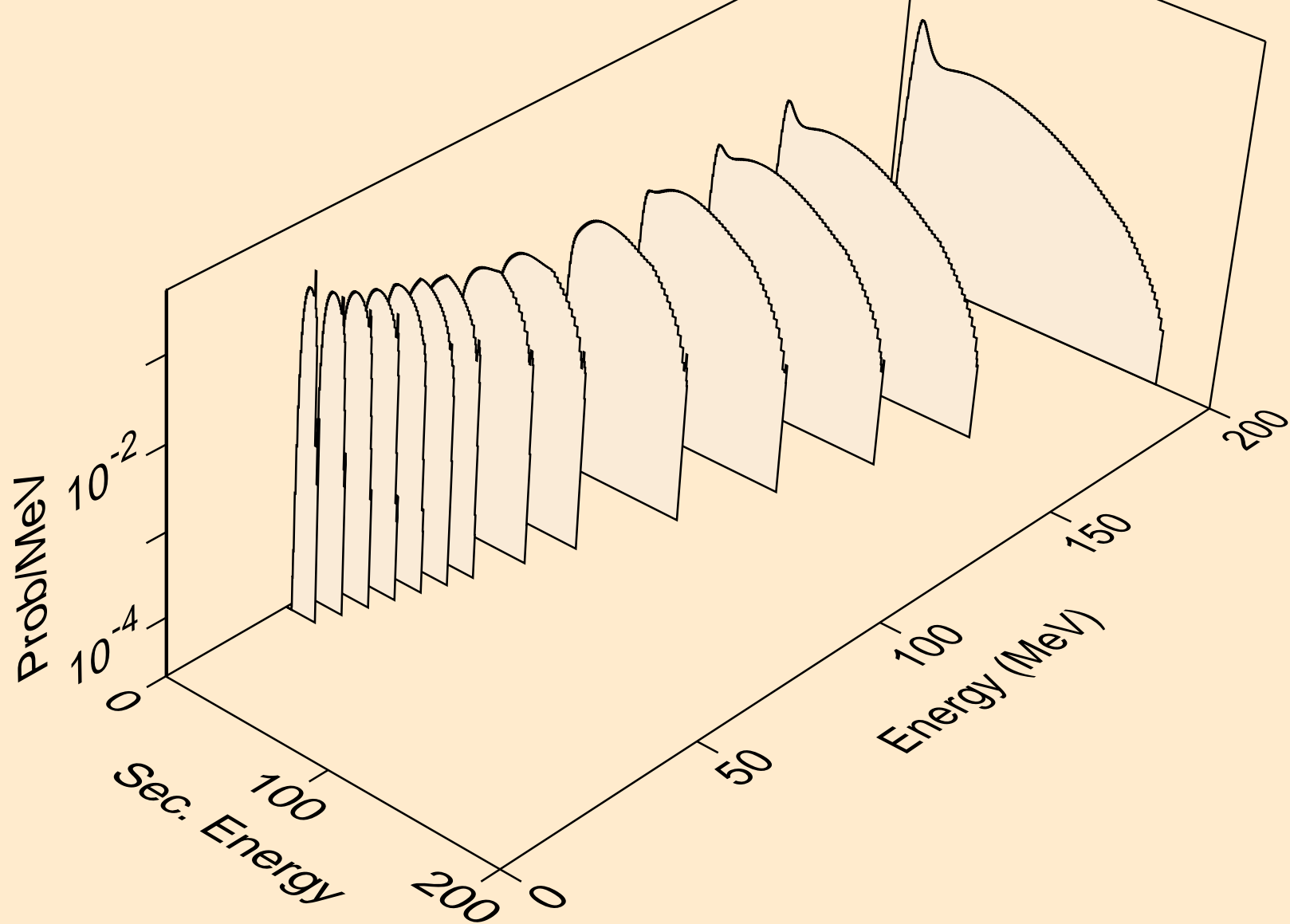

SC048 PROTON ACER TENDL-2024 LIBRARY; T=0.K  
he3s from (p,n\*)he3

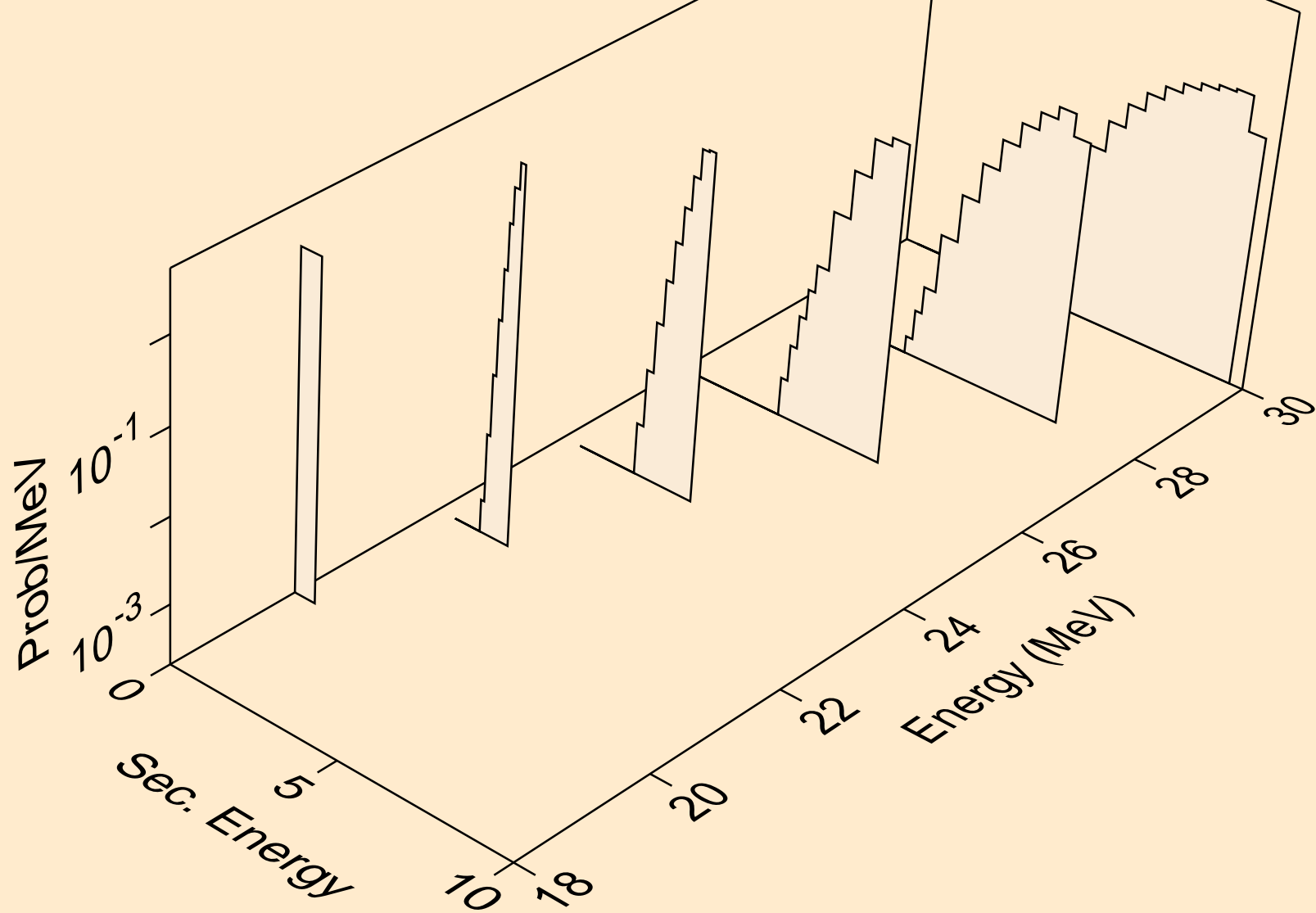

SC048 PROTON ACER TENDL-2024 LIBRARY; T=0.K  
he3s from (p,he3)

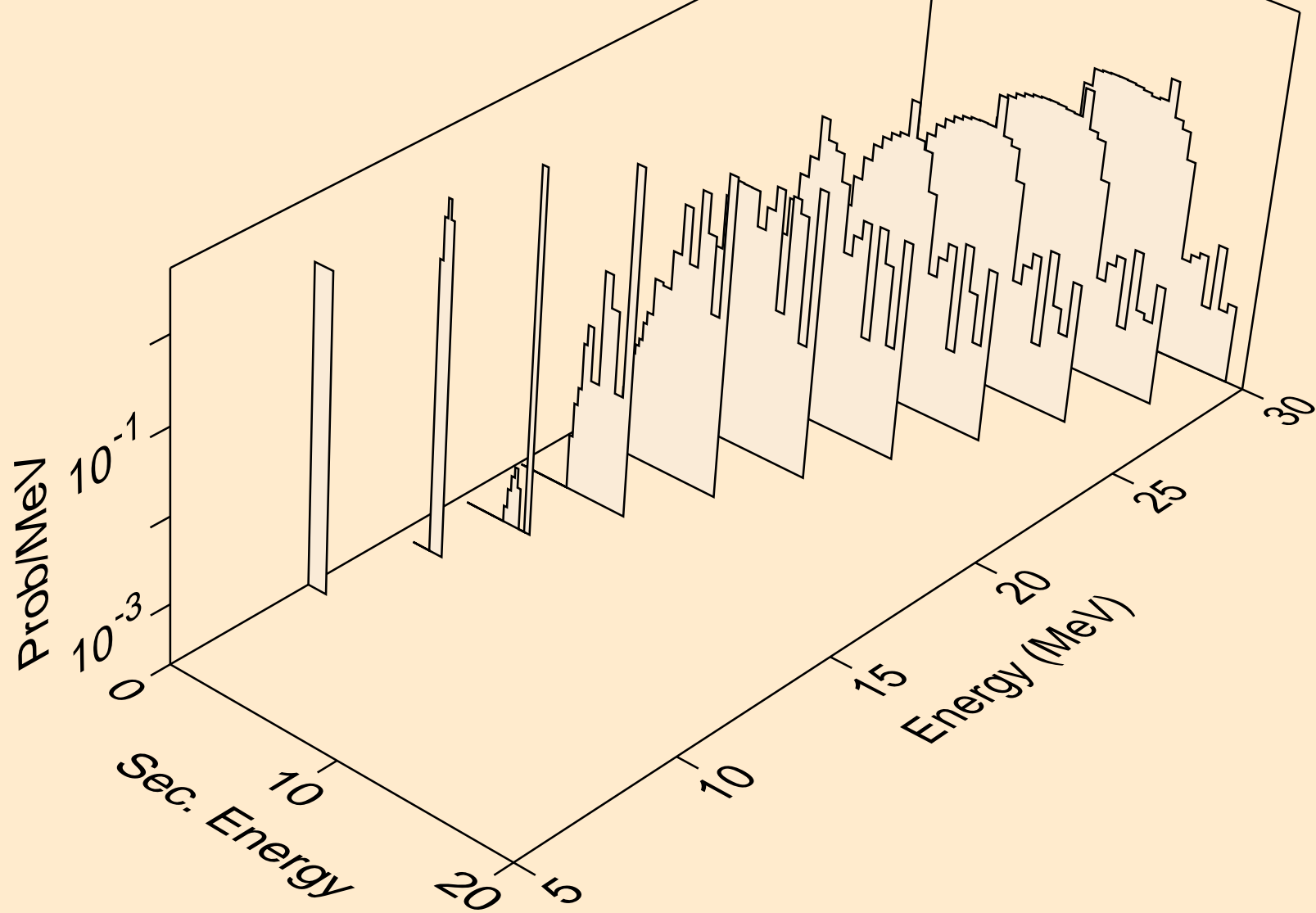

SC048 PROTON ACER TENDL-2024 LIBRARY; T=0.K  
alphas from (p,x)

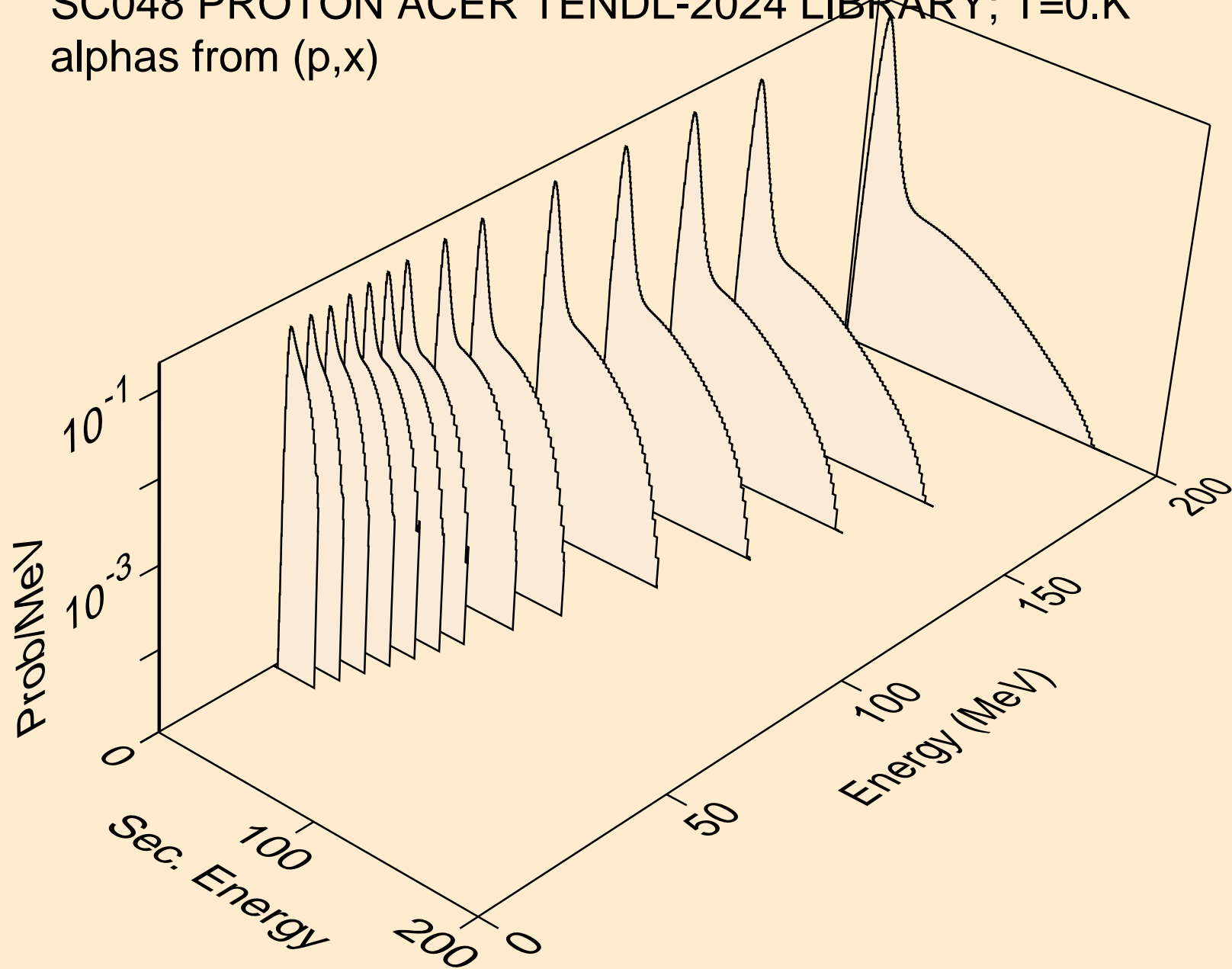

SC048 PROTON ACER TENDL-2024 LIBRARY; T=0.K  
alphas from (p,n\*)a

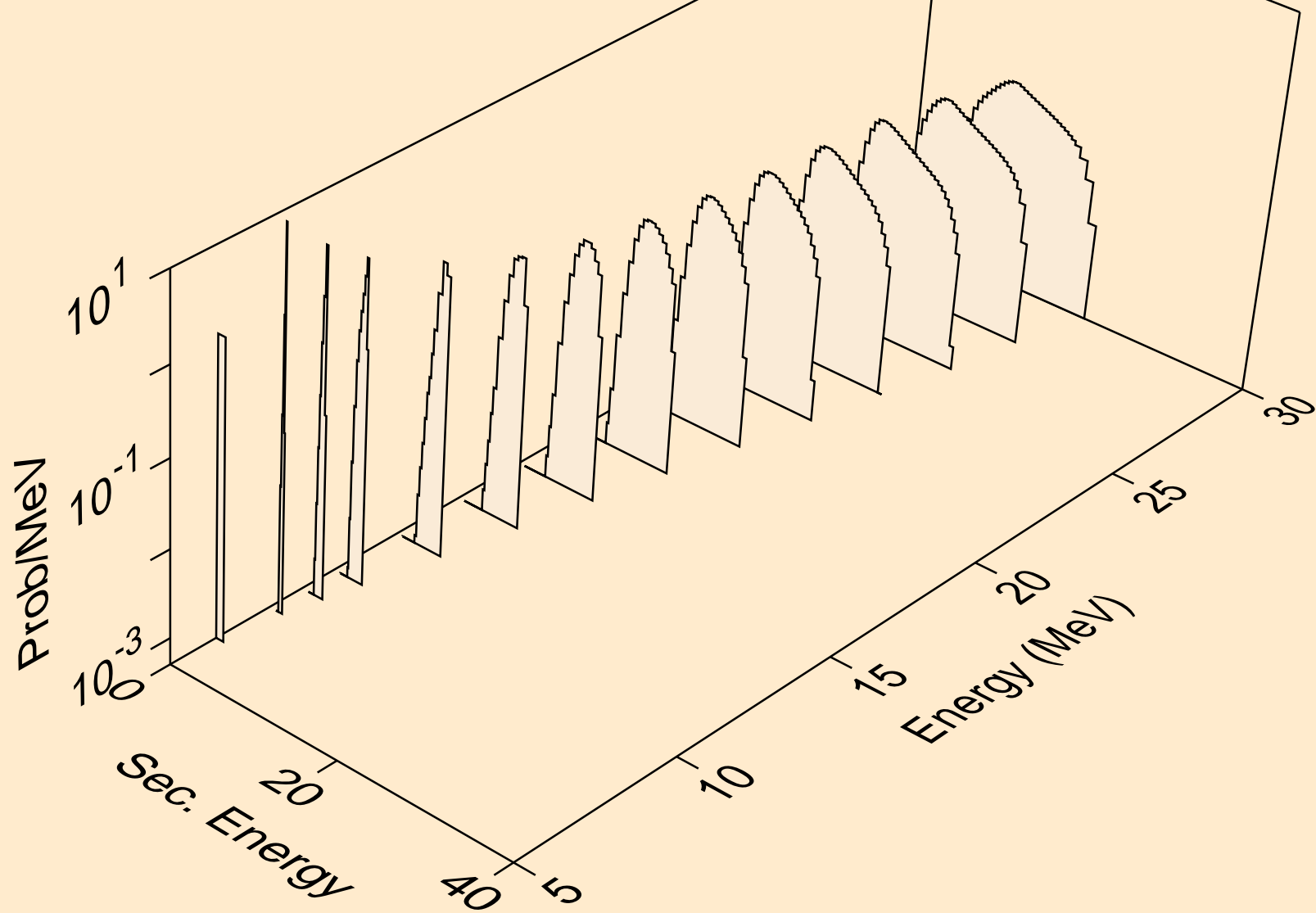

SC048 PROTON ACER TENDL-2024 LIBRARY; T=0.K  
alphas from (p,2n)a

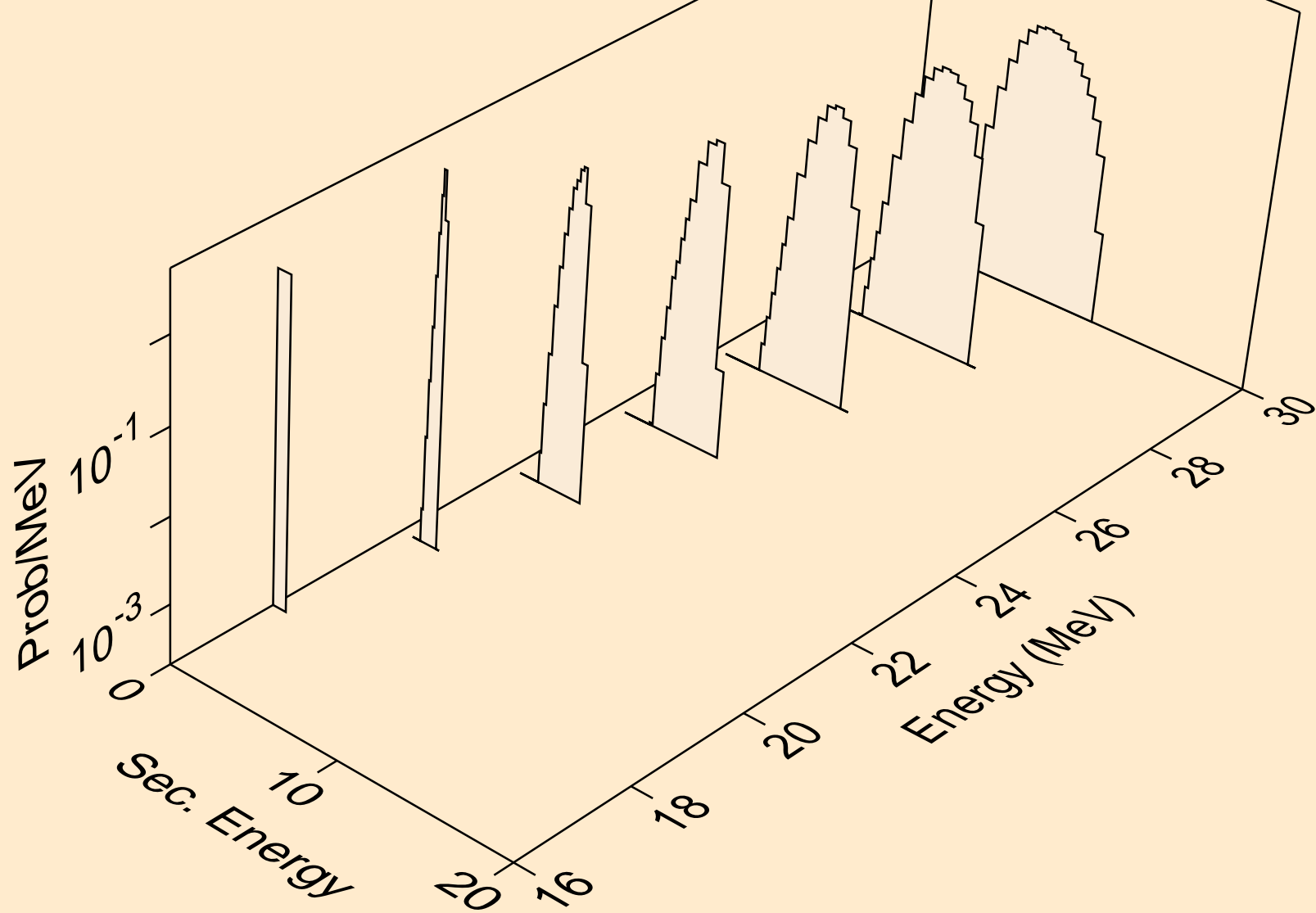

SC048 PROTON ACER TENDL-2024 LIBRARY; T=0.K  
alphas from (p,3n)a

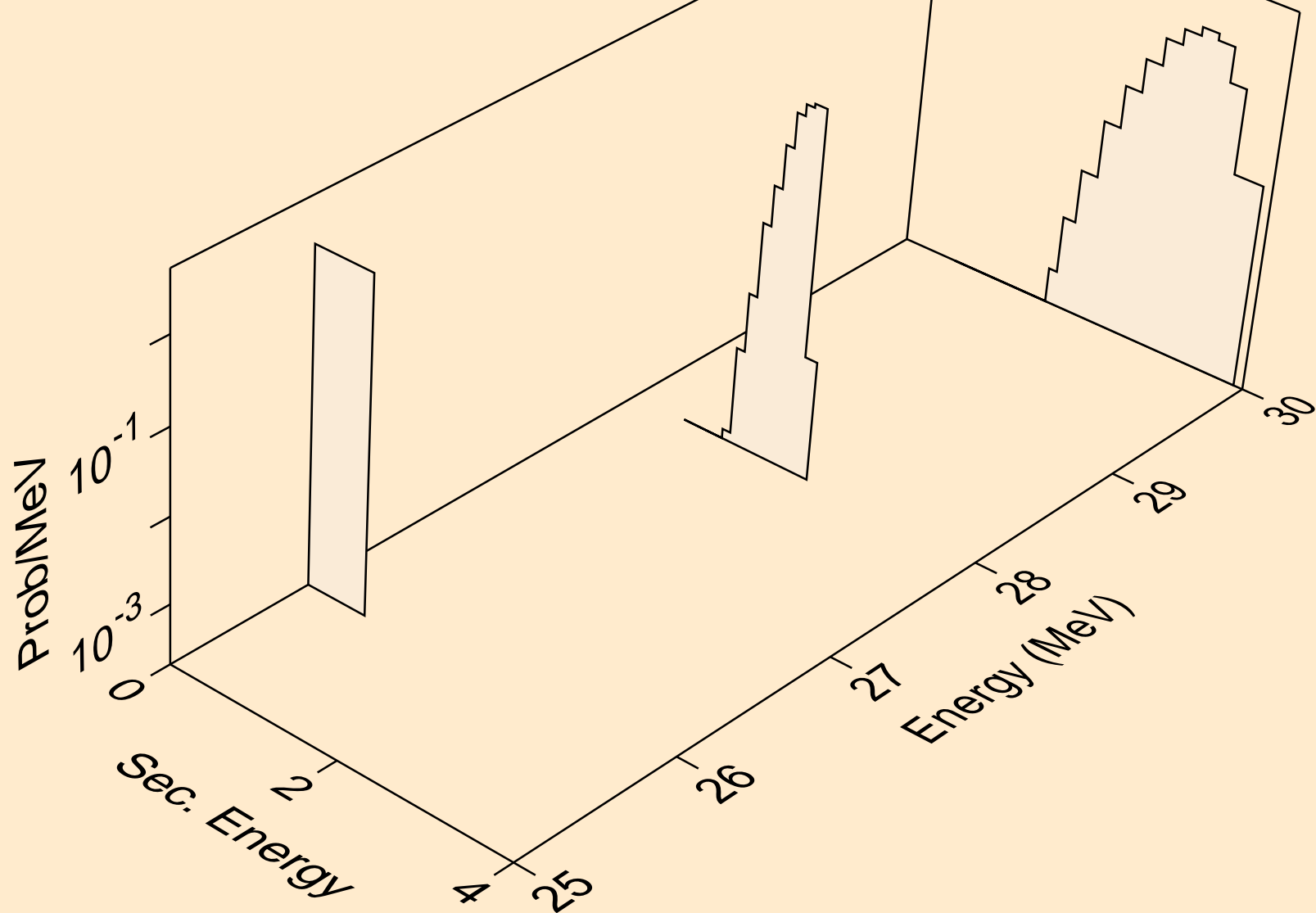

SC048 PROTON ACER TENDL-2024 LIBRARY; T=0.K  
alphas from (p,n\*)2a

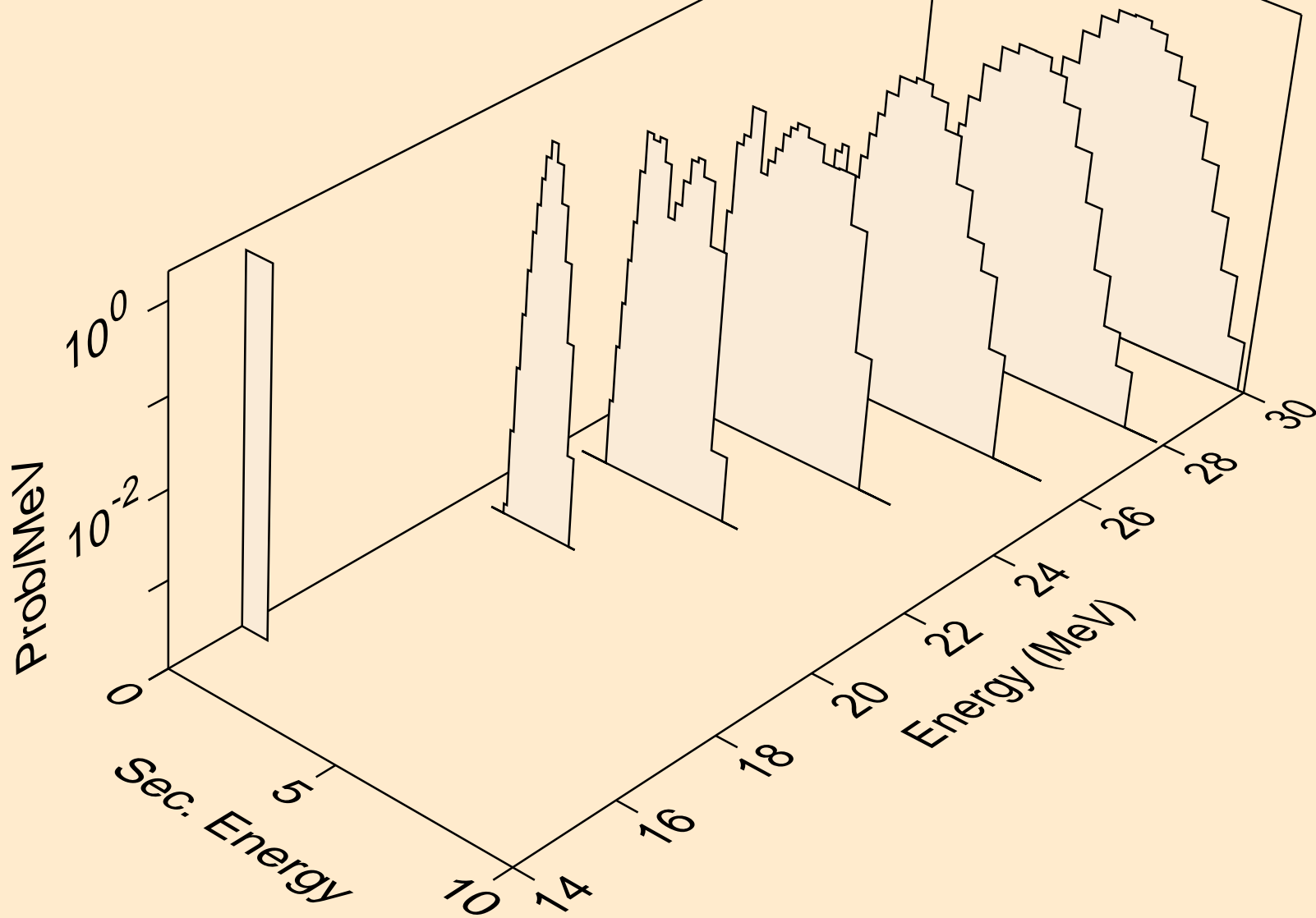

SC048 PROTON ACER TENDL-2024 LIBRARY; T=0.K  
alphas from (p,npa)

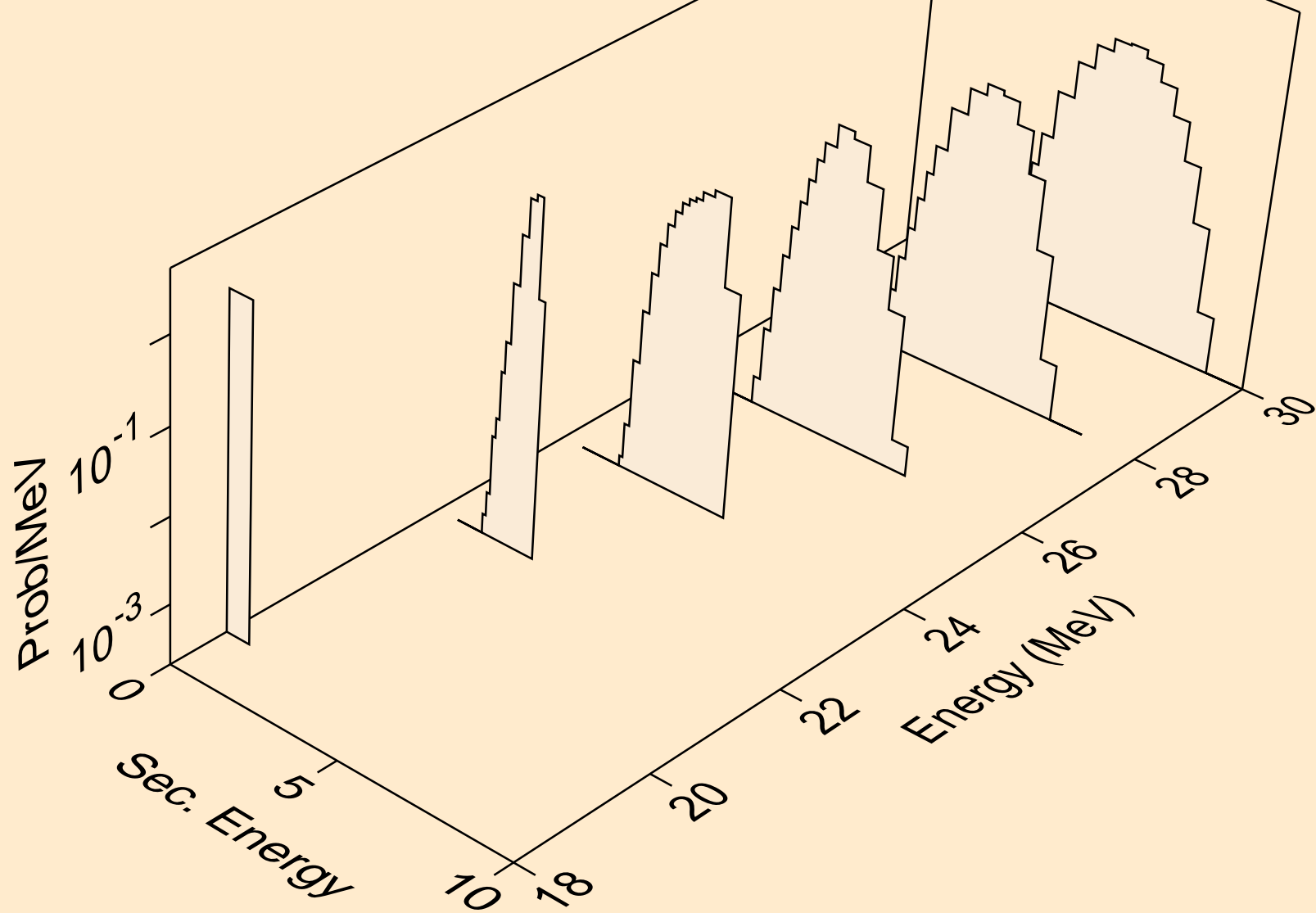

SC048 PROTON ACER TENDL-2024 LIBRARY; T=0.K  
alphas from (p,a)

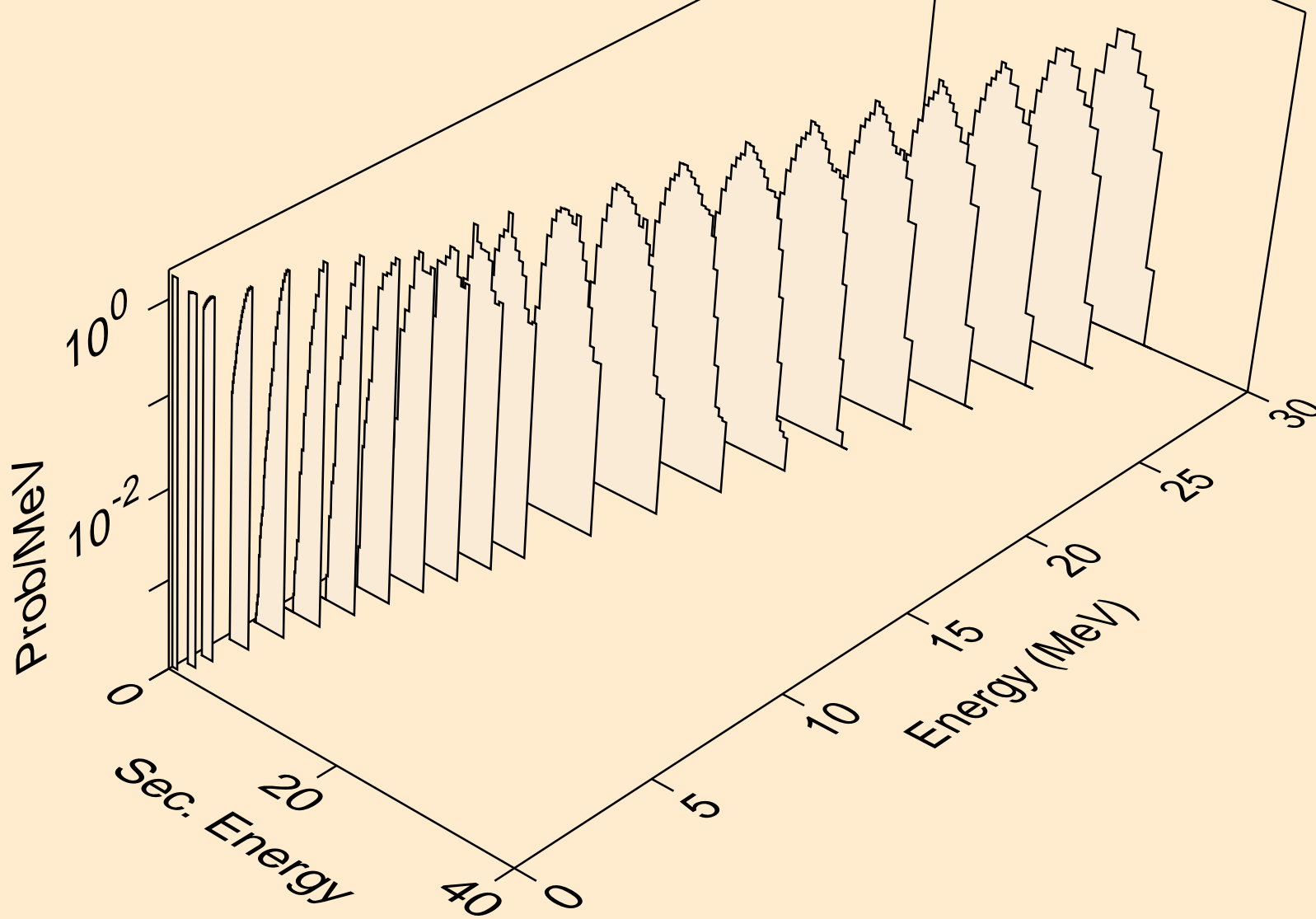

SC048 PROTON ACER TENDL-2024 LIBRARY; T=0.K  
alphas from (p,2a)

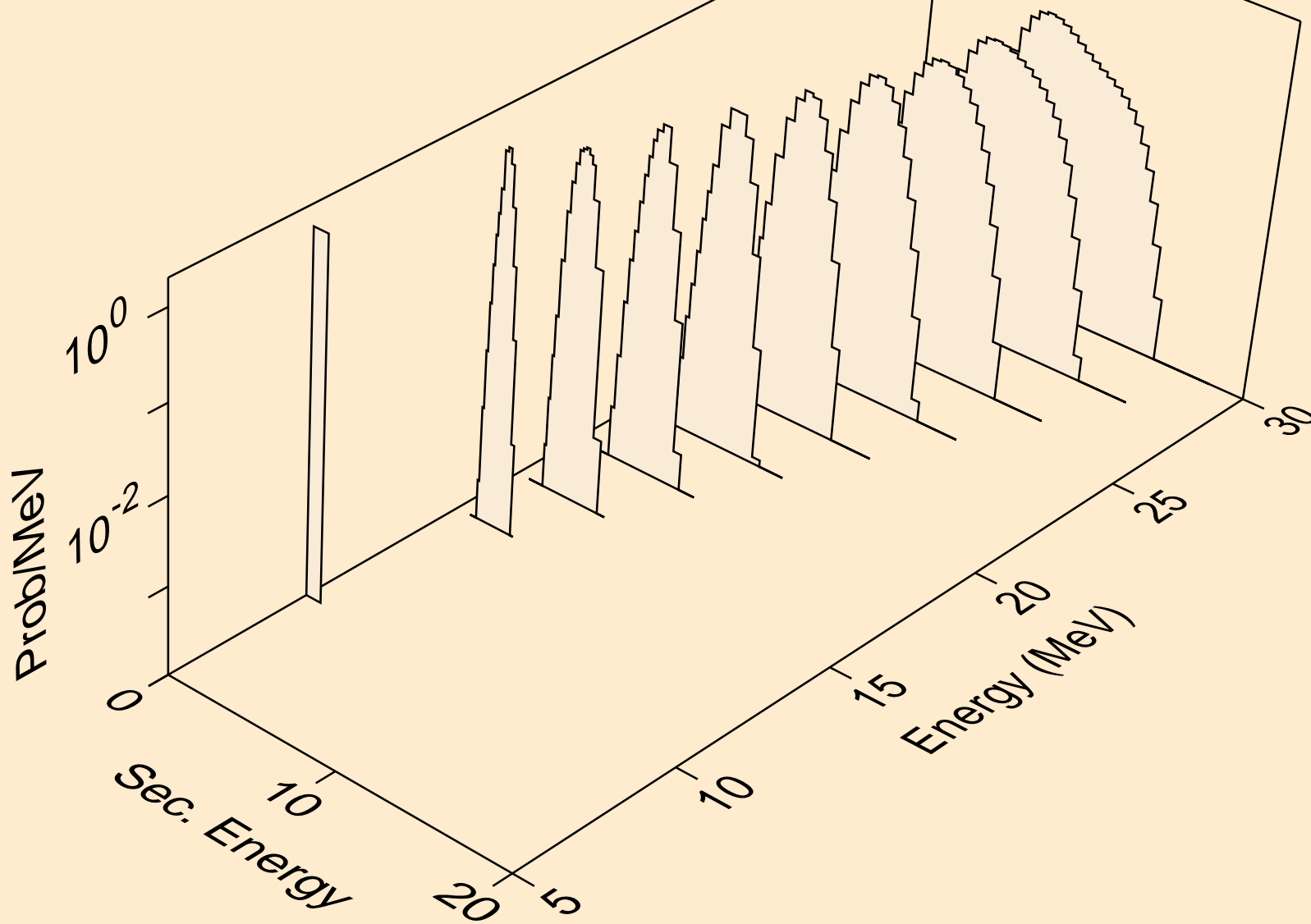

SC048 PROTON ACER TENDL-2024 LIBRARY; T=0.K  
alphas from (p,pa)

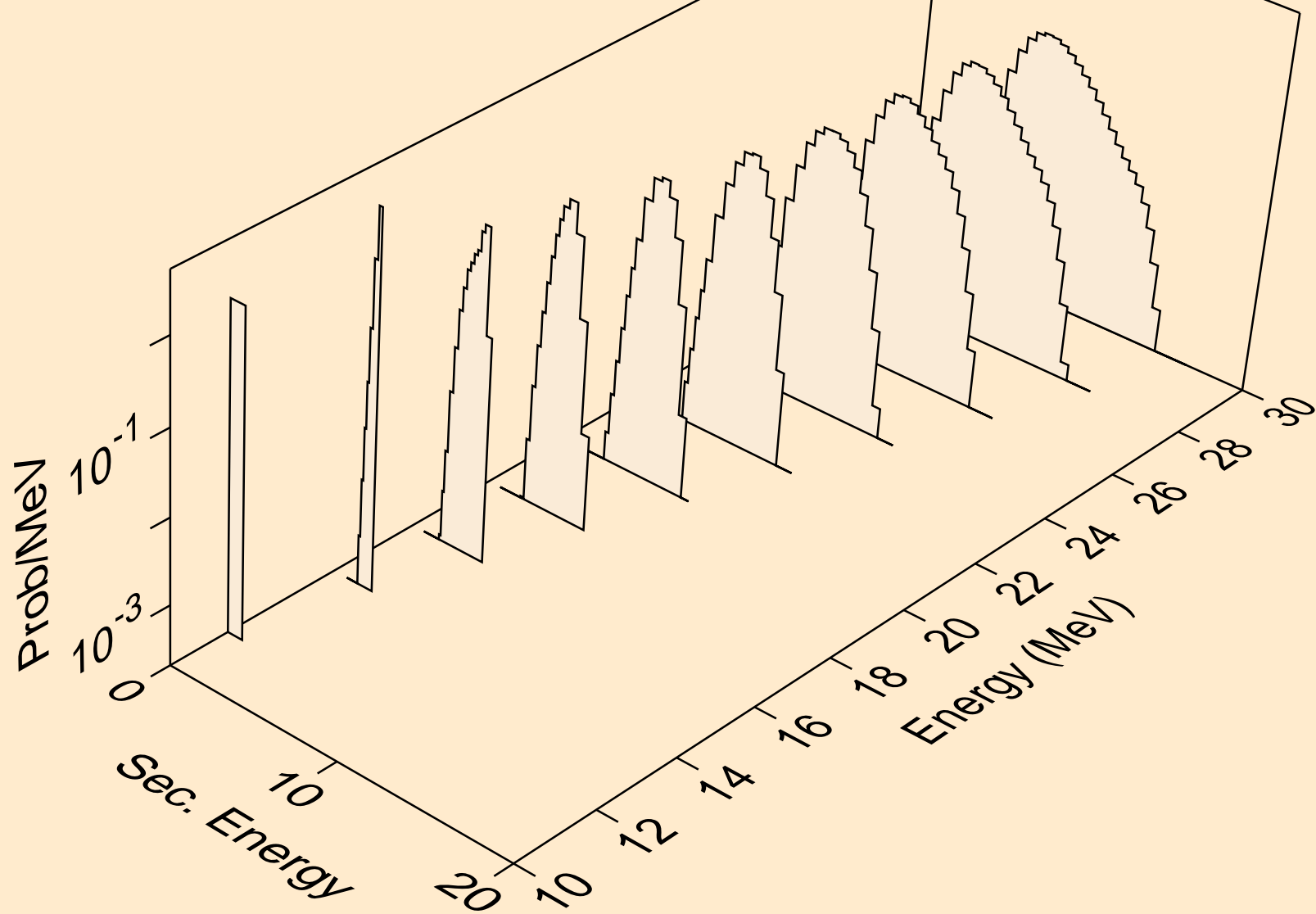

SC048 PROTON ACER TENDL-2024 LIBRARY; T=0.K  
alphas from (p,da)

