

SG265 PROTON ACER TENDL-2024 LIBRARY; T=0.K

Principal cross sections

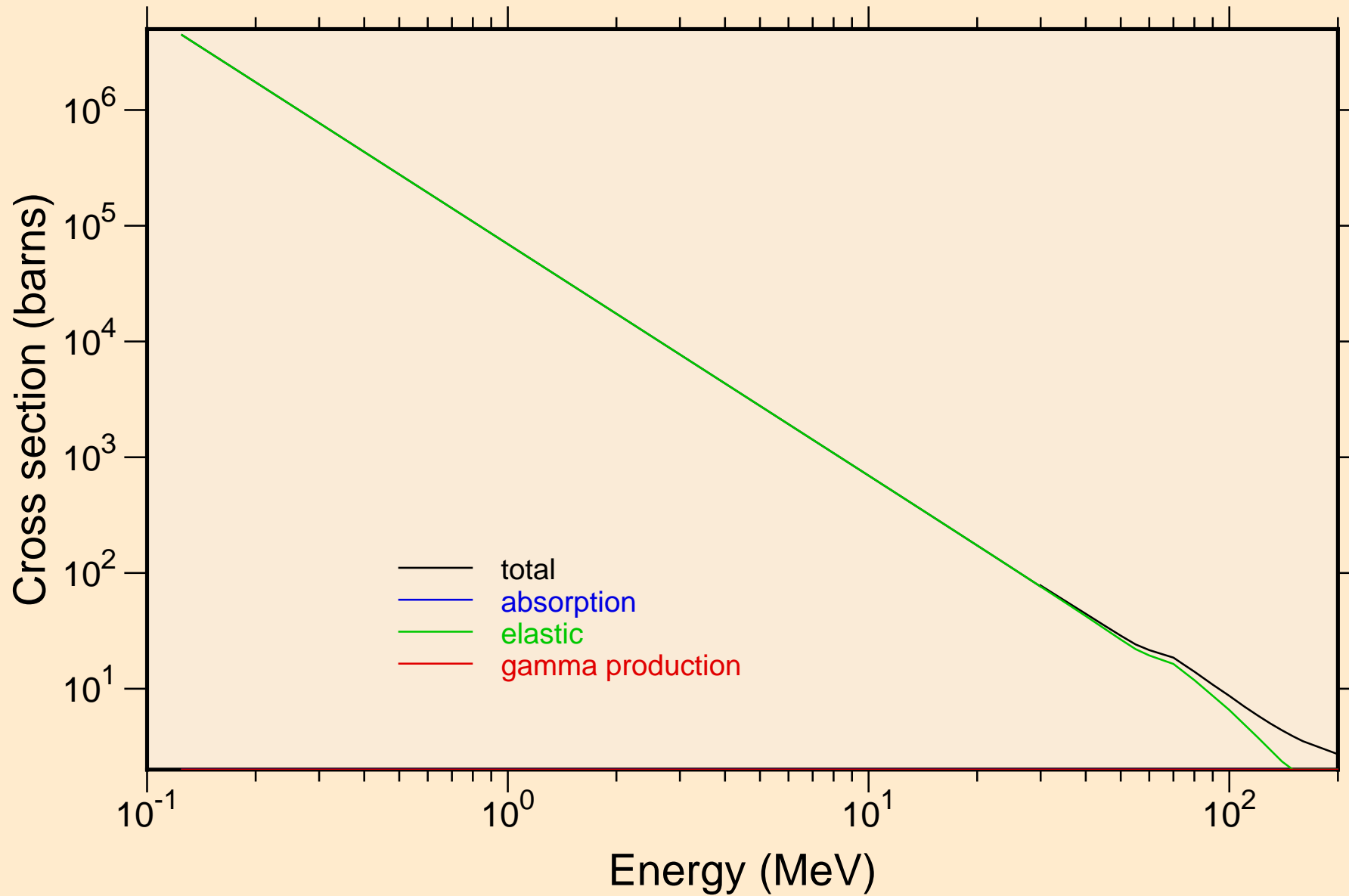

SG265 PROTON ACER TENDL-2024 LIBRARY; T=0.K

Heating

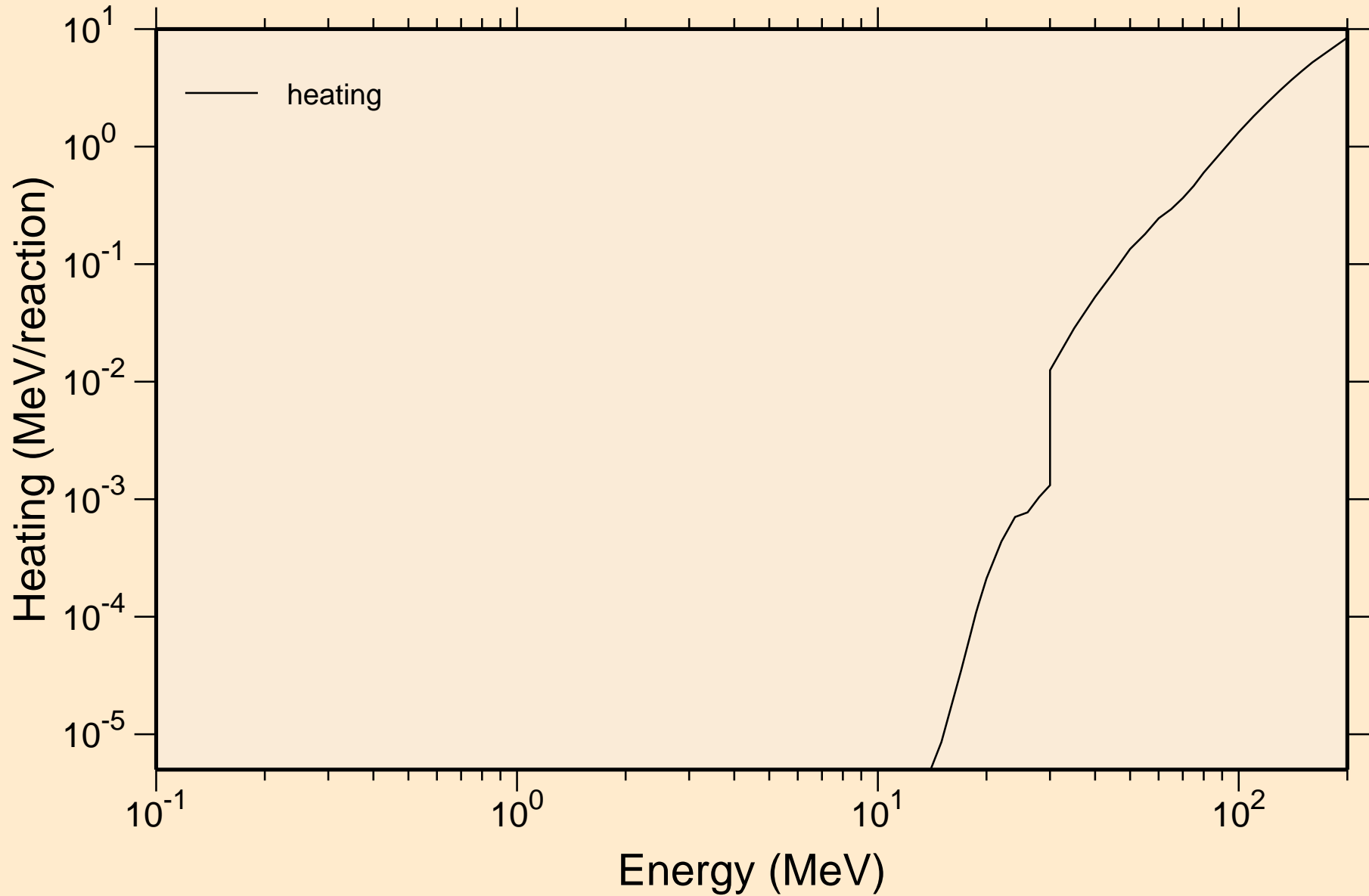

SG265 PROTON ACER TENDL-2024 LIBRARY; T=0.K

Principal cross sections

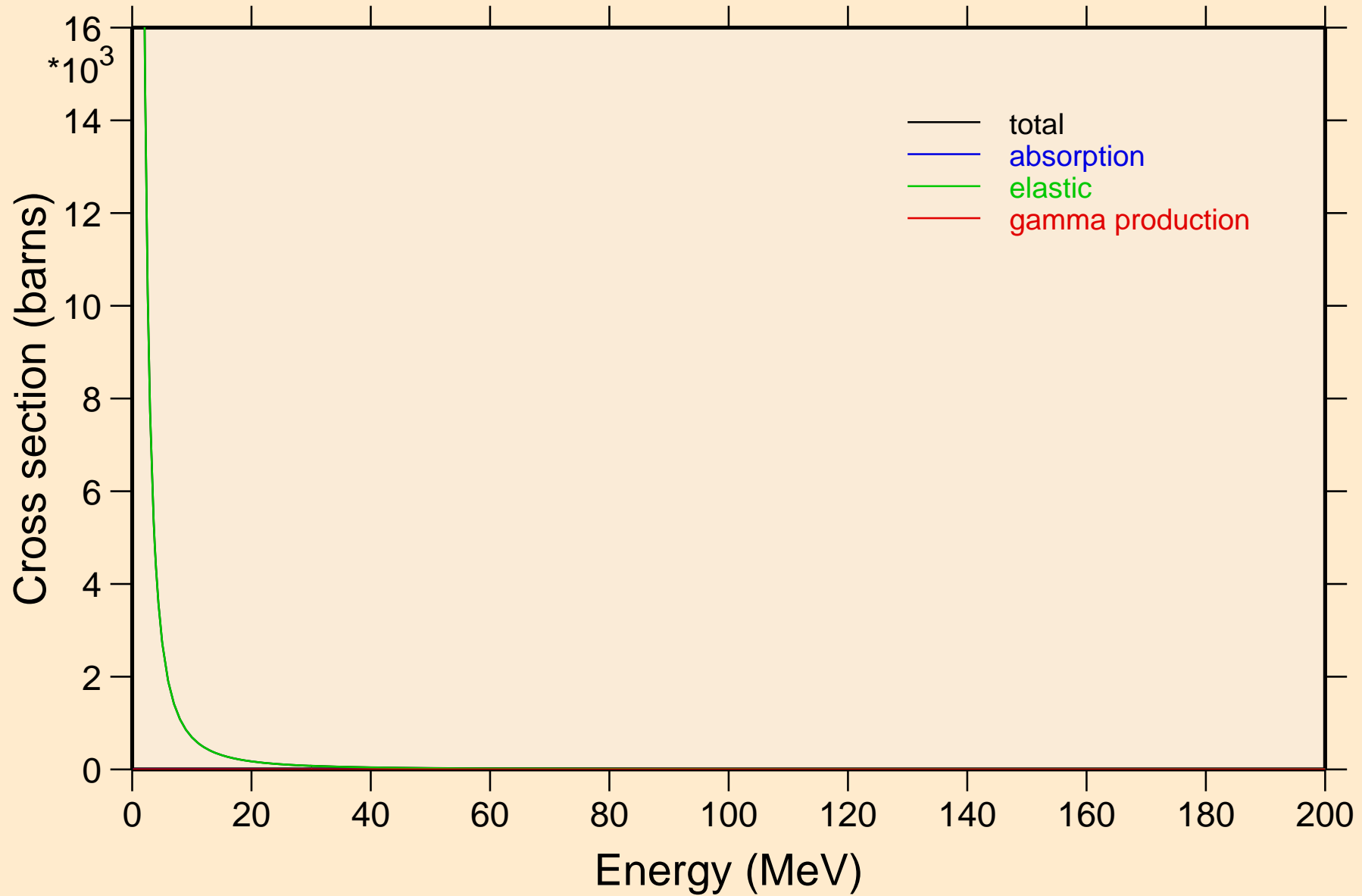

SG265 PROTON ACER TENDL-2024 LIBRARY; T=0.K

Heating

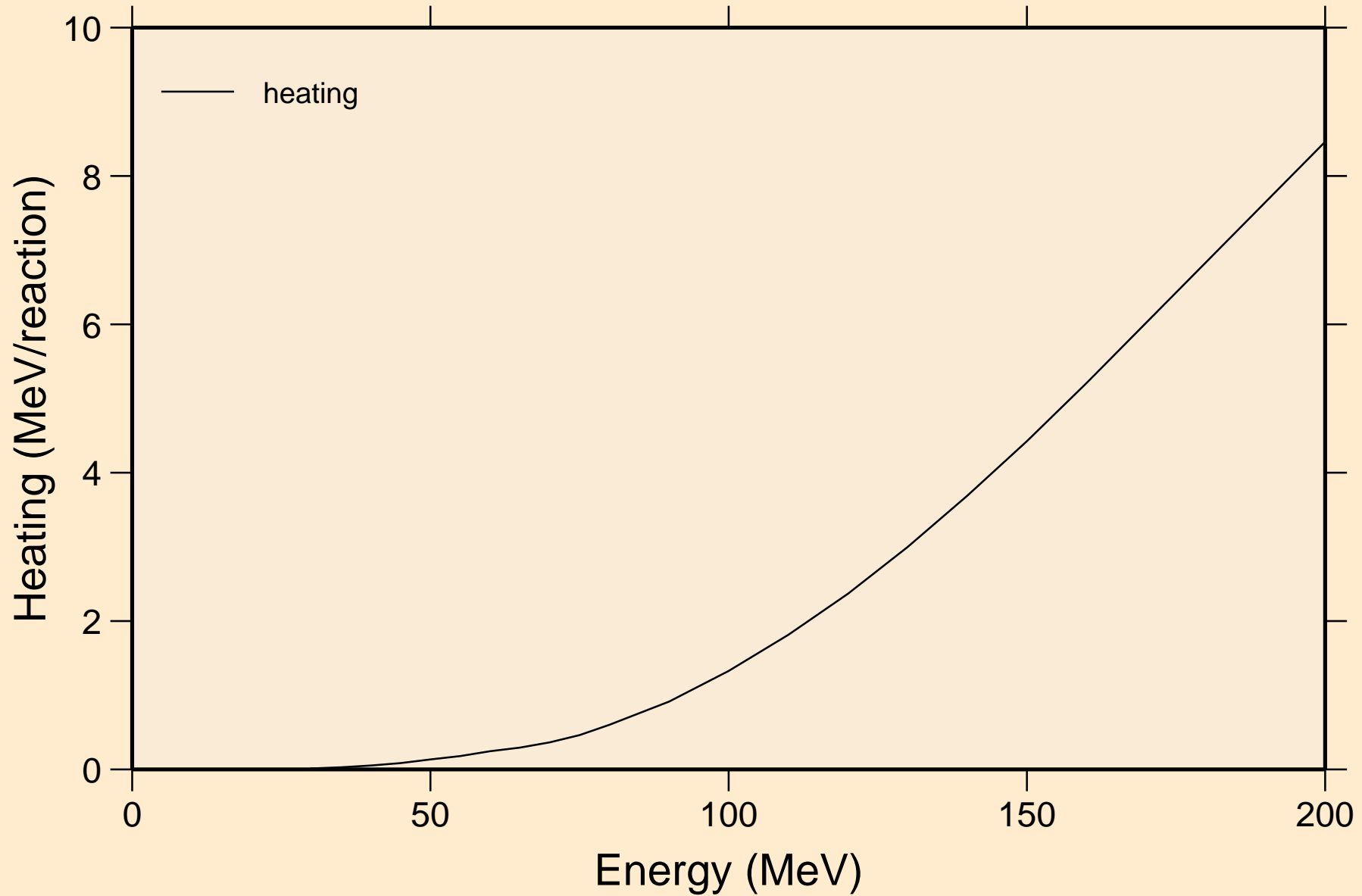

SG265 PROTON ACER TENDL-2024 LIBRARY; T=0.K

Threshold reactions

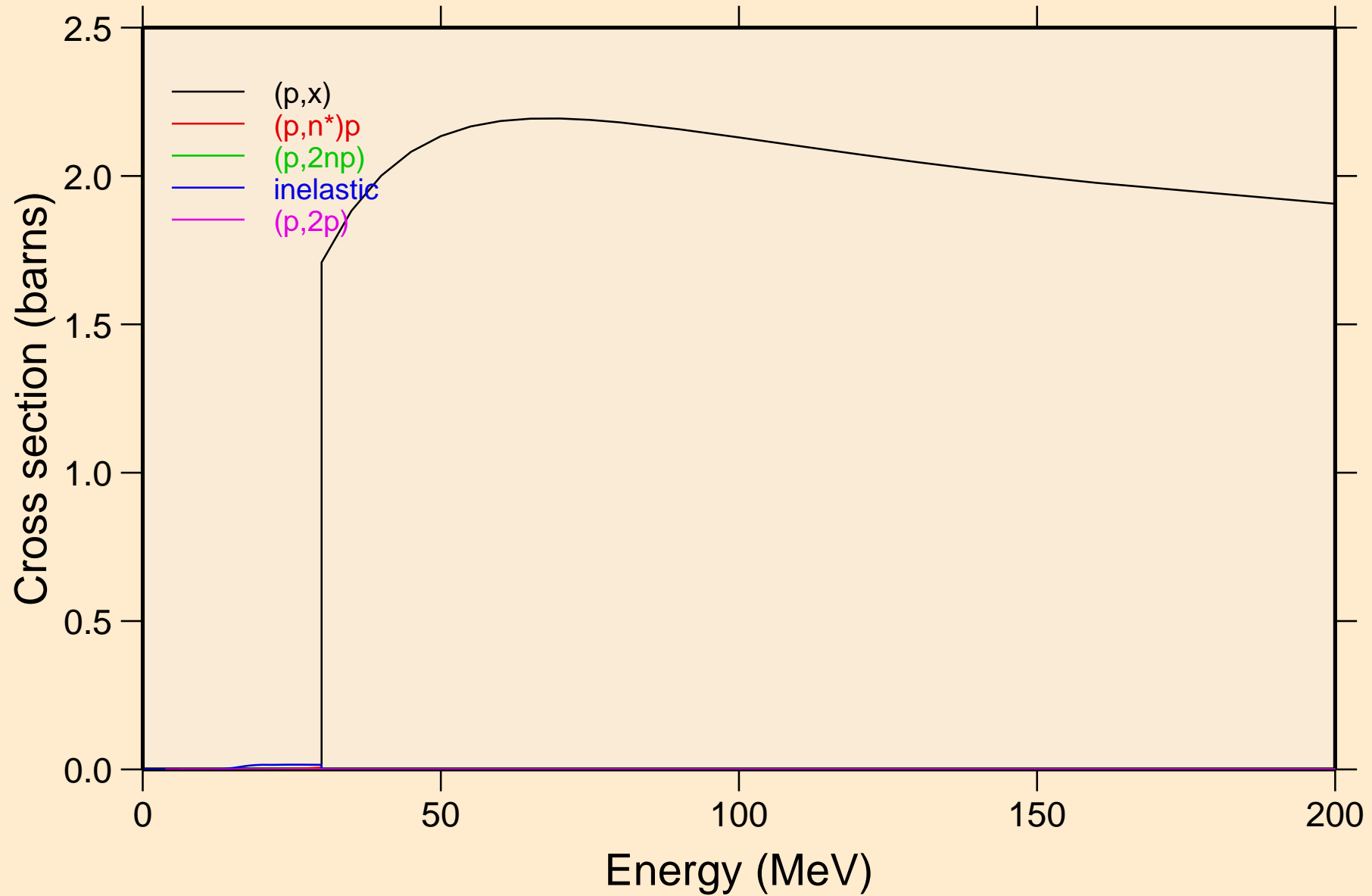

SG265 PROTON ACER TENDL-2024 LIBRARY; T=0.K
Threshold reactions

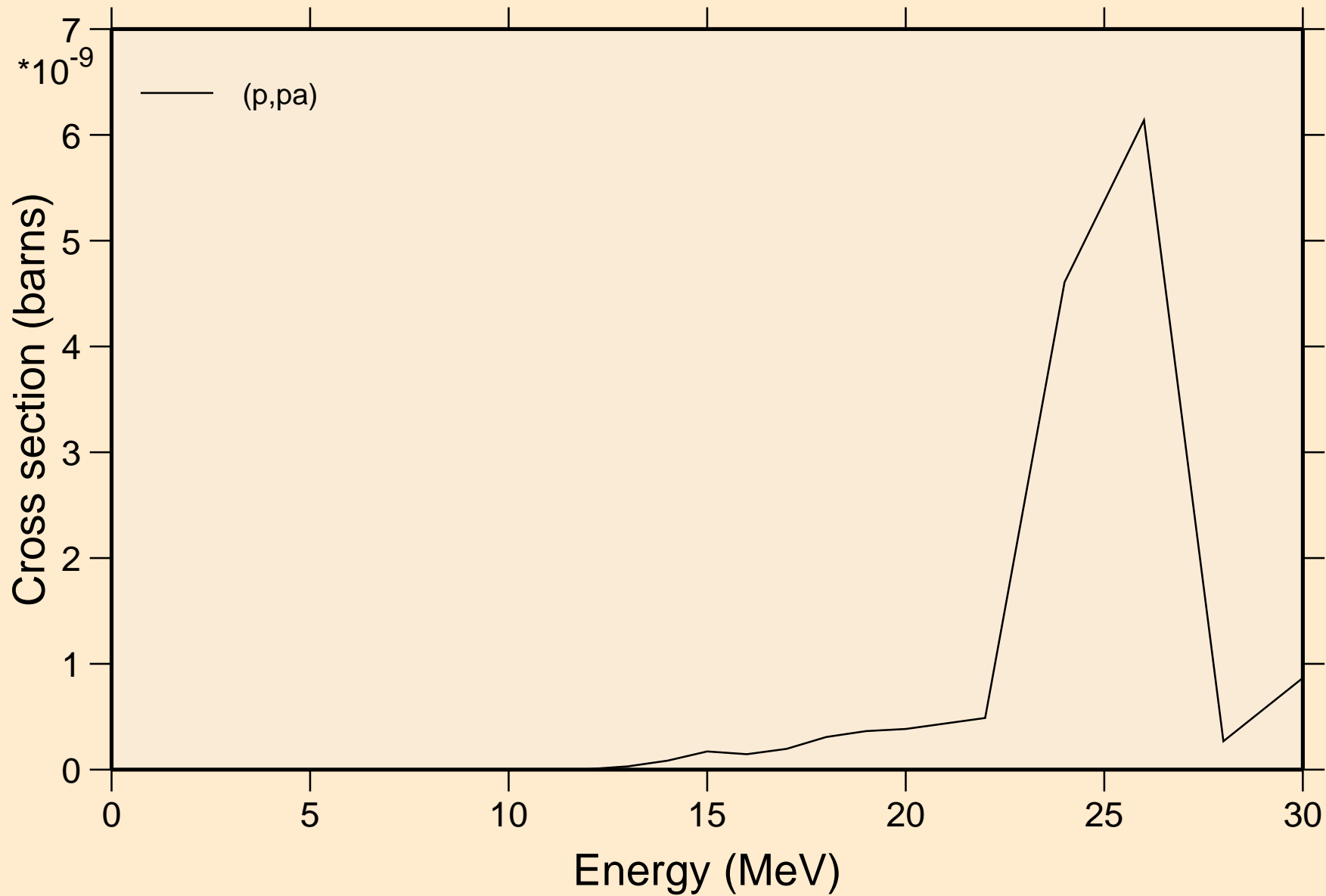

SG265 PROTON ACER TENDL-2024 LIBRARY; T=0.K
angular distribution for elastic

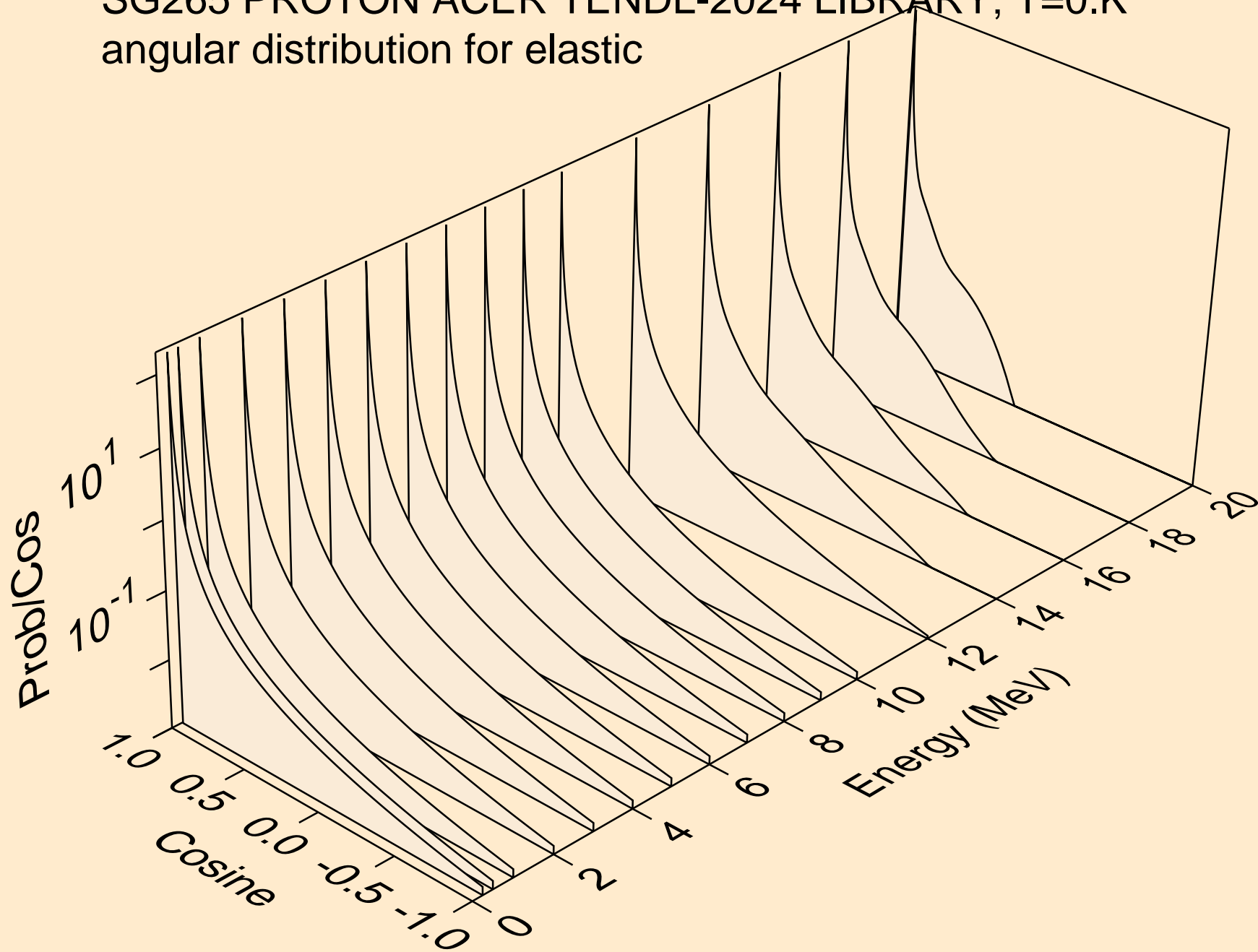

SG265 PROTON ACER TENDL-2024 LIBRARY; T=0.K
angular distribution for elastic

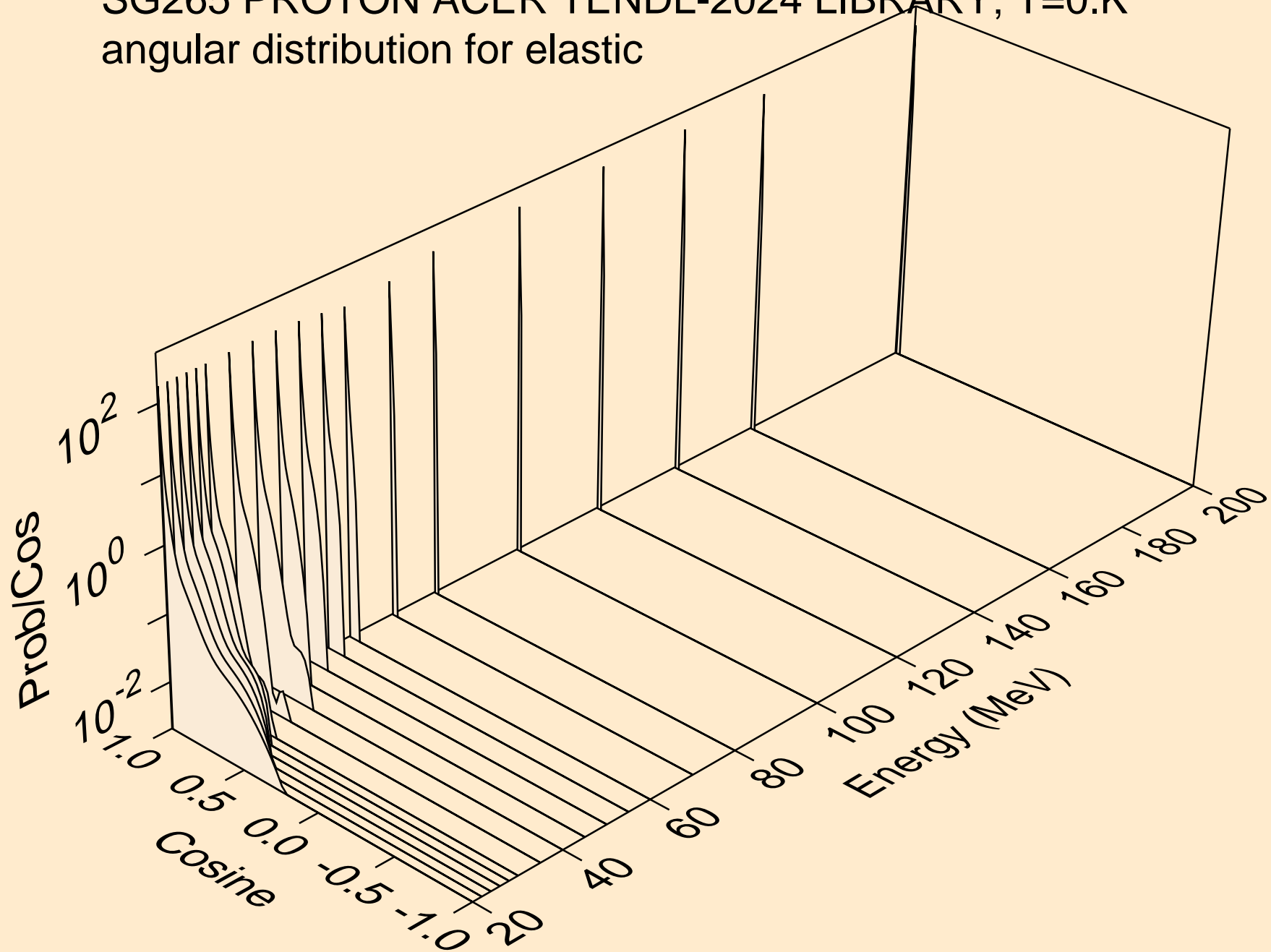

SG265 PROTON ACER TENDL-2024 LIBRARY; T=0.K
Proton emission for (p,x)

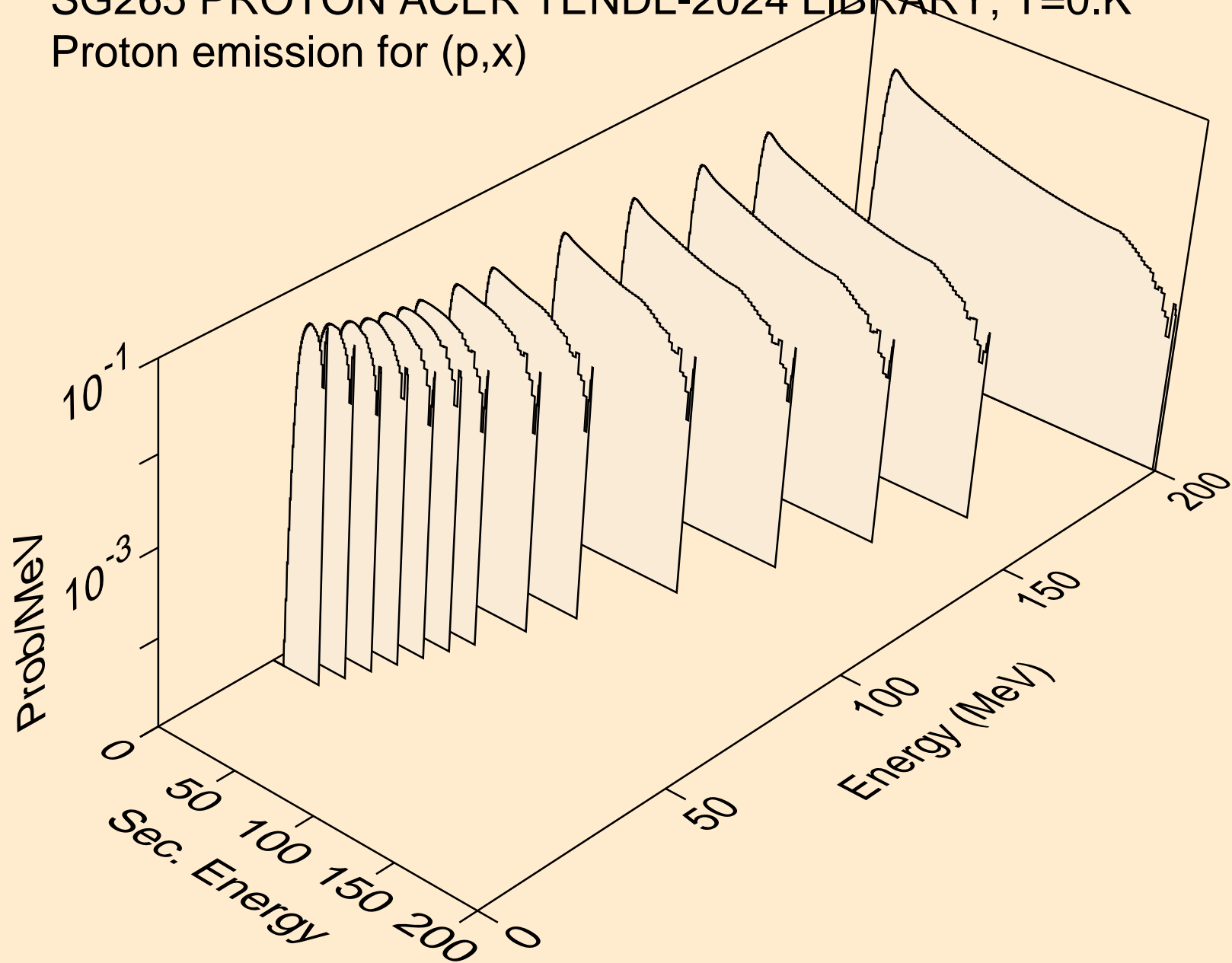

SG265 PROTON ACER TENDL-2024 LIBRARY; T=0.K
Proton emission for (p,n*)p

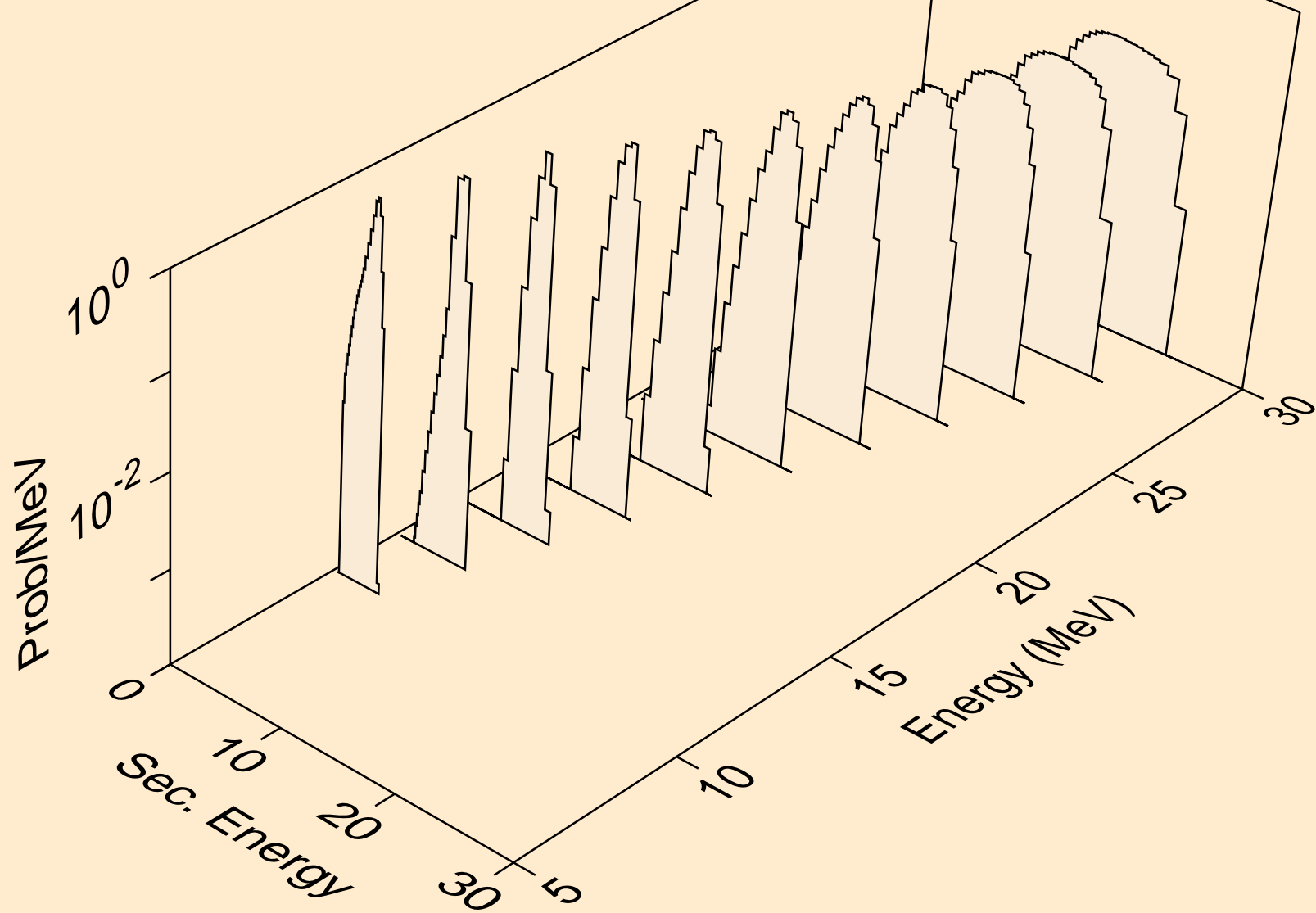

SG265 PROTON ACER TENDL-2024 LIBRARY; T=0.K
Proton emission for (p,2np)

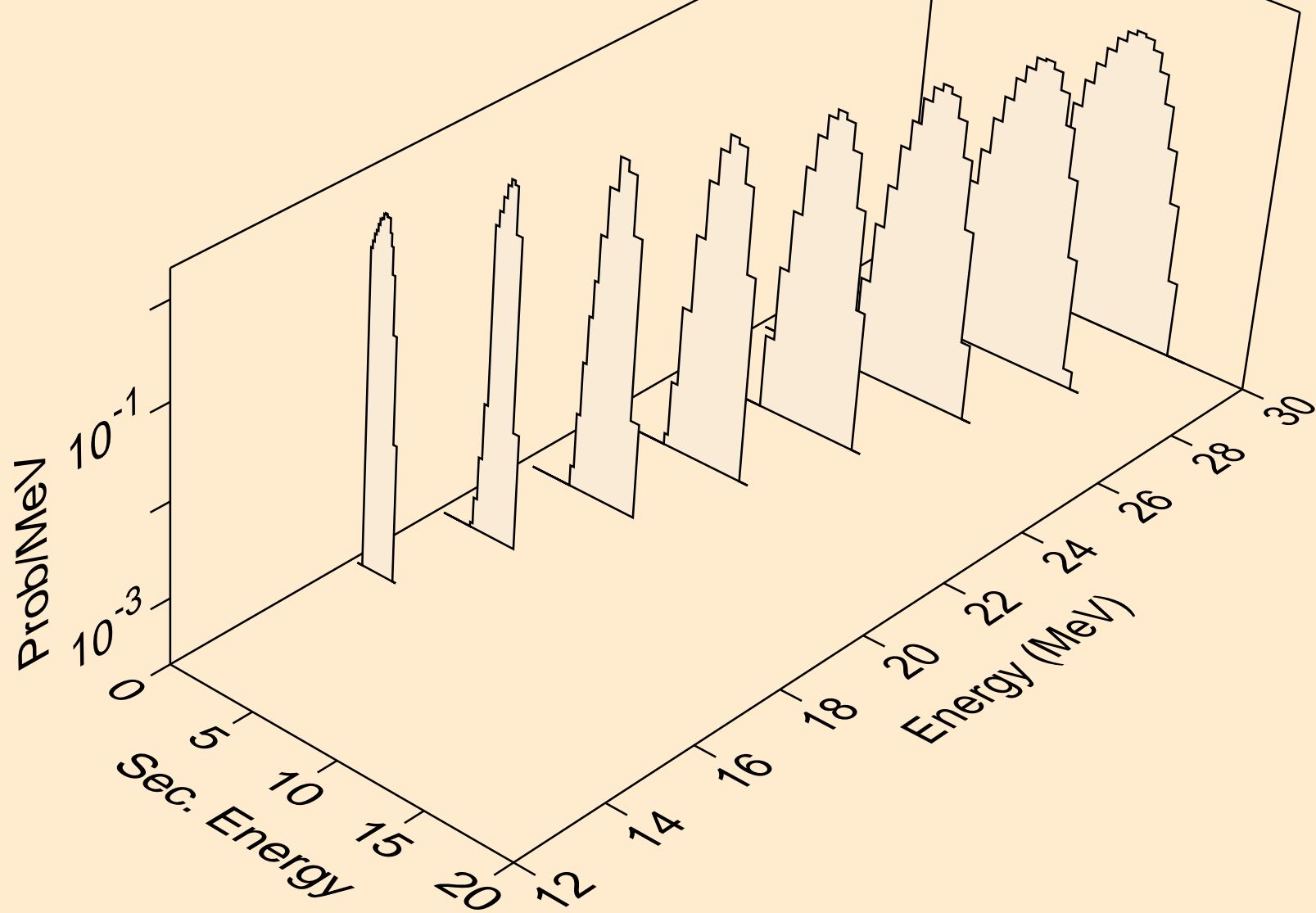

SG265 PROTON ACER TENDL-2024 LIBRARY; T=0.K
Proton emission for inelastic

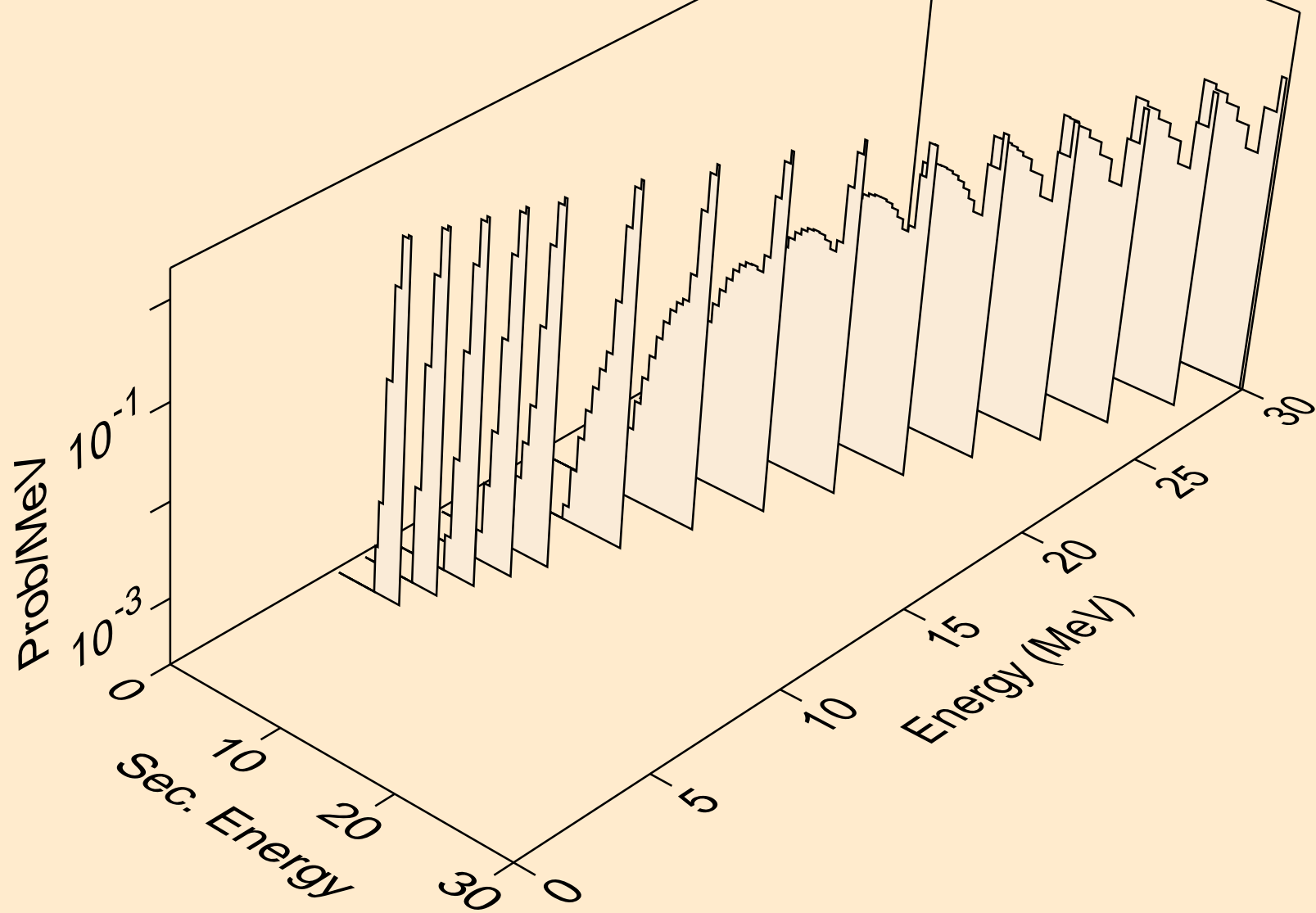

SG265 PROTON ACER TENDL-2024 LIBRARY; T=0.K
Proton emission for (p,2p)

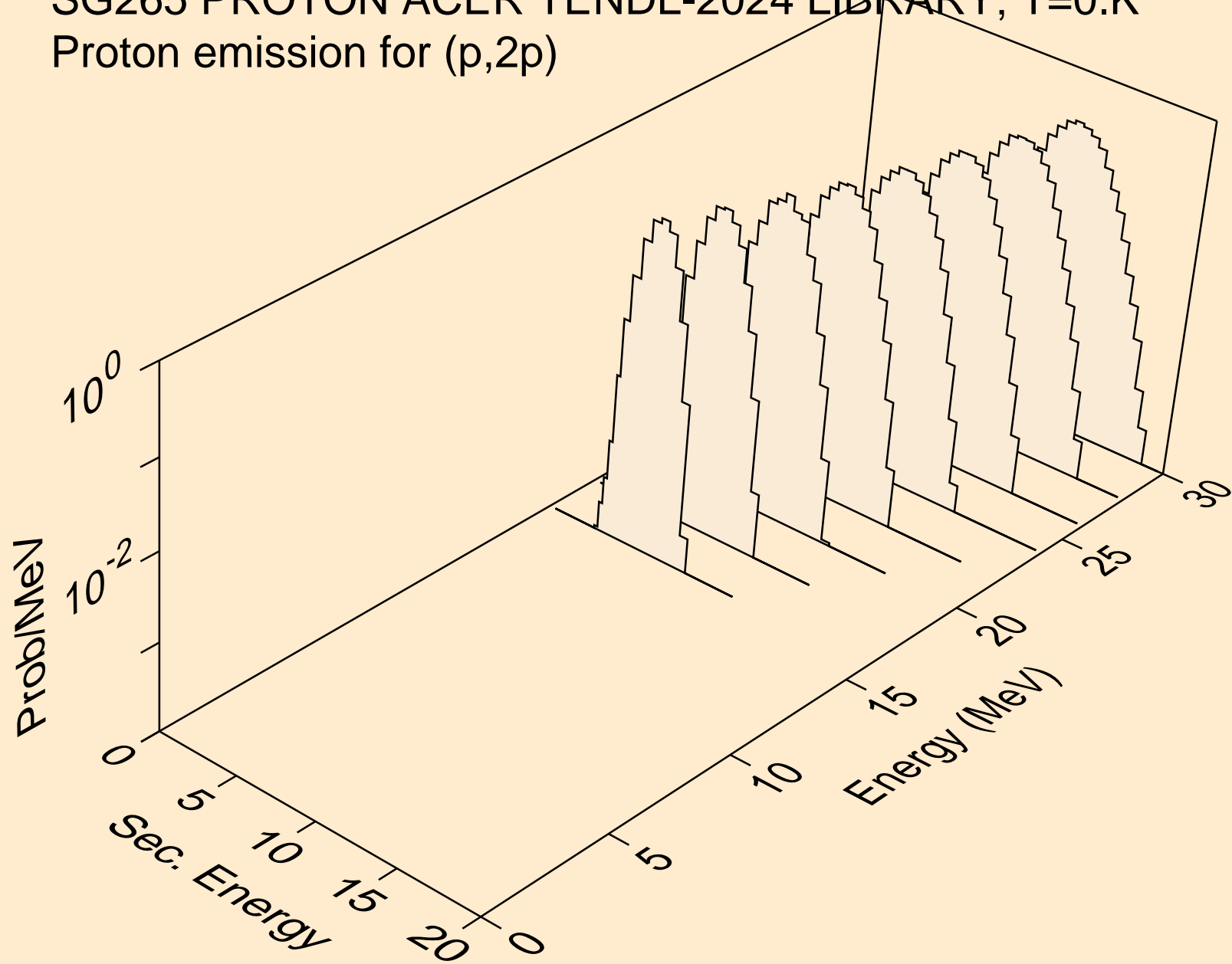

SG265 PROTON ACER TENDL-2024 LIBRARY; T=0.K
Proton emission for (p,pa)

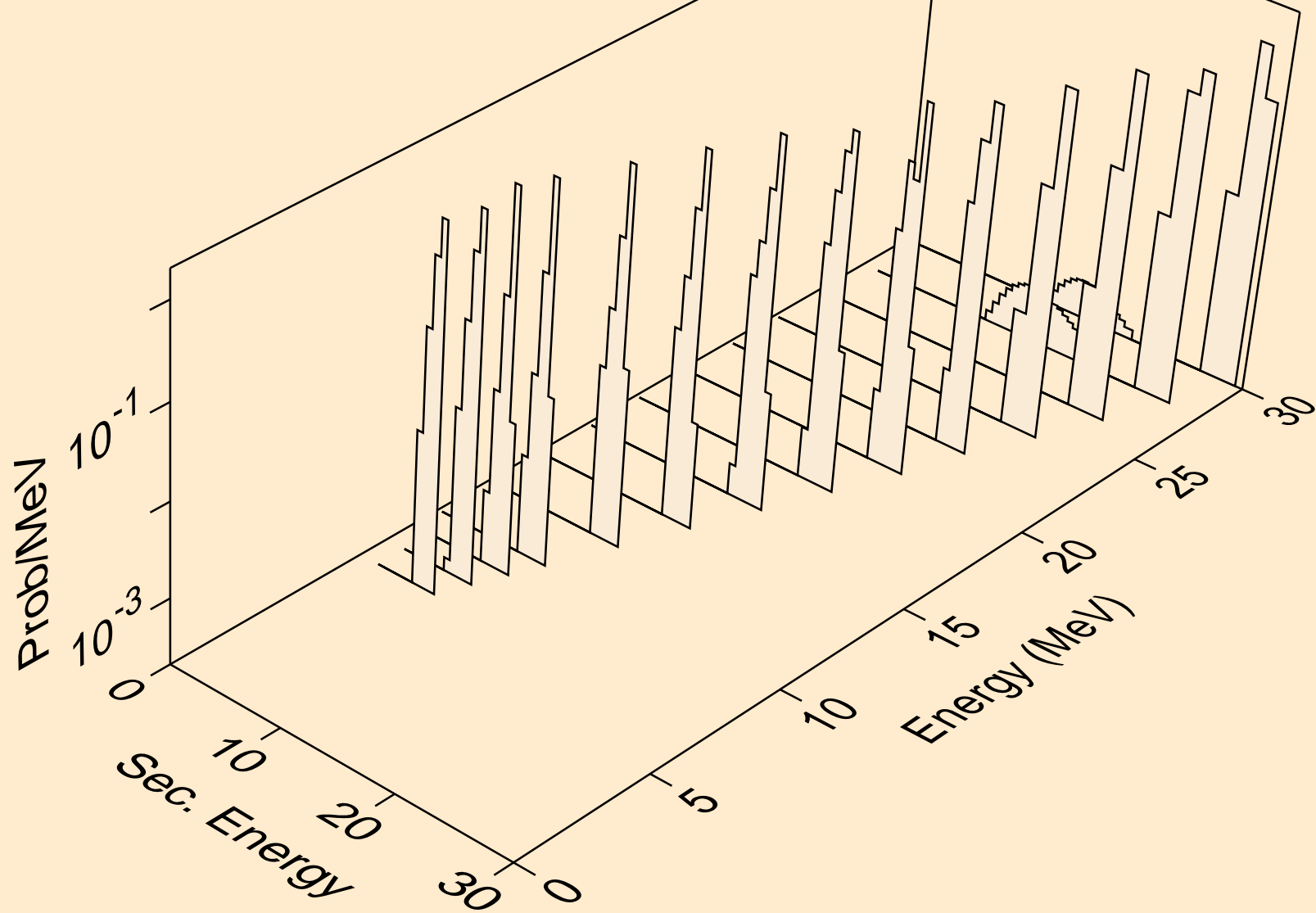

SG265 PROTON ACER TENDL-2024 LIBRARY; T=0.K
Photon emission for (z,n)

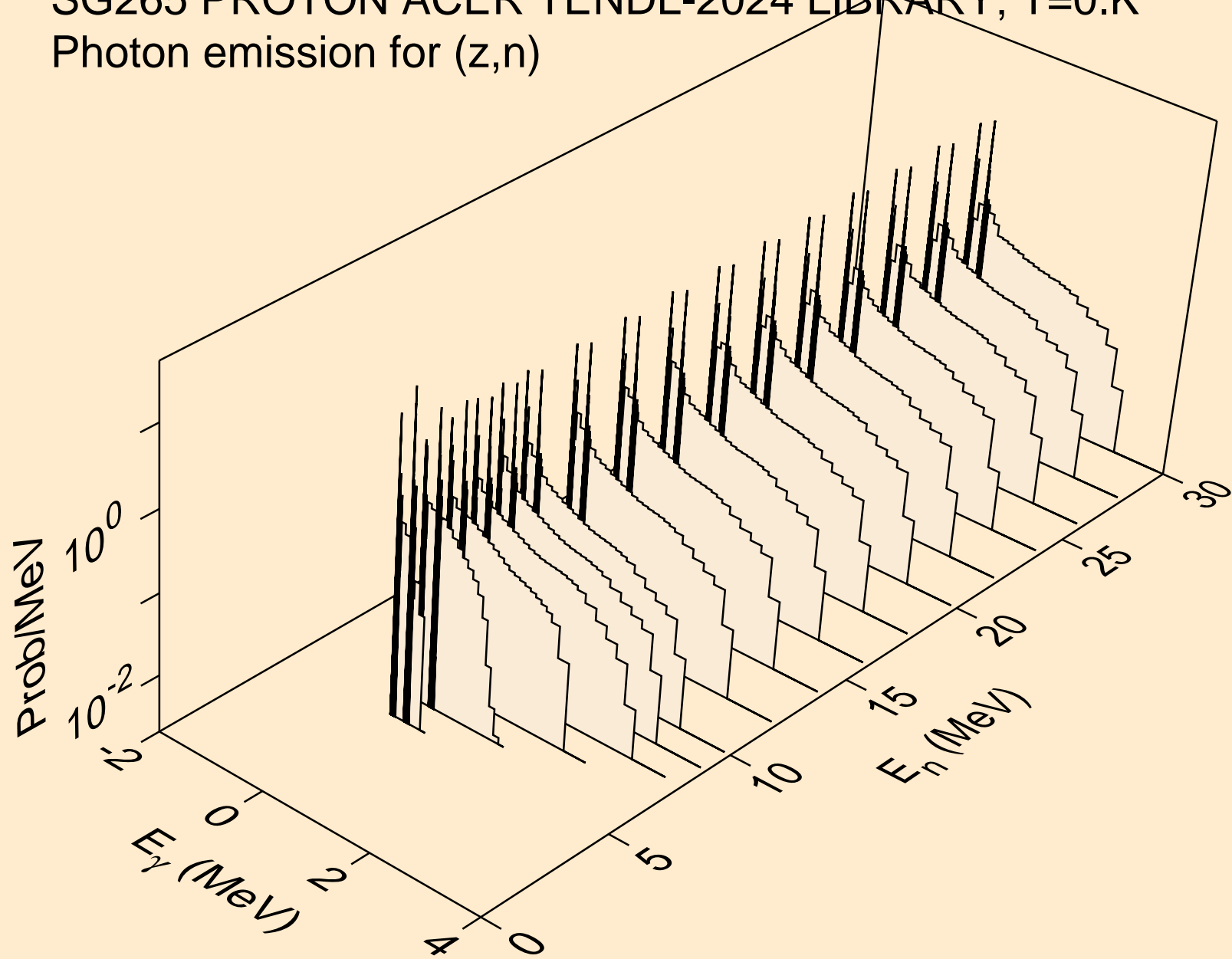

SG265 PROTON ACER TENDL-2024 LIBRARY; T=0.K
Photon emission for (z,x)

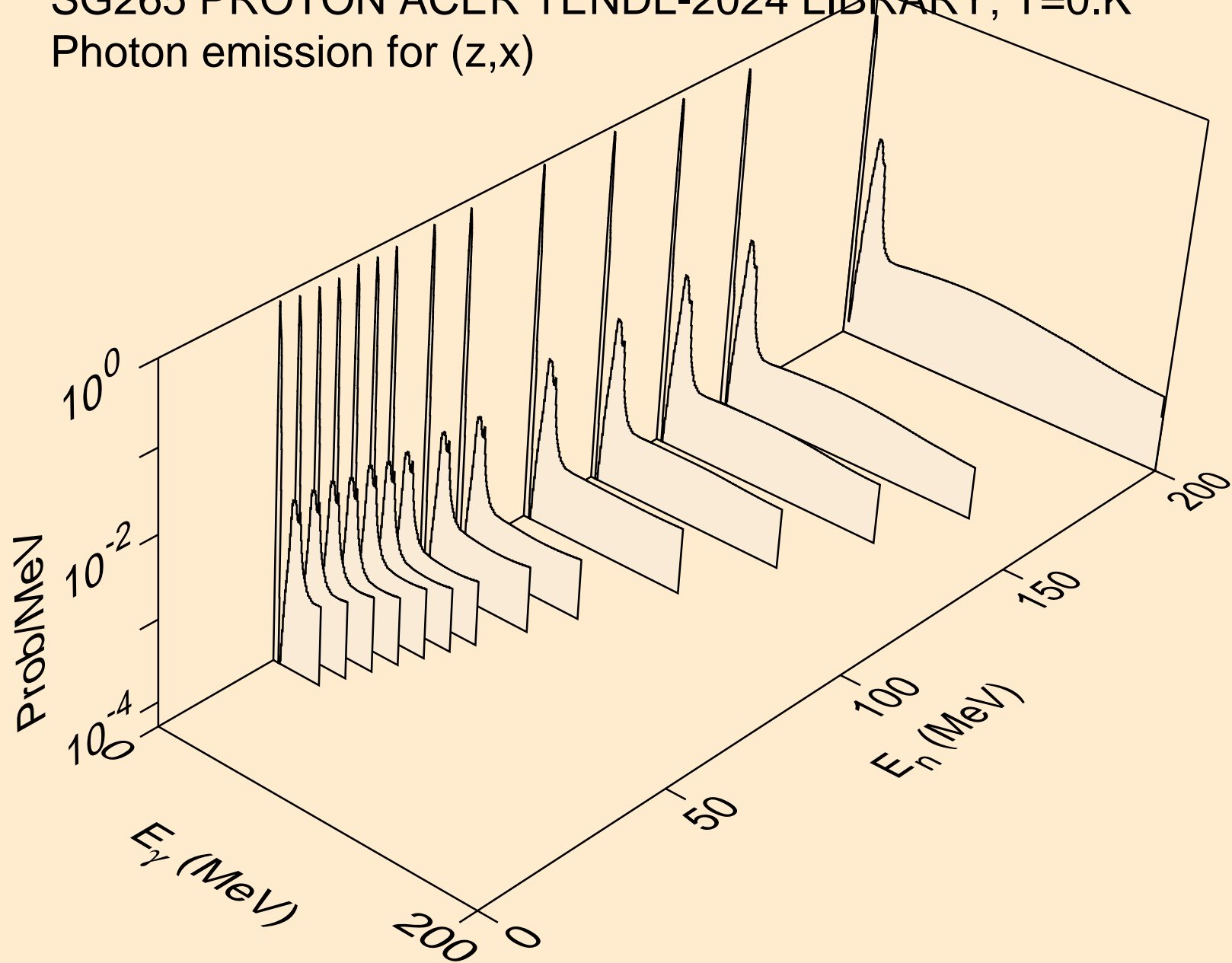

SG265 PROTON ACER TENDL-2024 LIBRARY; T=0.K
Photon emission for (n,2n)

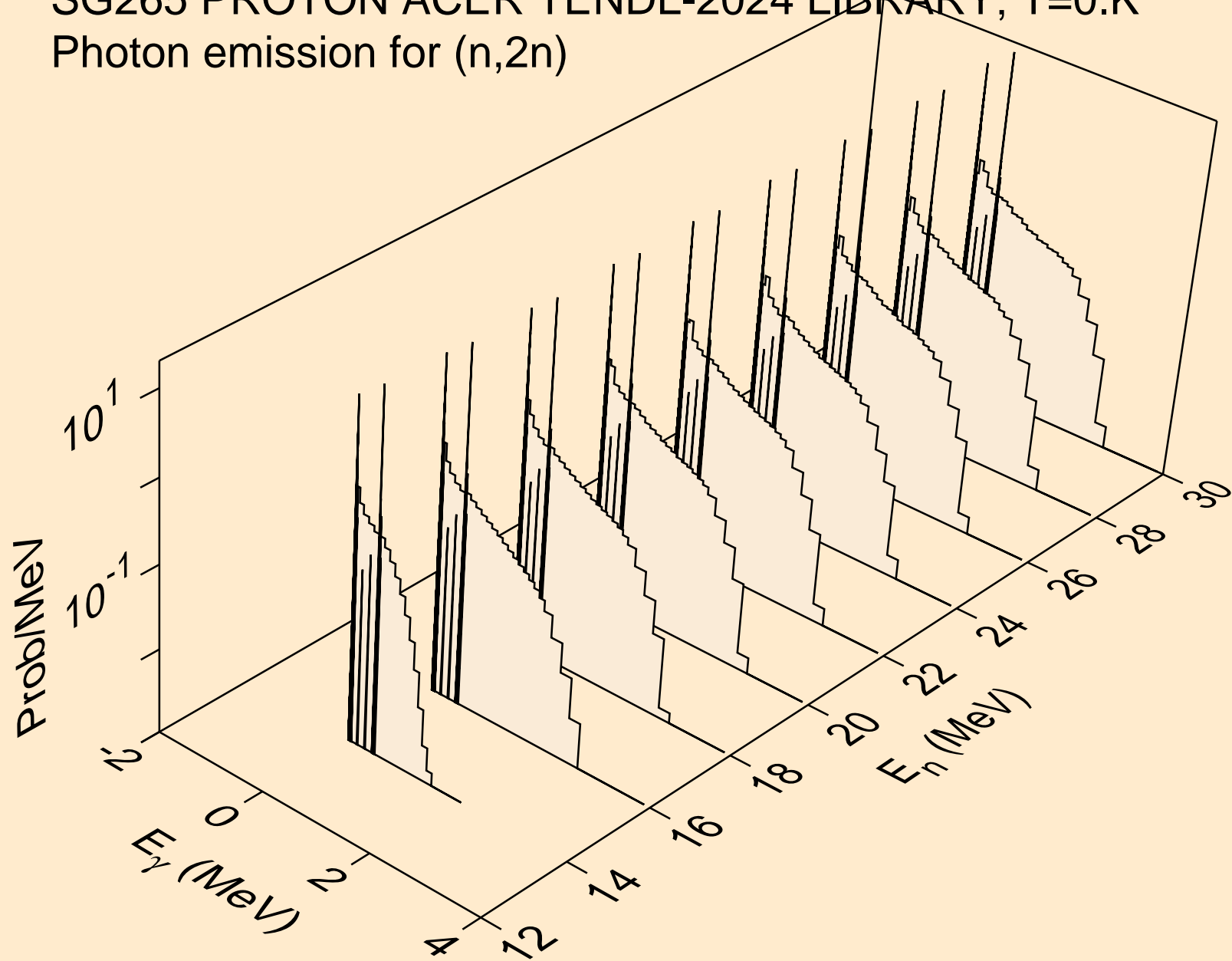

SG265 PROTON ACER TENDL-2024 LIBRARY; T=0.K
Photon emission for (n,3n)

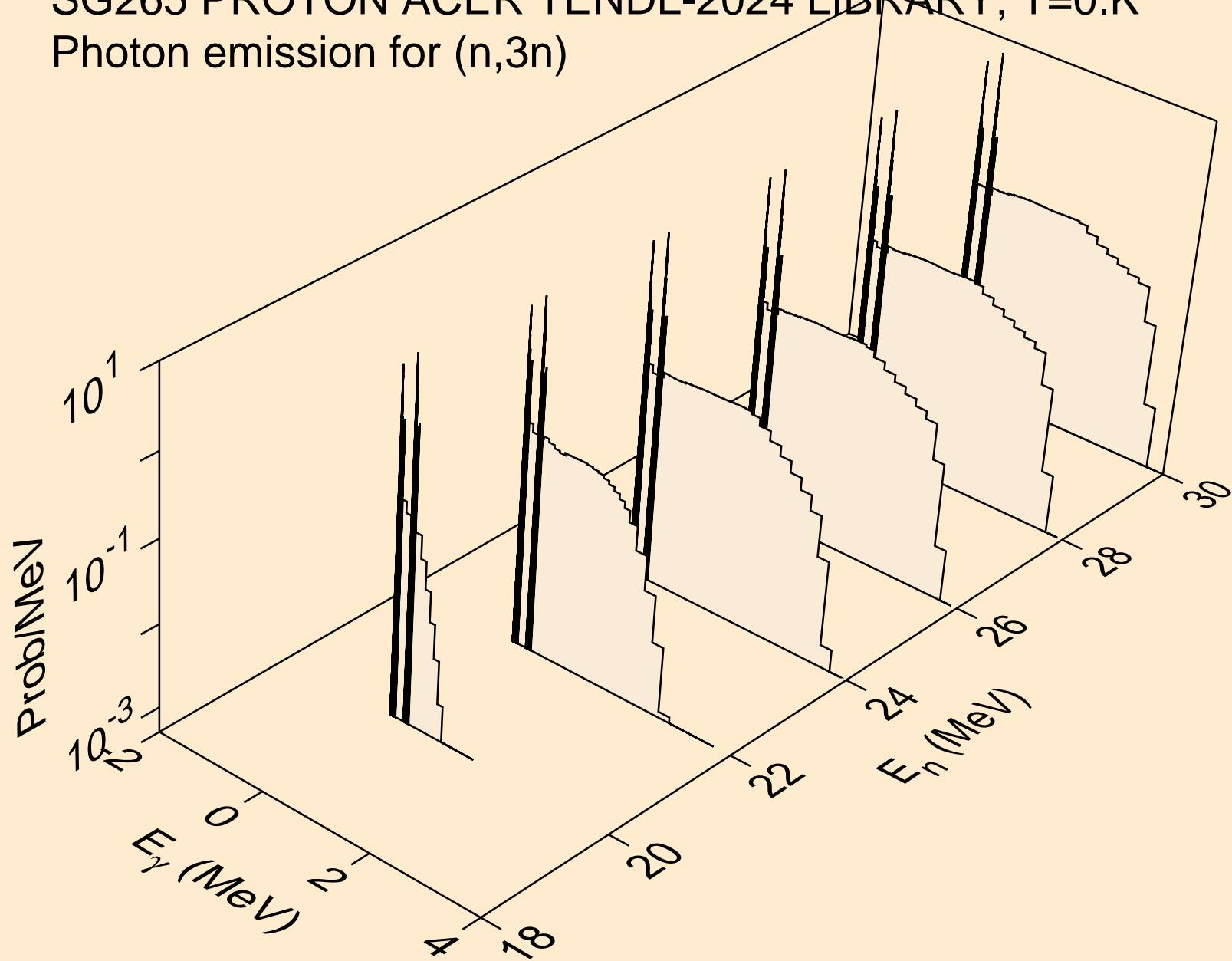

SG265 PROTON ACER TENDL-2024 LIBRARY; T=0.K
Photon emission for (n,n*)a

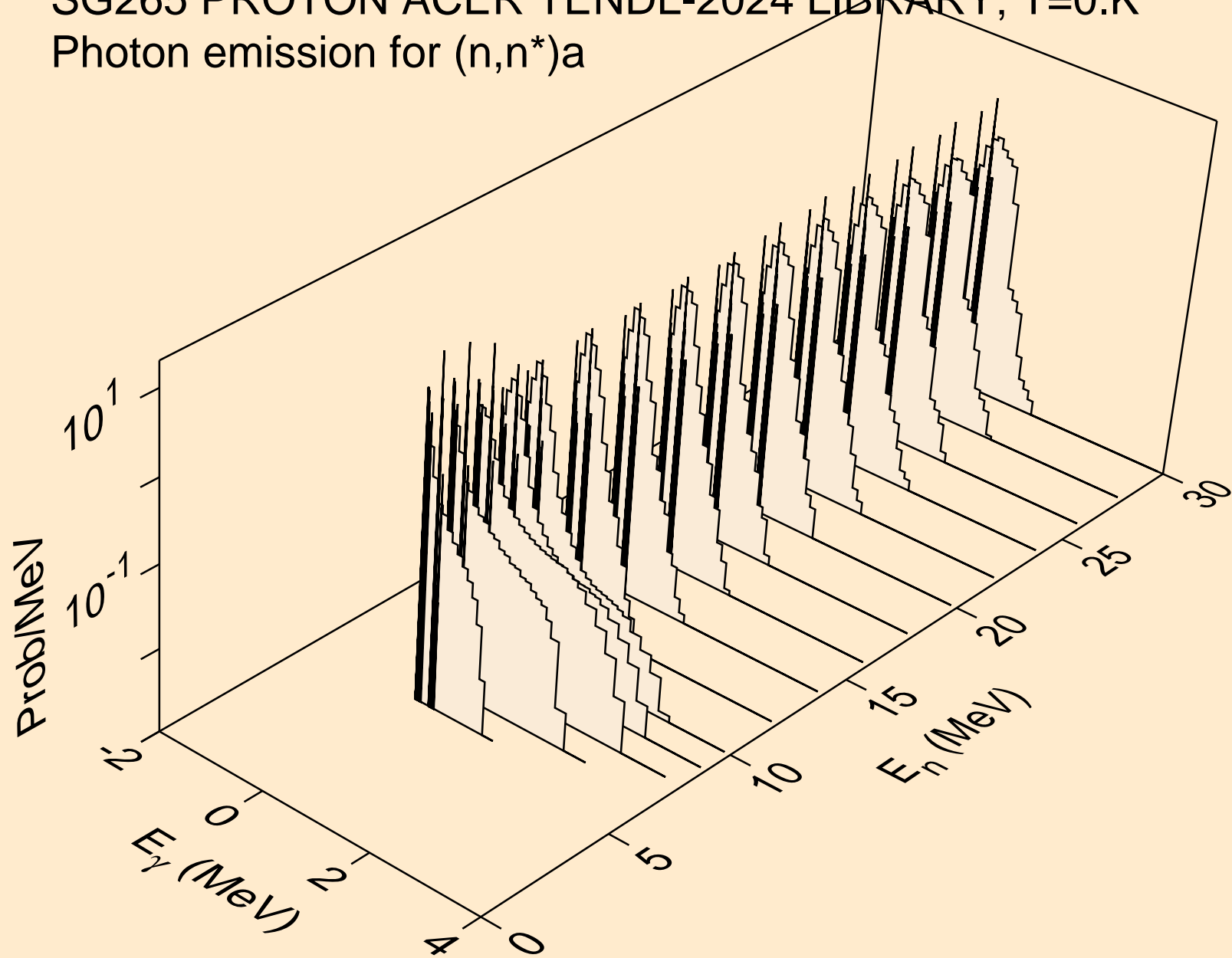

SG265 PROTON ACER TENDL-2024 LIBRARY; T=0.K
Photon emission for (n,2n)a

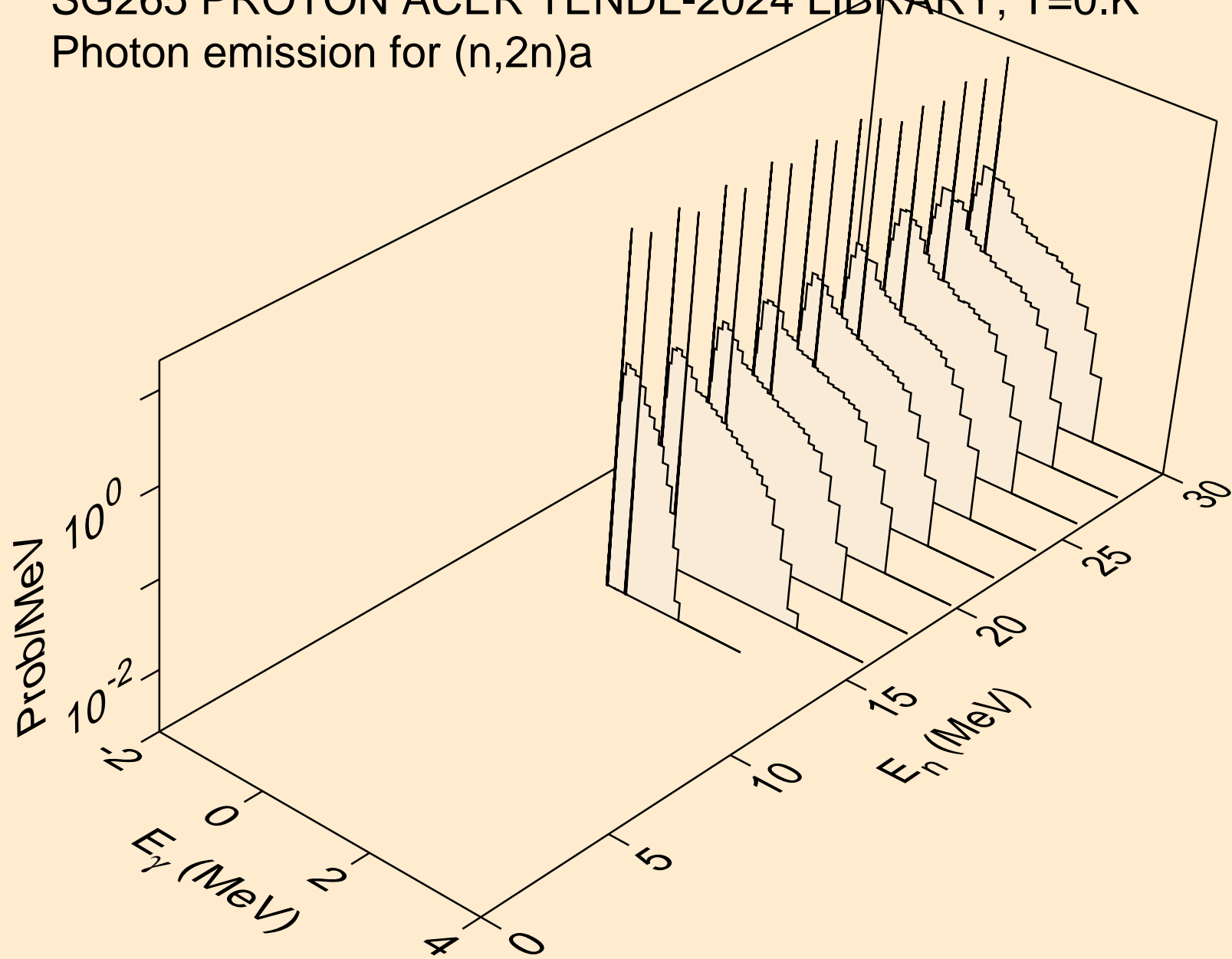

SG265 PROTON ACER TENDL-2024 LIBRARY; T=0.K
Photon emission for (n,n*)p

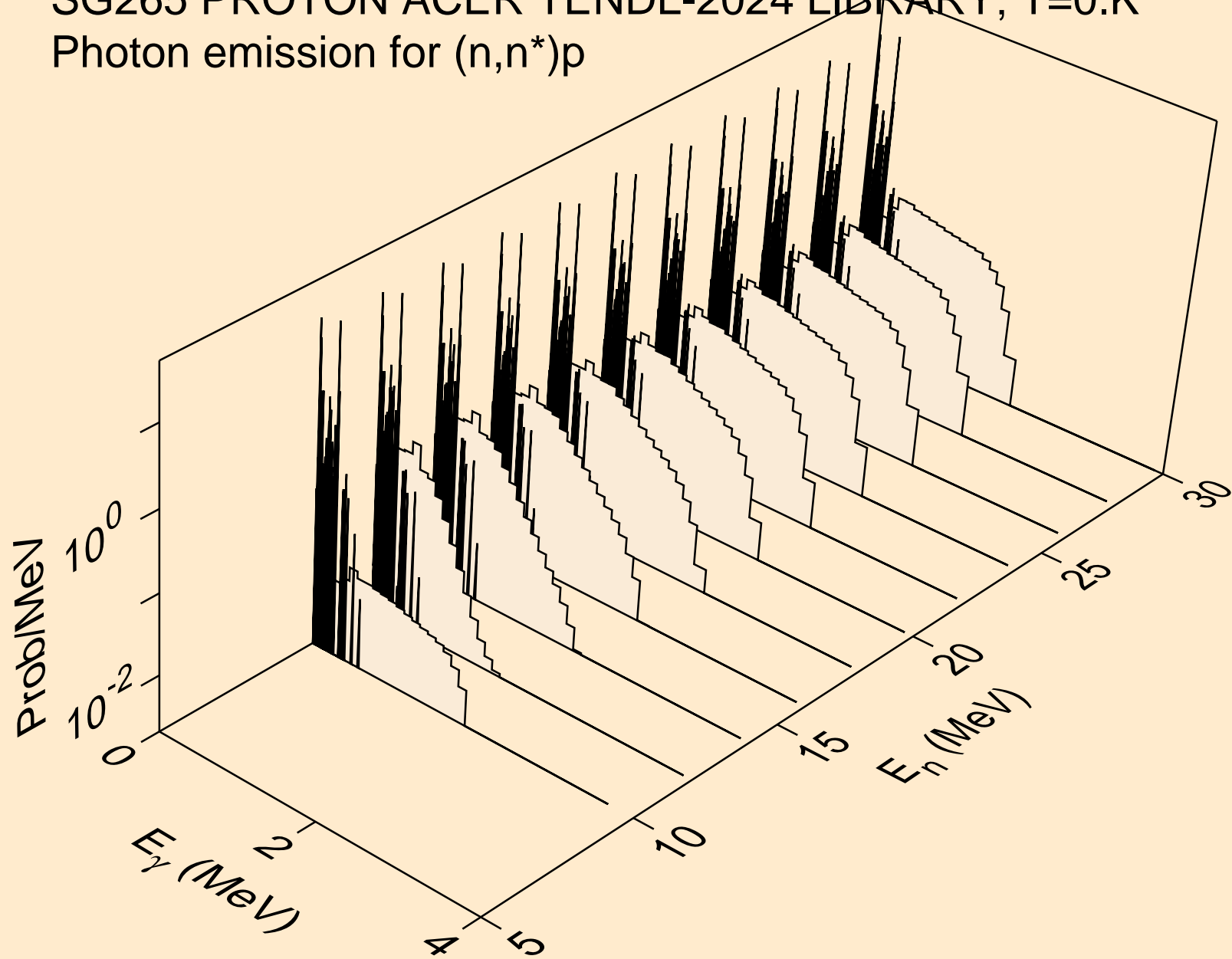

SG265 PROTON ACER TENDL-2024 LIBRARY; T=0.K
Photon emission for (n,n*)2a

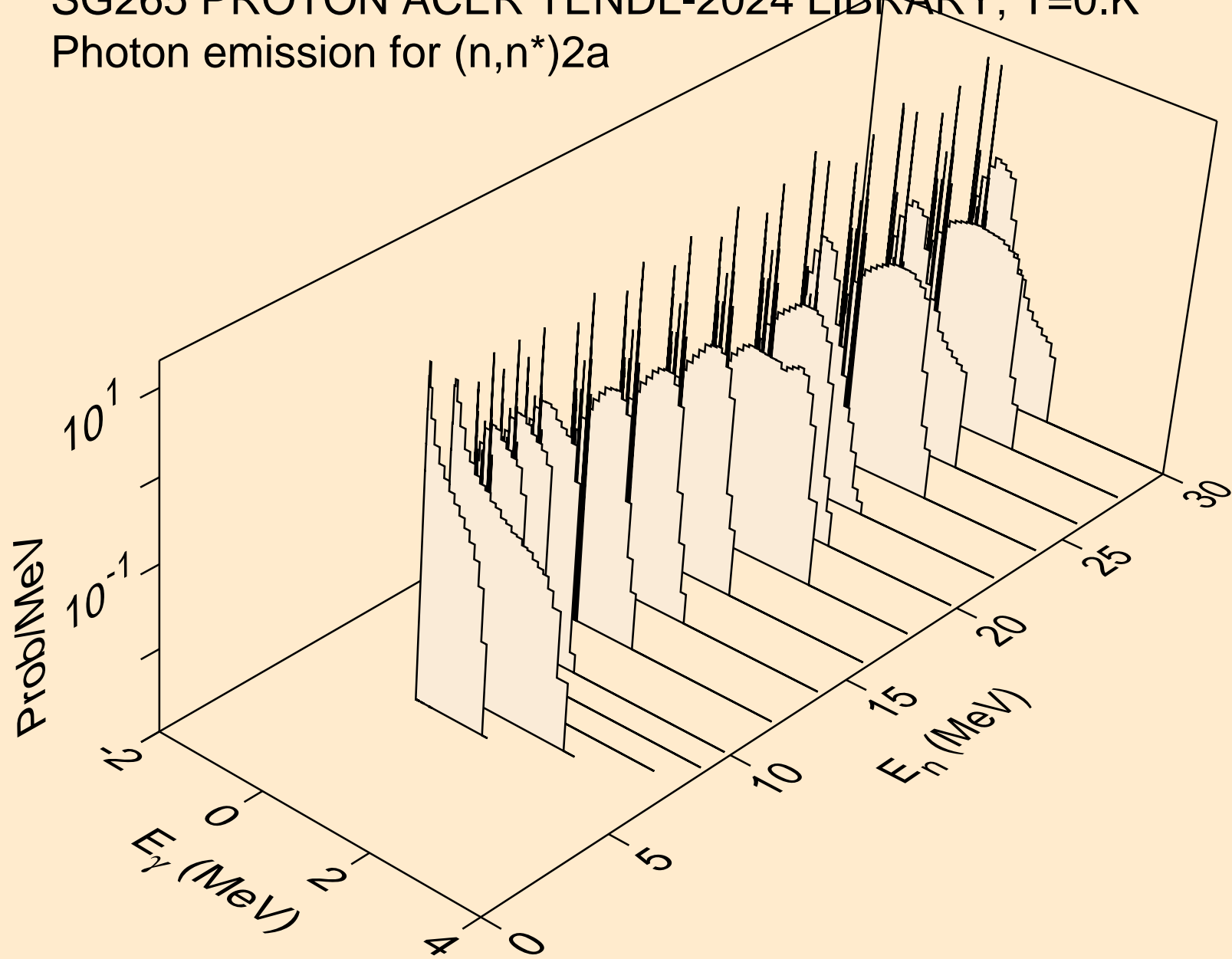

SG265 PROTON ACER TENDL-2024 LIBRARY; T=0.K
Photon emission for (n,n*)d

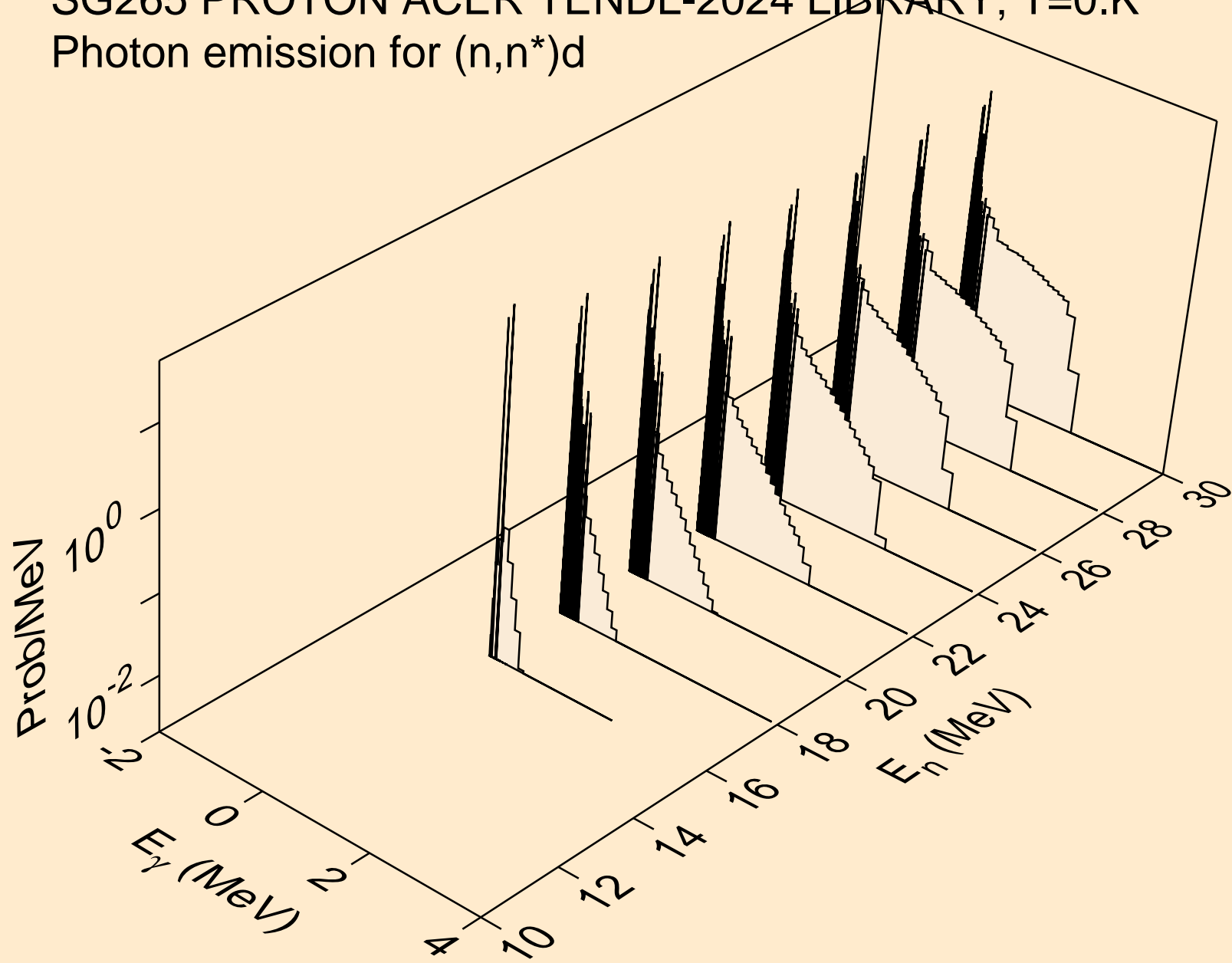

SG265 PROTON ACER TENDL-2024 LIBRARY; T=0.K
Photon emission for (n,n*)t

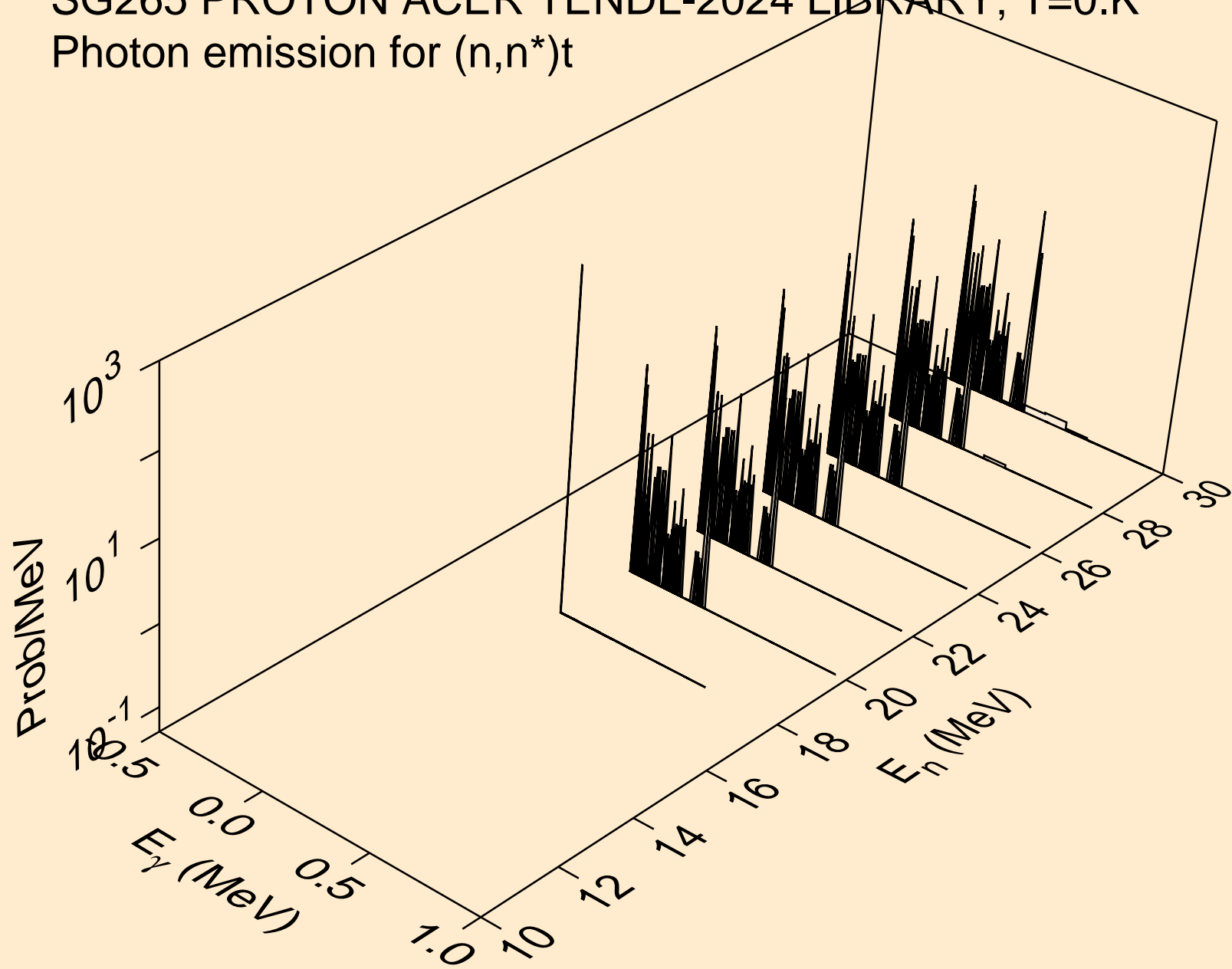

SG265 PROTON ACER TENDL-2024 LIBRARY; T=0.K
Photon emission for (n,2np)

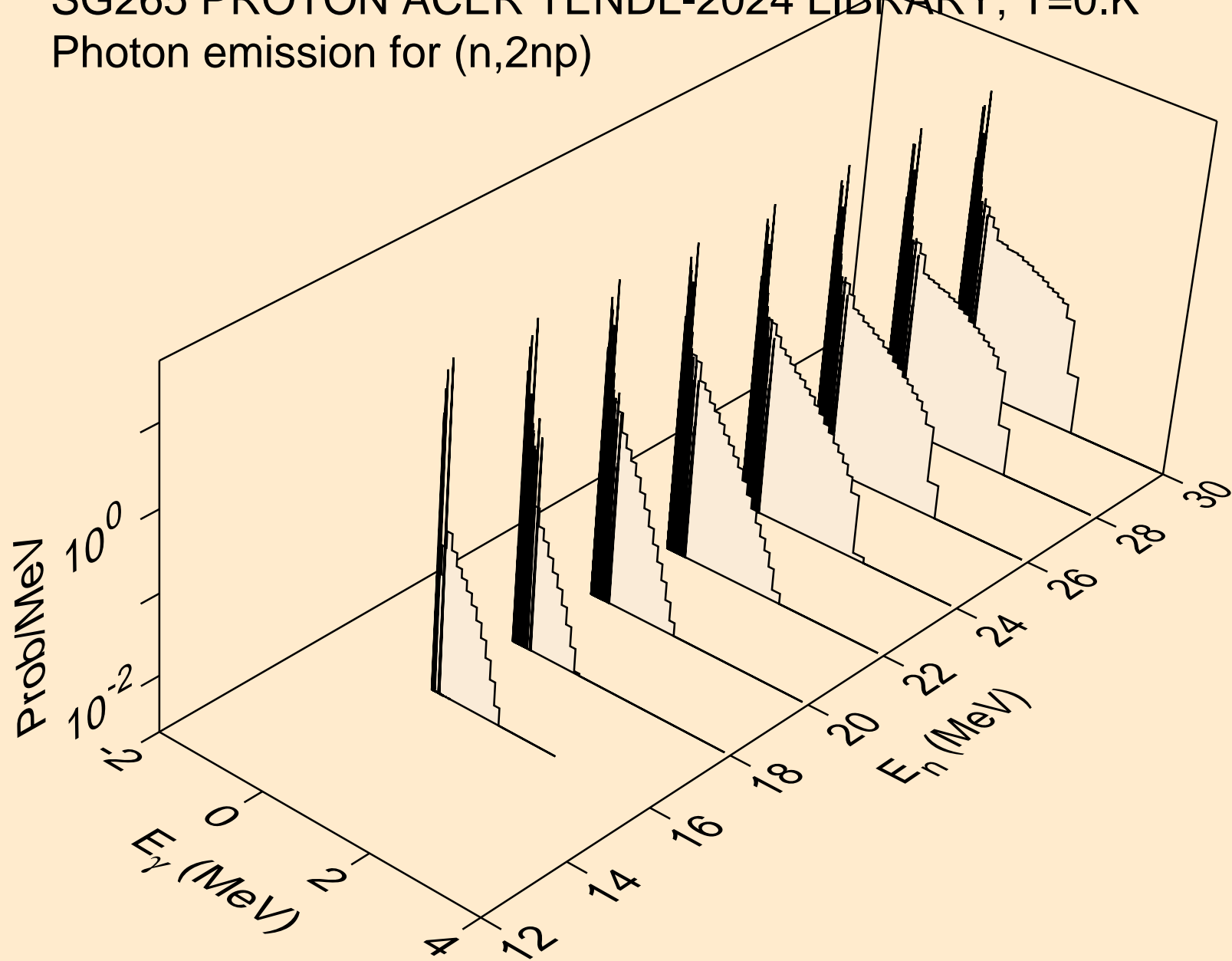

SG265 PROTON ACER TENDL-2024 LIBRARY; T=0.K
Photon emission for (n,gma)

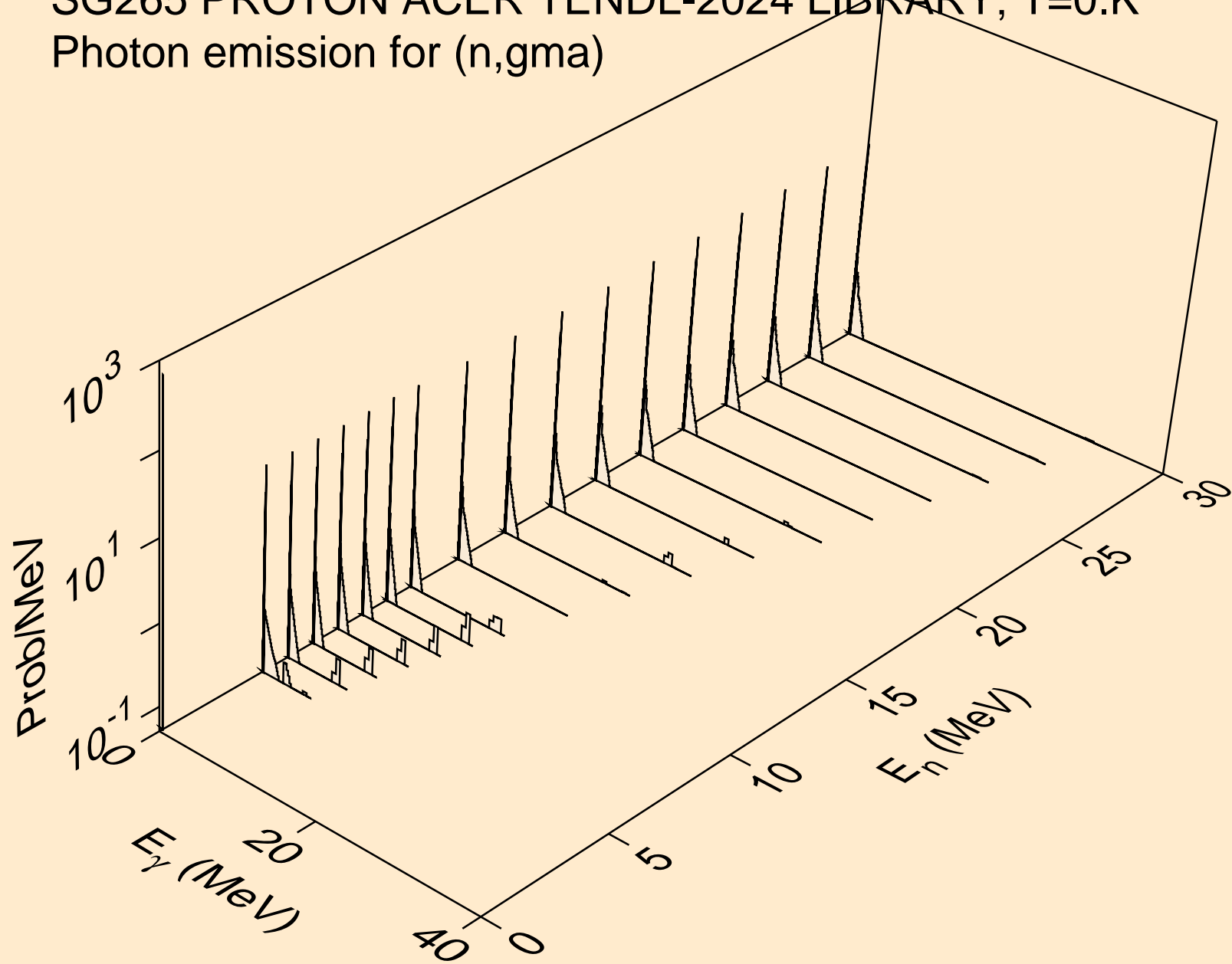

SG265 PROTON ACER TENDL-2024 LIBRARY; T=0.K
Photon emission for inelastic

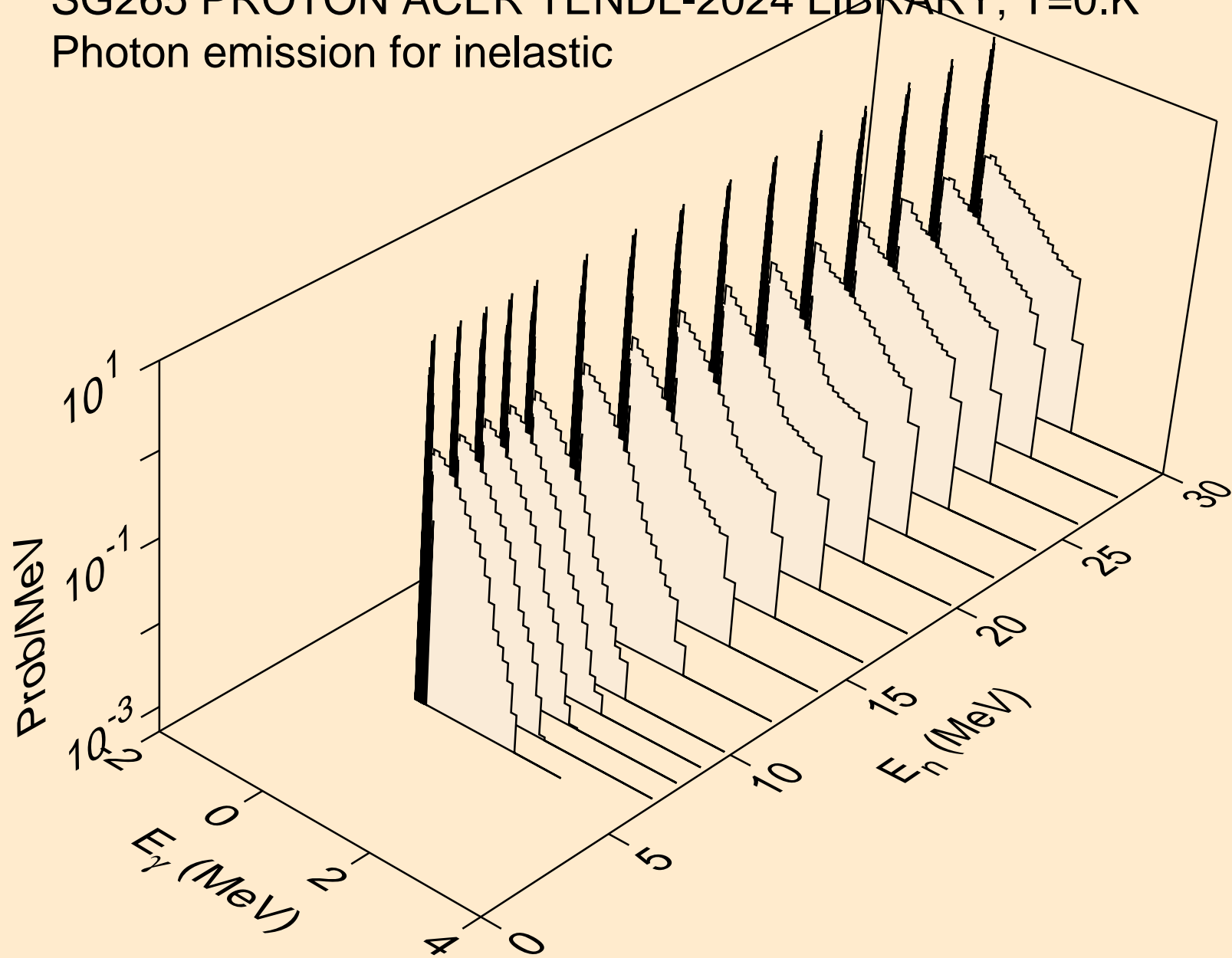

SG265 PROTON ACER TENDL-2024 LIBRARY; T=0.K
Photon emission for (n,d)

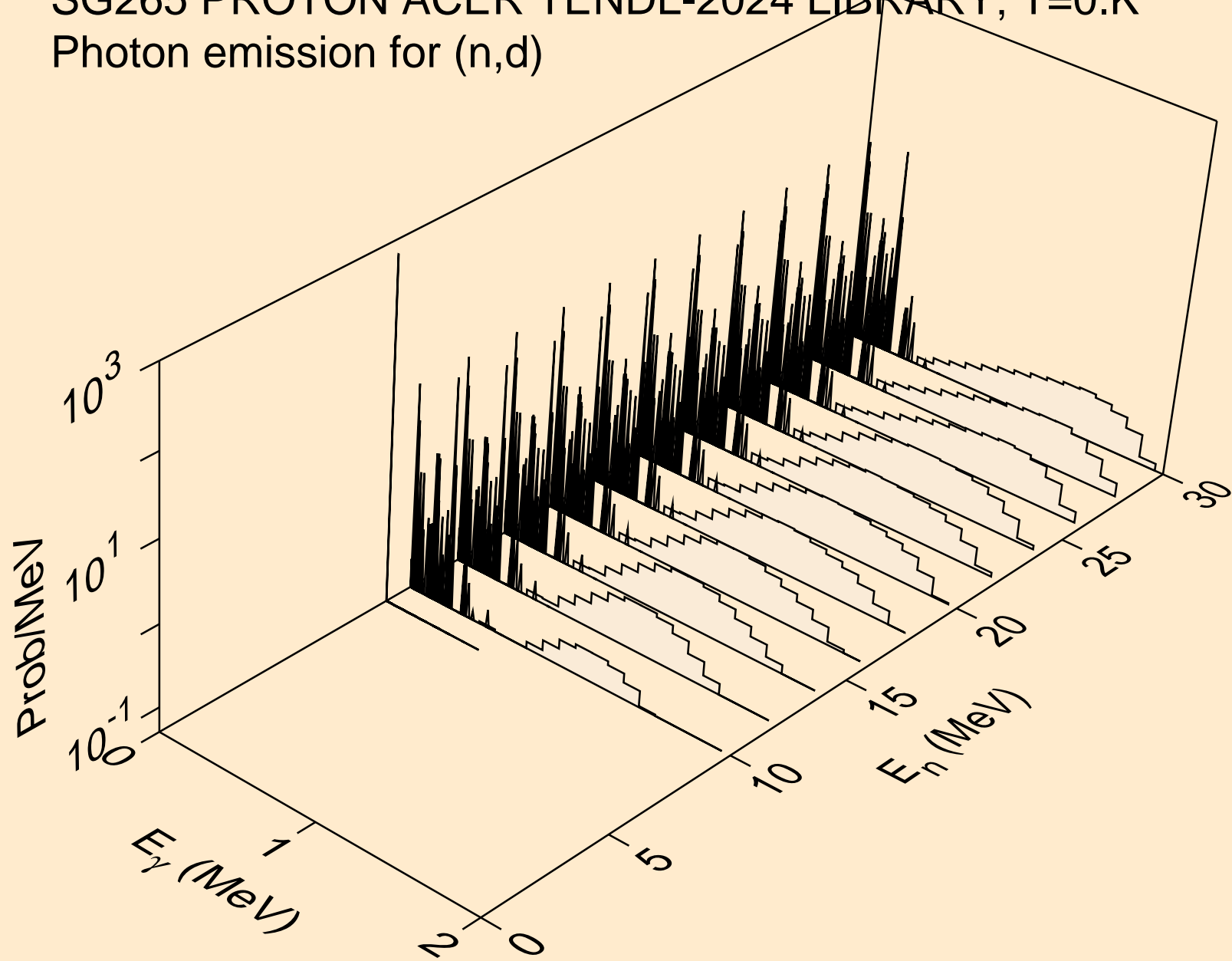

SG265 PROTON ACER TENDL-2024 LIBRARY; T=0.K
Photon emission for (n,t)

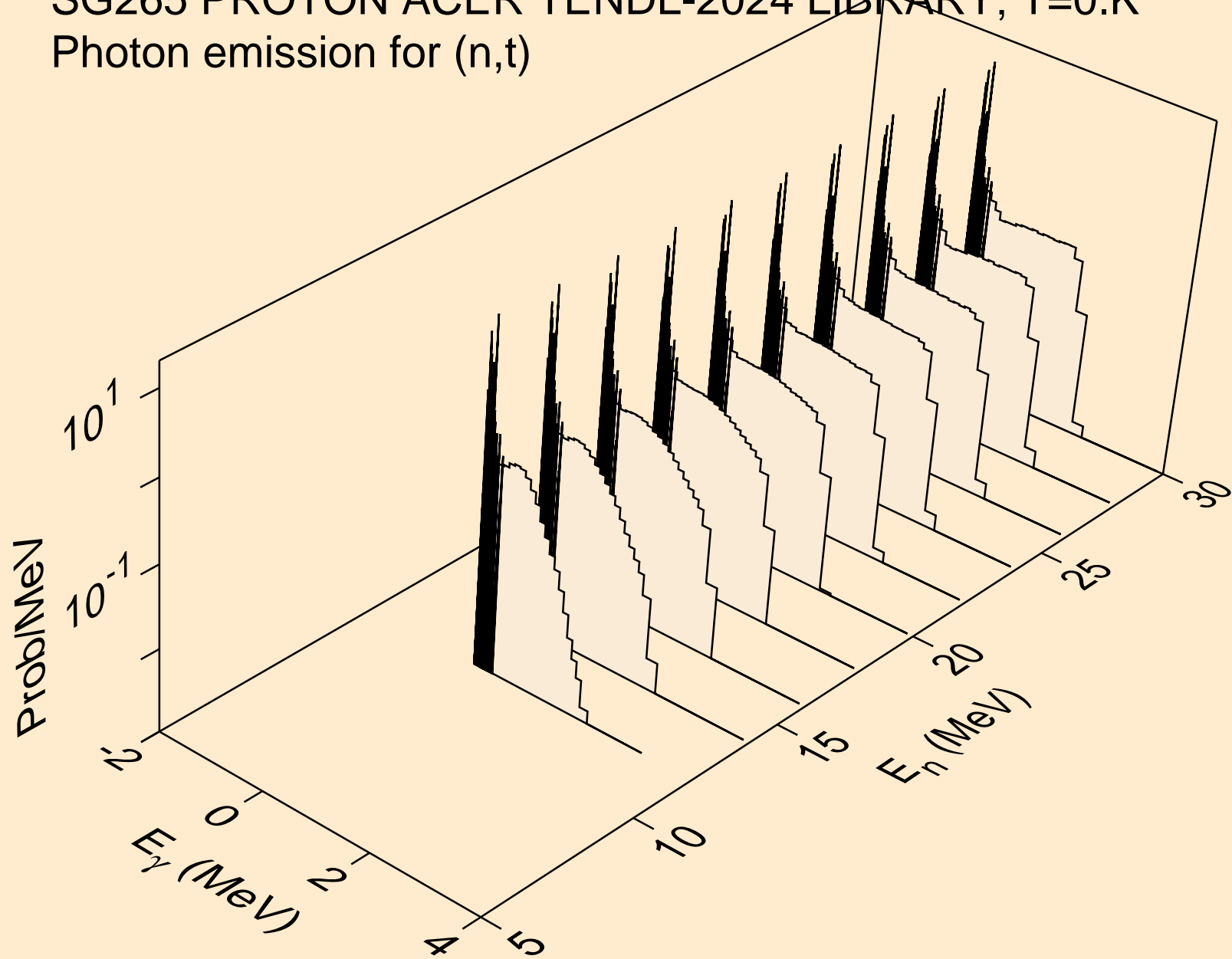

SG265 PROTON ACER TENDL-2024 LIBRARY; T=0.K
Photon emission for (n,he3)

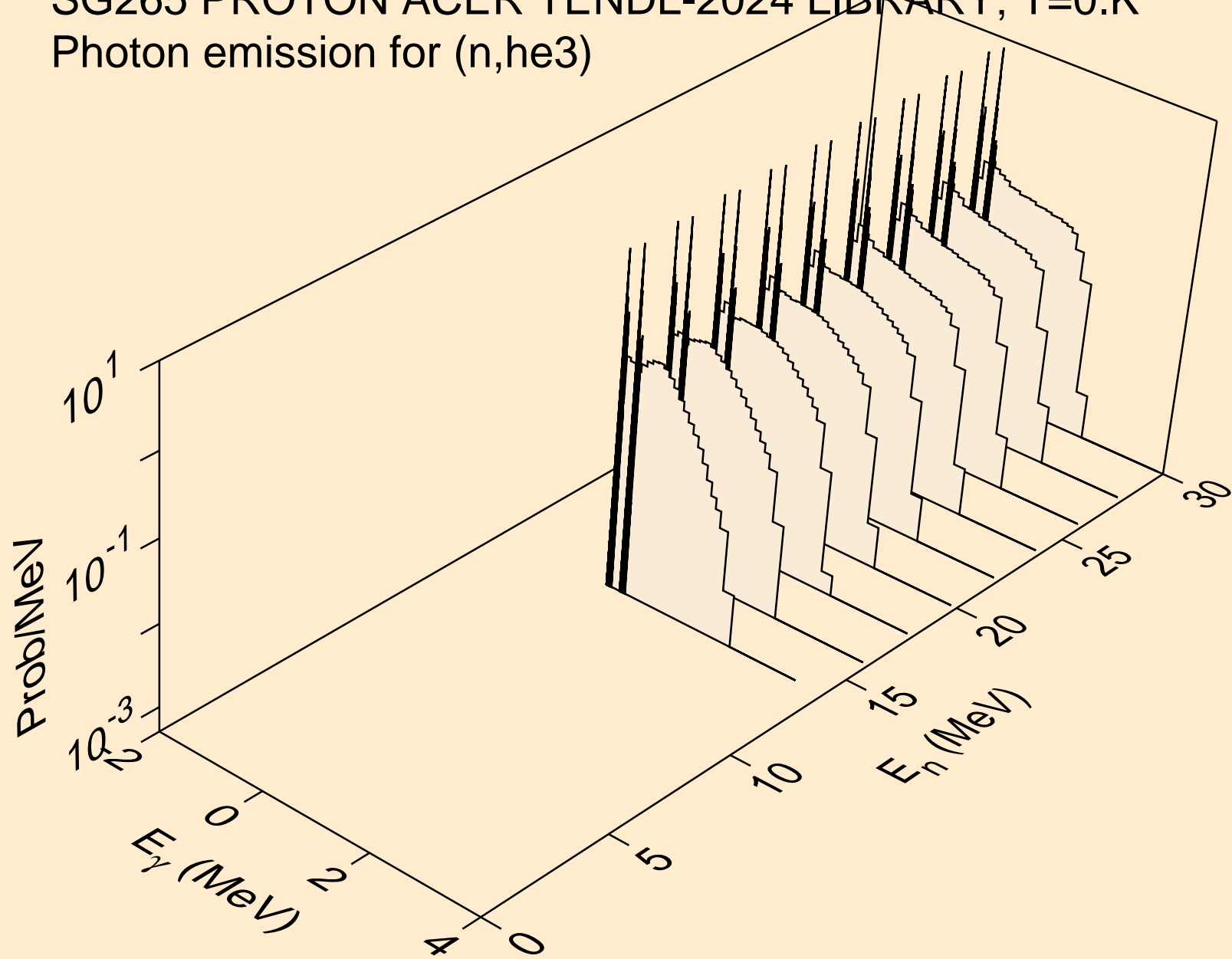

SG265 PROTON ACER TENDL-2024 LIBRARY; T=0.K
Photon emission for (n,a)

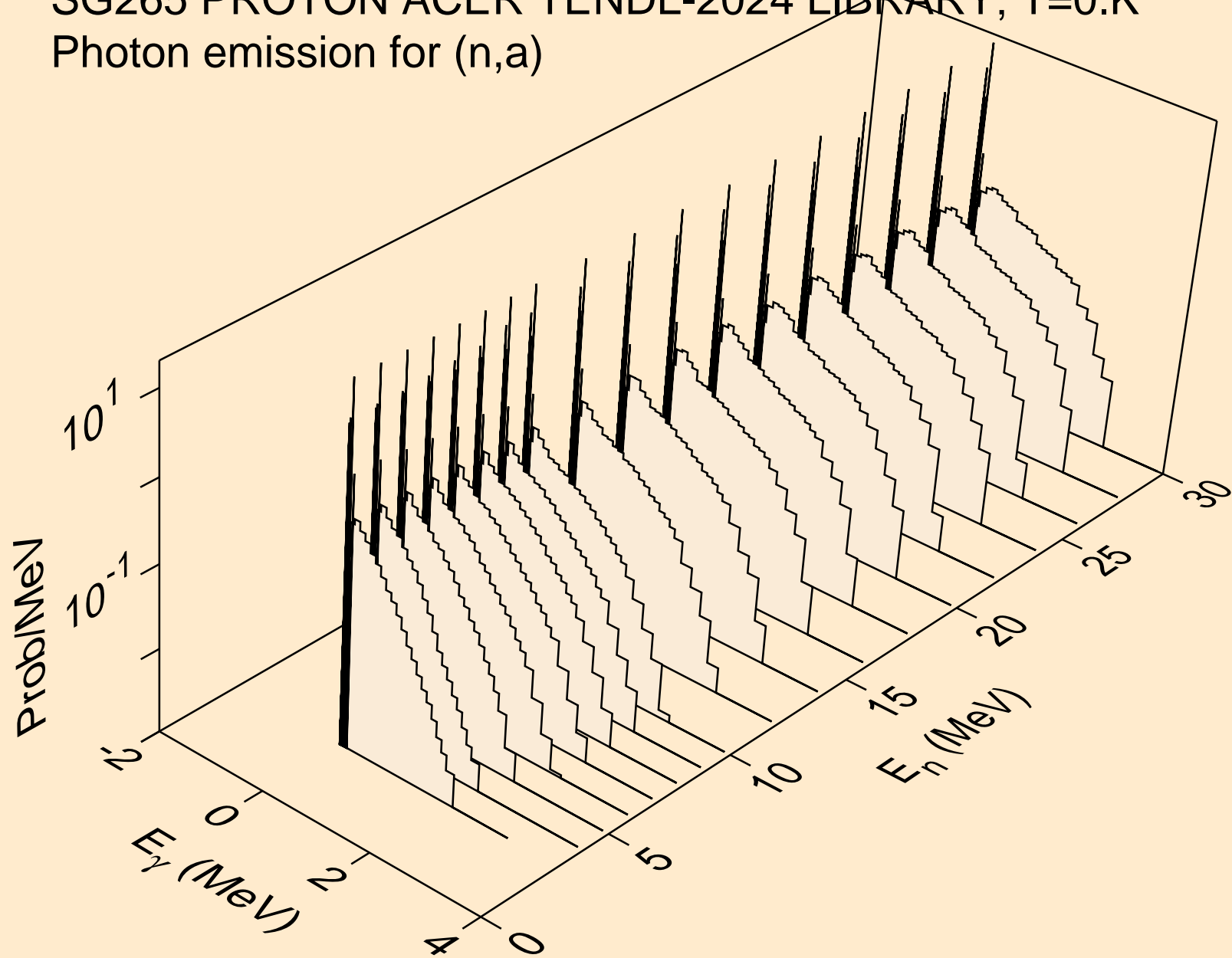

SG265 PROTON ACER TENDL-2024 LIBRARY; T=0.K
Photon emission for (n,2a)

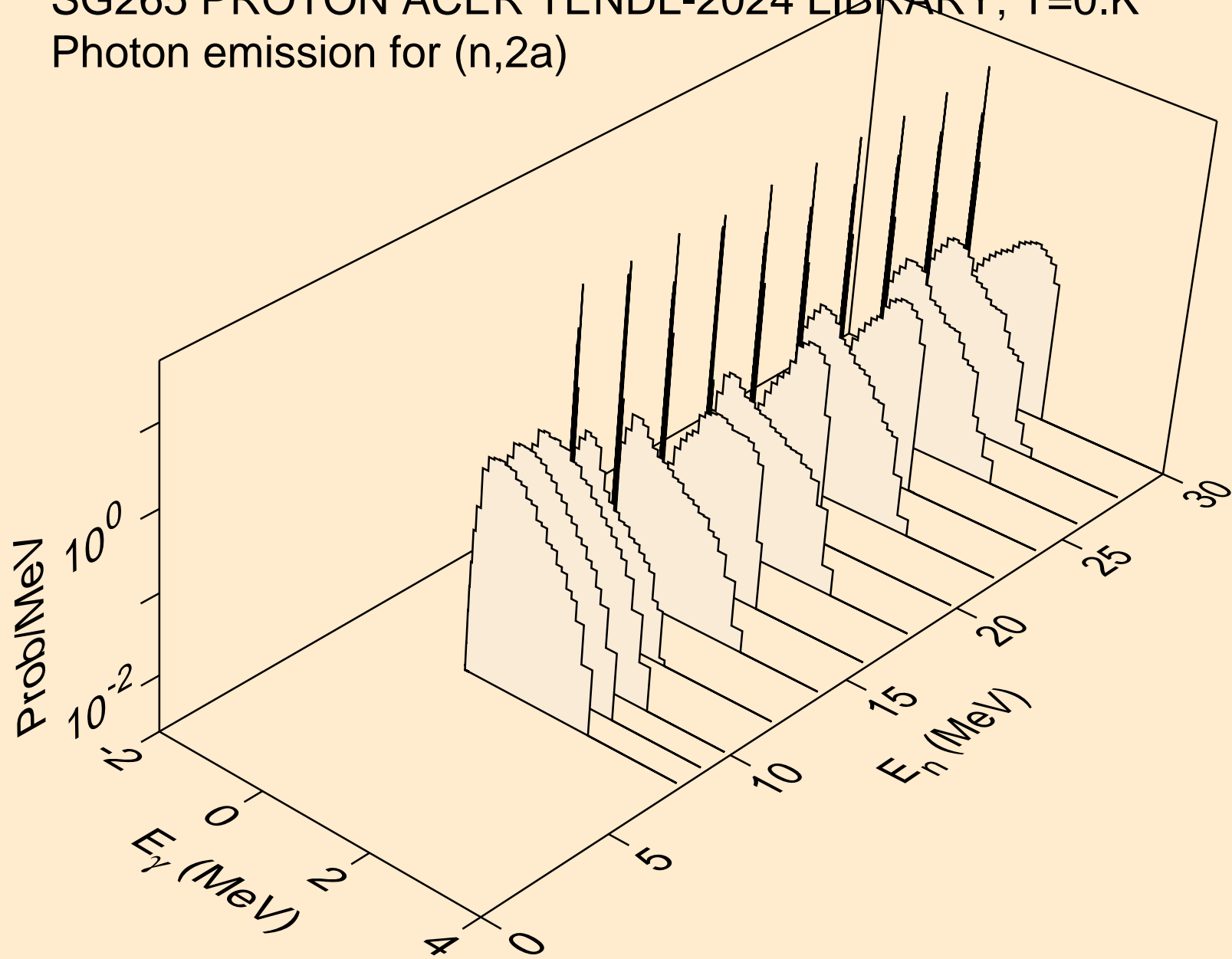

SG265 PROTON ACER TENDL-2024 LIBRARY; T=0.K
Photon emission for (n,3a)

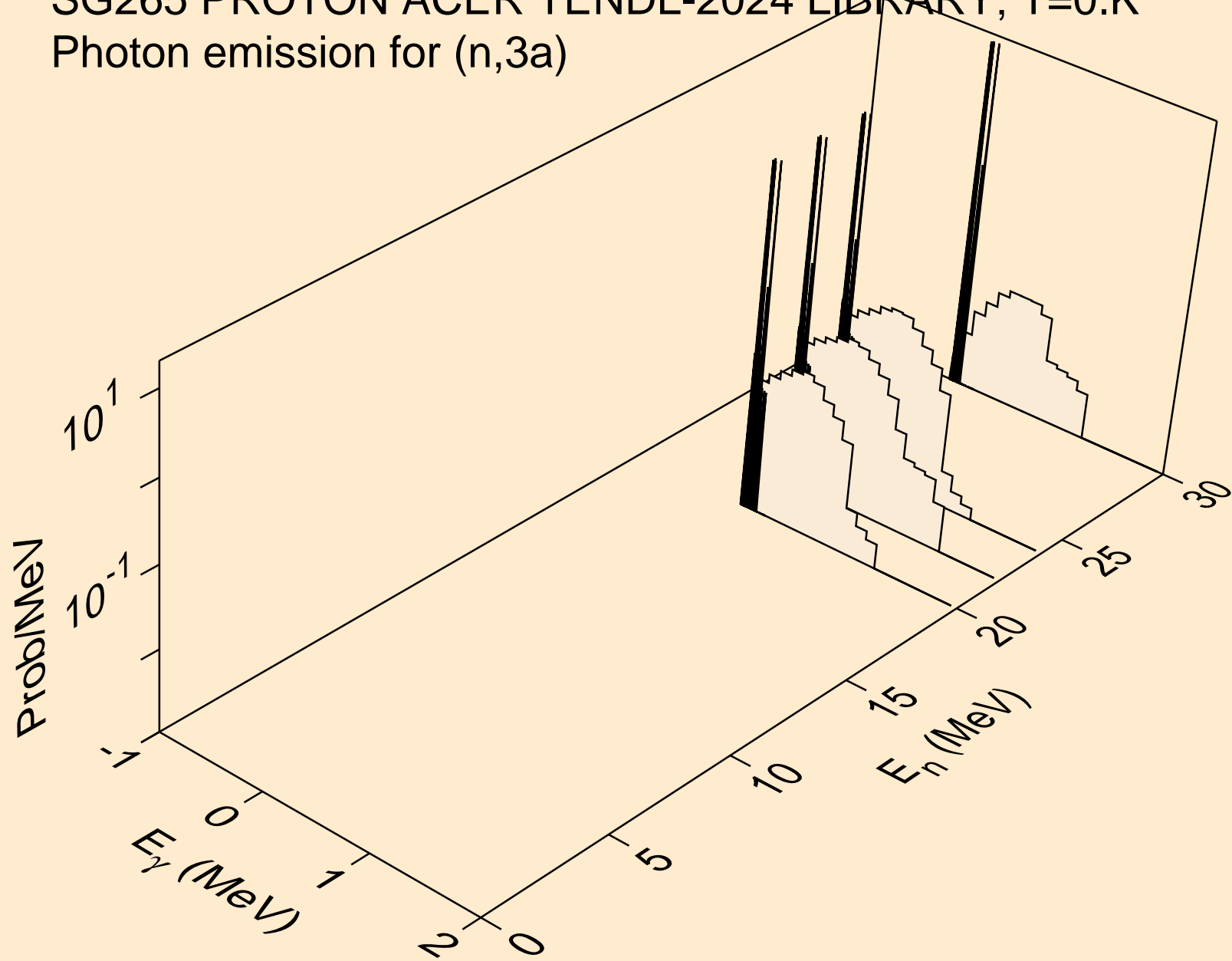

SG265 PROTON ACER TENDL-2024 LIBRARY; T=0.K
Photon emission for (n,2p)

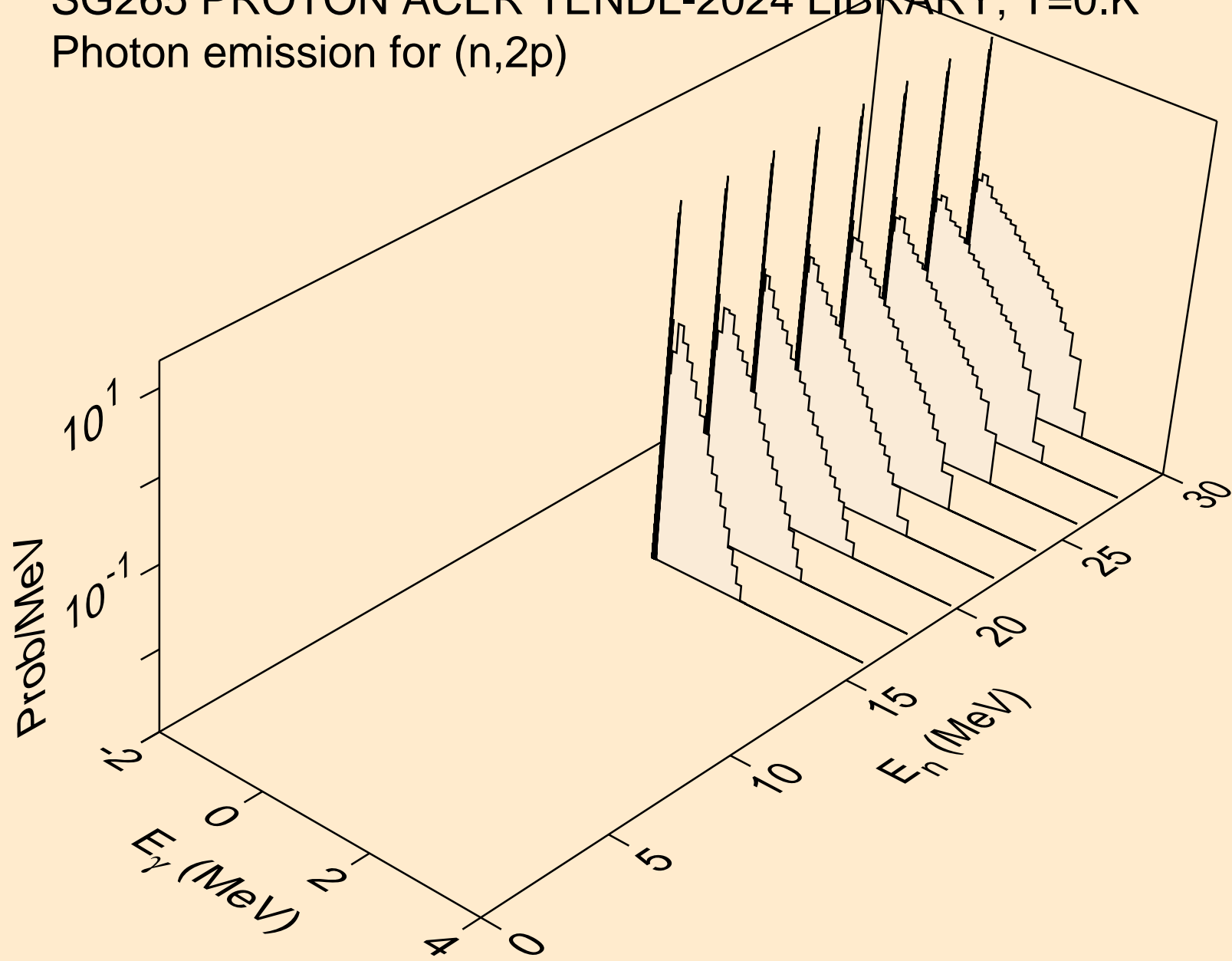

SG265 PROTON ACER TENDL-2024 LIBRARY; T=0.K
Photon emission for (n,pa)

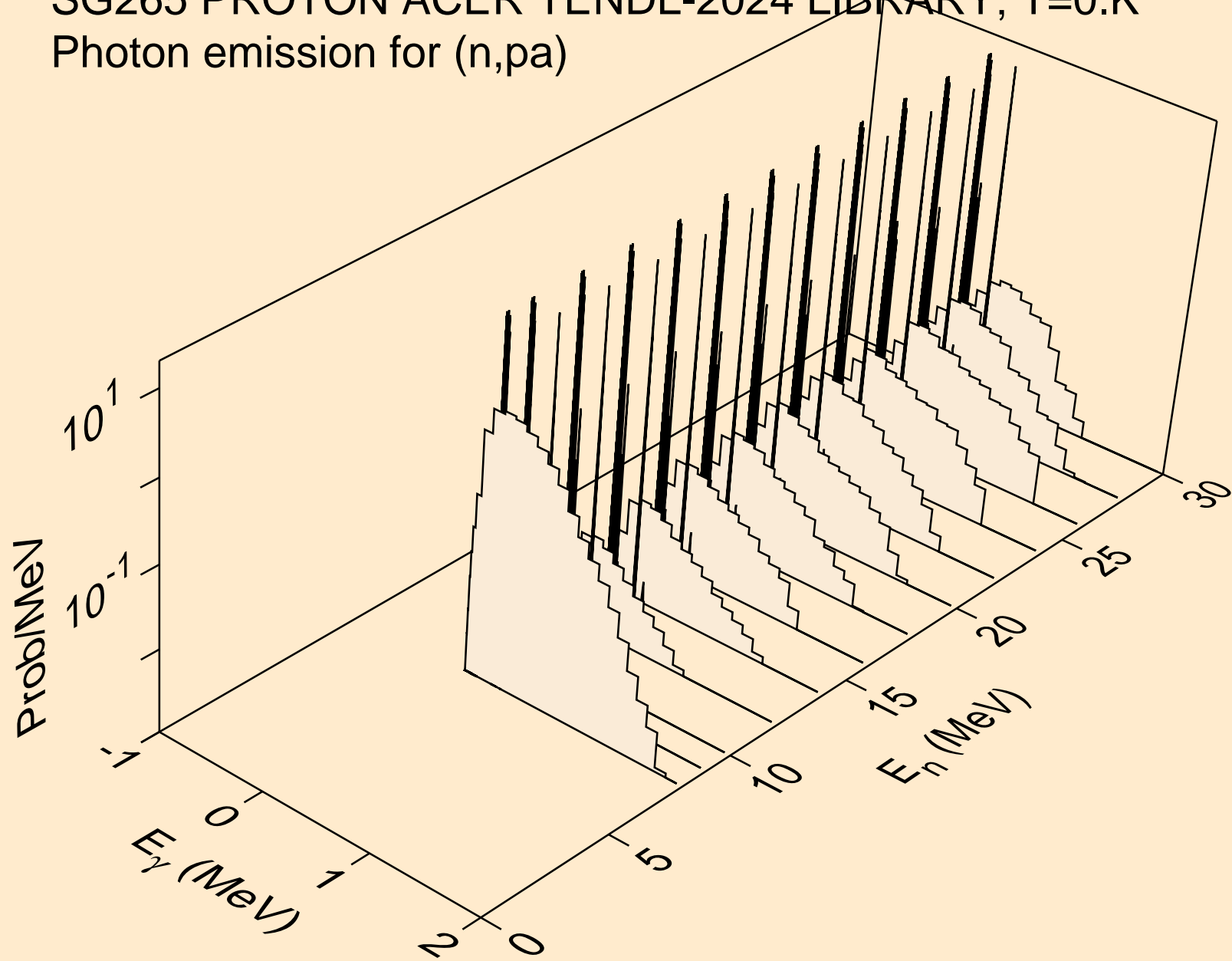

SG265 PROTON ACER TENDL-2024 LIBRARY; T=0.K

Particle heating contributions

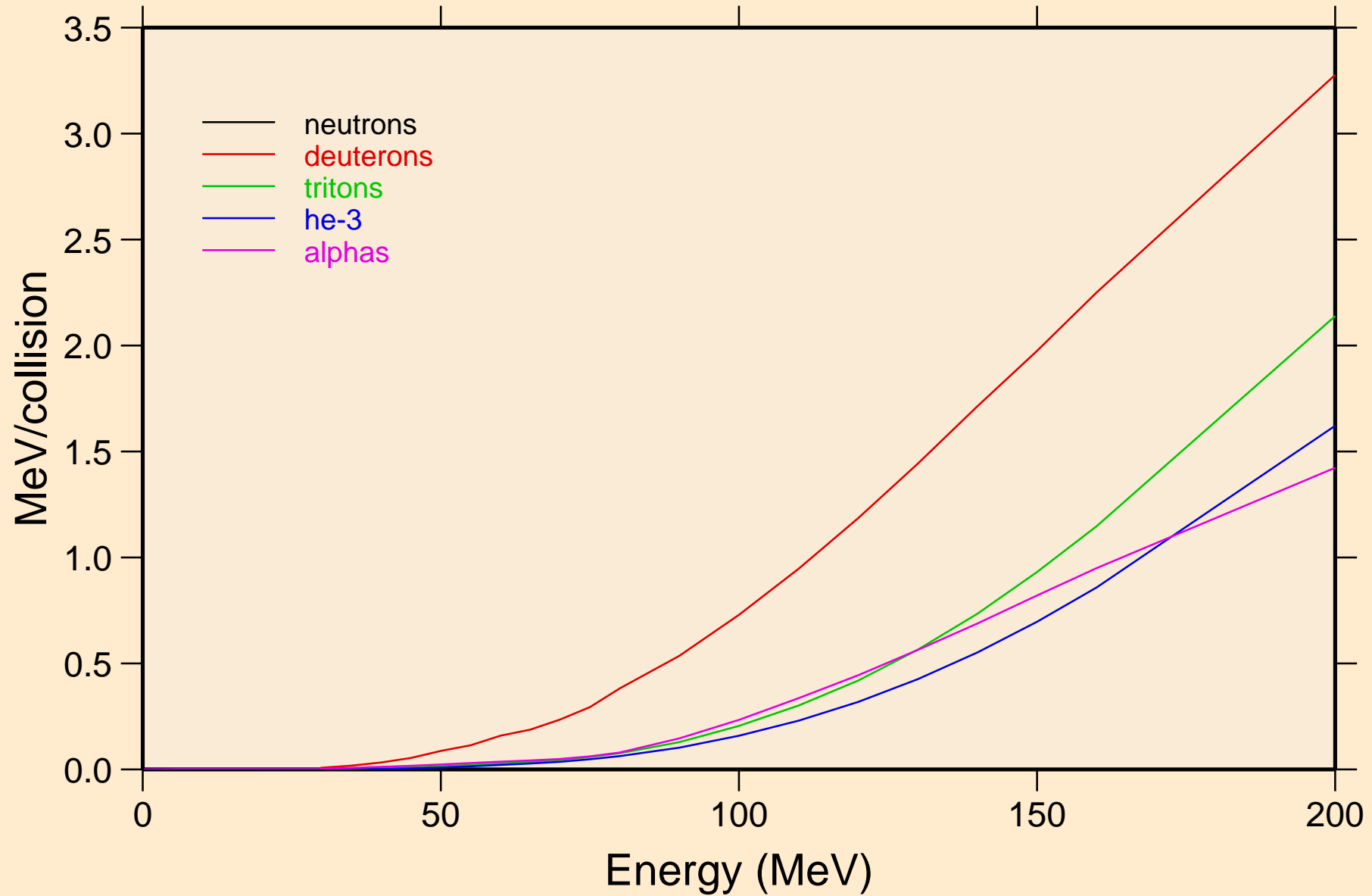

SG265 PROTON ACER TENDL-2024 LIBRARY; T=0.K
Recoil Heating

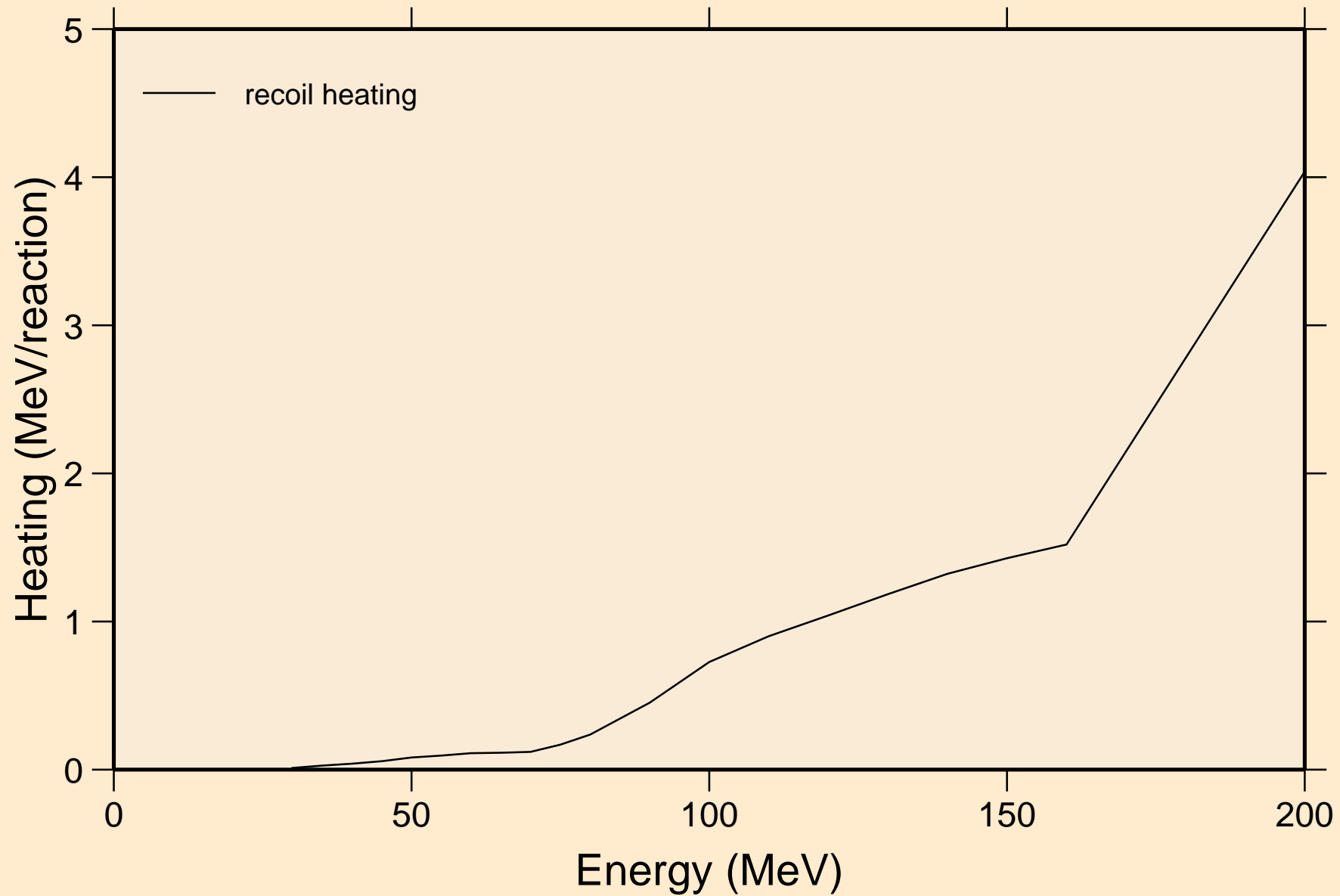

SG265 PROTON ACER TENDL-2024 LIBRARY; T=0.K

Particle production cross sections

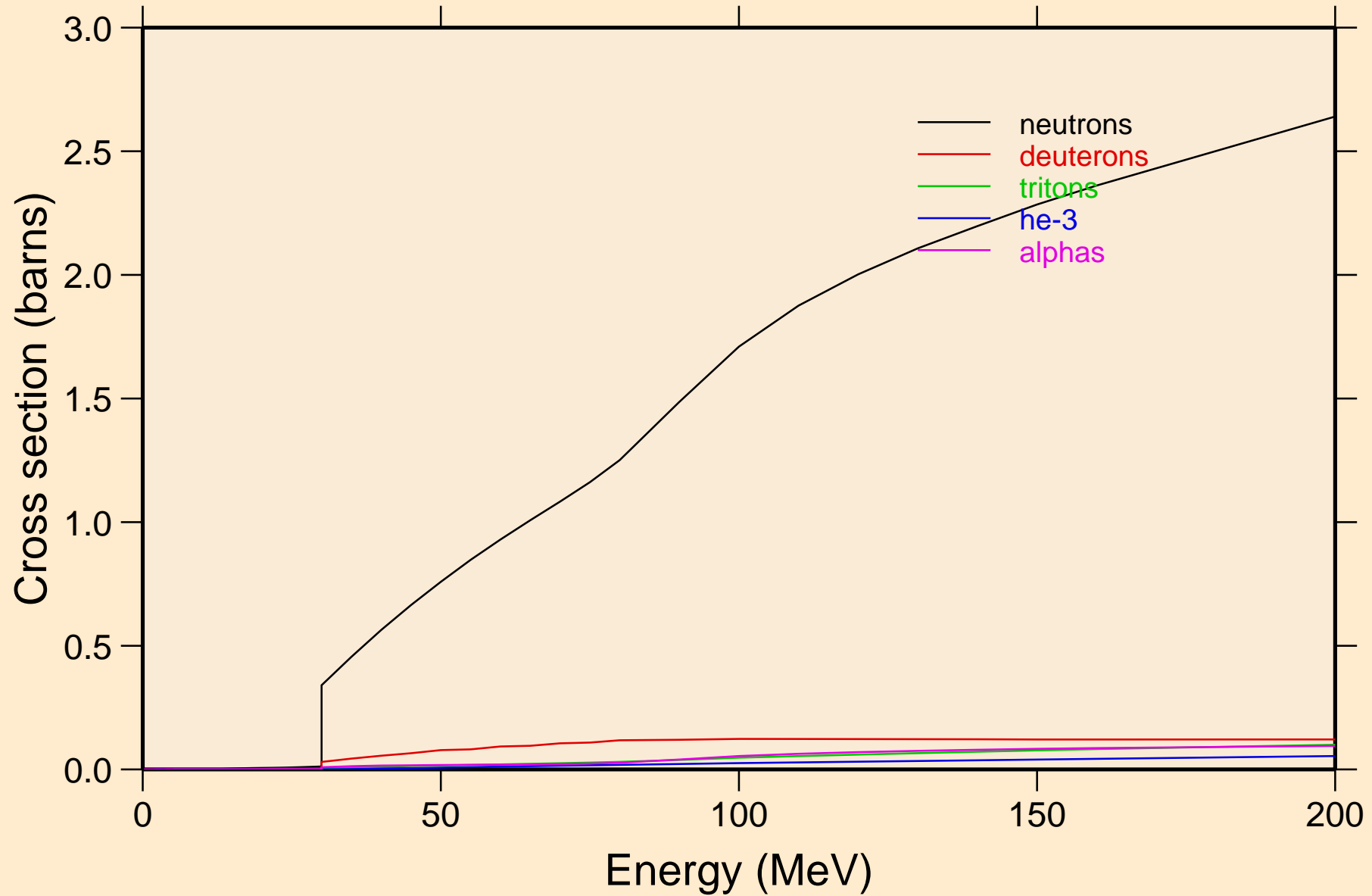

SG265 PROTON ACER TENDL-2024 LIBRARY; T=0.K
neutrons from (p,n)

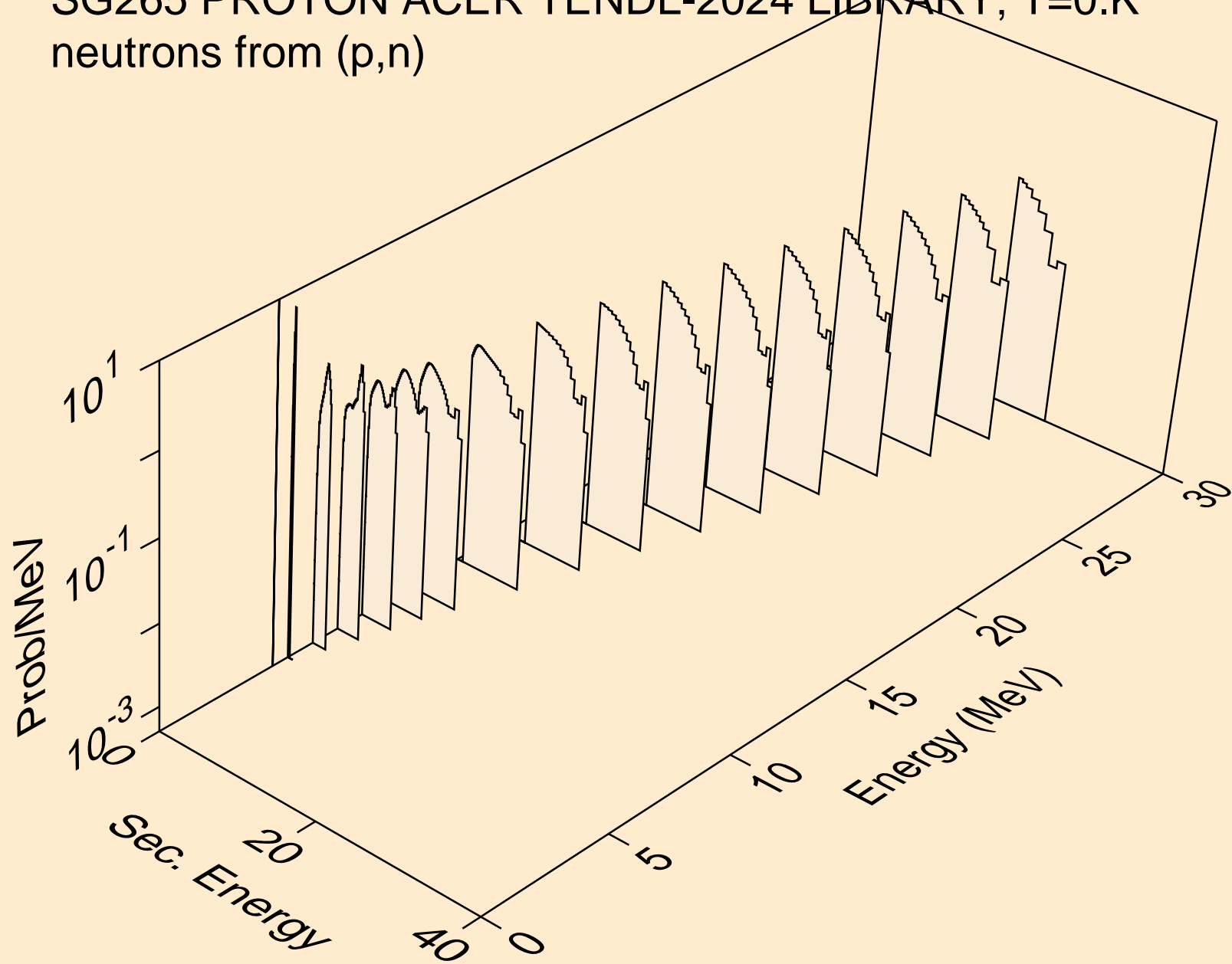

SG265 PROTON ACER TENDL-2024 LIBRARY; T=0.K
neutrons from (p,x)

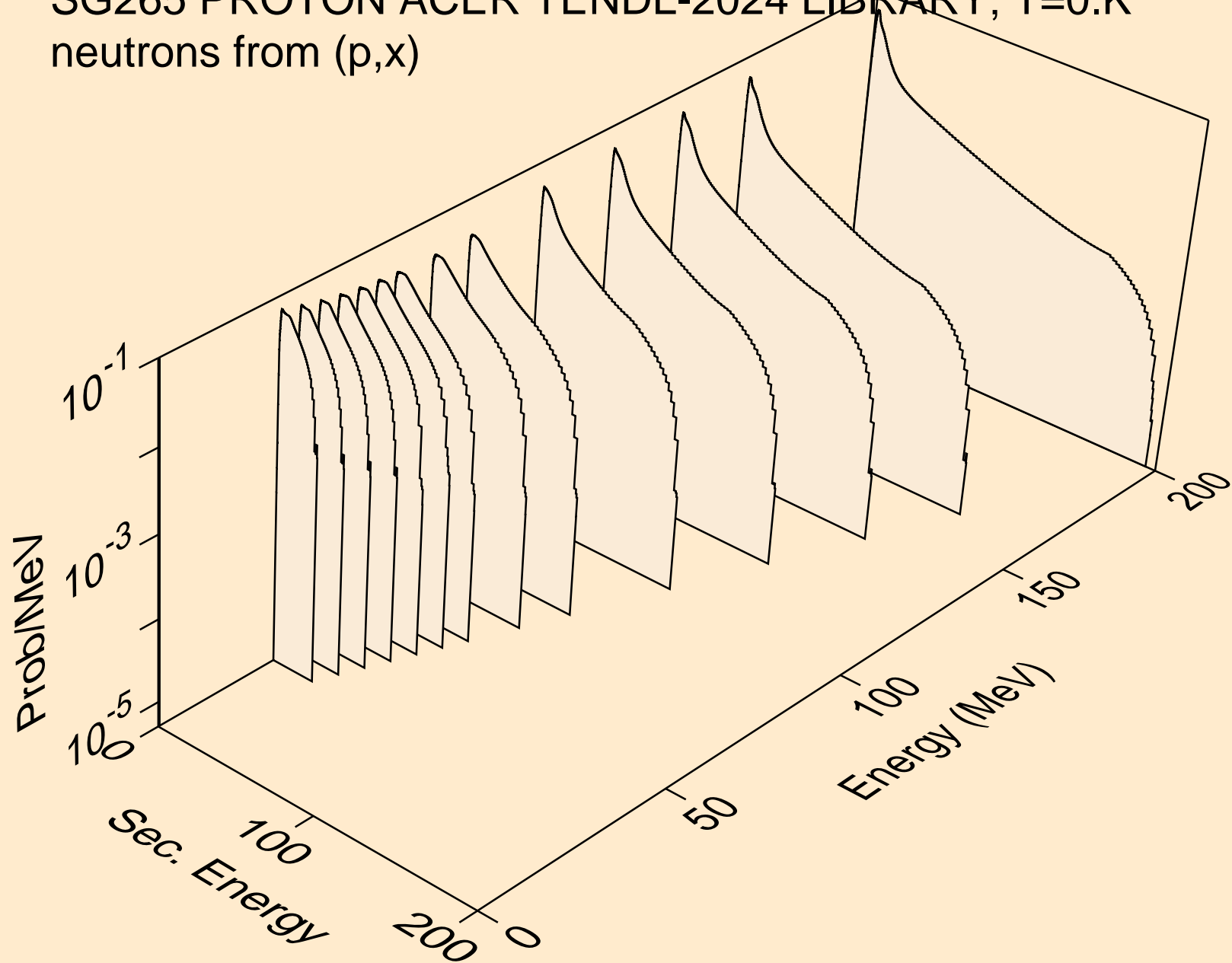

SG265 PROTON ACER TENDL-2024 LIBRARY; T=0.K
neutrons from (p,2n)

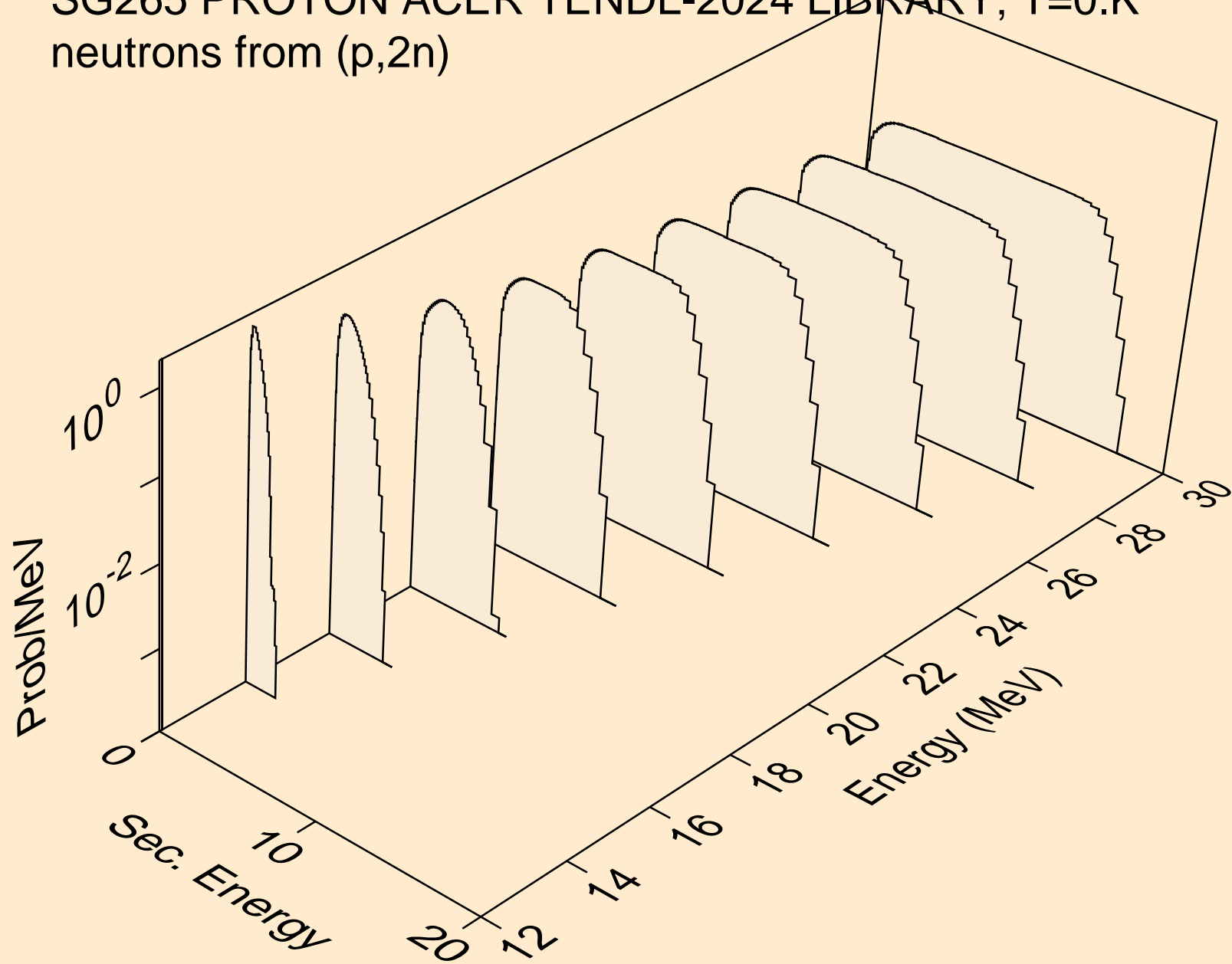

SG265 PROTON ACER TENDL-2024 LIBRARY; T=0.K
neutrons from (p,3n)

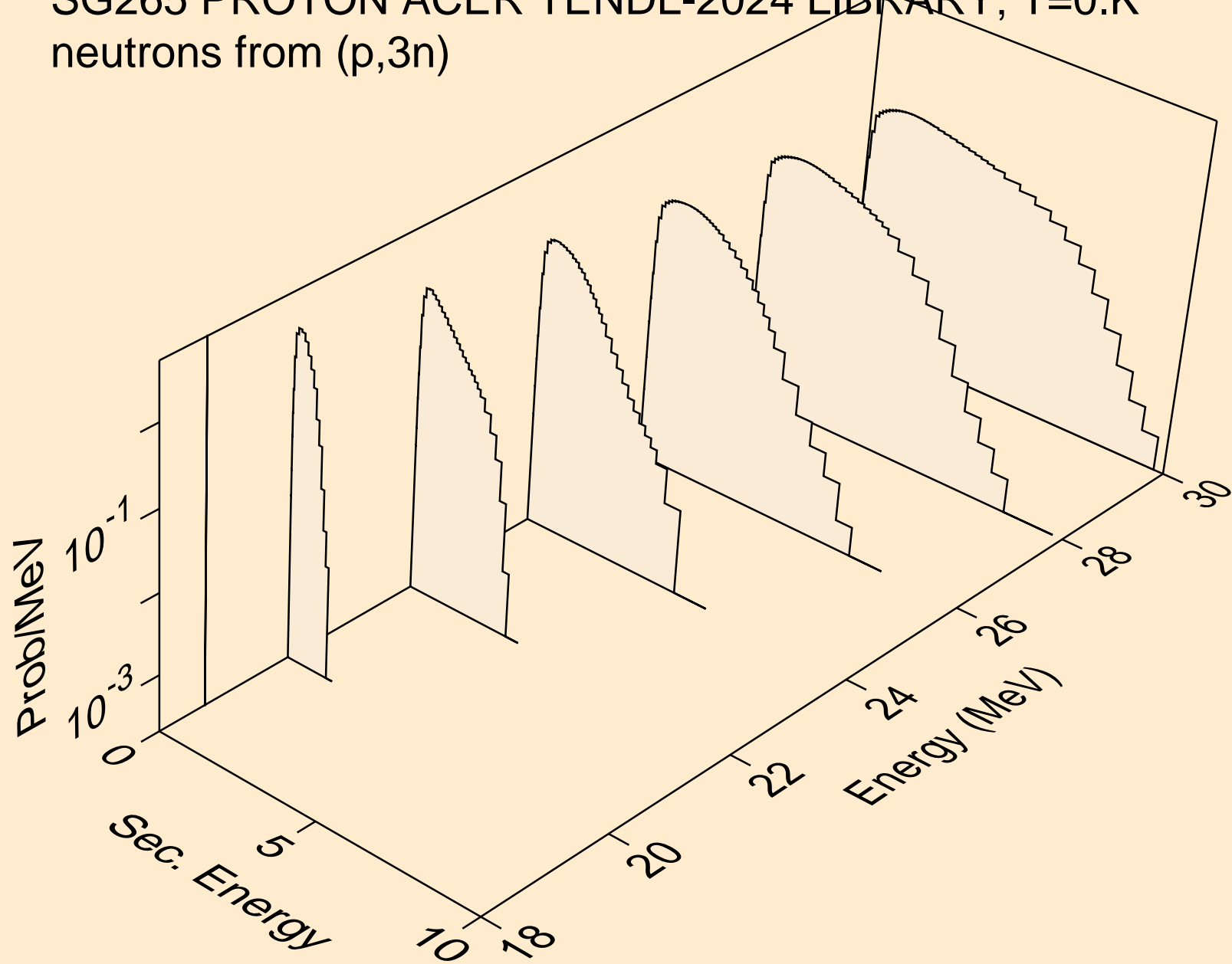

SG265 PROTON ACER TENDL-2024 LIBRARY; T=0.K
neutrons from (p,n*)a

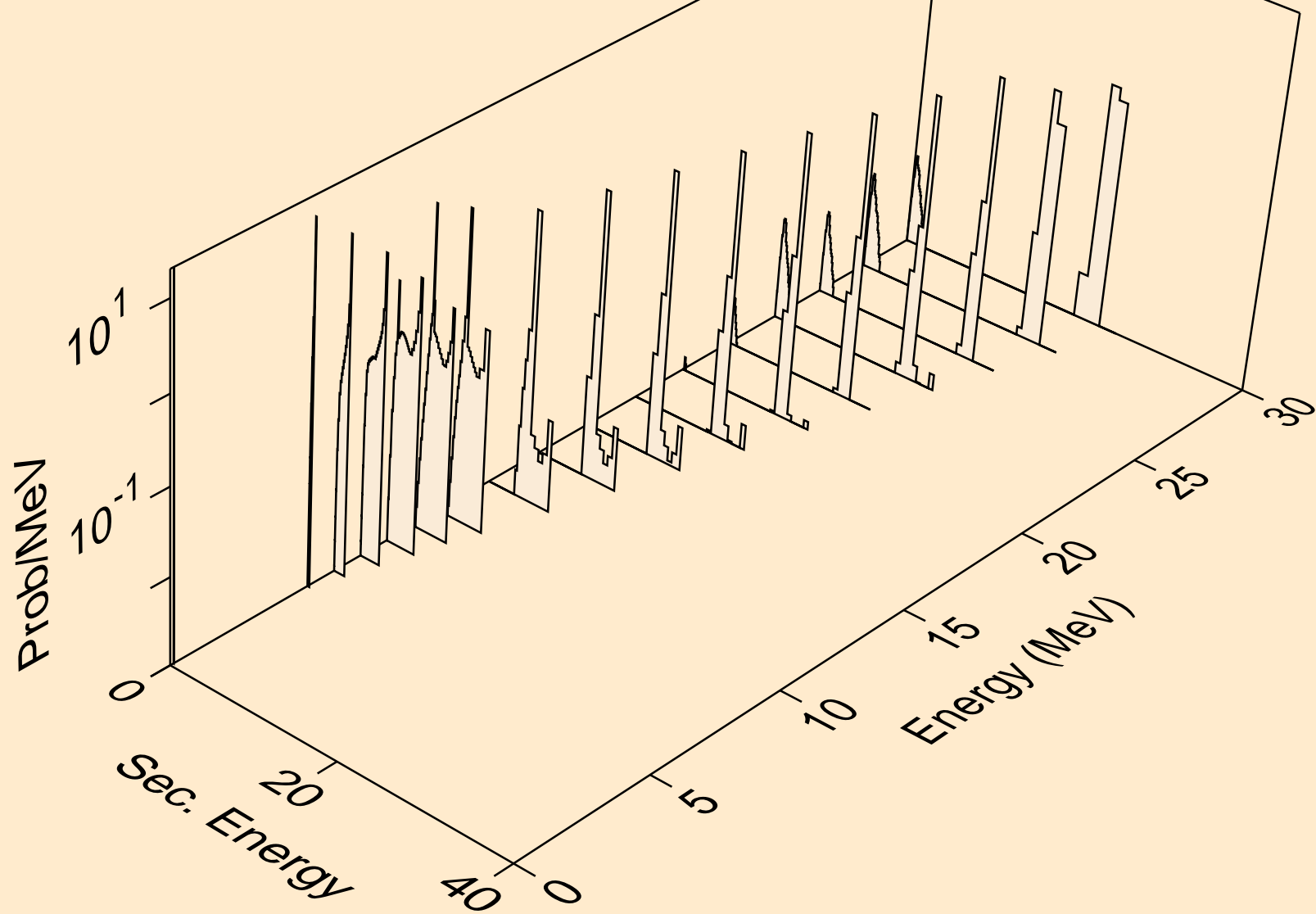

SG265 PROTON ACER TENDL-2024 LIBRARY; T=0.K
neutrons from (p,2n)a

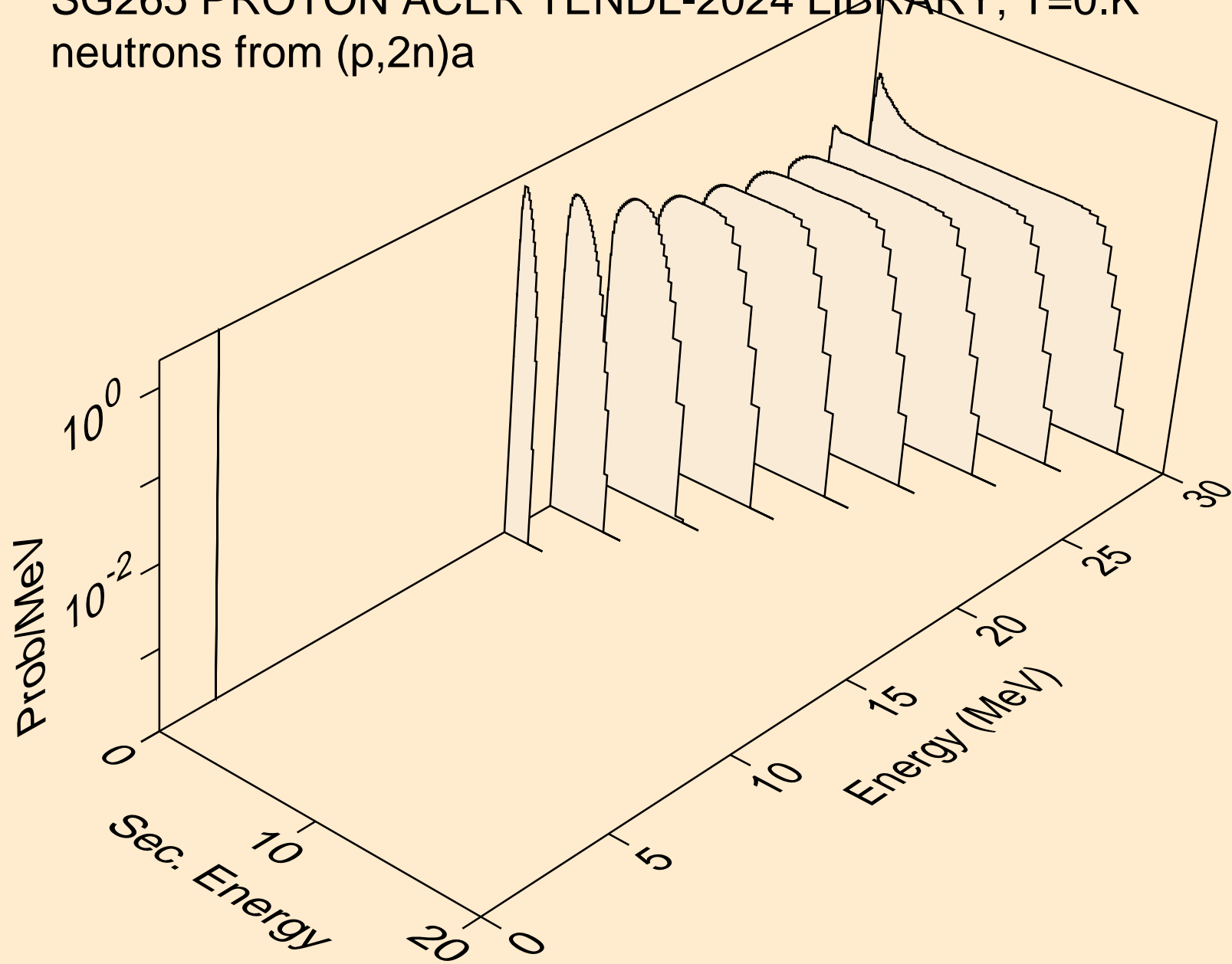

SG265 PROTON ACER TENDL-2024 LIBRARY; T=0.K
neutrons from (p,n*)p

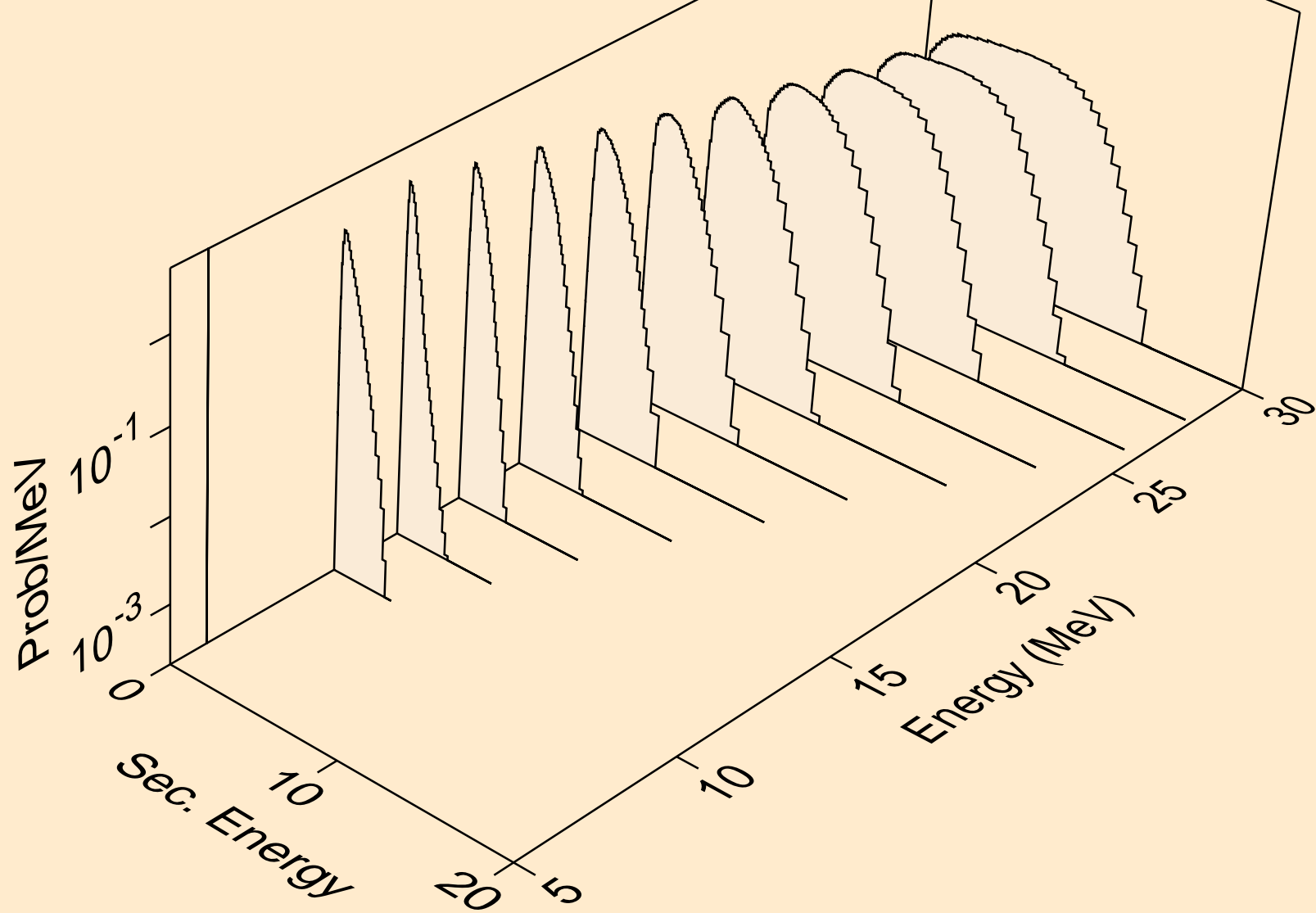

SG265 PROTON ACER TENDL-2024 LIBRARY; T=0.K
neutrons from (p,n*)2a

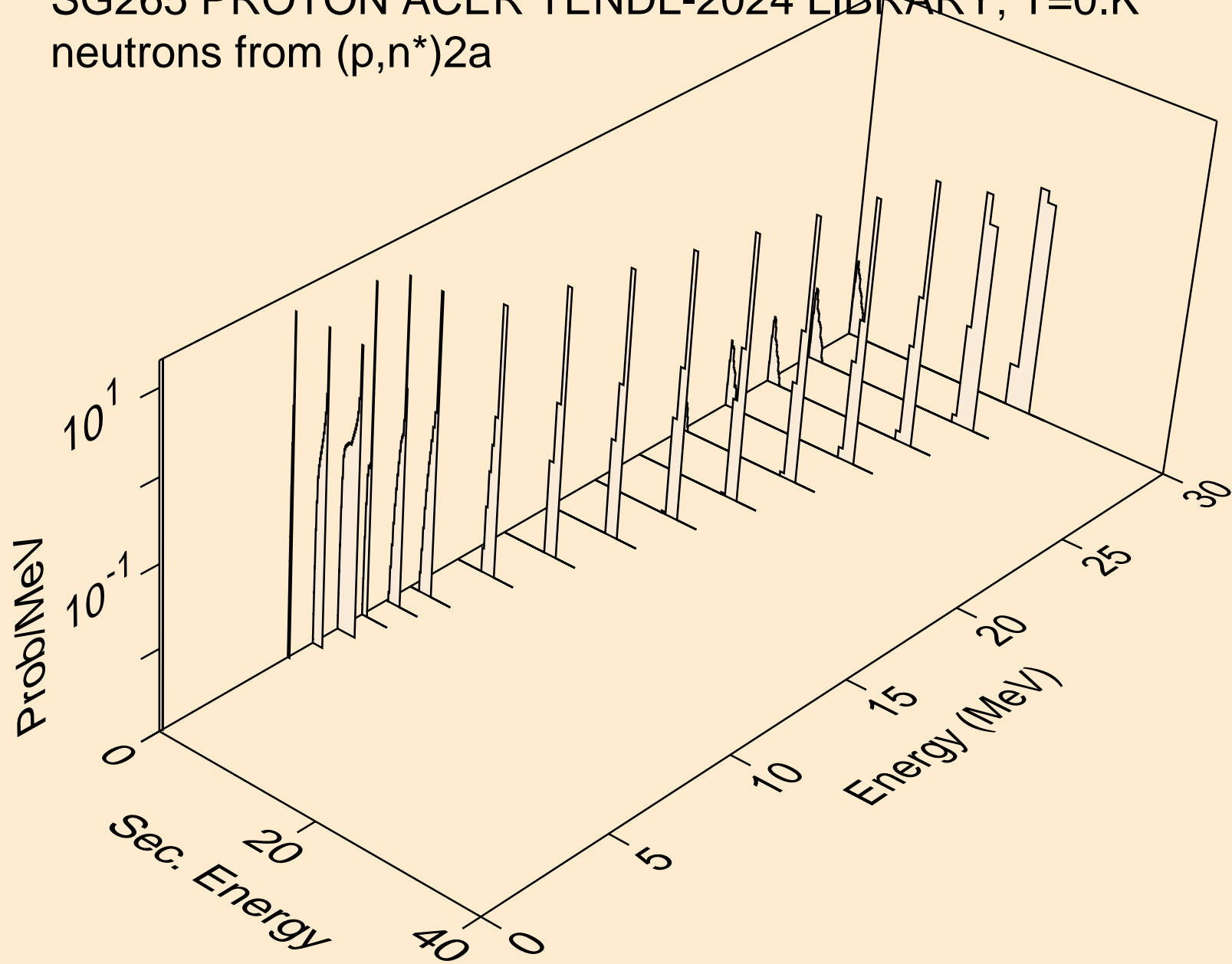

SG265 PROTON ACER TENDL-2024 LIBRARY; T=0.K
neutrons from (p,n*)d

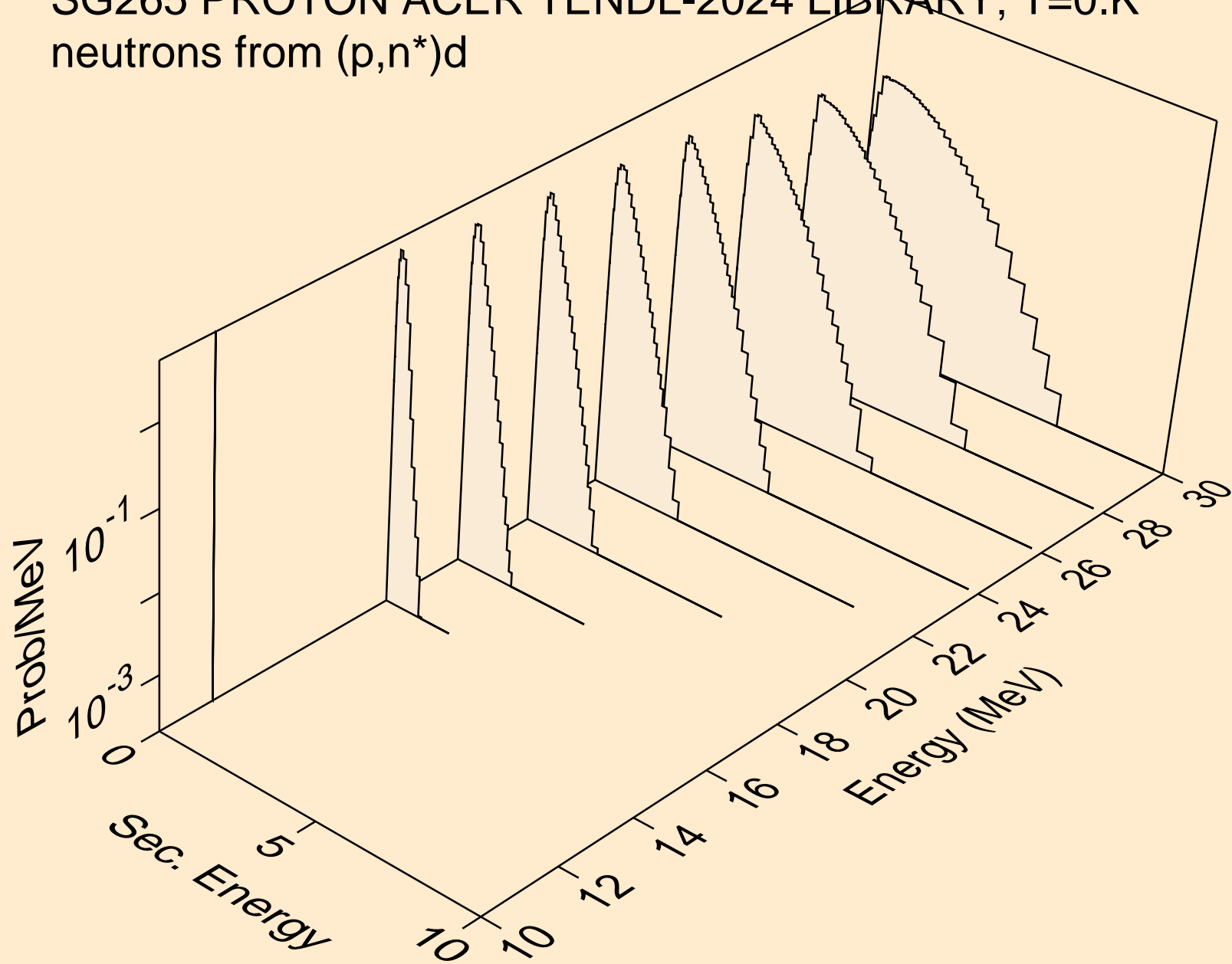

SG265 PROTON ACER TENDL-2024 LIBRARY; T=0.K
neutrons from (p,n*)t

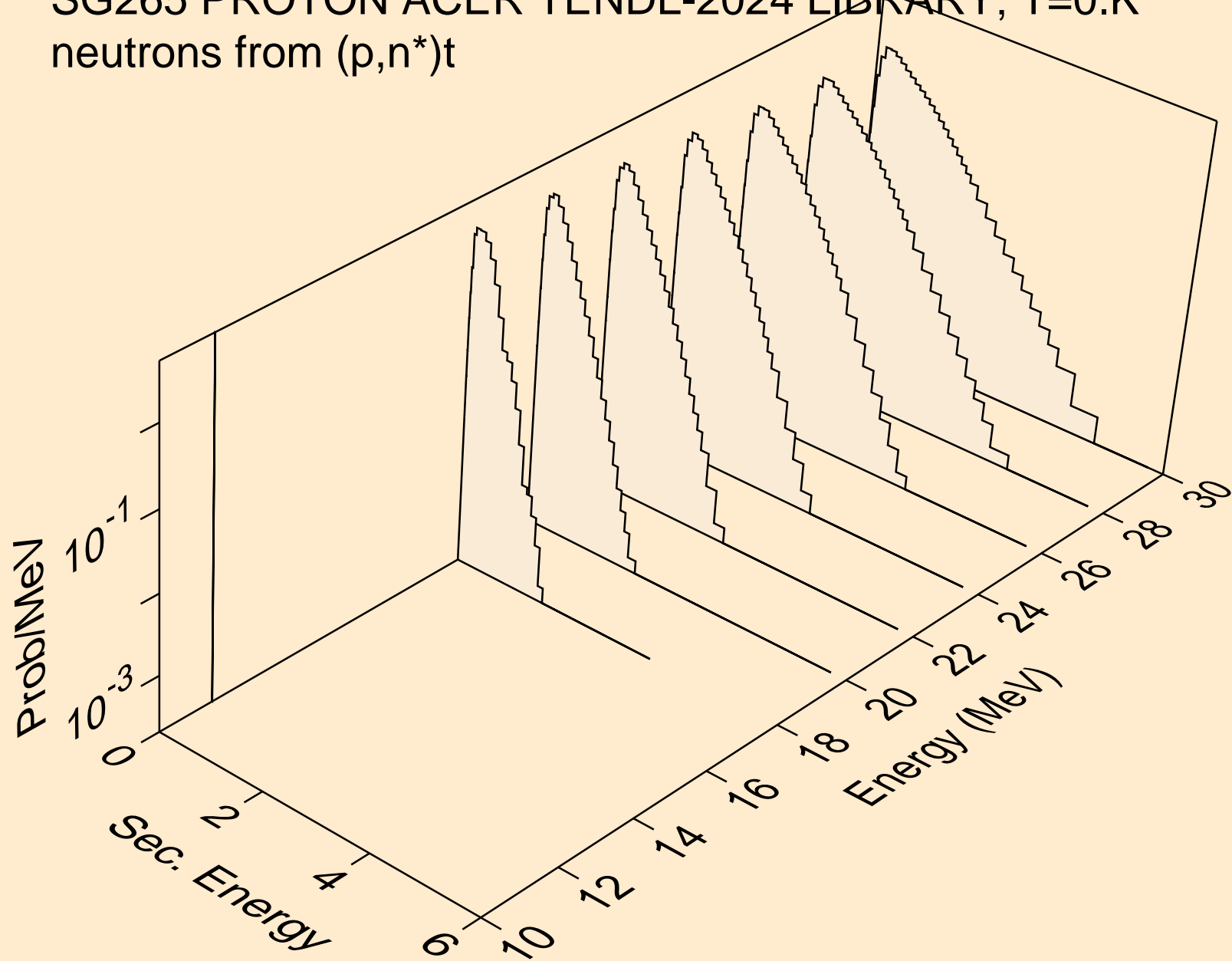

SG265 PROTON ACER TENDL-2024 LIBRARY; T=0.K
neutrons from (p,2np)

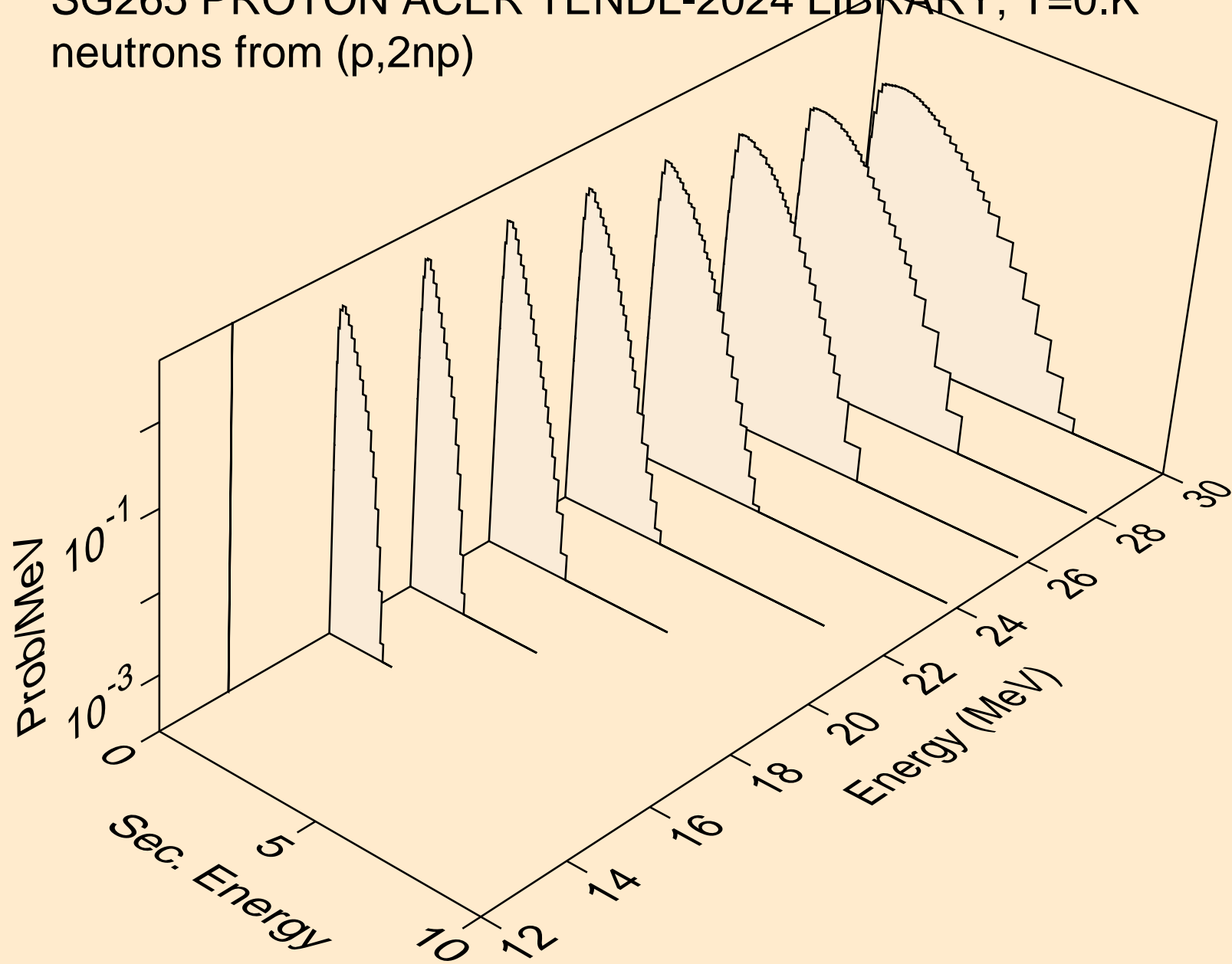

SG265 PROTON ACER TENDL-2024 LIBRARY; T=0.K
deuterons from (p,x)

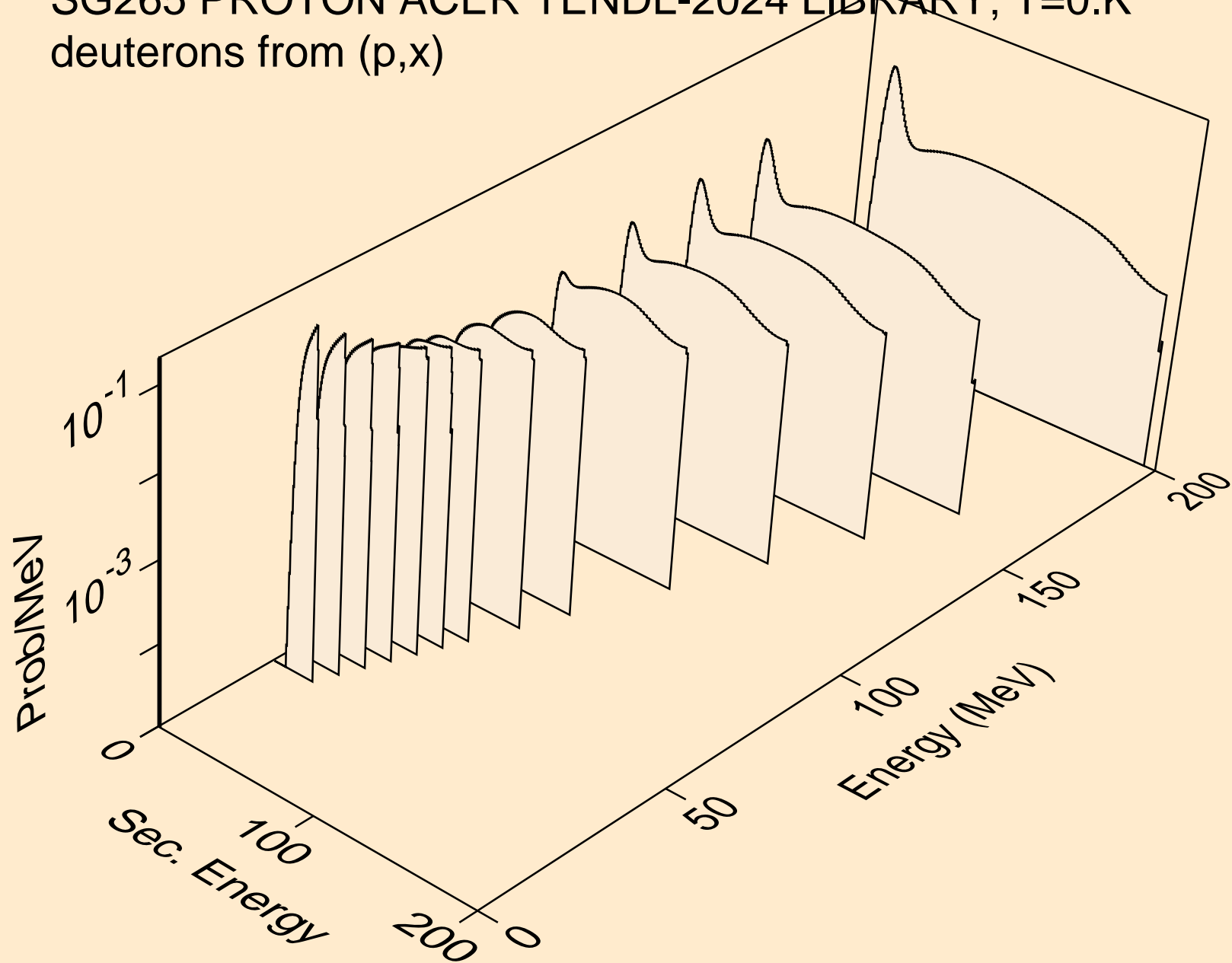

SG265 PROTON ACER TENDL-2024 LIBRARY; T=0.K
deuterons from (p,n*)d

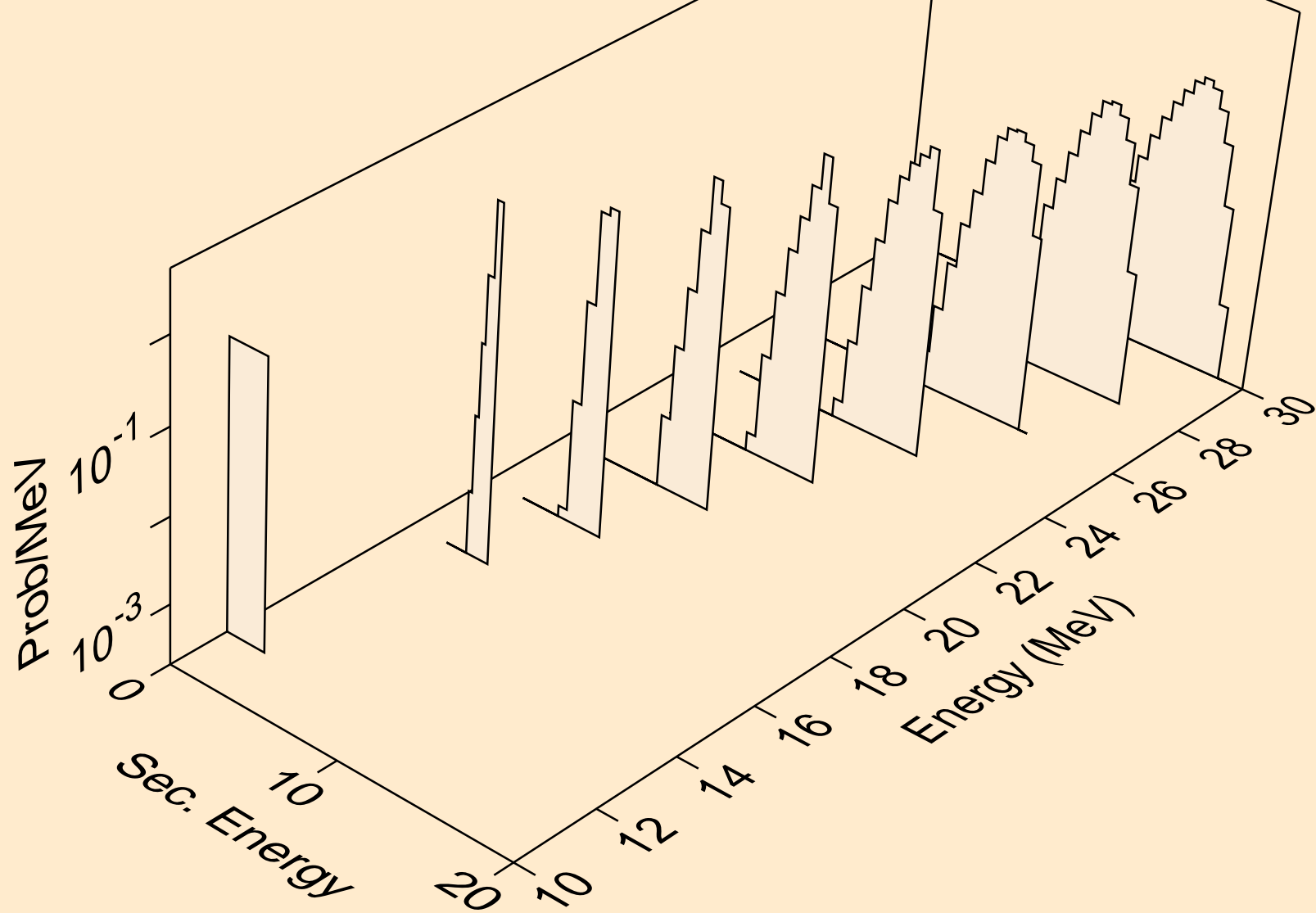

SG265 PROTON ACER TENDL-2024 LIBRARY; T=0.K
deuterons from (p,d)

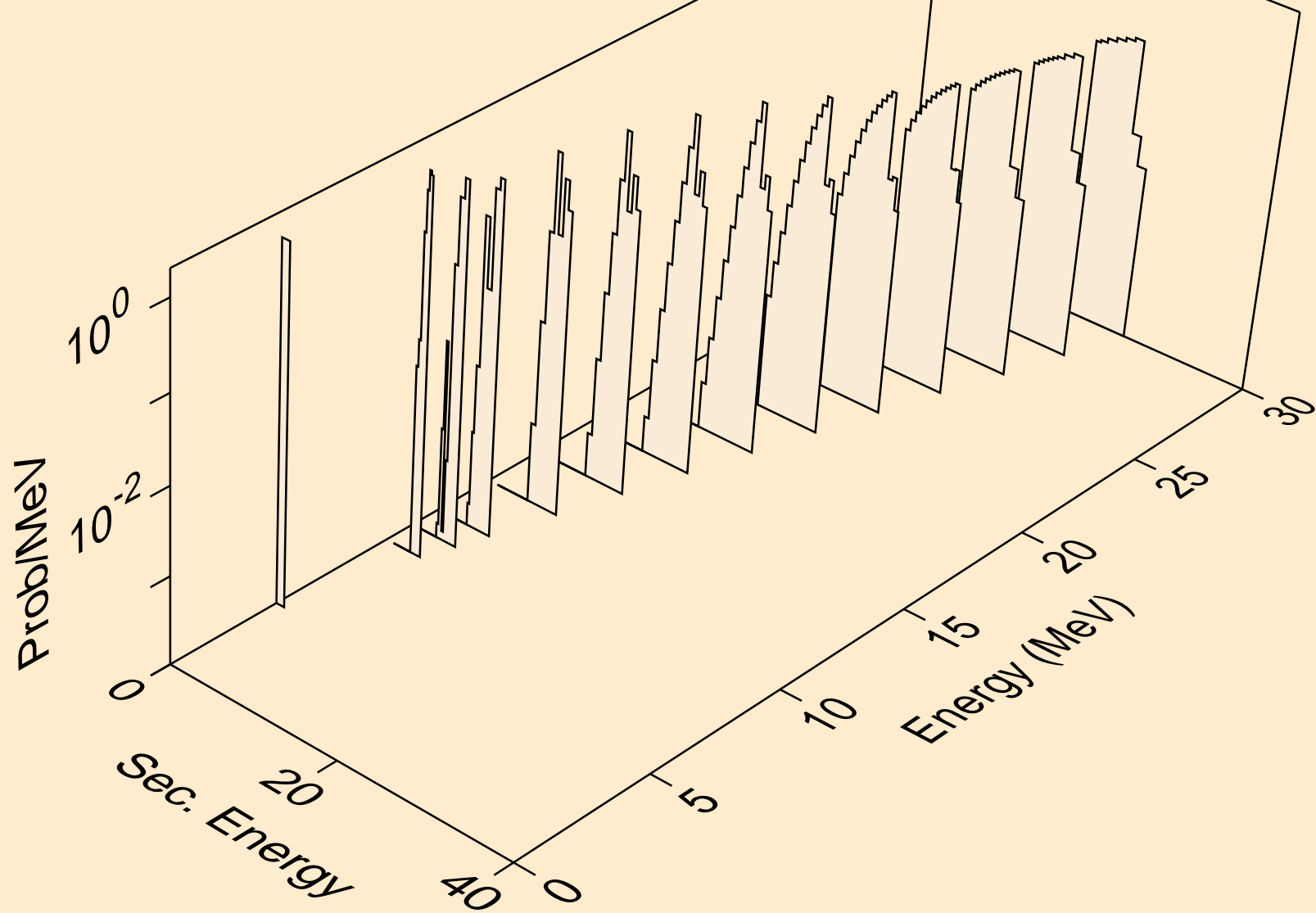

SG265 PROTON ACER TENDL-2024 LIBRARY; T=0.K
tritons from (p,x)

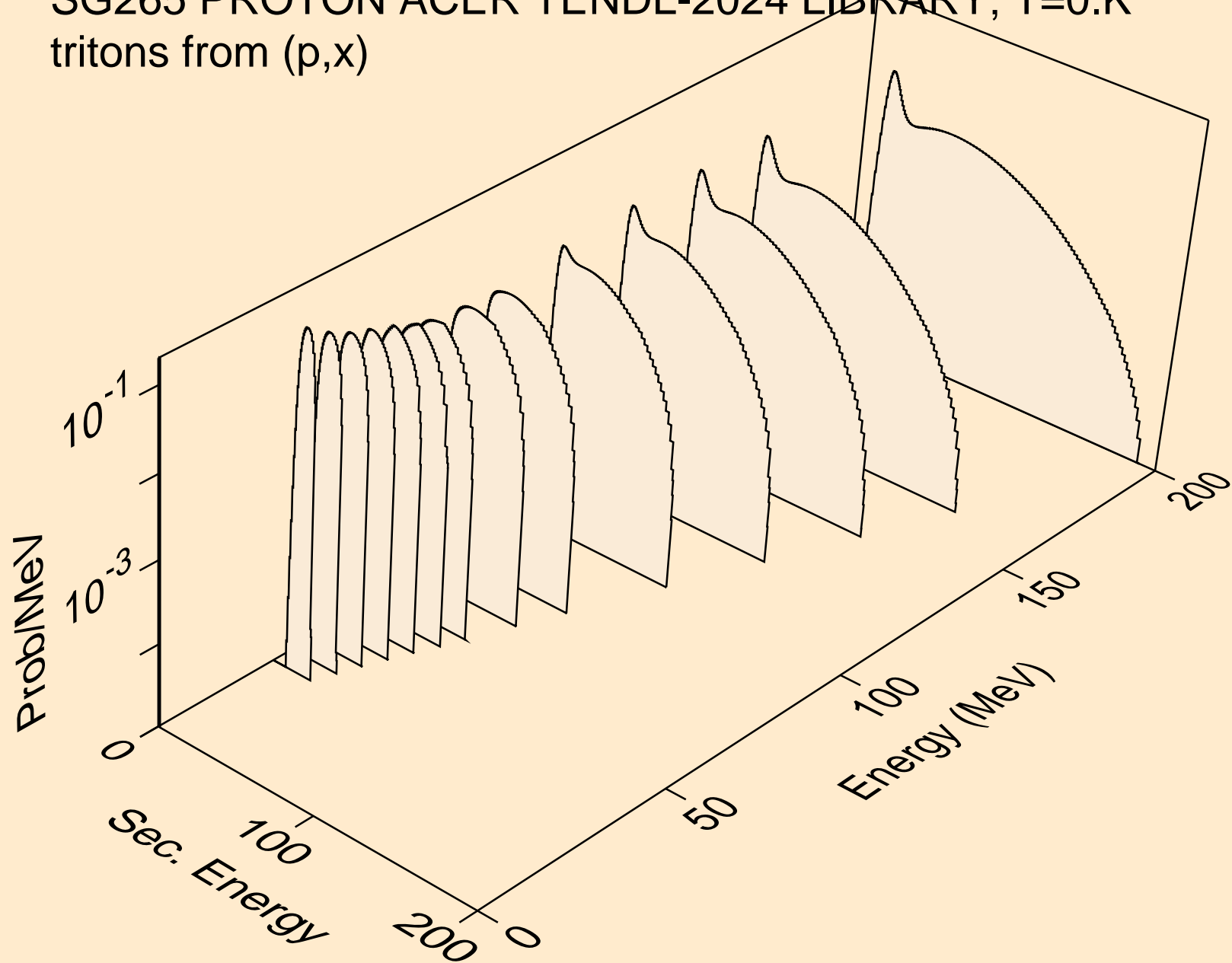

SG265 PROTON ACER TENDL-2024 LIBRARY; T=0.K
tritons from (p,n*)t

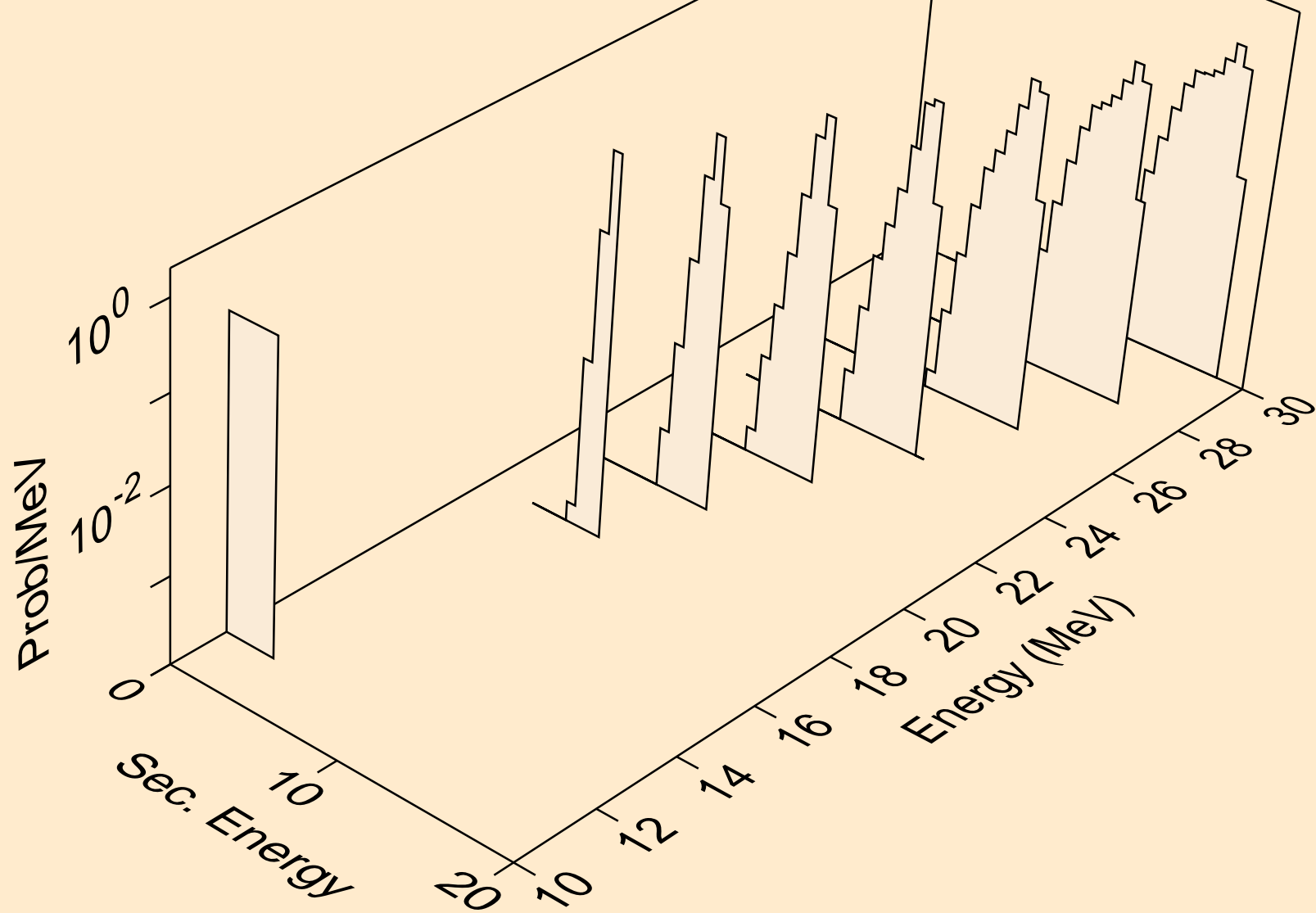

SG265 PROTON ACER TENDL-2024 LIBRARY; T=0.K
tritons from (p,t)

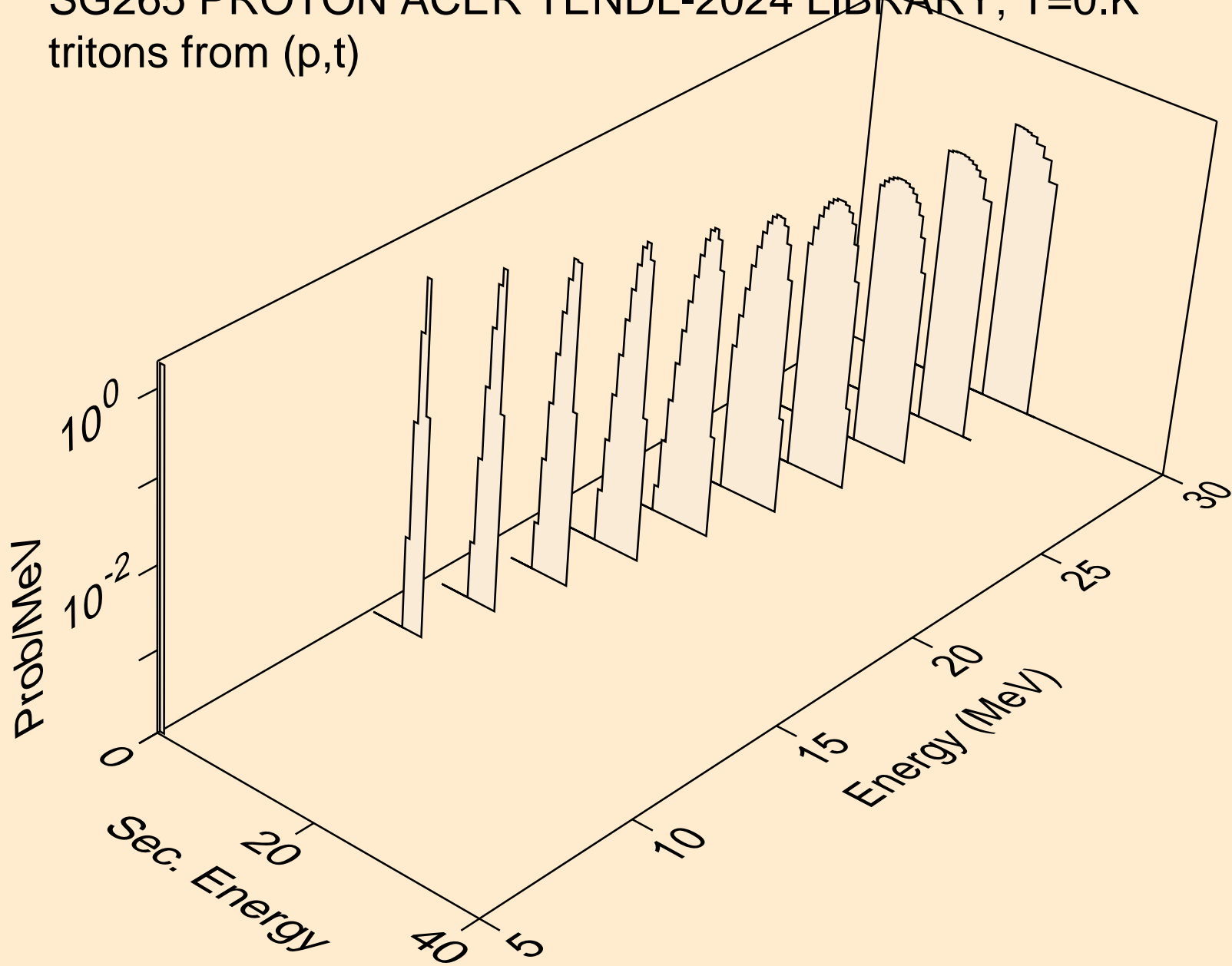

SG265 PROTON ACER TENDL-2024 LIBRARY; T=0.K
he3s from (p,x)

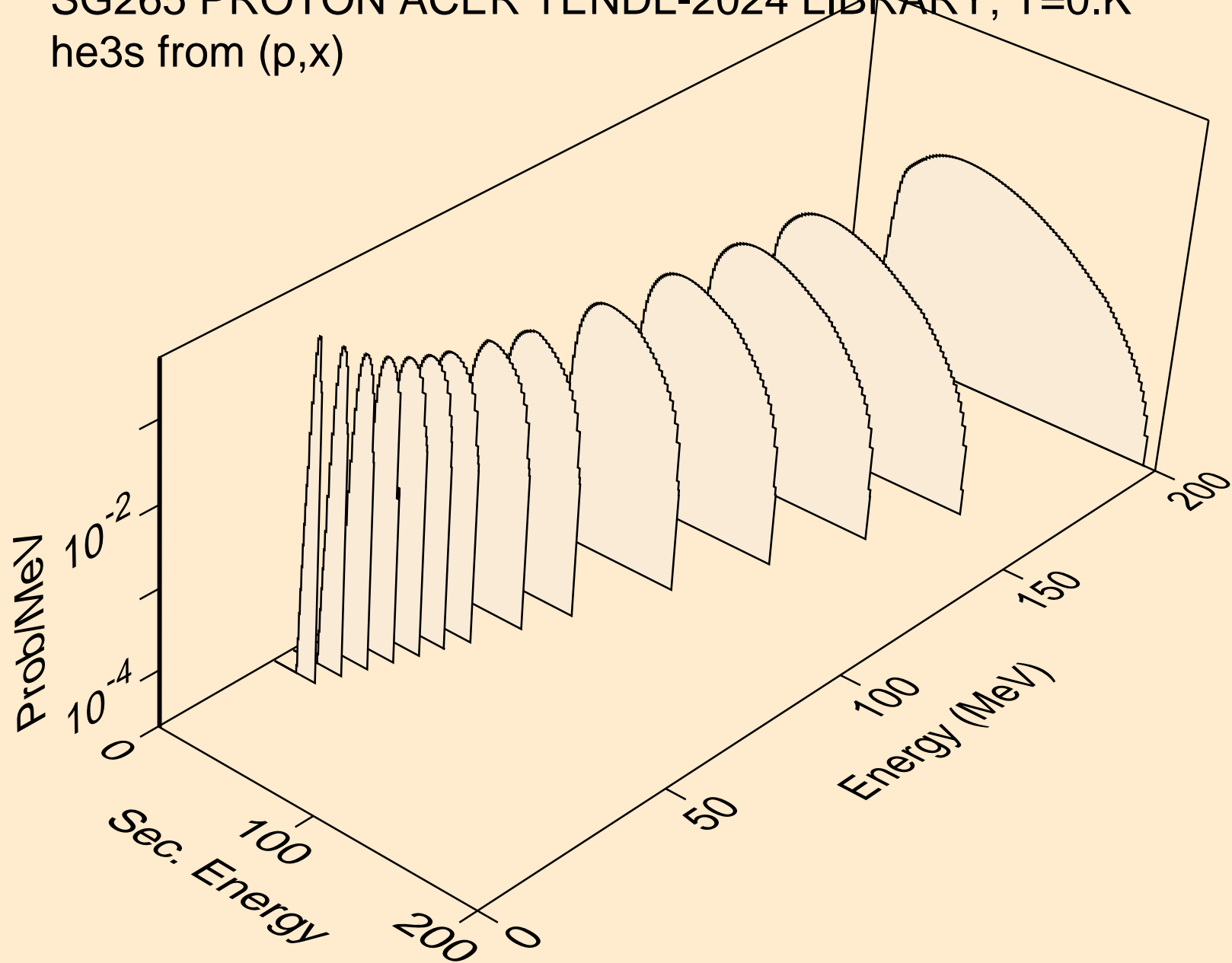

SG265 PROTON ACER TENDL-2024 LIBRARY; T=0.K
he3s from (p,he3)

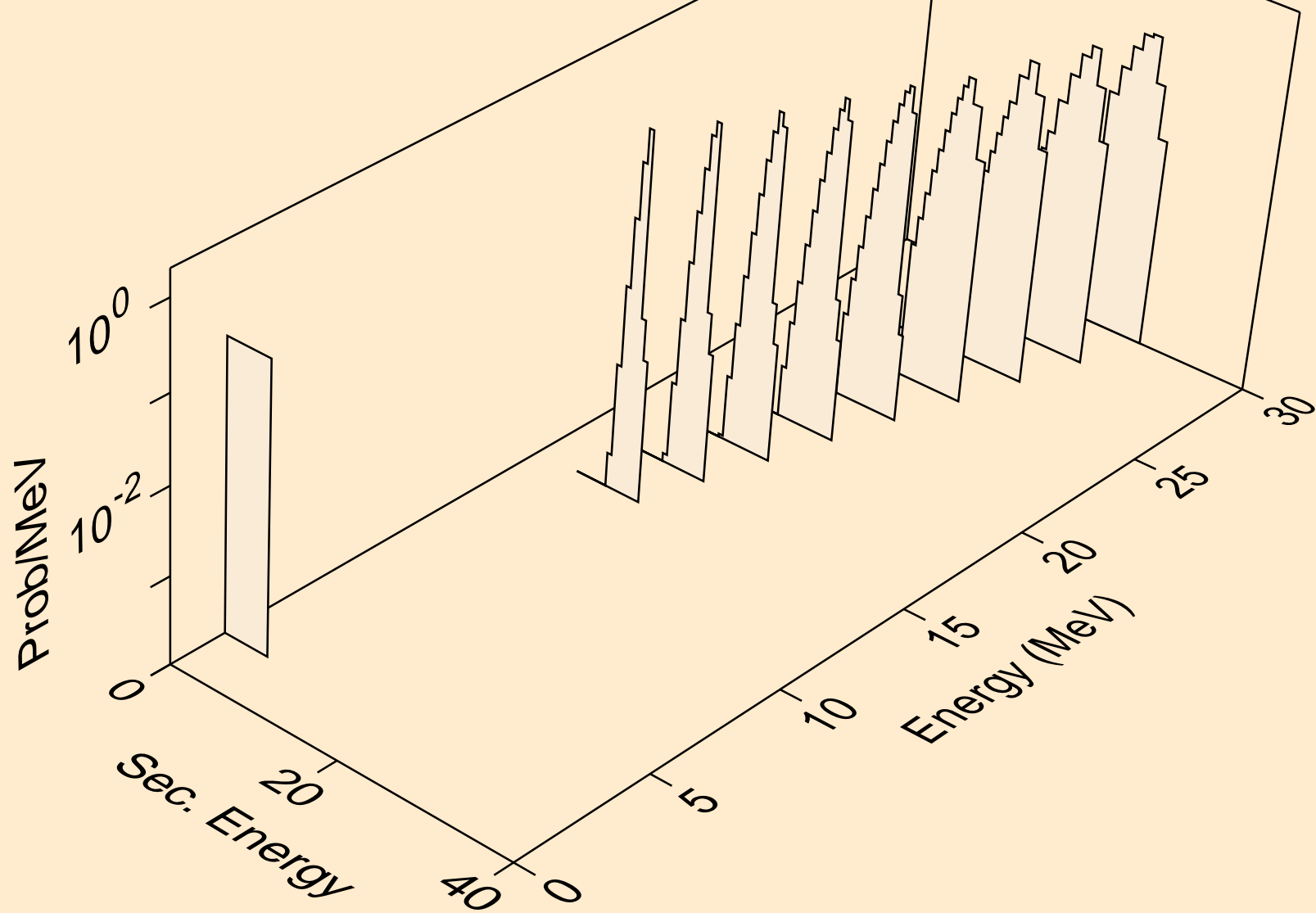

SG265 PROTON ACER TENDL-2024 LIBRARY; T=0.K
alphas from (p,x)

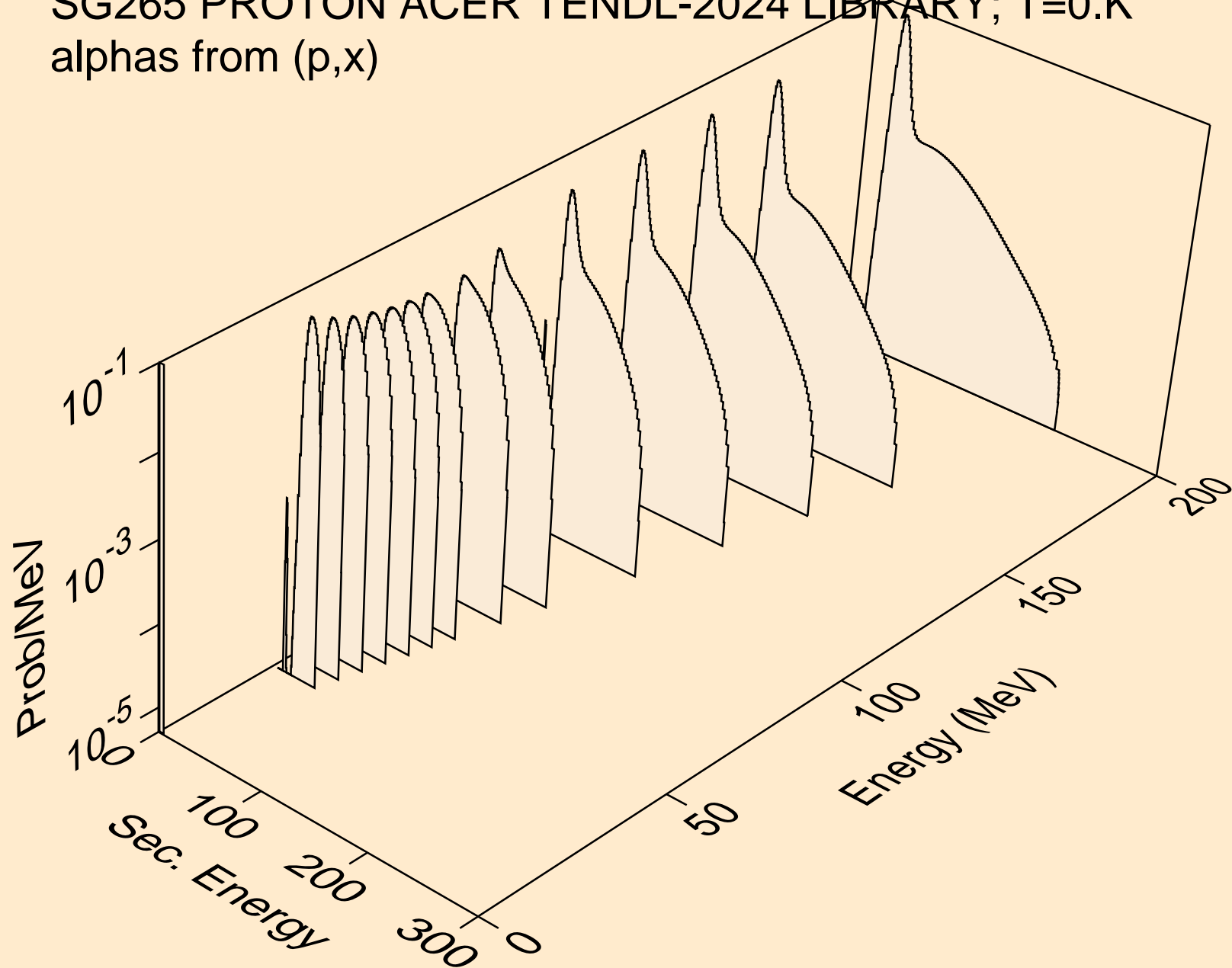

SG265 PROTON ACER TENDL-2024 LIBRARY; T=0.K
alphas from (p,n*)a

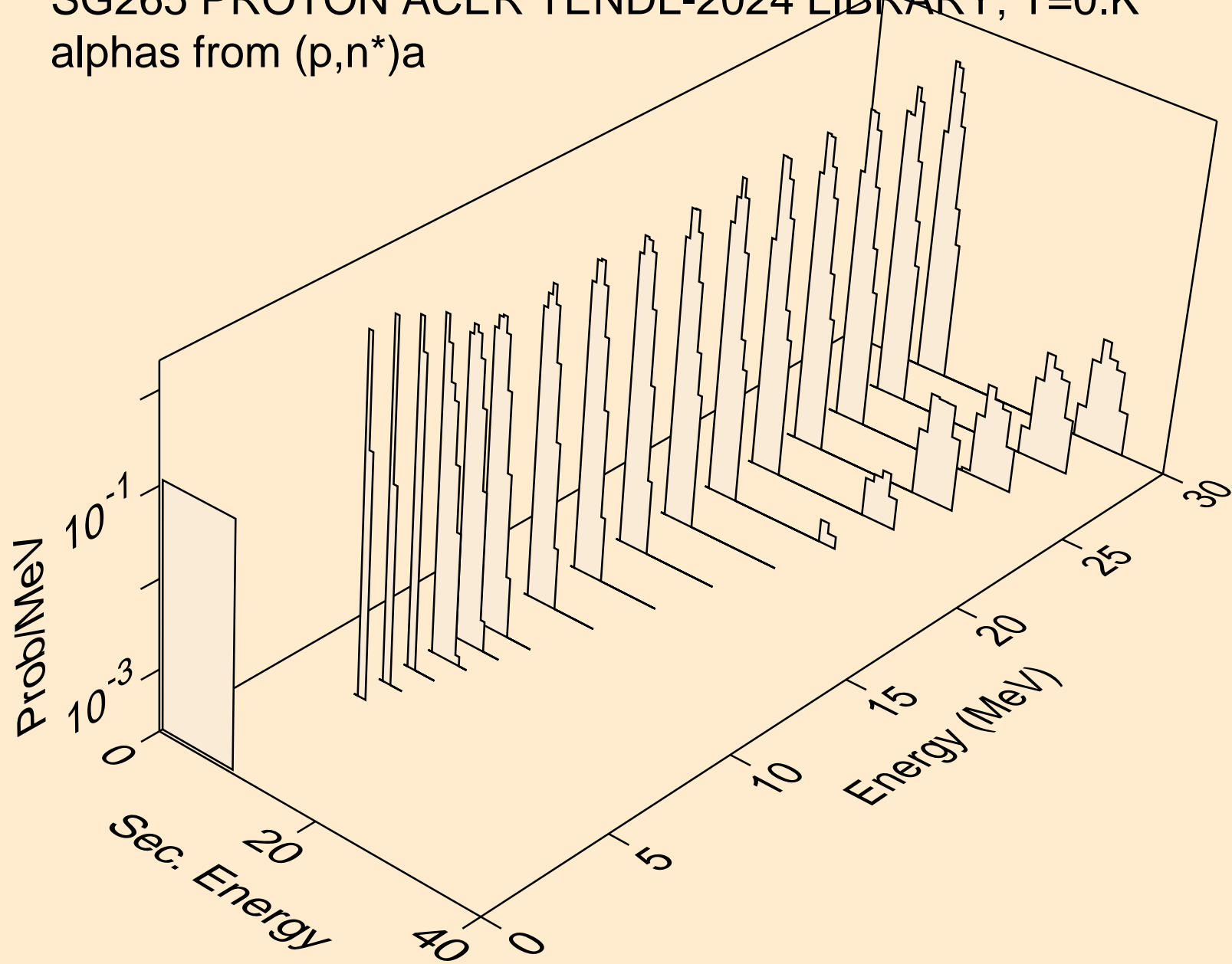

SG265 PROTON ACER TENDL-2024 LIBRARY; T=0.K
alphas from (p,2n)a

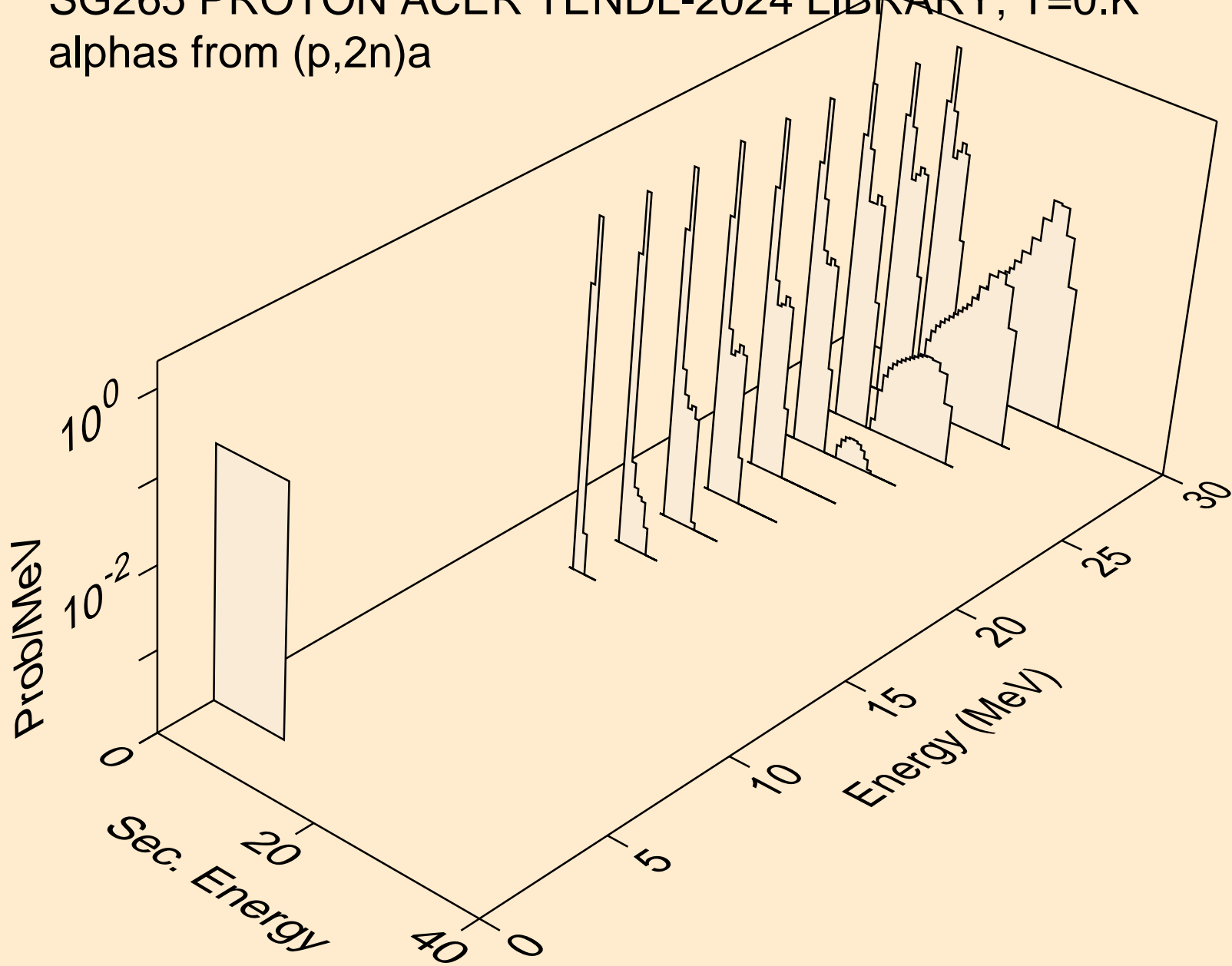

SG265 PROTON ACER TENDL-2024 LIBRARY; T=0.K
alphas from (p,n*)2a

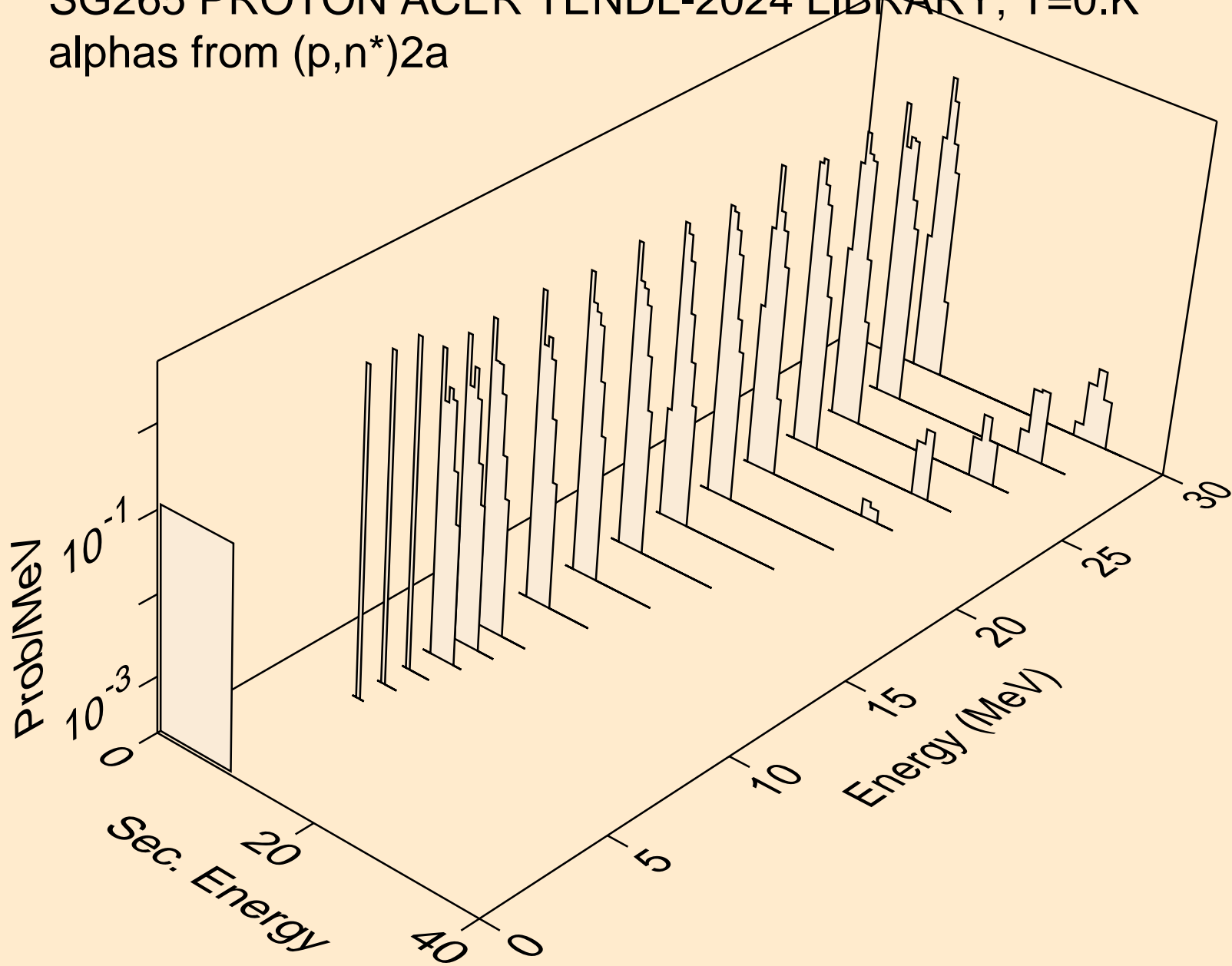

SG265 PROTON ACER TENDL-2024 LIBRARY; T=0.K
alphas from (p,a)

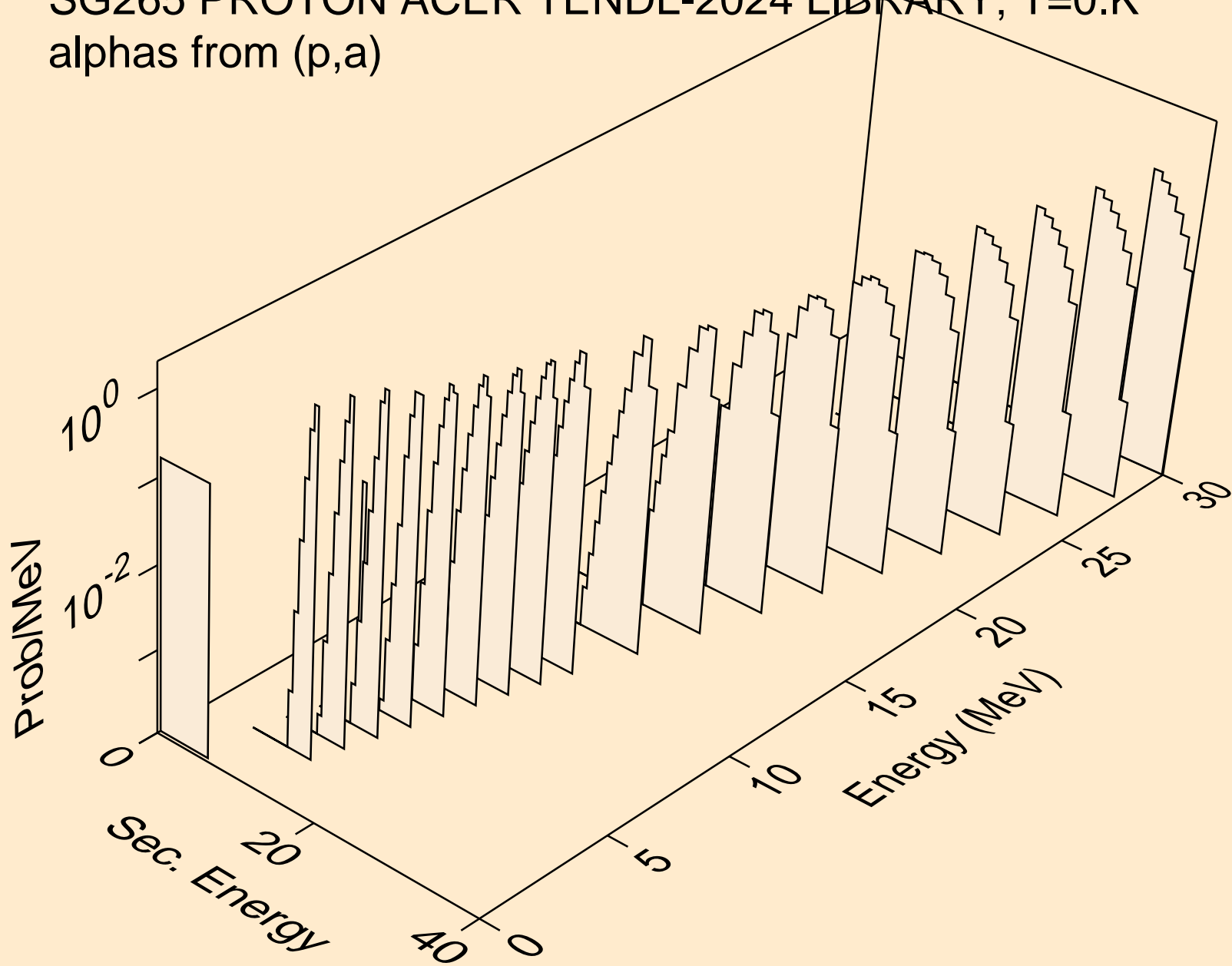

SG265 PROTON ACER TENDL-2024 LIBRARY; T=0.K
alphas from (p,2a)

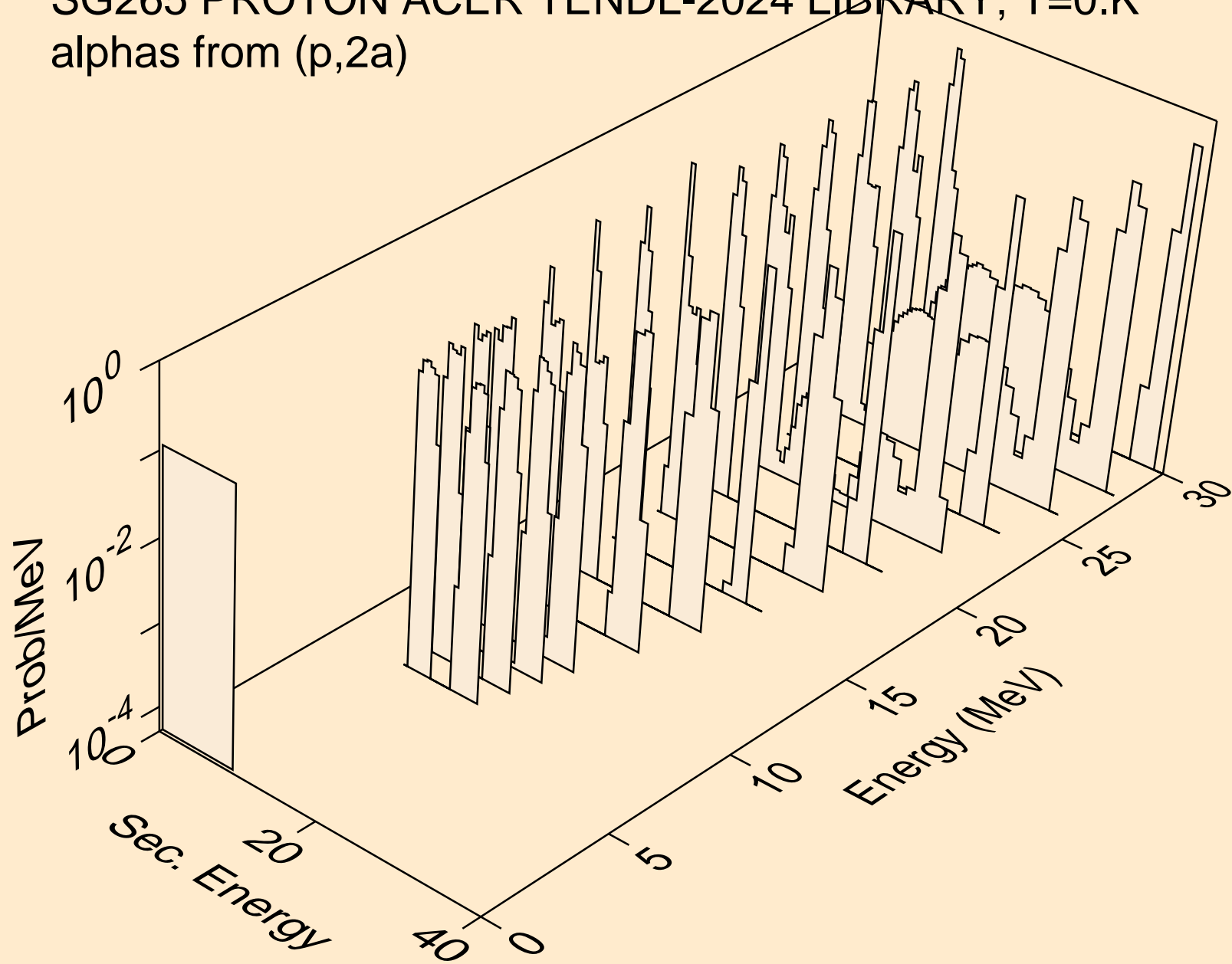

SG265 PROTON ACER TENDL-2024 LIBRARY; T=0.K
alphas from (p,3a)

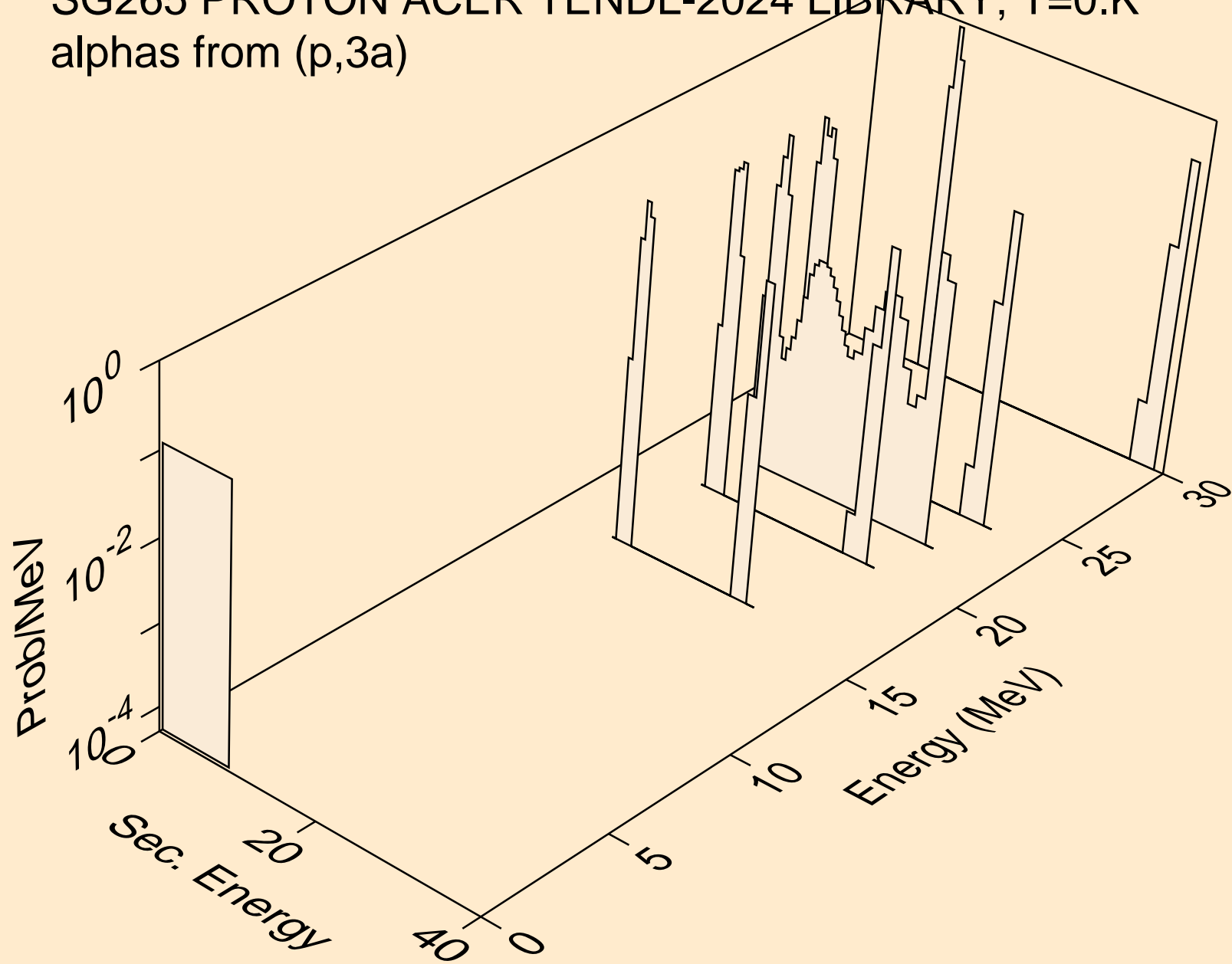

SG265 PROTON ACER TENDL-2024 LIBRARY; T=0.K
alphas from (p,pa)

