

TA192 PROTON ACER TENDL-2024 LIBRARY; T=0.K  
Principal cross sections

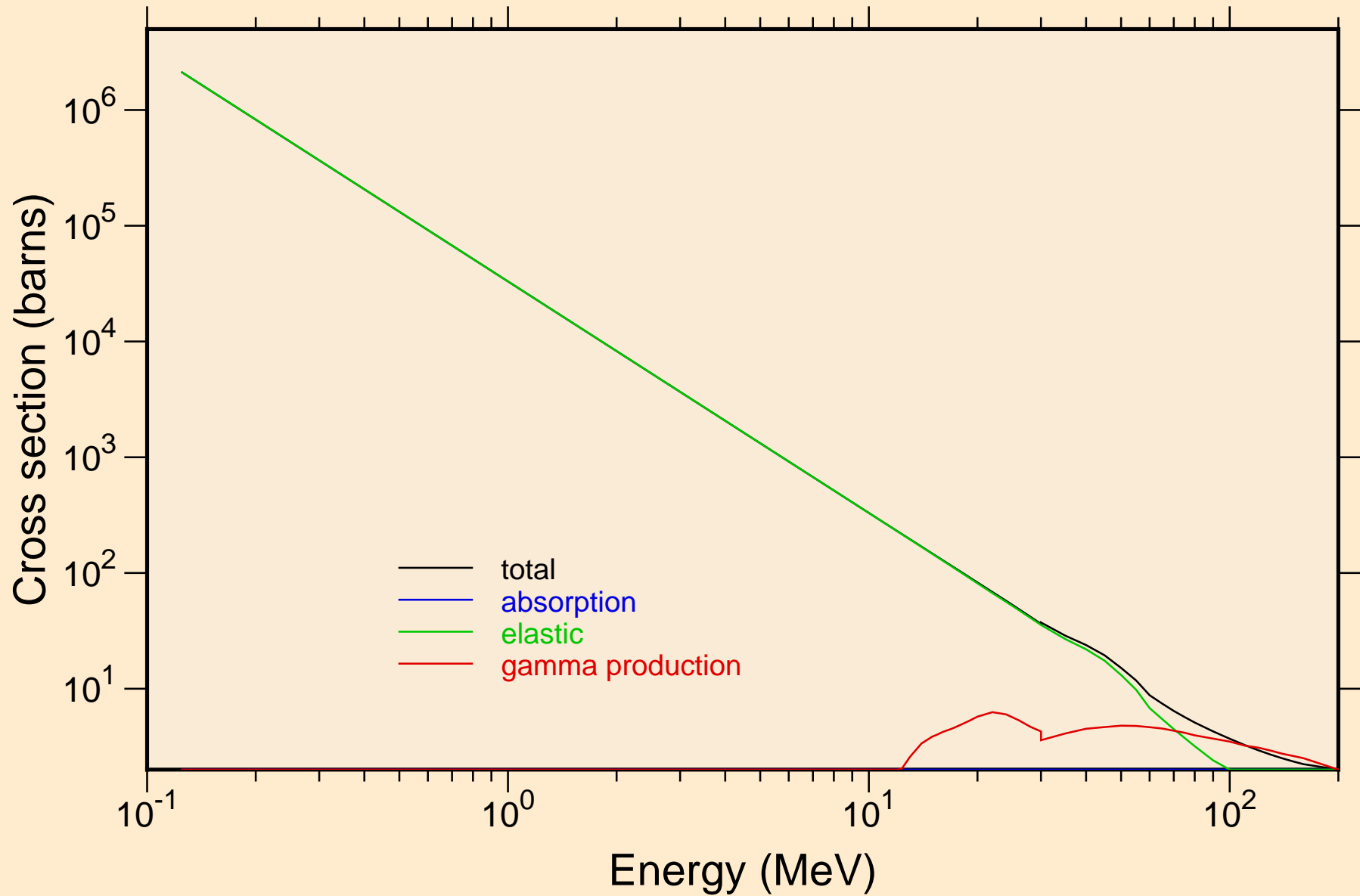

# TA192 PROTON ACER TENDL-2024 LIBRARY; T=0.K

## Heating

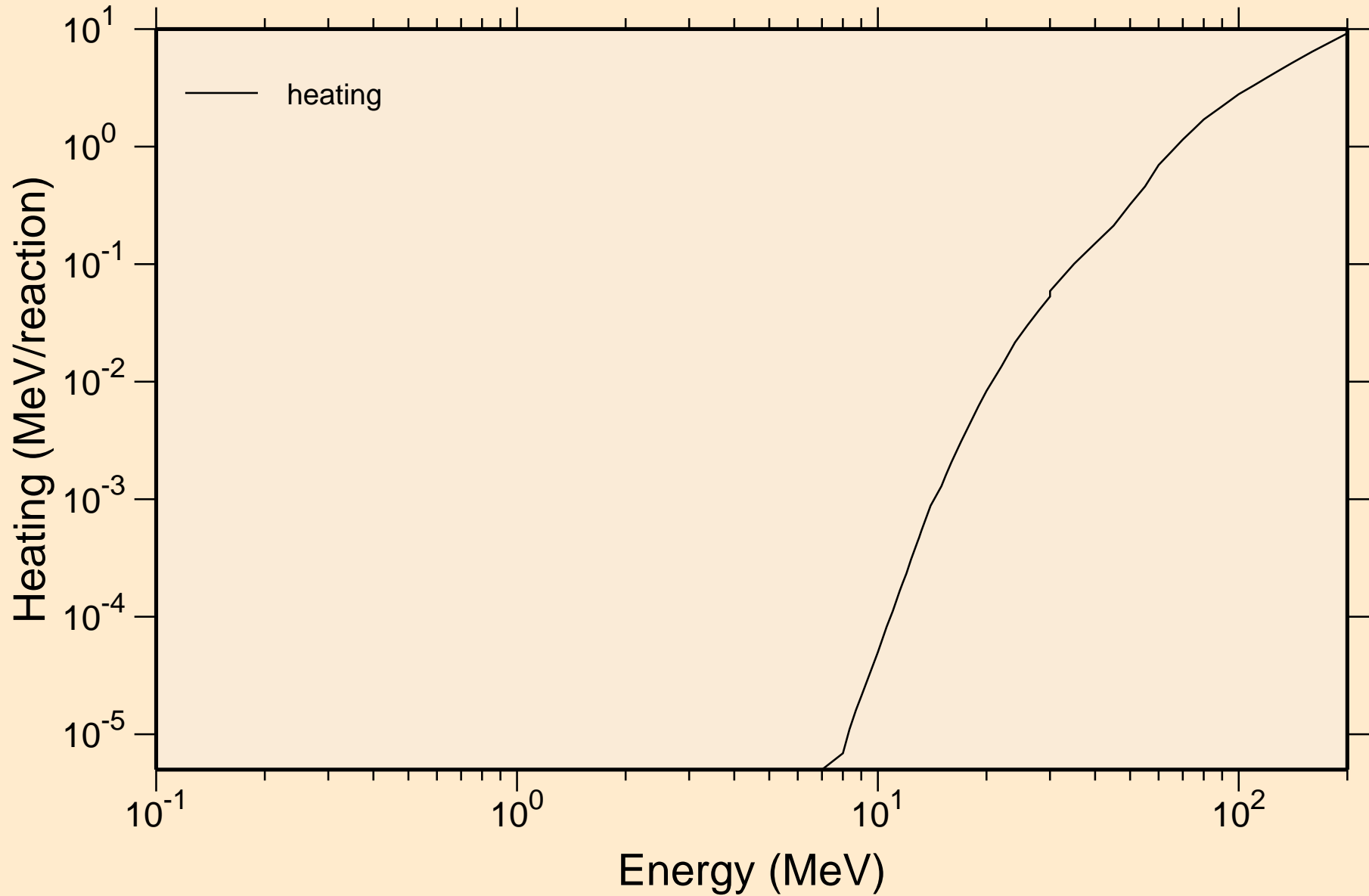

# TA192 PROTON ACER TENDL-2024 LIBRARY; T=0.K

## Principal cross sections

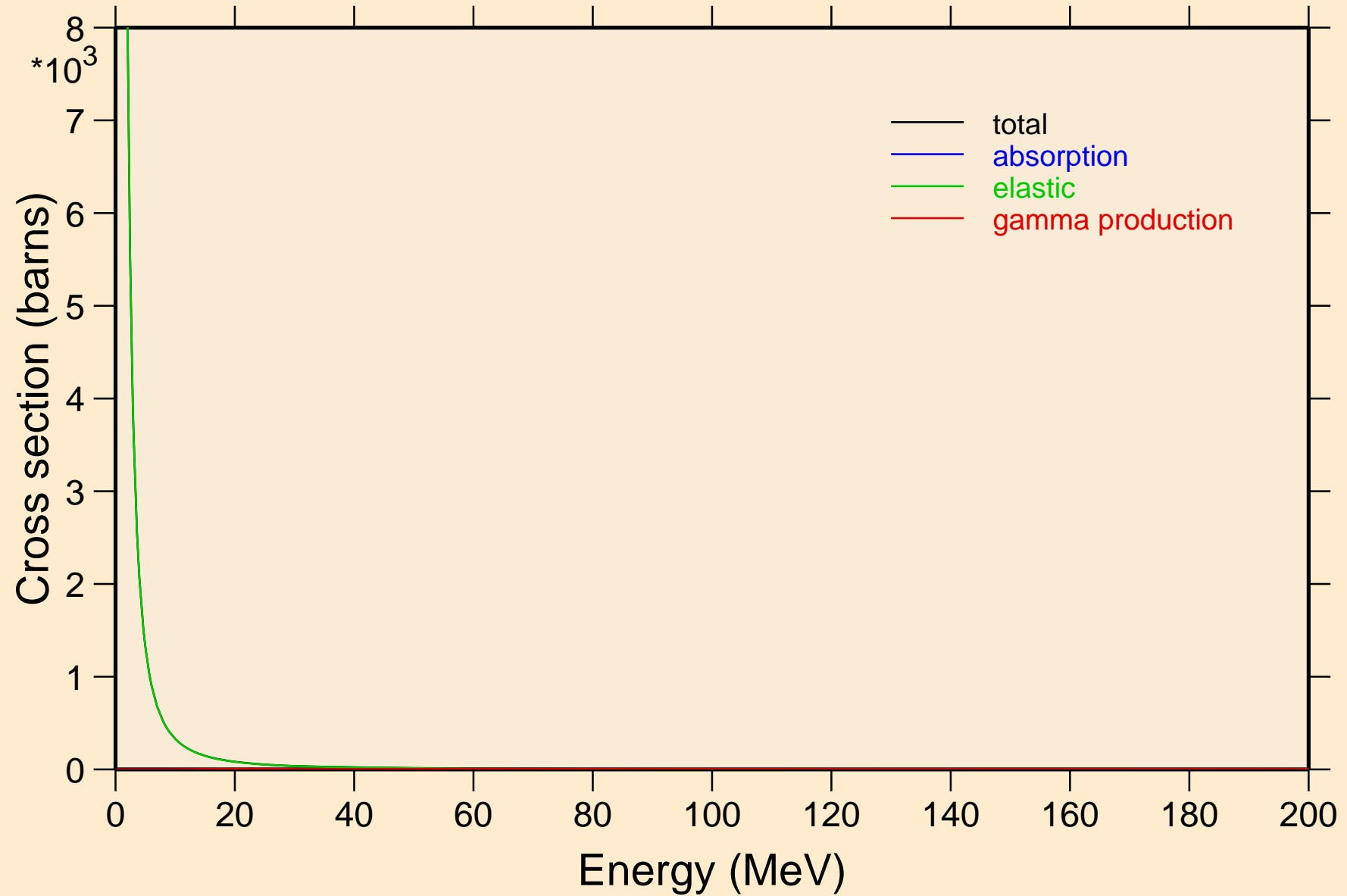

TA192 PROTON ACER TENDL-2024 LIBRARY; T=0.K

Heating

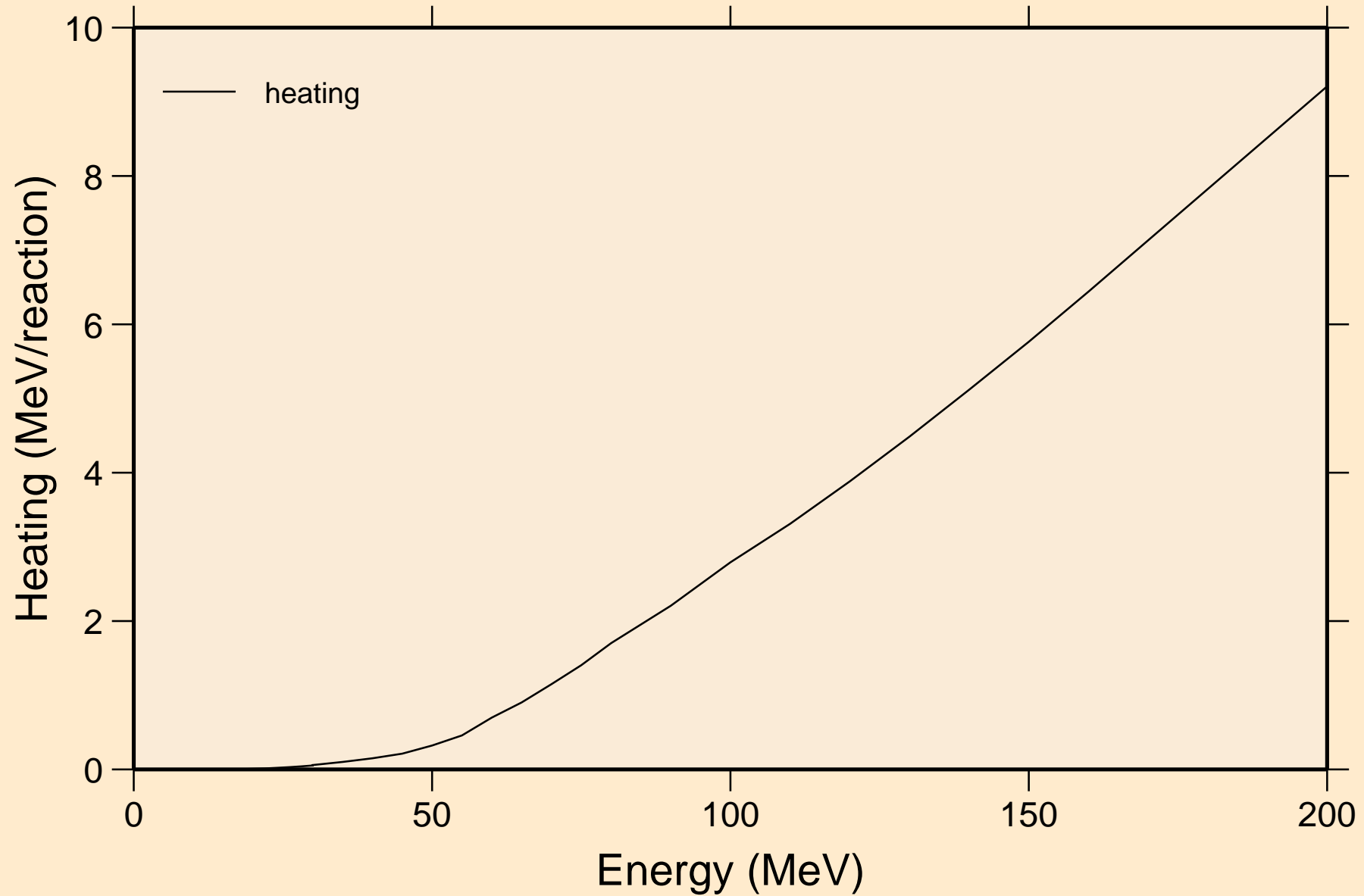

# TA192 PROTON ACER TENDL-2024 LIBRARY; T=0.K

## Threshold reactions

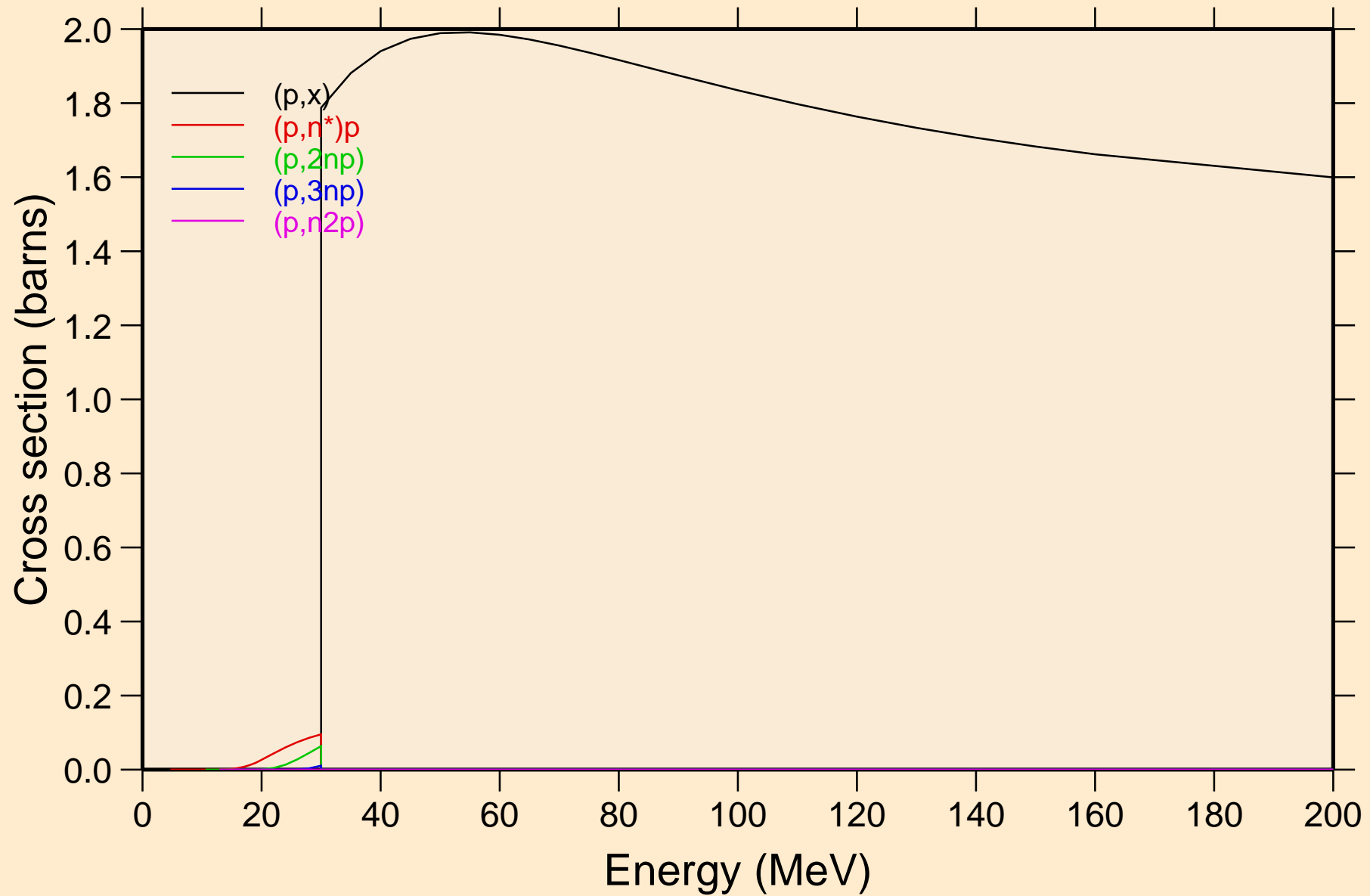

TA192 PROTON ACER TENDL-2024 LIBRARY; T=0.K  
Threshold reactions

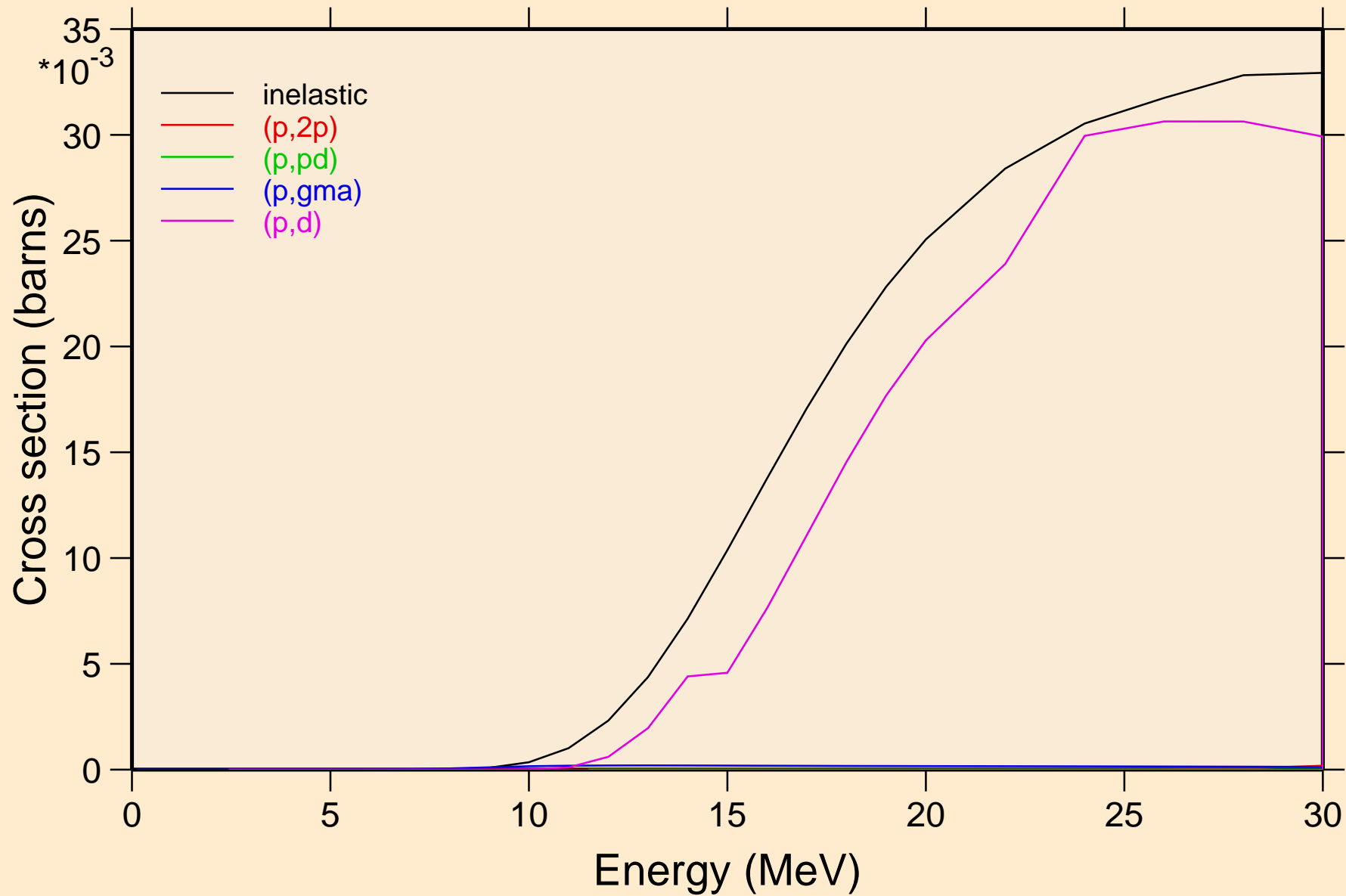

TA192 PROTON ACER TENDL-2024 LIBRARY; T=0.K  
Threshold reactions

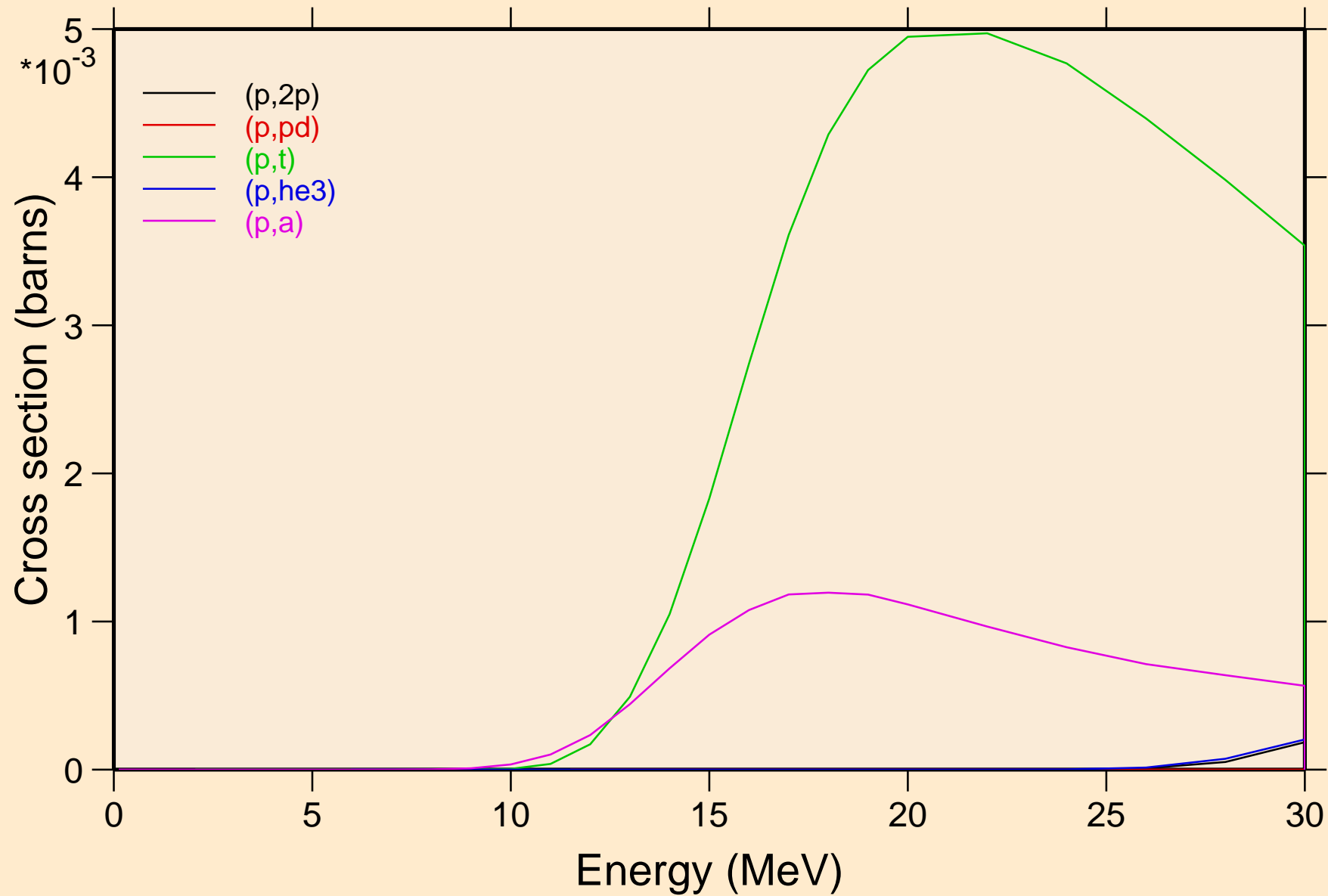

TA192 PROTON ACER TENDL-2024 LIBRARY; T=0.K  
Threshold reactions

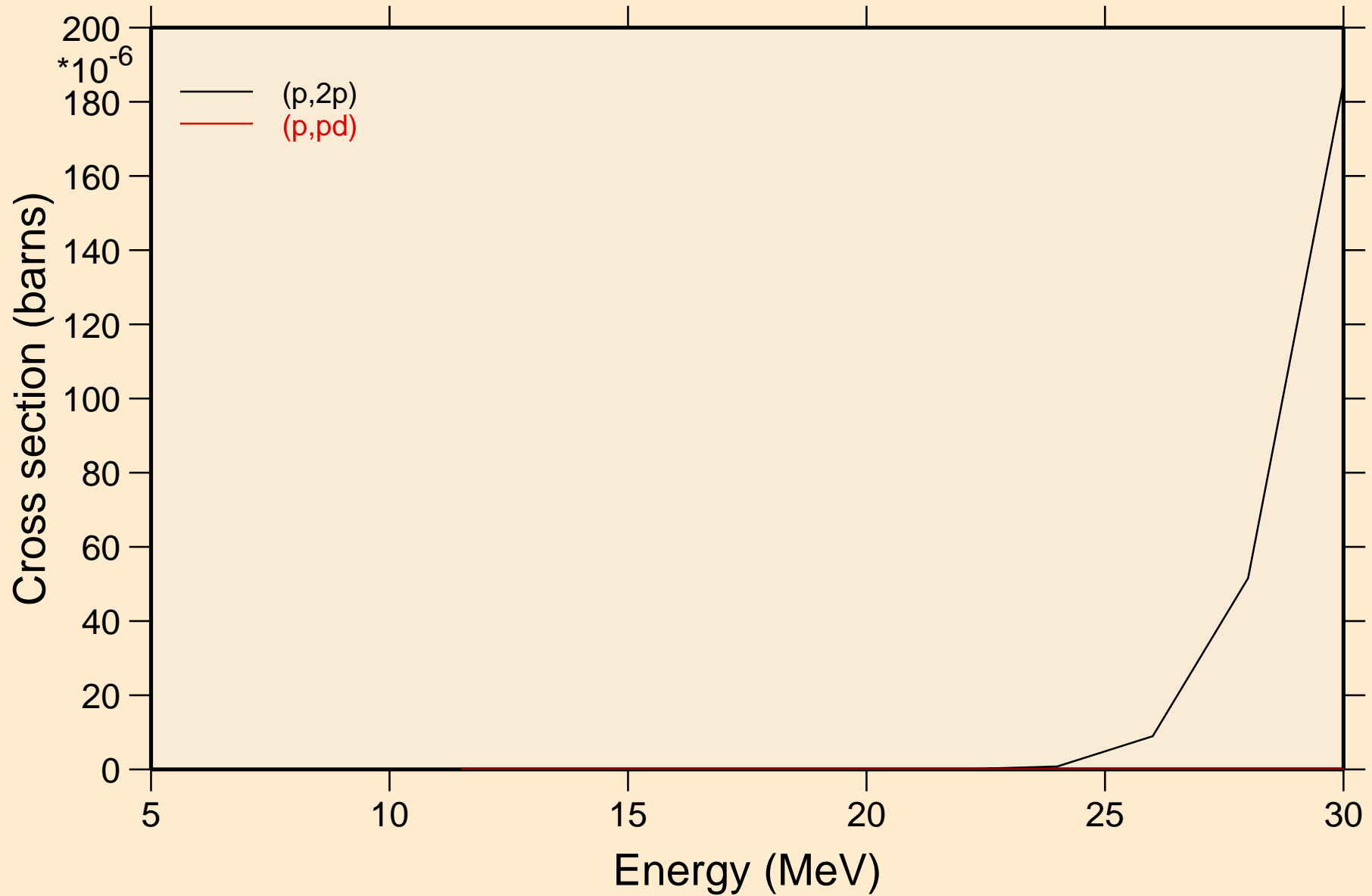

TA192 PROTON ACER TENDL-2024 LIBRARY; T=0.K  
angular distribution for elastic

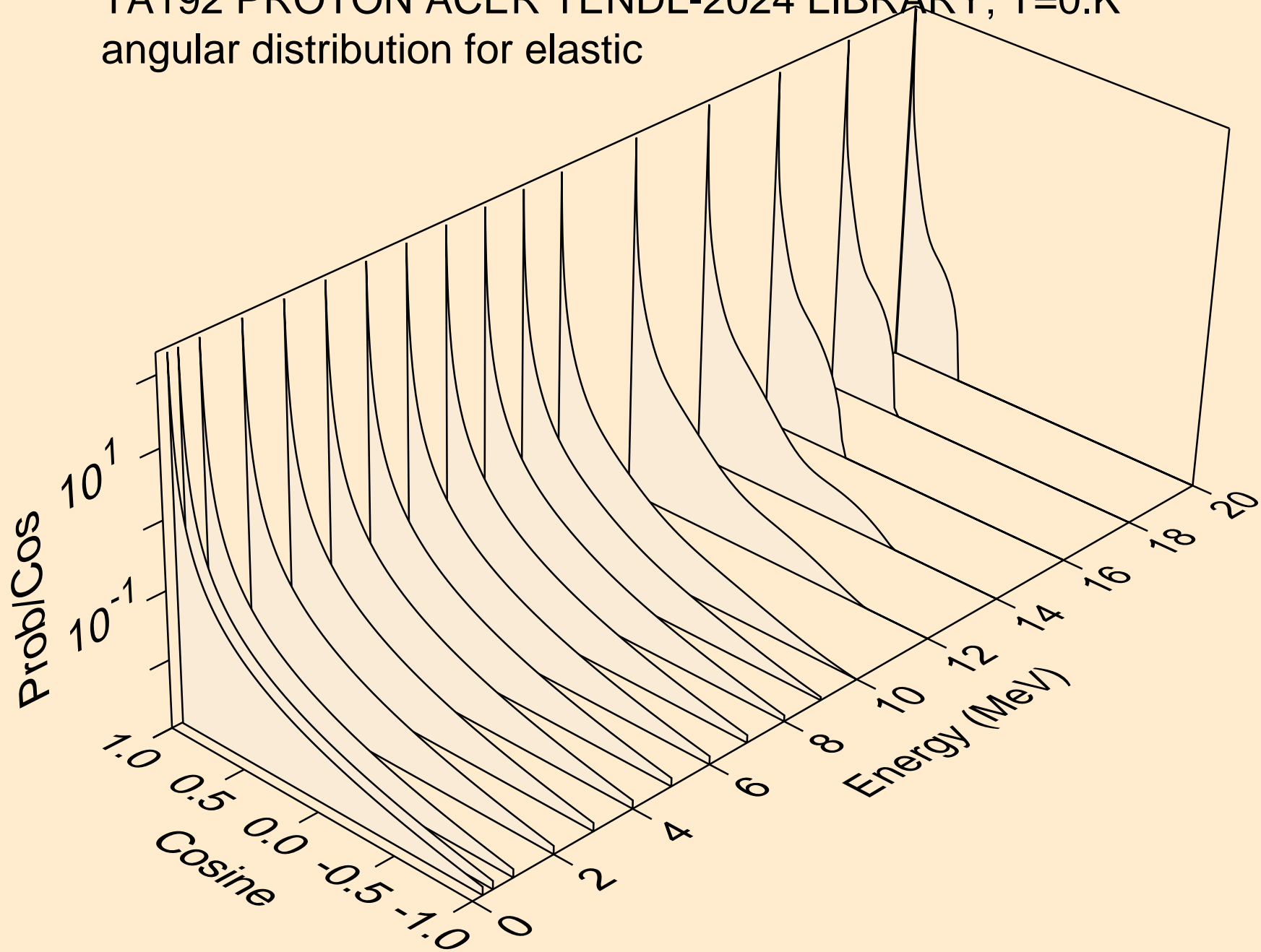

TA192 PROTON ACER TENDL-2024 LIBRARY; T=0.K  
angular distribution for elastic

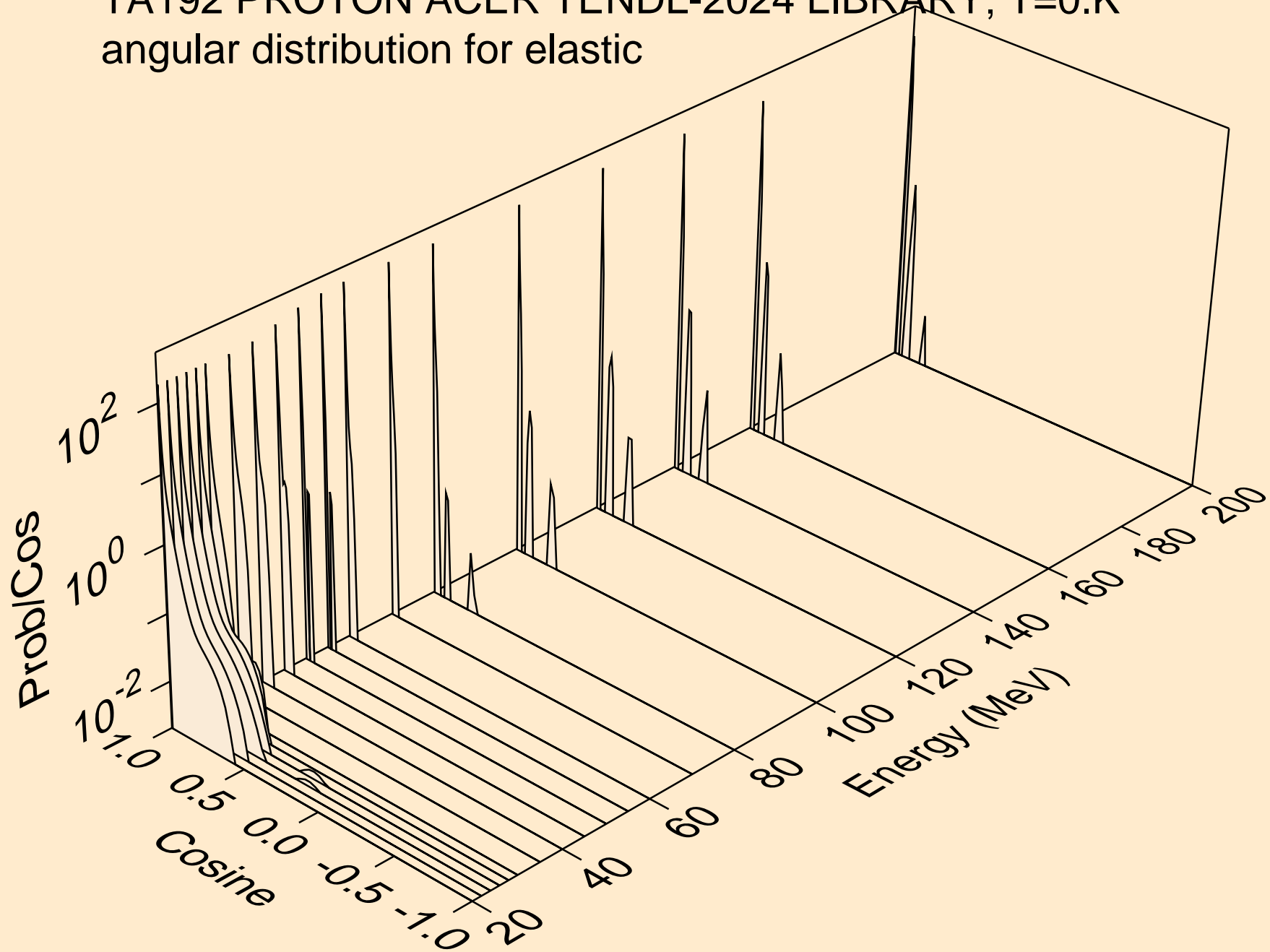

TA192 PROTON ACER TENDL-2024 LIBRARY; T=0.K  
Proton emission for (p,x)

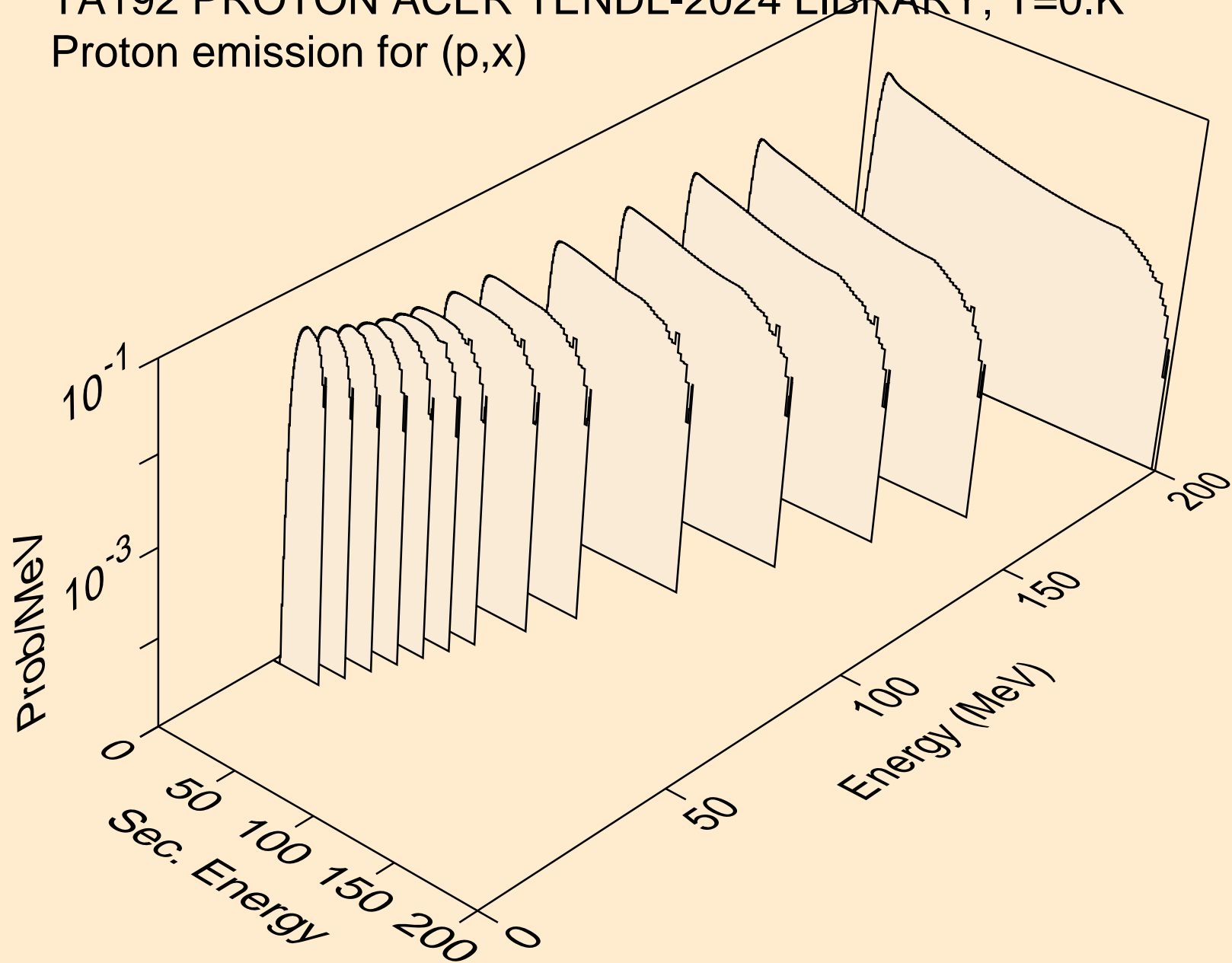

TA192 PROTON ACER TENDL-2024 LIBRARY; T=0.K  
Proton emission for (p,n\*)p

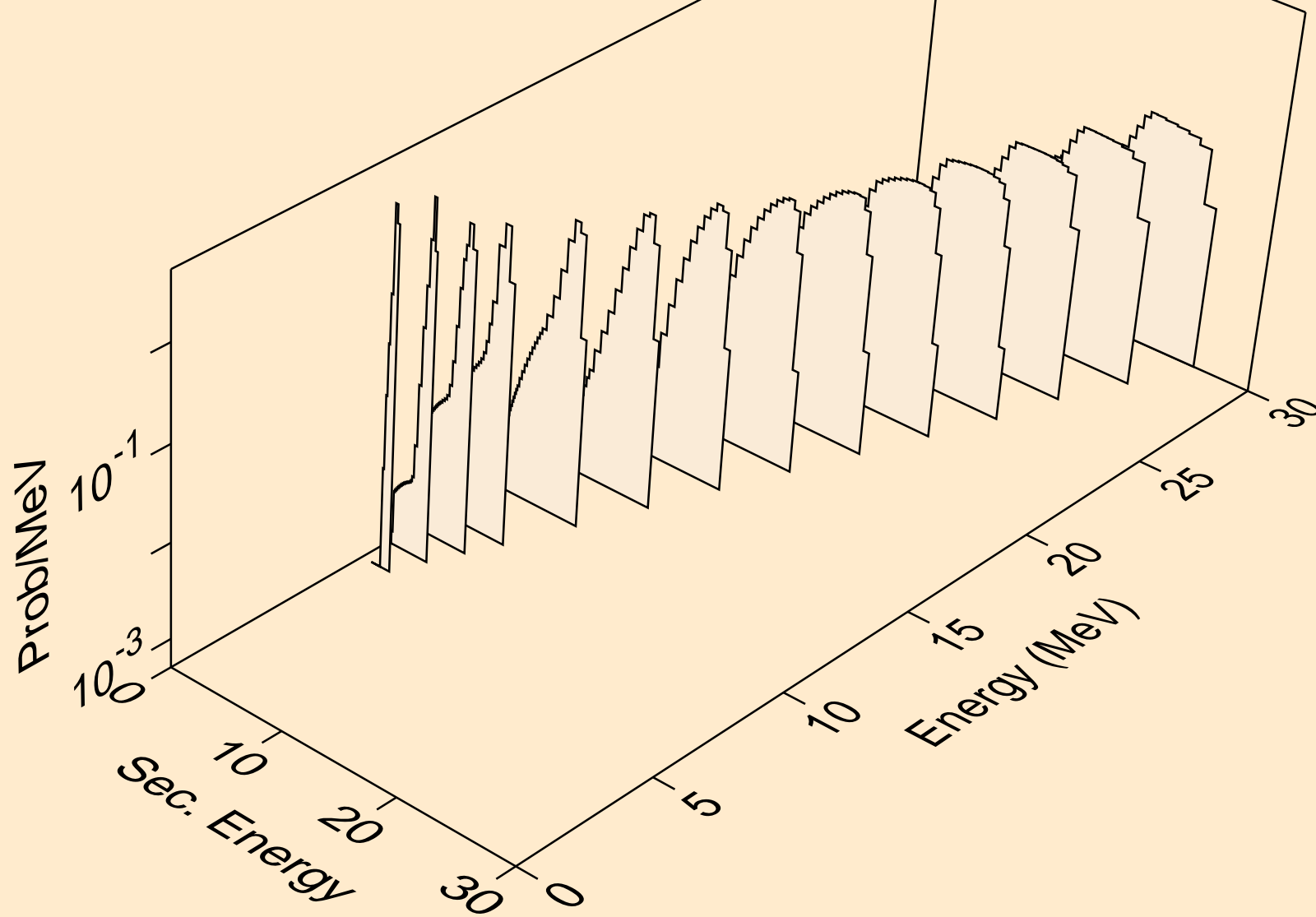

TA192 PROTON ACER TENDL-2024 LIBRARY; T=0.K  
Proton emission for (p,2np)

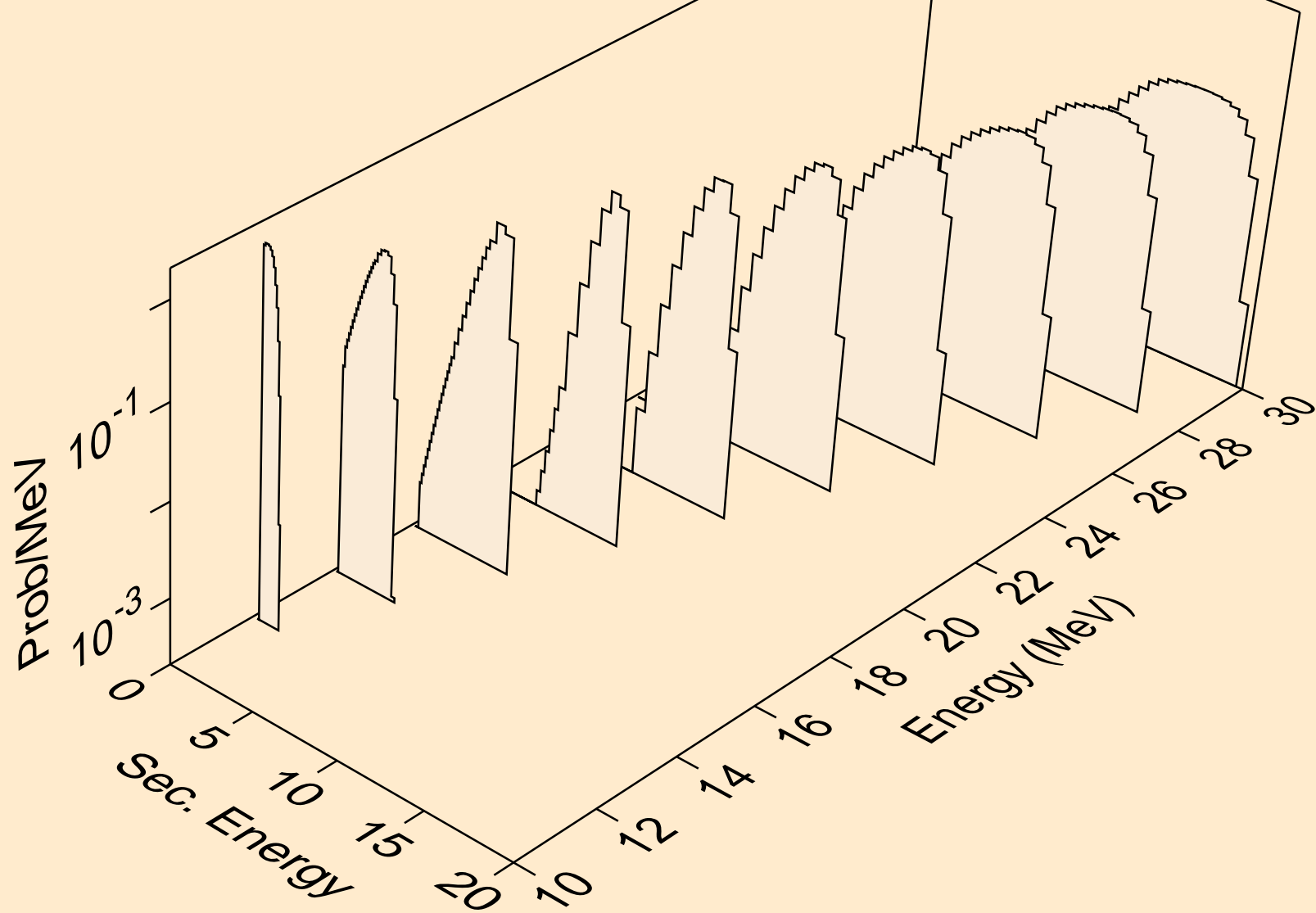

TA192 PROTON ACER TENDL-2024 LIBRARY; T=0.K  
Proton emission for (p,3np)

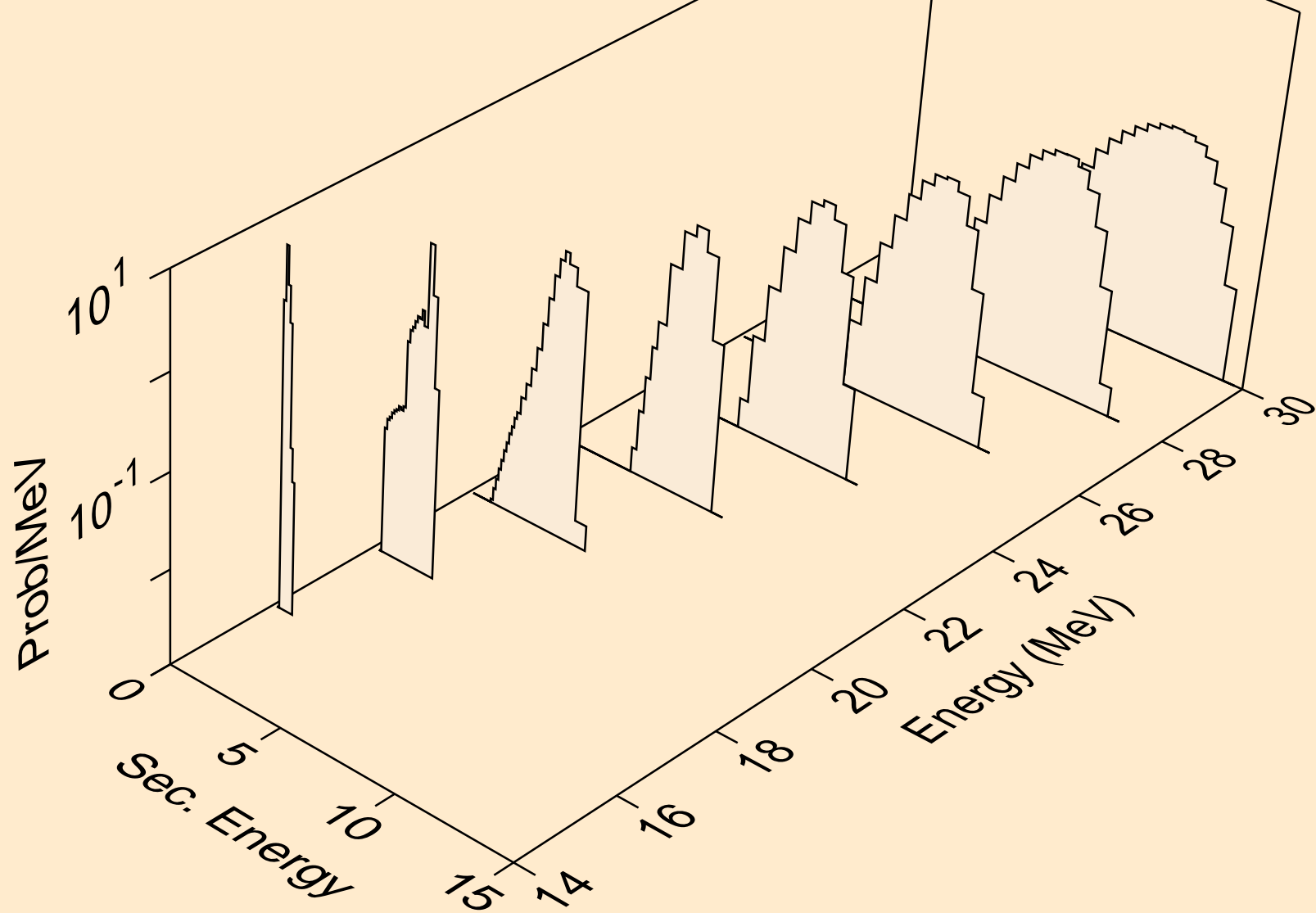

TA192 PROTON ACER TENDL-2024 LIBRARY; T=0.K  
Proton emission for (p,n2p)

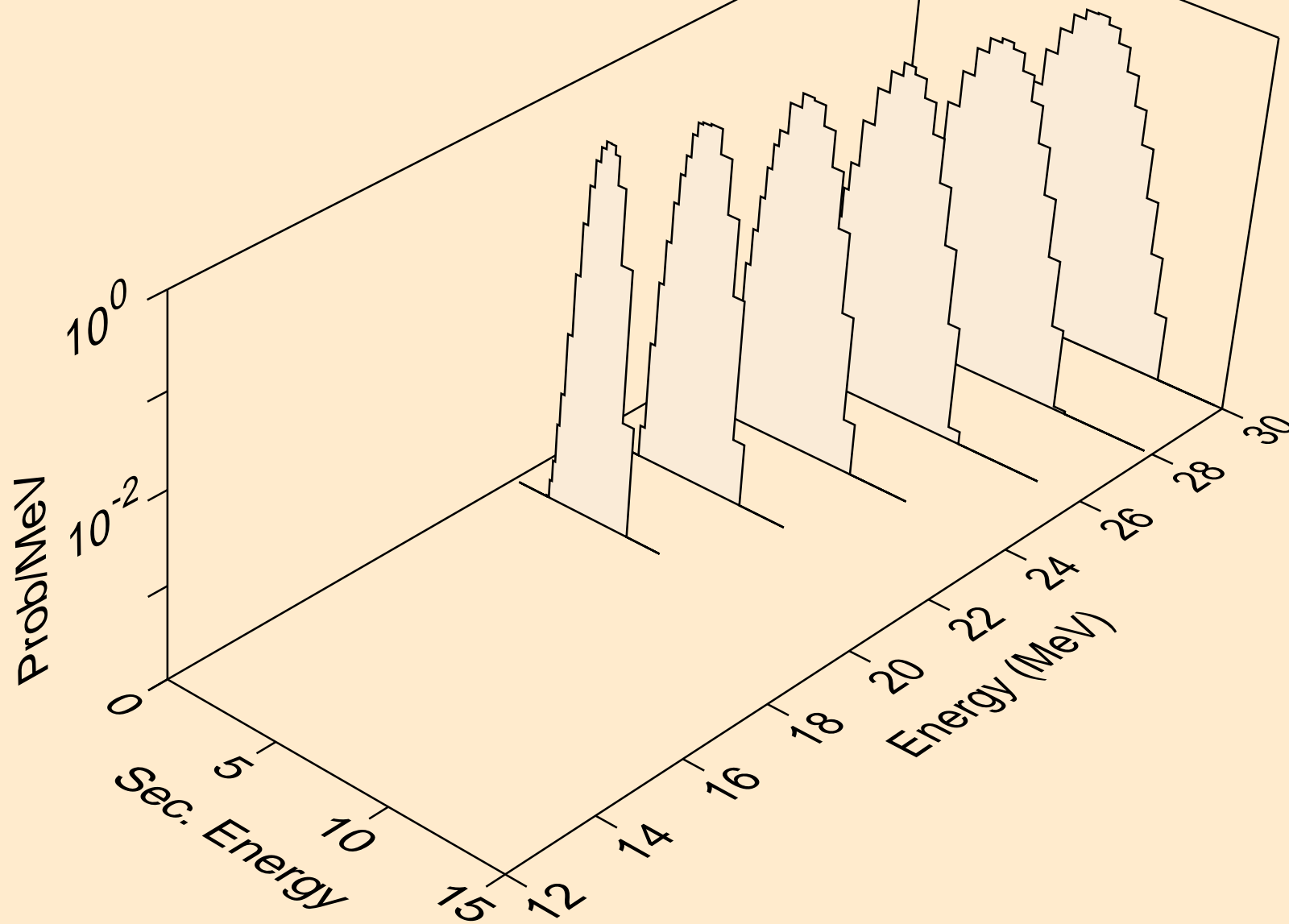

TA192 PROTON ACER TENDL-2024 LIBRARY; T=0.K  
Proton emission for inelastic

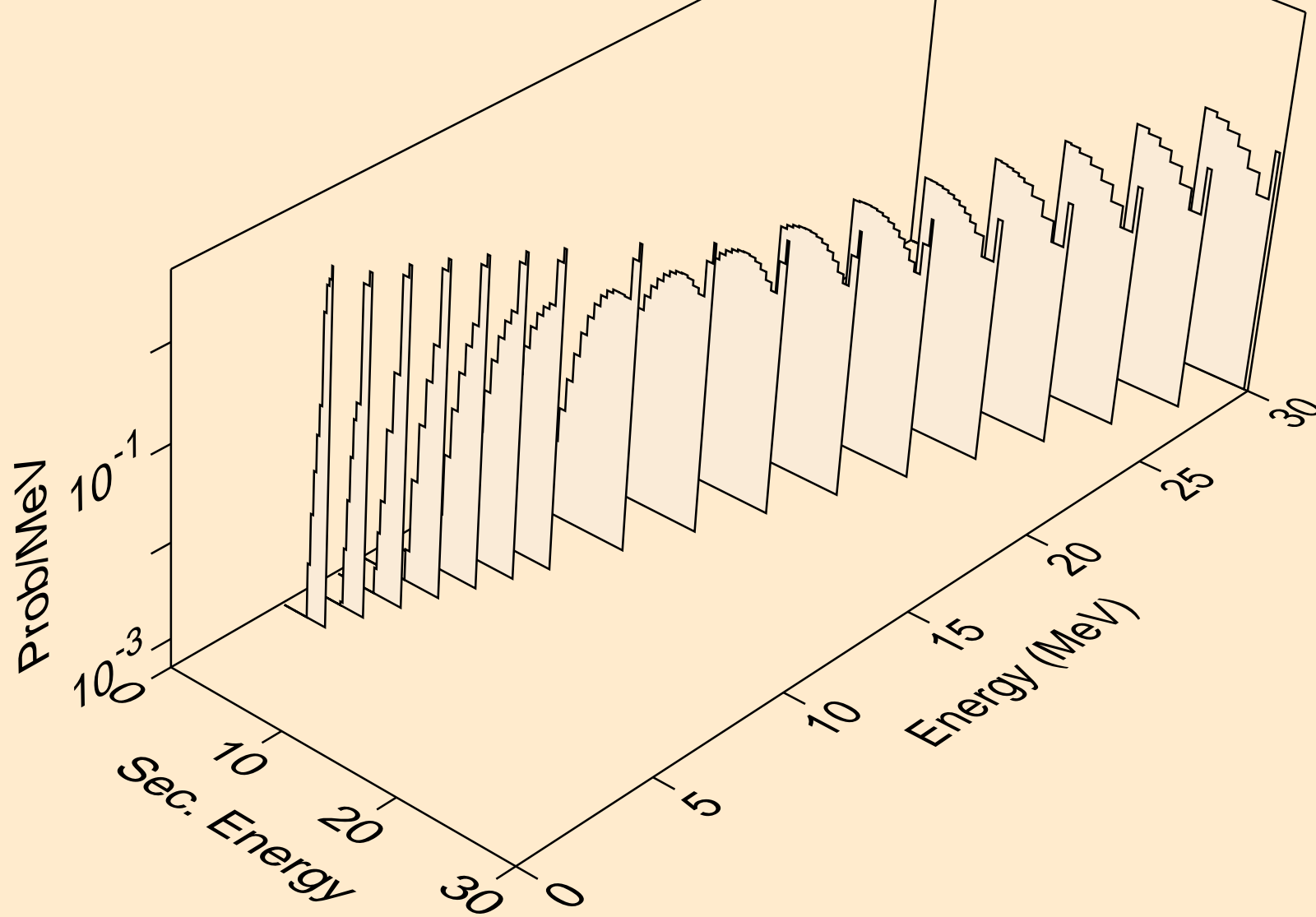

TA192 PROTON ACER TENDL-2024 LIBRARY; T=0.K  
Proton emission for (p,2p)

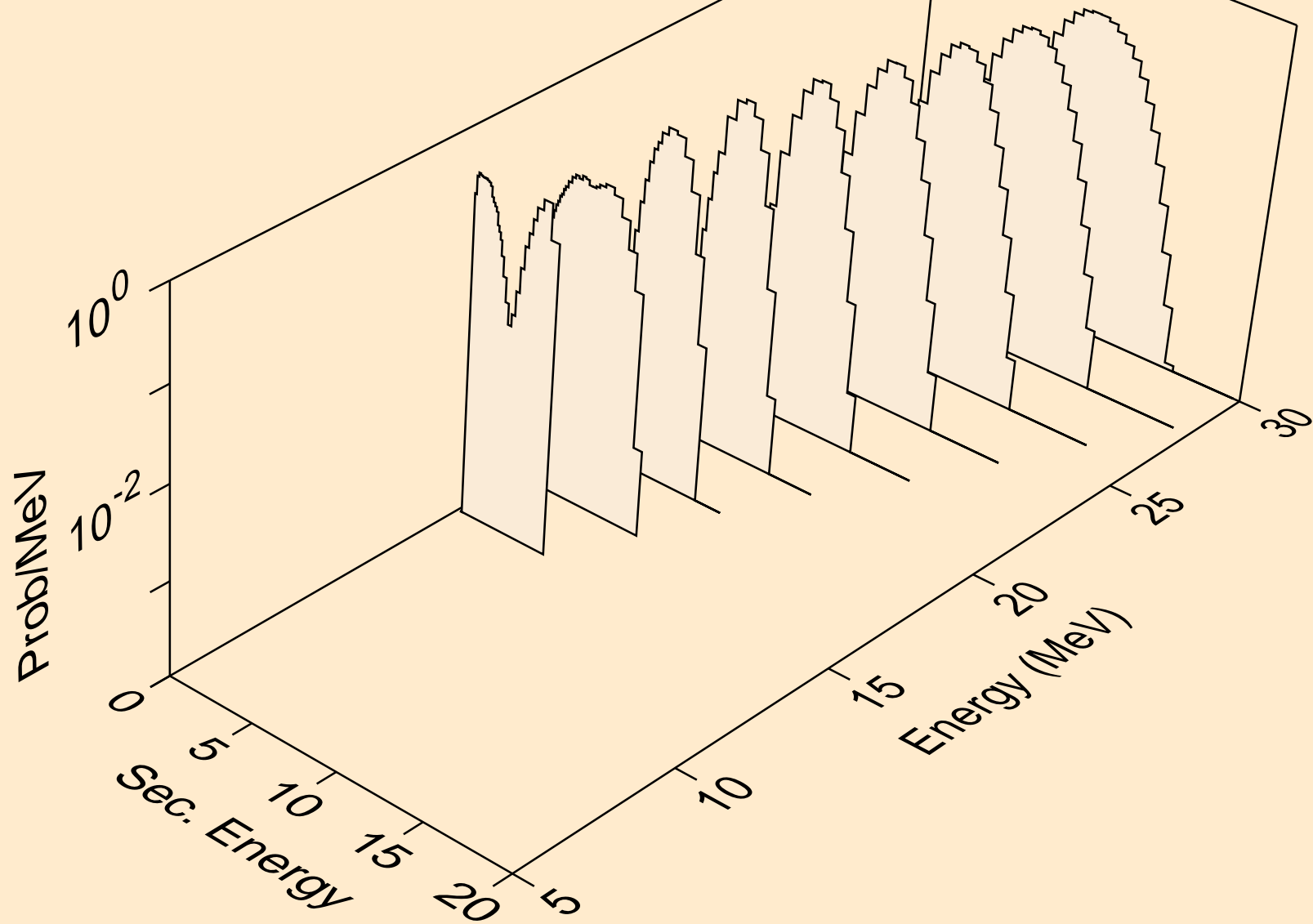

TA192 PROTON ACER TENDL-2024 LIBRARY; T=0.K  
Proton emission for (p,pd)

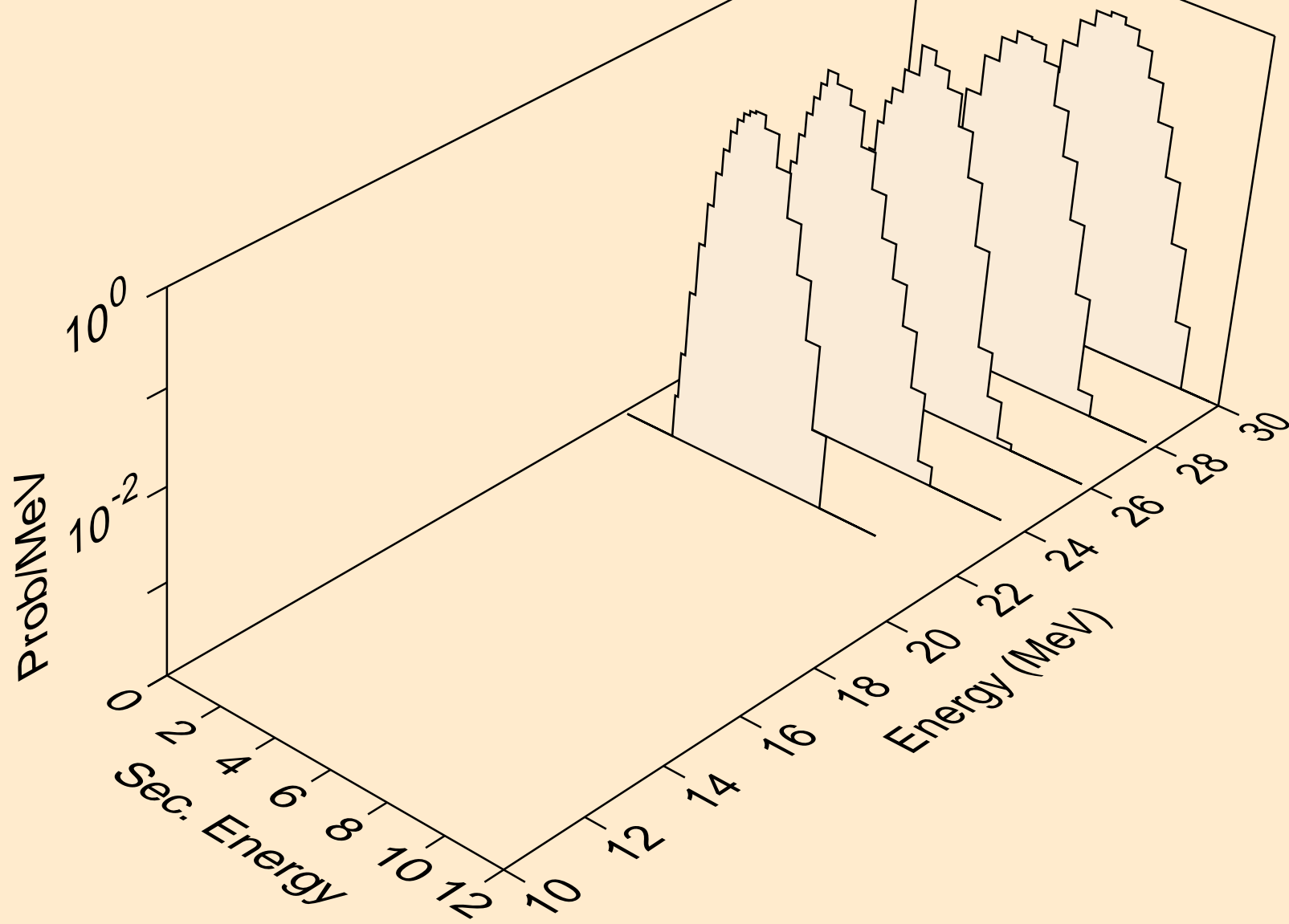

TA192 PROTON ACER TENDL-2024 LIBRARY; T=0.K  
Photon emission for (z,n)

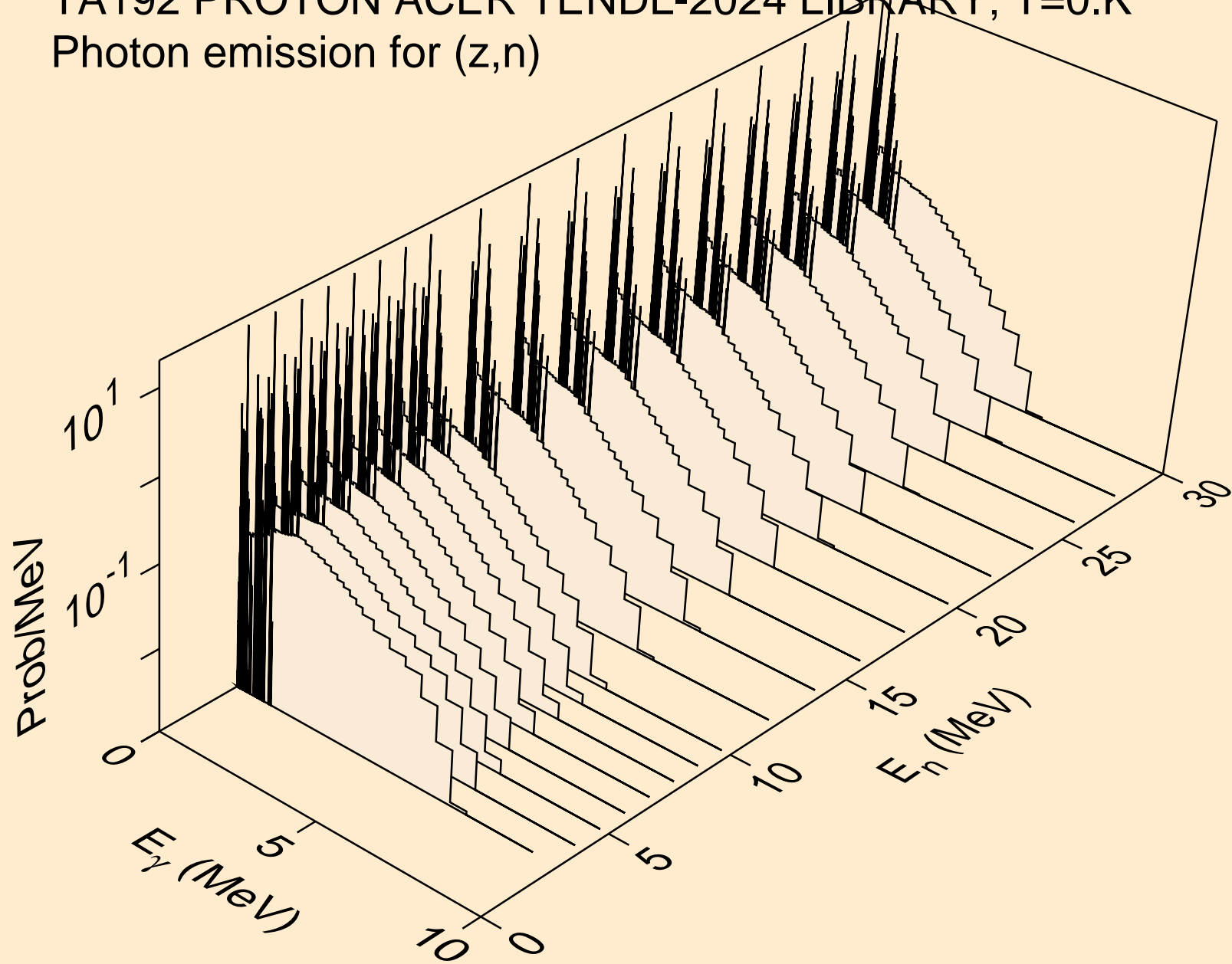

TA192 PROTON ACER TENDL-2024 LIBRARY; T=0.K  
Photon emission for (z,x)

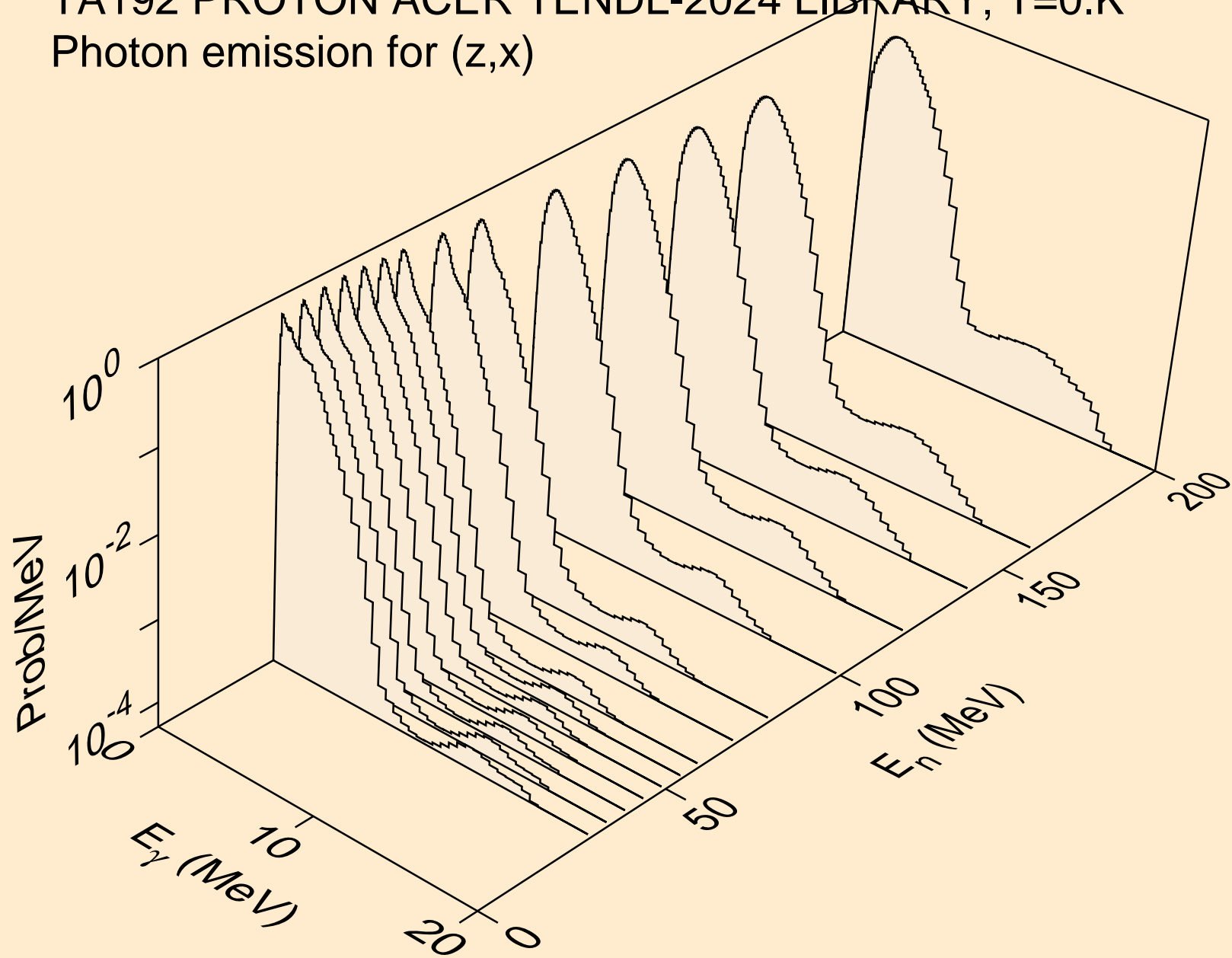

TA192 PROTON ACER TENDL-2024 LIBRARY; T=0.K  
Photon emission for (n,2nd)

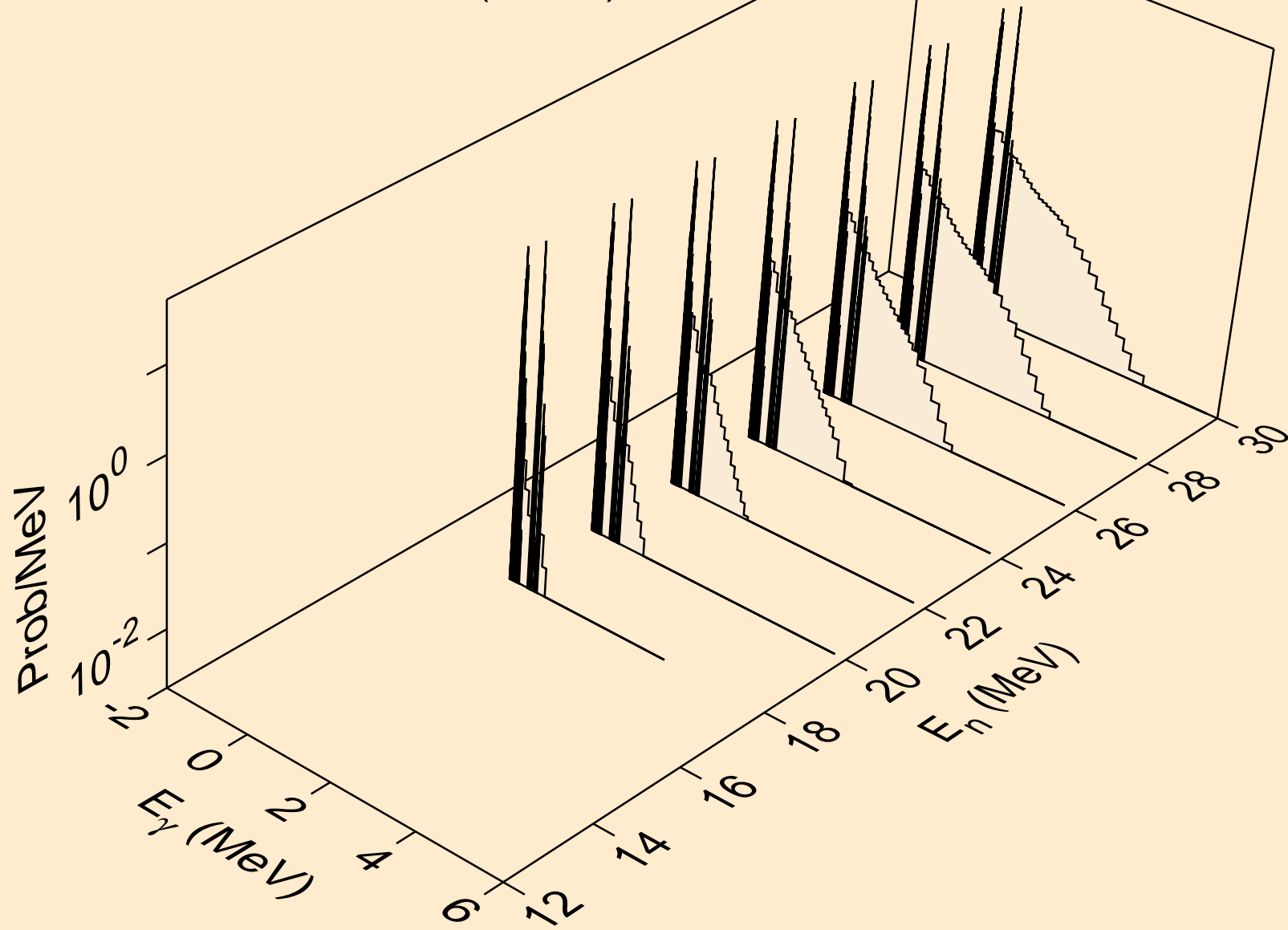

TA192 PROTON ACER TENDL-2024 LIBRARY; T=0.K  
Photon emission for (n,2n)

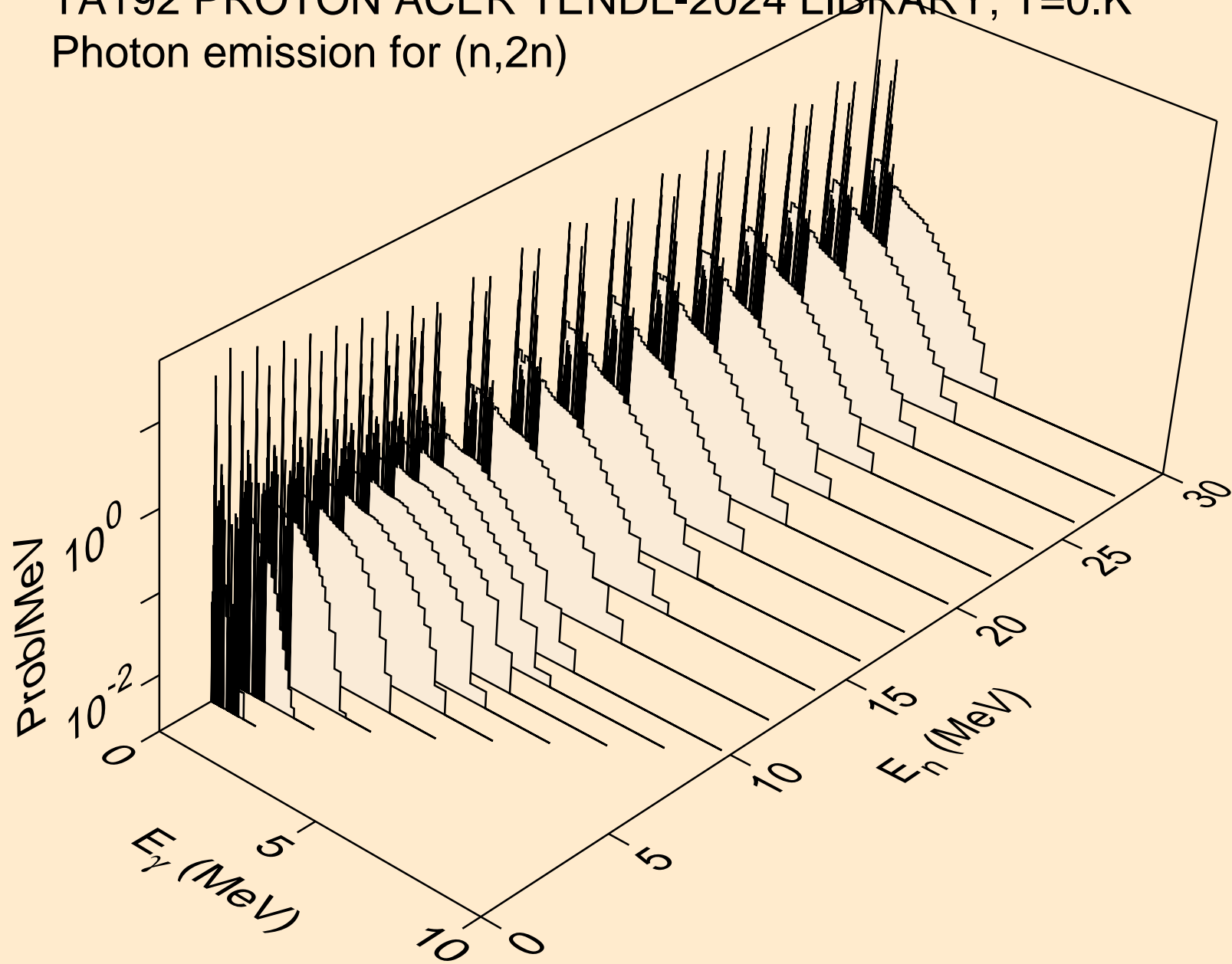

TA192 PROTON ACER TENDL-2024 LIBRARY; T=0.K  
Photon emission for (n,3n)

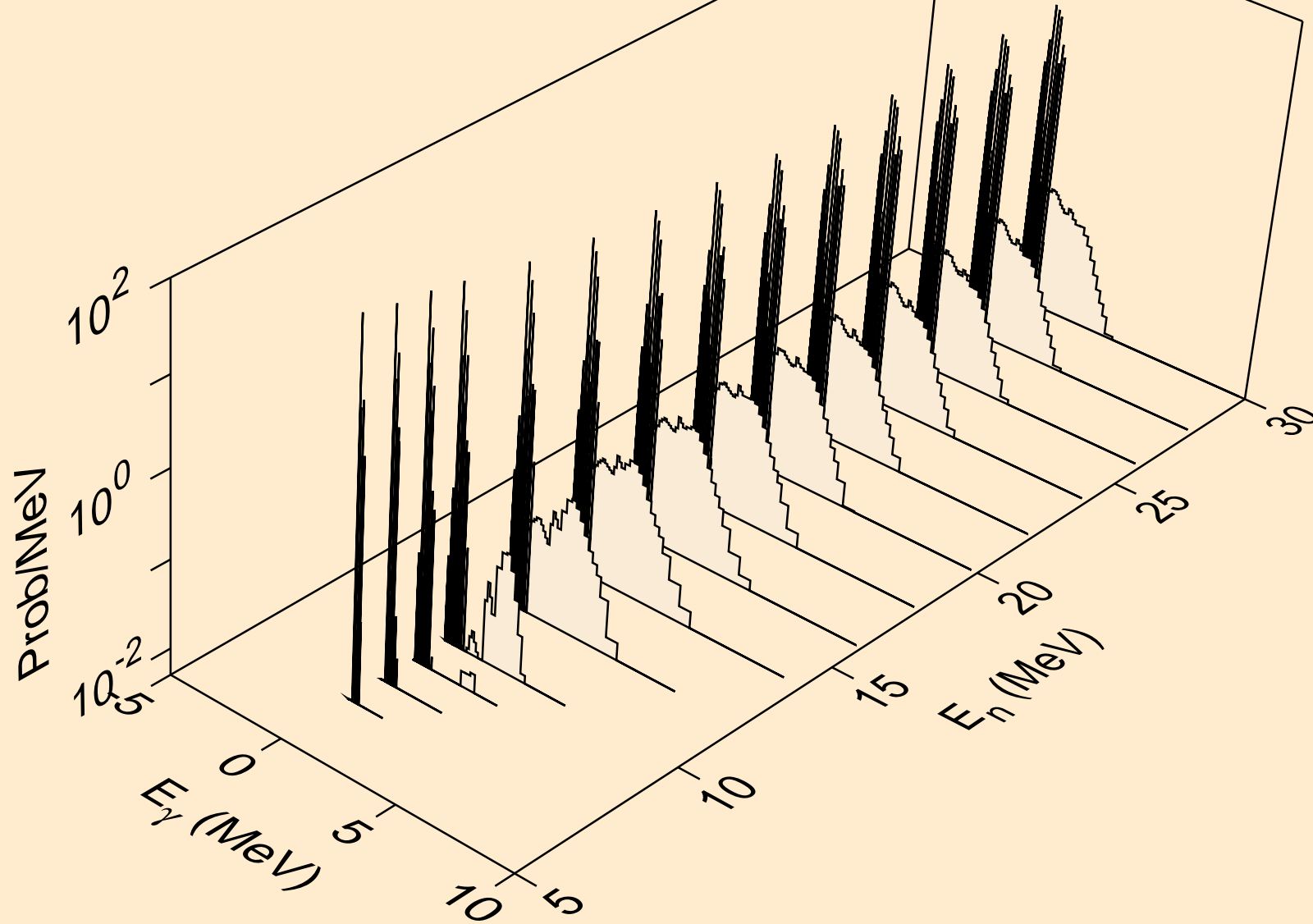

TA192 PROTON ACER TENDL-2024 LIBRARY; T=0.K  
Photon emission for (n,n\*)a

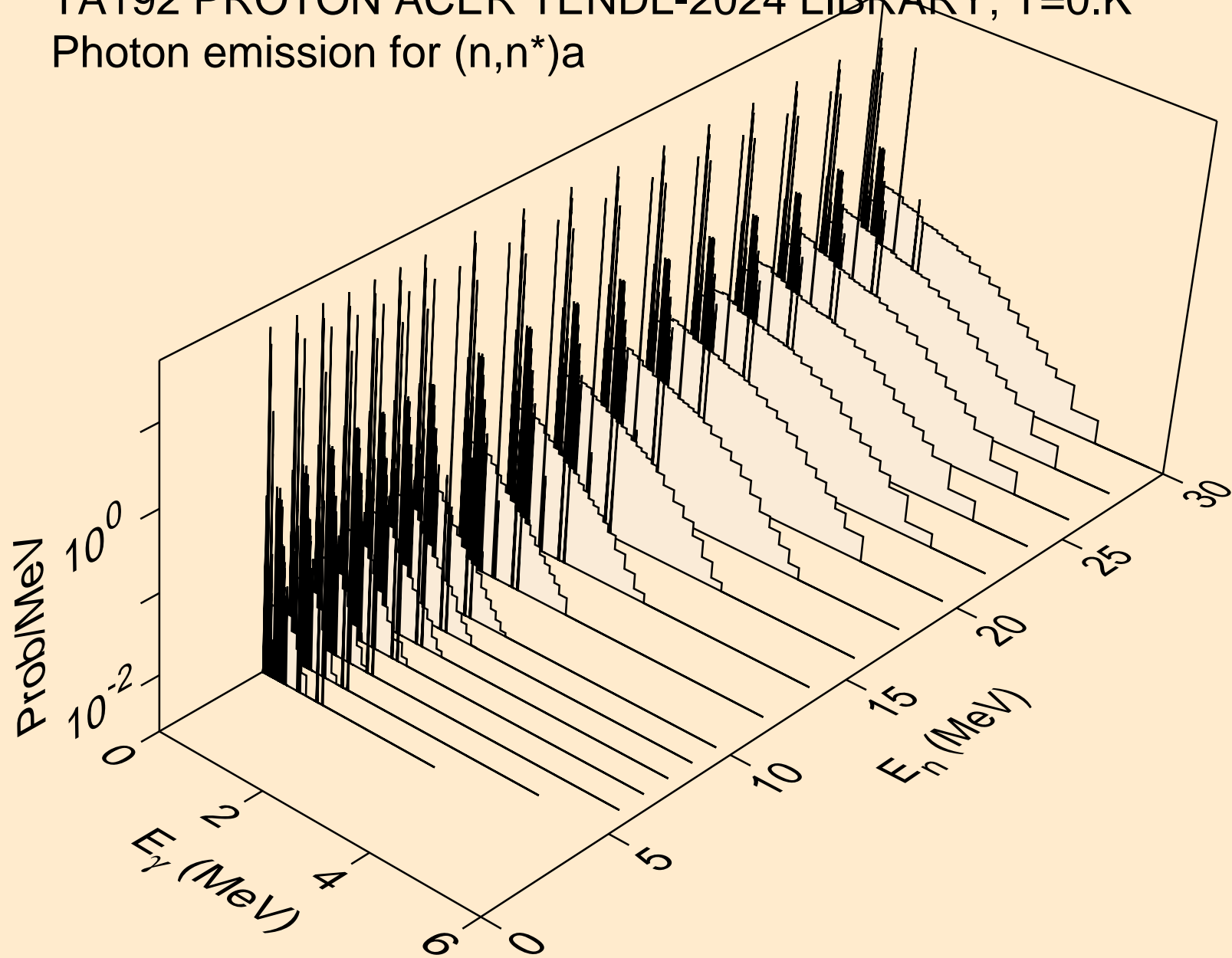

TA192 PROTON ACER TENDL-2024 LIBRARY; T=0.K  
Photon emission for (n,2n)a

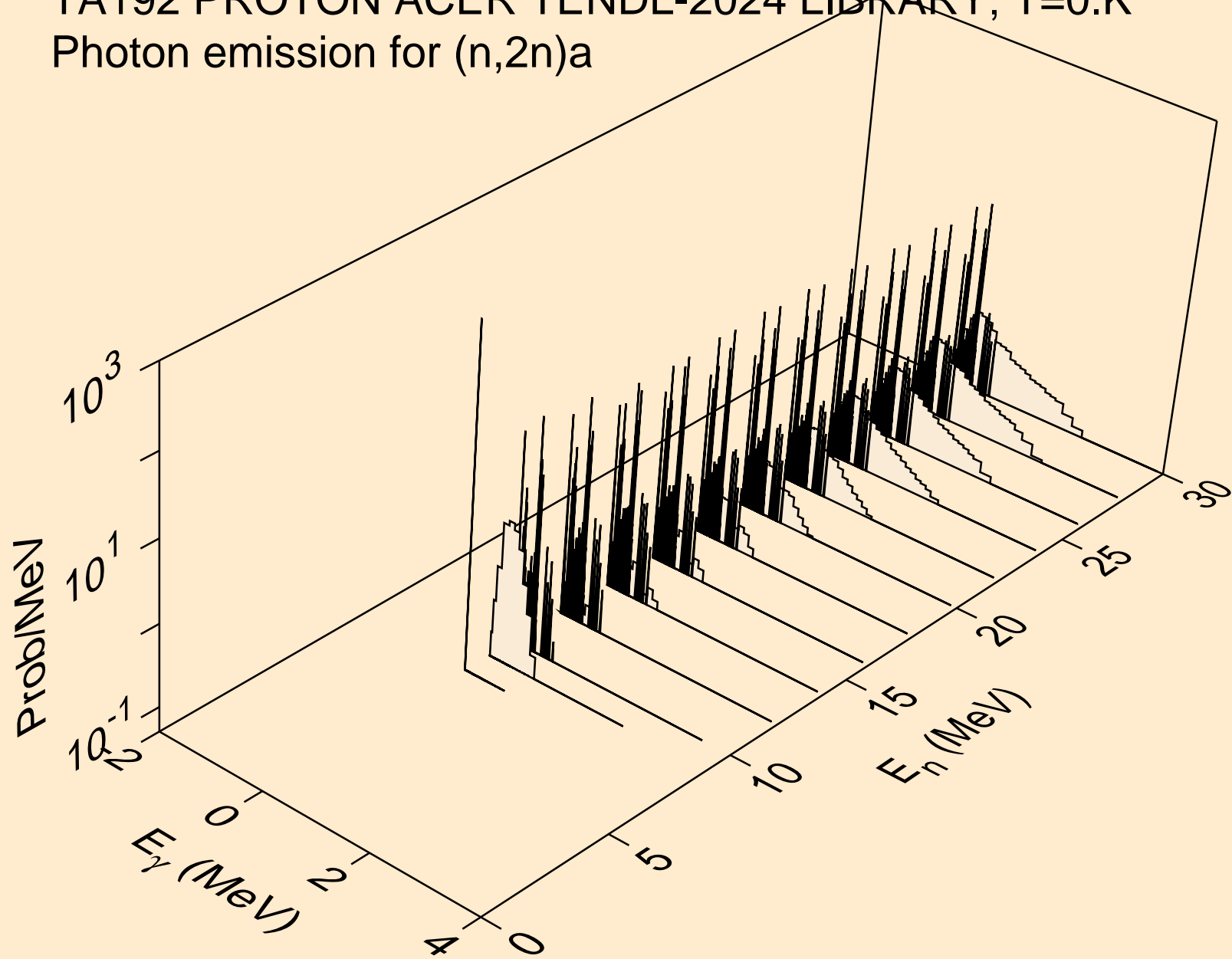

TA192 PROTON ACER TENDL-2024 LIBRARY; T=0.K  
Photon emission for (n,3n)a

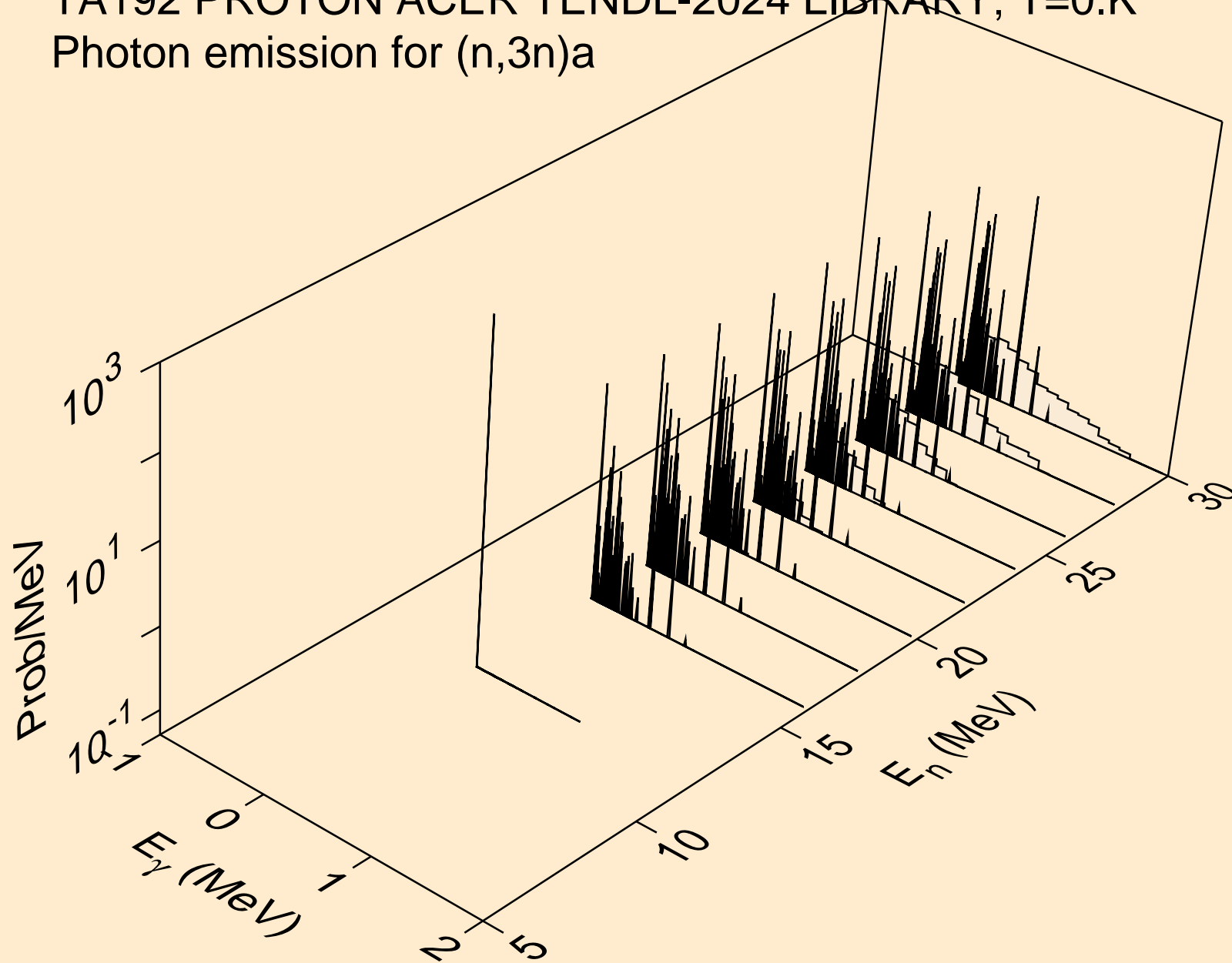

TA192 PROTON ACER TENDL-2024 LIBRARY; T=0.K  
Photon emission for (n,n\*)p

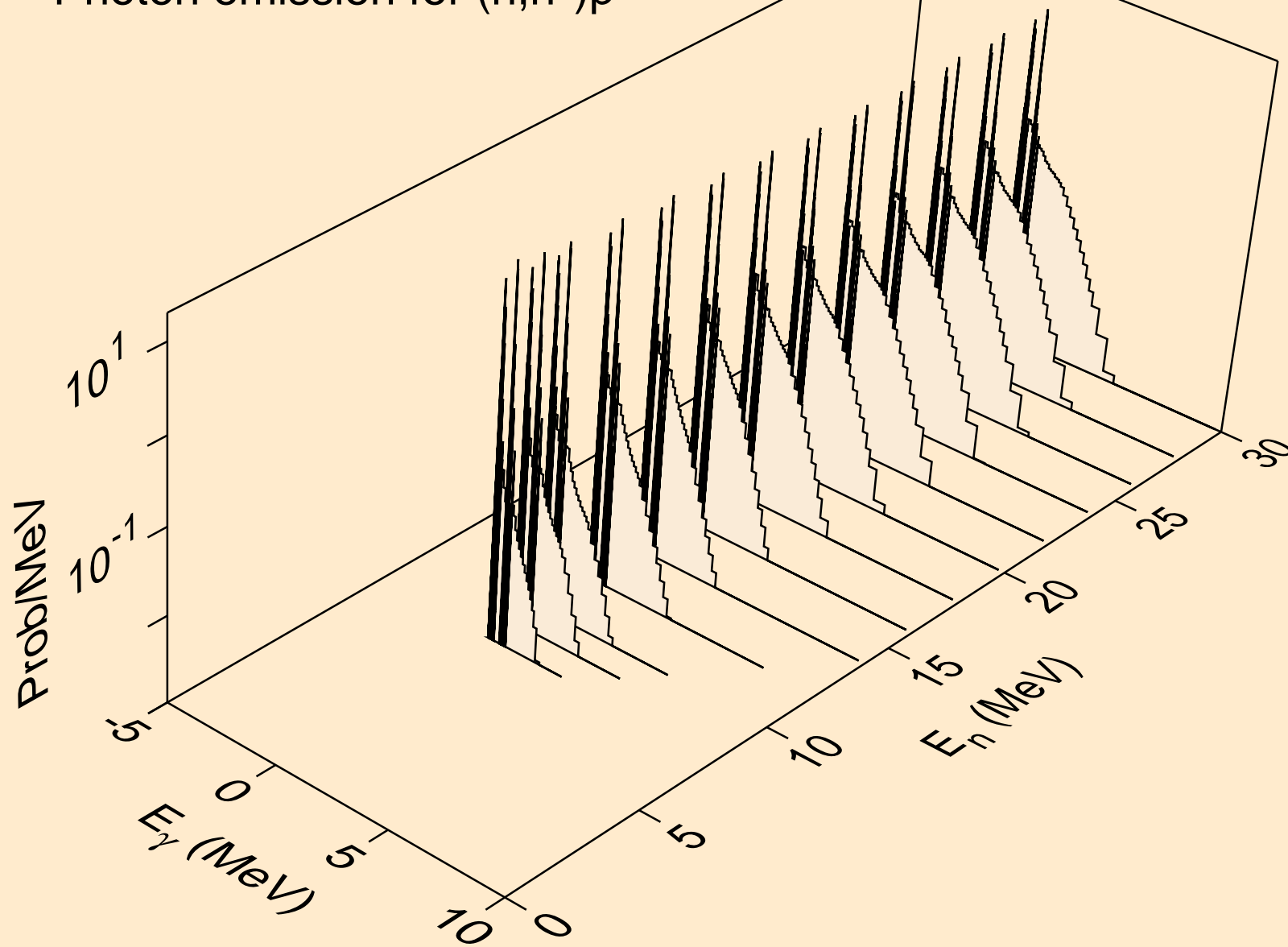

TA192 PROTON ACER TENDL-2024 LIBRARY; T=0.K  
Photon emission for (n,n\*)d

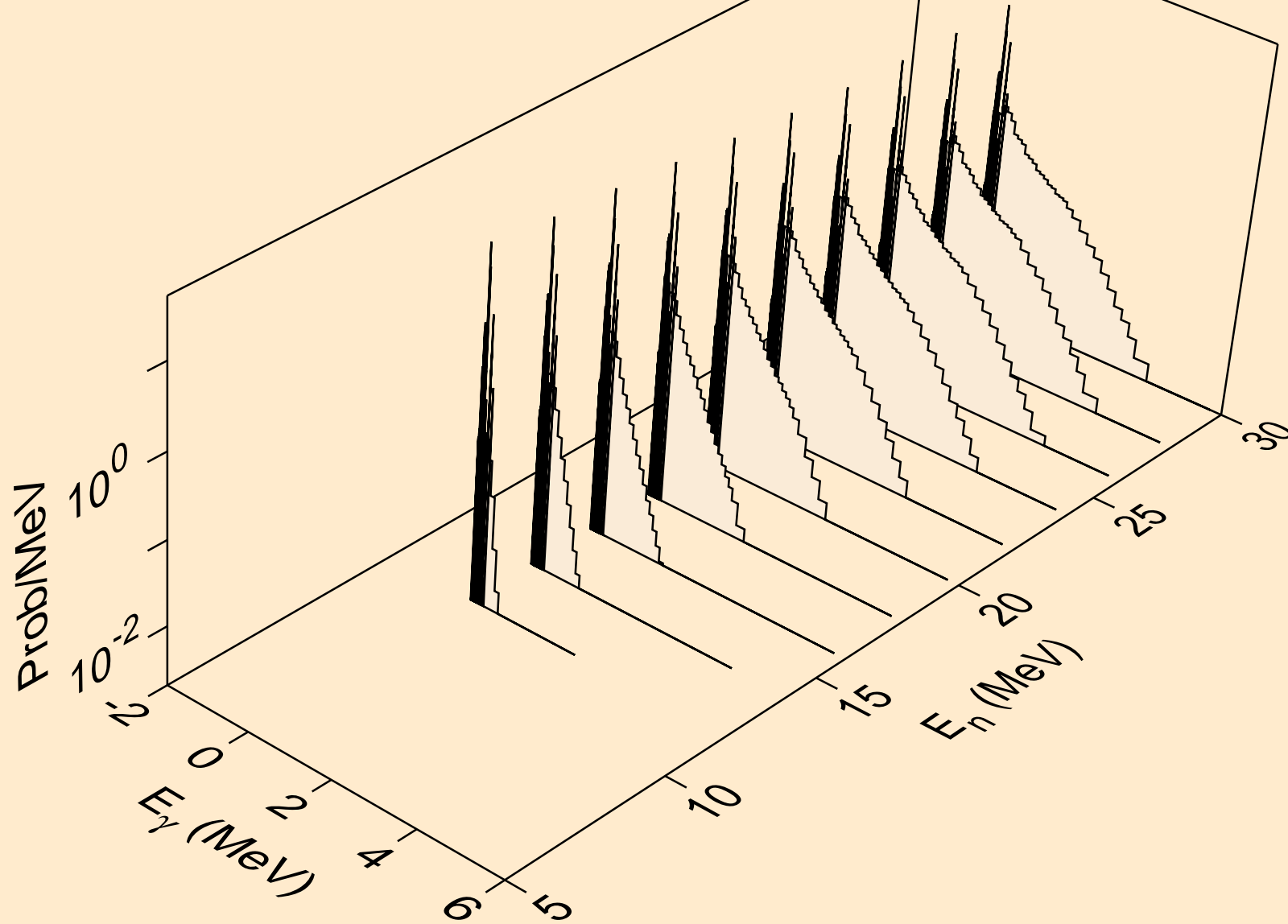

TA192 PROTON ACER TENDL-2024 LIBRARY; T=0.K  
Photon emission for (n,n\*)t

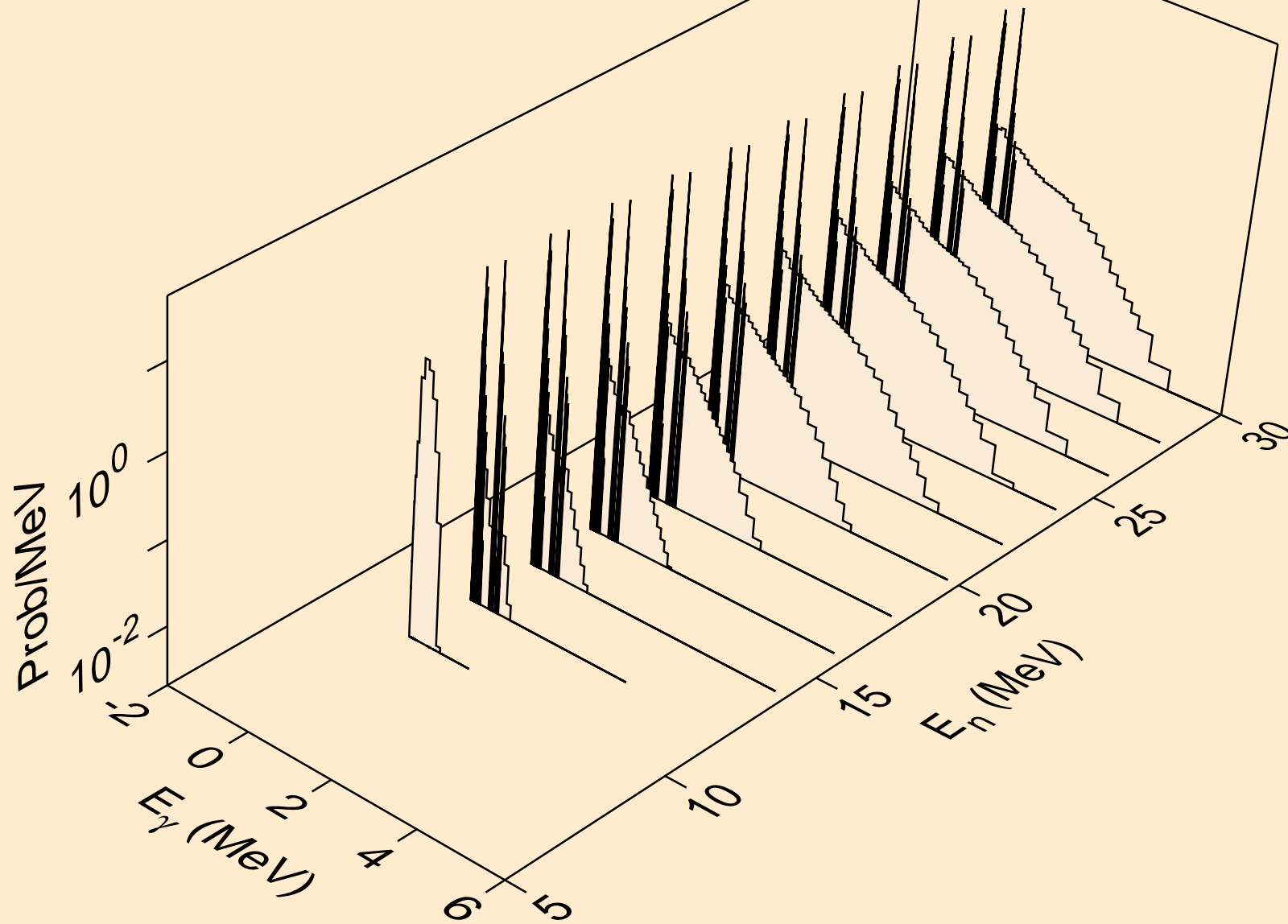

TA192 PROTON ACER TENDL-2024 LIBRARY; T=0.K  
Photon emission for (n,n\*)he3

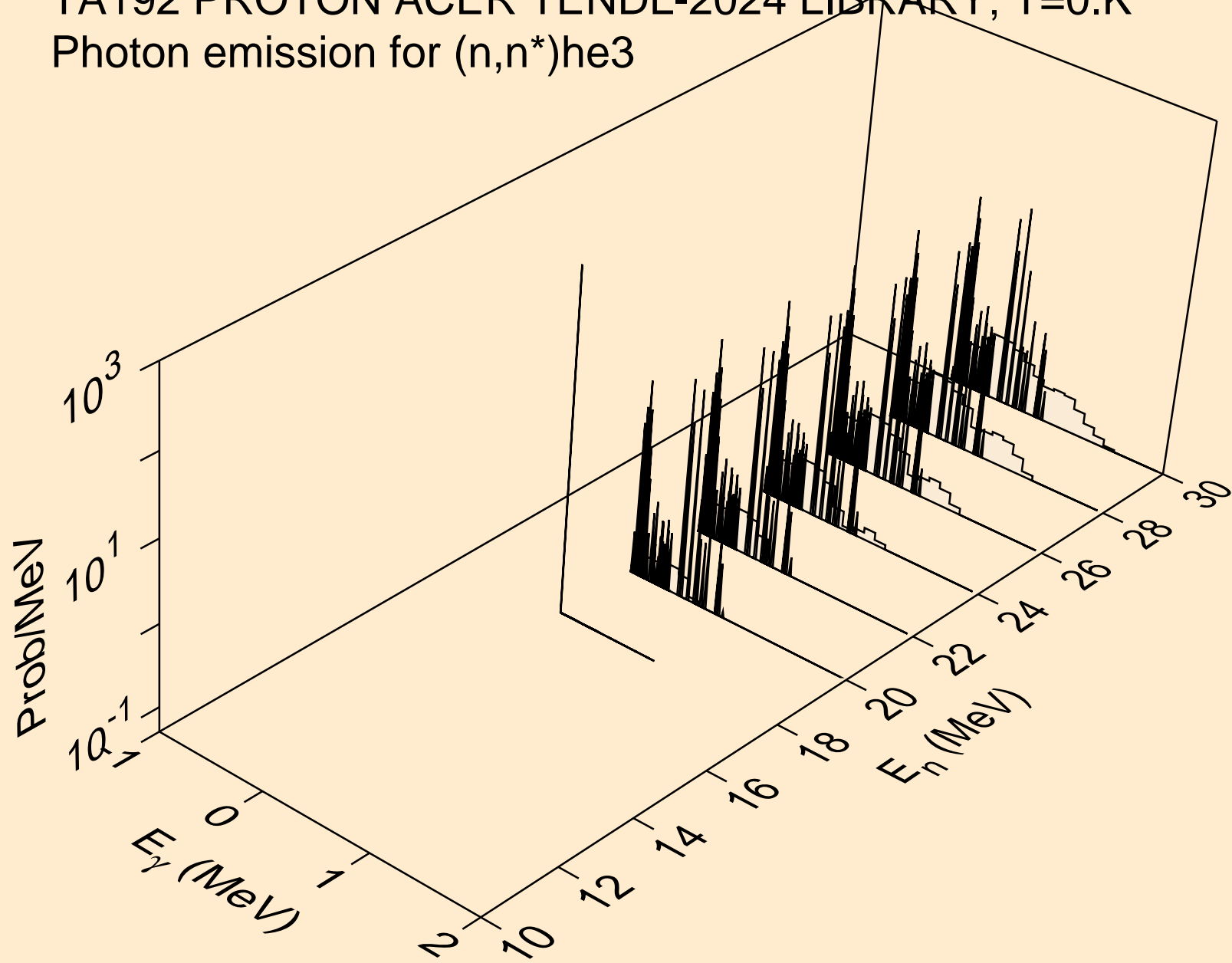

TA192 PROTON ACER TENDL-2024 LIBRARY; T=0.K  
Photon emission for (n,4n)

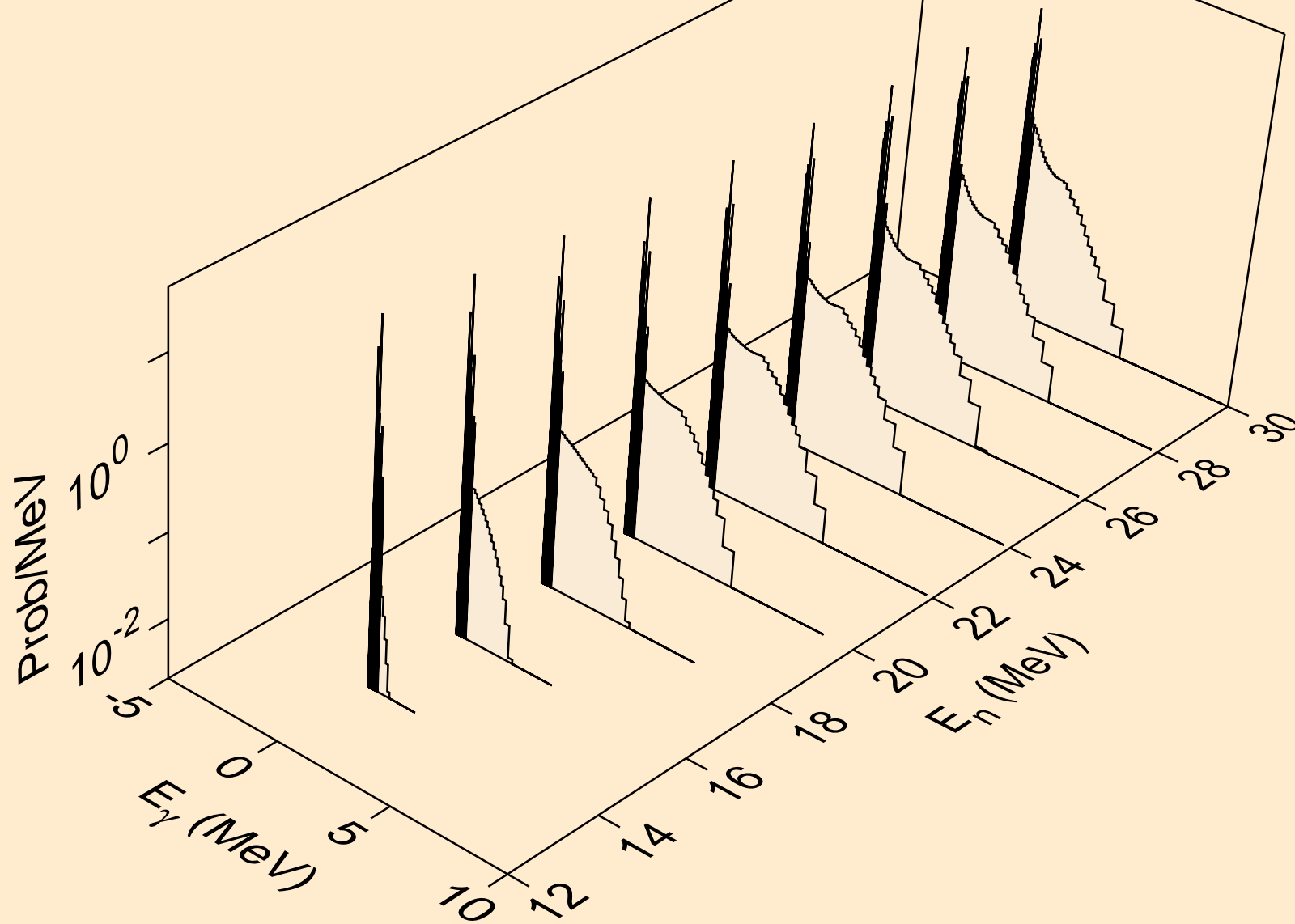

TA192 PROTON ACER TENDL-2024 LIBRARY; T=0.K  
Photon emission for (n,2np)

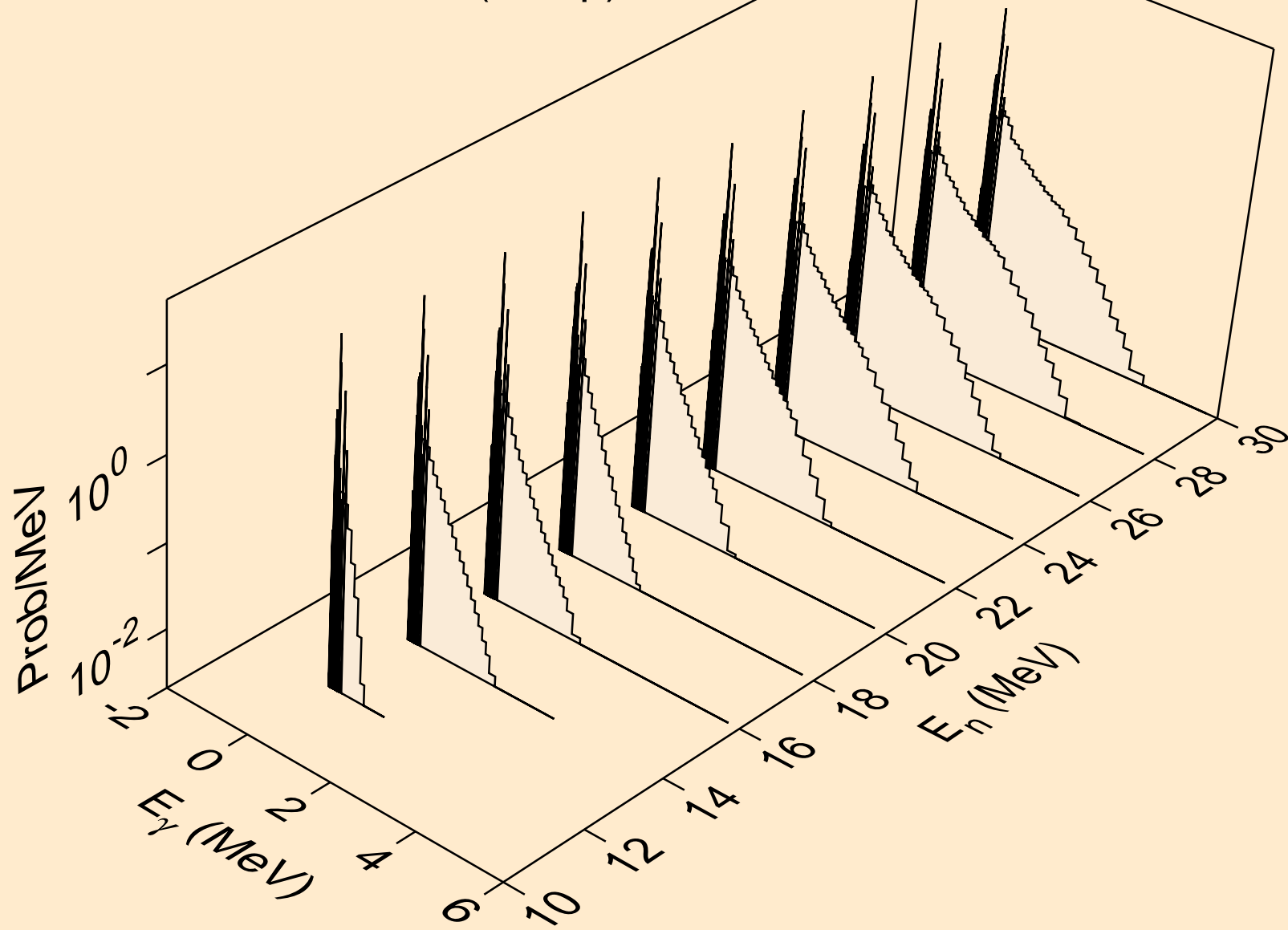

TA192 PROTON ACER TENDL-2024 LIBRARY; T=0.K  
Photon emission for (n,3np)

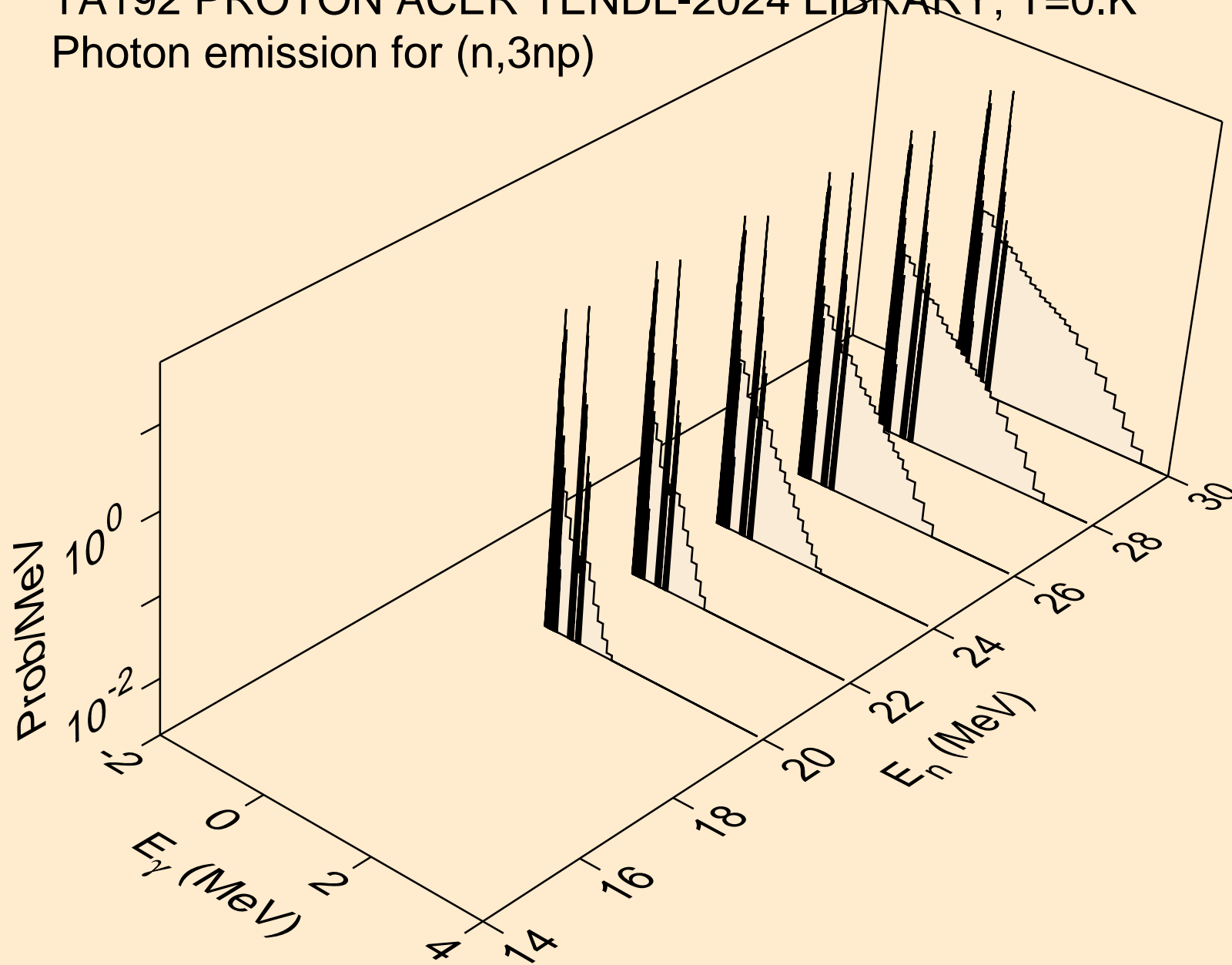

TA192 PROTON ACER TENDL-2024 LIBRARY; T=0.K  
Photon emission for (n,n2p)

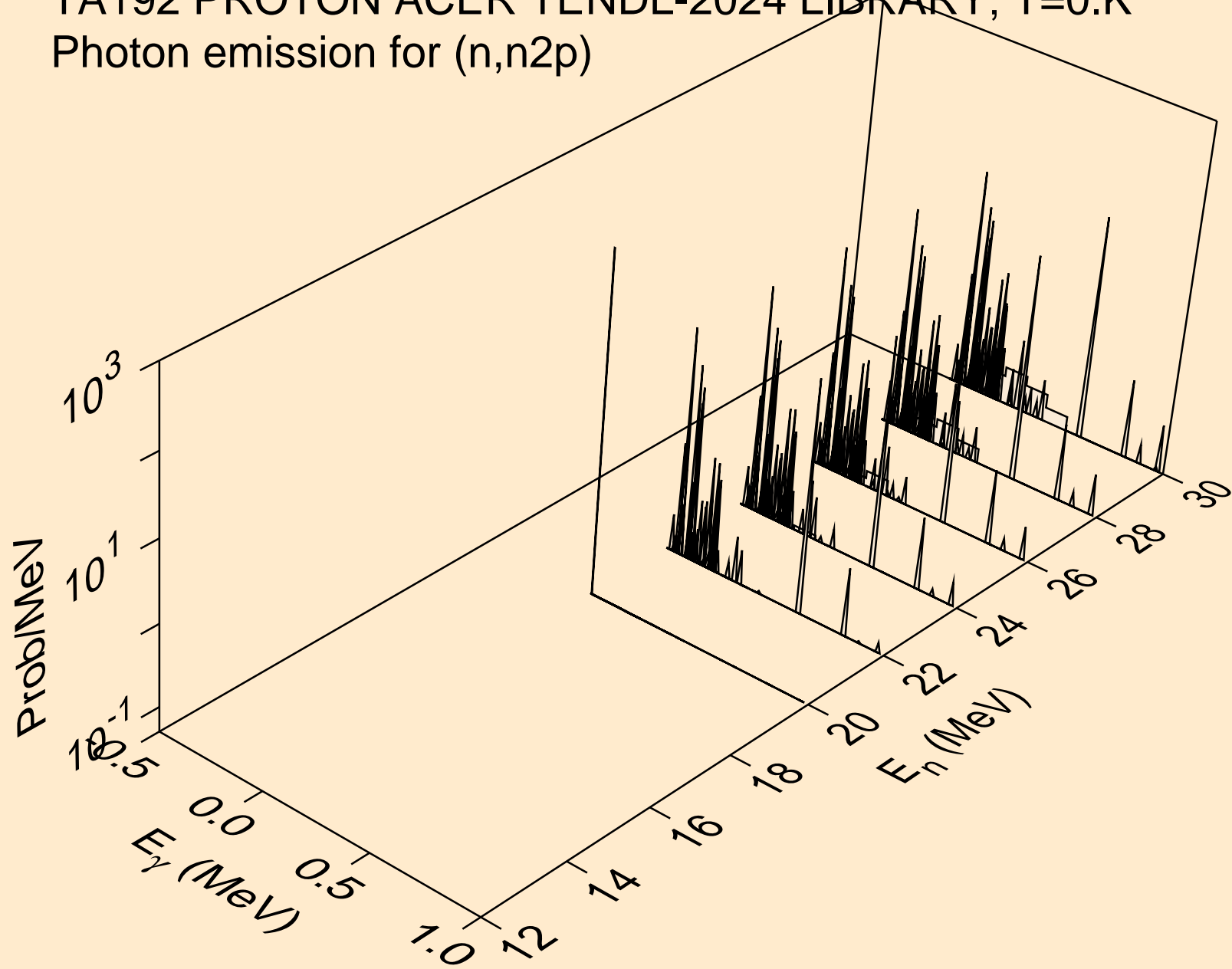

TA192 PROTON ACER TENDL-2024 LIBRARY; T=0.K  
Photon emission for (n,gma)

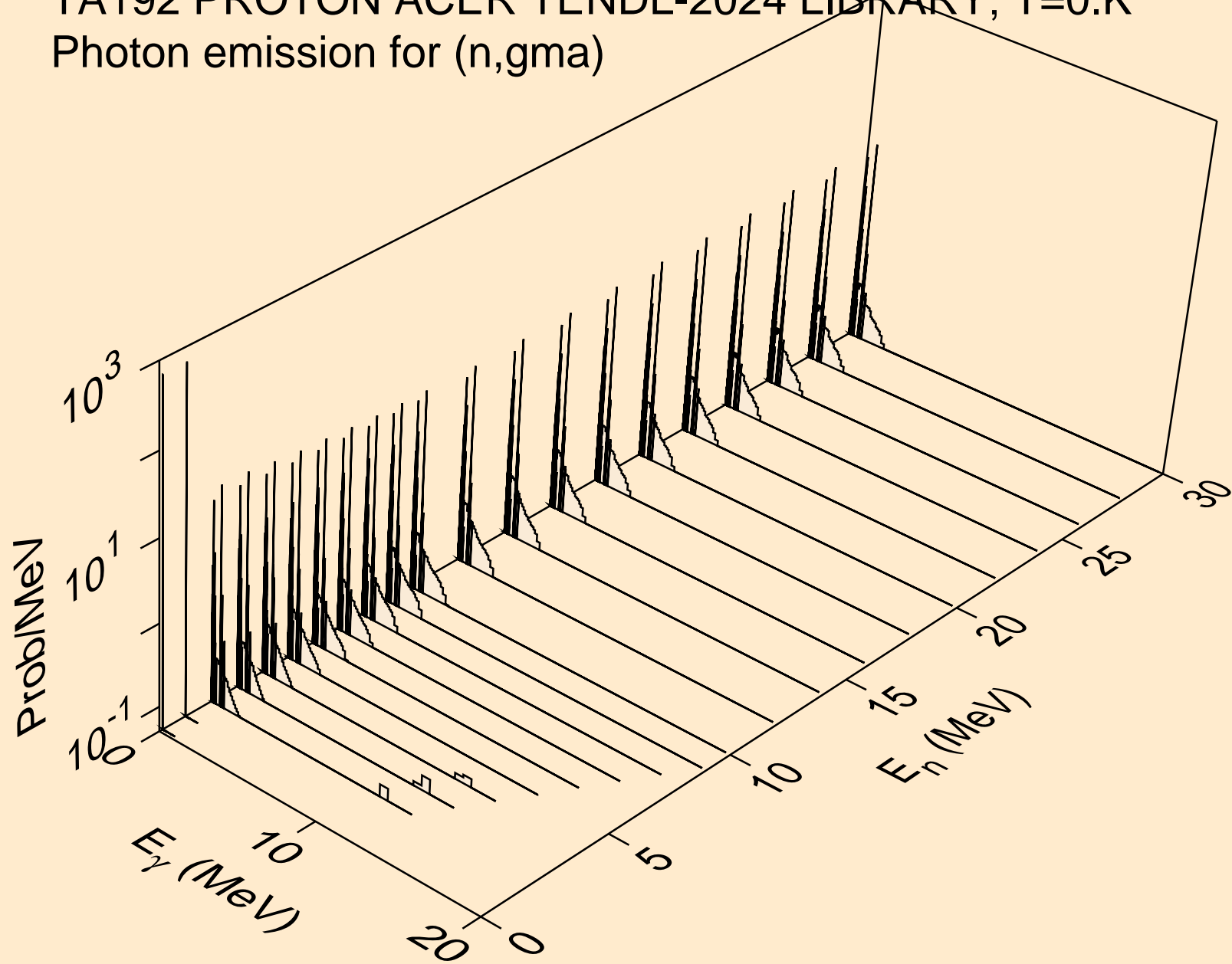

TA192 PROTON ACER TENDL-2024 LIBRARY; T=0.K  
Photon emission for inelastic

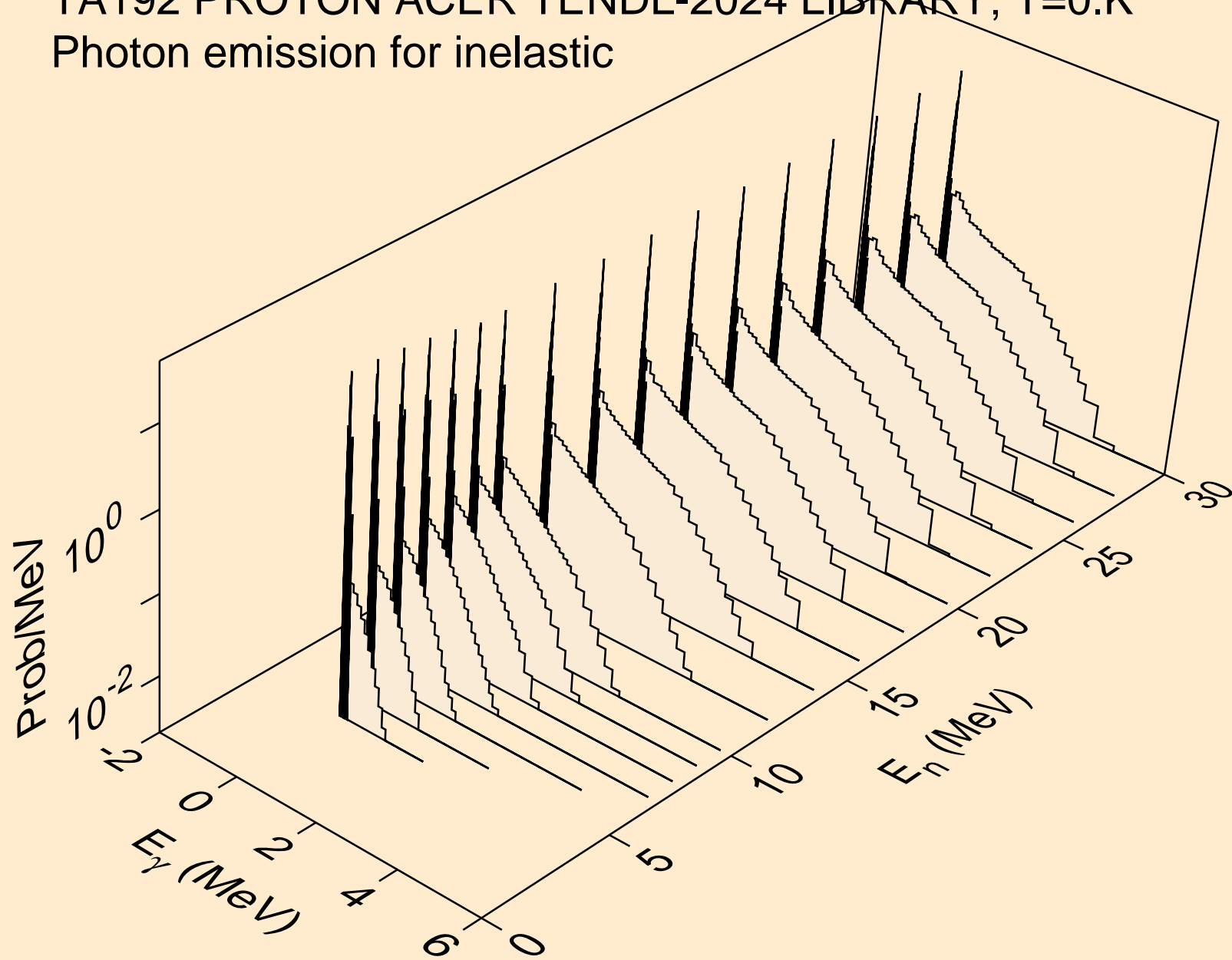

TA192 PROTON ACER TENDL-2024 LIBRARY; T=0.K  
Photon emission for (n,d)

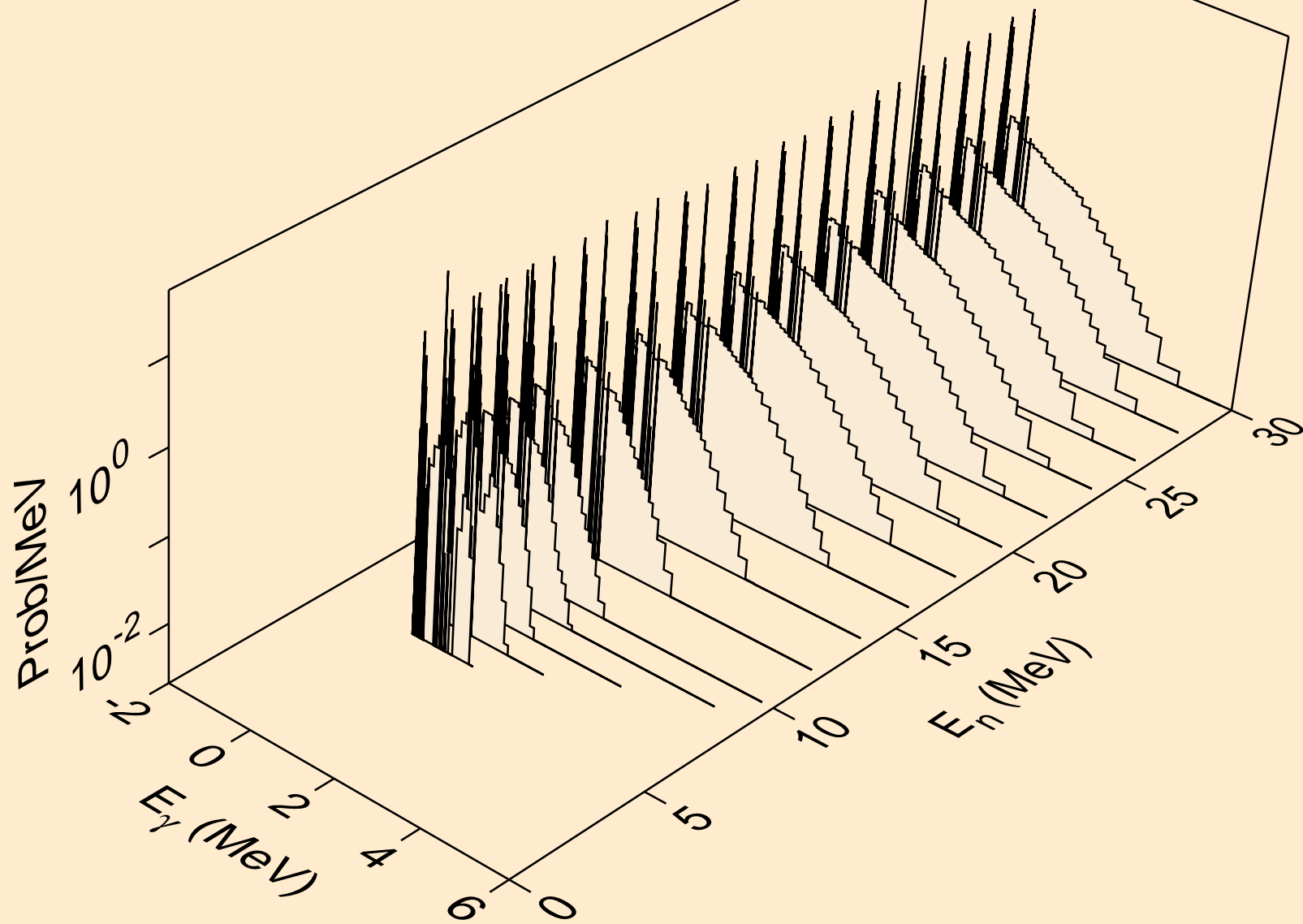

TA192 PROTON ACER TENDL-2024 LIBRARY; T=0.K  
Photon emission for (n,t)

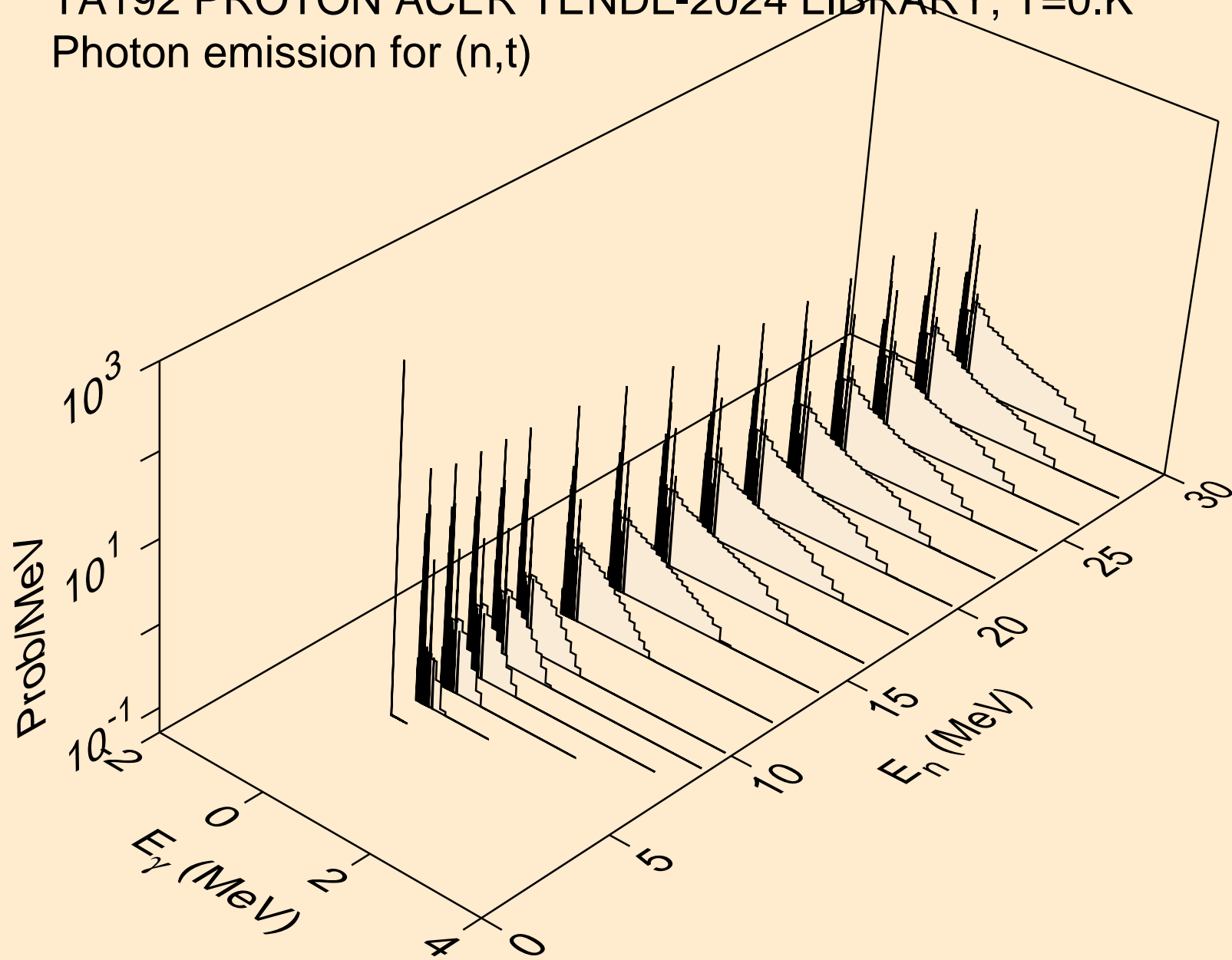

TA192 PROTON ACER TENDL-2024 LIBRARY; T=0.K  
Photon emission for (n,he3)

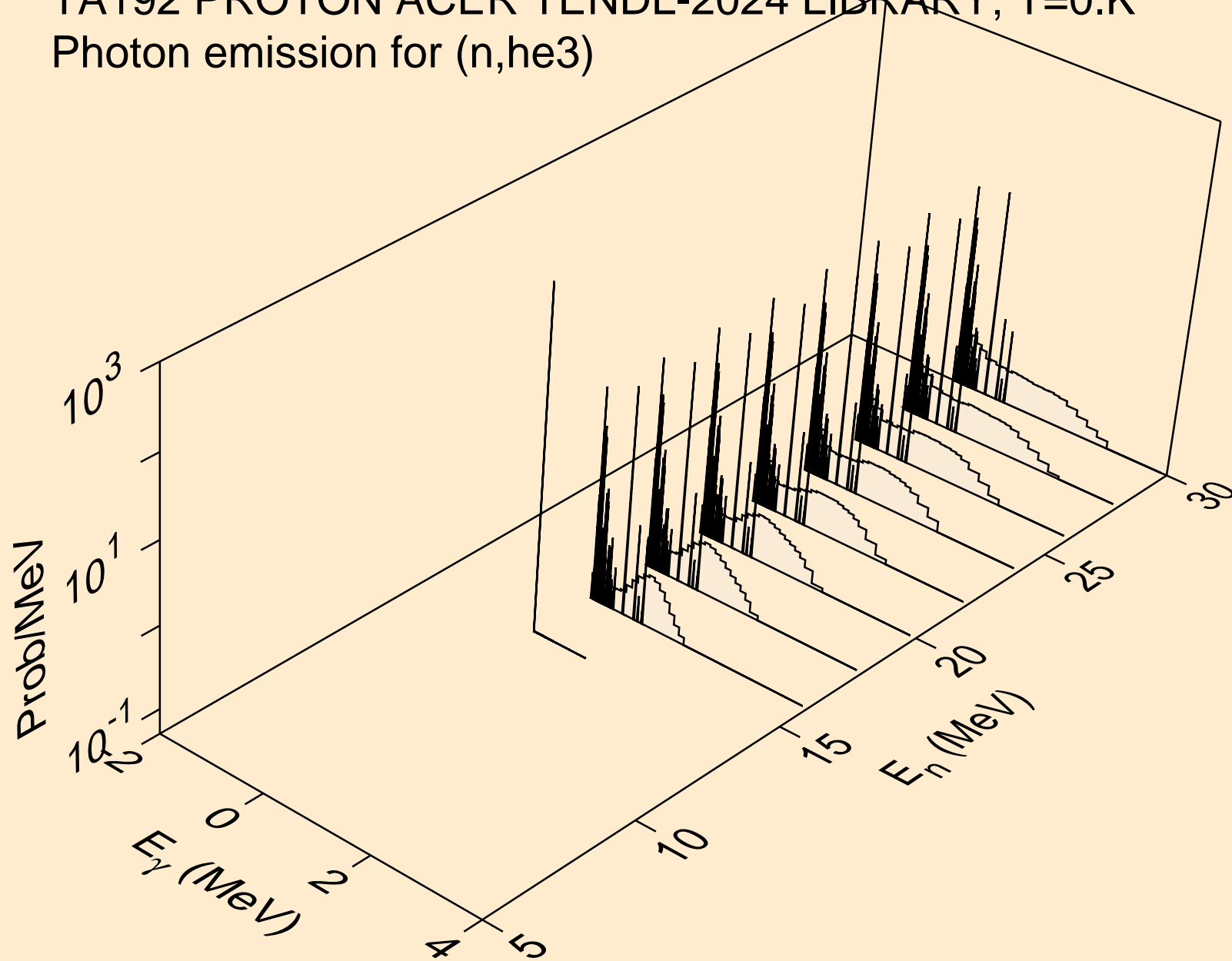

TA192 PROTON ACER TENDL-2024 LIBRARY; T=0.K  
Photon emission for (n,a)

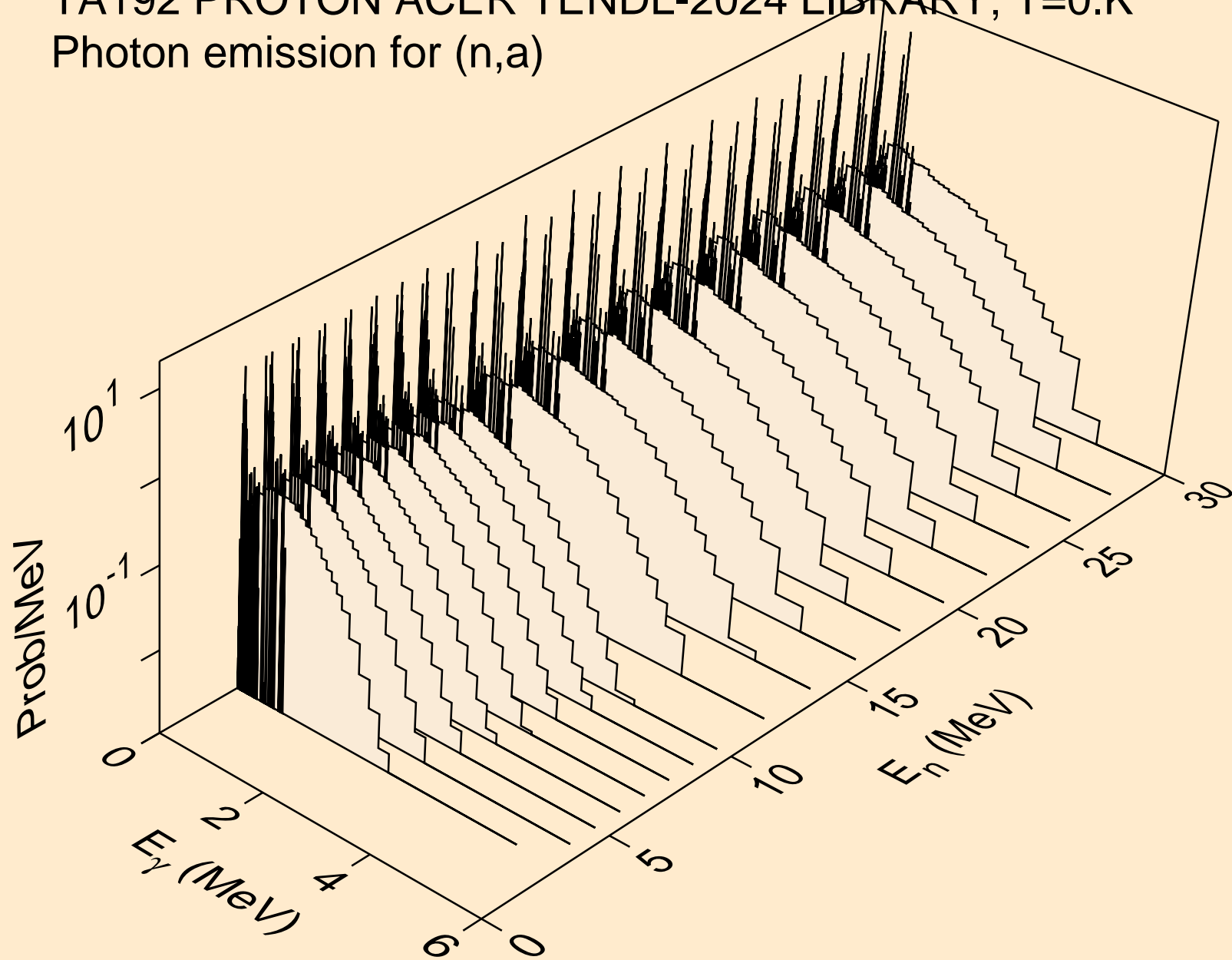

TA192 PROTON ACER TENDL-2024 LIBRARY; T=0.K  
Photon emission for (n,2p)

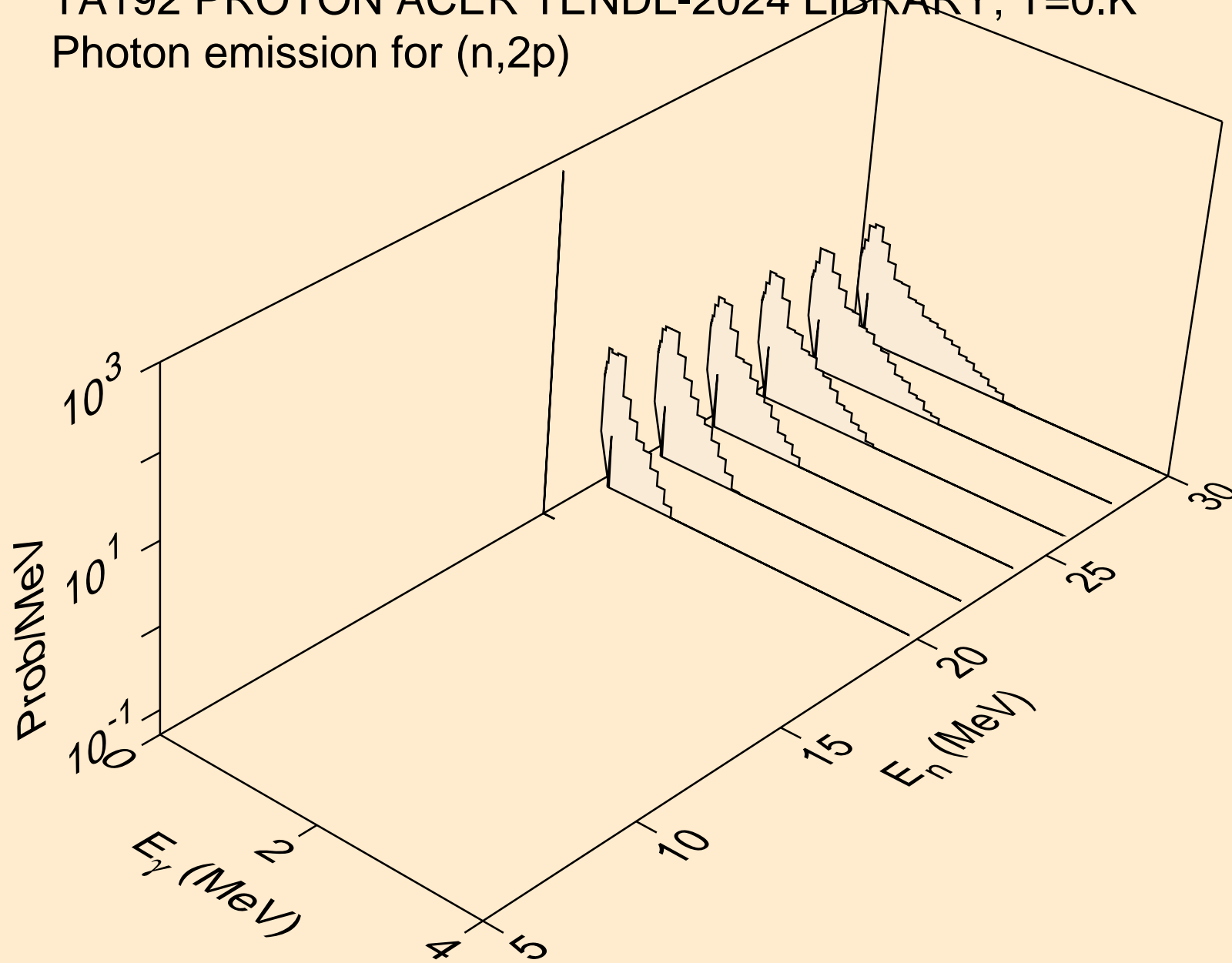

TA192 PROTON ACER TENDL-2024 LIBRARY; T=0.K  
Photon emission for (n,pd)

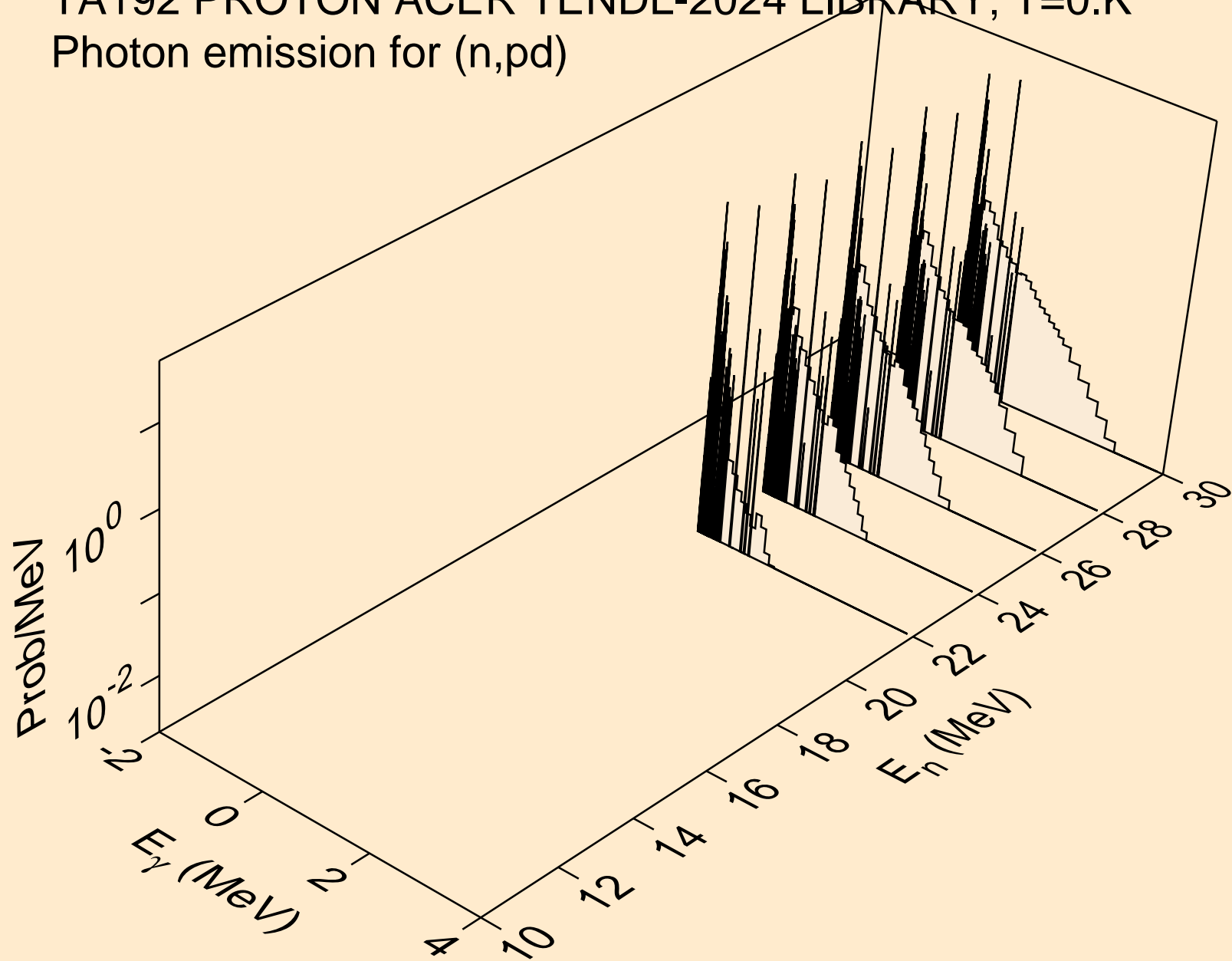

TA192 PROTON ACER TENDL-2024 LIBRARY; T=0.K  
Particle heating contributions

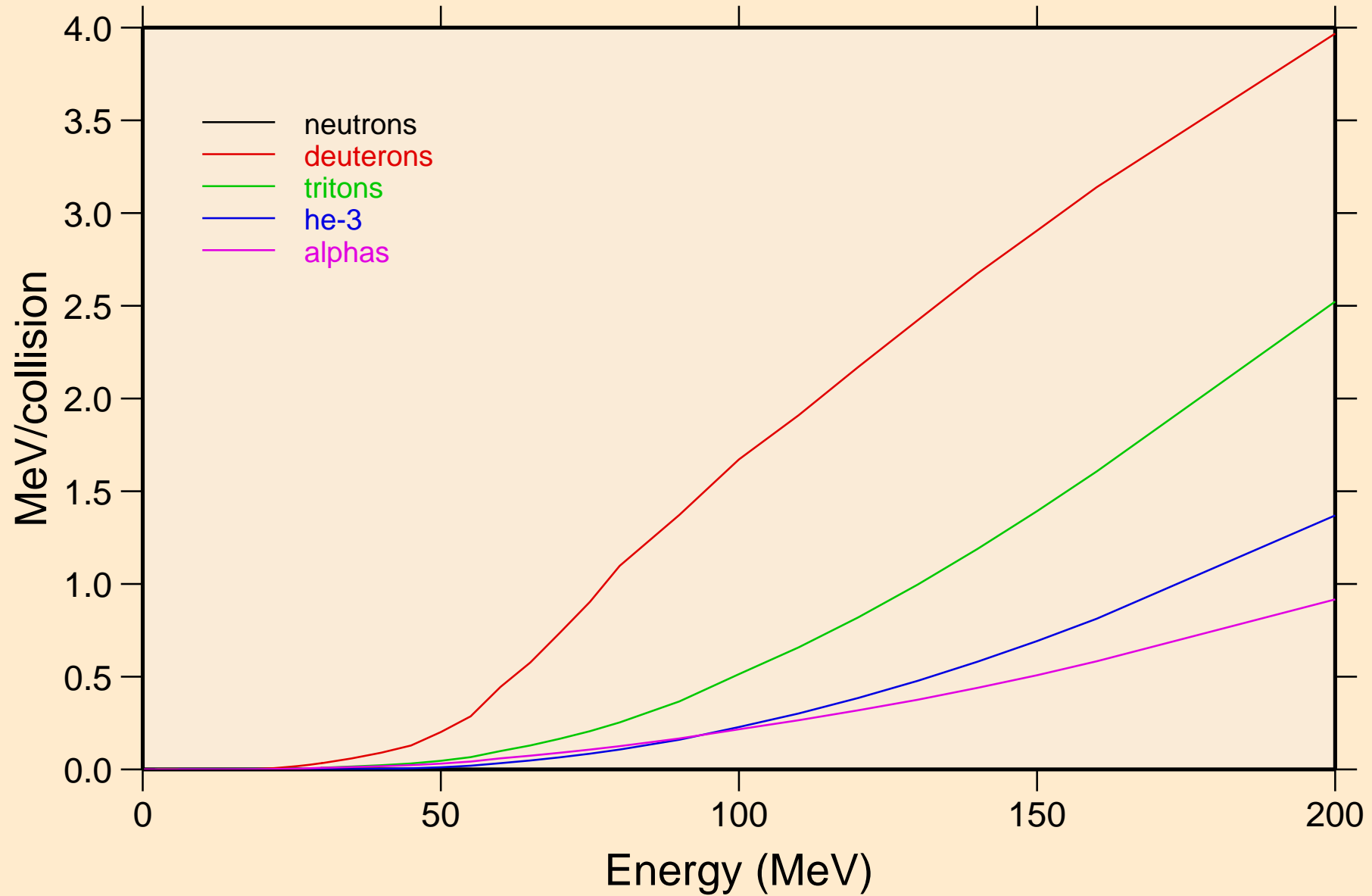

TA192 PROTON ACER TENDL-2024 LIBRARY; T=0.K  
Recoil Heating

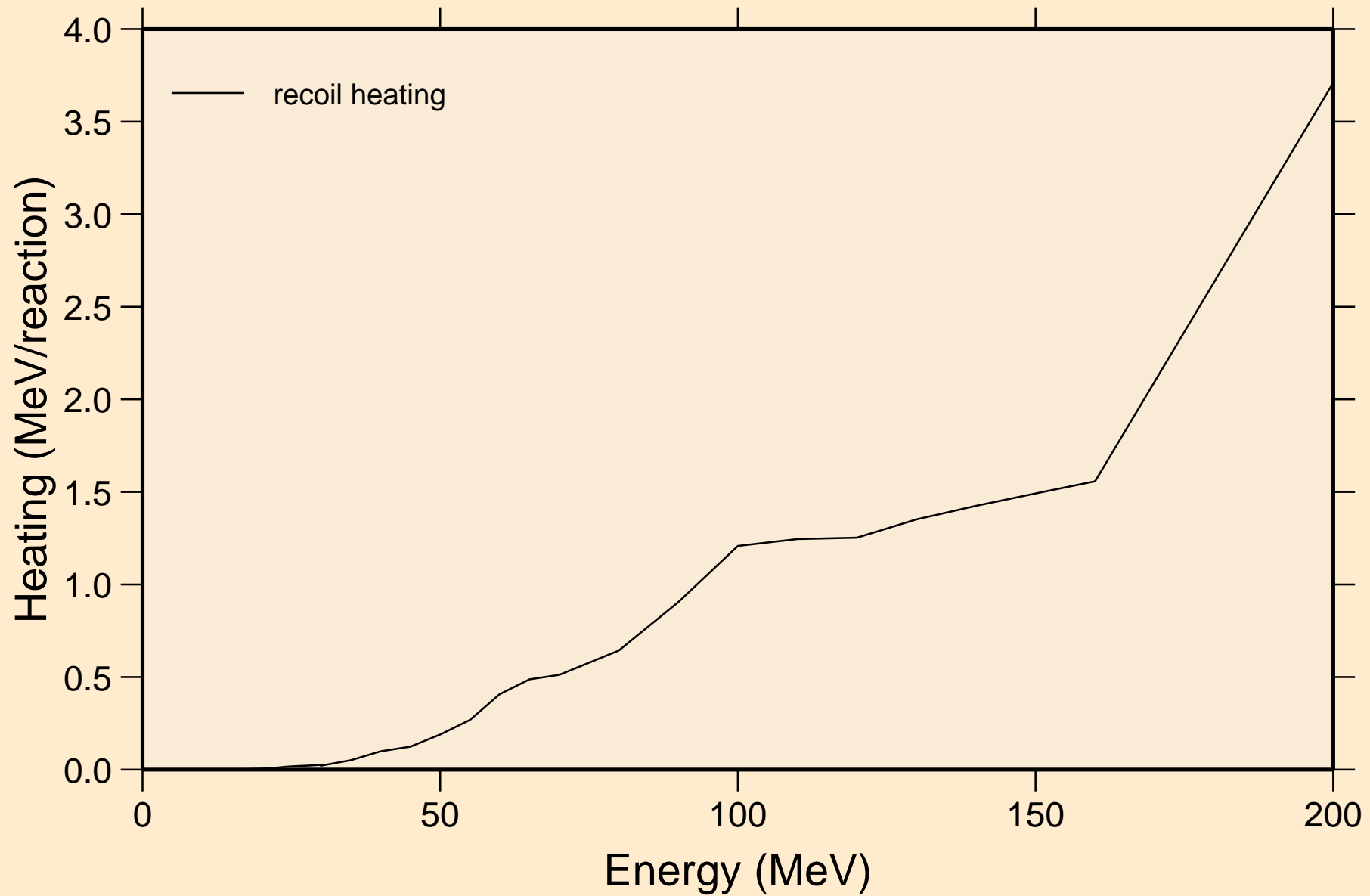

TA192 PROTON ACER TENDL-2024 LIBRARY; T=0.K  
Particle production cross sections

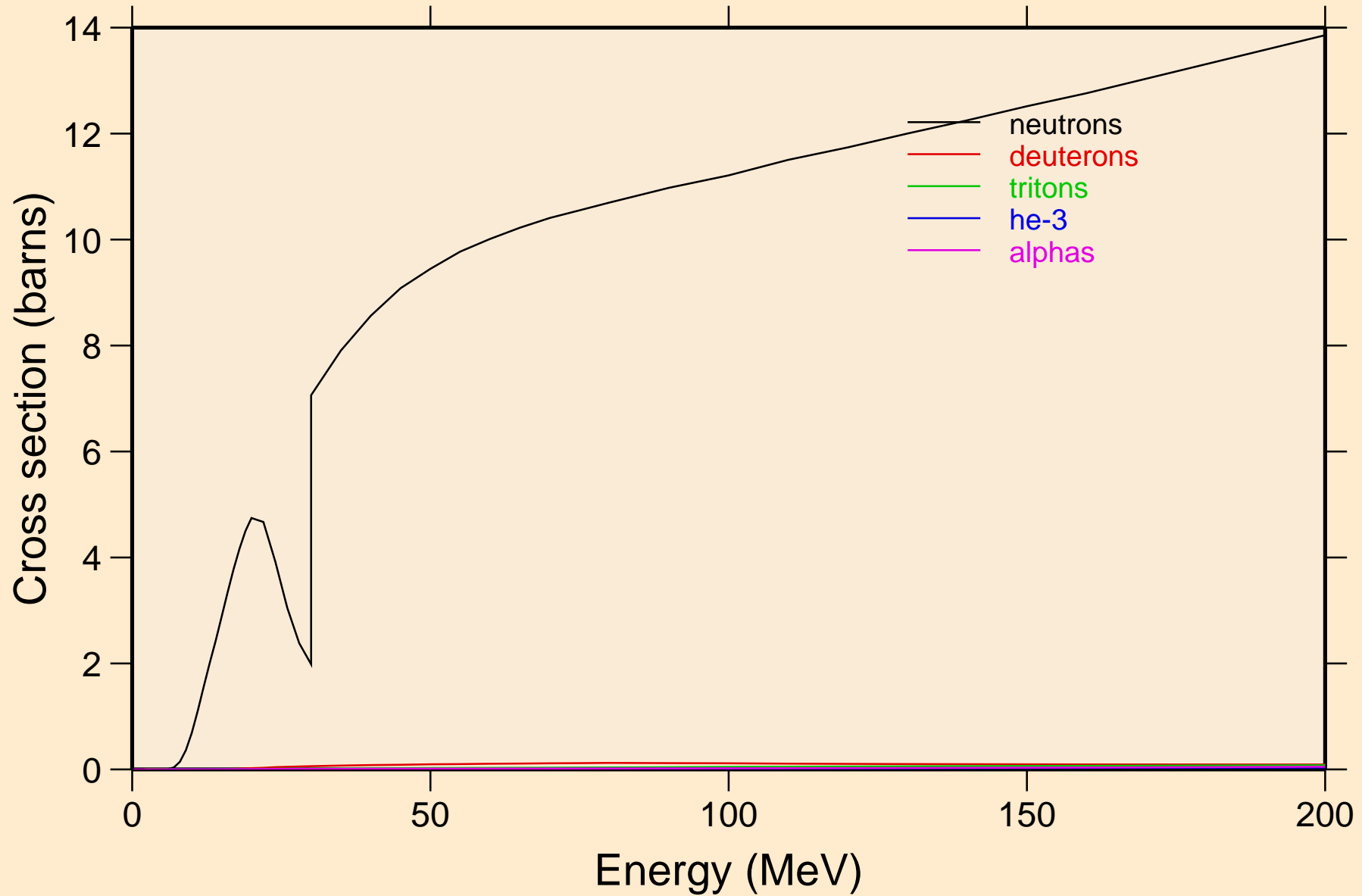

TA192 PROTON ACER TENDL-2024 LIBRARY; T=0.K  
neutrons from (p,n)

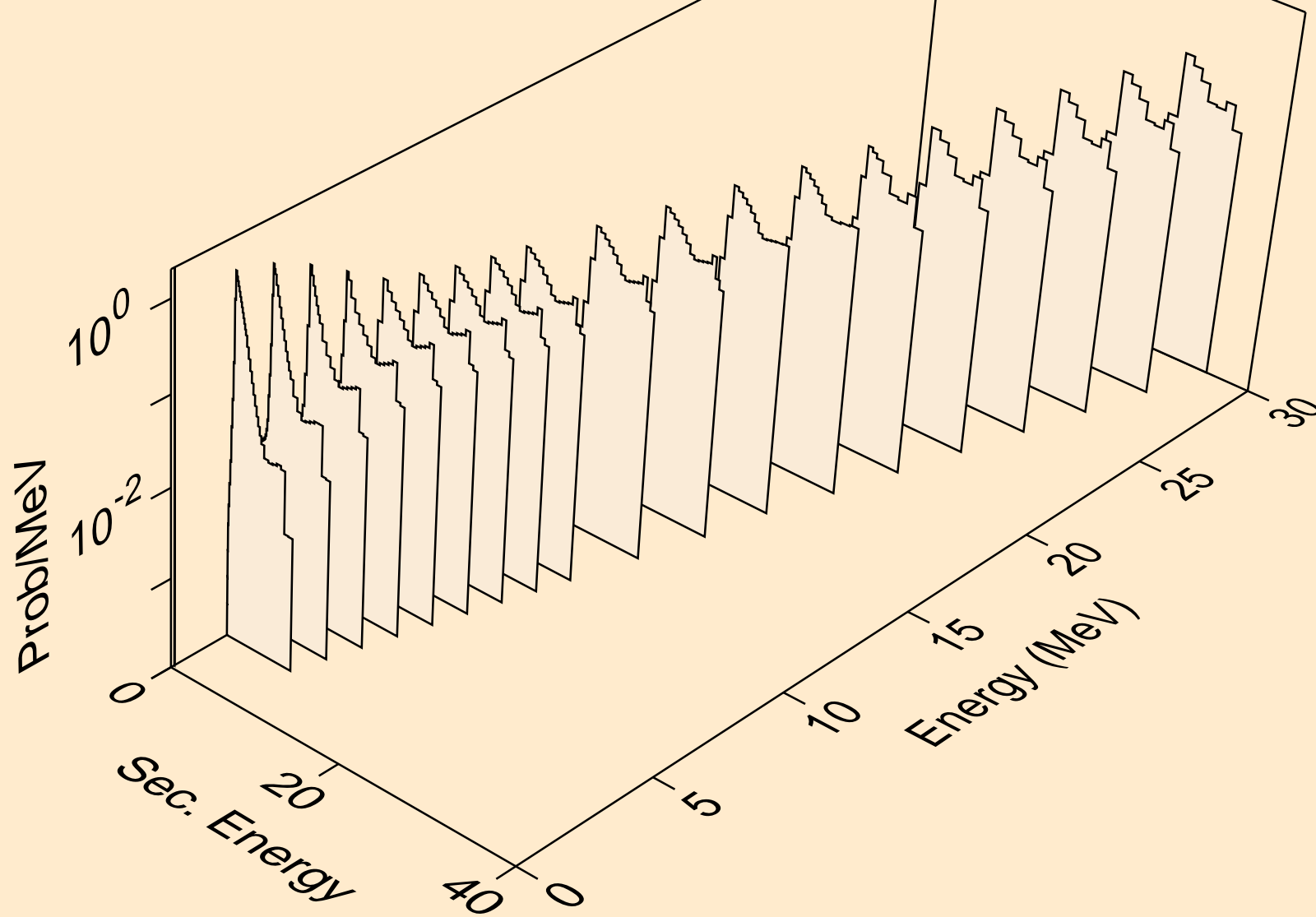

TA192 PROTON ACER TENDL-2024 LIBRARY; T=0.K  
neutrons from (p,x)

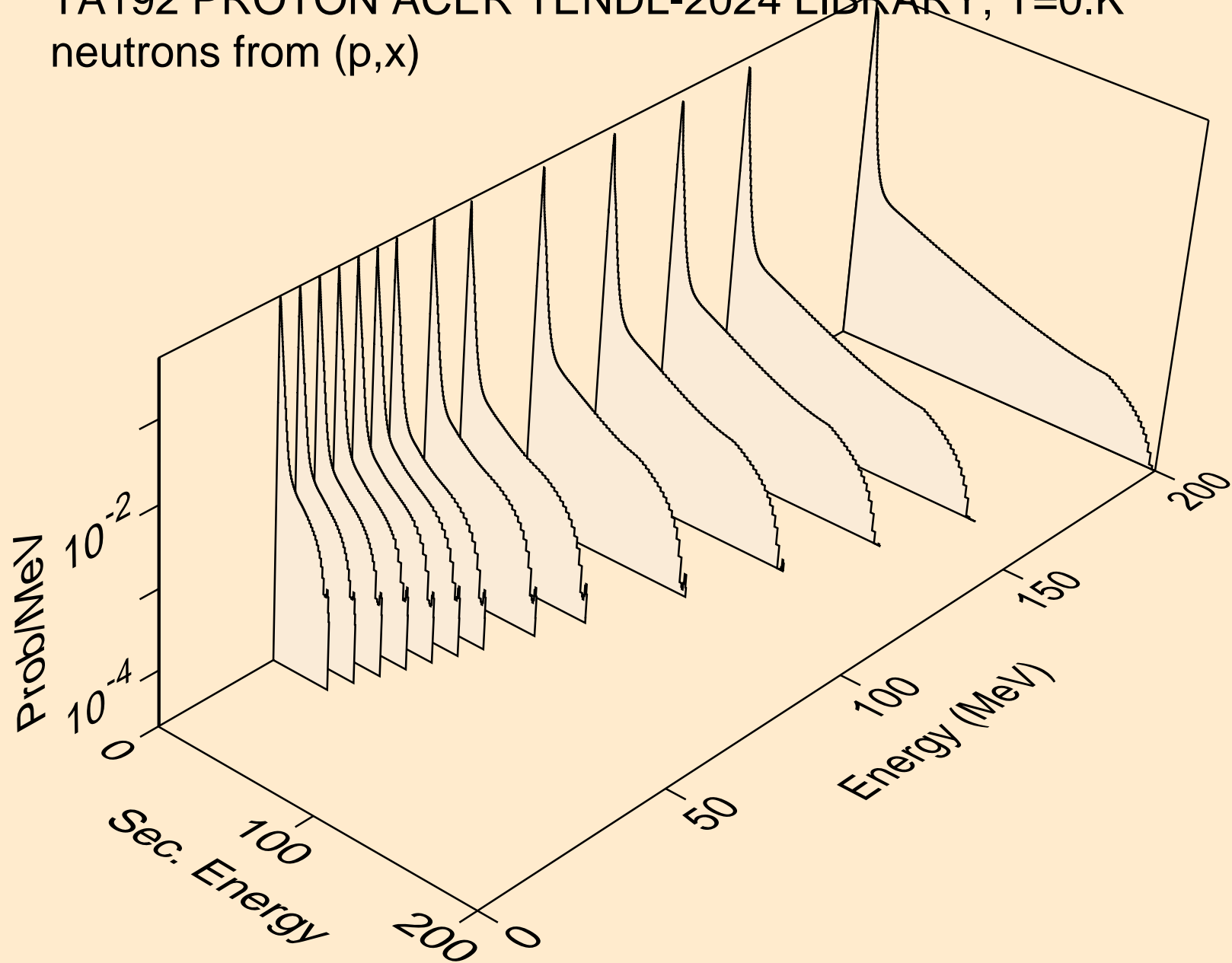

TA192 PROTON ACER TENDL-2024 LIBRARY; T=0.K  
neutrons from (p,2nd)

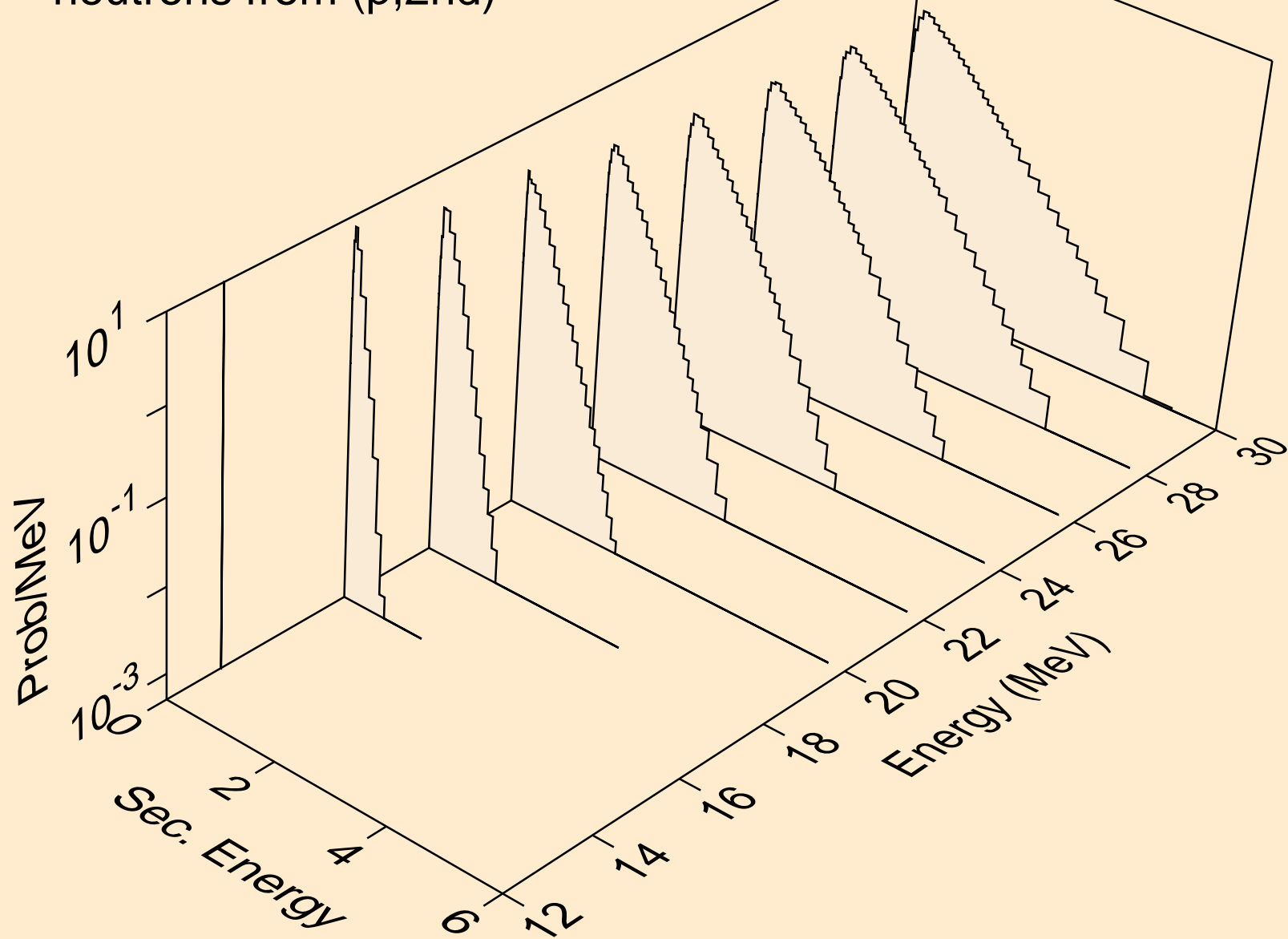

TA192 PROTON ACER TENDL-2024 LIBRARY; T=0.K  
neutrons from (p,2n)

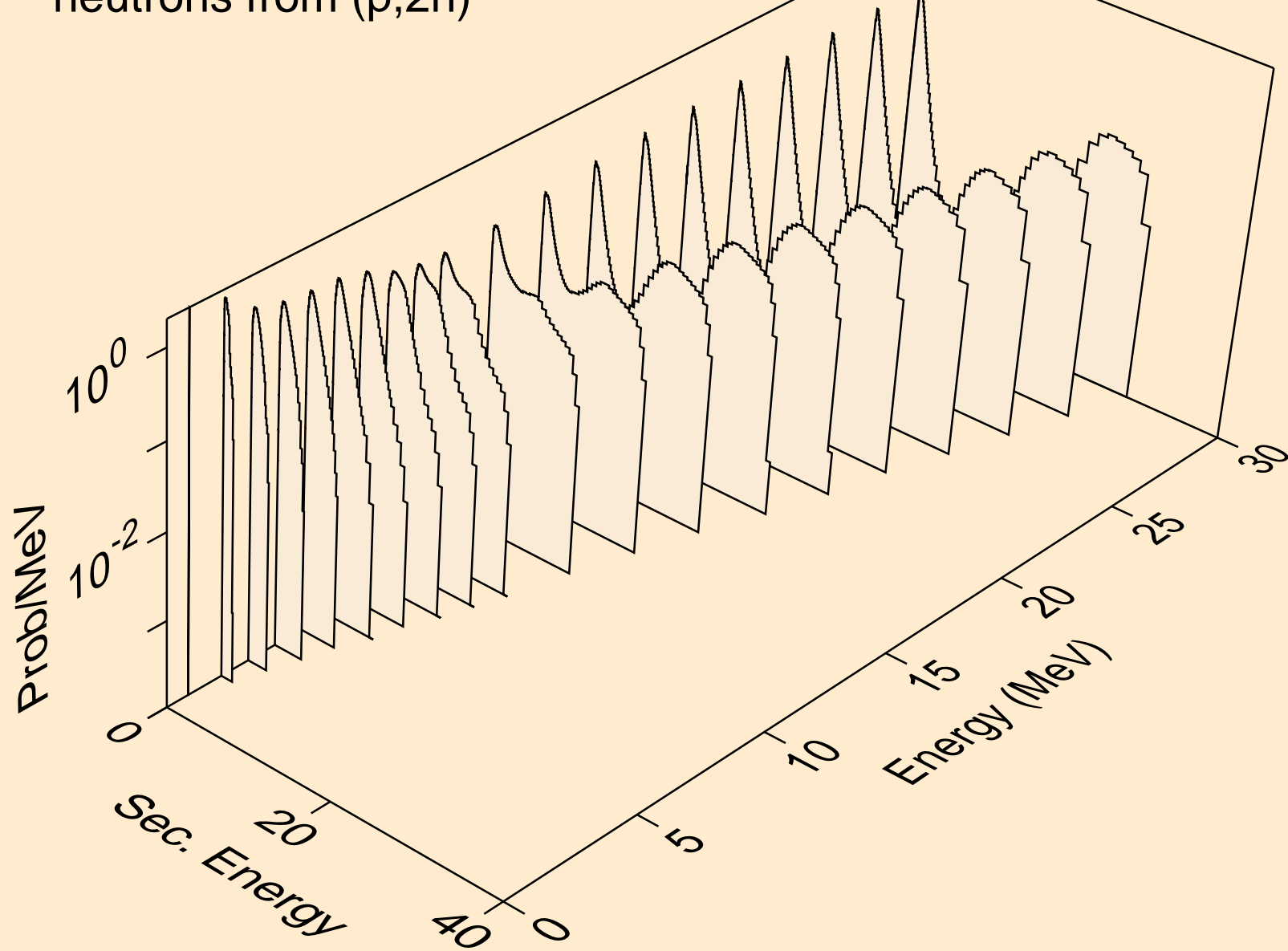

TA192 PROTON ACER TENDL-2024 LIBRARY; T=0.K  
neutrons from (p,3n)

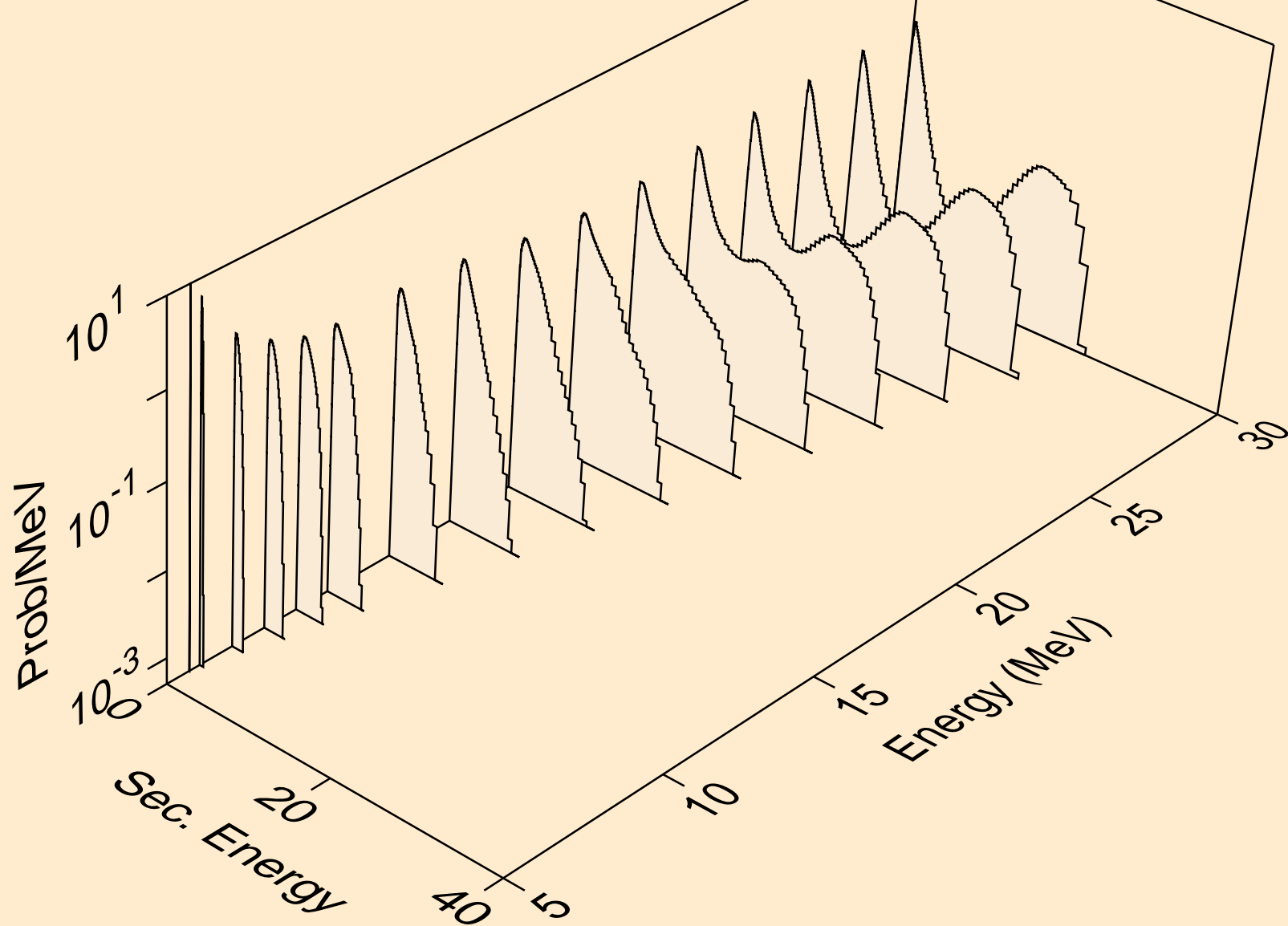

TA192 PROTON ACER TENDL-2024 LIBRARY; T=0.K  
neutrons from (p,n\*)a

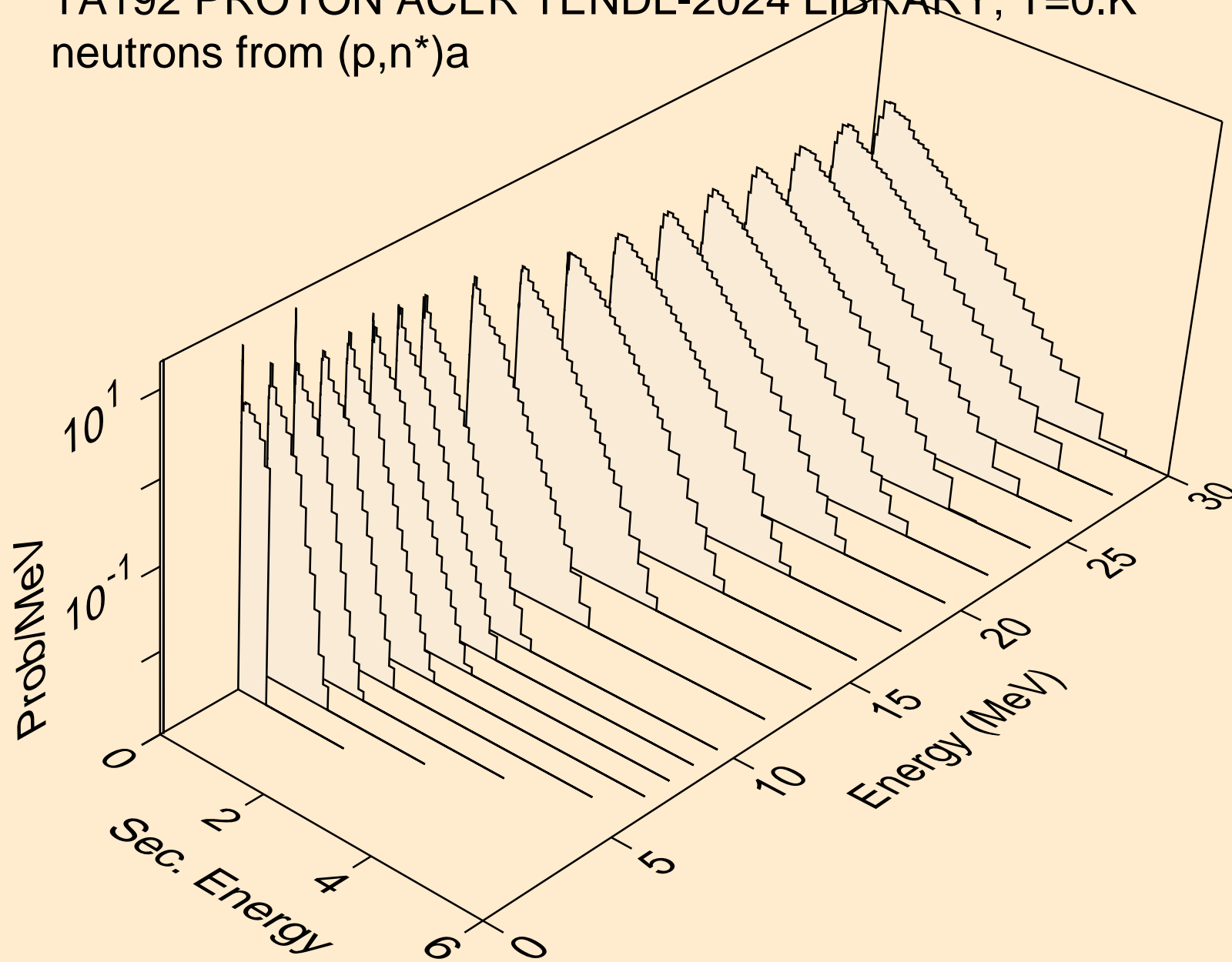

TA192 PROTON ACER TENDL-2024 LIBRARY; T=0.K  
neutrons from (p,2n)a

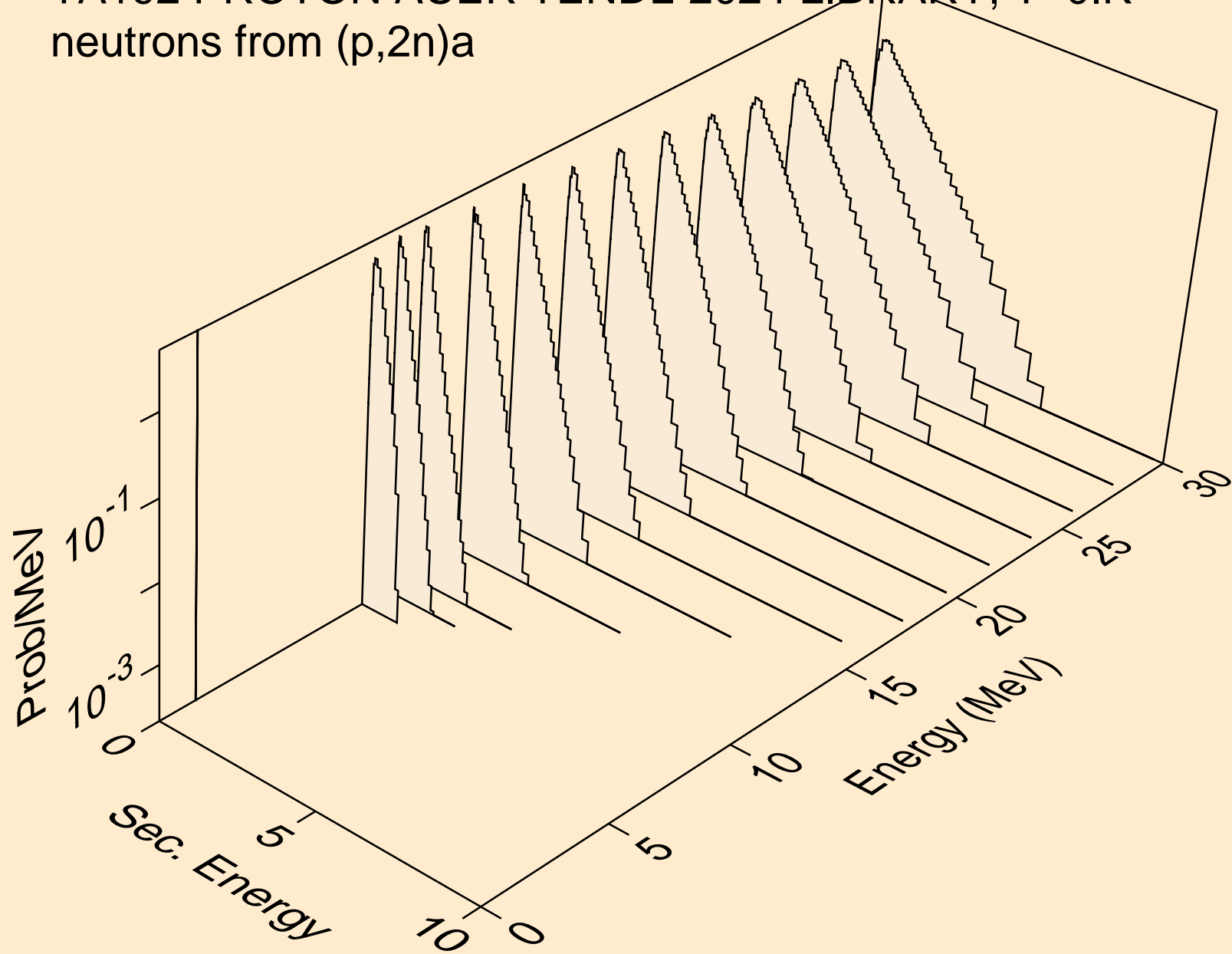

TA192 PROTON ACER TENDL-2024 LIBRARY; T=0.K  
neutrons from (p,3n)a

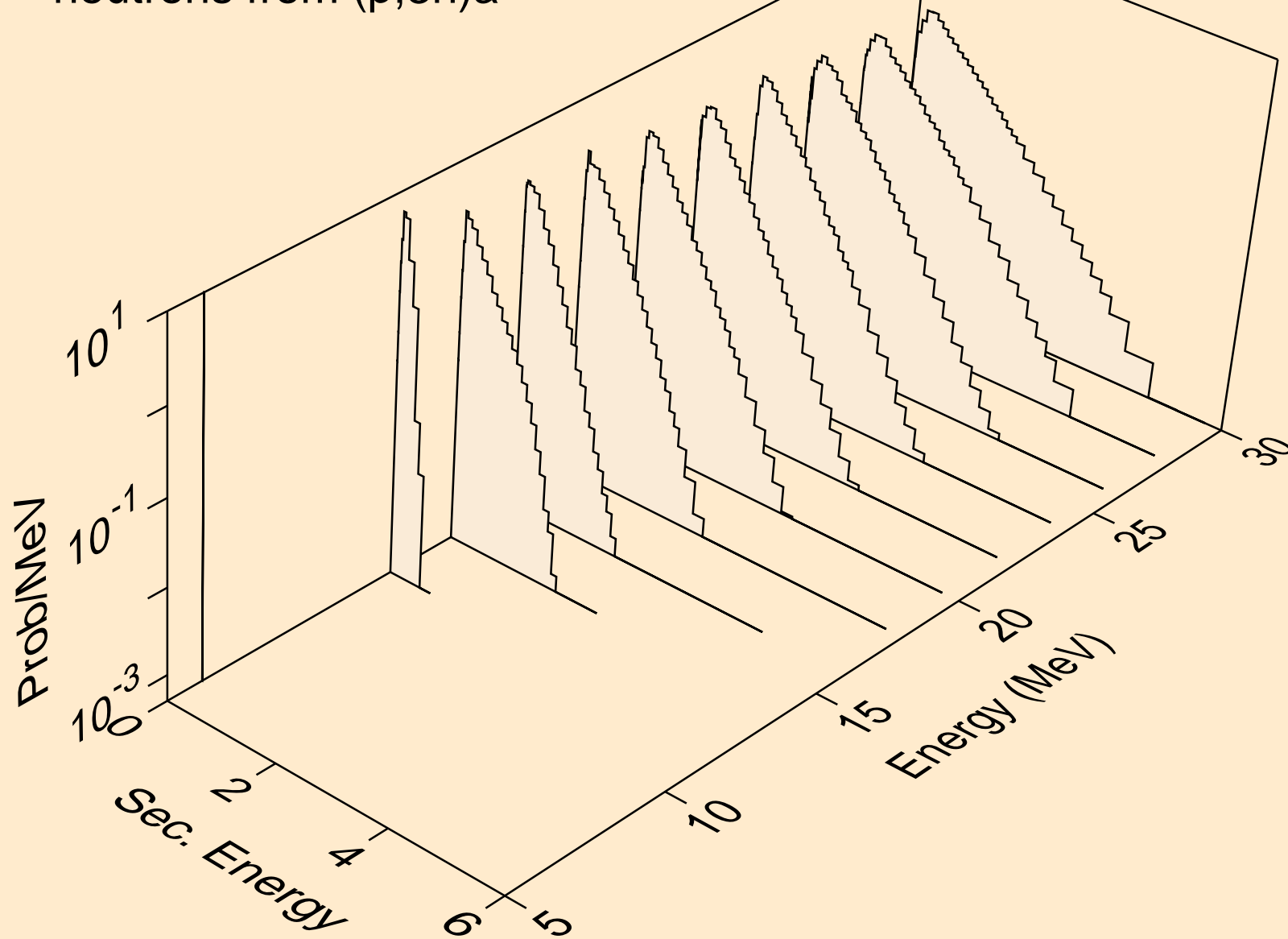

TA192 PROTON ACER TENDL-2024 LIBRARY; T=0.K  
neutrons from (p,n\*)p

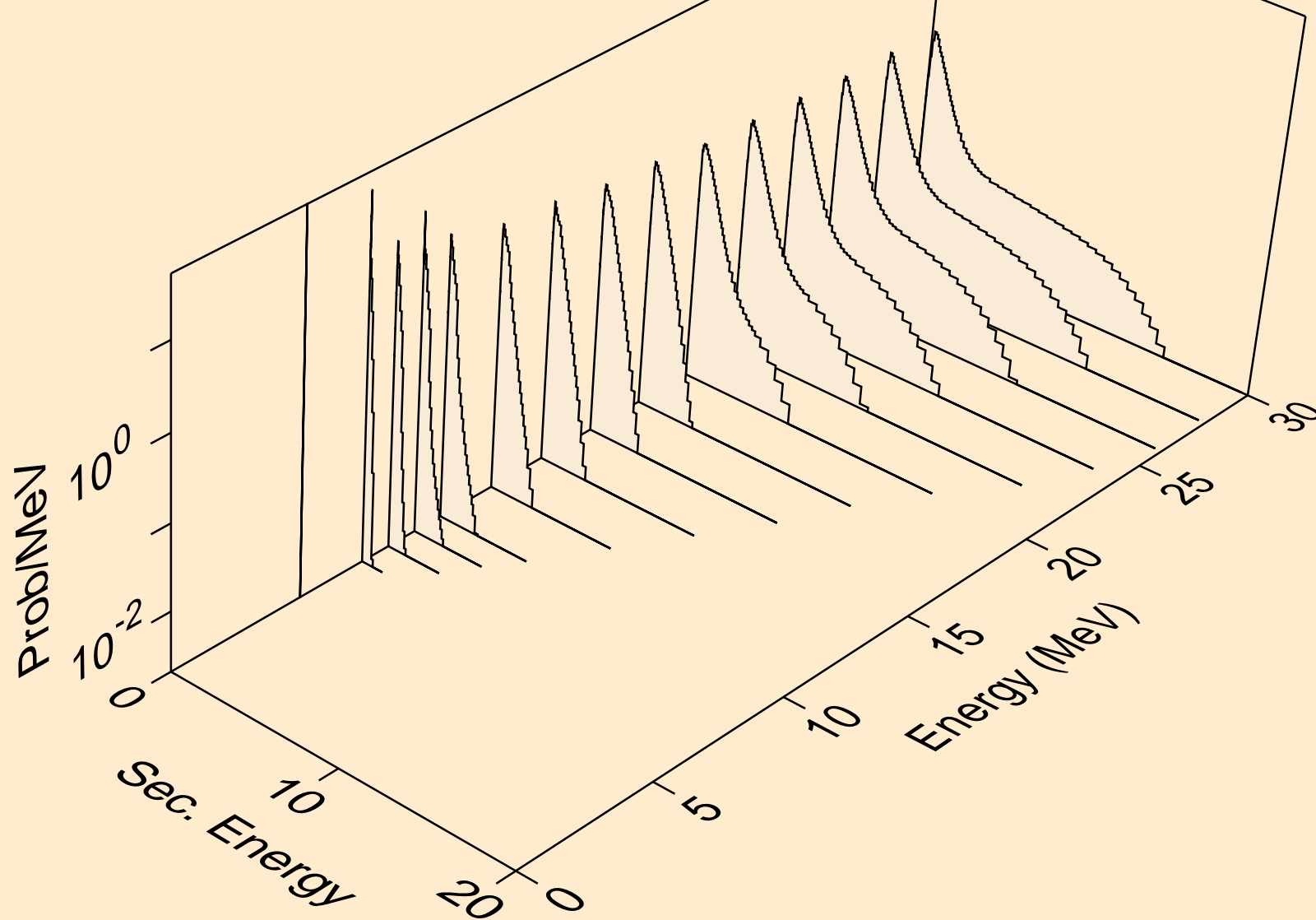

TA192 PROTON ACER TENDL-2024 LIBRARY; T=0.K  
neutrons from (p,n\*)d

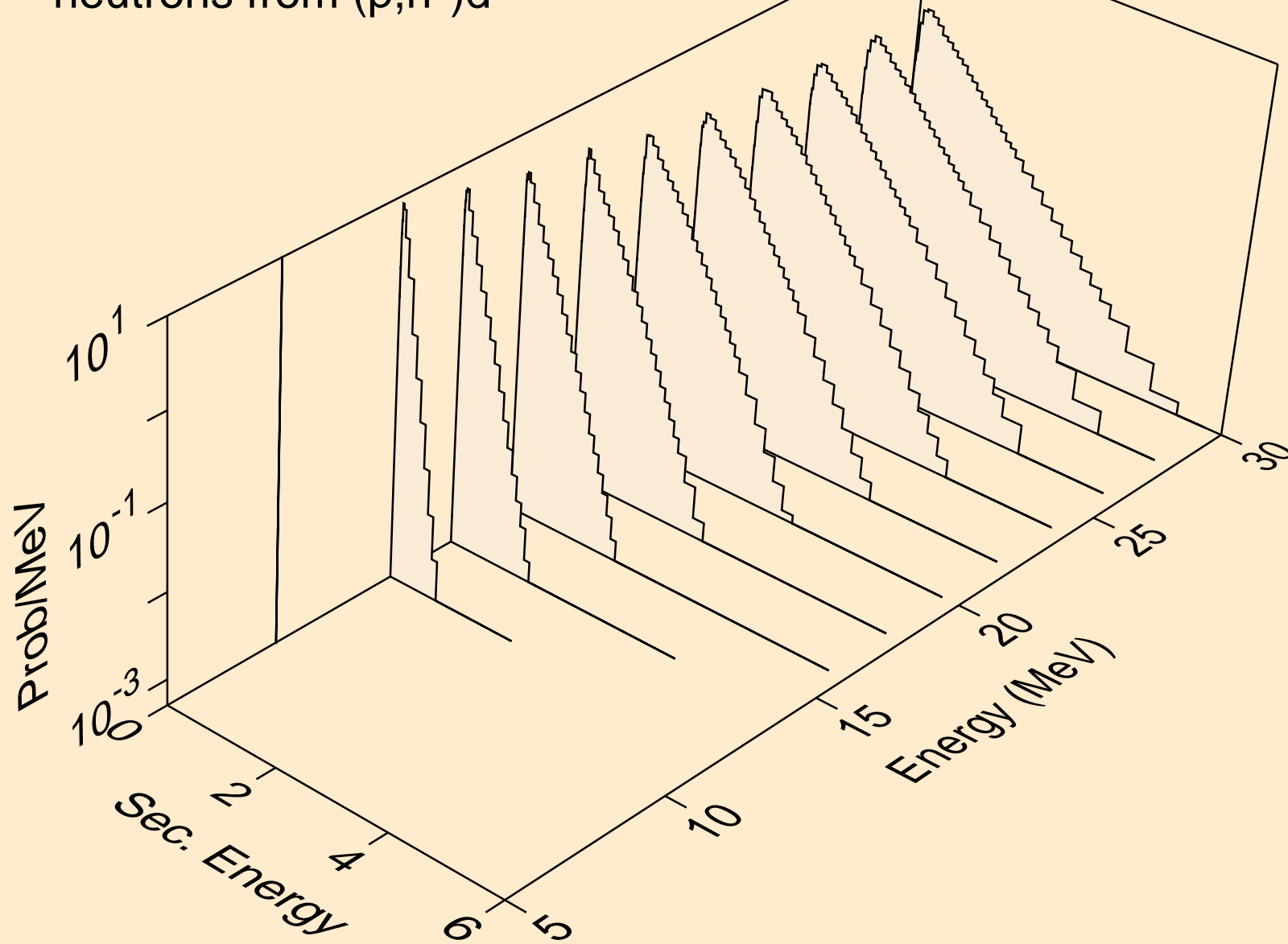

TA192 PROTON ACER TENDL-2024 LIBRARY; T=0.K  
neutrons from (p,n\*)t

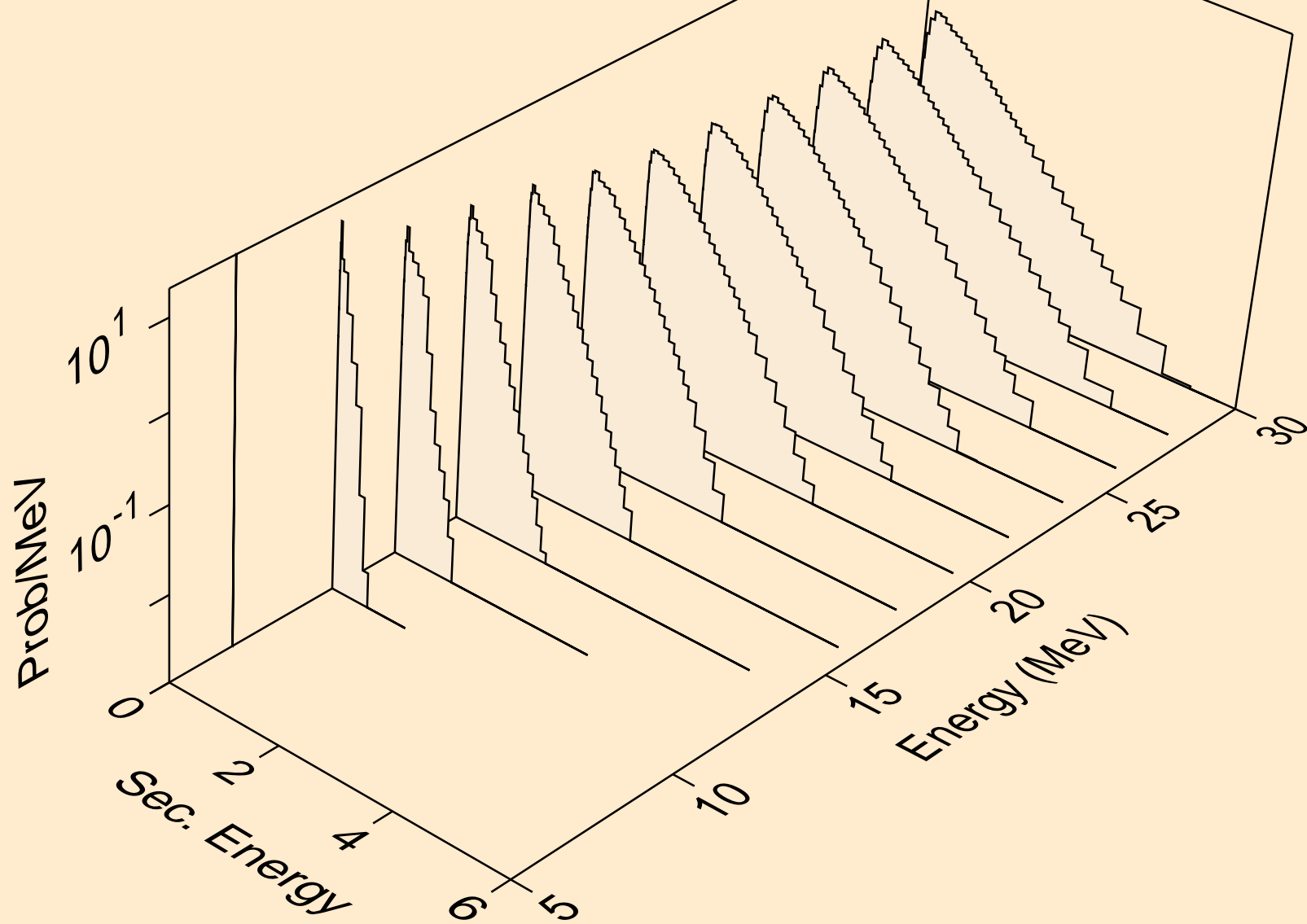

TA192 PROTON ACER TENDL-2024 LIBRARY; T=0.K  
neutrons from (p,n\*)he3

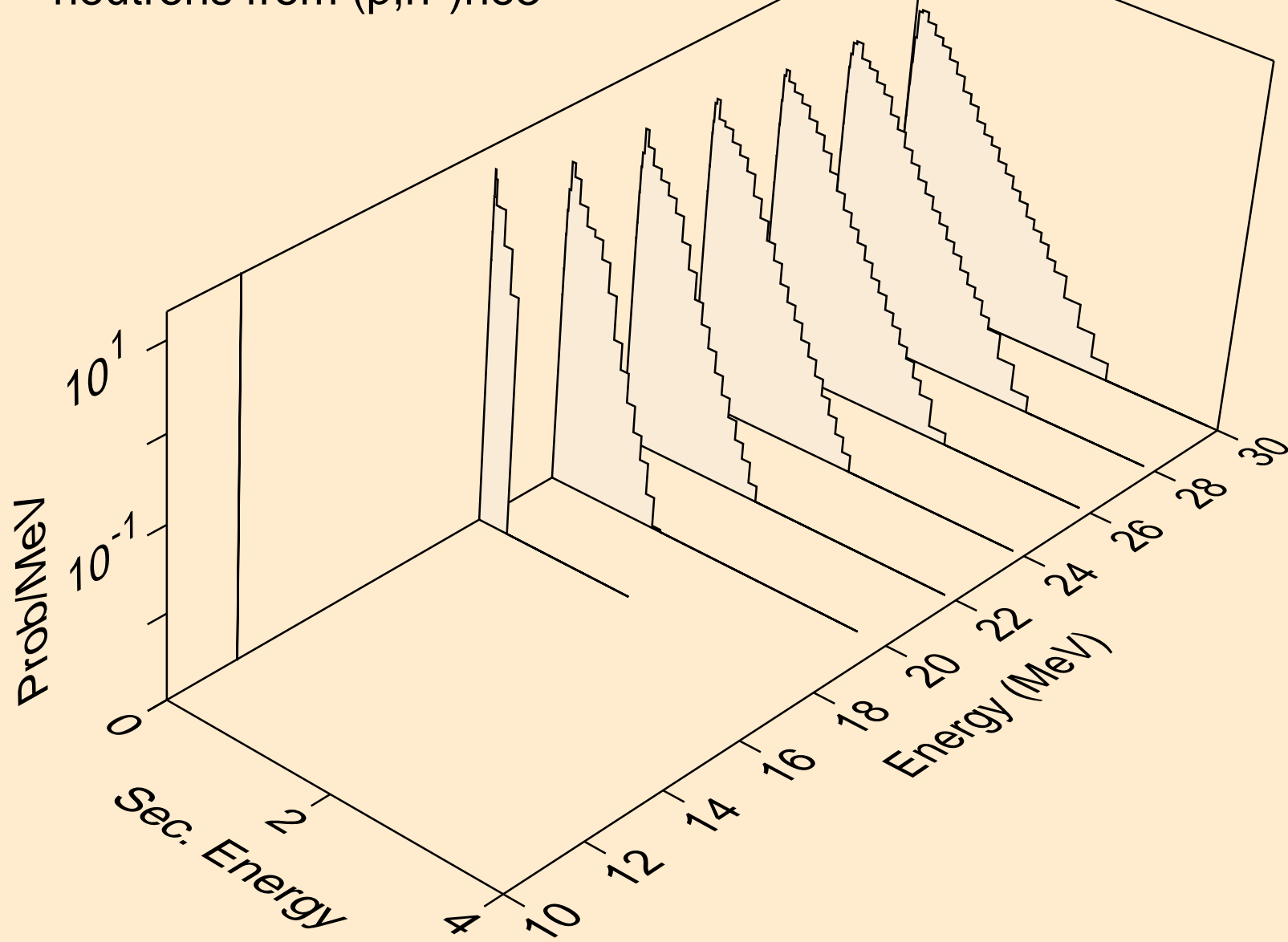

TA192 PROTON ACER TENDL-2024 LIBRARY; T=0.K  
neutrons from (p,4n)

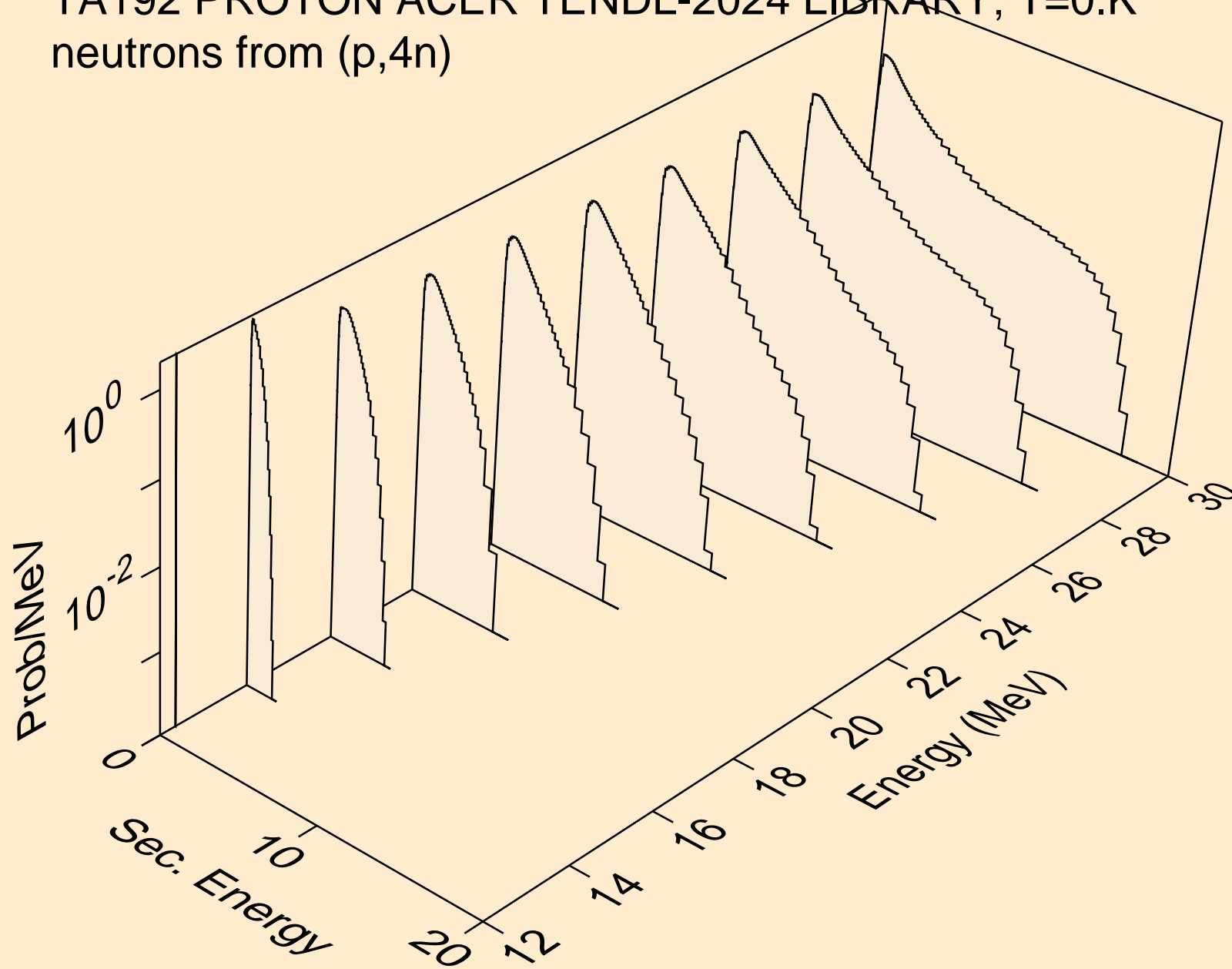

TA192 PROTON ACER TENDL-2024 LIBRARY; T=0.K  
neutrons from (p,2np)

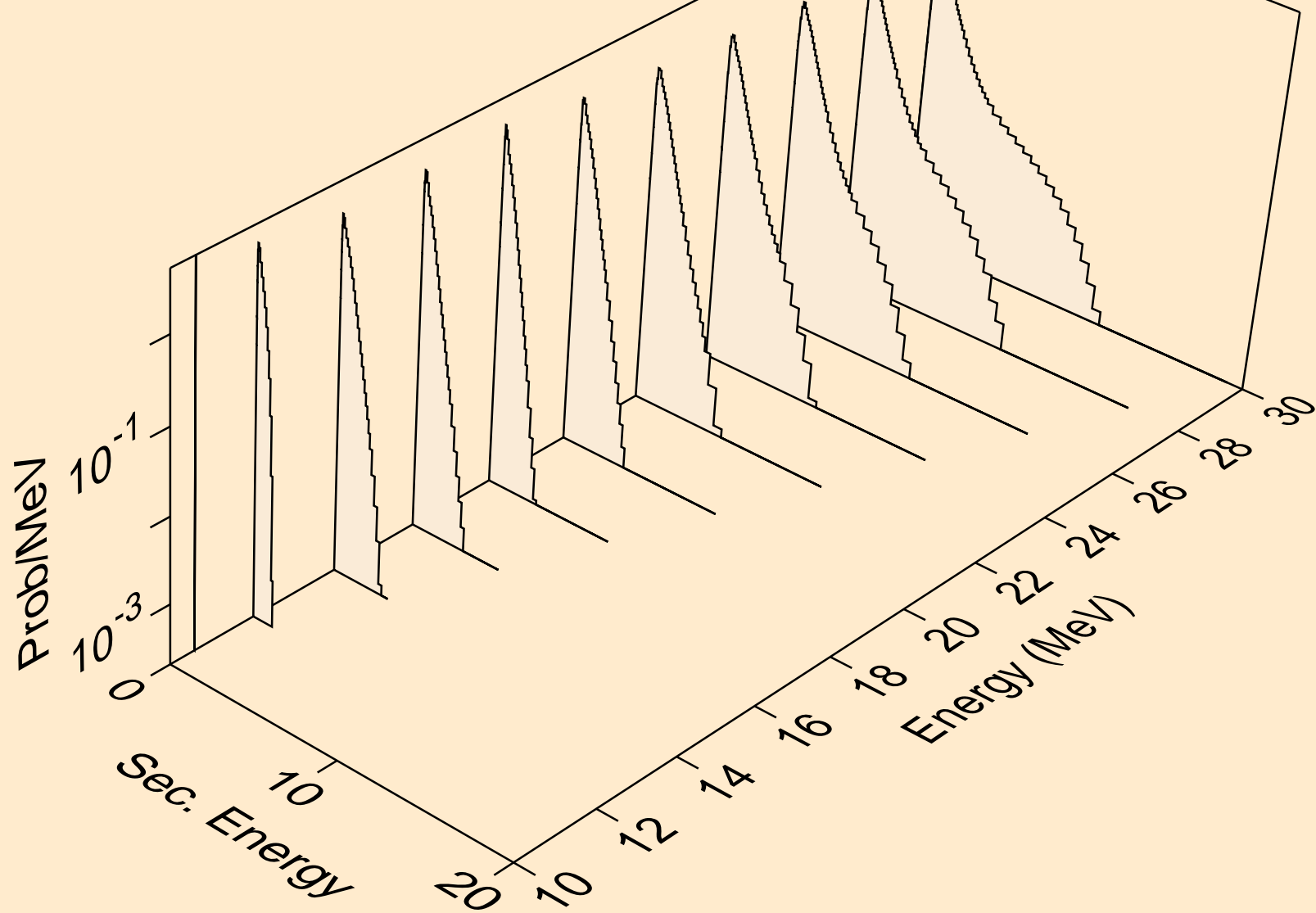

TA192 PROTON ACER TENDL-2024 LIBRARY; T=0.K  
neutrons from (p,3np)

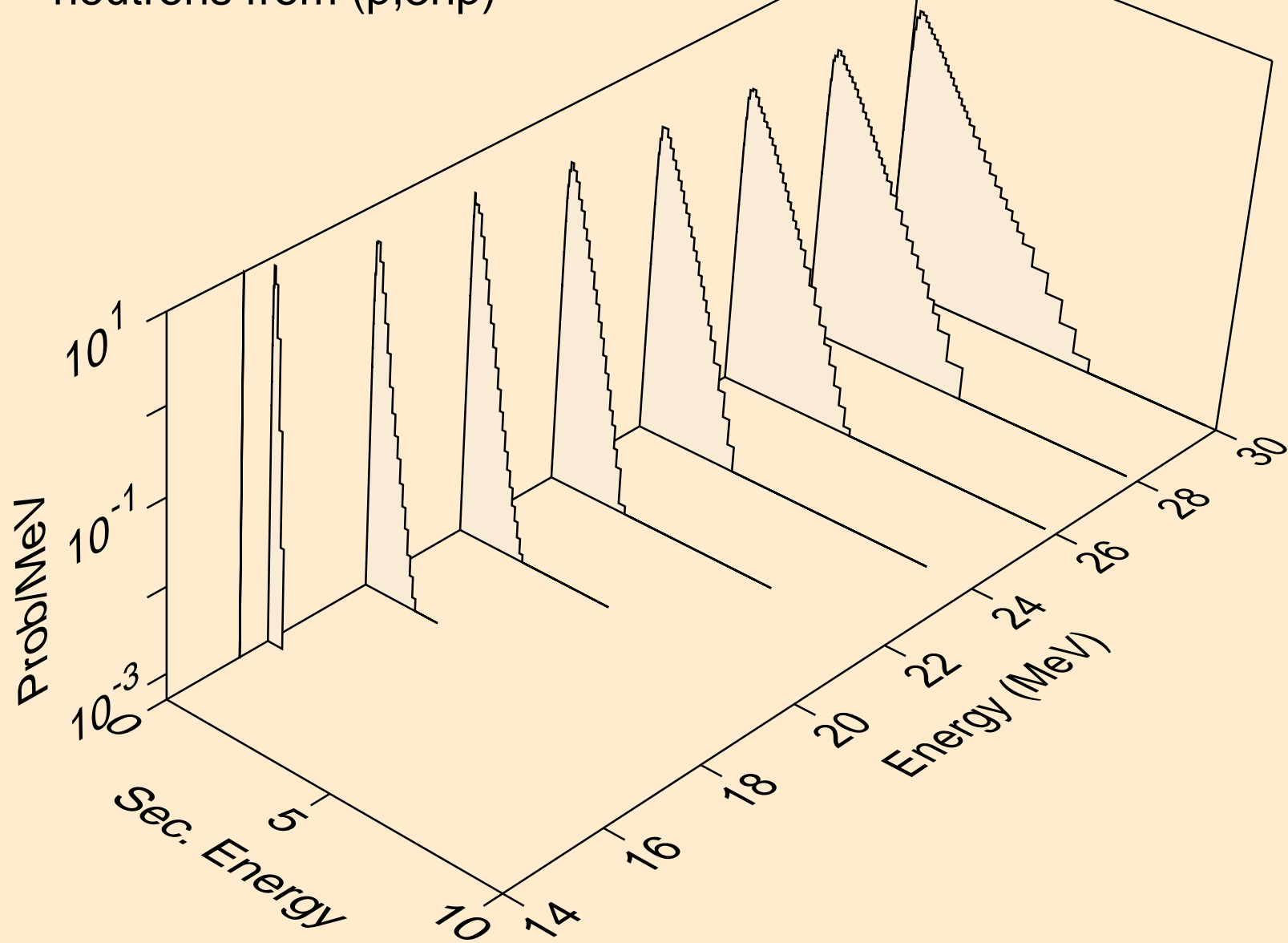

TA192 PROTON ACER TENDL-2024 LIBRARY; T=0.K  
neutrons from (p,n2p)

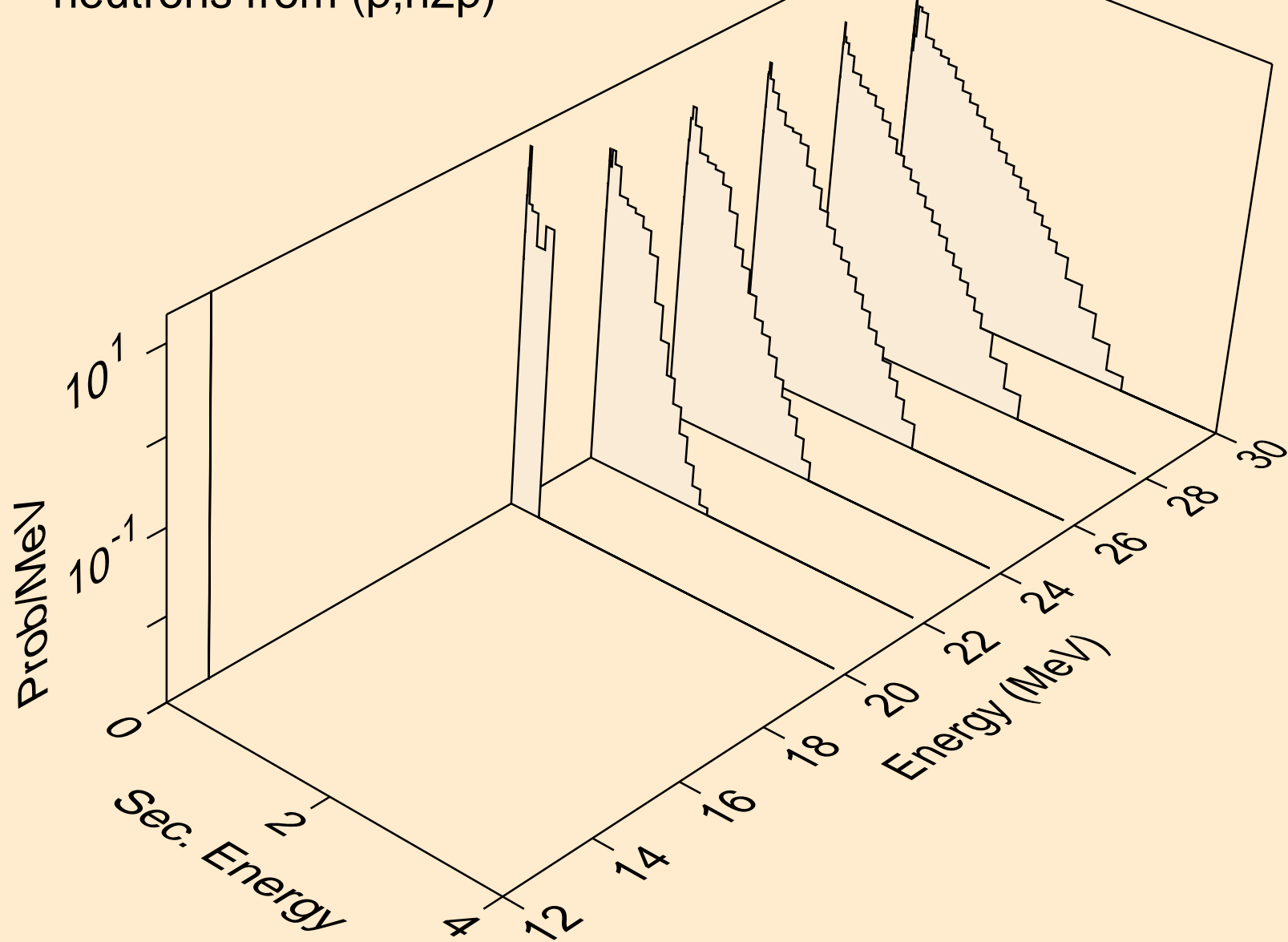

TA192 PROTON ACER TENDL-2024 LIBRARY; T=0.K  
deuterons from (p,x)

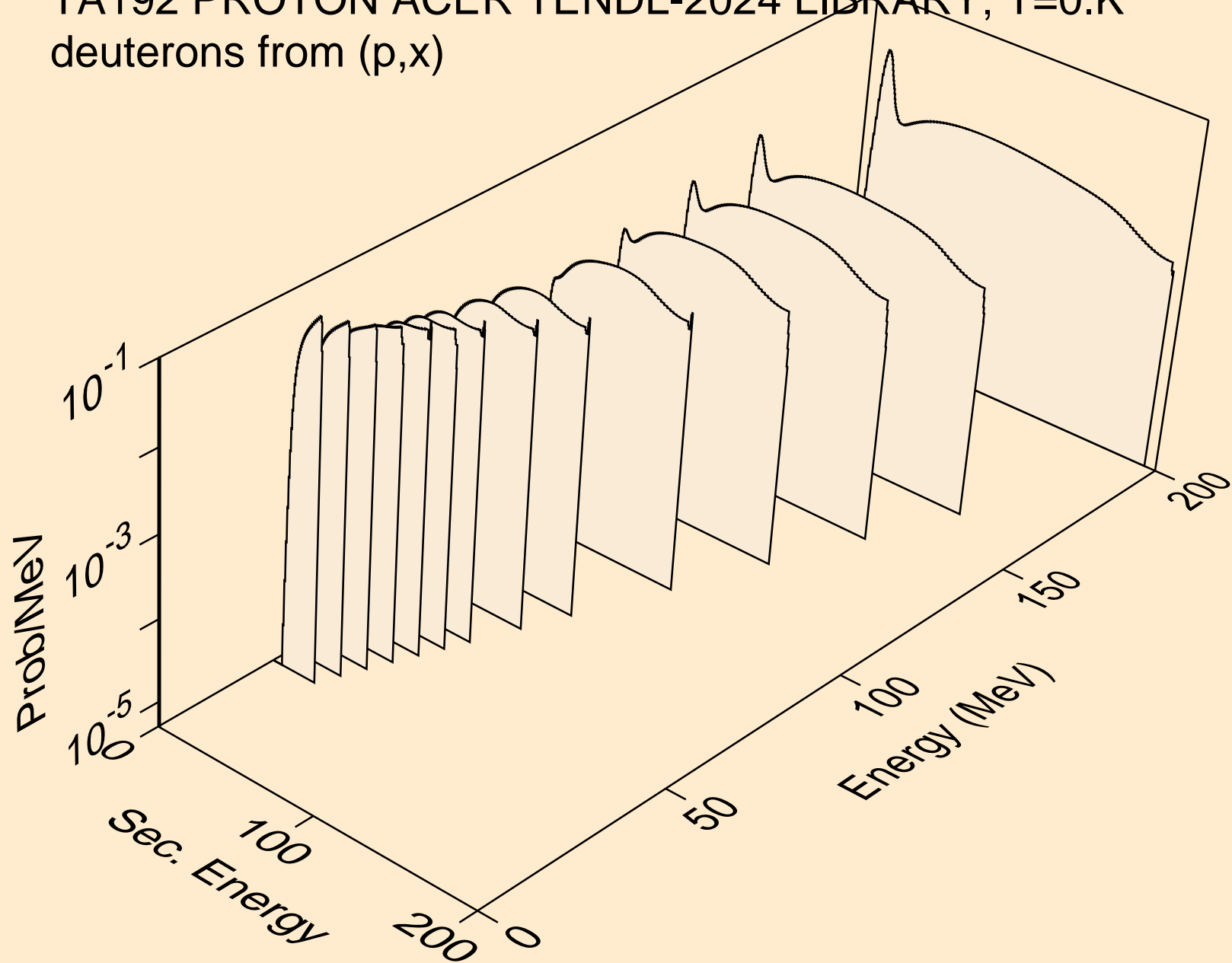

TA192 PROTON ACER TENDL-2024 LIBRARY; T=0.K  
deuterons from (p,2nd)

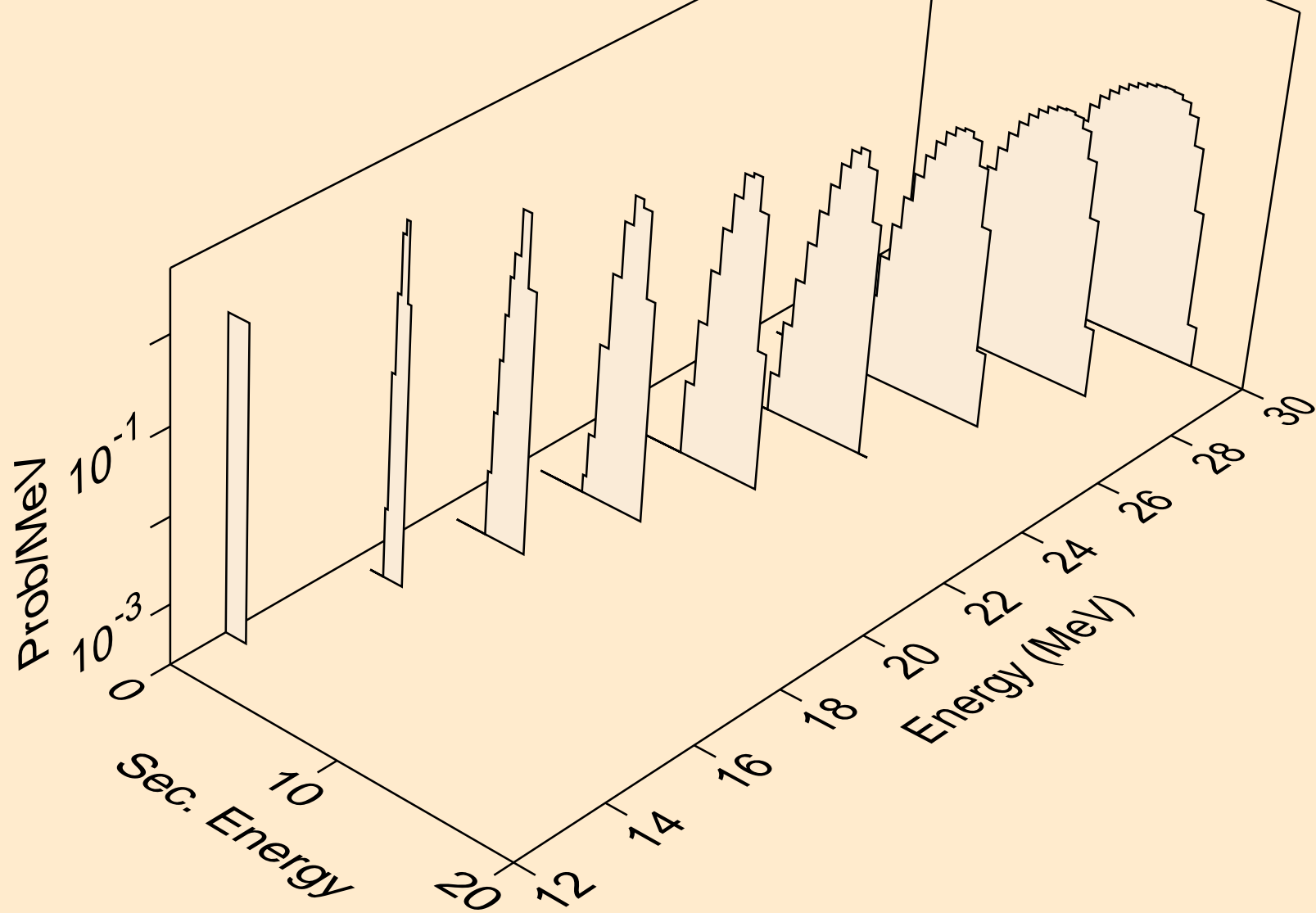

TA192 PROTON ACER TENDL-2024 LIBRARY; T=0.K  
deuterons from (p,n\*)d

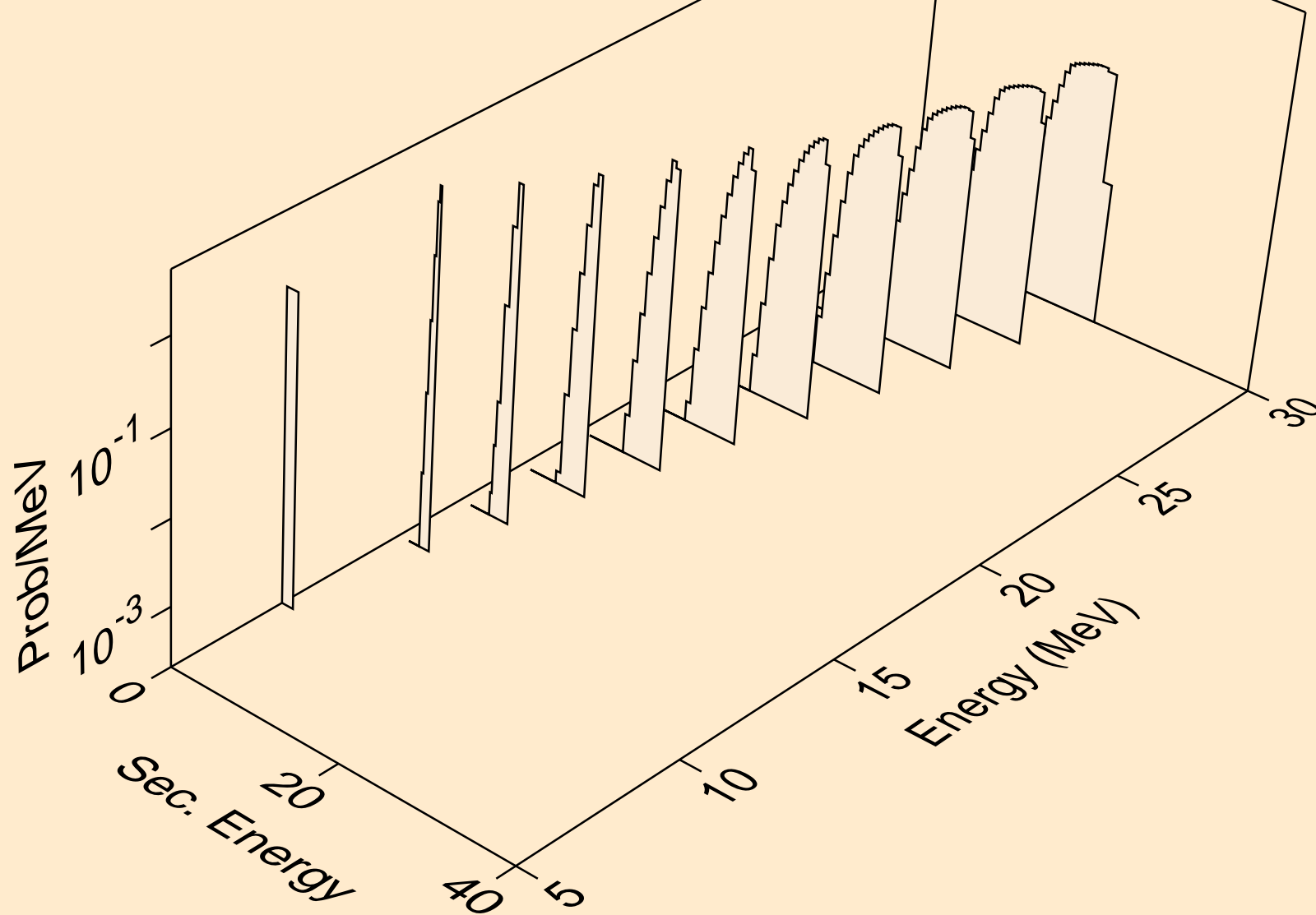

TA192 PROTON ACER TENDL-2024 LIBRARY; T=0.K  
deuterons from (p,d)

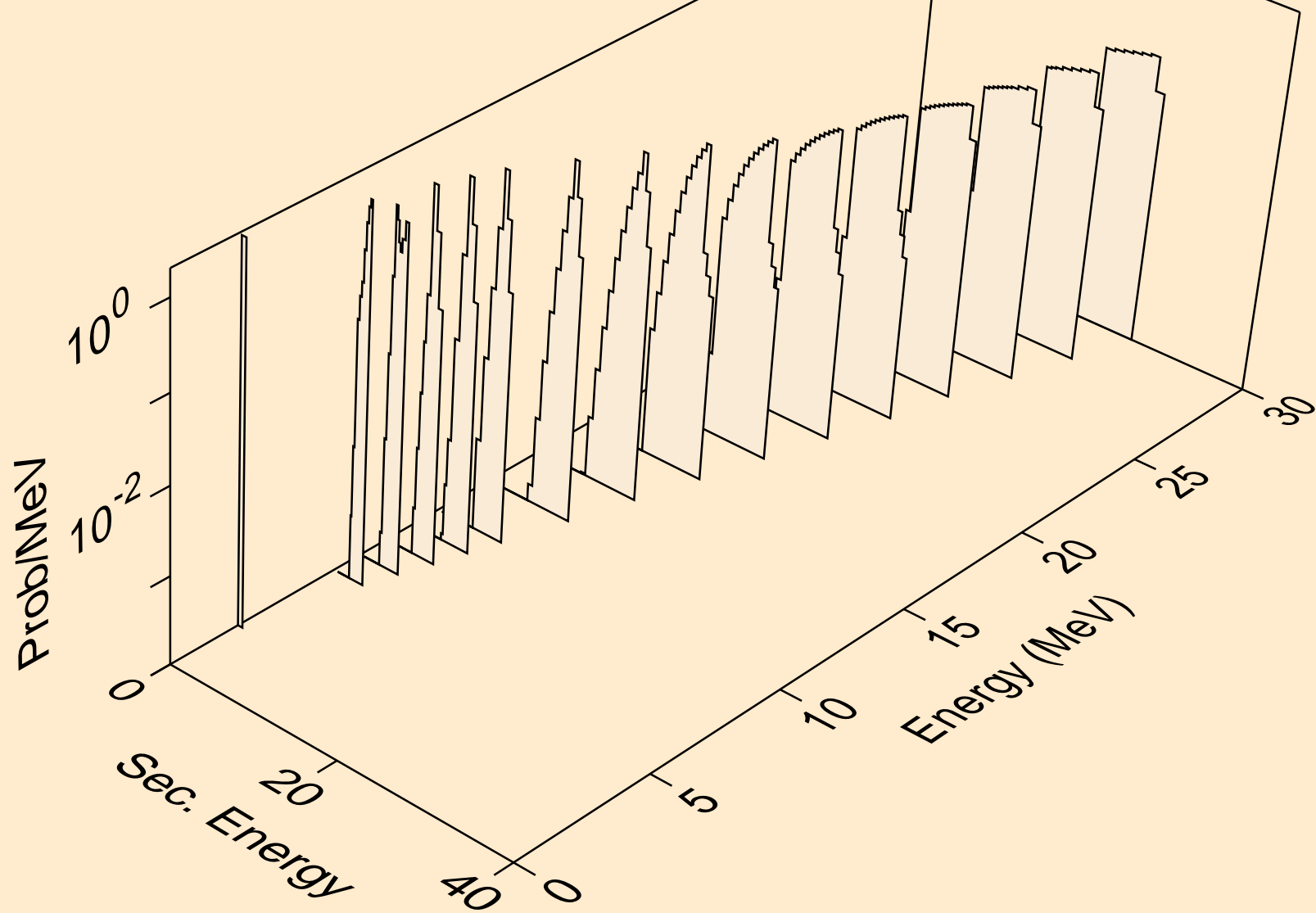

TA192 PROTON ACER TENDL-2024 LIBRARY; T=0.K  
deuterons from (p,pd)

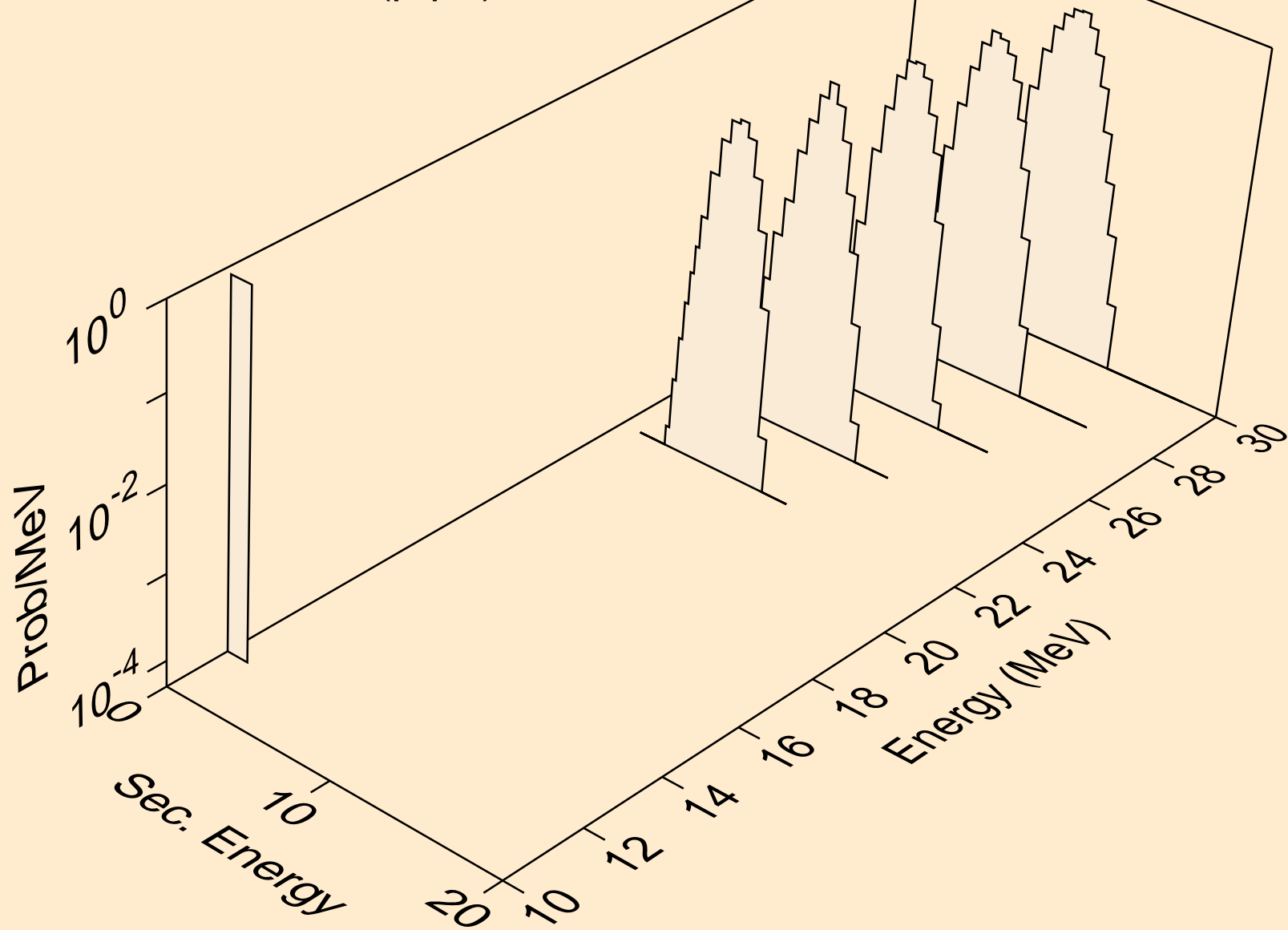

TA192 PROTON ACER TENDL-2024 LIBRARY; T=0.K  
tritons from (p,x)

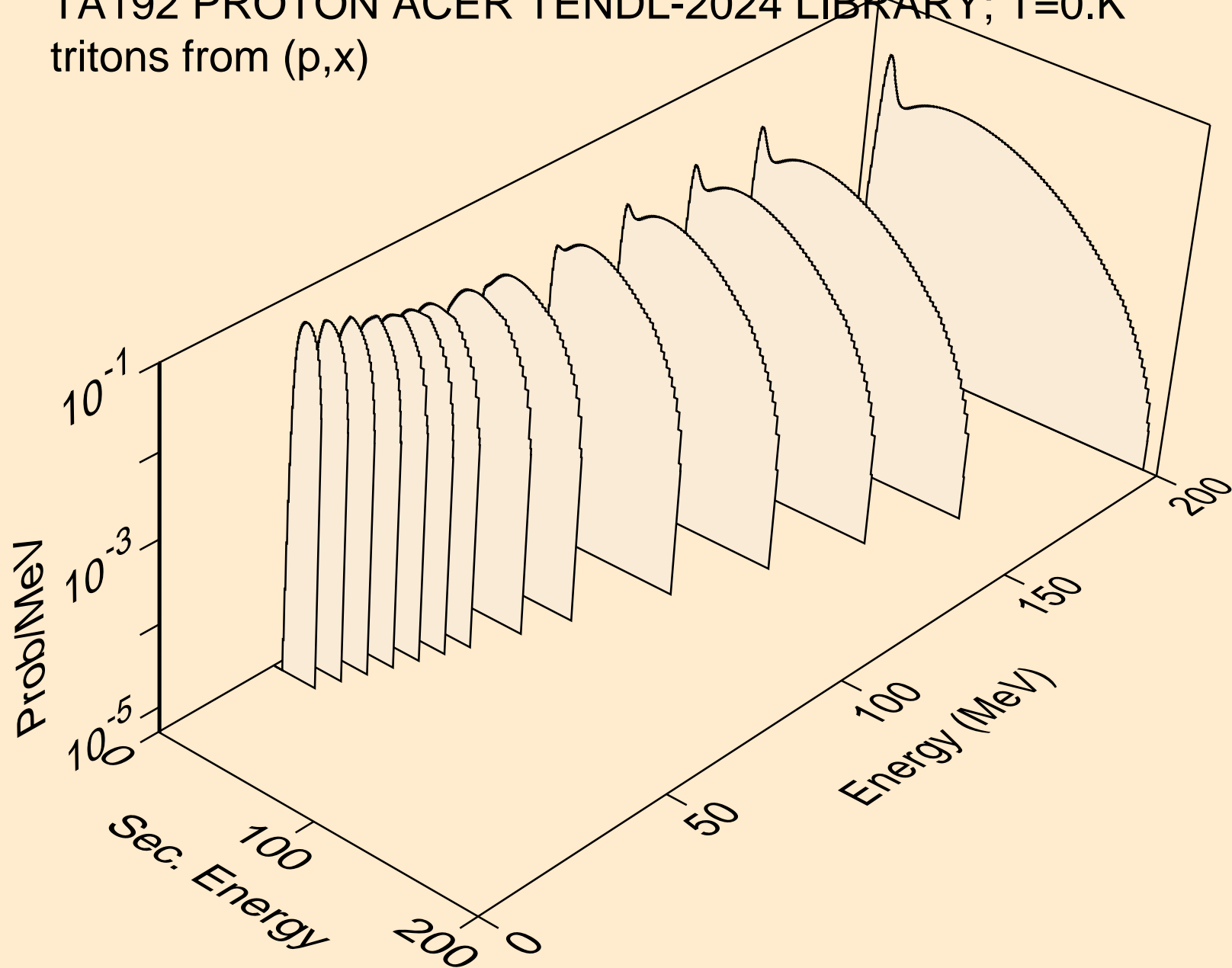

TA192 PROTON ACER TENDL-2024 LIBRARY; T=0.K  
tritons from (p,n\*)t

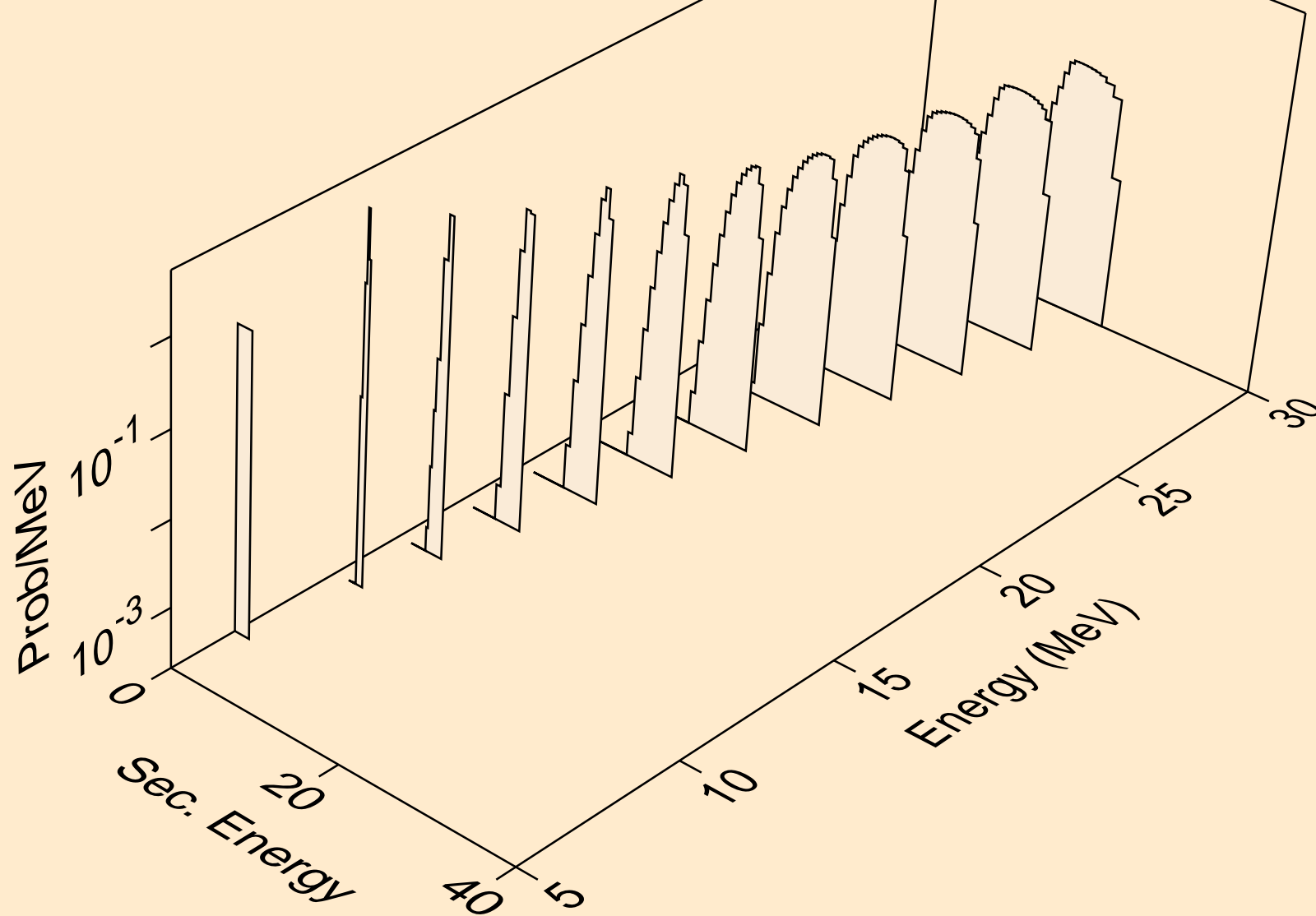

TA192 PROTON ACER TENDL-2024 LIBRARY; T=0.K  
tritons from (p,t)

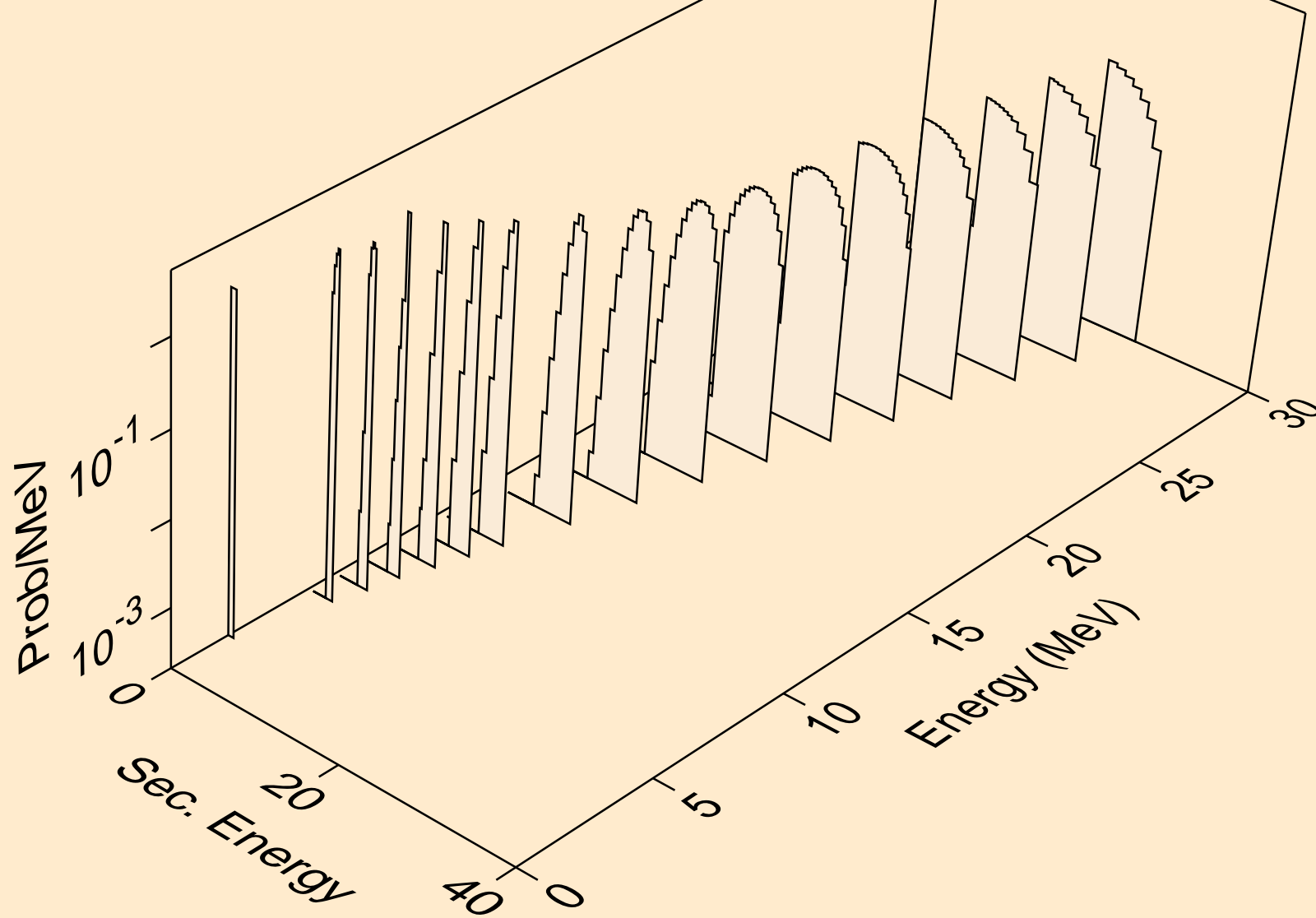

TA192 PROTON ACER TENDL-2024 LIBRARY; T=0.K  
he3s from (p,x)

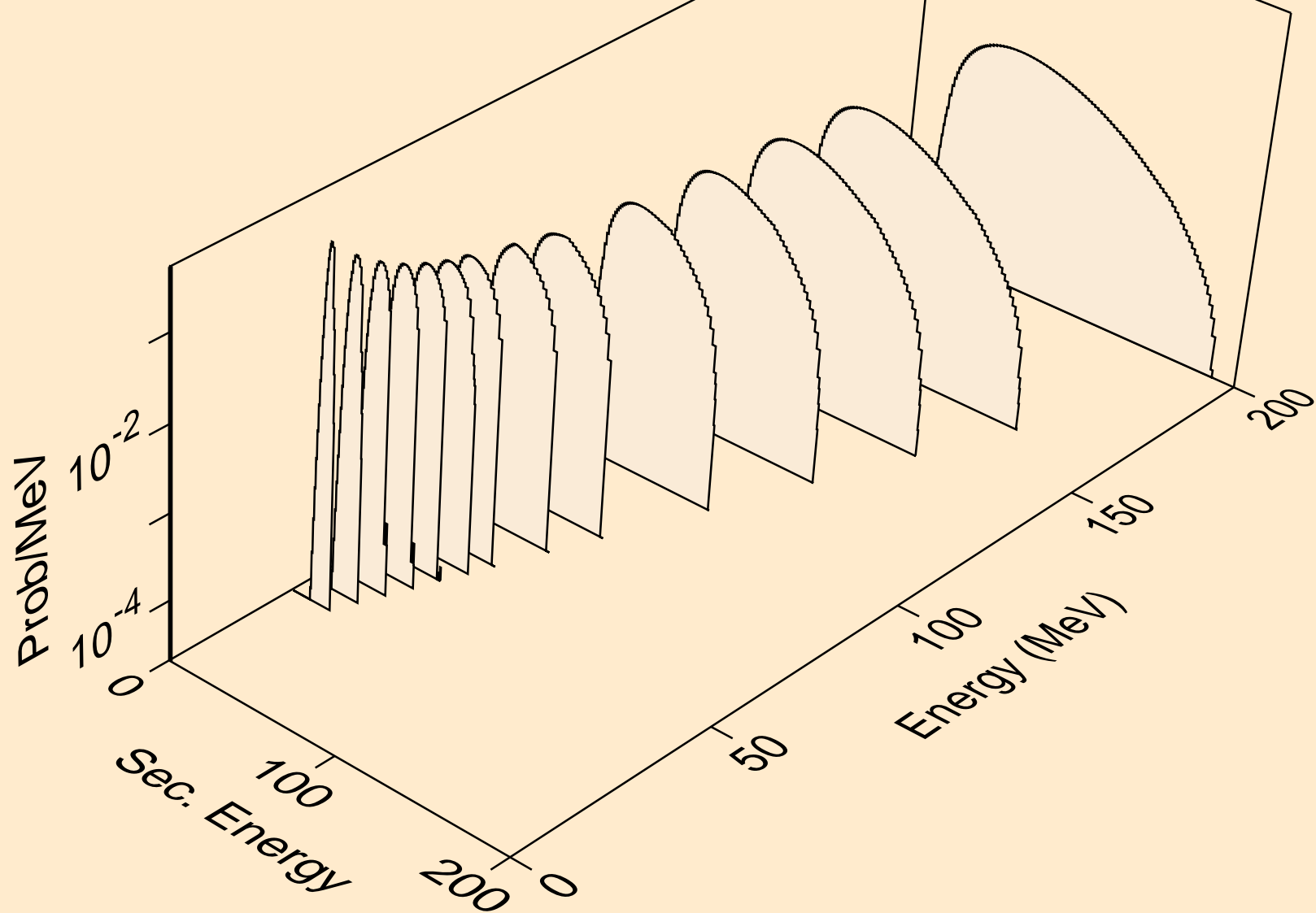

TA192 PROTON ACER TENDL-2024 LIBRARY; T=0.K  
he3s from (p,n\*)he3

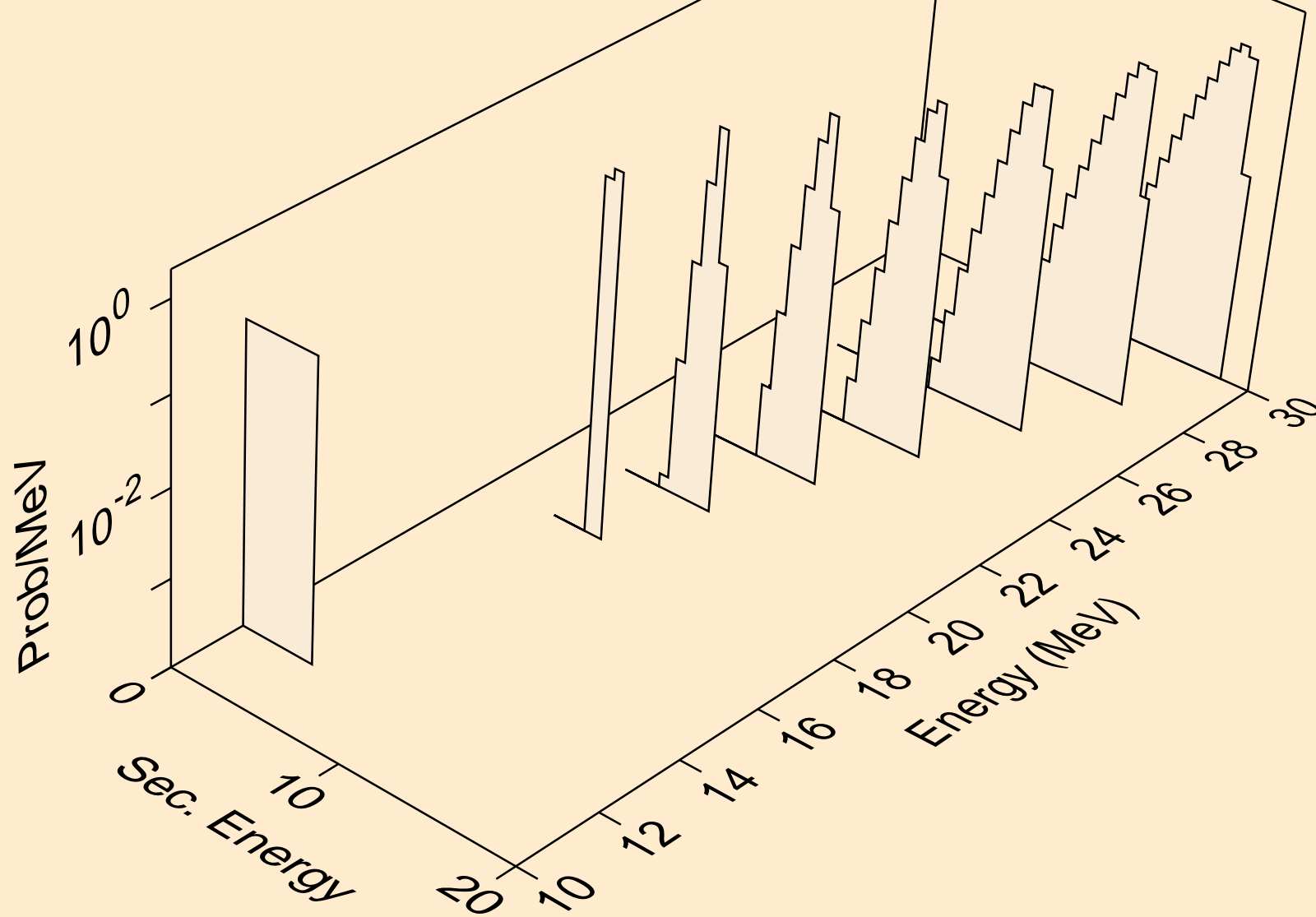

TA192 PROTON ACER TENDL-2024 LIBRARY; T=0.K  
he3s from (p,he3)

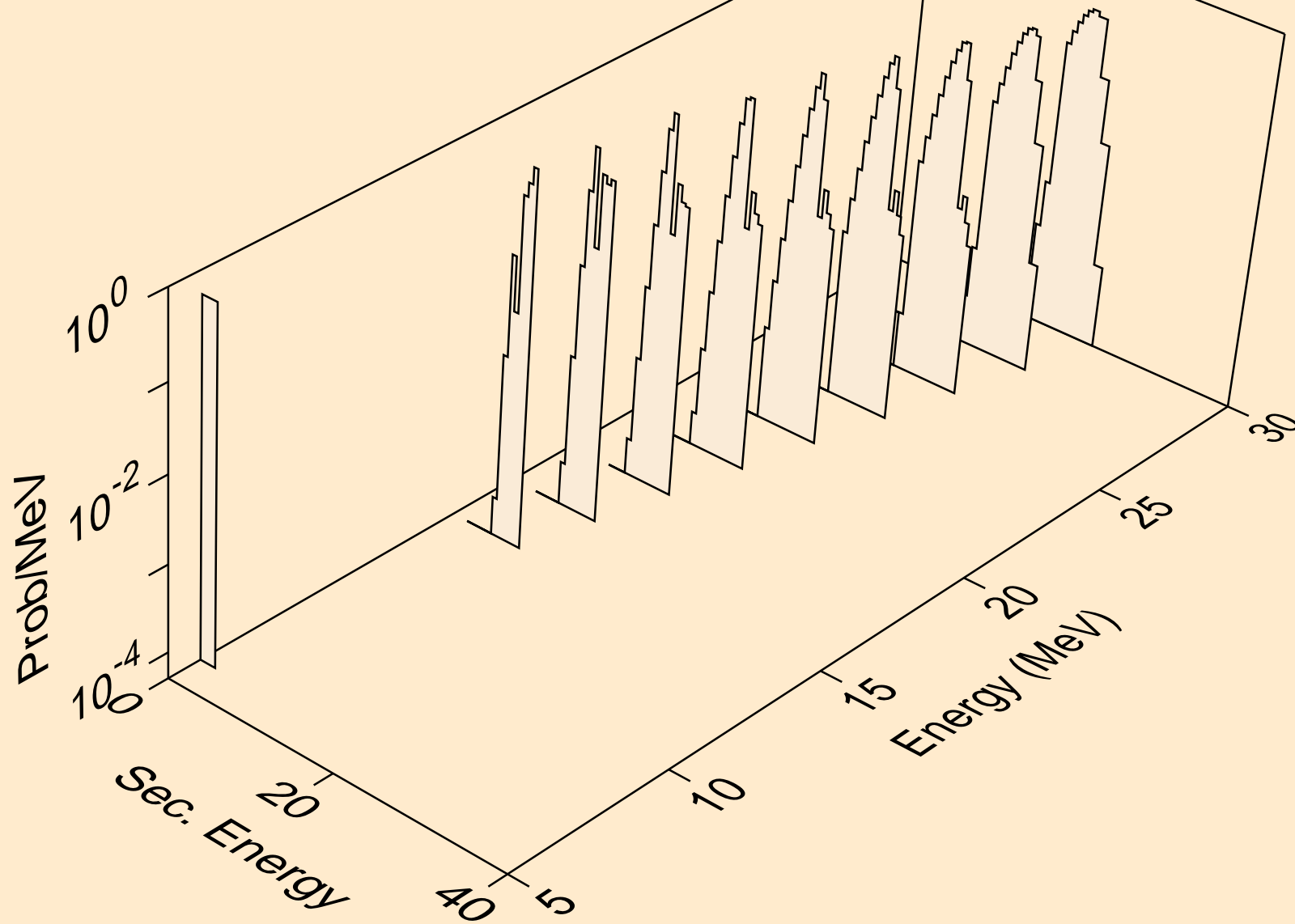

TA192 PROTON ACER TENDL-2024 LIBRARY; T=0.K  
alphas from (p,x)

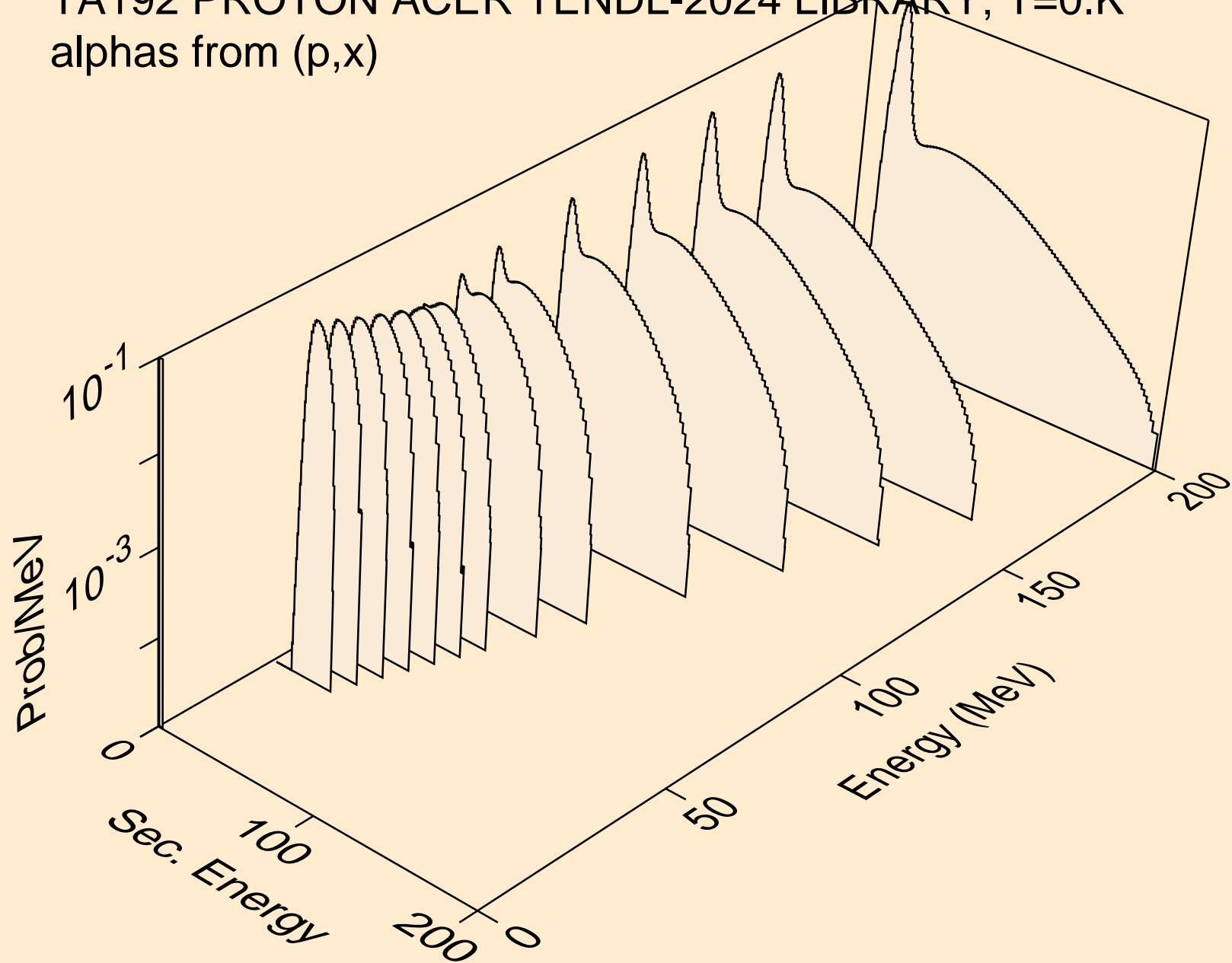

TA192 PROTON ACER TENDL-2024 LIBRARY; T=0.K  
alphas from (p,n\*)a

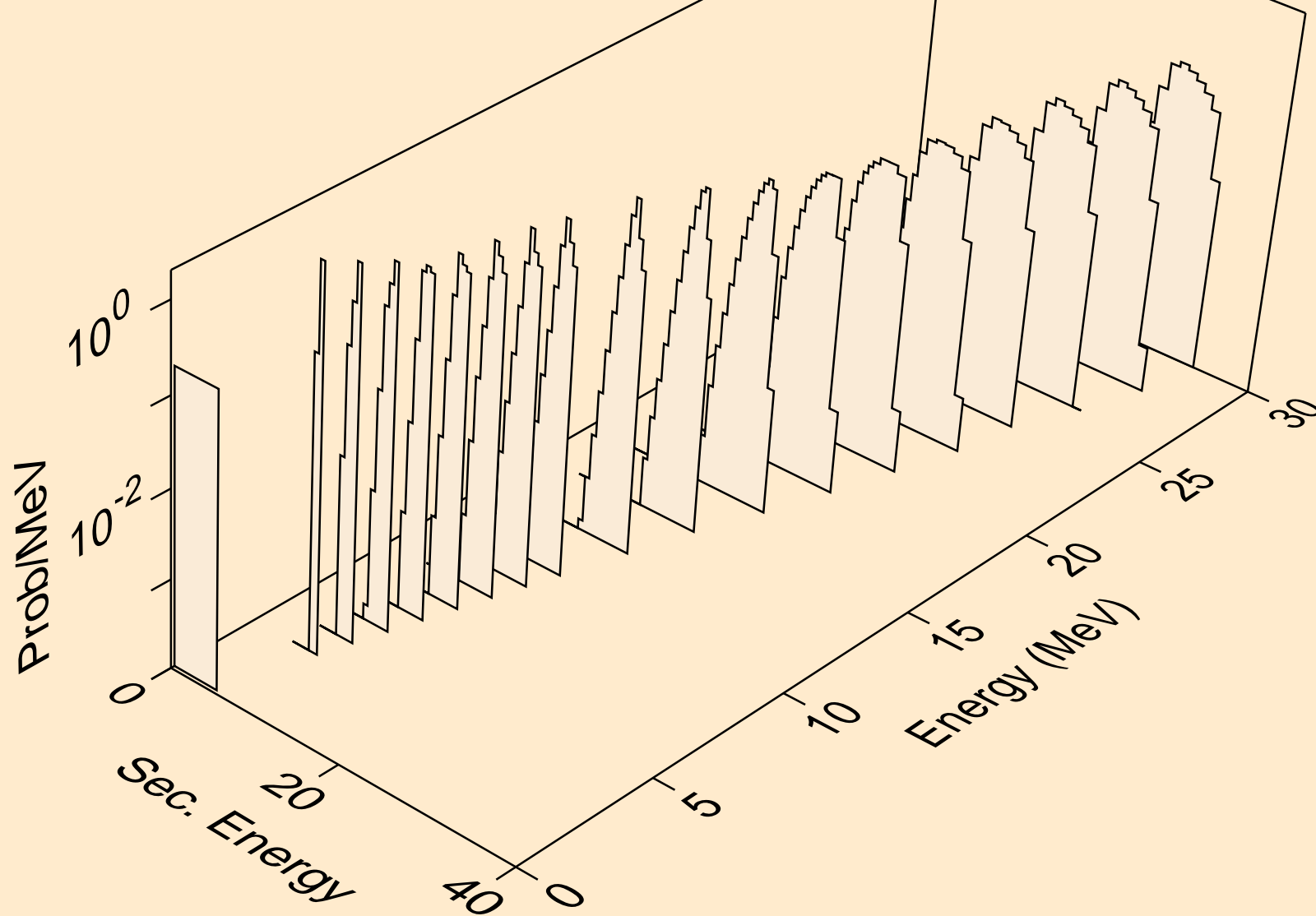

TA192 PROTON ACER TENDL-2024 LIBRARY; T=0.K  
alphas from (p,2n)a

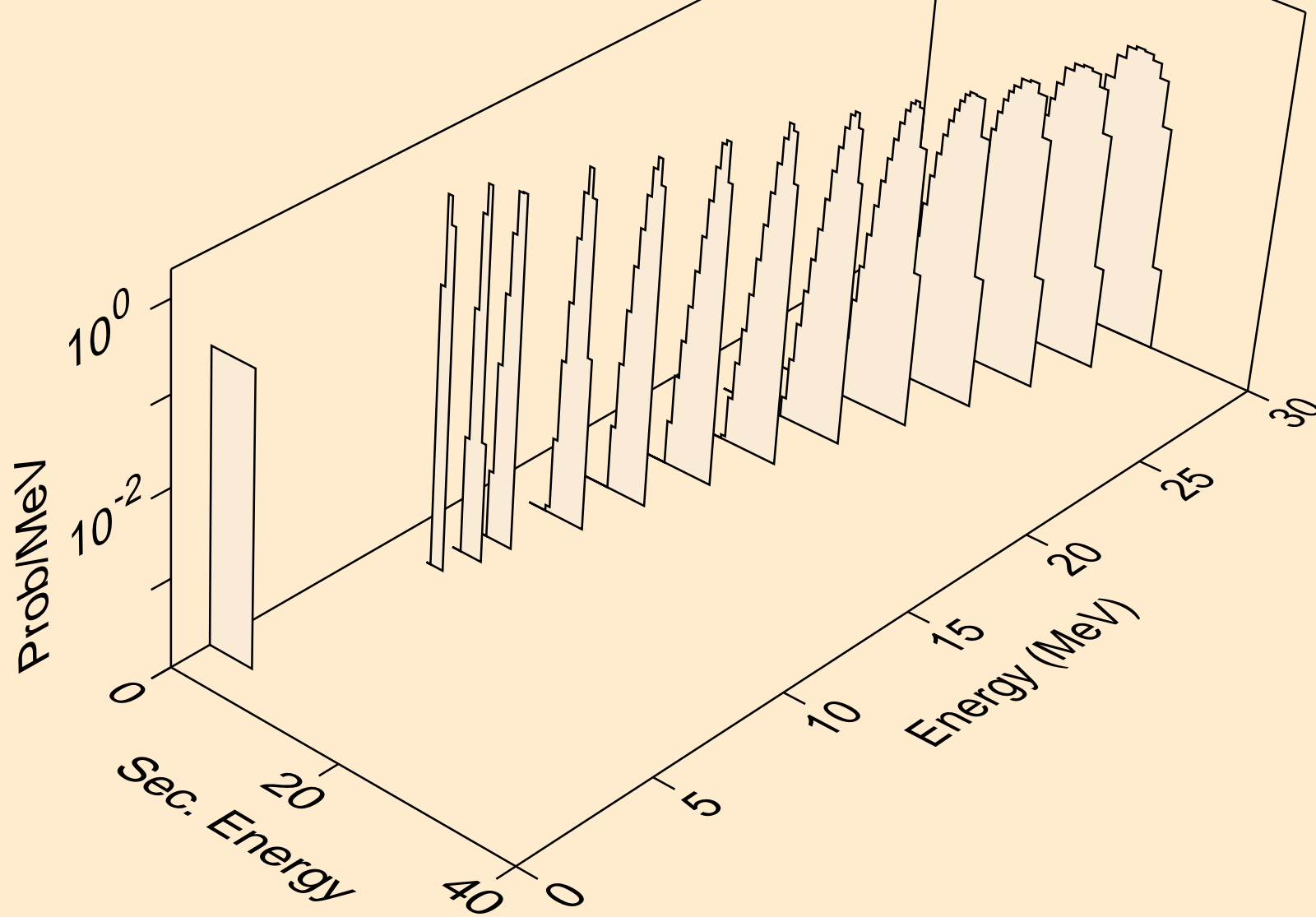

TA192 PROTON ACER TENDL-2024 LIBRARY; T=0.K  
alphas from (p,3n)a

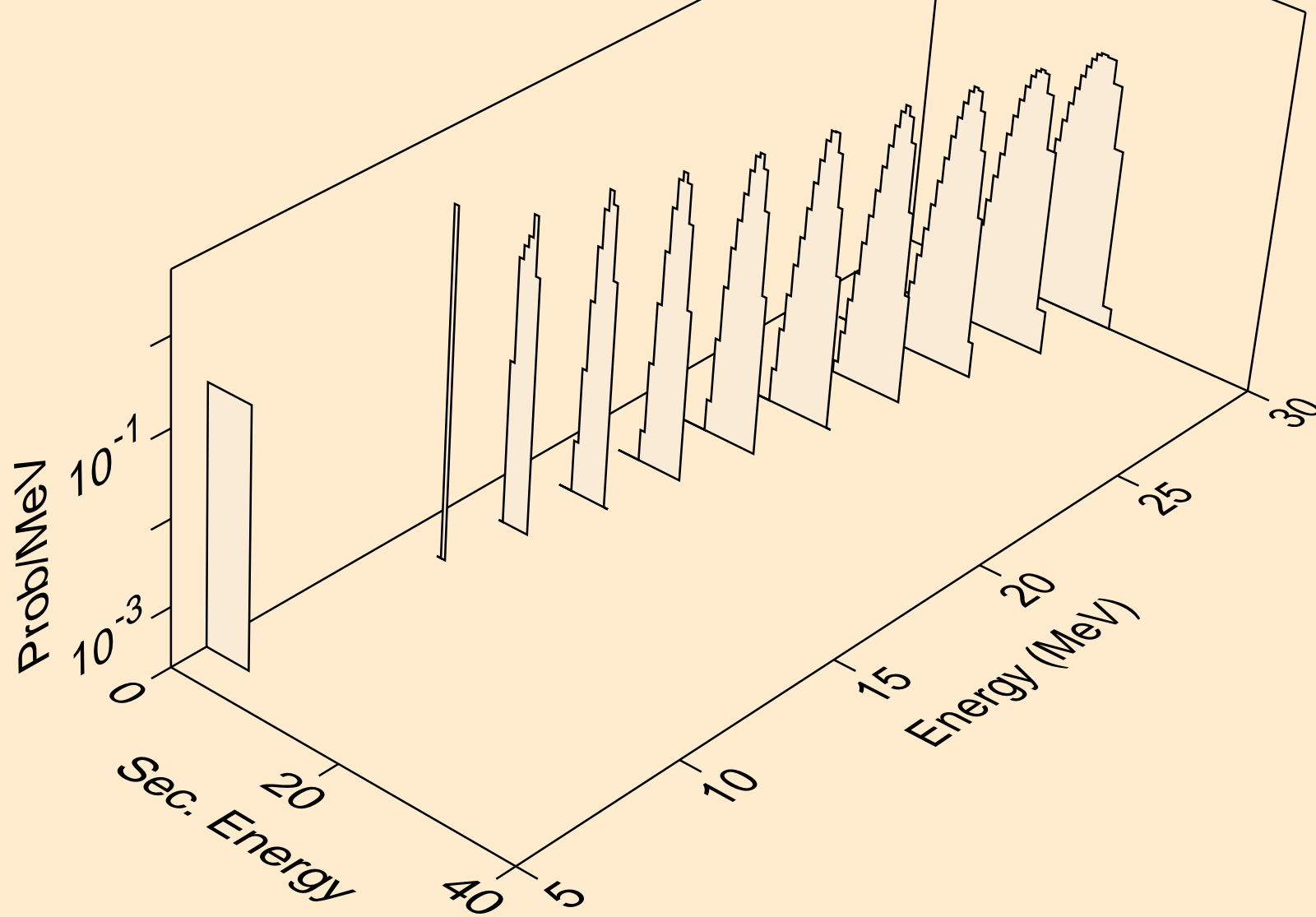

TA192 PROTON ACER TENDL-2024 LIBRARY; T=0.K  
alphas from (p,a)

